

Empty box for Centre Number

Candidate Name _____

**International General Certificate of Secondary Education
CAMBRIDGE INTERNATIONAL EXAMINATIONS
COMBINED SCIENCE
PAPER 2**

0653/2

OCTOBER/NOVEMBER SESSION 2002
1 hour

Candidates answer on the question paper.
No additional materials are required.

TIME 1 hour

INSTRUCTIONS TO CANDIDATES

Write your name, Centre number and candidate number in the spaces at the top of this page.

Answer **all** questions.

Write your answers in the spaces provided on the question paper.

INFORMATION FOR CANDIDATES

The number of marks is given in brackets [] at the end of each question or part question.

A copy of the Periodic Table is printed on page 16.

FOR EXAMINER'S USE	
1	
2	
3	
4	
5	
6	
7	
8	
9	
TOTAL	

This question paper consists of 13 printed pages and 3 blank pages.

- 1 In the circuit diagram shown in Fig. 1.1, the brightness of the lamp can be controlled by the variable resistor.

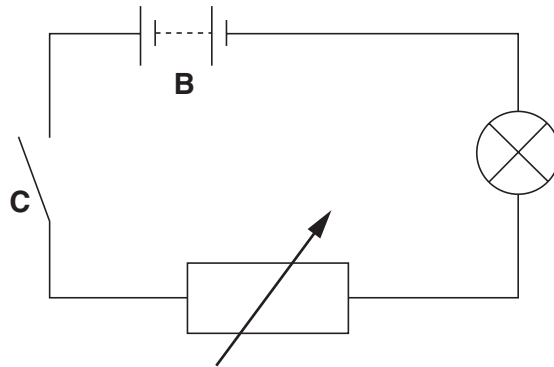

Fig. 1.1

- (a) Name components **B** and **C**.

B

C[2]

- (b) Redraw the circuit diagram to show how you would include an ammeter in the circuit to measure the current flowing through the lamp.

[2]

- (c) State the unit in which electric current is measured.

.....[1]

(d) State **two** electrical dangers that are visible in Fig. 1.2.

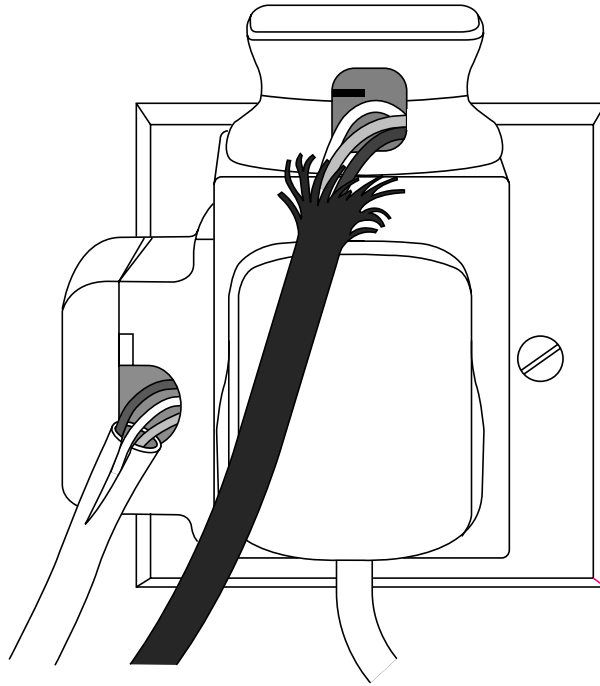

Fig. 1.2

danger 1

.....

danger 2

.....[2]

- 2 A student investigated the activity of the enzyme catalase, which is present in all living tissues. This enzyme catalyses the break-down of hydrogen peroxide to water and oxygen.

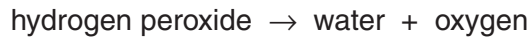

She put equal volumes of hydrogen peroxide into two small flasks. She took two pieces of fresh liver of equal mass, and cut one of them into small pieces. Then she placed each flask onto a balance and added the whole piece of liver to one flask and the small pieces of liver to the other. She read the mass of each flask every 30 seconds for five minutes. Fig. 2.1 shows her results.

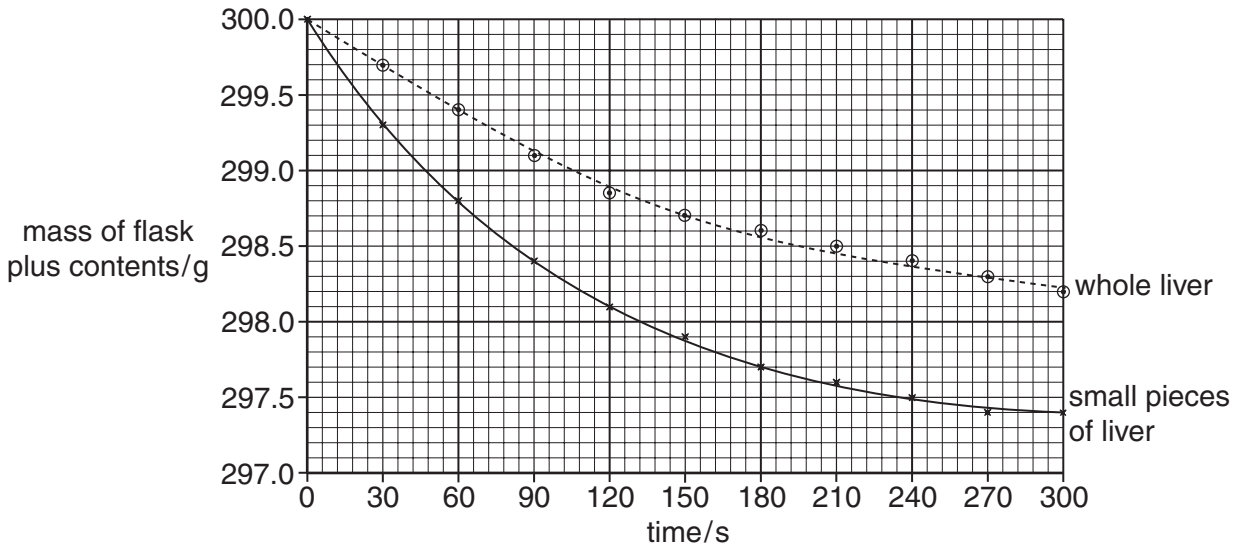

Fig. 2.1

- (a) Use the word equation above to explain why the mass of each flask and its contents decreased.

.....

 [2]

- (b) Explain why the mass of one flask and its contents decreased more rapidly than the other.

.....

 [2]

- (c) Predict the results that would be obtained if the liver was placed in boiling water for a few minutes before adding it to hydrogen peroxide. Explain your prediction.

.....

 [2]

- 3 Fig. 3.1 shows four sets of apparatus **P**, **Q**, **R** and **S** which are used to separate mixtures. The diagrams are not drawn to scale.

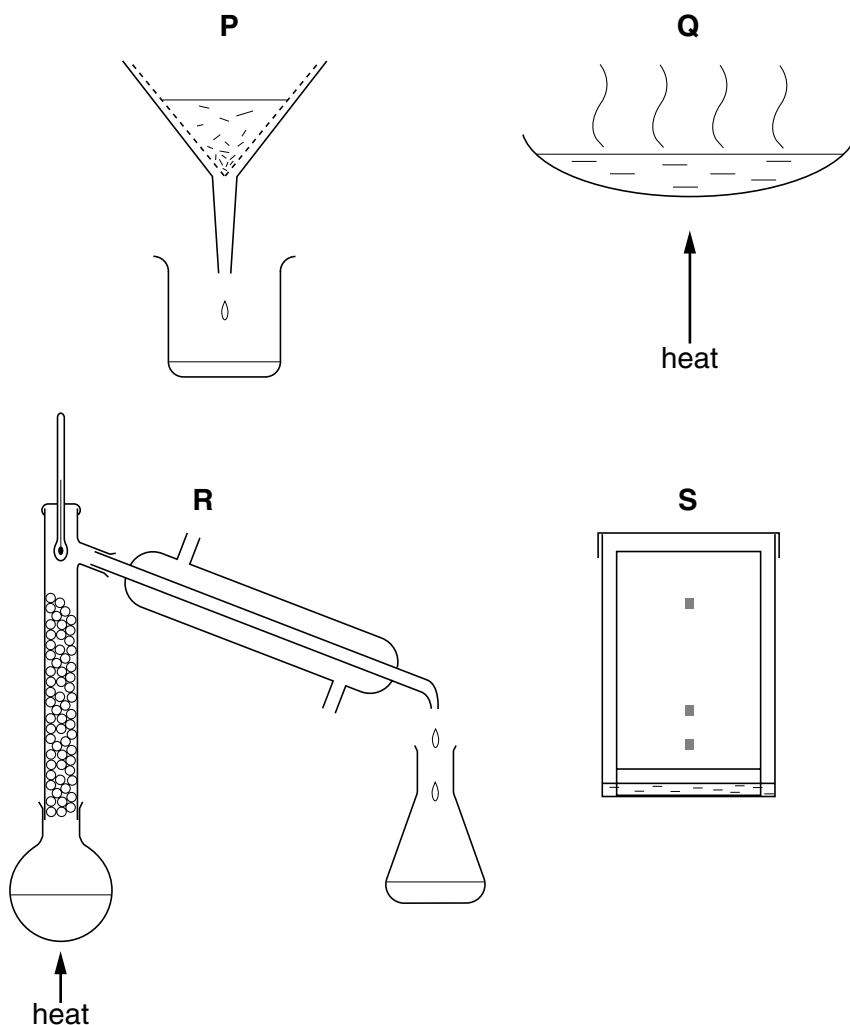

Fig. 3.1

- (a) State which apparatus, **P**, **Q**, **R** or **S** is normally used to separate
- the solid from a solid dissolved in a liquid,
- the solid from an insoluble solid suspended in a liquid,
- three differently coloured solids dissolved in a liquid. [3]
- (b) (i) Which of the diagrams **P**, **Q**, **R** or **S** in Fig. 3.1 shows apparatus used for fractional distillation?
-[1]
- (ii) Explain why fractional distillation is an important process in the oil industry.
-
-
-[2]

4 (a) (i) Describe how sound is produced when an object is hit.

.....[1]

(ii) Explain how a sound can be heard some distance away from where it was produced.

.....
.....
.....[2]

(b) Two astronauts walking on the Moon cannot talk directly to each other. They have to speak to each other by radio. Explain why this is so.

.....
.....
.....[2]

- 5 Fig. 5.1 shows a plant.

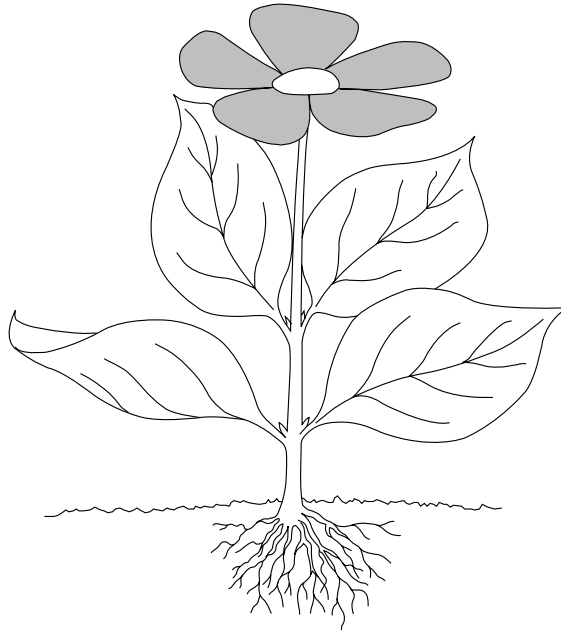

Fig. 5.1

- (a) On Fig. 5.1, draw a label line to each of the following parts, and label each one with the appropriate letter.

P a place where water enters the plant.

Q the part of the plant that is responsible for sexual reproduction. [2]

- (b) The palisade cells in the leaves of the plant are responsible for photosynthesis. In photosynthesis, energy from sunlight is used to make carbon dioxide and water react together to produce glucose and oxygen.

(i) Name the substance, present in the palisade cells, that traps sunlight energy.

.....[1]

(ii) Describe what happens to the glucose if the plant makes more than it immediately needs.

.....

.....

.....[2]

- (c) A leafy shoot was cut from a plant, and placed with its cut end in a solution of a red dye. After an hour, red lines could be seen in the leaves.

Explain how this happened.

.....

.....

.....[2]

6 Poly(ethene) is a material used to make plastic articles. Poly(ethene) is made from the hydrocarbon ethene.

(a) (i) Explain the meaning of the term *hydrocarbon*.

.....
.....[2]

(ii) Explain why a molecule of poly(ethene) has a much higher mass than a molecule of ethene.

.....
.....
.....[2]

(b) A student is heating a sample of poly(ethene) when it catches fire. She covers the burning poly(ethene) with a damp cloth.

Explain why this action puts the fire out.

.....
.....
.....[2]

7 Fig. 7.1 shows the male reproductive system.

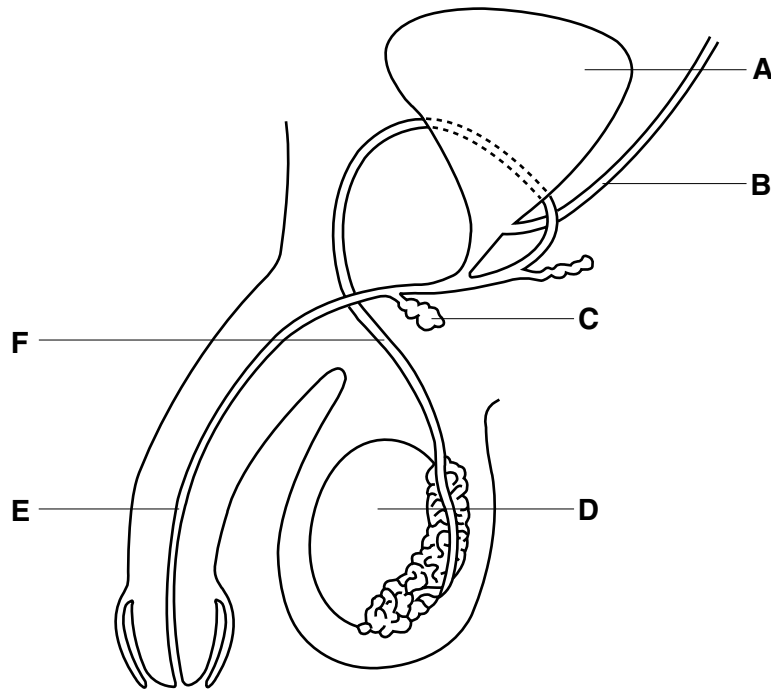

Fig. 7.1

(a) Give the letter of the structure on the diagram that matches each of the following descriptions. You may use each letter once, more than once, or not at all.

where sperms are made

the ureter

the tube that would be cut if the man was sterilised [3]

(b) Complete the sentences about sexual reproduction in humans.

Sperms are deposited close to the cervix, and swim from there to the

where fertilisation takes place. The new cell that is formed when the sperm fuses with

an egg is called a [2]

(c) Gonorrhoea is a disease that is spread by sexual intercourse.
Give **two** ways by which the spread of gonorrhoea can be reduced.

1

2 [2]

- 8 Fig. 8.1 shows one of the pyramids in Egypt. The pyramid is 140 m high.

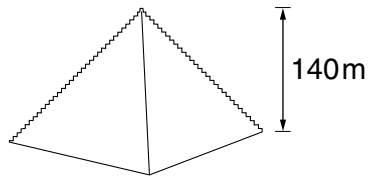

Fig. 8.1

A large number of blocks were used to build this pyramid.
Fig. 8.2 shows the final block weighing 100 000 N, that had to be raised to the top of the pyramid.

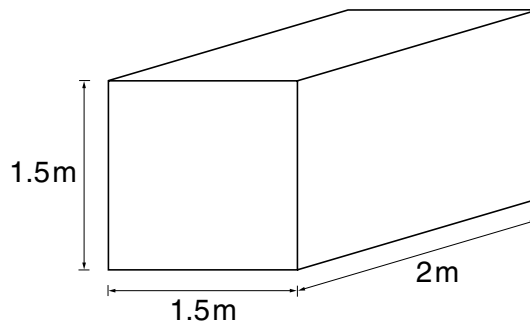

Fig. 8.2

- (a) Calculate the mass of this block. (The Earth's gravitational field strength is 10 N/kg)

.....kg [1]

- (b) Calculate the volume of the block

.....m³ [1]

- (c) Calculate the density of the block. Show your working and state any formula that you use.

.....kg/m³ [3]

- (d) Calculate the work done in raising this block through 140m to the top of the pyramid. Show your working and state any formula that you use.

.....J [3]

- 9 (a) A student added dilute hydrochloric acid to some substances contained in the four test tubes, **A** to **D**, shown in Fig. 9.1.

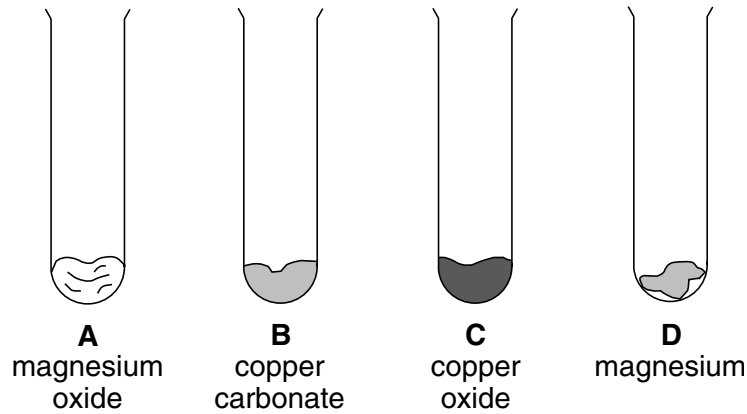

Fig. 9.1

- (i) The results the student recorded are shown in Fig. 9.2. Complete the right hand column in Fig. 9.2 by writing in the letters **A**, **B**, **C** or **D**.

results recorded during reaction	appearance of contents of tube when reaction complete	tube
solid dissolves and carbon dioxide gas evolved	blue solution	
solid dissolves	colourless solution	
solid dissolves	blue solution	

[3]

Fig. 9.2

- (ii) Describe the test for carbon dioxide gas.

.....

[2]

- (b) (i) What happens to the pH of an acid solution when a base is added to it?

.....[1]

- (ii) Complete the word equation below for the reaction between an acid and a base.

sulphuric acid + nickel oxide →[2]

DATA SHEET

The Periodic Table of the Elements

| Group | | I

 | II | III | IV | V | VI | VII | 0 | | | | | | | | | | | | |

 | | | | | | | | | | | | | | | | | | | |

 | | | | | | | | | | | | | | | | | | | |

 | | | | | | | | | | | | | | | | | | | |

 | | | | | | | | | | | | | | | | | | | |

 | | | | | | | | | | | | | | | | | | | |

 | | | | | | | | | | | | | | | | | | | |

 | | | | | | | | | | | | | | | | | | | |

 | | | | | | | | | | | | | | | | | | | |

 | | | | | | | | | | | | | | | | | | | |

 | | | | | | | | | | | | | | | | | | | |

 | | | | | | | | | | | | | | | | | | | |

 | | | | | | | | | | | | | | | | | | | |

 | | | | | | | | | | | | | | | | | | | |

 | | | | | | | | | | | | | | | | | | | |

 | | | | | | | | | | | | | | | | | | | |

 | | | | | | | | | | | | | | | | | | | |

 | | | | | | | | | | | | | | | | | | | |

 | | | | | | | | | | | | | | | | | | | |

 | | | | | | | | | | | | | | | | | | | |

 | | | | | | | | | | | | | | | | | | | |

 | | | | | | | | | | | | | | | | | | | |

 | | | | | | | | | | | | | | | | | | | |

 | | | | | | | | | | | | | | | | | | | |

 | | | | | | | | | | | | | | | | | | | |

 | | | | | | | | | | | | | | | | | | | |

 | | | | | | | | | | | | | | | | | | | |

 | | | | | | | | | | | | | | | | | | | |
 | | | | | | | | | | | | | | | | | | | |

 | | | | | | | | | | | | | | | | | | | |

 | | | | | | | | | | | | | | | | | | | |
 | | | | | | | | | | | | | | | | | | | |

 | | | | | | | | | | | | | | | | | | | |

 | | | | | | | | | | | | | | | | | | | |
 | | | | | | | | | | | | | | | | | | | |
 | | | | | | | | | | | | | | | | | | | |

 | | | | | | | | | | | | | | | | | | | |
 | | | | | | | | | | | | | | | | | | | |
 | | | | | | | | | | | | | | | | | | | |

 | | | | | | | | | | | | | | | | | | | | | | | | | | | | | | | | | | | | | | | | | | | | | | | | | | | | | | | | | | | | | | | | | | | | | | | | | | | | | | | | | | | | | | | | | | | | | | | | | | | |
 | | | | | | | | | | | | | | | | | | | |
 | | | | | | | | | | | | | | | | | | | |
 | | | | | | | | | | | | | | | | | | | |
 | | | | | | | | | | | | | | | | | | | |
 | | | | | | | | | | | | | | | | | | | |
 | | | | | | | | | | | | | | | | | | | |
 | | | | | | | | | | | | | | | | | | | |
 | | | | | | | | | | | | | | | | | | | |
 | | | | | | | | | | | | | | | | | | | | | | | | | | | | | | | | | | | | | | | |
 | | | | | | | | | | | | | | | | | | | |
 | | | | | | | | | | | | | | | | | | | | | | | | | | | | | | | | | | | | | | | |
 | | | | | | | | | | | | | | | | | | | | | | | | | | | | | | | | | | | | | | | |
 | | | | | | | | | | | | | | | | | | | | | | | | | | | | | | | | | | | | | | | |
 | | | | | | | | | | | | | | | | | | | | | | | | | | | | | | | | | | | | | | | | | | | | | | | | | | | | | | | | | | | | | | | | | | | | | | | | | | | | | | | | | | | | | | | | | | | | | | | | | | | |
 | | | | | | | | | | | | | | | | | | | | | | | | | | | | | | | | | | | | | | | | | | | | | | | |
|-------|--

-----------------------------------------------------------------------------------------------------------------------------------------------------------------------------------------------------------------------------------------------------------------------------------------------------------------------------------------------------------------------------------------------------------------------------------------------------------------------------------------------------------------------------------------------------------------------------------------------------------------------------------------------------------------------------------------------------------------------------------------------------------------------------------------------------------------------------------------------------------------------------------------------------------------------------------------------------------------------------------------------------------------------------------------------------------------------------------------------------------------------------------------------------------------------------------------------------------------------------------------------------------|----|-----|----|---|----|-----|---|--|--|--|--|--|--|--|--|--|--|--|--

-----------------------------------------------------------------------------------------------------------------------------------------------------------------------------------------------------------------------------------------------------------------------------------------------------------------------------------------------------------------------------------------------------------------------------------------------------------------------------------------------------------------------------------------------------------------------------------------------------------------------------------------------------------------------------------------------------------------------------------------------------|--|--|--|--|--|--|--|--|--|--|--|--|--|--|--|--|--|--|--

-----------------------------------------------------------------------------------------------------------------------------------------------------------------------------------------------------------------------------------------------|--|--|--|--|--|--|--|--|--|--|--|--|--|--|--|--|--|--|--

---------------------------------------------------------------------------------------------------------------------------------------------------------------------------------------------------------------------------------------------------------------------------------------------------------------------------------------------------------------------------------------------------------------------------------------------------------------------------------------------------------------------------------------------------------------------------------------------------------------------------------------------------------------------------------------------------------------------------------------------------------------------------------------------------------------------------------------------------------------------------------------------------------------------------------------------------------------------------------------------------------------------------------------------------------------------------------------------------------------------------------------------------------------------------------------------------------------------------------------------------------------------------------------------------------------------------------------------------------------------------------------------------------------------------------------------------------------------------------------------------------------------------------------------------------------------------------------------------------------------------------------------------------------------------------------------------------------------------------------------------------------------------------------------------------------------------------------------------------------------------------------------------------------------------------------------------------------------------------------------------------------------------------------------------------------------------------------------------------------------------------------------------------------------------------------------------------------------------------------------------------------------------------------------------------------------------------------------------------------------------------------------------------------------------------------------------------------------------------------------------------------------------------------------------------------------------------------------------------------------------------------------------------------------------------------------------------------------------------------------------------------------------------------------------------------------------------------------------------------------------------------------------------------------------------------------------------------------------------------------------------------------------------------------------------------------------------------------------------------------------------------------------------------------------------------------------------------------------------------------------------------------------------------------------------------------------------------------------------------------------------------------------------------------------------------------------------------------------------------------------------------------------------------------------------------------------------------------------------------------------------------------------------------------------------------------------------------------------------------------------------------------------------------------------------------------------------------------------------------------------------------------------------------------------------------------------------------------------------------------------------------------------------------------------------------------------------------------------------------------------------------------------------------------------------------------------------------------------------------------------------------------------------------------------------------------------------------------------------------------------------------------------------------------------------------------------------------------------------------------------------------------------------------------------------------------------------------------------------------------------------------------------------------------------------------------------------------------------------------------------------------------------------------------------------------------------------------------------------------------------------------------------------------------------------------------------------------------------------------------------------------------------------------------------------------------------------------------------------------------------------------------------------------------------------------------------------------------------------------------------------------------------------------------------------------------------------------------------------------------------------------------------------------------------------------------------------------------------------------------------------------------------------------------------------------------------------------------------------------------------------------------------------------------------------------------------------------------------------------------------------------------------------------------------------------------------------------------------------------------------------------------------------------------------------------------------------------------------------------------------------------------------------------------------------------------------------------------------------------------------------------------------------------------------------------------------------------------------------------------------------------------------------------------------------------------------------------------------------------------------------------------------------------------------------------------------------------------------------------------------------------------------------------------------------------------------------------------------------------------------------------------------------------------------------------------------------------------------------------------------------------------------------------------------------------------------------------------------------------------------------------------------------------------------------------------------------------------------------------------------------------------------------------------------------------------------------------------------------------------------------------------------------------------------------------------------------------------------------------------------------------------------------------------------------------------------------------------------------------------------------------------------------------------------------------------------------------------------------------------------------------------------------------------------------------------------------------------------------------------------------------------------------------------------------------------------------------------------------------------------------------------------------------------------------------------------------------------------------------------------------------------------------------------------------------------------------------------------------------------------------------------------------------------------------------------------------------------------------------------------------------------------------------------------------------------------------------------------------------------------------------------------------------------------------------------------------------------------------------------------------------------------------------------------------------------------------------------------------------------------------------------------------------------------------------------------------------------------------------------------------------------------------------------------------------------------------------------------------------------------------------------------------------------------------------------------------------------------------------------------------------------------------------------------------------------------------------------------------------------------------------------------------------------------------------------------------------------------------------------------------------------------------------------------------------------------------------------------------------------------------------------------------------------------------------------------------------------------------------------------------------------------------------------------------------------------------------------------------------------------------------------------------------------------------------------------------------------------------------------------------------------------------------------------------------------------------------------------------------------------------------------------------------------------------------------------------------------------------------------------------------------------------------------------------------------------------------------------------------------------------------------------------------------------------------------------------------------------------------------------------------------------------|--|--|--|--|--|--|--|--|--|--|--|--|--|--|--|--|--|--|--

---------------------------------------------------------------------------------------------------------------------------------------------------------------------------------------------------------------------------------------------------------------------------------------------------------------------------------------------------------------------------------------------------------------------------------------------------------------------------------------------------------------------------------------------------------------------------------------------------------------------------------------------------------------------------------------------------------------------------------------------------------------------------------------------------------------------------------------------------------------------------------------------------------------------------------------------------------------------------------------------------------------------------------------------------------------------------------------------------------------------------------------------------------------------------------------------------------------------------------------------------------------------------------------------------------------------------------------------------------------------------------------------------------------------------------------------------------------------------------------------------------------------------------------------------------------------------------------------------------------------------------------------------------------------------------------------------------------------------------------------------------------------------------------------------------------------------------------------------------------------------------------------------------------------------------------------------------------------------------------------------------------------------------------------------------------------------------------------------------------------------------------------------------------------------------------------------------------------------------------------------------------------------------------------------------------------------------------------------------------------------------------------------------------------------------------------------------------------------------------------------------------------------------------------------------------------------------------------------------------------------------------------------------------------------------------------------------------------------------------------------------------------------------------------------------------------------------------------------------------------------------------------------------------------------------------------------------------------------------------------------------------------------------------------------------------------------------------------------------------------------------------------------------------------------------------------------------------------------------------------------------------------------------------------------------------------------------------------------------------------------------------------------------------------------------------------------------------------------------------------------------------------------------------------------------------------------------------------------------------------------------------------------------------------------------------------------------------------------------------------------------------------------------------------------------------------------------------------------------------------------------------------------------------------------------------------------------------------------------------------------------------------------------------------------------------------------------------------------------------------------------------------------------------------------------------------------------------------------------------------------------------------------------------------------------------------------------------------------------------------------------------------------------------------------------------------------------------------------------------------------------------------------------------------------------------------------------------------------------------------------------------------------------------------------------------------------------------------------------------------------------------------------------------------------------------------------------------------------------------------------------------------------------------------------------------------------------------------------------------------------------------------------------------------------------------------------------------------------------------------------------------------------------------------------------------------------------------------------------------------------------------------------------------------------------------------------------------------------------------------------------------------------------------------------------------------------------------------------------------------------------------------------------------------------------------------------------------------------------------------------------------------------------------------------------------------------------------------------------------------------------------------------------------------------------------------------------------------------------------------------------------------------------------------------------------------------------------------------------------------------------------------------------------------------------------------------------------------------------------------------------------------------------------------------------------------------------------------------------------------------------------------------------------------------------------------------------------------------------------------------------------------------------------------------------------------------------------------------------------------------------------------------------------------------------------------------------------------------------------------------------------------------------------------------------------------------------------------------------------------------------------------------------------------------------------------------------------------------------------------------------------------------------------------------------------------------------------------------------------------------------------------------------------------------------------------------------------------------------------------------------------------------------------------------------------------------------------------------------------------------------------------------------------------------------------------------------------------------------------------------------------------------------------------------------------------------------------------------------------------------------------------------------------------------------------------------------------------------------------------------------------------------------------------------------------------------------------------------------------------------------------------------------------------------------------------------------------------------------------------------------------------------------------------------------------------------------------------------------------------------------------------------------------------------------------------------------------------------------------------------------------------------------------------------------------------------------------------------------------------------------------------------------------------------------------------------------------------------------------------------------------------------------------------------------------------------------------------------------------------------------------------------------------------------------------------------------------------------------------------------------------------------------------------------------------------------------------------------------------------------------------------------------------------------------------------------------------------------------------------------------------------------------------------------------------------------------------------------------------------------------------------------------------------------------------------------------------------------------------------------------------------------------------------------------------------------------------------------------------------------------------------------------------------------------------------------------------------------------------------------------------------------------------------------------------------------------------------------------------------------------------------------------------------------------------------------------------------------------------------------------------------------|--|--|--|--|--|--|--|--|--|--|--|--|--|--|--|--|--|--|--

---------------------------------------------------------------------------------------------------------------------------------------------------------------------------------------------------------------------------------------------------------------------------------------------------------------------------------------------------------------------------------------------------------------------------------------------------------------------------------------------------------------------------------------------------------------------------------------------------------------------------------------------------------------------------------------------------------------------------------------------------------------------------------------------------------------------------------------------------------------------------------------------------------------------------------------------------------------------------------------------------------------------------------------------------------------------------------------------------------------------------------------------------------------------------------------------------------------------------------------------------------------------------------------------------------------------------------------------------------------------------------------------------------------------------------------------------------------------------------------------------------------------------------------------------------------------------------------------------------------------------------------------------------------------------------------------------------------------------------------------------------------------------------------------------------------------------------------------------------------------------------------------------------------------------------------------------------------------------------------------------------------------------------------------------------------------------------------------------------------------------------------------------------------------------------------------------------------------------------------------------------------------------------------------------------------------------------------------------------------------------------------------------------------------------------------------------------------------------------------------------------------------------------------------------------------------------------------------------------------------------------------------------------------------------------------------------------------------------------------------------------------------------------------------------------------------------------------------------------------------------------------------------------------------------------------------------------------------------------------------------------------------------------------------------------------------------------------------------------------------------------------------------------------------------------------------------------------------------------------------------------------------------------------------------------------------------------------------------------------------------------------------------------------------------------------------------------------------------------------------------------------------------------------------------------------------------------------------------------------------------------------------------------------------------------------------------------------------------------------------------------------------------------------------------------------------------------------------------------------------------------------------------------------------------------------------------------------------------------------------------------------------------------------------------------------------------------------------------------------------------------------------------------------------------------------------------------------------------------------------------------------------------------------------------------------------------------------------------------------------------------------------------------------------------------------------------------------------------------------------------------------------------------------------------------------------------------------------------------------------------------------------------------------------------------------------------------------------------------------------------------------------------------------------------------------------------------------------------------------------------------------------------------------------------------------------------------------------------------------------------------------------------------------------------------------------------------------------------------------------------------------------------------------------------------------------------------------------------------------------------------------------------------------------------------------------------------------------------------------------------------------------------------------------------------------------------------------------------------------------------------------------------------------------------------------------------------------------------------------------------------------------------------------------------------------------------------------------------------------------------------------------------------------------------------------------------------------------------------------------------------------------------------------------------------------------------------------------------------------------------------------------------------------------------------------------------------------------------------------------------------------------------------------------------------------------------------------------------------------------------------------------------------------------------------------------------------------------------------------------------------------------------------------------------------------------------------------------------------------------------------------------------------------------------------------------------------------------------------------------------------------------------------------------------------------------------------------------------------------------------------------------------------------------------------------------------------------------------------------------------------------------------------------------------------------------------------------------------------------------------------------------------------------------------------------------------------------------------------------------------------------------------------------------------------------------------------------------------------------------------------------------------------------------------------------------------------------------------------------------------------------------------------------------------------------------------------------------------------------------------------------------------------------------------------------------------------------------------------------------------------------------------------------------------------------------------------------------------------------------------------------------------------------------------------------------------------------------------------------------------------------------------------------------------------------------------------------------------------------------------------------------------------------------------------------------------------------------------------------------------------------------------------------------------------------------------------------------------------------------------------------------------------------------------------------------------------------------------------------------------------------------------------------------------------------------------------------------------------------------------------------------------------------------------------------------------------------------------------------------------------------------------------------------------------------------------------------------------------------------------------------------------------------------------------------------------------------------------------------------------------------------------------------------------------------------------------------------------------------------------------------------------------------------------------------------------------------------------------------------------------------------|--|--|--|--|--|--|--|--|--|--|--|--|--|--|--|--|--|--|--

---------------------------------------------------------------------------------------------------------------------------------------------------------------------------------------------------------------------------------------------------------------------------------------------------------------------------------------------------------------------------------------------------------------------------------------------------------------------------------------------------------------------------------------------------------------------------------------------------------------------------------------------------------------------------------------------------------------------------------------------------------------------------------------------------------------------------------------------------------------------------------------------------------------------------------------------------------------------------------------------------------------------------------------------------------------------------------------------------------------------------------------------------------------------------------------------------------------------------------------------------------------------------------------------------------------------------------------------------------------------------------------------------------------------------------------------------------------------------------------------------------------------------------------------------------------------------------------------------------------------------------------------------------------------------------------------------------------------------------------------------------------------------------------------------------------------------------------------------------------------------------------------------------------------------------------------------------------------------------------------------------------------------------------------------------------------------------------------------------------------------------------------------------------------------------------------------------------------------------------------------------------------------------------------------------------------------------------------------------------------------------------------------------------------------------------------------------------------------------------------------------------------------------------------------------------------------------------------------------------------------------------------------------------------------------------------------------------------------------------------------------------------------------------------------------------------------------------------------------------------------------------------------------------------------------------------------------------------------------------------------------------------------------------------------------------------------------------------------------------------------------------------------------------------------------------------------------------------------------------------------------------------------------------------------------------------------------------------------------------------------------------------------------------------------------------------------------------------------------------------------------------------------------------------------------------------------------------------------------------------------------------------------------------------------------------------------------------------------------------------------------------------------------------------------------------------------------------------------------------------------------------------------------------------------------------------------------------------------------------------------------------------------------------------------------------------------------------------------------------------------------------------------------------------------------------------------------------------------------------------------------------------------------------------------------------------------------------------------------------------------------------------------------------------------------------------------------------------------------------------------------------------------------------------------------------------------------------------------------------------------------------------------------------------------------------------------------------------------------------------------------------------------------------------------------------------------------------------------------------------------------------------------------------------------------------------------------------------------------------------------------------------------------------------------------------------------------------------------------------------------------------------------------------------------------------------------------------------------------------------------------------------------------------------------------------------------------------------------------------------------------------------------------------------------------------------------------------------------------------------------------------------------------------------------------------------------------------------------------------------------------------------------------------------------------------------------------------------------------------------------------------------------------------------------------------------------------------------------------------------------------------------------------------------------------------------------------------------------------------------------------------------------------------------------------------------------------------------------------------------------------------------------------------------------------------------------------------------------------------------------------------------------------------------------------------------------------------------------------------------------------------------------------------------------------------------------------------------------------------------------------------------------------------------------------------------------------------------------------------------------------------------------------------------------------------------------------------------------------------------------------------------------------------------------------------------------------------------------------------------------------------------------------------------------------------------------------------------------------------------------------------------------------------------------------------------------------------------------------------------------------------------------------------------------------------------------------------------------------------------------------------------------------------------------------------------------------------------------------------------------------------------------------------------------------------------------------------------------------------------------------------------------------------------------------------------------------------------------------------------------------------------------------------------------------------------------------------------------------------------------------------------------------------------------------------------------------------------------------------------------------------------------------------------------------------------------------------------------------------------------------------------------------------------------------------------------------------------------------------------------------------------------------------------------------------------------------------------------------------------------------------------------------------------------------------------------------------------------------------------------------------------------------------------------------------------------------------------------------------------------------------------------------------------------------------------------------------------------------------------------------------|--|--|--|--|--|--|--|--|--|--|--|--|--|--|--|--|--|--|--

---------------------------------------------------------------------------------------------------------------------------------------------------------------------------------------------------------------------------------------------------------------------------------------------------------------------------------------------------------------------------------------------------------------------------------------------------------------------------------------------------------------------------------------------------------------------------------------------------------------------------------------------------------------------------------------------------------------------------------------------------------------------------------------------------------------------------------------------------------------------------------------------------------------------------------------------------------------------------------------------------------------------------------------------------------------------------------------------------------------------------------------------------------------------------------------------------------------------------------------------------------------------------------------------------------------------------------------------------------------------------------------------------------------------------------------------------------------------------------------------------------------------------------------------------------------------------------------------------------------------------------------------------------------------------------------------------------------------------------------------------------------------------------------------------------------------------------------------------------------------------------------------------------------------------------------------------------------------------------------------------------------------------------------------------------------------------------------------------------------------------------------------------------------------------------------------------------------------------------------------------------------------------------------------------------------------------------------------------------------------------------------------------------------------------------------------------------------------------------------------------------------------------------------------------------------------------------------------------------------------------------------------------------------------------------------------------------------------------------------------------------------------------------------------------------------------------------------------------------------------------------------------------------------------------------------------------------------------------------------------------------------------------------------------------------------------------------------------------------------------------------------------------------------------------------------------------------------------------------------------------------------------------------------------------------------------------------------------------------------------------------------------------------------------------------------------------------------------------------------------------------------------------------------------------------------------------------------------------------------------------------------------------------------------------------------------------------------------------------------------------------------------------------------------------------------------------------------------------------------------------------------------------------------------------------------------------------------------------------------------------------------------------------------------------------------------------------------------------------------------------------------------------------------------------------------------------------------------------------------------------------------------------------------------------------------------------------------------------------------------------------------------------------------------------------------------------------------------------------------------------------------------------------------------------------------------------------------------------------------------------------------------------------------------------------------------------------------------------------------------------------------------------------------------------------------------------------------------------------------------------------------------------------------------------------------------------------------------------------------------------------------------------------------------------------------------------------------------------------------------------------------------------------------------------------------------------------------------------------------------------------------------------------------------------------------------------------------------------------------------------------------------------------------------------------------------------------------------------------------------------------------------------------------------------------------------------------------------------------------------------------------------------------------------------------------------------------------------------------------------------------------------------------------------------------------------------------------------------------------------------------------------------------------------------------------------------------------------------------------------------------------------------------------------------------------------------------------------------------------------------------------------------------------------------------------------------------------------------------------------------------------------------------------------------------------------------------------------------------------------------------------------------------------------------------------------------------------------------------------------------------------------------------------------------------------------------------------------------------------------------------------------------------------------------------------------------------------------------------------------------------------------------------------------------------------------------------------------------------------------------------------------------------------------------------------------------------------------------------------------------------------------------------------------------------------------------------------------------------------------------------------------------------------------------------------------------------------------------------------------------------------------------------------------------------------------------------------------------------------------------------------------------------------------------------------------------------------------------------------------------------------------------------------------------------------------------------------------------------------------------------------------------------------------------------------------------------------------------------------------------------------------------------------------------------------------------------------------------------------------------------------------------------------------------------------------------------------------------------------------------------------------------------------------------------------------------------------------------------------------------------|--|--|--|--|--|--|--|--|--|--|--|--|--|--|--|--|--|--|--

---------------------------------------------------------------------------------------------------------------------------------------------------------------------------------------------------------------------------------------------------------------------------------------------------------------------------------------------------------------------------------------------------------------------------------------------------------------------------------------------------------------------------------------------------------------------------------------------------------------------------------------------------------------------------------------------------------------------------------------------------------------------------------------------------------------------------------------------------------------------------------------------------------------------------------------------------------------------------------------------------------------------------------------------------------------------------------------------------------------------------------------------------------------------------------------------------------------------------------------------------------------------------------------------------------------------------------------------------------------------------------------------------------------------------------------------------------------------------------------------------------------------------------------------------------------------------------------------------------------------------------------------------------------------------------------------------------------------------------------------------------------------------------------------------------------------------------------------------------------------------------------------------------------------------------------------------------------------------------------------------------------------------------------------------------------------------------------------------------------------------------------------------------------------------------------------------------------------------------------------------------------------------------------------------------------------------------------------------------------------------------------------------------------------------------------------------------------------------------------------------------------------------------------------------------------------------------------------------------------------------------------------------------------------------------------------------------------------------------------------------------------------------------------------------------------------------------------------------------------------------------------------------------------------------------------------------------------------------------------------------------------------------------------------------------------------------------------------------------------------------------------------------------------------------------------------------------------------------------------------------------------------------------------------------------------------------------------------------------------------------------------------------------------------------------------------------------------------------------------------------------------------------------------------------------------------------------------------------------------------------------------------------------------------------------------------------------------------------------------------------------------------------------------------------------------------------------------------------------------------------------------------------------------------------------------------------------------------------------------------------------------------------------------------------------------------------------------------------------------------------------------------------------------------------------------------------------------------------------------------------------------------------------------------------------------------------------------------------------------------------------------------------------------------------------------------------------------------------------------------------------------------------------------------------------------------------------------------------------------------------------------------------------------------------------------------------------------------------------------------------------------------------------------------------------------------------------------------------------------------------------------------------------------------------------------------------------------------------------------------------------------------------------------------------------------------------------------------------------------------------------------------------------------------------------------------------------------------------------------------------------------------------------------------------------------------------------------------------------------------------------------------------------------------------------------------------------------------------------------------------------------------------------------------------------------------------------------------------------------------------------------------------------------------------------------------------------------------------------------------------------------------------------------------------------------------------------------------------------------------------------------------------------------------------------------------------------------------------------------------------------------------------------------------------------------------------------------------------------------------------------------------------------------------------------------------------------------------------------------------------------------------------------------------------------------------------------------------------------------------------------------------------------------------------------------------------------------------------------------------------------------------------------------------------------------------------------------------------------------------------------------------------------------------------------------------------------------------------------------------------------------------------------------------------------------------------------------------------------------------------------------------------------------------------------------------------------------------------------------------------------------------------------------------------------------------------------------------------------------------------------------------------------------------------------------------------------------------------------------------------------------------------------------------------------------------------------------------------------------------------------------------------------------------------------------------------------------------------------------------------------------------------------------------------------------------------------------------------------------------------|--|--|--|--|--|--|--|--|--|--|--|--|--|--|--|--|--|--|--

---------------------------------------------------------------------------------------------------------------------------------------------------------------------------------------------------------------------------------------------------------------------------------------------------------------------------------------------------------------------------------------------------------------------------------------------------------------------------------------------------------------------------------------------------------------------------------------------------------------------------------------------------------------------------------------------------------------------------------------------------------------------------------------------------------------------------------------------------------------------------------------------------------------------------------------------------------------------------------------------------------------------------------------------------------------------------------------------------------------------------------------------------------------------------------------------------------------------------------------------------------------------------------------------------------------------------------------------------------------------------------------------------------------------------------------------------------------------------------------------------------------------------------------------------------------------------------------------------------------------------------------------------------------------------------------------------------------------------------------------------------------------------------------------------------------------------------------------------------------------------------------------------------------------------------------------------------------------------------------------------------------------------------------------------------------------------------------------------------------------------------------------------------------------------------------------------------------------------------------------------------------------------------------------------------------------------------------------------------------------------------------------------------------------------------------------------------------------------------------------------------------------------------------------------------------------------------------------------------------------------------------------------------------------------------------------------------------------------------------------------------------------------------------------------------------------------------------------------------------------------------------------------------------------------------------------------------------------------------------------------------------------------------------------------------------------------------------------------------------------------------------------------------------------------------------------------------------------------------------------------------------------------------------------------------------------------------------------------------------------------------------------------------------------------------------------------------------------------------------------------------------------------------------------------------------------------------------------------------------------------------------------------------------------------------------------------------------------------------------------------------------------------------------------------------------------------------------------------------------------------------------------------------------------------------------------------------------------------------------------------------------------------------------------------------------------------------------------------------------------------------------------------------------------------------------------------------------------------------------------------------------------------------------------------------------------------------------------------------------------------------------------------------------------------------------------------------------------------------------------------------------------------------------------------------------------------------------------------------------------------------------------------------------------------------------------------------------------------------------------------------------------------------------------------------------------------------------------------------------------------------------------------------------------------------------------------------------------------------------------------------------------------------------------------------------------------------------------------------------------------------------------------------------------------------------------------------------------------------------------------------------------------------------------------------------------------------------------------------------------------------------------------------------------------------------------------------------------------------------------------------------------------------------------------------------------------------------------------------------------------------------------------------------------------------------------------------------------------------------------------------------------------------------------------------------------------------------------------------------------------------------------------------------------------------------------------------------------------------------------------------------------------------------------------------------------------------------------------------------------------------------------------------------------------------------------------------------------------------------------------------------------------------------------------------------------------------------------------------------------------------------------------------------------------------------------------------------------------------------------------------------------------------------------------------------------------------------------------------------------------------------------------------------------------------------------------------------------------------------------------------------------------------------------------------------------------------------------------------------------------------------------------------------------------------------------------------------------------------------------------------------------------------------------------------------------------------------------------------------------|--|--|--|--|--|--|--|--|--|--|--|--|--|--|--|--|--|--|--

---------------------------------------------------------------------------------------------------------------------------------------------------------------------------------------------------------------------------------------------------------------------------------------------------------------------------------------------------------------------------------------------------------------------------------------------------------------------------------------------------------------------------------------------------------------------------------------------------------------------------------------------------------------------------------------------------------------------------------------------------------------------------------------------------------------------------------------------------------------------------------------------------------------------------------------------------------------------------------------------------------------------------------------------------------------------------------------------------------------------------------------------------------------------------------------------------------------------------------------------------------------------------------------------------------------------------------------------------------------------------------------------------------------------------------------------------------------------------------------------------------------------------------------------------------------------------------------------------------------------------------------------------------------------------------------------------------------------------------------------------------------------------------------------------------------------------------------------------------------------------------------------------------------------------------------------------------------------------------------------------------------------------------------------------------------------------------------------------------------------------------------------------------------------------------------------------------------------------------------------------------------------------------------------------------------------------------------------------------------------------------------------------------------------------------------------------------------------------------------------------------------------------------------------------------------------------------------------------------------------------------------------------------------------------------------------------------------------------------------------------------------------------------------------------------------------------------------------------------------------------------------------------------------------------------------------------------------------------------------------------------------------------------------------------------------------------------------------------------------------------------------------------------------------------------------------------------------------------------------------------------------------------------------------------------------------------------------------------------------------------------------------------------------------------------------------------------------------------------------------------------------------------------------------------------------------------------------------------------------------------------------------------------------------------------------------------------------------------------------------------------------------------------------------------------------------------------------------------------------------------------------------------------------------------------------------------------------------------------------------------------------------------------------------------------------------------------------------------------------------------------------------------------------------------------------------------------------------------------------------------------------------------------------------------------------------------------------------------------------------------------------------------------------------------------------------------------------------------------------------------------------------------------------------------------------------------------------------------------------------------------------------------------------------------------------------------------------------------------------------------------------------------------------------------------------------------------------------------------------------------------------------------------------------------------------------------------------------------------------------------------------------------------------------------------------------------------------------------------------------------------------------------------------------------------------------------------------------------------------------------------------------------------------------------------------------------------------------------------------------------------------------------------------------------------------------------------------------------------------------------------------------------------------------------------------------------------------------------------------------------------------------------------------------------------------------------------------------------------------------------------------------------------------------------------------------------------------------------------------------------------------------------------------------------------------------------------------------------------------------------------------------------------------------------------------------------------------------------------------------------------------------------------------------------------------------------------------------------------------------------------------------------------------------------------------------------------------------------------------------------------------------------------------------------------------------------------------------------------------------------------------------------------------------------------------------------------------------------------------|--|--|--|--|--|--|--|--|--|--|--|--|--|--|--|--|--|--|--

---------------------------------------------------------------------------------------------------------------------------------------------------------------------------------------------------------------------------------------------------------------------------------------------------------------------------------------------------------------------------------------------------------------------------------------------------------------------------------------------------------------------------------------------------------------------------------------------------------------------------------------------------------------------------------------------------------------------------------------------------------------------------------------------------------------------------------------------------------------------------------------------------------------------------------------------------------------------------------------------------------------------------------------------------------------------------------------------------------------------------------------------------------------------------------------------------------------------------------------------------------------------------------------------------------------------------------------------------------------------------------------------------------------------------------------------------------------------------------------------------------------------------------------------------------------------------------------------------------------------------------------------------------------------------------------------------------------------------------------------------------------------------------------------------------------------------------------------------------------------------------------------------------------------------------------------------------------------------------------------------------------------------------------------------------------------------------------------------------------------------------------------------------------------------------------------------------------------------------------------------------------------------------------------------------------------------------------------------------------------------------------------------------------------------------------------------------------------------------------------------------------------------------------------------------------------------------------------------------------------------------------------------------------------------------------------------------------------------------------------------------------------------------------------------------------------------------------------------------------------------------------------------------------------------------------------------------------------------------------------------------------------------------------------------------------------------------------------------------------------------------------------------------------------------------------------------------------------------------------------------------------------------------------------------------------------------------------------------------------------------------------------------------------------------------------------------------------------------------------------------------------------------------------------------------------------------------------------------------------------------------------------------------------------------------------------------------------------------------------------------------------------------------------------------------------------------------------------------------------------------------------------------------------------------------------------------------------------------------------------------------------------------------------------------------------------------------------------------------------------------------------------------------------------------------------------------------------------------------------------------------------------------------------------------------------------------------------------------------------------------------------------------------------------------------------------------------------------------------------------------------------------------------------------------------------------------------------------------------------------------------------------------------------------------------------------------------------------------------------------------------------------------------------------------------------------------------------------------------------------------------------------------------------------------------------------------------------------------------------------------------------------------------------------------------------------------------------------------------------------------------------------------------------------------------------------------------------------------------------------------------------------------------------------------------------------------------------------------------------------------------------------------------------------------------------------------------------------------------------------------------------------------------------------------------------------------------------------------------------------------------------------------------------------------------------------------------------------------------------------------------------------------------------------------------------------------------------------------------------------------------------------------------------------------------------------------------------------------------------------------------------------------------------------------------------------------------------------------------|--|--|--|--|--|--|--|--|--|--|--|--|--|--|--|--|--|--|--

---------------------------------------------------------------------------------------------------------------------------------------------------------------------------------------------------------------------------------------------------------------------------------------------------------------------------------------------------------------------------------------------------------------------------------------------------------------------------------------------------------------------------------------------------------------------------------------------------------------------------------------------------------------------------------------------------------------------------------------------------------------------------------------------------------------------------------------------------------------------------------------------------------------------------------------------------------------------------------------------------------------------------------------------------------------------------------------------------------------------------------------------------------------------------------------------------------------------------------------------------------------------------------------------------------------------------------------------------------------------------------------------------------------------------------------------------------------------------------------------------------------------------------------------------------------------------------------------------------------------------------------------------------------------------------------------------------------------------------------------------------------------------------------------------------------------------------------------------------------------------------------------------------------------------------------------------------------------------------------------------------------------------------------------------------------------------------------------------------------------------------------------------------------------------------------------------------------------------------------------------------------------------------------------------------------------------------------------------------------------------------------------------------------------------------------------------------------------------------------------------------------------------------------------------------------------------------------------------------------------------------------------------------------------------------------------------------------------------------------------------------------------------------------------------------------------------------------------------------------------------------------------------------------------------------------------------------------------------------------------------------------------------------------------------------------------------------------------------------------------------------------------------------------------------------------------------------------------------------------------------------------------------------------------------------------------------------------------------------------------------------------------------------------------------------------------------------------------------------------------------------------------------------------------------------------------------------------------------------------------------------------------------------------------------------------------------------------------------------------------------------------------------------------------------------------------------------------------------------------------------------------------------------------------------------------------------------------------------------------------------------------------------------------------------------------------------------------------------------------------------------------------------------------------------------------------------------------------------------------------------------------------------------------------------------------------------------------------------------------------------------------------------------------------------------------------------------------------------------------------------------------------------------------------------------------------------------------------------------------------------------------------------------------------------------------------------------------------------------------------------------------------------------------------------------------------------------------------------------------------------------------------------------------------------------------------------------------------------------------------------------------------------------------------------------------------------------------------------------------------------------------------------------------------------------------------------------------------------------------------------------------------------------------------------------------------------------------------------------------------------------------------------------------------------------------------------------------------------------------------------------------------------------------------------------------------------------------------------|--|--|--|--|--|--|--|--|--|--|--|--|--|--|--|--|--|--|--

---------------------------------------------------------------------------------------------------------------------------------------------------------------------------------------------------------------------------------------------------------------------------------------------------------------------------------------------------------------------------------------------------------------------------------------------------------------------------------------------------------------------------------------------------------------------------------------------------------------------------------------------------------------------------------------------------------------------------------------------------------------------------------------------------------------------------------------------------------------------------------------------------------------------------------------------------------------------------------------------------------------------------------------------------------------------------------------------------------------------------------------------------------------------------------------------------------------------------------------------------------------------------------------------------------------------------------------------------------------------------------------------------------------------------------------------------------------------------------------------------------------------------------------------------------------------------------------------------------------------------------------------------------------------------------------------------------------------------------------------------------------------------------------------------------------------------------------------------------------------------------------------------------------------------------------------------------------------------------------------------------------------------------------------------------------------------------------------------------------------------------------------------------------------------------------------------------------------------------------------------------------------------------------------------------------------------------------------------------------------------------------------------------------------------------------------------------------------------------------------------------------------------------------------------------------------------------------------------------------------------------------------------------------------------------------------------------------------------------------------------------------------------------------------------------------------------------------------------------------------------------------------------------------------------------------------------------------------------------------------------------------------------------------------------------------------------------------------------------------------------------------------------------------------------------------------------------------------------------------------------------------------------------------------------------------------------------------------------------------------------------------------------------------------------------------------------------------------------------------------------------------------------------------------------------------------------------------------------------------------------------------------------------------------------------------------------------------------------------------------------------------------------------------------------------------------------------------------------------------------------------------------------------------------------------------------------------------------------------------------------------------------------------------------------------------------------------------------------------------------------------------------------------------------------------------------------------------------------------------------------------------------------------------------------------------------------------------------------------------------------------------------------------------------------------------------------------------------------------------------------------------------------------------------------------------------------------------------------------------------------------------------------------------------------------------------------------------------------------------------------------------------------------------------------------------------------------------------------------------------------------------------------------------------------------------------------------------------------------------------------------------------------------------------------------------------------------------------|--|--|--|--|--|--|--|--|--|--|--|--|--|--|--|--|--|--|--

---------------------------------------------------------------------------------------------------------------------------------------------------------------------------------------------------------------------------------------------------------------------------------------------------------------------------------------------------------------------------------------------------------------------------------------------------------------------------------------------------------------------------------------------------------------------------------------------------------------------------------------------------------------------------------------------------------------------------------------------------------------------------------------------------------------------------------------------------------------------------------------------------------------------------------------------------------------------------------------------------------------------------------------------------------------------------------------------------------------------------------------------------------------------------------------------------------------------------------------------------------------------------------------------------------------------------------------------------------------------------------------------------------------------------------------------------------------------------------------------------------------------------------------------------------------------------------------------------------------------------------------------------------------------------------------------------------------------------------------------------------------------------------------------------------------------------------------------------------------------------------------------------------------------------------------------------------------------------------------------------------------------------------------------------------------------------------------------------------------------------------------------------------------------------------------------------------------------------------------------------------------------------------------------------------------------------------------------------------------------------------------------------------------------------------------------------------------------------------------------------------------------------------------------------------------------------------------------------------------------------------------------------------------------------------------------------------------------------------------------------------------------------------------------------------------------------------------------------------------------------------------------------------------------------------------------------------------------------------------------------------------------------------------------------------------------------------------------------------------------------------------------------------------------------------------------------------------------------------------------------------------------------------------------------------------------------------------------------------------------------------------------------------------------------------------------------------------------------------------------------------------------------------------------------------------------------------------------------------------------------------------------------------------------------------------------------------------------------------------------------------------------------------------------------------------------------------------------------------------------------------------------------------------------------------------------------------------------------------------------------------------------------------------------------------------------------------------------------------------------------------------------------------------------------------------------------------------------------------------------------------------------------------------------------------------------------------------------------------------------------------------------------------------------------------------------------------------------------------------------------------------------------------------------------------------------------------------|--|--|--|--|--|--|--|--|--|--|--|--|--|--|--|--|--|--|--

---------------------------------------------------------------------------------------------------------------------------------------------------------------------------------------------------------------------------------------------------------------------------------------------------------------------------------------------------------------------------------------------------------------------------------------------------------------------------------------------------------------------------------------------------------------------------------------------------------------------------------------------------------------------------------------------------------------------------------------------------------------------------------------------------------------------------------------------------------------------------------------------------------------------------------------------------------------------------------------------------------------------------------------------------------------------------------------------------------------------------------------------------------------------------------------------------------------------------------------------------------------------------------------------------------------------------------------------------------------------------------------------------------------------------------------------------------------------------------------------------------------------------------------------------------------------------------------------------------------------------------------------------------------------------------------------------------------------------------------------------------------------------------------------------------------------------------------------------------------------------------------------------------------------------------------------------------------------------------------------------------------------------------------------------------------------------------------------------------------------------------------------------------------------------------------------------------------------------------------------------------------------------------------------------------------------------------------------------------------------------------------------------------------------------------------------------------------------------------------------------------------------------------------------------------------------------------------------------------------------------------------------------------------------------------------------------------------------------------------------------------------------------------------------------------------------------------------------------------------------------------------------------------------------------------------------------------------------------------------------------------------------------------------------------------------------------------------------------------------------------------------------------------------------------------------------------------------------------------------------------------------------------------------------------------------------------------------------------------------------------------------------------------------------------------------------------------------------------------------------------------------------------------------------------------------------------------------------------------------------------------------------------------------------------------------------------------------------------------------------------------------------------------------------------------------------------------------------------------------------------------------------------------------------------------------------------------------------------------------------------------------------------------------------------------------------------------|--|--|--|--|--|--|--|--|--|--|--|--|--|--|--|--|--|--|--

---------------------------------------------------------------------------------------------------------------------------------------------------------------------------------------------------------------------------------------------------------------------------------------------------------------------------------------------------------------------------------------------------------------------------------------------------------------------------------------------------------------------------------------------------------------------------------------------------------------------------------------------------------------------------------------------------------------------------------------------------------------------------------------------------------------------------------------------------------------------------------------------------------------------------------------------------------------------------------------------------------------------------------------------------------------------------------------------------------------------------------------------------------------------------------------------------------------------------------------------------------------------------------------------------------------------------------------------------------------------------------------------------------------------------------------------------------------------------------------------------------------------------------------------------------------------------------------------------------------------------------------------------------------------------------------------------------------------------------------------------------------------------------------------------------------------------------------------------------------------------------------------------------------------------------------------------------------------------------------------------------------------------------------------------------------------------------------------------------------------------------------------------------------------------------------------------------------------------------------------------------------------------------------------------------------------------------------------------------------------------------------------------------------------------------------------------------------------------------------------------------------------------------------------------------------------------------------------------------------------------------------------------------------------------------------------------------------------------------------------------------------------------------------------------------------------------------------------------------------------------------------------------------------------------------------------------------------------------------------------------------------------------------------------------------------------------------------------------------------------------------------------------------------------------------------------------------------------------------------------------------------------------------------------------------------------------------------------------------------------------------------------------------------------------------------------------------------------------------------------------------------------------------------------------------------------------|--|--|--|--|--|--|--|--|--|--|--|--|--|--|--|--|--|--|--

---------------------------------------------------------------------------------------------------------------------------------------------------------------------------------------------------------------------------------------------------------------------------------------------------------------------------------------------------------------------------------------------------------------------------------------------------------------------------------------------------------------------------------------------------------------------------------------------------------------------------------------------------------------------------------------------------------------------------------------------------------------------------------------------------------------------------------------------------------------------------------------------------------------------------------------------------------------------------------------------------------------------------------------------------------------------------------------------------------------------------------------------------------------------------------------------------------------------------------------------------------------------------------------------------------------------------------------------------------------------------------------------------------------------------------------------------------------------------------------------------------------------------------------------------------------------------------------------------------------------------------------------------------------------------------------------------------------------------------------------------------------------------------------------------------------------------------------------------------------------------------------------------------------------------------------------------------------------------------------------------------------------------------------------------------------------------------------------------------------------------------------------------------------------------------------------------------------------------------------------------------------------------------------------------------------------------------------------------------------------------------------------------------------------------------------------------------------------------------------------------------------------------------------------------------------------------------------------------------------------------------------------------------------------------------------------------------------------------------------------------------------------------------------------------------------------------------------------------------------------------------------------------------------------------------------------------------------------------------------------------------------------------------------------------------------------|--|--|--|--|--|--|--|--|--|--|--|--|--|--|--|--|--|--|--

---------------------------------------------------------------------------------------------------------------------------------------------------------------------------------------------------------------------------------------------------------------------------------------------------------------------------------------------------------------------------------------------------------------------------------------------------------------------------------------------------------------------------------------------------------------------------------------------------------------------------------------------------------------------------------------------------------------------------------------------------------------------------------------------------------------------------------------------------------------------------------------------------------------------------------------------------------------------------------------------------------------------------------------------------------------------------------------------------------------------------------------------------------------------------------------------------------------------------------------------------------------------------------------------------------------------------------------------------------------------------------------------------------------------------------------------------------------------------------------------------------------------------------------------------------------------------------------------------------------------------------------------------------------------------------------------------------------------------------------------------------------------------------------------------------------------------------------------------------------------------------------------------------------------------------------------------------------------------------------------------------------------------------------------------------------------------------------------------------------------------------------------------------------------------------------------------------------------------------------------------------------------------------------------------------------------------------------------------------------------------------------------------------------------------------------------------------------------------------------------------------------------------------------------------------------|--|--|--|--|--|--|--|--|--|--|--|--|--|--|--|--|--|--|--

---------------------------------------------------------------------------------------------------------------------------------------------------------------------------------------------------------------------------------------------------------------------------------------------------------------------------------------------------------------------------------------------------------------------------------------------------------------------------------------------------------------------------------------------------------------------------------------------------------------------------------------------------------------------------------------------------------------------------------------------------------------------------------------------------------------------------------------------------------------------------------------------------------------------------------------------------------------------------------------------------------------------------------------------------------------------------------------------------------------------------------------------------------------------------------------------------------------------------------------------------------------------------------------------------------------------------------------------------------------------------------------------------------------------------------------------------------------------------------------------------------------------------------------------------------------------------------------------------------------------------------------------------------------------------------------------------------------------------------------------------------------------------------------------------------------------------------------------------------------------------------------------------------------------------------------------------------------------------------------------------------------------------------------------------------|--|--|--|--|--|--|--|--|--|--|--|--|--|--|--|--|--|--|--

---------------------------------------------------------------------------------------------------------------------------------------------------------------------------------------------------------------------------------------------------------------------------------------------------------------------------------------------------------------------------------------------------------------------------------------------------------------------------------------------------------------------------------------------------------------------------------------------------------------------------------------------------------------------------------------------------------------------------------------------------------------------------------------------------------------------------------------------------------------------------------------------------------------------------------------------------------------------------------------------------------------------------------------------------------------------------------------------------------------------------------------------------------------------------------------------------------------------------------------------------------------------------------------------------------------------------------------------------------------------------------------------------------------------------------------------------------------------------------------------------------------------------------------------------|--|--|--|--|--|--|--|--|--|--|--|--|--|--|--|--|--|--|--

---------------------------------------------------------------------------------------------------------------------------------------------------------------------------------------------------------------------------------------------------------------------------------------------------------------------------------------------------------------------------------------------------------------------------------------------------------------------------------------------------------------------------------------------------------------------------------------------------------------------------------------------------------------------------------------------------------------------------------------------------------------------------------------------------------------------------------------------------------------------------------------------------------------------------------------------------------------------------------------------------------------------------------------------|--|--|--|--|--|--|--|--|--|--|--|--|--|--|--|--|--|--|--

---------------------------------------------------------------------------------------------------------------------------------------------------------------------------------------------------------------------------------------------------------------------------------------------------------------------------------------------------------------------------------------------------------------------------------------------------------------------------------------------------------------------------------------|--|--|--|--|--|--|--|--|--|--|--|--|--|--|--|--|--|--|--

---------------------------------|--|--|--|--|--|--|--|--|--|--|--|--|--|--|--|--|--|--|--

-------------------------------------------------------------------------------------------------------------------------------------------------------------------------------------------------------------------------------------------------------------------------------------------------------------------------------------------------------------------------------------------------------------------------------------------------------------------------------------------------------------------------------------------------------------------------------------------------------------------------------------------------------------------------------------------------------------------------------------------------------------------------------------------------------------------------------------------------------------------------------------------------------------------------------------------------------------------------------------------------------------------------------------------------------------------------------------------------------------------------------------------------------------------------------------------------------------------------------------------------------------------------------------------------------------------------------------------------------------------------------------------------------------------------------------------------------------------------------------------------------------------------------------------------------------------------------------------------------------------------------------------------------------------------------------------------------------------------------------------------------------------------------------------------------------------------------------------------------------------------------------------------------------------------------------------------------------------------------------------------------------------------------------------------------------------------------------------------------------------------------------------------------------------------------------------------------------------------------------------------------------------------------------------------------------------------------------------------------------------------------------------------------------------------------------------------------------------------------------------------------------------------------------------------------------------------------------------------------------------------------------------------------------------------------------------------------------------------------------------------------------------------------------------------------------------------------------------------------------------------------------------------------------------------------------------------------------------------------------------------------------------------------------------------------------------------------------------------------------------------------------------------------------------------------------------------------------------------------------------------------------------------------------------------------------------------------------------------------------------------------------------------------------------------------------------------------------------------------------------------------------------------------------------------------------------------------------------------------------------------------------------------------------------------------------------------------------------------------------------------------------------------------------------------------------------------------------------------------------------------------------------------------------------------------------------------------------------------------------------------------------------------------------------------------------------------------------------------------------------------------------------------------------------------------------------------------------------------------------------------------------------------------------------------------------------------------------------------------------------------------------------------------------------------------------------------------------------------------------------------------------------------------------------------------------------------------------------------------------------------------------------------------------------------------------------------------------------------------------------------------------------------------------------------------------------------------------------------------------------------------------------------------------------------------------------------------------------------------------------------------------------------------------------------------------------------------------------------------------------------------------------------------------------------------------------------------------------------------------------------------------------------------------------------------------------------------------------------------------------------------------------------------------------------------------------------------------------------------------------------------------------------------------------------------------------------------------------------------------------------------------------------------------------------------------------------------------------------------------------------------------------------------------------------------------------------------------------------------------------------------------------------------------------------------------------------------------------------------------------------------------------------------------------------------------------------------------------------------------------------------------------------------------------------------------------------------------------------------------------------------------------------------------------------------------------------------------------------------------------------------------------------------------------------------------------------------------------------------------------------------------------------------------------------------------------------------------------------------------------------------------------------------------------------------------------------------------------------------------------------------------------------------------------------------------------------------------------------------------------------------------------------------------------------------------------------------------------------------------------------------------------------------------------------------------------------------------------------------------------------------------------------------------------------------------------------------------------------------------------------------------------------------------------------------------------------------------------------------------------------------------------------------------------------------------------------------------------------------------------------------------------------------------------------------------------------------------------------------------------------------------------------------------------------------------------------------------------------------------------------------------------------------------------------------------------------------------------------------------------------------------------------------------------------------------------------------------------------------------------------------------------------------------------------------------------------------------------------------------------------------------------------------------------------------------------------------------------------------------------------------------------------------------------------------------------------------------------------------------------------------------------------------------------------------------------------------------------------------------------------------------------------------------------------------------------------------------------------------------------------------------------------------------------------------------------------------------------------------------------------------------------------------------------------------------------------------------------------------------------------------------------------------------------------------------------------------------------------------------------------------------------------------------------------------------------------------------------------------------------------------------------------------------------------------------------------------------------------------------------------------------------------------------------------------------------------------------------------------------------------------------------------------------------------------------------------------------------------------------------------------------------------------------------------------------------------------------------------------------------------------------------------------------------------------------------------------------------------------------------------------------------------------------------------------------------------------------------------------------------------------------------------------------------------------------------|--|--|--|--|--|--|--|--|--|--|--|--|--|--|--|--|--|--|--

-------------------------------------------------------------------------------------------------------------------------------------------------------------------------------------------------------------------------------------------------------------------------------------------------------------------------------------------------------------------------------------------------------------------------------------------------------------------------------------------------------------------------------------------------------------------------------------------------------------------------------------------------------------------------------------------------------------------------------------------------------------------------------------------------------------------------------------------------------------------------------------------------------------------------------------------------------------------------------------------------------------------------------------------------------------------------------------------------------------------------------------------------------------------------------------------------------------------------------------------------------------------------------------------------------------------------------------------------------------------------------------------------------------------------------------------------------------------------------------------------------------------------------------------------------------------------------------------------------------------------------------------------------------------------------------------------------------------------------------------------------------------------------------------------------------------------------------------------------------------------------------------------------------------------------------------------------------------------------------------------------------------------------------------------------------------------------------------------------------------------------------------------------------------------------------------------------------------------------------------------------------------------------------------------------------------------------------------------------------------------------------------------------------------------------------------------------------------------------------------------------------------------------------------------------------------------------------------------------------------------------------------------------------------------------------------------------------------------------------------------------------------------------------------------------------------------------------------------------------------------------------------------------------------------------------------------------------------------------------------------------------------------------------------------------------------------------------------------------------------------------------------------------------------------------------------------------------------------------------------------------------------------------------------------------------------------------------------------------------------------------------------------------------------------------------------------------------------------------------------------------------------------------------------------------------------------------------------------------------------------------------------------------------------------------------------------------------------------------------------------------------------------------------------------------------------------------------------------------------------------------------------------------------------------------------------------------------------------------------------------------------------------------------------------------------------------------------------------------------------------------------------------------------------------------------------------------------------------------------------------------------------------------------------------------------------------------------------------------------------------------------------------------------------------------------------------------------------------------------------------------------------------------------------------------------------------------------------------------------------------------------------------------------------------------------------------------------------------------------------------------------------------------------------------------------------------------------------------------------------------------------------------------------------------------------------------------------------------------------------------------------------------------------------------------------------------------------------------------------------------------------------------------------------------------------------------------------------------------------------------------------------------------------------------------------------------------------------------------------------------------------------------------------------------------------------------------------------------------------------------------------------------------------------------------------------------------------------------------------------------------------------------------------------------------------------------------------------------------------------------------------------------------------------------------------------------------------------------------------------------------------------------------------------------------------------------------------------------------------------------------------------------------------------------------------------------------------------------------------------------------------------------------------------------------------------------------------------------------------------------------------------------------------------------------------------------------------------------------------------------------------------------------------------------------------------------------------------------------------------------------------------------------------------------------------------------------------------------------------------------------------------------------------------------------------------------------------------------------------------------------------------------------------------------------------------------------------------------------------------------------------------------------------------------------------------------------------------------------------------------------------------------------------------------------------------------------------------------------------------------------------------------------------------------------------------------------------------------------------------------------------------------------------------------------------------------------------------------------------------------------------------------------------------------------------------------------------------------------------------------------------------------------------------------------------------------------------------------------------------------------------------------------------------------------------------------------------------------------------------------------------------------------------------------------------------------------------------------------------------------------------------------------------------------------------------------------------------------------------------------------------------------------------------------------------------------------------------------------------------------------------------------------------------------------------------------------------------------------------------------------------------------------------------------------------------------------------------------------------------------------------------------------------------------------------------------------------------------------------------------------------------------------------------------------------------------------------------------------------------------------------------------------------------------------------------------------------------------------------------------------------------------------------------------------------------------------------------------------------------------------------------------------------------------------------------------------------------------------------------------------------------------------------------------------------------------------------------------------------------------------------------------------------------------------------------------------------------------------------------------------------------------------------------------------------------------------------------------------------------------------------------------------------------------------------|--|--|--|--|--|--|--|--|--|--|--|--|--|--|--|--|--|--|--

-------------------------------------------------------------------------------------------------------------------------------------------------------------------------------------------------------------------------------------------------------------------------------------------------------------------------------------------------------------------------------------------------------------------------------------------------------------------------------------------------------------------------------------------------------------------------------------------------------------------------------------------------------------------------------------------------------------------------------------------------------------------------------------------------------------------------------------------------------------------------------------------------------------------------------------------------------------------------------------------------------------------------------------------------------------------------------------------------------------------------------------------------------------------------------------------------------------------------------------------------------------------------------------------------------------------------------------------------------------------------------------------------------------------------------------------------------------------------------------------------------------------------------------------------------------------------------------------------------------------------------------------------------------------------------------------------------------------------------------------------------------------------------------------------------------------------------------------------------------------------------------------------------------------------------------------------------------------------------------------------------------------------------------------------------------------------------------------------------------------------------------------------------------------------------------------------------------------------------------------------------------------------------------------------------------------------------------------------------------------------------------------------------------------------------------------------------------------------------------------------------------------------------------------------------------------------------------------------------------------------------------------------------------------------------------------------------------------------------------------------------------------------------------------------------------------------------------------------------------------------------------------------------------------------------------------------------------------------------------------------------------------------------------------------------------------------------------------------------------------------------------------------------------------------------------------------------------------------------------------------------------------------------------------------------------------------------------------------------------------------------------------------------------------------------------------------------------------------------------------------------------------------------------------------------------------------------------------------------------------------------------------------------------------------------------------------------------------------------------------------------------------------------------------------------------------------------------------------------------------------------------------------------------------------------------------------------------------------------------------------------------------------------------------------------------------------------------------------------------------------------------------------------------------------------------------------------------------------------------------------------------------------------------------------------------------------------------------------------------------------------------------------------------------------------------------------------------------------------------------------------------------------------------------------------------------------------------------------------------------------------------------------------------------------------------------------------------------------------------------------------------------------------------------------------------------------------------------------------------------------------------------------------------------------------------------------------------------------------------------------------------------------------------------------------------------------------------------------------------------------------------------------------------------------------------------------------------------------------------------------------------------------------------------------------------------------------------------------------------------------------------------------------------------------------------------------------------------------------------------------------------------------------------------------------------------------------------------------------------------------------------------------------------------------------------------------------------------------------------------------------------------------------------------------------------------------------------------------------------------------------------------------------------------------------------------------------------------------------------------------------------------------------------------------------------------------------------------------------------------------------------------------------------------------------------------------------------------------------------------------------------------------------------------------------------------------------------------------------------------------------------------------------------------------------------------------------------------------------------------------------------------------------------------------------------------------------------------------------------------------------------------------------------------------------------------------------------------------------------------------------------------------------------------------------------------------------------------------------------------------------------------------------------------------------------------------------------------------------------------------------------------------------------------------------------------------------------------------------------------------------------------------------------------------------------------------------------------------------------------------------------------------------------------------------------------------------------------------------------------------------------------------------------------------------------------------------------------------------------------------------------------------------------------------------------------------------------------------------------------------------------------------------------------------------------------------------------------------------------------------------------------------------------------------------------------------------------------------------------------------------------------------------------------------------------------------------------------------------------------------------------------------------------------------------------------------------------------------------------------------------------------------------------------------------------------------------------------------------------------------------------------------------------------------------------------------------------------------------------------------------------------------------------------------------------------------------------------------------------------------------------------------------------------------------------------------------------------------------------------------------------------------------------------------------------------------------------------------------------------------------------------------------------------------------------------------------------------------------------------------------------------------------------------------------|--|--|--|--|--|--|--|--|--|--|--|--|--|--|--|--|--|--|--

-------------------------------------------------------------------------------------------------------------------------------------------------------------------------------------------------------------------------------------------------------------------------------------------------------------------------------------------------------------------------------------------------------------------------------------------------------------------------------------------------------------------------------------------------------------------------------------------------------------------------------------------------------------------------------------------------------------------------------------------------------------------------------------------------------------------------------------------------------------------------------------------------------------------------------------------------------------------------------------------------------------------------------------------------------------------------------------------------------------------------------------------------------------------------------------------------------------------------------------------------------------------------------------------------------------------------------------------------------------------------------------------------------------------------------------------------------------------------------------------------------------------------------------------------------------------------------------------------------------------------------------------------------------------------------------------------------------------------------------------------------------------------------------------------------------------------------------------------------------------------------------------------------------------------------------------------------------------------------------------------------------------------------------------------------------------------------------------------------------------------------------------------------------------------------------------------------------------------------------------------------------------------------------------------------------------------------------------------------------------------------------------------------------------------------------------------------------------------------------------------------------------------------------------------------------------------------------------------------------------------------------------------------------------------------------------------------------------------------------------------------------------------------------------------------------------------------------------------------------------------------------------------------------------------------------------------------------------------------------------------------------------------------------------------------------------------------------------------------------------------------------------------------------------------------------------------------------------------------------------------------------------------------------------------------------------------------------------------------------------------------------------------------------------------------------------------------------------------------------------------------------------------------------------------------------------------------------------------------------------------------------------------------------------------------------------------------------------------------------------------------------------------------------------------------------------------------------------------------------------------------------------------------------------------------------------------------------------------------------------------------------------------------------------------------------------------------------------------------------------------------------------------------------------------------------------------------------------------------------------------------------------------------------------------------------------------------------------------------------------------------------------------------------------------------------------------------------------------------------------------------------------------------------------------------------------------------------------------------------------------------------------------------------------------------------------------------------------------------------------------------------------------------------------------------------------------------------------------------------------------------------------------------------------------------------------------------------------------------------------------------------------------------------------------------------------------------------------------------------------------------------------------------------------------------------------------------------------------------------------------------------------------------------------------------------------------------------------------------------------------------------------------------------------------------------------------------------------------------------------------------------------------------------------------------------------------------------------------------------------------------------------------------------------------------------------------------------------------------------------------------------------------------------------------------------------------------------------------------------------------------------------------------------------------------------------------------------------------------------------------------------------------------------------------------------------------------------------------------------------------------------------------------------------------------------------------------------------------------------------------------------------------------------------------------------------------------------------------------------------------------------------------------------------------------------------------------------------------------------------------------------------------------------------------------------------------------------------------------------------------------------------------------------------------------------------------------------------------------------------------------------------------------------------------------------------------------------------------------------------------------------------------------------------------------------------------------------------------------------------------------------------------------------------------------------------------------------------------------------------------------------------------------------------------------------------------------------------------------------------------------------------------------------------------------------------------------------------------------------------------------------------------------------------------------------------------------------------------------------------------------------------------------------------------------------------------------------------------------------------------------------------------------------------------------------------------------------------------------------------------------------------------------------------------------------------------------------------------------------------------------------------------------------------------------------------------------------------------------------------------------------------------------------------------------------------------------------------------------------------------------------------------------------------------------------------------------------------------------------------------------------------------------------------------------------------------------------------------------------------------------------------------------------------------|--|--|--|--|--|--|--|--|--|--|--|--|--|--|--|--|--|--|--

-------------------------------------------------------------------------------------------------------------------------------------------------------------------------------------------------------------------------------------------------------------------------------------------------------------------------------------------------------------------------------------------------------------------------------------------------------------------------------------------------------------------------------------------------------------------------------------------------------------------------------------------------------------------------------------------------------------------------------------------------------------------------------------------------------------------------------------------------------------------------------------------------------------------------------------------------------------------------------------------------------------------------------------------------------------------------------------------------------------------------------------------------------------------------------------------------------------------------------------------------------------------------------------------------------------------------------------------------------------------------------------------------------------------------------------------------------------------------------------------------------------------------------------------------------------------------------------------------------------------------------------------------------------------------------------------------------------------------------------------------------------------------------------------------------------------------------------------------------------------------------------------------------------------------------------------------------------------------------------------------------------------------------------------------------------------------------------------------------------------------------------------------------------------------------------------------------------------------------------------------------------------------------------------------------------------------------------------------------------------------------------------------------------------------------------------------------------------------------------------------------------------------------------------------------------------------------------------------------------------------------------------------------------------------------------------------------------------------------------------------------------------------------------------------------------------------------------------------------------------------------------------------------------------------------------------------------------------------------------------------------------------------------------------------------------------------------------------------------------------------------------------------------------------------------------------------------------------------------------------------------------------------------------------------------------------------------------------------------------------------------------------------------------------------------------------------------------------------------------------------------------------------------------------------------------------------------------------------------------------------------------------------------------------------------------------------------------------------------------------------------------------------------------------------------------------------------------------------------------------------------------------------------------------------------------------------------------------------------------------------------------------------------------------------------------------------------------------------------------------------------------------------------------------------------------------------------------------------------------------------------------------------------------------------------------------------------------------------------------------------------------------------------------------------------------------------------------------------------------------------------------------------------------------------------------------------------------------------------------------------------------------------------------------------------------------------------------------------------------------------------------------------------------------------------------------------------------------------------------------------------------------------------------------------------------------------------------------------------------------------------------------------------------------------------------------------------------------------------------------------------------------------------------------------------------------------------------------------------------------------------------------------------------------------------------------------------------------------------------------------------------------------------------------------------------------------------------------------------------------------------------------------------------------------------------------------------------------------------------------------------------------------------------------------------------------------------------------------------------------------------------------------------------------------------------------------------------------------------------------------------------------------------------------------------------------------------------------------------------------------------------------------------------------------------------------------------------------------------------------------------------------------------------------------------------------------------------------------------------------------------------------------------------------------------------------------------------------------------------------------------------------------------------------------------------------------------------------------------------------------------------------------------------------------------------------------------------------------------------------------------------------------------------------------------------------------------------------------------------------------------------------------------------------------------------------------------------------------------------------------------------------------------------------------------------------------------------------------------------------------------------------------------------------------------------------------------------------------------------------------------------------------------------------------------------------------------------------------------------------------------------------------------------------------------------------------------------------------------------------------------------------------------------------------------------------------------------------------------------------------------------------------------------------------------------------------------------------------------------------------------------------------------------------------------------------------------------------------------------------------------------------------------------------------------------------------------------------------------------------------------------------------------------------|--|--|--|--|--|--|--|--|--|--|--|--|--|--|--|--|--|--|--

-------------------------------------------------------------------------------------------------------------------------------------------------------------------------------------------------------------------------------------------------------------------------------------------------------------------------------------------------------------------------------------------------------------------------------------------------------------------------------------------------------------------------------------------------------------------------------------------------------------------------------------------------------------------------------------------------------------------------------------------------------------------------------------------------------------------------------------------------------------------------------------------------------------------------------------------------------------------------------------------------------------------------------------------------------------------------------------------------------------------------------------------------------------------------------------------------------------------------------------------------------------------------------------------------------------------------------------------------------------------------------------------------------------------------------------------------------------------------------------------------------------------------------------------------------------------------------------------------------------------------------------------------------------------------------------------------------------------------------------------------------------------------------------------------------------------------------------------------------------------------------------------------------------------------------------------------------------------------------------------------------------------------------------------------------------------------------------------------------------------------------------------------------------------------------------------------------------------------------------------------------------------------------------------------------------------------------------------------------------------------------------------------------------------------------------------------------------------------------------------------------------------------------------------------------------------------------------------------------------------------------------------------------------------------------------------------------------------------------------------------------------------------------------------------------------------------------------------------------------------------------------------------------------------------------------------------------------------------------------------------------------------------------------------------------------------------------------------------------------------------------------------------------------------------------------------------------------------------------------------------------------------------------------------------------------------------------------------------------------------------------------------------------------------------------------------------------------------------------------------------------------------------------------------------------------------------------------------------------------------------------------------------------------------------------------------------------------------------------------------------------------------------------------------------------------------------------------------------------------------------------------------------------------------------------------------------------------------------------------------------------------------------------------------------------------------------------------------------------------------------------------------------------------------------------------------------------------------------------------------------------------------------------------------------------------------------------------------------------------------------------------------------------------------------------------------------------------------------------------------------------------------------------------------------------------------------------------------------------------------------------------------------------------------------------------------------------------------------------------------------------------------------------------------------------------------------------------------------------------------------------------------------------------------------------------------------------------------------------------------------------------------------------------------------------------------------------------------------------------------------------------------------------------------------------------------------------------------------------------------------------------------------------------------------------------------------------------------------------------------------------------------------------------------------------------------------------------------------------------------------------------------------------------------------------------------------------------------------------------------------------------------------------------------------------------------------------------------------------------------------------------------------------------------------------------------------------------------------------------------------------------------------------------------------------------------------------------------------------------------------------------------------------------------------------------------------------------------------------------------------------------------------------------------------------------------------------------------------------------------------------------------------------------------------------------------------------------------------------------------------------------------------------------------------------------------------------------------------------------------------------------------------------------------------------------------------------------------------------------------------------------------------------------------------------------------------------------------------------------------------------------------------------------------------------------------------------------------------------------------------------------------------------------------------------------------------------------------------------------------------------------------------------------------------------------------------------------------------------------------------------------------------------------------------------------------------------------------------------------------------------------------------------------------------------------------------------------------------------------------------------------------------------------|--|--|--|--|--|--|--|--|--|--|--|--|--|--|--|--|--|--|--

-------------------------------------------------------------------------------------------------------------------------------------------------------------------------------------------------------------------------------------------------------------------------------------------------------------------------------------------------------------------------------------------------------------------------------------------------------------------------------------------------------------------------------------------------------------------------------------------------------------------------------------------------------------------------------------------------------------------------------------------------------------------------------------------------------------------------------------------------------------------------------------------------------------------------------------------------------------------------------------------------------------------------------------------------------------------------------------------------------------------------------------------------------------------------------------------------------------------------------------------------------------------------------------------------------------------------------------------------------------------------------------------------------------------------------------------------------------------------------------------------------------------------------------------------------------------------------------------------------------------------------------------------------------------------------------------------------------------------------------------------------------------------------------------------------------------------------------------------------------------------------------------------------------------------------------------------------------------------------------------------------------------------------------------------------------------------------------------------------------------------------------------------------------------------------------------------------------------------------------------------------------------------------------------------------------------------------------------------------------------------------------------------------------------------------------------------------------------------------------------------------------------------------------------------------------------------------------------------------------------------------------------------------------------------------------------------------------------------------------------------------------------------------------------------------------------------------------------------------------------------------------------------------------------------------------------------------------------------------------------------------------------------------------------------------------------------------------------------------------------------------------------------------------------------------------------------------------------------------------------------------------------------------------------------------------------------------------------------------------------------------------------------------------------------------------------------------------------------------------------------------------------------------------------------------------------------------------------------------------------------------------------------------------------------------------------------------------------------------------------------------------------------------------------------------------------------------------------------------------------------------------------------------------------------------------------------------------------------------------------------------------------------------------------------------------------------------------------------------------------------------------------------------------------------------------------------------------------------------------------------------------------------------------------------------------------------------------------------------------------------------------------------------------------------------------------------------------------------------------------------------------------------------------------------------------------------------------------------------------------------------------------------------------------------------------------------------------------------------------------------------------------------------------------------------------------------------------------------------------------------------------------------------------------------------------------------------------------------------------------------------------------------------------------------------------------------------------------------------------------------------------------------------------------------------------------------------------------------------------------------------------------------------------------------------------------------------------------------------------------------------------------------------------------------------------------------------------------------------------------------------------------------------------------------------------------------------------------------------------------------------------------------------------------------------------------------------------------------------------------------------------------------------------------------------------------------------------------------------------------------------------------------------------------------------------------------------------------------------------------------------------------------------------------------------------------------------------------------------------------------------------------------------------------------------------------------------------------------------------------------------------------------------------------------------------------------------------------------------------------------------------------------------------------------------------------------------------------------------------------------------------------------------------------------------------------------------------------------------------------------------------------------------------------------------------------------------------------------------------------------------------------------------------------------------------------------------------------------------------------------------------------------------|--|--|--|--|--|--|--|--|--|--|--|--|--|--|--|--|--|--|--

-------------------------------------------------------------------------------------------------------------------------------------------------------------------------------------------------------------------------------------------------------------------------------------------------------------------------------------------------------------------------------------------------------------------------------------------------------------------------------------------------------------------------------------------------------------------------------------------------------------------------------------------------------------------------------------------------------------------------------------------------------------------------------------------------------------------------------------------------------------------------------------------------------------------------------------------------------------------------------------------------------------------------------------------------------------------------------------------------------------------------------------------------------------------------------------------------------------------------------------------------------------------------------------------------------------------------------------------------------------------------------------------------------------------------------------------------------------------------------------------------------------------------------------------------------------------------------------------------------------------------------------------------------------------------------------------------------------------------------------------------------------------------------------------------------------------------------------------------------------------------------------------------------------------------------------------------------------------------------------------------------------------------------------------------------------------------------------------------------------------------------------------------------------------------------------------------------------------------------------------------------------------------------------------------------------------------------------------------------------------------------------------------------------------------------------------------------------------------------------------------------------------------------------------------------------------------------------------------------------------------------------------------------------------------------------------------------------------------------------------------------------------------------------------------------------------------------------------------------------------------------------------------------------------------------------------------------------------------------------------------------------------------------------------------------------------------------------------------------------------------------------------------------------------------------------------------------------------------------------------------------------------------------------------------------------------------------------------------------------------------------------------------------------------------------------------------------------------------------------------------------------------------------------------------------------------------------------------------------------------------------------------------------------------------------------------------------------------------------------------------------------------------------------------------------------------------------------------------------------------------------------------------------------------------------------------------------------------------------------------------------------------------------------------------------------------------------------------------------------------------------------------------------------------------------------------------------------------------------------------------------------------------------------------------------------------------------------------------------------------------------------------------------------------------------------------------------------------------------------------------------------------------------------------------------------------------------------------------------------------------------------------------------------------------------------------------------------------------------------------------------------------------------------------------------------------------------------------------------------------------------------------------------------------------------------------------------------------------------------------------------------------------------------------------------------------------------------------------------------------------------------------------------------------------------------------------------------------------------------------------------------------------------------------------------------------------------------------------------------------------------------------------------------------------------------------------------------------------------------------------------------------------------------------------------------------------------------------------------------------------------------------------------------------------------------------------------------------------------------------------------------------------------------------------------------------------------------------------------------------------------------------------------------------------------------------------------------------------------------------------------------------------------------------------------------------------------------------------------------------------------------------------------------------------------------------------------------------------------------------------------------------------------------------------------------------------------------------------------------------------------------------------|--|--|--|--|--|--|--|--|--|--|--|--|--|--|--|--|--|--|--

-------------------------------------------------------------------------------------------------------------------------------------------------------------------------------------------------------------------------------------------------------------------------------------------------------------------------------------------------------------------------------------------------------------------------------------------------------------------------------------------------------------------------------------------------------------------------------------------------------------------------------------------------------------------------------------------------------------------------------------------------------------------------------------------------------------------------------------------------------------------------------------------------------------------------------------------------------------------------------------------------------------------------------------------------------------------------------------------------------------------------------------------------------------------------------------------------------------------------------------------------------------------------------------------------------------------------------------------------------------------------------------------------------------------------------------------------------------------------------------------------------------------------------------------------------------------------------------------------------------------------------------------------------------------------------------------------------------------------------------------------------------------------------------------------------------------------------------------------------------------------------------------------------------------------------------------------------------------------------------------------------------------------------------------------------------------------------------------------------------------------------------------------------------------------------------------------------------------------------------------------------------------------------------------------------------------------------------------------------------------------------------------------------------------------------------------------------------------------------------------------------------------------------------------------------------------------------------------------------------------------------------------------------------------------------------------------------------------------------------------------------------------------------------------------------------------------------------------------------------------------------------------------------------------------------------------------------------------------------------------------------------------------------------------------------------------------------------------------------------------------------------------------------------------------------------------------------------------------------------------------------------------------------------------------------------------------------------------------------------------------------------------------------------------------------------------------------------------------------------------------------------------------------------------------------------------------------------------------------------------------------------------------------------------------------------------------------------------------------------------------------------------------------------------------------------------------------------------------------------------------------------------------------------------------------------------------------------------------------------------------------------------------------------------------------------------------------------------------------------------------------------------------------------------------------------------------------------------------------------------------------------------------------------------------------------------------------------------------------------------------------------------------------------------------------------------------------------------------------------------------------------------------------------------------------------------------------------------------------------------------------------------------------------------------------------------------------------------------------------------------------------------------------------------------------------------------------------------------------------------------------------------------------------------------------------------------------------------------------------------------------------------------------------------------------------------------------------------------------------------------------------------------------------------------------------------------------------------------------------------------------------------------------------------------------------------------------------------------------------------------------------------------------------------------------------------------------------------------------------------------------------------------------------------------------------------------------------------------------------------------------------------------------------------------------------------------------------------------------------------------------------------------------------------------------------------------------------------------------------------------------------------|--|--|--|--|--|--|--|--|--|--|--|--|--|--|--|--|--|--|--

-------------------------------------------------------------------------------------------------------------------------------------------------------------------------------------------------------------------------------------------------------------------------------------------------------------------------------------------------------------------------------------------------------------------------------------------------------------------------------------------------------------------------------------------------------------------------------------------------------------------------------------------------------------------------------------------------------------------------------------------------------------------------------------------------------------------------------------------------------------------------------------------------------------------------------------------------------------------------------------------------------------------------------------------------------------------------------------------------------------------------------------------------------------------------------------------------------------------------------------------------------------------------------------------------------------------------------------------------------------------------------------------------------------------------------------------------------------------------------------------------------------------------------------------------------------------------------------------------------------------------------------------------------------------------------------------------------------------------------------------------------------------------------------------------------------------------------------------------------------------------------------------------------------------------------------------------------------------------------------------------------------------------------------------------------------------------------------------------------------------------------------------------------------------------------------------------------------------------------------------------------------------------------------------------------------------------------------------------------------------------------------------------------------------------------------------------------------------------------------------------------------------------------------------------------------------------------------------------------------------------------------------------------------------------------------------------------------------------------------------------------------------------------------------------------------------------------------------------------------------------------------------------------------------------------------------------------------------------------------------------------------------------------------------------------------------------------------------------------------------------------------------------------------------------------------------------------------------------------------------------------------------------------------------------------------------------------------------------------------------------------------------------------------------------------------------------------------------------------------------------------------------------------------------------------------------------------------------------------------------------------------------------------------------------------------------------------------------------------------------------------------------------------------------------------------------------------------------------------------------------------------------------------------------------------------------------------------------------------------------------------------------------------------------------------------------------------------------------------------------------------------------------------------------------------------------------------------------------------------------------------------------------------------------------------------------------------------------------------------------------------------------------------------------------------------------------------------------------------------------------------------------------------------------------------------------------------------------------------------------------------------------------------------------------------------------------------------------------------------------------------------------------------------------------------------------------------------------------------------------------------------------------------------------------------------------------------------------------------------------------------------------------------------------------------------------------------------------------------------------------------------------------------------------------------------------------------------------------------------------------------------------------------------------------------------------------------------------------------------------------------------|--|--|--|--|--|--|--|--|--|--|--|--|--|--|--|--|--|--|--

-------------------------------------------------------------------------------------------------------------------------------------------------------------------------------------------------------------------------------------------------------------------------------------------------------------------------------------------------------------------------------------------------------------------------------------------------------------------------------------------------------------------------------------------------------------------------------------------------------------------------------------------------------------------------------------------------------------------------------------------------------------------------------------------------------------------------------------------------------------------------------------------------------------------------------------------------------------------------------------------------------------------------------------------------------------------------------------------------------------------------------------------------------------------------------------------------------------------------------------------------------------------------------------------------------------------------------------------------------------------------------------------------------------------------------------------------------------------------------------------------------------------------------------------------------------------------------------------------------------------------------------------------------------------------------------------------------------------------------------------------------------------------------------------------------------------------------------------------------------------------------------------------------------------------------------------------------------------------------------------------------------------------------------------------------------------------------------------------------------------------------------------------------------------------------------------------------------------------------------------------------------------------------------------------------------------------------------------------------------------------------------------------------------------------------------------------------------------------------------------------------------------------------------------------------------------------------------------------------------------------------------------------------------------------------------------------------------------------------------------------------------------------------------------------------------------------------------------------------------------------------------------------------------------------------------------------------------------------------------------------------------------------------------------------------------------------------------------------------------------------------------------------------------------------------------------------------------------------------------------------------------------------------------------------------------------------------------------------------------------------------------------------------------------------------------------------------------------------------------------------------------------------------------------------------------------------------------------------------------------------------------------------------------------------------------------------------------------------------------------------------------------------------------------------------------------------------------------------------------------------------------------------------------------------------------------------------------------------------------------------------------------------------------------------------------------------------------------------------------------------------------------------------------------------------------------------------------------------------------------------------------------------------------------------------------------------------------------------------------------------------------------------------------------------------------------------------------------------------------------------------------------------------------------------------------------------------------------------------------------------------------------------------------------------------------------------------------------------------------------------------------------------------------------------------------------------------------------------------------------------------|--|--|--|--|--|--|--|--|--|--|--|--|--|--|--|--|--|--|--

-------------------------------------------------------------------------------------------------------------------------------------------------------------------------------------------------------------------------------------------------------------------------------------------------------------------------------------------------------------------------------------------------------------------------------------------------------------------------------------------------------------------------------------------------------------------------------------------------------------------------------------------------------------------------------------------------------------------------------------------------------------------------------------------------------------------------------------------------------------------------------------------------------------------------------------------------------------------------------------------------------------------------------------------------------------------------------------------------------------------------------------------------------------------------------------------------------------------------------------------------------------------------------------------------------------------------------------------------------------------------------------------------------------------------------------------------------------------------------------------------------------------------------------------------------------------------------------------------------------------------------------------------------------------------------------------------------------------------------------------------------------------------------------------------------------------------------------------------------------------------------------------------------------------------------------------------------------------------------------------------------------------------------------------------------------------------------------------------------------------------------------------------------------------------------------------------------------------------------------------------------------------------------------------------------------------------------------------------------------------------------------------------------------------------------------------------------------------------------------------------------------------------------------------------------------------------------------------------------------------------------------------------------------------------------------------------------------------------------------------------------------------------------------------------------------------------------------------------------------------------------------------------------------------------------------------------------------------------------------------------------------------------------------------------------------------------------------------------------------------------------------------------------------------------------------------------------------------------------------------------------------------------------------------------------------------------------------------------------------------------------------------------------------------------------------------------------------------------------------------------------------------------------------------------------------------------------------------------------------------------------------------------------------------------------------------------------------------------------------------------------------------------------------------------------------------------------------------------------------------------------------------------------------------------------------------------------------------------------------------------------------------------------------------------------------------------------------------------------------------------------------------------------------------------------------------------------------------------------------------------------------------------------------------------------------------------------------------------------------------------|--|--|--|--|--|--|--|--|--|--|--|--|--|--|--|--|--|--|--

-------------------------------------------------------------------------------------------------------------------------------------------------------------------------------------------------------------------------------------------------------------------------------------------------------------------------------------------------------------------------------------------------------------------------------------------------------------------------------------------------------------------------------------------------------------------------------------------------------------------------------------------------------------------------------------------------------------------------------------------------------------------------------------------------------------------------------------------------------------------------------------------------------------------------------------------------------------------------------------------------------------------------------------------------------------------------------------------------------------------------------------------------------------------------------------------------------------------------------------------------------------------------------------------------------------------------------------------------------------------------------------------------------------------------------------------------------------------------------------------------------------------------------------------------------------------------------------------------------------------------------------------------------------------------------------------------------------------------------------------------------------------------------------------------------------------------------------------------------------------------------------------------------------------------------------------------------------------------------------------------------------------------------------------------------------------------------------------------------------------------------------------------------------------------------------------------------------------------------------------------------------------------------------------------------------------------------------------------------------------------------------------------------------------------------------------------------------------------------------------------------------------------------------------------------------------------------------------------------------------------------------------------------------------------------------------------------------------------------------------------------------------------------------------------------------------------------------------------------------------------------------------------------------------------------------------------------------------------------------------------------------------------------------------------------------------------------------------------------------------------------------------------------------------------------------------------------------------------------------------------------------------------------------------------------------------------------------------------------------------------------------------------------------------------------------------------------------------------------------------------------------------------------------------------------------------------------------------------------------------------------------------------------------------------------------------------------------------------------------------------------------------------------------------------------------------------------------------------------------------|--|--|--|--|--|--|--|--|--|--|--|--|--|--|--|--|--|--|--

-------------------------------------------------------------------------------------------------------------------------------------------------------------------------------------------------------------------------------------------------------------------------------------------------------------------------------------------------------------------------------------------------------------------------------------------------------------------------------------------------------------------------------------------------------------------------------------------------------------------------------------------------------------------------------------------------------------------------------------------------------------------------------------------------------------------------------------------------------------------------------------------------------------------------------------------------------------------------------------------------------------------------------------------------------------------------------------------------------------------------------------------------------------------------------------------------------------------------------------------------------------------------------------------------------------------------------------------------------------------------------------------------------------------------------------------------------------------------------------------------------------------------------------------------------------------------------------------------------------------------------------------------------------------------------------------------------------------------------------------------------------------------------------------------------------------------------------------------------------------------------------------------------------------------------------------------------------------------------------------------------------------------------------------------------------------------------------------------------------------------------------------------------------------------------------------------------------------------------------------------------------------------------------------------------------------------------------------------------------------------------------------------------------------------------------------------------------------------------------------------------------------------------------------------------------------------------------------------------------------------------------------------------------------------------------------------------------------------------------------------------------------------------------------------------------------------------------------------------------------------------------------------------------------------------------------------------------------------------------------------------------------------------------------------------------------------------------------------------------------------------------------------------------------------------------------------------------------------------------------------------------------------------------------------------------------------------------------------------------|--|--|--|--|--|--|--|--|--|--|--|--|--|--|--|--|--|--|--

-------------------------------------------------------------------------------------------------------------------------------------------------------------------------------------------------------------------------------------------------------------------------------------------------------------------------------------------------------------------------------------------------------------------------------------------------------------------------------------------------------------------------------------------------------------------------------------------------------------------------------------------------------------------------------------------------------------------------------------------------------------------------------------------------------------------------------------------------------------------------------------------------------------------------------------------------------------------------------------------------------------------------------------------------------------------------------------------------------------------------------------------------------------------------------------------------------------------------------------------------------------------------------------------------------------------------------------------------------------------------------------------------------------------------------------------------------------------------------------------------------------------------------------------------------------------------------------------------------------------------------------------------------------------------------------------------------------------------------------------------------------------------------------------------------------------------------------------------------------------------------------------------------------------------------------------------------------------------------------------------------------------------------------------------------------------------------------------------------------------------------------------------------------------------------------------------------------------------------------------------------------------------------------------------------------------------------------------------------------------------------------------------------------------------------------------------------------------------------------------------------------------------------------------------------------------------------------------------------------------------------------------------------------------------------------------------------------------------------------------------------------------------------------------------------------------------------------------------------|--|--|--|--|--|--|--|--|--|--|--|--|--|--|--|--|--|--|--

-------------------------------------------------------------------------------------------------------------------------------------------------------------------------------------------------------------------------------------------------------------------------------------------------------------------------------------------------------------------------------------------------------------------------------------------------------------------------------------------------------------------------------------------------------------------------------------------------------------------------------------------------------------------------------------------------------------------------------------------------------------------------------------------------------------------------------------------------------------------------------------------------------------------------------------------------------------------------------------------------------------------------------------------------------------------------------------------------------------------------------------------------------------------------------------------------------------------------------------------------------------------------------------------------------------------------------------------------------------------------------------------------------------------------------------------------------------------------------------------------------------------------------------------------------------------------------------------------------------------------------------------------------------------------------------------------------------------------------------------------------------------------------------------------------------------------------------------------------------------------------------------------------------------------------------------------------------------------------------------------------------------------------------------------------------------------------------------------------------------------------------------------------------------------------------------------------------------------------------------------------------------------------------------------------------------------------------------------|--|--|--|--|--|--|--|--|--|--|--|--|--|--|--|--|--|--|--

-------------------------------------------------------------------------------------------------------------------------------------------------------------------------------------------------------------------------------------------------------------------------------------------------------------------------------------------------------------------------------------------------------------------------------------------------------------------------------------------------------------------------------------------------------------------------------------------------------------------------------------------------------------------------------------------------------------------------------------------------------------------------------------------------------------------------------------------------------------------------------------------------------------------------------------------------------------------------------------------------------------------------------------------------------------------------------------------------------------------------------------------------------------------------------------------------------------------------------------------------------------------------------------------------------------------------------------------------------------------------------------------------------------------------------------------------------------------------------------------------------------------------------------------------------------------------------------------------------------------------------------------------------------------------------------------------------------------------------------------------------------------------------------------------------------------------------------------|--|--|--|--|--|--|--|--|--|--|--|--|--|--|--|--|--|--|--

-------------------------------------------------------------------------------------------------------------------------------------------------------------------------------------------------------------------------------------------------------------------------------------------------------------------------------------------------------------------------------------------------------------------------------------------------------------------------------------------------------------------------------------------------------------------------------------------------------------------------------------------------------------------------------------------------------------------------------------------------------------------------------------------------------------------------------------------------------------------------------------------------------------------------------------------------------------------------------------------------------------------------------------------------------------------------------------------------------------------------------------------------------------------------------------------------------------------------------------------------------------------------------------------------------------------------------------|--|--|--|--|--|--|--|--|--|--|--|--|--|--|--|--|--|--|--

-------------------------------------------------------------------------------------------------------------------------------------------------------------------------------------------------------------------------------------------------------------------------------------------------------------------------------------------------------------------------------------------------------------------------------------------------------------------------------------------------------------------------------------------------------------------------------------------------------------------------------------------------------------------------------------------------------------------------------------------------------------------------------------------------------------------------------|--|--|--|--|--|--|--|--|--|--|--|--|--|--|--|--|--|--|--

-------------------------------------------------------------------------------------------------------------------------------------------------------------------------------------------------------------------------------------------------------------------------------------------------------------------------	--	--	--	--	--	--	--	--	--	--	--	--	--	--	--	--	--	--	--
-----------------------------------------------------------------------------------------------------------------------------------------------------------------------------------------------------------------------------------------------------------------------------------------------------------------------------------------------------------------------------------------------------------------------------------------------------------------------------------------------------------------------------------------------------------------------------------------------------------------------------------------------------------------------------------------------------------------------------------------------------------------------------------------------------------------------------------------------------------------------------------------------------------------------------------------------------------------------------------------------------------------------------------------------------------------------------------------------------------------------------------------------------------------------------------------------------------------------------------------------------------------------------------------------------------------------------------------------------------------------------------------------------------------------------------------------------------------------------------------------------------------------------------------------------------------------------------------------------------------------------------------------------------------------------------------------------------------------------------------------------------------------------------------------------------------------------------------------------------------------------------------------------------------------------------------------------------------------------------------------------------------------------------------------------------------------------------------------------------------------------------------------------------------------------------------------------------------------------------------------------------------------------------------------------------------------------------------------------------------------------------------------------------------------------------------------------------------------------------------------------------------------------------------------------------------------------------------------------------------------------------------------------------------------------------------------------------------------------------------------------------------------------------------------------------------------------------------------------------------------------------------------------------------------------------------------------------------------------------------------------------------------------------------------------------------------------------------------------------------------------------------------------------------------------------------------------------------------------------------------------------------------------------------------------------------------------------------------------------------------------------------------------------------------------------------------------------------------------------------------------------------------------------------------------------------------------------------------------------------------------------------------------------------------------------------------------------------------------------------------------------------------------------------------------------------------------------------------------------------------------------------------------------------------------------------------------------------------------------------------------------------------------------------------------------------------------------------------------------------------------------------------------------------------------------------------------------------------------------------------------------------------------------------------------------------------------------------------------------------------------------------------------------------------------------------------------------------------------------------------------------------------------------------------------------------------------------------------------------------------------------------------------------------------------------------------------------------------------------------------------------------------------------------------------------------------------------------------------------------------------------------------------------------------------------------------------------------------------------------------------------------------------------------------------------------------------------------------------------------------------------------------------------------------------------------------------------------------------------------------------------------------------------------------------------------------------------------------------------------------------------------------------------------------------------------------------------------------------------------------------------------------------------------------------------------------------------------------------------------------------------------------------------------------------------------------------------------------------------------------------------------------------------------------------------------------------------------------------------------------------------------------------------------------------------------------------------------------------------------------------------------------------------------------------------------------------------------------------------------------------------------------------------------------------------------------------------------------------------------------------------------------------------------------------------------------------------------------------------------------------------------------------------------------------------------------------------------------------------------------------------------------------------------------------------------------------------------------------------------------------------------------------------------------------------------------------------------------------------------------------------------------------------------------------------------------------------------------------------------------------------------------------------------------------------------------------------------------------------------------------------------------------------------------------------------------------------------------------------------------------------------------------------------------------------------------------------------------------------------------------------------------------------------------------------------------------------------------------------------------------------------------------------------------------------------------------------------------------------------------------------------------------------------------------------------------------------------------------------------------------------------------------------------------------------------------------------------------------------------------------------------------------------------------------------------------------------------------------------------------------------------------------------------------------------------------------------------------------------------------------------------------------------------------------------------------------------------------------------------------------------------------------------------------------------------------------------------------------------------------------------------------------------------------------------------------------------------------------------------------------------------------------------------------------------------------------------------------------------------------------------------------------------------------------------------------------------------------------------------------------------------------------------------------------------------------------------------------------------------------------------------------------------------------------------------------------------------------------------------------------------------------------------------------------------------------------------------------------------------------------------------------------------------------------------------------------------------------------------------------------------------------------------------------------------------------------------------------------------------------------------------------------------------------------------------------------------------------------------------------------------------------------------------------------------------------------------------------------------------------------------------------------------------------------------------------------------------------------------------------------------------------------------------------------------------------------------------------------	--	--	--	--	--	--	--	--	--	--	--	--	--	--	--	--	--	--	--
-----------------------------------------------------------------------------------------------------------------------------------------------------------------------------------------------------------------------------------------------------------------------------------------------------------------------------------------------------------------------------------------------------------------------------------------------------------------------------------------------------------------------------------------------------------------------------------------------------------------------------------------------------------------------------------------------------------------------------------------------------------------------------------------------------------------------------------------------------------------------------------------------------------------------------------------------------------------------------------------------------------------------------------------------------------------------------------------------------------------------------------------------------------------------------------------------------------------------------------------------------------------------------------------------------------------------------------------------------------------------------------------------------------------------------------------------------------------------------------------------------------------------------------------------------------------------------------------------------------------------------------------------------------------------------------------------------------------------------------------------------------------------------------------------------------------------------------------------------------------------------------------------------------------------------------------------------------------------------------------------------------------------------------------------------------------------------------------------------------------------------------------------------------------------------------------------------------------------------------------------------------------------------------------------------------------------------------------------------------------------------------------------------------------------------------------------------------------------------------------------------------------------------------------------------------------------------------------------------------------------------------------------------------------------------------------------------------------------------------------------------------------------------------------------------------------------------------------------------------------------------------------------------------------------------------------------------------------------------------------------------------------------------------------------------------------------------------------------------------------------------------------------------------------------------------------------------------------------------------------------------------------------------------------------------------------------------------------------------------------------------------------------------------------------------------------------------------------------------------------------------------------------------------------------------------------------------------------------------------------------------------------------------------------------------------------------------------------------------------------------------------------------------------------------------------------------------------------------------------------------------------------------------------------------------------------------------------------------------------------------------------------------------------------------------------------------------------------------------------------------------------------------------------------------------------------------------------------------------------------------------------------------------------------------------------------------------------------------------------------------------------------------------------------------------------------------------------------------------------------------------------------------------------------------------------------------------------------------------------------------------------------------------------------------------------------------------------------------------------------------------------------------------------------------------------------------------------------------------------------------------------------------------------------------------------------------------------------------------------------------------------------------------------------------------------------------------------------------------------------------------------------------------------------------------------------------------------------------------------------------------------------------------------------------------------------------------------------------------------------------------------------------------------------------------------------------------------------------------------------------------------------------------------------------------------------------------------------------------------------------------------------------------------------------------------------------------------------------------------------------------------------------------------------------------------------------------------------------------------------------------------------------------------------------------------------------------------------------------------------------------------------------------------------------------------------------------------------------------------------------------------------------------------------------------------------------------------------------------------------------------------------------------------------------------------------------------------------------------------------------------------------------------------------------------------------------------------------------------------------------------------------------------------------------------------------------------------------------------------------------------------------------------------------------------------------------------------------------------------------------------------------------------------------------------------------------------------------------------------------------------------------------------------------------------------------------------------------------------------------------------------------------------------------------------------------------------------------------------------------------------------------------------------------------------------------------------------------------------------------------------------------------------------------------------------------------------------------------------------------------------------------------------------------------------------------------------------------------------------------------------------------------------------------------------------------------------------------------------------------------------------------------------------------------------------------------------------------------------------------------------------------------------------------------------------------------------------------------------------------------------------------------------------------------------------------------------------------------------------------------------------------------------------------------------------------------------------------------------------------------------------------------------------------------------------------------------------------------------------------------------------------------------------------------------------------------------------------------------------------------------------------------------------------------------------------------------------------------------------------------------------------------------------------------------------------------------------------------------------------------------------------------------------------------------------------------------------------------------------------------------------------------------------------------------------------------------------------------------------------------------------------------------------------------------------------------------------------------------------------------------------------------------------------------------------------------------------------------------------------------------------------------------------------------------------------------------------------------	--	--	--	--	--	--	--	--	--	--	--	--	--	--	--	--	--	--	--
-----------------------------------------------------------------------------------------------------------------------------------------------------------------------------------------------------------------------------------------------------------------------------------------------------------------------------------------------------------------------------------------------------------------------------------------------------------------------------------------------------------------------------------------------------------------------------------------------------------------------------------------------------------------------------------------------------------------------------------------------------------------------------------------------------------------------------------------------------------------------------------------------------------------------------------------------------------------------------------------------------------------------------------------------------------------------------------------------------------------------------------------------------------------------------------------------------------------------------------------------------------------------------------------------------------------------------------------------------------------------------------------------------------------------------------------------------------------------------------------------------------------------------------------------------------------------------------------------------------------------------------------------------------------------------------------------------------------------------------------------------------------------------------------------------------------------------------------------------------------------------------------------------------------------------------------------------------------------------------------------------------------------------------------------------------------------------------------------------------------------------------------------------------------------------------------------------------------------------------------------------------------------------------------------------------------------------------------------------------------------------------------------------------------------------------------------------------------------------------------------------------------------------------------------------------------------------------------------------------------------------------------------------------------------------------------------------------------------------------------------------------------------------------------------------------------------------------------------------------------------------------------------------------------------------------------------------------------------------------------------------------------------------------------------------------------------------------------------------------------------------------------------------------------------------------------------------------------------------------------------------------------------------------------------------------------------------------------------------------------------------------------------------------------------------------------------------------------------------------------------------------------------------------------------------------------------------------------------------------------------------------------------------------------------------------------------------------------------------------------------------------------------------------------------------------------------------------------------------------------------------------------------------------------------------------------------------------------------------------------------------------------------------------------------------------------------------------------------------------------------------------------------------------------------------------------------------------------------------------------------------------------------------------------------------------------------------------------------------------------------------------------------------------------------------------------------------------------------------------------------------------------------------------------------------------------------------------------------------------------------------------------------------------------------------------------------------------------------------------------------------------------------------------------------------------------------------------------------------------------------------------------------------------------------------------------------------------------------------------------------------------------------------------------------------------------------------------------------------------------------------------------------------------------------------------------------------------------------------------------------------------------------------------------------------------------------------------------------------------------------------------------------------------------------------------------------------------------------------------------------------------------------------------------------------------------------------------------------------------------------------------------------------------------------------------------------------------------------------------------------------------------------------------------------------------------------------------------------------------------------------------------------------------------------------------------------------------------------------------------------------------------------------------------------------------------------------------------------------------------------------------------------------------------------------------------------------------------------------------------------------------------------------------------------------------------------------------------------------------------------------------------------------------------------------------------------------------------------------------------------------------------------------------------------------------------------------------------------------------------------------------------------------------------------------------------------------------------------------------------------------------------------------------------------------------------------------------------------------------------------------------------------------------------------------------------------------------------------------------------------------------------------------------------------------------------------------------------------------------------------------------------------------------------------------------------------------------------------------------------------------------------------------------------------------------------------------------------------------------------------------------------------------------------------------------------------------------------------------------------------------------------------------------------------------------------------------------------------------------------------------------------------------------------------------------------------------------------------------------------------------------------------------------------------------------------------------------------------------------------------------------------------------------------------------------------------------------------------------------------------------------------------------------------------------------------------------------------------------------------------------------------------------------------------------------------------------------------------------------------------------------------------------------------------------------------------------------------------------------------------------------------------------------------------------------------------------------------------------------------------------------------------------------------------------------------------------------------------------------------------------------------------------------------------------------------------------------------	--	--	--	--	--	--	--	--	--	--	--	--	--	--	--	--	--	--	--
-----------------------------------------------------------------------------------------------------------------------------------------------------------------------------------------------------------------------------------------------------------------------------------------------------------------------------------------------------------------------------------------------------------------------------------------------------------------------------------------------------------------------------------------------------------------------------------------------------------------------------------------------------------------------------------------------------------------------------------------------------------------------------------------------------------------------------------------------------------------------------------------------------------------------------------------------------------------------------------------------------------------------------------------------------------------------------------------------------------------------------------------------------------------------------------------------------------------------------------------------------------------------------------------------------------------------------------------------------------------------------------------------------------------------------------------------------------------------------------------------------------------------------------------------------------------------------------------------------------------------------------------------------------------------------------------------------------------------------------------------------------------------------------------------------------------------------------------------------------------------------------------------------------------------------------------------------------------------------------------------------------------------------------------------------------------------------------------------------------------------------------------------------------------------------------------------------------------------------------------------------------------------------------------------------------------------------------------------------------------------------------------------------------------------------------------------------------------------------------------------------------------------------------------------------------------------------------------------------------------------------------------------------------------------------------------------------------------------------------------------------------------------------------------------------------------------------------------------------------------------------------------------------------------------------------------------------------------------------------------------------------------------------------------------------------------------------------------------------------------------------------------------------------------------------------------------------------------------------------------------------------------------------------------------------------------------------------------------------------------------------------------------------------------------------------------------------------------------------------------------------------------------------------------------------------------------------------------------------------------------------------------------------------------------------------------------------------------------------------------------------------------------------------------------------------------------------------------------------------------------------------------------------------------------------------------------------------------------------------------------------------------------------------------------------------------------------------------------------------------------------------------------------------------------------------------------------------------------------------------------------------------------------------------------------------------------------------------------------------------------------------------------------------------------------------------------------------------------------------------------------------------------------------------------------------------------------------------------------------------------------------------------------------------------------------------------------------------------------------------------------------------------------------------------------------------------------------------------------------------------------------------------------------------------------------------------------------------------------------------------------------------------------------------------------------------------------------------------------------------------------------------------------------------------------------------------------------------------------------------------------------------------------------------------------------------------------------------------------------------------------------------------------------------------------------------------------------------------------------------------------------------------------------------------------------------------------------------------------------------------------------------------------------------------------------------------------------------------------------------------------------------------------------------------------------------------------------------------------------------------------------------------------------------------------------------------------------------------------------------------------------------------------------------------------------------------------------------------------------------------------------------------------------------------------------------------------------------------------------------------------------------------------------------------------------------------------------------------------------------------------------------------------------------------------------------------------------------------------------------------------------------------------------------------------------------------------------------------------------------------------------------------------------------------------------------------------------------------------------------------------------------------------------------------------------------------------------------------------------------------------------------------------------------------------------------------------------------------------------------------------------------------------------------------------------------------------------------------------------------------------------------------------------------------------------------------------------------------------------------------------------------------------------------------------------------------------------------------------------------------------------------------------------------------------------------------------------------------------------------------------------------------------------------------------------------------------------------------------------------------------------------------------------------------------------------------------------------------------------------------------------------------------------------------------------------------------------------------------------------------------------------------------------------------------------------------------------------------------------------------------------------------------------------------------------------------------------------------------------------------------------------------------------------------------------------------------------	--	--	--	--	--	--	--	--	--	--	--	--	--	--	--	--	--	--	--
-----------------------------------------------------------------------------------------------------------------------------------------------------------------------------------------------------------------------------------------------------------------------------------------------------------------------------------------------------------------------------------------------------------------------------------------------------------------------------------------------------------------------------------------------------------------------------------------------------------------------------------------------------------------------------------------------------------------------------------------------------------------------------------------------------------------------------------------------------------------------------------------------------------------------------------------------------------------------------------------------------------------------------------------------------------------------------------------------------------------------------------------------------------------------------------------------------------------------------------------------------------------------------------------------------------------------------------------------------------------------------------------------------------------------------------------------------------------------------------------------------------------------------------------------------------------------------------------------------------------------------------------------------------------------------------------------------------------------------------------------------------------------------------------------------------------------------------------------------------------------------------------------------------------------------------------------------------------------------------------------------------------------------------------------------------------------------------------------------------------------------------------------------------------------------------------------------------------------------------------------------------------------------------------------------------------------------------------------------------------------------------------------------------------------------------------------------------------------------------------------------------------------------------------------------------------------------------------------------------------------------------------------------------------------------------------------------------------------------------------------------------------------------------------------------------------------------------------------------------------------------------------------------------------------------------------------------------------------------------------------------------------------------------------------------------------------------------------------------------------------------------------------------------------------------------------------------------------------------------------------------------------------------------------------------------------------------------------------------------------------------------------------------------------------------------------------------------------------------------------------------------------------------------------------------------------------------------------------------------------------------------------------------------------------------------------------------------------------------------------------------------------------------------------------------------------------------------------------------------------------------------------------------------------------------------------------------------------------------------------------------------------------------------------------------------------------------------------------------------------------------------------------------------------------------------------------------------------------------------------------------------------------------------------------------------------------------------------------------------------------------------------------------------------------------------------------------------------------------------------------------------------------------------------------------------------------------------------------------------------------------------------------------------------------------------------------------------------------------------------------------------------------------------------------------------------------------------------------------------------------------------------------------------------------------------------------------------------------------------------------------------------------------------------------------------------------------------------------------------------------------------------------------------------------------------------------------------------------------------------------------------------------------------------------------------------------------------------------------------------------------------------------------------------------------------------------------------------------------------------------------------------------------------------------------------------------------------------------------------------------------------------------------------------------------------------------------------------------------------------------------------------------------------------------------------------------------------------------------------------------------------------------------------------------------------------------------------------------------------------------------------------------------------------------------------------------------------------------------------------------------------------------------------------------------------------------------------------------------------------------------------------------------------------------------------------------------------------------------------------------------------------------------------------------------------------------------------------------------------------------------------------------------------------------------------------------------------------------------------------------------------------------------------------------------------------------------------------------------------------------------------------------------------------------------------------------------------------------------------------------------------------------------------------------------------------------------------------------------------------------------------------------------------------------------------------------------------------------------------------------------------------------------------------------------------------------------------------------------------------------------------------------------------------------------------------------------------------------------------------------------------------------------------------------------------------------------------------------------------------------------------------------------------------------------------------------------------------------------------------------------------------------------------------------------------------------------	--	--	--	--	--	--	--	--	--	--	--	--	--	--	--	--	--	--	--
-----------------------------------------------------------------------------------------------------------------------------------------------------------------------------------------------------------------------------------------------------------------------------------------------------------------------------------------------------------------------------------------------------------------------------------------------------------------------------------------------------------------------------------------------------------------------------------------------------------------------------------------------------------------------------------------------------------------------------------------------------------------------------------------------------------------------------------------------------------------------------------------------------------------------------------------------------------------------------------------------------------------------------------------------------------------------------------------------------------------------------------------------------------------------------------------------------------------------------------------------------------------------------------------------------------------------------------------------------------------------------------------------------------------------------------------------------------------------------------------------------------------------------------------------------------------------------------------------------------------------------------------------------------------------------------------------------------------------------------------------------------------------------------------------------------------------------------------------------------------------------------------------------------------------------------------------------------------------------------------------------------------------------------------------------------------------------------------------------------------------------------------------------------------------------------------------------------------------------------------------------------------------------------------------------------------------------------------------------------------------------------------------------------------------------------------------------------------------------------------------------------------------------------------------------------------------------------------------------------------------------------------------------------------------------------------------------------------------------------------------------------------------------------------------------------------------------------------------------------------------------------------------------------------------------------------------------------------------------------------------------------------------------------------------------------------------------------------------------------------------------------------------------------------------------------------------------------------------------------------------------------------------------------------------------------------------------------------------------------------------------------------------------------------------------------------------------------------------------------------------------------------------------------------------------------------------------------------------------------------------------------------------------------------------------------------------------------------------------------------------------------------------------------------------------------------------------------------------------------------------------------------------------------------------------------------------------------------------------------------------------------------------------------------------------------------------------------------------------------------------------------------------------------------------------------------------------------------------------------------------------------------------------------------------------------------------------------------------------------------------------------------------------------------------------------------------------------------------------------------------------------------------------------------------------------------------------------------------------------------------------------------------------------------------------------------------------------------------------------------------------------------------------------------------------------------------------------------------------------------------------------------------------------------------------------------------------------------------------------------------------------------------------------------------------------------------------------------------------------------------------------------------------------------------------------------------------------------------------------------------------------------------------------------------------------------------------------------------------------------------------------------------------------------------------------------------------------------------------------------------------------------------------------------------------------------------------------------------------------------------------------------------------------------------------------------------------------------------------------------------------------------------------------------------------------------------------------------------------------------------------------------------------------------------------------------------------------------------------------------------------------------------------------------------------------------------------------------------------------------------------------------------------------------------------------------------------------------------------------------------------------------------------------------------------------------------------------------------------------------------------------------------------------------------------------------------------------------------------------------------------------------------------------------------------------------------------------------------------------------------------------------------------------------------------------------------------------------------------------------------------------------------------------------------------------------------------------------------------------------------------------------------------------------------------------------------------------------------------------------------------------------------------------------------------------------------------------------------------------------------------------------------------------------------------------------------	--	--	--	--	--	--	--	--	--	--	--	--	--	--	--	--	--	--	--
-----------------------------------------------------------------------------------------------------------------------------------------------------------------------------------------------------------------------------------------------------------------------------------------------------------------------------------------------------------------------------------------------------------------------------------------------------------------------------------------------------------------------------------------------------------------------------------------------------------------------------------------------------------------------------------------------------------------------------------------------------------------------------------------------------------------------------------------------------------------------------------------------------------------------------------------------------------------------------------------------------------------------------------------------------------------------------------------------------------------------------------------------------------------------------------------------------------------------------------------------------------------------------------------------------------------------------------------------------------------------------------------------------------------------------------------------------------------------------------------------------------------------------------------------------------------------------------------------------------------------------------------------------------------------------------------------------------------------------------------------------------------------------------------------------------------------------------------------------------------------------------------------------------------------------------------------------------------------------------------------------------------------------------------------------------------------------------------------------------------------------------------------------------------------------------------------------------------------------------------------------------------------------------------------------------------------------------------------------------------------------------------------------------------------------------------------------------------------------------------------------------------------------------------------------------------------------------------------------------------------------------------------------------------------------------------------------------------------------------------------------------------------------------------------------------------------------------------------------------------------------------------------------------------------------------------------------------------------------------------------------------------------------------------------------------------------------------------------------------------------------------------------------------------------------------------------------------------------------------------------------------------------------------------------------------------------------------------------------------------------------------------------------------------------------------------------------------------------------------------------------------------------------------------------------------------------------------------------------------------------------------------------------------------------------------------------------------------------------------------------------------------------------------------------------------------------------------------------------------------------------------------------------------------------------------------------------------------------------------------------------------------------------------------------------------------------------------------------------------------------------------------------------------------------------------------------------------------------------------------------------------------------------------------------------------------------------------------------------------------------------------------------------------------------------------------------------------------------------------------------------------------------------------------------------------------------------------------------------------------------------------------------------------------------------------------------------------------------------------------------------------------------------------------------------------------------------------------------------------------------------------------------------------------------------------------------------------------------------------------------------------------------------------------------------------------------------------------------------------------------------------------------------------------------------------------------------------------------------------------------------------------------------------------------------------------------------------------------------------------------------------------------------------------------------------------------------------------------------------------------------------------------------------------------------------------------------------------------------------------------------------------------------------------------------------------------------------------------------------------------------------------------------------------------------------------------------------------------------------------------------------------------------------------------------------------------------------------------------------------------------------------------------------------------------------------------------------------------------------------------------------------------------------------------------------------------------------------------------------------------------------------------------------------------------------------------------------------------------------------------------------------------------------------------------------------------------------------------------------------------------------------------------------------------------------------------------------------------------------------------------------------------------------------------------------------	--	--	--	--	--	--	--	--	--	--	--	--	--	--	--	--	--	--	--
-----------------------------------------------------------------------------------------------------------------------------------------------------------------------------------------------------------------------------------------------------------------------------------------------------------------------------------------------------------------------------------------------------------------------------------------------------------------------------------------------------------------------------------------------------------------------------------------------------------------------------------------------------------------------------------------------------------------------------------------------------------------------------------------------------------------------------------------------------------------------------------------------------------------------------------------------------------------------------------------------------------------------------------------------------------------------------------------------------------------------------------------------------------------------------------------------------------------------------------------------------------------------------------------------------------------------------------------------------------------------------------------------------------------------------------------------------------------------------------------------------------------------------------------------------------------------------------------------------------------------------------------------------------------------------------------------------------------------------------------------------------------------------------------------------------------------------------------------------------------------------------------------------------------------------------------------------------------------------------------------------------------------------------------------------------------------------------------------------------------------------------------------------------------------------------------------------------------------------------------------------------------------------------------------------------------------------------------------------------------------------------------------------------------------------------------------------------------------------------------------------------------------------------------------------------------------------------------------------------------------------------------------------------------------------------------------------------------------------------------------------------------------------------------------------------------------------------------------------------------------------------------------------------------------------------------------------------------------------------------------------------------------------------------------------------------------------------------------------------------------------------------------------------------------------------------------------------------------------------------------------------------------------------------------------------------------------------------------------------------------------------------------------------------------------------------------------------------------------------------------------------------------------------------------------------------------------------------------------------------------------------------------------------------------------------------------------------------------------------------------------------------------------------------------------------------------------------------------------------------------------------------------------------------------------------------------------------------------------------------------------------------------------------------------------------------------------------------------------------------------------------------------------------------------------------------------------------------------------------------------------------------------------------------------------------------------------------------------------------------------------------------------------------------------------------------------------------------------------------------------------------------------------------------------------------------------------------------------------------------------------------------------------------------------------------------------------------------------------------------------------------------------------------------------------------------------------------------------------------------------------------------------------------------------------------------------------------------------------------------------------------------------------------------------------------------------------------------------------------------------------------------------------------------------------------------------------------------------------------------------------------------------------------------------------------------------------------------------------------------------------------------------------------------------------------------------------------------------------------------------------------------------------------------------------------------------------------------------------------------------------------------------------------------------------------------------------------------------------------------------------------------------------------------------------------------------------------------------------------------------------------------------------------------------------------------------------------------------------------------------------------------------------------------------------------------------------------------------------------------------------------------------------------------------------------	--	--	--	--	--	--	--	--	--	--	--	--	--	--	--	--	--	--	--
-----------------------------------------------------------------------------------------------------------------------------------------------------------------------------------------------------------------------------------------------------------------------------------------------------------------------------------------------------------------------------------------------------------------------------------------------------------------------------------------------------------------------------------------------------------------------------------------------------------------------------------------------------------------------------------------------------------------------------------------------------------------------------------------------------------------------------------------------------------------------------------------------------------------------------------------------------------------------------------------------------------------------------------------------------------------------------------------------------------------------------------------------------------------------------------------------------------------------------------------------------------------------------------------------------------------------------------------------------------------------------------------------------------------------------------------------------------------------------------------------------------------------------------------------------------------------------------------------------------------------------------------------------------------------------------------------------------------------------------------------------------------------------------------------------------------------------------------------------------------------------------------------------------------------------------------------------------------------------------------------------------------------------------------------------------------------------------------------------------------------------------------------------------------------------------------------------------------------------------------------------------------------------------------------------------------------------------------------------------------------------------------------------------------------------------------------------------------------------------------------------------------------------------------------------------------------------------------------------------------------------------------------------------------------------------------------------------------------------------------------------------------------------------------------------------------------------------------------------------------------------------------------------------------------------------------------------------------------------------------------------------------------------------------------------------------------------------------------------------------------------------------------------------------------------------------------------------------------------------------------------------------------------------------------------------------------------------------------------------------------------------------------------------------------------------------------------------------------------------------------------------------------------------------------------------------------------------------------------------------------------------------------------------------------------------------------------------------------------------------------------------------------------------------------------------------------------------------------------------------------------------------------------------------------------------------------------------------------------------------------------------------------------------------------------------------------------------------------------------------------------------------------------------------------------------------------------------------------------------------------------------------------------------------------------------------------------------------------------------------------------------------------------------------------------------------------------------------------------------------------------------------------------------------------------------------------------------------------------------------------------------------------------------------------------------------------------------------------------------------------------------------------------------------------------------------------------------------------------------------------------------------------------------------------------------------------------------------------------------------------------------------------------------------------------------------------------------------------------------------------------------------------------------------------------------------------------------------------------------------------------------------------------------------------------------------------------------------------------------------------------------------------------------------------------------------------------------------------------------------------------------------------------------------------------------------------------------------------------------------------------------------------------------------------------	--	--	--	--	--	--	--	--	--	--	--	--	--	--	--	--	--	--	--
-----------------------------------------------------------------------------------------------------------------------------------------------------------------------------------------------------------------------------------------------------------------------------------------------------------------------------------------------------------------------------------------------------------------------------------------------------------------------------------------------------------------------------------------------------------------------------------------------------------------------------------------------------------------------------------------------------------------------------------------------------------------------------------------------------------------------------------------------------------------------------------------------------------------------------------------------------------------------------------------------------------------------------------------------------------------------------------------------------------------------------------------------------------------------------------------------------------------------------------------------------------------------------------------------------------------------------------------------------------------------------------------------------------------------------------------------------------------------------------------------------------------------------------------------------------------------------------------------------------------------------------------------------------------------------------------------------------------------------------------------------------------------------------------------------------------------------------------------------------------------------------------------------------------------------------------------------------------------------------------------------------------------------------------------------------------------------------------------------------------------------------------------------------------------------------------------------------------------------------------------------------------------------------------------------------------------------------------------------------------------------------------------------------------------------------------------------------------------------------------------------------------------------------------------------------------------------------------------------------------------------------------------------------------------------------------------------------------------------------------------------------------------------------------------------------------------------------------------------------------------------------------------------------------------------------------------------------------------------------------------------------------------------------------------------------------------------------------------------------------------------------------------------------------------------------------------------------------------------------------------------------------------------------------------------------------------------------------------------------------------------------------------------------------------------------------------------------------------------------------------------------------------------------------------------------------------------------------------------------------------------------------------------------------------------------------------------------------------------------------------------------------------------------------------------------------------------------------------------------------------------------------------------------------------------------------------------------------------------------------------------------------------------------------------------------------------------------------------------------------------------------------------------------------------------------------------------------------------------------------------------------------------------------------------------------------------------------------------------------------------------------------------------------------------------------------------------------------------------------------------------------------------------------------------------------------------------------------------------------------------------------------------------------------------------------------------------------------------------------------------------------------------------------------------------------------------------------------------------------------------------------------------------------------------------------------------------------------------------------------------------------------------------------------------------------------------------------------------------------------------------------------------------------------------	--	--	--	--	--	--	--	--	--	--	--	--	--	--	--	--	--	--	--
-----------------------------------------------------------------------------------------------------------------------------------------------------------------------------------------------------------------------------------------------------------------------------------------------------------------------------------------------------------------------------------------------------------------------------------------------------------------------------------------------------------------------------------------------------------------------------------------------------------------------------------------------------------------------------------------------------------------------------------------------------------------------------------------------------------------------------------------------------------------------------------------------------------------------------------------------------------------------------------------------------------------------------------------------------------------------------------------------------------------------------------------------------------------------------------------------------------------------------------------------------------------------------------------------------------------------------------------------------------------------------------------------------------------------------------------------------------------------------------------------------------------------------------------------------------------------------------------------------------------------------------------------------------------------------------------------------------------------------------------------------------------------------------------------------------------------------------------------------------------------------------------------------------------------------------------------------------------------------------------------------------------------------------------------------------------------------------------------------------------------------------------------------------------------------------------------------------------------------------------------------------------------------------------------------------------------------------------------------------------------------------------------------------------------------------------------------------------------------------------------------------------------------------------------------------------------------------------------------------------------------------------------------------------------------------------------------------------------------------------------------------------------------------------------------------------------------------------------------------------------------------------------------------------------------------------------------------------------------------------------------------------------------------------------------------------------------------------------------------------------------------------------------------------------------------------------------------------------------------------------------------------------------------------------------------------------------------------------------------------------------------------------------------------------------------------------------------------------------------------------------------------------------------------------------------------------------------------------------------------------------------------------------------------------------------------------------------------------------------------------------------------------------------------------------------------------------------------------------------------------------------------------------------------------------------------------------------------------------------------------------------------------------------------------------------------------------------------------------------------------------------------------------------	--	--	--	--	--	--	--	--	--	--	--	--	--	--	--	--	--	--	--
-----------------------------------------------------------------------------------------------------------------------------------------------------------------------------------------------------------------------------------------------------------------------------------------------------------------------------------------------------------------------------------------------------------------------------------------------------------------------------------------------------------------------------------------------------------------------------------------------------------------------------------------------------------------------------------------------------------------------------------------------------------------------------------------------------------------------------------------------------------------------------------------------------------------------------------------------------------------------------------------------------------------------------------------------------------------------------------------------------------------------------------------------------------------------------------------------------------------------------------------------------------------------------------------------------------------------------------------------------------------------------------------------------------------------------------------------------------------------------------------------------------------------------------------------------------------------------------------------------------------------------------------------------------------------------------------------------------------------------------------------------------------------------------------------------------------------------------------------------------------------------------------------------------------------------------------------------------------------------------------------------------------------------------------------------------------------------------------------------------------------------------------------------------------------------------------------------------------------------------------------------------------------------------------------------------------------------------------------------------------------------------------------------------------------------------------------------------------------------------------------------------------------------------------------------------------------------------------------------------------------------------------------------------------------------------------------------------------------------------------------------------------------------------------------------------------------------------------------------------------------------------------------------------------------------------------------------------------------------------------------------------------------------------------------------------------------------------------------------------------------------------------------	--	--	--	--	--	--	--	--	--	--	--	--	--	--	--	--	--	--	--
-----------------------------------------------------------------------------------------------------------------------------------------------------------------------------------------------------------------------------------------------------------------------------------------------------------------------------------------------------------------------------------------------------------------------------------------------------------------------------------------------------------------------------------------------------------------------------------------------------------------------------------------------------------------------------------------------------------------------------------------------------------------------------------------------------------------------------------------------------------------------------------------------------------------------------------------------------------------------------------------------------------------------------------------------------------------------------------------------------------------------	--	--	--	--	--	--	--	--	--	--	--	--	--	--	--	--	--	--	--
		<table border="1" style="width: 100%; border-collapse: collapse; text-align: center;"> <tr> <td style="width: 10%;"></td> <td style="width: 10%;"></td> <td style="width: 10%;"></td> <td style="width: 10%;"></td> <td style="width: 10%;"></td> <td style="width: 10%;"></td> <td style="width: 10%;"></td> <td style="width: 10%;"></td> <td style="width: 10%;"></td> <td style="width: 10%;"></td> </tr> <tr> <td></td> <td></td> <td colspan="8" style="text-align: center;"> <table border="1" style="width: 100%; border-collapse: collapse; text-align: center;"> <tr> <td style="width: 10%;"></td> <td style="width: 10%;"></td> <td style="width: 10%;"></td> <td style="width: 10%;"></td> <td style="width: 10%;"></td> <td style="width: 10%;"></td> <td style="width: 10%;"></td> <td style="width: 10%;"></td> <td style="width: 10%;"></td> <td style="width: 10%;"></td> </tr> <tr> <td></td> <td></td> <td colspan="8" style="text-align: center;"> <table border="1" style="width: 100%; border-collapse: collapse; text-align: center;"> <tr> <td style="width: 10%;"></td> <td style="width: 10%;"></td> <td style="width: 10%;"></td> <td style="width: 10%;"></td> <td style="width: 10%;"></td> <td style="width: 10%;"></td> <td style="width: 10%;"></td> <td style="width: 10%;"></td> <td style="width: 10%;"></td> <td style="width: 10%;"></td> </tr> <tr> <td></td> <td></td> <td colspan="8" style="text-align: center;"> <table border="1" style="width: 100%; border-collapse: collapse; text-align: center;"> <tr> <td style="width: 10%;"></td> <td style="width: 10%;"></td> <td style="width: 10%;"></td> <td style="width: 10%;"></td> <td style="width: 10%;"></td> <td style="width: 10%;"></td> <td style="width: 10%;"></td> <td style="width: 10%;"></td> <td style="width: 10%;"></td> <td style="width: 10%;"></td> </tr> <tr> <td></td> <td></td> <td colspan="8" style="text-align: center;"> <table border="1" style="width: 100%; border-collapse: collapse; text-align: center;"> <tr> <td style="width: 10%;"></td> <td style="width: 10%;"></td> <td style="width: 10%;"></td> <td style="width: 10%;"></td> <td style="width: 10%;"></td> <td style="width: 10%;"></td> <td style="width: 10%;"></td> <td style="width: 10%;"></td> <td style="width: 10%;"></td> <td style="width: 10%;"></td> </tr> <tr> <td></td> <td></td> <td colspan="8" style="text-align: center;"> <table border="1" style="width: 100%; border-collapse: collapse; text-align: center;"> <tr> <td style="width: 10%;"></td> <td style="width: 10%;"></td> <td style="width: 10%;"></td> <td style="width: 10%;"></td> <td style="width: 10%;"></td> <td style="width: 10%;"></td> <td style="width: 10%;"></td> <td style="width: 10%;"></td> <td style="width: 10%;"></td> <td style="width: 10%;"></td> </tr> <tr> <td></td> <td></td> <td colspan="8" style="text-align: center;"> <table border="1" style="width: 100%; border-collapse: collapse; text-align: center;"> <tr> <td style="width: 10%;"></td> <td style="width: 10%;"></td> <td style="width: 10%;"></td> <td style="width: 10%;"></td> <td style="width: 10%;"></td> <td style="width: 10%;"></td> <td style="width: 10%;"></td> <td style="width: 10%;"></td> <td style="width: 10%;"></td> <td style="width: 10%;"></td> </tr> <tr> <td></td> <td></td> <td colspan="8" style="text-align: center;"> <table border="1" style="width: 100%; border-collapse: collapse; text-align: center;"> <tr> <td style="width: 10%;"></td> <td style="width: 10%;"></td> <td style="width: 10%;"></td> <td style="width: 10%;"></td> <td style="width: 10%;"></td> <td style="width: 10%;"></td> <td style="width: 10%;"></td> <td style="width: 10%;"></td> <td style="width: 10%;"></td> <td style="width: 10%;"></td> </tr> <tr> <td></td> <td></td> <td colspan="8" style="text-align: center;"> <table border="1" style="width: 100%; border-collapse: collapse; text-align: center;"> <tr> <td style="width: 10%;"></td> <td style="width: 10%;"></td> <td style="width: 10%;"></td> <td style="width: 10%;"></td> <td style="width: 10%;"></td> <td style="width: 10%;"></td> <td style="width: 10%;"></td> <td style="width: 10%;"></td> <td style="width: 10%;"></td> <td style="width: 10%;"></td> </tr> <tr> <td></td> <td></td> <td colspan="8" style="text-align: center;"> <table border="1" style="width: 100%; border-collapse: collapse; text-align: center;"> <tr> <td style="width: 10%;"></td> <td style="width: 10%;"></td> <td style="width: 10%;"></td> <td style="width: 10%;"></td> <td style="width: 10%;"></td> <td style="width: 10%;"></td> <td style="width: 10%;"></td> <td style="width: 10%;"></td> <td style="width: 10%;"></td> <td style="width: 10%;"></td> </tr> <tr> <td></td> <td></td> <td colspan="8" style="text-align: center;"> <table border="1" style="width: 100%; border-collapse: collapse; text-align: center;"> <tr> <td style="width: 10%;"></td> <td style="width: 10%;"></td> <td style="width: 10%;"></td> <td style="width: 10%;"></td> <td style="width: 10%;"></td> <td style="width: 10%;"></td> <td style="width: 10%;"></td> <td style="width: 10%;"></td> <td style="width: 10%;"></td> <td style="width: 10%;"></td> </tr> <tr> <td></td> <td></td> <td colspan="8" style="text-align: center;"> <table border="1" style="width: 100%; border-collapse: collapse; text-align: center;"> <tr> <td style="width: 10%;"></td> <td style="width: 10%;"></td> <td style="width: 10%;"></td> <td style="width: 10%;"></td> <td style="width: 10%;"></td> <td style="width: 10%;"></td> <td style="width: 10%;"></td> <td style="width: 10%;"></td> <td style="width: 10%;"></td> <td style="width: 10%;"></td> </tr> <tr> <td></td> <td></td> <td colspan="8" style="text-align: center;"> <table border="1" style="width: 100%; border-collapse: collapse; text-align: center;"> <tr> <td style="width: 10%;"></td> <td style="width: 10%;"></td> <td style="width: 10%;"></td> <td style="width: 10%;"></td> <td style="width: 10%;"></td> <td style="width: 10%;"></td> <td style="width: 10%;"></td> <td style="width: 10%;"></td> <td style="width: 10%;"></td> <td style="width: 10%;"></td> </tr> <tr> <td></td> <td></td> <td colspan="8" style="text-align: center;"> <table border="1" style="width: 100%; border-collapse: collapse; text-align: center;"> <tr> <td style="width: 10%;"></td> <td style="width: 10%;"></td> <td style="width: 10%;"></td> <td style="width: 10%;"></td> <td style="width: 10%;"></td> <td style="width: 10%;"></td> <td style="width: 10%;"></td> <td style="width: 10%;"></td> <td style="width: 10%;"></td> <td style="width: 10%;"></td> </tr> <tr> <td></td> <td></td> <td colspan="8" style="text-align: center;"> <table border="1" style="width: 100%; border-collapse: collapse; text-align: center;"> <tr> <td style="width: 10%;"></td> <td style="width: 10%;"></td> <td style="width: 10%;"></td> <td style="width: 10%;"></td> <td style="width: 10%;"></td> <td style="width: 10%;"></td> <td style="width: 10%;"></td> <td style="width: 10%;"></td> <td style="width: 10%;"></td> <td style="width: 10%;"></td> </tr> <tr> <td></td> <td></td> <td colspan="8" style="text-align: center;"> <table border="1" style="width: 100%; border-collapse: collapse; text-align: center;"> <tr> <td style="width: 10%;"></td> <td style="width: 10%;"></td> <td style="width: 10%;"></td> <td style="width: 10%;"></td> <td style="width: 10%;"></td> <td style="width: 10%;"></td> <td style="width: 10%;"></td> <td style="width: 10%;"></td> <td style="width: 10%;"></td> <td style="width: 10%;"></td> </tr> <tr> <td></td> <td></td> <td colspan="8" style="text-align: center;"> <table border="1" style="width: 100%; border-collapse: collapse; text-align: center;"> <tr> <td style="width: 10%;"></td> <td style="width: 10%;"></td> <td style="width: 10%;"></td> <td style="width: 10%;"></td> <td style="width: 10%;"></td> <td style="width: 10%;"></td> <td style="width: 10%;"></td> <td style="width: 10%;"></td> <td style="width: 10%;"></td> <td style="width: 10%;"></td> </tr> <tr> <td></td> <td></td> <td colspan="8" style="text-align: center;"> <table border="1" style="width: 100%; border-collapse: collapse; text-align: center;"> <tr> <td style="width: 10%;"></td> <td style="width: 10%;"></td> <td style="width: 10%;"></td> <td style="width: 10%;"></td> <td style="width: 10%;"></td> <td style="width: 10%;"></td> <td style="width: 10%;"></td> <td style="width: 10%;"></td> <td style="width: 10%;"></td> <td style="width: 10%;"></td> </tr> <tr> <td></td> <td></td> <td colspan="8" style="text-align: center;"> <table border="1" style="width: 100%; border-collapse: collapse; text-align: center;"> <tr> <td style="width: 10%;"></td> <td style="width: 10%;"></td> <td style="width: 10%;"></td> <td style="width: 10%;"></td> <td style="width: 10%;"></td> <td style="width: 10%;"></td> <td style="width: 10%;"></td> <td style="width: 10%;"></td> <td style="width: 10%;"></td> <td style="width: 10%;"></td> </tr> <tr> <td></td> <td></td> <td colspan="8" style="text-align: center;"> <table border="1" style="width: 100%; border-collapse: collapse; text-align: center;"> <tr> <td style="width: 10%;"></td> <td style="width: 10%;"></td> <td style="width: 10%;"></td> <td style="width: 10%;"></td> <td style="width: 10%;"></td> <td style="width: 10%;"></td> <td style="width: 10%;"></td> <td style="width: 10%;"></td> <td style="width: 10%;"></td> <td style="width: 10%;"></td> </tr> <tr> <td></td> <td></td> <td colspan="8" style="text-align: center;"> <table border="1" style="width: 100%; border-collapse: collapse; text-align: center;"> <tr> <td style="width: 10%;"></td> <td style="width: 10%;"></td> <td style="width: 10%;"></td> <td style="width: 10%;"></td> <td style="width: 10%;"></td> <td style="width: 10%;"></td> <td style="width: 10%;"></td> <td style="width: 10%;"></td> <td style="width: 10%;"></td> <td style="width: 10%;"></td> </tr> <tr> <td></td> <td></td> <td colspan="8" style="text-align: center;"> <table border="1" style="width: 100%; border-collapse: collapse; text-align: center;"> <tr> <td style="width: 10%;"></td> <td style="width: 10%;"></td> <td																	
style="width: 10%;"></td> <td style="width: 10%;"></td> <td style="width: 10%;"></td> <td style="width: 10%;"></td> <td style="width: 10%;"></td> <td style="width: 10%;"></td> <td style="width: 10%;"></td> <td style="width: 10%;"></td> </tr> <tr> <td></td> <td></td> <td colspan="8" style="text-align: center;"> <table border="1" style="width: 100%; border-collapse: collapse; text-align: center;"> <tr> <td style="width: 10%;"></td> <td style="width: 10%;"></td> <td style="width: 10%;"></td> <td style="width: 10%;"></td> <td style="width: 10%;"></td> <td style="width: 10%;"></td> <td style="width: 10%;"></td> <td style="width: 10%;"></td> <td style="width: 10%;"></td> <td style="width: 10%;"></td> </tr> <tr> <td></td> <td></td> <td colspan="8" style="text-align: center;"> <table border="1" style="width: 100%; border-collapse: collapse; text-align: center;"> <tr> <td style="width: 10%;"></td> <td style="width: 10%;"></td> <td style="width: 10%;"></td> <td style="width: 10%;"></td> <td style="width: 10%;"></td> <td style="width: 10%;"></td> <td style="width: 10%;"></td> <td style="width: 10%;"></td> <td style="width: 10%;"></td> <td style="width: 10%;"></td> </tr> <tr> <td></td> <td></td> <td colspan="8" style="text-align: center;"> <table border="1" style="width: 100%; border-collapse: collapse; text-align: center;"> <tr> <td style="width: 10%;"></td> <td style="width: 10%;"></td> <td style="width: 10%;"></td> <td style="width: 10%;"></td> <td style="width: 10%;"></td> <td style="width: 10%;"></td> <td style="width: 10%;"></td> <td style="width: 10%;"></td> <td style="width: 10%;"></td> <td style="width: 10%;"></td> </tr> <tr> <td></td> <td></td> <td colspan="8" style="text-align: center;"> <table border="1" style="width: 100%; border-collapse: collapse; text-align: center;"> <tr> <td style="width: 10%;"></td> <td style="width: 10%;"></td> <td style="width: 10%;"></td> <td style="width: 10%;"></td> <td style="width: 10%;"></td> <td style="width: 10%;"></td> <td style="width: 10%;"></td> <td style="width: 10%;"></td> <td style="width: 10%;"></td> <td style="width: 10%;"></td> </tr> <tr> <td></td> <td></td> <td colspan="8" style="text-align: center;"> <table border="1" style="width: 100%; border-collapse: collapse; text-align: center;"> <tr> <td style="width: 10%;"></td> <td style="width: 10%;"></td> <td style="width: 10%;"></td> <td style="width: 10%;"></td> <td style="width: 10%;"></td> <td style="width: 10%;"></td> <td style="width: 10%;"></td> <td style="width: 10%;"></td> <td style="width: 10%;"></td> <td style="width: 10%;"></td> </tr> <tr> <td></td> <td></td> <td colspan="8" style="text-align: center;"> <table border="1" style="width: 100%; border-collapse: collapse; text-align: center;"> <tr> <td style="width: 10%;"></td> <td style="width: 10%;"></td> <td style="width: 10%;"></td> <td style="width: 10%;"></td> <td style="width: 10%;"></td> <td style="width: 10%;"></td> <td style="width: 10%;"></td> <td style="width: 10%;"></td> <td style="width: 10%;"></td> <td style="width: 10%;"></td> </tr> <tr> <td></td> <td></td> <td colspan="8" style="text-align: center;"> <table border="1" style="width: 100%; border-collapse: collapse; text-align: center;"> <tr> <td style="width: 10%;"></td> <td style="width: 10%;"></td> <td style="width: 10%;"></td> <td style="width: 10%;"></td> <td style="width: 10%;"></td> <td style="width: 10%;"></td> <td style="width: 10%;"></td> <td style="width: 10%;"></td> <td style="width: 10%;"></td> <td style="width: 10%;"></td> </tr> <tr> <td></td> <td></td> <td colspan="8" style="text-align: center;"> <table border="1" style="width: 100%; border-collapse: collapse; text-align: center;"> <tr> <td style="width: 10%;"></td> <td style="width: 10%;"></td> <td style="width: 10%;"></td> <td style="width: 10%;"></td> <td style="width: 10%;"></td> <td style="width: 10%;"></td> <td style="width: 10%;"></td> <td style="width: 10%;"></td> <td style="width: 10%;"></td> <td style="width: 10%;"></td> </tr> <tr> <td></td> <td></td> <td colspan="8" style="text-align: center;"> <table border="1" style="width: 100%; border-collapse: collapse; text-align: center;"> <tr> <td style="width: 10%;"></td> <td style="width: 10%;"></td> <td style="width: 10%;"></td> <td style="width: 10%;"></td> <td style="width: 10%;"></td> <td style="width: 10%;"></td> <td style="width: 10%;"></td> <td style="width: 10%;"></td> <td style="width: 10%;"></td> <td style="width: 10%;"></td> </tr> <tr> <td></td> <td></td> <td colspan="8" style="text-align: center;"> <table border="1" style="width: 100%; border-collapse: collapse; text-align: center;"> <tr> <td style="width: 10%;"></td> <td style="width: 10%;"></td> <td style="width: 10%;"></td> <td style="width: 10%;"></td> <td style="width: 10%;"></td> <td style="width: 10%;"></td> <td style="width: 10%;"></td> <td style="width: 10%;"></td> <td style="width: 10%;"></td> <td style="width: 10%;"></td> </tr> <tr> <td></td> <td></td> <td colspan="8" style="text-align: center;"> <table border="1" style="width: 100%; border-collapse: collapse; text-align: center;"> <tr> <td style="width: 10%;"></td> <td style="width: 10%;"></td> <td style="width: 10%;"></td> <td style="width: 10%;"></td> <td style="width: 10%;"></td> <td style="width: 10%;"></td> <td style="width: 10%;"></td> <td style="width: 10%;"></td> <td style="width: 10%;"></td> <td style="width: 10%;"></td> </tr> <tr> <td></td> <td></td> <td colspan="8" style="text-align: center;"> <table border="1" style="width: 100%; border-collapse: collapse; text-align: center;"> <tr> <td style="width: 10%;"></td> <td style="width: 10%;"></td> <td style="width: 10%;"></td> <td style="width: 10%;"></td> <td style="width: 10%;"></td> <td style="width: 10%;"></td> <td style="width: 10%;"></td> <td style="width: 10%;"></td> <td style="width: 10%;"></td> <td style="width: 10%;"></td> </tr> <tr> <td></td> <td></td> <td colspan="8" style="text-align: center;"> <table border="1" style="width: 100%; border-collapse: collapse; text-align: center;"> <tr> <td style="width: 10%;"></td> <td style="width: 10%;"></td> <td style="width: 10%;"></td> <td style="width: 10%;"></td> <td style="width: 10%;"></td> <td style="width: 10%;"></td> <td style="width: 10%;"></td> <td style="width: 10%;"></td> <td style="width: 10%;"></td> <td style="width: 10%;"></td> </tr> <tr> <td></td> <td></td> <td colspan="8" style="text-align: center;"> <table border="1" style="width: 100%; border-collapse: collapse; text-align: center;"> <tr> <td style="width: 10%;"></td> <td style="width: 10%;"></td> <td style="width: 10%;"></td> <td style="width: 10%;"></td> <td style="width: 10%;"></td> <td style="width: 10%;"></td> <td style="width: 10%;"></td> <td style="width: 10%;"></td> <td style="width: 10%;"></td> <td style="width: 10%;"></td> </tr> <tr> <td></td> <td></td> <td colspan="8" style="text-align: center;"> <table border="1" style="width: 100%; border-collapse: collapse; text-align: center;"> <tr> <td style="width: 10%;"></td> <td style="width: 10%;"></td> <td style="width: 10%;"></td> <td style="width: 10%;"></td> <td style="width: 10%;"></td> <td style="width: 10%;"></td> <td style="width: 10%;"></td> <td style="width: 10%;"></td> <td style="width: 10%;"></td> <td style="width: 10%;"></td> </tr> <tr> <td></td> <td></td> <td colspan="8" style="text-align: center;"> <table border="1" style="width: 100%; border-collapse: collapse; text-align: center;"> <tr> <td style="width: 10%;"></td> <td style="width: 10%;"></td> <td style="width: 10%;"></td> <td style="width: 10%;"></td> <td style="width: 10%;"></td> <td style="width: 10%;"></td> <td style="width: 10%;"></td> <td style="width: 10%;"></td> <td style="width: 10%;"></td> <td style="width: 10%;"></td> </tr> <tr> <td></td> <td></td> <td colspan="8" style="text-align: center;"> <table border="1" style="width: 100%; border-collapse: collapse; text-align: center;"> <tr> <td style="width: 10%;"></td> <td style="width: 10%;"></td> <td style="width: 10%;"></td> <td style="width: 10%;"></td> <td style="width: 10%;"></td> <td style="width: 10%;"></td> <td style="width: 10%;"></td> <td style="width: 10%;"></td> <td style="width: 10%;"></td> <td style="width: 10%;"></td> </tr> <tr> <td></td> <td></td> <td colspan="8" style="text-align: center;"> <table border="1" style="width: 100%; border-collapse: collapse; text-align: center;"> <tr> <td style="width: 10%;"></td> <td style="width: 10%;"></td> <td style="width: 10%;"></td> <td style="width: 10%;"></td> <td style="width: 10%;"></td> <td style="width: 10%;"></td> <td style="width: 10%;"></td> <td style="width: 10%;"></td> <td style="width: 10%;"></td> <td style="width: 10%;"></td> </tr> <tr> <td></td> <td></td> <td colspan="8" style="text-align: center;"> <table border="1" style="width: 100%; border-collapse: collapse; text-align: center;"> <tr> <td style="width: 10%;"></td> <td style="width: 10%;"></td> <td style="width: 10%;"></td> <td style="width: 10%;"></td> <td style="width: 10%;"></td> <td style="width: 10%;"></td> <td style="width: 10%;"></td> <td style="width: 10%;"></td> <td style="width: 10%;"></td> <td style="width: 10%;"></td> </tr> <tr> <td></td> <td></td> <td colspan="8" style="text-align: center;"> <table border="1" style="width: 100%; border-collapse: collapse; text-align: center;"> <tr> <td style="width: 10%;"></td> <td style="width: 10%;"></td> <td style="width: 10%;"></td> <td style="width: 10%;"></td> <td style="width: 10%;"></td> <td style="width: 10%;"></td> <td style="width: 10%;"></td> <td style="width: 10%;"></td> <td style="width: 10%;"></td> <td style="width: 10%;"></td> </tr> <tr> <td></td> <td></td> <td colspan="8" style="text-align: center;"> <table border="1" style="width: 100%; border-collapse: collapse; text-align: center;"> <tr> <td style="width: 10%;"></td> <td style="width: 10%;"></td> <td style="width: 10%;"></td> <td style="width: 10%;"></td> <td style="width: 10%;"></td> <td style="width: 10%;"></td> <td style="width: 10%;"></td> <td style="width:
10%;"></td> <td style="width: 10%;"></td> <td style="width: 10%;"></td> </tr> <tr> <td></td> <td></td> <td colspan="8" style="text-align: center;"> <table border="1" style="width: 100%; border-collapse: collapse; text-align: center;"> <tr> <td style="width: 10%;"></td> <td style="width: 10%;"></td> <td style="width: 10%;"></td> <td style="width: 10%;"></td> <td style="width: 10%;"></td> <td style="width: 10%;"></td> <td style="width: 10%;"></td> <td style="width: 10%;"></td> <td style="width: 10%;"></td> <td style="width: 10%;"></td> </tr> <tr> <td></td> <td></td> <td colspan="8" style="text-align: center;"> <table border="1" style="width: 100%; border-collapse: collapse; text-align: center;"> <tr> <td style="width: 10%;"></td> <td style="width: 10%;"></td> <td style="width: 10%;"></td> <td style="width: 10%;"></td> <td style="width: 10%;"></td> <td style="width: 10%;"></td> <td style="width: 10%;"></td> <td style="width: 10%;"></td> <td style="width: 10%;"></td> <td style="width: 10%;"></td> </tr> <tr> <td></td> <td></td> <td colspan="8" style="text-align: center;"> <table border="1" style="width: 100%; border-collapse: collapse; text-align: center;"> <tr> <td style="width: 10%;"></td> <td style="width: 10%;"></td> <td style="width: 10%;"></td> <td style="width: 10%;"></td> <td style="width: 10%;"></td> <td style="width: 10%;"></td> <td style="width: 10%;"></td> <td style="width: 10%;"></td> <td style="width: 10%;"></td> <td style="width: 10%;"></td> </tr> <tr> <td></td> <td></td> <td colspan="8" style="text-align: center;"> <table border="1" style="width: 100%; border-collapse: collapse; text-align: center;"> <tr> <td style="width: 10%;"></td> <td style="width: 10%;"></td> <td style="width: 10%;"></td> <td style="width: 10%;"></td> <td style="width: 10%;"></td> <td style="width: 10%;"></td> <td style="width: 10%;"></td> <td style="width: 10%;"></td> <td style="width: 10%;"></td> <td style="width: 10%;"></td> </tr> <tr> <td></td> <td></td> <td colspan="8" style="text-align: center;"> <table border="1" style="width: 100%; border-collapse: collapse; text-align: center;"> <tr> <td style="width: 10%;"></td> <td style="width: 10%;"></td> <td style="width: 10%;"></td> <td style="width: 10%;"></td> <td style="width: 10%;"></td> <td style="width: 10%;"></td> <td style="width: 10%;"></td> <td style="width: 10%;"></td> <td style="width: 10%;"></td> <td style="width: 10%;"></td> </tr> <tr> <td></td> <td></td> <td colspan="8" style="text-align: center;"> <table border="1" style="width: 100%; border-collapse: collapse; text-align: center;"> <tr> <td style="width: 10%;"></td> <td style="width: 10%;"></td> <td style="width: 10%;"></td> <td style="width: 10%;"></td> <td style="width: 10%;"></td> <td style="width: 10%;"></td> <td style="width: 10%;"></td> <td style="width: 10%;"></td> <td style="width: 10%;"></td> <td style="width: 10%;"></td> </tr> <tr> <td></td> <td></td> <td colspan="8" style="text-align: center;"> <table border="1" style="width: 100%; border-collapse: collapse; text-align: center;"> <tr> <td style="width: 10%;"></td> <td style="width: 10%;"></td> <td style="width: 10%;"></td> <td style="width: 10%;"></td> <td style="width: 10%;"></td> <td style="width: 10%;"></td> <td style="width: 10%;"></td> <td style="width: 10%;"></td> <td style="width: 10%;"></td> <td style="width: 10%;"></td> </tr> <tr> <td></td> <td></td> <td colspan="8" style="text-align: center;"> <table border="1" style="width: 100%; border-collapse: collapse; text-align: center;"> <tr> <td style="width: 10%;"></td> <td style="width: 10%;"></td> <td style="width: 10%;"></td> <td style="width: 10%;"></td> <td style="width: 10%;"></td> <td style="width: 10%;"></td> <td style="width: 10%;"></td> <td style="width: 10%;"></td> <td style="width: 10%;"></td> <td style="width: 10%;"></td> </tr> <tr> <td></td> <td></td> <td colspan="8" style="text-align: center;"> <table border="1" style="width: 100%; border-collapse: collapse; text-align: center;"> <tr> <td style="width: 10%;"></td> <td style="width: 10%;"></td> <td style="width: 10%;"></td> <td style="width: 10%;"></td> <td style="width: 10%;"></td> <td style="width: 10%;"></td> <td style="width: 10%;"></td> <td style="width: 10%;"></td> <td style="width: 10%;"></td> <td style="width: 10%;"></td> </tr> <tr> <td></td> <td></td> <td colspan="8" style="text-align: center;"> <table border="1" style="width: 100%; border-collapse: collapse; text-align: center;"> <tr> <td style="width: 10%;"></td> <td style="width: 10%;"></td> <td style="width: 10%;"></td> <td style="width: 10%;"></td> <td style="width: 10%;"></td> <td style="width: 10%;"></td> <td style="width: 10%;"></td> <td style="width: 10%;"></td> <td style="width: 10%;"></td> <td style="width: 10%;"></td> </tr> <tr> <td></td> <td></td> <td colspan="8" style="text-align: center;"> <table border="1" style="width: 100%; border-collapse: collapse; text-align: center;"> <tr> <td style="width: 10%;"></td> <td style="width: 10%;"></td> <td style="width: 10%;"></td> <td style="width: 10%;"></td> <td style="width: 10%;"></td> <td style="width: 10%;"></td> <td style="width: 10%;"></td> <td style="width: 10%;"></td> <td style="width: 10%;"></td> <td style="width: 10%;"></td> </tr> <tr> <td></td> <td></td> <td colspan="8" style="text-align: center;"> <table border="1" style="width: 100%; border-collapse: collapse; text-align: center;"> <tr> <td style="width: 10%;"></td> <td style="width: 10%;"></td> <td style="width: 10%;"></td> <td style="width: 10%;"></td> <td style="width: 10%;"></td> <td style="width: 10%;"></td> <td style="width: 10%;"></td> <td style="width: 10%;"></td> <td style="width: 10%;"></td> <td style="width: 10%;"></td> </tr> <tr> <td></td> <td></td> <td colspan="8" style="text-align: center;"> <table border="1" style="width: 100%; border-collapse: collapse; text-align: center;"> <tr> <td style="width: 10%;"></td> <td style="width: 10%;"></td> <td style="width: 10%;"></td> <td style="width: 10%;"></td> <td style="width: 10%;"></td> <td style="width: 10%;"></td> <td style="width: 10%;"></td> <td style="width: 10%;"></td> <td style="width: 10%;"></td> <td style="width: 10%;"></td> </tr> <tr> <td></td> <td></td> <td colspan="8" style="text-align: center;"> <table border="1" style="width: 100%; border-collapse: collapse; text-align: center;"> <tr> <td style="width: 10%;"></td> <td style="width: 10%;"></td> <td style="width: 10%;"></td> <td style="width: 10%;"></td> <td style="width: 10%;"></td> <td style="width: 10%;"></td> <td style="width: 10%;"></td> <td style="width: 10%;"></td> <td style="width: 10%;"></td> <td style="width: 10%;"></td> </tr> <tr> <td></td> <td></td> <td colspan="8" style="text-align: center;"> <table border="1" style="width: 100%; border-collapse: collapse; text-align: center;"> <tr> <td style="width: 10%;"></td> <td style="width: 10%;"></td> <td style="width: 10%;"></td> <td style="width: 10%;"></td> <td style="width: 10%;"></td> <td style="width: 10%;"></td> <td style="width: 10%;"></td> <td style="width: 10%;"></td> <td style="width: 10%;"></td> <td style="width: 10%;"></td> </tr> <tr> <td></td> <td></td> <td colspan="8" style="text-align: center;"> <table border="1" style="width: 100%; border-collapse: collapse; text-align: center;"> <tr> <td style="width: 10%;"></td> <td style="width: 10%;"></td> <td style="width: 10%;"></td> <td style="width: 10%;"></td> <td style="width: 10%;"></td> <td style="width: 10%;"></td> <td style="width: 10%;"></td> <td style="width: 10%;"></td> <td style="width: 10%;"></td> <td style="width: 10%;"></td> </tr> <tr> <td></td> <td></td> <td colspan="8" style="text-align: center;"> <table border="1" style="width: 100%; border-collapse: collapse; text-align: center;"> <tr> <td style="width: 10%;"></td> <td style="width: 10%;"></td> <td style="width: 10%;"></td> <td style="width: 10%;"></td> <td style="width: 10%;"></td> <td style="width: 10%;"></td> <td style="width: 10%;"></td> <td style="width: 10%;"></td> <td style="width: 10%;"></td> <td style="width: 10%;"></td> </tr> <tr> <td></td> <td></td> <td colspan="8" style="text-align: center;"> <table border="1" style="width: 100%; border-collapse: collapse; text-align: center;"> <tr> <td style="width: 10%;"></td> <td style="width: 10%;"></td> <td style="width: 10%;"></td> <td style="width: 10%;"></td> <td style="width: 10%;"></td> <td style="width: 10%;"></td> <td style="width: 10%;"></td> <td style="width: 10%;"></td> <td style="width: 10%;"></td> <td style="width: 10%;"></td> </tr> <tr> <td></td> <td></td> <td colspan="8" style="text-align: center;"> <table border="1" style="width: 100%; border-collapse: collapse; text-align: center;"> <tr> <td style="width: 10%;"></td> <td style="width: 10%;"></td> <td style="width: 10%;"></td> <td style="width: 10%;"></td> <td style="width: 10%;"></td> <td style="width: 10%;"></td> <td style="width: 10%;"></td> <td style="width: 10%;"></td> <td style="width: 10%;"></td> <td style="width: 10%;"></td> </tr> <tr> <td></td> <td></td> <td colspan="8" style="text-align: center;"> <table border="1" style="width: 100%; border-collapse: collapse; text-align: center;"> <tr> <td style="width: 10%;"></td> <td style="width: 10%;"></td> <td style="width: 10%;"></td> <td style="width: 10%;"></td> <td style="width: 10%;"></td> <td style="width: 10%;"></td> <td style="width: 10%;"></td> <td style="width: 10%;"></td> <td style="width: 10%;"></td> <td style="width: 10%;"></td> </tr> <tr> <td></td> <td></td> <td colspan="8" style="text-align: center;"> <table border="1" style="width: 100%; border-collapse: collapse; text-align: center;"> <tr> <td style="width: 10%;"></td> <td style="width: 10%;"></td> <td style="width: 10%;"></td> <td style="width: 10%;"></td> <td style="width: 10%;"></td> <td style="width: 10%;"></td> <td style="width: 10%;"></td> <td style="width: 10%;"></td> <td style="width: 10%;"></td> <td style="width: 10%;"></td> </tr> <tr> <td></td> <td></td> <td colspan="8" style="text-align: center;"> <table border="1"
style="width: 100%; border-collapse: collapse; text-align: center;"> <tr> </tr></table></td></tr></table></td></tr></table></td></tr></table></td></tr></table></td></tr></table></td></tr></table></td></tr></table></td></tr></table></td></tr></table></td></tr></table></td></tr></table></td></tr></table></td></tr></table></td></tr></table></td></tr></table></td></tr></table></td></tr></table></td></tr></table></td></tr></table></td></tr></table></td></tr></table></td></tr></table></td></tr></table></td></tr></table></td></tr></table></td></tr></table></td></tr></table></td></tr></table></td></tr></table></td></tr></table></td></tr></table></td></tr></table></td></tr></table></td></tr></table></td></tr></table></td></tr></table></td></tr></table></td></tr></table></td></tr></table></td></tr></table></td></tr></table></td></tr></table></td></tr></table></td></tr></table></td></tr></table></td></tr></table></td></tr></table></td></tr></table></td></tr></table></td></tr></table></td></tr></table></td></tr></table></td></tr></table></td></tr></table></td></tr></table></td></tr></table></td></tr></table></td></tr></table></td></tr></table></td></tr></table></td></tr></table></td></tr></table></td></tr></table></td></tr></table> | | | | | | | | | | | | | | | | | | | | <table border="1" style="width: 100%; border-collapse: collapse; text-align: center;"> <tr> <td style="width: 10%;"></td> <td style="width: 10%;"></td> <td style="width: 10%;"></td> <td style="width: 10%;"></td> <td style="width: 10%;"></td> <td style="width: 10%;"></td> <td style="width: 10%;"></td> <td style="width: 10%;"></td> <td style="width: 10%;"></td> <td style="width: 10%;"></td> </tr> <tr> <td></td> <td></td> <td colspan="8" style="text-align: center;"> <table border="1" style="width: 100%; border-collapse: collapse; text-align: center;"> <tr> <td style="width: 10%;"></td> <td style="width: 10%;"></td> <td style="width: 10%;"></td> <td style="width: 10%;"></td> <td style="width: 10%;"></td> <td style="width: 10%;"></td> <td style="width: 10%;"></td> <td style="width: 10%;"></td> <td style="width: 10%;"></td> <td style="width: 10%;"></td> </tr> <tr> <td></td> <td></td> <td colspan="8" style="text-align: center;"> <table border="1" style="width: 100%; border-collapse: collapse; text-align: center;"> <tr> <td style="width: 10%;"></td> <td style="width: 10%;"></td> <td style="width: 10%;"></td> <td style="width: 10%;"></td> <td style="width: 10%;"></td> <td style="width: 10%;"></td> <td style="width: 10%;"></td> <td style="width: 10%;"></td> <td style="width: 10%;"></td> <td style="width: 10%;"></td> </tr> <tr> <td></td> <td></td> <td colspan="8" style="text-align: center;"> <table border="1" style="width: 100%; border-collapse: collapse; text-align: center;"> <tr> <td style="width: 10%;"></td> <td style="width: 10%;"></td> <td style="width: 10%;"></td> <td style="width: 10%;"></td> <td style="width: 10%;"></td> <td style="width: 10%;"></td> <td style="width: 10%;"></td> <td style="width: 10%;"></td> <td style="width: 10%;"></td> <td style="width: 10%;"></td> </tr> <tr> <td></td> <td></td> <td colspan="8" style="text-align: center;"> <table border="1" style="width: 100%; border-collapse: collapse; text-align: center;"> <tr> <td style="width: 10%;"></td> <td style="width: 10%;"></td> <td style="width: 10%;"></td> <td style="width: 10%;"></td> <td style="width: 10%;"></td> <td style="width: 10%;"></td> <td style="width: 10%;"></td> <td style="width: 10%;"></td> <td style="width: 10%;"></td> <td style="width: 10%;"></td> </tr> <tr> <td></td> <td></td> <td colspan="8" style="text-align: center;"> <table border="1" style="width: 100%; border-collapse: collapse; text-align: center;"> <tr> <td style="width: 10%;"></td> <td style="width: 10%;"></td> <td style="width: 10%;"></td> <td style="width: 10%;"></td> <td style="width: 10%;"></td> <td style="width: 10%;"></td> <td style="width: 10%;"></td> <td style="width: 10%;"></td> <td style="width: 10%;"></td> <td style="width: 10%;"></td> </tr> <tr> <td></td> <td></td> <td colspan="8" style="text-align: center;"> <table border="1" style="width: 100%; border-collapse: collapse; text-align: center;"> <tr> <td style="width: 10%;"></td> <td style="width: 10%;"></td> <td style="width: 10%;"></td> <td style="width: 10%;"></td> <td style="width: 10%;"></td> <td style="width: 10%;"></td> <td style="width: 10%;"></td> <td style="width: 10%;"></td> <td style="width: 10%;"></td> <td style="width: 10%;"></td> </tr> <tr> <td></td> <td></td> <td colspan="8" style="text-align: center;"> <table border="1" style="width: 100%; border-collapse: collapse; text-align: center;"> <tr> <td style="width: 10%;"></td> <td style="width: 10%;"></td> <td style="width: 10%;"></td> <td style="width: 10%;"></td> <td style="width: 10%;"></td> <td style="width: 10%;"></td> <td style="width: 10%;"></td> <td style="width: 10%;"></td> <td style="width: 10%;"></td> <td style="width: 10%;"></td> </tr> <tr> <td></td> <td></td> <td colspan="8" style="text-align: center;"> <table border="1" style="width: 100%; border-collapse: collapse; text-align: center;"> <tr> <td style="width: 10%;"></td> <td style="width: 10%;"></td> <td style="width: 10%;"></td> <td style="width: 10%;"></td> <td style="width: 10%;"></td> <td style="width: 10%;"></td> <td style="width: 10%;"></td> <td style="width: 10%;"></td> <td style="width: 10%;"></td> <td style="width: 10%;"></td> </tr> <tr> <td></td> <td></td> <td colspan="8" style="text-align: center;"> <table border="1" style="width: 100%; border-collapse: collapse; text-align: center;"> <tr> <td style="width: 10%;"></td> <td style="width: 10%;"></td> <td style="width: 10%;"></td> <td style="width: 10%;"></td> <td style="width: 10%;"></td> <td style="width: 10%;"></td> <td style="width: 10%;"></td> <td style="width: 10%;"></td> <td style="width: 10%;"></td> <td style="width: 10%;"></td> </tr> <tr> <td></td> <td></td> <td colspan="8" style="text-align: center;"> <table border="1" style="width: 100%; border-collapse: collapse; text-align: center;"> <tr> <td style="width: 10%;"></td> <td style="width: 10%;"></td> <td style="width: 10%;"></td> <td style="width: 10%;"></td> <td style="width: 10%;"></td> <td style="width: 10%;"></td> <td style="width: 10%;"></td> <td style="width: 10%;"></td> <td style="width: 10%;"></td> <td style="width: 10%;"></td> </tr> <tr> <td></td> <td></td> <td colspan="8" style="text-align: center;"> <table border="1" style="width: 100%; border-collapse: collapse; text-align: center;"> <tr> <td style="width: 10%;"></td> <td style="width: 10%;"></td> <td style="width: 10%;"></td> <td style="width: 10%;"></td> <td style="width: 10%;"></td> <td style="width: 10%;"></td> <td style="width: 10%;"></td> <td style="width: 10%;"></td> <td style="width: 10%;"></td> <td style="width: 10%;"></td> </tr> <tr> <td></td> <td></td> <td colspan="8" style="text-align: center;"> <table border="1" style="width: 100%; border-collapse: collapse; text-align: center;"> <tr> <td style="width: 10%;"></td> <td style="width: 10%;"></td> <td style="width: 10%;"></td> <td style="width: 10%;"></td> <td style="width: 10%;"></td> <td style="width: 10%;"></td> <td style="width: 10%;"></td> <td style="width: 10%;"></td> <td style="width: 10%;"></td> <td style="width: 10%;"></td> </tr> <tr> <td></td> <td></td> <td colspan="8" style="text-align: center;"> <table border="1" style="width: 100%; border-collapse: collapse; text-align: center;"> <tr> <td style="width: 10%;"></td> <td style="width: 10%;"></td> <td style="width: 10%;"></td> <td style="width: 10%;"></td> <td style="width: 10%;"></td> <td style="width: 10%;"></td> <td style="width: 10%;"></td> <td style="width: 10%;"></td> <td style="width: 10%;"></td> <td style="width: 10%;"></td> </tr> <tr> <td></td> <td></td> <td colspan="8" style="text-align: center;"> <table border="1" style="width: 100%; border-collapse: collapse; text-align: center;"> <tr> <td style="width: 10%;"></td> <td style="width: 10%;"></td> <td style="width: 10%;"></td> <td style="width: 10%;"></td> <td style="width: 10%;"></td> <td style="width: 10%;"></td> <td style="width: 10%;"></td> <td style="width: 10%;"></td> <td style="width: 10%;"></td> <td style="width: 10%;"></td> </tr> <tr> <td></td> <td></td> <td colspan="8" style="text-align: center;"> <table border="1" style="width: 100%; border-collapse: collapse; text-align: center;"> <tr> <td style="width: 10%;"></td> <td style="width: 10%;"></td> <td style="width: 10%;"></td> <td style="width: 10%;"></td> <td style="width: 10%;"></td> <td style="width: 10%;"></td> <td style="width: 10%;"></td> <td style="width: 10%;"></td> <td style="width: 10%;"></td> <td style="width: 10%;"></td> </tr> <tr> <td></td> <td></td> <td colspan="8" style="text-align: center;"> <table border="1" style="width: 100%; border-collapse: collapse; text-align: center;"> <tr> <td style="width: 10%;"></td> <td style="width: 10%;"></td> <td style="width: 10%;"></td> <td style="width: 10%;"></td> <td style="width: 10%;"></td> <td style="width: 10%;"></td> <td style="width: 10%;"></td> <td style="width: 10%;"></td> <td style="width: 10%;"></td> <td style="width: 10%;"></td> </tr> <tr> <td></td> <td></td> <td colspan="8" style="text-align: center;"> <table border="1" style="width: 100%; border-collapse: collapse; text-align: center;"> <tr> <td style="width: 10%;"></td> <td style="width: 10%;"></td> <td style="width: 10%;"></td> <td style="width: 10%;"></td> <td style="width: 10%;"></td> <td style="width: 10%;"></td> <td style="width: 10%;"></td> <td style="width: 10%;"></td> <td style="width: 10%;"></td> <td style="width: 10%;"></td> </tr> <tr> <td></td> <td></td> <td colspan="8" style="text-align: center;"> <table border="1" style="width: 100%; border-collapse: collapse; text-align: center;"> <tr> <td style="width: 10%;"></td> <td style="width: 10%;"></td> <td style="width: 10%;"></td> <td style="width: 10%;"></td> <td style="width: 10%;"></td> <td style="width:
10%;"></td> <td style="width: 10%;"></td> <td style="width: 10%;"></td> <td style="width: 10%;"></td> <td style="width: 10%;"></td> </tr> <tr> <td></td> <td></td> <td colspan="8" style="text-align: center;"> <table border="1" style="width: 100%; border-collapse: collapse; text-align: center;"> <tr> <td style="width: 10%;"></td> <td style="width: 10%;"></td> <td style="width: 10%;"></td> <td style="width: 10%;"></td> <td style="width: 10%;"></td> <td style="width: 10%;"></td> <td style="width: 10%;"></td> <td style="width: 10%;"></td> <td style="width: 10%;"></td> <td style="width: 10%;"></td> </tr> <tr> <td></td> <td></td> <td colspan="8" style="text-align: center;"> <table border="1" style="width: 100%; border-collapse: collapse; text-align: center;"> <tr> <td style="width: 10%;"></td> <td style="width: 10%;"></td> <td style="width: 10%;"></td> <td style="width: 10%;"></td> <td style="width: 10%;"></td> <td style="width: 10%;"></td> <td style="width: 10%;"></td> <td style="width: 10%;"></td> <td style="width: 10%;"></td> <td style="width: 10%;"></td> </tr> <tr> <td></td> <td></td> <td colspan="8" style="text-align: center;"> <table border="1" style="width: 100%; border-collapse: collapse; text-align: center;"> <tr> <td style="width: 10%;"></td> <td style="width: 10%;"></td> <td style="width: 10%;"></td> <td style="width: 10%;"></td> <td style="width: 10%;"></td> <td style="width: 10%;"></td> <td style="width: 10%;"></td> <td style="width: 10%;"></td> <td style="width: 10%;"></td> <td style="width: 10%;"></td> </tr> <tr> <td></td> <td></td> <td colspan="8" style="text-align: center;"> <table border="1" style="width: 100%; border-collapse: collapse; text-align: center;"> <tr> <td style="width: 10%;"></td> <td style="width: 10%;"></td> <td style="width: 10%;"></td> <td style="width: 10%;"></td> <td style="width: 10%;"></td> <td style="width: 10%;"></td> <td style="width: 10%;"></td> <td style="width: 10%;"></td> <td style="width: 10%;"></td> <td style="width: 10%;"></td> </tr> <tr> <td></td> <td></td> <td colspan="8" style="text-align: center;"> <table border="1" style="width: 100%; border-collapse: collapse; text-align: center;"> <tr> <td style="width: 10%;"></td> <td style="width: 10%;"></td> <td style="width: 10%;"></td> <td style="width: 10%;"></td> <td style="width: 10%;"></td> <td style="width: 10%;"></td> <td style="width: 10%;"></td> <td style="width: 10%;"></td> <td style="width: 10%;"></td> <td style="width: 10%;"></td> </tr> <tr> <td></td> <td></td> <td colspan="8" style="text-align: center;"> <table border="1" style="width: 100%; border-collapse: collapse; text-align: center;"> <tr> <td style="width: 10%;"></td> <td style="width: 10%;"></td> <td style="width: 10%;"></td> <td style="width: 10%;"></td> <td style="width: 10%;"></td> <td style="width: 10%;"></td> <td style="width: 10%;"></td> <td style="width: 10%;"></td> <td style="width: 10%;"></td> <td style="width: 10%;"></td> </tr> <tr> <td></td> <td></td> <td colspan="8" style="text-align: center;"> <table border="1" style="width: 100%; border-collapse: collapse; text-align: center;"> <tr> <td style="width: 10%;"></td> <td style="width: 10%;"></td> <td style="width: 10%;"></td> <td style="width: 10%;"></td> <td style="width: 10%;"></td> <td style="width: 10%;"></td> <td style="width: 10%;"></td> <td style="width: 10%;"></td> <td style="width: 10%;"></td> <td style="width: 10%;"></td> </tr> <tr> <td></td> <td></td> <td colspan="8" style="text-align: center;"> <table border="1" style="width: 100%; border-collapse: collapse; text-align: center;"> <tr> <td style="width: 10%;"></td> <td style="width: 10%;"></td> <td style="width: 10%;"></td> <td style="width: 10%;"></td> <td style="width: 10%;"></td> <td style="width: 10%;"></td> <td style="width: 10%;"></td> <td style="width: 10%;"></td> <td style="width: 10%;"></td> <td style="width: 10%;"></td> </tr> <tr> <td></td> <td></td> <td colspan="8" style="text-align: center;"> <table border="1" style="width: 100%; border-collapse: collapse; text-align: center;"> <tr> <td style="width: 10%;"></td> <td style="width: 10%;"></td> <td style="width: 10%;"></td> <td style="width: 10%;"></td> <td style="width: 10%;"></td> <td style="width: 10%;"></td> <td style="width: 10%;"></td> <td style="width: 10%;"></td> <td style="width: 10%;"></td> <td style="width: 10%;"></td> </tr> <tr> <td></td> <td></td> <td colspan="8" style="text-align: center;"> <table border="1" style="width: 100%; border-collapse: collapse; text-align: center;"> <tr> <td style="width: 10%;"></td> <td style="width: 10%;"></td> <td style="width: 10%;"></td> <td style="width: 10%;"></td> <td style="width: 10%;"></td> <td style="width: 10%;"></td> <td style="width: 10%;"></td> <td style="width: 10%;"></td> <td style="width: 10%;"></td> <td style="width: 10%;"></td> </tr> <tr> <td></td> <td></td> <td colspan="8" style="text-align: center;"> <table border="1" style="width: 100%; border-collapse: collapse; text-align: center;"> <tr> <td style="width: 10%;"></td> <td style="width: 10%;"></td> <td style="width: 10%;"></td> <td style="width: 10%;"></td> <td style="width: 10%;"></td> <td style="width: 10%;"></td> <td style="width: 10%;"></td> <td style="width: 10%;"></td> <td style="width: 10%;"></td> <td style="width: 10%;"></td> </tr> <tr> <td></td> <td></td> <td colspan="8" style="text-align: center;"> <table border="1" style="width: 100%; border-collapse: collapse; text-align: center;"> <tr> <td style="width: 10%;"></td> <td style="width: 10%;"></td> <td style="width: 10%;"></td> <td style="width: 10%;"></td> <td style="width: 10%;"></td> <td style="width: 10%;"></td> <td style="width: 10%;"></td> <td style="width: 10%;"></td> <td style="width: 10%;"></td> <td style="width: 10%;"></td> </tr> <tr> <td></td> <td></td> <td colspan="8" style="text-align: center;"> <table border="1" style="width: 100%; border-collapse: collapse; text-align: center;"> <tr> <td style="width: 10%;"></td> <td style="width: 10%;"></td> <td style="width: 10%;"></td> <td style="width: 10%;"></td> <td style="width: 10%;"></td> <td style="width: 10%;"></td> <td style="width: 10%;"></td> <td style="width: 10%;"></td> <td style="width: 10%;"></td> <td style="width: 10%;"></td> </tr> <tr> <td></td> <td></td> <td colspan="8" style="text-align: center;"> <table border="1" style="width: 100%; border-collapse: collapse; text-align: center;"> <tr> <td style="width: 10%;"></td> <td style="width: 10%;"></td> <td style="width: 10%;"></td> <td style="width: 10%;"></td> <td style="width: 10%;"></td> <td style="width: 10%;"></td> <td style="width: 10%;"></td> <td style="width: 10%;"></td> <td style="width: 10%;"></td> <td style="width: 10%;"></td> </tr> <tr> <td></td> <td></td> <td colspan="8" style="text-align: center;"> <table border="1" style="width: 100%; border-collapse: collapse; text-align: center;"> <tr> <td style="width: 10%;"></td> <td style="width: 10%;"></td> <td style="width: 10%;"></td> <td style="width: 10%;"></td> <td style="width: 10%;"></td> <td style="width: 10%;"></td> <td style="width: 10%;"></td> <td style="width: 10%;"></td> <td style="width: 10%;"></td> <td style="width: 10%;"></td> </tr> <tr> <td></td> <td></td> <td colspan="8" style="text-align: center;"> <table border="1" style="width: 100%; border-collapse: collapse; text-align: center;"> <tr> <td style="width: 10%;"></td> <td style="width: 10%;"></td> <td style="width: 10%;"></td> <td style="width: 10%;"></td> <td style="width: 10%;"></td> <td style="width: 10%;"></td> <td style="width: 10%;"></td> <td style="width: 10%;"></td> <td style="width: 10%;"></td> <td style="width: 10%;"></td> </tr> <tr> <td></td> <td></td> <td colspan="8" style="text-align: center;"> <table border="1" style="width: 100%; border-collapse: collapse; text-align: center;"> <tr> <td style="width: 10%;"></td> <td style="width: 10%;"></td> <td style="width: 10%;"></td> <td style="width: 10%;"></td> <td style="width: 10%;"></td> <td style="width: 10%;"></td> <td style="width: 10%;"></td> <td style="width: 10%;"></td> <td style="width: 10%;"></td> <td style="width: 10%;"></td> </tr> <tr> <td></td> <td></td> <td colspan="8" style="text-align: center;"> <table border="1" style="width: 100%; border-collapse: collapse; text-align: center;"> <tr> <td style="width: 10%;"></td> <td style="width: 10%;"></td> <td style="width: 10%;"></td> <td style="width: 10%;"></td> <td style="width: 10%;"></td> <td style="width: 10%;"></td> <td style="width: 10%;"></td> <td style="width: 10%;"></td> <td style="width: 10%;"></td> <td style="width: 10%;"></td> </tr> <tr> <td></td> <td></td> <td colspan="8" style="text-align: center;"> <table border="1" style="width: 100%; border-collapse: collapse; text-align: center;"> <tr> <td style="width: 10%;"></td> <td style="width: 10%;"></td> <td style="width: 10%;"></td> <td style="width: 10%;"></td> <td style="width: 10%;"></td> <td style="width: 10%;"></td> <td style="width: 10%;"></td> <td style="width: 10%;"></td> <td style="width: 10%;"></td> <td style="width: 10%;"></td> </tr> <tr> <td></td> <td></td> <td colspan="8" style="text-align: center;"> <table border="1" style="width: 100%; border-collapse: collapse; text-align: center;"> <tr> <td style="width: 10%;"></td> <td style="width: 10%;"></td> <td style="width: 10%;"></td> <td style="width: 10%;"></td> <td style="width: 10%;"></td> <td style="width: 10%;"></td> <td style="width: 10%;"></td> <td style="width: 10%;"></td> <td style="width: 10%;"></td> <td style="width: 10%;"></td> </tr> <tr> <td></td> <td></td> <td colspan="8" style="text-align: center;"> <table border="1" style="width: 100%; border-collapse: collapse; text-align: center;"> <tr> <td style="width: 10%;"></td> <td style="width: 10%;"></td> <td style="width: 10%;"></td> <td style="width: 10%;"></td> <td style="width: 10%;"></td> <td style="width: 10%;"></td> <td style="width: 10%;"></td> <td style="width: 10%;"></td> <td style="width: 10%;"></td> <td style="width: 10%;"></td> </tr> <tr> <td></td> <td></td> <td
colspan="8" style="text-align: center;"> <table border="1" style="width: 100%; border-collapse: collapse; text-align: center;"> <tr> <td style="width: 10%;"></td> <td style="width: 10%;"></td> <td style="width: 10%;"></td> <td style="width: 10%;"></td> <td style="width: 10%;"></td> <td style="width: 10%;"></td> <td style="width: 10%;"></td> <td style="width: 10%;"></td> <td style="width: 10%;"></td> <td style="width: 10%;"></td> </tr> <tr> <td></td> <td></td> <td colspan="8" style="text-align: center;"> <table border="1" style="width: 100%; border-collapse: collapse; text-align: center;"> <tr> <td style="width: 10%;"></td> <td style="width: 10%;"></td> <td style="width: 10%;"></td> <td style="width: 10%;"></td> <td style="width: 10%;"></td> <td style="width: 10%;"></td> <td style="width: 10%;"></td> <td style="width: 10%;"></td> <td style="width: 10%;"></td> <td style="width: 10%;"></td> </tr> <tr> <td></td> <td></td> <td colspan="8" style="text-align: center;"> <table border="1" style="width: 100%; border-collapse: collapse; text-align: center;"> <tr> <td style="width: 10%;"></td> <td style="width: 10%;"></td> <td style="width: 10%;"></td> <td style="width: 10%;"></td> <td style="width: 10%;"></td> <td style="width: 10%;"></td> <td style="width: 10%;"></td> <td style="width: 10%;"></td> <td style="width: 10%;"></td> <td style="width: 10%;"></td> </tr> <tr> <td></td> <td></td> <td colspan="8" style="text-align: center;"> <table border="1" style="width: 100%; border-collapse: collapse; text-align: center;"> <tr> <td style="width: 10%;"></td> <td style="width: 10%;"></td> <td style="width: 10%;"></td> <td style="width: 10%;"></td> <td style="width: 10%;"></td> <td style="width: 10%;"></td> <td style="width: 10%;"></td> <td style="width: 10%;"></td> <td style="width: 10%;"></td> <td style="width: 10%;"></td> </tr> <tr> <td></td> <td></td> <td colspan="8" style="text-align: center;"> <table border="1" style="width: 100%; border-collapse: collapse; text-align: center;"> <tr> <td style="width: 10%;"></td> <td style="width: 10%;"></td> <td style="width: 10%;"></td> <td style="width: 10%;"></td> <td style="width: 10%;"></td> <td style="width: 10%;"></td> <td style="width: 10%;"></td> <td style="width: 10%;"></td> <td style="width: 10%;"></td> <td style="width: 10%;"></td> </tr> <tr> <td></td> <td></td> <td colspan="8" style="text-align: center;"> <table border="1" style="width: 100%; border-collapse: collapse; text-align: center;"> <tr> <td style="width: 10%;"></td> <td style="width: 10%;"></td> <td style="width: 10%;"></td> <td style="width: 10%;"></td> <td style="width: 10%;"></td> <td style="width: 10%;"></td> <td style="width: 10%;"></td> <td style="width: 10%;"></td> <td style="width: 10%;"></td> <td style="width: 10%;"></td> </tr> <tr> <td></td> <td></td> <td colspan="8" style="text-align: center;"> <table border="1" style="width: 100%; border-collapse: collapse; text-align: center;"> <tr> <td style="width: 10%;"></td> <td style="width: 10%;"></td> <td style="width: 10%;"></td> <td style="width: 10%;"></td> <td style="width: 10%;"></td> <td style="width: 10%;"></td> <td style="width: 10%;"></td> <td style="width: 10%;"></td> <td style="width: 10%;"></td> <td style="width: 10%;"></td> </tr> <tr> <td></td> <td></td> <td colspan="8" style="text-align: center;"> <table border="1" style="width: 100%; border-collapse: collapse; text-align: center;"> <tr> <td style="width: 10%;"></td> <td style="width: 10%;"></td> <td style="width: 10%;"></td> <td style="width: 10%;"></td> <td style="width: 10%;"></td> <td style="width: 10%;"></td> <td style="width: 10%;"></td> <td style="width: 10%;"></td> <td style="width: 10%;"></td> <td style="width: 10%;"></td> </tr> <tr> <td></td> <td></td> <td colspan="8" style="text-align: center;"> <table border="1" style="width: 100%; border-collapse: collapse; text-align: center;"> <tr> <td style="width: 10%;"></td> <td style="width: 10%;"></td> <td style="width: 10%;"></td> <td style="width: 10%;"></td> <td style="width: 10%;"></td> <td style="width: 10%;"></td> <td style="width: 10%;"></td> <td style="width: 10%;"></td> <td style="width: 10%;"></td> <td style="width: 10%;"></td> </tr> <tr> <td></td> <td></td> <td colspan="8" style="text-align: center;"> <table border="1" style="width: 100%; border-collapse: collapse; text-align: center;"> <tr> <td style="width: 10%;"></td> <td style="width: 10%;"></td> <td style="width: 10%;"></td> <td style="width: 10%;"></td> <td style="width: 10%;"></td> <td style="width: 10%;"></td> <td style="width: 10%;"></td> <td style="width: 10%;"></td> <td style="width: 10%;"></td> <td style="width: 10%;"></td> </tr> <tr> <td></td> <td></td> <td colspan="8" style="text-align: center;"> <table border="1" style="width: 100%; border-collapse: collapse; text-align: center;"> <tr> <td style="width: 10%;"></td> <td style="width: 10%;"></td> <td style="width: 10%;"></td> <td style="width: 10%;"></td> <td style="width: 10%;"></td> <td style="width: 10%;"></td> <td style="width: 10%;"></td> <td style="width: 10%;"></td> <td style="width: 10%;"></td> <td style="width: 10%;"></td> </tr> <tr> <td></td> <td></td> <td colspan="8" style="text-align: center;"> <table border="1" style="width: 100%; border-collapse: collapse; text-align: center;"> <tr> <td style="width: 10%;"></td> <td style="width: 10%;"></td> <td style="width: 10%;"></td> <td style="width: 10%;"></td> <td style="width: 10%;"></td> <td style="width: 10%;"></td> <td style="width: 10%;"></td> <td style="width: 10%;"></td> <td style="width: 10%;"></td> <td style="width: 10%;"></td> </tr> <tr> <td></td> <td></td> <td colspan="8" style="text-align: center;"> <table border="1" style="width: 100%; border-collapse: collapse; text-align: center;"> <tr> <td style="width: 10%;"></td> <td style="width: 10%;"></td> <td style="width: 10%;"></td> <td style="width: 10%;"></td> <td style="width: 10%;"></td> <td style="width: 10%;"></td> <td style="width: 10%;"></td> <td style="width: 10%;"></td> <td style="width: 10%;"></td> <td style="width: 10%;"></td> </tr> <tr> <td></td> <td></td> <td colspan="8" style="text-align: center;"> <table border="1" style="width: 100%; border-collapse: collapse; text-align: center;"> <tr> <td style="width: 10%;"></td> <td style="width: 10%;"></td> <td style="width: 10%;"></td> <td style="width: 10%;"></td> <td style="width: 10%;"></td> <td style="width: 10%;"></td> <td style="width: 10%;"></td> <td style="width: 10%;"></td> <td style="width: 10%;"></td> <td style="width: 10%;"></td> </tr> <tr> <td></td> <td></td> <td colspan="8" style="text-align: center;"> <table border="1" style="width: 100%; border-collapse: collapse; text-align: center;"> <tr> <td style="width: 10%;"></td> <td style="width: 10%;"></td> <td style="width: 10%;"></td> <td style="width: 10%;"></td> <td style="width: 10%;"></td> <td style="width: 10%;"></td> <td style="width: 10%;"></td> <td style="width: 10%;"></td> <td style="width: 10%;"></td> <td style="width: 10%;"></td> </tr> <tr> <td></td> <td></td> <td colspan="8" style="text-align: center;"> <table border="1" style="width: 100%; border-collapse: collapse; text-align: center;"> <tr> <td style="width: 10%;"></td> <td style="width: 10%;"></td> <td style="width: 10%;"></td> <td style="width: 10%;"></td> <td style="width: 10%;"></td> <td style="width: 10%;"></td> <td style="width: 10%;"></td> <td style="width: 10%;"></td> <td style="width: 10%;"></td> <td style="width: 10%;"></td> </tr> <tr> <td></td> <td></td> <td colspan="8" style="text-align: center;"> <table border="1" style="width: 100%; border-collapse: collapse; text-align: center;"> <tr> <td style="width: 10%;"></td> <td style="width: 10%;"></td> <td style="width: 10%;"></td> <td style="width: 10%;"></td> <td style="width: 10%;"></td> <td style="width: 10%;"></td> <td style="width: 10%;"></td> <td style="width: 10%;"></td> <td style="width: 10%;"></td> <td style="width: 10%;"></td> </tr> <tr> <td></td> <td></td> <td colspan="8" style="text-align: center;"> <table border="1" style="width: 100%; border-collapse: collapse; text-align: center;"> <tr> <td style="width: 10%;"></td> <td style="width: 10%;"></td> <td style="width: 10%;"></td> <td style="width: 10%;"></td> <td style="width: 10%;"></td> <td style="width: 10%;"></td> <td style="width: 10%;"></td> <td style="width: 10%;"></td> <td style="width: 10%;"></td> <td style="width: 10%;"></td> </tr> <tr> <td></td> <td></td> <td colspan="8" style="text-align: center;"> <table border="1" style="width: 100%; border-collapse: collapse; text-align: center;"> <tr> <td style="width: 10%;"></td> <td style="width: 10%;"></td> <td style="width: 10%;"></td> <td style="width: 10%;"></td> <td style="width: 10%;"></td> <td style="width: 10%;"></td> <td style="width: 10%;"></td> <td style="width: 10%;"></td> <td style="width: 10%;"></td> <td style="width: 10%;"></td> </tr> <tr> <td></td> <td></td> <td colspan="8" style="text-align: center;"> <table border="1" style="width: 100%; border-collapse: collapse; text-align: center;"> <tr> <td style="width: 10%;"></td> <td style="width: 10%;"></td> <td style="width: 10%;"></td> <td style="width: 10%;"></td> <td style="width: 10%;"></td> <td style="width: 10%;"></td> <td style="width: 10%;"></td> <td style="width: 10%;"></td> <td style="width: 10%;"></td> <td style="width: 10%;"></td> </tr> <tr> <td></td> <td></td> <td colspan="8" style="text-align: center;"> <table border="1" style="width: 100%; border-collapse: collapse; text-align: center;"> <tr> <td style="width: 10%;"></td> <td style="width: 10%;"></td> <td style="width: 10%;"></td> <td style="width: 10%;"></td> <td style="width: 10%;"></td> <td style="width: 10%;"></td> <td style="width: 10%;"></td> <td style="width: 10%;"></td> <td style="width: 10%;"></td> <td style="width: 10%;"></td> </tr> <tr> <td></td> <td></td> <td colspan="8" style="text-align: center;"> <table border="1" style="width: 100%; border-collapse: collapse; text-align: center;"> <tr> <td style="width: 10%;"></td> <td
style="width: 10%;"></td> <td style="width: 10%;"></td> <td style="width: 10%;"></td> <td style="width: 10%;"></td> <td style="width: 10%;"></td> <td style="width: 10%;"></td> <td style="width: 10%;"></td> <td style="width: 10%;"></td> <td style="width: 10%;"></td> </tr> <tr> <td></td> <td></td> <td colspan="8" style="text-align: center;"> <table border="1" style="width: 100%; border-collapse: collapse; text-align: center;"> <tr> <td style="width: 10%;"></td> <td style="width: 10%;"></td> <td style="width: 10%;"></td> <td style="width: 10%;"></td> <td style="width: 10%;"></td> <td style="width: 10%;"></td> <td style="width: 10%;"></td> <td style="width: 10%;"></td> <td style="width: 10%;"></td> <td style="width: 10%;"></td> </tr> <tr> <td></td> <td></td> <td colspan="8" style="text-align: center;"> <table border="1" style="width: 100%; border-collapse: collapse; text-align: center;"> <tr> </tr></table></td></tr></table></td></tr></table></td></tr></table></td></tr></table></td></tr></table></td></tr></table></td></tr></table></td></tr></table></td></tr></table></td></tr></table></td></tr></table></td></tr></table></td></tr></table></td></tr></table></td></tr></table></td></tr></table></td></tr></table></td></tr></table></td></tr></table></td></tr></table></td></tr></table></td></tr></table></td></tr></table></td></tr></table></td></tr></table></td></tr></table></td></tr></table></td></tr></table></td></tr></table></td></tr></table></td></tr></table></td></tr></table></td></tr></table></td></tr></table></td></tr></table></td></tr></table></td></tr></table></td></tr></table></td></tr></table></td></tr></table></td></tr></table></td></tr></table></td></tr></table></td></tr></table></td></tr></table></td></tr></table></td></tr></table></td></tr></table></td></tr></table></td></tr></table></td></tr></table></td></tr></table></td></tr></table></td></tr></table></td></tr></table></td></tr></table></td></tr></table></td></tr></table></td></tr></table></td></tr></table></td></tr></table></td></tr></table></td></tr></table> | | | | | | | | | | | | | | | | | | | | <table border="1" style="width: 100%; border-collapse: collapse; text-align: center;"> <tr> <td style="width: 10%;"></td> <td style="width: 10%;"></td> <td style="width: 10%;"></td> <td style="width: 10%;"></td> <td style="width: 10%;"></td> <td style="width: 10%;"></td> <td style="width: 10%;"></td> <td style="width: 10%;"></td> <td style="width: 10%;"></td> <td style="width: 10%;"></td> </tr> <tr> <td></td> <td></td> <td colspan="8" style="text-align: center;"> <table border="1" style="width: 100%; border-collapse: collapse; text-align: center;"> <tr> <td style="width: 10%;"></td> <td style="width: 10%;"></td> <td style="width: 10%;"></td> <td style="width: 10%;"></td> <td style="width: 10%;"></td> <td style="width: 10%;"></td> <td style="width: 10%;"></td> <td style="width: 10%;"></td> <td style="width: 10%;"></td> <td style="width: 10%;"></td> </tr> <tr> <td></td> <td></td> <td colspan="8" style="text-align: center;"> <table border="1" style="width: 100%; border-collapse: collapse; text-align: center;"> <tr> <td style="width: 10%;"></td> <td style="width: 10%;"></td> <td style="width: 10%;"></td> <td style="width: 10%;"></td> <td style="width: 10%;"></td> <td style="width: 10%;"></td> <td style="width: 10%;"></td> <td style="width: 10%;"></td> <td style="width: 10%;"></td> <td style="width: 10%;"></td> </tr> <tr> <td></td> <td></td> <td colspan="8" style="text-align: center;"> <table border="1" style="width: 100%; border-collapse: collapse; text-align: center;"> <tr> <td style="width: 10%;"></td> <td style="width: 10%;"></td> <td style="width: 10%;"></td> <td style="width: 10%;"></td> <td style="width: 10%;"></td> <td style="width: 10%;"></td> <td style="width: 10%;"></td> <td style="width: 10%;"></td> <td style="width: 10%;"></td> <td style="width: 10%;"></td> </tr> <tr> <td></td> <td></td> <td colspan="8" style="text-align: center;"> <table border="1" style="width: 100%; border-collapse: collapse; text-align: center;"> <tr> <td style="width: 10%;"></td> <td style="width: 10%;"></td> <td style="width: 10%;"></td> <td style="width: 10%;"></td> <td style="width: 10%;"></td> <td style="width: 10%;"></td> <td style="width: 10%;"></td> <td style="width: 10%;"></td> <td style="width: 10%;"></td> <td style="width: 10%;"></td> </tr> <tr> <td></td> <td></td> <td colspan="8" style="text-align: center;"> <table border="1" style="width: 100%; border-collapse: collapse; text-align: center;"> <tr> <td style="width: 10%;"></td> <td style="width: 10%;"></td> <td style="width: 10%;"></td> <td style="width: 10%;"></td> <td style="width: 10%;"></td> <td style="width: 10%;"></td> <td style="width: 10%;"></td> <td style="width: 10%;"></td> <td style="width: 10%;"></td> <td style="width: 10%;"></td> </tr> <tr> <td></td> <td></td> <td colspan="8" style="text-align: center;"> <table border="1" style="width: 100%; border-collapse: collapse; text-align: center;"> <tr> <td style="width: 10%;"></td> <td style="width: 10%;"></td> <td style="width: 10%;"></td> <td style="width: 10%;"></td> <td style="width: 10%;"></td> <td style="width: 10%;"></td> <td style="width: 10%;"></td> <td style="width: 10%;"></td> <td style="width: 10%;"></td> <td style="width: 10%;"></td> </tr> <tr> <td></td> <td></td> <td colspan="8" style="text-align: center;"> <table border="1" style="width: 100%; border-collapse: collapse; text-align: center;"> <tr> <td style="width: 10%;"></td> <td style="width: 10%;"></td> <td style="width: 10%;"></td> <td style="width: 10%;"></td> <td style="width: 10%;"></td> <td style="width: 10%;"></td> <td style="width: 10%;"></td> <td style="width: 10%;"></td> <td style="width: 10%;"></td> <td style="width: 10%;"></td> </tr> <tr> <td></td> <td></td> <td colspan="8" style="text-align: center;"> <table border="1" style="width: 100%; border-collapse: collapse; text-align: center;"> <tr> <td style="width: 10%;"></td> <td style="width: 10%;"></td> <td style="width: 10%;"></td> <td style="width: 10%;"></td> <td style="width: 10%;"></td> <td style="width: 10%;"></td> <td style="width: 10%;"></td> <td style="width: 10%;"></td> <td style="width: 10%;"></td> <td style="width: 10%;"></td> </tr> <tr> <td></td> <td></td> <td colspan="8" style="text-align: center;"> <table border="1" style="width: 100%; border-collapse: collapse; text-align: center;"> <tr> <td style="width: 10%;"></td> <td style="width: 10%;"></td> <td style="width: 10%;"></td> <td style="width: 10%;"></td> <td style="width: 10%;"></td> <td style="width: 10%;"></td> <td style="width: 10%;"></td> <td style="width: 10%;"></td> <td style="width: 10%;"></td> <td style="width: 10%;"></td> </tr> <tr> <td></td> <td></td> <td colspan="8" style="text-align: center;"> <table border="1" style="width: 100%; border-collapse: collapse; text-align: center;"> <tr> <td style="width: 10%;"></td> <td style="width: 10%;"></td> <td style="width: 10%;"></td> <td style="width: 10%;"></td> <td style="width: 10%;"></td> <td style="width: 10%;"></td> <td style="width: 10%;"></td> <td style="width: 10%;"></td> <td style="width: 10%;"></td> <td style="width: 10%;"></td> </tr> <tr> <td></td> <td></td> <td colspan="8" style="text-align: center;"> <table border="1" style="width: 100%; border-collapse: collapse; text-align: center;"> <tr> <td style="width: 10%;"></td> <td style="width: 10%;"></td> <td style="width: 10%;"></td> <td style="width: 10%;"></td> <td style="width: 10%;"></td> <td style="width: 10%;"></td> <td style="width: 10%;"></td> <td style="width: 10%;"></td> <td style="width: 10%;"></td> <td style="width: 10%;"></td> </tr> <tr> <td></td> <td></td> <td colspan="8" style="text-align: center;"> <table border="1" style="width: 100%; border-collapse: collapse; text-align: center;"> <tr> <td style="width: 10%;"></td> <td style="width: 10%;"></td> <td style="width: 10%;"></td> <td style="width: 10%;"></td> <td style="width: 10%;"></td> <td style="width: 10%;"></td> <td style="width: 10%;"></td> <td style="width: 10%;"></td> <td style="width: 10%;"></td> <td style="width: 10%;"></td> </tr> <tr> <td></td> <td></td> <td colspan="8" style="text-align: center;"> <table border="1" style="width: 100%; border-collapse: collapse; text-align: center;"> <tr> <td style="width: 10%;"></td> <td style="width: 10%;"></td> <td style="width: 10%;"></td> <td style="width: 10%;"></td> <td style="width: 10%;"></td> <td style="width: 10%;"></td> <td style="width: 10%;"></td> <td style="width: 10%;"></td> <td style="width: 10%;"></td> <td style="width: 10%;"></td> </tr> <tr> <td></td> <td></td> <td colspan="8" style="text-align: center;"> <table border="1" style="width: 100%; border-collapse: collapse; text-align: center;"> <tr> <td style="width: 10%;"></td> <td style="width: 10%;"></td> <td style="width: 10%;"></td> <td style="width: 10%;"></td> <td style="width: 10%;"></td> <td style="width: 10%;"></td> <td style="width: 10%;"></td> <td style="width: 10%;"></td> <td style="width: 10%;"></td> <td style="width: 10%;"></td> </tr> <tr> <td></td> <td></td> <td colspan="8" style="text-align: center;"> <table border="1" style="width: 100%; border-collapse: collapse; text-align: center;"> <tr> <td style="width: 10%;"></td> <td style="width: 10%;"></td> <td style="width: 10%;"></td> <td style="width: 10%;"></td> <td style="width: 10%;"></td> <td style="width: 10%;"></td> <td style="width: 10%;"></td> <td style="width: 10%;"></td> <td style="width: 10%;"></td> <td style="width: 10%;"></td> </tr> <tr> <td></td> <td></td> <td colspan="8" style="text-align: center;"> <table border="1" style="width: 100%; border-collapse: collapse; text-align: center;"> <tr> <td style="width: 10%;"></td> <td style="width: 10%;"></td> <td style="width: 10%;"></td> <td style="width: 10%;"></td> <td style="width: 10%;"></td> <td style="width: 10%;"></td> <td style="width: 10%;"></td> <td style="width: 10%;"></td> <td style="width: 10%;"></td> <td style="width: 10%;"></td> </tr> <tr>
<td></td> <td></td> <td colspan="8" style="text-align: center;"> <table border="1" style="width: 100%; border-collapse: collapse; text-align: center;"> <tr> <td style="width: 10%;"></td> <td style="width: 10%;"></td> <td style="width: 10%;"></td> <td style="width: 10%;"></td> <td style="width: 10%;"></td> <td style="width: 10%;"></td> <td style="width: 10%;"></td> <td style="width: 10%;"></td> <td style="width: 10%;"></td> <td style="width: 10%;"></td> </tr> <tr> <td></td> <td></td> <td colspan="8" style="text-align: center;"> <table border="1" style="width: 100%; border-collapse: collapse; text-align: center;"> <tr> <td style="width: 10%;"></td> <td style="width: 10%;"></td> <td style="width: 10%;"></td> <td style="width: 10%;"></td> <td style="width: 10%;"></td> <td style="width: 10%;"></td> <td style="width: 10%;"></td> <td style="width: 10%;"></td> <td style="width: 10%;"></td> <td style="width: 10%;"></td> </tr> <tr> <td></td> <td></td> <td colspan="8" style="text-align: center;"> <table border="1" style="width: 100%; border-collapse: collapse; text-align: center;"> <tr> <td style="width: 10%;"></td> <td style="width: 10%;"></td> <td style="width: 10%;"></td> <td style="width: 10%;"></td> <td style="width: 10%;"></td> <td style="width: 10%;"></td> <td style="width: 10%;"></td> <td style="width: 10%;"></td> <td style="width: 10%;"></td> <td style="width: 10%;"></td> </tr> <tr> <td></td> <td></td> <td colspan="8" style="text-align: center;"> <table border="1" style="width: 100%; border-collapse: collapse; text-align: center;"> <tr> <td style="width: 10%;"></td> <td style="width: 10%;"></td> <td style="width: 10%;"></td> <td style="width: 10%;"></td> <td style="width: 10%;"></td> <td style="width: 10%;"></td> <td style="width: 10%;"></td> <td style="width: 10%;"></td> <td style="width: 10%;"></td> <td style="width: 10%;"></td> </tr> <tr> <td></td> <td></td> <td colspan="8" style="text-align: center;"> <table border="1" style="width: 100%; border-collapse: collapse; text-align: center;"> <tr> <td style="width: 10%;"></td> <td style="width: 10%;"></td> <td style="width: 10%;"></td> <td style="width: 10%;"></td> <td style="width: 10%;"></td> <td style="width: 10%;"></td> <td style="width: 10%;"></td> <td style="width: 10%;"></td> <td style="width: 10%;"></td> <td style="width: 10%;"></td> </tr> <tr> <td></td> <td></td> <td colspan="8" style="text-align: center;"> <table border="1" style="width: 100%; border-collapse: collapse; text-align: center;"> <tr> <td style="width: 10%;"></td> <td style="width: 10%;"></td> <td style="width: 10%;"></td> <td style="width: 10%;"></td> <td style="width: 10%;"></td> <td style="width: 10%;"></td> <td style="width: 10%;"></td> <td style="width: 10%;"></td> <td style="width: 10%;"></td> <td style="width: 10%;"></td> </tr> <tr> <td></td> <td></td> <td colspan="8" style="text-align: center;"> <table border="1" style="width: 100%; border-collapse: collapse; text-align: center;"> <tr> <td style="width: 10%;"></td> <td style="width: 10%;"></td> <td style="width: 10%;"></td> <td style="width: 10%;"></td> <td style="width: 10%;"></td> <td style="width: 10%;"></td> <td style="width: 10%;"></td> <td style="width: 10%;"></td> <td style="width: 10%;"></td> <td style="width: 10%;"></td> </tr> <tr> <td></td> <td></td> <td colspan="8" style="text-align: center;"> <table border="1" style="width: 100%; border-collapse: collapse; text-align: center;"> <tr> <td style="width: 10%;"></td> <td style="width: 10%;"></td> <td style="width: 10%;"></td> <td style="width: 10%;"></td> <td style="width: 10%;"></td> <td style="width: 10%;"></td> <td style="width: 10%;"></td> <td style="width: 10%;"></td> <td style="width: 10%;"></td> <td style="width: 10%;"></td> </tr> <tr> <td></td> <td></td> <td colspan="8" style="text-align: center;"> <table border="1" style="width: 100%; border-collapse: collapse; text-align: center;"> <tr> <td style="width: 10%;"></td> <td style="width: 10%;"></td> <td style="width: 10%;"></td> <td style="width: 10%;"></td> <td style="width: 10%;"></td> <td style="width: 10%;"></td> <td style="width: 10%;"></td> <td style="width: 10%;"></td> <td style="width: 10%;"></td> <td style="width: 10%;"></td> </tr> <tr> <td></td> <td></td> <td colspan="8" style="text-align: center;"> <table border="1" style="width: 100%; border-collapse: collapse; text-align: center;"> <tr> <td style="width: 10%;"></td> <td style="width: 10%;"></td> <td style="width: 10%;"></td> <td style="width: 10%;"></td> <td style="width: 10%;"></td> <td style="width: 10%;"></td> <td style="width: 10%;"></td> <td style="width: 10%;"></td> <td style="width: 10%;"></td> <td style="width: 10%;"></td> </tr> <tr> <td></td> <td></td> <td colspan="8" style="text-align: center;"> <table border="1" style="width: 100%; border-collapse: collapse; text-align: center;"> <tr> <td style="width: 10%;"></td> <td style="width: 10%;"></td> <td style="width: 10%;"></td> <td style="width: 10%;"></td> <td style="width: 10%;"></td> <td style="width: 10%;"></td> <td style="width: 10%;"></td> <td style="width: 10%;"></td> <td style="width: 10%;"></td> <td style="width: 10%;"></td> </tr> <tr> <td></td> <td></td> <td colspan="8" style="text-align: center;"> <table border="1" style="width: 100%; border-collapse: collapse; text-align: center;"> <tr> <td style="width: 10%;"></td> <td style="width: 10%;"></td> <td style="width: 10%;"></td> <td style="width: 10%;"></td> <td style="width: 10%;"></td> <td style="width: 10%;"></td> <td style="width: 10%;"></td> <td style="width: 10%;"></td> <td style="width: 10%;"></td> <td style="width: 10%;"></td> </tr> <tr> <td></td> <td></td> <td colspan="8" style="text-align: center;"> <table border="1" style="width: 100%; border-collapse: collapse; text-align: center;"> <tr> <td style="width: 10%;"></td> <td style="width: 10%;"></td> <td style="width: 10%;"></td> <td style="width: 10%;"></td> <td style="width: 10%;"></td> <td style="width: 10%;"></td> <td style="width: 10%;"></td> <td style="width: 10%;"></td> <td style="width: 10%;"></td> <td style="width: 10%;"></td> </tr> <tr> <td></td> <td></td> <td colspan="8" style="text-align: center;"> <table border="1" style="width: 100%; border-collapse: collapse; text-align: center;"> <tr> <td style="width: 10%;"></td> <td style="width: 10%;"></td> <td style="width: 10%;"></td> <td style="width: 10%;"></td> <td style="width: 10%;"></td> <td style="width: 10%;"></td> <td style="width: 10%;"></td> <td style="width: 10%;"></td> <td style="width: 10%;"></td> <td style="width: 10%;"></td> </tr> <tr> <td></td> <td></td> <td colspan="8" style="text-align: center;"> <table border="1" style="width: 100%; border-collapse: collapse; text-align: center;"> <tr> <td style="width: 10%;"></td> <td style="width: 10%;"></td> <td style="width: 10%;"></td> <td style="width: 10%;"></td> <td style="width: 10%;"></td> <td style="width: 10%;"></td> <td style="width: 10%;"></td> <td style="width: 10%;"></td> <td style="width: 10%;"></td> <td style="width: 10%;"></td> </tr> <tr> <td></td> <td></td> <td colspan="8" style="text-align: center;"> <table border="1" style="width: 100%; border-collapse: collapse; text-align: center;"> <tr> <td style="width: 10%;"></td> <td style="width: 10%;"></td> <td style="width: 10%;"></td> <td style="width: 10%;"></td> <td style="width: 10%;"></td> <td style="width: 10%;"></td> <td style="width: 10%;"></td> <td style="width: 10%;"></td> <td style="width: 10%;"></td> <td style="width: 10%;"></td> </tr> <tr> <td></td> <td></td> <td colspan="8" style="text-align: center;"> <table border="1" style="width: 100%; border-collapse: collapse; text-align: center;"> <tr> <td style="width: 10%;"></td> <td style="width: 10%;"></td> <td style="width: 10%;"></td> <td style="width: 10%;"></td> <td style="width: 10%;"></td> <td style="width: 10%;"></td> <td style="width: 10%;"></td> <td style="width: 10%;"></td> <td style="width: 10%;"></td> <td style="width: 10%;"></td> </tr> <tr> <td></td> <td></td> <td colspan="8" style="text-align: center;"> <table border="1" style="width: 100%; border-collapse: collapse; text-align: center;"> <tr> <td style="width: 10%;"></td> <td style="width: 10%;"></td> <td style="width: 10%;"></td> <td style="width: 10%;"></td> <td style="width: 10%;"></td> <td style="width: 10%;"></td> <td style="width: 10%;"></td> <td style="width: 10%;"></td> <td style="width: 10%;"></td> <td style="width: 10%;"></td> </tr> <tr> <td></td> <td></td> <td colspan="8" style="text-align: center;"> <table border="1" style="width: 100%; border-collapse: collapse; text-align: center;"> <tr> <td style="width: 10%;"></td> <td style="width: 10%;"></td> <td style="width: 10%;"></td> <td style="width: 10%;"></td> <td style="width: 10%;"></td> <td style="width: 10%;"></td> <td style="width: 10%;"></td> <td style="width: 10%;"></td> <td style="width: 10%;"></td> <td style="width: 10%;"></td> </tr> <tr> <td></td> <td></td> <td colspan="8" style="text-align: center;"> <table border="1" style="width: 100%; border-collapse: collapse; text-align: center;"> <tr> <td style="width: 10%;"></td> <td style="width: 10%;"></td> <td style="width: 10%;"></td> <td style="width: 10%;"></td> <td style="width: 10%;"></td> <td style="width: 10%;"></td> <td style="width: 10%;"></td> <td style="width: 10%;"></td> <td style="width: 10%;"></td> <td style="width: 10%;"></td> </tr> <tr> <td></td> <td></td> <td colspan="8" style="text-align: center;"> <table border="1" style="width: 100%; border-collapse: collapse; text-align: center;"> <tr> <td style="width: 10%;"></td> <td style="width: 10%;"></td> <td style="width: 10%;"></td> <td style="width: 10%;"></td> <td style="width: 10%;"></td> <td style="width: 10%;"></td> <td style="width: 10%;"></td> <td style="width: 10%;"></td> <td style="width: 10%;"></td> <td style="width: 10%;"></td> </tr> <tr> <td></td> <td></td> <td colspan="8" style="text-align: center;"> <table border="1" style="width: 100%; border-collapse: collapse; text-align: center;"> <tr> <td
style="width: 10%;"></td> <td style="width: 10%;"></td> <td style="width: 10%;"></td> <td style="width: 10%;"></td> <td style="width: 10%;"></td> <td style="width: 10%;"></td> <td style="width: 10%;"></td> <td style="width: 10%;"></td> <td style="width: 10%;"></td> <td style="width: 10%;"></td> </tr> <tr> <td></td> <td></td> <td colspan="8" style="text-align: center;"> <table border="1" style="width: 100%; border-collapse: collapse; text-align: center;"> <tr> <td style="width: 10%;"></td> <td style="width: 10%;"></td> <td style="width: 10%;"></td> <td style="width: 10%;"></td> <td style="width: 10%;"></td> <td style="width: 10%;"></td> <td style="width: 10%;"></td> <td style="width: 10%;"></td> <td style="width: 10%;"></td> <td style="width: 10%;"></td> </tr> <tr> <td></td> <td></td> <td colspan="8" style="text-align: center;"> <table border="1" style="width: 100%; border-collapse: collapse; text-align: center;"> <tr> <td style="width: 10%;"></td> <td style="width: 10%;"></td> <td style="width: 10%;"></td> <td style="width: 10%;"></td> <td style="width: 10%;"></td> <td style="width: 10%;"></td> <td style="width: 10%;"></td> <td style="width: 10%;"></td> <td style="width: 10%;"></td> <td style="width: 10%;"></td> </tr> <tr> <td></td> <td></td> <td colspan="8" style="text-align: center;"> <table border="1" style="width: 100%; border-collapse: collapse; text-align: center;"> <tr> <td style="width: 10%;"></td> <td style="width: 10%;"></td> <td style="width: 10%;"></td> <td style="width: 10%;"></td> <td style="width: 10%;"></td> <td style="width: 10%;"></td> <td style="width: 10%;"></td> <td style="width: 10%;"></td> <td style="width: 10%;"></td> <td style="width: 10%;"></td> </tr> <tr> <td></td> <td></td> <td colspan="8" style="text-align: center;"> <table border="1" style="width: 100%; border-collapse: collapse; text-align: center;"> <tr> <td style="width: 10%;"></td> <td style="width: 10%;"></td> <td style="width: 10%;"></td> <td style="width: 10%;"></td> <td style="width: 10%;"></td> <td style="width: 10%;"></td> <td style="width: 10%;"></td> <td style="width: 10%;"></td> <td style="width: 10%;"></td> <td style="width: 10%;"></td> </tr> <tr> <td></td> <td></td> <td colspan="8" style="text-align: center;"> <table border="1" style="width: 100%; border-collapse: collapse; text-align: center;"> <tr> <td style="width: 10%;"></td> <td style="width: 10%;"></td> <td style="width: 10%;"></td> <td style="width: 10%;"></td> <td style="width: 10%;"></td> <td style="width: 10%;"></td> <td style="width: 10%;"></td> <td style="width: 10%;"></td> <td style="width: 10%;"></td> <td style="width: 10%;"></td> </tr> <tr> <td></td> <td></td> <td colspan="8" style="text-align: center;"> <table border="1" style="width: 100%; border-collapse: collapse; text-align: center;"> <tr> <td style="width: 10%;"></td> <td style="width: 10%;"></td> <td style="width: 10%;"></td> <td style="width: 10%;"></td> <td style="width: 10%;"></td> <td style="width: 10%;"></td> <td style="width: 10%;"></td> <td style="width: 10%;"></td> <td style="width: 10%;"></td> <td style="width: 10%;"></td> </tr> <tr> <td></td> <td></td> <td colspan="8" style="text-align: center;"> <table border="1" style="width: 100%; border-collapse: collapse; text-align: center;"> <tr> <td style="width: 10%;"></td> <td style="width: 10%;"></td> <td style="width: 10%;"></td> <td style="width: 10%;"></td> <td style="width: 10%;"></td> <td style="width: 10%;"></td> <td style="width: 10%;"></td> <td style="width: 10%;"></td> <td style="width: 10%;"></td> <td style="width: 10%;"></td> </tr> <tr> <td></td> <td></td> <td colspan="8" style="text-align: center;"> <table border="1" style="width: 100%; border-collapse: collapse; text-align: center;"> <tr> <td style="width: 10%;"></td> <td style="width: 10%;"></td> <td style="width: 10%;"></td> <td style="width: 10%;"></td> <td style="width: 10%;"></td> <td style="width: 10%;"></td> <td style="width: 10%;"></td> <td style="width: 10%;"></td> <td style="width: 10%;"></td> <td style="width: 10%;"></td> </tr> <tr> <td></td> <td></td> <td colspan="8" style="text-align: center;"> <table border="1" style="width: 100%; border-collapse: collapse; text-align: center;"> <tr> <td style="width: 10%;"></td> <td style="width: 10%;"></td> <td style="width: 10%;"></td> <td style="width: 10%;"></td> <td style="width: 10%;"></td> <td style="width: 10%;"></td> <td style="width: 10%;"></td> <td style="width: 10%;"></td> <td style="width: 10%;"></td> <td style="width: 10%;"></td> </tr> <tr> <td></td> <td></td> <td colspan="8" style="text-align: center;"> <table border="1" style="width: 100%; border-collapse: collapse; text-align: center;"> <tr> <td style="width: 10%;"></td> <td style="width: 10%;"></td> <td style="width: 10%;"></td> <td style="width: 10%;"></td> <td style="width: 10%;"></td> <td style="width: 10%;"></td> <td style="width: 10%;"></td> <td style="width: 10%;"></td> <td style="width: 10%;"></td> <td style="width: 10%;"></td> </tr> <tr> <td></td> <td></td> <td colspan="8" style="text-align: center;"> <table border="1" style="width: 100%; border-collapse: collapse; text-align: center;"> <tr> <td style="width: 10%;"></td> <td style="width: 10%;"></td> <td style="width: 10%;"></td> <td style="width: 10%;"></td> <td style="width: 10%;"></td> <td style="width: 10%;"></td> <td style="width: 10%;"></td> <td style="width: 10%;"></td> <td style="width: 10%;"></td> <td style="width: 10%;"></td> </tr> <tr> <td></td> <td></td> <td colspan="8" style="text-align: center;"> <table border="1" style="width: 100%; border-collapse: collapse; text-align: center;"> <tr> <td style="width: 10%;"></td> <td style="width: 10%;"></td> <td style="width: 10%;"></td> <td style="width: 10%;"></td> <td style="width: 10%;"></td> <td style="width: 10%;"></td> <td style="width: 10%;"></td> <td style="width: 10%;"></td> <td style="width: 10%;"></td> <td style="width: 10%;"></td> </tr> <tr> <td></td> <td></td> <td colspan="8" style="text-align: center;"> <table border="1" style="width: 100%; border-collapse: collapse; text-align: center;"> <tr> <td style="width: 10%;"></td> <td style="width: 10%;"></td> <td style="width: 10%;"></td> <td style="width: 10%;"></td> <td style="width: 10%;"></td> <td style="width: 10%;"></td> <td style="width: 10%;"></td> <td style="width: 10%;"></td> <td style="width: 10%;"></td> <td style="width: 10%;"></td> </tr> <tr> <td></td> <td></td> <td colspan="8" style="text-align: center;"> <table border="1" style="width: 100%; border-collapse: collapse; text-align: center;"> <tr> <td style="width: 10%;"></td> <td style="width: 10%;"></td> <td style="width: 10%;"></td> <td style="width: 10%;"></td> <td style="width: 10%;"></td> <td style="width: 10%;"></td> <td style="width: 10%;"></td> <td style="width: 10%;"></td> <td style="width: 10%;"></td> <td style="width: 10%;"></td> </tr> <tr> <td></td> <td></td> <td colspan="8" style="text-align: center;"> <table border="1" style="width: 100%; border-collapse: collapse; text-align: center;"> <tr> <td style="width: 10%;"></td> <td style="width: 10%;"></td> <td style="width: 10%;"></td> <td style="width: 10%;"></td> <td style="width: 10%;"></td> <td style="width: 10%;"></td> <td style="width: 10%;"></td> <td style="width: 10%;"></td> <td style="width: 10%;"></td> <td style="width: 10%;"></td> </tr> <tr> <td></td> <td></td> <td colspan="8" style="text-align: center;"> <table border="1" style="width: 100%; border-collapse: collapse; text-align: center;"> <tr> <td style="width: 10%;"></td> <td style="width: 10%;"></td> <td style="width: 10%;"></td> <td style="width: 10%;"></td> <td style="width: 10%;"></td> <td style="width: 10%;"></td> <td style="width: 10%;"></td> <td style="width: 10%;"></td> <td style="width: 10%;"></td> <td style="width: 10%;"></td> </tr> <tr> <td></td> <td></td> <td colspan="8" style="text-align: center;"> <table border="1" style="width: 100%; border-collapse: collapse; text-align: center;"> <tr> <td style="width: 10%;"></td> <td style="width: 10%;"></td> <td style="width: 10%;"></td> <td style="width: 10%;"></td> <td style="width: 10%;"></td> <td style="width: 10%;"></td> <td style="width: 10%;"></td> <td style="width: 10%;"></td> <td style="width: 10%;"></td> <td style="width: 10%;"></td> </tr> <tr> <td></td> <td></td> <td colspan="8" style="text-align: center;"> <table border="1" style="width: 100%; border-collapse: collapse; text-align: center;"> <tr> <td style="width: 10%;"></td> <td style="width: 10%;"></td> <td style="width: 10%;"></td> <td style="width: 10%;"></td> <td style="width: 10%;"></td> <td style="width: 10%;"></td> <td style="width: 10%;"></td> <td style="width: 10%;"></td> <td style="width: 10%;"></td> <td style="width: 10%;"></td> </tr> <tr> <td></td> <td></td> <td colspan="8" style="text-align: center;"> <table border="1" style="width: 100%; border-collapse: collapse; text-align: center;"> <tr> <td style="width: 10%;"></td> <td style="width: 10%;"></td> <td style="width: 10%;"></td> <td style="width: 10%;"></td> <td style="width: 10%;"></td> <td style="width: 10%;"></td> <td style="width: 10%;"></td> <td style="width: 10%;"></td> <td style="width: 10%;"></td> <td style="width: 10%;"></td> </tr> <tr> <td></td> <td></td> <td colspan="8" style="text-align: center;"> <table border="1" style="width: 100%; border-collapse: collapse; text-align: center;"> <tr> <td style="width: 10%;"></td> <td style="width: 10%;"></td> <td style="width: 10%;"></td> <td style="width: 10%;"></td> <td style="width: 10%;"></td> <td style="width: 10%;"></td> <td style="width: 10%;"></td> <td style="width: 10%;"></td> <td style="width: 10%;"></td> <td style="width: 10%;"></td> </tr> <tr> <td></td> <td></td> <td colspan="8" style="text-align: center;"> <table border="1" style="width: 100%; border-collapse: collapse; text-align: center;"> <tr> <td style="width: 10%;"></td> <td style="width: 10%;"></td> <td style="width: 10%;"></td> <td style="width: 10%;"></td> <td style="width: 10%;"></td> <td style="width:
10%;"></td> <td style="width: 10%;"></td> <td style="width: 10%;"></td> <td style="width: 10%;"></td> <td style="width: 10%;"></td> </tr> <tr> <td></td> <td></td> <td colspan="8" style="text-align: center;"> <table border="1" style="width: 100%; border-collapse: collapse; text-align: center;"> <tr> <td style="width: 10%;"></td> <td style="width: 10%;"></td> <td style="width: 10%;"></td> <td style="width: 10%;"></td> <td style="width: 10%;"></td> <td style="width: 10%;"></td> <td style="width: 10%;"></td> <td style="width: 10%;"></td> <td style="width: 10%;"></td> <td style="width: 10%;"></td> </tr> <tr> <td></td> <td></td> <td colspan="8" style="text-align: center;"> <table border="1" style="width: 100%; border-collapse: collapse; text-align: center;"> <tr> <td style="width: 10%;"></td> <td style="width: 10%;"></td> <td style="width: 10%;"></td> <td style="width: 10%;"></td> <td style="width: 10%;"></td> <td style="width: 10%;"></td> <td style="width: 10%;"></td> <td style="width: 10%;"></td> <td style="width: 10%;"></td> <td style="width: 10%;"></td> </tr> <tr> <td></td> <td></td> <td colspan="8" style="text-align: center;"> <table border="1" style="width: 100%; border-collapse: collapse; text-align: center;"> <tr> </tr></table></td></tr></table></td></tr></table></td></tr></table></td></tr></table></td></tr></table></td></tr></table></td></tr></table></td></tr></table></td></tr></table></td></tr></table></td></tr></table></td></tr></table></td></tr></table></td></tr></table></td></tr></table></td></tr></table></td></tr></table></td></tr></table></td></tr></table></td></tr></table></td></tr></table></td></tr></table></td></tr></table></td></tr></table></td></tr></table></td></tr></table></td></tr></table></td></tr></table></td></tr></table></td></tr></table></td></tr></table></td></tr></table></td></tr></table></td></tr></table></td></tr></table></td></tr></table></td></tr></table></td></tr></table></td></tr></table></td></tr></table></td></tr></table></td></tr></table></td></tr></table></td></tr></table></td></tr></table></td></tr></table></td></tr></table></td></tr></table></td></tr></table></td></tr></table></td></tr></table></td></tr></table></td></tr></table></td></tr></table></td></tr></table></td></tr></table></td></tr></table></td></tr></table></td></tr></table></td></tr></table></td></tr></table></td></tr></table> | | | | | | | | | | | | | | | | | | | | <table border="1" style="width: 100%; border-collapse: collapse; text-align: center;"> <tr> <td style="width: 10%;"></td> <td style="width: 10%;"></td> <td style="width: 10%;"></td> <td style="width: 10%;"></td> <td style="width: 10%;"></td> <td style="width: 10%;"></td> <td style="width: 10%;"></td> <td style="width: 10%;"></td> <td style="width: 10%;"></td> <td style="width: 10%;"></td> </tr> <tr> <td></td> <td></td> <td colspan="8" style="text-align: center;"> <table border="1" style="width: 100%; border-collapse: collapse; text-align: center;"> <tr> <td style="width: 10%;"></td> <td style="width: 10%;"></td> <td style="width: 10%;"></td> <td style="width: 10%;"></td> <td style="width: 10%;"></td> <td style="width: 10%;"></td> <td style="width: 10%;"></td> <td style="width: 10%;"></td> <td style="width: 10%;"></td> <td style="width: 10%;"></td> </tr> <tr> <td></td> <td></td> <td colspan="8" style="text-align: center;"> <table border="1" style="width: 100%; border-collapse: collapse; text-align: center;"> <tr> <td style="width: 10%;"></td> <td style="width: 10%;"></td> <td style="width: 10%;"></td> <td style="width: 10%;"></td> <td style="width: 10%;"></td> <td style="width: 10%;"></td> <td style="width: 10%;"></td> <td style="width: 10%;"></td> <td style="width: 10%;"></td> <td style="width: 10%;"></td> </tr> <tr> <td></td> <td></td> <td colspan="8" style="text-align: center;"> <table border="1" style="width: 100%; border-collapse: collapse; text-align: center;"> <tr> <td style="width: 10%;"></td> <td style="width: 10%;"></td> <td style="width: 10%;"></td> <td style="width: 10%;"></td> <td style="width: 10%;"></td> <td style="width: 10%;"></td> <td style="width: 10%;"></td> <td style="width: 10%;"></td> <td style="width: 10%;"></td> <td style="width: 10%;"></td> </tr> <tr> <td></td> <td></td> <td colspan="8" style="text-align: center;"> <table border="1" style="width: 100%; border-collapse: collapse; text-align: center;"> <tr> <td style="width: 10%;"></td> <td style="width: 10%;"></td> <td style="width: 10%;"></td> <td style="width: 10%;"></td> <td style="width: 10%;"></td> <td style="width: 10%;"></td> <td style="width: 10%;"></td> <td style="width: 10%;"></td> <td style="width: 10%;"></td> <td style="width: 10%;"></td> </tr> <tr> <td></td> <td></td> <td colspan="8" style="text-align: center;"> <table border="1" style="width: 100%; border-collapse: collapse; text-align: center;"> <tr> <td style="width: 10%;"></td> <td style="width: 10%;"></td> <td style="width: 10%;"></td> <td style="width: 10%;"></td> <td style="width: 10%;"></td> <td style="width: 10%;"></td> <td style="width: 10%;"></td> <td style="width: 10%;"></td> <td style="width: 10%;"></td> <td style="width: 10%;"></td> </tr> <tr> <td></td> <td></td> <td colspan="8" style="text-align: center;"> <table border="1" style="width: 100%; border-collapse: collapse; text-align: center;"> <tr> <td style="width: 10%;"></td> <td style="width: 10%;"></td> <td style="width: 10%;"></td> <td style="width: 10%;"></td> <td style="width: 10%;"></td> <td style="width: 10%;"></td> <td style="width: 10%;"></td> <td style="width: 10%;"></td> <td style="width: 10%;"></td> <td style="width: 10%;"></td> </tr> <tr> <td></td> <td></td> <td colspan="8" style="text-align: center;"> <table border="1" style="width: 100%; border-collapse: collapse; text-align: center;"> <tr> <td style="width: 10%;"></td> <td style="width: 10%;"></td> <td style="width: 10%;"></td> <td style="width: 10%;"></td> <td style="width: 10%;"></td> <td style="width: 10%;"></td> <td style="width: 10%;"></td> <td style="width: 10%;"></td> <td style="width: 10%;"></td> <td style="width: 10%;"></td> </tr> <tr> <td></td> <td></td> <td colspan="8" style="text-align: center;"> <table border="1" style="width: 100%; border-collapse: collapse; text-align: center;"> <tr> <td style="width: 10%;"></td> <td style="width: 10%;"></td> <td style="width: 10%;"></td> <td style="width: 10%;"></td> <td style="width: 10%;"></td> <td style="width: 10%;"></td> <td style="width: 10%;"></td> <td style="width: 10%;"></td> <td style="width: 10%;"></td> <td style="width: 10%;"></td> </tr> <tr> <td></td> <td></td> <td colspan="8" style="text-align: center;"> <table border="1" style="width: 100%; border-collapse: collapse; text-align: center;"> <tr> <td style="width: 10%;"></td> <td style="width: 10%;"></td> <td style="width: 10%;"></td> <td style="width: 10%;"></td> <td style="width: 10%;"></td> <td style="width: 10%;"></td> <td style="width: 10%;"></td> <td style="width: 10%;"></td> <td style="width: 10%;"></td> <td style="width: 10%;"></td> </tr> <tr> <td></td> <td></td> <td colspan="8" style="text-align: center;"> <table border="1" style="width: 100%; border-collapse: collapse; text-align: center;"> <tr> <td style="width: 10%;"></td> <td style="width: 10%;"></td> <td style="width: 10%;"></td> <td style="width: 10%;"></td> <td style="width: 10%;"></td> <td style="width: 10%;"></td> <td style="width: 10%;"></td> <td style="width: 10%;"></td> <td style="width: 10%;"></td> <td style="width: 10%;"></td> </tr> <tr> <td></td> <td></td> <td colspan="8" style="text-align: center;"> <table border="1" style="width: 100%; border-collapse: collapse; text-align: center;"> <tr> <td style="width: 10%;"></td> <td style="width: 10%;"></td> <td style="width: 10%;"></td> <td style="width: 10%;"></td> <td style="width: 10%;"></td> <td style="width: 10%;"></td> <td style="width: 10%;"></td> <td style="width: 10%;"></td> <td style="width: 10%;"></td> <td style="width: 10%;"></td> </tr> <tr> <td></td> <td></td> <td colspan="8" style="text-align: center;"> <table border="1" style="width: 100%; border-collapse: collapse; text-align: center;"> <tr> <td style="width: 10%;"></td> <td style="width: 10%;"></td> <td style="width: 10%;"></td> <td style="width: 10%;"></td> <td style="width: 10%;"></td> <td style="width: 10%;"></td> <td style="width: 10%;"></td> <td style="width: 10%;"></td> <td style="width: 10%;"></td> <td style="width: 10%;"></td> </tr> <tr> <td></td> <td></td> <td colspan="8" style="text-align: center;"> <table border="1" style="width: 100%; border-collapse: collapse; text-align: center;"> <tr> <td style="width: 10%;"></td> <td style="width: 10%;"></td> <td style="width: 10%;"></td> <td style="width: 10%;"></td> <td style="width: 10%;"></td> <td style="width: 10%;"></td> <td style="width: 10%;"></td> <td style="width: 10%;"></td> <td style="width: 10%;"></td> <td style="width: 10%;"></td> </tr> <tr> <td></td> <td></td> <td colspan="8" style="text-align: center;"> <table border="1" style="width: 100%; border-collapse: collapse; text-align: center;"> <tr> <td style="width: 10%;"></td> <td style="width: 10%;"></td> <td style="width: 10%;"></td> <td style="width: 10%;"></td> <td style="width: 10%;"></td> <td style="width: 10%;"></td> <td style="width: 10%;"></td> <td style="width: 10%;"></td> <td style="width: 10%;"></td> <td style="width: 10%;"></td> </tr> <tr> <td></td> <td></td> <td colspan="8" style="text-align: center;"> <table border="1" style="width: 100%; border-collapse: collapse; text-align: center;"> <tr> <td style="width: 10%;"></td> <td style="width: 10%;"></td> <td style="width: 10%;"></td> <td style="width: 10%;"></td> <td style="width: 10%;"></td> <td style="width: 10%;"></td> <td style="width: 10%;"></td> <td style="width: 10%;"></td> <td style="width: 10%;"></td> <td style="width: 10%;"></td> </tr> <tr> <td></td> <td></td> <td colspan="8" style="text-align: center;"> <table border="1" style="width: 100%; border-collapse: collapse; text-align: center;">
<tr> <td style="width: 10%;"></td> <td style="width: 10%;"></td> <td style="width: 10%;"></td> <td style="width: 10%;"></td> <td style="width: 10%;"></td> <td style="width: 10%;"></td> <td style="width: 10%;"></td> <td style="width: 10%;"></td> <td style="width: 10%;"></td> <td style="width: 10%;"></td> </tr> <tr> <td></td> <td></td> <td colspan="8" style="text-align: center;"> <table border="1" style="width: 100%; border-collapse: collapse; text-align: center;"> <tr> <td style="width: 10%;"></td> <td style="width: 10%;"></td> <td style="width: 10%;"></td> <td style="width: 10%;"></td> <td style="width: 10%;"></td> <td style="width: 10%;"></td> <td style="width: 10%;"></td> <td style="width: 10%;"></td> <td style="width: 10%;"></td> <td style="width: 10%;"></td> </tr> <tr> <td></td> <td></td> <td colspan="8" style="text-align: center;"> <table border="1" style="width: 100%; border-collapse: collapse; text-align: center;"> <tr> <td style="width: 10%;"></td> <td style="width: 10%;"></td> <td style="width: 10%;"></td> <td style="width: 10%;"></td> <td style="width: 10%;"></td> <td style="width: 10%;"></td> <td style="width: 10%;"></td> <td style="width: 10%;"></td> <td style="width: 10%;"></td> <td style="width: 10%;"></td> </tr> <tr> <td></td> <td></td> <td colspan="8" style="text-align: center;"> <table border="1" style="width: 100%; border-collapse: collapse; text-align: center;"> <tr> <td style="width: 10%;"></td> <td style="width: 10%;"></td> <td style="width: 10%;"></td> <td style="width: 10%;"></td> <td style="width: 10%;"></td> <td style="width: 10%;"></td> <td style="width: 10%;"></td> <td style="width: 10%;"></td> <td style="width: 10%;"></td> <td style="width: 10%;"></td> </tr> <tr> <td></td> <td></td> <td colspan="8" style="text-align: center;"> <table border="1" style="width: 100%; border-collapse: collapse; text-align: center;"> <tr> <td style="width: 10%;"></td> <td style="width: 10%;"></td> <td style="width: 10%;"></td> <td style="width: 10%;"></td> <td style="width: 10%;"></td> <td style="width: 10%;"></td> <td style="width: 10%;"></td> <td style="width: 10%;"></td> <td style="width: 10%;"></td> <td style="width: 10%;"></td> </tr> <tr> <td></td> <td></td> <td colspan="8" style="text-align: center;"> <table border="1" style="width: 100%; border-collapse: collapse; text-align: center;"> <tr> <td style="width: 10%;"></td> <td style="width: 10%;"></td> <td style="width: 10%;"></td> <td style="width: 10%;"></td> <td style="width: 10%;"></td> <td style="width: 10%;"></td> <td style="width: 10%;"></td> <td style="width: 10%;"></td> <td style="width: 10%;"></td> <td style="width: 10%;"></td> </tr> <tr> <td></td> <td></td> <td colspan="8" style="text-align: center;"> <table border="1" style="width: 100%; border-collapse: collapse; text-align: center;"> <tr> <td style="width: 10%;"></td> <td style="width: 10%;"></td> <td style="width: 10%;"></td> <td style="width: 10%;"></td> <td style="width: 10%;"></td> <td style="width: 10%;"></td> <td style="width: 10%;"></td> <td style="width: 10%;"></td> <td style="width: 10%;"></td> <td style="width: 10%;"></td> </tr> <tr> <td></td> <td></td> <td colspan="8" style="text-align: center;"> <table border="1" style="width: 100%; border-collapse: collapse; text-align: center;"> <tr> <td style="width: 10%;"></td> <td style="width: 10%;"></td> <td style="width: 10%;"></td> <td style="width: 10%;"></td> <td style="width: 10%;"></td> <td style="width: 10%;"></td> <td style="width: 10%;"></td> <td style="width: 10%;"></td> <td style="width: 10%;"></td> <td style="width: 10%;"></td> </tr> <tr> <td></td> <td></td> <td colspan="8" style="text-align: center;"> <table border="1" style="width: 100%; border-collapse: collapse; text-align: center;"> <tr> <td style="width: 10%;"></td> <td style="width: 10%;"></td> <td style="width: 10%;"></td> <td style="width: 10%;"></td> <td style="width: 10%;"></td> <td style="width: 10%;"></td> <td style="width: 10%;"></td> <td style="width: 10%;"></td> <td style="width: 10%;"></td> <td style="width: 10%;"></td> </tr> <tr> <td></td> <td></td> <td colspan="8" style="text-align: center;"> <table border="1" style="width: 100%; border-collapse: collapse; text-align: center;"> <tr> <td style="width: 10%;"></td> <td style="width: 10%;"></td> <td style="width: 10%;"></td> <td style="width: 10%;"></td> <td style="width: 10%;"></td> <td style="width: 10%;"></td> <td style="width: 10%;"></td> <td style="width: 10%;"></td> <td style="width: 10%;"></td> <td style="width: 10%;"></td> </tr> <tr> <td></td> <td></td> <td colspan="8" style="text-align: center;"> <table border="1" style="width: 100%; border-collapse: collapse; text-align: center;"> <tr> <td style="width: 10%;"></td> <td style="width: 10%;"></td> <td style="width: 10%;"></td> <td style="width: 10%;"></td> <td style="width: 10%;"></td> <td style="width: 10%;"></td> <td style="width: 10%;"></td> <td style="width: 10%;"></td> <td style="width: 10%;"></td> <td style="width: 10%;"></td> </tr> <tr> <td></td> <td></td> <td colspan="8" style="text-align: center;"> <table border="1" style="width: 100%; border-collapse: collapse; text-align: center;"> <tr> <td style="width: 10%;"></td> <td style="width: 10%;"></td> <td style="width: 10%;"></td> <td style="width: 10%;"></td> <td style="width: 10%;"></td> <td style="width: 10%;"></td> <td style="width: 10%;"></td> <td style="width: 10%;"></td> <td style="width: 10%;"></td> <td style="width: 10%;"></td> </tr> <tr> <td></td> <td></td> <td colspan="8" style="text-align: center;"> <table border="1" style="width: 100%; border-collapse: collapse; text-align: center;"> <tr> <td style="width: 10%;"></td> <td style="width: 10%;"></td> <td style="width: 10%;"></td> <td style="width: 10%;"></td> <td style="width: 10%;"></td> <td style="width: 10%;"></td> <td style="width: 10%;"></td> <td style="width: 10%;"></td> <td style="width: 10%;"></td> <td style="width: 10%;"></td> </tr> <tr> <td></td> <td></td> <td colspan="8" style="text-align: center;"> <table border="1" style="width: 100%; border-collapse: collapse; text-align: center;"> <tr> <td style="width: 10%;"></td> <td style="width: 10%;"></td> <td style="width: 10%;"></td> <td style="width: 10%;"></td> <td style="width: 10%;"></td> <td style="width: 10%;"></td> <td style="width: 10%;"></td> <td style="width: 10%;"></td> <td style="width: 10%;"></td> <td style="width: 10%;"></td> </tr> <tr> <td></td> <td></td> <td colspan="8" style="text-align: center;"> <table border="1" style="width: 100%; border-collapse: collapse; text-align: center;"> <tr> <td style="width: 10%;"></td> <td style="width: 10%;"></td> <td style="width: 10%;"></td> <td style="width: 10%;"></td> <td style="width: 10%;"></td> <td style="width: 10%;"></td> <td style="width: 10%;"></td> <td style="width: 10%;"></td> <td style="width: 10%;"></td> <td style="width: 10%;"></td> </tr> <tr> <td></td> <td></td> <td colspan="8" style="text-align: center;"> <table border="1" style="width: 100%; border-collapse: collapse; text-align: center;"> <tr> <td style="width: 10%;"></td> <td style="width: 10%;"></td> <td style="width: 10%;"></td> <td style="width: 10%;"></td> <td style="width: 10%;"></td> <td style="width: 10%;"></td> <td style="width: 10%;"></td> <td style="width: 10%;"></td> <td style="width: 10%;"></td> <td style="width: 10%;"></td> </tr> <tr> <td></td> <td></td> <td colspan="8" style="text-align: center;"> <table border="1" style="width: 100%; border-collapse: collapse; text-align: center;"> <tr> <td style="width: 10%;"></td> <td style="width: 10%;"></td> <td style="width: 10%;"></td> <td style="width: 10%;"></td> <td style="width: 10%;"></td> <td style="width: 10%;"></td> <td style="width: 10%;"></td> <td style="width: 10%;"></td> <td style="width: 10%;"></td> <td style="width: 10%;"></td> </tr> <tr> <td></td> <td></td> <td colspan="8" style="text-align: center;"> <table border="1" style="width: 100%; border-collapse: collapse; text-align: center;"> <tr> <td style="width: 10%;"></td> <td style="width: 10%;"></td> <td style="width: 10%;"></td> <td style="width: 10%;"></td> <td style="width: 10%;"></td> <td style="width: 10%;"></td> <td style="width: 10%;"></td> <td style="width: 10%;"></td> <td style="width: 10%;"></td> <td style="width: 10%;"></td> </tr> <tr> <td></td> <td></td> <td colspan="8" style="text-align: center;"> <table border="1" style="width: 100%; border-collapse: collapse; text-align: center;"> <tr> <td style="width: 10%;"></td> <td style="width: 10%;"></td> <td style="width: 10%;"></td> <td style="width: 10%;"></td> <td style="width: 10%;"></td> <td style="width: 10%;"></td> <td style="width: 10%;"></td> <td style="width: 10%;"></td> <td style="width: 10%;"></td> <td style="width: 10%;"></td> </tr> <tr> <td></td> <td></td> <td colspan="8" style="text-align: center;"> <table border="1" style="width: 100%; border-collapse: collapse; text-align: center;"> <tr> <td style="width: 10%;"></td> <td style="width: 10%;"></td> <td style="width: 10%;"></td> <td style="width: 10%;"></td> <td style="width: 10%;"></td> <td style="width: 10%;"></td> <td style="width: 10%;"></td> <td style="width: 10%;"></td> <td style="width: 10%;"></td> <td style="width: 10%;"></td> </tr> <tr> <td></td> <td></td> <td colspan="8" style="text-align: center;"> <table border="1" style="width: 100%; border-collapse: collapse; text-align: center;"> <tr> <td style="width: 10%;"></td> <td style="width: 10%;"></td> <td style="width: 10%;"></td> <td style="width: 10%;"></td> <td style="width: 10%;"></td> <td style="width: 10%;"></td> <td style="width: 10%;"></td> <td style="width: 10%;"></td> <td style="width: 10%;"></td> <td style="width: 10%;"></td> </tr> <tr> <td></td> <td></td> <td colspan="8" style="text-align: center;"> <table border="1" style="width: 100%; border-collapse: collapse; text-align: center;"> <tr> <td style="width: 10%;"></td> <td style="width: 10%;"></td> <td style="width: 10%;"></td> <td style="width: 10%;"></td> <td style="width: 10%;"></td> <td
style="width: 10%;"></td> <td style="width: 10%;"></td> <td style="width: 10%;"></td> <td style="width: 10%;"></td> <td style="width: 10%;"></td> </tr> <tr> <td></td> <td></td> <td colspan="8" style="text-align: center;"> <table border="1" style="width: 100%; border-collapse: collapse; text-align: center;"> <tr> <td style="width: 10%;"></td> <td style="width: 10%;"></td> <td style="width: 10%;"></td> <td style="width: 10%;"></td> <td style="width: 10%;"></td> <td style="width: 10%;"></td> <td style="width: 10%;"></td> <td style="width: 10%;"></td> <td style="width: 10%;"></td> <td style="width: 10%;"></td> </tr> <tr> <td></td> <td></td> <td colspan="8" style="text-align: center;"> <table border="1" style="width: 100%; border-collapse: collapse; text-align: center;"> <tr> <td style="width: 10%;"></td> <td style="width: 10%;"></td> <td style="width: 10%;"></td> <td style="width: 10%;"></td> <td style="width: 10%;"></td> <td style="width: 10%;"></td> <td style="width: 10%;"></td> <td style="width: 10%;"></td> <td style="width: 10%;"></td> <td style="width: 10%;"></td> </tr> <tr> <td></td> <td></td> <td colspan="8" style="text-align: center;"> <table border="1" style="width: 100%; border-collapse: collapse; text-align: center;"> <tr> <td style="width: 10%;"></td> <td style="width: 10%;"></td> <td style="width: 10%;"></td> <td style="width: 10%;"></td> <td style="width: 10%;"></td> <td style="width: 10%;"></td> <td style="width: 10%;"></td> <td style="width: 10%;"></td> <td style="width: 10%;"></td> <td style="width: 10%;"></td> </tr> <tr> <td></td> <td></td> <td colspan="8" style="text-align: center;"> <table border="1" style="width: 100%; border-collapse: collapse; text-align: center;"> <tr> <td style="width: 10%;"></td> <td style="width: 10%;"></td> <td style="width: 10%;"></td> <td style="width: 10%;"></td> <td style="width: 10%;"></td> <td style="width: 10%;"></td> <td style="width: 10%;"></td> <td style="width: 10%;"></td> <td style="width: 10%;"></td> <td style="width: 10%;"></td> </tr> <tr> <td></td> <td></td> <td colspan="8" style="text-align: center;"> <table border="1" style="width: 100%; border-collapse: collapse; text-align: center;"> <tr> <td style="width: 10%;"></td> <td style="width: 10%;"></td> <td style="width: 10%;"></td> <td style="width: 10%;"></td> <td style="width: 10%;"></td> <td style="width: 10%;"></td> <td style="width: 10%;"></td> <td style="width: 10%;"></td> <td style="width: 10%;"></td> <td style="width: 10%;"></td> </tr> <tr> <td></td> <td></td> <td colspan="8" style="text-align: center;"> <table border="1" style="width: 100%; border-collapse: collapse; text-align: center;"> <tr> <td style="width: 10%;"></td> <td style="width: 10%;"></td> <td style="width: 10%;"></td> <td style="width: 10%;"></td> <td style="width: 10%;"></td> <td style="width: 10%;"></td> <td style="width: 10%;"></td> <td style="width: 10%;"></td> <td style="width: 10%;"></td> <td style="width: 10%;"></td> </tr> <tr> <td></td> <td></td> <td colspan="8" style="text-align: center;"> <table border="1" style="width: 100%; border-collapse: collapse; text-align: center;"> <tr> <td style="width: 10%;"></td> <td style="width: 10%;"></td> <td style="width: 10%;"></td> <td style="width: 10%;"></td> <td style="width: 10%;"></td> <td style="width: 10%;"></td> <td style="width: 10%;"></td> <td style="width: 10%;"></td> <td style="width: 10%;"></td> <td style="width: 10%;"></td> </tr> <tr> <td></td> <td></td> <td colspan="8" style="text-align: center;"> <table border="1" style="width: 100%; border-collapse: collapse; text-align: center;"> <tr> <td style="width: 10%;"></td> <td style="width: 10%;"></td> <td style="width: 10%;"></td> <td style="width: 10%;"></td> <td style="width: 10%;"></td> <td style="width: 10%;"></td> <td style="width: 10%;"></td> <td style="width: 10%;"></td> <td style="width: 10%;"></td> <td style="width: 10%;"></td> </tr> <tr> <td></td> <td></td> <td colspan="8" style="text-align: center;"> <table border="1" style="width: 100%; border-collapse: collapse; text-align: center;"> <tr> <td style="width: 10%;"></td> <td style="width: 10%;"></td> <td style="width: 10%;"></td> <td style="width: 10%;"></td> <td style="width: 10%;"></td> <td style="width: 10%;"></td> <td style="width: 10%;"></td> <td style="width: 10%;"></td> <td style="width: 10%;"></td> <td style="width: 10%;"></td> </tr> <tr> <td></td> <td></td> <td colspan="8" style="text-align: center;"> <table border="1" style="width: 100%; border-collapse: collapse; text-align: center;"> <tr> <td style="width: 10%;"></td> <td style="width: 10%;"></td> <td style="width: 10%;"></td> <td style="width: 10%;"></td> <td style="width: 10%;"></td> <td style="width: 10%;"></td> <td style="width: 10%;"></td> <td style="width: 10%;"></td> <td style="width: 10%;"></td> <td style="width: 10%;"></td> </tr> <tr> <td></td> <td></td> <td colspan="8" style="text-align: center;"> <table border="1" style="width: 100%; border-collapse: collapse; text-align: center;"> <tr> <td style="width: 10%;"></td> <td style="width: 10%;"></td> <td style="width: 10%;"></td> <td style="width: 10%;"></td> <td style="width: 10%;"></td> <td style="width: 10%;"></td> <td style="width: 10%;"></td> <td style="width: 10%;"></td> <td style="width: 10%;"></td> <td style="width: 10%;"></td> </tr> <tr> <td></td> <td></td> <td colspan="8" style="text-align: center;"> <table border="1" style="width: 100%; border-collapse: collapse; text-align: center;"> <tr> <td style="width: 10%;"></td> <td style="width: 10%;"></td> <td style="width: 10%;"></td> <td style="width: 10%;"></td> <td style="width: 10%;"></td> <td style="width: 10%;"></td> <td style="width: 10%;"></td> <td style="width: 10%;"></td> <td style="width: 10%;"></td> <td style="width: 10%;"></td> </tr> <tr> <td></td> <td></td> <td colspan="8" style="text-align: center;"> <table border="1" style="width: 100%; border-collapse: collapse; text-align: center;"> <tr> <td style="width: 10%;"></td> <td style="width: 10%;"></td> <td style="width: 10%;"></td> <td style="width: 10%;"></td> <td style="width: 10%;"></td> <td style="width: 10%;"></td> <td style="width: 10%;"></td> <td style="width: 10%;"></td> <td style="width: 10%;"></td> <td style="width: 10%;"></td> </tr> <tr> <td></td> <td></td> <td colspan="8" style="text-align: center;"> <table border="1" style="width: 100%; border-collapse: collapse; text-align: center;"> <tr> <td style="width: 10%;"></td> <td style="width: 10%;"></td> <td style="width: 10%;"></td> <td style="width: 10%;"></td> <td style="width: 10%;"></td> <td style="width: 10%;"></td> <td style="width: 10%;"></td> <td style="width: 10%;"></td> <td style="width: 10%;"></td> <td style="width: 10%;"></td> </tr> <tr> <td></td> <td></td> <td colspan="8" style="text-align: center;"> <table border="1" style="width: 100%; border-collapse: collapse; text-align: center;"> <tr> <td style="width: 10%;"></td> <td style="width: 10%;"></td> <td style="width: 10%;"></td> <td style="width: 10%;"></td> <td style="width: 10%;"></td> <td style="width: 10%;"></td> <td style="width: 10%;"></td> <td style="width: 10%;"></td> <td style="width: 10%;"></td> <td style="width: 10%;"></td> </tr> <tr> <td></td> <td></td> <td colspan="8" style="text-align: center;"> <table border="1" style="width: 100%; border-collapse: collapse; text-align: center;"> <tr> <td style="width: 10%;"></td> <td style="width: 10%;"></td> <td style="width: 10%;"></td> <td style="width: 10%;"></td> <td style="width: 10%;"></td> <td style="width: 10%;"></td> <td style="width: 10%;"></td> <td style="width: 10%;"></td> <td style="width: 10%;"></td> <td style="width: 10%;"></td> </tr> <tr> <td></td> <td></td> <td colspan="8" style="text-align: center;"> <table border="1" style="width: 100%; border-collapse: collapse; text-align: center;"> <tr> <td style="width: 10%;"></td> <td style="width: 10%;"></td> <td style="width: 10%;"></td> <td style="width: 10%;"></td> <td style="width: 10%;"></td> <td style="width: 10%;"></td> <td style="width: 10%;"></td> <td style="width: 10%;"></td> <td style="width: 10%;"></td> <td style="width: 10%;"></td> </tr> <tr> <td></td> <td></td> <td colspan="8" style="text-align: center;"> <table border="1" style="width: 100%; border-collapse: collapse; text-align: center;"> <tr> <td style="width: 10%;"></td> <td style="width: 10%;"></td> <td style="width: 10%;"></td> <td style="width: 10%;"></td> <td style="width: 10%;"></td> <td style="width: 10%;"></td> <td style="width: 10%;"></td> <td style="width: 10%;"></td> <td style="width: 10%;"></td> <td style="width: 10%;"></td> </tr> <tr> <td></td> <td></td> <td colspan="8" style="text-align: center;"> <table border="1" style="width: 100%; border-collapse: collapse; text-align: center;"> <tr> <td style="width: 10%;"></td> <td style="width: 10%;"></td> <td style="width: 10%;"></td> <td style="width: 10%;"></td> <td style="width: 10%;"></td> <td style="width: 10%;"></td> <td style="width: 10%;"></td> <td style="width: 10%;"></td> <td style="width: 10%;"></td> <td style="width: 10%;"></td> </tr> <tr> <td></td> <td></td> <td colspan="8" style="text-align: center;"> <table border="1" style="width: 100%; border-collapse: collapse; text-align: center;"> <tr> <td style="width: 10%;"></td> <td style="width: 10%;"></td> <td style="width: 10%;"></td> <td style="width: 10%;"></td> <td style="width: 10%;"></td> <td style="width: 10%;"></td> <td style="width: 10%;"></td> <td style="width: 10%;"></td> <td style="width: 10%;"></td> <td style="width: 10%;"></td> </tr> <tr> <td></td> <td></td> <td colspan="8" style="text-align: center;"> <table border="1" style="width: 100%; border-collapse: collapse; text-align: center;"> <tr> <td style="width: 10%;"></td> <td style="width: 10%;"></td> <td style="width: 10%;"></td> <td style="width: 10%;"></td> <td style="width: 10%;"></td> <td style="width: 10%;"></td> <td style="width: 10%;"></td> <td style="width: 10%;"></td> <td style="width: 10%;"></td> <td style="width: 10%;"></td> </tr> <tr> <td></td>
<td></td> <td colspan="8" style="text-align: center;"> <table border="1" style="width: 100%; border-collapse: collapse; text-align: center;"> <tr> <td style="width: 10%;"></td> <td style="width: 10%;"></td> <td style="width: 10%;"></td> <td style="width: 10%;"></td> <td style="width: 10%;"></td> <td style="width: 10%;"></td> <td style="width: 10%;"></td> <td style="width: 10%;"></td> <td style="width: 10%;"></td> <td style="width: 10%;"></td> </tr> <tr> <td></td> <td></td> <td colspan="8" style="text-align: center;"> <table border="1" style="width: 100%; border-collapse: collapse; text-align: center;"> <tr> <td style="width: 10%;"></td> <td style="width: 10%;"></td> <td style="width: 10%;"></td> <td style="width: 10%;"></td> <td style="width: 10%;"></td> <td style="width: 10%;"></td> <td style="width: 10%;"></td> <td style="width: 10%;"></td> <td style="width: 10%;"></td> <td style="width: 10%;"></td> </tr> <tr> <td></td> <td></td> <td colspan="8" style="text-align: center;"> <table border="1" style="width: 100%; border-collapse: collapse; text-align: center;"> <tr> </tr></table></td></tr></table></td></tr></table></td></tr></table></td></tr></table></td></tr></table></td></tr></table></td></tr></table></td></tr></table></td></tr></table></td></tr></table></td></tr></table></td></tr></table></td></tr></table></td></tr></table></td></tr></table></td></tr></table></td></tr></table></td></tr></table></td></tr></table></td></tr></table></td></tr></table></td></tr></table></td></tr></table></td></tr></table></td></tr></table></td></tr></table></td></tr></table></td></tr></table></td></tr></table></td></tr></table></td></tr></table></td></tr></table></td></tr></table></td></tr></table></td></tr></table></td></tr></table></td></tr></table></td></tr></table></td></tr></table></td></tr></table></td></tr></table></td></tr></table></td></tr></table></td></tr></table></td></tr></table></td></tr></table></td></tr></table></td></tr></table></td></tr></table></td></tr></table></td></tr></table></td></tr></table></td></tr></table></td></tr></table></td></tr></table></td></tr></table></td></tr></table></td></tr></table></td></tr></table></td></tr></table></td></tr></table> | | | | | | | | | | | | | | | | | | | | <table border="1" style="width: 100%; border-collapse: collapse; text-align: center;"> <tr> <td style="width: 10%;"></td> <td style="width: 10%;"></td> <td style="width: 10%;"></td> <td style="width: 10%;"></td> <td style="width: 10%;"></td> <td style="width: 10%;"></td> <td style="width: 10%;"></td> <td style="width: 10%;"></td> <td style="width: 10%;"></td> <td style="width: 10%;"></td> </tr> <tr> <td></td> <td></td> <td colspan="8" style="text-align: center;"> <table border="1" style="width: 100%; border-collapse: collapse; text-align: center;"> <tr> <td style="width: 10%;"></td> <td style="width: 10%;"></td> <td style="width: 10%;"></td> <td style="width: 10%;"></td> <td style="width: 10%;"></td> <td style="width: 10%;"></td> <td style="width: 10%;"></td> <td style="width: 10%;"></td> <td style="width: 10%;"></td> <td style="width: 10%;"></td> </tr> <tr> <td></td> <td></td> <td colspan="8" style="text-align: center;"> <table border="1" style="width: 100%; border-collapse: collapse; text-align: center;"> <tr> <td style="width: 10%;"></td> <td style="width: 10%;"></td> <td style="width: 10%;"></td> <td style="width: 10%;"></td> <td style="width: 10%;"></td> <td style="width: 10%;"></td> <td style="width: 10%;"></td> <td style="width: 10%;"></td> <td style="width: 10%;"></td> <td style="width: 10%;"></td> </tr> <tr> <td></td> <td></td> <td colspan="8" style="text-align: center;"> <table border="1" style="width: 100%; border-collapse: collapse; text-align: center;"> <tr> <td style="width: 10%;"></td> <td style="width: 10%;"></td> <td style="width: 10%;"></td> <td style="width: 10%;"></td> <td style="width: 10%;"></td> <td style="width: 10%;"></td> <td style="width: 10%;"></td> <td style="width: 10%;"></td> <td style="width: 10%;"></td> <td style="width: 10%;"></td> </tr> <tr> <td></td> <td></td> <td colspan="8" style="text-align: center;"> <table border="1" style="width: 100%; border-collapse: collapse; text-align: center;"> <tr> <td style="width: 10%;"></td> <td style="width: 10%;"></td> <td style="width: 10%;"></td> <td style="width: 10%;"></td> <td style="width: 10%;"></td> <td style="width: 10%;"></td> <td style="width: 10%;"></td> <td style="width: 10%;"></td> <td style="width: 10%;"></td> <td style="width: 10%;"></td> </tr> <tr> <td></td> <td></td> <td colspan="8" style="text-align: center;"> <table border="1" style="width: 100%; border-collapse: collapse; text-align: center;"> <tr> <td style="width: 10%;"></td> <td style="width: 10%;"></td> <td style="width: 10%;"></td> <td style="width: 10%;"></td> <td style="width: 10%;"></td> <td style="width: 10%;"></td> <td style="width: 10%;"></td> <td style="width: 10%;"></td> <td style="width: 10%;"></td> <td style="width: 10%;"></td> </tr> <tr> <td></td> <td></td> <td colspan="8" style="text-align: center;"> <table border="1" style="width: 100%; border-collapse: collapse; text-align: center;"> <tr> <td style="width: 10%;"></td> <td style="width: 10%;"></td> <td style="width: 10%;"></td> <td style="width: 10%;"></td> <td style="width: 10%;"></td> <td style="width: 10%;"></td> <td style="width: 10%;"></td> <td style="width: 10%;"></td> <td style="width: 10%;"></td> <td style="width: 10%;"></td> </tr> <tr> <td></td> <td></td> <td colspan="8" style="text-align: center;"> <table border="1" style="width: 100%; border-collapse: collapse; text-align: center;"> <tr> <td style="width: 10%;"></td> <td style="width: 10%;"></td> <td style="width: 10%;"></td> <td style="width: 10%;"></td> <td style="width: 10%;"></td> <td style="width: 10%;"></td> <td style="width: 10%;"></td> <td style="width: 10%;"></td> <td style="width: 10%;"></td> <td style="width: 10%;"></td> </tr> <tr> <td></td> <td></td> <td colspan="8" style="text-align: center;"> <table border="1" style="width: 100%; border-collapse: collapse; text-align: center;"> <tr> <td style="width: 10%;"></td> <td style="width: 10%;"></td> <td style="width: 10%;"></td> <td style="width: 10%;"></td> <td style="width: 10%;"></td> <td style="width: 10%;"></td> <td style="width: 10%;"></td> <td style="width: 10%;"></td> <td style="width: 10%;"></td> <td style="width: 10%;"></td> </tr> <tr> <td></td> <td></td> <td colspan="8" style="text-align: center;"> <table border="1" style="width: 100%; border-collapse: collapse; text-align: center;"> <tr> <td style="width: 10%;"></td> <td style="width: 10%;"></td> <td style="width: 10%;"></td> <td style="width: 10%;"></td> <td style="width: 10%;"></td> <td style="width: 10%;"></td> <td style="width: 10%;"></td> <td style="width: 10%;"></td> <td style="width: 10%;"></td> <td style="width: 10%;"></td> </tr> <tr> <td></td> <td></td> <td colspan="8" style="text-align: center;"> <table border="1" style="width: 100%; border-collapse: collapse; text-align: center;"> <tr> <td style="width: 10%;"></td> <td style="width: 10%;"></td> <td style="width: 10%;"></td> <td style="width: 10%;"></td> <td style="width: 10%;"></td> <td style="width: 10%;"></td> <td style="width: 10%;"></td> <td style="width: 10%;"></td> <td style="width: 10%;"></td> <td style="width: 10%;"></td> </tr> <tr> <td></td> <td></td> <td colspan="8" style="text-align: center;"> <table border="1" style="width: 100%; border-collapse: collapse; text-align: center;"> <tr> <td style="width: 10%;"></td> <td style="width: 10%;"></td> <td style="width: 10%;"></td> <td style="width: 10%;"></td> <td style="width: 10%;"></td> <td style="width: 10%;"></td> <td style="width: 10%;"></td> <td style="width: 10%;"></td> <td style="width: 10%;"></td> <td style="width: 10%;"></td> </tr> <tr> <td></td> <td></td> <td colspan="8" style="text-align: center;"> <table border="1" style="width: 100%; border-collapse: collapse; text-align: center;"> <tr> <td style="width: 10%;"></td> <td style="width: 10%;"></td> <td style="width: 10%;"></td> <td style="width: 10%;"></td> <td style="width: 10%;"></td> <td style="width: 10%;"></td> <td style="width: 10%;"></td> <td style="width: 10%;"></td> <td style="width: 10%;"></td> <td style="width: 10%;"></td> </tr> <tr> <td></td> <td></td> <td colspan="8" style="text-align: center;"> <table border="1" style="width: 100%; border-collapse: collapse; text-align: center;"> <tr> <td style="width: 10%;"></td> <td style="width: 10%;"></td> <td style="width: 10%;"></td> <td style="width: 10%;"></td> <td style="width: 10%;"></td> <td style="width: 10%;"></td> <td style="width: 10%;"></td> <td style="width: 10%;"></td> <td style="width: 10%;"></td> <td style="width: 10%;"></td> </tr> <tr> <td></td> <td></td> <td colspan="8" style="text-align: center;"> <table border="1" style="width: 100%; border-collapse: collapse; text-align: center;"> <tr> <td style="width: 10%;"></td> <td style="width: 10%;"></td> <td style="width: 10%;"></td> <td style="width: 10%;"></td> <td style="width: 10%;"></td> <td style="width: 10%;"></td> <td style="width: 10%;"></td> <td style="width: 10%;"></td> <td style="width: 10%;"></td> <td style="width: 10%;"></td> </tr> <tr> <td></td> <td></td> <td colspan="8" style="text-align: center;"> <table border="1" style="width: 100%; border-collapse: collapse; text-align: center;"> <tr> <td style="width: 10%;"></td> <td style="width: 10%;"></td> <td style="width: 10%;"></td> <td style="width: 10%;"></td> <td style="width: 10%;"></td> <td style="width: 10%;"></td> <td style="width: 10%;"></td> <td style="width: 10%;"></td> <td style="width: 10%;"></td> <td style="width: 10%;"></td> </tr> <tr> <td></td> <td></td> <td colspan="8" style="text-align: center;"> <table border="1" style="width: 100%; border-collapse: collapse; text-align: center;"> <tr> <td style="width: 10%;"></td> <td style="width: 10%;"></td> <td style="width: 10%;"></td> <td style="width: 10%;"></td> <td style="width: 10%;"></td> <td
style="width: 10%;"></td> <td style="width: 10%;"></td> <td style="width: 10%;"></td> <td style="width: 10%;"></td> <td style="width: 10%;"></td> </tr> <tr> <td></td> <td></td> <td colspan="8" style="text-align: center;"> <table border="1" style="width: 100%; border-collapse: collapse; text-align: center;"> <tr> <td style="width: 10%;"></td> <td style="width: 10%;"></td> <td style="width: 10%;"></td> <td style="width: 10%;"></td> <td style="width: 10%;"></td> <td style="width: 10%;"></td> <td style="width: 10%;"></td> <td style="width: 10%;"></td> <td style="width: 10%;"></td> <td style="width: 10%;"></td> </tr> <tr> <td></td> <td></td> <td colspan="8" style="text-align: center;"> <table border="1" style="width: 100%; border-collapse: collapse; text-align: center;"> <tr> <td style="width: 10%;"></td> <td style="width: 10%;"></td> <td style="width: 10%;"></td> <td style="width: 10%;"></td> <td style="width: 10%;"></td> <td style="width: 10%;"></td> <td style="width: 10%;"></td> <td style="width: 10%;"></td> <td style="width: 10%;"></td> <td style="width: 10%;"></td> </tr> <tr> <td></td> <td></td> <td colspan="8" style="text-align: center;"> <table border="1" style="width: 100%; border-collapse: collapse; text-align: center;"> <tr> <td style="width: 10%;"></td> <td style="width: 10%;"></td> <td style="width: 10%;"></td> <td style="width: 10%;"></td> <td style="width: 10%;"></td> <td style="width: 10%;"></td> <td style="width: 10%;"></td> <td style="width: 10%;"></td> <td style="width: 10%;"></td> <td style="width: 10%;"></td> </tr> <tr> <td></td> <td></td> <td colspan="8" style="text-align: center;"> <table border="1" style="width: 100%; border-collapse: collapse; text-align: center;"> <tr> <td style="width: 10%;"></td> <td style="width: 10%;"></td> <td style="width: 10%;"></td> <td style="width: 10%;"></td> <td style="width: 10%;"></td> <td style="width: 10%;"></td> <td style="width: 10%;"></td> <td style="width: 10%;"></td> <td style="width: 10%;"></td> <td style="width: 10%;"></td> </tr> <tr> <td></td> <td></td> <td colspan="8" style="text-align: center;"> <table border="1" style="width: 100%; border-collapse: collapse; text-align: center;"> <tr> <td style="width: 10%;"></td> <td style="width: 10%;"></td> <td style="width: 10%;"></td> <td style="width: 10%;"></td> <td style="width: 10%;"></td> <td style="width: 10%;"></td> <td style="width: 10%;"></td> <td style="width: 10%;"></td> <td style="width: 10%;"></td> <td style="width: 10%;"></td> </tr> <tr> <td></td> <td></td> <td colspan="8" style="text-align: center;"> <table border="1" style="width: 100%; border-collapse: collapse; text-align: center;"> <tr> <td style="width: 10%;"></td> <td style="width: 10%;"></td> <td style="width: 10%;"></td> <td style="width: 10%;"></td> <td style="width: 10%;"></td> <td style="width: 10%;"></td> <td style="width: 10%;"></td> <td style="width: 10%;"></td> <td style="width: 10%;"></td> <td style="width: 10%;"></td> </tr> <tr> <td></td> <td></td> <td colspan="8" style="text-align: center;"> <table border="1" style="width: 100%; border-collapse: collapse; text-align: center;"> <tr> <td style="width: 10%;"></td> <td style="width: 10%;"></td> <td style="width: 10%;"></td> <td style="width: 10%;"></td> <td style="width: 10%;"></td> <td style="width: 10%;"></td> <td style="width: 10%;"></td> <td style="width: 10%;"></td> <td style="width: 10%;"></td> <td style="width: 10%;"></td> </tr> <tr> <td></td> <td></td> <td colspan="8" style="text-align: center;"> <table border="1" style="width: 100%; border-collapse: collapse; text-align: center;"> <tr> <td style="width: 10%;"></td> <td style="width: 10%;"></td> <td style="width: 10%;"></td> <td style="width: 10%;"></td> <td style="width: 10%;"></td> <td style="width: 10%;"></td> <td style="width: 10%;"></td> <td style="width: 10%;"></td> <td style="width: 10%;"></td> <td style="width: 10%;"></td> </tr> <tr> <td></td> <td></td> <td colspan="8" style="text-align: center;"> <table border="1" style="width: 100%; border-collapse: collapse; text-align: center;"> <tr> <td style="width: 10%;"></td> <td style="width: 10%;"></td> <td style="width: 10%;"></td> <td style="width: 10%;"></td> <td style="width: 10%;"></td> <td style="width: 10%;"></td> <td style="width: 10%;"></td> <td style="width: 10%;"></td> <td style="width: 10%;"></td> <td style="width: 10%;"></td> </tr> <tr> <td></td> <td></td> <td colspan="8" style="text-align: center;"> <table border="1" style="width: 100%; border-collapse: collapse; text-align: center;"> <tr> <td style="width: 10%;"></td> <td style="width: 10%;"></td> <td style="width: 10%;"></td> <td style="width: 10%;"></td> <td style="width: 10%;"></td> <td style="width: 10%;"></td> <td style="width: 10%;"></td> <td style="width: 10%;"></td> <td style="width: 10%;"></td> <td style="width: 10%;"></td> </tr> <tr> <td></td> <td></td> <td colspan="8" style="text-align: center;"> <table border="1" style="width: 100%; border-collapse: collapse; text-align: center;"> <tr> <td style="width: 10%;"></td> <td style="width: 10%;"></td> <td style="width: 10%;"></td> <td style="width: 10%;"></td> <td style="width: 10%;"></td> <td style="width: 10%;"></td> <td style="width: 10%;"></td> <td style="width: 10%;"></td> <td style="width: 10%;"></td> <td style="width: 10%;"></td> </tr> <tr> <td></td> <td></td> <td colspan="8" style="text-align: center;"> <table border="1" style="width: 100%; border-collapse: collapse; text-align: center;"> <tr> <td style="width: 10%;"></td> <td style="width: 10%;"></td> <td style="width: 10%;"></td> <td style="width: 10%;"></td> <td style="width: 10%;"></td> <td style="width: 10%;"></td> <td style="width: 10%;"></td> <td style="width: 10%;"></td> <td style="width: 10%;"></td> <td style="width: 10%;"></td> </tr> <tr> <td></td> <td></td> <td colspan="8" style="text-align: center;"> <table border="1" style="width: 100%; border-collapse: collapse; text-align: center;"> <tr> <td style="width: 10%;"></td> <td style="width: 10%;"></td> <td style="width: 10%;"></td> <td style="width: 10%;"></td> <td style="width: 10%;"></td> <td style="width: 10%;"></td> <td style="width: 10%;"></td> <td style="width: 10%;"></td> <td style="width: 10%;"></td> <td style="width: 10%;"></td> </tr> <tr> <td></td> <td></td> <td colspan="8" style="text-align: center;"> <table border="1" style="width: 100%; border-collapse: collapse; text-align: center;"> <tr> <td style="width: 10%;"></td> <td style="width: 10%;"></td> <td style="width: 10%;"></td> <td style="width: 10%;"></td> <td style="width: 10%;"></td> <td style="width: 10%;"></td> <td style="width: 10%;"></td> <td style="width: 10%;"></td> <td style="width: 10%;"></td> <td style="width: 10%;"></td> </tr> <tr> <td></td> <td></td> <td colspan="8" style="text-align: center;"> <table border="1" style="width: 100%; border-collapse: collapse; text-align: center;"> <tr> <td style="width: 10%;"></td> <td style="width: 10%;"></td> <td style="width: 10%;"></td> <td style="width: 10%;"></td> <td style="width: 10%;"></td> <td style="width: 10%;"></td> <td style="width: 10%;"></td> <td style="width: 10%;"></td> <td style="width: 10%;"></td> <td style="width: 10%;"></td> </tr> <tr> <td></td> <td></td> <td colspan="8" style="text-align: center;"> <table border="1" style="width: 100%; border-collapse: collapse; text-align: center;"> <tr> <td style="width: 10%;"></td> <td style="width: 10%;"></td> <td style="width: 10%;"></td> <td style="width: 10%;"></td> <td style="width: 10%;"></td> <td style="width: 10%;"></td> <td style="width: 10%;"></td> <td style="width: 10%;"></td> <td style="width: 10%;"></td> <td style="width: 10%;"></td> </tr> <tr> <td></td> <td></td> <td colspan="8" style="text-align: center;"> <table border="1" style="width: 100%; border-collapse: collapse; text-align: center;"> <tr> <td style="width: 10%;"></td> <td style="width: 10%;"></td> <td style="width: 10%;"></td> <td style="width: 10%;"></td> <td style="width: 10%;"></td> <td style="width: 10%;"></td> <td style="width: 10%;"></td> <td style="width: 10%;"></td> <td style="width: 10%;"></td> <td style="width: 10%;"></td> </tr> <tr> <td></td> <td></td> <td colspan="8" style="text-align: center;"> <table border="1" style="width: 100%; border-collapse: collapse; text-align: center;"> <tr> <td style="width: 10%;"></td> <td style="width: 10%;"></td> <td style="width: 10%;"></td> <td style="width: 10%;"></td> <td style="width: 10%;"></td> <td style="width: 10%;"></td> <td style="width: 10%;"></td> <td style="width: 10%;"></td> <td style="width: 10%;"></td> <td style="width: 10%;"></td> </tr> <tr> <td></td> <td></td> <td colspan="8" style="text-align: center;"> <table border="1" style="width: 100%; border-collapse: collapse; text-align: center;"> <tr> <td style="width: 10%;"></td> <td style="width: 10%;"></td> <td style="width: 10%;"></td> <td style="width: 10%;"></td> <td style="width: 10%;"></td> <td style="width: 10%;"></td> <td style="width: 10%;"></td> <td style="width: 10%;"></td> <td style="width: 10%;"></td> <td style="width: 10%;"></td> </tr> <tr> <td></td> <td></td> <td colspan="8" style="text-align: center;"> <table border="1" style="width: 100%; border-collapse: collapse; text-align: center;"> <tr> <td style="width: 10%;"></td> <td style="width: 10%;"></td> <td style="width: 10%;"></td> <td style="width: 10%;"></td> <td style="width: 10%;"></td> <td style="width: 10%;"></td> <td style="width: 10%;"></td> <td style="width: 10%;"></td> <td style="width: 10%;"></td> <td style="width: 10%;"></td> </tr> <tr> <td></td> <td></td> <td colspan="8" style="text-align: center;"> <table border="1" style="width: 100%; border-collapse: collapse; text-align: center;"> <tr> <td style="width: 10%;"></td> <td style="width: 10%;"></td> <td style="width: 10%;"></td> <td style="width: 10%;"></td> <td style="width: 10%;"></td> <td style="width: 10%;"></td> <td style="width: 10%;"></td> <td style="width: 10%;"></td> <td style="width: 10%;"></td> <td style="width: 10%;"></td> </tr> <tr> <td></td>
<td></td> <td colspan="8" style="text-align: center;"> <table border="1" style="width: 100%; border-collapse: collapse; text-align: center;"> <tr> <td style="width: 10%;"></td> <td style="width: 10%;"></td> <td style="width: 10%;"></td> <td style="width: 10%;"></td> <td style="width: 10%;"></td> <td style="width: 10%;"></td> <td style="width: 10%;"></td> <td style="width: 10%;"></td> <td style="width: 10%;"></td> <td style="width: 10%;"></td> </tr> <tr> <td></td> <td></td> <td colspan="8" style="text-align: center;"> <table border="1" style="width: 100%; border-collapse: collapse; text-align: center;"> <tr> <td style="width: 10%;"></td> <td style="width: 10%;"></td> <td style="width: 10%;"></td> <td style="width: 10%;"></td> <td style="width: 10%;"></td> <td style="width: 10%;"></td> <td style="width: 10%;"></td> <td style="width: 10%;"></td> <td style="width: 10%;"></td> <td style="width: 10%;"></td> </tr> <tr> <td></td> <td></td> <td colspan="8" style="text-align: center;"> <table border="1" style="width: 100%; border-collapse: collapse; text-align: center;"> <tr> <td style="width: 10%;"></td> <td style="width: 10%;"></td> <td style="width: 10%;"></td> <td style="width: 10%;"></td> <td style="width: 10%;"></td> <td style="width: 10%;"></td> <td style="width: 10%;"></td> <td style="width: 10%;"></td> <td style="width: 10%;"></td> <td style="width: 10%;"></td> </tr> <tr> <td></td> <td></td> <td colspan="8" style="text-align: center;"> <table border="1" style="width: 100%; border-collapse: collapse; text-align: center;"> <tr> <td style="width: 10%;"></td> <td style="width: 10%;"></td> <td style="width: 10%;"></td> <td style="width: 10%;"></td> <td style="width: 10%;"></td> <td style="width: 10%;"></td> <td style="width: 10%;"></td> <td style="width: 10%;"></td> <td style="width: 10%;"></td> <td style="width: 10%;"></td> </tr> <tr> <td></td> <td></td> <td colspan="8" style="text-align: center;"> <table border="1" style="width: 100%; border-collapse: collapse; text-align: center;"> <tr> <td style="width: 10%;"></td> <td style="width: 10%;"></td> <td style="width: 10%;"></td> <td style="width: 10%;"></td> <td style="width: 10%;"></td> <td style="width: 10%;"></td> <td style="width: 10%;"></td> <td style="width: 10%;"></td> <td style="width: 10%;"></td> <td style="width: 10%;"></td> </tr> <tr> <td></td> <td></td> <td colspan="8" style="text-align: center;"> <table border="1" style="width: 100%; border-collapse: collapse; text-align: center;"> <tr> <td style="width: 10%;"></td> <td style="width: 10%;"></td> <td style="width: 10%;"></td> <td style="width: 10%;"></td> <td style="width: 10%;"></td> <td style="width: 10%;"></td> <td style="width: 10%;"></td> <td style="width: 10%;"></td> <td style="width: 10%;"></td> <td style="width: 10%;"></td> </tr> <tr> <td></td> <td></td> <td colspan="8" style="text-align: center;"> <table border="1" style="width: 100%; border-collapse: collapse; text-align: center;"> <tr> <td style="width: 10%;"></td> <td style="width: 10%;"></td> <td style="width: 10%;"></td> <td style="width: 10%;"></td> <td style="width: 10%;"></td> <td style="width: 10%;"></td> <td style="width: 10%;"></td> <td style="width: 10%;"></td> <td style="width: 10%;"></td> <td style="width: 10%;"></td> </tr> <tr> <td></td> <td></td> <td colspan="8" style="text-align: center;"> <table border="1" style="width: 100%; border-collapse: collapse; text-align: center;"> <tr> <td style="width: 10%;"></td> <td style="width: 10%;"></td> <td style="width: 10%;"></td> <td style="width: 10%;"></td> <td style="width: 10%;"></td> <td style="width: 10%;"></td> <td style="width: 10%;"></td> <td style="width: 10%;"></td> <td style="width: 10%;"></td> <td style="width: 10%;"></td> </tr> <tr> <td></td> <td></td> <td colspan="8" style="text-align: center;"> <table border="1" style="width: 100%; border-collapse: collapse; text-align: center;"> <tr> <td style="width: 10%;"></td> <td style="width: 10%;"></td> <td style="width: 10%;"></td> <td style="width: 10%;"></td> <td style="width: 10%;"></td> <td style="width: 10%;"></td> <td style="width: 10%;"></td> <td style="width: 10%;"></td> <td style="width: 10%;"></td> <td style="width: 10%;"></td> </tr> <tr> <td></td> <td></td> <td colspan="8" style="text-align: center;"> <table border="1" style="width: 100%; border-collapse: collapse; text-align: center;"> <tr> <td style="width: 10%;"></td> <td style="width: 10%;"></td> <td style="width: 10%;"></td> <td style="width: 10%;"></td> <td style="width: 10%;"></td> <td style="width: 10%;"></td> <td style="width: 10%;"></td> <td style="width: 10%;"></td> <td style="width: 10%;"></td> <td style="width: 10%;"></td> </tr> <tr> <td></td> <td></td> <td colspan="8" style="text-align: center;"> <table border="1" style="width: 100%; border-collapse: collapse; text-align: center;"> <tr> <td style="width: 10%;"></td> <td style="width: 10%;"></td> <td style="width: 10%;"></td> <td style="width: 10%;"></td> <td style="width: 10%;"></td> <td style="width: 10%;"></td> <td style="width: 10%;"></td> <td style="width: 10%;"></td> <td style="width: 10%;"></td> <td style="width: 10%;"></td> </tr> <tr> <td></td> <td></td> <td colspan="8" style="text-align: center;"> <table border="1" style="width: 100%; border-collapse: collapse; text-align: center;"> <tr> <td style="width: 10%;"></td> <td style="width: 10%;"></td> <td style="width: 10%;"></td> <td style="width: 10%;"></td> <td style="width: 10%;"></td> <td style="width: 10%;"></td> <td style="width: 10%;"></td> <td style="width: 10%;"></td> <td style="width: 10%;"></td> <td style="width: 10%;"></td> </tr> <tr> <td></td> <td></td> <td colspan="8" style="text-align: center;"> <table border="1" style="width: 100%; border-collapse: collapse; text-align: center;"> <tr> <td style="width: 10%;"></td> <td style="width: 10%;"></td> <td style="width: 10%;"></td> <td style="width: 10%;"></td> <td style="width: 10%;"></td> <td style="width: 10%;"></td> <td style="width: 10%;"></td> <td style="width: 10%;"></td> <td style="width: 10%;"></td> <td style="width: 10%;"></td> </tr> <tr> <td></td> <td></td> <td colspan="8" style="text-align: center;"> <table border="1" style="width: 100%; border-collapse: collapse; text-align: center;"> <tr> <td style="width: 10%;"></td> <td style="width: 10%;"></td> <td style="width: 10%;"></td> <td style="width: 10%;"></td> <td style="width: 10%;"></td> <td style="width: 10%;"></td> <td style="width: 10%;"></td> <td style="width: 10%;"></td> <td style="width: 10%;"></td> <td style="width: 10%;"></td> </tr> <tr> <td></td> <td></td> <td colspan="8" style="text-align: center;"> <table border="1" style="width: 100%; border-collapse: collapse; text-align: center;"> <tr> <td style="width: 10%;"></td> <td style="width: 10%;"></td> <td style="width: 10%;"></td> <td style="width: 10%;"></td> <td style="width: 10%;"></td> <td style="width: 10%;"></td> <td style="width: 10%;"></td> <td style="width: 10%;"></td> <td style="width: 10%;"></td> <td style="width: 10%;"></td> </tr> <tr> <td></td> <td></td> <td colspan="8" style="text-align: center;"> <table border="1" style="width: 100%; border-collapse: collapse; text-align: center;"> <tr> <td style="width: 10%;"></td> <td style="width: 10%;"></td> <td style="width: 10%;"></td> <td style="width: 10%;"></td> <td style="width: 10%;"></td> <td style="width: 10%;"></td> <td style="width: 10%;"></td> <td style="width: 10%;"></td> <td style="width: 10%;"></td> <td style="width: 10%;"></td> </tr> <tr> <td></td> <td></td> <td colspan="8" style="text-align: center;"> <table border="1" style="width: 100%; border-collapse: collapse; text-align: center;"> <tr> <td style="width: 10%;"></td> <td style="width: 10%;"></td> <td style="width: 10%;"></td> <td style="width: 10%;"></td> <td style="width: 10%;"></td> <td style="width: 10%;"></td> <td style="width: 10%;"></td> <td style="width: 10%;"></td> <td style="width: 10%;"></td> <td style="width: 10%;"></td> </tr> <tr> <td></td> <td></td> <td colspan="8" style="text-align: center;"> <table border="1" style="width: 100%; border-collapse: collapse; text-align: center;"> <tr> <td style="width: 10%;"></td> <td style="width: 10%;"></td> <td style="width: 10%;"></td> <td style="width: 10%;"></td> <td style="width: 10%;"></td> <td style="width: 10%;"></td> <td style="width: 10%;"></td> <td style="width: 10%;"></td> <td style="width: 10%;"></td> <td style="width: 10%;"></td> </tr> <tr> <td></td> <td></td> <td colspan="8" style="text-align: center;"> <table border="1" style="width: 100%; border-collapse: collapse; text-align: center;"> <tr> <td style="width: 10%;"></td> <td style="width: 10%;"></td> <td style="width: 10%;"></td> <td style="width: 10%;"></td> <td style="width: 10%;"></td> <td style="width: 10%;"></td> <td style="width: 10%;"></td> <td style="width: 10%;"></td> <td style="width: 10%;"></td> <td style="width: 10%;"></td> </tr> <tr> <td></td> <td></td> <td colspan="8" style="text-align: center;"> <table border="1" style="width: 100%; border-collapse: collapse; text-align: center;"> <tr> <td style="width: 10%;"></td> <td style="width: 10%;"></td> <td style="width: 10%;"></td> <td style="width: 10%;"></td> <td style="width: 10%;"></td> <td style="width: 10%;"></td> <td style="width: 10%;"></td> <td style="width: 10%;"></td> <td style="width: 10%;"></td> <td style="width: 10%;"></td> </tr> <tr> <td></td> <td></td> <td colspan="8" style="text-align: center;"> <table border="1" style="width: 100%; border-collapse: collapse; text-align: center;"> <tr> <td style="width: 10%;"></td> <td style="width: 10%;"></td> <td style="width: 10%;"></td> <td style="width: 10%;"></td> <td style="width: 10%;"></td> <td style="width: 10%;"></td> <td style="width: 10%;"></td> <td style="width: 10%;"></td> <td style="width: 10%;"></td> <td style="width: 10%;"></td> </tr> <tr> <td></td> <td></td> <td colspan="8" style="text-align: center;"> <table border="1" style="width: 100%; border-collapse: collapse; text-align: center;"> <tr> <td style="width:
10%;"></td> <td style="width: 10%;"></td> <td style="width: 10%;"></td> <td style="width: 10%;"></td> <td style="width: 10%;"></td> <td style="width: 10%;"></td> <td style="width: 10%;"></td> <td style="width: 10%;"></td> <td style="width: 10%;"></td> <td style="width: 10%;"></td> </tr> <tr> <td></td> <td></td> <td colspan="8" style="text-align: center;"> <table border="1" style="width: 100%; border-collapse: collapse; text-align: center;"> <tr> </tr></table></td></tr></table></td></tr></table></td></tr></table></td></tr></table></td></tr></table></td></tr></table></td></tr></table></td></tr></table></td></tr></table></td></tr></table></td></tr></table></td></tr></table></td></tr></table></td></tr></table></td></tr></table></td></tr></table></td></tr></table></td></tr></table></td></tr></table></td></tr></table></td></tr></table></td></tr></table></td></tr></table></td></tr></table></td></tr></table></td></tr></table></td></tr></table></td></tr></table></td></tr></table></td></tr></table></td></tr></table></td></tr></table></td></tr></table></td></tr></table></td></tr></table></td></tr></table></td></tr></table></td></tr></table></td></tr></table></td></tr></table></td></tr></table></td></tr></table></td></tr></table></td></tr></table></td></tr></table></td></tr></table></td></tr></table></td></tr></table></td></tr></table></td></tr></table></td></tr></table></td></tr></table></td></tr></table></td></tr></table></td></tr></table></td></tr></table></td></tr></table></td></tr></table></td></tr></table></td></tr></table> | | | | | | | | | | | | | | | | | | | | <table border="1" style="width: 100%; border-collapse: collapse; text-align: center;"> <tr> <td style="width: 10%;"></td> <td style="width: 10%;"></td> <td style="width: 10%;"></td> <td style="width: 10%;"></td> <td style="width: 10%;"></td> <td style="width: 10%;"></td> <td style="width: 10%;"></td> <td style="width: 10%;"></td> <td style="width: 10%;"></td> <td style="width: 10%;"></td> </tr> <tr> <td></td> <td></td> <td colspan="8" style="text-align: center;"> <table border="1" style="width: 100%; border-collapse: collapse; text-align: center;"> <tr> <td style="width: 10%;"></td> <td style="width: 10%;"></td> <td style="width: 10%;"></td> <td style="width: 10%;"></td> <td style="width: 10%;"></td> <td style="width: 10%;"></td> <td style="width: 10%;"></td> <td style="width: 10%;"></td> <td style="width: 10%;"></td> <td style="width: 10%;"></td> </tr> <tr> <td></td> <td></td> <td colspan="8" style="text-align: center;"> <table border="1" style="width: 100%; border-collapse: collapse; text-align: center;"> <tr> <td style="width: 10%;"></td> <td style="width: 10%;"></td> <td style="width: 10%;"></td> <td style="width: 10%;"></td> <td style="width: 10%;"></td> <td style="width: 10%;"></td> <td style="width: 10%;"></td> <td style="width: 10%;"></td> <td style="width: 10%;"></td> <td style="width: 10%;"></td> </tr> <tr> <td></td> <td></td> <td colspan="8" style="text-align: center;"> <table border="1" style="width: 100%; border-collapse: collapse; text-align: center;"> <tr> <td style="width: 10%;"></td> <td style="width: 10%;"></td> <td style="width: 10%;"></td> <td style="width: 10%;"></td> <td style="width: 10%;"></td> <td style="width: 10%;"></td> <td style="width: 10%;"></td> <td style="width: 10%;"></td> <td style="width: 10%;"></td> <td style="width: 10%;"></td> </tr> <tr> <td></td> <td></td> <td colspan="8" style="text-align: center;"> <table border="1" style="width: 100%; border-collapse: collapse; text-align: center;"> <tr> <td style="width: 10%;"></td> <td style="width: 10%;"></td> <td style="width: 10%;"></td> <td style="width: 10%;"></td> <td style="width: 10%;"></td> <td style="width: 10%;"></td> <td style="width: 10%;"></td> <td style="width: 10%;"></td> <td style="width: 10%;"></td> <td style="width: 10%;"></td> </tr> <tr> <td></td> <td></td> <td colspan="8" style="text-align: center;"> <table border="1" style="width: 100%; border-collapse: collapse; text-align: center;"> <tr> <td style="width: 10%;"></td> <td style="width: 10%;"></td> <td style="width: 10%;"></td> <td style="width: 10%;"></td> <td style="width: 10%;"></td> <td style="width: 10%;"></td> <td style="width: 10%;"></td> <td style="width: 10%;"></td> <td style="width: 10%;"></td> <td style="width: 10%;"></td> </tr> <tr> <td></td> <td></td> <td colspan="8" style="text-align: center;"> <table border="1" style="width: 100%; border-collapse: collapse; text-align: center;"> <tr> <td style="width: 10%;"></td> <td style="width: 10%;"></td> <td style="width: 10%;"></td> <td style="width: 10%;"></td> <td style="width: 10%;"></td> <td style="width: 10%;"></td> <td style="width: 10%;"></td> <td style="width: 10%;"></td> <td style="width: 10%;"></td> <td style="width: 10%;"></td> </tr> <tr> <td></td> <td></td> <td colspan="8" style="text-align: center;"> <table border="1" style="width: 100%; border-collapse: collapse; text-align: center;"> <tr> <td style="width: 10%;"></td> <td style="width: 10%;"></td> <td style="width: 10%;"></td> <td style="width: 10%;"></td> <td style="width: 10%;"></td> <td style="width: 10%;"></td> <td style="width: 10%;"></td> <td style="width: 10%;"></td> <td style="width: 10%;"></td> <td style="width: 10%;"></td> </tr> <tr> <td></td> <td></td> <td colspan="8" style="text-align: center;"> <table border="1" style="width: 100%; border-collapse: collapse; text-align: center;"> <tr> <td style="width: 10%;"></td> <td style="width: 10%;"></td> <td style="width: 10%;"></td> <td style="width: 10%;"></td> <td style="width: 10%;"></td> <td style="width: 10%;"></td> <td style="width: 10%;"></td> <td style="width: 10%;"></td> <td style="width: 10%;"></td> <td style="width: 10%;"></td> </tr> <tr> <td></td> <td></td> <td colspan="8" style="text-align: center;"> <table border="1" style="width: 100%; border-collapse: collapse; text-align: center;"> <tr> <td style="width: 10%;"></td> <td style="width: 10%;"></td> <td style="width: 10%;"></td> <td style="width: 10%;"></td> <td style="width: 10%;"></td> <td style="width: 10%;"></td> <td style="width: 10%;"></td> <td style="width: 10%;"></td> <td style="width: 10%;"></td> <td style="width: 10%;"></td> </tr> <tr> <td></td> <td></td> <td colspan="8" style="text-align: center;"> <table border="1" style="width: 100%; border-collapse: collapse; text-align: center;"> <tr> <td style="width: 10%;"></td> <td style="width: 10%;"></td> <td style="width: 10%;"></td> <td style="width: 10%;"></td> <td style="width: 10%;"></td> <td style="width: 10%;"></td> <td style="width: 10%;"></td> <td style="width: 10%;"></td> <td style="width: 10%;"></td> <td style="width: 10%;"></td> </tr> <tr> <td></td> <td></td> <td colspan="8" style="text-align: center;"> <table border="1" style="width: 100%; border-collapse: collapse; text-align: center;"> <tr> <td style="width: 10%;"></td> <td style="width: 10%;"></td> <td style="width: 10%;"></td> <td style="width: 10%;"></td> <td style="width: 10%;"></td> <td style="width: 10%;"></td> <td style="width: 10%;"></td> <td style="width: 10%;"></td> <td style="width: 10%;"></td> <td style="width: 10%;"></td> </tr> <tr> <td></td> <td></td> <td colspan="8" style="text-align: center;"> <table border="1" style="width: 100%; border-collapse: collapse; text-align: center;"> <tr> <td style="width: 10%;"></td> <td style="width: 10%;"></td> <td style="width: 10%;"></td> <td style="width: 10%;"></td> <td style="width: 10%;"></td> <td style="width: 10%;"></td> <td style="width: 10%;"></td> <td style="width: 10%;"></td> <td style="width: 10%;"></td> <td style="width: 10%;"></td> </tr> <tr> <td></td> <td></td> <td colspan="8" style="text-align: center;"> <table border="1" style="width: 100%; border-collapse: collapse; text-align: center;"> <tr> <td style="width: 10%;"></td> <td style="width: 10%;"></td> <td style="width: 10%;"></td> <td style="width: 10%;"></td> <td style="width: 10%;"></td> <td style="width: 10%;"></td> <td style="width: 10%;"></td> <td style="width: 10%;"></td> <td style="width: 10%;"></td> <td style="width: 10%;"></td> </tr> <tr> <td></td> <td></td> <td colspan="8" style="text-align: center;"> <table border="1" style="width: 100%; border-collapse: collapse; text-align: center;"> <tr> <td style="width: 10%;"></td> <td style="width: 10%;"></td> <td style="width: 10%;"></td> <td style="width: 10%;"></td> <td style="width: 10%;"></td> <td style="width: 10%;"></td> <td style="width: 10%;"></td> <td style="width: 10%;"></td> <td style="width: 10%;"></td> <td style="width: 10%;"></td> </tr> <tr> <td></td> <td></td> <td colspan="8" style="text-align: center;"> <table border="1" style="width: 100%; border-collapse: collapse; text-align: center;"> <tr> <td style="width: 10%;"></td> <td style="width: 10%;"></td> <td style="width: 10%;"></td> <td style="width: 10%;"></td> <td style="width: 10%;"></td> <td style="width: 10%;"></td> <td style="width: 10%;"></td> <td style="width: 10%;"></td> <td style="width: 10%;"></td> <td style="width: 10%;"></td> </tr> <tr> <td></td> <td></td> <td colspan="8" style="text-align: center;"> <table border="1" style="width: 100%; border-collapse: collapse; text-align: center;"> <tr> <td style="width: 10%;"></td> <td style="width: 10%;"></td> <td style="width: 10%;"></td> <td style="width: 10%;"></td> <td style="width: 10%;"></td> <td style="width: 10%;"></td> <td style="width: 10%;"></td> <td style="width: 10%;"></td> <td style="width: 10%;"></td> <td style="width: 10%;"></td> </tr> <tr> <td></td> <td></td> <td colspan="8" style="text-align: center;"> <table border="1" style="width: 100%; border-collapse: collapse; text-align: center;"> <tr> <td style="width: 10%;"></td> <td style="width: 10%;"></td> <td style="width: 10%;"></td> <td style="width: 10%;"></td> <td style="width: 10%;"></td> <td style="width: 10%;"></td> <td style="width: 10%;"></td> <td style="width: 10%;"></td> <td style="width: 10%;"></td> <td style="width: 10%;"></td> </tr> <tr> <td></td> <td></td> <td colspan="8"
style="text-align: center;"> <table border="1" style="width: 100%; border-collapse: collapse; text-align: center;"> <tr> <td style="width: 10%;"></td> <td style="width: 10%;"></td> <td style="width: 10%;"></td> <td style="width: 10%;"></td> <td style="width: 10%;"></td> <td style="width: 10%;"></td> <td style="width: 10%;"></td> <td style="width: 10%;"></td> <td style="width: 10%;"></td> <td style="width: 10%;"></td> </tr> <tr> <td></td> <td></td> <td colspan="8" style="text-align: center;"> <table border="1" style="width: 100%; border-collapse: collapse; text-align: center;"> <tr> <td style="width: 10%;"></td> <td style="width: 10%;"></td> <td style="width: 10%;"></td> <td style="width: 10%;"></td> <td style="width: 10%;"></td> <td style="width: 10%;"></td> <td style="width: 10%;"></td> <td style="width: 10%;"></td> <td style="width: 10%;"></td> <td style="width: 10%;"></td> </tr> <tr> <td></td> <td></td> <td colspan="8" style="text-align: center;"> <table border="1" style="width: 100%; border-collapse: collapse; text-align: center;"> <tr> <td style="width: 10%;"></td> <td style="width: 10%;"></td> <td style="width: 10%;"></td> <td style="width: 10%;"></td> <td style="width: 10%;"></td> <td style="width: 10%;"></td> <td style="width: 10%;"></td> <td style="width: 10%;"></td> <td style="width: 10%;"></td> <td style="width: 10%;"></td> </tr> <tr> <td></td> <td></td> <td colspan="8" style="text-align: center;"> <table border="1" style="width: 100%; border-collapse: collapse; text-align: center;"> <tr> <td style="width: 10%;"></td> <td style="width: 10%;"></td> <td style="width: 10%;"></td> <td style="width: 10%;"></td> <td style="width: 10%;"></td> <td style="width: 10%;"></td> <td style="width: 10%;"></td> <td style="width: 10%;"></td> <td style="width: 10%;"></td> <td style="width: 10%;"></td> </tr> <tr> <td></td> <td></td> <td colspan="8" style="text-align: center;"> <table border="1" style="width: 100%; border-collapse: collapse; text-align: center;"> <tr> <td style="width: 10%;"></td> <td style="width: 10%;"></td> <td style="width: 10%;"></td> <td style="width: 10%;"></td> <td style="width: 10%;"></td> <td style="width: 10%;"></td> <td style="width: 10%;"></td> <td style="width: 10%;"></td> <td style="width: 10%;"></td> <td style="width: 10%;"></td> </tr> <tr> <td></td> <td></td> <td colspan="8" style="text-align: center;"> <table border="1" style="width: 100%; border-collapse: collapse; text-align: center;"> <tr> <td style="width: 10%;"></td> <td style="width: 10%;"></td> <td style="width: 10%;"></td> <td style="width: 10%;"></td> <td style="width: 10%;"></td> <td style="width: 10%;"></td> <td style="width: 10%;"></td> <td style="width: 10%;"></td> <td style="width: 10%;"></td> <td style="width: 10%;"></td> </tr> <tr> <td></td> <td></td> <td colspan="8" style="text-align: center;"> <table border="1" style="width: 100%; border-collapse: collapse; text-align: center;"> <tr> <td style="width: 10%;"></td> <td style="width: 10%;"></td> <td style="width: 10%;"></td> <td style="width: 10%;"></td> <td style="width: 10%;"></td> <td style="width: 10%;"></td> <td style="width: 10%;"></td> <td style="width: 10%;"></td> <td style="width: 10%;"></td> <td style="width: 10%;"></td> </tr> <tr> <td></td> <td></td> <td colspan="8" style="text-align: center;"> <table border="1" style="width: 100%; border-collapse: collapse; text-align: center;"> <tr> <td style="width: 10%;"></td> <td style="width: 10%;"></td> <td style="width: 10%;"></td> <td style="width: 10%;"></td> <td style="width: 10%;"></td> <td style="width: 10%;"></td> <td style="width: 10%;"></td> <td style="width: 10%;"></td> <td style="width: 10%;"></td> <td style="width: 10%;"></td> </tr> <tr> <td></td> <td></td> <td colspan="8" style="text-align: center;"> <table border="1" style="width: 100%; border-collapse: collapse; text-align: center;"> <tr> <td style="width: 10%;"></td> <td style="width: 10%;"></td> <td style="width: 10%;"></td> <td style="width: 10%;"></td> <td style="width: 10%;"></td> <td style="width: 10%;"></td> <td style="width: 10%;"></td> <td style="width: 10%;"></td> <td style="width: 10%;"></td> <td style="width: 10%;"></td> </tr> <tr> <td></td> <td></td> <td colspan="8" style="text-align: center;"> <table border="1" style="width: 100%; border-collapse: collapse; text-align: center;"> <tr> <td style="width: 10%;"></td> <td style="width: 10%;"></td> <td style="width: 10%;"></td> <td style="width: 10%;"></td> <td style="width: 10%;"></td> <td style="width: 10%;"></td> <td style="width: 10%;"></td> <td style="width: 10%;"></td> <td style="width: 10%;"></td> <td style="width: 10%;"></td> </tr> <tr> <td></td> <td></td> <td colspan="8" style="text-align: center;"> <table border="1" style="width: 100%; border-collapse: collapse; text-align: center;"> <tr> <td style="width: 10%;"></td> <td style="width: 10%;"></td> <td style="width: 10%;"></td> <td style="width: 10%;"></td> <td style="width: 10%;"></td> <td style="width: 10%;"></td> <td style="width: 10%;"></td> <td style="width: 10%;"></td> <td style="width: 10%;"></td> <td style="width: 10%;"></td> </tr> <tr> <td></td> <td></td> <td colspan="8" style="text-align: center;"> <table border="1" style="width: 100%; border-collapse: collapse; text-align: center;"> <tr> <td style="width: 10%;"></td> <td style="width: 10%;"></td> <td style="width: 10%;"></td> <td style="width: 10%;"></td> <td style="width: 10%;"></td> <td style="width: 10%;"></td> <td style="width: 10%;"></td> <td style="width: 10%;"></td> <td style="width: 10%;"></td> <td style="width: 10%;"></td> </tr> <tr> <td></td> <td></td> <td colspan="8" style="text-align: center;"> <table border="1" style="width: 100%; border-collapse: collapse; text-align: center;"> <tr> <td style="width: 10%;"></td> <td style="width: 10%;"></td> <td style="width: 10%;"></td> <td style="width: 10%;"></td> <td style="width: 10%;"></td> <td style="width: 10%;"></td> <td style="width: 10%;"></td> <td style="width: 10%;"></td> <td style="width: 10%;"></td> <td style="width: 10%;"></td> </tr> <tr> <td></td> <td></td> <td colspan="8" style="text-align: center;"> <table border="1" style="width: 100%; border-collapse: collapse; text-align: center;"> <tr> <td style="width: 10%;"></td> <td style="width: 10%;"></td> <td style="width: 10%;"></td> <td style="width: 10%;"></td> <td style="width: 10%;"></td> <td style="width: 10%;"></td> <td style="width: 10%;"></td> <td style="width: 10%;"></td> <td style="width: 10%;"></td> <td style="width: 10%;"></td> </tr> <tr> <td></td> <td></td> <td colspan="8" style="text-align: center;"> <table border="1" style="width: 100%; border-collapse: collapse; text-align: center;"> <tr> <td style="width: 10%;"></td> <td style="width: 10%;"></td> <td style="width: 10%;"></td> <td style="width: 10%;"></td> <td style="width: 10%;"></td> <td style="width: 10%;"></td> <td style="width: 10%;"></td> <td style="width: 10%;"></td> <td style="width: 10%;"></td> <td style="width: 10%;"></td> </tr> <tr> <td></td> <td></td> <td colspan="8" style="text-align: center;"> <table border="1" style="width: 100%; border-collapse: collapse; text-align: center;"> <tr> <td style="width: 10%;"></td> <td style="width: 10%;"></td> <td style="width: 10%;"></td> <td style="width: 10%;"></td> <td style="width: 10%;"></td> <td style="width: 10%;"></td> <td style="width: 10%;"></td> <td style="width: 10%;"></td> <td style="width: 10%;"></td> <td style="width: 10%;"></td> </tr> <tr> <td></td> <td></td> <td colspan="8" style="text-align: center;"> <table border="1" style="width: 100%; border-collapse: collapse; text-align: center;"> <tr> <td style="width: 10%;"></td> <td style="width: 10%;"></td> <td style="width: 10%;"></td> <td style="width: 10%;"></td> <td style="width: 10%;"></td> <td style="width: 10%;"></td> <td style="width: 10%;"></td> <td style="width: 10%;"></td> <td style="width: 10%;"></td> <td style="width: 10%;"></td> </tr> <tr> <td></td> <td></td> <td colspan="8" style="text-align: center;"> <table border="1" style="width: 100%; border-collapse: collapse; text-align: center;"> <tr> <td style="width: 10%;"></td> <td style="width: 10%;"></td> <td style="width: 10%;"></td> <td style="width: 10%;"></td> <td style="width: 10%;"></td> <td style="width: 10%;"></td> <td style="width: 10%;"></td> <td style="width: 10%;"></td> <td style="width: 10%;"></td> <td style="width: 10%;"></td> </tr> <tr> <td></td> <td></td> <td colspan="8" style="text-align: center;"> <table border="1" style="width: 100%; border-collapse: collapse; text-align: center;"> <tr> <td style="width: 10%;"></td> <td style="width: 10%;"></td> <td style="width: 10%;"></td> <td style="width: 10%;"></td> <td style="width: 10%;"></td> <td style="width: 10%;"></td> <td style="width: 10%;"></td> <td style="width: 10%;"></td> <td style="width: 10%;"></td> <td style="width: 10%;"></td> </tr> <tr> <td></td> <td></td> <td colspan="8" style="text-align: center;"> <table border="1" style="width: 100%; border-collapse: collapse; text-align: center;"> <tr> <td style="width: 10%;"></td> <td style="width: 10%;"></td> <td style="width: 10%;"></td> <td style="width: 10%;"></td> <td style="width: 10%;"></td> <td style="width: 10%;"></td> <td style="width: 10%;"></td> <td style="width: 10%;"></td> <td style="width: 10%;"></td> <td style="width: 10%;"></td> </tr> <tr> <td></td> <td></td> <td colspan="8" style="text-align: center;"> <table border="1" style="width: 100%; border-collapse: collapse; text-align: center;"> <tr> <td style="width: 10%;"></td> <td style="width: 10%;"></td> <td style="width: 10%;"></td> <td style="width: 10%;"></td> <td style="width: 10%;"></td> <td style="width: 10%;"></td> <td style="width: 10%;"></td> <td style="width: 10%;"></td> <td style="width: 10%;"></td> <td style="width: 10%;"></td> </tr> <tr> <td></td> <td></td> <td colspan="8" style="text-align: center;"> <table border="1" style="width: 100%; border-collapse: collapse; text-align: center;"> <tr> <td style="width: 10%;"></td> <td style="width:
10%;"></td> <td style="width: 10%;"></td> <td style="width: 10%;"></td> <td style="width: 10%;"></td> <td style="width: 10%;"></td> <td style="width: 10%;"></td> <td style="width: 10%;"></td> <td style="width: 10%;"></td> <td style="width: 10%;"></td> </tr> <tr> <td></td> <td></td> <td colspan="8" style="text-align: center;"> <table border="1" style="width: 100%; border-collapse: collapse; text-align: center;"> <tr> <td style="width: 10%;"></td> <td style="width: 10%;"></td> <td style="width: 10%;"></td> <td style="width: 10%;"></td> <td style="width: 10%;"></td> <td style="width: 10%;"></td> <td style="width: 10%;"></td> <td style="width: 10%;"></td> <td style="width: 10%;"></td> <td style="width: 10%;"></td> </tr> <tr> <td></td> <td></td> <td colspan="8" style="text-align: center;"> <table border="1" style="width: 100%; border-collapse: collapse; text-align: center;"> <tr> <td style="width: 10%;"></td> <td style="width: 10%;"></td> <td style="width: 10%;"></td> <td style="width: 10%;"></td> <td style="width: 10%;"></td> <td style="width: 10%;"></td> <td style="width: 10%;"></td> <td style="width: 10%;"></td> <td style="width: 10%;"></td> <td style="width: 10%;"></td> </tr> <tr> <td></td> <td></td> <td colspan="8" style="text-align: center;"> <table border="1" style="width: 100%; border-collapse: collapse; text-align: center;"> <tr> <td style="width: 10%;"></td> <td style="width: 10%;"></td> <td style="width: 10%;"></td> <td style="width: 10%;"></td> <td style="width: 10%;"></td> <td style="width: 10%;"></td> <td style="width: 10%;"></td> <td style="width: 10%;"></td> <td style="width: 10%;"></td> <td style="width: 10%;"></td> </tr> <tr> <td></td> <td></td> <td colspan="8" style="text-align: center;"> <table border="1" style="width: 100%; border-collapse: collapse; text-align: center;"> <tr> <td style="width: 10%;"></td> <td style="width: 10%;"></td> <td style="width: 10%;"></td> <td style="width: 10%;"></td> <td style="width: 10%;"></td> <td style="width: 10%;"></td> <td style="width: 10%;"></td> <td style="width: 10%;"></td> <td style="width: 10%;"></td> <td style="width: 10%;"></td> </tr> <tr> <td></td> <td></td> <td colspan="8" style="text-align: center;"> <table border="1" style="width: 100%; border-collapse: collapse; text-align: center;"> <tr> <td style="width: 10%;"></td> <td style="width: 10%;"></td> <td style="width: 10%;"></td> <td style="width: 10%;"></td> <td style="width: 10%;"></td> <td style="width: 10%;"></td> <td style="width: 10%;"></td> <td style="width: 10%;"></td> <td style="width: 10%;"></td> <td style="width: 10%;"></td> </tr> <tr> <td></td> <td></td> <td colspan="8" style="text-align: center;"> <table border="1" style="width: 100%; border-collapse: collapse; text-align: center;"> <tr> <td style="width: 10%;"></td> <td style="width: 10%;"></td> <td style="width: 10%;"></td> <td style="width: 10%;"></td> <td style="width: 10%;"></td> <td style="width: 10%;"></td> <td style="width: 10%;"></td> <td style="width: 10%;"></td> <td style="width: 10%;"></td> <td style="width: 10%;"></td> </tr> <tr> <td></td> <td></td> <td colspan="8" style="text-align: center;"> <table border="1" style="width: 100%; border-collapse: collapse; text-align: center;"> <tr> <td style="width: 10%;"></td> <td style="width: 10%;"></td> <td style="width: 10%;"></td> <td style="width: 10%;"></td> <td style="width: 10%;"></td> <td style="width: 10%;"></td> <td style="width: 10%;"></td> <td style="width: 10%;"></td> <td style="width: 10%;"></td> <td style="width: 10%;"></td> </tr> <tr> <td></td> <td></td> <td colspan="8" style="text-align: center;"> <table border="1" style="width: 100%; border-collapse: collapse; text-align: center;"> <tr> <td style="width: 10%;"></td> <td style="width: 10%;"></td> <td style="width: 10%;"></td> <td style="width: 10%;"></td> <td style="width: 10%;"></td> <td style="width: 10%;"></td> <td style="width: 10%;"></td> <td style="width: 10%;"></td> <td style="width: 10%;"></td> <td style="width: 10%;"></td> </tr> <tr> <td></td> <td></td> <td colspan="8" style="text-align: center;"> <table border="1" style="width: 100%; border-collapse: collapse; text-align: center;"> <tr> <td style="width: 10%;"></td> <td style="width: 10%;"></td> <td style="width: 10%;"></td> <td style="width: 10%;"></td> <td style="width: 10%;"></td> <td style="width: 10%;"></td> <td style="width: 10%;"></td> <td style="width: 10%;"></td> <td style="width: 10%;"></td> <td style="width: 10%;"></td> </tr> <tr> <td></td> <td></td> <td colspan="8" style="text-align: center;"> <table border="1" style="width: 100%; border-collapse: collapse; text-align: center;"> <tr> <td style="width: 10%;"></td> <td style="width: 10%;"></td> <td style="width: 10%;"></td> <td style="width: 10%;"></td> <td style="width: 10%;"></td> <td style="width: 10%;"></td> <td style="width: 10%;"></td> <td style="width: 10%;"></td> <td style="width: 10%;"></td> <td style="width: 10%;"></td> </tr> <tr> <td></td> <td></td> <td colspan="8" style="text-align: center;"> <table border="1" style="width: 100%; border-collapse: collapse; text-align: center;"> <tr> <td style="width: 10%;"></td> <td style="width: 10%;"></td> <td style="width: 10%;"></td> <td style="width: 10%;"></td> <td style="width: 10%;"></td> <td style="width: 10%;"></td> <td style="width: 10%;"></td> <td style="width: 10%;"></td> <td style="width: 10%;"></td> <td style="width: 10%;"></td> </tr> <tr> <td></td> <td></td> <td colspan="8" style="text-align: center;"> <table border="1" style="width: 100%; border-collapse: collapse; text-align: center;"> <tr> <td style="width: 10%;"></td> <td style="width: 10%;"></td> <td style="width: 10%;"></td> <td style="width: 10%;"></td> <td style="width: 10%;"></td> <td style="width: 10%;"></td> <td style="width: 10%;"></td> <td style="width: 10%;"></td> <td style="width: 10%;"></td> <td style="width: 10%;"></td> </tr> <tr> <td></td> <td></td> <td colspan="8" style="text-align: center;"> <table border="1" style="width: 100%; border-collapse: collapse; text-align: center;"> <tr> <td style="width: 10%;"></td> <td style="width: 10%;"></td> <td style="width: 10%;"></td> <td style="width: 10%;"></td> <td style="width: 10%;"></td> <td style="width: 10%;"></td> <td style="width: 10%;"></td> <td style="width: 10%;"></td> <td style="width: 10%;"></td> <td style="width: 10%;"></td> </tr> <tr> <td></td> <td></td> <td colspan="8" style="text-align: center;"> <table border="1" style="width: 100%; border-collapse: collapse; text-align: center;"> <tr> <td style="width: 10%;"></td> <td style="width: 10%;"></td> <td style="width: 10%;"></td> <td style="width: 10%;"></td> <td style="width: 10%;"></td> <td style="width: 10%;"></td> <td style="width: 10%;"></td> <td style="width: 10%;"></td> <td style="width: 10%;"></td> <td style="width: 10%;"></td> </tr> <tr> <td></td> <td></td> <td colspan="8" style="text-align: center;"> <table border="1" style="width: 100%; border-collapse: collapse; text-align: center;"> <tr> <td style="width: 10%;"></td> <td style="width: 10%;"></td> <td style="width: 10%;"></td> <td style="width: 10%;"></td> <td style="width: 10%;"></td> <td style="width: 10%;"></td> <td style="width: 10%;"></td> <td style="width: 10%;"></td> <td style="width: 10%;"></td> <td style="width: 10%;"></td> </tr> <tr> <td></td> <td></td> <td colspan="8" style="text-align: center;"> <table border="1" style="width: 100%; border-collapse: collapse; text-align: center;"> <tr> <td style="width: 10%;"></td> <td style="width: 10%;"></td> <td style="width: 10%;"></td> <td style="width: 10%;"></td> <td style="width: 10%;"></td> <td style="width: 10%;"></td> <td style="width: 10%;"></td> <td style="width: 10%;"></td> <td style="width: 10%;"></td> <td style="width: 10%;"></td> </tr> <tr> <td></td> <td></td> <td colspan="8" style="text-align: center;"> <table border="1" style="width: 100%; border-collapse: collapse; text-align: center;"> <tr> <td style="width: 10%;"></td> <td style="width: 10%;"></td> <td style="width: 10%;"></td> <td style="width: 10%;"></td> <td style="width: 10%;"></td> <td style="width: 10%;"></td> <td style="width: 10%;"></td> <td style="width: 10%;"></td> <td style="width: 10%;"></td> <td style="width: 10%;"></td> </tr> <tr> <td></td> <td></td> <td colspan="8" style="text-align: center;"> <table border="1" style="width: 100%; border-collapse: collapse; text-align: center;"> <tr> <td style="width: 10%;"></td> <td style="width: 10%;"></td> <td style="width: 10%;"></td> <td style="width: 10%;"></td> <td style="width: 10%;"></td> <td style="width: 10%;"></td> <td style="width: 10%;"></td> <td style="width: 10%;"></td> <td style="width: 10%;"></td> <td style="width: 10%;"></td> </tr> <tr> <td></td> <td></td> <td colspan="8" style="text-align: center;"> <table border="1" style="width: 100%; border-collapse: collapse; text-align: center;"> <tr> <td style="width: 10%;"></td> <td style="width: 10%;"></td> <td style="width: 10%;"></td> <td style="width: 10%;"></td> <td style="width: 10%;"></td> <td style="width: 10%;"></td> <td style="width: 10%;"></td> <td style="width: 10%;"></td> <td style="width: 10%;"></td> <td style="width: 10%;"></td> </tr> <tr> <td></td> <td></td> <td colspan="8" style="text-align: center;"> <table border="1" style="width: 100%; border-collapse: collapse; text-align: center;"> <tr>
</tr></table></td></tr></table></td></tr></table></td></tr></table></td></tr></table></td></tr></table></td></tr></table></td></tr></table></td></tr></table></td></tr></table></td></tr></table></td></tr></table></td></tr></table></td></tr></table></td></tr></table></td></tr></table></td></tr></table></td></tr></table></td></tr></table></td></tr></table></td></tr></table></td></tr></table></td></tr></table></td></tr></table></td></tr></table></td></tr></table></td></tr></table></td></tr></table></td></tr></table></td></tr></table></td></tr></table></td></tr></table></td></tr></table></td></tr></table></td></tr></table></td></tr></table></td></tr></table></td></tr></table></td></tr></table></td></tr></table></td></tr></table></td></tr></table></td></tr></table></td></tr></table></td></tr></table></td></tr></table></td></tr></table></td></tr></table></td></tr></table></td></tr></table></td></tr></table></td></tr></table></td></tr></table></td></tr></table></td></tr></table></td></tr></table></td></tr></table></td></tr></table></td></tr></table></td></tr></table> | | | | | | | | | | | | | | | | | | | | <table border="1" style="width: 100%; border-collapse: collapse; text-align: center;"> <tr> <td style="width: 10%;"></td> <td style="width: 10%;"></td> <td style="width: 10%;"></td> <td style="width: 10%;"></td> <td style="width: 10%;"></td> <td style="width: 10%;"></td> <td style="width: 10%;"></td> <td style="width: 10%;"></td> <td style="width: 10%;"></td> <td style="width: 10%;"></td> </tr> <tr> <td></td> <td></td> <td colspan="8" style="text-align: center;"> <table border="1" style="width: 100%; border-collapse: collapse; text-align: center;"> <tr> <td style="width: 10%;"></td> <td style="width: 10%;"></td> <td style="width: 10%;"></td> <td style="width: 10%;"></td> <td style="width: 10%;"></td> <td style="width: 10%;"></td> <td style="width: 10%;"></td> <td style="width: 10%;"></td> <td style="width: 10%;"></td> <td style="width: 10%;"></td> </tr> <tr> <td></td> <td></td> <td colspan="8" style="text-align: center;"> <table border="1" style="width: 100%; border-collapse: collapse; text-align: center;"> <tr> <td style="width: 10%;"></td> <td style="width: 10%;"></td> <td style="width: 10%;"></td> <td style="width: 10%;"></td> <td style="width: 10%;"></td> <td style="width: 10%;"></td> <td style="width: 10%;"></td> <td style="width: 10%;"></td> <td style="width: 10%;"></td> <td style="width: 10%;"></td> </tr> <tr> <td></td> <td></td> <td colspan="8" style="text-align: center;"> <table border="1" style="width: 100%; border-collapse: collapse; text-align: center;"> <tr> <td style="width: 10%;"></td> <td style="width: 10%;"></td> <td style="width: 10%;"></td> <td style="width: 10%;"></td> <td style="width: 10%;"></td> <td style="width: 10%;"></td> <td style="width: 10%;"></td> <td style="width: 10%;"></td> <td style="width: 10%;"></td> <td style="width: 10%;"></td> </tr> <tr> <td></td> <td></td> <td colspan="8" style="text-align: center;"> <table border="1" style="width: 100%; border-collapse: collapse; text-align: center;"> <tr> <td style="width: 10%;"></td> <td style="width: 10%;"></td> <td style="width: 10%;"></td> <td style="width: 10%;"></td> <td style="width: 10%;"></td> <td style="width: 10%;"></td> <td style="width: 10%;"></td> <td style="width: 10%;"></td> <td style="width: 10%;"></td> <td style="width: 10%;"></td> </tr> <tr> <td></td> <td></td> <td colspan="8" style="text-align: center;"> <table border="1" style="width: 100%; border-collapse: collapse; text-align: center;"> <tr> <td style="width: 10%;"></td> <td style="width: 10%;"></td> <td style="width: 10%;"></td> <td style="width: 10%;"></td> <td style="width: 10%;"></td> <td style="width: 10%;"></td> <td style="width: 10%;"></td> <td style="width: 10%;"></td> <td style="width: 10%;"></td> <td style="width: 10%;"></td> </tr> <tr> <td></td> <td></td> <td colspan="8" style="text-align: center;"> <table border="1" style="width: 100%; border-collapse: collapse; text-align: center;"> <tr> <td style="width: 10%;"></td> <td style="width: 10%;"></td> <td style="width: 10%;"></td> <td style="width: 10%;"></td> <td style="width: 10%;"></td> <td style="width: 10%;"></td> <td style="width: 10%;"></td> <td style="width: 10%;"></td> <td style="width: 10%;"></td> <td style="width: 10%;"></td> </tr> <tr> <td></td> <td></td> <td colspan="8" style="text-align: center;"> <table border="1" style="width: 100%; border-collapse: collapse; text-align: center;"> <tr> <td style="width: 10%;"></td> <td style="width: 10%;"></td> <td style="width: 10%;"></td> <td style="width: 10%;"></td> <td style="width: 10%;"></td> <td style="width: 10%;"></td> <td style="width: 10%;"></td> <td style="width: 10%;"></td> <td style="width: 10%;"></td> <td style="width: 10%;"></td> </tr> <tr> <td></td> <td></td> <td colspan="8" style="text-align: center;"> <table border="1" style="width: 100%; border-collapse: collapse; text-align: center;"> <tr> <td style="width: 10%;"></td> <td style="width: 10%;"></td> <td style="width: 10%;"></td> <td style="width: 10%;"></td> <td style="width: 10%;"></td> <td style="width: 10%;"></td> <td style="width: 10%;"></td> <td style="width: 10%;"></td> <td style="width: 10%;"></td> <td style="width: 10%;"></td> </tr> <tr> <td></td> <td></td> <td colspan="8" style="text-align: center;"> <table border="1" style="width: 100%; border-collapse: collapse; text-align: center;"> <tr> <td style="width: 10%;"></td> <td style="width: 10%;"></td> <td style="width: 10%;"></td> <td style="width: 10%;"></td> <td style="width: 10%;"></td> <td style="width: 10%;"></td> <td style="width: 10%;"></td> <td style="width: 10%;"></td> <td style="width: 10%;"></td> <td style="width: 10%;"></td> </tr> <tr> <td></td> <td></td> <td colspan="8" style="text-align: center;"> <table border="1" style="width: 100%; border-collapse: collapse; text-align: center;"> <tr> <td style="width: 10%;"></td> <td style="width: 10%;"></td> <td style="width: 10%;"></td> <td style="width: 10%;"></td> <td style="width: 10%;"></td> <td style="width: 10%;"></td> <td style="width: 10%;"></td> <td style="width: 10%;"></td> <td style="width: 10%;"></td> <td style="width: 10%;"></td> </tr> <tr> <td></td> <td></td> <td colspan="8" style="text-align: center;"> <table border="1" style="width: 100%; border-collapse: collapse; text-align: center;"> <tr> <td style="width: 10%;"></td> <td style="width: 10%;"></td> <td style="width: 10%;"></td> <td style="width: 10%;"></td> <td style="width: 10%;"></td> <td style="width: 10%;"></td> <td style="width: 10%;"></td> <td style="width: 10%;"></td> <td style="width: 10%;"></td> <td style="width: 10%;"></td> </tr> <tr> <td></td> <td></td> <td colspan="8" style="text-align: center;"> <table border="1" style="width: 100%; border-collapse: collapse; text-align: center;"> <tr> <td style="width: 10%;"></td> <td style="width: 10%;"></td> <td style="width: 10%;"></td> <td style="width: 10%;"></td> <td style="width: 10%;"></td> <td style="width: 10%;"></td> <td style="width: 10%;"></td> <td style="width: 10%;"></td> <td style="width: 10%;"></td> <td style="width: 10%;"></td> </tr> <tr> <td></td> <td></td> <td colspan="8" style="text-align: center;"> <table border="1" style="width: 100%; border-collapse: collapse; text-align: center;"> <tr> <td style="width: 10%;"></td> <td style="width: 10%;"></td> <td style="width: 10%;"></td> <td style="width: 10%;"></td> <td style="width: 10%;"></td> <td style="width: 10%;"></td> <td style="width: 10%;"></td> <td style="width: 10%;"></td> <td style="width: 10%;"></td> <td style="width: 10%;"></td> </tr> <tr> <td></td> <td></td> <td colspan="8" style="text-align: center;"> <table border="1" style="width: 100%; border-collapse: collapse; text-align: center;"> <tr> <td style="width: 10%;"></td> <td style="width: 10%;"></td> <td style="width: 10%;"></td> <td style="width: 10%;"></td> <td style="width: 10%;"></td> <td style="width: 10%;"></td> <td style="width: 10%;"></td> <td style="width: 10%;"></td> <td style="width: 10%;"></td> <td style="width: 10%;"></td> </tr> <tr> <td></td> <td></td> <td colspan="8" style="text-align: center;"> <table border="1" style="width: 100%; border-collapse: collapse; text-align: center;"> <tr> <td style="width: 10%;"></td> <td style="width: 10%;"></td> <td style="width: 10%;"></td> <td style="width: 10%;"></td> <td style="width: 10%;"></td> <td style="width: 10%;"></td> <td style="width: 10%;"></td> <td style="width: 10%;"></td> <td style="width: 10%;"></td> <td style="width: 10%;"></td> </tr> <tr> <td></td> <td></td> <td colspan="8" style="text-align: center;"> <table border="1" style="width: 100%; border-collapse: collapse; text-align: center;"> <tr> <td style="width: 10%;"></td> <td style="width: 10%;"></td> <td style="width: 10%;"></td> <td style="width: 10%;"></td> <td style="width: 10%;"></td> <td style="width: 10%;"></td> <td style="width: 10%;"></td> <td style="width: 10%;"></td> <td style="width: 10%;"></td> <td style="width: 10%;"></td> </tr> <tr> <td></td> <td></td> <td colspan="8" style="text-align: center;"> <table border="1" style="width: 100%; border-collapse: collapse; text-align: center;"> <tr> <td style="width: 10%;"></td> <td style="width: 10%;"></td> <td style="width: 10%;"></td> <td style="width: 10%;"></td> <td style="width: 10%;"></td> <td style="width: 10%;"></td> <td style="width: 10%;"></td> <td style="width: 10%;"></td> <td style="width: 10%;"></td> <td style="width: 10%;"></td> </tr> <tr> <td></td> <td></td> <td colspan="8" style="text-align: center;"> <table border="1" style="width: 100%; border-collapse: collapse; text-align: center;"> <tr> <td style="width: 10%;"></td> <td style="width: 10%;"></td> <td style="width: 10%;"></td> <td style="width: 10%;"></td> <td style="width: 10%;"></td> <td style="width: 10%;"></td> <td style="width: 10%;"></td> <td style="width: 10%;"></td> <td style="width: 10%;"></td> <td style="width: 10%;"></td> </tr> <tr> <td></td> <td></td> <td colspan="8"
style="text-align: center;"> <table border="1" style="width: 100%; border-collapse: collapse; text-align: center;"> <tr> <td style="width: 10%;"></td> <td style="width: 10%;"></td> <td style="width: 10%;"></td> <td style="width: 10%;"></td> <td style="width: 10%;"></td> <td style="width: 10%;"></td> <td style="width: 10%;"></td> <td style="width: 10%;"></td> <td style="width: 10%;"></td> <td style="width: 10%;"></td> </tr> <tr> <td></td> <td></td> <td colspan="8" style="text-align: center;"> <table border="1" style="width: 100%; border-collapse: collapse; text-align: center;"> <tr> <td style="width: 10%;"></td> <td style="width: 10%;"></td> <td style="width: 10%;"></td> <td style="width: 10%;"></td> <td style="width: 10%;"></td> <td style="width: 10%;"></td> <td style="width: 10%;"></td> <td style="width: 10%;"></td> <td style="width: 10%;"></td> <td style="width: 10%;"></td> </tr> <tr> <td></td> <td></td> <td colspan="8" style="text-align: center;"> <table border="1" style="width: 100%; border-collapse: collapse; text-align: center;"> <tr> <td style="width: 10%;"></td> <td style="width: 10%;"></td> <td style="width: 10%;"></td> <td style="width: 10%;"></td> <td style="width: 10%;"></td> <td style="width: 10%;"></td> <td style="width: 10%;"></td> <td style="width: 10%;"></td> <td style="width: 10%;"></td> <td style="width: 10%;"></td> </tr> <tr> <td></td> <td></td> <td colspan="8" style="text-align: center;"> <table border="1" style="width: 100%; border-collapse: collapse; text-align: center;"> <tr> <td style="width: 10%;"></td> <td style="width: 10%;"></td> <td style="width: 10%;"></td> <td style="width: 10%;"></td> <td style="width: 10%;"></td> <td style="width: 10%;"></td> <td style="width: 10%;"></td> <td style="width: 10%;"></td> <td style="width: 10%;"></td> <td style="width: 10%;"></td> </tr> <tr> <td></td> <td></td> <td colspan="8" style="text-align: center;"> <table border="1" style="width: 100%; border-collapse: collapse; text-align: center;"> <tr> <td style="width: 10%;"></td> <td style="width: 10%;"></td> <td style="width: 10%;"></td> <td style="width: 10%;"></td> <td style="width: 10%;"></td> <td style="width: 10%;"></td> <td style="width: 10%;"></td> <td style="width: 10%;"></td> <td style="width: 10%;"></td> <td style="width: 10%;"></td> </tr> <tr> <td></td> <td></td> <td colspan="8" style="text-align: center;"> <table border="1" style="width: 100%; border-collapse: collapse; text-align: center;"> <tr> <td style="width: 10%;"></td> <td style="width: 10%;"></td> <td style="width: 10%;"></td> <td style="width: 10%;"></td> <td style="width: 10%;"></td> <td style="width: 10%;"></td> <td style="width: 10%;"></td> <td style="width: 10%;"></td> <td style="width: 10%;"></td> <td style="width: 10%;"></td> </tr> <tr> <td></td> <td></td> <td colspan="8" style="text-align: center;"> <table border="1" style="width: 100%; border-collapse: collapse; text-align: center;"> <tr> <td style="width: 10%;"></td> <td style="width: 10%;"></td> <td style="width: 10%;"></td> <td style="width: 10%;"></td> <td style="width: 10%;"></td> <td style="width: 10%;"></td> <td style="width: 10%;"></td> <td style="width: 10%;"></td> <td style="width: 10%;"></td> <td style="width: 10%;"></td> </tr> <tr> <td></td> <td></td> <td colspan="8" style="text-align: center;"> <table border="1" style="width: 100%; border-collapse: collapse; text-align: center;"> <tr> <td style="width: 10%;"></td> <td style="width: 10%;"></td> <td style="width: 10%;"></td> <td style="width: 10%;"></td> <td style="width: 10%;"></td> <td style="width: 10%;"></td> <td style="width: 10%;"></td> <td style="width: 10%;"></td> <td style="width: 10%;"></td> <td style="width: 10%;"></td> </tr> <tr> <td></td> <td></td> <td colspan="8" style="text-align: center;"> <table border="1" style="width: 100%; border-collapse: collapse; text-align: center;"> <tr> <td style="width: 10%;"></td> <td style="width: 10%;"></td> <td style="width: 10%;"></td> <td style="width: 10%;"></td> <td style="width: 10%;"></td> <td style="width: 10%;"></td> <td style="width: 10%;"></td> <td style="width: 10%;"></td> <td style="width: 10%;"></td> <td style="width: 10%;"></td> </tr> <tr> <td></td> <td></td> <td colspan="8" style="text-align: center;"> <table border="1" style="width: 100%; border-collapse: collapse; text-align: center;"> <tr> <td style="width: 10%;"></td> <td style="width: 10%;"></td> <td style="width: 10%;"></td> <td style="width: 10%;"></td> <td style="width: 10%;"></td> <td style="width: 10%;"></td> <td style="width: 10%;"></td> <td style="width: 10%;"></td> <td style="width: 10%;"></td> <td style="width: 10%;"></td> </tr> <tr> <td></td> <td></td> <td colspan="8" style="text-align: center;"> <table border="1" style="width: 100%; border-collapse: collapse; text-align: center;"> <tr> <td style="width: 10%;"></td> <td style="width: 10%;"></td> <td style="width: 10%;"></td> <td style="width: 10%;"></td> <td style="width: 10%;"></td> <td style="width: 10%;"></td> <td style="width: 10%;"></td> <td style="width: 10%;"></td> <td style="width: 10%;"></td> <td style="width: 10%;"></td> </tr> <tr> <td></td> <td></td> <td colspan="8" style="text-align: center;"> <table border="1" style="width: 100%; border-collapse: collapse; text-align: center;"> <tr> <td style="width: 10%;"></td> <td style="width: 10%;"></td> <td style="width: 10%;"></td> <td style="width: 10%;"></td> <td style="width: 10%;"></td> <td style="width: 10%;"></td> <td style="width: 10%;"></td> <td style="width: 10%;"></td> <td style="width: 10%;"></td> <td style="width: 10%;"></td> </tr> <tr> <td></td> <td></td> <td colspan="8" style="text-align: center;"> <table border="1" style="width: 100%; border-collapse: collapse; text-align: center;"> <tr> <td style="width: 10%;"></td> <td style="width: 10%;"></td> <td style="width: 10%;"></td> <td style="width: 10%;"></td> <td style="width: 10%;"></td> <td style="width: 10%;"></td> <td style="width: 10%;"></td> <td style="width: 10%;"></td> <td style="width: 10%;"></td> <td style="width: 10%;"></td> </tr> <tr> <td></td> <td></td> <td colspan="8" style="text-align: center;"> <table border="1" style="width: 100%; border-collapse: collapse; text-align: center;"> <tr> <td style="width: 10%;"></td> <td style="width: 10%;"></td> <td style="width: 10%;"></td> <td style="width: 10%;"></td> <td style="width: 10%;"></td> <td style="width: 10%;"></td> <td style="width: 10%;"></td> <td style="width: 10%;"></td> <td style="width: 10%;"></td> <td style="width: 10%;"></td> </tr> <tr> <td></td> <td></td> <td colspan="8" style="text-align: center;"> <table border="1" style="width: 100%; border-collapse: collapse; text-align: center;"> <tr> <td style="width: 10%;"></td> <td style="width: 10%;"></td> <td style="width: 10%;"></td> <td style="width: 10%;"></td> <td style="width: 10%;"></td> <td style="width: 10%;"></td> <td style="width: 10%;"></td> <td style="width: 10%;"></td> <td style="width: 10%;"></td> <td style="width: 10%;"></td> </tr> <tr> <td></td> <td></td> <td colspan="8" style="text-align: center;"> <table border="1" style="width: 100%; border-collapse: collapse; text-align: center;"> <tr> <td style="width: 10%;"></td> <td style="width: 10%;"></td> <td style="width: 10%;"></td> <td style="width: 10%;"></td> <td style="width: 10%;"></td> <td style="width: 10%;"></td> <td style="width: 10%;"></td> <td style="width: 10%;"></td> <td style="width: 10%;"></td> <td style="width: 10%;"></td> </tr> <tr> <td></td> <td></td> <td colspan="8" style="text-align: center;"> <table border="1" style="width: 100%; border-collapse: collapse; text-align: center;"> <tr> <td style="width: 10%;"></td> <td style="width: 10%;"></td> <td style="width: 10%;"></td> <td style="width: 10%;"></td> <td style="width: 10%;"></td> <td style="width: 10%;"></td> <td style="width: 10%;"></td> <td style="width: 10%;"></td> <td style="width: 10%;"></td> <td style="width: 10%;"></td> </tr> <tr> <td></td> <td></td> <td colspan="8" style="text-align: center;"> <table border="1" style="width: 100%; border-collapse: collapse; text-align: center;"> <tr> <td style="width: 10%;"></td> <td style="width: 10%;"></td> <td style="width: 10%;"></td> <td style="width: 10%;"></td> <td style="width: 10%;"></td> <td style="width: 10%;"></td> <td style="width: 10%;"></td> <td style="width: 10%;"></td> <td style="width: 10%;"></td> <td style="width: 10%;"></td> </tr> <tr> <td></td> <td></td> <td colspan="8" style="text-align: center;"> <table border="1" style="width: 100%; border-collapse: collapse; text-align: center;"> <tr> <td style="width: 10%;"></td> <td style="width: 10%;"></td> <td style="width: 10%;"></td> <td style="width: 10%;"></td> <td style="width: 10%;"></td> <td style="width: 10%;"></td> <td style="width: 10%;"></td> <td style="width: 10%;"></td> <td style="width: 10%;"></td> <td style="width: 10%;"></td> </tr> <tr> <td></td> <td></td> <td colspan="8" style="text-align: center;"> <table border="1" style="width: 100%; border-collapse: collapse; text-align: center;"> <tr> <td style="width: 10%;"></td> <td style="width: 10%;"></td> <td style="width: 10%;"></td> <td style="width: 10%;"></td> <td style="width: 10%;"></td> <td style="width: 10%;"></td> <td style="width: 10%;"></td> <td style="width: 10%;"></td> <td style="width: 10%;"></td> <td style="width: 10%;"></td> </tr> <tr> <td></td> <td></td> <td colspan="8" style="text-align: center;"> <table border="1" style="width: 100%; border-collapse: collapse; text-align: center;"> <tr> <td style="width: 10%;"></td> <td style="width: 10%;"></td> <td style="width: 10%;"></td> <td style="width: 10%;"></td> <td style="width: 10%;"></td> <td style="width: 10%;"></td> <td style="width: 10%;"></td> <td style="width: 10%;"></td> <td style="width: 10%;"></td> <td style="width: 10%;"></td> </tr> <tr> <td></td> <td></td> <td colspan="8" style="text-align: center;"> <table border="1" style="width: 100%; border-collapse: collapse; text-align: center;"> <tr> <td style="width: 10%;"></td> <td style="width:
10%;"></td> <td style="width: 10%;"></td> <td style="width: 10%;"></td> <td style="width: 10%;"></td> <td style="width: 10%;"></td> <td style="width: 10%;"></td> <td style="width: 10%;"></td> <td style="width: 10%;"></td> <td style="width: 10%;"></td> </tr> <tr> <td></td> <td></td> <td colspan="8" style="text-align: center;"> <table border="1" style="width: 100%; border-collapse: collapse; text-align: center;"> <tr> <td style="width: 10%;"></td> <td style="width: 10%;"></td> <td style="width: 10%;"></td> <td style="width: 10%;"></td> <td style="width: 10%;"></td> <td style="width: 10%;"></td> <td style="width: 10%;"></td> <td style="width: 10%;"></td> <td style="width: 10%;"></td> <td style="width: 10%;"></td> </tr> <tr> <td></td> <td></td> <td colspan="8" style="text-align: center;"> <table border="1" style="width: 100%; border-collapse: collapse; text-align: center;"> <tr> <td style="width: 10%;"></td> <td style="width: 10%;"></td> <td style="width: 10%;"></td> <td style="width: 10%;"></td> <td style="width: 10%;"></td> <td style="width: 10%;"></td> <td style="width: 10%;"></td> <td style="width: 10%;"></td> <td style="width: 10%;"></td> <td style="width: 10%;"></td> </tr> <tr> <td></td> <td></td> <td colspan="8" style="text-align: center;"> <table border="1" style="width: 100%; border-collapse: collapse; text-align: center;"> <tr> <td style="width: 10%;"></td> <td style="width: 10%;"></td> <td style="width: 10%;"></td> <td style="width: 10%;"></td> <td style="width: 10%;"></td> <td style="width: 10%;"></td> <td style="width: 10%;"></td> <td style="width: 10%;"></td> <td style="width: 10%;"></td> <td style="width: 10%;"></td> </tr> <tr> <td></td> <td></td> <td colspan="8" style="text-align: center;"> <table border="1" style="width: 100%; border-collapse: collapse; text-align: center;"> <tr> <td style="width: 10%;"></td> <td style="width: 10%;"></td> <td style="width: 10%;"></td> <td style="width: 10%;"></td> <td style="width: 10%;"></td> <td style="width: 10%;"></td> <td style="width: 10%;"></td> <td style="width: 10%;"></td> <td style="width: 10%;"></td> <td style="width: 10%;"></td> </tr> <tr> <td></td> <td></td> <td colspan="8" style="text-align: center;"> <table border="1" style="width: 100%; border-collapse: collapse; text-align: center;"> <tr> <td style="width: 10%;"></td> <td style="width: 10%;"></td> <td style="width: 10%;"></td> <td style="width: 10%;"></td> <td style="width: 10%;"></td> <td style="width: 10%;"></td> <td style="width: 10%;"></td> <td style="width: 10%;"></td> <td style="width: 10%;"></td> <td style="width: 10%;"></td> </tr> <tr> <td></td> <td></td> <td colspan="8" style="text-align: center;"> <table border="1" style="width: 100%; border-collapse: collapse; text-align: center;"> <tr> <td style="width: 10%;"></td> <td style="width: 10%;"></td> <td style="width: 10%;"></td> <td style="width: 10%;"></td> <td style="width: 10%;"></td> <td style="width: 10%;"></td> <td style="width: 10%;"></td> <td style="width: 10%;"></td> <td style="width: 10%;"></td> <td style="width: 10%;"></td> </tr> <tr> <td></td> <td></td> <td colspan="8" style="text-align: center;"> <table border="1" style="width: 100%; border-collapse: collapse; text-align: center;"> <tr> <td style="width: 10%;"></td> <td style="width: 10%;"></td> <td style="width: 10%;"></td> <td style="width: 10%;"></td> <td style="width: 10%;"></td> <td style="width: 10%;"></td> <td style="width: 10%;"></td> <td style="width: 10%;"></td> <td style="width: 10%;"></td> <td style="width: 10%;"></td> </tr> <tr> <td></td> <td></td> <td colspan="8" style="text-align: center;"> <table border="1" style="width: 100%; border-collapse: collapse; text-align: center;"> <tr> <td style="width: 10%;"></td> <td style="width: 10%;"></td> <td style="width: 10%;"></td> <td style="width: 10%;"></td> <td style="width: 10%;"></td> <td style="width: 10%;"></td> <td style="width: 10%;"></td> <td style="width: 10%;"></td> <td style="width: 10%;"></td> <td style="width: 10%;"></td> </tr> <tr> <td></td> <td></td> <td colspan="8" style="text-align: center;"> <table border="1" style="width: 100%; border-collapse: collapse; text-align: center;"> <tr> <td style="width: 10%;"></td> <td style="width: 10%;"></td> <td style="width: 10%;"></td> <td style="width: 10%;"></td> <td style="width: 10%;"></td> <td style="width: 10%;"></td> <td style="width: 10%;"></td> <td style="width: 10%;"></td> <td style="width: 10%;"></td> <td style="width: 10%;"></td> </tr> <tr> <td></td> <td></td> <td colspan="8" style="text-align: center;"> <table border="1" style="width: 100%; border-collapse: collapse; text-align: center;"> <tr> <td style="width: 10%;"></td> <td style="width: 10%;"></td> <td style="width: 10%;"></td> <td style="width: 10%;"></td> <td style="width: 10%;"></td> <td style="width: 10%;"></td> <td style="width: 10%;"></td> <td style="width: 10%;"></td> <td style="width: 10%;"></td> <td style="width: 10%;"></td> </tr> <tr> <td></td> <td></td> <td colspan="8" style="text-align: center;"> <table border="1" style="width: 100%; border-collapse: collapse; text-align: center;"> <tr> <td style="width: 10%;"></td> <td style="width: 10%;"></td> <td style="width: 10%;"></td> <td style="width: 10%;"></td> <td style="width: 10%;"></td> <td style="width: 10%;"></td> <td style="width: 10%;"></td> <td style="width: 10%;"></td> <td style="width: 10%;"></td> <td style="width: 10%;"></td> </tr> <tr> <td></td> <td></td> <td colspan="8" style="text-align: center;"> <table border="1" style="width: 100%; border-collapse: collapse; text-align: center;"> <tr> <td style="width: 10%;"></td> <td style="width: 10%;"></td> <td style="width: 10%;"></td> <td style="width: 10%;"></td> <td style="width: 10%;"></td> <td style="width: 10%;"></td> <td style="width: 10%;"></td> <td style="width: 10%;"></td> <td style="width: 10%;"></td> <td style="width: 10%;"></td> </tr> <tr> <td></td> <td></td> <td colspan="8" style="text-align: center;"> <table border="1" style="width: 100%; border-collapse: collapse; text-align: center;"> <tr> <td style="width: 10%;"></td> <td style="width: 10%;"></td> <td style="width: 10%;"></td> <td style="width: 10%;"></td> <td style="width: 10%;"></td> <td style="width: 10%;"></td> <td style="width: 10%;"></td> <td style="width: 10%;"></td> <td style="width: 10%;"></td> <td style="width: 10%;"></td> </tr> <tr> <td></td> <td></td> <td colspan="8" style="text-align: center;"> <table border="1" style="width: 100%; border-collapse: collapse; text-align: center;"> <tr> <td style="width: 10%;"></td> <td style="width: 10%;"></td> <td style="width: 10%;"></td> <td style="width: 10%;"></td> <td style="width: 10%;"></td> <td style="width: 10%;"></td> <td style="width: 10%;"></td> <td style="width: 10%;"></td> <td style="width: 10%;"></td> <td style="width: 10%;"></td> </tr> <tr> <td></td> <td></td> <td colspan="8" style="text-align: center;"> <table border="1" style="width: 100%; border-collapse: collapse; text-align: center;"> <tr> <td style="width: 10%;"></td> <td style="width: 10%;"></td> <td style="width: 10%;"></td> <td style="width: 10%;"></td> <td style="width: 10%;"></td> <td style="width: 10%;"></td> <td style="width: 10%;"></td> <td style="width: 10%;"></td> <td style="width: 10%;"></td> <td style="width: 10%;"></td> </tr> <tr> <td></td> <td></td> <td colspan="8" style="text-align: center;"> <table border="1" style="width: 100%; border-collapse: collapse; text-align: center;"> <tr> <td style="width: 10%;"></td> <td style="width: 10%;"></td> <td style="width: 10%;"></td> <td style="width: 10%;"></td> <td style="width: 10%;"></td> <td style="width: 10%;"></td> <td style="width: 10%;"></td> <td style="width: 10%;"></td> <td style="width: 10%;"></td> <td style="width: 10%;"></td> </tr> <tr> <td></td> <td></td> <td colspan="8" style="text-align: center;"> <table border="1" style="width: 100%; border-collapse: collapse; text-align: center;"> <tr> <td style="width: 10%;"></td> <td style="width: 10%;"></td> <td style="width: 10%;"></td> <td style="width: 10%;"></td> <td style="width: 10%;"></td> <td style="width: 10%;"></td> <td style="width: 10%;"></td> <td style="width: 10%;"></td> <td style="width: 10%;"></td> <td style="width: 10%;"></td> </tr> <tr> <td></td> <td></td> <td colspan="8" style="text-align: center;"> <table border="1" style="width: 100%; border-collapse: collapse; text-align: center;"> <tr> </tr></table></td></tr></table></td></tr></table></td></tr></table></td></tr></table></td></tr></table></td></tr></table></td></tr></table></td></tr></table></td></tr></table></td></tr></table></td></tr></table></td></tr></table></td></tr></table></td></tr></table></td></tr></table></td></tr></table></td></tr></table></td></tr></table></td></tr></table></td></tr></table></td></tr></table></td></tr></table></td></tr></table></td></tr></table></td></tr></table></td></tr></table></td></tr></table></td></tr></table></td></tr></table></td></tr></table></td></tr></table></td></tr></table></td></tr></table></td></tr></table></td></tr></table></td></tr></table></td></tr></table></td></tr></table></td></tr></table></td></tr></table></td></tr></table></td></tr></table></td></tr></table></td></tr></table></td></tr></table></td></tr></table></td></tr></table></td></tr></table></td></tr></table></td></tr></table></td></tr></table></td></tr></table></td></tr></table></td></tr></table></td></tr></table></td></tr></table></td></tr></table></td></tr></table> | | | | | | | | | | | | | | | | | | | | <table border="1" style="width: 100%; border-collapse: collapse; text-align: center;"> <tr> <td style="width: 10%;"></td> <td style="width: 10%;"></td> <td style="width: 10%;"></td> <td style="width: 10%;"></td> <td style="width: 10%;"></td> <td style="width: 10%;"></td> <td style="width: 10%;"></td> <td style="width: 10%;"></td> <td style="width: 10%;"></td> <td style="width: 10%;"></td> </tr> <tr> <td></td> <td></td> <td colspan="8" style="text-align: center;"> <table border="1" style="width: 100%;
border-collapse: collapse; text-align: center;"> <tr> <td style="width: 10%;"></td> <td style="width: 10%;"></td> <td style="width: 10%;"></td> <td style="width: 10%;"></td> <td style="width: 10%;"></td> <td style="width: 10%;"></td> <td style="width: 10%;"></td> <td style="width: 10%;"></td> <td style="width: 10%;"></td> <td style="width: 10%;"></td> </tr> <tr> <td></td> <td></td> <td colspan="8" style="text-align: center;"> <table border="1" style="width: 100%; border-collapse: collapse; text-align: center;"> <tr> <td style="width: 10%;"></td> <td style="width: 10%;"></td> <td style="width: 10%;"></td> <td style="width: 10%;"></td> <td style="width: 10%;"></td> <td style="width: 10%;"></td> <td style="width: 10%;"></td> <td style="width: 10%;"></td> <td style="width: 10%;"></td> <td style="width: 10%;"></td> </tr> <tr> <td></td> <td></td> <td colspan="8" style="text-align: center;"> <table border="1" style="width: 100%; border-collapse: collapse; text-align: center;"> <tr> <td style="width: 10%;"></td> <td style="width: 10%;"></td> <td style="width: 10%;"></td> <td style="width: 10%;"></td> <td style="width: 10%;"></td> <td style="width: 10%;"></td> <td style="width: 10%;"></td> <td style="width: 10%;"></td> <td style="width: 10%;"></td> <td style="width: 10%;"></td> </tr> <tr> <td></td> <td></td> <td colspan="8" style="text-align: center;"> <table border="1" style="width: 100%; border-collapse: collapse; text-align: center;"> <tr> <td style="width: 10%;"></td> <td style="width: 10%;"></td> <td style="width: 10%;"></td> <td style="width: 10%;"></td> <td style="width: 10%;"></td> <td style="width: 10%;"></td> <td style="width: 10%;"></td> <td style="width: 10%;"></td> <td style="width: 10%;"></td> <td style="width: 10%;"></td> </tr> <tr> <td></td> <td></td> <td colspan="8" style="text-align: center;"> <table border="1" style="width: 100%; border-collapse: collapse; text-align: center;"> <tr> <td style="width: 10%;"></td> <td style="width: 10%;"></td> <td style="width: 10%;"></td> <td style="width: 10%;"></td> <td style="width: 10%;"></td> <td style="width: 10%;"></td> <td style="width: 10%;"></td> <td style="width: 10%;"></td> <td style="width: 10%;"></td> <td style="width: 10%;"></td> </tr> <tr> <td></td> <td></td> <td colspan="8" style="text-align: center;"> <table border="1" style="width: 100%; border-collapse: collapse; text-align: center;"> <tr> <td style="width: 10%;"></td> <td style="width: 10%;"></td> <td style="width: 10%;"></td> <td style="width: 10%;"></td> <td style="width: 10%;"></td> <td style="width: 10%;"></td> <td style="width: 10%;"></td> <td style="width: 10%;"></td> <td style="width: 10%;"></td> <td style="width: 10%;"></td> </tr> <tr> <td></td> <td></td> <td colspan="8" style="text-align: center;"> <table border="1" style="width: 100%; border-collapse: collapse; text-align: center;"> <tr> <td style="width: 10%;"></td> <td style="width: 10%;"></td> <td style="width: 10%;"></td> <td style="width: 10%;"></td> <td style="width: 10%;"></td> <td style="width: 10%;"></td> <td style="width: 10%;"></td> <td style="width: 10%;"></td> <td style="width: 10%;"></td> <td style="width: 10%;"></td> </tr> <tr> <td></td> <td></td> <td colspan="8" style="text-align: center;"> <table border="1" style="width: 100%; border-collapse: collapse; text-align: center;"> <tr> <td style="width: 10%;"></td> <td style="width: 10%;"></td> <td style="width: 10%;"></td> <td style="width: 10%;"></td> <td style="width: 10%;"></td> <td style="width: 10%;"></td> <td style="width: 10%;"></td> <td style="width: 10%;"></td> <td style="width: 10%;"></td> <td style="width: 10%;"></td> </tr> <tr> <td></td> <td></td> <td colspan="8" style="text-align: center;"> <table border="1" style="width: 100%; border-collapse: collapse; text-align: center;"> <tr> <td style="width: 10%;"></td> <td style="width: 10%;"></td> <td style="width: 10%;"></td> <td style="width: 10%;"></td> <td style="width: 10%;"></td> <td style="width: 10%;"></td> <td style="width: 10%;"></td> <td style="width: 10%;"></td> <td style="width: 10%;"></td> <td style="width: 10%;"></td> </tr> <tr> <td></td> <td></td> <td colspan="8" style="text-align: center;"> <table border="1" style="width: 100%; border-collapse: collapse; text-align: center;"> <tr> <td style="width: 10%;"></td> <td style="width: 10%;"></td> <td style="width: 10%;"></td> <td style="width: 10%;"></td> <td style="width: 10%;"></td> <td style="width: 10%;"></td> <td style="width: 10%;"></td> <td style="width: 10%;"></td> <td style="width: 10%;"></td> <td style="width: 10%;"></td> </tr> <tr> <td></td> <td></td> <td colspan="8" style="text-align: center;"> <table border="1" style="width: 100%; border-collapse: collapse; text-align: center;"> <tr> <td style="width: 10%;"></td> <td style="width: 10%;"></td> <td style="width: 10%;"></td> <td style="width: 10%;"></td> <td style="width: 10%;"></td> <td style="width: 10%;"></td> <td style="width: 10%;"></td> <td style="width: 10%;"></td> <td style="width: 10%;"></td> <td style="width: 10%;"></td> </tr> <tr> <td></td> <td></td> <td colspan="8" style="text-align: center;"> <table border="1" style="width: 100%; border-collapse: collapse; text-align: center;"> <tr> <td style="width: 10%;"></td> <td style="width: 10%;"></td> <td style="width: 10%;"></td> <td style="width: 10%;"></td> <td style="width: 10%;"></td> <td style="width: 10%;"></td> <td style="width: 10%;"></td> <td style="width: 10%;"></td> <td style="width: 10%;"></td> <td style="width: 10%;"></td> </tr> <tr> <td></td> <td></td> <td colspan="8" style="text-align: center;"> <table border="1" style="width: 100%; border-collapse: collapse; text-align: center;"> <tr> <td style="width: 10%;"></td> <td style="width: 10%;"></td> <td style="width: 10%;"></td> <td style="width: 10%;"></td> <td style="width: 10%;"></td> <td style="width: 10%;"></td> <td style="width: 10%;"></td> <td style="width: 10%;"></td> <td style="width: 10%;"></td> <td style="width: 10%;"></td> </tr> <tr> <td></td> <td></td> <td colspan="8" style="text-align: center;"> <table border="1" style="width: 100%; border-collapse: collapse; text-align: center;"> <tr> <td style="width: 10%;"></td> <td style="width: 10%;"></td> <td style="width: 10%;"></td> <td style="width: 10%;"></td> <td style="width: 10%;"></td> <td style="width: 10%;"></td> <td style="width: 10%;"></td> <td style="width: 10%;"></td> <td style="width: 10%;"></td> <td style="width: 10%;"></td> </tr> <tr> <td></td> <td></td> <td colspan="8" style="text-align: center;"> <table border="1" style="width: 100%; border-collapse: collapse; text-align: center;"> <tr> <td style="width: 10%;"></td> <td style="width: 10%;"></td> <td style="width: 10%;"></td> <td style="width: 10%;"></td> <td style="width: 10%;"></td> <td style="width: 10%;"></td> <td style="width: 10%;"></td> <td style="width: 10%;"></td> <td style="width: 10%;"></td> <td style="width: 10%;"></td> </tr> <tr> <td></td> <td></td> <td colspan="8" style="text-align: center;"> <table border="1" style="width: 100%; border-collapse: collapse; text-align: center;"> <tr> <td style="width: 10%;"></td> <td style="width: 10%;"></td> <td style="width: 10%;"></td> <td style="width: 10%;"></td> <td style="width: 10%;"></td> <td style="width: 10%;"></td> <td style="width: 10%;"></td> <td style="width: 10%;"></td> <td style="width: 10%;"></td> <td style="width: 10%;"></td> </tr> <tr> <td></td> <td></td> <td colspan="8" style="text-align: center;"> <table border="1" style="width: 100%; border-collapse: collapse; text-align: center;"> <tr> <td style="width: 10%;"></td> <td style="width: 10%;"></td> <td style="width: 10%;"></td> <td style="width: 10%;"></td> <td style="width: 10%;"></td> <td style="width: 10%;"></td> <td style="width: 10%;"></td> <td style="width: 10%;"></td> <td style="width: 10%;"></td> <td style="width: 10%;"></td> </tr> <tr> <td></td> <td></td> <td colspan="8" style="text-align: center;"> <table border="1" style="width: 100%; border-collapse: collapse; text-align: center;"> <tr> <td style="width: 10%;"></td> <td style="width: 10%;"></td> <td style="width: 10%;"></td> <td style="width: 10%;"></td> <td style="width: 10%;"></td> <td style="width: 10%;"></td> <td style="width: 10%;"></td> <td style="width: 10%;"></td> <td style="width: 10%;"></td> <td style="width: 10%;"></td> </tr> <tr> <td></td> <td></td> <td colspan="8" style="text-align: center;"> <table border="1" style="width: 100%; border-collapse: collapse; text-align: center;"> <tr> <td style="width: 10%;"></td> <td style="width: 10%;"></td> <td style="width: 10%;"></td> <td style="width: 10%;"></td> <td style="width: 10%;"></td> <td style="width: 10%;"></td> <td style="width: 10%;"></td> <td style="width: 10%;"></td> <td style="width: 10%;"></td> <td style="width: 10%;"></td> </tr> <tr> <td></td> <td></td> <td colspan="8" style="text-align: center;"> <table border="1" style="width: 100%; border-collapse: collapse; text-align: center;"> <tr> <td style="width: 10%;"></td> <td style="width: 10%;"></td> <td style="width: 10%;"></td> <td style="width: 10%;"></td> <td style="width: 10%;"></td> <td style="width: 10%;"></td> <td style="width: 10%;"></td> <td style="width: 10%;"></td> <td style="width: 10%;"></td> <td style="width: 10%;"></td> </tr> <tr> <td></td> <td></td> <td colspan="8" style="text-align: center;"> <table border="1" style="width: 100%; border-collapse: collapse; text-align: center;"> <tr> <td style="width: 10%;"></td> <td style="width: 10%;"></td> <td style="width: 10%;"></td> <td style="width: 10%;"></td> <td style="width: 10%;"></td> <td style="width: 10%;"></td> <td style="width: 10%;"></td> <td style="width: 10%;"></td> <td style="width: 10%;"></td> <td style="width: 10%;"></td> </tr> <tr> <td></td> <td></td> <td colspan="8" style="text-align: center;"> <table border="1" style="width: 100%; border-collapse: collapse; text-align: center;"> <tr> <td style="width: 10%;"></td> <td style="width: 10%;"></td> <td style="width: 10%;"></td> <td style="width:
10%;"></td> <td style="width: 10%;"></td> <td style="width: 10%;"></td> <td style="width: 10%;"></td> <td style="width: 10%;"></td> <td style="width: 10%;"></td> <td style="width: 10%;"></td> </tr> <tr> <td></td> <td></td> <td colspan="8" style="text-align: center;"> <table border="1" style="width: 100%; border-collapse: collapse; text-align: center;"> <tr> <td style="width: 10%;"></td> <td style="width: 10%;"></td> <td style="width: 10%;"></td> <td style="width: 10%;"></td> <td style="width: 10%;"></td> <td style="width: 10%;"></td> <td style="width: 10%;"></td> <td style="width: 10%;"></td> <td style="width: 10%;"></td> <td style="width: 10%;"></td> </tr> <tr> <td></td> <td></td> <td colspan="8" style="text-align: center;"> <table border="1" style="width: 100%; border-collapse: collapse; text-align: center;"> <tr> <td style="width: 10%;"></td> <td style="width: 10%;"></td> <td style="width: 10%;"></td> <td style="width: 10%;"></td> <td style="width: 10%;"></td> <td style="width: 10%;"></td> <td style="width: 10%;"></td> <td style="width: 10%;"></td> <td style="width: 10%;"></td> <td style="width: 10%;"></td> </tr> <tr> <td></td> <td></td> <td colspan="8" style="text-align: center;"> <table border="1" style="width: 100%; border-collapse: collapse; text-align: center;"> <tr> <td style="width: 10%;"></td> <td style="width: 10%;"></td> <td style="width: 10%;"></td> <td style="width: 10%;"></td> <td style="width: 10%;"></td> <td style="width: 10%;"></td> <td style="width: 10%;"></td> <td style="width: 10%;"></td> <td style="width: 10%;"></td> <td style="width: 10%;"></td> </tr> <tr> <td></td> <td></td> <td colspan="8" style="text-align: center;"> <table border="1" style="width: 100%; border-collapse: collapse; text-align: center;"> <tr> <td style="width: 10%;"></td> <td style="width: 10%;"></td> <td style="width: 10%;"></td> <td style="width: 10%;"></td> <td style="width: 10%;"></td> <td style="width: 10%;"></td> <td style="width: 10%;"></td> <td style="width: 10%;"></td> <td style="width: 10%;"></td> <td style="width: 10%;"></td> </tr> <tr> <td></td> <td></td> <td colspan="8" style="text-align: center;"> <table border="1" style="width: 100%; border-collapse: collapse; text-align: center;"> <tr> <td style="width: 10%;"></td> <td style="width: 10%;"></td> <td style="width: 10%;"></td> <td style="width: 10%;"></td> <td style="width: 10%;"></td> <td style="width: 10%;"></td> <td style="width: 10%;"></td> <td style="width: 10%;"></td> <td style="width: 10%;"></td> <td style="width: 10%;"></td> </tr> <tr> <td></td> <td></td> <td colspan="8" style="text-align: center;"> <table border="1" style="width: 100%; border-collapse: collapse; text-align: center;"> <tr> <td style="width: 10%;"></td> <td style="width: 10%;"></td> <td style="width: 10%;"></td> <td style="width: 10%;"></td> <td style="width: 10%;"></td> <td style="width: 10%;"></td> <td style="width: 10%;"></td> <td style="width: 10%;"></td> <td style="width: 10%;"></td> <td style="width: 10%;"></td> </tr> <tr> <td></td> <td></td> <td colspan="8" style="text-align: center;"> <table border="1" style="width: 100%; border-collapse: collapse; text-align: center;"> <tr> <td style="width: 10%;"></td> <td style="width: 10%;"></td> <td style="width: 10%;"></td> <td style="width: 10%;"></td> <td style="width: 10%;"></td> <td style="width: 10%;"></td> <td style="width: 10%;"></td> <td style="width: 10%;"></td> <td style="width: 10%;"></td> <td style="width: 10%;"></td> </tr> <tr> <td></td> <td></td> <td colspan="8" style="text-align: center;"> <table border="1" style="width: 100%; border-collapse: collapse; text-align: center;"> <tr> <td style="width: 10%;"></td> <td style="width: 10%;"></td> <td style="width: 10%;"></td> <td style="width: 10%;"></td> <td style="width: 10%;"></td> <td style="width: 10%;"></td> <td style="width: 10%;"></td> <td style="width: 10%;"></td> <td style="width: 10%;"></td> <td style="width: 10%;"></td> </tr> <tr> <td></td> <td></td> <td colspan="8" style="text-align: center;"> <table border="1" style="width: 100%; border-collapse: collapse; text-align: center;"> <tr> <td style="width: 10%;"></td> <td style="width: 10%;"></td> <td style="width: 10%;"></td> <td style="width: 10%;"></td> <td style="width: 10%;"></td> <td style="width: 10%;"></td> <td style="width: 10%;"></td> <td style="width: 10%;"></td> <td style="width: 10%;"></td> <td style="width: 10%;"></td> </tr> <tr> <td></td> <td></td> <td colspan="8" style="text-align: center;"> <table border="1" style="width: 100%; border-collapse: collapse; text-align: center;"> <tr> <td style="width: 10%;"></td> <td style="width: 10%;"></td> <td style="width: 10%;"></td> <td style="width: 10%;"></td> <td style="width: 10%;"></td> <td style="width: 10%;"></td> <td style="width: 10%;"></td> <td style="width: 10%;"></td> <td style="width: 10%;"></td> <td style="width: 10%;"></td> </tr> <tr> <td></td> <td></td> <td colspan="8" style="text-align: center;"> <table border="1" style="width: 100%; border-collapse: collapse; text-align: center;"> <tr> <td style="width: 10%;"></td> <td style="width: 10%;"></td> <td style="width: 10%;"></td> <td style="width: 10%;"></td> <td style="width: 10%;"></td> <td style="width: 10%;"></td> <td style="width: 10%;"></td> <td style="width: 10%;"></td> <td style="width: 10%;"></td> <td style="width: 10%;"></td> </tr> <tr> <td></td> <td></td> <td colspan="8" style="text-align: center;"> <table border="1" style="width: 100%; border-collapse: collapse; text-align: center;"> <tr> <td style="width: 10%;"></td> <td style="width: 10%;"></td> <td style="width: 10%;"></td> <td style="width: 10%;"></td> <td style="width: 10%;"></td> <td style="width: 10%;"></td> <td style="width: 10%;"></td> <td style="width: 10%;"></td> <td style="width: 10%;"></td> <td style="width: 10%;"></td> </tr> <tr> <td></td> <td></td> <td colspan="8" style="text-align: center;"> <table border="1" style="width: 100%; border-collapse: collapse; text-align: center;"> <tr> <td style="width: 10%;"></td> <td style="width: 10%;"></td> <td style="width: 10%;"></td> <td style="width: 10%;"></td> <td style="width: 10%;"></td> <td style="width: 10%;"></td> <td style="width: 10%;"></td> <td style="width: 10%;"></td> <td style="width: 10%;"></td> <td style="width: 10%;"></td> </tr> <tr> <td></td> <td></td> <td colspan="8" style="text-align: center;"> <table border="1" style="width: 100%; border-collapse: collapse; text-align: center;"> <tr> <td style="width: 10%;"></td> <td style="width: 10%;"></td> <td style="width: 10%;"></td> <td style="width: 10%;"></td> <td style="width: 10%;"></td> <td style="width: 10%;"></td> <td style="width: 10%;"></td> <td style="width: 10%;"></td> <td style="width: 10%;"></td> <td style="width: 10%;"></td> </tr> <tr> <td></td> <td></td> <td colspan="8" style="text-align: center;"> <table border="1" style="width: 100%; border-collapse: collapse; text-align: center;"> <tr> <td style="width: 10%;"></td> <td style="width: 10%;"></td> <td style="width: 10%;"></td> <td style="width: 10%;"></td> <td style="width: 10%;"></td> <td style="width: 10%;"></td> <td style="width: 10%;"></td> <td style="width: 10%;"></td> <td style="width: 10%;"></td> <td style="width: 10%;"></td> </tr> <tr> <td></td> <td></td> <td colspan="8" style="text-align: center;"> <table border="1" style="width: 100%; border-collapse: collapse; text-align: center;"> <tr> <td style="width: 10%;"></td> <td style="width: 10%;"></td> <td style="width: 10%;"></td> <td style="width: 10%;"></td> <td style="width: 10%;"></td> <td style="width: 10%;"></td> <td style="width: 10%;"></td> <td style="width: 10%;"></td> <td style="width: 10%;"></td> <td style="width: 10%;"></td> </tr> <tr> <td></td> <td></td> <td colspan="8" style="text-align: center;"> <table border="1" style="width: 100%; border-collapse: collapse; text-align: center;"> <tr> <td style="width: 10%;"></td> <td style="width: 10%;"></td> <td style="width: 10%;"></td> <td style="width: 10%;"></td> <td style="width: 10%;"></td> <td style="width: 10%;"></td> <td style="width: 10%;"></td> <td style="width: 10%;"></td> <td style="width: 10%;"></td> <td style="width: 10%;"></td> </tr> <tr> <td></td> <td></td> <td colspan="8" style="text-align: center;"> <table border="1" style="width: 100%; border-collapse: collapse; text-align: center;"> <tr> <td style="width: 10%;"></td> <td style="width: 10%;"></td> <td style="width: 10%;"></td> <td style="width: 10%;"></td> <td style="width: 10%;"></td> <td style="width: 10%;"></td> <td style="width: 10%;"></td> <td style="width: 10%;"></td> <td style="width: 10%;"></td> <td style="width: 10%;"></td> </tr> <tr> <td></td> <td></td> <td colspan="8" style="text-align: center;"> <table border="1" style="width: 100%; border-collapse: collapse; text-align: center;"> <tr> <td style="width: 10%;"></td> <td style="width: 10%;"></td> <td style="width: 10%;"></td> <td style="width: 10%;"></td> <td style="width: 10%;"></td> <td style="width: 10%;"></td> <td style="width: 10%;"></td> <td style="width: 10%;"></td> <td style="width: 10%;"></td> <td style="width: 10%;"></td> </tr> <tr> <td></td> <td></td> <td colspan="8" style="text-align: center;"> <table border="1" style="width: 100%; border-collapse: collapse; text-align: center;"> <tr> <td style="width: 10%;"></td> <td style="width: 10%;"></td> <td style="width: 10%;"></td> <td style="width: 10%;"></td> <td style="width: 10%;"></td> <td style="width: 10%;"></td> <td style="width: 10%;"></td> <td style="width: 10%;"></td> <td style="width: 10%;"></td> <td style="width: 10%;"></td> </tr> <tr> <td></td> <td></td> <td colspan="8" style="text-align: center;"> <table border="1" style="width: 100%; border-collapse: collapse; text-align: center;"> <tr> <td style="width: 10%;"></td> <td style="width: 10%;"></td> <td style="width: 10%;"></td> <td style="width: 10%;"></td> <td style="width: 10%;"></td> <td style="width: 10%;"></td> <td style="width: 10%;"></td> <td style="width: 10%;"></td> <td style="width: 10%;"></td> <td
style="width: 10%;"></td> </tr> <tr> <td></td> <td></td> <td colspan="8" style="text-align: center;"> <table border="1" style="width: 100%; border-collapse: collapse; text-align: center;"> <tr> <td style="width: 10%;"></td> <td style="width: 10%;"></td> <td style="width: 10%;"></td> <td style="width: 10%;"></td> <td style="width: 10%;"></td> <td style="width: 10%;"></td> <td style="width: 10%;"></td> <td style="width: 10%;"></td> <td style="width: 10%;"></td> <td style="width: 10%;"></td> </tr> <tr> <td></td> <td></td> <td colspan="8" style="text-align: center;"> <table border="1" style="width: 100%; border-collapse: collapse; text-align: center;"> <tr> <td style="width: 10%;"></td> <td style="width: 10%;"></td> <td style="width: 10%;"></td> <td style="width: 10%;"></td> <td style="width: 10%;"></td> <td style="width: 10%;"></td> <td style="width: 10%;"></td> <td style="width: 10%;"></td> <td style="width: 10%;"></td> <td style="width: 10%;"></td> </tr> <tr> <td></td> <td></td> <td colspan="8" style="text-align: center;"> <table border="1" style="width: 100%; border-collapse: collapse; text-align: center;"> <tr> <td style="width: 10%;"></td> <td style="width: 10%;"></td> <td style="width: 10%;"></td> <td style="width: 10%;"></td> <td style="width: 10%;"></td> <td style="width: 10%;"></td> <td style="width: 10%;"></td> <td style="width: 10%;"></td> <td style="width: 10%;"></td> <td style="width: 10%;"></td> </tr> <tr> <td></td> <td></td> <td colspan="8" style="text-align: center;"> <table border="1" style="width: 100%; border-collapse: collapse; text-align: center;"> <tr> <td style="width: 10%;"></td> <td style="width: 10%;"></td> <td style="width: 10%;"></td> <td style="width: 10%;"></td> <td style="width: 10%;"></td> <td style="width: 10%;"></td> <td style="width: 10%;"></td> <td style="width: 10%;"></td> <td style="width: 10%;"></td> <td style="width: 10%;"></td> </tr> <tr> <td></td> <td></td> <td colspan="8" style="text-align: center;"> <table border="1" style="width: 100%; border-collapse: collapse; text-align: center;"> <tr> <td style="width: 10%;"></td> <td style="width: 10%;"></td> <td style="width: 10%;"></td> <td style="width: 10%;"></td> <td style="width: 10%;"></td> <td style="width: 10%;"></td> <td style="width: 10%;"></td> <td style="width: 10%;"></td> <td style="width: 10%;"></td> <td style="width: 10%;"></td> </tr> <tr> <td></td> <td></td> <td colspan="8" style="text-align: center;"> <table border="1" style="width: 100%; border-collapse: collapse; text-align: center;"> <tr> <td style="width: 10%;"></td> <td style="width: 10%;"></td> <td style="width: 10%;"></td> <td style="width: 10%;"></td> <td style="width: 10%;"></td> <td style="width: 10%;"></td> <td style="width: 10%;"></td> <td style="width: 10%;"></td> <td style="width: 10%;"></td> <td style="width: 10%;"></td> </tr> <tr> <td></td> <td></td> <td colspan="8" style="text-align: center;"> <table border="1" style="width: 100%; border-collapse: collapse; text-align: center;"> <tr> <td style="width: 10%;"></td> <td style="width: 10%;"></td> <td style="width: 10%;"></td> <td style="width: 10%;"></td> <td style="width: 10%;"></td> <td style="width: 10%;"></td> <td style="width: 10%;"></td> <td style="width: 10%;"></td> <td style="width: 10%;"></td> <td style="width: 10%;"></td> </tr> <tr> <td></td> <td></td> <td colspan="8" style="text-align: center;"> <table border="1" style="width: 100%; border-collapse: collapse; text-align: center;"> <tr> <td style="width: 10%;"></td> <td style="width: 10%;"></td> <td style="width: 10%;"></td> <td style="width: 10%;"></td> <td style="width: 10%;"></td> <td style="width: 10%;"></td> <td style="width: 10%;"></td> <td style="width: 10%;"></td> <td style="width: 10%;"></td> <td style="width: 10%;"></td> </tr> <tr> <td></td> <td></td> <td colspan="8" style="text-align: center;"> <table border="1" style="width: 100%; border-collapse: collapse; text-align: center;"> <tr> <td style="width: 10%;"></td> <td style="width: 10%;"></td> <td style="width: 10%;"></td> <td style="width: 10%;"></td> <td style="width: 10%;"></td> <td style="width: 10%;"></td> <td style="width: 10%;"></td> <td style="width: 10%;"></td> <td style="width: 10%;"></td> <td style="width: 10%;"></td> </tr> <tr> <td></td> <td></td> <td colspan="8" style="text-align: center;"> <table border="1" style="width: 100%; border-collapse: collapse; text-align: center;"> <tr> <td style="width: 10%;"></td> <td style="width: 10%;"></td> <td style="width: 10%;"></td> <td style="width: 10%;"></td> <td style="width: 10%;"></td> <td style="width: 10%;"></td> <td style="width: 10%;"></td> <td style="width: 10%;"></td> <td style="width: 10%;"></td> <td style="width: 10%;"></td> </tr> <tr> <td></td> <td></td> <td colspan="8" style="text-align: center;"> <table border="1" style="width: 100%; border-collapse: collapse; text-align: center;"> <tr> <td style="width: 10%;"></td> <td style="width: 10%;"></td> <td style="width: 10%;"></td> <td style="width: 10%;"></td> <td style="width: 10%;"></td> <td style="width: 10%;"></td> <td style="width: 10%;"></td> <td style="width: 10%;"></td> <td style="width: 10%;"></td> <td style="width: 10%;"></td> </tr> <tr> <td></td> <td></td> <td colspan="8" style="text-align: center;"> <table border="1" style="width: 100%; border-collapse: collapse; text-align: center;"> <tr> <td style="width: 10%;"></td> <td style="width: 10%;"></td> <td style="width: 10%;"></td> <td style="width: 10%;"></td> <td style="width: 10%;"></td> <td style="width: 10%;"></td> <td style="width: 10%;"></td> <td style="width: 10%;"></td> <td style="width: 10%;"></td> <td style="width: 10%;"></td> </tr> <tr> <td></td> <td></td> <td colspan="8" style="text-align: center;"> <table border="1" style="width: 100%; border-collapse: collapse; text-align: center;"> <tr> <td style="width: 10%;"></td> <td style="width: 10%;"></td> <td style="width: 10%;"></td> <td style="width: 10%;"></td> <td style="width: 10%;"></td> <td style="width: 10%;"></td> <td style="width: 10%;"></td> <td style="width: 10%;"></td> <td style="width: 10%;"></td> <td style="width: 10%;"></td> </tr> <tr> <td></td> <td></td> <td colspan="8" style="text-align: center;"> <table border="1" style="width: 100%; border-collapse: collapse; text-align: center;"> <tr> </tr></table></td></tr></table></td></tr></table></td></tr></table></td></tr></table></td></tr></table></td></tr></table></td></tr></table></td></tr></table></td></tr></table></td></tr></table></td></tr></table></td></tr></table></td></tr></table></td></tr></table></td></tr></table></td></tr></table></td></tr></table></td></tr></table></td></tr></table></td></tr></table></td></tr></table></td></tr></table></td></tr></table></td></tr></table></td></tr></table></td></tr></table></td></tr></table></td></tr></table></td></tr></table></td></tr></table></td></tr></table></td></tr></table></td></tr></table></td></tr></table></td></tr></table></td></tr></table></td></tr></table></td></tr></table></td></tr></table></td></tr></table></td></tr></table></td></tr></table></td></tr></table></td></tr></table></td></tr></table></td></tr></table></td></tr></table></td></tr></table></td></tr></table></td></tr></table></td></tr></table></td></tr></table></td></tr></table></td></tr></table></td></tr></table></td></tr></table></td></tr></table> | | | | | | | | | | | | | | | | | | | | <table border="1" style="width: 100%; border-collapse: collapse; text-align: center;"> <tr> <td style="width: 10%;"></td> <td style="width: 10%;"></td> <td style="width: 10%;"></td> <td style="width: 10%;"></td> <td style="width: 10%;"></td> <td style="width: 10%;"></td> <td style="width: 10%;"></td> <td style="width: 10%;"></td> <td style="width: 10%;"></td> <td style="width: 10%;"></td> </tr> <tr> <td></td> <td></td> <td colspan="8" style="text-align: center;"> <table border="1" style="width: 100%; border-collapse: collapse; text-align: center;"> <tr> <td style="width: 10%;"></td> <td style="width: 10%;"></td> <td style="width: 10%;"></td> <td style="width: 10%;"></td> <td style="width: 10%;"></td> <td style="width: 10%;"></td> <td style="width: 10%;"></td> <td style="width: 10%;"></td> <td style="width: 10%;"></td> <td style="width: 10%;"></td> </tr> <tr> <td></td> <td></td> <td colspan="8" style="text-align: center;"> <table border="1" style="width: 100%; border-collapse: collapse; text-align: center;"> <tr> <td style="width: 10%;"></td> <td style="width: 10%;"></td> <td style="width: 10%;"></td> <td style="width: 10%;"></td> <td style="width: 10%;"></td> <td style="width: 10%;"></td> <td style="width: 10%;"></td> <td style="width: 10%;"></td> <td style="width: 10%;"></td> <td style="width: 10%;"></td> </tr> <tr> <td></td> <td></td> <td colspan="8" style="text-align: center;"> <table border="1" style="width: 100%; border-collapse: collapse; text-align: center;"> <tr> <td style="width: 10%;"></td> <td style="width: 10%;"></td> <td style="width: 10%;"></td> <td style="width: 10%;"></td> <td style="width: 10%;"></td> <td style="width: 10%;"></td> <td style="width: 10%;"></td> <td style="width: 10%;"></td> <td style="width: 10%;"></td> <td style="width: 10%;"></td> </tr> <tr> <td></td> <td></td> <td colspan="8" style="text-align: center;"> <table border="1" style="width: 100%; border-collapse: collapse; text-align: center;"> <tr> <td style="width: 10%;"></td> <td style="width: 10%;"></td> <td style="width: 10%;"></td> <td style="width: 10%;"></td> <td style="width: 10%;"></td> <td style="width: 10%;"></td> <td style="width: 10%;"></td> <td style="width: 10%;"></td> <td style="width: 10%;"></td> <td style="width: 10%;"></td> </tr> <tr> <td></td> <td></td> <td colspan="8" style="text-align: center;"> <table border="1" style="width: 100%; border-collapse: collapse; text-align: center;"> <tr> <td style="width: 10%;"></td> <td style="width: 10%;"></td> <td style="width: 10%;"></td> <td style="width: 10%;"></td> <td style="width: 10%;"></td> <td style="width: 10%;"></td> <td
style="width: 10%;"></td> <td style="width: 10%;"></td> <td style="width: 10%;"></td> <td style="width: 10%;"></td> </tr> <tr> <td></td> <td></td> <td colspan="8" style="text-align: center;"> <table border="1" style="width: 100%; border-collapse: collapse; text-align: center;"> <tr> <td style="width: 10%;"></td> <td style="width: 10%;"></td> <td style="width: 10%;"></td> <td style="width: 10%;"></td> <td style="width: 10%;"></td> <td style="width: 10%;"></td> <td style="width: 10%;"></td> <td style="width: 10%;"></td> <td style="width: 10%;"></td> <td style="width: 10%;"></td> </tr> <tr> <td></td> <td></td> <td colspan="8" style="text-align: center;"> <table border="1" style="width: 100%; border-collapse: collapse; text-align: center;"> <tr> <td style="width: 10%;"></td> <td style="width: 10%;"></td> <td style="width: 10%;"></td> <td style="width: 10%;"></td> <td style="width: 10%;"></td> <td style="width: 10%;"></td> <td style="width: 10%;"></td> <td style="width: 10%;"></td> <td style="width: 10%;"></td> <td style="width: 10%;"></td> </tr> <tr> <td></td> <td></td> <td colspan="8" style="text-align: center;"> <table border="1" style="width: 100%; border-collapse: collapse; text-align: center;"> <tr> <td style="width: 10%;"></td> <td style="width: 10%;"></td> <td style="width: 10%;"></td> <td style="width: 10%;"></td> <td style="width: 10%;"></td> <td style="width: 10%;"></td> <td style="width: 10%;"></td> <td style="width: 10%;"></td> <td style="width: 10%;"></td> <td style="width: 10%;"></td> </tr> <tr> <td></td> <td></td> <td colspan="8" style="text-align: center;"> <table border="1" style="width: 100%; border-collapse: collapse; text-align: center;"> <tr> <td style="width: 10%;"></td> <td style="width: 10%;"></td> <td style="width: 10%;"></td> <td style="width: 10%;"></td> <td style="width: 10%;"></td> <td style="width: 10%;"></td> <td style="width: 10%;"></td> <td style="width: 10%;"></td> <td style="width: 10%;"></td> <td style="width: 10%;"></td> </tr> <tr> <td></td> <td></td> <td colspan="8" style="text-align: center;"> <table border="1" style="width: 100%; border-collapse: collapse; text-align: center;"> <tr> <td style="width: 10%;"></td> <td style="width: 10%;"></td> <td style="width: 10%;"></td> <td style="width: 10%;"></td> <td style="width: 10%;"></td> <td style="width: 10%;"></td> <td style="width: 10%;"></td> <td style="width: 10%;"></td> <td style="width: 10%;"></td> <td style="width: 10%;"></td> </tr> <tr> <td></td> <td></td> <td colspan="8" style="text-align: center;"> <table border="1" style="width: 100%; border-collapse: collapse; text-align: center;"> <tr> <td style="width: 10%;"></td> <td style="width: 10%;"></td> <td style="width: 10%;"></td> <td style="width: 10%;"></td> <td style="width: 10%;"></td> <td style="width: 10%;"></td> <td style="width: 10%;"></td> <td style="width: 10%;"></td> <td style="width: 10%;"></td> <td style="width: 10%;"></td> </tr> <tr> <td></td> <td></td> <td colspan="8" style="text-align: center;"> <table border="1" style="width: 100%; border-collapse: collapse; text-align: center;"> <tr> <td style="width: 10%;"></td> <td style="width: 10%;"></td> <td style="width: 10%;"></td> <td style="width: 10%;"></td> <td style="width: 10%;"></td> <td style="width: 10%;"></td> <td style="width: 10%;"></td> <td style="width: 10%;"></td> <td style="width: 10%;"></td> <td style="width: 10%;"></td> </tr> <tr> <td></td> <td></td> <td colspan="8" style="text-align: center;"> <table border="1" style="width: 100%; border-collapse: collapse; text-align: center;"> <tr> <td style="width: 10%;"></td> <td style="width: 10%;"></td> <td style="width: 10%;"></td> <td style="width: 10%;"></td> <td style="width: 10%;"></td> <td style="width: 10%;"></td> <td style="width: 10%;"></td> <td style="width: 10%;"></td> <td style="width: 10%;"></td> <td style="width: 10%;"></td> </tr> <tr> <td></td> <td></td> <td colspan="8" style="text-align: center;"> <table border="1" style="width: 100%; border-collapse: collapse; text-align: center;"> <tr> <td style="width: 10%;"></td> <td style="width: 10%;"></td> <td style="width: 10%;"></td> <td style="width: 10%;"></td> <td style="width: 10%;"></td> <td style="width: 10%;"></td> <td style="width: 10%;"></td> <td style="width: 10%;"></td> <td style="width: 10%;"></td> <td style="width: 10%;"></td> </tr> <tr> <td></td> <td></td> <td colspan="8" style="text-align: center;"> <table border="1" style="width: 100%; border-collapse: collapse; text-align: center;"> <tr> <td style="width: 10%;"></td> <td style="width: 10%;"></td> <td style="width: 10%;"></td> <td style="width: 10%;"></td> <td style="width: 10%;"></td> <td style="width: 10%;"></td> <td style="width: 10%;"></td> <td style="width: 10%;"></td> <td style="width: 10%;"></td> <td style="width: 10%;"></td> </tr> <tr> <td></td> <td></td> <td colspan="8" style="text-align: center;"> <table border="1" style="width: 100%; border-collapse: collapse; text-align: center;"> <tr> <td style="width: 10%;"></td> <td style="width: 10%;"></td> <td style="width: 10%;"></td> <td style="width: 10%;"></td> <td style="width: 10%;"></td> <td style="width: 10%;"></td> <td style="width: 10%;"></td> <td style="width: 10%;"></td> <td style="width: 10%;"></td> <td style="width: 10%;"></td> </tr> <tr> <td></td> <td></td> <td colspan="8" style="text-align: center;"> <table border="1" style="width: 100%; border-collapse: collapse; text-align: center;"> <tr> <td style="width: 10%;"></td> <td style="width: 10%;"></td> <td style="width: 10%;"></td> <td style="width: 10%;"></td> <td style="width: 10%;"></td> <td style="width: 10%;"></td> <td style="width: 10%;"></td> <td style="width: 10%;"></td> <td style="width: 10%;"></td> <td style="width: 10%;"></td> </tr> <tr> <td></td> <td></td> <td colspan="8" style="text-align: center;"> <table border="1" style="width: 100%; border-collapse: collapse; text-align: center;"> <tr> <td style="width: 10%;"></td> <td style="width: 10%;"></td> <td style="width: 10%;"></td> <td style="width: 10%;"></td> <td style="width: 10%;"></td> <td style="width: 10%;"></td> <td style="width: 10%;"></td> <td style="width: 10%;"></td> <td style="width: 10%;"></td> <td style="width: 10%;"></td> </tr> <tr> <td></td> <td></td> <td colspan="8" style="text-align: center;"> <table border="1" style="width: 100%; border-collapse: collapse; text-align: center;"> <tr> <td style="width: 10%;"></td> <td style="width: 10%;"></td> <td style="width: 10%;"></td> <td style="width: 10%;"></td> <td style="width: 10%;"></td> <td style="width: 10%;"></td> <td style="width: 10%;"></td> <td style="width: 10%;"></td> <td style="width: 10%;"></td> <td style="width: 10%;"></td> </tr> <tr> <td></td> <td></td> <td colspan="8" style="text-align: center;"> <table border="1" style="width: 100%; border-collapse: collapse; text-align: center;"> <tr> <td style="width: 10%;"></td> <td style="width: 10%;"></td> <td style="width: 10%;"></td> <td style="width: 10%;"></td> <td style="width: 10%;"></td> <td style="width: 10%;"></td> <td style="width: 10%;"></td> <td style="width: 10%;"></td> <td style="width: 10%;"></td> <td style="width: 10%;"></td> </tr> <tr> <td></td> <td></td> <td colspan="8" style="text-align: center;"> <table border="1" style="width: 100%; border-collapse: collapse; text-align: center;"> <tr> <td style="width: 10%;"></td> <td style="width: 10%;"></td> <td style="width: 10%;"></td> <td style="width: 10%;"></td> <td style="width: 10%;"></td> <td style="width: 10%;"></td> <td style="width: 10%;"></td> <td style="width: 10%;"></td> <td style="width: 10%;"></td> <td style="width: 10%;"></td> </tr> <tr> <td></td> <td></td> <td colspan="8" style="text-align: center;"> <table border="1" style="width: 100%; border-collapse: collapse; text-align: center;"> <tr> <td style="width: 10%;"></td> <td style="width: 10%;"></td> <td style="width: 10%;"></td> <td style="width: 10%;"></td> <td style="width: 10%;"></td> <td style="width: 10%;"></td> <td style="width: 10%;"></td> <td style="width: 10%;"></td> <td style="width: 10%;"></td> <td style="width: 10%;"></td> </tr> <tr> <td></td> <td></td> <td colspan="8" style="text-align: center;"> <table border="1" style="width: 100%; border-collapse: collapse; text-align: center;"> <tr> <td style="width: 10%;"></td> <td style="width: 10%;"></td> <td style="width: 10%;"></td> <td style="width: 10%;"></td> <td style="width: 10%;"></td> <td style="width: 10%;"></td> <td style="width: 10%;"></td> <td style="width: 10%;"></td> <td style="width: 10%;"></td> <td style="width: 10%;"></td> </tr> <tr> <td></td> <td></td> <td colspan="8" style="text-align: center;"> <table border="1" style="width: 100%; border-collapse: collapse; text-align: center;"> <tr> <td style="width: 10%;"></td> <td style="width: 10%;"></td> <td style="width: 10%;"></td> <td style="width: 10%;"></td> <td style="width: 10%;"></td> <td style="width: 10%;"></td> <td style="width: 10%;"></td> <td style="width: 10%;"></td> <td style="width: 10%;"></td> <td style="width: 10%;"></td> </tr> <tr> <td></td> <td></td> <td colspan="8" style="text-align: center;"> <table border="1" style="width: 100%; border-collapse: collapse; text-align: center;"> <tr> <td style="width: 10%;"></td> <td style="width: 10%;"></td> <td style="width: 10%;"></td> <td style="width: 10%;"></td> <td style="width: 10%;"></td> <td style="width: 10%;"></td> <td style="width: 10%;"></td> <td style="width: 10%;"></td> <td style="width: 10%;"></td> <td style="width: 10%;"></td> </tr> <tr> <td></td> <td></td> <td colspan="8" style="text-align: center;"> <table border="1" style="width: 100%; border-collapse: collapse; text-align: center;"> <tr> <td style="width: 10%;"></td> <td style="width: 10%;"></td> <td style="width: 10%;"></td> <td style="width: 10%;"></td> <td style="width: 10%;"></td> <td style="width: 10%;"></td> <td style="width: 10%;"></td> <td style="width: 10%;"></td> <td style="width: 10%;"></td> <td style="width: 10%;"></td> </tr> <tr> <td></td> <td></td> <td colspan="8"
style="text-align: center;"> <table border="1" style="width: 100%; border-collapse: collapse; text-align: center;"> <tr> <td style="width: 10%;"></td> <td style="width: 10%;"></td> <td style="width: 10%;"></td> <td style="width: 10%;"></td> <td style="width: 10%;"></td> <td style="width: 10%;"></td> <td style="width: 10%;"></td> <td style="width: 10%;"></td> <td style="width: 10%;"></td> <td style="width: 10%;"></td> </tr> <tr> <td></td> <td></td> <td colspan="8" style="text-align: center;"> <table border="1" style="width: 100%; border-collapse: collapse; text-align: center;"> <tr> <td style="width: 10%;"></td> <td style="width: 10%;"></td> <td style="width: 10%;"></td> <td style="width: 10%;"></td> <td style="width: 10%;"></td> <td style="width: 10%;"></td> <td style="width: 10%;"></td> <td style="width: 10%;"></td> <td style="width: 10%;"></td> <td style="width: 10%;"></td> </tr> <tr> <td></td> <td></td> <td colspan="8" style="text-align: center;"> <table border="1" style="width: 100%; border-collapse: collapse; text-align: center;"> <tr> <td style="width: 10%;"></td> <td style="width: 10%;"></td> <td style="width: 10%;"></td> <td style="width: 10%;"></td> <td style="width: 10%;"></td> <td style="width: 10%;"></td> <td style="width: 10%;"></td> <td style="width: 10%;"></td> <td style="width: 10%;"></td> <td style="width: 10%;"></td> </tr> <tr> <td></td> <td></td> <td colspan="8" style="text-align: center;"> <table border="1" style="width: 100%; border-collapse: collapse; text-align: center;"> <tr> <td style="width: 10%;"></td> <td style="width: 10%;"></td> <td style="width: 10%;"></td> <td style="width: 10%;"></td> <td style="width: 10%;"></td> <td style="width: 10%;"></td> <td style="width: 10%;"></td> <td style="width: 10%;"></td> <td style="width: 10%;"></td> <td style="width: 10%;"></td> </tr> <tr> <td></td> <td></td> <td colspan="8" style="text-align: center;"> <table border="1" style="width: 100%; border-collapse: collapse; text-align: center;"> <tr> <td style="width: 10%;"></td> <td style="width: 10%;"></td> <td style="width: 10%;"></td> <td style="width: 10%;"></td> <td style="width: 10%;"></td> <td style="width: 10%;"></td> <td style="width: 10%;"></td> <td style="width: 10%;"></td> <td style="width: 10%;"></td> <td style="width: 10%;"></td> </tr> <tr> <td></td> <td></td> <td colspan="8" style="text-align: center;"> <table border="1" style="width: 100%; border-collapse: collapse; text-align: center;"> <tr> <td style="width: 10%;"></td> <td style="width: 10%;"></td> <td style="width: 10%;"></td> <td style="width: 10%;"></td> <td style="width: 10%;"></td> <td style="width: 10%;"></td> <td style="width: 10%;"></td> <td style="width: 10%;"></td> <td style="width: 10%;"></td> <td style="width: 10%;"></td> </tr> <tr> <td></td> <td></td> <td colspan="8" style="text-align: center;"> <table border="1" style="width: 100%; border-collapse: collapse; text-align: center;"> <tr> <td style="width: 10%;"></td> <td style="width: 10%;"></td> <td style="width: 10%;"></td> <td style="width: 10%;"></td> <td style="width: 10%;"></td> <td style="width: 10%;"></td> <td style="width: 10%;"></td> <td style="width: 10%;"></td> <td style="width: 10%;"></td> <td style="width: 10%;"></td> </tr> <tr> <td></td> <td></td> <td colspan="8" style="text-align: center;"> <table border="1" style="width: 100%; border-collapse: collapse; text-align: center;"> <tr> <td style="width: 10%;"></td> <td style="width: 10%;"></td> <td style="width: 10%;"></td> <td style="width: 10%;"></td> <td style="width: 10%;"></td> <td style="width: 10%;"></td> <td style="width: 10%;"></td> <td style="width: 10%;"></td> <td style="width: 10%;"></td> <td style="width: 10%;"></td> </tr> <tr> <td></td> <td></td> <td colspan="8" style="text-align: center;"> <table border="1" style="width: 100%; border-collapse: collapse; text-align: center;"> <tr> <td style="width: 10%;"></td> <td style="width: 10%;"></td> <td style="width: 10%;"></td> <td style="width: 10%;"></td> <td style="width: 10%;"></td> <td style="width: 10%;"></td> <td style="width: 10%;"></td> <td style="width: 10%;"></td> <td style="width: 10%;"></td> <td style="width: 10%;"></td> </tr> <tr> <td></td> <td></td> <td colspan="8" style="text-align: center;"> <table border="1" style="width: 100%; border-collapse: collapse; text-align: center;"> <tr> <td style="width: 10%;"></td> <td style="width: 10%;"></td> <td style="width: 10%;"></td> <td style="width: 10%;"></td> <td style="width: 10%;"></td> <td style="width: 10%;"></td> <td style="width: 10%;"></td> <td style="width: 10%;"></td> <td style="width: 10%;"></td> <td style="width: 10%;"></td> </tr> <tr> <td></td> <td></td> <td colspan="8" style="text-align: center;"> <table border="1" style="width: 100%; border-collapse: collapse; text-align: center;"> <tr> <td style="width: 10%;"></td> <td style="width: 10%;"></td> <td style="width: 10%;"></td> <td style="width: 10%;"></td> <td style="width: 10%;"></td> <td style="width: 10%;"></td> <td style="width: 10%;"></td> <td style="width: 10%;"></td> <td style="width: 10%;"></td> <td style="width: 10%;"></td> </tr> <tr> <td></td> <td></td> <td colspan="8" style="text-align: center;"> <table border="1" style="width: 100%; border-collapse: collapse; text-align: center;"> <tr> <td style="width: 10%;"></td> <td style="width: 10%;"></td> <td style="width: 10%;"></td> <td style="width: 10%;"></td> <td style="width: 10%;"></td> <td style="width: 10%;"></td> <td style="width: 10%;"></td> <td style="width: 10%;"></td> <td style="width: 10%;"></td> <td style="width: 10%;"></td> </tr> <tr> <td></td> <td></td> <td colspan="8" style="text-align: center;"> <table border="1" style="width: 100%; border-collapse: collapse; text-align: center;"> <tr> <td style="width: 10%;"></td> <td style="width: 10%;"></td> <td style="width: 10%;"></td> <td style="width: 10%;"></td> <td style="width: 10%;"></td> <td style="width: 10%;"></td> <td style="width: 10%;"></td> <td style="width: 10%;"></td> <td style="width: 10%;"></td> <td style="width: 10%;"></td> </tr> <tr> <td></td> <td></td> <td colspan="8" style="text-align: center;"> <table border="1" style="width: 100%; border-collapse: collapse; text-align: center;"> <tr> <td style="width: 10%;"></td> <td style="width: 10%;"></td> <td style="width: 10%;"></td> <td style="width: 10%;"></td> <td style="width: 10%;"></td> <td style="width: 10%;"></td> <td style="width: 10%;"></td> <td style="width: 10%;"></td> <td style="width: 10%;"></td> <td style="width: 10%;"></td> </tr> <tr> <td></td> <td></td> <td colspan="8" style="text-align: center;"> <table border="1" style="width: 100%; border-collapse: collapse; text-align: center;"> <tr> <td style="width: 10%;"></td> <td style="width: 10%;"></td> <td style="width: 10%;"></td> <td style="width: 10%;"></td> <td style="width: 10%;"></td> <td style="width: 10%;"></td> <td style="width: 10%;"></td> <td style="width: 10%;"></td> <td style="width: 10%;"></td> <td style="width: 10%;"></td> </tr> <tr> <td></td> <td></td> <td colspan="8" style="text-align: center;"> <table border="1" style="width: 100%; border-collapse: collapse; text-align: center;"> <tr> <td style="width: 10%;"></td> <td style="width: 10%;"></td> <td style="width: 10%;"></td> <td style="width: 10%;"></td> <td style="width: 10%;"></td> <td style="width: 10%;"></td> <td style="width: 10%;"></td> <td style="width: 10%;"></td> <td style="width: 10%;"></td> <td style="width: 10%;"></td> </tr> <tr> <td></td> <td></td> <td colspan="8" style="text-align: center;"> <table border="1" style="width: 100%; border-collapse: collapse; text-align: center;"> <tr> <td style="width: 10%;"></td> <td style="width: 10%;"></td> <td style="width: 10%;"></td> <td style="width: 10%;"></td> <td style="width: 10%;"></td> <td style="width: 10%;"></td> <td style="width: 10%;"></td> <td style="width: 10%;"></td> <td style="width: 10%;"></td> <td style="width: 10%;"></td> </tr> <tr> <td></td> <td></td> <td colspan="8" style="text-align: center;"> <table border="1" style="width: 100%; border-collapse: collapse; text-align: center;"> <tr> <td style="width: 10%;"></td> <td style="width: 10%;"></td> <td style="width: 10%;"></td> <td style="width: 10%;"></td> <td style="width: 10%;"></td> <td style="width: 10%;"></td> <td style="width: 10%;"></td> <td style="width: 10%;"></td> <td style="width: 10%;"></td> <td style="width: 10%;"></td> </tr> <tr> <td></td> <td></td> <td colspan="8" style="text-align: center;"> <table border="1" style="width: 100%; border-collapse: collapse; text-align: center;"> <tr> <td style="width: 10%;"></td> <td style="width: 10%;"></td> <td style="width: 10%;"></td> <td style="width: 10%;"></td> <td style="width: 10%;"></td> <td style="width: 10%;"></td> <td style="width: 10%;"></td> <td style="width: 10%;"></td> <td style="width: 10%;"></td> <td style="width: 10%;"></td> </tr> <tr> <td></td> <td></td> <td colspan="8" style="text-align: center;"> <table border="1" style="width: 100%; border-collapse: collapse; text-align: center;"> <tr> <td style="width: 10%;"></td> <td style="width: 10%;"></td> <td style="width: 10%;"></td> <td style="width: 10%;"></td> <td style="width: 10%;"></td> <td style="width: 10%;"></td> <td style="width: 10%;"></td> <td style="width: 10%;"></td> <td style="width: 10%;"></td> <td style="width: 10%;"></td> </tr> <tr> <td></td> <td></td> <td colspan="8" style="text-align: center;"> <table border="1" style="width: 100%; border-collapse: collapse; text-align: center;"> <tr> <td style="width: 10%;"></td> <td style="width: 10%;"></td> <td style="width: 10%;"></td> <td style="width: 10%;"></td> <td style="width: 10%;"></td> <td style="width: 10%;"></td> <td style="width: 10%;"></td> <td style="width: 10%;"></td> <td style="width: 10%;"></td> <td style="width: 10%;"></td> </tr> <tr> <td></td> <td></td> <td colspan="8" style="text-align: center;"> <table border="1" style="width: 100%; border-collapse: collapse; text-align: center;"> <tr> <td style="width: 10%;"></td> <td style="width:
10%;"></td> <td style="width: 10%;"></td> <td style="width: 10%;"></td> <td style="width: 10%;"></td> <td style="width: 10%;"></td> <td style="width: 10%;"></td> <td style="width: 10%;"></td> <td style="width: 10%;"></td> <td style="width: 10%;"></td> </tr> <tr> <td></td> <td></td> <td colspan="8" style="text-align: center;"> <table border="1" style="width: 100%; border-collapse: collapse; text-align: center;"> <tr> <td style="width: 10%;"></td> <td style="width: 10%;"></td> <td style="width: 10%;"></td> <td style="width: 10%;"></td> <td style="width: 10%;"></td> <td style="width: 10%;"></td> <td style="width: 10%;"></td> <td style="width: 10%;"></td> <td style="width: 10%;"></td> <td style="width: 10%;"></td> </tr> <tr> <td></td> <td></td> <td colspan="8" style="text-align: center;"> <table border="1" style="width: 100%; border-collapse: collapse; text-align: center;"> <tr> <td style="width: 10%;"></td> <td style="width: 10%;"></td> <td style="width: 10%;"></td> <td style="width: 10%;"></td> <td style="width: 10%;"></td> <td style="width: 10%;"></td> <td style="width: 10%;"></td> <td style="width: 10%;"></td> <td style="width: 10%;"></td> <td style="width: 10%;"></td> </tr> <tr> <td></td> <td></td> <td colspan="8" style="text-align: center;"> <table border="1" style="width: 100%; border-collapse: collapse; text-align: center;"> <tr> <td style="width: 10%;"></td> <td style="width: 10%;"></td> <td style="width: 10%;"></td> <td style="width: 10%;"></td> <td style="width: 10%;"></td> <td style="width: 10%;"></td> <td style="width: 10%;"></td> <td style="width: 10%;"></td> <td style="width: 10%;"></td> <td style="width: 10%;"></td> </tr> <tr> <td></td> <td></td> <td colspan="8" style="text-align: center;"> <table border="1" style="width: 100%; border-collapse: collapse; text-align: center;"> <tr> <td style="width: 10%;"></td> <td style="width: 10%;"></td> <td style="width: 10%;"></td> <td style="width: 10%;"></td> <td style="width: 10%;"></td> <td style="width: 10%;"></td> <td style="width: 10%;"></td> <td style="width: 10%;"></td> <td style="width: 10%;"></td> <td style="width: 10%;"></td> </tr> <tr> <td></td> <td></td> <td colspan="8" style="text-align: center;"> <table border="1" style="width: 100%; border-collapse: collapse; text-align: center;"> <tr> <td style="width: 10%;"></td> <td style="width: 10%;"></td> <td style="width: 10%;"></td> <td style="width: 10%;"></td> <td style="width: 10%;"></td> <td style="width: 10%;"></td> <td style="width: 10%;"></td> <td style="width: 10%;"></td> <td style="width: 10%;"></td> <td style="width: 10%;"></td> </tr> <tr> <td></td> <td></td> <td colspan="8" style="text-align: center;"> <table border="1" style="width: 100%; border-collapse: collapse; text-align: center;"> <tr> <td style="width: 10%;"></td> <td style="width: 10%;"></td> <td style="width: 10%;"></td> <td style="width: 10%;"></td> <td style="width: 10%;"></td> <td style="width: 10%;"></td> <td style="width: 10%;"></td> <td style="width: 10%;"></td> <td style="width: 10%;"></td> <td style="width: 10%;"></td> </tr> <tr> <td></td> <td></td> <td colspan="8" style="text-align: center;"> <table border="1" style="width: 100%; border-collapse: collapse; text-align: center;"> <tr> <td style="width: 10%;"></td> <td style="width: 10%;"></td> <td style="width: 10%;"></td> <td style="width: 10%;"></td> <td style="width: 10%;"></td> <td style="width: 10%;"></td> <td style="width: 10%;"></td> <td style="width: 10%;"></td> <td style="width: 10%;"></td> <td style="width: 10%;"></td> </tr> <tr> <td></td> <td></td> <td colspan="8" style="text-align: center;"> <table border="1" style="width: 100%; border-collapse: collapse; text-align: center;"> <tr> </tr></table></td></tr></table></td></tr></table></td></tr></table></td></tr></table></td></tr></table></td></tr></table></td></tr></table></td></tr></table></td></tr></table></td></tr></table></td></tr></table></td></tr></table></td></tr></table></td></tr></table></td></tr></table></td></tr></table></td></tr></table></td></tr></table></td></tr></table></td></tr></table></td></tr></table></td></tr></table></td></tr></table></td></tr></table></td></tr></table></td></tr></table></td></tr></table></td></tr></table></td></tr></table></td></tr></table></td></tr></table></td></tr></table></td></tr></table></td></tr></table></td></tr></table></td></tr></table></td></tr></table></td></tr></table></td></tr></table></td></tr></table></td></tr></table></td></tr></table></td></tr></table></td></tr></table></td></tr></table></td></tr></table></td></tr></table></td></tr></table></td></tr></table></td></tr></table></td></tr></table></td></tr></table></td></tr></table></td></tr></table></td></tr></table></td></tr></table> | | | | | | | | | | | | | | | | | | | | <table border="1" style="width: 100%; border-collapse: collapse; text-align: center;"> <tr> <td style="width: 10%;"></td> <td style="width: 10%;"></td> <td style="width: 10%;"></td> <td style="width: 10%;"></td> <td style="width: 10%;"></td> <td style="width: 10%;"></td> <td style="width: 10%;"></td> <td style="width: 10%;"></td> <td style="width: 10%;"></td> <td style="width: 10%;"></td> </tr> <tr> <td></td> <td></td> <td colspan="8" style="text-align: center;"> <table border="1" style="width: 100%; border-collapse: collapse; text-align: center;"> <tr> <td style="width: 10%;"></td> <td style="width: 10%;"></td> <td style="width: 10%;"></td> <td style="width: 10%;"></td> <td style="width: 10%;"></td> <td style="width: 10%;"></td> <td style="width: 10%;"></td> <td style="width: 10%;"></td> <td style="width: 10%;"></td> <td style="width: 10%;"></td> </tr> <tr> <td></td> <td></td> <td colspan="8" style="text-align: center;"> <table border="1" style="width: 100%; border-collapse: collapse; text-align: center;"> <tr> <td style="width: 10%;"></td> <td style="width: 10%;"></td> <td style="width: 10%;"></td> <td style="width: 10%;"></td> <td style="width: 10%;"></td> <td style="width: 10%;"></td> <td style="width: 10%;"></td> <td style="width: 10%;"></td> <td style="width: 10%;"></td> <td style="width: 10%;"></td> </tr> <tr> <td></td> <td></td> <td colspan="8" style="text-align: center;"> <table border="1" style="width: 100%; border-collapse: collapse; text-align: center;"> <tr> <td style="width: 10%;"></td> <td style="width: 10%;"></td> <td style="width: 10%;"></td> <td style="width: 10%;"></td> <td style="width: 10%;"></td> <td style="width: 10%;"></td> <td style="width: 10%;"></td> <td style="width: 10%;"></td> <td style="width: 10%;"></td> <td style="width: 10%;"></td> </tr> <tr> <td></td> <td></td> <td colspan="8" style="text-align: center;"> <table border="1" style="width: 100%; border-collapse: collapse; text-align: center;"> <tr> <td style="width: 10%;"></td> <td style="width: 10%;"></td> <td style="width: 10%;"></td> <td style="width: 10%;"></td> <td style="width: 10%;"></td> <td style="width: 10%;"></td> <td style="width: 10%;"></td> <td style="width: 10%;"></td> <td style="width: 10%;"></td> <td style="width: 10%;"></td> </tr> <tr> <td></td> <td></td> <td colspan="8" style="text-align: center;"> <table border="1" style="width: 100%; border-collapse: collapse; text-align: center;"> <tr> <td style="width: 10%;"></td> <td style="width: 10%;"></td> <td style="width: 10%;"></td> <td style="width: 10%;"></td> <td style="width: 10%;"></td> <td style="width: 10%;"></td> <td style="width: 10%;"></td> <td style="width: 10%;"></td> <td style="width: 10%;"></td> <td style="width: 10%;"></td> </tr> <tr> <td></td> <td></td> <td colspan="8" style="text-align: center;"> <table border="1" style="width: 100%; border-collapse: collapse; text-align: center;"> <tr> <td style="width: 10%;"></td> <td style="width: 10%;"></td> <td style="width: 10%;"></td> <td style="width: 10%;"></td> <td style="width: 10%;"></td> <td style="width: 10%;"></td> <td style="width: 10%;"></td> <td style="width: 10%;"></td> <td style="width: 10%;"></td> <td style="width: 10%;"></td> </tr> <tr> <td></td> <td></td> <td colspan="8" style="text-align: center;"> <table border="1" style="width: 100%; border-collapse: collapse; text-align: center;"> <tr> <td style="width: 10%;"></td> <td style="width: 10%;"></td> <td style="width: 10%;"></td> <td style="width: 10%;"></td> <td style="width: 10%;"></td> <td style="width: 10%;"></td> <td style="width: 10%;"></td> <td style="width: 10%;"></td> <td style="width: 10%;"></td> <td style="width: 10%;"></td> </tr> <tr> <td></td> <td></td> <td colspan="8" style="text-align: center;"> <table border="1" style="width: 100%; border-collapse: collapse; text-align: center;"> <tr> <td style="width: 10%;"></td> <td style="width: 10%;"></td> <td style="width: 10%;"></td> <td style="width: 10%;"></td> <td style="width: 10%;"></td> <td style="width: 10%;"></td> <td style="width: 10%;"></td> <td style="width: 10%;"></td> <td style="width: 10%;"></td> <td style="width: 10%;"></td> </tr> <tr> <td></td> <td></td> <td colspan="8" style="text-align: center;"> <table border="1" style="width: 100%; border-collapse: collapse; text-align: center;"> <tr> <td style="width: 10%;"></td> <td style="width: 10%;"></td> <td style="width: 10%;"></td> <td style="width: 10%;"></td> <td style="width: 10%;"></td> <td style="width: 10%;"></td> <td style="width: 10%;"></td> <td style="width: 10%;"></td> <td style="width: 10%;"></td> <td style="width: 10%;"></td> </tr> <tr> <td></td> <td></td> <td colspan="8" style="text-align: center;"> <table border="1" style="width: 100%; border-collapse: collapse; text-align: center;"> <tr> <td style="width: 10%;"></td> <td style="width: 10%;"></td> <td style="width: 10%;"></td> <td style="width: 10%;"></td> <td style="width: 10%;"></td> <td style="width: 10%;"></td> <td style="width: 10%;"></td> <td style="width: 10%;"></td> <td style="width: 10%;"></td> <td style="width: 10%;"></td> </tr> <tr> <td></td> <td></td> <td colspan="8" style="text-align: center;"> <table border="1" style="width: 100%; border-collapse: collapse;
text-align: center;"> <tr> <td style="width: 10%;"></td> <td style="width: 10%;"></td> <td style="width: 10%;"></td> <td style="width: 10%;"></td> <td style="width: 10%;"></td> <td style="width: 10%;"></td> <td style="width: 10%;"></td> <td style="width: 10%;"></td> <td style="width: 10%;"></td> <td style="width: 10%;"></td> </tr> <tr> <td></td> <td></td> <td colspan="8" style="text-align: center;"> <table border="1" style="width: 100%; border-collapse: collapse; text-align: center;"> <tr> <td style="width: 10%;"></td> <td style="width: 10%;"></td> <td style="width: 10%;"></td> <td style="width: 10%;"></td> <td style="width: 10%;"></td> <td style="width: 10%;"></td> <td style="width: 10%;"></td> <td style="width: 10%;"></td> <td style="width: 10%;"></td> <td style="width: 10%;"></td> </tr> <tr> <td></td> <td></td> <td colspan="8" style="text-align: center;"> <table border="1" style="width: 100%; border-collapse: collapse; text-align: center;"> <tr> <td style="width: 10%;"></td> <td style="width: 10%;"></td> <td style="width: 10%;"></td> <td style="width: 10%;"></td> <td style="width: 10%;"></td> <td style="width: 10%;"></td> <td style="width: 10%;"></td> <td style="width: 10%;"></td> <td style="width: 10%;"></td> <td style="width: 10%;"></td> </tr> <tr> <td></td> <td></td> <td colspan="8" style="text-align: center;"> <table border="1" style="width: 100%; border-collapse: collapse; text-align: center;"> <tr> <td style="width: 10%;"></td> <td style="width: 10%;"></td> <td style="width: 10%;"></td> <td style="width: 10%;"></td> <td style="width: 10%;"></td> <td style="width: 10%;"></td> <td style="width: 10%;"></td> <td style="width: 10%;"></td> <td style="width: 10%;"></td> <td style="width: 10%;"></td> </tr> <tr> <td></td> <td></td> <td colspan="8" style="text-align: center;"> <table border="1" style="width: 100%; border-collapse: collapse; text-align: center;"> <tr> <td style="width: 10%;"></td> <td style="width: 10%;"></td> <td style="width: 10%;"></td> <td style="width: 10%;"></td> <td style="width: 10%;"></td> <td style="width: 10%;"></td> <td style="width: 10%;"></td> <td style="width: 10%;"></td> <td style="width: 10%;"></td> <td style="width: 10%;"></td> </tr> <tr> <td></td> <td></td> <td colspan="8" style="text-align: center;"> <table border="1" style="width: 100%; border-collapse: collapse; text-align: center;"> <tr> <td style="width: 10%;"></td> <td style="width: 10%;"></td> <td style="width: 10%;"></td> <td style="width: 10%;"></td> <td style="width: 10%;"></td> <td style="width: 10%;"></td> <td style="width: 10%;"></td> <td style="width: 10%;"></td> <td style="width: 10%;"></td> <td style="width: 10%;"></td> </tr> <tr> <td></td> <td></td> <td colspan="8" style="text-align: center;"> <table border="1" style="width: 100%; border-collapse: collapse; text-align: center;"> <tr> <td style="width: 10%;"></td> <td style="width: 10%;"></td> <td style="width: 10%;"></td> <td style="width: 10%;"></td> <td style="width: 10%;"></td> <td style="width: 10%;"></td> <td style="width: 10%;"></td> <td style="width: 10%;"></td> <td style="width: 10%;"></td> <td style="width: 10%;"></td> </tr> <tr> <td></td> <td></td> <td colspan="8" style="text-align: center;"> <table border="1" style="width: 100%; border-collapse: collapse; text-align: center;"> <tr> <td style="width: 10%;"></td> <td style="width: 10%;"></td> <td style="width: 10%;"></td> <td style="width: 10%;"></td> <td style="width: 10%;"></td> <td style="width: 10%;"></td> <td style="width: 10%;"></td> <td style="width: 10%;"></td> <td style="width: 10%;"></td> <td style="width: 10%;"></td> </tr> <tr> <td></td> <td></td> <td colspan="8" style="text-align: center;"> <table border="1" style="width: 100%; border-collapse: collapse; text-align: center;"> <tr> <td style="width: 10%;"></td> <td style="width: 10%;"></td> <td style="width: 10%;"></td> <td style="width: 10%;"></td> <td style="width: 10%;"></td> <td style="width: 10%;"></td> <td style="width: 10%;"></td> <td style="width: 10%;"></td> <td style="width: 10%;"></td> <td style="width: 10%;"></td> </tr> <tr> <td></td> <td></td> <td colspan="8" style="text-align: center;"> <table border="1" style="width: 100%; border-collapse: collapse; text-align: center;"> <tr> <td style="width: 10%;"></td> <td style="width: 10%;"></td> <td style="width: 10%;"></td> <td style="width: 10%;"></td> <td style="width: 10%;"></td> <td style="width: 10%;"></td> <td style="width: 10%;"></td> <td style="width: 10%;"></td> <td style="width: 10%;"></td> <td style="width: 10%;"></td> </tr> <tr> <td></td> <td></td> <td colspan="8" style="text-align: center;"> <table border="1" style="width: 100%; border-collapse: collapse; text-align: center;"> <tr> <td style="width: 10%;"></td> <td style="width: 10%;"></td> <td style="width: 10%;"></td> <td style="width: 10%;"></td> <td style="width: 10%;"></td> <td style="width: 10%;"></td> <td style="width: 10%;"></td> <td style="width: 10%;"></td> <td style="width: 10%;"></td> <td style="width: 10%;"></td> </tr> <tr> <td></td> <td></td> <td colspan="8" style="text-align: center;"> <table border="1" style="width: 100%; border-collapse: collapse; text-align: center;"> <tr> <td style="width: 10%;"></td> <td style="width: 10%;"></td> <td style="width: 10%;"></td> <td style="width: 10%;"></td> <td style="width: 10%;"></td> <td style="width: 10%;"></td> <td style="width: 10%;"></td> <td style="width: 10%;"></td> <td style="width: 10%;"></td> <td style="width: 10%;"></td> </tr> <tr> <td></td> <td></td> <td colspan="8" style="text-align: center;"> <table border="1" style="width: 100%; border-collapse: collapse; text-align: center;"> <tr> <td style="width: 10%;"></td> <td style="width: 10%;"></td> <td style="width: 10%;"></td> <td style="width: 10%;"></td> <td style="width: 10%;"></td> <td style="width: 10%;"></td> <td style="width: 10%;"></td> <td style="width: 10%;"></td> <td style="width: 10%;"></td> <td style="width: 10%;"></td> </tr> <tr> <td></td> <td></td> <td colspan="8" style="text-align: center;"> <table border="1" style="width: 100%; border-collapse: collapse; text-align: center;"> <tr> <td style="width: 10%;"></td> <td style="width: 10%;"></td> <td style="width: 10%;"></td> <td style="width: 10%;"></td> <td style="width: 10%;"></td> <td style="width: 10%;"></td> <td style="width: 10%;"></td> <td style="width: 10%;"></td> <td style="width: 10%;"></td> <td style="width: 10%;"></td> </tr> <tr> <td></td> <td></td> <td colspan="8" style="text-align: center;"> <table border="1" style="width: 100%; border-collapse: collapse; text-align: center;"> <tr> <td style="width: 10%;"></td> <td style="width: 10%;"></td> <td style="width: 10%;"></td> <td style="width: 10%;"></td> <td style="width: 10%;"></td> <td style="width: 10%;"></td> <td style="width: 10%;"></td> <td style="width: 10%;"></td> <td style="width: 10%;"></td> <td style="width: 10%;"></td> </tr> <tr> <td></td> <td></td> <td colspan="8" style="text-align: center;"> <table border="1" style="width: 100%; border-collapse: collapse; text-align: center;"> <tr> <td style="width: 10%;"></td> <td style="width: 10%;"></td> <td style="width: 10%;"></td> <td style="width: 10%;"></td> <td style="width: 10%;"></td> <td style="width: 10%;"></td> <td style="width: 10%;"></td> <td style="width: 10%;"></td> <td style="width: 10%;"></td> <td style="width: 10%;"></td> </tr> <tr> <td></td> <td></td> <td colspan="8" style="text-align: center;"> <table border="1" style="width: 100%; border-collapse: collapse; text-align: center;"> <tr> <td style="width: 10%;"></td> <td style="width: 10%;"></td> <td style="width: 10%;"></td> <td style="width: 10%;"></td> <td style="width: 10%;"></td> <td style="width: 10%;"></td> <td style="width: 10%;"></td> <td style="width: 10%;"></td> <td style="width: 10%;"></td> <td style="width: 10%;"></td> </tr> <tr> <td></td> <td></td> <td colspan="8" style="text-align: center;"> <table border="1" style="width: 100%; border-collapse: collapse; text-align: center;"> <tr> <td style="width: 10%;"></td> <td style="width: 10%;"></td> <td style="width: 10%;"></td> <td style="width: 10%;"></td> <td style="width: 10%;"></td> <td style="width: 10%;"></td> <td style="width: 10%;"></td> <td style="width: 10%;"></td> <td style="width: 10%;"></td> <td style="width: 10%;"></td> </tr> <tr> <td></td> <td></td> <td colspan="8" style="text-align: center;"> <table border="1" style="width: 100%; border-collapse: collapse; text-align: center;"> <tr> <td style="width: 10%;"></td> <td style="width: 10%;"></td> <td style="width: 10%;"></td> <td style="width: 10%;"></td> <td style="width: 10%;"></td> <td style="width: 10%;"></td> <td style="width: 10%;"></td> <td style="width: 10%;"></td> <td style="width: 10%;"></td> <td style="width: 10%;"></td> </tr> <tr> <td></td> <td></td> <td colspan="8" style="text-align: center;"> <table border="1" style="width: 100%; border-collapse: collapse; text-align: center;"> <tr> <td style="width: 10%;"></td> <td style="width: 10%;"></td> <td style="width: 10%;"></td> <td style="width: 10%;"></td> <td style="width: 10%;"></td> <td style="width: 10%;"></td> <td style="width: 10%;"></td> <td style="width: 10%;"></td> <td style="width: 10%;"></td> <td style="width: 10%;"></td> </tr> <tr> <td></td> <td></td> <td colspan="8" style="text-align: center;"> <table border="1" style="width: 100%; border-collapse: collapse; text-align: center;"> <tr> <td style="width: 10%;"></td> <td style="width: 10%;"></td> <td style="width: 10%;"></td> <td style="width: 10%;"></td> <td style="width: 10%;"></td> <td style="width: 10%;"></td> <td style="width: 10%;"></td> <td style="width: 10%;"></td> <td style="width: 10%;"></td> <td style="width: 10%;"></td> </tr> <tr> <td></td> <td></td> <td colspan="8" style="text-align: center;"> <table border="1" style="width: 100%; border-collapse: collapse; text-align: center;"> <tr> <td style="width: 10%;"></td> <td style="width: 10%;"></td> <td style="width: 10%;"></td> <td style="width: 10%;"></td> <td style="width:
10%;"></td> <td style="width: 10%;"></td> <td style="width: 10%;"></td> <td style="width: 10%;"></td> <td style="width: 10%;"></td> <td style="width: 10%;"></td> </tr> <tr> <td></td> <td></td> <td colspan="8" style="text-align: center;"> <table border="1" style="width: 100%; border-collapse: collapse; text-align: center;"> <tr> <td style="width: 10%;"></td> <td style="width: 10%;"></td> <td style="width: 10%;"></td> <td style="width: 10%;"></td> <td style="width: 10%;"></td> <td style="width: 10%;"></td> <td style="width: 10%;"></td> <td style="width: 10%;"></td> <td style="width: 10%;"></td> <td style="width: 10%;"></td> </tr> <tr> <td></td> <td></td> <td colspan="8" style="text-align: center;"> <table border="1" style="width: 100%; border-collapse: collapse; text-align: center;"> <tr> <td style="width: 10%;"></td> <td style="width: 10%;"></td> <td style="width: 10%;"></td> <td style="width: 10%;"></td> <td style="width: 10%;"></td> <td style="width: 10%;"></td> <td style="width: 10%;"></td> <td style="width: 10%;"></td> <td style="width: 10%;"></td> <td style="width: 10%;"></td> </tr> <tr> <td></td> <td></td> <td colspan="8" style="text-align: center;"> <table border="1" style="width: 100%; border-collapse: collapse; text-align: center;"> <tr> <td style="width: 10%;"></td> <td style="width: 10%;"></td> <td style="width: 10%;"></td> <td style="width: 10%;"></td> <td style="width: 10%;"></td> <td style="width: 10%;"></td> <td style="width: 10%;"></td> <td style="width: 10%;"></td> <td style="width: 10%;"></td> <td style="width: 10%;"></td> </tr> <tr> <td></td> <td></td> <td colspan="8" style="text-align: center;"> <table border="1" style="width: 100%; border-collapse: collapse; text-align: center;"> <tr> <td style="width: 10%;"></td> <td style="width: 10%;"></td> <td style="width: 10%;"></td> <td style="width: 10%;"></td> <td style="width: 10%;"></td> <td style="width: 10%;"></td> <td style="width: 10%;"></td> <td style="width: 10%;"></td> <td style="width: 10%;"></td> <td style="width: 10%;"></td> </tr> <tr> <td></td> <td></td> <td colspan="8" style="text-align: center;"> <table border="1" style="width: 100%; border-collapse: collapse; text-align: center;"> <tr> <td style="width: 10%;"></td> <td style="width: 10%;"></td> <td style="width: 10%;"></td> <td style="width: 10%;"></td> <td style="width: 10%;"></td> <td style="width: 10%;"></td> <td style="width: 10%;"></td> <td style="width: 10%;"></td> <td style="width: 10%;"></td> <td style="width: 10%;"></td> </tr> <tr> <td></td> <td></td> <td colspan="8" style="text-align: center;"> <table border="1" style="width: 100%; border-collapse: collapse; text-align: center;"> <tr> <td style="width: 10%;"></td> <td style="width: 10%;"></td> <td style="width: 10%;"></td> <td style="width: 10%;"></td> <td style="width: 10%;"></td> <td style="width: 10%;"></td> <td style="width: 10%;"></td> <td style="width: 10%;"></td> <td style="width: 10%;"></td> <td style="width: 10%;"></td> </tr> <tr> <td></td> <td></td> <td colspan="8" style="text-align: center;"> <table border="1" style="width: 100%; border-collapse: collapse; text-align: center;"> <tr> <td style="width: 10%;"></td> <td style="width: 10%;"></td> <td style="width: 10%;"></td> <td style="width: 10%;"></td> <td style="width: 10%;"></td> <td style="width: 10%;"></td> <td style="width: 10%;"></td> <td style="width: 10%;"></td> <td style="width: 10%;"></td> <td style="width: 10%;"></td> </tr> <tr> <td></td> <td></td> <td colspan="8" style="text-align: center;"> <table border="1" style="width: 100%; border-collapse: collapse; text-align: center;"> <tr> <td style="width: 10%;"></td> <td style="width: 10%;"></td> <td style="width: 10%;"></td> <td style="width: 10%;"></td> <td style="width: 10%;"></td> <td style="width: 10%;"></td> <td style="width: 10%;"></td> <td style="width: 10%;"></td> <td style="width: 10%;"></td> <td style="width: 10%;"></td> </tr> <tr> <td></td> <td></td> <td colspan="8" style="text-align: center;"> <table border="1" style="width: 100%; border-collapse: collapse; text-align: center;"> <tr> <td style="width: 10%;"></td> <td style="width: 10%;"></td> <td style="width: 10%;"></td> <td style="width: 10%;"></td> <td style="width: 10%;"></td> <td style="width: 10%;"></td> <td style="width: 10%;"></td> <td style="width: 10%;"></td> <td style="width: 10%;"></td> <td style="width: 10%;"></td> </tr> <tr> <td></td> <td></td> <td colspan="8" style="text-align: center;"> <table border="1" style="width: 100%; border-collapse: collapse; text-align: center;"> <tr> <td style="width: 10%;"></td> <td style="width: 10%;"></td> <td style="width: 10%;"></td> <td style="width: 10%;"></td> <td style="width: 10%;"></td> <td style="width: 10%;"></td> <td style="width: 10%;"></td> <td style="width: 10%;"></td> <td style="width: 10%;"></td> <td style="width: 10%;"></td> </tr> <tr> <td></td> <td></td> <td colspan="8" style="text-align: center;"> <table border="1" style="width: 100%; border-collapse: collapse; text-align: center;"> <tr> <td style="width: 10%;"></td> <td style="width: 10%;"></td> <td style="width: 10%;"></td> <td style="width: 10%;"></td> <td style="width: 10%;"></td> <td style="width: 10%;"></td> <td style="width: 10%;"></td> <td style="width: 10%;"></td> <td style="width: 10%;"></td> <td style="width: 10%;"></td> </tr> <tr> <td></td> <td></td> <td colspan="8" style="text-align: center;"> <table border="1" style="width: 100%; border-collapse: collapse; text-align: center;"> <tr> <td style="width: 10%;"></td> <td style="width: 10%;"></td> <td style="width: 10%;"></td> <td style="width: 10%;"></td> <td style="width: 10%;"></td> <td style="width: 10%;"></td> <td style="width: 10%;"></td> <td style="width: 10%;"></td> <td style="width: 10%;"></td> <td style="width: 10%;"></td> </tr> <tr> <td></td> <td></td> <td colspan="8" style="text-align: center;"> <table border="1" style="width: 100%; border-collapse: collapse; text-align: center;"> <tr> <td style="width: 10%;"></td> <td style="width: 10%;"></td> <td style="width: 10%;"></td> <td style="width: 10%;"></td> <td style="width: 10%;"></td> <td style="width: 10%;"></td> <td style="width: 10%;"></td> <td style="width: 10%;"></td> <td style="width: 10%;"></td> <td style="width: 10%;"></td> </tr> <tr> <td></td> <td></td> <td colspan="8" style="text-align: center;"> <table border="1" style="width: 100%; border-collapse: collapse; text-align: center;"> <tr> <td style="width: 10%;"></td> <td style="width: 10%;"></td> <td style="width: 10%;"></td> <td style="width: 10%;"></td> <td style="width: 10%;"></td> <td style="width: 10%;"></td> <td style="width: 10%;"></td> <td style="width: 10%;"></td> <td style="width: 10%;"></td> <td style="width: 10%;"></td> </tr> <tr> <td></td> <td></td> <td colspan="8" style="text-align: center;"> <table border="1" style="width: 100%; border-collapse: collapse; text-align: center;"> <tr> <td style="width: 10%;"></td> <td style="width: 10%;"></td> <td style="width: 10%;"></td> <td style="width: 10%;"></td> <td style="width: 10%;"></td> <td style="width: 10%;"></td> <td style="width: 10%;"></td> <td style="width: 10%;"></td> <td style="width: 10%;"></td> <td style="width: 10%;"></td> </tr> <tr> <td></td> <td></td> <td colspan="8" style="text-align: center;"> <table border="1" style="width: 100%; border-collapse: collapse; text-align: center;"> <tr> <td style="width: 10%;"></td> <td style="width: 10%;"></td> <td style="width: 10%;"></td> <td style="width: 10%;"></td> <td style="width: 10%;"></td> <td style="width: 10%;"></td> <td style="width: 10%;"></td> <td style="width: 10%;"></td> <td style="width: 10%;"></td> <td style="width: 10%;"></td> </tr> <tr> <td></td> <td></td> <td colspan="8" style="text-align: center;"> <table border="1" style="width: 100%; border-collapse: collapse; text-align: center;"> <tr> <td style="width: 10%;"></td> <td style="width: 10%;"></td> <td style="width: 10%;"></td> <td style="width: 10%;"></td> <td style="width: 10%;"></td> <td style="width: 10%;"></td> <td style="width: 10%;"></td> <td style="width: 10%;"></td> <td style="width: 10%;"></td> <td style="width: 10%;"></td> </tr> <tr> <td></td> <td></td> <td colspan="8" style="text-align: center;"> <table border="1" style="width: 100%; border-collapse: collapse; text-align: center;"> <tr> <td style="width: 10%;"></td> <td style="width: 10%;"></td> <td style="width: 10%;"></td> <td style="width: 10%;"></td> <td style="width: 10%;"></td> <td style="width: 10%;"></td> <td style="width: 10%;"></td> <td style="width: 10%;"></td> <td style="width: 10%;"></td> <td style="width: 10%;"></td> </tr> <tr> <td></td> <td></td> <td colspan="8" style="text-align: center;"> <table border="1" style="width: 100%; border-collapse: collapse; text-align: center;"> <tr> <td style="width: 10%;"></td> <td style="width: 10%;"></td> <td style="width: 10%;"></td> <td style="width: 10%;"></td> <td style="width: 10%;"></td> <td style="width: 10%;"></td> <td style="width: 10%;"></td> <td style="width: 10%;"></td> <td style="width: 10%;"></td> <td style="width: 10%;"></td> </tr> <tr> <td></td> <td></td> <td colspan="8" style="text-align: center;"> <table border="1" style="width: 100%; border-collapse: collapse; text-align: center;"> <tr> <td style="width: 10%;"></td> <td style="width: 10%;"></td> <td style="width: 10%;"></td> <td style="width: 10%;"></td> <td style="width: 10%;"></td> <td style="width: 10%;"></td> <td style="width: 10%;"></td> <td style="width: 10%;"></td> <td style="width: 10%;"></td> <td style="width: 10%;"></td> </tr> <tr> <td></td> <td></td> <td colspan="8" style="text-align: center;"> <table border="1" style="width: 100%; border-collapse: collapse; text-align: center;"> <tr> <td style="width: 10%;"></td> <td style="width: 10%;"></td> <td style="width: 10%;"></td> <td style="width: 10%;"></td> <td style="width: 10%;"></td> <td style="width: 10%;"></td> <td style="width: 10%;"></td> <td style="width: 10%;"></td> <td style="width: 10%;"></td> <td style="width: 10%;"></td> </tr>
<tr> <td></td> <td></td> <td colspan="8" style="text-align: center;"> <table border="1" style="width: 100%; border-collapse: collapse; text-align: center;"> <tr> <td style="width: 10%;"></td> <td style="width: 10%;"></td> <td style="width: 10%;"></td> <td style="width: 10%;"></td> <td style="width: 10%;"></td> <td style="width: 10%;"></td> <td style="width: 10%;"></td> <td style="width: 10%;"></td> <td style="width: 10%;"></td> <td style="width: 10%;"></td> </tr> <tr> <td></td> <td></td> <td colspan="8" style="text-align: center;"> <table border="1" style="width: 100%; border-collapse: collapse; text-align: center;"> <tr> </tr></table></td></tr></table></td></tr></table></td></tr></table></td></tr></table></td></tr></table></td></tr></table></td></tr></table></td></tr></table></td></tr></table></td></tr></table></td></tr></table></td></tr></table></td></tr></table></td></tr></table></td></tr></table></td></tr></table></td></tr></table></td></tr></table></td></tr></table></td></tr></table></td></tr></table></td></tr></table></td></tr></table></td></tr></table></td></tr></table></td></tr></table></td></tr></table></td></tr></table></td></tr></table></td></tr></table></td></tr></table></td></tr></table></td></tr></table></td></tr></table></td></tr></table></td></tr></table></td></tr></table></td></tr></table></td></tr></table></td></tr></table></td></tr></table></td></tr></table></td></tr></table></td></tr></table></td></tr></table></td></tr></table></td></tr></table></td></tr></table></td></tr></table></td></tr></table></td></tr></table></td></tr></table></td></tr></table></td></tr></table></td></tr></table> | | | | | | | | | | | | | | | | | | | | <table border="1" style="width: 100%; border-collapse: collapse; text-align: center;"> <tr> <td style="width: 10%;"></td> <td style="width: 10%;"></td> <td style="width: 10%;"></td> <td style="width: 10%;"></td> <td style="width: 10%;"></td> <td style="width: 10%;"></td> <td style="width: 10%;"></td> <td style="width: 10%;"></td> <td style="width: 10%;"></td> <td style="width: 10%;"></td> </tr> <tr> <td></td> <td></td> <td colspan="8" style="text-align: center;"> <table border="1" style="width: 100%; border-collapse: collapse; text-align: center;"> <tr> <td style="width: 10%;"></td> <td style="width: 10%;"></td> <td style="width: 10%;"></td> <td style="width: 10%;"></td> <td style="width: 10%;"></td> <td style="width: 10%;"></td> <td style="width: 10%;"></td> <td style="width: 10%;"></td> <td style="width: 10%;"></td> <td style="width: 10%;"></td> </tr> <tr> <td></td> <td></td> <td colspan="8" style="text-align: center;"> <table border="1" style="width: 100%; border-collapse: collapse; text-align: center;"> <tr> <td style="width: 10%;"></td> <td style="width: 10%;"></td> <td style="width: 10%;"></td> <td style="width: 10%;"></td> <td style="width: 10%;"></td> <td style="width: 10%;"></td> <td style="width: 10%;"></td> <td style="width: 10%;"></td> <td style="width: 10%;"></td> <td style="width: 10%;"></td> </tr> <tr> <td></td> <td></td> <td colspan="8" style="text-align: center;"> <table border="1" style="width: 100%; border-collapse: collapse; text-align: center;"> <tr> <td style="width: 10%;"></td> <td style="width: 10%;"></td> <td style="width: 10%;"></td> <td style="width: 10%;"></td> <td style="width: 10%;"></td> <td style="width: 10%;"></td> <td style="width: 10%;"></td> <td style="width: 10%;"></td> <td style="width: 10%;"></td> <td style="width: 10%;"></td> </tr> <tr> <td></td> <td></td> <td colspan="8" style="text-align: center;"> <table border="1" style="width: 100%; border-collapse: collapse; text-align: center;"> <tr> <td style="width: 10%;"></td> <td style="width: 10%;"></td> <td style="width: 10%;"></td> <td style="width: 10%;"></td> <td style="width: 10%;"></td> <td style="width: 10%;"></td> <td style="width: 10%;"></td> <td style="width: 10%;"></td> <td style="width: 10%;"></td> <td style="width: 10%;"></td> </tr> <tr> <td></td> <td></td> <td colspan="8" style="text-align: center;"> <table border="1" style="width: 100%; border-collapse: collapse; text-align: center;"> <tr> <td style="width: 10%;"></td> <td style="width: 10%;"></td> <td style="width: 10%;"></td> <td style="width: 10%;"></td> <td style="width: 10%;"></td> <td style="width: 10%;"></td> <td style="width: 10%;"></td> <td style="width: 10%;"></td> <td style="width: 10%;"></td> <td style="width: 10%;"></td> </tr> <tr> <td></td> <td></td> <td colspan="8" style="text-align: center;"> <table border="1" style="width: 100%; border-collapse: collapse; text-align: center;"> <tr> <td style="width: 10%;"></td> <td style="width: 10%;"></td> <td style="width: 10%;"></td> <td style="width: 10%;"></td> <td style="width: 10%;"></td> <td style="width: 10%;"></td> <td style="width: 10%;"></td> <td style="width: 10%;"></td> <td style="width: 10%;"></td> <td style="width: 10%;"></td> </tr> <tr> <td></td> <td></td> <td colspan="8" style="text-align: center;"> <table border="1" style="width: 100%; border-collapse: collapse; text-align: center;"> <tr> <td style="width: 10%;"></td> <td style="width: 10%;"></td> <td style="width: 10%;"></td> <td style="width: 10%;"></td> <td style="width: 10%;"></td> <td style="width: 10%;"></td> <td style="width: 10%;"></td> <td style="width: 10%;"></td> <td style="width: 10%;"></td> <td style="width: 10%;"></td> </tr> <tr> <td></td> <td></td> <td colspan="8" style="text-align: center;"> <table border="1" style="width: 100%; border-collapse: collapse; text-align: center;"> <tr> <td style="width: 10%;"></td> <td style="width: 10%;"></td> <td style="width: 10%;"></td> <td style="width: 10%;"></td> <td style="width: 10%;"></td> <td style="width: 10%;"></td> <td style="width: 10%;"></td> <td style="width: 10%;"></td> <td style="width: 10%;"></td> <td style="width: 10%;"></td> </tr> <tr> <td></td> <td></td> <td colspan="8" style="text-align: center;"> <table border="1" style="width: 100%; border-collapse: collapse; text-align: center;"> <tr> <td style="width: 10%;"></td> <td style="width: 10%;"></td> <td style="width: 10%;"></td> <td style="width: 10%;"></td> <td style="width: 10%;"></td> <td style="width: 10%;"></td> <td style="width: 10%;"></td> <td style="width: 10%;"></td> <td style="width: 10%;"></td> <td style="width: 10%;"></td> </tr> <tr> <td></td> <td></td> <td colspan="8" style="text-align: center;"> <table border="1" style="width: 100%; border-collapse: collapse; text-align: center;"> <tr> <td style="width: 10%;"></td> <td style="width: 10%;"></td> <td style="width: 10%;"></td> <td style="width: 10%;"></td> <td style="width: 10%;"></td> <td style="width: 10%;"></td> <td style="width: 10%;"></td> <td style="width: 10%;"></td> <td style="width: 10%;"></td> <td style="width: 10%;"></td> </tr> <tr> <td></td> <td></td> <td colspan="8" style="text-align: center;"> <table border="1" style="width: 100%; border-collapse: collapse; text-align: center;"> <tr> <td style="width: 10%;"></td> <td style="width: 10%;"></td> <td style="width: 10%;"></td> <td style="width: 10%;"></td> <td style="width: 10%;"></td> <td style="width: 10%;"></td> <td style="width: 10%;"></td> <td style="width: 10%;"></td> <td style="width: 10%;"></td> <td style="width: 10%;"></td> </tr> <tr> <td></td> <td></td> <td colspan="8" style="text-align: center;"> <table border="1" style="width: 100%; border-collapse: collapse; text-align: center;"> <tr> <td style="width: 10%;"></td> <td style="width: 10%;"></td> <td style="width: 10%;"></td> <td style="width: 10%;"></td> <td style="width: 10%;"></td> <td style="width: 10%;"></td> <td style="width: 10%;"></td> <td style="width: 10%;"></td> <td style="width: 10%;"></td> <td style="width: 10%;"></td> </tr> <tr> <td></td> <td></td> <td colspan="8" style="text-align: center;"> <table border="1" style="width: 100%; border-collapse: collapse; text-align: center;"> <tr> <td style="width: 10%;"></td> <td style="width: 10%;"></td> <td style="width: 10%;"></td> <td style="width: 10%;"></td> <td style="width: 10%;"></td> <td style="width: 10%;"></td> <td style="width: 10%;"></td> <td style="width: 10%;"></td> <td style="width: 10%;"></td> <td style="width: 10%;"></td> </tr> <tr> <td></td> <td></td> <td colspan="8" style="text-align: center;"> <table border="1" style="width: 100%; border-collapse: collapse; text-align: center;"> <tr> <td style="width: 10%;"></td> <td style="width: 10%;"></td> <td style="width: 10%;"></td> <td style="width: 10%;"></td> <td style="width: 10%;"></td> <td style="width: 10%;"></td> <td style="width: 10%;"></td> <td style="width: 10%;"></td> <td style="width: 10%;"></td> <td style="width: 10%;"></td> </tr> <tr> <td></td> <td></td> <td colspan="8" style="text-align: center;"> <table border="1" style="width: 100%; border-collapse: collapse; text-align: center;"> <tr> <td style="width: 10%;"></td> <td style="width: 10%;"></td> <td style="width: 10%;"></td> <td style="width: 10%;"></td> <td style="width: 10%;"></td> <td style="width: 10%;"></td> <td style="width: 10%;"></td> <td style="width: 10%;"></td> <td style="width: 10%;"></td> <td style="width: 10%;"></td> </tr> <tr> <td></td> <td></td> <td colspan="8" style="text-align: center;"> <table border="1" style="width: 100%; border-collapse: collapse; text-align: center;"> <tr> <td style="width: 10%;"></td> <td style="width: 10%;"></td> <td style="width: 10%;"></td> <td style="width: 10%;"></td> <td style="width: 10%;"></td> <td style="width: 10%;"></td> <td style="width: 10%;"></td> <td style="width: 10%;"></td> <td style="width: 10%;"></td> <td style="width: 10%;"></td> </tr> <tr> <td></td> <td></td> <td colspan="8" style="text-align: center;"> <table border="1" style="width: 100%; border-collapse: collapse; text-align: center;"> <tr> <td style="width: 10%;"></td> <td style="width: 10%;"></td> <td style="width: 10%;"></td> <td style="width: 10%;"></td> <td style="width: 10%;"></td> <td style="width: 10%;"></td> <td style="width: 10%;"></td> <td style="width: 10%;"></td> <td style="width:
10%;"></td> <td style="width: 10%;"></td> </tr> <tr> <td></td> <td></td> <td colspan="8" style="text-align: center;"> <table border="1" style="width: 100%; border-collapse: collapse; text-align: center;"> <tr> <td style="width: 10%;"></td> <td style="width: 10%;"></td> <td style="width: 10%;"></td> <td style="width: 10%;"></td> <td style="width: 10%;"></td> <td style="width: 10%;"></td> <td style="width: 10%;"></td> <td style="width: 10%;"></td> <td style="width: 10%;"></td> <td style="width: 10%;"></td> </tr> <tr> <td></td> <td></td> <td colspan="8" style="text-align: center;"> <table border="1" style="width: 100%; border-collapse: collapse; text-align: center;"> <tr> <td style="width: 10%;"></td> <td style="width: 10%;"></td> <td style="width: 10%;"></td> <td style="width: 10%;"></td> <td style="width: 10%;"></td> <td style="width: 10%;"></td> <td style="width: 10%;"></td> <td style="width: 10%;"></td> <td style="width: 10%;"></td> <td style="width: 10%;"></td> </tr> <tr> <td></td> <td></td> <td colspan="8" style="text-align: center;"> <table border="1" style="width: 100%; border-collapse: collapse; text-align: center;"> <tr> <td style="width: 10%;"></td> <td style="width: 10%;"></td> <td style="width: 10%;"></td> <td style="width: 10%;"></td> <td style="width: 10%;"></td> <td style="width: 10%;"></td> <td style="width: 10%;"></td> <td style="width: 10%;"></td> <td style="width: 10%;"></td> <td style="width: 10%;"></td> </tr> <tr> <td></td> <td></td> <td colspan="8" style="text-align: center;"> <table border="1" style="width: 100%; border-collapse: collapse; text-align: center;"> <tr> <td style="width: 10%;"></td> <td style="width: 10%;"></td> <td style="width: 10%;"></td> <td style="width: 10%;"></td> <td style="width: 10%;"></td> <td style="width: 10%;"></td> <td style="width: 10%;"></td> <td style="width: 10%;"></td> <td style="width: 10%;"></td> <td style="width: 10%;"></td> </tr> <tr> <td></td> <td></td> <td colspan="8" style="text-align: center;"> <table border="1" style="width: 100%; border-collapse: collapse; text-align: center;"> <tr> <td style="width: 10%;"></td> <td style="width: 10%;"></td> <td style="width: 10%;"></td> <td style="width: 10%;"></td> <td style="width: 10%;"></td> <td style="width: 10%;"></td> <td style="width: 10%;"></td> <td style="width: 10%;"></td> <td style="width: 10%;"></td> <td style="width: 10%;"></td> </tr> <tr> <td></td> <td></td> <td colspan="8" style="text-align: center;"> <table border="1" style="width: 100%; border-collapse: collapse; text-align: center;"> <tr> <td style="width: 10%;"></td> <td style="width: 10%;"></td> <td style="width: 10%;"></td> <td style="width: 10%;"></td> <td style="width: 10%;"></td> <td style="width: 10%;"></td> <td style="width: 10%;"></td> <td style="width: 10%;"></td> <td style="width: 10%;"></td> <td style="width: 10%;"></td> </tr> <tr> <td></td> <td></td> <td colspan="8" style="text-align: center;"> <table border="1" style="width: 100%; border-collapse: collapse; text-align: center;"> <tr> <td style="width: 10%;"></td> <td style="width: 10%;"></td> <td style="width: 10%;"></td> <td style="width: 10%;"></td> <td style="width: 10%;"></td> <td style="width: 10%;"></td> <td style="width: 10%;"></td> <td style="width: 10%;"></td> <td style="width: 10%;"></td> <td style="width: 10%;"></td> </tr> <tr> <td></td> <td></td> <td colspan="8" style="text-align: center;"> <table border="1" style="width: 100%; border-collapse: collapse; text-align: center;"> <tr> <td style="width: 10%;"></td> <td style="width: 10%;"></td> <td style="width: 10%;"></td> <td style="width: 10%;"></td> <td style="width: 10%;"></td> <td style="width: 10%;"></td> <td style="width: 10%;"></td> <td style="width: 10%;"></td> <td style="width: 10%;"></td> <td style="width: 10%;"></td> </tr> <tr> <td></td> <td></td> <td colspan="8" style="text-align: center;"> <table border="1" style="width: 100%; border-collapse: collapse; text-align: center;"> <tr> <td style="width: 10%;"></td> <td style="width: 10%;"></td> <td style="width: 10%;"></td> <td style="width: 10%;"></td> <td style="width: 10%;"></td> <td style="width: 10%;"></td> <td style="width: 10%;"></td> <td style="width: 10%;"></td> <td style="width: 10%;"></td> <td style="width: 10%;"></td> </tr> <tr> <td></td> <td></td> <td colspan="8" style="text-align: center;"> <table border="1" style="width: 100%; border-collapse: collapse; text-align: center;"> <tr> <td style="width: 10%;"></td> <td style="width: 10%;"></td> <td style="width: 10%;"></td> <td style="width: 10%;"></td> <td style="width: 10%;"></td> <td style="width: 10%;"></td> <td style="width: 10%;"></td> <td style="width: 10%;"></td> <td style="width: 10%;"></td> <td style="width: 10%;"></td> </tr> <tr> <td></td> <td></td> <td colspan="8" style="text-align: center;"> <table border="1" style="width: 100%; border-collapse: collapse; text-align: center;"> <tr> <td style="width: 10%;"></td> <td style="width: 10%;"></td> <td style="width: 10%;"></td> <td style="width: 10%;"></td> <td style="width: 10%;"></td> <td style="width: 10%;"></td> <td style="width: 10%;"></td> <td style="width: 10%;"></td> <td style="width: 10%;"></td> <td style="width: 10%;"></td> </tr> <tr> <td></td> <td></td> <td colspan="8" style="text-align: center;"> <table border="1" style="width: 100%; border-collapse: collapse; text-align: center;"> <tr> <td style="width: 10%;"></td> <td style="width: 10%;"></td> <td style="width: 10%;"></td> <td style="width: 10%;"></td> <td style="width: 10%;"></td> <td style="width: 10%;"></td> <td style="width: 10%;"></td> <td style="width: 10%;"></td> <td style="width: 10%;"></td> <td style="width: 10%;"></td> </tr> <tr> <td></td> <td></td> <td colspan="8" style="text-align: center;"> <table border="1" style="width: 100%; border-collapse: collapse; text-align: center;"> <tr> <td style="width: 10%;"></td> <td style="width: 10%;"></td> <td style="width: 10%;"></td> <td style="width: 10%;"></td> <td style="width: 10%;"></td> <td style="width: 10%;"></td> <td style="width: 10%;"></td> <td style="width: 10%;"></td> <td style="width: 10%;"></td> <td style="width: 10%;"></td> </tr> <tr> <td></td> <td></td> <td colspan="8" style="text-align: center;"> <table border="1" style="width: 100%; border-collapse: collapse; text-align: center;"> <tr> <td style="width: 10%;"></td> <td style="width: 10%;"></td> <td style="width: 10%;"></td> <td style="width: 10%;"></td> <td style="width: 10%;"></td> <td style="width: 10%;"></td> <td style="width: 10%;"></td> <td style="width: 10%;"></td> <td style="width: 10%;"></td> <td style="width: 10%;"></td> </tr> <tr> <td></td> <td></td> <td colspan="8" style="text-align: center;"> <table border="1" style="width: 100%; border-collapse: collapse; text-align: center;"> <tr> <td style="width: 10%;"></td> <td style="width: 10%;"></td> <td style="width: 10%;"></td> <td style="width: 10%;"></td> <td style="width: 10%;"></td> <td style="width: 10%;"></td> <td style="width: 10%;"></td> <td style="width: 10%;"></td> <td style="width: 10%;"></td> <td style="width: 10%;"></td> </tr> <tr> <td></td> <td></td> <td colspan="8" style="text-align: center;"> <table border="1" style="width: 100%; border-collapse: collapse; text-align: center;"> <tr> <td style="width: 10%;"></td> <td style="width: 10%;"></td> <td style="width: 10%;"></td> <td style="width: 10%;"></td> <td style="width: 10%;"></td> <td style="width: 10%;"></td> <td style="width: 10%;"></td> <td style="width: 10%;"></td> <td style="width: 10%;"></td> <td style="width: 10%;"></td> </tr> <tr> <td></td> <td></td> <td colspan="8" style="text-align: center;"> <table border="1" style="width: 100%; border-collapse: collapse; text-align: center;"> <tr> <td style="width: 10%;"></td> <td style="width: 10%;"></td> <td style="width: 10%;"></td> <td style="width: 10%;"></td> <td style="width: 10%;"></td> <td style="width: 10%;"></td> <td style="width: 10%;"></td> <td style="width: 10%;"></td> <td style="width: 10%;"></td> <td style="width: 10%;"></td> </tr> <tr> <td></td> <td></td> <td colspan="8" style="text-align: center;"> <table border="1" style="width: 100%; border-collapse: collapse; text-align: center;"> <tr> <td style="width: 10%;"></td> <td style="width: 10%;"></td> <td style="width: 10%;"></td> <td style="width: 10%;"></td> <td style="width: 10%;"></td> <td style="width: 10%;"></td> <td style="width: 10%;"></td> <td style="width: 10%;"></td> <td style="width: 10%;"></td> <td style="width: 10%;"></td> </tr> <tr> <td></td> <td></td> <td colspan="8" style="text-align: center;"> <table border="1" style="width: 100%; border-collapse: collapse; text-align: center;"> <tr> <td style="width: 10%;"></td> <td style="width: 10%;"></td> <td style="width: 10%;"></td> <td style="width: 10%;"></td> <td style="width: 10%;"></td> <td style="width: 10%;"></td> <td style="width: 10%;"></td> <td style="width: 10%;"></td> <td style="width: 10%;"></td> <td style="width: 10%;"></td> </tr> <tr> <td></td> <td></td> <td colspan="8" style="text-align: center;"> <table border="1" style="width: 100%; border-collapse: collapse; text-align: center;"> <tr> <td style="width: 10%;"></td> <td style="width: 10%;"></td> <td style="width: 10%;"></td> <td style="width: 10%;"></td> <td style="width: 10%;"></td> <td style="width: 10%;"></td> <td style="width: 10%;"></td> <td style="width: 10%;"></td> <td style="width: 10%;"></td> <td style="width: 10%;"></td> </tr> <tr> <td></td> <td></td> <td colspan="8" style="text-align: center;"> <table border="1" style="width: 100%; border-collapse: collapse; text-align: center;"> <tr> <td style="width: 10%;"></td> <td style="width: 10%;"></td> <td style="width: 10%;"></td> <td style="width: 10%;"></td> <td style="width: 10%;"></td> <td style="width: 10%;"></td> <td style="width: 10%;"></td> <td style="width: 10%;"></td> <td style="width: 10%;"></td> <td style="width: 10%;"></td> </tr> <tr> <td></td> <td></td> <td colspan="8" style="text-align: center;"> <table border="1" style="width: 100%;
border-collapse: collapse; text-align: center;"> <tr> <td style="width: 10%;"></td> <td style="width: 10%;"></td> <td style="width: 10%;"></td> <td style="width: 10%;"></td> <td style="width: 10%;"></td> <td style="width: 10%;"></td> <td style="width: 10%;"></td> <td style="width: 10%;"></td> <td style="width: 10%;"></td> <td style="width: 10%;"></td> </tr> <tr> <td></td> <td></td> <td colspan="8" style="text-align: center;"> <table border="1" style="width: 100%; border-collapse: collapse; text-align: center;"> <tr> <td style="width: 10%;"></td> <td style="width: 10%;"></td> <td style="width: 10%;"></td> <td style="width: 10%;"></td> <td style="width: 10%;"></td> <td style="width: 10%;"></td> <td style="width: 10%;"></td> <td style="width: 10%;"></td> <td style="width: 10%;"></td> <td style="width: 10%;"></td> </tr> <tr> <td></td> <td></td> <td colspan="8" style="text-align: center;"> <table border="1" style="width: 100%; border-collapse: collapse; text-align: center;"> <tr> <td style="width: 10%;"></td> <td style="width: 10%;"></td> <td style="width: 10%;"></td> <td style="width: 10%;"></td> <td style="width: 10%;"></td> <td style="width: 10%;"></td> <td style="width: 10%;"></td> <td style="width: 10%;"></td> <td style="width: 10%;"></td> <td style="width: 10%;"></td> </tr> <tr> <td></td> <td></td> <td colspan="8" style="text-align: center;"> <table border="1" style="width: 100%; border-collapse: collapse; text-align: center;"> <tr> <td style="width: 10%;"></td> <td style="width: 10%;"></td> <td style="width: 10%;"></td> <td style="width: 10%;"></td> <td style="width: 10%;"></td> <td style="width: 10%;"></td> <td style="width: 10%;"></td> <td style="width: 10%;"></td> <td style="width: 10%;"></td> <td style="width: 10%;"></td> </tr> <tr> <td></td> <td></td> <td colspan="8" style="text-align: center;"> <table border="1" style="width: 100%; border-collapse: collapse; text-align: center;"> <tr> <td style="width: 10%;"></td> <td style="width: 10%;"></td> <td style="width: 10%;"></td> <td style="width: 10%;"></td> <td style="width: 10%;"></td> <td style="width: 10%;"></td> <td style="width: 10%;"></td> <td style="width: 10%;"></td> <td style="width: 10%;"></td> <td style="width: 10%;"></td> </tr> <tr> <td></td> <td></td> <td colspan="8" style="text-align: center;"> <table border="1" style="width: 100%; border-collapse: collapse; text-align: center;"> <tr> <td style="width: 10%;"></td> <td style="width: 10%;"></td> <td style="width: 10%;"></td> <td style="width: 10%;"></td> <td style="width: 10%;"></td> <td style="width: 10%;"></td> <td style="width: 10%;"></td> <td style="width: 10%;"></td> <td style="width: 10%;"></td> <td style="width: 10%;"></td> </tr> <tr> <td></td> <td></td> <td colspan="8" style="text-align: center;"> <table border="1" style="width: 100%; border-collapse: collapse; text-align: center;"> <tr> <td style="width: 10%;"></td> <td style="width: 10%;"></td> <td style="width: 10%;"></td> <td style="width: 10%;"></td> <td style="width: 10%;"></td> <td style="width: 10%;"></td> <td style="width: 10%;"></td> <td style="width: 10%;"></td> <td style="width: 10%;"></td> <td style="width: 10%;"></td> </tr> <tr> <td></td> <td></td> <td colspan="8" style="text-align: center;"> <table border="1" style="width: 100%; border-collapse: collapse; text-align: center;"> <tr> <td style="width: 10%;"></td> <td style="width: 10%;"></td> <td style="width: 10%;"></td> <td style="width: 10%;"></td> <td style="width: 10%;"></td> <td style="width: 10%;"></td> <td style="width: 10%;"></td> <td style="width: 10%;"></td> <td style="width: 10%;"></td> <td style="width: 10%;"></td> </tr> <tr> <td></td> <td></td> <td colspan="8" style="text-align: center;"> <table border="1" style="width: 100%; border-collapse: collapse; text-align: center;"> <tr> <td style="width: 10%;"></td> <td style="width: 10%;"></td> <td style="width: 10%;"></td> <td style="width: 10%;"></td> <td style="width: 10%;"></td> <td style="width: 10%;"></td> <td style="width: 10%;"></td> <td style="width: 10%;"></td> <td style="width: 10%;"></td> <td style="width: 10%;"></td> </tr> <tr> <td></td> <td></td> <td colspan="8" style="text-align: center;"> <table border="1" style="width: 100%; border-collapse: collapse; text-align: center;"> <tr> <td style="width: 10%;"></td> <td style="width: 10%;"></td> <td style="width: 10%;"></td> <td style="width: 10%;"></td> <td style="width: 10%;"></td> <td style="width: 10%;"></td> <td style="width: 10%;"></td> <td style="width: 10%;"></td> <td style="width: 10%;"></td> <td style="width: 10%;"></td> </tr> <tr> <td></td> <td></td> <td colspan="8" style="text-align: center;"> <table border="1" style="width: 100%; border-collapse: collapse; text-align: center;"> <tr> <td style="width: 10%;"></td> <td style="width: 10%;"></td> <td style="width: 10%;"></td> <td style="width: 10%;"></td> <td style="width: 10%;"></td> <td style="width: 10%;"></td> <td style="width: 10%;"></td> <td style="width: 10%;"></td> <td style="width: 10%;"></td> <td style="width: 10%;"></td> </tr> <tr> <td></td> <td></td> <td colspan="8" style="text-align: center;"> <table border="1" style="width: 100%; border-collapse: collapse; text-align: center;"> <tr> <td style="width: 10%;"></td> <td style="width: 10%;"></td> <td style="width: 10%;"></td> <td style="width: 10%;"></td> <td style="width: 10%;"></td> <td style="width: 10%;"></td> <td style="width: 10%;"></td> <td style="width: 10%;"></td> <td style="width: 10%;"></td> <td style="width: 10%;"></td> </tr> <tr> <td></td> <td></td> <td colspan="8" style="text-align: center;"> <table border="1" style="width: 100%; border-collapse: collapse; text-align: center;"> <tr> <td style="width: 10%;"></td> <td style="width: 10%;"></td> <td style="width: 10%;"></td> <td style="width: 10%;"></td> <td style="width: 10%;"></td> <td style="width: 10%;"></td> <td style="width: 10%;"></td> <td style="width: 10%;"></td> <td style="width: 10%;"></td> <td style="width: 10%;"></td> </tr> <tr> <td></td> <td></td> <td colspan="8" style="text-align: center;"> <table border="1" style="width: 100%; border-collapse: collapse; text-align: center;"> <tr> <td style="width: 10%;"></td> <td style="width: 10%;"></td> <td style="width: 10%;"></td> <td style="width: 10%;"></td> <td style="width: 10%;"></td> <td style="width: 10%;"></td> <td style="width: 10%;"></td> <td style="width: 10%;"></td> <td style="width: 10%;"></td> <td style="width: 10%;"></td> </tr> <tr> <td></td> <td></td> <td colspan="8" style="text-align: center;"> <table border="1" style="width: 100%; border-collapse: collapse; text-align: center;"> <tr> <td style="width: 10%;"></td> <td style="width: 10%;"></td> <td style="width: 10%;"></td> <td style="width: 10%;"></td> <td style="width: 10%;"></td> <td style="width: 10%;"></td> <td style="width: 10%;"></td> <td style="width: 10%;"></td> <td style="width: 10%;"></td> <td style="width: 10%;"></td> </tr> <tr> <td></td> <td></td> <td colspan="8" style="text-align: center;"> <table border="1" style="width: 100%; border-collapse: collapse; text-align: center;"> <tr> </tr></table></td></tr></table></td></tr></table></td></tr></table></td></tr></table></td></tr></table></td></tr></table></td></tr></table></td></tr></table></td></tr></table></td></tr></table></td></tr></table></td></tr></table></td></tr></table></td></tr></table></td></tr></table></td></tr></table></td></tr></table></td></tr></table></td></tr></table></td></tr></table></td></tr></table></td></tr></table></td></tr></table></td></tr></table></td></tr></table></td></tr></table></td></tr></table></td></tr></table></td></tr></table></td></tr></table></td></tr></table></td></tr></table></td></tr></table></td></tr></table></td></tr></table></td></tr></table></td></tr></table></td></tr></table></td></tr></table></td></tr></table></td></tr></table></td></tr></table></td></tr></table></td></tr></table></td></tr></table></td></tr></table></td></tr></table></td></tr></table></td></tr></table></td></tr></table></td></tr></table></td></tr></table></td></tr></table></td></tr></table> | | | | | | | | | | | | | | | | | | | | <table border="1" style="width: 100%; border-collapse: collapse; text-align: center;"> <tr> <td style="width: 10%;"></td> <td style="width: 10%;"></td> <td style="width: 10%;"></td> <td style="width: 10%;"></td> <td style="width: 10%;"></td> <td style="width: 10%;"></td> <td style="width: 10%;"></td> <td style="width: 10%;"></td> <td style="width: 10%;"></td> <td style="width: 10%;"></td> </tr> <tr> <td></td> <td></td> <td colspan="8" style="text-align: center;"> <table border="1" style="width: 100%; border-collapse: collapse; text-align: center;"> <tr> <td style="width: 10%;"></td> <td style="width: 10%;"></td> <td style="width: 10%;"></td> <td style="width: 10%;"></td> <td style="width: 10%;"></td> <td style="width: 10%;"></td> <td style="width: 10%;"></td> <td style="width: 10%;"></td> <td style="width: 10%;"></td> <td style="width: 10%;"></td> </tr> <tr> <td></td> <td></td> <td colspan="8" style="text-align: center;"> <table border="1" style="width: 100%; border-collapse: collapse; text-align: center;"> <tr> <td style="width: 10%;"></td> <td style="width: 10%;"></td> <td style="width: 10%;"></td> <td style="width: 10%;"></td> <td style="width: 10%;"></td> <td style="width: 10%;"></td> <td style="width: 10%;"></td> <td style="width: 10%;"></td> <td style="width: 10%;"></td> <td style="width: 10%;"></td> </tr> <tr> <td></td> <td></td> <td colspan="8" style="text-align: center;"> <table border="1" style="width: 100%; border-collapse: collapse; text-align: center;"> <tr> <td style="width: 10%;"></td> <td style="width: 10%;"></td> <td style="width: 10%;"></td> <td style="width: 10%;"></td> <td style="width: 10%;"></td> <td style="width: 10%;"></td> <td style="width: 10%;"></td> <td style="width: 10%;"></td> <td style="width: 10%;"></td> <td style="width: 10%;"></td> </tr> <tr> <td></td> <td></td> <td colspan="8" style="text-align: center;"> <table
border="1" style="width: 100%; border-collapse: collapse; text-align: center;"> <tr> <td style="width: 10%;"></td> <td style="width: 10%;"></td> <td style="width: 10%;"></td> <td style="width: 10%;"></td> <td style="width: 10%;"></td> <td style="width: 10%;"></td> <td style="width: 10%;"></td> <td style="width: 10%;"></td> <td style="width: 10%;"></td> <td style="width: 10%;"></td> </tr> <tr> <td></td> <td></td> <td colspan="8" style="text-align: center;"> <table border="1" style="width: 100%; border-collapse: collapse; text-align: center;"> <tr> <td style="width: 10%;"></td> <td style="width: 10%;"></td> <td style="width: 10%;"></td> <td style="width: 10%;"></td> <td style="width: 10%;"></td> <td style="width: 10%;"></td> <td style="width: 10%;"></td> <td style="width: 10%;"></td> <td style="width: 10%;"></td> <td style="width: 10%;"></td> </tr> <tr> <td></td> <td></td> <td colspan="8" style="text-align: center;"> <table border="1" style="width: 100%; border-collapse: collapse; text-align: center;"> <tr> <td style="width: 10%;"></td> <td style="width: 10%;"></td> <td style="width: 10%;"></td> <td style="width: 10%;"></td> <td style="width: 10%;"></td> <td style="width: 10%;"></td> <td style="width: 10%;"></td> <td style="width: 10%;"></td> <td style="width: 10%;"></td> <td style="width: 10%;"></td> </tr> <tr> <td></td> <td></td> <td colspan="8" style="text-align: center;"> <table border="1" style="width: 100%; border-collapse: collapse; text-align: center;"> <tr> <td style="width: 10%;"></td> <td style="width: 10%;"></td> <td style="width: 10%;"></td> <td style="width: 10%;"></td> <td style="width: 10%;"></td> <td style="width: 10%;"></td> <td style="width: 10%;"></td> <td style="width: 10%;"></td> <td style="width: 10%;"></td> <td style="width: 10%;"></td> </tr> <tr> <td></td> <td></td> <td colspan="8" style="text-align: center;"> <table border="1" style="width: 100%; border-collapse: collapse; text-align: center;"> <tr> <td style="width: 10%;"></td> <td style="width: 10%;"></td> <td style="width: 10%;"></td> <td style="width: 10%;"></td> <td style="width: 10%;"></td> <td style="width: 10%;"></td> <td style="width: 10%;"></td> <td style="width: 10%;"></td> <td style="width: 10%;"></td> <td style="width: 10%;"></td> </tr> <tr> <td></td> <td></td> <td colspan="8" style="text-align: center;"> <table border="1" style="width: 100%; border-collapse: collapse; text-align: center;"> <tr> <td style="width: 10%;"></td> <td style="width: 10%;"></td> <td style="width: 10%;"></td> <td style="width: 10%;"></td> <td style="width: 10%;"></td> <td style="width: 10%;"></td> <td style="width: 10%;"></td> <td style="width: 10%;"></td> <td style="width: 10%;"></td> <td style="width: 10%;"></td> </tr> <tr> <td></td> <td></td> <td colspan="8" style="text-align: center;"> <table border="1" style="width: 100%; border-collapse: collapse; text-align: center;"> <tr> <td style="width: 10%;"></td> <td style="width: 10%;"></td> <td style="width: 10%;"></td> <td style="width: 10%;"></td> <td style="width: 10%;"></td> <td style="width: 10%;"></td> <td style="width: 10%;"></td> <td style="width: 10%;"></td> <td style="width: 10%;"></td> <td style="width: 10%;"></td> </tr> <tr> <td></td> <td></td> <td colspan="8" style="text-align: center;"> <table border="1" style="width: 100%; border-collapse: collapse; text-align: center;"> <tr> <td style="width: 10%;"></td> <td style="width: 10%;"></td> <td style="width: 10%;"></td> <td style="width: 10%;"></td> <td style="width: 10%;"></td> <td style="width: 10%;"></td> <td style="width: 10%;"></td> <td style="width: 10%;"></td> <td style="width: 10%;"></td> <td style="width: 10%;"></td> </tr> <tr> <td></td> <td></td> <td colspan="8" style="text-align: center;"> <table border="1" style="width: 100%; border-collapse: collapse; text-align: center;"> <tr> <td style="width: 10%;"></td> <td style="width: 10%;"></td> <td style="width: 10%;"></td> <td style="width: 10%;"></td> <td style="width: 10%;"></td> <td style="width: 10%;"></td> <td style="width: 10%;"></td> <td style="width: 10%;"></td> <td style="width: 10%;"></td> <td style="width: 10%;"></td> </tr> <tr> <td></td> <td></td> <td colspan="8" style="text-align: center;"> <table border="1" style="width: 100%; border-collapse: collapse; text-align: center;"> <tr> <td style="width: 10%;"></td> <td style="width: 10%;"></td> <td style="width: 10%;"></td> <td style="width: 10%;"></td> <td style="width: 10%;"></td> <td style="width: 10%;"></td> <td style="width: 10%;"></td> <td style="width: 10%;"></td> <td style="width: 10%;"></td> <td style="width: 10%;"></td> </tr> <tr> <td></td> <td></td> <td colspan="8" style="text-align: center;"> <table border="1" style="width: 100%; border-collapse: collapse; text-align: center;"> <tr> <td style="width: 10%;"></td> <td style="width: 10%;"></td> <td style="width: 10%;"></td> <td style="width: 10%;"></td> <td style="width: 10%;"></td> <td style="width: 10%;"></td> <td style="width: 10%;"></td> <td style="width: 10%;"></td> <td style="width: 10%;"></td> <td style="width: 10%;"></td> </tr> <tr> <td></td> <td></td> <td colspan="8" style="text-align: center;"> <table border="1" style="width: 100%; border-collapse: collapse; text-align: center;"> <tr> <td style="width: 10%;"></td> <td style="width: 10%;"></td> <td style="width: 10%;"></td> <td style="width: 10%;"></td> <td style="width: 10%;"></td> <td style="width: 10%;"></td> <td style="width: 10%;"></td> <td style="width: 10%;"></td> <td style="width: 10%;"></td> <td style="width: 10%;"></td> </tr> <tr> <td></td> <td></td> <td colspan="8" style="text-align: center;"> <table border="1" style="width: 100%; border-collapse: collapse; text-align: center;"> <tr> <td style="width: 10%;"></td> <td style="width: 10%;"></td> <td style="width: 10%;"></td> <td style="width: 10%;"></td> <td style="width: 10%;"></td> <td style="width: 10%;"></td> <td style="width: 10%;"></td> <td style="width: 10%;"></td> <td style="width: 10%;"></td> <td style="width: 10%;"></td> </tr> <tr> <td></td> <td></td> <td colspan="8" style="text-align: center;"> <table border="1" style="width: 100%; border-collapse: collapse; text-align: center;"> <tr> <td style="width: 10%;"></td> <td style="width: 10%;"></td> <td style="width: 10%;"></td> <td style="width: 10%;"></td> <td style="width: 10%;"></td> <td style="width: 10%;"></td> <td style="width: 10%;"></td> <td style="width: 10%;"></td> <td style="width: 10%;"></td> <td style="width: 10%;"></td> </tr> <tr> <td></td> <td></td> <td colspan="8" style="text-align: center;"> <table border="1" style="width: 100%; border-collapse: collapse; text-align: center;"> <tr> <td style="width: 10%;"></td> <td style="width: 10%;"></td> <td style="width: 10%;"></td> <td style="width: 10%;"></td> <td style="width: 10%;"></td> <td style="width: 10%;"></td> <td style="width: 10%;"></td> <td style="width: 10%;"></td> <td style="width: 10%;"></td> <td style="width: 10%;"></td> </tr> <tr> <td></td> <td></td> <td colspan="8" style="text-align: center;"> <table border="1" style="width: 100%; border-collapse: collapse; text-align: center;"> <tr> <td style="width: 10%;"></td> <td style="width: 10%;"></td> <td style="width: 10%;"></td> <td style="width: 10%;"></td> <td style="width: 10%;"></td> <td style="width: 10%;"></td> <td style="width: 10%;"></td> <td style="width: 10%;"></td> <td style="width: 10%;"></td> <td style="width: 10%;"></td> </tr> <tr> <td></td> <td></td> <td colspan="8" style="text-align: center;"> <table border="1" style="width: 100%; border-collapse: collapse; text-align: center;"> <tr> <td style="width: 10%;"></td> <td style="width: 10%;"></td> <td style="width: 10%;"></td> <td style="width: 10%;"></td> <td style="width: 10%;"></td> <td style="width: 10%;"></td> <td style="width: 10%;"></td> <td style="width: 10%;"></td> <td style="width: 10%;"></td> <td style="width: 10%;"></td> </tr> <tr> <td></td> <td></td> <td colspan="8" style="text-align: center;"> <table border="1" style="width: 100%; border-collapse: collapse; text-align: center;"> <tr> <td style="width: 10%;"></td> <td style="width: 10%;"></td> <td style="width: 10%;"></td> <td style="width: 10%;"></td> <td style="width: 10%;"></td> <td style="width: 10%;"></td> <td style="width: 10%;"></td> <td style="width: 10%;"></td> <td style="width: 10%;"></td> <td style="width: 10%;"></td> </tr> <tr> <td></td> <td></td> <td colspan="8" style="text-align: center;"> <table border="1" style="width: 100%; border-collapse: collapse; text-align: center;"> <tr> <td style="width: 10%;"></td> <td style="width: 10%;"></td> <td style="width: 10%;"></td> <td style="width: 10%;"></td> <td style="width: 10%;"></td> <td style="width: 10%;"></td> <td style="width: 10%;"></td> <td style="width: 10%;"></td> <td style="width: 10%;"></td> <td style="width: 10%;"></td> </tr> <tr> <td></td> <td></td> <td colspan="8" style="text-align: center;"> <table border="1" style="width: 100%; border-collapse: collapse; text-align: center;"> <tr> <td style="width: 10%;"></td> <td style="width: 10%;"></td> <td style="width: 10%;"></td> <td style="width: 10%;"></td> <td style="width: 10%;"></td> <td style="width: 10%;"></td> <td style="width: 10%;"></td> <td style="width: 10%;"></td> <td style="width: 10%;"></td> <td style="width: 10%;"></td> </tr> <tr> <td></td> <td></td> <td colspan="8" style="text-align: center;"> <table border="1" style="width: 100%; border-collapse: collapse; text-align: center;"> <tr> <td style="width: 10%;"></td> <td style="width: 10%;"></td> <td style="width: 10%;"></td> <td style="width: 10%;"></td> <td style="width: 10%;"></td> <td style="width: 10%;"></td> <td style="width: 10%;"></td> <td style="width: 10%;"></td> <td style="width: 10%;"></td> <td style="width: 10%;"></td> </tr> <tr> <td></td> <td></td> <td colspan="8" style="text-align: center;"> <table border="1" style="width: 100%; border-collapse: collapse; text-align: center;"> <tr> <td style="width: 10%;"></td> <td style="width: 10%;"></td> <td style="width:
10%;"></td> <td style="width: 10%;"></td> <td style="width: 10%;"></td> <td style="width: 10%;"></td> <td style="width: 10%;"></td> <td style="width: 10%;"></td> <td style="width: 10%;"></td> <td style="width: 10%;"></td> </tr> <tr> <td></td> <td></td> <td colspan="8" style="text-align: center;"> <table border="1" style="width: 100%; border-collapse: collapse; text-align: center;"> <tr> <td style="width: 10%;"></td> <td style="width: 10%;"></td> <td style="width: 10%;"></td> <td style="width: 10%;"></td> <td style="width: 10%;"></td> <td style="width: 10%;"></td> <td style="width: 10%;"></td> <td style="width: 10%;"></td> <td style="width: 10%;"></td> <td style="width: 10%;"></td> </tr> <tr> <td></td> <td></td> <td colspan="8" style="text-align: center;"> <table border="1" style="width: 100%; border-collapse: collapse; text-align: center;"> <tr> <td style="width: 10%;"></td> <td style="width: 10%;"></td> <td style="width: 10%;"></td> <td style="width: 10%;"></td> <td style="width: 10%;"></td> <td style="width: 10%;"></td> <td style="width: 10%;"></td> <td style="width: 10%;"></td> <td style="width: 10%;"></td> <td style="width: 10%;"></td> </tr> <tr> <td></td> <td></td> <td colspan="8" style="text-align: center;"> <table border="1" style="width: 100%; border-collapse: collapse; text-align: center;"> <tr> <td style="width: 10%;"></td> <td style="width: 10%;"></td> <td style="width: 10%;"></td> <td style="width: 10%;"></td> <td style="width: 10%;"></td> <td style="width: 10%;"></td> <td style="width: 10%;"></td> <td style="width: 10%;"></td> <td style="width: 10%;"></td> <td style="width: 10%;"></td> </tr> <tr> <td></td> <td></td> <td colspan="8" style="text-align: center;"> <table border="1" style="width: 100%; border-collapse: collapse; text-align: center;"> <tr> <td style="width: 10%;"></td> <td style="width: 10%;"></td> <td style="width: 10%;"></td> <td style="width: 10%;"></td> <td style="width: 10%;"></td> <td style="width: 10%;"></td> <td style="width: 10%;"></td> <td style="width: 10%;"></td> <td style="width: 10%;"></td> <td style="width: 10%;"></td> </tr> <tr> <td></td> <td></td> <td colspan="8" style="text-align: center;"> <table border="1" style="width: 100%; border-collapse: collapse; text-align: center;"> <tr> <td style="width: 10%;"></td> <td style="width: 10%;"></td> <td style="width: 10%;"></td> <td style="width: 10%;"></td> <td style="width: 10%;"></td> <td style="width: 10%;"></td> <td style="width: 10%;"></td> <td style="width: 10%;"></td> <td style="width: 10%;"></td> <td style="width: 10%;"></td> </tr> <tr> <td></td> <td></td> <td colspan="8" style="text-align: center;"> <table border="1" style="width: 100%; border-collapse: collapse; text-align: center;"> <tr> <td style="width: 10%;"></td> <td style="width: 10%;"></td> <td style="width: 10%;"></td> <td style="width: 10%;"></td> <td style="width: 10%;"></td> <td style="width: 10%;"></td> <td style="width: 10%;"></td> <td style="width: 10%;"></td> <td style="width: 10%;"></td> <td style="width: 10%;"></td> </tr> <tr> <td></td> <td></td> <td colspan="8" style="text-align: center;"> <table border="1" style="width: 100%; border-collapse: collapse; text-align: center;"> <tr> <td style="width: 10%;"></td> <td style="width: 10%;"></td> <td style="width: 10%;"></td> <td style="width: 10%;"></td> <td style="width: 10%;"></td> <td style="width: 10%;"></td> <td style="width: 10%;"></td> <td style="width: 10%;"></td> <td style="width: 10%;"></td> <td style="width: 10%;"></td> </tr> <tr> <td></td> <td></td> <td colspan="8" style="text-align: center;"> <table border="1" style="width: 100%; border-collapse: collapse; text-align: center;"> <tr> <td style="width: 10%;"></td> <td style="width: 10%;"></td> <td style="width: 10%;"></td> <td style="width: 10%;"></td> <td style="width: 10%;"></td> <td style="width: 10%;"></td> <td style="width: 10%;"></td> <td style="width: 10%;"></td> <td style="width: 10%;"></td> <td style="width: 10%;"></td> </tr> <tr> <td></td> <td></td> <td colspan="8" style="text-align: center;"> <table border="1" style="width: 100%; border-collapse: collapse; text-align: center;"> <tr> <td style="width: 10%;"></td> <td style="width: 10%;"></td> <td style="width: 10%;"></td> <td style="width: 10%;"></td> <td style="width: 10%;"></td> <td style="width: 10%;"></td> <td style="width: 10%;"></td> <td style="width: 10%;"></td> <td style="width: 10%;"></td> <td style="width: 10%;"></td> </tr> <tr> <td></td> <td></td> <td colspan="8" style="text-align: center;"> <table border="1" style="width: 100%; border-collapse: collapse; text-align: center;"> <tr> <td style="width: 10%;"></td> <td style="width: 10%;"></td> <td style="width: 10%;"></td> <td style="width: 10%;"></td> <td style="width: 10%;"></td> <td style="width: 10%;"></td> <td style="width: 10%;"></td> <td style="width: 10%;"></td> <td style="width: 10%;"></td> <td style="width: 10%;"></td> </tr> <tr> <td></td> <td></td> <td colspan="8" style="text-align: center;"> <table border="1" style="width: 100%; border-collapse: collapse; text-align: center;"> <tr> <td style="width: 10%;"></td> <td style="width: 10%;"></td> <td style="width: 10%;"></td> <td style="width: 10%;"></td> <td style="width: 10%;"></td> <td style="width: 10%;"></td> <td style="width: 10%;"></td> <td style="width: 10%;"></td> <td style="width: 10%;"></td> <td style="width: 10%;"></td> </tr> <tr> <td></td> <td></td> <td colspan="8" style="text-align: center;"> <table border="1" style="width: 100%; border-collapse: collapse; text-align: center;"> <tr> <td style="width: 10%;"></td> <td style="width: 10%;"></td> <td style="width: 10%;"></td> <td style="width: 10%;"></td> <td style="width: 10%;"></td> <td style="width: 10%;"></td> <td style="width: 10%;"></td> <td style="width: 10%;"></td> <td style="width: 10%;"></td> <td style="width: 10%;"></td> </tr> <tr> <td></td> <td></td> <td colspan="8" style="text-align: center;"> <table border="1" style="width: 100%; border-collapse: collapse; text-align: center;"> <tr> <td style="width: 10%;"></td> <td style="width: 10%;"></td> <td style="width: 10%;"></td> <td style="width: 10%;"></td> <td style="width: 10%;"></td> <td style="width: 10%;"></td> <td style="width: 10%;"></td> <td style="width: 10%;"></td> <td style="width: 10%;"></td> <td style="width: 10%;"></td> </tr> <tr> <td></td> <td></td> <td colspan="8" style="text-align: center;"> <table border="1" style="width: 100%; border-collapse: collapse; text-align: center;"> <tr> <td style="width: 10%;"></td> <td style="width: 10%;"></td> <td style="width: 10%;"></td> <td style="width: 10%;"></td> <td style="width: 10%;"></td> <td style="width: 10%;"></td> <td style="width: 10%;"></td> <td style="width: 10%;"></td> <td style="width: 10%;"></td> <td style="width: 10%;"></td> </tr> <tr> <td></td> <td></td> <td colspan="8" style="text-align: center;"> <table border="1" style="width: 100%; border-collapse: collapse; text-align: center;"> <tr> <td style="width: 10%;"></td> <td style="width: 10%;"></td> <td style="width: 10%;"></td> <td style="width: 10%;"></td> <td style="width: 10%;"></td> <td style="width: 10%;"></td> <td style="width: 10%;"></td> <td style="width: 10%;"></td> <td style="width: 10%;"></td> <td style="width: 10%;"></td> </tr> <tr> <td></td> <td></td> <td colspan="8" style="text-align: center;"> <table border="1" style="width: 100%; border-collapse: collapse; text-align: center;"> <tr> <td style="width: 10%;"></td> <td style="width: 10%;"></td> <td style="width: 10%;"></td> <td style="width: 10%;"></td> <td style="width: 10%;"></td> <td style="width: 10%;"></td> <td style="width: 10%;"></td> <td style="width: 10%;"></td> <td style="width: 10%;"></td> <td style="width: 10%;"></td> </tr> <tr> <td></td> <td></td> <td colspan="8" style="text-align: center;"> <table border="1" style="width: 100%; border-collapse: collapse; text-align: center;"> <tr> <td style="width: 10%;"></td> <td style="width: 10%;"></td> <td style="width: 10%;"></td> <td style="width: 10%;"></td> <td style="width: 10%;"></td> <td style="width: 10%;"></td> <td style="width: 10%;"></td> <td style="width: 10%;"></td> <td style="width: 10%;"></td> <td style="width: 10%;"></td> </tr> <tr> <td></td> <td></td> <td colspan="8" style="text-align: center;"> <table border="1" style="width: 100%; border-collapse: collapse; text-align: center;"> <tr> <td style="width: 10%;"></td> <td style="width: 10%;"></td> <td style="width: 10%;"></td> <td style="width: 10%;"></td> <td style="width: 10%;"></td> <td style="width: 10%;"></td> <td style="width: 10%;"></td> <td style="width: 10%;"></td> <td style="width: 10%;"></td> <td style="width: 10%;"></td> </tr> <tr> <td></td> <td></td> <td colspan="8" style="text-align: center;"> <table border="1" style="width: 100%; border-collapse: collapse; text-align: center;"> <tr> <td style="width: 10%;"></td> <td style="width: 10%;"></td> <td style="width: 10%;"></td> <td style="width: 10%;"></td> <td style="width: 10%;"></td> <td style="width: 10%;"></td> <td style="width: 10%;"></td> <td style="width: 10%;"></td> <td style="width: 10%;"></td> <td style="width: 10%;"></td> </tr> <tr> <td></td> <td></td> <td colspan="8" style="text-align: center;"> <table border="1" style="width: 100%; border-collapse: collapse; text-align: center;"> <tr> <td style="width: 10%;"></td> <td style="width: 10%;"></td> <td style="width: 10%;"></td> <td style="width: 10%;"></td> <td style="width: 10%;"></td> <td style="width: 10%;"></td> <td style="width: 10%;"></td> <td style="width: 10%;"></td> <td style="width: 10%;"></td> <td style="width: 10%;"></td> </tr> <tr> <td></td> <td></td> <td colspan="8" style="text-align: center;"> <table border="1" style="width: 100%; border-collapse: collapse; text-align: center;"> <tr> <td style="width: 10%;"></td> <td style="width: 10%;"></td> <td style="width: 10%;"></td> <td style="width: 10%;"></td> <td style="width: 10%;"></td> <td style="width: 10%;"></td> <td style="width: 10%;"></td> <td style="width: 10%;"></td> <td
style="width: 10%;"></td> <td style="width: 10%;"></td> </tr> <tr> <td></td> <td></td> <td colspan="8" style="text-align: center;"> <table border="1" style="width: 100%; border-collapse: collapse; text-align: center;"> <tr> <td style="width: 10%;"></td> <td style="width: 10%;"></td> <td style="width: 10%;"></td> <td style="width: 10%;"></td> <td style="width: 10%;"></td> <td style="width: 10%;"></td> <td style="width: 10%;"></td> <td style="width: 10%;"></td> <td style="width: 10%;"></td> <td style="width: 10%;"></td> </tr> <tr> <td></td> <td></td> <td colspan="8" style="text-align: center;"> <table border="1" style="width: 100%; border-collapse: collapse; text-align: center;"> <tr> <td style="width: 10%;"></td> <td style="width: 10%;"></td> <td style="width: 10%;"></td> <td style="width: 10%;"></td> <td style="width: 10%;"></td> <td style="width: 10%;"></td> <td style="width: 10%;"></td> <td style="width: 10%;"></td> <td style="width: 10%;"></td> <td style="width: 10%;"></td> </tr> <tr> <td></td> <td></td> <td colspan="8" style="text-align: center;"> <table border="1" style="width: 100%; border-collapse: collapse; text-align: center;"> <tr> <td style="width: 10%;"></td> <td style="width: 10%;"></td> <td style="width: 10%;"></td> <td style="width: 10%;"></td> <td style="width: 10%;"></td> <td style="width: 10%;"></td> <td style="width: 10%;"></td> <td style="width: 10%;"></td> <td style="width: 10%;"></td> <td style="width: 10%;"></td> </tr> <tr> <td></td> <td></td> <td colspan="8" style="text-align: center;"> <table border="1" style="width: 100%; border-collapse: collapse; text-align: center;"> <tr> <td style="width: 10%;"></td> <td style="width: 10%;"></td> <td style="width: 10%;"></td> <td style="width: 10%;"></td> <td style="width: 10%;"></td> <td style="width: 10%;"></td> <td style="width: 10%;"></td> <td style="width: 10%;"></td> <td style="width: 10%;"></td> <td style="width: 10%;"></td> </tr> <tr> <td></td> <td></td> <td colspan="8" style="text-align: center;"> <table border="1" style="width: 100%; border-collapse: collapse; text-align: center;"> <tr> <td style="width: 10%;"></td> <td style="width: 10%;"></td> <td style="width: 10%;"></td> <td style="width: 10%;"></td> <td style="width: 10%;"></td> <td style="width: 10%;"></td> <td style="width: 10%;"></td> <td style="width: 10%;"></td> <td style="width: 10%;"></td> <td style="width: 10%;"></td> </tr> <tr> <td></td> <td></td> <td colspan="8" style="text-align: center;"> <table border="1" style="width: 100%; border-collapse: collapse; text-align: center;"> <tr> <td style="width: 10%;"></td> <td style="width: 10%;"></td> <td style="width: 10%;"></td> <td style="width: 10%;"></td> <td style="width: 10%;"></td> <td style="width: 10%;"></td> <td style="width: 10%;"></td> <td style="width: 10%;"></td> <td style="width: 10%;"></td> <td style="width: 10%;"></td> </tr> <tr> <td></td> <td></td> <td colspan="8" style="text-align: center;"> <table border="1" style="width: 100%; border-collapse: collapse; text-align: center;"> <tr> </tr></table></td></tr></table></td></tr></table></td></tr></table></td></tr></table></td></tr></table></td></tr></table></td></tr></table></td></tr></table></td></tr></table></td></tr></table></td></tr></table></td></tr></table></td></tr></table></td></tr></table></td></tr></table></td></tr></table></td></tr></table></td></tr></table></td></tr></table></td></tr></table></td></tr></table></td></tr></table></td></tr></table></td></tr></table></td></tr></table></td></tr></table></td></tr></table></td></tr></table></td></tr></table></td></tr></table></td></tr></table></td></tr></table></td></tr></table></td></tr></table></td></tr></table></td></tr></table></td></tr></table></td></tr></table></td></tr></table></td></tr></table></td></tr></table></td></tr></table></td></tr></table></td></tr></table></td></tr></table></td></tr></table></td></tr></table></td></tr></table></td></tr></table></td></tr></table></td></tr></table></td></tr></table></td></tr></table> | | | | | | | | | | | | | | | | | | | | <table border="1" style="width: 100%; border-collapse: collapse; text-align: center;"> <tr> <td style="width: 10%;"></td> <td style="width: 10%;"></td> <td style="width: 10%;"></td> <td style="width: 10%;"></td> <td style="width: 10%;"></td> <td style="width: 10%;"></td> <td style="width: 10%;"></td> <td style="width: 10%;"></td> <td style="width: 10%;"></td> <td style="width: 10%;"></td> </tr> <tr> <td></td> <td></td> <td colspan="8" style="text-align: center;"> <table border="1" style="width: 100%; border-collapse: collapse; text-align: center;"> <tr> <td style="width: 10%;"></td> <td style="width: 10%;"></td> <td style="width: 10%;"></td> <td style="width: 10%;"></td> <td style="width: 10%;"></td> <td style="width: 10%;"></td> <td style="width: 10%;"></td> <td style="width: 10%;"></td> <td style="width: 10%;"></td> <td style="width: 10%;"></td> </tr> <tr> <td></td> <td></td> <td colspan="8" style="text-align: center;"> <table border="1" style="width: 100%; border-collapse: collapse; text-align: center;"> <tr> <td style="width: 10%;"></td> <td style="width: 10%;"></td> <td style="width: 10%;"></td> <td style="width: 10%;"></td> <td style="width: 10%;"></td> <td style="width: 10%;"></td> <td style="width: 10%;"></td> <td style="width: 10%;"></td> <td style="width: 10%;"></td> <td style="width: 10%;"></td> </tr> <tr> <td></td> <td></td> <td colspan="8" style="text-align: center;"> <table border="1" style="width: 100%; border-collapse: collapse; text-align: center;"> <tr> <td style="width: 10%;"></td> <td style="width: 10%;"></td> <td style="width: 10%;"></td> <td style="width: 10%;"></td> <td style="width: 10%;"></td> <td style="width: 10%;"></td> <td style="width: 10%;"></td> <td style="width: 10%;"></td> <td style="width: 10%;"></td> <td style="width: 10%;"></td> </tr> <tr> <td></td> <td></td> <td colspan="8" style="text-align: center;"> <table border="1" style="width: 100%; border-collapse: collapse; text-align: center;"> <tr> <td style="width: 10%;"></td> <td style="width: 10%;"></td> <td style="width: 10%;"></td> <td style="width: 10%;"></td> <td style="width: 10%;"></td> <td style="width: 10%;"></td> <td style="width: 10%;"></td> <td style="width: 10%;"></td> <td style="width: 10%;"></td> <td style="width: 10%;"></td> </tr> <tr> <td></td> <td></td> <td colspan="8" style="text-align: center;"> <table border="1" style="width: 100%; border-collapse: collapse; text-align: center;"> <tr> <td style="width: 10%;"></td> <td style="width: 10%;"></td> <td style="width: 10%;"></td> <td style="width: 10%;"></td> <td style="width: 10%;"></td> <td style="width: 10%;"></td> <td style="width: 10%;"></td> <td style="width: 10%;"></td> <td style="width: 10%;"></td> <td style="width: 10%;"></td> </tr> <tr> <td></td> <td></td> <td colspan="8" style="text-align: center;"> <table border="1" style="width: 100%; border-collapse: collapse; text-align: center;"> <tr> <td style="width: 10%;"></td> <td style="width: 10%;"></td> <td style="width: 10%;"></td> <td style="width: 10%;"></td> <td style="width: 10%;"></td> <td style="width: 10%;"></td> <td style="width: 10%;"></td> <td style="width: 10%;"></td> <td style="width: 10%;"></td> <td style="width: 10%;"></td> </tr> <tr> <td></td> <td></td> <td colspan="8" style="text-align: center;"> <table border="1" style="width: 100%; border-collapse: collapse; text-align: center;"> <tr> <td style="width: 10%;"></td> <td style="width: 10%;"></td> <td style="width: 10%;"></td> <td style="width: 10%;"></td> <td style="width: 10%;"></td> <td style="width: 10%;"></td> <td style="width: 10%;"></td> <td style="width: 10%;"></td> <td style="width: 10%;"></td> <td style="width: 10%;"></td> </tr> <tr> <td></td> <td></td> <td colspan="8" style="text-align: center;"> <table border="1" style="width: 100%; border-collapse: collapse; text-align: center;"> <tr> <td style="width: 10%;"></td> <td style="width: 10%;"></td> <td style="width: 10%;"></td> <td style="width: 10%;"></td> <td style="width: 10%;"></td> <td style="width: 10%;"></td> <td style="width: 10%;"></td> <td style="width: 10%;"></td> <td style="width: 10%;"></td> <td style="width: 10%;"></td> </tr> <tr> <td></td> <td></td> <td colspan="8" style="text-align: center;"> <table border="1" style="width: 100%; border-collapse: collapse; text-align: center;"> <tr> <td style="width: 10%;"></td> <td style="width: 10%;"></td> <td style="width: 10%;"></td> <td style="width: 10%;"></td> <td style="width: 10%;"></td> <td style="width: 10%;"></td> <td style="width: 10%;"></td> <td style="width: 10%;"></td> <td style="width: 10%;"></td> <td style="width: 10%;"></td> </tr> <tr> <td></td> <td></td> <td colspan="8" style="text-align: center;"> <table border="1" style="width: 100%; border-collapse: collapse; text-align: center;"> <tr> <td style="width: 10%;"></td> <td style="width: 10%;"></td> <td style="width: 10%;"></td> <td style="width: 10%;"></td> <td style="width: 10%;"></td> <td style="width: 10%;"></td> <td style="width: 10%;"></td> <td style="width: 10%;"></td> <td style="width: 10%;"></td> <td style="width: 10%;"></td> </tr> <tr> <td></td> <td></td> <td colspan="8" style="text-align: center;"> <table border="1" style="width: 100%; border-collapse: collapse; text-align: center;"> <tr> <td style="width: 10%;"></td> <td style="width: 10%;"></td> <td style="width: 10%;"></td> <td style="width: 10%;"></td> <td style="width: 10%;"></td> <td style="width: 10%;"></td> <td style="width: 10%;"></td> <td style="width: 10%;"></td> <td style="width: 10%;"></td> <td style="width: 10%;"></td> </tr> <tr> <td></td> <td></td> <td colspan="8" style="text-align: center;"> <table border="1" style="width: 100%; border-collapse: collapse; text-align: center;"> <tr> <td style="width: 10%;"></td> <td style="width: 10%;"></td> <td style="width: 10%;"></td> <td style="width: 10%;"></td> <td style="width: 10%;"></td> <td style="width: 10%;"></td> <td style="width: 10%;"></td> <td style="width:
10%;"></td> <td style="width: 10%;"></td> <td style="width: 10%;"></td> </tr> <tr> <td></td> <td></td> <td colspan="8" style="text-align: center;"> <table border="1" style="width: 100%; border-collapse: collapse; text-align: center;"> <tr> <td style="width: 10%;"></td> <td style="width: 10%;"></td> <td style="width: 10%;"></td> <td style="width: 10%;"></td> <td style="width: 10%;"></td> <td style="width: 10%;"></td> <td style="width: 10%;"></td> <td style="width: 10%;"></td> <td style="width: 10%;"></td> <td style="width: 10%;"></td> </tr> <tr> <td></td> <td></td> <td colspan="8" style="text-align: center;"> <table border="1" style="width: 100%; border-collapse: collapse; text-align: center;"> <tr> <td style="width: 10%;"></td> <td style="width: 10%;"></td> <td style="width: 10%;"></td> <td style="width: 10%;"></td> <td style="width: 10%;"></td> <td style="width: 10%;"></td> <td style="width: 10%;"></td> <td style="width: 10%;"></td> <td style="width: 10%;"></td> <td style="width: 10%;"></td> </tr> <tr> <td></td> <td></td> <td colspan="8" style="text-align: center;"> <table border="1" style="width: 100%; border-collapse: collapse; text-align: center;"> <tr> <td style="width: 10%;"></td> <td style="width: 10%;"></td> <td style="width: 10%;"></td> <td style="width: 10%;"></td> <td style="width: 10%;"></td> <td style="width: 10%;"></td> <td style="width: 10%;"></td> <td style="width: 10%;"></td> <td style="width: 10%;"></td> <td style="width: 10%;"></td> </tr> <tr> <td></td> <td></td> <td colspan="8" style="text-align: center;"> <table border="1" style="width: 100%; border-collapse: collapse; text-align: center;"> <tr> <td style="width: 10%;"></td> <td style="width: 10%;"></td> <td style="width: 10%;"></td> <td style="width: 10%;"></td> <td style="width: 10%;"></td> <td style="width: 10%;"></td> <td style="width: 10%;"></td> <td style="width: 10%;"></td> <td style="width: 10%;"></td> <td style="width: 10%;"></td> </tr> <tr> <td></td> <td></td> <td colspan="8" style="text-align: center;"> <table border="1" style="width: 100%; border-collapse: collapse; text-align: center;"> <tr> <td style="width: 10%;"></td> <td style="width: 10%;"></td> <td style="width: 10%;"></td> <td style="width: 10%;"></td> <td style="width: 10%;"></td> <td style="width: 10%;"></td> <td style="width: 10%;"></td> <td style="width: 10%;"></td> <td style="width: 10%;"></td> <td style="width: 10%;"></td> </tr> <tr> <td></td> <td></td> <td colspan="8" style="text-align: center;"> <table border="1" style="width: 100%; border-collapse: collapse; text-align: center;"> <tr> <td style="width: 10%;"></td> <td style="width: 10%;"></td> <td style="width: 10%;"></td> <td style="width: 10%;"></td> <td style="width: 10%;"></td> <td style="width: 10%;"></td> <td style="width: 10%;"></td> <td style="width: 10%;"></td> <td style="width: 10%;"></td> <td style="width: 10%;"></td> </tr> <tr> <td></td> <td></td> <td colspan="8" style="text-align: center;"> <table border="1" style="width: 100%; border-collapse: collapse; text-align: center;"> <tr> <td style="width: 10%;"></td> <td style="width: 10%;"></td> <td style="width: 10%;"></td> <td style="width: 10%;"></td> <td style="width: 10%;"></td> <td style="width: 10%;"></td> <td style="width: 10%;"></td> <td style="width: 10%;"></td> <td style="width: 10%;"></td> <td style="width: 10%;"></td> </tr> <tr> <td></td> <td></td> <td colspan="8" style="text-align: center;"> <table border="1" style="width: 100%; border-collapse: collapse; text-align: center;"> <tr> <td style="width: 10%;"></td> <td style="width: 10%;"></td> <td style="width: 10%;"></td> <td style="width: 10%;"></td> <td style="width: 10%;"></td> <td style="width: 10%;"></td> <td style="width: 10%;"></td> <td style="width: 10%;"></td> <td style="width: 10%;"></td> <td style="width: 10%;"></td> </tr> <tr> <td></td> <td></td> <td colspan="8" style="text-align: center;"> <table border="1" style="width: 100%; border-collapse: collapse; text-align: center;"> <tr> <td style="width: 10%;"></td> <td style="width: 10%;"></td> <td style="width: 10%;"></td> <td style="width: 10%;"></td> <td style="width: 10%;"></td> <td style="width: 10%;"></td> <td style="width: 10%;"></td> <td style="width: 10%;"></td> <td style="width: 10%;"></td> <td style="width: 10%;"></td> </tr> <tr> <td></td> <td></td> <td colspan="8" style="text-align: center;"> <table border="1" style="width: 100%; border-collapse: collapse; text-align: center;"> <tr> <td style="width: 10%;"></td> <td style="width: 10%;"></td> <td style="width: 10%;"></td> <td style="width: 10%;"></td> <td style="width: 10%;"></td> <td style="width: 10%;"></td> <td style="width: 10%;"></td> <td style="width: 10%;"></td> <td style="width: 10%;"></td> <td style="width: 10%;"></td> </tr> <tr> <td></td> <td></td> <td colspan="8" style="text-align: center;"> <table border="1" style="width: 100%; border-collapse: collapse; text-align: center;"> <tr> <td style="width: 10%;"></td> <td style="width: 10%;"></td> <td style="width: 10%;"></td> <td style="width: 10%;"></td> <td style="width: 10%;"></td> <td style="width: 10%;"></td> <td style="width: 10%;"></td> <td style="width: 10%;"></td> <td style="width: 10%;"></td> <td style="width: 10%;"></td> </tr> <tr> <td></td> <td></td> <td colspan="8" style="text-align: center;"> <table border="1" style="width: 100%; border-collapse: collapse; text-align: center;"> <tr> <td style="width: 10%;"></td> <td style="width: 10%;"></td> <td style="width: 10%;"></td> <td style="width: 10%;"></td> <td style="width: 10%;"></td> <td style="width: 10%;"></td> <td style="width: 10%;"></td> <td style="width: 10%;"></td> <td style="width: 10%;"></td> <td style="width: 10%;"></td> </tr> <tr> <td></td> <td></td> <td colspan="8" style="text-align: center;"> <table border="1" style="width: 100%; border-collapse: collapse; text-align: center;"> <tr> <td style="width: 10%;"></td> <td style="width: 10%;"></td> <td style="width: 10%;"></td> <td style="width: 10%;"></td> <td style="width: 10%;"></td> <td style="width: 10%;"></td> <td style="width: 10%;"></td> <td style="width: 10%;"></td> <td style="width: 10%;"></td> <td style="width: 10%;"></td> </tr> <tr> <td></td> <td></td> <td colspan="8" style="text-align: center;"> <table border="1" style="width: 100%; border-collapse: collapse; text-align: center;"> <tr> <td style="width: 10%;"></td> <td style="width: 10%;"></td> <td style="width: 10%;"></td> <td style="width: 10%;"></td> <td style="width: 10%;"></td> <td style="width: 10%;"></td> <td style="width: 10%;"></td> <td style="width: 10%;"></td> <td style="width: 10%;"></td> <td style="width: 10%;"></td> </tr> <tr> <td></td> <td></td> <td colspan="8" style="text-align: center;"> <table border="1" style="width: 100%; border-collapse: collapse; text-align: center;"> <tr> <td style="width: 10%;"></td> <td style="width: 10%;"></td> <td style="width: 10%;"></td> <td style="width: 10%;"></td> <td style="width: 10%;"></td> <td style="width: 10%;"></td> <td style="width: 10%;"></td> <td style="width: 10%;"></td> <td style="width: 10%;"></td> <td style="width: 10%;"></td> </tr> <tr> <td></td> <td></td> <td colspan="8" style="text-align: center;"> <table border="1" style="width: 100%; border-collapse: collapse; text-align: center;"> <tr> <td style="width: 10%;"></td> <td style="width: 10%;"></td> <td style="width: 10%;"></td> <td style="width: 10%;"></td> <td style="width: 10%;"></td> <td style="width: 10%;"></td> <td style="width: 10%;"></td> <td style="width: 10%;"></td> <td style="width: 10%;"></td> <td style="width: 10%;"></td> </tr> <tr> <td></td> <td></td> <td colspan="8" style="text-align: center;"> <table border="1" style="width: 100%; border-collapse: collapse; text-align: center;"> <tr> <td style="width: 10%;"></td> <td style="width: 10%;"></td> <td style="width: 10%;"></td> <td style="width: 10%;"></td> <td style="width: 10%;"></td> <td style="width: 10%;"></td> <td style="width: 10%;"></td> <td style="width: 10%;"></td> <td style="width: 10%;"></td> <td style="width: 10%;"></td> </tr> <tr> <td></td> <td></td> <td colspan="8" style="text-align: center;"> <table border="1" style="width: 100%; border-collapse: collapse; text-align: center;"> <tr> <td style="width: 10%;"></td> <td style="width: 10%;"></td> <td style="width: 10%;"></td> <td style="width: 10%;"></td> <td style="width: 10%;"></td> <td style="width: 10%;"></td> <td style="width: 10%;"></td> <td style="width: 10%;"></td> <td style="width: 10%;"></td> <td style="width: 10%;"></td> </tr> <tr> <td></td> <td></td> <td colspan="8" style="text-align: center;"> <table border="1" style="width: 100%; border-collapse: collapse; text-align: center;"> <tr> <td style="width: 10%;"></td> <td style="width: 10%;"></td> <td style="width: 10%;"></td> <td style="width: 10%;"></td> <td style="width: 10%;"></td> <td style="width: 10%;"></td> <td style="width: 10%;"></td> <td style="width: 10%;"></td> <td style="width: 10%;"></td> <td style="width: 10%;"></td> </tr> <tr> <td></td> <td></td> <td colspan="8" style="text-align: center;"> <table border="1" style="width: 100%; border-collapse: collapse; text-align: center;"> <tr> <td style="width: 10%;"></td> <td style="width: 10%;"></td> <td style="width: 10%;"></td> <td style="width: 10%;"></td> <td style="width: 10%;"></td> <td style="width: 10%;"></td> <td style="width: 10%;"></td> <td style="width: 10%;"></td> <td style="width: 10%;"></td> <td style="width: 10%;"></td> </tr> <tr> <td></td> <td></td> <td colspan="8" style="text-align: center;"> <table border="1" style="width: 100%; border-collapse: collapse; text-align: center;"> <tr> <td style="width: 10%;"></td> <td style="width: 10%;"></td> <td style="width: 10%;"></td> <td style="width: 10%;"></td> <td style="width: 10%;"></td> <td style="width: 10%;"></td> <td style="width: 10%;"></td> <td style="width: 10%;"></td> <td style="width: 10%;"></td> <td style="width: 10%;"></td> </tr> <tr> <td></td> <td></td> <td colspan="8" style="text-align: center;"> <table border="1"
style="width: 100%; border-collapse: collapse; text-align: center;"> <tr> <td style="width: 10%;"></td> <td style="width: 10%;"></td> <td style="width: 10%;"></td> <td style="width: 10%;"></td> <td style="width: 10%;"></td> <td style="width: 10%;"></td> <td style="width: 10%;"></td> <td style="width: 10%;"></td> <td style="width: 10%;"></td> <td style="width: 10%;"></td> </tr> <tr> <td></td> <td></td> <td colspan="8" style="text-align: center;"> <table border="1" style="width: 100%; border-collapse: collapse; text-align: center;"> <tr> <td style="width: 10%;"></td> <td style="width: 10%;"></td> <td style="width: 10%;"></td> <td style="width: 10%;"></td> <td style="width: 10%;"></td> <td style="width: 10%;"></td> <td style="width: 10%;"></td> <td style="width: 10%;"></td> <td style="width: 10%;"></td> <td style="width: 10%;"></td> </tr> <tr> <td></td> <td></td> <td colspan="8" style="text-align: center;"> <table border="1" style="width: 100%; border-collapse: collapse; text-align: center;"> <tr> <td style="width: 10%;"></td> <td style="width: 10%;"></td> <td style="width: 10%;"></td> <td style="width: 10%;"></td> <td style="width: 10%;"></td> <td style="width: 10%;"></td> <td style="width: 10%;"></td> <td style="width: 10%;"></td> <td style="width: 10%;"></td> <td style="width: 10%;"></td> </tr> <tr> <td></td> <td></td> <td colspan="8" style="text-align: center;"> <table border="1" style="width: 100%; border-collapse: collapse; text-align: center;"> <tr> <td style="width: 10%;"></td> <td style="width: 10%;"></td> <td style="width: 10%;"></td> <td style="width: 10%;"></td> <td style="width: 10%;"></td> <td style="width: 10%;"></td> <td style="width: 10%;"></td> <td style="width: 10%;"></td> <td style="width: 10%;"></td> <td style="width: 10%;"></td> </tr> <tr> <td></td> <td></td> <td colspan="8" style="text-align: center;"> <table border="1" style="width: 100%; border-collapse: collapse; text-align: center;"> <tr> <td style="width: 10%;"></td> <td style="width: 10%;"></td> <td style="width: 10%;"></td> <td style="width: 10%;"></td> <td style="width: 10%;"></td> <td style="width: 10%;"></td> <td style="width: 10%;"></td> <td style="width: 10%;"></td> <td style="width: 10%;"></td> <td style="width: 10%;"></td> </tr> <tr> <td></td> <td></td> <td colspan="8" style="text-align: center;"> <table border="1" style="width: 100%; border-collapse: collapse; text-align: center;"> <tr> <td style="width: 10%;"></td> <td style="width: 10%;"></td> <td style="width: 10%;"></td> <td style="width: 10%;"></td> <td style="width: 10%;"></td> <td style="width: 10%;"></td> <td style="width: 10%;"></td> <td style="width: 10%;"></td> <td style="width: 10%;"></td> <td style="width: 10%;"></td> </tr> <tr> <td></td> <td></td> <td colspan="8" style="text-align: center;"> <table border="1" style="width: 100%; border-collapse: collapse; text-align: center;"> <tr> <td style="width: 10%;"></td> <td style="width: 10%;"></td> <td style="width: 10%;"></td> <td style="width: 10%;"></td> <td style="width: 10%;"></td> <td style="width: 10%;"></td> <td style="width: 10%;"></td> <td style="width: 10%;"></td> <td style="width: 10%;"></td> <td style="width: 10%;"></td> </tr> <tr> <td></td> <td></td> <td colspan="8" style="text-align: center;"> <table border="1" style="width: 100%; border-collapse: collapse; text-align: center;"> <tr> <td style="width: 10%;"></td> <td style="width: 10%;"></td> <td style="width: 10%;"></td> <td style="width: 10%;"></td> <td style="width: 10%;"></td> <td style="width: 10%;"></td> <td style="width: 10%;"></td> <td style="width: 10%;"></td> <td style="width: 10%;"></td> <td style="width: 10%;"></td> </tr> <tr> <td></td> <td></td> <td colspan="8" style="text-align: center;"> <table border="1" style="width: 100%; border-collapse: collapse; text-align: center;"> <tr> <td style="width: 10%;"></td> <td style="width: 10%;"></td> <td style="width: 10%;"></td> <td style="width: 10%;"></td> <td style="width: 10%;"></td> <td style="width: 10%;"></td> <td style="width: 10%;"></td> <td style="width: 10%;"></td> <td style="width: 10%;"></td> <td style="width: 10%;"></td> </tr> <tr> <td></td> <td></td> <td colspan="8" style="text-align: center;"> <table border="1" style="width: 100%; border-collapse: collapse; text-align: center;"> <tr> <td style="width: 10%;"></td> <td style="width: 10%;"></td> <td style="width: 10%;"></td> <td style="width: 10%;"></td> <td style="width: 10%;"></td> <td style="width: 10%;"></td> <td style="width: 10%;"></td> <td style="width: 10%;"></td> <td style="width: 10%;"></td> <td style="width: 10%;"></td> </tr> <tr> <td></td> <td></td> <td colspan="8" style="text-align: center;"> <table border="1" style="width: 100%; border-collapse: collapse; text-align: center;"> <tr> <td style="width: 10%;"></td> <td style="width: 10%;"></td> <td style="width: 10%;"></td> <td style="width: 10%;"></td> <td style="width: 10%;"></td> <td style="width: 10%;"></td> <td style="width: 10%;"></td> <td style="width: 10%;"></td> <td style="width: 10%;"></td> <td style="width: 10%;"></td> </tr> <tr> <td></td> <td></td> <td colspan="8" style="text-align: center;"> <table border="1" style="width: 100%; border-collapse: collapse; text-align: center;"> <tr> <td style="width: 10%;"></td> <td style="width: 10%;"></td> <td style="width: 10%;"></td> <td style="width: 10%;"></td> <td style="width: 10%;"></td> <td style="width: 10%;"></td> <td style="width: 10%;"></td> <td style="width: 10%;"></td> <td style="width: 10%;"></td> <td style="width: 10%;"></td> </tr> <tr> <td></td> <td></td> <td colspan="8" style="text-align: center;"> <table border="1" style="width: 100%; border-collapse: collapse; text-align: center;"> <tr> <td style="width: 10%;"></td> <td style="width: 10%;"></td> <td style="width: 10%;"></td> <td style="width: 10%;"></td> <td style="width: 10%;"></td> <td style="width: 10%;"></td> <td style="width: 10%;"></td> <td style="width: 10%;"></td> <td style="width: 10%;"></td> <td style="width: 10%;"></td> </tr> <tr> <td></td> <td></td> <td colspan="8" style="text-align: center;"> <table border="1" style="width: 100%; border-collapse: collapse; text-align: center;"> <tr> <td style="width: 10%;"></td> <td style="width: 10%;"></td> <td style="width: 10%;"></td> <td style="width: 10%;"></td> <td style="width: 10%;"></td> <td style="width: 10%;"></td> <td style="width: 10%;"></td> <td style="width: 10%;"></td> <td style="width: 10%;"></td> <td style="width: 10%;"></td> </tr> <tr> <td></td> <td></td> <td colspan="8" style="text-align: center;"> <table border="1" style="width: 100%; border-collapse: collapse; text-align: center;"> <tr> <td style="width: 10%;"></td> <td style="width: 10%;"></td> <td style="width: 10%;"></td> <td style="width: 10%;"></td> <td style="width: 10%;"></td> <td style="width: 10%;"></td> <td style="width: 10%;"></td> <td style="width: 10%;"></td> <td style="width: 10%;"></td> <td style="width: 10%;"></td> </tr> <tr> <td></td> <td></td> <td colspan="8" style="text-align: center;"> <table border="1" style="width: 100%; border-collapse: collapse; text-align: center;"> <tr> <td style="width: 10%;"></td> <td style="width: 10%;"></td> <td style="width: 10%;"></td> <td style="width: 10%;"></td> <td style="width: 10%;"></td> <td style="width: 10%;"></td> <td style="width: 10%;"></td> <td style="width: 10%;"></td> <td style="width: 10%;"></td> <td style="width: 10%;"></td> </tr> <tr> <td></td> <td></td> <td colspan="8" style="text-align: center;"> <table border="1" style="width: 100%; border-collapse: collapse; text-align: center;"> <tr> <td style="width: 10%;"></td> <td style="width: 10%;"></td> <td style="width: 10%;"></td> <td style="width: 10%;"></td> <td style="width: 10%;"></td> <td style="width: 10%;"></td> <td style="width: 10%;"></td> <td style="width: 10%;"></td> <td style="width: 10%;"></td> <td style="width: 10%;"></td> </tr> <tr> <td></td> <td></td> <td colspan="8" style="text-align: center;"> <table border="1" style="width: 100%; border-collapse: collapse; text-align: center;"> <tr> <td style="width: 10%;"></td> <td style="width: 10%;"></td> <td style="width: 10%;"></td> <td style="width: 10%;"></td> <td style="width: 10%;"></td> <td style="width: 10%;"></td> <td style="width: 10%;"></td> <td style="width: 10%;"></td> <td style="width: 10%;"></td> <td style="width: 10%;"></td> </tr> <tr> <td></td> <td></td> <td colspan="8" style="text-align: center;"> <table border="1" style="width: 100%; border-collapse: collapse; text-align: center;"> <tr> </tr></table></td></tr></table></td></tr></table></td></tr></table></td></tr></table></td></tr></table></td></tr></table></td></tr></table></td></tr></table></td></tr></table></td></tr></table></td></tr></table></td></tr></table></td></tr></table></td></tr></table></td></tr></table></td></tr></table></td></tr></table></td></tr></table></td></tr></table></td></tr></table></td></tr></table></td></tr></table></td></tr></table></td></tr></table></td></tr></table></td></tr></table></td></tr></table></td></tr></table></td></tr></table></td></tr></table></td></tr></table></td></tr></table></td></tr></table></td></tr></table></td></tr></table></td></tr></table></td></tr></table></td></tr></table></td></tr></table></td></tr></table></td></tr></table></td></tr></table></td></tr></table></td></tr></table></td></tr></table></td></tr></table></td></tr></table></td></tr></table></td></tr></table></td></tr></table></td></tr></table></td></tr></table> | | | | | | | | | | | | | | | | | | | | <table border="1" style="width: 100%; border-collapse: collapse; text-align: center;"> <tr> <td style="width: 10%;"></td> <td style="width: 10%;"></td> <td style="width: 10%;"></td> <td style="width: 10%;"></td> <td style="width: 10%;"></td> <td style="width: 10%;"></td> <td style="width: 10%;"></td> <td style="width: 10%;"></td> <td style="width: 10%;"></td> <td style="width: 10%;"></td> </tr> <tr> <td></td> <td></td> <td colspan="8" style="text-align: center;"> <table border="1"
style="width: 100%; border-collapse: collapse; text-align: center;"> <tr> <td style="width: 10%;"></td> <td style="width: 10%;"></td> <td style="width: 10%;"></td> <td style="width: 10%;"></td> <td style="width: 10%;"></td> <td style="width: 10%;"></td> <td style="width: 10%;"></td> <td style="width: 10%;"></td> <td style="width: 10%;"></td> <td style="width: 10%;"></td> </tr> <tr> <td></td> <td></td> <td colspan="8" style="text-align: center;"> <table border="1" style="width: 100%; border-collapse: collapse; text-align: center;"> <tr> <td style="width: 10%;"></td> <td style="width: 10%;"></td> <td style="width: 10%;"></td> <td style="width: 10%;"></td> <td style="width: 10%;"></td> <td style="width: 10%;"></td> <td style="width: 10%;"></td> <td style="width: 10%;"></td> <td style="width: 10%;"></td> <td style="width: 10%;"></td> </tr> <tr> <td></td> <td></td> <td colspan="8" style="text-align: center;"> <table border="1" style="width: 100%; border-collapse: collapse; text-align: center;"> <tr> <td style="width: 10%;"></td> <td style="width: 10%;"></td> <td style="width: 10%;"></td> <td style="width: 10%;"></td> <td style="width: 10%;"></td> <td style="width: 10%;"></td> <td style="width: 10%;"></td> <td style="width: 10%;"></td> <td style="width: 10%;"></td> <td style="width: 10%;"></td> </tr> <tr> <td></td> <td></td> <td colspan="8" style="text-align: center;"> <table border="1" style="width: 100%; border-collapse: collapse; text-align: center;"> <tr> <td style="width: 10%;"></td> <td style="width: 10%;"></td> <td style="width: 10%;"></td> <td style="width: 10%;"></td> <td style="width: 10%;"></td> <td style="width: 10%;"></td> <td style="width: 10%;"></td> <td style="width: 10%;"></td> <td style="width: 10%;"></td> <td style="width: 10%;"></td> </tr> <tr> <td></td> <td></td> <td colspan="8" style="text-align: center;"> <table border="1" style="width: 100%; border-collapse: collapse; text-align: center;"> <tr> <td style="width: 10%;"></td> <td style="width: 10%;"></td> <td style="width: 10%;"></td> <td style="width: 10%;"></td> <td style="width: 10%;"></td> <td style="width: 10%;"></td> <td style="width: 10%;"></td> <td style="width: 10%;"></td> <td style="width: 10%;"></td> <td style="width: 10%;"></td> </tr> <tr> <td></td> <td></td> <td colspan="8" style="text-align: center;"> <table border="1" style="width: 100%; border-collapse: collapse; text-align: center;"> <tr> <td style="width: 10%;"></td> <td style="width: 10%;"></td> <td style="width: 10%;"></td> <td style="width: 10%;"></td> <td style="width: 10%;"></td> <td style="width: 10%;"></td> <td style="width: 10%;"></td> <td style="width: 10%;"></td> <td style="width: 10%;"></td> <td style="width: 10%;"></td> </tr> <tr> <td></td> <td></td> <td colspan="8" style="text-align: center;"> <table border="1" style="width: 100%; border-collapse: collapse; text-align: center;"> <tr> <td style="width: 10%;"></td> <td style="width: 10%;"></td> <td style="width: 10%;"></td> <td style="width: 10%;"></td> <td style="width: 10%;"></td> <td style="width: 10%;"></td> <td style="width: 10%;"></td> <td style="width: 10%;"></td> <td style="width: 10%;"></td> <td style="width: 10%;"></td> </tr> <tr> <td></td> <td></td> <td colspan="8" style="text-align: center;"> <table border="1" style="width: 100%; border-collapse: collapse; text-align: center;"> <tr> <td style="width: 10%;"></td> <td style="width: 10%;"></td> <td style="width: 10%;"></td> <td style="width: 10%;"></td> <td style="width: 10%;"></td> <td style="width: 10%;"></td> <td style="width: 10%;"></td> <td style="width: 10%;"></td> <td style="width: 10%;"></td> <td style="width: 10%;"></td> </tr> <tr> <td></td> <td></td> <td colspan="8" style="text-align: center;"> <table border="1" style="width: 100%; border-collapse: collapse; text-align: center;"> <tr> <td style="width: 10%;"></td> <td style="width: 10%;"></td> <td style="width: 10%;"></td> <td style="width: 10%;"></td> <td style="width: 10%;"></td> <td style="width: 10%;"></td> <td style="width: 10%;"></td> <td style="width: 10%;"></td> <td style="width: 10%;"></td> <td style="width: 10%;"></td> </tr> <tr> <td></td> <td></td> <td colspan="8" style="text-align: center;"> <table border="1" style="width: 100%; border-collapse: collapse; text-align: center;"> <tr> <td style="width: 10%;"></td> <td style="width: 10%;"></td> <td style="width: 10%;"></td> <td style="width: 10%;"></td> <td style="width: 10%;"></td> <td style="width: 10%;"></td> <td style="width: 10%;"></td> <td style="width: 10%;"></td> <td style="width: 10%;"></td> <td style="width: 10%;"></td> </tr> <tr> <td></td> <td></td> <td colspan="8" style="text-align: center;"> <table border="1" style="width: 100%; border-collapse: collapse; text-align: center;"> <tr> <td style="width: 10%;"></td> <td style="width: 10%;"></td> <td style="width: 10%;"></td> <td style="width: 10%;"></td> <td style="width: 10%;"></td> <td style="width: 10%;"></td> <td style="width: 10%;"></td> <td style="width: 10%;"></td> <td style="width: 10%;"></td> <td style="width: 10%;"></td> </tr> <tr> <td></td> <td></td> <td colspan="8" style="text-align: center;"> <table border="1" style="width: 100%; border-collapse: collapse; text-align: center;"> <tr> <td style="width: 10%;"></td> <td style="width: 10%;"></td> <td style="width: 10%;"></td> <td style="width: 10%;"></td> <td style="width: 10%;"></td> <td style="width: 10%;"></td> <td style="width: 10%;"></td> <td style="width: 10%;"></td> <td style="width: 10%;"></td> <td style="width: 10%;"></td> </tr> <tr> <td></td> <td></td> <td colspan="8" style="text-align: center;"> <table border="1" style="width: 100%; border-collapse: collapse; text-align: center;"> <tr> <td style="width: 10%;"></td> <td style="width: 10%;"></td> <td style="width: 10%;"></td> <td style="width: 10%;"></td> <td style="width: 10%;"></td> <td style="width: 10%;"></td> <td style="width: 10%;"></td> <td style="width: 10%;"></td> <td style="width: 10%;"></td> <td style="width: 10%;"></td> </tr> <tr> <td></td> <td></td> <td colspan="8" style="text-align: center;"> <table border="1" style="width: 100%; border-collapse: collapse; text-align: center;"> <tr> <td style="width: 10%;"></td> <td style="width: 10%;"></td> <td style="width: 10%;"></td> <td style="width: 10%;"></td> <td style="width: 10%;"></td> <td style="width: 10%;"></td> <td style="width: 10%;"></td> <td style="width: 10%;"></td> <td style="width: 10%;"></td> <td style="width: 10%;"></td> </tr> <tr> <td></td> <td></td> <td colspan="8" style="text-align: center;"> <table border="1" style="width: 100%; border-collapse: collapse; text-align: center;"> <tr> <td style="width: 10%;"></td> <td style="width: 10%;"></td> <td style="width: 10%;"></td> <td style="width: 10%;"></td> <td style="width: 10%;"></td> <td style="width: 10%;"></td> <td style="width: 10%;"></td> <td style="width: 10%;"></td> <td style="width: 10%;"></td> <td style="width: 10%;"></td> </tr> <tr> <td></td> <td></td> <td colspan="8" style="text-align: center;"> <table border="1" style="width: 100%; border-collapse: collapse; text-align: center;"> <tr> <td style="width: 10%;"></td> <td style="width: 10%;"></td> <td style="width: 10%;"></td> <td style="width: 10%;"></td> <td style="width: 10%;"></td> <td style="width: 10%;"></td> <td style="width: 10%;"></td> <td style="width: 10%;"></td> <td style="width: 10%;"></td> <td style="width: 10%;"></td> </tr> <tr> <td></td> <td></td> <td colspan="8" style="text-align: center;"> <table border="1" style="width: 100%; border-collapse: collapse; text-align: center;"> <tr> <td style="width: 10%;"></td> <td style="width: 10%;"></td> <td style="width: 10%;"></td> <td style="width: 10%;"></td> <td style="width: 10%;"></td> <td style="width: 10%;"></td> <td style="width: 10%;"></td> <td style="width: 10%;"></td> <td style="width: 10%;"></td> <td style="width: 10%;"></td> </tr> <tr> <td></td> <td></td> <td colspan="8" style="text-align: center;"> <table border="1" style="width: 100%; border-collapse: collapse; text-align: center;"> <tr> <td style="width: 10%;"></td> <td style="width: 10%;"></td> <td style="width: 10%;"></td> <td style="width: 10%;"></td> <td style="width: 10%;"></td> <td style="width: 10%;"></td> <td style="width: 10%;"></td> <td style="width: 10%;"></td> <td style="width: 10%;"></td> <td style="width: 10%;"></td> </tr> <tr> <td></td> <td></td> <td colspan="8" style="text-align: center;"> <table border="1" style="width: 100%; border-collapse: collapse; text-align: center;"> <tr> <td style="width: 10%;"></td> <td style="width: 10%;"></td> <td style="width: 10%;"></td> <td style="width: 10%;"></td> <td style="width: 10%;"></td> <td style="width: 10%;"></td> <td style="width: 10%;"></td> <td style="width: 10%;"></td> <td style="width: 10%;"></td> <td style="width: 10%;"></td> </tr> <tr> <td></td> <td></td> <td colspan="8" style="text-align: center;"> <table border="1" style="width: 100%; border-collapse: collapse; text-align: center;"> <tr> <td style="width: 10%;"></td> <td style="width: 10%;"></td> <td style="width: 10%;"></td> <td style="width: 10%;"></td> <td style="width: 10%;"></td> <td style="width: 10%;"></td> <td style="width: 10%;"></td> <td style="width: 10%;"></td> <td style="width: 10%;"></td> <td style="width: 10%;"></td> </tr> <tr> <td></td> <td></td> <td colspan="8" style="text-align: center;"> <table border="1" style="width: 100%; border-collapse: collapse; text-align: center;"> <tr> <td style="width: 10%;"></td> <td style="width: 10%;"></td> <td style="width: 10%;"></td> <td style="width: 10%;"></td> <td style="width: 10%;"></td> <td style="width: 10%;"></td> <td style="width: 10%;"></td> <td style="width: 10%;"></td> <td style="width: 10%;"></td> <td style="width: 10%;"></td> </tr> <tr> <td></td> <td></td> <td colspan="8" style="text-align: center;"> <table border="1" style="width: 100%; border-collapse: collapse; text-align: center;"> <tr> <td style="width: 10%;"></td> <td style="width: 10%;"></td> <td style="width: 10%;"></td> <td
style="width: 10%;"></td> <td style="width: 10%;"></td> <td style="width: 10%;"></td> <td style="width: 10%;"></td> <td style="width: 10%;"></td> <td style="width: 10%;"></td> <td style="width: 10%;"></td> </tr> <tr> <td></td> <td></td> <td colspan="8" style="text-align: center;"> <table border="1" style="width: 100%; border-collapse: collapse; text-align: center;"> <tr> <td style="width: 10%;"></td> <td style="width: 10%;"></td> <td style="width: 10%;"></td> <td style="width: 10%;"></td> <td style="width: 10%;"></td> <td style="width: 10%;"></td> <td style="width: 10%;"></td> <td style="width: 10%;"></td> <td style="width: 10%;"></td> <td style="width: 10%;"></td> </tr> <tr> <td></td> <td></td> <td colspan="8" style="text-align: center;"> <table border="1" style="width: 100%; border-collapse: collapse; text-align: center;"> <tr> <td style="width: 10%;"></td> <td style="width: 10%;"></td> <td style="width: 10%;"></td> <td style="width: 10%;"></td> <td style="width: 10%;"></td> <td style="width: 10%;"></td> <td style="width: 10%;"></td> <td style="width: 10%;"></td> <td style="width: 10%;"></td> <td style="width: 10%;"></td> </tr> <tr> <td></td> <td></td> <td colspan="8" style="text-align: center;"> <table border="1" style="width: 100%; border-collapse: collapse; text-align: center;"> <tr> <td style="width: 10%;"></td> <td style="width: 10%;"></td> <td style="width: 10%;"></td> <td style="width: 10%;"></td> <td style="width: 10%;"></td> <td style="width: 10%;"></td> <td style="width: 10%;"></td> <td style="width: 10%;"></td> <td style="width: 10%;"></td> <td style="width: 10%;"></td> </tr> <tr> <td></td> <td></td> <td colspan="8" style="text-align: center;"> <table border="1" style="width: 100%; border-collapse: collapse; text-align: center;"> <tr> <td style="width: 10%;"></td> <td style="width: 10%;"></td> <td style="width: 10%;"></td> <td style="width: 10%;"></td> <td style="width: 10%;"></td> <td style="width: 10%;"></td> <td style="width: 10%;"></td> <td style="width: 10%;"></td> <td style="width: 10%;"></td> <td style="width: 10%;"></td> </tr> <tr> <td></td> <td></td> <td colspan="8" style="text-align: center;"> <table border="1" style="width: 100%; border-collapse: collapse; text-align: center;"> <tr> <td style="width: 10%;"></td> <td style="width: 10%;"></td> <td style="width: 10%;"></td> <td style="width: 10%;"></td> <td style="width: 10%;"></td> <td style="width: 10%;"></td> <td style="width: 10%;"></td> <td style="width: 10%;"></td> <td style="width: 10%;"></td> <td style="width: 10%;"></td> </tr> <tr> <td></td> <td></td> <td colspan="8" style="text-align: center;"> <table border="1" style="width: 100%; border-collapse: collapse; text-align: center;"> <tr> <td style="width: 10%;"></td> <td style="width: 10%;"></td> <td style="width: 10%;"></td> <td style="width: 10%;"></td> <td style="width: 10%;"></td> <td style="width: 10%;"></td> <td style="width: 10%;"></td> <td style="width: 10%;"></td> <td style="width: 10%;"></td> <td style="width: 10%;"></td> </tr> <tr> <td></td> <td></td> <td colspan="8" style="text-align: center;"> <table border="1" style="width: 100%; border-collapse: collapse; text-align: center;"> <tr> <td style="width: 10%;"></td> <td style="width: 10%;"></td> <td style="width: 10%;"></td> <td style="width: 10%;"></td> <td style="width: 10%;"></td> <td style="width: 10%;"></td> <td style="width: 10%;"></td> <td style="width: 10%;"></td> <td style="width: 10%;"></td> <td style="width: 10%;"></td> </tr> <tr> <td></td> <td></td> <td colspan="8" style="text-align: center;"> <table border="1" style="width: 100%; border-collapse: collapse; text-align: center;"> <tr> <td style="width: 10%;"></td> <td style="width: 10%;"></td> <td style="width: 10%;"></td> <td style="width: 10%;"></td> <td style="width: 10%;"></td> <td style="width: 10%;"></td> <td style="width: 10%;"></td> <td style="width: 10%;"></td> <td style="width: 10%;"></td> <td style="width: 10%;"></td> </tr> <tr> <td></td> <td></td> <td colspan="8" style="text-align: center;"> <table border="1" style="width: 100%; border-collapse: collapse; text-align: center;"> <tr> <td style="width: 10%;"></td> <td style="width: 10%;"></td> <td style="width: 10%;"></td> <td style="width: 10%;"></td> <td style="width: 10%;"></td> <td style="width: 10%;"></td> <td style="width: 10%;"></td> <td style="width: 10%;"></td> <td style="width: 10%;"></td> <td style="width: 10%;"></td> </tr> <tr> <td></td> <td></td> <td colspan="8" style="text-align: center;"> <table border="1" style="width: 100%; border-collapse: collapse; text-align: center;"> <tr> <td style="width: 10%;"></td> <td style="width: 10%;"></td> <td style="width: 10%;"></td> <td style="width: 10%;"></td> <td style="width: 10%;"></td> <td style="width: 10%;"></td> <td style="width: 10%;"></td> <td style="width: 10%;"></td> <td style="width: 10%;"></td> <td style="width: 10%;"></td> </tr> <tr> <td></td> <td></td> <td colspan="8" style="text-align: center;"> <table border="1" style="width: 100%; border-collapse: collapse; text-align: center;"> <tr> <td style="width: 10%;"></td> <td style="width: 10%;"></td> <td style="width: 10%;"></td> <td style="width: 10%;"></td> <td style="width: 10%;"></td> <td style="width: 10%;"></td> <td style="width: 10%;"></td> <td style="width: 10%;"></td> <td style="width: 10%;"></td> <td style="width: 10%;"></td> </tr> <tr> <td></td> <td></td> <td colspan="8" style="text-align: center;"> <table border="1" style="width: 100%; border-collapse: collapse; text-align: center;"> <tr> <td style="width: 10%;"></td> <td style="width: 10%;"></td> <td style="width: 10%;"></td> <td style="width: 10%;"></td> <td style="width: 10%;"></td> <td style="width: 10%;"></td> <td style="width: 10%;"></td> <td style="width: 10%;"></td> <td style="width: 10%;"></td> <td style="width: 10%;"></td> </tr> <tr> <td></td> <td></td> <td colspan="8" style="text-align: center;"> <table border="1" style="width: 100%; border-collapse: collapse; text-align: center;"> <tr> <td style="width: 10%;"></td> <td style="width: 10%;"></td> <td style="width: 10%;"></td> <td style="width: 10%;"></td> <td style="width: 10%;"></td> <td style="width: 10%;"></td> <td style="width: 10%;"></td> <td style="width: 10%;"></td> <td style="width: 10%;"></td> <td style="width: 10%;"></td> </tr> <tr> <td></td> <td></td> <td colspan="8" style="text-align: center;"> <table border="1" style="width: 100%; border-collapse: collapse; text-align: center;"> <tr> <td style="width: 10%;"></td> <td style="width: 10%;"></td> <td style="width: 10%;"></td> <td style="width: 10%;"></td> <td style="width: 10%;"></td> <td style="width: 10%;"></td> <td style="width: 10%;"></td> <td style="width: 10%;"></td> <td style="width: 10%;"></td> <td style="width: 10%;"></td> </tr> <tr> <td></td> <td></td> <td colspan="8" style="text-align: center;"> <table border="1" style="width: 100%; border-collapse: collapse; text-align: center;"> <tr> <td style="width: 10%;"></td> <td style="width: 10%;"></td> <td style="width: 10%;"></td> <td style="width: 10%;"></td> <td style="width: 10%;"></td> <td style="width: 10%;"></td> <td style="width: 10%;"></td> <td style="width: 10%;"></td> <td style="width: 10%;"></td> <td style="width: 10%;"></td> </tr> <tr> <td></td> <td></td> <td colspan="8" style="text-align: center;"> <table border="1" style="width: 100%; border-collapse: collapse; text-align: center;"> <tr> <td style="width: 10%;"></td> <td style="width: 10%;"></td> <td style="width: 10%;"></td> <td style="width: 10%;"></td> <td style="width: 10%;"></td> <td style="width: 10%;"></td> <td style="width: 10%;"></td> <td style="width: 10%;"></td> <td style="width: 10%;"></td> <td style="width: 10%;"></td> </tr> <tr> <td></td> <td></td> <td colspan="8" style="text-align: center;"> <table border="1" style="width: 100%; border-collapse: collapse; text-align: center;"> <tr> <td style="width: 10%;"></td> <td style="width: 10%;"></td> <td style="width: 10%;"></td> <td style="width: 10%;"></td> <td style="width: 10%;"></td> <td style="width: 10%;"></td> <td style="width: 10%;"></td> <td style="width: 10%;"></td> <td style="width: 10%;"></td> <td style="width: 10%;"></td> </tr> <tr> <td></td> <td></td> <td colspan="8" style="text-align: center;"> <table border="1" style="width: 100%; border-collapse: collapse; text-align: center;"> <tr> <td style="width: 10%;"></td> <td style="width: 10%;"></td> <td style="width: 10%;"></td> <td style="width: 10%;"></td> <td style="width: 10%;"></td> <td style="width: 10%;"></td> <td style="width: 10%;"></td> <td style="width: 10%;"></td> <td style="width: 10%;"></td> <td style="width: 10%;"></td> </tr> <tr> <td></td> <td></td> <td colspan="8" style="text-align: center;"> <table border="1" style="width: 100%; border-collapse: collapse; text-align: center;"> <tr> <td style="width: 10%;"></td> <td style="width: 10%;"></td> <td style="width: 10%;"></td> <td style="width: 10%;"></td> <td style="width: 10%;"></td> <td style="width: 10%;"></td> <td style="width: 10%;"></td> <td style="width: 10%;"></td> <td style="width: 10%;"></td> <td style="width: 10%;"></td> </tr> <tr> <td></td> <td></td> <td colspan="8" style="text-align: center;"> <table border="1" style="width: 100%; border-collapse: collapse; text-align: center;"> <tr> <td style="width: 10%;"></td> <td style="width: 10%;"></td> <td style="width: 10%;"></td> <td style="width: 10%;"></td> <td style="width: 10%;"></td> <td style="width: 10%;"></td> <td style="width: 10%;"></td> <td style="width: 10%;"></td> <td style="width: 10%;"></td> <td style="width: 10%;"></td> </tr> <tr> <td></td> <td></td> <td colspan="8" style="text-align: center;"> <table border="1" style="width: 100%; border-collapse: collapse; text-align: center;"> <tr> <td style="width: 10%;"></td> <td style="width: 10%;"></td> <td style="width: 10%;"></td> <td style="width: 10%;"></td> <td style="width: 10%;"></td> <td style="width: 10%;"></td> <td style="width: 10%;"></td> <td style="width: 10%;"></td> <td style="width:
10%;"></td> <td style="width: 10%;"></td> </tr> <tr> <td></td> <td></td> <td colspan="8" style="text-align: center;"> <table border="1" style="width: 100%; border-collapse: collapse; text-align: center;"> <tr> <td style="width: 10%;"></td> <td style="width: 10%;"></td> <td style="width: 10%;"></td> <td style="width: 10%;"></td> <td style="width: 10%;"></td> <td style="width: 10%;"></td> <td style="width: 10%;"></td> <td style="width: 10%;"></td> <td style="width: 10%;"></td> <td style="width: 10%;"></td> </tr> <tr> <td></td> <td></td> <td colspan="8" style="text-align: center;"> <table border="1" style="width: 100%; border-collapse: collapse; text-align: center;"> <tr> <td style="width: 10%;"></td> <td style="width: 10%;"></td> <td style="width: 10%;"></td> <td style="width: 10%;"></td> <td style="width: 10%;"></td> <td style="width: 10%;"></td> <td style="width: 10%;"></td> <td style="width: 10%;"></td> <td style="width: 10%;"></td> <td style="width: 10%;"></td> </tr> <tr> <td></td> <td></td> <td colspan="8" style="text-align: center;"> <table border="1" style="width: 100%; border-collapse: collapse; text-align: center;"> <tr> <td style="width: 10%;"></td> <td style="width: 10%;"></td> <td style="width: 10%;"></td> <td style="width: 10%;"></td> <td style="width: 10%;"></td> <td style="width: 10%;"></td> <td style="width: 10%;"></td> <td style="width: 10%;"></td> <td style="width: 10%;"></td> <td style="width: 10%;"></td> </tr> <tr> <td></td> <td></td> <td colspan="8" style="text-align: center;"> <table border="1" style="width: 100%; border-collapse: collapse; text-align: center;"> <tr> <td style="width: 10%;"></td> <td style="width: 10%;"></td> <td style="width: 10%;"></td> <td style="width: 10%;"></td> <td style="width: 10%;"></td> <td style="width: 10%;"></td> <td style="width: 10%;"></td> <td style="width: 10%;"></td> <td style="width: 10%;"></td> <td style="width: 10%;"></td> </tr> <tr> <td></td> <td></td> <td colspan="8" style="text-align: center;"> <table border="1" style="width: 100%; border-collapse: collapse; text-align: center;"> <tr> <td style="width: 10%;"></td> <td style="width: 10%;"></td> <td style="width: 10%;"></td> <td style="width: 10%;"></td> <td style="width: 10%;"></td> <td style="width: 10%;"></td> <td style="width: 10%;"></td> <td style="width: 10%;"></td> <td style="width: 10%;"></td> <td style="width: 10%;"></td> </tr> <tr> <td></td> <td></td> <td colspan="8" style="text-align: center;"> <table border="1" style="width: 100%; border-collapse: collapse; text-align: center;"> <tr> <td style="width: 10%;"></td> <td style="width: 10%;"></td> <td style="width: 10%;"></td> <td style="width: 10%;"></td> <td style="width: 10%;"></td> <td style="width: 10%;"></td> <td style="width: 10%;"></td> <td style="width: 10%;"></td> <td style="width: 10%;"></td> <td style="width: 10%;"></td> </tr> <tr> <td></td> <td></td> <td colspan="8" style="text-align: center;"> <table border="1" style="width: 100%; border-collapse: collapse; text-align: center;"> <tr> <td style="width: 10%;"></td> <td style="width: 10%;"></td> <td style="width: 10%;"></td> <td style="width: 10%;"></td> <td style="width: 10%;"></td> <td style="width: 10%;"></td> <td style="width: 10%;"></td> <td style="width: 10%;"></td> <td style="width: 10%;"></td> <td style="width: 10%;"></td> </tr> <tr> <td></td> <td></td> <td colspan="8" style="text-align: center;"> <table border="1" style="width: 100%; border-collapse: collapse; text-align: center;"> <tr> </tr></table></td></tr></table></td></tr></table></td></tr></table></td></tr></table></td></tr></table></td></tr></table></td></tr></table></td></tr></table></td></tr></table></td></tr></table></td></tr></table></td></tr></table></td></tr></table></td></tr></table></td></tr></table></td></tr></table></td></tr></table></td></tr></table></td></tr></table></td></tr></table></td></tr></table></td></tr></table></td></tr></table></td></tr></table></td></tr></table></td></tr></table></td></tr></table></td></tr></table></td></tr></table></td></tr></table></td></tr></table></td></tr></table></td></tr></table></td></tr></table></td></tr></table></td></tr></table></td></tr></table></td></tr></table></td></tr></table></td></tr></table></td></tr></table></td></tr></table></td></tr></table></td></tr></table></td></tr></table></td></tr></table></td></tr></table></td></tr></table></td></tr></table></td></tr></table></td></tr></table> | | | | | | | | | | | | | | | | | | | | <table border="1" style="width: 100%; border-collapse: collapse; text-align: center;"> <tr> <td style="width: 10%;"></td> <td style="width: 10%;"></td> <td style="width: 10%;"></td> <td style="width: 10%;"></td> <td style="width: 10%;"></td> <td style="width: 10%;"></td> <td style="width: 10%;"></td> <td style="width: 10%;"></td> <td style="width: 10%;"></td> <td style="width: 10%;"></td> </tr> <tr> <td></td> <td></td> <td colspan="8" style="text-align: center;"> <table border="1" style="width: 100%; border-collapse: collapse; text-align: center;"> <tr> <td style="width: 10%;"></td> <td style="width: 10%;"></td> <td style="width: 10%;"></td> <td style="width: 10%;"></td> <td style="width: 10%;"></td> <td style="width: 10%;"></td> <td style="width: 10%;"></td> <td style="width: 10%;"></td> <td style="width: 10%;"></td> <td style="width: 10%;"></td> </tr> <tr> <td></td> <td></td> <td colspan="8" style="text-align: center;"> <table border="1" style="width: 100%; border-collapse: collapse; text-align: center;"> <tr> <td style="width: 10%;"></td> <td style="width: 10%;"></td> <td style="width: 10%;"></td> <td style="width: 10%;"></td> <td style="width: 10%;"></td> <td style="width: 10%;"></td> <td style="width: 10%;"></td> <td style="width: 10%;"></td> <td style="width: 10%;"></td> <td style="width: 10%;"></td> </tr> <tr> <td></td> <td></td> <td colspan="8" style="text-align: center;"> <table border="1" style="width: 100%; border-collapse: collapse; text-align: center;"> <tr> <td style="width: 10%;"></td> <td style="width: 10%;"></td> <td style="width: 10%;"></td> <td style="width: 10%;"></td> <td style="width: 10%;"></td> <td style="width: 10%;"></td> <td style="width: 10%;"></td> <td style="width: 10%;"></td> <td style="width: 10%;"></td> <td style="width: 10%;"></td> </tr> <tr> <td></td> <td></td> <td colspan="8" style="text-align: center;"> <table border="1" style="width: 100%; border-collapse: collapse; text-align: center;"> <tr> <td style="width: 10%;"></td> <td style="width: 10%;"></td> <td style="width: 10%;"></td> <td style="width: 10%;"></td> <td style="width: 10%;"></td> <td style="width: 10%;"></td> <td style="width: 10%;"></td> <td style="width: 10%;"></td> <td style="width: 10%;"></td> <td style="width: 10%;"></td> </tr> <tr> <td></td> <td></td> <td colspan="8" style="text-align: center;"> <table border="1" style="width: 100%; border-collapse: collapse; text-align: center;"> <tr> <td style="width: 10%;"></td> <td style="width: 10%;"></td> <td style="width: 10%;"></td> <td style="width: 10%;"></td> <td style="width: 10%;"></td> <td style="width: 10%;"></td> <td style="width: 10%;"></td> <td style="width: 10%;"></td> <td style="width: 10%;"></td> <td style="width: 10%;"></td> </tr> <tr> <td></td> <td></td> <td colspan="8" style="text-align: center;"> <table border="1" style="width: 100%; border-collapse: collapse; text-align: center;"> <tr> <td style="width: 10%;"></td> <td style="width: 10%;"></td> <td style="width: 10%;"></td> <td style="width: 10%;"></td> <td style="width: 10%;"></td> <td style="width: 10%;"></td> <td style="width: 10%;"></td> <td style="width: 10%;"></td> <td style="width: 10%;"></td> <td style="width: 10%;"></td> </tr> <tr> <td></td> <td></td> <td colspan="8" style="text-align: center;"> <table border="1" style="width: 100%; border-collapse: collapse; text-align: center;"> <tr> <td style="width: 10%;"></td> <td style="width: 10%;"></td> <td style="width: 10%;"></td> <td style="width: 10%;"></td> <td style="width: 10%;"></td> <td style="width: 10%;"></td> <td style="width: 10%;"></td> <td style="width: 10%;"></td> <td style="width: 10%;"></td> <td style="width: 10%;"></td> </tr> <tr> <td></td> <td></td> <td colspan="8" style="text-align: center;"> <table border="1" style="width: 100%; border-collapse: collapse; text-align: center;"> <tr> <td style="width: 10%;"></td> <td style="width: 10%;"></td> <td style="width: 10%;"></td> <td style="width: 10%;"></td> <td style="width: 10%;"></td> <td style="width: 10%;"></td> <td style="width: 10%;"></td> <td style="width: 10%;"></td> <td style="width: 10%;"></td> <td style="width: 10%;"></td> </tr> <tr> <td></td> <td></td> <td colspan="8" style="text-align: center;"> <table border="1" style="width: 100%; border-collapse: collapse; text-align: center;"> <tr> <td style="width: 10%;"></td> <td style="width: 10%;"></td> <td style="width: 10%;"></td> <td style="width: 10%;"></td> <td style="width: 10%;"></td> <td style="width: 10%;"></td> <td style="width: 10%;"></td> <td style="width: 10%;"></td> <td style="width: 10%;"></td> <td style="width: 10%;"></td> </tr> <tr> <td></td> <td></td> <td colspan="8" style="text-align: center;"> <table border="1" style="width: 100%; border-collapse: collapse; text-align: center;"> <tr> <td style="width: 10%;"></td> <td style="width: 10%;"></td> <td style="width: 10%;"></td> <td style="width: 10%;"></td> <td style="width: 10%;"></td> <td style="width: 10%;"></td> <td style="width: 10%;"></td> <td style="width: 10%;"></td> <td style="width: 10%;"></td> <td style="width: 10%;"></td> </tr> <tr> <td></td> <td></td> <td colspan="8" style="text-align: center;"> <table border="1" style="width: 100%; border-collapse: collapse; text-align: center;"> <tr> <td style="width: 10%;"></td> <td style="width: 10%;"></td> <td style="width: 10%;"></td> <td style="width: 10%;"></td> <td style="width: 10%;"></td> <td style="width: 10%;"></td> <td style="width: 10%;"></td> <td style="width: 10%;"></td> <td style="width: 10%;"></td> <td
style="width: 10%;"></td> </tr> <tr> <td></td> <td></td> <td colspan="8" style="text-align: center;"> <table border="1" style="width: 100%; border-collapse: collapse; text-align: center;"> <tr> <td style="width: 10%;"></td> <td style="width: 10%;"></td> <td style="width: 10%;"></td> <td style="width: 10%;"></td> <td style="width: 10%;"></td> <td style="width: 10%;"></td> <td style="width: 10%;"></td> <td style="width: 10%;"></td> <td style="width: 10%;"></td> <td style="width: 10%;"></td> </tr> <tr> <td></td> <td></td> <td colspan="8" style="text-align: center;"> <table border="1" style="width: 100%; border-collapse: collapse; text-align: center;"> <tr> <td style="width: 10%;"></td> <td style="width: 10%;"></td> <td style="width: 10%;"></td> <td style="width: 10%;"></td> <td style="width: 10%;"></td> <td style="width: 10%;"></td> <td style="width: 10%;"></td> <td style="width: 10%;"></td> <td style="width: 10%;"></td> <td style="width: 10%;"></td> </tr> <tr> <td></td> <td></td> <td colspan="8" style="text-align: center;"> <table border="1" style="width: 100%; border-collapse: collapse; text-align: center;"> <tr> <td style="width: 10%;"></td> <td style="width: 10%;"></td> <td style="width: 10%;"></td> <td style="width: 10%;"></td> <td style="width: 10%;"></td> <td style="width: 10%;"></td> <td style="width: 10%;"></td> <td style="width: 10%;"></td> <td style="width: 10%;"></td> <td style="width: 10%;"></td> </tr> <tr> <td></td> <td></td> <td colspan="8" style="text-align: center;"> <table border="1" style="width: 100%; border-collapse: collapse; text-align: center;"> <tr> <td style="width: 10%;"></td> <td style="width: 10%;"></td> <td style="width: 10%;"></td> <td style="width: 10%;"></td> <td style="width: 10%;"></td> <td style="width: 10%;"></td> <td style="width: 10%;"></td> <td style="width: 10%;"></td> <td style="width: 10%;"></td> <td style="width: 10%;"></td> </tr> <tr> <td></td> <td></td> <td colspan="8" style="text-align: center;"> <table border="1" style="width: 100%; border-collapse: collapse; text-align: center;"> <tr> <td style="width: 10%;"></td> <td style="width: 10%;"></td> <td style="width: 10%;"></td> <td style="width: 10%;"></td> <td style="width: 10%;"></td> <td style="width: 10%;"></td> <td style="width: 10%;"></td> <td style="width: 10%;"></td> <td style="width: 10%;"></td> <td style="width: 10%;"></td> </tr> <tr> <td></td> <td></td> <td colspan="8" style="text-align: center;"> <table border="1" style="width: 100%; border-collapse: collapse; text-align: center;"> <tr> <td style="width: 10%;"></td> <td style="width: 10%;"></td> <td style="width: 10%;"></td> <td style="width: 10%;"></td> <td style="width: 10%;"></td> <td style="width: 10%;"></td> <td style="width: 10%;"></td> <td style="width: 10%;"></td> <td style="width: 10%;"></td> <td style="width: 10%;"></td> </tr> <tr> <td></td> <td></td> <td colspan="8" style="text-align: center;"> <table border="1" style="width: 100%; border-collapse: collapse; text-align: center;"> <tr> <td style="width: 10%;"></td> <td style="width: 10%;"></td> <td style="width: 10%;"></td> <td style="width: 10%;"></td> <td style="width: 10%;"></td> <td style="width: 10%;"></td> <td style="width: 10%;"></td> <td style="width: 10%;"></td> <td style="width: 10%;"></td> <td style="width: 10%;"></td> </tr> <tr> <td></td> <td></td> <td colspan="8" style="text-align: center;"> <table border="1" style="width: 100%; border-collapse: collapse; text-align: center;"> <tr> <td style="width: 10%;"></td> <td style="width: 10%;"></td> <td style="width: 10%;"></td> <td style="width: 10%;"></td> <td style="width: 10%;"></td> <td style="width: 10%;"></td> <td style="width: 10%;"></td> <td style="width: 10%;"></td> <td style="width: 10%;"></td> <td style="width: 10%;"></td> </tr> <tr> <td></td> <td></td> <td colspan="8" style="text-align: center;"> <table border="1" style="width: 100%; border-collapse: collapse; text-align: center;"> <tr> <td style="width: 10%;"></td> <td style="width: 10%;"></td> <td style="width: 10%;"></td> <td style="width: 10%;"></td> <td style="width: 10%;"></td> <td style="width: 10%;"></td> <td style="width: 10%;"></td> <td style="width: 10%;"></td> <td style="width: 10%;"></td> <td style="width: 10%;"></td> </tr> <tr> <td></td> <td></td> <td colspan="8" style="text-align: center;"> <table border="1" style="width: 100%; border-collapse: collapse; text-align: center;"> <tr> <td style="width: 10%;"></td> <td style="width: 10%;"></td> <td style="width: 10%;"></td> <td style="width: 10%;"></td> <td style="width: 10%;"></td> <td style="width: 10%;"></td> <td style="width: 10%;"></td> <td style="width: 10%;"></td> <td style="width: 10%;"></td> <td style="width: 10%;"></td> </tr> <tr> <td></td> <td></td> <td colspan="8" style="text-align: center;"> <table border="1" style="width: 100%; border-collapse: collapse; text-align: center;"> <tr> <td style="width: 10%;"></td> <td style="width: 10%;"></td> <td style="width: 10%;"></td> <td style="width: 10%;"></td> <td style="width: 10%;"></td> <td style="width: 10%;"></td> <td style="width: 10%;"></td> <td style="width: 10%;"></td> <td style="width: 10%;"></td> <td style="width: 10%;"></td> </tr> <tr> <td></td> <td></td> <td colspan="8" style="text-align: center;"> <table border="1" style="width: 100%; border-collapse: collapse; text-align: center;"> <tr> <td style="width: 10%;"></td> <td style="width: 10%;"></td> <td style="width: 10%;"></td> <td style="width: 10%;"></td> <td style="width: 10%;"></td> <td style="width: 10%;"></td> <td style="width: 10%;"></td> <td style="width: 10%;"></td> <td style="width: 10%;"></td> <td style="width: 10%;"></td> </tr> <tr> <td></td> <td></td> <td colspan="8" style="text-align: center;"> <table border="1" style="width: 100%; border-collapse: collapse; text-align: center;"> <tr> <td style="width: 10%;"></td> <td style="width: 10%;"></td> <td style="width: 10%;"></td> <td style="width: 10%;"></td> <td style="width: 10%;"></td> <td style="width: 10%;"></td> <td style="width: 10%;"></td> <td style="width: 10%;"></td> <td style="width: 10%;"></td> <td style="width: 10%;"></td> </tr> <tr> <td></td> <td></td> <td colspan="8" style="text-align: center;"> <table border="1" style="width: 100%; border-collapse: collapse; text-align: center;"> <tr> <td style="width: 10%;"></td> <td style="width: 10%;"></td> <td style="width: 10%;"></td> <td style="width: 10%;"></td> <td style="width: 10%;"></td> <td style="width: 10%;"></td> <td style="width: 10%;"></td> <td style="width: 10%;"></td> <td style="width: 10%;"></td> <td style="width: 10%;"></td> </tr> <tr> <td></td> <td></td> <td colspan="8" style="text-align: center;"> <table border="1" style="width: 100%; border-collapse: collapse; text-align: center;"> <tr> <td style="width: 10%;"></td> <td style="width: 10%;"></td> <td style="width: 10%;"></td> <td style="width: 10%;"></td> <td style="width: 10%;"></td> <td style="width: 10%;"></td> <td style="width: 10%;"></td> <td style="width: 10%;"></td> <td style="width: 10%;"></td> <td style="width: 10%;"></td> </tr> <tr> <td></td> <td></td> <td colspan="8" style="text-align: center;"> <table border="1" style="width: 100%; border-collapse: collapse; text-align: center;"> <tr> <td style="width: 10%;"></td> <td style="width: 10%;"></td> <td style="width: 10%;"></td> <td style="width: 10%;"></td> <td style="width: 10%;"></td> <td style="width: 10%;"></td> <td style="width: 10%;"></td> <td style="width: 10%;"></td> <td style="width: 10%;"></td> <td style="width: 10%;"></td> </tr> <tr> <td></td> <td></td> <td colspan="8" style="text-align: center;"> <table border="1" style="width: 100%; border-collapse: collapse; text-align: center;"> <tr> <td style="width: 10%;"></td> <td style="width: 10%;"></td> <td style="width: 10%;"></td> <td style="width: 10%;"></td> <td style="width: 10%;"></td> <td style="width: 10%;"></td> <td style="width: 10%;"></td> <td style="width: 10%;"></td> <td style="width: 10%;"></td> <td style="width: 10%;"></td> </tr> <tr> <td></td> <td></td> <td colspan="8" style="text-align: center;"> <table border="1" style="width: 100%; border-collapse: collapse; text-align: center;"> <tr> <td style="width: 10%;"></td> <td style="width: 10%;"></td> <td style="width: 10%;"></td> <td style="width: 10%;"></td> <td style="width: 10%;"></td> <td style="width: 10%;"></td> <td style="width: 10%;"></td> <td style="width: 10%;"></td> <td style="width: 10%;"></td> <td style="width: 10%;"></td> </tr> <tr> <td></td> <td></td> <td colspan="8" style="text-align: center;"> <table border="1" style="width: 100%; border-collapse: collapse; text-align: center;"> <tr> <td style="width: 10%;"></td> <td style="width: 10%;"></td> <td style="width: 10%;"></td> <td style="width: 10%;"></td> <td style="width: 10%;"></td> <td style="width: 10%;"></td> <td style="width: 10%;"></td> <td style="width: 10%;"></td> <td style="width: 10%;"></td> <td style="width: 10%;"></td> </tr> <tr> <td></td> <td></td> <td colspan="8" style="text-align: center;"> <table border="1" style="width: 100%; border-collapse: collapse; text-align: center;"> <tr> <td style="width: 10%;"></td> <td style="width: 10%;"></td> <td style="width: 10%;"></td> <td style="width: 10%;"></td> <td style="width: 10%;"></td> <td style="width: 10%;"></td> <td style="width: 10%;"></td> <td style="width: 10%;"></td> <td style="width: 10%;"></td> <td style="width: 10%;"></td> </tr> <tr> <td></td> <td></td> <td colspan="8" style="text-align: center;"> <table border="1" style="width: 100%; border-collapse: collapse; text-align: center;"> <tr> <td style="width: 10%;"></td> <td style="width: 10%;"></td> <td style="width: 10%;"></td> <td style="width: 10%;"></td> <td style="width: 10%;"></td> <td style="width: 10%;"></td> <td style="width: 10%;"></td> <td style="width: 10%;"></td> <td style="width: 10%;"></td> <td style="width: 10%;"></td> </tr> <tr> <td></td> <td></td> <td colspan="8" style="text-align: center;"> <table border="1" style="width: 100%; border-collapse: collapse;
text-align: center;"> <tr> <td style="width: 10%;"></td> <td style="width: 10%;"></td> <td style="width: 10%;"></td> <td style="width: 10%;"></td> <td style="width: 10%;"></td> <td style="width: 10%;"></td> <td style="width: 10%;"></td> <td style="width: 10%;"></td> <td style="width: 10%;"></td> <td style="width: 10%;"></td> </tr> <tr> <td></td> <td></td> <td colspan="8" style="text-align: center;"> <table border="1" style="width: 100%; border-collapse: collapse; text-align: center;"> <tr> <td style="width: 10%;"></td> <td style="width: 10%;"></td> <td style="width: 10%;"></td> <td style="width: 10%;"></td> <td style="width: 10%;"></td> <td style="width: 10%;"></td> <td style="width: 10%;"></td> <td style="width: 10%;"></td> <td style="width: 10%;"></td> <td style="width: 10%;"></td> </tr> <tr> <td></td> <td></td> <td colspan="8" style="text-align: center;"> <table border="1" style="width: 100%; border-collapse: collapse; text-align: center;"> <tr> <td style="width: 10%;"></td> <td style="width: 10%;"></td> <td style="width: 10%;"></td> <td style="width: 10%;"></td> <td style="width: 10%;"></td> <td style="width: 10%;"></td> <td style="width: 10%;"></td> <td style="width: 10%;"></td> <td style="width: 10%;"></td> <td style="width: 10%;"></td> </tr> <tr> <td></td> <td></td> <td colspan="8" style="text-align: center;"> <table border="1" style="width: 100%; border-collapse: collapse; text-align: center;"> <tr> <td style="width: 10%;"></td> <td style="width: 10%;"></td> <td style="width: 10%;"></td> <td style="width: 10%;"></td> <td style="width: 10%;"></td> <td style="width: 10%;"></td> <td style="width: 10%;"></td> <td style="width: 10%;"></td> <td style="width: 10%;"></td> <td style="width: 10%;"></td> </tr> <tr> <td></td> <td></td> <td colspan="8" style="text-align: center;"> <table border="1" style="width: 100%; border-collapse: collapse; text-align: center;"> <tr> <td style="width: 10%;"></td> <td style="width: 10%;"></td> <td style="width: 10%;"></td> <td style="width: 10%;"></td> <td style="width: 10%;"></td> <td style="width: 10%;"></td> <td style="width: 10%;"></td> <td style="width: 10%;"></td> <td style="width: 10%;"></td> <td style="width: 10%;"></td> </tr> <tr> <td></td> <td></td> <td colspan="8" style="text-align: center;"> <table border="1" style="width: 100%; border-collapse: collapse; text-align: center;"> <tr> <td style="width: 10%;"></td> <td style="width: 10%;"></td> <td style="width: 10%;"></td> <td style="width: 10%;"></td> <td style="width: 10%;"></td> <td style="width: 10%;"></td> <td style="width: 10%;"></td> <td style="width: 10%;"></td> <td style="width: 10%;"></td> <td style="width: 10%;"></td> </tr> <tr> <td></td> <td></td> <td colspan="8" style="text-align: center;"> <table border="1" style="width: 100%; border-collapse: collapse; text-align: center;"> <tr> <td style="width: 10%;"></td> <td style="width: 10%;"></td> <td style="width: 10%;"></td> <td style="width: 10%;"></td> <td style="width: 10%;"></td> <td style="width: 10%;"></td> <td style="width: 10%;"></td> <td style="width: 10%;"></td> <td style="width: 10%;"></td> <td style="width: 10%;"></td> </tr> <tr> <td></td> <td></td> <td colspan="8" style="text-align: center;"> <table border="1" style="width: 100%; border-collapse: collapse; text-align: center;"> <tr> <td style="width: 10%;"></td> <td style="width: 10%;"></td> <td style="width: 10%;"></td> <td style="width: 10%;"></td> <td style="width: 10%;"></td> <td style="width: 10%;"></td> <td style="width: 10%;"></td> <td style="width: 10%;"></td> <td style="width: 10%;"></td> <td style="width: 10%;"></td> </tr> <tr> <td></td> <td></td> <td colspan="8" style="text-align: center;"> <table border="1" style="width: 100%; border-collapse: collapse; text-align: center;"> <tr> <td style="width: 10%;"></td> <td style="width: 10%;"></td> <td style="width: 10%;"></td> <td style="width: 10%;"></td> <td style="width: 10%;"></td> <td style="width: 10%;"></td> <td style="width: 10%;"></td> <td style="width: 10%;"></td> <td style="width: 10%;"></td> <td style="width: 10%;"></td> </tr> <tr> <td></td> <td></td> <td colspan="8" style="text-align: center;"> <table border="1" style="width: 100%; border-collapse: collapse; text-align: center;"> <tr> <td style="width: 10%;"></td> <td style="width: 10%;"></td> <td style="width: 10%;"></td> <td style="width: 10%;"></td> <td style="width: 10%;"></td> <td style="width: 10%;"></td> <td style="width: 10%;"></td> <td style="width: 10%;"></td> <td style="width: 10%;"></td> <td style="width: 10%;"></td> </tr> <tr> <td></td> <td></td> <td colspan="8" style="text-align: center;"> <table border="1" style="width: 100%; border-collapse: collapse; text-align: center;"> <tr> <td style="width: 10%;"></td> <td style="width: 10%;"></td> <td style="width: 10%;"></td> <td style="width: 10%;"></td> <td style="width: 10%;"></td> <td style="width: 10%;"></td> <td style="width: 10%;"></td> <td style="width: 10%;"></td> <td style="width: 10%;"></td> <td style="width: 10%;"></td> </tr> <tr> <td></td> <td></td> <td colspan="8" style="text-align: center;"> <table border="1" style="width: 100%; border-collapse: collapse; text-align: center;"> <tr> <td style="width: 10%;"></td> <td style="width: 10%;"></td> <td style="width: 10%;"></td> <td style="width: 10%;"></td> <td style="width: 10%;"></td> <td style="width: 10%;"></td> <td style="width: 10%;"></td> <td style="width: 10%;"></td> <td style="width: 10%;"></td> <td style="width: 10%;"></td> </tr> <tr> <td></td> <td></td> <td colspan="8" style="text-align: center;"> <table border="1" style="width: 100%; border-collapse: collapse; text-align: center;"> <tr> <td style="width: 10%;"></td> <td style="width: 10%;"></td> <td style="width: 10%;"></td> <td style="width: 10%;"></td> <td style="width: 10%;"></td> <td style="width: 10%;"></td> <td style="width: 10%;"></td> <td style="width: 10%;"></td> <td style="width: 10%;"></td> <td style="width: 10%;"></td> </tr> <tr> <td></td> <td></td> <td colspan="8" style="text-align: center;"> <table border="1" style="width: 100%; border-collapse: collapse; text-align: center;"> <tr> <td style="width: 10%;"></td> <td style="width: 10%;"></td> <td style="width: 10%;"></td> <td style="width: 10%;"></td> <td style="width: 10%;"></td> <td style="width: 10%;"></td> <td style="width: 10%;"></td> <td style="width: 10%;"></td> <td style="width: 10%;"></td> <td style="width: 10%;"></td> </tr> <tr> <td></td> <td></td> <td colspan="8" style="text-align: center;"> <table border="1" style="width: 100%; border-collapse: collapse; text-align: center;"> <tr> <td style="width: 10%;"></td> <td style="width: 10%;"></td> <td style="width: 10%;"></td> <td style="width: 10%;"></td> <td style="width: 10%;"></td> <td style="width: 10%;"></td> <td style="width: 10%;"></td> <td style="width: 10%;"></td> <td style="width: 10%;"></td> <td style="width: 10%;"></td> </tr> <tr> <td></td> <td></td> <td colspan="8" style="text-align: center;"> <table border="1" style="width: 100%; border-collapse: collapse; text-align: center;"> <tr> <td style="width: 10%;"></td> <td style="width: 10%;"></td> <td style="width: 10%;"></td> <td style="width: 10%;"></td> <td style="width: 10%;"></td> <td style="width: 10%;"></td> <td style="width: 10%;"></td> <td style="width: 10%;"></td> <td style="width: 10%;"></td> <td style="width: 10%;"></td> </tr> <tr> <td></td> <td></td> <td colspan="8" style="text-align: center;"> <table border="1" style="width: 100%; border-collapse: collapse; text-align: center;"> <tr> <td style="width: 10%;"></td> <td style="width: 10%;"></td> <td style="width: 10%;"></td> <td style="width: 10%;"></td> <td style="width: 10%;"></td> <td style="width: 10%;"></td> <td style="width: 10%;"></td> <td style="width: 10%;"></td> <td style="width: 10%;"></td> <td style="width: 10%;"></td> </tr> <tr> <td></td> <td></td> <td colspan="8" style="text-align: center;"> <table border="1" style="width: 100%; border-collapse: collapse; text-align: center;"> <tr> </tr></table></td></tr></table></td></tr></table></td></tr></table></td></tr></table></td></tr></table></td></tr></table></td></tr></table></td></tr></table></td></tr></table></td></tr></table></td></tr></table></td></tr></table></td></tr></table></td></tr></table></td></tr></table></td></tr></table></td></tr></table></td></tr></table></td></tr></table></td></tr></table></td></tr></table></td></tr></table></td></tr></table></td></tr></table></td></tr></table></td></tr></table></td></tr></table></td></tr></table></td></tr></table></td></tr></table></td></tr></table></td></tr></table></td></tr></table></td></tr></table></td></tr></table></td></tr></table></td></tr></table></td></tr></table></td></tr></table></td></tr></table></td></tr></table></td></tr></table></td></tr></table></td></tr></table></td></tr></table></td></tr></table></td></tr></table></td></tr></table></td></tr></table></td></tr></table> | | | | | | | | | | | | | | | | | | | | <table border="1" style="width: 100%; border-collapse: collapse; text-align: center;"> <tr> <td style="width: 10%;"></td> <td style="width: 10%;"></td> <td style="width: 10%;"></td> <td style="width: 10%;"></td> <td style="width: 10%;"></td> <td style="width: 10%;"></td> <td style="width: 10%;"></td> <td style="width: 10%;"></td> <td style="width: 10%;"></td> <td style="width: 10%;"></td> </tr> <tr> <td></td> <td></td> <td colspan="8" style="text-align: center;"> <table border="1" style="width: 100%; border-collapse: collapse; text-align: center;"> <tr> <td style="width: 10%;"></td> <td style="width: 10%;"></td> <td style="width: 10%;"></td> <td style="width: 10%;"></td> <td style="width: 10%;"></td> <td style="width: 10%;"></td> <td style="width: 10%;"></td> <td style="width: 10%;"></td> <td style="width: 10%;"></td> <td style="width: 10%;"></td> </tr> <tr> <td></td> <td></td> <td colspan="8" style="text-align: center;"> <table border="1" style="width: 100%; border-collapse: collapse; text-align: center;"> <tr> <td
style="width: 10%;"></td> <td style="width: 10%;"></td> <td style="width: 10%;"></td> <td style="width: 10%;"></td> <td style="width: 10%;"></td> <td style="width: 10%;"></td> <td style="width: 10%;"></td> <td style="width: 10%;"></td> <td style="width: 10%;"></td> <td style="width: 10%;"></td> </tr> <tr> <td></td> <td></td> <td colspan="8" style="text-align: center;"> <table border="1" style="width: 100%; border-collapse: collapse; text-align: center;"> <tr> <td style="width: 10%;"></td> <td style="width: 10%;"></td> <td style="width: 10%;"></td> <td style="width: 10%;"></td> <td style="width: 10%;"></td> <td style="width: 10%;"></td> <td style="width: 10%;"></td> <td style="width: 10%;"></td> <td style="width: 10%;"></td> <td style="width: 10%;"></td> </tr> <tr> <td></td> <td></td> <td colspan="8" style="text-align: center;"> <table border="1" style="width: 100%; border-collapse: collapse; text-align: center;"> <tr> <td style="width: 10%;"></td> <td style="width: 10%;"></td> <td style="width: 10%;"></td> <td style="width: 10%;"></td> <td style="width: 10%;"></td> <td style="width: 10%;"></td> <td style="width: 10%;"></td> <td style="width: 10%;"></td> <td style="width: 10%;"></td> <td style="width: 10%;"></td> </tr> <tr> <td></td> <td></td> <td colspan="8" style="text-align: center;"> <table border="1" style="width: 100%; border-collapse: collapse; text-align: center;"> <tr> <td style="width: 10%;"></td> <td style="width: 10%;"></td> <td style="width: 10%;"></td> <td style="width: 10%;"></td> <td style="width: 10%;"></td> <td style="width: 10%;"></td> <td style="width: 10%;"></td> <td style="width: 10%;"></td> <td style="width: 10%;"></td> <td style="width: 10%;"></td> </tr> <tr> <td></td> <td></td> <td colspan="8" style="text-align: center;"> <table border="1" style="width: 100%; border-collapse: collapse; text-align: center;"> <tr> <td style="width: 10%;"></td> <td style="width: 10%;"></td> <td style="width: 10%;"></td> <td style="width: 10%;"></td> <td style="width: 10%;"></td> <td style="width: 10%;"></td> <td style="width: 10%;"></td> <td style="width: 10%;"></td> <td style="width: 10%;"></td> <td style="width: 10%;"></td> </tr> <tr> <td></td> <td></td> <td colspan="8" style="text-align: center;"> <table border="1" style="width: 100%; border-collapse: collapse; text-align: center;"> <tr> <td style="width: 10%;"></td> <td style="width: 10%;"></td> <td style="width: 10%;"></td> <td style="width: 10%;"></td> <td style="width: 10%;"></td> <td style="width: 10%;"></td> <td style="width: 10%;"></td> <td style="width: 10%;"></td> <td style="width: 10%;"></td> <td style="width: 10%;"></td> </tr> <tr> <td></td> <td></td> <td colspan="8" style="text-align: center;"> <table border="1" style="width: 100%; border-collapse: collapse; text-align: center;"> <tr> <td style="width: 10%;"></td> <td style="width: 10%;"></td> <td style="width: 10%;"></td> <td style="width: 10%;"></td> <td style="width: 10%;"></td> <td style="width: 10%;"></td> <td style="width: 10%;"></td> <td style="width: 10%;"></td> <td style="width: 10%;"></td> <td style="width: 10%;"></td> </tr> <tr> <td></td> <td></td> <td colspan="8" style="text-align: center;"> <table border="1" style="width: 100%; border-collapse: collapse; text-align: center;"> <tr> <td style="width: 10%;"></td> <td style="width: 10%;"></td> <td style="width: 10%;"></td> <td style="width: 10%;"></td> <td style="width: 10%;"></td> <td style="width: 10%;"></td> <td style="width: 10%;"></td> <td style="width: 10%;"></td> <td style="width: 10%;"></td> <td style="width: 10%;"></td> </tr> <tr> <td></td> <td></td> <td colspan="8" style="text-align: center;"> <table border="1" style="width: 100%; border-collapse: collapse; text-align: center;"> <tr> <td style="width: 10%;"></td> <td style="width: 10%;"></td> <td style="width: 10%;"></td> <td style="width: 10%;"></td> <td style="width: 10%;"></td> <td style="width: 10%;"></td> <td style="width: 10%;"></td> <td style="width: 10%;"></td> <td style="width: 10%;"></td> <td style="width: 10%;"></td> </tr> <tr> <td></td> <td></td> <td colspan="8" style="text-align: center;"> <table border="1" style="width: 100%; border-collapse: collapse; text-align: center;"> <tr> <td style="width: 10%;"></td> <td style="width: 10%;"></td> <td style="width: 10%;"></td> <td style="width: 10%;"></td> <td style="width: 10%;"></td> <td style="width: 10%;"></td> <td style="width: 10%;"></td> <td style="width: 10%;"></td> <td style="width: 10%;"></td> <td style="width: 10%;"></td> </tr> <tr> <td></td> <td></td> <td colspan="8" style="text-align: center;"> <table border="1" style="width: 100%; border-collapse: collapse; text-align: center;"> <tr> <td style="width: 10%;"></td> <td style="width: 10%;"></td> <td style="width: 10%;"></td> <td style="width: 10%;"></td> <td style="width: 10%;"></td> <td style="width: 10%;"></td> <td style="width: 10%;"></td> <td style="width: 10%;"></td> <td style="width: 10%;"></td> <td style="width: 10%;"></td> </tr> <tr> <td></td> <td></td> <td colspan="8" style="text-align: center;"> <table border="1" style="width: 100%; border-collapse: collapse; text-align: center;"> <tr> <td style="width: 10%;"></td> <td style="width: 10%;"></td> <td style="width: 10%;"></td> <td style="width: 10%;"></td> <td style="width: 10%;"></td> <td style="width: 10%;"></td> <td style="width: 10%;"></td> <td style="width: 10%;"></td> <td style="width: 10%;"></td> <td style="width: 10%;"></td> </tr> <tr> <td></td> <td></td> <td colspan="8" style="text-align: center;"> <table border="1" style="width: 100%; border-collapse: collapse; text-align: center;"> <tr> <td style="width: 10%;"></td> <td style="width: 10%;"></td> <td style="width: 10%;"></td> <td style="width: 10%;"></td> <td style="width: 10%;"></td> <td style="width: 10%;"></td> <td style="width: 10%;"></td> <td style="width: 10%;"></td> <td style="width: 10%;"></td> <td style="width: 10%;"></td> </tr> <tr> <td></td> <td></td> <td colspan="8" style="text-align: center;"> <table border="1" style="width: 100%; border-collapse: collapse; text-align: center;"> <tr> <td style="width: 10%;"></td> <td style="width: 10%;"></td> <td style="width: 10%;"></td> <td style="width: 10%;"></td> <td style="width: 10%;"></td> <td style="width: 10%;"></td> <td style="width: 10%;"></td> <td style="width: 10%;"></td> <td style="width: 10%;"></td> <td style="width: 10%;"></td> </tr> <tr> <td></td> <td></td> <td colspan="8" style="text-align: center;"> <table border="1" style="width: 100%; border-collapse: collapse; text-align: center;"> <tr> <td style="width: 10%;"></td> <td style="width: 10%;"></td> <td style="width: 10%;"></td> <td style="width: 10%;"></td> <td style="width: 10%;"></td> <td style="width: 10%;"></td> <td style="width: 10%;"></td> <td style="width: 10%;"></td> <td style="width: 10%;"></td> <td style="width: 10%;"></td> </tr> <tr> <td></td> <td></td> <td colspan="8" style="text-align: center;"> <table border="1" style="width: 100%; border-collapse: collapse; text-align: center;"> <tr> <td style="width: 10%;"></td> <td style="width: 10%;"></td> <td style="width: 10%;"></td> <td style="width: 10%;"></td> <td style="width: 10%;"></td> <td style="width: 10%;"></td> <td style="width: 10%;"></td> <td style="width: 10%;"></td> <td style="width: 10%;"></td> <td style="width: 10%;"></td> </tr> <tr> <td></td> <td></td> <td colspan="8" style="text-align: center;"> <table border="1" style="width: 100%; border-collapse: collapse; text-align: center;"> <tr> <td style="width: 10%;"></td> <td style="width: 10%;"></td> <td style="width: 10%;"></td> <td style="width: 10%;"></td> <td style="width: 10%;"></td> <td style="width: 10%;"></td> <td style="width: 10%;"></td> <td style="width: 10%;"></td> <td style="width: 10%;"></td> <td style="width: 10%;"></td> </tr> <tr> <td></td> <td></td> <td colspan="8" style="text-align: center;"> <table border="1" style="width: 100%; border-collapse: collapse; text-align: center;"> <tr> <td style="width: 10%;"></td> <td style="width: 10%;"></td> <td style="width: 10%;"></td> <td style="width: 10%;"></td> <td style="width: 10%;"></td> <td style="width: 10%;"></td> <td style="width: 10%;"></td> <td style="width: 10%;"></td> <td style="width: 10%;"></td> <td style="width: 10%;"></td> </tr> <tr> <td></td> <td></td> <td colspan="8" style="text-align: center;"> <table border="1" style="width: 100%; border-collapse: collapse; text-align: center;"> <tr> <td style="width: 10%;"></td> <td style="width: 10%;"></td> <td style="width: 10%;"></td> <td style="width: 10%;"></td> <td style="width: 10%;"></td> <td style="width: 10%;"></td> <td style="width: 10%;"></td> <td style="width: 10%;"></td> <td style="width: 10%;"></td> <td style="width: 10%;"></td> </tr> <tr> <td></td> <td></td> <td colspan="8" style="text-align: center;"> <table border="1" style="width: 100%; border-collapse: collapse; text-align: center;"> <tr> <td style="width: 10%;"></td> <td style="width: 10%;"></td> <td style="width: 10%;"></td> <td style="width: 10%;"></td> <td style="width: 10%;"></td> <td style="width: 10%;"></td> <td style="width: 10%;"></td> <td style="width: 10%;"></td> <td style="width: 10%;"></td> <td style="width: 10%;"></td> </tr> <tr> <td></td> <td></td> <td colspan="8" style="text-align: center;"> <table border="1" style="width: 100%; border-collapse: collapse; text-align: center;"> <tr> <td style="width: 10%;"></td> <td style="width: 10%;"></td> <td style="width: 10%;"></td> <td style="width: 10%;"></td> <td style="width: 10%;"></td> <td style="width: 10%;"></td> <td style="width: 10%;"></td> <td style="width: 10%;"></td> <td style="width: 10%;"></td> <td style="width: 10%;"></td> </tr> <tr> <td></td> <td></td> <td colspan="8" style="text-align: center;"> <table border="1" style="width: 100%; border-collapse: collapse; text-align: center;"> <tr> <td style="width: 10%;"></td> <td style="width: 10%;"></td> <td style="width: 10%;"></td> <td style="width: 10%;"></td> <td style="width: 10%;"></td> <td style="width:
10%;"></td> <td style="width: 10%;"></td> <td style="width: 10%;"></td> <td style="width: 10%;"></td> <td style="width: 10%;"></td> </tr> <tr> <td></td> <td></td> <td colspan="8" style="text-align: center;"> <table border="1" style="width: 100%; border-collapse: collapse; text-align: center;"> <tr> <td style="width: 10%;"></td> <td style="width: 10%;"></td> <td style="width: 10%;"></td> <td style="width: 10%;"></td> <td style="width: 10%;"></td> <td style="width: 10%;"></td> <td style="width: 10%;"></td> <td style="width: 10%;"></td> <td style="width: 10%;"></td> <td style="width: 10%;"></td> </tr> <tr> <td></td> <td></td> <td colspan="8" style="text-align: center;"> <table border="1" style="width: 100%; border-collapse: collapse; text-align: center;"> <tr> <td style="width: 10%;"></td> <td style="width: 10%;"></td> <td style="width: 10%;"></td> <td style="width: 10%;"></td> <td style="width: 10%;"></td> <td style="width: 10%;"></td> <td style="width: 10%;"></td> <td style="width: 10%;"></td> <td style="width: 10%;"></td> <td style="width: 10%;"></td> </tr> <tr> <td></td> <td></td> <td colspan="8" style="text-align: center;"> <table border="1" style="width: 100%; border-collapse: collapse; text-align: center;"> <tr> <td style="width: 10%;"></td> <td style="width: 10%;"></td> <td style="width: 10%;"></td> <td style="width: 10%;"></td> <td style="width: 10%;"></td> <td style="width: 10%;"></td> <td style="width: 10%;"></td> <td style="width: 10%;"></td> <td style="width: 10%;"></td> <td style="width: 10%;"></td> </tr> <tr> <td></td> <td></td> <td colspan="8" style="text-align: center;"> <table border="1" style="width: 100%; border-collapse: collapse; text-align: center;"> <tr> <td style="width: 10%;"></td> <td style="width: 10%;"></td> <td style="width: 10%;"></td> <td style="width: 10%;"></td> <td style="width: 10%;"></td> <td style="width: 10%;"></td> <td style="width: 10%;"></td> <td style="width: 10%;"></td> <td style="width: 10%;"></td> <td style="width: 10%;"></td> </tr> <tr> <td></td> <td></td> <td colspan="8" style="text-align: center;"> <table border="1" style="width: 100%; border-collapse: collapse; text-align: center;"> <tr> <td style="width: 10%;"></td> <td style="width: 10%;"></td> <td style="width: 10%;"></td> <td style="width: 10%;"></td> <td style="width: 10%;"></td> <td style="width: 10%;"></td> <td style="width: 10%;"></td> <td style="width: 10%;"></td> <td style="width: 10%;"></td> <td style="width: 10%;"></td> </tr> <tr> <td></td> <td></td> <td colspan="8" style="text-align: center;"> <table border="1" style="width: 100%; border-collapse: collapse; text-align: center;"> <tr> <td style="width: 10%;"></td> <td style="width: 10%;"></td> <td style="width: 10%;"></td> <td style="width: 10%;"></td> <td style="width: 10%;"></td> <td style="width: 10%;"></td> <td style="width: 10%;"></td> <td style="width: 10%;"></td> <td style="width: 10%;"></td> <td style="width: 10%;"></td> </tr> <tr> <td></td> <td></td> <td colspan="8" style="text-align: center;"> <table border="1" style="width: 100%; border-collapse: collapse; text-align: center;"> <tr> <td style="width: 10%;"></td> <td style="width: 10%;"></td> <td style="width: 10%;"></td> <td style="width: 10%;"></td> <td style="width: 10%;"></td> <td style="width: 10%;"></td> <td style="width: 10%;"></td> <td style="width: 10%;"></td> <td style="width: 10%;"></td> <td style="width: 10%;"></td> </tr> <tr> <td></td> <td></td> <td colspan="8" style="text-align: center;"> <table border="1" style="width: 100%; border-collapse: collapse; text-align: center;"> <tr> <td style="width: 10%;"></td> <td style="width: 10%;"></td> <td style="width: 10%;"></td> <td style="width: 10%;"></td> <td style="width: 10%;"></td> <td style="width: 10%;"></td> <td style="width: 10%;"></td> <td style="width: 10%;"></td> <td style="width: 10%;"></td> <td style="width: 10%;"></td> </tr> <tr> <td></td> <td></td> <td colspan="8" style="text-align: center;"> <table border="1" style="width: 100%; border-collapse: collapse; text-align: center;"> <tr> <td style="width: 10%;"></td> <td style="width: 10%;"></td> <td style="width: 10%;"></td> <td style="width: 10%;"></td> <td style="width: 10%;"></td> <td style="width: 10%;"></td> <td style="width: 10%;"></td> <td style="width: 10%;"></td> <td style="width: 10%;"></td> <td style="width: 10%;"></td> </tr> <tr> <td></td> <td></td> <td colspan="8" style="text-align: center;"> <table border="1" style="width: 100%; border-collapse: collapse; text-align: center;"> <tr> <td style="width: 10%;"></td> <td style="width: 10%;"></td> <td style="width: 10%;"></td> <td style="width: 10%;"></td> <td style="width: 10%;"></td> <td style="width: 10%;"></td> <td style="width: 10%;"></td> <td style="width: 10%;"></td> <td style="width: 10%;"></td> <td style="width: 10%;"></td> </tr> <tr> <td></td> <td></td> <td colspan="8" style="text-align: center;"> <table border="1" style="width: 100%; border-collapse: collapse; text-align: center;"> <tr> <td style="width: 10%;"></td> <td style="width: 10%;"></td> <td style="width: 10%;"></td> <td style="width: 10%;"></td> <td style="width: 10%;"></td> <td style="width: 10%;"></td> <td style="width: 10%;"></td> <td style="width: 10%;"></td> <td style="width: 10%;"></td> <td style="width: 10%;"></td> </tr> <tr> <td></td> <td></td> <td colspan="8" style="text-align: center;"> <table border="1" style="width: 100%; border-collapse: collapse; text-align: center;"> <tr> <td style="width: 10%;"></td> <td style="width: 10%;"></td> <td style="width: 10%;"></td> <td style="width: 10%;"></td> <td style="width: 10%;"></td> <td style="width: 10%;"></td> <td style="width: 10%;"></td> <td style="width: 10%;"></td> <td style="width: 10%;"></td> <td style="width: 10%;"></td> </tr> <tr> <td></td> <td></td> <td colspan="8" style="text-align: center;"> <table border="1" style="width: 100%; border-collapse: collapse; text-align: center;"> <tr> <td style="width: 10%;"></td> <td style="width: 10%;"></td> <td style="width: 10%;"></td> <td style="width: 10%;"></td> <td style="width: 10%;"></td> <td style="width: 10%;"></td> <td style="width: 10%;"></td> <td style="width: 10%;"></td> <td style="width: 10%;"></td> <td style="width: 10%;"></td> </tr> <tr> <td></td> <td></td> <td colspan="8" style="text-align: center;"> <table border="1" style="width: 100%; border-collapse: collapse; text-align: center;"> <tr> <td style="width: 10%;"></td> <td style="width: 10%;"></td> <td style="width: 10%;"></td> <td style="width: 10%;"></td> <td style="width: 10%;"></td> <td style="width: 10%;"></td> <td style="width: 10%;"></td> <td style="width: 10%;"></td> <td style="width: 10%;"></td> <td style="width: 10%;"></td> </tr> <tr> <td></td> <td></td> <td colspan="8" style="text-align: center;"> <table border="1" style="width: 100%; border-collapse: collapse; text-align: center;"> <tr> <td style="width: 10%;"></td> <td style="width: 10%;"></td> <td style="width: 10%;"></td> <td style="width: 10%;"></td> <td style="width: 10%;"></td> <td style="width: 10%;"></td> <td style="width: 10%;"></td> <td style="width: 10%;"></td> <td style="width: 10%;"></td> <td style="width: 10%;"></td> </tr> <tr> <td></td> <td></td> <td colspan="8" style="text-align: center;"> <table border="1" style="width: 100%; border-collapse: collapse; text-align: center;"> <tr> <td style="width: 10%;"></td> <td style="width: 10%;"></td> <td style="width: 10%;"></td> <td style="width: 10%;"></td> <td style="width: 10%;"></td> <td style="width: 10%;"></td> <td style="width: 10%;"></td> <td style="width: 10%;"></td> <td style="width: 10%;"></td> <td style="width: 10%;"></td> </tr> <tr> <td></td> <td></td> <td colspan="8" style="text-align: center;"> <table border="1" style="width: 100%; border-collapse: collapse; text-align: center;"> <tr> <td style="width: 10%;"></td> <td style="width: 10%;"></td> <td style="width: 10%;"></td> <td style="width: 10%;"></td> <td style="width: 10%;"></td> <td style="width: 10%;"></td> <td style="width: 10%;"></td> <td style="width: 10%;"></td> <td style="width: 10%;"></td> <td style="width: 10%;"></td> </tr> <tr> <td></td> <td></td> <td colspan="8" style="text-align: center;"> <table border="1" style="width: 100%; border-collapse: collapse; text-align: center;"> <tr> <td style="width: 10%;"></td> <td style="width: 10%;"></td> <td style="width: 10%;"></td> <td style="width: 10%;"></td> <td style="width: 10%;"></td> <td style="width: 10%;"></td> <td style="width: 10%;"></td> <td style="width: 10%;"></td> <td style="width: 10%;"></td> <td style="width: 10%;"></td> </tr> <tr> <td></td> <td></td> <td colspan="8" style="text-align: center;"> <table border="1" style="width: 100%; border-collapse: collapse; text-align: center;"> <tr> <td style="width: 10%;"></td> <td style="width: 10%;"></td> <td style="width: 10%;"></td> <td style="width: 10%;"></td> <td style="width: 10%;"></td> <td style="width: 10%;"></td> <td style="width: 10%;"></td> <td style="width: 10%;"></td> <td style="width: 10%;"></td> <td style="width: 10%;"></td> </tr> <tr> <td></td> <td></td> <td colspan="8" style="text-align: center;"> <table border="1" style="width: 100%; border-collapse: collapse; text-align: center;"> <tr> <td style="width: 10%;"></td> <td style="width: 10%;"></td> <td style="width: 10%;"></td> <td style="width: 10%;"></td> <td style="width: 10%;"></td> <td style="width: 10%;"></td> <td style="width: 10%;"></td> <td style="width: 10%;"></td> <td style="width: 10%;"></td> <td style="width: 10%;"></td> </tr> <tr> <td></td> <td></td> <td colspan="8" style="text-align: center;"> <table border="1" style="width: 100%; border-collapse: collapse; text-align: center;"> <tr> <td style="width: 10%;"></td> <td style="width: 10%;"></td> <td style="width: 10%;"></td> <td style="width: 10%;"></td> <td style="width: 10%;"></td> <td style="width: 10%;"></td> <td style="width: 10%;"></td> <td style="width: 10%;"></td> <td style="width: 10%;"></td> <td style="width: 10%;"></td> </tr> <tr> <td></td> <td></td> <td
colspan="8" style="text-align: center;"> <table border="1" style="width: 100%; border-collapse: collapse; text-align: center;"> <tr> <td style="width: 10%;"></td> <td style="width: 10%;"></td> <td style="width: 10%;"></td> <td style="width: 10%;"></td> <td style="width: 10%;"></td> <td style="width: 10%;"></td> <td style="width: 10%;"></td> <td style="width: 10%;"></td> <td style="width: 10%;"></td> <td style="width: 10%;"></td> </tr> <tr> <td></td> <td></td> <td colspan="8" style="text-align: center;"> <table border="1" style="width: 100%; border-collapse: collapse; text-align: center;"> <tr> <td style="width: 10%;"></td> <td style="width: 10%;"></td> <td style="width: 10%;"></td> <td style="width: 10%;"></td> <td style="width: 10%;"></td> <td style="width: 10%;"></td> <td style="width: 10%;"></td> <td style="width: 10%;"></td> <td style="width: 10%;"></td> <td style="width: 10%;"></td> </tr> <tr> <td></td> <td></td> <td colspan="8" style="text-align: center;"> <table border="1" style="width: 100%; border-collapse: collapse; text-align: center;"> <tr> <td style="width: 10%;"></td> <td style="width: 10%;"></td> <td style="width: 10%;"></td> <td style="width: 10%;"></td> <td style="width: 10%;"></td> <td style="width: 10%;"></td> <td style="width: 10%;"></td> <td style="width: 10%;"></td> <td style="width: 10%;"></td> <td style="width: 10%;"></td> </tr> <tr> <td></td> <td></td> <td colspan="8" style="text-align: center;"> <table border="1" style="width: 100%; border-collapse: collapse; text-align: center;"> <tr> <td style="width: 10%;"></td> <td style="width: 10%;"></td> <td style="width: 10%;"></td> <td style="width: 10%;"></td> <td style="width: 10%;"></td> <td style="width: 10%;"></td> <td style="width: 10%;"></td> <td style="width: 10%;"></td> <td style="width: 10%;"></td> <td style="width: 10%;"></td> </tr> <tr> <td></td> <td></td> <td colspan="8" style="text-align: center;"> <table border="1" style="width: 100%; border-collapse: collapse; text-align: center;"> <tr> </tr></table></td></tr></table></td></tr></table></td></tr></table></td></tr></table></td></tr></table></td></tr></table></td></tr></table></td></tr></table></td></tr></table></td></tr></table></td></tr></table></td></tr></table></td></tr></table></td></tr></table></td></tr></table></td></tr></table></td></tr></table></td></tr></table></td></tr></table></td></tr></table></td></tr></table></td></tr></table></td></tr></table></td></tr></table></td></tr></table></td></tr></table></td></tr></table></td></tr></table></td></tr></table></td></tr></table></td></tr></table></td></tr></table></td></tr></table></td></tr></table></td></tr></table></td></tr></table></td></tr></table></td></tr></table></td></tr></table></td></tr></table></td></tr></table></td></tr></table></td></tr></table></td></tr></table></td></tr></table></td></tr></table></td></tr></table></td></tr></table></td></tr></table> | | | | | | | | | | | | | | | | | | | | <table border="1" style="width: 100%; border-collapse: collapse; text-align: center;"> <tr> <td style="width: 10%;"></td> <td style="width: 10%;"></td> <td style="width: 10%;"></td> <td style="width: 10%;"></td> <td style="width: 10%;"></td> <td style="width: 10%;"></td> <td style="width: 10%;"></td> <td style="width: 10%;"></td> <td style="width: 10%;"></td> <td style="width: 10%;"></td> </tr> <tr> <td></td> <td></td> <td colspan="8" style="text-align: center;"> <table border="1" style="width: 100%; border-collapse: collapse; text-align: center;"> <tr> <td style="width: 10%;"></td> <td style="width: 10%;"></td> <td style="width: 10%;"></td> <td style="width: 10%;"></td> <td style="width: 10%;"></td> <td style="width: 10%;"></td> <td style="width: 10%;"></td> <td style="width: 10%;"></td> <td style="width: 10%;"></td> <td style="width: 10%;"></td> </tr> <tr> <td></td> <td></td> <td colspan="8" style="text-align: center;"> <table border="1" style="width: 100%; border-collapse: collapse; text-align: center;"> <tr> <td style="width: 10%;"></td> <td style="width: 10%;"></td> <td style="width: 10%;"></td> <td style="width: 10%;"></td> <td style="width: 10%;"></td> <td style="width: 10%;"></td> <td style="width: 10%;"></td> <td style="width: 10%;"></td> <td style="width: 10%;"></td> <td style="width: 10%;"></td> </tr> <tr> <td></td> <td></td> <td colspan="8" style="text-align: center;"> <table border="1" style="width: 100%; border-collapse: collapse; text-align: center;"> <tr> <td style="width: 10%;"></td> <td style="width: 10%;"></td> <td style="width: 10%;"></td> <td style="width: 10%;"></td> <td style="width: 10%;"></td> <td style="width: 10%;"></td> <td style="width: 10%;"></td> <td style="width: 10%;"></td> <td style="width: 10%;"></td> <td style="width: 10%;"></td> </tr> <tr> <td></td> <td></td> <td colspan="8" style="text-align: center;"> <table border="1" style="width: 100%; border-collapse: collapse; text-align: center;"> <tr> <td style="width: 10%;"></td> <td style="width: 10%;"></td> <td style="width: 10%;"></td> <td style="width: 10%;"></td> <td style="width: 10%;"></td> <td style="width: 10%;"></td> <td style="width: 10%;"></td> <td style="width: 10%;"></td> <td style="width: 10%;"></td> <td style="width: 10%;"></td> </tr> <tr> <td></td> <td></td> <td colspan="8" style="text-align: center;"> <table border="1" style="width: 100%; border-collapse: collapse; text-align: center;"> <tr> <td style="width: 10%;"></td> <td style="width: 10%;"></td> <td style="width: 10%;"></td> <td style="width: 10%;"></td> <td style="width: 10%;"></td> <td style="width: 10%;"></td> <td style="width: 10%;"></td> <td style="width: 10%;"></td> <td style="width: 10%;"></td> <td style="width: 10%;"></td> </tr> <tr> <td></td> <td></td> <td colspan="8" style="text-align: center;"> <table border="1" style="width: 100%; border-collapse: collapse; text-align: center;"> <tr> <td style="width: 10%;"></td> <td style="width: 10%;"></td> <td style="width: 10%;"></td> <td style="width: 10%;"></td> <td style="width: 10%;"></td> <td style="width: 10%;"></td> <td style="width: 10%;"></td> <td style="width: 10%;"></td> <td style="width: 10%;"></td> <td style="width: 10%;"></td> </tr> <tr> <td></td> <td></td> <td colspan="8" style="text-align: center;"> <table border="1" style="width: 100%; border-collapse: collapse; text-align: center;"> <tr> <td style="width: 10%;"></td> <td style="width: 10%;"></td> <td style="width: 10%;"></td> <td style="width: 10%;"></td> <td style="width: 10%;"></td> <td style="width: 10%;"></td> <td style="width: 10%;"></td> <td style="width: 10%;"></td> <td style="width: 10%;"></td> <td style="width: 10%;"></td> </tr> <tr> <td></td> <td></td> <td colspan="8" style="text-align: center;"> <table border="1" style="width: 100%; border-collapse: collapse; text-align: center;"> <tr> <td style="width: 10%;"></td> <td style="width: 10%;"></td> <td style="width: 10%;"></td> <td style="width: 10%;"></td> <td style="width: 10%;"></td> <td style="width: 10%;"></td> <td style="width: 10%;"></td> <td style="width: 10%;"></td> <td style="width: 10%;"></td> <td style="width: 10%;"></td> </tr> <tr> <td></td> <td></td> <td colspan="8" style="text-align: center;"> <table border="1" style="width: 100%; border-collapse: collapse; text-align: center;"> <tr> <td style="width: 10%;"></td> <td style="width: 10%;"></td> <td style="width: 10%;"></td> <td style="width: 10%;"></td> <td style="width: 10%;"></td> <td style="width: 10%;"></td> <td style="width: 10%;"></td> <td style="width: 10%;"></td> <td style="width: 10%;"></td> <td style="width: 10%;"></td> </tr> <tr> <td></td> <td></td> <td colspan="8" style="text-align: center;"> <table border="1" style="width: 100%; border-collapse: collapse; text-align: center;"> <tr> <td style="width: 10%;"></td> <td style="width: 10%;"></td> <td style="width: 10%;"></td> <td style="width: 10%;"></td> <td style="width: 10%;"></td> <td style="width: 10%;"></td> <td style="width: 10%;"></td> <td style="width: 10%;"></td> <td style="width: 10%;"></td> <td style="width: 10%;"></td> </tr> <tr> <td></td> <td></td> <td colspan="8" style="text-align: center;"> <table border="1" style="width: 100%; border-collapse: collapse; text-align: center;"> <tr> <td style="width: 10%;"></td> <td style="width: 10%;"></td> <td style="width: 10%;"></td> <td style="width: 10%;"></td> <td style="width: 10%;"></td> <td style="width: 10%;"></td> <td style="width: 10%;"></td> <td style="width: 10%;"></td> <td style="width: 10%;"></td> <td style="width: 10%;"></td> </tr> <tr> <td></td> <td></td> <td colspan="8" style="text-align: center;"> <table border="1" style="width: 100%; border-collapse: collapse; text-align: center;"> <tr> <td style="width: 10%;"></td> <td style="width: 10%;"></td> <td style="width: 10%;"></td> <td style="width: 10%;"></td> <td style="width: 10%;"></td> <td style="width: 10%;"></td> <td style="width: 10%;"></td> <td style="width: 10%;"></td> <td style="width: 10%;"></td> <td style="width: 10%;"></td> </tr> <tr> <td></td> <td></td> <td colspan="8" style="text-align: center;"> <table border="1" style="width: 100%; border-collapse: collapse; text-align: center;"> <tr> <td style="width: 10%;"></td> <td style="width: 10%;"></td> <td style="width: 10%;"></td> <td style="width: 10%;"></td> <td style="width: 10%;"></td> <td style="width: 10%;"></td> <td style="width: 10%;"></td> <td style="width: 10%;"></td> <td style="width: 10%;"></td> <td style="width: 10%;"></td> </tr> <tr> <td></td> <td></td> <td colspan="8" style="text-align: center;"> <table border="1" style="width: 100%; border-collapse: collapse; text-align: center;"> <tr> <td style="width: 10%;"></td> <td style="width: 10%;"></td> <td style="width: 10%;"></td> <td style="width: 10%;"></td> <td style="width: 10%;"></td> <td style="width: 10%;"></td> <td style="width: 10%;"></td> <td style="width: 10%;"></td> <td style="width: 10%;"></td> <td style="width: 10%;"></td> </tr> <tr> <td></td> <td></td> <td colspan="8" style="text-align: center;"> <table border="1"
style="width: 100%; border-collapse: collapse; text-align: center;"> <tr> <td style="width: 10%;"></td> <td style="width: 10%;"></td> <td style="width: 10%;"></td> <td style="width: 10%;"></td> <td style="width: 10%;"></td> <td style="width: 10%;"></td> <td style="width: 10%;"></td> <td style="width: 10%;"></td> <td style="width: 10%;"></td> <td style="width: 10%;"></td> </tr> <tr> <td></td> <td></td> <td colspan="8" style="text-align: center;"> <table border="1" style="width: 100%; border-collapse: collapse; text-align: center;"> <tr> <td style="width: 10%;"></td> <td style="width: 10%;"></td> <td style="width: 10%;"></td> <td style="width: 10%;"></td> <td style="width: 10%;"></td> <td style="width: 10%;"></td> <td style="width: 10%;"></td> <td style="width: 10%;"></td> <td style="width: 10%;"></td> <td style="width: 10%;"></td> </tr> <tr> <td></td> <td></td> <td colspan="8" style="text-align: center;"> <table border="1" style="width: 100%; border-collapse: collapse; text-align: center;"> <tr> <td style="width: 10%;"></td> <td style="width: 10%;"></td> <td style="width: 10%;"></td> <td style="width: 10%;"></td> <td style="width: 10%;"></td> <td style="width: 10%;"></td> <td style="width: 10%;"></td> <td style="width: 10%;"></td> <td style="width: 10%;"></td> <td style="width: 10%;"></td> </tr> <tr> <td></td> <td></td> <td colspan="8" style="text-align: center;"> <table border="1" style="width: 100%; border-collapse: collapse; text-align: center;"> <tr> <td style="width: 10%;"></td> <td style="width: 10%;"></td> <td style="width: 10%;"></td> <td style="width: 10%;"></td> <td style="width: 10%;"></td> <td style="width: 10%;"></td> <td style="width: 10%;"></td> <td style="width: 10%;"></td> <td style="width: 10%;"></td> <td style="width: 10%;"></td> </tr> <tr> <td></td> <td></td> <td colspan="8" style="text-align: center;"> <table border="1" style="width: 100%; border-collapse: collapse; text-align: center;"> <tr> <td style="width: 10%;"></td> <td style="width: 10%;"></td> <td style="width: 10%;"></td> <td style="width: 10%;"></td> <td style="width: 10%;"></td> <td style="width: 10%;"></td> <td style="width: 10%;"></td> <td style="width: 10%;"></td> <td style="width: 10%;"></td> <td style="width: 10%;"></td> </tr> <tr> <td></td> <td></td> <td colspan="8" style="text-align: center;"> <table border="1" style="width: 100%; border-collapse: collapse; text-align: center;"> <tr> <td style="width: 10%;"></td> <td style="width: 10%;"></td> <td style="width: 10%;"></td> <td style="width: 10%;"></td> <td style="width: 10%;"></td> <td style="width: 10%;"></td> <td style="width: 10%;"></td> <td style="width: 10%;"></td> <td style="width: 10%;"></td> <td style="width: 10%;"></td> </tr> <tr> <td></td> <td></td> <td colspan="8" style="text-align: center;"> <table border="1" style="width: 100%; border-collapse: collapse; text-align: center;"> <tr> <td style="width: 10%;"></td> <td style="width: 10%;"></td> <td style="width: 10%;"></td> <td style="width: 10%;"></td> <td style="width: 10%;"></td> <td style="width: 10%;"></td> <td style="width: 10%;"></td> <td style="width: 10%;"></td> <td style="width: 10%;"></td> <td style="width: 10%;"></td> </tr> <tr> <td></td> <td></td> <td colspan="8" style="text-align: center;"> <table border="1" style="width: 100%; border-collapse: collapse; text-align: center;"> <tr> <td style="width: 10%;"></td> <td style="width: 10%;"></td> <td style="width: 10%;"></td> <td style="width: 10%;"></td> <td style="width: 10%;"></td> <td style="width: 10%;"></td> <td style="width: 10%;"></td> <td style="width: 10%;"></td> <td style="width: 10%;"></td> <td style="width: 10%;"></td> </tr> <tr> <td></td> <td></td> <td colspan="8" style="text-align: center;"> <table border="1" style="width: 100%; border-collapse: collapse; text-align: center;"> <tr> <td style="width: 10%;"></td> <td style="width: 10%;"></td> <td style="width: 10%;"></td> <td style="width: 10%;"></td> <td style="width: 10%;"></td> <td style="width: 10%;"></td> <td style="width: 10%;"></td> <td style="width: 10%;"></td> <td style="width: 10%;"></td> <td style="width: 10%;"></td> </tr> <tr> <td></td> <td></td> <td colspan="8" style="text-align: center;"> <table border="1" style="width: 100%; border-collapse: collapse; text-align: center;"> <tr> <td style="width: 10%;"></td> <td style="width: 10%;"></td> <td style="width: 10%;"></td> <td style="width: 10%;"></td> <td style="width: 10%;"></td> <td style="width: 10%;"></td> <td style="width: 10%;"></td> <td style="width: 10%;"></td> <td style="width: 10%;"></td> <td style="width: 10%;"></td> </tr> <tr> <td></td> <td></td> <td colspan="8" style="text-align: center;"> <table border="1" style="width: 100%; border-collapse: collapse; text-align: center;"> <tr> <td style="width: 10%;"></td> <td style="width: 10%;"></td> <td style="width: 10%;"></td> <td style="width: 10%;"></td> <td style="width: 10%;"></td> <td style="width: 10%;"></td> <td style="width: 10%;"></td> <td style="width: 10%;"></td> <td style="width: 10%;"></td> <td style="width: 10%;"></td> </tr> <tr> <td></td> <td></td> <td colspan="8" style="text-align: center;"> <table border="1" style="width: 100%; border-collapse: collapse; text-align: center;"> <tr> <td style="width: 10%;"></td> <td style="width: 10%;"></td> <td style="width: 10%;"></td> <td style="width: 10%;"></td> <td style="width: 10%;"></td> <td style="width: 10%;"></td> <td style="width: 10%;"></td> <td style="width: 10%;"></td> <td style="width: 10%;"></td> <td style="width: 10%;"></td> </tr> <tr> <td></td> <td></td> <td colspan="8" style="text-align: center;"> <table border="1" style="width: 100%; border-collapse: collapse; text-align: center;"> <tr> <td style="width: 10%;"></td> <td style="width: 10%;"></td> <td style="width: 10%;"></td> <td style="width: 10%;"></td> <td style="width: 10%;"></td> <td style="width: 10%;"></td> <td style="width: 10%;"></td> <td style="width: 10%;"></td> <td style="width: 10%;"></td> <td style="width: 10%;"></td> </tr> <tr> <td></td> <td></td> <td colspan="8" style="text-align: center;"> <table border="1" style="width: 100%; border-collapse: collapse; text-align: center;"> <tr> <td style="width: 10%;"></td> <td style="width: 10%;"></td> <td style="width: 10%;"></td> <td style="width: 10%;"></td> <td style="width: 10%;"></td> <td style="width: 10%;"></td> <td style="width: 10%;"></td> <td style="width: 10%;"></td> <td style="width: 10%;"></td> <td style="width: 10%;"></td> </tr> <tr> <td></td> <td></td> <td colspan="8" style="text-align: center;"> <table border="1" style="width: 100%; border-collapse: collapse; text-align: center;"> <tr> <td style="width: 10%;"></td> <td style="width: 10%;"></td> <td style="width: 10%;"></td> <td style="width: 10%;"></td> <td style="width: 10%;"></td> <td style="width: 10%;"></td> <td style="width: 10%;"></td> <td style="width: 10%;"></td> <td style="width: 10%;"></td> <td style="width: 10%;"></td> </tr> <tr> <td></td> <td></td> <td colspan="8" style="text-align: center;"> <table border="1" style="width: 100%; border-collapse: collapse; text-align: center;"> <tr> <td style="width: 10%;"></td> <td style="width: 10%;"></td> <td style="width: 10%;"></td> <td style="width: 10%;"></td> <td style="width: 10%;"></td> <td style="width: 10%;"></td> <td style="width: 10%;"></td> <td style="width: 10%;"></td> <td style="width: 10%;"></td> <td style="width: 10%;"></td> </tr> <tr> <td></td> <td></td> <td colspan="8" style="text-align: center;"> <table border="1" style="width: 100%; border-collapse: collapse; text-align: center;"> <tr> <td style="width: 10%;"></td> <td style="width: 10%;"></td> <td style="width: 10%;"></td> <td style="width: 10%;"></td> <td style="width: 10%;"></td> <td style="width: 10%;"></td> <td style="width: 10%;"></td> <td style="width: 10%;"></td> <td style="width: 10%;"></td> <td style="width: 10%;"></td> </tr> <tr> <td></td> <td></td> <td colspan="8" style="text-align: center;"> <table border="1" style="width: 100%; border-collapse: collapse; text-align: center;"> <tr> <td style="width: 10%;"></td> <td style="width: 10%;"></td> <td style="width: 10%;"></td> <td style="width: 10%;"></td> <td style="width: 10%;"></td> <td style="width: 10%;"></td> <td style="width: 10%;"></td> <td style="width: 10%;"></td> <td style="width: 10%;"></td> <td style="width: 10%;"></td> </tr> <tr> <td></td> <td></td> <td colspan="8" style="text-align: center;"> <table border="1" style="width: 100%; border-collapse: collapse; text-align: center;"> <tr> <td style="width: 10%;"></td> <td style="width: 10%;"></td> <td style="width: 10%;"></td> <td style="width: 10%;"></td> <td style="width: 10%;"></td> <td style="width: 10%;"></td> <td style="width: 10%;"></td> <td style="width: 10%;"></td> <td style="width: 10%;"></td> <td style="width: 10%;"></td> </tr> <tr> <td></td> <td></td> <td colspan="8" style="text-align: center;"> <table border="1" style="width: 100%; border-collapse: collapse; text-align: center;"> <tr> <td style="width: 10%;"></td> <td style="width: 10%;"></td> <td style="width: 10%;"></td> <td style="width: 10%;"></td> <td style="width: 10%;"></td> <td style="width: 10%;"></td> <td style="width: 10%;"></td> <td style="width: 10%;"></td> <td style="width: 10%;"></td> <td style="width: 10%;"></td> </tr> <tr> <td></td> <td></td> <td colspan="8" style="text-align: center;"> <table border="1" style="width: 100%; border-collapse: collapse; text-align: center;"> <tr> <td style="width: 10%;"></td> <td style="width: 10%;"></td> <td style="width: 10%;"></td> <td style="width: 10%;"></td> <td style="width: 10%;"></td> <td style="width: 10%;"></td> <td style="width: 10%;"></td> <td style="width: 10%;"></td> <td style="width: 10%;"></td> <td style="width: 10%;"></td> </tr> <tr> <td></td> <td></td> <td colspan="8" style="text-align: center;"> <table border="1" style="width: 100%; border-collapse: collapse; text-align: center;"> <tr> <td style="width: 10%;"></td> <td style="width: 10%;"></td> <td style="width: 10%;"></td> <td
style="width: 10%;"></td> <td style="width: 10%;"></td> <td style="width: 10%;"></td> <td style="width: 10%;"></td> <td style="width: 10%;"></td> <td style="width: 10%;"></td> <td style="width: 10%;"></td> </tr> <tr> <td></td> <td></td> <td colspan="8" style="text-align: center;"> <table border="1" style="width: 100%; border-collapse: collapse; text-align: center;"> <tr> <td style="width: 10%;"></td> <td style="width: 10%;"></td> <td style="width: 10%;"></td> <td style="width: 10%;"></td> <td style="width: 10%;"></td> <td style="width: 10%;"></td> <td style="width: 10%;"></td> <td style="width: 10%;"></td> <td style="width: 10%;"></td> <td style="width: 10%;"></td> </tr> <tr> <td></td> <td></td> <td colspan="8" style="text-align: center;"> <table border="1" style="width: 100%; border-collapse: collapse; text-align: center;"> <tr> <td style="width: 10%;"></td> <td style="width: 10%;"></td> <td style="width: 10%;"></td> <td style="width: 10%;"></td> <td style="width: 10%;"></td> <td style="width: 10%;"></td> <td style="width: 10%;"></td> <td style="width: 10%;"></td> <td style="width: 10%;"></td> <td style="width: 10%;"></td> </tr> <tr> <td></td> <td></td> <td colspan="8" style="text-align: center;"> <table border="1" style="width: 100%; border-collapse: collapse; text-align: center;"> <tr> <td style="width: 10%;"></td> <td style="width: 10%;"></td> <td style="width: 10%;"></td> <td style="width: 10%;"></td> <td style="width: 10%;"></td> <td style="width: 10%;"></td> <td style="width: 10%;"></td> <td style="width: 10%;"></td> <td style="width: 10%;"></td> <td style="width: 10%;"></td> </tr> <tr> <td></td> <td></td> <td colspan="8" style="text-align: center;"> <table border="1" style="width: 100%; border-collapse: collapse; text-align: center;"> <tr> <td style="width: 10%;"></td> <td style="width: 10%;"></td> <td style="width: 10%;"></td> <td style="width: 10%;"></td> <td style="width: 10%;"></td> <td style="width: 10%;"></td> <td style="width: 10%;"></td> <td style="width: 10%;"></td> <td style="width: 10%;"></td> <td style="width: 10%;"></td> </tr> <tr> <td></td> <td></td> <td colspan="8" style="text-align: center;"> <table border="1" style="width: 100%; border-collapse: collapse; text-align: center;"> <tr> <td style="width: 10%;"></td> <td style="width: 10%;"></td> <td style="width: 10%;"></td> <td style="width: 10%;"></td> <td style="width: 10%;"></td> <td style="width: 10%;"></td> <td style="width: 10%;"></td> <td style="width: 10%;"></td> <td style="width: 10%;"></td> <td style="width: 10%;"></td> </tr> <tr> <td></td> <td></td> <td colspan="8" style="text-align: center;"> <table border="1" style="width: 100%; border-collapse: collapse; text-align: center;"> <tr> <td style="width: 10%;"></td> <td style="width: 10%;"></td> <td style="width: 10%;"></td> <td style="width: 10%;"></td> <td style="width: 10%;"></td> <td style="width: 10%;"></td> <td style="width: 10%;"></td> <td style="width: 10%;"></td> <td style="width: 10%;"></td> <td style="width: 10%;"></td> </tr> <tr> <td></td> <td></td> <td colspan="8" style="text-align: center;"> <table border="1" style="width: 100%; border-collapse: collapse; text-align: center;"> <tr> <td style="width: 10%;"></td> <td style="width: 10%;"></td> <td style="width: 10%;"></td> <td style="width: 10%;"></td> <td style="width: 10%;"></td> <td style="width: 10%;"></td> <td style="width: 10%;"></td> <td style="width: 10%;"></td> <td style="width: 10%;"></td> <td style="width: 10%;"></td> </tr> <tr> <td></td> <td></td> <td colspan="8" style="text-align: center;"> <table border="1" style="width: 100%; border-collapse: collapse; text-align: center;"> <tr> <td style="width: 10%;"></td> <td style="width: 10%;"></td> <td style="width: 10%;"></td> <td style="width: 10%;"></td> <td style="width: 10%;"></td> <td style="width: 10%;"></td> <td style="width: 10%;"></td> <td style="width: 10%;"></td> <td style="width: 10%;"></td> <td style="width: 10%;"></td> </tr> <tr> <td></td> <td></td> <td colspan="8" style="text-align: center;"> <table border="1" style="width: 100%; border-collapse: collapse; text-align: center;"> <tr> <td style="width: 10%;"></td> <td style="width: 10%;"></td> <td style="width: 10%;"></td> <td style="width: 10%;"></td> <td style="width: 10%;"></td> <td style="width: 10%;"></td> <td style="width: 10%;"></td> <td style="width: 10%;"></td> <td style="width: 10%;"></td> <td style="width: 10%;"></td> </tr> <tr> <td></td> <td></td> <td colspan="8" style="text-align: center;"> <table border="1" style="width: 100%; border-collapse: collapse; text-align: center;"> <tr> <td style="width: 10%;"></td> <td style="width: 10%;"></td> <td style="width: 10%;"></td> <td style="width: 10%;"></td> <td style="width: 10%;"></td> <td style="width: 10%;"></td> <td style="width: 10%;"></td> <td style="width: 10%;"></td> <td style="width: 10%;"></td> <td style="width: 10%;"></td> </tr> <tr> <td></td> <td></td> <td colspan="8" style="text-align: center;"> <table border="1" style="width: 100%; border-collapse: collapse; text-align: center;"> <tr> <td style="width: 10%;"></td> <td style="width: 10%;"></td> <td style="width: 10%;"></td> <td style="width: 10%;"></td> <td style="width: 10%;"></td> <td style="width: 10%;"></td> <td style="width: 10%;"></td> <td style="width: 10%;"></td> <td style="width: 10%;"></td> <td style="width: 10%;"></td> </tr> <tr> <td></td> <td></td> <td colspan="8" style="text-align: center;"> <table border="1" style="width: 100%; border-collapse: collapse; text-align: center;"> <tr> </tr></table></td></tr></table></td></tr></table></td></tr></table></td></tr></table></td></tr></table></td></tr></table></td></tr></table></td></tr></table></td></tr></table></td></tr></table></td></tr></table></td></tr></table></td></tr></table></td></tr></table></td></tr></table></td></tr></table></td></tr></table></td></tr></table></td></tr></table></td></tr></table></td></tr></table></td></tr></table></td></tr></table></td></tr></table></td></tr></table></td></tr></table></td></tr></table></td></tr></table></td></tr></table></td></tr></table></td></tr></table></td></tr></table></td></tr></table></td></tr></table></td></tr></table></td></tr></table></td></tr></table></td></tr></table></td></tr></table></td></tr></table></td></tr></table></td></tr></table></td></tr></table></td></tr></table></td></tr></table></td></tr></table></td></tr></table></td></tr></table> | | | | | | | | | | | | | | | | | | | | <table border="1" style="width: 100%; border-collapse: collapse; text-align: center;"> <tr> <td style="width: 10%;"></td> <td style="width: 10%;"></td> <td style="width: 10%;"></td> <td style="width: 10%;"></td> <td style="width: 10%;"></td> <td style="width: 10%;"></td> <td style="width: 10%;"></td> <td style="width: 10%;"></td> <td style="width: 10%;"></td> <td style="width: 10%;"></td> </tr> <tr> <td></td> <td></td> <td colspan="8" style="text-align: center;"> <table border="1" style="width: 100%; border-collapse: collapse; text-align: center;"> <tr> <td style="width: 10%;"></td> <td style="width: 10%;"></td> <td style="width: 10%;"></td> <td style="width: 10%;"></td> <td style="width: 10%;"></td> <td style="width: 10%;"></td> <td style="width: 10%;"></td> <td style="width: 10%;"></td> <td style="width: 10%;"></td> <td style="width: 10%;"></td> </tr> <tr> <td></td> <td></td> <td colspan="8" style="text-align: center;"> <table border="1" style="width: 100%; border-collapse: collapse; text-align: center;"> <tr> <td style="width: 10%;"></td> <td style="width: 10%;"></td> <td style="width: 10%;"></td> <td style="width: 10%;"></td> <td style="width: 10%;"></td> <td style="width: 10%;"></td> <td style="width: 10%;"></td> <td style="width: 10%;"></td> <td style="width: 10%;"></td> <td style="width: 10%;"></td> </tr> <tr> <td></td> <td></td> <td colspan="8" style="text-align: center;"> <table border="1" style="width: 100%; border-collapse: collapse; text-align: center;"> <tr> <td style="width: 10%;"></td> <td style="width: 10%;"></td> <td style="width: 10%;"></td> <td style="width: 10%;"></td> <td style="width: 10%;"></td> <td style="width: 10%;"></td> <td style="width: 10%;"></td> <td style="width: 10%;"></td> <td style="width: 10%;"></td> <td style="width: 10%;"></td> </tr> <tr> <td></td> <td></td> <td colspan="8" style="text-align: center;"> <table border="1" style="width: 100%; border-collapse: collapse; text-align: center;"> <tr> <td style="width: 10%;"></td> <td style="width: 10%;"></td> <td style="width: 10%;"></td> <td style="width: 10%;"></td> <td style="width: 10%;"></td> <td style="width: 10%;"></td> <td style="width: 10%;"></td> <td style="width: 10%;"></td> <td style="width: 10%;"></td> <td style="width: 10%;"></td> </tr> <tr> <td></td> <td></td> <td colspan="8" style="text-align: center;"> <table border="1" style="width: 100%; border-collapse: collapse; text-align: center;"> <tr> <td style="width: 10%;"></td> <td style="width: 10%;"></td> <td style="width: 10%;"></td> <td style="width: 10%;"></td> <td style="width: 10%;"></td> <td style="width: 10%;"></td> <td style="width: 10%;"></td> <td style="width: 10%;"></td> <td style="width: 10%;"></td> <td style="width: 10%;"></td> </tr> <tr> <td></td> <td></td> <td colspan="8" style="text-align: center;"> <table border="1" style="width: 100%; border-collapse: collapse; text-align: center;"> <tr> <td style="width: 10%;"></td> <td style="width: 10%;"></td> <td style="width: 10%;"></td> <td style="width: 10%;"></td> <td style="width: 10%;"></td> <td style="width: 10%;"></td> <td style="width: 10%;"></td> <td style="width: 10%;"></td> <td style="width: 10%;"></td> <td style="width: 10%;"></td> </tr> <tr> <td></td> <td></td> <td colspan="8" style="text-align: center;"> <table border="1" style="width: 100%; border-collapse: collapse; text-align: center;"> <tr> <td style="width: 10%;"></td> <td style="width: 10%;"></td> <td style="width: 10%;"></td> <td style="width: 10%;"></td> <td style="width: 10%;"></td> <td style="width:
10%;"></td> <td style="width: 10%;"></td> <td style="width: 10%;"></td> <td style="width: 10%;"></td> <td style="width: 10%;"></td> </tr> <tr> <td></td> <td></td> <td colspan="8" style="text-align: center;"> <table border="1" style="width: 100%; border-collapse: collapse; text-align: center;"> <tr> <td style="width: 10%;"></td> <td style="width: 10%;"></td> <td style="width: 10%;"></td> <td style="width: 10%;"></td> <td style="width: 10%;"></td> <td style="width: 10%;"></td> <td style="width: 10%;"></td> <td style="width: 10%;"></td> <td style="width: 10%;"></td> <td style="width: 10%;"></td> </tr> <tr> <td></td> <td></td> <td colspan="8" style="text-align: center;"> <table border="1" style="width: 100%; border-collapse: collapse; text-align: center;"> <tr> <td style="width: 10%;"></td> <td style="width: 10%;"></td> <td style="width: 10%;"></td> <td style="width: 10%;"></td> <td style="width: 10%;"></td> <td style="width: 10%;"></td> <td style="width: 10%;"></td> <td style="width: 10%;"></td> <td style="width: 10%;"></td> <td style="width: 10%;"></td> </tr> <tr> <td></td> <td></td> <td colspan="8" style="text-align: center;"> <table border="1" style="width: 100%; border-collapse: collapse; text-align: center;"> <tr> <td style="width: 10%;"></td> <td style="width: 10%;"></td> <td style="width: 10%;"></td> <td style="width: 10%;"></td> <td style="width: 10%;"></td> <td style="width: 10%;"></td> <td style="width: 10%;"></td> <td style="width: 10%;"></td> <td style="width: 10%;"></td> <td style="width: 10%;"></td> </tr> <tr> <td></td> <td></td> <td colspan="8" style="text-align: center;"> <table border="1" style="width: 100%; border-collapse: collapse; text-align: center;"> <tr> <td style="width: 10%;"></td> <td style="width: 10%;"></td> <td style="width: 10%;"></td> <td style="width: 10%;"></td> <td style="width: 10%;"></td> <td style="width: 10%;"></td> <td style="width: 10%;"></td> <td style="width: 10%;"></td> <td style="width: 10%;"></td> <td style="width: 10%;"></td> </tr> <tr> <td></td> <td></td> <td colspan="8" style="text-align: center;"> <table border="1" style="width: 100%; border-collapse: collapse; text-align: center;"> <tr> <td style="width: 10%;"></td> <td style="width: 10%;"></td> <td style="width: 10%;"></td> <td style="width: 10%;"></td> <td style="width: 10%;"></td> <td style="width: 10%;"></td> <td style="width: 10%;"></td> <td style="width: 10%;"></td> <td style="width: 10%;"></td> <td style="width: 10%;"></td> </tr> <tr> <td></td> <td></td> <td colspan="8" style="text-align: center;"> <table border="1" style="width: 100%; border-collapse: collapse; text-align: center;"> <tr> <td style="width: 10%;"></td> <td style="width: 10%;"></td> <td style="width: 10%;"></td> <td style="width: 10%;"></td> <td style="width: 10%;"></td> <td style="width: 10%;"></td> <td style="width: 10%;"></td> <td style="width: 10%;"></td> <td style="width: 10%;"></td> <td style="width: 10%;"></td> </tr> <tr> <td></td> <td></td> <td colspan="8" style="text-align: center;"> <table border="1" style="width: 100%; border-collapse: collapse; text-align: center;"> <tr> <td style="width: 10%;"></td> <td style="width: 10%;"></td> <td style="width: 10%;"></td> <td style="width: 10%;"></td> <td style="width: 10%;"></td> <td style="width: 10%;"></td> <td style="width: 10%;"></td> <td style="width: 10%;"></td> <td style="width: 10%;"></td> <td style="width: 10%;"></td> </tr> <tr> <td></td> <td></td> <td colspan="8" style="text-align: center;"> <table border="1" style="width: 100%; border-collapse: collapse; text-align: center;"> <tr> <td style="width: 10%;"></td> <td style="width: 10%;"></td> <td style="width: 10%;"></td> <td style="width: 10%;"></td> <td style="width: 10%;"></td> <td style="width: 10%;"></td> <td style="width: 10%;"></td> <td style="width: 10%;"></td> <td style="width: 10%;"></td> <td style="width: 10%;"></td> </tr> <tr> <td></td> <td></td> <td colspan="8" style="text-align: center;"> <table border="1" style="width: 100%; border-collapse: collapse; text-align: center;"> <tr> <td style="width: 10%;"></td> <td style="width: 10%;"></td> <td style="width: 10%;"></td> <td style="width: 10%;"></td> <td style="width: 10%;"></td> <td style="width: 10%;"></td> <td style="width: 10%;"></td> <td style="width: 10%;"></td> <td style="width: 10%;"></td> <td style="width: 10%;"></td> </tr> <tr> <td></td> <td></td> <td colspan="8" style="text-align: center;"> <table border="1" style="width: 100%; border-collapse: collapse; text-align: center;"> <tr> <td style="width: 10%;"></td> <td style="width: 10%;"></td> <td style="width: 10%;"></td> <td style="width: 10%;"></td> <td style="width: 10%;"></td> <td style="width: 10%;"></td> <td style="width: 10%;"></td> <td style="width: 10%;"></td> <td style="width: 10%;"></td> <td style="width: 10%;"></td> </tr> <tr> <td></td> <td></td> <td colspan="8" style="text-align: center;"> <table border="1" style="width: 100%; border-collapse: collapse; text-align: center;"> <tr> <td style="width: 10%;"></td> <td style="width: 10%;"></td> <td style="width: 10%;"></td> <td style="width: 10%;"></td> <td style="width: 10%;"></td> <td style="width: 10%;"></td> <td style="width: 10%;"></td> <td style="width: 10%;"></td> <td style="width: 10%;"></td> <td style="width: 10%;"></td> </tr> <tr> <td></td> <td></td> <td colspan="8" style="text-align: center;"> <table border="1" style="width: 100%; border-collapse: collapse; text-align: center;"> <tr> <td style="width: 10%;"></td> <td style="width: 10%;"></td> <td style="width: 10%;"></td> <td style="width: 10%;"></td> <td style="width: 10%;"></td> <td style="width: 10%;"></td> <td style="width: 10%;"></td> <td style="width: 10%;"></td> <td style="width: 10%;"></td> <td style="width: 10%;"></td> </tr> <tr> <td></td> <td></td> <td colspan="8" style="text-align: center;"> <table border="1" style="width: 100%; border-collapse: collapse; text-align: center;"> <tr> <td style="width: 10%;"></td> <td style="width: 10%;"></td> <td style="width: 10%;"></td> <td style="width: 10%;"></td> <td style="width: 10%;"></td> <td style="width: 10%;"></td> <td style="width: 10%;"></td> <td style="width: 10%;"></td> <td style="width: 10%;"></td> <td style="width: 10%;"></td> </tr> <tr> <td></td> <td></td> <td colspan="8" style="text-align: center;"> <table border="1" style="width: 100%; border-collapse: collapse; text-align: center;"> <tr> <td style="width: 10%;"></td> <td style="width: 10%;"></td> <td style="width: 10%;"></td> <td style="width: 10%;"></td> <td style="width: 10%;"></td> <td style="width: 10%;"></td> <td style="width: 10%;"></td> <td style="width: 10%;"></td> <td style="width: 10%;"></td> <td style="width: 10%;"></td> </tr> <tr> <td></td> <td></td> <td colspan="8" style="text-align: center;"> <table border="1" style="width: 100%; border-collapse: collapse; text-align: center;"> <tr> <td style="width: 10%;"></td> <td style="width: 10%;"></td> <td style="width: 10%;"></td> <td style="width: 10%;"></td> <td style="width: 10%;"></td> <td style="width: 10%;"></td> <td style="width: 10%;"></td> <td style="width: 10%;"></td> <td style="width: 10%;"></td> <td style="width: 10%;"></td> </tr> <tr> <td></td> <td></td> <td colspan="8" style="text-align: center;"> <table border="1" style="width: 100%; border-collapse: collapse; text-align: center;"> <tr> <td style="width: 10%;"></td> <td style="width: 10%;"></td> <td style="width: 10%;"></td> <td style="width: 10%;"></td> <td style="width: 10%;"></td> <td style="width: 10%;"></td> <td style="width: 10%;"></td> <td style="width: 10%;"></td> <td style="width: 10%;"></td> <td style="width: 10%;"></td> </tr> <tr> <td></td> <td></td> <td colspan="8" style="text-align: center;"> <table border="1" style="width: 100%; border-collapse: collapse; text-align: center;"> <tr> <td style="width: 10%;"></td> <td style="width: 10%;"></td> <td style="width: 10%;"></td> <td style="width: 10%;"></td> <td style="width: 10%;"></td> <td style="width: 10%;"></td> <td style="width: 10%;"></td> <td style="width: 10%;"></td> <td style="width: 10%;"></td> <td style="width: 10%;"></td> </tr> <tr> <td></td> <td></td> <td colspan="8" style="text-align: center;"> <table border="1" style="width: 100%; border-collapse: collapse; text-align: center;"> <tr> <td style="width: 10%;"></td> <td style="width: 10%;"></td> <td style="width: 10%;"></td> <td style="width: 10%;"></td> <td style="width: 10%;"></td> <td style="width: 10%;"></td> <td style="width: 10%;"></td> <td style="width: 10%;"></td> <td style="width: 10%;"></td> <td style="width: 10%;"></td> </tr> <tr> <td></td> <td></td> <td colspan="8" style="text-align: center;"> <table border="1" style="width: 100%; border-collapse: collapse; text-align: center;"> <tr> <td style="width: 10%;"></td> <td style="width: 10%;"></td> <td style="width: 10%;"></td> <td style="width: 10%;"></td> <td style="width: 10%;"></td> <td style="width: 10%;"></td> <td style="width: 10%;"></td> <td style="width: 10%;"></td> <td style="width: 10%;"></td> <td style="width: 10%;"></td> </tr> <tr> <td></td> <td></td> <td colspan="8" style="text-align: center;"> <table border="1" style="width: 100%; border-collapse: collapse; text-align: center;"> <tr> <td style="width: 10%;"></td> <td style="width: 10%;"></td> <td style="width: 10%;"></td> <td style="width: 10%;"></td> <td style="width: 10%;"></td> <td style="width: 10%;"></td> <td style="width: 10%;"></td> <td style="width: 10%;"></td> <td style="width: 10%;"></td> <td style="width: 10%;"></td> </tr> <tr> <td></td> <td></td> <td colspan="8" style="text-align: center;"> <table border="1" style="width: 100%; border-collapse: collapse; text-align: center;"> <tr> <td style="width: 10%;"></td> <td style="width: 10%;"></td> <td style="width: 10%;"></td> <td style="width: 10%;"></td> <td style="width: 10%;"></td> <td style="width: 10%;"></td> <td style="width: 10%;"></td> <td style="width: 10%;"></td> <td style="width: 10%;"></td> <td style="width: 10%;"></td> </tr> <tr> <td></td> <td></td> <td
colspan="8" style="text-align: center;"> <table border="1" style="width: 100%; border-collapse: collapse; text-align: center;"> <tr> <td style="width: 10%;"></td> <td style="width: 10%;"></td> <td style="width: 10%;"></td> <td style="width: 10%;"></td> <td style="width: 10%;"></td> <td style="width: 10%;"></td> <td style="width: 10%;"></td> <td style="width: 10%;"></td> <td style="width: 10%;"></td> <td style="width: 10%;"></td> </tr> <tr> <td></td> <td></td> <td colspan="8" style="text-align: center;"> <table border="1" style="width: 100%; border-collapse: collapse; text-align: center;"> <tr> <td style="width: 10%;"></td> <td style="width: 10%;"></td> <td style="width: 10%;"></td> <td style="width: 10%;"></td> <td style="width: 10%;"></td> <td style="width: 10%;"></td> <td style="width: 10%;"></td> <td style="width: 10%;"></td> <td style="width: 10%;"></td> <td style="width: 10%;"></td> </tr> <tr> <td></td> <td></td> <td colspan="8" style="text-align: center;"> <table border="1" style="width: 100%; border-collapse: collapse; text-align: center;"> <tr> <td style="width: 10%;"></td> <td style="width: 10%;"></td> <td style="width: 10%;"></td> <td style="width: 10%;"></td> <td style="width: 10%;"></td> <td style="width: 10%;"></td> <td style="width: 10%;"></td> <td style="width: 10%;"></td> <td style="width: 10%;"></td> <td style="width: 10%;"></td> </tr> <tr> <td></td> <td></td> <td colspan="8" style="text-align: center;"> <table border="1" style="width: 100%; border-collapse: collapse; text-align: center;"> <tr> <td style="width: 10%;"></td> <td style="width: 10%;"></td> <td style="width: 10%;"></td> <td style="width: 10%;"></td> <td style="width: 10%;"></td> <td style="width: 10%;"></td> <td style="width: 10%;"></td> <td style="width: 10%;"></td> <td style="width: 10%;"></td> <td style="width: 10%;"></td> </tr> <tr> <td></td> <td></td> <td colspan="8" style="text-align: center;"> <table border="1" style="width: 100%; border-collapse: collapse; text-align: center;"> <tr> <td style="width: 10%;"></td> <td style="width: 10%;"></td> <td style="width: 10%;"></td> <td style="width: 10%;"></td> <td style="width: 10%;"></td> <td style="width: 10%;"></td> <td style="width: 10%;"></td> <td style="width: 10%;"></td> <td style="width: 10%;"></td> <td style="width: 10%;"></td> </tr> <tr> <td></td> <td></td> <td colspan="8" style="text-align: center;"> <table border="1" style="width: 100%; border-collapse: collapse; text-align: center;"> <tr> <td style="width: 10%;"></td> <td style="width: 10%;"></td> <td style="width: 10%;"></td> <td style="width: 10%;"></td> <td style="width: 10%;"></td> <td style="width: 10%;"></td> <td style="width: 10%;"></td> <td style="width: 10%;"></td> <td style="width: 10%;"></td> <td style="width: 10%;"></td> </tr> <tr> <td></td> <td></td> <td colspan="8" style="text-align: center;"> <table border="1" style="width: 100%; border-collapse: collapse; text-align: center;"> <tr> <td style="width: 10%;"></td> <td style="width: 10%;"></td> <td style="width: 10%;"></td> <td style="width: 10%;"></td> <td style="width: 10%;"></td> <td style="width: 10%;"></td> <td style="width: 10%;"></td> <td style="width: 10%;"></td> <td style="width: 10%;"></td> <td style="width: 10%;"></td> </tr> <tr> <td></td> <td></td> <td colspan="8" style="text-align: center;"> <table border="1" style="width: 100%; border-collapse: collapse; text-align: center;"> <tr> <td style="width: 10%;"></td> <td style="width: 10%;"></td> <td style="width: 10%;"></td> <td style="width: 10%;"></td> <td style="width: 10%;"></td> <td style="width: 10%;"></td> <td style="width: 10%;"></td> <td style="width: 10%;"></td> <td style="width: 10%;"></td> <td style="width: 10%;"></td> </tr> <tr> <td></td> <td></td> <td colspan="8" style="text-align: center;"> <table border="1" style="width: 100%; border-collapse: collapse; text-align: center;"> <tr> <td style="width: 10%;"></td> <td style="width: 10%;"></td> <td style="width: 10%;"></td> <td style="width: 10%;"></td> <td style="width: 10%;"></td> <td style="width: 10%;"></td> <td style="width: 10%;"></td> <td style="width: 10%;"></td> <td style="width: 10%;"></td> <td style="width: 10%;"></td> </tr> <tr> <td></td> <td></td> <td colspan="8" style="text-align: center;"> <table border="1" style="width: 100%; border-collapse: collapse; text-align: center;"> <tr> <td style="width: 10%;"></td> <td style="width: 10%;"></td> <td style="width: 10%;"></td> <td style="width: 10%;"></td> <td style="width: 10%;"></td> <td style="width: 10%;"></td> <td style="width: 10%;"></td> <td style="width: 10%;"></td> <td style="width: 10%;"></td> <td style="width: 10%;"></td> </tr> <tr> <td></td> <td></td> <td colspan="8" style="text-align: center;"> <table border="1" style="width: 100%; border-collapse: collapse; text-align: center;"> <tr> <td style="width: 10%;"></td> <td style="width: 10%;"></td> <td style="width: 10%;"></td> <td style="width: 10%;"></td> <td style="width: 10%;"></td> <td style="width: 10%;"></td> <td style="width: 10%;"></td> <td style="width: 10%;"></td> <td style="width: 10%;"></td> <td style="width: 10%;"></td> </tr> <tr> <td></td> <td></td> <td colspan="8" style="text-align: center;"> <table border="1" style="width: 100%; border-collapse: collapse; text-align: center;"> <tr> <td style="width: 10%;"></td> <td style="width: 10%;"></td> <td style="width: 10%;"></td> <td style="width: 10%;"></td> <td style="width: 10%;"></td> <td style="width: 10%;"></td> <td style="width: 10%;"></td> <td style="width: 10%;"></td> <td style="width: 10%;"></td> <td style="width: 10%;"></td> </tr> <tr> <td></td> <td></td> <td colspan="8" style="text-align: center;"> <table border="1" style="width: 100%; border-collapse: collapse; text-align: center;"> <tr> <td style="width: 10%;"></td> <td style="width: 10%;"></td> <td style="width: 10%;"></td> <td style="width: 10%;"></td> <td style="width: 10%;"></td> <td style="width: 10%;"></td> <td style="width: 10%;"></td> <td style="width: 10%;"></td> <td style="width: 10%;"></td> <td style="width: 10%;"></td> </tr> <tr> <td></td> <td></td> <td colspan="8" style="text-align: center;"> <table border="1" style="width: 100%; border-collapse: collapse; text-align: center;"> <tr> <td style="width: 10%;"></td> <td style="width: 10%;"></td> <td style="width: 10%;"></td> <td style="width: 10%;"></td> <td style="width: 10%;"></td> <td style="width: 10%;"></td> <td style="width: 10%;"></td> <td style="width: 10%;"></td> <td style="width: 10%;"></td> <td style="width: 10%;"></td> </tr> <tr> <td></td> <td></td> <td colspan="8" style="text-align: center;"> <table border="1" style="width: 100%; border-collapse: collapse; text-align: center;"> <tr> <td style="width: 10%;"></td> <td style="width: 10%;"></td> <td style="width: 10%;"></td> <td style="width: 10%;"></td> <td style="width: 10%;"></td> <td style="width: 10%;"></td> <td style="width: 10%;"></td> <td style="width: 10%;"></td> <td style="width: 10%;"></td> <td style="width: 10%;"></td> </tr> <tr> <td></td> <td></td> <td colspan="8" style="text-align: center;"> <table border="1" style="width: 100%; border-collapse: collapse; text-align: center;"> <tr> <td style="width: 10%;"></td> <td style="width: 10%;"></td> <td style="width: 10%;"></td> <td style="width: 10%;"></td> <td style="width: 10%;"></td> <td style="width: 10%;"></td> <td style="width: 10%;"></td> <td style="width: 10%;"></td> <td style="width: 10%;"></td> <td style="width: 10%;"></td> </tr> <tr> <td></td> <td></td> <td colspan="8" style="text-align: center;"> <table border="1" style="width: 100%; border-collapse: collapse; text-align: center;"> <tr> <td style="width: 10%;"></td> <td style="width: 10%;"></td> <td style="width: 10%;"></td> <td style="width: 10%;"></td> <td style="width: 10%;"></td> <td style="width: 10%;"></td> <td style="width: 10%;"></td> <td style="width: 10%;"></td> <td style="width: 10%;"></td> <td style="width: 10%;"></td> </tr> <tr> <td></td> <td></td> <td colspan="8" style="text-align: center;"> <table border="1" style="width: 100%; border-collapse: collapse; text-align: center;"> <tr> <td style="width: 10%;"></td> <td style="width: 10%;"></td> <td style="width: 10%;"></td> <td style="width: 10%;"></td> <td style="width: 10%;"></td> <td style="width: 10%;"></td> <td style="width: 10%;"></td> <td style="width: 10%;"></td> <td style="width: 10%;"></td> <td style="width: 10%;"></td> </tr> <tr> <td></td> <td></td> <td colspan="8" style="text-align: center;"> <table border="1" style="width: 100%; border-collapse: collapse; text-align: center;"> <tr> </tr></table></td></tr></table></td></tr></table></td></tr></table></td></tr></table></td></tr></table></td></tr></table></td></tr></table></td></tr></table></td></tr></table></td></tr></table></td></tr></table></td></tr></table></td></tr></table></td></tr></table></td></tr></table></td></tr></table></td></tr></table></td></tr></table></td></tr></table></td></tr></table></td></tr></table></td></tr></table></td></tr></table></td></tr></table></td></tr></table></td></tr></table></td></tr></table></td></tr></table></td></tr></table></td></tr></table></td></tr></table></td></tr></table></td></tr></table></td></tr></table></td></tr></table></td></tr></table></td></tr></table></td></tr></table></td></tr></table></td></tr></table></td></tr></table></td></tr></table></td></tr></table></td></tr></table></td></tr></table></td></tr></table></td></tr></table> | | | | | | | | | | | | | | | | | | | | <table border="1" style="width: 100%; border-collapse: collapse; text-align: center;"> <tr> <td style="width: 10%;"></td> <td style="width: 10%;"></td> <td style="width: 10%;"></td> <td style="width: 10%;"></td> <td style="width: 10%;"></td> <td style="width: 10%;"></td> <td style="width: 10%;"></td> <td style="width: 10%;"></td> <td style="width: 10%;"></td> <td style="width: 10%;"></td> </tr> <tr> <td></td> <td></td> <td colspan="8" style="text-align: center;"> <table border="1" style="width: 100%; border-collapse:
collapse; text-align: center;"> <tr> <td style="width: 10%;"></td> <td style="width: 10%;"></td> <td style="width: 10%;"></td> <td style="width: 10%;"></td> <td style="width: 10%;"></td> <td style="width: 10%;"></td> <td style="width: 10%;"></td> <td style="width: 10%;"></td> <td style="width: 10%;"></td> <td style="width: 10%;"></td> </tr> <tr> <td></td> <td></td> <td colspan="8" style="text-align: center;"> <table border="1" style="width: 100%; border-collapse: collapse; text-align: center;"> <tr> <td style="width: 10%;"></td> <td style="width: 10%;"></td> <td style="width: 10%;"></td> <td style="width: 10%;"></td> <td style="width: 10%;"></td> <td style="width: 10%;"></td> <td style="width: 10%;"></td> <td style="width: 10%;"></td> <td style="width: 10%;"></td> <td style="width: 10%;"></td> </tr> <tr> <td></td> <td></td> <td colspan="8" style="text-align: center;"> <table border="1" style="width: 100%; border-collapse: collapse; text-align: center;"> <tr> <td style="width: 10%;"></td> <td style="width: 10%;"></td> <td style="width: 10%;"></td> <td style="width: 10%;"></td> <td style="width: 10%;"></td> <td style="width: 10%;"></td> <td style="width: 10%;"></td> <td style="width: 10%;"></td> <td style="width: 10%;"></td> <td style="width: 10%;"></td> </tr> <tr> <td></td> <td></td> <td colspan="8" style="text-align: center;"> <table border="1" style="width: 100%; border-collapse: collapse; text-align: center;"> <tr> <td style="width: 10%;"></td> <td style="width: 10%;"></td> <td style="width: 10%;"></td> <td style="width: 10%;"></td> <td style="width: 10%;"></td> <td style="width: 10%;"></td> <td style="width: 10%;"></td> <td style="width: 10%;"></td> <td style="width: 10%;"></td> <td style="width: 10%;"></td> </tr> <tr> <td></td> <td></td> <td colspan="8" style="text-align: center;"> <table border="1" style="width: 100%; border-collapse: collapse; text-align: center;"> <tr> <td style="width: 10%;"></td> <td style="width: 10%;"></td> <td style="width: 10%;"></td> <td style="width: 10%;"></td> <td style="width: 10%;"></td> <td style="width: 10%;"></td> <td style="width: 10%;"></td> <td style="width: 10%;"></td> <td style="width: 10%;"></td> <td style="width: 10%;"></td> </tr> <tr> <td></td> <td></td> <td colspan="8" style="text-align: center;"> <table border="1" style="width: 100%; border-collapse: collapse; text-align: center;"> <tr> <td style="width: 10%;"></td> <td style="width: 10%;"></td> <td style="width: 10%;"></td> <td style="width: 10%;"></td> <td style="width: 10%;"></td> <td style="width: 10%;"></td> <td style="width: 10%;"></td> <td style="width: 10%;"></td> <td style="width: 10%;"></td> <td style="width: 10%;"></td> </tr> <tr> <td></td> <td></td> <td colspan="8" style="text-align: center;"> <table border="1" style="width: 100%; border-collapse: collapse; text-align: center;"> <tr> <td style="width: 10%;"></td> <td style="width: 10%;"></td> <td style="width: 10%;"></td> <td style="width: 10%;"></td> <td style="width: 10%;"></td> <td style="width: 10%;"></td> <td style="width: 10%;"></td> <td style="width: 10%;"></td> <td style="width: 10%;"></td> <td style="width: 10%;"></td> </tr> <tr> <td></td> <td></td> <td colspan="8" style="text-align: center;"> <table border="1" style="width: 100%; border-collapse: collapse; text-align: center;"> <tr> <td style="width: 10%;"></td> <td style="width: 10%;"></td> <td style="width: 10%;"></td> <td style="width: 10%;"></td> <td style="width: 10%;"></td> <td style="width: 10%;"></td> <td style="width: 10%;"></td> <td style="width: 10%;"></td> <td style="width: 10%;"></td> <td style="width: 10%;"></td> </tr> <tr> <td></td> <td></td> <td colspan="8" style="text-align: center;"> <table border="1" style="width: 100%; border-collapse: collapse; text-align: center;"> <tr> <td style="width: 10%;"></td> <td style="width: 10%;"></td> <td style="width: 10%;"></td> <td style="width: 10%;"></td> <td style="width: 10%;"></td> <td style="width: 10%;"></td> <td style="width: 10%;"></td> <td style="width: 10%;"></td> <td style="width: 10%;"></td> <td style="width: 10%;"></td> </tr> <tr> <td></td> <td></td> <td colspan="8" style="text-align: center;"> <table border="1" style="width: 100%; border-collapse: collapse; text-align: center;"> <tr> <td style="width: 10%;"></td> <td style="width: 10%;"></td> <td style="width: 10%;"></td> <td style="width: 10%;"></td> <td style="width: 10%;"></td> <td style="width: 10%;"></td> <td style="width: 10%;"></td> <td style="width: 10%;"></td> <td style="width: 10%;"></td> <td style="width: 10%;"></td> </tr> <tr> <td></td> <td></td> <td colspan="8" style="text-align: center;"> <table border="1" style="width: 100%; border-collapse: collapse; text-align: center;"> <tr> <td style="width: 10%;"></td> <td style="width: 10%;"></td> <td style="width: 10%;"></td> <td style="width: 10%;"></td> <td style="width: 10%;"></td> <td style="width: 10%;"></td> <td style="width: 10%;"></td> <td style="width: 10%;"></td> <td style="width: 10%;"></td> <td style="width: 10%;"></td> </tr> <tr> <td></td> <td></td> <td colspan="8" style="text-align: center;"> <table border="1" style="width: 100%; border-collapse: collapse; text-align: center;"> <tr> <td style="width: 10%;"></td> <td style="width: 10%;"></td> <td style="width: 10%;"></td> <td style="width: 10%;"></td> <td style="width: 10%;"></td> <td style="width: 10%;"></td> <td style="width: 10%;"></td> <td style="width: 10%;"></td> <td style="width: 10%;"></td> <td style="width: 10%;"></td> </tr> <tr> <td></td> <td></td> <td colspan="8" style="text-align: center;"> <table border="1" style="width: 100%; border-collapse: collapse; text-align: center;"> <tr> <td style="width: 10%;"></td> <td style="width: 10%;"></td> <td style="width: 10%;"></td> <td style="width: 10%;"></td> <td style="width: 10%;"></td> <td style="width: 10%;"></td> <td style="width: 10%;"></td> <td style="width: 10%;"></td> <td style="width: 10%;"></td> <td style="width: 10%;"></td> </tr> <tr> <td></td> <td></td> <td colspan="8" style="text-align: center;"> <table border="1" style="width: 100%; border-collapse: collapse; text-align: center;"> <tr> <td style="width: 10%;"></td> <td style="width: 10%;"></td> <td style="width: 10%;"></td> <td style="width: 10%;"></td> <td style="width: 10%;"></td> <td style="width: 10%;"></td> <td style="width: 10%;"></td> <td style="width: 10%;"></td> <td style="width: 10%;"></td> <td style="width: 10%;"></td> </tr> <tr> <td></td> <td></td> <td colspan="8" style="text-align: center;"> <table border="1" style="width: 100%; border-collapse: collapse; text-align: center;"> <tr> <td style="width: 10%;"></td> <td style="width: 10%;"></td> <td style="width: 10%;"></td> <td style="width: 10%;"></td> <td style="width: 10%;"></td> <td style="width: 10%;"></td> <td style="width: 10%;"></td> <td style="width: 10%;"></td> <td style="width: 10%;"></td> <td style="width: 10%;"></td> </tr> <tr> <td></td> <td></td> <td colspan="8" style="text-align: center;"> <table border="1" style="width: 100%; border-collapse: collapse; text-align: center;"> <tr> <td style="width: 10%;"></td> <td style="width: 10%;"></td> <td style="width: 10%;"></td> <td style="width: 10%;"></td> <td style="width: 10%;"></td> <td style="width: 10%;"></td> <td style="width: 10%;"></td> <td style="width: 10%;"></td> <td style="width: 10%;"></td> <td style="width: 10%;"></td> </tr> <tr> <td></td> <td></td> <td colspan="8" style="text-align: center;"> <table border="1" style="width: 100%; border-collapse: collapse; text-align: center;"> <tr> <td style="width: 10%;"></td> <td style="width: 10%;"></td> <td style="width: 10%;"></td> <td style="width: 10%;"></td> <td style="width: 10%;"></td> <td style="width: 10%;"></td> <td style="width: 10%;"></td> <td style="width: 10%;"></td> <td style="width: 10%;"></td> <td style="width: 10%;"></td> </tr> <tr> <td></td> <td></td> <td colspan="8" style="text-align: center;"> <table border="1" style="width: 100%; border-collapse: collapse; text-align: center;"> <tr> <td style="width: 10%;"></td> <td style="width: 10%;"></td> <td style="width: 10%;"></td> <td style="width: 10%;"></td> <td style="width: 10%;"></td> <td style="width: 10%;"></td> <td style="width: 10%;"></td> <td style="width: 10%;"></td> <td style="width: 10%;"></td> <td style="width: 10%;"></td> </tr> <tr> <td></td> <td></td> <td colspan="8" style="text-align: center;"> <table border="1" style="width: 100%; border-collapse: collapse; text-align: center;"> <tr> <td style="width: 10%;"></td> <td style="width: 10%;"></td> <td style="width: 10%;"></td> <td style="width: 10%;"></td> <td style="width: 10%;"></td> <td style="width: 10%;"></td> <td style="width: 10%;"></td> <td style="width: 10%;"></td> <td style="width: 10%;"></td> <td style="width: 10%;"></td> </tr> <tr> <td></td> <td></td> <td colspan="8" style="text-align: center;"> <table border="1" style="width: 100%; border-collapse: collapse; text-align: center;"> <tr> <td style="width: 10%;"></td> <td style="width: 10%;"></td> <td style="width: 10%;"></td> <td style="width: 10%;"></td> <td style="width: 10%;"></td> <td style="width: 10%;"></td> <td style="width: 10%;"></td> <td style="width: 10%;"></td> <td style="width: 10%;"></td> <td style="width: 10%;"></td> </tr> <tr> <td></td> <td></td> <td colspan="8" style="text-align: center;"> <table border="1" style="width: 100%; border-collapse: collapse; text-align: center;"> <tr> <td style="width: 10%;"></td> <td style="width: 10%;"></td> <td style="width: 10%;"></td> <td style="width: 10%;"></td> <td style="width: 10%;"></td> <td style="width: 10%;"></td> <td style="width: 10%;"></td> <td style="width: 10%;"></td> <td style="width: 10%;"></td> <td style="width: 10%;"></td> </tr> <tr> <td></td> <td></td> <td colspan="8" style="text-align: center;"> <table border="1" style="width: 100%; border-collapse: collapse; text-align: center;"> <tr> <td style="width: 10%;"></td> <td style="width: 10%;"></td> <td style="width: 10%;"></td> <td style="width: 10%;"></td> <td
style="width: 10%;"></td> <td style="width: 10%;"></td> <td style="width: 10%;"></td> <td style="width: 10%;"></td> <td style="width: 10%;"></td> <td style="width: 10%;"></td> </tr> <tr> <td></td> <td></td> <td colspan="8" style="text-align: center;"> <table border="1" style="width: 100%; border-collapse: collapse; text-align: center;"> <tr> <td style="width: 10%;"></td> <td style="width: 10%;"></td> <td style="width: 10%;"></td> <td style="width: 10%;"></td> <td style="width: 10%;"></td> <td style="width: 10%;"></td> <td style="width: 10%;"></td> <td style="width: 10%;"></td> <td style="width: 10%;"></td> <td style="width: 10%;"></td> </tr> <tr> <td></td> <td></td> <td colspan="8" style="text-align: center;"> <table border="1" style="width: 100%; border-collapse: collapse; text-align: center;"> <tr> <td style="width: 10%;"></td> <td style="width: 10%;"></td> <td style="width: 10%;"></td> <td style="width: 10%;"></td> <td style="width: 10%;"></td> <td style="width: 10%;"></td> <td style="width: 10%;"></td> <td style="width: 10%;"></td> <td style="width: 10%;"></td> <td style="width: 10%;"></td> </tr> <tr> <td></td> <td></td> <td colspan="8" style="text-align: center;"> <table border="1" style="width: 100%; border-collapse: collapse; text-align: center;"> <tr> <td style="width: 10%;"></td> <td style="width: 10%;"></td> <td style="width: 10%;"></td> <td style="width: 10%;"></td> <td style="width: 10%;"></td> <td style="width: 10%;"></td> <td style="width: 10%;"></td> <td style="width: 10%;"></td> <td style="width: 10%;"></td> <td style="width: 10%;"></td> </tr> <tr> <td></td> <td></td> <td colspan="8" style="text-align: center;"> <table border="1" style="width: 100%; border-collapse: collapse; text-align: center;"> <tr> <td style="width: 10%;"></td> <td style="width: 10%;"></td> <td style="width: 10%;"></td> <td style="width: 10%;"></td> <td style="width: 10%;"></td> <td style="width: 10%;"></td> <td style="width: 10%;"></td> <td style="width: 10%;"></td> <td style="width: 10%;"></td> <td style="width: 10%;"></td> </tr> <tr> <td></td> <td></td> <td colspan="8" style="text-align: center;"> <table border="1" style="width: 100%; border-collapse: collapse; text-align: center;"> <tr> <td style="width: 10%;"></td> <td style="width: 10%;"></td> <td style="width: 10%;"></td> <td style="width: 10%;"></td> <td style="width: 10%;"></td> <td style="width: 10%;"></td> <td style="width: 10%;"></td> <td style="width: 10%;"></td> <td style="width: 10%;"></td> <td style="width: 10%;"></td> </tr> <tr> <td></td> <td></td> <td colspan="8" style="text-align: center;"> <table border="1" style="width: 100%; border-collapse: collapse; text-align: center;"> <tr> <td style="width: 10%;"></td> <td style="width: 10%;"></td> <td style="width: 10%;"></td> <td style="width: 10%;"></td> <td style="width: 10%;"></td> <td style="width: 10%;"></td> <td style="width: 10%;"></td> <td style="width: 10%;"></td> <td style="width: 10%;"></td> <td style="width: 10%;"></td> </tr> <tr> <td></td> <td></td> <td colspan="8" style="text-align: center;"> <table border="1" style="width: 100%; border-collapse: collapse; text-align: center;"> <tr> <td style="width: 10%;"></td> <td style="width: 10%;"></td> <td style="width: 10%;"></td> <td style="width: 10%;"></td> <td style="width: 10%;"></td> <td style="width: 10%;"></td> <td style="width: 10%;"></td> <td style="width: 10%;"></td> <td style="width: 10%;"></td> <td style="width: 10%;"></td> </tr> <tr> <td></td> <td></td> <td colspan="8" style="text-align: center;"> <table border="1" style="width: 100%; border-collapse: collapse; text-align: center;"> <tr> <td style="width: 10%;"></td> <td style="width: 10%;"></td> <td style="width: 10%;"></td> <td style="width: 10%;"></td> <td style="width: 10%;"></td> <td style="width: 10%;"></td> <td style="width: 10%;"></td> <td style="width: 10%;"></td> <td style="width: 10%;"></td> <td style="width: 10%;"></td> </tr> <tr> <td></td> <td></td> <td colspan="8" style="text-align: center;"> <table border="1" style="width: 100%; border-collapse: collapse; text-align: center;"> <tr> <td style="width: 10%;"></td> <td style="width: 10%;"></td> <td style="width: 10%;"></td> <td style="width: 10%;"></td> <td style="width: 10%;"></td> <td style="width: 10%;"></td> <td style="width: 10%;"></td> <td style="width: 10%;"></td> <td style="width: 10%;"></td> <td style="width: 10%;"></td> </tr> <tr> <td></td> <td></td> <td colspan="8" style="text-align: center;"> <table border="1" style="width: 100%; border-collapse: collapse; text-align: center;"> <tr> <td style="width: 10%;"></td> <td style="width: 10%;"></td> <td style="width: 10%;"></td> <td style="width: 10%;"></td> <td style="width: 10%;"></td> <td style="width: 10%;"></td> <td style="width: 10%;"></td> <td style="width: 10%;"></td> <td style="width: 10%;"></td> <td style="width: 10%;"></td> </tr> <tr> <td></td> <td></td> <td colspan="8" style="text-align: center;"> <table border="1" style="width: 100%; border-collapse: collapse; text-align: center;"> <tr> <td style="width: 10%;"></td> <td style="width: 10%;"></td> <td style="width: 10%;"></td> <td style="width: 10%;"></td> <td style="width: 10%;"></td> <td style="width: 10%;"></td> <td style="width: 10%;"></td> <td style="width: 10%;"></td> <td style="width: 10%;"></td> <td style="width: 10%;"></td> </tr> <tr> <td></td> <td></td> <td colspan="8" style="text-align: center;"> <table border="1" style="width: 100%; border-collapse: collapse; text-align: center;"> <tr> <td style="width: 10%;"></td> <td style="width: 10%;"></td> <td style="width: 10%;"></td> <td style="width: 10%;"></td> <td style="width: 10%;"></td> <td style="width: 10%;"></td> <td style="width: 10%;"></td> <td style="width: 10%;"></td> <td style="width: 10%;"></td> <td style="width: 10%;"></td> </tr> <tr> <td></td> <td></td> <td colspan="8" style="text-align: center;"> <table border="1" style="width: 100%; border-collapse: collapse; text-align: center;"> <tr> <td style="width: 10%;"></td> <td style="width: 10%;"></td> <td style="width: 10%;"></td> <td style="width: 10%;"></td> <td style="width: 10%;"></td> <td style="width: 10%;"></td> <td style="width: 10%;"></td> <td style="width: 10%;"></td> <td style="width: 10%;"></td> <td style="width: 10%;"></td> </tr> <tr> <td></td> <td></td> <td colspan="8" style="text-align: center;"> <table border="1" style="width: 100%; border-collapse: collapse; text-align: center;"> <tr> <td style="width: 10%;"></td> <td style="width: 10%;"></td> <td style="width: 10%;"></td> <td style="width: 10%;"></td> <td style="width: 10%;"></td> <td style="width: 10%;"></td> <td style="width: 10%;"></td> <td style="width: 10%;"></td> <td style="width: 10%;"></td> <td style="width: 10%;"></td> </tr> <tr> <td></td> <td></td> <td colspan="8" style="text-align: center;"> <table border="1" style="width: 100%; border-collapse: collapse; text-align: center;"> <tr> <td style="width: 10%;"></td> <td style="width: 10%;"></td> <td style="width: 10%;"></td> <td style="width: 10%;"></td> <td style="width: 10%;"></td> <td style="width: 10%;"></td> <td style="width: 10%;"></td> <td style="width: 10%;"></td> <td style="width: 10%;"></td> <td style="width: 10%;"></td> </tr> <tr> <td></td> <td></td> <td colspan="8" style="text-align: center;"> <table border="1" style="width: 100%; border-collapse: collapse; text-align: center;"> <tr> <td style="width: 10%;"></td> <td style="width: 10%;"></td> <td style="width: 10%;"></td> <td style="width: 10%;"></td> <td style="width: 10%;"></td> <td style="width: 10%;"></td> <td style="width: 10%;"></td> <td style="width: 10%;"></td> <td style="width: 10%;"></td> <td style="width: 10%;"></td> </tr> <tr> <td></td> <td></td> <td colspan="8" style="text-align: center;"> <table border="1" style="width: 100%; border-collapse: collapse; text-align: center;"> <tr> <td style="width: 10%;"></td> <td style="width: 10%;"></td> <td style="width: 10%;"></td> <td style="width: 10%;"></td> <td style="width: 10%;"></td> <td style="width: 10%;"></td> <td style="width: 10%;"></td> <td style="width: 10%;"></td> <td style="width: 10%;"></td> <td style="width: 10%;"></td> </tr> <tr> <td></td> <td></td> <td colspan="8" style="text-align: center;"> <table border="1" style="width: 100%; border-collapse: collapse; text-align: center;"> <tr> <td style="width: 10%;"></td> <td style="width: 10%;"></td> <td style="width: 10%;"></td> <td style="width: 10%;"></td> <td style="width: 10%;"></td> <td style="width: 10%;"></td> <td style="width: 10%;"></td> <td style="width: 10%;"></td> <td style="width: 10%;"></td> <td style="width: 10%;"></td> </tr> <tr> <td></td> <td></td> <td colspan="8" style="text-align: center;"> <table border="1" style="width: 100%; border-collapse: collapse; text-align: center;"> <tr> <td style="width: 10%;"></td> <td style="width: 10%;"></td> <td style="width: 10%;"></td> <td style="width: 10%;"></td> <td style="width: 10%;"></td> <td style="width: 10%;"></td> <td style="width: 10%;"></td> <td style="width: 10%;"></td> <td style="width: 10%;"></td> <td style="width: 10%;"></td> </tr> <tr> <td></td> <td></td> <td colspan="8" style="text-align: center;"> <table border="1" style="width: 100%; border-collapse: collapse; text-align: center;"> <tr> <td style="width: 10%;"></td> <td style="width: 10%;"></td> <td style="width: 10%;"></td> <td style="width: 10%;"></td> <td style="width: 10%;"></td> <td style="width: 10%;"></td> <td style="width: 10%;"></td> <td style="width: 10%;"></td> <td style="width: 10%;"></td> <td style="width: 10%;"></td> </tr> <tr> <td></td> <td></td> <td colspan="8" style="text-align: center;"> <table border="1" style="width: 100%; border-collapse: collapse; text-align: center;"> <tr> <td style="width: 10%;"></td> <td style="width: 10%;"></td> <td style="width: 10%;"></td> <td style="width: 10%;"></td> <td style="width: 10%;"></td> <td style="width: 10%;"></td> <td style="width: 10%;"></td> <td style="width: 10%;"></td> <td style="width: 10%;"></td> <td style="width:
10%;"></td> </tr> <tr> <td></td> <td></td> <td colspan="8" style="text-align: center;"> <table border="1" style="width: 100%; border-collapse: collapse; text-align: center;"> <tr> <td style="width: 10%;"></td> <td style="width: 10%;"></td> <td style="width: 10%;"></td> <td style="width: 10%;"></td> <td style="width: 10%;"></td> <td style="width: 10%;"></td> <td style="width: 10%;"></td> <td style="width: 10%;"></td> <td style="width: 10%;"></td> <td style="width: 10%;"></td> </tr> <tr> <td></td> <td></td> <td colspan="8" style="text-align: center;"> <table border="1" style="width: 100%; border-collapse: collapse; text-align: center;"> <tr> <td style="width: 10%;"></td> <td style="width: 10%;"></td> <td style="width: 10%;"></td> <td style="width: 10%;"></td> <td style="width: 10%;"></td> <td style="width: 10%;"></td> <td style="width: 10%;"></td> <td style="width: 10%;"></td> <td style="width: 10%;"></td> <td style="width: 10%;"></td> </tr> <tr> <td></td> <td></td> <td colspan="8" style="text-align: center;"> <table border="1" style="width: 100%; border-collapse: collapse; text-align: center;"> <tr> </tr></table></td></tr></table></td></tr></table></td></tr></table></td></tr></table></td></tr></table></td></tr></table></td></tr></table></td></tr></table></td></tr></table></td></tr></table></td></tr></table></td></tr></table></td></tr></table></td></tr></table></td></tr></table></td></tr></table></td></tr></table></td></tr></table></td></tr></table></td></tr></table></td></tr></table></td></tr></table></td></tr></table></td></tr></table></td></tr></table></td></tr></table></td></tr></table></td></tr></table></td></tr></table></td></tr></table></td></tr></table></td></tr></table></td></tr></table></td></tr></table></td></tr></table></td></tr></table></td></tr></table></td></tr></table></td></tr></table></td></tr></table></td></tr></table></td></tr></table></td></tr></table></td></tr></table></td></tr></table></td></tr></table> | | | | | | | | | | | | | | | | | | | | <table border="1" style="width: 100%; border-collapse: collapse; text-align: center;"> <tr> <td style="width: 10%;"></td> <td style="width: 10%;"></td> <td style="width: 10%;"></td> <td style="width: 10%;"></td> <td style="width: 10%;"></td> <td style="width: 10%;"></td> <td style="width: 10%;"></td> <td style="width: 10%;"></td> <td style="width: 10%;"></td> <td style="width: 10%;"></td> </tr> <tr> <td></td> <td></td> <td colspan="8" style="text-align: center;"> <table border="1" style="width: 100%; border-collapse: collapse; text-align: center;"> <tr> <td style="width: 10%;"></td> <td style="width: 10%;"></td> <td style="width: 10%;"></td> <td style="width: 10%;"></td> <td style="width: 10%;"></td> <td style="width: 10%;"></td> <td style="width: 10%;"></td> <td style="width: 10%;"></td> <td style="width: 10%;"></td> <td style="width: 10%;"></td> </tr> <tr> <td></td> <td></td> <td colspan="8" style="text-align: center;"> <table border="1" style="width: 100%; border-collapse: collapse; text-align: center;"> <tr> <td style="width: 10%;"></td> <td style="width: 10%;"></td> <td style="width: 10%;"></td> <td style="width: 10%;"></td> <td style="width: 10%;"></td> <td style="width: 10%;"></td> <td style="width: 10%;"></td> <td style="width: 10%;"></td> <td style="width: 10%;"></td> <td style="width: 10%;"></td> </tr> <tr> <td></td> <td></td> <td colspan="8" style="text-align: center;"> <table border="1" style="width: 100%; border-collapse: collapse; text-align: center;"> <tr> <td style="width: 10%;"></td> <td style="width: 10%;"></td> <td style="width: 10%;"></td> <td style="width: 10%;"></td> <td style="width: 10%;"></td> <td style="width: 10%;"></td> <td style="width: 10%;"></td> <td style="width: 10%;"></td> <td style="width: 10%;"></td> <td style="width: 10%;"></td> </tr> <tr> <td></td> <td></td> <td colspan="8" style="text-align: center;"> <table border="1" style="width: 100%; border-collapse: collapse; text-align: center;"> <tr> <td style="width: 10%;"></td> <td style="width: 10%;"></td> <td style="width: 10%;"></td> <td style="width: 10%;"></td> <td style="width: 10%;"></td> <td style="width: 10%;"></td> <td style="width: 10%;"></td> <td style="width: 10%;"></td> <td style="width: 10%;"></td> <td style="width: 10%;"></td> </tr> <tr> <td></td> <td></td> <td colspan="8" style="text-align: center;"> <table border="1" style="width: 100%; border-collapse: collapse; text-align: center;"> <tr> <td style="width: 10%;"></td> <td style="width: 10%;"></td> <td style="width: 10%;"></td> <td style="width: 10%;"></td> <td style="width: 10%;"></td> <td style="width: 10%;"></td> <td style="width: 10%;"></td> <td style="width: 10%;"></td> <td style="width: 10%;"></td> <td style="width: 10%;"></td> </tr> <tr> <td></td> <td></td> <td colspan="8" style="text-align: center;"> <table border="1" style="width: 100%; border-collapse: collapse; text-align: center;"> <tr> <td style="width: 10%;"></td> <td style="width: 10%;"></td> <td style="width: 10%;"></td> <td style="width: 10%;"></td> <td style="width: 10%;"></td> <td style="width: 10%;"></td> <td style="width: 10%;"></td> <td style="width: 10%;"></td> <td style="width: 10%;"></td> <td style="width: 10%;"></td> </tr> <tr> <td></td> <td></td> <td colspan="8" style="text-align: center;"> <table border="1" style="width: 100%; border-collapse: collapse; text-align: center;"> <tr> <td style="width: 10%;"></td> <td style="width: 10%;"></td> <td style="width: 10%;"></td> <td style="width: 10%;"></td> <td style="width: 10%;"></td> <td style="width: 10%;"></td> <td style="width: 10%;"></td> <td style="width: 10%;"></td> <td style="width: 10%;"></td> <td style="width: 10%;"></td> </tr> <tr> <td></td> <td></td> <td colspan="8" style="text-align: center;"> <table border="1" style="width: 100%; border-collapse: collapse; text-align: center;"> <tr> <td style="width: 10%;"></td> <td style="width: 10%;"></td> <td style="width: 10%;"></td> <td style="width: 10%;"></td> <td style="width: 10%;"></td> <td style="width: 10%;"></td> <td style="width: 10%;"></td> <td style="width: 10%;"></td> <td style="width: 10%;"></td> <td style="width: 10%;"></td> </tr> <tr> <td></td> <td></td> <td colspan="8" style="text-align: center;"> <table border="1" style="width: 100%; border-collapse: collapse; text-align: center;"> <tr> <td style="width: 10%;"></td> <td style="width: 10%;"></td> <td style="width: 10%;"></td> <td style="width: 10%;"></td> <td style="width: 10%;"></td> <td style="width: 10%;"></td> <td style="width: 10%;"></td> <td style="width: 10%;"></td> <td style="width: 10%;"></td> <td style="width: 10%;"></td> </tr> <tr> <td></td> <td></td> <td colspan="8" style="text-align: center;"> <table border="1" style="width: 100%; border-collapse: collapse; text-align: center;"> <tr> <td style="width: 10%;"></td> <td style="width: 10%;"></td> <td style="width: 10%;"></td> <td style="width: 10%;"></td> <td style="width: 10%;"></td> <td style="width: 10%;"></td> <td style="width: 10%;"></td> <td style="width: 10%;"></td> <td style="width: 10%;"></td> <td style="width: 10%;"></td> </tr> <tr> <td></td> <td></td> <td colspan="8" style="text-align: center;"> <table border="1" style="width: 100%; border-collapse: collapse; text-align: center;"> <tr> <td style="width: 10%;"></td> <td style="width: 10%;"></td> <td style="width: 10%;"></td> <td style="width: 10%;"></td> <td style="width: 10%;"></td> <td style="width: 10%;"></td> <td style="width: 10%;"></td> <td style="width: 10%;"></td> <td style="width: 10%;"></td> <td style="width: 10%;"></td> </tr> <tr> <td></td> <td></td> <td colspan="8" style="text-align: center;"> <table border="1" style="width: 100%; border-collapse: collapse; text-align: center;"> <tr> <td style="width: 10%;"></td> <td style="width: 10%;"></td> <td style="width: 10%;"></td> <td style="width: 10%;"></td> <td style="width: 10%;"></td> <td style="width: 10%;"></td> <td style="width: 10%;"></td> <td style="width: 10%;"></td> <td style="width: 10%;"></td> <td style="width: 10%;"></td> </tr> <tr> <td></td> <td></td> <td colspan="8" style="text-align: center;"> <table border="1" style="width: 100%; border-collapse: collapse; text-align: center;"> <tr> <td style="width: 10%;"></td> <td style="width: 10%;"></td> <td style="width: 10%;"></td> <td style="width: 10%;"></td> <td style="width: 10%;"></td> <td style="width: 10%;"></td> <td style="width: 10%;"></td> <td style="width: 10%;"></td> <td style="width: 10%;"></td> <td style="width: 10%;"></td> </tr> <tr> <td></td> <td></td> <td colspan="8" style="text-align: center;"> <table border="1" style="width: 100%; border-collapse: collapse; text-align: center;"> <tr> <td style="width: 10%;"></td> <td style="width: 10%;"></td> <td style="width: 10%;"></td> <td style="width: 10%;"></td> <td style="width: 10%;"></td> <td style="width: 10%;"></td> <td style="width: 10%;"></td> <td style="width: 10%;"></td> <td style="width: 10%;"></td> <td style="width: 10%;"></td> </tr> <tr> <td></td> <td></td> <td colspan="8" style="text-align: center;"> <table border="1" style="width: 100%; border-collapse: collapse; text-align: center;"> <tr> <td style="width: 10%;"></td> <td style="width: 10%;"></td> <td style="width: 10%;"></td> <td style="width: 10%;"></td> <td style="width: 10%;"></td> <td style="width: 10%;"></td> <td style="width: 10%;"></td> <td style="width: 10%;"></td> <td style="width: 10%;"></td> <td style="width: 10%;"></td> </tr> <tr> <td></td> <td></td> <td colspan="8" style="text-align: center;"> <table border="1" style="width: 100%; border-collapse: collapse; text-align: center;"> <tr> <td style="width: 10%;"></td> <td style="width: 10%;"></td> <td style="width: 10%;"></td> <td style="width: 10%;"></td> <td style="width: 10%;"></td> <td style="width: 10%;"></td> <td style="width: 10%;"></td> <td style="width: 10%;"></td> <td style="width: 10%;"></td> <td style="width: 10%;"></td> </tr> <tr> <td></td> <td></td> <td colspan="8" style="text-align: center;"> <table border="1"
style="width: 100%; border-collapse: collapse; text-align: center;"> <tr> <td style="width: 10%;"></td> <td style="width: 10%;"></td> <td style="width: 10%;"></td> <td style="width: 10%;"></td> <td style="width: 10%;"></td> <td style="width: 10%;"></td> <td style="width: 10%;"></td> <td style="width: 10%;"></td> <td style="width: 10%;"></td> <td style="width: 10%;"></td> </tr> <tr> <td></td> <td></td> <td colspan="8" style="text-align: center;"> <table border="1" style="width: 100%; border-collapse: collapse; text-align: center;"> <tr> <td style="width: 10%;"></td> <td style="width: 10%;"></td> <td style="width: 10%;"></td> <td style="width: 10%;"></td> <td style="width: 10%;"></td> <td style="width: 10%;"></td> <td style="width: 10%;"></td> <td style="width: 10%;"></td> <td style="width: 10%;"></td> <td style="width: 10%;"></td> </tr> <tr> <td></td> <td></td> <td colspan="8" style="text-align: center;"> <table border="1" style="width: 100%; border-collapse: collapse; text-align: center;"> <tr> <td style="width: 10%;"></td> <td style="width: 10%;"></td> <td style="width: 10%;"></td> <td style="width: 10%;"></td> <td style="width: 10%;"></td> <td style="width: 10%;"></td> <td style="width: 10%;"></td> <td style="width: 10%;"></td> <td style="width: 10%;"></td> <td style="width: 10%;"></td> </tr> <tr> <td></td> <td></td> <td colspan="8" style="text-align: center;"> <table border="1" style="width: 100%; border-collapse: collapse; text-align: center;"> <tr> <td style="width: 10%;"></td> <td style="width: 10%;"></td> <td style="width: 10%;"></td> <td style="width: 10%;"></td> <td style="width: 10%;"></td> <td style="width: 10%;"></td> <td style="width: 10%;"></td> <td style="width: 10%;"></td> <td style="width: 10%;"></td> <td style="width: 10%;"></td> </tr> <tr> <td></td> <td></td> <td colspan="8" style="text-align: center;"> <table border="1" style="width: 100%; border-collapse: collapse; text-align: center;"> <tr> <td style="width: 10%;"></td> <td style="width: 10%;"></td> <td style="width: 10%;"></td> <td style="width: 10%;"></td> <td style="width: 10%;"></td> <td style="width: 10%;"></td> <td style="width: 10%;"></td> <td style="width: 10%;"></td> <td style="width: 10%;"></td> <td style="width: 10%;"></td> </tr> <tr> <td></td> <td></td> <td colspan="8" style="text-align: center;"> <table border="1" style="width: 100%; border-collapse: collapse; text-align: center;"> <tr> <td style="width: 10%;"></td> <td style="width: 10%;"></td> <td style="width: 10%;"></td> <td style="width: 10%;"></td> <td style="width: 10%;"></td> <td style="width: 10%;"></td> <td style="width: 10%;"></td> <td style="width: 10%;"></td> <td style="width: 10%;"></td> <td style="width: 10%;"></td> </tr> <tr> <td></td> <td></td> <td colspan="8" style="text-align: center;"> <table border="1" style="width: 100%; border-collapse: collapse; text-align: center;"> <tr> <td style="width: 10%;"></td> <td style="width: 10%;"></td> <td style="width: 10%;"></td> <td style="width: 10%;"></td> <td style="width: 10%;"></td> <td style="width: 10%;"></td> <td style="width: 10%;"></td> <td style="width: 10%;"></td> <td style="width: 10%;"></td> <td style="width: 10%;"></td> </tr> <tr> <td></td> <td></td> <td colspan="8" style="text-align: center;"> <table border="1" style="width: 100%; border-collapse: collapse; text-align: center;"> <tr> <td style="width: 10%;"></td> <td style="width: 10%;"></td> <td style="width: 10%;"></td> <td style="width: 10%;"></td> <td style="width: 10%;"></td> <td style="width: 10%;"></td> <td style="width: 10%;"></td> <td style="width: 10%;"></td> <td style="width: 10%;"></td> <td style="width: 10%;"></td> </tr> <tr> <td></td> <td></td> <td colspan="8" style="text-align: center;"> <table border="1" style="width: 100%; border-collapse: collapse; text-align: center;"> <tr> <td style="width: 10%;"></td> <td style="width: 10%;"></td> <td style="width: 10%;"></td> <td style="width: 10%;"></td> <td style="width: 10%;"></td> <td style="width: 10%;"></td> <td style="width: 10%;"></td> <td style="width: 10%;"></td> <td style="width: 10%;"></td> <td style="width: 10%;"></td> </tr> <tr> <td></td> <td></td> <td colspan="8" style="text-align: center;"> <table border="1" style="width: 100%; border-collapse: collapse; text-align: center;"> <tr> <td style="width: 10%;"></td> <td style="width: 10%;"></td> <td style="width: 10%;"></td> <td style="width: 10%;"></td> <td style="width: 10%;"></td> <td style="width: 10%;"></td> <td style="width: 10%;"></td> <td style="width: 10%;"></td> <td style="width: 10%;"></td> <td style="width: 10%;"></td> </tr> <tr> <td></td> <td></td> <td colspan="8" style="text-align: center;"> <table border="1" style="width: 100%; border-collapse: collapse; text-align: center;"> <tr> <td style="width: 10%;"></td> <td style="width: 10%;"></td> <td style="width: 10%;"></td> <td style="width: 10%;"></td> <td style="width: 10%;"></td> <td style="width: 10%;"></td> <td style="width: 10%;"></td> <td style="width: 10%;"></td> <td style="width: 10%;"></td> <td style="width: 10%;"></td> </tr> <tr> <td></td> <td></td> <td colspan="8" style="text-align: center;"> <table border="1" style="width: 100%; border-collapse: collapse; text-align: center;"> <tr> <td style="width: 10%;"></td> <td style="width: 10%;"></td> <td style="width: 10%;"></td> <td style="width: 10%;"></td> <td style="width: 10%;"></td> <td style="width: 10%;"></td> <td style="width: 10%;"></td> <td style="width: 10%;"></td> <td style="width: 10%;"></td> <td style="width: 10%;"></td> </tr> <tr> <td></td> <td></td> <td colspan="8" style="text-align: center;"> <table border="1" style="width: 100%; border-collapse: collapse; text-align: center;"> <tr> <td style="width: 10%;"></td> <td style="width: 10%;"></td> <td style="width: 10%;"></td> <td style="width: 10%;"></td> <td style="width: 10%;"></td> <td style="width: 10%;"></td> <td style="width: 10%;"></td> <td style="width: 10%;"></td> <td style="width: 10%;"></td> <td style="width: 10%;"></td> </tr> <tr> <td></td> <td></td> <td colspan="8" style="text-align: center;"> <table border="1" style="width: 100%; border-collapse: collapse; text-align: center;"> <tr> <td style="width: 10%;"></td> <td style="width: 10%;"></td> <td style="width: 10%;"></td> <td style="width: 10%;"></td> <td style="width: 10%;"></td> <td style="width: 10%;"></td> <td style="width: 10%;"></td> <td style="width: 10%;"></td> <td style="width: 10%;"></td> <td style="width: 10%;"></td> </tr> <tr> <td></td> <td></td> <td colspan="8" style="text-align: center;"> <table border="1" style="width: 100%; border-collapse: collapse; text-align: center;"> <tr> <td style="width: 10%;"></td> <td style="width: 10%;"></td> <td style="width: 10%;"></td> <td style="width: 10%;"></td> <td style="width: 10%;"></td> <td style="width: 10%;"></td> <td style="width: 10%;"></td> <td style="width: 10%;"></td> <td style="width: 10%;"></td> <td style="width: 10%;"></td> </tr> <tr> <td></td> <td></td> <td colspan="8" style="text-align: center;"> <table border="1" style="width: 100%; border-collapse: collapse; text-align: center;"> <tr> <td style="width: 10%;"></td> <td style="width: 10%;"></td> <td style="width: 10%;"></td> <td style="width: 10%;"></td> <td style="width: 10%;"></td> <td style="width: 10%;"></td> <td style="width: 10%;"></td> <td style="width: 10%;"></td> <td style="width: 10%;"></td> <td style="width: 10%;"></td> </tr> <tr> <td></td> <td></td> <td colspan="8" style="text-align: center;"> <table border="1" style="width: 100%; border-collapse: collapse; text-align: center;"> <tr> <td style="width: 10%;"></td> <td style="width: 10%;"></td> <td style="width: 10%;"></td> <td style="width: 10%;"></td> <td style="width: 10%;"></td> <td style="width: 10%;"></td> <td style="width: 10%;"></td> <td style="width: 10%;"></td> <td style="width: 10%;"></td> <td style="width: 10%;"></td> </tr> <tr> <td></td> <td></td> <td colspan="8" style="text-align: center;"> <table border="1" style="width: 100%; border-collapse: collapse; text-align: center;"> <tr> <td style="width: 10%;"></td> <td style="width: 10%;"></td> <td style="width: 10%;"></td> <td style="width: 10%;"></td> <td style="width: 10%;"></td> <td style="width: 10%;"></td> <td style="width: 10%;"></td> <td style="width: 10%;"></td> <td style="width: 10%;"></td> <td style="width: 10%;"></td> </tr> <tr> <td></td> <td></td> <td colspan="8" style="text-align: center;"> <table border="1" style="width: 100%; border-collapse: collapse; text-align: center;"> <tr> <td style="width: 10%;"></td> <td style="width: 10%;"></td> <td style="width: 10%;"></td> <td style="width: 10%;"></td> <td style="width: 10%;"></td> <td style="width: 10%;"></td> <td style="width: 10%;"></td> <td style="width: 10%;"></td> <td style="width: 10%;"></td> <td style="width: 10%;"></td> </tr> <tr> <td></td> <td></td> <td colspan="8" style="text-align: center;"> <table border="1" style="width: 100%; border-collapse: collapse; text-align: center;"> <tr> <td style="width: 10%;"></td> <td style="width: 10%;"></td> <td style="width: 10%;"></td> <td style="width: 10%;"></td> <td style="width: 10%;"></td> <td style="width: 10%;"></td> <td style="width: 10%;"></td> <td style="width: 10%;"></td> <td style="width: 10%;"></td> <td style="width: 10%;"></td> </tr> <tr> <td></td> <td></td> <td colspan="8" style="text-align: center;"> <table border="1" style="width: 100%; border-collapse: collapse; text-align: center;"> <tr> <td style="width: 10%;"></td> <td style="width: 10%;"></td> <td style="width: 10%;"></td> <td style="width: 10%;"></td> <td style="width: 10%;"></td> <td style="width: 10%;"></td> <td style="width: 10%;"></td> <td style="width: 10%;"></td> <td style="width: 10%;"></td> <td style="width: 10%;"></td> </tr> <tr> <td></td> <td></td> <td colspan="8" style="text-align: center;"> <table border="1" style="width: 100%; border-collapse: collapse; text-align: center;"> <tr> <td style="width: 10%;"></td> <td style="width: 10%;"></td> <td style="width: 10%;"></td> <td
style="width: 10%;"></td> <td style="width: 10%;"></td> <td style="width: 10%;"></td> <td style="width: 10%;"></td> <td style="width: 10%;"></td> <td style="width: 10%;"></td> <td style="width: 10%;"></td> </tr> <tr> <td></td> <td></td> <td colspan="8" style="text-align: center;"> <table border="1" style="width: 100%; border-collapse: collapse; text-align: center;"> <tr> <td style="width: 10%;"></td> <td style="width: 10%;"></td> <td style="width: 10%;"></td> <td style="width: 10%;"></td> <td style="width: 10%;"></td> <td style="width: 10%;"></td> <td style="width: 10%;"></td> <td style="width: 10%;"></td> <td style="width: 10%;"></td> <td style="width: 10%;"></td> </tr> <tr> <td></td> <td></td> <td colspan="8" style="text-align: center;"> <table border="1" style="width: 100%; border-collapse: collapse; text-align: center;"> <tr> <td style="width: 10%;"></td> <td style="width: 10%;"></td> <td style="width: 10%;"></td> <td style="width: 10%;"></td> <td style="width: 10%;"></td> <td style="width: 10%;"></td> <td style="width: 10%;"></td> <td style="width: 10%;"></td> <td style="width: 10%;"></td> <td style="width: 10%;"></td> </tr> <tr> <td></td> <td></td> <td colspan="8" style="text-align: center;"> <table border="1" style="width: 100%; border-collapse: collapse; text-align: center;"> <tr> <td style="width: 10%;"></td> <td style="width: 10%;"></td> <td style="width: 10%;"></td> <td style="width: 10%;"></td> <td style="width: 10%;"></td> <td style="width: 10%;"></td> <td style="width: 10%;"></td> <td style="width: 10%;"></td> <td style="width: 10%;"></td> <td style="width: 10%;"></td> </tr> <tr> <td></td> <td></td> <td colspan="8" style="text-align: center;"> <table border="1" style="width: 100%; border-collapse: collapse; text-align: center;"> <tr> <td style="width: 10%;"></td> <td style="width: 10%;"></td> <td style="width: 10%;"></td> <td style="width: 10%;"></td> <td style="width: 10%;"></td> <td style="width: 10%;"></td> <td style="width: 10%;"></td> <td style="width: 10%;"></td> <td style="width: 10%;"></td> <td style="width: 10%;"></td> </tr> <tr> <td></td> <td></td> <td colspan="8" style="text-align: center;"> <table border="1" style="width: 100%; border-collapse: collapse; text-align: center;"> <tr> <td style="width: 10%;"></td> <td style="width: 10%;"></td> <td style="width: 10%;"></td> <td style="width: 10%;"></td> <td style="width: 10%;"></td> <td style="width: 10%;"></td> <td style="width: 10%;"></td> <td style="width: 10%;"></td> <td style="width: 10%;"></td> <td style="width: 10%;"></td> </tr> <tr> <td></td> <td></td> <td colspan="8" style="text-align: center;"> <table border="1" style="width: 100%; border-collapse: collapse; text-align: center;"> <tr> <td style="width: 10%;"></td> <td style="width: 10%;"></td> <td style="width: 10%;"></td> <td style="width: 10%;"></td> <td style="width: 10%;"></td> <td style="width: 10%;"></td> <td style="width: 10%;"></td> <td style="width: 10%;"></td> <td style="width: 10%;"></td> <td style="width: 10%;"></td> </tr> <tr> <td></td> <td></td> <td colspan="8" style="text-align: center;"> <table border="1" style="width: 100%; border-collapse: collapse; text-align: center;"> <tr> </tr></table></td></tr></table></td></tr></table></td></tr></table></td></tr></table></td></tr></table></td></tr></table></td></tr></table></td></tr></table></td></tr></table></td></tr></table></td></tr></table></td></tr></table></td></tr></table></td></tr></table></td></tr></table></td></tr></table></td></tr></table></td></tr></table></td></tr></table></td></tr></table></td></tr></table></td></tr></table></td></tr></table></td></tr></table></td></tr></table></td></tr></table></td></tr></table></td></tr></table></td></tr></table></td></tr></table></td></tr></table></td></tr></table></td></tr></table></td></tr></table></td></tr></table></td></tr></table></td></tr></table></td></tr></table></td></tr></table></td></tr></table></td></tr></table></td></tr></table></td></tr></table></td></tr></table></td></tr></table> | | | | | | | | | | | | | | | | | | | | <table border="1" style="width: 100%; border-collapse: collapse; text-align: center;"> <tr> <td style="width: 10%;"></td> <td style="width: 10%;"></td> <td style="width: 10%;"></td> <td style="width: 10%;"></td> <td style="width: 10%;"></td> <td style="width: 10%;"></td> <td style="width: 10%;"></td> <td style="width: 10%;"></td> <td style="width: 10%;"></td> <td style="width: 10%;"></td> </tr> <tr> <td></td> <td></td> <td colspan="8" style="text-align: center;"> <table border="1" style="width: 100%; border-collapse: collapse; text-align: center;"> <tr> <td style="width: 10%;"></td> <td style="width: 10%;"></td> <td style="width: 10%;"></td> <td style="width: 10%;"></td> <td style="width: 10%;"></td> <td style="width: 10%;"></td> <td style="width: 10%;"></td> <td style="width: 10%;"></td> <td style="width: 10%;"></td> <td style="width: 10%;"></td> </tr> <tr> <td></td> <td></td> <td colspan="8" style="text-align: center;"> <table border="1" style="width: 100%; border-collapse: collapse; text-align: center;"> <tr> <td style="width: 10%;"></td> <td style="width: 10%;"></td> <td style="width: 10%;"></td> <td style="width: 10%;"></td> <td style="width: 10%;"></td> <td style="width: 10%;"></td> <td style="width: 10%;"></td> <td style="width: 10%;"></td> <td style="width: 10%;"></td> <td style="width: 10%;"></td> </tr> <tr> <td></td> <td></td> <td colspan="8" style="text-align: center;"> <table border="1" style="width: 100%; border-collapse: collapse; text-align: center;"> <tr> <td style="width: 10%;"></td> <td style="width: 10%;"></td> <td style="width: 10%;"></td> <td style="width: 10%;"></td> <td style="width: 10%;"></td> <td style="width: 10%;"></td> <td style="width: 10%;"></td> <td style="width: 10%;"></td> <td style="width: 10%;"></td> <td style="width: 10%;"></td> </tr> <tr> <td></td> <td></td> <td colspan="8" style="text-align: center;"> <table border="1" style="width: 100%; border-collapse: collapse; text-align: center;"> <tr> <td style="width: 10%;"></td> <td style="width: 10%;"></td> <td style="width: 10%;"></td> <td style="width: 10%;"></td> <td style="width: 10%;"></td> <td style="width: 10%;"></td> <td style="width: 10%;"></td> <td style="width: 10%;"></td> <td style="width: 10%;"></td> <td style="width: 10%;"></td> </tr> <tr> <td></td> <td></td> <td colspan="8" style="text-align: center;"> <table border="1" style="width: 100%; border-collapse: collapse; text-align: center;"> <tr> <td style="width: 10%;"></td> <td style="width: 10%;"></td> <td style="width: 10%;"></td> <td style="width: 10%;"></td> <td style="width: 10%;"></td> <td style="width: 10%;"></td> <td style="width: 10%;"></td> <td style="width: 10%;"></td> <td style="width: 10%;"></td> <td style="width: 10%;"></td> </tr> <tr> <td></td> <td></td> <td colspan="8" style="text-align: center;"> <table border="1" style="width: 100%; border-collapse: collapse; text-align: center;"> <tr> <td style="width: 10%;"></td> <td style="width: 10%;"></td> <td style="width: 10%;"></td> <td style="width: 10%;"></td> <td style="width: 10%;"></td> <td style="width: 10%;"></td> <td style="width: 10%;"></td> <td style="width: 10%;"></td> <td style="width: 10%;"></td> <td style="width: 10%;"></td> </tr> <tr> <td></td> <td></td> <td colspan="8" style="text-align: center;"> <table border="1" style="width: 100%; border-collapse: collapse; text-align: center;"> <tr> <td style="width: 10%;"></td> <td style="width: 10%;"></td> <td style="width: 10%;"></td> <td style="width: 10%;"></td> <td style="width: 10%;"></td> <td style="width: 10%;"></td> <td style="width: 10%;"></td> <td style="width: 10%;"></td> <td style="width: 10%;"></td> <td style="width: 10%;"></td> </tr> <tr> <td></td> <td></td> <td colspan="8" style="text-align: center;"> <table border="1" style="width: 100%; border-collapse: collapse; text-align: center;"> <tr> <td style="width: 10%;"></td> <td style="width: 10%;"></td> <td style="width: 10%;"></td> <td style="width: 10%;"></td> <td style="width: 10%;"></td> <td style="width: 10%;"></td> <td style="width: 10%;"></td> <td style="width: 10%;"></td> <td style="width: 10%;"></td> <td style="width: 10%;"></td> </tr> <tr> <td></td> <td></td> <td colspan="8" style="text-align: center;"> <table border="1" style="width: 100%; border-collapse: collapse; text-align: center;"> <tr> <td style="width: 10%;"></td> <td style="width: 10%;"></td> <td style="width: 10%;"></td> <td style="width: 10%;"></td> <td style="width: 10%;"></td> <td style="width: 10%;"></td> <td style="width: 10%;"></td> <td style="width: 10%;"></td> <td style="width: 10%;"></td> <td style="width: 10%;"></td> </tr> <tr> <td></td> <td></td> <td colspan="8" style="text-align: center;"> <table border="1" style="width: 100%; border-collapse: collapse; text-align: center;"> <tr> <td style="width: 10%;"></td> <td style="width: 10%;"></td> <td style="width: 10%;"></td> <td style="width: 10%;"></td> <td style="width: 10%;"></td> <td style="width: 10%;"></td> <td style="width: 10%;"></td> <td style="width: 10%;"></td> <td style="width: 10%;"></td> <td style="width: 10%;"></td> </tr> <tr> <td></td> <td></td> <td colspan="8" style="text-align: center;"> <table border="1" style="width: 100%; border-collapse: collapse; text-align: center;"> <tr> <td style="width: 10%;"></td> <td style="width: 10%;"></td> <td style="width: 10%;"></td> <td style="width: 10%;"></td> <td style="width: 10%;"></td> <td style="width: 10%;"></td> <td style="width: 10%;"></td> <td style="width: 10%;"></td> <td style="width: 10%;"></td> <td style="width: 10%;"></td> </tr> <tr> <td></td> <td></td> <td colspan="8" style="text-align: center;"> <table border="1" style="width: 100%; border-collapse: collapse; text-align: center;"> <tr> <td style="width: 10%;"></td> <td style="width: 10%;"></td> <td style="width: 10%;"></td> <td style="width: 10%;"></td> <td style="width: 10%;"></td> <td style="width: 10%;"></td> <td style="width: 10%;"></td> <td
style="width: 10%;"></td> <td style="width: 10%;"></td> <td style="width: 10%;"></td> </tr> <tr> <td></td> <td></td> <td colspan="8" style="text-align: center;"> <table border="1" style="width: 100%; border-collapse: collapse; text-align: center;"> <tr> <td style="width: 10%;"></td> <td style="width: 10%;"></td> <td style="width: 10%;"></td> <td style="width: 10%;"></td> <td style="width: 10%;"></td> <td style="width: 10%;"></td> <td style="width: 10%;"></td> <td style="width: 10%;"></td> <td style="width: 10%;"></td> <td style="width: 10%;"></td> </tr> <tr> <td></td> <td></td> <td colspan="8" style="text-align: center;"> <table border="1" style="width: 100%; border-collapse: collapse; text-align: center;"> <tr> <td style="width: 10%;"></td> <td style="width: 10%;"></td> <td style="width: 10%;"></td> <td style="width: 10%;"></td> <td style="width: 10%;"></td> <td style="width: 10%;"></td> <td style="width: 10%;"></td> <td style="width: 10%;"></td> <td style="width: 10%;"></td> <td style="width: 10%;"></td> </tr> <tr> <td></td> <td></td> <td colspan="8" style="text-align: center;"> <table border="1" style="width: 100%; border-collapse: collapse; text-align: center;"> <tr> <td style="width: 10%;"></td> <td style="width: 10%;"></td> <td style="width: 10%;"></td> <td style="width: 10%;"></td> <td style="width: 10%;"></td> <td style="width: 10%;"></td> <td style="width: 10%;"></td> <td style="width: 10%;"></td> <td style="width: 10%;"></td> <td style="width: 10%;"></td> </tr> <tr> <td></td> <td></td> <td colspan="8" style="text-align: center;"> <table border="1" style="width: 100%; border-collapse: collapse; text-align: center;"> <tr> <td style="width: 10%;"></td> <td style="width: 10%;"></td> <td style="width: 10%;"></td> <td style="width: 10%;"></td> <td style="width: 10%;"></td> <td style="width: 10%;"></td> <td style="width: 10%;"></td> <td style="width: 10%;"></td> <td style="width: 10%;"></td> <td style="width: 10%;"></td> </tr> <tr> <td></td> <td></td> <td colspan="8" style="text-align: center;"> <table border="1" style="width: 100%; border-collapse: collapse; text-align: center;"> <tr> <td style="width: 10%;"></td> <td style="width: 10%;"></td> <td style="width: 10%;"></td> <td style="width: 10%;"></td> <td style="width: 10%;"></td> <td style="width: 10%;"></td> <td style="width: 10%;"></td> <td style="width: 10%;"></td> <td style="width: 10%;"></td> <td style="width: 10%;"></td> </tr> <tr> <td></td> <td></td> <td colspan="8" style="text-align: center;"> <table border="1" style="width: 100%; border-collapse: collapse; text-align: center;"> <tr> <td style="width: 10%;"></td> <td style="width: 10%;"></td> <td style="width: 10%;"></td> <td style="width: 10%;"></td> <td style="width: 10%;"></td> <td style="width: 10%;"></td> <td style="width: 10%;"></td> <td style="width: 10%;"></td> <td style="width: 10%;"></td> <td style="width: 10%;"></td> </tr> <tr> <td></td> <td></td> <td colspan="8" style="text-align: center;"> <table border="1" style="width: 100%; border-collapse: collapse; text-align: center;"> <tr> <td style="width: 10%;"></td> <td style="width: 10%;"></td> <td style="width: 10%;"></td> <td style="width: 10%;"></td> <td style="width: 10%;"></td> <td style="width: 10%;"></td> <td style="width: 10%;"></td> <td style="width: 10%;"></td> <td style="width: 10%;"></td> <td style="width: 10%;"></td> </tr> <tr> <td></td> <td></td> <td colspan="8" style="text-align: center;"> <table border="1" style="width: 100%; border-collapse: collapse; text-align: center;"> <tr> <td style="width: 10%;"></td> <td style="width: 10%;"></td> <td style="width: 10%;"></td> <td style="width: 10%;"></td> <td style="width: 10%;"></td> <td style="width: 10%;"></td> <td style="width: 10%;"></td> <td style="width: 10%;"></td> <td style="width: 10%;"></td> <td style="width: 10%;"></td> </tr> <tr> <td></td> <td></td> <td colspan="8" style="text-align: center;"> <table border="1" style="width: 100%; border-collapse: collapse; text-align: center;"> <tr> <td style="width: 10%;"></td> <td style="width: 10%;"></td> <td style="width: 10%;"></td> <td style="width: 10%;"></td> <td style="width: 10%;"></td> <td style="width: 10%;"></td> <td style="width: 10%;"></td> <td style="width: 10%;"></td> <td style="width: 10%;"></td> <td style="width: 10%;"></td> </tr> <tr> <td></td> <td></td> <td colspan="8" style="text-align: center;"> <table border="1" style="width: 100%; border-collapse: collapse; text-align: center;"> <tr> <td style="width: 10%;"></td> <td style="width: 10%;"></td> <td style="width: 10%;"></td> <td style="width: 10%;"></td> <td style="width: 10%;"></td> <td style="width: 10%;"></td> <td style="width: 10%;"></td> <td style="width: 10%;"></td> <td style="width: 10%;"></td> <td style="width: 10%;"></td> </tr> <tr> <td></td> <td></td> <td colspan="8" style="text-align: center;"> <table border="1" style="width: 100%; border-collapse: collapse; text-align: center;"> <tr> <td style="width: 10%;"></td> <td style="width: 10%;"></td> <td style="width: 10%;"></td> <td style="width: 10%;"></td> <td style="width: 10%;"></td> <td style="width: 10%;"></td> <td style="width: 10%;"></td> <td style="width: 10%;"></td> <td style="width: 10%;"></td> <td style="width: 10%;"></td> </tr> <tr> <td></td> <td></td> <td colspan="8" style="text-align: center;"> <table border="1" style="width: 100%; border-collapse: collapse; text-align: center;"> <tr> <td style="width: 10%;"></td> <td style="width: 10%;"></td> <td style="width: 10%;"></td> <td style="width: 10%;"></td> <td style="width: 10%;"></td> <td style="width: 10%;"></td> <td style="width: 10%;"></td> <td style="width: 10%;"></td> <td style="width: 10%;"></td> <td style="width: 10%;"></td> </tr> <tr> <td></td> <td></td> <td colspan="8" style="text-align: center;"> <table border="1" style="width: 100%; border-collapse: collapse; text-align: center;"> <tr> <td style="width: 10%;"></td> <td style="width: 10%;"></td> <td style="width: 10%;"></td> <td style="width: 10%;"></td> <td style="width: 10%;"></td> <td style="width: 10%;"></td> <td style="width: 10%;"></td> <td style="width: 10%;"></td> <td style="width: 10%;"></td> <td style="width: 10%;"></td> </tr> <tr> <td></td> <td></td> <td colspan="8" style="text-align: center;"> <table border="1" style="width: 100%; border-collapse: collapse; text-align: center;"> <tr> <td style="width: 10%;"></td> <td style="width: 10%;"></td> <td style="width: 10%;"></td> <td style="width: 10%;"></td> <td style="width: 10%;"></td> <td style="width: 10%;"></td> <td style="width: 10%;"></td> <td style="width: 10%;"></td> <td style="width: 10%;"></td> <td style="width: 10%;"></td> </tr> <tr> <td></td> <td></td> <td colspan="8" style="text-align: center;"> <table border="1" style="width: 100%; border-collapse: collapse; text-align: center;"> <tr> <td style="width: 10%;"></td> <td style="width: 10%;"></td> <td style="width: 10%;"></td> <td style="width: 10%;"></td> <td style="width: 10%;"></td> <td style="width: 10%;"></td> <td style="width: 10%;"></td> <td style="width: 10%;"></td> <td style="width: 10%;"></td> <td style="width: 10%;"></td> </tr> <tr> <td></td> <td></td> <td colspan="8" style="text-align: center;"> <table border="1" style="width: 100%; border-collapse: collapse; text-align: center;"> <tr> <td style="width: 10%;"></td> <td style="width: 10%;"></td> <td style="width: 10%;"></td> <td style="width: 10%;"></td> <td style="width: 10%;"></td> <td style="width: 10%;"></td> <td style="width: 10%;"></td> <td style="width: 10%;"></td> <td style="width: 10%;"></td> <td style="width: 10%;"></td> </tr> <tr> <td></td> <td></td> <td colspan="8" style="text-align: center;"> <table border="1" style="width: 100%; border-collapse: collapse; text-align: center;"> <tr> <td style="width: 10%;"></td> <td style="width: 10%;"></td> <td style="width: 10%;"></td> <td style="width: 10%;"></td> <td style="width: 10%;"></td> <td style="width: 10%;"></td> <td style="width: 10%;"></td> <td style="width: 10%;"></td> <td style="width: 10%;"></td> <td style="width: 10%;"></td> </tr> <tr> <td></td> <td></td> <td colspan="8" style="text-align: center;"> <table border="1" style="width: 100%; border-collapse: collapse; text-align: center;"> <tr> <td style="width: 10%;"></td> <td style="width: 10%;"></td> <td style="width: 10%;"></td> <td style="width: 10%;"></td> <td style="width: 10%;"></td> <td style="width: 10%;"></td> <td style="width: 10%;"></td> <td style="width: 10%;"></td> <td style="width: 10%;"></td> <td style="width: 10%;"></td> </tr> <tr> <td></td> <td></td> <td colspan="8" style="text-align: center;"> <table border="1" style="width: 100%; border-collapse: collapse; text-align: center;"> <tr> <td style="width: 10%;"></td> <td style="width: 10%;"></td> <td style="width: 10%;"></td> <td style="width: 10%;"></td> <td style="width: 10%;"></td> <td style="width: 10%;"></td> <td style="width: 10%;"></td> <td style="width: 10%;"></td> <td style="width: 10%;"></td> <td style="width: 10%;"></td> </tr> <tr> <td></td> <td></td> <td colspan="8" style="text-align: center;"> <table border="1" style="width: 100%; border-collapse: collapse; text-align: center;"> <tr> <td style="width: 10%;"></td> <td style="width: 10%;"></td> <td style="width: 10%;"></td> <td style="width: 10%;"></td> <td style="width: 10%;"></td> <td style="width: 10%;"></td> <td style="width: 10%;"></td> <td style="width: 10%;"></td> <td style="width: 10%;"></td> <td style="width: 10%;"></td> </tr> <tr> <td></td> <td></td> <td colspan="8" style="text-align: center;"> <table border="1" style="width: 100%; border-collapse: collapse; text-align: center;"> <tr> <td style="width: 10%;"></td> <td style="width: 10%;"></td> <td style="width: 10%;"></td> <td style="width: 10%;"></td> <td style="width: 10%;"></td> <td style="width: 10%;"></td> <td style="width: 10%;"></td> <td style="width: 10%;"></td> <td style="width: 10%;"></td> <td style="width: 10%;"></td> </tr> <tr> <td></td> <td></td> <td colspan="8" style="text-align: center;"> <table
border="1" style="width: 100%; border-collapse: collapse; text-align: center;"> <tr> <td style="width: 10%;"></td> <td style="width: 10%;"></td> <td style="width: 10%;"></td> <td style="width: 10%;"></td> <td style="width: 10%;"></td> <td style="width: 10%;"></td> <td style="width: 10%;"></td> <td style="width: 10%;"></td> <td style="width: 10%;"></td> <td style="width: 10%;"></td> </tr> <tr> <td></td> <td></td> <td colspan="8" style="text-align: center;"> <table border="1" style="width: 100%; border-collapse: collapse; text-align: center;"> <tr> <td style="width: 10%;"></td> <td style="width: 10%;"></td> <td style="width: 10%;"></td> <td style="width: 10%;"></td> <td style="width: 10%;"></td> <td style="width: 10%;"></td> <td style="width: 10%;"></td> <td style="width: 10%;"></td> <td style="width: 10%;"></td> <td style="width: 10%;"></td> </tr> <tr> <td></td> <td></td> <td colspan="8" style="text-align: center;"> <table border="1" style="width: 100%; border-collapse: collapse; text-align: center;"> <tr> <td style="width: 10%;"></td> <td style="width: 10%;"></td> <td style="width: 10%;"></td> <td style="width: 10%;"></td> <td style="width: 10%;"></td> <td style="width: 10%;"></td> <td style="width: 10%;"></td> <td style="width: 10%;"></td> <td style="width: 10%;"></td> <td style="width: 10%;"></td> </tr> <tr> <td></td> <td></td> <td colspan="8" style="text-align: center;"> <table border="1" style="width: 100%; border-collapse: collapse; text-align: center;"> <tr> <td style="width: 10%;"></td> <td style="width: 10%;"></td> <td style="width: 10%;"></td> <td style="width: 10%;"></td> <td style="width: 10%;"></td> <td style="width: 10%;"></td> <td style="width: 10%;"></td> <td style="width: 10%;"></td> <td style="width: 10%;"></td> <td style="width: 10%;"></td> </tr> <tr> <td></td> <td></td> <td colspan="8" style="text-align: center;"> <table border="1" style="width: 100%; border-collapse: collapse; text-align: center;"> <tr> <td style="width: 10%;"></td> <td style="width: 10%;"></td> <td style="width: 10%;"></td> <td style="width: 10%;"></td> <td style="width: 10%;"></td> <td style="width: 10%;"></td> <td style="width: 10%;"></td> <td style="width: 10%;"></td> <td style="width: 10%;"></td> <td style="width: 10%;"></td> </tr> <tr> <td></td> <td></td> <td colspan="8" style="text-align: center;"> <table border="1" style="width: 100%; border-collapse: collapse; text-align: center;"> <tr> <td style="width: 10%;"></td> <td style="width: 10%;"></td> <td style="width: 10%;"></td> <td style="width: 10%;"></td> <td style="width: 10%;"></td> <td style="width: 10%;"></td> <td style="width: 10%;"></td> <td style="width: 10%;"></td> <td style="width: 10%;"></td> <td style="width: 10%;"></td> </tr> <tr> <td></td> <td></td> <td colspan="8" style="text-align: center;"> <table border="1" style="width: 100%; border-collapse: collapse; text-align: center;"> <tr> <td style="width: 10%;"></td> <td style="width: 10%;"></td> <td style="width: 10%;"></td> <td style="width: 10%;"></td> <td style="width: 10%;"></td> <td style="width: 10%;"></td> <td style="width: 10%;"></td> <td style="width: 10%;"></td> <td style="width: 10%;"></td> <td style="width: 10%;"></td> </tr> <tr> <td></td> <td></td> <td colspan="8" style="text-align: center;"> <table border="1" style="width: 100%; border-collapse: collapse; text-align: center;"> <tr> <td style="width: 10%;"></td> <td style="width: 10%;"></td> <td style="width: 10%;"></td> <td style="width: 10%;"></td> <td style="width: 10%;"></td> <td style="width: 10%;"></td> <td style="width: 10%;"></td> <td style="width: 10%;"></td> <td style="width: 10%;"></td> <td style="width: 10%;"></td> </tr> <tr> <td></td> <td></td> <td colspan="8" style="text-align: center;"> <table border="1" style="width: 100%; border-collapse: collapse; text-align: center;"> <tr> <td style="width: 10%;"></td> <td style="width: 10%;"></td> <td style="width: 10%;"></td> <td style="width: 10%;"></td> <td style="width: 10%;"></td> <td style="width: 10%;"></td> <td style="width: 10%;"></td> <td style="width: 10%;"></td> <td style="width: 10%;"></td> <td style="width: 10%;"></td> </tr> <tr> <td></td> <td></td> <td colspan="8" style="text-align: center;"> <table border="1" style="width: 100%; border-collapse: collapse; text-align: center;"> <tr> <td style="width: 10%;"></td> <td style="width: 10%;"></td> <td style="width: 10%;"></td> <td style="width: 10%;"></td> <td style="width: 10%;"></td> <td style="width: 10%;"></td> <td style="width: 10%;"></td> <td style="width: 10%;"></td> <td style="width: 10%;"></td> <td style="width: 10%;"></td> </tr> <tr> <td></td> <td></td> <td colspan="8" style="text-align: center;"> <table border="1" style="width: 100%; border-collapse: collapse; text-align: center;"> <tr> </tr></table></td></tr></table></td></tr></table></td></tr></table></td></tr></table></td></tr></table></td></tr></table></td></tr></table></td></tr></table></td></tr></table></td></tr></table></td></tr></table></td></tr></table></td></tr></table></td></tr></table></td></tr></table></td></tr></table></td></tr></table></td></tr></table></td></tr></table></td></tr></table></td></tr></table></td></tr></table></td></tr></table></td></tr></table></td></tr></table></td></tr></table></td></tr></table></td></tr></table></td></tr></table></td></tr></table></td></tr></table></td></tr></table></td></tr></table></td></tr></table></td></tr></table></td></tr></table></td></tr></table></td></tr></table></td></tr></table></td></tr></table></td></tr></table></td></tr></table></td></tr></table></td></tr></table> | | | | | | | | | | | | | | | | | | | | <table border="1" style="width: 100%; border-collapse: collapse; text-align: center;"> <tr> <td style="width: 10%;"></td> <td style="width: 10%;"></td> <td style="width: 10%;"></td> <td style="width: 10%;"></td> <td style="width: 10%;"></td> <td style="width: 10%;"></td> <td style="width: 10%;"></td> <td style="width: 10%;"></td> <td style="width: 10%;"></td> <td style="width: 10%;"></td> </tr> <tr> <td></td> <td></td> <td colspan="8" style="text-align: center;"> <table border="1" style="width: 100%; border-collapse: collapse; text-align: center;"> <tr> <td style="width: 10%;"></td> <td style="width: 10%;"></td> <td style="width: 10%;"></td> <td style="width: 10%;"></td> <td style="width: 10%;"></td> <td style="width: 10%;"></td> <td style="width: 10%;"></td> <td style="width: 10%;"></td> <td style="width: 10%;"></td> <td style="width: 10%;"></td> </tr> <tr> <td></td> <td></td> <td colspan="8" style="text-align: center;"> <table border="1" style="width: 100%; border-collapse: collapse; text-align: center;"> <tr> <td style="width: 10%;"></td> <td style="width: 10%;"></td> <td style="width: 10%;"></td> <td style="width: 10%;"></td> <td style="width: 10%;"></td> <td style="width: 10%;"></td> <td style="width: 10%;"></td> <td style="width: 10%;"></td> <td style="width: 10%;"></td> <td style="width: 10%;"></td> </tr> <tr> <td></td> <td></td> <td colspan="8" style="text-align: center;"> <table border="1" style="width: 100%; border-collapse: collapse; text-align: center;"> <tr> <td style="width: 10%;"></td> <td style="width: 10%;"></td> <td style="width: 10%;"></td> <td style="width: 10%;"></td> <td style="width: 10%;"></td> <td style="width: 10%;"></td> <td style="width: 10%;"></td> <td style="width: 10%;"></td> <td style="width: 10%;"></td> <td style="width: 10%;"></td> </tr> <tr> <td></td> <td></td> <td colspan="8" style="text-align: center;"> <table border="1" style="width: 100%; border-collapse: collapse; text-align: center;"> <tr> <td style="width: 10%;"></td> <td style="width: 10%;"></td> <td style="width: 10%;"></td> <td style="width: 10%;"></td> <td style="width: 10%;"></td> <td style="width: 10%;"></td> <td style="width: 10%;"></td> <td style="width: 10%;"></td> <td style="width: 10%;"></td> <td style="width: 10%;"></td> </tr> <tr> <td></td> <td></td> <td colspan="8" style="text-align: center;"> <table border="1" style="width: 100%; border-collapse: collapse; text-align: center;"> <tr> <td style="width: 10%;"></td> <td style="width: 10%;"></td> <td style="width: 10%;"></td> <td style="width: 10%;"></td> <td style="width: 10%;"></td> <td style="width: 10%;"></td> <td style="width: 10%;"></td> <td style="width: 10%;"></td> <td style="width: 10%;"></td> <td style="width: 10%;"></td> </tr> <tr> <td></td> <td></td> <td colspan="8" style="text-align: center;"> <table border="1" style="width: 100%; border-collapse: collapse; text-align: center;"> <tr> <td style="width: 10%;"></td> <td style="width: 10%;"></td> <td style="width: 10%;"></td> <td style="width: 10%;"></td> <td style="width: 10%;"></td> <td style="width: 10%;"></td> <td style="width: 10%;"></td> <td style="width: 10%;"></td> <td style="width: 10%;"></td> <td style="width: 10%;"></td> </tr> <tr> <td></td> <td></td> <td colspan="8" style="text-align: center;"> <table border="1" style="width: 100%; border-collapse: collapse; text-align: center;"> <tr> <td style="width: 10%;"></td> <td style="width: 10%;"></td> <td style="width: 10%;"></td> <td style="width: 10%;"></td> <td style="width: 10%;"></td> <td style="width: 10%;"></td> <td style="width: 10%;"></td> <td style="width: 10%;"></td> <td style="width: 10%;"></td> <td style="width: 10%;"></td> </tr> <tr> <td></td> <td></td> <td colspan="8" style="text-align: center;"> <table border="1" style="width: 100%; border-collapse: collapse; text-align: center;"> <tr> <td style="width: 10%;"></td> <td style="width: 10%;"></td> <td style="width: 10%;"></td> <td style="width: 10%;"></td> <td style="width: 10%;"></td> <td style="width: 10%;"></td> <td style="width: 10%;"></td> <td style="width: 10%;"></td> <td style="width: 10%;"></td> <td style="width: 10%;"></td> </tr> <tr> <td></td> <td></td> <td colspan="8" style="text-align: center;"> <table border="1" style="width: 100%; border-collapse: collapse; text-align: center;"> <tr> <td style="width: 10%;"></td> <td style="width: 10%;"></td> <td
style="width: 10%;"></td> <td style="width: 10%;"></td> <td style="width: 10%;"></td> <td style="width: 10%;"></td> <td style="width: 10%;"></td> <td style="width: 10%;"></td> <td style="width: 10%;"></td> <td style="width: 10%;"></td> </tr> <tr> <td></td> <td></td> <td colspan="8" style="text-align: center;"> <table border="1" style="width: 100%; border-collapse: collapse; text-align: center;"> <tr> <td style="width: 10%;"></td> <td style="width: 10%;"></td> <td style="width: 10%;"></td> <td style="width: 10%;"></td> <td style="width: 10%;"></td> <td style="width: 10%;"></td> <td style="width: 10%;"></td> <td style="width: 10%;"></td> <td style="width: 10%;"></td> <td style="width: 10%;"></td> </tr> <tr> <td></td> <td></td> <td colspan="8" style="text-align: center;"> <table border="1" style="width: 100%; border-collapse: collapse; text-align: center;"> <tr> <td style="width: 10%;"></td> <td style="width: 10%;"></td> <td style="width: 10%;"></td> <td style="width: 10%;"></td> <td style="width: 10%;"></td> <td style="width: 10%;"></td> <td style="width: 10%;"></td> <td style="width: 10%;"></td> <td style="width: 10%;"></td> <td style="width: 10%;"></td> </tr> <tr> <td></td> <td></td> <td colspan="8" style="text-align: center;"> <table border="1" style="width: 100%; border-collapse: collapse; text-align: center;"> <tr> <td style="width: 10%;"></td> <td style="width: 10%;"></td> <td style="width: 10%;"></td> <td style="width: 10%;"></td> <td style="width: 10%;"></td> <td style="width: 10%;"></td> <td style="width: 10%;"></td> <td style="width: 10%;"></td> <td style="width: 10%;"></td> <td style="width: 10%;"></td> </tr> <tr> <td></td> <td></td> <td colspan="8" style="text-align: center;"> <table border="1" style="width: 100%; border-collapse: collapse; text-align: center;"> <tr> <td style="width: 10%;"></td> <td style="width: 10%;"></td> <td style="width: 10%;"></td> <td style="width: 10%;"></td> <td style="width: 10%;"></td> <td style="width: 10%;"></td> <td style="width: 10%;"></td> <td style="width: 10%;"></td> <td style="width: 10%;"></td> <td style="width: 10%;"></td> </tr> <tr> <td></td> <td></td> <td colspan="8" style="text-align: center;"> <table border="1" style="width: 100%; border-collapse: collapse; text-align: center;"> <tr> <td style="width: 10%;"></td> <td style="width: 10%;"></td> <td style="width: 10%;"></td> <td style="width: 10%;"></td> <td style="width: 10%;"></td> <td style="width: 10%;"></td> <td style="width: 10%;"></td> <td style="width: 10%;"></td> <td style="width: 10%;"></td> <td style="width: 10%;"></td> </tr> <tr> <td></td> <td></td> <td colspan="8" style="text-align: center;"> <table border="1" style="width: 100%; border-collapse: collapse; text-align: center;"> <tr> <td style="width: 10%;"></td> <td style="width: 10%;"></td> <td style="width: 10%;"></td> <td style="width: 10%;"></td> <td style="width: 10%;"></td> <td style="width: 10%;"></td> <td style="width: 10%;"></td> <td style="width: 10%;"></td> <td style="width: 10%;"></td> <td style="width: 10%;"></td> </tr> <tr> <td></td> <td></td> <td colspan="8" style="text-align: center;"> <table border="1" style="width: 100%; border-collapse: collapse; text-align: center;"> <tr> <td style="width: 10%;"></td> <td style="width: 10%;"></td> <td style="width: 10%;"></td> <td style="width: 10%;"></td> <td style="width: 10%;"></td> <td style="width: 10%;"></td> <td style="width: 10%;"></td> <td style="width: 10%;"></td> <td style="width: 10%;"></td> <td style="width: 10%;"></td> </tr> <tr> <td></td> <td></td> <td colspan="8" style="text-align: center;"> <table border="1" style="width: 100%; border-collapse: collapse; text-align: center;"> <tr> <td style="width: 10%;"></td> <td style="width: 10%;"></td> <td style="width: 10%;"></td> <td style="width: 10%;"></td> <td style="width: 10%;"></td> <td style="width: 10%;"></td> <td style="width: 10%;"></td> <td style="width: 10%;"></td> <td style="width: 10%;"></td> <td style="width: 10%;"></td> </tr> <tr> <td></td> <td></td> <td colspan="8" style="text-align: center;"> <table border="1" style="width: 100%; border-collapse: collapse; text-align: center;"> <tr> <td style="width: 10%;"></td> <td style="width: 10%;"></td> <td style="width: 10%;"></td> <td style="width: 10%;"></td> <td style="width: 10%;"></td> <td style="width: 10%;"></td> <td style="width: 10%;"></td> <td style="width: 10%;"></td> <td style="width: 10%;"></td> <td style="width: 10%;"></td> </tr> <tr> <td></td> <td></td> <td colspan="8" style="text-align: center;"> <table border="1" style="width: 100%; border-collapse: collapse; text-align: center;"> <tr> <td style="width: 10%;"></td> <td style="width: 10%;"></td> <td style="width: 10%;"></td> <td style="width: 10%;"></td> <td style="width: 10%;"></td> <td style="width: 10%;"></td> <td style="width: 10%;"></td> <td style="width: 10%;"></td> <td style="width: 10%;"></td> <td style="width: 10%;"></td> </tr> <tr> <td></td> <td></td> <td colspan="8" style="text-align: center;"> <table border="1" style="width: 100%; border-collapse: collapse; text-align: center;"> <tr> <td style="width: 10%;"></td> <td style="width: 10%;"></td> <td style="width: 10%;"></td> <td style="width: 10%;"></td> <td style="width: 10%;"></td> <td style="width: 10%;"></td> <td style="width: 10%;"></td> <td style="width: 10%;"></td> <td style="width: 10%;"></td> <td style="width: 10%;"></td> </tr> <tr> <td></td> <td></td> <td colspan="8" style="text-align: center;"> <table border="1" style="width: 100%; border-collapse: collapse; text-align: center;"> <tr> <td style="width: 10%;"></td> <td style="width: 10%;"></td> <td style="width: 10%;"></td> <td style="width: 10%;"></td> <td style="width: 10%;"></td> <td style="width: 10%;"></td> <td style="width: 10%;"></td> <td style="width: 10%;"></td> <td style="width: 10%;"></td> <td style="width: 10%;"></td> </tr> <tr> <td></td> <td></td> <td colspan="8" style="text-align: center;"> <table border="1" style="width: 100%; border-collapse: collapse; text-align: center;"> <tr> <td style="width: 10%;"></td> <td style="width: 10%;"></td> <td style="width: 10%;"></td> <td style="width: 10%;"></td> <td style="width: 10%;"></td> <td style="width: 10%;"></td> <td style="width: 10%;"></td> <td style="width: 10%;"></td> <td style="width: 10%;"></td> <td style="width: 10%;"></td> </tr> <tr> <td></td> <td></td> <td colspan="8" style="text-align: center;"> <table border="1" style="width: 100%; border-collapse: collapse; text-align: center;"> <tr> <td style="width: 10%;"></td> <td style="width: 10%;"></td> <td style="width: 10%;"></td> <td style="width: 10%;"></td> <td style="width: 10%;"></td> <td style="width: 10%;"></td> <td style="width: 10%;"></td> <td style="width: 10%;"></td> <td style="width: 10%;"></td> <td style="width: 10%;"></td> </tr> <tr> <td></td> <td></td> <td colspan="8" style="text-align: center;"> <table border="1" style="width: 100%; border-collapse: collapse; text-align: center;"> <tr> <td style="width: 10%;"></td> <td style="width: 10%;"></td> <td style="width: 10%;"></td> <td style="width: 10%;"></td> <td style="width: 10%;"></td> <td style="width: 10%;"></td> <td style="width: 10%;"></td> <td style="width: 10%;"></td> <td style="width: 10%;"></td> <td style="width: 10%;"></td> </tr> <tr> <td></td> <td></td> <td colspan="8" style="text-align: center;"> <table border="1" style="width: 100%; border-collapse: collapse; text-align: center;"> <tr> <td style="width: 10%;"></td> <td style="width: 10%;"></td> <td style="width: 10%;"></td> <td style="width: 10%;"></td> <td style="width: 10%;"></td> <td style="width: 10%;"></td> <td style="width: 10%;"></td> <td style="width: 10%;"></td> <td style="width: 10%;"></td> <td style="width: 10%;"></td> </tr> <tr> <td></td> <td></td> <td colspan="8" style="text-align: center;"> <table border="1" style="width: 100%; border-collapse: collapse; text-align: center;"> <tr> <td style="width: 10%;"></td> <td style="width: 10%;"></td> <td style="width: 10%;"></td> <td style="width: 10%;"></td> <td style="width: 10%;"></td> <td style="width: 10%;"></td> <td style="width: 10%;"></td> <td style="width: 10%;"></td> <td style="width: 10%;"></td> <td style="width: 10%;"></td> </tr> <tr> <td></td> <td></td> <td colspan="8" style="text-align: center;"> <table border="1" style="width: 100%; border-collapse: collapse; text-align: center;"> <tr> <td style="width: 10%;"></td> <td style="width: 10%;"></td> <td style="width: 10%;"></td> <td style="width: 10%;"></td> <td style="width: 10%;"></td> <td style="width: 10%;"></td> <td style="width: 10%;"></td> <td style="width: 10%;"></td> <td style="width: 10%;"></td> <td style="width: 10%;"></td> </tr> <tr> <td></td> <td></td> <td colspan="8" style="text-align: center;"> <table border="1" style="width: 100%; border-collapse: collapse; text-align: center;"> <tr> <td style="width: 10%;"></td> <td style="width: 10%;"></td> <td style="width: 10%;"></td> <td style="width: 10%;"></td> <td style="width: 10%;"></td> <td style="width: 10%;"></td> <td style="width: 10%;"></td> <td style="width: 10%;"></td> <td style="width: 10%;"></td> <td style="width: 10%;"></td> </tr> <tr> <td></td> <td></td> <td colspan="8" style="text-align: center;"> <table border="1" style="width: 100%; border-collapse: collapse; text-align: center;"> <tr> <td style="width: 10%;"></td> <td style="width: 10%;"></td> <td style="width: 10%;"></td> <td style="width: 10%;"></td> <td style="width: 10%;"></td> <td style="width: 10%;"></td> <td style="width: 10%;"></td> <td style="width: 10%;"></td> <td style="width: 10%;"></td> <td style="width: 10%;"></td> </tr> <tr> <td></td> <td></td> <td colspan="8" style="text-align: center;"> <table border="1" style="width: 100%; border-collapse: collapse; text-align: center;"> <tr> <td style="width: 10%;"></td> <td style="width: 10%;"></td> <td style="width: 10%;"></td> <td style="width: 10%;"></td> <td style="width: 10%;"></td> <td style="width: 10%;"></td> <td style="width: 10%;"></td> <td style="width:
10%;"></td> <td style="width: 10%;"></td> <td style="width: 10%;"></td> </tr> <tr> <td></td> <td></td> <td colspan="8" style="text-align: center;"> <table border="1" style="width: 100%; border-collapse: collapse; text-align: center;"> <tr> <td style="width: 10%;"></td> <td style="width: 10%;"></td> <td style="width: 10%;"></td> <td style="width: 10%;"></td> <td style="width: 10%;"></td> <td style="width: 10%;"></td> <td style="width: 10%;"></td> <td style="width: 10%;"></td> <td style="width: 10%;"></td> <td style="width: 10%;"></td> </tr> <tr> <td></td> <td></td> <td colspan="8" style="text-align: center;"> <table border="1" style="width: 100%; border-collapse: collapse; text-align: center;"> <tr> <td style="width: 10%;"></td> <td style="width: 10%;"></td> <td style="width: 10%;"></td> <td style="width: 10%;"></td> <td style="width: 10%;"></td> <td style="width: 10%;"></td> <td style="width: 10%;"></td> <td style="width: 10%;"></td> <td style="width: 10%;"></td> <td style="width: 10%;"></td> </tr> <tr> <td></td> <td></td> <td colspan="8" style="text-align: center;"> <table border="1" style="width: 100%; border-collapse: collapse; text-align: center;"> <tr> <td style="width: 10%;"></td> <td style="width: 10%;"></td> <td style="width: 10%;"></td> <td style="width: 10%;"></td> <td style="width: 10%;"></td> <td style="width: 10%;"></td> <td style="width: 10%;"></td> <td style="width: 10%;"></td> <td style="width: 10%;"></td> <td style="width: 10%;"></td> </tr> <tr> <td></td> <td></td> <td colspan="8" style="text-align: center;"> <table border="1" style="width: 100%; border-collapse: collapse; text-align: center;"> <tr> <td style="width: 10%;"></td> <td style="width: 10%;"></td> <td style="width: 10%;"></td> <td style="width: 10%;"></td> <td style="width: 10%;"></td> <td style="width: 10%;"></td> <td style="width: 10%;"></td> <td style="width: 10%;"></td> <td style="width: 10%;"></td> <td style="width: 10%;"></td> </tr> <tr> <td></td> <td></td> <td colspan="8" style="text-align: center;"> <table border="1" style="width: 100%; border-collapse: collapse; text-align: center;"> <tr> <td style="width: 10%;"></td> <td style="width: 10%;"></td> <td style="width: 10%;"></td> <td style="width: 10%;"></td> <td style="width: 10%;"></td> <td style="width: 10%;"></td> <td style="width: 10%;"></td> <td style="width: 10%;"></td> <td style="width: 10%;"></td> <td style="width: 10%;"></td> </tr> <tr> <td></td> <td></td> <td colspan="8" style="text-align: center;"> <table border="1" style="width: 100%; border-collapse: collapse; text-align: center;"> <tr> <td style="width: 10%;"></td> <td style="width: 10%;"></td> <td style="width: 10%;"></td> <td style="width: 10%;"></td> <td style="width: 10%;"></td> <td style="width: 10%;"></td> <td style="width: 10%;"></td> <td style="width: 10%;"></td> <td style="width: 10%;"></td> <td style="width: 10%;"></td> </tr> <tr> <td></td> <td></td> <td colspan="8" style="text-align: center;"> <table border="1" style="width: 100%; border-collapse: collapse; text-align: center;"> <tr> <td style="width: 10%;"></td> <td style="width: 10%;"></td> <td style="width: 10%;"></td> <td style="width: 10%;"></td> <td style="width: 10%;"></td> <td style="width: 10%;"></td> <td style="width: 10%;"></td> <td style="width: 10%;"></td> <td style="width: 10%;"></td> <td style="width: 10%;"></td> </tr> <tr> <td></td> <td></td> <td colspan="8" style="text-align: center;"> <table border="1" style="width: 100%; border-collapse: collapse; text-align: center;"> <tr> <td style="width: 10%;"></td> <td style="width: 10%;"></td> <td style="width: 10%;"></td> <td style="width: 10%;"></td> <td style="width: 10%;"></td> <td style="width: 10%;"></td> <td style="width: 10%;"></td> <td style="width: 10%;"></td> <td style="width: 10%;"></td> <td style="width: 10%;"></td> </tr> <tr> <td></td> <td></td> <td colspan="8" style="text-align: center;"> <table border="1" style="width: 100%; border-collapse: collapse; text-align: center;"> <tr> <td style="width: 10%;"></td> <td style="width: 10%;"></td> <td style="width: 10%;"></td> <td style="width: 10%;"></td> <td style="width: 10%;"></td> <td style="width: 10%;"></td> <td style="width: 10%;"></td> <td style="width: 10%;"></td> <td style="width: 10%;"></td> <td style="width: 10%;"></td> </tr> <tr> <td></td> <td></td> <td colspan="8" style="text-align: center;"> <table border="1" style="width: 100%; border-collapse: collapse; text-align: center;"> <tr> <td style="width: 10%;"></td> <td style="width: 10%;"></td> <td style="width: 10%;"></td> <td style="width: 10%;"></td> <td style="width: 10%;"></td> <td style="width: 10%;"></td> <td style="width: 10%;"></td> <td style="width: 10%;"></td> <td style="width: 10%;"></td> <td style="width: 10%;"></td> </tr> <tr> <td></td> <td></td> <td colspan="8" style="text-align: center;"> <table border="1" style="width: 100%; border-collapse: collapse; text-align: center;"> <tr> <td style="width: 10%;"></td> <td style="width: 10%;"></td> <td style="width: 10%;"></td> <td style="width: 10%;"></td> <td style="width: 10%;"></td> <td style="width: 10%;"></td> <td style="width: 10%;"></td> <td style="width: 10%;"></td> <td style="width: 10%;"></td> <td style="width: 10%;"></td> </tr> <tr> <td></td> <td></td> <td colspan="8" style="text-align: center;"> <table border="1" style="width: 100%; border-collapse: collapse; text-align: center;"> <tr> <td style="width: 10%;"></td> <td style="width: 10%;"></td> <td style="width: 10%;"></td> <td style="width: 10%;"></td> <td style="width: 10%;"></td> <td style="width: 10%;"></td> <td style="width: 10%;"></td> <td style="width: 10%;"></td> <td style="width: 10%;"></td> <td style="width: 10%;"></td> </tr> <tr> <td></td> <td></td> <td colspan="8" style="text-align: center;"> <table border="1" style="width: 100%; border-collapse: collapse; text-align: center;"> <tr> </tr></table></td></tr></table></td></tr></table></td></tr></table></td></tr></table></td></tr></table></td></tr></table></td></tr></table></td></tr></table></td></tr></table></td></tr></table></td></tr></table></td></tr></table></td></tr></table></td></tr></table></td></tr></table></td></tr></table></td></tr></table></td></tr></table></td></tr></table></td></tr></table></td></tr></table></td></tr></table></td></tr></table></td></tr></table></td></tr></table></td></tr></table></td></tr></table></td></tr></table></td></tr></table></td></tr></table></td></tr></table></td></tr></table></td></tr></table></td></tr></table></td></tr></table></td></tr></table></td></tr></table></td></tr></table></td></tr></table></td></tr></table></td></tr></table></td></tr></table></td></tr></table> | | | | | | | | | | | | | | | | | | | | <table border="1" style="width: 100%; border-collapse: collapse; text-align: center;"> <tr> <td style="width: 10%;"></td> <td style="width: 10%;"></td> <td style="width: 10%;"></td> <td style="width: 10%;"></td> <td style="width: 10%;"></td> <td style="width: 10%;"></td> <td style="width: 10%;"></td> <td style="width: 10%;"></td> <td style="width: 10%;"></td> <td style="width: 10%;"></td> </tr> <tr> <td></td> <td></td> <td colspan="8" style="text-align: center;"> <table border="1" style="width: 100%; border-collapse: collapse; text-align: center;"> <tr> <td style="width: 10%;"></td> <td style="width: 10%;"></td> <td style="width: 10%;"></td> <td style="width: 10%;"></td> <td style="width: 10%;"></td> <td style="width: 10%;"></td> <td style="width: 10%;"></td> <td style="width: 10%;"></td> <td style="width: 10%;"></td> <td style="width: 10%;"></td> </tr> <tr> <td></td> <td></td> <td colspan="8" style="text-align: center;"> <table border="1" style="width: 100%; border-collapse: collapse; text-align: center;"> <tr> <td style="width: 10%;"></td> <td style="width: 10%;"></td> <td style="width: 10%;"></td> <td style="width: 10%;"></td> <td style="width: 10%;"></td> <td style="width: 10%;"></td> <td style="width: 10%;"></td> <td style="width: 10%;"></td> <td style="width: 10%;"></td> <td style="width: 10%;"></td> </tr> <tr> <td></td> <td></td> <td colspan="8" style="text-align: center;"> <table border="1" style="width: 100%; border-collapse: collapse; text-align: center;"> <tr> <td style="width: 10%;"></td> <td style="width: 10%;"></td> <td style="width: 10%;"></td> <td style="width: 10%;"></td> <td style="width: 10%;"></td> <td style="width: 10%;"></td> <td style="width: 10%;"></td> <td style="width: 10%;"></td> <td style="width: 10%;"></td> <td style="width: 10%;"></td> </tr> <tr> <td></td> <td></td> <td colspan="8" style="text-align: center;"> <table border="1" style="width: 100%; border-collapse: collapse; text-align: center;"> <tr> <td style="width: 10%;"></td> <td style="width: 10%;"></td> <td style="width: 10%;"></td> <td style="width: 10%;"></td> <td style="width: 10%;"></td> <td style="width: 10%;"></td> <td style="width: 10%;"></td> <td style="width: 10%;"></td> <td style="width: 10%;"></td> <td style="width: 10%;"></td> </tr> <tr> <td></td> <td></td> <td colspan="8" style="text-align: center;"> <table border="1" style="width: 100%; border-collapse: collapse; text-align: center;"> <tr> <td style="width: 10%;"></td> <td style="width: 10%;"></td> <td style="width: 10%;"></td> <td style="width: 10%;"></td> <td style="width: 10%;"></td> <td style="width: 10%;"></td> <td style="width: 10%;"></td> <td style="width: 10%;"></td> <td style="width: 10%;"></td> <td style="width: 10%;"></td> </tr> <tr> <td></td> <td></td> <td colspan="8" style="text-align: center;"> <table border="1" style="width: 100%; border-collapse: collapse; text-align: center;"> <tr> <td style="width: 10%;"></td> <td style="width: 10%;"></td> <td style="width: 10%;"></td> <td style="width: 10%;"></td> <td style="width: 10%;"></td> <td style="width: 10%;"></td> <td style="width: 10%;"></td> <td style="width: 10%;"></td> <td style="width: 10%;"></td> <td style="width: 10%;"></td> </tr> <tr> <td></td> <td></td> <td colspan="8" style="text-align: center;"> <table border="1"
style="width: 100%; border-collapse: collapse; text-align: center;"> <tr> <td style="width: 10%;"></td> <td style="width: 10%;"></td> <td style="width: 10%;"></td> <td style="width: 10%;"></td> <td style="width: 10%;"></td> <td style="width: 10%;"></td> <td style="width: 10%;"></td> <td style="width: 10%;"></td> <td style="width: 10%;"></td> <td style="width: 10%;"></td> </tr> <tr> <td></td> <td></td> <td colspan="8" style="text-align: center;"> <table border="1" style="width: 100%; border-collapse: collapse; text-align: center;"> <tr> <td style="width: 10%;"></td> <td style="width: 10%;"></td> <td style="width: 10%;"></td> <td style="width: 10%;"></td> <td style="width: 10%;"></td> <td style="width: 10%;"></td> <td style="width: 10%;"></td> <td style="width: 10%;"></td> <td style="width: 10%;"></td> <td style="width: 10%;"></td> </tr> <tr> <td></td> <td></td> <td colspan="8" style="text-align: center;"> <table border="1" style="width: 100%; border-collapse: collapse; text-align: center;"> <tr> <td style="width: 10%;"></td> <td style="width: 10%;"></td> <td style="width: 10%;"></td> <td style="width: 10%;"></td> <td style="width: 10%;"></td> <td style="width: 10%;"></td> <td style="width: 10%;"></td> <td style="width: 10%;"></td> <td style="width: 10%;"></td> <td style="width: 10%;"></td> </tr> <tr> <td></td> <td></td> <td colspan="8" style="text-align: center;"> <table border="1" style="width: 100%; border-collapse: collapse; text-align: center;"> <tr> <td style="width: 10%;"></td> <td style="width: 10%;"></td> <td style="width: 10%;"></td> <td style="width: 10%;"></td> <td style="width: 10%;"></td> <td style="width: 10%;"></td> <td style="width: 10%;"></td> <td style="width: 10%;"></td> <td style="width: 10%;"></td> <td style="width: 10%;"></td> </tr> <tr> <td></td> <td></td> <td colspan="8" style="text-align: center;"> <table border="1" style="width: 100%; border-collapse: collapse; text-align: center;"> <tr> <td style="width: 10%;"></td> <td style="width: 10%;"></td> <td style="width: 10%;"></td> <td style="width: 10%;"></td> <td style="width: 10%;"></td> <td style="width: 10%;"></td> <td style="width: 10%;"></td> <td style="width: 10%;"></td> <td style="width: 10%;"></td> <td style="width: 10%;"></td> </tr> <tr> <td></td> <td></td> <td colspan="8" style="text-align: center;"> <table border="1" style="width: 100%; border-collapse: collapse; text-align: center;"> <tr> <td style="width: 10%;"></td> <td style="width: 10%;"></td> <td style="width: 10%;"></td> <td style="width: 10%;"></td> <td style="width: 10%;"></td> <td style="width: 10%;"></td> <td style="width: 10%;"></td> <td style="width: 10%;"></td> <td style="width: 10%;"></td> <td style="width: 10%;"></td> </tr> <tr> <td></td> <td></td> <td colspan="8" style="text-align: center;"> <table border="1" style="width: 100%; border-collapse: collapse; text-align: center;"> <tr> <td style="width: 10%;"></td> <td style="width: 10%;"></td> <td style="width: 10%;"></td> <td style="width: 10%;"></td> <td style="width: 10%;"></td> <td style="width: 10%;"></td> <td style="width: 10%;"></td> <td style="width: 10%;"></td> <td style="width: 10%;"></td> <td style="width: 10%;"></td> </tr> <tr> <td></td> <td></td> <td colspan="8" style="text-align: center;"> <table border="1" style="width: 100%; border-collapse: collapse; text-align: center;"> <tr> <td style="width: 10%;"></td> <td style="width: 10%;"></td> <td style="width: 10%;"></td> <td style="width: 10%;"></td> <td style="width: 10%;"></td> <td style="width: 10%;"></td> <td style="width: 10%;"></td> <td style="width: 10%;"></td> <td style="width: 10%;"></td> <td style="width: 10%;"></td> </tr> <tr> <td></td> <td></td> <td colspan="8" style="text-align: center;"> <table border="1" style="width: 100%; border-collapse: collapse; text-align: center;"> <tr> <td style="width: 10%;"></td> <td style="width: 10%;"></td> <td style="width: 10%;"></td> <td style="width: 10%;"></td> <td style="width: 10%;"></td> <td style="width: 10%;"></td> <td style="width: 10%;"></td> <td style="width: 10%;"></td> <td style="width: 10%;"></td> <td style="width: 10%;"></td> </tr> <tr> <td></td> <td></td> <td colspan="8" style="text-align: center;"> <table border="1" style="width: 100%; border-collapse: collapse; text-align: center;"> <tr> <td style="width: 10%;"></td> <td style="width: 10%;"></td> <td style="width: 10%;"></td> <td style="width: 10%;"></td> <td style="width: 10%;"></td> <td style="width: 10%;"></td> <td style="width: 10%;"></td> <td style="width: 10%;"></td> <td style="width: 10%;"></td> <td style="width: 10%;"></td> </tr> <tr> <td></td> <td></td> <td colspan="8" style="text-align: center;"> <table border="1" style="width: 100%; border-collapse: collapse; text-align: center;"> <tr> <td style="width: 10%;"></td> <td style="width: 10%;"></td> <td style="width: 10%;"></td> <td style="width: 10%;"></td> <td style="width: 10%;"></td> <td style="width: 10%;"></td> <td style="width: 10%;"></td> <td style="width: 10%;"></td> <td style="width: 10%;"></td> <td style="width: 10%;"></td> </tr> <tr> <td></td> <td></td> <td colspan="8" style="text-align: center;"> <table border="1" style="width: 100%; border-collapse: collapse; text-align: center;"> <tr> <td style="width: 10%;"></td> <td style="width: 10%;"></td> <td style="width: 10%;"></td> <td style="width: 10%;"></td> <td style="width: 10%;"></td> <td style="width: 10%;"></td> <td style="width: 10%;"></td> <td style="width: 10%;"></td> <td style="width: 10%;"></td> <td style="width: 10%;"></td> </tr> <tr> <td></td> <td></td> <td colspan="8" style="text-align: center;"> <table border="1" style="width: 100%; border-collapse: collapse; text-align: center;"> <tr> <td style="width: 10%;"></td> <td style="width: 10%;"></td> <td style="width: 10%;"></td> <td style="width: 10%;"></td> <td style="width: 10%;"></td> <td style="width: 10%;"></td> <td style="width: 10%;"></td> <td style="width: 10%;"></td> <td style="width: 10%;"></td> <td style="width: 10%;"></td> </tr> <tr> <td></td> <td></td> <td colspan="8" style="text-align: center;"> <table border="1" style="width: 100%; border-collapse: collapse; text-align: center;"> <tr> <td style="width: 10%;"></td> <td style="width: 10%;"></td> <td style="width: 10%;"></td> <td style="width: 10%;"></td> <td style="width: 10%;"></td> <td style="width: 10%;"></td> <td style="width: 10%;"></td> <td style="width: 10%;"></td> <td style="width: 10%;"></td> <td style="width: 10%;"></td> </tr> <tr> <td></td> <td></td> <td colspan="8" style="text-align: center;"> <table border="1" style="width: 100%; border-collapse: collapse; text-align: center;"> <tr> <td style="width: 10%;"></td> <td style="width: 10%;"></td> <td style="width: 10%;"></td> <td style="width: 10%;"></td> <td style="width: 10%;"></td> <td style="width: 10%;"></td> <td style="width: 10%;"></td> <td style="width: 10%;"></td> <td style="width: 10%;"></td> <td style="width: 10%;"></td> </tr> <tr> <td></td> <td></td> <td colspan="8" style="text-align: center;"> <table border="1" style="width: 100%; border-collapse: collapse; text-align: center;"> <tr> <td style="width: 10%;"></td> <td style="width: 10%;"></td> <td style="width: 10%;"></td> <td style="width: 10%;"></td> <td style="width: 10%;"></td> <td style="width: 10%;"></td> <td style="width: 10%;"></td> <td style="width: 10%;"></td> <td style="width: 10%;"></td> <td style="width: 10%;"></td> </tr> <tr> <td></td> <td></td> <td colspan="8" style="text-align: center;"> <table border="1" style="width: 100%; border-collapse: collapse; text-align: center;"> <tr> <td style="width: 10%;"></td> <td style="width: 10%;"></td> <td style="width: 10%;"></td> <td style="width: 10%;"></td> <td style="width: 10%;"></td> <td style="width: 10%;"></td> <td style="width: 10%;"></td> <td style="width: 10%;"></td> <td style="width: 10%;"></td> <td style="width: 10%;"></td> </tr> <tr> <td></td> <td></td> <td colspan="8" style="text-align: center;"> <table border="1" style="width: 100%; border-collapse: collapse; text-align: center;"> <tr> <td style="width: 10%;"></td> <td style="width: 10%;"></td> <td style="width: 10%;"></td> <td style="width: 10%;"></td> <td style="width: 10%;"></td> <td style="width: 10%;"></td> <td style="width: 10%;"></td> <td style="width: 10%;"></td> <td style="width: 10%;"></td> <td style="width: 10%;"></td> </tr> <tr> <td></td> <td></td> <td colspan="8" style="text-align: center;"> <table border="1" style="width: 100%; border-collapse: collapse; text-align: center;"> <tr> <td style="width: 10%;"></td> <td style="width: 10%;"></td> <td style="width: 10%;"></td> <td style="width: 10%;"></td> <td style="width: 10%;"></td> <td style="width: 10%;"></td> <td style="width: 10%;"></td> <td style="width: 10%;"></td> <td style="width: 10%;"></td> <td style="width: 10%;"></td> </tr> <tr> <td></td> <td></td> <td colspan="8" style="text-align: center;"> <table border="1" style="width: 100%; border-collapse: collapse; text-align: center;"> <tr> <td style="width: 10%;"></td> <td style="width: 10%;"></td> <td style="width: 10%;"></td> <td style="width: 10%;"></td> <td style="width: 10%;"></td> <td style="width: 10%;"></td> <td style="width: 10%;"></td> <td style="width: 10%;"></td> <td style="width: 10%;"></td> <td style="width: 10%;"></td> </tr> <tr> <td></td> <td></td> <td colspan="8" style="text-align: center;"> <table border="1" style="width: 100%; border-collapse: collapse; text-align: center;"> <tr> <td style="width: 10%;"></td> <td style="width: 10%;"></td> <td style="width: 10%;"></td> <td style="width: 10%;"></td> <td style="width: 10%;"></td> <td style="width: 10%;"></td> <td style="width: 10%;"></td> <td style="width: 10%;"></td> <td style="width: 10%;"></td> <td style="width: 10%;"></td> </tr> <tr> <td></td> <td></td> <td colspan="8" style="text-align: center;"> <table border="1" style="width: 100%; border-collapse: collapse; text-align: center;"> <tr> <td style="width: 10%;"></td> <td style="width: 10%;"></td> <td style="width: 10%;"></td> <td
style="width: 10%;"></td> <td style="width: 10%;"></td> <td style="width: 10%;"></td> <td style="width: 10%;"></td> <td style="width: 10%;"></td> <td style="width: 10%;"></td> <td style="width: 10%;"></td> </tr> <tr> <td></td> <td></td> <td colspan="8" style="text-align: center;"> <table border="1" style="width: 100%; border-collapse: collapse; text-align: center;"> <tr> <td style="width: 10%;"></td> <td style="width: 10%;"></td> <td style="width: 10%;"></td> <td style="width: 10%;"></td> <td style="width: 10%;"></td> <td style="width: 10%;"></td> <td style="width: 10%;"></td> <td style="width: 10%;"></td> <td style="width: 10%;"></td> <td style="width: 10%;"></td> </tr> <tr> <td></td> <td></td> <td colspan="8" style="text-align: center;"> <table border="1" style="width: 100%; border-collapse: collapse; text-align: center;"> <tr> <td style="width: 10%;"></td> <td style="width: 10%;"></td> <td style="width: 10%;"></td> <td style="width: 10%;"></td> <td style="width: 10%;"></td> <td style="width: 10%;"></td> <td style="width: 10%;"></td> <td style="width: 10%;"></td> <td style="width: 10%;"></td> <td style="width: 10%;"></td> </tr> <tr> <td></td> <td></td> <td colspan="8" style="text-align: center;"> <table border="1" style="width: 100%; border-collapse: collapse; text-align: center;"> <tr> <td style="width: 10%;"></td> <td style="width: 10%;"></td> <td style="width: 10%;"></td> <td style="width: 10%;"></td> <td style="width: 10%;"></td> <td style="width: 10%;"></td> <td style="width: 10%;"></td> <td style="width: 10%;"></td> <td style="width: 10%;"></td> <td style="width: 10%;"></td> </tr> <tr> <td></td> <td></td> <td colspan="8" style="text-align: center;"> <table border="1" style="width: 100%; border-collapse: collapse; text-align: center;"> <tr> <td style="width: 10%;"></td> <td style="width: 10%;"></td> <td style="width: 10%;"></td> <td style="width: 10%;"></td> <td style="width: 10%;"></td> <td style="width: 10%;"></td> <td style="width: 10%;"></td> <td style="width: 10%;"></td> <td style="width: 10%;"></td> <td style="width: 10%;"></td> </tr> <tr> <td></td> <td></td> <td colspan="8" style="text-align: center;"> <table border="1" style="width: 100%; border-collapse: collapse; text-align: center;"> <tr> <td style="width: 10%;"></td> <td style="width: 10%;"></td> <td style="width: 10%;"></td> <td style="width: 10%;"></td> <td style="width: 10%;"></td> <td style="width: 10%;"></td> <td style="width: 10%;"></td> <td style="width: 10%;"></td> <td style="width: 10%;"></td> <td style="width: 10%;"></td> </tr> <tr> <td></td> <td></td> <td colspan="8" style="text-align: center;"> <table border="1" style="width: 100%; border-collapse: collapse; text-align: center;"> <tr> <td style="width: 10%;"></td> <td style="width: 10%;"></td> <td style="width: 10%;"></td> <td style="width: 10%;"></td> <td style="width: 10%;"></td> <td style="width: 10%;"></td> <td style="width: 10%;"></td> <td style="width: 10%;"></td> <td style="width: 10%;"></td> <td style="width: 10%;"></td> </tr> <tr> <td></td> <td></td> <td colspan="8" style="text-align: center;"> <table border="1" style="width: 100%; border-collapse: collapse; text-align: center;"> <tr> <td style="width: 10%;"></td> <td style="width: 10%;"></td> <td style="width: 10%;"></td> <td style="width: 10%;"></td> <td style="width: 10%;"></td> <td style="width: 10%;"></td> <td style="width: 10%;"></td> <td style="width: 10%;"></td> <td style="width: 10%;"></td> <td style="width: 10%;"></td> </tr> <tr> <td></td> <td></td> <td colspan="8" style="text-align: center;"> <table border="1" style="width: 100%; border-collapse: collapse; text-align: center;"> <tr> <td style="width: 10%;"></td> <td style="width: 10%;"></td> <td style="width: 10%;"></td> <td style="width: 10%;"></td> <td style="width: 10%;"></td> <td style="width: 10%;"></td> <td style="width: 10%;"></td> <td style="width: 10%;"></td> <td style="width: 10%;"></td> <td style="width: 10%;"></td> </tr> <tr> <td></td> <td></td> <td colspan="8" style="text-align: center;"> <table border="1" style="width: 100%; border-collapse: collapse; text-align: center;"> <tr> <td style="width: 10%;"></td> <td style="width: 10%;"></td> <td style="width: 10%;"></td> <td style="width: 10%;"></td> <td style="width: 10%;"></td> <td style="width: 10%;"></td> <td style="width: 10%;"></td> <td style="width: 10%;"></td> <td style="width: 10%;"></td> <td style="width: 10%;"></td> </tr> <tr> <td></td> <td></td> <td colspan="8" style="text-align: center;"> <table border="1" style="width: 100%; border-collapse: collapse; text-align: center;"> <tr> <td style="width: 10%;"></td> <td style="width: 10%;"></td> <td style="width: 10%;"></td> <td style="width: 10%;"></td> <td style="width: 10%;"></td> <td style="width: 10%;"></td> <td style="width: 10%;"></td> <td style="width: 10%;"></td> <td style="width: 10%;"></td> <td style="width: 10%;"></td> </tr> <tr> <td></td> <td></td> <td colspan="8" style="text-align: center;"> <table border="1" style="width: 100%; border-collapse: collapse; text-align: center;"> <tr> <td style="width: 10%;"></td> <td style="width: 10%;"></td> <td style="width: 10%;"></td> <td style="width: 10%;"></td> <td style="width: 10%;"></td> <td style="width: 10%;"></td> <td style="width: 10%;"></td> <td style="width: 10%;"></td> <td style="width: 10%;"></td> <td style="width: 10%;"></td> </tr> <tr> <td></td> <td></td> <td colspan="8" style="text-align: center;"> <table border="1" style="width: 100%; border-collapse: collapse; text-align: center;"> <tr> <td style="width: 10%;"></td> <td style="width: 10%;"></td> <td style="width: 10%;"></td> <td style="width: 10%;"></td> <td style="width: 10%;"></td> <td style="width: 10%;"></td> <td style="width: 10%;"></td> <td style="width: 10%;"></td> <td style="width: 10%;"></td> <td style="width: 10%;"></td> </tr> <tr> <td></td> <td></td> <td colspan="8" style="text-align: center;"> <table border="1" style="width: 100%; border-collapse: collapse; text-align: center;"> <tr> <td style="width: 10%;"></td> <td style="width: 10%;"></td> <td style="width: 10%;"></td> <td style="width: 10%;"></td> <td style="width: 10%;"></td> <td style="width: 10%;"></td> <td style="width: 10%;"></td> <td style="width: 10%;"></td> <td style="width: 10%;"></td> <td style="width: 10%;"></td> </tr> <tr> <td></td> <td></td> <td colspan="8" style="text-align: center;"> <table border="1" style="width: 100%; border-collapse: collapse; text-align: center;"> <tr> </tr></table></td></tr></table></td></tr></table></td></tr></table></td></tr></table></td></tr></table></td></tr></table></td></tr></table></td></tr></table></td></tr></table></td></tr></table></td></tr></table></td></tr></table></td></tr></table></td></tr></table></td></tr></table></td></tr></table></td></tr></table></td></tr></table></td></tr></table></td></tr></table></td></tr></table></td></tr></table></td></tr></table></td></tr></table></td></tr></table></td></tr></table></td></tr></table></td></tr></table></td></tr></table></td></tr></table></td></tr></table></td></tr></table></td></tr></table></td></tr></table></td></tr></table></td></tr></table></td></tr></table></td></tr></table></td></tr></table></td></tr></table></td></tr></table></td></tr></table> | | | | | | | | | | | | | | | | | | | | <table border="1" style="width: 100%; border-collapse: collapse; text-align: center;"> <tr> <td style="width: 10%;"></td> <td style="width: 10%;"></td> <td style="width: 10%;"></td> <td style="width: 10%;"></td> <td style="width: 10%;"></td> <td style="width: 10%;"></td> <td style="width: 10%;"></td> <td style="width: 10%;"></td> <td style="width: 10%;"></td> <td style="width: 10%;"></td> </tr> <tr> <td></td> <td></td> <td colspan="8" style="text-align: center;"> <table border="1" style="width: 100%; border-collapse: collapse; text-align: center;"> <tr> <td style="width: 10%;"></td> <td style="width: 10%;"></td> <td style="width: 10%;"></td> <td style="width: 10%;"></td> <td style="width: 10%;"></td> <td style="width: 10%;"></td> <td style="width: 10%;"></td> <td style="width: 10%;"></td> <td style="width: 10%;"></td> <td style="width: 10%;"></td> </tr> <tr> <td></td> <td></td> <td colspan="8" style="text-align: center;"> <table border="1" style="width: 100%; border-collapse: collapse; text-align: center;"> <tr> <td style="width: 10%;"></td> <td style="width: 10%;"></td> <td style="width: 10%;"></td> <td style="width: 10%;"></td> <td style="width: 10%;"></td> <td style="width: 10%;"></td> <td style="width: 10%;"></td> <td style="width: 10%;"></td> <td style="width: 10%;"></td> <td style="width: 10%;"></td> </tr> <tr> <td></td> <td></td> <td colspan="8" style="text-align: center;"> <table border="1" style="width: 100%; border-collapse: collapse; text-align: center;"> <tr> <td style="width: 10%;"></td> <td style="width: 10%;"></td> <td style="width: 10%;"></td> <td style="width: 10%;"></td> <td style="width: 10%;"></td> <td style="width: 10%;"></td> <td style="width: 10%;"></td> <td style="width: 10%;"></td> <td style="width: 10%;"></td> <td style="width: 10%;"></td> </tr> <tr> <td></td> <td></td> <td colspan="8" style="text-align: center;"> <table border="1" style="width: 100%; border-collapse: collapse; text-align: center;"> <tr> <td style="width: 10%;"></td> <td style="width: 10%;"></td> <td style="width: 10%;"></td> <td style="width: 10%;"></td> <td style="width: 10%;"></td> <td style="width: 10%;"></td> <td style="width: 10%;"></td> <td style="width: 10%;"></td> <td style="width: 10%;"></td> <td style="width: 10%;"></td> </tr> <tr> <td></td> <td></td> <td colspan="8" style="text-align: center;"> <table border="1" style="width: 100%; border-collapse: collapse; text-align: center;"> <tr> <td style="width: 10%;"></td> <td style="width: 10%;"></td> <td style="width: 10%;"></td> <td style="width: 10%;"></td> <td style="width: 10%;"></td> <td style="width: 10%;"></td> <td style="width: 10%;"></td> <td style="width: 10%;"></td> <td style="width: 10%;"></td> <td
style="width: 10%;"></td> </tr> <tr> <td></td> <td></td> <td colspan="8" style="text-align: center;"> <table border="1" style="width: 100%; border-collapse: collapse; text-align: center;"> <tr> <td style="width: 10%;"></td> <td style="width: 10%;"></td> <td style="width: 10%;"></td> <td style="width: 10%;"></td> <td style="width: 10%;"></td> <td style="width: 10%;"></td> <td style="width: 10%;"></td> <td style="width: 10%;"></td> <td style="width: 10%;"></td> <td style="width: 10%;"></td> </tr> <tr> <td></td> <td></td> <td colspan="8" style="text-align: center;"> <table border="1" style="width: 100%; border-collapse: collapse; text-align: center;"> <tr> <td style="width: 10%;"></td> <td style="width: 10%;"></td> <td style="width: 10%;"></td> <td style="width: 10%;"></td> <td style="width: 10%;"></td> <td style="width: 10%;"></td> <td style="width: 10%;"></td> <td style="width: 10%;"></td> <td style="width: 10%;"></td> <td style="width: 10%;"></td> </tr> <tr> <td></td> <td></td> <td colspan="8" style="text-align: center;"> <table border="1" style="width: 100%; border-collapse: collapse; text-align: center;"> <tr> <td style="width: 10%;"></td> <td style="width: 10%;"></td> <td style="width: 10%;"></td> <td style="width: 10%;"></td> <td style="width: 10%;"></td> <td style="width: 10%;"></td> <td style="width: 10%;"></td> <td style="width: 10%;"></td> <td style="width: 10%;"></td> <td style="width: 10%;"></td> </tr> <tr> <td></td> <td></td> <td colspan="8" style="text-align: center;"> <table border="1" style="width: 100%; border-collapse: collapse; text-align: center;"> <tr> <td style="width: 10%;"></td> <td style="width: 10%;"></td> <td style="width: 10%;"></td> <td style="width: 10%;"></td> <td style="width: 10%;"></td> <td style="width: 10%;"></td> <td style="width: 10%;"></td> <td style="width: 10%;"></td> <td style="width: 10%;"></td> <td style="width: 10%;"></td> </tr> <tr> <td></td> <td></td> <td colspan="8" style="text-align: center;"> <table border="1" style="width: 100%; border-collapse: collapse; text-align: center;"> <tr> <td style="width: 10%;"></td> <td style="width: 10%;"></td> <td style="width: 10%;"></td> <td style="width: 10%;"></td> <td style="width: 10%;"></td> <td style="width: 10%;"></td> <td style="width: 10%;"></td> <td style="width: 10%;"></td> <td style="width: 10%;"></td> <td style="width: 10%;"></td> </tr> <tr> <td></td> <td></td> <td colspan="8" style="text-align: center;"> <table border="1" style="width: 100%; border-collapse: collapse; text-align: center;"> <tr> <td style="width: 10%;"></td> <td style="width: 10%;"></td> <td style="width: 10%;"></td> <td style="width: 10%;"></td> <td style="width: 10%;"></td> <td style="width: 10%;"></td> <td style="width: 10%;"></td> <td style="width: 10%;"></td> <td style="width: 10%;"></td> <td style="width: 10%;"></td> </tr> <tr> <td></td> <td></td> <td colspan="8" style="text-align: center;"> <table border="1" style="width: 100%; border-collapse: collapse; text-align: center;"> <tr> <td style="width: 10%;"></td> <td style="width: 10%;"></td> <td style="width: 10%;"></td> <td style="width: 10%;"></td> <td style="width: 10%;"></td> <td style="width: 10%;"></td> <td style="width: 10%;"></td> <td style="width: 10%;"></td> <td style="width: 10%;"></td> <td style="width: 10%;"></td> </tr> <tr> <td></td> <td></td> <td colspan="8" style="text-align: center;"> <table border="1" style="width: 100%; border-collapse: collapse; text-align: center;"> <tr> <td style="width: 10%;"></td> <td style="width: 10%;"></td> <td style="width: 10%;"></td> <td style="width: 10%;"></td> <td style="width: 10%;"></td> <td style="width: 10%;"></td> <td style="width: 10%;"></td> <td style="width: 10%;"></td> <td style="width: 10%;"></td> <td style="width: 10%;"></td> </tr> <tr> <td></td> <td></td> <td colspan="8" style="text-align: center;"> <table border="1" style="width: 100%; border-collapse: collapse; text-align: center;"> <tr> <td style="width: 10%;"></td> <td style="width: 10%;"></td> <td style="width: 10%;"></td> <td style="width: 10%;"></td> <td style="width: 10%;"></td> <td style="width: 10%;"></td> <td style="width: 10%;"></td> <td style="width: 10%;"></td> <td style="width: 10%;"></td> <td style="width: 10%;"></td> </tr> <tr> <td></td> <td></td> <td colspan="8" style="text-align: center;"> <table border="1" style="width: 100%; border-collapse: collapse; text-align: center;"> <tr> <td style="width: 10%;"></td> <td style="width: 10%;"></td> <td style="width: 10%;"></td> <td style="width: 10%;"></td> <td style="width: 10%;"></td> <td style="width: 10%;"></td> <td style="width: 10%;"></td> <td style="width: 10%;"></td> <td style="width: 10%;"></td> <td style="width: 10%;"></td> </tr> <tr> <td></td> <td></td> <td colspan="8" style="text-align: center;"> <table border="1" style="width: 100%; border-collapse: collapse; text-align: center;"> <tr> <td style="width: 10%;"></td> <td style="width: 10%;"></td> <td style="width: 10%;"></td> <td style="width: 10%;"></td> <td style="width: 10%;"></td> <td style="width: 10%;"></td> <td style="width: 10%;"></td> <td style="width: 10%;"></td> <td style="width: 10%;"></td> <td style="width: 10%;"></td> </tr> <tr> <td></td> <td></td> <td colspan="8" style="text-align: center;"> <table border="1" style="width: 100%; border-collapse: collapse; text-align: center;"> <tr> <td style="width: 10%;"></td> <td style="width: 10%;"></td> <td style="width: 10%;"></td> <td style="width: 10%;"></td> <td style="width: 10%;"></td> <td style="width: 10%;"></td> <td style="width: 10%;"></td> <td style="width: 10%;"></td> <td style="width: 10%;"></td> <td style="width: 10%;"></td> </tr> <tr> <td></td> <td></td> <td colspan="8" style="text-align: center;"> <table border="1" style="width: 100%; border-collapse: collapse; text-align: center;"> <tr> <td style="width: 10%;"></td> <td style="width: 10%;"></td> <td style="width: 10%;"></td> <td style="width: 10%;"></td> <td style="width: 10%;"></td> <td style="width: 10%;"></td> <td style="width: 10%;"></td> <td style="width: 10%;"></td> <td style="width: 10%;"></td> <td style="width: 10%;"></td> </tr> <tr> <td></td> <td></td> <td colspan="8" style="text-align: center;"> <table border="1" style="width: 100%; border-collapse: collapse; text-align: center;"> <tr> <td style="width: 10%;"></td> <td style="width: 10%;"></td> <td style="width: 10%;"></td> <td style="width: 10%;"></td> <td style="width: 10%;"></td> <td style="width: 10%;"></td> <td style="width: 10%;"></td> <td style="width: 10%;"></td> <td style="width: 10%;"></td> <td style="width: 10%;"></td> </tr> <tr> <td></td> <td></td> <td colspan="8" style="text-align: center;"> <table border="1" style="width: 100%; border-collapse: collapse; text-align: center;"> <tr> <td style="width: 10%;"></td> <td style="width: 10%;"></td> <td style="width: 10%;"></td> <td style="width: 10%;"></td> <td style="width: 10%;"></td> <td style="width: 10%;"></td> <td style="width: 10%;"></td> <td style="width: 10%;"></td> <td style="width: 10%;"></td> <td style="width: 10%;"></td> </tr> <tr> <td></td> <td></td> <td colspan="8" style="text-align: center;"> <table border="1" style="width: 100%; border-collapse: collapse; text-align: center;"> <tr> <td style="width: 10%;"></td> <td style="width: 10%;"></td> <td style="width: 10%;"></td> <td style="width: 10%;"></td> <td style="width: 10%;"></td> <td style="width: 10%;"></td> <td style="width: 10%;"></td> <td style="width: 10%;"></td> <td style="width: 10%;"></td> <td style="width: 10%;"></td> </tr> <tr> <td></td> <td></td> <td colspan="8" style="text-align: center;"> <table border="1" style="width: 100%; border-collapse: collapse; text-align: center;"> <tr> <td style="width: 10%;"></td> <td style="width: 10%;"></td> <td style="width: 10%;"></td> <td style="width: 10%;"></td> <td style="width: 10%;"></td> <td style="width: 10%;"></td> <td style="width: 10%;"></td> <td style="width: 10%;"></td> <td style="width: 10%;"></td> <td style="width: 10%;"></td> </tr> <tr> <td></td> <td></td> <td colspan="8" style="text-align: center;"> <table border="1" style="width: 100%; border-collapse: collapse; text-align: center;"> <tr> <td style="width: 10%;"></td> <td style="width: 10%;"></td> <td style="width: 10%;"></td> <td style="width: 10%;"></td> <td style="width: 10%;"></td> <td style="width: 10%;"></td> <td style="width: 10%;"></td> <td style="width: 10%;"></td> <td style="width: 10%;"></td> <td style="width: 10%;"></td> </tr> <tr> <td></td> <td></td> <td colspan="8" style="text-align: center;"> <table border="1" style="width: 100%; border-collapse: collapse; text-align: center;"> <tr> <td style="width: 10%;"></td> <td style="width: 10%;"></td> <td style="width: 10%;"></td> <td style="width: 10%;"></td> <td style="width: 10%;"></td> <td style="width: 10%;"></td> <td style="width: 10%;"></td> <td style="width: 10%;"></td> <td style="width: 10%;"></td> <td style="width: 10%;"></td> </tr> <tr> <td></td> <td></td> <td colspan="8" style="text-align: center;"> <table border="1" style="width: 100%; border-collapse: collapse; text-align: center;"> <tr> <td style="width: 10%;"></td> <td style="width: 10%;"></td> <td style="width: 10%;"></td> <td style="width: 10%;"></td> <td style="width: 10%;"></td> <td style="width: 10%;"></td> <td style="width: 10%;"></td> <td style="width: 10%;"></td> <td style="width: 10%;"></td> <td style="width: 10%;"></td> </tr> <tr> <td></td> <td></td> <td colspan="8" style="text-align: center;"> <table border="1" style="width: 100%; border-collapse: collapse; text-align: center;"> <tr> <td style="width: 10%;"></td> <td style="width: 10%;"></td> <td style="width: 10%;"></td> <td style="width: 10%;"></td> <td style="width: 10%;"></td> <td style="width: 10%;"></td> <td style="width: 10%;"></td> <td style="width: 10%;"></td> <td style="width: 10%;"></td> <td style="width: 10%;"></td> </tr> <tr> <td></td> <td></td> <td colspan="8" style="text-align: center;"> <table border="1" style="width: 100%; border-collapse: collapse;
text-align: center;"> <tr> <td style="width: 10%;"></td> <td style="width: 10%;"></td> <td style="width: 10%;"></td> <td style="width: 10%;"></td> <td style="width: 10%;"></td> <td style="width: 10%;"></td> <td style="width: 10%;"></td> <td style="width: 10%;"></td> <td style="width: 10%;"></td> <td style="width: 10%;"></td> </tr> <tr> <td></td> <td></td> <td colspan="8" style="text-align: center;"> <table border="1" style="width: 100%; border-collapse: collapse; text-align: center;"> <tr> <td style="width: 10%;"></td> <td style="width: 10%;"></td> <td style="width: 10%;"></td> <td style="width: 10%;"></td> <td style="width: 10%;"></td> <td style="width: 10%;"></td> <td style="width: 10%;"></td> <td style="width: 10%;"></td> <td style="width: 10%;"></td> <td style="width: 10%;"></td> </tr> <tr> <td></td> <td></td> <td colspan="8" style="text-align: center;"> <table border="1" style="width: 100%; border-collapse: collapse; text-align: center;"> <tr> <td style="width: 10%;"></td> <td style="width: 10%;"></td> <td style="width: 10%;"></td> <td style="width: 10%;"></td> <td style="width: 10%;"></td> <td style="width: 10%;"></td> <td style="width: 10%;"></td> <td style="width: 10%;"></td> <td style="width: 10%;"></td> <td style="width: 10%;"></td> </tr> <tr> <td></td> <td></td> <td colspan="8" style="text-align: center;"> <table border="1" style="width: 100%; border-collapse: collapse; text-align: center;"> <tr> <td style="width: 10%;"></td> <td style="width: 10%;"></td> <td style="width: 10%;"></td> <td style="width: 10%;"></td> <td style="width: 10%;"></td> <td style="width: 10%;"></td> <td style="width: 10%;"></td> <td style="width: 10%;"></td> <td style="width: 10%;"></td> <td style="width: 10%;"></td> </tr> <tr> <td></td> <td></td> <td colspan="8" style="text-align: center;"> <table border="1" style="width: 100%; border-collapse: collapse; text-align: center;"> <tr> <td style="width: 10%;"></td> <td style="width: 10%;"></td> <td style="width: 10%;"></td> <td style="width: 10%;"></td> <td style="width: 10%;"></td> <td style="width: 10%;"></td> <td style="width: 10%;"></td> <td style="width: 10%;"></td> <td style="width: 10%;"></td> <td style="width: 10%;"></td> </tr> <tr> <td></td> <td></td> <td colspan="8" style="text-align: center;"> <table border="1" style="width: 100%; border-collapse: collapse; text-align: center;"> <tr> <td style="width: 10%;"></td> <td style="width: 10%;"></td> <td style="width: 10%;"></td> <td style="width: 10%;"></td> <td style="width: 10%;"></td> <td style="width: 10%;"></td> <td style="width: 10%;"></td> <td style="width: 10%;"></td> <td style="width: 10%;"></td> <td style="width: 10%;"></td> </tr> <tr> <td></td> <td></td> <td colspan="8" style="text-align: center;"> <table border="1" style="width: 100%; border-collapse: collapse; text-align: center;"> <tr> <td style="width: 10%;"></td> <td style="width: 10%;"></td> <td style="width: 10%;"></td> <td style="width: 10%;"></td> <td style="width: 10%;"></td> <td style="width: 10%;"></td> <td style="width: 10%;"></td> <td style="width: 10%;"></td> <td style="width: 10%;"></td> <td style="width: 10%;"></td> </tr> <tr> <td></td> <td></td> <td colspan="8" style="text-align: center;"> <table border="1" style="width: 100%; border-collapse: collapse; text-align: center;"> <tr> <td style="width: 10%;"></td> <td style="width: 10%;"></td> <td style="width: 10%;"></td> <td style="width: 10%;"></td> <td style="width: 10%;"></td> <td style="width: 10%;"></td> <td style="width: 10%;"></td> <td style="width: 10%;"></td> <td style="width: 10%;"></td> <td style="width: 10%;"></td> </tr> <tr> <td></td> <td></td> <td colspan="8" style="text-align: center;"> <table border="1" style="width: 100%; border-collapse: collapse; text-align: center;"> <tr> <td style="width: 10%;"></td> <td style="width: 10%;"></td> <td style="width: 10%;"></td> <td style="width: 10%;"></td> <td style="width: 10%;"></td> <td style="width: 10%;"></td> <td style="width: 10%;"></td> <td style="width: 10%;"></td> <td style="width: 10%;"></td> <td style="width: 10%;"></td> </tr> <tr> <td></td> <td></td> <td colspan="8" style="text-align: center;"> <table border="1" style="width: 100%; border-collapse: collapse; text-align: center;"> <tr> <td style="width: 10%;"></td> <td style="width: 10%;"></td> <td style="width: 10%;"></td> <td style="width: 10%;"></td> <td style="width: 10%;"></td> <td style="width: 10%;"></td> <td style="width: 10%;"></td> <td style="width: 10%;"></td> <td style="width: 10%;"></td> <td style="width: 10%;"></td> </tr> <tr> <td></td> <td></td> <td colspan="8" style="text-align: center;"> <table border="1" style="width: 100%; border-collapse: collapse; text-align: center;"> <tr> <td style="width: 10%;"></td> <td style="width: 10%;"></td> <td style="width: 10%;"></td> <td style="width: 10%;"></td> <td style="width: 10%;"></td> <td style="width: 10%;"></td> <td style="width: 10%;"></td> <td style="width: 10%;"></td> <td style="width: 10%;"></td> <td style="width: 10%;"></td> </tr> <tr> <td></td> <td></td> <td colspan="8" style="text-align: center;"> <table border="1" style="width: 100%; border-collapse: collapse; text-align: center;"> <tr> <td style="width: 10%;"></td> <td style="width: 10%;"></td> <td style="width: 10%;"></td> <td style="width: 10%;"></td> <td style="width: 10%;"></td> <td style="width: 10%;"></td> <td style="width: 10%;"></td> <td style="width: 10%;"></td> <td style="width: 10%;"></td> <td style="width: 10%;"></td> </tr> <tr> <td></td> <td></td> <td colspan="8" style="text-align: center;"> <table border="1" style="width: 100%; border-collapse: collapse; text-align: center;"> <tr> <td style="width: 10%;"></td> <td style="width: 10%;"></td> <td style="width: 10%;"></td> <td style="width: 10%;"></td> <td style="width: 10%;"></td> <td style="width: 10%;"></td> <td style="width: 10%;"></td> <td style="width: 10%;"></td> <td style="width: 10%;"></td> <td style="width: 10%;"></td> </tr> <tr> <td></td> <td></td> <td colspan="8" style="text-align: center;"> <table border="1" style="width: 100%; border-collapse: collapse; text-align: center;"> <tr> <td style="width: 10%;"></td> <td style="width: 10%;"></td> <td style="width: 10%;"></td> <td style="width: 10%;"></td> <td style="width: 10%;"></td> <td style="width: 10%;"></td> <td style="width: 10%;"></td> <td style="width: 10%;"></td> <td style="width: 10%;"></td> <td style="width: 10%;"></td> </tr> <tr> <td></td> <td></td> <td colspan="8" style="text-align: center;"> <table border="1" style="width: 100%; border-collapse: collapse; text-align: center;"> <tr> </tr></table></td></tr></table></td></tr></table></td></tr></table></td></tr></table></td></tr></table></td></tr></table></td></tr></table></td></tr></table></td></tr></table></td></tr></table></td></tr></table></td></tr></table></td></tr></table></td></tr></table></td></tr></table></td></tr></table></td></tr></table></td></tr></table></td></tr></table></td></tr></table></td></tr></table></td></tr></table></td></tr></table></td></tr></table></td></tr></table></td></tr></table></td></tr></table></td></tr></table></td></tr></table></td></tr></table></td></tr></table></td></tr></table></td></tr></table></td></tr></table></td></tr></table></td></tr></table></td></tr></table></td></tr></table></td></tr></table></td></tr></table></td></tr></table> | | | | | | | | | | | | | | | | | | | | <table border="1" style="width: 100%; border-collapse: collapse; text-align: center;"> <tr> <td style="width: 10%;"></td> <td style="width: 10%;"></td> <td style="width: 10%;"></td> <td style="width: 10%;"></td> <td style="width: 10%;"></td> <td style="width: 10%;"></td> <td style="width: 10%;"></td> <td style="width: 10%;"></td> <td style="width: 10%;"></td> <td style="width: 10%;"></td> </tr> <tr> <td></td> <td></td> <td colspan="8" style="text-align: center;"> <table border="1" style="width: 100%; border-collapse: collapse; text-align: center;"> <tr> <td style="width: 10%;"></td> <td style="width: 10%;"></td> <td style="width: 10%;"></td> <td style="width: 10%;"></td> <td style="width: 10%;"></td> <td style="width: 10%;"></td> <td style="width: 10%;"></td> <td style="width: 10%;"></td> <td style="width: 10%;"></td> <td style="width: 10%;"></td> </tr> <tr> <td></td> <td></td> <td colspan="8" style="text-align: center;"> <table border="1" style="width: 100%; border-collapse: collapse; text-align: center;"> <tr> <td style="width: 10%;"></td> <td style="width: 10%;"></td> <td style="width: 10%;"></td> <td style="width: 10%;"></td> <td style="width: 10%;"></td> <td style="width: 10%;"></td> <td style="width: 10%;"></td> <td style="width: 10%;"></td> <td style="width: 10%;"></td> <td style="width: 10%;"></td> </tr> <tr> <td></td> <td></td> <td colspan="8" style="text-align: center;"> <table border="1" style="width: 100%; border-collapse: collapse; text-align: center;"> <tr> <td style="width: 10%;"></td> <td style="width: 10%;"></td> <td style="width: 10%;"></td> <td style="width: 10%;"></td> <td style="width: 10%;"></td> <td style="width: 10%;"></td> <td style="width: 10%;"></td> <td style="width: 10%;"></td> <td style="width: 10%;"></td> <td style="width: 10%;"></td> </tr> <tr> <td></td> <td></td> <td colspan="8" style="text-align: center;"> <table border="1" style="width: 100%; border-collapse: collapse; text-align: center;"> <tr> <td style="width: 10%;"></td> <td style="width: 10%;"></td> <td style="width: 10%;"></td> <td style="width: 10%;"></td> <td style="width: 10%;"></td> <td style="width: 10%;"></td> <td style="width: 10%;"></td> <td style="width: 10%;"></td> <td style="width: 10%;"></td> <td style="width: 10%;"></td> </tr> <tr> <td></td> <td></td> <td colspan="8" style="text-align: center;"> <table border="1" style="width: 100%; border-collapse: collapse; text-align: center;"> <tr> <td style="width: 10%;"></td> <td style="width: 10%;"></td> <td style="width: 10%;"></td> <td style="width: 10%;"></td> <td style="width: 10%;"></td> <td style="width:
10%;"></td> <td style="width: 10%;"></td> <td style="width: 10%;"></td> <td style="width: 10%;"></td> <td style="width: 10%;"></td> </tr> <tr> <td></td> <td></td> <td colspan="8" style="text-align: center;"> <table border="1" style="width: 100%; border-collapse: collapse; text-align: center;"> <tr> <td style="width: 10%;"></td> <td style="width: 10%;"></td> <td style="width: 10%;"></td> <td style="width: 10%;"></td> <td style="width: 10%;"></td> <td style="width: 10%;"></td> <td style="width: 10%;"></td> <td style="width: 10%;"></td> <td style="width: 10%;"></td> <td style="width: 10%;"></td> </tr> <tr> <td></td> <td></td> <td colspan="8" style="text-align: center;"> <table border="1" style="width: 100%; border-collapse: collapse; text-align: center;"> <tr> <td style="width: 10%;"></td> <td style="width: 10%;"></td> <td style="width: 10%;"></td> <td style="width: 10%;"></td> <td style="width: 10%;"></td> <td style="width: 10%;"></td> <td style="width: 10%;"></td> <td style="width: 10%;"></td> <td style="width: 10%;"></td> <td style="width: 10%;"></td> </tr> <tr> <td></td> <td></td> <td colspan="8" style="text-align: center;"> <table border="1" style="width: 100%; border-collapse: collapse; text-align: center;"> <tr> <td style="width: 10%;"></td> <td style="width: 10%;"></td> <td style="width: 10%;"></td> <td style="width: 10%;"></td> <td style="width: 10%;"></td> <td style="width: 10%;"></td> <td style="width: 10%;"></td> <td style="width: 10%;"></td> <td style="width: 10%;"></td> <td style="width: 10%;"></td> </tr> <tr> <td></td> <td></td> <td colspan="8" style="text-align: center;"> <table border="1" style="width: 100%; border-collapse: collapse; text-align: center;"> <tr> <td style="width: 10%;"></td> <td style="width: 10%;"></td> <td style="width: 10%;"></td> <td style="width: 10%;"></td> <td style="width: 10%;"></td> <td style="width: 10%;"></td> <td style="width: 10%;"></td> <td style="width: 10%;"></td> <td style="width: 10%;"></td> <td style="width: 10%;"></td> </tr> <tr> <td></td> <td></td> <td colspan="8" style="text-align: center;"> <table border="1" style="width: 100%; border-collapse: collapse; text-align: center;"> <tr> <td style="width: 10%;"></td> <td style="width: 10%;"></td> <td style="width: 10%;"></td> <td style="width: 10%;"></td> <td style="width: 10%;"></td> <td style="width: 10%;"></td> <td style="width: 10%;"></td> <td style="width: 10%;"></td> <td style="width: 10%;"></td> <td style="width: 10%;"></td> </tr> <tr> <td></td> <td></td> <td colspan="8" style="text-align: center;"> <table border="1" style="width: 100%; border-collapse: collapse; text-align: center;"> <tr> <td style="width: 10%;"></td> <td style="width: 10%;"></td> <td style="width: 10%;"></td> <td style="width: 10%;"></td> <td style="width: 10%;"></td> <td style="width: 10%;"></td> <td style="width: 10%;"></td> <td style="width: 10%;"></td> <td style="width: 10%;"></td> <td style="width: 10%;"></td> </tr> <tr> <td></td> <td></td> <td colspan="8" style="text-align: center;"> <table border="1" style="width: 100%; border-collapse: collapse; text-align: center;"> <tr> <td style="width: 10%;"></td> <td style="width: 10%;"></td> <td style="width: 10%;"></td> <td style="width: 10%;"></td> <td style="width: 10%;"></td> <td style="width: 10%;"></td> <td style="width: 10%;"></td> <td style="width: 10%;"></td> <td style="width: 10%;"></td> <td style="width: 10%;"></td> </tr> <tr> <td></td> <td></td> <td colspan="8" style="text-align: center;"> <table border="1" style="width: 100%; border-collapse: collapse; text-align: center;"> <tr> <td style="width: 10%;"></td> <td style="width: 10%;"></td> <td style="width: 10%;"></td> <td style="width: 10%;"></td> <td style="width: 10%;"></td> <td style="width: 10%;"></td> <td style="width: 10%;"></td> <td style="width: 10%;"></td> <td style="width: 10%;"></td> <td style="width: 10%;"></td> </tr> <tr> <td></td> <td></td> <td colspan="8" style="text-align: center;"> <table border="1" style="width: 100%; border-collapse: collapse; text-align: center;"> <tr> <td style="width: 10%;"></td> <td style="width: 10%;"></td> <td style="width: 10%;"></td> <td style="width: 10%;"></td> <td style="width: 10%;"></td> <td style="width: 10%;"></td> <td style="width: 10%;"></td> <td style="width: 10%;"></td> <td style="width: 10%;"></td> <td style="width: 10%;"></td> </tr> <tr> <td></td> <td></td> <td colspan="8" style="text-align: center;"> <table border="1" style="width: 100%; border-collapse: collapse; text-align: center;"> <tr> <td style="width: 10%;"></td> <td style="width: 10%;"></td> <td style="width: 10%;"></td> <td style="width: 10%;"></td> <td style="width: 10%;"></td> <td style="width: 10%;"></td> <td style="width: 10%;"></td> <td style="width: 10%;"></td> <td style="width: 10%;"></td> <td style="width: 10%;"></td> </tr> <tr> <td></td> <td></td> <td colspan="8" style="text-align: center;"> <table border="1" style="width: 100%; border-collapse: collapse; text-align: center;"> <tr> <td style="width: 10%;"></td> <td style="width: 10%;"></td> <td style="width: 10%;"></td> <td style="width: 10%;"></td> <td style="width: 10%;"></td> <td style="width: 10%;"></td> <td style="width: 10%;"></td> <td style="width: 10%;"></td> <td style="width: 10%;"></td> <td style="width: 10%;"></td> </tr> <tr> <td></td> <td></td> <td colspan="8" style="text-align: center;"> <table border="1" style="width: 100%; border-collapse: collapse; text-align: center;"> <tr> <td style="width: 10%;"></td> <td style="width: 10%;"></td> <td style="width: 10%;"></td> <td style="width: 10%;"></td> <td style="width: 10%;"></td> <td style="width: 10%;"></td> <td style="width: 10%;"></td> <td style="width: 10%;"></td> <td style="width: 10%;"></td> <td style="width: 10%;"></td> </tr> <tr> <td></td> <td></td> <td colspan="8" style="text-align: center;"> <table border="1" style="width: 100%; border-collapse: collapse; text-align: center;"> <tr> <td style="width: 10%;"></td> <td style="width: 10%;"></td> <td style="width: 10%;"></td> <td style="width: 10%;"></td> <td style="width: 10%;"></td> <td style="width: 10%;"></td> <td style="width: 10%;"></td> <td style="width: 10%;"></td> <td style="width: 10%;"></td> <td style="width: 10%;"></td> </tr> <tr> <td></td> <td></td> <td colspan="8" style="text-align: center;"> <table border="1" style="width: 100%; border-collapse: collapse; text-align: center;"> <tr> <td style="width: 10%;"></td> <td style="width: 10%;"></td> <td style="width: 10%;"></td> <td style="width: 10%;"></td> <td style="width: 10%;"></td> <td style="width: 10%;"></td> <td style="width: 10%;"></td> <td style="width: 10%;"></td> <td style="width: 10%;"></td> <td style="width: 10%;"></td> </tr> <tr> <td></td> <td></td> <td colspan="8" style="text-align: center;"> <table border="1" style="width: 100%; border-collapse: collapse; text-align: center;"> <tr> <td style="width: 10%;"></td> <td style="width: 10%;"></td> <td style="width: 10%;"></td> <td style="width: 10%;"></td> <td style="width: 10%;"></td> <td style="width: 10%;"></td> <td style="width: 10%;"></td> <td style="width: 10%;"></td> <td style="width: 10%;"></td> <td style="width: 10%;"></td> </tr> <tr> <td></td> <td></td> <td colspan="8" style="text-align: center;"> <table border="1" style="width: 100%; border-collapse: collapse; text-align: center;"> <tr> <td style="width: 10%;"></td> <td style="width: 10%;"></td> <td style="width: 10%;"></td> <td style="width: 10%;"></td> <td style="width: 10%;"></td> <td style="width: 10%;"></td> <td style="width: 10%;"></td> <td style="width: 10%;"></td> <td style="width: 10%;"></td> <td style="width: 10%;"></td> </tr> <tr> <td></td> <td></td> <td colspan="8" style="text-align: center;"> <table border="1" style="width: 100%; border-collapse: collapse; text-align: center;"> <tr> <td style="width: 10%;"></td> <td style="width: 10%;"></td> <td style="width: 10%;"></td> <td style="width: 10%;"></td> <td style="width: 10%;"></td> <td style="width: 10%;"></td> <td style="width: 10%;"></td> <td style="width: 10%;"></td> <td style="width: 10%;"></td> <td style="width: 10%;"></td> </tr> <tr> <td></td> <td></td> <td colspan="8" style="text-align: center;"> <table border="1" style="width: 100%; border-collapse: collapse; text-align: center;"> <tr> <td style="width: 10%;"></td> <td style="width: 10%;"></td> <td style="width: 10%;"></td> <td style="width: 10%;"></td> <td style="width: 10%;"></td> <td style="width: 10%;"></td> <td style="width: 10%;"></td> <td style="width: 10%;"></td> <td style="width: 10%;"></td> <td style="width: 10%;"></td> </tr> <tr> <td></td> <td></td> <td colspan="8" style="text-align: center;"> <table border="1" style="width: 100%; border-collapse: collapse; text-align: center;"> <tr> <td style="width: 10%;"></td> <td style="width: 10%;"></td> <td style="width: 10%;"></td> <td style="width: 10%;"></td> <td style="width: 10%;"></td> <td style="width: 10%;"></td> <td style="width: 10%;"></td> <td style="width: 10%;"></td> <td style="width: 10%;"></td> <td style="width: 10%;"></td> </tr> <tr> <td></td> <td></td> <td colspan="8" style="text-align: center;"> <table border="1" style="width: 100%; border-collapse: collapse; text-align: center;"> <tr> <td style="width: 10%;"></td> <td style="width: 10%;"></td> <td style="width: 10%;"></td> <td style="width: 10%;"></td> <td style="width: 10%;"></td> <td style="width: 10%;"></td> <td style="width: 10%;"></td> <td style="width: 10%;"></td> <td style="width: 10%;"></td> <td style="width: 10%;"></td> </tr> <tr> <td></td> <td></td> <td colspan="8" style="text-align: center;"> <table border="1" style="width: 100%; border-collapse: collapse; text-align: center;"> <tr> <td style="width: 10%;"></td> <td style="width: 10%;"></td> <td style="width: 10%;"></td> <td style="width: 10%;"></td> <td style="width: 10%;"></td> <td style="width: 10%;"></td> <td style="width: 10%;"></td> <td style="width: 10%;"></td> <td style="width: 10%;"></td> <td style="width: 10%;"></td> </tr> <tr> <td></td> <td></td> <td
colspan="8" style="text-align: center;"> <table border="1" style="width: 100%; border-collapse: collapse; text-align: center;"> <tr> <td style="width: 10%;"></td> <td style="width: 10%;"></td> <td style="width: 10%;"></td> <td style="width: 10%;"></td> <td style="width: 10%;"></td> <td style="width: 10%;"></td> <td style="width: 10%;"></td> <td style="width: 10%;"></td> <td style="width: 10%;"></td> <td style="width: 10%;"></td> </tr> <tr> <td></td> <td></td> <td colspan="8" style="text-align: center;"> <table border="1" style="width: 100%; border-collapse: collapse; text-align: center;"> <tr> <td style="width: 10%;"></td> <td style="width: 10%;"></td> <td style="width: 10%;"></td> <td style="width: 10%;"></td> <td style="width: 10%;"></td> <td style="width: 10%;"></td> <td style="width: 10%;"></td> <td style="width: 10%;"></td> <td style="width: 10%;"></td> <td style="width: 10%;"></td> </tr> <tr> <td></td> <td></td> <td colspan="8" style="text-align: center;"> <table border="1" style="width: 100%; border-collapse: collapse; text-align: center;"> <tr> <td style="width: 10%;"></td> <td style="width: 10%;"></td> <td style="width: 10%;"></td> <td style="width: 10%;"></td> <td style="width: 10%;"></td> <td style="width: 10%;"></td> <td style="width: 10%;"></td> <td style="width: 10%;"></td> <td style="width: 10%;"></td> <td style="width: 10%;"></td> </tr> <tr> <td></td> <td></td> <td colspan="8" style="text-align: center;"> <table border="1" style="width: 100%; border-collapse: collapse; text-align: center;"> <tr> <td style="width: 10%;"></td> <td style="width: 10%;"></td> <td style="width: 10%;"></td> <td style="width: 10%;"></td> <td style="width: 10%;"></td> <td style="width: 10%;"></td> <td style="width: 10%;"></td> <td style="width: 10%;"></td> <td style="width: 10%;"></td> <td style="width: 10%;"></td> </tr> <tr> <td></td> <td></td> <td colspan="8" style="text-align: center;"> <table border="1" style="width: 100%; border-collapse: collapse; text-align: center;"> <tr> <td style="width: 10%;"></td> <td style="width: 10%;"></td> <td style="width: 10%;"></td> <td style="width: 10%;"></td> <td style="width: 10%;"></td> <td style="width: 10%;"></td> <td style="width: 10%;"></td> <td style="width: 10%;"></td> <td style="width: 10%;"></td> <td style="width: 10%;"></td> </tr> <tr> <td></td> <td></td> <td colspan="8" style="text-align: center;"> <table border="1" style="width: 100%; border-collapse: collapse; text-align: center;"> <tr> <td style="width: 10%;"></td> <td style="width: 10%;"></td> <td style="width: 10%;"></td> <td style="width: 10%;"></td> <td style="width: 10%;"></td> <td style="width: 10%;"></td> <td style="width: 10%;"></td> <td style="width: 10%;"></td> <td style="width: 10%;"></td> <td style="width: 10%;"></td> </tr> <tr> <td></td> <td></td> <td colspan="8" style="text-align: center;"> <table border="1" style="width: 100%; border-collapse: collapse; text-align: center;"> <tr> <td style="width: 10%;"></td> <td style="width: 10%;"></td> <td style="width: 10%;"></td> <td style="width: 10%;"></td> <td style="width: 10%;"></td> <td style="width: 10%;"></td> <td style="width: 10%;"></td> <td style="width: 10%;"></td> <td style="width: 10%;"></td> <td style="width: 10%;"></td> </tr> <tr> <td></td> <td></td> <td colspan="8" style="text-align: center;"> <table border="1" style="width: 100%; border-collapse: collapse; text-align: center;"> <tr> <td style="width: 10%;"></td> <td style="width: 10%;"></td> <td style="width: 10%;"></td> <td style="width: 10%;"></td> <td style="width: 10%;"></td> <td style="width: 10%;"></td> <td style="width: 10%;"></td> <td style="width: 10%;"></td> <td style="width: 10%;"></td> <td style="width: 10%;"></td> </tr> <tr> <td></td> <td></td> <td colspan="8" style="text-align: center;"> <table border="1" style="width: 100%; border-collapse: collapse; text-align: center;"> <tr> <td style="width: 10%;"></td> <td style="width: 10%;"></td> <td style="width: 10%;"></td> <td style="width: 10%;"></td> <td style="width: 10%;"></td> <td style="width: 10%;"></td> <td style="width: 10%;"></td> <td style="width: 10%;"></td> <td style="width: 10%;"></td> <td style="width: 10%;"></td> </tr> <tr> <td></td> <td></td> <td colspan="8" style="text-align: center;"> <table border="1" style="width: 100%; border-collapse: collapse; text-align: center;"> <tr> <td style="width: 10%;"></td> <td style="width: 10%;"></td> <td style="width: 10%;"></td> <td style="width: 10%;"></td> <td style="width: 10%;"></td> <td style="width: 10%;"></td> <td style="width: 10%;"></td> <td style="width: 10%;"></td> <td style="width: 10%;"></td> <td style="width: 10%;"></td> </tr> <tr> <td></td> <td></td> <td colspan="8" style="text-align: center;"> <table border="1" style="width: 100%; border-collapse: collapse; text-align: center;"> <tr> <td style="width: 10%;"></td> <td style="width: 10%;"></td> <td style="width: 10%;"></td> <td style="width: 10%;"></td> <td style="width: 10%;"></td> <td style="width: 10%;"></td> <td style="width: 10%;"></td> <td style="width: 10%;"></td> <td style="width: 10%;"></td> <td style="width: 10%;"></td> </tr> <tr> <td></td> <td></td> <td colspan="8" style="text-align: center;"> <table border="1" style="width: 100%; border-collapse: collapse; text-align: center;"> <tr> <td style="width: 10%;"></td> <td style="width: 10%;"></td> <td style="width: 10%;"></td> <td style="width: 10%;"></td> <td style="width: 10%;"></td> <td style="width: 10%;"></td> <td style="width: 10%;"></td> <td style="width: 10%;"></td> <td style="width: 10%;"></td> <td style="width: 10%;"></td> </tr> <tr> <td></td> <td></td> <td colspan="8" style="text-align: center;"> <table border="1" style="width: 100%; border-collapse: collapse; text-align: center;"> <tr> <td style="width: 10%;"></td> <td style="width: 10%;"></td> <td style="width: 10%;"></td> <td style="width: 10%;"></td> <td style="width: 10%;"></td> <td style="width: 10%;"></td> <td style="width: 10%;"></td> <td style="width: 10%;"></td> <td style="width: 10%;"></td> <td style="width: 10%;"></td> </tr> <tr> <td></td> <td></td> <td colspan="8" style="text-align: center;"> <table border="1" style="width: 100%; border-collapse: collapse; text-align: center;"> <tr> </tr></table></td></tr></table></td></tr></table></td></tr></table></td></tr></table></td></tr></table></td></tr></table></td></tr></table></td></tr></table></td></tr></table></td></tr></table></td></tr></table></td></tr></table></td></tr></table></td></tr></table></td></tr></table></td></tr></table></td></tr></table></td></tr></table></td></tr></table></td></tr></table></td></tr></table></td></tr></table></td></tr></table></td></tr></table></td></tr></table></td></tr></table></td></tr></table></td></tr></table></td></tr></table></td></tr></table></td></tr></table></td></tr></table></td></tr></table></td></tr></table></td></tr></table></td></tr></table></td></tr></table></td></tr></table></td></tr></table></td></tr></table> | | | | | | | | | | | | | | | | | | | | <table border="1" style="width: 100%; border-collapse: collapse; text-align: center;"> <tr> <td style="width: 10%;"></td> <td style="width: 10%;"></td> <td style="width: 10%;"></td> <td style="width: 10%;"></td> <td style="width: 10%;"></td> <td style="width: 10%;"></td> <td style="width: 10%;"></td> <td style="width: 10%;"></td> <td style="width: 10%;"></td> <td style="width: 10%;"></td> </tr> <tr> <td></td> <td></td> <td colspan="8" style="text-align: center;"> <table border="1" style="width: 100%; border-collapse: collapse; text-align: center;"> <tr> <td style="width: 10%;"></td> <td style="width: 10%;"></td> <td style="width: 10%;"></td> <td style="width: 10%;"></td> <td style="width: 10%;"></td> <td style="width: 10%;"></td> <td style="width: 10%;"></td> <td style="width: 10%;"></td> <td style="width: 10%;"></td> <td style="width: 10%;"></td> </tr> <tr> <td></td> <td></td> <td colspan="8" style="text-align: center;"> <table border="1" style="width: 100%; border-collapse: collapse; text-align: center;"> <tr> <td style="width: 10%;"></td> <td style="width: 10%;"></td> <td style="width: 10%;"></td> <td style="width: 10%;"></td> <td style="width: 10%;"></td> <td style="width: 10%;"></td> <td style="width: 10%;"></td> <td style="width: 10%;"></td> <td style="width: 10%;"></td> <td style="width: 10%;"></td> </tr> <tr> <td></td> <td></td> <td colspan="8" style="text-align: center;"> <table border="1" style="width: 100%; border-collapse: collapse; text-align: center;"> <tr> <td style="width: 10%;"></td> <td style="width: 10%;"></td> <td style="width: 10%;"></td> <td style="width: 10%;"></td> <td style="width: 10%;"></td> <td style="width: 10%;"></td> <td style="width: 10%;"></td> <td style="width: 10%;"></td> <td style="width: 10%;"></td> <td style="width: 10%;"></td> </tr> <tr> <td></td> <td></td> <td colspan="8" style="text-align: center;"> <table border="1" style="width: 100%; border-collapse: collapse; text-align: center;"> <tr> <td style="width: 10%;"></td> <td style="width: 10%;"></td> <td style="width: 10%;"></td> <td style="width: 10%;"></td> <td style="width: 10%;"></td> <td style="width: 10%;"></td> <td style="width: 10%;"></td> <td style="width: 10%;"></td> <td style="width: 10%;"></td> <td style="width: 10%;"></td> </tr> <tr> <td></td> <td></td> <td colspan="8" style="text-align: center;"> <table border="1" style="width: 100%; border-collapse: collapse; text-align: center;"> <tr> <td style="width: 10%;"></td> <td style="width: 10%;"></td> <td style="width: 10%;"></td> <td style="width: 10%;"></td> <td style="width: 10%;"></td> <td style="width: 10%;"></td> <td style="width: 10%;"></td> <td style="width: 10%;"></td> <td style="width: 10%;"></td> <td style="width: 10%;"></td> </tr> <tr> <td></td> <td></td> <td colspan="8" style="text-align: center;"> <table border="1" style="width: 100%; border-collapse: collapse; text-align: center;"> <tr> <td style="width: 10%;"></td> <td style="width: 10%;"></td> <td style="width: 10%;"></td>
<td style="width: 10%;"></td> <td style="width: 10%;"></td> <td style="width: 10%;"></td> <td style="width: 10%;"></td> <td style="width: 10%;"></td> <td style="width: 10%;"></td> <td style="width: 10%;"></td> </tr> <tr> <td></td> <td></td> <td colspan="8" style="text-align: center;"> <table border="1" style="width: 100%; border-collapse: collapse; text-align: center;"> <tr> <td style="width: 10%;"></td> <td style="width: 10%;"></td> <td style="width: 10%;"></td> <td style="width: 10%;"></td> <td style="width: 10%;"></td> <td style="width: 10%;"></td> <td style="width: 10%;"></td> <td style="width: 10%;"></td> <td style="width: 10%;"></td> <td style="width: 10%;"></td> </tr> <tr> <td></td> <td></td> <td colspan="8" style="text-align: center;"> <table border="1" style="width: 100%; border-collapse: collapse; text-align: center;"> <tr> <td style="width: 10%;"></td> <td style="width: 10%;"></td> <td style="width: 10%;"></td> <td style="width: 10%;"></td> <td style="width: 10%;"></td> <td style="width: 10%;"></td> <td style="width: 10%;"></td> <td style="width: 10%;"></td> <td style="width: 10%;"></td> <td style="width: 10%;"></td> </tr> <tr> <td></td> <td></td> <td colspan="8" style="text-align: center;"> <table border="1" style="width: 100%; border-collapse: collapse; text-align: center;"> <tr> <td style="width: 10%;"></td> <td style="width: 10%;"></td> <td style="width: 10%;"></td> <td style="width: 10%;"></td> <td style="width: 10%;"></td> <td style="width: 10%;"></td> <td style="width: 10%;"></td> <td style="width: 10%;"></td> <td style="width: 10%;"></td> <td style="width: 10%;"></td> </tr> <tr> <td></td> <td></td> <td colspan="8" style="text-align: center;"> <table border="1" style="width: 100%; border-collapse: collapse; text-align: center;"> <tr> <td style="width: 10%;"></td> <td style="width: 10%;"></td> <td style="width: 10%;"></td> <td style="width: 10%;"></td> <td style="width: 10%;"></td> <td style="width: 10%;"></td> <td style="width: 10%;"></td> <td style="width: 10%;"></td> <td style="width: 10%;"></td> <td style="width: 10%;"></td> </tr> <tr> <td></td> <td></td> <td colspan="8" style="text-align: center;"> <table border="1" style="width: 100%; border-collapse: collapse; text-align: center;"> <tr> <td style="width: 10%;"></td> <td style="width: 10%;"></td> <td style="width: 10%;"></td> <td style="width: 10%;"></td> <td style="width: 10%;"></td> <td style="width: 10%;"></td> <td style="width: 10%;"></td> <td style="width: 10%;"></td> <td style="width: 10%;"></td> <td style="width: 10%;"></td> </tr> <tr> <td></td> <td></td> <td colspan="8" style="text-align: center;"> <table border="1" style="width: 100%; border-collapse: collapse; text-align: center;"> <tr> <td style="width: 10%;"></td> <td style="width: 10%;"></td> <td style="width: 10%;"></td> <td style="width: 10%;"></td> <td style="width: 10%;"></td> <td style="width: 10%;"></td> <td style="width: 10%;"></td> <td style="width: 10%;"></td> <td style="width: 10%;"></td> <td style="width: 10%;"></td> </tr> <tr> <td></td> <td></td> <td colspan="8" style="text-align: center;"> <table border="1" style="width: 100%; border-collapse: collapse; text-align: center;"> <tr> <td style="width: 10%;"></td> <td style="width: 10%;"></td> <td style="width: 10%;"></td> <td style="width: 10%;"></td> <td style="width: 10%;"></td> <td style="width: 10%;"></td> <td style="width: 10%;"></td> <td style="width: 10%;"></td> <td style="width: 10%;"></td> <td style="width: 10%;"></td> </tr> <tr> <td></td> <td></td> <td colspan="8" style="text-align: center;"> <table border="1" style="width: 100%; border-collapse: collapse; text-align: center;"> <tr> <td style="width: 10%;"></td> <td style="width: 10%;"></td> <td style="width: 10%;"></td> <td style="width: 10%;"></td> <td style="width: 10%;"></td> <td style="width: 10%;"></td> <td style="width: 10%;"></td> <td style="width: 10%;"></td> <td style="width: 10%;"></td> <td style="width: 10%;"></td> </tr> <tr> <td></td> <td></td> <td colspan="8" style="text-align: center;"> <table border="1" style="width: 100%; border-collapse: collapse; text-align: center;"> <tr> <td style="width: 10%;"></td> <td style="width: 10%;"></td> <td style="width: 10%;"></td> <td style="width: 10%;"></td> <td style="width: 10%;"></td> <td style="width: 10%;"></td> <td style="width: 10%;"></td> <td style="width: 10%;"></td> <td style="width: 10%;"></td> <td style="width: 10%;"></td> </tr> <tr> <td></td> <td></td> <td colspan="8" style="text-align: center;"> <table border="1" style="width: 100%; border-collapse: collapse; text-align: center;"> <tr> <td style="width: 10%;"></td> <td style="width: 10%;"></td> <td style="width: 10%;"></td> <td style="width: 10%;"></td> <td style="width: 10%;"></td> <td style="width: 10%;"></td> <td style="width: 10%;"></td> <td style="width: 10%;"></td> <td style="width: 10%;"></td> <td style="width: 10%;"></td> </tr> <tr> <td></td> <td></td> <td colspan="8" style="text-align: center;"> <table border="1" style="width: 100%; border-collapse: collapse; text-align: center;"> <tr> <td style="width: 10%;"></td> <td style="width: 10%;"></td> <td style="width: 10%;"></td> <td style="width: 10%;"></td> <td style="width: 10%;"></td> <td style="width: 10%;"></td> <td style="width: 10%;"></td> <td style="width: 10%;"></td> <td style="width: 10%;"></td> <td style="width: 10%;"></td> </tr> <tr> <td></td> <td></td> <td colspan="8" style="text-align: center;"> <table border="1" style="width: 100%; border-collapse: collapse; text-align: center;"> <tr> <td style="width: 10%;"></td> <td style="width: 10%;"></td> <td style="width: 10%;"></td> <td style="width: 10%;"></td> <td style="width: 10%;"></td> <td style="width: 10%;"></td> <td style="width: 10%;"></td> <td style="width: 10%;"></td> <td style="width: 10%;"></td> <td style="width: 10%;"></td> </tr> <tr> <td></td> <td></td> <td colspan="8" style="text-align: center;"> <table border="1" style="width: 100%; border-collapse: collapse; text-align: center;"> <tr> <td style="width: 10%;"></td> <td style="width: 10%;"></td> <td style="width: 10%;"></td> <td style="width: 10%;"></td> <td style="width: 10%;"></td> <td style="width: 10%;"></td> <td style="width: 10%;"></td> <td style="width: 10%;"></td> <td style="width: 10%;"></td> <td style="width: 10%;"></td> </tr> <tr> <td></td> <td></td> <td colspan="8" style="text-align: center;"> <table border="1" style="width: 100%; border-collapse: collapse; text-align: center;"> <tr> <td style="width: 10%;"></td> <td style="width: 10%;"></td> <td style="width: 10%;"></td> <td style="width: 10%;"></td> <td style="width: 10%;"></td> <td style="width: 10%;"></td> <td style="width: 10%;"></td> <td style="width: 10%;"></td> <td style="width: 10%;"></td> <td style="width: 10%;"></td> </tr> <tr> <td></td> <td></td> <td colspan="8" style="text-align: center;"> <table border="1" style="width: 100%; border-collapse: collapse; text-align: center;"> <tr> <td style="width: 10%;"></td> <td style="width: 10%;"></td> <td style="width: 10%;"></td> <td style="width: 10%;"></td> <td style="width: 10%;"></td> <td style="width: 10%;"></td> <td style="width: 10%;"></td> <td style="width: 10%;"></td> <td style="width: 10%;"></td> <td style="width: 10%;"></td> </tr> <tr> <td></td> <td></td> <td colspan="8" style="text-align: center;"> <table border="1" style="width: 100%; border-collapse: collapse; text-align: center;"> <tr> <td style="width: 10%;"></td> <td style="width: 10%;"></td> <td style="width: 10%;"></td> <td style="width: 10%;"></td> <td style="width: 10%;"></td> <td style="width: 10%;"></td> <td style="width: 10%;"></td> <td style="width: 10%;"></td> <td style="width: 10%;"></td> <td style="width: 10%;"></td> </tr> <tr> <td></td> <td></td> <td colspan="8" style="text-align: center;"> <table border="1" style="width: 100%; border-collapse: collapse; text-align: center;"> <tr> <td style="width: 10%;"></td> <td style="width: 10%;"></td> <td style="width: 10%;"></td> <td style="width: 10%;"></td> <td style="width: 10%;"></td> <td style="width: 10%;"></td> <td style="width: 10%;"></td> <td style="width: 10%;"></td> <td style="width: 10%;"></td> <td style="width: 10%;"></td> </tr> <tr> <td></td> <td></td> <td colspan="8" style="text-align: center;"> <table border="1" style="width: 100%; border-collapse: collapse; text-align: center;"> <tr> <td style="width: 10%;"></td> <td style="width: 10%;"></td> <td style="width: 10%;"></td> <td style="width: 10%;"></td> <td style="width: 10%;"></td> <td style="width: 10%;"></td> <td style="width: 10%;"></td> <td style="width: 10%;"></td> <td style="width: 10%;"></td> <td style="width: 10%;"></td> </tr> <tr> <td></td> <td></td> <td colspan="8" style="text-align: center;"> <table border="1" style="width: 100%; border-collapse: collapse; text-align: center;"> <tr> <td style="width: 10%;"></td> <td style="width: 10%;"></td> <td style="width: 10%;"></td> <td style="width: 10%;"></td> <td style="width: 10%;"></td> <td style="width: 10%;"></td> <td style="width: 10%;"></td> <td style="width: 10%;"></td> <td style="width: 10%;"></td> <td style="width: 10%;"></td> </tr> <tr> <td></td> <td></td> <td colspan="8" style="text-align: center;"> <table border="1" style="width: 100%; border-collapse: collapse; text-align: center;"> <tr> <td style="width: 10%;"></td> <td style="width: 10%;"></td> <td style="width: 10%;"></td> <td style="width: 10%;"></td> <td style="width: 10%;"></td> <td style="width: 10%;"></td> <td style="width: 10%;"></td> <td style="width: 10%;"></td> <td style="width: 10%;"></td> <td style="width: 10%;"></td> </tr> <tr> <td></td> <td></td> <td colspan="8" style="text-align: center;"> <table border="1" style="width: 100%; border-collapse: collapse; text-align: center;"> <tr> <td style="width: 10%;"></td> <td style="width: 10%;"></td> <td style="width: 10%;"></td> <td style="width: 10%;"></td> <td style="width: 10%;"></td> <td style="width: 10%;"></td> <td style="width: 10%;"></td> <td style="width: 10%;"></td> <td style="width:
10%;"></td> <td style="width: 10%;"></td> </tr> <tr> <td></td> <td></td> <td colspan="8" style="text-align: center;"> <table border="1" style="width: 100%; border-collapse: collapse; text-align: center;"> <tr> <td style="width: 10%;"></td> <td style="width: 10%;"></td> <td style="width: 10%;"></td> <td style="width: 10%;"></td> <td style="width: 10%;"></td> <td style="width: 10%;"></td> <td style="width: 10%;"></td> <td style="width: 10%;"></td> <td style="width: 10%;"></td> <td style="width: 10%;"></td> </tr> <tr> <td></td> <td></td> <td colspan="8" style="text-align: center;"> <table border="1" style="width: 100%; border-collapse: collapse; text-align: center;"> <tr> <td style="width: 10%;"></td> <td style="width: 10%;"></td> <td style="width: 10%;"></td> <td style="width: 10%;"></td> <td style="width: 10%;"></td> <td style="width: 10%;"></td> <td style="width: 10%;"></td> <td style="width: 10%;"></td> <td style="width: 10%;"></td> <td style="width: 10%;"></td> </tr> <tr> <td></td> <td></td> <td colspan="8" style="text-align: center;"> <table border="1" style="width: 100%; border-collapse: collapse; text-align: center;"> <tr> <td style="width: 10%;"></td> <td style="width: 10%;"></td> <td style="width: 10%;"></td> <td style="width: 10%;"></td> <td style="width: 10%;"></td> <td style="width: 10%;"></td> <td style="width: 10%;"></td> <td style="width: 10%;"></td> <td style="width: 10%;"></td> <td style="width: 10%;"></td> </tr> <tr> <td></td> <td></td> <td colspan="8" style="text-align: center;"> <table border="1" style="width: 100%; border-collapse: collapse; text-align: center;"> <tr> <td style="width: 10%;"></td> <td style="width: 10%;"></td> <td style="width: 10%;"></td> <td style="width: 10%;"></td> <td style="width: 10%;"></td> <td style="width: 10%;"></td> <td style="width: 10%;"></td> <td style="width: 10%;"></td> <td style="width: 10%;"></td> <td style="width: 10%;"></td> </tr> <tr> <td></td> <td></td> <td colspan="8" style="text-align: center;"> <table border="1" style="width: 100%; border-collapse: collapse; text-align: center;"> <tr> <td style="width: 10%;"></td> <td style="width: 10%;"></td> <td style="width: 10%;"></td> <td style="width: 10%;"></td> <td style="width: 10%;"></td> <td style="width: 10%;"></td> <td style="width: 10%;"></td> <td style="width: 10%;"></td> <td style="width: 10%;"></td> <td style="width: 10%;"></td> </tr> <tr> <td></td> <td></td> <td colspan="8" style="text-align: center;"> <table border="1" style="width: 100%; border-collapse: collapse; text-align: center;"> <tr> <td style="width: 10%;"></td> <td style="width: 10%;"></td> <td style="width: 10%;"></td> <td style="width: 10%;"></td> <td style="width: 10%;"></td> <td style="width: 10%;"></td> <td style="width: 10%;"></td> <td style="width: 10%;"></td> <td style="width: 10%;"></td> <td style="width: 10%;"></td> </tr> <tr> <td></td> <td></td> <td colspan="8" style="text-align: center;"> <table border="1" style="width: 100%; border-collapse: collapse; text-align: center;"> <tr> <td style="width: 10%;"></td> <td style="width: 10%;"></td> <td style="width: 10%;"></td> <td style="width: 10%;"></td> <td style="width: 10%;"></td> <td style="width: 10%;"></td> <td style="width: 10%;"></td> <td style="width: 10%;"></td> <td style="width: 10%;"></td> <td style="width: 10%;"></td> </tr> <tr> <td></td> <td></td> <td colspan="8" style="text-align: center;"> <table border="1" style="width: 100%; border-collapse: collapse; text-align: center;"> <tr> <td style="width: 10%;"></td> <td style="width: 10%;"></td> <td style="width: 10%;"></td> <td style="width: 10%;"></td> <td style="width: 10%;"></td> <td style="width: 10%;"></td> <td style="width: 10%;"></td> <td style="width: 10%;"></td> <td style="width: 10%;"></td> <td style="width: 10%;"></td> </tr> <tr> <td></td> <td></td> <td colspan="8" style="text-align: center;"> <table border="1" style="width: 100%; border-collapse: collapse; text-align: center;"> <tr> <td style="width: 10%;"></td> <td style="width: 10%;"></td> <td style="width: 10%;"></td> <td style="width: 10%;"></td> <td style="width: 10%;"></td> <td style="width: 10%;"></td> <td style="width: 10%;"></td> <td style="width: 10%;"></td> <td style="width: 10%;"></td> <td style="width: 10%;"></td> </tr> <tr> <td></td> <td></td> <td colspan="8" style="text-align: center;"> <table border="1" style="width: 100%; border-collapse: collapse; text-align: center;"> <tr> <td style="width: 10%;"></td> <td style="width: 10%;"></td> <td style="width: 10%;"></td> <td style="width: 10%;"></td> <td style="width: 10%;"></td> <td style="width: 10%;"></td> <td style="width: 10%;"></td> <td style="width: 10%;"></td> <td style="width: 10%;"></td> <td style="width: 10%;"></td> </tr> <tr> <td></td> <td></td> <td colspan="8" style="text-align: center;"> <table border="1" style="width: 100%; border-collapse: collapse; text-align: center;"> <tr> <td style="width: 10%;"></td> <td style="width: 10%;"></td> <td style="width: 10%;"></td> <td style="width: 10%;"></td> <td style="width: 10%;"></td> <td style="width: 10%;"></td> <td style="width: 10%;"></td> <td style="width: 10%;"></td> <td style="width: 10%;"></td> <td style="width: 10%;"></td> </tr> <tr> <td></td> <td></td> <td colspan="8" style="text-align: center;"> <table border="1" style="width: 100%; border-collapse: collapse; text-align: center;"> <tr> </tr></table></td></tr></table></td></tr></table></td></tr></table></td></tr></table></td></tr></table></td></tr></table></td></tr></table></td></tr></table></td></tr></table></td></tr></table></td></tr></table></td></tr></table></td></tr></table></td></tr></table></td></tr></table></td></tr></table></td></tr></table></td></tr></table></td></tr></table></td></tr></table></td></tr></table></td></tr></table></td></tr></table></td></tr></table></td></tr></table></td></tr></table></td></tr></table></td></tr></table></td></tr></table></td></tr></table></td></tr></table></td></tr></table></td></tr></table></td></tr></table></td></tr></table></td></tr></table></td></tr></table></td></tr></table></td></tr></table> | | | | | | | | | | | | | | | | | | | | <table border="1" style="width: 100%; border-collapse: collapse; text-align: center;"> <tr> <td style="width: 10%;"></td> <td style="width: 10%;"></td> <td style="width: 10%;"></td> <td style="width: 10%;"></td> <td style="width: 10%;"></td> <td style="width: 10%;"></td> <td style="width: 10%;"></td> <td style="width: 10%;"></td> <td style="width: 10%;"></td> <td style="width: 10%;"></td> </tr> <tr> <td></td> <td></td> <td colspan="8" style="text-align: center;"> <table border="1" style="width: 100%; border-collapse: collapse; text-align: center;"> <tr> <td style="width: 10%;"></td> <td style="width: 10%;"></td> <td style="width: 10%;"></td> <td style="width: 10%;"></td> <td style="width: 10%;"></td> <td style="width: 10%;"></td> <td style="width: 10%;"></td> <td style="width: 10%;"></td> <td style="width: 10%;"></td> <td style="width: 10%;"></td> </tr> <tr> <td></td> <td></td> <td colspan="8" style="text-align: center;"> <table border="1" style="width: 100%; border-collapse: collapse; text-align: center;"> <tr> <td style="width: 10%;"></td> <td style="width: 10%;"></td> <td style="width: 10%;"></td> <td style="width: 10%;"></td> <td style="width: 10%;"></td> <td style="width: 10%;"></td> <td style="width: 10%;"></td> <td style="width: 10%;"></td> <td style="width: 10%;"></td> <td style="width: 10%;"></td> </tr> <tr> <td></td> <td></td> <td colspan="8" style="text-align: center;"> <table border="1" style="width: 100%; border-collapse: collapse; text-align: center;"> <tr> <td style="width: 10%;"></td> <td style="width: 10%;"></td> <td style="width: 10%;"></td> <td style="width: 10%;"></td> <td style="width: 10%;"></td> <td style="width: 10%;"></td> <td style="width: 10%;"></td> <td style="width: 10%;"></td> <td style="width: 10%;"></td> <td style="width: 10%;"></td> </tr> <tr> <td></td> <td></td> <td colspan="8" style="text-align: center;"> <table border="1" style="width: 100%; border-collapse: collapse; text-align: center;"> <tr> <td style="width: 10%;"></td> <td style="width: 10%;"></td> <td style="width: 10%;"></td> <td style="width: 10%;"></td> <td style="width: 10%;"></td> <td style="width: 10%;"></td> <td style="width: 10%;"></td> <td style="width: 10%;"></td> <td style="width: 10%;"></td> <td style="width: 10%;"></td> </tr> <tr> <td></td> <td></td> <td colspan="8" style="text-align: center;"> <table border="1" style="width: 100%; border-collapse: collapse; text-align: center;"> <tr> <td style="width: 10%;"></td> <td style="width: 10%;"></td> <td style="width: 10%;"></td> <td style="width: 10%;"></td> <td style="width: 10%;"></td> <td style="width: 10%;"></td> <td style="width: 10%;"></td> <td style="width: 10%;"></td> <td style="width: 10%;"></td> <td style="width: 10%;"></td> </tr> <tr> <td></td> <td></td> <td colspan="8" style="text-align: center;"> <table border="1" style="width: 100%; border-collapse: collapse; text-align: center;"> <tr> <td style="width: 10%;"></td> <td style="width: 10%;"></td> <td style="width: 10%;"></td> <td style="width: 10%;"></td> <td style="width: 10%;"></td> <td style="width: 10%;"></td> <td style="width: 10%;"></td> <td style="width: 10%;"></td> <td style="width: 10%;"></td> <td style="width: 10%;"></td> </tr> <tr> <td></td> <td></td> <td colspan="8" style="text-align: center;"> <table border="1" style="width: 100%; border-collapse: collapse; text-align: center;"> <tr> <td style="width: 10%;"></td> <td style="width: 10%;"></td> <td style="width: 10%;"></td> <td style="width: 10%;"></td> <td style="width: 10%;"></td> <td style="width: 10%;"></td> <td style="width: 10%;"></td> <td style="width: 10%;"></td> <td style="width: 10%;"></td> <td style="width: 10%;"></td> </tr> <tr> <td></td> <td></td> <td colspan="8" style="text-align: center;"> <table border="1" style="width: 100%; border-collapse: collapse; text-align: center;"> <tr> <td style="width: 10%;"></td>
<td style="width: 10%;"></td> <td style="width: 10%;"></td> <td style="width: 10%;"></td> <td style="width: 10%;"></td> <td style="width: 10%;"></td> <td style="width: 10%;"></td> <td style="width: 10%;"></td> <td style="width: 10%;"></td> <td style="width: 10%;"></td> </tr> <tr> <td></td> <td></td> <td colspan="8" style="text-align: center;"> <table border="1" style="width: 100%; border-collapse: collapse; text-align: center;"> <tr> <td style="width: 10%;"></td> <td style="width: 10%;"></td> <td style="width: 10%;"></td> <td style="width: 10%;"></td> <td style="width: 10%;"></td> <td style="width: 10%;"></td> <td style="width: 10%;"></td> <td style="width: 10%;"></td> <td style="width: 10%;"></td> <td style="width: 10%;"></td> </tr> <tr> <td></td> <td></td> <td colspan="8" style="text-align: center;"> <table border="1" style="width: 100%; border-collapse: collapse; text-align: center;"> <tr> <td style="width: 10%;"></td> <td style="width: 10%;"></td> <td style="width: 10%;"></td> <td style="width: 10%;"></td> <td style="width: 10%;"></td> <td style="width: 10%;"></td> <td style="width: 10%;"></td> <td style="width: 10%;"></td> <td style="width: 10%;"></td> <td style="width: 10%;"></td> </tr> <tr> <td></td> <td></td> <td colspan="8" style="text-align: center;"> <table border="1" style="width: 100%; border-collapse: collapse; text-align: center;"> <tr> <td style="width: 10%;"></td> <td style="width: 10%;"></td> <td style="width: 10%;"></td> <td style="width: 10%;"></td> <td style="width: 10%;"></td> <td style="width: 10%;"></td> <td style="width: 10%;"></td> <td style="width: 10%;"></td> <td style="width: 10%;"></td> <td style="width: 10%;"></td> </tr> <tr> <td></td> <td></td> <td colspan="8" style="text-align: center;"> <table border="1" style="width: 100%; border-collapse: collapse; text-align: center;"> <tr> <td style="width: 10%;"></td> <td style="width: 10%;"></td> <td style="width: 10%;"></td> <td style="width: 10%;"></td> <td style="width: 10%;"></td> <td style="width: 10%;"></td> <td style="width: 10%;"></td> <td style="width: 10%;"></td> <td style="width: 10%;"></td> <td style="width: 10%;"></td> </tr> <tr> <td></td> <td></td> <td colspan="8" style="text-align: center;"> <table border="1" style="width: 100%; border-collapse: collapse; text-align: center;"> <tr> <td style="width: 10%;"></td> <td style="width: 10%;"></td> <td style="width: 10%;"></td> <td style="width: 10%;"></td> <td style="width: 10%;"></td> <td style="width: 10%;"></td> <td style="width: 10%;"></td> <td style="width: 10%;"></td> <td style="width: 10%;"></td> <td style="width: 10%;"></td> </tr> <tr> <td></td> <td></td> <td colspan="8" style="text-align: center;"> <table border="1" style="width: 100%; border-collapse: collapse; text-align: center;"> <tr> <td style="width: 10%;"></td> <td style="width: 10%;"></td> <td style="width: 10%;"></td> <td style="width: 10%;"></td> <td style="width: 10%;"></td> <td style="width: 10%;"></td> <td style="width: 10%;"></td> <td style="width: 10%;"></td> <td style="width: 10%;"></td> <td style="width: 10%;"></td> </tr> <tr> <td></td> <td></td> <td colspan="8" style="text-align: center;"> <table border="1" style="width: 100%; border-collapse: collapse; text-align: center;"> <tr> <td style="width: 10%;"></td> <td style="width: 10%;"></td> <td style="width: 10%;"></td> <td style="width: 10%;"></td> <td style="width: 10%;"></td> <td style="width: 10%;"></td> <td style="width: 10%;"></td> <td style="width: 10%;"></td> <td style="width: 10%;"></td> <td style="width: 10%;"></td> </tr> <tr> <td></td> <td></td> <td colspan="8" style="text-align: center;"> <table border="1" style="width: 100%; border-collapse: collapse; text-align: center;"> <tr> <td style="width: 10%;"></td> <td style="width: 10%;"></td> <td style="width: 10%;"></td> <td style="width: 10%;"></td> <td style="width: 10%;"></td> <td style="width: 10%;"></td> <td style="width: 10%;"></td> <td style="width: 10%;"></td> <td style="width: 10%;"></td> <td style="width: 10%;"></td> </tr> <tr> <td></td> <td></td> <td colspan="8" style="text-align: center;"> <table border="1" style="width: 100%; border-collapse: collapse; text-align: center;"> <tr> <td style="width: 10%;"></td> <td style="width: 10%;"></td> <td style="width: 10%;"></td> <td style="width: 10%;"></td> <td style="width: 10%;"></td> <td style="width: 10%;"></td> <td style="width: 10%;"></td> <td style="width: 10%;"></td> <td style="width: 10%;"></td> <td style="width: 10%;"></td> </tr> <tr> <td></td> <td></td> <td colspan="8" style="text-align: center;"> <table border="1" style="width: 100%; border-collapse: collapse; text-align: center;"> <tr> <td style="width: 10%;"></td> <td style="width: 10%;"></td> <td style="width: 10%;"></td> <td style="width: 10%;"></td> <td style="width: 10%;"></td> <td style="width: 10%;"></td> <td style="width: 10%;"></td> <td style="width: 10%;"></td> <td style="width: 10%;"></td> <td style="width: 10%;"></td> </tr> <tr> <td></td> <td></td> <td colspan="8" style="text-align: center;"> <table border="1" style="width: 100%; border-collapse: collapse; text-align: center;"> <tr> <td style="width: 10%;"></td> <td style="width: 10%;"></td> <td style="width: 10%;"></td> <td style="width: 10%;"></td> <td style="width: 10%;"></td> <td style="width: 10%;"></td> <td style="width: 10%;"></td> <td style="width: 10%;"></td> <td style="width: 10%;"></td> <td style="width: 10%;"></td> </tr> <tr> <td></td> <td></td> <td colspan="8" style="text-align: center;"> <table border="1" style="width: 100%; border-collapse: collapse; text-align: center;"> <tr> <td style="width: 10%;"></td> <td style="width: 10%;"></td> <td style="width: 10%;"></td> <td style="width: 10%;"></td> <td style="width: 10%;"></td> <td style="width: 10%;"></td> <td style="width: 10%;"></td> <td style="width: 10%;"></td> <td style="width: 10%;"></td> <td style="width: 10%;"></td> </tr> <tr> <td></td> <td></td> <td colspan="8" style="text-align: center;"> <table border="1" style="width: 100%; border-collapse: collapse; text-align: center;"> <tr> <td style="width: 10%;"></td> <td style="width: 10%;"></td> <td style="width: 10%;"></td> <td style="width: 10%;"></td> <td style="width: 10%;"></td> <td style="width: 10%;"></td> <td style="width: 10%;"></td> <td style="width: 10%;"></td> <td style="width: 10%;"></td> <td style="width: 10%;"></td> </tr> <tr> <td></td> <td></td> <td colspan="8" style="text-align: center;"> <table border="1" style="width: 100%; border-collapse: collapse; text-align: center;"> <tr> <td style="width: 10%;"></td> <td style="width: 10%;"></td> <td style="width: 10%;"></td> <td style="width: 10%;"></td> <td style="width: 10%;"></td> <td style="width: 10%;"></td> <td style="width: 10%;"></td> <td style="width: 10%;"></td> <td style="width: 10%;"></td> <td style="width: 10%;"></td> </tr> <tr> <td></td> <td></td> <td colspan="8" style="text-align: center;"> <table border="1" style="width: 100%; border-collapse: collapse; text-align: center;"> <tr> <td style="width: 10%;"></td> <td style="width: 10%;"></td> <td style="width: 10%;"></td> <td style="width: 10%;"></td> <td style="width: 10%;"></td> <td style="width: 10%;"></td> <td style="width: 10%;"></td> <td style="width: 10%;"></td> <td style="width: 10%;"></td> <td style="width: 10%;"></td> </tr> <tr> <td></td> <td></td> <td colspan="8" style="text-align: center;"> <table border="1" style="width: 100%; border-collapse: collapse; text-align: center;"> <tr> <td style="width: 10%;"></td> <td style="width: 10%;"></td> <td style="width: 10%;"></td> <td style="width: 10%;"></td> <td style="width: 10%;"></td> <td style="width: 10%;"></td> <td style="width: 10%;"></td> <td style="width: 10%;"></td> <td style="width: 10%;"></td> <td style="width: 10%;"></td> </tr> <tr> <td></td> <td></td> <td colspan="8" style="text-align: center;"> <table border="1" style="width: 100%; border-collapse: collapse; text-align: center;"> <tr> <td style="width: 10%;"></td> <td style="width: 10%;"></td> <td style="width: 10%;"></td> <td style="width: 10%;"></td> <td style="width: 10%;"></td> <td style="width: 10%;"></td> <td style="width: 10%;"></td> <td style="width: 10%;"></td> <td style="width: 10%;"></td> <td style="width: 10%;"></td> </tr> <tr> <td></td> <td></td> <td colspan="8" style="text-align: center;"> <table border="1" style="width: 100%; border-collapse: collapse; text-align: center;"> <tr> <td style="width: 10%;"></td> <td style="width: 10%;"></td> <td style="width: 10%;"></td> <td style="width: 10%;"></td> <td style="width: 10%;"></td> <td style="width: 10%;"></td> <td style="width: 10%;"></td> <td style="width: 10%;"></td> <td style="width: 10%;"></td> <td style="width: 10%;"></td> </tr> <tr> <td></td> <td></td> <td colspan="8" style="text-align: center;"> <table border="1" style="width: 100%; border-collapse: collapse; text-align: center;"> <tr> <td style="width: 10%;"></td> <td style="width: 10%;"></td> <td style="width: 10%;"></td> <td style="width: 10%;"></td> <td style="width: 10%;"></td> <td style="width: 10%;"></td> <td style="width: 10%;"></td> <td style="width: 10%;"></td> <td style="width: 10%;"></td> <td style="width: 10%;"></td> </tr> <tr> <td></td> <td></td> <td colspan="8" style="text-align: center;"> <table border="1" style="width: 100%; border-collapse: collapse; text-align: center;"> <tr> <td style="width: 10%;"></td> <td style="width: 10%;"></td> <td style="width: 10%;"></td> <td style="width: 10%;"></td> <td style="width: 10%;"></td> <td style="width: 10%;"></td> <td style="width: 10%;"></td> <td style="width: 10%;"></td> <td style="width: 10%;"></td> <td style="width: 10%;"></td> </tr> <tr> <td></td> <td></td> <td colspan="8" style="text-align: center;"> <table border="1" style="width: 100%; border-collapse: collapse; text-align: center;"> <tr> <td style="width: 10%;"></td> <td style="width: 10%;"></td> <td style="width: 10%;"></td> <td style="width: 10%;"></td> <td style="width: 10%;"></td> <td style="width: 10%;"></td> <td style="width:
10%;"></td> <td style="width: 10%;"></td> <td style="width: 10%;"></td> <td style="width: 10%;"></td> </tr> <tr> <td></td> <td></td> <td colspan="8" style="text-align: center;"> <table border="1" style="width: 100%; border-collapse: collapse; text-align: center;"> <tr> <td style="width: 10%;"></td> <td style="width: 10%;"></td> <td style="width: 10%;"></td> <td style="width: 10%;"></td> <td style="width: 10%;"></td> <td style="width: 10%;"></td> <td style="width: 10%;"></td> <td style="width: 10%;"></td> <td style="width: 10%;"></td> <td style="width: 10%;"></td> </tr> <tr> <td></td> <td></td> <td colspan="8" style="text-align: center;"> <table border="1" style="width: 100%; border-collapse: collapse; text-align: center;"> <tr> <td style="width: 10%;"></td> <td style="width: 10%;"></td> <td style="width: 10%;"></td> <td style="width: 10%;"></td> <td style="width: 10%;"></td> <td style="width: 10%;"></td> <td style="width: 10%;"></td> <td style="width: 10%;"></td> <td style="width: 10%;"></td> <td style="width: 10%;"></td> </tr> <tr> <td></td> <td></td> <td colspan="8" style="text-align: center;"> <table border="1" style="width: 100%; border-collapse: collapse; text-align: center;"> <tr> <td style="width: 10%;"></td> <td style="width: 10%;"></td> <td style="width: 10%;"></td> <td style="width: 10%;"></td> <td style="width: 10%;"></td> <td style="width: 10%;"></td> <td style="width: 10%;"></td> <td style="width: 10%;"></td> <td style="width: 10%;"></td> <td style="width: 10%;"></td> </tr> <tr> <td></td> <td></td> <td colspan="8" style="text-align: center;"> <table border="1" style="width: 100%; border-collapse: collapse; text-align: center;"> <tr> <td style="width: 10%;"></td> <td style="width: 10%;"></td> <td style="width: 10%;"></td> <td style="width: 10%;"></td> <td style="width: 10%;"></td> <td style="width: 10%;"></td> <td style="width: 10%;"></td> <td style="width: 10%;"></td> <td style="width: 10%;"></td> <td style="width: 10%;"></td> </tr> <tr> <td></td> <td></td> <td colspan="8" style="text-align: center;"> <table border="1" style="width: 100%; border-collapse: collapse; text-align: center;"> <tr> <td style="width: 10%;"></td> <td style="width: 10%;"></td> <td style="width: 10%;"></td> <td style="width: 10%;"></td> <td style="width: 10%;"></td> <td style="width: 10%;"></td> <td style="width: 10%;"></td> <td style="width: 10%;"></td> <td style="width: 10%;"></td> <td style="width: 10%;"></td> </tr> <tr> <td></td> <td></td> <td colspan="8" style="text-align: center;"> <table border="1" style="width: 100%; border-collapse: collapse; text-align: center;"> <tr> <td style="width: 10%;"></td> <td style="width: 10%;"></td> <td style="width: 10%;"></td> <td style="width: 10%;"></td> <td style="width: 10%;"></td> <td style="width: 10%;"></td> <td style="width: 10%;"></td> <td style="width: 10%;"></td> <td style="width: 10%;"></td> <td style="width: 10%;"></td> </tr> <tr> <td></td> <td></td> <td colspan="8" style="text-align: center;"> <table border="1" style="width: 100%; border-collapse: collapse; text-align: center;"> <tr> <td style="width: 10%;"></td> <td style="width: 10%;"></td> <td style="width: 10%;"></td> <td style="width: 10%;"></td> <td style="width: 10%;"></td> <td style="width: 10%;"></td> <td style="width: 10%;"></td> <td style="width: 10%;"></td> <td style="width: 10%;"></td> <td style="width: 10%;"></td> </tr> <tr> <td></td> <td></td> <td colspan="8" style="text-align: center;"> <table border="1" style="width: 100%; border-collapse: collapse; text-align: center;"> <tr> <td style="width: 10%;"></td> <td style="width: 10%;"></td> <td style="width: 10%;"></td> <td style="width: 10%;"></td> <td style="width: 10%;"></td> <td style="width: 10%;"></td> <td style="width: 10%;"></td> <td style="width: 10%;"></td> <td style="width: 10%;"></td> <td style="width: 10%;"></td> </tr> <tr> <td></td> <td></td> <td colspan="8" style="text-align: center;"> <table border="1" style="width: 100%; border-collapse: collapse; text-align: center;"> <tr> </tr></table></td></tr></table></td></tr></table></td></tr></table></td></tr></table></td></tr></table></td></tr></table></td></tr></table></td></tr></table></td></tr></table></td></tr></table></td></tr></table></td></tr></table></td></tr></table></td></tr></table></td></tr></table></td></tr></table></td></tr></table></td></tr></table></td></tr></table></td></tr></table></td></tr></table></td></tr></table></td></tr></table></td></tr></table></td></tr></table></td></tr></table></td></tr></table></td></tr></table></td></tr></table></td></tr></table></td></tr></table></td></tr></table></td></tr></table></td></tr></table></td></tr></table></td></tr></table></td></tr></table></td></tr></table> | | | | | | | | | | | | | | | | | | | | <table border="1" style="width: 100%; border-collapse: collapse; text-align: center;"> <tr> <td style="width: 10%;"></td> <td style="width: 10%;"></td> <td style="width: 10%;"></td> <td style="width: 10%;"></td> <td style="width: 10%;"></td> <td style="width: 10%;"></td> <td style="width: 10%;"></td> <td style="width: 10%;"></td> <td style="width: 10%;"></td> <td style="width: 10%;"></td> </tr> <tr> <td></td> <td></td> <td colspan="8" style="text-align: center;"> <table border="1" style="width: 100%; border-collapse: collapse; text-align: center;"> <tr> <td style="width: 10%;"></td> <td style="width: 10%;"></td> <td style="width: 10%;"></td> <td style="width: 10%;"></td> <td style="width: 10%;"></td> <td style="width: 10%;"></td> <td style="width: 10%;"></td> <td style="width: 10%;"></td> <td style="width: 10%;"></td> <td style="width: 10%;"></td> </tr> <tr> <td></td> <td></td> <td colspan="8" style="text-align: center;"> <table border="1" style="width: 100%; border-collapse: collapse; text-align: center;"> <tr> <td style="width: 10%;"></td> <td style="width: 10%;"></td> <td style="width: 10%;"></td> <td style="width: 10%;"></td> <td style="width: 10%;"></td> <td style="width: 10%;"></td> <td style="width: 10%;"></td> <td style="width: 10%;"></td> <td style="width: 10%;"></td> <td style="width: 10%;"></td> </tr> <tr> <td></td> <td></td> <td colspan="8" style="text-align: center;"> <table border="1" style="width: 100%; border-collapse: collapse; text-align: center;"> <tr> <td style="width: 10%;"></td> <td style="width: 10%;"></td> <td style="width: 10%;"></td> <td style="width: 10%;"></td> <td style="width: 10%;"></td> <td style="width: 10%;"></td> <td style="width: 10%;"></td> <td style="width: 10%;"></td> <td style="width: 10%;"></td> <td style="width: 10%;"></td> </tr> <tr> <td></td> <td></td> <td colspan="8" style="text-align: center;"> <table border="1" style="width: 100%; border-collapse: collapse; text-align: center;"> <tr> <td style="width: 10%;"></td> <td style="width: 10%;"></td> <td style="width: 10%;"></td> <td style="width: 10%;"></td> <td style="width: 10%;"></td> <td style="width: 10%;"></td> <td style="width: 10%;"></td> <td style="width: 10%;"></td> <td style="width: 10%;"></td> <td style="width: 10%;"></td> </tr> <tr> <td></td> <td></td> <td colspan="8" style="text-align: center;"> <table border="1" style="width: 100%; border-collapse: collapse; text-align: center;"> <tr> <td style="width: 10%;"></td> <td style="width: 10%;"></td> <td style="width: 10%;"></td> <td style="width: 10%;"></td> <td style="width: 10%;"></td> <td style="width: 10%;"></td> <td style="width: 10%;"></td> <td style="width: 10%;"></td> <td style="width: 10%;"></td> <td style="width: 10%;"></td> </tr> <tr> <td></td> <td></td> <td colspan="8" style="text-align: center;"> <table border="1" style="width: 100%; border-collapse: collapse; text-align: center;"> <tr> <td style="width: 10%;"></td> <td style="width: 10%;"></td> <td style="width: 10%;"></td> <td style="width: 10%;"></td> <td style="width: 10%;"></td> <td style="width: 10%;"></td> <td style="width: 10%;"></td> <td style="width: 10%;"></td> <td style="width: 10%;"></td> <td style="width: 10%;"></td> </tr> <tr> <td></td> <td></td> <td colspan="8" style="text-align: center;"> <table border="1" style="width: 100%; border-collapse: collapse; text-align: center;"> <tr> <td style="width: 10%;"></td> <td style="width: 10%;"></td> <td style="width: 10%;"></td> <td style="width: 10%;"></td> <td style="width: 10%;"></td> <td style="width: 10%;"></td> <td style="width: 10%;"></td> <td style="width: 10%;"></td> <td style="width: 10%;"></td> <td style="width: 10%;"></td> </tr> <tr> <td></td> <td></td> <td colspan="8" style="text-align: center;"> <table border="1" style="width: 100%; border-collapse: collapse; text-align: center;"> <tr> <td style="width: 10%;"></td> <td style="width: 10%;"></td> <td style="width: 10%;"></td> <td style="width: 10%;"></td> <td style="width: 10%;"></td> <td style="width: 10%;"></td> <td style="width: 10%;"></td> <td style="width: 10%;"></td> <td style="width: 10%;"></td> <td style="width: 10%;"></td> </tr> <tr> <td></td> <td></td> <td colspan="8" style="text-align: center;"> <table border="1" style="width: 100%; border-collapse: collapse; text-align: center;"> <tr> <td style="width: 10%;"></td> <td style="width: 10%;"></td> <td style="width: 10%;"></td> <td style="width: 10%;"></td> <td style="width: 10%;"></td> <td style="width: 10%;"></td> <td style="width: 10%;"></td> <td style="width: 10%;"></td> <td style="width: 10%;"></td> <td style="width: 10%;"></td> </tr> <tr> <td></td> <td></td> <td colspan="8" style="text-align: center;"> <table border="1" style="width: 100%; border-collapse: collapse; text-align: center;"> <tr> <td style="width: 10%;"></td> <td style="width: 10%;"></td> <td style="width: 10%;"></td> <td style="width: 10%;"></td> <td style="width: 10%;"></td> <td style="width: 10%;"></td> <td style="width: 10%;"></td> <td style="width: 10%;"></td> <td style="width: 10%;"></td> <td style="width: 10%;"></td> </tr> <tr> <td></td> <td></td> <td colspan="8" style="text-align: center;"> <table border="1" style="width: 100%; border-collapse: collapse; text-align:
center;"> <tr> <td style="width: 10%;"></td> <td style="width: 10%;"></td> <td style="width: 10%;"></td> <td style="width: 10%;"></td> <td style="width: 10%;"></td> <td style="width: 10%;"></td> <td style="width: 10%;"></td> <td style="width: 10%;"></td> <td style="width: 10%;"></td> <td style="width: 10%;"></td> </tr> <tr> <td></td> <td></td> <td colspan="8" style="text-align: center;"> <table border="1" style="width: 100%; border-collapse: collapse; text-align: center;"> <tr> <td style="width: 10%;"></td> <td style="width: 10%;"></td> <td style="width: 10%;"></td> <td style="width: 10%;"></td> <td style="width: 10%;"></td> <td style="width: 10%;"></td> <td style="width: 10%;"></td> <td style="width: 10%;"></td> <td style="width: 10%;"></td> <td style="width: 10%;"></td> </tr> <tr> <td></td> <td></td> <td colspan="8" style="text-align: center;"> <table border="1" style="width: 100%; border-collapse: collapse; text-align: center;"> <tr> <td style="width: 10%;"></td> <td style="width: 10%;"></td> <td style="width: 10%;"></td> <td style="width: 10%;"></td> <td style="width: 10%;"></td> <td style="width: 10%;"></td> <td style="width: 10%;"></td> <td style="width: 10%;"></td> <td style="width: 10%;"></td> <td style="width: 10%;"></td> </tr> <tr> <td></td> <td></td> <td colspan="8" style="text-align: center;"> <table border="1" style="width: 100%; border-collapse: collapse; text-align: center;"> <tr> <td style="width: 10%;"></td> <td style="width: 10%;"></td> <td style="width: 10%;"></td> <td style="width: 10%;"></td> <td style="width: 10%;"></td> <td style="width: 10%;"></td> <td style="width: 10%;"></td> <td style="width: 10%;"></td> <td style="width: 10%;"></td> <td style="width: 10%;"></td> </tr> <tr> <td></td> <td></td> <td colspan="8" style="text-align: center;"> <table border="1" style="width: 100%; border-collapse: collapse; text-align: center;"> <tr> <td style="width: 10%;"></td> <td style="width: 10%;"></td> <td style="width: 10%;"></td> <td style="width: 10%;"></td> <td style="width: 10%;"></td> <td style="width: 10%;"></td> <td style="width: 10%;"></td> <td style="width: 10%;"></td> <td style="width: 10%;"></td> <td style="width: 10%;"></td> </tr> <tr> <td></td> <td></td> <td colspan="8" style="text-align: center;"> <table border="1" style="width: 100%; border-collapse: collapse; text-align: center;"> <tr> <td style="width: 10%;"></td> <td style="width: 10%;"></td> <td style="width: 10%;"></td> <td style="width: 10%;"></td> <td style="width: 10%;"></td> <td style="width: 10%;"></td> <td style="width: 10%;"></td> <td style="width: 10%;"></td> <td style="width: 10%;"></td> <td style="width: 10%;"></td> </tr> <tr> <td></td> <td></td> <td colspan="8" style="text-align: center;"> <table border="1" style="width: 100%; border-collapse: collapse; text-align: center;"> <tr> <td style="width: 10%;"></td> <td style="width: 10%;"></td> <td style="width: 10%;"></td> <td style="width: 10%;"></td> <td style="width: 10%;"></td> <td style="width: 10%;"></td> <td style="width: 10%;"></td> <td style="width: 10%;"></td> <td style="width: 10%;"></td> <td style="width: 10%;"></td> </tr> <tr> <td></td> <td></td> <td colspan="8" style="text-align: center;"> <table border="1" style="width: 100%; border-collapse: collapse; text-align: center;"> <tr> <td style="width: 10%;"></td> <td style="width: 10%;"></td> <td style="width: 10%;"></td> <td style="width: 10%;"></td> <td style="width: 10%;"></td> <td style="width: 10%;"></td> <td style="width: 10%;"></td> <td style="width: 10%;"></td> <td style="width: 10%;"></td> <td style="width: 10%;"></td> </tr> <tr> <td></td> <td></td> <td colspan="8" style="text-align: center;"> <table border="1" style="width: 100%; border-collapse: collapse; text-align: center;"> <tr> <td style="width: 10%;"></td> <td style="width: 10%;"></td> <td style="width: 10%;"></td> <td style="width: 10%;"></td> <td style="width: 10%;"></td> <td style="width: 10%;"></td> <td style="width: 10%;"></td> <td style="width: 10%;"></td> <td style="width: 10%;"></td> <td style="width: 10%;"></td> </tr> <tr> <td></td> <td></td> <td colspan="8" style="text-align: center;"> <table border="1" style="width: 100%; border-collapse: collapse; text-align: center;"> <tr> <td style="width: 10%;"></td> <td style="width: 10%;"></td> <td style="width: 10%;"></td> <td style="width: 10%;"></td> <td style="width: 10%;"></td> <td style="width: 10%;"></td> <td style="width: 10%;"></td> <td style="width: 10%;"></td> <td style="width: 10%;"></td> <td style="width: 10%;"></td> </tr> <tr> <td></td> <td></td> <td colspan="8" style="text-align: center;"> <table border="1" style="width: 100%; border-collapse: collapse; text-align: center;"> <tr> <td style="width: 10%;"></td> <td style="width: 10%;"></td> <td style="width: 10%;"></td> <td style="width: 10%;"></td> <td style="width: 10%;"></td> <td style="width: 10%;"></td> <td style="width: 10%;"></td> <td style="width: 10%;"></td> <td style="width: 10%;"></td> <td style="width: 10%;"></td> </tr> <tr> <td></td> <td></td> <td colspan="8" style="text-align: center;"> <table border="1" style="width: 100%; border-collapse: collapse; text-align: center;"> <tr> <td style="width: 10%;"></td> <td style="width: 10%;"></td> <td style="width: 10%;"></td> <td style="width: 10%;"></td> <td style="width: 10%;"></td> <td style="width: 10%;"></td> <td style="width: 10%;"></td> <td style="width: 10%;"></td> <td style="width: 10%;"></td> <td style="width: 10%;"></td> </tr> <tr> <td></td> <td></td> <td colspan="8" style="text-align: center;"> <table border="1" style="width: 100%; border-collapse: collapse; text-align: center;"> <tr> <td style="width: 10%;"></td> <td style="width: 10%;"></td> <td style="width: 10%;"></td> <td style="width: 10%;"></td> <td style="width: 10%;"></td> <td style="width: 10%;"></td> <td style="width: 10%;"></td> <td style="width: 10%;"></td> <td style="width: 10%;"></td> <td style="width: 10%;"></td> </tr> <tr> <td></td> <td></td> <td colspan="8" style="text-align: center;"> <table border="1" style="width: 100%; border-collapse: collapse; text-align: center;"> <tr> <td style="width: 10%;"></td> <td style="width: 10%;"></td> <td style="width: 10%;"></td> <td style="width: 10%;"></td> <td style="width: 10%;"></td> <td style="width: 10%;"></td> <td style="width: 10%;"></td> <td style="width: 10%;"></td> <td style="width: 10%;"></td> <td style="width: 10%;"></td> </tr> <tr> <td></td> <td></td> <td colspan="8" style="text-align: center;"> <table border="1" style="width: 100%; border-collapse: collapse; text-align: center;"> <tr> <td style="width: 10%;"></td> <td style="width: 10%;"></td> <td style="width: 10%;"></td> <td style="width: 10%;"></td> <td style="width: 10%;"></td> <td style="width: 10%;"></td> <td style="width: 10%;"></td> <td style="width: 10%;"></td> <td style="width: 10%;"></td> <td style="width: 10%;"></td> </tr> <tr> <td></td> <td></td> <td colspan="8" style="text-align: center;"> <table border="1" style="width: 100%; border-collapse: collapse; text-align: center;"> <tr> <td style="width: 10%;"></td> <td style="width: 10%;"></td> <td style="width: 10%;"></td> <td style="width: 10%;"></td> <td style="width: 10%;"></td> <td style="width: 10%;"></td> <td style="width: 10%;"></td> <td style="width: 10%;"></td> <td style="width: 10%;"></td> <td style="width: 10%;"></td> </tr> <tr> <td></td> <td></td> <td colspan="8" style="text-align: center;"> <table border="1" style="width: 100%; border-collapse: collapse; text-align: center;"> <tr> <td style="width: 10%;"></td> <td style="width: 10%;"></td> <td style="width: 10%;"></td> <td style="width: 10%;"></td> <td style="width: 10%;"></td> <td style="width: 10%;"></td> <td style="width: 10%;"></td> <td style="width: 10%;"></td> <td style="width: 10%;"></td> <td style="width: 10%;"></td> </tr> <tr> <td></td> <td></td> <td colspan="8" style="text-align: center;"> <table border="1" style="width: 100%; border-collapse: collapse; text-align: center;"> <tr> <td style="width: 10%;"></td> <td style="width: 10%;"></td> <td style="width: 10%;"></td> <td style="width: 10%;"></td> <td style="width: 10%;"></td> <td style="width: 10%;"></td> <td style="width: 10%;"></td> <td style="width: 10%;"></td> <td style="width: 10%;"></td> <td style="width: 10%;"></td> </tr> <tr> <td></td> <td></td> <td colspan="8" style="text-align: center;"> <table border="1" style="width: 100%; border-collapse: collapse; text-align: center;"> <tr> <td style="width: 10%;"></td> <td style="width: 10%;"></td> <td style="width: 10%;"></td> <td style="width: 10%;"></td> <td style="width: 10%;"></td> <td style="width: 10%;"></td> <td style="width: 10%;"></td> <td style="width: 10%;"></td> <td style="width: 10%;"></td> <td style="width: 10%;"></td> </tr> <tr> <td></td> <td></td> <td colspan="8" style="text-align: center;"> <table border="1" style="width: 100%; border-collapse: collapse; text-align: center;"> <tr> <td style="width: 10%;"></td> <td style="width: 10%;"></td> <td style="width: 10%;"></td> <td style="width: 10%;"></td> <td style="width: 10%;"></td> <td style="width: 10%;"></td> <td style="width: 10%;"></td> <td style="width: 10%;"></td> <td style="width: 10%;"></td> <td style="width: 10%;"></td> </tr> <tr> <td></td> <td></td> <td colspan="8" style="text-align: center;"> <table border="1" style="width: 100%; border-collapse: collapse; text-align: center;"> <tr> <td style="width: 10%;"></td> <td style="width: 10%;"></td> <td style="width: 10%;"></td> <td style="width: 10%;"></td> <td style="width: 10%;"></td> <td style="width: 10%;"></td> <td style="width: 10%;"></td> <td style="width: 10%;"></td> <td style="width: 10%;"></td> <td style="width: 10%;"></td> </tr> <tr> <td></td> <td></td> <td colspan="8" style="text-align: center;"> <table border="1" style="width: 100%; border-collapse: collapse; text-align: center;"> <tr> <td style="width: 10%;"></td> <td style="width: 10%;"></td> <td style="width: 10%;"></td> <td style="width: 10%;"></td> <td style="width: 10%;"></td> <td
style="width: 10%;"></td> <td style="width: 10%;"></td> <td style="width: 10%;"></td> <td style="width: 10%;"></td> <td style="width: 10%;"></td> </tr> <tr> <td></td> <td></td> <td colspan="8" style="text-align: center;"> <table border="1" style="width: 100%; border-collapse: collapse; text-align: center;"> <tr> <td style="width: 10%;"></td> <td style="width: 10%;"></td> <td style="width: 10%;"></td> <td style="width: 10%;"></td> <td style="width: 10%;"></td> <td style="width: 10%;"></td> <td style="width: 10%;"></td> <td style="width: 10%;"></td> <td style="width: 10%;"></td> <td style="width: 10%;"></td> </tr> <tr> <td></td> <td></td> <td colspan="8" style="text-align: center;"> <table border="1" style="width: 100%; border-collapse: collapse; text-align: center;"> <tr> <td style="width: 10%;"></td> <td style="width: 10%;"></td> <td style="width: 10%;"></td> <td style="width: 10%;"></td> <td style="width: 10%;"></td> <td style="width: 10%;"></td> <td style="width: 10%;"></td> <td style="width: 10%;"></td> <td style="width: 10%;"></td> <td style="width: 10%;"></td> </tr> <tr> <td></td> <td></td> <td colspan="8" style="text-align: center;"> <table border="1" style="width: 100%; border-collapse: collapse; text-align: center;"> <tr> <td style="width: 10%;"></td> <td style="width: 10%;"></td> <td style="width: 10%;"></td> <td style="width: 10%;"></td> <td style="width: 10%;"></td> <td style="width: 10%;"></td> <td style="width: 10%;"></td> <td style="width: 10%;"></td> <td style="width: 10%;"></td> <td style="width: 10%;"></td> </tr> <tr> <td></td> <td></td> <td colspan="8" style="text-align: center;"> <table border="1" style="width: 100%; border-collapse: collapse; text-align: center;"> <tr> <td style="width: 10%;"></td> <td style="width: 10%;"></td> <td style="width: 10%;"></td> <td style="width: 10%;"></td> <td style="width: 10%;"></td> <td style="width: 10%;"></td> <td style="width: 10%;"></td> <td style="width: 10%;"></td> <td style="width: 10%;"></td> <td style="width: 10%;"></td> </tr> <tr> <td></td> <td></td> <td colspan="8" style="text-align: center;"> <table border="1" style="width: 100%; border-collapse: collapse; text-align: center;"> <tr> </tr></table></td></tr></table></td></tr></table></td></tr></table></td></tr></table></td></tr></table></td></tr></table></td></tr></table></td></tr></table></td></tr></table></td></tr></table></td></tr></table></td></tr></table></td></tr></table></td></tr></table></td></tr></table></td></tr></table></td></tr></table></td></tr></table></td></tr></table></td></tr></table></td></tr></table></td></tr></table></td></tr></table></td></tr></table></td></tr></table></td></tr></table></td></tr></table></td></tr></table></td></tr></table></td></tr></table></td></tr></table></td></tr></table></td></tr></table></td></tr></table></td></tr></table></td></tr></table></td></tr></table> | | | | | | | | | | | | | | | | | | | | <table border="1" style="width: 100%; border-collapse: collapse; text-align: center;"> <tr> <td style="width: 10%;"></td> <td style="width: 10%;"></td> <td style="width: 10%;"></td> <td style="width: 10%;"></td> <td style="width: 10%;"></td> <td style="width: 10%;"></td> <td style="width: 10%;"></td> <td style="width: 10%;"></td> <td style="width: 10%;"></td> <td style="width: 10%;"></td> </tr> <tr> <td></td> <td></td> <td colspan="8" style="text-align: center;"> <table border="1" style="width: 100%; border-collapse: collapse; text-align: center;"> <tr> <td style="width: 10%;"></td> <td style="width: 10%;"></td> <td style="width: 10%;"></td> <td style="width: 10%;"></td> <td style="width: 10%;"></td> <td style="width: 10%;"></td> <td style="width: 10%;"></td> <td style="width: 10%;"></td> <td style="width: 10%;"></td> <td style="width: 10%;"></td> </tr> <tr> <td></td> <td></td> <td colspan="8" style="text-align: center;"> <table border="1" style="width: 100%; border-collapse: collapse; text-align: center;"> <tr> <td style="width: 10%;"></td> <td style="width: 10%;"></td> <td style="width: 10%;"></td> <td style="width: 10%;"></td> <td style="width: 10%;"></td> <td style="width: 10%;"></td> <td style="width: 10%;"></td> <td style="width: 10%;"></td> <td style="width: 10%;"></td> <td style="width: 10%;"></td> </tr> <tr> <td></td> <td></td> <td colspan="8" style="text-align: center;"> <table border="1" style="width: 100%; border-collapse: collapse; text-align: center;"> <tr> <td style="width: 10%;"></td> <td style="width: 10%;"></td> <td style="width: 10%;"></td> <td style="width: 10%;"></td> <td style="width: 10%;"></td> <td style="width: 10%;"></td> <td style="width: 10%;"></td> <td style="width: 10%;"></td> <td style="width: 10%;"></td> <td style="width: 10%;"></td> </tr> <tr> <td></td> <td></td> <td colspan="8" style="text-align: center;"> <table border="1" style="width: 100%; border-collapse: collapse; text-align: center;"> <tr> <td style="width: 10%;"></td> <td style="width: 10%;"></td> <td style="width: 10%;"></td> <td style="width: 10%;"></td> <td style="width: 10%;"></td> <td style="width: 10%;"></td> <td style="width: 10%;"></td> <td style="width: 10%;"></td> <td style="width: 10%;"></td> <td style="width: 10%;"></td> </tr> <tr> <td></td> <td></td> <td colspan="8" style="text-align: center;"> <table border="1" style="width: 100%; border-collapse: collapse; text-align: center;"> <tr> <td style="width: 10%;"></td> <td style="width: 10%;"></td> <td style="width: 10%;"></td> <td style="width: 10%;"></td> <td style="width: 10%;"></td> <td style="width: 10%;"></td> <td style="width: 10%;"></td> <td style="width: 10%;"></td> <td style="width: 10%;"></td> <td style="width: 10%;"></td> </tr> <tr> <td></td> <td></td> <td colspan="8" style="text-align: center;"> <table border="1" style="width: 100%; border-collapse: collapse; text-align: center;"> <tr> <td style="width: 10%;"></td> <td style="width: 10%;"></td> <td style="width: 10%;"></td> <td style="width: 10%;"></td> <td style="width: 10%;"></td> <td style="width: 10%;"></td> <td style="width: 10%;"></td> <td style="width: 10%;"></td> <td style="width: 10%;"></td> <td style="width: 10%;"></td> </tr> <tr> <td></td> <td></td> <td colspan="8" style="text-align: center;"> <table border="1" style="width: 100%; border-collapse: collapse; text-align: center;"> <tr> <td style="width: 10%;"></td> <td style="width: 10%;"></td> <td style="width: 10%;"></td> <td style="width: 10%;"></td> <td style="width: 10%;"></td> <td style="width: 10%;"></td> <td style="width: 10%;"></td> <td style="width: 10%;"></td> <td style="width: 10%;"></td> <td style="width: 10%;"></td> </tr> <tr> <td></td> <td></td> <td colspan="8" style="text-align: center;"> <table border="1" style="width: 100%; border-collapse: collapse; text-align: center;"> <tr> <td style="width: 10%;"></td> <td style="width: 10%;"></td> <td style="width: 10%;"></td> <td style="width: 10%;"></td> <td style="width: 10%;"></td> <td style="width: 10%;"></td> <td style="width: 10%;"></td> <td style="width: 10%;"></td> <td style="width: 10%;"></td> <td style="width: 10%;"></td> </tr> <tr> <td></td> <td></td> <td colspan="8" style="text-align: center;"> <table border="1" style="width: 100%; border-collapse: collapse; text-align: center;"> <tr> <td style="width: 10%;"></td> <td style="width: 10%;"></td> <td style="width: 10%;"></td> <td style="width: 10%;"></td> <td style="width: 10%;"></td> <td style="width: 10%;"></td> <td style="width: 10%;"></td> <td style="width: 10%;"></td> <td style="width: 10%;"></td> <td style="width: 10%;"></td> </tr> <tr> <td></td> <td></td> <td colspan="8" style="text-align: center;"> <table border="1" style="width: 100%; border-collapse: collapse; text-align: center;"> <tr> <td style="width: 10%;"></td> <td style="width: 10%;"></td> <td style="width: 10%;"></td> <td style="width: 10%;"></td> <td style="width: 10%;"></td> <td style="width: 10%;"></td> <td style="width: 10%;"></td> <td style="width: 10%;"></td> <td style="width: 10%;"></td> <td style="width: 10%;"></td> </tr> <tr> <td></td> <td></td> <td colspan="8" style="text-align: center;"> <table border="1" style="width: 100%; border-collapse: collapse; text-align: center;"> <tr> <td style="width: 10%;"></td> <td style="width: 10%;"></td> <td style="width: 10%;"></td> <td style="width: 10%;"></td> <td style="width: 10%;"></td> <td style="width: 10%;"></td> <td style="width: 10%;"></td> <td style="width: 10%;"></td> <td style="width: 10%;"></td> <td style="width: 10%;"></td> </tr> <tr> <td></td> <td></td> <td colspan="8" style="text-align: center;"> <table border="1" style="width: 100%; border-collapse: collapse; text-align: center;"> <tr> <td style="width: 10%;"></td> <td style="width: 10%;"></td> <td style="width: 10%;"></td> <td style="width: 10%;"></td> <td style="width: 10%;"></td> <td style="width: 10%;"></td> <td style="width: 10%;"></td> <td style="width: 10%;"></td> <td style="width: 10%;"></td> <td style="width: 10%;"></td> </tr> <tr> <td></td> <td></td> <td colspan="8" style="text-align: center;"> <table border="1" style="width: 100%; border-collapse: collapse; text-align: center;"> <tr> <td style="width: 10%;"></td> <td style="width: 10%;"></td> <td style="width: 10%;"></td> <td style="width: 10%;"></td> <td style="width: 10%;"></td> <td style="width: 10%;"></td> <td style="width: 10%;"></td> <td style="width: 10%;"></td> <td style="width: 10%;"></td> <td style="width: 10%;"></td> </tr> <tr> <td></td> <td></td> <td colspan="8" style="text-align: center;"> <table border="1" style="width: 100%; border-collapse: collapse; text-align: center;"> <tr> <td style="width: 10%;"></td> <td style="width: 10%;"></td> <td style="width: 10%;"></td> <td style="width: 10%;"></td> <td style="width: 10%;"></td> <td style="width: 10%;"></td> <td style="width: 10%;"></td> <td style="width: 10%;"></td> <td style="width: 10%;"></td> <td style="width: 10%;"></td> </tr> <tr> <td></td> <td></td> <td colspan="8" style="text-align: center;"> <table border="1" style="width: 100%; border-collapse:
collapse; text-align: center;"> <tr> <td style="width: 10%;"></td> <td style="width: 10%;"></td> <td style="width: 10%;"></td> <td style="width: 10%;"></td> <td style="width: 10%;"></td> <td style="width: 10%;"></td> <td style="width: 10%;"></td> <td style="width: 10%;"></td> <td style="width: 10%;"></td> <td style="width: 10%;"></td> </tr> <tr> <td></td> <td></td> <td colspan="8" style="text-align: center;"> <table border="1" style="width: 100%; border-collapse: collapse; text-align: center;"> <tr> <td style="width: 10%;"></td> <td style="width: 10%;"></td> <td style="width: 10%;"></td> <td style="width: 10%;"></td> <td style="width: 10%;"></td> <td style="width: 10%;"></td> <td style="width: 10%;"></td> <td style="width: 10%;"></td> <td style="width: 10%;"></td> <td style="width: 10%;"></td> </tr> <tr> <td></td> <td></td> <td colspan="8" style="text-align: center;"> <table border="1" style="width: 100%; border-collapse: collapse; text-align: center;"> <tr> <td style="width: 10%;"></td> <td style="width: 10%;"></td> <td style="width: 10%;"></td> <td style="width: 10%;"></td> <td style="width: 10%;"></td> <td style="width: 10%;"></td> <td style="width: 10%;"></td> <td style="width: 10%;"></td> <td style="width: 10%;"></td> <td style="width: 10%;"></td> </tr> <tr> <td></td> <td></td> <td colspan="8" style="text-align: center;"> <table border="1" style="width: 100%; border-collapse: collapse; text-align: center;"> <tr> <td style="width: 10%;"></td> <td style="width: 10%;"></td> <td style="width: 10%;"></td> <td style="width: 10%;"></td> <td style="width: 10%;"></td> <td style="width: 10%;"></td> <td style="width: 10%;"></td> <td style="width: 10%;"></td> <td style="width: 10%;"></td> <td style="width: 10%;"></td> </tr> <tr> <td></td> <td></td> <td colspan="8" style="text-align: center;"> <table border="1" style="width: 100%; border-collapse: collapse; text-align: center;"> <tr> <td style="width: 10%;"></td> <td style="width: 10%;"></td> <td style="width: 10%;"></td> <td style="width: 10%;"></td> <td style="width: 10%;"></td> <td style="width: 10%;"></td> <td style="width: 10%;"></td> <td style="width: 10%;"></td> <td style="width: 10%;"></td> <td style="width: 10%;"></td> </tr> <tr> <td></td> <td></td> <td colspan="8" style="text-align: center;"> <table border="1" style="width: 100%; border-collapse: collapse; text-align: center;"> <tr> <td style="width: 10%;"></td> <td style="width: 10%;"></td> <td style="width: 10%;"></td> <td style="width: 10%;"></td> <td style="width: 10%;"></td> <td style="width: 10%;"></td> <td style="width: 10%;"></td> <td style="width: 10%;"></td> <td style="width: 10%;"></td> <td style="width: 10%;"></td> </tr> <tr> <td></td> <td></td> <td colspan="8" style="text-align: center;"> <table border="1" style="width: 100%; border-collapse: collapse; text-align: center;"> <tr> <td style="width: 10%;"></td> <td style="width: 10%;"></td> <td style="width: 10%;"></td> <td style="width: 10%;"></td> <td style="width: 10%;"></td> <td style="width: 10%;"></td> <td style="width: 10%;"></td> <td style="width: 10%;"></td> <td style="width: 10%;"></td> <td style="width: 10%;"></td> </tr> <tr> <td></td> <td></td> <td colspan="8" style="text-align: center;"> <table border="1" style="width: 100%; border-collapse: collapse; text-align: center;"> <tr> <td style="width: 10%;"></td> <td style="width: 10%;"></td> <td style="width: 10%;"></td> <td style="width: 10%;"></td> <td style="width: 10%;"></td> <td style="width: 10%;"></td> <td style="width: 10%;"></td> <td style="width: 10%;"></td> <td style="width: 10%;"></td> <td style="width: 10%;"></td> </tr> <tr> <td></td> <td></td> <td colspan="8" style="text-align: center;"> <table border="1" style="width: 100%; border-collapse: collapse; text-align: center;"> <tr> <td style="width: 10%;"></td> <td style="width: 10%;"></td> <td style="width: 10%;"></td> <td style="width: 10%;"></td> <td style="width: 10%;"></td> <td style="width: 10%;"></td> <td style="width: 10%;"></td> <td style="width: 10%;"></td> <td style="width: 10%;"></td> <td style="width: 10%;"></td> </tr> <tr> <td></td> <td></td> <td colspan="8" style="text-align: center;"> <table border="1" style="width: 100%; border-collapse: collapse; text-align: center;"> <tr> <td style="width: 10%;"></td> <td style="width: 10%;"></td> <td style="width: 10%;"></td> <td style="width: 10%;"></td> <td style="width: 10%;"></td> <td style="width: 10%;"></td> <td style="width: 10%;"></td> <td style="width: 10%;"></td> <td style="width: 10%;"></td> <td style="width: 10%;"></td> </tr> <tr> <td></td> <td></td> <td colspan="8" style="text-align: center;"> <table border="1" style="width: 100%; border-collapse: collapse; text-align: center;"> <tr> <td style="width: 10%;"></td> <td style="width: 10%;"></td> <td style="width: 10%;"></td> <td style="width: 10%;"></td> <td style="width: 10%;"></td> <td style="width: 10%;"></td> <td style="width: 10%;"></td> <td style="width: 10%;"></td> <td style="width: 10%;"></td> <td style="width: 10%;"></td> </tr> <tr> <td></td> <td></td> <td colspan="8" style="text-align: center;"> <table border="1" style="width: 100%; border-collapse: collapse; text-align: center;"> <tr> <td style="width: 10%;"></td> <td style="width: 10%;"></td> <td style="width: 10%;"></td> <td style="width: 10%;"></td> <td style="width: 10%;"></td> <td style="width: 10%;"></td> <td style="width: 10%;"></td> <td style="width: 10%;"></td> <td style="width: 10%;"></td> <td style="width: 10%;"></td> </tr> <tr> <td></td> <td></td> <td colspan="8" style="text-align: center;"> <table border="1" style="width: 100%; border-collapse: collapse; text-align: center;"> <tr> <td style="width: 10%;"></td> <td style="width: 10%;"></td> <td style="width: 10%;"></td> <td style="width: 10%;"></td> <td style="width: 10%;"></td> <td style="width: 10%;"></td> <td style="width: 10%;"></td> <td style="width: 10%;"></td> <td style="width: 10%;"></td> <td style="width: 10%;"></td> </tr> <tr> <td></td> <td></td> <td colspan="8" style="text-align: center;"> <table border="1" style="width: 100%; border-collapse: collapse; text-align: center;"> <tr> <td style="width: 10%;"></td> <td style="width: 10%;"></td> <td style="width: 10%;"></td> <td style="width: 10%;"></td> <td style="width: 10%;"></td> <td style="width: 10%;"></td> <td style="width: 10%;"></td> <td style="width: 10%;"></td> <td style="width: 10%;"></td> <td style="width: 10%;"></td> </tr> <tr> <td></td> <td></td> <td colspan="8" style="text-align: center;"> <table border="1" style="width: 100%; border-collapse: collapse; text-align: center;"> <tr> <td style="width: 10%;"></td> <td style="width: 10%;"></td> <td style="width: 10%;"></td> <td style="width: 10%;"></td> <td style="width: 10%;"></td> <td style="width: 10%;"></td> <td style="width: 10%;"></td> <td style="width: 10%;"></td> <td style="width: 10%;"></td> <td style="width: 10%;"></td> </tr> <tr> <td></td> <td></td> <td colspan="8" style="text-align: center;"> <table border="1" style="width: 100%; border-collapse: collapse; text-align: center;"> <tr> <td style="width: 10%;"></td> <td style="width: 10%;"></td> <td style="width: 10%;"></td> <td style="width: 10%;"></td> <td style="width: 10%;"></td> <td style="width: 10%;"></td> <td style="width: 10%;"></td> <td style="width: 10%;"></td> <td style="width: 10%;"></td> <td style="width: 10%;"></td> </tr> <tr> <td></td> <td></td> <td colspan="8" style="text-align: center;"> <table border="1" style="width: 100%; border-collapse: collapse; text-align: center;"> <tr> <td style="width: 10%;"></td> <td style="width: 10%;"></td> <td style="width: 10%;"></td> <td style="width: 10%;"></td> <td style="width: 10%;"></td> <td style="width: 10%;"></td> <td style="width: 10%;"></td> <td style="width: 10%;"></td> <td style="width: 10%;"></td> <td style="width: 10%;"></td> </tr> <tr> <td></td> <td></td> <td colspan="8" style="text-align: center;"> <table border="1" style="width: 100%; border-collapse: collapse; text-align: center;"> <tr> <td style="width: 10%;"></td> <td style="width: 10%;"></td> <td style="width: 10%;"></td> <td style="width: 10%;"></td> <td style="width: 10%;"></td> <td style="width: 10%;"></td> <td style="width: 10%;"></td> <td style="width: 10%;"></td> <td style="width: 10%;"></td> <td style="width: 10%;"></td> </tr> <tr> <td></td> <td></td> <td colspan="8" style="text-align: center;"> <table border="1" style="width: 100%; border-collapse: collapse; text-align: center;"> <tr> <td style="width: 10%;"></td> <td style="width: 10%;"></td> <td style="width: 10%;"></td> <td style="width: 10%;"></td> <td style="width: 10%;"></td> <td style="width: 10%;"></td> <td style="width: 10%;"></td> <td style="width: 10%;"></td> <td style="width: 10%;"></td> <td style="width: 10%;"></td> </tr> <tr> <td></td> <td></td> <td colspan="8" style="text-align: center;"> <table border="1" style="width: 100%; border-collapse: collapse; text-align: center;"> <tr> <td style="width: 10%;"></td> <td style="width: 10%;"></td> <td style="width: 10%;"></td> <td style="width: 10%;"></td> <td style="width: 10%;"></td> <td style="width: 10%;"></td> <td style="width: 10%;"></td> <td style="width: 10%;"></td> <td style="width: 10%;"></td> <td style="width: 10%;"></td> </tr> <tr> <td></td> <td></td> <td colspan="8" style="text-align: center;"> <table border="1" style="width: 100%; border-collapse: collapse; text-align: center;"> <tr> <td style="width: 10%;"></td> <td style="width: 10%;"></td> <td style="width: 10%;"></td> <td style="width: 10%;"></td> <td style="width: 10%;"></td> <td style="width: 10%;"></td> <td style="width: 10%;"></td> <td style="width: 10%;"></td> <td style="width: 10%;"></td> <td style="width: 10%;"></td> </tr> <tr> <td></td> <td></td> <td colspan="8" style="text-align: center;"> <table border="1" style="width: 100%; border-collapse: collapse; text-align: center;"> <tr>
</tr></table></td></tr></table></td></tr></table></td></tr></table></td></tr></table></td></tr></table></td></tr></table></td></tr></table></td></tr></table></td></tr></table></td></tr></table></td></tr></table></td></tr></table></td></tr></table></td></tr></table></td></tr></table></td></tr></table></td></tr></table></td></tr></table></td></tr></table></td></tr></table></td></tr></table></td></tr></table></td></tr></table></td></tr></table></td></tr></table></td></tr></table></td></tr></table></td></tr></table></td></tr></table></td></tr></table></td></tr></table></td></tr></table></td></tr></table></td></tr></table></td></tr></table></td></tr></table> | | | | | | | | | | | | | | | | | | | | <table border="1" style="width: 100%; border-collapse: collapse; text-align: center;"> <tr> <td style="width: 10%;"></td> <td style="width: 10%;"></td> <td style="width: 10%;"></td> <td style="width: 10%;"></td> <td style="width: 10%;"></td> <td style="width: 10%;"></td> <td style="width: 10%;"></td> <td style="width: 10%;"></td> <td style="width: 10%;"></td> <td style="width: 10%;"></td> </tr> <tr> <td></td> <td></td> <td colspan="8" style="text-align: center;"> <table border="1" style="width: 100%; border-collapse: collapse; text-align: center;"> <tr> <td style="width: 10%;"></td> <td style="width: 10%;"></td> <td style="width: 10%;"></td> <td style="width: 10%;"></td> <td style="width: 10%;"></td> <td style="width: 10%;"></td> <td style="width: 10%;"></td> <td style="width: 10%;"></td> <td style="width: 10%;"></td> <td style="width: 10%;"></td> </tr> <tr> <td></td> <td></td> <td colspan="8" style="text-align: center;"> <table border="1" style="width: 100%; border-collapse: collapse; text-align: center;"> <tr> <td style="width: 10%;"></td> <td style="width: 10%;"></td> <td style="width: 10%;"></td> <td style="width: 10%;"></td> <td style="width: 10%;"></td> <td style="width: 10%;"></td> <td style="width: 10%;"></td> <td style="width: 10%;"></td> <td style="width: 10%;"></td> <td style="width: 10%;"></td> </tr> <tr> <td></td> <td></td> <td colspan="8" style="text-align: center;"> <table border="1" style="width: 100%; border-collapse: collapse; text-align: center;"> <tr> <td style="width: 10%;"></td> <td style="width: 10%;"></td> <td style="width: 10%;"></td> <td style="width: 10%;"></td> <td style="width: 10%;"></td> <td style="width: 10%;"></td> <td style="width: 10%;"></td> <td style="width: 10%;"></td> <td style="width: 10%;"></td> <td style="width: 10%;"></td> </tr> <tr> <td></td> <td></td> <td colspan="8" style="text-align: center;"> <table border="1" style="width: 100%; border-collapse: collapse; text-align: center;"> <tr> <td style="width: 10%;"></td> <td style="width: 10%;"></td> <td style="width: 10%;"></td> <td style="width: 10%;"></td> <td style="width: 10%;"></td> <td style="width: 10%;"></td> <td style="width: 10%;"></td> <td style="width: 10%;"></td> <td style="width: 10%;"></td> <td style="width: 10%;"></td> </tr> <tr> <td></td> <td></td> <td colspan="8" style="text-align: center;"> <table border="1" style="width: 100%; border-collapse: collapse; text-align: center;"> <tr> <td style="width: 10%;"></td> <td style="width: 10%;"></td> <td style="width: 10%;"></td> <td style="width: 10%;"></td> <td style="width: 10%;"></td> <td style="width: 10%;"></td> <td style="width: 10%;"></td> <td style="width: 10%;"></td> <td style="width: 10%;"></td> <td style="width: 10%;"></td> </tr> <tr> <td></td> <td></td> <td colspan="8" style="text-align: center;"> <table border="1" style="width: 100%; border-collapse: collapse; text-align: center;"> <tr> <td style="width: 10%;"></td> <td style="width: 10%;"></td> <td style="width: 10%;"></td> <td style="width: 10%;"></td> <td style="width: 10%;"></td> <td style="width: 10%;"></td> <td style="width: 10%;"></td> <td style="width: 10%;"></td> <td style="width: 10%;"></td> <td style="width: 10%;"></td> </tr> <tr> <td></td> <td></td> <td colspan="8" style="text-align: center;"> <table border="1" style="width: 100%; border-collapse: collapse; text-align: center;"> <tr> <td style="width: 10%;"></td> <td style="width: 10%;"></td> <td style="width: 10%;"></td> <td style="width: 10%;"></td> <td style="width: 10%;"></td> <td style="width: 10%;"></td> <td style="width: 10%;"></td> <td style="width: 10%;"></td> <td style="width: 10%;"></td> <td style="width: 10%;"></td> </tr> <tr> <td></td> <td></td> <td colspan="8" style="text-align: center;"> <table border="1" style="width: 100%; border-collapse: collapse; text-align: center;"> <tr> <td style="width: 10%;"></td> <td style="width: 10%;"></td> <td style="width: 10%;"></td> <td style="width: 10%;"></td> <td style="width: 10%;"></td> <td style="width: 10%;"></td> <td style="width: 10%;"></td> <td style="width: 10%;"></td> <td style="width: 10%;"></td> <td style="width: 10%;"></td> </tr> <tr> <td></td> <td></td> <td colspan="8" style="text-align: center;"> <table border="1" style="width: 100%; border-collapse: collapse; text-align: center;"> <tr> <td style="width: 10%;"></td> <td style="width: 10%;"></td> <td style="width: 10%;"></td> <td style="width: 10%;"></td> <td style="width: 10%;"></td> <td style="width: 10%;"></td> <td style="width: 10%;"></td> <td style="width: 10%;"></td> <td style="width: 10%;"></td> <td style="width: 10%;"></td> </tr> <tr> <td></td> <td></td> <td colspan="8" style="text-align: center;"> <table border="1" style="width: 100%; border-collapse: collapse; text-align: center;"> <tr> <td style="width: 10%;"></td> <td style="width: 10%;"></td> <td style="width: 10%;"></td> <td style="width: 10%;"></td> <td style="width: 10%;"></td> <td style="width: 10%;"></td> <td style="width: 10%;"></td> <td style="width: 10%;"></td> <td style="width: 10%;"></td> <td style="width: 10%;"></td> </tr> <tr> <td></td> <td></td> <td colspan="8" style="text-align: center;"> <table border="1" style="width: 100%; border-collapse: collapse; text-align: center;"> <tr> <td style="width: 10%;"></td> <td style="width: 10%;"></td> <td style="width: 10%;"></td> <td style="width: 10%;"></td> <td style="width: 10%;"></td> <td style="width: 10%;"></td> <td style="width: 10%;"></td> <td style="width: 10%;"></td> <td style="width: 10%;"></td> <td style="width: 10%;"></td> </tr> <tr> <td></td> <td></td> <td colspan="8" style="text-align: center;"> <table border="1" style="width: 100%; border-collapse: collapse; text-align: center;"> <tr> <td style="width: 10%;"></td> <td style="width: 10%;"></td> <td style="width: 10%;"></td> <td style="width: 10%;"></td> <td style="width: 10%;"></td> <td style="width: 10%;"></td> <td style="width: 10%;"></td> <td style="width: 10%;"></td> <td style="width: 10%;"></td> <td style="width: 10%;"></td> </tr> <tr> <td></td> <td></td> <td colspan="8" style="text-align: center;"> <table border="1" style="width: 100%; border-collapse: collapse; text-align: center;"> <tr> <td style="width: 10%;"></td> <td style="width: 10%;"></td> <td style="width: 10%;"></td> <td style="width: 10%;"></td> <td style="width: 10%;"></td> <td style="width: 10%;"></td> <td style="width: 10%;"></td> <td style="width: 10%;"></td> <td style="width: 10%;"></td> <td style="width: 10%;"></td> </tr> <tr> <td></td> <td></td> <td colspan="8" style="text-align: center;"> <table border="1" style="width: 100%; border-collapse: collapse; text-align: center;"> <tr> <td style="width: 10%;"></td> <td style="width: 10%;"></td> <td style="width: 10%;"></td> <td style="width: 10%;"></td> <td style="width: 10%;"></td> <td style="width: 10%;"></td> <td style="width: 10%;"></td> <td style="width: 10%;"></td> <td style="width: 10%;"></td> <td style="width: 10%;"></td> </tr> <tr> <td></td> <td></td> <td colspan="8" style="text-align: center;"> <table border="1" style="width: 100%; border-collapse: collapse; text-align: center;"> <tr> <td style="width: 10%;"></td> <td style="width: 10%;"></td> <td style="width: 10%;"></td> <td style="width: 10%;"></td> <td style="width: 10%;"></td> <td style="width: 10%;"></td> <td style="width: 10%;"></td> <td style="width: 10%;"></td> <td style="width: 10%;"></td> <td style="width: 10%;"></td> </tr> <tr> <td></td> <td></td> <td colspan="8" style="text-align: center;"> <table border="1" style="width: 100%; border-collapse: collapse; text-align: center;"> <tr> <td style="width: 10%;"></td> <td style="width: 10%;"></td> <td style="width: 10%;"></td> <td style="width: 10%;"></td> <td style="width: 10%;"></td> <td style="width: 10%;"></td> <td style="width: 10%;"></td> <td style="width: 10%;"></td> <td style="width: 10%;"></td> <td style="width: 10%;"></td> </tr> <tr> <td></td> <td></td> <td colspan="8" style="text-align: center;"> <table border="1" style="width: 100%; border-collapse: collapse; text-align: center;"> <tr> <td style="width: 10%;"></td> <td style="width: 10%;"></td> <td style="width: 10%;"></td> <td style="width: 10%;"></td> <td style="width: 10%;"></td> <td style="width: 10%;"></td> <td style="width: 10%;"></td> <td style="width: 10%;"></td> <td style="width: 10%;"></td> <td style="width: 10%;"></td> </tr> <tr> <td></td> <td></td> <td colspan="8" style="text-align: center;"> <table border="1" style="width: 100%; border-collapse: collapse; text-align: center;"> <tr> <td style="width: 10%;"></td> <td style="width: 10%;"></td> <td style="width: 10%;"></td> <td style="width: 10%;"></td> <td style="width: 10%;"></td> <td style="width: 10%;"></td> <td style="width: 10%;"></td> <td style="width: 10%;"></td> <td style="width: 10%;"></td> <td style="width: 10%;"></td> </tr> <tr> <td></td> <td></td> <td colspan="8" style="text-align: center;"> <table border="1" style="width: 100%; border-collapse: collapse; text-align: center;"> <tr> <td style="width: 10%;"></td> <td style="width: 10%;"></td> <td style="width: 10%;"></td> <td style="width: 10%;"></td> <td style="width: 10%;"></td> <td style="width: 10%;"></td> <td style="width: 10%;"></td> <td style="width: 10%;"></td> <td style="width: 10%;"></td> <td style="width:
10%;"></td> </tr> <tr> <td></td> <td></td> <td colspan="8" style="text-align: center;"> <table border="1" style="width: 100%; border-collapse: collapse; text-align: center;"> <tr> <td style="width: 10%;"></td> <td style="width: 10%;"></td> <td style="width: 10%;"></td> <td style="width: 10%;"></td> <td style="width: 10%;"></td> <td style="width: 10%;"></td> <td style="width: 10%;"></td> <td style="width: 10%;"></td> <td style="width: 10%;"></td> <td style="width: 10%;"></td> </tr> <tr> <td></td> <td></td> <td colspan="8" style="text-align: center;"> <table border="1" style="width: 100%; border-collapse: collapse; text-align: center;"> <tr> <td style="width: 10%;"></td> <td style="width: 10%;"></td> <td style="width: 10%;"></td> <td style="width: 10%;"></td> <td style="width: 10%;"></td> <td style="width: 10%;"></td> <td style="width: 10%;"></td> <td style="width: 10%;"></td> <td style="width: 10%;"></td> <td style="width: 10%;"></td> </tr> <tr> <td></td> <td></td> <td colspan="8" style="text-align: center;"> <table border="1" style="width: 100%; border-collapse: collapse; text-align: center;"> <tr> <td style="width: 10%;"></td> <td style="width: 10%;"></td> <td style="width: 10%;"></td> <td style="width: 10%;"></td> <td style="width: 10%;"></td> <td style="width: 10%;"></td> <td style="width: 10%;"></td> <td style="width: 10%;"></td> <td style="width: 10%;"></td> <td style="width: 10%;"></td> </tr> <tr> <td></td> <td></td> <td colspan="8" style="text-align: center;"> <table border="1" style="width: 100%; border-collapse: collapse; text-align: center;"> <tr> <td style="width: 10%;"></td> <td style="width: 10%;"></td> <td style="width: 10%;"></td> <td style="width: 10%;"></td> <td style="width: 10%;"></td> <td style="width: 10%;"></td> <td style="width: 10%;"></td> <td style="width: 10%;"></td> <td style="width: 10%;"></td> <td style="width: 10%;"></td> </tr> <tr> <td></td> <td></td> <td colspan="8" style="text-align: center;"> <table border="1" style="width: 100%; border-collapse: collapse; text-align: center;"> <tr> <td style="width: 10%;"></td> <td style="width: 10%;"></td> <td style="width: 10%;"></td> <td style="width: 10%;"></td> <td style="width: 10%;"></td> <td style="width: 10%;"></td> <td style="width: 10%;"></td> <td style="width: 10%;"></td> <td style="width: 10%;"></td> <td style="width: 10%;"></td> </tr> <tr> <td></td> <td></td> <td colspan="8" style="text-align: center;"> <table border="1" style="width: 100%; border-collapse: collapse; text-align: center;"> <tr> <td style="width: 10%;"></td> <td style="width: 10%;"></td> <td style="width: 10%;"></td> <td style="width: 10%;"></td> <td style="width: 10%;"></td> <td style="width: 10%;"></td> <td style="width: 10%;"></td> <td style="width: 10%;"></td> <td style="width: 10%;"></td> <td style="width: 10%;"></td> </tr> <tr> <td></td> <td></td> <td colspan="8" style="text-align: center;"> <table border="1" style="width: 100%; border-collapse: collapse; text-align: center;"> <tr> <td style="width: 10%;"></td> <td style="width: 10%;"></td> <td style="width: 10%;"></td> <td style="width: 10%;"></td> <td style="width: 10%;"></td> <td style="width: 10%;"></td> <td style="width: 10%;"></td> <td style="width: 10%;"></td> <td style="width: 10%;"></td> <td style="width: 10%;"></td> </tr> <tr> <td></td> <td></td> <td colspan="8" style="text-align: center;"> <table border="1" style="width: 100%; border-collapse: collapse; text-align: center;"> <tr> <td style="width: 10%;"></td> <td style="width: 10%;"></td> <td style="width: 10%;"></td> <td style="width: 10%;"></td> <td style="width: 10%;"></td> <td style="width: 10%;"></td> <td style="width: 10%;"></td> <td style="width: 10%;"></td> <td style="width: 10%;"></td> <td style="width: 10%;"></td> </tr> <tr> <td></td> <td></td> <td colspan="8" style="text-align: center;"> <table border="1" style="width: 100%; border-collapse: collapse; text-align: center;"> <tr> <td style="width: 10%;"></td> <td style="width: 10%;"></td> <td style="width: 10%;"></td> <td style="width: 10%;"></td> <td style="width: 10%;"></td> <td style="width: 10%;"></td> <td style="width: 10%;"></td> <td style="width: 10%;"></td> <td style="width: 10%;"></td> <td style="width: 10%;"></td> </tr> <tr> <td></td> <td></td> <td colspan="8" style="text-align: center;"> <table border="1" style="width: 100%; border-collapse: collapse; text-align: center;"> <tr> <td style="width: 10%;"></td> <td style="width: 10%;"></td> <td style="width: 10%;"></td> <td style="width: 10%;"></td> <td style="width: 10%;"></td> <td style="width: 10%;"></td> <td style="width: 10%;"></td> <td style="width: 10%;"></td> <td style="width: 10%;"></td> <td style="width: 10%;"></td> </tr> <tr> <td></td> <td></td> <td colspan="8" style="text-align: center;"> <table border="1" style="width: 100%; border-collapse: collapse; text-align: center;"> <tr> <td style="width: 10%;"></td> <td style="width: 10%;"></td> <td style="width: 10%;"></td> <td style="width: 10%;"></td> <td style="width: 10%;"></td> <td style="width: 10%;"></td> <td style="width: 10%;"></td> <td style="width: 10%;"></td> <td style="width: 10%;"></td> <td style="width: 10%;"></td> </tr> <tr> <td></td> <td></td> <td colspan="8" style="text-align: center;"> <table border="1" style="width: 100%; border-collapse: collapse; text-align: center;"> <tr> <td style="width: 10%;"></td> <td style="width: 10%;"></td> <td style="width: 10%;"></td> <td style="width: 10%;"></td> <td style="width: 10%;"></td> <td style="width: 10%;"></td> <td style="width: 10%;"></td> <td style="width: 10%;"></td> <td style="width: 10%;"></td> <td style="width: 10%;"></td> </tr> <tr> <td></td> <td></td> <td colspan="8" style="text-align: center;"> <table border="1" style="width: 100%; border-collapse: collapse; text-align: center;"> <tr> <td style="width: 10%;"></td> <td style="width: 10%;"></td> <td style="width: 10%;"></td> <td style="width: 10%;"></td> <td style="width: 10%;"></td> <td style="width: 10%;"></td> <td style="width: 10%;"></td> <td style="width: 10%;"></td> <td style="width: 10%;"></td> <td style="width: 10%;"></td> </tr> <tr> <td></td> <td></td> <td colspan="8" style="text-align: center;"> <table border="1" style="width: 100%; border-collapse: collapse; text-align: center;"> <tr> <td style="width: 10%;"></td> <td style="width: 10%;"></td> <td style="width: 10%;"></td> <td style="width: 10%;"></td> <td style="width: 10%;"></td> <td style="width: 10%;"></td> <td style="width: 10%;"></td> <td style="width: 10%;"></td> <td style="width: 10%;"></td> <td style="width: 10%;"></td> </tr> <tr> <td></td> <td></td> <td colspan="8" style="text-align: center;"> <table border="1" style="width: 100%; border-collapse: collapse; text-align: center;"> <tr> <td style="width: 10%;"></td> <td style="width: 10%;"></td> <td style="width: 10%;"></td> <td style="width: 10%;"></td> <td style="width: 10%;"></td> <td style="width: 10%;"></td> <td style="width: 10%;"></td> <td style="width: 10%;"></td> <td style="width: 10%;"></td> <td style="width: 10%;"></td> </tr> <tr> <td></td> <td></td> <td colspan="8" style="text-align: center;"> <table border="1" style="width: 100%; border-collapse: collapse; text-align: center;"> <tr> </tr></table></td></tr></table></td></tr></table></td></tr></table></td></tr></table></td></tr></table></td></tr></table></td></tr></table></td></tr></table></td></tr></table></td></tr></table></td></tr></table></td></tr></table></td></tr></table></td></tr></table></td></tr></table></td></tr></table></td></tr></table></td></tr></table></td></tr></table></td></tr></table></td></tr></table></td></tr></table></td></tr></table></td></tr></table></td></tr></table></td></tr></table></td></tr></table></td></tr></table></td></tr></table></td></tr></table></td></tr></table></td></tr></table></td></tr></table></td></tr></table></td></tr></table> | | | | | | | | | | | | | | | | | | | | <table border="1" style="width: 100%; border-collapse: collapse; text-align: center;"> <tr> <td style="width: 10%;"></td> <td style="width: 10%;"></td> <td style="width: 10%;"></td> <td style="width: 10%;"></td> <td style="width: 10%;"></td> <td style="width: 10%;"></td> <td style="width: 10%;"></td> <td style="width: 10%;"></td> <td style="width: 10%;"></td> <td style="width: 10%;"></td> </tr> <tr> <td></td> <td></td> <td colspan="8" style="text-align: center;"> <table border="1" style="width: 100%; border-collapse: collapse; text-align: center;"> <tr> <td style="width: 10%;"></td> <td style="width: 10%;"></td> <td style="width: 10%;"></td> <td style="width: 10%;"></td> <td style="width: 10%;"></td> <td style="width: 10%;"></td> <td style="width: 10%;"></td> <td style="width: 10%;"></td> <td style="width: 10%;"></td> <td style="width: 10%;"></td> </tr> <tr> <td></td> <td></td> <td colspan="8" style="text-align: center;"> <table border="1" style="width: 100%; border-collapse: collapse; text-align: center;"> <tr> <td style="width: 10%;"></td> <td style="width: 10%;"></td> <td style="width: 10%;"></td> <td style="width: 10%;"></td> <td style="width: 10%;"></td> <td style="width: 10%;"></td> <td style="width: 10%;"></td> <td style="width: 10%;"></td> <td style="width: 10%;"></td> <td style="width: 10%;"></td> </tr> <tr> <td></td> <td></td> <td colspan="8" style="text-align: center;"> <table border="1" style="width: 100%; border-collapse: collapse; text-align: center;"> <tr> <td style="width: 10%;"></td> <td style="width: 10%;"></td> <td style="width: 10%;"></td> <td style="width: 10%;"></td> <td style="width: 10%;"></td> <td style="width: 10%;"></td> <td style="width: 10%;"></td> <td style="width: 10%;"></td> <td style="width: 10%;"></td> <td style="width: 10%;"></td> </tr> <tr> <td></td> <td></td> <td colspan="8" style="text-align: center;"> <table border="1" style="width: 100%; border-collapse: collapse; text-align: center;"> <tr> <td style="width: 10%;"></td> <td style="width: 10%;"></td> <td style="width: 10%;"></td> <td style="width: 10%;"></td> <td
style="width: 10%;"></td> <td style="width: 10%;"></td> <td style="width: 10%;"></td> <td style="width: 10%;"></td> <td style="width: 10%;"></td> <td style="width: 10%;"></td> </tr> <tr> <td></td> <td></td> <td colspan="8" style="text-align: center;"> <table border="1" style="width: 100%; border-collapse: collapse; text-align: center;"> <tr> <td style="width: 10%;"></td> <td style="width: 10%;"></td> <td style="width: 10%;"></td> <td style="width: 10%;"></td> <td style="width: 10%;"></td> <td style="width: 10%;"></td> <td style="width: 10%;"></td> <td style="width: 10%;"></td> <td style="width: 10%;"></td> <td style="width: 10%;"></td> </tr> <tr> <td></td> <td></td> <td colspan="8" style="text-align: center;"> <table border="1" style="width: 100%; border-collapse: collapse; text-align: center;"> <tr> <td style="width: 10%;"></td> <td style="width: 10%;"></td> <td style="width: 10%;"></td> <td style="width: 10%;"></td> <td style="width: 10%;"></td> <td style="width: 10%;"></td> <td style="width: 10%;"></td> <td style="width: 10%;"></td> <td style="width: 10%;"></td> <td style="width: 10%;"></td> </tr> <tr> <td></td> <td></td> <td colspan="8" style="text-align: center;"> <table border="1" style="width: 100%; border-collapse: collapse; text-align: center;"> <tr> <td style="width: 10%;"></td> <td style="width: 10%;"></td> <td style="width: 10%;"></td> <td style="width: 10%;"></td> <td style="width: 10%;"></td> <td style="width: 10%;"></td> <td style="width: 10%;"></td> <td style="width: 10%;"></td> <td style="width: 10%;"></td> <td style="width: 10%;"></td> </tr> <tr> <td></td> <td></td> <td colspan="8" style="text-align: center;"> <table border="1" style="width: 100%; border-collapse: collapse; text-align: center;"> <tr> <td style="width: 10%;"></td> <td style="width: 10%;"></td> <td style="width: 10%;"></td> <td style="width: 10%;"></td> <td style="width: 10%;"></td> <td style="width: 10%;"></td> <td style="width: 10%;"></td> <td style="width: 10%;"></td> <td style="width: 10%;"></td> <td style="width: 10%;"></td> </tr> <tr> <td></td> <td></td> <td colspan="8" style="text-align: center;"> <table border="1" style="width: 100%; border-collapse: collapse; text-align: center;"> <tr> <td style="width: 10%;"></td> <td style="width: 10%;"></td> <td style="width: 10%;"></td> <td style="width: 10%;"></td> <td style="width: 10%;"></td> <td style="width: 10%;"></td> <td style="width: 10%;"></td> <td style="width: 10%;"></td> <td style="width: 10%;"></td> <td style="width: 10%;"></td> </tr> <tr> <td></td> <td></td> <td colspan="8" style="text-align: center;"> <table border="1" style="width: 100%; border-collapse: collapse; text-align: center;"> <tr> <td style="width: 10%;"></td> <td style="width: 10%;"></td> <td style="width: 10%;"></td> <td style="width: 10%;"></td> <td style="width: 10%;"></td> <td style="width: 10%;"></td> <td style="width: 10%;"></td> <td style="width: 10%;"></td> <td style="width: 10%;"></td> <td style="width: 10%;"></td> </tr> <tr> <td></td> <td></td> <td colspan="8" style="text-align: center;"> <table border="1" style="width: 100%; border-collapse: collapse; text-align: center;"> <tr> <td style="width: 10%;"></td> <td style="width: 10%;"></td> <td style="width: 10%;"></td> <td style="width: 10%;"></td> <td style="width: 10%;"></td> <td style="width: 10%;"></td> <td style="width: 10%;"></td> <td style="width: 10%;"></td> <td style="width: 10%;"></td> <td style="width: 10%;"></td> </tr> <tr> <td></td> <td></td> <td colspan="8" style="text-align: center;"> <table border="1" style="width: 100%; border-collapse: collapse; text-align: center;"> <tr> <td style="width: 10%;"></td> <td style="width: 10%;"></td> <td style="width: 10%;"></td> <td style="width: 10%;"></td> <td style="width: 10%;"></td> <td style="width: 10%;"></td> <td style="width: 10%;"></td> <td style="width: 10%;"></td> <td style="width: 10%;"></td> <td style="width: 10%;"></td> </tr> <tr> <td></td> <td></td> <td colspan="8" style="text-align: center;"> <table border="1" style="width: 100%; border-collapse: collapse; text-align: center;"> <tr> <td style="width: 10%;"></td> <td style="width: 10%;"></td> <td style="width: 10%;"></td> <td style="width: 10%;"></td> <td style="width: 10%;"></td> <td style="width: 10%;"></td> <td style="width: 10%;"></td> <td style="width: 10%;"></td> <td style="width: 10%;"></td> <td style="width: 10%;"></td> </tr> <tr> <td></td> <td></td> <td colspan="8" style="text-align: center;"> <table border="1" style="width: 100%; border-collapse: collapse; text-align: center;"> <tr> <td style="width: 10%;"></td> <td style="width: 10%;"></td> <td style="width: 10%;"></td> <td style="width: 10%;"></td> <td style="width: 10%;"></td> <td style="width: 10%;"></td> <td style="width: 10%;"></td> <td style="width: 10%;"></td> <td style="width: 10%;"></td> <td style="width: 10%;"></td> </tr> <tr> <td></td> <td></td> <td colspan="8" style="text-align: center;"> <table border="1" style="width: 100%; border-collapse: collapse; text-align: center;"> <tr> <td style="width: 10%;"></td> <td style="width: 10%;"></td> <td style="width: 10%;"></td> <td style="width: 10%;"></td> <td style="width: 10%;"></td> <td style="width: 10%;"></td> <td style="width: 10%;"></td> <td style="width: 10%;"></td> <td style="width: 10%;"></td> <td style="width: 10%;"></td> </tr> <tr> <td></td> <td></td> <td colspan="8" style="text-align: center;"> <table border="1" style="width: 100%; border-collapse: collapse; text-align: center;"> <tr> <td style="width: 10%;"></td> <td style="width: 10%;"></td> <td style="width: 10%;"></td> <td style="width: 10%;"></td> <td style="width: 10%;"></td> <td style="width: 10%;"></td> <td style="width: 10%;"></td> <td style="width: 10%;"></td> <td style="width: 10%;"></td> <td style="width: 10%;"></td> </tr> <tr> <td></td> <td></td> <td colspan="8" style="text-align: center;"> <table border="1" style="width: 100%; border-collapse: collapse; text-align: center;"> <tr> <td style="width: 10%;"></td> <td style="width: 10%;"></td> <td style="width: 10%;"></td> <td style="width: 10%;"></td> <td style="width: 10%;"></td> <td style="width: 10%;"></td> <td style="width: 10%;"></td> <td style="width: 10%;"></td> <td style="width: 10%;"></td> <td style="width: 10%;"></td> </tr> <tr> <td></td> <td></td> <td colspan="8" style="text-align: center;"> <table border="1" style="width: 100%; border-collapse: collapse; text-align: center;"> <tr> <td style="width: 10%;"></td> <td style="width: 10%;"></td> <td style="width: 10%;"></td> <td style="width: 10%;"></td> <td style="width: 10%;"></td> <td style="width: 10%;"></td> <td style="width: 10%;"></td> <td style="width: 10%;"></td> <td style="width: 10%;"></td> <td style="width: 10%;"></td> </tr> <tr> <td></td> <td></td> <td colspan="8" style="text-align: center;"> <table border="1" style="width: 100%; border-collapse: collapse; text-align: center;"> <tr> <td style="width: 10%;"></td> <td style="width: 10%;"></td> <td style="width: 10%;"></td> <td style="width: 10%;"></td> <td style="width: 10%;"></td> <td style="width: 10%;"></td> <td style="width: 10%;"></td> <td style="width: 10%;"></td> <td style="width: 10%;"></td> <td style="width: 10%;"></td> </tr> <tr> <td></td> <td></td> <td colspan="8" style="text-align: center;"> <table border="1" style="width: 100%; border-collapse: collapse; text-align: center;"> <tr> <td style="width: 10%;"></td> <td style="width: 10%;"></td> <td style="width: 10%;"></td> <td style="width: 10%;"></td> <td style="width: 10%;"></td> <td style="width: 10%;"></td> <td style="width: 10%;"></td> <td style="width: 10%;"></td> <td style="width: 10%;"></td> <td style="width: 10%;"></td> </tr> <tr> <td></td> <td></td> <td colspan="8" style="text-align: center;"> <table border="1" style="width: 100%; border-collapse: collapse; text-align: center;"> <tr> <td style="width: 10%;"></td> <td style="width: 10%;"></td> <td style="width: 10%;"></td> <td style="width: 10%;"></td> <td style="width: 10%;"></td> <td style="width: 10%;"></td> <td style="width: 10%;"></td> <td style="width: 10%;"></td> <td style="width: 10%;"></td> <td style="width: 10%;"></td> </tr> <tr> <td></td> <td></td> <td colspan="8" style="text-align: center;"> <table border="1" style="width: 100%; border-collapse: collapse; text-align: center;"> <tr> <td style="width: 10%;"></td> <td style="width: 10%;"></td> <td style="width: 10%;"></td> <td style="width: 10%;"></td> <td style="width: 10%;"></td> <td style="width: 10%;"></td> <td style="width: 10%;"></td> <td style="width: 10%;"></td> <td style="width: 10%;"></td> <td style="width: 10%;"></td> </tr> <tr> <td></td> <td></td> <td colspan="8" style="text-align: center;"> <table border="1" style="width: 100%; border-collapse: collapse; text-align: center;"> <tr> <td style="width: 10%;"></td> <td style="width: 10%;"></td> <td style="width: 10%;"></td> <td style="width: 10%;"></td> <td style="width: 10%;"></td> <td style="width: 10%;"></td> <td style="width: 10%;"></td> <td style="width: 10%;"></td> <td style="width: 10%;"></td> <td style="width: 10%;"></td> </tr> <tr> <td></td> <td></td> <td colspan="8" style="text-align: center;"> <table border="1" style="width: 100%; border-collapse: collapse; text-align: center;"> <tr> <td style="width: 10%;"></td> <td style="width: 10%;"></td> <td style="width: 10%;"></td> <td style="width: 10%;"></td> <td style="width: 10%;"></td> <td style="width: 10%;"></td> <td style="width: 10%;"></td> <td style="width: 10%;"></td> <td style="width: 10%;"></td> <td style="width: 10%;"></td> </tr> <tr> <td></td> <td></td> <td colspan="8" style="text-align: center;"> <table border="1" style="width: 100%; border-collapse: collapse; text-align: center;"> <tr> <td style="width: 10%;"></td> <td style="width: 10%;"></td> <td style="width: 10%;"></td> <td style="width: 10%;"></td> <td style="width: 10%;"></td> <td style="width: 10%;"></td> <td style="width: 10%;"></td> <td style="width: 10%;"></td> <td style="width: 10%;"></td> <td style="width:
10%;"></td> </tr> <tr> <td></td> <td></td> <td colspan="8" style="text-align: center;"> <table border="1" style="width: 100%; border-collapse: collapse; text-align: center;"> <tr> <td style="width: 10%;"></td> <td style="width: 10%;"></td> <td style="width: 10%;"></td> <td style="width: 10%;"></td> <td style="width: 10%;"></td> <td style="width: 10%;"></td> <td style="width: 10%;"></td> <td style="width: 10%;"></td> <td style="width: 10%;"></td> <td style="width: 10%;"></td> </tr> <tr> <td></td> <td></td> <td colspan="8" style="text-align: center;"> <table border="1" style="width: 100%; border-collapse: collapse; text-align: center;"> <tr> <td style="width: 10%;"></td> <td style="width: 10%;"></td> <td style="width: 10%;"></td> <td style="width: 10%;"></td> <td style="width: 10%;"></td> <td style="width: 10%;"></td> <td style="width: 10%;"></td> <td style="width: 10%;"></td> <td style="width: 10%;"></td> <td style="width: 10%;"></td> </tr> <tr> <td></td> <td></td> <td colspan="8" style="text-align: center;"> <table border="1" style="width: 100%; border-collapse: collapse; text-align: center;"> <tr> <td style="width: 10%;"></td> <td style="width: 10%;"></td> <td style="width: 10%;"></td> <td style="width: 10%;"></td> <td style="width: 10%;"></td> <td style="width: 10%;"></td> <td style="width: 10%;"></td> <td style="width: 10%;"></td> <td style="width: 10%;"></td> <td style="width: 10%;"></td> </tr> <tr> <td></td> <td></td> <td colspan="8" style="text-align: center;"> <table border="1" style="width: 100%; border-collapse: collapse; text-align: center;"> <tr> <td style="width: 10%;"></td> <td style="width: 10%;"></td> <td style="width: 10%;"></td> <td style="width: 10%;"></td> <td style="width: 10%;"></td> <td style="width: 10%;"></td> <td style="width: 10%;"></td> <td style="width: 10%;"></td> <td style="width: 10%;"></td> <td style="width: 10%;"></td> </tr> <tr> <td></td> <td></td> <td colspan="8" style="text-align: center;"> <table border="1" style="width: 100%; border-collapse: collapse; text-align: center;"> <tr> <td style="width: 10%;"></td> <td style="width: 10%;"></td> <td style="width: 10%;"></td> <td style="width: 10%;"></td> <td style="width: 10%;"></td> <td style="width: 10%;"></td> <td style="width: 10%;"></td> <td style="width: 10%;"></td> <td style="width: 10%;"></td> <td style="width: 10%;"></td> </tr> <tr> <td></td> <td></td> <td colspan="8" style="text-align: center;"> <table border="1" style="width: 100%; border-collapse: collapse; text-align: center;"> <tr> <td style="width: 10%;"></td> <td style="width: 10%;"></td> <td style="width: 10%;"></td> <td style="width: 10%;"></td> <td style="width: 10%;"></td> <td style="width: 10%;"></td> <td style="width: 10%;"></td> <td style="width: 10%;"></td> <td style="width: 10%;"></td> <td style="width: 10%;"></td> </tr> <tr> <td></td> <td></td> <td colspan="8" style="text-align: center;"> <table border="1" style="width: 100%; border-collapse: collapse; text-align: center;"> <tr> <td style="width: 10%;"></td> <td style="width: 10%;"></td> <td style="width: 10%;"></td> <td style="width: 10%;"></td> <td style="width: 10%;"></td> <td style="width: 10%;"></td> <td style="width: 10%;"></td> <td style="width: 10%;"></td> <td style="width: 10%;"></td> <td style="width: 10%;"></td> </tr> <tr> <td></td> <td></td> <td colspan="8" style="text-align: center;"> <table border="1" style="width: 100%; border-collapse: collapse; text-align: center;"> <tr> <td style="width: 10%;"></td> <td style="width: 10%;"></td> <td style="width: 10%;"></td> <td style="width: 10%;"></td> <td style="width: 10%;"></td> <td style="width: 10%;"></td> <td style="width: 10%;"></td> <td style="width: 10%;"></td> <td style="width: 10%;"></td> <td style="width: 10%;"></td> </tr> <tr> <td></td> <td></td> <td colspan="8" style="text-align: center;"> <table border="1" style="width: 100%; border-collapse: collapse; text-align: center;"> <tr> </tr></table></td></tr></table></td></tr></table></td></tr></table></td></tr></table></td></tr></table></td></tr></table></td></tr></table></td></tr></table></td></tr></table></td></tr></table></td></tr></table></td></tr></table></td></tr></table></td></tr></table></td></tr></table></td></tr></table></td></tr></table></td></tr></table></td></tr></table></td></tr></table></td></tr></table></td></tr></table></td></tr></table></td></tr></table></td></tr></table></td></tr></table></td></tr></table></td></tr></table></td></tr></table></td></tr></table></td></tr></table></td></tr></table></td></tr></table></td></tr></table> | | | | | | | | | | | | | | | | | | | | <table border="1" style="width: 100%; border-collapse: collapse; text-align: center;"> <tr> <td style="width: 10%;"></td> <td style="width: 10%;"></td> <td style="width: 10%;"></td> <td style="width: 10%;"></td> <td style="width: 10%;"></td> <td style="width: 10%;"></td> <td style="width: 10%;"></td> <td style="width: 10%;"></td> <td style="width: 10%;"></td> <td style="width: 10%;"></td> </tr> <tr> <td></td> <td></td> <td colspan="8" style="text-align: center;"> <table border="1" style="width: 100%; border-collapse: collapse; text-align: center;"> <tr> <td style="width: 10%;"></td> <td style="width: 10%;"></td> <td style="width: 10%;"></td> <td style="width: 10%;"></td> <td style="width: 10%;"></td> <td style="width: 10%;"></td> <td style="width: 10%;"></td> <td style="width: 10%;"></td> <td style="width: 10%;"></td> <td style="width: 10%;"></td> </tr> <tr> <td></td> <td></td> <td colspan="8" style="text-align: center;"> <table border="1" style="width: 100%; border-collapse: collapse; text-align: center;"> <tr> <td style="width: 10%;"></td> <td style="width: 10%;"></td> <td style="width: 10%;"></td> <td style="width: 10%;"></td> <td style="width: 10%;"></td> <td style="width: 10%;"></td> <td style="width: 10%;"></td> <td style="width: 10%;"></td> <td style="width: 10%;"></td> <td style="width: 10%;"></td> </tr> <tr> <td></td> <td></td> <td colspan="8" style="text-align: center;"> <table border="1" style="width: 100%; border-collapse: collapse; text-align: center;"> <tr> <td style="width: 10%;"></td> <td style="width: 10%;"></td> <td style="width: 10%;"></td> <td style="width: 10%;"></td> <td style="width: 10%;"></td> <td style="width: 10%;"></td> <td style="width: 10%;"></td> <td style="width: 10%;"></td> <td style="width: 10%;"></td> <td style="width: 10%;"></td> </tr> <tr> <td></td> <td></td> <td colspan="8" style="text-align: center;"> <table border="1" style="width: 100%; border-collapse: collapse; text-align: center;"> <tr> <td style="width: 10%;"></td> <td style="width: 10%;"></td> <td style="width: 10%;"></td> <td style="width: 10%;"></td> <td style="width: 10%;"></td> <td style="width: 10%;"></td> <td style="width: 10%;"></td> <td style="width: 10%;"></td> <td style="width: 10%;"></td> <td style="width: 10%;"></td> </tr> <tr> <td></td> <td></td> <td colspan="8" style="text-align: center;"> <table border="1" style="width: 100%; border-collapse: collapse; text-align: center;"> <tr> <td style="width: 10%;"></td> <td style="width: 10%;"></td> <td style="width: 10%;"></td> <td style="width: 10%;"></td> <td style="width: 10%;"></td> <td style="width: 10%;"></td> <td style="width: 10%;"></td> <td style="width: 10%;"></td> <td style="width: 10%;"></td> <td style="width: 10%;"></td> </tr> <tr> <td></td> <td></td> <td colspan="8" style="text-align: center;"> <table border="1" style="width: 100%; border-collapse: collapse; text-align: center;"> <tr> <td style="width: 10%;"></td> <td style="width: 10%;"></td> <td style="width: 10%;"></td> <td style="width: 10%;"></td> <td style="width: 10%;"></td> <td style="width: 10%;"></td> <td style="width: 10%;"></td> <td style="width: 10%;"></td> <td style="width: 10%;"></td> <td style="width: 10%;"></td> </tr> <tr> <td></td> <td></td> <td colspan="8" style="text-align: center;"> <table border="1" style="width: 100%; border-collapse: collapse; text-align: center;"> <tr> <td style="width: 10%;"></td> <td style="width: 10%;"></td> <td style="width: 10%;"></td> <td style="width: 10%;"></td> <td style="width: 10%;"></td> <td style="width: 10%;"></td> <td style="width: 10%;"></td> <td style="width: 10%;"></td> <td style="width: 10%;"></td> <td style="width: 10%;"></td> </tr> <tr> <td></td> <td></td> <td colspan="8" style="text-align: center;"> <table border="1" style="width: 100%; border-collapse: collapse; text-align: center;"> <tr> <td style="width: 10%;"></td> <td style="width: 10%;"></td> <td style="width: 10%;"></td> <td style="width: 10%;"></td> <td style="width: 10%;"></td> <td style="width: 10%;"></td> <td style="width: 10%;"></td> <td style="width: 10%;"></td> <td style="width: 10%;"></td> <td style="width: 10%;"></td> </tr> <tr> <td></td> <td></td> <td colspan="8" style="text-align: center;"> <table border="1" style="width: 100%; border-collapse: collapse; text-align: center;"> <tr> <td style="width: 10%;"></td> <td style="width: 10%;"></td> <td style="width: 10%;"></td> <td style="width: 10%;"></td> <td style="width: 10%;"></td> <td style="width: 10%;"></td> <td style="width: 10%;"></td> <td style="width: 10%;"></td> <td style="width: 10%;"></td> <td style="width: 10%;"></td> </tr> <tr> <td></td> <td></td> <td colspan="8" style="text-align: center;"> <table border="1" style="width: 100%; border-collapse: collapse; text-align: center;"> <tr> <td style="width: 10%;"></td> <td style="width: 10%;"></td> <td style="width: 10%;"></td> <td style="width: 10%;"></td> <td style="width: 10%;"></td> <td style="width: 10%;"></td> <td style="width: 10%;"></td> <td style="width: 10%;"></td> <td style="width: 10%;"></td> <td style="width: 10%;"></td> </tr> <tr> <td></td> <td></td> <td colspan="8" style="text-align: center;"> <table border="1" style="width: 100%; border-collapse: collapse; text-align: center;"> <tr> <td style="width: 10%;"></td> <td style="width: 10%;"></td> <td style="width: 10%;"></td> <td style="width: 10%;"></td> <td style="width: 10%;"></td>
<td style="width: 10%;"></td> <td style="width: 10%;"></td> <td style="width: 10%;"></td> <td style="width: 10%;"></td> <td style="width: 10%;"></td> </tr> <tr> <td></td> <td></td> <td colspan="8" style="text-align: center;"> <table border="1" style="width: 100%; border-collapse: collapse; text-align: center;"> <tr> <td style="width: 10%;"></td> <td style="width: 10%;"></td> <td style="width: 10%;"></td> <td style="width: 10%;"></td> <td style="width: 10%;"></td> <td style="width: 10%;"></td> <td style="width: 10%;"></td> <td style="width: 10%;"></td> <td style="width: 10%;"></td> <td style="width: 10%;"></td> </tr> <tr> <td></td> <td></td> <td colspan="8" style="text-align: center;"> <table border="1" style="width: 100%; border-collapse: collapse; text-align: center;"> <tr> <td style="width: 10%;"></td> <td style="width: 10%;"></td> <td style="width: 10%;"></td> <td style="width: 10%;"></td> <td style="width: 10%;"></td> <td style="width: 10%;"></td> <td style="width: 10%;"></td> <td style="width: 10%;"></td> <td style="width: 10%;"></td> <td style="width: 10%;"></td> </tr> <tr> <td></td> <td></td> <td colspan="8" style="text-align: center;"> <table border="1" style="width: 100%; border-collapse: collapse; text-align: center;"> <tr> <td style="width: 10%;"></td> <td style="width: 10%;"></td> <td style="width: 10%;"></td> <td style="width: 10%;"></td> <td style="width: 10%;"></td> <td style="width: 10%;"></td> <td style="width: 10%;"></td> <td style="width: 10%;"></td> <td style="width: 10%;"></td> <td style="width: 10%;"></td> </tr> <tr> <td></td> <td></td> <td colspan="8" style="text-align: center;"> <table border="1" style="width: 100%; border-collapse: collapse; text-align: center;"> <tr> <td style="width: 10%;"></td> <td style="width: 10%;"></td> <td style="width: 10%;"></td> <td style="width: 10%;"></td> <td style="width: 10%;"></td> <td style="width: 10%;"></td> <td style="width: 10%;"></td> <td style="width: 10%;"></td> <td style="width: 10%;"></td> <td style="width: 10%;"></td> </tr> <tr> <td></td> <td></td> <td colspan="8" style="text-align: center;"> <table border="1" style="width: 100%; border-collapse: collapse; text-align: center;"> <tr> <td style="width: 10%;"></td> <td style="width: 10%;"></td> <td style="width: 10%;"></td> <td style="width: 10%;"></td> <td style="width: 10%;"></td> <td style="width: 10%;"></td> <td style="width: 10%;"></td> <td style="width: 10%;"></td> <td style="width: 10%;"></td> <td style="width: 10%;"></td> </tr> <tr> <td></td> <td></td> <td colspan="8" style="text-align: center;"> <table border="1" style="width: 100%; border-collapse: collapse; text-align: center;"> <tr> <td style="width: 10%;"></td> <td style="width: 10%;"></td> <td style="width: 10%;"></td> <td style="width: 10%;"></td> <td style="width: 10%;"></td> <td style="width: 10%;"></td> <td style="width: 10%;"></td> <td style="width: 10%;"></td> <td style="width: 10%;"></td> <td style="width: 10%;"></td> </tr> <tr> <td></td> <td></td> <td colspan="8" style="text-align: center;"> <table border="1" style="width: 100%; border-collapse: collapse; text-align: center;"> <tr> <td style="width: 10%;"></td> <td style="width: 10%;"></td> <td style="width: 10%;"></td> <td style="width: 10%;"></td> <td style="width: 10%;"></td> <td style="width: 10%;"></td> <td style="width: 10%;"></td> <td style="width: 10%;"></td> <td style="width: 10%;"></td> <td style="width: 10%;"></td> </tr> <tr> <td></td> <td></td> <td colspan="8" style="text-align: center;"> <table border="1" style="width: 100%; border-collapse: collapse; text-align: center;"> <tr> <td style="width: 10%;"></td> <td style="width: 10%;"></td> <td style="width: 10%;"></td> <td style="width: 10%;"></td> <td style="width: 10%;"></td> <td style="width: 10%;"></td> <td style="width: 10%;"></td> <td style="width: 10%;"></td> <td style="width: 10%;"></td> <td style="width: 10%;"></td> </tr> <tr> <td></td> <td></td> <td colspan="8" style="text-align: center;"> <table border="1" style="width: 100%; border-collapse: collapse; text-align: center;"> <tr> <td style="width: 10%;"></td> <td style="width: 10%;"></td> <td style="width: 10%;"></td> <td style="width: 10%;"></td> <td style="width: 10%;"></td> <td style="width: 10%;"></td> <td style="width: 10%;"></td> <td style="width: 10%;"></td> <td style="width: 10%;"></td> <td style="width: 10%;"></td> </tr> <tr> <td></td> <td></td> <td colspan="8" style="text-align: center;"> <table border="1" style="width: 100%; border-collapse: collapse; text-align: center;"> <tr> <td style="width: 10%;"></td> <td style="width: 10%;"></td> <td style="width: 10%;"></td> <td style="width: 10%;"></td> <td style="width: 10%;"></td> <td style="width: 10%;"></td> <td style="width: 10%;"></td> <td style="width: 10%;"></td> <td style="width: 10%;"></td> <td style="width: 10%;"></td> </tr> <tr> <td></td> <td></td> <td colspan="8" style="text-align: center;"> <table border="1" style="width: 100%; border-collapse: collapse; text-align: center;"> <tr> <td style="width: 10%;"></td> <td style="width: 10%;"></td> <td style="width: 10%;"></td> <td style="width: 10%;"></td> <td style="width: 10%;"></td> <td style="width: 10%;"></td> <td style="width: 10%;"></td> <td style="width: 10%;"></td> <td style="width: 10%;"></td> <td style="width: 10%;"></td> </tr> <tr> <td></td> <td></td> <td colspan="8" style="text-align: center;"> <table border="1" style="width: 100%; border-collapse: collapse; text-align: center;"> <tr> <td style="width: 10%;"></td> <td style="width: 10%;"></td> <td style="width: 10%;"></td> <td style="width: 10%;"></td> <td style="width: 10%;"></td> <td style="width: 10%;"></td> <td style="width: 10%;"></td> <td style="width: 10%;"></td> <td style="width: 10%;"></td> <td style="width: 10%;"></td> </tr> <tr> <td></td> <td></td> <td colspan="8" style="text-align: center;"> <table border="1" style="width: 100%; border-collapse: collapse; text-align: center;"> <tr> <td style="width: 10%;"></td> <td style="width: 10%;"></td> <td style="width: 10%;"></td> <td style="width: 10%;"></td> <td style="width: 10%;"></td> <td style="width: 10%;"></td> <td style="width: 10%;"></td> <td style="width: 10%;"></td> <td style="width: 10%;"></td> <td style="width: 10%;"></td> </tr> <tr> <td></td> <td></td> <td colspan="8" style="text-align: center;"> <table border="1" style="width: 100%; border-collapse: collapse; text-align: center;"> <tr> <td style="width: 10%;"></td> <td style="width: 10%;"></td> <td style="width: 10%;"></td> <td style="width: 10%;"></td> <td style="width: 10%;"></td> <td style="width: 10%;"></td> <td style="width: 10%;"></td> <td style="width: 10%;"></td> <td style="width: 10%;"></td> <td style="width: 10%;"></td> </tr> <tr> <td></td> <td></td> <td colspan="8" style="text-align: center;"> <table border="1" style="width: 100%; border-collapse: collapse; text-align: center;"> <tr> <td style="width: 10%;"></td> <td style="width: 10%;"></td> <td style="width: 10%;"></td> <td style="width: 10%;"></td> <td style="width: 10%;"></td> <td style="width: 10%;"></td> <td style="width: 10%;"></td> <td style="width: 10%;"></td> <td style="width: 10%;"></td> <td style="width: 10%;"></td> </tr> <tr> <td></td> <td></td> <td colspan="8" style="text-align: center;"> <table border="1" style="width: 100%; border-collapse: collapse; text-align: center;"> <tr> <td style="width: 10%;"></td> <td style="width: 10%;"></td> <td style="width: 10%;"></td> <td style="width: 10%;"></td> <td style="width: 10%;"></td> <td style="width: 10%;"></td> <td style="width: 10%;"></td> <td style="width: 10%;"></td> <td style="width: 10%;"></td> <td style="width: 10%;"></td> </tr> <tr> <td></td> <td></td> <td colspan="8" style="text-align: center;"> <table border="1" style="width: 100%; border-collapse: collapse; text-align: center;"> <tr> <td style="width: 10%;"></td> <td style="width: 10%;"></td> <td style="width: 10%;"></td> <td style="width: 10%;"></td> <td style="width: 10%;"></td> <td style="width: 10%;"></td> <td style="width: 10%;"></td> <td style="width: 10%;"></td> <td style="width: 10%;"></td> <td style="width: 10%;"></td> </tr> <tr> <td></td> <td></td> <td colspan="8" style="text-align: center;"> <table border="1" style="width: 100%; border-collapse: collapse; text-align: center;"> <tr> <td style="width: 10%;"></td> <td style="width: 10%;"></td> <td style="width: 10%;"></td> <td style="width: 10%;"></td> <td style="width: 10%;"></td> <td style="width: 10%;"></td> <td style="width: 10%;"></td> <td style="width: 10%;"></td> <td style="width: 10%;"></td> <td style="width: 10%;"></td> </tr> <tr> <td></td> <td></td> <td colspan="8" style="text-align: center;"> <table border="1" style="width: 100%; border-collapse: collapse; text-align: center;"> <tr> <td style="width: 10%;"></td> <td style="width: 10%;"></td> <td style="width: 10%;"></td> <td style="width: 10%;"></td> <td style="width: 10%;"></td> <td style="width: 10%;"></td> <td style="width: 10%;"></td> <td style="width: 10%;"></td> <td style="width: 10%;"></td> <td style="width: 10%;"></td> </tr> <tr> <td></td> <td></td> <td colspan="8" style="text-align: center;"> <table border="1" style="width: 100%; border-collapse: collapse; text-align: center;"> <tr> <td style="width: 10%;"></td> <td style="width: 10%;"></td> <td style="width: 10%;"></td> <td style="width: 10%;"></td> <td style="width: 10%;"></td> <td style="width: 10%;"></td> <td style="width: 10%;"></td> <td style="width: 10%;"></td> <td style="width: 10%;"></td> <td style="width: 10%;"></td> </tr> <tr> <td></td> <td></td> <td colspan="8" style="text-align: center;"> <table border="1" style="width: 100%; border-collapse: collapse; text-align: center;"> <tr> <td style="width: 10%;"></td> <td style="width: 10%;"></td> <td style="width: 10%;"></td> <td style="width: 10%;"></td> <td style="width: 10%;"></td> <td style="width: 10%;"></td> <td style="width: 10%;"></td> <td style="width: 10%;"></td> <td style="width: 10%;"></td> <td style="width: 10%;"></td> </tr> <tr> <td></td>
<td></td> <td colspan="8" style="text-align: center;"> <table border="1" style="width: 100%; border-collapse: collapse; text-align: center;"> <tr> </tr></table></td></tr></table></td></tr></table></td></tr></table></td></tr></table></td></tr></table></td></tr></table></td></tr></table></td></tr></table></td></tr></table></td></tr></table></td></tr></table></td></tr></table></td></tr></table></td></tr></table></td></tr></table></td></tr></table></td></tr></table></td></tr></table></td></tr></table></td></tr></table></td></tr></table></td></tr></table></td></tr></table></td></tr></table></td></tr></table></td></tr></table></td></tr></table></td></tr></table></td></tr></table></td></tr></table></td></tr></table></td></tr></table></td></tr></table> | | | | | | | | | | | | | | | | | | | | <table border="1" style="width: 100%; border-collapse: collapse; text-align: center;"> <tr> <td style="width: 10%;"></td> <td style="width: 10%;"></td> <td style="width: 10%;"></td> <td style="width: 10%;"></td> <td style="width: 10%;"></td> <td style="width: 10%;"></td> <td style="width: 10%;"></td> <td style="width: 10%;"></td> <td style="width: 10%;"></td> <td style="width: 10%;"></td> </tr> <tr> <td></td> <td></td> <td colspan="8" style="text-align: center;"> <table border="1" style="width: 100%; border-collapse: collapse; text-align: center;"> <tr> <td style="width: 10%;"></td> <td style="width: 10%;"></td> <td style="width: 10%;"></td> <td style="width: 10%;"></td> <td style="width: 10%;"></td> <td style="width: 10%;"></td> <td style="width: 10%;"></td> <td style="width: 10%;"></td> <td style="width: 10%;"></td> <td style="width: 10%;"></td> </tr> <tr> <td></td> <td></td> <td colspan="8" style="text-align: center;"> <table border="1" style="width: 100%; border-collapse: collapse; text-align: center;"> <tr> <td style="width: 10%;"></td> <td style="width: 10%;"></td> <td style="width: 10%;"></td> <td style="width: 10%;"></td> <td style="width: 10%;"></td> <td style="width: 10%;"></td> <td style="width: 10%;"></td> <td style="width: 10%;"></td> <td style="width: 10%;"></td> <td style="width: 10%;"></td> </tr> <tr> <td></td> <td></td> <td colspan="8" style="text-align: center;"> <table border="1" style="width: 100%; border-collapse: collapse; text-align: center;"> <tr> <td style="width: 10%;"></td> <td style="width: 10%;"></td> <td style="width: 10%;"></td> <td style="width: 10%;"></td> <td style="width: 10%;"></td> <td style="width: 10%;"></td> <td style="width: 10%;"></td> <td style="width: 10%;"></td> <td style="width: 10%;"></td> <td style="width: 10%;"></td> </tr> <tr> <td></td> <td></td> <td colspan="8" style="text-align: center;"> <table border="1" style="width: 100%; border-collapse: collapse; text-align: center;"> <tr> <td style="width: 10%;"></td> <td style="width: 10%;"></td> <td style="width: 10%;"></td> <td style="width: 10%;"></td> <td style="width: 10%;"></td> <td style="width: 10%;"></td> <td style="width: 10%;"></td> <td style="width: 10%;"></td> <td style="width: 10%;"></td> <td style="width: 10%;"></td> </tr> <tr> <td></td> <td></td> <td colspan="8" style="text-align: center;"> <table border="1" style="width: 100%; border-collapse: collapse; text-align: center;"> <tr> <td style="width: 10%;"></td> <td style="width: 10%;"></td> <td style="width: 10%;"></td> <td style="width: 10%;"></td> <td style="width: 10%;"></td> <td style="width: 10%;"></td> <td style="width: 10%;"></td> <td style="width: 10%;"></td> <td style="width: 10%;"></td> <td style="width: 10%;"></td> </tr> <tr> <td></td> <td></td> <td colspan="8" style="text-align: center;"> <table border="1" style="width: 100%; border-collapse: collapse; text-align: center;"> <tr> <td style="width: 10%;"></td> <td style="width: 10%;"></td> <td style="width: 10%;"></td> <td style="width: 10%;"></td> <td style="width: 10%;"></td> <td style="width: 10%;"></td> <td style="width: 10%;"></td> <td style="width: 10%;"></td> <td style="width: 10%;"></td> <td style="width: 10%;"></td> </tr> <tr> <td></td> <td></td> <td colspan="8" style="text-align: center;"> <table border="1" style="width: 100%; border-collapse: collapse; text-align: center;"> <tr> <td style="width: 10%;"></td> <td style="width: 10%;"></td> <td style="width: 10%;"></td> <td style="width: 10%;"></td> <td style="width: 10%;"></td> <td style="width: 10%;"></td> <td style="width: 10%;"></td> <td style="width: 10%;"></td> <td style="width: 10%;"></td> <td style="width: 10%;"></td> </tr> <tr> <td></td> <td></td> <td colspan="8" style="text-align: center;"> <table border="1" style="width: 100%; border-collapse: collapse; text-align: center;"> <tr> <td style="width: 10%;"></td> <td style="width: 10%;"></td> <td style="width: 10%;"></td> <td style="width: 10%;"></td> <td style="width: 10%;"></td> <td style="width: 10%;"></td> <td style="width: 10%;"></td> <td style="width: 10%;"></td> <td style="width: 10%;"></td> <td style="width: 10%;"></td> </tr> <tr> <td></td> <td></td> <td colspan="8" style="text-align: center;"> <table border="1" style="width: 100%; border-collapse: collapse; text-align: center;"> <tr> <td style="width: 10%;"></td> <td style="width: 10%;"></td> <td style="width: 10%;"></td> <td style="width: 10%;"></td> <td style="width: 10%;"></td> <td style="width: 10%;"></td> <td style="width: 10%;"></td> <td style="width: 10%;"></td> <td style="width: 10%;"></td> <td style="width: 10%;"></td> </tr> <tr> <td></td> <td></td> <td colspan="8" style="text-align: center;"> <table border="1" style="width: 100%; border-collapse: collapse; text-align: center;"> <tr> <td style="width: 10%;"></td> <td style="width: 10%;"></td> <td style="width: 10%;"></td> <td style="width: 10%;"></td> <td style="width: 10%;"></td> <td style="width: 10%;"></td> <td style="width: 10%;"></td> <td style="width: 10%;"></td> <td style="width: 10%;"></td> <td style="width: 10%;"></td> </tr> <tr> <td></td> <td></td> <td colspan="8" style="text-align: center;"> <table border="1" style="width: 100%; border-collapse: collapse; text-align: center;"> <tr> <td style="width: 10%;"></td> <td style="width: 10%;"></td> <td style="width: 10%;"></td> <td style="width: 10%;"></td> <td style="width: 10%;"></td> <td style="width: 10%;"></td> <td style="width: 10%;"></td> <td style="width: 10%;"></td> <td style="width: 10%;"></td> <td style="width: 10%;"></td> </tr> <tr> <td></td> <td></td> <td colspan="8" style="text-align: center;"> <table border="1" style="width: 100%; border-collapse: collapse; text-align: center;"> <tr> <td style="width: 10%;"></td> <td style="width: 10%;"></td> <td style="width: 10%;"></td> <td style="width: 10%;"></td> <td style="width: 10%;"></td> <td style="width: 10%;"></td> <td style="width: 10%;"></td> <td style="width: 10%;"></td> <td style="width: 10%;"></td> <td style="width: 10%;"></td> </tr> <tr> <td></td> <td></td> <td colspan="8" style="text-align: center;"> <table border="1" style="width: 100%; border-collapse: collapse; text-align: center;"> <tr> <td style="width: 10%;"></td> <td style="width: 10%;"></td> <td style="width: 10%;"></td> <td style="width: 10%;"></td> <td style="width: 10%;"></td> <td style="width: 10%;"></td> <td style="width: 10%;"></td> <td style="width: 10%;"></td> <td style="width: 10%;"></td> <td style="width: 10%;"></td> </tr> <tr> <td></td> <td></td> <td colspan="8" style="text-align: center;"> <table border="1" style="width: 100%; border-collapse: collapse; text-align: center;"> <tr> <td style="width: 10%;"></td> <td style="width: 10%;"></td> <td style="width: 10%;"></td> <td style="width: 10%;"></td> <td style="width: 10%;"></td> <td style="width: 10%;"></td> <td style="width: 10%;"></td> <td style="width: 10%;"></td> <td style="width: 10%;"></td> <td style="width: 10%;"></td> </tr> <tr> <td></td> <td></td> <td colspan="8" style="text-align: center;"> <table border="1" style="width: 100%; border-collapse: collapse; text-align: center;"> <tr> <td style="width: 10%;"></td> <td style="width: 10%;"></td> <td style="width: 10%;"></td> <td style="width: 10%;"></td> <td style="width: 10%;"></td> <td style="width: 10%;"></td> <td style="width: 10%;"></td> <td style="width: 10%;"></td> <td style="width: 10%;"></td> <td style="width: 10%;"></td> </tr> <tr> <td></td> <td></td> <td colspan="8" style="text-align: center;"> <table border="1" style="width: 100%; border-collapse: collapse; text-align: center;"> <tr> <td style="width: 10%;"></td> <td style="width: 10%;"></td> <td style="width: 10%;"></td> <td style="width: 10%;"></td> <td style="width: 10%;"></td> <td style="width: 10%;"></td> <td style="width: 10%;"></td> <td style="width: 10%;"></td> <td style="width: 10%;"></td> <td style="width: 10%;"></td> </tr> <tr> <td></td> <td></td> <td colspan="8" style="text-align: center;"> <table border="1" style="width: 100%; border-collapse: collapse; text-align: center;"> <tr> <td style="width: 10%;"></td> <td style="width: 10%;"></td> <td style="width: 10%;"></td> <td style="width: 10%;"></td> <td style="width: 10%;"></td> <td style="width: 10%;"></td> <td style="width: 10%;"></td> <td style="width: 10%;"></td> <td style="width: 10%;"></td> <td style="width: 10%;"></td> </tr> <tr> <td></td> <td></td> <td colspan="8" style="text-align: center;"> <table border="1" style="width: 100%; border-collapse: collapse; text-align: center;"> <tr> <td style="width: 10%;"></td> <td style="width: 10%;"></td> <td style="width: 10%;"></td> <td style="width: 10%;"></td> <td style="width: 10%;"></td> <td style="width: 10%;"></td> <td style="width: 10%;"></td> <td style="width: 10%;"></td> <td style="width: 10%;"></td> <td style="width: 10%;"></td> </tr> <tr> <td></td> <td></td> <td colspan="8" style="text-align: center;"> <table border="1" style="width: 100%; border-collapse: collapse; text-align: center;"> <tr> <td style="width: 10%;"></td> <td style="width: 10%;"></td> <td style="width: 10%;"></td> <td style="width: 10%;"></td> <td style="width: 10%;"></td> <td style="width: 10%;"></td> <td style="width:
10%;"></td> <td style="width: 10%;"></td> <td style="width: 10%;"></td> <td style="width: 10%;"></td> </tr> <tr> <td></td> <td></td> <td colspan="8" style="text-align: center;"> <table border="1" style="width: 100%; border-collapse: collapse; text-align: center;"> <tr> <td style="width: 10%;"></td> <td style="width: 10%;"></td> <td style="width: 10%;"></td> <td style="width: 10%;"></td> <td style="width: 10%;"></td> <td style="width: 10%;"></td> <td style="width: 10%;"></td> <td style="width: 10%;"></td> <td style="width: 10%;"></td> <td style="width: 10%;"></td> </tr> <tr> <td></td> <td></td> <td colspan="8" style="text-align: center;"> <table border="1" style="width: 100%; border-collapse: collapse; text-align: center;"> <tr> <td style="width: 10%;"></td> <td style="width: 10%;"></td> <td style="width: 10%;"></td> <td style="width: 10%;"></td> <td style="width: 10%;"></td> <td style="width: 10%;"></td> <td style="width: 10%;"></td> <td style="width: 10%;"></td> <td style="width: 10%;"></td> <td style="width: 10%;"></td> </tr> <tr> <td></td> <td></td> <td colspan="8" style="text-align: center;"> <table border="1" style="width: 100%; border-collapse: collapse; text-align: center;"> <tr> <td style="width: 10%;"></td> <td style="width: 10%;"></td> <td style="width: 10%;"></td> <td style="width: 10%;"></td> <td style="width: 10%;"></td> <td style="width: 10%;"></td> <td style="width: 10%;"></td> <td style="width: 10%;"></td> <td style="width: 10%;"></td> <td style="width: 10%;"></td> </tr> <tr> <td></td> <td></td> <td colspan="8" style="text-align: center;"> <table border="1" style="width: 100%; border-collapse: collapse; text-align: center;"> <tr> <td style="width: 10%;"></td> <td style="width: 10%;"></td> <td style="width: 10%;"></td> <td style="width: 10%;"></td> <td style="width: 10%;"></td> <td style="width: 10%;"></td> <td style="width: 10%;"></td> <td style="width: 10%;"></td> <td style="width: 10%;"></td> <td style="width: 10%;"></td> </tr> <tr> <td></td> <td></td> <td colspan="8" style="text-align: center;"> <table border="1" style="width: 100%; border-collapse: collapse; text-align: center;"> <tr> <td style="width: 10%;"></td> <td style="width: 10%;"></td> <td style="width: 10%;"></td> <td style="width: 10%;"></td> <td style="width: 10%;"></td> <td style="width: 10%;"></td> <td style="width: 10%;"></td> <td style="width: 10%;"></td> <td style="width: 10%;"></td> <td style="width: 10%;"></td> </tr> <tr> <td></td> <td></td> <td colspan="8" style="text-align: center;"> <table border="1" style="width: 100%; border-collapse: collapse; text-align: center;"> <tr> <td style="width: 10%;"></td> <td style="width: 10%;"></td> <td style="width: 10%;"></td> <td style="width: 10%;"></td> <td style="width: 10%;"></td> <td style="width: 10%;"></td> <td style="width: 10%;"></td> <td style="width: 10%;"></td> <td style="width: 10%;"></td> <td style="width: 10%;"></td> </tr> <tr> <td></td> <td></td> <td colspan="8" style="text-align: center;"> <table border="1" style="width: 100%; border-collapse: collapse; text-align: center;"> <tr> <td style="width: 10%;"></td> <td style="width: 10%;"></td> <td style="width: 10%;"></td> <td style="width: 10%;"></td> <td style="width: 10%;"></td> <td style="width: 10%;"></td> <td style="width: 10%;"></td> <td style="width: 10%;"></td> <td style="width: 10%;"></td> <td style="width: 10%;"></td> </tr> <tr> <td></td> <td></td> <td colspan="8" style="text-align: center;"> <table border="1" style="width: 100%; border-collapse: collapse; text-align: center;"> <tr> <td style="width: 10%;"></td> <td style="width: 10%;"></td> <td style="width: 10%;"></td> <td style="width: 10%;"></td> <td style="width: 10%;"></td> <td style="width: 10%;"></td> <td style="width: 10%;"></td> <td style="width: 10%;"></td> <td style="width: 10%;"></td> <td style="width: 10%;"></td> </tr> <tr> <td></td> <td></td> <td colspan="8" style="text-align: center;"> <table border="1" style="width: 100%; border-collapse: collapse; text-align: center;"> <tr> <td style="width: 10%;"></td> <td style="width: 10%;"></td> <td style="width: 10%;"></td> <td style="width: 10%;"></td> <td style="width: 10%;"></td> <td style="width: 10%;"></td> <td style="width: 10%;"></td> <td style="width: 10%;"></td> <td style="width: 10%;"></td> <td style="width: 10%;"></td> </tr> <tr> <td></td> <td></td> <td colspan="8" style="text-align: center;"> <table border="1" style="width: 100%; border-collapse: collapse; text-align: center;"> <tr> <td style="width: 10%;"></td> <td style="width: 10%;"></td> <td style="width: 10%;"></td> <td style="width: 10%;"></td> <td style="width: 10%;"></td> <td style="width: 10%;"></td> <td style="width: 10%;"></td> <td style="width: 10%;"></td> <td style="width: 10%;"></td> <td style="width: 10%;"></td> </tr> <tr> <td></td> <td></td> <td colspan="8" style="text-align: center;"> <table border="1" style="width: 100%; border-collapse: collapse; text-align: center;"> <tr> <td style="width: 10%;"></td> <td style="width: 10%;"></td> <td style="width: 10%;"></td> <td style="width: 10%;"></td> <td style="width: 10%;"></td> <td style="width: 10%;"></td> <td style="width: 10%;"></td> <td style="width: 10%;"></td> <td style="width: 10%;"></td> <td style="width: 10%;"></td> </tr> <tr> <td></td> <td></td> <td colspan="8" style="text-align: center;"> <table border="1" style="width: 100%; border-collapse: collapse; text-align: center;"> <tr> <td style="width: 10%;"></td> <td style="width: 10%;"></td> <td style="width: 10%;"></td> <td style="width: 10%;"></td> <td style="width: 10%;"></td> <td style="width: 10%;"></td> <td style="width: 10%;"></td> <td style="width: 10%;"></td> <td style="width: 10%;"></td> <td style="width: 10%;"></td> </tr> <tr> <td></td> <td></td> <td colspan="8" style="text-align: center;"> <table border="1" style="width: 100%; border-collapse: collapse; text-align: center;"> <tr> </tr></table></td></tr></table></td></tr></table></td></tr></table></td></tr></table></td></tr></table></td></tr></table></td></tr></table></td></tr></table></td></tr></table></td></tr></table></td></tr></table></td></tr></table></td></tr></table></td></tr></table></td></tr></table></td></tr></table></td></tr></table></td></tr></table></td></tr></table></td></tr></table></td></tr></table></td></tr></table></td></tr></table></td></tr></table></td></tr></table></td></tr></table></td></tr></table></td></tr></table></td></tr></table></td></tr></table></td></tr></table></td></tr></table> | | | | | | | | | | | | | | | | | | | | <table border="1" style="width: 100%; border-collapse: collapse; text-align: center;"> <tr> <td style="width: 10%;"></td> <td style="width: 10%;"></td> <td style="width: 10%;"></td> <td style="width: 10%;"></td> <td style="width: 10%;"></td> <td style="width: 10%;"></td> <td style="width: 10%;"></td> <td style="width: 10%;"></td> <td style="width: 10%;"></td> <td style="width: 10%;"></td> </tr> <tr> <td></td> <td></td> <td colspan="8" style="text-align: center;"> <table border="1" style="width: 100%; border-collapse: collapse; text-align: center;"> <tr> <td style="width: 10%;"></td> <td style="width: 10%;"></td> <td style="width: 10%;"></td> <td style="width: 10%;"></td> <td style="width: 10%;"></td> <td style="width: 10%;"></td> <td style="width: 10%;"></td> <td style="width: 10%;"></td> <td style="width: 10%;"></td> <td style="width: 10%;"></td> </tr> <tr> <td></td> <td></td> <td colspan="8" style="text-align: center;"> <table border="1" style="width: 100%; border-collapse: collapse; text-align: center;"> <tr> <td style="width: 10%;"></td> <td style="width: 10%;"></td> <td style="width: 10%;"></td> <td style="width: 10%;"></td> <td style="width: 10%;"></td> <td style="width: 10%;"></td> <td style="width: 10%;"></td> <td style="width: 10%;"></td> <td style="width: 10%;"></td> <td style="width: 10%;"></td> </tr> <tr> <td></td> <td></td> <td colspan="8" style="text-align: center;"> <table border="1" style="width: 100%; border-collapse: collapse; text-align: center;"> <tr> <td style="width: 10%;"></td> <td style="width: 10%;"></td> <td style="width: 10%;"></td> <td style="width: 10%;"></td> <td style="width: 10%;"></td> <td style="width: 10%;"></td> <td style="width: 10%;"></td> <td style="width: 10%;"></td> <td style="width: 10%;"></td> <td style="width: 10%;"></td> </tr> <tr> <td></td> <td></td> <td colspan="8" style="text-align: center;"> <table border="1" style="width: 100%; border-collapse: collapse; text-align: center;"> <tr> <td style="width: 10%;"></td> <td style="width: 10%;"></td> <td style="width: 10%;"></td> <td style="width: 10%;"></td> <td style="width: 10%;"></td> <td style="width: 10%;"></td> <td style="width: 10%;"></td> <td style="width: 10%;"></td> <td style="width: 10%;"></td> <td style="width: 10%;"></td> </tr> <tr> <td></td> <td></td> <td colspan="8" style="text-align: center;"> <table border="1" style="width: 100%; border-collapse: collapse; text-align: center;"> <tr> <td style="width: 10%;"></td> <td style="width: 10%;"></td> <td style="width: 10%;"></td> <td style="width: 10%;"></td> <td style="width: 10%;"></td> <td style="width: 10%;"></td> <td style="width: 10%;"></td> <td style="width: 10%;"></td> <td style="width: 10%;"></td> <td style="width: 10%;"></td> </tr> <tr> <td></td> <td></td> <td colspan="8" style="text-align: center;"> <table border="1" style="width: 100%; border-collapse: collapse; text-align: center;"> <tr> <td style="width: 10%;"></td> <td style="width: 10%;"></td> <td style="width: 10%;"></td> <td style="width: 10%;"></td> <td style="width: 10%;"></td> <td style="width: 10%;"></td> <td style="width: 10%;"></td> <td style="width: 10%;"></td> <td style="width: 10%;"></td> <td style="width: 10%;"></td> </tr> <tr> <td></td> <td></td> <td colspan="8" style="text-align: center;"> <table border="1" style="width: 100%; border-collapse: collapse; text-align: center;"> <tr> <td style="width: 10%;"></td> <td style="width: 10%;"></td> <td style="width: 10%;"></td> <td
style="width: 10%;"></td> <td style="width: 10%;"></td> <td style="width: 10%;"></td> <td style="width: 10%;"></td> <td style="width: 10%;"></td> <td style="width: 10%;"></td> <td style="width: 10%;"></td> </tr> <tr> <td></td> <td></td> <td colspan="8" style="text-align: center;"> <table border="1" style="width: 100%; border-collapse: collapse; text-align: center;"> <tr> <td style="width: 10%;"></td> <td style="width: 10%;"></td> <td style="width: 10%;"></td> <td style="width: 10%;"></td> <td style="width: 10%;"></td> <td style="width: 10%;"></td> <td style="width: 10%;"></td> <td style="width: 10%;"></td> <td style="width: 10%;"></td> <td style="width: 10%;"></td> </tr> <tr> <td></td> <td></td> <td colspan="8" style="text-align: center;"> <table border="1" style="width: 100%; border-collapse: collapse; text-align: center;"> <tr> <td style="width: 10%;"></td> <td style="width: 10%;"></td> <td style="width: 10%;"></td> <td style="width: 10%;"></td> <td style="width: 10%;"></td> <td style="width: 10%;"></td> <td style="width: 10%;"></td> <td style="width: 10%;"></td> <td style="width: 10%;"></td> <td style="width: 10%;"></td> </tr> <tr> <td></td> <td></td> <td colspan="8" style="text-align: center;"> <table border="1" style="width: 100%; border-collapse: collapse; text-align: center;"> <tr> <td style="width: 10%;"></td> <td style="width: 10%;"></td> <td style="width: 10%;"></td> <td style="width: 10%;"></td> <td style="width: 10%;"></td> <td style="width: 10%;"></td> <td style="width: 10%;"></td> <td style="width: 10%;"></td> <td style="width: 10%;"></td> <td style="width: 10%;"></td> </tr> <tr> <td></td> <td></td> <td colspan="8" style="text-align: center;"> <table border="1" style="width: 100%; border-collapse: collapse; text-align: center;"> <tr> <td style="width: 10%;"></td> <td style="width: 10%;"></td> <td style="width: 10%;"></td> <td style="width: 10%;"></td> <td style="width: 10%;"></td> <td style="width: 10%;"></td> <td style="width: 10%;"></td> <td style="width: 10%;"></td> <td style="width: 10%;"></td> <td style="width: 10%;"></td> </tr> <tr> <td></td> <td></td> <td colspan="8" style="text-align: center;"> <table border="1" style="width: 100%; border-collapse: collapse; text-align: center;"> <tr> <td style="width: 10%;"></td> <td style="width: 10%;"></td> <td style="width: 10%;"></td> <td style="width: 10%;"></td> <td style="width: 10%;"></td> <td style="width: 10%;"></td> <td style="width: 10%;"></td> <td style="width: 10%;"></td> <td style="width: 10%;"></td> <td style="width: 10%;"></td> </tr> <tr> <td></td> <td></td> <td colspan="8" style="text-align: center;"> <table border="1" style="width: 100%; border-collapse: collapse; text-align: center;"> <tr> <td style="width: 10%;"></td> <td style="width: 10%;"></td> <td style="width: 10%;"></td> <td style="width: 10%;"></td> <td style="width: 10%;"></td> <td style="width: 10%;"></td> <td style="width: 10%;"></td> <td style="width: 10%;"></td> <td style="width: 10%;"></td> <td style="width: 10%;"></td> </tr> <tr> <td></td> <td></td> <td colspan="8" style="text-align: center;"> <table border="1" style="width: 100%; border-collapse: collapse; text-align: center;"> <tr> <td style="width: 10%;"></td> <td style="width: 10%;"></td> <td style="width: 10%;"></td> <td style="width: 10%;"></td> <td style="width: 10%;"></td> <td style="width: 10%;"></td> <td style="width: 10%;"></td> <td style="width: 10%;"></td> <td style="width: 10%;"></td> <td style="width: 10%;"></td> </tr> <tr> <td></td> <td></td> <td colspan="8" style="text-align: center;"> <table border="1" style="width: 100%; border-collapse: collapse; text-align: center;"> <tr> <td style="width: 10%;"></td> <td style="width: 10%;"></td> <td style="width: 10%;"></td> <td style="width: 10%;"></td> <td style="width: 10%;"></td> <td style="width: 10%;"></td> <td style="width: 10%;"></td> <td style="width: 10%;"></td> <td style="width: 10%;"></td> <td style="width: 10%;"></td> </tr> <tr> <td></td> <td></td> <td colspan="8" style="text-align: center;"> <table border="1" style="width: 100%; border-collapse: collapse; text-align: center;"> <tr> <td style="width: 10%;"></td> <td style="width: 10%;"></td> <td style="width: 10%;"></td> <td style="width: 10%;"></td> <td style="width: 10%;"></td> <td style="width: 10%;"></td> <td style="width: 10%;"></td> <td style="width: 10%;"></td> <td style="width: 10%;"></td> <td style="width: 10%;"></td> </tr> <tr> <td></td> <td></td> <td colspan="8" style="text-align: center;"> <table border="1" style="width: 100%; border-collapse: collapse; text-align: center;"> <tr> <td style="width: 10%;"></td> <td style="width: 10%;"></td> <td style="width: 10%;"></td> <td style="width: 10%;"></td> <td style="width: 10%;"></td> <td style="width: 10%;"></td> <td style="width: 10%;"></td> <td style="width: 10%;"></td> <td style="width: 10%;"></td> <td style="width: 10%;"></td> </tr> <tr> <td></td> <td></td> <td colspan="8" style="text-align: center;"> <table border="1" style="width: 100%; border-collapse: collapse; text-align: center;"> <tr> <td style="width: 10%;"></td> <td style="width: 10%;"></td> <td style="width: 10%;"></td> <td style="width: 10%;"></td> <td style="width: 10%;"></td> <td style="width: 10%;"></td> <td style="width: 10%;"></td> <td style="width: 10%;"></td> <td style="width: 10%;"></td> <td style="width: 10%;"></td> </tr> <tr> <td></td> <td></td> <td colspan="8" style="text-align: center;"> <table border="1" style="width: 100%; border-collapse: collapse; text-align: center;"> <tr> <td style="width: 10%;"></td> <td style="width: 10%;"></td> <td style="width: 10%;"></td> <td style="width: 10%;"></td> <td style="width: 10%;"></td> <td style="width: 10%;"></td> <td style="width: 10%;"></td> <td style="width: 10%;"></td> <td style="width: 10%;"></td> <td style="width: 10%;"></td> </tr> <tr> <td></td> <td></td> <td colspan="8" style="text-align: center;"> <table border="1" style="width: 100%; border-collapse: collapse; text-align: center;"> <tr> <td style="width: 10%;"></td> <td style="width: 10%;"></td> <td style="width: 10%;"></td> <td style="width: 10%;"></td> <td style="width: 10%;"></td> <td style="width: 10%;"></td> <td style="width: 10%;"></td> <td style="width: 10%;"></td> <td style="width: 10%;"></td> <td style="width: 10%;"></td> </tr> <tr> <td></td> <td></td> <td colspan="8" style="text-align: center;"> <table border="1" style="width: 100%; border-collapse: collapse; text-align: center;"> <tr> <td style="width: 10%;"></td> <td style="width: 10%;"></td> <td style="width: 10%;"></td> <td style="width: 10%;"></td> <td style="width: 10%;"></td> <td style="width: 10%;"></td> <td style="width: 10%;"></td> <td style="width: 10%;"></td> <td style="width: 10%;"></td> <td style="width: 10%;"></td> </tr> <tr> <td></td> <td></td> <td colspan="8" style="text-align: center;"> <table border="1" style="width: 100%; border-collapse: collapse; text-align: center;"> <tr> <td style="width: 10%;"></td> <td style="width: 10%;"></td> <td style="width: 10%;"></td> <td style="width: 10%;"></td> <td style="width: 10%;"></td> <td style="width: 10%;"></td> <td style="width: 10%;"></td> <td style="width: 10%;"></td> <td style="width: 10%;"></td> <td style="width: 10%;"></td> </tr> <tr> <td></td> <td></td> <td colspan="8" style="text-align: center;"> <table border="1" style="width: 100%; border-collapse: collapse; text-align: center;"> <tr> <td style="width: 10%;"></td> <td style="width: 10%;"></td> <td style="width: 10%;"></td> <td style="width: 10%;"></td> <td style="width: 10%;"></td> <td style="width: 10%;"></td> <td style="width: 10%;"></td> <td style="width: 10%;"></td> <td style="width: 10%;"></td> <td style="width: 10%;"></td> </tr> <tr> <td></td> <td></td> <td colspan="8" style="text-align: center;"> <table border="1" style="width: 100%; border-collapse: collapse; text-align: center;"> <tr> <td style="width: 10%;"></td> <td style="width: 10%;"></td> <td style="width: 10%;"></td> <td style="width: 10%;"></td> <td style="width: 10%;"></td> <td style="width: 10%;"></td> <td style="width: 10%;"></td> <td style="width: 10%;"></td> <td style="width: 10%;"></td> <td style="width: 10%;"></td> </tr> <tr> <td></td> <td></td> <td colspan="8" style="text-align: center;"> <table border="1" style="width: 100%; border-collapse: collapse; text-align: center;"> <tr> <td style="width: 10%;"></td> <td style="width: 10%;"></td> <td style="width: 10%;"></td> <td style="width: 10%;"></td> <td style="width: 10%;"></td> <td style="width: 10%;"></td> <td style="width: 10%;"></td> <td style="width: 10%;"></td> <td style="width: 10%;"></td> <td style="width: 10%;"></td> </tr> <tr> <td></td> <td></td> <td colspan="8" style="text-align: center;"> <table border="1" style="width: 100%; border-collapse: collapse; text-align: center;"> <tr> <td style="width: 10%;"></td> <td style="width: 10%;"></td> <td style="width: 10%;"></td> <td style="width: 10%;"></td> <td style="width: 10%;"></td> <td style="width: 10%;"></td> <td style="width: 10%;"></td> <td style="width: 10%;"></td> <td style="width: 10%;"></td> <td style="width: 10%;"></td> </tr> <tr> <td></td> <td></td> <td colspan="8" style="text-align: center;"> <table border="1" style="width: 100%; border-collapse: collapse; text-align: center;"> <tr> <td style="width: 10%;"></td> <td style="width: 10%;"></td> <td style="width: 10%;"></td> <td style="width: 10%;"></td> <td style="width: 10%;"></td> <td style="width: 10%;"></td> <td style="width: 10%;"></td> <td style="width: 10%;"></td> <td style="width: 10%;"></td> <td style="width: 10%;"></td> </tr> <tr> <td></td> <td></td> <td colspan="8" style="text-align: center;"> <table border="1" style="width: 100%; border-collapse: collapse; text-align: center;"> <tr> <td style="width: 10%;"></td> <td style="width: 10%;"></td> <td style="width: 10%;"></td> <td style="width: 10%;"></td> <td style="width: 10%;"></td> <td style="width: 10%;"></td> <td style="width: 10%;"></td> <td style="width: 10%;"></td> <td style="width:
10%;"></td> <td style="width: 10%;"></td> </tr> <tr> <td></td> <td></td> <td colspan="8" style="text-align: center;"> <table border="1" style="width: 100%; border-collapse: collapse; text-align: center;"> <tr> <td style="width: 10%;"></td> <td style="width: 10%;"></td> <td style="width: 10%;"></td> <td style="width: 10%;"></td> <td style="width: 10%;"></td> <td style="width: 10%;"></td> <td style="width: 10%;"></td> <td style="width: 10%;"></td> <td style="width: 10%;"></td> <td style="width: 10%;"></td> </tr> <tr> <td></td> <td></td> <td colspan="8" style="text-align: center;"> <table border="1" style="width: 100%; border-collapse: collapse; text-align: center;"> <tr> <td style="width: 10%;"></td> <td style="width: 10%;"></td> <td style="width: 10%;"></td> <td style="width: 10%;"></td> <td style="width: 10%;"></td> <td style="width: 10%;"></td> <td style="width: 10%;"></td> <td style="width: 10%;"></td> <td style="width: 10%;"></td> <td style="width: 10%;"></td> </tr> <tr> <td></td> <td></td> <td colspan="8" style="text-align: center;"> <table border="1" style="width: 100%; border-collapse: collapse; text-align: center;"> <tr> </tr></table></td></tr></table></td></tr></table></td></tr></table></td></tr></table></td></tr></table></td></tr></table></td></tr></table></td></tr></table></td></tr></table></td></tr></table></td></tr></table></td></tr></table></td></tr></table></td></tr></table></td></tr></table></td></tr></table></td></tr></table></td></tr></table></td></tr></table></td></tr></table></td></tr></table></td></tr></table></td></tr></table></td></tr></table></td></tr></table></td></tr></table></td></tr></table></td></tr></table></td></tr></table></td></tr></table></td></tr></table> | | | | | | | | | | | | | | | | | | | | <table border="1" style="width: 100%; border-collapse: collapse; text-align: center;"> <tr> <td style="width: 10%;"></td> <td style="width: 10%;"></td> <td style="width: 10%;"></td> <td style="width: 10%;"></td> <td style="width: 10%;"></td> <td style="width: 10%;"></td> <td style="width: 10%;"></td> <td style="width: 10%;"></td> <td style="width: 10%;"></td> <td style="width: 10%;"></td> </tr> <tr> <td></td> <td></td> <td colspan="8" style="text-align: center;"> <table border="1" style="width: 100%; border-collapse: collapse; text-align: center;"> <tr> <td style="width: 10%;"></td> <td style="width: 10%;"></td> <td style="width: 10%;"></td> <td style="width: 10%;"></td> <td style="width: 10%;"></td> <td style="width: 10%;"></td> <td style="width: 10%;"></td> <td style="width: 10%;"></td> <td style="width: 10%;"></td> <td style="width: 10%;"></td> </tr> <tr> <td></td> <td></td> <td colspan="8" style="text-align: center;"> <table border="1" style="width: 100%; border-collapse: collapse; text-align: center;"> <tr> <td style="width: 10%;"></td> <td style="width: 10%;"></td> <td style="width: 10%;"></td> <td style="width: 10%;"></td> <td style="width: 10%;"></td> <td style="width: 10%;"></td> <td style="width: 10%;"></td> <td style="width: 10%;"></td> <td style="width: 10%;"></td> <td style="width: 10%;"></td> </tr> <tr> <td></td> <td></td> <td colspan="8" style="text-align: center;"> <table border="1" style="width: 100%; border-collapse: collapse; text-align: center;"> <tr> <td style="width: 10%;"></td> <td style="width: 10%;"></td> <td style="width: 10%;"></td> <td style="width: 10%;"></td> <td style="width: 10%;"></td> <td style="width: 10%;"></td> <td style="width: 10%;"></td> <td style="width: 10%;"></td> <td style="width: 10%;"></td> <td style="width: 10%;"></td> </tr> <tr> <td></td> <td></td> <td colspan="8" style="text-align: center;"> <table border="1" style="width: 100%; border-collapse: collapse; text-align: center;"> <tr> <td style="width: 10%;"></td> <td style="width: 10%;"></td> <td style="width: 10%;"></td> <td style="width: 10%;"></td> <td style="width: 10%;"></td> <td style="width: 10%;"></td> <td style="width: 10%;"></td> <td style="width: 10%;"></td> <td style="width: 10%;"></td> <td style="width: 10%;"></td> </tr> <tr> <td></td> <td></td> <td colspan="8" style="text-align: center;"> <table border="1" style="width: 100%; border-collapse: collapse; text-align: center;"> <tr> <td style="width: 10%;"></td> <td style="width: 10%;"></td> <td style="width: 10%;"></td> <td style="width: 10%;"></td> <td style="width: 10%;"></td> <td style="width: 10%;"></td> <td style="width: 10%;"></td> <td style="width: 10%;"></td> <td style="width: 10%;"></td> <td style="width: 10%;"></td> </tr> <tr> <td></td> <td></td> <td colspan="8" style="text-align: center;"> <table border="1" style="width: 100%; border-collapse: collapse; text-align: center;"> <tr> <td style="width: 10%;"></td> <td style="width: 10%;"></td> <td style="width: 10%;"></td> <td style="width: 10%;"></td> <td style="width: 10%;"></td> <td style="width: 10%;"></td> <td style="width: 10%;"></td> <td style="width: 10%;"></td> <td style="width: 10%;"></td> <td style="width: 10%;"></td> </tr> <tr> <td></td> <td></td> <td colspan="8" style="text-align: center;"> <table border="1" style="width: 100%; border-collapse: collapse; text-align: center;"> <tr> <td style="width: 10%;"></td> <td style="width: 10%;"></td> <td style="width: 10%;"></td> <td style="width: 10%;"></td> <td style="width: 10%;"></td> <td style="width: 10%;"></td> <td style="width: 10%;"></td> <td style="width: 10%;"></td> <td style="width: 10%;"></td> <td style="width: 10%;"></td> </tr> <tr> <td></td> <td></td> <td colspan="8" style="text-align: center;"> <table border="1" style="width: 100%; border-collapse: collapse; text-align: center;"> <tr> <td style="width: 10%;"></td> <td style="width: 10%;"></td> <td style="width: 10%;"></td> <td style="width: 10%;"></td> <td style="width: 10%;"></td> <td style="width: 10%;"></td> <td style="width: 10%;"></td> <td style="width: 10%;"></td> <td style="width: 10%;"></td> <td style="width: 10%;"></td> </tr> <tr> <td></td> <td></td> <td colspan="8" style="text-align: center;"> <table border="1" style="width: 100%; border-collapse: collapse; text-align: center;"> <tr> <td style="width: 10%;"></td> <td style="width: 10%;"></td> <td style="width: 10%;"></td> <td style="width: 10%;"></td> <td style="width: 10%;"></td> <td style="width: 10%;"></td> <td style="width: 10%;"></td> <td style="width: 10%;"></td> <td style="width: 10%;"></td> <td style="width: 10%;"></td> </tr> <tr> <td></td> <td></td> <td colspan="8" style="text-align: center;"> <table border="1" style="width: 100%; border-collapse: collapse; text-align: center;"> <tr> <td style="width: 10%;"></td> <td style="width: 10%;"></td> <td style="width: 10%;"></td> <td style="width: 10%;"></td> <td style="width: 10%;"></td> <td style="width: 10%;"></td> <td style="width: 10%;"></td> <td style="width: 10%;"></td> <td style="width: 10%;"></td> <td style="width: 10%;"></td> </tr> <tr> <td></td> <td></td> <td colspan="8" style="text-align: center;"> <table border="1" style="width: 100%; border-collapse: collapse; text-align: center;"> <tr> <td style="width: 10%;"></td> <td style="width: 10%;"></td> <td style="width: 10%;"></td> <td style="width: 10%;"></td> <td style="width: 10%;"></td> <td style="width: 10%;"></td> <td style="width: 10%;"></td> <td style="width: 10%;"></td> <td style="width: 10%;"></td> <td style="width: 10%;"></td> </tr> <tr> <td></td> <td></td> <td colspan="8" style="text-align: center;"> <table border="1" style="width: 100%; border-collapse: collapse; text-align: center;"> <tr> <td style="width: 10%;"></td> <td style="width: 10%;"></td> <td style="width: 10%;"></td> <td style="width: 10%;"></td> <td style="width: 10%;"></td> <td style="width: 10%;"></td> <td style="width: 10%;"></td> <td style="width: 10%;"></td> <td style="width: 10%;"></td> <td style="width: 10%;"></td> </tr> <tr> <td></td> <td></td> <td colspan="8" style="text-align: center;"> <table border="1" style="width: 100%; border-collapse: collapse; text-align: center;"> <tr> <td style="width: 10%;"></td> <td style="width: 10%;"></td> <td style="width: 10%;"></td> <td style="width: 10%;"></td> <td style="width: 10%;"></td> <td style="width: 10%;"></td> <td style="width: 10%;"></td> <td style="width: 10%;"></td> <td style="width: 10%;"></td> <td style="width: 10%;"></td> </tr> <tr> <td></td> <td></td> <td colspan="8" style="text-align: center;"> <table border="1" style="width: 100%; border-collapse: collapse; text-align: center;"> <tr> <td style="width: 10%;"></td> <td style="width: 10%;"></td> <td style="width: 10%;"></td> <td style="width: 10%;"></td> <td style="width: 10%;"></td> <td style="width: 10%;"></td> <td style="width: 10%;"></td> <td style="width: 10%;"></td> <td style="width: 10%;"></td> <td style="width: 10%;"></td> </tr> <tr> <td></td> <td></td> <td colspan="8" style="text-align: center;"> <table border="1" style="width: 100%; border-collapse: collapse; text-align: center;"> <tr> <td style="width: 10%;"></td> <td style="width: 10%;"></td> <td style="width: 10%;"></td> <td style="width: 10%;"></td> <td style="width: 10%;"></td> <td style="width: 10%;"></td> <td style="width: 10%;"></td> <td style="width: 10%;"></td> <td style="width: 10%;"></td> <td style="width: 10%;"></td> </tr> <tr> <td></td> <td></td> <td colspan="8" style="text-align: center;"> <table border="1" style="width: 100%; border-collapse: collapse; text-align: center;"> <tr> <td style="width: 10%;"></td> <td style="width: 10%;"></td> <td style="width: 10%;"></td> <td style="width: 10%;"></td> <td style="width: 10%;"></td> <td style="width: 10%;"></td> <td style="width: 10%;"></td> <td style="width: 10%;"></td> <td style="width: 10%;"></td> <td style="width: 10%;"></td> </tr> <tr> <td></td> <td></td> <td colspan="8" style="text-align: center;"> <table border="1" style="width: 100%; border-collapse: collapse; text-align: center;"> <tr> <td style="width: 10%;"></td> <td style="width: 10%;"></td> <td style="width: 10%;"></td> <td style="width: 10%;"></td> <td style="width: 10%;"></td> <td style="width:
10%;"></td> <td style="width: 10%;"></td> <td style="width: 10%;"></td> <td style="width: 10%;"></td> <td style="width: 10%;"></td> </tr> <tr> <td></td> <td></td> <td colspan="8" style="text-align: center;"> <table border="1" style="width: 100%; border-collapse: collapse; text-align: center;"> <tr> <td style="width: 10%;"></td> <td style="width: 10%;"></td> <td style="width: 10%;"></td> <td style="width: 10%;"></td> <td style="width: 10%;"></td> <td style="width: 10%;"></td> <td style="width: 10%;"></td> <td style="width: 10%;"></td> <td style="width: 10%;"></td> <td style="width: 10%;"></td> </tr> <tr> <td></td> <td></td> <td colspan="8" style="text-align: center;"> <table border="1" style="width: 100%; border-collapse: collapse; text-align: center;"> <tr> <td style="width: 10%;"></td> <td style="width: 10%;"></td> <td style="width: 10%;"></td> <td style="width: 10%;"></td> <td style="width: 10%;"></td> <td style="width: 10%;"></td> <td style="width: 10%;"></td> <td style="width: 10%;"></td> <td style="width: 10%;"></td> <td style="width: 10%;"></td> </tr> <tr> <td></td> <td></td> <td colspan="8" style="text-align: center;"> <table border="1" style="width: 100%; border-collapse: collapse; text-align: center;"> <tr> <td style="width: 10%;"></td> <td style="width: 10%;"></td> <td style="width: 10%;"></td> <td style="width: 10%;"></td> <td style="width: 10%;"></td> <td style="width: 10%;"></td> <td style="width: 10%;"></td> <td style="width: 10%;"></td> <td style="width: 10%;"></td> <td style="width: 10%;"></td> </tr> <tr> <td></td> <td></td> <td colspan="8" style="text-align: center;"> <table border="1" style="width: 100%; border-collapse: collapse; text-align: center;"> <tr> <td style="width: 10%;"></td> <td style="width: 10%;"></td> <td style="width: 10%;"></td> <td style="width: 10%;"></td> <td style="width: 10%;"></td> <td style="width: 10%;"></td> <td style="width: 10%;"></td> <td style="width: 10%;"></td> <td style="width: 10%;"></td> <td style="width: 10%;"></td> </tr> <tr> <td></td> <td></td> <td colspan="8" style="text-align: center;"> <table border="1" style="width: 100%; border-collapse: collapse; text-align: center;"> <tr> <td style="width: 10%;"></td> <td style="width: 10%;"></td> <td style="width: 10%;"></td> <td style="width: 10%;"></td> <td style="width: 10%;"></td> <td style="width: 10%;"></td> <td style="width: 10%;"></td> <td style="width: 10%;"></td> <td style="width: 10%;"></td> <td style="width: 10%;"></td> </tr> <tr> <td></td> <td></td> <td colspan="8" style="text-align: center;"> <table border="1" style="width: 100%; border-collapse: collapse; text-align: center;"> <tr> <td style="width: 10%;"></td> <td style="width: 10%;"></td> <td style="width: 10%;"></td> <td style="width: 10%;"></td> <td style="width: 10%;"></td> <td style="width: 10%;"></td> <td style="width: 10%;"></td> <td style="width: 10%;"></td> <td style="width: 10%;"></td> <td style="width: 10%;"></td> </tr> <tr> <td></td> <td></td> <td colspan="8" style="text-align: center;"> <table border="1" style="width: 100%; border-collapse: collapse; text-align: center;"> <tr> <td style="width: 10%;"></td> <td style="width: 10%;"></td> <td style="width: 10%;"></td> <td style="width: 10%;"></td> <td style="width: 10%;"></td> <td style="width: 10%;"></td> <td style="width: 10%;"></td> <td style="width: 10%;"></td> <td style="width: 10%;"></td> <td style="width: 10%;"></td> </tr> <tr> <td></td> <td></td> <td colspan="8" style="text-align: center;"> <table border="1" style="width: 100%; border-collapse: collapse; text-align: center;"> <tr> <td style="width: 10%;"></td> <td style="width: 10%;"></td> <td style="width: 10%;"></td> <td style="width: 10%;"></td> <td style="width: 10%;"></td> <td style="width: 10%;"></td> <td style="width: 10%;"></td> <td style="width: 10%;"></td> <td style="width: 10%;"></td> <td style="width: 10%;"></td> </tr> <tr> <td></td> <td></td> <td colspan="8" style="text-align: center;"> <table border="1" style="width: 100%; border-collapse: collapse; text-align: center;"> <tr> <td style="width: 10%;"></td> <td style="width: 10%;"></td> <td style="width: 10%;"></td> <td style="width: 10%;"></td> <td style="width: 10%;"></td> <td style="width: 10%;"></td> <td style="width: 10%;"></td> <td style="width: 10%;"></td> <td style="width: 10%;"></td> <td style="width: 10%;"></td> </tr> <tr> <td></td> <td></td> <td colspan="8" style="text-align: center;"> <table border="1" style="width: 100%; border-collapse: collapse; text-align: center;"> <tr> <td style="width: 10%;"></td> <td style="width: 10%;"></td> <td style="width: 10%;"></td> <td style="width: 10%;"></td> <td style="width: 10%;"></td> <td style="width: 10%;"></td> <td style="width: 10%;"></td> <td style="width: 10%;"></td> <td style="width: 10%;"></td> <td style="width: 10%;"></td> </tr> <tr> <td></td> <td></td> <td colspan="8" style="text-align: center;"> <table border="1" style="width: 100%; border-collapse: collapse; text-align: center;"> <tr> <td style="width: 10%;"></td> <td style="width: 10%;"></td> <td style="width: 10%;"></td> <td style="width: 10%;"></td> <td style="width: 10%;"></td> <td style="width: 10%;"></td> <td style="width: 10%;"></td> <td style="width: 10%;"></td> <td style="width: 10%;"></td> <td style="width: 10%;"></td> </tr> <tr> <td></td> <td></td> <td colspan="8" style="text-align: center;"> <table border="1" style="width: 100%; border-collapse: collapse; text-align: center;"> <tr> <td style="width: 10%;"></td> <td style="width: 10%;"></td> <td style="width: 10%;"></td> <td style="width: 10%;"></td> <td style="width: 10%;"></td> <td style="width: 10%;"></td> <td style="width: 10%;"></td> <td style="width: 10%;"></td> <td style="width: 10%;"></td> <td style="width: 10%;"></td> </tr> <tr> <td></td> <td></td> <td colspan="8" style="text-align: center;"> <table border="1" style="width: 100%; border-collapse: collapse; text-align: center;"> <tr> </tr></table></td></tr></table></td></tr></table></td></tr></table></td></tr></table></td></tr></table></td></tr></table></td></tr></table></td></tr></table></td></tr></table></td></tr></table></td></tr></table></td></tr></table></td></tr></table></td></tr></table></td></tr></table></td></tr></table></td></tr></table></td></tr></table></td></tr></table></td></tr></table></td></tr></table></td></tr></table></td></tr></table></td></tr></table></td></tr></table></td></tr></table></td></tr></table></td></tr></table></td></tr></table></td></tr></table> | | | | | | | | | | | | | | | | | | | | <table border="1" style="width: 100%; border-collapse: collapse; text-align: center;"> <tr> <td style="width: 10%;"></td> <td style="width: 10%;"></td> <td style="width: 10%;"></td> <td style="width: 10%;"></td> <td style="width: 10%;"></td> <td style="width: 10%;"></td> <td style="width: 10%;"></td> <td style="width: 10%;"></td> <td style="width: 10%;"></td> <td style="width: 10%;"></td> </tr> <tr> <td></td> <td></td> <td colspan="8" style="text-align: center;"> <table border="1" style="width: 100%; border-collapse: collapse; text-align: center;"> <tr> <td style="width: 10%;"></td> <td style="width: 10%;"></td> <td style="width: 10%;"></td> <td style="width: 10%;"></td> <td style="width: 10%;"></td> <td style="width: 10%;"></td> <td style="width: 10%;"></td> <td style="width: 10%;"></td> <td style="width: 10%;"></td> <td style="width: 10%;"></td> </tr> <tr> <td></td> <td></td> <td colspan="8" style="text-align: center;"> <table border="1" style="width: 100%; border-collapse: collapse; text-align: center;"> <tr> <td style="width: 10%;"></td> <td style="width: 10%;"></td> <td style="width: 10%;"></td> <td style="width: 10%;"></td> <td style="width: 10%;"></td> <td style="width: 10%;"></td> <td style="width: 10%;"></td> <td style="width: 10%;"></td> <td style="width: 10%;"></td> <td style="width: 10%;"></td> </tr> <tr> <td></td> <td></td> <td colspan="8" style="text-align: center;"> <table border="1" style="width: 100%; border-collapse: collapse; text-align: center;"> <tr> <td style="width: 10%;"></td> <td style="width: 10%;"></td> <td style="width: 10%;"></td> <td style="width: 10%;"></td> <td style="width: 10%;"></td> <td style="width: 10%;"></td> <td style="width: 10%;"></td> <td style="width: 10%;"></td> <td style="width: 10%;"></td> <td style="width: 10%;"></td> </tr> <tr> <td></td> <td></td> <td colspan="8" style="text-align: center;"> <table border="1" style="width: 100%; border-collapse: collapse; text-align: center;"> <tr> <td style="width: 10%;"></td> <td style="width: 10%;"></td> <td style="width: 10%;"></td> <td style="width: 10%;"></td> <td style="width: 10%;"></td> <td style="width: 10%;"></td> <td style="width: 10%;"></td> <td style="width: 10%;"></td> <td style="width: 10%;"></td> <td style="width: 10%;"></td> </tr> <tr> <td></td> <td></td> <td colspan="8" style="text-align: center;"> <table border="1" style="width: 100%; border-collapse: collapse; text-align: center;"> <tr> <td style="width: 10%;"></td> <td style="width: 10%;"></td> <td style="width: 10%;"></td> <td style="width: 10%;"></td> <td style="width: 10%;"></td> <td style="width: 10%;"></td> <td style="width: 10%;"></td> <td style="width: 10%;"></td> <td style="width: 10%;"></td> <td style="width: 10%;"></td> </tr> <tr> <td></td> <td></td> <td colspan="8" style="text-align: center;"> <table border="1" style="width: 100%; border-collapse: collapse; text-align: center;"> <tr> <td style="width: 10%;"></td> <td style="width: 10%;"></td> <td style="width: 10%;"></td> <td style="width: 10%;"></td> <td style="width: 10%;"></td> <td style="width: 10%;"></td> <td style="width: 10%;"></td> <td style="width: 10%;"></td> <td style="width: 10%;"></td> <td style="width: 10%;"></td> </tr> <tr> <td></td> <td></td> <td colspan="8" style="text-align: center;"> <table border="1" style="width: 100%; border-collapse: collapse; text-align: center;"> <tr> <td style="width: 10%;"></td> <td style="width: 10%;"></td> <td style="width: 10%;"></td> <td
style="width: 10%;"></td> <td style="width: 10%;"></td> <td style="width: 10%;"></td> <td style="width: 10%;"></td> <td style="width: 10%;"></td> <td style="width: 10%;"></td> <td style="width: 10%;"></td> </tr> <tr> <td></td> <td></td> <td colspan="8" style="text-align: center;"> <table border="1" style="width: 100%; border-collapse: collapse; text-align: center;"> <tr> <td style="width: 10%;"></td> <td style="width: 10%;"></td> <td style="width: 10%;"></td> <td style="width: 10%;"></td> <td style="width: 10%;"></td> <td style="width: 10%;"></td> <td style="width: 10%;"></td> <td style="width: 10%;"></td> <td style="width: 10%;"></td> <td style="width: 10%;"></td> </tr> <tr> <td></td> <td></td> <td colspan="8" style="text-align: center;"> <table border="1" style="width: 100%; border-collapse: collapse; text-align: center;"> <tr> <td style="width: 10%;"></td> <td style="width: 10%;"></td> <td style="width: 10%;"></td> <td style="width: 10%;"></td> <td style="width: 10%;"></td> <td style="width: 10%;"></td> <td style="width: 10%;"></td> <td style="width: 10%;"></td> <td style="width: 10%;"></td> <td style="width: 10%;"></td> </tr> <tr> <td></td> <td></td> <td colspan="8" style="text-align: center;"> <table border="1" style="width: 100%; border-collapse: collapse; text-align: center;"> <tr> <td style="width: 10%;"></td> <td style="width: 10%;"></td> <td style="width: 10%;"></td> <td style="width: 10%;"></td> <td style="width: 10%;"></td> <td style="width: 10%;"></td> <td style="width: 10%;"></td> <td style="width: 10%;"></td> <td style="width: 10%;"></td> <td style="width: 10%;"></td> </tr> <tr> <td></td> <td></td> <td colspan="8" style="text-align: center;"> <table border="1" style="width: 100%; border-collapse: collapse; text-align: center;"> <tr> <td style="width: 10%;"></td> <td style="width: 10%;"></td> <td style="width: 10%;"></td> <td style="width: 10%;"></td> <td style="width: 10%;"></td> <td style="width: 10%;"></td> <td style="width: 10%;"></td> <td style="width: 10%;"></td> <td style="width: 10%;"></td> <td style="width: 10%;"></td> </tr> <tr> <td></td> <td></td> <td colspan="8" style="text-align: center;"> <table border="1" style="width: 100%; border-collapse: collapse; text-align: center;"> <tr> <td style="width: 10%;"></td> <td style="width: 10%;"></td> <td style="width: 10%;"></td> <td style="width: 10%;"></td> <td style="width: 10%;"></td> <td style="width: 10%;"></td> <td style="width: 10%;"></td> <td style="width: 10%;"></td> <td style="width: 10%;"></td> <td style="width: 10%;"></td> </tr> <tr> <td></td> <td></td> <td colspan="8" style="text-align: center;"> <table border="1" style="width: 100%; border-collapse: collapse; text-align: center;"> <tr> <td style="width: 10%;"></td> <td style="width: 10%;"></td> <td style="width: 10%;"></td> <td style="width: 10%;"></td> <td style="width: 10%;"></td> <td style="width: 10%;"></td> <td style="width: 10%;"></td> <td style="width: 10%;"></td> <td style="width: 10%;"></td> <td style="width: 10%;"></td> </tr> <tr> <td></td> <td></td> <td colspan="8" style="text-align: center;"> <table border="1" style="width: 100%; border-collapse: collapse; text-align: center;"> <tr> <td style="width: 10%;"></td> <td style="width: 10%;"></td> <td style="width: 10%;"></td> <td style="width: 10%;"></td> <td style="width: 10%;"></td> <td style="width: 10%;"></td> <td style="width: 10%;"></td> <td style="width: 10%;"></td> <td style="width: 10%;"></td> <td style="width: 10%;"></td> </tr> <tr> <td></td> <td></td> <td colspan="8" style="text-align: center;"> <table border="1" style="width: 100%; border-collapse: collapse; text-align: center;"> <tr> <td style="width: 10%;"></td> <td style="width: 10%;"></td> <td style="width: 10%;"></td> <td style="width: 10%;"></td> <td style="width: 10%;"></td> <td style="width: 10%;"></td> <td style="width: 10%;"></td> <td style="width: 10%;"></td> <td style="width: 10%;"></td> <td style="width: 10%;"></td> </tr> <tr> <td></td> <td></td> <td colspan="8" style="text-align: center;"> <table border="1" style="width: 100%; border-collapse: collapse; text-align: center;"> <tr> <td style="width: 10%;"></td> <td style="width: 10%;"></td> <td style="width: 10%;"></td> <td style="width: 10%;"></td> <td style="width: 10%;"></td> <td style="width: 10%;"></td> <td style="width: 10%;"></td> <td style="width: 10%;"></td> <td style="width: 10%;"></td> <td style="width: 10%;"></td> </tr> <tr> <td></td> <td></td> <td colspan="8" style="text-align: center;"> <table border="1" style="width: 100%; border-collapse: collapse; text-align: center;"> <tr> <td style="width: 10%;"></td> <td style="width: 10%;"></td> <td style="width: 10%;"></td> <td style="width: 10%;"></td> <td style="width: 10%;"></td> <td style="width: 10%;"></td> <td style="width: 10%;"></td> <td style="width: 10%;"></td> <td style="width: 10%;"></td> <td style="width: 10%;"></td> </tr> <tr> <td></td> <td></td> <td colspan="8" style="text-align: center;"> <table border="1" style="width: 100%; border-collapse: collapse; text-align: center;"> <tr> <td style="width: 10%;"></td> <td style="width: 10%;"></td> <td style="width: 10%;"></td> <td style="width: 10%;"></td> <td style="width: 10%;"></td> <td style="width: 10%;"></td> <td style="width: 10%;"></td> <td style="width: 10%;"></td> <td style="width: 10%;"></td> <td style="width: 10%;"></td> </tr> <tr> <td></td> <td></td> <td colspan="8" style="text-align: center;"> <table border="1" style="width: 100%; border-collapse: collapse; text-align: center;"> <tr> <td style="width: 10%;"></td> <td style="width: 10%;"></td> <td style="width: 10%;"></td> <td style="width: 10%;"></td> <td style="width: 10%;"></td> <td style="width: 10%;"></td> <td style="width: 10%;"></td> <td style="width: 10%;"></td> <td style="width: 10%;"></td> <td style="width: 10%;"></td> </tr> <tr> <td></td> <td></td> <td colspan="8" style="text-align: center;"> <table border="1" style="width: 100%; border-collapse: collapse; text-align: center;"> <tr> <td style="width: 10%;"></td> <td style="width: 10%;"></td> <td style="width: 10%;"></td> <td style="width: 10%;"></td> <td style="width: 10%;"></td> <td style="width: 10%;"></td> <td style="width: 10%;"></td> <td style="width: 10%;"></td> <td style="width: 10%;"></td> <td style="width: 10%;"></td> </tr> <tr> <td></td> <td></td> <td colspan="8" style="text-align: center;"> <table border="1" style="width: 100%; border-collapse: collapse; text-align: center;"> <tr> <td style="width: 10%;"></td> <td style="width: 10%;"></td> <td style="width: 10%;"></td> <td style="width: 10%;"></td> <td style="width: 10%;"></td> <td style="width: 10%;"></td> <td style="width: 10%;"></td> <td style="width: 10%;"></td> <td style="width: 10%;"></td> <td style="width: 10%;"></td> </tr> <tr> <td></td> <td></td> <td colspan="8" style="text-align: center;"> <table border="1" style="width: 100%; border-collapse: collapse; text-align: center;"> <tr> <td style="width: 10%;"></td> <td style="width: 10%;"></td> <td style="width: 10%;"></td> <td style="width: 10%;"></td> <td style="width: 10%;"></td> <td style="width: 10%;"></td> <td style="width: 10%;"></td> <td style="width: 10%;"></td> <td style="width: 10%;"></td> <td style="width: 10%;"></td> </tr> <tr> <td></td> <td></td> <td colspan="8" style="text-align: center;"> <table border="1" style="width: 100%; border-collapse: collapse; text-align: center;"> <tr> <td style="width: 10%;"></td> <td style="width: 10%;"></td> <td style="width: 10%;"></td> <td style="width: 10%;"></td> <td style="width: 10%;"></td> <td style="width: 10%;"></td> <td style="width: 10%;"></td> <td style="width: 10%;"></td> <td style="width: 10%;"></td> <td style="width: 10%;"></td> </tr> <tr> <td></td> <td></td> <td colspan="8" style="text-align: center;"> <table border="1" style="width: 100%; border-collapse: collapse; text-align: center;"> <tr> <td style="width: 10%;"></td> <td style="width: 10%;"></td> <td style="width: 10%;"></td> <td style="width: 10%;"></td> <td style="width: 10%;"></td> <td style="width: 10%;"></td> <td style="width: 10%;"></td> <td style="width: 10%;"></td> <td style="width: 10%;"></td> <td style="width: 10%;"></td> </tr> <tr> <td></td> <td></td> <td colspan="8" style="text-align: center;"> <table border="1" style="width: 100%; border-collapse: collapse; text-align: center;"> <tr> <td style="width: 10%;"></td> <td style="width: 10%;"></td> <td style="width: 10%;"></td> <td style="width: 10%;"></td> <td style="width: 10%;"></td> <td style="width: 10%;"></td> <td style="width: 10%;"></td> <td style="width: 10%;"></td> <td style="width: 10%;"></td> <td style="width: 10%;"></td> </tr> <tr> <td></td> <td></td> <td colspan="8" style="text-align: center;"> <table border="1" style="width: 100%; border-collapse: collapse; text-align: center;"> <tr> <td style="width: 10%;"></td> <td style="width: 10%;"></td> <td style="width: 10%;"></td> <td style="width: 10%;"></td> <td style="width: 10%;"></td> <td style="width: 10%;"></td> <td style="width: 10%;"></td> <td style="width: 10%;"></td> <td style="width: 10%;"></td> <td style="width: 10%;"></td> </tr> <tr> <td></td> <td></td> <td colspan="8" style="text-align: center;"> <table border="1" style="width: 100%; border-collapse: collapse; text-align: center;"> <tr> <td style="width: 10%;"></td> <td style="width: 10%;"></td> <td style="width: 10%;"></td> <td style="width: 10%;"></td> <td style="width: 10%;"></td> <td style="width: 10%;"></td> <td style="width: 10%;"></td> <td style="width: 10%;"></td> <td style="width: 10%;"></td> <td style="width: 10%;"></td> </tr> <tr> <td></td> <td></td> <td colspan="8" style="text-align: center;"> <table border="1" style="width: 100%; border-collapse: collapse; text-align: center;"> <tr> <td style="width: 10%;"></td> <td style="width: 10%;"></td> <td style="width: 10%;"></td> <td style="width: 10%;"></td> <td style="width: 10%;"></td> <td style="width: 10%;"></td> <td style="width: 10%;"></td> <td style="width: 10%;"></td> <td style="width:
10%;"></td> <td style="width: 10%;"></td> </tr> <tr> <td></td> <td></td> <td colspan="8" style="text-align: center;"> <table border="1" style="width: 100%; border-collapse: collapse; text-align: center;"> <tr> </tr></table></td></tr></table></td></tr></table></td></tr></table></td></tr></table></td></tr></table></td></tr></table></td></tr></table></td></tr></table></td></tr></table></td></tr></table></td></tr></table></td></tr></table></td></tr></table></td></tr></table></td></tr></table></td></tr></table></td></tr></table></td></tr></table></td></tr></table></td></tr></table></td></tr></table></td></tr></table></td></tr></table></td></tr></table></td></tr></table></td></tr></table></td></tr></table></td></tr></table></td></tr></table> | | | | | | | | | | | | | | | | | | | | <table border="1" style="width: 100%; border-collapse: collapse; text-align: center;"> <tr> <td style="width: 10%;"></td> <td style="width: 10%;"></td> <td style="width: 10%;"></td> <td style="width: 10%;"></td> <td style="width: 10%;"></td> <td style="width: 10%;"></td> <td style="width: 10%;"></td> <td style="width: 10%;"></td> <td style="width: 10%;"></td> <td style="width: 10%;"></td> </tr> <tr> <td></td> <td></td> <td colspan="8" style="text-align: center;"> <table border="1" style="width: 100%; border-collapse: collapse; text-align: center;"> <tr> <td style="width: 10%;"></td> <td style="width: 10%;"></td> <td style="width: 10%;"></td> <td style="width: 10%;"></td> <td style="width: 10%;"></td> <td style="width: 10%;"></td> <td style="width: 10%;"></td> <td style="width: 10%;"></td> <td style="width: 10%;"></td> <td style="width: 10%;"></td> </tr> <tr> <td></td> <td></td> <td colspan="8" style="text-align: center;"> <table border="1" style="width: 100%; border-collapse: collapse; text-align: center;"> <tr> <td style="width: 10%;"></td> <td style="width: 10%;"></td> <td style="width: 10%;"></td> <td style="width: 10%;"></td> <td style="width: 10%;"></td> <td style="width: 10%;"></td> <td style="width: 10%;"></td> <td style="width: 10%;"></td> <td style="width: 10%;"></td> <td style="width: 10%;"></td> </tr> <tr> <td></td> <td></td> <td colspan="8" style="text-align: center;"> <table border="1" style="width: 100%; border-collapse: collapse; text-align: center;"> <tr> <td style="width: 10%;"></td> <td style="width: 10%;"></td> <td style="width: 10%;"></td> <td style="width: 10%;"></td> <td style="width: 10%;"></td> <td style="width: 10%;"></td> <td style="width: 10%;"></td> <td style="width: 10%;"></td> <td style="width: 10%;"></td> <td style="width: 10%;"></td> </tr> <tr> <td></td> <td></td> <td colspan="8" style="text-align: center;"> <table border="1" style="width: 100%; border-collapse: collapse; text-align: center;"> <tr> <td style="width: 10%;"></td> <td style="width: 10%;"></td> <td style="width: 10%;"></td> <td style="width: 10%;"></td> <td style="width: 10%;"></td> <td style="width: 10%;"></td> <td style="width: 10%;"></td> <td style="width: 10%;"></td> <td style="width: 10%;"></td> <td style="width: 10%;"></td> </tr> <tr> <td></td> <td></td> <td colspan="8" style="text-align: center;"> <table border="1" style="width: 100%; border-collapse: collapse; text-align: center;"> <tr> <td style="width: 10%;"></td> <td style="width: 10%;"></td> <td style="width: 10%;"></td> <td style="width: 10%;"></td> <td style="width: 10%;"></td> <td style="width: 10%;"></td> <td style="width: 10%;"></td> <td style="width: 10%;"></td> <td style="width: 10%;"></td> <td style="width: 10%;"></td> </tr> <tr> <td></td> <td></td> <td colspan="8" style="text-align: center;"> <table border="1" style="width: 100%; border-collapse: collapse; text-align: center;"> <tr> <td style="width: 10%;"></td> <td style="width: 10%;"></td> <td style="width: 10%;"></td> <td style="width: 10%;"></td> <td style="width: 10%;"></td> <td style="width: 10%;"></td> <td style="width: 10%;"></td> <td style="width: 10%;"></td> <td style="width: 10%;"></td> <td style="width: 10%;"></td> </tr> <tr> <td></td> <td></td> <td colspan="8" style="text-align: center;"> <table border="1" style="width: 100%; border-collapse: collapse; text-align: center;"> <tr> <td style="width: 10%;"></td> <td style="width: 10%;"></td> <td style="width: 10%;"></td> <td style="width: 10%;"></td> <td style="width: 10%;"></td> <td style="width: 10%;"></td> <td style="width: 10%;"></td> <td style="width: 10%;"></td> <td style="width: 10%;"></td> <td style="width: 10%;"></td> </tr> <tr> <td></td> <td></td> <td colspan="8" style="text-align: center;"> <table border="1" style="width: 100%; border-collapse: collapse; text-align: center;"> <tr> <td style="width: 10%;"></td> <td style="width: 10%;"></td> <td style="width: 10%;"></td> <td style="width: 10%;"></td> <td style="width: 10%;"></td> <td style="width: 10%;"></td> <td style="width: 10%;"></td> <td style="width: 10%;"></td> <td style="width: 10%;"></td> <td style="width: 10%;"></td> </tr> <tr> <td></td> <td></td> <td colspan="8" style="text-align: center;"> <table border="1" style="width: 100%; border-collapse: collapse; text-align: center;"> <tr> <td style="width: 10%;"></td> <td style="width: 10%;"></td> <td style="width: 10%;"></td> <td style="width: 10%;"></td> <td style="width: 10%;"></td> <td style="width: 10%;"></td> <td style="width: 10%;"></td> <td style="width: 10%;"></td> <td style="width: 10%;"></td> <td style="width: 10%;"></td> </tr> <tr> <td></td> <td></td> <td colspan="8" style="text-align: center;"> <table border="1" style="width: 100%; border-collapse: collapse; text-align: center;"> <tr> <td style="width: 10%;"></td> <td style="width: 10%;"></td> <td style="width: 10%;"></td> <td style="width: 10%;"></td> <td style="width: 10%;"></td> <td style="width: 10%;"></td> <td style="width: 10%;"></td> <td style="width: 10%;"></td> <td style="width: 10%;"></td> <td style="width: 10%;"></td> </tr> <tr> <td></td> <td></td> <td colspan="8" style="text-align: center;"> <table border="1" style="width: 100%; border-collapse: collapse; text-align: center;"> <tr> <td style="width: 10%;"></td> <td style="width: 10%;"></td> <td style="width: 10%;"></td> <td style="width: 10%;"></td> <td style="width: 10%;"></td> <td style="width: 10%;"></td> <td style="width: 10%;"></td> <td style="width: 10%;"></td> <td style="width: 10%;"></td> <td style="width: 10%;"></td> </tr> <tr> <td></td> <td></td> <td colspan="8" style="text-align: center;"> <table border="1" style="width: 100%; border-collapse: collapse; text-align: center;"> <tr> <td style="width: 10%;"></td> <td style="width: 10%;"></td> <td style="width: 10%;"></td> <td style="width: 10%;"></td> <td style="width: 10%;"></td> <td style="width: 10%;"></td> <td style="width: 10%;"></td> <td style="width: 10%;"></td> <td style="width: 10%;"></td> <td style="width: 10%;"></td> </tr> <tr> <td></td> <td></td> <td colspan="8" style="text-align: center;"> <table border="1" style="width: 100%; border-collapse: collapse; text-align: center;"> <tr> <td style="width: 10%;"></td> <td style="width: 10%;"></td> <td style="width: 10%;"></td> <td style="width: 10%;"></td> <td style="width: 10%;"></td> <td style="width: 10%;"></td> <td style="width: 10%;"></td> <td style="width: 10%;"></td> <td style="width: 10%;"></td> <td style="width: 10%;"></td> </tr> <tr> <td></td> <td></td> <td colspan="8" style="text-align: center;"> <table border="1" style="width: 100%; border-collapse: collapse; text-align: center;"> <tr> <td style="width: 10%;"></td> <td style="width: 10%;"></td> <td style="width: 10%;"></td> <td style="width: 10%;"></td> <td style="width: 10%;"></td> <td style="width: 10%;"></td> <td style="width: 10%;"></td> <td style="width: 10%;"></td> <td style="width: 10%;"></td> <td style="width: 10%;"></td> </tr> <tr> <td></td> <td></td> <td colspan="8" style="text-align: center;"> <table border="1" style="width: 100%; border-collapse: collapse; text-align: center;"> <tr> <td style="width: 10%;"></td> <td style="width: 10%;"></td> <td style="width: 10%;"></td> <td style="width: 10%;"></td> <td style="width: 10%;"></td> <td style="width: 10%;"></td> <td style="width: 10%;"></td> <td style="width: 10%;"></td> <td style="width: 10%;"></td> <td style="width: 10%;"></td> </tr> <tr> <td></td> <td></td> <td colspan="8" style="text-align: center;"> <table border="1" style="width: 100%; border-collapse: collapse; text-align: center;"> <tr> <td style="width: 10%;"></td> <td style="width: 10%;"></td> <td style="width: 10%;"></td> <td style="width: 10%;"></td> <td style="width: 10%;"></td> <td style="width: 10%;"></td> <td style="width: 10%;"></td> <td style="width: 10%;"></td> <td style="width: 10%;"></td> <td style="width: 10%;"></td> </tr> <tr> <td></td> <td></td> <td colspan="8" style="text-align: center;"> <table border="1" style="width: 100%; border-collapse: collapse; text-align: center;"> <tr> <td style="width: 10%;"></td> <td style="width: 10%;"></td> <td style="width: 10%;"></td> <td style="width: 10%;"></td> <td style="width: 10%;"></td> <td style="width: 10%;"></td> <td style="width: 10%;"></td> <td style="width: 10%;"></td> <td style="width: 10%;"></td> <td style="width: 10%;"></td> </tr> <tr> <td></td> <td></td> <td colspan="8" style="text-align: center;"> <table border="1" style="width: 100%; border-collapse: collapse; text-align: center;"> <tr> <td style="width: 10%;"></td> <td style="width: 10%;"></td> <td style="width: 10%;"></td> <td style="width: 10%;"></td> <td style="width: 10%;"></td> <td style="width: 10%;"></td> <td style="width: 10%;"></td> <td style="width: 10%;"></td> <td style="width: 10%;"></td> <td style="width: 10%;"></td> </tr> <tr> <td></td> <td></td> <td colspan="8" style="text-align: center;"> <table border="1" style="width: 100%; border-collapse: collapse; text-align: center;"> <tr> <td style="width: 10%;"></td> <td style="width: 10%;"></td> <td style="width: 10%;"></td> <td style="width: 10%;"></td> <td style="width: 10%;"></td> <td style="width: 10%;"></td> <td style="width: 10%;"></td>
<td style="width: 10%;"></td> <td style="width: 10%;"></td> <td style="width: 10%;"></td> </tr> <tr> <td></td> <td></td> <td colspan="8" style="text-align: center;"> <table border="1" style="width: 100%; border-collapse: collapse; text-align: center;"> <tr> <td style="width: 10%;"></td> <td style="width: 10%;"></td> <td style="width: 10%;"></td> <td style="width: 10%;"></td> <td style="width: 10%;"></td> <td style="width: 10%;"></td> <td style="width: 10%;"></td> <td style="width: 10%;"></td> <td style="width: 10%;"></td> <td style="width: 10%;"></td> </tr> <tr> <td></td> <td></td> <td colspan="8" style="text-align: center;"> <table border="1" style="width: 100%; border-collapse: collapse; text-align: center;"> <tr> <td style="width: 10%;"></td> <td style="width: 10%;"></td> <td style="width: 10%;"></td> <td style="width: 10%;"></td> <td style="width: 10%;"></td> <td style="width: 10%;"></td> <td style="width: 10%;"></td> <td style="width: 10%;"></td> <td style="width: 10%;"></td> <td style="width: 10%;"></td> </tr> <tr> <td></td> <td></td> <td colspan="8" style="text-align: center;"> <table border="1" style="width: 100%; border-collapse: collapse; text-align: center;"> <tr> <td style="width: 10%;"></td> <td style="width: 10%;"></td> <td style="width: 10%;"></td> <td style="width: 10%;"></td> <td style="width: 10%;"></td> <td style="width: 10%;"></td> <td style="width: 10%;"></td> <td style="width: 10%;"></td> <td style="width: 10%;"></td> <td style="width: 10%;"></td> </tr> <tr> <td></td> <td></td> <td colspan="8" style="text-align: center;"> <table border="1" style="width: 100%; border-collapse: collapse; text-align: center;"> <tr> <td style="width: 10%;"></td> <td style="width: 10%;"></td> <td style="width: 10%;"></td> <td style="width: 10%;"></td> <td style="width: 10%;"></td> <td style="width: 10%;"></td> <td style="width: 10%;"></td> <td style="width: 10%;"></td> <td style="width: 10%;"></td> <td style="width: 10%;"></td> </tr> <tr> <td></td> <td></td> <td colspan="8" style="text-align: center;"> <table border="1" style="width: 100%; border-collapse: collapse; text-align: center;"> <tr> <td style="width: 10%;"></td> <td style="width: 10%;"></td> <td style="width: 10%;"></td> <td style="width: 10%;"></td> <td style="width: 10%;"></td> <td style="width: 10%;"></td> <td style="width: 10%;"></td> <td style="width: 10%;"></td> <td style="width: 10%;"></td> <td style="width: 10%;"></td> </tr> <tr> <td></td> <td></td> <td colspan="8" style="text-align: center;"> <table border="1" style="width: 100%; border-collapse: collapse; text-align: center;"> <tr> <td style="width: 10%;"></td> <td style="width: 10%;"></td> <td style="width: 10%;"></td> <td style="width: 10%;"></td> <td style="width: 10%;"></td> <td style="width: 10%;"></td> <td style="width: 10%;"></td> <td style="width: 10%;"></td> <td style="width: 10%;"></td> <td style="width: 10%;"></td> </tr> <tr> <td></td> <td></td> <td colspan="8" style="text-align: center;"> <table border="1" style="width: 100%; border-collapse: collapse; text-align: center;"> <tr> <td style="width: 10%;"></td> <td style="width: 10%;"></td> <td style="width: 10%;"></td> <td style="width: 10%;"></td> <td style="width: 10%;"></td> <td style="width: 10%;"></td> <td style="width: 10%;"></td> <td style="width: 10%;"></td> <td style="width: 10%;"></td> <td style="width: 10%;"></td> </tr> <tr> <td></td> <td></td> <td colspan="8" style="text-align: center;"> <table border="1" style="width: 100%; border-collapse: collapse; text-align: center;"> <tr> <td style="width: 10%;"></td> <td style="width: 10%;"></td> <td style="width: 10%;"></td> <td style="width: 10%;"></td> <td style="width: 10%;"></td> <td style="width: 10%;"></td> <td style="width: 10%;"></td> <td style="width: 10%;"></td> <td style="width: 10%;"></td> <td style="width: 10%;"></td> </tr> <tr> <td></td> <td></td> <td colspan="8" style="text-align: center;"> <table border="1" style="width: 100%; border-collapse: collapse; text-align: center;"> <tr> </tr></table></td></tr></table></td></tr></table></td></tr></table></td></tr></table></td></tr></table></td></tr></table></td></tr></table></td></tr></table></td></tr></table></td></tr></table></td></tr></table></td></tr></table></td></tr></table></td></tr></table></td></tr></table></td></tr></table></td></tr></table></td></tr></table></td></tr></table></td></tr></table></td></tr></table></td></tr></table></td></tr></table></td></tr></table></td></tr></table></td></tr></table></td></tr></table></td></tr></table> | | | | | | | | | | | | | | | | | | | | <table border="1" style="width: 100%; border-collapse: collapse; text-align: center;"> <tr> <td style="width: 10%;"></td> <td style="width: 10%;"></td> <td style="width: 10%;"></td> <td style="width: 10%;"></td> <td style="width: 10%;"></td> <td style="width: 10%;"></td> <td style="width: 10%;"></td> <td style="width: 10%;"></td> <td style="width: 10%;"></td> <td style="width: 10%;"></td> </tr> <tr> <td></td> <td></td> <td colspan="8" style="text-align: center;"> <table border="1" style="width: 100%; border-collapse: collapse; text-align: center;"> <tr> <td style="width: 10%;"></td> <td style="width: 10%;"></td> <td style="width: 10%;"></td> <td style="width: 10%;"></td> <td style="width: 10%;"></td> <td style="width: 10%;"></td> <td style="width: 10%;"></td> <td style="width: 10%;"></td> <td style="width: 10%;"></td> <td style="width: 10%;"></td> </tr> <tr> <td></td> <td></td> <td colspan="8" style="text-align: center;"> <table border="1" style="width: 100%; border-collapse: collapse; text-align: center;"> <tr> <td style="width: 10%;"></td> <td style="width: 10%;"></td> <td style="width: 10%;"></td> <td style="width: 10%;"></td> <td style="width: 10%;"></td> <td style="width: 10%;"></td> <td style="width: 10%;"></td> <td style="width: 10%;"></td> <td style="width: 10%;"></td> <td style="width: 10%;"></td> </tr> <tr> <td></td> <td></td> <td colspan="8" style="text-align: center;"> <table border="1" style="width: 100%; border-collapse: collapse; text-align: center;"> <tr> <td style="width: 10%;"></td> <td style="width: 10%;"></td> <td style="width: 10%;"></td> <td style="width: 10%;"></td> <td style="width: 10%;"></td> <td style="width: 10%;"></td> <td style="width: 10%;"></td> <td style="width: 10%;"></td> <td style="width: 10%;"></td> <td style="width: 10%;"></td> </tr> <tr> <td></td> <td></td> <td colspan="8" style="text-align: center;"> <table border="1" style="width: 100%; border-collapse: collapse; text-align: center;"> <tr> <td style="width: 10%;"></td> <td style="width: 10%;"></td> <td style="width: 10%;"></td> <td style="width: 10%;"></td> <td style="width: 10%;"></td> <td style="width: 10%;"></td> <td style="width: 10%;"></td> <td style="width: 10%;"></td> <td style="width: 10%;"></td> <td style="width: 10%;"></td> </tr> <tr> <td></td> <td></td> <td colspan="8" style="text-align: center;"> <table border="1" style="width: 100%; border-collapse: collapse; text-align: center;"> <tr> <td style="width: 10%;"></td> <td style="width: 10%;"></td> <td style="width: 10%;"></td> <td style="width: 10%;"></td> <td style="width: 10%;"></td> <td style="width: 10%;"></td> <td style="width: 10%;"></td> <td style="width: 10%;"></td> <td style="width: 10%;"></td> <td style="width: 10%;"></td> </tr> <tr> <td></td> <td></td> <td colspan="8" style="text-align: center;"> <table border="1" style="width: 100%; border-collapse: collapse; text-align: center;"> <tr> <td style="width: 10%;"></td> <td style="width: 10%;"></td> <td style="width: 10%;"></td> <td style="width: 10%;"></td> <td style="width: 10%;"></td> <td style="width: 10%;"></td> <td style="width: 10%;"></td> <td style="width: 10%;"></td> <td style="width: 10%;"></td> <td style="width: 10%;"></td> </tr> <tr> <td></td> <td></td> <td colspan="8" style="text-align: center;"> <table border="1" style="width: 100%; border-collapse: collapse; text-align: center;"> <tr> <td style="width: 10%;"></td> <td style="width: 10%;"></td> <td style="width: 10%;"></td> <td style="width: 10%;"></td> <td style="width: 10%;"></td> <td style="width: 10%;"></td> <td style="width: 10%;"></td> <td style="width: 10%;"></td> <td style="width: 10%;"></td> <td style="width: 10%;"></td> </tr> <tr> <td></td> <td></td> <td colspan="8" style="text-align: center;"> <table border="1" style="width: 100%; border-collapse: collapse; text-align: center;"> <tr> <td style="width: 10%;"></td> <td style="width: 10%;"></td> <td style="width: 10%;"></td> <td style="width: 10%;"></td> <td style="width: 10%;"></td> <td style="width: 10%;"></td> <td style="width: 10%;"></td> <td style="width: 10%;"></td> <td style="width: 10%;"></td> <td style="width: 10%;"></td> </tr> <tr> <td></td> <td></td> <td colspan="8" style="text-align: center;"> <table border="1" style="width: 100%; border-collapse: collapse; text-align: center;"> <tr> <td style="width: 10%;"></td> <td style="width: 10%;"></td> <td style="width: 10%;"></td> <td style="width: 10%;"></td> <td style="width: 10%;"></td> <td style="width: 10%;"></td> <td style="width: 10%;"></td> <td style="width: 10%;"></td> <td style="width: 10%;"></td> <td style="width: 10%;"></td> </tr> <tr> <td></td> <td></td> <td colspan="8" style="text-align: center;"> <table border="1" style="width: 100%; border-collapse: collapse; text-align: center;"> <tr> <td style="width: 10%;"></td> <td style="width: 10%;"></td> <td style="width: 10%;"></td> <td style="width: 10%;"></td> <td style="width: 10%;"></td> <td style="width: 10%;"></td> <td style="width: 10%;"></td> <td style="width: 10%;"></td> <td style="width: 10%;"></td> <td style="width: 10%;"></td> </tr> <tr> <td></td> <td></td> <td colspan="8" style="text-align: center;"> <table border="1" style="width: 100%; border-collapse: collapse; text-align: center;"> <tr> <td style="width: 10%;"></td> <td style="width: 10%;"></td> <td style="width: 10%;"></td> <td style="width: 10%;"></td> <td style="width: 10%;"></td> <td style="width: 10%;"></td>
<td style="width: 10%;"></td> <td style="width: 10%;"></td> <td style="width: 10%;"></td> <td style="width: 10%;"></td> </tr> <tr> <td></td> <td></td> <td colspan="8" style="text-align: center;"> <table border="1" style="width: 100%; border-collapse: collapse; text-align: center;"> <tr> <td style="width: 10%;"></td> <td style="width: 10%;"></td> <td style="width: 10%;"></td> <td style="width: 10%;"></td> <td style="width: 10%;"></td> <td style="width: 10%;"></td> <td style="width: 10%;"></td> <td style="width: 10%;"></td> <td style="width: 10%;"></td> <td style="width: 10%;"></td> </tr> <tr> <td></td> <td></td> <td colspan="8" style="text-align: center;"> <table border="1" style="width: 100%; border-collapse: collapse; text-align: center;"> <tr> <td style="width: 10%;"></td> <td style="width: 10%;"></td> <td style="width: 10%;"></td> <td style="width: 10%;"></td> <td style="width: 10%;"></td> <td style="width: 10%;"></td> <td style="width: 10%;"></td> <td style="width: 10%;"></td> <td style="width: 10%;"></td> <td style="width: 10%;"></td> </tr> <tr> <td></td> <td></td> <td colspan="8" style="text-align: center;"> <table border="1" style="width: 100%; border-collapse: collapse; text-align: center;"> <tr> <td style="width: 10%;"></td> <td style="width: 10%;"></td> <td style="width: 10%;"></td> <td style="width: 10%;"></td> <td style="width: 10%;"></td> <td style="width: 10%;"></td> <td style="width: 10%;"></td> <td style="width: 10%;"></td> <td style="width: 10%;"></td> <td style="width: 10%;"></td> </tr> <tr> <td></td> <td></td> <td colspan="8" style="text-align: center;"> <table border="1" style="width: 100%; border-collapse: collapse; text-align: center;"> <tr> <td style="width: 10%;"></td> <td style="width: 10%;"></td> <td style="width: 10%;"></td> <td style="width: 10%;"></td> <td style="width: 10%;"></td> <td style="width: 10%;"></td> <td style="width: 10%;"></td> <td style="width: 10%;"></td> <td style="width: 10%;"></td> <td style="width: 10%;"></td> </tr> <tr> <td></td> <td></td> <td colspan="8" style="text-align: center;"> <table border="1" style="width: 100%; border-collapse: collapse; text-align: center;"> <tr> <td style="width: 10%;"></td> <td style="width: 10%;"></td> <td style="width: 10%;"></td> <td style="width: 10%;"></td> <td style="width: 10%;"></td> <td style="width: 10%;"></td> <td style="width: 10%;"></td> <td style="width: 10%;"></td> <td style="width: 10%;"></td> <td style="width: 10%;"></td> </tr> <tr> <td></td> <td></td> <td colspan="8" style="text-align: center;"> <table border="1" style="width: 100%; border-collapse: collapse; text-align: center;"> <tr> <td style="width: 10%;"></td> <td style="width: 10%;"></td> <td style="width: 10%;"></td> <td style="width: 10%;"></td> <td style="width: 10%;"></td> <td style="width: 10%;"></td> <td style="width: 10%;"></td> <td style="width: 10%;"></td> <td style="width: 10%;"></td> <td style="width: 10%;"></td> </tr> <tr> <td></td> <td></td> <td colspan="8" style="text-align: center;"> <table border="1" style="width: 100%; border-collapse: collapse; text-align: center;"> <tr> <td style="width: 10%;"></td> <td style="width: 10%;"></td> <td style="width: 10%;"></td> <td style="width: 10%;"></td> <td style="width: 10%;"></td> <td style="width: 10%;"></td> <td style="width: 10%;"></td> <td style="width: 10%;"></td> <td style="width: 10%;"></td> <td style="width: 10%;"></td> </tr> <tr> <td></td> <td></td> <td colspan="8" style="text-align: center;"> <table border="1" style="width: 100%; border-collapse: collapse; text-align: center;"> <tr> <td style="width: 10%;"></td> <td style="width: 10%;"></td> <td style="width: 10%;"></td> <td style="width: 10%;"></td> <td style="width: 10%;"></td> <td style="width: 10%;"></td> <td style="width: 10%;"></td> <td style="width: 10%;"></td> <td style="width: 10%;"></td> <td style="width: 10%;"></td> </tr> <tr> <td></td> <td></td> <td colspan="8" style="text-align: center;"> <table border="1" style="width: 100%; border-collapse: collapse; text-align: center;"> <tr> <td style="width: 10%;"></td> <td style="width: 10%;"></td> <td style="width: 10%;"></td> <td style="width: 10%;"></td> <td style="width: 10%;"></td> <td style="width: 10%;"></td> <td style="width: 10%;"></td> <td style="width: 10%;"></td> <td style="width: 10%;"></td> <td style="width: 10%;"></td> </tr> <tr> <td></td> <td></td> <td colspan="8" style="text-align: center;"> <table border="1" style="width: 100%; border-collapse: collapse; text-align: center;"> <tr> <td style="width: 10%;"></td> <td style="width: 10%;"></td> <td style="width: 10%;"></td> <td style="width: 10%;"></td> <td style="width: 10%;"></td> <td style="width: 10%;"></td> <td style="width: 10%;"></td> <td style="width: 10%;"></td> <td style="width: 10%;"></td> <td style="width: 10%;"></td> </tr> <tr> <td></td> <td></td> <td colspan="8" style="text-align: center;"> <table border="1" style="width: 100%; border-collapse: collapse; text-align: center;"> <tr> <td style="width: 10%;"></td> <td style="width: 10%;"></td> <td style="width: 10%;"></td> <td style="width: 10%;"></td> <td style="width: 10%;"></td> <td style="width: 10%;"></td> <td style="width: 10%;"></td> <td style="width: 10%;"></td> <td style="width: 10%;"></td> <td style="width: 10%;"></td> </tr> <tr> <td></td> <td></td> <td colspan="8" style="text-align: center;"> <table border="1" style="width: 100%; border-collapse: collapse; text-align: center;"> <tr> <td style="width: 10%;"></td> <td style="width: 10%;"></td> <td style="width: 10%;"></td> <td style="width: 10%;"></td> <td style="width: 10%;"></td> <td style="width: 10%;"></td> <td style="width: 10%;"></td> <td style="width: 10%;"></td> <td style="width: 10%;"></td> <td style="width: 10%;"></td> </tr> <tr> <td></td> <td></td> <td colspan="8" style="text-align: center;"> <table border="1" style="width: 100%; border-collapse: collapse; text-align: center;"> <tr> <td style="width: 10%;"></td> <td style="width: 10%;"></td> <td style="width: 10%;"></td> <td style="width: 10%;"></td> <td style="width: 10%;"></td> <td style="width: 10%;"></td> <td style="width: 10%;"></td> <td style="width: 10%;"></td> <td style="width: 10%;"></td> <td style="width: 10%;"></td> </tr> <tr> <td></td> <td></td> <td colspan="8" style="text-align: center;"> <table border="1" style="width: 100%; border-collapse: collapse; text-align: center;"> <tr> <td style="width: 10%;"></td> <td style="width: 10%;"></td> <td style="width: 10%;"></td> <td style="width: 10%;"></td> <td style="width: 10%;"></td> <td style="width: 10%;"></td> <td style="width: 10%;"></td> <td style="width: 10%;"></td> <td style="width: 10%;"></td> <td style="width: 10%;"></td> </tr> <tr> <td></td> <td></td> <td colspan="8" style="text-align: center;"> <table border="1" style="width: 100%; border-collapse: collapse; text-align: center;"> <tr> <td style="width: 10%;"></td> <td style="width: 10%;"></td> <td style="width: 10%;"></td> <td style="width: 10%;"></td> <td style="width: 10%;"></td> <td style="width: 10%;"></td> <td style="width: 10%;"></td> <td style="width: 10%;"></td> <td style="width: 10%;"></td> <td style="width: 10%;"></td> </tr> <tr> <td></td> <td></td> <td colspan="8" style="text-align: center;"> <table border="1" style="width: 100%; border-collapse: collapse; text-align: center;"> <tr> </tr></table></td></tr></table></td></tr></table></td></tr></table></td></tr></table></td></tr></table></td></tr></table></td></tr></table></td></tr></table></td></tr></table></td></tr></table></td></tr></table></td></tr></table></td></tr></table></td></tr></table></td></tr></table></td></tr></table></td></tr></table></td></tr></table></td></tr></table></td></tr></table></td></tr></table></td></tr></table></td></tr></table></td></tr></table></td></tr></table></td></tr></table></td></tr></table> | | | | | | | | | | | | | | | | | | | | <table border="1" style="width: 100%; border-collapse: collapse; text-align: center;"> <tr> <td style="width: 10%;"></td> <td style="width: 10%;"></td> <td style="width: 10%;"></td> <td style="width: 10%;"></td> <td style="width: 10%;"></td> <td style="width: 10%;"></td> <td style="width: 10%;"></td> <td style="width: 10%;"></td> <td style="width: 10%;"></td> <td style="width: 10%;"></td> </tr> <tr> <td></td> <td></td> <td colspan="8" style="text-align: center;"> <table border="1" style="width: 100%; border-collapse: collapse; text-align: center;"> <tr> <td style="width: 10%;"></td> <td style="width: 10%;"></td> <td style="width: 10%;"></td> <td style="width: 10%;"></td> <td style="width: 10%;"></td> <td style="width: 10%;"></td> <td style="width: 10%;"></td> <td style="width: 10%;"></td> <td style="width: 10%;"></td> <td style="width: 10%;"></td> </tr> <tr> <td></td> <td></td> <td colspan="8" style="text-align: center;"> <table border="1" style="width: 100%; border-collapse: collapse; text-align: center;"> <tr> <td style="width: 10%;"></td> <td style="width: 10%;"></td> <td style="width: 10%;"></td> <td style="width: 10%;"></td> <td style="width: 10%;"></td> <td style="width: 10%;"></td> <td style="width: 10%;"></td> <td style="width: 10%;"></td> <td style="width: 10%;"></td> <td style="width: 10%;"></td> </tr> <tr> <td></td> <td></td> <td colspan="8" style="text-align: center;"> <table border="1" style="width: 100%; border-collapse: collapse; text-align: center;"> <tr> <td style="width: 10%;"></td> <td style="width: 10%;"></td> <td style="width: 10%;"></td> <td style="width: 10%;"></td> <td style="width: 10%;"></td> <td style="width: 10%;"></td> <td style="width: 10%;"></td> <td style="width: 10%;"></td> <td style="width: 10%;"></td> <td style="width: 10%;"></td> </tr> <tr> <td></td> <td></td> <td colspan="8" style="text-align: center;"> <table border="1" style="width: 100%; border-collapse: collapse; text-align: center;"> <tr> <td style="width: 10%;"></td> <td style="width: 10%;"></td> <td style="width: 10%;"></td> <td style="width: 10%;"></td> <td style="width: 10%;"></td> <td style="width:
10%;"></td> <td style="width: 10%;"></td> <td style="width: 10%;"></td> <td style="width: 10%;"></td> <td style="width: 10%;"></td> </tr> <tr> <td></td> <td></td> <td colspan="8" style="text-align: center;"> <table border="1" style="width: 100%; border-collapse: collapse; text-align: center;"> <tr> <td style="width: 10%;"></td> <td style="width: 10%;"></td> <td style="width: 10%;"></td> <td style="width: 10%;"></td> <td style="width: 10%;"></td> <td style="width: 10%;"></td> <td style="width: 10%;"></td> <td style="width: 10%;"></td> <td style="width: 10%;"></td> <td style="width: 10%;"></td> </tr> <tr> <td></td> <td></td> <td colspan="8" style="text-align: center;"> <table border="1" style="width: 100%; border-collapse: collapse; text-align: center;"> <tr> <td style="width: 10%;"></td> <td style="width: 10%;"></td> <td style="width: 10%;"></td> <td style="width: 10%;"></td> <td style="width: 10%;"></td> <td style="width: 10%;"></td> <td style="width: 10%;"></td> <td style="width: 10%;"></td> <td style="width: 10%;"></td> <td style="width: 10%;"></td> </tr> <tr> <td></td> <td></td> <td colspan="8" style="text-align: center;"> <table border="1" style="width: 100%; border-collapse: collapse; text-align: center;"> <tr> <td style="width: 10%;"></td> <td style="width: 10%;"></td> <td style="width: 10%;"></td> <td style="width: 10%;"></td> <td style="width: 10%;"></td> <td style="width: 10%;"></td> <td style="width: 10%;"></td> <td style="width: 10%;"></td> <td style="width: 10%;"></td> <td style="width: 10%;"></td> </tr> <tr> <td></td> <td></td> <td colspan="8" style="text-align: center;"> <table border="1" style="width: 100%; border-collapse: collapse; text-align: center;"> <tr> <td style="width: 10%;"></td> <td style="width: 10%;"></td> <td style="width: 10%;"></td> <td style="width: 10%;"></td> <td style="width: 10%;"></td> <td style="width: 10%;"></td> <td style="width: 10%;"></td> <td style="width: 10%;"></td> <td style="width: 10%;"></td> <td style="width: 10%;"></td> </tr> <tr> <td></td> <td></td> <td colspan="8" style="text-align: center;"> <table border="1" style="width: 100%; border-collapse: collapse; text-align: center;"> <tr> <td style="width: 10%;"></td> <td style="width: 10%;"></td> <td style="width: 10%;"></td> <td style="width: 10%;"></td> <td style="width: 10%;"></td> <td style="width: 10%;"></td> <td style="width: 10%;"></td> <td style="width: 10%;"></td> <td style="width: 10%;"></td> <td style="width: 10%;"></td> </tr> <tr> <td></td> <td></td> <td colspan="8" style="text-align: center;"> <table border="1" style="width: 100%; border-collapse: collapse; text-align: center;"> <tr> <td style="width: 10%;"></td> <td style="width: 10%;"></td> <td style="width: 10%;"></td> <td style="width: 10%;"></td> <td style="width: 10%;"></td> <td style="width: 10%;"></td> <td style="width: 10%;"></td> <td style="width: 10%;"></td> <td style="width: 10%;"></td> <td style="width: 10%;"></td> </tr> <tr> <td></td> <td></td> <td colspan="8" style="text-align: center;"> <table border="1" style="width: 100%; border-collapse: collapse; text-align: center;"> <tr> <td style="width: 10%;"></td> <td style="width: 10%;"></td> <td style="width: 10%;"></td> <td style="width: 10%;"></td> <td style="width: 10%;"></td> <td style="width: 10%;"></td> <td style="width: 10%;"></td> <td style="width: 10%;"></td> <td style="width: 10%;"></td> <td style="width: 10%;"></td> </tr> <tr> <td></td> <td></td> <td colspan="8" style="text-align: center;"> <table border="1" style="width: 100%; border-collapse: collapse; text-align: center;"> <tr> <td style="width: 10%;"></td> <td style="width: 10%;"></td> <td style="width: 10%;"></td> <td style="width: 10%;"></td> <td style="width: 10%;"></td> <td style="width: 10%;"></td> <td style="width: 10%;"></td> <td style="width: 10%;"></td> <td style="width: 10%;"></td> <td style="width: 10%;"></td> </tr> <tr> <td></td> <td></td> <td colspan="8" style="text-align: center;"> <table border="1" style="width: 100%; border-collapse: collapse; text-align: center;"> <tr> <td style="width: 10%;"></td> <td style="width: 10%;"></td> <td style="width: 10%;"></td> <td style="width: 10%;"></td> <td style="width: 10%;"></td> <td style="width: 10%;"></td> <td style="width: 10%;"></td> <td style="width: 10%;"></td> <td style="width: 10%;"></td> <td style="width: 10%;"></td> </tr> <tr> <td></td> <td></td> <td colspan="8" style="text-align: center;"> <table border="1" style="width: 100%; border-collapse: collapse; text-align: center;"> <tr> <td style="width: 10%;"></td> <td style="width: 10%;"></td> <td style="width: 10%;"></td> <td style="width: 10%;"></td> <td style="width: 10%;"></td> <td style="width: 10%;"></td> <td style="width: 10%;"></td> <td style="width: 10%;"></td> <td style="width: 10%;"></td> <td style="width: 10%;"></td> </tr> <tr> <td></td> <td></td> <td colspan="8" style="text-align: center;"> <table border="1" style="width: 100%; border-collapse: collapse; text-align: center;"> <tr> <td style="width: 10%;"></td> <td style="width: 10%;"></td> <td style="width: 10%;"></td> <td style="width: 10%;"></td> <td style="width: 10%;"></td> <td style="width: 10%;"></td> <td style="width: 10%;"></td> <td style="width: 10%;"></td> <td style="width: 10%;"></td> <td style="width: 10%;"></td> </tr> <tr> <td></td> <td></td> <td colspan="8" style="text-align: center;"> <table border="1" style="width: 100%; border-collapse: collapse; text-align: center;"> <tr> <td style="width: 10%;"></td> <td style="width: 10%;"></td> <td style="width: 10%;"></td> <td style="width: 10%;"></td> <td style="width: 10%;"></td> <td style="width: 10%;"></td> <td style="width: 10%;"></td> <td style="width: 10%;"></td> <td style="width: 10%;"></td> <td style="width: 10%;"></td> </tr> <tr> <td></td> <td></td> <td colspan="8" style="text-align: center;"> <table border="1" style="width: 100%; border-collapse: collapse; text-align: center;"> <tr> <td style="width: 10%;"></td> <td style="width: 10%;"></td> <td style="width: 10%;"></td> <td style="width: 10%;"></td> <td style="width: 10%;"></td> <td style="width: 10%;"></td> <td style="width: 10%;"></td> <td style="width: 10%;"></td> <td style="width: 10%;"></td> <td style="width: 10%;"></td> </tr> <tr> <td></td> <td></td> <td colspan="8" style="text-align: center;"> <table border="1" style="width: 100%; border-collapse: collapse; text-align: center;"> <tr> <td style="width: 10%;"></td> <td style="width: 10%;"></td> <td style="width: 10%;"></td> <td style="width: 10%;"></td> <td style="width: 10%;"></td> <td style="width: 10%;"></td> <td style="width: 10%;"></td> <td style="width: 10%;"></td> <td style="width: 10%;"></td> <td style="width: 10%;"></td> </tr> <tr> <td></td> <td></td> <td colspan="8" style="text-align: center;"> <table border="1" style="width: 100%; border-collapse: collapse; text-align: center;"> <tr> <td style="width: 10%;"></td> <td style="width: 10%;"></td> <td style="width: 10%;"></td> <td style="width: 10%;"></td> <td style="width: 10%;"></td> <td style="width: 10%;"></td> <td style="width: 10%;"></td> <td style="width: 10%;"></td> <td style="width: 10%;"></td> <td style="width: 10%;"></td> </tr> <tr> <td></td> <td></td> <td colspan="8" style="text-align: center;"> <table border="1" style="width: 100%; border-collapse: collapse; text-align: center;"> <tr> <td style="width: 10%;"></td> <td style="width: 10%;"></td> <td style="width: 10%;"></td> <td style="width: 10%;"></td> <td style="width: 10%;"></td> <td style="width: 10%;"></td> <td style="width: 10%;"></td> <td style="width: 10%;"></td> <td style="width: 10%;"></td> <td style="width: 10%;"></td> </tr> <tr> <td></td> <td></td> <td colspan="8" style="text-align: center;"> <table border="1" style="width: 100%; border-collapse: collapse; text-align: center;"> <tr> <td style="width: 10%;"></td> <td style="width: 10%;"></td> <td style="width: 10%;"></td> <td style="width: 10%;"></td> <td style="width: 10%;"></td> <td style="width: 10%;"></td> <td style="width: 10%;"></td> <td style="width: 10%;"></td> <td style="width: 10%;"></td> <td style="width: 10%;"></td> </tr> <tr> <td></td> <td></td> <td colspan="8" style="text-align: center;"> <table border="1" style="width: 100%; border-collapse: collapse; text-align: center;"> <tr> <td style="width: 10%;"></td> <td style="width: 10%;"></td> <td style="width: 10%;"></td> <td style="width: 10%;"></td> <td style="width: 10%;"></td> <td style="width: 10%;"></td> <td style="width: 10%;"></td> <td style="width: 10%;"></td> <td style="width: 10%;"></td> <td style="width: 10%;"></td> </tr> <tr> <td></td> <td></td> <td colspan="8" style="text-align: center;"> <table border="1" style="width: 100%; border-collapse: collapse; text-align: center;"> <tr> <td style="width: 10%;"></td> <td style="width: 10%;"></td> <td style="width: 10%;"></td> <td style="width: 10%;"></td> <td style="width: 10%;"></td> <td style="width: 10%;"></td> <td style="width: 10%;"></td> <td style="width: 10%;"></td> <td style="width: 10%;"></td> <td style="width: 10%;"></td> </tr> <tr> <td></td> <td></td> <td colspan="8" style="text-align: center;"> <table border="1" style="width: 100%; border-collapse: collapse; text-align: center;"> <tr> <td style="width: 10%;"></td> <td style="width: 10%;"></td> <td style="width: 10%;"></td> <td style="width: 10%;"></td> <td style="width: 10%;"></td> <td style="width: 10%;"></td> <td style="width: 10%;"></td> <td style="width: 10%;"></td> <td style="width: 10%;"></td> <td style="width: 10%;"></td> </tr> <tr> <td></td> <td></td> <td colspan="8" style="text-align: center;"> <table border="1" style="width: 100%; border-collapse: collapse; text-align: center;"> <tr> <td style="width: 10%;"></td> <td style="width: 10%;"></td> <td style="width: 10%;"></td> <td style="width: 10%;"></td> <td style="width: 10%;"></td> <td style="width: 10%;"></td> <td style="width: 10%;"></td> <td style="width: 10%;"></td> <td style="width: 10%;"></td> <td style="width: 10%;"></td> </tr> <tr> <td></td> <td></td> <td
colspan="8" style="text-align: center;"> <table border="1" style="width: 100%; border-collapse: collapse; text-align: center;"> <tr> </tr></table></td></tr></table></td></tr></table></td></tr></table></td></tr></table></td></tr></table></td></tr></table></td></tr></table></td></tr></table></td></tr></table></td></tr></table></td></tr></table></td></tr></table></td></tr></table></td></tr></table></td></tr></table></td></tr></table></td></tr></table></td></tr></table></td></tr></table></td></tr></table></td></tr></table></td></tr></table></td></tr></table></td></tr></table></td></tr></table></td></tr></table> | | | | | | | | | | | | | | | | | | | | <table border="1" style="width: 100%; border-collapse: collapse; text-align: center;"> <tr> <td style="width: 10%;"></td> <td style="width: 10%;"></td> <td style="width: 10%;"></td> <td style="width: 10%;"></td> <td style="width: 10%;"></td> <td style="width: 10%;"></td> <td style="width: 10%;"></td> <td style="width: 10%;"></td> <td style="width: 10%;"></td> <td style="width: 10%;"></td> </tr> <tr> <td></td> <td></td> <td colspan="8" style="text-align: center;"> <table border="1" style="width: 100%; border-collapse: collapse; text-align: center;"> <tr> <td style="width: 10%;"></td> <td style="width: 10%;"></td> <td style="width: 10%;"></td> <td style="width: 10%;"></td> <td style="width: 10%;"></td> <td style="width: 10%;"></td> <td style="width: 10%;"></td> <td style="width: 10%;"></td> <td style="width: 10%;"></td> <td style="width: 10%;"></td> </tr> <tr> <td></td> <td></td> <td colspan="8" style="text-align: center;"> <table border="1" style="width: 100%; border-collapse: collapse; text-align: center;"> <tr> <td style="width: 10%;"></td> <td style="width: 10%;"></td> <td style="width: 10%;"></td> <td style="width: 10%;"></td> <td style="width: 10%;"></td> <td style="width: 10%;"></td> <td style="width: 10%;"></td> <td style="width: 10%;"></td> <td style="width: 10%;"></td> <td style="width: 10%;"></td> </tr> <tr> <td></td> <td></td> <td colspan="8" style="text-align: center;"> <table border="1" style="width: 100%; border-collapse: collapse; text-align: center;"> <tr> <td style="width: 10%;"></td> <td style="width: 10%;"></td> <td style="width: 10%;"></td> <td style="width: 10%;"></td> <td style="width: 10%;"></td> <td style="width: 10%;"></td> <td style="width: 10%;"></td> <td style="width: 10%;"></td> <td style="width: 10%;"></td> <td style="width: 10%;"></td> </tr> <tr> <td></td> <td></td> <td colspan="8" style="text-align: center;"> <table border="1" style="width: 100%; border-collapse: collapse; text-align: center;"> <tr> <td style="width: 10%;"></td> <td style="width: 10%;"></td> <td style="width: 10%;"></td> <td style="width: 10%;"></td> <td style="width: 10%;"></td> <td style="width: 10%;"></td> <td style="width: 10%;"></td> <td style="width: 10%;"></td> <td style="width: 10%;"></td> <td style="width: 10%;"></td> </tr> <tr> <td></td> <td></td> <td colspan="8" style="text-align: center;"> <table border="1" style="width: 100%; border-collapse: collapse; text-align: center;"> <tr> <td style="width: 10%;"></td> <td style="width: 10%;"></td> <td style="width: 10%;"></td> <td style="width: 10%;"></td> <td style="width: 10%;"></td> <td style="width: 10%;"></td> <td style="width: 10%;"></td> <td style="width: 10%;"></td> <td style="width: 10%;"></td> <td style="width: 10%;"></td> </tr> <tr> <td></td> <td></td> <td colspan="8" style="text-align: center;"> <table border="1" style="width: 100%; border-collapse: collapse; text-align: center;"> <tr> <td style="width: 10%;"></td> <td style="width: 10%;"></td> <td style="width: 10%;"></td> <td style="width: 10%;"></td> <td style="width: 10%;"></td> <td style="width: 10%;"></td> <td style="width: 10%;"></td> <td style="width: 10%;"></td> <td style="width: 10%;"></td> <td style="width: 10%;"></td> </tr> <tr> <td></td> <td></td> <td colspan="8" style="text-align: center;"> <table border="1" style="width: 100%; border-collapse: collapse; text-align: center;"> <tr> <td style="width: 10%;"></td> <td style="width: 10%;"></td> <td style="width: 10%;"></td> <td style="width: 10%;"></td> <td style="width: 10%;"></td> <td style="width: 10%;"></td> <td style="width: 10%;"></td> <td style="width: 10%;"></td> <td style="width: 10%;"></td> <td style="width: 10%;"></td> </tr> <tr> <td></td> <td></td> <td colspan="8" style="text-align: center;"> <table border="1" style="width: 100%; border-collapse: collapse; text-align: center;"> <tr> <td style="width: 10%;"></td> <td style="width: 10%;"></td> <td style="width: 10%;"></td> <td style="width: 10%;"></td> <td style="width: 10%;"></td> <td style="width: 10%;"></td> <td style="width: 10%;"></td> <td style="width: 10%;"></td> <td style="width: 10%;"></td> <td style="width: 10%;"></td> </tr> <tr> <td></td> <td></td> <td colspan="8" style="text-align: center;"> <table border="1" style="width: 100%; border-collapse: collapse; text-align: center;"> <tr> <td style="width: 10%;"></td> <td style="width: 10%;"></td> <td style="width: 10%;"></td> <td style="width: 10%;"></td> <td style="width: 10%;"></td> <td style="width: 10%;"></td> <td style="width: 10%;"></td> <td style="width: 10%;"></td> <td style="width: 10%;"></td> <td style="width: 10%;"></td> </tr> <tr> <td></td> <td></td> <td colspan="8" style="text-align: center;"> <table border="1" style="width: 100%; border-collapse: collapse; text-align: center;"> <tr> <td style="width: 10%;"></td> <td style="width: 10%;"></td> <td style="width: 10%;"></td> <td style="width: 10%;"></td> <td style="width: 10%;"></td> <td style="width: 10%;"></td> <td style="width: 10%;"></td> <td style="width: 10%;"></td> <td style="width: 10%;"></td> <td style="width: 10%;"></td> </tr> <tr> <td></td> <td></td> <td colspan="8" style="text-align: center;"> <table border="1" style="width: 100%; border-collapse: collapse; text-align: center;"> <tr> <td style="width: 10%;"></td> <td style="width: 10%;"></td> <td style="width: 10%;"></td> <td style="width: 10%;"></td> <td style="width: 10%;"></td> <td style="width: 10%;"></td> <td style="width: 10%;"></td> <td style="width: 10%;"></td> <td style="width: 10%;"></td> <td style="width: 10%;"></td> </tr> <tr> <td></td> <td></td> <td colspan="8" style="text-align: center;"> <table border="1" style="width: 100%; border-collapse: collapse; text-align: center;"> <tr> <td style="width: 10%;"></td> <td style="width: 10%;"></td> <td style="width: 10%;"></td> <td style="width: 10%;"></td> <td style="width: 10%;"></td> <td style="width: 10%;"></td> <td style="width: 10%;"></td> <td style="width: 10%;"></td> <td style="width: 10%;"></td> <td style="width: 10%;"></td> </tr> <tr> <td></td> <td></td> <td colspan="8" style="text-align: center;"> <table border="1" style="width: 100%; border-collapse: collapse; text-align: center;"> <tr> <td style="width: 10%;"></td> <td style="width: 10%;"></td> <td style="width: 10%;"></td> <td style="width: 10%;"></td> <td style="width: 10%;"></td> <td style="width: 10%;"></td> <td style="width: 10%;"></td> <td style="width: 10%;"></td> <td style="width: 10%;"></td> <td style="width: 10%;"></td> </tr> <tr> <td></td> <td></td> <td colspan="8" style="text-align: center;"> <table border="1" style="width: 100%; border-collapse: collapse; text-align: center;"> <tr> <td style="width: 10%;"></td> <td style="width: 10%;"></td> <td style="width: 10%;"></td> <td style="width: 10%;"></td> <td style="width: 10%;"></td> <td style="width: 10%;"></td> <td style="width: 10%;"></td> <td style="width: 10%;"></td> <td style="width: 10%;"></td> <td style="width: 10%;"></td> </tr> <tr> <td></td> <td></td> <td colspan="8" style="text-align: center;"> <table border="1" style="width: 100%; border-collapse: collapse; text-align: center;"> <tr> <td style="width: 10%;"></td> <td style="width: 10%;"></td> <td style="width: 10%;"></td> <td style="width: 10%;"></td> <td style="width: 10%;"></td> <td style="width: 10%;"></td> <td style="width: 10%;"></td> <td style="width: 10%;"></td> <td style="width: 10%;"></td> <td style="width: 10%;"></td> </tr> <tr> <td></td> <td></td> <td colspan="8" style="text-align: center;"> <table border="1" style="width: 100%; border-collapse: collapse; text-align: center;"> <tr> <td style="width: 10%;"></td> <td style="width: 10%;"></td> <td style="width: 10%;"></td> <td style="width: 10%;"></td> <td style="width: 10%;"></td> <td style="width: 10%;"></td> <td style="width: 10%;"></td> <td style="width: 10%;"></td> <td style="width: 10%;"></td> <td style="width: 10%;"></td> </tr> <tr> <td></td> <td></td> <td colspan="8" style="text-align: center;"> <table border="1" style="width: 100%; border-collapse: collapse; text-align: center;"> <tr> <td style="width: 10%;"></td> <td style="width: 10%;"></td> <td style="width: 10%;"></td> <td style="width: 10%;"></td> <td style="width: 10%;"></td> <td style="width: 10%;"></td> <td style="width: 10%;"></td> <td style="width: 10%;"></td> <td style="width: 10%;"></td> <td style="width: 10%;"></td> </tr> <tr> <td></td> <td></td> <td colspan="8" style="text-align: center;"> <table border="1" style="width: 100%; border-collapse: collapse; text-align: center;"> <tr> <td style="width: 10%;"></td> <td style="width: 10%;"></td> <td style="width: 10%;"></td> <td style="width: 10%;"></td> <td style="width: 10%;"></td> <td style="width: 10%;"></td> <td style="width: 10%;"></td> <td style="width: 10%;"></td> <td style="width: 10%;"></td> <td style="width: 10%;"></td> </tr> <tr> <td></td> <td></td> <td colspan="8" style="text-align: center;"> <table border="1" style="width: 100%; border-collapse: collapse; text-align: center;"> <tr> <td style="width: 10%;"></td> <td style="width: 10%;"></td> <td style="width: 10%;"></td> <td style="width: 10%;"></td> <td style="width: 10%;"></td> <td style="width: 10%;"></td> <td style="width: 10%;"></td> <td style="width: 10%;"></td> <td style="width: 10%;"></td> <td style="width: 10%;"></td> </tr> <tr> <td></td> <td></td> <td
colspan="8" style="text-align: center;"> <table border="1" style="width: 100%; border-collapse: collapse; text-align: center;"> <tr> <td style="width: 10%;"></td> <td style="width: 10%;"></td> <td style="width: 10%;"></td> <td style="width: 10%;"></td> <td style="width: 10%;"></td> <td style="width: 10%;"></td> <td style="width: 10%;"></td> <td style="width: 10%;"></td> <td style="width: 10%;"></td> <td style="width: 10%;"></td> </tr> <tr> <td></td> <td></td> <td colspan="8" style="text-align: center;"> <table border="1" style="width: 100%; border-collapse: collapse; text-align: center;"> <tr> <td style="width: 10%;"></td> <td style="width: 10%;"></td> <td style="width: 10%;"></td> <td style="width: 10%;"></td> <td style="width: 10%;"></td> <td style="width: 10%;"></td> <td style="width: 10%;"></td> <td style="width: 10%;"></td> <td style="width: 10%;"></td> <td style="width: 10%;"></td> </tr> <tr> <td></td> <td></td> <td colspan="8" style="text-align: center;"> <table border="1" style="width: 100%; border-collapse: collapse; text-align: center;"> <tr> <td style="width: 10%;"></td> <td style="width: 10%;"></td> <td style="width: 10%;"></td> <td style="width: 10%;"></td> <td style="width: 10%;"></td> <td style="width: 10%;"></td> <td style="width: 10%;"></td> <td style="width: 10%;"></td> <td style="width: 10%;"></td> <td style="width: 10%;"></td> </tr> <tr> <td></td> <td></td> <td colspan="8" style="text-align: center;"> <table border="1" style="width: 100%; border-collapse: collapse; text-align: center;"> <tr> <td style="width: 10%;"></td> <td style="width: 10%;"></td> <td style="width: 10%;"></td> <td style="width: 10%;"></td> <td style="width: 10%;"></td> <td style="width: 10%;"></td> <td style="width: 10%;"></td> <td style="width: 10%;"></td> <td style="width: 10%;"></td> <td style="width: 10%;"></td> </tr> <tr> <td></td> <td></td> <td colspan="8" style="text-align: center;"> <table border="1" style="width: 100%; border-collapse: collapse; text-align: center;"> <tr> <td style="width: 10%;"></td> <td style="width: 10%;"></td> <td style="width: 10%;"></td> <td style="width: 10%;"></td> <td style="width: 10%;"></td> <td style="width: 10%;"></td> <td style="width: 10%;"></td> <td style="width: 10%;"></td> <td style="width: 10%;"></td> <td style="width: 10%;"></td> </tr> <tr> <td></td> <td></td> <td colspan="8" style="text-align: center;"> <table border="1" style="width: 100%; border-collapse: collapse; text-align: center;"> <tr> </tr></table></td></tr></table></td></tr></table></td></tr></table></td></tr></table></td></tr></table></td></tr></table></td></tr></table></td></tr></table></td></tr></table></td></tr></table></td></tr></table></td></tr></table></td></tr></table></td></tr></table></td></tr></table></td></tr></table></td></tr></table></td></tr></table></td></tr></table></td></tr></table></td></tr></table></td></tr></table></td></tr></table></td></tr></table></td></tr></table> | | | | | | | | | | | | | | | | | | | | <table border="1" style="width: 100%; border-collapse: collapse; text-align: center;"> <tr> <td style="width: 10%;"></td> <td style="width: 10%;"></td> <td style="width: 10%;"></td> <td style="width: 10%;"></td> <td style="width: 10%;"></td> <td style="width: 10%;"></td> <td style="width: 10%;"></td> <td style="width: 10%;"></td> <td style="width: 10%;"></td> <td style="width: 10%;"></td> </tr> <tr> <td></td> <td></td> <td colspan="8" style="text-align: center;"> <table border="1" style="width: 100%; border-collapse: collapse; text-align: center;"> <tr> <td style="width: 10%;"></td> <td style="width: 10%;"></td> <td style="width: 10%;"></td> <td style="width: 10%;"></td> <td style="width: 10%;"></td> <td style="width: 10%;"></td> <td style="width: 10%;"></td> <td style="width: 10%;"></td> <td style="width: 10%;"></td> <td style="width: 10%;"></td> </tr> <tr> <td></td> <td></td> <td colspan="8" style="text-align: center;"> <table border="1" style="width: 100%; border-collapse: collapse; text-align: center;"> <tr> <td style="width: 10%;"></td> <td style="width: 10%;"></td> <td style="width: 10%;"></td> <td style="width: 10%;"></td> <td style="width: 10%;"></td> <td style="width: 10%;"></td> <td style="width: 10%;"></td> <td style="width: 10%;"></td> <td style="width: 10%;"></td> <td style="width: 10%;"></td> </tr> <tr> <td></td> <td></td> <td colspan="8" style="text-align: center;"> <table border="1" style="width: 100%; border-collapse: collapse; text-align: center;"> <tr> <td style="width: 10%;"></td> <td style="width: 10%;"></td> <td style="width: 10%;"></td> <td style="width: 10%;"></td> <td style="width: 10%;"></td> <td style="width: 10%;"></td> <td style="width: 10%;"></td> <td style="width: 10%;"></td> <td style="width: 10%;"></td> <td style="width: 10%;"></td> </tr> <tr> <td></td> <td></td> <td colspan="8" style="text-align: center;"> <table border="1" style="width: 100%; border-collapse: collapse; text-align: center;"> <tr> <td style="width: 10%;"></td> <td style="width: 10%;"></td> <td style="width: 10%;"></td> <td style="width: 10%;"></td> <td style="width: 10%;"></td> <td style="width: 10%;"></td> <td style="width: 10%;"></td> <td style="width: 10%;"></td> <td style="width: 10%;"></td> <td style="width: 10%;"></td> </tr> <tr> <td></td> <td></td> <td colspan="8" style="text-align: center;"> <table border="1" style="width: 100%; border-collapse: collapse; text-align: center;"> <tr> <td style="width: 10%;"></td> <td style="width: 10%;"></td> <td style="width: 10%;"></td> <td style="width: 10%;"></td> <td style="width: 10%;"></td> <td style="width: 10%;"></td> <td style="width: 10%;"></td> <td style="width: 10%;"></td> <td style="width: 10%;"></td> <td style="width: 10%;"></td> </tr> <tr> <td></td> <td></td> <td colspan="8" style="text-align: center;"> <table border="1" style="width: 100%; border-collapse: collapse; text-align: center;"> <tr> <td style="width: 10%;"></td> <td style="width: 10%;"></td> <td style="width: 10%;"></td> <td style="width: 10%;"></td> <td style="width: 10%;"></td> <td style="width: 10%;"></td> <td style="width: 10%;"></td> <td style="width: 10%;"></td> <td style="width: 10%;"></td> <td style="width: 10%;"></td> </tr> <tr> <td></td> <td></td> <td colspan="8" style="text-align: center;"> <table border="1" style="width: 100%; border-collapse: collapse; text-align: center;"> <tr> <td style="width: 10%;"></td> <td style="width: 10%;"></td> <td style="width: 10%;"></td> <td style="width: 10%;"></td> <td style="width: 10%;"></td> <td style="width: 10%;"></td> <td style="width: 10%;"></td> <td style="width: 10%;"></td> <td style="width: 10%;"></td> <td style="width: 10%;"></td> </tr> <tr> <td></td> <td></td> <td colspan="8" style="text-align: center;"> <table border="1" style="width: 100%; border-collapse: collapse; text-align: center;"> <tr> <td style="width: 10%;"></td> <td style="width: 10%;"></td> <td style="width: 10%;"></td> <td style="width: 10%;"></td> <td style="width: 10%;"></td> <td style="width: 10%;"></td> <td style="width: 10%;"></td> <td style="width: 10%;"></td> <td style="width: 10%;"></td> <td style="width: 10%;"></td> </tr> <tr> <td></td> <td></td> <td colspan="8" style="text-align: center;"> <table border="1" style="width: 100%; border-collapse: collapse; text-align: center;"> <tr> <td style="width: 10%;"></td> <td style="width: 10%;"></td> <td style="width: 10%;"></td> <td style="width: 10%;"></td> <td style="width: 10%;"></td> <td style="width: 10%;"></td> <td style="width: 10%;"></td> <td style="width: 10%;"></td> <td style="width: 10%;"></td> <td style="width: 10%;"></td> </tr> <tr> <td></td> <td></td> <td colspan="8" style="text-align: center;"> <table border="1" style="width: 100%; border-collapse: collapse; text-align: center;"> <tr> <td style="width: 10%;"></td> <td style="width: 10%;"></td> <td style="width: 10%;"></td> <td style="width: 10%;"></td> <td style="width: 10%;"></td> <td style="width: 10%;"></td> <td style="width: 10%;"></td> <td style="width: 10%;"></td> <td style="width: 10%;"></td> <td style="width: 10%;"></td> </tr> <tr> <td></td> <td></td> <td colspan="8" style="text-align: center;"> <table border="1" style="width: 100%; border-collapse: collapse; text-align: center;"> <tr> <td style="width: 10%;"></td> <td style="width: 10%;"></td> <td style="width: 10%;"></td> <td style="width: 10%;"></td> <td style="width: 10%;"></td> <td style="width: 10%;"></td> <td style="width: 10%;"></td> <td style="width: 10%;"></td> <td style="width: 10%;"></td> <td style="width: 10%;"></td> </tr> <tr> <td></td> <td></td> <td colspan="8" style="text-align: center;"> <table border="1" style="width: 100%; border-collapse: collapse; text-align: center;"> <tr> <td style="width: 10%;"></td> <td style="width: 10%;"></td> <td style="width: 10%;"></td> <td style="width: 10%;"></td> <td style="width: 10%;"></td> <td style="width: 10%;"></td> <td style="width: 10%;"></td> <td style="width: 10%;"></td> <td style="width: 10%;"></td> <td style="width: 10%;"></td> </tr> <tr> <td></td> <td></td> <td colspan="8" style="text-align: center;"> <table border="1" style="width: 100%; border-collapse: collapse; text-align: center;"> <tr> <td style="width: 10%;"></td> <td style="width: 10%;"></td> <td style="width: 10%;"></td> <td style="width: 10%;"></td> <td style="width: 10%;"></td> <td style="width: 10%;"></td> <td style="width: 10%;"></td> <td style="width: 10%;"></td> <td style="width: 10%;"></td> <td style="width: 10%;"></td> </tr> <tr> <td></td> <td></td> <td colspan="8" style="text-align: center;"> <table border="1" style="width: 100%; border-collapse: collapse; text-align: center;"> <tr> <td style="width: 10%;"></td> <td style="width: 10%;"></td> <td style="width: 10%;"></td> <td style="width: 10%;"></td> <td style="width: 10%;"></td> <td style="width: 10%;"></td> <td style="width: 10%;"></td> <td style="width: 10%;"></td> <td style="width: 10%;"></td> <td style="width: 10%;"></td> </tr> <tr> <td></td> <td></td> <td colspan="8"
style="text-align: center;"> <table border="1" style="width: 100%; border-collapse: collapse; text-align: center;"> <tr> <td style="width: 10%;"></td> <td style="width: 10%;"></td> <td style="width: 10%;"></td> <td style="width: 10%;"></td> <td style="width: 10%;"></td> <td style="width: 10%;"></td> <td style="width: 10%;"></td> <td style="width: 10%;"></td> <td style="width: 10%;"></td> <td style="width: 10%;"></td> </tr> <tr> <td></td> <td></td> <td colspan="8" style="text-align: center;"> <table border="1" style="width: 100%; border-collapse: collapse; text-align: center;"> <tr> <td style="width: 10%;"></td> <td style="width: 10%;"></td> <td style="width: 10%;"></td> <td style="width: 10%;"></td> <td style="width: 10%;"></td> <td style="width: 10%;"></td> <td style="width: 10%;"></td> <td style="width: 10%;"></td> <td style="width: 10%;"></td> <td style="width: 10%;"></td> </tr> <tr> <td></td> <td></td> <td colspan="8" style="text-align: center;"> <table border="1" style="width: 100%; border-collapse: collapse; text-align: center;"> <tr> <td style="width: 10%;"></td> <td style="width: 10%;"></td> <td style="width: 10%;"></td> <td style="width: 10%;"></td> <td style="width: 10%;"></td> <td style="width: 10%;"></td> <td style="width: 10%;"></td> <td style="width: 10%;"></td> <td style="width: 10%;"></td> <td style="width: 10%;"></td> </tr> <tr> <td></td> <td></td> <td colspan="8" style="text-align: center;"> <table border="1" style="width: 100%; border-collapse: collapse; text-align: center;"> <tr> <td style="width: 10%;"></td> <td style="width: 10%;"></td> <td style="width: 10%;"></td> <td style="width: 10%;"></td> <td style="width: 10%;"></td> <td style="width: 10%;"></td> <td style="width: 10%;"></td> <td style="width: 10%;"></td> <td style="width: 10%;"></td> <td style="width: 10%;"></td> </tr> <tr> <td></td> <td></td> <td colspan="8" style="text-align: center;"> <table border="1" style="width: 100%; border-collapse: collapse; text-align: center;"> <tr> <td style="width: 10%;"></td> <td style="width: 10%;"></td> <td style="width: 10%;"></td> <td style="width: 10%;"></td> <td style="width: 10%;"></td> <td style="width: 10%;"></td> <td style="width: 10%;"></td> <td style="width: 10%;"></td> <td style="width: 10%;"></td> <td style="width: 10%;"></td> </tr> <tr> <td></td> <td></td> <td colspan="8" style="text-align: center;"> <table border="1" style="width: 100%; border-collapse: collapse; text-align: center;"> <tr> <td style="width: 10%;"></td> <td style="width: 10%;"></td> <td style="width: 10%;"></td> <td style="width: 10%;"></td> <td style="width: 10%;"></td> <td style="width: 10%;"></td> <td style="width: 10%;"></td> <td style="width: 10%;"></td> <td style="width: 10%;"></td> <td style="width: 10%;"></td> </tr> <tr> <td></td> <td></td> <td colspan="8" style="text-align: center;"> <table border="1" style="width: 100%; border-collapse: collapse; text-align: center;"> <tr> <td style="width: 10%;"></td> <td style="width: 10%;"></td> <td style="width: 10%;"></td> <td style="width: 10%;"></td> <td style="width: 10%;"></td> <td style="width: 10%;"></td> <td style="width: 10%;"></td> <td style="width: 10%;"></td> <td style="width: 10%;"></td> <td style="width: 10%;"></td> </tr> <tr> <td></td> <td></td> <td colspan="8" style="text-align: center;"> <table border="1" style="width: 100%; border-collapse: collapse; text-align: center;"> <tr> <td style="width: 10%;"></td> <td style="width: 10%;"></td> <td style="width: 10%;"></td> <td style="width: 10%;"></td> <td style="width: 10%;"></td> <td style="width: 10%;"></td> <td style="width: 10%;"></td> <td style="width: 10%;"></td> <td style="width: 10%;"></td> <td style="width: 10%;"></td> </tr> <tr> <td></td> <td></td> <td colspan="8" style="text-align: center;"> <table border="1" style="width: 100%; border-collapse: collapse; text-align: center;"> <tr> <td style="width: 10%;"></td> <td style="width: 10%;"></td> <td style="width: 10%;"></td> <td style="width: 10%;"></td> <td style="width: 10%;"></td> <td style="width: 10%;"></td> <td style="width: 10%;"></td> <td style="width: 10%;"></td> <td style="width: 10%;"></td> <td style="width: 10%;"></td> </tr> <tr> <td></td> <td></td> <td colspan="8" style="text-align: center;"> <table border="1" style="width: 100%; border-collapse: collapse; text-align: center;"> <tr> </tr></table></td></tr></table></td></tr></table></td></tr></table></td></tr></table></td></tr></table></td></tr></table></td></tr></table></td></tr></table></td></tr></table></td></tr></table></td></tr></table></td></tr></table></td></tr></table></td></tr></table></td></tr></table></td></tr></table></td></tr></table></td></tr></table></td></tr></table></td></tr></table></td></tr></table></td></tr></table></td></tr></table></td></tr></table> | | | | | | | | | | | | | | | | | | | | <table border="1" style="width: 100%; border-collapse: collapse; text-align: center;"> <tr> <td style="width: 10%;"></td> <td style="width: 10%;"></td> <td style="width: 10%;"></td> <td style="width: 10%;"></td> <td style="width: 10%;"></td> <td style="width: 10%;"></td> <td style="width: 10%;"></td> <td style="width: 10%;"></td> <td style="width: 10%;"></td> <td style="width: 10%;"></td> </tr> <tr> <td></td> <td></td> <td colspan="8" style="text-align: center;"> <table border="1" style="width: 100%; border-collapse: collapse; text-align: center;"> <tr> <td style="width: 10%;"></td> <td style="width: 10%;"></td> <td style="width: 10%;"></td> <td style="width: 10%;"></td> <td style="width: 10%;"></td> <td style="width: 10%;"></td> <td style="width: 10%;"></td> <td style="width: 10%;"></td> <td style="width: 10%;"></td> <td style="width: 10%;"></td> </tr> <tr> <td></td> <td></td> <td colspan="8" style="text-align: center;"> <table border="1" style="width: 100%; border-collapse: collapse; text-align: center;"> <tr> <td style="width: 10%;"></td> <td style="width: 10%;"></td> <td style="width: 10%;"></td> <td style="width: 10%;"></td> <td style="width: 10%;"></td> <td style="width: 10%;"></td> <td style="width: 10%;"></td> <td style="width: 10%;"></td> <td style="width: 10%;"></td> <td style="width: 10%;"></td> </tr> <tr> <td></td> <td></td> <td colspan="8" style="text-align: center;"> <table border="1" style="width: 100%; border-collapse: collapse; text-align: center;"> <tr> <td style="width: 10%;"></td> <td style="width: 10%;"></td> <td style="width: 10%;"></td> <td style="width: 10%;"></td> <td style="width: 10%;"></td> <td style="width: 10%;"></td> <td style="width: 10%;"></td> <td style="width: 10%;"></td> <td style="width: 10%;"></td> <td style="width: 10%;"></td> </tr> <tr> <td></td> <td></td> <td colspan="8" style="text-align: center;"> <table border="1" style="width: 100%; border-collapse: collapse; text-align: center;"> <tr> <td style="width: 10%;"></td> <td style="width: 10%;"></td> <td style="width: 10%;"></td> <td style="width: 10%;"></td> <td style="width: 10%;"></td> <td style="width: 10%;"></td> <td style="width: 10%;"></td> <td style="width: 10%;"></td> <td style="width: 10%;"></td> <td style="width: 10%;"></td> </tr> <tr> <td></td> <td></td> <td colspan="8" style="text-align: center;"> <table border="1" style="width: 100%; border-collapse: collapse; text-align: center;"> <tr> <td style="width: 10%;"></td> <td style="width: 10%;"></td> <td style="width: 10%;"></td> <td style="width: 10%;"></td> <td style="width: 10%;"></td> <td style="width: 10%;"></td> <td style="width: 10%;"></td> <td style="width: 10%;"></td> <td style="width: 10%;"></td> <td style="width: 10%;"></td> </tr> <tr> <td></td> <td></td> <td colspan="8" style="text-align: center;"> <table border="1" style="width: 100%; border-collapse: collapse; text-align: center;"> <tr> <td style="width: 10%;"></td> <td style="width: 10%;"></td> <td style="width: 10%;"></td> <td style="width: 10%;"></td> <td style="width: 10%;"></td> <td style="width: 10%;"></td> <td style="width: 10%;"></td> <td style="width: 10%;"></td> <td style="width: 10%;"></td> <td style="width: 10%;"></td> </tr> <tr> <td></td> <td></td> <td colspan="8" style="text-align: center;"> <table border="1" style="width: 100%; border-collapse: collapse; text-align: center;"> <tr> <td style="width: 10%;"></td> <td style="width: 10%;"></td> <td style="width: 10%;"></td> <td style="width: 10%;"></td> <td style="width: 10%;"></td> <td style="width: 10%;"></td> <td style="width: 10%;"></td> <td style="width: 10%;"></td> <td style="width: 10%;"></td> <td style="width: 10%;"></td> </tr> <tr> <td></td> <td></td> <td colspan="8" style="text-align: center;"> <table border="1" style="width: 100%; border-collapse: collapse; text-align: center;"> <tr> <td style="width: 10%;"></td> <td style="width: 10%;"></td> <td style="width: 10%;"></td> <td style="width: 10%;"></td> <td style="width: 10%;"></td> <td style="width: 10%;"></td> <td style="width: 10%;"></td> <td style="width: 10%;"></td> <td style="width: 10%;"></td> <td style="width: 10%;"></td> </tr> <tr> <td></td> <td></td> <td colspan="8" style="text-align: center;"> <table border="1" style="width: 100%; border-collapse: collapse; text-align: center;"> <tr> <td style="width: 10%;"></td> <td style="width: 10%;"></td> <td style="width: 10%;"></td> <td style="width: 10%;"></td> <td style="width: 10%;"></td> <td style="width: 10%;"></td> <td style="width: 10%;"></td> <td style="width: 10%;"></td> <td style="width: 10%;"></td> <td style="width: 10%;"></td> </tr> <tr> <td></td> <td></td> <td colspan="8" style="text-align: center;"> <table border="1" style="width: 100%; border-collapse: collapse; text-align: center;"> <tr> <td style="width: 10%;"></td> <td style="width: 10%;"></td> <td style="width: 10%;"></td> <td style="width: 10%;"></td> <td style="width: 10%;"></td> <td style="width: 10%;"></td> <td style="width: 10%;"></td> <td style="width: 10%;"></td> <td style="width: 10%;"></td> <td style="width: 10%;"></td> </tr> <tr> <td></td> <td></td> <td colspan="8" style="text-align: center;"> <table
border="1" style="width: 100%; border-collapse: collapse; text-align: center;"> <tr> <td style="width: 10%;"></td> <td style="width: 10%;"></td> <td style="width: 10%;"></td> <td style="width: 10%;"></td> <td style="width: 10%;"></td> <td style="width: 10%;"></td> <td style="width: 10%;"></td> <td style="width: 10%;"></td> <td style="width: 10%;"></td> <td style="width: 10%;"></td> </tr> <tr> <td></td> <td></td> <td colspan="8" style="text-align: center;"> <table border="1" style="width: 100%; border-collapse: collapse; text-align: center;"> <tr> <td style="width: 10%;"></td> <td style="width: 10%;"></td> <td style="width: 10%;"></td> <td style="width: 10%;"></td> <td style="width: 10%;"></td> <td style="width: 10%;"></td> <td style="width: 10%;"></td> <td style="width: 10%;"></td> <td style="width: 10%;"></td> <td style="width: 10%;"></td> </tr> <tr> <td></td> <td></td> <td colspan="8" style="text-align: center;"> <table border="1" style="width: 100%; border-collapse: collapse; text-align: center;"> <tr> <td style="width: 10%;"></td> <td style="width: 10%;"></td> <td style="width: 10%;"></td> <td style="width: 10%;"></td> <td style="width: 10%;"></td> <td style="width: 10%;"></td> <td style="width: 10%;"></td> <td style="width: 10%;"></td> <td style="width: 10%;"></td> <td style="width: 10%;"></td> </tr> <tr> <td></td> <td></td> <td colspan="8" style="text-align: center;"> <table border="1" style="width: 100%; border-collapse: collapse; text-align: center;"> <tr> <td style="width: 10%;"></td> <td style="width: 10%;"></td> <td style="width: 10%;"></td> <td style="width: 10%;"></td> <td style="width: 10%;"></td> <td style="width: 10%;"></td> <td style="width: 10%;"></td> <td style="width: 10%;"></td> <td style="width: 10%;"></td> <td style="width: 10%;"></td> </tr> <tr> <td></td> <td></td> <td colspan="8" style="text-align: center;"> <table border="1" style="width: 100%; border-collapse: collapse; text-align: center;"> <tr> <td style="width: 10%;"></td> <td style="width: 10%;"></td> <td style="width: 10%;"></td> <td style="width: 10%;"></td> <td style="width: 10%;"></td> <td style="width: 10%;"></td> <td style="width: 10%;"></td> <td style="width: 10%;"></td> <td style="width: 10%;"></td> <td style="width: 10%;"></td> </tr> <tr> <td></td> <td></td> <td colspan="8" style="text-align: center;"> <table border="1" style="width: 100%; border-collapse: collapse; text-align: center;"> <tr> <td style="width: 10%;"></td> <td style="width: 10%;"></td> <td style="width: 10%;"></td> <td style="width: 10%;"></td> <td style="width: 10%;"></td> <td style="width: 10%;"></td> <td style="width: 10%;"></td> <td style="width: 10%;"></td> <td style="width: 10%;"></td> <td style="width: 10%;"></td> </tr> <tr> <td></td> <td></td> <td colspan="8" style="text-align: center;"> <table border="1" style="width: 100%; border-collapse: collapse; text-align: center;"> <tr> <td style="width: 10%;"></td> <td style="width: 10%;"></td> <td style="width: 10%;"></td> <td style="width: 10%;"></td> <td style="width: 10%;"></td> <td style="width: 10%;"></td> <td style="width: 10%;"></td> <td style="width: 10%;"></td> <td style="width: 10%;"></td> <td style="width: 10%;"></td> </tr> <tr> <td></td> <td></td> <td colspan="8" style="text-align: center;"> <table border="1" style="width: 100%; border-collapse: collapse; text-align: center;"> <tr> <td style="width: 10%;"></td> <td style="width: 10%;"></td> <td style="width: 10%;"></td> <td style="width: 10%;"></td> <td style="width: 10%;"></td> <td style="width: 10%;"></td> <td style="width: 10%;"></td> <td style="width: 10%;"></td> <td style="width: 10%;"></td> <td style="width: 10%;"></td> </tr> <tr> <td></td> <td></td> <td colspan="8" style="text-align: center;"> <table border="1" style="width: 100%; border-collapse: collapse; text-align: center;"> <tr> <td style="width: 10%;"></td> <td style="width: 10%;"></td> <td style="width: 10%;"></td> <td style="width: 10%;"></td> <td style="width: 10%;"></td> <td style="width: 10%;"></td> <td style="width: 10%;"></td> <td style="width: 10%;"></td> <td style="width: 10%;"></td> <td style="width: 10%;"></td> </tr> <tr> <td></td> <td></td> <td colspan="8" style="text-align: center;"> <table border="1" style="width: 100%; border-collapse: collapse; text-align: center;"> <tr> <td style="width: 10%;"></td> <td style="width: 10%;"></td> <td style="width: 10%;"></td> <td style="width: 10%;"></td> <td style="width: 10%;"></td> <td style="width: 10%;"></td> <td style="width: 10%;"></td> <td style="width: 10%;"></td> <td style="width: 10%;"></td> <td style="width: 10%;"></td> </tr> <tr> <td></td> <td></td> <td colspan="8" style="text-align: center;"> <table border="1" style="width: 100%; border-collapse: collapse; text-align: center;"> <tr> <td style="width: 10%;"></td> <td style="width: 10%;"></td> <td style="width: 10%;"></td> <td style="width: 10%;"></td> <td style="width: 10%;"></td> <td style="width: 10%;"></td> <td style="width: 10%;"></td> <td style="width: 10%;"></td> <td style="width: 10%;"></td> <td style="width: 10%;"></td> </tr> <tr> <td></td> <td></td> <td colspan="8" style="text-align: center;"> <table border="1" style="width: 100%; border-collapse: collapse; text-align: center;"> <tr> <td style="width: 10%;"></td> <td style="width: 10%;"></td> <td style="width: 10%;"></td> <td style="width: 10%;"></td> <td style="width: 10%;"></td> <td style="width: 10%;"></td> <td style="width: 10%;"></td> <td style="width: 10%;"></td> <td style="width: 10%;"></td> <td style="width: 10%;"></td> </tr> <tr> <td></td> <td></td> <td colspan="8" style="text-align: center;"> <table border="1" style="width: 100%; border-collapse: collapse; text-align: center;"> <tr> </tr></table></td></tr></table></td></tr></table></td></tr></table></td></tr></table></td></tr></table></td></tr></table></td></tr></table></td></tr></table></td></tr></table></td></tr></table></td></tr></table></td></tr></table></td></tr></table></td></tr></table></td></tr></table></td></tr></table></td></tr></table></td></tr></table></td></tr></table></td></tr></table></td></tr></table></td></tr></table></td></tr></table> | | | | | | | | | | | | | | | | | | | | <table border="1" style="width: 100%; border-collapse: collapse; text-align: center;"> <tr> <td style="width: 10%;"></td> <td style="width: 10%;"></td> <td style="width: 10%;"></td> <td style="width: 10%;"></td> <td style="width: 10%;"></td> <td style="width: 10%;"></td> <td style="width: 10%;"></td> <td style="width: 10%;"></td> <td style="width: 10%;"></td> <td style="width: 10%;"></td> </tr> <tr> <td></td> <td></td> <td colspan="8" style="text-align: center;"> <table border="1" style="width: 100%; border-collapse: collapse; text-align: center;"> <tr> <td style="width: 10%;"></td> <td style="width: 10%;"></td> <td style="width: 10%;"></td> <td style="width: 10%;"></td> <td style="width: 10%;"></td> <td style="width: 10%;"></td> <td style="width: 10%;"></td> <td style="width: 10%;"></td> <td style="width: 10%;"></td> <td style="width: 10%;"></td> </tr> <tr> <td></td> <td></td> <td colspan="8" style="text-align: center;"> <table border="1" style="width: 100%; border-collapse: collapse; text-align: center;"> <tr> <td style="width: 10%;"></td> <td style="width: 10%;"></td> <td style="width: 10%;"></td> <td style="width: 10%;"></td> <td style="width: 10%;"></td> <td style="width: 10%;"></td> <td style="width: 10%;"></td> <td style="width: 10%;"></td> <td style="width: 10%;"></td> <td style="width: 10%;"></td> </tr> <tr> <td></td> <td></td> <td colspan="8" style="text-align: center;"> <table border="1" style="width: 100%; border-collapse: collapse; text-align: center;"> <tr> <td style="width: 10%;"></td> <td style="width: 10%;"></td> <td style="width: 10%;"></td> <td style="width: 10%;"></td> <td style="width: 10%;"></td> <td style="width: 10%;"></td> <td style="width: 10%;"></td> <td style="width: 10%;"></td> <td style="width: 10%;"></td> <td style="width: 10%;"></td> </tr> <tr> <td></td> <td></td> <td colspan="8" style="text-align: center;"> <table border="1" style="width: 100%; border-collapse: collapse; text-align: center;"> <tr> <td style="width: 10%;"></td> <td style="width: 10%;"></td> <td style="width: 10%;"></td> <td style="width: 10%;"></td> <td style="width: 10%;"></td> <td style="width: 10%;"></td> <td style="width: 10%;"></td> <td style="width: 10%;"></td> <td style="width: 10%;"></td> <td style="width: 10%;"></td> </tr> <tr> <td></td> <td></td> <td colspan="8" style="text-align: center;"> <table border="1" style="width: 100%; border-collapse: collapse; text-align: center;"> <tr> <td style="width: 10%;"></td> <td style="width: 10%;"></td> <td style="width: 10%;"></td> <td style="width: 10%;"></td> <td style="width: 10%;"></td> <td style="width: 10%;"></td> <td style="width: 10%;"></td> <td style="width: 10%;"></td> <td style="width: 10%;"></td> <td style="width: 10%;"></td> </tr> <tr> <td></td> <td></td> <td colspan="8" style="text-align: center;"> <table border="1" style="width: 100%; border-collapse: collapse; text-align: center;"> <tr> <td style="width: 10%;"></td> <td style="width: 10%;"></td> <td style="width: 10%;"></td> <td style="width: 10%;"></td> <td style="width: 10%;"></td> <td style="width: 10%;"></td> <td style="width: 10%;"></td> <td style="width: 10%;"></td> <td style="width: 10%;"></td> <td style="width: 10%;"></td> </tr> <tr> <td></td> <td></td> <td colspan="8" style="text-align: center;"> <table border="1" style="width: 100%; border-collapse: collapse; text-align: center;"> <tr> <td style="width: 10%;"></td> <td style="width: 10%;"></td> <td style="width: 10%;"></td> <td style="width: 10%;"></td> <td style="width: 10%;"></td> <td style="width: 10%;"></td> <td style="width: 10%;"></td> <td style="width: 10%;"></td> <td style="width: 10%;"></td> <td style="width: 10%;"></td> </tr> <tr> <td></td> <td></td> <td colspan="8" style="text-align: center;"> <table border="1" style="width: 100%; border-collapse: collapse;
text-align: center;"> <tr> <td style="width: 10%;"></td> <td style="width: 10%;"></td> <td style="width: 10%;"></td> <td style="width: 10%;"></td> <td style="width: 10%;"></td> <td style="width: 10%;"></td> <td style="width: 10%;"></td> <td style="width: 10%;"></td> <td style="width: 10%;"></td> <td style="width: 10%;"></td> </tr> <tr> <td></td> <td></td> <td colspan="8" style="text-align: center;"> <table border="1" style="width: 100%; border-collapse: collapse; text-align: center;"> <tr> <td style="width: 10%;"></td> <td style="width: 10%;"></td> <td style="width: 10%;"></td> <td style="width: 10%;"></td> <td style="width: 10%;"></td> <td style="width: 10%;"></td> <td style="width: 10%;"></td> <td style="width: 10%;"></td> <td style="width: 10%;"></td> <td style="width: 10%;"></td> </tr> <tr> <td></td> <td></td> <td colspan="8" style="text-align: center;"> <table border="1" style="width: 100%; border-collapse: collapse; text-align: center;"> <tr> <td style="width: 10%;"></td> <td style="width: 10%;"></td> <td style="width: 10%;"></td> <td style="width: 10%;"></td> <td style="width: 10%;"></td> <td style="width: 10%;"></td> <td style="width: 10%;"></td> <td style="width: 10%;"></td> <td style="width: 10%;"></td> <td style="width: 10%;"></td> </tr> <tr> <td></td> <td></td> <td colspan="8" style="text-align: center;"> <table border="1" style="width: 100%; border-collapse: collapse; text-align: center;"> <tr> <td style="width: 10%;"></td> <td style="width: 10%;"></td> <td style="width: 10%;"></td> <td style="width: 10%;"></td> <td style="width: 10%;"></td> <td style="width: 10%;"></td> <td style="width: 10%;"></td> <td style="width: 10%;"></td> <td style="width: 10%;"></td> <td style="width: 10%;"></td> </tr> <tr> <td></td> <td></td> <td colspan="8" style="text-align: center;"> <table border="1" style="width: 100%; border-collapse: collapse; text-align: center;"> <tr> <td style="width: 10%;"></td> <td style="width: 10%;"></td> <td style="width: 10%;"></td> <td style="width: 10%;"></td> <td style="width: 10%;"></td> <td style="width: 10%;"></td> <td style="width: 10%;"></td> <td style="width: 10%;"></td> <td style="width: 10%;"></td> <td style="width: 10%;"></td> </tr> <tr> <td></td> <td></td> <td colspan="8" style="text-align: center;"> <table border="1" style="width: 100%; border-collapse: collapse; text-align: center;"> <tr> <td style="width: 10%;"></td> <td style="width: 10%;"></td> <td style="width: 10%;"></td> <td style="width: 10%;"></td> <td style="width: 10%;"></td> <td style="width: 10%;"></td> <td style="width: 10%;"></td> <td style="width: 10%;"></td> <td style="width: 10%;"></td> <td style="width: 10%;"></td> </tr> <tr> <td></td> <td></td> <td colspan="8" style="text-align: center;"> <table border="1" style="width: 100%; border-collapse: collapse; text-align: center;"> <tr> <td style="width: 10%;"></td> <td style="width: 10%;"></td> <td style="width: 10%;"></td> <td style="width: 10%;"></td> <td style="width: 10%;"></td> <td style="width: 10%;"></td> <td style="width: 10%;"></td> <td style="width: 10%;"></td> <td style="width: 10%;"></td> <td style="width: 10%;"></td> </tr> <tr> <td></td> <td></td> <td colspan="8" style="text-align: center;"> <table border="1" style="width: 100%; border-collapse: collapse; text-align: center;"> <tr> <td style="width: 10%;"></td> <td style="width: 10%;"></td> <td style="width: 10%;"></td> <td style="width: 10%;"></td> <td style="width: 10%;"></td> <td style="width: 10%;"></td> <td style="width: 10%;"></td> <td style="width: 10%;"></td> <td style="width: 10%;"></td> <td style="width: 10%;"></td> </tr> <tr> <td></td> <td></td> <td colspan="8" style="text-align: center;"> <table border="1" style="width: 100%; border-collapse: collapse; text-align: center;"> <tr> <td style="width: 10%;"></td> <td style="width: 10%;"></td> <td style="width: 10%;"></td> <td style="width: 10%;"></td> <td style="width: 10%;"></td> <td style="width: 10%;"></td> <td style="width: 10%;"></td> <td style="width: 10%;"></td> <td style="width: 10%;"></td> <td style="width: 10%;"></td> </tr> <tr> <td></td> <td></td> <td colspan="8" style="text-align: center;"> <table border="1" style="width: 100%; border-collapse: collapse; text-align: center;"> <tr> <td style="width: 10%;"></td> <td style="width: 10%;"></td> <td style="width: 10%;"></td> <td style="width: 10%;"></td> <td style="width: 10%;"></td> <td style="width: 10%;"></td> <td style="width: 10%;"></td> <td style="width: 10%;"></td> <td style="width: 10%;"></td> <td style="width: 10%;"></td> </tr> <tr> <td></td> <td></td> <td colspan="8" style="text-align: center;"> <table border="1" style="width: 100%; border-collapse: collapse; text-align: center;"> <tr> <td style="width: 10%;"></td> <td style="width: 10%;"></td> <td style="width: 10%;"></td> <td style="width: 10%;"></td> <td style="width: 10%;"></td> <td style="width: 10%;"></td> <td style="width: 10%;"></td> <td style="width: 10%;"></td> <td style="width: 10%;"></td> <td style="width: 10%;"></td> </tr> <tr> <td></td> <td></td> <td colspan="8" style="text-align: center;"> <table border="1" style="width: 100%; border-collapse: collapse; text-align: center;"> <tr> <td style="width: 10%;"></td> <td style="width: 10%;"></td> <td style="width: 10%;"></td> <td style="width: 10%;"></td> <td style="width: 10%;"></td> <td style="width: 10%;"></td> <td style="width: 10%;"></td> <td style="width: 10%;"></td> <td style="width: 10%;"></td> <td style="width: 10%;"></td> </tr> <tr> <td></td> <td></td> <td colspan="8" style="text-align: center;"> <table border="1" style="width: 100%; border-collapse: collapse; text-align: center;"> <tr> <td style="width: 10%;"></td> <td style="width: 10%;"></td> <td style="width: 10%;"></td> <td style="width: 10%;"></td> <td style="width: 10%;"></td> <td style="width: 10%;"></td> <td style="width: 10%;"></td> <td style="width: 10%;"></td> <td style="width: 10%;"></td> <td style="width: 10%;"></td> </tr> <tr> <td></td> <td></td> <td colspan="8" style="text-align: center;"> <table border="1" style="width: 100%; border-collapse: collapse; text-align: center;"> <tr> <td style="width: 10%;"></td> <td style="width: 10%;"></td> <td style="width: 10%;"></td> <td style="width: 10%;"></td> <td style="width: 10%;"></td> <td style="width: 10%;"></td> <td style="width: 10%;"></td> <td style="width: 10%;"></td> <td style="width: 10%;"></td> <td style="width: 10%;"></td> </tr> <tr> <td></td> <td></td> <td colspan="8" style="text-align: center;"> <table border="1" style="width: 100%; border-collapse: collapse; text-align: center;"> <tr> </tr></table></td></tr></table></td></tr></table></td></tr></table></td></tr></table></td></tr></table></td></tr></table></td></tr></table></td></tr></table></td></tr></table></td></tr></table></td></tr></table></td></tr></table></td></tr></table></td></tr></table></td></tr></table></td></tr></table></td></tr></table></td></tr></table></td></tr></table></td></tr></table></td></tr></table></td></tr></table> | | | | | | | | | | | | | | | | | | | | <table border="1" style="width: 100%; border-collapse: collapse; text-align: center;"> <tr> <td style="width: 10%;"></td> <td style="width: 10%;"></td> <td style="width: 10%;"></td> <td style="width: 10%;"></td> <td style="width: 10%;"></td> <td style="width: 10%;"></td> <td style="width: 10%;"></td> <td style="width: 10%;"></td> <td style="width: 10%;"></td> <td style="width: 10%;"></td> </tr> <tr> <td></td> <td></td> <td colspan="8" style="text-align: center;"> <table border="1" style="width: 100%; border-collapse: collapse; text-align: center;"> <tr> <td style="width: 10%;"></td> <td style="width: 10%;"></td> <td style="width: 10%;"></td> <td style="width: 10%;"></td> <td style="width: 10%;"></td> <td style="width: 10%;"></td> <td style="width: 10%;"></td> <td style="width: 10%;"></td> <td style="width: 10%;"></td> <td style="width: 10%;"></td> </tr> <tr> <td></td> <td></td> <td colspan="8" style="text-align: center;"> <table border="1" style="width: 100%; border-collapse: collapse; text-align: center;"> <tr> <td style="width: 10%;"></td> <td style="width: 10%;"></td> <td style="width: 10%;"></td> <td style="width: 10%;"></td> <td style="width: 10%;"></td> <td style="width: 10%;"></td> <td style="width: 10%;"></td> <td style="width: 10%;"></td> <td style="width: 10%;"></td> <td style="width: 10%;"></td> </tr> <tr> <td></td> <td></td> <td colspan="8" style="text-align: center;"> <table border="1" style="width: 100%; border-collapse: collapse; text-align: center;"> <tr> <td style="width: 10%;"></td> <td style="width: 10%;"></td> <td style="width: 10%;"></td> <td style="width: 10%;"></td> <td style="width: 10%;"></td> <td style="width: 10%;"></td> <td style="width: 10%;"></td> <td style="width: 10%;"></td> <td style="width: 10%;"></td> <td style="width: 10%;"></td> </tr> <tr> <td></td> <td></td> <td colspan="8" style="text-align: center;"> <table border="1" style="width: 100%; border-collapse: collapse; text-align: center;"> <tr> <td style="width: 10%;"></td> <td style="width: 10%;"></td> <td style="width: 10%;"></td> <td style="width: 10%;"></td> <td style="width: 10%;"></td> <td style="width: 10%;"></td> <td style="width: 10%;"></td> <td style="width: 10%;"></td> <td style="width: 10%;"></td> <td style="width: 10%;"></td> </tr> <tr> <td></td> <td></td> <td colspan="8" style="text-align: center;"> <table border="1" style="width: 100%; border-collapse: collapse; text-align: center;"> <tr> <td style="width: 10%;"></td> <td style="width: 10%;"></td> <td style="width: 10%;"></td> <td style="width: 10%;"></td> <td style="width: 10%;"></td> <td style="width: 10%;"></td> <td style="width: 10%;"></td> <td style="width: 10%;"></td> <td style="width: 10%;"></td> <td style="width: 10%;"></td> </tr> <tr> <td></td> <td></td> <td colspan="8" style="text-align: center;"> <table border="1" style="width: 100%; border-collapse: collapse; text-align: center;"> <tr> <td style="width: 10%;"></td> <td style="width:
10%;"></td> <td style="width: 10%;"></td> <td style="width: 10%;"></td> <td style="width: 10%;"></td> <td style="width: 10%;"></td> <td style="width: 10%;"></td> <td style="width: 10%;"></td> <td style="width: 10%;"></td> <td style="width: 10%;"></td> </tr> <tr> <td></td> <td></td> <td colspan="8" style="text-align: center;"> <table border="1" style="width: 100%; border-collapse: collapse; text-align: center;"> <tr> <td style="width: 10%;"></td> <td style="width: 10%;"></td> <td style="width: 10%;"></td> <td style="width: 10%;"></td> <td style="width: 10%;"></td> <td style="width: 10%;"></td> <td style="width: 10%;"></td> <td style="width: 10%;"></td> <td style="width: 10%;"></td> <td style="width: 10%;"></td> </tr> <tr> <td></td> <td></td> <td colspan="8" style="text-align: center;"> <table border="1" style="width: 100%; border-collapse: collapse; text-align: center;"> <tr> <td style="width: 10%;"></td> <td style="width: 10%;"></td> <td style="width: 10%;"></td> <td style="width: 10%;"></td> <td style="width: 10%;"></td> <td style="width: 10%;"></td> <td style="width: 10%;"></td> <td style="width: 10%;"></td> <td style="width: 10%;"></td> <td style="width: 10%;"></td> </tr> <tr> <td></td> <td></td> <td colspan="8" style="text-align: center;"> <table border="1" style="width: 100%; border-collapse: collapse; text-align: center;"> <tr> <td style="width: 10%;"></td> <td style="width: 10%;"></td> <td style="width: 10%;"></td> <td style="width: 10%;"></td> <td style="width: 10%;"></td> <td style="width: 10%;"></td> <td style="width: 10%;"></td> <td style="width: 10%;"></td> <td style="width: 10%;"></td> <td style="width: 10%;"></td> </tr> <tr> <td></td> <td></td> <td colspan="8" style="text-align: center;"> <table border="1" style="width: 100%; border-collapse: collapse; text-align: center;"> <tr> <td style="width: 10%;"></td> <td style="width: 10%;"></td> <td style="width: 10%;"></td> <td style="width: 10%;"></td> <td style="width: 10%;"></td> <td style="width: 10%;"></td> <td style="width: 10%;"></td> <td style="width: 10%;"></td> <td style="width: 10%;"></td> <td style="width: 10%;"></td> </tr> <tr> <td></td> <td></td> <td colspan="8" style="text-align: center;"> <table border="1" style="width: 100%; border-collapse: collapse; text-align: center;"> <tr> <td style="width: 10%;"></td> <td style="width: 10%;"></td> <td style="width: 10%;"></td> <td style="width: 10%;"></td> <td style="width: 10%;"></td> <td style="width: 10%;"></td> <td style="width: 10%;"></td> <td style="width: 10%;"></td> <td style="width: 10%;"></td> <td style="width: 10%;"></td> </tr> <tr> <td></td> <td></td> <td colspan="8" style="text-align: center;"> <table border="1" style="width: 100%; border-collapse: collapse; text-align: center;"> <tr> <td style="width: 10%;"></td> <td style="width: 10%;"></td> <td style="width: 10%;"></td> <td style="width: 10%;"></td> <td style="width: 10%;"></td> <td style="width: 10%;"></td> <td style="width: 10%;"></td> <td style="width: 10%;"></td> <td style="width: 10%;"></td> <td style="width: 10%;"></td> </tr> <tr> <td></td> <td></td> <td colspan="8" style="text-align: center;"> <table border="1" style="width: 100%; border-collapse: collapse; text-align: center;"> <tr> <td style="width: 10%;"></td> <td style="width: 10%;"></td> <td style="width: 10%;"></td> <td style="width: 10%;"></td> <td style="width: 10%;"></td> <td style="width: 10%;"></td> <td style="width: 10%;"></td> <td style="width: 10%;"></td> <td style="width: 10%;"></td> <td style="width: 10%;"></td> </tr> <tr> <td></td> <td></td> <td colspan="8" style="text-align: center;"> <table border="1" style="width: 100%; border-collapse: collapse; text-align: center;"> <tr> <td style="width: 10%;"></td> <td style="width: 10%;"></td> <td style="width: 10%;"></td> <td style="width: 10%;"></td> <td style="width: 10%;"></td> <td style="width: 10%;"></td> <td style="width: 10%;"></td> <td style="width: 10%;"></td> <td style="width: 10%;"></td> <td style="width: 10%;"></td> </tr> <tr> <td></td> <td></td> <td colspan="8" style="text-align: center;"> <table border="1" style="width: 100%; border-collapse: collapse; text-align: center;"> <tr> <td style="width: 10%;"></td> <td style="width: 10%;"></td> <td style="width: 10%;"></td> <td style="width: 10%;"></td> <td style="width: 10%;"></td> <td style="width: 10%;"></td> <td style="width: 10%;"></td> <td style="width: 10%;"></td> <td style="width: 10%;"></td> <td style="width: 10%;"></td> </tr> <tr> <td></td> <td></td> <td colspan="8" style="text-align: center;"> <table border="1" style="width: 100%; border-collapse: collapse; text-align: center;"> <tr> <td style="width: 10%;"></td> <td style="width: 10%;"></td> <td style="width: 10%;"></td> <td style="width: 10%;"></td> <td style="width: 10%;"></td> <td style="width: 10%;"></td> <td style="width: 10%;"></td> <td style="width: 10%;"></td> <td style="width: 10%;"></td> <td style="width: 10%;"></td> </tr> <tr> <td></td> <td></td> <td colspan="8" style="text-align: center;"> <table border="1" style="width: 100%; border-collapse: collapse; text-align: center;"> <tr> <td style="width: 10%;"></td> <td style="width: 10%;"></td> <td style="width: 10%;"></td> <td style="width: 10%;"></td> <td style="width: 10%;"></td> <td style="width: 10%;"></td> <td style="width: 10%;"></td> <td style="width: 10%;"></td> <td style="width: 10%;"></td> <td style="width: 10%;"></td> </tr> <tr> <td></td> <td></td> <td colspan="8" style="text-align: center;"> <table border="1" style="width: 100%; border-collapse: collapse; text-align: center;"> <tr> <td style="width: 10%;"></td> <td style="width: 10%;"></td> <td style="width: 10%;"></td> <td style="width: 10%;"></td> <td style="width: 10%;"></td> <td style="width: 10%;"></td> <td style="width: 10%;"></td> <td style="width: 10%;"></td> <td style="width: 10%;"></td> <td style="width: 10%;"></td> </tr> <tr> <td></td> <td></td> <td colspan="8" style="text-align: center;"> <table border="1" style="width: 100%; border-collapse: collapse; text-align: center;"> <tr> <td style="width: 10%;"></td> <td style="width: 10%;"></td> <td style="width: 10%;"></td> <td style="width: 10%;"></td> <td style="width: 10%;"></td> <td style="width: 10%;"></td> <td style="width: 10%;"></td> <td style="width: 10%;"></td> <td style="width: 10%;"></td> <td style="width: 10%;"></td> </tr> <tr> <td></td> <td></td> <td colspan="8" style="text-align: center;"> <table border="1" style="width: 100%; border-collapse: collapse; text-align: center;"> <tr> <td style="width: 10%;"></td> <td style="width: 10%;"></td> <td style="width: 10%;"></td> <td style="width: 10%;"></td> <td style="width: 10%;"></td> <td style="width: 10%;"></td> <td style="width: 10%;"></td> <td style="width: 10%;"></td> <td style="width: 10%;"></td> <td style="width: 10%;"></td> </tr> <tr> <td></td> <td></td> <td colspan="8" style="text-align: center;"> <table border="1" style="width: 100%; border-collapse: collapse; text-align: center;"> <tr> </tr></table></td></tr></table></td></tr></table></td></tr></table></td></tr></table></td></tr></table></td></tr></table></td></tr></table></td></tr></table></td></tr></table></td></tr></table></td></tr></table></td></tr></table></td></tr></table></td></tr></table></td></tr></table></td></tr></table></td></tr></table></td></tr></table></td></tr></table></td></tr></table></td></tr></table> | | | | | | | | | | | | | | | | | | | | <table border="1" style="width: 100%; border-collapse: collapse; text-align: center;"> <tr> <td style="width: 10%;"></td> <td style="width: 10%;"></td> <td style="width: 10%;"></td> <td style="width: 10%;"></td> <td style="width: 10%;"></td> <td style="width: 10%;"></td> <td style="width: 10%;"></td> <td style="width: 10%;"></td> <td style="width: 10%;"></td> <td style="width: 10%;"></td> </tr> <tr> <td></td> <td></td> <td colspan="8" style="text-align: center;"> <table border="1" style="width: 100%; border-collapse: collapse; text-align: center;"> <tr> <td style="width: 10%;"></td> <td style="width: 10%;"></td> <td style="width: 10%;"></td> <td style="width: 10%;"></td> <td style="width: 10%;"></td> <td style="width: 10%;"></td> <td style="width: 10%;"></td> <td style="width: 10%;"></td> <td style="width: 10%;"></td> <td style="width: 10%;"></td> </tr> <tr> <td></td> <td></td> <td colspan="8" style="text-align: center;"> <table border="1" style="width: 100%; border-collapse: collapse; text-align: center;"> <tr> <td style="width: 10%;"></td> <td style="width: 10%;"></td> <td style="width: 10%;"></td> <td style="width: 10%;"></td> <td style="width: 10%;"></td> <td style="width: 10%;"></td> <td style="width: 10%;"></td> <td style="width: 10%;"></td> <td style="width: 10%;"></td> <td style="width: 10%;"></td> </tr> <tr> <td></td> <td></td> <td colspan="8" style="text-align: center;"> <table border="1" style="width: 100%; border-collapse: collapse; text-align: center;"> <tr> <td style="width: 10%;"></td> <td style="width: 10%;"></td> <td style="width: 10%;"></td> <td style="width: 10%;"></td> <td style="width: 10%;"></td> <td style="width: 10%;"></td> <td style="width: 10%;"></td> <td style="width: 10%;"></td> <td style="width: 10%;"></td> <td style="width: 10%;"></td> </tr> <tr> <td></td> <td></td> <td colspan="8" style="text-align: center;"> <table border="1" style="width: 100%; border-collapse: collapse; text-align: center;"> <tr> <td style="width: 10%;"></td> <td style="width: 10%;"></td> <td style="width: 10%;"></td> <td style="width: 10%;"></td> <td style="width: 10%;"></td> <td style="width: 10%;"></td> <td style="width: 10%;"></td> <td style="width: 10%;"></td> <td style="width: 10%;"></td> <td style="width: 10%;"></td> </tr> <tr> <td></td> <td></td> <td colspan="8" style="text-align: center;"> <table border="1" style="width: 100%; border-collapse: collapse; text-align: center;"> <tr> <td style="width: 10%;"></td> <td style="width: 10%;"></td> <td style="width: 10%;"></td> <td style="width: 10%;"></td> <td style="width:
10%;"></td> <td style="width: 10%;"></td> <td style="width: 10%;"></td> <td style="width: 10%;"></td> <td style="width: 10%;"></td> <td style="width: 10%;"></td> </tr> <tr> <td></td> <td></td> <td colspan="8" style="text-align: center;"> <table border="1" style="width: 100%; border-collapse: collapse; text-align: center;"> <tr> <td style="width: 10%;"></td> <td style="width: 10%;"></td> <td style="width: 10%;"></td> <td style="width: 10%;"></td> <td style="width: 10%;"></td> <td style="width: 10%;"></td> <td style="width: 10%;"></td> <td style="width: 10%;"></td> <td style="width: 10%;"></td> <td style="width: 10%;"></td> </tr> <tr> <td></td> <td></td> <td colspan="8" style="text-align: center;"> <table border="1" style="width: 100%; border-collapse: collapse; text-align: center;"> <tr> <td style="width: 10%;"></td> <td style="width: 10%;"></td> <td style="width: 10%;"></td> <td style="width: 10%;"></td> <td style="width: 10%;"></td> <td style="width: 10%;"></td> <td style="width: 10%;"></td> <td style="width: 10%;"></td> <td style="width: 10%;"></td> <td style="width: 10%;"></td> </tr> <tr> <td></td> <td></td> <td colspan="8" style="text-align: center;"> <table border="1" style="width: 100%; border-collapse: collapse; text-align: center;"> <tr> <td style="width: 10%;"></td> <td style="width: 10%;"></td> <td style="width: 10%;"></td> <td style="width: 10%;"></td> <td style="width: 10%;"></td> <td style="width: 10%;"></td> <td style="width: 10%;"></td> <td style="width: 10%;"></td> <td style="width: 10%;"></td> <td style="width: 10%;"></td> </tr> <tr> <td></td> <td></td> <td colspan="8" style="text-align: center;"> <table border="1" style="width: 100%; border-collapse: collapse; text-align: center;"> <tr> <td style="width: 10%;"></td> <td style="width: 10%;"></td> <td style="width: 10%;"></td> <td style="width: 10%;"></td> <td style="width: 10%;"></td> <td style="width: 10%;"></td> <td style="width: 10%;"></td> <td style="width: 10%;"></td> <td style="width: 10%;"></td> <td style="width: 10%;"></td> </tr> <tr> <td></td> <td></td> <td colspan="8" style="text-align: center;"> <table border="1" style="width: 100%; border-collapse: collapse; text-align: center;"> <tr> <td style="width: 10%;"></td> <td style="width: 10%;"></td> <td style="width: 10%;"></td> <td style="width: 10%;"></td> <td style="width: 10%;"></td> <td style="width: 10%;"></td> <td style="width: 10%;"></td> <td style="width: 10%;"></td> <td style="width: 10%;"></td> <td style="width: 10%;"></td> </tr> <tr> <td></td> <td></td> <td colspan="8" style="text-align: center;"> <table border="1" style="width: 100%; border-collapse: collapse; text-align: center;"> <tr> <td style="width: 10%;"></td> <td style="width: 10%;"></td> <td style="width: 10%;"></td> <td style="width: 10%;"></td> <td style="width: 10%;"></td> <td style="width: 10%;"></td> <td style="width: 10%;"></td> <td style="width: 10%;"></td> <td style="width: 10%;"></td> <td style="width: 10%;"></td> </tr> <tr> <td></td> <td></td> <td colspan="8" style="text-align: center;"> <table border="1" style="width: 100%; border-collapse: collapse; text-align: center;"> <tr> <td style="width: 10%;"></td> <td style="width: 10%;"></td> <td style="width: 10%;"></td> <td style="width: 10%;"></td> <td style="width: 10%;"></td> <td style="width: 10%;"></td> <td style="width: 10%;"></td> <td style="width: 10%;"></td> <td style="width: 10%;"></td> <td style="width: 10%;"></td> </tr> <tr> <td></td> <td></td> <td colspan="8" style="text-align: center;"> <table border="1" style="width: 100%; border-collapse: collapse; text-align: center;"> <tr> <td style="width: 10%;"></td> <td style="width: 10%;"></td> <td style="width: 10%;"></td> <td style="width: 10%;"></td> <td style="width: 10%;"></td> <td style="width: 10%;"></td> <td style="width: 10%;"></td> <td style="width: 10%;"></td> <td style="width: 10%;"></td> <td style="width: 10%;"></td> </tr> <tr> <td></td> <td></td> <td colspan="8" style="text-align: center;"> <table border="1" style="width: 100%; border-collapse: collapse; text-align: center;"> <tr> <td style="width: 10%;"></td> <td style="width: 10%;"></td> <td style="width: 10%;"></td> <td style="width: 10%;"></td> <td style="width: 10%;"></td> <td style="width: 10%;"></td> <td style="width: 10%;"></td> <td style="width: 10%;"></td> <td style="width: 10%;"></td> <td style="width: 10%;"></td> </tr> <tr> <td></td> <td></td> <td colspan="8" style="text-align: center;"> <table border="1" style="width: 100%; border-collapse: collapse; text-align: center;"> <tr> <td style="width: 10%;"></td> <td style="width: 10%;"></td> <td style="width: 10%;"></td> <td style="width: 10%;"></td> <td style="width: 10%;"></td> <td style="width: 10%;"></td> <td style="width: 10%;"></td> <td style="width: 10%;"></td> <td style="width: 10%;"></td> <td style="width: 10%;"></td> </tr> <tr> <td></td> <td></td> <td colspan="8" style="text-align: center;"> <table border="1" style="width: 100%; border-collapse: collapse; text-align: center;"> <tr> <td style="width: 10%;"></td> <td style="width: 10%;"></td> <td style="width: 10%;"></td> <td style="width: 10%;"></td> <td style="width: 10%;"></td> <td style="width: 10%;"></td> <td style="width: 10%;"></td> <td style="width: 10%;"></td> <td style="width: 10%;"></td> <td style="width: 10%;"></td> </tr> <tr> <td></td> <td></td> <td colspan="8" style="text-align: center;"> <table border="1" style="width: 100%; border-collapse: collapse; text-align: center;"> <tr> <td style="width: 10%;"></td> <td style="width: 10%;"></td> <td style="width: 10%;"></td> <td style="width: 10%;"></td> <td style="width: 10%;"></td> <td style="width: 10%;"></td> <td style="width: 10%;"></td> <td style="width: 10%;"></td> <td style="width: 10%;"></td> <td style="width: 10%;"></td> </tr> <tr> <td></td> <td></td> <td colspan="8" style="text-align: center;"> <table border="1" style="width: 100%; border-collapse: collapse; text-align: center;"> <tr> <td style="width: 10%;"></td> <td style="width: 10%;"></td> <td style="width: 10%;"></td> <td style="width: 10%;"></td> <td style="width: 10%;"></td> <td style="width: 10%;"></td> <td style="width: 10%;"></td> <td style="width: 10%;"></td> <td style="width: 10%;"></td> <td style="width: 10%;"></td> </tr> <tr> <td></td> <td></td> <td colspan="8" style="text-align: center;"> <table border="1" style="width: 100%; border-collapse: collapse; text-align: center;"> <tr> <td style="width: 10%;"></td> <td style="width: 10%;"></td> <td style="width: 10%;"></td> <td style="width: 10%;"></td> <td style="width: 10%;"></td> <td style="width: 10%;"></td> <td style="width: 10%;"></td> <td style="width: 10%;"></td> <td style="width: 10%;"></td> <td style="width: 10%;"></td> </tr> <tr> <td></td> <td></td> <td colspan="8" style="text-align: center;"> <table border="1" style="width: 100%; border-collapse: collapse; text-align: center;"> <tr> </tr></table></td></tr></table></td></tr></table></td></tr></table></td></tr></table></td></tr></table></td></tr></table></td></tr></table></td></tr></table></td></tr></table></td></tr></table></td></tr></table></td></tr></table></td></tr></table></td></tr></table></td></tr></table></td></tr></table></td></tr></table></td></tr></table></td></tr></table></td></tr></table> | | | | | | | | | | | | | | | | | | | | <table border="1" style="width: 100%; border-collapse: collapse; text-align: center;"> <tr> <td style="width: 10%;"></td> <td style="width: 10%;"></td> <td style="width: 10%;"></td> <td style="width: 10%;"></td> <td style="width: 10%;"></td> <td style="width: 10%;"></td> <td style="width: 10%;"></td> <td style="width: 10%;"></td> <td style="width: 10%;"></td> <td style="width: 10%;"></td> </tr> <tr> <td></td> <td></td> <td colspan="8" style="text-align: center;"> <table border="1" style="width: 100%; border-collapse: collapse; text-align: center;"> <tr> <td style="width: 10%;"></td> <td style="width: 10%;"></td> <td style="width: 10%;"></td> <td style="width: 10%;"></td> <td style="width: 10%;"></td> <td style="width: 10%;"></td> <td style="width: 10%;"></td> <td style="width: 10%;"></td> <td style="width: 10%;"></td> <td style="width: 10%;"></td> </tr> <tr> <td></td> <td></td> <td colspan="8" style="text-align: center;"> <table border="1" style="width: 100%; border-collapse: collapse; text-align: center;"> <tr> <td style="width: 10%;"></td> <td style="width: 10%;"></td> <td style="width: 10%;"></td> <td style="width: 10%;"></td> <td style="width: 10%;"></td> <td style="width: 10%;"></td> <td style="width: 10%;"></td> <td style="width: 10%;"></td> <td style="width: 10%;"></td> <td style="width: 10%;"></td> </tr> <tr> <td></td> <td></td> <td colspan="8" style="text-align: center;"> <table border="1" style="width: 100%; border-collapse: collapse; text-align: center;"> <tr> <td style="width: 10%;"></td> <td style="width: 10%;"></td> <td style="width: 10%;"></td> <td style="width: 10%;"></td> <td style="width: 10%;"></td> <td style="width: 10%;"></td> <td style="width: 10%;"></td> <td style="width: 10%;"></td> <td style="width: 10%;"></td> <td style="width: 10%;"></td> </tr> <tr> <td></td> <td></td> <td colspan="8" style="text-align: center;"> <table border="1" style="width: 100%; border-collapse: collapse; text-align: center;"> <tr> <td style="width: 10%;"></td> <td style="width: 10%;"></td> <td style="width: 10%;"></td> <td style="width: 10%;"></td> <td style="width: 10%;"></td> <td style="width: 10%;"></td> <td style="width: 10%;"></td> <td style="width: 10%;"></td> <td style="width: 10%;"></td> <td style="width: 10%;"></td> </tr> <tr> <td></td> <td></td> <td colspan="8" style="text-align: center;"> <table border="1" style="width: 100%; border-collapse: collapse; text-align: center;"> <tr> <td style="width: 10%;"></td> <td style="width: 10%;"></td> <td style="width: 10%;"></td> <td style="width: 10%;"></td> <td style="width: 10%;"></td> <td style="width: 10%;"></td> <td style="width: 10%;"></td> <td style="width: 10%;"></td> <td
style="width: 10%;"></td> <td style="width: 10%;"></td> </tr> <tr> <td></td> <td></td> <td colspan="8" style="text-align: center;"> <table border="1" style="width: 100%; border-collapse: collapse; text-align: center;"> <tr> <td style="width: 10%;"></td> <td style="width: 10%;"></td> <td style="width: 10%;"></td> <td style="width: 10%;"></td> <td style="width: 10%;"></td> <td style="width: 10%;"></td> <td style="width: 10%;"></td> <td style="width: 10%;"></td> <td style="width: 10%;"></td> <td style="width: 10%;"></td> </tr> <tr> <td></td> <td></td> <td colspan="8" style="text-align: center;"> <table border="1" style="width: 100%; border-collapse: collapse; text-align: center;"> <tr> <td style="width: 10%;"></td> <td style="width: 10%;"></td> <td style="width: 10%;"></td> <td style="width: 10%;"></td> <td style="width: 10%;"></td> <td style="width: 10%;"></td> <td style="width: 10%;"></td> <td style="width: 10%;"></td> <td style="width: 10%;"></td> <td style="width: 10%;"></td> </tr> <tr> <td></td> <td></td> <td colspan="8" style="text-align: center;"> <table border="1" style="width: 100%; border-collapse: collapse; text-align: center;"> <tr> <td style="width: 10%;"></td> <td style="width: 10%;"></td> <td style="width: 10%;"></td> <td style="width: 10%;"></td> <td style="width: 10%;"></td> <td style="width: 10%;"></td> <td style="width: 10%;"></td> <td style="width: 10%;"></td> <td style="width: 10%;"></td> <td style="width: 10%;"></td> </tr> <tr> <td></td> <td></td> <td colspan="8" style="text-align: center;"> <table border="1" style="width: 100%; border-collapse: collapse; text-align: center;"> <tr> <td style="width: 10%;"></td> <td style="width: 10%;"></td> <td style="width: 10%;"></td> <td style="width: 10%;"></td> <td style="width: 10%;"></td> <td style="width: 10%;"></td> <td style="width: 10%;"></td> <td style="width: 10%;"></td> <td style="width: 10%;"></td> <td style="width: 10%;"></td> </tr> <tr> <td></td> <td></td> <td colspan="8" style="text-align: center;"> <table border="1" style="width: 100%; border-collapse: collapse; text-align: center;"> <tr> <td style="width: 10%;"></td> <td style="width: 10%;"></td> <td style="width: 10%;"></td> <td style="width: 10%;"></td> <td style="width: 10%;"></td> <td style="width: 10%;"></td> <td style="width: 10%;"></td> <td style="width: 10%;"></td> <td style="width: 10%;"></td> <td style="width: 10%;"></td> </tr> <tr> <td></td> <td></td> <td colspan="8" style="text-align: center;"> <table border="1" style="width: 100%; border-collapse: collapse; text-align: center;"> <tr> <td style="width: 10%;"></td> <td style="width: 10%;"></td> <td style="width: 10%;"></td> <td style="width: 10%;"></td> <td style="width: 10%;"></td> <td style="width: 10%;"></td> <td style="width: 10%;"></td> <td style="width: 10%;"></td> <td style="width: 10%;"></td> <td style="width: 10%;"></td> </tr> <tr> <td></td> <td></td> <td colspan="8" style="text-align: center;"> <table border="1" style="width: 100%; border-collapse: collapse; text-align: center;"> <tr> <td style="width: 10%;"></td> <td style="width: 10%;"></td> <td style="width: 10%;"></td> <td style="width: 10%;"></td> <td style="width: 10%;"></td> <td style="width: 10%;"></td> <td style="width: 10%;"></td> <td style="width: 10%;"></td> <td style="width: 10%;"></td> <td style="width: 10%;"></td> </tr> <tr> <td></td> <td></td> <td colspan="8" style="text-align: center;"> <table border="1" style="width: 100%; border-collapse: collapse; text-align: center;"> <tr> <td style="width: 10%;"></td> <td style="width: 10%;"></td> <td style="width: 10%;"></td> <td style="width: 10%;"></td> <td style="width: 10%;"></td> <td style="width: 10%;"></td> <td style="width: 10%;"></td> <td style="width: 10%;"></td> <td style="width: 10%;"></td> <td style="width: 10%;"></td> </tr> <tr> <td></td> <td></td> <td colspan="8" style="text-align: center;"> <table border="1" style="width: 100%; border-collapse: collapse; text-align: center;"> <tr> <td style="width: 10%;"></td> <td style="width: 10%;"></td> <td style="width: 10%;"></td> <td style="width: 10%;"></td> <td style="width: 10%;"></td> <td style="width: 10%;"></td> <td style="width: 10%;"></td> <td style="width: 10%;"></td> <td style="width: 10%;"></td> <td style="width: 10%;"></td> </tr> <tr> <td></td> <td></td> <td colspan="8" style="text-align: center;"> <table border="1" style="width: 100%; border-collapse: collapse; text-align: center;"> <tr> <td style="width: 10%;"></td> <td style="width: 10%;"></td> <td style="width: 10%;"></td> <td style="width: 10%;"></td> <td style="width: 10%;"></td> <td style="width: 10%;"></td> <td style="width: 10%;"></td> <td style="width: 10%;"></td> <td style="width: 10%;"></td> <td style="width: 10%;"></td> </tr> <tr> <td></td> <td></td> <td colspan="8" style="text-align: center;"> <table border="1" style="width: 100%; border-collapse: collapse; text-align: center;"> <tr> <td style="width: 10%;"></td> <td style="width: 10%;"></td> <td style="width: 10%;"></td> <td style="width: 10%;"></td> <td style="width: 10%;"></td> <td style="width: 10%;"></td> <td style="width: 10%;"></td> <td style="width: 10%;"></td> <td style="width: 10%;"></td> <td style="width: 10%;"></td> </tr> <tr> <td></td> <td></td> <td colspan="8" style="text-align: center;"> <table border="1" style="width: 100%; border-collapse: collapse; text-align: center;"> <tr> <td style="width: 10%;"></td> <td style="width: 10%;"></td> <td style="width: 10%;"></td> <td style="width: 10%;"></td> <td style="width: 10%;"></td> <td style="width: 10%;"></td> <td style="width: 10%;"></td> <td style="width: 10%;"></td> <td style="width: 10%;"></td> <td style="width: 10%;"></td> </tr> <tr> <td></td> <td></td> <td colspan="8" style="text-align: center;"> <table border="1" style="width: 100%; border-collapse: collapse; text-align: center;"> <tr> <td style="width: 10%;"></td> <td style="width: 10%;"></td> <td style="width: 10%;"></td> <td style="width: 10%;"></td> <td style="width: 10%;"></td> <td style="width: 10%;"></td> <td style="width: 10%;"></td> <td style="width: 10%;"></td> <td style="width: 10%;"></td> <td style="width: 10%;"></td> </tr> <tr> <td></td> <td></td> <td colspan="8" style="text-align: center;"> <table border="1" style="width: 100%; border-collapse: collapse; text-align: center;"> <tr> </tr></table></td></tr></table></td></tr></table></td></tr></table></td></tr></table></td></tr></table></td></tr></table></td></tr></table></td></tr></table></td></tr></table></td></tr></table></td></tr></table></td></tr></table></td></tr></table></td></tr></table></td></tr></table></td></tr></table></td></tr></table></td></tr></table></td></tr></table> | | | | | | | | | | | | | | | | | | | | <table border="1" style="width: 100%; border-collapse: collapse; text-align: center;"> <tr> <td style="width: 10%;"></td> <td style="width: 10%;"></td> <td style="width: 10%;"></td> <td style="width: 10%;"></td> <td style="width: 10%;"></td> <td style="width: 10%;"></td> <td style="width: 10%;"></td> <td style="width: 10%;"></td> <td style="width: 10%;"></td> <td style="width: 10%;"></td> </tr> <tr> <td></td> <td></td> <td colspan="8" style="text-align: center;"> <table border="1" style="width: 100%; border-collapse: collapse; text-align: center;"> <tr> <td style="width: 10%;"></td> <td style="width: 10%;"></td> <td style="width: 10%;"></td> <td style="width: 10%;"></td> <td style="width: 10%;"></td> <td style="width: 10%;"></td> <td style="width: 10%;"></td> <td style="width: 10%;"></td> <td style="width: 10%;"></td> <td style="width: 10%;"></td> </tr> <tr> <td></td> <td></td> <td colspan="8" style="text-align: center;"> <table border="1" style="width: 100%; border-collapse: collapse; text-align: center;"> <tr> <td style="width: 10%;"></td> <td style="width: 10%;"></td> <td style="width: 10%;"></td> <td style="width: 10%;"></td> <td style="width: 10%;"></td> <td style="width: 10%;"></td> <td style="width: 10%;"></td> <td style="width: 10%;"></td> <td style="width: 10%;"></td> <td style="width: 10%;"></td> </tr> <tr> <td></td> <td></td> <td colspan="8" style="text-align: center;"> <table border="1" style="width: 100%; border-collapse: collapse; text-align: center;"> <tr> <td style="width: 10%;"></td> <td style="width: 10%;"></td> <td style="width: 10%;"></td> <td style="width: 10%;"></td> <td style="width: 10%;"></td> <td style="width: 10%;"></td> <td style="width: 10%;"></td> <td style="width: 10%;"></td> <td style="width: 10%;"></td> <td style="width: 10%;"></td> </tr> <tr> <td></td> <td></td> <td colspan="8" style="text-align: center;"> <table border="1" style="width: 100%; border-collapse: collapse; text-align: center;"> <tr> <td style="width: 10%;"></td> <td style="width: 10%;"></td> <td style="width: 10%;"></td> <td style="width: 10%;"></td> <td style="width: 10%;"></td> <td style="width: 10%;"></td> <td style="width: 10%;"></td> <td style="width: 10%;"></td> <td style="width: 10%;"></td> <td style="width: 10%;"></td> </tr> <tr> <td></td> <td></td> <td colspan="8" style="text-align: center;"> <table border="1" style="width: 100%; border-collapse: collapse; text-align: center;"> <tr> <td style="width: 10%;"></td> <td style="width: 10%;"></td> <td style="width: 10%;"></td> <td style="width: 10%;"></td> <td style="width: 10%;"></td> <td style="width: 10%;"></td> <td style="width: 10%;"></td> <td style="width: 10%;"></td> <td style="width: 10%;"></td> <td style="width: 10%;"></td> </tr> <tr> <td></td> <td></td> <td colspan="8" style="text-align: center;"> <table border="1" style="width: 100%; border-collapse: collapse; text-align: center;"> <tr> <td style="width: 10%;"></td> <td style="width: 10%;"></td> <td style="width: 10%;"></td> <td style="width: 10%;"></td> <td style="width: 10%;"></td> <td style="width: 10%;"></td> <td style="width: 10%;"></td> <td style="width: 10%;"></td> <td style="width: 10%;"></td> <td style="width: 10%;"></td> </tr> <tr> <td></td> <td></td> <td colspan="8" style="text-align: center;">
<table border="1" style="width: 100%; border-collapse: collapse; text-align: center;"> <tr> <td style="width: 10%;"></td> <td style="width: 10%;"></td> <td style="width: 10%;"></td> <td style="width: 10%;"></td> <td style="width: 10%;"></td> <td style="width: 10%;"></td> <td style="width: 10%;"></td> <td style="width: 10%;"></td> <td style="width: 10%;"></td> <td style="width: 10%;"></td> </tr> <tr> <td></td> <td></td> <td colspan="8" style="text-align: center;"> <table border="1" style="width: 100%; border-collapse: collapse; text-align: center;"> <tr> <td style="width: 10%;"></td> <td style="width: 10%;"></td> <td style="width: 10%;"></td> <td style="width: 10%;"></td> <td style="width: 10%;"></td> <td style="width: 10%;"></td> <td style="width: 10%;"></td> <td style="width: 10%;"></td> <td style="width: 10%;"></td> <td style="width: 10%;"></td> </tr> <tr> <td></td> <td></td> <td colspan="8" style="text-align: center;"> <table border="1" style="width: 100%; border-collapse: collapse; text-align: center;"> <tr> <td style="width: 10%;"></td> <td style="width: 10%;"></td> <td style="width: 10%;"></td> <td style="width: 10%;"></td> <td style="width: 10%;"></td> <td style="width: 10%;"></td> <td style="width: 10%;"></td> <td style="width: 10%;"></td> <td style="width: 10%;"></td> <td style="width: 10%;"></td> </tr> <tr> <td></td> <td></td> <td colspan="8" style="text-align: center;"> <table border="1" style="width: 100%; border-collapse: collapse; text-align: center;"> <tr> <td style="width: 10%;"></td> <td style="width: 10%;"></td> <td style="width: 10%;"></td> <td style="width: 10%;"></td> <td style="width: 10%;"></td> <td style="width: 10%;"></td> <td style="width: 10%;"></td> <td style="width: 10%;"></td> <td style="width: 10%;"></td> <td style="width: 10%;"></td> </tr> <tr> <td></td> <td></td> <td colspan="8" style="text-align: center;"> <table border="1" style="width: 100%; border-collapse: collapse; text-align: center;"> <tr> <td style="width: 10%;"></td> <td style="width: 10%;"></td> <td style="width: 10%;"></td> <td style="width: 10%;"></td> <td style="width: 10%;"></td> <td style="width: 10%;"></td> <td style="width: 10%;"></td> <td style="width: 10%;"></td> <td style="width: 10%;"></td> <td style="width: 10%;"></td> </tr> <tr> <td></td> <td></td> <td colspan="8" style="text-align: center;"> <table border="1" style="width: 100%; border-collapse: collapse; text-align: center;"> <tr> <td style="width: 10%;"></td> <td style="width: 10%;"></td> <td style="width: 10%;"></td> <td style="width: 10%;"></td> <td style="width: 10%;"></td> <td style="width: 10%;"></td> <td style="width: 10%;"></td> <td style="width: 10%;"></td> <td style="width: 10%;"></td> <td style="width: 10%;"></td> </tr> <tr> <td></td> <td></td> <td colspan="8" style="text-align: center;"> <table border="1" style="width: 100%; border-collapse: collapse; text-align: center;"> <tr> <td style="width: 10%;"></td> <td style="width: 10%;"></td> <td style="width: 10%;"></td> <td style="width: 10%;"></td> <td style="width: 10%;"></td> <td style="width: 10%;"></td> <td style="width: 10%;"></td> <td style="width: 10%;"></td> <td style="width: 10%;"></td> <td style="width: 10%;"></td> </tr> <tr> <td></td> <td></td> <td colspan="8" style="text-align: center;"> <table border="1" style="width: 100%; border-collapse: collapse; text-align: center;"> <tr> <td style="width: 10%;"></td> <td style="width: 10%;"></td> <td style="width: 10%;"></td> <td style="width: 10%;"></td> <td style="width: 10%;"></td> <td style="width: 10%;"></td> <td style="width: 10%;"></td> <td style="width: 10%;"></td> <td style="width: 10%;"></td> <td style="width: 10%;"></td> </tr> <tr> <td></td> <td></td> <td colspan="8" style="text-align: center;"> <table border="1" style="width: 100%; border-collapse: collapse; text-align: center;"> <tr> <td style="width: 10%;"></td> <td style="width: 10%;"></td> <td style="width: 10%;"></td> <td style="width: 10%;"></td> <td style="width: 10%;"></td> <td style="width: 10%;"></td> <td style="width: 10%;"></td> <td style="width: 10%;"></td> <td style="width: 10%;"></td> <td style="width: 10%;"></td> </tr> <tr> <td></td> <td></td> <td colspan="8" style="text-align: center;"> <table border="1" style="width: 100%; border-collapse: collapse; text-align: center;"> <tr> <td style="width: 10%;"></td> <td style="width: 10%;"></td> <td style="width: 10%;"></td> <td style="width: 10%;"></td> <td style="width: 10%;"></td> <td style="width: 10%;"></td> <td style="width: 10%;"></td> <td style="width: 10%;"></td> <td style="width: 10%;"></td> <td style="width: 10%;"></td> </tr> <tr> <td></td> <td></td> <td colspan="8" style="text-align: center;"> <table border="1" style="width: 100%; border-collapse: collapse; text-align: center;"> <tr> <td style="width: 10%;"></td> <td style="width: 10%;"></td> <td style="width: 10%;"></td> <td style="width: 10%;"></td> <td style="width: 10%;"></td> <td style="width: 10%;"></td> <td style="width: 10%;"></td> <td style="width: 10%;"></td> <td style="width: 10%;"></td> <td style="width: 10%;"></td> </tr> <tr> <td></td> <td></td> <td colspan="8" style="text-align: center;"> <table border="1" style="width: 100%; border-collapse: collapse; text-align: center;"> <tr> </tr></table></td></tr></table></td></tr></table></td></tr></table></td></tr></table></td></tr></table></td></tr></table></td></tr></table></td></tr></table></td></tr></table></td></tr></table></td></tr></table></td></tr></table></td></tr></table></td></tr></table></td></tr></table></td></tr></table></td></tr></table></td></tr></table> | | | | | | | | | | | | | | | | | | | | <table border="1" style="width: 100%; border-collapse: collapse; text-align: center;"> <tr> <td style="width: 10%;"></td> <td style="width: 10%;"></td> <td style="width: 10%;"></td> <td style="width: 10%;"></td> <td style="width: 10%;"></td> <td style="width: 10%;"></td> <td style="width: 10%;"></td> <td style="width: 10%;"></td> <td style="width: 10%;"></td> <td style="width: 10%;"></td> </tr> <tr> <td></td> <td></td> <td colspan="8" style="text-align: center;"> <table border="1" style="width: 100%; border-collapse: collapse; text-align: center;"> <tr> <td style="width: 10%;"></td> <td style="width: 10%;"></td> <td style="width: 10%;"></td> <td style="width: 10%;"></td> <td style="width: 10%;"></td> <td style="width: 10%;"></td> <td style="width: 10%;"></td> <td style="width: 10%;"></td> <td style="width: 10%;"></td> <td style="width: 10%;"></td> </tr> <tr> <td></td> <td></td> <td colspan="8" style="text-align: center;"> <table border="1" style="width: 100%; border-collapse: collapse; text-align: center;"> <tr> <td style="width: 10%;"></td> <td style="width: 10%;"></td> <td style="width: 10%;"></td> <td style="width: 10%;"></td> <td style="width: 10%;"></td> <td style="width: 10%;"></td> <td style="width: 10%;"></td> <td style="width: 10%;"></td> <td style="width: 10%;"></td> <td style="width: 10%;"></td> </tr> <tr> <td></td> <td></td> <td colspan="8" style="text-align: center;"> <table border="1" style="width: 100%; border-collapse: collapse; text-align: center;"> <tr> <td style="width: 10%;"></td> <td style="width: 10%;"></td> <td style="width: 10%;"></td> <td style="width: 10%;"></td> <td style="width: 10%;"></td> <td style="width: 10%;"></td> <td style="width: 10%;"></td> <td style="width: 10%;"></td> <td style="width: 10%;"></td> <td style="width: 10%;"></td> </tr> <tr> <td></td> <td></td> <td colspan="8" style="text-align: center;"> <table border="1" style="width: 100%; border-collapse: collapse; text-align: center;"> <tr> <td style="width: 10%;"></td> <td style="width: 10%;"></td> <td style="width: 10%;"></td> <td style="width: 10%;"></td> <td style="width: 10%;"></td> <td style="width: 10%;"></td> <td style="width: 10%;"></td> <td style="width: 10%;"></td> <td style="width: 10%;"></td> <td style="width: 10%;"></td> </tr> <tr> <td></td> <td></td> <td colspan="8" style="text-align: center;"> <table border="1" style="width: 100%; border-collapse: collapse; text-align: center;"> <tr> <td style="width: 10%;"></td> <td style="width: 10%;"></td> <td style="width: 10%;"></td> <td style="width: 10%;"></td> <td style="width: 10%;"></td> <td style="width: 10%;"></td> <td style="width: 10%;"></td> <td style="width: 10%;"></td> <td style="width: 10%;"></td> <td style="width: 10%;"></td> </tr> <tr> <td></td> <td></td> <td colspan="8" style="text-align: center;"> <table border="1" style="width: 100%; border-collapse: collapse; text-align: center;"> <tr> <td style="width: 10%;"></td> <td style="width: 10%;"></td> <td style="width: 10%;"></td> <td style="width: 10%;"></td> <td style="width: 10%;"></td> <td style="width: 10%;"></td> <td style="width: 10%;"></td> <td style="width: 10%;"></td> <td style="width: 10%;"></td> <td style="width: 10%;"></td> </tr> <tr> <td></td> <td></td> <td colspan="8" style="text-align: center;"> <table border="1" style="width: 100%; border-collapse: collapse; text-align: center;"> <tr> <td style="width: 10%;"></td> <td style="width: 10%;"></td> <td style="width: 10%;"></td> <td style="width: 10%;"></td> <td style="width: 10%;"></td> <td style="width: 10%;"></td> <td style="width: 10%;"></td> <td style="width: 10%;"></td> <td style="width: 10%;"></td> <td style="width: 10%;"></td> </tr> <tr> <td></td> <td></td> <td colspan="8" style="text-align: center;"> <table border="1" style="width: 100%; border-collapse: collapse; text-align: center;"> <tr> <td style="width: 10%;"></td> <td style="width: 10%;"></td> <td style="width: 10%;"></td> <td style="width: 10%;"></td> <td style="width: 10%;"></td> <td style="width: 10%;"></td> <td style="width: 10%;"></td> <td style="width: 10%;"></td> <td style="width: 10%;"></td> <td style="width: 10%;"></td> </tr> <tr> <td></td> <td></td> <td colspan="8" style="text-align: center;"> <table border="1" style="width: 100%; border-collapse: collapse; text-align: center;"> <tr> <td style="width: 10%;"></td> <td style="width:
10%;"></td> <td style="width: 10%;"></td> <td style="width: 10%;"></td> <td style="width: 10%;"></td> <td style="width: 10%;"></td> <td style="width: 10%;"></td> <td style="width: 10%;"></td> <td style="width: 10%;"></td> <td style="width: 10%;"></td> </tr> <tr> <td></td> <td></td> <td colspan="8" style="text-align: center;"> <table border="1" style="width: 100%; border-collapse: collapse; text-align: center;"> <tr> <td style="width: 10%;"></td> <td style="width: 10%;"></td> <td style="width: 10%;"></td> <td style="width: 10%;"></td> <td style="width: 10%;"></td> <td style="width: 10%;"></td> <td style="width: 10%;"></td> <td style="width: 10%;"></td> <td style="width: 10%;"></td> <td style="width: 10%;"></td> </tr> <tr> <td></td> <td></td> <td colspan="8" style="text-align: center;"> <table border="1" style="width: 100%; border-collapse: collapse; text-align: center;"> <tr> <td style="width: 10%;"></td> <td style="width: 10%;"></td> <td style="width: 10%;"></td> <td style="width: 10%;"></td> <td style="width: 10%;"></td> <td style="width: 10%;"></td> <td style="width: 10%;"></td> <td style="width: 10%;"></td> <td style="width: 10%;"></td> <td style="width: 10%;"></td> </tr> <tr> <td></td> <td></td> <td colspan="8" style="text-align: center;"> <table border="1" style="width: 100%; border-collapse: collapse; text-align: center;"> <tr> <td style="width: 10%;"></td> <td style="width: 10%;"></td> <td style="width: 10%;"></td> <td style="width: 10%;"></td> <td style="width: 10%;"></td> <td style="width: 10%;"></td> <td style="width: 10%;"></td> <td style="width: 10%;"></td> <td style="width: 10%;"></td> <td style="width: 10%;"></td> </tr> <tr> <td></td> <td></td> <td colspan="8" style="text-align: center;"> <table border="1" style="width: 100%; border-collapse: collapse; text-align: center;"> <tr> <td style="width: 10%;"></td> <td style="width: 10%;"></td> <td style="width: 10%;"></td> <td style="width: 10%;"></td> <td style="width: 10%;"></td> <td style="width: 10%;"></td> <td style="width: 10%;"></td> <td style="width: 10%;"></td> <td style="width: 10%;"></td> <td style="width: 10%;"></td> </tr> <tr> <td></td> <td></td> <td colspan="8" style="text-align: center;"> <table border="1" style="width: 100%; border-collapse: collapse; text-align: center;"> <tr> <td style="width: 10%;"></td> <td style="width: 10%;"></td> <td style="width: 10%;"></td> <td style="width: 10%;"></td> <td style="width: 10%;"></td> <td style="width: 10%;"></td> <td style="width: 10%;"></td> <td style="width: 10%;"></td> <td style="width: 10%;"></td> <td style="width: 10%;"></td> </tr> <tr> <td></td> <td></td> <td colspan="8" style="text-align: center;"> <table border="1" style="width: 100%; border-collapse: collapse; text-align: center;"> <tr> <td style="width: 10%;"></td> <td style="width: 10%;"></td> <td style="width: 10%;"></td> <td style="width: 10%;"></td> <td style="width: 10%;"></td> <td style="width: 10%;"></td> <td style="width: 10%;"></td> <td style="width: 10%;"></td> <td style="width: 10%;"></td> <td style="width: 10%;"></td> </tr> <tr> <td></td> <td></td> <td colspan="8" style="text-align: center;"> <table border="1" style="width: 100%; border-collapse: collapse; text-align: center;"> <tr> <td style="width: 10%;"></td> <td style="width: 10%;"></td> <td style="width: 10%;"></td> <td style="width: 10%;"></td> <td style="width: 10%;"></td> <td style="width: 10%;"></td> <td style="width: 10%;"></td> <td style="width: 10%;"></td> <td style="width: 10%;"></td> <td style="width: 10%;"></td> </tr> <tr> <td></td> <td></td> <td colspan="8" style="text-align: center;"> <table border="1" style="width: 100%; border-collapse: collapse; text-align: center;"> <tr> </tr></table></td></tr></table></td></tr></table></td></tr></table></td></tr></table></td></tr></table></td></tr></table></td></tr></table></td></tr></table></td></tr></table></td></tr></table></td></tr></table></td></tr></table></td></tr></table></td></tr></table></td></tr></table></td></tr></table></td></tr></table> | | | | | | | | | | | | | | | | | | | | <table border="1" style="width: 100%; border-collapse: collapse; text-align: center;"> <tr> <td style="width: 10%;"></td> <td style="width: 10%;"></td> <td style="width: 10%;"></td> <td style="width: 10%;"></td> <td style="width: 10%;"></td> <td style="width: 10%;"></td> <td style="width: 10%;"></td> <td style="width: 10%;"></td> <td style="width: 10%;"></td> <td style="width: 10%;"></td> </tr> <tr> <td></td> <td></td> <td colspan="8" style="text-align: center;"> <table border="1" style="width: 100%; border-collapse: collapse; text-align: center;"> <tr> <td style="width: 10%;"></td> <td style="width: 10%;"></td> <td style="width: 10%;"></td> <td style="width: 10%;"></td> <td style="width: 10%;"></td> <td style="width: 10%;"></td> <td style="width: 10%;"></td> <td style="width: 10%;"></td> <td style="width: 10%;"></td> <td style="width: 10%;"></td> </tr> <tr> <td></td> <td></td> <td colspan="8" style="text-align: center;"> <table border="1" style="width: 100%; border-collapse: collapse; text-align: center;"> <tr> <td style="width: 10%;"></td> <td style="width: 10%;"></td> <td style="width: 10%;"></td> <td style="width: 10%;"></td> <td style="width: 10%;"></td> <td style="width: 10%;"></td> <td style="width: 10%;"></td> <td style="width: 10%;"></td> <td style="width: 10%;"></td> <td style="width: 10%;"></td> </tr> <tr> <td></td> <td></td> <td colspan="8" style="text-align: center;"> <table border="1" style="width: 100%; border-collapse: collapse; text-align: center;"> <tr> <td style="width: 10%;"></td> <td style="width: 10%;"></td> <td style="width: 10%;"></td> <td style="width: 10%;"></td> <td style="width: 10%;"></td> <td style="width: 10%;"></td> <td style="width: 10%;"></td> <td style="width: 10%;"></td> <td style="width: 10%;"></td> <td style="width: 10%;"></td> </tr> <tr> <td></td> <td></td> <td colspan="8" style="text-align: center;"> <table border="1" style="width: 100%; border-collapse: collapse; text-align: center;"> <tr> <td style="width: 10%;"></td> <td style="width: 10%;"></td> <td style="width: 10%;"></td> <td style="width: 10%;"></td> <td style="width: 10%;"></td> <td style="width: 10%;"></td> <td style="width: 10%;"></td> <td style="width: 10%;"></td> <td style="width: 10%;"></td> <td style="width: 10%;"></td> </tr> <tr> <td></td> <td></td> <td colspan="8" style="text-align: center;"> <table border="1" style="width: 100%; border-collapse: collapse; text-align: center;"> <tr> <td style="width: 10%;"></td> <td style="width: 10%;"></td> <td style="width: 10%;"></td> <td style="width: 10%;"></td> <td style="width: 10%;"></td> <td style="width: 10%;"></td> <td style="width: 10%;"></td> <td style="width: 10%;"></td> <td style="width: 10%;"></td> <td style="width: 10%;"></td> </tr> <tr> <td></td> <td></td> <td colspan="8" style="text-align: center;"> <table border="1" style="width: 100%; border-collapse: collapse; text-align: center;"> <tr> <td style="width: 10%;"></td> <td style="width: 10%;"></td> <td style="width: 10%;"></td> <td style="width: 10%;"></td> <td style="width: 10%;"></td> <td style="width: 10%;"></td> <td style="width: 10%;"></td> <td style="width: 10%;"></td> <td style="width: 10%;"></td> <td style="width: 10%;"></td> </tr> <tr> <td></td> <td></td> <td colspan="8" style="text-align: center;"> <table border="1" style="width: 100%; border-collapse: collapse; text-align: center;"> <tr> <td style="width: 10%;"></td> <td style="width: 10%;"></td> <td style="width: 10%;"></td> <td style="width: 10%;"></td> <td style="width: 10%;"></td> <td style="width: 10%;"></td> <td style="width: 10%;"></td> <td style="width: 10%;"></td> <td style="width: 10%;"></td> <td style="width: 10%;"></td> </tr> <tr> <td></td> <td></td> <td colspan="8" style="text-align: center;"> <table border="1" style="width: 100%; border-collapse: collapse; text-align: center;"> <tr> <td style="width: 10%;"></td> <td style="width: 10%;"></td> <td style="width: 10%;"></td> <td style="width: 10%;"></td> <td style="width: 10%;"></td> <td style="width: 10%;"></td> <td style="width: 10%;"></td> <td style="width: 10%;"></td> <td style="width: 10%;"></td> <td style="width: 10%;"></td> </tr> <tr> <td></td> <td></td> <td colspan="8" style="text-align: center;"> <table border="1" style="width: 100%; border-collapse: collapse; text-align: center;"> <tr> <td style="width: 10%;"></td> <td style="width: 10%;"></td> <td style="width: 10%;"></td> <td style="width: 10%;"></td> <td style="width: 10%;"></td> <td style="width: 10%;"></td> <td style="width: 10%;"></td> <td style="width: 10%;"></td> <td style="width: 10%;"></td> <td style="width: 10%;"></td> </tr> <tr> <td></td> <td></td> <td colspan="8" style="text-align: center;"> <table border="1" style="width: 100%; border-collapse: collapse; text-align: center;"> <tr> <td style="width: 10%;"></td> <td style="width: 10%;"></td> <td style="width: 10%;"></td> <td style="width: 10%;"></td> <td style="width: 10%;"></td> <td style="width: 10%;"></td> <td style="width: 10%;"></td> <td style="width: 10%;"></td> <td style="width: 10%;"></td> <td style="width: 10%;"></td> </tr> <tr> <td></td> <td></td> <td colspan="8" style="text-align: center;"> <table border="1" style="width: 100%; border-collapse: collapse; text-align: center;"> <tr> <td style="width: 10%;"></td> <td style="width: 10%;"></td> <td style="width: 10%;"></td> <td style="width: 10%;"></td> <td style="width: 10%;"></td> <td style="width: 10%;"></td> <td style="width: 10%;"></td> <td style="width: 10%;"></td> <td style="width: 10%;"></td> <td style="width: 10%;"></td> </tr> <tr> <td></td> <td></td> <td colspan="8" style="text-align: center;"> <table border="1" style="width: 100%; border-collapse: collapse; text-align: center;"> <tr> <td style="width: 10%;"></td> <td style="width: 10%;"></td> <td style="width: 10%;"></td> <td style="width: 10%;"></td> <td style="width: 10%;"></td> <td style="width: 10%;"></td> <td style="width: 10%;"></td> <td
style="width: 10%;"></td> <td style="width: 10%;"></td> <td style="width: 10%;"></td> </tr> <tr> <td></td> <td></td> <td colspan="8" style="text-align: center;"> <table border="1" style="width: 100%; border-collapse: collapse; text-align: center;"> <tr> <td style="width: 10%;"></td> <td style="width: 10%;"></td> <td style="width: 10%;"></td> <td style="width: 10%;"></td> <td style="width: 10%;"></td> <td style="width: 10%;"></td> <td style="width: 10%;"></td> <td style="width: 10%;"></td> <td style="width: 10%;"></td> <td style="width: 10%;"></td> </tr> <tr> <td></td> <td></td> <td colspan="8" style="text-align: center;"> <table border="1" style="width: 100%; border-collapse: collapse; text-align: center;"> <tr> <td style="width: 10%;"></td> <td style="width: 10%;"></td> <td style="width: 10%;"></td> <td style="width: 10%;"></td> <td style="width: 10%;"></td> <td style="width: 10%;"></td> <td style="width: 10%;"></td> <td style="width: 10%;"></td> <td style="width: 10%;"></td> <td style="width: 10%;"></td> </tr> <tr> <td></td> <td></td> <td colspan="8" style="text-align: center;"> <table border="1" style="width: 100%; border-collapse: collapse; text-align: center;"> <tr> <td style="width: 10%;"></td> <td style="width: 10%;"></td> <td style="width: 10%;"></td> <td style="width: 10%;"></td> <td style="width: 10%;"></td> <td style="width: 10%;"></td> <td style="width: 10%;"></td> <td style="width: 10%;"></td> <td style="width: 10%;"></td> <td style="width: 10%;"></td> </tr> <tr> <td></td> <td></td> <td colspan="8" style="text-align: center;"> <table border="1" style="width: 100%; border-collapse: collapse; text-align: center;"> <tr> </tr></table></td></tr></table></td></tr></table></td></tr></table></td></tr></table></td></tr></table></td></tr></table></td></tr></table></td></tr></table></td></tr></table></td></tr></table></td></tr></table></td></tr></table></td></tr></table></td></tr></table></td></tr></table></td></tr></table> | | | | | | | | | | | | | | | | | | | | <table border="1" style="width: 100%; border-collapse: collapse; text-align: center;"> <tr> <td style="width: 10%;"></td> <td style="width: 10%;"></td> <td style="width: 10%;"></td> <td style="width: 10%;"></td> <td style="width: 10%;"></td> <td style="width: 10%;"></td> <td style="width: 10%;"></td> <td style="width: 10%;"></td> <td style="width: 10%;"></td> <td style="width: 10%;"></td> </tr> <tr> <td></td> <td></td> <td colspan="8" style="text-align: center;"> <table border="1" style="width: 100%; border-collapse: collapse; text-align: center;"> <tr> <td style="width: 10%;"></td> <td style="width: 10%;"></td> <td style="width: 10%;"></td> <td style="width: 10%;"></td> <td style="width: 10%;"></td> <td style="width: 10%;"></td> <td style="width: 10%;"></td> <td style="width: 10%;"></td> <td style="width: 10%;"></td> <td style="width: 10%;"></td> </tr> <tr> <td></td> <td></td> <td colspan="8" style="text-align: center;"> <table border="1" style="width: 100%; border-collapse: collapse; text-align: center;"> <tr> <td style="width: 10%;"></td> <td style="width: 10%;"></td> <td style="width: 10%;"></td> <td style="width: 10%;"></td> <td style="width: 10%;"></td> <td style="width: 10%;"></td> <td style="width: 10%;"></td> <td style="width: 10%;"></td> <td style="width: 10%;"></td> <td style="width: 10%;"></td> </tr> <tr> <td></td> <td></td> <td colspan="8" style="text-align: center;"> <table border="1" style="width: 100%; border-collapse: collapse; text-align: center;"> <tr> <td style="width: 10%;"></td> <td style="width: 10%;"></td> <td style="width: 10%;"></td> <td style="width: 10%;"></td> <td style="width: 10%;"></td> <td style="width: 10%;"></td> <td style="width: 10%;"></td> <td style="width: 10%;"></td> <td style="width: 10%;"></td> <td style="width: 10%;"></td> </tr> <tr> <td></td> <td></td> <td colspan="8" style="text-align: center;"> <table border="1" style="width: 100%; border-collapse: collapse; text-align: center;"> <tr> <td style="width: 10%;"></td> <td style="width: 10%;"></td> <td style="width: 10%;"></td> <td style="width: 10%;"></td> <td style="width: 10%;"></td> <td style="width: 10%;"></td> <td style="width: 10%;"></td> <td style="width: 10%;"></td> <td style="width: 10%;"></td> <td style="width: 10%;"></td> </tr> <tr> <td></td> <td></td> <td colspan="8" style="text-align: center;"> <table border="1" style="width: 100%; border-collapse: collapse; text-align: center;"> <tr> <td style="width: 10%;"></td> <td style="width: 10%;"></td> <td style="width: 10%;"></td> <td style="width: 10%;"></td> <td style="width: 10%;"></td> <td style="width: 10%;"></td> <td style="width: 10%;"></td> <td style="width: 10%;"></td> <td style="width: 10%;"></td> <td style="width: 10%;"></td> </tr> <tr> <td></td> <td></td> <td colspan="8" style="text-align: center;"> <table border="1" style="width: 100%; border-collapse: collapse; text-align: center;"> <tr> <td style="width: 10%;"></td> <td style="width: 10%;"></td> <td style="width: 10%;"></td> <td style="width: 10%;"></td> <td style="width: 10%;"></td> <td style="width: 10%;"></td> <td style="width: 10%;"></td> <td style="width: 10%;"></td> <td style="width: 10%;"></td> <td style="width: 10%;"></td> </tr> <tr> <td></td> <td></td> <td colspan="8" style="text-align: center;"> <table border="1" style="width: 100%; border-collapse: collapse; text-align: center;"> <tr> <td style="width: 10%;"></td> <td style="width: 10%;"></td> <td style="width: 10%;"></td> <td style="width: 10%;"></td> <td style="width: 10%;"></td> <td style="width: 10%;"></td> <td style="width: 10%;"></td> <td style="width: 10%;"></td> <td style="width: 10%;"></td> <td style="width: 10%;"></td> </tr> <tr> <td></td> <td></td> <td colspan="8" style="text-align: center;"> <table border="1" style="width: 100%; border-collapse: collapse; text-align: center;"> <tr> <td style="width: 10%;"></td> <td style="width: 10%;"></td> <td style="width: 10%;"></td> <td style="width: 10%;"></td> <td style="width: 10%;"></td> <td style="width: 10%;"></td> <td style="width: 10%;"></td> <td style="width: 10%;"></td> <td style="width: 10%;"></td> <td style="width: 10%;"></td> </tr> <tr> <td></td> <td></td> <td colspan="8" style="text-align: center;"> <table border="1" style="width: 100%; border-collapse: collapse; text-align: center;"> <tr> <td style="width: 10%;"></td> <td style="width: 10%;"></td> <td style="width: 10%;"></td> <td style="width: 10%;"></td> <td style="width: 10%;"></td> <td style="width: 10%;"></td> <td style="width: 10%;"></td> <td style="width: 10%;"></td> <td style="width: 10%;"></td> <td style="width: 10%;"></td> </tr> <tr> <td></td> <td></td> <td colspan="8" style="text-align: center;"> <table border="1" style="width: 100%; border-collapse: collapse; text-align: center;"> <tr> <td style="width: 10%;"></td> <td style="width: 10%;"></td> <td style="width: 10%;"></td> <td style="width: 10%;"></td> <td style="width: 10%;"></td> <td style="width: 10%;"></td> <td style="width: 10%;"></td> <td style="width: 10%;"></td> <td style="width: 10%;"></td> <td style="width: 10%;"></td> </tr> <tr> <td></td> <td></td> <td colspan="8" style="text-align: center;"> <table border="1" style="width: 100%; border-collapse: collapse; text-align: center;"> <tr> <td style="width: 10%;"></td> <td style="width: 10%;"></td> <td style="width: 10%;"></td> <td style="width: 10%;"></td> <td style="width: 10%;"></td> <td style="width: 10%;"></td> <td style="width: 10%;"></td> <td style="width: 10%;"></td> <td style="width: 10%;"></td> <td style="width: 10%;"></td> </tr> <tr> <td></td> <td></td> <td colspan="8" style="text-align: center;"> <table border="1" style="width: 100%; border-collapse: collapse; text-align: center;"> <tr> <td style="width: 10%;"></td> <td style="width: 10%;"></td> <td style="width: 10%;"></td> <td style="width: 10%;"></td> <td style="width: 10%;"></td> <td style="width: 10%;"></td> <td style="width: 10%;"></td> <td style="width: 10%;"></td> <td style="width: 10%;"></td> <td style="width: 10%;"></td> </tr> <tr> <td></td> <td></td> <td colspan="8" style="text-align: center;"> <table border="1" style="width: 100%; border-collapse: collapse; text-align: center;"> <tr> <td style="width: 10%;"></td> <td style="width: 10%;"></td> <td style="width: 10%;"></td> <td style="width: 10%;"></td> <td style="width: 10%;"></td> <td style="width: 10%;"></td> <td style="width: 10%;"></td> <td style="width: 10%;"></td> <td style="width: 10%;"></td> <td style="width: 10%;"></td> </tr> <tr> <td></td> <td></td> <td colspan="8" style="text-align: center;"> <table border="1" style="width: 100%; border-collapse: collapse; text-align: center;"> <tr> <td style="width: 10%;"></td> <td style="width: 10%;"></td> <td style="width: 10%;"></td> <td style="width: 10%;"></td> <td style="width: 10%;"></td> <td style="width: 10%;"></td> <td style="width: 10%;"></td> <td style="width: 10%;"></td> <td style="width: 10%;"></td> <td style="width: 10%;"></td> </tr> <tr> <td></td> <td></td> <td colspan="8" style="text-align: center;"> <table border="1" style="width: 100%; border-collapse: collapse; text-align: center;"> <tr> </tr></table></td></tr></table></td></tr></table></td></tr></table></td></tr></table></td></tr></table></td></tr></table></td></tr></table></td></tr></table></td></tr></table></td></tr></table></td></tr></table></td></tr></table></td></tr></table></td></tr></table></td></tr></table> | | | | | | | | | | | | | | | | | | | | <table border="1" style="width: 100%; border-collapse: collapse; text-align: center;"> <tr> <td style="width: 10%;"></td> <td style="width: 10%;"></td> <td style="width: 10%;"></td> <td style="width: 10%;"></td> <td style="width: 10%;"></td> <td style="width: 10%;"></td> <td style="width: 10%;"></td> <td style="width: 10%;"></td> <td style="width: 10%;"></td> <td style="width: 10%;"></td> </tr> <tr> <td></td> <td></td> <td colspan="8" style="text-align: center;"> <table border="1" style="width: 100%; border-collapse:
collapse; text-align: center;"> <tr> <td style="width: 10%;"></td> <td style="width: 10%;"></td> <td style="width: 10%;"></td> <td style="width: 10%;"></td> <td style="width: 10%;"></td> <td style="width: 10%;"></td> <td style="width: 10%;"></td> <td style="width: 10%;"></td> <td style="width: 10%;"></td> <td style="width: 10%;"></td> </tr> <tr> <td></td> <td></td> <td colspan="8" style="text-align: center;"> <table border="1" style="width: 100%; border-collapse: collapse; text-align: center;"> <tr> <td style="width: 10%;"></td> <td style="width: 10%;"></td> <td style="width: 10%;"></td> <td style="width: 10%;"></td> <td style="width: 10%;"></td> <td style="width: 10%;"></td> <td style="width: 10%;"></td> <td style="width: 10%;"></td> <td style="width: 10%;"></td> <td style="width: 10%;"></td> </tr> <tr> <td></td> <td></td> <td colspan="8" style="text-align: center;"> <table border="1" style="width: 100%; border-collapse: collapse; text-align: center;"> <tr> <td style="width: 10%;"></td> <td style="width: 10%;"></td> <td style="width: 10%;"></td> <td style="width: 10%;"></td> <td style="width: 10%;"></td> <td style="width: 10%;"></td> <td style="width: 10%;"></td> <td style="width: 10%;"></td> <td style="width: 10%;"></td> <td style="width: 10%;"></td> </tr> <tr> <td></td> <td></td> <td colspan="8" style="text-align: center;"> <table border="1" style="width: 100%; border-collapse: collapse; text-align: center;"> <tr> <td style="width: 10%;"></td> <td style="width: 10%;"></td> <td style="width: 10%;"></td> <td style="width: 10%;"></td> <td style="width: 10%;"></td> <td style="width: 10%;"></td> <td style="width: 10%;"></td> <td style="width: 10%;"></td> <td style="width: 10%;"></td> <td style="width: 10%;"></td> </tr> <tr> <td></td> <td></td> <td colspan="8" style="text-align: center;"> <table border="1" style="width: 100%; border-collapse: collapse; text-align: center;"> <tr> <td style="width: 10%;"></td> <td style="width: 10%;"></td> <td style="width: 10%;"></td> <td style="width: 10%;"></td> <td style="width: 10%;"></td> <td style="width: 10%;"></td> <td style="width: 10%;"></td> <td style="width: 10%;"></td> <td style="width: 10%;"></td> <td style="width: 10%;"></td> </tr> <tr> <td></td> <td></td> <td colspan="8" style="text-align: center;"> <table border="1" style="width: 100%; border-collapse: collapse; text-align: center;"> <tr> <td style="width: 10%;"></td> <td style="width: 10%;"></td> <td style="width: 10%;"></td> <td style="width: 10%;"></td> <td style="width: 10%;"></td> <td style="width: 10%;"></td> <td style="width: 10%;"></td> <td style="width: 10%;"></td> <td style="width: 10%;"></td> <td style="width: 10%;"></td> </tr> <tr> <td></td> <td></td> <td colspan="8" style="text-align: center;"> <table border="1" style="width: 100%; border-collapse: collapse; text-align: center;"> <tr> <td style="width: 10%;"></td> <td style="width: 10%;"></td> <td style="width: 10%;"></td> <td style="width: 10%;"></td> <td style="width: 10%;"></td> <td style="width: 10%;"></td> <td style="width: 10%;"></td> <td style="width: 10%;"></td> <td style="width: 10%;"></td> <td style="width: 10%;"></td> </tr> <tr> <td></td> <td></td> <td colspan="8" style="text-align: center;"> <table border="1" style="width: 100%; border-collapse: collapse; text-align: center;"> <tr> <td style="width: 10%;"></td> <td style="width: 10%;"></td> <td style="width: 10%;"></td> <td style="width: 10%;"></td> <td style="width: 10%;"></td> <td style="width: 10%;"></td> <td style="width: 10%;"></td> <td style="width: 10%;"></td> <td style="width: 10%;"></td> <td style="width: 10%;"></td> </tr> <tr> <td></td> <td></td> <td colspan="8" style="text-align: center;"> <table border="1" style="width: 100%; border-collapse: collapse; text-align: center;"> <tr> <td style="width: 10%;"></td> <td style="width: 10%;"></td> <td style="width: 10%;"></td> <td style="width: 10%;"></td> <td style="width: 10%;"></td> <td style="width: 10%;"></td> <td style="width: 10%;"></td> <td style="width: 10%;"></td> <td style="width: 10%;"></td> <td style="width: 10%;"></td> </tr> <tr> <td></td> <td></td> <td colspan="8" style="text-align: center;"> <table border="1" style="width: 100%; border-collapse: collapse; text-align: center;"> <tr> <td style="width: 10%;"></td> <td style="width: 10%;"></td> <td style="width: 10%;"></td> <td style="width: 10%;"></td> <td style="width: 10%;"></td> <td style="width: 10%;"></td> <td style="width: 10%;"></td> <td style="width: 10%;"></td> <td style="width: 10%;"></td> <td style="width: 10%;"></td> </tr> <tr> <td></td> <td></td> <td colspan="8" style="text-align: center;"> <table border="1" style="width: 100%; border-collapse: collapse; text-align: center;"> <tr> <td style="width: 10%;"></td> <td style="width: 10%;"></td> <td style="width: 10%;"></td> <td style="width: 10%;"></td> <td style="width: 10%;"></td> <td style="width: 10%;"></td> <td style="width: 10%;"></td> <td style="width: 10%;"></td> <td style="width: 10%;"></td> <td style="width: 10%;"></td> </tr> <tr> <td></td> <td></td> <td colspan="8" style="text-align: center;"> <table border="1" style="width: 100%; border-collapse: collapse; text-align: center;"> <tr> <td style="width: 10%;"></td> <td style="width: 10%;"></td> <td style="width: 10%;"></td> <td style="width: 10%;"></td> <td style="width: 10%;"></td> <td style="width: 10%;"></td> <td style="width: 10%;"></td> <td style="width: 10%;"></td> <td style="width: 10%;"></td> <td style="width: 10%;"></td> </tr> <tr> <td></td> <td></td> <td colspan="8" style="text-align: center;"> <table border="1" style="width: 100%; border-collapse: collapse; text-align: center;"> <tr> <td style="width: 10%;"></td> <td style="width: 10%;"></td> <td style="width: 10%;"></td> <td style="width: 10%;"></td> <td style="width: 10%;"></td> <td style="width: 10%;"></td> <td style="width: 10%;"></td> <td style="width: 10%;"></td> <td style="width: 10%;"></td> <td style="width: 10%;"></td> </tr> <tr> <td></td> <td></td> <td colspan="8" style="text-align: center;"> <table border="1" style="width: 100%; border-collapse: collapse; text-align: center;"> <tr> </tr></table></td></tr></table></td></tr></table></td></tr></table></td></tr></table></td></tr></table></td></tr></table></td></tr></table></td></tr></table></td></tr></table></td></tr></table></td></tr></table></td></tr></table></td></tr></table></td></tr></table> | | | | | | | | | | | | | | | | | | | | <table border="1" style="width: 100%; border-collapse: collapse; text-align: center;"> <tr> <td style="width: 10%;"></td> <td style="width: 10%;"></td> <td style="width: 10%;"></td> <td style="width: 10%;"></td> <td style="width: 10%;"></td> <td style="width: 10%;"></td> <td style="width: 10%;"></td> <td style="width: 10%;"></td> <td style="width: 10%;"></td> <td style="width: 10%;"></td> </tr> <tr> <td></td> <td></td> <td colspan="8" style="text-align: center;"> <table border="1" style="width: 100%; border-collapse: collapse; text-align: center;"> <tr> <td style="width: 10%;"></td> <td style="width: 10%;"></td> <td style="width: 10%;"></td> <td style="width: 10%;"></td> <td style="width: 10%;"></td> <td style="width: 10%;"></td> <td style="width: 10%;"></td> <td style="width: 10%;"></td> <td style="width: 10%;"></td> <td style="width: 10%;"></td> </tr> <tr> <td></td> <td></td> <td colspan="8" style="text-align: center;"> <table border="1" style="width: 100%; border-collapse: collapse; text-align: center;"> <tr> <td style="width: 10%;"></td> <td style="width: 10%;"></td> <td style="width: 10%;"></td> <td style="width: 10%;"></td> <td style="width: 10%;"></td> <td style="width: 10%;"></td> <td style="width: 10%;"></td> <td style="width: 10%;"></td> <td style="width: 10%;"></td> <td style="width: 10%;"></td> </tr> <tr> <td></td> <td></td> <td colspan="8" style="text-align: center;"> <table border="1" style="width: 100%; border-collapse: collapse; text-align: center;"> <tr> <td style="width: 10%;"></td> <td style="width: 10%;"></td> <td style="width: 10%;"></td> <td style="width: 10%;"></td> <td style="width: 10%;"></td> <td style="width: 10%;"></td> <td style="width: 10%;"></td> <td style="width: 10%;"></td> <td style="width: 10%;"></td> <td style="width: 10%;"></td> </tr> <tr> <td></td> <td></td> <td colspan="8" style="text-align: center;"> <table border="1" style="width: 100%; border-collapse: collapse; text-align: center;"> <tr> <td style="width: 10%;"></td> <td style="width: 10%;"></td> <td style="width: 10%;"></td> <td style="width: 10%;"></td> <td style="width: 10%;"></td> <td style="width: 10%;"></td> <td style="width: 10%;"></td> <td style="width: 10%;"></td> <td style="width: 10%;"></td> <td style="width: 10%;"></td> </tr> <tr> <td></td> <td></td> <td colspan="8" style="text-align: center;"> <table border="1" style="width: 100%; border-collapse: collapse; text-align: center;"> <tr> <td style="width: 10%;"></td> <td style="width: 10%;"></td> <td style="width: 10%;"></td> <td style="width: 10%;"></td> <td style="width: 10%;"></td> <td style="width: 10%;"></td> <td style="width: 10%;"></td> <td style="width: 10%;"></td> <td style="width: 10%;"></td> <td style="width: 10%;"></td> </tr> <tr> <td></td> <td></td> <td colspan="8" style="text-align: center;"> <table border="1" style="width: 100%; border-collapse: collapse; text-align: center;"> <tr> <td style="width: 10%;"></td> <td style="width: 10%;"></td> <td style="width: 10%;"></td> <td style="width: 10%;"></td> <td style="width: 10%;"></td> <td style="width: 10%;"></td> <td style="width: 10%;"></td> <td style="width: 10%;"></td> <td style="width: 10%;"></td> <td style="width: 10%;"></td> </tr> <tr> <td></td> <td></td> <td colspan="8" style="text-align: center;"> <table border="1" style="width: 100%; border-collapse: collapse; text-align: center;"> <tr> <td style="width: 10%;"></td> <td style="width: 10%;"></td> <td style="width: 10%;"></td> <td style="width: 10%;"></td> <td style="width: 10%;"></td> <td style="width: 10%;"></td> <td
style="width: 10%;"></td> <td style="width: 10%;"></td> <td style="width: 10%;"></td> <td style="width: 10%;"></td> </tr> <tr> <td></td> <td></td> <td colspan="8" style="text-align: center;"> <table border="1" style="width: 100%; border-collapse: collapse; text-align: center;"> <tr> <td style="width: 10%;"></td> <td style="width: 10%;"></td> <td style="width: 10%;"></td> <td style="width: 10%;"></td> <td style="width: 10%;"></td> <td style="width: 10%;"></td> <td style="width: 10%;"></td> <td style="width: 10%;"></td> <td style="width: 10%;"></td> <td style="width: 10%;"></td> </tr> <tr> <td></td> <td></td> <td colspan="8" style="text-align: center;"> <table border="1" style="width: 100%; border-collapse: collapse; text-align: center;"> <tr> <td style="width: 10%;"></td> <td style="width: 10%;"></td> <td style="width: 10%;"></td> <td style="width: 10%;"></td> <td style="width: 10%;"></td> <td style="width: 10%;"></td> <td style="width: 10%;"></td> <td style="width: 10%;"></td> <td style="width: 10%;"></td> <td style="width: 10%;"></td> </tr> <tr> <td></td> <td></td> <td colspan="8" style="text-align: center;"> <table border="1" style="width: 100%; border-collapse: collapse; text-align: center;"> <tr> <td style="width: 10%;"></td> <td style="width: 10%;"></td> <td style="width: 10%;"></td> <td style="width: 10%;"></td> <td style="width: 10%;"></td> <td style="width: 10%;"></td> <td style="width: 10%;"></td> <td style="width: 10%;"></td> <td style="width: 10%;"></td> <td style="width: 10%;"></td> </tr> <tr> <td></td> <td></td> <td colspan="8" style="text-align: center;"> <table border="1" style="width: 100%; border-collapse: collapse; text-align: center;"> <tr> <td style="width: 10%;"></td> <td style="width: 10%;"></td> <td style="width: 10%;"></td> <td style="width: 10%;"></td> <td style="width: 10%;"></td> <td style="width: 10%;"></td> <td style="width: 10%;"></td> <td style="width: 10%;"></td> <td style="width: 10%;"></td> <td style="width: 10%;"></td> </tr> <tr> <td></td> <td></td> <td colspan="8" style="text-align: center;"> <table border="1" style="width: 100%; border-collapse: collapse; text-align: center;"> <tr> <td style="width: 10%;"></td> <td style="width: 10%;"></td> <td style="width: 10%;"></td> <td style="width: 10%;"></td> <td style="width: 10%;"></td> <td style="width: 10%;"></td> <td style="width: 10%;"></td> <td style="width: 10%;"></td> <td style="width: 10%;"></td> <td style="width: 10%;"></td> </tr> <tr> <td></td> <td></td> <td colspan="8" style="text-align: center;"> <table border="1" style="width: 100%; border-collapse: collapse; text-align: center;"> <tr> </tr></table></td></tr></table></td></tr></table></td></tr></table></td></tr></table></td></tr></table></td></tr></table></td></tr></table></td></tr></table></td></tr></table></td></tr></table></td></tr></table></td></tr></table></td></tr></table> | | | | | | | | | | | | | | | | | | | | <table border="1" style="width: 100%; border-collapse: collapse; text-align: center;"> <tr> <td style="width: 10%;"></td> <td style="width: 10%;"></td> <td style="width: 10%;"></td> <td style="width: 10%;"></td> <td style="width: 10%;"></td> <td style="width: 10%;"></td> <td style="width: 10%;"></td> <td style="width: 10%;"></td> <td style="width: 10%;"></td> <td style="width: 10%;"></td> </tr> <tr> <td></td> <td></td> <td colspan="8" style="text-align: center;"> <table border="1" style="width: 100%; border-collapse: collapse; text-align: center;"> <tr> <td style="width: 10%;"></td> <td style="width: 10%;"></td> <td style="width: 10%;"></td> <td style="width: 10%;"></td> <td style="width: 10%;"></td> <td style="width: 10%;"></td> <td style="width: 10%;"></td> <td style="width: 10%;"></td> <td style="width: 10%;"></td> <td style="width: 10%;"></td> </tr> <tr> <td></td> <td></td> <td colspan="8" style="text-align: center;"> <table border="1" style="width: 100%; border-collapse: collapse; text-align: center;"> <tr> <td style="width: 10%;"></td> <td style="width: 10%;"></td> <td style="width: 10%;"></td> <td style="width: 10%;"></td> <td style="width: 10%;"></td> <td style="width: 10%;"></td> <td style="width: 10%;"></td> <td style="width: 10%;"></td> <td style="width: 10%;"></td> <td style="width: 10%;"></td> </tr> <tr> <td></td> <td></td> <td colspan="8" style="text-align: center;"> <table border="1" style="width: 100%; border-collapse: collapse; text-align: center;"> <tr> <td style="width: 10%;"></td> <td style="width: 10%;"></td> <td style="width: 10%;"></td> <td style="width: 10%;"></td> <td style="width: 10%;"></td> <td style="width: 10%;"></td> <td style="width: 10%;"></td> <td style="width: 10%;"></td> <td style="width: 10%;"></td> <td style="width: 10%;"></td> </tr> <tr> <td></td> <td></td> <td colspan="8" style="text-align: center;"> <table border="1" style="width: 100%; border-collapse: collapse; text-align: center;"> <tr> <td style="width: 10%;"></td> <td style="width: 10%;"></td> <td style="width: 10%;"></td> <td style="width: 10%;"></td> <td style="width: 10%;"></td> <td style="width: 10%;"></td> <td style="width: 10%;"></td> <td style="width: 10%;"></td> <td style="width: 10%;"></td> <td style="width: 10%;"></td> </tr> <tr> <td></td> <td></td> <td colspan="8" style="text-align: center;"> <table border="1" style="width: 100%; border-collapse: collapse; text-align: center;"> <tr> <td style="width: 10%;"></td> <td style="width: 10%;"></td> <td style="width: 10%;"></td> <td style="width: 10%;"></td> <td style="width: 10%;"></td> <td style="width: 10%;"></td> <td style="width: 10%;"></td> <td style="width: 10%;"></td> <td style="width: 10%;"></td> <td style="width: 10%;"></td> </tr> <tr> <td></td> <td></td> <td colspan="8" style="text-align: center;"> <table border="1" style="width: 100%; border-collapse: collapse; text-align: center;"> <tr> <td style="width: 10%;"></td> <td style="width: 10%;"></td> <td style="width: 10%;"></td> <td style="width: 10%;"></td> <td style="width: 10%;"></td> <td style="width: 10%;"></td> <td style="width: 10%;"></td> <td style="width: 10%;"></td> <td style="width: 10%;"></td> <td style="width: 10%;"></td> </tr> <tr> <td></td> <td></td> <td colspan="8" style="text-align: center;"> <table border="1" style="width: 100%; border-collapse: collapse; text-align: center;"> <tr> <td style="width: 10%;"></td> <td style="width: 10%;"></td> <td style="width: 10%;"></td> <td style="width: 10%;"></td> <td style="width: 10%;"></td> <td style="width: 10%;"></td> <td style="width: 10%;"></td> <td style="width: 10%;"></td> <td style="width: 10%;"></td> <td style="width: 10%;"></td> </tr> <tr> <td></td> <td></td> <td colspan="8" style="text-align: center;"> <table border="1" style="width: 100%; border-collapse: collapse; text-align: center;"> <tr> <td style="width: 10%;"></td> <td style="width: 10%;"></td> <td style="width: 10%;"></td> <td style="width: 10%;"></td> <td style="width: 10%;"></td> <td style="width: 10%;"></td> <td style="width: 10%;"></td> <td style="width: 10%;"></td> <td style="width: 10%;"></td> <td style="width: 10%;"></td> </tr> <tr> <td></td> <td></td> <td colspan="8" style="text-align: center;"> <table border="1" style="width: 100%; border-collapse: collapse; text-align: center;"> <tr> <td style="width: 10%;"></td> <td style="width: 10%;"></td> <td style="width: 10%;"></td> <td style="width: 10%;"></td> <td style="width: 10%;"></td> <td style="width: 10%;"></td> <td style="width: 10%;"></td> <td style="width: 10%;"></td> <td style="width: 10%;"></td> <td style="width: 10%;"></td> </tr> <tr> <td></td> <td></td> <td colspan="8" style="text-align: center;"> <table border="1" style="width: 100%; border-collapse: collapse; text-align: center;"> <tr> <td style="width: 10%;"></td> <td style="width: 10%;"></td> <td style="width: 10%;"></td> <td style="width: 10%;"></td> <td style="width: 10%;"></td> <td style="width: 10%;"></td> <td style="width: 10%;"></td> <td style="width: 10%;"></td> <td style="width: 10%;"></td> <td style="width: 10%;"></td> </tr> <tr> <td></td> <td></td> <td colspan="8" style="text-align: center;"> <table border="1" style="width: 100%; border-collapse: collapse; text-align: center;"> <tr> <td style="width: 10%;"></td> <td style="width: 10%;"></td> <td style="width: 10%;"></td> <td style="width: 10%;"></td> <td style="width: 10%;"></td> <td style="width: 10%;"></td> <td style="width: 10%;"></td> <td style="width: 10%;"></td> <td style="width: 10%;"></td> <td style="width: 10%;"></td> </tr> <tr> <td></td> <td></td> <td colspan="8" style="text-align: center;"> <table border="1" style="width: 100%; border-collapse: collapse; text-align: center;"> <tr> </tr></table></td></tr></table></td></tr></table></td></tr></table></td></tr></table></td></tr></table></td></tr></table></td></tr></table></td></tr></table></td></tr></table></td></tr></table></td></tr></table></td></tr></table> | | | | | | | | | | | | | | | | | | | | <table border="1" style="width: 100%; border-collapse: collapse; text-align: center;"> <tr> <td style="width: 10%;"></td> <td style="width: 10%;"></td> <td style="width: 10%;"></td> <td style="width: 10%;"></td> <td style="width: 10%;"></td> <td style="width: 10%;"></td> <td style="width: 10%;"></td> <td style="width: 10%;"></td> <td style="width: 10%;"></td> <td style="width: 10%;"></td> </tr> <tr> <td></td> <td></td> <td colspan="8" style="text-align: center;"> <table border="1" style="width: 100%; border-collapse: collapse; text-align: center;"> <tr> <td style="width: 10%;"></td> <td style="width: 10%;"></td> <td style="width: 10%;"></td> <td style="width: 10%;"></td> <td style="width: 10%;"></td> <td style="width: 10%;"></td> <td style="width: 10%;"></td> <td style="width: 10%;"></td> <td style="width: 10%;"></td> <td style="width: 10%;"></td> </tr> <tr> <td></td> <td></td> <td colspan="8" style="text-align: center;"> <table border="1" style="width: 100%; border-collapse: collapse; text-align: center;"> <tr> <td style="width: 10%;"></td> <td
style="width: 10%;"></td> <td style="width: 10%;"></td> <td style="width: 10%;"></td> <td style="width: 10%;"></td> <td style="width: 10%;"></td> <td style="width: 10%;"></td> <td style="width: 10%;"></td> <td style="width: 10%;"></td> <td style="width: 10%;"></td> </tr> <tr> <td></td> <td></td> <td colspan="8" style="text-align: center;"> <table border="1" style="width: 100%; border-collapse: collapse; text-align: center;"> <tr> <td style="width: 10%;"></td> <td style="width: 10%;"></td> <td style="width: 10%;"></td> <td style="width: 10%;"></td> <td style="width: 10%;"></td> <td style="width: 10%;"></td> <td style="width: 10%;"></td> <td style="width: 10%;"></td> <td style="width: 10%;"></td> <td style="width: 10%;"></td> </tr> <tr> <td></td> <td></td> <td colspan="8" style="text-align: center;"> <table border="1" style="width: 100%; border-collapse: collapse; text-align: center;"> <tr> <td style="width: 10%;"></td> <td style="width: 10%;"></td> <td style="width: 10%;"></td> <td style="width: 10%;"></td> <td style="width: 10%;"></td> <td style="width: 10%;"></td> <td style="width: 10%;"></td> <td style="width: 10%;"></td> <td style="width: 10%;"></td> <td style="width: 10%;"></td> </tr> <tr> <td></td> <td></td> <td colspan="8" style="text-align: center;"> <table border="1" style="width: 100%; border-collapse: collapse; text-align: center;"> <tr> <td style="width: 10%;"></td> <td style="width: 10%;"></td> <td style="width: 10%;"></td> <td style="width: 10%;"></td> <td style="width: 10%;"></td> <td style="width: 10%;"></td> <td style="width: 10%;"></td> <td style="width: 10%;"></td> <td style="width: 10%;"></td> <td style="width: 10%;"></td> </tr> <tr> <td></td> <td></td> <td colspan="8" style="text-align: center;"> <table border="1" style="width: 100%; border-collapse: collapse; text-align: center;"> <tr> <td style="width: 10%;"></td> <td style="width: 10%;"></td> <td style="width: 10%;"></td> <td style="width: 10%;"></td> <td style="width: 10%;"></td> <td style="width: 10%;"></td> <td style="width: 10%;"></td> <td style="width: 10%;"></td> <td style="width: 10%;"></td> <td style="width: 10%;"></td> </tr> <tr> <td></td> <td></td> <td colspan="8" style="text-align: center;"> <table border="1" style="width: 100%; border-collapse: collapse; text-align: center;"> <tr> <td style="width: 10%;"></td> <td style="width: 10%;"></td> <td style="width: 10%;"></td> <td style="width: 10%;"></td> <td style="width: 10%;"></td> <td style="width: 10%;"></td> <td style="width: 10%;"></td> <td style="width: 10%;"></td> <td style="width: 10%;"></td> <td style="width: 10%;"></td> </tr> <tr> <td></td> <td></td> <td colspan="8" style="text-align: center;"> <table border="1" style="width: 100%; border-collapse: collapse; text-align: center;"> <tr> <td style="width: 10%;"></td> <td style="width: 10%;"></td> <td style="width: 10%;"></td> <td style="width: 10%;"></td> <td style="width: 10%;"></td> <td style="width: 10%;"></td> <td style="width: 10%;"></td> <td style="width: 10%;"></td> <td style="width: 10%;"></td> <td style="width: 10%;"></td> </tr> <tr> <td></td> <td></td> <td colspan="8" style="text-align: center;"> <table border="1" style="width: 100%; border-collapse: collapse; text-align: center;"> <tr> <td style="width: 10%;"></td> <td style="width: 10%;"></td> <td style="width: 10%;"></td> <td style="width: 10%;"></td> <td style="width: 10%;"></td> <td style="width: 10%;"></td> <td style="width: 10%;"></td> <td style="width: 10%;"></td> <td style="width: 10%;"></td> <td style="width: 10%;"></td> </tr> <tr> <td></td> <td></td> <td colspan="8" style="text-align: center;"> <table border="1" style="width: 100%; border-collapse: collapse; text-align: center;"> <tr> <td style="width: 10%;"></td> <td style="width: 10%;"></td> <td style="width: 10%;"></td> <td style="width: 10%;"></td> <td style="width: 10%;"></td> <td style="width: 10%;"></td> <td style="width: 10%;"></td> <td style="width: 10%;"></td> <td style="width: 10%;"></td> <td style="width: 10%;"></td> </tr> <tr> <td></td> <td></td> <td colspan="8" style="text-align: center;"> <table border="1" style="width: 100%; border-collapse: collapse; text-align: center;"> <tr> </tr></table></td></tr></table></td></tr></table></td></tr></table></td></tr></table></td></tr></table></td></tr></table></td></tr></table></td></tr></table></td></tr></table></td></tr></table></td></tr></table> | | | | | | | | | | | | | | | | | | | | <table border="1" style="width: 100%; border-collapse: collapse; text-align: center;"> <tr> <td style="width: 10%;"></td> <td style="width: 10%;"></td> <td style="width: 10%;"></td> <td style="width: 10%;"></td> <td style="width: 10%;"></td> <td style="width: 10%;"></td> <td style="width: 10%;"></td> <td style="width: 10%;"></td> <td style="width: 10%;"></td> <td style="width: 10%;"></td> </tr> <tr> <td></td> <td></td> <td colspan="8" style="text-align: center;"> <table border="1" style="width: 100%; border-collapse: collapse; text-align: center;"> <tr> <td style="width: 10%;"></td> <td style="width: 10%;"></td> <td style="width: 10%;"></td> <td style="width: 10%;"></td> <td style="width: 10%;"></td> <td style="width: 10%;"></td> <td style="width: 10%;"></td> <td style="width: 10%;"></td> <td style="width: 10%;"></td> <td style="width: 10%;"></td> </tr> <tr> <td></td> <td></td> <td colspan="8" style="text-align: center;"> <table border="1" style="width: 100%; border-collapse: collapse; text-align: center;"> <tr> <td style="width: 10%;"></td> <td style="width: 10%;"></td> <td style="width: 10%;"></td> <td style="width: 10%;"></td> <td style="width: 10%;"></td> <td style="width: 10%;"></td> <td style="width: 10%;"></td> <td style="width: 10%;"></td> <td style="width: 10%;"></td> <td style="width: 10%;"></td> </tr> <tr> <td></td> <td></td> <td colspan="8" style="text-align: center;"> <table border="1" style="width: 100%; border-collapse: collapse; text-align: center;"> <tr> <td style="width: 10%;"></td> <td style="width: 10%;"></td> <td style="width: 10%;"></td> <td style="width: 10%;"></td> <td style="width: 10%;"></td> <td style="width: 10%;"></td> <td style="width: 10%;"></td> <td style="width: 10%;"></td> <td style="width: 10%;"></td> <td style="width: 10%;"></td> </tr> <tr> <td></td> <td></td> <td colspan="8" style="text-align: center;"> <table border="1" style="width: 100%; border-collapse: collapse; text-align: center;"> <tr> <td style="width: 10%;"></td> <td style="width: 10%;"></td> <td style="width: 10%;"></td> <td style="width: 10%;"></td> <td style="width: 10%;"></td> <td style="width: 10%;"></td> <td style="width: 10%;"></td> <td style="width: 10%;"></td> <td style="width: 10%;"></td> <td style="width: 10%;"></td> </tr> <tr> <td></td> <td></td> <td colspan="8" style="text-align: center;"> <table border="1" style="width: 100%; border-collapse: collapse; text-align: center;"> <tr> <td style="width: 10%;"></td> <td style="width: 10%;"></td> <td style="width: 10%;"></td> <td style="width: 10%;"></td> <td style="width: 10%;"></td> <td style="width: 10%;"></td> <td style="width: 10%;"></td> <td style="width: 10%;"></td> <td style="width: 10%;"></td> <td style="width: 10%;"></td> </tr> <tr> <td></td> <td></td> <td colspan="8" style="text-align: center;"> <table border="1" style="width: 100%; border-collapse: collapse; text-align: center;"> <tr> <td style="width: 10%;"></td> <td style="width: 10%;"></td> <td style="width: 10%;"></td> <td style="width: 10%;"></td> <td style="width: 10%;"></td> <td style="width: 10%;"></td> <td style="width: 10%;"></td> <td style="width: 10%;"></td> <td style="width: 10%;"></td> <td style="width: 10%;"></td> </tr> <tr> <td></td> <td></td> <td colspan="8" style="text-align: center;"> <table border="1" style="width: 100%; border-collapse: collapse; text-align: center;"> <tr> <td style="width: 10%;"></td> <td style="width: 10%;"></td> <td style="width: 10%;"></td> <td style="width: 10%;"></td> <td style="width: 10%;"></td> <td style="width: 10%;"></td> <td style="width: 10%;"></td> <td style="width: 10%;"></td> <td style="width: 10%;"></td> <td style="width: 10%;"></td> </tr> <tr> <td></td> <td></td> <td colspan="8" style="text-align: center;"> <table border="1" style="width: 100%; border-collapse: collapse; text-align: center;"> <tr> <td style="width: 10%;"></td> <td style="width: 10%;"></td> <td style="width: 10%;"></td> <td style="width: 10%;"></td> <td style="width: 10%;"></td> <td style="width: 10%;"></td> <td style="width: 10%;"></td> <td style="width: 10%;"></td> <td style="width: 10%;"></td> <td style="width: 10%;"></td> </tr> <tr> <td></td> <td></td> <td colspan="8" style="text-align: center;"> <table border="1" style="width: 100%; border-collapse: collapse; text-align: center;"> <tr> <td style="width: 10%;"></td> <td style="width: 10%;"></td> <td style="width: 10%;"></td> <td style="width: 10%;"></td> <td style="width: 10%;"></td> <td style="width: 10%;"></td> <td style="width: 10%;"></td> <td style="width: 10%;"></td> <td style="width: 10%;"></td> <td style="width: 10%;"></td> </tr> <tr> <td></td> <td></td> <td colspan="8" style="text-align: center;"> <table border="1" style="width: 100%; border-collapse: collapse; text-align: center;"> <tr> </tr></table></td></tr></table></td></tr></table></td></tr></table></td></tr></table></td></tr></table></td></tr></table></td></tr></table></td></tr></table></td></tr></table></td></tr></table> | | | | | | | | | | | | | | | | | | | | <table border="1" style="width: 100%; border-collapse: collapse; text-align: center;"> <tr> <td style="width: 10%;"></td> <td style="width: 10%;"></td> <td style="width: 10%;"></td> <td style="width: 10%;"></td> <td style="width: 10%;"></td> <td style="width: 10%;"></td> <td style="width: 10%;"></td> <td style="width: 10%;"></td> <td style="width: 10%;"></td> <td style="width: 10%;"></td> </tr> <tr> <td></td> <td></td> <td colspan="8" style="text-align: center;"> <table border="1" style="width: 100%; border-collapse:
collapse; text-align: center;"> <tr> <td style="width: 10%;"></td> <td style="width: 10%;"></td> <td style="width: 10%;"></td> <td style="width: 10%;"></td> <td style="width: 10%;"></td> <td style="width: 10%;"></td> <td style="width: 10%;"></td> <td style="width: 10%;"></td> <td style="width: 10%;"></td> <td style="width: 10%;"></td> </tr> <tr> <td></td> <td></td> <td colspan="8" style="text-align: center;"> <table border="1" style="width: 100%; border-collapse: collapse; text-align: center;"> <tr> <td style="width: 10%;"></td> <td style="width: 10%;"></td> <td style="width: 10%;"></td> <td style="width: 10%;"></td> <td style="width: 10%;"></td> <td style="width: 10%;"></td> <td style="width: 10%;"></td> <td style="width: 10%;"></td> <td style="width: 10%;"></td> <td style="width: 10%;"></td> </tr> <tr> <td></td> <td></td> <td colspan="8" style="text-align: center;"> <table border="1" style="width: 100%; border-collapse: collapse; text-align: center;"> <tr> <td style="width: 10%;"></td> <td style="width: 10%;"></td> <td style="width: 10%;"></td> <td style="width: 10%;"></td> <td style="width: 10%;"></td> <td style="width: 10%;"></td> <td style="width: 10%;"></td> <td style="width: 10%;"></td> <td style="width: 10%;"></td> <td style="width: 10%;"></td> </tr> <tr> <td></td> <td></td> <td colspan="8" style="text-align: center;"> <table border="1" style="width: 100%; border-collapse: collapse; text-align: center;"> <tr> <td style="width: 10%;"></td> <td style="width: 10%;"></td> <td style="width: 10%;"></td> <td style="width: 10%;"></td> <td style="width: 10%;"></td> <td style="width: 10%;"></td> <td style="width: 10%;"></td> <td style="width: 10%;"></td> <td style="width: 10%;"></td> <td style="width: 10%;"></td> </tr> <tr> <td></td> <td></td> <td colspan="8" style="text-align: center;"> <table border="1" style="width: 100%; border-collapse: collapse; text-align: center;"> <tr> <td style="width: 10%;"></td> <td style="width: 10%;"></td> <td style="width: 10%;"></td> <td style="width: 10%;"></td> <td style="width: 10%;"></td> <td style="width: 10%;"></td> <td style="width: 10%;"></td> <td style="width: 10%;"></td> <td style="width: 10%;"></td> <td style="width: 10%;"></td> </tr> <tr> <td></td> <td></td> <td colspan="8" style="text-align: center;"> <table border="1" style="width: 100%; border-collapse: collapse; text-align: center;"> <tr> <td style="width: 10%;"></td> <td style="width: 10%;"></td> <td style="width: 10%;"></td> <td style="width: 10%;"></td> <td style="width: 10%;"></td> <td style="width: 10%;"></td> <td style="width: 10%;"></td> <td style="width: 10%;"></td> <td style="width: 10%;"></td> <td style="width: 10%;"></td> </tr> <tr> <td></td> <td></td> <td colspan="8" style="text-align: center;"> <table border="1" style="width: 100%; border-collapse: collapse; text-align: center;"> <tr> <td style="width: 10%;"></td> <td style="width: 10%;"></td> <td style="width: 10%;"></td> <td style="width: 10%;"></td> <td style="width: 10%;"></td> <td style="width: 10%;"></td> <td style="width: 10%;"></td> <td style="width: 10%;"></td> <td style="width: 10%;"></td> <td style="width: 10%;"></td> </tr> <tr> <td></td> <td></td> <td colspan="8" style="text-align: center;"> <table border="1" style="width: 100%; border-collapse: collapse; text-align: center;"> <tr> <td style="width: 10%;"></td> <td style="width: 10%;"></td> <td style="width: 10%;"></td> <td style="width: 10%;"></td> <td style="width: 10%;"></td> <td style="width: 10%;"></td> <td style="width: 10%;"></td> <td style="width: 10%;"></td> <td style="width: 10%;"></td> <td style="width: 10%;"></td> </tr> <tr> <td></td> <td></td> <td colspan="8" style="text-align: center;"> <table border="1" style="width: 100%; border-collapse: collapse; text-align: center;"> <tr> </tr></table></td></tr></table></td></tr></table></td></tr></table></td></tr></table></td></tr></table></td></tr></table></td></tr></table></td></tr></table></td></tr></table> | | | | | | | | | | | | | | | | | | | | <table border="1" style="width: 100%; border-collapse: collapse; text-align: center;"> <tr> <td style="width: 10%;"></td> <td style="width: 10%;"></td> <td style="width: 10%;"></td> <td style="width: 10%;"></td> <td style="width: 10%;"></td> <td style="width: 10%;"></td> <td style="width: 10%;"></td> <td style="width: 10%;"></td> <td style="width: 10%;"></td> <td style="width: 10%;"></td> </tr> <tr> <td></td> <td></td> <td colspan="8" style="text-align: center;"> <table border="1" style="width: 100%; border-collapse: collapse; text-align: center;"> <tr> <td style="width: 10%;"></td> <td style="width: 10%;"></td> <td style="width: 10%;"></td> <td style="width: 10%;"></td> <td style="width: 10%;"></td> <td style="width: 10%;"></td> <td style="width: 10%;"></td> <td style="width: 10%;"></td> <td style="width: 10%;"></td> <td style="width: 10%;"></td> </tr> <tr> <td></td> <td></td> <td colspan="8" style="text-align: center;"> <table border="1" style="width: 100%; border-collapse: collapse; text-align: center;"> <tr> <td style="width: 10%;"></td> <td style="width: 10%;"></td> <td style="width: 10%;"></td> <td style="width: 10%;"></td> <td style="width: 10%;"></td> <td style="width: 10%;"></td> <td style="width: 10%;"></td> <td style="width: 10%;"></td> <td style="width: 10%;"></td> <td style="width: 10%;"></td> </tr> <tr> <td></td> <td></td> <td colspan="8" style="text-align: center;"> <table border="1" style="width: 100%; border-collapse: collapse; text-align: center;"> <tr> <td style="width: 10%;"></td> <td style="width: 10%;"></td> <td style="width: 10%;"></td> <td style="width: 10%;"></td> <td style="width: 10%;"></td> <td style="width: 10%;"></td> <td style="width: 10%;"></td> <td style="width: 10%;"></td> <td style="width: 10%;"></td> <td style="width: 10%;"></td> </tr> <tr> <td></td> <td></td> <td colspan="8" style="text-align: center;"> <table border="1" style="width: 100%; border-collapse: collapse; text-align: center;"> <tr> <td style="width: 10%;"></td> <td style="width: 10%;"></td> <td style="width: 10%;"></td> <td style="width: 10%;"></td> <td style="width: 10%;"></td> <td style="width: 10%;"></td> <td style="width: 10%;"></td> <td style="width: 10%;"></td> <td style="width: 10%;"></td> <td style="width: 10%;"></td> </tr> <tr> <td></td> <td></td> <td colspan="8" style="text-align: center;"> <table border="1" style="width: 100%; border-collapse: collapse; text-align: center;"> <tr> <td style="width: 10%;"></td> <td style="width: 10%;"></td> <td style="width: 10%;"></td> <td style="width: 10%;"></td> <td style="width: 10%;"></td> <td style="width: 10%;"></td> <td style="width: 10%;"></td> <td style="width: 10%;"></td> <td style="width: 10%;"></td> <td style="width: 10%;"></td> </tr> <tr> <td></td> <td></td> <td colspan="8" style="text-align: center;"> <table border="1" style="width: 100%; border-collapse: collapse; text-align: center;"> <tr> <td style="width: 10%;"></td> <td style="width: 10%;"></td> <td style="width: 10%;"></td> <td style="width: 10%;"></td> <td style="width: 10%;"></td> <td style="width: 10%;"></td> <td style="width: 10%;"></td> <td style="width: 10%;"></td> <td style="width: 10%;"></td> <td style="width: 10%;"></td> </tr> <tr> <td></td> <td></td> <td colspan="8" style="text-align: center;"> <table border="1" style="width: 100%; border-collapse: collapse; text-align: center;"> <tr> <td style="width: 10%;"></td> <td style="width: 10%;"></td> <td style="width: 10%;"></td> <td style="width: 10%;"></td> <td style="width: 10%;"></td> <td style="width: 10%;"></td> <td style="width: 10%;"></td> <td style="width: 10%;"></td> <td style="width: 10%;"></td> <td style="width: 10%;"></td> </tr> <tr> <td></td> <td></td> <td colspan="8" style="text-align: center;"> <table border="1" style="width: 100%; border-collapse: collapse; text-align: center;"> <tr> </tr></table></td></tr></table></td></tr></table></td></tr></table></td></tr></table></td></tr></table></td></tr></table></td></tr></table></td></tr></table> | | | | | | | | | | | | | | | | | | | | <table border="1" style="width: 100%; border-collapse: collapse; text-align: center;"> <tr> <td style="width: 10%;"></td> <td style="width: 10%;"></td> <td style="width: 10%;"></td> <td style="width: 10%;"></td> <td style="width: 10%;"></td> <td style="width: 10%;"></td> <td style="width: 10%;"></td> <td style="width: 10%;"></td> <td style="width: 10%;"></td> <td style="width: 10%;"></td> </tr> <tr> <td></td> <td></td> <td colspan="8" style="text-align: center;"> <table border="1" style="width: 100%; border-collapse: collapse; text-align: center;"> <tr> <td style="width: 10%;"></td> <td style="width: 10%;"></td> <td style="width: 10%;"></td> <td style="width: 10%;"></td> <td style="width: 10%;"></td> <td style="width: 10%;"></td> <td style="width: 10%;"></td> <td style="width: 10%;"></td> <td style="width: 10%;"></td> <td style="width: 10%;"></td> </tr> <tr> <td></td> <td></td> <td colspan="8" style="text-align: center;"> <table border="1" style="width: 100%; border-collapse: collapse; text-align: center;"> <tr> <td style="width: 10%;"></td> <td style="width: 10%;"></td> <td style="width: 10%;"></td> <td style="width: 10%;"></td> <td style="width: 10%;"></td> <td style="width: 10%;"></td> <td style="width: 10%;"></td> <td style="width: 10%;"></td> <td style="width: 10%;"></td> <td style="width: 10%;"></td> </tr> <tr> <td></td> <td></td> <td colspan="8" style="text-align: center;"> <table border="1" style="width: 100%; border-collapse: collapse; text-align: center;"> <tr> <td style="width: 10%;"></td> <td style="width: 10%;"></td> <td style="width: 10%;"></td> <td style="width: 10%;"></td> <td style="width: 10%;"></td> <td style="width: 10%;"></td> <td style="width: 10%;"></td> <td style="width: 10%;"></td> <td style="width: 10%;"></td> <td style="width: 10%;"></td> </tr> <tr> <td></td> <td></td> <td colspan="8" style="text-align: center;"> <table border="1" style="width: 100%; border-collapse:
collapse; text-align: center;"> <tr> <td style="width: 10%;"></td> <td style="width: 10%;"></td> <td style="width: 10%;"></td> <td style="width: 10%;"></td> <td style="width: 10%;"></td> <td style="width: 10%;"></td> <td style="width: 10%;"></td> <td style="width: 10%;"></td> <td style="width: 10%;"></td> <td style="width: 10%;"></td> </tr> <tr> <td></td> <td></td> <td colspan="8" style="text-align: center;"> <table border="1" style="width: 100%; border-collapse: collapse; text-align: center;"> <tr> <td style="width: 10%;"></td> <td style="width: 10%;"></td> <td style="width: 10%;"></td> <td style="width: 10%;"></td> <td style="width: 10%;"></td> <td style="width: 10%;"></td> <td style="width: 10%;"></td> <td style="width: 10%;"></td> <td style="width: 10%;"></td> <td style="width: 10%;"></td> </tr> <tr> <td></td> <td></td> <td colspan="8" style="text-align: center;"> <table border="1" style="width: 100%; border-collapse: collapse; text-align: center;"> <tr> <td style="width: 10%;"></td> <td style="width: 10%;"></td> <td style="width: 10%;"></td> <td style="width: 10%;"></td> <td style="width: 10%;"></td> <td style="width: 10%;"></td> <td style="width: 10%;"></td> <td style="width: 10%;"></td> <td style="width: 10%;"></td> <td style="width: 10%;"></td> </tr> <tr> <td></td> <td></td> <td colspan="8" style="text-align: center;"> <table border="1" style="width: 100%; border-collapse: collapse; text-align: center;"> <tr> </tr></table></td></tr></table></td></tr></table></td></tr></table></td></tr></table></td></tr></table></td></tr></table></td></tr></table> | | | | | | | | | | | | | | | | | | | | <table border="1" style="width: 100%; border-collapse: collapse; text-align: center;"> <tr> <td style="width: 10%;"></td> <td style="width: 10%;"></td> <td style="width: 10%;"></td> <td style="width: 10%;"></td> <td style="width: 10%;"></td> <td style="width: 10%;"></td> <td style="width: 10%;"></td> <td style="width: 10%;"></td> <td style="width: 10%;"></td> <td style="width: 10%;"></td> </tr> <tr> <td></td> <td></td> <td colspan="8" style="text-align: center;"> <table border="1" style="width: 100%; border-collapse: collapse; text-align: center;"> <tr> <td style="width: 10%;"></td> <td style="width: 10%;"></td> <td style="width: 10%;"></td> <td style="width: 10%;"></td> <td style="width: 10%;"></td> <td style="width: 10%;"></td> <td style="width: 10%;"></td> <td style="width: 10%;"></td> <td style="width: 10%;"></td> <td style="width: 10%;"></td> </tr> <tr> <td></td> <td></td> <td colspan="8" style="text-align: center;"> <table border="1" style="width: 100%; border-collapse: collapse; text-align: center;"> <tr> <td style="width: 10%;"></td> <td style="width: 10%;"></td> <td style="width: 10%;"></td> <td style="width: 10%;"></td> <td style="width: 10%;"></td> <td style="width: 10%;"></td> <td style="width: 10%;"></td> <td style="width: 10%;"></td> <td style="width: 10%;"></td> <td style="width: 10%;"></td> </tr> <tr> <td></td> <td></td> <td colspan="8" style="text-align: center;"> <table border="1" style="width: 100%; border-collapse: collapse; text-align: center;"> <tr> <td style="width: 10%;"></td> <td style="width: 10%;"></td> <td style="width: 10%;"></td> <td style="width: 10%;"></td> <td style="width: 10%;"></td> <td style="width: 10%;"></td> <td style="width: 10%;"></td> <td style="width: 10%;"></td> <td style="width: 10%;"></td> <td style="width: 10%;"></td> </tr> <tr> <td></td> <td></td> <td colspan="8" style="text-align: center;"> <table border="1" style="width: 100%; border-collapse: collapse; text-align: center;"> <tr> <td style="width: 10%;"></td> <td style="width: 10%;"></td> <td style="width: 10%;"></td> <td style="width: 10%;"></td> <td style="width: 10%;"></td> <td style="width: 10%;"></td> <td style="width: 10%;"></td> <td style="width: 10%;"></td> <td style="width: 10%;"></td> <td style="width: 10%;"></td> </tr> <tr> <td></td> <td></td> <td colspan="8" style="text-align: center;"> <table border="1" style="width: 100%; border-collapse: collapse; text-align: center;"> <tr> <td style="width: 10%;"></td> <td style="width: 10%;"></td> <td style="width: 10%;"></td> <td style="width: 10%;"></td> <td style="width: 10%;"></td> <td style="width: 10%;"></td> <td style="width: 10%;"></td> <td style="width: 10%;"></td> <td style="width: 10%;"></td> <td style="width: 10%;"></td> </tr> <tr> <td></td> <td></td> <td colspan="8" style="text-align: center;"> <table border="1" style="width: 100%; border-collapse: collapse; text-align: center;"> <tr> </tr></table></td></tr></table></td></tr></table></td></tr></table></td></tr></table></td></tr></table></td></tr></table> | | | | | | | | | | | | | | | | | | | | <table border="1" style="width: 100%; border-collapse: collapse; text-align: center;"> <tr> <td style="width: 10%;"></td> <td style="width: 10%;"></td> <td style="width: 10%;"></td> <td style="width: 10%;"></td> <td style="width: 10%;"></td> <td style="width: 10%;"></td> <td style="width: 10%;"></td> <td style="width: 10%;"></td> <td style="width: 10%;"></td> <td style="width: 10%;"></td> </tr> <tr> <td></td> <td></td> <td colspan="8" style="text-align: center;"> <table border="1" style="width: 100%; border-collapse: collapse; text-align: center;"> <tr> <td style="width: 10%;"></td> <td style="width: 10%;"></td> <td style="width: 10%;"></td> <td style="width: 10%;"></td> <td style="width: 10%;"></td> <td style="width: 10%;"></td> <td style="width: 10%;"></td> <td style="width: 10%;"></td> <td style="width: 10%;"></td> <td style="width: 10%;"></td> </tr> <tr> <td></td> <td></td> <td colspan="8" style="text-align: center;"> <table border="1" style="width: 100%; border-collapse: collapse; text-align: center;"> <tr> <td style="width: 10%;"></td> <td style="width: 10%;"></td> <td style="width: 10%;"></td> <td style="width: 10%;"></td> <td style="width: 10%;"></td> <td style="width: 10%;"></td> <td style="width: 10%;"></td> <td style="width: 10%;"></td> <td style="width: 10%;"></td> <td style="width: 10%;"></td> </tr> <tr> <td></td> <td></td> <td colspan="8" style="text-align: center;"> <table border="1" style="width: 100%; border-collapse: collapse; text-align: center;"> <tr> <td style="width: 10%;"></td> <td style="width: 10%;"></td> <td style="width: 10%;"></td> <td style="width: 10%;"></td> <td style="width: 10%;"></td> <td style="width: 10%;"></td> <td style="width: 10%;"></td> <td style="width: 10%;"></td> <td style="width: 10%;"></td> <td style="width: 10%;"></td> </tr> <tr> <td></td> <td></td> <td colspan="8" style="text-align: center;"> <table border="1" style="width: 100%; border-collapse: collapse; text-align: center;"> <tr> <td style="width: 10%;"></td> <td style="width: 10%;"></td> <td style="width: 10%;"></td> <td style="width: 10%;"></td> <td style="width: 10%;"></td> <td style="width: 10%;"></td> <td style="width: 10%;"></td> <td style="width: 10%;"></td> <td style="width: 10%;"></td> <td style="width: 10%;"></td> </tr> <tr> <td></td> <td></td> <td colspan="8" style="text-align: center;"> <table border="1" style="width: 100%; border-collapse: collapse; text-align: center;"> <tr> </tr></table></td></tr></table></td></tr></table></td></tr></table></td></tr></table></td></tr></table> | | | | | | | | | | | | | | | | | | | | <table border="1" style="width: 100%; border-collapse: collapse; text-align: center;"> <tr> <td style="width: 10%;"></td> <td style="width: 10%;"></td> <td style="width: 10%;"></td> <td style="width: 10%;"></td> <td style="width: 10%;"></td> <td style="width: 10%;"></td> <td style="width: 10%;"></td> <td style="width: 10%;"></td> <td style="width: 10%;"></td> <td style="width: 10%;"></td> </tr> <tr> <td></td> <td></td> <td colspan="8" style="text-align: center;"> <table border="1" style="width: 100%; border-collapse: collapse; text-align: center;"> <tr> <td style="width: 10%;"></td> <td style="width: 10%;"></td> <td style="width: 10%;"></td> <td style="width: 10%;"></td> <td style="width: 10%;"></td> <td style="width: 10%;"></td> <td style="width: 10%;"></td> <td style="width: 10%;"></td> <td style="width: 10%;"></td> <td style="width: 10%;"></td> </tr> <tr> <td></td> <td></td> <td colspan="8" style="text-align: center;"> <table border="1" style="width: 100%; border-collapse: collapse; text-align: center;"> <tr> <td style="width: 10%;"></td> <td style="width: 10%;"></td> <td style="width: 10%;"></td> <td style="width: 10%;"></td> <td style="width: 10%;"></td> <td style="width: 10%;"></td> <td style="width: 10%;"></td> <td style="width: 10%;"></td> <td style="width: 10%;"></td> <td style="width: 10%;"></td> </tr> <tr> <td></td> <td></td> <td colspan="8" style="text-align: center;"> <table border="1" style="width: 100%; border-collapse: collapse; text-align: center;"> <tr> <td style="width: 10%;"></td> <td style="width: 10%;"></td> <td style="width: 10%;"></td> <td style="width: 10%;"></td> <td style="width: 10%;"></td> <td style="width: 10%;"></td> <td style="width: 10%;"></td> <td style="width: 10%;"></td> <td style="width: 10%;"></td> <td style="width: 10%;"></td> </tr> <tr> <td></td> <td></td> <td colspan="8" style="text-align: center;"> <table border="1" style="width: 100%; border-collapse: collapse; text-align: center;"> <tr> </tr></table></td></tr></table></td></tr></table></td></tr></table></td></tr></table> | | | | | | | | | | | | | | | | | | | | <table border="1" style="width: 100%; border-collapse: collapse; text-align: center;"> <tr> <td style="width: 10%;"></td> <td style="width: 10%;"></td> <td style="width: 10%;"></td> <td style="width: 10%;"></td> <td style="width: 10%;"></td> <td style="width: 10%;"></td> <td style="width: 10%;"></td> <td style="width: 10%;"></td> <td style="width: 10%;"></td> <td style="width: 10%;"></td> </tr> <tr> <td></td> <td></td> <td colspan="8" style="text-align: center;"> <table border="1" style="width: 100%; border-collapse: collapse; text-align: center;"> <tr> <td
style="width: 10%;"></td> <td style="width: 10%;"></td> <td style="width: 10%;"></td> <td style="width: 10%;"></td> <td style="width: 10%;"></td> <td style="width: 10%;"></td> <td style="width: 10%;"></td> <td style="width: 10%;"></td> <td style="width: 10%;"></td> <td style="width: 10%;"></td> </tr> <tr> <td></td> <td></td> <td colspan="8" style="text-align: center;"> <table border="1" style="width: 100%; border-collapse: collapse; text-align: center;"> <tr> <td style="width: 10%;"></td> <td style="width: 10%;"></td> <td style="width: 10%;"></td> <td style="width: 10%;"></td> <td style="width: 10%;"></td> <td style="width: 10%;"></td> <td style="width: 10%;"></td> <td style="width: 10%;"></td> <td style="width: 10%;"></td> <td style="width: 10%;"></td> </tr> <tr> <td></td> <td></td> <td colspan="8" style="text-align: center;"> <table border="1" style="width: 100%; border-collapse: collapse; text-align: center;"> <tr> </tr></table></td></tr></table></td></tr></table></td></tr></table> | | | | | | | | | | | | | | | | | | | | <table border="1" style="width: 100%; border-collapse: collapse; text-align: center;"> <tr> <td style="width: 10%;"></td> <td style="width: 10%;"></td> <td style="width: 10%;"></td> <td style="width: 10%;"></td> <td style="width: 10%;"></td> <td style="width: 10%;"></td> <td style="width: 10%;"></td> <td style="width: 10%;"></td> <td style="width: 10%;"></td> <td style="width: 10%;"></td> </tr> <tr> <td></td> <td></td> <td colspan="8" style="text-align: center;"> <table border="1" style="width: 100%; border-collapse: collapse; text-align: center;"> <tr> <td style="width: 10%;"></td> <td style="width: 10%;"></td> <td style="width: 10%;"></td> <td style="width: 10%;"></td> <td style="width: 10%;"></td> <td style="width: 10%;"></td> <td style="width: 10%;"></td> <td style="width: 10%;"></td> <td style="width: 10%;"></td> <td style="width: 10%;"></td> </tr> <tr> <td></td> <td></td> <td colspan="8" style="text-align: center;"> <table border="1" style="width: 100%; border-collapse: collapse; text-align: center;"> <tr> </tr></table></td></tr></table></td></tr></table> | | | | | | | | | | | | | | | | | | | | <table border="1" style="width: 100%; border-collapse: collapse; text-align: center;"> <tr> <td style="width: 10%;"></td> <td style="width: 10%;"></td> <td style="width: 10%;"></td> <td style="width: 10%;"></td> <td style="width: 10%;"></td> <td style="width: 10%;"></td> <td style="width: 10%;"></td> <td style="width: 10%;"></td> <td style="width: 10%;"></td> <td style="width: 10%;"></td> </tr> <tr> <td></td> <td></td> <td colspan="8" style="text-align: center;"> <table border="1" style="width: 100%; border-collapse: collapse; text-align: center;"> <tr> </tr></table></td></tr></table> | | | | | | | | | | | | | | | | | | | | <table border="1" style="width: 100%; border-collapse: collapse; text-align: center;"> <tr> </tr></table> | | | | | | | |
| | |

 | | | | | | | | | | | | | | | | | | | |

 | | | | | | | | | | | | | | | | | | | |

 | | | | | | | | | | | | | | | | | | | |

 | | | | | | | | | | | | | | | | | | | |

 | | | | | | | | | | | | | | | | | | | |

 | | | | | | | | | | | | | | | | | | | |

 | | | | | | | | | | | | | | | | | | | |

 | | | | | | | | | | | | | | | | | | | |

 | | | | | | | | | | | | | | | | | | | |

 | | | | | | | | | | | | | | | | | | | |

 | | | | | | | | | | | | | | | | | | | |

 | | | | | | | | | | | | | | | | | | | |

 | | | | | | | | | | | | | | | | | | | |

 | | | | | | | | | | | | | | | | | | | |

 | | | | | | | | | | | | | | | | | | | |

 | | | | | | | | | | | | | | | | | | | |

 | | | | | | | | | | | | | | | | | | | |

 | | | | | | | | | | | | | | | | | | | |

 | | | | | | | | | | | | | | | | | | | |

 | | | | | | | | | | | | | | | | | | | |

 | | | | | | | | | | | | | | | | | | | |

 | | | | | | | | | | | | | | | | | | | |

 | | | | | | | | | | | | | | | | | | | |

 | | | | | | | | | | | | | | | | | | | |

 | | | | | | | | | | | | | | | | | | | |

 | | | | | | | | | | | | | | | | | | | |

 | | | | | | | | | | | | | | | | | | | |

 | | | | | | | | | | | | | | | | | | | |
 | | | | | | | | | | | | | | | | | | | |

 | | | | | | | | | | | | | | | | | | | |

 | | | | | | | | | | | | | | | | | | | |
 | | | | | | | | | | | | | | | | | | | |

 | | | | | | | | | | | | | | | | | | | |

 | | | | | | | | | | | | | | | | | | | |
 | | | | | | | | | | | | | | | | | | | |
 | | | | | | | | | | | | | | | | | | | |

 | | | | | | | | | | | | | | | | | | | |
 | | | | | | | | | | | | | | | | | | | |
 | | | | | | | | | | | | | | | | | | | |

 | | | | | | | | | | | | | | | | | | | | | | | | | | | | | | | | | | | | | | | | | | | | | | | | | | | | | | | | | | | | | | | | | | | | | | | | | | | | | | | | | | | | | | | | | | | | | | | | | | | |
 | | | | | | | | | | | | | | | | | | | |
 | | | | | | | | | | | | | | | | | | | |
 | | | | | | | | | | | | | | | | | | | |
 | | | | | | | | | | | | | | | | | | | |
 | | | | | | | | | | | | | | | | | | | |
 | | | | | | | | | | | | | | | | | | | |
 | | | | | | | | | | | | | | | | | | | |
 | | | | | | | | | | | | | | | | | | | |
 | | | | | | | | | | | | | | | | | | | | | | | | | | | | | | | | | | | | | | | |
 | | | | | | | | | | | | | | | | | | | |
 | | | | | | | | | | | | | | | | | | | | | | | | | | | | | | | | | | | | | | | |
 | | | | | | | | | | | | | | | | | | | | | | | | | | | | | | | | | | | | | | | |
 | | | | | | | | | | | | | | | | | | | | | | | | | | | | | | | | | | | | | | | |
 | | | | | | | | | | | | | | | | | | | | | | | | | | | | | | | | | | | | | | | | | | | | | | | | | | | | | | | | | | | | | | | | | | | | | | | | | | | | | | | | | | | | | | | | | | | | | | | | | | | |
 | | | | | | | | | | | | | | | | | | | | | | | | | | | | | | | | | | | | | | | | | | | | | | | |
| | | <table border="1" style="width: 100%; border-collapse: collapse; text-align: center;"> <tr> <td style="width: 10%;"></td> <td style="width: 10%;"></td> <td style="width: 10%;"></td> <td style="width: 10%;"></td> <td style="width: 10%;"></td> <td style="width: 10%;"></td> <td style="width: 10%;"></td> <td style="width: 10%;"></td> <td style="width: 10%;"></td> <td style="width: 10%;"></td> </tr> <tr> <td></td> <td></td> <td colspan="8" style="text-align: center;"> <table border="1" style="width: 100%; border-collapse: collapse; text-align: center;"> <tr> <td style="width: 10%;"></td> <td style="width: 10%;"></td> <td style="width: 10%;"></td> <td style="width: 10%;"></td> <td style="width: 10%;"></td> <td style="width: 10%;"></td> <td style="width: 10%;"></td> <td style="width: 10%;"></td> <td style="width: 10%;"></td> <td style="width: 10%;"></td> </tr> <tr> <td></td> <td></td> <td colspan="8" style="text-align: center;"> <table border="1" style="width: 100%; border-collapse: collapse; text-align: center;"> <tr> <td style="width: 10%;"></td> <td style="width: 10%;"></td> <td style="width: 10%;"></td> <td style="width: 10%;"></td> <td style="width: 10%;"></td> <td style="width: 10%;"></td> <td style="width: 10%;"></td> <td style="width: 10%;"></td> <td style="width: 10%;"></td> <td style="width: 10%;"></td> </tr> <tr> <td></td> <td></td> <td colspan="8" style="text-align: center;"> <table border="1" style="width: 100%; border-collapse: collapse; text-align: center;"> <tr> <td style="width: 10%;"></td> <td style="width: 10%;"></td> <td style="width: 10%;"></td> <td style="width: 10%;"></td> <td style="width: 10%;"></td> <td style="width: 10%;"></td> <td style="width: 10%;"></td> <td style="width: 10%;"></td> <td style="width: 10%;"></td> <td style="width: 10%;"></td> </tr> <tr> <td></td> <td></td> <td colspan="8" style="text-align: center;"> <table border="1" style="width: 100%; border-collapse: collapse; text-align: center;"> <tr> <td style="width: 10%;"></td> <td style="width: 10%;"></td> <td style="width: 10%;"></td> <td style="width: 10%;"></td> <td style="width: 10%;"></td> <td style="width: 10%;"></td> <td style="width: 10%;"></td> <td style="width: 10%;"></td> <td style="width: 10%;"></td> <td style="width: 10%;"></td> </tr> <tr> <td></td> <td></td> <td colspan="8" style="text-align: center;"> <table border="1" style="width: 100%; border-collapse: collapse; text-align: center;"> <tr> <td style="width: 10%;"></td> <td style="width: 10%;"></td> <td style="width: 10%;"></td> <td style="width: 10%;"></td> <td style="width: 10%;"></td> <td style="width: 10%;"></td> <td style="width: 10%;"></td> <td style="width: 10%;"></td> <td style="width: 10%;"></td> <td style="width: 10%;"></td> </tr> <tr> <td></td> <td></td> <td colspan="8" style="text-align: center;"> <table border="1" style="width: 100%; border-collapse: collapse; text-align: center;"> <tr> <td style="width: 10%;"></td> <td style="width: 10%;"></td> <td style="width: 10%;"></td> <td style="width: 10%;"></td> <td style="width: 10%;"></td> <td style="width: 10%;"></td> <td style="width: 10%;"></td> <td style="width: 10%;"></td> <td style="width: 10%;"></td> <td style="width: 10%;"></td> </tr> <tr> <td></td> <td></td> <td colspan="8" style="text-align: center;"> <table border="1" style="width: 100%; border-collapse: collapse; text-align: center;"> <tr> <td style="width: 10%;"></td> <td style="width: 10%;"></td> <td style="width: 10%;"></td> <td style="width: 10%;"></td> <td style="width: 10%;"></td> <td style="width: 10%;"></td> <td style="width: 10%;"></td> <td style="width: 10%;"></td> <td style="width: 10%;"></td> <td style="width: 10%;"></td> </tr> <tr> <td></td> <td></td> <td colspan="8" style="text-align: center;"> <table border="1" style="width: 100%; border-collapse: collapse; text-align: center;"> <tr> <td style="width: 10%;"></td> <td style="width: 10%;"></td> <td style="width: 10%;"></td> <td style="width: 10%;"></td> <td style="width: 10%;"></td> <td style="width: 10%;"></td> <td style="width: 10%;"></td> <td style="width: 10%;"></td> <td style="width: 10%;"></td> <td style="width: 10%;"></td> </tr> <tr> <td></td> <td></td> <td colspan="8" style="text-align: center;"> <table border="1" style="width: 100%; border-collapse: collapse; text-align: center;"> <tr> <td style="width: 10%;"></td> <td style="width: 10%;"></td> <td style="width: 10%;"></td> <td style="width: 10%;"></td> <td style="width: 10%;"></td> <td style="width: 10%;"></td> <td style="width: 10%;"></td> <td style="width: 10%;"></td> <td style="width: 10%;"></td> <td style="width: 10%;"></td> </tr> <tr> <td></td> <td></td> <td colspan="8" style="text-align: center;"> <table border="1" style="width: 100%; border-collapse: collapse; text-align: center;"> <tr> <td style="width: 10%;"></td> <td style="width: 10%;"></td> <td style="width: 10%;"></td> <td style="width: 10%;"></td> <td style="width: 10%;"></td> <td style="width: 10%;"></td> <td style="width: 10%;"></td> <td style="width: 10%;"></td> <td style="width: 10%;"></td> <td style="width: 10%;"></td> </tr> <tr> <td></td> <td></td> <td colspan="8" style="text-align: center;"> <table border="1" style="width: 100%; border-collapse: collapse; text-align: center;"> <tr> <td style="width: 10%;"></td> <td style="width: 10%;"></td> <td style="width: 10%;"></td> <td style="width: 10%;"></td> <td style="width: 10%;"></td> <td style="width: 10%;"></td> <td style="width: 10%;"></td> <td style="width: 10%;"></td> <td style="width: 10%;"></td> <td style="width: 10%;"></td> </tr> <tr> <td></td> <td></td> <td colspan="8" style="text-align: center;"> <table border="1" style="width: 100%; border-collapse: collapse; text-align: center;"> <tr> <td style="width: 10%;"></td> <td style="width: 10%;"></td> <td style="width: 10%;"></td> <td style="width: 10%;"></td> <td style="width: 10%;"></td> <td style="width: 10%;"></td> <td style="width: 10%;"></td> <td style="width: 10%;"></td> <td style="width: 10%;"></td> <td style="width: 10%;"></td> </tr> <tr> <td></td> <td></td> <td colspan="8" style="text-align: center;"> <table border="1" style="width: 100%; border-collapse: collapse; text-align: center;"> <tr> <td style="width: 10%;"></td> <td style="width: 10%;"></td> <td style="width: 10%;"></td> <td style="width: 10%;"></td> <td style="width: 10%;"></td> <td style="width: 10%;"></td> <td style="width: 10%;"></td> <td style="width: 10%;"></td> <td style="width: 10%;"></td> <td style="width: 10%;"></td> </tr> <tr> <td></td> <td></td> <td colspan="8" style="text-align: center;"> <table border="1" style="width: 100%; border-collapse: collapse; text-align: center;"> <tr> <td style="width: 10%;"></td> <td style="width: 10%;"></td> <td style="width: 10%;"></td> <td style="width: 10%;"></td> <td style="width: 10%;"></td> <td style="width: 10%;"></td> <td style="width: 10%;"></td> <td style="width: 10%;"></td> <td style="width: 10%;"></td> <td style="width: 10%;"></td> </tr> <tr> <td></td> <td></td> <td colspan="8" style="text-align: center;"> <table border="1" style="width: 100%; border-collapse: collapse; text-align: center;"> <tr> <td style="width: 10%;"></td> <td style="width: 10%;"></td> <td style="width: 10%;"></td> <td style="width: 10%;"></td> <td style="width: 10%;"></td> <td style="width: 10%;"></td> <td style="width: 10%;"></td> <td style="width: 10%;"></td> <td style="width: 10%;"></td> <td style="width: 10%;"></td> </tr> <tr> <td></td> <td></td> <td colspan="8" style="text-align: center;"> <table border="1" style="width: 100%; border-collapse: collapse; text-align: center;"> <tr> <td style="width: 10%;"></td> <td style="width: 10%;"></td> <td style="width: 10%;"></td> <td style="width: 10%;"></td> <td style="width: 10%;"></td> <td style="width: 10%;"></td> <td style="width: 10%;"></td> <td style="width: 10%;"></td> <td style="width: 10%;"></td> <td style="width: 10%;"></td> </tr> <tr> <td></td> <td></td> <td colspan="8" style="text-align: center;"> <table border="1" style="width: 100%; border-collapse: collapse; text-align: center;"> <tr> <td style="width: 10%;"></td> <td style="width: 10%;"></td> <td style="width: 10%;"></td> <td style="width: 10%;"></td> <td style="width: 10%;"></td> <td style="width: 10%;"></td> <td style="width: 10%;"></td> <td style="width: 10%;"></td> <td style="width: 10%;"></td> <td style="width: 10%;"></td> </tr> <tr> <td></td> <td></td> <td colspan="8" style="text-align: center;"> <table border="1" style="width: 100%; border-collapse: collapse; text-align: center;"> <tr> <td style="width: 10%;"></td> <td style="width: 10%;"></td> <td style="width: 10%;"></td> <td style="width: 10%;"></td> <td style="width: 10%;"></td> <td style="width: 10%;"></td> <td style="width: 10%;"></td> <td style="width: 10%;"></td> <td style="width: 10%;"></td> <td style="width: 10%;"></td> </tr> <tr> <td></td> <td></td> <td colspan="8" style="text-align: center;"> <table border="1" style="width: 100%; border-collapse: collapse; text-align: center;"> <tr> <td style="width: 10%;"></td> <td style="width: 10%;"></td> <td style="width: 10%;"></td> <td style="width: 10%;"></td> <td style="width: 10%;"></td> <td style="width: 10%;"></td> <td style="width: 10%;"></td> <td style="width: 10%;"></td> <td style="width: 10%;"></td> <td style="width: 10%;"></td> </tr> <tr> <td></td> <td></td> <td colspan="8" style="text-align: center;"> <table border="1" style="width: 100%; border-collapse: collapse; text-align: center;"> <tr> <td style="width: 10%;"></td> <td style="width: 10%;"></td> <td style="width: 10%;"></td> <td style="width: 10%;"></td> <td style="width: 10%;"></td> <td style="width: 10%;"></td> <td style="width: 10%;"></td> <td style="width: 10%;"></td> <td style="width: 10%;"></td> <td style="width: 10%;"></td> </tr> <tr> <td></td> <td></td> <td colspan="8" style="text-align: center;"> <table border="1" style="width: 100%; border-collapse: collapse; text-align: center;"> <tr> <td style="width: 10%;"></td> <td style="width: 10%;"></td> <td
style="width: 10%;"></td> <td style="width: 10%;"></td> <td style="width: 10%;"></td> <td style="width: 10%;"></td> <td style="width: 10%;"></td> <td style="width: 10%;"></td> <td style="width: 10%;"></td> <td style="width: 10%;"></td> </tr> <tr> <td></td> <td></td> <td colspan="8" style="text-align: center;"> <table border="1" style="width: 100%; border-collapse: collapse; text-align: center;"> <tr> <td style="width: 10%;"></td> <td style="width: 10%;"></td> <td style="width: 10%;"></td> <td style="width: 10%;"></td> <td style="width: 10%;"></td> <td style="width: 10%;"></td> <td style="width: 10%;"></td> <td style="width: 10%;"></td> <td style="width: 10%;"></td> <td style="width: 10%;"></td> </tr> <tr> <td></td> <td></td> <td colspan="8" style="text-align: center;"> <table border="1" style="width: 100%; border-collapse: collapse; text-align: center;"> <tr> <td style="width: 10%;"></td> <td style="width: 10%;"></td> <td style="width: 10%;"></td> <td style="width: 10%;"></td> <td style="width: 10%;"></td> <td style="width: 10%;"></td> <td style="width: 10%;"></td> <td style="width: 10%;"></td> <td style="width: 10%;"></td> <td style="width: 10%;"></td> </tr> <tr> <td></td> <td></td> <td colspan="8" style="text-align: center;"> <table border="1" style="width: 100%; border-collapse: collapse; text-align: center;"> <tr> <td style="width: 10%;"></td> <td style="width: 10%;"></td> <td style="width: 10%;"></td> <td style="width: 10%;"></td> <td style="width: 10%;"></td> <td style="width: 10%;"></td> <td style="width: 10%;"></td> <td style="width: 10%;"></td> <td style="width: 10%;"></td> <td style="width: 10%;"></td> </tr> <tr> <td></td> <td></td> <td colspan="8" style="text-align: center;"> <table border="1" style="width: 100%; border-collapse: collapse; text-align: center;"> <tr> <td style="width: 10%;"></td> <td style="width: 10%;"></td> <td style="width: 10%;"></td> <td style="width: 10%;"></td> <td style="width: 10%;"></td> <td style="width: 10%;"></td> <td style="width: 10%;"></td> <td style="width: 10%;"></td> <td style="width: 10%;"></td> <td style="width: 10%;"></td> </tr> <tr> <td></td> <td></td> <td colspan="8" style="text-align: center;"> <table border="1" style="width: 100%; border-collapse: collapse; text-align: center;"> <tr> <td style="width: 10%;"></td> <td style="width: 10%;"></td> <td style="width: 10%;"></td> <td style="width: 10%;"></td> <td style="width: 10%;"></td> <td style="width: 10%;"></td> <td style="width: 10%;"></td> <td style="width: 10%;"></td> <td style="width: 10%;"></td> <td style="width: 10%;"></td> </tr> <tr> <td></td> <td></td> <td colspan="8" style="text-align: center;"> <table border="1" style="width: 100%; border-collapse: collapse; text-align: center;"> <tr> <td style="width: 10%;"></td> <td style="width: 10%;"></td> <td style="width: 10%;"></td> <td style="width: 10%;"></td> <td style="width: 10%;"></td> <td style="width: 10%;"></td> <td style="width: 10%;"></td> <td style="width: 10%;"></td> <td style="width: 10%;"></td> <td style="width: 10%;"></td> </tr> <tr> <td></td> <td></td> <td colspan="8" style="text-align: center;"> <table border="1" style="width: 100%; border-collapse: collapse; text-align: center;"> <tr> <td style="width: 10%;"></td> <td style="width: 10%;"></td> <td style="width: 10%;"></td> <td style="width: 10%;"></td> <td style="width: 10%;"></td> <td style="width: 10%;"></td> <td style="width: 10%;"></td> <td style="width: 10%;"></td> <td style="width: 10%;"></td> <td style="width: 10%;"></td> </tr> <tr> <td></td> <td></td> <td colspan="8" style="text-align: center;"> <table border="1" style="width: 100%; border-collapse: collapse; text-align: center;"> <tr> <td style="width: 10%;"></td> <td style="width: 10%;"></td> <td style="width: 10%;"></td> <td style="width: 10%;"></td> <td style="width: 10%;"></td> <td style="width: 10%;"></td> <td style="width: 10%;"></td> <td style="width: 10%;"></td> <td style="width: 10%;"></td> <td style="width: 10%;"></td> </tr> <tr> <td></td> <td></td> <td colspan="8" style="text-align: center;"> <table border="1" style="width: 100%; border-collapse: collapse; text-align: center;"> <tr> <td style="width: 10%;"></td> <td style="width: 10%;"></td> <td style="width: 10%;"></td> <td style="width: 10%;"></td> <td style="width: 10%;"></td> <td style="width: 10%;"></td> <td style="width: 10%;"></td> <td style="width: 10%;"></td> <td style="width: 10%;"></td> <td style="width: 10%;"></td> </tr> <tr> <td></td> <td></td> <td colspan="8" style="text-align: center;"> <table border="1" style="width: 100%; border-collapse: collapse; text-align: center;"> <tr> <td style="width: 10%;"></td> <td style="width: 10%;"></td> <td style="width: 10%;"></td> <td style="width: 10%;"></td> <td style="width: 10%;"></td> <td style="width: 10%;"></td> <td style="width: 10%;"></td> <td style="width: 10%;"></td> <td style="width: 10%;"></td> <td style="width: 10%;"></td> </tr> <tr> <td></td> <td></td> <td colspan="8" style="text-align: center;"> <table border="1" style="width: 100%; border-collapse: collapse; text-align: center;"> <tr> <td style="width: 10%;"></td> <td style="width: 10%;"></td> <td style="width: 10%;"></td> <td style="width: 10%;"></td> <td style="width: 10%;"></td> <td style="width: 10%;"></td> <td style="width: 10%;"></td> <td style="width: 10%;"></td> <td style="width: 10%;"></td> <td style="width: 10%;"></td> </tr> <tr> <td></td> <td></td> <td colspan="8" style="text-align: center;"> <table border="1" style="width: 100%; border-collapse: collapse; text-align: center;"> <tr> <td style="width: 10%;"></td> <td style="width: 10%;"></td> <td style="width: 10%;"></td> <td style="width: 10%;"></td> <td style="width: 10%;"></td> <td style="width: 10%;"></td> <td style="width: 10%;"></td> <td style="width: 10%;"></td> <td style="width: 10%;"></td> <td style="width: 10%;"></td> </tr> <tr> <td></td> <td></td> <td colspan="8" style="text-align: center;"> <table border="1" style="width: 100%; border-collapse: collapse; text-align: center;"> <tr> <td style="width: 10%;"></td> <td style="width: 10%;"></td> <td style="width: 10%;"></td> <td style="width: 10%;"></td> <td style="width: 10%;"></td> <td style="width: 10%;"></td> <td style="width: 10%;"></td> <td style="width: 10%;"></td> <td style="width: 10%;"></td> <td style="width: 10%;"></td> </tr> <tr> <td></td> <td></td> <td colspan="8" style="text-align: center;"> <table border="1" style="width: 100%; border-collapse: collapse; text-align: center;"> <tr> <td style="width: 10%;"></td> <td style="width: 10%;"></td> <td style="width: 10%;"></td> <td style="width: 10%;"></td> <td style="width: 10%;"></td> <td style="width: 10%;"></td> <td style="width: 10%;"></td> <td style="width: 10%;"></td> <td style="width: 10%;"></td> <td style="width: 10%;"></td> </tr> <tr> <td></td> <td></td> <td colspan="8" style="text-align: center;"> <table border="1" style="width: 100%; border-collapse: collapse; text-align: center;"> <tr> <td style="width: 10%;"></td> <td style="width: 10%;"></td> <td style="width: 10%;"></td> <td style="width: 10%;"></td> <td style="width: 10%;"></td> <td style="width: 10%;"></td> <td style="width: 10%;"></td> <td style="width: 10%;"></td> <td style="width: 10%;"></td> <td style="width: 10%;"></td> </tr> <tr> <td></td> <td></td> <td colspan="8" style="text-align: center;"> <table border="1" style="width: 100%; border-collapse: collapse; text-align: center;"> <tr> <td style="width: 10%;"></td> <td style="width: 10%;"></td> <td style="width: 10%;"></td> <td style="width: 10%;"></td> <td style="width: 10%;"></td> <td style="width: 10%;"></td> <td style="width: 10%;"></td> <td style="width: 10%;"></td> <td style="width: 10%;"></td> <td style="width: 10%;"></td> </tr> <tr> <td></td> <td></td> <td colspan="8" style="text-align: center;"> <table border="1" style="width: 100%; border-collapse: collapse; text-align: center;"> <tr> <td style="width: 10%;"></td> <td style="width: 10%;"></td> <td style="width: 10%;"></td> <td style="width: 10%;"></td> <td style="width: 10%;"></td> <td style="width: 10%;"></td> <td style="width: 10%;"></td> <td style="width: 10%;"></td> <td style="width: 10%;"></td> <td style="width: 10%;"></td> </tr> <tr> <td></td> <td></td> <td colspan="8" style="text-align: center;"> <table border="1" style="width: 100%; border-collapse: collapse; text-align: center;"> <tr> <td style="width: 10%;"></td> <td style="width: 10%;"></td> <td style="width: 10%;"></td> <td style="width: 10%;"></td> <td style="width: 10%;"></td> <td style="width: 10%;"></td> <td style="width: 10%;"></td> <td style="width: 10%;"></td> <td style="width: 10%;"></td> <td style="width: 10%;"></td> </tr> <tr> <td></td> <td></td> <td colspan="8" style="text-align: center;"> <table border="1" style="width: 100%; border-collapse: collapse; text-align: center;"> <tr> <td style="width: 10%;"></td> <td style="width: 10%;"></td> <td style="width: 10%;"></td> <td style="width: 10%;"></td> <td style="width: 10%;"></td> <td style="width: 10%;"></td> <td style="width: 10%;"></td> <td style="width: 10%;"></td> <td style="width: 10%;"></td> <td style="width: 10%;"></td> </tr> <tr> <td></td> <td></td> <td colspan="8" style="text-align: center;"> <table border="1" style="width: 100%; border-collapse: collapse; text-align: center;"> <tr> <td style="width: 10%;"></td> <td style="width: 10%;"></td> <td style="width: 10%;"></td> <td style="width: 10%;"></td> <td style="width: 10%;"></td> <td style="width: 10%;"></td> <td style="width: 10%;"></td> <td style="width: 10%;"></td> <td style="width: 10%;"></td> <td style="width: 10%;"></td> </tr> <tr> <td></td> <td></td> <td colspan="8" style="text-align: center;"> <table border="1" style="width: 100%; border-collapse: collapse; text-align: center;"> <tr> <td style="width: 10%;"></td> <td style="width: 10%;"></td> <td style="width: 10%;"></td> <td style="width: 10%;"></td> <td style="width: 10%;"></td> <td style="width: 10%;"></td> <td style="width: 10%;"></td> <td style="width:
10%;"></td> <td style="width: 10%;"></td> <td style="width: 10%;"></td> </tr> <tr> <td></td> <td></td> <td colspan="8" style="text-align: center;"> <table border="1" style="width: 100%; border-collapse: collapse; text-align: center;"> <tr> <td style="width: 10%;"></td> <td style="width: 10%;"></td> <td style="width: 10%;"></td> <td style="width: 10%;"></td> <td style="width: 10%;"></td> <td style="width: 10%;"></td> <td style="width: 10%;"></td> <td style="width: 10%;"></td> <td style="width: 10%;"></td> <td style="width: 10%;"></td> </tr> <tr> <td></td> <td></td> <td colspan="8" style="text-align: center;"> <table border="1" style="width: 100%; border-collapse: collapse; text-align: center;"> <tr> <td style="width: 10%;"></td> <td style="width: 10%;"></td> <td style="width: 10%;"></td> <td style="width: 10%;"></td> <td style="width: 10%;"></td> <td style="width: 10%;"></td> <td style="width: 10%;"></td> <td style="width: 10%;"></td> <td style="width: 10%;"></td> <td style="width: 10%;"></td> </tr> <tr> <td></td> <td></td> <td colspan="8" style="text-align: center;"> <table border="1" style="width: 100%; border-collapse: collapse; text-align: center;"> <tr> <td style="width: 10%;"></td> <td style="width: 10%;"></td> <td style="width: 10%;"></td> <td style="width: 10%;"></td> <td style="width: 10%;"></td> <td style="width: 10%;"></td> <td style="width: 10%;"></td> <td style="width: 10%;"></td> <td style="width: 10%;"></td> <td style="width: 10%;"></td> </tr> <tr> <td></td> <td></td> <td colspan="8" style="text-align: center;"> <table border="1" style="width: 100%; border-collapse: collapse; text-align: center;"> <tr> <td style="width: 10%;"></td> <td style="width: 10%;"></td> <td style="width: 10%;"></td> <td style="width: 10%;"></td> <td style="width: 10%;"></td> <td style="width: 10%;"></td> <td style="width: 10%;"></td> <td style="width: 10%;"></td> <td style="width: 10%;"></td> <td style="width: 10%;"></td> </tr> <tr> <td></td> <td></td> <td colspan="8" style="text-align: center;"> <table border="1" style="width: 100%; border-collapse: collapse; text-align: center;"> <tr> <td style="width: 10%;"></td> <td style="width: 10%;"></td> <td style="width: 10%;"></td> <td style="width: 10%;"></td> <td style="width: 10%;"></td> <td style="width: 10%;"></td> <td style="width: 10%;"></td> <td style="width: 10%;"></td> <td style="width: 10%;"></td> <td style="width: 10%;"></td> </tr> <tr> <td></td> <td></td> <td colspan="8" style="text-align: center;"> <table border="1" style="width: 100%; border-collapse: collapse; text-align: center;"> <tr> <td style="width: 10%;"></td> <td style="width: 10%;"></td> <td style="width: 10%;"></td> <td style="width: 10%;"></td> <td style="width: 10%;"></td> <td style="width: 10%;"></td> <td style="width: 10%;"></td> <td style="width: 10%;"></td> <td style="width: 10%;"></td> <td style="width: 10%;"></td> </tr> <tr> <td></td> <td></td> <td colspan="8" style="text-align: center;"> <table border="1" style="width: 100%; border-collapse: collapse; text-align: center;"> <tr> <td style="width: 10%;"></td> <td style="width: 10%;"></td> <td style="width: 10%;"></td> <td style="width: 10%;"></td> <td style="width: 10%;"></td> <td style="width: 10%;"></td> <td style="width: 10%;"></td> <td style="width: 10%;"></td> <td style="width: 10%;"></td> <td style="width: 10%;"></td> </tr> <tr> <td></td> <td></td> <td colspan="8" style="text-align: center;"> <table border="1" style="width: 100%; border-collapse: collapse; text-align: center;"> <tr> <td style="width: 10%;"></td> <td style="width: 10%;"></td> <td style="width: 10%;"></td> <td style="width: 10%;"></td> <td style="width: 10%;"></td> <td style="width: 10%;"></td> <td style="width: 10%;"></td> <td style="width: 10%;"></td> <td style="width: 10%;"></td> <td style="width: 10%;"></td> </tr> <tr> <td></td> <td></td> <td colspan="8" style="text-align: center;"> <table border="1" style="width: 100%; border-collapse: collapse; text-align: center;"> <tr> <td style="width: 10%;"></td> <td style="width: 10%;"></td> <td style="width: 10%;"></td> <td style="width: 10%;"></td> <td style="width: 10%;"></td> <td style="width: 10%;"></td> <td style="width: 10%;"></td> <td style="width: 10%;"></td> <td style="width: 10%;"></td> <td style="width: 10%;"></td> </tr> <tr> <td></td> <td></td> <td colspan="8" style="text-align: center;"> <table border="1" style="width: 100%; border-collapse: collapse; text-align: center;"> <tr> <td style="width: 10%;"></td> <td style="width: 10%;"></td> <td style="width: 10%;"></td> <td style="width: 10%;"></td> <td style="width: 10%;"></td> <td style="width: 10%;"></td> <td style="width: 10%;"></td> <td style="width: 10%;"></td> <td style="width: 10%;"></td> <td style="width: 10%;"></td> </tr> <tr> <td></td> <td></td> <td colspan="8" style="text-align: center;"> <table border="1" style="width: 100%; border-collapse: collapse; text-align: center;"> <tr> <td style="width: 10%;"></td> <td style="width: 10%;"></td> <td style="width: 10%;"></td> <td style="width: 10%;"></td> <td style="width: 10%;"></td> <td style="width: 10%;"></td> <td style="width: 10%;"></td> <td style="width: 10%;"></td> <td style="width: 10%;"></td> <td style="width: 10%;"></td> </tr> <tr> <td></td> <td></td> <td colspan="8" style="text-align: center;"> <table border="1" style="width: 100%; border-collapse: collapse; text-align: center;"> <tr> <td style="width: 10%;"></td> <td style="width: 10%;"></td> <td style="width: 10%;"></td> <td style="width: 10%;"></td> <td style="width: 10%;"></td> <td style="width: 10%;"></td> <td style="width: 10%;"></td> <td style="width: 10%;"></td> <td style="width: 10%;"></td> <td style="width: 10%;"></td> </tr> <tr> <td></td> <td></td> <td colspan="8" style="text-align: center;"> <table border="1" style="width: 100%; border-collapse: collapse; text-align: center;"> <tr> <td style="width: 10%;"></td> <td style="width: 10%;"></td> <td style="width: 10%;"></td> <td style="width: 10%;"></td> <td style="width: 10%;"></td> <td style="width: 10%;"></td> <td style="width: 10%;"></td> <td style="width: 10%;"></td> <td style="width: 10%;"></td> <td style="width: 10%;"></td> </tr> <tr> <td></td> <td></td> <td colspan="8" style="text-align: center;"> <table border="1" style="width: 100%; border-collapse: collapse; text-align: center;"> <tr> <td style="width: 10%;"></td> <td style="width: 10%;"></td> <td style="width: 10%;"></td> <td style="width: 10%;"></td> <td style="width: 10%;"></td> <td style="width: 10%;"></td> <td style="width: 10%;"></td> <td style="width: 10%;"></td> <td style="width: 10%;"></td> <td style="width: 10%;"></td> </tr> <tr> <td></td> <td></td> <td colspan="8" style="text-align: center;"> <table border="1" style="width: 100%; border-collapse: collapse; text-align: center;"> <tr> <td style="width: 10%;"></td> <td style="width: 10%;"></td> <td style="width: 10%;"></td> <td style="width: 10%;"></td> <td style="width: 10%;"></td> <td style="width: 10%;"></td> <td style="width: 10%;"></td> <td style="width: 10%;"></td> <td style="width: 10%;"></td> <td style="width: 10%;"></td> </tr> <tr> <td></td> <td></td> <td colspan="8" style="text-align: center;"> <table border="1" style="width: 100%; border-collapse: collapse; text-align: center;"> <tr> <td style="width: 10%;"></td> <td style="width: 10%;"></td> <td style="width: 10%;"></td> <td style="width: 10%;"></td> <td style="width: 10%;"></td> <td style="width: 10%;"></td> <td style="width: 10%;"></td> <td style="width: 10%;"></td> <td style="width: 10%;"></td> <td style="width: 10%;"></td> </tr> <tr> <td></td> <td></td> <td colspan="8" style="text-align: center;"> <table border="1" style="width: 100%; border-collapse: collapse; text-align: center;"> <tr> <td style="width: 10%;"></td> <td style="width: 10%;"></td> <td style="width: 10%;"></td> <td style="width: 10%;"></td> <td style="width: 10%;"></td> <td style="width: 10%;"></td> <td style="width: 10%;"></td> <td style="width: 10%;"></td> <td style="width: 10%;"></td> <td style="width: 10%;"></td> </tr> <tr> <td></td> <td></td> <td colspan="8" style="text-align: center;"> <table border="1" style="width: 100%; border-collapse: collapse; text-align: center;"> <tr> <td style="width: 10%;"></td> <td style="width: 10%;"></td> <td style="width: 10%;"></td> <td style="width: 10%;"></td> <td style="width: 10%;"></td> <td style="width: 10%;"></td> <td style="width: 10%;"></td> <td style="width: 10%;"></td> <td style="width: 10%;"></td> <td style="width: 10%;"></td> </tr> <tr> <td></td> <td></td> <td colspan="8" style="text-align: center;"> <table border="1" style="width: 100%; border-collapse: collapse; text-align: center;"> <tr> <td style="width: 10%;"></td> <td style="width: 10%;"></td> <td style="width: 10%;"></td> <td style="width: 10%;"></td> <td style="width: 10%;"></td> <td style="width: 10%;"></td> <td style="width: 10%;"></td> <td style="width: 10%;"></td> <td style="width: 10%;"></td> <td style="width: 10%;"></td> </tr> <tr> <td></td> <td></td> <td colspan="8" style="text-align: center;"> <table border="1" style="width: 100%; border-collapse: collapse; text-align: center;"> <tr> <td style="width: 10%;"></td> <td style="width: 10%;"></td> <td style="width: 10%;"></td> <td style="width: 10%;"></td> <td style="width: 10%;"></td> <td style="width: 10%;"></td> <td style="width: 10%;"></td> <td style="width: 10%;"></td> <td style="width: 10%;"></td> <td style="width: 10%;"></td> </tr> <tr> <td></td> <td></td> <td colspan="8" style="text-align: center;"> <table border="1" style="width: 100%; border-collapse: collapse; text-align: center;"> <tr>
</tr></table></td></tr></table></td></tr></table></td></tr></table></td></tr></table></td></tr></table></td></tr></table></td></tr></table></td></tr></table></td></tr></table></td></tr></table></td></tr></table></td></tr></table></td></tr></table></td></tr></table></td></tr></table></td></tr></table></td></tr></table></td></tr></table></td></tr></table></td></tr></table></td></tr></table></td></tr></table></td></tr></table></td></tr></table></td></tr></table></td></tr></table></td></tr></table></td></tr></table></td></tr></table></td></tr></table></td></tr></table></td></tr></table></td></tr></table></td></tr></table></td></tr></table></td></tr></table></td></tr></table></td></tr></table></td></tr></table></td></tr></table></td></tr></table></td></tr></table></td></tr></table></td></tr></table></td></tr></table></td></tr></table></td></tr></table></td></tr></table></td></tr></table></td></tr></table></td></tr></table></td></tr></table></td></tr></table></td></tr></table></td></tr></table></td></tr></table></td></tr></table></td></tr></table></td></tr></table></td></tr></table></td></tr></table></td></tr></table></td></tr></table> | | | | | | | | | | | | | | | | | | | | <table border="1" style="width: 100%; border-collapse: collapse; text-align: center;"> <tr> <td style="width: 10%;"></td> <td style="width: 10%;"></td> <td style="width: 10%;"></td> <td style="width: 10%;"></td> <td style="width: 10%;"></td> <td style="width: 10%;"></td> <td style="width: 10%;"></td> <td style="width: 10%;"></td> <td style="width: 10%;"></td> <td style="width: 10%;"></td> </tr> <tr> <td></td> <td></td> <td colspan="8" style="text-align: center;"> <table border="1" style="width: 100%; border-collapse: collapse; text-align: center;"> <tr> <td style="width: 10%;"></td> <td style="width: 10%;"></td> <td style="width: 10%;"></td> <td style="width: 10%;"></td> <td style="width: 10%;"></td> <td style="width: 10%;"></td> <td style="width: 10%;"></td> <td style="width: 10%;"></td> <td style="width: 10%;"></td> <td style="width: 10%;"></td> </tr> <tr> <td></td> <td></td> <td colspan="8" style="text-align: center;"> <table border="1" style="width: 100%; border-collapse: collapse; text-align: center;"> <tr> <td style="width: 10%;"></td> <td style="width: 10%;"></td> <td style="width: 10%;"></td> <td style="width: 10%;"></td> <td style="width: 10%;"></td> <td style="width: 10%;"></td> <td style="width: 10%;"></td> <td style="width: 10%;"></td> <td style="width: 10%;"></td> <td style="width: 10%;"></td> </tr> <tr> <td></td> <td></td> <td colspan="8" style="text-align: center;"> <table border="1" style="width: 100%; border-collapse: collapse; text-align: center;"> <tr> <td style="width: 10%;"></td> <td style="width: 10%;"></td> <td style="width: 10%;"></td> <td style="width: 10%;"></td> <td style="width: 10%;"></td> <td style="width: 10%;"></td> <td style="width: 10%;"></td> <td style="width: 10%;"></td> <td style="width: 10%;"></td> <td style="width: 10%;"></td> </tr> <tr> <td></td> <td></td> <td colspan="8" style="text-align: center;"> <table border="1" style="width: 100%; border-collapse: collapse; text-align: center;"> <tr> <td style="width: 10%;"></td> <td style="width: 10%;"></td> <td style="width: 10%;"></td> <td style="width: 10%;"></td> <td style="width: 10%;"></td> <td style="width: 10%;"></td> <td style="width: 10%;"></td> <td style="width: 10%;"></td> <td style="width: 10%;"></td> <td style="width: 10%;"></td> </tr> <tr> <td></td> <td></td> <td colspan="8" style="text-align: center;"> <table border="1" style="width: 100%; border-collapse: collapse; text-align: center;"> <tr> <td style="width: 10%;"></td> <td style="width: 10%;"></td> <td style="width: 10%;"></td> <td style="width: 10%;"></td> <td style="width: 10%;"></td> <td style="width: 10%;"></td> <td style="width: 10%;"></td> <td style="width: 10%;"></td> <td style="width: 10%;"></td> <td style="width: 10%;"></td> </tr> <tr> <td></td> <td></td> <td colspan="8" style="text-align: center;"> <table border="1" style="width: 100%; border-collapse: collapse; text-align: center;"> <tr> <td style="width: 10%;"></td> <td style="width: 10%;"></td> <td style="width: 10%;"></td> <td style="width: 10%;"></td> <td style="width: 10%;"></td> <td style="width: 10%;"></td> <td style="width: 10%;"></td> <td style="width: 10%;"></td> <td style="width: 10%;"></td> <td style="width: 10%;"></td> </tr> <tr> <td></td> <td></td> <td colspan="8" style="text-align: center;"> <table border="1" style="width: 100%; border-collapse: collapse; text-align: center;"> <tr> <td style="width: 10%;"></td> <td style="width: 10%;"></td> <td style="width: 10%;"></td> <td style="width: 10%;"></td> <td style="width: 10%;"></td> <td style="width: 10%;"></td> <td style="width: 10%;"></td> <td style="width: 10%;"></td> <td style="width: 10%;"></td> <td style="width: 10%;"></td> </tr> <tr> <td></td> <td></td> <td colspan="8" style="text-align: center;"> <table border="1" style="width: 100%; border-collapse: collapse; text-align: center;"> <tr> <td style="width: 10%;"></td> <td style="width: 10%;"></td> <td style="width: 10%;"></td> <td style="width: 10%;"></td> <td style="width: 10%;"></td> <td style="width: 10%;"></td> <td style="width: 10%;"></td> <td style="width: 10%;"></td> <td style="width: 10%;"></td> <td style="width: 10%;"></td> </tr> <tr> <td></td> <td></td> <td colspan="8" style="text-align: center;"> <table border="1" style="width: 100%; border-collapse: collapse; text-align: center;"> <tr> <td style="width: 10%;"></td> <td style="width: 10%;"></td> <td style="width: 10%;"></td> <td style="width: 10%;"></td> <td style="width: 10%;"></td> <td style="width: 10%;"></td> <td style="width: 10%;"></td> <td style="width: 10%;"></td> <td style="width: 10%;"></td> <td style="width: 10%;"></td> </tr> <tr> <td></td> <td></td> <td colspan="8" style="text-align: center;"> <table border="1" style="width: 100%; border-collapse: collapse; text-align: center;"> <tr> <td style="width: 10%;"></td> <td style="width: 10%;"></td> <td style="width: 10%;"></td> <td style="width: 10%;"></td> <td style="width: 10%;"></td> <td style="width: 10%;"></td> <td style="width: 10%;"></td> <td style="width: 10%;"></td> <td style="width: 10%;"></td> <td style="width: 10%;"></td> </tr> <tr> <td></td> <td></td> <td colspan="8" style="text-align: center;"> <table border="1" style="width: 100%; border-collapse: collapse; text-align: center;"> <tr> <td style="width: 10%;"></td> <td style="width: 10%;"></td> <td style="width: 10%;"></td> <td style="width: 10%;"></td> <td style="width: 10%;"></td> <td style="width: 10%;"></td> <td style="width: 10%;"></td> <td style="width: 10%;"></td> <td style="width: 10%;"></td> <td style="width: 10%;"></td> </tr> <tr> <td></td> <td></td> <td colspan="8" style="text-align: center;"> <table border="1" style="width: 100%; border-collapse: collapse; text-align: center;"> <tr> <td style="width: 10%;"></td> <td style="width: 10%;"></td> <td style="width: 10%;"></td> <td style="width: 10%;"></td> <td style="width: 10%;"></td> <td style="width: 10%;"></td> <td style="width: 10%;"></td> <td style="width: 10%;"></td> <td style="width: 10%;"></td> <td style="width: 10%;"></td> </tr> <tr> <td></td> <td></td> <td colspan="8" style="text-align: center;"> <table border="1" style="width: 100%; border-collapse: collapse; text-align: center;"> <tr> <td style="width: 10%;"></td> <td style="width: 10%;"></td> <td style="width: 10%;"></td> <td style="width: 10%;"></td> <td style="width: 10%;"></td> <td style="width: 10%;"></td> <td style="width: 10%;"></td> <td style="width: 10%;"></td> <td style="width: 10%;"></td> <td style="width: 10%;"></td> </tr> <tr> <td></td> <td></td> <td colspan="8" style="text-align: center;"> <table border="1" style="width: 100%; border-collapse: collapse; text-align: center;"> <tr> <td style="width: 10%;"></td> <td style="width: 10%;"></td> <td style="width: 10%;"></td> <td style="width: 10%;"></td> <td style="width: 10%;"></td> <td style="width: 10%;"></td> <td style="width: 10%;"></td> <td style="width: 10%;"></td> <td style="width: 10%;"></td> <td style="width: 10%;"></td> </tr> <tr> <td></td> <td></td> <td colspan="8" style="text-align: center;"> <table border="1" style="width: 100%; border-collapse: collapse; text-align: center;"> <tr> <td style="width: 10%;"></td> <td style="width: 10%;"></td> <td style="width: 10%;"></td> <td style="width: 10%;"></td> <td style="width: 10%;"></td> <td style="width: 10%;"></td> <td style="width: 10%;"></td> <td style="width: 10%;"></td> <td style="width: 10%;"></td> <td style="width: 10%;"></td> </tr> <tr> <td></td> <td></td> <td colspan="8" style="text-align: center;"> <table border="1" style="width: 100%; border-collapse: collapse; text-align: center;"> <tr> <td style="width: 10%;"></td> <td style="width: 10%;"></td> <td style="width: 10%;"></td> <td style="width: 10%;"></td> <td style="width: 10%;"></td> <td style="width: 10%;"></td> <td style="width: 10%;"></td> <td style="width: 10%;"></td> <td style="width: 10%;"></td> <td style="width: 10%;"></td> </tr> <tr> <td></td> <td></td> <td colspan="8" style="text-align: center;"> <table border="1" style="width: 100%; border-collapse: collapse; text-align: center;"> <tr> <td style="width: 10%;"></td> <td style="width: 10%;"></td> <td style="width: 10%;"></td> <td style="width: 10%;"></td> <td style="width: 10%;"></td> <td style="width: 10%;"></td> <td style="width: 10%;"></td> <td style="width: 10%;"></td> <td
style="width: 10%;"></td> <td style="width: 10%;"></td> </tr> <tr> <td></td> <td></td> <td colspan="8" style="text-align: center;"> <table border="1" style="width: 100%; border-collapse: collapse; text-align: center;"> <tr> <td style="width: 10%;"></td> <td style="width: 10%;"></td> <td style="width: 10%;"></td> <td style="width: 10%;"></td> <td style="width: 10%;"></td> <td style="width: 10%;"></td> <td style="width: 10%;"></td> <td style="width: 10%;"></td> <td style="width: 10%;"></td> <td style="width: 10%;"></td> </tr> <tr> <td></td> <td></td> <td colspan="8" style="text-align: center;"> <table border="1" style="width: 100%; border-collapse: collapse; text-align: center;"> <tr> <td style="width: 10%;"></td> <td style="width: 10%;"></td> <td style="width: 10%;"></td> <td style="width: 10%;"></td> <td style="width: 10%;"></td> <td style="width: 10%;"></td> <td style="width: 10%;"></td> <td style="width: 10%;"></td> <td style="width: 10%;"></td> <td style="width: 10%;"></td> </tr> <tr> <td></td> <td></td> <td colspan="8" style="text-align: center;"> <table border="1" style="width: 100%; border-collapse: collapse; text-align: center;"> <tr> <td style="width: 10%;"></td> <td style="width: 10%;"></td> <td style="width: 10%;"></td> <td style="width: 10%;"></td> <td style="width: 10%;"></td> <td style="width: 10%;"></td> <td style="width: 10%;"></td> <td style="width: 10%;"></td> <td style="width: 10%;"></td> <td style="width: 10%;"></td> </tr> <tr> <td></td> <td></td> <td colspan="8" style="text-align: center;"> <table border="1" style="width: 100%; border-collapse: collapse; text-align: center;"> <tr> <td style="width: 10%;"></td> <td style="width: 10%;"></td> <td style="width: 10%;"></td> <td style="width: 10%;"></td> <td style="width: 10%;"></td> <td style="width: 10%;"></td> <td style="width: 10%;"></td> <td style="width: 10%;"></td> <td style="width: 10%;"></td> <td style="width: 10%;"></td> </tr> <tr> <td></td> <td></td> <td colspan="8" style="text-align: center;"> <table border="1" style="width: 100%; border-collapse: collapse; text-align: center;"> <tr> <td style="width: 10%;"></td> <td style="width: 10%;"></td> <td style="width: 10%;"></td> <td style="width: 10%;"></td> <td style="width: 10%;"></td> <td style="width: 10%;"></td> <td style="width: 10%;"></td> <td style="width: 10%;"></td> <td style="width: 10%;"></td> <td style="width: 10%;"></td> </tr> <tr> <td></td> <td></td> <td colspan="8" style="text-align: center;"> <table border="1" style="width: 100%; border-collapse: collapse; text-align: center;"> <tr> <td style="width: 10%;"></td> <td style="width: 10%;"></td> <td style="width: 10%;"></td> <td style="width: 10%;"></td> <td style="width: 10%;"></td> <td style="width: 10%;"></td> <td style="width: 10%;"></td> <td style="width: 10%;"></td> <td style="width: 10%;"></td> <td style="width: 10%;"></td> </tr> <tr> <td></td> <td></td> <td colspan="8" style="text-align: center;"> <table border="1" style="width: 100%; border-collapse: collapse; text-align: center;"> <tr> <td style="width: 10%;"></td> <td style="width: 10%;"></td> <td style="width: 10%;"></td> <td style="width: 10%;"></td> <td style="width: 10%;"></td> <td style="width: 10%;"></td> <td style="width: 10%;"></td> <td style="width: 10%;"></td> <td style="width: 10%;"></td> <td style="width: 10%;"></td> </tr> <tr> <td></td> <td></td> <td colspan="8" style="text-align: center;"> <table border="1" style="width: 100%; border-collapse: collapse; text-align: center;"> <tr> <td style="width: 10%;"></td> <td style="width: 10%;"></td> <td style="width: 10%;"></td> <td style="width: 10%;"></td> <td style="width: 10%;"></td> <td style="width: 10%;"></td> <td style="width: 10%;"></td> <td style="width: 10%;"></td> <td style="width: 10%;"></td> <td style="width: 10%;"></td> </tr> <tr> <td></td> <td></td> <td colspan="8" style="text-align: center;"> <table border="1" style="width: 100%; border-collapse: collapse; text-align: center;"> <tr> <td style="width: 10%;"></td> <td style="width: 10%;"></td> <td style="width: 10%;"></td> <td style="width: 10%;"></td> <td style="width: 10%;"></td> <td style="width: 10%;"></td> <td style="width: 10%;"></td> <td style="width: 10%;"></td> <td style="width: 10%;"></td> <td style="width: 10%;"></td> </tr> <tr> <td></td> <td></td> <td colspan="8" style="text-align: center;"> <table border="1" style="width: 100%; border-collapse: collapse; text-align: center;"> <tr> <td style="width: 10%;"></td> <td style="width: 10%;"></td> <td style="width: 10%;"></td> <td style="width: 10%;"></td> <td style="width: 10%;"></td> <td style="width: 10%;"></td> <td style="width: 10%;"></td> <td style="width: 10%;"></td> <td style="width: 10%;"></td> <td style="width: 10%;"></td> </tr> <tr> <td></td> <td></td> <td colspan="8" style="text-align: center;"> <table border="1" style="width: 100%; border-collapse: collapse; text-align: center;"> <tr> <td style="width: 10%;"></td> <td style="width: 10%;"></td> <td style="width: 10%;"></td> <td style="width: 10%;"></td> <td style="width: 10%;"></td> <td style="width: 10%;"></td> <td style="width: 10%;"></td> <td style="width: 10%;"></td> <td style="width: 10%;"></td> <td style="width: 10%;"></td> </tr> <tr> <td></td> <td></td> <td colspan="8" style="text-align: center;"> <table border="1" style="width: 100%; border-collapse: collapse; text-align: center;"> <tr> <td style="width: 10%;"></td> <td style="width: 10%;"></td> <td style="width: 10%;"></td> <td style="width: 10%;"></td> <td style="width: 10%;"></td> <td style="width: 10%;"></td> <td style="width: 10%;"></td> <td style="width: 10%;"></td> <td style="width: 10%;"></td> <td style="width: 10%;"></td> </tr> <tr> <td></td> <td></td> <td colspan="8" style="text-align: center;"> <table border="1" style="width: 100%; border-collapse: collapse; text-align: center;"> <tr> <td style="width: 10%;"></td> <td style="width: 10%;"></td> <td style="width: 10%;"></td> <td style="width: 10%;"></td> <td style="width: 10%;"></td> <td style="width: 10%;"></td> <td style="width: 10%;"></td> <td style="width: 10%;"></td> <td style="width: 10%;"></td> <td style="width: 10%;"></td> </tr> <tr> <td></td> <td></td> <td colspan="8" style="text-align: center;"> <table border="1" style="width: 100%; border-collapse: collapse; text-align: center;"> <tr> <td style="width: 10%;"></td> <td style="width: 10%;"></td> <td style="width: 10%;"></td> <td style="width: 10%;"></td> <td style="width: 10%;"></td> <td style="width: 10%;"></td> <td style="width: 10%;"></td> <td style="width: 10%;"></td> <td style="width: 10%;"></td> <td style="width: 10%;"></td> </tr> <tr> <td></td> <td></td> <td colspan="8" style="text-align: center;"> <table border="1" style="width: 100%; border-collapse: collapse; text-align: center;"> <tr> <td style="width: 10%;"></td> <td style="width: 10%;"></td> <td style="width: 10%;"></td> <td style="width: 10%;"></td> <td style="width: 10%;"></td> <td style="width: 10%;"></td> <td style="width: 10%;"></td> <td style="width: 10%;"></td> <td style="width: 10%;"></td> <td style="width: 10%;"></td> </tr> <tr> <td></td> <td></td> <td colspan="8" style="text-align: center;"> <table border="1" style="width: 100%; border-collapse: collapse; text-align: center;"> <tr> <td style="width: 10%;"></td> <td style="width: 10%;"></td> <td style="width: 10%;"></td> <td style="width: 10%;"></td> <td style="width: 10%;"></td> <td style="width: 10%;"></td> <td style="width: 10%;"></td> <td style="width: 10%;"></td> <td style="width: 10%;"></td> <td style="width: 10%;"></td> </tr> <tr> <td></td> <td></td> <td colspan="8" style="text-align: center;"> <table border="1" style="width: 100%; border-collapse: collapse; text-align: center;"> <tr> <td style="width: 10%;"></td> <td style="width: 10%;"></td> <td style="width: 10%;"></td> <td style="width: 10%;"></td> <td style="width: 10%;"></td> <td style="width: 10%;"></td> <td style="width: 10%;"></td> <td style="width: 10%;"></td> <td style="width: 10%;"></td> <td style="width: 10%;"></td> </tr> <tr> <td></td> <td></td> <td colspan="8" style="text-align: center;"> <table border="1" style="width: 100%; border-collapse: collapse; text-align: center;"> <tr> <td style="width: 10%;"></td> <td style="width: 10%;"></td> <td style="width: 10%;"></td> <td style="width: 10%;"></td> <td style="width: 10%;"></td> <td style="width: 10%;"></td> <td style="width: 10%;"></td> <td style="width: 10%;"></td> <td style="width: 10%;"></td> <td style="width: 10%;"></td> </tr> <tr> <td></td> <td></td> <td colspan="8" style="text-align: center;"> <table border="1" style="width: 100%; border-collapse: collapse; text-align: center;"> <tr> <td style="width: 10%;"></td> <td style="width: 10%;"></td> <td style="width: 10%;"></td> <td style="width: 10%;"></td> <td style="width: 10%;"></td> <td style="width: 10%;"></td> <td style="width: 10%;"></td> <td style="width: 10%;"></td> <td style="width: 10%;"></td> <td style="width: 10%;"></td> </tr> <tr> <td></td> <td></td> <td colspan="8" style="text-align: center;"> <table border="1" style="width: 100%; border-collapse: collapse; text-align: center;"> <tr> <td style="width: 10%;"></td> <td style="width: 10%;"></td> <td style="width: 10%;"></td> <td style="width: 10%;"></td> <td style="width: 10%;"></td> <td style="width: 10%;"></td> <td style="width: 10%;"></td> <td style="width: 10%;"></td> <td style="width: 10%;"></td> <td style="width: 10%;"></td> </tr> <tr> <td></td> <td></td> <td colspan="8" style="text-align: center;"> <table border="1" style="width: 100%; border-collapse: collapse; text-align: center;"> <tr> <td style="width: 10%;"></td> <td style="width: 10%;"></td> <td style="width: 10%;"></td> <td style="width: 10%;"></td> <td style="width: 10%;"></td> <td style="width: 10%;"></td> <td style="width: 10%;"></td> <td style="width: 10%;"></td> <td style="width: 10%;"></td> <td style="width: 10%;"></td> </tr> <tr> <td></td> <td></td> <td colspan="8" style="text-align: center;"> <table border="1" style="width: 100%;
border-collapse: collapse; text-align: center;"> <tr> <td style="width: 10%;"></td> <td style="width: 10%;"></td> <td style="width: 10%;"></td> <td style="width: 10%;"></td> <td style="width: 10%;"></td> <td style="width: 10%;"></td> <td style="width: 10%;"></td> <td style="width: 10%;"></td> <td style="width: 10%;"></td> <td style="width: 10%;"></td> </tr> <tr> <td></td> <td></td> <td colspan="8" style="text-align: center;"> <table border="1" style="width: 100%; border-collapse: collapse; text-align: center;"> <tr> <td style="width: 10%;"></td> <td style="width: 10%;"></td> <td style="width: 10%;"></td> <td style="width: 10%;"></td> <td style="width: 10%;"></td> <td style="width: 10%;"></td> <td style="width: 10%;"></td> <td style="width: 10%;"></td> <td style="width: 10%;"></td> <td style="width: 10%;"></td> </tr> <tr> <td></td> <td></td> <td colspan="8" style="text-align: center;"> <table border="1" style="width: 100%; border-collapse: collapse; text-align: center;"> <tr> <td style="width: 10%;"></td> <td style="width: 10%;"></td> <td style="width: 10%;"></td> <td style="width: 10%;"></td> <td style="width: 10%;"></td> <td style="width: 10%;"></td> <td style="width: 10%;"></td> <td style="width: 10%;"></td> <td style="width: 10%;"></td> <td style="width: 10%;"></td> </tr> <tr> <td></td> <td></td> <td colspan="8" style="text-align: center;"> <table border="1" style="width: 100%; border-collapse: collapse; text-align: center;"> <tr> <td style="width: 10%;"></td> <td style="width: 10%;"></td> <td style="width: 10%;"></td> <td style="width: 10%;"></td> <td style="width: 10%;"></td> <td style="width: 10%;"></td> <td style="width: 10%;"></td> <td style="width: 10%;"></td> <td style="width: 10%;"></td> <td style="width: 10%;"></td> </tr> <tr> <td></td> <td></td> <td colspan="8" style="text-align: center;"> <table border="1" style="width: 100%; border-collapse: collapse; text-align: center;"> <tr> <td style="width: 10%;"></td> <td style="width: 10%;"></td> <td style="width: 10%;"></td> <td style="width: 10%;"></td> <td style="width: 10%;"></td> <td style="width: 10%;"></td> <td style="width: 10%;"></td> <td style="width: 10%;"></td> <td style="width: 10%;"></td> <td style="width: 10%;"></td> </tr> <tr> <td></td> <td></td> <td colspan="8" style="text-align: center;"> <table border="1" style="width: 100%; border-collapse: collapse; text-align: center;"> <tr> <td style="width: 10%;"></td> <td style="width: 10%;"></td> <td style="width: 10%;"></td> <td style="width: 10%;"></td> <td style="width: 10%;"></td> <td style="width: 10%;"></td> <td style="width: 10%;"></td> <td style="width: 10%;"></td> <td style="width: 10%;"></td> <td style="width: 10%;"></td> </tr> <tr> <td></td> <td></td> <td colspan="8" style="text-align: center;"> <table border="1" style="width: 100%; border-collapse: collapse; text-align: center;"> <tr> <td style="width: 10%;"></td> <td style="width: 10%;"></td> <td style="width: 10%;"></td> <td style="width: 10%;"></td> <td style="width: 10%;"></td> <td style="width: 10%;"></td> <td style="width: 10%;"></td> <td style="width: 10%;"></td> <td style="width: 10%;"></td> <td style="width: 10%;"></td> </tr> <tr> <td></td> <td></td> <td colspan="8" style="text-align: center;"> <table border="1" style="width: 100%; border-collapse: collapse; text-align: center;"> <tr> <td style="width: 10%;"></td> <td style="width: 10%;"></td> <td style="width: 10%;"></td> <td style="width: 10%;"></td> <td style="width: 10%;"></td> <td style="width: 10%;"></td> <td style="width: 10%;"></td> <td style="width: 10%;"></td> <td style="width: 10%;"></td> <td style="width: 10%;"></td> </tr> <tr> <td></td> <td></td> <td colspan="8" style="text-align: center;"> <table border="1" style="width: 100%; border-collapse: collapse; text-align: center;"> <tr> <td style="width: 10%;"></td> <td style="width: 10%;"></td> <td style="width: 10%;"></td> <td style="width: 10%;"></td> <td style="width: 10%;"></td> <td style="width: 10%;"></td> <td style="width: 10%;"></td> <td style="width: 10%;"></td> <td style="width: 10%;"></td> <td style="width: 10%;"></td> </tr> <tr> <td></td> <td></td> <td colspan="8" style="text-align: center;"> <table border="1" style="width: 100%; border-collapse: collapse; text-align: center;"> <tr> <td style="width: 10%;"></td> <td style="width: 10%;"></td> <td style="width: 10%;"></td> <td style="width: 10%;"></td> <td style="width: 10%;"></td> <td style="width: 10%;"></td> <td style="width: 10%;"></td> <td style="width: 10%;"></td> <td style="width: 10%;"></td> <td style="width: 10%;"></td> </tr> <tr> <td></td> <td></td> <td colspan="8" style="text-align: center;"> <table border="1" style="width: 100%; border-collapse: collapse; text-align: center;"> <tr> <td style="width: 10%;"></td> <td style="width: 10%;"></td> <td style="width: 10%;"></td> <td style="width: 10%;"></td> <td style="width: 10%;"></td> <td style="width: 10%;"></td> <td style="width: 10%;"></td> <td style="width: 10%;"></td> <td style="width: 10%;"></td> <td style="width: 10%;"></td> </tr> <tr> <td></td> <td></td> <td colspan="8" style="text-align: center;"> <table border="1" style="width: 100%; border-collapse: collapse; text-align: center;"> <tr> <td style="width: 10%;"></td> <td style="width: 10%;"></td> <td style="width: 10%;"></td> <td style="width: 10%;"></td> <td style="width: 10%;"></td> <td style="width: 10%;"></td> <td style="width: 10%;"></td> <td style="width: 10%;"></td> <td style="width: 10%;"></td> <td style="width: 10%;"></td> </tr> <tr> <td></td> <td></td> <td colspan="8" style="text-align: center;"> <table border="1" style="width: 100%; border-collapse: collapse; text-align: center;"> <tr> <td style="width: 10%;"></td> <td style="width: 10%;"></td> <td style="width: 10%;"></td> <td style="width: 10%;"></td> <td style="width: 10%;"></td> <td style="width: 10%;"></td> <td style="width: 10%;"></td> <td style="width: 10%;"></td> <td style="width: 10%;"></td> <td style="width: 10%;"></td> </tr> <tr> <td></td> <td></td> <td colspan="8" style="text-align: center;"> <table border="1" style="width: 100%; border-collapse: collapse; text-align: center;"> <tr> <td style="width: 10%;"></td> <td style="width: 10%;"></td> <td style="width: 10%;"></td> <td style="width: 10%;"></td> <td style="width: 10%;"></td> <td style="width: 10%;"></td> <td style="width: 10%;"></td> <td style="width: 10%;"></td> <td style="width: 10%;"></td> <td style="width: 10%;"></td> </tr> <tr> <td></td> <td></td> <td colspan="8" style="text-align: center;"> <table border="1" style="width: 100%; border-collapse: collapse; text-align: center;"> <tr> <td style="width: 10%;"></td> <td style="width: 10%;"></td> <td style="width: 10%;"></td> <td style="width: 10%;"></td> <td style="width: 10%;"></td> <td style="width: 10%;"></td> <td style="width: 10%;"></td> <td style="width: 10%;"></td> <td style="width: 10%;"></td> <td style="width: 10%;"></td> </tr> <tr> <td></td> <td></td> <td colspan="8" style="text-align: center;"> <table border="1" style="width: 100%; border-collapse: collapse; text-align: center;"> <tr> <td style="width: 10%;"></td> <td style="width: 10%;"></td> <td style="width: 10%;"></td> <td style="width: 10%;"></td> <td style="width: 10%;"></td> <td style="width: 10%;"></td> <td style="width: 10%;"></td> <td style="width: 10%;"></td> <td style="width: 10%;"></td> <td style="width: 10%;"></td> </tr> <tr> <td></td> <td></td> <td colspan="8" style="text-align: center;"> <table border="1" style="width: 100%; border-collapse: collapse; text-align: center;"> <tr> <td style="width: 10%;"></td> <td style="width: 10%;"></td> <td style="width: 10%;"></td> <td style="width: 10%;"></td> <td style="width: 10%;"></td> <td style="width: 10%;"></td> <td style="width: 10%;"></td> <td style="width: 10%;"></td> <td style="width: 10%;"></td> <td style="width: 10%;"></td> </tr> <tr> <td></td> <td></td> <td colspan="8" style="text-align: center;"> <table border="1" style="width: 100%; border-collapse: collapse; text-align: center;"> <tr> <td style="width: 10%;"></td> <td style="width: 10%;"></td> <td style="width: 10%;"></td> <td style="width: 10%;"></td> <td style="width: 10%;"></td> <td style="width: 10%;"></td> <td style="width: 10%;"></td> <td style="width: 10%;"></td> <td style="width: 10%;"></td> <td style="width: 10%;"></td> </tr> <tr> <td></td> <td></td> <td colspan="8" style="text-align: center;"> <table border="1" style="width: 100%; border-collapse: collapse; text-align: center;"> <tr> <td style="width: 10%;"></td> <td style="width: 10%;"></td> <td style="width: 10%;"></td> <td style="width: 10%;"></td> <td style="width: 10%;"></td> <td style="width: 10%;"></td> <td style="width: 10%;"></td> <td style="width: 10%;"></td> <td style="width: 10%;"></td> <td style="width: 10%;"></td> </tr> <tr> <td></td> <td></td> <td colspan="8" style="text-align: center;"> <table border="1" style="width: 100%; border-collapse: collapse; text-align: center;"> <tr> <td style="width: 10%;"></td> <td style="width: 10%;"></td> <td style="width: 10%;"></td> <td style="width: 10%;"></td> <td style="width: 10%;"></td> <td style="width: 10%;"></td> <td style="width: 10%;"></td> <td style="width: 10%;"></td> <td style="width: 10%;"></td> <td style="width: 10%;"></td> </tr> <tr> <td></td> <td></td> <td colspan="8" style="text-align: center;"> <table border="1" style="width: 100%; border-collapse: collapse; text-align: center;"> <tr> <td style="width: 10%;"></td> <td style="width: 10%;"></td> <td style="width: 10%;"></td> <td style="width: 10%;"></td> <td style="width: 10%;"></td> <td style="width: 10%;"></td> <td style="width: 10%;"></td> <td style="width: 10%;"></td> <td style="width: 10%;"></td> <td style="width: 10%;"></td> </tr> <tr> <td></td> <td></td> <td colspan="8" style="text-align: center;"> <table border="1" style="width: 100%; border-collapse: collapse; text-align: center;"> <tr> <td style="width: 10%;"></td> <td style="width: 10%;"></td> <td style="width: 10%;"></td> <td style="width:
10%;"></td> <td style="width: 10%;"></td> <td style="width: 10%;"></td> <td style="width: 10%;"></td> <td style="width: 10%;"></td> <td style="width: 10%;"></td> <td style="width: 10%;"></td> </tr> <tr> <td></td> <td></td> <td colspan="8" style="text-align: center;"> <table border="1" style="width: 100%; border-collapse: collapse; text-align: center;"> <tr> <td style="width: 10%;"></td> <td style="width: 10%;"></td> <td style="width: 10%;"></td> <td style="width: 10%;"></td> <td style="width: 10%;"></td> <td style="width: 10%;"></td> <td style="width: 10%;"></td> <td style="width: 10%;"></td> <td style="width: 10%;"></td> <td style="width: 10%;"></td> </tr> <tr> <td></td> <td></td> <td colspan="8" style="text-align: center;"> <table border="1" style="width: 100%; border-collapse: collapse; text-align: center;"> <tr> </tr></table></td></tr></table></td></tr></table></td></tr></table></td></tr></table></td></tr></table></td></tr></table></td></tr></table></td></tr></table></td></tr></table></td></tr></table></td></tr></table></td></tr></table></td></tr></table></td></tr></table></td></tr></table></td></tr></table></td></tr></table></td></tr></table></td></tr></table></td></tr></table></td></tr></table></td></tr></table></td></tr></table></td></tr></table></td></tr></table></td></tr></table></td></tr></table></td></tr></table></td></tr></table></td></tr></table></td></tr></table></td></tr></table></td></tr></table></td></tr></table></td></tr></table></td></tr></table></td></tr></table></td></tr></table></td></tr></table></td></tr></table></td></tr></table></td></tr></table></td></tr></table></td></tr></table></td></tr></table></td></tr></table></td></tr></table></td></tr></table></td></tr></table></td></tr></table></td></tr></table></td></tr></table></td></tr></table></td></tr></table></td></tr></table></td></tr></table></td></tr></table></td></tr></table></td></tr></table></td></tr></table></td></tr></table></td></tr></table> | | | | | | | | | | | | | | | | | | | | <table border="1" style="width: 100%; border-collapse: collapse; text-align: center;"> <tr> <td style="width: 10%;"></td> <td style="width: 10%;"></td> <td style="width: 10%;"></td> <td style="width: 10%;"></td> <td style="width: 10%;"></td> <td style="width: 10%;"></td> <td style="width: 10%;"></td> <td style="width: 10%;"></td> <td style="width: 10%;"></td> <td style="width: 10%;"></td> </tr> <tr> <td></td> <td></td> <td colspan="8" style="text-align: center;"> <table border="1" style="width: 100%; border-collapse: collapse; text-align: center;"> <tr> <td style="width: 10%;"></td> <td style="width: 10%;"></td> <td style="width: 10%;"></td> <td style="width: 10%;"></td> <td style="width: 10%;"></td> <td style="width: 10%;"></td> <td style="width: 10%;"></td> <td style="width: 10%;"></td> <td style="width: 10%;"></td> <td style="width: 10%;"></td> </tr> <tr> <td></td> <td></td> <td colspan="8" style="text-align: center;"> <table border="1" style="width: 100%; border-collapse: collapse; text-align: center;"> <tr> <td style="width: 10%;"></td> <td style="width: 10%;"></td> <td style="width: 10%;"></td> <td style="width: 10%;"></td> <td style="width: 10%;"></td> <td style="width: 10%;"></td> <td style="width: 10%;"></td> <td style="width: 10%;"></td> <td style="width: 10%;"></td> <td style="width: 10%;"></td> </tr> <tr> <td></td> <td></td> <td colspan="8" style="text-align: center;"> <table border="1" style="width: 100%; border-collapse: collapse; text-align: center;"> <tr> <td style="width: 10%;"></td> <td style="width: 10%;"></td> <td style="width: 10%;"></td> <td style="width: 10%;"></td> <td style="width: 10%;"></td> <td style="width: 10%;"></td> <td style="width: 10%;"></td> <td style="width: 10%;"></td> <td style="width: 10%;"></td> <td style="width: 10%;"></td> </tr> <tr> <td></td> <td></td> <td colspan="8" style="text-align: center;"> <table border="1" style="width: 100%; border-collapse: collapse; text-align: center;"> <tr> <td style="width: 10%;"></td> <td style="width: 10%;"></td> <td style="width: 10%;"></td> <td style="width: 10%;"></td> <td style="width: 10%;"></td> <td style="width: 10%;"></td> <td style="width: 10%;"></td> <td style="width: 10%;"></td> <td style="width: 10%;"></td> <td style="width: 10%;"></td> </tr> <tr> <td></td> <td></td> <td colspan="8" style="text-align: center;"> <table border="1" style="width: 100%; border-collapse: collapse; text-align: center;"> <tr> <td style="width: 10%;"></td> <td style="width: 10%;"></td> <td style="width: 10%;"></td> <td style="width: 10%;"></td> <td style="width: 10%;"></td> <td style="width: 10%;"></td> <td style="width: 10%;"></td> <td style="width: 10%;"></td> <td style="width: 10%;"></td> <td style="width: 10%;"></td> </tr> <tr> <td></td> <td></td> <td colspan="8" style="text-align: center;"> <table border="1" style="width: 100%; border-collapse: collapse; text-align: center;"> <tr> <td style="width: 10%;"></td> <td style="width: 10%;"></td> <td style="width: 10%;"></td> <td style="width: 10%;"></td> <td style="width: 10%;"></td> <td style="width: 10%;"></td> <td style="width: 10%;"></td> <td style="width: 10%;"></td> <td style="width: 10%;"></td> <td style="width: 10%;"></td> </tr> <tr> <td></td> <td></td> <td colspan="8" style="text-align: center;"> <table border="1" style="width: 100%; border-collapse: collapse; text-align: center;"> <tr> <td style="width: 10%;"></td> <td style="width: 10%;"></td> <td style="width: 10%;"></td> <td style="width: 10%;"></td> <td style="width: 10%;"></td> <td style="width: 10%;"></td> <td style="width: 10%;"></td> <td style="width: 10%;"></td> <td style="width: 10%;"></td> <td style="width: 10%;"></td> </tr> <tr> <td></td> <td></td> <td colspan="8" style="text-align: center;"> <table border="1" style="width: 100%; border-collapse: collapse; text-align: center;"> <tr> <td style="width: 10%;"></td> <td style="width: 10%;"></td> <td style="width: 10%;"></td> <td style="width: 10%;"></td> <td style="width: 10%;"></td> <td style="width: 10%;"></td> <td style="width: 10%;"></td> <td style="width: 10%;"></td> <td style="width: 10%;"></td> <td style="width: 10%;"></td> </tr> <tr> <td></td> <td></td> <td colspan="8" style="text-align: center;"> <table border="1" style="width: 100%; border-collapse: collapse; text-align: center;"> <tr> <td style="width: 10%;"></td> <td style="width: 10%;"></td> <td style="width: 10%;"></td> <td style="width: 10%;"></td> <td style="width: 10%;"></td> <td style="width: 10%;"></td> <td style="width: 10%;"></td> <td style="width: 10%;"></td> <td style="width: 10%;"></td> <td style="width: 10%;"></td> </tr> <tr> <td></td> <td></td> <td colspan="8" style="text-align: center;"> <table border="1" style="width: 100%; border-collapse: collapse; text-align: center;"> <tr> <td style="width: 10%;"></td> <td style="width: 10%;"></td> <td style="width: 10%;"></td> <td style="width: 10%;"></td> <td style="width: 10%;"></td> <td style="width: 10%;"></td> <td style="width: 10%;"></td> <td style="width: 10%;"></td> <td style="width: 10%;"></td> <td style="width: 10%;"></td> </tr> <tr> <td></td> <td></td> <td colspan="8" style="text-align: center;"> <table border="1" style="width: 100%; border-collapse: collapse; text-align: center;"> <tr> <td style="width: 10%;"></td> <td style="width: 10%;"></td> <td style="width: 10%;"></td> <td style="width: 10%;"></td> <td style="width: 10%;"></td> <td style="width: 10%;"></td> <td style="width: 10%;"></td> <td style="width: 10%;"></td> <td style="width: 10%;"></td> <td style="width: 10%;"></td> </tr> <tr> <td></td> <td></td> <td colspan="8" style="text-align: center;"> <table border="1" style="width: 100%; border-collapse: collapse; text-align: center;"> <tr> <td style="width: 10%;"></td> <td style="width: 10%;"></td> <td style="width: 10%;"></td> <td style="width: 10%;"></td> <td style="width: 10%;"></td> <td style="width: 10%;"></td> <td style="width: 10%;"></td> <td style="width: 10%;"></td> <td style="width: 10%;"></td> <td style="width: 10%;"></td> </tr> <tr> <td></td> <td></td> <td colspan="8" style="text-align: center;"> <table border="1" style="width: 100%; border-collapse: collapse; text-align: center;"> <tr> <td style="width: 10%;"></td> <td style="width: 10%;"></td> <td style="width: 10%;"></td> <td style="width: 10%;"></td> <td style="width: 10%;"></td> <td style="width: 10%;"></td> <td style="width: 10%;"></td> <td style="width: 10%;"></td> <td style="width: 10%;"></td> <td style="width: 10%;"></td> </tr> <tr> <td></td> <td></td> <td colspan="8" style="text-align: center;"> <table border="1" style="width: 100%; border-collapse: collapse; text-align: center;"> <tr> <td style="width: 10%;"></td> <td style="width: 10%;"></td> <td style="width: 10%;"></td> <td style="width: 10%;"></td> <td style="width: 10%;"></td> <td style="width: 10%;"></td> <td style="width: 10%;"></td> <td style="width: 10%;"></td> <td style="width: 10%;"></td> <td style="width: 10%;"></td> </tr> <tr> <td></td> <td></td> <td colspan="8" style="text-align: center;"> <table border="1" style="width: 100%; border-collapse: collapse; text-align: center;"> <tr> <td style="width: 10%;"></td> <td style="width: 10%;"></td> <td style="width: 10%;"></td> <td style="width: 10%;"></td> <td style="width: 10%;"></td> <td style="width: 10%;"></td> <td style="width: 10%;"></td> <td style="width: 10%;"></td> <td style="width: 10%;"></td> <td style="width: 10%;"></td> </tr> <tr> <td></td> <td></td> <td colspan="8" style="text-align: center;"> <table
border="1" style="width: 100%; border-collapse: collapse; text-align: center;"> <tr> <td style="width: 10%;"></td> <td style="width: 10%;"></td> <td style="width: 10%;"></td> <td style="width: 10%;"></td> <td style="width: 10%;"></td> <td style="width: 10%;"></td> <td style="width: 10%;"></td> <td style="width: 10%;"></td> <td style="width: 10%;"></td> <td style="width: 10%;"></td> </tr> <tr> <td></td> <td></td> <td colspan="8" style="text-align: center;"> <table border="1" style="width: 100%; border-collapse: collapse; text-align: center;"> <tr> <td style="width: 10%;"></td> <td style="width: 10%;"></td> <td style="width: 10%;"></td> <td style="width: 10%;"></td> <td style="width: 10%;"></td> <td style="width: 10%;"></td> <td style="width: 10%;"></td> <td style="width: 10%;"></td> <td style="width: 10%;"></td> <td style="width: 10%;"></td> </tr> <tr> <td></td> <td></td> <td colspan="8" style="text-align: center;"> <table border="1" style="width: 100%; border-collapse: collapse; text-align: center;"> <tr> <td style="width: 10%;"></td> <td style="width: 10%;"></td> <td style="width: 10%;"></td> <td style="width: 10%;"></td> <td style="width: 10%;"></td> <td style="width: 10%;"></td> <td style="width: 10%;"></td> <td style="width: 10%;"></td> <td style="width: 10%;"></td> <td style="width: 10%;"></td> </tr> <tr> <td></td> <td></td> <td colspan="8" style="text-align: center;"> <table border="1" style="width: 100%; border-collapse: collapse; text-align: center;"> <tr> <td style="width: 10%;"></td> <td style="width: 10%;"></td> <td style="width: 10%;"></td> <td style="width: 10%;"></td> <td style="width: 10%;"></td> <td style="width: 10%;"></td> <td style="width: 10%;"></td> <td style="width: 10%;"></td> <td style="width: 10%;"></td> <td style="width: 10%;"></td> </tr> <tr> <td></td> <td></td> <td colspan="8" style="text-align: center;"> <table border="1" style="width: 100%; border-collapse: collapse; text-align: center;"> <tr> <td style="width: 10%;"></td> <td style="width: 10%;"></td> <td style="width: 10%;"></td> <td style="width: 10%;"></td> <td style="width: 10%;"></td> <td style="width: 10%;"></td> <td style="width: 10%;"></td> <td style="width: 10%;"></td> <td style="width: 10%;"></td> <td style="width: 10%;"></td> </tr> <tr> <td></td> <td></td> <td colspan="8" style="text-align: center;"> <table border="1" style="width: 100%; border-collapse: collapse; text-align: center;"> <tr> <td style="width: 10%;"></td> <td style="width: 10%;"></td> <td style="width: 10%;"></td> <td style="width: 10%;"></td> <td style="width: 10%;"></td> <td style="width: 10%;"></td> <td style="width: 10%;"></td> <td style="width: 10%;"></td> <td style="width: 10%;"></td> <td style="width: 10%;"></td> </tr> <tr> <td></td> <td></td> <td colspan="8" style="text-align: center;"> <table border="1" style="width: 100%; border-collapse: collapse; text-align: center;"> <tr> <td style="width: 10%;"></td> <td style="width: 10%;"></td> <td style="width: 10%;"></td> <td style="width: 10%;"></td> <td style="width: 10%;"></td> <td style="width: 10%;"></td> <td style="width: 10%;"></td> <td style="width: 10%;"></td> <td style="width: 10%;"></td> <td style="width: 10%;"></td> </tr> <tr> <td></td> <td></td> <td colspan="8" style="text-align: center;"> <table border="1" style="width: 100%; border-collapse: collapse; text-align: center;"> <tr> <td style="width: 10%;"></td> <td style="width: 10%;"></td> <td style="width: 10%;"></td> <td style="width: 10%;"></td> <td style="width: 10%;"></td> <td style="width: 10%;"></td> <td style="width: 10%;"></td> <td style="width: 10%;"></td> <td style="width: 10%;"></td> <td style="width: 10%;"></td> </tr> <tr> <td></td> <td></td> <td colspan="8" style="text-align: center;"> <table border="1" style="width: 100%; border-collapse: collapse; text-align: center;"> <tr> <td style="width: 10%;"></td> <td style="width: 10%;"></td> <td style="width: 10%;"></td> <td style="width: 10%;"></td> <td style="width: 10%;"></td> <td style="width: 10%;"></td> <td style="width: 10%;"></td> <td style="width: 10%;"></td> <td style="width: 10%;"></td> <td style="width: 10%;"></td> </tr> <tr> <td></td> <td></td> <td colspan="8" style="text-align: center;"> <table border="1" style="width: 100%; border-collapse: collapse; text-align: center;"> <tr> <td style="width: 10%;"></td> <td style="width: 10%;"></td> <td style="width: 10%;"></td> <td style="width: 10%;"></td> <td style="width: 10%;"></td> <td style="width: 10%;"></td> <td style="width: 10%;"></td> <td style="width: 10%;"></td> <td style="width: 10%;"></td> <td style="width: 10%;"></td> </tr> <tr> <td></td> <td></td> <td colspan="8" style="text-align: center;"> <table border="1" style="width: 100%; border-collapse: collapse; text-align: center;"> <tr> <td style="width: 10%;"></td> <td style="width: 10%;"></td> <td style="width: 10%;"></td> <td style="width: 10%;"></td> <td style="width: 10%;"></td> <td style="width: 10%;"></td> <td style="width: 10%;"></td> <td style="width: 10%;"></td> <td style="width: 10%;"></td> <td style="width: 10%;"></td> </tr> <tr> <td></td> <td></td> <td colspan="8" style="text-align: center;"> <table border="1" style="width: 100%; border-collapse: collapse; text-align: center;"> <tr> <td style="width: 10%;"></td> <td style="width: 10%;"></td> <td style="width: 10%;"></td> <td style="width: 10%;"></td> <td style="width: 10%;"></td> <td style="width: 10%;"></td> <td style="width: 10%;"></td> <td style="width: 10%;"></td> <td style="width: 10%;"></td> <td style="width: 10%;"></td> </tr> <tr> <td></td> <td></td> <td colspan="8" style="text-align: center;"> <table border="1" style="width: 100%; border-collapse: collapse; text-align: center;"> <tr> <td style="width: 10%;"></td> <td style="width: 10%;"></td> <td style="width: 10%;"></td> <td style="width: 10%;"></td> <td style="width: 10%;"></td> <td style="width: 10%;"></td> <td style="width: 10%;"></td> <td style="width: 10%;"></td> <td style="width: 10%;"></td> <td style="width: 10%;"></td> </tr> <tr> <td></td> <td></td> <td colspan="8" style="text-align: center;"> <table border="1" style="width: 100%; border-collapse: collapse; text-align: center;"> <tr> <td style="width: 10%;"></td> <td style="width: 10%;"></td> <td style="width: 10%;"></td> <td style="width: 10%;"></td> <td style="width: 10%;"></td> <td style="width: 10%;"></td> <td style="width: 10%;"></td> <td style="width: 10%;"></td> <td style="width: 10%;"></td> <td style="width: 10%;"></td> </tr> <tr> <td></td> <td></td> <td colspan="8" style="text-align: center;"> <table border="1" style="width: 100%; border-collapse: collapse; text-align: center;"> <tr> <td style="width: 10%;"></td> <td style="width: 10%;"></td> <td style="width: 10%;"></td> <td style="width: 10%;"></td> <td style="width: 10%;"></td> <td style="width: 10%;"></td> <td style="width: 10%;"></td> <td style="width: 10%;"></td> <td style="width: 10%;"></td> <td style="width: 10%;"></td> </tr> <tr> <td></td> <td></td> <td colspan="8" style="text-align: center;"> <table border="1" style="width: 100%; border-collapse: collapse; text-align: center;"> <tr> <td style="width: 10%;"></td> <td style="width: 10%;"></td> <td style="width: 10%;"></td> <td style="width: 10%;"></td> <td style="width: 10%;"></td> <td style="width: 10%;"></td> <td style="width: 10%;"></td> <td style="width: 10%;"></td> <td style="width: 10%;"></td> <td style="width: 10%;"></td> </tr> <tr> <td></td> <td></td> <td colspan="8" style="text-align: center;"> <table border="1" style="width: 100%; border-collapse: collapse; text-align: center;"> <tr> <td style="width: 10%;"></td> <td style="width: 10%;"></td> <td style="width: 10%;"></td> <td style="width: 10%;"></td> <td style="width: 10%;"></td> <td style="width: 10%;"></td> <td style="width: 10%;"></td> <td style="width: 10%;"></td> <td style="width: 10%;"></td> <td style="width: 10%;"></td> </tr> <tr> <td></td> <td></td> <td colspan="8" style="text-align: center;"> <table border="1" style="width: 100%; border-collapse: collapse; text-align: center;"> <tr> <td style="width: 10%;"></td> <td style="width: 10%;"></td> <td style="width: 10%;"></td> <td style="width: 10%;"></td> <td style="width: 10%;"></td> <td style="width: 10%;"></td> <td style="width: 10%;"></td> <td style="width: 10%;"></td> <td style="width: 10%;"></td> <td style="width: 10%;"></td> </tr> <tr> <td></td> <td></td> <td colspan="8" style="text-align: center;"> <table border="1" style="width: 100%; border-collapse: collapse; text-align: center;"> <tr> <td style="width: 10%;"></td> <td style="width: 10%;"></td> <td style="width: 10%;"></td> <td style="width: 10%;"></td> <td style="width: 10%;"></td> <td style="width: 10%;"></td> <td style="width: 10%;"></td> <td style="width: 10%;"></td> <td style="width: 10%;"></td> <td style="width: 10%;"></td> </tr> <tr> <td></td> <td></td> <td colspan="8" style="text-align: center;"> <table border="1" style="width: 100%; border-collapse: collapse; text-align: center;"> <tr> <td style="width: 10%;"></td> <td style="width: 10%;"></td> <td style="width: 10%;"></td> <td style="width: 10%;"></td> <td style="width: 10%;"></td> <td style="width: 10%;"></td> <td style="width: 10%;"></td> <td style="width: 10%;"></td> <td style="width: 10%;"></td> <td style="width: 10%;"></td> </tr> <tr> <td></td> <td></td> <td colspan="8" style="text-align: center;"> <table border="1" style="width: 100%; border-collapse: collapse; text-align: center;"> <tr> <td style="width: 10%;"></td> <td style="width: 10%;"></td> <td style="width: 10%;"></td> <td style="width: 10%;"></td> <td style="width: 10%;"></td> <td style="width: 10%;"></td> <td style="width: 10%;"></td> <td style="width: 10%;"></td> <td style="width: 10%;"></td> <td style="width: 10%;"></td> </tr> <tr> <td></td> <td></td> <td colspan="8" style="text-align: center;"> <table border="1" style="width: 100%; border-collapse: collapse; text-align: center;"> <tr> <td style="width: 10%;"></td> <td style="width: 10%;"></td> <td style="width:
10%;"></td> <td style="width: 10%;"></td> <td style="width: 10%;"></td> <td style="width: 10%;"></td> <td style="width: 10%;"></td> <td style="width: 10%;"></td> <td style="width: 10%;"></td> <td style="width: 10%;"></td> </tr> <tr> <td></td> <td></td> <td colspan="8" style="text-align: center;"> <table border="1" style="width: 100%; border-collapse: collapse; text-align: center;"> <tr> <td style="width: 10%;"></td> <td style="width: 10%;"></td> <td style="width: 10%;"></td> <td style="width: 10%;"></td> <td style="width: 10%;"></td> <td style="width: 10%;"></td> <td style="width: 10%;"></td> <td style="width: 10%;"></td> <td style="width: 10%;"></td> <td style="width: 10%;"></td> </tr> <tr> <td></td> <td></td> <td colspan="8" style="text-align: center;"> <table border="1" style="width: 100%; border-collapse: collapse; text-align: center;"> <tr> <td style="width: 10%;"></td> <td style="width: 10%;"></td> <td style="width: 10%;"></td> <td style="width: 10%;"></td> <td style="width: 10%;"></td> <td style="width: 10%;"></td> <td style="width: 10%;"></td> <td style="width: 10%;"></td> <td style="width: 10%;"></td> <td style="width: 10%;"></td> </tr> <tr> <td></td> <td></td> <td colspan="8" style="text-align: center;"> <table border="1" style="width: 100%; border-collapse: collapse; text-align: center;"> <tr> <td style="width: 10%;"></td> <td style="width: 10%;"></td> <td style="width: 10%;"></td> <td style="width: 10%;"></td> <td style="width: 10%;"></td> <td style="width: 10%;"></td> <td style="width: 10%;"></td> <td style="width: 10%;"></td> <td style="width: 10%;"></td> <td style="width: 10%;"></td> </tr> <tr> <td></td> <td></td> <td colspan="8" style="text-align: center;"> <table border="1" style="width: 100%; border-collapse: collapse; text-align: center;"> <tr> <td style="width: 10%;"></td> <td style="width: 10%;"></td> <td style="width: 10%;"></td> <td style="width: 10%;"></td> <td style="width: 10%;"></td> <td style="width: 10%;"></td> <td style="width: 10%;"></td> <td style="width: 10%;"></td> <td style="width: 10%;"></td> <td style="width: 10%;"></td> </tr> <tr> <td></td> <td></td> <td colspan="8" style="text-align: center;"> <table border="1" style="width: 100%; border-collapse: collapse; text-align: center;"> <tr> <td style="width: 10%;"></td> <td style="width: 10%;"></td> <td style="width: 10%;"></td> <td style="width: 10%;"></td> <td style="width: 10%;"></td> <td style="width: 10%;"></td> <td style="width: 10%;"></td> <td style="width: 10%;"></td> <td style="width: 10%;"></td> <td style="width: 10%;"></td> </tr> <tr> <td></td> <td></td> <td colspan="8" style="text-align: center;"> <table border="1" style="width: 100%; border-collapse: collapse; text-align: center;"> <tr> <td style="width: 10%;"></td> <td style="width: 10%;"></td> <td style="width: 10%;"></td> <td style="width: 10%;"></td> <td style="width: 10%;"></td> <td style="width: 10%;"></td> <td style="width: 10%;"></td> <td style="width: 10%;"></td> <td style="width: 10%;"></td> <td style="width: 10%;"></td> </tr> <tr> <td></td> <td></td> <td colspan="8" style="text-align: center;"> <table border="1" style="width: 100%; border-collapse: collapse; text-align: center;"> <tr> <td style="width: 10%;"></td> <td style="width: 10%;"></td> <td style="width: 10%;"></td> <td style="width: 10%;"></td> <td style="width: 10%;"></td> <td style="width: 10%;"></td> <td style="width: 10%;"></td> <td style="width: 10%;"></td> <td style="width: 10%;"></td> <td style="width: 10%;"></td> </tr> <tr> <td></td> <td></td> <td colspan="8" style="text-align: center;"> <table border="1" style="width: 100%; border-collapse: collapse; text-align: center;"> <tr> <td style="width: 10%;"></td> <td style="width: 10%;"></td> <td style="width: 10%;"></td> <td style="width: 10%;"></td> <td style="width: 10%;"></td> <td style="width: 10%;"></td> <td style="width: 10%;"></td> <td style="width: 10%;"></td> <td style="width: 10%;"></td> <td style="width: 10%;"></td> </tr> <tr> <td></td> <td></td> <td colspan="8" style="text-align: center;"> <table border="1" style="width: 100%; border-collapse: collapse; text-align: center;"> <tr> <td style="width: 10%;"></td> <td style="width: 10%;"></td> <td style="width: 10%;"></td> <td style="width: 10%;"></td> <td style="width: 10%;"></td> <td style="width: 10%;"></td> <td style="width: 10%;"></td> <td style="width: 10%;"></td> <td style="width: 10%;"></td> <td style="width: 10%;"></td> </tr> <tr> <td></td> <td></td> <td colspan="8" style="text-align: center;"> <table border="1" style="width: 100%; border-collapse: collapse; text-align: center;"> <tr> <td style="width: 10%;"></td> <td style="width: 10%;"></td> <td style="width: 10%;"></td> <td style="width: 10%;"></td> <td style="width: 10%;"></td> <td style="width: 10%;"></td> <td style="width: 10%;"></td> <td style="width: 10%;"></td> <td style="width: 10%;"></td> <td style="width: 10%;"></td> </tr> <tr> <td></td> <td></td> <td colspan="8" style="text-align: center;"> <table border="1" style="width: 100%; border-collapse: collapse; text-align: center;"> <tr> <td style="width: 10%;"></td> <td style="width: 10%;"></td> <td style="width: 10%;"></td> <td style="width: 10%;"></td> <td style="width: 10%;"></td> <td style="width: 10%;"></td> <td style="width: 10%;"></td> <td style="width: 10%;"></td> <td style="width: 10%;"></td> <td style="width: 10%;"></td> </tr> <tr> <td></td> <td></td> <td colspan="8" style="text-align: center;"> <table border="1" style="width: 100%; border-collapse: collapse; text-align: center;"> <tr> <td style="width: 10%;"></td> <td style="width: 10%;"></td> <td style="width: 10%;"></td> <td style="width: 10%;"></td> <td style="width: 10%;"></td> <td style="width: 10%;"></td> <td style="width: 10%;"></td> <td style="width: 10%;"></td> <td style="width: 10%;"></td> <td style="width: 10%;"></td> </tr> <tr> <td></td> <td></td> <td colspan="8" style="text-align: center;"> <table border="1" style="width: 100%; border-collapse: collapse; text-align: center;"> <tr> <td style="width: 10%;"></td> <td style="width: 10%;"></td> <td style="width: 10%;"></td> <td style="width: 10%;"></td> <td style="width: 10%;"></td> <td style="width: 10%;"></td> <td style="width: 10%;"></td> <td style="width: 10%;"></td> <td style="width: 10%;"></td> <td style="width: 10%;"></td> </tr> <tr> <td></td> <td></td> <td colspan="8" style="text-align: center;"> <table border="1" style="width: 100%; border-collapse: collapse; text-align: center;"> <tr> <td style="width: 10%;"></td> <td style="width: 10%;"></td> <td style="width: 10%;"></td> <td style="width: 10%;"></td> <td style="width: 10%;"></td> <td style="width: 10%;"></td> <td style="width: 10%;"></td> <td style="width: 10%;"></td> <td style="width: 10%;"></td> <td style="width: 10%;"></td> </tr> <tr> <td></td> <td></td> <td colspan="8" style="text-align: center;"> <table border="1" style="width: 100%; border-collapse: collapse; text-align: center;"> <tr> <td style="width: 10%;"></td> <td style="width: 10%;"></td> <td style="width: 10%;"></td> <td style="width: 10%;"></td> <td style="width: 10%;"></td> <td style="width: 10%;"></td> <td style="width: 10%;"></td> <td style="width: 10%;"></td> <td style="width: 10%;"></td> <td style="width: 10%;"></td> </tr> <tr> <td></td> <td></td> <td colspan="8" style="text-align: center;"> <table border="1" style="width: 100%; border-collapse: collapse; text-align: center;"> <tr> <td style="width: 10%;"></td> <td style="width: 10%;"></td> <td style="width: 10%;"></td> <td style="width: 10%;"></td> <td style="width: 10%;"></td> <td style="width: 10%;"></td> <td style="width: 10%;"></td> <td style="width: 10%;"></td> <td style="width: 10%;"></td> <td style="width: 10%;"></td> </tr> <tr> <td></td> <td></td> <td colspan="8" style="text-align: center;"> <table border="1" style="width: 100%; border-collapse: collapse; text-align: center;"> <tr> <td style="width: 10%;"></td> <td style="width: 10%;"></td> <td style="width: 10%;"></td> <td style="width: 10%;"></td> <td style="width: 10%;"></td> <td style="width: 10%;"></td> <td style="width: 10%;"></td> <td style="width: 10%;"></td> <td style="width: 10%;"></td> <td style="width: 10%;"></td> </tr> <tr> <td></td> <td></td> <td colspan="8" style="text-align: center;"> <table border="1" style="width: 100%; border-collapse: collapse; text-align: center;"> <tr> <td style="width: 10%;"></td> <td style="width: 10%;"></td> <td style="width: 10%;"></td> <td style="width: 10%;"></td> <td style="width: 10%;"></td> <td style="width: 10%;"></td> <td style="width: 10%;"></td> <td style="width: 10%;"></td> <td style="width: 10%;"></td> <td style="width: 10%;"></td> </tr> <tr> <td></td> <td></td> <td colspan="8" style="text-align: center;"> <table border="1" style="width: 100%; border-collapse: collapse; text-align: center;"> <tr> <td style="width: 10%;"></td> <td style="width: 10%;"></td> <td style="width: 10%;"></td> <td style="width: 10%;"></td> <td style="width: 10%;"></td> <td style="width: 10%;"></td> <td style="width: 10%;"></td> <td style="width: 10%;"></td> <td style="width: 10%;"></td> <td style="width: 10%;"></td> </tr> <tr> <td></td> <td></td> <td colspan="8" style="text-align: center;"> <table border="1" style="width: 100%; border-collapse: collapse; text-align: center;"> <tr> <td style="width: 10%;"></td> <td style="width: 10%;"></td> <td style="width: 10%;"></td> <td style="width: 10%;"></td> <td style="width: 10%;"></td> <td style="width: 10%;"></td> <td style="width: 10%;"></td> <td style="width: 10%;"></td> <td style="width: 10%;"></td> <td style="width: 10%;"></td> </tr> <tr> <td></td> <td></td> <td colspan="8" style="text-align: center;"> <table border="1" style="width: 100%; border-collapse: collapse; text-align: center;"> <tr> <td style="width: 10%;"></td> <td style="width: 10%;"></td> <td style="width: 10%;"></td> <td style="width: 10%;"></td> <td style="width: 10%;"></td> <td style="width: 10%;"></td> <td style="width: 10%;"></td> <td style="width: 10%;"></td> <td
style="width: 10%;"></td> <td style="width: 10%;"></td> </tr> <tr> <td></td> <td></td> <td colspan="8" style="text-align: center;"> <table border="1" style="width: 100%; border-collapse: collapse; text-align: center;"> <tr> <td style="width: 10%;"></td> <td style="width: 10%;"></td> <td style="width: 10%;"></td> <td style="width: 10%;"></td> <td style="width: 10%;"></td> <td style="width: 10%;"></td> <td style="width: 10%;"></td> <td style="width: 10%;"></td> <td style="width: 10%;"></td> <td style="width: 10%;"></td> </tr> <tr> <td></td> <td></td> <td colspan="8" style="text-align: center;"> <table border="1" style="width: 100%; border-collapse: collapse; text-align: center;"> <tr> <td style="width: 10%;"></td> <td style="width: 10%;"></td> <td style="width: 10%;"></td> <td style="width: 10%;"></td> <td style="width: 10%;"></td> <td style="width: 10%;"></td> <td style="width: 10%;"></td> <td style="width: 10%;"></td> <td style="width: 10%;"></td> <td style="width: 10%;"></td> </tr> <tr> <td></td> <td></td> <td colspan="8" style="text-align: center;"> <table border="1" style="width: 100%; border-collapse: collapse; text-align: center;"> <tr> </tr></table></td></tr></table></td></tr></table></td></tr></table></td></tr></table></td></tr></table></td></tr></table></td></tr></table></td></tr></table></td></tr></table></td></tr></table></td></tr></table></td></tr></table></td></tr></table></td></tr></table></td></tr></table></td></tr></table></td></tr></table></td></tr></table></td></tr></table></td></tr></table></td></tr></table></td></tr></table></td></tr></table></td></tr></table></td></tr></table></td></tr></table></td></tr></table></td></tr></table></td></tr></table></td></tr></table></td></tr></table></td></tr></table></td></tr></table></td></tr></table></td></tr></table></td></tr></table></td></tr></table></td></tr></table></td></tr></table></td></tr></table></td></tr></table></td></tr></table></td></tr></table></td></tr></table></td></tr></table></td></tr></table></td></tr></table></td></tr></table></td></tr></table></td></tr></table></td></tr></table></td></tr></table></td></tr></table></td></tr></table></td></tr></table></td></tr></table></td></tr></table></td></tr></table></td></tr></table></td></tr></table></td></tr></table> | | | | | | | | | | | | | | | | | | | | <table border="1" style="width: 100%; border-collapse: collapse; text-align: center;"> <tr> <td style="width: 10%;"></td> <td style="width: 10%;"></td> <td style="width: 10%;"></td> <td style="width: 10%;"></td> <td style="width: 10%;"></td> <td style="width: 10%;"></td> <td style="width: 10%;"></td> <td style="width: 10%;"></td> <td style="width: 10%;"></td> <td style="width: 10%;"></td> </tr> <tr> <td></td> <td></td> <td colspan="8" style="text-align: center;"> <table border="1" style="width: 100%; border-collapse: collapse; text-align: center;"> <tr> <td style="width: 10%;"></td> <td style="width: 10%;"></td> <td style="width: 10%;"></td> <td style="width: 10%;"></td> <td style="width: 10%;"></td> <td style="width: 10%;"></td> <td style="width: 10%;"></td> <td style="width: 10%;"></td> <td style="width: 10%;"></td> <td style="width: 10%;"></td> </tr> <tr> <td></td> <td></td> <td colspan="8" style="text-align: center;"> <table border="1" style="width: 100%; border-collapse: collapse; text-align: center;"> <tr> <td style="width: 10%;"></td> <td style="width: 10%;"></td> <td style="width: 10%;"></td> <td style="width: 10%;"></td> <td style="width: 10%;"></td> <td style="width: 10%;"></td> <td style="width: 10%;"></td> <td style="width: 10%;"></td> <td style="width: 10%;"></td> <td style="width: 10%;"></td> </tr> <tr> <td></td> <td></td> <td colspan="8" style="text-align: center;"> <table border="1" style="width: 100%; border-collapse: collapse; text-align: center;"> <tr> <td style="width: 10%;"></td> <td style="width: 10%;"></td> <td style="width: 10%;"></td> <td style="width: 10%;"></td> <td style="width: 10%;"></td> <td style="width: 10%;"></td> <td style="width: 10%;"></td> <td style="width: 10%;"></td> <td style="width: 10%;"></td> <td style="width: 10%;"></td> </tr> <tr> <td></td> <td></td> <td colspan="8" style="text-align: center;"> <table border="1" style="width: 100%; border-collapse: collapse; text-align: center;"> <tr> <td style="width: 10%;"></td> <td style="width: 10%;"></td> <td style="width: 10%;"></td> <td style="width: 10%;"></td> <td style="width: 10%;"></td> <td style="width: 10%;"></td> <td style="width: 10%;"></td> <td style="width: 10%;"></td> <td style="width: 10%;"></td> <td style="width: 10%;"></td> </tr> <tr> <td></td> <td></td> <td colspan="8" style="text-align: center;"> <table border="1" style="width: 100%; border-collapse: collapse; text-align: center;"> <tr> <td style="width: 10%;"></td> <td style="width: 10%;"></td> <td style="width: 10%;"></td> <td style="width: 10%;"></td> <td style="width: 10%;"></td> <td style="width: 10%;"></td> <td style="width: 10%;"></td> <td style="width: 10%;"></td> <td style="width: 10%;"></td> <td style="width: 10%;"></td> </tr> <tr> <td></td> <td></td> <td colspan="8" style="text-align: center;"> <table border="1" style="width: 100%; border-collapse: collapse; text-align: center;"> <tr> <td style="width: 10%;"></td> <td style="width: 10%;"></td> <td style="width: 10%;"></td> <td style="width: 10%;"></td> <td style="width: 10%;"></td> <td style="width: 10%;"></td> <td style="width: 10%;"></td> <td style="width: 10%;"></td> <td style="width: 10%;"></td> <td style="width: 10%;"></td> </tr> <tr> <td></td> <td></td> <td colspan="8" style="text-align: center;"> <table border="1" style="width: 100%; border-collapse: collapse; text-align: center;"> <tr> <td style="width: 10%;"></td> <td style="width: 10%;"></td> <td style="width: 10%;"></td> <td style="width: 10%;"></td> <td style="width: 10%;"></td> <td style="width: 10%;"></td> <td style="width: 10%;"></td> <td style="width: 10%;"></td> <td style="width: 10%;"></td> <td style="width: 10%;"></td> </tr> <tr> <td></td> <td></td> <td colspan="8" style="text-align: center;"> <table border="1" style="width: 100%; border-collapse: collapse; text-align: center;"> <tr> <td style="width: 10%;"></td> <td style="width: 10%;"></td> <td style="width: 10%;"></td> <td style="width: 10%;"></td> <td style="width: 10%;"></td> <td style="width: 10%;"></td> <td style="width: 10%;"></td> <td style="width: 10%;"></td> <td style="width: 10%;"></td> <td style="width: 10%;"></td> </tr> <tr> <td></td> <td></td> <td colspan="8" style="text-align: center;"> <table border="1" style="width: 100%; border-collapse: collapse; text-align: center;"> <tr> <td style="width: 10%;"></td> <td style="width: 10%;"></td> <td style="width: 10%;"></td> <td style="width: 10%;"></td> <td style="width: 10%;"></td> <td style="width: 10%;"></td> <td style="width: 10%;"></td> <td style="width: 10%;"></td> <td style="width: 10%;"></td> <td style="width: 10%;"></td> </tr> <tr> <td></td> <td></td> <td colspan="8" style="text-align: center;"> <table border="1" style="width: 100%; border-collapse: collapse; text-align: center;"> <tr> <td style="width: 10%;"></td> <td style="width: 10%;"></td> <td style="width: 10%;"></td> <td style="width: 10%;"></td> <td style="width: 10%;"></td> <td style="width: 10%;"></td> <td style="width: 10%;"></td> <td style="width: 10%;"></td> <td style="width: 10%;"></td> <td style="width: 10%;"></td> </tr> <tr> <td></td> <td></td> <td colspan="8" style="text-align: center;"> <table border="1" style="width: 100%; border-collapse: collapse; text-align: center;"> <tr> <td style="width: 10%;"></td> <td style="width: 10%;"></td> <td style="width: 10%;"></td> <td style="width: 10%;"></td> <td style="width: 10%;"></td> <td style="width: 10%;"></td> <td style="width: 10%;"></td> <td style="width: 10%;"></td> <td style="width: 10%;"></td> <td style="width: 10%;"></td> </tr> <tr> <td></td> <td></td> <td colspan="8" style="text-align: center;"> <table border="1" style="width: 100%; border-collapse: collapse; text-align: center;"> <tr> <td style="width: 10%;"></td> <td style="width: 10%;"></td> <td style="width: 10%;"></td> <td style="width: 10%;"></td> <td style="width: 10%;"></td> <td style="width: 10%;"></td> <td style="width: 10%;"></td> <td style="width: 10%;"></td> <td style="width: 10%;"></td> <td style="width: 10%;"></td> </tr> <tr> <td></td> <td></td> <td colspan="8" style="text-align: center;"> <table border="1" style="width: 100%; border-collapse: collapse; text-align: center;"> <tr> <td style="width: 10%;"></td> <td style="width: 10%;"></td> <td style="width: 10%;"></td> <td style="width: 10%;"></td> <td style="width: 10%;"></td> <td style="width: 10%;"></td> <td style="width: 10%;"></td> <td style="width: 10%;"></td> <td style="width: 10%;"></td> <td style="width: 10%;"></td> </tr> <tr> <td></td> <td></td> <td colspan="8" style="text-align: center;"> <table border="1" style="width: 100%; border-collapse: collapse; text-align: center;"> <tr> <td style="width: 10%;"></td> <td style="width: 10%;"></td> <td style="width: 10%;"></td> <td style="width: 10%;"></td> <td style="width: 10%;"></td> <td style="width: 10%;"></td> <td style="width: 10%;"></td> <td style="width: 10%;"></td> <td style="width: 10%;"></td> <td style="width: 10%;"></td> </tr> <tr> <td></td> <td></td> <td colspan="8" style="text-align: center;"> <table border="1" style="width: 100%; border-collapse: collapse; text-align: center;"> <tr> <td style="width: 10%;"></td> <td style="width: 10%;"></td> <td
style="width: 10%;"></td> <td style="width: 10%;"></td> <td style="width: 10%;"></td> <td style="width: 10%;"></td> <td style="width: 10%;"></td> <td style="width: 10%;"></td> <td style="width: 10%;"></td> <td style="width: 10%;"></td> </tr> <tr> <td></td> <td></td> <td colspan="8" style="text-align: center;"> <table border="1" style="width: 100%; border-collapse: collapse; text-align: center;"> <tr> <td style="width: 10%;"></td> <td style="width: 10%;"></td> <td style="width: 10%;"></td> <td style="width: 10%;"></td> <td style="width: 10%;"></td> <td style="width: 10%;"></td> <td style="width: 10%;"></td> <td style="width: 10%;"></td> <td style="width: 10%;"></td> <td style="width: 10%;"></td> </tr> <tr> <td></td> <td></td> <td colspan="8" style="text-align: center;"> <table border="1" style="width: 100%; border-collapse: collapse; text-align: center;"> <tr> <td style="width: 10%;"></td> <td style="width: 10%;"></td> <td style="width: 10%;"></td> <td style="width: 10%;"></td> <td style="width: 10%;"></td> <td style="width: 10%;"></td> <td style="width: 10%;"></td> <td style="width: 10%;"></td> <td style="width: 10%;"></td> <td style="width: 10%;"></td> </tr> <tr> <td></td> <td></td> <td colspan="8" style="text-align: center;"> <table border="1" style="width: 100%; border-collapse: collapse; text-align: center;"> <tr> <td style="width: 10%;"></td> <td style="width: 10%;"></td> <td style="width: 10%;"></td> <td style="width: 10%;"></td> <td style="width: 10%;"></td> <td style="width: 10%;"></td> <td style="width: 10%;"></td> <td style="width: 10%;"></td> <td style="width: 10%;"></td> <td style="width: 10%;"></td> </tr> <tr> <td></td> <td></td> <td colspan="8" style="text-align: center;"> <table border="1" style="width: 100%; border-collapse: collapse; text-align: center;"> <tr> <td style="width: 10%;"></td> <td style="width: 10%;"></td> <td style="width: 10%;"></td> <td style="width: 10%;"></td> <td style="width: 10%;"></td> <td style="width: 10%;"></td> <td style="width: 10%;"></td> <td style="width: 10%;"></td> <td style="width: 10%;"></td> <td style="width: 10%;"></td> </tr> <tr> <td></td> <td></td> <td colspan="8" style="text-align: center;"> <table border="1" style="width: 100%; border-collapse: collapse; text-align: center;"> <tr> <td style="width: 10%;"></td> <td style="width: 10%;"></td> <td style="width: 10%;"></td> <td style="width: 10%;"></td> <td style="width: 10%;"></td> <td style="width: 10%;"></td> <td style="width: 10%;"></td> <td style="width: 10%;"></td> <td style="width: 10%;"></td> <td style="width: 10%;"></td> </tr> <tr> <td></td> <td></td> <td colspan="8" style="text-align: center;"> <table border="1" style="width: 100%; border-collapse: collapse; text-align: center;"> <tr> <td style="width: 10%;"></td> <td style="width: 10%;"></td> <td style="width: 10%;"></td> <td style="width: 10%;"></td> <td style="width: 10%;"></td> <td style="width: 10%;"></td> <td style="width: 10%;"></td> <td style="width: 10%;"></td> <td style="width: 10%;"></td> <td style="width: 10%;"></td> </tr> <tr> <td></td> <td></td> <td colspan="8" style="text-align: center;"> <table border="1" style="width: 100%; border-collapse: collapse; text-align: center;"> <tr> <td style="width: 10%;"></td> <td style="width: 10%;"></td> <td style="width: 10%;"></td> <td style="width: 10%;"></td> <td style="width: 10%;"></td> <td style="width: 10%;"></td> <td style="width: 10%;"></td> <td style="width: 10%;"></td> <td style="width: 10%;"></td> <td style="width: 10%;"></td> </tr> <tr> <td></td> <td></td> <td colspan="8" style="text-align: center;"> <table border="1" style="width: 100%; border-collapse: collapse; text-align: center;"> <tr> <td style="width: 10%;"></td> <td style="width: 10%;"></td> <td style="width: 10%;"></td> <td style="width: 10%;"></td> <td style="width: 10%;"></td> <td style="width: 10%;"></td> <td style="width: 10%;"></td> <td style="width: 10%;"></td> <td style="width: 10%;"></td> <td style="width: 10%;"></td> </tr> <tr> <td></td> <td></td> <td colspan="8" style="text-align: center;"> <table border="1" style="width: 100%; border-collapse: collapse; text-align: center;"> <tr> <td style="width: 10%;"></td> <td style="width: 10%;"></td> <td style="width: 10%;"></td> <td style="width: 10%;"></td> <td style="width: 10%;"></td> <td style="width: 10%;"></td> <td style="width: 10%;"></td> <td style="width: 10%;"></td> <td style="width: 10%;"></td> <td style="width: 10%;"></td> </tr> <tr> <td></td> <td></td> <td colspan="8" style="text-align: center;"> <table border="1" style="width: 100%; border-collapse: collapse; text-align: center;"> <tr> <td style="width: 10%;"></td> <td style="width: 10%;"></td> <td style="width: 10%;"></td> <td style="width: 10%;"></td> <td style="width: 10%;"></td> <td style="width: 10%;"></td> <td style="width: 10%;"></td> <td style="width: 10%;"></td> <td style="width: 10%;"></td> <td style="width: 10%;"></td> </tr> <tr> <td></td> <td></td> <td colspan="8" style="text-align: center;"> <table border="1" style="width: 100%; border-collapse: collapse; text-align: center;"> <tr> <td style="width: 10%;"></td> <td style="width: 10%;"></td> <td style="width: 10%;"></td> <td style="width: 10%;"></td> <td style="width: 10%;"></td> <td style="width: 10%;"></td> <td style="width: 10%;"></td> <td style="width: 10%;"></td> <td style="width: 10%;"></td> <td style="width: 10%;"></td> </tr> <tr> <td></td> <td></td> <td colspan="8" style="text-align: center;"> <table border="1" style="width: 100%; border-collapse: collapse; text-align: center;"> <tr> <td style="width: 10%;"></td> <td style="width: 10%;"></td> <td style="width: 10%;"></td> <td style="width: 10%;"></td> <td style="width: 10%;"></td> <td style="width: 10%;"></td> <td style="width: 10%;"></td> <td style="width: 10%;"></td> <td style="width: 10%;"></td> <td style="width: 10%;"></td> </tr> <tr> <td></td> <td></td> <td colspan="8" style="text-align: center;"> <table border="1" style="width: 100%; border-collapse: collapse; text-align: center;"> <tr> <td style="width: 10%;"></td> <td style="width: 10%;"></td> <td style="width: 10%;"></td> <td style="width: 10%;"></td> <td style="width: 10%;"></td> <td style="width: 10%;"></td> <td style="width: 10%;"></td> <td style="width: 10%;"></td> <td style="width: 10%;"></td> <td style="width: 10%;"></td> </tr> <tr> <td></td> <td></td> <td colspan="8" style="text-align: center;"> <table border="1" style="width: 100%; border-collapse: collapse; text-align: center;"> <tr> <td style="width: 10%;"></td> <td style="width: 10%;"></td> <td style="width: 10%;"></td> <td style="width: 10%;"></td> <td style="width: 10%;"></td> <td style="width: 10%;"></td> <td style="width: 10%;"></td> <td style="width: 10%;"></td> <td style="width: 10%;"></td> <td style="width: 10%;"></td> </tr> <tr> <td></td> <td></td> <td colspan="8" style="text-align: center;"> <table border="1" style="width: 100%; border-collapse: collapse; text-align: center;"> <tr> <td style="width: 10%;"></td> <td style="width: 10%;"></td> <td style="width: 10%;"></td> <td style="width: 10%;"></td> <td style="width: 10%;"></td> <td style="width: 10%;"></td> <td style="width: 10%;"></td> <td style="width: 10%;"></td> <td style="width: 10%;"></td> <td style="width: 10%;"></td> </tr> <tr> <td></td> <td></td> <td colspan="8" style="text-align: center;"> <table border="1" style="width: 100%; border-collapse: collapse; text-align: center;"> <tr> <td style="width: 10%;"></td> <td style="width: 10%;"></td> <td style="width: 10%;"></td> <td style="width: 10%;"></td> <td style="width: 10%;"></td> <td style="width: 10%;"></td> <td style="width: 10%;"></td> <td style="width: 10%;"></td> <td style="width: 10%;"></td> <td style="width: 10%;"></td> </tr> <tr> <td></td> <td></td> <td colspan="8" style="text-align: center;"> <table border="1" style="width: 100%; border-collapse: collapse; text-align: center;"> <tr> <td style="width: 10%;"></td> <td style="width: 10%;"></td> <td style="width: 10%;"></td> <td style="width: 10%;"></td> <td style="width: 10%;"></td> <td style="width: 10%;"></td> <td style="width: 10%;"></td> <td style="width: 10%;"></td> <td style="width: 10%;"></td> <td style="width: 10%;"></td> </tr> <tr> <td></td> <td></td> <td colspan="8" style="text-align: center;"> <table border="1" style="width: 100%; border-collapse: collapse; text-align: center;"> <tr> <td style="width: 10%;"></td> <td style="width: 10%;"></td> <td style="width: 10%;"></td> <td style="width: 10%;"></td> <td style="width: 10%;"></td> <td style="width: 10%;"></td> <td style="width: 10%;"></td> <td style="width: 10%;"></td> <td style="width: 10%;"></td> <td style="width: 10%;"></td> </tr> <tr> <td></td> <td></td> <td colspan="8" style="text-align: center;"> <table border="1" style="width: 100%; border-collapse: collapse; text-align: center;"> <tr> <td style="width: 10%;"></td> <td style="width: 10%;"></td> <td style="width: 10%;"></td> <td style="width: 10%;"></td> <td style="width: 10%;"></td> <td style="width: 10%;"></td> <td style="width: 10%;"></td> <td style="width: 10%;"></td> <td style="width: 10%;"></td> <td style="width: 10%;"></td> </tr> <tr> <td></td> <td></td> <td colspan="8" style="text-align: center;"> <table border="1" style="width: 100%; border-collapse: collapse; text-align: center;"> <tr> <td style="width: 10%;"></td> <td style="width: 10%;"></td> <td style="width: 10%;"></td> <td style="width: 10%;"></td> <td style="width: 10%;"></td> <td style="width: 10%;"></td> <td style="width: 10%;"></td> <td style="width: 10%;"></td> <td style="width: 10%;"></td> <td style="width: 10%;"></td> </tr> <tr> <td></td> <td></td> <td colspan="8" style="text-align: center;"> <table border="1" style="width: 100%; border-collapse: collapse; text-align: center;"> <tr> <td style="width: 10%;"></td> <td style="width: 10%;"></td> <td style="width: 10%;"></td> <td style="width: 10%;"></td> <td style="width: 10%;"></td> <td style="width: 10%;"></td> <td style="width: 10%;"></td> <td style="width:
10%;"></td> <td style="width: 10%;"></td> <td style="width: 10%;"></td> </tr> <tr> <td></td> <td></td> <td colspan="8" style="text-align: center;"> <table border="1" style="width: 100%; border-collapse: collapse; text-align: center;"> <tr> <td style="width: 10%;"></td> <td style="width: 10%;"></td> <td style="width: 10%;"></td> <td style="width: 10%;"></td> <td style="width: 10%;"></td> <td style="width: 10%;"></td> <td style="width: 10%;"></td> <td style="width: 10%;"></td> <td style="width: 10%;"></td> <td style="width: 10%;"></td> </tr> <tr> <td></td> <td></td> <td colspan="8" style="text-align: center;"> <table border="1" style="width: 100%; border-collapse: collapse; text-align: center;"> <tr> <td style="width: 10%;"></td> <td style="width: 10%;"></td> <td style="width: 10%;"></td> <td style="width: 10%;"></td> <td style="width: 10%;"></td> <td style="width: 10%;"></td> <td style="width: 10%;"></td> <td style="width: 10%;"></td> <td style="width: 10%;"></td> <td style="width: 10%;"></td> </tr> <tr> <td></td> <td></td> <td colspan="8" style="text-align: center;"> <table border="1" style="width: 100%; border-collapse: collapse; text-align: center;"> <tr> <td style="width: 10%;"></td> <td style="width: 10%;"></td> <td style="width: 10%;"></td> <td style="width: 10%;"></td> <td style="width: 10%;"></td> <td style="width: 10%;"></td> <td style="width: 10%;"></td> <td style="width: 10%;"></td> <td style="width: 10%;"></td> <td style="width: 10%;"></td> </tr> <tr> <td></td> <td></td> <td colspan="8" style="text-align: center;"> <table border="1" style="width: 100%; border-collapse: collapse; text-align: center;"> <tr> <td style="width: 10%;"></td> <td style="width: 10%;"></td> <td style="width: 10%;"></td> <td style="width: 10%;"></td> <td style="width: 10%;"></td> <td style="width: 10%;"></td> <td style="width: 10%;"></td> <td style="width: 10%;"></td> <td style="width: 10%;"></td> <td style="width: 10%;"></td> </tr> <tr> <td></td> <td></td> <td colspan="8" style="text-align: center;"> <table border="1" style="width: 100%; border-collapse: collapse; text-align: center;"> <tr> <td style="width: 10%;"></td> <td style="width: 10%;"></td> <td style="width: 10%;"></td> <td style="width: 10%;"></td> <td style="width: 10%;"></td> <td style="width: 10%;"></td> <td style="width: 10%;"></td> <td style="width: 10%;"></td> <td style="width: 10%;"></td> <td style="width: 10%;"></td> </tr> <tr> <td></td> <td></td> <td colspan="8" style="text-align: center;"> <table border="1" style="width: 100%; border-collapse: collapse; text-align: center;"> <tr> <td style="width: 10%;"></td> <td style="width: 10%;"></td> <td style="width: 10%;"></td> <td style="width: 10%;"></td> <td style="width: 10%;"></td> <td style="width: 10%;"></td> <td style="width: 10%;"></td> <td style="width: 10%;"></td> <td style="width: 10%;"></td> <td style="width: 10%;"></td> </tr> <tr> <td></td> <td></td> <td colspan="8" style="text-align: center;"> <table border="1" style="width: 100%; border-collapse: collapse; text-align: center;"> <tr> <td style="width: 10%;"></td> <td style="width: 10%;"></td> <td style="width: 10%;"></td> <td style="width: 10%;"></td> <td style="width: 10%;"></td> <td style="width: 10%;"></td> <td style="width: 10%;"></td> <td style="width: 10%;"></td> <td style="width: 10%;"></td> <td style="width: 10%;"></td> </tr> <tr> <td></td> <td></td> <td colspan="8" style="text-align: center;"> <table border="1" style="width: 100%; border-collapse: collapse; text-align: center;"> <tr> <td style="width: 10%;"></td> <td style="width: 10%;"></td> <td style="width: 10%;"></td> <td style="width: 10%;"></td> <td style="width: 10%;"></td> <td style="width: 10%;"></td> <td style="width: 10%;"></td> <td style="width: 10%;"></td> <td style="width: 10%;"></td> <td style="width: 10%;"></td> </tr> <tr> <td></td> <td></td> <td colspan="8" style="text-align: center;"> <table border="1" style="width: 100%; border-collapse: collapse; text-align: center;"> <tr> <td style="width: 10%;"></td> <td style="width: 10%;"></td> <td style="width: 10%;"></td> <td style="width: 10%;"></td> <td style="width: 10%;"></td> <td style="width: 10%;"></td> <td style="width: 10%;"></td> <td style="width: 10%;"></td> <td style="width: 10%;"></td> <td style="width: 10%;"></td> </tr> <tr> <td></td> <td></td> <td colspan="8" style="text-align: center;"> <table border="1" style="width: 100%; border-collapse: collapse; text-align: center;"> <tr> <td style="width: 10%;"></td> <td style="width: 10%;"></td> <td style="width: 10%;"></td> <td style="width: 10%;"></td> <td style="width: 10%;"></td> <td style="width: 10%;"></td> <td style="width: 10%;"></td> <td style="width: 10%;"></td> <td style="width: 10%;"></td> <td style="width: 10%;"></td> </tr> <tr> <td></td> <td></td> <td colspan="8" style="text-align: center;"> <table border="1" style="width: 100%; border-collapse: collapse; text-align: center;"> <tr> <td style="width: 10%;"></td> <td style="width: 10%;"></td> <td style="width: 10%;"></td> <td style="width: 10%;"></td> <td style="width: 10%;"></td> <td style="width: 10%;"></td> <td style="width: 10%;"></td> <td style="width: 10%;"></td> <td style="width: 10%;"></td> <td style="width: 10%;"></td> </tr> <tr> <td></td> <td></td> <td colspan="8" style="text-align: center;"> <table border="1" style="width: 100%; border-collapse: collapse; text-align: center;"> <tr> <td style="width: 10%;"></td> <td style="width: 10%;"></td> <td style="width: 10%;"></td> <td style="width: 10%;"></td> <td style="width: 10%;"></td> <td style="width: 10%;"></td> <td style="width: 10%;"></td> <td style="width: 10%;"></td> <td style="width: 10%;"></td> <td style="width: 10%;"></td> </tr> <tr> <td></td> <td></td> <td colspan="8" style="text-align: center;"> <table border="1" style="width: 100%; border-collapse: collapse; text-align: center;"> <tr> <td style="width: 10%;"></td> <td style="width: 10%;"></td> <td style="width: 10%;"></td> <td style="width: 10%;"></td> <td style="width: 10%;"></td> <td style="width: 10%;"></td> <td style="width: 10%;"></td> <td style="width: 10%;"></td> <td style="width: 10%;"></td> <td style="width: 10%;"></td> </tr> <tr> <td></td> <td></td> <td colspan="8" style="text-align: center;"> <table border="1" style="width: 100%; border-collapse: collapse; text-align: center;"> <tr> <td style="width: 10%;"></td> <td style="width: 10%;"></td> <td style="width: 10%;"></td> <td style="width: 10%;"></td> <td style="width: 10%;"></td> <td style="width: 10%;"></td> <td style="width: 10%;"></td> <td style="width: 10%;"></td> <td style="width: 10%;"></td> <td style="width: 10%;"></td> </tr> <tr> <td></td> <td></td> <td colspan="8" style="text-align: center;"> <table border="1" style="width: 100%; border-collapse: collapse; text-align: center;"> <tr> <td style="width: 10%;"></td> <td style="width: 10%;"></td> <td style="width: 10%;"></td> <td style="width: 10%;"></td> <td style="width: 10%;"></td> <td style="width: 10%;"></td> <td style="width: 10%;"></td> <td style="width: 10%;"></td> <td style="width: 10%;"></td> <td style="width: 10%;"></td> </tr> <tr> <td></td> <td></td> <td colspan="8" style="text-align: center;"> <table border="1" style="width: 100%; border-collapse: collapse; text-align: center;"> <tr> <td style="width: 10%;"></td> <td style="width: 10%;"></td> <td style="width: 10%;"></td> <td style="width: 10%;"></td> <td style="width: 10%;"></td> <td style="width: 10%;"></td> <td style="width: 10%;"></td> <td style="width: 10%;"></td> <td style="width: 10%;"></td> <td style="width: 10%;"></td> </tr> <tr> <td></td> <td></td> <td colspan="8" style="text-align: center;"> <table border="1" style="width: 100%; border-collapse: collapse; text-align: center;"> <tr> <td style="width: 10%;"></td> <td style="width: 10%;"></td> <td style="width: 10%;"></td> <td style="width: 10%;"></td> <td style="width: 10%;"></td> <td style="width: 10%;"></td> <td style="width: 10%;"></td> <td style="width: 10%;"></td> <td style="width: 10%;"></td> <td style="width: 10%;"></td> </tr> <tr> <td></td> <td></td> <td colspan="8" style="text-align: center;"> <table border="1" style="width: 100%; border-collapse: collapse; text-align: center;"> <tr> <td style="width: 10%;"></td> <td style="width: 10%;"></td> <td style="width: 10%;"></td> <td style="width: 10%;"></td> <td style="width: 10%;"></td> <td style="width: 10%;"></td> <td style="width: 10%;"></td> <td style="width: 10%;"></td> <td style="width: 10%;"></td> <td style="width: 10%;"></td> </tr> <tr> <td></td> <td></td> <td colspan="8" style="text-align: center;"> <table border="1" style="width: 100%; border-collapse: collapse; text-align: center;"> <tr> <td style="width: 10%;"></td> <td style="width: 10%;"></td> <td style="width: 10%;"></td> <td style="width: 10%;"></td> <td style="width: 10%;"></td> <td style="width: 10%;"></td> <td style="width: 10%;"></td> <td style="width: 10%;"></td> <td style="width: 10%;"></td> <td style="width: 10%;"></td> </tr> <tr> <td></td> <td></td> <td colspan="8" style="text-align: center;"> <table border="1" style="width: 100%; border-collapse: collapse; text-align: center;"> <tr> <td style="width: 10%;"></td> <td style="width: 10%;"></td> <td style="width: 10%;"></td> <td style="width: 10%;"></td> <td style="width: 10%;"></td> <td style="width: 10%;"></td> <td style="width: 10%;"></td> <td style="width: 10%;"></td> <td style="width: 10%;"></td> <td style="width: 10%;"></td> </tr> <tr> <td></td> <td></td> <td colspan="8" style="text-align: center;"> <table border="1" style="width: 100%; border-collapse: collapse; text-align: center;"> <tr> <td style="width: 10%;"></td> <td style="width: 10%;"></td> <td style="width: 10%;"></td> <td style="width: 10%;"></td> <td style="width: 10%;"></td> <td style="width: 10%;"></td> <td style="width: 10%;"></td> <td style="width: 10%;"></td> <td style="width: 10%;"></td> <td style="width: 10%;"></td> </tr> <tr> <td></td> <td></td> <td colspan="8" style="text-align: center;"> <table border="1"
style="width: 100%; border-collapse: collapse; text-align: center;"> <tr> <td style="width: 10%;"></td> <td style="width: 10%;"></td> <td style="width: 10%;"></td> <td style="width: 10%;"></td> <td style="width: 10%;"></td> <td style="width: 10%;"></td> <td style="width: 10%;"></td> <td style="width: 10%;"></td> <td style="width: 10%;"></td> <td style="width: 10%;"></td> </tr> <tr> <td></td> <td></td> <td colspan="8" style="text-align: center;"> <table border="1" style="width: 100%; border-collapse: collapse; text-align: center;"> <tr> <td style="width: 10%;"></td> <td style="width: 10%;"></td> <td style="width: 10%;"></td> <td style="width: 10%;"></td> <td style="width: 10%;"></td> <td style="width: 10%;"></td> <td style="width: 10%;"></td> <td style="width: 10%;"></td> <td style="width: 10%;"></td> <td style="width: 10%;"></td> </tr> <tr> <td></td> <td></td> <td colspan="8" style="text-align: center;"> <table border="1" style="width: 100%; border-collapse: collapse; text-align: center;"> <tr> </tr></table></td></tr></table></td></tr></table></td></tr></table></td></tr></table></td></tr></table></td></tr></table></td></tr></table></td></tr></table></td></tr></table></td></tr></table></td></tr></table></td></tr></table></td></tr></table></td></tr></table></td></tr></table></td></tr></table></td></tr></table></td></tr></table></td></tr></table></td></tr></table></td></tr></table></td></tr></table></td></tr></table></td></tr></table></td></tr></table></td></tr></table></td></tr></table></td></tr></table></td></tr></table></td></tr></table></td></tr></table></td></tr></table></td></tr></table></td></tr></table></td></tr></table></td></tr></table></td></tr></table></td></tr></table></td></tr></table></td></tr></table></td></tr></table></td></tr></table></td></tr></table></td></tr></table></td></tr></table></td></tr></table></td></tr></table></td></tr></table></td></tr></table></td></tr></table></td></tr></table></td></tr></table></td></tr></table></td></tr></table></td></tr></table></td></tr></table></td></tr></table></td></tr></table></td></tr></table></td></tr></table> | | | | | | | | | | | | | | | | | | | | <table border="1" style="width: 100%; border-collapse: collapse; text-align: center;"> <tr> <td style="width: 10%;"></td> <td style="width: 10%;"></td> <td style="width: 10%;"></td> <td style="width: 10%;"></td> <td style="width: 10%;"></td> <td style="width: 10%;"></td> <td style="width: 10%;"></td> <td style="width: 10%;"></td> <td style="width: 10%;"></td> <td style="width: 10%;"></td> </tr> <tr> <td></td> <td></td> <td colspan="8" style="text-align: center;"> <table border="1" style="width: 100%; border-collapse: collapse; text-align: center;"> <tr> <td style="width: 10%;"></td> <td style="width: 10%;"></td> <td style="width: 10%;"></td> <td style="width: 10%;"></td> <td style="width: 10%;"></td> <td style="width: 10%;"></td> <td style="width: 10%;"></td> <td style="width: 10%;"></td> <td style="width: 10%;"></td> <td style="width: 10%;"></td> </tr> <tr> <td></td> <td></td> <td colspan="8" style="text-align: center;"> <table border="1" style="width: 100%; border-collapse: collapse; text-align: center;"> <tr> <td style="width: 10%;"></td> <td style="width: 10%;"></td> <td style="width: 10%;"></td> <td style="width: 10%;"></td> <td style="width: 10%;"></td> <td style="width: 10%;"></td> <td style="width: 10%;"></td> <td style="width: 10%;"></td> <td style="width: 10%;"></td> <td style="width: 10%;"></td> </tr> <tr> <td></td> <td></td> <td colspan="8" style="text-align: center;"> <table border="1" style="width: 100%; border-collapse: collapse; text-align: center;"> <tr> <td style="width: 10%;"></td> <td style="width: 10%;"></td> <td style="width: 10%;"></td> <td style="width: 10%;"></td> <td style="width: 10%;"></td> <td style="width: 10%;"></td> <td style="width: 10%;"></td> <td style="width: 10%;"></td> <td style="width: 10%;"></td> <td style="width: 10%;"></td> </tr> <tr> <td></td> <td></td> <td colspan="8" style="text-align: center;"> <table border="1" style="width: 100%; border-collapse: collapse; text-align: center;"> <tr> <td style="width: 10%;"></td> <td style="width: 10%;"></td> <td style="width: 10%;"></td> <td style="width: 10%;"></td> <td style="width: 10%;"></td> <td style="width: 10%;"></td> <td style="width: 10%;"></td> <td style="width: 10%;"></td> <td style="width: 10%;"></td> <td style="width: 10%;"></td> </tr> <tr> <td></td> <td></td> <td colspan="8" style="text-align: center;"> <table border="1" style="width: 100%; border-collapse: collapse; text-align: center;"> <tr> <td style="width: 10%;"></td> <td style="width: 10%;"></td> <td style="width: 10%;"></td> <td style="width: 10%;"></td> <td style="width: 10%;"></td> <td style="width: 10%;"></td> <td style="width: 10%;"></td> <td style="width: 10%;"></td> <td style="width: 10%;"></td> <td style="width: 10%;"></td> </tr> <tr> <td></td> <td></td> <td colspan="8" style="text-align: center;"> <table border="1" style="width: 100%; border-collapse: collapse; text-align: center;"> <tr> <td style="width: 10%;"></td> <td style="width: 10%;"></td> <td style="width: 10%;"></td> <td style="width: 10%;"></td> <td style="width: 10%;"></td> <td style="width: 10%;"></td> <td style="width: 10%;"></td> <td style="width: 10%;"></td> <td style="width: 10%;"></td> <td style="width: 10%;"></td> </tr> <tr> <td></td> <td></td> <td colspan="8" style="text-align: center;"> <table border="1" style="width: 100%; border-collapse: collapse; text-align: center;"> <tr> <td style="width: 10%;"></td> <td style="width: 10%;"></td> <td style="width: 10%;"></td> <td style="width: 10%;"></td> <td style="width: 10%;"></td> <td style="width: 10%;"></td> <td style="width: 10%;"></td> <td style="width: 10%;"></td> <td style="width: 10%;"></td> <td style="width: 10%;"></td> </tr> <tr> <td></td> <td></td> <td colspan="8" style="text-align: center;"> <table border="1" style="width: 100%; border-collapse: collapse; text-align: center;"> <tr> <td style="width: 10%;"></td> <td style="width: 10%;"></td> <td style="width: 10%;"></td> <td style="width: 10%;"></td> <td style="width: 10%;"></td> <td style="width: 10%;"></td> <td style="width: 10%;"></td> <td style="width: 10%;"></td> <td style="width: 10%;"></td> <td style="width: 10%;"></td> </tr> <tr> <td></td> <td></td> <td colspan="8" style="text-align: center;"> <table border="1" style="width: 100%; border-collapse: collapse; text-align: center;"> <tr> <td style="width: 10%;"></td> <td style="width: 10%;"></td> <td style="width: 10%;"></td> <td style="width: 10%;"></td> <td style="width: 10%;"></td> <td style="width: 10%;"></td> <td style="width: 10%;"></td> <td style="width: 10%;"></td> <td style="width: 10%;"></td> <td style="width: 10%;"></td> </tr> <tr> <td></td> <td></td> <td colspan="8" style="text-align: center;"> <table border="1" style="width: 100%; border-collapse: collapse; text-align: center;"> <tr> <td style="width: 10%;"></td> <td style="width: 10%;"></td> <td style="width: 10%;"></td> <td style="width: 10%;"></td> <td style="width: 10%;"></td> <td style="width: 10%;"></td> <td style="width: 10%;"></td> <td style="width: 10%;"></td> <td style="width: 10%;"></td> <td style="width: 10%;"></td> </tr> <tr> <td></td> <td></td> <td colspan="8" style="text-align: center;"> <table border="1" style="width: 100%; border-collapse: collapse; text-align: center;"> <tr> <td style="width: 10%;"></td> <td style="width: 10%;"></td> <td style="width: 10%;"></td> <td style="width: 10%;"></td> <td style="width: 10%;"></td> <td style="width: 10%;"></td> <td style="width: 10%;"></td> <td style="width: 10%;"></td> <td style="width: 10%;"></td> <td style="width: 10%;"></td> </tr> <tr> <td></td> <td></td> <td colspan="8" style="text-align: center;"> <table border="1" style="width: 100%; border-collapse: collapse; text-align: center;"> <tr> <td style="width: 10%;"></td> <td style="width: 10%;"></td> <td style="width: 10%;"></td> <td style="width: 10%;"></td> <td style="width: 10%;"></td> <td style="width: 10%;"></td> <td style="width: 10%;"></td> <td style="width: 10%;"></td> <td style="width: 10%;"></td> <td style="width: 10%;"></td> </tr> <tr> <td></td> <td></td> <td colspan="8" style="text-align: center;"> <table border="1" style="width: 100%; border-collapse: collapse; text-align: center;"> <tr> <td style="width: 10%;"></td> <td style="width: 10%;"></td> <td style="width: 10%;"></td> <td style="width: 10%;"></td> <td style="width: 10%;"></td> <td style="width: 10%;"></td> <td style="width: 10%;"></td> <td style="width: 10%;"></td> <td style="width: 10%;"></td> <td style="width: 10%;"></td> </tr> <tr> <td></td> <td></td> <td colspan="8" style="text-align: center;"> <table border="1" style="width: 100%; border-collapse: collapse; text-align: center;"> <tr> <td style="width: 10%;"></td> <td style="width: 10%;"></td> <td style="width: 10%;"></td> <td style="width: 10%;"></td> <td style="width: 10%;"></td> <td style="width: 10%;"></td> <td style="width: 10%;"></td> <td style="width: 10%;"></td> <td style="width: 10%;"></td> <td style="width: 10%;"></td> </tr> <tr> <td></td> <td></td> <td colspan="8" style="text-align: center;"> <table border="1" style="width: 100%; border-collapse: collapse; text-align: center;"> <tr> <td style="width: 10%;"></td> <td style="width: 10%;"></td> <td style="width: 10%;"></td> <td style="width: 10%;"></td> <td style="width: 10%;"></td> <td style="width: 10%;"></td> <td style="width: 10%;"></td> <td style="width:
10%;"></td> <td style="width: 10%;"></td> <td style="width: 10%;"></td> </tr> <tr> <td></td> <td></td> <td colspan="8" style="text-align: center;"> <table border="1" style="width: 100%; border-collapse: collapse; text-align: center;"> <tr> <td style="width: 10%;"></td> <td style="width: 10%;"></td> <td style="width: 10%;"></td> <td style="width: 10%;"></td> <td style="width: 10%;"></td> <td style="width: 10%;"></td> <td style="width: 10%;"></td> <td style="width: 10%;"></td> <td style="width: 10%;"></td> <td style="width: 10%;"></td> </tr> <tr> <td></td> <td></td> <td colspan="8" style="text-align: center;"> <table border="1" style="width: 100%; border-collapse: collapse; text-align: center;"> <tr> <td style="width: 10%;"></td> <td style="width: 10%;"></td> <td style="width: 10%;"></td> <td style="width: 10%;"></td> <td style="width: 10%;"></td> <td style="width: 10%;"></td> <td style="width: 10%;"></td> <td style="width: 10%;"></td> <td style="width: 10%;"></td> <td style="width: 10%;"></td> </tr> <tr> <td></td> <td></td> <td colspan="8" style="text-align: center;"> <table border="1" style="width: 100%; border-collapse: collapse; text-align: center;"> <tr> <td style="width: 10%;"></td> <td style="width: 10%;"></td> <td style="width: 10%;"></td> <td style="width: 10%;"></td> <td style="width: 10%;"></td> <td style="width: 10%;"></td> <td style="width: 10%;"></td> <td style="width: 10%;"></td> <td style="width: 10%;"></td> <td style="width: 10%;"></td> </tr> <tr> <td></td> <td></td> <td colspan="8" style="text-align: center;"> <table border="1" style="width: 100%; border-collapse: collapse; text-align: center;"> <tr> <td style="width: 10%;"></td> <td style="width: 10%;"></td> <td style="width: 10%;"></td> <td style="width: 10%;"></td> <td style="width: 10%;"></td> <td style="width: 10%;"></td> <td style="width: 10%;"></td> <td style="width: 10%;"></td> <td style="width: 10%;"></td> <td style="width: 10%;"></td> </tr> <tr> <td></td> <td></td> <td colspan="8" style="text-align: center;"> <table border="1" style="width: 100%; border-collapse: collapse; text-align: center;"> <tr> <td style="width: 10%;"></td> <td style="width: 10%;"></td> <td style="width: 10%;"></td> <td style="width: 10%;"></td> <td style="width: 10%;"></td> <td style="width: 10%;"></td> <td style="width: 10%;"></td> <td style="width: 10%;"></td> <td style="width: 10%;"></td> <td style="width: 10%;"></td> </tr> <tr> <td></td> <td></td> <td colspan="8" style="text-align: center;"> <table border="1" style="width: 100%; border-collapse: collapse; text-align: center;"> <tr> <td style="width: 10%;"></td> <td style="width: 10%;"></td> <td style="width: 10%;"></td> <td style="width: 10%;"></td> <td style="width: 10%;"></td> <td style="width: 10%;"></td> <td style="width: 10%;"></td> <td style="width: 10%;"></td> <td style="width: 10%;"></td> <td style="width: 10%;"></td> </tr> <tr> <td></td> <td></td> <td colspan="8" style="text-align: center;"> <table border="1" style="width: 100%; border-collapse: collapse; text-align: center;"> <tr> <td style="width: 10%;"></td> <td style="width: 10%;"></td> <td style="width: 10%;"></td> <td style="width: 10%;"></td> <td style="width: 10%;"></td> <td style="width: 10%;"></td> <td style="width: 10%;"></td> <td style="width: 10%;"></td> <td style="width: 10%;"></td> <td style="width: 10%;"></td> </tr> <tr> <td></td> <td></td> <td colspan="8" style="text-align: center;"> <table border="1" style="width: 100%; border-collapse: collapse; text-align: center;"> <tr> <td style="width: 10%;"></td> <td style="width: 10%;"></td> <td style="width: 10%;"></td> <td style="width: 10%;"></td> <td style="width: 10%;"></td> <td style="width: 10%;"></td> <td style="width: 10%;"></td> <td style="width: 10%;"></td> <td style="width: 10%;"></td> <td style="width: 10%;"></td> </tr> <tr> <td></td> <td></td> <td colspan="8" style="text-align: center;"> <table border="1" style="width: 100%; border-collapse: collapse; text-align: center;"> <tr> <td style="width: 10%;"></td> <td style="width: 10%;"></td> <td style="width: 10%;"></td> <td style="width: 10%;"></td> <td style="width: 10%;"></td> <td style="width: 10%;"></td> <td style="width: 10%;"></td> <td style="width: 10%;"></td> <td style="width: 10%;"></td> <td style="width: 10%;"></td> </tr> <tr> <td></td> <td></td> <td colspan="8" style="text-align: center;"> <table border="1" style="width: 100%; border-collapse: collapse; text-align: center;"> <tr> <td style="width: 10%;"></td> <td style="width: 10%;"></td> <td style="width: 10%;"></td> <td style="width: 10%;"></td> <td style="width: 10%;"></td> <td style="width: 10%;"></td> <td style="width: 10%;"></td> <td style="width: 10%;"></td> <td style="width: 10%;"></td> <td style="width: 10%;"></td> </tr> <tr> <td></td> <td></td> <td colspan="8" style="text-align: center;"> <table border="1" style="width: 100%; border-collapse: collapse; text-align: center;"> <tr> <td style="width: 10%;"></td> <td style="width: 10%;"></td> <td style="width: 10%;"></td> <td style="width: 10%;"></td> <td style="width: 10%;"></td> <td style="width: 10%;"></td> <td style="width: 10%;"></td> <td style="width: 10%;"></td> <td style="width: 10%;"></td> <td style="width: 10%;"></td> </tr> <tr> <td></td> <td></td> <td colspan="8" style="text-align: center;"> <table border="1" style="width: 100%; border-collapse: collapse; text-align: center;"> <tr> <td style="width: 10%;"></td> <td style="width: 10%;"></td> <td style="width: 10%;"></td> <td style="width: 10%;"></td> <td style="width: 10%;"></td> <td style="width: 10%;"></td> <td style="width: 10%;"></td> <td style="width: 10%;"></td> <td style="width: 10%;"></td> <td style="width: 10%;"></td> </tr> <tr> <td></td> <td></td> <td colspan="8" style="text-align: center;"> <table border="1" style="width: 100%; border-collapse: collapse; text-align: center;"> <tr> <td style="width: 10%;"></td> <td style="width: 10%;"></td> <td style="width: 10%;"></td> <td style="width: 10%;"></td> <td style="width: 10%;"></td> <td style="width: 10%;"></td> <td style="width: 10%;"></td> <td style="width: 10%;"></td> <td style="width: 10%;"></td> <td style="width: 10%;"></td> </tr> <tr> <td></td> <td></td> <td colspan="8" style="text-align: center;"> <table border="1" style="width: 100%; border-collapse: collapse; text-align: center;"> <tr> <td style="width: 10%;"></td> <td style="width: 10%;"></td> <td style="width: 10%;"></td> <td style="width: 10%;"></td> <td style="width: 10%;"></td> <td style="width: 10%;"></td> <td style="width: 10%;"></td> <td style="width: 10%;"></td> <td style="width: 10%;"></td> <td style="width: 10%;"></td> </tr> <tr> <td></td> <td></td> <td colspan="8" style="text-align: center;"> <table border="1" style="width: 100%; border-collapse: collapse; text-align: center;"> <tr> <td style="width: 10%;"></td> <td style="width: 10%;"></td> <td style="width: 10%;"></td> <td style="width: 10%;"></td> <td style="width: 10%;"></td> <td style="width: 10%;"></td> <td style="width: 10%;"></td> <td style="width: 10%;"></td> <td style="width: 10%;"></td> <td style="width: 10%;"></td> </tr> <tr> <td></td> <td></td> <td colspan="8" style="text-align: center;"> <table border="1" style="width: 100%; border-collapse: collapse; text-align: center;"> <tr> <td style="width: 10%;"></td> <td style="width: 10%;"></td> <td style="width: 10%;"></td> <td style="width: 10%;"></td> <td style="width: 10%;"></td> <td style="width: 10%;"></td> <td style="width: 10%;"></td> <td style="width: 10%;"></td> <td style="width: 10%;"></td> <td style="width: 10%;"></td> </tr> <tr> <td></td> <td></td> <td colspan="8" style="text-align: center;"> <table border="1" style="width: 100%; border-collapse: collapse; text-align: center;"> <tr> <td style="width: 10%;"></td> <td style="width: 10%;"></td> <td style="width: 10%;"></td> <td style="width: 10%;"></td> <td style="width: 10%;"></td> <td style="width: 10%;"></td> <td style="width: 10%;"></td> <td style="width: 10%;"></td> <td style="width: 10%;"></td> <td style="width: 10%;"></td> </tr> <tr> <td></td> <td></td> <td colspan="8" style="text-align: center;"> <table border="1" style="width: 100%; border-collapse: collapse; text-align: center;"> <tr> <td style="width: 10%;"></td> <td style="width: 10%;"></td> <td style="width: 10%;"></td> <td style="width: 10%;"></td> <td style="width: 10%;"></td> <td style="width: 10%;"></td> <td style="width: 10%;"></td> <td style="width: 10%;"></td> <td style="width: 10%;"></td> <td style="width: 10%;"></td> </tr> <tr> <td></td> <td></td> <td colspan="8" style="text-align: center;"> <table border="1" style="width: 100%; border-collapse: collapse; text-align: center;"> <tr> <td style="width: 10%;"></td> <td style="width: 10%;"></td> <td style="width: 10%;"></td> <td style="width: 10%;"></td> <td style="width: 10%;"></td> <td style="width: 10%;"></td> <td style="width: 10%;"></td> <td style="width: 10%;"></td> <td style="width: 10%;"></td> <td style="width: 10%;"></td> </tr> <tr> <td></td> <td></td> <td colspan="8" style="text-align: center;"> <table border="1" style="width: 100%; border-collapse: collapse; text-align: center;"> <tr> <td style="width: 10%;"></td> <td style="width: 10%;"></td> <td style="width: 10%;"></td> <td style="width: 10%;"></td> <td style="width: 10%;"></td> <td style="width: 10%;"></td> <td style="width: 10%;"></td> <td style="width: 10%;"></td> <td style="width: 10%;"></td> <td style="width: 10%;"></td> </tr> <tr> <td></td> <td></td> <td colspan="8" style="text-align: center;"> <table border="1" style="width: 100%; border-collapse: collapse; text-align: center;"> <tr> <td style="width: 10%;"></td> <td style="width: 10%;"></td> <td style="width: 10%;"></td> <td style="width: 10%;"></td> <td style="width: 10%;"></td> <td style="width: 10%;"></td> <td style="width: 10%;"></td> <td style="width: 10%;"></td> <td style="width: 10%;"></td> <td style="width: 10%;"></td> </tr> <tr> <td></td> <td></td> <td colspan="8" style="text-align: center;"> <table border="1"
style="width: 100%; border-collapse: collapse; text-align: center;"> <tr> <td style="width: 10%;"></td> <td style="width: 10%;"></td> <td style="width: 10%;"></td> <td style="width: 10%;"></td> <td style="width: 10%;"></td> <td style="width: 10%;"></td> <td style="width: 10%;"></td> <td style="width: 10%;"></td> <td style="width: 10%;"></td> <td style="width: 10%;"></td> </tr> <tr> <td></td> <td></td> <td colspan="8" style="text-align: center;"> <table border="1" style="width: 100%; border-collapse: collapse; text-align: center;"> <tr> <td style="width: 10%;"></td> <td style="width: 10%;"></td> <td style="width: 10%;"></td> <td style="width: 10%;"></td> <td style="width: 10%;"></td> <td style="width: 10%;"></td> <td style="width: 10%;"></td> <td style="width: 10%;"></td> <td style="width: 10%;"></td> <td style="width: 10%;"></td> </tr> <tr> <td></td> <td></td> <td colspan="8" style="text-align: center;"> <table border="1" style="width: 100%; border-collapse: collapse; text-align: center;"> <tr> <td style="width: 10%;"></td> <td style="width: 10%;"></td> <td style="width: 10%;"></td> <td style="width: 10%;"></td> <td style="width: 10%;"></td> <td style="width: 10%;"></td> <td style="width: 10%;"></td> <td style="width: 10%;"></td> <td style="width: 10%;"></td> <td style="width: 10%;"></td> </tr> <tr> <td></td> <td></td> <td colspan="8" style="text-align: center;"> <table border="1" style="width: 100%; border-collapse: collapse; text-align: center;"> <tr> <td style="width: 10%;"></td> <td style="width: 10%;"></td> <td style="width: 10%;"></td> <td style="width: 10%;"></td> <td style="width: 10%;"></td> <td style="width: 10%;"></td> <td style="width: 10%;"></td> <td style="width: 10%;"></td> <td style="width: 10%;"></td> <td style="width: 10%;"></td> </tr> <tr> <td></td> <td></td> <td colspan="8" style="text-align: center;"> <table border="1" style="width: 100%; border-collapse: collapse; text-align: center;"> <tr> <td style="width: 10%;"></td> <td style="width: 10%;"></td> <td style="width: 10%;"></td> <td style="width: 10%;"></td> <td style="width: 10%;"></td> <td style="width: 10%;"></td> <td style="width: 10%;"></td> <td style="width: 10%;"></td> <td style="width: 10%;"></td> <td style="width: 10%;"></td> </tr> <tr> <td></td> <td></td> <td colspan="8" style="text-align: center;"> <table border="1" style="width: 100%; border-collapse: collapse; text-align: center;"> <tr> <td style="width: 10%;"></td> <td style="width: 10%;"></td> <td style="width: 10%;"></td> <td style="width: 10%;"></td> <td style="width: 10%;"></td> <td style="width: 10%;"></td> <td style="width: 10%;"></td> <td style="width: 10%;"></td> <td style="width: 10%;"></td> <td style="width: 10%;"></td> </tr> <tr> <td></td> <td></td> <td colspan="8" style="text-align: center;"> <table border="1" style="width: 100%; border-collapse: collapse; text-align: center;"> <tr> <td style="width: 10%;"></td> <td style="width: 10%;"></td> <td style="width: 10%;"></td> <td style="width: 10%;"></td> <td style="width: 10%;"></td> <td style="width: 10%;"></td> <td style="width: 10%;"></td> <td style="width: 10%;"></td> <td style="width: 10%;"></td> <td style="width: 10%;"></td> </tr> <tr> <td></td> <td></td> <td colspan="8" style="text-align: center;"> <table border="1" style="width: 100%; border-collapse: collapse; text-align: center;"> <tr> <td style="width: 10%;"></td> <td style="width: 10%;"></td> <td style="width: 10%;"></td> <td style="width: 10%;"></td> <td style="width: 10%;"></td> <td style="width: 10%;"></td> <td style="width: 10%;"></td> <td style="width: 10%;"></td> <td style="width: 10%;"></td> <td style="width: 10%;"></td> </tr> <tr> <td></td> <td></td> <td colspan="8" style="text-align: center;"> <table border="1" style="width: 100%; border-collapse: collapse; text-align: center;"> <tr> <td style="width: 10%;"></td> <td style="width: 10%;"></td> <td style="width: 10%;"></td> <td style="width: 10%;"></td> <td style="width: 10%;"></td> <td style="width: 10%;"></td> <td style="width: 10%;"></td> <td style="width: 10%;"></td> <td style="width: 10%;"></td> <td style="width: 10%;"></td> </tr> <tr> <td></td> <td></td> <td colspan="8" style="text-align: center;"> <table border="1" style="width: 100%; border-collapse: collapse; text-align: center;"> <tr> <td style="width: 10%;"></td> <td style="width: 10%;"></td> <td style="width: 10%;"></td> <td style="width: 10%;"></td> <td style="width: 10%;"></td> <td style="width: 10%;"></td> <td style="width: 10%;"></td> <td style="width: 10%;"></td> <td style="width: 10%;"></td> <td style="width: 10%;"></td> </tr> <tr> <td></td> <td></td> <td colspan="8" style="text-align: center;"> <table border="1" style="width: 100%; border-collapse: collapse; text-align: center;"> <tr> <td style="width: 10%;"></td> <td style="width: 10%;"></td> <td style="width: 10%;"></td> <td style="width: 10%;"></td> <td style="width: 10%;"></td> <td style="width: 10%;"></td> <td style="width: 10%;"></td> <td style="width: 10%;"></td> <td style="width: 10%;"></td> <td style="width: 10%;"></td> </tr> <tr> <td></td> <td></td> <td colspan="8" style="text-align: center;"> <table border="1" style="width: 100%; border-collapse: collapse; text-align: center;"> <tr> <td style="width: 10%;"></td> <td style="width: 10%;"></td> <td style="width: 10%;"></td> <td style="width: 10%;"></td> <td style="width: 10%;"></td> <td style="width: 10%;"></td> <td style="width: 10%;"></td> <td style="width: 10%;"></td> <td style="width: 10%;"></td> <td style="width: 10%;"></td> </tr> <tr> <td></td> <td></td> <td colspan="8" style="text-align: center;"> <table border="1" style="width: 100%; border-collapse: collapse; text-align: center;"> <tr> <td style="width: 10%;"></td> <td style="width: 10%;"></td> <td style="width: 10%;"></td> <td style="width: 10%;"></td> <td style="width: 10%;"></td> <td style="width: 10%;"></td> <td style="width: 10%;"></td> <td style="width: 10%;"></td> <td style="width: 10%;"></td> <td style="width: 10%;"></td> </tr> <tr> <td></td> <td></td> <td colspan="8" style="text-align: center;"> <table border="1" style="width: 100%; border-collapse: collapse; text-align: center;"> <tr> <td style="width: 10%;"></td> <td style="width: 10%;"></td> <td style="width: 10%;"></td> <td style="width: 10%;"></td> <td style="width: 10%;"></td> <td style="width: 10%;"></td> <td style="width: 10%;"></td> <td style="width: 10%;"></td> <td style="width: 10%;"></td> <td style="width: 10%;"></td> </tr> <tr> <td></td> <td></td> <td colspan="8" style="text-align: center;"> <table border="1" style="width: 100%; border-collapse: collapse; text-align: center;"> <tr> <td style="width: 10%;"></td> <td style="width: 10%;"></td> <td style="width: 10%;"></td> <td style="width: 10%;"></td> <td style="width: 10%;"></td> <td style="width: 10%;"></td> <td style="width: 10%;"></td> <td style="width: 10%;"></td> <td style="width: 10%;"></td> <td style="width: 10%;"></td> </tr> <tr> <td></td> <td></td> <td colspan="8" style="text-align: center;"> <table border="1" style="width: 100%; border-collapse: collapse; text-align: center;"> <tr> <td style="width: 10%;"></td> <td style="width: 10%;"></td> <td style="width: 10%;"></td> <td style="width: 10%;"></td> <td style="width: 10%;"></td> <td style="width: 10%;"></td> <td style="width: 10%;"></td> <td style="width: 10%;"></td> <td style="width: 10%;"></td> <td style="width: 10%;"></td> </tr> <tr> <td></td> <td></td> <td colspan="8" style="text-align: center;"> <table border="1" style="width: 100%; border-collapse: collapse; text-align: center;"> <tr> <td style="width: 10%;"></td> <td style="width: 10%;"></td> <td style="width: 10%;"></td> <td style="width: 10%;"></td> <td style="width: 10%;"></td> <td style="width: 10%;"></td> <td style="width: 10%;"></td> <td style="width: 10%;"></td> <td style="width: 10%;"></td> <td style="width: 10%;"></td> </tr> <tr> <td></td> <td></td> <td colspan="8" style="text-align: center;"> <table border="1" style="width: 100%; border-collapse: collapse; text-align: center;"> <tr> <td style="width: 10%;"></td> <td style="width: 10%;"></td> <td style="width: 10%;"></td> <td style="width: 10%;"></td> <td style="width: 10%;"></td> <td style="width: 10%;"></td> <td style="width: 10%;"></td> <td style="width: 10%;"></td> <td style="width: 10%;"></td> <td style="width: 10%;"></td> </tr> <tr> <td></td> <td></td> <td colspan="8" style="text-align: center;"> <table border="1" style="width: 100%; border-collapse: collapse; text-align: center;"> <tr> <td style="width: 10%;"></td> <td style="width: 10%;"></td> <td style="width: 10%;"></td> <td style="width: 10%;"></td> <td style="width: 10%;"></td> <td style="width: 10%;"></td> <td style="width: 10%;"></td> <td style="width: 10%;"></td> <td style="width: 10%;"></td> <td style="width: 10%;"></td> </tr> <tr> <td></td> <td></td> <td colspan="8" style="text-align: center;"> <table border="1" style="width: 100%; border-collapse: collapse; text-align: center;"> <tr> <td style="width: 10%;"></td> <td style="width: 10%;"></td> <td style="width: 10%;"></td> <td style="width: 10%;"></td> <td style="width: 10%;"></td> <td style="width: 10%;"></td> <td style="width: 10%;"></td> <td style="width: 10%;"></td> <td style="width: 10%;"></td> <td style="width: 10%;"></td> </tr> <tr> <td></td> <td></td> <td colspan="8" style="text-align: center;"> <table border="1" style="width: 100%; border-collapse: collapse; text-align: center;"> <tr> <td style="width: 10%;"></td> <td style="width: 10%;"></td> <td style="width: 10%;"></td> <td style="width: 10%;"></td> <td style="width: 10%;"></td> <td style="width: 10%;"></td> <td style="width: 10%;"></td> <td style="width: 10%;"></td> <td style="width: 10%;"></td> <td style="width: 10%;"></td> </tr> <tr> <td></td> <td></td> <td colspan="8" style="text-align: center;"> <table border="1" style="width: 100%; border-collapse: collapse; text-align: center;"> <tr> <td style="width: 10%;"></td> <td style="width: 10%;"></td> <td style="width: 10%;"></td> <td
style="width: 10%;"></td> <td style="width: 10%;"></td> <td style="width: 10%;"></td> <td style="width: 10%;"></td> <td style="width: 10%;"></td> <td style="width: 10%;"></td> <td style="width: 10%;"></td> </tr> <tr> <td></td> <td></td> <td colspan="8" style="text-align: center;"> <table border="1" style="width: 100%; border-collapse: collapse; text-align: center;"> <tr> </tr></table></td></tr></table></td></tr></table></td></tr></table></td></tr></table></td></tr></table></td></tr></table></td></tr></table></td></tr></table></td></tr></table></td></tr></table></td></tr></table></td></tr></table></td></tr></table></td></tr></table></td></tr></table></td></tr></table></td></tr></table></td></tr></table></td></tr></table></td></tr></table></td></tr></table></td></tr></table></td></tr></table></td></tr></table></td></tr></table></td></tr></table></td></tr></table></td></tr></table></td></tr></table></td></tr></table></td></tr></table></td></tr></table></td></tr></table></td></tr></table></td></tr></table></td></tr></table></td></tr></table></td></tr></table></td></tr></table></td></tr></table></td></tr></table></td></tr></table></td></tr></table></td></tr></table></td></tr></table></td></tr></table></td></tr></table></td></tr></table></td></tr></table></td></tr></table></td></tr></table></td></tr></table></td></tr></table></td></tr></table></td></tr></table></td></tr></table></td></tr></table></td></tr></table></td></tr></table> | | | | | | | | | | | | | | | | | | | | <table border="1" style="width: 100%; border-collapse: collapse; text-align: center;"> <tr> <td style="width: 10%;"></td> <td style="width: 10%;"></td> <td style="width: 10%;"></td> <td style="width: 10%;"></td> <td style="width: 10%;"></td> <td style="width: 10%;"></td> <td style="width: 10%;"></td> <td style="width: 10%;"></td> <td style="width: 10%;"></td> <td style="width: 10%;"></td> </tr> <tr> <td></td> <td></td> <td colspan="8" style="text-align: center;"> <table border="1" style="width: 100%; border-collapse: collapse; text-align: center;"> <tr> <td style="width: 10%;"></td> <td style="width: 10%;"></td> <td style="width: 10%;"></td> <td style="width: 10%;"></td> <td style="width: 10%;"></td> <td style="width: 10%;"></td> <td style="width: 10%;"></td> <td style="width: 10%;"></td> <td style="width: 10%;"></td> <td style="width: 10%;"></td> </tr> <tr> <td></td> <td></td> <td colspan="8" style="text-align: center;"> <table border="1" style="width: 100%; border-collapse: collapse; text-align: center;"> <tr> <td style="width: 10%;"></td> <td style="width: 10%;"></td> <td style="width: 10%;"></td> <td style="width: 10%;"></td> <td style="width: 10%;"></td> <td style="width: 10%;"></td> <td style="width: 10%;"></td> <td style="width: 10%;"></td> <td style="width: 10%;"></td> <td style="width: 10%;"></td> </tr> <tr> <td></td> <td></td> <td colspan="8" style="text-align: center;"> <table border="1" style="width: 100%; border-collapse: collapse; text-align: center;"> <tr> <td style="width: 10%;"></td> <td style="width: 10%;"></td> <td style="width: 10%;"></td> <td style="width: 10%;"></td> <td style="width: 10%;"></td> <td style="width: 10%;"></td> <td style="width: 10%;"></td> <td style="width: 10%;"></td> <td style="width: 10%;"></td> <td style="width: 10%;"></td> </tr> <tr> <td></td> <td></td> <td colspan="8" style="text-align: center;"> <table border="1" style="width: 100%; border-collapse: collapse; text-align: center;"> <tr> <td style="width: 10%;"></td> <td style="width: 10%;"></td> <td style="width: 10%;"></td> <td style="width: 10%;"></td> <td style="width: 10%;"></td> <td style="width: 10%;"></td> <td style="width: 10%;"></td> <td style="width: 10%;"></td> <td style="width: 10%;"></td> <td style="width: 10%;"></td> </tr> <tr> <td></td> <td></td> <td colspan="8" style="text-align: center;"> <table border="1" style="width: 100%; border-collapse: collapse; text-align: center;"> <tr> <td style="width: 10%;"></td> <td style="width: 10%;"></td> <td style="width: 10%;"></td> <td style="width: 10%;"></td> <td style="width: 10%;"></td> <td style="width: 10%;"></td> <td style="width: 10%;"></td> <td style="width: 10%;"></td> <td style="width: 10%;"></td> <td style="width: 10%;"></td> </tr> <tr> <td></td> <td></td> <td colspan="8" style="text-align: center;"> <table border="1" style="width: 100%; border-collapse: collapse; text-align: center;"> <tr> <td style="width: 10%;"></td> <td style="width: 10%;"></td> <td style="width: 10%;"></td> <td style="width: 10%;"></td> <td style="width: 10%;"></td> <td style="width: 10%;"></td> <td style="width: 10%;"></td> <td style="width: 10%;"></td> <td style="width: 10%;"></td> <td style="width: 10%;"></td> </tr> <tr> <td></td> <td></td> <td colspan="8" style="text-align: center;"> <table border="1" style="width: 100%; border-collapse: collapse; text-align: center;"> <tr> <td style="width: 10%;"></td> <td style="width: 10%;"></td> <td style="width: 10%;"></td> <td style="width: 10%;"></td> <td style="width: 10%;"></td> <td style="width: 10%;"></td> <td style="width: 10%;"></td> <td style="width: 10%;"></td> <td style="width: 10%;"></td> <td style="width: 10%;"></td> </tr> <tr> <td></td> <td></td> <td colspan="8" style="text-align: center;"> <table border="1" style="width: 100%; border-collapse: collapse; text-align: center;"> <tr> <td style="width: 10%;"></td> <td style="width: 10%;"></td> <td style="width: 10%;"></td> <td style="width: 10%;"></td> <td style="width: 10%;"></td> <td style="width: 10%;"></td> <td style="width: 10%;"></td> <td style="width: 10%;"></td> <td style="width: 10%;"></td> <td style="width: 10%;"></td> </tr> <tr> <td></td> <td></td> <td colspan="8" style="text-align: center;"> <table border="1" style="width: 100%; border-collapse: collapse; text-align: center;"> <tr> <td style="width: 10%;"></td> <td style="width: 10%;"></td> <td style="width: 10%;"></td> <td style="width: 10%;"></td> <td style="width: 10%;"></td> <td style="width: 10%;"></td> <td style="width: 10%;"></td> <td style="width: 10%;"></td> <td style="width: 10%;"></td> <td style="width: 10%;"></td> </tr> <tr> <td></td> <td></td> <td colspan="8" style="text-align: center;"> <table border="1" style="width: 100%; border-collapse: collapse; text-align: center;"> <tr> <td style="width: 10%;"></td> <td style="width: 10%;"></td> <td style="width: 10%;"></td> <td style="width: 10%;"></td> <td style="width: 10%;"></td> <td style="width: 10%;"></td> <td style="width: 10%;"></td> <td style="width: 10%;"></td> <td style="width: 10%;"></td> <td style="width: 10%;"></td> </tr> <tr> <td></td> <td></td> <td colspan="8" style="text-align: center;"> <table border="1" style="width: 100%; border-collapse: collapse; text-align: center;"> <tr> <td style="width: 10%;"></td> <td style="width: 10%;"></td> <td style="width: 10%;"></td> <td style="width: 10%;"></td> <td style="width: 10%;"></td> <td style="width: 10%;"></td> <td style="width: 10%;"></td> <td style="width: 10%;"></td> <td style="width: 10%;"></td> <td style="width: 10%;"></td> </tr> <tr> <td></td> <td></td> <td colspan="8" style="text-align: center;"> <table border="1" style="width: 100%; border-collapse: collapse; text-align: center;"> <tr> <td style="width: 10%;"></td> <td style="width: 10%;"></td> <td style="width: 10%;"></td> <td style="width: 10%;"></td> <td style="width: 10%;"></td> <td style="width: 10%;"></td> <td style="width: 10%;"></td> <td style="width: 10%;"></td> <td style="width: 10%;"></td> <td style="width: 10%;"></td> </tr> <tr> <td></td> <td></td> <td colspan="8" style="text-align: center;"> <table border="1" style="width: 100%; border-collapse: collapse; text-align: center;"> <tr> <td style="width: 10%;"></td> <td style="width: 10%;"></td> <td style="width: 10%;"></td> <td style="width: 10%;"></td> <td style="width: 10%;"></td> <td style="width: 10%;"></td> <td style="width: 10%;"></td> <td style="width: 10%;"></td> <td style="width: 10%;"></td> <td style="width: 10%;"></td> </tr> <tr> <td></td> <td></td> <td colspan="8" style="text-align: center;"> <table border="1" style="width: 100%; border-collapse: collapse; text-align: center;"> <tr> <td style="width: 10%;"></td> <td style="width: 10%;"></td> <td style="width: 10%;"></td> <td style="width: 10%;"></td> <td style="width: 10%;"></td> <td style="width: 10%;"></td> <td style="width: 10%;"></td> <td style="width: 10%;"></td> <td style="width: 10%;"></td> <td style="width: 10%;"></td> </tr> <tr> <td></td> <td></td> <td colspan="8" style="text-align: center;"> <table border="1" style="width: 100%; border-collapse: collapse; text-align: center;"> <tr> <td style="width: 10%;"></td> <td style="width: 10%;"></td> <td style="width: 10%;"></td> <td style="width: 10%;"></td> <td style="width: 10%;"></td> <td style="width: 10%;"></td> <td style="width: 10%;"></td> <td style="width: 10%;"></td> <td style="width: 10%;"></td> <td style="width: 10%;"></td> </tr> <tr> <td></td> <td></td> <td colspan="8" style="text-align: center;"> <table border="1" style="width: 100%; border-collapse: collapse; text-align: center;"> <tr> <td style="width: 10%;"></td> <td style="width: 10%;"></td> <td style="width: 10%;"></td> <td style="width: 10%;"></td> <td style="width: 10%;"></td> <td style="width: 10%;"></td> <td style="width: 10%;"></td> <td style="width: 10%;"></td> <td style="width: 10%;"></td> <td style="width: 10%;"></td> </tr> <tr> <td></td> <td></td> <td colspan="8" style="text-align: center;"> <table border="1" style="width: 100%;
border-collapse: collapse; text-align: center;"> <tr> <td style="width: 10%;"></td> <td style="width: 10%;"></td> <td style="width: 10%;"></td> <td style="width: 10%;"></td> <td style="width: 10%;"></td> <td style="width: 10%;"></td> <td style="width: 10%;"></td> <td style="width: 10%;"></td> <td style="width: 10%;"></td> <td style="width: 10%;"></td> </tr> <tr> <td></td> <td></td> <td colspan="8" style="text-align: center;"> <table border="1" style="width: 100%; border-collapse: collapse; text-align: center;"> <tr> <td style="width: 10%;"></td> <td style="width: 10%;"></td> <td style="width: 10%;"></td> <td style="width: 10%;"></td> <td style="width: 10%;"></td> <td style="width: 10%;"></td> <td style="width: 10%;"></td> <td style="width: 10%;"></td> <td style="width: 10%;"></td> <td style="width: 10%;"></td> </tr> <tr> <td></td> <td></td> <td colspan="8" style="text-align: center;"> <table border="1" style="width: 100%; border-collapse: collapse; text-align: center;"> <tr> <td style="width: 10%;"></td> <td style="width: 10%;"></td> <td style="width: 10%;"></td> <td style="width: 10%;"></td> <td style="width: 10%;"></td> <td style="width: 10%;"></td> <td style="width: 10%;"></td> <td style="width: 10%;"></td> <td style="width: 10%;"></td> <td style="width: 10%;"></td> </tr> <tr> <td></td> <td></td> <td colspan="8" style="text-align: center;"> <table border="1" style="width: 100%; border-collapse: collapse; text-align: center;"> <tr> <td style="width: 10%;"></td> <td style="width: 10%;"></td> <td style="width: 10%;"></td> <td style="width: 10%;"></td> <td style="width: 10%;"></td> <td style="width: 10%;"></td> <td style="width: 10%;"></td> <td style="width: 10%;"></td> <td style="width: 10%;"></td> <td style="width: 10%;"></td> </tr> <tr> <td></td> <td></td> <td colspan="8" style="text-align: center;"> <table border="1" style="width: 100%; border-collapse: collapse; text-align: center;"> <tr> <td style="width: 10%;"></td> <td style="width: 10%;"></td> <td style="width: 10%;"></td> <td style="width: 10%;"></td> <td style="width: 10%;"></td> <td style="width: 10%;"></td> <td style="width: 10%;"></td> <td style="width: 10%;"></td> <td style="width: 10%;"></td> <td style="width: 10%;"></td> </tr> <tr> <td></td> <td></td> <td colspan="8" style="text-align: center;"> <table border="1" style="width: 100%; border-collapse: collapse; text-align: center;"> <tr> <td style="width: 10%;"></td> <td style="width: 10%;"></td> <td style="width: 10%;"></td> <td style="width: 10%;"></td> <td style="width: 10%;"></td> <td style="width: 10%;"></td> <td style="width: 10%;"></td> <td style="width: 10%;"></td> <td style="width: 10%;"></td> <td style="width: 10%;"></td> </tr> <tr> <td></td> <td></td> <td colspan="8" style="text-align: center;"> <table border="1" style="width: 100%; border-collapse: collapse; text-align: center;"> <tr> <td style="width: 10%;"></td> <td style="width: 10%;"></td> <td style="width: 10%;"></td> <td style="width: 10%;"></td> <td style="width: 10%;"></td> <td style="width: 10%;"></td> <td style="width: 10%;"></td> <td style="width: 10%;"></td> <td style="width: 10%;"></td> <td style="width: 10%;"></td> </tr> <tr> <td></td> <td></td> <td colspan="8" style="text-align: center;"> <table border="1" style="width: 100%; border-collapse: collapse; text-align: center;"> <tr> <td style="width: 10%;"></td> <td style="width: 10%;"></td> <td style="width: 10%;"></td> <td style="width: 10%;"></td> <td style="width: 10%;"></td> <td style="width: 10%;"></td> <td style="width: 10%;"></td> <td style="width: 10%;"></td> <td style="width: 10%;"></td> <td style="width: 10%;"></td> </tr> <tr> <td></td> <td></td> <td colspan="8" style="text-align: center;"> <table border="1" style="width: 100%; border-collapse: collapse; text-align: center;"> <tr> <td style="width: 10%;"></td> <td style="width: 10%;"></td> <td style="width: 10%;"></td> <td style="width: 10%;"></td> <td style="width: 10%;"></td> <td style="width: 10%;"></td> <td style="width: 10%;"></td> <td style="width: 10%;"></td> <td style="width: 10%;"></td> <td style="width: 10%;"></td> </tr> <tr> <td></td> <td></td> <td colspan="8" style="text-align: center;"> <table border="1" style="width: 100%; border-collapse: collapse; text-align: center;"> <tr> <td style="width: 10%;"></td> <td style="width: 10%;"></td> <td style="width: 10%;"></td> <td style="width: 10%;"></td> <td style="width: 10%;"></td> <td style="width: 10%;"></td> <td style="width: 10%;"></td> <td style="width: 10%;"></td> <td style="width: 10%;"></td> <td style="width: 10%;"></td> </tr> <tr> <td></td> <td></td> <td colspan="8" style="text-align: center;"> <table border="1" style="width: 100%; border-collapse: collapse; text-align: center;"> <tr> <td style="width: 10%;"></td> <td style="width: 10%;"></td> <td style="width: 10%;"></td> <td style="width: 10%;"></td> <td style="width: 10%;"></td> <td style="width: 10%;"></td> <td style="width: 10%;"></td> <td style="width: 10%;"></td> <td style="width: 10%;"></td> <td style="width: 10%;"></td> </tr> <tr> <td></td> <td></td> <td colspan="8" style="text-align: center;"> <table border="1" style="width: 100%; border-collapse: collapse; text-align: center;"> <tr> <td style="width: 10%;"></td> <td style="width: 10%;"></td> <td style="width: 10%;"></td> <td style="width: 10%;"></td> <td style="width: 10%;"></td> <td style="width: 10%;"></td> <td style="width: 10%;"></td> <td style="width: 10%;"></td> <td style="width: 10%;"></td> <td style="width: 10%;"></td> </tr> <tr> <td></td> <td></td> <td colspan="8" style="text-align: center;"> <table border="1" style="width: 100%; border-collapse: collapse; text-align: center;"> <tr> <td style="width: 10%;"></td> <td style="width: 10%;"></td> <td style="width: 10%;"></td> <td style="width: 10%;"></td> <td style="width: 10%;"></td> <td style="width: 10%;"></td> <td style="width: 10%;"></td> <td style="width: 10%;"></td> <td style="width: 10%;"></td> <td style="width: 10%;"></td> </tr> <tr> <td></td> <td></td> <td colspan="8" style="text-align: center;"> <table border="1" style="width: 100%; border-collapse: collapse; text-align: center;"> <tr> <td style="width: 10%;"></td> <td style="width: 10%;"></td> <td style="width: 10%;"></td> <td style="width: 10%;"></td> <td style="width: 10%;"></td> <td style="width: 10%;"></td> <td style="width: 10%;"></td> <td style="width: 10%;"></td> <td style="width: 10%;"></td> <td style="width: 10%;"></td> </tr> <tr> <td></td> <td></td> <td colspan="8" style="text-align: center;"> <table border="1" style="width: 100%; border-collapse: collapse; text-align: center;"> <tr> <td style="width: 10%;"></td> <td style="width: 10%;"></td> <td style="width: 10%;"></td> <td style="width: 10%;"></td> <td style="width: 10%;"></td> <td style="width: 10%;"></td> <td style="width: 10%;"></td> <td style="width: 10%;"></td> <td style="width: 10%;"></td> <td style="width: 10%;"></td> </tr> <tr> <td></td> <td></td> <td colspan="8" style="text-align: center;"> <table border="1" style="width: 100%; border-collapse: collapse; text-align: center;"> <tr> <td style="width: 10%;"></td> <td style="width: 10%;"></td> <td style="width: 10%;"></td> <td style="width: 10%;"></td> <td style="width: 10%;"></td> <td style="width: 10%;"></td> <td style="width: 10%;"></td> <td style="width: 10%;"></td> <td style="width: 10%;"></td> <td style="width: 10%;"></td> </tr> <tr> <td></td> <td></td> <td colspan="8" style="text-align: center;"> <table border="1" style="width: 100%; border-collapse: collapse; text-align: center;"> <tr> <td style="width: 10%;"></td> <td style="width: 10%;"></td> <td style="width: 10%;"></td> <td style="width: 10%;"></td> <td style="width: 10%;"></td> <td style="width: 10%;"></td> <td style="width: 10%;"></td> <td style="width: 10%;"></td> <td style="width: 10%;"></td> <td style="width: 10%;"></td> </tr> <tr> <td></td> <td></td> <td colspan="8" style="text-align: center;"> <table border="1" style="width: 100%; border-collapse: collapse; text-align: center;"> <tr> <td style="width: 10%;"></td> <td style="width: 10%;"></td> <td style="width: 10%;"></td> <td style="width: 10%;"></td> <td style="width: 10%;"></td> <td style="width: 10%;"></td> <td style="width: 10%;"></td> <td style="width: 10%;"></td> <td style="width: 10%;"></td> <td style="width: 10%;"></td> </tr> <tr> <td></td> <td></td> <td colspan="8" style="text-align: center;"> <table border="1" style="width: 100%; border-collapse: collapse; text-align: center;"> <tr> <td style="width: 10%;"></td> <td style="width: 10%;"></td> <td style="width: 10%;"></td> <td style="width: 10%;"></td> <td style="width: 10%;"></td> <td style="width: 10%;"></td> <td style="width: 10%;"></td> <td style="width: 10%;"></td> <td style="width: 10%;"></td> <td style="width: 10%;"></td> </tr> <tr> <td></td> <td></td> <td colspan="8" style="text-align: center;"> <table border="1" style="width: 100%; border-collapse: collapse; text-align: center;"> <tr> <td style="width: 10%;"></td> <td style="width: 10%;"></td> <td style="width: 10%;"></td> <td style="width: 10%;"></td> <td style="width: 10%;"></td> <td style="width: 10%;"></td> <td style="width: 10%;"></td> <td style="width: 10%;"></td> <td style="width: 10%;"></td> <td style="width: 10%;"></td> </tr> <tr> <td></td> <td></td> <td colspan="8" style="text-align: center;"> <table border="1" style="width: 100%; border-collapse: collapse; text-align: center;"> <tr> <td style="width: 10%;"></td> <td style="width: 10%;"></td> <td style="width: 10%;"></td> <td style="width: 10%;"></td> <td style="width: 10%;"></td> <td style="width: 10%;"></td> <td style="width: 10%;"></td> <td style="width: 10%;"></td> <td style="width: 10%;"></td> <td style="width: 10%;"></td> </tr> <tr> <td></td> <td></td> <td colspan="8" style="text-align: center;"> <table border="1" style="width: 100%; border-collapse: collapse; text-align: center;"> <tr> <td style="width: 10%;"></td> <td style="width: 10%;"></td> <td style="width: 10%;"></td> <td style="width:
10%;"></td> <td style="width: 10%;"></td> <td style="width: 10%;"></td> <td style="width: 10%;"></td> <td style="width: 10%;"></td> <td style="width: 10%;"></td> <td style="width: 10%;"></td> </tr> <tr> <td></td> <td></td> <td colspan="8" style="text-align: center;"> <table border="1" style="width: 100%; border-collapse: collapse; text-align: center;"> <tr> <td style="width: 10%;"></td> <td style="width: 10%;"></td> <td style="width: 10%;"></td> <td style="width: 10%;"></td> <td style="width: 10%;"></td> <td style="width: 10%;"></td> <td style="width: 10%;"></td> <td style="width: 10%;"></td> <td style="width: 10%;"></td> <td style="width: 10%;"></td> </tr> <tr> <td></td> <td></td> <td colspan="8" style="text-align: center;"> <table border="1" style="width: 100%; border-collapse: collapse; text-align: center;"> <tr> <td style="width: 10%;"></td> <td style="width: 10%;"></td> <td style="width: 10%;"></td> <td style="width: 10%;"></td> <td style="width: 10%;"></td> <td style="width: 10%;"></td> <td style="width: 10%;"></td> <td style="width: 10%;"></td> <td style="width: 10%;"></td> <td style="width: 10%;"></td> </tr> <tr> <td></td> <td></td> <td colspan="8" style="text-align: center;"> <table border="1" style="width: 100%; border-collapse: collapse; text-align: center;"> <tr> <td style="width: 10%;"></td> <td style="width: 10%;"></td> <td style="width: 10%;"></td> <td style="width: 10%;"></td> <td style="width: 10%;"></td> <td style="width: 10%;"></td> <td style="width: 10%;"></td> <td style="width: 10%;"></td> <td style="width: 10%;"></td> <td style="width: 10%;"></td> </tr> <tr> <td></td> <td></td> <td colspan="8" style="text-align: center;"> <table border="1" style="width: 100%; border-collapse: collapse; text-align: center;"> <tr> <td style="width: 10%;"></td> <td style="width: 10%;"></td> <td style="width: 10%;"></td> <td style="width: 10%;"></td> <td style="width: 10%;"></td> <td style="width: 10%;"></td> <td style="width: 10%;"></td> <td style="width: 10%;"></td> <td style="width: 10%;"></td> <td style="width: 10%;"></td> </tr> <tr> <td></td> <td></td> <td colspan="8" style="text-align: center;"> <table border="1" style="width: 100%; border-collapse: collapse; text-align: center;"> <tr> <td style="width: 10%;"></td> <td style="width: 10%;"></td> <td style="width: 10%;"></td> <td style="width: 10%;"></td> <td style="width: 10%;"></td> <td style="width: 10%;"></td> <td style="width: 10%;"></td> <td style="width: 10%;"></td> <td style="width: 10%;"></td> <td style="width: 10%;"></td> </tr> <tr> <td></td> <td></td> <td colspan="8" style="text-align: center;"> <table border="1" style="width: 100%; border-collapse: collapse; text-align: center;"> <tr> <td style="width: 10%;"></td> <td style="width: 10%;"></td> <td style="width: 10%;"></td> <td style="width: 10%;"></td> <td style="width: 10%;"></td> <td style="width: 10%;"></td> <td style="width: 10%;"></td> <td style="width: 10%;"></td> <td style="width: 10%;"></td> <td style="width: 10%;"></td> </tr> <tr> <td></td> <td></td> <td colspan="8" style="text-align: center;"> <table border="1" style="width: 100%; border-collapse: collapse; text-align: center;"> <tr> <td style="width: 10%;"></td> <td style="width: 10%;"></td> <td style="width: 10%;"></td> <td style="width: 10%;"></td> <td style="width: 10%;"></td> <td style="width: 10%;"></td> <td style="width: 10%;"></td> <td style="width: 10%;"></td> <td style="width: 10%;"></td> <td style="width: 10%;"></td> </tr> <tr> <td></td> <td></td> <td colspan="8" style="text-align: center;"> <table border="1" style="width: 100%; border-collapse: collapse; text-align: center;"> <tr> <td style="width: 10%;"></td> <td style="width: 10%;"></td> <td style="width: 10%;"></td> <td style="width: 10%;"></td> <td style="width: 10%;"></td> <td style="width: 10%;"></td> <td style="width: 10%;"></td> <td style="width: 10%;"></td> <td style="width: 10%;"></td> <td style="width: 10%;"></td> </tr> <tr> <td></td> <td></td> <td colspan="8" style="text-align: center;"> <table border="1" style="width: 100%; border-collapse: collapse; text-align: center;"> <tr> <td style="width: 10%;"></td> <td style="width: 10%;"></td> <td style="width: 10%;"></td> <td style="width: 10%;"></td> <td style="width: 10%;"></td> <td style="width: 10%;"></td> <td style="width: 10%;"></td> <td style="width: 10%;"></td> <td style="width: 10%;"></td> <td style="width: 10%;"></td> </tr> <tr> <td></td> <td></td> <td colspan="8" style="text-align: center;"> <table border="1" style="width: 100%; border-collapse: collapse; text-align: center;"> <tr> <td style="width: 10%;"></td> <td style="width: 10%;"></td> <td style="width: 10%;"></td> <td style="width: 10%;"></td> <td style="width: 10%;"></td> <td style="width: 10%;"></td> <td style="width: 10%;"></td> <td style="width: 10%;"></td> <td style="width: 10%;"></td> <td style="width: 10%;"></td> </tr> <tr> <td></td> <td></td> <td colspan="8" style="text-align: center;"> <table border="1" style="width: 100%; border-collapse: collapse; text-align: center;"> <tr> <td style="width: 10%;"></td> <td style="width: 10%;"></td> <td style="width: 10%;"></td> <td style="width: 10%;"></td> <td style="width: 10%;"></td> <td style="width: 10%;"></td> <td style="width: 10%;"></td> <td style="width: 10%;"></td> <td style="width: 10%;"></td> <td style="width: 10%;"></td> </tr> <tr> <td></td> <td></td> <td colspan="8" style="text-align: center;"> <table border="1" style="width: 100%; border-collapse: collapse; text-align: center;"> <tr> <td style="width: 10%;"></td> <td style="width: 10%;"></td> <td style="width: 10%;"></td> <td style="width: 10%;"></td> <td style="width: 10%;"></td> <td style="width: 10%;"></td> <td style="width: 10%;"></td> <td style="width: 10%;"></td> <td style="width: 10%;"></td> <td style="width: 10%;"></td> </tr> <tr> <td></td> <td></td> <td colspan="8" style="text-align: center;"> <table border="1" style="width: 100%; border-collapse: collapse; text-align: center;"> <tr> <td style="width: 10%;"></td> <td style="width: 10%;"></td> <td style="width: 10%;"></td> <td style="width: 10%;"></td> <td style="width: 10%;"></td> <td style="width: 10%;"></td> <td style="width: 10%;"></td> <td style="width: 10%;"></td> <td style="width: 10%;"></td> <td style="width: 10%;"></td> </tr> <tr> <td></td> <td></td> <td colspan="8" style="text-align: center;"> <table border="1" style="width: 100%; border-collapse: collapse; text-align: center;"> <tr> <td style="width: 10%;"></td> <td style="width: 10%;"></td> <td style="width: 10%;"></td> <td style="width: 10%;"></td> <td style="width: 10%;"></td> <td style="width: 10%;"></td> <td style="width: 10%;"></td> <td style="width: 10%;"></td> <td style="width: 10%;"></td> <td style="width: 10%;"></td> </tr> <tr> <td></td> <td></td> <td colspan="8" style="text-align: center;"> <table border="1" style="width: 100%; border-collapse: collapse; text-align: center;"> <tr> <td style="width: 10%;"></td> <td style="width: 10%;"></td> <td style="width: 10%;"></td> <td style="width: 10%;"></td> <td style="width: 10%;"></td> <td style="width: 10%;"></td> <td style="width: 10%;"></td> <td style="width: 10%;"></td> <td style="width: 10%;"></td> <td style="width: 10%;"></td> </tr> <tr> <td></td> <td></td> <td colspan="8" style="text-align: center;"> <table border="1" style="width: 100%; border-collapse: collapse; text-align: center;"> <tr> <td style="width: 10%;"></td> <td style="width: 10%;"></td> <td style="width: 10%;"></td> <td style="width: 10%;"></td> <td style="width: 10%;"></td> <td style="width: 10%;"></td> <td style="width: 10%;"></td> <td style="width: 10%;"></td> <td style="width: 10%;"></td> <td style="width: 10%;"></td> </tr> <tr> <td></td> <td></td> <td colspan="8" style="text-align: center;"> <table border="1" style="width: 100%; border-collapse: collapse; text-align: center;"> <tr> <td style="width: 10%;"></td> <td style="width: 10%;"></td> <td style="width: 10%;"></td> <td style="width: 10%;"></td> <td style="width: 10%;"></td> <td style="width: 10%;"></td> <td style="width: 10%;"></td> <td style="width: 10%;"></td> <td style="width: 10%;"></td> <td style="width: 10%;"></td> </tr> <tr> <td></td> <td></td> <td colspan="8" style="text-align: center;"> <table border="1" style="width: 100%; border-collapse: collapse; text-align: center;"> <tr> <td style="width: 10%;"></td> <td style="width: 10%;"></td> <td style="width: 10%;"></td> <td style="width: 10%;"></td> <td style="width: 10%;"></td> <td style="width: 10%;"></td> <td style="width: 10%;"></td> <td style="width: 10%;"></td> <td style="width: 10%;"></td> <td style="width: 10%;"></td> </tr> <tr> <td></td> <td></td> <td colspan="8" style="text-align: center;"> <table border="1" style="width: 100%; border-collapse: collapse; text-align: center;"> <tr> <td style="width: 10%;"></td> <td style="width: 10%;"></td> <td style="width: 10%;"></td> <td style="width: 10%;"></td> <td style="width: 10%;"></td> <td style="width: 10%;"></td> <td style="width: 10%;"></td> <td style="width: 10%;"></td> <td style="width: 10%;"></td> <td style="width: 10%;"></td> </tr> <tr> <td></td> <td></td> <td colspan="8" style="text-align: center;"> <table border="1" style="width: 100%; border-collapse: collapse; text-align: center;"> <tr>
</tr></table></td></tr></table></td></tr></table></td></tr></table></td></tr></table></td></tr></table></td></tr></table></td></tr></table></td></tr></table></td></tr></table></td></tr></table></td></tr></table></td></tr></table></td></tr></table></td></tr></table></td></tr></table></td></tr></table></td></tr></table></td></tr></table></td></tr></table></td></tr></table></td></tr></table></td></tr></table></td></tr></table></td></tr></table></td></tr></table></td></tr></table></td></tr></table></td></tr></table></td></tr></table></td></tr></table></td></tr></table></td></tr></table></td></tr></table></td></tr></table></td></tr></table></td></tr></table></td></tr></table></td></tr></table></td></tr></table></td></tr></table></td></tr></table></td></tr></table></td></tr></table></td></tr></table></td></tr></table></td></tr></table></td></tr></table></td></tr></table></td></tr></table></td></tr></table></td></tr></table></td></tr></table></td></tr></table></td></tr></table></td></tr></table></td></tr></table></td></tr></table></td></tr></table> | | | | | | | | | | | | | | | | | | | | <table border="1" style="width: 100%; border-collapse: collapse; text-align: center;"> <tr> <td style="width: 10%;"></td> <td style="width: 10%;"></td> <td style="width: 10%;"></td> <td style="width: 10%;"></td> <td style="width: 10%;"></td> <td style="width: 10%;"></td> <td style="width: 10%;"></td> <td style="width: 10%;"></td> <td style="width: 10%;"></td> <td style="width: 10%;"></td> </tr> <tr> <td></td> <td></td> <td colspan="8" style="text-align: center;"> <table border="1" style="width: 100%; border-collapse: collapse; text-align: center;"> <tr> <td style="width: 10%;"></td> <td style="width: 10%;"></td> <td style="width: 10%;"></td> <td style="width: 10%;"></td> <td style="width: 10%;"></td> <td style="width: 10%;"></td> <td style="width: 10%;"></td> <td style="width: 10%;"></td> <td style="width: 10%;"></td> <td style="width: 10%;"></td> </tr> <tr> <td></td> <td></td> <td colspan="8" style="text-align: center;"> <table border="1" style="width: 100%; border-collapse: collapse; text-align: center;"> <tr> <td style="width: 10%;"></td> <td style="width: 10%;"></td> <td style="width: 10%;"></td> <td style="width: 10%;"></td> <td style="width: 10%;"></td> <td style="width: 10%;"></td> <td style="width: 10%;"></td> <td style="width: 10%;"></td> <td style="width: 10%;"></td> <td style="width: 10%;"></td> </tr> <tr> <td></td> <td></td> <td colspan="8" style="text-align: center;"> <table border="1" style="width: 100%; border-collapse: collapse; text-align: center;"> <tr> <td style="width: 10%;"></td> <td style="width: 10%;"></td> <td style="width: 10%;"></td> <td style="width: 10%;"></td> <td style="width: 10%;"></td> <td style="width: 10%;"></td> <td style="width: 10%;"></td> <td style="width: 10%;"></td> <td style="width: 10%;"></td> <td style="width: 10%;"></td> </tr> <tr> <td></td> <td></td> <td colspan="8" style="text-align: center;"> <table border="1" style="width: 100%; border-collapse: collapse; text-align: center;"> <tr> <td style="width: 10%;"></td> <td style="width: 10%;"></td> <td style="width: 10%;"></td> <td style="width: 10%;"></td> <td style="width: 10%;"></td> <td style="width: 10%;"></td> <td style="width: 10%;"></td> <td style="width: 10%;"></td> <td style="width: 10%;"></td> <td style="width: 10%;"></td> </tr> <tr> <td></td> <td></td> <td colspan="8" style="text-align: center;"> <table border="1" style="width: 100%; border-collapse: collapse; text-align: center;"> <tr> <td style="width: 10%;"></td> <td style="width: 10%;"></td> <td style="width: 10%;"></td> <td style="width: 10%;"></td> <td style="width: 10%;"></td> <td style="width: 10%;"></td> <td style="width: 10%;"></td> <td style="width: 10%;"></td> <td style="width: 10%;"></td> <td style="width: 10%;"></td> </tr> <tr> <td></td> <td></td> <td colspan="8" style="text-align: center;"> <table border="1" style="width: 100%; border-collapse: collapse; text-align: center;"> <tr> <td style="width: 10%;"></td> <td style="width: 10%;"></td> <td style="width: 10%;"></td> <td style="width: 10%;"></td> <td style="width: 10%;"></td> <td style="width: 10%;"></td> <td style="width: 10%;"></td> <td style="width: 10%;"></td> <td style="width: 10%;"></td> <td style="width: 10%;"></td> </tr> <tr> <td></td> <td></td> <td colspan="8" style="text-align: center;"> <table border="1" style="width: 100%; border-collapse: collapse; text-align: center;"> <tr> <td style="width: 10%;"></td> <td style="width: 10%;"></td> <td style="width: 10%;"></td> <td style="width: 10%;"></td> <td style="width: 10%;"></td> <td style="width: 10%;"></td> <td style="width: 10%;"></td> <td style="width: 10%;"></td> <td style="width: 10%;"></td> <td style="width: 10%;"></td> </tr> <tr> <td></td> <td></td> <td colspan="8" style="text-align: center;"> <table border="1" style="width: 100%; border-collapse: collapse; text-align: center;"> <tr> <td style="width: 10%;"></td> <td style="width: 10%;"></td> <td style="width: 10%;"></td> <td style="width: 10%;"></td> <td style="width: 10%;"></td> <td style="width: 10%;"></td> <td style="width: 10%;"></td> <td style="width: 10%;"></td> <td style="width: 10%;"></td> <td style="width: 10%;"></td> </tr> <tr> <td></td> <td></td> <td colspan="8" style="text-align: center;"> <table border="1" style="width: 100%; border-collapse: collapse; text-align: center;"> <tr> <td style="width: 10%;"></td> <td style="width: 10%;"></td> <td style="width: 10%;"></td> <td style="width: 10%;"></td> <td style="width: 10%;"></td> <td style="width: 10%;"></td> <td style="width: 10%;"></td> <td style="width: 10%;"></td> <td style="width: 10%;"></td> <td style="width: 10%;"></td> </tr> <tr> <td></td> <td></td> <td colspan="8" style="text-align: center;"> <table border="1" style="width: 100%; border-collapse: collapse; text-align: center;"> <tr> <td style="width: 10%;"></td> <td style="width: 10%;"></td> <td style="width: 10%;"></td> <td style="width: 10%;"></td> <td style="width: 10%;"></td> <td style="width: 10%;"></td> <td style="width: 10%;"></td> <td style="width: 10%;"></td> <td style="width: 10%;"></td> <td style="width: 10%;"></td> </tr> <tr> <td></td> <td></td> <td colspan="8" style="text-align: center;"> <table border="1" style="width: 100%; border-collapse: collapse; text-align: center;"> <tr> <td style="width: 10%;"></td> <td style="width: 10%;"></td> <td style="width: 10%;"></td> <td style="width: 10%;"></td> <td style="width: 10%;"></td> <td style="width: 10%;"></td> <td style="width: 10%;"></td> <td style="width: 10%;"></td> <td style="width: 10%;"></td> <td style="width: 10%;"></td> </tr> <tr> <td></td> <td></td> <td colspan="8" style="text-align: center;"> <table border="1" style="width: 100%; border-collapse: collapse; text-align: center;"> <tr> <td style="width: 10%;"></td> <td style="width: 10%;"></td> <td style="width: 10%;"></td> <td style="width: 10%;"></td> <td style="width: 10%;"></td> <td style="width: 10%;"></td> <td style="width: 10%;"></td> <td style="width: 10%;"></td> <td style="width: 10%;"></td> <td style="width: 10%;"></td> </tr> <tr> <td></td> <td></td> <td colspan="8" style="text-align: center;"> <table border="1" style="width: 100%; border-collapse: collapse; text-align: center;"> <tr> <td style="width: 10%;"></td> <td style="width: 10%;"></td> <td style="width: 10%;"></td> <td style="width: 10%;"></td> <td style="width: 10%;"></td> <td style="width: 10%;"></td> <td style="width: 10%;"></td> <td style="width: 10%;"></td> <td style="width: 10%;"></td> <td style="width: 10%;"></td> </tr> <tr> <td></td> <td></td> <td colspan="8" style="text-align: center;"> <table border="1" style="width: 100%; border-collapse: collapse; text-align: center;"> <tr> <td style="width: 10%;"></td> <td style="width: 10%;"></td> <td style="width: 10%;"></td> <td style="width: 10%;"></td> <td style="width: 10%;"></td> <td style="width: 10%;"></td> <td style="width: 10%;"></td> <td style="width: 10%;"></td> <td style="width: 10%;"></td> <td style="width: 10%;"></td> </tr> <tr> <td></td> <td></td> <td colspan="8" style="text-align: center;"> <table border="1" style="width: 100%; border-collapse: collapse; text-align: center;"> <tr> <td style="width: 10%;"></td> <td style="width: 10%;"></td> <td style="width: 10%;"></td> <td style="width: 10%;"></td> <td style="width: 10%;"></td> <td style="width: 10%;"></td> <td style="width: 10%;"></td> <td style="width: 10%;"></td> <td style="width: 10%;"></td> <td style="width: 10%;"></td> </tr> <tr> <td></td> <td></td> <td colspan="8" style="text-align: center;"> <table border="1" style="width: 100%; border-collapse: collapse; text-align: center;"> <tr> <td style="width: 10%;"></td> <td style="width: 10%;"></td> <td style="width: 10%;"></td> <td style="width: 10%;"></td> <td style="width: 10%;"></td> <td style="width: 10%;"></td> <td style="width: 10%;"></td> <td style="width: 10%;"></td> <td style="width: 10%;"></td> <td style="width: 10%;"></td> </tr> <tr> <td></td> <td></td> <td colspan="8" style="text-align: center;"> <table border="1" style="width: 100%; border-collapse: collapse; text-align: center;"> <tr> <td style="width: 10%;"></td> <td style="width: 10%;"></td> <td style="width: 10%;"></td> <td style="width: 10%;"></td> <td style="width: 10%;"></td> <td style="width: 10%;"></td> <td style="width: 10%;"></td> <td style="width: 10%;"></td> <td style="width: 10%;"></td> <td style="width: 10%;"></td> </tr> <tr> <td></td> <td></td> <td colspan="8"
style="text-align: center;"> <table border="1" style="width: 100%; border-collapse: collapse; text-align: center;"> <tr> <td style="width: 10%;"></td> <td style="width: 10%;"></td> <td style="width: 10%;"></td> <td style="width: 10%;"></td> <td style="width: 10%;"></td> <td style="width: 10%;"></td> <td style="width: 10%;"></td> <td style="width: 10%;"></td> <td style="width: 10%;"></td> <td style="width: 10%;"></td> </tr> <tr> <td></td> <td></td> <td colspan="8" style="text-align: center;"> <table border="1" style="width: 100%; border-collapse: collapse; text-align: center;"> <tr> <td style="width: 10%;"></td> <td style="width: 10%;"></td> <td style="width: 10%;"></td> <td style="width: 10%;"></td> <td style="width: 10%;"></td> <td style="width: 10%;"></td> <td style="width: 10%;"></td> <td style="width: 10%;"></td> <td style="width: 10%;"></td> <td style="width: 10%;"></td> </tr> <tr> <td></td> <td></td> <td colspan="8" style="text-align: center;"> <table border="1" style="width: 100%; border-collapse: collapse; text-align: center;"> <tr> <td style="width: 10%;"></td> <td style="width: 10%;"></td> <td style="width: 10%;"></td> <td style="width: 10%;"></td> <td style="width: 10%;"></td> <td style="width: 10%;"></td> <td style="width: 10%;"></td> <td style="width: 10%;"></td> <td style="width: 10%;"></td> <td style="width: 10%;"></td> </tr> <tr> <td></td> <td></td> <td colspan="8" style="text-align: center;"> <table border="1" style="width: 100%; border-collapse: collapse; text-align: center;"> <tr> <td style="width: 10%;"></td> <td style="width: 10%;"></td> <td style="width: 10%;"></td> <td style="width: 10%;"></td> <td style="width: 10%;"></td> <td style="width: 10%;"></td> <td style="width: 10%;"></td> <td style="width: 10%;"></td> <td style="width: 10%;"></td> <td style="width: 10%;"></td> </tr> <tr> <td></td> <td></td> <td colspan="8" style="text-align: center;"> <table border="1" style="width: 100%; border-collapse: collapse; text-align: center;"> <tr> <td style="width: 10%;"></td> <td style="width: 10%;"></td> <td style="width: 10%;"></td> <td style="width: 10%;"></td> <td style="width: 10%;"></td> <td style="width: 10%;"></td> <td style="width: 10%;"></td> <td style="width: 10%;"></td> <td style="width: 10%;"></td> <td style="width: 10%;"></td> </tr> <tr> <td></td> <td></td> <td colspan="8" style="text-align: center;"> <table border="1" style="width: 100%; border-collapse: collapse; text-align: center;"> <tr> <td style="width: 10%;"></td> <td style="width: 10%;"></td> <td style="width: 10%;"></td> <td style="width: 10%;"></td> <td style="width: 10%;"></td> <td style="width: 10%;"></td> <td style="width: 10%;"></td> <td style="width: 10%;"></td> <td style="width: 10%;"></td> <td style="width: 10%;"></td> </tr> <tr> <td></td> <td></td> <td colspan="8" style="text-align: center;"> <table border="1" style="width: 100%; border-collapse: collapse; text-align: center;"> <tr> <td style="width: 10%;"></td> <td style="width: 10%;"></td> <td style="width: 10%;"></td> <td style="width: 10%;"></td> <td style="width: 10%;"></td> <td style="width: 10%;"></td> <td style="width: 10%;"></td> <td style="width: 10%;"></td> <td style="width: 10%;"></td> <td style="width: 10%;"></td> </tr> <tr> <td></td> <td></td> <td colspan="8" style="text-align: center;"> <table border="1" style="width: 100%; border-collapse: collapse; text-align: center;"> <tr> <td style="width: 10%;"></td> <td style="width: 10%;"></td> <td style="width: 10%;"></td> <td style="width: 10%;"></td> <td style="width: 10%;"></td> <td style="width: 10%;"></td> <td style="width: 10%;"></td> <td style="width: 10%;"></td> <td style="width: 10%;"></td> <td style="width: 10%;"></td> </tr> <tr> <td></td> <td></td> <td colspan="8" style="text-align: center;"> <table border="1" style="width: 100%; border-collapse: collapse; text-align: center;"> <tr> <td style="width: 10%;"></td> <td style="width: 10%;"></td> <td style="width: 10%;"></td> <td style="width: 10%;"></td> <td style="width: 10%;"></td> <td style="width: 10%;"></td> <td style="width: 10%;"></td> <td style="width: 10%;"></td> <td style="width: 10%;"></td> <td style="width: 10%;"></td> </tr> <tr> <td></td> <td></td> <td colspan="8" style="text-align: center;"> <table border="1" style="width: 100%; border-collapse: collapse; text-align: center;"> <tr> <td style="width: 10%;"></td> <td style="width: 10%;"></td> <td style="width: 10%;"></td> <td style="width: 10%;"></td> <td style="width: 10%;"></td> <td style="width: 10%;"></td> <td style="width: 10%;"></td> <td style="width: 10%;"></td> <td style="width: 10%;"></td> <td style="width: 10%;"></td> </tr> <tr> <td></td> <td></td> <td colspan="8" style="text-align: center;"> <table border="1" style="width: 100%; border-collapse: collapse; text-align: center;"> <tr> <td style="width: 10%;"></td> <td style="width: 10%;"></td> <td style="width: 10%;"></td> <td style="width: 10%;"></td> <td style="width: 10%;"></td> <td style="width: 10%;"></td> <td style="width: 10%;"></td> <td style="width: 10%;"></td> <td style="width: 10%;"></td> <td style="width: 10%;"></td> </tr> <tr> <td></td> <td></td> <td colspan="8" style="text-align: center;"> <table border="1" style="width: 100%; border-collapse: collapse; text-align: center;"> <tr> <td style="width: 10%;"></td> <td style="width: 10%;"></td> <td style="width: 10%;"></td> <td style="width: 10%;"></td> <td style="width: 10%;"></td> <td style="width: 10%;"></td> <td style="width: 10%;"></td> <td style="width: 10%;"></td> <td style="width: 10%;"></td> <td style="width: 10%;"></td> </tr> <tr> <td></td> <td></td> <td colspan="8" style="text-align: center;"> <table border="1" style="width: 100%; border-collapse: collapse; text-align: center;"> <tr> <td style="width: 10%;"></td> <td style="width: 10%;"></td> <td style="width: 10%;"></td> <td style="width: 10%;"></td> <td style="width: 10%;"></td> <td style="width: 10%;"></td> <td style="width: 10%;"></td> <td style="width: 10%;"></td> <td style="width: 10%;"></td> <td style="width: 10%;"></td> </tr> <tr> <td></td> <td></td> <td colspan="8" style="text-align: center;"> <table border="1" style="width: 100%; border-collapse: collapse; text-align: center;"> <tr> <td style="width: 10%;"></td> <td style="width: 10%;"></td> <td style="width: 10%;"></td> <td style="width: 10%;"></td> <td style="width: 10%;"></td> <td style="width: 10%;"></td> <td style="width: 10%;"></td> <td style="width: 10%;"></td> <td style="width: 10%;"></td> <td style="width: 10%;"></td> </tr> <tr> <td></td> <td></td> <td colspan="8" style="text-align: center;"> <table border="1" style="width: 100%; border-collapse: collapse; text-align: center;"> <tr> <td style="width: 10%;"></td> <td style="width: 10%;"></td> <td style="width: 10%;"></td> <td style="width: 10%;"></td> <td style="width: 10%;"></td> <td style="width: 10%;"></td> <td style="width: 10%;"></td> <td style="width: 10%;"></td> <td style="width: 10%;"></td> <td style="width: 10%;"></td> </tr> <tr> <td></td> <td></td> <td colspan="8" style="text-align: center;"> <table border="1" style="width: 100%; border-collapse: collapse; text-align: center;"> <tr> <td style="width: 10%;"></td> <td style="width: 10%;"></td> <td style="width: 10%;"></td> <td style="width: 10%;"></td> <td style="width: 10%;"></td> <td style="width: 10%;"></td> <td style="width: 10%;"></td> <td style="width: 10%;"></td> <td style="width: 10%;"></td> <td style="width: 10%;"></td> </tr> <tr> <td></td> <td></td> <td colspan="8" style="text-align: center;"> <table border="1" style="width: 100%; border-collapse: collapse; text-align: center;"> <tr> <td style="width: 10%;"></td> <td style="width: 10%;"></td> <td style="width: 10%;"></td> <td style="width: 10%;"></td> <td style="width: 10%;"></td> <td style="width: 10%;"></td> <td style="width: 10%;"></td> <td style="width: 10%;"></td> <td style="width: 10%;"></td> <td style="width: 10%;"></td> </tr> <tr> <td></td> <td></td> <td colspan="8" style="text-align: center;"> <table border="1" style="width: 100%; border-collapse: collapse; text-align: center;"> <tr> <td style="width: 10%;"></td> <td style="width: 10%;"></td> <td style="width: 10%;"></td> <td style="width: 10%;"></td> <td style="width: 10%;"></td> <td style="width: 10%;"></td> <td style="width: 10%;"></td> <td style="width: 10%;"></td> <td style="width: 10%;"></td> <td style="width: 10%;"></td> </tr> <tr> <td></td> <td></td> <td colspan="8" style="text-align: center;"> <table border="1" style="width: 100%; border-collapse: collapse; text-align: center;"> <tr> <td style="width: 10%;"></td> <td style="width: 10%;"></td> <td style="width: 10%;"></td> <td style="width: 10%;"></td> <td style="width: 10%;"></td> <td style="width: 10%;"></td> <td style="width: 10%;"></td> <td style="width: 10%;"></td> <td style="width: 10%;"></td> <td style="width: 10%;"></td> </tr> <tr> <td></td> <td></td> <td colspan="8" style="text-align: center;"> <table border="1" style="width: 100%; border-collapse: collapse; text-align: center;"> <tr> <td style="width: 10%;"></td> <td style="width: 10%;"></td> <td style="width: 10%;"></td> <td style="width: 10%;"></td> <td style="width: 10%;"></td> <td style="width: 10%;"></td> <td style="width: 10%;"></td> <td style="width: 10%;"></td> <td style="width: 10%;"></td> <td style="width: 10%;"></td> </tr> <tr> <td></td> <td></td> <td colspan="8" style="text-align: center;"> <table border="1" style="width: 100%; border-collapse: collapse; text-align: center;"> <tr> <td style="width: 10%;"></td> <td style="width: 10%;"></td> <td style="width: 10%;"></td> <td style="width: 10%;"></td> <td style="width: 10%;"></td> <td style="width: 10%;"></td> <td style="width: 10%;"></td> <td style="width: 10%;"></td> <td style="width: 10%;"></td> <td style="width: 10%;"></td> </tr> <tr> <td></td> <td></td> <td colspan="8" style="text-align: center;"> <table border="1" style="width: 100%; border-collapse: collapse; text-align: center;"> <tr> <td style="width: 10%;"></td> <td style="width:
10%;"></td> <td style="width: 10%;"></td> <td style="width: 10%;"></td> <td style="width: 10%;"></td> <td style="width: 10%;"></td> <td style="width: 10%;"></td> <td style="width: 10%;"></td> <td style="width: 10%;"></td> <td style="width: 10%;"></td> </tr> <tr> <td></td> <td></td> <td colspan="8" style="text-align: center;"> <table border="1" style="width: 100%; border-collapse: collapse; text-align: center;"> <tr> <td style="width: 10%;"></td> <td style="width: 10%;"></td> <td style="width: 10%;"></td> <td style="width: 10%;"></td> <td style="width: 10%;"></td> <td style="width: 10%;"></td> <td style="width: 10%;"></td> <td style="width: 10%;"></td> <td style="width: 10%;"></td> <td style="width: 10%;"></td> </tr> <tr> <td></td> <td></td> <td colspan="8" style="text-align: center;"> <table border="1" style="width: 100%; border-collapse: collapse; text-align: center;"> <tr> <td style="width: 10%;"></td> <td style="width: 10%;"></td> <td style="width: 10%;"></td> <td style="width: 10%;"></td> <td style="width: 10%;"></td> <td style="width: 10%;"></td> <td style="width: 10%;"></td> <td style="width: 10%;"></td> <td style="width: 10%;"></td> <td style="width: 10%;"></td> </tr> <tr> <td></td> <td></td> <td colspan="8" style="text-align: center;"> <table border="1" style="width: 100%; border-collapse: collapse; text-align: center;"> <tr> <td style="width: 10%;"></td> <td style="width: 10%;"></td> <td style="width: 10%;"></td> <td style="width: 10%;"></td> <td style="width: 10%;"></td> <td style="width: 10%;"></td> <td style="width: 10%;"></td> <td style="width: 10%;"></td> <td style="width: 10%;"></td> <td style="width: 10%;"></td> </tr> <tr> <td></td> <td></td> <td colspan="8" style="text-align: center;"> <table border="1" style="width: 100%; border-collapse: collapse; text-align: center;"> <tr> <td style="width: 10%;"></td> <td style="width: 10%;"></td> <td style="width: 10%;"></td> <td style="width: 10%;"></td> <td style="width: 10%;"></td> <td style="width: 10%;"></td> <td style="width: 10%;"></td> <td style="width: 10%;"></td> <td style="width: 10%;"></td> <td style="width: 10%;"></td> </tr> <tr> <td></td> <td></td> <td colspan="8" style="text-align: center;"> <table border="1" style="width: 100%; border-collapse: collapse; text-align: center;"> <tr> <td style="width: 10%;"></td> <td style="width: 10%;"></td> <td style="width: 10%;"></td> <td style="width: 10%;"></td> <td style="width: 10%;"></td> <td style="width: 10%;"></td> <td style="width: 10%;"></td> <td style="width: 10%;"></td> <td style="width: 10%;"></td> <td style="width: 10%;"></td> </tr> <tr> <td></td> <td></td> <td colspan="8" style="text-align: center;"> <table border="1" style="width: 100%; border-collapse: collapse; text-align: center;"> <tr> <td style="width: 10%;"></td> <td style="width: 10%;"></td> <td style="width: 10%;"></td> <td style="width: 10%;"></td> <td style="width: 10%;"></td> <td style="width: 10%;"></td> <td style="width: 10%;"></td> <td style="width: 10%;"></td> <td style="width: 10%;"></td> <td style="width: 10%;"></td> </tr> <tr> <td></td> <td></td> <td colspan="8" style="text-align: center;"> <table border="1" style="width: 100%; border-collapse: collapse; text-align: center;"> <tr> <td style="width: 10%;"></td> <td style="width: 10%;"></td> <td style="width: 10%;"></td> <td style="width: 10%;"></td> <td style="width: 10%;"></td> <td style="width: 10%;"></td> <td style="width: 10%;"></td> <td style="width: 10%;"></td> <td style="width: 10%;"></td> <td style="width: 10%;"></td> </tr> <tr> <td></td> <td></td> <td colspan="8" style="text-align: center;"> <table border="1" style="width: 100%; border-collapse: collapse; text-align: center;"> <tr> <td style="width: 10%;"></td> <td style="width: 10%;"></td> <td style="width: 10%;"></td> <td style="width: 10%;"></td> <td style="width: 10%;"></td> <td style="width: 10%;"></td> <td style="width: 10%;"></td> <td style="width: 10%;"></td> <td style="width: 10%;"></td> <td style="width: 10%;"></td> </tr> <tr> <td></td> <td></td> <td colspan="8" style="text-align: center;"> <table border="1" style="width: 100%; border-collapse: collapse; text-align: center;"> <tr> <td style="width: 10%;"></td> <td style="width: 10%;"></td> <td style="width: 10%;"></td> <td style="width: 10%;"></td> <td style="width: 10%;"></td> <td style="width: 10%;"></td> <td style="width: 10%;"></td> <td style="width: 10%;"></td> <td style="width: 10%;"></td> <td style="width: 10%;"></td> </tr> <tr> <td></td> <td></td> <td colspan="8" style="text-align: center;"> <table border="1" style="width: 100%; border-collapse: collapse; text-align: center;"> <tr> <td style="width: 10%;"></td> <td style="width: 10%;"></td> <td style="width: 10%;"></td> <td style="width: 10%;"></td> <td style="width: 10%;"></td> <td style="width: 10%;"></td> <td style="width: 10%;"></td> <td style="width: 10%;"></td> <td style="width: 10%;"></td> <td style="width: 10%;"></td> </tr> <tr> <td></td> <td></td> <td colspan="8" style="text-align: center;"> <table border="1" style="width: 100%; border-collapse: collapse; text-align: center;"> <tr> <td style="width: 10%;"></td> <td style="width: 10%;"></td> <td style="width: 10%;"></td> <td style="width: 10%;"></td> <td style="width: 10%;"></td> <td style="width: 10%;"></td> <td style="width: 10%;"></td> <td style="width: 10%;"></td> <td style="width: 10%;"></td> <td style="width: 10%;"></td> </tr> <tr> <td></td> <td></td> <td colspan="8" style="text-align: center;"> <table border="1" style="width: 100%; border-collapse: collapse; text-align: center;"> <tr> <td style="width: 10%;"></td> <td style="width: 10%;"></td> <td style="width: 10%;"></td> <td style="width: 10%;"></td> <td style="width: 10%;"></td> <td style="width: 10%;"></td> <td style="width: 10%;"></td> <td style="width: 10%;"></td> <td style="width: 10%;"></td> <td style="width: 10%;"></td> </tr> <tr> <td></td> <td></td> <td colspan="8" style="text-align: center;"> <table border="1" style="width: 100%; border-collapse: collapse; text-align: center;"> <tr> <td style="width: 10%;"></td> <td style="width: 10%;"></td> <td style="width: 10%;"></td> <td style="width: 10%;"></td> <td style="width: 10%;"></td> <td style="width: 10%;"></td> <td style="width: 10%;"></td> <td style="width: 10%;"></td> <td style="width: 10%;"></td> <td style="width: 10%;"></td> </tr> <tr> <td></td> <td></td> <td colspan="8" style="text-align: center;"> <table border="1" style="width: 100%; border-collapse: collapse; text-align: center;"> <tr> <td style="width: 10%;"></td> <td style="width: 10%;"></td> <td style="width: 10%;"></td> <td style="width: 10%;"></td> <td style="width: 10%;"></td> <td style="width: 10%;"></td> <td style="width: 10%;"></td> <td style="width: 10%;"></td> <td style="width: 10%;"></td> <td style="width: 10%;"></td> </tr> <tr> <td></td> <td></td> <td colspan="8" style="text-align: center;"> <table border="1" style="width: 100%; border-collapse: collapse; text-align: center;"> <tr> <td style="width: 10%;"></td> <td style="width: 10%;"></td> <td style="width: 10%;"></td> <td style="width: 10%;"></td> <td style="width: 10%;"></td> <td style="width: 10%;"></td> <td style="width: 10%;"></td> <td style="width: 10%;"></td> <td style="width: 10%;"></td> <td style="width: 10%;"></td> </tr> <tr> <td></td> <td></td> <td colspan="8" style="text-align: center;"> <table border="1" style="width: 100%; border-collapse: collapse; text-align: center;"> <tr> <td style="width: 10%;"></td> <td style="width: 10%;"></td> <td style="width: 10%;"></td> <td style="width: 10%;"></td> <td style="width: 10%;"></td> <td style="width: 10%;"></td> <td style="width: 10%;"></td> <td style="width: 10%;"></td> <td style="width: 10%;"></td> <td style="width: 10%;"></td> </tr> <tr> <td></td> <td></td> <td colspan="8" style="text-align: center;"> <table border="1" style="width: 100%; border-collapse: collapse; text-align: center;"> <tr> <td style="width: 10%;"></td> <td style="width: 10%;"></td> <td style="width: 10%;"></td> <td style="width: 10%;"></td> <td style="width: 10%;"></td> <td style="width: 10%;"></td> <td style="width: 10%;"></td> <td style="width: 10%;"></td> <td style="width: 10%;"></td> <td style="width: 10%;"></td> </tr> <tr> <td></td> <td></td> <td colspan="8" style="text-align: center;"> <table border="1" style="width: 100%; border-collapse: collapse; text-align: center;"> <tr> </tr></table></td></tr></table></td></tr></table></td></tr></table></td></tr></table></td></tr></table></td></tr></table></td></tr></table></td></tr></table></td></tr></table></td></tr></table></td></tr></table></td></tr></table></td></tr></table></td></tr></table></td></tr></table></td></tr></table></td></tr></table></td></tr></table></td></tr></table></td></tr></table></td></tr></table></td></tr></table></td></tr></table></td></tr></table></td></tr></table></td></tr></table></td></tr></table></td></tr></table></td></tr></table></td></tr></table></td></tr></table></td></tr></table></td></tr></table></td></tr></table></td></tr></table></td></tr></table></td></tr></table></td></tr></table></td></tr></table></td></tr></table></td></tr></table></td></tr></table></td></tr></table></td></tr></table></td></tr></table></td></tr></table></td></tr></table></td></tr></table></td></tr></table></td></tr></table></td></tr></table></td></tr></table></td></tr></table></td></tr></table></td></tr></table></td></tr></table></td></tr></table> | | | | | | | | | | | | | | | | | | | | <table border="1" style="width: 100%;
border-collapse: collapse; text-align: center;"> <tr> <td style="width: 10%;"></td> <td style="width: 10%;"></td> <td style="width: 10%;"></td> <td style="width: 10%;"></td> <td style="width: 10%;"></td> <td style="width: 10%;"></td> <td style="width: 10%;"></td> <td style="width: 10%;"></td> <td style="width: 10%;"></td> <td style="width: 10%;"></td> </tr> <tr> <td></td> <td></td> <td colspan="8" style="text-align: center;"> <table border="1" style="width: 100%; border-collapse: collapse; text-align: center;"> <tr> <td style="width: 10%;"></td> <td style="width: 10%;"></td> <td style="width: 10%;"></td> <td style="width: 10%;"></td> <td style="width: 10%;"></td> <td style="width: 10%;"></td> <td style="width: 10%;"></td> <td style="width: 10%;"></td> <td style="width: 10%;"></td> <td style="width: 10%;"></td> </tr> <tr> <td></td> <td></td> <td colspan="8" style="text-align: center;"> <table border="1" style="width: 100%; border-collapse: collapse; text-align: center;"> <tr> <td style="width: 10%;"></td> <td style="width: 10%;"></td> <td style="width: 10%;"></td> <td style="width: 10%;"></td> <td style="width: 10%;"></td> <td style="width: 10%;"></td> <td style="width: 10%;"></td> <td style="width: 10%;"></td> <td style="width: 10%;"></td> <td style="width: 10%;"></td> </tr> <tr> <td></td> <td></td> <td colspan="8" style="text-align: center;"> <table border="1" style="width: 100%; border-collapse: collapse; text-align: center;"> <tr> <td style="width: 10%;"></td> <td style="width: 10%;"></td> <td style="width: 10%;"></td> <td style="width: 10%;"></td> <td style="width: 10%;"></td> <td style="width: 10%;"></td> <td style="width: 10%;"></td> <td style="width: 10%;"></td> <td style="width: 10%;"></td> <td style="width: 10%;"></td> </tr> <tr> <td></td> <td></td> <td colspan="8" style="text-align: center;"> <table border="1" style="width: 100%; border-collapse: collapse; text-align: center;"> <tr> <td style="width: 10%;"></td> <td style="width: 10%;"></td> <td style="width: 10%;"></td> <td style="width: 10%;"></td> <td style="width: 10%;"></td> <td style="width: 10%;"></td> <td style="width: 10%;"></td> <td style="width: 10%;"></td> <td style="width: 10%;"></td> <td style="width: 10%;"></td> </tr> <tr> <td></td> <td></td> <td colspan="8" style="text-align: center;"> <table border="1" style="width: 100%; border-collapse: collapse; text-align: center;"> <tr> <td style="width: 10%;"></td> <td style="width: 10%;"></td> <td style="width: 10%;"></td> <td style="width: 10%;"></td> <td style="width: 10%;"></td> <td style="width: 10%;"></td> <td style="width: 10%;"></td> <td style="width: 10%;"></td> <td style="width: 10%;"></td> <td style="width: 10%;"></td> </tr> <tr> <td></td> <td></td> <td colspan="8" style="text-align: center;"> <table border="1" style="width: 100%; border-collapse: collapse; text-align: center;"> <tr> <td style="width: 10%;"></td> <td style="width: 10%;"></td> <td style="width: 10%;"></td> <td style="width: 10%;"></td> <td style="width: 10%;"></td> <td style="width: 10%;"></td> <td style="width: 10%;"></td> <td style="width: 10%;"></td> <td style="width: 10%;"></td> <td style="width: 10%;"></td> </tr> <tr> <td></td> <td></td> <td colspan="8" style="text-align: center;"> <table border="1" style="width: 100%; border-collapse: collapse; text-align: center;"> <tr> <td style="width: 10%;"></td> <td style="width: 10%;"></td> <td style="width: 10%;"></td> <td style="width: 10%;"></td> <td style="width: 10%;"></td> <td style="width: 10%;"></td> <td style="width: 10%;"></td> <td style="width: 10%;"></td> <td style="width: 10%;"></td> <td style="width: 10%;"></td> </tr> <tr> <td></td> <td></td> <td colspan="8" style="text-align: center;"> <table border="1" style="width: 100%; border-collapse: collapse; text-align: center;"> <tr> <td style="width: 10%;"></td> <td style="width: 10%;"></td> <td style="width: 10%;"></td> <td style="width: 10%;"></td> <td style="width: 10%;"></td> <td style="width: 10%;"></td> <td style="width: 10%;"></td> <td style="width: 10%;"></td> <td style="width: 10%;"></td> <td style="width: 10%;"></td> </tr> <tr> <td></td> <td></td> <td colspan="8" style="text-align: center;"> <table border="1" style="width: 100%; border-collapse: collapse; text-align: center;"> <tr> <td style="width: 10%;"></td> <td style="width: 10%;"></td> <td style="width: 10%;"></td> <td style="width: 10%;"></td> <td style="width: 10%;"></td> <td style="width: 10%;"></td> <td style="width: 10%;"></td> <td style="width: 10%;"></td> <td style="width: 10%;"></td> <td style="width: 10%;"></td> </tr> <tr> <td></td> <td></td> <td colspan="8" style="text-align: center;"> <table border="1" style="width: 100%; border-collapse: collapse; text-align: center;"> <tr> <td style="width: 10%;"></td> <td style="width: 10%;"></td> <td style="width: 10%;"></td> <td style="width: 10%;"></td> <td style="width: 10%;"></td> <td style="width: 10%;"></td> <td style="width: 10%;"></td> <td style="width: 10%;"></td> <td style="width: 10%;"></td> <td style="width: 10%;"></td> </tr> <tr> <td></td> <td></td> <td colspan="8" style="text-align: center;"> <table border="1" style="width: 100%; border-collapse: collapse; text-align: center;"> <tr> <td style="width: 10%;"></td> <td style="width: 10%;"></td> <td style="width: 10%;"></td> <td style="width: 10%;"></td> <td style="width: 10%;"></td> <td style="width: 10%;"></td> <td style="width: 10%;"></td> <td style="width: 10%;"></td> <td style="width: 10%;"></td> <td style="width: 10%;"></td> </tr> <tr> <td></td> <td></td> <td colspan="8" style="text-align: center;"> <table border="1" style="width: 100%; border-collapse: collapse; text-align: center;"> <tr> <td style="width: 10%;"></td> <td style="width: 10%;"></td> <td style="width: 10%;"></td> <td style="width: 10%;"></td> <td style="width: 10%;"></td> <td style="width: 10%;"></td> <td style="width: 10%;"></td> <td style="width: 10%;"></td> <td style="width: 10%;"></td> <td style="width: 10%;"></td> </tr> <tr> <td></td> <td></td> <td colspan="8" style="text-align: center;"> <table border="1" style="width: 100%; border-collapse: collapse; text-align: center;"> <tr> <td style="width: 10%;"></td> <td style="width: 10%;"></td> <td style="width: 10%;"></td> <td style="width: 10%;"></td> <td style="width: 10%;"></td> <td style="width: 10%;"></td> <td style="width: 10%;"></td> <td style="width: 10%;"></td> <td style="width: 10%;"></td> <td style="width: 10%;"></td> </tr> <tr> <td></td> <td></td> <td colspan="8" style="text-align: center;"> <table border="1" style="width: 100%; border-collapse: collapse; text-align: center;"> <tr> <td style="width: 10%;"></td> <td style="width: 10%;"></td> <td style="width: 10%;"></td> <td style="width: 10%;"></td> <td style="width: 10%;"></td> <td style="width: 10%;"></td> <td style="width: 10%;"></td> <td style="width: 10%;"></td> <td style="width: 10%;"></td> <td style="width: 10%;"></td> </tr> <tr> <td></td> <td></td> <td colspan="8" style="text-align: center;"> <table border="1" style="width: 100%; border-collapse: collapse; text-align: center;"> <tr> <td style="width: 10%;"></td> <td style="width: 10%;"></td> <td style="width: 10%;"></td> <td style="width: 10%;"></td> <td style="width: 10%;"></td> <td style="width: 10%;"></td> <td style="width: 10%;"></td> <td style="width: 10%;"></td> <td style="width: 10%;"></td> <td style="width: 10%;"></td> </tr> <tr> <td></td> <td></td> <td colspan="8" style="text-align: center;"> <table border="1" style="width: 100%; border-collapse: collapse; text-align: center;"> <tr> <td style="width: 10%;"></td> <td style="width: 10%;"></td> <td style="width: 10%;"></td> <td style="width: 10%;"></td> <td style="width: 10%;"></td> <td style="width: 10%;"></td> <td style="width: 10%;"></td> <td style="width: 10%;"></td> <td style="width: 10%;"></td> <td style="width: 10%;"></td> </tr> <tr> <td></td> <td></td> <td colspan="8" style="text-align: center;"> <table border="1" style="width: 100%; border-collapse: collapse; text-align: center;"> <tr> <td style="width: 10%;"></td> <td style="width: 10%;"></td> <td style="width: 10%;"></td> <td style="width: 10%;"></td> <td style="width: 10%;"></td> <td style="width: 10%;"></td> <td style="width: 10%;"></td> <td style="width: 10%;"></td> <td style="width: 10%;"></td> <td style="width: 10%;"></td> </tr> <tr> <td></td> <td></td> <td colspan="8" style="text-align: center;"> <table border="1" style="width: 100%; border-collapse: collapse; text-align: center;"> <tr> <td style="width: 10%;"></td> <td style="width: 10%;"></td> <td style="width: 10%;"></td> <td style="width: 10%;"></td> <td style="width: 10%;"></td> <td style="width: 10%;"></td> <td style="width: 10%;"></td> <td style="width: 10%;"></td> <td style="width: 10%;"></td> <td style="width: 10%;"></td> </tr> <tr> <td></td> <td></td> <td colspan="8" style="text-align: center;"> <table border="1" style="width: 100%; border-collapse: collapse; text-align: center;"> <tr> <td style="width: 10%;"></td> <td style="width: 10%;"></td> <td style="width: 10%;"></td> <td style="width: 10%;"></td> <td style="width: 10%;"></td> <td style="width: 10%;"></td> <td style="width: 10%;"></td> <td style="width: 10%;"></td> <td style="width: 10%;"></td> <td style="width: 10%;"></td> </tr> <tr> <td></td> <td></td> <td colspan="8" style="text-align: center;"> <table border="1" style="width: 100%; border-collapse: collapse; text-align: center;"> <tr> <td style="width: 10%;"></td> <td style="width: 10%;"></td> <td style="width: 10%;"></td> <td style="width: 10%;"></td> <td style="width: 10%;"></td> <td style="width: 10%;"></td> <td style="width: 10%;"></td> <td style="width: 10%;"></td> <td style="width: 10%;"></td> <td style="width: 10%;"></td> </tr> <tr> <td></td> <td></td> <td colspan="8" style="text-align: center;"> <table border="1" style="width: 100%; border-collapse: collapse; text-align: center;"> <tr> <td style="width: 10%;"></td> <td style="width: 10%;"></td> <td style="width: 10%;"></td> <td style="width:
10%;"></td> <td style="width: 10%;"></td> <td style="width: 10%;"></td> <td style="width: 10%;"></td> <td style="width: 10%;"></td> <td style="width: 10%;"></td> <td style="width: 10%;"></td> </tr> <tr> <td></td> <td></td> <td colspan="8" style="text-align: center;"> <table border="1" style="width: 100%; border-collapse: collapse; text-align: center;"> <tr> <td style="width: 10%;"></td> <td style="width: 10%;"></td> <td style="width: 10%;"></td> <td style="width: 10%;"></td> <td style="width: 10%;"></td> <td style="width: 10%;"></td> <td style="width: 10%;"></td> <td style="width: 10%;"></td> <td style="width: 10%;"></td> <td style="width: 10%;"></td> </tr> <tr> <td></td> <td></td> <td colspan="8" style="text-align: center;"> <table border="1" style="width: 100%; border-collapse: collapse; text-align: center;"> <tr> <td style="width: 10%;"></td> <td style="width: 10%;"></td> <td style="width: 10%;"></td> <td style="width: 10%;"></td> <td style="width: 10%;"></td> <td style="width: 10%;"></td> <td style="width: 10%;"></td> <td style="width: 10%;"></td> <td style="width: 10%;"></td> <td style="width: 10%;"></td> </tr> <tr> <td></td> <td></td> <td colspan="8" style="text-align: center;"> <table border="1" style="width: 100%; border-collapse: collapse; text-align: center;"> <tr> <td style="width: 10%;"></td> <td style="width: 10%;"></td> <td style="width: 10%;"></td> <td style="width: 10%;"></td> <td style="width: 10%;"></td> <td style="width: 10%;"></td> <td style="width: 10%;"></td> <td style="width: 10%;"></td> <td style="width: 10%;"></td> <td style="width: 10%;"></td> </tr> <tr> <td></td> <td></td> <td colspan="8" style="text-align: center;"> <table border="1" style="width: 100%; border-collapse: collapse; text-align: center;"> <tr> <td style="width: 10%;"></td> <td style="width: 10%;"></td> <td style="width: 10%;"></td> <td style="width: 10%;"></td> <td style="width: 10%;"></td> <td style="width: 10%;"></td> <td style="width: 10%;"></td> <td style="width: 10%;"></td> <td style="width: 10%;"></td> <td style="width: 10%;"></td> </tr> <tr> <td></td> <td></td> <td colspan="8" style="text-align: center;"> <table border="1" style="width: 100%; border-collapse: collapse; text-align: center;"> <tr> <td style="width: 10%;"></td> <td style="width: 10%;"></td> <td style="width: 10%;"></td> <td style="width: 10%;"></td> <td style="width: 10%;"></td> <td style="width: 10%;"></td> <td style="width: 10%;"></td> <td style="width: 10%;"></td> <td style="width: 10%;"></td> <td style="width: 10%;"></td> </tr> <tr> <td></td> <td></td> <td colspan="8" style="text-align: center;"> <table border="1" style="width: 100%; border-collapse: collapse; text-align: center;"> <tr> <td style="width: 10%;"></td> <td style="width: 10%;"></td> <td style="width: 10%;"></td> <td style="width: 10%;"></td> <td style="width: 10%;"></td> <td style="width: 10%;"></td> <td style="width: 10%;"></td> <td style="width: 10%;"></td> <td style="width: 10%;"></td> <td style="width: 10%;"></td> </tr> <tr> <td></td> <td></td> <td colspan="8" style="text-align: center;"> <table border="1" style="width: 100%; border-collapse: collapse; text-align: center;"> <tr> <td style="width: 10%;"></td> <td style="width: 10%;"></td> <td style="width: 10%;"></td> <td style="width: 10%;"></td> <td style="width: 10%;"></td> <td style="width: 10%;"></td> <td style="width: 10%;"></td> <td style="width: 10%;"></td> <td style="width: 10%;"></td> <td style="width: 10%;"></td> </tr> <tr> <td></td> <td></td> <td colspan="8" style="text-align: center;"> <table border="1" style="width: 100%; border-collapse: collapse; text-align: center;"> <tr> <td style="width: 10%;"></td> <td style="width: 10%;"></td> <td style="width: 10%;"></td> <td style="width: 10%;"></td> <td style="width: 10%;"></td> <td style="width: 10%;"></td> <td style="width: 10%;"></td> <td style="width: 10%;"></td> <td style="width: 10%;"></td> <td style="width: 10%;"></td> </tr> <tr> <td></td> <td></td> <td colspan="8" style="text-align: center;"> <table border="1" style="width: 100%; border-collapse: collapse; text-align: center;"> <tr> <td style="width: 10%;"></td> <td style="width: 10%;"></td> <td style="width: 10%;"></td> <td style="width: 10%;"></td> <td style="width: 10%;"></td> <td style="width: 10%;"></td> <td style="width: 10%;"></td> <td style="width: 10%;"></td> <td style="width: 10%;"></td> <td style="width: 10%;"></td> </tr> <tr> <td></td> <td></td> <td colspan="8" style="text-align: center;"> <table border="1" style="width: 100%; border-collapse: collapse; text-align: center;"> <tr> <td style="width: 10%;"></td> <td style="width: 10%;"></td> <td style="width: 10%;"></td> <td style="width: 10%;"></td> <td style="width: 10%;"></td> <td style="width: 10%;"></td> <td style="width: 10%;"></td> <td style="width: 10%;"></td> <td style="width: 10%;"></td> <td style="width: 10%;"></td> </tr> <tr> <td></td> <td></td> <td colspan="8" style="text-align: center;"> <table border="1" style="width: 100%; border-collapse: collapse; text-align: center;"> <tr> <td style="width: 10%;"></td> <td style="width: 10%;"></td> <td style="width: 10%;"></td> <td style="width: 10%;"></td> <td style="width: 10%;"></td> <td style="width: 10%;"></td> <td style="width: 10%;"></td> <td style="width: 10%;"></td> <td style="width: 10%;"></td> <td style="width: 10%;"></td> </tr> <tr> <td></td> <td></td> <td colspan="8" style="text-align: center;"> <table border="1" style="width: 100%; border-collapse: collapse; text-align: center;"> <tr> <td style="width: 10%;"></td> <td style="width: 10%;"></td> <td style="width: 10%;"></td> <td style="width: 10%;"></td> <td style="width: 10%;"></td> <td style="width: 10%;"></td> <td style="width: 10%;"></td> <td style="width: 10%;"></td> <td style="width: 10%;"></td> <td style="width: 10%;"></td> </tr> <tr> <td></td> <td></td> <td colspan="8" style="text-align: center;"> <table border="1" style="width: 100%; border-collapse: collapse; text-align: center;"> <tr> <td style="width: 10%;"></td> <td style="width: 10%;"></td> <td style="width: 10%;"></td> <td style="width: 10%;"></td> <td style="width: 10%;"></td> <td style="width: 10%;"></td> <td style="width: 10%;"></td> <td style="width: 10%;"></td> <td style="width: 10%;"></td> <td style="width: 10%;"></td> </tr> <tr> <td></td> <td></td> <td colspan="8" style="text-align: center;"> <table border="1" style="width: 100%; border-collapse: collapse; text-align: center;"> <tr> <td style="width: 10%;"></td> <td style="width: 10%;"></td> <td style="width: 10%;"></td> <td style="width: 10%;"></td> <td style="width: 10%;"></td> <td style="width: 10%;"></td> <td style="width: 10%;"></td> <td style="width: 10%;"></td> <td style="width: 10%;"></td> <td style="width: 10%;"></td> </tr> <tr> <td></td> <td></td> <td colspan="8" style="text-align: center;"> <table border="1" style="width: 100%; border-collapse: collapse; text-align: center;"> <tr> <td style="width: 10%;"></td> <td style="width: 10%;"></td> <td style="width: 10%;"></td> <td style="width: 10%;"></td> <td style="width: 10%;"></td> <td style="width: 10%;"></td> <td style="width: 10%;"></td> <td style="width: 10%;"></td> <td style="width: 10%;"></td> <td style="width: 10%;"></td> </tr> <tr> <td></td> <td></td> <td colspan="8" style="text-align: center;"> <table border="1" style="width: 100%; border-collapse: collapse; text-align: center;"> <tr> <td style="width: 10%;"></td> <td style="width: 10%;"></td> <td style="width: 10%;"></td> <td style="width: 10%;"></td> <td style="width: 10%;"></td> <td style="width: 10%;"></td> <td style="width: 10%;"></td> <td style="width: 10%;"></td> <td style="width: 10%;"></td> <td style="width: 10%;"></td> </tr> <tr> <td></td> <td></td> <td colspan="8" style="text-align: center;"> <table border="1" style="width: 100%; border-collapse: collapse; text-align: center;"> <tr> <td style="width: 10%;"></td> <td style="width: 10%;"></td> <td style="width: 10%;"></td> <td style="width: 10%;"></td> <td style="width: 10%;"></td> <td style="width: 10%;"></td> <td style="width: 10%;"></td> <td style="width: 10%;"></td> <td style="width: 10%;"></td> <td style="width: 10%;"></td> </tr> <tr> <td></td> <td></td> <td colspan="8" style="text-align: center;"> <table border="1" style="width: 100%; border-collapse: collapse; text-align: center;"> <tr> <td style="width: 10%;"></td> <td style="width: 10%;"></td> <td style="width: 10%;"></td> <td style="width: 10%;"></td> <td style="width: 10%;"></td> <td style="width: 10%;"></td> <td style="width: 10%;"></td> <td style="width: 10%;"></td> <td style="width: 10%;"></td> <td style="width: 10%;"></td> </tr> <tr> <td></td> <td></td> <td colspan="8" style="text-align: center;"> <table border="1" style="width: 100%; border-collapse: collapse; text-align: center;"> <tr> <td style="width: 10%;"></td> <td style="width: 10%;"></td> <td style="width: 10%;"></td> <td style="width: 10%;"></td> <td style="width: 10%;"></td> <td style="width: 10%;"></td> <td style="width: 10%;"></td> <td style="width: 10%;"></td> <td style="width: 10%;"></td> <td style="width: 10%;"></td> </tr> <tr> <td></td> <td></td> <td colspan="8" style="text-align: center;"> <table border="1" style="width: 100%; border-collapse: collapse; text-align: center;"> <tr> <td style="width: 10%;"></td> <td style="width: 10%;"></td> <td style="width: 10%;"></td> <td style="width: 10%;"></td> <td style="width: 10%;"></td> <td style="width: 10%;"></td> <td style="width: 10%;"></td> <td style="width: 10%;"></td> <td style="width: 10%;"></td> <td style="width: 10%;"></td> </tr> <tr> <td></td> <td></td> <td colspan="8" style="text-align: center;"> <table border="1" style="width: 100%; border-collapse: collapse; text-align: center;"> <tr> <td style="width: 10%;"></td> <td style="width: 10%;"></td> <td style="width: 10%;"></td> <td style="width: 10%;"></td> <td style="width: 10%;"></td> <td style="width: 10%;"></td> <td style="width: 10%;"></td> <td style="width: 10%;"></td> <td style="width: 10%;"></td> <td
style="width: 10%;"></td> </tr> <tr> <td></td> <td></td> <td colspan="8" style="text-align: center;"> <table border="1" style="width: 100%; border-collapse: collapse; text-align: center;"> <tr> <td style="width: 10%;"></td> <td style="width: 10%;"></td> <td style="width: 10%;"></td> <td style="width: 10%;"></td> <td style="width: 10%;"></td> <td style="width: 10%;"></td> <td style="width: 10%;"></td> <td style="width: 10%;"></td> <td style="width: 10%;"></td> <td style="width: 10%;"></td> </tr> <tr> <td></td> <td></td> <td colspan="8" style="text-align: center;"> <table border="1" style="width: 100%; border-collapse: collapse; text-align: center;"> <tr> <td style="width: 10%;"></td> <td style="width: 10%;"></td> <td style="width: 10%;"></td> <td style="width: 10%;"></td> <td style="width: 10%;"></td> <td style="width: 10%;"></td> <td style="width: 10%;"></td> <td style="width: 10%;"></td> <td style="width: 10%;"></td> <td style="width: 10%;"></td> </tr> <tr> <td></td> <td></td> <td colspan="8" style="text-align: center;"> <table border="1" style="width: 100%; border-collapse: collapse; text-align: center;"> <tr> <td style="width: 10%;"></td> <td style="width: 10%;"></td> <td style="width: 10%;"></td> <td style="width: 10%;"></td> <td style="width: 10%;"></td> <td style="width: 10%;"></td> <td style="width: 10%;"></td> <td style="width: 10%;"></td> <td style="width: 10%;"></td> <td style="width: 10%;"></td> </tr> <tr> <td></td> <td></td> <td colspan="8" style="text-align: center;"> <table border="1" style="width: 100%; border-collapse: collapse; text-align: center;"> <tr> <td style="width: 10%;"></td> <td style="width: 10%;"></td> <td style="width: 10%;"></td> <td style="width: 10%;"></td> <td style="width: 10%;"></td> <td style="width: 10%;"></td> <td style="width: 10%;"></td> <td style="width: 10%;"></td> <td style="width: 10%;"></td> <td style="width: 10%;"></td> </tr> <tr> <td></td> <td></td> <td colspan="8" style="text-align: center;"> <table border="1" style="width: 100%; border-collapse: collapse; text-align: center;"> <tr> <td style="width: 10%;"></td> <td style="width: 10%;"></td> <td style="width: 10%;"></td> <td style="width: 10%;"></td> <td style="width: 10%;"></td> <td style="width: 10%;"></td> <td style="width: 10%;"></td> <td style="width: 10%;"></td> <td style="width: 10%;"></td> <td style="width: 10%;"></td> </tr> <tr> <td></td> <td></td> <td colspan="8" style="text-align: center;"> <table border="1" style="width: 100%; border-collapse: collapse; text-align: center;"> <tr> <td style="width: 10%;"></td> <td style="width: 10%;"></td> <td style="width: 10%;"></td> <td style="width: 10%;"></td> <td style="width: 10%;"></td> <td style="width: 10%;"></td> <td style="width: 10%;"></td> <td style="width: 10%;"></td> <td style="width: 10%;"></td> <td style="width: 10%;"></td> </tr> <tr> <td></td> <td></td> <td colspan="8" style="text-align: center;"> <table border="1" style="width: 100%; border-collapse: collapse; text-align: center;"> <tr> <td style="width: 10%;"></td> <td style="width: 10%;"></td> <td style="width: 10%;"></td> <td style="width: 10%;"></td> <td style="width: 10%;"></td> <td style="width: 10%;"></td> <td style="width: 10%;"></td> <td style="width: 10%;"></td> <td style="width: 10%;"></td> <td style="width: 10%;"></td> </tr> <tr> <td></td> <td></td> <td colspan="8" style="text-align: center;"> <table border="1" style="width: 100%; border-collapse: collapse; text-align: center;"> <tr> <td style="width: 10%;"></td> <td style="width: 10%;"></td> <td style="width: 10%;"></td> <td style="width: 10%;"></td> <td style="width: 10%;"></td> <td style="width: 10%;"></td> <td style="width: 10%;"></td> <td style="width: 10%;"></td> <td style="width: 10%;"></td> <td style="width: 10%;"></td> </tr> <tr> <td></td> <td></td> <td colspan="8" style="text-align: center;"> <table border="1" style="width: 100%; border-collapse: collapse; text-align: center;"> <tr> <td style="width: 10%;"></td> <td style="width: 10%;"></td> <td style="width: 10%;"></td> <td style="width: 10%;"></td> <td style="width: 10%;"></td> <td style="width: 10%;"></td> <td style="width: 10%;"></td> <td style="width: 10%;"></td> <td style="width: 10%;"></td> <td style="width: 10%;"></td> </tr> <tr> <td></td> <td></td> <td colspan="8" style="text-align: center;"> <table border="1" style="width: 100%; border-collapse: collapse; text-align: center;"> <tr> <td style="width: 10%;"></td> <td style="width: 10%;"></td> <td style="width: 10%;"></td> <td style="width: 10%;"></td> <td style="width: 10%;"></td> <td style="width: 10%;"></td> <td style="width: 10%;"></td> <td style="width: 10%;"></td> <td style="width: 10%;"></td> <td style="width: 10%;"></td> </tr> <tr> <td></td> <td></td> <td colspan="8" style="text-align: center;"> <table border="1" style="width: 100%; border-collapse: collapse; text-align: center;"> <tr> <td style="width: 10%;"></td> <td style="width: 10%;"></td> <td style="width: 10%;"></td> <td style="width: 10%;"></td> <td style="width: 10%;"></td> <td style="width: 10%;"></td> <td style="width: 10%;"></td> <td style="width: 10%;"></td> <td style="width: 10%;"></td> <td style="width: 10%;"></td> </tr> <tr> <td></td> <td></td> <td colspan="8" style="text-align: center;"> <table border="1" style="width: 100%; border-collapse: collapse; text-align: center;"> <tr> <td style="width: 10%;"></td> <td style="width: 10%;"></td> <td style="width: 10%;"></td> <td style="width: 10%;"></td> <td style="width: 10%;"></td> <td style="width: 10%;"></td> <td style="width: 10%;"></td> <td style="width: 10%;"></td> <td style="width: 10%;"></td> <td style="width: 10%;"></td> </tr> <tr> <td></td> <td></td> <td colspan="8" style="text-align: center;"> <table border="1" style="width: 100%; border-collapse: collapse; text-align: center;"> <tr> <td style="width: 10%;"></td> <td style="width: 10%;"></td> <td style="width: 10%;"></td> <td style="width: 10%;"></td> <td style="width: 10%;"></td> <td style="width: 10%;"></td> <td style="width: 10%;"></td> <td style="width: 10%;"></td> <td style="width: 10%;"></td> <td style="width: 10%;"></td> </tr> <tr> <td></td> <td></td> <td colspan="8" style="text-align: center;"> <table border="1" style="width: 100%; border-collapse: collapse; text-align: center;"> <tr> </tr></table></td></tr></table></td></tr></table></td></tr></table></td></tr></table></td></tr></table></td></tr></table></td></tr></table></td></tr></table></td></tr></table></td></tr></table></td></tr></table></td></tr></table></td></tr></table></td></tr></table></td></tr></table></td></tr></table></td></tr></table></td></tr></table></td></tr></table></td></tr></table></td></tr></table></td></tr></table></td></tr></table></td></tr></table></td></tr></table></td></tr></table></td></tr></table></td></tr></table></td></tr></table></td></tr></table></td></tr></table></td></tr></table></td></tr></table></td></tr></table></td></tr></table></td></tr></table></td></tr></table></td></tr></table></td></tr></table></td></tr></table></td></tr></table></td></tr></table></td></tr></table></td></tr></table></td></tr></table></td></tr></table></td></tr></table></td></tr></table></td></tr></table></td></tr></table></td></tr></table></td></tr></table></td></tr></table></td></tr></table></td></tr></table></td></tr></table> | | | | | | | | | | | | | | | | | | | | <table border="1" style="width: 100%; border-collapse: collapse; text-align: center;"> <tr> <td style="width: 10%;"></td> <td style="width: 10%;"></td> <td style="width: 10%;"></td> <td style="width: 10%;"></td> <td style="width: 10%;"></td> <td style="width: 10%;"></td> <td style="width: 10%;"></td> <td style="width: 10%;"></td> <td style="width: 10%;"></td> <td style="width: 10%;"></td> </tr> <tr> <td></td> <td></td> <td colspan="8" style="text-align: center;"> <table border="1" style="width: 100%; border-collapse: collapse; text-align: center;"> <tr> <td style="width: 10%;"></td> <td style="width: 10%;"></td> <td style="width: 10%;"></td> <td style="width: 10%;"></td> <td style="width: 10%;"></td> <td style="width: 10%;"></td> <td style="width: 10%;"></td> <td style="width: 10%;"></td> <td style="width: 10%;"></td> <td style="width: 10%;"></td> </tr> <tr> <td></td> <td></td> <td colspan="8" style="text-align: center;"> <table border="1" style="width: 100%; border-collapse: collapse; text-align: center;"> <tr> <td style="width: 10%;"></td> <td style="width: 10%;"></td> <td style="width: 10%;"></td> <td style="width: 10%;"></td> <td style="width: 10%;"></td> <td style="width: 10%;"></td> <td style="width: 10%;"></td> <td style="width: 10%;"></td> <td style="width: 10%;"></td> <td style="width: 10%;"></td> </tr> <tr> <td></td> <td></td> <td colspan="8" style="text-align: center;"> <table border="1" style="width: 100%; border-collapse: collapse; text-align: center;"> <tr> <td style="width: 10%;"></td> <td style="width: 10%;"></td> <td style="width: 10%;"></td> <td style="width: 10%;"></td> <td style="width: 10%;"></td> <td style="width: 10%;"></td> <td style="width: 10%;"></td> <td style="width: 10%;"></td> <td style="width: 10%;"></td> <td style="width: 10%;"></td> </tr> <tr> <td></td> <td></td> <td colspan="8" style="text-align: center;"> <table border="1" style="width: 100%; border-collapse: collapse; text-align: center;"> <tr> <td style="width: 10%;"></td> <td style="width: 10%;"></td> <td style="width: 10%;"></td> <td style="width: 10%;"></td> <td style="width: 10%;"></td> <td style="width: 10%;"></td> <td
style="width: 10%;"></td> <td style="width: 10%;"></td> <td style="width: 10%;"></td> <td style="width: 10%;"></td> </tr> <tr> <td></td> <td></td> <td colspan="8" style="text-align: center;"> <table border="1" style="width: 100%; border-collapse: collapse; text-align: center;"> <tr> <td style="width: 10%;"></td> <td style="width: 10%;"></td> <td style="width: 10%;"></td> <td style="width: 10%;"></td> <td style="width: 10%;"></td> <td style="width: 10%;"></td> <td style="width: 10%;"></td> <td style="width: 10%;"></td> <td style="width: 10%;"></td> <td style="width: 10%;"></td> </tr> <tr> <td></td> <td></td> <td colspan="8" style="text-align: center;"> <table border="1" style="width: 100%; border-collapse: collapse; text-align: center;"> <tr> <td style="width: 10%;"></td> <td style="width: 10%;"></td> <td style="width: 10%;"></td> <td style="width: 10%;"></td> <td style="width: 10%;"></td> <td style="width: 10%;"></td> <td style="width: 10%;"></td> <td style="width: 10%;"></td> <td style="width: 10%;"></td> <td style="width: 10%;"></td> </tr> <tr> <td></td> <td></td> <td colspan="8" style="text-align: center;"> <table border="1" style="width: 100%; border-collapse: collapse; text-align: center;"> <tr> <td style="width: 10%;"></td> <td style="width: 10%;"></td> <td style="width: 10%;"></td> <td style="width: 10%;"></td> <td style="width: 10%;"></td> <td style="width: 10%;"></td> <td style="width: 10%;"></td> <td style="width: 10%;"></td> <td style="width: 10%;"></td> <td style="width: 10%;"></td> </tr> <tr> <td></td> <td></td> <td colspan="8" style="text-align: center;"> <table border="1" style="width: 100%; border-collapse: collapse; text-align: center;"> <tr> <td style="width: 10%;"></td> <td style="width: 10%;"></td> <td style="width: 10%;"></td> <td style="width: 10%;"></td> <td style="width: 10%;"></td> <td style="width: 10%;"></td> <td style="width: 10%;"></td> <td style="width: 10%;"></td> <td style="width: 10%;"></td> <td style="width: 10%;"></td> </tr> <tr> <td></td> <td></td> <td colspan="8" style="text-align: center;"> <table border="1" style="width: 100%; border-collapse: collapse; text-align: center;"> <tr> <td style="width: 10%;"></td> <td style="width: 10%;"></td> <td style="width: 10%;"></td> <td style="width: 10%;"></td> <td style="width: 10%;"></td> <td style="width: 10%;"></td> <td style="width: 10%;"></td> <td style="width: 10%;"></td> <td style="width: 10%;"></td> <td style="width: 10%;"></td> </tr> <tr> <td></td> <td></td> <td colspan="8" style="text-align: center;"> <table border="1" style="width: 100%; border-collapse: collapse; text-align: center;"> <tr> <td style="width: 10%;"></td> <td style="width: 10%;"></td> <td style="width: 10%;"></td> <td style="width: 10%;"></td> <td style="width: 10%;"></td> <td style="width: 10%;"></td> <td style="width: 10%;"></td> <td style="width: 10%;"></td> <td style="width: 10%;"></td> <td style="width: 10%;"></td> </tr> <tr> <td></td> <td></td> <td colspan="8" style="text-align: center;"> <table border="1" style="width: 100%; border-collapse: collapse; text-align: center;"> <tr> <td style="width: 10%;"></td> <td style="width: 10%;"></td> <td style="width: 10%;"></td> <td style="width: 10%;"></td> <td style="width: 10%;"></td> <td style="width: 10%;"></td> <td style="width: 10%;"></td> <td style="width: 10%;"></td> <td style="width: 10%;"></td> <td style="width: 10%;"></td> </tr> <tr> <td></td> <td></td> <td colspan="8" style="text-align: center;"> <table border="1" style="width: 100%; border-collapse: collapse; text-align: center;"> <tr> <td style="width: 10%;"></td> <td style="width: 10%;"></td> <td style="width: 10%;"></td> <td style="width: 10%;"></td> <td style="width: 10%;"></td> <td style="width: 10%;"></td> <td style="width: 10%;"></td> <td style="width: 10%;"></td> <td style="width: 10%;"></td> <td style="width: 10%;"></td> </tr> <tr> <td></td> <td></td> <td colspan="8" style="text-align: center;"> <table border="1" style="width: 100%; border-collapse: collapse; text-align: center;"> <tr> <td style="width: 10%;"></td> <td style="width: 10%;"></td> <td style="width: 10%;"></td> <td style="width: 10%;"></td> <td style="width: 10%;"></td> <td style="width: 10%;"></td> <td style="width: 10%;"></td> <td style="width: 10%;"></td> <td style="width: 10%;"></td> <td style="width: 10%;"></td> </tr> <tr> <td></td> <td></td> <td colspan="8" style="text-align: center;"> <table border="1" style="width: 100%; border-collapse: collapse; text-align: center;"> <tr> <td style="width: 10%;"></td> <td style="width: 10%;"></td> <td style="width: 10%;"></td> <td style="width: 10%;"></td> <td style="width: 10%;"></td> <td style="width: 10%;"></td> <td style="width: 10%;"></td> <td style="width: 10%;"></td> <td style="width: 10%;"></td> <td style="width: 10%;"></td> </tr> <tr> <td></td> <td></td> <td colspan="8" style="text-align: center;"> <table border="1" style="width: 100%; border-collapse: collapse; text-align: center;"> <tr> <td style="width: 10%;"></td> <td style="width: 10%;"></td> <td style="width: 10%;"></td> <td style="width: 10%;"></td> <td style="width: 10%;"></td> <td style="width: 10%;"></td> <td style="width: 10%;"></td> <td style="width: 10%;"></td> <td style="width: 10%;"></td> <td style="width: 10%;"></td> </tr> <tr> <td></td> <td></td> <td colspan="8" style="text-align: center;"> <table border="1" style="width: 100%; border-collapse: collapse; text-align: center;"> <tr> <td style="width: 10%;"></td> <td style="width: 10%;"></td> <td style="width: 10%;"></td> <td style="width: 10%;"></td> <td style="width: 10%;"></td> <td style="width: 10%;"></td> <td style="width: 10%;"></td> <td style="width: 10%;"></td> <td style="width: 10%;"></td> <td style="width: 10%;"></td> </tr> <tr> <td></td> <td></td> <td colspan="8" style="text-align: center;"> <table border="1" style="width: 100%; border-collapse: collapse; text-align: center;"> <tr> <td style="width: 10%;"></td> <td style="width: 10%;"></td> <td style="width: 10%;"></td> <td style="width: 10%;"></td> <td style="width: 10%;"></td> <td style="width: 10%;"></td> <td style="width: 10%;"></td> <td style="width: 10%;"></td> <td style="width: 10%;"></td> <td style="width: 10%;"></td> </tr> <tr> <td></td> <td></td> <td colspan="8" style="text-align: center;"> <table border="1" style="width: 100%; border-collapse: collapse; text-align: center;"> <tr> <td style="width: 10%;"></td> <td style="width: 10%;"></td> <td style="width: 10%;"></td> <td style="width: 10%;"></td> <td style="width: 10%;"></td> <td style="width: 10%;"></td> <td style="width: 10%;"></td> <td style="width: 10%;"></td> <td style="width: 10%;"></td> <td style="width: 10%;"></td> </tr> <tr> <td></td> <td></td> <td colspan="8" style="text-align: center;"> <table border="1" style="width: 100%; border-collapse: collapse; text-align: center;"> <tr> <td style="width: 10%;"></td> <td style="width: 10%;"></td> <td style="width: 10%;"></td> <td style="width: 10%;"></td> <td style="width: 10%;"></td> <td style="width: 10%;"></td> <td style="width: 10%;"></td> <td style="width: 10%;"></td> <td style="width: 10%;"></td> <td style="width: 10%;"></td> </tr> <tr> <td></td> <td></td> <td colspan="8" style="text-align: center;"> <table border="1" style="width: 100%; border-collapse: collapse; text-align: center;"> <tr> <td style="width: 10%;"></td> <td style="width: 10%;"></td> <td style="width: 10%;"></td> <td style="width: 10%;"></td> <td style="width: 10%;"></td> <td style="width: 10%;"></td> <td style="width: 10%;"></td> <td style="width: 10%;"></td> <td style="width: 10%;"></td> <td style="width: 10%;"></td> </tr> <tr> <td></td> <td></td> <td colspan="8" style="text-align: center;"> <table border="1" style="width: 100%; border-collapse: collapse; text-align: center;"> <tr> <td style="width: 10%;"></td> <td style="width: 10%;"></td> <td style="width: 10%;"></td> <td style="width: 10%;"></td> <td style="width: 10%;"></td> <td style="width: 10%;"></td> <td style="width: 10%;"></td> <td style="width: 10%;"></td> <td style="width: 10%;"></td> <td style="width: 10%;"></td> </tr> <tr> <td></td> <td></td> <td colspan="8" style="text-align: center;"> <table border="1" style="width: 100%; border-collapse: collapse; text-align: center;"> <tr> <td style="width: 10%;"></td> <td style="width: 10%;"></td> <td style="width: 10%;"></td> <td style="width: 10%;"></td> <td style="width: 10%;"></td> <td style="width: 10%;"></td> <td style="width: 10%;"></td> <td style="width: 10%;"></td> <td style="width: 10%;"></td> <td style="width: 10%;"></td> </tr> <tr> <td></td> <td></td> <td colspan="8" style="text-align: center;"> <table border="1" style="width: 100%; border-collapse: collapse; text-align: center;"> <tr> <td style="width: 10%;"></td> <td style="width: 10%;"></td> <td style="width: 10%;"></td> <td style="width: 10%;"></td> <td style="width: 10%;"></td> <td style="width: 10%;"></td> <td style="width: 10%;"></td> <td style="width: 10%;"></td> <td style="width: 10%;"></td> <td style="width: 10%;"></td> </tr> <tr> <td></td> <td></td> <td colspan="8" style="text-align: center;"> <table border="1" style="width: 100%; border-collapse: collapse; text-align: center;"> <tr> <td style="width: 10%;"></td> <td style="width: 10%;"></td> <td style="width: 10%;"></td> <td style="width: 10%;"></td> <td style="width: 10%;"></td> <td style="width: 10%;"></td> <td style="width: 10%;"></td> <td style="width: 10%;"></td> <td style="width: 10%;"></td> <td style="width: 10%;"></td> </tr> <tr> <td></td> <td></td> <td colspan="8" style="text-align: center;"> <table border="1" style="width: 100%; border-collapse: collapse; text-align: center;"> <tr> <td style="width: 10%;"></td> <td style="width: 10%;"></td> <td style="width: 10%;"></td> <td style="width: 10%;"></td> <td style="width: 10%;"></td> <td style="width: 10%;"></td> <td style="width: 10%;"></td> <td style="width: 10%;"></td> <td style="width: 10%;"></td> <td style="width: 10%;"></td> </tr> <tr> <td></td> <td></td> <td colspan="8"
style="text-align: center;"> <table border="1" style="width: 100%; border-collapse: collapse; text-align: center;"> <tr> <td style="width: 10%;"></td> <td style="width: 10%;"></td> <td style="width: 10%;"></td> <td style="width: 10%;"></td> <td style="width: 10%;"></td> <td style="width: 10%;"></td> <td style="width: 10%;"></td> <td style="width: 10%;"></td> <td style="width: 10%;"></td> <td style="width: 10%;"></td> </tr> <tr> <td></td> <td></td> <td colspan="8" style="text-align: center;"> <table border="1" style="width: 100%; border-collapse: collapse; text-align: center;"> <tr> <td style="width: 10%;"></td> <td style="width: 10%;"></td> <td style="width: 10%;"></td> <td style="width: 10%;"></td> <td style="width: 10%;"></td> <td style="width: 10%;"></td> <td style="width: 10%;"></td> <td style="width: 10%;"></td> <td style="width: 10%;"></td> <td style="width: 10%;"></td> </tr> <tr> <td></td> <td></td> <td colspan="8" style="text-align: center;"> <table border="1" style="width: 100%; border-collapse: collapse; text-align: center;"> <tr> <td style="width: 10%;"></td> <td style="width: 10%;"></td> <td style="width: 10%;"></td> <td style="width: 10%;"></td> <td style="width: 10%;"></td> <td style="width: 10%;"></td> <td style="width: 10%;"></td> <td style="width: 10%;"></td> <td style="width: 10%;"></td> <td style="width: 10%;"></td> </tr> <tr> <td></td> <td></td> <td colspan="8" style="text-align: center;"> <table border="1" style="width: 100%; border-collapse: collapse; text-align: center;"> <tr> <td style="width: 10%;"></td> <td style="width: 10%;"></td> <td style="width: 10%;"></td> <td style="width: 10%;"></td> <td style="width: 10%;"></td> <td style="width: 10%;"></td> <td style="width: 10%;"></td> <td style="width: 10%;"></td> <td style="width: 10%;"></td> <td style="width: 10%;"></td> </tr> <tr> <td></td> <td></td> <td colspan="8" style="text-align: center;"> <table border="1" style="width: 100%; border-collapse: collapse; text-align: center;"> <tr> <td style="width: 10%;"></td> <td style="width: 10%;"></td> <td style="width: 10%;"></td> <td style="width: 10%;"></td> <td style="width: 10%;"></td> <td style="width: 10%;"></td> <td style="width: 10%;"></td> <td style="width: 10%;"></td> <td style="width: 10%;"></td> <td style="width: 10%;"></td> </tr> <tr> <td></td> <td></td> <td colspan="8" style="text-align: center;"> <table border="1" style="width: 100%; border-collapse: collapse; text-align: center;"> <tr> <td style="width: 10%;"></td> <td style="width: 10%;"></td> <td style="width: 10%;"></td> <td style="width: 10%;"></td> <td style="width: 10%;"></td> <td style="width: 10%;"></td> <td style="width: 10%;"></td> <td style="width: 10%;"></td> <td style="width: 10%;"></td> <td style="width: 10%;"></td> </tr> <tr> <td></td> <td></td> <td colspan="8" style="text-align: center;"> <table border="1" style="width: 100%; border-collapse: collapse; text-align: center;"> <tr> <td style="width: 10%;"></td> <td style="width: 10%;"></td> <td style="width: 10%;"></td> <td style="width: 10%;"></td> <td style="width: 10%;"></td> <td style="width: 10%;"></td> <td style="width: 10%;"></td> <td style="width: 10%;"></td> <td style="width: 10%;"></td> <td style="width: 10%;"></td> </tr> <tr> <td></td> <td></td> <td colspan="8" style="text-align: center;"> <table border="1" style="width: 100%; border-collapse: collapse; text-align: center;"> <tr> <td style="width: 10%;"></td> <td style="width: 10%;"></td> <td style="width: 10%;"></td> <td style="width: 10%;"></td> <td style="width: 10%;"></td> <td style="width: 10%;"></td> <td style="width: 10%;"></td> <td style="width: 10%;"></td> <td style="width: 10%;"></td> <td style="width: 10%;"></td> </tr> <tr> <td></td> <td></td> <td colspan="8" style="text-align: center;"> <table border="1" style="width: 100%; border-collapse: collapse; text-align: center;"> <tr> <td style="width: 10%;"></td> <td style="width: 10%;"></td> <td style="width: 10%;"></td> <td style="width: 10%;"></td> <td style="width: 10%;"></td> <td style="width: 10%;"></td> <td style="width: 10%;"></td> <td style="width: 10%;"></td> <td style="width: 10%;"></td> <td style="width: 10%;"></td> </tr> <tr> <td></td> <td></td> <td colspan="8" style="text-align: center;"> <table border="1" style="width: 100%; border-collapse: collapse; text-align: center;"> <tr> <td style="width: 10%;"></td> <td style="width: 10%;"></td> <td style="width: 10%;"></td> <td style="width: 10%;"></td> <td style="width: 10%;"></td> <td style="width: 10%;"></td> <td style="width: 10%;"></td> <td style="width: 10%;"></td> <td style="width: 10%;"></td> <td style="width: 10%;"></td> </tr> <tr> <td></td> <td></td> <td colspan="8" style="text-align: center;"> <table border="1" style="width: 100%; border-collapse: collapse; text-align: center;"> <tr> <td style="width: 10%;"></td> <td style="width: 10%;"></td> <td style="width: 10%;"></td> <td style="width: 10%;"></td> <td style="width: 10%;"></td> <td style="width: 10%;"></td> <td style="width: 10%;"></td> <td style="width: 10%;"></td> <td style="width: 10%;"></td> <td style="width: 10%;"></td> </tr> <tr> <td></td> <td></td> <td colspan="8" style="text-align: center;"> <table border="1" style="width: 100%; border-collapse: collapse; text-align: center;"> <tr> <td style="width: 10%;"></td> <td style="width: 10%;"></td> <td style="width: 10%;"></td> <td style="width: 10%;"></td> <td style="width: 10%;"></td> <td style="width: 10%;"></td> <td style="width: 10%;"></td> <td style="width: 10%;"></td> <td style="width: 10%;"></td> <td style="width: 10%;"></td> </tr> <tr> <td></td> <td></td> <td colspan="8" style="text-align: center;"> <table border="1" style="width: 100%; border-collapse: collapse; text-align: center;"> <tr> <td style="width: 10%;"></td> <td style="width: 10%;"></td> <td style="width: 10%;"></td> <td style="width: 10%;"></td> <td style="width: 10%;"></td> <td style="width: 10%;"></td> <td style="width: 10%;"></td> <td style="width: 10%;"></td> <td style="width: 10%;"></td> <td style="width: 10%;"></td> </tr> <tr> <td></td> <td></td> <td colspan="8" style="text-align: center;"> <table border="1" style="width: 100%; border-collapse: collapse; text-align: center;"> <tr> <td style="width: 10%;"></td> <td style="width: 10%;"></td> <td style="width: 10%;"></td> <td style="width: 10%;"></td> <td style="width: 10%;"></td> <td style="width: 10%;"></td> <td style="width: 10%;"></td> <td style="width: 10%;"></td> <td style="width: 10%;"></td> <td style="width: 10%;"></td> </tr> <tr> <td></td> <td></td> <td colspan="8" style="text-align: center;"> <table border="1" style="width: 100%; border-collapse: collapse; text-align: center;"> <tr> <td style="width: 10%;"></td> <td style="width: 10%;"></td> <td style="width: 10%;"></td> <td style="width: 10%;"></td> <td style="width: 10%;"></td> <td style="width: 10%;"></td> <td style="width: 10%;"></td> <td style="width: 10%;"></td> <td style="width: 10%;"></td> <td style="width: 10%;"></td> </tr> <tr> <td></td> <td></td> <td colspan="8" style="text-align: center;"> <table border="1" style="width: 100%; border-collapse: collapse; text-align: center;"> <tr> <td style="width: 10%;"></td> <td style="width: 10%;"></td> <td style="width: 10%;"></td> <td style="width: 10%;"></td> <td style="width: 10%;"></td> <td style="width: 10%;"></td> <td style="width: 10%;"></td> <td style="width: 10%;"></td> <td style="width: 10%;"></td> <td style="width: 10%;"></td> </tr> <tr> <td></td> <td></td> <td colspan="8" style="text-align: center;"> <table border="1" style="width: 100%; border-collapse: collapse; text-align: center;"> <tr> <td style="width: 10%;"></td> <td style="width: 10%;"></td> <td style="width: 10%;"></td> <td style="width: 10%;"></td> <td style="width: 10%;"></td> <td style="width: 10%;"></td> <td style="width: 10%;"></td> <td style="width: 10%;"></td> <td style="width: 10%;"></td> <td style="width: 10%;"></td> </tr> <tr> <td></td> <td></td> <td colspan="8" style="text-align: center;"> <table border="1" style="width: 100%; border-collapse: collapse; text-align: center;"> <tr> <td style="width: 10%;"></td> <td style="width: 10%;"></td> <td style="width: 10%;"></td> <td style="width: 10%;"></td> <td style="width: 10%;"></td> <td style="width: 10%;"></td> <td style="width: 10%;"></td> <td style="width: 10%;"></td> <td style="width: 10%;"></td> <td style="width: 10%;"></td> </tr> <tr> <td></td> <td></td> <td colspan="8" style="text-align: center;"> <table border="1" style="width: 100%; border-collapse: collapse; text-align: center;"> <tr> <td style="width: 10%;"></td> <td style="width: 10%;"></td> <td style="width: 10%;"></td> <td style="width: 10%;"></td> <td style="width: 10%;"></td> <td style="width: 10%;"></td> <td style="width: 10%;"></td> <td style="width: 10%;"></td> <td style="width: 10%;"></td> <td style="width: 10%;"></td> </tr> <tr> <td></td> <td></td> <td colspan="8" style="text-align: center;"> <table border="1" style="width: 100%; border-collapse: collapse; text-align: center;"> <tr> <td style="width: 10%;"></td> <td style="width: 10%;"></td> <td style="width: 10%;"></td> <td style="width: 10%;"></td> <td style="width: 10%;"></td> <td style="width: 10%;"></td> <td style="width: 10%;"></td> <td style="width: 10%;"></td> <td style="width: 10%;"></td> <td style="width: 10%;"></td> </tr> <tr> <td></td> <td></td> <td colspan="8" style="text-align: center;"> <table border="1" style="width: 100%; border-collapse: collapse; text-align: center;"> <tr> <td style="width: 10%;"></td> <td style="width: 10%;"></td> <td style="width: 10%;"></td> <td style="width: 10%;"></td> <td style="width: 10%;"></td> <td style="width: 10%;"></td> <td style="width: 10%;"></td> <td style="width: 10%;"></td> <td style="width: 10%;"></td> <td style="width: 10%;"></td> </tr> <tr> <td></td> <td></td> <td colspan="8" style="text-align: center;"> <table border="1" style="width: 100%; border-collapse: collapse; text-align: center;"> <tr> <td style="width: 10%;"></td> <td style="width:
10%;"></td> <td style="width: 10%;"></td> <td style="width: 10%;"></td> <td style="width: 10%;"></td> <td style="width: 10%;"></td> <td style="width: 10%;"></td> <td style="width: 10%;"></td> <td style="width: 10%;"></td> <td style="width: 10%;"></td> </tr> <tr> <td></td> <td></td> <td colspan="8" style="text-align: center;"> <table border="1" style="width: 100%; border-collapse: collapse; text-align: center;"> <tr> <td style="width: 10%;"></td> <td style="width: 10%;"></td> <td style="width: 10%;"></td> <td style="width: 10%;"></td> <td style="width: 10%;"></td> <td style="width: 10%;"></td> <td style="width: 10%;"></td> <td style="width: 10%;"></td> <td style="width: 10%;"></td> <td style="width: 10%;"></td> </tr> <tr> <td></td> <td></td> <td colspan="8" style="text-align: center;"> <table border="1" style="width: 100%; border-collapse: collapse; text-align: center;"> <tr> <td style="width: 10%;"></td> <td style="width: 10%;"></td> <td style="width: 10%;"></td> <td style="width: 10%;"></td> <td style="width: 10%;"></td> <td style="width: 10%;"></td> <td style="width: 10%;"></td> <td style="width: 10%;"></td> <td style="width: 10%;"></td> <td style="width: 10%;"></td> </tr> <tr> <td></td> <td></td> <td colspan="8" style="text-align: center;"> <table border="1" style="width: 100%; border-collapse: collapse; text-align: center;"> <tr> <td style="width: 10%;"></td> <td style="width: 10%;"></td> <td style="width: 10%;"></td> <td style="width: 10%;"></td> <td style="width: 10%;"></td> <td style="width: 10%;"></td> <td style="width: 10%;"></td> <td style="width: 10%;"></td> <td style="width: 10%;"></td> <td style="width: 10%;"></td> </tr> <tr> <td></td> <td></td> <td colspan="8" style="text-align: center;"> <table border="1" style="width: 100%; border-collapse: collapse; text-align: center;"> <tr> <td style="width: 10%;"></td> <td style="width: 10%;"></td> <td style="width: 10%;"></td> <td style="width: 10%;"></td> <td style="width: 10%;"></td> <td style="width: 10%;"></td> <td style="width: 10%;"></td> <td style="width: 10%;"></td> <td style="width: 10%;"></td> <td style="width: 10%;"></td> </tr> <tr> <td></td> <td></td> <td colspan="8" style="text-align: center;"> <table border="1" style="width: 100%; border-collapse: collapse; text-align: center;"> <tr> <td style="width: 10%;"></td> <td style="width: 10%;"></td> <td style="width: 10%;"></td> <td style="width: 10%;"></td> <td style="width: 10%;"></td> <td style="width: 10%;"></td> <td style="width: 10%;"></td> <td style="width: 10%;"></td> <td style="width: 10%;"></td> <td style="width: 10%;"></td> </tr> <tr> <td></td> <td></td> <td colspan="8" style="text-align: center;"> <table border="1" style="width: 100%; border-collapse: collapse; text-align: center;"> <tr> <td style="width: 10%;"></td> <td style="width: 10%;"></td> <td style="width: 10%;"></td> <td style="width: 10%;"></td> <td style="width: 10%;"></td> <td style="width: 10%;"></td> <td style="width: 10%;"></td> <td style="width: 10%;"></td> <td style="width: 10%;"></td> <td style="width: 10%;"></td> </tr> <tr> <td></td> <td></td> <td colspan="8" style="text-align: center;"> <table border="1" style="width: 100%; border-collapse: collapse; text-align: center;"> <tr> <td style="width: 10%;"></td> <td style="width: 10%;"></td> <td style="width: 10%;"></td> <td style="width: 10%;"></td> <td style="width: 10%;"></td> <td style="width: 10%;"></td> <td style="width: 10%;"></td> <td style="width: 10%;"></td> <td style="width: 10%;"></td> <td style="width: 10%;"></td> </tr> <tr> <td></td> <td></td> <td colspan="8" style="text-align: center;"> <table border="1" style="width: 100%; border-collapse: collapse; text-align: center;"> <tr> </tr></table></td></tr></table></td></tr></table></td></tr></table></td></tr></table></td></tr></table></td></tr></table></td></tr></table></td></tr></table></td></tr></table></td></tr></table></td></tr></table></td></tr></table></td></tr></table></td></tr></table></td></tr></table></td></tr></table></td></tr></table></td></tr></table></td></tr></table></td></tr></table></td></tr></table></td></tr></table></td></tr></table></td></tr></table></td></tr></table></td></tr></table></td></tr></table></td></tr></table></td></tr></table></td></tr></table></td></tr></table></td></tr></table></td></tr></table></td></tr></table></td></tr></table></td></tr></table></td></tr></table></td></tr></table></td></tr></table></td></tr></table></td></tr></table></td></tr></table></td></tr></table></td></tr></table></td></tr></table></td></tr></table></td></tr></table></td></tr></table></td></tr></table></td></tr></table></td></tr></table></td></tr></table></td></tr></table></td></tr></table></td></tr></table> | | | | | | | | | | | | | | | | | | | | <table border="1" style="width: 100%; border-collapse: collapse; text-align: center;"> <tr> <td style="width: 10%;"></td> <td style="width: 10%;"></td> <td style="width: 10%;"></td> <td style="width: 10%;"></td> <td style="width: 10%;"></td> <td style="width: 10%;"></td> <td style="width: 10%;"></td> <td style="width: 10%;"></td> <td style="width: 10%;"></td> <td style="width: 10%;"></td> </tr> <tr> <td></td> <td></td> <td colspan="8" style="text-align: center;"> <table border="1" style="width: 100%; border-collapse: collapse; text-align: center;"> <tr> <td style="width: 10%;"></td> <td style="width: 10%;"></td> <td style="width: 10%;"></td> <td style="width: 10%;"></td> <td style="width: 10%;"></td> <td style="width: 10%;"></td> <td style="width: 10%;"></td> <td style="width: 10%;"></td> <td style="width: 10%;"></td> <td style="width: 10%;"></td> </tr> <tr> <td></td> <td></td> <td colspan="8" style="text-align: center;"> <table border="1" style="width: 100%; border-collapse: collapse; text-align: center;"> <tr> <td style="width: 10%;"></td> <td style="width: 10%;"></td> <td style="width: 10%;"></td> <td style="width: 10%;"></td> <td style="width: 10%;"></td> <td style="width: 10%;"></td> <td style="width: 10%;"></td> <td style="width: 10%;"></td> <td style="width: 10%;"></td> <td style="width: 10%;"></td> </tr> <tr> <td></td> <td></td> <td colspan="8" style="text-align: center;"> <table border="1" style="width: 100%; border-collapse: collapse; text-align: center;"> <tr> <td style="width: 10%;"></td> <td style="width: 10%;"></td> <td style="width: 10%;"></td> <td style="width: 10%;"></td> <td style="width: 10%;"></td> <td style="width: 10%;"></td> <td style="width: 10%;"></td> <td style="width: 10%;"></td> <td style="width: 10%;"></td> <td style="width: 10%;"></td> </tr> <tr> <td></td> <td></td> <td colspan="8" style="text-align: center;"> <table border="1" style="width: 100%; border-collapse: collapse; text-align: center;"> <tr> <td style="width: 10%;"></td> <td style="width: 10%;"></td> <td style="width: 10%;"></td> <td style="width: 10%;"></td> <td style="width: 10%;"></td> <td style="width: 10%;"></td> <td style="width: 10%;"></td> <td style="width: 10%;"></td> <td style="width: 10%;"></td> <td style="width: 10%;"></td> </tr> <tr> <td></td> <td></td> <td colspan="8" style="text-align: center;"> <table border="1" style="width: 100%; border-collapse: collapse; text-align: center;"> <tr> <td style="width: 10%;"></td> <td style="width: 10%;"></td> <td style="width: 10%;"></td> <td style="width: 10%;"></td> <td style="width: 10%;"></td> <td style="width: 10%;"></td> <td style="width: 10%;"></td> <td style="width: 10%;"></td> <td style="width: 10%;"></td> <td style="width: 10%;"></td> </tr> <tr> <td></td> <td></td> <td colspan="8" style="text-align: center;"> <table border="1" style="width: 100%; border-collapse: collapse; text-align: center;"> <tr> <td style="width: 10%;"></td> <td style="width: 10%;"></td> <td style="width: 10%;"></td> <td style="width: 10%;"></td> <td style="width: 10%;"></td> <td style="width: 10%;"></td> <td style="width: 10%;"></td> <td style="width: 10%;"></td> <td style="width: 10%;"></td> <td style="width: 10%;"></td> </tr> <tr> <td></td> <td></td> <td colspan="8" style="text-align: center;"> <table border="1" style="width: 100%; border-collapse: collapse; text-align: center;"> <tr> <td style="width: 10%;"></td> <td style="width: 10%;"></td> <td style="width: 10%;"></td> <td style="width: 10%;"></td> <td style="width: 10%;"></td> <td style="width: 10%;"></td> <td style="width: 10%;"></td> <td style="width: 10%;"></td> <td style="width: 10%;"></td> <td style="width: 10%;"></td> </tr> <tr> <td></td> <td></td> <td colspan="8" style="text-align: center;"> <table border="1" style="width: 100%; border-collapse: collapse; text-align: center;"> <tr> <td style="width: 10%;"></td> <td style="width: 10%;"></td> <td style="width: 10%;"></td> <td style="width: 10%;"></td> <td style="width: 10%;"></td> <td style="width: 10%;"></td> <td style="width: 10%;"></td> <td style="width: 10%;"></td> <td style="width: 10%;"></td> <td style="width: 10%;"></td> </tr> <tr> <td></td> <td></td> <td colspan="8" style="text-align: center;"> <table border="1" style="width: 100%; border-collapse: collapse; text-align: center;"> <tr> <td style="width: 10%;"></td> <td style="width: 10%;"></td> <td style="width: 10%;"></td> <td style="width: 10%;"></td> <td style="width: 10%;"></td> <td style="width: 10%;"></td> <td style="width: 10%;"></td> <td style="width: 10%;"></td> <td style="width: 10%;"></td> <td style="width: 10%;"></td> </tr> <tr> <td></td> <td></td> <td colspan="8" style="text-align: center;"> <table border="1" style="width: 100%; border-collapse: collapse;
text-align: center;"> <tr> <td style="width: 10%;"></td> <td style="width: 10%;"></td> <td style="width: 10%;"></td> <td style="width: 10%;"></td> <td style="width: 10%;"></td> <td style="width: 10%;"></td> <td style="width: 10%;"></td> <td style="width: 10%;"></td> <td style="width: 10%;"></td> <td style="width: 10%;"></td> </tr> <tr> <td></td> <td></td> <td colspan="8" style="text-align: center;"> <table border="1" style="width: 100%; border-collapse: collapse; text-align: center;"> <tr> <td style="width: 10%;"></td> <td style="width: 10%;"></td> <td style="width: 10%;"></td> <td style="width: 10%;"></td> <td style="width: 10%;"></td> <td style="width: 10%;"></td> <td style="width: 10%;"></td> <td style="width: 10%;"></td> <td style="width: 10%;"></td> <td style="width: 10%;"></td> </tr> <tr> <td></td> <td></td> <td colspan="8" style="text-align: center;"> <table border="1" style="width: 100%; border-collapse: collapse; text-align: center;"> <tr> <td style="width: 10%;"></td> <td style="width: 10%;"></td> <td style="width: 10%;"></td> <td style="width: 10%;"></td> <td style="width: 10%;"></td> <td style="width: 10%;"></td> <td style="width: 10%;"></td> <td style="width: 10%;"></td> <td style="width: 10%;"></td> <td style="width: 10%;"></td> </tr> <tr> <td></td> <td></td> <td colspan="8" style="text-align: center;"> <table border="1" style="width: 100%; border-collapse: collapse; text-align: center;"> <tr> <td style="width: 10%;"></td> <td style="width: 10%;"></td> <td style="width: 10%;"></td> <td style="width: 10%;"></td> <td style="width: 10%;"></td> <td style="width: 10%;"></td> <td style="width: 10%;"></td> <td style="width: 10%;"></td> <td style="width: 10%;"></td> <td style="width: 10%;"></td> </tr> <tr> <td></td> <td></td> <td colspan="8" style="text-align: center;"> <table border="1" style="width: 100%; border-collapse: collapse; text-align: center;"> <tr> <td style="width: 10%;"></td> <td style="width: 10%;"></td> <td style="width: 10%;"></td> <td style="width: 10%;"></td> <td style="width: 10%;"></td> <td style="width: 10%;"></td> <td style="width: 10%;"></td> <td style="width: 10%;"></td> <td style="width: 10%;"></td> <td style="width: 10%;"></td> </tr> <tr> <td></td> <td></td> <td colspan="8" style="text-align: center;"> <table border="1" style="width: 100%; border-collapse: collapse; text-align: center;"> <tr> <td style="width: 10%;"></td> <td style="width: 10%;"></td> <td style="width: 10%;"></td> <td style="width: 10%;"></td> <td style="width: 10%;"></td> <td style="width: 10%;"></td> <td style="width: 10%;"></td> <td style="width: 10%;"></td> <td style="width: 10%;"></td> <td style="width: 10%;"></td> </tr> <tr> <td></td> <td></td> <td colspan="8" style="text-align: center;"> <table border="1" style="width: 100%; border-collapse: collapse; text-align: center;"> <tr> <td style="width: 10%;"></td> <td style="width: 10%;"></td> <td style="width: 10%;"></td> <td style="width: 10%;"></td> <td style="width: 10%;"></td> <td style="width: 10%;"></td> <td style="width: 10%;"></td> <td style="width: 10%;"></td> <td style="width: 10%;"></td> <td style="width: 10%;"></td> </tr> <tr> <td></td> <td></td> <td colspan="8" style="text-align: center;"> <table border="1" style="width: 100%; border-collapse: collapse; text-align: center;"> <tr> <td style="width: 10%;"></td> <td style="width: 10%;"></td> <td style="width: 10%;"></td> <td style="width: 10%;"></td> <td style="width: 10%;"></td> <td style="width: 10%;"></td> <td style="width: 10%;"></td> <td style="width: 10%;"></td> <td style="width: 10%;"></td> <td style="width: 10%;"></td> </tr> <tr> <td></td> <td></td> <td colspan="8" style="text-align: center;"> <table border="1" style="width: 100%; border-collapse: collapse; text-align: center;"> <tr> <td style="width: 10%;"></td> <td style="width: 10%;"></td> <td style="width: 10%;"></td> <td style="width: 10%;"></td> <td style="width: 10%;"></td> <td style="width: 10%;"></td> <td style="width: 10%;"></td> <td style="width: 10%;"></td> <td style="width: 10%;"></td> <td style="width: 10%;"></td> </tr> <tr> <td></td> <td></td> <td colspan="8" style="text-align: center;"> <table border="1" style="width: 100%; border-collapse: collapse; text-align: center;"> <tr> <td style="width: 10%;"></td> <td style="width: 10%;"></td> <td style="width: 10%;"></td> <td style="width: 10%;"></td> <td style="width: 10%;"></td> <td style="width: 10%;"></td> <td style="width: 10%;"></td> <td style="width: 10%;"></td> <td style="width: 10%;"></td> <td style="width: 10%;"></td> </tr> <tr> <td></td> <td></td> <td colspan="8" style="text-align: center;"> <table border="1" style="width: 100%; border-collapse: collapse; text-align: center;"> <tr> <td style="width: 10%;"></td> <td style="width: 10%;"></td> <td style="width: 10%;"></td> <td style="width: 10%;"></td> <td style="width: 10%;"></td> <td style="width: 10%;"></td> <td style="width: 10%;"></td> <td style="width: 10%;"></td> <td style="width: 10%;"></td> <td style="width: 10%;"></td> </tr> <tr> <td></td> <td></td> <td colspan="8" style="text-align: center;"> <table border="1" style="width: 100%; border-collapse: collapse; text-align: center;"> <tr> <td style="width: 10%;"></td> <td style="width: 10%;"></td> <td style="width: 10%;"></td> <td style="width: 10%;"></td> <td style="width: 10%;"></td> <td style="width: 10%;"></td> <td style="width: 10%;"></td> <td style="width: 10%;"></td> <td style="width: 10%;"></td> <td style="width: 10%;"></td> </tr> <tr> <td></td> <td></td> <td colspan="8" style="text-align: center;"> <table border="1" style="width: 100%; border-collapse: collapse; text-align: center;"> <tr> <td style="width: 10%;"></td> <td style="width: 10%;"></td> <td style="width: 10%;"></td> <td style="width: 10%;"></td> <td style="width: 10%;"></td> <td style="width: 10%;"></td> <td style="width: 10%;"></td> <td style="width: 10%;"></td> <td style="width: 10%;"></td> <td style="width: 10%;"></td> </tr> <tr> <td></td> <td></td> <td colspan="8" style="text-align: center;"> <table border="1" style="width: 100%; border-collapse: collapse; text-align: center;"> <tr> <td style="width: 10%;"></td> <td style="width: 10%;"></td> <td style="width: 10%;"></td> <td style="width: 10%;"></td> <td style="width: 10%;"></td> <td style="width: 10%;"></td> <td style="width: 10%;"></td> <td style="width: 10%;"></td> <td style="width: 10%;"></td> <td style="width: 10%;"></td> </tr> <tr> <td></td> <td></td> <td colspan="8" style="text-align: center;"> <table border="1" style="width: 100%; border-collapse: collapse; text-align: center;"> <tr> <td style="width: 10%;"></td> <td style="width: 10%;"></td> <td style="width: 10%;"></td> <td style="width: 10%;"></td> <td style="width: 10%;"></td> <td style="width: 10%;"></td> <td style="width: 10%;"></td> <td style="width: 10%;"></td> <td style="width: 10%;"></td> <td style="width: 10%;"></td> </tr> <tr> <td></td> <td></td> <td colspan="8" style="text-align: center;"> <table border="1" style="width: 100%; border-collapse: collapse; text-align: center;"> <tr> <td style="width: 10%;"></td> <td style="width: 10%;"></td> <td style="width: 10%;"></td> <td style="width: 10%;"></td> <td style="width: 10%;"></td> <td style="width: 10%;"></td> <td style="width: 10%;"></td> <td style="width: 10%;"></td> <td style="width: 10%;"></td> <td style="width: 10%;"></td> </tr> <tr> <td></td> <td></td> <td colspan="8" style="text-align: center;"> <table border="1" style="width: 100%; border-collapse: collapse; text-align: center;"> <tr> <td style="width: 10%;"></td> <td style="width: 10%;"></td> <td style="width: 10%;"></td> <td style="width: 10%;"></td> <td style="width: 10%;"></td> <td style="width: 10%;"></td> <td style="width: 10%;"></td> <td style="width: 10%;"></td> <td style="width: 10%;"></td> <td style="width: 10%;"></td> </tr> <tr> <td></td> <td></td> <td colspan="8" style="text-align: center;"> <table border="1" style="width: 100%; border-collapse: collapse; text-align: center;"> <tr> <td style="width: 10%;"></td> <td style="width: 10%;"></td> <td style="width: 10%;"></td> <td style="width: 10%;"></td> <td style="width: 10%;"></td> <td style="width: 10%;"></td> <td style="width: 10%;"></td> <td style="width: 10%;"></td> <td style="width: 10%;"></td> <td style="width: 10%;"></td> </tr> <tr> <td></td> <td></td> <td colspan="8" style="text-align: center;"> <table border="1" style="width: 100%; border-collapse: collapse; text-align: center;"> <tr> <td style="width: 10%;"></td> <td style="width: 10%;"></td> <td style="width: 10%;"></td> <td style="width: 10%;"></td> <td style="width: 10%;"></td> <td style="width: 10%;"></td> <td style="width: 10%;"></td> <td style="width: 10%;"></td> <td style="width: 10%;"></td> <td style="width: 10%;"></td> </tr> <tr> <td></td> <td></td> <td colspan="8" style="text-align: center;"> <table border="1" style="width: 100%; border-collapse: collapse; text-align: center;"> <tr> <td style="width: 10%;"></td> <td style="width: 10%;"></td> <td style="width: 10%;"></td> <td style="width: 10%;"></td> <td style="width: 10%;"></td> <td style="width: 10%;"></td> <td style="width: 10%;"></td> <td style="width: 10%;"></td> <td style="width: 10%;"></td> <td style="width: 10%;"></td> </tr> <tr> <td></td> <td></td> <td colspan="8" style="text-align: center;"> <table border="1" style="width: 100%; border-collapse: collapse; text-align: center;"> <tr> <td style="width: 10%;"></td> <td style="width: 10%;"></td> <td style="width: 10%;"></td> <td style="width: 10%;"></td> <td style="width: 10%;"></td> <td style="width: 10%;"></td> <td style="width: 10%;"></td> <td style="width: 10%;"></td> <td style="width: 10%;"></td> <td style="width: 10%;"></td> </tr> <tr> <td></td> <td></td> <td colspan="8" style="text-align: center;"> <table border="1" style="width: 100%; border-collapse: collapse; text-align: center;"> <tr> <td style="width: 10%;"></td> <td style="width: 10%;"></td> <td style="width: 10%;"></td> <td style="width: 10%;"></td> <td style="width:
10%;"></td> <td style="width: 10%;"></td> <td style="width: 10%;"></td> <td style="width: 10%;"></td> <td style="width: 10%;"></td> <td style="width: 10%;"></td> </tr> <tr> <td></td> <td></td> <td colspan="8" style="text-align: center;"> <table border="1" style="width: 100%; border-collapse: collapse; text-align: center;"> <tr> <td style="width: 10%;"></td> <td style="width: 10%;"></td> <td style="width: 10%;"></td> <td style="width: 10%;"></td> <td style="width: 10%;"></td> <td style="width: 10%;"></td> <td style="width: 10%;"></td> <td style="width: 10%;"></td> <td style="width: 10%;"></td> <td style="width: 10%;"></td> </tr> <tr> <td></td> <td></td> <td colspan="8" style="text-align: center;"> <table border="1" style="width: 100%; border-collapse: collapse; text-align: center;"> <tr> <td style="width: 10%;"></td> <td style="width: 10%;"></td> <td style="width: 10%;"></td> <td style="width: 10%;"></td> <td style="width: 10%;"></td> <td style="width: 10%;"></td> <td style="width: 10%;"></td> <td style="width: 10%;"></td> <td style="width: 10%;"></td> <td style="width: 10%;"></td> </tr> <tr> <td></td> <td></td> <td colspan="8" style="text-align: center;"> <table border="1" style="width: 100%; border-collapse: collapse; text-align: center;"> <tr> <td style="width: 10%;"></td> <td style="width: 10%;"></td> <td style="width: 10%;"></td> <td style="width: 10%;"></td> <td style="width: 10%;"></td> <td style="width: 10%;"></td> <td style="width: 10%;"></td> <td style="width: 10%;"></td> <td style="width: 10%;"></td> <td style="width: 10%;"></td> </tr> <tr> <td></td> <td></td> <td colspan="8" style="text-align: center;"> <table border="1" style="width: 100%; border-collapse: collapse; text-align: center;"> <tr> <td style="width: 10%;"></td> <td style="width: 10%;"></td> <td style="width: 10%;"></td> <td style="width: 10%;"></td> <td style="width: 10%;"></td> <td style="width: 10%;"></td> <td style="width: 10%;"></td> <td style="width: 10%;"></td> <td style="width: 10%;"></td> <td style="width: 10%;"></td> </tr> <tr> <td></td> <td></td> <td colspan="8" style="text-align: center;"> <table border="1" style="width: 100%; border-collapse: collapse; text-align: center;"> <tr> <td style="width: 10%;"></td> <td style="width: 10%;"></td> <td style="width: 10%;"></td> <td style="width: 10%;"></td> <td style="width: 10%;"></td> <td style="width: 10%;"></td> <td style="width: 10%;"></td> <td style="width: 10%;"></td> <td style="width: 10%;"></td> <td style="width: 10%;"></td> </tr> <tr> <td></td> <td></td> <td colspan="8" style="text-align: center;"> <table border="1" style="width: 100%; border-collapse: collapse; text-align: center;"> <tr> <td style="width: 10%;"></td> <td style="width: 10%;"></td> <td style="width: 10%;"></td> <td style="width: 10%;"></td> <td style="width: 10%;"></td> <td style="width: 10%;"></td> <td style="width: 10%;"></td> <td style="width: 10%;"></td> <td style="width: 10%;"></td> <td style="width: 10%;"></td> </tr> <tr> <td></td> <td></td> <td colspan="8" style="text-align: center;"> <table border="1" style="width: 100%; border-collapse: collapse; text-align: center;"> <tr> <td style="width: 10%;"></td> <td style="width: 10%;"></td> <td style="width: 10%;"></td> <td style="width: 10%;"></td> <td style="width: 10%;"></td> <td style="width: 10%;"></td> <td style="width: 10%;"></td> <td style="width: 10%;"></td> <td style="width: 10%;"></td> <td style="width: 10%;"></td> </tr> <tr> <td></td> <td></td> <td colspan="8" style="text-align: center;"> <table border="1" style="width: 100%; border-collapse: collapse; text-align: center;"> <tr> <td style="width: 10%;"></td> <td style="width: 10%;"></td> <td style="width: 10%;"></td> <td style="width: 10%;"></td> <td style="width: 10%;"></td> <td style="width: 10%;"></td> <td style="width: 10%;"></td> <td style="width: 10%;"></td> <td style="width: 10%;"></td> <td style="width: 10%;"></td> </tr> <tr> <td></td> <td></td> <td colspan="8" style="text-align: center;"> <table border="1" style="width: 100%; border-collapse: collapse; text-align: center;"> <tr> <td style="width: 10%;"></td> <td style="width: 10%;"></td> <td style="width: 10%;"></td> <td style="width: 10%;"></td> <td style="width: 10%;"></td> <td style="width: 10%;"></td> <td style="width: 10%;"></td> <td style="width: 10%;"></td> <td style="width: 10%;"></td> <td style="width: 10%;"></td> </tr> <tr> <td></td> <td></td> <td colspan="8" style="text-align: center;"> <table border="1" style="width: 100%; border-collapse: collapse; text-align: center;"> <tr> <td style="width: 10%;"></td> <td style="width: 10%;"></td> <td style="width: 10%;"></td> <td style="width: 10%;"></td> <td style="width: 10%;"></td> <td style="width: 10%;"></td> <td style="width: 10%;"></td> <td style="width: 10%;"></td> <td style="width: 10%;"></td> <td style="width: 10%;"></td> </tr> <tr> <td></td> <td></td> <td colspan="8" style="text-align: center;"> <table border="1" style="width: 100%; border-collapse: collapse; text-align: center;"> <tr> <td style="width: 10%;"></td> <td style="width: 10%;"></td> <td style="width: 10%;"></td> <td style="width: 10%;"></td> <td style="width: 10%;"></td> <td style="width: 10%;"></td> <td style="width: 10%;"></td> <td style="width: 10%;"></td> <td style="width: 10%;"></td> <td style="width: 10%;"></td> </tr> <tr> <td></td> <td></td> <td colspan="8" style="text-align: center;"> <table border="1" style="width: 100%; border-collapse: collapse; text-align: center;"> <tr> <td style="width: 10%;"></td> <td style="width: 10%;"></td> <td style="width: 10%;"></td> <td style="width: 10%;"></td> <td style="width: 10%;"></td> <td style="width: 10%;"></td> <td style="width: 10%;"></td> <td style="width: 10%;"></td> <td style="width: 10%;"></td> <td style="width: 10%;"></td> </tr> <tr> <td></td> <td></td> <td colspan="8" style="text-align: center;"> <table border="1" style="width: 100%; border-collapse: collapse; text-align: center;"> <tr> <td style="width: 10%;"></td> <td style="width: 10%;"></td> <td style="width: 10%;"></td> <td style="width: 10%;"></td> <td style="width: 10%;"></td> <td style="width: 10%;"></td> <td style="width: 10%;"></td> <td style="width: 10%;"></td> <td style="width: 10%;"></td> <td style="width: 10%;"></td> </tr> <tr> <td></td> <td></td> <td colspan="8" style="text-align: center;"> <table border="1" style="width: 100%; border-collapse: collapse; text-align: center;"> <tr> <td style="width: 10%;"></td> <td style="width: 10%;"></td> <td style="width: 10%;"></td> <td style="width: 10%;"></td> <td style="width: 10%;"></td> <td style="width: 10%;"></td> <td style="width: 10%;"></td> <td style="width: 10%;"></td> <td style="width: 10%;"></td> <td style="width: 10%;"></td> </tr> <tr> <td></td> <td></td> <td colspan="8" style="text-align: center;"> <table border="1" style="width: 100%; border-collapse: collapse; text-align: center;"> <tr> <td style="width: 10%;"></td> <td style="width: 10%;"></td> <td style="width: 10%;"></td> <td style="width: 10%;"></td> <td style="width: 10%;"></td> <td style="width: 10%;"></td> <td style="width: 10%;"></td> <td style="width: 10%;"></td> <td style="width: 10%;"></td> <td style="width: 10%;"></td> </tr> <tr> <td></td> <td></td> <td colspan="8" style="text-align: center;"> <table border="1" style="width: 100%; border-collapse: collapse; text-align: center;"> <tr> <td style="width: 10%;"></td> <td style="width: 10%;"></td> <td style="width: 10%;"></td> <td style="width: 10%;"></td> <td style="width: 10%;"></td> <td style="width: 10%;"></td> <td style="width: 10%;"></td> <td style="width: 10%;"></td> <td style="width: 10%;"></td> <td style="width: 10%;"></td> </tr> <tr> <td></td> <td></td> <td colspan="8" style="text-align: center;"> <table border="1" style="width: 100%; border-collapse: collapse; text-align: center;"> <tr> <td style="width: 10%;"></td> <td style="width: 10%;"></td> <td style="width: 10%;"></td> <td style="width: 10%;"></td> <td style="width: 10%;"></td> <td style="width: 10%;"></td> <td style="width: 10%;"></td> <td style="width: 10%;"></td> <td style="width: 10%;"></td> <td style="width: 10%;"></td> </tr> <tr> <td></td> <td></td> <td colspan="8" style="text-align: center;"> <table border="1" style="width: 100%; border-collapse: collapse; text-align: center;"> <tr> <td style="width: 10%;"></td> <td style="width: 10%;"></td> <td style="width: 10%;"></td> <td style="width: 10%;"></td> <td style="width: 10%;"></td> <td style="width: 10%;"></td> <td style="width: 10%;"></td> <td style="width: 10%;"></td> <td style="width: 10%;"></td> <td style="width: 10%;"></td> </tr> <tr> <td></td> <td></td> <td colspan="8" style="text-align: center;"> <table border="1" style="width: 100%; border-collapse: collapse; text-align: center;"> <tr> <td style="width: 10%;"></td> <td style="width: 10%;"></td> <td style="width: 10%;"></td> <td style="width: 10%;"></td> <td style="width: 10%;"></td> <td style="width: 10%;"></td> <td style="width: 10%;"></td> <td style="width: 10%;"></td> <td style="width: 10%;"></td> <td style="width: 10%;"></td> </tr> <tr> <td></td> <td></td> <td colspan="8" style="text-align: center;"> <table border="1" style="width: 100%; border-collapse: collapse; text-align: center;"> <tr> <td style="width: 10%;"></td> <td style="width: 10%;"></td> <td style="width: 10%;"></td> <td style="width: 10%;"></td> <td style="width: 10%;"></td> <td style="width: 10%;"></td> <td style="width: 10%;"></td> <td style="width: 10%;"></td> <td style="width: 10%;"></td> <td style="width: 10%;"></td> </tr> <tr> <td></td> <td></td> <td colspan="8" style="text-align: center;"> <table border="1" style="width: 100%; border-collapse: collapse; text-align: center;"> <tr> <td style="width: 10%;"></td> <td style="width: 10%;"></td> <td style="width: 10%;"></td> <td style="width: 10%;"></td> <td style="width: 10%;"></td> <td style="width: 10%;"></td> <td style="width: 10%;"></td> <td style="width: 10%;"></td> <td style="width: 10%;"></td> <td style="width: 10%;"></td> </tr>
<tr> <td></td> <td></td> <td colspan="8" style="text-align: center;"> <table border="1" style="width: 100%; border-collapse: collapse; text-align: center;"> <tr> <td style="width: 10%;"></td> <td style="width: 10%;"></td> <td style="width: 10%;"></td> <td style="width: 10%;"></td> <td style="width: 10%;"></td> <td style="width: 10%;"></td> <td style="width: 10%;"></td> <td style="width: 10%;"></td> <td style="width: 10%;"></td> <td style="width: 10%;"></td> </tr> <tr> <td></td> <td></td> <td colspan="8" style="text-align: center;"> <table border="1" style="width: 100%; border-collapse: collapse; text-align: center;"> <tr> </tr></table></td></tr></table></td></tr></table></td></tr></table></td></tr></table></td></tr></table></td></tr></table></td></tr></table></td></tr></table></td></tr></table></td></tr></table></td></tr></table></td></tr></table></td></tr></table></td></tr></table></td></tr></table></td></tr></table></td></tr></table></td></tr></table></td></tr></table></td></tr></table></td></tr></table></td></tr></table></td></tr></table></td></tr></table></td></tr></table></td></tr></table></td></tr></table></td></tr></table></td></tr></table></td></tr></table></td></tr></table></td></tr></table></td></tr></table></td></tr></table></td></tr></table></td></tr></table></td></tr></table></td></tr></table></td></tr></table></td></tr></table></td></tr></table></td></tr></table></td></tr></table></td></tr></table></td></tr></table></td></tr></table></td></tr></table></td></tr></table></td></tr></table></td></tr></table></td></tr></table></td></tr></table></td></tr></table></td></tr></table> | | | | | | | | | | | | | | | | | | | | <table border="1" style="width: 100%; border-collapse: collapse; text-align: center;"> <tr> <td style="width: 10%;"></td> <td style="width: 10%;"></td> <td style="width: 10%;"></td> <td style="width: 10%;"></td> <td style="width: 10%;"></td> <td style="width: 10%;"></td> <td style="width: 10%;"></td> <td style="width: 10%;"></td> <td style="width: 10%;"></td> <td style="width: 10%;"></td> </tr> <tr> <td></td> <td></td> <td colspan="8" style="text-align: center;"> <table border="1" style="width: 100%; border-collapse: collapse; text-align: center;"> <tr> <td style="width: 10%;"></td> <td style="width: 10%;"></td> <td style="width: 10%;"></td> <td style="width: 10%;"></td> <td style="width: 10%;"></td> <td style="width: 10%;"></td> <td style="width: 10%;"></td> <td style="width: 10%;"></td> <td style="width: 10%;"></td> <td style="width: 10%;"></td> </tr> <tr> <td></td> <td></td> <td colspan="8" style="text-align: center;"> <table border="1" style="width: 100%; border-collapse: collapse; text-align: center;"> <tr> <td style="width: 10%;"></td> <td style="width: 10%;"></td> <td style="width: 10%;"></td> <td style="width: 10%;"></td> <td style="width: 10%;"></td> <td style="width: 10%;"></td> <td style="width: 10%;"></td> <td style="width: 10%;"></td> <td style="width: 10%;"></td> <td style="width: 10%;"></td> </tr> <tr> <td></td> <td></td> <td colspan="8" style="text-align: center;"> <table border="1" style="width: 100%; border-collapse: collapse; text-align: center;"> <tr> <td style="width: 10%;"></td> <td style="width: 10%;"></td> <td style="width: 10%;"></td> <td style="width: 10%;"></td> <td style="width: 10%;"></td> <td style="width: 10%;"></td> <td style="width: 10%;"></td> <td style="width: 10%;"></td> <td style="width: 10%;"></td> <td style="width: 10%;"></td> </tr> <tr> <td></td> <td></td> <td colspan="8" style="text-align: center;"> <table border="1" style="width: 100%; border-collapse: collapse; text-align: center;"> <tr> <td style="width: 10%;"></td> <td style="width: 10%;"></td> <td style="width: 10%;"></td> <td style="width: 10%;"></td> <td style="width: 10%;"></td> <td style="width: 10%;"></td> <td style="width: 10%;"></td> <td style="width: 10%;"></td> <td style="width: 10%;"></td> <td style="width: 10%;"></td> </tr> <tr> <td></td> <td></td> <td colspan="8" style="text-align: center;"> <table border="1" style="width: 100%; border-collapse: collapse; text-align: center;"> <tr> <td style="width: 10%;"></td> <td style="width: 10%;"></td> <td style="width: 10%;"></td> <td style="width: 10%;"></td> <td style="width: 10%;"></td> <td style="width: 10%;"></td> <td style="width: 10%;"></td> <td style="width: 10%;"></td> <td style="width: 10%;"></td> <td style="width: 10%;"></td> </tr> <tr> <td></td> <td></td> <td colspan="8" style="text-align: center;"> <table border="1" style="width: 100%; border-collapse: collapse; text-align: center;"> <tr> <td style="width: 10%;"></td> <td style="width: 10%;"></td> <td style="width: 10%;"></td> <td style="width: 10%;"></td> <td style="width: 10%;"></td> <td style="width: 10%;"></td> <td style="width: 10%;"></td> <td style="width: 10%;"></td> <td style="width: 10%;"></td> <td style="width: 10%;"></td> </tr> <tr> <td></td> <td></td> <td colspan="8" style="text-align: center;"> <table border="1" style="width: 100%; border-collapse: collapse; text-align: center;"> <tr> <td style="width: 10%;"></td> <td style="width: 10%;"></td> <td style="width: 10%;"></td> <td style="width: 10%;"></td> <td style="width: 10%;"></td> <td style="width: 10%;"></td> <td style="width: 10%;"></td> <td style="width: 10%;"></td> <td style="width: 10%;"></td> <td style="width: 10%;"></td> </tr> <tr> <td></td> <td></td> <td colspan="8" style="text-align: center;"> <table border="1" style="width: 100%; border-collapse: collapse; text-align: center;"> <tr> <td style="width: 10%;"></td> <td style="width: 10%;"></td> <td style="width: 10%;"></td> <td style="width: 10%;"></td> <td style="width: 10%;"></td> <td style="width: 10%;"></td> <td style="width: 10%;"></td> <td style="width: 10%;"></td> <td style="width: 10%;"></td> <td style="width: 10%;"></td> </tr> <tr> <td></td> <td></td> <td colspan="8" style="text-align: center;"> <table border="1" style="width: 100%; border-collapse: collapse; text-align: center;"> <tr> <td style="width: 10%;"></td> <td style="width: 10%;"></td> <td style="width: 10%;"></td> <td style="width: 10%;"></td> <td style="width: 10%;"></td> <td style="width: 10%;"></td> <td style="width: 10%;"></td> <td style="width: 10%;"></td> <td style="width: 10%;"></td> <td style="width: 10%;"></td> </tr> <tr> <td></td> <td></td> <td colspan="8" style="text-align: center;"> <table border="1" style="width: 100%; border-collapse: collapse; text-align: center;"> <tr> <td style="width: 10%;"></td> <td style="width: 10%;"></td> <td style="width: 10%;"></td> <td style="width: 10%;"></td> <td style="width: 10%;"></td> <td style="width: 10%;"></td> <td style="width: 10%;"></td> <td style="width: 10%;"></td> <td style="width: 10%;"></td> <td style="width: 10%;"></td> </tr> <tr> <td></td> <td></td> <td colspan="8" style="text-align: center;"> <table border="1" style="width: 100%; border-collapse: collapse; text-align: center;"> <tr> <td style="width: 10%;"></td> <td style="width: 10%;"></td> <td style="width: 10%;"></td> <td style="width: 10%;"></td> <td style="width: 10%;"></td> <td style="width: 10%;"></td> <td style="width: 10%;"></td> <td style="width: 10%;"></td> <td style="width: 10%;"></td> <td style="width: 10%;"></td> </tr> <tr> <td></td> <td></td> <td colspan="8" style="text-align: center;"> <table border="1" style="width: 100%; border-collapse: collapse; text-align: center;"> <tr> <td style="width: 10%;"></td> <td style="width: 10%;"></td> <td style="width: 10%;"></td> <td style="width: 10%;"></td> <td style="width: 10%;"></td> <td style="width: 10%;"></td> <td style="width: 10%;"></td> <td style="width: 10%;"></td> <td style="width: 10%;"></td> <td style="width: 10%;"></td> </tr> <tr> <td></td> <td></td> <td colspan="8" style="text-align: center;"> <table border="1" style="width: 100%; border-collapse: collapse; text-align: center;"> <tr> <td style="width: 10%;"></td> <td style="width: 10%;"></td> <td style="width: 10%;"></td> <td style="width: 10%;"></td> <td style="width: 10%;"></td> <td style="width: 10%;"></td> <td style="width: 10%;"></td> <td style="width: 10%;"></td> <td style="width: 10%;"></td> <td style="width: 10%;"></td> </tr> <tr> <td></td> <td></td> <td colspan="8" style="text-align: center;"> <table border="1" style="width: 100%; border-collapse: collapse; text-align: center;"> <tr> <td style="width: 10%;"></td> <td style="width: 10%;"></td> <td style="width: 10%;"></td> <td style="width: 10%;"></td> <td style="width: 10%;"></td> <td style="width: 10%;"></td> <td style="width: 10%;"></td> <td style="width: 10%;"></td> <td style="width: 10%;"></td> <td style="width: 10%;"></td> </tr> <tr> <td></td> <td></td> <td colspan="8" style="text-align: center;"> <table border="1" style="width: 100%; border-collapse: collapse; text-align: center;"> <tr> <td style="width: 10%;"></td> <td style="width: 10%;"></td> <td style="width: 10%;"></td> <td style="width: 10%;"></td> <td style="width: 10%;"></td> <td style="width: 10%;"></td> <td style="width: 10%;"></td> <td style="width: 10%;"></td> <td style="width: 10%;"></td> <td style="width: 10%;"></td> </tr> <tr> <td></td> <td></td> <td colspan="8" style="text-align: center;"> <table border="1" style="width: 100%; border-collapse: collapse; text-align: center;"> <tr> <td style="width: 10%;"></td> <td style="width: 10%;"></td> <td style="width: 10%;"></td> <td style="width: 10%;"></td> <td style="width: 10%;"></td> <td style="width: 10%;"></td> <td style="width: 10%;"></td> <td style="width: 10%;"></td> <td style="width:
10%;"></td> <td style="width: 10%;"></td> </tr> <tr> <td></td> <td></td> <td colspan="8" style="text-align: center;"> <table border="1" style="width: 100%; border-collapse: collapse; text-align: center;"> <tr> <td style="width: 10%;"></td> <td style="width: 10%;"></td> <td style="width: 10%;"></td> <td style="width: 10%;"></td> <td style="width: 10%;"></td> <td style="width: 10%;"></td> <td style="width: 10%;"></td> <td style="width: 10%;"></td> <td style="width: 10%;"></td> <td style="width: 10%;"></td> </tr> <tr> <td></td> <td></td> <td colspan="8" style="text-align: center;"> <table border="1" style="width: 100%; border-collapse: collapse; text-align: center;"> <tr> <td style="width: 10%;"></td> <td style="width: 10%;"></td> <td style="width: 10%;"></td> <td style="width: 10%;"></td> <td style="width: 10%;"></td> <td style="width: 10%;"></td> <td style="width: 10%;"></td> <td style="width: 10%;"></td> <td style="width: 10%;"></td> <td style="width: 10%;"></td> </tr> <tr> <td></td> <td></td> <td colspan="8" style="text-align: center;"> <table border="1" style="width: 100%; border-collapse: collapse; text-align: center;"> <tr> <td style="width: 10%;"></td> <td style="width: 10%;"></td> <td style="width: 10%;"></td> <td style="width: 10%;"></td> <td style="width: 10%;"></td> <td style="width: 10%;"></td> <td style="width: 10%;"></td> <td style="width: 10%;"></td> <td style="width: 10%;"></td> <td style="width: 10%;"></td> </tr> <tr> <td></td> <td></td> <td colspan="8" style="text-align: center;"> <table border="1" style="width: 100%; border-collapse: collapse; text-align: center;"> <tr> <td style="width: 10%;"></td> <td style="width: 10%;"></td> <td style="width: 10%;"></td> <td style="width: 10%;"></td> <td style="width: 10%;"></td> <td style="width: 10%;"></td> <td style="width: 10%;"></td> <td style="width: 10%;"></td> <td style="width: 10%;"></td> <td style="width: 10%;"></td> </tr> <tr> <td></td> <td></td> <td colspan="8" style="text-align: center;"> <table border="1" style="width: 100%; border-collapse: collapse; text-align: center;"> <tr> <td style="width: 10%;"></td> <td style="width: 10%;"></td> <td style="width: 10%;"></td> <td style="width: 10%;"></td> <td style="width: 10%;"></td> <td style="width: 10%;"></td> <td style="width: 10%;"></td> <td style="width: 10%;"></td> <td style="width: 10%;"></td> <td style="width: 10%;"></td> </tr> <tr> <td></td> <td></td> <td colspan="8" style="text-align: center;"> <table border="1" style="width: 100%; border-collapse: collapse; text-align: center;"> <tr> <td style="width: 10%;"></td> <td style="width: 10%;"></td> <td style="width: 10%;"></td> <td style="width: 10%;"></td> <td style="width: 10%;"></td> <td style="width: 10%;"></td> <td style="width: 10%;"></td> <td style="width: 10%;"></td> <td style="width: 10%;"></td> <td style="width: 10%;"></td> </tr> <tr> <td></td> <td></td> <td colspan="8" style="text-align: center;"> <table border="1" style="width: 100%; border-collapse: collapse; text-align: center;"> <tr> <td style="width: 10%;"></td> <td style="width: 10%;"></td> <td style="width: 10%;"></td> <td style="width: 10%;"></td> <td style="width: 10%;"></td> <td style="width: 10%;"></td> <td style="width: 10%;"></td> <td style="width: 10%;"></td> <td style="width: 10%;"></td> <td style="width: 10%;"></td> </tr> <tr> <td></td> <td></td> <td colspan="8" style="text-align: center;"> <table border="1" style="width: 100%; border-collapse: collapse; text-align: center;"> <tr> <td style="width: 10%;"></td> <td style="width: 10%;"></td> <td style="width: 10%;"></td> <td style="width: 10%;"></td> <td style="width: 10%;"></td> <td style="width: 10%;"></td> <td style="width: 10%;"></td> <td style="width: 10%;"></td> <td style="width: 10%;"></td> <td style="width: 10%;"></td> </tr> <tr> <td></td> <td></td> <td colspan="8" style="text-align: center;"> <table border="1" style="width: 100%; border-collapse: collapse; text-align: center;"> <tr> <td style="width: 10%;"></td> <td style="width: 10%;"></td> <td style="width: 10%;"></td> <td style="width: 10%;"></td> <td style="width: 10%;"></td> <td style="width: 10%;"></td> <td style="width: 10%;"></td> <td style="width: 10%;"></td> <td style="width: 10%;"></td> <td style="width: 10%;"></td> </tr> <tr> <td></td> <td></td> <td colspan="8" style="text-align: center;"> <table border="1" style="width: 100%; border-collapse: collapse; text-align: center;"> <tr> <td style="width: 10%;"></td> <td style="width: 10%;"></td> <td style="width: 10%;"></td> <td style="width: 10%;"></td> <td style="width: 10%;"></td> <td style="width: 10%;"></td> <td style="width: 10%;"></td> <td style="width: 10%;"></td> <td style="width: 10%;"></td> <td style="width: 10%;"></td> </tr> <tr> <td></td> <td></td> <td colspan="8" style="text-align: center;"> <table border="1" style="width: 100%; border-collapse: collapse; text-align: center;"> <tr> <td style="width: 10%;"></td> <td style="width: 10%;"></td> <td style="width: 10%;"></td> <td style="width: 10%;"></td> <td style="width: 10%;"></td> <td style="width: 10%;"></td> <td style="width: 10%;"></td> <td style="width: 10%;"></td> <td style="width: 10%;"></td> <td style="width: 10%;"></td> </tr> <tr> <td></td> <td></td> <td colspan="8" style="text-align: center;"> <table border="1" style="width: 100%; border-collapse: collapse; text-align: center;"> <tr> <td style="width: 10%;"></td> <td style="width: 10%;"></td> <td style="width: 10%;"></td> <td style="width: 10%;"></td> <td style="width: 10%;"></td> <td style="width: 10%;"></td> <td style="width: 10%;"></td> <td style="width: 10%;"></td> <td style="width: 10%;"></td> <td style="width: 10%;"></td> </tr> <tr> <td></td> <td></td> <td colspan="8" style="text-align: center;"> <table border="1" style="width: 100%; border-collapse: collapse; text-align: center;"> <tr> <td style="width: 10%;"></td> <td style="width: 10%;"></td> <td style="width: 10%;"></td> <td style="width: 10%;"></td> <td style="width: 10%;"></td> <td style="width: 10%;"></td> <td style="width: 10%;"></td> <td style="width: 10%;"></td> <td style="width: 10%;"></td> <td style="width: 10%;"></td> </tr> <tr> <td></td> <td></td> <td colspan="8" style="text-align: center;"> <table border="1" style="width: 100%; border-collapse: collapse; text-align: center;"> <tr> <td style="width: 10%;"></td> <td style="width: 10%;"></td> <td style="width: 10%;"></td> <td style="width: 10%;"></td> <td style="width: 10%;"></td> <td style="width: 10%;"></td> <td style="width: 10%;"></td> <td style="width: 10%;"></td> <td style="width: 10%;"></td> <td style="width: 10%;"></td> </tr> <tr> <td></td> <td></td> <td colspan="8" style="text-align: center;"> <table border="1" style="width: 100%; border-collapse: collapse; text-align: center;"> <tr> <td style="width: 10%;"></td> <td style="width: 10%;"></td> <td style="width: 10%;"></td> <td style="width: 10%;"></td> <td style="width: 10%;"></td> <td style="width: 10%;"></td> <td style="width: 10%;"></td> <td style="width: 10%;"></td> <td style="width: 10%;"></td> <td style="width: 10%;"></td> </tr> <tr> <td></td> <td></td> <td colspan="8" style="text-align: center;"> <table border="1" style="width: 100%; border-collapse: collapse; text-align: center;"> <tr> <td style="width: 10%;"></td> <td style="width: 10%;"></td> <td style="width: 10%;"></td> <td style="width: 10%;"></td> <td style="width: 10%;"></td> <td style="width: 10%;"></td> <td style="width: 10%;"></td> <td style="width: 10%;"></td> <td style="width: 10%;"></td> <td style="width: 10%;"></td> </tr> <tr> <td></td> <td></td> <td colspan="8" style="text-align: center;"> <table border="1" style="width: 100%; border-collapse: collapse; text-align: center;"> <tr> <td style="width: 10%;"></td> <td style="width: 10%;"></td> <td style="width: 10%;"></td> <td style="width: 10%;"></td> <td style="width: 10%;"></td> <td style="width: 10%;"></td> <td style="width: 10%;"></td> <td style="width: 10%;"></td> <td style="width: 10%;"></td> <td style="width: 10%;"></td> </tr> <tr> <td></td> <td></td> <td colspan="8" style="text-align: center;"> <table border="1" style="width: 100%; border-collapse: collapse; text-align: center;"> <tr> <td style="width: 10%;"></td> <td style="width: 10%;"></td> <td style="width: 10%;"></td> <td style="width: 10%;"></td> <td style="width: 10%;"></td> <td style="width: 10%;"></td> <td style="width: 10%;"></td> <td style="width: 10%;"></td> <td style="width: 10%;"></td> <td style="width: 10%;"></td> </tr> <tr> <td></td> <td></td> <td colspan="8" style="text-align: center;"> <table border="1" style="width: 100%; border-collapse: collapse; text-align: center;"> <tr> <td style="width: 10%;"></td> <td style="width: 10%;"></td> <td style="width: 10%;"></td> <td style="width: 10%;"></td> <td style="width: 10%;"></td> <td style="width: 10%;"></td> <td style="width: 10%;"></td> <td style="width: 10%;"></td> <td style="width: 10%;"></td> <td style="width: 10%;"></td> </tr> <tr> <td></td> <td></td> <td colspan="8" style="text-align: center;"> <table border="1" style="width: 100%; border-collapse: collapse; text-align: center;"> <tr> <td style="width: 10%;"></td> <td style="width: 10%;"></td> <td style="width: 10%;"></td> <td style="width: 10%;"></td> <td style="width: 10%;"></td> <td style="width: 10%;"></td> <td style="width: 10%;"></td> <td style="width: 10%;"></td> <td style="width: 10%;"></td> <td style="width: 10%;"></td> </tr> <tr> <td></td> <td></td> <td colspan="8" style="text-align: center;"> <table border="1" style="width: 100%; border-collapse: collapse; text-align: center;"> <tr> <td style="width: 10%;"></td> <td style="width: 10%;"></td> <td style="width: 10%;"></td> <td style="width: 10%;"></td> <td style="width: 10%;"></td> <td style="width: 10%;"></td> <td style="width: 10%;"></td> <td style="width: 10%;"></td> <td style="width: 10%;"></td> <td style="width: 10%;"></td> </tr> <tr> <td></td> <td></td> <td colspan="8" style="text-align: center;"> <table border="1" style="width: 100%;
border-collapse: collapse; text-align: center;"> <tr> <td style="width: 10%;"></td> <td style="width: 10%;"></td> <td style="width: 10%;"></td> <td style="width: 10%;"></td> <td style="width: 10%;"></td> <td style="width: 10%;"></td> <td style="width: 10%;"></td> <td style="width: 10%;"></td> <td style="width: 10%;"></td> <td style="width: 10%;"></td> </tr> <tr> <td></td> <td></td> <td colspan="8" style="text-align: center;"> <table border="1" style="width: 100%; border-collapse: collapse; text-align: center;"> <tr> <td style="width: 10%;"></td> <td style="width: 10%;"></td> <td style="width: 10%;"></td> <td style="width: 10%;"></td> <td style="width: 10%;"></td> <td style="width: 10%;"></td> <td style="width: 10%;"></td> <td style="width: 10%;"></td> <td style="width: 10%;"></td> <td style="width: 10%;"></td> </tr> <tr> <td></td> <td></td> <td colspan="8" style="text-align: center;"> <table border="1" style="width: 100%; border-collapse: collapse; text-align: center;"> <tr> <td style="width: 10%;"></td> <td style="width: 10%;"></td> <td style="width: 10%;"></td> <td style="width: 10%;"></td> <td style="width: 10%;"></td> <td style="width: 10%;"></td> <td style="width: 10%;"></td> <td style="width: 10%;"></td> <td style="width: 10%;"></td> <td style="width: 10%;"></td> </tr> <tr> <td></td> <td></td> <td colspan="8" style="text-align: center;"> <table border="1" style="width: 100%; border-collapse: collapse; text-align: center;"> <tr> <td style="width: 10%;"></td> <td style="width: 10%;"></td> <td style="width: 10%;"></td> <td style="width: 10%;"></td> <td style="width: 10%;"></td> <td style="width: 10%;"></td> <td style="width: 10%;"></td> <td style="width: 10%;"></td> <td style="width: 10%;"></td> <td style="width: 10%;"></td> </tr> <tr> <td></td> <td></td> <td colspan="8" style="text-align: center;"> <table border="1" style="width: 100%; border-collapse: collapse; text-align: center;"> <tr> <td style="width: 10%;"></td> <td style="width: 10%;"></td> <td style="width: 10%;"></td> <td style="width: 10%;"></td> <td style="width: 10%;"></td> <td style="width: 10%;"></td> <td style="width: 10%;"></td> <td style="width: 10%;"></td> <td style="width: 10%;"></td> <td style="width: 10%;"></td> </tr> <tr> <td></td> <td></td> <td colspan="8" style="text-align: center;"> <table border="1" style="width: 100%; border-collapse: collapse; text-align: center;"> <tr> <td style="width: 10%;"></td> <td style="width: 10%;"></td> <td style="width: 10%;"></td> <td style="width: 10%;"></td> <td style="width: 10%;"></td> <td style="width: 10%;"></td> <td style="width: 10%;"></td> <td style="width: 10%;"></td> <td style="width: 10%;"></td> <td style="width: 10%;"></td> </tr> <tr> <td></td> <td></td> <td colspan="8" style="text-align: center;"> <table border="1" style="width: 100%; border-collapse: collapse; text-align: center;"> <tr> <td style="width: 10%;"></td> <td style="width: 10%;"></td> <td style="width: 10%;"></td> <td style="width: 10%;"></td> <td style="width: 10%;"></td> <td style="width: 10%;"></td> <td style="width: 10%;"></td> <td style="width: 10%;"></td> <td style="width: 10%;"></td> <td style="width: 10%;"></td> </tr> <tr> <td></td> <td></td> <td colspan="8" style="text-align: center;"> <table border="1" style="width: 100%; border-collapse: collapse; text-align: center;"> <tr> <td style="width: 10%;"></td> <td style="width: 10%;"></td> <td style="width: 10%;"></td> <td style="width: 10%;"></td> <td style="width: 10%;"></td> <td style="width: 10%;"></td> <td style="width: 10%;"></td> <td style="width: 10%;"></td> <td style="width: 10%;"></td> <td style="width: 10%;"></td> </tr> <tr> <td></td> <td></td> <td colspan="8" style="text-align: center;"> <table border="1" style="width: 100%; border-collapse: collapse; text-align: center;"> <tr> <td style="width: 10%;"></td> <td style="width: 10%;"></td> <td style="width: 10%;"></td> <td style="width: 10%;"></td> <td style="width: 10%;"></td> <td style="width: 10%;"></td> <td style="width: 10%;"></td> <td style="width: 10%;"></td> <td style="width: 10%;"></td> <td style="width: 10%;"></td> </tr> <tr> <td></td> <td></td> <td colspan="8" style="text-align: center;"> <table border="1" style="width: 100%; border-collapse: collapse; text-align: center;"> <tr> <td style="width: 10%;"></td> <td style="width: 10%;"></td> <td style="width: 10%;"></td> <td style="width: 10%;"></td> <td style="width: 10%;"></td> <td style="width: 10%;"></td> <td style="width: 10%;"></td> <td style="width: 10%;"></td> <td style="width: 10%;"></td> <td style="width: 10%;"></td> </tr> <tr> <td></td> <td></td> <td colspan="8" style="text-align: center;"> <table border="1" style="width: 100%; border-collapse: collapse; text-align: center;"> <tr> <td style="width: 10%;"></td> <td style="width: 10%;"></td> <td style="width: 10%;"></td> <td style="width: 10%;"></td> <td style="width: 10%;"></td> <td style="width: 10%;"></td> <td style="width: 10%;"></td> <td style="width: 10%;"></td> <td style="width: 10%;"></td> <td style="width: 10%;"></td> </tr> <tr> <td></td> <td></td> <td colspan="8" style="text-align: center;"> <table border="1" style="width: 100%; border-collapse: collapse; text-align: center;"> <tr> <td style="width: 10%;"></td> <td style="width: 10%;"></td> <td style="width: 10%;"></td> <td style="width: 10%;"></td> <td style="width: 10%;"></td> <td style="width: 10%;"></td> <td style="width: 10%;"></td> <td style="width: 10%;"></td> <td style="width: 10%;"></td> <td style="width: 10%;"></td> </tr> <tr> <td></td> <td></td> <td colspan="8" style="text-align: center;"> <table border="1" style="width: 100%; border-collapse: collapse; text-align: center;"> <tr> <td style="width: 10%;"></td> <td style="width: 10%;"></td> <td style="width: 10%;"></td> <td style="width: 10%;"></td> <td style="width: 10%;"></td> <td style="width: 10%;"></td> <td style="width: 10%;"></td> <td style="width: 10%;"></td> <td style="width: 10%;"></td> <td style="width: 10%;"></td> </tr> <tr> <td></td> <td></td> <td colspan="8" style="text-align: center;"> <table border="1" style="width: 100%; border-collapse: collapse; text-align: center;"> <tr> <td style="width: 10%;"></td> <td style="width: 10%;"></td> <td style="width: 10%;"></td> <td style="width: 10%;"></td> <td style="width: 10%;"></td> <td style="width: 10%;"></td> <td style="width: 10%;"></td> <td style="width: 10%;"></td> <td style="width: 10%;"></td> <td style="width: 10%;"></td> </tr> <tr> <td></td> <td></td> <td colspan="8" style="text-align: center;"> <table border="1" style="width: 100%; border-collapse: collapse; text-align: center;"> <tr> <td style="width: 10%;"></td> <td style="width: 10%;"></td> <td style="width: 10%;"></td> <td style="width: 10%;"></td> <td style="width: 10%;"></td> <td style="width: 10%;"></td> <td style="width: 10%;"></td> <td style="width: 10%;"></td> <td style="width: 10%;"></td> <td style="width: 10%;"></td> </tr> <tr> <td></td> <td></td> <td colspan="8" style="text-align: center;"> <table border="1" style="width: 100%; border-collapse: collapse; text-align: center;"> <tr> </tr></table></td></tr></table></td></tr></table></td></tr></table></td></tr></table></td></tr></table></td></tr></table></td></tr></table></td></tr></table></td></tr></table></td></tr></table></td></tr></table></td></tr></table></td></tr></table></td></tr></table></td></tr></table></td></tr></table></td></tr></table></td></tr></table></td></tr></table></td></tr></table></td></tr></table></td></tr></table></td></tr></table></td></tr></table></td></tr></table></td></tr></table></td></tr></table></td></tr></table></td></tr></table></td></tr></table></td></tr></table></td></tr></table></td></tr></table></td></tr></table></td></tr></table></td></tr></table></td></tr></table></td></tr></table></td></tr></table></td></tr></table></td></tr></table></td></tr></table></td></tr></table></td></tr></table></td></tr></table></td></tr></table></td></tr></table></td></tr></table></td></tr></table></td></tr></table></td></tr></table></td></tr></table></td></tr></table> | | | | | | | | | | | | | | | | | | | | <table border="1" style="width: 100%; border-collapse: collapse; text-align: center;"> <tr> <td style="width: 10%;"></td> <td style="width: 10%;"></td> <td style="width: 10%;"></td> <td style="width: 10%;"></td> <td style="width: 10%;"></td> <td style="width: 10%;"></td> <td style="width: 10%;"></td> <td style="width: 10%;"></td> <td style="width: 10%;"></td> <td style="width: 10%;"></td> </tr> <tr> <td></td> <td></td> <td colspan="8" style="text-align: center;"> <table border="1" style="width: 100%; border-collapse: collapse; text-align: center;"> <tr> <td style="width: 10%;"></td> <td style="width: 10%;"></td> <td style="width: 10%;"></td> <td style="width: 10%;"></td> <td style="width: 10%;"></td> <td style="width: 10%;"></td> <td style="width: 10%;"></td> <td style="width: 10%;"></td> <td style="width: 10%;"></td> <td style="width: 10%;"></td> </tr> <tr> <td></td> <td></td> <td colspan="8" style="text-align: center;"> <table border="1" style="width: 100%; border-collapse: collapse; text-align: center;"> <tr> <td style="width: 10%;"></td> <td style="width: 10%;"></td> <td style="width: 10%;"></td> <td style="width: 10%;"></td> <td style="width: 10%;"></td> <td style="width: 10%;"></td> <td style="width: 10%;"></td> <td style="width: 10%;"></td> <td style="width: 10%;"></td> <td style="width: 10%;"></td> </tr> <tr> <td></td> <td></td> <td colspan="8" style="text-align: center;"> <table
border="1" style="width: 100%; border-collapse: collapse; text-align: center;"> <tr> <td style="width: 10%;"></td> <td style="width: 10%;"></td> <td style="width: 10%;"></td> <td style="width: 10%;"></td> <td style="width: 10%;"></td> <td style="width: 10%;"></td> <td style="width: 10%;"></td> <td style="width: 10%;"></td> <td style="width: 10%;"></td> <td style="width: 10%;"></td> </tr> <tr> <td></td> <td></td> <td colspan="8" style="text-align: center;"> <table border="1" style="width: 100%; border-collapse: collapse; text-align: center;"> <tr> <td style="width: 10%;"></td> <td style="width: 10%;"></td> <td style="width: 10%;"></td> <td style="width: 10%;"></td> <td style="width: 10%;"></td> <td style="width: 10%;"></td> <td style="width: 10%;"></td> <td style="width: 10%;"></td> <td style="width: 10%;"></td> <td style="width: 10%;"></td> </tr> <tr> <td></td> <td></td> <td colspan="8" style="text-align: center;"> <table border="1" style="width: 100%; border-collapse: collapse; text-align: center;"> <tr> <td style="width: 10%;"></td> <td style="width: 10%;"></td> <td style="width: 10%;"></td> <td style="width: 10%;"></td> <td style="width: 10%;"></td> <td style="width: 10%;"></td> <td style="width: 10%;"></td> <td style="width: 10%;"></td> <td style="width: 10%;"></td> <td style="width: 10%;"></td> </tr> <tr> <td></td> <td></td> <td colspan="8" style="text-align: center;"> <table border="1" style="width: 100%; border-collapse: collapse; text-align: center;"> <tr> <td style="width: 10%;"></td> <td style="width: 10%;"></td> <td style="width: 10%;"></td> <td style="width: 10%;"></td> <td style="width: 10%;"></td> <td style="width: 10%;"></td> <td style="width: 10%;"></td> <td style="width: 10%;"></td> <td style="width: 10%;"></td> <td style="width: 10%;"></td> </tr> <tr> <td></td> <td></td> <td colspan="8" style="text-align: center;"> <table border="1" style="width: 100%; border-collapse: collapse; text-align: center;"> <tr> <td style="width: 10%;"></td> <td style="width: 10%;"></td> <td style="width: 10%;"></td> <td style="width: 10%;"></td> <td style="width: 10%;"></td> <td style="width: 10%;"></td> <td style="width: 10%;"></td> <td style="width: 10%;"></td> <td style="width: 10%;"></td> <td style="width: 10%;"></td> </tr> <tr> <td></td> <td></td> <td colspan="8" style="text-align: center;"> <table border="1" style="width: 100%; border-collapse: collapse; text-align: center;"> <tr> <td style="width: 10%;"></td> <td style="width: 10%;"></td> <td style="width: 10%;"></td> <td style="width: 10%;"></td> <td style="width: 10%;"></td> <td style="width: 10%;"></td> <td style="width: 10%;"></td> <td style="width: 10%;"></td> <td style="width: 10%;"></td> <td style="width: 10%;"></td> </tr> <tr> <td></td> <td></td> <td colspan="8" style="text-align: center;"> <table border="1" style="width: 100%; border-collapse: collapse; text-align: center;"> <tr> <td style="width: 10%;"></td> <td style="width: 10%;"></td> <td style="width: 10%;"></td> <td style="width: 10%;"></td> <td style="width: 10%;"></td> <td style="width: 10%;"></td> <td style="width: 10%;"></td> <td style="width: 10%;"></td> <td style="width: 10%;"></td> <td style="width: 10%;"></td> </tr> <tr> <td></td> <td></td> <td colspan="8" style="text-align: center;"> <table border="1" style="width: 100%; border-collapse: collapse; text-align: center;"> <tr> <td style="width: 10%;"></td> <td style="width: 10%;"></td> <td style="width: 10%;"></td> <td style="width: 10%;"></td> <td style="width: 10%;"></td> <td style="width: 10%;"></td> <td style="width: 10%;"></td> <td style="width: 10%;"></td> <td style="width: 10%;"></td> <td style="width: 10%;"></td> </tr> <tr> <td></td> <td></td> <td colspan="8" style="text-align: center;"> <table border="1" style="width: 100%; border-collapse: collapse; text-align: center;"> <tr> <td style="width: 10%;"></td> <td style="width: 10%;"></td> <td style="width: 10%;"></td> <td style="width: 10%;"></td> <td style="width: 10%;"></td> <td style="width: 10%;"></td> <td style="width: 10%;"></td> <td style="width: 10%;"></td> <td style="width: 10%;"></td> <td style="width: 10%;"></td> </tr> <tr> <td></td> <td></td> <td colspan="8" style="text-align: center;"> <table border="1" style="width: 100%; border-collapse: collapse; text-align: center;"> <tr> <td style="width: 10%;"></td> <td style="width: 10%;"></td> <td style="width: 10%;"></td> <td style="width: 10%;"></td> <td style="width: 10%;"></td> <td style="width: 10%;"></td> <td style="width: 10%;"></td> <td style="width: 10%;"></td> <td style="width: 10%;"></td> <td style="width: 10%;"></td> </tr> <tr> <td></td> <td></td> <td colspan="8" style="text-align: center;"> <table border="1" style="width: 100%; border-collapse: collapse; text-align: center;"> <tr> <td style="width: 10%;"></td> <td style="width: 10%;"></td> <td style="width: 10%;"></td> <td style="width: 10%;"></td> <td style="width: 10%;"></td> <td style="width: 10%;"></td> <td style="width: 10%;"></td> <td style="width: 10%;"></td> <td style="width: 10%;"></td> <td style="width: 10%;"></td> </tr> <tr> <td></td> <td></td> <td colspan="8" style="text-align: center;"> <table border="1" style="width: 100%; border-collapse: collapse; text-align: center;"> <tr> <td style="width: 10%;"></td> <td style="width: 10%;"></td> <td style="width: 10%;"></td> <td style="width: 10%;"></td> <td style="width: 10%;"></td> <td style="width: 10%;"></td> <td style="width: 10%;"></td> <td style="width: 10%;"></td> <td style="width: 10%;"></td> <td style="width: 10%;"></td> </tr> <tr> <td></td> <td></td> <td colspan="8" style="text-align: center;"> <table border="1" style="width: 100%; border-collapse: collapse; text-align: center;"> <tr> <td style="width: 10%;"></td> <td style="width: 10%;"></td> <td style="width: 10%;"></td> <td style="width: 10%;"></td> <td style="width: 10%;"></td> <td style="width: 10%;"></td> <td style="width: 10%;"></td> <td style="width: 10%;"></td> <td style="width: 10%;"></td> <td style="width: 10%;"></td> </tr> <tr> <td></td> <td></td> <td colspan="8" style="text-align: center;"> <table border="1" style="width: 100%; border-collapse: collapse; text-align: center;"> <tr> <td style="width: 10%;"></td> <td style="width: 10%;"></td> <td style="width: 10%;"></td> <td style="width: 10%;"></td> <td style="width: 10%;"></td> <td style="width: 10%;"></td> <td style="width: 10%;"></td> <td style="width: 10%;"></td> <td style="width: 10%;"></td> <td style="width: 10%;"></td> </tr> <tr> <td></td> <td></td> <td colspan="8" style="text-align: center;"> <table border="1" style="width: 100%; border-collapse: collapse; text-align: center;"> <tr> <td style="width: 10%;"></td> <td style="width: 10%;"></td> <td style="width: 10%;"></td> <td style="width: 10%;"></td> <td style="width: 10%;"></td> <td style="width: 10%;"></td> <td style="width: 10%;"></td> <td style="width: 10%;"></td> <td style="width: 10%;"></td> <td style="width: 10%;"></td> </tr> <tr> <td></td> <td></td> <td colspan="8" style="text-align: center;"> <table border="1" style="width: 100%; border-collapse: collapse; text-align: center;"> <tr> <td style="width: 10%;"></td> <td style="width: 10%;"></td> <td style="width: 10%;"></td> <td style="width: 10%;"></td> <td style="width: 10%;"></td> <td style="width: 10%;"></td> <td style="width: 10%;"></td> <td style="width: 10%;"></td> <td style="width: 10%;"></td> <td style="width: 10%;"></td> </tr> <tr> <td></td> <td></td> <td colspan="8" style="text-align: center;"> <table border="1" style="width: 100%; border-collapse: collapse; text-align: center;"> <tr> <td style="width: 10%;"></td> <td style="width: 10%;"></td> <td style="width: 10%;"></td> <td style="width: 10%;"></td> <td style="width: 10%;"></td> <td style="width: 10%;"></td> <td style="width: 10%;"></td> <td style="width: 10%;"></td> <td style="width: 10%;"></td> <td style="width: 10%;"></td> </tr> <tr> <td></td> <td></td> <td colspan="8" style="text-align: center;"> <table border="1" style="width: 100%; border-collapse: collapse; text-align: center;"> <tr> <td style="width: 10%;"></td> <td style="width: 10%;"></td> <td style="width: 10%;"></td> <td style="width: 10%;"></td> <td style="width: 10%;"></td> <td style="width: 10%;"></td> <td style="width: 10%;"></td> <td style="width: 10%;"></td> <td style="width: 10%;"></td> <td style="width: 10%;"></td> </tr> <tr> <td></td> <td></td> <td colspan="8" style="text-align: center;"> <table border="1" style="width: 100%; border-collapse: collapse; text-align: center;"> <tr> <td style="width: 10%;"></td> <td style="width: 10%;"></td> <td style="width: 10%;"></td> <td style="width: 10%;"></td> <td style="width: 10%;"></td> <td style="width: 10%;"></td> <td style="width: 10%;"></td> <td style="width: 10%;"></td> <td style="width: 10%;"></td> <td style="width: 10%;"></td> </tr> <tr> <td></td> <td></td> <td colspan="8" style="text-align: center;"> <table border="1" style="width: 100%; border-collapse: collapse; text-align: center;"> <tr> <td style="width: 10%;"></td> <td style="width: 10%;"></td> <td style="width: 10%;"></td> <td style="width: 10%;"></td> <td style="width: 10%;"></td> <td style="width: 10%;"></td> <td style="width: 10%;"></td> <td style="width: 10%;"></td> <td style="width: 10%;"></td> <td style="width: 10%;"></td> </tr> <tr> <td></td> <td></td> <td colspan="8" style="text-align: center;"> <table border="1" style="width: 100%; border-collapse: collapse; text-align: center;"> <tr> <td style="width: 10%;"></td> <td style="width: 10%;"></td> <td style="width: 10%;"></td> <td style="width: 10%;"></td> <td style="width: 10%;"></td> <td style="width: 10%;"></td> <td style="width: 10%;"></td> <td style="width: 10%;"></td> <td style="width: 10%;"></td> <td style="width: 10%;"></td> </tr> <tr> <td></td> <td></td> <td colspan="8" style="text-align: center;"> <table border="1" style="width: 100%; border-collapse: collapse; text-align: center;"> <tr> <td style="width: 10%;"></td> <td style="width: 10%;"></td> <td style="width:
10%;"></td> <td style="width: 10%;"></td> <td style="width: 10%;"></td> <td style="width: 10%;"></td> <td style="width: 10%;"></td> <td style="width: 10%;"></td> <td style="width: 10%;"></td> <td style="width: 10%;"></td> </tr> <tr> <td></td> <td></td> <td colspan="8" style="text-align: center;"> <table border="1" style="width: 100%; border-collapse: collapse; text-align: center;"> <tr> <td style="width: 10%;"></td> <td style="width: 10%;"></td> <td style="width: 10%;"></td> <td style="width: 10%;"></td> <td style="width: 10%;"></td> <td style="width: 10%;"></td> <td style="width: 10%;"></td> <td style="width: 10%;"></td> <td style="width: 10%;"></td> <td style="width: 10%;"></td> </tr> <tr> <td></td> <td></td> <td colspan="8" style="text-align: center;"> <table border="1" style="width: 100%; border-collapse: collapse; text-align: center;"> <tr> <td style="width: 10%;"></td> <td style="width: 10%;"></td> <td style="width: 10%;"></td> <td style="width: 10%;"></td> <td style="width: 10%;"></td> <td style="width: 10%;"></td> <td style="width: 10%;"></td> <td style="width: 10%;"></td> <td style="width: 10%;"></td> <td style="width: 10%;"></td> </tr> <tr> <td></td> <td></td> <td colspan="8" style="text-align: center;"> <table border="1" style="width: 100%; border-collapse: collapse; text-align: center;"> <tr> <td style="width: 10%;"></td> <td style="width: 10%;"></td> <td style="width: 10%;"></td> <td style="width: 10%;"></td> <td style="width: 10%;"></td> <td style="width: 10%;"></td> <td style="width: 10%;"></td> <td style="width: 10%;"></td> <td style="width: 10%;"></td> <td style="width: 10%;"></td> </tr> <tr> <td></td> <td></td> <td colspan="8" style="text-align: center;"> <table border="1" style="width: 100%; border-collapse: collapse; text-align: center;"> <tr> <td style="width: 10%;"></td> <td style="width: 10%;"></td> <td style="width: 10%;"></td> <td style="width: 10%;"></td> <td style="width: 10%;"></td> <td style="width: 10%;"></td> <td style="width: 10%;"></td> <td style="width: 10%;"></td> <td style="width: 10%;"></td> <td style="width: 10%;"></td> </tr> <tr> <td></td> <td></td> <td colspan="8" style="text-align: center;"> <table border="1" style="width: 100%; border-collapse: collapse; text-align: center;"> <tr> <td style="width: 10%;"></td> <td style="width: 10%;"></td> <td style="width: 10%;"></td> <td style="width: 10%;"></td> <td style="width: 10%;"></td> <td style="width: 10%;"></td> <td style="width: 10%;"></td> <td style="width: 10%;"></td> <td style="width: 10%;"></td> <td style="width: 10%;"></td> </tr> <tr> <td></td> <td></td> <td colspan="8" style="text-align: center;"> <table border="1" style="width: 100%; border-collapse: collapse; text-align: center;"> <tr> <td style="width: 10%;"></td> <td style="width: 10%;"></td> <td style="width: 10%;"></td> <td style="width: 10%;"></td> <td style="width: 10%;"></td> <td style="width: 10%;"></td> <td style="width: 10%;"></td> <td style="width: 10%;"></td> <td style="width: 10%;"></td> <td style="width: 10%;"></td> </tr> <tr> <td></td> <td></td> <td colspan="8" style="text-align: center;"> <table border="1" style="width: 100%; border-collapse: collapse; text-align: center;"> <tr> <td style="width: 10%;"></td> <td style="width: 10%;"></td> <td style="width: 10%;"></td> <td style="width: 10%;"></td> <td style="width: 10%;"></td> <td style="width: 10%;"></td> <td style="width: 10%;"></td> <td style="width: 10%;"></td> <td style="width: 10%;"></td> <td style="width: 10%;"></td> </tr> <tr> <td></td> <td></td> <td colspan="8" style="text-align: center;"> <table border="1" style="width: 100%; border-collapse: collapse; text-align: center;"> <tr> <td style="width: 10%;"></td> <td style="width: 10%;"></td> <td style="width: 10%;"></td> <td style="width: 10%;"></td> <td style="width: 10%;"></td> <td style="width: 10%;"></td> <td style="width: 10%;"></td> <td style="width: 10%;"></td> <td style="width: 10%;"></td> <td style="width: 10%;"></td> </tr> <tr> <td></td> <td></td> <td colspan="8" style="text-align: center;"> <table border="1" style="width: 100%; border-collapse: collapse; text-align: center;"> <tr> <td style="width: 10%;"></td> <td style="width: 10%;"></td> <td style="width: 10%;"></td> <td style="width: 10%;"></td> <td style="width: 10%;"></td> <td style="width: 10%;"></td> <td style="width: 10%;"></td> <td style="width: 10%;"></td> <td style="width: 10%;"></td> <td style="width: 10%;"></td> </tr> <tr> <td></td> <td></td> <td colspan="8" style="text-align: center;"> <table border="1" style="width: 100%; border-collapse: collapse; text-align: center;"> <tr> <td style="width: 10%;"></td> <td style="width: 10%;"></td> <td style="width: 10%;"></td> <td style="width: 10%;"></td> <td style="width: 10%;"></td> <td style="width: 10%;"></td> <td style="width: 10%;"></td> <td style="width: 10%;"></td> <td style="width: 10%;"></td> <td style="width: 10%;"></td> </tr> <tr> <td></td> <td></td> <td colspan="8" style="text-align: center;"> <table border="1" style="width: 100%; border-collapse: collapse; text-align: center;"> <tr> <td style="width: 10%;"></td> <td style="width: 10%;"></td> <td style="width: 10%;"></td> <td style="width: 10%;"></td> <td style="width: 10%;"></td> <td style="width: 10%;"></td> <td style="width: 10%;"></td> <td style="width: 10%;"></td> <td style="width: 10%;"></td> <td style="width: 10%;"></td> </tr> <tr> <td></td> <td></td> <td colspan="8" style="text-align: center;"> <table border="1" style="width: 100%; border-collapse: collapse; text-align: center;"> <tr> <td style="width: 10%;"></td> <td style="width: 10%;"></td> <td style="width: 10%;"></td> <td style="width: 10%;"></td> <td style="width: 10%;"></td> <td style="width: 10%;"></td> <td style="width: 10%;"></td> <td style="width: 10%;"></td> <td style="width: 10%;"></td> <td style="width: 10%;"></td> </tr> <tr> <td></td> <td></td> <td colspan="8" style="text-align: center;"> <table border="1" style="width: 100%; border-collapse: collapse; text-align: center;"> <tr> <td style="width: 10%;"></td> <td style="width: 10%;"></td> <td style="width: 10%;"></td> <td style="width: 10%;"></td> <td style="width: 10%;"></td> <td style="width: 10%;"></td> <td style="width: 10%;"></td> <td style="width: 10%;"></td> <td style="width: 10%;"></td> <td style="width: 10%;"></td> </tr> <tr> <td></td> <td></td> <td colspan="8" style="text-align: center;"> <table border="1" style="width: 100%; border-collapse: collapse; text-align: center;"> <tr> <td style="width: 10%;"></td> <td style="width: 10%;"></td> <td style="width: 10%;"></td> <td style="width: 10%;"></td> <td style="width: 10%;"></td> <td style="width: 10%;"></td> <td style="width: 10%;"></td> <td style="width: 10%;"></td> <td style="width: 10%;"></td> <td style="width: 10%;"></td> </tr> <tr> <td></td> <td></td> <td colspan="8" style="text-align: center;"> <table border="1" style="width: 100%; border-collapse: collapse; text-align: center;"> <tr> <td style="width: 10%;"></td> <td style="width: 10%;"></td> <td style="width: 10%;"></td> <td style="width: 10%;"></td> <td style="width: 10%;"></td> <td style="width: 10%;"></td> <td style="width: 10%;"></td> <td style="width: 10%;"></td> <td style="width: 10%;"></td> <td style="width: 10%;"></td> </tr> <tr> <td></td> <td></td> <td colspan="8" style="text-align: center;"> <table border="1" style="width: 100%; border-collapse: collapse; text-align: center;"> <tr> <td style="width: 10%;"></td> <td style="width: 10%;"></td> <td style="width: 10%;"></td> <td style="width: 10%;"></td> <td style="width: 10%;"></td> <td style="width: 10%;"></td> <td style="width: 10%;"></td> <td style="width: 10%;"></td> <td style="width: 10%;"></td> <td style="width: 10%;"></td> </tr> <tr> <td></td> <td></td> <td colspan="8" style="text-align: center;"> <table border="1" style="width: 100%; border-collapse: collapse; text-align: center;"> <tr> <td style="width: 10%;"></td> <td style="width: 10%;"></td> <td style="width: 10%;"></td> <td style="width: 10%;"></td> <td style="width: 10%;"></td> <td style="width: 10%;"></td> <td style="width: 10%;"></td> <td style="width: 10%;"></td> <td style="width: 10%;"></td> <td style="width: 10%;"></td> </tr> <tr> <td></td> <td></td> <td colspan="8" style="text-align: center;"> <table border="1" style="width: 100%; border-collapse: collapse; text-align: center;"> <tr> <td style="width: 10%;"></td> <td style="width: 10%;"></td> <td style="width: 10%;"></td> <td style="width: 10%;"></td> <td style="width: 10%;"></td> <td style="width: 10%;"></td> <td style="width: 10%;"></td> <td style="width: 10%;"></td> <td style="width: 10%;"></td> <td style="width: 10%;"></td> </tr> <tr> <td></td> <td></td> <td colspan="8" style="text-align: center;"> <table border="1" style="width: 100%; border-collapse: collapse; text-align: center;"> <tr> <td style="width: 10%;"></td> <td style="width: 10%;"></td> <td style="width: 10%;"></td> <td style="width: 10%;"></td> <td style="width: 10%;"></td> <td style="width: 10%;"></td> <td style="width: 10%;"></td> <td style="width: 10%;"></td> <td style="width: 10%;"></td> <td style="width: 10%;"></td> </tr> <tr> <td></td> <td></td> <td colspan="8" style="text-align: center;"> <table border="1" style="width: 100%; border-collapse: collapse; text-align: center;"> <tr> <td style="width: 10%;"></td> <td style="width: 10%;"></td> <td style="width: 10%;"></td> <td style="width: 10%;"></td> <td style="width: 10%;"></td> <td style="width: 10%;"></td> <td style="width: 10%;"></td> <td style="width: 10%;"></td> <td style="width: 10%;"></td> <td style="width: 10%;"></td> </tr> <tr> <td></td> <td></td> <td colspan="8" style="text-align: center;"> <table border="1" style="width: 100%; border-collapse: collapse; text-align: center;"> <tr> <td style="width: 10%;"></td> <td style="width: 10%;"></td> <td style="width: 10%;"></td> <td style="width: 10%;"></td> <td style="width: 10%;"></td> <td style="width: 10%;"></td> <td style="width: 10%;"></td> <td style="width: 10%;"></td> <td
style="width: 10%;"></td> <td style="width: 10%;"></td> </tr> <tr> <td></td> <td></td> <td colspan="8" style="text-align: center;"> <table border="1" style="width: 100%; border-collapse: collapse; text-align: center;"> <tr> <td style="width: 10%;"></td> <td style="width: 10%;"></td> <td style="width: 10%;"></td> <td style="width: 10%;"></td> <td style="width: 10%;"></td> <td style="width: 10%;"></td> <td style="width: 10%;"></td> <td style="width: 10%;"></td> <td style="width: 10%;"></td> <td style="width: 10%;"></td> </tr> <tr> <td></td> <td></td> <td colspan="8" style="text-align: center;"> <table border="1" style="width: 100%; border-collapse: collapse; text-align: center;"> <tr> <td style="width: 10%;"></td> <td style="width: 10%;"></td> <td style="width: 10%;"></td> <td style="width: 10%;"></td> <td style="width: 10%;"></td> <td style="width: 10%;"></td> <td style="width: 10%;"></td> <td style="width: 10%;"></td> <td style="width: 10%;"></td> <td style="width: 10%;"></td> </tr> <tr> <td></td> <td></td> <td colspan="8" style="text-align: center;"> <table border="1" style="width: 100%; border-collapse: collapse; text-align: center;"> <tr> <td style="width: 10%;"></td> <td style="width: 10%;"></td> <td style="width: 10%;"></td> <td style="width: 10%;"></td> <td style="width: 10%;"></td> <td style="width: 10%;"></td> <td style="width: 10%;"></td> <td style="width: 10%;"></td> <td style="width: 10%;"></td> <td style="width: 10%;"></td> </tr> <tr> <td></td> <td></td> <td colspan="8" style="text-align: center;"> <table border="1" style="width: 100%; border-collapse: collapse; text-align: center;"> <tr> <td style="width: 10%;"></td> <td style="width: 10%;"></td> <td style="width: 10%;"></td> <td style="width: 10%;"></td> <td style="width: 10%;"></td> <td style="width: 10%;"></td> <td style="width: 10%;"></td> <td style="width: 10%;"></td> <td style="width: 10%;"></td> <td style="width: 10%;"></td> </tr> <tr> <td></td> <td></td> <td colspan="8" style="text-align: center;"> <table border="1" style="width: 100%; border-collapse: collapse; text-align: center;"> <tr> <td style="width: 10%;"></td> <td style="width: 10%;"></td> <td style="width: 10%;"></td> <td style="width: 10%;"></td> <td style="width: 10%;"></td> <td style="width: 10%;"></td> <td style="width: 10%;"></td> <td style="width: 10%;"></td> <td style="width: 10%;"></td> <td style="width: 10%;"></td> </tr> <tr> <td></td> <td></td> <td colspan="8" style="text-align: center;"> <table border="1" style="width: 100%; border-collapse: collapse; text-align: center;"> <tr> <td style="width: 10%;"></td> <td style="width: 10%;"></td> <td style="width: 10%;"></td> <td style="width: 10%;"></td> <td style="width: 10%;"></td> <td style="width: 10%;"></td> <td style="width: 10%;"></td> <td style="width: 10%;"></td> <td style="width: 10%;"></td> <td style="width: 10%;"></td> </tr> <tr> <td></td> <td></td> <td colspan="8" style="text-align: center;"> <table border="1" style="width: 100%; border-collapse: collapse; text-align: center;"> <tr> </tr></table></td></tr></table></td></tr></table></td></tr></table></td></tr></table></td></tr></table></td></tr></table></td></tr></table></td></tr></table></td></tr></table></td></tr></table></td></tr></table></td></tr></table></td></tr></table></td></tr></table></td></tr></table></td></tr></table></td></tr></table></td></tr></table></td></tr></table></td></tr></table></td></tr></table></td></tr></table></td></tr></table></td></tr></table></td></tr></table></td></tr></table></td></tr></table></td></tr></table></td></tr></table></td></tr></table></td></tr></table></td></tr></table></td></tr></table></td></tr></table></td></tr></table></td></tr></table></td></tr></table></td></tr></table></td></tr></table></td></tr></table></td></tr></table></td></tr></table></td></tr></table></td></tr></table></td></tr></table></td></tr></table></td></tr></table></td></tr></table></td></tr></table></td></tr></table></td></tr></table></td></tr></table> | | | | | | | | | | | | | | | | | | | | <table border="1" style="width: 100%; border-collapse: collapse; text-align: center;"> <tr> <td style="width: 10%;"></td> <td style="width: 10%;"></td> <td style="width: 10%;"></td> <td style="width: 10%;"></td> <td style="width: 10%;"></td> <td style="width: 10%;"></td> <td style="width: 10%;"></td> <td style="width: 10%;"></td> <td style="width: 10%;"></td> <td style="width: 10%;"></td> </tr> <tr> <td></td> <td></td> <td colspan="8" style="text-align: center;"> <table border="1" style="width: 100%; border-collapse: collapse; text-align: center;"> <tr> <td style="width: 10%;"></td> <td style="width: 10%;"></td> <td style="width: 10%;"></td> <td style="width: 10%;"></td> <td style="width: 10%;"></td> <td style="width: 10%;"></td> <td style="width: 10%;"></td> <td style="width: 10%;"></td> <td style="width: 10%;"></td> <td style="width: 10%;"></td> </tr> <tr> <td></td> <td></td> <td colspan="8" style="text-align: center;"> <table border="1" style="width: 100%; border-collapse: collapse; text-align: center;"> <tr> <td style="width: 10%;"></td> <td style="width: 10%;"></td> <td style="width: 10%;"></td> <td style="width: 10%;"></td> <td style="width: 10%;"></td> <td style="width: 10%;"></td> <td style="width: 10%;"></td> <td style="width: 10%;"></td> <td style="width: 10%;"></td> <td style="width: 10%;"></td> </tr> <tr> <td></td> <td></td> <td colspan="8" style="text-align: center;"> <table border="1" style="width: 100%; border-collapse: collapse; text-align: center;"> <tr> <td style="width: 10%;"></td> <td style="width: 10%;"></td> <td style="width: 10%;"></td> <td style="width: 10%;"></td> <td style="width: 10%;"></td> <td style="width: 10%;"></td> <td style="width: 10%;"></td> <td style="width: 10%;"></td> <td style="width: 10%;"></td> <td style="width: 10%;"></td> </tr> <tr> <td></td> <td></td> <td colspan="8" style="text-align: center;"> <table border="1" style="width: 100%; border-collapse: collapse; text-align: center;"> <tr> <td style="width: 10%;"></td> <td style="width: 10%;"></td> <td style="width: 10%;"></td> <td style="width: 10%;"></td> <td style="width: 10%;"></td> <td style="width: 10%;"></td> <td style="width: 10%;"></td> <td style="width: 10%;"></td> <td style="width: 10%;"></td> <td style="width: 10%;"></td> </tr> <tr> <td></td> <td></td> <td colspan="8" style="text-align: center;"> <table border="1" style="width: 100%; border-collapse: collapse; text-align: center;"> <tr> <td style="width: 10%;"></td> <td style="width: 10%;"></td> <td style="width: 10%;"></td> <td style="width: 10%;"></td> <td style="width: 10%;"></td> <td style="width: 10%;"></td> <td style="width: 10%;"></td> <td style="width: 10%;"></td> <td style="width: 10%;"></td> <td style="width: 10%;"></td> </tr> <tr> <td></td> <td></td> <td colspan="8" style="text-align: center;"> <table border="1" style="width: 100%; border-collapse: collapse; text-align: center;"> <tr> <td style="width: 10%;"></td> <td style="width: 10%;"></td> <td style="width: 10%;"></td> <td style="width: 10%;"></td> <td style="width: 10%;"></td> <td style="width: 10%;"></td> <td style="width: 10%;"></td> <td style="width: 10%;"></td> <td style="width: 10%;"></td> <td style="width: 10%;"></td> </tr> <tr> <td></td> <td></td> <td colspan="8" style="text-align: center;"> <table border="1" style="width: 100%; border-collapse: collapse; text-align: center;"> <tr> <td style="width: 10%;"></td> <td style="width: 10%;"></td> <td style="width: 10%;"></td> <td style="width: 10%;"></td> <td style="width: 10%;"></td> <td style="width: 10%;"></td> <td style="width: 10%;"></td> <td style="width: 10%;"></td> <td style="width: 10%;"></td> <td style="width: 10%;"></td> </tr> <tr> <td></td> <td></td> <td colspan="8" style="text-align: center;"> <table border="1" style="width: 100%; border-collapse: collapse; text-align: center;"> <tr> <td style="width: 10%;"></td> <td style="width: 10%;"></td> <td style="width: 10%;"></td> <td style="width: 10%;"></td> <td style="width: 10%;"></td> <td style="width: 10%;"></td> <td style="width: 10%;"></td> <td style="width: 10%;"></td> <td style="width: 10%;"></td> <td style="width: 10%;"></td> </tr> <tr> <td></td> <td></td> <td colspan="8" style="text-align: center;"> <table border="1" style="width: 100%; border-collapse: collapse; text-align: center;"> <tr> <td style="width: 10%;"></td> <td style="width: 10%;"></td> <td style="width: 10%;"></td> <td style="width: 10%;"></td> <td style="width: 10%;"></td> <td style="width: 10%;"></td> <td style="width: 10%;"></td> <td style="width: 10%;"></td> <td style="width: 10%;"></td> <td style="width: 10%;"></td> </tr> <tr> <td></td> <td></td> <td colspan="8" style="text-align: center;"> <table border="1" style="width: 100%; border-collapse: collapse; text-align: center;"> <tr> <td style="width: 10%;"></td> <td style="width: 10%;"></td> <td style="width: 10%;"></td> <td style="width: 10%;"></td> <td style="width: 10%;"></td> <td style="width: 10%;"></td> <td style="width: 10%;"></td> <td style="width: 10%;"></td> <td style="width: 10%;"></td> <td style="width: 10%;"></td> </tr> <tr> <td></td> <td></td> <td colspan="8" style="text-align: center;"> <table border="1" style="width: 100%; border-collapse: collapse; text-align: center;"> <tr> <td style="width: 10%;"></td> <td style="width: 10%;"></td> <td style="width: 10%;"></td> <td style="width: 10%;"></td> <td style="width: 10%;"></td> <td style="width: 10%;"></td> <td style="width: 10%;"></td> <td style="width:
10%;"></td> <td style="width: 10%;"></td> <td style="width: 10%;"></td> </tr> <tr> <td></td> <td></td> <td colspan="8" style="text-align: center;"> <table border="1" style="width: 100%; border-collapse: collapse; text-align: center;"> <tr> <td style="width: 10%;"></td> <td style="width: 10%;"></td> <td style="width: 10%;"></td> <td style="width: 10%;"></td> <td style="width: 10%;"></td> <td style="width: 10%;"></td> <td style="width: 10%;"></td> <td style="width: 10%;"></td> <td style="width: 10%;"></td> <td style="width: 10%;"></td> </tr> <tr> <td></td> <td></td> <td colspan="8" style="text-align: center;"> <table border="1" style="width: 100%; border-collapse: collapse; text-align: center;"> <tr> <td style="width: 10%;"></td> <td style="width: 10%;"></td> <td style="width: 10%;"></td> <td style="width: 10%;"></td> <td style="width: 10%;"></td> <td style="width: 10%;"></td> <td style="width: 10%;"></td> <td style="width: 10%;"></td> <td style="width: 10%;"></td> <td style="width: 10%;"></td> </tr> <tr> <td></td> <td></td> <td colspan="8" style="text-align: center;"> <table border="1" style="width: 100%; border-collapse: collapse; text-align: center;"> <tr> <td style="width: 10%;"></td> <td style="width: 10%;"></td> <td style="width: 10%;"></td> <td style="width: 10%;"></td> <td style="width: 10%;"></td> <td style="width: 10%;"></td> <td style="width: 10%;"></td> <td style="width: 10%;"></td> <td style="width: 10%;"></td> <td style="width: 10%;"></td> </tr> <tr> <td></td> <td></td> <td colspan="8" style="text-align: center;"> <table border="1" style="width: 100%; border-collapse: collapse; text-align: center;"> <tr> <td style="width: 10%;"></td> <td style="width: 10%;"></td> <td style="width: 10%;"></td> <td style="width: 10%;"></td> <td style="width: 10%;"></td> <td style="width: 10%;"></td> <td style="width: 10%;"></td> <td style="width: 10%;"></td> <td style="width: 10%;"></td> <td style="width: 10%;"></td> </tr> <tr> <td></td> <td></td> <td colspan="8" style="text-align: center;"> <table border="1" style="width: 100%; border-collapse: collapse; text-align: center;"> <tr> <td style="width: 10%;"></td> <td style="width: 10%;"></td> <td style="width: 10%;"></td> <td style="width: 10%;"></td> <td style="width: 10%;"></td> <td style="width: 10%;"></td> <td style="width: 10%;"></td> <td style="width: 10%;"></td> <td style="width: 10%;"></td> <td style="width: 10%;"></td> </tr> <tr> <td></td> <td></td> <td colspan="8" style="text-align: center;"> <table border="1" style="width: 100%; border-collapse: collapse; text-align: center;"> <tr> <td style="width: 10%;"></td> <td style="width: 10%;"></td> <td style="width: 10%;"></td> <td style="width: 10%;"></td> <td style="width: 10%;"></td> <td style="width: 10%;"></td> <td style="width: 10%;"></td> <td style="width: 10%;"></td> <td style="width: 10%;"></td> <td style="width: 10%;"></td> </tr> <tr> <td></td> <td></td> <td colspan="8" style="text-align: center;"> <table border="1" style="width: 100%; border-collapse: collapse; text-align: center;"> <tr> <td style="width: 10%;"></td> <td style="width: 10%;"></td> <td style="width: 10%;"></td> <td style="width: 10%;"></td> <td style="width: 10%;"></td> <td style="width: 10%;"></td> <td style="width: 10%;"></td> <td style="width: 10%;"></td> <td style="width: 10%;"></td> <td style="width: 10%;"></td> </tr> <tr> <td></td> <td></td> <td colspan="8" style="text-align: center;"> <table border="1" style="width: 100%; border-collapse: collapse; text-align: center;"> <tr> <td style="width: 10%;"></td> <td style="width: 10%;"></td> <td style="width: 10%;"></td> <td style="width: 10%;"></td> <td style="width: 10%;"></td> <td style="width: 10%;"></td> <td style="width: 10%;"></td> <td style="width: 10%;"></td> <td style="width: 10%;"></td> <td style="width: 10%;"></td> </tr> <tr> <td></td> <td></td> <td colspan="8" style="text-align: center;"> <table border="1" style="width: 100%; border-collapse: collapse; text-align: center;"> <tr> <td style="width: 10%;"></td> <td style="width: 10%;"></td> <td style="width: 10%;"></td> <td style="width: 10%;"></td> <td style="width: 10%;"></td> <td style="width: 10%;"></td> <td style="width: 10%;"></td> <td style="width: 10%;"></td> <td style="width: 10%;"></td> <td style="width: 10%;"></td> </tr> <tr> <td></td> <td></td> <td colspan="8" style="text-align: center;"> <table border="1" style="width: 100%; border-collapse: collapse; text-align: center;"> <tr> <td style="width: 10%;"></td> <td style="width: 10%;"></td> <td style="width: 10%;"></td> <td style="width: 10%;"></td> <td style="width: 10%;"></td> <td style="width: 10%;"></td> <td style="width: 10%;"></td> <td style="width: 10%;"></td> <td style="width: 10%;"></td> <td style="width: 10%;"></td> </tr> <tr> <td></td> <td></td> <td colspan="8" style="text-align: center;"> <table border="1" style="width: 100%; border-collapse: collapse; text-align: center;"> <tr> <td style="width: 10%;"></td> <td style="width: 10%;"></td> <td style="width: 10%;"></td> <td style="width: 10%;"></td> <td style="width: 10%;"></td> <td style="width: 10%;"></td> <td style="width: 10%;"></td> <td style="width: 10%;"></td> <td style="width: 10%;"></td> <td style="width: 10%;"></td> </tr> <tr> <td></td> <td></td> <td colspan="8" style="text-align: center;"> <table border="1" style="width: 100%; border-collapse: collapse; text-align: center;"> <tr> <td style="width: 10%;"></td> <td style="width: 10%;"></td> <td style="width: 10%;"></td> <td style="width: 10%;"></td> <td style="width: 10%;"></td> <td style="width: 10%;"></td> <td style="width: 10%;"></td> <td style="width: 10%;"></td> <td style="width: 10%;"></td> <td style="width: 10%;"></td> </tr> <tr> <td></td> <td></td> <td colspan="8" style="text-align: center;"> <table border="1" style="width: 100%; border-collapse: collapse; text-align: center;"> <tr> <td style="width: 10%;"></td> <td style="width: 10%;"></td> <td style="width: 10%;"></td> <td style="width: 10%;"></td> <td style="width: 10%;"></td> <td style="width: 10%;"></td> <td style="width: 10%;"></td> <td style="width: 10%;"></td> <td style="width: 10%;"></td> <td style="width: 10%;"></td> </tr> <tr> <td></td> <td></td> <td colspan="8" style="text-align: center;"> <table border="1" style="width: 100%; border-collapse: collapse; text-align: center;"> <tr> <td style="width: 10%;"></td> <td style="width: 10%;"></td> <td style="width: 10%;"></td> <td style="width: 10%;"></td> <td style="width: 10%;"></td> <td style="width: 10%;"></td> <td style="width: 10%;"></td> <td style="width: 10%;"></td> <td style="width: 10%;"></td> <td style="width: 10%;"></td> </tr> <tr> <td></td> <td></td> <td colspan="8" style="text-align: center;"> <table border="1" style="width: 100%; border-collapse: collapse; text-align: center;"> <tr> <td style="width: 10%;"></td> <td style="width: 10%;"></td> <td style="width: 10%;"></td> <td style="width: 10%;"></td> <td style="width: 10%;"></td> <td style="width: 10%;"></td> <td style="width: 10%;"></td> <td style="width: 10%;"></td> <td style="width: 10%;"></td> <td style="width: 10%;"></td> </tr> <tr> <td></td> <td></td> <td colspan="8" style="text-align: center;"> <table border="1" style="width: 100%; border-collapse: collapse; text-align: center;"> <tr> <td style="width: 10%;"></td> <td style="width: 10%;"></td> <td style="width: 10%;"></td> <td style="width: 10%;"></td> <td style="width: 10%;"></td> <td style="width: 10%;"></td> <td style="width: 10%;"></td> <td style="width: 10%;"></td> <td style="width: 10%;"></td> <td style="width: 10%;"></td> </tr> <tr> <td></td> <td></td> <td colspan="8" style="text-align: center;"> <table border="1" style="width: 100%; border-collapse: collapse; text-align: center;"> <tr> <td style="width: 10%;"></td> <td style="width: 10%;"></td> <td style="width: 10%;"></td> <td style="width: 10%;"></td> <td style="width: 10%;"></td> <td style="width: 10%;"></td> <td style="width: 10%;"></td> <td style="width: 10%;"></td> <td style="width: 10%;"></td> <td style="width: 10%;"></td> </tr> <tr> <td></td> <td></td> <td colspan="8" style="text-align: center;"> <table border="1" style="width: 100%; border-collapse: collapse; text-align: center;"> <tr> <td style="width: 10%;"></td> <td style="width: 10%;"></td> <td style="width: 10%;"></td> <td style="width: 10%;"></td> <td style="width: 10%;"></td> <td style="width: 10%;"></td> <td style="width: 10%;"></td> <td style="width: 10%;"></td> <td style="width: 10%;"></td> <td style="width: 10%;"></td> </tr> <tr> <td></td> <td></td> <td colspan="8" style="text-align: center;"> <table border="1" style="width: 100%; border-collapse: collapse; text-align: center;"> <tr> <td style="width: 10%;"></td> <td style="width: 10%;"></td> <td style="width: 10%;"></td> <td style="width: 10%;"></td> <td style="width: 10%;"></td> <td style="width: 10%;"></td> <td style="width: 10%;"></td> <td style="width: 10%;"></td> <td style="width: 10%;"></td> <td style="width: 10%;"></td> </tr> <tr> <td></td> <td></td> <td colspan="8" style="text-align: center;"> <table border="1" style="width: 100%; border-collapse: collapse; text-align: center;"> <tr> <td style="width: 10%;"></td> <td style="width: 10%;"></td> <td style="width: 10%;"></td> <td style="width: 10%;"></td> <td style="width: 10%;"></td> <td style="width: 10%;"></td> <td style="width: 10%;"></td> <td style="width: 10%;"></td> <td style="width: 10%;"></td> <td style="width: 10%;"></td> </tr> <tr> <td></td> <td></td> <td colspan="8" style="text-align: center;"> <table border="1" style="width: 100%; border-collapse: collapse; text-align: center;"> <tr> <td style="width: 10%;"></td> <td style="width: 10%;"></td> <td style="width: 10%;"></td> <td style="width: 10%;"></td> <td style="width: 10%;"></td> <td style="width: 10%;"></td> <td style="width: 10%;"></td> <td style="width: 10%;"></td> <td style="width: 10%;"></td> <td style="width: 10%;"></td> </tr> <tr> <td></td> <td></td> <td colspan="8" style="text-align: center;"> <table border="1"
style="width: 100%; border-collapse: collapse; text-align: center;"> <tr> <td style="width: 10%;"></td> <td style="width: 10%;"></td> <td style="width: 10%;"></td> <td style="width: 10%;"></td> <td style="width: 10%;"></td> <td style="width: 10%;"></td> <td style="width: 10%;"></td> <td style="width: 10%;"></td> <td style="width: 10%;"></td> <td style="width: 10%;"></td> </tr> <tr> <td></td> <td></td> <td colspan="8" style="text-align: center;"> <table border="1" style="width: 100%; border-collapse: collapse; text-align: center;"> <tr> <td style="width: 10%;"></td> <td style="width: 10%;"></td> <td style="width: 10%;"></td> <td style="width: 10%;"></td> <td style="width: 10%;"></td> <td style="width: 10%;"></td> <td style="width: 10%;"></td> <td style="width: 10%;"></td> <td style="width: 10%;"></td> <td style="width: 10%;"></td> </tr> <tr> <td></td> <td></td> <td colspan="8" style="text-align: center;"> <table border="1" style="width: 100%; border-collapse: collapse; text-align: center;"> <tr> <td style="width: 10%;"></td> <td style="width: 10%;"></td> <td style="width: 10%;"></td> <td style="width: 10%;"></td> <td style="width: 10%;"></td> <td style="width: 10%;"></td> <td style="width: 10%;"></td> <td style="width: 10%;"></td> <td style="width: 10%;"></td> <td style="width: 10%;"></td> </tr> <tr> <td></td> <td></td> <td colspan="8" style="text-align: center;"> <table border="1" style="width: 100%; border-collapse: collapse; text-align: center;"> <tr> <td style="width: 10%;"></td> <td style="width: 10%;"></td> <td style="width: 10%;"></td> <td style="width: 10%;"></td> <td style="width: 10%;"></td> <td style="width: 10%;"></td> <td style="width: 10%;"></td> <td style="width: 10%;"></td> <td style="width: 10%;"></td> <td style="width: 10%;"></td> </tr> <tr> <td></td> <td></td> <td colspan="8" style="text-align: center;"> <table border="1" style="width: 100%; border-collapse: collapse; text-align: center;"> <tr> <td style="width: 10%;"></td> <td style="width: 10%;"></td> <td style="width: 10%;"></td> <td style="width: 10%;"></td> <td style="width: 10%;"></td> <td style="width: 10%;"></td> <td style="width: 10%;"></td> <td style="width: 10%;"></td> <td style="width: 10%;"></td> <td style="width: 10%;"></td> </tr> <tr> <td></td> <td></td> <td colspan="8" style="text-align: center;"> <table border="1" style="width: 100%; border-collapse: collapse; text-align: center;"> <tr> <td style="width: 10%;"></td> <td style="width: 10%;"></td> <td style="width: 10%;"></td> <td style="width: 10%;"></td> <td style="width: 10%;"></td> <td style="width: 10%;"></td> <td style="width: 10%;"></td> <td style="width: 10%;"></td> <td style="width: 10%;"></td> <td style="width: 10%;"></td> </tr> <tr> <td></td> <td></td> <td colspan="8" style="text-align: center;"> <table border="1" style="width: 100%; border-collapse: collapse; text-align: center;"> <tr> <td style="width: 10%;"></td> <td style="width: 10%;"></td> <td style="width: 10%;"></td> <td style="width: 10%;"></td> <td style="width: 10%;"></td> <td style="width: 10%;"></td> <td style="width: 10%;"></td> <td style="width: 10%;"></td> <td style="width: 10%;"></td> <td style="width: 10%;"></td> </tr> <tr> <td></td> <td></td> <td colspan="8" style="text-align: center;"> <table border="1" style="width: 100%; border-collapse: collapse; text-align: center;"> <tr> <td style="width: 10%;"></td> <td style="width: 10%;"></td> <td style="width: 10%;"></td> <td style="width: 10%;"></td> <td style="width: 10%;"></td> <td style="width: 10%;"></td> <td style="width: 10%;"></td> <td style="width: 10%;"></td> <td style="width: 10%;"></td> <td style="width: 10%;"></td> </tr> <tr> <td></td> <td></td> <td colspan="8" style="text-align: center;"> <table border="1" style="width: 100%; border-collapse: collapse; text-align: center;"> <tr> <td style="width: 10%;"></td> <td style="width: 10%;"></td> <td style="width: 10%;"></td> <td style="width: 10%;"></td> <td style="width: 10%;"></td> <td style="width: 10%;"></td> <td style="width: 10%;"></td> <td style="width: 10%;"></td> <td style="width: 10%;"></td> <td style="width: 10%;"></td> </tr> <tr> <td></td> <td></td> <td colspan="8" style="text-align: center;"> <table border="1" style="width: 100%; border-collapse: collapse; text-align: center;"> <tr> <td style="width: 10%;"></td> <td style="width: 10%;"></td> <td style="width: 10%;"></td> <td style="width: 10%;"></td> <td style="width: 10%;"></td> <td style="width: 10%;"></td> <td style="width: 10%;"></td> <td style="width: 10%;"></td> <td style="width: 10%;"></td> <td style="width: 10%;"></td> </tr> <tr> <td></td> <td></td> <td colspan="8" style="text-align: center;"> <table border="1" style="width: 100%; border-collapse: collapse; text-align: center;"> <tr> <td style="width: 10%;"></td> <td style="width: 10%;"></td> <td style="width: 10%;"></td> <td style="width: 10%;"></td> <td style="width: 10%;"></td> <td style="width: 10%;"></td> <td style="width: 10%;"></td> <td style="width: 10%;"></td> <td style="width: 10%;"></td> <td style="width: 10%;"></td> </tr> <tr> <td></td> <td></td> <td colspan="8" style="text-align: center;"> <table border="1" style="width: 100%; border-collapse: collapse; text-align: center;"> <tr> <td style="width: 10%;"></td> <td style="width: 10%;"></td> <td style="width: 10%;"></td> <td style="width: 10%;"></td> <td style="width: 10%;"></td> <td style="width: 10%;"></td> <td style="width: 10%;"></td> <td style="width: 10%;"></td> <td style="width: 10%;"></td> <td style="width: 10%;"></td> </tr> <tr> <td></td> <td></td> <td colspan="8" style="text-align: center;"> <table border="1" style="width: 100%; border-collapse: collapse; text-align: center;"> <tr> <td style="width: 10%;"></td> <td style="width: 10%;"></td> <td style="width: 10%;"></td> <td style="width: 10%;"></td> <td style="width: 10%;"></td> <td style="width: 10%;"></td> <td style="width: 10%;"></td> <td style="width: 10%;"></td> <td style="width: 10%;"></td> <td style="width: 10%;"></td> </tr> <tr> <td></td> <td></td> <td colspan="8" style="text-align: center;"> <table border="1" style="width: 100%; border-collapse: collapse; text-align: center;"> <tr> <td style="width: 10%;"></td> <td style="width: 10%;"></td> <td style="width: 10%;"></td> <td style="width: 10%;"></td> <td style="width: 10%;"></td> <td style="width: 10%;"></td> <td style="width: 10%;"></td> <td style="width: 10%;"></td> <td style="width: 10%;"></td> <td style="width: 10%;"></td> </tr> <tr> <td></td> <td></td> <td colspan="8" style="text-align: center;"> <table border="1" style="width: 100%; border-collapse: collapse; text-align: center;"> <tr> <td style="width: 10%;"></td> <td style="width: 10%;"></td> <td style="width: 10%;"></td> <td style="width: 10%;"></td> <td style="width: 10%;"></td> <td style="width: 10%;"></td> <td style="width: 10%;"></td> <td style="width: 10%;"></td> <td style="width: 10%;"></td> <td style="width: 10%;"></td> </tr> <tr> <td></td> <td></td> <td colspan="8" style="text-align: center;"> <table border="1" style="width: 100%; border-collapse: collapse; text-align: center;"> <tr> <td style="width: 10%;"></td> <td style="width: 10%;"></td> <td style="width: 10%;"></td> <td style="width: 10%;"></td> <td style="width: 10%;"></td> <td style="width: 10%;"></td> <td style="width: 10%;"></td> <td style="width: 10%;"></td> <td style="width: 10%;"></td> <td style="width: 10%;"></td> </tr> <tr> <td></td> <td></td> <td colspan="8" style="text-align: center;"> <table border="1" style="width: 100%; border-collapse: collapse; text-align: center;"> <tr> <td style="width: 10%;"></td> <td style="width: 10%;"></td> <td style="width: 10%;"></td> <td style="width: 10%;"></td> <td style="width: 10%;"></td> <td style="width: 10%;"></td> <td style="width: 10%;"></td> <td style="width: 10%;"></td> <td style="width: 10%;"></td> <td style="width: 10%;"></td> </tr> <tr> <td></td> <td></td> <td colspan="8" style="text-align: center;"> <table border="1" style="width: 100%; border-collapse: collapse; text-align: center;"> <tr> <td style="width: 10%;"></td> <td style="width: 10%;"></td> <td style="width: 10%;"></td> <td style="width: 10%;"></td> <td style="width: 10%;"></td> <td style="width: 10%;"></td> <td style="width: 10%;"></td> <td style="width: 10%;"></td> <td style="width: 10%;"></td> <td style="width: 10%;"></td> </tr> <tr> <td></td> <td></td> <td colspan="8" style="text-align: center;"> <table border="1" style="width: 100%; border-collapse: collapse; text-align: center;"> <tr> </tr></table></td></tr></table></td></tr></table></td></tr></table></td></tr></table></td></tr></table></td></tr></table></td></tr></table></td></tr></table></td></tr></table></td></tr></table></td></tr></table></td></tr></table></td></tr></table></td></tr></table></td></tr></table></td></tr></table></td></tr></table></td></tr></table></td></tr></table></td></tr></table></td></tr></table></td></tr></table></td></tr></table></td></tr></table></td></tr></table></td></tr></table></td></tr></table></td></tr></table></td></tr></table></td></tr></table></td></tr></table></td></tr></table></td></tr></table></td></tr></table></td></tr></table></td></tr></table></td></tr></table></td></tr></table></td></tr></table></td></tr></table></td></tr></table></td></tr></table></td></tr></table></td></tr></table></td></tr></table></td></tr></table></td></tr></table></td></tr></table></td></tr></table></td></tr></table></td></tr></table> | | | | | | | | | | | | | | | | | | | | <table border="1"
style="width: 100%; border-collapse: collapse; text-align: center;"> <tr> <td style="width: 10%;"></td> <td style="width: 10%;"></td> <td style="width: 10%;"></td> <td style="width: 10%;"></td> <td style="width: 10%;"></td> <td style="width: 10%;"></td> <td style="width: 10%;"></td> <td style="width: 10%;"></td> <td style="width: 10%;"></td> <td style="width: 10%;"></td> </tr> <tr> <td></td> <td></td> <td colspan="8" style="text-align: center;"> <table border="1" style="width: 100%; border-collapse: collapse; text-align: center;"> <tr> <td style="width: 10%;"></td> <td style="width: 10%;"></td> <td style="width: 10%;"></td> <td style="width: 10%;"></td> <td style="width: 10%;"></td> <td style="width: 10%;"></td> <td style="width: 10%;"></td> <td style="width: 10%;"></td> <td style="width: 10%;"></td> <td style="width: 10%;"></td> </tr> <tr> <td></td> <td></td> <td colspan="8" style="text-align: center;"> <table border="1" style="width: 100%; border-collapse: collapse; text-align: center;"> <tr> <td style="width: 10%;"></td> <td style="width: 10%;"></td> <td style="width: 10%;"></td> <td style="width: 10%;"></td> <td style="width: 10%;"></td> <td style="width: 10%;"></td> <td style="width: 10%;"></td> <td style="width: 10%;"></td> <td style="width: 10%;"></td> <td style="width: 10%;"></td> </tr> <tr> <td></td> <td></td> <td colspan="8" style="text-align: center;"> <table border="1" style="width: 100%; border-collapse: collapse; text-align: center;"> <tr> <td style="width: 10%;"></td> <td style="width: 10%;"></td> <td style="width: 10%;"></td> <td style="width: 10%;"></td> <td style="width: 10%;"></td> <td style="width: 10%;"></td> <td style="width: 10%;"></td> <td style="width: 10%;"></td> <td style="width: 10%;"></td> <td style="width: 10%;"></td> </tr> <tr> <td></td> <td></td> <td colspan="8" style="text-align: center;"> <table border="1" style="width: 100%; border-collapse: collapse; text-align: center;"> <tr> <td style="width: 10%;"></td> <td style="width: 10%;"></td> <td style="width: 10%;"></td> <td style="width: 10%;"></td> <td style="width: 10%;"></td> <td style="width: 10%;"></td> <td style="width: 10%;"></td> <td style="width: 10%;"></td> <td style="width: 10%;"></td> <td style="width: 10%;"></td> </tr> <tr> <td></td> <td></td> <td colspan="8" style="text-align: center;"> <table border="1" style="width: 100%; border-collapse: collapse; text-align: center;"> <tr> <td style="width: 10%;"></td> <td style="width: 10%;"></td> <td style="width: 10%;"></td> <td style="width: 10%;"></td> <td style="width: 10%;"></td> <td style="width: 10%;"></td> <td style="width: 10%;"></td> <td style="width: 10%;"></td> <td style="width: 10%;"></td> <td style="width: 10%;"></td> </tr> <tr> <td></td> <td></td> <td colspan="8" style="text-align: center;"> <table border="1" style="width: 100%; border-collapse: collapse; text-align: center;"> <tr> <td style="width: 10%;"></td> <td style="width: 10%;"></td> <td style="width: 10%;"></td> <td style="width: 10%;"></td> <td style="width: 10%;"></td> <td style="width: 10%;"></td> <td style="width: 10%;"></td> <td style="width: 10%;"></td> <td style="width: 10%;"></td> <td style="width: 10%;"></td> </tr> <tr> <td></td> <td></td> <td colspan="8" style="text-align: center;"> <table border="1" style="width: 100%; border-collapse: collapse; text-align: center;"> <tr> <td style="width: 10%;"></td> <td style="width: 10%;"></td> <td style="width: 10%;"></td> <td style="width: 10%;"></td> <td style="width: 10%;"></td> <td style="width: 10%;"></td> <td style="width: 10%;"></td> <td style="width: 10%;"></td> <td style="width: 10%;"></td> <td style="width: 10%;"></td> </tr> <tr> <td></td> <td></td> <td colspan="8" style="text-align: center;"> <table border="1" style="width: 100%; border-collapse: collapse; text-align: center;"> <tr> <td style="width: 10%;"></td> <td style="width: 10%;"></td> <td style="width: 10%;"></td> <td style="width: 10%;"></td> <td style="width: 10%;"></td> <td style="width: 10%;"></td> <td style="width: 10%;"></td> <td style="width: 10%;"></td> <td style="width: 10%;"></td> <td style="width: 10%;"></td> </tr> <tr> <td></td> <td></td> <td colspan="8" style="text-align: center;"> <table border="1" style="width: 100%; border-collapse: collapse; text-align: center;"> <tr> <td style="width: 10%;"></td> <td style="width: 10%;"></td> <td style="width: 10%;"></td> <td style="width: 10%;"></td> <td style="width: 10%;"></td> <td style="width: 10%;"></td> <td style="width: 10%;"></td> <td style="width: 10%;"></td> <td style="width: 10%;"></td> <td style="width: 10%;"></td> </tr> <tr> <td></td> <td></td> <td colspan="8" style="text-align: center;"> <table border="1" style="width: 100%; border-collapse: collapse; text-align: center;"> <tr> <td style="width: 10%;"></td> <td style="width: 10%;"></td> <td style="width: 10%;"></td> <td style="width: 10%;"></td> <td style="width: 10%;"></td> <td style="width: 10%;"></td> <td style="width: 10%;"></td> <td style="width: 10%;"></td> <td style="width: 10%;"></td> <td style="width: 10%;"></td> </tr> <tr> <td></td> <td></td> <td colspan="8" style="text-align: center;"> <table border="1" style="width: 100%; border-collapse: collapse; text-align: center;"> <tr> <td style="width: 10%;"></td> <td style="width: 10%;"></td> <td style="width: 10%;"></td> <td style="width: 10%;"></td> <td style="width: 10%;"></td> <td style="width: 10%;"></td> <td style="width: 10%;"></td> <td style="width: 10%;"></td> <td style="width: 10%;"></td> <td style="width: 10%;"></td> </tr> <tr> <td></td> <td></td> <td colspan="8" style="text-align: center;"> <table border="1" style="width: 100%; border-collapse: collapse; text-align: center;"> <tr> <td style="width: 10%;"></td> <td style="width: 10%;"></td> <td style="width: 10%;"></td> <td style="width: 10%;"></td> <td style="width: 10%;"></td> <td style="width: 10%;"></td> <td style="width: 10%;"></td> <td style="width: 10%;"></td> <td style="width: 10%;"></td> <td style="width: 10%;"></td> </tr> <tr> <td></td> <td></td> <td colspan="8" style="text-align: center;"> <table border="1" style="width: 100%; border-collapse: collapse; text-align: center;"> <tr> <td style="width: 10%;"></td> <td style="width: 10%;"></td> <td style="width: 10%;"></td> <td style="width: 10%;"></td> <td style="width: 10%;"></td> <td style="width: 10%;"></td> <td style="width: 10%;"></td> <td style="width: 10%;"></td> <td style="width: 10%;"></td> <td style="width: 10%;"></td> </tr> <tr> <td></td> <td></td> <td colspan="8" style="text-align: center;"> <table border="1" style="width: 100%; border-collapse: collapse; text-align: center;"> <tr> <td style="width: 10%;"></td> <td style="width: 10%;"></td> <td style="width: 10%;"></td> <td style="width: 10%;"></td> <td style="width: 10%;"></td> <td style="width: 10%;"></td> <td style="width: 10%;"></td> <td style="width: 10%;"></td> <td style="width: 10%;"></td> <td style="width: 10%;"></td> </tr> <tr> <td></td> <td></td> <td colspan="8" style="text-align: center;"> <table border="1" style="width: 100%; border-collapse: collapse; text-align: center;"> <tr> <td style="width: 10%;"></td> <td style="width: 10%;"></td> <td style="width: 10%;"></td> <td style="width: 10%;"></td> <td style="width: 10%;"></td> <td style="width: 10%;"></td> <td style="width: 10%;"></td> <td style="width: 10%;"></td> <td style="width: 10%;"></td> <td style="width: 10%;"></td> </tr> <tr> <td></td> <td></td> <td colspan="8" style="text-align: center;"> <table border="1" style="width: 100%; border-collapse: collapse; text-align: center;"> <tr> <td style="width: 10%;"></td> <td style="width: 10%;"></td> <td style="width: 10%;"></td> <td style="width: 10%;"></td> <td style="width: 10%;"></td> <td style="width: 10%;"></td> <td style="width: 10%;"></td> <td style="width: 10%;"></td> <td style="width: 10%;"></td> <td style="width: 10%;"></td> </tr> <tr> <td></td> <td></td> <td colspan="8" style="text-align: center;"> <table border="1" style="width: 100%; border-collapse: collapse; text-align: center;"> <tr> <td style="width: 10%;"></td> <td style="width: 10%;"></td> <td style="width: 10%;"></td> <td style="width: 10%;"></td> <td style="width: 10%;"></td> <td style="width: 10%;"></td> <td style="width: 10%;"></td> <td style="width: 10%;"></td> <td style="width: 10%;"></td> <td style="width: 10%;"></td> </tr> <tr> <td></td> <td></td> <td colspan="8" style="text-align: center;"> <table border="1" style="width: 100%; border-collapse: collapse; text-align: center;"> <tr> <td style="width: 10%;"></td> <td style="width: 10%;"></td> <td style="width: 10%;"></td> <td style="width: 10%;"></td> <td style="width: 10%;"></td> <td style="width: 10%;"></td> <td style="width: 10%;"></td> <td style="width: 10%;"></td> <td style="width: 10%;"></td> <td style="width: 10%;"></td> </tr> <tr> <td></td> <td></td> <td colspan="8" style="text-align: center;"> <table border="1" style="width: 100%; border-collapse: collapse; text-align: center;"> <tr> <td style="width: 10%;"></td> <td style="width: 10%;"></td> <td style="width: 10%;"></td> <td style="width: 10%;"></td> <td style="width: 10%;"></td> <td style="width: 10%;"></td> <td style="width: 10%;"></td> <td style="width: 10%;"></td> <td style="width: 10%;"></td> <td style="width: 10%;"></td> </tr> <tr> <td></td> <td></td> <td colspan="8" style="text-align: center;"> <table border="1" style="width: 100%; border-collapse: collapse; text-align: center;"> <tr> <td style="width: 10%;"></td> <td style="width: 10%;"></td> <td style="width: 10%;"></td> <td style="width: 10%;"></td> <td style="width: 10%;"></td> <td style="width: 10%;"></td> <td style="width: 10%;"></td> <td style="width: 10%;"></td> <td style="width: 10%;"></td> <td style="width: 10%;"></td> </tr> <tr> <td></td> <td></td> <td colspan="8" style="text-align: center;"> <table border="1" style="width: 100%; border-collapse: collapse; text-align: center;"> <tr> <td style="width: 10%;"></td> <td style="width: 10%;"></td> <td style="width: 10%;"></td> <td
style="width: 10%;"></td> <td style="width: 10%;"></td> <td style="width: 10%;"></td> <td style="width: 10%;"></td> <td style="width: 10%;"></td> <td style="width: 10%;"></td> <td style="width: 10%;"></td> </tr> <tr> <td></td> <td></td> <td colspan="8" style="text-align: center;"> <table border="1" style="width: 100%; border-collapse: collapse; text-align: center;"> <tr> <td style="width: 10%;"></td> <td style="width: 10%;"></td> <td style="width: 10%;"></td> <td style="width: 10%;"></td> <td style="width: 10%;"></td> <td style="width: 10%;"></td> <td style="width: 10%;"></td> <td style="width: 10%;"></td> <td style="width: 10%;"></td> <td style="width: 10%;"></td> </tr> <tr> <td></td> <td></td> <td colspan="8" style="text-align: center;"> <table border="1" style="width: 100%; border-collapse: collapse; text-align: center;"> <tr> <td style="width: 10%;"></td> <td style="width: 10%;"></td> <td style="width: 10%;"></td> <td style="width: 10%;"></td> <td style="width: 10%;"></td> <td style="width: 10%;"></td> <td style="width: 10%;"></td> <td style="width: 10%;"></td> <td style="width: 10%;"></td> <td style="width: 10%;"></td> </tr> <tr> <td></td> <td></td> <td colspan="8" style="text-align: center;"> <table border="1" style="width: 100%; border-collapse: collapse; text-align: center;"> <tr> <td style="width: 10%;"></td> <td style="width: 10%;"></td> <td style="width: 10%;"></td> <td style="width: 10%;"></td> <td style="width: 10%;"></td> <td style="width: 10%;"></td> <td style="width: 10%;"></td> <td style="width: 10%;"></td> <td style="width: 10%;"></td> <td style="width: 10%;"></td> </tr> <tr> <td></td> <td></td> <td colspan="8" style="text-align: center;"> <table border="1" style="width: 100%; border-collapse: collapse; text-align: center;"> <tr> <td style="width: 10%;"></td> <td style="width: 10%;"></td> <td style="width: 10%;"></td> <td style="width: 10%;"></td> <td style="width: 10%;"></td> <td style="width: 10%;"></td> <td style="width: 10%;"></td> <td style="width: 10%;"></td> <td style="width: 10%;"></td> <td style="width: 10%;"></td> </tr> <tr> <td></td> <td></td> <td colspan="8" style="text-align: center;"> <table border="1" style="width: 100%; border-collapse: collapse; text-align: center;"> <tr> <td style="width: 10%;"></td> <td style="width: 10%;"></td> <td style="width: 10%;"></td> <td style="width: 10%;"></td> <td style="width: 10%;"></td> <td style="width: 10%;"></td> <td style="width: 10%;"></td> <td style="width: 10%;"></td> <td style="width: 10%;"></td> <td style="width: 10%;"></td> </tr> <tr> <td></td> <td></td> <td colspan="8" style="text-align: center;"> <table border="1" style="width: 100%; border-collapse: collapse; text-align: center;"> <tr> <td style="width: 10%;"></td> <td style="width: 10%;"></td> <td style="width: 10%;"></td> <td style="width: 10%;"></td> <td style="width: 10%;"></td> <td style="width: 10%;"></td> <td style="width: 10%;"></td> <td style="width: 10%;"></td> <td style="width: 10%;"></td> <td style="width: 10%;"></td> </tr> <tr> <td></td> <td></td> <td colspan="8" style="text-align: center;"> <table border="1" style="width: 100%; border-collapse: collapse; text-align: center;"> <tr> <td style="width: 10%;"></td> <td style="width: 10%;"></td> <td style="width: 10%;"></td> <td style="width: 10%;"></td> <td style="width: 10%;"></td> <td style="width: 10%;"></td> <td style="width: 10%;"></td> <td style="width: 10%;"></td> <td style="width: 10%;"></td> <td style="width: 10%;"></td> </tr> <tr> <td></td> <td></td> <td colspan="8" style="text-align: center;"> <table border="1" style="width: 100%; border-collapse: collapse; text-align: center;"> <tr> <td style="width: 10%;"></td> <td style="width: 10%;"></td> <td style="width: 10%;"></td> <td style="width: 10%;"></td> <td style="width: 10%;"></td> <td style="width: 10%;"></td> <td style="width: 10%;"></td> <td style="width: 10%;"></td> <td style="width: 10%;"></td> <td style="width: 10%;"></td> </tr> <tr> <td></td> <td></td> <td colspan="8" style="text-align: center;"> <table border="1" style="width: 100%; border-collapse: collapse; text-align: center;"> <tr> <td style="width: 10%;"></td> <td style="width: 10%;"></td> <td style="width: 10%;"></td> <td style="width: 10%;"></td> <td style="width: 10%;"></td> <td style="width: 10%;"></td> <td style="width: 10%;"></td> <td style="width: 10%;"></td> <td style="width: 10%;"></td> <td style="width: 10%;"></td> </tr> <tr> <td></td> <td></td> <td colspan="8" style="text-align: center;"> <table border="1" style="width: 100%; border-collapse: collapse; text-align: center;"> <tr> <td style="width: 10%;"></td> <td style="width: 10%;"></td> <td style="width: 10%;"></td> <td style="width: 10%;"></td> <td style="width: 10%;"></td> <td style="width: 10%;"></td> <td style="width: 10%;"></td> <td style="width: 10%;"></td> <td style="width: 10%;"></td> <td style="width: 10%;"></td> </tr> <tr> <td></td> <td></td> <td colspan="8" style="text-align: center;"> <table border="1" style="width: 100%; border-collapse: collapse; text-align: center;"> <tr> <td style="width: 10%;"></td> <td style="width: 10%;"></td> <td style="width: 10%;"></td> <td style="width: 10%;"></td> <td style="width: 10%;"></td> <td style="width: 10%;"></td> <td style="width: 10%;"></td> <td style="width: 10%;"></td> <td style="width: 10%;"></td> <td style="width: 10%;"></td> </tr> <tr> <td></td> <td></td> <td colspan="8" style="text-align: center;"> <table border="1" style="width: 100%; border-collapse: collapse; text-align: center;"> <tr> <td style="width: 10%;"></td> <td style="width: 10%;"></td> <td style="width: 10%;"></td> <td style="width: 10%;"></td> <td style="width: 10%;"></td> <td style="width: 10%;"></td> <td style="width: 10%;"></td> <td style="width: 10%;"></td> <td style="width: 10%;"></td> <td style="width: 10%;"></td> </tr> <tr> <td></td> <td></td> <td colspan="8" style="text-align: center;"> <table border="1" style="width: 100%; border-collapse: collapse; text-align: center;"> <tr> <td style="width: 10%;"></td> <td style="width: 10%;"></td> <td style="width: 10%;"></td> <td style="width: 10%;"></td> <td style="width: 10%;"></td> <td style="width: 10%;"></td> <td style="width: 10%;"></td> <td style="width: 10%;"></td> <td style="width: 10%;"></td> <td style="width: 10%;"></td> </tr> <tr> <td></td> <td></td> <td colspan="8" style="text-align: center;"> <table border="1" style="width: 100%; border-collapse: collapse; text-align: center;"> <tr> <td style="width: 10%;"></td> <td style="width: 10%;"></td> <td style="width: 10%;"></td> <td style="width: 10%;"></td> <td style="width: 10%;"></td> <td style="width: 10%;"></td> <td style="width: 10%;"></td> <td style="width: 10%;"></td> <td style="width: 10%;"></td> <td style="width: 10%;"></td> </tr> <tr> <td></td> <td></td> <td colspan="8" style="text-align: center;"> <table border="1" style="width: 100%; border-collapse: collapse; text-align: center;"> <tr> <td style="width: 10%;"></td> <td style="width: 10%;"></td> <td style="width: 10%;"></td> <td style="width: 10%;"></td> <td style="width: 10%;"></td> <td style="width: 10%;"></td> <td style="width: 10%;"></td> <td style="width: 10%;"></td> <td style="width: 10%;"></td> <td style="width: 10%;"></td> </tr> <tr> <td></td> <td></td> <td colspan="8" style="text-align: center;"> <table border="1" style="width: 100%; border-collapse: collapse; text-align: center;"> <tr> <td style="width: 10%;"></td> <td style="width: 10%;"></td> <td style="width: 10%;"></td> <td style="width: 10%;"></td> <td style="width: 10%;"></td> <td style="width: 10%;"></td> <td style="width: 10%;"></td> <td style="width: 10%;"></td> <td style="width: 10%;"></td> <td style="width: 10%;"></td> </tr> <tr> <td></td> <td></td> <td colspan="8" style="text-align: center;"> <table border="1" style="width: 100%; border-collapse: collapse; text-align: center;"> <tr> <td style="width: 10%;"></td> <td style="width: 10%;"></td> <td style="width: 10%;"></td> <td style="width: 10%;"></td> <td style="width: 10%;"></td> <td style="width: 10%;"></td> <td style="width: 10%;"></td> <td style="width: 10%;"></td> <td style="width: 10%;"></td> <td style="width: 10%;"></td> </tr> <tr> <td></td> <td></td> <td colspan="8" style="text-align: center;"> <table border="1" style="width: 100%; border-collapse: collapse; text-align: center;"> <tr> <td style="width: 10%;"></td> <td style="width: 10%;"></td> <td style="width: 10%;"></td> <td style="width: 10%;"></td> <td style="width: 10%;"></td> <td style="width: 10%;"></td> <td style="width: 10%;"></td> <td style="width: 10%;"></td> <td style="width: 10%;"></td> <td style="width: 10%;"></td> </tr> <tr> <td></td> <td></td> <td colspan="8" style="text-align: center;"> <table border="1" style="width: 100%; border-collapse: collapse; text-align: center;"> <tr> <td style="width: 10%;"></td> <td style="width: 10%;"></td> <td style="width: 10%;"></td> <td style="width: 10%;"></td> <td style="width: 10%;"></td> <td style="width: 10%;"></td> <td style="width: 10%;"></td> <td style="width: 10%;"></td> <td style="width: 10%;"></td> <td style="width: 10%;"></td> </tr> <tr> <td></td> <td></td> <td colspan="8" style="text-align: center;"> <table border="1" style="width: 100%; border-collapse: collapse; text-align: center;"> <tr> <td style="width: 10%;"></td> <td style="width: 10%;"></td> <td style="width: 10%;"></td> <td style="width: 10%;"></td> <td style="width: 10%;"></td> <td style="width: 10%;"></td> <td style="width: 10%;"></td> <td style="width: 10%;"></td> <td style="width: 10%;"></td> <td style="width: 10%;"></td> </tr> <tr> <td></td> <td></td> <td colspan="8" style="text-align: center;"> <table border="1" style="width: 100%; border-collapse: collapse; text-align: center;"> <tr> <td style="width: 10%;"></td> <td style="width: 10%;"></td> <td style="width: 10%;"></td> <td style="width: 10%;"></td> <td style="width: 10%;"></td> <td style="width: 10%;"></td> <td style="width: 10%;"></td> <td style="width: 10%;"></td> <td style="width:
10%;"></td> <td style="width: 10%;"></td> </tr> <tr> <td></td> <td></td> <td colspan="8" style="text-align: center;"> <table border="1" style="width: 100%; border-collapse: collapse; text-align: center;"> <tr> <td style="width: 10%;"></td> <td style="width: 10%;"></td> <td style="width: 10%;"></td> <td style="width: 10%;"></td> <td style="width: 10%;"></td> <td style="width: 10%;"></td> <td style="width: 10%;"></td> <td style="width: 10%;"></td> <td style="width: 10%;"></td> <td style="width: 10%;"></td> </tr> <tr> <td></td> <td></td> <td colspan="8" style="text-align: center;"> <table border="1" style="width: 100%; border-collapse: collapse; text-align: center;"> <tr> <td style="width: 10%;"></td> <td style="width: 10%;"></td> <td style="width: 10%;"></td> <td style="width: 10%;"></td> <td style="width: 10%;"></td> <td style="width: 10%;"></td> <td style="width: 10%;"></td> <td style="width: 10%;"></td> <td style="width: 10%;"></td> <td style="width: 10%;"></td> </tr> <tr> <td></td> <td></td> <td colspan="8" style="text-align: center;"> <table border="1" style="width: 100%; border-collapse: collapse; text-align: center;"> <tr> <td style="width: 10%;"></td> <td style="width: 10%;"></td> <td style="width: 10%;"></td> <td style="width: 10%;"></td> <td style="width: 10%;"></td> <td style="width: 10%;"></td> <td style="width: 10%;"></td> <td style="width: 10%;"></td> <td style="width: 10%;"></td> <td style="width: 10%;"></td> </tr> <tr> <td></td> <td></td> <td colspan="8" style="text-align: center;"> <table border="1" style="width: 100%; border-collapse: collapse; text-align: center;"> <tr> <td style="width: 10%;"></td> <td style="width: 10%;"></td> <td style="width: 10%;"></td> <td style="width: 10%;"></td> <td style="width: 10%;"></td> <td style="width: 10%;"></td> <td style="width: 10%;"></td> <td style="width: 10%;"></td> <td style="width: 10%;"></td> <td style="width: 10%;"></td> </tr> <tr> <td></td> <td></td> <td colspan="8" style="text-align: center;"> <table border="1" style="width: 100%; border-collapse: collapse; text-align: center;"> <tr> <td style="width: 10%;"></td> <td style="width: 10%;"></td> <td style="width: 10%;"></td> <td style="width: 10%;"></td> <td style="width: 10%;"></td> <td style="width: 10%;"></td> <td style="width: 10%;"></td> <td style="width: 10%;"></td> <td style="width: 10%;"></td> <td style="width: 10%;"></td> </tr> <tr> <td></td> <td></td> <td colspan="8" style="text-align: center;"> <table border="1" style="width: 100%; border-collapse: collapse; text-align: center;"> <tr> <td style="width: 10%;"></td> <td style="width: 10%;"></td> <td style="width: 10%;"></td> <td style="width: 10%;"></td> <td style="width: 10%;"></td> <td style="width: 10%;"></td> <td style="width: 10%;"></td> <td style="width: 10%;"></td> <td style="width: 10%;"></td> <td style="width: 10%;"></td> </tr> <tr> <td></td> <td></td> <td colspan="8" style="text-align: center;"> <table border="1" style="width: 100%; border-collapse: collapse; text-align: center;"> <tr> <td style="width: 10%;"></td> <td style="width: 10%;"></td> <td style="width: 10%;"></td> <td style="width: 10%;"></td> <td style="width: 10%;"></td> <td style="width: 10%;"></td> <td style="width: 10%;"></td> <td style="width: 10%;"></td> <td style="width: 10%;"></td> <td style="width: 10%;"></td> </tr> <tr> <td></td> <td></td> <td colspan="8" style="text-align: center;"> <table border="1" style="width: 100%; border-collapse: collapse; text-align: center;"> <tr> </tr></table></td></tr></table></td></tr></table></td></tr></table></td></tr></table></td></tr></table></td></tr></table></td></tr></table></td></tr></table></td></tr></table></td></tr></table></td></tr></table></td></tr></table></td></tr></table></td></tr></table></td></tr></table></td></tr></table></td></tr></table></td></tr></table></td></tr></table></td></tr></table></td></tr></table></td></tr></table></td></tr></table></td></tr></table></td></tr></table></td></tr></table></td></tr></table></td></tr></table></td></tr></table></td></tr></table></td></tr></table></td></tr></table></td></tr></table></td></tr></table></td></tr></table></td></tr></table></td></tr></table></td></tr></table></td></tr></table></td></tr></table></td></tr></table></td></tr></table></td></tr></table></td></tr></table></td></tr></table></td></tr></table></td></tr></table></td></tr></table></td></tr></table></td></tr></table> | | | | | | | | | | | | | | | | | | | | <table border="1" style="width: 100%; border-collapse: collapse; text-align: center;"> <tr> <td style="width: 10%;"></td> <td style="width: 10%;"></td> <td style="width: 10%;"></td> <td style="width: 10%;"></td> <td style="width: 10%;"></td> <td style="width: 10%;"></td> <td style="width: 10%;"></td> <td style="width: 10%;"></td> <td style="width: 10%;"></td> <td style="width: 10%;"></td> </tr> <tr> <td></td> <td></td> <td colspan="8" style="text-align: center;"> <table border="1" style="width: 100%; border-collapse: collapse; text-align: center;"> <tr> <td style="width: 10%;"></td> <td style="width: 10%;"></td> <td style="width: 10%;"></td> <td style="width: 10%;"></td> <td style="width: 10%;"></td> <td style="width: 10%;"></td> <td style="width: 10%;"></td> <td style="width: 10%;"></td> <td style="width: 10%;"></td> <td style="width: 10%;"></td> </tr> <tr> <td></td> <td></td> <td colspan="8" style="text-align: center;"> <table border="1" style="width: 100%; border-collapse: collapse; text-align: center;"> <tr> <td style="width: 10%;"></td> <td style="width: 10%;"></td> <td style="width: 10%;"></td> <td style="width: 10%;"></td> <td style="width: 10%;"></td> <td style="width: 10%;"></td> <td style="width: 10%;"></td> <td style="width: 10%;"></td> <td style="width: 10%;"></td> <td style="width: 10%;"></td> </tr> <tr> <td></td> <td></td> <td colspan="8" style="text-align: center;"> <table border="1" style="width: 100%; border-collapse: collapse; text-align: center;"> <tr> <td style="width: 10%;"></td> <td style="width: 10%;"></td> <td style="width: 10%;"></td> <td style="width: 10%;"></td> <td style="width: 10%;"></td> <td style="width: 10%;"></td> <td style="width: 10%;"></td> <td style="width: 10%;"></td> <td style="width: 10%;"></td> <td style="width: 10%;"></td> </tr> <tr> <td></td> <td></td> <td colspan="8" style="text-align: center;"> <table border="1" style="width: 100%; border-collapse: collapse; text-align: center;"> <tr> <td style="width: 10%;"></td> <td style="width: 10%;"></td> <td style="width: 10%;"></td> <td style="width: 10%;"></td> <td style="width: 10%;"></td> <td style="width: 10%;"></td> <td style="width: 10%;"></td> <td style="width: 10%;"></td> <td style="width: 10%;"></td> <td style="width: 10%;"></td> </tr> <tr> <td></td> <td></td> <td colspan="8" style="text-align: center;"> <table border="1" style="width: 100%; border-collapse: collapse; text-align: center;"> <tr> <td style="width: 10%;"></td> <td style="width: 10%;"></td> <td style="width: 10%;"></td> <td style="width: 10%;"></td> <td style="width: 10%;"></td> <td style="width: 10%;"></td> <td style="width: 10%;"></td> <td style="width: 10%;"></td> <td style="width: 10%;"></td> <td style="width: 10%;"></td> </tr> <tr> <td></td> <td></td> <td colspan="8" style="text-align: center;"> <table border="1" style="width: 100%; border-collapse: collapse; text-align: center;"> <tr> <td style="width: 10%;"></td> <td style="width: 10%;"></td> <td style="width: 10%;"></td> <td style="width: 10%;"></td> <td style="width: 10%;"></td> <td style="width: 10%;"></td> <td style="width: 10%;"></td> <td style="width: 10%;"></td> <td style="width: 10%;"></td> <td style="width: 10%;"></td> </tr> <tr> <td></td> <td></td> <td colspan="8" style="text-align: center;"> <table border="1" style="width: 100%; border-collapse: collapse; text-align: center;"> <tr> <td style="width: 10%;"></td> <td style="width: 10%;"></td> <td style="width: 10%;"></td> <td style="width: 10%;"></td> <td style="width: 10%;"></td> <td style="width: 10%;"></td> <td style="width: 10%;"></td> <td style="width: 10%;"></td> <td style="width: 10%;"></td> <td style="width: 10%;"></td> </tr> <tr> <td></td> <td></td> <td colspan="8" style="text-align: center;"> <table border="1" style="width: 100%; border-collapse: collapse; text-align: center;"> <tr> <td style="width: 10%;"></td> <td style="width: 10%;"></td> <td style="width: 10%;"></td> <td style="width: 10%;"></td> <td style="width: 10%;"></td> <td style="width: 10%;"></td> <td style="width: 10%;"></td> <td style="width: 10%;"></td> <td style="width: 10%;"></td> <td style="width: 10%;"></td> </tr> <tr> <td></td> <td></td> <td colspan="8" style="text-align: center;"> <table border="1" style="width: 100%; border-collapse: collapse; text-align: center;"> <tr> <td style="width: 10%;"></td> <td style="width: 10%;"></td> <td style="width: 10%;"></td> <td style="width: 10%;"></td> <td style="width: 10%;"></td> <td style="width: 10%;"></td> <td style="width: 10%;"></td> <td style="width: 10%;"></td> <td style="width: 10%;"></td> <td style="width: 10%;"></td> </tr> <tr> <td></td> <td></td> <td colspan="8" style="text-align: center;"> <table border="1" style="width: 100%; border-collapse: collapse; text-align: center;"> <tr> <td style="width: 10%;"></td> <td style="width: 10%;"></td> <td style="width: 10%;"></td> <td style="width: 10%;"></td> <td style="width: 10%;"></td> <td style="width: 10%;"></td> <td style="width: 10%;"></td> <td style="width: 10%;"></td> <td style="width: 10%;"></td> <td
style="width: 10%;"></td> </tr> <tr> <td></td> <td></td> <td colspan="8" style="text-align: center;"> <table border="1" style="width: 100%; border-collapse: collapse; text-align: center;"> <tr> <td style="width: 10%;"></td> <td style="width: 10%;"></td> <td style="width: 10%;"></td> <td style="width: 10%;"></td> <td style="width: 10%;"></td> <td style="width: 10%;"></td> <td style="width: 10%;"></td> <td style="width: 10%;"></td> <td style="width: 10%;"></td> <td style="width: 10%;"></td> </tr> <tr> <td></td> <td></td> <td colspan="8" style="text-align: center;"> <table border="1" style="width: 100%; border-collapse: collapse; text-align: center;"> <tr> <td style="width: 10%;"></td> <td style="width: 10%;"></td> <td style="width: 10%;"></td> <td style="width: 10%;"></td> <td style="width: 10%;"></td> <td style="width: 10%;"></td> <td style="width: 10%;"></td> <td style="width: 10%;"></td> <td style="width: 10%;"></td> <td style="width: 10%;"></td> </tr> <tr> <td></td> <td></td> <td colspan="8" style="text-align: center;"> <table border="1" style="width: 100%; border-collapse: collapse; text-align: center;"> <tr> <td style="width: 10%;"></td> <td style="width: 10%;"></td> <td style="width: 10%;"></td> <td style="width: 10%;"></td> <td style="width: 10%;"></td> <td style="width: 10%;"></td> <td style="width: 10%;"></td> <td style="width: 10%;"></td> <td style="width: 10%;"></td> <td style="width: 10%;"></td> </tr> <tr> <td></td> <td></td> <td colspan="8" style="text-align: center;"> <table border="1" style="width: 100%; border-collapse: collapse; text-align: center;"> <tr> <td style="width: 10%;"></td> <td style="width: 10%;"></td> <td style="width: 10%;"></td> <td style="width: 10%;"></td> <td style="width: 10%;"></td> <td style="width: 10%;"></td> <td style="width: 10%;"></td> <td style="width: 10%;"></td> <td style="width: 10%;"></td> <td style="width: 10%;"></td> </tr> <tr> <td></td> <td></td> <td colspan="8" style="text-align: center;"> <table border="1" style="width: 100%; border-collapse: collapse; text-align: center;"> <tr> <td style="width: 10%;"></td> <td style="width: 10%;"></td> <td style="width: 10%;"></td> <td style="width: 10%;"></td> <td style="width: 10%;"></td> <td style="width: 10%;"></td> <td style="width: 10%;"></td> <td style="width: 10%;"></td> <td style="width: 10%;"></td> <td style="width: 10%;"></td> </tr> <tr> <td></td> <td></td> <td colspan="8" style="text-align: center;"> <table border="1" style="width: 100%; border-collapse: collapse; text-align: center;"> <tr> <td style="width: 10%;"></td> <td style="width: 10%;"></td> <td style="width: 10%;"></td> <td style="width: 10%;"></td> <td style="width: 10%;"></td> <td style="width: 10%;"></td> <td style="width: 10%;"></td> <td style="width: 10%;"></td> <td style="width: 10%;"></td> <td style="width: 10%;"></td> </tr> <tr> <td></td> <td></td> <td colspan="8" style="text-align: center;"> <table border="1" style="width: 100%; border-collapse: collapse; text-align: center;"> <tr> <td style="width: 10%;"></td> <td style="width: 10%;"></td> <td style="width: 10%;"></td> <td style="width: 10%;"></td> <td style="width: 10%;"></td> <td style="width: 10%;"></td> <td style="width: 10%;"></td> <td style="width: 10%;"></td> <td style="width: 10%;"></td> <td style="width: 10%;"></td> </tr> <tr> <td></td> <td></td> <td colspan="8" style="text-align: center;"> <table border="1" style="width: 100%; border-collapse: collapse; text-align: center;"> <tr> <td style="width: 10%;"></td> <td style="width: 10%;"></td> <td style="width: 10%;"></td> <td style="width: 10%;"></td> <td style="width: 10%;"></td> <td style="width: 10%;"></td> <td style="width: 10%;"></td> <td style="width: 10%;"></td> <td style="width: 10%;"></td> <td style="width: 10%;"></td> </tr> <tr> <td></td> <td></td> <td colspan="8" style="text-align: center;"> <table border="1" style="width: 100%; border-collapse: collapse; text-align: center;"> <tr> <td style="width: 10%;"></td> <td style="width: 10%;"></td> <td style="width: 10%;"></td> <td style="width: 10%;"></td> <td style="width: 10%;"></td> <td style="width: 10%;"></td> <td style="width: 10%;"></td> <td style="width: 10%;"></td> <td style="width: 10%;"></td> <td style="width: 10%;"></td> </tr> <tr> <td></td> <td></td> <td colspan="8" style="text-align: center;"> <table border="1" style="width: 100%; border-collapse: collapse; text-align: center;"> <tr> <td style="width: 10%;"></td> <td style="width: 10%;"></td> <td style="width: 10%;"></td> <td style="width: 10%;"></td> <td style="width: 10%;"></td> <td style="width: 10%;"></td> <td style="width: 10%;"></td> <td style="width: 10%;"></td> <td style="width: 10%;"></td> <td style="width: 10%;"></td> </tr> <tr> <td></td> <td></td> <td colspan="8" style="text-align: center;"> <table border="1" style="width: 100%; border-collapse: collapse; text-align: center;"> <tr> <td style="width: 10%;"></td> <td style="width: 10%;"></td> <td style="width: 10%;"></td> <td style="width: 10%;"></td> <td style="width: 10%;"></td> <td style="width: 10%;"></td> <td style="width: 10%;"></td> <td style="width: 10%;"></td> <td style="width: 10%;"></td> <td style="width: 10%;"></td> </tr> <tr> <td></td> <td></td> <td colspan="8" style="text-align: center;"> <table border="1" style="width: 100%; border-collapse: collapse; text-align: center;"> <tr> <td style="width: 10%;"></td> <td style="width: 10%;"></td> <td style="width: 10%;"></td> <td style="width: 10%;"></td> <td style="width: 10%;"></td> <td style="width: 10%;"></td> <td style="width: 10%;"></td> <td style="width: 10%;"></td> <td style="width: 10%;"></td> <td style="width: 10%;"></td> </tr> <tr> <td></td> <td></td> <td colspan="8" style="text-align: center;"> <table border="1" style="width: 100%; border-collapse: collapse; text-align: center;"> <tr> <td style="width: 10%;"></td> <td style="width: 10%;"></td> <td style="width: 10%;"></td> <td style="width: 10%;"></td> <td style="width: 10%;"></td> <td style="width: 10%;"></td> <td style="width: 10%;"></td> <td style="width: 10%;"></td> <td style="width: 10%;"></td> <td style="width: 10%;"></td> </tr> <tr> <td></td> <td></td> <td colspan="8" style="text-align: center;"> <table border="1" style="width: 100%; border-collapse: collapse; text-align: center;"> <tr> <td style="width: 10%;"></td> <td style="width: 10%;"></td> <td style="width: 10%;"></td> <td style="width: 10%;"></td> <td style="width: 10%;"></td> <td style="width: 10%;"></td> <td style="width: 10%;"></td> <td style="width: 10%;"></td> <td style="width: 10%;"></td> <td style="width: 10%;"></td> </tr> <tr> <td></td> <td></td> <td colspan="8" style="text-align: center;"> <table border="1" style="width: 100%; border-collapse: collapse; text-align: center;"> <tr> <td style="width: 10%;"></td> <td style="width: 10%;"></td> <td style="width: 10%;"></td> <td style="width: 10%;"></td> <td style="width: 10%;"></td> <td style="width: 10%;"></td> <td style="width: 10%;"></td> <td style="width: 10%;"></td> <td style="width: 10%;"></td> <td style="width: 10%;"></td> </tr> <tr> <td></td> <td></td> <td colspan="8" style="text-align: center;"> <table border="1" style="width: 100%; border-collapse: collapse; text-align: center;"> <tr> <td style="width: 10%;"></td> <td style="width: 10%;"></td> <td style="width: 10%;"></td> <td style="width: 10%;"></td> <td style="width: 10%;"></td> <td style="width: 10%;"></td> <td style="width: 10%;"></td> <td style="width: 10%;"></td> <td style="width: 10%;"></td> <td style="width: 10%;"></td> </tr> <tr> <td></td> <td></td> <td colspan="8" style="text-align: center;"> <table border="1" style="width: 100%; border-collapse: collapse; text-align: center;"> <tr> <td style="width: 10%;"></td> <td style="width: 10%;"></td> <td style="width: 10%;"></td> <td style="width: 10%;"></td> <td style="width: 10%;"></td> <td style="width: 10%;"></td> <td style="width: 10%;"></td> <td style="width: 10%;"></td> <td style="width: 10%;"></td> <td style="width: 10%;"></td> </tr> <tr> <td></td> <td></td> <td colspan="8" style="text-align: center;"> <table border="1" style="width: 100%; border-collapse: collapse; text-align: center;"> <tr> <td style="width: 10%;"></td> <td style="width: 10%;"></td> <td style="width: 10%;"></td> <td style="width: 10%;"></td> <td style="width: 10%;"></td> <td style="width: 10%;"></td> <td style="width: 10%;"></td> <td style="width: 10%;"></td> <td style="width: 10%;"></td> <td style="width: 10%;"></td> </tr> <tr> <td></td> <td></td> <td colspan="8" style="text-align: center;"> <table border="1" style="width: 100%; border-collapse: collapse; text-align: center;"> <tr> <td style="width: 10%;"></td> <td style="width: 10%;"></td> <td style="width: 10%;"></td> <td style="width: 10%;"></td> <td style="width: 10%;"></td> <td style="width: 10%;"></td> <td style="width: 10%;"></td> <td style="width: 10%;"></td> <td style="width: 10%;"></td> <td style="width: 10%;"></td> </tr> <tr> <td></td> <td></td> <td colspan="8" style="text-align: center;"> <table border="1" style="width: 100%; border-collapse: collapse; text-align: center;"> <tr> <td style="width: 10%;"></td> <td style="width: 10%;"></td> <td style="width: 10%;"></td> <td style="width: 10%;"></td> <td style="width: 10%;"></td> <td style="width: 10%;"></td> <td style="width: 10%;"></td> <td style="width: 10%;"></td> <td style="width: 10%;"></td> <td style="width: 10%;"></td> </tr> <tr> <td></td> <td></td> <td colspan="8" style="text-align: center;"> <table border="1" style="width: 100%; border-collapse: collapse; text-align: center;"> <tr> <td style="width: 10%;"></td> <td style="width: 10%;"></td> <td style="width: 10%;"></td> <td style="width: 10%;"></td> <td style="width: 10%;"></td> <td style="width: 10%;"></td> <td style="width: 10%;"></td> <td style="width: 10%;"></td> <td style="width: 10%;"></td> <td style="width: 10%;"></td> </tr> <tr> <td></td> <td></td> <td colspan="8" style="text-align: center;"> <table border="1" style="width: 100%; border-collapse: collapse;
text-align: center;"> <tr> <td style="width: 10%;"></td> <td style="width: 10%;"></td> <td style="width: 10%;"></td> <td style="width: 10%;"></td> <td style="width: 10%;"></td> <td style="width: 10%;"></td> <td style="width: 10%;"></td> <td style="width: 10%;"></td> <td style="width: 10%;"></td> <td style="width: 10%;"></td> </tr> <tr> <td></td> <td></td> <td colspan="8" style="text-align: center;"> <table border="1" style="width: 100%; border-collapse: collapse; text-align: center;"> <tr> <td style="width: 10%;"></td> <td style="width: 10%;"></td> <td style="width: 10%;"></td> <td style="width: 10%;"></td> <td style="width: 10%;"></td> <td style="width: 10%;"></td> <td style="width: 10%;"></td> <td style="width: 10%;"></td> <td style="width: 10%;"></td> <td style="width: 10%;"></td> </tr> <tr> <td></td> <td></td> <td colspan="8" style="text-align: center;"> <table border="1" style="width: 100%; border-collapse: collapse; text-align: center;"> <tr> <td style="width: 10%;"></td> <td style="width: 10%;"></td> <td style="width: 10%;"></td> <td style="width: 10%;"></td> <td style="width: 10%;"></td> <td style="width: 10%;"></td> <td style="width: 10%;"></td> <td style="width: 10%;"></td> <td style="width: 10%;"></td> <td style="width: 10%;"></td> </tr> <tr> <td></td> <td></td> <td colspan="8" style="text-align: center;"> <table border="1" style="width: 100%; border-collapse: collapse; text-align: center;"> <tr> <td style="width: 10%;"></td> <td style="width: 10%;"></td> <td style="width: 10%;"></td> <td style="width: 10%;"></td> <td style="width: 10%;"></td> <td style="width: 10%;"></td> <td style="width: 10%;"></td> <td style="width: 10%;"></td> <td style="width: 10%;"></td> <td style="width: 10%;"></td> </tr> <tr> <td></td> <td></td> <td colspan="8" style="text-align: center;"> <table border="1" style="width: 100%; border-collapse: collapse; text-align: center;"> <tr> <td style="width: 10%;"></td> <td style="width: 10%;"></td> <td style="width: 10%;"></td> <td style="width: 10%;"></td> <td style="width: 10%;"></td> <td style="width: 10%;"></td> <td style="width: 10%;"></td> <td style="width: 10%;"></td> <td style="width: 10%;"></td> <td style="width: 10%;"></td> </tr> <tr> <td></td> <td></td> <td colspan="8" style="text-align: center;"> <table border="1" style="width: 100%; border-collapse: collapse; text-align: center;"> <tr> <td style="width: 10%;"></td> <td style="width: 10%;"></td> <td style="width: 10%;"></td> <td style="width: 10%;"></td> <td style="width: 10%;"></td> <td style="width: 10%;"></td> <td style="width: 10%;"></td> <td style="width: 10%;"></td> <td style="width: 10%;"></td> <td style="width: 10%;"></td> </tr> <tr> <td></td> <td></td> <td colspan="8" style="text-align: center;"> <table border="1" style="width: 100%; border-collapse: collapse; text-align: center;"> <tr> <td style="width: 10%;"></td> <td style="width: 10%;"></td> <td style="width: 10%;"></td> <td style="width: 10%;"></td> <td style="width: 10%;"></td> <td style="width: 10%;"></td> <td style="width: 10%;"></td> <td style="width: 10%;"></td> <td style="width: 10%;"></td> <td style="width: 10%;"></td> </tr> <tr> <td></td> <td></td> <td colspan="8" style="text-align: center;"> <table border="1" style="width: 100%; border-collapse: collapse; text-align: center;"> <tr> <td style="width: 10%;"></td> <td style="width: 10%;"></td> <td style="width: 10%;"></td> <td style="width: 10%;"></td> <td style="width: 10%;"></td> <td style="width: 10%;"></td> <td style="width: 10%;"></td> <td style="width: 10%;"></td> <td style="width: 10%;"></td> <td style="width: 10%;"></td> </tr> <tr> <td></td> <td></td> <td colspan="8" style="text-align: center;"> <table border="1" style="width: 100%; border-collapse: collapse; text-align: center;"> <tr> <td style="width: 10%;"></td> <td style="width: 10%;"></td> <td style="width: 10%;"></td> <td style="width: 10%;"></td> <td style="width: 10%;"></td> <td style="width: 10%;"></td> <td style="width: 10%;"></td> <td style="width: 10%;"></td> <td style="width: 10%;"></td> <td style="width: 10%;"></td> </tr> <tr> <td></td> <td></td> <td colspan="8" style="text-align: center;"> <table border="1" style="width: 100%; border-collapse: collapse; text-align: center;"> <tr> <td style="width: 10%;"></td> <td style="width: 10%;"></td> <td style="width: 10%;"></td> <td style="width: 10%;"></td> <td style="width: 10%;"></td> <td style="width: 10%;"></td> <td style="width: 10%;"></td> <td style="width: 10%;"></td> <td style="width: 10%;"></td> <td style="width: 10%;"></td> </tr> <tr> <td></td> <td></td> <td colspan="8" style="text-align: center;"> <table border="1" style="width: 100%; border-collapse: collapse; text-align: center;"> <tr> <td style="width: 10%;"></td> <td style="width: 10%;"></td> <td style="width: 10%;"></td> <td style="width: 10%;"></td> <td style="width: 10%;"></td> <td style="width: 10%;"></td> <td style="width: 10%;"></td> <td style="width: 10%;"></td> <td style="width: 10%;"></td> <td style="width: 10%;"></td> </tr> <tr> <td></td> <td></td> <td colspan="8" style="text-align: center;"> <table border="1" style="width: 100%; border-collapse: collapse; text-align: center;"> <tr> <td style="width: 10%;"></td> <td style="width: 10%;"></td> <td style="width: 10%;"></td> <td style="width: 10%;"></td> <td style="width: 10%;"></td> <td style="width: 10%;"></td> <td style="width: 10%;"></td> <td style="width: 10%;"></td> <td style="width: 10%;"></td> <td style="width: 10%;"></td> </tr> <tr> <td></td> <td></td> <td colspan="8" style="text-align: center;"> <table border="1" style="width: 100%; border-collapse: collapse; text-align: center;"> <tr> <td style="width: 10%;"></td> <td style="width: 10%;"></td> <td style="width: 10%;"></td> <td style="width: 10%;"></td> <td style="width: 10%;"></td> <td style="width: 10%;"></td> <td style="width: 10%;"></td> <td style="width: 10%;"></td> <td style="width: 10%;"></td> <td style="width: 10%;"></td> </tr> <tr> <td></td> <td></td> <td colspan="8" style="text-align: center;"> <table border="1" style="width: 100%; border-collapse: collapse; text-align: center;"> <tr> <td style="width: 10%;"></td> <td style="width: 10%;"></td> <td style="width: 10%;"></td> <td style="width: 10%;"></td> <td style="width: 10%;"></td> <td style="width: 10%;"></td> <td style="width: 10%;"></td> <td style="width: 10%;"></td> <td style="width: 10%;"></td> <td style="width: 10%;"></td> </tr> <tr> <td></td> <td></td> <td colspan="8" style="text-align: center;"> <table border="1" style="width: 100%; border-collapse: collapse; text-align: center;"> <tr> <td style="width: 10%;"></td> <td style="width: 10%;"></td> <td style="width: 10%;"></td> <td style="width: 10%;"></td> <td style="width: 10%;"></td> <td style="width: 10%;"></td> <td style="width: 10%;"></td> <td style="width: 10%;"></td> <td style="width: 10%;"></td> <td style="width: 10%;"></td> </tr> <tr> <td></td> <td></td> <td colspan="8" style="text-align: center;"> <table border="1" style="width: 100%; border-collapse: collapse; text-align: center;"> <tr> <td style="width: 10%;"></td> <td style="width: 10%;"></td> <td style="width: 10%;"></td> <td style="width: 10%;"></td> <td style="width: 10%;"></td> <td style="width: 10%;"></td> <td style="width: 10%;"></td> <td style="width: 10%;"></td> <td style="width: 10%;"></td> <td style="width: 10%;"></td> </tr> <tr> <td></td> <td></td> <td colspan="8" style="text-align: center;"> <table border="1" style="width: 100%; border-collapse: collapse; text-align: center;"> <tr> <td style="width: 10%;"></td> <td style="width: 10%;"></td> <td style="width: 10%;"></td> <td style="width: 10%;"></td> <td style="width: 10%;"></td> <td style="width: 10%;"></td> <td style="width: 10%;"></td> <td style="width: 10%;"></td> <td style="width: 10%;"></td> <td style="width: 10%;"></td> </tr> <tr> <td></td> <td></td> <td colspan="8" style="text-align: center;"> <table border="1" style="width: 100%; border-collapse: collapse; text-align: center;"> <tr> </tr></table></td></tr></table></td></tr></table></td></tr></table></td></tr></table></td></tr></table></td></tr></table></td></tr></table></td></tr></table></td></tr></table></td></tr></table></td></tr></table></td></tr></table></td></tr></table></td></tr></table></td></tr></table></td></tr></table></td></tr></table></td></tr></table></td></tr></table></td></tr></table></td></tr></table></td></tr></table></td></tr></table></td></tr></table></td></tr></table></td></tr></table></td></tr></table></td></tr></table></td></tr></table></td></tr></table></td></tr></table></td></tr></table></td></tr></table></td></tr></table></td></tr></table></td></tr></table></td></tr></table></td></tr></table></td></tr></table></td></tr></table></td></tr></table></td></tr></table></td></tr></table></td></tr></table></td></tr></table></td></tr></table></td></tr></table></td></tr></table></td></tr></table> | | | | | | | | | | | | | | | | | | | | <table border="1" style="width: 100%; border-collapse: collapse; text-align: center;"> <tr> <td style="width: 10%;"></td> <td style="width: 10%;"></td> <td style="width: 10%;"></td> <td style="width: 10%;"></td> <td style="width: 10%;"></td> <td style="width: 10%;"></td> <td style="width: 10%;"></td> <td style="width: 10%;"></td> <td style="width: 10%;"></td> <td style="width: 10%;"></td> </tr> <tr> <td></td> <td></td> <td colspan="8" style="text-align: center;"> <table border="1" style="width: 100%; border-collapse: collapse; text-align: center;"> <tr> <td
style="width: 10%;"></td> <td style="width: 10%;"></td> <td style="width: 10%;"></td> <td style="width: 10%;"></td> <td style="width: 10%;"></td> <td style="width: 10%;"></td> <td style="width: 10%;"></td> <td style="width: 10%;"></td> <td style="width: 10%;"></td> <td style="width: 10%;"></td> </tr> <tr> <td></td> <td></td> <td colspan="8" style="text-align: center;"> <table border="1" style="width: 100%; border-collapse: collapse; text-align: center;"> <tr> <td style="width: 10%;"></td> <td style="width: 10%;"></td> <td style="width: 10%;"></td> <td style="width: 10%;"></td> <td style="width: 10%;"></td> <td style="width: 10%;"></td> <td style="width: 10%;"></td> <td style="width: 10%;"></td> <td style="width: 10%;"></td> <td style="width: 10%;"></td> </tr> <tr> <td></td> <td></td> <td colspan="8" style="text-align: center;"> <table border="1" style="width: 100%; border-collapse: collapse; text-align: center;"> <tr> <td style="width: 10%;"></td> <td style="width: 10%;"></td> <td style="width: 10%;"></td> <td style="width: 10%;"></td> <td style="width: 10%;"></td> <td style="width: 10%;"></td> <td style="width: 10%;"></td> <td style="width: 10%;"></td> <td style="width: 10%;"></td> <td style="width: 10%;"></td> </tr> <tr> <td></td> <td></td> <td colspan="8" style="text-align: center;"> <table border="1" style="width: 100%; border-collapse: collapse; text-align: center;"> <tr> <td style="width: 10%;"></td> <td style="width: 10%;"></td> <td style="width: 10%;"></td> <td style="width: 10%;"></td> <td style="width: 10%;"></td> <td style="width: 10%;"></td> <td style="width: 10%;"></td> <td style="width: 10%;"></td> <td style="width: 10%;"></td> <td style="width: 10%;"></td> </tr> <tr> <td></td> <td></td> <td colspan="8" style="text-align: center;"> <table border="1" style="width: 100%; border-collapse: collapse; text-align: center;"> <tr> <td style="width: 10%;"></td> <td style="width: 10%;"></td> <td style="width: 10%;"></td> <td style="width: 10%;"></td> <td style="width: 10%;"></td> <td style="width: 10%;"></td> <td style="width: 10%;"></td> <td style="width: 10%;"></td> <td style="width: 10%;"></td> <td style="width: 10%;"></td> </tr> <tr> <td></td> <td></td> <td colspan="8" style="text-align: center;"> <table border="1" style="width: 100%; border-collapse: collapse; text-align: center;"> <tr> <td style="width: 10%;"></td> <td style="width: 10%;"></td> <td style="width: 10%;"></td> <td style="width: 10%;"></td> <td style="width: 10%;"></td> <td style="width: 10%;"></td> <td style="width: 10%;"></td> <td style="width: 10%;"></td> <td style="width: 10%;"></td> <td style="width: 10%;"></td> </tr> <tr> <td></td> <td></td> <td colspan="8" style="text-align: center;"> <table border="1" style="width: 100%; border-collapse: collapse; text-align: center;"> <tr> <td style="width: 10%;"></td> <td style="width: 10%;"></td> <td style="width: 10%;"></td> <td style="width: 10%;"></td> <td style="width: 10%;"></td> <td style="width: 10%;"></td> <td style="width: 10%;"></td> <td style="width: 10%;"></td> <td style="width: 10%;"></td> <td style="width: 10%;"></td> </tr> <tr> <td></td> <td></td> <td colspan="8" style="text-align: center;"> <table border="1" style="width: 100%; border-collapse: collapse; text-align: center;"> <tr> <td style="width: 10%;"></td> <td style="width: 10%;"></td> <td style="width: 10%;"></td> <td style="width: 10%;"></td> <td style="width: 10%;"></td> <td style="width: 10%;"></td> <td style="width: 10%;"></td> <td style="width: 10%;"></td> <td style="width: 10%;"></td> <td style="width: 10%;"></td> </tr> <tr> <td></td> <td></td> <td colspan="8" style="text-align: center;"> <table border="1" style="width: 100%; border-collapse: collapse; text-align: center;"> <tr> <td style="width: 10%;"></td> <td style="width: 10%;"></td> <td style="width: 10%;"></td> <td style="width: 10%;"></td> <td style="width: 10%;"></td> <td style="width: 10%;"></td> <td style="width: 10%;"></td> <td style="width: 10%;"></td> <td style="width: 10%;"></td> <td style="width: 10%;"></td> </tr> <tr> <td></td> <td></td> <td colspan="8" style="text-align: center;"> <table border="1" style="width: 100%; border-collapse: collapse; text-align: center;"> <tr> <td style="width: 10%;"></td> <td style="width: 10%;"></td> <td style="width: 10%;"></td> <td style="width: 10%;"></td> <td style="width: 10%;"></td> <td style="width: 10%;"></td> <td style="width: 10%;"></td> <td style="width: 10%;"></td> <td style="width: 10%;"></td> <td style="width: 10%;"></td> </tr> <tr> <td></td> <td></td> <td colspan="8" style="text-align: center;"> <table border="1" style="width: 100%; border-collapse: collapse; text-align: center;"> <tr> <td style="width: 10%;"></td> <td style="width: 10%;"></td> <td style="width: 10%;"></td> <td style="width: 10%;"></td> <td style="width: 10%;"></td> <td style="width: 10%;"></td> <td style="width: 10%;"></td> <td style="width: 10%;"></td> <td style="width: 10%;"></td> <td style="width: 10%;"></td> </tr> <tr> <td></td> <td></td> <td colspan="8" style="text-align: center;"> <table border="1" style="width: 100%; border-collapse: collapse; text-align: center;"> <tr> <td style="width: 10%;"></td> <td style="width: 10%;"></td> <td style="width: 10%;"></td> <td style="width: 10%;"></td> <td style="width: 10%;"></td> <td style="width: 10%;"></td> <td style="width: 10%;"></td> <td style="width: 10%;"></td> <td style="width: 10%;"></td> <td style="width: 10%;"></td> </tr> <tr> <td></td> <td></td> <td colspan="8" style="text-align: center;"> <table border="1" style="width: 100%; border-collapse: collapse; text-align: center;"> <tr> <td style="width: 10%;"></td> <td style="width: 10%;"></td> <td style="width: 10%;"></td> <td style="width: 10%;"></td> <td style="width: 10%;"></td> <td style="width: 10%;"></td> <td style="width: 10%;"></td> <td style="width: 10%;"></td> <td style="width: 10%;"></td> <td style="width: 10%;"></td> </tr> <tr> <td></td> <td></td> <td colspan="8" style="text-align: center;"> <table border="1" style="width: 100%; border-collapse: collapse; text-align: center;"> <tr> <td style="width: 10%;"></td> <td style="width: 10%;"></td> <td style="width: 10%;"></td> <td style="width: 10%;"></td> <td style="width: 10%;"></td> <td style="width: 10%;"></td> <td style="width: 10%;"></td> <td style="width: 10%;"></td> <td style="width: 10%;"></td> <td style="width: 10%;"></td> </tr> <tr> <td></td> <td></td> <td colspan="8" style="text-align: center;"> <table border="1" style="width: 100%; border-collapse: collapse; text-align: center;"> <tr> <td style="width: 10%;"></td> <td style="width: 10%;"></td> <td style="width: 10%;"></td> <td style="width: 10%;"></td> <td style="width: 10%;"></td> <td style="width: 10%;"></td> <td style="width: 10%;"></td> <td style="width: 10%;"></td> <td style="width: 10%;"></td> <td style="width: 10%;"></td> </tr> <tr> <td></td> <td></td> <td colspan="8" style="text-align: center;"> <table border="1" style="width: 100%; border-collapse: collapse; text-align: center;"> <tr> <td style="width: 10%;"></td> <td style="width: 10%;"></td> <td style="width: 10%;"></td> <td style="width: 10%;"></td> <td style="width: 10%;"></td> <td style="width: 10%;"></td> <td style="width: 10%;"></td> <td style="width: 10%;"></td> <td style="width: 10%;"></td> <td style="width: 10%;"></td> </tr> <tr> <td></td> <td></td> <td colspan="8" style="text-align: center;"> <table border="1" style="width: 100%; border-collapse: collapse; text-align: center;"> <tr> <td style="width: 10%;"></td> <td style="width: 10%;"></td> <td style="width: 10%;"></td> <td style="width: 10%;"></td> <td style="width: 10%;"></td> <td style="width: 10%;"></td> <td style="width: 10%;"></td> <td style="width: 10%;"></td> <td style="width: 10%;"></td> <td style="width: 10%;"></td> </tr> <tr> <td></td> <td></td> <td colspan="8" style="text-align: center;"> <table border="1" style="width: 100%; border-collapse: collapse; text-align: center;"> <tr> <td style="width: 10%;"></td> <td style="width: 10%;"></td> <td style="width: 10%;"></td> <td style="width: 10%;"></td> <td style="width: 10%;"></td> <td style="width: 10%;"></td> <td style="width: 10%;"></td> <td style="width: 10%;"></td> <td style="width: 10%;"></td> <td style="width: 10%;"></td> </tr> <tr> <td></td> <td></td> <td colspan="8" style="text-align: center;"> <table border="1" style="width: 100%; border-collapse: collapse; text-align: center;"> <tr> <td style="width: 10%;"></td> <td style="width: 10%;"></td> <td style="width: 10%;"></td> <td style="width: 10%;"></td> <td style="width: 10%;"></td> <td style="width: 10%;"></td> <td style="width: 10%;"></td> <td style="width: 10%;"></td> <td style="width: 10%;"></td> <td style="width: 10%;"></td> </tr> <tr> <td></td> <td></td> <td colspan="8" style="text-align: center;"> <table border="1" style="width: 100%; border-collapse: collapse; text-align: center;"> <tr> <td style="width: 10%;"></td> <td style="width: 10%;"></td> <td style="width: 10%;"></td> <td style="width: 10%;"></td> <td style="width: 10%;"></td> <td style="width: 10%;"></td> <td style="width: 10%;"></td> <td style="width: 10%;"></td> <td style="width: 10%;"></td> <td style="width: 10%;"></td> </tr> <tr> <td></td> <td></td> <td colspan="8" style="text-align: center;"> <table border="1" style="width: 100%; border-collapse: collapse; text-align: center;"> <tr> <td style="width: 10%;"></td> <td style="width: 10%;"></td> <td style="width: 10%;"></td> <td style="width: 10%;"></td> <td style="width: 10%;"></td> <td style="width: 10%;"></td> <td style="width: 10%;"></td> <td style="width: 10%;"></td> <td style="width: 10%;"></td> <td style="width: 10%;"></td> </tr> <tr> <td></td> <td></td> <td colspan="8" style="text-align: center;"> <table border="1" style="width: 100%; border-collapse: collapse; text-align: center;"> <tr> <td style="width: 10%;"></td> <td style="width: 10%;"></td> <td style="width: 10%;"></td> <td style="width: 10%;"></td> <td style="width: 10%;"></td> <td style="width:
10%;"></td> <td style="width: 10%;"></td> <td style="width: 10%;"></td> <td style="width: 10%;"></td> <td style="width: 10%;"></td> </tr> <tr> <td></td> <td></td> <td colspan="8" style="text-align: center;"> <table border="1" style="width: 100%; border-collapse: collapse; text-align: center;"> <tr> <td style="width: 10%;"></td> <td style="width: 10%;"></td> <td style="width: 10%;"></td> <td style="width: 10%;"></td> <td style="width: 10%;"></td> <td style="width: 10%;"></td> <td style="width: 10%;"></td> <td style="width: 10%;"></td> <td style="width: 10%;"></td> <td style="width: 10%;"></td> </tr> <tr> <td></td> <td></td> <td colspan="8" style="text-align: center;"> <table border="1" style="width: 100%; border-collapse: collapse; text-align: center;"> <tr> <td style="width: 10%;"></td> <td style="width: 10%;"></td> <td style="width: 10%;"></td> <td style="width: 10%;"></td> <td style="width: 10%;"></td> <td style="width: 10%;"></td> <td style="width: 10%;"></td> <td style="width: 10%;"></td> <td style="width: 10%;"></td> <td style="width: 10%;"></td> </tr> <tr> <td></td> <td></td> <td colspan="8" style="text-align: center;"> <table border="1" style="width: 100%; border-collapse: collapse; text-align: center;"> <tr> <td style="width: 10%;"></td> <td style="width: 10%;"></td> <td style="width: 10%;"></td> <td style="width: 10%;"></td> <td style="width: 10%;"></td> <td style="width: 10%;"></td> <td style="width: 10%;"></td> <td style="width: 10%;"></td> <td style="width: 10%;"></td> <td style="width: 10%;"></td> </tr> <tr> <td></td> <td></td> <td colspan="8" style="text-align: center;"> <table border="1" style="width: 100%; border-collapse: collapse; text-align: center;"> <tr> <td style="width: 10%;"></td> <td style="width: 10%;"></td> <td style="width: 10%;"></td> <td style="width: 10%;"></td> <td style="width: 10%;"></td> <td style="width: 10%;"></td> <td style="width: 10%;"></td> <td style="width: 10%;"></td> <td style="width: 10%;"></td> <td style="width: 10%;"></td> </tr> <tr> <td></td> <td></td> <td colspan="8" style="text-align: center;"> <table border="1" style="width: 100%; border-collapse: collapse; text-align: center;"> <tr> <td style="width: 10%;"></td> <td style="width: 10%;"></td> <td style="width: 10%;"></td> <td style="width: 10%;"></td> <td style="width: 10%;"></td> <td style="width: 10%;"></td> <td style="width: 10%;"></td> <td style="width: 10%;"></td> <td style="width: 10%;"></td> <td style="width: 10%;"></td> </tr> <tr> <td></td> <td></td> <td colspan="8" style="text-align: center;"> <table border="1" style="width: 100%; border-collapse: collapse; text-align: center;"> <tr> <td style="width: 10%;"></td> <td style="width: 10%;"></td> <td style="width: 10%;"></td> <td style="width: 10%;"></td> <td style="width: 10%;"></td> <td style="width: 10%;"></td> <td style="width: 10%;"></td> <td style="width: 10%;"></td> <td style="width: 10%;"></td> <td style="width: 10%;"></td> </tr> <tr> <td></td> <td></td> <td colspan="8" style="text-align: center;"> <table border="1" style="width: 100%; border-collapse: collapse; text-align: center;"> <tr> <td style="width: 10%;"></td> <td style="width: 10%;"></td> <td style="width: 10%;"></td> <td style="width: 10%;"></td> <td style="width: 10%;"></td> <td style="width: 10%;"></td> <td style="width: 10%;"></td> <td style="width: 10%;"></td> <td style="width: 10%;"></td> <td style="width: 10%;"></td> </tr> <tr> <td></td> <td></td> <td colspan="8" style="text-align: center;"> <table border="1" style="width: 100%; border-collapse: collapse; text-align: center;"> <tr> <td style="width: 10%;"></td> <td style="width: 10%;"></td> <td style="width: 10%;"></td> <td style="width: 10%;"></td> <td style="width: 10%;"></td> <td style="width: 10%;"></td> <td style="width: 10%;"></td> <td style="width: 10%;"></td> <td style="width: 10%;"></td> <td style="width: 10%;"></td> </tr> <tr> <td></td> <td></td> <td colspan="8" style="text-align: center;"> <table border="1" style="width: 100%; border-collapse: collapse; text-align: center;"> <tr> <td style="width: 10%;"></td> <td style="width: 10%;"></td> <td style="width: 10%;"></td> <td style="width: 10%;"></td> <td style="width: 10%;"></td> <td style="width: 10%;"></td> <td style="width: 10%;"></td> <td style="width: 10%;"></td> <td style="width: 10%;"></td> <td style="width: 10%;"></td> </tr> <tr> <td></td> <td></td> <td colspan="8" style="text-align: center;"> <table border="1" style="width: 100%; border-collapse: collapse; text-align: center;"> <tr> <td style="width: 10%;"></td> <td style="width: 10%;"></td> <td style="width: 10%;"></td> <td style="width: 10%;"></td> <td style="width: 10%;"></td> <td style="width: 10%;"></td> <td style="width: 10%;"></td> <td style="width: 10%;"></td> <td style="width: 10%;"></td> <td style="width: 10%;"></td> </tr> <tr> <td></td> <td></td> <td colspan="8" style="text-align: center;"> <table border="1" style="width: 100%; border-collapse: collapse; text-align: center;"> <tr> <td style="width: 10%;"></td> <td style="width: 10%;"></td> <td style="width: 10%;"></td> <td style="width: 10%;"></td> <td style="width: 10%;"></td> <td style="width: 10%;"></td> <td style="width: 10%;"></td> <td style="width: 10%;"></td> <td style="width: 10%;"></td> <td style="width: 10%;"></td> </tr> <tr> <td></td> <td></td> <td colspan="8" style="text-align: center;"> <table border="1" style="width: 100%; border-collapse: collapse; text-align: center;"> <tr> <td style="width: 10%;"></td> <td style="width: 10%;"></td> <td style="width: 10%;"></td> <td style="width: 10%;"></td> <td style="width: 10%;"></td> <td style="width: 10%;"></td> <td style="width: 10%;"></td> <td style="width: 10%;"></td> <td style="width: 10%;"></td> <td style="width: 10%;"></td> </tr> <tr> <td></td> <td></td> <td colspan="8" style="text-align: center;"> <table border="1" style="width: 100%; border-collapse: collapse; text-align: center;"> <tr> <td style="width: 10%;"></td> <td style="width: 10%;"></td> <td style="width: 10%;"></td> <td style="width: 10%;"></td> <td style="width: 10%;"></td> <td style="width: 10%;"></td> <td style="width: 10%;"></td> <td style="width: 10%;"></td> <td style="width: 10%;"></td> <td style="width: 10%;"></td> </tr> <tr> <td></td> <td></td> <td colspan="8" style="text-align: center;"> <table border="1" style="width: 100%; border-collapse: collapse; text-align: center;"> <tr> <td style="width: 10%;"></td> <td style="width: 10%;"></td> <td style="width: 10%;"></td> <td style="width: 10%;"></td> <td style="width: 10%;"></td> <td style="width: 10%;"></td> <td style="width: 10%;"></td> <td style="width: 10%;"></td> <td style="width: 10%;"></td> <td style="width: 10%;"></td> </tr> <tr> <td></td> <td></td> <td colspan="8" style="text-align: center;"> <table border="1" style="width: 100%; border-collapse: collapse; text-align: center;"> <tr> <td style="width: 10%;"></td> <td style="width: 10%;"></td> <td style="width: 10%;"></td> <td style="width: 10%;"></td> <td style="width: 10%;"></td> <td style="width: 10%;"></td> <td style="width: 10%;"></td> <td style="width: 10%;"></td> <td style="width: 10%;"></td> <td style="width: 10%;"></td> </tr> <tr> <td></td> <td></td> <td colspan="8" style="text-align: center;"> <table border="1" style="width: 100%; border-collapse: collapse; text-align: center;"> <tr> <td style="width: 10%;"></td> <td style="width: 10%;"></td> <td style="width: 10%;"></td> <td style="width: 10%;"></td> <td style="width: 10%;"></td> <td style="width: 10%;"></td> <td style="width: 10%;"></td> <td style="width: 10%;"></td> <td style="width: 10%;"></td> <td style="width: 10%;"></td> </tr> <tr> <td></td> <td></td> <td colspan="8" style="text-align: center;"> <table border="1" style="width: 100%; border-collapse: collapse; text-align: center;"> <tr> <td style="width: 10%;"></td> <td style="width: 10%;"></td> <td style="width: 10%;"></td> <td style="width: 10%;"></td> <td style="width: 10%;"></td> <td style="width: 10%;"></td> <td style="width: 10%;"></td> <td style="width: 10%;"></td> <td style="width: 10%;"></td> <td style="width: 10%;"></td> </tr> <tr> <td></td> <td></td> <td colspan="8" style="text-align: center;"> <table border="1" style="width: 100%; border-collapse: collapse; text-align: center;"> <tr> <td style="width: 10%;"></td> <td style="width: 10%;"></td> <td style="width: 10%;"></td> <td style="width: 10%;"></td> <td style="width: 10%;"></td> <td style="width: 10%;"></td> <td style="width: 10%;"></td> <td style="width: 10%;"></td> <td style="width: 10%;"></td> <td style="width: 10%;"></td> </tr> <tr> <td></td> <td></td> <td colspan="8" style="text-align: center;"> <table border="1" style="width: 100%; border-collapse: collapse; text-align: center;"> <tr> <td style="width: 10%;"></td> <td style="width: 10%;"></td> <td style="width: 10%;"></td> <td style="width: 10%;"></td> <td style="width: 10%;"></td> <td style="width: 10%;"></td> <td style="width: 10%;"></td> <td style="width: 10%;"></td> <td style="width: 10%;"></td> <td style="width: 10%;"></td> </tr> <tr> <td></td> <td></td> <td colspan="8" style="text-align: center;"> <table border="1" style="width: 100%; border-collapse: collapse; text-align: center;"> <tr> <td style="width: 10%;"></td> <td style="width: 10%;"></td> <td style="width: 10%;"></td> <td style="width: 10%;"></td> <td style="width: 10%;"></td> <td style="width: 10%;"></td> <td style="width: 10%;"></td> <td style="width: 10%;"></td> <td style="width: 10%;"></td> <td style="width: 10%;"></td> </tr> <tr> <td></td> <td></td> <td colspan="8" style="text-align: center;"> <table border="1" style="width: 100%; border-collapse: collapse; text-align: center;"> <tr> <td style="width: 10%;"></td> <td style="width: 10%;"></td> <td style="width: 10%;"></td> <td style="width: 10%;"></td> <td style="width: 10%;"></td> <td style="width: 10%;"></td> <td style="width: 10%;"></td> <td style="width: 10%;"></td> <td style="width: 10%;"></td> <td style="width: 10%;"></td> </tr> <tr> <td></td> <td></td> <td
colspan="8" style="text-align: center;"> <table border="1" style="width: 100%; border-collapse: collapse; text-align: center;"> <tr> <td style="width: 10%;"></td> <td style="width: 10%;"></td> <td style="width: 10%;"></td> <td style="width: 10%;"></td> <td style="width: 10%;"></td> <td style="width: 10%;"></td> <td style="width: 10%;"></td> <td style="width: 10%;"></td> <td style="width: 10%;"></td> <td style="width: 10%;"></td> </tr> <tr> <td></td> <td></td> <td colspan="8" style="text-align: center;"> <table border="1" style="width: 100%; border-collapse: collapse; text-align: center;"> <tr> <td style="width: 10%;"></td> <td style="width: 10%;"></td> <td style="width: 10%;"></td> <td style="width: 10%;"></td> <td style="width: 10%;"></td> <td style="width: 10%;"></td> <td style="width: 10%;"></td> <td style="width: 10%;"></td> <td style="width: 10%;"></td> <td style="width: 10%;"></td> </tr> <tr> <td></td> <td></td> <td colspan="8" style="text-align: center;"> <table border="1" style="width: 100%; border-collapse: collapse; text-align: center;"> <tr> <td style="width: 10%;"></td> <td style="width: 10%;"></td> <td style="width: 10%;"></td> <td style="width: 10%;"></td> <td style="width: 10%;"></td> <td style="width: 10%;"></td> <td style="width: 10%;"></td> <td style="width: 10%;"></td> <td style="width: 10%;"></td> <td style="width: 10%;"></td> </tr> <tr> <td></td> <td></td> <td colspan="8" style="text-align: center;"> <table border="1" style="width: 100%; border-collapse: collapse; text-align: center;"> <tr> <td style="width: 10%;"></td> <td style="width: 10%;"></td> <td style="width: 10%;"></td> <td style="width: 10%;"></td> <td style="width: 10%;"></td> <td style="width: 10%;"></td> <td style="width: 10%;"></td> <td style="width: 10%;"></td> <td style="width: 10%;"></td> <td style="width: 10%;"></td> </tr> <tr> <td></td> <td></td> <td colspan="8" style="text-align: center;"> <table border="1" style="width: 100%; border-collapse: collapse; text-align: center;"> <tr> </tr></table></td></tr></table></td></tr></table></td></tr></table></td></tr></table></td></tr></table></td></tr></table></td></tr></table></td></tr></table></td></tr></table></td></tr></table></td></tr></table></td></tr></table></td></tr></table></td></tr></table></td></tr></table></td></tr></table></td></tr></table></td></tr></table></td></tr></table></td></tr></table></td></tr></table></td></tr></table></td></tr></table></td></tr></table></td></tr></table></td></tr></table></td></tr></table></td></tr></table></td></tr></table></td></tr></table></td></tr></table></td></tr></table></td></tr></table></td></tr></table></td></tr></table></td></tr></table></td></tr></table></td></tr></table></td></tr></table></td></tr></table></td></tr></table></td></tr></table></td></tr></table></td></tr></table></td></tr></table></td></tr></table></td></tr></table></td></tr></table> | | | | | | | | | | | | | | | | | | | | <table border="1" style="width: 100%; border-collapse: collapse; text-align: center;"> <tr> <td style="width: 10%;"></td> <td style="width: 10%;"></td> <td style="width: 10%;"></td> <td style="width: 10%;"></td> <td style="width: 10%;"></td> <td style="width: 10%;"></td> <td style="width: 10%;"></td> <td style="width: 10%;"></td> <td style="width: 10%;"></td> <td style="width: 10%;"></td> </tr> <tr> <td></td> <td></td> <td colspan="8" style="text-align: center;"> <table border="1" style="width: 100%; border-collapse: collapse; text-align: center;"> <tr> <td style="width: 10%;"></td> <td style="width: 10%;"></td> <td style="width: 10%;"></td> <td style="width: 10%;"></td> <td style="width: 10%;"></td> <td style="width: 10%;"></td> <td style="width: 10%;"></td> <td style="width: 10%;"></td> <td style="width: 10%;"></td> <td style="width: 10%;"></td> </tr> <tr> <td></td> <td></td> <td colspan="8" style="text-align: center;"> <table border="1" style="width: 100%; border-collapse: collapse; text-align: center;"> <tr> <td style="width: 10%;"></td> <td style="width: 10%;"></td> <td style="width: 10%;"></td> <td style="width: 10%;"></td> <td style="width: 10%;"></td> <td style="width: 10%;"></td> <td style="width: 10%;"></td> <td style="width: 10%;"></td> <td style="width: 10%;"></td> <td style="width: 10%;"></td> </tr> <tr> <td></td> <td></td> <td colspan="8" style="text-align: center;"> <table border="1" style="width: 100%; border-collapse: collapse; text-align: center;"> <tr> <td style="width: 10%;"></td> <td style="width: 10%;"></td> <td style="width: 10%;"></td> <td style="width: 10%;"></td> <td style="width: 10%;"></td> <td style="width: 10%;"></td> <td style="width: 10%;"></td> <td style="width: 10%;"></td> <td style="width: 10%;"></td> <td style="width: 10%;"></td> </tr> <tr> <td></td> <td></td> <td colspan="8" style="text-align: center;"> <table border="1" style="width: 100%; border-collapse: collapse; text-align: center;"> <tr> <td style="width: 10%;"></td> <td style="width: 10%;"></td> <td style="width: 10%;"></td> <td style="width: 10%;"></td> <td style="width: 10%;"></td> <td style="width: 10%;"></td> <td style="width: 10%;"></td> <td style="width: 10%;"></td> <td style="width: 10%;"></td> <td style="width: 10%;"></td> </tr> <tr> <td></td> <td></td> <td colspan="8" style="text-align: center;"> <table border="1" style="width: 100%; border-collapse: collapse; text-align: center;"> <tr> <td style="width: 10%;"></td> <td style="width: 10%;"></td> <td style="width: 10%;"></td> <td style="width: 10%;"></td> <td style="width: 10%;"></td> <td style="width: 10%;"></td> <td style="width: 10%;"></td> <td style="width: 10%;"></td> <td style="width: 10%;"></td> <td style="width: 10%;"></td> </tr> <tr> <td></td> <td></td> <td colspan="8" style="text-align: center;"> <table border="1" style="width: 100%; border-collapse: collapse; text-align: center;"> <tr> <td style="width: 10%;"></td> <td style="width: 10%;"></td> <td style="width: 10%;"></td> <td style="width: 10%;"></td> <td style="width: 10%;"></td> <td style="width: 10%;"></td> <td style="width: 10%;"></td> <td style="width: 10%;"></td> <td style="width: 10%;"></td> <td style="width: 10%;"></td> </tr> <tr> <td></td> <td></td> <td colspan="8" style="text-align: center;"> <table border="1" style="width: 100%; border-collapse: collapse; text-align: center;"> <tr> <td style="width: 10%;"></td> <td style="width: 10%;"></td> <td style="width: 10%;"></td> <td style="width: 10%;"></td> <td style="width: 10%;"></td> <td style="width: 10%;"></td> <td style="width: 10%;"></td> <td style="width: 10%;"></td> <td style="width: 10%;"></td> <td style="width: 10%;"></td> </tr> <tr> <td></td> <td></td> <td colspan="8" style="text-align: center;"> <table border="1" style="width: 100%; border-collapse: collapse; text-align: center;"> <tr> <td style="width: 10%;"></td> <td style="width: 10%;"></td> <td style="width: 10%;"></td> <td style="width: 10%;"></td> <td style="width: 10%;"></td> <td style="width: 10%;"></td> <td style="width: 10%;"></td> <td style="width: 10%;"></td> <td style="width: 10%;"></td> <td style="width: 10%;"></td> </tr> <tr> <td></td> <td></td> <td colspan="8" style="text-align: center;"> <table border="1" style="width: 100%; border-collapse: collapse; text-align: center;"> <tr> <td style="width: 10%;"></td> <td style="width: 10%;"></td> <td style="width: 10%;"></td> <td style="width: 10%;"></td> <td style="width: 10%;"></td> <td style="width: 10%;"></td> <td style="width: 10%;"></td> <td style="width: 10%;"></td> <td style="width: 10%;"></td> <td style="width: 10%;"></td> </tr> <tr> <td></td> <td></td> <td colspan="8" style="text-align: center;"> <table border="1" style="width: 100%; border-collapse: collapse; text-align: center;"> <tr> <td style="width: 10%;"></td> <td style="width: 10%;"></td> <td style="width: 10%;"></td> <td style="width: 10%;"></td> <td style="width: 10%;"></td> <td style="width: 10%;"></td> <td style="width: 10%;"></td> <td style="width: 10%;"></td> <td style="width: 10%;"></td> <td style="width: 10%;"></td> </tr> <tr> <td></td> <td></td> <td colspan="8" style="text-align: center;"> <table border="1" style="width: 100%; border-collapse: collapse; text-align: center;"> <tr> <td style="width: 10%;"></td> <td style="width: 10%;"></td> <td style="width: 10%;"></td> <td style="width: 10%;"></td> <td style="width: 10%;"></td> <td style="width: 10%;"></td> <td style="width: 10%;"></td> <td style="width: 10%;"></td> <td style="width: 10%;"></td> <td style="width: 10%;"></td> </tr> <tr> <td></td> <td></td> <td colspan="8" style="text-align: center;"> <table border="1" style="width: 100%; border-collapse: collapse; text-align: center;"> <tr> <td style="width: 10%;"></td> <td style="width: 10%;"></td> <td style="width: 10%;"></td> <td style="width: 10%;"></td> <td style="width: 10%;"></td> <td style="width: 10%;"></td> <td style="width: 10%;"></td> <td style="width: 10%;"></td> <td style="width: 10%;"></td> <td style="width: 10%;"></td> </tr> <tr> <td></td> <td></td> <td colspan="8" style="text-align: center;"> <table border="1" style="width: 100%; border-collapse: collapse; text-align: center;"> <tr> <td style="width: 10%;"></td> <td style="width: 10%;"></td> <td style="width: 10%;"></td> <td style="width: 10%;"></td> <td style="width: 10%;"></td> <td style="width: 10%;"></td> <td style="width: 10%;"></td> <td style="width: 10%;"></td> <td style="width: 10%;"></td> <td style="width: 10%;"></td> </tr> <tr> <td></td> <td></td> <td colspan="8" style="text-align: center;"> <table border="1"
style="width: 100%; border-collapse: collapse; text-align: center;"> <tr> <td style="width: 10%;"></td> <td style="width: 10%;"></td> <td style="width: 10%;"></td> <td style="width: 10%;"></td> <td style="width: 10%;"></td> <td style="width: 10%;"></td> <td style="width: 10%;"></td> <td style="width: 10%;"></td> <td style="width: 10%;"></td> <td style="width: 10%;"></td> </tr> <tr> <td></td> <td></td> <td colspan="8" style="text-align: center;"> <table border="1" style="width: 100%; border-collapse: collapse; text-align: center;"> <tr> <td style="width: 10%;"></td> <td style="width: 10%;"></td> <td style="width: 10%;"></td> <td style="width: 10%;"></td> <td style="width: 10%;"></td> <td style="width: 10%;"></td> <td style="width: 10%;"></td> <td style="width: 10%;"></td> <td style="width: 10%;"></td> <td style="width: 10%;"></td> </tr> <tr> <td></td> <td></td> <td colspan="8" style="text-align: center;"> <table border="1" style="width: 100%; border-collapse: collapse; text-align: center;"> <tr> <td style="width: 10%;"></td> <td style="width: 10%;"></td> <td style="width: 10%;"></td> <td style="width: 10%;"></td> <td style="width: 10%;"></td> <td style="width: 10%;"></td> <td style="width: 10%;"></td> <td style="width: 10%;"></td> <td style="width: 10%;"></td> <td style="width: 10%;"></td> </tr> <tr> <td></td> <td></td> <td colspan="8" style="text-align: center;"> <table border="1" style="width: 100%; border-collapse: collapse; text-align: center;"> <tr> <td style="width: 10%;"></td> <td style="width: 10%;"></td> <td style="width: 10%;"></td> <td style="width: 10%;"></td> <td style="width: 10%;"></td> <td style="width: 10%;"></td> <td style="width: 10%;"></td> <td style="width: 10%;"></td> <td style="width: 10%;"></td> <td style="width: 10%;"></td> </tr> <tr> <td></td> <td></td> <td colspan="8" style="text-align: center;"> <table border="1" style="width: 100%; border-collapse: collapse; text-align: center;"> <tr> <td style="width: 10%;"></td> <td style="width: 10%;"></td> <td style="width: 10%;"></td> <td style="width: 10%;"></td> <td style="width: 10%;"></td> <td style="width: 10%;"></td> <td style="width: 10%;"></td> <td style="width: 10%;"></td> <td style="width: 10%;"></td> <td style="width: 10%;"></td> </tr> <tr> <td></td> <td></td> <td colspan="8" style="text-align: center;"> <table border="1" style="width: 100%; border-collapse: collapse; text-align: center;"> <tr> <td style="width: 10%;"></td> <td style="width: 10%;"></td> <td style="width: 10%;"></td> <td style="width: 10%;"></td> <td style="width: 10%;"></td> <td style="width: 10%;"></td> <td style="width: 10%;"></td> <td style="width: 10%;"></td> <td style="width: 10%;"></td> <td style="width: 10%;"></td> </tr> <tr> <td></td> <td></td> <td colspan="8" style="text-align: center;"> <table border="1" style="width: 100%; border-collapse: collapse; text-align: center;"> <tr> <td style="width: 10%;"></td> <td style="width: 10%;"></td> <td style="width: 10%;"></td> <td style="width: 10%;"></td> <td style="width: 10%;"></td> <td style="width: 10%;"></td> <td style="width: 10%;"></td> <td style="width: 10%;"></td> <td style="width: 10%;"></td> <td style="width: 10%;"></td> </tr> <tr> <td></td> <td></td> <td colspan="8" style="text-align: center;"> <table border="1" style="width: 100%; border-collapse: collapse; text-align: center;"> <tr> <td style="width: 10%;"></td> <td style="width: 10%;"></td> <td style="width: 10%;"></td> <td style="width: 10%;"></td> <td style="width: 10%;"></td> <td style="width: 10%;"></td> <td style="width: 10%;"></td> <td style="width: 10%;"></td> <td style="width: 10%;"></td> <td style="width: 10%;"></td> </tr> <tr> <td></td> <td></td> <td colspan="8" style="text-align: center;"> <table border="1" style="width: 100%; border-collapse: collapse; text-align: center;"> <tr> <td style="width: 10%;"></td> <td style="width: 10%;"></td> <td style="width: 10%;"></td> <td style="width: 10%;"></td> <td style="width: 10%;"></td> <td style="width: 10%;"></td> <td style="width: 10%;"></td> <td style="width: 10%;"></td> <td style="width: 10%;"></td> <td style="width: 10%;"></td> </tr> <tr> <td></td> <td></td> <td colspan="8" style="text-align: center;"> <table border="1" style="width: 100%; border-collapse: collapse; text-align: center;"> <tr> <td style="width: 10%;"></td> <td style="width: 10%;"></td> <td style="width: 10%;"></td> <td style="width: 10%;"></td> <td style="width: 10%;"></td> <td style="width: 10%;"></td> <td style="width: 10%;"></td> <td style="width: 10%;"></td> <td style="width: 10%;"></td> <td style="width: 10%;"></td> </tr> <tr> <td></td> <td></td> <td colspan="8" style="text-align: center;"> <table border="1" style="width: 100%; border-collapse: collapse; text-align: center;"> <tr> <td style="width: 10%;"></td> <td style="width: 10%;"></td> <td style="width: 10%;"></td> <td style="width: 10%;"></td> <td style="width: 10%;"></td> <td style="width: 10%;"></td> <td style="width: 10%;"></td> <td style="width: 10%;"></td> <td style="width: 10%;"></td> <td style="width: 10%;"></td> </tr> <tr> <td></td> <td></td> <td colspan="8" style="text-align: center;"> <table border="1" style="width: 100%; border-collapse: collapse; text-align: center;"> <tr> <td style="width: 10%;"></td> <td style="width: 10%;"></td> <td style="width: 10%;"></td> <td style="width: 10%;"></td> <td style="width: 10%;"></td> <td style="width: 10%;"></td> <td style="width: 10%;"></td> <td style="width: 10%;"></td> <td style="width: 10%;"></td> <td style="width: 10%;"></td> </tr> <tr> <td></td> <td></td> <td colspan="8" style="text-align: center;"> <table border="1" style="width: 100%; border-collapse: collapse; text-align: center;"> <tr> <td style="width: 10%;"></td> <td style="width: 10%;"></td> <td style="width: 10%;"></td> <td style="width: 10%;"></td> <td style="width: 10%;"></td> <td style="width: 10%;"></td> <td style="width: 10%;"></td> <td style="width: 10%;"></td> <td style="width: 10%;"></td> <td style="width: 10%;"></td> </tr> <tr> <td></td> <td></td> <td colspan="8" style="text-align: center;"> <table border="1" style="width: 100%; border-collapse: collapse; text-align: center;"> <tr> <td style="width: 10%;"></td> <td style="width: 10%;"></td> <td style="width: 10%;"></td> <td style="width: 10%;"></td> <td style="width: 10%;"></td> <td style="width: 10%;"></td> <td style="width: 10%;"></td> <td style="width: 10%;"></td> <td style="width: 10%;"></td> <td style="width: 10%;"></td> </tr> <tr> <td></td> <td></td> <td colspan="8" style="text-align: center;"> <table border="1" style="width: 100%; border-collapse: collapse; text-align: center;"> <tr> <td style="width: 10%;"></td> <td style="width: 10%;"></td> <td style="width: 10%;"></td> <td style="width: 10%;"></td> <td style="width: 10%;"></td> <td style="width: 10%;"></td> <td style="width: 10%;"></td> <td style="width: 10%;"></td> <td style="width: 10%;"></td> <td style="width: 10%;"></td> </tr> <tr> <td></td> <td></td> <td colspan="8" style="text-align: center;"> <table border="1" style="width: 100%; border-collapse: collapse; text-align: center;"> <tr> <td style="width: 10%;"></td> <td style="width: 10%;"></td> <td style="width: 10%;"></td> <td style="width: 10%;"></td> <td style="width: 10%;"></td> <td style="width: 10%;"></td> <td style="width: 10%;"></td> <td style="width: 10%;"></td> <td style="width: 10%;"></td> <td style="width: 10%;"></td> </tr> <tr> <td></td> <td></td> <td colspan="8" style="text-align: center;"> <table border="1" style="width: 100%; border-collapse: collapse; text-align: center;"> <tr> <td style="width: 10%;"></td> <td style="width: 10%;"></td> <td style="width: 10%;"></td> <td style="width: 10%;"></td> <td style="width: 10%;"></td> <td style="width: 10%;"></td> <td style="width: 10%;"></td> <td style="width: 10%;"></td> <td style="width: 10%;"></td> <td style="width: 10%;"></td> </tr> <tr> <td></td> <td></td> <td colspan="8" style="text-align: center;"> <table border="1" style="width: 100%; border-collapse: collapse; text-align: center;"> <tr> <td style="width: 10%;"></td> <td style="width: 10%;"></td> <td style="width: 10%;"></td> <td style="width: 10%;"></td> <td style="width: 10%;"></td> <td style="width: 10%;"></td> <td style="width: 10%;"></td> <td style="width: 10%;"></td> <td style="width: 10%;"></td> <td style="width: 10%;"></td> </tr> <tr> <td></td> <td></td> <td colspan="8" style="text-align: center;"> <table border="1" style="width: 100%; border-collapse: collapse; text-align: center;"> <tr> <td style="width: 10%;"></td> <td style="width: 10%;"></td> <td style="width: 10%;"></td> <td style="width: 10%;"></td> <td style="width: 10%;"></td> <td style="width: 10%;"></td> <td style="width: 10%;"></td> <td style="width: 10%;"></td> <td style="width: 10%;"></td> <td style="width: 10%;"></td> </tr> <tr> <td></td> <td></td> <td colspan="8" style="text-align: center;"> <table border="1" style="width: 100%; border-collapse: collapse; text-align: center;"> <tr> <td style="width: 10%;"></td> <td style="width: 10%;"></td> <td style="width: 10%;"></td> <td style="width: 10%;"></td> <td style="width: 10%;"></td> <td style="width: 10%;"></td> <td style="width: 10%;"></td> <td style="width: 10%;"></td> <td style="width: 10%;"></td> <td style="width: 10%;"></td> </tr> <tr> <td></td> <td></td> <td colspan="8" style="text-align: center;"> <table border="1" style="width: 100%; border-collapse: collapse; text-align: center;"> <tr> <td style="width: 10%;"></td> <td style="width: 10%;"></td> <td style="width: 10%;"></td> <td style="width: 10%;"></td> <td style="width: 10%;"></td> <td style="width: 10%;"></td> <td style="width: 10%;"></td> <td style="width: 10%;"></td> <td style="width: 10%;"></td> <td style="width: 10%;"></td> </tr> <tr> <td></td> <td></td> <td colspan="8" style="text-align: center;"> <table border="1" style="width: 100%; border-collapse: collapse; text-align: center;"> <tr> <td style="width: 10%;"></td> <td style="width: 10%;"></td> <td style="width: 10%;"></td> <td
style="width: 10%;"></td> <td style="width: 10%;"></td> <td style="width: 10%;"></td> <td style="width: 10%;"></td> <td style="width: 10%;"></td> <td style="width: 10%;"></td> <td style="width: 10%;"></td> </tr> <tr> <td></td> <td></td> <td colspan="8" style="text-align: center;"> <table border="1" style="width: 100%; border-collapse: collapse; text-align: center;"> <tr> <td style="width: 10%;"></td> <td style="width: 10%;"></td> <td style="width: 10%;"></td> <td style="width: 10%;"></td> <td style="width: 10%;"></td> <td style="width: 10%;"></td> <td style="width: 10%;"></td> <td style="width: 10%;"></td> <td style="width: 10%;"></td> <td style="width: 10%;"></td> </tr> <tr> <td></td> <td></td> <td colspan="8" style="text-align: center;"> <table border="1" style="width: 100%; border-collapse: collapse; text-align: center;"> <tr> <td style="width: 10%;"></td> <td style="width: 10%;"></td> <td style="width: 10%;"></td> <td style="width: 10%;"></td> <td style="width: 10%;"></td> <td style="width: 10%;"></td> <td style="width: 10%;"></td> <td style="width: 10%;"></td> <td style="width: 10%;"></td> <td style="width: 10%;"></td> </tr> <tr> <td></td> <td></td> <td colspan="8" style="text-align: center;"> <table border="1" style="width: 100%; border-collapse: collapse; text-align: center;"> <tr> <td style="width: 10%;"></td> <td style="width: 10%;"></td> <td style="width: 10%;"></td> <td style="width: 10%;"></td> <td style="width: 10%;"></td> <td style="width: 10%;"></td> <td style="width: 10%;"></td> <td style="width: 10%;"></td> <td style="width: 10%;"></td> <td style="width: 10%;"></td> </tr> <tr> <td></td> <td></td> <td colspan="8" style="text-align: center;"> <table border="1" style="width: 100%; border-collapse: collapse; text-align: center;"> <tr> <td style="width: 10%;"></td> <td style="width: 10%;"></td> <td style="width: 10%;"></td> <td style="width: 10%;"></td> <td style="width: 10%;"></td> <td style="width: 10%;"></td> <td style="width: 10%;"></td> <td style="width: 10%;"></td> <td style="width: 10%;"></td> <td style="width: 10%;"></td> </tr> <tr> <td></td> <td></td> <td colspan="8" style="text-align: center;"> <table border="1" style="width: 100%; border-collapse: collapse; text-align: center;"> <tr> <td style="width: 10%;"></td> <td style="width: 10%;"></td> <td style="width: 10%;"></td> <td style="width: 10%;"></td> <td style="width: 10%;"></td> <td style="width: 10%;"></td> <td style="width: 10%;"></td> <td style="width: 10%;"></td> <td style="width: 10%;"></td> <td style="width: 10%;"></td> </tr> <tr> <td></td> <td></td> <td colspan="8" style="text-align: center;"> <table border="1" style="width: 100%; border-collapse: collapse; text-align: center;"> <tr> <td style="width: 10%;"></td> <td style="width: 10%;"></td> <td style="width: 10%;"></td> <td style="width: 10%;"></td> <td style="width: 10%;"></td> <td style="width: 10%;"></td> <td style="width: 10%;"></td> <td style="width: 10%;"></td> <td style="width: 10%;"></td> <td style="width: 10%;"></td> </tr> <tr> <td></td> <td></td> <td colspan="8" style="text-align: center;"> <table border="1" style="width: 100%; border-collapse: collapse; text-align: center;"> <tr> <td style="width: 10%;"></td> <td style="width: 10%;"></td> <td style="width: 10%;"></td> <td style="width: 10%;"></td> <td style="width: 10%;"></td> <td style="width: 10%;"></td> <td style="width: 10%;"></td> <td style="width: 10%;"></td> <td style="width: 10%;"></td> <td style="width: 10%;"></td> </tr> <tr> <td></td> <td></td> <td colspan="8" style="text-align: center;"> <table border="1" style="width: 100%; border-collapse: collapse; text-align: center;"> <tr> <td style="width: 10%;"></td> <td style="width: 10%;"></td> <td style="width: 10%;"></td> <td style="width: 10%;"></td> <td style="width: 10%;"></td> <td style="width: 10%;"></td> <td style="width: 10%;"></td> <td style="width: 10%;"></td> <td style="width: 10%;"></td> <td style="width: 10%;"></td> </tr> <tr> <td></td> <td></td> <td colspan="8" style="text-align: center;"> <table border="1" style="width: 100%; border-collapse: collapse; text-align: center;"> <tr> <td style="width: 10%;"></td> <td style="width: 10%;"></td> <td style="width: 10%;"></td> <td style="width: 10%;"></td> <td style="width: 10%;"></td> <td style="width: 10%;"></td> <td style="width: 10%;"></td> <td style="width: 10%;"></td> <td style="width: 10%;"></td> <td style="width: 10%;"></td> </tr> <tr> <td></td> <td></td> <td colspan="8" style="text-align: center;"> <table border="1" style="width: 100%; border-collapse: collapse; text-align: center;"> <tr> <td style="width: 10%;"></td> <td style="width: 10%;"></td> <td style="width: 10%;"></td> <td style="width: 10%;"></td> <td style="width: 10%;"></td> <td style="width: 10%;"></td> <td style="width: 10%;"></td> <td style="width: 10%;"></td> <td style="width: 10%;"></td> <td style="width: 10%;"></td> </tr> <tr> <td></td> <td></td> <td colspan="8" style="text-align: center;"> <table border="1" style="width: 100%; border-collapse: collapse; text-align: center;"> <tr> <td style="width: 10%;"></td> <td style="width: 10%;"></td> <td style="width: 10%;"></td> <td style="width: 10%;"></td> <td style="width: 10%;"></td> <td style="width: 10%;"></td> <td style="width: 10%;"></td> <td style="width: 10%;"></td> <td style="width: 10%;"></td> <td style="width: 10%;"></td> </tr> <tr> <td></td> <td></td> <td colspan="8" style="text-align: center;"> <table border="1" style="width: 100%; border-collapse: collapse; text-align: center;"> <tr> </tr></table></td></tr></table></td></tr></table></td></tr></table></td></tr></table></td></tr></table></td></tr></table></td></tr></table></td></tr></table></td></tr></table></td></tr></table></td></tr></table></td></tr></table></td></tr></table></td></tr></table></td></tr></table></td></tr></table></td></tr></table></td></tr></table></td></tr></table></td></tr></table></td></tr></table></td></tr></table></td></tr></table></td></tr></table></td></tr></table></td></tr></table></td></tr></table></td></tr></table></td></tr></table></td></tr></table></td></tr></table></td></tr></table></td></tr></table></td></tr></table></td></tr></table></td></tr></table></td></tr></table></td></tr></table></td></tr></table></td></tr></table></td></tr></table></td></tr></table></td></tr></table></td></tr></table></td></tr></table></td></tr></table></td></tr></table> | | | | | | | | | | | | | | | | | | | | <table border="1" style="width: 100%; border-collapse: collapse; text-align: center;"> <tr> <td style="width: 10%;"></td> <td style="width: 10%;"></td> <td style="width: 10%;"></td> <td style="width: 10%;"></td> <td style="width: 10%;"></td> <td style="width: 10%;"></td> <td style="width: 10%;"></td> <td style="width: 10%;"></td> <td style="width: 10%;"></td> <td style="width: 10%;"></td> </tr> <tr> <td></td> <td></td> <td colspan="8" style="text-align: center;"> <table border="1" style="width: 100%; border-collapse: collapse; text-align: center;"> <tr> <td style="width: 10%;"></td> <td style="width: 10%;"></td> <td style="width: 10%;"></td> <td style="width: 10%;"></td> <td style="width: 10%;"></td> <td style="width: 10%;"></td> <td style="width: 10%;"></td> <td style="width: 10%;"></td> <td style="width: 10%;"></td> <td style="width: 10%;"></td> </tr> <tr> <td></td> <td></td> <td colspan="8" style="text-align: center;"> <table border="1" style="width: 100%; border-collapse: collapse; text-align: center;"> <tr> <td style="width: 10%;"></td> <td style="width: 10%;"></td> <td style="width: 10%;"></td> <td style="width: 10%;"></td> <td style="width: 10%;"></td> <td style="width: 10%;"></td> <td style="width: 10%;"></td> <td style="width: 10%;"></td> <td style="width: 10%;"></td> <td style="width: 10%;"></td> </tr> <tr> <td></td> <td></td> <td colspan="8" style="text-align: center;"> <table border="1" style="width: 100%; border-collapse: collapse; text-align: center;"> <tr> <td style="width: 10%;"></td> <td style="width: 10%;"></td> <td style="width: 10%;"></td> <td style="width: 10%;"></td> <td style="width: 10%;"></td> <td style="width: 10%;"></td> <td style="width: 10%;"></td> <td style="width: 10%;"></td> <td style="width: 10%;"></td> <td style="width: 10%;"></td> </tr> <tr> <td></td> <td></td> <td colspan="8" style="text-align: center;"> <table border="1" style="width: 100%; border-collapse: collapse; text-align: center;"> <tr> <td style="width: 10%;"></td> <td style="width: 10%;"></td> <td style="width: 10%;"></td> <td style="width: 10%;"></td> <td style="width: 10%;"></td> <td style="width: 10%;"></td> <td style="width: 10%;"></td> <td style="width: 10%;"></td> <td style="width: 10%;"></td> <td style="width: 10%;"></td> </tr> <tr> <td></td> <td></td> <td colspan="8" style="text-align: center;"> <table border="1" style="width: 100%; border-collapse: collapse; text-align: center;"> <tr> <td style="width: 10%;"></td> <td style="width: 10%;"></td> <td style="width: 10%;"></td> <td style="width: 10%;"></td> <td style="width: 10%;"></td> <td style="width: 10%;"></td> <td style="width: 10%;"></td> <td style="width: 10%;"></td> <td style="width: 10%;"></td> <td style="width: 10%;"></td> </tr> <tr> <td></td> <td></td> <td colspan="8" style="text-align: center;"> <table border="1" style="width: 100%; border-collapse: collapse; text-align: center;"> <tr> <td style="width: 10%;"></td> <td style="width: 10%;"></td> <td style="width: 10%;"></td> <td style="width: 10%;"></td> <td style="width: 10%;"></td> <td style="width:
10%;"></td> <td style="width: 10%;"></td> <td style="width: 10%;"></td> <td style="width: 10%;"></td> <td style="width: 10%;"></td> </tr> <tr> <td></td> <td></td> <td colspan="8" style="text-align: center;"> <table border="1" style="width: 100%; border-collapse: collapse; text-align: center;"> <tr> <td style="width: 10%;"></td> <td style="width: 10%;"></td> <td style="width: 10%;"></td> <td style="width: 10%;"></td> <td style="width: 10%;"></td> <td style="width: 10%;"></td> <td style="width: 10%;"></td> <td style="width: 10%;"></td> <td style="width: 10%;"></td> <td style="width: 10%;"></td> </tr> <tr> <td></td> <td></td> <td colspan="8" style="text-align: center;"> <table border="1" style="width: 100%; border-collapse: collapse; text-align: center;"> <tr> <td style="width: 10%;"></td> <td style="width: 10%;"></td> <td style="width: 10%;"></td> <td style="width: 10%;"></td> <td style="width: 10%;"></td> <td style="width: 10%;"></td> <td style="width: 10%;"></td> <td style="width: 10%;"></td> <td style="width: 10%;"></td> <td style="width: 10%;"></td> </tr> <tr> <td></td> <td></td> <td colspan="8" style="text-align: center;"> <table border="1" style="width: 100%; border-collapse: collapse; text-align: center;"> <tr> <td style="width: 10%;"></td> <td style="width: 10%;"></td> <td style="width: 10%;"></td> <td style="width: 10%;"></td> <td style="width: 10%;"></td> <td style="width: 10%;"></td> <td style="width: 10%;"></td> <td style="width: 10%;"></td> <td style="width: 10%;"></td> <td style="width: 10%;"></td> </tr> <tr> <td></td> <td></td> <td colspan="8" style="text-align: center;"> <table border="1" style="width: 100%; border-collapse: collapse; text-align: center;"> <tr> <td style="width: 10%;"></td> <td style="width: 10%;"></td> <td style="width: 10%;"></td> <td style="width: 10%;"></td> <td style="width: 10%;"></td> <td style="width: 10%;"></td> <td style="width: 10%;"></td> <td style="width: 10%;"></td> <td style="width: 10%;"></td> <td style="width: 10%;"></td> </tr> <tr> <td></td> <td></td> <td colspan="8" style="text-align: center;"> <table border="1" style="width: 100%; border-collapse: collapse; text-align: center;"> <tr> <td style="width: 10%;"></td> <td style="width: 10%;"></td> <td style="width: 10%;"></td> <td style="width: 10%;"></td> <td style="width: 10%;"></td> <td style="width: 10%;"></td> <td style="width: 10%;"></td> <td style="width: 10%;"></td> <td style="width: 10%;"></td> <td style="width: 10%;"></td> </tr> <tr> <td></td> <td></td> <td colspan="8" style="text-align: center;"> <table border="1" style="width: 100%; border-collapse: collapse; text-align: center;"> <tr> <td style="width: 10%;"></td> <td style="width: 10%;"></td> <td style="width: 10%;"></td> <td style="width: 10%;"></td> <td style="width: 10%;"></td> <td style="width: 10%;"></td> <td style="width: 10%;"></td> <td style="width: 10%;"></td> <td style="width: 10%;"></td> <td style="width: 10%;"></td> </tr> <tr> <td></td> <td></td> <td colspan="8" style="text-align: center;"> <table border="1" style="width: 100%; border-collapse: collapse; text-align: center;"> <tr> <td style="width: 10%;"></td> <td style="width: 10%;"></td> <td style="width: 10%;"></td> <td style="width: 10%;"></td> <td style="width: 10%;"></td> <td style="width: 10%;"></td> <td style="width: 10%;"></td> <td style="width: 10%;"></td> <td style="width: 10%;"></td> <td style="width: 10%;"></td> </tr> <tr> <td></td> <td></td> <td colspan="8" style="text-align: center;"> <table border="1" style="width: 100%; border-collapse: collapse; text-align: center;"> <tr> <td style="width: 10%;"></td> <td style="width: 10%;"></td> <td style="width: 10%;"></td> <td style="width: 10%;"></td> <td style="width: 10%;"></td> <td style="width: 10%;"></td> <td style="width: 10%;"></td> <td style="width: 10%;"></td> <td style="width: 10%;"></td> <td style="width: 10%;"></td> </tr> <tr> <td></td> <td></td> <td colspan="8" style="text-align: center;"> <table border="1" style="width: 100%; border-collapse: collapse; text-align: center;"> <tr> <td style="width: 10%;"></td> <td style="width: 10%;"></td> <td style="width: 10%;"></td> <td style="width: 10%;"></td> <td style="width: 10%;"></td> <td style="width: 10%;"></td> <td style="width: 10%;"></td> <td style="width: 10%;"></td> <td style="width: 10%;"></td> <td style="width: 10%;"></td> </tr> <tr> <td></td> <td></td> <td colspan="8" style="text-align: center;"> <table border="1" style="width: 100%; border-collapse: collapse; text-align: center;"> <tr> <td style="width: 10%;"></td> <td style="width: 10%;"></td> <td style="width: 10%;"></td> <td style="width: 10%;"></td> <td style="width: 10%;"></td> <td style="width: 10%;"></td> <td style="width: 10%;"></td> <td style="width: 10%;"></td> <td style="width: 10%;"></td> <td style="width: 10%;"></td> </tr> <tr> <td></td> <td></td> <td colspan="8" style="text-align: center;"> <table border="1" style="width: 100%; border-collapse: collapse; text-align: center;"> <tr> <td style="width: 10%;"></td> <td style="width: 10%;"></td> <td style="width: 10%;"></td> <td style="width: 10%;"></td> <td style="width: 10%;"></td> <td style="width: 10%;"></td> <td style="width: 10%;"></td> <td style="width: 10%;"></td> <td style="width: 10%;"></td> <td style="width: 10%;"></td> </tr> <tr> <td></td> <td></td> <td colspan="8" style="text-align: center;"> <table border="1" style="width: 100%; border-collapse: collapse; text-align: center;"> <tr> <td style="width: 10%;"></td> <td style="width: 10%;"></td> <td style="width: 10%;"></td> <td style="width: 10%;"></td> <td style="width: 10%;"></td> <td style="width: 10%;"></td> <td style="width: 10%;"></td> <td style="width: 10%;"></td> <td style="width: 10%;"></td> <td style="width: 10%;"></td> </tr> <tr> <td></td> <td></td> <td colspan="8" style="text-align: center;"> <table border="1" style="width: 100%; border-collapse: collapse; text-align: center;"> <tr> <td style="width: 10%;"></td> <td style="width: 10%;"></td> <td style="width: 10%;"></td> <td style="width: 10%;"></td> <td style="width: 10%;"></td> <td style="width: 10%;"></td> <td style="width: 10%;"></td> <td style="width: 10%;"></td> <td style="width: 10%;"></td> <td style="width: 10%;"></td> </tr> <tr> <td></td> <td></td> <td colspan="8" style="text-align: center;"> <table border="1" style="width: 100%; border-collapse: collapse; text-align: center;"> <tr> <td style="width: 10%;"></td> <td style="width: 10%;"></td> <td style="width: 10%;"></td> <td style="width: 10%;"></td> <td style="width: 10%;"></td> <td style="width: 10%;"></td> <td style="width: 10%;"></td> <td style="width: 10%;"></td> <td style="width: 10%;"></td> <td style="width: 10%;"></td> </tr> <tr> <td></td> <td></td> <td colspan="8" style="text-align: center;"> <table border="1" style="width: 100%; border-collapse: collapse; text-align: center;"> <tr> <td style="width: 10%;"></td> <td style="width: 10%;"></td> <td style="width: 10%;"></td> <td style="width: 10%;"></td> <td style="width: 10%;"></td> <td style="width: 10%;"></td> <td style="width: 10%;"></td> <td style="width: 10%;"></td> <td style="width: 10%;"></td> <td style="width: 10%;"></td> </tr> <tr> <td></td> <td></td> <td colspan="8" style="text-align: center;"> <table border="1" style="width: 100%; border-collapse: collapse; text-align: center;"> <tr> <td style="width: 10%;"></td> <td style="width: 10%;"></td> <td style="width: 10%;"></td> <td style="width: 10%;"></td> <td style="width: 10%;"></td> <td style="width: 10%;"></td> <td style="width: 10%;"></td> <td style="width: 10%;"></td> <td style="width: 10%;"></td> <td style="width: 10%;"></td> </tr> <tr> <td></td> <td></td> <td colspan="8" style="text-align: center;"> <table border="1" style="width: 100%; border-collapse: collapse; text-align: center;"> <tr> <td style="width: 10%;"></td> <td style="width: 10%;"></td> <td style="width: 10%;"></td> <td style="width: 10%;"></td> <td style="width: 10%;"></td> <td style="width: 10%;"></td> <td style="width: 10%;"></td> <td style="width: 10%;"></td> <td style="width: 10%;"></td> <td style="width: 10%;"></td> </tr> <tr> <td></td> <td></td> <td colspan="8" style="text-align: center;"> <table border="1" style="width: 100%; border-collapse: collapse; text-align: center;"> <tr> <td style="width: 10%;"></td> <td style="width: 10%;"></td> <td style="width: 10%;"></td> <td style="width: 10%;"></td> <td style="width: 10%;"></td> <td style="width: 10%;"></td> <td style="width: 10%;"></td> <td style="width: 10%;"></td> <td style="width: 10%;"></td> <td style="width: 10%;"></td> </tr> <tr> <td></td> <td></td> <td colspan="8" style="text-align: center;"> <table border="1" style="width: 100%; border-collapse: collapse; text-align: center;"> <tr> <td style="width: 10%;"></td> <td style="width: 10%;"></td> <td style="width: 10%;"></td> <td style="width: 10%;"></td> <td style="width: 10%;"></td> <td style="width: 10%;"></td> <td style="width: 10%;"></td> <td style="width: 10%;"></td> <td style="width: 10%;"></td> <td style="width: 10%;"></td> </tr> <tr> <td></td> <td></td> <td colspan="8" style="text-align: center;"> <table border="1" style="width: 100%; border-collapse: collapse; text-align: center;"> <tr> <td style="width: 10%;"></td> <td style="width: 10%;"></td> <td style="width: 10%;"></td> <td style="width: 10%;"></td> <td style="width: 10%;"></td> <td style="width: 10%;"></td> <td style="width: 10%;"></td> <td style="width: 10%;"></td> <td style="width: 10%;"></td> <td style="width: 10%;"></td> </tr> <tr> <td></td> <td></td> <td colspan="8" style="text-align: center;"> <table border="1" style="width: 100%; border-collapse: collapse; text-align: center;"> <tr> <td style="width: 10%;"></td> <td style="width: 10%;"></td> <td style="width: 10%;"></td> <td style="width: 10%;"></td> <td style="width: 10%;"></td> <td style="width: 10%;"></td> <td style="width: 10%;"></td> <td style="width: 10%;"></td> <td style="width: 10%;"></td> <td style="width: 10%;"></td> </tr> <tr> <td></td> <td></td> <td
colspan="8" style="text-align: center;"> <table border="1" style="width: 100%; border-collapse: collapse; text-align: center;"> <tr> <td style="width: 10%;"></td> <td style="width: 10%;"></td> <td style="width: 10%;"></td> <td style="width: 10%;"></td> <td style="width: 10%;"></td> <td style="width: 10%;"></td> <td style="width: 10%;"></td> <td style="width: 10%;"></td> <td style="width: 10%;"></td> <td style="width: 10%;"></td> </tr> <tr> <td></td> <td></td> <td colspan="8" style="text-align: center;"> <table border="1" style="width: 100%; border-collapse: collapse; text-align: center;"> <tr> <td style="width: 10%;"></td> <td style="width: 10%;"></td> <td style="width: 10%;"></td> <td style="width: 10%;"></td> <td style="width: 10%;"></td> <td style="width: 10%;"></td> <td style="width: 10%;"></td> <td style="width: 10%;"></td> <td style="width: 10%;"></td> <td style="width: 10%;"></td> </tr> <tr> <td></td> <td></td> <td colspan="8" style="text-align: center;"> <table border="1" style="width: 100%; border-collapse: collapse; text-align: center;"> <tr> <td style="width: 10%;"></td> <td style="width: 10%;"></td> <td style="width: 10%;"></td> <td style="width: 10%;"></td> <td style="width: 10%;"></td> <td style="width: 10%;"></td> <td style="width: 10%;"></td> <td style="width: 10%;"></td> <td style="width: 10%;"></td> <td style="width: 10%;"></td> </tr> <tr> <td></td> <td></td> <td colspan="8" style="text-align: center;"> <table border="1" style="width: 100%; border-collapse: collapse; text-align: center;"> <tr> <td style="width: 10%;"></td> <td style="width: 10%;"></td> <td style="width: 10%;"></td> <td style="width: 10%;"></td> <td style="width: 10%;"></td> <td style="width: 10%;"></td> <td style="width: 10%;"></td> <td style="width: 10%;"></td> <td style="width: 10%;"></td> <td style="width: 10%;"></td> </tr> <tr> <td></td> <td></td> <td colspan="8" style="text-align: center;"> <table border="1" style="width: 100%; border-collapse: collapse; text-align: center;"> <tr> <td style="width: 10%;"></td> <td style="width: 10%;"></td> <td style="width: 10%;"></td> <td style="width: 10%;"></td> <td style="width: 10%;"></td> <td style="width: 10%;"></td> <td style="width: 10%;"></td> <td style="width: 10%;"></td> <td style="width: 10%;"></td> <td style="width: 10%;"></td> </tr> <tr> <td></td> <td></td> <td colspan="8" style="text-align: center;"> <table border="1" style="width: 100%; border-collapse: collapse; text-align: center;"> <tr> <td style="width: 10%;"></td> <td style="width: 10%;"></td> <td style="width: 10%;"></td> <td style="width: 10%;"></td> <td style="width: 10%;"></td> <td style="width: 10%;"></td> <td style="width: 10%;"></td> <td style="width: 10%;"></td> <td style="width: 10%;"></td> <td style="width: 10%;"></td> </tr> <tr> <td></td> <td></td> <td colspan="8" style="text-align: center;"> <table border="1" style="width: 100%; border-collapse: collapse; text-align: center;"> <tr> <td style="width: 10%;"></td> <td style="width: 10%;"></td> <td style="width: 10%;"></td> <td style="width: 10%;"></td> <td style="width: 10%;"></td> <td style="width: 10%;"></td> <td style="width: 10%;"></td> <td style="width: 10%;"></td> <td style="width: 10%;"></td> <td style="width: 10%;"></td> </tr> <tr> <td></td> <td></td> <td colspan="8" style="text-align: center;"> <table border="1" style="width: 100%; border-collapse: collapse; text-align: center;"> <tr> <td style="width: 10%;"></td> <td style="width: 10%;"></td> <td style="width: 10%;"></td> <td style="width: 10%;"></td> <td style="width: 10%;"></td> <td style="width: 10%;"></td> <td style="width: 10%;"></td> <td style="width: 10%;"></td> <td style="width: 10%;"></td> <td style="width: 10%;"></td> </tr> <tr> <td></td> <td></td> <td colspan="8" style="text-align: center;"> <table border="1" style="width: 100%; border-collapse: collapse; text-align: center;"> <tr> <td style="width: 10%;"></td> <td style="width: 10%;"></td> <td style="width: 10%;"></td> <td style="width: 10%;"></td> <td style="width: 10%;"></td> <td style="width: 10%;"></td> <td style="width: 10%;"></td> <td style="width: 10%;"></td> <td style="width: 10%;"></td> <td style="width: 10%;"></td> </tr> <tr> <td></td> <td></td> <td colspan="8" style="text-align: center;"> <table border="1" style="width: 100%; border-collapse: collapse; text-align: center;"> <tr> <td style="width: 10%;"></td> <td style="width: 10%;"></td> <td style="width: 10%;"></td> <td style="width: 10%;"></td> <td style="width: 10%;"></td> <td style="width: 10%;"></td> <td style="width: 10%;"></td> <td style="width: 10%;"></td> <td style="width: 10%;"></td> <td style="width: 10%;"></td> </tr> <tr> <td></td> <td></td> <td colspan="8" style="text-align: center;"> <table border="1" style="width: 100%; border-collapse: collapse; text-align: center;"> <tr> <td style="width: 10%;"></td> <td style="width: 10%;"></td> <td style="width: 10%;"></td> <td style="width: 10%;"></td> <td style="width: 10%;"></td> <td style="width: 10%;"></td> <td style="width: 10%;"></td> <td style="width: 10%;"></td> <td style="width: 10%;"></td> <td style="width: 10%;"></td> </tr> <tr> <td></td> <td></td> <td colspan="8" style="text-align: center;"> <table border="1" style="width: 100%; border-collapse: collapse; text-align: center;"> <tr> <td style="width: 10%;"></td> <td style="width: 10%;"></td> <td style="width: 10%;"></td> <td style="width: 10%;"></td> <td style="width: 10%;"></td> <td style="width: 10%;"></td> <td style="width: 10%;"></td> <td style="width: 10%;"></td> <td style="width: 10%;"></td> <td style="width: 10%;"></td> </tr> <tr> <td></td> <td></td> <td colspan="8" style="text-align: center;"> <table border="1" style="width: 100%; border-collapse: collapse; text-align: center;"> <tr> <td style="width: 10%;"></td> <td style="width: 10%;"></td> <td style="width: 10%;"></td> <td style="width: 10%;"></td> <td style="width: 10%;"></td> <td style="width: 10%;"></td> <td style="width: 10%;"></td> <td style="width: 10%;"></td> <td style="width: 10%;"></td> <td style="width: 10%;"></td> </tr> <tr> <td></td> <td></td> <td colspan="8" style="text-align: center;"> <table border="1" style="width: 100%; border-collapse: collapse; text-align: center;"> <tr> <td style="width: 10%;"></td> <td style="width: 10%;"></td> <td style="width: 10%;"></td> <td style="width: 10%;"></td> <td style="width: 10%;"></td> <td style="width: 10%;"></td> <td style="width: 10%;"></td> <td style="width: 10%;"></td> <td style="width: 10%;"></td> <td style="width: 10%;"></td> </tr> <tr> <td></td> <td></td> <td colspan="8" style="text-align: center;"> <table border="1" style="width: 100%; border-collapse: collapse; text-align: center;"> <tr> <td style="width: 10%;"></td> <td style="width: 10%;"></td> <td style="width: 10%;"></td> <td style="width: 10%;"></td> <td style="width: 10%;"></td> <td style="width: 10%;"></td> <td style="width: 10%;"></td> <td style="width: 10%;"></td> <td style="width: 10%;"></td> <td style="width: 10%;"></td> </tr> <tr> <td></td> <td></td> <td colspan="8" style="text-align: center;"> <table border="1" style="width: 100%; border-collapse: collapse; text-align: center;"> <tr> <td style="width: 10%;"></td> <td style="width: 10%;"></td> <td style="width: 10%;"></td> <td style="width: 10%;"></td> <td style="width: 10%;"></td> <td style="width: 10%;"></td> <td style="width: 10%;"></td> <td style="width: 10%;"></td> <td style="width: 10%;"></td> <td style="width: 10%;"></td> </tr> <tr> <td></td> <td></td> <td colspan="8" style="text-align: center;"> <table border="1" style="width: 100%; border-collapse: collapse; text-align: center;"> <tr> <td style="width: 10%;"></td> <td style="width: 10%;"></td> <td style="width: 10%;"></td> <td style="width: 10%;"></td> <td style="width: 10%;"></td> <td style="width: 10%;"></td> <td style="width: 10%;"></td> <td style="width: 10%;"></td> <td style="width: 10%;"></td> <td style="width: 10%;"></td> </tr> <tr> <td></td> <td></td> <td colspan="8" style="text-align: center;"> <table border="1" style="width: 100%; border-collapse: collapse; text-align: center;"> <tr> <td style="width: 10%;"></td> <td style="width: 10%;"></td> <td style="width: 10%;"></td> <td style="width: 10%;"></td> <td style="width: 10%;"></td> <td style="width: 10%;"></td> <td style="width: 10%;"></td> <td style="width: 10%;"></td> <td style="width: 10%;"></td> <td style="width: 10%;"></td> </tr> <tr> <td></td> <td></td> <td colspan="8" style="text-align: center;"> <table border="1" style="width: 100%; border-collapse: collapse; text-align: center;"> <tr> </tr></table></td></tr></table></td></tr></table></td></tr></table></td></tr></table></td></tr></table></td></tr></table></td></tr></table></td></tr></table></td></tr></table></td></tr></table></td></tr></table></td></tr></table></td></tr></table></td></tr></table></td></tr></table></td></tr></table></td></tr></table></td></tr></table></td></tr></table></td></tr></table></td></tr></table></td></tr></table></td></tr></table></td></tr></table></td></tr></table></td></tr></table></td></tr></table></td></tr></table></td></tr></table></td></tr></table></td></tr></table></td></tr></table></td></tr></table></td></tr></table></td></tr></table></td></tr></table></td></tr></table></td></tr></table></td></tr></table></td></tr></table></td></tr></table></td></tr></table></td></tr></table></td></tr></table></td></tr></table></td></tr></table> | | | | | | | | | | | | | | | | | | | | <table border="1" style="width: 100%; border-collapse:
collapse; text-align: center;"> <tr> <td style="width: 10%;"></td> <td style="width: 10%;"></td> <td style="width: 10%;"></td> <td style="width: 10%;"></td> <td style="width: 10%;"></td> <td style="width: 10%;"></td> <td style="width: 10%;"></td> <td style="width: 10%;"></td> <td style="width: 10%;"></td> <td style="width: 10%;"></td> </tr> <tr> <td></td> <td></td> <td colspan="8" style="text-align: center;"> <table border="1" style="width: 100%; border-collapse: collapse; text-align: center;"> <tr> <td style="width: 10%;"></td> <td style="width: 10%;"></td> <td style="width: 10%;"></td> <td style="width: 10%;"></td> <td style="width: 10%;"></td> <td style="width: 10%;"></td> <td style="width: 10%;"></td> <td style="width: 10%;"></td> <td style="width: 10%;"></td> <td style="width: 10%;"></td> </tr> <tr> <td></td> <td></td> <td colspan="8" style="text-align: center;"> <table border="1" style="width: 100%; border-collapse: collapse; text-align: center;"> <tr> <td style="width: 10%;"></td> <td style="width: 10%;"></td> <td style="width: 10%;"></td> <td style="width: 10%;"></td> <td style="width: 10%;"></td> <td style="width: 10%;"></td> <td style="width: 10%;"></td> <td style="width: 10%;"></td> <td style="width: 10%;"></td> <td style="width: 10%;"></td> </tr> <tr> <td></td> <td></td> <td colspan="8" style="text-align: center;"> <table border="1" style="width: 100%; border-collapse: collapse; text-align: center;"> <tr> <td style="width: 10%;"></td> <td style="width: 10%;"></td> <td style="width: 10%;"></td> <td style="width: 10%;"></td> <td style="width: 10%;"></td> <td style="width: 10%;"></td> <td style="width: 10%;"></td> <td style="width: 10%;"></td> <td style="width: 10%;"></td> <td style="width: 10%;"></td> </tr> <tr> <td></td> <td></td> <td colspan="8" style="text-align: center;"> <table border="1" style="width: 100%; border-collapse: collapse; text-align: center;"> <tr> <td style="width: 10%;"></td> <td style="width: 10%;"></td> <td style="width: 10%;"></td> <td style="width: 10%;"></td> <td style="width: 10%;"></td> <td style="width: 10%;"></td> <td style="width: 10%;"></td> <td style="width: 10%;"></td> <td style="width: 10%;"></td> <td style="width: 10%;"></td> </tr> <tr> <td></td> <td></td> <td colspan="8" style="text-align: center;"> <table border="1" style="width: 100%; border-collapse: collapse; text-align: center;"> <tr> <td style="width: 10%;"></td> <td style="width: 10%;"></td> <td style="width: 10%;"></td> <td style="width: 10%;"></td> <td style="width: 10%;"></td> <td style="width: 10%;"></td> <td style="width: 10%;"></td> <td style="width: 10%;"></td> <td style="width: 10%;"></td> <td style="width: 10%;"></td> </tr> <tr> <td></td> <td></td> <td colspan="8" style="text-align: center;"> <table border="1" style="width: 100%; border-collapse: collapse; text-align: center;"> <tr> <td style="width: 10%;"></td> <td style="width: 10%;"></td> <td style="width: 10%;"></td> <td style="width: 10%;"></td> <td style="width: 10%;"></td> <td style="width: 10%;"></td> <td style="width: 10%;"></td> <td style="width: 10%;"></td> <td style="width: 10%;"></td> <td style="width: 10%;"></td> </tr> <tr> <td></td> <td></td> <td colspan="8" style="text-align: center;"> <table border="1" style="width: 100%; border-collapse: collapse; text-align: center;"> <tr> <td style="width: 10%;"></td> <td style="width: 10%;"></td> <td style="width: 10%;"></td> <td style="width: 10%;"></td> <td style="width: 10%;"></td> <td style="width: 10%;"></td> <td style="width: 10%;"></td> <td style="width: 10%;"></td> <td style="width: 10%;"></td> <td style="width: 10%;"></td> </tr> <tr> <td></td> <td></td> <td colspan="8" style="text-align: center;"> <table border="1" style="width: 100%; border-collapse: collapse; text-align: center;"> <tr> <td style="width: 10%;"></td> <td style="width: 10%;"></td> <td style="width: 10%;"></td> <td style="width: 10%;"></td> <td style="width: 10%;"></td> <td style="width: 10%;"></td> <td style="width: 10%;"></td> <td style="width: 10%;"></td> <td style="width: 10%;"></td> <td style="width: 10%;"></td> </tr> <tr> <td></td> <td></td> <td colspan="8" style="text-align: center;"> <table border="1" style="width: 100%; border-collapse: collapse; text-align: center;"> <tr> <td style="width: 10%;"></td> <td style="width: 10%;"></td> <td style="width: 10%;"></td> <td style="width: 10%;"></td> <td style="width: 10%;"></td> <td style="width: 10%;"></td> <td style="width: 10%;"></td> <td style="width: 10%;"></td> <td style="width: 10%;"></td> <td style="width: 10%;"></td> </tr> <tr> <td></td> <td></td> <td colspan="8" style="text-align: center;"> <table border="1" style="width: 100%; border-collapse: collapse; text-align: center;"> <tr> <td style="width: 10%;"></td> <td style="width: 10%;"></td> <td style="width: 10%;"></td> <td style="width: 10%;"></td> <td style="width: 10%;"></td> <td style="width: 10%;"></td> <td style="width: 10%;"></td> <td style="width: 10%;"></td> <td style="width: 10%;"></td> <td style="width: 10%;"></td> </tr> <tr> <td></td> <td></td> <td colspan="8" style="text-align: center;"> <table border="1" style="width: 100%; border-collapse: collapse; text-align: center;"> <tr> <td style="width: 10%;"></td> <td style="width: 10%;"></td> <td style="width: 10%;"></td> <td style="width: 10%;"></td> <td style="width: 10%;"></td> <td style="width: 10%;"></td> <td style="width: 10%;"></td> <td style="width: 10%;"></td> <td style="width: 10%;"></td> <td style="width: 10%;"></td> </tr> <tr> <td></td> <td></td> <td colspan="8" style="text-align: center;"> <table border="1" style="width: 100%; border-collapse: collapse; text-align: center;"> <tr> <td style="width: 10%;"></td> <td style="width: 10%;"></td> <td style="width: 10%;"></td> <td style="width: 10%;"></td> <td style="width: 10%;"></td> <td style="width: 10%;"></td> <td style="width: 10%;"></td> <td style="width: 10%;"></td> <td style="width: 10%;"></td> <td style="width: 10%;"></td> </tr> <tr> <td></td> <td></td> <td colspan="8" style="text-align: center;"> <table border="1" style="width: 100%; border-collapse: collapse; text-align: center;"> <tr> <td style="width: 10%;"></td> <td style="width: 10%;"></td> <td style="width: 10%;"></td> <td style="width: 10%;"></td> <td style="width: 10%;"></td> <td style="width: 10%;"></td> <td style="width: 10%;"></td> <td style="width: 10%;"></td> <td style="width: 10%;"></td> <td style="width: 10%;"></td> </tr> <tr> <td></td> <td></td> <td colspan="8" style="text-align: center;"> <table border="1" style="width: 100%; border-collapse: collapse; text-align: center;"> <tr> <td style="width: 10%;"></td> <td style="width: 10%;"></td> <td style="width: 10%;"></td> <td style="width: 10%;"></td> <td style="width: 10%;"></td> <td style="width: 10%;"></td> <td style="width: 10%;"></td> <td style="width: 10%;"></td> <td style="width: 10%;"></td> <td style="width: 10%;"></td> </tr> <tr> <td></td> <td></td> <td colspan="8" style="text-align: center;"> <table border="1" style="width: 100%; border-collapse: collapse; text-align: center;"> <tr> <td style="width: 10%;"></td> <td style="width: 10%;"></td> <td style="width: 10%;"></td> <td style="width: 10%;"></td> <td style="width: 10%;"></td> <td style="width: 10%;"></td> <td style="width: 10%;"></td> <td style="width: 10%;"></td> <td style="width: 10%;"></td> <td style="width: 10%;"></td> </tr> <tr> <td></td> <td></td> <td colspan="8" style="text-align: center;"> <table border="1" style="width: 100%; border-collapse: collapse; text-align: center;"> <tr> <td style="width: 10%;"></td> <td style="width: 10%;"></td> <td style="width: 10%;"></td> <td style="width: 10%;"></td> <td style="width: 10%;"></td> <td style="width: 10%;"></td> <td style="width: 10%;"></td> <td style="width: 10%;"></td> <td style="width: 10%;"></td> <td style="width: 10%;"></td> </tr> <tr> <td></td> <td></td> <td colspan="8" style="text-align: center;"> <table border="1" style="width: 100%; border-collapse: collapse; text-align: center;"> <tr> <td style="width: 10%;"></td> <td style="width: 10%;"></td> <td style="width: 10%;"></td> <td style="width: 10%;"></td> <td style="width: 10%;"></td> <td style="width: 10%;"></td> <td style="width: 10%;"></td> <td style="width: 10%;"></td> <td style="width: 10%;"></td> <td style="width: 10%;"></td> </tr> <tr> <td></td> <td></td> <td colspan="8" style="text-align: center;"> <table border="1" style="width: 100%; border-collapse: collapse; text-align: center;"> <tr> <td style="width: 10%;"></td> <td style="width: 10%;"></td> <td style="width: 10%;"></td> <td style="width: 10%;"></td> <td style="width: 10%;"></td> <td style="width: 10%;"></td> <td style="width: 10%;"></td> <td style="width: 10%;"></td> <td style="width: 10%;"></td> <td style="width: 10%;"></td> </tr> <tr> <td></td> <td></td> <td colspan="8" style="text-align: center;"> <table border="1" style="width: 100%; border-collapse: collapse; text-align: center;"> <tr> <td style="width: 10%;"></td> <td style="width: 10%;"></td> <td style="width: 10%;"></td> <td style="width: 10%;"></td> <td style="width: 10%;"></td> <td style="width: 10%;"></td> <td style="width: 10%;"></td> <td style="width: 10%;"></td> <td style="width: 10%;"></td> <td style="width: 10%;"></td> </tr> <tr> <td></td> <td></td> <td colspan="8" style="text-align: center;"> <table border="1" style="width: 100%; border-collapse: collapse; text-align: center;"> <tr> <td style="width: 10%;"></td> <td style="width: 10%;"></td> <td style="width: 10%;"></td> <td style="width: 10%;"></td> <td style="width: 10%;"></td> <td style="width: 10%;"></td> <td style="width: 10%;"></td> <td style="width: 10%;"></td> <td style="width: 10%;"></td> <td style="width: 10%;"></td> </tr> <tr> <td></td> <td></td> <td colspan="8" style="text-align: center;"> <table border="1" style="width: 100%; border-collapse: collapse; text-align: center;"> <tr> <td style="width: 10%;"></td> <td style="width: 10%;"></td> <td style="width: 10%;"></td> <td style="width: 10%;"></td> <td
style="width: 10%;"></td> <td style="width: 10%;"></td> <td style="width: 10%;"></td> <td style="width: 10%;"></td> <td style="width: 10%;"></td> <td style="width: 10%;"></td> </tr> <tr> <td></td> <td></td> <td colspan="8" style="text-align: center;"> <table border="1" style="width: 100%; border-collapse: collapse; text-align: center;"> <tr> <td style="width: 10%;"></td> <td style="width: 10%;"></td> <td style="width: 10%;"></td> <td style="width: 10%;"></td> <td style="width: 10%;"></td> <td style="width: 10%;"></td> <td style="width: 10%;"></td> <td style="width: 10%;"></td> <td style="width: 10%;"></td> <td style="width: 10%;"></td> </tr> <tr> <td></td> <td></td> <td colspan="8" style="text-align: center;"> <table border="1" style="width: 100%; border-collapse: collapse; text-align: center;"> <tr> <td style="width: 10%;"></td> <td style="width: 10%;"></td> <td style="width: 10%;"></td> <td style="width: 10%;"></td> <td style="width: 10%;"></td> <td style="width: 10%;"></td> <td style="width: 10%;"></td> <td style="width: 10%;"></td> <td style="width: 10%;"></td> <td style="width: 10%;"></td> </tr> <tr> <td></td> <td></td> <td colspan="8" style="text-align: center;"> <table border="1" style="width: 100%; border-collapse: collapse; text-align: center;"> <tr> <td style="width: 10%;"></td> <td style="width: 10%;"></td> <td style="width: 10%;"></td> <td style="width: 10%;"></td> <td style="width: 10%;"></td> <td style="width: 10%;"></td> <td style="width: 10%;"></td> <td style="width: 10%;"></td> <td style="width: 10%;"></td> <td style="width: 10%;"></td> </tr> <tr> <td></td> <td></td> <td colspan="8" style="text-align: center;"> <table border="1" style="width: 100%; border-collapse: collapse; text-align: center;"> <tr> <td style="width: 10%;"></td> <td style="width: 10%;"></td> <td style="width: 10%;"></td> <td style="width: 10%;"></td> <td style="width: 10%;"></td> <td style="width: 10%;"></td> <td style="width: 10%;"></td> <td style="width: 10%;"></td> <td style="width: 10%;"></td> <td style="width: 10%;"></td> </tr> <tr> <td></td> <td></td> <td colspan="8" style="text-align: center;"> <table border="1" style="width: 100%; border-collapse: collapse; text-align: center;"> <tr> <td style="width: 10%;"></td> <td style="width: 10%;"></td> <td style="width: 10%;"></td> <td style="width: 10%;"></td> <td style="width: 10%;"></td> <td style="width: 10%;"></td> <td style="width: 10%;"></td> <td style="width: 10%;"></td> <td style="width: 10%;"></td> <td style="width: 10%;"></td> </tr> <tr> <td></td> <td></td> <td colspan="8" style="text-align: center;"> <table border="1" style="width: 100%; border-collapse: collapse; text-align: center;"> <tr> <td style="width: 10%;"></td> <td style="width: 10%;"></td> <td style="width: 10%;"></td> <td style="width: 10%;"></td> <td style="width: 10%;"></td> <td style="width: 10%;"></td> <td style="width: 10%;"></td> <td style="width: 10%;"></td> <td style="width: 10%;"></td> <td style="width: 10%;"></td> </tr> <tr> <td></td> <td></td> <td colspan="8" style="text-align: center;"> <table border="1" style="width: 100%; border-collapse: collapse; text-align: center;"> <tr> <td style="width: 10%;"></td> <td style="width: 10%;"></td> <td style="width: 10%;"></td> <td style="width: 10%;"></td> <td style="width: 10%;"></td> <td style="width: 10%;"></td> <td style="width: 10%;"></td> <td style="width: 10%;"></td> <td style="width: 10%;"></td> <td style="width: 10%;"></td> </tr> <tr> <td></td> <td></td> <td colspan="8" style="text-align: center;"> <table border="1" style="width: 100%; border-collapse: collapse; text-align: center;"> <tr> <td style="width: 10%;"></td> <td style="width: 10%;"></td> <td style="width: 10%;"></td> <td style="width: 10%;"></td> <td style="width: 10%;"></td> <td style="width: 10%;"></td> <td style="width: 10%;"></td> <td style="width: 10%;"></td> <td style="width: 10%;"></td> <td style="width: 10%;"></td> </tr> <tr> <td></td> <td></td> <td colspan="8" style="text-align: center;"> <table border="1" style="width: 100%; border-collapse: collapse; text-align: center;"> <tr> <td style="width: 10%;"></td> <td style="width: 10%;"></td> <td style="width: 10%;"></td> <td style="width: 10%;"></td> <td style="width: 10%;"></td> <td style="width: 10%;"></td> <td style="width: 10%;"></td> <td style="width: 10%;"></td> <td style="width: 10%;"></td> <td style="width: 10%;"></td> </tr> <tr> <td></td> <td></td> <td colspan="8" style="text-align: center;"> <table border="1" style="width: 100%; border-collapse: collapse; text-align: center;"> <tr> <td style="width: 10%;"></td> <td style="width: 10%;"></td> <td style="width: 10%;"></td> <td style="width: 10%;"></td> <td style="width: 10%;"></td> <td style="width: 10%;"></td> <td style="width: 10%;"></td> <td style="width: 10%;"></td> <td style="width: 10%;"></td> <td style="width: 10%;"></td> </tr> <tr> <td></td> <td></td> <td colspan="8" style="text-align: center;"> <table border="1" style="width: 100%; border-collapse: collapse; text-align: center;"> <tr> <td style="width: 10%;"></td> <td style="width: 10%;"></td> <td style="width: 10%;"></td> <td style="width: 10%;"></td> <td style="width: 10%;"></td> <td style="width: 10%;"></td> <td style="width: 10%;"></td> <td style="width: 10%;"></td> <td style="width: 10%;"></td> <td style="width: 10%;"></td> </tr> <tr> <td></td> <td></td> <td colspan="8" style="text-align: center;"> <table border="1" style="width: 100%; border-collapse: collapse; text-align: center;"> <tr> <td style="width: 10%;"></td> <td style="width: 10%;"></td> <td style="width: 10%;"></td> <td style="width: 10%;"></td> <td style="width: 10%;"></td> <td style="width: 10%;"></td> <td style="width: 10%;"></td> <td style="width: 10%;"></td> <td style="width: 10%;"></td> <td style="width: 10%;"></td> </tr> <tr> <td></td> <td></td> <td colspan="8" style="text-align: center;"> <table border="1" style="width: 100%; border-collapse: collapse; text-align: center;"> <tr> <td style="width: 10%;"></td> <td style="width: 10%;"></td> <td style="width: 10%;"></td> <td style="width: 10%;"></td> <td style="width: 10%;"></td> <td style="width: 10%;"></td> <td style="width: 10%;"></td> <td style="width: 10%;"></td> <td style="width: 10%;"></td> <td style="width: 10%;"></td> </tr> <tr> <td></td> <td></td> <td colspan="8" style="text-align: center;"> <table border="1" style="width: 100%; border-collapse: collapse; text-align: center;"> <tr> <td style="width: 10%;"></td> <td style="width: 10%;"></td> <td style="width: 10%;"></td> <td style="width: 10%;"></td> <td style="width: 10%;"></td> <td style="width: 10%;"></td> <td style="width: 10%;"></td> <td style="width: 10%;"></td> <td style="width: 10%;"></td> <td style="width: 10%;"></td> </tr> <tr> <td></td> <td></td> <td colspan="8" style="text-align: center;"> <table border="1" style="width: 100%; border-collapse: collapse; text-align: center;"> <tr> <td style="width: 10%;"></td> <td style="width: 10%;"></td> <td style="width: 10%;"></td> <td style="width: 10%;"></td> <td style="width: 10%;"></td> <td style="width: 10%;"></td> <td style="width: 10%;"></td> <td style="width: 10%;"></td> <td style="width: 10%;"></td> <td style="width: 10%;"></td> </tr> <tr> <td></td> <td></td> <td colspan="8" style="text-align: center;"> <table border="1" style="width: 100%; border-collapse: collapse; text-align: center;"> <tr> <td style="width: 10%;"></td> <td style="width: 10%;"></td> <td style="width: 10%;"></td> <td style="width: 10%;"></td> <td style="width: 10%;"></td> <td style="width: 10%;"></td> <td style="width: 10%;"></td> <td style="width: 10%;"></td> <td style="width: 10%;"></td> <td style="width: 10%;"></td> </tr> <tr> <td></td> <td></td> <td colspan="8" style="text-align: center;"> <table border="1" style="width: 100%; border-collapse: collapse; text-align: center;"> <tr> <td style="width: 10%;"></td> <td style="width: 10%;"></td> <td style="width: 10%;"></td> <td style="width: 10%;"></td> <td style="width: 10%;"></td> <td style="width: 10%;"></td> <td style="width: 10%;"></td> <td style="width: 10%;"></td> <td style="width: 10%;"></td> <td style="width: 10%;"></td> </tr> <tr> <td></td> <td></td> <td colspan="8" style="text-align: center;"> <table border="1" style="width: 100%; border-collapse: collapse; text-align: center;"> <tr> <td style="width: 10%;"></td> <td style="width: 10%;"></td> <td style="width: 10%;"></td> <td style="width: 10%;"></td> <td style="width: 10%;"></td> <td style="width: 10%;"></td> <td style="width: 10%;"></td> <td style="width: 10%;"></td> <td style="width: 10%;"></td> <td style="width: 10%;"></td> </tr> <tr> <td></td> <td></td> <td colspan="8" style="text-align: center;"> <table border="1" style="width: 100%; border-collapse: collapse; text-align: center;"> <tr> <td style="width: 10%;"></td> <td style="width: 10%;"></td> <td style="width: 10%;"></td> <td style="width: 10%;"></td> <td style="width: 10%;"></td> <td style="width: 10%;"></td> <td style="width: 10%;"></td> <td style="width: 10%;"></td> <td style="width: 10%;"></td> <td style="width: 10%;"></td> </tr> <tr> <td></td> <td></td> <td colspan="8" style="text-align: center;"> <table border="1" style="width: 100%; border-collapse: collapse; text-align: center;"> <tr> <td style="width: 10%;"></td> <td style="width: 10%;"></td> <td style="width: 10%;"></td> <td style="width: 10%;"></td> <td style="width: 10%;"></td> <td style="width: 10%;"></td> <td style="width: 10%;"></td> <td style="width: 10%;"></td> <td style="width: 10%;"></td> <td style="width: 10%;"></td> </tr> <tr> <td></td> <td></td> <td colspan="8" style="text-align: center;"> <table border="1" style="width: 100%; border-collapse: collapse; text-align: center;"> <tr> <td style="width: 10%;"></td> <td style="width: 10%;"></td> <td style="width: 10%;"></td> <td style="width: 10%;"></td> <td style="width: 10%;"></td> <td style="width: 10%;"></td> <td style="width: 10%;"></td> <td style="width: 10%;"></td> <td style="width: 10%;"></td> <td style="width:
10%;"></td> </tr> <tr> <td></td> <td></td> <td colspan="8" style="text-align: center;"> <table border="1" style="width: 100%; border-collapse: collapse; text-align: center;"> <tr> <td style="width: 10%;"></td> <td style="width: 10%;"></td> <td style="width: 10%;"></td> <td style="width: 10%;"></td> <td style="width: 10%;"></td> <td style="width: 10%;"></td> <td style="width: 10%;"></td> <td style="width: 10%;"></td> <td style="width: 10%;"></td> <td style="width: 10%;"></td> </tr> <tr> <td></td> <td></td> <td colspan="8" style="text-align: center;"> <table border="1" style="width: 100%; border-collapse: collapse; text-align: center;"> <tr> <td style="width: 10%;"></td> <td style="width: 10%;"></td> <td style="width: 10%;"></td> <td style="width: 10%;"></td> <td style="width: 10%;"></td> <td style="width: 10%;"></td> <td style="width: 10%;"></td> <td style="width: 10%;"></td> <td style="width: 10%;"></td> <td style="width: 10%;"></td> </tr> <tr> <td></td> <td></td> <td colspan="8" style="text-align: center;"> <table border="1" style="width: 100%; border-collapse: collapse; text-align: center;"> <tr> </tr></table></td></tr></table></td></tr></table></td></tr></table></td></tr></table></td></tr></table></td></tr></table></td></tr></table></td></tr></table></td></tr></table></td></tr></table></td></tr></table></td></tr></table></td></tr></table></td></tr></table></td></tr></table></td></tr></table></td></tr></table></td></tr></table></td></tr></table></td></tr></table></td></tr></table></td></tr></table></td></tr></table></td></tr></table></td></tr></table></td></tr></table></td></tr></table></td></tr></table></td></tr></table></td></tr></table></td></tr></table></td></tr></table></td></tr></table></td></tr></table></td></tr></table></td></tr></table></td></tr></table></td></tr></table></td></tr></table></td></tr></table></td></tr></table></td></tr></table></td></tr></table></td></tr></table></td></tr></table> | | | | | | | | | | | | | | | | | | | | <table border="1" style="width: 100%; border-collapse: collapse; text-align: center;"> <tr> <td style="width: 10%;"></td> <td style="width: 10%;"></td> <td style="width: 10%;"></td> <td style="width: 10%;"></td> <td style="width: 10%;"></td> <td style="width: 10%;"></td> <td style="width: 10%;"></td> <td style="width: 10%;"></td> <td style="width: 10%;"></td> <td style="width: 10%;"></td> </tr> <tr> <td></td> <td></td> <td colspan="8" style="text-align: center;"> <table border="1" style="width: 100%; border-collapse: collapse; text-align: center;"> <tr> <td style="width: 10%;"></td> <td style="width: 10%;"></td> <td style="width: 10%;"></td> <td style="width: 10%;"></td> <td style="width: 10%;"></td> <td style="width: 10%;"></td> <td style="width: 10%;"></td> <td style="width: 10%;"></td> <td style="width: 10%;"></td> <td style="width: 10%;"></td> </tr> <tr> <td></td> <td></td> <td colspan="8" style="text-align: center;"> <table border="1" style="width: 100%; border-collapse: collapse; text-align: center;"> <tr> <td style="width: 10%;"></td> <td style="width: 10%;"></td> <td style="width: 10%;"></td> <td style="width: 10%;"></td> <td style="width: 10%;"></td> <td style="width: 10%;"></td> <td style="width: 10%;"></td> <td style="width: 10%;"></td> <td style="width: 10%;"></td> <td style="width: 10%;"></td> </tr> <tr> <td></td> <td></td> <td colspan="8" style="text-align: center;"> <table border="1" style="width: 100%; border-collapse: collapse; text-align: center;"> <tr> <td style="width: 10%;"></td> <td style="width: 10%;"></td> <td style="width: 10%;"></td> <td style="width: 10%;"></td> <td style="width: 10%;"></td> <td style="width: 10%;"></td> <td style="width: 10%;"></td> <td style="width: 10%;"></td> <td style="width: 10%;"></td> <td style="width: 10%;"></td> </tr> <tr> <td></td> <td></td> <td colspan="8" style="text-align: center;"> <table border="1" style="width: 100%; border-collapse: collapse; text-align: center;"> <tr> <td style="width: 10%;"></td> <td style="width: 10%;"></td> <td style="width: 10%;"></td> <td style="width: 10%;"></td> <td style="width: 10%;"></td> <td style="width: 10%;"></td> <td style="width: 10%;"></td> <td style="width: 10%;"></td> <td style="width: 10%;"></td> <td style="width: 10%;"></td> </tr> <tr> <td></td> <td></td> <td colspan="8" style="text-align: center;"> <table border="1" style="width: 100%; border-collapse: collapse; text-align: center;"> <tr> <td style="width: 10%;"></td> <td style="width: 10%;"></td> <td style="width: 10%;"></td> <td style="width: 10%;"></td> <td style="width: 10%;"></td> <td style="width: 10%;"></td> <td style="width: 10%;"></td> <td style="width: 10%;"></td> <td style="width: 10%;"></td> <td style="width: 10%;"></td> </tr> <tr> <td></td> <td></td> <td colspan="8" style="text-align: center;"> <table border="1" style="width: 100%; border-collapse: collapse; text-align: center;"> <tr> <td style="width: 10%;"></td> <td style="width: 10%;"></td> <td style="width: 10%;"></td> <td style="width: 10%;"></td> <td style="width: 10%;"></td> <td style="width: 10%;"></td> <td style="width: 10%;"></td> <td style="width: 10%;"></td> <td style="width: 10%;"></td> <td style="width: 10%;"></td> </tr> <tr> <td></td> <td></td> <td colspan="8" style="text-align: center;"> <table border="1" style="width: 100%; border-collapse: collapse; text-align: center;"> <tr> <td style="width: 10%;"></td> <td style="width: 10%;"></td> <td style="width: 10%;"></td> <td style="width: 10%;"></td> <td style="width: 10%;"></td> <td style="width: 10%;"></td> <td style="width: 10%;"></td> <td style="width: 10%;"></td> <td style="width: 10%;"></td> <td style="width: 10%;"></td> </tr> <tr> <td></td> <td></td> <td colspan="8" style="text-align: center;"> <table border="1" style="width: 100%; border-collapse: collapse; text-align: center;"> <tr> <td style="width: 10%;"></td> <td style="width: 10%;"></td> <td style="width: 10%;"></td> <td style="width: 10%;"></td> <td style="width: 10%;"></td> <td style="width: 10%;"></td> <td style="width: 10%;"></td> <td style="width: 10%;"></td> <td style="width: 10%;"></td> <td style="width: 10%;"></td> </tr> <tr> <td></td> <td></td> <td colspan="8" style="text-align: center;"> <table border="1" style="width: 100%; border-collapse: collapse; text-align: center;"> <tr> <td style="width: 10%;"></td> <td style="width: 10%;"></td> <td style="width: 10%;"></td> <td style="width: 10%;"></td> <td style="width: 10%;"></td> <td style="width: 10%;"></td> <td style="width: 10%;"></td> <td style="width: 10%;"></td> <td style="width: 10%;"></td> <td style="width: 10%;"></td> </tr> <tr> <td></td> <td></td> <td colspan="8" style="text-align: center;"> <table border="1" style="width: 100%; border-collapse: collapse; text-align: center;"> <tr> <td style="width: 10%;"></td> <td style="width: 10%;"></td> <td style="width: 10%;"></td> <td style="width: 10%;"></td> <td style="width: 10%;"></td> <td style="width: 10%;"></td> <td style="width: 10%;"></td> <td style="width: 10%;"></td> <td style="width: 10%;"></td> <td style="width: 10%;"></td> </tr> <tr> <td></td> <td></td> <td colspan="8" style="text-align: center;"> <table border="1" style="width: 100%; border-collapse: collapse; text-align: center;"> <tr> <td style="width: 10%;"></td> <td style="width: 10%;"></td> <td style="width: 10%;"></td> <td style="width: 10%;"></td> <td style="width: 10%;"></td> <td style="width: 10%;"></td> <td style="width: 10%;"></td> <td style="width: 10%;"></td> <td style="width: 10%;"></td> <td style="width: 10%;"></td> </tr> <tr> <td></td> <td></td> <td colspan="8" style="text-align: center;"> <table border="1" style="width: 100%; border-collapse: collapse; text-align: center;"> <tr> <td style="width: 10%;"></td> <td style="width: 10%;"></td> <td style="width: 10%;"></td> <td style="width: 10%;"></td> <td style="width: 10%;"></td> <td style="width: 10%;"></td> <td style="width: 10%;"></td> <td style="width: 10%;"></td> <td style="width: 10%;"></td> <td style="width: 10%;"></td> </tr> <tr> <td></td> <td></td> <td colspan="8" style="text-align: center;"> <table border="1" style="width: 100%; border-collapse: collapse; text-align: center;"> <tr> <td style="width: 10%;"></td> <td style="width: 10%;"></td> <td style="width: 10%;"></td> <td style="width: 10%;"></td> <td style="width: 10%;"></td> <td style="width: 10%;"></td> <td style="width: 10%;"></td> <td style="width: 10%;"></td> <td style="width: 10%;"></td> <td style="width: 10%;"></td> </tr> <tr> <td></td> <td></td> <td colspan="8" style="text-align: center;"> <table border="1" style="width: 100%; border-collapse: collapse; text-align: center;"> <tr> <td style="width: 10%;"></td> <td style="width: 10%;"></td> <td style="width: 10%;"></td> <td style="width: 10%;"></td> <td style="width: 10%;"></td> <td style="width: 10%;"></td> <td style="width: 10%;"></td> <td style="width: 10%;"></td> <td style="width: 10%;"></td> <td style="width: 10%;"></td> </tr> <tr> <td></td> <td></td> <td colspan="8" style="text-align: center;"> <table border="1" style="width: 100%; border-collapse: collapse; text-align: center;"> <tr> <td style="width: 10%;"></td> <td style="width: 10%;"></td> <td style="width: 10%;"></td> <td style="width: 10%;"></td> <td style="width: 10%;"></td> <td style="width: 10%;"></td> <td style="width: 10%;"></td> <td style="width: 10%;"></td> <td style="width: 10%;"></td> <td style="width: 10%;"></td> </tr> <tr> <td></td> <td></td> <td colspan="8" style="text-align: center;"> <table border="1"
style="width: 100%; border-collapse: collapse; text-align: center;"> <tr> <td style="width: 10%;"></td> <td style="width: 10%;"></td> <td style="width: 10%;"></td> <td style="width: 10%;"></td> <td style="width: 10%;"></td> <td style="width: 10%;"></td> <td style="width: 10%;"></td> <td style="width: 10%;"></td> <td style="width: 10%;"></td> <td style="width: 10%;"></td> </tr> <tr> <td></td> <td></td> <td colspan="8" style="text-align: center;"> <table border="1" style="width: 100%; border-collapse: collapse; text-align: center;"> <tr> <td style="width: 10%;"></td> <td style="width: 10%;"></td> <td style="width: 10%;"></td> <td style="width: 10%;"></td> <td style="width: 10%;"></td> <td style="width: 10%;"></td> <td style="width: 10%;"></td> <td style="width: 10%;"></td> <td style="width: 10%;"></td> <td style="width: 10%;"></td> </tr> <tr> <td></td> <td></td> <td colspan="8" style="text-align: center;"> <table border="1" style="width: 100%; border-collapse: collapse; text-align: center;"> <tr> <td style="width: 10%;"></td> <td style="width: 10%;"></td> <td style="width: 10%;"></td> <td style="width: 10%;"></td> <td style="width: 10%;"></td> <td style="width: 10%;"></td> <td style="width: 10%;"></td> <td style="width: 10%;"></td> <td style="width: 10%;"></td> <td style="width: 10%;"></td> </tr> <tr> <td></td> <td></td> <td colspan="8" style="text-align: center;"> <table border="1" style="width: 100%; border-collapse: collapse; text-align: center;"> <tr> <td style="width: 10%;"></td> <td style="width: 10%;"></td> <td style="width: 10%;"></td> <td style="width: 10%;"></td> <td style="width: 10%;"></td> <td style="width: 10%;"></td> <td style="width: 10%;"></td> <td style="width: 10%;"></td> <td style="width: 10%;"></td> <td style="width: 10%;"></td> </tr> <tr> <td></td> <td></td> <td colspan="8" style="text-align: center;"> <table border="1" style="width: 100%; border-collapse: collapse; text-align: center;"> <tr> <td style="width: 10%;"></td> <td style="width: 10%;"></td> <td style="width: 10%;"></td> <td style="width: 10%;"></td> <td style="width: 10%;"></td> <td style="width: 10%;"></td> <td style="width: 10%;"></td> <td style="width: 10%;"></td> <td style="width: 10%;"></td> <td style="width: 10%;"></td> </tr> <tr> <td></td> <td></td> <td colspan="8" style="text-align: center;"> <table border="1" style="width: 100%; border-collapse: collapse; text-align: center;"> <tr> <td style="width: 10%;"></td> <td style="width: 10%;"></td> <td style="width: 10%;"></td> <td style="width: 10%;"></td> <td style="width: 10%;"></td> <td style="width: 10%;"></td> <td style="width: 10%;"></td> <td style="width: 10%;"></td> <td style="width: 10%;"></td> <td style="width: 10%;"></td> </tr> <tr> <td></td> <td></td> <td colspan="8" style="text-align: center;"> <table border="1" style="width: 100%; border-collapse: collapse; text-align: center;"> <tr> <td style="width: 10%;"></td> <td style="width: 10%;"></td> <td style="width: 10%;"></td> <td style="width: 10%;"></td> <td style="width: 10%;"></td> <td style="width: 10%;"></td> <td style="width: 10%;"></td> <td style="width: 10%;"></td> <td style="width: 10%;"></td> <td style="width: 10%;"></td> </tr> <tr> <td></td> <td></td> <td colspan="8" style="text-align: center;"> <table border="1" style="width: 100%; border-collapse: collapse; text-align: center;"> <tr> <td style="width: 10%;"></td> <td style="width: 10%;"></td> <td style="width: 10%;"></td> <td style="width: 10%;"></td> <td style="width: 10%;"></td> <td style="width: 10%;"></td> <td style="width: 10%;"></td> <td style="width: 10%;"></td> <td style="width: 10%;"></td> <td style="width: 10%;"></td> </tr> <tr> <td></td> <td></td> <td colspan="8" style="text-align: center;"> <table border="1" style="width: 100%; border-collapse: collapse; text-align: center;"> <tr> <td style="width: 10%;"></td> <td style="width: 10%;"></td> <td style="width: 10%;"></td> <td style="width: 10%;"></td> <td style="width: 10%;"></td> <td style="width: 10%;"></td> <td style="width: 10%;"></td> <td style="width: 10%;"></td> <td style="width: 10%;"></td> <td style="width: 10%;"></td> </tr> <tr> <td></td> <td></td> <td colspan="8" style="text-align: center;"> <table border="1" style="width: 100%; border-collapse: collapse; text-align: center;"> <tr> <td style="width: 10%;"></td> <td style="width: 10%;"></td> <td style="width: 10%;"></td> <td style="width: 10%;"></td> <td style="width: 10%;"></td> <td style="width: 10%;"></td> <td style="width: 10%;"></td> <td style="width: 10%;"></td> <td style="width: 10%;"></td> <td style="width: 10%;"></td> </tr> <tr> <td></td> <td></td> <td colspan="8" style="text-align: center;"> <table border="1" style="width: 100%; border-collapse: collapse; text-align: center;"> <tr> <td style="width: 10%;"></td> <td style="width: 10%;"></td> <td style="width: 10%;"></td> <td style="width: 10%;"></td> <td style="width: 10%;"></td> <td style="width: 10%;"></td> <td style="width: 10%;"></td> <td style="width: 10%;"></td> <td style="width: 10%;"></td> <td style="width: 10%;"></td> </tr> <tr> <td></td> <td></td> <td colspan="8" style="text-align: center;"> <table border="1" style="width: 100%; border-collapse: collapse; text-align: center;"> <tr> <td style="width: 10%;"></td> <td style="width: 10%;"></td> <td style="width: 10%;"></td> <td style="width: 10%;"></td> <td style="width: 10%;"></td> <td style="width: 10%;"></td> <td style="width: 10%;"></td> <td style="width: 10%;"></td> <td style="width: 10%;"></td> <td style="width: 10%;"></td> </tr> <tr> <td></td> <td></td> <td colspan="8" style="text-align: center;"> <table border="1" style="width: 100%; border-collapse: collapse; text-align: center;"> <tr> <td style="width: 10%;"></td> <td style="width: 10%;"></td> <td style="width: 10%;"></td> <td style="width: 10%;"></td> <td style="width: 10%;"></td> <td style="width: 10%;"></td> <td style="width: 10%;"></td> <td style="width: 10%;"></td> <td style="width: 10%;"></td> <td style="width: 10%;"></td> </tr> <tr> <td></td> <td></td> <td colspan="8" style="text-align: center;"> <table border="1" style="width: 100%; border-collapse: collapse; text-align: center;"> <tr> <td style="width: 10%;"></td> <td style="width: 10%;"></td> <td style="width: 10%;"></td> <td style="width: 10%;"></td> <td style="width: 10%;"></td> <td style="width: 10%;"></td> <td style="width: 10%;"></td> <td style="width: 10%;"></td> <td style="width: 10%;"></td> <td style="width: 10%;"></td> </tr> <tr> <td></td> <td></td> <td colspan="8" style="text-align: center;"> <table border="1" style="width: 100%; border-collapse: collapse; text-align: center;"> <tr> <td style="width: 10%;"></td> <td style="width: 10%;"></td> <td style="width: 10%;"></td> <td style="width: 10%;"></td> <td style="width: 10%;"></td> <td style="width: 10%;"></td> <td style="width: 10%;"></td> <td style="width: 10%;"></td> <td style="width: 10%;"></td> <td style="width: 10%;"></td> </tr> <tr> <td></td> <td></td> <td colspan="8" style="text-align: center;"> <table border="1" style="width: 100%; border-collapse: collapse; text-align: center;"> <tr> <td style="width: 10%;"></td> <td style="width: 10%;"></td> <td style="width: 10%;"></td> <td style="width: 10%;"></td> <td style="width: 10%;"></td> <td style="width: 10%;"></td> <td style="width: 10%;"></td> <td style="width: 10%;"></td> <td style="width: 10%;"></td> <td style="width: 10%;"></td> </tr> <tr> <td></td> <td></td> <td colspan="8" style="text-align: center;"> <table border="1" style="width: 100%; border-collapse: collapse; text-align: center;"> <tr> <td style="width: 10%;"></td> <td style="width: 10%;"></td> <td style="width: 10%;"></td> <td style="width: 10%;"></td> <td style="width: 10%;"></td> <td style="width: 10%;"></td> <td style="width: 10%;"></td> <td style="width: 10%;"></td> <td style="width: 10%;"></td> <td style="width: 10%;"></td> </tr> <tr> <td></td> <td></td> <td colspan="8" style="text-align: center;"> <table border="1" style="width: 100%; border-collapse: collapse; text-align: center;"> <tr> <td style="width: 10%;"></td> <td style="width: 10%;"></td> <td style="width: 10%;"></td> <td style="width: 10%;"></td> <td style="width: 10%;"></td> <td style="width: 10%;"></td> <td style="width: 10%;"></td> <td style="width: 10%;"></td> <td style="width: 10%;"></td> <td style="width: 10%;"></td> </tr> <tr> <td></td> <td></td> <td colspan="8" style="text-align: center;"> <table border="1" style="width: 100%; border-collapse: collapse; text-align: center;"> <tr> <td style="width: 10%;"></td> <td style="width: 10%;"></td> <td style="width: 10%;"></td> <td style="width: 10%;"></td> <td style="width: 10%;"></td> <td style="width: 10%;"></td> <td style="width: 10%;"></td> <td style="width: 10%;"></td> <td style="width: 10%;"></td> <td style="width: 10%;"></td> </tr> <tr> <td></td> <td></td> <td colspan="8" style="text-align: center;"> <table border="1" style="width: 100%; border-collapse: collapse; text-align: center;"> <tr> <td style="width: 10%;"></td> <td style="width: 10%;"></td> <td style="width: 10%;"></td> <td style="width: 10%;"></td> <td style="width: 10%;"></td> <td style="width: 10%;"></td> <td style="width: 10%;"></td> <td style="width: 10%;"></td> <td style="width: 10%;"></td> <td style="width: 10%;"></td> </tr> <tr> <td></td> <td></td> <td colspan="8" style="text-align: center;"> <table border="1" style="width: 100%; border-collapse: collapse; text-align: center;"> <tr> <td style="width: 10%;"></td> <td style="width: 10%;"></td> <td style="width: 10%;"></td> <td style="width: 10%;"></td> <td style="width: 10%;"></td> <td style="width: 10%;"></td> <td style="width: 10%;"></td> <td style="width: 10%;"></td> <td style="width: 10%;"></td> <td style="width: 10%;"></td> </tr> <tr> <td></td> <td></td> <td colspan="8" style="text-align: center;"> <table border="1" style="width: 100%; border-collapse: collapse; text-align: center;"> <tr> <td style="width: 10%;"></td> <td style="width: 10%;"></td> <td style="width: 10%;"></td> <td
style="width: 10%;"></td> <td style="width: 10%;"></td> <td style="width: 10%;"></td> <td style="width: 10%;"></td> <td style="width: 10%;"></td> <td style="width: 10%;"></td> <td style="width: 10%;"></td> </tr> <tr> <td></td> <td></td> <td colspan="8" style="text-align: center;"> <table border="1" style="width: 100%; border-collapse: collapse; text-align: center;"> <tr> <td style="width: 10%;"></td> <td style="width: 10%;"></td> <td style="width: 10%;"></td> <td style="width: 10%;"></td> <td style="width: 10%;"></td> <td style="width: 10%;"></td> <td style="width: 10%;"></td> <td style="width: 10%;"></td> <td style="width: 10%;"></td> <td style="width: 10%;"></td> </tr> <tr> <td></td> <td></td> <td colspan="8" style="text-align: center;"> <table border="1" style="width: 100%; border-collapse: collapse; text-align: center;"> <tr> <td style="width: 10%;"></td> <td style="width: 10%;"></td> <td style="width: 10%;"></td> <td style="width: 10%;"></td> <td style="width: 10%;"></td> <td style="width: 10%;"></td> <td style="width: 10%;"></td> <td style="width: 10%;"></td> <td style="width: 10%;"></td> <td style="width: 10%;"></td> </tr> <tr> <td></td> <td></td> <td colspan="8" style="text-align: center;"> <table border="1" style="width: 100%; border-collapse: collapse; text-align: center;"> <tr> <td style="width: 10%;"></td> <td style="width: 10%;"></td> <td style="width: 10%;"></td> <td style="width: 10%;"></td> <td style="width: 10%;"></td> <td style="width: 10%;"></td> <td style="width: 10%;"></td> <td style="width: 10%;"></td> <td style="width: 10%;"></td> <td style="width: 10%;"></td> </tr> <tr> <td></td> <td></td> <td colspan="8" style="text-align: center;"> <table border="1" style="width: 100%; border-collapse: collapse; text-align: center;"> <tr> <td style="width: 10%;"></td> <td style="width: 10%;"></td> <td style="width: 10%;"></td> <td style="width: 10%;"></td> <td style="width: 10%;"></td> <td style="width: 10%;"></td> <td style="width: 10%;"></td> <td style="width: 10%;"></td> <td style="width: 10%;"></td> <td style="width: 10%;"></td> </tr> <tr> <td></td> <td></td> <td colspan="8" style="text-align: center;"> <table border="1" style="width: 100%; border-collapse: collapse; text-align: center;"> <tr> <td style="width: 10%;"></td> <td style="width: 10%;"></td> <td style="width: 10%;"></td> <td style="width: 10%;"></td> <td style="width: 10%;"></td> <td style="width: 10%;"></td> <td style="width: 10%;"></td> <td style="width: 10%;"></td> <td style="width: 10%;"></td> <td style="width: 10%;"></td> </tr> <tr> <td></td> <td></td> <td colspan="8" style="text-align: center;"> <table border="1" style="width: 100%; border-collapse: collapse; text-align: center;"> <tr> <td style="width: 10%;"></td> <td style="width: 10%;"></td> <td style="width: 10%;"></td> <td style="width: 10%;"></td> <td style="width: 10%;"></td> <td style="width: 10%;"></td> <td style="width: 10%;"></td> <td style="width: 10%;"></td> <td style="width: 10%;"></td> <td style="width: 10%;"></td> </tr> <tr> <td></td> <td></td> <td colspan="8" style="text-align: center;"> <table border="1" style="width: 100%; border-collapse: collapse; text-align: center;"> <tr> </tr></table></td></tr></table></td></tr></table></td></tr></table></td></tr></table></td></tr></table></td></tr></table></td></tr></table></td></tr></table></td></tr></table></td></tr></table></td></tr></table></td></tr></table></td></tr></table></td></tr></table></td></tr></table></td></tr></table></td></tr></table></td></tr></table></td></tr></table></td></tr></table></td></tr></table></td></tr></table></td></tr></table></td></tr></table></td></tr></table></td></tr></table></td></tr></table></td></tr></table></td></tr></table></td></tr></table></td></tr></table></td></tr></table></td></tr></table></td></tr></table></td></tr></table></td></tr></table></td></tr></table></td></tr></table></td></tr></table></td></tr></table></td></tr></table></td></tr></table></td></tr></table></td></tr></table> | | | | | | | | | | | | | | | | | | | | <table border="1" style="width: 100%; border-collapse: collapse; text-align: center;"> <tr> <td style="width: 10%;"></td> <td style="width: 10%;"></td> <td style="width: 10%;"></td> <td style="width: 10%;"></td> <td style="width: 10%;"></td> <td style="width: 10%;"></td> <td style="width: 10%;"></td> <td style="width: 10%;"></td> <td style="width: 10%;"></td> <td style="width: 10%;"></td> </tr> <tr> <td></td> <td></td> <td colspan="8" style="text-align: center;"> <table border="1" style="width: 100%; border-collapse: collapse; text-align: center;"> <tr> <td style="width: 10%;"></td> <td style="width: 10%;"></td> <td style="width: 10%;"></td> <td style="width: 10%;"></td> <td style="width: 10%;"></td> <td style="width: 10%;"></td> <td style="width: 10%;"></td> <td style="width: 10%;"></td> <td style="width: 10%;"></td> <td style="width: 10%;"></td> </tr> <tr> <td></td> <td></td> <td colspan="8" style="text-align: center;"> <table border="1" style="width: 100%; border-collapse: collapse; text-align: center;"> <tr> <td style="width: 10%;"></td> <td style="width: 10%;"></td> <td style="width: 10%;"></td> <td style="width: 10%;"></td> <td style="width: 10%;"></td> <td style="width: 10%;"></td> <td style="width: 10%;"></td> <td style="width: 10%;"></td> <td style="width: 10%;"></td> <td style="width: 10%;"></td> </tr> <tr> <td></td> <td></td> <td colspan="8" style="text-align: center;"> <table border="1" style="width: 100%; border-collapse: collapse; text-align: center;"> <tr> <td style="width: 10%;"></td> <td style="width: 10%;"></td> <td style="width: 10%;"></td> <td style="width: 10%;"></td> <td style="width: 10%;"></td> <td style="width: 10%;"></td> <td style="width: 10%;"></td> <td style="width: 10%;"></td> <td style="width: 10%;"></td> <td style="width: 10%;"></td> </tr> <tr> <td></td> <td></td> <td colspan="8" style="text-align: center;"> <table border="1" style="width: 100%; border-collapse: collapse; text-align: center;"> <tr> <td style="width: 10%;"></td> <td style="width: 10%;"></td> <td style="width: 10%;"></td> <td style="width: 10%;"></td> <td style="width: 10%;"></td> <td style="width: 10%;"></td> <td style="width: 10%;"></td> <td style="width: 10%;"></td> <td style="width: 10%;"></td> <td style="width: 10%;"></td> </tr> <tr> <td></td> <td></td> <td colspan="8" style="text-align: center;"> <table border="1" style="width: 100%; border-collapse: collapse; text-align: center;"> <tr> <td style="width: 10%;"></td> <td style="width: 10%;"></td> <td style="width: 10%;"></td> <td style="width: 10%;"></td> <td style="width: 10%;"></td> <td style="width: 10%;"></td> <td style="width: 10%;"></td> <td style="width: 10%;"></td> <td style="width: 10%;"></td> <td style="width: 10%;"></td> </tr> <tr> <td></td> <td></td> <td colspan="8" style="text-align: center;"> <table border="1" style="width: 100%; border-collapse: collapse; text-align: center;"> <tr> <td style="width: 10%;"></td> <td style="width: 10%;"></td> <td style="width: 10%;"></td> <td style="width: 10%;"></td> <td style="width: 10%;"></td> <td style="width: 10%;"></td> <td style="width: 10%;"></td> <td style="width: 10%;"></td> <td style="width: 10%;"></td> <td style="width: 10%;"></td> </tr> <tr> <td></td> <td></td> <td colspan="8" style="text-align: center;"> <table border="1" style="width: 100%; border-collapse: collapse; text-align: center;"> <tr> <td style="width: 10%;"></td> <td style="width: 10%;"></td> <td style="width: 10%;"></td> <td style="width: 10%;"></td> <td style="width: 10%;"></td> <td style="width: 10%;"></td> <td style="width: 10%;"></td> <td style="width: 10%;"></td> <td style="width: 10%;"></td> <td style="width: 10%;"></td> </tr> <tr> <td></td> <td></td> <td colspan="8" style="text-align: center;"> <table border="1" style="width: 100%; border-collapse: collapse; text-align: center;"> <tr> <td style="width: 10%;"></td> <td style="width: 10%;"></td> <td style="width: 10%;"></td> <td style="width: 10%;"></td> <td style="width: 10%;"></td> <td style="width: 10%;"></td> <td style="width: 10%;"></td> <td style="width: 10%;"></td> <td style="width: 10%;"></td> <td style="width: 10%;"></td> </tr> <tr> <td></td> <td></td> <td colspan="8" style="text-align: center;"> <table border="1" style="width: 100%; border-collapse: collapse; text-align: center;"> <tr> <td style="width: 10%;"></td> <td style="width: 10%;"></td> <td style="width: 10%;"></td> <td style="width: 10%;"></td> <td style="width: 10%;"></td> <td style="width: 10%;"></td> <td style="width: 10%;"></td> <td style="width: 10%;"></td> <td style="width: 10%;"></td> <td style="width: 10%;"></td> </tr> <tr> <td></td> <td></td> <td colspan="8" style="text-align: center;"> <table border="1" style="width: 100%; border-collapse: collapse; text-align: center;"> <tr> <td style="width: 10%;"></td> <td style="width: 10%;"></td> <td style="width: 10%;"></td> <td style="width: 10%;"></td> <td style="width: 10%;"></td> <td style="width: 10%;"></td> <td style="width: 10%;"></td> <td style="width: 10%;"></td> <td style="width: 10%;"></td> <td style="width: 10%;"></td> </tr> <tr> <td></td> <td></td> <td colspan="8" style="text-align: center;"> <table border="1" style="width: 100%; border-collapse: collapse; text-align: center;"> <tr> <td style="width: 10%;"></td> <td style="width: 10%;"></td> <td style="width: 10%;"></td> <td style="width: 10%;"></td> <td style="width: 10%;"></td> <td style="width: 10%;"></td> <td style="width: 10%;"></td> <td
style="width: 10%;"></td> <td style="width: 10%;"></td> <td style="width: 10%;"></td> </tr> <tr> <td></td> <td></td> <td colspan="8" style="text-align: center;"> <table border="1" style="width: 100%; border-collapse: collapse; text-align: center;"> <tr> <td style="width: 10%;"></td> <td style="width: 10%;"></td> <td style="width: 10%;"></td> <td style="width: 10%;"></td> <td style="width: 10%;"></td> <td style="width: 10%;"></td> <td style="width: 10%;"></td> <td style="width: 10%;"></td> <td style="width: 10%;"></td> <td style="width: 10%;"></td> </tr> <tr> <td></td> <td></td> <td colspan="8" style="text-align: center;"> <table border="1" style="width: 100%; border-collapse: collapse; text-align: center;"> <tr> <td style="width: 10%;"></td> <td style="width: 10%;"></td> <td style="width: 10%;"></td> <td style="width: 10%;"></td> <td style="width: 10%;"></td> <td style="width: 10%;"></td> <td style="width: 10%;"></td> <td style="width: 10%;"></td> <td style="width: 10%;"></td> <td style="width: 10%;"></td> </tr> <tr> <td></td> <td></td> <td colspan="8" style="text-align: center;"> <table border="1" style="width: 100%; border-collapse: collapse; text-align: center;"> <tr> <td style="width: 10%;"></td> <td style="width: 10%;"></td> <td style="width: 10%;"></td> <td style="width: 10%;"></td> <td style="width: 10%;"></td> <td style="width: 10%;"></td> <td style="width: 10%;"></td> <td style="width: 10%;"></td> <td style="width: 10%;"></td> <td style="width: 10%;"></td> </tr> <tr> <td></td> <td></td> <td colspan="8" style="text-align: center;"> <table border="1" style="width: 100%; border-collapse: collapse; text-align: center;"> <tr> <td style="width: 10%;"></td> <td style="width: 10%;"></td> <td style="width: 10%;"></td> <td style="width: 10%;"></td> <td style="width: 10%;"></td> <td style="width: 10%;"></td> <td style="width: 10%;"></td> <td style="width: 10%;"></td> <td style="width: 10%;"></td> <td style="width: 10%;"></td> </tr> <tr> <td></td> <td></td> <td colspan="8" style="text-align: center;"> <table border="1" style="width: 100%; border-collapse: collapse; text-align: center;"> <tr> <td style="width: 10%;"></td> <td style="width: 10%;"></td> <td style="width: 10%;"></td> <td style="width: 10%;"></td> <td style="width: 10%;"></td> <td style="width: 10%;"></td> <td style="width: 10%;"></td> <td style="width: 10%;"></td> <td style="width: 10%;"></td> <td style="width: 10%;"></td> </tr> <tr> <td></td> <td></td> <td colspan="8" style="text-align: center;"> <table border="1" style="width: 100%; border-collapse: collapse; text-align: center;"> <tr> <td style="width: 10%;"></td> <td style="width: 10%;"></td> <td style="width: 10%;"></td> <td style="width: 10%;"></td> <td style="width: 10%;"></td> <td style="width: 10%;"></td> <td style="width: 10%;"></td> <td style="width: 10%;"></td> <td style="width: 10%;"></td> <td style="width: 10%;"></td> </tr> <tr> <td></td> <td></td> <td colspan="8" style="text-align: center;"> <table border="1" style="width: 100%; border-collapse: collapse; text-align: center;"> <tr> <td style="width: 10%;"></td> <td style="width: 10%;"></td> <td style="width: 10%;"></td> <td style="width: 10%;"></td> <td style="width: 10%;"></td> <td style="width: 10%;"></td> <td style="width: 10%;"></td> <td style="width: 10%;"></td> <td style="width: 10%;"></td> <td style="width: 10%;"></td> </tr> <tr> <td></td> <td></td> <td colspan="8" style="text-align: center;"> <table border="1" style="width: 100%; border-collapse: collapse; text-align: center;"> <tr> <td style="width: 10%;"></td> <td style="width: 10%;"></td> <td style="width: 10%;"></td> <td style="width: 10%;"></td> <td style="width: 10%;"></td> <td style="width: 10%;"></td> <td style="width: 10%;"></td> <td style="width: 10%;"></td> <td style="width: 10%;"></td> <td style="width: 10%;"></td> </tr> <tr> <td></td> <td></td> <td colspan="8" style="text-align: center;"> <table border="1" style="width: 100%; border-collapse: collapse; text-align: center;"> <tr> <td style="width: 10%;"></td> <td style="width: 10%;"></td> <td style="width: 10%;"></td> <td style="width: 10%;"></td> <td style="width: 10%;"></td> <td style="width: 10%;"></td> <td style="width: 10%;"></td> <td style="width: 10%;"></td> <td style="width: 10%;"></td> <td style="width: 10%;"></td> </tr> <tr> <td></td> <td></td> <td colspan="8" style="text-align: center;"> <table border="1" style="width: 100%; border-collapse: collapse; text-align: center;"> <tr> <td style="width: 10%;"></td> <td style="width: 10%;"></td> <td style="width: 10%;"></td> <td style="width: 10%;"></td> <td style="width: 10%;"></td> <td style="width: 10%;"></td> <td style="width: 10%;"></td> <td style="width: 10%;"></td> <td style="width: 10%;"></td> <td style="width: 10%;"></td> </tr> <tr> <td></td> <td></td> <td colspan="8" style="text-align: center;"> <table border="1" style="width: 100%; border-collapse: collapse; text-align: center;"> <tr> <td style="width: 10%;"></td> <td style="width: 10%;"></td> <td style="width: 10%;"></td> <td style="width: 10%;"></td> <td style="width: 10%;"></td> <td style="width: 10%;"></td> <td style="width: 10%;"></td> <td style="width: 10%;"></td> <td style="width: 10%;"></td> <td style="width: 10%;"></td> </tr> <tr> <td></td> <td></td> <td colspan="8" style="text-align: center;"> <table border="1" style="width: 100%; border-collapse: collapse; text-align: center;"> <tr> <td style="width: 10%;"></td> <td style="width: 10%;"></td> <td style="width: 10%;"></td> <td style="width: 10%;"></td> <td style="width: 10%;"></td> <td style="width: 10%;"></td> <td style="width: 10%;"></td> <td style="width: 10%;"></td> <td style="width: 10%;"></td> <td style="width: 10%;"></td> </tr> <tr> <td></td> <td></td> <td colspan="8" style="text-align: center;"> <table border="1" style="width: 100%; border-collapse: collapse; text-align: center;"> <tr> <td style="width: 10%;"></td> <td style="width: 10%;"></td> <td style="width: 10%;"></td> <td style="width: 10%;"></td> <td style="width: 10%;"></td> <td style="width: 10%;"></td> <td style="width: 10%;"></td> <td style="width: 10%;"></td> <td style="width: 10%;"></td> <td style="width: 10%;"></td> </tr> <tr> <td></td> <td></td> <td colspan="8" style="text-align: center;"> <table border="1" style="width: 100%; border-collapse: collapse; text-align: center;"> <tr> <td style="width: 10%;"></td> <td style="width: 10%;"></td> <td style="width: 10%;"></td> <td style="width: 10%;"></td> <td style="width: 10%;"></td> <td style="width: 10%;"></td> <td style="width: 10%;"></td> <td style="width: 10%;"></td> <td style="width: 10%;"></td> <td style="width: 10%;"></td> </tr> <tr> <td></td> <td></td> <td colspan="8" style="text-align: center;"> <table border="1" style="width: 100%; border-collapse: collapse; text-align: center;"> <tr> <td style="width: 10%;"></td> <td style="width: 10%;"></td> <td style="width: 10%;"></td> <td style="width: 10%;"></td> <td style="width: 10%;"></td> <td style="width: 10%;"></td> <td style="width: 10%;"></td> <td style="width: 10%;"></td> <td style="width: 10%;"></td> <td style="width: 10%;"></td> </tr> <tr> <td></td> <td></td> <td colspan="8" style="text-align: center;"> <table border="1" style="width: 100%; border-collapse: collapse; text-align: center;"> <tr> <td style="width: 10%;"></td> <td style="width: 10%;"></td> <td style="width: 10%;"></td> <td style="width: 10%;"></td> <td style="width: 10%;"></td> <td style="width: 10%;"></td> <td style="width: 10%;"></td> <td style="width: 10%;"></td> <td style="width: 10%;"></td> <td style="width: 10%;"></td> </tr> <tr> <td></td> <td></td> <td colspan="8" style="text-align: center;"> <table border="1" style="width: 100%; border-collapse: collapse; text-align: center;"> <tr> <td style="width: 10%;"></td> <td style="width: 10%;"></td> <td style="width: 10%;"></td> <td style="width: 10%;"></td> <td style="width: 10%;"></td> <td style="width: 10%;"></td> <td style="width: 10%;"></td> <td style="width: 10%;"></td> <td style="width: 10%;"></td> <td style="width: 10%;"></td> </tr> <tr> <td></td> <td></td> <td colspan="8" style="text-align: center;"> <table border="1" style="width: 100%; border-collapse: collapse; text-align: center;"> <tr> <td style="width: 10%;"></td> <td style="width: 10%;"></td> <td style="width: 10%;"></td> <td style="width: 10%;"></td> <td style="width: 10%;"></td> <td style="width: 10%;"></td> <td style="width: 10%;"></td> <td style="width: 10%;"></td> <td style="width: 10%;"></td> <td style="width: 10%;"></td> </tr> <tr> <td></td> <td></td> <td colspan="8" style="text-align: center;"> <table border="1" style="width: 100%; border-collapse: collapse; text-align: center;"> <tr> <td style="width: 10%;"></td> <td style="width: 10%;"></td> <td style="width: 10%;"></td> <td style="width: 10%;"></td> <td style="width: 10%;"></td> <td style="width: 10%;"></td> <td style="width: 10%;"></td> <td style="width: 10%;"></td> <td style="width: 10%;"></td> <td style="width: 10%;"></td> </tr> <tr> <td></td> <td></td> <td colspan="8" style="text-align: center;"> <table border="1" style="width: 100%; border-collapse: collapse; text-align: center;"> <tr> <td style="width: 10%;"></td> <td style="width: 10%;"></td> <td style="width: 10%;"></td> <td style="width: 10%;"></td> <td style="width: 10%;"></td> <td style="width: 10%;"></td> <td style="width: 10%;"></td> <td style="width: 10%;"></td> <td style="width: 10%;"></td> <td style="width: 10%;"></td> </tr> <tr> <td></td> <td></td> <td colspan="8" style="text-align: center;"> <table border="1" style="width: 100%; border-collapse: collapse; text-align: center;"> <tr> <td style="width: 10%;"></td> <td style="width: 10%;"></td> <td style="width: 10%;"></td> <td style="width: 10%;"></td> <td style="width: 10%;"></td> <td style="width: 10%;"></td> <td style="width: 10%;"></td> <td style="width: 10%;"></td> <td style="width: 10%;"></td> <td style="width: 10%;"></td> </tr> <tr> <td></td> <td></td> <td colspan="8" style="text-align: center;"> <table
border="1" style="width: 100%; border-collapse: collapse; text-align: center;"> <tr> <td style="width: 10%;"></td> <td style="width: 10%;"></td> <td style="width: 10%;"></td> <td style="width: 10%;"></td> <td style="width: 10%;"></td> <td style="width: 10%;"></td> <td style="width: 10%;"></td> <td style="width: 10%;"></td> <td style="width: 10%;"></td> <td style="width: 10%;"></td> </tr> <tr> <td></td> <td></td> <td colspan="8" style="text-align: center;"> <table border="1" style="width: 100%; border-collapse: collapse; text-align: center;"> <tr> <td style="width: 10%;"></td> <td style="width: 10%;"></td> <td style="width: 10%;"></td> <td style="width: 10%;"></td> <td style="width: 10%;"></td> <td style="width: 10%;"></td> <td style="width: 10%;"></td> <td style="width: 10%;"></td> <td style="width: 10%;"></td> <td style="width: 10%;"></td> </tr> <tr> <td></td> <td></td> <td colspan="8" style="text-align: center;"> <table border="1" style="width: 100%; border-collapse: collapse; text-align: center;"> <tr> <td style="width: 10%;"></td> <td style="width: 10%;"></td> <td style="width: 10%;"></td> <td style="width: 10%;"></td> <td style="width: 10%;"></td> <td style="width: 10%;"></td> <td style="width: 10%;"></td> <td style="width: 10%;"></td> <td style="width: 10%;"></td> <td style="width: 10%;"></td> </tr> <tr> <td></td> <td></td> <td colspan="8" style="text-align: center;"> <table border="1" style="width: 100%; border-collapse: collapse; text-align: center;"> <tr> <td style="width: 10%;"></td> <td style="width: 10%;"></td> <td style="width: 10%;"></td> <td style="width: 10%;"></td> <td style="width: 10%;"></td> <td style="width: 10%;"></td> <td style="width: 10%;"></td> <td style="width: 10%;"></td> <td style="width: 10%;"></td> <td style="width: 10%;"></td> </tr> <tr> <td></td> <td></td> <td colspan="8" style="text-align: center;"> <table border="1" style="width: 100%; border-collapse: collapse; text-align: center;"> <tr> <td style="width: 10%;"></td> <td style="width: 10%;"></td> <td style="width: 10%;"></td> <td style="width: 10%;"></td> <td style="width: 10%;"></td> <td style="width: 10%;"></td> <td style="width: 10%;"></td> <td style="width: 10%;"></td> <td style="width: 10%;"></td> <td style="width: 10%;"></td> </tr> <tr> <td></td> <td></td> <td colspan="8" style="text-align: center;"> <table border="1" style="width: 100%; border-collapse: collapse; text-align: center;"> <tr> <td style="width: 10%;"></td> <td style="width: 10%;"></td> <td style="width: 10%;"></td> <td style="width: 10%;"></td> <td style="width: 10%;"></td> <td style="width: 10%;"></td> <td style="width: 10%;"></td> <td style="width: 10%;"></td> <td style="width: 10%;"></td> <td style="width: 10%;"></td> </tr> <tr> <td></td> <td></td> <td colspan="8" style="text-align: center;"> <table border="1" style="width: 100%; border-collapse: collapse; text-align: center;"> <tr> <td style="width: 10%;"></td> <td style="width: 10%;"></td> <td style="width: 10%;"></td> <td style="width: 10%;"></td> <td style="width: 10%;"></td> <td style="width: 10%;"></td> <td style="width: 10%;"></td> <td style="width: 10%;"></td> <td style="width: 10%;"></td> <td style="width: 10%;"></td> </tr> <tr> <td></td> <td></td> <td colspan="8" style="text-align: center;"> <table border="1" style="width: 100%; border-collapse: collapse; text-align: center;"> <tr> <td style="width: 10%;"></td> <td style="width: 10%;"></td> <td style="width: 10%;"></td> <td style="width: 10%;"></td> <td style="width: 10%;"></td> <td style="width: 10%;"></td> <td style="width: 10%;"></td> <td style="width: 10%;"></td> <td style="width: 10%;"></td> <td style="width: 10%;"></td> </tr> <tr> <td></td> <td></td> <td colspan="8" style="text-align: center;"> <table border="1" style="width: 100%; border-collapse: collapse; text-align: center;"> <tr> <td style="width: 10%;"></td> <td style="width: 10%;"></td> <td style="width: 10%;"></td> <td style="width: 10%;"></td> <td style="width: 10%;"></td> <td style="width: 10%;"></td> <td style="width: 10%;"></td> <td style="width: 10%;"></td> <td style="width: 10%;"></td> <td style="width: 10%;"></td> </tr> <tr> <td></td> <td></td> <td colspan="8" style="text-align: center;"> <table border="1" style="width: 100%; border-collapse: collapse; text-align: center;"> <tr> <td style="width: 10%;"></td> <td style="width: 10%;"></td> <td style="width: 10%;"></td> <td style="width: 10%;"></td> <td style="width: 10%;"></td> <td style="width: 10%;"></td> <td style="width: 10%;"></td> <td style="width: 10%;"></td> <td style="width: 10%;"></td> <td style="width: 10%;"></td> </tr> <tr> <td></td> <td></td> <td colspan="8" style="text-align: center;"> <table border="1" style="width: 100%; border-collapse: collapse; text-align: center;"> <tr> </tr></table></td></tr></table></td></tr></table></td></tr></table></td></tr></table></td></tr></table></td></tr></table></td></tr></table></td></tr></table></td></tr></table></td></tr></table></td></tr></table></td></tr></table></td></tr></table></td></tr></table></td></tr></table></td></tr></table></td></tr></table></td></tr></table></td></tr></table></td></tr></table></td></tr></table></td></tr></table></td></tr></table></td></tr></table></td></tr></table></td></tr></table></td></tr></table></td></tr></table></td></tr></table></td></tr></table></td></tr></table></td></tr></table></td></tr></table></td></tr></table></td></tr></table></td></tr></table></td></tr></table></td></tr></table></td></tr></table></td></tr></table></td></tr></table></td></tr></table></td></tr></table> | | | | | | | | | | | | | | | | | | | | <table border="1" style="width: 100%; border-collapse: collapse; text-align: center;"> <tr> <td style="width: 10%;"></td> <td style="width: 10%;"></td> <td style="width: 10%;"></td> <td style="width: 10%;"></td> <td style="width: 10%;"></td> <td style="width: 10%;"></td> <td style="width: 10%;"></td> <td style="width: 10%;"></td> <td style="width: 10%;"></td> <td style="width: 10%;"></td> </tr> <tr> <td></td> <td></td> <td colspan="8" style="text-align: center;"> <table border="1" style="width: 100%; border-collapse: collapse; text-align: center;"> <tr> <td style="width: 10%;"></td> <td style="width: 10%;"></td> <td style="width: 10%;"></td> <td style="width: 10%;"></td> <td style="width: 10%;"></td> <td style="width: 10%;"></td> <td style="width: 10%;"></td> <td style="width: 10%;"></td> <td style="width: 10%;"></td> <td style="width: 10%;"></td> </tr> <tr> <td></td> <td></td> <td colspan="8" style="text-align: center;"> <table border="1" style="width: 100%; border-collapse: collapse; text-align: center;"> <tr> <td style="width: 10%;"></td> <td style="width: 10%;"></td> <td style="width: 10%;"></td> <td style="width: 10%;"></td> <td style="width: 10%;"></td> <td style="width: 10%;"></td> <td style="width: 10%;"></td> <td style="width: 10%;"></td> <td style="width: 10%;"></td> <td style="width: 10%;"></td> </tr> <tr> <td></td> <td></td> <td colspan="8" style="text-align: center;"> <table border="1" style="width: 100%; border-collapse: collapse; text-align: center;"> <tr> <td style="width: 10%;"></td> <td style="width: 10%;"></td> <td style="width: 10%;"></td> <td style="width: 10%;"></td> <td style="width: 10%;"></td> <td style="width: 10%;"></td> <td style="width: 10%;"></td> <td style="width: 10%;"></td> <td style="width: 10%;"></td> <td style="width: 10%;"></td> </tr> <tr> <td></td> <td></td> <td colspan="8" style="text-align: center;"> <table border="1" style="width: 100%; border-collapse: collapse; text-align: center;"> <tr> <td style="width: 10%;"></td> <td style="width: 10%;"></td> <td style="width: 10%;"></td> <td style="width: 10%;"></td> <td style="width: 10%;"></td> <td style="width: 10%;"></td> <td style="width: 10%;"></td> <td style="width: 10%;"></td> <td style="width: 10%;"></td> <td style="width: 10%;"></td> </tr> <tr> <td></td> <td></td> <td colspan="8" style="text-align: center;"> <table border="1" style="width: 100%; border-collapse: collapse; text-align: center;"> <tr> <td style="width: 10%;"></td> <td style="width: 10%;"></td> <td style="width: 10%;"></td> <td style="width: 10%;"></td> <td style="width: 10%;"></td> <td style="width: 10%;"></td> <td style="width: 10%;"></td> <td style="width: 10%;"></td> <td style="width: 10%;"></td> <td style="width: 10%;"></td> </tr> <tr> <td></td> <td></td> <td colspan="8" style="text-align: center;"> <table border="1" style="width: 100%; border-collapse: collapse; text-align: center;"> <tr> <td style="width: 10%;"></td> <td style="width: 10%;"></td> <td style="width: 10%;"></td> <td style="width: 10%;"></td> <td style="width: 10%;"></td> <td style="width: 10%;"></td> <td style="width: 10%;"></td> <td style="width: 10%;"></td> <td style="width: 10%;"></td> <td style="width: 10%;"></td> </tr> <tr> <td></td> <td></td> <td colspan="8" style="text-align: center;"> <table border="1" style="width: 100%; border-collapse: collapse; text-align: center;"> <tr> <td style="width: 10%;"></td> <td style="width: 10%;"></td> <td style="width: 10%;"></td> <td style="width: 10%;"></td> <td style="width: 10%;"></td> <td style="width: 10%;"></td> <td style="width: 10%;"></td> <td style="width: 10%;"></td> <td style="width: 10%;"></td> <td style="width: 10%;"></td> </tr> <tr> <td></td> <td></td> <td colspan="8" style="text-align: center;"> <table border="1" style="width: 100%; border-collapse: collapse; text-align: center;"> <tr> <td style="width: 10%;"></td> <td style="width: 10%;"></td> <td
style="width: 10%;"></td> <td style="width: 10%;"></td> <td style="width: 10%;"></td> <td style="width: 10%;"></td> <td style="width: 10%;"></td> <td style="width: 10%;"></td> <td style="width: 10%;"></td> <td style="width: 10%;"></td> </tr> <tr> <td></td> <td></td> <td colspan="8" style="text-align: center;"> <table border="1" style="width: 100%; border-collapse: collapse; text-align: center;"> <tr> <td style="width: 10%;"></td> <td style="width: 10%;"></td> <td style="width: 10%;"></td> <td style="width: 10%;"></td> <td style="width: 10%;"></td> <td style="width: 10%;"></td> <td style="width: 10%;"></td> <td style="width: 10%;"></td> <td style="width: 10%;"></td> <td style="width: 10%;"></td> </tr> <tr> <td></td> <td></td> <td colspan="8" style="text-align: center;"> <table border="1" style="width: 100%; border-collapse: collapse; text-align: center;"> <tr> <td style="width: 10%;"></td> <td style="width: 10%;"></td> <td style="width: 10%;"></td> <td style="width: 10%;"></td> <td style="width: 10%;"></td> <td style="width: 10%;"></td> <td style="width: 10%;"></td> <td style="width: 10%;"></td> <td style="width: 10%;"></td> <td style="width: 10%;"></td> </tr> <tr> <td></td> <td></td> <td colspan="8" style="text-align: center;"> <table border="1" style="width: 100%; border-collapse: collapse; text-align: center;"> <tr> <td style="width: 10%;"></td> <td style="width: 10%;"></td> <td style="width: 10%;"></td> <td style="width: 10%;"></td> <td style="width: 10%;"></td> <td style="width: 10%;"></td> <td style="width: 10%;"></td> <td style="width: 10%;"></td> <td style="width: 10%;"></td> <td style="width: 10%;"></td> </tr> <tr> <td></td> <td></td> <td colspan="8" style="text-align: center;"> <table border="1" style="width: 100%; border-collapse: collapse; text-align: center;"> <tr> <td style="width: 10%;"></td> <td style="width: 10%;"></td> <td style="width: 10%;"></td> <td style="width: 10%;"></td> <td style="width: 10%;"></td> <td style="width: 10%;"></td> <td style="width: 10%;"></td> <td style="width: 10%;"></td> <td style="width: 10%;"></td> <td style="width: 10%;"></td> </tr> <tr> <td></td> <td></td> <td colspan="8" style="text-align: center;"> <table border="1" style="width: 100%; border-collapse: collapse; text-align: center;"> <tr> <td style="width: 10%;"></td> <td style="width: 10%;"></td> <td style="width: 10%;"></td> <td style="width: 10%;"></td> <td style="width: 10%;"></td> <td style="width: 10%;"></td> <td style="width: 10%;"></td> <td style="width: 10%;"></td> <td style="width: 10%;"></td> <td style="width: 10%;"></td> </tr> <tr> <td></td> <td></td> <td colspan="8" style="text-align: center;"> <table border="1" style="width: 100%; border-collapse: collapse; text-align: center;"> <tr> <td style="width: 10%;"></td> <td style="width: 10%;"></td> <td style="width: 10%;"></td> <td style="width: 10%;"></td> <td style="width: 10%;"></td> <td style="width: 10%;"></td> <td style="width: 10%;"></td> <td style="width: 10%;"></td> <td style="width: 10%;"></td> <td style="width: 10%;"></td> </tr> <tr> <td></td> <td></td> <td colspan="8" style="text-align: center;"> <table border="1" style="width: 100%; border-collapse: collapse; text-align: center;"> <tr> <td style="width: 10%;"></td> <td style="width: 10%;"></td> <td style="width: 10%;"></td> <td style="width: 10%;"></td> <td style="width: 10%;"></td> <td style="width: 10%;"></td> <td style="width: 10%;"></td> <td style="width: 10%;"></td> <td style="width: 10%;"></td> <td style="width: 10%;"></td> </tr> <tr> <td></td> <td></td> <td colspan="8" style="text-align: center;"> <table border="1" style="width: 100%; border-collapse: collapse; text-align: center;"> <tr> <td style="width: 10%;"></td> <td style="width: 10%;"></td> <td style="width: 10%;"></td> <td style="width: 10%;"></td> <td style="width: 10%;"></td> <td style="width: 10%;"></td> <td style="width: 10%;"></td> <td style="width: 10%;"></td> <td style="width: 10%;"></td> <td style="width: 10%;"></td> </tr> <tr> <td></td> <td></td> <td colspan="8" style="text-align: center;"> <table border="1" style="width: 100%; border-collapse: collapse; text-align: center;"> <tr> <td style="width: 10%;"></td> <td style="width: 10%;"></td> <td style="width: 10%;"></td> <td style="width: 10%;"></td> <td style="width: 10%;"></td> <td style="width: 10%;"></td> <td style="width: 10%;"></td> <td style="width: 10%;"></td> <td style="width: 10%;"></td> <td style="width: 10%;"></td> </tr> <tr> <td></td> <td></td> <td colspan="8" style="text-align: center;"> <table border="1" style="width: 100%; border-collapse: collapse; text-align: center;"> <tr> <td style="width: 10%;"></td> <td style="width: 10%;"></td> <td style="width: 10%;"></td> <td style="width: 10%;"></td> <td style="width: 10%;"></td> <td style="width: 10%;"></td> <td style="width: 10%;"></td> <td style="width: 10%;"></td> <td style="width: 10%;"></td> <td style="width: 10%;"></td> </tr> <tr> <td></td> <td></td> <td colspan="8" style="text-align: center;"> <table border="1" style="width: 100%; border-collapse: collapse; text-align: center;"> <tr> <td style="width: 10%;"></td> <td style="width: 10%;"></td> <td style="width: 10%;"></td> <td style="width: 10%;"></td> <td style="width: 10%;"></td> <td style="width: 10%;"></td> <td style="width: 10%;"></td> <td style="width: 10%;"></td> <td style="width: 10%;"></td> <td style="width: 10%;"></td> </tr> <tr> <td></td> <td></td> <td colspan="8" style="text-align: center;"> <table border="1" style="width: 100%; border-collapse: collapse; text-align: center;"> <tr> <td style="width: 10%;"></td> <td style="width: 10%;"></td> <td style="width: 10%;"></td> <td style="width: 10%;"></td> <td style="width: 10%;"></td> <td style="width: 10%;"></td> <td style="width: 10%;"></td> <td style="width: 10%;"></td> <td style="width: 10%;"></td> <td style="width: 10%;"></td> </tr> <tr> <td></td> <td></td> <td colspan="8" style="text-align: center;"> <table border="1" style="width: 100%; border-collapse: collapse; text-align: center;"> <tr> <td style="width: 10%;"></td> <td style="width: 10%;"></td> <td style="width: 10%;"></td> <td style="width: 10%;"></td> <td style="width: 10%;"></td> <td style="width: 10%;"></td> <td style="width: 10%;"></td> <td style="width: 10%;"></td> <td style="width: 10%;"></td> <td style="width: 10%;"></td> </tr> <tr> <td></td> <td></td> <td colspan="8" style="text-align: center;"> <table border="1" style="width: 100%; border-collapse: collapse; text-align: center;"> <tr> <td style="width: 10%;"></td> <td style="width: 10%;"></td> <td style="width: 10%;"></td> <td style="width: 10%;"></td> <td style="width: 10%;"></td> <td style="width: 10%;"></td> <td style="width: 10%;"></td> <td style="width: 10%;"></td> <td style="width: 10%;"></td> <td style="width: 10%;"></td> </tr> <tr> <td></td> <td></td> <td colspan="8" style="text-align: center;"> <table border="1" style="width: 100%; border-collapse: collapse; text-align: center;"> <tr> <td style="width: 10%;"></td> <td style="width: 10%;"></td> <td style="width: 10%;"></td> <td style="width: 10%;"></td> <td style="width: 10%;"></td> <td style="width: 10%;"></td> <td style="width: 10%;"></td> <td style="width: 10%;"></td> <td style="width: 10%;"></td> <td style="width: 10%;"></td> </tr> <tr> <td></td> <td></td> <td colspan="8" style="text-align: center;"> <table border="1" style="width: 100%; border-collapse: collapse; text-align: center;"> <tr> <td style="width: 10%;"></td> <td style="width: 10%;"></td> <td style="width: 10%;"></td> <td style="width: 10%;"></td> <td style="width: 10%;"></td> <td style="width: 10%;"></td> <td style="width: 10%;"></td> <td style="width: 10%;"></td> <td style="width: 10%;"></td> <td style="width: 10%;"></td> </tr> <tr> <td></td> <td></td> <td colspan="8" style="text-align: center;"> <table border="1" style="width: 100%; border-collapse: collapse; text-align: center;"> <tr> <td style="width: 10%;"></td> <td style="width: 10%;"></td> <td style="width: 10%;"></td> <td style="width: 10%;"></td> <td style="width: 10%;"></td> <td style="width: 10%;"></td> <td style="width: 10%;"></td> <td style="width: 10%;"></td> <td style="width: 10%;"></td> <td style="width: 10%;"></td> </tr> <tr> <td></td> <td></td> <td colspan="8" style="text-align: center;"> <table border="1" style="width: 100%; border-collapse: collapse; text-align: center;"> <tr> <td style="width: 10%;"></td> <td style="width: 10%;"></td> <td style="width: 10%;"></td> <td style="width: 10%;"></td> <td style="width: 10%;"></td> <td style="width: 10%;"></td> <td style="width: 10%;"></td> <td style="width: 10%;"></td> <td style="width: 10%;"></td> <td style="width: 10%;"></td> </tr> <tr> <td></td> <td></td> <td colspan="8" style="text-align: center;"> <table border="1" style="width: 100%; border-collapse: collapse; text-align: center;"> <tr> <td style="width: 10%;"></td> <td style="width: 10%;"></td> <td style="width: 10%;"></td> <td style="width: 10%;"></td> <td style="width: 10%;"></td> <td style="width: 10%;"></td> <td style="width: 10%;"></td> <td style="width: 10%;"></td> <td style="width: 10%;"></td> <td style="width: 10%;"></td> </tr> <tr> <td></td> <td></td> <td colspan="8" style="text-align: center;"> <table border="1" style="width: 100%; border-collapse: collapse; text-align: center;"> <tr> <td style="width: 10%;"></td> <td style="width: 10%;"></td> <td style="width: 10%;"></td> <td style="width: 10%;"></td> <td style="width: 10%;"></td> <td style="width: 10%;"></td> <td style="width: 10%;"></td> <td style="width: 10%;"></td> <td style="width: 10%;"></td> <td style="width: 10%;"></td> </tr> <tr> <td></td> <td></td> <td colspan="8" style="text-align: center;"> <table border="1" style="width: 100%; border-collapse: collapse; text-align: center;"> <tr> <td style="width: 10%;"></td> <td style="width: 10%;"></td> <td style="width: 10%;"></td> <td style="width: 10%;"></td> <td style="width: 10%;"></td> <td style="width: 10%;"></td> <td style="width: 10%;"></td> <td style="width:
10%;"></td> <td style="width: 10%;"></td> <td style="width: 10%;"></td> </tr> <tr> <td></td> <td></td> <td colspan="8" style="text-align: center;"> <table border="1" style="width: 100%; border-collapse: collapse; text-align: center;"> <tr> <td style="width: 10%;"></td> <td style="width: 10%;"></td> <td style="width: 10%;"></td> <td style="width: 10%;"></td> <td style="width: 10%;"></td> <td style="width: 10%;"></td> <td style="width: 10%;"></td> <td style="width: 10%;"></td> <td style="width: 10%;"></td> <td style="width: 10%;"></td> </tr> <tr> <td></td> <td></td> <td colspan="8" style="text-align: center;"> <table border="1" style="width: 100%; border-collapse: collapse; text-align: center;"> <tr> <td style="width: 10%;"></td> <td style="width: 10%;"></td> <td style="width: 10%;"></td> <td style="width: 10%;"></td> <td style="width: 10%;"></td> <td style="width: 10%;"></td> <td style="width: 10%;"></td> <td style="width: 10%;"></td> <td style="width: 10%;"></td> <td style="width: 10%;"></td> </tr> <tr> <td></td> <td></td> <td colspan="8" style="text-align: center;"> <table border="1" style="width: 100%; border-collapse: collapse; text-align: center;"> <tr> <td style="width: 10%;"></td> <td style="width: 10%;"></td> <td style="width: 10%;"></td> <td style="width: 10%;"></td> <td style="width: 10%;"></td> <td style="width: 10%;"></td> <td style="width: 10%;"></td> <td style="width: 10%;"></td> <td style="width: 10%;"></td> <td style="width: 10%;"></td> </tr> <tr> <td></td> <td></td> <td colspan="8" style="text-align: center;"> <table border="1" style="width: 100%; border-collapse: collapse; text-align: center;"> <tr> <td style="width: 10%;"></td> <td style="width: 10%;"></td> <td style="width: 10%;"></td> <td style="width: 10%;"></td> <td style="width: 10%;"></td> <td style="width: 10%;"></td> <td style="width: 10%;"></td> <td style="width: 10%;"></td> <td style="width: 10%;"></td> <td style="width: 10%;"></td> </tr> <tr> <td></td> <td></td> <td colspan="8" style="text-align: center;"> <table border="1" style="width: 100%; border-collapse: collapse; text-align: center;"> <tr> <td style="width: 10%;"></td> <td style="width: 10%;"></td> <td style="width: 10%;"></td> <td style="width: 10%;"></td> <td style="width: 10%;"></td> <td style="width: 10%;"></td> <td style="width: 10%;"></td> <td style="width: 10%;"></td> <td style="width: 10%;"></td> <td style="width: 10%;"></td> </tr> <tr> <td></td> <td></td> <td colspan="8" style="text-align: center;"> <table border="1" style="width: 100%; border-collapse: collapse; text-align: center;"> <tr> <td style="width: 10%;"></td> <td style="width: 10%;"></td> <td style="width: 10%;"></td> <td style="width: 10%;"></td> <td style="width: 10%;"></td> <td style="width: 10%;"></td> <td style="width: 10%;"></td> <td style="width: 10%;"></td> <td style="width: 10%;"></td> <td style="width: 10%;"></td> </tr> <tr> <td></td> <td></td> <td colspan="8" style="text-align: center;"> <table border="1" style="width: 100%; border-collapse: collapse; text-align: center;"> <tr> <td style="width: 10%;"></td> <td style="width: 10%;"></td> <td style="width: 10%;"></td> <td style="width: 10%;"></td> <td style="width: 10%;"></td> <td style="width: 10%;"></td> <td style="width: 10%;"></td> <td style="width: 10%;"></td> <td style="width: 10%;"></td> <td style="width: 10%;"></td> </tr> <tr> <td></td> <td></td> <td colspan="8" style="text-align: center;"> <table border="1" style="width: 100%; border-collapse: collapse; text-align: center;"> <tr> <td style="width: 10%;"></td> <td style="width: 10%;"></td> <td style="width: 10%;"></td> <td style="width: 10%;"></td> <td style="width: 10%;"></td> <td style="width: 10%;"></td> <td style="width: 10%;"></td> <td style="width: 10%;"></td> <td style="width: 10%;"></td> <td style="width: 10%;"></td> </tr> <tr> <td></td> <td></td> <td colspan="8" style="text-align: center;"> <table border="1" style="width: 100%; border-collapse: collapse; text-align: center;"> <tr> <td style="width: 10%;"></td> <td style="width: 10%;"></td> <td style="width: 10%;"></td> <td style="width: 10%;"></td> <td style="width: 10%;"></td> <td style="width: 10%;"></td> <td style="width: 10%;"></td> <td style="width: 10%;"></td> <td style="width: 10%;"></td> <td style="width: 10%;"></td> </tr> <tr> <td></td> <td></td> <td colspan="8" style="text-align: center;"> <table border="1" style="width: 100%; border-collapse: collapse; text-align: center;"> <tr> <td style="width: 10%;"></td> <td style="width: 10%;"></td> <td style="width: 10%;"></td> <td style="width: 10%;"></td> <td style="width: 10%;"></td> <td style="width: 10%;"></td> <td style="width: 10%;"></td> <td style="width: 10%;"></td> <td style="width: 10%;"></td> <td style="width: 10%;"></td> </tr> <tr> <td></td> <td></td> <td colspan="8" style="text-align: center;"> <table border="1" style="width: 100%; border-collapse: collapse; text-align: center;"> <tr> <td style="width: 10%;"></td> <td style="width: 10%;"></td> <td style="width: 10%;"></td> <td style="width: 10%;"></td> <td style="width: 10%;"></td> <td style="width: 10%;"></td> <td style="width: 10%;"></td> <td style="width: 10%;"></td> <td style="width: 10%;"></td> <td style="width: 10%;"></td> </tr> <tr> <td></td> <td></td> <td colspan="8" style="text-align: center;"> <table border="1" style="width: 100%; border-collapse: collapse; text-align: center;"> <tr> <td style="width: 10%;"></td> <td style="width: 10%;"></td> <td style="width: 10%;"></td> <td style="width: 10%;"></td> <td style="width: 10%;"></td> <td style="width: 10%;"></td> <td style="width: 10%;"></td> <td style="width: 10%;"></td> <td style="width: 10%;"></td> <td style="width: 10%;"></td> </tr> <tr> <td></td> <td></td> <td colspan="8" style="text-align: center;"> <table border="1" style="width: 100%; border-collapse: collapse; text-align: center;"> <tr> </tr></table></td></tr></table></td></tr></table></td></tr></table></td></tr></table></td></tr></table></td></tr></table></td></tr></table></td></tr></table></td></tr></table></td></tr></table></td></tr></table></td></tr></table></td></tr></table></td></tr></table></td></tr></table></td></tr></table></td></tr></table></td></tr></table></td></tr></table></td></tr></table></td></tr></table></td></tr></table></td></tr></table></td></tr></table></td></tr></table></td></tr></table></td></tr></table></td></tr></table></td></tr></table></td></tr></table></td></tr></table></td></tr></table></td></tr></table></td></tr></table></td></tr></table></td></tr></table></td></tr></table></td></tr></table></td></tr></table></td></tr></table></td></tr></table></td></tr></table> | | | | | | | | | | | | | | | | | | | | <table border="1" style="width: 100%; border-collapse: collapse; text-align: center;"> <tr> <td style="width: 10%;"></td> <td style="width: 10%;"></td> <td style="width: 10%;"></td> <td style="width: 10%;"></td> <td style="width: 10%;"></td> <td style="width: 10%;"></td> <td style="width: 10%;"></td> <td style="width: 10%;"></td> <td style="width: 10%;"></td> <td style="width: 10%;"></td> </tr> <tr> <td></td> <td></td> <td colspan="8" style="text-align: center;"> <table border="1" style="width: 100%; border-collapse: collapse; text-align: center;"> <tr> <td style="width: 10%;"></td> <td style="width: 10%;"></td> <td style="width: 10%;"></td> <td style="width: 10%;"></td> <td style="width: 10%;"></td> <td style="width: 10%;"></td> <td style="width: 10%;"></td> <td style="width: 10%;"></td> <td style="width: 10%;"></td> <td style="width: 10%;"></td> </tr> <tr> <td></td> <td></td> <td colspan="8" style="text-align: center;"> <table border="1" style="width: 100%; border-collapse: collapse; text-align: center;"> <tr> <td style="width: 10%;"></td> <td style="width: 10%;"></td> <td style="width: 10%;"></td> <td style="width: 10%;"></td> <td style="width: 10%;"></td> <td style="width: 10%;"></td> <td style="width: 10%;"></td> <td style="width: 10%;"></td> <td style="width: 10%;"></td> <td style="width: 10%;"></td> </tr> <tr> <td></td> <td></td> <td colspan="8" style="text-align: center;"> <table border="1" style="width: 100%; border-collapse: collapse; text-align: center;"> <tr> <td style="width: 10%;"></td> <td style="width: 10%;"></td> <td style="width: 10%;"></td> <td style="width: 10%;"></td> <td style="width: 10%;"></td> <td style="width: 10%;"></td> <td style="width: 10%;"></td> <td style="width: 10%;"></td> <td style="width: 10%;"></td> <td style="width: 10%;"></td> </tr> <tr> <td></td> <td></td> <td colspan="8" style="text-align: center;"> <table border="1" style="width: 100%; border-collapse: collapse; text-align: center;"> <tr> <td style="width: 10%;"></td> <td style="width: 10%;"></td> <td style="width: 10%;"></td> <td style="width: 10%;"></td> <td style="width: 10%;"></td> <td style="width: 10%;"></td> <td style="width: 10%;"></td> <td style="width: 10%;"></td> <td style="width: 10%;"></td> <td style="width: 10%;"></td> </tr> <tr> <td></td> <td></td> <td colspan="8" style="text-align: center;"> <table border="1" style="width: 100%; border-collapse: collapse; text-align: center;"> <tr> <td style="width: 10%;"></td> <td style="width: 10%;"></td> <td style="width: 10%;"></td> <td style="width: 10%;"></td> <td style="width: 10%;"></td> <td style="width: 10%;"></td> <td style="width: 10%;"></td> <td style="width: 10%;"></td> <td style="width: 10%;"></td> <td style="width: 10%;"></td> </tr> <tr> <td></td> <td></td> <td colspan="8" style="text-align: center;"> <table border="1"
style="width: 100%; border-collapse: collapse; text-align: center;"> <tr> <td style="width: 10%;"></td> <td style="width: 10%;"></td> <td style="width: 10%;"></td> <td style="width: 10%;"></td> <td style="width: 10%;"></td> <td style="width: 10%;"></td> <td style="width: 10%;"></td> <td style="width: 10%;"></td> <td style="width: 10%;"></td> <td style="width: 10%;"></td> </tr> <tr> <td></td> <td></td> <td colspan="8" style="text-align: center;"> <table border="1" style="width: 100%; border-collapse: collapse; text-align: center;"> <tr> <td style="width: 10%;"></td> <td style="width: 10%;"></td> <td style="width: 10%;"></td> <td style="width: 10%;"></td> <td style="width: 10%;"></td> <td style="width: 10%;"></td> <td style="width: 10%;"></td> <td style="width: 10%;"></td> <td style="width: 10%;"></td> <td style="width: 10%;"></td> </tr> <tr> <td></td> <td></td> <td colspan="8" style="text-align: center;"> <table border="1" style="width: 100%; border-collapse: collapse; text-align: center;"> <tr> <td style="width: 10%;"></td> <td style="width: 10%;"></td> <td style="width: 10%;"></td> <td style="width: 10%;"></td> <td style="width: 10%;"></td> <td style="width: 10%;"></td> <td style="width: 10%;"></td> <td style="width: 10%;"></td> <td style="width: 10%;"></td> <td style="width: 10%;"></td> </tr> <tr> <td></td> <td></td> <td colspan="8" style="text-align: center;"> <table border="1" style="width: 100%; border-collapse: collapse; text-align: center;"> <tr> <td style="width: 10%;"></td> <td style="width: 10%;"></td> <td style="width: 10%;"></td> <td style="width: 10%;"></td> <td style="width: 10%;"></td> <td style="width: 10%;"></td> <td style="width: 10%;"></td> <td style="width: 10%;"></td> <td style="width: 10%;"></td> <td style="width: 10%;"></td> </tr> <tr> <td></td> <td></td> <td colspan="8" style="text-align: center;"> <table border="1" style="width: 100%; border-collapse: collapse; text-align: center;"> <tr> <td style="width: 10%;"></td> <td style="width: 10%;"></td> <td style="width: 10%;"></td> <td style="width: 10%;"></td> <td style="width: 10%;"></td> <td style="width: 10%;"></td> <td style="width: 10%;"></td> <td style="width: 10%;"></td> <td style="width: 10%;"></td> <td style="width: 10%;"></td> </tr> <tr> <td></td> <td></td> <td colspan="8" style="text-align: center;"> <table border="1" style="width: 100%; border-collapse: collapse; text-align: center;"> <tr> <td style="width: 10%;"></td> <td style="width: 10%;"></td> <td style="width: 10%;"></td> <td style="width: 10%;"></td> <td style="width: 10%;"></td> <td style="width: 10%;"></td> <td style="width: 10%;"></td> <td style="width: 10%;"></td> <td style="width: 10%;"></td> <td style="width: 10%;"></td> </tr> <tr> <td></td> <td></td> <td colspan="8" style="text-align: center;"> <table border="1" style="width: 100%; border-collapse: collapse; text-align: center;"> <tr> <td style="width: 10%;"></td> <td style="width: 10%;"></td> <td style="width: 10%;"></td> <td style="width: 10%;"></td> <td style="width: 10%;"></td> <td style="width: 10%;"></td> <td style="width: 10%;"></td> <td style="width: 10%;"></td> <td style="width: 10%;"></td> <td style="width: 10%;"></td> </tr> <tr> <td></td> <td></td> <td colspan="8" style="text-align: center;"> <table border="1" style="width: 100%; border-collapse: collapse; text-align: center;"> <tr> <td style="width: 10%;"></td> <td style="width: 10%;"></td> <td style="width: 10%;"></td> <td style="width: 10%;"></td> <td style="width: 10%;"></td> <td style="width: 10%;"></td> <td style="width: 10%;"></td> <td style="width: 10%;"></td> <td style="width: 10%;"></td> <td style="width: 10%;"></td> </tr> <tr> <td></td> <td></td> <td colspan="8" style="text-align: center;"> <table border="1" style="width: 100%; border-collapse: collapse; text-align: center;"> <tr> <td style="width: 10%;"></td> <td style="width: 10%;"></td> <td style="width: 10%;"></td> <td style="width: 10%;"></td> <td style="width: 10%;"></td> <td style="width: 10%;"></td> <td style="width: 10%;"></td> <td style="width: 10%;"></td> <td style="width: 10%;"></td> <td style="width: 10%;"></td> </tr> <tr> <td></td> <td></td> <td colspan="8" style="text-align: center;"> <table border="1" style="width: 100%; border-collapse: collapse; text-align: center;"> <tr> <td style="width: 10%;"></td> <td style="width: 10%;"></td> <td style="width: 10%;"></td> <td style="width: 10%;"></td> <td style="width: 10%;"></td> <td style="width: 10%;"></td> <td style="width: 10%;"></td> <td style="width: 10%;"></td> <td style="width: 10%;"></td> <td style="width: 10%;"></td> </tr> <tr> <td></td> <td></td> <td colspan="8" style="text-align: center;"> <table border="1" style="width: 100%; border-collapse: collapse; text-align: center;"> <tr> <td style="width: 10%;"></td> <td style="width: 10%;"></td> <td style="width: 10%;"></td> <td style="width: 10%;"></td> <td style="width: 10%;"></td> <td style="width: 10%;"></td> <td style="width: 10%;"></td> <td style="width: 10%;"></td> <td style="width: 10%;"></td> <td style="width: 10%;"></td> </tr> <tr> <td></td> <td></td> <td colspan="8" style="text-align: center;"> <table border="1" style="width: 100%; border-collapse: collapse; text-align: center;"> <tr> <td style="width: 10%;"></td> <td style="width: 10%;"></td> <td style="width: 10%;"></td> <td style="width: 10%;"></td> <td style="width: 10%;"></td> <td style="width: 10%;"></td> <td style="width: 10%;"></td> <td style="width: 10%;"></td> <td style="width: 10%;"></td> <td style="width: 10%;"></td> </tr> <tr> <td></td> <td></td> <td colspan="8" style="text-align: center;"> <table border="1" style="width: 100%; border-collapse: collapse; text-align: center;"> <tr> <td style="width: 10%;"></td> <td style="width: 10%;"></td> <td style="width: 10%;"></td> <td style="width: 10%;"></td> <td style="width: 10%;"></td> <td style="width: 10%;"></td> <td style="width: 10%;"></td> <td style="width: 10%;"></td> <td style="width: 10%;"></td> <td style="width: 10%;"></td> </tr> <tr> <td></td> <td></td> <td colspan="8" style="text-align: center;"> <table border="1" style="width: 100%; border-collapse: collapse; text-align: center;"> <tr> <td style="width: 10%;"></td> <td style="width: 10%;"></td> <td style="width: 10%;"></td> <td style="width: 10%;"></td> <td style="width: 10%;"></td> <td style="width: 10%;"></td> <td style="width: 10%;"></td> <td style="width: 10%;"></td> <td style="width: 10%;"></td> <td style="width: 10%;"></td> </tr> <tr> <td></td> <td></td> <td colspan="8" style="text-align: center;"> <table border="1" style="width: 100%; border-collapse: collapse; text-align: center;"> <tr> <td style="width: 10%;"></td> <td style="width: 10%;"></td> <td style="width: 10%;"></td> <td style="width: 10%;"></td> <td style="width: 10%;"></td> <td style="width: 10%;"></td> <td style="width: 10%;"></td> <td style="width: 10%;"></td> <td style="width: 10%;"></td> <td style="width: 10%;"></td> </tr> <tr> <td></td> <td></td> <td colspan="8" style="text-align: center;"> <table border="1" style="width: 100%; border-collapse: collapse; text-align: center;"> <tr> <td style="width: 10%;"></td> <td style="width: 10%;"></td> <td style="width: 10%;"></td> <td style="width: 10%;"></td> <td style="width: 10%;"></td> <td style="width: 10%;"></td> <td style="width: 10%;"></td> <td style="width: 10%;"></td> <td style="width: 10%;"></td> <td style="width: 10%;"></td> </tr> <tr> <td></td> <td></td> <td colspan="8" style="text-align: center;"> <table border="1" style="width: 100%; border-collapse: collapse; text-align: center;"> <tr> <td style="width: 10%;"></td> <td style="width: 10%;"></td> <td style="width: 10%;"></td> <td style="width: 10%;"></td> <td style="width: 10%;"></td> <td style="width: 10%;"></td> <td style="width: 10%;"></td> <td style="width: 10%;"></td> <td style="width: 10%;"></td> <td style="width: 10%;"></td> </tr> <tr> <td></td> <td></td> <td colspan="8" style="text-align: center;"> <table border="1" style="width: 100%; border-collapse: collapse; text-align: center;"> <tr> <td style="width: 10%;"></td> <td style="width: 10%;"></td> <td style="width: 10%;"></td> <td style="width: 10%;"></td> <td style="width: 10%;"></td> <td style="width: 10%;"></td> <td style="width: 10%;"></td> <td style="width: 10%;"></td> <td style="width: 10%;"></td> <td style="width: 10%;"></td> </tr> <tr> <td></td> <td></td> <td colspan="8" style="text-align: center;"> <table border="1" style="width: 100%; border-collapse: collapse; text-align: center;"> <tr> <td style="width: 10%;"></td> <td style="width: 10%;"></td> <td style="width: 10%;"></td> <td style="width: 10%;"></td> <td style="width: 10%;"></td> <td style="width: 10%;"></td> <td style="width: 10%;"></td> <td style="width: 10%;"></td> <td style="width: 10%;"></td> <td style="width: 10%;"></td> </tr> <tr> <td></td> <td></td> <td colspan="8" style="text-align: center;"> <table border="1" style="width: 100%; border-collapse: collapse; text-align: center;"> <tr> <td style="width: 10%;"></td> <td style="width: 10%;"></td> <td style="width: 10%;"></td> <td style="width: 10%;"></td> <td style="width: 10%;"></td> <td style="width: 10%;"></td> <td style="width: 10%;"></td> <td style="width: 10%;"></td> <td style="width: 10%;"></td> <td style="width: 10%;"></td> </tr> <tr> <td></td> <td></td> <td colspan="8" style="text-align: center;"> <table border="1" style="width: 100%; border-collapse: collapse; text-align: center;"> <tr> <td style="width: 10%;"></td> <td style="width: 10%;"></td> <td style="width: 10%;"></td> <td style="width: 10%;"></td> <td style="width: 10%;"></td> <td style="width: 10%;"></td> <td style="width: 10%;"></td> <td style="width: 10%;"></td> <td style="width: 10%;"></td> <td style="width: 10%;"></td> </tr> <tr> <td></td> <td></td> <td colspan="8" style="text-align: center;"> <table border="1" style="width: 100%; border-collapse: collapse; text-align: center;"> <tr> <td style="width: 10%;"></td> <td style="width: 10%;"></td> <td style="width: 10%;"></td> <td
style="width: 10%;"></td> <td style="width: 10%;"></td> <td style="width: 10%;"></td> <td style="width: 10%;"></td> <td style="width: 10%;"></td> <td style="width: 10%;"></td> <td style="width: 10%;"></td> </tr> <tr> <td></td> <td></td> <td colspan="8" style="text-align: center;"> <table border="1" style="width: 100%; border-collapse: collapse; text-align: center;"> <tr> <td style="width: 10%;"></td> <td style="width: 10%;"></td> <td style="width: 10%;"></td> <td style="width: 10%;"></td> <td style="width: 10%;"></td> <td style="width: 10%;"></td> <td style="width: 10%;"></td> <td style="width: 10%;"></td> <td style="width: 10%;"></td> <td style="width: 10%;"></td> </tr> <tr> <td></td> <td></td> <td colspan="8" style="text-align: center;"> <table border="1" style="width: 100%; border-collapse: collapse; text-align: center;"> <tr> <td style="width: 10%;"></td> <td style="width: 10%;"></td> <td style="width: 10%;"></td> <td style="width: 10%;"></td> <td style="width: 10%;"></td> <td style="width: 10%;"></td> <td style="width: 10%;"></td> <td style="width: 10%;"></td> <td style="width: 10%;"></td> <td style="width: 10%;"></td> </tr> <tr> <td></td> <td></td> <td colspan="8" style="text-align: center;"> <table border="1" style="width: 100%; border-collapse: collapse; text-align: center;"> <tr> <td style="width: 10%;"></td> <td style="width: 10%;"></td> <td style="width: 10%;"></td> <td style="width: 10%;"></td> <td style="width: 10%;"></td> <td style="width: 10%;"></td> <td style="width: 10%;"></td> <td style="width: 10%;"></td> <td style="width: 10%;"></td> <td style="width: 10%;"></td> </tr> <tr> <td></td> <td></td> <td colspan="8" style="text-align: center;"> <table border="1" style="width: 100%; border-collapse: collapse; text-align: center;"> <tr> <td style="width: 10%;"></td> <td style="width: 10%;"></td> <td style="width: 10%;"></td> <td style="width: 10%;"></td> <td style="width: 10%;"></td> <td style="width: 10%;"></td> <td style="width: 10%;"></td> <td style="width: 10%;"></td> <td style="width: 10%;"></td> <td style="width: 10%;"></td> </tr> <tr> <td></td> <td></td> <td colspan="8" style="text-align: center;"> <table border="1" style="width: 100%; border-collapse: collapse; text-align: center;"> <tr> <td style="width: 10%;"></td> <td style="width: 10%;"></td> <td style="width: 10%;"></td> <td style="width: 10%;"></td> <td style="width: 10%;"></td> <td style="width: 10%;"></td> <td style="width: 10%;"></td> <td style="width: 10%;"></td> <td style="width: 10%;"></td> <td style="width: 10%;"></td> </tr> <tr> <td></td> <td></td> <td colspan="8" style="text-align: center;"> <table border="1" style="width: 100%; border-collapse: collapse; text-align: center;"> <tr> <td style="width: 10%;"></td> <td style="width: 10%;"></td> <td style="width: 10%;"></td> <td style="width: 10%;"></td> <td style="width: 10%;"></td> <td style="width: 10%;"></td> <td style="width: 10%;"></td> <td style="width: 10%;"></td> <td style="width: 10%;"></td> <td style="width: 10%;"></td> </tr> <tr> <td></td> <td></td> <td colspan="8" style="text-align: center;"> <table border="1" style="width: 100%; border-collapse: collapse; text-align: center;"> <tr> <td style="width: 10%;"></td> <td style="width: 10%;"></td> <td style="width: 10%;"></td> <td style="width: 10%;"></td> <td style="width: 10%;"></td> <td style="width: 10%;"></td> <td style="width: 10%;"></td> <td style="width: 10%;"></td> <td style="width: 10%;"></td> <td style="width: 10%;"></td> </tr> <tr> <td></td> <td></td> <td colspan="8" style="text-align: center;"> <table border="1" style="width: 100%; border-collapse: collapse; text-align: center;"> <tr> <td style="width: 10%;"></td> <td style="width: 10%;"></td> <td style="width: 10%;"></td> <td style="width: 10%;"></td> <td style="width: 10%;"></td> <td style="width: 10%;"></td> <td style="width: 10%;"></td> <td style="width: 10%;"></td> <td style="width: 10%;"></td> <td style="width: 10%;"></td> </tr> <tr> <td></td> <td></td> <td colspan="8" style="text-align: center;"> <table border="1" style="width: 100%; border-collapse: collapse; text-align: center;"> <tr> <td style="width: 10%;"></td> <td style="width: 10%;"></td> <td style="width: 10%;"></td> <td style="width: 10%;"></td> <td style="width: 10%;"></td> <td style="width: 10%;"></td> <td style="width: 10%;"></td> <td style="width: 10%;"></td> <td style="width: 10%;"></td> <td style="width: 10%;"></td> </tr> <tr> <td></td> <td></td> <td colspan="8" style="text-align: center;"> <table border="1" style="width: 100%; border-collapse: collapse; text-align: center;"> <tr> <td style="width: 10%;"></td> <td style="width: 10%;"></td> <td style="width: 10%;"></td> <td style="width: 10%;"></td> <td style="width: 10%;"></td> <td style="width: 10%;"></td> <td style="width: 10%;"></td> <td style="width: 10%;"></td> <td style="width: 10%;"></td> <td style="width: 10%;"></td> </tr> <tr> <td></td> <td></td> <td colspan="8" style="text-align: center;"> <table border="1" style="width: 100%; border-collapse: collapse; text-align: center;"> <tr> <td style="width: 10%;"></td> <td style="width: 10%;"></td> <td style="width: 10%;"></td> <td style="width: 10%;"></td> <td style="width: 10%;"></td> <td style="width: 10%;"></td> <td style="width: 10%;"></td> <td style="width: 10%;"></td> <td style="width: 10%;"></td> <td style="width: 10%;"></td> </tr> <tr> <td></td> <td></td> <td colspan="8" style="text-align: center;"> <table border="1" style="width: 100%; border-collapse: collapse; text-align: center;"> <tr> <td style="width: 10%;"></td> <td style="width: 10%;"></td> <td style="width: 10%;"></td> <td style="width: 10%;"></td> <td style="width: 10%;"></td> <td style="width: 10%;"></td> <td style="width: 10%;"></td> <td style="width: 10%;"></td> <td style="width: 10%;"></td> <td style="width: 10%;"></td> </tr> <tr> <td></td> <td></td> <td colspan="8" style="text-align: center;"> <table border="1" style="width: 100%; border-collapse: collapse; text-align: center;"> <tr> <td style="width: 10%;"></td> <td style="width: 10%;"></td> <td style="width: 10%;"></td> <td style="width: 10%;"></td> <td style="width: 10%;"></td> <td style="width: 10%;"></td> <td style="width: 10%;"></td> <td style="width: 10%;"></td> <td style="width: 10%;"></td> <td style="width: 10%;"></td> </tr> <tr> <td></td> <td></td> <td colspan="8" style="text-align: center;"> <table border="1" style="width: 100%; border-collapse: collapse; text-align: center;"> <tr> </tr></table></td></tr></table></td></tr></table></td></tr></table></td></tr></table></td></tr></table></td></tr></table></td></tr></table></td></tr></table></td></tr></table></td></tr></table></td></tr></table></td></tr></table></td></tr></table></td></tr></table></td></tr></table></td></tr></table></td></tr></table></td></tr></table></td></tr></table></td></tr></table></td></tr></table></td></tr></table></td></tr></table></td></tr></table></td></tr></table></td></tr></table></td></tr></table></td></tr></table></td></tr></table></td></tr></table></td></tr></table></td></tr></table></td></tr></table></td></tr></table></td></tr></table></td></tr></table></td></tr></table></td></tr></table></td></tr></table></td></tr></table></td></tr></table> | | | | | | | | | | | | | | | | | | | | <table border="1" style="width: 100%; border-collapse: collapse; text-align: center;"> <tr> <td style="width: 10%;"></td> <td style="width: 10%;"></td> <td style="width: 10%;"></td> <td style="width: 10%;"></td> <td style="width: 10%;"></td> <td style="width: 10%;"></td> <td style="width: 10%;"></td> <td style="width: 10%;"></td> <td style="width: 10%;"></td> <td style="width: 10%;"></td> </tr> <tr> <td></td> <td></td> <td colspan="8" style="text-align: center;"> <table border="1" style="width: 100%; border-collapse: collapse; text-align: center;"> <tr> <td style="width: 10%;"></td> <td style="width: 10%;"></td> <td style="width: 10%;"></td> <td style="width: 10%;"></td> <td style="width: 10%;"></td> <td style="width: 10%;"></td> <td style="width: 10%;"></td> <td style="width: 10%;"></td> <td style="width: 10%;"></td> <td style="width: 10%;"></td> </tr> <tr> <td></td> <td></td> <td colspan="8" style="text-align: center;"> <table border="1" style="width: 100%; border-collapse: collapse; text-align: center;"> <tr> <td style="width: 10%;"></td> <td style="width: 10%;"></td> <td style="width: 10%;"></td> <td style="width: 10%;"></td> <td style="width: 10%;"></td> <td style="width: 10%;"></td> <td style="width: 10%;"></td> <td style="width: 10%;"></td> <td style="width: 10%;"></td> <td style="width: 10%;"></td> </tr> <tr> <td></td> <td></td> <td colspan="8" style="text-align: center;"> <table border="1" style="width: 100%; border-collapse: collapse; text-align: center;"> <tr> <td style="width: 10%;"></td> <td style="width: 10%;"></td> <td style="width: 10%;"></td> <td style="width: 10%;"></td> <td style="width: 10%;"></td> <td style="width: 10%;"></td> <td style="width: 10%;"></td> <td style="width: 10%;"></td> <td style="width: 10%;"></td> <td style="width: 10%;"></td> </tr> <tr> <td></td> <td></td> <td colspan="8" style="text-align: center;"> <table border="1" style="width: 100%; border-collapse: collapse; text-align: center;"> <tr> <td style="width: 10%;"></td> <td style="width: 10%;"></td> <td style="width: 10%;"></td> <td style="width: 10%;"></td> <td style="width: 10%;"></td> <td style="width: 10%;"></td> <td style="width: 10%;"></td> <td style="width: 10%;"></td> <td style="width: 10%;"></td> <td
style="width: 10%;"></td> </tr> <tr> <td></td> <td></td> <td colspan="8" style="text-align: center;"> <table border="1" style="width: 100%; border-collapse: collapse; text-align: center;"> <tr> <td style="width: 10%;"></td> <td style="width: 10%;"></td> <td style="width: 10%;"></td> <td style="width: 10%;"></td> <td style="width: 10%;"></td> <td style="width: 10%;"></td> <td style="width: 10%;"></td> <td style="width: 10%;"></td> <td style="width: 10%;"></td> <td style="width: 10%;"></td> </tr> <tr> <td></td> <td></td> <td colspan="8" style="text-align: center;"> <table border="1" style="width: 100%; border-collapse: collapse; text-align: center;"> <tr> <td style="width: 10%;"></td> <td style="width: 10%;"></td> <td style="width: 10%;"></td> <td style="width: 10%;"></td> <td style="width: 10%;"></td> <td style="width: 10%;"></td> <td style="width: 10%;"></td> <td style="width: 10%;"></td> <td style="width: 10%;"></td> <td style="width: 10%;"></td> </tr> <tr> <td></td> <td></td> <td colspan="8" style="text-align: center;"> <table border="1" style="width: 100%; border-collapse: collapse; text-align: center;"> <tr> <td style="width: 10%;"></td> <td style="width: 10%;"></td> <td style="width: 10%;"></td> <td style="width: 10%;"></td> <td style="width: 10%;"></td> <td style="width: 10%;"></td> <td style="width: 10%;"></td> <td style="width: 10%;"></td> <td style="width: 10%;"></td> <td style="width: 10%;"></td> </tr> <tr> <td></td> <td></td> <td colspan="8" style="text-align: center;"> <table border="1" style="width: 100%; border-collapse: collapse; text-align: center;"> <tr> <td style="width: 10%;"></td> <td style="width: 10%;"></td> <td style="width: 10%;"></td> <td style="width: 10%;"></td> <td style="width: 10%;"></td> <td style="width: 10%;"></td> <td style="width: 10%;"></td> <td style="width: 10%;"></td> <td style="width: 10%;"></td> <td style="width: 10%;"></td> </tr> <tr> <td></td> <td></td> <td colspan="8" style="text-align: center;"> <table border="1" style="width: 100%; border-collapse: collapse; text-align: center;"> <tr> <td style="width: 10%;"></td> <td style="width: 10%;"></td> <td style="width: 10%;"></td> <td style="width: 10%;"></td> <td style="width: 10%;"></td> <td style="width: 10%;"></td> <td style="width: 10%;"></td> <td style="width: 10%;"></td> <td style="width: 10%;"></td> <td style="width: 10%;"></td> </tr> <tr> <td></td> <td></td> <td colspan="8" style="text-align: center;"> <table border="1" style="width: 100%; border-collapse: collapse; text-align: center;"> <tr> <td style="width: 10%;"></td> <td style="width: 10%;"></td> <td style="width: 10%;"></td> <td style="width: 10%;"></td> <td style="width: 10%;"></td> <td style="width: 10%;"></td> <td style="width: 10%;"></td> <td style="width: 10%;"></td> <td style="width: 10%;"></td> <td style="width: 10%;"></td> </tr> <tr> <td></td> <td></td> <td colspan="8" style="text-align: center;"> <table border="1" style="width: 100%; border-collapse: collapse; text-align: center;"> <tr> <td style="width: 10%;"></td> <td style="width: 10%;"></td> <td style="width: 10%;"></td> <td style="width: 10%;"></td> <td style="width: 10%;"></td> <td style="width: 10%;"></td> <td style="width: 10%;"></td> <td style="width: 10%;"></td> <td style="width: 10%;"></td> <td style="width: 10%;"></td> </tr> <tr> <td></td> <td></td> <td colspan="8" style="text-align: center;"> <table border="1" style="width: 100%; border-collapse: collapse; text-align: center;"> <tr> <td style="width: 10%;"></td> <td style="width: 10%;"></td> <td style="width: 10%;"></td> <td style="width: 10%;"></td> <td style="width: 10%;"></td> <td style="width: 10%;"></td> <td style="width: 10%;"></td> <td style="width: 10%;"></td> <td style="width: 10%;"></td> <td style="width: 10%;"></td> </tr> <tr> <td></td> <td></td> <td colspan="8" style="text-align: center;"> <table border="1" style="width: 100%; border-collapse: collapse; text-align: center;"> <tr> <td style="width: 10%;"></td> <td style="width: 10%;"></td> <td style="width: 10%;"></td> <td style="width: 10%;"></td> <td style="width: 10%;"></td> <td style="width: 10%;"></td> <td style="width: 10%;"></td> <td style="width: 10%;"></td> <td style="width: 10%;"></td> <td style="width: 10%;"></td> </tr> <tr> <td></td> <td></td> <td colspan="8" style="text-align: center;"> <table border="1" style="width: 100%; border-collapse: collapse; text-align: center;"> <tr> <td style="width: 10%;"></td> <td style="width: 10%;"></td> <td style="width: 10%;"></td> <td style="width: 10%;"></td> <td style="width: 10%;"></td> <td style="width: 10%;"></td> <td style="width: 10%;"></td> <td style="width: 10%;"></td> <td style="width: 10%;"></td> <td style="width: 10%;"></td> </tr> <tr> <td></td> <td></td> <td colspan="8" style="text-align: center;"> <table border="1" style="width: 100%; border-collapse: collapse; text-align: center;"> <tr> <td style="width: 10%;"></td> <td style="width: 10%;"></td> <td style="width: 10%;"></td> <td style="width: 10%;"></td> <td style="width: 10%;"></td> <td style="width: 10%;"></td> <td style="width: 10%;"></td> <td style="width: 10%;"></td> <td style="width: 10%;"></td> <td style="width: 10%;"></td> </tr> <tr> <td></td> <td></td> <td colspan="8" style="text-align: center;"> <table border="1" style="width: 100%; border-collapse: collapse; text-align: center;"> <tr> <td style="width: 10%;"></td> <td style="width: 10%;"></td> <td style="width: 10%;"></td> <td style="width: 10%;"></td> <td style="width: 10%;"></td> <td style="width: 10%;"></td> <td style="width: 10%;"></td> <td style="width: 10%;"></td> <td style="width: 10%;"></td> <td style="width: 10%;"></td> </tr> <tr> <td></td> <td></td> <td colspan="8" style="text-align: center;"> <table border="1" style="width: 100%; border-collapse: collapse; text-align: center;"> <tr> <td style="width: 10%;"></td> <td style="width: 10%;"></td> <td style="width: 10%;"></td> <td style="width: 10%;"></td> <td style="width: 10%;"></td> <td style="width: 10%;"></td> <td style="width: 10%;"></td> <td style="width: 10%;"></td> <td style="width: 10%;"></td> <td style="width: 10%;"></td> </tr> <tr> <td></td> <td></td> <td colspan="8" style="text-align: center;"> <table border="1" style="width: 100%; border-collapse: collapse; text-align: center;"> <tr> <td style="width: 10%;"></td> <td style="width: 10%;"></td> <td style="width: 10%;"></td> <td style="width: 10%;"></td> <td style="width: 10%;"></td> <td style="width: 10%;"></td> <td style="width: 10%;"></td> <td style="width: 10%;"></td> <td style="width: 10%;"></td> <td style="width: 10%;"></td> </tr> <tr> <td></td> <td></td> <td colspan="8" style="text-align: center;"> <table border="1" style="width: 100%; border-collapse: collapse; text-align: center;"> <tr> <td style="width: 10%;"></td> <td style="width: 10%;"></td> <td style="width: 10%;"></td> <td style="width: 10%;"></td> <td style="width: 10%;"></td> <td style="width: 10%;"></td> <td style="width: 10%;"></td> <td style="width: 10%;"></td> <td style="width: 10%;"></td> <td style="width: 10%;"></td> </tr> <tr> <td></td> <td></td> <td colspan="8" style="text-align: center;"> <table border="1" style="width: 100%; border-collapse: collapse; text-align: center;"> <tr> <td style="width: 10%;"></td> <td style="width: 10%;"></td> <td style="width: 10%;"></td> <td style="width: 10%;"></td> <td style="width: 10%;"></td> <td style="width: 10%;"></td> <td style="width: 10%;"></td> <td style="width: 10%;"></td> <td style="width: 10%;"></td> <td style="width: 10%;"></td> </tr> <tr> <td></td> <td></td> <td colspan="8" style="text-align: center;"> <table border="1" style="width: 100%; border-collapse: collapse; text-align: center;"> <tr> <td style="width: 10%;"></td> <td style="width: 10%;"></td> <td style="width: 10%;"></td> <td style="width: 10%;"></td> <td style="width: 10%;"></td> <td style="width: 10%;"></td> <td style="width: 10%;"></td> <td style="width: 10%;"></td> <td style="width: 10%;"></td> <td style="width: 10%;"></td> </tr> <tr> <td></td> <td></td> <td colspan="8" style="text-align: center;"> <table border="1" style="width: 100%; border-collapse: collapse; text-align: center;"> <tr> <td style="width: 10%;"></td> <td style="width: 10%;"></td> <td style="width: 10%;"></td> <td style="width: 10%;"></td> <td style="width: 10%;"></td> <td style="width: 10%;"></td> <td style="width: 10%;"></td> <td style="width: 10%;"></td> <td style="width: 10%;"></td> <td style="width: 10%;"></td> </tr> <tr> <td></td> <td></td> <td colspan="8" style="text-align: center;"> <table border="1" style="width: 100%; border-collapse: collapse; text-align: center;"> <tr> <td style="width: 10%;"></td> <td style="width: 10%;"></td> <td style="width: 10%;"></td> <td style="width: 10%;"></td> <td style="width: 10%;"></td> <td style="width: 10%;"></td> <td style="width: 10%;"></td> <td style="width: 10%;"></td> <td style="width: 10%;"></td> <td style="width: 10%;"></td> </tr> <tr> <td></td> <td></td> <td colspan="8" style="text-align: center;"> <table border="1" style="width: 100%; border-collapse: collapse; text-align: center;"> <tr> <td style="width: 10%;"></td> <td style="width: 10%;"></td> <td style="width: 10%;"></td> <td style="width: 10%;"></td> <td style="width: 10%;"></td> <td style="width: 10%;"></td> <td style="width: 10%;"></td> <td style="width: 10%;"></td> <td style="width: 10%;"></td> <td style="width: 10%;"></td> </tr> <tr> <td></td> <td></td> <td colspan="8" style="text-align: center;"> <table border="1" style="width: 100%; border-collapse: collapse; text-align: center;"> <tr> <td style="width: 10%;"></td> <td style="width: 10%;"></td> <td style="width: 10%;"></td> <td style="width: 10%;"></td> <td style="width: 10%;"></td> <td style="width: 10%;"></td> <td style="width: 10%;"></td> <td style="width: 10%;"></td> <td style="width: 10%;"></td> <td style="width: 10%;"></td> </tr> <tr> <td></td> <td></td> <td colspan="8" style="text-align: center;"> <table border="1" style="width: 100%; border-collapse: collapse;
text-align: center;"> <tr> <td style="width: 10%;"></td> <td style="width: 10%;"></td> <td style="width: 10%;"></td> <td style="width: 10%;"></td> <td style="width: 10%;"></td> <td style="width: 10%;"></td> <td style="width: 10%;"></td> <td style="width: 10%;"></td> <td style="width: 10%;"></td> <td style="width: 10%;"></td> </tr> <tr> <td></td> <td></td> <td colspan="8" style="text-align: center;"> <table border="1" style="width: 100%; border-collapse: collapse; text-align: center;"> <tr> <td style="width: 10%;"></td> <td style="width: 10%;"></td> <td style="width: 10%;"></td> <td style="width: 10%;"></td> <td style="width: 10%;"></td> <td style="width: 10%;"></td> <td style="width: 10%;"></td> <td style="width: 10%;"></td> <td style="width: 10%;"></td> <td style="width: 10%;"></td> </tr> <tr> <td></td> <td></td> <td colspan="8" style="text-align: center;"> <table border="1" style="width: 100%; border-collapse: collapse; text-align: center;"> <tr> <td style="width: 10%;"></td> <td style="width: 10%;"></td> <td style="width: 10%;"></td> <td style="width: 10%;"></td> <td style="width: 10%;"></td> <td style="width: 10%;"></td> <td style="width: 10%;"></td> <td style="width: 10%;"></td> <td style="width: 10%;"></td> <td style="width: 10%;"></td> </tr> <tr> <td></td> <td></td> <td colspan="8" style="text-align: center;"> <table border="1" style="width: 100%; border-collapse: collapse; text-align: center;"> <tr> <td style="width: 10%;"></td> <td style="width: 10%;"></td> <td style="width: 10%;"></td> <td style="width: 10%;"></td> <td style="width: 10%;"></td> <td style="width: 10%;"></td> <td style="width: 10%;"></td> <td style="width: 10%;"></td> <td style="width: 10%;"></td> <td style="width: 10%;"></td> </tr> <tr> <td></td> <td></td> <td colspan="8" style="text-align: center;"> <table border="1" style="width: 100%; border-collapse: collapse; text-align: center;"> <tr> <td style="width: 10%;"></td> <td style="width: 10%;"></td> <td style="width: 10%;"></td> <td style="width: 10%;"></td> <td style="width: 10%;"></td> <td style="width: 10%;"></td> <td style="width: 10%;"></td> <td style="width: 10%;"></td> <td style="width: 10%;"></td> <td style="width: 10%;"></td> </tr> <tr> <td></td> <td></td> <td colspan="8" style="text-align: center;"> <table border="1" style="width: 100%; border-collapse: collapse; text-align: center;"> <tr> <td style="width: 10%;"></td> <td style="width: 10%;"></td> <td style="width: 10%;"></td> <td style="width: 10%;"></td> <td style="width: 10%;"></td> <td style="width: 10%;"></td> <td style="width: 10%;"></td> <td style="width: 10%;"></td> <td style="width: 10%;"></td> <td style="width: 10%;"></td> </tr> <tr> <td></td> <td></td> <td colspan="8" style="text-align: center;"> <table border="1" style="width: 100%; border-collapse: collapse; text-align: center;"> <tr> <td style="width: 10%;"></td> <td style="width: 10%;"></td> <td style="width: 10%;"></td> <td style="width: 10%;"></td> <td style="width: 10%;"></td> <td style="width: 10%;"></td> <td style="width: 10%;"></td> <td style="width: 10%;"></td> <td style="width: 10%;"></td> <td style="width: 10%;"></td> </tr> <tr> <td></td> <td></td> <td colspan="8" style="text-align: center;"> <table border="1" style="width: 100%; border-collapse: collapse; text-align: center;"> <tr> <td style="width: 10%;"></td> <td style="width: 10%;"></td> <td style="width: 10%;"></td> <td style="width: 10%;"></td> <td style="width: 10%;"></td> <td style="width: 10%;"></td> <td style="width: 10%;"></td> <td style="width: 10%;"></td> <td style="width: 10%;"></td> <td style="width: 10%;"></td> </tr> <tr> <td></td> <td></td> <td colspan="8" style="text-align: center;"> <table border="1" style="width: 100%; border-collapse: collapse; text-align: center;"> <tr> <td style="width: 10%;"></td> <td style="width: 10%;"></td> <td style="width: 10%;"></td> <td style="width: 10%;"></td> <td style="width: 10%;"></td> <td style="width: 10%;"></td> <td style="width: 10%;"></td> <td style="width: 10%;"></td> <td style="width: 10%;"></td> <td style="width: 10%;"></td> </tr> <tr> <td></td> <td></td> <td colspan="8" style="text-align: center;"> <table border="1" style="width: 100%; border-collapse: collapse; text-align: center;"> <tr> <td style="width: 10%;"></td> <td style="width: 10%;"></td> <td style="width: 10%;"></td> <td style="width: 10%;"></td> <td style="width: 10%;"></td> <td style="width: 10%;"></td> <td style="width: 10%;"></td> <td style="width: 10%;"></td> <td style="width: 10%;"></td> <td style="width: 10%;"></td> </tr> <tr> <td></td> <td></td> <td colspan="8" style="text-align: center;"> <table border="1" style="width: 100%; border-collapse: collapse; text-align: center;"> <tr> <td style="width: 10%;"></td> <td style="width: 10%;"></td> <td style="width: 10%;"></td> <td style="width: 10%;"></td> <td style="width: 10%;"></td> <td style="width: 10%;"></td> <td style="width: 10%;"></td> <td style="width: 10%;"></td> <td style="width: 10%;"></td> <td style="width: 10%;"></td> </tr> <tr> <td></td> <td></td> <td colspan="8" style="text-align: center;"> <table border="1" style="width: 100%; border-collapse: collapse; text-align: center;"> <tr> <td style="width: 10%;"></td> <td style="width: 10%;"></td> <td style="width: 10%;"></td> <td style="width: 10%;"></td> <td style="width: 10%;"></td> <td style="width: 10%;"></td> <td style="width: 10%;"></td> <td style="width: 10%;"></td> <td style="width: 10%;"></td> <td style="width: 10%;"></td> </tr> <tr> <td></td> <td></td> <td colspan="8" style="text-align: center;"> <table border="1" style="width: 100%; border-collapse: collapse; text-align: center;"> <tr> <td style="width: 10%;"></td> <td style="width: 10%;"></td> <td style="width: 10%;"></td> <td style="width: 10%;"></td> <td style="width: 10%;"></td> <td style="width: 10%;"></td> <td style="width: 10%;"></td> <td style="width: 10%;"></td> <td style="width: 10%;"></td> <td style="width: 10%;"></td> </tr> <tr> <td></td> <td></td> <td colspan="8" style="text-align: center;"> <table border="1" style="width: 100%; border-collapse: collapse; text-align: center;"> <tr> <td style="width: 10%;"></td> <td style="width: 10%;"></td> <td style="width: 10%;"></td> <td style="width: 10%;"></td> <td style="width: 10%;"></td> <td style="width: 10%;"></td> <td style="width: 10%;"></td> <td style="width: 10%;"></td> <td style="width: 10%;"></td> <td style="width: 10%;"></td> </tr> <tr> <td></td> <td></td> <td colspan="8" style="text-align: center;"> <table border="1" style="width: 100%; border-collapse: collapse; text-align: center;"> <tr> </tr></table></td></tr></table></td></tr></table></td></tr></table></td></tr></table></td></tr></table></td></tr></table></td></tr></table></td></tr></table></td></tr></table></td></tr></table></td></tr></table></td></tr></table></td></tr></table></td></tr></table></td></tr></table></td></tr></table></td></tr></table></td></tr></table></td></tr></table></td></tr></table></td></tr></table></td></tr></table></td></tr></table></td></tr></table></td></tr></table></td></tr></table></td></tr></table></td></tr></table></td></tr></table></td></tr></table></td></tr></table></td></tr></table></td></tr></table></td></tr></table></td></tr></table></td></tr></table></td></tr></table></td></tr></table></td></tr></table></td></tr></table> | | | | | | | | | | | | | | | | | | | | <table border="1" style="width: 100%; border-collapse: collapse; text-align: center;"> <tr> <td style="width: 10%;"></td> <td style="width: 10%;"></td> <td style="width: 10%;"></td> <td style="width: 10%;"></td> <td style="width: 10%;"></td> <td style="width: 10%;"></td> <td style="width: 10%;"></td> <td style="width: 10%;"></td> <td style="width: 10%;"></td> <td style="width: 10%;"></td> </tr> <tr> <td></td> <td></td> <td colspan="8" style="text-align: center;"> <table border="1" style="width: 100%; border-collapse: collapse; text-align: center;"> <tr> <td style="width: 10%;"></td> <td style="width: 10%;"></td> <td style="width: 10%;"></td> <td style="width: 10%;"></td> <td style="width: 10%;"></td> <td style="width: 10%;"></td> <td style="width: 10%;"></td> <td style="width: 10%;"></td> <td style="width: 10%;"></td> <td style="width: 10%;"></td> </tr> <tr> <td></td> <td></td> <td colspan="8" style="text-align: center;"> <table border="1" style="width: 100%; border-collapse: collapse; text-align: center;"> <tr> <td style="width: 10%;"></td> <td style="width: 10%;"></td> <td style="width: 10%;"></td> <td style="width: 10%;"></td> <td style="width: 10%;"></td> <td style="width: 10%;"></td> <td style="width: 10%;"></td> <td style="width: 10%;"></td> <td style="width: 10%;"></td> <td style="width: 10%;"></td> </tr> <tr> <td></td> <td></td> <td colspan="8" style="text-align: center;"> <table border="1" style="width: 100%; border-collapse: collapse; text-align: center;"> <tr> <td style="width: 10%;"></td> <td style="width: 10%;"></td> <td style="width: 10%;"></td> <td style="width: 10%;"></td> <td style="width: 10%;"></td> <td style="width: 10%;"></td> <td style="width: 10%;"></td> <td style="width: 10%;"></td> <td style="width: 10%;"></td> <td style="width: 10%;"></td> </tr> <tr> <td></td> <td></td> <td colspan="8" style="text-align: center;"> <table border="1" style="width: 100%; border-collapse: collapse; text-align: center;"> <tr> <td style="width: 10%;"></td> <td style="width: 10%;"></td> <td style="width: 10%;"></td> <td style="width: 10%;"></td> <td style="width: 10%;"></td> <td style="width:
10%;"></td> <td style="width: 10%;"></td> <td style="width: 10%;"></td> <td style="width: 10%;"></td> <td style="width: 10%;"></td> </tr> <tr> <td></td> <td></td> <td colspan="8" style="text-align: center;"> <table border="1" style="width: 100%; border-collapse: collapse; text-align: center;"> <tr> <td style="width: 10%;"></td> <td style="width: 10%;"></td> <td style="width: 10%;"></td> <td style="width: 10%;"></td> <td style="width: 10%;"></td> <td style="width: 10%;"></td> <td style="width: 10%;"></td> <td style="width: 10%;"></td> <td style="width: 10%;"></td> <td style="width: 10%;"></td> </tr> <tr> <td></td> <td></td> <td colspan="8" style="text-align: center;"> <table border="1" style="width: 100%; border-collapse: collapse; text-align: center;"> <tr> <td style="width: 10%;"></td> <td style="width: 10%;"></td> <td style="width: 10%;"></td> <td style="width: 10%;"></td> <td style="width: 10%;"></td> <td style="width: 10%;"></td> <td style="width: 10%;"></td> <td style="width: 10%;"></td> <td style="width: 10%;"></td> <td style="width: 10%;"></td> </tr> <tr> <td></td> <td></td> <td colspan="8" style="text-align: center;"> <table border="1" style="width: 100%; border-collapse: collapse; text-align: center;"> <tr> <td style="width: 10%;"></td> <td style="width: 10%;"></td> <td style="width: 10%;"></td> <td style="width: 10%;"></td> <td style="width: 10%;"></td> <td style="width: 10%;"></td> <td style="width: 10%;"></td> <td style="width: 10%;"></td> <td style="width: 10%;"></td> <td style="width: 10%;"></td> </tr> <tr> <td></td> <td></td> <td colspan="8" style="text-align: center;"> <table border="1" style="width: 100%; border-collapse: collapse; text-align: center;"> <tr> <td style="width: 10%;"></td> <td style="width: 10%;"></td> <td style="width: 10%;"></td> <td style="width: 10%;"></td> <td style="width: 10%;"></td> <td style="width: 10%;"></td> <td style="width: 10%;"></td> <td style="width: 10%;"></td> <td style="width: 10%;"></td> <td style="width: 10%;"></td> </tr> <tr> <td></td> <td></td> <td colspan="8" style="text-align: center;"> <table border="1" style="width: 100%; border-collapse: collapse; text-align: center;"> <tr> <td style="width: 10%;"></td> <td style="width: 10%;"></td> <td style="width: 10%;"></td> <td style="width: 10%;"></td> <td style="width: 10%;"></td> <td style="width: 10%;"></td> <td style="width: 10%;"></td> <td style="width: 10%;"></td> <td style="width: 10%;"></td> <td style="width: 10%;"></td> </tr> <tr> <td></td> <td></td> <td colspan="8" style="text-align: center;"> <table border="1" style="width: 100%; border-collapse: collapse; text-align: center;"> <tr> <td style="width: 10%;"></td> <td style="width: 10%;"></td> <td style="width: 10%;"></td> <td style="width: 10%;"></td> <td style="width: 10%;"></td> <td style="width: 10%;"></td> <td style="width: 10%;"></td> <td style="width: 10%;"></td> <td style="width: 10%;"></td> <td style="width: 10%;"></td> </tr> <tr> <td></td> <td></td> <td colspan="8" style="text-align: center;"> <table border="1" style="width: 100%; border-collapse: collapse; text-align: center;"> <tr> <td style="width: 10%;"></td> <td style="width: 10%;"></td> <td style="width: 10%;"></td> <td style="width: 10%;"></td> <td style="width: 10%;"></td> <td style="width: 10%;"></td> <td style="width: 10%;"></td> <td style="width: 10%;"></td> <td style="width: 10%;"></td> <td style="width: 10%;"></td> </tr> <tr> <td></td> <td></td> <td colspan="8" style="text-align: center;"> <table border="1" style="width: 100%; border-collapse: collapse; text-align: center;"> <tr> <td style="width: 10%;"></td> <td style="width: 10%;"></td> <td style="width: 10%;"></td> <td style="width: 10%;"></td> <td style="width: 10%;"></td> <td style="width: 10%;"></td> <td style="width: 10%;"></td> <td style="width: 10%;"></td> <td style="width: 10%;"></td> <td style="width: 10%;"></td> </tr> <tr> <td></td> <td></td> <td colspan="8" style="text-align: center;"> <table border="1" style="width: 100%; border-collapse: collapse; text-align: center;"> <tr> <td style="width: 10%;"></td> <td style="width: 10%;"></td> <td style="width: 10%;"></td> <td style="width: 10%;"></td> <td style="width: 10%;"></td> <td style="width: 10%;"></td> <td style="width: 10%;"></td> <td style="width: 10%;"></td> <td style="width: 10%;"></td> <td style="width: 10%;"></td> </tr> <tr> <td></td> <td></td> <td colspan="8" style="text-align: center;"> <table border="1" style="width: 100%; border-collapse: collapse; text-align: center;"> <tr> <td style="width: 10%;"></td> <td style="width: 10%;"></td> <td style="width: 10%;"></td> <td style="width: 10%;"></td> <td style="width: 10%;"></td> <td style="width: 10%;"></td> <td style="width: 10%;"></td> <td style="width: 10%;"></td> <td style="width: 10%;"></td> <td style="width: 10%;"></td> </tr> <tr> <td></td> <td></td> <td colspan="8" style="text-align: center;"> <table border="1" style="width: 100%; border-collapse: collapse; text-align: center;"> <tr> <td style="width: 10%;"></td> <td style="width: 10%;"></td> <td style="width: 10%;"></td> <td style="width: 10%;"></td> <td style="width: 10%;"></td> <td style="width: 10%;"></td> <td style="width: 10%;"></td> <td style="width: 10%;"></td> <td style="width: 10%;"></td> <td style="width: 10%;"></td> </tr> <tr> <td></td> <td></td> <td colspan="8" style="text-align: center;"> <table border="1" style="width: 100%; border-collapse: collapse; text-align: center;"> <tr> <td style="width: 10%;"></td> <td style="width: 10%;"></td> <td style="width: 10%;"></td> <td style="width: 10%;"></td> <td style="width: 10%;"></td> <td style="width: 10%;"></td> <td style="width: 10%;"></td> <td style="width: 10%;"></td> <td style="width: 10%;"></td> <td style="width: 10%;"></td> </tr> <tr> <td></td> <td></td> <td colspan="8" style="text-align: center;"> <table border="1" style="width: 100%; border-collapse: collapse; text-align: center;"> <tr> <td style="width: 10%;"></td> <td style="width: 10%;"></td> <td style="width: 10%;"></td> <td style="width: 10%;"></td> <td style="width: 10%;"></td> <td style="width: 10%;"></td> <td style="width: 10%;"></td> <td style="width: 10%;"></td> <td style="width: 10%;"></td> <td style="width: 10%;"></td> </tr> <tr> <td></td> <td></td> <td colspan="8" style="text-align: center;"> <table border="1" style="width: 100%; border-collapse: collapse; text-align: center;"> <tr> <td style="width: 10%;"></td> <td style="width: 10%;"></td> <td style="width: 10%;"></td> <td style="width: 10%;"></td> <td style="width: 10%;"></td> <td style="width: 10%;"></td> <td style="width: 10%;"></td> <td style="width: 10%;"></td> <td style="width: 10%;"></td> <td style="width: 10%;"></td> </tr> <tr> <td></td> <td></td> <td colspan="8" style="text-align: center;"> <table border="1" style="width: 100%; border-collapse: collapse; text-align: center;"> <tr> <td style="width: 10%;"></td> <td style="width: 10%;"></td> <td style="width: 10%;"></td> <td style="width: 10%;"></td> <td style="width: 10%;"></td> <td style="width: 10%;"></td> <td style="width: 10%;"></td> <td style="width: 10%;"></td> <td style="width: 10%;"></td> <td style="width: 10%;"></td> </tr> <tr> <td></td> <td></td> <td colspan="8" style="text-align: center;"> <table border="1" style="width: 100%; border-collapse: collapse; text-align: center;"> <tr> <td style="width: 10%;"></td> <td style="width: 10%;"></td> <td style="width: 10%;"></td> <td style="width: 10%;"></td> <td style="width: 10%;"></td> <td style="width: 10%;"></td> <td style="width: 10%;"></td> <td style="width: 10%;"></td> <td style="width: 10%;"></td> <td style="width: 10%;"></td> </tr> <tr> <td></td> <td></td> <td colspan="8" style="text-align: center;"> <table border="1" style="width: 100%; border-collapse: collapse; text-align: center;"> <tr> <td style="width: 10%;"></td> <td style="width: 10%;"></td> <td style="width: 10%;"></td> <td style="width: 10%;"></td> <td style="width: 10%;"></td> <td style="width: 10%;"></td> <td style="width: 10%;"></td> <td style="width: 10%;"></td> <td style="width: 10%;"></td> <td style="width: 10%;"></td> </tr> <tr> <td></td> <td></td> <td colspan="8" style="text-align: center;"> <table border="1" style="width: 100%; border-collapse: collapse; text-align: center;"> <tr> <td style="width: 10%;"></td> <td style="width: 10%;"></td> <td style="width: 10%;"></td> <td style="width: 10%;"></td> <td style="width: 10%;"></td> <td style="width: 10%;"></td> <td style="width: 10%;"></td> <td style="width: 10%;"></td> <td style="width: 10%;"></td> <td style="width: 10%;"></td> </tr> <tr> <td></td> <td></td> <td colspan="8" style="text-align: center;"> <table border="1" style="width: 100%; border-collapse: collapse; text-align: center;"> <tr> <td style="width: 10%;"></td> <td style="width: 10%;"></td> <td style="width: 10%;"></td> <td style="width: 10%;"></td> <td style="width: 10%;"></td> <td style="width: 10%;"></td> <td style="width: 10%;"></td> <td style="width: 10%;"></td> <td style="width: 10%;"></td> <td style="width: 10%;"></td> </tr> <tr> <td></td> <td></td> <td colspan="8" style="text-align: center;"> <table border="1" style="width: 100%; border-collapse: collapse; text-align: center;"> <tr> <td style="width: 10%;"></td> <td style="width: 10%;"></td> <td style="width: 10%;"></td> <td style="width: 10%;"></td> <td style="width: 10%;"></td> <td style="width: 10%;"></td> <td style="width: 10%;"></td> <td style="width: 10%;"></td> <td style="width: 10%;"></td> <td style="width: 10%;"></td> </tr> <tr> <td></td> <td></td> <td colspan="8" style="text-align: center;"> <table border="1" style="width: 100%; border-collapse: collapse; text-align: center;"> <tr> <td style="width: 10%;"></td> <td style="width: 10%;"></td> <td style="width: 10%;"></td> <td style="width: 10%;"></td> <td style="width: 10%;"></td> <td style="width: 10%;"></td> <td style="width: 10%;"></td> <td style="width: 10%;"></td> <td style="width: 10%;"></td> <td style="width: 10%;"></td> </tr> <tr> <td></td> <td></td> <td
colspan="8" style="text-align: center;"> <table border="1" style="width: 100%; border-collapse: collapse; text-align: center;"> <tr> <td style="width: 10%;"></td> <td style="width: 10%;"></td> <td style="width: 10%;"></td> <td style="width: 10%;"></td> <td style="width: 10%;"></td> <td style="width: 10%;"></td> <td style="width: 10%;"></td> <td style="width: 10%;"></td> <td style="width: 10%;"></td> <td style="width: 10%;"></td> </tr> <tr> <td></td> <td></td> <td colspan="8" style="text-align: center;"> <table border="1" style="width: 100%; border-collapse: collapse; text-align: center;"> <tr> <td style="width: 10%;"></td> <td style="width: 10%;"></td> <td style="width: 10%;"></td> <td style="width: 10%;"></td> <td style="width: 10%;"></td> <td style="width: 10%;"></td> <td style="width: 10%;"></td> <td style="width: 10%;"></td> <td style="width: 10%;"></td> <td style="width: 10%;"></td> </tr> <tr> <td></td> <td></td> <td colspan="8" style="text-align: center;"> <table border="1" style="width: 100%; border-collapse: collapse; text-align: center;"> <tr> <td style="width: 10%;"></td> <td style="width: 10%;"></td> <td style="width: 10%;"></td> <td style="width: 10%;"></td> <td style="width: 10%;"></td> <td style="width: 10%;"></td> <td style="width: 10%;"></td> <td style="width: 10%;"></td> <td style="width: 10%;"></td> <td style="width: 10%;"></td> </tr> <tr> <td></td> <td></td> <td colspan="8" style="text-align: center;"> <table border="1" style="width: 100%; border-collapse: collapse; text-align: center;"> <tr> <td style="width: 10%;"></td> <td style="width: 10%;"></td> <td style="width: 10%;"></td> <td style="width: 10%;"></td> <td style="width: 10%;"></td> <td style="width: 10%;"></td> <td style="width: 10%;"></td> <td style="width: 10%;"></td> <td style="width: 10%;"></td> <td style="width: 10%;"></td> </tr> <tr> <td></td> <td></td> <td colspan="8" style="text-align: center;"> <table border="1" style="width: 100%; border-collapse: collapse; text-align: center;"> <tr> <td style="width: 10%;"></td> <td style="width: 10%;"></td> <td style="width: 10%;"></td> <td style="width: 10%;"></td> <td style="width: 10%;"></td> <td style="width: 10%;"></td> <td style="width: 10%;"></td> <td style="width: 10%;"></td> <td style="width: 10%;"></td> <td style="width: 10%;"></td> </tr> <tr> <td></td> <td></td> <td colspan="8" style="text-align: center;"> <table border="1" style="width: 100%; border-collapse: collapse; text-align: center;"> <tr> <td style="width: 10%;"></td> <td style="width: 10%;"></td> <td style="width: 10%;"></td> <td style="width: 10%;"></td> <td style="width: 10%;"></td> <td style="width: 10%;"></td> <td style="width: 10%;"></td> <td style="width: 10%;"></td> <td style="width: 10%;"></td> <td style="width: 10%;"></td> </tr> <tr> <td></td> <td></td> <td colspan="8" style="text-align: center;"> <table border="1" style="width: 100%; border-collapse: collapse; text-align: center;"> <tr> <td style="width: 10%;"></td> <td style="width: 10%;"></td> <td style="width: 10%;"></td> <td style="width: 10%;"></td> <td style="width: 10%;"></td> <td style="width: 10%;"></td> <td style="width: 10%;"></td> <td style="width: 10%;"></td> <td style="width: 10%;"></td> <td style="width: 10%;"></td> </tr> <tr> <td></td> <td></td> <td colspan="8" style="text-align: center;"> <table border="1" style="width: 100%; border-collapse: collapse; text-align: center;"> <tr> <td style="width: 10%;"></td> <td style="width: 10%;"></td> <td style="width: 10%;"></td> <td style="width: 10%;"></td> <td style="width: 10%;"></td> <td style="width: 10%;"></td> <td style="width: 10%;"></td> <td style="width: 10%;"></td> <td style="width: 10%;"></td> <td style="width: 10%;"></td> </tr> <tr> <td></td> <td></td> <td colspan="8" style="text-align: center;"> <table border="1" style="width: 100%; border-collapse: collapse; text-align: center;"> <tr> <td style="width: 10%;"></td> <td style="width: 10%;"></td> <td style="width: 10%;"></td> <td style="width: 10%;"></td> <td style="width: 10%;"></td> <td style="width: 10%;"></td> <td style="width: 10%;"></td> <td style="width: 10%;"></td> <td style="width: 10%;"></td> <td style="width: 10%;"></td> </tr> <tr> <td></td> <td></td> <td colspan="8" style="text-align: center;"> <table border="1" style="width: 100%; border-collapse: collapse; text-align: center;"> <tr> <td style="width: 10%;"></td> <td style="width: 10%;"></td> <td style="width: 10%;"></td> <td style="width: 10%;"></td> <td style="width: 10%;"></td> <td style="width: 10%;"></td> <td style="width: 10%;"></td> <td style="width: 10%;"></td> <td style="width: 10%;"></td> <td style="width: 10%;"></td> </tr> <tr> <td></td> <td></td> <td colspan="8" style="text-align: center;"> <table border="1" style="width: 100%; border-collapse: collapse; text-align: center;"> <tr> <td style="width: 10%;"></td> <td style="width: 10%;"></td> <td style="width: 10%;"></td> <td style="width: 10%;"></td> <td style="width: 10%;"></td> <td style="width: 10%;"></td> <td style="width: 10%;"></td> <td style="width: 10%;"></td> <td style="width: 10%;"></td> <td style="width: 10%;"></td> </tr> <tr> <td></td> <td></td> <td colspan="8" style="text-align: center;"> <table border="1" style="width: 100%; border-collapse: collapse; text-align: center;"> <tr> <td style="width: 10%;"></td> <td style="width: 10%;"></td> <td style="width: 10%;"></td> <td style="width: 10%;"></td> <td style="width: 10%;"></td> <td style="width: 10%;"></td> <td style="width: 10%;"></td> <td style="width: 10%;"></td> <td style="width: 10%;"></td> <td style="width: 10%;"></td> </tr> <tr> <td></td> <td></td> <td colspan="8" style="text-align: center;"> <table border="1" style="width: 100%; border-collapse: collapse; text-align: center;"> <tr> <td style="width: 10%;"></td> <td style="width: 10%;"></td> <td style="width: 10%;"></td> <td style="width: 10%;"></td> <td style="width: 10%;"></td> <td style="width: 10%;"></td> <td style="width: 10%;"></td> <td style="width: 10%;"></td> <td style="width: 10%;"></td> <td style="width: 10%;"></td> </tr> <tr> <td></td> <td></td> <td colspan="8" style="text-align: center;"> <table border="1" style="width: 100%; border-collapse: collapse; text-align: center;"> <tr> </tr></table></td></tr></table></td></tr></table></td></tr></table></td></tr></table></td></tr></table></td></tr></table></td></tr></table></td></tr></table></td></tr></table></td></tr></table></td></tr></table></td></tr></table></td></tr></table></td></tr></table></td></tr></table></td></tr></table></td></tr></table></td></tr></table></td></tr></table></td></tr></table></td></tr></table></td></tr></table></td></tr></table></td></tr></table></td></tr></table></td></tr></table></td></tr></table></td></tr></table></td></tr></table></td></tr></table></td></tr></table></td></tr></table></td></tr></table></td></tr></table></td></tr></table></td></tr></table></td></tr></table></td></tr></table></td></tr></table> | | | | | | | | | | | | | | | | | | | | <table border="1" style="width: 100%; border-collapse: collapse; text-align: center;"> <tr> <td style="width: 10%;"></td> <td style="width: 10%;"></td> <td style="width: 10%;"></td> <td style="width: 10%;"></td> <td style="width: 10%;"></td> <td style="width: 10%;"></td> <td style="width: 10%;"></td> <td style="width: 10%;"></td> <td style="width: 10%;"></td> <td style="width: 10%;"></td> </tr> <tr> <td></td> <td></td> <td colspan="8" style="text-align: center;"> <table border="1" style="width: 100%; border-collapse: collapse; text-align: center;"> <tr> <td style="width: 10%;"></td> <td style="width: 10%;"></td> <td style="width: 10%;"></td> <td style="width: 10%;"></td> <td style="width: 10%;"></td> <td style="width: 10%;"></td> <td style="width: 10%;"></td> <td style="width: 10%;"></td> <td style="width: 10%;"></td> <td style="width: 10%;"></td> </tr> <tr> <td></td> <td></td> <td colspan="8" style="text-align: center;"> <table border="1" style="width: 100%; border-collapse: collapse; text-align: center;"> <tr> <td style="width: 10%;"></td> <td style="width: 10%;"></td> <td style="width: 10%;"></td> <td style="width: 10%;"></td> <td style="width: 10%;"></td> <td style="width: 10%;"></td> <td style="width: 10%;"></td> <td style="width: 10%;"></td> <td style="width: 10%;"></td> <td style="width: 10%;"></td> </tr> <tr> <td></td> <td></td> <td colspan="8" style="text-align: center;"> <table border="1" style="width: 100%; border-collapse: collapse; text-align: center;"> <tr> <td style="width: 10%;"></td> <td style="width: 10%;"></td> <td style="width: 10%;"></td> <td style="width: 10%;"></td> <td style="width: 10%;"></td> <td style="width: 10%;"></td> <td style="width: 10%;"></td> <td style="width: 10%;"></td> <td style="width: 10%;"></td> <td style="width: 10%;"></td> </tr> <tr> <td></td> <td></td> <td colspan="8" style="text-align: center;"> <table border="1" style="width: 100%; border-collapse: collapse; text-align: center;"> <tr> <td style="width: 10%;"></td> <td style="width: 10%;"></td> <td style="width: 10%;"></td> <td style="width: 10%;"></td> <td style="width: 10%;"></td> <td style="width: 10%;"></td> <td style="width: 10%;"></td> <td style="width: 10%;"></td> <td style="width: 10%;"></td> <td style="width: 10%;"></td> </tr> <tr> <td></td> <td></td> <td colspan="8" style="text-align: center;"> <table border="1" style="width: 100%; border-collapse: collapse; text-align: center;"> <tr> <td style="width: 10%;"></td> <td style="width: 10%;"></td> <td style="width: 10%;"></td>
<td style="width: 10%;"></td> <td style="width: 10%;"></td> <td style="width: 10%;"></td> <td style="width: 10%;"></td> <td style="width: 10%;"></td> <td style="width: 10%;"></td> <td style="width: 10%;"></td> </tr> <tr> <td></td> <td></td> <td colspan="8" style="text-align: center;"> <table border="1" style="width: 100%; border-collapse: collapse; text-align: center;"> <tr> <td style="width: 10%;"></td> <td style="width: 10%;"></td> <td style="width: 10%;"></td> <td style="width: 10%;"></td> <td style="width: 10%;"></td> <td style="width: 10%;"></td> <td style="width: 10%;"></td> <td style="width: 10%;"></td> <td style="width: 10%;"></td> <td style="width: 10%;"></td> </tr> <tr> <td></td> <td></td> <td colspan="8" style="text-align: center;"> <table border="1" style="width: 100%; border-collapse: collapse; text-align: center;"> <tr> <td style="width: 10%;"></td> <td style="width: 10%;"></td> <td style="width: 10%;"></td> <td style="width: 10%;"></td> <td style="width: 10%;"></td> <td style="width: 10%;"></td> <td style="width: 10%;"></td> <td style="width: 10%;"></td> <td style="width: 10%;"></td> <td style="width: 10%;"></td> </tr> <tr> <td></td> <td></td> <td colspan="8" style="text-align: center;"> <table border="1" style="width: 100%; border-collapse: collapse; text-align: center;"> <tr> <td style="width: 10%;"></td> <td style="width: 10%;"></td> <td style="width: 10%;"></td> <td style="width: 10%;"></td> <td style="width: 10%;"></td> <td style="width: 10%;"></td> <td style="width: 10%;"></td> <td style="width: 10%;"></td> <td style="width: 10%;"></td> <td style="width: 10%;"></td> </tr> <tr> <td></td> <td></td> <td colspan="8" style="text-align: center;"> <table border="1" style="width: 100%; border-collapse: collapse; text-align: center;"> <tr> <td style="width: 10%;"></td> <td style="width: 10%;"></td> <td style="width: 10%;"></td> <td style="width: 10%;"></td> <td style="width: 10%;"></td> <td style="width: 10%;"></td> <td style="width: 10%;"></td> <td style="width: 10%;"></td> <td style="width: 10%;"></td> <td style="width: 10%;"></td> </tr> <tr> <td></td> <td></td> <td colspan="8" style="text-align: center;"> <table border="1" style="width: 100%; border-collapse: collapse; text-align: center;"> <tr> <td style="width: 10%;"></td> <td style="width: 10%;"></td> <td style="width: 10%;"></td> <td style="width: 10%;"></td> <td style="width: 10%;"></td> <td style="width: 10%;"></td> <td style="width: 10%;"></td> <td style="width: 10%;"></td> <td style="width: 10%;"></td> <td style="width: 10%;"></td> </tr> <tr> <td></td> <td></td> <td colspan="8" style="text-align: center;"> <table border="1" style="width: 100%; border-collapse: collapse; text-align: center;"> <tr> <td style="width: 10%;"></td> <td style="width: 10%;"></td> <td style="width: 10%;"></td> <td style="width: 10%;"></td> <td style="width: 10%;"></td> <td style="width: 10%;"></td> <td style="width: 10%;"></td> <td style="width: 10%;"></td> <td style="width: 10%;"></td> <td style="width: 10%;"></td> </tr> <tr> <td></td> <td></td> <td colspan="8" style="text-align: center;"> <table border="1" style="width: 100%; border-collapse: collapse; text-align: center;"> <tr> <td style="width: 10%;"></td> <td style="width: 10%;"></td> <td style="width: 10%;"></td> <td style="width: 10%;"></td> <td style="width: 10%;"></td> <td style="width: 10%;"></td> <td style="width: 10%;"></td> <td style="width: 10%;"></td> <td style="width: 10%;"></td> <td style="width: 10%;"></td> </tr> <tr> <td></td> <td></td> <td colspan="8" style="text-align: center;"> <table border="1" style="width: 100%; border-collapse: collapse; text-align: center;"> <tr> <td style="width: 10%;"></td> <td style="width: 10%;"></td> <td style="width: 10%;"></td> <td style="width: 10%;"></td> <td style="width: 10%;"></td> <td style="width: 10%;"></td> <td style="width: 10%;"></td> <td style="width: 10%;"></td> <td style="width: 10%;"></td> <td style="width: 10%;"></td> </tr> <tr> <td></td> <td></td> <td colspan="8" style="text-align: center;"> <table border="1" style="width: 100%; border-collapse: collapse; text-align: center;"> <tr> <td style="width: 10%;"></td> <td style="width: 10%;"></td> <td style="width: 10%;"></td> <td style="width: 10%;"></td> <td style="width: 10%;"></td> <td style="width: 10%;"></td> <td style="width: 10%;"></td> <td style="width: 10%;"></td> <td style="width: 10%;"></td> <td style="width: 10%;"></td> </tr> <tr> <td></td> <td></td> <td colspan="8" style="text-align: center;"> <table border="1" style="width: 100%; border-collapse: collapse; text-align: center;"> <tr> <td style="width: 10%;"></td> <td style="width: 10%;"></td> <td style="width: 10%;"></td> <td style="width: 10%;"></td> <td style="width: 10%;"></td> <td style="width: 10%;"></td> <td style="width: 10%;"></td> <td style="width: 10%;"></td> <td style="width: 10%;"></td> <td style="width: 10%;"></td> </tr> <tr> <td></td> <td></td> <td colspan="8" style="text-align: center;"> <table border="1" style="width: 100%; border-collapse: collapse; text-align: center;"> <tr> <td style="width: 10%;"></td> <td style="width: 10%;"></td> <td style="width: 10%;"></td> <td style="width: 10%;"></td> <td style="width: 10%;"></td> <td style="width: 10%;"></td> <td style="width: 10%;"></td> <td style="width: 10%;"></td> <td style="width: 10%;"></td> <td style="width: 10%;"></td> </tr> <tr> <td></td> <td></td> <td colspan="8" style="text-align: center;"> <table border="1" style="width: 100%; border-collapse: collapse; text-align: center;"> <tr> <td style="width: 10%;"></td> <td style="width: 10%;"></td> <td style="width: 10%;"></td> <td style="width: 10%;"></td> <td style="width: 10%;"></td> <td style="width: 10%;"></td> <td style="width: 10%;"></td> <td style="width: 10%;"></td> <td style="width: 10%;"></td> <td style="width: 10%;"></td> </tr> <tr> <td></td> <td></td> <td colspan="8" style="text-align: center;"> <table border="1" style="width: 100%; border-collapse: collapse; text-align: center;"> <tr> <td style="width: 10%;"></td> <td style="width: 10%;"></td> <td style="width: 10%;"></td> <td style="width: 10%;"></td> <td style="width: 10%;"></td> <td style="width: 10%;"></td> <td style="width: 10%;"></td> <td style="width: 10%;"></td> <td style="width: 10%;"></td> <td style="width: 10%;"></td> </tr> <tr> <td></td> <td></td> <td colspan="8" style="text-align: center;"> <table border="1" style="width: 100%; border-collapse: collapse; text-align: center;"> <tr> <td style="width: 10%;"></td> <td style="width: 10%;"></td> <td style="width: 10%;"></td> <td style="width: 10%;"></td> <td style="width: 10%;"></td> <td style="width: 10%;"></td> <td style="width: 10%;"></td> <td style="width: 10%;"></td> <td style="width: 10%;"></td> <td style="width: 10%;"></td> </tr> <tr> <td></td> <td></td> <td colspan="8" style="text-align: center;"> <table border="1" style="width: 100%; border-collapse: collapse; text-align: center;"> <tr> <td style="width: 10%;"></td> <td style="width: 10%;"></td> <td style="width: 10%;"></td> <td style="width: 10%;"></td> <td style="width: 10%;"></td> <td style="width: 10%;"></td> <td style="width: 10%;"></td> <td style="width: 10%;"></td> <td style="width: 10%;"></td> <td style="width: 10%;"></td> </tr> <tr> <td></td> <td></td> <td colspan="8" style="text-align: center;"> <table border="1" style="width: 100%; border-collapse: collapse; text-align: center;"> <tr> <td style="width: 10%;"></td> <td style="width: 10%;"></td> <td style="width: 10%;"></td> <td style="width: 10%;"></td> <td style="width: 10%;"></td> <td style="width: 10%;"></td> <td style="width: 10%;"></td> <td style="width: 10%;"></td> <td style="width: 10%;"></td> <td style="width: 10%;"></td> </tr> <tr> <td></td> <td></td> <td colspan="8" style="text-align: center;"> <table border="1" style="width: 100%; border-collapse: collapse; text-align: center;"> <tr> <td style="width: 10%;"></td> <td style="width: 10%;"></td> <td style="width: 10%;"></td> <td style="width: 10%;"></td> <td style="width: 10%;"></td> <td style="width: 10%;"></td> <td style="width: 10%;"></td> <td style="width: 10%;"></td> <td style="width: 10%;"></td> <td style="width: 10%;"></td> </tr> <tr> <td></td> <td></td> <td colspan="8" style="text-align: center;"> <table border="1" style="width: 100%; border-collapse: collapse; text-align: center;"> <tr> <td style="width: 10%;"></td> <td style="width: 10%;"></td> <td style="width: 10%;"></td> <td style="width: 10%;"></td> <td style="width: 10%;"></td> <td style="width: 10%;"></td> <td style="width: 10%;"></td> <td style="width: 10%;"></td> <td style="width: 10%;"></td> <td style="width: 10%;"></td> </tr> <tr> <td></td> <td></td> <td colspan="8" style="text-align: center;"> <table border="1" style="width: 100%; border-collapse: collapse; text-align: center;"> <tr> <td style="width: 10%;"></td> <td style="width: 10%;"></td> <td style="width: 10%;"></td> <td style="width: 10%;"></td> <td style="width: 10%;"></td> <td style="width: 10%;"></td> <td style="width: 10%;"></td> <td style="width: 10%;"></td> <td style="width: 10%;"></td> <td style="width: 10%;"></td> </tr> <tr> <td></td> <td></td> <td colspan="8" style="text-align: center;"> <table border="1" style="width: 100%; border-collapse: collapse; text-align: center;"> <tr> <td style="width: 10%;"></td> <td style="width: 10%;"></td> <td style="width: 10%;"></td> <td style="width: 10%;"></td> <td style="width: 10%;"></td> <td style="width: 10%;"></td> <td style="width: 10%;"></td> <td style="width: 10%;"></td> <td style="width: 10%;"></td> <td style="width: 10%;"></td> </tr> <tr> <td></td> <td></td> <td colspan="8" style="text-align: center;"> <table border="1" style="width: 100%; border-collapse: collapse; text-align: center;"> <tr> <td style="width: 10%;"></td> <td style="width: 10%;"></td> <td style="width: 10%;"></td> <td style="width: 10%;"></td> <td style="width: 10%;"></td> <td style="width: 10%;"></td> <td style="width: 10%;"></td> <td style="width: 10%;"></td> <td style="width:
10%;"></td> <td style="width: 10%;"></td> </tr> <tr> <td></td> <td></td> <td colspan="8" style="text-align: center;"> <table border="1" style="width: 100%; border-collapse: collapse; text-align: center;"> <tr> <td style="width: 10%;"></td> <td style="width: 10%;"></td> <td style="width: 10%;"></td> <td style="width: 10%;"></td> <td style="width: 10%;"></td> <td style="width: 10%;"></td> <td style="width: 10%;"></td> <td style="width: 10%;"></td> <td style="width: 10%;"></td> <td style="width: 10%;"></td> </tr> <tr> <td></td> <td></td> <td colspan="8" style="text-align: center;"> <table border="1" style="width: 100%; border-collapse: collapse; text-align: center;"> <tr> <td style="width: 10%;"></td> <td style="width: 10%;"></td> <td style="width: 10%;"></td> <td style="width: 10%;"></td> <td style="width: 10%;"></td> <td style="width: 10%;"></td> <td style="width: 10%;"></td> <td style="width: 10%;"></td> <td style="width: 10%;"></td> <td style="width: 10%;"></td> </tr> <tr> <td></td> <td></td> <td colspan="8" style="text-align: center;"> <table border="1" style="width: 100%; border-collapse: collapse; text-align: center;"> <tr> <td style="width: 10%;"></td> <td style="width: 10%;"></td> <td style="width: 10%;"></td> <td style="width: 10%;"></td> <td style="width: 10%;"></td> <td style="width: 10%;"></td> <td style="width: 10%;"></td> <td style="width: 10%;"></td> <td style="width: 10%;"></td> <td style="width: 10%;"></td> </tr> <tr> <td></td> <td></td> <td colspan="8" style="text-align: center;"> <table border="1" style="width: 100%; border-collapse: collapse; text-align: center;"> <tr> <td style="width: 10%;"></td> <td style="width: 10%;"></td> <td style="width: 10%;"></td> <td style="width: 10%;"></td> <td style="width: 10%;"></td> <td style="width: 10%;"></td> <td style="width: 10%;"></td> <td style="width: 10%;"></td> <td style="width: 10%;"></td> <td style="width: 10%;"></td> </tr> <tr> <td></td> <td></td> <td colspan="8" style="text-align: center;"> <table border="1" style="width: 100%; border-collapse: collapse; text-align: center;"> <tr> <td style="width: 10%;"></td> <td style="width: 10%;"></td> <td style="width: 10%;"></td> <td style="width: 10%;"></td> <td style="width: 10%;"></td> <td style="width: 10%;"></td> <td style="width: 10%;"></td> <td style="width: 10%;"></td> <td style="width: 10%;"></td> <td style="width: 10%;"></td> </tr> <tr> <td></td> <td></td> <td colspan="8" style="text-align: center;"> <table border="1" style="width: 100%; border-collapse: collapse; text-align: center;"> <tr> <td style="width: 10%;"></td> <td style="width: 10%;"></td> <td style="width: 10%;"></td> <td style="width: 10%;"></td> <td style="width: 10%;"></td> <td style="width: 10%;"></td> <td style="width: 10%;"></td> <td style="width: 10%;"></td> <td style="width: 10%;"></td> <td style="width: 10%;"></td> </tr> <tr> <td></td> <td></td> <td colspan="8" style="text-align: center;"> <table border="1" style="width: 100%; border-collapse: collapse; text-align: center;"> <tr> <td style="width: 10%;"></td> <td style="width: 10%;"></td> <td style="width: 10%;"></td> <td style="width: 10%;"></td> <td style="width: 10%;"></td> <td style="width: 10%;"></td> <td style="width: 10%;"></td> <td style="width: 10%;"></td> <td style="width: 10%;"></td> <td style="width: 10%;"></td> </tr> <tr> <td></td> <td></td> <td colspan="8" style="text-align: center;"> <table border="1" style="width: 100%; border-collapse: collapse; text-align: center;"> <tr> <td style="width: 10%;"></td> <td style="width: 10%;"></td> <td style="width: 10%;"></td> <td style="width: 10%;"></td> <td style="width: 10%;"></td> <td style="width: 10%;"></td> <td style="width: 10%;"></td> <td style="width: 10%;"></td> <td style="width: 10%;"></td> <td style="width: 10%;"></td> </tr> <tr> <td></td> <td></td> <td colspan="8" style="text-align: center;"> <table border="1" style="width: 100%; border-collapse: collapse; text-align: center;"> <tr> <td style="width: 10%;"></td> <td style="width: 10%;"></td> <td style="width: 10%;"></td> <td style="width: 10%;"></td> <td style="width: 10%;"></td> <td style="width: 10%;"></td> <td style="width: 10%;"></td> <td style="width: 10%;"></td> <td style="width: 10%;"></td> <td style="width: 10%;"></td> </tr> <tr> <td></td> <td></td> <td colspan="8" style="text-align: center;"> <table border="1" style="width: 100%; border-collapse: collapse; text-align: center;"> <tr> <td style="width: 10%;"></td> <td style="width: 10%;"></td> <td style="width: 10%;"></td> <td style="width: 10%;"></td> <td style="width: 10%;"></td> <td style="width: 10%;"></td> <td style="width: 10%;"></td> <td style="width: 10%;"></td> <td style="width: 10%;"></td> <td style="width: 10%;"></td> </tr> <tr> <td></td> <td></td> <td colspan="8" style="text-align: center;"> <table border="1" style="width: 100%; border-collapse: collapse; text-align: center;"> <tr> <td style="width: 10%;"></td> <td style="width: 10%;"></td> <td style="width: 10%;"></td> <td style="width: 10%;"></td> <td style="width: 10%;"></td> <td style="width: 10%;"></td> <td style="width: 10%;"></td> <td style="width: 10%;"></td> <td style="width: 10%;"></td> <td style="width: 10%;"></td> </tr> <tr> <td></td> <td></td> <td colspan="8" style="text-align: center;"> <table border="1" style="width: 100%; border-collapse: collapse; text-align: center;"> <tr> </tr></table></td></tr></table></td></tr></table></td></tr></table></td></tr></table></td></tr></table></td></tr></table></td></tr></table></td></tr></table></td></tr></table></td></tr></table></td></tr></table></td></tr></table></td></tr></table></td></tr></table></td></tr></table></td></tr></table></td></tr></table></td></tr></table></td></tr></table></td></tr></table></td></tr></table></td></tr></table></td></tr></table></td></tr></table></td></tr></table></td></tr></table></td></tr></table></td></tr></table></td></tr></table></td></tr></table></td></tr></table></td></tr></table></td></tr></table></td></tr></table></td></tr></table></td></tr></table></td></tr></table></td></tr></table> | | | | | | | | | | | | | | | | | | | | <table border="1" style="width: 100%; border-collapse: collapse; text-align: center;"> <tr> <td style="width: 10%;"></td> <td style="width: 10%;"></td> <td style="width: 10%;"></td> <td style="width: 10%;"></td> <td style="width: 10%;"></td> <td style="width: 10%;"></td> <td style="width: 10%;"></td> <td style="width: 10%;"></td> <td style="width: 10%;"></td> <td style="width: 10%;"></td> </tr> <tr> <td></td> <td></td> <td colspan="8" style="text-align: center;"> <table border="1" style="width: 100%; border-collapse: collapse; text-align: center;"> <tr> <td style="width: 10%;"></td> <td style="width: 10%;"></td> <td style="width: 10%;"></td> <td style="width: 10%;"></td> <td style="width: 10%;"></td> <td style="width: 10%;"></td> <td style="width: 10%;"></td> <td style="width: 10%;"></td> <td style="width: 10%;"></td> <td style="width: 10%;"></td> </tr> <tr> <td></td> <td></td> <td colspan="8" style="text-align: center;"> <table border="1" style="width: 100%; border-collapse: collapse; text-align: center;"> <tr> <td style="width: 10%;"></td> <td style="width: 10%;"></td> <td style="width: 10%;"></td> <td style="width: 10%;"></td> <td style="width: 10%;"></td> <td style="width: 10%;"></td> <td style="width: 10%;"></td> <td style="width: 10%;"></td> <td style="width: 10%;"></td> <td style="width: 10%;"></td> </tr> <tr> <td></td> <td></td> <td colspan="8" style="text-align: center;"> <table border="1" style="width: 100%; border-collapse: collapse; text-align: center;"> <tr> <td style="width: 10%;"></td> <td style="width: 10%;"></td> <td style="width: 10%;"></td> <td style="width: 10%;"></td> <td style="width: 10%;"></td> <td style="width: 10%;"></td> <td style="width: 10%;"></td> <td style="width: 10%;"></td> <td style="width: 10%;"></td> <td style="width: 10%;"></td> </tr> <tr> <td></td> <td></td> <td colspan="8" style="text-align: center;"> <table border="1" style="width: 100%; border-collapse: collapse; text-align: center;"> <tr> <td style="width: 10%;"></td> <td style="width: 10%;"></td> <td style="width: 10%;"></td> <td style="width: 10%;"></td> <td style="width: 10%;"></td> <td style="width: 10%;"></td> <td style="width: 10%;"></td> <td style="width: 10%;"></td> <td style="width: 10%;"></td> <td style="width: 10%;"></td> </tr> <tr> <td></td> <td></td> <td colspan="8" style="text-align: center;"> <table border="1" style="width: 100%; border-collapse: collapse; text-align: center;"> <tr> <td style="width: 10%;"></td> <td style="width: 10%;"></td> <td style="width: 10%;"></td> <td style="width: 10%;"></td> <td style="width: 10%;"></td> <td style="width: 10%;"></td> <td style="width: 10%;"></td> <td style="width: 10%;"></td> <td style="width: 10%;"></td> <td style="width: 10%;"></td> </tr> <tr> <td></td> <td></td> <td colspan="8" style="text-align: center;"> <table border="1" style="width: 100%; border-collapse: collapse; text-align: center;"> <tr> <td style="width: 10%;"></td> <td style="width: 10%;"></td> <td style="width: 10%;"></td> <td style="width: 10%;"></td> <td style="width: 10%;"></td> <td style="width: 10%;"></td> <td style="width: 10%;"></td> <td style="width: 10%;"></td> <td style="width: 10%;"></td> <td style="width: 10%;"></td> </tr> <tr> <td></td> <td></td> <td colspan="8" style="text-align: center;"> <table border="1" style="width: 100%; border-collapse: collapse; text-align: center;"> <tr> <td style="width: 10%;"></td>
<td style="width: 10%;"></td> <td style="width: 10%;"></td> <td style="width: 10%;"></td> <td style="width: 10%;"></td> <td style="width: 10%;"></td> <td style="width: 10%;"></td> <td style="width: 10%;"></td> <td style="width: 10%;"></td> <td style="width: 10%;"></td> </tr> <tr> <td></td> <td></td> <td colspan="8" style="text-align: center;"> <table border="1" style="width: 100%; border-collapse: collapse; text-align: center;"> <tr> <td style="width: 10%;"></td> <td style="width: 10%;"></td> <td style="width: 10%;"></td> <td style="width: 10%;"></td> <td style="width: 10%;"></td> <td style="width: 10%;"></td> <td style="width: 10%;"></td> <td style="width: 10%;"></td> <td style="width: 10%;"></td> <td style="width: 10%;"></td> </tr> <tr> <td></td> <td></td> <td colspan="8" style="text-align: center;"> <table border="1" style="width: 100%; border-collapse: collapse; text-align: center;"> <tr> <td style="width: 10%;"></td> <td style="width: 10%;"></td> <td style="width: 10%;"></td> <td style="width: 10%;"></td> <td style="width: 10%;"></td> <td style="width: 10%;"></td> <td style="width: 10%;"></td> <td style="width: 10%;"></td> <td style="width: 10%;"></td> <td style="width: 10%;"></td> </tr> <tr> <td></td> <td></td> <td colspan="8" style="text-align: center;"> <table border="1" style="width: 100%; border-collapse: collapse; text-align: center;"> <tr> <td style="width: 10%;"></td> <td style="width: 10%;"></td> <td style="width: 10%;"></td> <td style="width: 10%;"></td> <td style="width: 10%;"></td> <td style="width: 10%;"></td> <td style="width: 10%;"></td> <td style="width: 10%;"></td> <td style="width: 10%;"></td> <td style="width: 10%;"></td> </tr> <tr> <td></td> <td></td> <td colspan="8" style="text-align: center;"> <table border="1" style="width: 100%; border-collapse: collapse; text-align: center;"> <tr> <td style="width: 10%;"></td> <td style="width: 10%;"></td> <td style="width: 10%;"></td> <td style="width: 10%;"></td> <td style="width: 10%;"></td> <td style="width: 10%;"></td> <td style="width: 10%;"></td> <td style="width: 10%;"></td> <td style="width: 10%;"></td> <td style="width: 10%;"></td> </tr> <tr> <td></td> <td></td> <td colspan="8" style="text-align: center;"> <table border="1" style="width: 100%; border-collapse: collapse; text-align: center;"> <tr> <td style="width: 10%;"></td> <td style="width: 10%;"></td> <td style="width: 10%;"></td> <td style="width: 10%;"></td> <td style="width: 10%;"></td> <td style="width: 10%;"></td> <td style="width: 10%;"></td> <td style="width: 10%;"></td> <td style="width: 10%;"></td> <td style="width: 10%;"></td> </tr> <tr> <td></td> <td></td> <td colspan="8" style="text-align: center;"> <table border="1" style="width: 100%; border-collapse: collapse; text-align: center;"> <tr> <td style="width: 10%;"></td> <td style="width: 10%;"></td> <td style="width: 10%;"></td> <td style="width: 10%;"></td> <td style="width: 10%;"></td> <td style="width: 10%;"></td> <td style="width: 10%;"></td> <td style="width: 10%;"></td> <td style="width: 10%;"></td> <td style="width: 10%;"></td> </tr> <tr> <td></td> <td></td> <td colspan="8" style="text-align: center;"> <table border="1" style="width: 100%; border-collapse: collapse; text-align: center;"> <tr> <td style="width: 10%;"></td> <td style="width: 10%;"></td> <td style="width: 10%;"></td> <td style="width: 10%;"></td> <td style="width: 10%;"></td> <td style="width: 10%;"></td> <td style="width: 10%;"></td> <td style="width: 10%;"></td> <td style="width: 10%;"></td> <td style="width: 10%;"></td> </tr> <tr> <td></td> <td></td> <td colspan="8" style="text-align: center;"> <table border="1" style="width: 100%; border-collapse: collapse; text-align: center;"> <tr> <td style="width: 10%;"></td> <td style="width: 10%;"></td> <td style="width: 10%;"></td> <td style="width: 10%;"></td> <td style="width: 10%;"></td> <td style="width: 10%;"></td> <td style="width: 10%;"></td> <td style="width: 10%;"></td> <td style="width: 10%;"></td> <td style="width: 10%;"></td> </tr> <tr> <td></td> <td></td> <td colspan="8" style="text-align: center;"> <table border="1" style="width: 100%; border-collapse: collapse; text-align: center;"> <tr> <td style="width: 10%;"></td> <td style="width: 10%;"></td> <td style="width: 10%;"></td> <td style="width: 10%;"></td> <td style="width: 10%;"></td> <td style="width: 10%;"></td> <td style="width: 10%;"></td> <td style="width: 10%;"></td> <td style="width: 10%;"></td> <td style="width: 10%;"></td> </tr> <tr> <td></td> <td></td> <td colspan="8" style="text-align: center;"> <table border="1" style="width: 100%; border-collapse: collapse; text-align: center;"> <tr> <td style="width: 10%;"></td> <td style="width: 10%;"></td> <td style="width: 10%;"></td> <td style="width: 10%;"></td> <td style="width: 10%;"></td> <td style="width: 10%;"></td> <td style="width: 10%;"></td> <td style="width: 10%;"></td> <td style="width: 10%;"></td> <td style="width: 10%;"></td> </tr> <tr> <td></td> <td></td> <td colspan="8" style="text-align: center;"> <table border="1" style="width: 100%; border-collapse: collapse; text-align: center;"> <tr> <td style="width: 10%;"></td> <td style="width: 10%;"></td> <td style="width: 10%;"></td> <td style="width: 10%;"></td> <td style="width: 10%;"></td> <td style="width: 10%;"></td> <td style="width: 10%;"></td> <td style="width: 10%;"></td> <td style="width: 10%;"></td> <td style="width: 10%;"></td> </tr> <tr> <td></td> <td></td> <td colspan="8" style="text-align: center;"> <table border="1" style="width: 100%; border-collapse: collapse; text-align: center;"> <tr> <td style="width: 10%;"></td> <td style="width: 10%;"></td> <td style="width: 10%;"></td> <td style="width: 10%;"></td> <td style="width: 10%;"></td> <td style="width: 10%;"></td> <td style="width: 10%;"></td> <td style="width: 10%;"></td> <td style="width: 10%;"></td> <td style="width: 10%;"></td> </tr> <tr> <td></td> <td></td> <td colspan="8" style="text-align: center;"> <table border="1" style="width: 100%; border-collapse: collapse; text-align: center;"> <tr> <td style="width: 10%;"></td> <td style="width: 10%;"></td> <td style="width: 10%;"></td> <td style="width: 10%;"></td> <td style="width: 10%;"></td> <td style="width: 10%;"></td> <td style="width: 10%;"></td> <td style="width: 10%;"></td> <td style="width: 10%;"></td> <td style="width: 10%;"></td> </tr> <tr> <td></td> <td></td> <td colspan="8" style="text-align: center;"> <table border="1" style="width: 100%; border-collapse: collapse; text-align: center;"> <tr> <td style="width: 10%;"></td> <td style="width: 10%;"></td> <td style="width: 10%;"></td> <td style="width: 10%;"></td> <td style="width: 10%;"></td> <td style="width: 10%;"></td> <td style="width: 10%;"></td> <td style="width: 10%;"></td> <td style="width: 10%;"></td> <td style="width: 10%;"></td> </tr> <tr> <td></td> <td></td> <td colspan="8" style="text-align: center;"> <table border="1" style="width: 100%; border-collapse: collapse; text-align: center;"> <tr> <td style="width: 10%;"></td> <td style="width: 10%;"></td> <td style="width: 10%;"></td> <td style="width: 10%;"></td> <td style="width: 10%;"></td> <td style="width: 10%;"></td> <td style="width: 10%;"></td> <td style="width: 10%;"></td> <td style="width: 10%;"></td> <td style="width: 10%;"></td> </tr> <tr> <td></td> <td></td> <td colspan="8" style="text-align: center;"> <table border="1" style="width: 100%; border-collapse: collapse; text-align: center;"> <tr> <td style="width: 10%;"></td> <td style="width: 10%;"></td> <td style="width: 10%;"></td> <td style="width: 10%;"></td> <td style="width: 10%;"></td> <td style="width: 10%;"></td> <td style="width: 10%;"></td> <td style="width: 10%;"></td> <td style="width: 10%;"></td> <td style="width: 10%;"></td> </tr> <tr> <td></td> <td></td> <td colspan="8" style="text-align: center;"> <table border="1" style="width: 100%; border-collapse: collapse; text-align: center;"> <tr> <td style="width: 10%;"></td> <td style="width: 10%;"></td> <td style="width: 10%;"></td> <td style="width: 10%;"></td> <td style="width: 10%;"></td> <td style="width: 10%;"></td> <td style="width: 10%;"></td> <td style="width: 10%;"></td> <td style="width: 10%;"></td> <td style="width: 10%;"></td> </tr> <tr> <td></td> <td></td> <td colspan="8" style="text-align: center;"> <table border="1" style="width: 100%; border-collapse: collapse; text-align: center;"> <tr> <td style="width: 10%;"></td> <td style="width: 10%;"></td> <td style="width: 10%;"></td> <td style="width: 10%;"></td> <td style="width: 10%;"></td> <td style="width: 10%;"></td> <td style="width: 10%;"></td> <td style="width: 10%;"></td> <td style="width: 10%;"></td> <td style="width: 10%;"></td> </tr> <tr> <td></td> <td></td> <td colspan="8" style="text-align: center;"> <table border="1" style="width: 100%; border-collapse: collapse; text-align: center;"> <tr> <td style="width: 10%;"></td> <td style="width: 10%;"></td> <td style="width: 10%;"></td> <td style="width: 10%;"></td> <td style="width: 10%;"></td> <td style="width: 10%;"></td> <td style="width: 10%;"></td> <td style="width: 10%;"></td> <td style="width: 10%;"></td> <td style="width: 10%;"></td> </tr> <tr> <td></td> <td></td> <td colspan="8" style="text-align: center;"> <table border="1" style="width: 100%; border-collapse: collapse; text-align: center;"> <tr> <td style="width: 10%;"></td> <td style="width: 10%;"></td> <td style="width: 10%;"></td> <td style="width: 10%;"></td> <td style="width: 10%;"></td> <td style="width: 10%;"></td> <td style="width: 10%;"></td> <td style="width: 10%;"></td> <td style="width: 10%;"></td> <td style="width: 10%;"></td> </tr> <tr> <td></td> <td></td> <td colspan="8" style="text-align: center;"> <table border="1" style="width: 100%; border-collapse: collapse; text-align: center;"> <tr> <td style="width: 10%;"></td> <td style="width: 10%;"></td> <td style="width: 10%;"></td> <td style="width: 10%;"></td> <td style="width: 10%;"></td> <td style="width: 10%;"></td> <td style="width:
10%;"></td> <td style="width: 10%;"></td> <td style="width: 10%;"></td> <td style="width: 10%;"></td> </tr> <tr> <td></td> <td></td> <td colspan="8" style="text-align: center;"> <table border="1" style="width: 100%; border-collapse: collapse; text-align: center;"> <tr> <td style="width: 10%;"></td> <td style="width: 10%;"></td> <td style="width: 10%;"></td> <td style="width: 10%;"></td> <td style="width: 10%;"></td> <td style="width: 10%;"></td> <td style="width: 10%;"></td> <td style="width: 10%;"></td> <td style="width: 10%;"></td> <td style="width: 10%;"></td> </tr> <tr> <td></td> <td></td> <td colspan="8" style="text-align: center;"> <table border="1" style="width: 100%; border-collapse: collapse; text-align: center;"> <tr> <td style="width: 10%;"></td> <td style="width: 10%;"></td> <td style="width: 10%;"></td> <td style="width: 10%;"></td> <td style="width: 10%;"></td> <td style="width: 10%;"></td> <td style="width: 10%;"></td> <td style="width: 10%;"></td> <td style="width: 10%;"></td> <td style="width: 10%;"></td> </tr> <tr> <td></td> <td></td> <td colspan="8" style="text-align: center;"> <table border="1" style="width: 100%; border-collapse: collapse; text-align: center;"> <tr> <td style="width: 10%;"></td> <td style="width: 10%;"></td> <td style="width: 10%;"></td> <td style="width: 10%;"></td> <td style="width: 10%;"></td> <td style="width: 10%;"></td> <td style="width: 10%;"></td> <td style="width: 10%;"></td> <td style="width: 10%;"></td> <td style="width: 10%;"></td> </tr> <tr> <td></td> <td></td> <td colspan="8" style="text-align: center;"> <table border="1" style="width: 100%; border-collapse: collapse; text-align: center;"> <tr> <td style="width: 10%;"></td> <td style="width: 10%;"></td> <td style="width: 10%;"></td> <td style="width: 10%;"></td> <td style="width: 10%;"></td> <td style="width: 10%;"></td> <td style="width: 10%;"></td> <td style="width: 10%;"></td> <td style="width: 10%;"></td> <td style="width: 10%;"></td> </tr> <tr> <td></td> <td></td> <td colspan="8" style="text-align: center;"> <table border="1" style="width: 100%; border-collapse: collapse; text-align: center;"> <tr> <td style="width: 10%;"></td> <td style="width: 10%;"></td> <td style="width: 10%;"></td> <td style="width: 10%;"></td> <td style="width: 10%;"></td> <td style="width: 10%;"></td> <td style="width: 10%;"></td> <td style="width: 10%;"></td> <td style="width: 10%;"></td> <td style="width: 10%;"></td> </tr> <tr> <td></td> <td></td> <td colspan="8" style="text-align: center;"> <table border="1" style="width: 100%; border-collapse: collapse; text-align: center;"> <tr> <td style="width: 10%;"></td> <td style="width: 10%;"></td> <td style="width: 10%;"></td> <td style="width: 10%;"></td> <td style="width: 10%;"></td> <td style="width: 10%;"></td> <td style="width: 10%;"></td> <td style="width: 10%;"></td> <td style="width: 10%;"></td> <td style="width: 10%;"></td> </tr> <tr> <td></td> <td></td> <td colspan="8" style="text-align: center;"> <table border="1" style="width: 100%; border-collapse: collapse; text-align: center;"> <tr> <td style="width: 10%;"></td> <td style="width: 10%;"></td> <td style="width: 10%;"></td> <td style="width: 10%;"></td> <td style="width: 10%;"></td> <td style="width: 10%;"></td> <td style="width: 10%;"></td> <td style="width: 10%;"></td> <td style="width: 10%;"></td> <td style="width: 10%;"></td> </tr> <tr> <td></td> <td></td> <td colspan="8" style="text-align: center;"> <table border="1" style="width: 100%; border-collapse: collapse; text-align: center;"> <tr> <td style="width: 10%;"></td> <td style="width: 10%;"></td> <td style="width: 10%;"></td> <td style="width: 10%;"></td> <td style="width: 10%;"></td> <td style="width: 10%;"></td> <td style="width: 10%;"></td> <td style="width: 10%;"></td> <td style="width: 10%;"></td> <td style="width: 10%;"></td> </tr> <tr> <td></td> <td></td> <td colspan="8" style="text-align: center;"> <table border="1" style="width: 100%; border-collapse: collapse; text-align: center;"> <tr> </tr></table></td></tr></table></td></tr></table></td></tr></table></td></tr></table></td></tr></table></td></tr></table></td></tr></table></td></tr></table></td></tr></table></td></tr></table></td></tr></table></td></tr></table></td></tr></table></td></tr></table></td></tr></table></td></tr></table></td></tr></table></td></tr></table></td></tr></table></td></tr></table></td></tr></table></td></tr></table></td></tr></table></td></tr></table></td></tr></table></td></tr></table></td></tr></table></td></tr></table></td></tr></table></td></tr></table></td></tr></table></td></tr></table></td></tr></table></td></tr></table></td></tr></table></td></tr></table></td></tr></table> | | | | | | | | | | | | | | | | | | | | <table border="1" style="width: 100%; border-collapse: collapse; text-align: center;"> <tr> <td style="width: 10%;"></td> <td style="width: 10%;"></td> <td style="width: 10%;"></td> <td style="width: 10%;"></td> <td style="width: 10%;"></td> <td style="width: 10%;"></td> <td style="width: 10%;"></td> <td style="width: 10%;"></td> <td style="width: 10%;"></td> <td style="width: 10%;"></td> </tr> <tr> <td></td> <td></td> <td colspan="8" style="text-align: center;"> <table border="1" style="width: 100%; border-collapse: collapse; text-align: center;"> <tr> <td style="width: 10%;"></td> <td style="width: 10%;"></td> <td style="width: 10%;"></td> <td style="width: 10%;"></td> <td style="width: 10%;"></td> <td style="width: 10%;"></td> <td style="width: 10%;"></td> <td style="width: 10%;"></td> <td style="width: 10%;"></td> <td style="width: 10%;"></td> </tr> <tr> <td></td> <td></td> <td colspan="8" style="text-align: center;"> <table border="1" style="width: 100%; border-collapse: collapse; text-align: center;"> <tr> <td style="width: 10%;"></td> <td style="width: 10%;"></td> <td style="width: 10%;"></td> <td style="width: 10%;"></td> <td style="width: 10%;"></td> <td style="width: 10%;"></td> <td style="width: 10%;"></td> <td style="width: 10%;"></td> <td style="width: 10%;"></td> <td style="width: 10%;"></td> </tr> <tr> <td></td> <td></td> <td colspan="8" style="text-align: center;"> <table border="1" style="width: 100%; border-collapse: collapse; text-align: center;"> <tr> <td style="width: 10%;"></td> <td style="width: 10%;"></td> <td style="width: 10%;"></td> <td style="width: 10%;"></td> <td style="width: 10%;"></td> <td style="width: 10%;"></td> <td style="width: 10%;"></td> <td style="width: 10%;"></td> <td style="width: 10%;"></td> <td style="width: 10%;"></td> </tr> <tr> <td></td> <td></td> <td colspan="8" style="text-align: center;"> <table border="1" style="width: 100%; border-collapse: collapse; text-align: center;"> <tr> <td style="width: 10%;"></td> <td style="width: 10%;"></td> <td style="width: 10%;"></td> <td style="width: 10%;"></td> <td style="width: 10%;"></td> <td style="width: 10%;"></td> <td style="width: 10%;"></td> <td style="width: 10%;"></td> <td style="width: 10%;"></td> <td style="width: 10%;"></td> </tr> <tr> <td></td> <td></td> <td colspan="8" style="text-align: center;"> <table border="1" style="width: 100%; border-collapse: collapse; text-align: center;"> <tr> <td style="width: 10%;"></td> <td style="width: 10%;"></td> <td style="width: 10%;"></td> <td style="width: 10%;"></td> <td style="width: 10%;"></td> <td style="width: 10%;"></td> <td style="width: 10%;"></td> <td style="width: 10%;"></td> <td style="width: 10%;"></td> <td style="width: 10%;"></td> </tr> <tr> <td></td> <td></td> <td colspan="8" style="text-align: center;"> <table border="1" style="width: 100%; border-collapse: collapse; text-align: center;"> <tr> <td style="width: 10%;"></td> <td style="width: 10%;"></td> <td style="width: 10%;"></td> <td style="width: 10%;"></td> <td style="width: 10%;"></td> <td style="width: 10%;"></td> <td style="width: 10%;"></td> <td style="width: 10%;"></td> <td style="width: 10%;"></td> <td style="width: 10%;"></td> </tr> <tr> <td></td> <td></td> <td colspan="8" style="text-align: center;"> <table border="1" style="width: 100%; border-collapse: collapse; text-align: center;"> <tr> <td style="width: 10%;"></td> <td style="width: 10%;"></td> <td style="width: 10%;"></td> <td style="width: 10%;"></td> <td style="width: 10%;"></td> <td style="width: 10%;"></td> <td style="width: 10%;"></td> <td style="width: 10%;"></td> <td style="width: 10%;"></td> <td style="width: 10%;"></td> </tr> <tr> <td></td> <td></td> <td colspan="8" style="text-align: center;"> <table border="1" style="width: 100%; border-collapse: collapse; text-align: center;"> <tr> <td style="width: 10%;"></td> <td style="width: 10%;"></td> <td style="width: 10%;"></td> <td style="width: 10%;"></td> <td style="width: 10%;"></td> <td style="width: 10%;"></td> <td style="width: 10%;"></td> <td style="width: 10%;"></td> <td style="width: 10%;"></td> <td style="width: 10%;"></td> </tr> <tr> <td></td> <td></td> <td colspan="8" style="text-align: center;"> <table border="1" style="width: 100%; border-collapse: collapse; text-align: center;"> <tr> <td style="width: 10%;"></td> <td style="width: 10%;"></td> <td style="width: 10%;"></td> <td style="width: 10%;"></td> <td style="width: 10%;"></td> <td style="width: 10%;"></td> <td style="width: 10%;"></td> <td style="width: 10%;"></td> <td style="width: 10%;"></td> <td style="width: 10%;"></td> </tr> <tr> <td></td> <td></td> <td colspan="8" style="text-align: center;"> <table border="1" style="width: 100%; border-collapse: collapse; text-align:
center;"> <tr> <td style="width: 10%;"></td> <td style="width: 10%;"></td> <td style="width: 10%;"></td> <td style="width: 10%;"></td> <td style="width: 10%;"></td> <td style="width: 10%;"></td> <td style="width: 10%;"></td> <td style="width: 10%;"></td> <td style="width: 10%;"></td> <td style="width: 10%;"></td> </tr> <tr> <td></td> <td></td> <td colspan="8" style="text-align: center;"> <table border="1" style="width: 100%; border-collapse: collapse; text-align: center;"> <tr> <td style="width: 10%;"></td> <td style="width: 10%;"></td> <td style="width: 10%;"></td> <td style="width: 10%;"></td> <td style="width: 10%;"></td> <td style="width: 10%;"></td> <td style="width: 10%;"></td> <td style="width: 10%;"></td> <td style="width: 10%;"></td> <td style="width: 10%;"></td> </tr> <tr> <td></td> <td></td> <td colspan="8" style="text-align: center;"> <table border="1" style="width: 100%; border-collapse: collapse; text-align: center;"> <tr> <td style="width: 10%;"></td> <td style="width: 10%;"></td> <td style="width: 10%;"></td> <td style="width: 10%;"></td> <td style="width: 10%;"></td> <td style="width: 10%;"></td> <td style="width: 10%;"></td> <td style="width: 10%;"></td> <td style="width: 10%;"></td> <td style="width: 10%;"></td> </tr> <tr> <td></td> <td></td> <td colspan="8" style="text-align: center;"> <table border="1" style="width: 100%; border-collapse: collapse; text-align: center;"> <tr> <td style="width: 10%;"></td> <td style="width: 10%;"></td> <td style="width: 10%;"></td> <td style="width: 10%;"></td> <td style="width: 10%;"></td> <td style="width: 10%;"></td> <td style="width: 10%;"></td> <td style="width: 10%;"></td> <td style="width: 10%;"></td> <td style="width: 10%;"></td> </tr> <tr> <td></td> <td></td> <td colspan="8" style="text-align: center;"> <table border="1" style="width: 100%; border-collapse: collapse; text-align: center;"> <tr> <td style="width: 10%;"></td> <td style="width: 10%;"></td> <td style="width: 10%;"></td> <td style="width: 10%;"></td> <td style="width: 10%;"></td> <td style="width: 10%;"></td> <td style="width: 10%;"></td> <td style="width: 10%;"></td> <td style="width: 10%;"></td> <td style="width: 10%;"></td> </tr> <tr> <td></td> <td></td> <td colspan="8" style="text-align: center;"> <table border="1" style="width: 100%; border-collapse: collapse; text-align: center;"> <tr> <td style="width: 10%;"></td> <td style="width: 10%;"></td> <td style="width: 10%;"></td> <td style="width: 10%;"></td> <td style="width: 10%;"></td> <td style="width: 10%;"></td> <td style="width: 10%;"></td> <td style="width: 10%;"></td> <td style="width: 10%;"></td> <td style="width: 10%;"></td> </tr> <tr> <td></td> <td></td> <td colspan="8" style="text-align: center;"> <table border="1" style="width: 100%; border-collapse: collapse; text-align: center;"> <tr> <td style="width: 10%;"></td> <td style="width: 10%;"></td> <td style="width: 10%;"></td> <td style="width: 10%;"></td> <td style="width: 10%;"></td> <td style="width: 10%;"></td> <td style="width: 10%;"></td> <td style="width: 10%;"></td> <td style="width: 10%;"></td> <td style="width: 10%;"></td> </tr> <tr> <td></td> <td></td> <td colspan="8" style="text-align: center;"> <table border="1" style="width: 100%; border-collapse: collapse; text-align: center;"> <tr> <td style="width: 10%;"></td> <td style="width: 10%;"></td> <td style="width: 10%;"></td> <td style="width: 10%;"></td> <td style="width: 10%;"></td> <td style="width: 10%;"></td> <td style="width: 10%;"></td> <td style="width: 10%;"></td> <td style="width: 10%;"></td> <td style="width: 10%;"></td> </tr> <tr> <td></td> <td></td> <td colspan="8" style="text-align: center;"> <table border="1" style="width: 100%; border-collapse: collapse; text-align: center;"> <tr> <td style="width: 10%;"></td> <td style="width: 10%;"></td> <td style="width: 10%;"></td> <td style="width: 10%;"></td> <td style="width: 10%;"></td> <td style="width: 10%;"></td> <td style="width: 10%;"></td> <td style="width: 10%;"></td> <td style="width: 10%;"></td> <td style="width: 10%;"></td> </tr> <tr> <td></td> <td></td> <td colspan="8" style="text-align: center;"> <table border="1" style="width: 100%; border-collapse: collapse; text-align: center;"> <tr> <td style="width: 10%;"></td> <td style="width: 10%;"></td> <td style="width: 10%;"></td> <td style="width: 10%;"></td> <td style="width: 10%;"></td> <td style="width: 10%;"></td> <td style="width: 10%;"></td> <td style="width: 10%;"></td> <td style="width: 10%;"></td> <td style="width: 10%;"></td> </tr> <tr> <td></td> <td></td> <td colspan="8" style="text-align: center;"> <table border="1" style="width: 100%; border-collapse: collapse; text-align: center;"> <tr> <td style="width: 10%;"></td> <td style="width: 10%;"></td> <td style="width: 10%;"></td> <td style="width: 10%;"></td> <td style="width: 10%;"></td> <td style="width: 10%;"></td> <td style="width: 10%;"></td> <td style="width: 10%;"></td> <td style="width: 10%;"></td> <td style="width: 10%;"></td> </tr> <tr> <td></td> <td></td> <td colspan="8" style="text-align: center;"> <table border="1" style="width: 100%; border-collapse: collapse; text-align: center;"> <tr> <td style="width: 10%;"></td> <td style="width: 10%;"></td> <td style="width: 10%;"></td> <td style="width: 10%;"></td> <td style="width: 10%;"></td> <td style="width: 10%;"></td> <td style="width: 10%;"></td> <td style="width: 10%;"></td> <td style="width: 10%;"></td> <td style="width: 10%;"></td> </tr> <tr> <td></td> <td></td> <td colspan="8" style="text-align: center;"> <table border="1" style="width: 100%; border-collapse: collapse; text-align: center;"> <tr> <td style="width: 10%;"></td> <td style="width: 10%;"></td> <td style="width: 10%;"></td> <td style="width: 10%;"></td> <td style="width: 10%;"></td> <td style="width: 10%;"></td> <td style="width: 10%;"></td> <td style="width: 10%;"></td> <td style="width: 10%;"></td> <td style="width: 10%;"></td> </tr> <tr> <td></td> <td></td> <td colspan="8" style="text-align: center;"> <table border="1" style="width: 100%; border-collapse: collapse; text-align: center;"> <tr> <td style="width: 10%;"></td> <td style="width: 10%;"></td> <td style="width: 10%;"></td> <td style="width: 10%;"></td> <td style="width: 10%;"></td> <td style="width: 10%;"></td> <td style="width: 10%;"></td> <td style="width: 10%;"></td> <td style="width: 10%;"></td> <td style="width: 10%;"></td> </tr> <tr> <td></td> <td></td> <td colspan="8" style="text-align: center;"> <table border="1" style="width: 100%; border-collapse: collapse; text-align: center;"> <tr> <td style="width: 10%;"></td> <td style="width: 10%;"></td> <td style="width: 10%;"></td> <td style="width: 10%;"></td> <td style="width: 10%;"></td> <td style="width: 10%;"></td> <td style="width: 10%;"></td> <td style="width: 10%;"></td> <td style="width: 10%;"></td> <td style="width: 10%;"></td> </tr> <tr> <td></td> <td></td> <td colspan="8" style="text-align: center;"> <table border="1" style="width: 100%; border-collapse: collapse; text-align: center;"> <tr> <td style="width: 10%;"></td> <td style="width: 10%;"></td> <td style="width: 10%;"></td> <td style="width: 10%;"></td> <td style="width: 10%;"></td> <td style="width: 10%;"></td> <td style="width: 10%;"></td> <td style="width: 10%;"></td> <td style="width: 10%;"></td> <td style="width: 10%;"></td> </tr> <tr> <td></td> <td></td> <td colspan="8" style="text-align: center;"> <table border="1" style="width: 100%; border-collapse: collapse; text-align: center;"> <tr> <td style="width: 10%;"></td> <td style="width: 10%;"></td> <td style="width: 10%;"></td> <td style="width: 10%;"></td> <td style="width: 10%;"></td> <td style="width: 10%;"></td> <td style="width: 10%;"></td> <td style="width: 10%;"></td> <td style="width: 10%;"></td> <td style="width: 10%;"></td> </tr> <tr> <td></td> <td></td> <td colspan="8" style="text-align: center;"> <table border="1" style="width: 100%; border-collapse: collapse; text-align: center;"> <tr> <td style="width: 10%;"></td> <td style="width: 10%;"></td> <td style="width: 10%;"></td> <td style="width: 10%;"></td> <td style="width: 10%;"></td> <td style="width: 10%;"></td> <td style="width: 10%;"></td> <td style="width: 10%;"></td> <td style="width: 10%;"></td> <td style="width: 10%;"></td> </tr> <tr> <td></td> <td></td> <td colspan="8" style="text-align: center;"> <table border="1" style="width: 100%; border-collapse: collapse; text-align: center;"> <tr> <td style="width: 10%;"></td> <td style="width: 10%;"></td> <td style="width: 10%;"></td> <td style="width: 10%;"></td> <td style="width: 10%;"></td> <td style="width: 10%;"></td> <td style="width: 10%;"></td> <td style="width: 10%;"></td> <td style="width: 10%;"></td> <td style="width: 10%;"></td> </tr> <tr> <td></td> <td></td> <td colspan="8" style="text-align: center;"> <table border="1" style="width: 100%; border-collapse: collapse; text-align: center;"> <tr> <td style="width: 10%;"></td> <td style="width: 10%;"></td> <td style="width: 10%;"></td> <td style="width: 10%;"></td> <td style="width: 10%;"></td> <td style="width: 10%;"></td> <td style="width: 10%;"></td> <td style="width: 10%;"></td> <td style="width: 10%;"></td> <td style="width: 10%;"></td> </tr> <tr> <td></td> <td></td> <td colspan="8" style="text-align: center;"> <table border="1" style="width: 100%; border-collapse: collapse; text-align: center;"> <tr> <td style="width: 10%;"></td> <td style="width: 10%;"></td> <td style="width: 10%;"></td> <td style="width: 10%;"></td> <td style="width: 10%;"></td> <td style="width: 10%;"></td> <td style="width: 10%;"></td> <td style="width: 10%;"></td> <td style="width: 10%;"></td> <td style="width: 10%;"></td> </tr> <tr> <td></td> <td></td> <td colspan="8" style="text-align: center;"> <table border="1" style="width: 100%; border-collapse: collapse; text-align: center;"> <tr> <td style="width: 10%;"></td> <td style="width: 10%;"></td> <td style="width: 10%;"></td> <td style="width: 10%;"></td> <td style="width: 10%;"></td> <td
style="width: 10%;"></td> <td style="width: 10%;"></td> <td style="width: 10%;"></td> <td style="width: 10%;"></td> <td style="width: 10%;"></td> </tr> <tr> <td></td> <td></td> <td colspan="8" style="text-align: center;"> <table border="1" style="width: 100%; border-collapse: collapse; text-align: center;"> <tr> <td style="width: 10%;"></td> <td style="width: 10%;"></td> <td style="width: 10%;"></td> <td style="width: 10%;"></td> <td style="width: 10%;"></td> <td style="width: 10%;"></td> <td style="width: 10%;"></td> <td style="width: 10%;"></td> <td style="width: 10%;"></td> <td style="width: 10%;"></td> </tr> <tr> <td></td> <td></td> <td colspan="8" style="text-align: center;"> <table border="1" style="width: 100%; border-collapse: collapse; text-align: center;"> <tr> <td style="width: 10%;"></td> <td style="width: 10%;"></td> <td style="width: 10%;"></td> <td style="width: 10%;"></td> <td style="width: 10%;"></td> <td style="width: 10%;"></td> <td style="width: 10%;"></td> <td style="width: 10%;"></td> <td style="width: 10%;"></td> <td style="width: 10%;"></td> </tr> <tr> <td></td> <td></td> <td colspan="8" style="text-align: center;"> <table border="1" style="width: 100%; border-collapse: collapse; text-align: center;"> <tr> <td style="width: 10%;"></td> <td style="width: 10%;"></td> <td style="width: 10%;"></td> <td style="width: 10%;"></td> <td style="width: 10%;"></td> <td style="width: 10%;"></td> <td style="width: 10%;"></td> <td style="width: 10%;"></td> <td style="width: 10%;"></td> <td style="width: 10%;"></td> </tr> <tr> <td></td> <td></td> <td colspan="8" style="text-align: center;"> <table border="1" style="width: 100%; border-collapse: collapse; text-align: center;"> <tr> <td style="width: 10%;"></td> <td style="width: 10%;"></td> <td style="width: 10%;"></td> <td style="width: 10%;"></td> <td style="width: 10%;"></td> <td style="width: 10%;"></td> <td style="width: 10%;"></td> <td style="width: 10%;"></td> <td style="width: 10%;"></td> <td style="width: 10%;"></td> </tr> <tr> <td></td> <td></td> <td colspan="8" style="text-align: center;"> <table border="1" style="width: 100%; border-collapse: collapse; text-align: center;"> <tr> </tr></table></td></tr></table></td></tr></table></td></tr></table></td></tr></table></td></tr></table></td></tr></table></td></tr></table></td></tr></table></td></tr></table></td></tr></table></td></tr></table></td></tr></table></td></tr></table></td></tr></table></td></tr></table></td></tr></table></td></tr></table></td></tr></table></td></tr></table></td></tr></table></td></tr></table></td></tr></table></td></tr></table></td></tr></table></td></tr></table></td></tr></table></td></tr></table></td></tr></table></td></tr></table></td></tr></table></td></tr></table></td></tr></table></td></tr></table></td></tr></table></td></tr></table></td></tr></table> | | | | | | | | | | | | | | | | | | | | <table border="1" style="width: 100%; border-collapse: collapse; text-align: center;"> <tr> <td style="width: 10%;"></td> <td style="width: 10%;"></td> <td style="width: 10%;"></td> <td style="width: 10%;"></td> <td style="width: 10%;"></td> <td style="width: 10%;"></td> <td style="width: 10%;"></td> <td style="width: 10%;"></td> <td style="width: 10%;"></td> <td style="width: 10%;"></td> </tr> <tr> <td></td> <td></td> <td colspan="8" style="text-align: center;"> <table border="1" style="width: 100%; border-collapse: collapse; text-align: center;"> <tr> <td style="width: 10%;"></td> <td style="width: 10%;"></td> <td style="width: 10%;"></td> <td style="width: 10%;"></td> <td style="width: 10%;"></td> <td style="width: 10%;"></td> <td style="width: 10%;"></td> <td style="width: 10%;"></td> <td style="width: 10%;"></td> <td style="width: 10%;"></td> </tr> <tr> <td></td> <td></td> <td colspan="8" style="text-align: center;"> <table border="1" style="width: 100%; border-collapse: collapse; text-align: center;"> <tr> <td style="width: 10%;"></td> <td style="width: 10%;"></td> <td style="width: 10%;"></td> <td style="width: 10%;"></td> <td style="width: 10%;"></td> <td style="width: 10%;"></td> <td style="width: 10%;"></td> <td style="width: 10%;"></td> <td style="width: 10%;"></td> <td style="width: 10%;"></td> </tr> <tr> <td></td> <td></td> <td colspan="8" style="text-align: center;"> <table border="1" style="width: 100%; border-collapse: collapse; text-align: center;"> <tr> <td style="width: 10%;"></td> <td style="width: 10%;"></td> <td style="width: 10%;"></td> <td style="width: 10%;"></td> <td style="width: 10%;"></td> <td style="width: 10%;"></td> <td style="width: 10%;"></td> <td style="width: 10%;"></td> <td style="width: 10%;"></td> <td style="width: 10%;"></td> </tr> <tr> <td></td> <td></td> <td colspan="8" style="text-align: center;"> <table border="1" style="width: 100%; border-collapse: collapse; text-align: center;"> <tr> <td style="width: 10%;"></td> <td style="width: 10%;"></td> <td style="width: 10%;"></td> <td style="width: 10%;"></td> <td style="width: 10%;"></td> <td style="width: 10%;"></td> <td style="width: 10%;"></td> <td style="width: 10%;"></td> <td style="width: 10%;"></td> <td style="width: 10%;"></td> </tr> <tr> <td></td> <td></td> <td colspan="8" style="text-align: center;"> <table border="1" style="width: 100%; border-collapse: collapse; text-align: center;"> <tr> <td style="width: 10%;"></td> <td style="width: 10%;"></td> <td style="width: 10%;"></td> <td style="width: 10%;"></td> <td style="width: 10%;"></td> <td style="width: 10%;"></td> <td style="width: 10%;"></td> <td style="width: 10%;"></td> <td style="width: 10%;"></td> <td style="width: 10%;"></td> </tr> <tr> <td></td> <td></td> <td colspan="8" style="text-align: center;"> <table border="1" style="width: 100%; border-collapse: collapse; text-align: center;"> <tr> <td style="width: 10%;"></td> <td style="width: 10%;"></td> <td style="width: 10%;"></td> <td style="width: 10%;"></td> <td style="width: 10%;"></td> <td style="width: 10%;"></td> <td style="width: 10%;"></td> <td style="width: 10%;"></td> <td style="width: 10%;"></td> <td style="width: 10%;"></td> </tr> <tr> <td></td> <td></td> <td colspan="8" style="text-align: center;"> <table border="1" style="width: 100%; border-collapse: collapse; text-align: center;"> <tr> <td style="width: 10%;"></td> <td style="width: 10%;"></td> <td style="width: 10%;"></td> <td style="width: 10%;"></td> <td style="width: 10%;"></td> <td style="width: 10%;"></td> <td style="width: 10%;"></td> <td style="width: 10%;"></td> <td style="width: 10%;"></td> <td style="width: 10%;"></td> </tr> <tr> <td></td> <td></td> <td colspan="8" style="text-align: center;"> <table border="1" style="width: 100%; border-collapse: collapse; text-align: center;"> <tr> <td style="width: 10%;"></td> <td style="width: 10%;"></td> <td style="width: 10%;"></td> <td style="width: 10%;"></td> <td style="width: 10%;"></td> <td style="width: 10%;"></td> <td style="width: 10%;"></td> <td style="width: 10%;"></td> <td style="width: 10%;"></td> <td style="width: 10%;"></td> </tr> <tr> <td></td> <td></td> <td colspan="8" style="text-align: center;"> <table border="1" style="width: 100%; border-collapse: collapse; text-align: center;"> <tr> <td style="width: 10%;"></td> <td style="width: 10%;"></td> <td style="width: 10%;"></td> <td style="width: 10%;"></td> <td style="width: 10%;"></td> <td style="width: 10%;"></td> <td style="width: 10%;"></td> <td style="width: 10%;"></td> <td style="width: 10%;"></td> <td style="width: 10%;"></td> </tr> <tr> <td></td> <td></td> <td colspan="8" style="text-align: center;"> <table border="1" style="width: 100%; border-collapse: collapse; text-align: center;"> <tr> <td style="width: 10%;"></td> <td style="width: 10%;"></td> <td style="width: 10%;"></td> <td style="width: 10%;"></td> <td style="width: 10%;"></td> <td style="width: 10%;"></td> <td style="width: 10%;"></td> <td style="width: 10%;"></td> <td style="width: 10%;"></td> <td style="width: 10%;"></td> </tr> <tr> <td></td> <td></td> <td colspan="8" style="text-align: center;"> <table border="1" style="width: 100%; border-collapse: collapse; text-align: center;"> <tr> <td style="width: 10%;"></td> <td style="width: 10%;"></td> <td style="width: 10%;"></td> <td style="width: 10%;"></td> <td style="width: 10%;"></td> <td style="width: 10%;"></td> <td style="width: 10%;"></td> <td style="width: 10%;"></td> <td style="width: 10%;"></td> <td style="width: 10%;"></td> </tr> <tr> <td></td> <td></td> <td colspan="8" style="text-align: center;"> <table border="1" style="width: 100%; border-collapse: collapse; text-align: center;"> <tr> <td style="width: 10%;"></td> <td style="width: 10%;"></td> <td style="width: 10%;"></td> <td style="width: 10%;"></td> <td style="width: 10%;"></td> <td style="width: 10%;"></td> <td style="width: 10%;"></td> <td style="width: 10%;"></td> <td style="width: 10%;"></td> <td style="width: 10%;"></td> </tr> <tr> <td></td> <td></td> <td colspan="8" style="text-align: center;"> <table border="1" style="width: 100%; border-collapse: collapse; text-align: center;"> <tr> <td style="width: 10%;"></td> <td style="width: 10%;"></td> <td style="width: 10%;"></td> <td style="width: 10%;"></td> <td style="width: 10%;"></td> <td style="width: 10%;"></td> <td style="width: 10%;"></td> <td style="width: 10%;"></td> <td style="width: 10%;"></td> <td style="width: 10%;"></td> </tr> <tr> <td></td> <td></td> <td colspan="8" style="text-align: center;"> <table border="1" style="width: 100%; border-collapse:
collapse; text-align: center;"> <tr> <td style="width: 10%;"></td> <td style="width: 10%;"></td> <td style="width: 10%;"></td> <td style="width: 10%;"></td> <td style="width: 10%;"></td> <td style="width: 10%;"></td> <td style="width: 10%;"></td> <td style="width: 10%;"></td> <td style="width: 10%;"></td> <td style="width: 10%;"></td> </tr> <tr> <td></td> <td></td> <td colspan="8" style="text-align: center;"> <table border="1" style="width: 100%; border-collapse: collapse; text-align: center;"> <tr> <td style="width: 10%;"></td> <td style="width: 10%;"></td> <td style="width: 10%;"></td> <td style="width: 10%;"></td> <td style="width: 10%;"></td> <td style="width: 10%;"></td> <td style="width: 10%;"></td> <td style="width: 10%;"></td> <td style="width: 10%;"></td> <td style="width: 10%;"></td> </tr> <tr> <td></td> <td></td> <td colspan="8" style="text-align: center;"> <table border="1" style="width: 100%; border-collapse: collapse; text-align: center;"> <tr> <td style="width: 10%;"></td> <td style="width: 10%;"></td> <td style="width: 10%;"></td> <td style="width: 10%;"></td> <td style="width: 10%;"></td> <td style="width: 10%;"></td> <td style="width: 10%;"></td> <td style="width: 10%;"></td> <td style="width: 10%;"></td> <td style="width: 10%;"></td> </tr> <tr> <td></td> <td></td> <td colspan="8" style="text-align: center;"> <table border="1" style="width: 100%; border-collapse: collapse; text-align: center;"> <tr> <td style="width: 10%;"></td> <td style="width: 10%;"></td> <td style="width: 10%;"></td> <td style="width: 10%;"></td> <td style="width: 10%;"></td> <td style="width: 10%;"></td> <td style="width: 10%;"></td> <td style="width: 10%;"></td> <td style="width: 10%;"></td> <td style="width: 10%;"></td> </tr> <tr> <td></td> <td></td> <td colspan="8" style="text-align: center;"> <table border="1" style="width: 100%; border-collapse: collapse; text-align: center;"> <tr> <td style="width: 10%;"></td> <td style="width: 10%;"></td> <td style="width: 10%;"></td> <td style="width: 10%;"></td> <td style="width: 10%;"></td> <td style="width: 10%;"></td> <td style="width: 10%;"></td> <td style="width: 10%;"></td> <td style="width: 10%;"></td> <td style="width: 10%;"></td> </tr> <tr> <td></td> <td></td> <td colspan="8" style="text-align: center;"> <table border="1" style="width: 100%; border-collapse: collapse; text-align: center;"> <tr> <td style="width: 10%;"></td> <td style="width: 10%;"></td> <td style="width: 10%;"></td> <td style="width: 10%;"></td> <td style="width: 10%;"></td> <td style="width: 10%;"></td> <td style="width: 10%;"></td> <td style="width: 10%;"></td> <td style="width: 10%;"></td> <td style="width: 10%;"></td> </tr> <tr> <td></td> <td></td> <td colspan="8" style="text-align: center;"> <table border="1" style="width: 100%; border-collapse: collapse; text-align: center;"> <tr> <td style="width: 10%;"></td> <td style="width: 10%;"></td> <td style="width: 10%;"></td> <td style="width: 10%;"></td> <td style="width: 10%;"></td> <td style="width: 10%;"></td> <td style="width: 10%;"></td> <td style="width: 10%;"></td> <td style="width: 10%;"></td> <td style="width: 10%;"></td> </tr> <tr> <td></td> <td></td> <td colspan="8" style="text-align: center;"> <table border="1" style="width: 100%; border-collapse: collapse; text-align: center;"> <tr> <td style="width: 10%;"></td> <td style="width: 10%;"></td> <td style="width: 10%;"></td> <td style="width: 10%;"></td> <td style="width: 10%;"></td> <td style="width: 10%;"></td> <td style="width: 10%;"></td> <td style="width: 10%;"></td> <td style="width: 10%;"></td> <td style="width: 10%;"></td> </tr> <tr> <td></td> <td></td> <td colspan="8" style="text-align: center;"> <table border="1" style="width: 100%; border-collapse: collapse; text-align: center;"> <tr> <td style="width: 10%;"></td> <td style="width: 10%;"></td> <td style="width: 10%;"></td> <td style="width: 10%;"></td> <td style="width: 10%;"></td> <td style="width: 10%;"></td> <td style="width: 10%;"></td> <td style="width: 10%;"></td> <td style="width: 10%;"></td> <td style="width: 10%;"></td> </tr> <tr> <td></td> <td></td> <td colspan="8" style="text-align: center;"> <table border="1" style="width: 100%; border-collapse: collapse; text-align: center;"> <tr> <td style="width: 10%;"></td> <td style="width: 10%;"></td> <td style="width: 10%;"></td> <td style="width: 10%;"></td> <td style="width: 10%;"></td> <td style="width: 10%;"></td> <td style="width: 10%;"></td> <td style="width: 10%;"></td> <td style="width: 10%;"></td> <td style="width: 10%;"></td> </tr> <tr> <td></td> <td></td> <td colspan="8" style="text-align: center;"> <table border="1" style="width: 100%; border-collapse: collapse; text-align: center;"> <tr> <td style="width: 10%;"></td> <td style="width: 10%;"></td> <td style="width: 10%;"></td> <td style="width: 10%;"></td> <td style="width: 10%;"></td> <td style="width: 10%;"></td> <td style="width: 10%;"></td> <td style="width: 10%;"></td> <td style="width: 10%;"></td> <td style="width: 10%;"></td> </tr> <tr> <td></td> <td></td> <td colspan="8" style="text-align: center;"> <table border="1" style="width: 100%; border-collapse: collapse; text-align: center;"> <tr> <td style="width: 10%;"></td> <td style="width: 10%;"></td> <td style="width: 10%;"></td> <td style="width: 10%;"></td> <td style="width: 10%;"></td> <td style="width: 10%;"></td> <td style="width: 10%;"></td> <td style="width: 10%;"></td> <td style="width: 10%;"></td> <td style="width: 10%;"></td> </tr> <tr> <td></td> <td></td> <td colspan="8" style="text-align: center;"> <table border="1" style="width: 100%; border-collapse: collapse; text-align: center;"> <tr> <td style="width: 10%;"></td> <td style="width: 10%;"></td> <td style="width: 10%;"></td> <td style="width: 10%;"></td> <td style="width: 10%;"></td> <td style="width: 10%;"></td> <td style="width: 10%;"></td> <td style="width: 10%;"></td> <td style="width: 10%;"></td> <td style="width: 10%;"></td> </tr> <tr> <td></td> <td></td> <td colspan="8" style="text-align: center;"> <table border="1" style="width: 100%; border-collapse: collapse; text-align: center;"> <tr> <td style="width: 10%;"></td> <td style="width: 10%;"></td> <td style="width: 10%;"></td> <td style="width: 10%;"></td> <td style="width: 10%;"></td> <td style="width: 10%;"></td> <td style="width: 10%;"></td> <td style="width: 10%;"></td> <td style="width: 10%;"></td> <td style="width: 10%;"></td> </tr> <tr> <td></td> <td></td> <td colspan="8" style="text-align: center;"> <table border="1" style="width: 100%; border-collapse: collapse; text-align: center;"> <tr> <td style="width: 10%;"></td> <td style="width: 10%;"></td> <td style="width: 10%;"></td> <td style="width: 10%;"></td> <td style="width: 10%;"></td> <td style="width: 10%;"></td> <td style="width: 10%;"></td> <td style="width: 10%;"></td> <td style="width: 10%;"></td> <td style="width: 10%;"></td> </tr> <tr> <td></td> <td></td> <td colspan="8" style="text-align: center;"> <table border="1" style="width: 100%; border-collapse: collapse; text-align: center;"> <tr> <td style="width: 10%;"></td> <td style="width: 10%;"></td> <td style="width: 10%;"></td> <td style="width: 10%;"></td> <td style="width: 10%;"></td> <td style="width: 10%;"></td> <td style="width: 10%;"></td> <td style="width: 10%;"></td> <td style="width: 10%;"></td> <td style="width: 10%;"></td> </tr> <tr> <td></td> <td></td> <td colspan="8" style="text-align: center;"> <table border="1" style="width: 100%; border-collapse: collapse; text-align: center;"> <tr> <td style="width: 10%;"></td> <td style="width: 10%;"></td> <td style="width: 10%;"></td> <td style="width: 10%;"></td> <td style="width: 10%;"></td> <td style="width: 10%;"></td> <td style="width: 10%;"></td> <td style="width: 10%;"></td> <td style="width: 10%;"></td> <td style="width: 10%;"></td> </tr> <tr> <td></td> <td></td> <td colspan="8" style="text-align: center;"> <table border="1" style="width: 100%; border-collapse: collapse; text-align: center;"> <tr> <td style="width: 10%;"></td> <td style="width: 10%;"></td> <td style="width: 10%;"></td> <td style="width: 10%;"></td> <td style="width: 10%;"></td> <td style="width: 10%;"></td> <td style="width: 10%;"></td> <td style="width: 10%;"></td> <td style="width: 10%;"></td> <td style="width: 10%;"></td> </tr> <tr> <td></td> <td></td> <td colspan="8" style="text-align: center;"> <table border="1" style="width: 100%; border-collapse: collapse; text-align: center;"> <tr> <td style="width: 10%;"></td> <td style="width: 10%;"></td> <td style="width: 10%;"></td> <td style="width: 10%;"></td> <td style="width: 10%;"></td> <td style="width: 10%;"></td> <td style="width: 10%;"></td> <td style="width: 10%;"></td> <td style="width: 10%;"></td> <td style="width: 10%;"></td> </tr> <tr> <td></td> <td></td> <td colspan="8" style="text-align: center;"> <table border="1" style="width: 100%; border-collapse: collapse; text-align: center;"> <tr> <td style="width: 10%;"></td> <td style="width: 10%;"></td> <td style="width: 10%;"></td> <td style="width: 10%;"></td> <td style="width: 10%;"></td> <td style="width: 10%;"></td> <td style="width: 10%;"></td> <td style="width: 10%;"></td> <td style="width: 10%;"></td> <td style="width: 10%;"></td> </tr> <tr> <td></td> <td></td> <td colspan="8" style="text-align: center;"> <table border="1" style="width: 100%; border-collapse: collapse; text-align: center;"> <tr> <td style="width: 10%;"></td> <td style="width: 10%;"></td> <td style="width: 10%;"></td> <td style="width: 10%;"></td> <td style="width: 10%;"></td> <td style="width: 10%;"></td> <td style="width: 10%;"></td> <td style="width: 10%;"></td> <td style="width: 10%;"></td> <td style="width: 10%;"></td> </tr> <tr> <td></td> <td></td> <td colspan="8" style="text-align: center;"> <table border="1" style="width: 100%; border-collapse: collapse; text-align: center;"> <tr>
</tr></table></td></tr></table></td></tr></table></td></tr></table></td></tr></table></td></tr></table></td></tr></table></td></tr></table></td></tr></table></td></tr></table></td></tr></table></td></tr></table></td></tr></table></td></tr></table></td></tr></table></td></tr></table></td></tr></table></td></tr></table></td></tr></table></td></tr></table></td></tr></table></td></tr></table></td></tr></table></td></tr></table></td></tr></table></td></tr></table></td></tr></table></td></tr></table></td></tr></table></td></tr></table></td></tr></table></td></tr></table></td></tr></table></td></tr></table></td></tr></table></td></tr></table> | | | | | | | | | | | | | | | | | | | | <table border="1" style="width: 100%; border-collapse: collapse; text-align: center;"> <tr> <td style="width: 10%;"></td> <td style="width: 10%;"></td> <td style="width: 10%;"></td> <td style="width: 10%;"></td> <td style="width: 10%;"></td> <td style="width: 10%;"></td> <td style="width: 10%;"></td> <td style="width: 10%;"></td> <td style="width: 10%;"></td> <td style="width: 10%;"></td> </tr> <tr> <td></td> <td></td> <td colspan="8" style="text-align: center;"> <table border="1" style="width: 100%; border-collapse: collapse; text-align: center;"> <tr> <td style="width: 10%;"></td> <td style="width: 10%;"></td> <td style="width: 10%;"></td> <td style="width: 10%;"></td> <td style="width: 10%;"></td> <td style="width: 10%;"></td> <td style="width: 10%;"></td> <td style="width: 10%;"></td> <td style="width: 10%;"></td> <td style="width: 10%;"></td> </tr> <tr> <td></td> <td></td> <td colspan="8" style="text-align: center;"> <table border="1" style="width: 100%; border-collapse: collapse; text-align: center;"> <tr> <td style="width: 10%;"></td> <td style="width: 10%;"></td> <td style="width: 10%;"></td> <td style="width: 10%;"></td> <td style="width: 10%;"></td> <td style="width: 10%;"></td> <td style="width: 10%;"></td> <td style="width: 10%;"></td> <td style="width: 10%;"></td> <td style="width: 10%;"></td> </tr> <tr> <td></td> <td></td> <td colspan="8" style="text-align: center;"> <table border="1" style="width: 100%; border-collapse: collapse; text-align: center;"> <tr> <td style="width: 10%;"></td> <td style="width: 10%;"></td> <td style="width: 10%;"></td> <td style="width: 10%;"></td> <td style="width: 10%;"></td> <td style="width: 10%;"></td> <td style="width: 10%;"></td> <td style="width: 10%;"></td> <td style="width: 10%;"></td> <td style="width: 10%;"></td> </tr> <tr> <td></td> <td></td> <td colspan="8" style="text-align: center;"> <table border="1" style="width: 100%; border-collapse: collapse; text-align: center;"> <tr> <td style="width: 10%;"></td> <td style="width: 10%;"></td> <td style="width: 10%;"></td> <td style="width: 10%;"></td> <td style="width: 10%;"></td> <td style="width: 10%;"></td> <td style="width: 10%;"></td> <td style="width: 10%;"></td> <td style="width: 10%;"></td> <td style="width: 10%;"></td> </tr> <tr> <td></td> <td></td> <td colspan="8" style="text-align: center;"> <table border="1" style="width: 100%; border-collapse: collapse; text-align: center;"> <tr> <td style="width: 10%;"></td> <td style="width: 10%;"></td> <td style="width: 10%;"></td> <td style="width: 10%;"></td> <td style="width: 10%;"></td> <td style="width: 10%;"></td> <td style="width: 10%;"></td> <td style="width: 10%;"></td> <td style="width: 10%;"></td> <td style="width: 10%;"></td> </tr> <tr> <td></td> <td></td> <td colspan="8" style="text-align: center;"> <table border="1" style="width: 100%; border-collapse: collapse; text-align: center;"> <tr> <td style="width: 10%;"></td> <td style="width: 10%;"></td> <td style="width: 10%;"></td> <td style="width: 10%;"></td> <td style="width: 10%;"></td> <td style="width: 10%;"></td> <td style="width: 10%;"></td> <td style="width: 10%;"></td> <td style="width: 10%;"></td> <td style="width: 10%;"></td> </tr> <tr> <td></td> <td></td> <td colspan="8" style="text-align: center;"> <table border="1" style="width: 100%; border-collapse: collapse; text-align: center;"> <tr> <td style="width: 10%;"></td> <td style="width: 10%;"></td> <td style="width: 10%;"></td> <td style="width: 10%;"></td> <td style="width: 10%;"></td> <td style="width: 10%;"></td> <td style="width: 10%;"></td> <td style="width: 10%;"></td> <td style="width: 10%;"></td> <td style="width: 10%;"></td> </tr> <tr> <td></td> <td></td> <td colspan="8" style="text-align: center;"> <table border="1" style="width: 100%; border-collapse: collapse; text-align: center;"> <tr> <td style="width: 10%;"></td> <td style="width: 10%;"></td> <td style="width: 10%;"></td> <td style="width: 10%;"></td> <td style="width: 10%;"></td> <td style="width: 10%;"></td> <td style="width: 10%;"></td> <td style="width: 10%;"></td> <td style="width: 10%;"></td> <td style="width: 10%;"></td> </tr> <tr> <td></td> <td></td> <td colspan="8" style="text-align: center;"> <table border="1" style="width: 100%; border-collapse: collapse; text-align: center;"> <tr> <td style="width: 10%;"></td> <td style="width: 10%;"></td> <td style="width: 10%;"></td> <td style="width: 10%;"></td> <td style="width: 10%;"></td> <td style="width: 10%;"></td> <td style="width: 10%;"></td> <td style="width: 10%;"></td> <td style="width: 10%;"></td> <td style="width: 10%;"></td> </tr> <tr> <td></td> <td></td> <td colspan="8" style="text-align: center;"> <table border="1" style="width: 100%; border-collapse: collapse; text-align: center;"> <tr> <td style="width: 10%;"></td> <td style="width: 10%;"></td> <td style="width: 10%;"></td> <td style="width: 10%;"></td> <td style="width: 10%;"></td> <td style="width: 10%;"></td> <td style="width: 10%;"></td> <td style="width: 10%;"></td> <td style="width: 10%;"></td> <td style="width: 10%;"></td> </tr> <tr> <td></td> <td></td> <td colspan="8" style="text-align: center;"> <table border="1" style="width: 100%; border-collapse: collapse; text-align: center;"> <tr> <td style="width: 10%;"></td> <td style="width: 10%;"></td> <td style="width: 10%;"></td> <td style="width: 10%;"></td> <td style="width: 10%;"></td> <td style="width: 10%;"></td> <td style="width: 10%;"></td> <td style="width: 10%;"></td> <td style="width: 10%;"></td> <td style="width: 10%;"></td> </tr> <tr> <td></td> <td></td> <td colspan="8" style="text-align: center;"> <table border="1" style="width: 100%; border-collapse: collapse; text-align: center;"> <tr> <td style="width: 10%;"></td> <td style="width: 10%;"></td> <td style="width: 10%;"></td> <td style="width: 10%;"></td> <td style="width: 10%;"></td> <td style="width: 10%;"></td> <td style="width: 10%;"></td> <td style="width: 10%;"></td> <td style="width: 10%;"></td> <td style="width: 10%;"></td> </tr> <tr> <td></td> <td></td> <td colspan="8" style="text-align: center;"> <table border="1" style="width: 100%; border-collapse: collapse; text-align: center;"> <tr> <td style="width: 10%;"></td> <td style="width: 10%;"></td> <td style="width: 10%;"></td> <td style="width: 10%;"></td> <td style="width: 10%;"></td> <td style="width: 10%;"></td> <td style="width: 10%;"></td> <td style="width: 10%;"></td> <td style="width: 10%;"></td> <td style="width: 10%;"></td> </tr> <tr> <td></td> <td></td> <td colspan="8" style="text-align: center;"> <table border="1" style="width: 100%; border-collapse: collapse; text-align: center;"> <tr> <td style="width: 10%;"></td> <td style="width: 10%;"></td> <td style="width: 10%;"></td> <td style="width: 10%;"></td> <td style="width: 10%;"></td> <td style="width: 10%;"></td> <td style="width: 10%;"></td> <td style="width: 10%;"></td> <td style="width: 10%;"></td> <td style="width: 10%;"></td> </tr> <tr> <td></td> <td></td> <td colspan="8" style="text-align: center;"> <table border="1" style="width: 100%; border-collapse: collapse; text-align: center;"> <tr> <td style="width: 10%;"></td> <td style="width: 10%;"></td> <td style="width: 10%;"></td> <td style="width: 10%;"></td> <td style="width: 10%;"></td> <td style="width: 10%;"></td> <td style="width: 10%;"></td> <td style="width: 10%;"></td> <td style="width: 10%;"></td> <td style="width: 10%;"></td> </tr> <tr> <td></td> <td></td> <td colspan="8" style="text-align: center;"> <table border="1" style="width: 100%; border-collapse: collapse; text-align: center;"> <tr> <td style="width: 10%;"></td> <td style="width: 10%;"></td> <td style="width: 10%;"></td> <td style="width: 10%;"></td> <td style="width: 10%;"></td> <td style="width: 10%;"></td> <td style="width: 10%;"></td> <td style="width: 10%;"></td> <td style="width: 10%;"></td> <td style="width: 10%;"></td> </tr> <tr> <td></td> <td></td> <td colspan="8" style="text-align: center;"> <table border="1" style="width: 100%; border-collapse: collapse; text-align: center;"> <tr> <td style="width: 10%;"></td> <td style="width: 10%;"></td> <td style="width: 10%;"></td> <td style="width: 10%;"></td> <td style="width: 10%;"></td> <td style="width: 10%;"></td> <td style="width: 10%;"></td> <td style="width: 10%;"></td> <td style="width: 10%;"></td> <td style="width: 10%;"></td> </tr> <tr> <td></td> <td></td> <td colspan="8" style="text-align: center;"> <table border="1" style="width: 100%; border-collapse: collapse; text-align: center;"> <tr> <td style="width: 10%;"></td> <td style="width: 10%;"></td> <td style="width: 10%;"></td> <td style="width: 10%;"></td> <td style="width: 10%;"></td> <td style="width: 10%;"></td> <td style="width: 10%;"></td> <td style="width: 10%;"></td> <td style="width: 10%;"></td> <td style="width:
10%;"></td> </tr> <tr> <td></td> <td></td> <td colspan="8" style="text-align: center;"> <table border="1" style="width: 100%; border-collapse: collapse; text-align: center;"> <tr> <td style="width: 10%;"></td> <td style="width: 10%;"></td> <td style="width: 10%;"></td> <td style="width: 10%;"></td> <td style="width: 10%;"></td> <td style="width: 10%;"></td> <td style="width: 10%;"></td> <td style="width: 10%;"></td> <td style="width: 10%;"></td> <td style="width: 10%;"></td> </tr> <tr> <td></td> <td></td> <td colspan="8" style="text-align: center;"> <table border="1" style="width: 100%; border-collapse: collapse; text-align: center;"> <tr> <td style="width: 10%;"></td> <td style="width: 10%;"></td> <td style="width: 10%;"></td> <td style="width: 10%;"></td> <td style="width: 10%;"></td> <td style="width: 10%;"></td> <td style="width: 10%;"></td> <td style="width: 10%;"></td> <td style="width: 10%;"></td> <td style="width: 10%;"></td> </tr> <tr> <td></td> <td></td> <td colspan="8" style="text-align: center;"> <table border="1" style="width: 100%; border-collapse: collapse; text-align: center;"> <tr> <td style="width: 10%;"></td> <td style="width: 10%;"></td> <td style="width: 10%;"></td> <td style="width: 10%;"></td> <td style="width: 10%;"></td> <td style="width: 10%;"></td> <td style="width: 10%;"></td> <td style="width: 10%;"></td> <td style="width: 10%;"></td> <td style="width: 10%;"></td> </tr> <tr> <td></td> <td></td> <td colspan="8" style="text-align: center;"> <table border="1" style="width: 100%; border-collapse: collapse; text-align: center;"> <tr> <td style="width: 10%;"></td> <td style="width: 10%;"></td> <td style="width: 10%;"></td> <td style="width: 10%;"></td> <td style="width: 10%;"></td> <td style="width: 10%;"></td> <td style="width: 10%;"></td> <td style="width: 10%;"></td> <td style="width: 10%;"></td> <td style="width: 10%;"></td> </tr> <tr> <td></td> <td></td> <td colspan="8" style="text-align: center;"> <table border="1" style="width: 100%; border-collapse: collapse; text-align: center;"> <tr> <td style="width: 10%;"></td> <td style="width: 10%;"></td> <td style="width: 10%;"></td> <td style="width: 10%;"></td> <td style="width: 10%;"></td> <td style="width: 10%;"></td> <td style="width: 10%;"></td> <td style="width: 10%;"></td> <td style="width: 10%;"></td> <td style="width: 10%;"></td> </tr> <tr> <td></td> <td></td> <td colspan="8" style="text-align: center;"> <table border="1" style="width: 100%; border-collapse: collapse; text-align: center;"> <tr> <td style="width: 10%;"></td> <td style="width: 10%;"></td> <td style="width: 10%;"></td> <td style="width: 10%;"></td> <td style="width: 10%;"></td> <td style="width: 10%;"></td> <td style="width: 10%;"></td> <td style="width: 10%;"></td> <td style="width: 10%;"></td> <td style="width: 10%;"></td> </tr> <tr> <td></td> <td></td> <td colspan="8" style="text-align: center;"> <table border="1" style="width: 100%; border-collapse: collapse; text-align: center;"> <tr> <td style="width: 10%;"></td> <td style="width: 10%;"></td> <td style="width: 10%;"></td> <td style="width: 10%;"></td> <td style="width: 10%;"></td> <td style="width: 10%;"></td> <td style="width: 10%;"></td> <td style="width: 10%;"></td> <td style="width: 10%;"></td> <td style="width: 10%;"></td> </tr> <tr> <td></td> <td></td> <td colspan="8" style="text-align: center;"> <table border="1" style="width: 100%; border-collapse: collapse; text-align: center;"> <tr> <td style="width: 10%;"></td> <td style="width: 10%;"></td> <td style="width: 10%;"></td> <td style="width: 10%;"></td> <td style="width: 10%;"></td> <td style="width: 10%;"></td> <td style="width: 10%;"></td> <td style="width: 10%;"></td> <td style="width: 10%;"></td> <td style="width: 10%;"></td> </tr> <tr> <td></td> <td></td> <td colspan="8" style="text-align: center;"> <table border="1" style="width: 100%; border-collapse: collapse; text-align: center;"> <tr> <td style="width: 10%;"></td> <td style="width: 10%;"></td> <td style="width: 10%;"></td> <td style="width: 10%;"></td> <td style="width: 10%;"></td> <td style="width: 10%;"></td> <td style="width: 10%;"></td> <td style="width: 10%;"></td> <td style="width: 10%;"></td> <td style="width: 10%;"></td> </tr> <tr> <td></td> <td></td> <td colspan="8" style="text-align: center;"> <table border="1" style="width: 100%; border-collapse: collapse; text-align: center;"> <tr> <td style="width: 10%;"></td> <td style="width: 10%;"></td> <td style="width: 10%;"></td> <td style="width: 10%;"></td> <td style="width: 10%;"></td> <td style="width: 10%;"></td> <td style="width: 10%;"></td> <td style="width: 10%;"></td> <td style="width: 10%;"></td> <td style="width: 10%;"></td> </tr> <tr> <td></td> <td></td> <td colspan="8" style="text-align: center;"> <table border="1" style="width: 100%; border-collapse: collapse; text-align: center;"> <tr> <td style="width: 10%;"></td> <td style="width: 10%;"></td> <td style="width: 10%;"></td> <td style="width: 10%;"></td> <td style="width: 10%;"></td> <td style="width: 10%;"></td> <td style="width: 10%;"></td> <td style="width: 10%;"></td> <td style="width: 10%;"></td> <td style="width: 10%;"></td> </tr> <tr> <td></td> <td></td> <td colspan="8" style="text-align: center;"> <table border="1" style="width: 100%; border-collapse: collapse; text-align: center;"> <tr> <td style="width: 10%;"></td> <td style="width: 10%;"></td> <td style="width: 10%;"></td> <td style="width: 10%;"></td> <td style="width: 10%;"></td> <td style="width: 10%;"></td> <td style="width: 10%;"></td> <td style="width: 10%;"></td> <td style="width: 10%;"></td> <td style="width: 10%;"></td> </tr> <tr> <td></td> <td></td> <td colspan="8" style="text-align: center;"> <table border="1" style="width: 100%; border-collapse: collapse; text-align: center;"> <tr> <td style="width: 10%;"></td> <td style="width: 10%;"></td> <td style="width: 10%;"></td> <td style="width: 10%;"></td> <td style="width: 10%;"></td> <td style="width: 10%;"></td> <td style="width: 10%;"></td> <td style="width: 10%;"></td> <td style="width: 10%;"></td> <td style="width: 10%;"></td> </tr> <tr> <td></td> <td></td> <td colspan="8" style="text-align: center;"> <table border="1" style="width: 100%; border-collapse: collapse; text-align: center;"> <tr> <td style="width: 10%;"></td> <td style="width: 10%;"></td> <td style="width: 10%;"></td> <td style="width: 10%;"></td> <td style="width: 10%;"></td> <td style="width: 10%;"></td> <td style="width: 10%;"></td> <td style="width: 10%;"></td> <td style="width: 10%;"></td> <td style="width: 10%;"></td> </tr> <tr> <td></td> <td></td> <td colspan="8" style="text-align: center;"> <table border="1" style="width: 100%; border-collapse: collapse; text-align: center;"> <tr> <td style="width: 10%;"></td> <td style="width: 10%;"></td> <td style="width: 10%;"></td> <td style="width: 10%;"></td> <td style="width: 10%;"></td> <td style="width: 10%;"></td> <td style="width: 10%;"></td> <td style="width: 10%;"></td> <td style="width: 10%;"></td> <td style="width: 10%;"></td> </tr> <tr> <td></td> <td></td> <td colspan="8" style="text-align: center;"> <table border="1" style="width: 100%; border-collapse: collapse; text-align: center;"> <tr> </tr></table></td></tr></table></td></tr></table></td></tr></table></td></tr></table></td></tr></table></td></tr></table></td></tr></table></td></tr></table></td></tr></table></td></tr></table></td></tr></table></td></tr></table></td></tr></table></td></tr></table></td></tr></table></td></tr></table></td></tr></table></td></tr></table></td></tr></table></td></tr></table></td></tr></table></td></tr></table></td></tr></table></td></tr></table></td></tr></table></td></tr></table></td></tr></table></td></tr></table></td></tr></table></td></tr></table></td></tr></table></td></tr></table></td></tr></table></td></tr></table> | | | | | | | | | | | | | | | | | | | | <table border="1" style="width: 100%; border-collapse: collapse; text-align: center;"> <tr> <td style="width: 10%;"></td> <td style="width: 10%;"></td> <td style="width: 10%;"></td> <td style="width: 10%;"></td> <td style="width: 10%;"></td> <td style="width: 10%;"></td> <td style="width: 10%;"></td> <td style="width: 10%;"></td> <td style="width: 10%;"></td> <td style="width: 10%;"></td> </tr> <tr> <td></td> <td></td> <td colspan="8" style="text-align: center;"> <table border="1" style="width: 100%; border-collapse: collapse; text-align: center;"> <tr> <td style="width: 10%;"></td> <td style="width: 10%;"></td> <td style="width: 10%;"></td> <td style="width: 10%;"></td> <td style="width: 10%;"></td> <td style="width: 10%;"></td> <td style="width: 10%;"></td> <td style="width: 10%;"></td> <td style="width: 10%;"></td> <td style="width: 10%;"></td> </tr> <tr> <td></td> <td></td> <td colspan="8" style="text-align: center;"> <table border="1" style="width: 100%; border-collapse: collapse; text-align: center;"> <tr> <td style="width: 10%;"></td> <td style="width: 10%;"></td> <td style="width: 10%;"></td> <td style="width: 10%;"></td> <td style="width: 10%;"></td> <td style="width: 10%;"></td> <td style="width: 10%;"></td> <td style="width: 10%;"></td> <td style="width: 10%;"></td> <td style="width: 10%;"></td> </tr> <tr> <td></td> <td></td> <td colspan="8" style="text-align: center;"> <table border="1" style="width: 100%; border-collapse: collapse; text-align: center;"> <tr> <td style="width: 10%;"></td> <td style="width: 10%;"></td> <td style="width: 10%;"></td> <td style="width: 10%;"></td> <td
style="width: 10%;"></td> <td style="width: 10%;"></td> <td style="width: 10%;"></td> <td style="width: 10%;"></td> <td style="width: 10%;"></td> <td style="width: 10%;"></td> </tr> <tr> <td></td> <td></td> <td colspan="8" style="text-align: center;"> <table border="1" style="width: 100%; border-collapse: collapse; text-align: center;"> <tr> <td style="width: 10%;"></td> <td style="width: 10%;"></td> <td style="width: 10%;"></td> <td style="width: 10%;"></td> <td style="width: 10%;"></td> <td style="width: 10%;"></td> <td style="width: 10%;"></td> <td style="width: 10%;"></td> <td style="width: 10%;"></td> <td style="width: 10%;"></td> </tr> <tr> <td></td> <td></td> <td colspan="8" style="text-align: center;"> <table border="1" style="width: 100%; border-collapse: collapse; text-align: center;"> <tr> <td style="width: 10%;"></td> <td style="width: 10%;"></td> <td style="width: 10%;"></td> <td style="width: 10%;"></td> <td style="width: 10%;"></td> <td style="width: 10%;"></td> <td style="width: 10%;"></td> <td style="width: 10%;"></td> <td style="width: 10%;"></td> <td style="width: 10%;"></td> </tr> <tr> <td></td> <td></td> <td colspan="8" style="text-align: center;"> <table border="1" style="width: 100%; border-collapse: collapse; text-align: center;"> <tr> <td style="width: 10%;"></td> <td style="width: 10%;"></td> <td style="width: 10%;"></td> <td style="width: 10%;"></td> <td style="width: 10%;"></td> <td style="width: 10%;"></td> <td style="width: 10%;"></td> <td style="width: 10%;"></td> <td style="width: 10%;"></td> <td style="width: 10%;"></td> </tr> <tr> <td></td> <td></td> <td colspan="8" style="text-align: center;"> <table border="1" style="width: 100%; border-collapse: collapse; text-align: center;"> <tr> <td style="width: 10%;"></td> <td style="width: 10%;"></td> <td style="width: 10%;"></td> <td style="width: 10%;"></td> <td style="width: 10%;"></td> <td style="width: 10%;"></td> <td style="width: 10%;"></td> <td style="width: 10%;"></td> <td style="width: 10%;"></td> <td style="width: 10%;"></td> </tr> <tr> <td></td> <td></td> <td colspan="8" style="text-align: center;"> <table border="1" style="width: 100%; border-collapse: collapse; text-align: center;"> <tr> <td style="width: 10%;"></td> <td style="width: 10%;"></td> <td style="width: 10%;"></td> <td style="width: 10%;"></td> <td style="width: 10%;"></td> <td style="width: 10%;"></td> <td style="width: 10%;"></td> <td style="width: 10%;"></td> <td style="width: 10%;"></td> <td style="width: 10%;"></td> </tr> <tr> <td></td> <td></td> <td colspan="8" style="text-align: center;"> <table border="1" style="width: 100%; border-collapse: collapse; text-align: center;"> <tr> <td style="width: 10%;"></td> <td style="width: 10%;"></td> <td style="width: 10%;"></td> <td style="width: 10%;"></td> <td style="width: 10%;"></td> <td style="width: 10%;"></td> <td style="width: 10%;"></td> <td style="width: 10%;"></td> <td style="width: 10%;"></td> <td style="width: 10%;"></td> </tr> <tr> <td></td> <td></td> <td colspan="8" style="text-align: center;"> <table border="1" style="width: 100%; border-collapse: collapse; text-align: center;"> <tr> <td style="width: 10%;"></td> <td style="width: 10%;"></td> <td style="width: 10%;"></td> <td style="width: 10%;"></td> <td style="width: 10%;"></td> <td style="width: 10%;"></td> <td style="width: 10%;"></td> <td style="width: 10%;"></td> <td style="width: 10%;"></td> <td style="width: 10%;"></td> </tr> <tr> <td></td> <td></td> <td colspan="8" style="text-align: center;"> <table border="1" style="width: 100%; border-collapse: collapse; text-align: center;"> <tr> <td style="width: 10%;"></td> <td style="width: 10%;"></td> <td style="width: 10%;"></td> <td style="width: 10%;"></td> <td style="width: 10%;"></td> <td style="width: 10%;"></td> <td style="width: 10%;"></td> <td style="width: 10%;"></td> <td style="width: 10%;"></td> <td style="width: 10%;"></td> </tr> <tr> <td></td> <td></td> <td colspan="8" style="text-align: center;"> <table border="1" style="width: 100%; border-collapse: collapse; text-align: center;"> <tr> <td style="width: 10%;"></td> <td style="width: 10%;"></td> <td style="width: 10%;"></td> <td style="width: 10%;"></td> <td style="width: 10%;"></td> <td style="width: 10%;"></td> <td style="width: 10%;"></td> <td style="width: 10%;"></td> <td style="width: 10%;"></td> <td style="width: 10%;"></td> </tr> <tr> <td></td> <td></td> <td colspan="8" style="text-align: center;"> <table border="1" style="width: 100%; border-collapse: collapse; text-align: center;"> <tr> <td style="width: 10%;"></td> <td style="width: 10%;"></td> <td style="width: 10%;"></td> <td style="width: 10%;"></td> <td style="width: 10%;"></td> <td style="width: 10%;"></td> <td style="width: 10%;"></td> <td style="width: 10%;"></td> <td style="width: 10%;"></td> <td style="width: 10%;"></td> </tr> <tr> <td></td> <td></td> <td colspan="8" style="text-align: center;"> <table border="1" style="width: 100%; border-collapse: collapse; text-align: center;"> <tr> <td style="width: 10%;"></td> <td style="width: 10%;"></td> <td style="width: 10%;"></td> <td style="width: 10%;"></td> <td style="width: 10%;"></td> <td style="width: 10%;"></td> <td style="width: 10%;"></td> <td style="width: 10%;"></td> <td style="width: 10%;"></td> <td style="width: 10%;"></td> </tr> <tr> <td></td> <td></td> <td colspan="8" style="text-align: center;"> <table border="1" style="width: 100%; border-collapse: collapse; text-align: center;"> <tr> <td style="width: 10%;"></td> <td style="width: 10%;"></td> <td style="width: 10%;"></td> <td style="width: 10%;"></td> <td style="width: 10%;"></td> <td style="width: 10%;"></td> <td style="width: 10%;"></td> <td style="width: 10%;"></td> <td style="width: 10%;"></td> <td style="width: 10%;"></td> </tr> <tr> <td></td> <td></td> <td colspan="8" style="text-align: center;"> <table border="1" style="width: 100%; border-collapse: collapse; text-align: center;"> <tr> <td style="width: 10%;"></td> <td style="width: 10%;"></td> <td style="width: 10%;"></td> <td style="width: 10%;"></td> <td style="width: 10%;"></td> <td style="width: 10%;"></td> <td style="width: 10%;"></td> <td style="width: 10%;"></td> <td style="width: 10%;"></td> <td style="width: 10%;"></td> </tr> <tr> <td></td> <td></td> <td colspan="8" style="text-align: center;"> <table border="1" style="width: 100%; border-collapse: collapse; text-align: center;"> <tr> <td style="width: 10%;"></td> <td style="width: 10%;"></td> <td style="width: 10%;"></td> <td style="width: 10%;"></td> <td style="width: 10%;"></td> <td style="width: 10%;"></td> <td style="width: 10%;"></td> <td style="width: 10%;"></td> <td style="width: 10%;"></td> <td style="width: 10%;"></td> </tr> <tr> <td></td> <td></td> <td colspan="8" style="text-align: center;"> <table border="1" style="width: 100%; border-collapse: collapse; text-align: center;"> <tr> <td style="width: 10%;"></td> <td style="width: 10%;"></td> <td style="width: 10%;"></td> <td style="width: 10%;"></td> <td style="width: 10%;"></td> <td style="width: 10%;"></td> <td style="width: 10%;"></td> <td style="width: 10%;"></td> <td style="width: 10%;"></td> <td style="width: 10%;"></td> </tr> <tr> <td></td> <td></td> <td colspan="8" style="text-align: center;"> <table border="1" style="width: 100%; border-collapse: collapse; text-align: center;"> <tr> <td style="width: 10%;"></td> <td style="width: 10%;"></td> <td style="width: 10%;"></td> <td style="width: 10%;"></td> <td style="width: 10%;"></td> <td style="width: 10%;"></td> <td style="width: 10%;"></td> <td style="width: 10%;"></td> <td style="width: 10%;"></td> <td style="width: 10%;"></td> </tr> <tr> <td></td> <td></td> <td colspan="8" style="text-align: center;"> <table border="1" style="width: 100%; border-collapse: collapse; text-align: center;"> <tr> <td style="width: 10%;"></td> <td style="width: 10%;"></td> <td style="width: 10%;"></td> <td style="width: 10%;"></td> <td style="width: 10%;"></td> <td style="width: 10%;"></td> <td style="width: 10%;"></td> <td style="width: 10%;"></td> <td style="width: 10%;"></td> <td style="width: 10%;"></td> </tr> <tr> <td></td> <td></td> <td colspan="8" style="text-align: center;"> <table border="1" style="width: 100%; border-collapse: collapse; text-align: center;"> <tr> <td style="width: 10%;"></td> <td style="width: 10%;"></td> <td style="width: 10%;"></td> <td style="width: 10%;"></td> <td style="width: 10%;"></td> <td style="width: 10%;"></td> <td style="width: 10%;"></td> <td style="width: 10%;"></td> <td style="width: 10%;"></td> <td style="width: 10%;"></td> </tr> <tr> <td></td> <td></td> <td colspan="8" style="text-align: center;"> <table border="1" style="width: 100%; border-collapse: collapse; text-align: center;"> <tr> <td style="width: 10%;"></td> <td style="width: 10%;"></td> <td style="width: 10%;"></td> <td style="width: 10%;"></td> <td style="width: 10%;"></td> <td style="width: 10%;"></td> <td style="width: 10%;"></td> <td style="width: 10%;"></td> <td style="width: 10%;"></td> <td style="width: 10%;"></td> </tr> <tr> <td></td> <td></td> <td colspan="8" style="text-align: center;"> <table border="1" style="width: 100%; border-collapse: collapse; text-align: center;"> <tr> <td style="width: 10%;"></td> <td style="width: 10%;"></td> <td style="width: 10%;"></td> <td style="width: 10%;"></td> <td style="width: 10%;"></td> <td style="width: 10%;"></td> <td style="width: 10%;"></td> <td style="width: 10%;"></td> <td style="width: 10%;"></td> <td style="width: 10%;"></td> </tr> <tr> <td></td> <td></td> <td colspan="8" style="text-align: center;"> <table border="1" style="width: 100%; border-collapse: collapse; text-align: center;"> <tr> <td style="width: 10%;"></td> <td style="width: 10%;"></td> <td style="width: 10%;"></td> <td style="width: 10%;"></td> <td style="width: 10%;"></td> <td style="width: 10%;"></td> <td style="width: 10%;"></td> <td style="width: 10%;"></td> <td style="width: 10%;"></td> <td style="width:
10%;"></td> </tr> <tr> <td></td> <td></td> <td colspan="8" style="text-align: center;"> <table border="1" style="width: 100%; border-collapse: collapse; text-align: center;"> <tr> <td style="width: 10%;"></td> <td style="width: 10%;"></td> <td style="width: 10%;"></td> <td style="width: 10%;"></td> <td style="width: 10%;"></td> <td style="width: 10%;"></td> <td style="width: 10%;"></td> <td style="width: 10%;"></td> <td style="width: 10%;"></td> <td style="width: 10%;"></td> </tr> <tr> <td></td> <td></td> <td colspan="8" style="text-align: center;"> <table border="1" style="width: 100%; border-collapse: collapse; text-align: center;"> <tr> <td style="width: 10%;"></td> <td style="width: 10%;"></td> <td style="width: 10%;"></td> <td style="width: 10%;"></td> <td style="width: 10%;"></td> <td style="width: 10%;"></td> <td style="width: 10%;"></td> <td style="width: 10%;"></td> <td style="width: 10%;"></td> <td style="width: 10%;"></td> </tr> <tr> <td></td> <td></td> <td colspan="8" style="text-align: center;"> <table border="1" style="width: 100%; border-collapse: collapse; text-align: center;"> <tr> <td style="width: 10%;"></td> <td style="width: 10%;"></td> <td style="width: 10%;"></td> <td style="width: 10%;"></td> <td style="width: 10%;"></td> <td style="width: 10%;"></td> <td style="width: 10%;"></td> <td style="width: 10%;"></td> <td style="width: 10%;"></td> <td style="width: 10%;"></td> </tr> <tr> <td></td> <td></td> <td colspan="8" style="text-align: center;"> <table border="1" style="width: 100%; border-collapse: collapse; text-align: center;"> <tr> <td style="width: 10%;"></td> <td style="width: 10%;"></td> <td style="width: 10%;"></td> <td style="width: 10%;"></td> <td style="width: 10%;"></td> <td style="width: 10%;"></td> <td style="width: 10%;"></td> <td style="width: 10%;"></td> <td style="width: 10%;"></td> <td style="width: 10%;"></td> </tr> <tr> <td></td> <td></td> <td colspan="8" style="text-align: center;"> <table border="1" style="width: 100%; border-collapse: collapse; text-align: center;"> <tr> <td style="width: 10%;"></td> <td style="width: 10%;"></td> <td style="width: 10%;"></td> <td style="width: 10%;"></td> <td style="width: 10%;"></td> <td style="width: 10%;"></td> <td style="width: 10%;"></td> <td style="width: 10%;"></td> <td style="width: 10%;"></td> <td style="width: 10%;"></td> </tr> <tr> <td></td> <td></td> <td colspan="8" style="text-align: center;"> <table border="1" style="width: 100%; border-collapse: collapse; text-align: center;"> <tr> <td style="width: 10%;"></td> <td style="width: 10%;"></td> <td style="width: 10%;"></td> <td style="width: 10%;"></td> <td style="width: 10%;"></td> <td style="width: 10%;"></td> <td style="width: 10%;"></td> <td style="width: 10%;"></td> <td style="width: 10%;"></td> <td style="width: 10%;"></td> </tr> <tr> <td></td> <td></td> <td colspan="8" style="text-align: center;"> <table border="1" style="width: 100%; border-collapse: collapse; text-align: center;"> <tr> <td style="width: 10%;"></td> <td style="width: 10%;"></td> <td style="width: 10%;"></td> <td style="width: 10%;"></td> <td style="width: 10%;"></td> <td style="width: 10%;"></td> <td style="width: 10%;"></td> <td style="width: 10%;"></td> <td style="width: 10%;"></td> <td style="width: 10%;"></td> </tr> <tr> <td></td> <td></td> <td colspan="8" style="text-align: center;"> <table border="1" style="width: 100%; border-collapse: collapse; text-align: center;"> <tr> <td style="width: 10%;"></td> <td style="width: 10%;"></td> <td style="width: 10%;"></td> <td style="width: 10%;"></td> <td style="width: 10%;"></td> <td style="width: 10%;"></td> <td style="width: 10%;"></td> <td style="width: 10%;"></td> <td style="width: 10%;"></td> <td style="width: 10%;"></td> </tr> <tr> <td></td> <td></td> <td colspan="8" style="text-align: center;"> <table border="1" style="width: 100%; border-collapse: collapse; text-align: center;"> <tr> </tr></table></td></tr></table></td></tr></table></td></tr></table></td></tr></table></td></tr></table></td></tr></table></td></tr></table></td></tr></table></td></tr></table></td></tr></table></td></tr></table></td></tr></table></td></tr></table></td></tr></table></td></tr></table></td></tr></table></td></tr></table></td></tr></table></td></tr></table></td></tr></table></td></tr></table></td></tr></table></td></tr></table></td></tr></table></td></tr></table></td></tr></table></td></tr></table></td></tr></table></td></tr></table></td></tr></table></td></tr></table></td></tr></table></td></tr></table> | | | | | | | | | | | | | | | | | | | | <table border="1" style="width: 100%; border-collapse: collapse; text-align: center;"> <tr> <td style="width: 10%;"></td> <td style="width: 10%;"></td> <td style="width: 10%;"></td> <td style="width: 10%;"></td> <td style="width: 10%;"></td> <td style="width: 10%;"></td> <td style="width: 10%;"></td> <td style="width: 10%;"></td> <td style="width: 10%;"></td> <td style="width: 10%;"></td> </tr> <tr> <td></td> <td></td> <td colspan="8" style="text-align: center;"> <table border="1" style="width: 100%; border-collapse: collapse; text-align: center;"> <tr> <td style="width: 10%;"></td> <td style="width: 10%;"></td> <td style="width: 10%;"></td> <td style="width: 10%;"></td> <td style="width: 10%;"></td> <td style="width: 10%;"></td> <td style="width: 10%;"></td> <td style="width: 10%;"></td> <td style="width: 10%;"></td> <td style="width: 10%;"></td> </tr> <tr> <td></td> <td></td> <td colspan="8" style="text-align: center;"> <table border="1" style="width: 100%; border-collapse: collapse; text-align: center;"> <tr> <td style="width: 10%;"></td> <td style="width: 10%;"></td> <td style="width: 10%;"></td> <td style="width: 10%;"></td> <td style="width: 10%;"></td> <td style="width: 10%;"></td> <td style="width: 10%;"></td> <td style="width: 10%;"></td> <td style="width: 10%;"></td> <td style="width: 10%;"></td> </tr> <tr> <td></td> <td></td> <td colspan="8" style="text-align: center;"> <table border="1" style="width: 100%; border-collapse: collapse; text-align: center;"> <tr> <td style="width: 10%;"></td> <td style="width: 10%;"></td> <td style="width: 10%;"></td> <td style="width: 10%;"></td> <td style="width: 10%;"></td> <td style="width: 10%;"></td> <td style="width: 10%;"></td> <td style="width: 10%;"></td> <td style="width: 10%;"></td> <td style="width: 10%;"></td> </tr> <tr> <td></td> <td></td> <td colspan="8" style="text-align: center;"> <table border="1" style="width: 100%; border-collapse: collapse; text-align: center;"> <tr> <td style="width: 10%;"></td> <td style="width: 10%;"></td> <td style="width: 10%;"></td> <td style="width: 10%;"></td> <td style="width: 10%;"></td> <td style="width: 10%;"></td> <td style="width: 10%;"></td> <td style="width: 10%;"></td> <td style="width: 10%;"></td> <td style="width: 10%;"></td> </tr> <tr> <td></td> <td></td> <td colspan="8" style="text-align: center;"> <table border="1" style="width: 100%; border-collapse: collapse; text-align: center;"> <tr> <td style="width: 10%;"></td> <td style="width: 10%;"></td> <td style="width: 10%;"></td> <td style="width: 10%;"></td> <td style="width: 10%;"></td> <td style="width: 10%;"></td> <td style="width: 10%;"></td> <td style="width: 10%;"></td> <td style="width: 10%;"></td> <td style="width: 10%;"></td> </tr> <tr> <td></td> <td></td> <td colspan="8" style="text-align: center;"> <table border="1" style="width: 100%; border-collapse: collapse; text-align: center;"> <tr> <td style="width: 10%;"></td> <td style="width: 10%;"></td> <td style="width: 10%;"></td> <td style="width: 10%;"></td> <td style="width: 10%;"></td> <td style="width: 10%;"></td> <td style="width: 10%;"></td> <td style="width: 10%;"></td> <td style="width: 10%;"></td> <td style="width: 10%;"></td> </tr> <tr> <td></td> <td></td> <td colspan="8" style="text-align: center;"> <table border="1" style="width: 100%; border-collapse: collapse; text-align: center;"> <tr> <td style="width: 10%;"></td> <td style="width: 10%;"></td> <td style="width: 10%;"></td> <td style="width: 10%;"></td> <td style="width: 10%;"></td> <td style="width: 10%;"></td> <td style="width: 10%;"></td> <td style="width: 10%;"></td> <td style="width: 10%;"></td> <td style="width: 10%;"></td> </tr> <tr> <td></td> <td></td> <td colspan="8" style="text-align: center;"> <table border="1" style="width: 100%; border-collapse: collapse; text-align: center;"> <tr> <td style="width: 10%;"></td> <td style="width: 10%;"></td> <td style="width: 10%;"></td> <td style="width: 10%;"></td> <td style="width: 10%;"></td> <td style="width: 10%;"></td> <td style="width: 10%;"></td> <td style="width: 10%;"></td> <td style="width: 10%;"></td> <td style="width: 10%;"></td> </tr> <tr> <td></td> <td></td> <td colspan="8" style="text-align: center;"> <table border="1" style="width: 100%; border-collapse: collapse; text-align: center;"> <tr> <td style="width: 10%;"></td> <td style="width: 10%;"></td> <td style="width: 10%;"></td> <td style="width: 10%;"></td> <td style="width: 10%;"></td> <td style="width: 10%;"></td> <td style="width: 10%;"></td> <td style="width: 10%;"></td> <td style="width: 10%;"></td> <td style="width: 10%;"></td> </tr> <tr> <td></td> <td></td> <td colspan="8" style="text-align: center;"> <table border="1" style="width: 100%; border-collapse: collapse; text-align: center;"> <tr> <td style="width: 10%;"></td> <td style="width: 10%;"></td> <td style="width: 10%;"></td> <td style="width: 10%;"></td> <td style="width: 10%;"></td>
<td style="width: 10%;"></td> <td style="width: 10%;"></td> <td style="width: 10%;"></td> <td style="width: 10%;"></td> <td style="width: 10%;"></td> </tr> <tr> <td></td> <td></td> <td colspan="8" style="text-align: center;"> <table border="1" style="width: 100%; border-collapse: collapse; text-align: center;"> <tr> <td style="width: 10%;"></td> <td style="width: 10%;"></td> <td style="width: 10%;"></td> <td style="width: 10%;"></td> <td style="width: 10%;"></td> <td style="width: 10%;"></td> <td style="width: 10%;"></td> <td style="width: 10%;"></td> <td style="width: 10%;"></td> <td style="width: 10%;"></td> </tr> <tr> <td></td> <td></td> <td colspan="8" style="text-align: center;"> <table border="1" style="width: 100%; border-collapse: collapse; text-align: center;"> <tr> <td style="width: 10%;"></td> <td style="width: 10%;"></td> <td style="width: 10%;"></td> <td style="width: 10%;"></td> <td style="width: 10%;"></td> <td style="width: 10%;"></td> <td style="width: 10%;"></td> <td style="width: 10%;"></td> <td style="width: 10%;"></td> <td style="width: 10%;"></td> </tr> <tr> <td></td> <td></td> <td colspan="8" style="text-align: center;"> <table border="1" style="width: 100%; border-collapse: collapse; text-align: center;"> <tr> <td style="width: 10%;"></td> <td style="width: 10%;"></td> <td style="width: 10%;"></td> <td style="width: 10%;"></td> <td style="width: 10%;"></td> <td style="width: 10%;"></td> <td style="width: 10%;"></td> <td style="width: 10%;"></td> <td style="width: 10%;"></td> <td style="width: 10%;"></td> </tr> <tr> <td></td> <td></td> <td colspan="8" style="text-align: center;"> <table border="1" style="width: 100%; border-collapse: collapse; text-align: center;"> <tr> <td style="width: 10%;"></td> <td style="width: 10%;"></td> <td style="width: 10%;"></td> <td style="width: 10%;"></td> <td style="width: 10%;"></td> <td style="width: 10%;"></td> <td style="width: 10%;"></td> <td style="width: 10%;"></td> <td style="width: 10%;"></td> <td style="width: 10%;"></td> </tr> <tr> <td></td> <td></td> <td colspan="8" style="text-align: center;"> <table border="1" style="width: 100%; border-collapse: collapse; text-align: center;"> <tr> <td style="width: 10%;"></td> <td style="width: 10%;"></td> <td style="width: 10%;"></td> <td style="width: 10%;"></td> <td style="width: 10%;"></td> <td style="width: 10%;"></td> <td style="width: 10%;"></td> <td style="width: 10%;"></td> <td style="width: 10%;"></td> <td style="width: 10%;"></td> </tr> <tr> <td></td> <td></td> <td colspan="8" style="text-align: center;"> <table border="1" style="width: 100%; border-collapse: collapse; text-align: center;"> <tr> <td style="width: 10%;"></td> <td style="width: 10%;"></td> <td style="width: 10%;"></td> <td style="width: 10%;"></td> <td style="width: 10%;"></td> <td style="width: 10%;"></td> <td style="width: 10%;"></td> <td style="width: 10%;"></td> <td style="width: 10%;"></td> <td style="width: 10%;"></td> </tr> <tr> <td></td> <td></td> <td colspan="8" style="text-align: center;"> <table border="1" style="width: 100%; border-collapse: collapse; text-align: center;"> <tr> <td style="width: 10%;"></td> <td style="width: 10%;"></td> <td style="width: 10%;"></td> <td style="width: 10%;"></td> <td style="width: 10%;"></td> <td style="width: 10%;"></td> <td style="width: 10%;"></td> <td style="width: 10%;"></td> <td style="width: 10%;"></td> <td style="width: 10%;"></td> </tr> <tr> <td></td> <td></td> <td colspan="8" style="text-align: center;"> <table border="1" style="width: 100%; border-collapse: collapse; text-align: center;"> <tr> <td style="width: 10%;"></td> <td style="width: 10%;"></td> <td style="width: 10%;"></td> <td style="width: 10%;"></td> <td style="width: 10%;"></td> <td style="width: 10%;"></td> <td style="width: 10%;"></td> <td style="width: 10%;"></td> <td style="width: 10%;"></td> <td style="width: 10%;"></td> </tr> <tr> <td></td> <td></td> <td colspan="8" style="text-align: center;"> <table border="1" style="width: 100%; border-collapse: collapse; text-align: center;"> <tr> <td style="width: 10%;"></td> <td style="width: 10%;"></td> <td style="width: 10%;"></td> <td style="width: 10%;"></td> <td style="width: 10%;"></td> <td style="width: 10%;"></td> <td style="width: 10%;"></td> <td style="width: 10%;"></td> <td style="width: 10%;"></td> <td style="width: 10%;"></td> </tr> <tr> <td></td> <td></td> <td colspan="8" style="text-align: center;"> <table border="1" style="width: 100%; border-collapse: collapse; text-align: center;"> <tr> <td style="width: 10%;"></td> <td style="width: 10%;"></td> <td style="width: 10%;"></td> <td style="width: 10%;"></td> <td style="width: 10%;"></td> <td style="width: 10%;"></td> <td style="width: 10%;"></td> <td style="width: 10%;"></td> <td style="width: 10%;"></td> <td style="width: 10%;"></td> </tr> <tr> <td></td> <td></td> <td colspan="8" style="text-align: center;"> <table border="1" style="width: 100%; border-collapse: collapse; text-align: center;"> <tr> <td style="width: 10%;"></td> <td style="width: 10%;"></td> <td style="width: 10%;"></td> <td style="width: 10%;"></td> <td style="width: 10%;"></td> <td style="width: 10%;"></td> <td style="width: 10%;"></td> <td style="width: 10%;"></td> <td style="width: 10%;"></td> <td style="width: 10%;"></td> </tr> <tr> <td></td> <td></td> <td colspan="8" style="text-align: center;"> <table border="1" style="width: 100%; border-collapse: collapse; text-align: center;"> <tr> <td style="width: 10%;"></td> <td style="width: 10%;"></td> <td style="width: 10%;"></td> <td style="width: 10%;"></td> <td style="width: 10%;"></td> <td style="width: 10%;"></td> <td style="width: 10%;"></td> <td style="width: 10%;"></td> <td style="width: 10%;"></td> <td style="width: 10%;"></td> </tr> <tr> <td></td> <td></td> <td colspan="8" style="text-align: center;"> <table border="1" style="width: 100%; border-collapse: collapse; text-align: center;"> <tr> <td style="width: 10%;"></td> <td style="width: 10%;"></td> <td style="width: 10%;"></td> <td style="width: 10%;"></td> <td style="width: 10%;"></td> <td style="width: 10%;"></td> <td style="width: 10%;"></td> <td style="width: 10%;"></td> <td style="width: 10%;"></td> <td style="width: 10%;"></td> </tr> <tr> <td></td> <td></td> <td colspan="8" style="text-align: center;"> <table border="1" style="width: 100%; border-collapse: collapse; text-align: center;"> <tr> <td style="width: 10%;"></td> <td style="width: 10%;"></td> <td style="width: 10%;"></td> <td style="width: 10%;"></td> <td style="width: 10%;"></td> <td style="width: 10%;"></td> <td style="width: 10%;"></td> <td style="width: 10%;"></td> <td style="width: 10%;"></td> <td style="width: 10%;"></td> </tr> <tr> <td></td> <td></td> <td colspan="8" style="text-align: center;"> <table border="1" style="width: 100%; border-collapse: collapse; text-align: center;"> <tr> <td style="width: 10%;"></td> <td style="width: 10%;"></td> <td style="width: 10%;"></td> <td style="width: 10%;"></td> <td style="width: 10%;"></td> <td style="width: 10%;"></td> <td style="width: 10%;"></td> <td style="width: 10%;"></td> <td style="width: 10%;"></td> <td style="width: 10%;"></td> </tr> <tr> <td></td> <td></td> <td colspan="8" style="text-align: center;"> <table border="1" style="width: 100%; border-collapse: collapse; text-align: center;"> <tr> <td style="width: 10%;"></td> <td style="width: 10%;"></td> <td style="width: 10%;"></td> <td style="width: 10%;"></td> <td style="width: 10%;"></td> <td style="width: 10%;"></td> <td style="width: 10%;"></td> <td style="width: 10%;"></td> <td style="width: 10%;"></td> <td style="width: 10%;"></td> </tr> <tr> <td></td> <td></td> <td colspan="8" style="text-align: center;"> <table border="1" style="width: 100%; border-collapse: collapse; text-align: center;"> <tr> <td style="width: 10%;"></td> <td style="width: 10%;"></td> <td style="width: 10%;"></td> <td style="width: 10%;"></td> <td style="width: 10%;"></td> <td style="width: 10%;"></td> <td style="width: 10%;"></td> <td style="width: 10%;"></td> <td style="width: 10%;"></td> <td style="width: 10%;"></td> </tr> <tr> <td></td> <td></td> <td colspan="8" style="text-align: center;"> <table border="1" style="width: 100%; border-collapse: collapse; text-align: center;"> <tr> <td style="width: 10%;"></td> <td style="width: 10%;"></td> <td style="width: 10%;"></td> <td style="width: 10%;"></td> <td style="width: 10%;"></td> <td style="width: 10%;"></td> <td style="width: 10%;"></td> <td style="width: 10%;"></td> <td style="width: 10%;"></td> <td style="width: 10%;"></td> </tr> <tr> <td></td> <td></td> <td colspan="8" style="text-align: center;"> <table border="1" style="width: 100%; border-collapse: collapse; text-align: center;"> <tr> <td style="width: 10%;"></td> <td style="width: 10%;"></td> <td style="width: 10%;"></td> <td style="width: 10%;"></td> <td style="width: 10%;"></td> <td style="width: 10%;"></td> <td style="width: 10%;"></td> <td style="width: 10%;"></td> <td style="width: 10%;"></td> <td style="width: 10%;"></td> </tr> <tr> <td></td> <td></td> <td colspan="8" style="text-align: center;"> <table border="1" style="width: 100%; border-collapse: collapse; text-align: center;"> <tr> <td style="width: 10%;"></td> <td style="width: 10%;"></td> <td style="width: 10%;"></td> <td style="width: 10%;"></td> <td style="width: 10%;"></td> <td style="width: 10%;"></td> <td style="width: 10%;"></td> <td style="width: 10%;"></td> <td style="width: 10%;"></td> <td style="width: 10%;"></td> </tr> <tr> <td></td> <td></td> <td colspan="8" style="text-align: center;"> <table border="1" style="width: 100%; border-collapse: collapse; text-align: center;"> <tr> <td style="width: 10%;"></td> <td style="width: 10%;"></td> <td style="width: 10%;"></td> <td style="width: 10%;"></td> <td style="width: 10%;"></td> <td style="width: 10%;"></td> <td style="width: 10%;"></td> <td style="width: 10%;"></td> <td style="width: 10%;"></td> <td style="width: 10%;"></td> </tr> <tr> <td></td>
<td></td> <td colspan="8" style="text-align: center;"> <table border="1" style="width: 100%; border-collapse: collapse; text-align: center;"> <tr> </tr></table></td></tr></table></td></tr></table></td></tr></table></td></tr></table></td></tr></table></td></tr></table></td></tr></table></td></tr></table></td></tr></table></td></tr></table></td></tr></table></td></tr></table></td></tr></table></td></tr></table></td></tr></table></td></tr></table></td></tr></table></td></tr></table></td></tr></table></td></tr></table></td></tr></table></td></tr></table></td></tr></table></td></tr></table></td></tr></table></td></tr></table></td></tr></table></td></tr></table></td></tr></table></td></tr></table></td></tr></table></td></tr></table> | | | | | | | | | | | | | | | | | | | | <table border="1" style="width: 100%; border-collapse: collapse; text-align: center;"> <tr> <td style="width: 10%;"></td> <td style="width: 10%;"></td> <td style="width: 10%;"></td> <td style="width: 10%;"></td> <td style="width: 10%;"></td> <td style="width: 10%;"></td> <td style="width: 10%;"></td> <td style="width: 10%;"></td> <td style="width: 10%;"></td> <td style="width: 10%;"></td> </tr> <tr> <td></td> <td></td> <td colspan="8" style="text-align: center;"> <table border="1" style="width: 100%; border-collapse: collapse; text-align: center;"> <tr> <td style="width: 10%;"></td> <td style="width: 10%;"></td> <td style="width: 10%;"></td> <td style="width: 10%;"></td> <td style="width: 10%;"></td> <td style="width: 10%;"></td> <td style="width: 10%;"></td> <td style="width: 10%;"></td> <td style="width: 10%;"></td> <td style="width: 10%;"></td> </tr> <tr> <td></td> <td></td> <td colspan="8" style="text-align: center;"> <table border="1" style="width: 100%; border-collapse: collapse; text-align: center;"> <tr> <td style="width: 10%;"></td> <td style="width: 10%;"></td> <td style="width: 10%;"></td> <td style="width: 10%;"></td> <td style="width: 10%;"></td> <td style="width: 10%;"></td> <td style="width: 10%;"></td> <td style="width: 10%;"></td> <td style="width: 10%;"></td> <td style="width: 10%;"></td> </tr> <tr> <td></td> <td></td> <td colspan="8" style="text-align: center;"> <table border="1" style="width: 100%; border-collapse: collapse; text-align: center;"> <tr> <td style="width: 10%;"></td> <td style="width: 10%;"></td> <td style="width: 10%;"></td> <td style="width: 10%;"></td> <td style="width: 10%;"></td> <td style="width: 10%;"></td> <td style="width: 10%;"></td> <td style="width: 10%;"></td> <td style="width: 10%;"></td> <td style="width: 10%;"></td> </tr> <tr> <td></td> <td></td> <td colspan="8" style="text-align: center;"> <table border="1" style="width: 100%; border-collapse: collapse; text-align: center;"> <tr> <td style="width: 10%;"></td> <td style="width: 10%;"></td> <td style="width: 10%;"></td> <td style="width: 10%;"></td> <td style="width: 10%;"></td> <td style="width: 10%;"></td> <td style="width: 10%;"></td> <td style="width: 10%;"></td> <td style="width: 10%;"></td> <td style="width: 10%;"></td> </tr> <tr> <td></td> <td></td> <td colspan="8" style="text-align: center;"> <table border="1" style="width: 100%; border-collapse: collapse; text-align: center;"> <tr> <td style="width: 10%;"></td> <td style="width: 10%;"></td> <td style="width: 10%;"></td> <td style="width: 10%;"></td> <td style="width: 10%;"></td> <td style="width: 10%;"></td> <td style="width: 10%;"></td> <td style="width: 10%;"></td> <td style="width: 10%;"></td> <td style="width: 10%;"></td> </tr> <tr> <td></td> <td></td> <td colspan="8" style="text-align: center;"> <table border="1" style="width: 100%; border-collapse: collapse; text-align: center;"> <tr> <td style="width: 10%;"></td> <td style="width: 10%;"></td> <td style="width: 10%;"></td> <td style="width: 10%;"></td> <td style="width: 10%;"></td> <td style="width: 10%;"></td> <td style="width: 10%;"></td> <td style="width: 10%;"></td> <td style="width: 10%;"></td> <td style="width: 10%;"></td> </tr> <tr> <td></td> <td></td> <td colspan="8" style="text-align: center;"> <table border="1" style="width: 100%; border-collapse: collapse; text-align: center;"> <tr> <td style="width: 10%;"></td> <td style="width: 10%;"></td> <td style="width: 10%;"></td> <td style="width: 10%;"></td> <td style="width: 10%;"></td> <td style="width: 10%;"></td> <td style="width: 10%;"></td> <td style="width: 10%;"></td> <td style="width: 10%;"></td> <td style="width: 10%;"></td> </tr> <tr> <td></td> <td></td> <td colspan="8" style="text-align: center;"> <table border="1" style="width: 100%; border-collapse: collapse; text-align: center;"> <tr> <td style="width: 10%;"></td> <td style="width: 10%;"></td> <td style="width: 10%;"></td> <td style="width: 10%;"></td> <td style="width: 10%;"></td> <td style="width: 10%;"></td> <td style="width: 10%;"></td> <td style="width: 10%;"></td> <td style="width: 10%;"></td> <td style="width: 10%;"></td> </tr> <tr> <td></td> <td></td> <td colspan="8" style="text-align: center;"> <table border="1" style="width: 100%; border-collapse: collapse; text-align: center;"> <tr> <td style="width: 10%;"></td> <td style="width: 10%;"></td> <td style="width: 10%;"></td> <td style="width: 10%;"></td> <td style="width: 10%;"></td> <td style="width: 10%;"></td> <td style="width: 10%;"></td> <td style="width: 10%;"></td> <td style="width: 10%;"></td> <td style="width: 10%;"></td> </tr> <tr> <td></td> <td></td> <td colspan="8" style="text-align: center;"> <table border="1" style="width: 100%; border-collapse: collapse; text-align: center;"> <tr> <td style="width: 10%;"></td> <td style="width: 10%;"></td> <td style="width: 10%;"></td> <td style="width: 10%;"></td> <td style="width: 10%;"></td> <td style="width: 10%;"></td> <td style="width: 10%;"></td> <td style="width: 10%;"></td> <td style="width: 10%;"></td> <td style="width: 10%;"></td> </tr> <tr> <td></td> <td></td> <td colspan="8" style="text-align: center;"> <table border="1" style="width: 100%; border-collapse: collapse; text-align: center;"> <tr> <td style="width: 10%;"></td> <td style="width: 10%;"></td> <td style="width: 10%;"></td> <td style="width: 10%;"></td> <td style="width: 10%;"></td> <td style="width: 10%;"></td> <td style="width: 10%;"></td> <td style="width: 10%;"></td> <td style="width: 10%;"></td> <td style="width: 10%;"></td> </tr> <tr> <td></td> <td></td> <td colspan="8" style="text-align: center;"> <table border="1" style="width: 100%; border-collapse: collapse; text-align: center;"> <tr> <td style="width: 10%;"></td> <td style="width: 10%;"></td> <td style="width: 10%;"></td> <td style="width: 10%;"></td> <td style="width: 10%;"></td> <td style="width: 10%;"></td> <td style="width: 10%;"></td> <td style="width: 10%;"></td> <td style="width: 10%;"></td> <td style="width: 10%;"></td> </tr> <tr> <td></td> <td></td> <td colspan="8" style="text-align: center;"> <table border="1" style="width: 100%; border-collapse: collapse; text-align: center;"> <tr> <td style="width: 10%;"></td> <td style="width: 10%;"></td> <td style="width: 10%;"></td> <td style="width: 10%;"></td> <td style="width: 10%;"></td> <td style="width: 10%;"></td> <td style="width: 10%;"></td> <td style="width: 10%;"></td> <td style="width: 10%;"></td> <td style="width: 10%;"></td> </tr> <tr> <td></td> <td></td> <td colspan="8" style="text-align: center;"> <table border="1" style="width: 100%; border-collapse: collapse; text-align: center;"> <tr> <td style="width: 10%;"></td> <td style="width: 10%;"></td> <td style="width: 10%;"></td> <td style="width: 10%;"></td> <td style="width: 10%;"></td> <td style="width: 10%;"></td> <td style="width: 10%;"></td> <td style="width: 10%;"></td> <td style="width: 10%;"></td> <td style="width: 10%;"></td> </tr> <tr> <td></td> <td></td> <td colspan="8" style="text-align: center;"> <table border="1" style="width: 100%; border-collapse: collapse; text-align: center;"> <tr> <td style="width: 10%;"></td> <td style="width: 10%;"></td> <td style="width: 10%;"></td> <td style="width: 10%;"></td> <td style="width: 10%;"></td> <td style="width: 10%;"></td> <td style="width: 10%;"></td> <td style="width: 10%;"></td> <td style="width: 10%;"></td> <td style="width: 10%;"></td> </tr> <tr> <td></td> <td></td> <td colspan="8" style="text-align: center;"> <table border="1" style="width: 100%; border-collapse: collapse; text-align: center;"> <tr> <td style="width: 10%;"></td> <td style="width: 10%;"></td> <td style="width: 10%;"></td> <td style="width: 10%;"></td> <td style="width: 10%;"></td> <td style="width: 10%;"></td> <td style="width: 10%;"></td> <td style="width: 10%;"></td> <td style="width: 10%;"></td> <td style="width: 10%;"></td> </tr> <tr> <td></td> <td></td> <td colspan="8" style="text-align: center;"> <table border="1" style="width: 100%; border-collapse: collapse; text-align: center;"> <tr> <td style="width: 10%;"></td> <td style="width: 10%;"></td> <td style="width: 10%;"></td> <td style="width: 10%;"></td> <td style="width: 10%;"></td> <td style="width: 10%;"></td> <td style="width: 10%;"></td> <td style="width: 10%;"></td> <td style="width: 10%;"></td> <td style="width: 10%;"></td> </tr> <tr> <td></td> <td></td> <td colspan="8" style="text-align: center;"> <table border="1" style="width: 100%; border-collapse: collapse; text-align: center;"> <tr> <td style="width: 10%;"></td> <td style="width: 10%;"></td> <td style="width: 10%;"></td> <td style="width: 10%;"></td> <td style="width: 10%;"></td> <td style="width: 10%;"></td> <td style="width:
10%;"></td> <td style="width: 10%;"></td> <td style="width: 10%;"></td> <td style="width: 10%;"></td> </tr> <tr> <td></td> <td></td> <td colspan="8" style="text-align: center;"> <table border="1" style="width: 100%; border-collapse: collapse; text-align: center;"> <tr> <td style="width: 10%;"></td> <td style="width: 10%;"></td> <td style="width: 10%;"></td> <td style="width: 10%;"></td> <td style="width: 10%;"></td> <td style="width: 10%;"></td> <td style="width: 10%;"></td> <td style="width: 10%;"></td> <td style="width: 10%;"></td> <td style="width: 10%;"></td> </tr> <tr> <td></td> <td></td> <td colspan="8" style="text-align: center;"> <table border="1" style="width: 100%; border-collapse: collapse; text-align: center;"> <tr> <td style="width: 10%;"></td> <td style="width: 10%;"></td> <td style="width: 10%;"></td> <td style="width: 10%;"></td> <td style="width: 10%;"></td> <td style="width: 10%;"></td> <td style="width: 10%;"></td> <td style="width: 10%;"></td> <td style="width: 10%;"></td> <td style="width: 10%;"></td> </tr> <tr> <td></td> <td></td> <td colspan="8" style="text-align: center;"> <table border="1" style="width: 100%; border-collapse: collapse; text-align: center;"> <tr> <td style="width: 10%;"></td> <td style="width: 10%;"></td> <td style="width: 10%;"></td> <td style="width: 10%;"></td> <td style="width: 10%;"></td> <td style="width: 10%;"></td> <td style="width: 10%;"></td> <td style="width: 10%;"></td> <td style="width: 10%;"></td> <td style="width: 10%;"></td> </tr> <tr> <td></td> <td></td> <td colspan="8" style="text-align: center;"> <table border="1" style="width: 100%; border-collapse: collapse; text-align: center;"> <tr> <td style="width: 10%;"></td> <td style="width: 10%;"></td> <td style="width: 10%;"></td> <td style="width: 10%;"></td> <td style="width: 10%;"></td> <td style="width: 10%;"></td> <td style="width: 10%;"></td> <td style="width: 10%;"></td> <td style="width: 10%;"></td> <td style="width: 10%;"></td> </tr> <tr> <td></td> <td></td> <td colspan="8" style="text-align: center;"> <table border="1" style="width: 100%; border-collapse: collapse; text-align: center;"> <tr> <td style="width: 10%;"></td> <td style="width: 10%;"></td> <td style="width: 10%;"></td> <td style="width: 10%;"></td> <td style="width: 10%;"></td> <td style="width: 10%;"></td> <td style="width: 10%;"></td> <td style="width: 10%;"></td> <td style="width: 10%;"></td> <td style="width: 10%;"></td> </tr> <tr> <td></td> <td></td> <td colspan="8" style="text-align: center;"> <table border="1" style="width: 100%; border-collapse: collapse; text-align: center;"> <tr> <td style="width: 10%;"></td> <td style="width: 10%;"></td> <td style="width: 10%;"></td> <td style="width: 10%;"></td> <td style="width: 10%;"></td> <td style="width: 10%;"></td> <td style="width: 10%;"></td> <td style="width: 10%;"></td> <td style="width: 10%;"></td> <td style="width: 10%;"></td> </tr> <tr> <td></td> <td></td> <td colspan="8" style="text-align: center;"> <table border="1" style="width: 100%; border-collapse: collapse; text-align: center;"> <tr> <td style="width: 10%;"></td> <td style="width: 10%;"></td> <td style="width: 10%;"></td> <td style="width: 10%;"></td> <td style="width: 10%;"></td> <td style="width: 10%;"></td> <td style="width: 10%;"></td> <td style="width: 10%;"></td> <td style="width: 10%;"></td> <td style="width: 10%;"></td> </tr> <tr> <td></td> <td></td> <td colspan="8" style="text-align: center;"> <table border="1" style="width: 100%; border-collapse: collapse; text-align: center;"> <tr> <td style="width: 10%;"></td> <td style="width: 10%;"></td> <td style="width: 10%;"></td> <td style="width: 10%;"></td> <td style="width: 10%;"></td> <td style="width: 10%;"></td> <td style="width: 10%;"></td> <td style="width: 10%;"></td> <td style="width: 10%;"></td> <td style="width: 10%;"></td> </tr> <tr> <td></td> <td></td> <td colspan="8" style="text-align: center;"> <table border="1" style="width: 100%; border-collapse: collapse; text-align: center;"> <tr> <td style="width: 10%;"></td> <td style="width: 10%;"></td> <td style="width: 10%;"></td> <td style="width: 10%;"></td> <td style="width: 10%;"></td> <td style="width: 10%;"></td> <td style="width: 10%;"></td> <td style="width: 10%;"></td> <td style="width: 10%;"></td> <td style="width: 10%;"></td> </tr> <tr> <td></td> <td></td> <td colspan="8" style="text-align: center;"> <table border="1" style="width: 100%; border-collapse: collapse; text-align: center;"> <tr> <td style="width: 10%;"></td> <td style="width: 10%;"></td> <td style="width: 10%;"></td> <td style="width: 10%;"></td> <td style="width: 10%;"></td> <td style="width: 10%;"></td> <td style="width: 10%;"></td> <td style="width: 10%;"></td> <td style="width: 10%;"></td> <td style="width: 10%;"></td> </tr> <tr> <td></td> <td></td> <td colspan="8" style="text-align: center;"> <table border="1" style="width: 100%; border-collapse: collapse; text-align: center;"> <tr> <td style="width: 10%;"></td> <td style="width: 10%;"></td> <td style="width: 10%;"></td> <td style="width: 10%;"></td> <td style="width: 10%;"></td> <td style="width: 10%;"></td> <td style="width: 10%;"></td> <td style="width: 10%;"></td> <td style="width: 10%;"></td> <td style="width: 10%;"></td> </tr> <tr> <td></td> <td></td> <td colspan="8" style="text-align: center;"> <table border="1" style="width: 100%; border-collapse: collapse; text-align: center;"> <tr> <td style="width: 10%;"></td> <td style="width: 10%;"></td> <td style="width: 10%;"></td> <td style="width: 10%;"></td> <td style="width: 10%;"></td> <td style="width: 10%;"></td> <td style="width: 10%;"></td> <td style="width: 10%;"></td> <td style="width: 10%;"></td> <td style="width: 10%;"></td> </tr> <tr> <td></td> <td></td> <td colspan="8" style="text-align: center;"> <table border="1" style="width: 100%; border-collapse: collapse; text-align: center;"> <tr> </tr></table></td></tr></table></td></tr></table></td></tr></table></td></tr></table></td></tr></table></td></tr></table></td></tr></table></td></tr></table></td></tr></table></td></tr></table></td></tr></table></td></tr></table></td></tr></table></td></tr></table></td></tr></table></td></tr></table></td></tr></table></td></tr></table></td></tr></table></td></tr></table></td></tr></table></td></tr></table></td></tr></table></td></tr></table></td></tr></table></td></tr></table></td></tr></table></td></tr></table></td></tr></table></td></tr></table></td></tr></table> | | | | | | | | | | | | | | | | | | | | <table border="1" style="width: 100%; border-collapse: collapse; text-align: center;"> <tr> <td style="width: 10%;"></td> <td style="width: 10%;"></td> <td style="width: 10%;"></td> <td style="width: 10%;"></td> <td style="width: 10%;"></td> <td style="width: 10%;"></td> <td style="width: 10%;"></td> <td style="width: 10%;"></td> <td style="width: 10%;"></td> <td style="width: 10%;"></td> </tr> <tr> <td></td> <td></td> <td colspan="8" style="text-align: center;"> <table border="1" style="width: 100%; border-collapse: collapse; text-align: center;"> <tr> <td style="width: 10%;"></td> <td style="width: 10%;"></td> <td style="width: 10%;"></td> <td style="width: 10%;"></td> <td style="width: 10%;"></td> <td style="width: 10%;"></td> <td style="width: 10%;"></td> <td style="width: 10%;"></td> <td style="width: 10%;"></td> <td style="width: 10%;"></td> </tr> <tr> <td></td> <td></td> <td colspan="8" style="text-align: center;"> <table border="1" style="width: 100%; border-collapse: collapse; text-align: center;"> <tr> <td style="width: 10%;"></td> <td style="width: 10%;"></td> <td style="width: 10%;"></td> <td style="width: 10%;"></td> <td style="width: 10%;"></td> <td style="width: 10%;"></td> <td style="width: 10%;"></td> <td style="width: 10%;"></td> <td style="width: 10%;"></td> <td style="width: 10%;"></td> </tr> <tr> <td></td> <td></td> <td colspan="8" style="text-align: center;"> <table border="1" style="width: 100%; border-collapse: collapse; text-align: center;"> <tr> <td style="width: 10%;"></td> <td style="width: 10%;"></td> <td style="width: 10%;"></td> <td style="width: 10%;"></td> <td style="width: 10%;"></td> <td style="width: 10%;"></td> <td style="width: 10%;"></td> <td style="width: 10%;"></td> <td style="width: 10%;"></td> <td style="width: 10%;"></td> </tr> <tr> <td></td> <td></td> <td colspan="8" style="text-align: center;"> <table border="1" style="width: 100%; border-collapse: collapse; text-align: center;"> <tr> <td style="width: 10%;"></td> <td style="width: 10%;"></td> <td style="width: 10%;"></td> <td style="width: 10%;"></td> <td style="width: 10%;"></td> <td style="width: 10%;"></td> <td style="width: 10%;"></td> <td style="width: 10%;"></td> <td style="width: 10%;"></td> <td style="width: 10%;"></td> </tr> <tr> <td></td> <td></td> <td colspan="8" style="text-align: center;"> <table border="1" style="width: 100%; border-collapse: collapse; text-align: center;"> <tr> <td style="width: 10%;"></td> <td style="width: 10%;"></td> <td style="width: 10%;"></td> <td style="width: 10%;"></td> <td style="width: 10%;"></td> <td style="width: 10%;"></td> <td style="width: 10%;"></td> <td style="width: 10%;"></td> <td style="width: 10%;"></td> <td style="width: 10%;"></td> </tr> <tr> <td></td> <td></td> <td colspan="8" style="text-align: center;"> <table border="1" style="width: 100%; border-collapse: collapse; text-align: center;"> <tr> <td style="width: 10%;"></td> <td style="width: 10%;"></td> <td style="width: 10%;"></td> <td
style="width: 10%;"></td> <td style="width: 10%;"></td> <td style="width: 10%;"></td> <td style="width: 10%;"></td> <td style="width: 10%;"></td> <td style="width: 10%;"></td> <td style="width: 10%;"></td> </tr> <tr> <td></td> <td></td> <td colspan="8" style="text-align: center;"> <table border="1" style="width: 100%; border-collapse: collapse; text-align: center;"> <tr> <td style="width: 10%;"></td> <td style="width: 10%;"></td> <td style="width: 10%;"></td> <td style="width: 10%;"></td> <td style="width: 10%;"></td> <td style="width: 10%;"></td> <td style="width: 10%;"></td> <td style="width: 10%;"></td> <td style="width: 10%;"></td> <td style="width: 10%;"></td> </tr> <tr> <td></td> <td></td> <td colspan="8" style="text-align: center;"> <table border="1" style="width: 100%; border-collapse: collapse; text-align: center;"> <tr> <td style="width: 10%;"></td> <td style="width: 10%;"></td> <td style="width: 10%;"></td> <td style="width: 10%;"></td> <td style="width: 10%;"></td> <td style="width: 10%;"></td> <td style="width: 10%;"></td> <td style="width: 10%;"></td> <td style="width: 10%;"></td> <td style="width: 10%;"></td> </tr> <tr> <td></td> <td></td> <td colspan="8" style="text-align: center;"> <table border="1" style="width: 100%; border-collapse: collapse; text-align: center;"> <tr> <td style="width: 10%;"></td> <td style="width: 10%;"></td> <td style="width: 10%;"></td> <td style="width: 10%;"></td> <td style="width: 10%;"></td> <td style="width: 10%;"></td> <td style="width: 10%;"></td> <td style="width: 10%;"></td> <td style="width: 10%;"></td> <td style="width: 10%;"></td> </tr> <tr> <td></td> <td></td> <td colspan="8" style="text-align: center;"> <table border="1" style="width: 100%; border-collapse: collapse; text-align: center;"> <tr> <td style="width: 10%;"></td> <td style="width: 10%;"></td> <td style="width: 10%;"></td> <td style="width: 10%;"></td> <td style="width: 10%;"></td> <td style="width: 10%;"></td> <td style="width: 10%;"></td> <td style="width: 10%;"></td> <td style="width: 10%;"></td> <td style="width: 10%;"></td> </tr> <tr> <td></td> <td></td> <td colspan="8" style="text-align: center;"> <table border="1" style="width: 100%; border-collapse: collapse; text-align: center;"> <tr> <td style="width: 10%;"></td> <td style="width: 10%;"></td> <td style="width: 10%;"></td> <td style="width: 10%;"></td> <td style="width: 10%;"></td> <td style="width: 10%;"></td> <td style="width: 10%;"></td> <td style="width: 10%;"></td> <td style="width: 10%;"></td> <td style="width: 10%;"></td> </tr> <tr> <td></td> <td></td> <td colspan="8" style="text-align: center;"> <table border="1" style="width: 100%; border-collapse: collapse; text-align: center;"> <tr> <td style="width: 10%;"></td> <td style="width: 10%;"></td> <td style="width: 10%;"></td> <td style="width: 10%;"></td> <td style="width: 10%;"></td> <td style="width: 10%;"></td> <td style="width: 10%;"></td> <td style="width: 10%;"></td> <td style="width: 10%;"></td> <td style="width: 10%;"></td> </tr> <tr> <td></td> <td></td> <td colspan="8" style="text-align: center;"> <table border="1" style="width: 100%; border-collapse: collapse; text-align: center;"> <tr> <td style="width: 10%;"></td> <td style="width: 10%;"></td> <td style="width: 10%;"></td> <td style="width: 10%;"></td> <td style="width: 10%;"></td> <td style="width: 10%;"></td> <td style="width: 10%;"></td> <td style="width: 10%;"></td> <td style="width: 10%;"></td> <td style="width: 10%;"></td> </tr> <tr> <td></td> <td></td> <td colspan="8" style="text-align: center;"> <table border="1" style="width: 100%; border-collapse: collapse; text-align: center;"> <tr> <td style="width: 10%;"></td> <td style="width: 10%;"></td> <td style="width: 10%;"></td> <td style="width: 10%;"></td> <td style="width: 10%;"></td> <td style="width: 10%;"></td> <td style="width: 10%;"></td> <td style="width: 10%;"></td> <td style="width: 10%;"></td> <td style="width: 10%;"></td> </tr> <tr> <td></td> <td></td> <td colspan="8" style="text-align: center;"> <table border="1" style="width: 100%; border-collapse: collapse; text-align: center;"> <tr> <td style="width: 10%;"></td> <td style="width: 10%;"></td> <td style="width: 10%;"></td> <td style="width: 10%;"></td> <td style="width: 10%;"></td> <td style="width: 10%;"></td> <td style="width: 10%;"></td> <td style="width: 10%;"></td> <td style="width: 10%;"></td> <td style="width: 10%;"></td> </tr> <tr> <td></td> <td></td> <td colspan="8" style="text-align: center;"> <table border="1" style="width: 100%; border-collapse: collapse; text-align: center;"> <tr> <td style="width: 10%;"></td> <td style="width: 10%;"></td> <td style="width: 10%;"></td> <td style="width: 10%;"></td> <td style="width: 10%;"></td> <td style="width: 10%;"></td> <td style="width: 10%;"></td> <td style="width: 10%;"></td> <td style="width: 10%;"></td> <td style="width: 10%;"></td> </tr> <tr> <td></td> <td></td> <td colspan="8" style="text-align: center;"> <table border="1" style="width: 100%; border-collapse: collapse; text-align: center;"> <tr> <td style="width: 10%;"></td> <td style="width: 10%;"></td> <td style="width: 10%;"></td> <td style="width: 10%;"></td> <td style="width: 10%;"></td> <td style="width: 10%;"></td> <td style="width: 10%;"></td> <td style="width: 10%;"></td> <td style="width: 10%;"></td> <td style="width: 10%;"></td> </tr> <tr> <td></td> <td></td> <td colspan="8" style="text-align: center;"> <table border="1" style="width: 100%; border-collapse: collapse; text-align: center;"> <tr> <td style="width: 10%;"></td> <td style="width: 10%;"></td> <td style="width: 10%;"></td> <td style="width: 10%;"></td> <td style="width: 10%;"></td> <td style="width: 10%;"></td> <td style="width: 10%;"></td> <td style="width: 10%;"></td> <td style="width: 10%;"></td> <td style="width: 10%;"></td> </tr> <tr> <td></td> <td></td> <td colspan="8" style="text-align: center;"> <table border="1" style="width: 100%; border-collapse: collapse; text-align: center;"> <tr> <td style="width: 10%;"></td> <td style="width: 10%;"></td> <td style="width: 10%;"></td> <td style="width: 10%;"></td> <td style="width: 10%;"></td> <td style="width: 10%;"></td> <td style="width: 10%;"></td> <td style="width: 10%;"></td> <td style="width: 10%;"></td> <td style="width: 10%;"></td> </tr> <tr> <td></td> <td></td> <td colspan="8" style="text-align: center;"> <table border="1" style="width: 100%; border-collapse: collapse; text-align: center;"> <tr> <td style="width: 10%;"></td> <td style="width: 10%;"></td> <td style="width: 10%;"></td> <td style="width: 10%;"></td> <td style="width: 10%;"></td> <td style="width: 10%;"></td> <td style="width: 10%;"></td> <td style="width: 10%;"></td> <td style="width: 10%;"></td> <td style="width: 10%;"></td> </tr> <tr> <td></td> <td></td> <td colspan="8" style="text-align: center;"> <table border="1" style="width: 100%; border-collapse: collapse; text-align: center;"> <tr> <td style="width: 10%;"></td> <td style="width: 10%;"></td> <td style="width: 10%;"></td> <td style="width: 10%;"></td> <td style="width: 10%;"></td> <td style="width: 10%;"></td> <td style="width: 10%;"></td> <td style="width: 10%;"></td> <td style="width: 10%;"></td> <td style="width: 10%;"></td> </tr> <tr> <td></td> <td></td> <td colspan="8" style="text-align: center;"> <table border="1" style="width: 100%; border-collapse: collapse; text-align: center;"> <tr> <td style="width: 10%;"></td> <td style="width: 10%;"></td> <td style="width: 10%;"></td> <td style="width: 10%;"></td> <td style="width: 10%;"></td> <td style="width: 10%;"></td> <td style="width: 10%;"></td> <td style="width: 10%;"></td> <td style="width: 10%;"></td> <td style="width: 10%;"></td> </tr> <tr> <td></td> <td></td> <td colspan="8" style="text-align: center;"> <table border="1" style="width: 100%; border-collapse: collapse; text-align: center;"> <tr> <td style="width: 10%;"></td> <td style="width: 10%;"></td> <td style="width: 10%;"></td> <td style="width: 10%;"></td> <td style="width: 10%;"></td> <td style="width: 10%;"></td> <td style="width: 10%;"></td> <td style="width: 10%;"></td> <td style="width: 10%;"></td> <td style="width: 10%;"></td> </tr> <tr> <td></td> <td></td> <td colspan="8" style="text-align: center;"> <table border="1" style="width: 100%; border-collapse: collapse; text-align: center;"> <tr> <td style="width: 10%;"></td> <td style="width: 10%;"></td> <td style="width: 10%;"></td> <td style="width: 10%;"></td> <td style="width: 10%;"></td> <td style="width: 10%;"></td> <td style="width: 10%;"></td> <td style="width: 10%;"></td> <td style="width: 10%;"></td> <td style="width: 10%;"></td> </tr> <tr> <td></td> <td></td> <td colspan="8" style="text-align: center;"> <table border="1" style="width: 100%; border-collapse: collapse; text-align: center;"> <tr> <td style="width: 10%;"></td> <td style="width: 10%;"></td> <td style="width: 10%;"></td> <td style="width: 10%;"></td> <td style="width: 10%;"></td> <td style="width: 10%;"></td> <td style="width: 10%;"></td> <td style="width: 10%;"></td> <td style="width: 10%;"></td> <td style="width: 10%;"></td> </tr> <tr> <td></td> <td></td> <td colspan="8" style="text-align: center;"> <table border="1" style="width: 100%; border-collapse: collapse; text-align: center;"> <tr> <td style="width: 10%;"></td> <td style="width: 10%;"></td> <td style="width: 10%;"></td> <td style="width: 10%;"></td> <td style="width: 10%;"></td> <td style="width: 10%;"></td> <td style="width: 10%;"></td> <td style="width: 10%;"></td> <td style="width: 10%;"></td> <td style="width: 10%;"></td> </tr> <tr> <td></td> <td></td> <td colspan="8" style="text-align: center;"> <table border="1" style="width: 100%; border-collapse: collapse; text-align: center;"> <tr> <td style="width: 10%;"></td> <td style="width: 10%;"></td> <td style="width: 10%;"></td> <td style="width: 10%;"></td> <td style="width: 10%;"></td> <td style="width: 10%;"></td> <td style="width: 10%;"></td> <td style="width: 10%;"></td> <td style="width:
10%;"></td> <td style="width: 10%;"></td> </tr> <tr> <td></td> <td></td> <td colspan="8" style="text-align: center;"> <table border="1" style="width: 100%; border-collapse: collapse; text-align: center;"> <tr> <td style="width: 10%;"></td> <td style="width: 10%;"></td> <td style="width: 10%;"></td> <td style="width: 10%;"></td> <td style="width: 10%;"></td> <td style="width: 10%;"></td> <td style="width: 10%;"></td> <td style="width: 10%;"></td> <td style="width: 10%;"></td> <td style="width: 10%;"></td> </tr> <tr> <td></td> <td></td> <td colspan="8" style="text-align: center;"> <table border="1" style="width: 100%; border-collapse: collapse; text-align: center;"> <tr> <td style="width: 10%;"></td> <td style="width: 10%;"></td> <td style="width: 10%;"></td> <td style="width: 10%;"></td> <td style="width: 10%;"></td> <td style="width: 10%;"></td> <td style="width: 10%;"></td> <td style="width: 10%;"></td> <td style="width: 10%;"></td> <td style="width: 10%;"></td> </tr> <tr> <td></td> <td></td> <td colspan="8" style="text-align: center;"> <table border="1" style="width: 100%; border-collapse: collapse; text-align: center;"> <tr> </tr></table></td></tr></table></td></tr></table></td></tr></table></td></tr></table></td></tr></table></td></tr></table></td></tr></table></td></tr></table></td></tr></table></td></tr></table></td></tr></table></td></tr></table></td></tr></table></td></tr></table></td></tr></table></td></tr></table></td></tr></table></td></tr></table></td></tr></table></td></tr></table></td></tr></table></td></tr></table></td></tr></table></td></tr></table></td></tr></table></td></tr></table></td></tr></table></td></tr></table></td></tr></table></td></tr></table> | | | | | | | | | | | | | | | | | | | | <table border="1" style="width: 100%; border-collapse: collapse; text-align: center;"> <tr> <td style="width: 10%;"></td> <td style="width: 10%;"></td> <td style="width: 10%;"></td> <td style="width: 10%;"></td> <td style="width: 10%;"></td> <td style="width: 10%;"></td> <td style="width: 10%;"></td> <td style="width: 10%;"></td> <td style="width: 10%;"></td> <td style="width: 10%;"></td> </tr> <tr> <td></td> <td></td> <td colspan="8" style="text-align: center;"> <table border="1" style="width: 100%; border-collapse: collapse; text-align: center;"> <tr> <td style="width: 10%;"></td> <td style="width: 10%;"></td> <td style="width: 10%;"></td> <td style="width: 10%;"></td> <td style="width: 10%;"></td> <td style="width: 10%;"></td> <td style="width: 10%;"></td> <td style="width: 10%;"></td> <td style="width: 10%;"></td> <td style="width: 10%;"></td> </tr> <tr> <td></td> <td></td> <td colspan="8" style="text-align: center;"> <table border="1" style="width: 100%; border-collapse: collapse; text-align: center;"> <tr> <td style="width: 10%;"></td> <td style="width: 10%;"></td> <td style="width: 10%;"></td> <td style="width: 10%;"></td> <td style="width: 10%;"></td> <td style="width: 10%;"></td> <td style="width: 10%;"></td> <td style="width: 10%;"></td> <td style="width: 10%;"></td> <td style="width: 10%;"></td> </tr> <tr> <td></td> <td></td> <td colspan="8" style="text-align: center;"> <table border="1" style="width: 100%; border-collapse: collapse; text-align: center;"> <tr> <td style="width: 10%;"></td> <td style="width: 10%;"></td> <td style="width: 10%;"></td> <td style="width: 10%;"></td> <td style="width: 10%;"></td> <td style="width: 10%;"></td> <td style="width: 10%;"></td> <td style="width: 10%;"></td> <td style="width: 10%;"></td> <td style="width: 10%;"></td> </tr> <tr> <td></td> <td></td> <td colspan="8" style="text-align: center;"> <table border="1" style="width: 100%; border-collapse: collapse; text-align: center;"> <tr> <td style="width: 10%;"></td> <td style="width: 10%;"></td> <td style="width: 10%;"></td> <td style="width: 10%;"></td> <td style="width: 10%;"></td> <td style="width: 10%;"></td> <td style="width: 10%;"></td> <td style="width: 10%;"></td> <td style="width: 10%;"></td> <td style="width: 10%;"></td> </tr> <tr> <td></td> <td></td> <td colspan="8" style="text-align: center;"> <table border="1" style="width: 100%; border-collapse: collapse; text-align: center;"> <tr> <td style="width: 10%;"></td> <td style="width: 10%;"></td> <td style="width: 10%;"></td> <td style="width: 10%;"></td> <td style="width: 10%;"></td> <td style="width: 10%;"></td> <td style="width: 10%;"></td> <td style="width: 10%;"></td> <td style="width: 10%;"></td> <td style="width: 10%;"></td> </tr> <tr> <td></td> <td></td> <td colspan="8" style="text-align: center;"> <table border="1" style="width: 100%; border-collapse: collapse; text-align: center;"> <tr> <td style="width: 10%;"></td> <td style="width: 10%;"></td> <td style="width: 10%;"></td> <td style="width: 10%;"></td> <td style="width: 10%;"></td> <td style="width: 10%;"></td> <td style="width: 10%;"></td> <td style="width: 10%;"></td> <td style="width: 10%;"></td> <td style="width: 10%;"></td> </tr> <tr> <td></td> <td></td> <td colspan="8" style="text-align: center;"> <table border="1" style="width: 100%; border-collapse: collapse; text-align: center;"> <tr> <td style="width: 10%;"></td> <td style="width: 10%;"></td> <td style="width: 10%;"></td> <td style="width: 10%;"></td> <td style="width: 10%;"></td> <td style="width: 10%;"></td> <td style="width: 10%;"></td> <td style="width: 10%;"></td> <td style="width: 10%;"></td> <td style="width: 10%;"></td> </tr> <tr> <td></td> <td></td> <td colspan="8" style="text-align: center;"> <table border="1" style="width: 100%; border-collapse: collapse; text-align: center;"> <tr> <td style="width: 10%;"></td> <td style="width: 10%;"></td> <td style="width: 10%;"></td> <td style="width: 10%;"></td> <td style="width: 10%;"></td> <td style="width: 10%;"></td> <td style="width: 10%;"></td> <td style="width: 10%;"></td> <td style="width: 10%;"></td> <td style="width: 10%;"></td> </tr> <tr> <td></td> <td></td> <td colspan="8" style="text-align: center;"> <table border="1" style="width: 100%; border-collapse: collapse; text-align: center;"> <tr> <td style="width: 10%;"></td> <td style="width: 10%;"></td> <td style="width: 10%;"></td> <td style="width: 10%;"></td> <td style="width: 10%;"></td> <td style="width: 10%;"></td> <td style="width: 10%;"></td> <td style="width: 10%;"></td> <td style="width: 10%;"></td> <td style="width: 10%;"></td> </tr> <tr> <td></td> <td></td> <td colspan="8" style="text-align: center;"> <table border="1" style="width: 100%; border-collapse: collapse; text-align: center;"> <tr> <td style="width: 10%;"></td> <td style="width: 10%;"></td> <td style="width: 10%;"></td> <td style="width: 10%;"></td> <td style="width: 10%;"></td> <td style="width: 10%;"></td> <td style="width: 10%;"></td> <td style="width: 10%;"></td> <td style="width: 10%;"></td> <td style="width: 10%;"></td> </tr> <tr> <td></td> <td></td> <td colspan="8" style="text-align: center;"> <table border="1" style="width: 100%; border-collapse: collapse; text-align: center;"> <tr> <td style="width: 10%;"></td> <td style="width: 10%;"></td> <td style="width: 10%;"></td> <td style="width: 10%;"></td> <td style="width: 10%;"></td> <td style="width: 10%;"></td> <td style="width: 10%;"></td> <td style="width: 10%;"></td> <td style="width: 10%;"></td> <td style="width: 10%;"></td> </tr> <tr> <td></td> <td></td> <td colspan="8" style="text-align: center;"> <table border="1" style="width: 100%; border-collapse: collapse; text-align: center;"> <tr> <td style="width: 10%;"></td> <td style="width: 10%;"></td> <td style="width: 10%;"></td> <td style="width: 10%;"></td> <td style="width: 10%;"></td> <td style="width: 10%;"></td> <td style="width: 10%;"></td> <td style="width: 10%;"></td> <td style="width: 10%;"></td> <td style="width: 10%;"></td> </tr> <tr> <td></td> <td></td> <td colspan="8" style="text-align: center;"> <table border="1" style="width: 100%; border-collapse: collapse; text-align: center;"> <tr> <td style="width: 10%;"></td> <td style="width: 10%;"></td> <td style="width: 10%;"></td> <td style="width: 10%;"></td> <td style="width: 10%;"></td> <td style="width: 10%;"></td> <td style="width: 10%;"></td> <td style="width: 10%;"></td> <td style="width: 10%;"></td> <td style="width: 10%;"></td> </tr> <tr> <td></td> <td></td> <td colspan="8" style="text-align: center;"> <table border="1" style="width: 100%; border-collapse: collapse; text-align: center;"> <tr> <td style="width: 10%;"></td> <td style="width: 10%;"></td> <td style="width: 10%;"></td> <td style="width: 10%;"></td> <td style="width: 10%;"></td> <td style="width: 10%;"></td> <td style="width: 10%;"></td> <td style="width: 10%;"></td> <td style="width: 10%;"></td> <td style="width: 10%;"></td> </tr> <tr> <td></td> <td></td> <td colspan="8" style="text-align: center;"> <table border="1" style="width: 100%; border-collapse: collapse; text-align: center;"> <tr> <td style="width: 10%;"></td> <td style="width: 10%;"></td> <td style="width: 10%;"></td> <td style="width: 10%;"></td> <td style="width: 10%;"></td> <td style="width: 10%;"></td> <td style="width: 10%;"></td> <td style="width: 10%;"></td> <td style="width: 10%;"></td> <td style="width: 10%;"></td> </tr> <tr> <td></td> <td></td> <td colspan="8" style="text-align: center;"> <table border="1" style="width: 100%; border-collapse: collapse; text-align: center;"> <tr> <td style="width: 10%;"></td> <td style="width: 10%;"></td> <td style="width: 10%;"></td> <td style="width: 10%;"></td> <td style="width: 10%;"></td> <td style="width:
10%;"></td> <td style="width: 10%;"></td> <td style="width: 10%;"></td> <td style="width: 10%;"></td> <td style="width: 10%;"></td> </tr> <tr> <td></td> <td></td> <td colspan="8" style="text-align: center;"> <table border="1" style="width: 100%; border-collapse: collapse; text-align: center;"> <tr> <td style="width: 10%;"></td> <td style="width: 10%;"></td> <td style="width: 10%;"></td> <td style="width: 10%;"></td> <td style="width: 10%;"></td> <td style="width: 10%;"></td> <td style="width: 10%;"></td> <td style="width: 10%;"></td> <td style="width: 10%;"></td> <td style="width: 10%;"></td> </tr> <tr> <td></td> <td></td> <td colspan="8" style="text-align: center;"> <table border="1" style="width: 100%; border-collapse: collapse; text-align: center;"> <tr> <td style="width: 10%;"></td> <td style="width: 10%;"></td> <td style="width: 10%;"></td> <td style="width: 10%;"></td> <td style="width: 10%;"></td> <td style="width: 10%;"></td> <td style="width: 10%;"></td> <td style="width: 10%;"></td> <td style="width: 10%;"></td> <td style="width: 10%;"></td> </tr> <tr> <td></td> <td></td> <td colspan="8" style="text-align: center;"> <table border="1" style="width: 100%; border-collapse: collapse; text-align: center;"> <tr> <td style="width: 10%;"></td> <td style="width: 10%;"></td> <td style="width: 10%;"></td> <td style="width: 10%;"></td> <td style="width: 10%;"></td> <td style="width: 10%;"></td> <td style="width: 10%;"></td> <td style="width: 10%;"></td> <td style="width: 10%;"></td> <td style="width: 10%;"></td> </tr> <tr> <td></td> <td></td> <td colspan="8" style="text-align: center;"> <table border="1" style="width: 100%; border-collapse: collapse; text-align: center;"> <tr> <td style="width: 10%;"></td> <td style="width: 10%;"></td> <td style="width: 10%;"></td> <td style="width: 10%;"></td> <td style="width: 10%;"></td> <td style="width: 10%;"></td> <td style="width: 10%;"></td> <td style="width: 10%;"></td> <td style="width: 10%;"></td> <td style="width: 10%;"></td> </tr> <tr> <td></td> <td></td> <td colspan="8" style="text-align: center;"> <table border="1" style="width: 100%; border-collapse: collapse; text-align: center;"> <tr> <td style="width: 10%;"></td> <td style="width: 10%;"></td> <td style="width: 10%;"></td> <td style="width: 10%;"></td> <td style="width: 10%;"></td> <td style="width: 10%;"></td> <td style="width: 10%;"></td> <td style="width: 10%;"></td> <td style="width: 10%;"></td> <td style="width: 10%;"></td> </tr> <tr> <td></td> <td></td> <td colspan="8" style="text-align: center;"> <table border="1" style="width: 100%; border-collapse: collapse; text-align: center;"> <tr> <td style="width: 10%;"></td> <td style="width: 10%;"></td> <td style="width: 10%;"></td> <td style="width: 10%;"></td> <td style="width: 10%;"></td> <td style="width: 10%;"></td> <td style="width: 10%;"></td> <td style="width: 10%;"></td> <td style="width: 10%;"></td> <td style="width: 10%;"></td> </tr> <tr> <td></td> <td></td> <td colspan="8" style="text-align: center;"> <table border="1" style="width: 100%; border-collapse: collapse; text-align: center;"> <tr> <td style="width: 10%;"></td> <td style="width: 10%;"></td> <td style="width: 10%;"></td> <td style="width: 10%;"></td> <td style="width: 10%;"></td> <td style="width: 10%;"></td> <td style="width: 10%;"></td> <td style="width: 10%;"></td> <td style="width: 10%;"></td> <td style="width: 10%;"></td> </tr> <tr> <td></td> <td></td> <td colspan="8" style="text-align: center;"> <table border="1" style="width: 100%; border-collapse: collapse; text-align: center;"> <tr> <td style="width: 10%;"></td> <td style="width: 10%;"></td> <td style="width: 10%;"></td> <td style="width: 10%;"></td> <td style="width: 10%;"></td> <td style="width: 10%;"></td> <td style="width: 10%;"></td> <td style="width: 10%;"></td> <td style="width: 10%;"></td> <td style="width: 10%;"></td> </tr> <tr> <td></td> <td></td> <td colspan="8" style="text-align: center;"> <table border="1" style="width: 100%; border-collapse: collapse; text-align: center;"> <tr> <td style="width: 10%;"></td> <td style="width: 10%;"></td> <td style="width: 10%;"></td> <td style="width: 10%;"></td> <td style="width: 10%;"></td> <td style="width: 10%;"></td> <td style="width: 10%;"></td> <td style="width: 10%;"></td> <td style="width: 10%;"></td> <td style="width: 10%;"></td> </tr> <tr> <td></td> <td></td> <td colspan="8" style="text-align: center;"> <table border="1" style="width: 100%; border-collapse: collapse; text-align: center;"> <tr> <td style="width: 10%;"></td> <td style="width: 10%;"></td> <td style="width: 10%;"></td> <td style="width: 10%;"></td> <td style="width: 10%;"></td> <td style="width: 10%;"></td> <td style="width: 10%;"></td> <td style="width: 10%;"></td> <td style="width: 10%;"></td> <td style="width: 10%;"></td> </tr> <tr> <td></td> <td></td> <td colspan="8" style="text-align: center;"> <table border="1" style="width: 100%; border-collapse: collapse; text-align: center;"> <tr> <td style="width: 10%;"></td> <td style="width: 10%;"></td> <td style="width: 10%;"></td> <td style="width: 10%;"></td> <td style="width: 10%;"></td> <td style="width: 10%;"></td> <td style="width: 10%;"></td> <td style="width: 10%;"></td> <td style="width: 10%;"></td> <td style="width: 10%;"></td> </tr> <tr> <td></td> <td></td> <td colspan="8" style="text-align: center;"> <table border="1" style="width: 100%; border-collapse: collapse; text-align: center;"> <tr> <td style="width: 10%;"></td> <td style="width: 10%;"></td> <td style="width: 10%;"></td> <td style="width: 10%;"></td> <td style="width: 10%;"></td> <td style="width: 10%;"></td> <td style="width: 10%;"></td> <td style="width: 10%;"></td> <td style="width: 10%;"></td> <td style="width: 10%;"></td> </tr> <tr> <td></td> <td></td> <td colspan="8" style="text-align: center;"> <table border="1" style="width: 100%; border-collapse: collapse; text-align: center;"> <tr> </tr></table></td></tr></table></td></tr></table></td></tr></table></td></tr></table></td></tr></table></td></tr></table></td></tr></table></td></tr></table></td></tr></table></td></tr></table></td></tr></table></td></tr></table></td></tr></table></td></tr></table></td></tr></table></td></tr></table></td></tr></table></td></tr></table></td></tr></table></td></tr></table></td></tr></table></td></tr></table></td></tr></table></td></tr></table></td></tr></table></td></tr></table></td></tr></table></td></tr></table></td></tr></table> | | | | | | | | | | | | | | | | | | | | <table border="1" style="width: 100%; border-collapse: collapse; text-align: center;"> <tr> <td style="width: 10%;"></td> <td style="width: 10%;"></td> <td style="width: 10%;"></td> <td style="width: 10%;"></td> <td style="width: 10%;"></td> <td style="width: 10%;"></td> <td style="width: 10%;"></td> <td style="width: 10%;"></td> <td style="width: 10%;"></td> <td style="width: 10%;"></td> </tr> <tr> <td></td> <td></td> <td colspan="8" style="text-align: center;"> <table border="1" style="width: 100%; border-collapse: collapse; text-align: center;"> <tr> <td style="width: 10%;"></td> <td style="width: 10%;"></td> <td style="width: 10%;"></td> <td style="width: 10%;"></td> <td style="width: 10%;"></td> <td style="width: 10%;"></td> <td style="width: 10%;"></td> <td style="width: 10%;"></td> <td style="width: 10%;"></td> <td style="width: 10%;"></td> </tr> <tr> <td></td> <td></td> <td colspan="8" style="text-align: center;"> <table border="1" style="width: 100%; border-collapse: collapse; text-align: center;"> <tr> <td style="width: 10%;"></td> <td style="width: 10%;"></td> <td style="width: 10%;"></td> <td style="width: 10%;"></td> <td style="width: 10%;"></td> <td style="width: 10%;"></td> <td style="width: 10%;"></td> <td style="width: 10%;"></td> <td style="width: 10%;"></td> <td style="width: 10%;"></td> </tr> <tr> <td></td> <td></td> <td colspan="8" style="text-align: center;"> <table border="1" style="width: 100%; border-collapse: collapse; text-align: center;"> <tr> <td style="width: 10%;"></td> <td style="width: 10%;"></td> <td style="width: 10%;"></td> <td style="width: 10%;"></td> <td style="width: 10%;"></td> <td style="width: 10%;"></td> <td style="width: 10%;"></td> <td style="width: 10%;"></td> <td style="width: 10%;"></td> <td style="width: 10%;"></td> </tr> <tr> <td></td> <td></td> <td colspan="8" style="text-align: center;"> <table border="1" style="width: 100%; border-collapse: collapse; text-align: center;"> <tr> <td style="width: 10%;"></td> <td style="width: 10%;"></td> <td style="width: 10%;"></td> <td style="width: 10%;"></td> <td style="width: 10%;"></td> <td style="width: 10%;"></td> <td style="width: 10%;"></td> <td style="width: 10%;"></td> <td style="width: 10%;"></td> <td style="width: 10%;"></td> </tr> <tr> <td></td> <td></td> <td colspan="8" style="text-align: center;"> <table border="1" style="width: 100%; border-collapse: collapse; text-align: center;"> <tr> <td style="width: 10%;"></td> <td style="width: 10%;"></td> <td style="width: 10%;"></td> <td style="width: 10%;"></td> <td style="width: 10%;"></td> <td style="width: 10%;"></td> <td style="width: 10%;"></td> <td style="width: 10%;"></td> <td style="width: 10%;"></td> <td style="width: 10%;"></td> </tr> <tr> <td></td> <td></td> <td colspan="8" style="text-align: center;"> <table border="1" style="width: 100%; border-collapse: collapse; text-align: center;"> <tr> <td style="width: 10%;"></td> <td style="width: 10%;"></td> <td style="width: 10%;"></td> <td
style="width: 10%;"></td> <td style="width: 10%;"></td> <td style="width: 10%;"></td> <td style="width: 10%;"></td> <td style="width: 10%;"></td> <td style="width: 10%;"></td> <td style="width: 10%;"></td> </tr> <tr> <td></td> <td></td> <td colspan="8" style="text-align: center;"> <table border="1" style="width: 100%; border-collapse: collapse; text-align: center;"> <tr> <td style="width: 10%;"></td> <td style="width: 10%;"></td> <td style="width: 10%;"></td> <td style="width: 10%;"></td> <td style="width: 10%;"></td> <td style="width: 10%;"></td> <td style="width: 10%;"></td> <td style="width: 10%;"></td> <td style="width: 10%;"></td> <td style="width: 10%;"></td> </tr> <tr> <td></td> <td></td> <td colspan="8" style="text-align: center;"> <table border="1" style="width: 100%; border-collapse: collapse; text-align: center;"> <tr> <td style="width: 10%;"></td> <td style="width: 10%;"></td> <td style="width: 10%;"></td> <td style="width: 10%;"></td> <td style="width: 10%;"></td> <td style="width: 10%;"></td> <td style="width: 10%;"></td> <td style="width: 10%;"></td> <td style="width: 10%;"></td> <td style="width: 10%;"></td> </tr> <tr> <td></td> <td></td> <td colspan="8" style="text-align: center;"> <table border="1" style="width: 100%; border-collapse: collapse; text-align: center;"> <tr> <td style="width: 10%;"></td> <td style="width: 10%;"></td> <td style="width: 10%;"></td> <td style="width: 10%;"></td> <td style="width: 10%;"></td> <td style="width: 10%;"></td> <td style="width: 10%;"></td> <td style="width: 10%;"></td> <td style="width: 10%;"></td> <td style="width: 10%;"></td> </tr> <tr> <td></td> <td></td> <td colspan="8" style="text-align: center;"> <table border="1" style="width: 100%; border-collapse: collapse; text-align: center;"> <tr> <td style="width: 10%;"></td> <td style="width: 10%;"></td> <td style="width: 10%;"></td> <td style="width: 10%;"></td> <td style="width: 10%;"></td> <td style="width: 10%;"></td> <td style="width: 10%;"></td> <td style="width: 10%;"></td> <td style="width: 10%;"></td> <td style="width: 10%;"></td> </tr> <tr> <td></td> <td></td> <td colspan="8" style="text-align: center;"> <table border="1" style="width: 100%; border-collapse: collapse; text-align: center;"> <tr> <td style="width: 10%;"></td> <td style="width: 10%;"></td> <td style="width: 10%;"></td> <td style="width: 10%;"></td> <td style="width: 10%;"></td> <td style="width: 10%;"></td> <td style="width: 10%;"></td> <td style="width: 10%;"></td> <td style="width: 10%;"></td> <td style="width: 10%;"></td> </tr> <tr> <td></td> <td></td> <td colspan="8" style="text-align: center;"> <table border="1" style="width: 100%; border-collapse: collapse; text-align: center;"> <tr> <td style="width: 10%;"></td> <td style="width: 10%;"></td> <td style="width: 10%;"></td> <td style="width: 10%;"></td> <td style="width: 10%;"></td> <td style="width: 10%;"></td> <td style="width: 10%;"></td> <td style="width: 10%;"></td> <td style="width: 10%;"></td> <td style="width: 10%;"></td> </tr> <tr> <td></td> <td></td> <td colspan="8" style="text-align: center;"> <table border="1" style="width: 100%; border-collapse: collapse; text-align: center;"> <tr> <td style="width: 10%;"></td> <td style="width: 10%;"></td> <td style="width: 10%;"></td> <td style="width: 10%;"></td> <td style="width: 10%;"></td> <td style="width: 10%;"></td> <td style="width: 10%;"></td> <td style="width: 10%;"></td> <td style="width: 10%;"></td> <td style="width: 10%;"></td> </tr> <tr> <td></td> <td></td> <td colspan="8" style="text-align: center;"> <table border="1" style="width: 100%; border-collapse: collapse; text-align: center;"> <tr> <td style="width: 10%;"></td> <td style="width: 10%;"></td> <td style="width: 10%;"></td> <td style="width: 10%;"></td> <td style="width: 10%;"></td> <td style="width: 10%;"></td> <td style="width: 10%;"></td> <td style="width: 10%;"></td> <td style="width: 10%;"></td> <td style="width: 10%;"></td> </tr> <tr> <td></td> <td></td> <td colspan="8" style="text-align: center;"> <table border="1" style="width: 100%; border-collapse: collapse; text-align: center;"> <tr> <td style="width: 10%;"></td> <td style="width: 10%;"></td> <td style="width: 10%;"></td> <td style="width: 10%;"></td> <td style="width: 10%;"></td> <td style="width: 10%;"></td> <td style="width: 10%;"></td> <td style="width: 10%;"></td> <td style="width: 10%;"></td> <td style="width: 10%;"></td> </tr> <tr> <td></td> <td></td> <td colspan="8" style="text-align: center;"> <table border="1" style="width: 100%; border-collapse: collapse; text-align: center;"> <tr> <td style="width: 10%;"></td> <td style="width: 10%;"></td> <td style="width: 10%;"></td> <td style="width: 10%;"></td> <td style="width: 10%;"></td> <td style="width: 10%;"></td> <td style="width: 10%;"></td> <td style="width: 10%;"></td> <td style="width: 10%;"></td> <td style="width: 10%;"></td> </tr> <tr> <td></td> <td></td> <td colspan="8" style="text-align: center;"> <table border="1" style="width: 100%; border-collapse: collapse; text-align: center;"> <tr> <td style="width: 10%;"></td> <td style="width: 10%;"></td> <td style="width: 10%;"></td> <td style="width: 10%;"></td> <td style="width: 10%;"></td> <td style="width: 10%;"></td> <td style="width: 10%;"></td> <td style="width: 10%;"></td> <td style="width: 10%;"></td> <td style="width: 10%;"></td> </tr> <tr> <td></td> <td></td> <td colspan="8" style="text-align: center;"> <table border="1" style="width: 100%; border-collapse: collapse; text-align: center;"> <tr> <td style="width: 10%;"></td> <td style="width: 10%;"></td> <td style="width: 10%;"></td> <td style="width: 10%;"></td> <td style="width: 10%;"></td> <td style="width: 10%;"></td> <td style="width: 10%;"></td> <td style="width: 10%;"></td> <td style="width: 10%;"></td> <td style="width: 10%;"></td> </tr> <tr> <td></td> <td></td> <td colspan="8" style="text-align: center;"> <table border="1" style="width: 100%; border-collapse: collapse; text-align: center;"> <tr> <td style="width: 10%;"></td> <td style="width: 10%;"></td> <td style="width: 10%;"></td> <td style="width: 10%;"></td> <td style="width: 10%;"></td> <td style="width: 10%;"></td> <td style="width: 10%;"></td> <td style="width: 10%;"></td> <td style="width: 10%;"></td> <td style="width: 10%;"></td> </tr> <tr> <td></td> <td></td> <td colspan="8" style="text-align: center;"> <table border="1" style="width: 100%; border-collapse: collapse; text-align: center;"> <tr> <td style="width: 10%;"></td> <td style="width: 10%;"></td> <td style="width: 10%;"></td> <td style="width: 10%;"></td> <td style="width: 10%;"></td> <td style="width: 10%;"></td> <td style="width: 10%;"></td> <td style="width: 10%;"></td> <td style="width: 10%;"></td> <td style="width: 10%;"></td> </tr> <tr> <td></td> <td></td> <td colspan="8" style="text-align: center;"> <table border="1" style="width: 100%; border-collapse: collapse; text-align: center;"> <tr> <td style="width: 10%;"></td> <td style="width: 10%;"></td> <td style="width: 10%;"></td> <td style="width: 10%;"></td> <td style="width: 10%;"></td> <td style="width: 10%;"></td> <td style="width: 10%;"></td> <td style="width: 10%;"></td> <td style="width: 10%;"></td> <td style="width: 10%;"></td> </tr> <tr> <td></td> <td></td> <td colspan="8" style="text-align: center;"> <table border="1" style="width: 100%; border-collapse: collapse; text-align: center;"> <tr> <td style="width: 10%;"></td> <td style="width: 10%;"></td> <td style="width: 10%;"></td> <td style="width: 10%;"></td> <td style="width: 10%;"></td> <td style="width: 10%;"></td> <td style="width: 10%;"></td> <td style="width: 10%;"></td> <td style="width: 10%;"></td> <td style="width: 10%;"></td> </tr> <tr> <td></td> <td></td> <td colspan="8" style="text-align: center;"> <table border="1" style="width: 100%; border-collapse: collapse; text-align: center;"> <tr> <td style="width: 10%;"></td> <td style="width: 10%;"></td> <td style="width: 10%;"></td> <td style="width: 10%;"></td> <td style="width: 10%;"></td> <td style="width: 10%;"></td> <td style="width: 10%;"></td> <td style="width: 10%;"></td> <td style="width: 10%;"></td> <td style="width: 10%;"></td> </tr> <tr> <td></td> <td></td> <td colspan="8" style="text-align: center;"> <table border="1" style="width: 100%; border-collapse: collapse; text-align: center;"> <tr> <td style="width: 10%;"></td> <td style="width: 10%;"></td> <td style="width: 10%;"></td> <td style="width: 10%;"></td> <td style="width: 10%;"></td> <td style="width: 10%;"></td> <td style="width: 10%;"></td> <td style="width: 10%;"></td> <td style="width: 10%;"></td> <td style="width: 10%;"></td> </tr> <tr> <td></td> <td></td> <td colspan="8" style="text-align: center;"> <table border="1" style="width: 100%; border-collapse: collapse; text-align: center;"> <tr> <td style="width: 10%;"></td> <td style="width: 10%;"></td> <td style="width: 10%;"></td> <td style="width: 10%;"></td> <td style="width: 10%;"></td> <td style="width: 10%;"></td> <td style="width: 10%;"></td> <td style="width: 10%;"></td> <td style="width: 10%;"></td> <td style="width: 10%;"></td> </tr> <tr> <td></td> <td></td> <td colspan="8" style="text-align: center;"> <table border="1" style="width: 100%; border-collapse: collapse; text-align: center;"> <tr> <td style="width: 10%;"></td> <td style="width: 10%;"></td> <td style="width: 10%;"></td> <td style="width: 10%;"></td> <td style="width: 10%;"></td> <td style="width: 10%;"></td> <td style="width: 10%;"></td> <td style="width: 10%;"></td> <td style="width: 10%;"></td> <td style="width: 10%;"></td> </tr> <tr> <td></td> <td></td> <td colspan="8" style="text-align: center;"> <table border="1" style="width: 100%; border-collapse: collapse; text-align: center;"> <tr> <td style="width: 10%;"></td> <td style="width: 10%;"></td> <td style="width: 10%;"></td> <td style="width: 10%;"></td> <td style="width: 10%;"></td> <td style="width: 10%;"></td> <td style="width: 10%;"></td> <td style="width: 10%;"></td> <td style="width:
10%;"></td> <td style="width: 10%;"></td> </tr> <tr> <td></td> <td></td> <td colspan="8" style="text-align: center;"> <table border="1" style="width: 100%; border-collapse: collapse; text-align: center;"> <tr> </tr></table></td></tr></table></td></tr></table></td></tr></table></td></tr></table></td></tr></table></td></tr></table></td></tr></table></td></tr></table></td></tr></table></td></tr></table></td></tr></table></td></tr></table></td></tr></table></td></tr></table></td></tr></table></td></tr></table></td></tr></table></td></tr></table></td></tr></table></td></tr></table></td></tr></table></td></tr></table></td></tr></table></td></tr></table></td></tr></table></td></tr></table></td></tr></table></td></tr></table> | | | | | | | | | | | | | | | | | | | | <table border="1" style="width: 100%; border-collapse: collapse; text-align: center;"> <tr> <td style="width: 10%;"></td> <td style="width: 10%;"></td> <td style="width: 10%;"></td> <td style="width: 10%;"></td> <td style="width: 10%;"></td> <td style="width: 10%;"></td> <td style="width: 10%;"></td> <td style="width: 10%;"></td> <td style="width: 10%;"></td> <td style="width: 10%;"></td> </tr> <tr> <td></td> <td></td> <td colspan="8" style="text-align: center;"> <table border="1" style="width: 100%; border-collapse: collapse; text-align: center;"> <tr> <td style="width: 10%;"></td> <td style="width: 10%;"></td> <td style="width: 10%;"></td> <td style="width: 10%;"></td> <td style="width: 10%;"></td> <td style="width: 10%;"></td> <td style="width: 10%;"></td> <td style="width: 10%;"></td> <td style="width: 10%;"></td> <td style="width: 10%;"></td> </tr> <tr> <td></td> <td></td> <td colspan="8" style="text-align: center;"> <table border="1" style="width: 100%; border-collapse: collapse; text-align: center;"> <tr> <td style="width: 10%;"></td> <td style="width: 10%;"></td> <td style="width: 10%;"></td> <td style="width: 10%;"></td> <td style="width: 10%;"></td> <td style="width: 10%;"></td> <td style="width: 10%;"></td> <td style="width: 10%;"></td> <td style="width: 10%;"></td> <td style="width: 10%;"></td> </tr> <tr> <td></td> <td></td> <td colspan="8" style="text-align: center;"> <table border="1" style="width: 100%; border-collapse: collapse; text-align: center;"> <tr> <td style="width: 10%;"></td> <td style="width: 10%;"></td> <td style="width: 10%;"></td> <td style="width: 10%;"></td> <td style="width: 10%;"></td> <td style="width: 10%;"></td> <td style="width: 10%;"></td> <td style="width: 10%;"></td> <td style="width: 10%;"></td> <td style="width: 10%;"></td> </tr> <tr> <td></td> <td></td> <td colspan="8" style="text-align: center;"> <table border="1" style="width: 100%; border-collapse: collapse; text-align: center;"> <tr> <td style="width: 10%;"></td> <td style="width: 10%;"></td> <td style="width: 10%;"></td> <td style="width: 10%;"></td> <td style="width: 10%;"></td> <td style="width: 10%;"></td> <td style="width: 10%;"></td> <td style="width: 10%;"></td> <td style="width: 10%;"></td> <td style="width: 10%;"></td> </tr> <tr> <td></td> <td></td> <td colspan="8" style="text-align: center;"> <table border="1" style="width: 100%; border-collapse: collapse; text-align: center;"> <tr> <td style="width: 10%;"></td> <td style="width: 10%;"></td> <td style="width: 10%;"></td> <td style="width: 10%;"></td> <td style="width: 10%;"></td> <td style="width: 10%;"></td> <td style="width: 10%;"></td> <td style="width: 10%;"></td> <td style="width: 10%;"></td> <td style="width: 10%;"></td> </tr> <tr> <td></td> <td></td> <td colspan="8" style="text-align: center;"> <table border="1" style="width: 100%; border-collapse: collapse; text-align: center;"> <tr> <td style="width: 10%;"></td> <td style="width: 10%;"></td> <td style="width: 10%;"></td> <td style="width: 10%;"></td> <td style="width: 10%;"></td> <td style="width: 10%;"></td> <td style="width: 10%;"></td> <td style="width: 10%;"></td> <td style="width: 10%;"></td> <td style="width: 10%;"></td> </tr> <tr> <td></td> <td></td> <td colspan="8" style="text-align: center;"> <table border="1" style="width: 100%; border-collapse: collapse; text-align: center;"> <tr> <td style="width: 10%;"></td> <td style="width: 10%;"></td> <td style="width: 10%;"></td> <td style="width: 10%;"></td> <td style="width: 10%;"></td> <td style="width: 10%;"></td> <td style="width: 10%;"></td> <td style="width: 10%;"></td> <td style="width: 10%;"></td> <td style="width: 10%;"></td> </tr> <tr> <td></td> <td></td> <td colspan="8" style="text-align: center;"> <table border="1" style="width: 100%; border-collapse: collapse; text-align: center;"> <tr> <td style="width: 10%;"></td> <td style="width: 10%;"></td> <td style="width: 10%;"></td> <td style="width: 10%;"></td> <td style="width: 10%;"></td> <td style="width: 10%;"></td> <td style="width: 10%;"></td> <td style="width: 10%;"></td> <td style="width: 10%;"></td> <td style="width: 10%;"></td> </tr> <tr> <td></td> <td></td> <td colspan="8" style="text-align: center;"> <table border="1" style="width: 100%; border-collapse: collapse; text-align: center;"> <tr> <td style="width: 10%;"></td> <td style="width: 10%;"></td> <td style="width: 10%;"></td> <td style="width: 10%;"></td> <td style="width: 10%;"></td> <td style="width: 10%;"></td> <td style="width: 10%;"></td> <td style="width: 10%;"></td> <td style="width: 10%;"></td> <td style="width: 10%;"></td> </tr> <tr> <td></td> <td></td> <td colspan="8" style="text-align: center;"> <table border="1" style="width: 100%; border-collapse: collapse; text-align: center;"> <tr> <td style="width: 10%;"></td> <td style="width: 10%;"></td> <td style="width: 10%;"></td> <td style="width: 10%;"></td> <td style="width: 10%;"></td> <td style="width: 10%;"></td> <td style="width: 10%;"></td> <td style="width: 10%;"></td> <td style="width: 10%;"></td> <td style="width: 10%;"></td> </tr> <tr> <td></td> <td></td> <td colspan="8" style="text-align: center;"> <table border="1" style="width: 100%; border-collapse: collapse; text-align: center;"> <tr> <td style="width: 10%;"></td> <td style="width: 10%;"></td> <td style="width: 10%;"></td> <td style="width: 10%;"></td> <td style="width: 10%;"></td> <td style="width: 10%;"></td> <td style="width: 10%;"></td> <td style="width: 10%;"></td> <td style="width: 10%;"></td> <td style="width: 10%;"></td> </tr> <tr> <td></td> <td></td> <td colspan="8" style="text-align: center;"> <table border="1" style="width: 100%; border-collapse: collapse; text-align: center;"> <tr> <td style="width: 10%;"></td> <td style="width: 10%;"></td> <td style="width: 10%;"></td> <td style="width: 10%;"></td> <td style="width: 10%;"></td> <td style="width: 10%;"></td> <td style="width: 10%;"></td> <td style="width: 10%;"></td> <td style="width: 10%;"></td> <td style="width: 10%;"></td> </tr> <tr> <td></td> <td></td> <td colspan="8" style="text-align: center;"> <table border="1" style="width: 100%; border-collapse: collapse; text-align: center;"> <tr> <td style="width: 10%;"></td> <td style="width: 10%;"></td> <td style="width: 10%;"></td> <td style="width: 10%;"></td> <td style="width: 10%;"></td> <td style="width: 10%;"></td> <td style="width: 10%;"></td> <td style="width: 10%;"></td> <td style="width: 10%;"></td> <td style="width: 10%;"></td> </tr> <tr> <td></td> <td></td> <td colspan="8" style="text-align: center;"> <table border="1" style="width: 100%; border-collapse: collapse; text-align: center;"> <tr> <td style="width: 10%;"></td> <td style="width: 10%;"></td> <td style="width: 10%;"></td> <td style="width: 10%;"></td> <td style="width: 10%;"></td> <td style="width: 10%;"></td> <td style="width: 10%;"></td> <td style="width: 10%;"></td> <td style="width: 10%;"></td> <td style="width: 10%;"></td> </tr> <tr> <td></td> <td></td> <td colspan="8" style="text-align: center;"> <table border="1" style="width: 100%; border-collapse: collapse; text-align: center;"> <tr> <td style="width: 10%;"></td> <td style="width: 10%;"></td> <td style="width: 10%;"></td> <td style="width: 10%;"></td> <td style="width: 10%;"></td> <td style="width: 10%;"></td> <td style="width: 10%;"></td> <td style="width: 10%;"></td> <td style="width: 10%;"></td> <td style="width: 10%;"></td> </tr> <tr> <td></td> <td></td> <td colspan="8" style="text-align: center;"> <table border="1" style="width: 100%; border-collapse: collapse; text-align: center;"> <tr> <td style="width: 10%;"></td> <td style="width: 10%;"></td> <td style="width: 10%;"></td> <td style="width: 10%;"></td> <td style="width: 10%;"></td> <td style="width: 10%;"></td> <td style="width: 10%;"></td> <td style="width: 10%;"></td> <td style="width: 10%;"></td> <td style="width: 10%;"></td> </tr> <tr> <td></td> <td></td> <td colspan="8" style="text-align: center;"> <table border="1" style="width: 100%; border-collapse: collapse; text-align: center;"> <tr> <td style="width: 10%;"></td> <td style="width: 10%;"></td> <td style="width: 10%;"></td> <td style="width: 10%;"></td> <td style="width: 10%;"></td> <td style="width: 10%;"></td> <td style="width: 10%;"></td> <td style="width: 10%;"></td> <td style="width: 10%;"></td> <td style="width: 10%;"></td> </tr> <tr> <td></td> <td></td> <td colspan="8" style="text-align: center;"> <table border="1" style="width: 100%; border-collapse: collapse; text-align: center;"> <tr> <td style="width: 10%;"></td> <td style="width: 10%;"></td> <td style="width: 10%;"></td> <td style="width: 10%;"></td> <td style="width: 10%;"></td> <td style="width: 10%;"></td> <td style="width: 10%;"></td>
<td style="width: 10%;"></td> <td style="width: 10%;"></td> <td style="width: 10%;"></td> </tr> <tr> <td></td> <td></td> <td colspan="8" style="text-align: center;"> <table border="1" style="width: 100%; border-collapse: collapse; text-align: center;"> <tr> <td style="width: 10%;"></td> <td style="width: 10%;"></td> <td style="width: 10%;"></td> <td style="width: 10%;"></td> <td style="width: 10%;"></td> <td style="width: 10%;"></td> <td style="width: 10%;"></td> <td style="width: 10%;"></td> <td style="width: 10%;"></td> <td style="width: 10%;"></td> </tr> <tr> <td></td> <td></td> <td colspan="8" style="text-align: center;"> <table border="1" style="width: 100%; border-collapse: collapse; text-align: center;"> <tr> <td style="width: 10%;"></td> <td style="width: 10%;"></td> <td style="width: 10%;"></td> <td style="width: 10%;"></td> <td style="width: 10%;"></td> <td style="width: 10%;"></td> <td style="width: 10%;"></td> <td style="width: 10%;"></td> <td style="width: 10%;"></td> <td style="width: 10%;"></td> </tr> <tr> <td></td> <td></td> <td colspan="8" style="text-align: center;"> <table border="1" style="width: 100%; border-collapse: collapse; text-align: center;"> <tr> <td style="width: 10%;"></td> <td style="width: 10%;"></td> <td style="width: 10%;"></td> <td style="width: 10%;"></td> <td style="width: 10%;"></td> <td style="width: 10%;"></td> <td style="width: 10%;"></td> <td style="width: 10%;"></td> <td style="width: 10%;"></td> <td style="width: 10%;"></td> </tr> <tr> <td></td> <td></td> <td colspan="8" style="text-align: center;"> <table border="1" style="width: 100%; border-collapse: collapse; text-align: center;"> <tr> <td style="width: 10%;"></td> <td style="width: 10%;"></td> <td style="width: 10%;"></td> <td style="width: 10%;"></td> <td style="width: 10%;"></td> <td style="width: 10%;"></td> <td style="width: 10%;"></td> <td style="width: 10%;"></td> <td style="width: 10%;"></td> <td style="width: 10%;"></td> </tr> <tr> <td></td> <td></td> <td colspan="8" style="text-align: center;"> <table border="1" style="width: 100%; border-collapse: collapse; text-align: center;"> <tr> <td style="width: 10%;"></td> <td style="width: 10%;"></td> <td style="width: 10%;"></td> <td style="width: 10%;"></td> <td style="width: 10%;"></td> <td style="width: 10%;"></td> <td style="width: 10%;"></td> <td style="width: 10%;"></td> <td style="width: 10%;"></td> <td style="width: 10%;"></td> </tr> <tr> <td></td> <td></td> <td colspan="8" style="text-align: center;"> <table border="1" style="width: 100%; border-collapse: collapse; text-align: center;"> <tr> <td style="width: 10%;"></td> <td style="width: 10%;"></td> <td style="width: 10%;"></td> <td style="width: 10%;"></td> <td style="width: 10%;"></td> <td style="width: 10%;"></td> <td style="width: 10%;"></td> <td style="width: 10%;"></td> <td style="width: 10%;"></td> <td style="width: 10%;"></td> </tr> <tr> <td></td> <td></td> <td colspan="8" style="text-align: center;"> <table border="1" style="width: 100%; border-collapse: collapse; text-align: center;"> <tr> <td style="width: 10%;"></td> <td style="width: 10%;"></td> <td style="width: 10%;"></td> <td style="width: 10%;"></td> <td style="width: 10%;"></td> <td style="width: 10%;"></td> <td style="width: 10%;"></td> <td style="width: 10%;"></td> <td style="width: 10%;"></td> <td style="width: 10%;"></td> </tr> <tr> <td></td> <td></td> <td colspan="8" style="text-align: center;"> <table border="1" style="width: 100%; border-collapse: collapse; text-align: center;"> <tr> <td style="width: 10%;"></td> <td style="width: 10%;"></td> <td style="width: 10%;"></td> <td style="width: 10%;"></td> <td style="width: 10%;"></td> <td style="width: 10%;"></td> <td style="width: 10%;"></td> <td style="width: 10%;"></td> <td style="width: 10%;"></td> <td style="width: 10%;"></td> </tr> <tr> <td></td> <td></td> <td colspan="8" style="text-align: center;"> <table border="1" style="width: 100%; border-collapse: collapse; text-align: center;"> <tr> </tr></table></td></tr></table></td></tr></table></td></tr></table></td></tr></table></td></tr></table></td></tr></table></td></tr></table></td></tr></table></td></tr></table></td></tr></table></td></tr></table></td></tr></table></td></tr></table></td></tr></table></td></tr></table></td></tr></table></td></tr></table></td></tr></table></td></tr></table></td></tr></table></td></tr></table></td></tr></table></td></tr></table></td></tr></table></td></tr></table></td></tr></table></td></tr></table> | | | | | | | | | | | | | | | | | | | | <table border="1" style="width: 100%; border-collapse: collapse; text-align: center;"> <tr> <td style="width: 10%;"></td> <td style="width: 10%;"></td> <td style="width: 10%;"></td> <td style="width: 10%;"></td> <td style="width: 10%;"></td> <td style="width: 10%;"></td> <td style="width: 10%;"></td> <td style="width: 10%;"></td> <td style="width: 10%;"></td> <td style="width: 10%;"></td> </tr> <tr> <td></td> <td></td> <td colspan="8" style="text-align: center;"> <table border="1" style="width: 100%; border-collapse: collapse; text-align: center;"> <tr> <td style="width: 10%;"></td> <td style="width: 10%;"></td> <td style="width: 10%;"></td> <td style="width: 10%;"></td> <td style="width: 10%;"></td> <td style="width: 10%;"></td> <td style="width: 10%;"></td> <td style="width: 10%;"></td> <td style="width: 10%;"></td> <td style="width: 10%;"></td> </tr> <tr> <td></td> <td></td> <td colspan="8" style="text-align: center;"> <table border="1" style="width: 100%; border-collapse: collapse; text-align: center;"> <tr> <td style="width: 10%;"></td> <td style="width: 10%;"></td> <td style="width: 10%;"></td> <td style="width: 10%;"></td> <td style="width: 10%;"></td> <td style="width: 10%;"></td> <td style="width: 10%;"></td> <td style="width: 10%;"></td> <td style="width: 10%;"></td> <td style="width: 10%;"></td> </tr> <tr> <td></td> <td></td> <td colspan="8" style="text-align: center;"> <table border="1" style="width: 100%; border-collapse: collapse; text-align: center;"> <tr> <td style="width: 10%;"></td> <td style="width: 10%;"></td> <td style="width: 10%;"></td> <td style="width: 10%;"></td> <td style="width: 10%;"></td> <td style="width: 10%;"></td> <td style="width: 10%;"></td> <td style="width: 10%;"></td> <td style="width: 10%;"></td> <td style="width: 10%;"></td> </tr> <tr> <td></td> <td></td> <td colspan="8" style="text-align: center;"> <table border="1" style="width: 100%; border-collapse: collapse; text-align: center;"> <tr> <td style="width: 10%;"></td> <td style="width: 10%;"></td> <td style="width: 10%;"></td> <td style="width: 10%;"></td> <td style="width: 10%;"></td> <td style="width: 10%;"></td> <td style="width: 10%;"></td> <td style="width: 10%;"></td> <td style="width: 10%;"></td> <td style="width: 10%;"></td> </tr> <tr> <td></td> <td></td> <td colspan="8" style="text-align: center;"> <table border="1" style="width: 100%; border-collapse: collapse; text-align: center;"> <tr> <td style="width: 10%;"></td> <td style="width: 10%;"></td> <td style="width: 10%;"></td> <td style="width: 10%;"></td> <td style="width: 10%;"></td> <td style="width: 10%;"></td> <td style="width: 10%;"></td> <td style="width: 10%;"></td> <td style="width: 10%;"></td> <td style="width: 10%;"></td> </tr> <tr> <td></td> <td></td> <td colspan="8" style="text-align: center;"> <table border="1" style="width: 100%; border-collapse: collapse; text-align: center;"> <tr> <td style="width: 10%;"></td> <td style="width: 10%;"></td> <td style="width: 10%;"></td> <td style="width: 10%;"></td> <td style="width: 10%;"></td> <td style="width: 10%;"></td> <td style="width: 10%;"></td> <td style="width: 10%;"></td> <td style="width: 10%;"></td> <td style="width: 10%;"></td> </tr> <tr> <td></td> <td></td> <td colspan="8" style="text-align: center;"> <table border="1" style="width: 100%; border-collapse: collapse; text-align: center;"> <tr> <td style="width: 10%;"></td> <td style="width: 10%;"></td> <td style="width: 10%;"></td> <td style="width: 10%;"></td> <td style="width: 10%;"></td> <td style="width: 10%;"></td> <td style="width: 10%;"></td> <td style="width: 10%;"></td> <td style="width: 10%;"></td> <td style="width: 10%;"></td> </tr> <tr> <td></td> <td></td> <td colspan="8" style="text-align: center;"> <table border="1" style="width: 100%; border-collapse: collapse; text-align: center;"> <tr> <td style="width: 10%;"></td> <td style="width: 10%;"></td> <td style="width: 10%;"></td> <td style="width: 10%;"></td> <td style="width: 10%;"></td> <td style="width: 10%;"></td> <td style="width: 10%;"></td> <td style="width: 10%;"></td> <td style="width: 10%;"></td> <td style="width: 10%;"></td> </tr> <tr> <td></td> <td></td> <td colspan="8" style="text-align: center;"> <table border="1" style="width: 100%; border-collapse: collapse; text-align: center;"> <tr> <td style="width: 10%;"></td> <td style="width: 10%;"></td> <td style="width: 10%;"></td> <td style="width: 10%;"></td> <td style="width: 10%;"></td> <td style="width: 10%;"></td> <td style="width: 10%;"></td> <td style="width: 10%;"></td> <td style="width: 10%;"></td> <td style="width: 10%;"></td> </tr> <tr> <td></td> <td></td> <td colspan="8" style="text-align: center;"> <table border="1" style="width: 100%; border-collapse: collapse; text-align: center;"> <tr> <td style="width: 10%;"></td> <td style="width: 10%;"></td> <td style="width: 10%;"></td> <td style="width: 10%;"></td> <td style="width: 10%;"></td> <td style="width: 10%;"></td>
<td style="width: 10%;"></td> <td style="width: 10%;"></td> <td style="width: 10%;"></td> <td style="width: 10%;"></td> </tr> <tr> <td></td> <td></td> <td colspan="8" style="text-align: center;"> <table border="1" style="width: 100%; border-collapse: collapse; text-align: center;"> <tr> <td style="width: 10%;"></td> <td style="width: 10%;"></td> <td style="width: 10%;"></td> <td style="width: 10%;"></td> <td style="width: 10%;"></td> <td style="width: 10%;"></td> <td style="width: 10%;"></td> <td style="width: 10%;"></td> <td style="width: 10%;"></td> <td style="width: 10%;"></td> </tr> <tr> <td></td> <td></td> <td colspan="8" style="text-align: center;"> <table border="1" style="width: 100%; border-collapse: collapse; text-align: center;"> <tr> <td style="width: 10%;"></td> <td style="width: 10%;"></td> <td style="width: 10%;"></td> <td style="width: 10%;"></td> <td style="width: 10%;"></td> <td style="width: 10%;"></td> <td style="width: 10%;"></td> <td style="width: 10%;"></td> <td style="width: 10%;"></td> <td style="width: 10%;"></td> </tr> <tr> <td></td> <td></td> <td colspan="8" style="text-align: center;"> <table border="1" style="width: 100%; border-collapse: collapse; text-align: center;"> <tr> <td style="width: 10%;"></td> <td style="width: 10%;"></td> <td style="width: 10%;"></td> <td style="width: 10%;"></td> <td style="width: 10%;"></td> <td style="width: 10%;"></td> <td style="width: 10%;"></td> <td style="width: 10%;"></td> <td style="width: 10%;"></td> <td style="width: 10%;"></td> </tr> <tr> <td></td> <td></td> <td colspan="8" style="text-align: center;"> <table border="1" style="width: 100%; border-collapse: collapse; text-align: center;"> <tr> <td style="width: 10%;"></td> <td style="width: 10%;"></td> <td style="width: 10%;"></td> <td style="width: 10%;"></td> <td style="width: 10%;"></td> <td style="width: 10%;"></td> <td style="width: 10%;"></td> <td style="width: 10%;"></td> <td style="width: 10%;"></td> <td style="width: 10%;"></td> </tr> <tr> <td></td> <td></td> <td colspan="8" style="text-align: center;"> <table border="1" style="width: 100%; border-collapse: collapse; text-align: center;"> <tr> <td style="width: 10%;"></td> <td style="width: 10%;"></td> <td style="width: 10%;"></td> <td style="width: 10%;"></td> <td style="width: 10%;"></td> <td style="width: 10%;"></td> <td style="width: 10%;"></td> <td style="width: 10%;"></td> <td style="width: 10%;"></td> <td style="width: 10%;"></td> </tr> <tr> <td></td> <td></td> <td colspan="8" style="text-align: center;"> <table border="1" style="width: 100%; border-collapse: collapse; text-align: center;"> <tr> <td style="width: 10%;"></td> <td style="width: 10%;"></td> <td style="width: 10%;"></td> <td style="width: 10%;"></td> <td style="width: 10%;"></td> <td style="width: 10%;"></td> <td style="width: 10%;"></td> <td style="width: 10%;"></td> <td style="width: 10%;"></td> <td style="width: 10%;"></td> </tr> <tr> <td></td> <td></td> <td colspan="8" style="text-align: center;"> <table border="1" style="width: 100%; border-collapse: collapse; text-align: center;"> <tr> <td style="width: 10%;"></td> <td style="width: 10%;"></td> <td style="width: 10%;"></td> <td style="width: 10%;"></td> <td style="width: 10%;"></td> <td style="width: 10%;"></td> <td style="width: 10%;"></td> <td style="width: 10%;"></td> <td style="width: 10%;"></td> <td style="width: 10%;"></td> </tr> <tr> <td></td> <td></td> <td colspan="8" style="text-align: center;"> <table border="1" style="width: 100%; border-collapse: collapse; text-align: center;"> <tr> <td style="width: 10%;"></td> <td style="width: 10%;"></td> <td style="width: 10%;"></td> <td style="width: 10%;"></td> <td style="width: 10%;"></td> <td style="width: 10%;"></td> <td style="width: 10%;"></td> <td style="width: 10%;"></td> <td style="width: 10%;"></td> <td style="width: 10%;"></td> </tr> <tr> <td></td> <td></td> <td colspan="8" style="text-align: center;"> <table border="1" style="width: 100%; border-collapse: collapse; text-align: center;"> <tr> <td style="width: 10%;"></td> <td style="width: 10%;"></td> <td style="width: 10%;"></td> <td style="width: 10%;"></td> <td style="width: 10%;"></td> <td style="width: 10%;"></td> <td style="width: 10%;"></td> <td style="width: 10%;"></td> <td style="width: 10%;"></td> <td style="width: 10%;"></td> </tr> <tr> <td></td> <td></td> <td colspan="8" style="text-align: center;"> <table border="1" style="width: 100%; border-collapse: collapse; text-align: center;"> <tr> <td style="width: 10%;"></td> <td style="width: 10%;"></td> <td style="width: 10%;"></td> <td style="width: 10%;"></td> <td style="width: 10%;"></td> <td style="width: 10%;"></td> <td style="width: 10%;"></td> <td style="width: 10%;"></td> <td style="width: 10%;"></td> <td style="width: 10%;"></td> </tr> <tr> <td></td> <td></td> <td colspan="8" style="text-align: center;"> <table border="1" style="width: 100%; border-collapse: collapse; text-align: center;"> <tr> <td style="width: 10%;"></td> <td style="width: 10%;"></td> <td style="width: 10%;"></td> <td style="width: 10%;"></td> <td style="width: 10%;"></td> <td style="width: 10%;"></td> <td style="width: 10%;"></td> <td style="width: 10%;"></td> <td style="width: 10%;"></td> <td style="width: 10%;"></td> </tr> <tr> <td></td> <td></td> <td colspan="8" style="text-align: center;"> <table border="1" style="width: 100%; border-collapse: collapse; text-align: center;"> <tr> <td style="width: 10%;"></td> <td style="width: 10%;"></td> <td style="width: 10%;"></td> <td style="width: 10%;"></td> <td style="width: 10%;"></td> <td style="width: 10%;"></td> <td style="width: 10%;"></td> <td style="width: 10%;"></td> <td style="width: 10%;"></td> <td style="width: 10%;"></td> </tr> <tr> <td></td> <td></td> <td colspan="8" style="text-align: center;"> <table border="1" style="width: 100%; border-collapse: collapse; text-align: center;"> <tr> <td style="width: 10%;"></td> <td style="width: 10%;"></td> <td style="width: 10%;"></td> <td style="width: 10%;"></td> <td style="width: 10%;"></td> <td style="width: 10%;"></td> <td style="width: 10%;"></td> <td style="width: 10%;"></td> <td style="width: 10%;"></td> <td style="width: 10%;"></td> </tr> <tr> <td></td> <td></td> <td colspan="8" style="text-align: center;"> <table border="1" style="width: 100%; border-collapse: collapse; text-align: center;"> <tr> <td style="width: 10%;"></td> <td style="width: 10%;"></td> <td style="width: 10%;"></td> <td style="width: 10%;"></td> <td style="width: 10%;"></td> <td style="width: 10%;"></td> <td style="width: 10%;"></td> <td style="width: 10%;"></td> <td style="width: 10%;"></td> <td style="width: 10%;"></td> </tr> <tr> <td></td> <td></td> <td colspan="8" style="text-align: center;"> <table border="1" style="width: 100%; border-collapse: collapse; text-align: center;"> <tr> <td style="width: 10%;"></td> <td style="width: 10%;"></td> <td style="width: 10%;"></td> <td style="width: 10%;"></td> <td style="width: 10%;"></td> <td style="width: 10%;"></td> <td style="width: 10%;"></td> <td style="width: 10%;"></td> <td style="width: 10%;"></td> <td style="width: 10%;"></td> </tr> <tr> <td></td> <td></td> <td colspan="8" style="text-align: center;"> <table border="1" style="width: 100%; border-collapse: collapse; text-align: center;"> <tr> </tr></table></td></tr></table></td></tr></table></td></tr></table></td></tr></table></td></tr></table></td></tr></table></td></tr></table></td></tr></table></td></tr></table></td></tr></table></td></tr></table></td></tr></table></td></tr></table></td></tr></table></td></tr></table></td></tr></table></td></tr></table></td></tr></table></td></tr></table></td></tr></table></td></tr></table></td></tr></table></td></tr></table></td></tr></table></td></tr></table></td></tr></table> | | | | | | | | | | | | | | | | | | | | <table border="1" style="width: 100%; border-collapse: collapse; text-align: center;"> <tr> <td style="width: 10%;"></td> <td style="width: 10%;"></td> <td style="width: 10%;"></td> <td style="width: 10%;"></td> <td style="width: 10%;"></td> <td style="width: 10%;"></td> <td style="width: 10%;"></td> <td style="width: 10%;"></td> <td style="width: 10%;"></td> <td style="width: 10%;"></td> </tr> <tr> <td></td> <td></td> <td colspan="8" style="text-align: center;"> <table border="1" style="width: 100%; border-collapse: collapse; text-align: center;"> <tr> <td style="width: 10%;"></td> <td style="width: 10%;"></td> <td style="width: 10%;"></td> <td style="width: 10%;"></td> <td style="width: 10%;"></td> <td style="width: 10%;"></td> <td style="width: 10%;"></td> <td style="width: 10%;"></td> <td style="width: 10%;"></td> <td style="width: 10%;"></td> </tr> <tr> <td></td> <td></td> <td colspan="8" style="text-align: center;"> <table border="1" style="width: 100%; border-collapse: collapse; text-align: center;"> <tr> <td style="width: 10%;"></td> <td style="width: 10%;"></td> <td style="width: 10%;"></td> <td style="width: 10%;"></td> <td style="width: 10%;"></td> <td style="width: 10%;"></td> <td style="width: 10%;"></td> <td style="width: 10%;"></td> <td style="width: 10%;"></td> <td style="width: 10%;"></td> </tr> <tr> <td></td> <td></td> <td colspan="8" style="text-align: center;"> <table border="1" style="width: 100%; border-collapse: collapse; text-align: center;"> <tr> <td style="width: 10%;"></td> <td style="width: 10%;"></td> <td style="width: 10%;"></td> <td style="width: 10%;"></td> <td style="width: 10%;"></td> <td style="width:
10%;"></td> <td style="width: 10%;"></td> <td style="width: 10%;"></td> <td style="width: 10%;"></td> <td style="width: 10%;"></td> </tr> <tr> <td></td> <td></td> <td colspan="8" style="text-align: center;"> <table border="1" style="width: 100%; border-collapse: collapse; text-align: center;"> <tr> <td style="width: 10%;"></td> <td style="width: 10%;"></td> <td style="width: 10%;"></td> <td style="width: 10%;"></td> <td style="width: 10%;"></td> <td style="width: 10%;"></td> <td style="width: 10%;"></td> <td style="width: 10%;"></td> <td style="width: 10%;"></td> <td style="width: 10%;"></td> </tr> <tr> <td></td> <td></td> <td colspan="8" style="text-align: center;"> <table border="1" style="width: 100%; border-collapse: collapse; text-align: center;"> <tr> <td style="width: 10%;"></td> <td style="width: 10%;"></td> <td style="width: 10%;"></td> <td style="width: 10%;"></td> <td style="width: 10%;"></td> <td style="width: 10%;"></td> <td style="width: 10%;"></td> <td style="width: 10%;"></td> <td style="width: 10%;"></td> <td style="width: 10%;"></td> </tr> <tr> <td></td> <td></td> <td colspan="8" style="text-align: center;"> <table border="1" style="width: 100%; border-collapse: collapse; text-align: center;"> <tr> <td style="width: 10%;"></td> <td style="width: 10%;"></td> <td style="width: 10%;"></td> <td style="width: 10%;"></td> <td style="width: 10%;"></td> <td style="width: 10%;"></td> <td style="width: 10%;"></td> <td style="width: 10%;"></td> <td style="width: 10%;"></td> <td style="width: 10%;"></td> </tr> <tr> <td></td> <td></td> <td colspan="8" style="text-align: center;"> <table border="1" style="width: 100%; border-collapse: collapse; text-align: center;"> <tr> <td style="width: 10%;"></td> <td style="width: 10%;"></td> <td style="width: 10%;"></td> <td style="width: 10%;"></td> <td style="width: 10%;"></td> <td style="width: 10%;"></td> <td style="width: 10%;"></td> <td style="width: 10%;"></td> <td style="width: 10%;"></td> <td style="width: 10%;"></td> </tr> <tr> <td></td> <td></td> <td colspan="8" style="text-align: center;"> <table border="1" style="width: 100%; border-collapse: collapse; text-align: center;"> <tr> <td style="width: 10%;"></td> <td style="width: 10%;"></td> <td style="width: 10%;"></td> <td style="width: 10%;"></td> <td style="width: 10%;"></td> <td style="width: 10%;"></td> <td style="width: 10%;"></td> <td style="width: 10%;"></td> <td style="width: 10%;"></td> <td style="width: 10%;"></td> </tr> <tr> <td></td> <td></td> <td colspan="8" style="text-align: center;"> <table border="1" style="width: 100%; border-collapse: collapse; text-align: center;"> <tr> <td style="width: 10%;"></td> <td style="width: 10%;"></td> <td style="width: 10%;"></td> <td style="width: 10%;"></td> <td style="width: 10%;"></td> <td style="width: 10%;"></td> <td style="width: 10%;"></td> <td style="width: 10%;"></td> <td style="width: 10%;"></td> <td style="width: 10%;"></td> </tr> <tr> <td></td> <td></td> <td colspan="8" style="text-align: center;"> <table border="1" style="width: 100%; border-collapse: collapse; text-align: center;"> <tr> <td style="width: 10%;"></td> <td style="width: 10%;"></td> <td style="width: 10%;"></td> <td style="width: 10%;"></td> <td style="width: 10%;"></td> <td style="width: 10%;"></td> <td style="width: 10%;"></td> <td style="width: 10%;"></td> <td style="width: 10%;"></td> <td style="width: 10%;"></td> </tr> <tr> <td></td> <td></td> <td colspan="8" style="text-align: center;"> <table border="1" style="width: 100%; border-collapse: collapse; text-align: center;"> <tr> <td style="width: 10%;"></td> <td style="width: 10%;"></td> <td style="width: 10%;"></td> <td style="width: 10%;"></td> <td style="width: 10%;"></td> <td style="width: 10%;"></td> <td style="width: 10%;"></td> <td style="width: 10%;"></td> <td style="width: 10%;"></td> <td style="width: 10%;"></td> </tr> <tr> <td></td> <td></td> <td colspan="8" style="text-align: center;"> <table border="1" style="width: 100%; border-collapse: collapse; text-align: center;"> <tr> <td style="width: 10%;"></td> <td style="width: 10%;"></td> <td style="width: 10%;"></td> <td style="width: 10%;"></td> <td style="width: 10%;"></td> <td style="width: 10%;"></td> <td style="width: 10%;"></td> <td style="width: 10%;"></td> <td style="width: 10%;"></td> <td style="width: 10%;"></td> </tr> <tr> <td></td> <td></td> <td colspan="8" style="text-align: center;"> <table border="1" style="width: 100%; border-collapse: collapse; text-align: center;"> <tr> <td style="width: 10%;"></td> <td style="width: 10%;"></td> <td style="width: 10%;"></td> <td style="width: 10%;"></td> <td style="width: 10%;"></td> <td style="width: 10%;"></td> <td style="width: 10%;"></td> <td style="width: 10%;"></td> <td style="width: 10%;"></td> <td style="width: 10%;"></td> </tr> <tr> <td></td> <td></td> <td colspan="8" style="text-align: center;"> <table border="1" style="width: 100%; border-collapse: collapse; text-align: center;"> <tr> <td style="width: 10%;"></td> <td style="width: 10%;"></td> <td style="width: 10%;"></td> <td style="width: 10%;"></td> <td style="width: 10%;"></td> <td style="width: 10%;"></td> <td style="width: 10%;"></td> <td style="width: 10%;"></td> <td style="width: 10%;"></td> <td style="width: 10%;"></td> </tr> <tr> <td></td> <td></td> <td colspan="8" style="text-align: center;"> <table border="1" style="width: 100%; border-collapse: collapse; text-align: center;"> <tr> <td style="width: 10%;"></td> <td style="width: 10%;"></td> <td style="width: 10%;"></td> <td style="width: 10%;"></td> <td style="width: 10%;"></td> <td style="width: 10%;"></td> <td style="width: 10%;"></td> <td style="width: 10%;"></td> <td style="width: 10%;"></td> <td style="width: 10%;"></td> </tr> <tr> <td></td> <td></td> <td colspan="8" style="text-align: center;"> <table border="1" style="width: 100%; border-collapse: collapse; text-align: center;"> <tr> <td style="width: 10%;"></td> <td style="width: 10%;"></td> <td style="width: 10%;"></td> <td style="width: 10%;"></td> <td style="width: 10%;"></td> <td style="width: 10%;"></td> <td style="width: 10%;"></td> <td style="width: 10%;"></td> <td style="width: 10%;"></td> <td style="width: 10%;"></td> </tr> <tr> <td></td> <td></td> <td colspan="8" style="text-align: center;"> <table border="1" style="width: 100%; border-collapse: collapse; text-align: center;"> <tr> <td style="width: 10%;"></td> <td style="width: 10%;"></td> <td style="width: 10%;"></td> <td style="width: 10%;"></td> <td style="width: 10%;"></td> <td style="width: 10%;"></td> <td style="width: 10%;"></td> <td style="width: 10%;"></td> <td style="width: 10%;"></td> <td style="width: 10%;"></td> </tr> <tr> <td></td> <td></td> <td colspan="8" style="text-align: center;"> <table border="1" style="width: 100%; border-collapse: collapse; text-align: center;"> <tr> <td style="width: 10%;"></td> <td style="width: 10%;"></td> <td style="width: 10%;"></td> <td style="width: 10%;"></td> <td style="width: 10%;"></td> <td style="width: 10%;"></td> <td style="width: 10%;"></td> <td style="width: 10%;"></td> <td style="width: 10%;"></td> <td style="width: 10%;"></td> </tr> <tr> <td></td> <td></td> <td colspan="8" style="text-align: center;"> <table border="1" style="width: 100%; border-collapse: collapse; text-align: center;"> <tr> <td style="width: 10%;"></td> <td style="width: 10%;"></td> <td style="width: 10%;"></td> <td style="width: 10%;"></td> <td style="width: 10%;"></td> <td style="width: 10%;"></td> <td style="width: 10%;"></td> <td style="width: 10%;"></td> <td style="width: 10%;"></td> <td style="width: 10%;"></td> </tr> <tr> <td></td> <td></td> <td colspan="8" style="text-align: center;"> <table border="1" style="width: 100%; border-collapse: collapse; text-align: center;"> <tr> <td style="width: 10%;"></td> <td style="width: 10%;"></td> <td style="width: 10%;"></td> <td style="width: 10%;"></td> <td style="width: 10%;"></td> <td style="width: 10%;"></td> <td style="width: 10%;"></td> <td style="width: 10%;"></td> <td style="width: 10%;"></td> <td style="width: 10%;"></td> </tr> <tr> <td></td> <td></td> <td colspan="8" style="text-align: center;"> <table border="1" style="width: 100%; border-collapse: collapse; text-align: center;"> <tr> <td style="width: 10%;"></td> <td style="width: 10%;"></td> <td style="width: 10%;"></td> <td style="width: 10%;"></td> <td style="width: 10%;"></td> <td style="width: 10%;"></td> <td style="width: 10%;"></td> <td style="width: 10%;"></td> <td style="width: 10%;"></td> <td style="width: 10%;"></td> </tr> <tr> <td></td> <td></td> <td colspan="8" style="text-align: center;"> <table border="1" style="width: 100%; border-collapse: collapse; text-align: center;"> <tr> <td style="width: 10%;"></td> <td style="width: 10%;"></td> <td style="width: 10%;"></td> <td style="width: 10%;"></td> <td style="width: 10%;"></td> <td style="width: 10%;"></td> <td style="width: 10%;"></td> <td style="width: 10%;"></td> <td style="width: 10%;"></td> <td style="width: 10%;"></td> </tr> <tr> <td></td> <td></td> <td colspan="8" style="text-align: center;"> <table border="1" style="width: 100%; border-collapse: collapse; text-align: center;"> <tr> <td style="width: 10%;"></td> <td style="width: 10%;"></td> <td style="width: 10%;"></td> <td style="width: 10%;"></td> <td style="width: 10%;"></td> <td style="width: 10%;"></td> <td style="width: 10%;"></td> <td style="width: 10%;"></td> <td style="width: 10%;"></td> <td style="width: 10%;"></td> </tr> <tr> <td></td> <td></td> <td colspan="8" style="text-align: center;"> <table border="1" style="width: 100%; border-collapse: collapse; text-align: center;"> <tr> <td style="width: 10%;"></td> <td style="width: 10%;"></td> <td style="width: 10%;"></td> <td style="width: 10%;"></td> <td style="width: 10%;"></td> <td style="width: 10%;"></td> <td style="width: 10%;"></td> <td style="width: 10%;"></td> <td style="width: 10%;"></td> <td style="width: 10%;"></td> </tr> <tr> <td></td> <td></td> <td
colspan="8" style="text-align: center;"> <table border="1" style="width: 100%; border-collapse: collapse; text-align: center;"> <tr> </tr></table></td></tr></table></td></tr></table></td></tr></table></td></tr></table></td></tr></table></td></tr></table></td></tr></table></td></tr></table></td></tr></table></td></tr></table></td></tr></table></td></tr></table></td></tr></table></td></tr></table></td></tr></table></td></tr></table></td></tr></table></td></tr></table></td></tr></table></td></tr></table></td></tr></table></td></tr></table></td></tr></table></td></tr></table></td></tr></table> | | | | | | | | | | | | | | | | | | | | <table border="1" style="width: 100%; border-collapse: collapse; text-align: center;"> <tr> <td style="width: 10%;"></td> <td style="width: 10%;"></td> <td style="width: 10%;"></td> <td style="width: 10%;"></td> <td style="width: 10%;"></td> <td style="width: 10%;"></td> <td style="width: 10%;"></td> <td style="width: 10%;"></td> <td style="width: 10%;"></td> <td style="width: 10%;"></td> </tr> <tr> <td></td> <td></td> <td colspan="8" style="text-align: center;"> <table border="1" style="width: 100%; border-collapse: collapse; text-align: center;"> <tr> <td style="width: 10%;"></td> <td style="width: 10%;"></td> <td style="width: 10%;"></td> <td style="width: 10%;"></td> <td style="width: 10%;"></td> <td style="width: 10%;"></td> <td style="width: 10%;"></td> <td style="width: 10%;"></td> <td style="width: 10%;"></td> <td style="width: 10%;"></td> </tr> <tr> <td></td> <td></td> <td colspan="8" style="text-align: center;"> <table border="1" style="width: 100%; border-collapse: collapse; text-align: center;"> <tr> <td style="width: 10%;"></td> <td style="width: 10%;"></td> <td style="width: 10%;"></td> <td style="width: 10%;"></td> <td style="width: 10%;"></td> <td style="width: 10%;"></td> <td style="width: 10%;"></td> <td style="width: 10%;"></td> <td style="width: 10%;"></td> <td style="width: 10%;"></td> </tr> <tr> <td></td> <td></td> <td colspan="8" style="text-align: center;"> <table border="1" style="width: 100%; border-collapse: collapse; text-align: center;"> <tr> <td style="width: 10%;"></td> <td style="width: 10%;"></td> <td style="width: 10%;"></td> <td style="width: 10%;"></td> <td style="width: 10%;"></td> <td style="width: 10%;"></td> <td style="width: 10%;"></td> <td style="width: 10%;"></td> <td style="width: 10%;"></td> <td style="width: 10%;"></td> </tr> <tr> <td></td> <td></td> <td colspan="8" style="text-align: center;"> <table border="1" style="width: 100%; border-collapse: collapse; text-align: center;"> <tr> <td style="width: 10%;"></td> <td style="width: 10%;"></td> <td style="width: 10%;"></td> <td style="width: 10%;"></td> <td style="width: 10%;"></td> <td style="width: 10%;"></td> <td style="width: 10%;"></td> <td style="width: 10%;"></td> <td style="width: 10%;"></td> <td style="width: 10%;"></td> </tr> <tr> <td></td> <td></td> <td colspan="8" style="text-align: center;"> <table border="1" style="width: 100%; border-collapse: collapse; text-align: center;"> <tr> <td style="width: 10%;"></td> <td style="width: 10%;"></td> <td style="width: 10%;"></td> <td style="width: 10%;"></td> <td style="width: 10%;"></td> <td style="width: 10%;"></td> <td style="width: 10%;"></td> <td style="width: 10%;"></td> <td style="width: 10%;"></td> <td style="width: 10%;"></td> </tr> <tr> <td></td> <td></td> <td colspan="8" style="text-align: center;"> <table border="1" style="width: 100%; border-collapse: collapse; text-align: center;"> <tr> <td style="width: 10%;"></td> <td style="width: 10%;"></td> <td style="width: 10%;"></td> <td style="width: 10%;"></td> <td style="width: 10%;"></td> <td style="width: 10%;"></td> <td style="width: 10%;"></td> <td style="width: 10%;"></td> <td style="width: 10%;"></td> <td style="width: 10%;"></td> </tr> <tr> <td></td> <td></td> <td colspan="8" style="text-align: center;"> <table border="1" style="width: 100%; border-collapse: collapse; text-align: center;"> <tr> <td style="width: 10%;"></td> <td style="width: 10%;"></td> <td style="width: 10%;"></td> <td style="width: 10%;"></td> <td style="width: 10%;"></td> <td style="width: 10%;"></td> <td style="width: 10%;"></td> <td style="width: 10%;"></td> <td style="width: 10%;"></td> <td style="width: 10%;"></td> </tr> <tr> <td></td> <td></td> <td colspan="8" style="text-align: center;"> <table border="1" style="width: 100%; border-collapse: collapse; text-align: center;"> <tr> <td style="width: 10%;"></td> <td style="width: 10%;"></td> <td style="width: 10%;"></td> <td style="width: 10%;"></td> <td style="width: 10%;"></td> <td style="width: 10%;"></td> <td style="width: 10%;"></td> <td style="width: 10%;"></td> <td style="width: 10%;"></td> <td style="width: 10%;"></td> </tr> <tr> <td></td> <td></td> <td colspan="8" style="text-align: center;"> <table border="1" style="width: 100%; border-collapse: collapse; text-align: center;"> <tr> <td style="width: 10%;"></td> <td style="width: 10%;"></td> <td style="width: 10%;"></td> <td style="width: 10%;"></td> <td style="width: 10%;"></td> <td style="width: 10%;"></td> <td style="width: 10%;"></td> <td style="width: 10%;"></td> <td style="width: 10%;"></td> <td style="width: 10%;"></td> </tr> <tr> <td></td> <td></td> <td colspan="8" style="text-align: center;"> <table border="1" style="width: 100%; border-collapse: collapse; text-align: center;"> <tr> <td style="width: 10%;"></td> <td style="width: 10%;"></td> <td style="width: 10%;"></td> <td style="width: 10%;"></td> <td style="width: 10%;"></td> <td style="width: 10%;"></td> <td style="width: 10%;"></td> <td style="width: 10%;"></td> <td style="width: 10%;"></td> <td style="width: 10%;"></td> </tr> <tr> <td></td> <td></td> <td colspan="8" style="text-align: center;"> <table border="1" style="width: 100%; border-collapse: collapse; text-align: center;"> <tr> <td style="width: 10%;"></td> <td style="width: 10%;"></td> <td style="width: 10%;"></td> <td style="width: 10%;"></td> <td style="width: 10%;"></td> <td style="width: 10%;"></td> <td style="width: 10%;"></td> <td style="width: 10%;"></td> <td style="width: 10%;"></td> <td style="width: 10%;"></td> </tr> <tr> <td></td> <td></td> <td colspan="8" style="text-align: center;"> <table border="1" style="width: 100%; border-collapse: collapse; text-align: center;"> <tr> <td style="width: 10%;"></td> <td style="width: 10%;"></td> <td style="width: 10%;"></td> <td style="width: 10%;"></td> <td style="width: 10%;"></td> <td style="width: 10%;"></td> <td style="width: 10%;"></td> <td style="width: 10%;"></td> <td style="width: 10%;"></td> <td style="width: 10%;"></td> </tr> <tr> <td></td> <td></td> <td colspan="8" style="text-align: center;"> <table border="1" style="width: 100%; border-collapse: collapse; text-align: center;"> <tr> <td style="width: 10%;"></td> <td style="width: 10%;"></td> <td style="width: 10%;"></td> <td style="width: 10%;"></td> <td style="width: 10%;"></td> <td style="width: 10%;"></td> <td style="width: 10%;"></td> <td style="width: 10%;"></td> <td style="width: 10%;"></td> <td style="width: 10%;"></td> </tr> <tr> <td></td> <td></td> <td colspan="8" style="text-align: center;"> <table border="1" style="width: 100%; border-collapse: collapse; text-align: center;"> <tr> <td style="width: 10%;"></td> <td style="width: 10%;"></td> <td style="width: 10%;"></td> <td style="width: 10%;"></td> <td style="width: 10%;"></td> <td style="width: 10%;"></td> <td style="width: 10%;"></td> <td style="width: 10%;"></td> <td style="width: 10%;"></td> <td style="width: 10%;"></td> </tr> <tr> <td></td> <td></td> <td colspan="8" style="text-align: center;"> <table border="1" style="width: 100%; border-collapse: collapse; text-align: center;"> <tr> <td style="width: 10%;"></td> <td style="width: 10%;"></td> <td style="width: 10%;"></td> <td style="width: 10%;"></td> <td style="width: 10%;"></td> <td style="width: 10%;"></td> <td style="width: 10%;"></td> <td style="width: 10%;"></td> <td style="width: 10%;"></td> <td style="width: 10%;"></td> </tr> <tr> <td></td> <td></td> <td colspan="8" style="text-align: center;"> <table border="1" style="width: 100%; border-collapse: collapse; text-align: center;"> <tr> <td style="width: 10%;"></td> <td style="width: 10%;"></td> <td style="width: 10%;"></td> <td style="width: 10%;"></td> <td style="width: 10%;"></td> <td style="width: 10%;"></td> <td style="width: 10%;"></td> <td style="width: 10%;"></td> <td style="width: 10%;"></td> <td style="width: 10%;"></td> </tr> <tr> <td></td> <td></td> <td colspan="8" style="text-align: center;"> <table border="1" style="width: 100%; border-collapse: collapse; text-align: center;"> <tr> <td style="width: 10%;"></td> <td style="width: 10%;"></td> <td style="width: 10%;"></td> <td style="width: 10%;"></td> <td style="width: 10%;"></td> <td style="width: 10%;"></td> <td style="width: 10%;"></td> <td style="width: 10%;"></td> <td style="width: 10%;"></td> <td style="width: 10%;"></td> </tr> <tr> <td></td> <td></td> <td colspan="8" style="text-align: center;"> <table border="1" style="width: 100%; border-collapse: collapse; text-align: center;"> <tr> <td style="width: 10%;"></td> <td style="width: 10%;"></td> <td style="width: 10%;"></td> <td style="width: 10%;"></td> <td style="width: 10%;"></td> <td style="width: 10%;"></td> <td style="width: 10%;"></td> <td style="width: 10%;"></td> <td style="width: 10%;"></td> <td style="width: 10%;"></td> </tr> <tr> <td></td> <td></td> <td
colspan="8" style="text-align: center;"> <table border="1" style="width: 100%; border-collapse: collapse; text-align: center;"> <tr> <td style="width: 10%;"></td> <td style="width: 10%;"></td> <td style="width: 10%;"></td> <td style="width: 10%;"></td> <td style="width: 10%;"></td> <td style="width: 10%;"></td> <td style="width: 10%;"></td> <td style="width: 10%;"></td> <td style="width: 10%;"></td> <td style="width: 10%;"></td> </tr> <tr> <td></td> <td></td> <td colspan="8" style="text-align: center;"> <table border="1" style="width: 100%; border-collapse: collapse; text-align: center;"> <tr> <td style="width: 10%;"></td> <td style="width: 10%;"></td> <td style="width: 10%;"></td> <td style="width: 10%;"></td> <td style="width: 10%;"></td> <td style="width: 10%;"></td> <td style="width: 10%;"></td> <td style="width: 10%;"></td> <td style="width: 10%;"></td> <td style="width: 10%;"></td> </tr> <tr> <td></td> <td></td> <td colspan="8" style="text-align: center;"> <table border="1" style="width: 100%; border-collapse: collapse; text-align: center;"> <tr> <td style="width: 10%;"></td> <td style="width: 10%;"></td> <td style="width: 10%;"></td> <td style="width: 10%;"></td> <td style="width: 10%;"></td> <td style="width: 10%;"></td> <td style="width: 10%;"></td> <td style="width: 10%;"></td> <td style="width: 10%;"></td> <td style="width: 10%;"></td> </tr> <tr> <td></td> <td></td> <td colspan="8" style="text-align: center;"> <table border="1" style="width: 100%; border-collapse: collapse; text-align: center;"> <tr> <td style="width: 10%;"></td> <td style="width: 10%;"></td> <td style="width: 10%;"></td> <td style="width: 10%;"></td> <td style="width: 10%;"></td> <td style="width: 10%;"></td> <td style="width: 10%;"></td> <td style="width: 10%;"></td> <td style="width: 10%;"></td> <td style="width: 10%;"></td> </tr> <tr> <td></td> <td></td> <td colspan="8" style="text-align: center;"> <table border="1" style="width: 100%; border-collapse: collapse; text-align: center;"> <tr> <td style="width: 10%;"></td> <td style="width: 10%;"></td> <td style="width: 10%;"></td> <td style="width: 10%;"></td> <td style="width: 10%;"></td> <td style="width: 10%;"></td> <td style="width: 10%;"></td> <td style="width: 10%;"></td> <td style="width: 10%;"></td> <td style="width: 10%;"></td> </tr> <tr> <td></td> <td></td> <td colspan="8" style="text-align: center;"> <table border="1" style="width: 100%; border-collapse: collapse; text-align: center;"> <tr> </tr></table></td></tr></table></td></tr></table></td></tr></table></td></tr></table></td></tr></table></td></tr></table></td></tr></table></td></tr></table></td></tr></table></td></tr></table></td></tr></table></td></tr></table></td></tr></table></td></tr></table></td></tr></table></td></tr></table></td></tr></table></td></tr></table></td></tr></table></td></tr></table></td></tr></table></td></tr></table></td></tr></table></td></tr></table> | | | | | | | | | | | | | | | | | | | | <table border="1" style="width: 100%; border-collapse: collapse; text-align: center;"> <tr> <td style="width: 10%;"></td> <td style="width: 10%;"></td> <td style="width: 10%;"></td> <td style="width: 10%;"></td> <td style="width: 10%;"></td> <td style="width: 10%;"></td> <td style="width: 10%;"></td> <td style="width: 10%;"></td> <td style="width: 10%;"></td> <td style="width: 10%;"></td> </tr> <tr> <td></td> <td></td> <td colspan="8" style="text-align: center;"> <table border="1" style="width: 100%; border-collapse: collapse; text-align: center;"> <tr> <td style="width: 10%;"></td> <td style="width: 10%;"></td> <td style="width: 10%;"></td> <td style="width: 10%;"></td> <td style="width: 10%;"></td> <td style="width: 10%;"></td> <td style="width: 10%;"></td> <td style="width: 10%;"></td> <td style="width: 10%;"></td> <td style="width: 10%;"></td> </tr> <tr> <td></td> <td></td> <td colspan="8" style="text-align: center;"> <table border="1" style="width: 100%; border-collapse: collapse; text-align: center;"> <tr> <td style="width: 10%;"></td> <td style="width: 10%;"></td> <td style="width: 10%;"></td> <td style="width: 10%;"></td> <td style="width: 10%;"></td> <td style="width: 10%;"></td> <td style="width: 10%;"></td> <td style="width: 10%;"></td> <td style="width: 10%;"></td> <td style="width: 10%;"></td> </tr> <tr> <td></td> <td></td> <td colspan="8" style="text-align: center;"> <table border="1" style="width: 100%; border-collapse: collapse; text-align: center;"> <tr> <td style="width: 10%;"></td> <td style="width: 10%;"></td> <td style="width: 10%;"></td> <td style="width: 10%;"></td> <td style="width: 10%;"></td> <td style="width: 10%;"></td> <td style="width: 10%;"></td> <td style="width: 10%;"></td> <td style="width: 10%;"></td> <td style="width: 10%;"></td> </tr> <tr> <td></td> <td></td> <td colspan="8" style="text-align: center;"> <table border="1" style="width: 100%; border-collapse: collapse; text-align: center;"> <tr> <td style="width: 10%;"></td> <td style="width: 10%;"></td> <td style="width: 10%;"></td> <td style="width: 10%;"></td> <td style="width: 10%;"></td> <td style="width: 10%;"></td> <td style="width: 10%;"></td> <td style="width: 10%;"></td> <td style="width: 10%;"></td> <td style="width: 10%;"></td> </tr> <tr> <td></td> <td></td> <td colspan="8" style="text-align: center;"> <table border="1" style="width: 100%; border-collapse: collapse; text-align: center;"> <tr> <td style="width: 10%;"></td> <td style="width: 10%;"></td> <td style="width: 10%;"></td> <td style="width: 10%;"></td> <td style="width: 10%;"></td> <td style="width: 10%;"></td> <td style="width: 10%;"></td> <td style="width: 10%;"></td> <td style="width: 10%;"></td> <td style="width: 10%;"></td> </tr> <tr> <td></td> <td></td> <td colspan="8" style="text-align: center;"> <table border="1" style="width: 100%; border-collapse: collapse; text-align: center;"> <tr> <td style="width: 10%;"></td> <td style="width: 10%;"></td> <td style="width: 10%;"></td> <td style="width: 10%;"></td> <td style="width: 10%;"></td> <td style="width: 10%;"></td> <td style="width: 10%;"></td> <td style="width: 10%;"></td> <td style="width: 10%;"></td> <td style="width: 10%;"></td> </tr> <tr> <td></td> <td></td> <td colspan="8" style="text-align: center;"> <table border="1" style="width: 100%; border-collapse: collapse; text-align: center;"> <tr> <td style="width: 10%;"></td> <td style="width: 10%;"></td> <td style="width: 10%;"></td> <td style="width: 10%;"></td> <td style="width: 10%;"></td> <td style="width: 10%;"></td> <td style="width: 10%;"></td> <td style="width: 10%;"></td> <td style="width: 10%;"></td> <td style="width: 10%;"></td> </tr> <tr> <td></td> <td></td> <td colspan="8" style="text-align: center;"> <table border="1" style="width: 100%; border-collapse: collapse; text-align: center;"> <tr> <td style="width: 10%;"></td> <td style="width: 10%;"></td> <td style="width: 10%;"></td> <td style="width: 10%;"></td> <td style="width: 10%;"></td> <td style="width: 10%;"></td> <td style="width: 10%;"></td> <td style="width: 10%;"></td> <td style="width: 10%;"></td> <td style="width: 10%;"></td> </tr> <tr> <td></td> <td></td> <td colspan="8" style="text-align: center;"> <table border="1" style="width: 100%; border-collapse: collapse; text-align: center;"> <tr> <td style="width: 10%;"></td> <td style="width: 10%;"></td> <td style="width: 10%;"></td> <td style="width: 10%;"></td> <td style="width: 10%;"></td> <td style="width: 10%;"></td> <td style="width: 10%;"></td> <td style="width: 10%;"></td> <td style="width: 10%;"></td> <td style="width: 10%;"></td> </tr> <tr> <td></td> <td></td> <td colspan="8" style="text-align: center;"> <table border="1" style="width: 100%; border-collapse: collapse; text-align: center;"> <tr> <td style="width: 10%;"></td> <td style="width: 10%;"></td> <td style="width: 10%;"></td> <td style="width: 10%;"></td> <td style="width: 10%;"></td> <td style="width: 10%;"></td> <td style="width: 10%;"></td> <td style="width: 10%;"></td> <td style="width: 10%;"></td> <td style="width: 10%;"></td> </tr> <tr> <td></td> <td></td> <td colspan="8" style="text-align: center;"> <table border="1" style="width: 100%; border-collapse: collapse; text-align: center;"> <tr> <td style="width: 10%;"></td> <td style="width: 10%;"></td> <td style="width: 10%;"></td> <td style="width: 10%;"></td> <td style="width: 10%;"></td> <td style="width: 10%;"></td> <td style="width: 10%;"></td> <td style="width: 10%;"></td> <td style="width: 10%;"></td> <td style="width: 10%;"></td> </tr> <tr> <td></td> <td></td> <td colspan="8" style="text-align: center;"> <table border="1" style="width: 100%; border-collapse: collapse; text-align: center;"> <tr> <td style="width: 10%;"></td> <td style="width: 10%;"></td> <td style="width: 10%;"></td> <td style="width: 10%;"></td> <td style="width: 10%;"></td> <td style="width: 10%;"></td> <td style="width: 10%;"></td> <td style="width: 10%;"></td> <td style="width: 10%;"></td> <td style="width: 10%;"></td> </tr> <tr> <td></td> <td></td> <td colspan="8" style="text-align: center;"> <table border="1" style="width: 100%; border-collapse: collapse; text-align: center;"> <tr> <td style="width: 10%;"></td> <td style="width: 10%;"></td> <td style="width: 10%;"></td> <td style="width: 10%;"></td> <td style="width: 10%;"></td> <td style="width: 10%;"></td> <td style="width: 10%;"></td> <td style="width: 10%;"></td> <td style="width: 10%;"></td> <td style="width: 10%;"></td> </tr> <tr> <td></td> <td></td> <td colspan="8"
style="text-align: center;"> <table border="1" style="width: 100%; border-collapse: collapse; text-align: center;"> <tr> <td style="width: 10%;"></td> <td style="width: 10%;"></td> <td style="width: 10%;"></td> <td style="width: 10%;"></td> <td style="width: 10%;"></td> <td style="width: 10%;"></td> <td style="width: 10%;"></td> <td style="width: 10%;"></td> <td style="width: 10%;"></td> <td style="width: 10%;"></td> </tr> <tr> <td></td> <td></td> <td colspan="8" style="text-align: center;"> <table border="1" style="width: 100%; border-collapse: collapse; text-align: center;"> <tr> <td style="width: 10%;"></td> <td style="width: 10%;"></td> <td style="width: 10%;"></td> <td style="width: 10%;"></td> <td style="width: 10%;"></td> <td style="width: 10%;"></td> <td style="width: 10%;"></td> <td style="width: 10%;"></td> <td style="width: 10%;"></td> <td style="width: 10%;"></td> </tr> <tr> <td></td> <td></td> <td colspan="8" style="text-align: center;"> <table border="1" style="width: 100%; border-collapse: collapse; text-align: center;"> <tr> <td style="width: 10%;"></td> <td style="width: 10%;"></td> <td style="width: 10%;"></td> <td style="width: 10%;"></td> <td style="width: 10%;"></td> <td style="width: 10%;"></td> <td style="width: 10%;"></td> <td style="width: 10%;"></td> <td style="width: 10%;"></td> <td style="width: 10%;"></td> </tr> <tr> <td></td> <td></td> <td colspan="8" style="text-align: center;"> <table border="1" style="width: 100%; border-collapse: collapse; text-align: center;"> <tr> <td style="width: 10%;"></td> <td style="width: 10%;"></td> <td style="width: 10%;"></td> <td style="width: 10%;"></td> <td style="width: 10%;"></td> <td style="width: 10%;"></td> <td style="width: 10%;"></td> <td style="width: 10%;"></td> <td style="width: 10%;"></td> <td style="width: 10%;"></td> </tr> <tr> <td></td> <td></td> <td colspan="8" style="text-align: center;"> <table border="1" style="width: 100%; border-collapse: collapse; text-align: center;"> <tr> <td style="width: 10%;"></td> <td style="width: 10%;"></td> <td style="width: 10%;"></td> <td style="width: 10%;"></td> <td style="width: 10%;"></td> <td style="width: 10%;"></td> <td style="width: 10%;"></td> <td style="width: 10%;"></td> <td style="width: 10%;"></td> <td style="width: 10%;"></td> </tr> <tr> <td></td> <td></td> <td colspan="8" style="text-align: center;"> <table border="1" style="width: 100%; border-collapse: collapse; text-align: center;"> <tr> <td style="width: 10%;"></td> <td style="width: 10%;"></td> <td style="width: 10%;"></td> <td style="width: 10%;"></td> <td style="width: 10%;"></td> <td style="width: 10%;"></td> <td style="width: 10%;"></td> <td style="width: 10%;"></td> <td style="width: 10%;"></td> <td style="width: 10%;"></td> </tr> <tr> <td></td> <td></td> <td colspan="8" style="text-align: center;"> <table border="1" style="width: 100%; border-collapse: collapse; text-align: center;"> <tr> <td style="width: 10%;"></td> <td style="width: 10%;"></td> <td style="width: 10%;"></td> <td style="width: 10%;"></td> <td style="width: 10%;"></td> <td style="width: 10%;"></td> <td style="width: 10%;"></td> <td style="width: 10%;"></td> <td style="width: 10%;"></td> <td style="width: 10%;"></td> </tr> <tr> <td></td> <td></td> <td colspan="8" style="text-align: center;"> <table border="1" style="width: 100%; border-collapse: collapse; text-align: center;"> <tr> <td style="width: 10%;"></td> <td style="width: 10%;"></td> <td style="width: 10%;"></td> <td style="width: 10%;"></td> <td style="width: 10%;"></td> <td style="width: 10%;"></td> <td style="width: 10%;"></td> <td style="width: 10%;"></td> <td style="width: 10%;"></td> <td style="width: 10%;"></td> </tr> <tr> <td></td> <td></td> <td colspan="8" style="text-align: center;"> <table border="1" style="width: 100%; border-collapse: collapse; text-align: center;"> <tr> <td style="width: 10%;"></td> <td style="width: 10%;"></td> <td style="width: 10%;"></td> <td style="width: 10%;"></td> <td style="width: 10%;"></td> <td style="width: 10%;"></td> <td style="width: 10%;"></td> <td style="width: 10%;"></td> <td style="width: 10%;"></td> <td style="width: 10%;"></td> </tr> <tr> <td></td> <td></td> <td colspan="8" style="text-align: center;"> <table border="1" style="width: 100%; border-collapse: collapse; text-align: center;"> <tr> </tr></table></td></tr></table></td></tr></table></td></tr></table></td></tr></table></td></tr></table></td></tr></table></td></tr></table></td></tr></table></td></tr></table></td></tr></table></td></tr></table></td></tr></table></td></tr></table></td></tr></table></td></tr></table></td></tr></table></td></tr></table></td></tr></table></td></tr></table></td></tr></table></td></tr></table></td></tr></table></td></tr></table> | | | | | | | | | | | | | | | | | | | | <table border="1" style="width: 100%; border-collapse: collapse; text-align: center;"> <tr> <td style="width: 10%;"></td> <td style="width: 10%;"></td> <td style="width: 10%;"></td> <td style="width: 10%;"></td> <td style="width: 10%;"></td> <td style="width: 10%;"></td> <td style="width: 10%;"></td> <td style="width: 10%;"></td> <td style="width: 10%;"></td> <td style="width: 10%;"></td> </tr> <tr> <td></td> <td></td> <td colspan="8" style="text-align: center;"> <table border="1" style="width: 100%; border-collapse: collapse; text-align: center;"> <tr> <td style="width: 10%;"></td> <td style="width: 10%;"></td> <td style="width: 10%;"></td> <td style="width: 10%;"></td> <td style="width: 10%;"></td> <td style="width: 10%;"></td> <td style="width: 10%;"></td> <td style="width: 10%;"></td> <td style="width: 10%;"></td> <td style="width: 10%;"></td> </tr> <tr> <td></td> <td></td> <td colspan="8" style="text-align: center;"> <table border="1" style="width: 100%; border-collapse: collapse; text-align: center;"> <tr> <td style="width: 10%;"></td> <td style="width: 10%;"></td> <td style="width: 10%;"></td> <td style="width: 10%;"></td> <td style="width: 10%;"></td> <td style="width: 10%;"></td> <td style="width: 10%;"></td> <td style="width: 10%;"></td> <td style="width: 10%;"></td> <td style="width: 10%;"></td> </tr> <tr> <td></td> <td></td> <td colspan="8" style="text-align: center;"> <table border="1" style="width: 100%; border-collapse: collapse; text-align: center;"> <tr> <td style="width: 10%;"></td> <td style="width: 10%;"></td> <td style="width: 10%;"></td> <td style="width: 10%;"></td> <td style="width: 10%;"></td> <td style="width: 10%;"></td> <td style="width: 10%;"></td> <td style="width: 10%;"></td> <td style="width: 10%;"></td> <td style="width: 10%;"></td> </tr> <tr> <td></td> <td></td> <td colspan="8" style="text-align: center;"> <table border="1" style="width: 100%; border-collapse: collapse; text-align: center;"> <tr> <td style="width: 10%;"></td> <td style="width: 10%;"></td> <td style="width: 10%;"></td> <td style="width: 10%;"></td> <td style="width: 10%;"></td> <td style="width: 10%;"></td> <td style="width: 10%;"></td> <td style="width: 10%;"></td> <td style="width: 10%;"></td> <td style="width: 10%;"></td> </tr> <tr> <td></td> <td></td> <td colspan="8" style="text-align: center;"> <table border="1" style="width: 100%; border-collapse: collapse; text-align: center;"> <tr> <td style="width: 10%;"></td> <td style="width: 10%;"></td> <td style="width: 10%;"></td> <td style="width: 10%;"></td> <td style="width: 10%;"></td> <td style="width: 10%;"></td> <td style="width: 10%;"></td> <td style="width: 10%;"></td> <td style="width: 10%;"></td> <td style="width: 10%;"></td> </tr> <tr> <td></td> <td></td> <td colspan="8" style="text-align: center;"> <table border="1" style="width: 100%; border-collapse: collapse; text-align: center;"> <tr> <td style="width: 10%;"></td> <td style="width: 10%;"></td> <td style="width: 10%;"></td> <td style="width: 10%;"></td> <td style="width: 10%;"></td> <td style="width: 10%;"></td> <td style="width: 10%;"></td> <td style="width: 10%;"></td> <td style="width: 10%;"></td> <td style="width: 10%;"></td> </tr> <tr> <td></td> <td></td> <td colspan="8" style="text-align: center;"> <table border="1" style="width: 100%; border-collapse: collapse; text-align: center;"> <tr> <td style="width: 10%;"></td> <td style="width: 10%;"></td> <td style="width: 10%;"></td> <td style="width: 10%;"></td> <td style="width: 10%;"></td> <td style="width: 10%;"></td> <td style="width: 10%;"></td> <td style="width: 10%;"></td> <td style="width: 10%;"></td> <td style="width: 10%;"></td> </tr> <tr> <td></td> <td></td> <td colspan="8" style="text-align: center;"> <table border="1" style="width: 100%; border-collapse: collapse; text-align: center;"> <tr> <td style="width: 10%;"></td> <td style="width: 10%;"></td> <td style="width: 10%;"></td> <td style="width: 10%;"></td> <td style="width: 10%;"></td> <td style="width: 10%;"></td> <td style="width: 10%;"></td> <td style="width: 10%;"></td> <td style="width: 10%;"></td> <td style="width: 10%;"></td> </tr> <tr> <td></td> <td></td> <td colspan="8" style="text-align: center;"> <table border="1" style="width: 100%; border-collapse: collapse; text-align: center;"> <tr> <td style="width: 10%;"></td> <td style="width: 10%;"></td> <td style="width: 10%;"></td> <td style="width: 10%;"></td> <td style="width: 10%;"></td> <td style="width: 10%;"></td> <td style="width: 10%;"></td> <td style="width: 10%;"></td> <td style="width: 10%;"></td> <td style="width: 10%;"></td> </tr> <tr> <td></td> <td></td> <td colspan="8" style="text-align: center;"> <table
border="1" style="width: 100%; border-collapse: collapse; text-align: center;"> <tr> <td style="width: 10%;"></td> <td style="width: 10%;"></td> <td style="width: 10%;"></td> <td style="width: 10%;"></td> <td style="width: 10%;"></td> <td style="width: 10%;"></td> <td style="width: 10%;"></td> <td style="width: 10%;"></td> <td style="width: 10%;"></td> <td style="width: 10%;"></td> </tr> <tr> <td></td> <td></td> <td colspan="8" style="text-align: center;"> <table border="1" style="width: 100%; border-collapse: collapse; text-align: center;"> <tr> <td style="width: 10%;"></td> <td style="width: 10%;"></td> <td style="width: 10%;"></td> <td style="width: 10%;"></td> <td style="width: 10%;"></td> <td style="width: 10%;"></td> <td style="width: 10%;"></td> <td style="width: 10%;"></td> <td style="width: 10%;"></td> <td style="width: 10%;"></td> </tr> <tr> <td></td> <td></td> <td colspan="8" style="text-align: center;"> <table border="1" style="width: 100%; border-collapse: collapse; text-align: center;"> <tr> <td style="width: 10%;"></td> <td style="width: 10%;"></td> <td style="width: 10%;"></td> <td style="width: 10%;"></td> <td style="width: 10%;"></td> <td style="width: 10%;"></td> <td style="width: 10%;"></td> <td style="width: 10%;"></td> <td style="width: 10%;"></td> <td style="width: 10%;"></td> </tr> <tr> <td></td> <td></td> <td colspan="8" style="text-align: center;"> <table border="1" style="width: 100%; border-collapse: collapse; text-align: center;"> <tr> <td style="width: 10%;"></td> <td style="width: 10%;"></td> <td style="width: 10%;"></td> <td style="width: 10%;"></td> <td style="width: 10%;"></td> <td style="width: 10%;"></td> <td style="width: 10%;"></td> <td style="width: 10%;"></td> <td style="width: 10%;"></td> <td style="width: 10%;"></td> </tr> <tr> <td></td> <td></td> <td colspan="8" style="text-align: center;"> <table border="1" style="width: 100%; border-collapse: collapse; text-align: center;"> <tr> <td style="width: 10%;"></td> <td style="width: 10%;"></td> <td style="width: 10%;"></td> <td style="width: 10%;"></td> <td style="width: 10%;"></td> <td style="width: 10%;"></td> <td style="width: 10%;"></td> <td style="width: 10%;"></td> <td style="width: 10%;"></td> <td style="width: 10%;"></td> </tr> <tr> <td></td> <td></td> <td colspan="8" style="text-align: center;"> <table border="1" style="width: 100%; border-collapse: collapse; text-align: center;"> <tr> <td style="width: 10%;"></td> <td style="width: 10%;"></td> <td style="width: 10%;"></td> <td style="width: 10%;"></td> <td style="width: 10%;"></td> <td style="width: 10%;"></td> <td style="width: 10%;"></td> <td style="width: 10%;"></td> <td style="width: 10%;"></td> <td style="width: 10%;"></td> </tr> <tr> <td></td> <td></td> <td colspan="8" style="text-align: center;"> <table border="1" style="width: 100%; border-collapse: collapse; text-align: center;"> <tr> <td style="width: 10%;"></td> <td style="width: 10%;"></td> <td style="width: 10%;"></td> <td style="width: 10%;"></td> <td style="width: 10%;"></td> <td style="width: 10%;"></td> <td style="width: 10%;"></td> <td style="width: 10%;"></td> <td style="width: 10%;"></td> <td style="width: 10%;"></td> </tr> <tr> <td></td> <td></td> <td colspan="8" style="text-align: center;"> <table border="1" style="width: 100%; border-collapse: collapse; text-align: center;"> <tr> <td style="width: 10%;"></td> <td style="width: 10%;"></td> <td style="width: 10%;"></td> <td style="width: 10%;"></td> <td style="width: 10%;"></td> <td style="width: 10%;"></td> <td style="width: 10%;"></td> <td style="width: 10%;"></td> <td style="width: 10%;"></td> <td style="width: 10%;"></td> </tr> <tr> <td></td> <td></td> <td colspan="8" style="text-align: center;"> <table border="1" style="width: 100%; border-collapse: collapse; text-align: center;"> <tr> <td style="width: 10%;"></td> <td style="width: 10%;"></td> <td style="width: 10%;"></td> <td style="width: 10%;"></td> <td style="width: 10%;"></td> <td style="width: 10%;"></td> <td style="width: 10%;"></td> <td style="width: 10%;"></td> <td style="width: 10%;"></td> <td style="width: 10%;"></td> </tr> <tr> <td></td> <td></td> <td colspan="8" style="text-align: center;"> <table border="1" style="width: 100%; border-collapse: collapse; text-align: center;"> <tr> <td style="width: 10%;"></td> <td style="width: 10%;"></td> <td style="width: 10%;"></td> <td style="width: 10%;"></td> <td style="width: 10%;"></td> <td style="width: 10%;"></td> <td style="width: 10%;"></td> <td style="width: 10%;"></td> <td style="width: 10%;"></td> <td style="width: 10%;"></td> </tr> <tr> <td></td> <td></td> <td colspan="8" style="text-align: center;"> <table border="1" style="width: 100%; border-collapse: collapse; text-align: center;"> <tr> <td style="width: 10%;"></td> <td style="width: 10%;"></td> <td style="width: 10%;"></td> <td style="width: 10%;"></td> <td style="width: 10%;"></td> <td style="width: 10%;"></td> <td style="width: 10%;"></td> <td style="width: 10%;"></td> <td style="width: 10%;"></td> <td style="width: 10%;"></td> </tr> <tr> <td></td> <td></td> <td colspan="8" style="text-align: center;"> <table border="1" style="width: 100%; border-collapse: collapse; text-align: center;"> <tr> <td style="width: 10%;"></td> <td style="width: 10%;"></td> <td style="width: 10%;"></td> <td style="width: 10%;"></td> <td style="width: 10%;"></td> <td style="width: 10%;"></td> <td style="width: 10%;"></td> <td style="width: 10%;"></td> <td style="width: 10%;"></td> <td style="width: 10%;"></td> </tr> <tr> <td></td> <td></td> <td colspan="8" style="text-align: center;"> <table border="1" style="width: 100%; border-collapse: collapse; text-align: center;"> <tr> </tr></table></td></tr></table></td></tr></table></td></tr></table></td></tr></table></td></tr></table></td></tr></table></td></tr></table></td></tr></table></td></tr></table></td></tr></table></td></tr></table></td></tr></table></td></tr></table></td></tr></table></td></tr></table></td></tr></table></td></tr></table></td></tr></table></td></tr></table></td></tr></table></td></tr></table></td></tr></table> | | | | | | | | | | | | | | | | | | | | <table border="1" style="width: 100%; border-collapse: collapse; text-align: center;"> <tr> <td style="width: 10%;"></td> <td style="width: 10%;"></td> <td style="width: 10%;"></td> <td style="width: 10%;"></td> <td style="width: 10%;"></td> <td style="width: 10%;"></td> <td style="width: 10%;"></td> <td style="width: 10%;"></td> <td style="width: 10%;"></td> <td style="width: 10%;"></td> </tr> <tr> <td></td> <td></td> <td colspan="8" style="text-align: center;"> <table border="1" style="width: 100%; border-collapse: collapse; text-align: center;"> <tr> <td style="width: 10%;"></td> <td style="width: 10%;"></td> <td style="width: 10%;"></td> <td style="width: 10%;"></td> <td style="width: 10%;"></td> <td style="width: 10%;"></td> <td style="width: 10%;"></td> <td style="width: 10%;"></td> <td style="width: 10%;"></td> <td style="width: 10%;"></td> </tr> <tr> <td></td> <td></td> <td colspan="8" style="text-align: center;"> <table border="1" style="width: 100%; border-collapse: collapse; text-align: center;"> <tr> <td style="width: 10%;"></td> <td style="width: 10%;"></td> <td style="width: 10%;"></td> <td style="width: 10%;"></td> <td style="width: 10%;"></td> <td style="width: 10%;"></td> <td style="width: 10%;"></td> <td style="width: 10%;"></td> <td style="width: 10%;"></td> <td style="width: 10%;"></td> </tr> <tr> <td></td> <td></td> <td colspan="8" style="text-align: center;"> <table border="1" style="width: 100%; border-collapse: collapse; text-align: center;"> <tr> <td style="width: 10%;"></td> <td style="width: 10%;"></td> <td style="width: 10%;"></td> <td style="width: 10%;"></td> <td style="width: 10%;"></td> <td style="width: 10%;"></td> <td style="width: 10%;"></td> <td style="width: 10%;"></td> <td style="width: 10%;"></td> <td style="width: 10%;"></td> </tr> <tr> <td></td> <td></td> <td colspan="8" style="text-align: center;"> <table border="1" style="width: 100%; border-collapse: collapse; text-align: center;"> <tr> <td style="width: 10%;"></td> <td style="width: 10%;"></td> <td style="width: 10%;"></td> <td style="width: 10%;"></td> <td style="width: 10%;"></td> <td style="width: 10%;"></td> <td style="width: 10%;"></td> <td style="width: 10%;"></td> <td style="width: 10%;"></td> <td style="width: 10%;"></td> </tr> <tr> <td></td> <td></td> <td colspan="8" style="text-align: center;"> <table border="1" style="width: 100%; border-collapse: collapse; text-align: center;"> <tr> <td style="width: 10%;"></td> <td style="width: 10%;"></td> <td style="width: 10%;"></td> <td style="width: 10%;"></td> <td style="width: 10%;"></td> <td style="width: 10%;"></td> <td style="width: 10%;"></td> <td style="width: 10%;"></td> <td style="width: 10%;"></td> <td style="width: 10%;"></td> </tr> <tr> <td></td> <td></td> <td colspan="8" style="text-align: center;"> <table border="1" style="width: 100%; border-collapse: collapse; text-align: center;"> <tr> <td style="width: 10%;"></td> <td style="width: 10%;"></td> <td style="width: 10%;"></td> <td style="width: 10%;"></td> <td style="width: 10%;"></td> <td style="width: 10%;"></td> <td style="width: 10%;"></td> <td style="width: 10%;"></td> <td style="width: 10%;"></td> <td style="width: 10%;"></td> </tr> <tr> <td></td> <td></td> <td colspan="8" style="text-align: center;"> <table border="1" style="width: 100%; border-collapse: collapse;
text-align: center;"> <tr> <td style="width: 10%;"></td> <td style="width: 10%;"></td> <td style="width: 10%;"></td> <td style="width: 10%;"></td> <td style="width: 10%;"></td> <td style="width: 10%;"></td> <td style="width: 10%;"></td> <td style="width: 10%;"></td> <td style="width: 10%;"></td> <td style="width: 10%;"></td> </tr> <tr> <td></td> <td></td> <td colspan="8" style="text-align: center;"> <table border="1" style="width: 100%; border-collapse: collapse; text-align: center;"> <tr> <td style="width: 10%;"></td> <td style="width: 10%;"></td> <td style="width: 10%;"></td> <td style="width: 10%;"></td> <td style="width: 10%;"></td> <td style="width: 10%;"></td> <td style="width: 10%;"></td> <td style="width: 10%;"></td> <td style="width: 10%;"></td> <td style="width: 10%;"></td> </tr> <tr> <td></td> <td></td> <td colspan="8" style="text-align: center;"> <table border="1" style="width: 100%; border-collapse: collapse; text-align: center;"> <tr> <td style="width: 10%;"></td> <td style="width: 10%;"></td> <td style="width: 10%;"></td> <td style="width: 10%;"></td> <td style="width: 10%;"></td> <td style="width: 10%;"></td> <td style="width: 10%;"></td> <td style="width: 10%;"></td> <td style="width: 10%;"></td> <td style="width: 10%;"></td> </tr> <tr> <td></td> <td></td> <td colspan="8" style="text-align: center;"> <table border="1" style="width: 100%; border-collapse: collapse; text-align: center;"> <tr> <td style="width: 10%;"></td> <td style="width: 10%;"></td> <td style="width: 10%;"></td> <td style="width: 10%;"></td> <td style="width: 10%;"></td> <td style="width: 10%;"></td> <td style="width: 10%;"></td> <td style="width: 10%;"></td> <td style="width: 10%;"></td> <td style="width: 10%;"></td> </tr> <tr> <td></td> <td></td> <td colspan="8" style="text-align: center;"> <table border="1" style="width: 100%; border-collapse: collapse; text-align: center;"> <tr> <td style="width: 10%;"></td> <td style="width: 10%;"></td> <td style="width: 10%;"></td> <td style="width: 10%;"></td> <td style="width: 10%;"></td> <td style="width: 10%;"></td> <td style="width: 10%;"></td> <td style="width: 10%;"></td> <td style="width: 10%;"></td> <td style="width: 10%;"></td> </tr> <tr> <td></td> <td></td> <td colspan="8" style="text-align: center;"> <table border="1" style="width: 100%; border-collapse: collapse; text-align: center;"> <tr> <td style="width: 10%;"></td> <td style="width: 10%;"></td> <td style="width: 10%;"></td> <td style="width: 10%;"></td> <td style="width: 10%;"></td> <td style="width: 10%;"></td> <td style="width: 10%;"></td> <td style="width: 10%;"></td> <td style="width: 10%;"></td> <td style="width: 10%;"></td> </tr> <tr> <td></td> <td></td> <td colspan="8" style="text-align: center;"> <table border="1" style="width: 100%; border-collapse: collapse; text-align: center;"> <tr> <td style="width: 10%;"></td> <td style="width: 10%;"></td> <td style="width: 10%;"></td> <td style="width: 10%;"></td> <td style="width: 10%;"></td> <td style="width: 10%;"></td> <td style="width: 10%;"></td> <td style="width: 10%;"></td> <td style="width: 10%;"></td> <td style="width: 10%;"></td> </tr> <tr> <td></td> <td></td> <td colspan="8" style="text-align: center;"> <table border="1" style="width: 100%; border-collapse: collapse; text-align: center;"> <tr> <td style="width: 10%;"></td> <td style="width: 10%;"></td> <td style="width: 10%;"></td> <td style="width: 10%;"></td> <td style="width: 10%;"></td> <td style="width: 10%;"></td> <td style="width: 10%;"></td> <td style="width: 10%;"></td> <td style="width: 10%;"></td> <td style="width: 10%;"></td> </tr> <tr> <td></td> <td></td> <td colspan="8" style="text-align: center;"> <table border="1" style="width: 100%; border-collapse: collapse; text-align: center;"> <tr> <td style="width: 10%;"></td> <td style="width: 10%;"></td> <td style="width: 10%;"></td> <td style="width: 10%;"></td> <td style="width: 10%;"></td> <td style="width: 10%;"></td> <td style="width: 10%;"></td> <td style="width: 10%;"></td> <td style="width: 10%;"></td> <td style="width: 10%;"></td> </tr> <tr> <td></td> <td></td> <td colspan="8" style="text-align: center;"> <table border="1" style="width: 100%; border-collapse: collapse; text-align: center;"> <tr> <td style="width: 10%;"></td> <td style="width: 10%;"></td> <td style="width: 10%;"></td> <td style="width: 10%;"></td> <td style="width: 10%;"></td> <td style="width: 10%;"></td> <td style="width: 10%;"></td> <td style="width: 10%;"></td> <td style="width: 10%;"></td> <td style="width: 10%;"></td> </tr> <tr> <td></td> <td></td> <td colspan="8" style="text-align: center;"> <table border="1" style="width: 100%; border-collapse: collapse; text-align: center;"> <tr> <td style="width: 10%;"></td> <td style="width: 10%;"></td> <td style="width: 10%;"></td> <td style="width: 10%;"></td> <td style="width: 10%;"></td> <td style="width: 10%;"></td> <td style="width: 10%;"></td> <td style="width: 10%;"></td> <td style="width: 10%;"></td> <td style="width: 10%;"></td> </tr> <tr> <td></td> <td></td> <td colspan="8" style="text-align: center;"> <table border="1" style="width: 100%; border-collapse: collapse; text-align: center;"> <tr> <td style="width: 10%;"></td> <td style="width: 10%;"></td> <td style="width: 10%;"></td> <td style="width: 10%;"></td> <td style="width: 10%;"></td> <td style="width: 10%;"></td> <td style="width: 10%;"></td> <td style="width: 10%;"></td> <td style="width: 10%;"></td> <td style="width: 10%;"></td> </tr> <tr> <td></td> <td></td> <td colspan="8" style="text-align: center;"> <table border="1" style="width: 100%; border-collapse: collapse; text-align: center;"> <tr> <td style="width: 10%;"></td> <td style="width: 10%;"></td> <td style="width: 10%;"></td> <td style="width: 10%;"></td> <td style="width: 10%;"></td> <td style="width: 10%;"></td> <td style="width: 10%;"></td> <td style="width: 10%;"></td> <td style="width: 10%;"></td> <td style="width: 10%;"></td> </tr> <tr> <td></td> <td></td> <td colspan="8" style="text-align: center;"> <table border="1" style="width: 100%; border-collapse: collapse; text-align: center;"> <tr> <td style="width: 10%;"></td> <td style="width: 10%;"></td> <td style="width: 10%;"></td> <td style="width: 10%;"></td> <td style="width: 10%;"></td> <td style="width: 10%;"></td> <td style="width: 10%;"></td> <td style="width: 10%;"></td> <td style="width: 10%;"></td> <td style="width: 10%;"></td> </tr> <tr> <td></td> <td></td> <td colspan="8" style="text-align: center;"> <table border="1" style="width: 100%; border-collapse: collapse; text-align: center;"> <tr> </tr></table></td></tr></table></td></tr></table></td></tr></table></td></tr></table></td></tr></table></td></tr></table></td></tr></table></td></tr></table></td></tr></table></td></tr></table></td></tr></table></td></tr></table></td></tr></table></td></tr></table></td></tr></table></td></tr></table></td></tr></table></td></tr></table></td></tr></table></td></tr></table></td></tr></table> | | | | | | | | | | | | | | | | | | | | <table border="1" style="width: 100%; border-collapse: collapse; text-align: center;"> <tr> <td style="width: 10%;"></td> <td style="width: 10%;"></td> <td style="width: 10%;"></td> <td style="width: 10%;"></td> <td style="width: 10%;"></td> <td style="width: 10%;"></td> <td style="width: 10%;"></td> <td style="width: 10%;"></td> <td style="width: 10%;"></td> <td style="width: 10%;"></td> </tr> <tr> <td></td> <td></td> <td colspan="8" style="text-align: center;"> <table border="1" style="width: 100%; border-collapse: collapse; text-align: center;"> <tr> <td style="width: 10%;"></td> <td style="width: 10%;"></td> <td style="width: 10%;"></td> <td style="width: 10%;"></td> <td style="width: 10%;"></td> <td style="width: 10%;"></td> <td style="width: 10%;"></td> <td style="width: 10%;"></td> <td style="width: 10%;"></td> <td style="width: 10%;"></td> </tr> <tr> <td></td> <td></td> <td colspan="8" style="text-align: center;"> <table border="1" style="width: 100%; border-collapse: collapse; text-align: center;"> <tr> <td style="width: 10%;"></td> <td style="width: 10%;"></td> <td style="width: 10%;"></td> <td style="width: 10%;"></td> <td style="width: 10%;"></td> <td style="width: 10%;"></td> <td style="width: 10%;"></td> <td style="width: 10%;"></td> <td style="width: 10%;"></td> <td style="width: 10%;"></td> </tr> <tr> <td></td> <td></td> <td colspan="8" style="text-align: center;"> <table border="1" style="width: 100%; border-collapse: collapse; text-align: center;"> <tr> <td style="width: 10%;"></td> <td style="width: 10%;"></td> <td style="width: 10%;"></td> <td style="width: 10%;"></td> <td style="width: 10%;"></td> <td style="width: 10%;"></td> <td style="width: 10%;"></td> <td style="width: 10%;"></td> <td style="width: 10%;"></td> <td style="width: 10%;"></td> </tr> <tr> <td></td> <td></td> <td colspan="8" style="text-align: center;"> <table border="1" style="width: 100%; border-collapse: collapse; text-align: center;"> <tr> <td style="width: 10%;"></td> <td style="width: 10%;"></td> <td style="width: 10%;"></td> <td style="width: 10%;"></td> <td style="width: 10%;"></td> <td style="width: 10%;"></td> <td style="width: 10%;"></td> <td style="width: 10%;"></td> <td style="width: 10%;"></td> <td style="width: 10%;"></td> </tr> <tr> <td></td> <td></td> <td colspan="8" style="text-align: center;"> <table border="1" style="width: 100%; border-collapse: collapse; text-align: center;"> <tr> <td style="width: 10%;"></td> <td style="width:
10%;"></td> <td style="width: 10%;"></td> <td style="width: 10%;"></td> <td style="width: 10%;"></td> <td style="width: 10%;"></td> <td style="width: 10%;"></td> <td style="width: 10%;"></td> <td style="width: 10%;"></td> <td style="width: 10%;"></td> </tr> <tr> <td></td> <td></td> <td colspan="8" style="text-align: center;"> <table border="1" style="width: 100%; border-collapse: collapse; text-align: center;"> <tr> <td style="width: 10%;"></td> <td style="width: 10%;"></td> <td style="width: 10%;"></td> <td style="width: 10%;"></td> <td style="width: 10%;"></td> <td style="width: 10%;"></td> <td style="width: 10%;"></td> <td style="width: 10%;"></td> <td style="width: 10%;"></td> <td style="width: 10%;"></td> </tr> <tr> <td></td> <td></td> <td colspan="8" style="text-align: center;"> <table border="1" style="width: 100%; border-collapse: collapse; text-align: center;"> <tr> <td style="width: 10%;"></td> <td style="width: 10%;"></td> <td style="width: 10%;"></td> <td style="width: 10%;"></td> <td style="width: 10%;"></td> <td style="width: 10%;"></td> <td style="width: 10%;"></td> <td style="width: 10%;"></td> <td style="width: 10%;"></td> <td style="width: 10%;"></td> </tr> <tr> <td></td> <td></td> <td colspan="8" style="text-align: center;"> <table border="1" style="width: 100%; border-collapse: collapse; text-align: center;"> <tr> <td style="width: 10%;"></td> <td style="width: 10%;"></td> <td style="width: 10%;"></td> <td style="width: 10%;"></td> <td style="width: 10%;"></td> <td style="width: 10%;"></td> <td style="width: 10%;"></td> <td style="width: 10%;"></td> <td style="width: 10%;"></td> <td style="width: 10%;"></td> </tr> <tr> <td></td> <td></td> <td colspan="8" style="text-align: center;"> <table border="1" style="width: 100%; border-collapse: collapse; text-align: center;"> <tr> <td style="width: 10%;"></td> <td style="width: 10%;"></td> <td style="width: 10%;"></td> <td style="width: 10%;"></td> <td style="width: 10%;"></td> <td style="width: 10%;"></td> <td style="width: 10%;"></td> <td style="width: 10%;"></td> <td style="width: 10%;"></td> <td style="width: 10%;"></td> </tr> <tr> <td></td> <td></td> <td colspan="8" style="text-align: center;"> <table border="1" style="width: 100%; border-collapse: collapse; text-align: center;"> <tr> <td style="width: 10%;"></td> <td style="width: 10%;"></td> <td style="width: 10%;"></td> <td style="width: 10%;"></td> <td style="width: 10%;"></td> <td style="width: 10%;"></td> <td style="width: 10%;"></td> <td style="width: 10%;"></td> <td style="width: 10%;"></td> <td style="width: 10%;"></td> </tr> <tr> <td></td> <td></td> <td colspan="8" style="text-align: center;"> <table border="1" style="width: 100%; border-collapse: collapse; text-align: center;"> <tr> <td style="width: 10%;"></td> <td style="width: 10%;"></td> <td style="width: 10%;"></td> <td style="width: 10%;"></td> <td style="width: 10%;"></td> <td style="width: 10%;"></td> <td style="width: 10%;"></td> <td style="width: 10%;"></td> <td style="width: 10%;"></td> <td style="width: 10%;"></td> </tr> <tr> <td></td> <td></td> <td colspan="8" style="text-align: center;"> <table border="1" style="width: 100%; border-collapse: collapse; text-align: center;"> <tr> <td style="width: 10%;"></td> <td style="width: 10%;"></td> <td style="width: 10%;"></td> <td style="width: 10%;"></td> <td style="width: 10%;"></td> <td style="width: 10%;"></td> <td style="width: 10%;"></td> <td style="width: 10%;"></td> <td style="width: 10%;"></td> <td style="width: 10%;"></td> </tr> <tr> <td></td> <td></td> <td colspan="8" style="text-align: center;"> <table border="1" style="width: 100%; border-collapse: collapse; text-align: center;"> <tr> <td style="width: 10%;"></td> <td style="width: 10%;"></td> <td style="width: 10%;"></td> <td style="width: 10%;"></td> <td style="width: 10%;"></td> <td style="width: 10%;"></td> <td style="width: 10%;"></td> <td style="width: 10%;"></td> <td style="width: 10%;"></td> <td style="width: 10%;"></td> </tr> <tr> <td></td> <td></td> <td colspan="8" style="text-align: center;"> <table border="1" style="width: 100%; border-collapse: collapse; text-align: center;"> <tr> <td style="width: 10%;"></td> <td style="width: 10%;"></td> <td style="width: 10%;"></td> <td style="width: 10%;"></td> <td style="width: 10%;"></td> <td style="width: 10%;"></td> <td style="width: 10%;"></td> <td style="width: 10%;"></td> <td style="width: 10%;"></td> <td style="width: 10%;"></td> </tr> <tr> <td></td> <td></td> <td colspan="8" style="text-align: center;"> <table border="1" style="width: 100%; border-collapse: collapse; text-align: center;"> <tr> <td style="width: 10%;"></td> <td style="width: 10%;"></td> <td style="width: 10%;"></td> <td style="width: 10%;"></td> <td style="width: 10%;"></td> <td style="width: 10%;"></td> <td style="width: 10%;"></td> <td style="width: 10%;"></td> <td style="width: 10%;"></td> <td style="width: 10%;"></td> </tr> <tr> <td></td> <td></td> <td colspan="8" style="text-align: center;"> <table border="1" style="width: 100%; border-collapse: collapse; text-align: center;"> <tr> <td style="width: 10%;"></td> <td style="width: 10%;"></td> <td style="width: 10%;"></td> <td style="width: 10%;"></td> <td style="width: 10%;"></td> <td style="width: 10%;"></td> <td style="width: 10%;"></td> <td style="width: 10%;"></td> <td style="width: 10%;"></td> <td style="width: 10%;"></td> </tr> <tr> <td></td> <td></td> <td colspan="8" style="text-align: center;"> <table border="1" style="width: 100%; border-collapse: collapse; text-align: center;"> <tr> <td style="width: 10%;"></td> <td style="width: 10%;"></td> <td style="width: 10%;"></td> <td style="width: 10%;"></td> <td style="width: 10%;"></td> <td style="width: 10%;"></td> <td style="width: 10%;"></td> <td style="width: 10%;"></td> <td style="width: 10%;"></td> <td style="width: 10%;"></td> </tr> <tr> <td></td> <td></td> <td colspan="8" style="text-align: center;"> <table border="1" style="width: 100%; border-collapse: collapse; text-align: center;"> <tr> <td style="width: 10%;"></td> <td style="width: 10%;"></td> <td style="width: 10%;"></td> <td style="width: 10%;"></td> <td style="width: 10%;"></td> <td style="width: 10%;"></td> <td style="width: 10%;"></td> <td style="width: 10%;"></td> <td style="width: 10%;"></td> <td style="width: 10%;"></td> </tr> <tr> <td></td> <td></td> <td colspan="8" style="text-align: center;"> <table border="1" style="width: 100%; border-collapse: collapse; text-align: center;"> <tr> <td style="width: 10%;"></td> <td style="width: 10%;"></td> <td style="width: 10%;"></td> <td style="width: 10%;"></td> <td style="width: 10%;"></td> <td style="width: 10%;"></td> <td style="width: 10%;"></td> <td style="width: 10%;"></td> <td style="width: 10%;"></td> <td style="width: 10%;"></td> </tr> <tr> <td></td> <td></td> <td colspan="8" style="text-align: center;"> <table border="1" style="width: 100%; border-collapse: collapse; text-align: center;"> <tr> </tr></table></td></tr></table></td></tr></table></td></tr></table></td></tr></table></td></tr></table></td></tr></table></td></tr></table></td></tr></table></td></tr></table></td></tr></table></td></tr></table></td></tr></table></td></tr></table></td></tr></table></td></tr></table></td></tr></table></td></tr></table></td></tr></table></td></tr></table></td></tr></table> | | | | | | | | | | | | | | | | | | | | <table border="1" style="width: 100%; border-collapse: collapse; text-align: center;"> <tr> <td style="width: 10%;"></td> <td style="width: 10%;"></td> <td style="width: 10%;"></td> <td style="width: 10%;"></td> <td style="width: 10%;"></td> <td style="width: 10%;"></td> <td style="width: 10%;"></td> <td style="width: 10%;"></td> <td style="width: 10%;"></td> <td style="width: 10%;"></td> </tr> <tr> <td></td> <td></td> <td colspan="8" style="text-align: center;"> <table border="1" style="width: 100%; border-collapse: collapse; text-align: center;"> <tr> <td style="width: 10%;"></td> <td style="width: 10%;"></td> <td style="width: 10%;"></td> <td style="width: 10%;"></td> <td style="width: 10%;"></td> <td style="width: 10%;"></td> <td style="width: 10%;"></td> <td style="width: 10%;"></td> <td style="width: 10%;"></td> <td style="width: 10%;"></td> </tr> <tr> <td></td> <td></td> <td colspan="8" style="text-align: center;"> <table border="1" style="width: 100%; border-collapse: collapse; text-align: center;"> <tr> <td style="width: 10%;"></td> <td style="width: 10%;"></td> <td style="width: 10%;"></td> <td style="width: 10%;"></td> <td style="width: 10%;"></td> <td style="width: 10%;"></td> <td style="width: 10%;"></td> <td style="width: 10%;"></td> <td style="width: 10%;"></td> <td style="width: 10%;"></td> </tr> <tr> <td></td> <td></td> <td colspan="8" style="text-align: center;"> <table border="1" style="width: 100%; border-collapse: collapse; text-align: center;"> <tr> <td style="width: 10%;"></td> <td style="width: 10%;"></td> <td style="width: 10%;"></td> <td style="width: 10%;"></td> <td style="width: 10%;"></td> <td style="width: 10%;"></td> <td style="width: 10%;"></td> <td style="width: 10%;"></td> <td style="width: 10%;"></td> <td style="width: 10%;"></td> </tr> <tr> <td></td> <td></td> <td colspan="8" style="text-align: center;"> <table border="1" style="width: 100%; border-collapse: collapse; text-align: center;"> <tr> <td style="width: 10%;"></td> <td style="width: 10%;"></td> <td style="width: 10%;"></td> <td style="width: 10%;"></td> <td style="width:
10%;"></td> <td style="width: 10%;"></td> <td style="width: 10%;"></td> <td style="width: 10%;"></td> <td style="width: 10%;"></td> <td style="width: 10%;"></td> </tr> <tr> <td></td> <td></td> <td colspan="8" style="text-align: center;"> <table border="1" style="width: 100%; border-collapse: collapse; text-align: center;"> <tr> <td style="width: 10%;"></td> <td style="width: 10%;"></td> <td style="width: 10%;"></td> <td style="width: 10%;"></td> <td style="width: 10%;"></td> <td style="width: 10%;"></td> <td style="width: 10%;"></td> <td style="width: 10%;"></td> <td style="width: 10%;"></td> <td style="width: 10%;"></td> </tr> <tr> <td></td> <td></td> <td colspan="8" style="text-align: center;"> <table border="1" style="width: 100%; border-collapse: collapse; text-align: center;"> <tr> <td style="width: 10%;"></td> <td style="width: 10%;"></td> <td style="width: 10%;"></td> <td style="width: 10%;"></td> <td style="width: 10%;"></td> <td style="width: 10%;"></td> <td style="width: 10%;"></td> <td style="width: 10%;"></td> <td style="width: 10%;"></td> <td style="width: 10%;"></td> </tr> <tr> <td></td> <td></td> <td colspan="8" style="text-align: center;"> <table border="1" style="width: 100%; border-collapse: collapse; text-align: center;"> <tr> <td style="width: 10%;"></td> <td style="width: 10%;"></td> <td style="width: 10%;"></td> <td style="width: 10%;"></td> <td style="width: 10%;"></td> <td style="width: 10%;"></td> <td style="width: 10%;"></td> <td style="width: 10%;"></td> <td style="width: 10%;"></td> <td style="width: 10%;"></td> </tr> <tr> <td></td> <td></td> <td colspan="8" style="text-align: center;"> <table border="1" style="width: 100%; border-collapse: collapse; text-align: center;"> <tr> <td style="width: 10%;"></td> <td style="width: 10%;"></td> <td style="width: 10%;"></td> <td style="width: 10%;"></td> <td style="width: 10%;"></td> <td style="width: 10%;"></td> <td style="width: 10%;"></td> <td style="width: 10%;"></td> <td style="width: 10%;"></td> <td style="width: 10%;"></td> </tr> <tr> <td></td> <td></td> <td colspan="8" style="text-align: center;"> <table border="1" style="width: 100%; border-collapse: collapse; text-align: center;"> <tr> <td style="width: 10%;"></td> <td style="width: 10%;"></td> <td style="width: 10%;"></td> <td style="width: 10%;"></td> <td style="width: 10%;"></td> <td style="width: 10%;"></td> <td style="width: 10%;"></td> <td style="width: 10%;"></td> <td style="width: 10%;"></td> <td style="width: 10%;"></td> </tr> <tr> <td></td> <td></td> <td colspan="8" style="text-align: center;"> <table border="1" style="width: 100%; border-collapse: collapse; text-align: center;"> <tr> <td style="width: 10%;"></td> <td style="width: 10%;"></td> <td style="width: 10%;"></td> <td style="width: 10%;"></td> <td style="width: 10%;"></td> <td style="width: 10%;"></td> <td style="width: 10%;"></td> <td style="width: 10%;"></td> <td style="width: 10%;"></td> <td style="width: 10%;"></td> </tr> <tr> <td></td> <td></td> <td colspan="8" style="text-align: center;"> <table border="1" style="width: 100%; border-collapse: collapse; text-align: center;"> <tr> <td style="width: 10%;"></td> <td style="width: 10%;"></td> <td style="width: 10%;"></td> <td style="width: 10%;"></td> <td style="width: 10%;"></td> <td style="width: 10%;"></td> <td style="width: 10%;"></td> <td style="width: 10%;"></td> <td style="width: 10%;"></td> <td style="width: 10%;"></td> </tr> <tr> <td></td> <td></td> <td colspan="8" style="text-align: center;"> <table border="1" style="width: 100%; border-collapse: collapse; text-align: center;"> <tr> <td style="width: 10%;"></td> <td style="width: 10%;"></td> <td style="width: 10%;"></td> <td style="width: 10%;"></td> <td style="width: 10%;"></td> <td style="width: 10%;"></td> <td style="width: 10%;"></td> <td style="width: 10%;"></td> <td style="width: 10%;"></td> <td style="width: 10%;"></td> </tr> <tr> <td></td> <td></td> <td colspan="8" style="text-align: center;"> <table border="1" style="width: 100%; border-collapse: collapse; text-align: center;"> <tr> <td style="width: 10%;"></td> <td style="width: 10%;"></td> <td style="width: 10%;"></td> <td style="width: 10%;"></td> <td style="width: 10%;"></td> <td style="width: 10%;"></td> <td style="width: 10%;"></td> <td style="width: 10%;"></td> <td style="width: 10%;"></td> <td style="width: 10%;"></td> </tr> <tr> <td></td> <td></td> <td colspan="8" style="text-align: center;"> <table border="1" style="width: 100%; border-collapse: collapse; text-align: center;"> <tr> <td style="width: 10%;"></td> <td style="width: 10%;"></td> <td style="width: 10%;"></td> <td style="width: 10%;"></td> <td style="width: 10%;"></td> <td style="width: 10%;"></td> <td style="width: 10%;"></td> <td style="width: 10%;"></td> <td style="width: 10%;"></td> <td style="width: 10%;"></td> </tr> <tr> <td></td> <td></td> <td colspan="8" style="text-align: center;"> <table border="1" style="width: 100%; border-collapse: collapse; text-align: center;"> <tr> <td style="width: 10%;"></td> <td style="width: 10%;"></td> <td style="width: 10%;"></td> <td style="width: 10%;"></td> <td style="width: 10%;"></td> <td style="width: 10%;"></td> <td style="width: 10%;"></td> <td style="width: 10%;"></td> <td style="width: 10%;"></td> <td style="width: 10%;"></td> </tr> <tr> <td></td> <td></td> <td colspan="8" style="text-align: center;"> <table border="1" style="width: 100%; border-collapse: collapse; text-align: center;"> <tr> <td style="width: 10%;"></td> <td style="width: 10%;"></td> <td style="width: 10%;"></td> <td style="width: 10%;"></td> <td style="width: 10%;"></td> <td style="width: 10%;"></td> <td style="width: 10%;"></td> <td style="width: 10%;"></td> <td style="width: 10%;"></td> <td style="width: 10%;"></td> </tr> <tr> <td></td> <td></td> <td colspan="8" style="text-align: center;"> <table border="1" style="width: 100%; border-collapse: collapse; text-align: center;"> <tr> <td style="width: 10%;"></td> <td style="width: 10%;"></td> <td style="width: 10%;"></td> <td style="width: 10%;"></td> <td style="width: 10%;"></td> <td style="width: 10%;"></td> <td style="width: 10%;"></td> <td style="width: 10%;"></td> <td style="width: 10%;"></td> <td style="width: 10%;"></td> </tr> <tr> <td></td> <td></td> <td colspan="8" style="text-align: center;"> <table border="1" style="width: 100%; border-collapse: collapse; text-align: center;"> <tr> <td style="width: 10%;"></td> <td style="width: 10%;"></td> <td style="width: 10%;"></td> <td style="width: 10%;"></td> <td style="width: 10%;"></td> <td style="width: 10%;"></td> <td style="width: 10%;"></td> <td style="width: 10%;"></td> <td style="width: 10%;"></td> <td style="width: 10%;"></td> </tr> <tr> <td></td> <td></td> <td colspan="8" style="text-align: center;"> <table border="1" style="width: 100%; border-collapse: collapse; text-align: center;"> <tr> </tr></table></td></tr></table></td></tr></table></td></tr></table></td></tr></table></td></tr></table></td></tr></table></td></tr></table></td></tr></table></td></tr></table></td></tr></table></td></tr></table></td></tr></table></td></tr></table></td></tr></table></td></tr></table></td></tr></table></td></tr></table></td></tr></table></td></tr></table> | | | | | | | | | | | | | | | | | | | | <table border="1" style="width: 100%; border-collapse: collapse; text-align: center;"> <tr> <td style="width: 10%;"></td> <td style="width: 10%;"></td> <td style="width: 10%;"></td> <td style="width: 10%;"></td> <td style="width: 10%;"></td> <td style="width: 10%;"></td> <td style="width: 10%;"></td> <td style="width: 10%;"></td> <td style="width: 10%;"></td> <td style="width: 10%;"></td> </tr> <tr> <td></td> <td></td> <td colspan="8" style="text-align: center;"> <table border="1" style="width: 100%; border-collapse: collapse; text-align: center;"> <tr> <td style="width: 10%;"></td> <td style="width: 10%;"></td> <td style="width: 10%;"></td> <td style="width: 10%;"></td> <td style="width: 10%;"></td> <td style="width: 10%;"></td> <td style="width: 10%;"></td> <td style="width: 10%;"></td> <td style="width: 10%;"></td> <td style="width: 10%;"></td> </tr> <tr> <td></td> <td></td> <td colspan="8" style="text-align: center;"> <table border="1" style="width: 100%; border-collapse: collapse; text-align: center;"> <tr> <td style="width: 10%;"></td> <td style="width: 10%;"></td> <td style="width: 10%;"></td> <td style="width: 10%;"></td> <td style="width: 10%;"></td> <td style="width: 10%;"></td> <td style="width: 10%;"></td> <td style="width: 10%;"></td> <td style="width: 10%;"></td> <td style="width: 10%;"></td> </tr> <tr> <td></td> <td></td> <td colspan="8" style="text-align: center;"> <table border="1" style="width: 100%; border-collapse: collapse; text-align: center;"> <tr> <td style="width: 10%;"></td> <td style="width: 10%;"></td> <td style="width: 10%;"></td> <td style="width: 10%;"></td> <td style="width: 10%;"></td> <td style="width: 10%;"></td> <td style="width: 10%;"></td> <td style="width: 10%;"></td> <td style="width: 10%;"></td> <td style="width: 10%;"></td> </tr> <tr> <td></td> <td></td> <td colspan="8" style="text-align: center;"> <table border="1" style="width: 100%; border-collapse: collapse; text-align: center;"> <tr> <td style="width: 10%;"></td> <td style="width: 10%;"></td> <td style="width: 10%;"></td> <td style="width: 10%;"></td> <td style="width: 10%;"></td> <td style="width: 10%;"></td> <td style="width: 10%;"></td> <td style="width: 10%;"></td> <td
style="width: 10%;"></td> <td style="width: 10%;"></td> </tr> <tr> <td></td> <td></td> <td colspan="8" style="text-align: center;"> <table border="1" style="width: 100%; border-collapse: collapse; text-align: center;"> <tr> <td style="width: 10%;"></td> <td style="width: 10%;"></td> <td style="width: 10%;"></td> <td style="width: 10%;"></td> <td style="width: 10%;"></td> <td style="width: 10%;"></td> <td style="width: 10%;"></td> <td style="width: 10%;"></td> <td style="width: 10%;"></td> <td style="width: 10%;"></td> </tr> <tr> <td></td> <td></td> <td colspan="8" style="text-align: center;"> <table border="1" style="width: 100%; border-collapse: collapse; text-align: center;"> <tr> <td style="width: 10%;"></td> <td style="width: 10%;"></td> <td style="width: 10%;"></td> <td style="width: 10%;"></td> <td style="width: 10%;"></td> <td style="width: 10%;"></td> <td style="width: 10%;"></td> <td style="width: 10%;"></td> <td style="width: 10%;"></td> <td style="width: 10%;"></td> </tr> <tr> <td></td> <td></td> <td colspan="8" style="text-align: center;"> <table border="1" style="width: 100%; border-collapse: collapse; text-align: center;"> <tr> <td style="width: 10%;"></td> <td style="width: 10%;"></td> <td style="width: 10%;"></td> <td style="width: 10%;"></td> <td style="width: 10%;"></td> <td style="width: 10%;"></td> <td style="width: 10%;"></td> <td style="width: 10%;"></td> <td style="width: 10%;"></td> <td style="width: 10%;"></td> </tr> <tr> <td></td> <td></td> <td colspan="8" style="text-align: center;"> <table border="1" style="width: 100%; border-collapse: collapse; text-align: center;"> <tr> <td style="width: 10%;"></td> <td style="width: 10%;"></td> <td style="width: 10%;"></td> <td style="width: 10%;"></td> <td style="width: 10%;"></td> <td style="width: 10%;"></td> <td style="width: 10%;"></td> <td style="width: 10%;"></td> <td style="width: 10%;"></td> <td style="width: 10%;"></td> </tr> <tr> <td></td> <td></td> <td colspan="8" style="text-align: center;"> <table border="1" style="width: 100%; border-collapse: collapse; text-align: center;"> <tr> <td style="width: 10%;"></td> <td style="width: 10%;"></td> <td style="width: 10%;"></td> <td style="width: 10%;"></td> <td style="width: 10%;"></td> <td style="width: 10%;"></td> <td style="width: 10%;"></td> <td style="width: 10%;"></td> <td style="width: 10%;"></td> <td style="width: 10%;"></td> </tr> <tr> <td></td> <td></td> <td colspan="8" style="text-align: center;"> <table border="1" style="width: 100%; border-collapse: collapse; text-align: center;"> <tr> <td style="width: 10%;"></td> <td style="width: 10%;"></td> <td style="width: 10%;"></td> <td style="width: 10%;"></td> <td style="width: 10%;"></td> <td style="width: 10%;"></td> <td style="width: 10%;"></td> <td style="width: 10%;"></td> <td style="width: 10%;"></td> <td style="width: 10%;"></td> </tr> <tr> <td></td> <td></td> <td colspan="8" style="text-align: center;"> <table border="1" style="width: 100%; border-collapse: collapse; text-align: center;"> <tr> <td style="width: 10%;"></td> <td style="width: 10%;"></td> <td style="width: 10%;"></td> <td style="width: 10%;"></td> <td style="width: 10%;"></td> <td style="width: 10%;"></td> <td style="width: 10%;"></td> <td style="width: 10%;"></td> <td style="width: 10%;"></td> <td style="width: 10%;"></td> </tr> <tr> <td></td> <td></td> <td colspan="8" style="text-align: center;"> <table border="1" style="width: 100%; border-collapse: collapse; text-align: center;"> <tr> <td style="width: 10%;"></td> <td style="width: 10%;"></td> <td style="width: 10%;"></td> <td style="width: 10%;"></td> <td style="width: 10%;"></td> <td style="width: 10%;"></td> <td style="width: 10%;"></td> <td style="width: 10%;"></td> <td style="width: 10%;"></td> <td style="width: 10%;"></td> </tr> <tr> <td></td> <td></td> <td colspan="8" style="text-align: center;"> <table border="1" style="width: 100%; border-collapse: collapse; text-align: center;"> <tr> <td style="width: 10%;"></td> <td style="width: 10%;"></td> <td style="width: 10%;"></td> <td style="width: 10%;"></td> <td style="width: 10%;"></td> <td style="width: 10%;"></td> <td style="width: 10%;"></td> <td style="width: 10%;"></td> <td style="width: 10%;"></td> <td style="width: 10%;"></td> </tr> <tr> <td></td> <td></td> <td colspan="8" style="text-align: center;"> <table border="1" style="width: 100%; border-collapse: collapse; text-align: center;"> <tr> <td style="width: 10%;"></td> <td style="width: 10%;"></td> <td style="width: 10%;"></td> <td style="width: 10%;"></td> <td style="width: 10%;"></td> <td style="width: 10%;"></td> <td style="width: 10%;"></td> <td style="width: 10%;"></td> <td style="width: 10%;"></td> <td style="width: 10%;"></td> </tr> <tr> <td></td> <td></td> <td colspan="8" style="text-align: center;"> <table border="1" style="width: 100%; border-collapse: collapse; text-align: center;"> <tr> <td style="width: 10%;"></td> <td style="width: 10%;"></td> <td style="width: 10%;"></td> <td style="width: 10%;"></td> <td style="width: 10%;"></td> <td style="width: 10%;"></td> <td style="width: 10%;"></td> <td style="width: 10%;"></td> <td style="width: 10%;"></td> <td style="width: 10%;"></td> </tr> <tr> <td></td> <td></td> <td colspan="8" style="text-align: center;"> <table border="1" style="width: 100%; border-collapse: collapse; text-align: center;"> <tr> <td style="width: 10%;"></td> <td style="width: 10%;"></td> <td style="width: 10%;"></td> <td style="width: 10%;"></td> <td style="width: 10%;"></td> <td style="width: 10%;"></td> <td style="width: 10%;"></td> <td style="width: 10%;"></td> <td style="width: 10%;"></td> <td style="width: 10%;"></td> </tr> <tr> <td></td> <td></td> <td colspan="8" style="text-align: center;"> <table border="1" style="width: 100%; border-collapse: collapse; text-align: center;"> <tr> <td style="width: 10%;"></td> <td style="width: 10%;"></td> <td style="width: 10%;"></td> <td style="width: 10%;"></td> <td style="width: 10%;"></td> <td style="width: 10%;"></td> <td style="width: 10%;"></td> <td style="width: 10%;"></td> <td style="width: 10%;"></td> <td style="width: 10%;"></td> </tr> <tr> <td></td> <td></td> <td colspan="8" style="text-align: center;"> <table border="1" style="width: 100%; border-collapse: collapse; text-align: center;"> <tr> </tr></table></td></tr></table></td></tr></table></td></tr></table></td></tr></table></td></tr></table></td></tr></table></td></tr></table></td></tr></table></td></tr></table></td></tr></table></td></tr></table></td></tr></table></td></tr></table></td></tr></table></td></tr></table></td></tr></table></td></tr></table></td></tr></table> | | | | | | | | | | | | | | | | | | | | <table border="1" style="width: 100%; border-collapse: collapse; text-align: center;"> <tr> <td style="width: 10%;"></td> <td style="width: 10%;"></td> <td style="width: 10%;"></td> <td style="width: 10%;"></td> <td style="width: 10%;"></td> <td style="width: 10%;"></td> <td style="width: 10%;"></td> <td style="width: 10%;"></td> <td style="width: 10%;"></td> <td style="width: 10%;"></td> </tr> <tr> <td></td> <td></td> <td colspan="8" style="text-align: center;"> <table border="1" style="width: 100%; border-collapse: collapse; text-align: center;"> <tr> <td style="width: 10%;"></td> <td style="width: 10%;"></td> <td style="width: 10%;"></td> <td style="width: 10%;"></td> <td style="width: 10%;"></td> <td style="width: 10%;"></td> <td style="width: 10%;"></td> <td style="width: 10%;"></td> <td style="width: 10%;"></td> <td style="width: 10%;"></td> </tr> <tr> <td></td> <td></td> <td colspan="8" style="text-align: center;"> <table border="1" style="width: 100%; border-collapse: collapse; text-align: center;"> <tr> <td style="width: 10%;"></td> <td style="width: 10%;"></td> <td style="width: 10%;"></td> <td style="width: 10%;"></td> <td style="width: 10%;"></td> <td style="width: 10%;"></td> <td style="width: 10%;"></td> <td style="width: 10%;"></td> <td style="width: 10%;"></td> <td style="width: 10%;"></td> </tr> <tr> <td></td> <td></td> <td colspan="8" style="text-align: center;"> <table border="1" style="width: 100%; border-collapse: collapse; text-align: center;"> <tr> <td style="width: 10%;"></td> <td style="width: 10%;"></td> <td style="width: 10%;"></td> <td style="width: 10%;"></td> <td style="width: 10%;"></td> <td style="width: 10%;"></td> <td style="width: 10%;"></td> <td style="width: 10%;"></td> <td style="width: 10%;"></td> <td style="width: 10%;"></td> </tr> <tr> <td></td> <td></td> <td colspan="8" style="text-align: center;"> <table border="1" style="width: 100%; border-collapse: collapse; text-align: center;"> <tr> <td style="width: 10%;"></td> <td style="width: 10%;"></td> <td style="width: 10%;"></td> <td style="width: 10%;"></td> <td style="width: 10%;"></td> <td style="width: 10%;"></td> <td style="width: 10%;"></td> <td style="width: 10%;"></td> <td style="width: 10%;"></td> <td style="width: 10%;"></td> </tr> <tr> <td></td> <td></td> <td colspan="8" style="text-align: center;"> <table border="1" style="width: 100%; border-collapse: collapse; text-align: center;"> <tr> <td style="width: 10%;"></td> <td style="width: 10%;"></td> <td style="width: 10%;"></td> <td style="width: 10%;"></td> <td style="width: 10%;"></td> <td style="width: 10%;"></td> <td style="width: 10%;"></td> <td style="width: 10%;"></td> <td style="width: 10%;"></td> <td style="width: 10%;"></td> </tr> <tr> <td></td> <td></td> <td colspan="8" style="text-align: center;">
<table border="1" style="width: 100%; border-collapse: collapse; text-align: center;"> <tr> <td style="width: 10%;"></td> <td style="width: 10%;"></td> <td style="width: 10%;"></td> <td style="width: 10%;"></td> <td style="width: 10%;"></td> <td style="width: 10%;"></td> <td style="width: 10%;"></td> <td style="width: 10%;"></td> <td style="width: 10%;"></td> <td style="width: 10%;"></td> </tr> <tr> <td></td> <td></td> <td colspan="8" style="text-align: center;"> <table border="1" style="width: 100%; border-collapse: collapse; text-align: center;"> <tr> <td style="width: 10%;"></td> <td style="width: 10%;"></td> <td style="width: 10%;"></td> <td style="width: 10%;"></td> <td style="width: 10%;"></td> <td style="width: 10%;"></td> <td style="width: 10%;"></td> <td style="width: 10%;"></td> <td style="width: 10%;"></td> <td style="width: 10%;"></td> </tr> <tr> <td></td> <td></td> <td colspan="8" style="text-align: center;"> <table border="1" style="width: 100%; border-collapse: collapse; text-align: center;"> <tr> <td style="width: 10%;"></td> <td style="width: 10%;"></td> <td style="width: 10%;"></td> <td style="width: 10%;"></td> <td style="width: 10%;"></td> <td style="width: 10%;"></td> <td style="width: 10%;"></td> <td style="width: 10%;"></td> <td style="width: 10%;"></td> <td style="width: 10%;"></td> </tr> <tr> <td></td> <td></td> <td colspan="8" style="text-align: center;"> <table border="1" style="width: 100%; border-collapse: collapse; text-align: center;"> <tr> <td style="width: 10%;"></td> <td style="width: 10%;"></td> <td style="width: 10%;"></td> <td style="width: 10%;"></td> <td style="width: 10%;"></td> <td style="width: 10%;"></td> <td style="width: 10%;"></td> <td style="width: 10%;"></td> <td style="width: 10%;"></td> <td style="width: 10%;"></td> </tr> <tr> <td></td> <td></td> <td colspan="8" style="text-align: center;"> <table border="1" style="width: 100%; border-collapse: collapse; text-align: center;"> <tr> <td style="width: 10%;"></td> <td style="width: 10%;"></td> <td style="width: 10%;"></td> <td style="width: 10%;"></td> <td style="width: 10%;"></td> <td style="width: 10%;"></td> <td style="width: 10%;"></td> <td style="width: 10%;"></td> <td style="width: 10%;"></td> <td style="width: 10%;"></td> </tr> <tr> <td></td> <td></td> <td colspan="8" style="text-align: center;"> <table border="1" style="width: 100%; border-collapse: collapse; text-align: center;"> <tr> <td style="width: 10%;"></td> <td style="width: 10%;"></td> <td style="width: 10%;"></td> <td style="width: 10%;"></td> <td style="width: 10%;"></td> <td style="width: 10%;"></td> <td style="width: 10%;"></td> <td style="width: 10%;"></td> <td style="width: 10%;"></td> <td style="width: 10%;"></td> </tr> <tr> <td></td> <td></td> <td colspan="8" style="text-align: center;"> <table border="1" style="width: 100%; border-collapse: collapse; text-align: center;"> <tr> <td style="width: 10%;"></td> <td style="width: 10%;"></td> <td style="width: 10%;"></td> <td style="width: 10%;"></td> <td style="width: 10%;"></td> <td style="width: 10%;"></td> <td style="width: 10%;"></td> <td style="width: 10%;"></td> <td style="width: 10%;"></td> <td style="width: 10%;"></td> </tr> <tr> <td></td> <td></td> <td colspan="8" style="text-align: center;"> <table border="1" style="width: 100%; border-collapse: collapse; text-align: center;"> <tr> <td style="width: 10%;"></td> <td style="width: 10%;"></td> <td style="width: 10%;"></td> <td style="width: 10%;"></td> <td style="width: 10%;"></td> <td style="width: 10%;"></td> <td style="width: 10%;"></td> <td style="width: 10%;"></td> <td style="width: 10%;"></td> <td style="width: 10%;"></td> </tr> <tr> <td></td> <td></td> <td colspan="8" style="text-align: center;"> <table border="1" style="width: 100%; border-collapse: collapse; text-align: center;"> <tr> <td style="width: 10%;"></td> <td style="width: 10%;"></td> <td style="width: 10%;"></td> <td style="width: 10%;"></td> <td style="width: 10%;"></td> <td style="width: 10%;"></td> <td style="width: 10%;"></td> <td style="width: 10%;"></td> <td style="width: 10%;"></td> <td style="width: 10%;"></td> </tr> <tr> <td></td> <td></td> <td colspan="8" style="text-align: center;"> <table border="1" style="width: 100%; border-collapse: collapse; text-align: center;"> <tr> <td style="width: 10%;"></td> <td style="width: 10%;"></td> <td style="width: 10%;"></td> <td style="width: 10%;"></td> <td style="width: 10%;"></td> <td style="width: 10%;"></td> <td style="width: 10%;"></td> <td style="width: 10%;"></td> <td style="width: 10%;"></td> <td style="width: 10%;"></td> </tr> <tr> <td></td> <td></td> <td colspan="8" style="text-align: center;"> <table border="1" style="width: 100%; border-collapse: collapse; text-align: center;"> <tr> <td style="width: 10%;"></td> <td style="width: 10%;"></td> <td style="width: 10%;"></td> <td style="width: 10%;"></td> <td style="width: 10%;"></td> <td style="width: 10%;"></td> <td style="width: 10%;"></td> <td style="width: 10%;"></td> <td style="width: 10%;"></td> <td style="width: 10%;"></td> </tr> <tr> <td></td> <td></td> <td colspan="8" style="text-align: center;"> <table border="1" style="width: 100%; border-collapse: collapse; text-align: center;"> <tr> </tr></table></td></tr></table></td></tr></table></td></tr></table></td></tr></table></td></tr></table></td></tr></table></td></tr></table></td></tr></table></td></tr></table></td></tr></table></td></tr></table></td></tr></table></td></tr></table></td></tr></table></td></tr></table></td></tr></table></td></tr></table> | | | | | | | | | | | | | | | | | | | | <table border="1" style="width: 100%; border-collapse: collapse; text-align: center;"> <tr> <td style="width: 10%;"></td> <td style="width: 10%;"></td> <td style="width: 10%;"></td> <td style="width: 10%;"></td> <td style="width: 10%;"></td> <td style="width: 10%;"></td> <td style="width: 10%;"></td> <td style="width: 10%;"></td> <td style="width: 10%;"></td> <td style="width: 10%;"></td> </tr> <tr> <td></td> <td></td> <td colspan="8" style="text-align: center;"> <table border="1" style="width: 100%; border-collapse: collapse; text-align: center;"> <tr> <td style="width: 10%;"></td> <td style="width: 10%;"></td> <td style="width: 10%;"></td> <td style="width: 10%;"></td> <td style="width: 10%;"></td> <td style="width: 10%;"></td> <td style="width: 10%;"></td> <td style="width: 10%;"></td> <td style="width: 10%;"></td> <td style="width: 10%;"></td> </tr> <tr> <td></td> <td></td> <td colspan="8" style="text-align: center;"> <table border="1" style="width: 100%; border-collapse: collapse; text-align: center;"> <tr> <td style="width: 10%;"></td> <td style="width: 10%;"></td> <td style="width: 10%;"></td> <td style="width: 10%;"></td> <td style="width: 10%;"></td> <td style="width: 10%;"></td> <td style="width: 10%;"></td> <td style="width: 10%;"></td> <td style="width: 10%;"></td> <td style="width: 10%;"></td> </tr> <tr> <td></td> <td></td> <td colspan="8" style="text-align: center;"> <table border="1" style="width: 100%; border-collapse: collapse; text-align: center;"> <tr> <td style="width: 10%;"></td> <td style="width: 10%;"></td> <td style="width: 10%;"></td> <td style="width: 10%;"></td> <td style="width: 10%;"></td> <td style="width: 10%;"></td> <td style="width: 10%;"></td> <td style="width: 10%;"></td> <td style="width: 10%;"></td> <td style="width: 10%;"></td> </tr> <tr> <td></td> <td></td> <td colspan="8" style="text-align: center;"> <table border="1" style="width: 100%; border-collapse: collapse; text-align: center;"> <tr> <td style="width: 10%;"></td> <td style="width: 10%;"></td> <td style="width: 10%;"></td> <td style="width: 10%;"></td> <td style="width: 10%;"></td> <td style="width: 10%;"></td> <td style="width: 10%;"></td> <td style="width: 10%;"></td> <td style="width: 10%;"></td> <td style="width: 10%;"></td> </tr> <tr> <td></td> <td></td> <td colspan="8" style="text-align: center;"> <table border="1" style="width: 100%; border-collapse: collapse; text-align: center;"> <tr> <td style="width: 10%;"></td> <td style="width: 10%;"></td> <td style="width: 10%;"></td> <td style="width: 10%;"></td> <td style="width: 10%;"></td> <td style="width: 10%;"></td> <td style="width: 10%;"></td> <td style="width: 10%;"></td> <td style="width: 10%;"></td> <td style="width: 10%;"></td> </tr> <tr> <td></td> <td></td> <td colspan="8" style="text-align: center;"> <table border="1" style="width: 100%; border-collapse: collapse; text-align: center;"> <tr> <td style="width: 10%;"></td> <td style="width: 10%;"></td> <td style="width: 10%;"></td> <td style="width: 10%;"></td> <td style="width: 10%;"></td> <td style="width: 10%;"></td> <td style="width: 10%;"></td> <td style="width: 10%;"></td> <td style="width: 10%;"></td> <td style="width: 10%;"></td> </tr> <tr> <td></td> <td></td> <td colspan="8" style="text-align: center;"> <table border="1" style="width: 100%; border-collapse: collapse; text-align: center;"> <tr> <td style="width: 10%;"></td> <td style="width: 10%;"></td> <td style="width: 10%;"></td> <td style="width: 10%;"></td> <td style="width: 10%;"></td> <td style="width: 10%;"></td> <td style="width: 10%;"></td> <td style="width: 10%;"></td> <td style="width: 10%;"></td> <td style="width: 10%;"></td> </tr> <tr> <td></td> <td></td> <td colspan="8" style="text-align: center;"> <table border="1" style="width: 100%; border-collapse: collapse; text-align: center;"> <tr> <td style="width: 10%;"></td> <td style="width:
10%;"></td> <td style="width: 10%;"></td> <td style="width: 10%;"></td> <td style="width: 10%;"></td> <td style="width: 10%;"></td> <td style="width: 10%;"></td> <td style="width: 10%;"></td> <td style="width: 10%;"></td> <td style="width: 10%;"></td> </tr> <tr> <td></td> <td></td> <td colspan="8" style="text-align: center;"> <table border="1" style="width: 100%; border-collapse: collapse; text-align: center;"> <tr> <td style="width: 10%;"></td> <td style="width: 10%;"></td> <td style="width: 10%;"></td> <td style="width: 10%;"></td> <td style="width: 10%;"></td> <td style="width: 10%;"></td> <td style="width: 10%;"></td> <td style="width: 10%;"></td> <td style="width: 10%;"></td> <td style="width: 10%;"></td> </tr> <tr> <td></td> <td></td> <td colspan="8" style="text-align: center;"> <table border="1" style="width: 100%; border-collapse: collapse; text-align: center;"> <tr> <td style="width: 10%;"></td> <td style="width: 10%;"></td> <td style="width: 10%;"></td> <td style="width: 10%;"></td> <td style="width: 10%;"></td> <td style="width: 10%;"></td> <td style="width: 10%;"></td> <td style="width: 10%;"></td> <td style="width: 10%;"></td> <td style="width: 10%;"></td> </tr> <tr> <td></td> <td></td> <td colspan="8" style="text-align: center;"> <table border="1" style="width: 100%; border-collapse: collapse; text-align: center;"> <tr> <td style="width: 10%;"></td> <td style="width: 10%;"></td> <td style="width: 10%;"></td> <td style="width: 10%;"></td> <td style="width: 10%;"></td> <td style="width: 10%;"></td> <td style="width: 10%;"></td> <td style="width: 10%;"></td> <td style="width: 10%;"></td> <td style="width: 10%;"></td> </tr> <tr> <td></td> <td></td> <td colspan="8" style="text-align: center;"> <table border="1" style="width: 100%; border-collapse: collapse; text-align: center;"> <tr> <td style="width: 10%;"></td> <td style="width: 10%;"></td> <td style="width: 10%;"></td> <td style="width: 10%;"></td> <td style="width: 10%;"></td> <td style="width: 10%;"></td> <td style="width: 10%;"></td> <td style="width: 10%;"></td> <td style="width: 10%;"></td> <td style="width: 10%;"></td> </tr> <tr> <td></td> <td></td> <td colspan="8" style="text-align: center;"> <table border="1" style="width: 100%; border-collapse: collapse; text-align: center;"> <tr> <td style="width: 10%;"></td> <td style="width: 10%;"></td> <td style="width: 10%;"></td> <td style="width: 10%;"></td> <td style="width: 10%;"></td> <td style="width: 10%;"></td> <td style="width: 10%;"></td> <td style="width: 10%;"></td> <td style="width: 10%;"></td> <td style="width: 10%;"></td> </tr> <tr> <td></td> <td></td> <td colspan="8" style="text-align: center;"> <table border="1" style="width: 100%; border-collapse: collapse; text-align: center;"> <tr> <td style="width: 10%;"></td> <td style="width: 10%;"></td> <td style="width: 10%;"></td> <td style="width: 10%;"></td> <td style="width: 10%;"></td> <td style="width: 10%;"></td> <td style="width: 10%;"></td> <td style="width: 10%;"></td> <td style="width: 10%;"></td> <td style="width: 10%;"></td> </tr> <tr> <td></td> <td></td> <td colspan="8" style="text-align: center;"> <table border="1" style="width: 100%; border-collapse: collapse; text-align: center;"> <tr> <td style="width: 10%;"></td> <td style="width: 10%;"></td> <td style="width: 10%;"></td> <td style="width: 10%;"></td> <td style="width: 10%;"></td> <td style="width: 10%;"></td> <td style="width: 10%;"></td> <td style="width: 10%;"></td> <td style="width: 10%;"></td> <td style="width: 10%;"></td> </tr> <tr> <td></td> <td></td> <td colspan="8" style="text-align: center;"> <table border="1" style="width: 100%; border-collapse: collapse; text-align: center;"> <tr> </tr></table></td></tr></table></td></tr></table></td></tr></table></td></tr></table></td></tr></table></td></tr></table></td></tr></table></td></tr></table></td></tr></table></td></tr></table></td></tr></table></td></tr></table></td></tr></table></td></tr></table></td></tr></table></td></tr></table> | | | | | | | | | | | | | | | | | | | | <table border="1" style="width: 100%; border-collapse: collapse; text-align: center;"> <tr> <td style="width: 10%;"></td> <td style="width: 10%;"></td> <td style="width: 10%;"></td> <td style="width: 10%;"></td> <td style="width: 10%;"></td> <td style="width: 10%;"></td> <td style="width: 10%;"></td> <td style="width: 10%;"></td> <td style="width: 10%;"></td> <td style="width: 10%;"></td> </tr> <tr> <td></td> <td></td> <td colspan="8" style="text-align: center;"> <table border="1" style="width: 100%; border-collapse: collapse; text-align: center;"> <tr> <td style="width: 10%;"></td> <td style="width: 10%;"></td> <td style="width: 10%;"></td> <td style="width: 10%;"></td> <td style="width: 10%;"></td> <td style="width: 10%;"></td> <td style="width: 10%;"></td> <td style="width: 10%;"></td> <td style="width: 10%;"></td> <td style="width: 10%;"></td> </tr> <tr> <td></td> <td></td> <td colspan="8" style="text-align: center;"> <table border="1" style="width: 100%; border-collapse: collapse; text-align: center;"> <tr> <td style="width: 10%;"></td> <td style="width: 10%;"></td> <td style="width: 10%;"></td> <td style="width: 10%;"></td> <td style="width: 10%;"></td> <td style="width: 10%;"></td> <td style="width: 10%;"></td> <td style="width: 10%;"></td> <td style="width: 10%;"></td> <td style="width: 10%;"></td> </tr> <tr> <td></td> <td></td> <td colspan="8" style="text-align: center;"> <table border="1" style="width: 100%; border-collapse: collapse; text-align: center;"> <tr> <td style="width: 10%;"></td> <td style="width: 10%;"></td> <td style="width: 10%;"></td> <td style="width: 10%;"></td> <td style="width: 10%;"></td> <td style="width: 10%;"></td> <td style="width: 10%;"></td> <td style="width: 10%;"></td> <td style="width: 10%;"></td> <td style="width: 10%;"></td> </tr> <tr> <td></td> <td></td> <td colspan="8" style="text-align: center;"> <table border="1" style="width: 100%; border-collapse: collapse; text-align: center;"> <tr> <td style="width: 10%;"></td> <td style="width: 10%;"></td> <td style="width: 10%;"></td> <td style="width: 10%;"></td> <td style="width: 10%;"></td> <td style="width: 10%;"></td> <td style="width: 10%;"></td> <td style="width: 10%;"></td> <td style="width: 10%;"></td> <td style="width: 10%;"></td> </tr> <tr> <td></td> <td></td> <td colspan="8" style="text-align: center;"> <table border="1" style="width: 100%; border-collapse: collapse; text-align: center;"> <tr> <td style="width: 10%;"></td> <td style="width: 10%;"></td> <td style="width: 10%;"></td> <td style="width: 10%;"></td> <td style="width: 10%;"></td> <td style="width: 10%;"></td> <td style="width: 10%;"></td> <td style="width: 10%;"></td> <td style="width: 10%;"></td> <td style="width: 10%;"></td> </tr> <tr> <td></td> <td></td> <td colspan="8" style="text-align: center;"> <table border="1" style="width: 100%; border-collapse: collapse; text-align: center;"> <tr> <td style="width: 10%;"></td> <td style="width: 10%;"></td> <td style="width: 10%;"></td> <td style="width: 10%;"></td> <td style="width: 10%;"></td> <td style="width: 10%;"></td> <td style="width: 10%;"></td> <td style="width: 10%;"></td> <td style="width: 10%;"></td> <td style="width: 10%;"></td> </tr> <tr> <td></td> <td></td> <td colspan="8" style="text-align: center;"> <table border="1" style="width: 100%; border-collapse: collapse; text-align: center;"> <tr> <td style="width: 10%;"></td> <td style="width: 10%;"></td> <td style="width: 10%;"></td> <td style="width: 10%;"></td> <td style="width: 10%;"></td> <td style="width: 10%;"></td> <td style="width: 10%;"></td> <td style="width: 10%;"></td> <td style="width: 10%;"></td> <td style="width: 10%;"></td> </tr> <tr> <td></td> <td></td> <td colspan="8" style="text-align: center;"> <table border="1" style="width: 100%; border-collapse: collapse; text-align: center;"> <tr> <td style="width: 10%;"></td> <td style="width: 10%;"></td> <td style="width: 10%;"></td> <td style="width: 10%;"></td> <td style="width: 10%;"></td> <td style="width: 10%;"></td> <td style="width: 10%;"></td> <td style="width: 10%;"></td> <td style="width: 10%;"></td> <td style="width: 10%;"></td> </tr> <tr> <td></td> <td></td> <td colspan="8" style="text-align: center;"> <table border="1" style="width: 100%; border-collapse: collapse; text-align: center;"> <tr> <td style="width: 10%;"></td> <td style="width: 10%;"></td> <td style="width: 10%;"></td> <td style="width: 10%;"></td> <td style="width: 10%;"></td> <td style="width: 10%;"></td> <td style="width: 10%;"></td> <td style="width: 10%;"></td> <td style="width: 10%;"></td> <td style="width: 10%;"></td> </tr> <tr> <td></td> <td></td> <td colspan="8" style="text-align: center;"> <table border="1" style="width: 100%; border-collapse: collapse; text-align: center;"> <tr> <td style="width: 10%;"></td> <td style="width: 10%;"></td> <td style="width: 10%;"></td> <td style="width: 10%;"></td> <td style="width: 10%;"></td> <td style="width: 10%;"></td> <td style="width: 10%;"></td> <td style="width: 10%;"></td> <td style="width: 10%;"></td> <td style="width: 10%;"></td> </tr> <tr> <td></td> <td></td> <td colspan="8" style="text-align: center;"> <table border="1" style="width: 100%; border-collapse: collapse; text-align: center;"> <tr> <td style="width: 10%;"></td> <td style="width: 10%;"></td> <td style="width: 10%;"></td> <td style="width: 10%;"></td> <td style="width: 10%;"></td> <td style="width: 10%;"></td> <td style="width: 10%;"></td> <td
style="width: 10%;"></td> <td style="width: 10%;"></td> <td style="width: 10%;"></td> </tr> <tr> <td></td> <td></td> <td colspan="8" style="text-align: center;"> <table border="1" style="width: 100%; border-collapse: collapse; text-align: center;"> <tr> <td style="width: 10%;"></td> <td style="width: 10%;"></td> <td style="width: 10%;"></td> <td style="width: 10%;"></td> <td style="width: 10%;"></td> <td style="width: 10%;"></td> <td style="width: 10%;"></td> <td style="width: 10%;"></td> <td style="width: 10%;"></td> <td style="width: 10%;"></td> </tr> <tr> <td></td> <td></td> <td colspan="8" style="text-align: center;"> <table border="1" style="width: 100%; border-collapse: collapse; text-align: center;"> <tr> <td style="width: 10%;"></td> <td style="width: 10%;"></td> <td style="width: 10%;"></td> <td style="width: 10%;"></td> <td style="width: 10%;"></td> <td style="width: 10%;"></td> <td style="width: 10%;"></td> <td style="width: 10%;"></td> <td style="width: 10%;"></td> <td style="width: 10%;"></td> </tr> <tr> <td></td> <td></td> <td colspan="8" style="text-align: center;"> <table border="1" style="width: 100%; border-collapse: collapse; text-align: center;"> <tr> <td style="width: 10%;"></td> <td style="width: 10%;"></td> <td style="width: 10%;"></td> <td style="width: 10%;"></td> <td style="width: 10%;"></td> <td style="width: 10%;"></td> <td style="width: 10%;"></td> <td style="width: 10%;"></td> <td style="width: 10%;"></td> <td style="width: 10%;"></td> </tr> <tr> <td></td> <td></td> <td colspan="8" style="text-align: center;"> <table border="1" style="width: 100%; border-collapse: collapse; text-align: center;"> <tr> </tr></table></td></tr></table></td></tr></table></td></tr></table></td></tr></table></td></tr></table></td></tr></table></td></tr></table></td></tr></table></td></tr></table></td></tr></table></td></tr></table></td></tr></table></td></tr></table></td></tr></table></td></tr></table> | | | | | | | | | | | | | | | | | | | | <table border="1" style="width: 100%; border-collapse: collapse; text-align: center;"> <tr> <td style="width: 10%;"></td> <td style="width: 10%;"></td> <td style="width: 10%;"></td> <td style="width: 10%;"></td> <td style="width: 10%;"></td> <td style="width: 10%;"></td> <td style="width: 10%;"></td> <td style="width: 10%;"></td> <td style="width: 10%;"></td> <td style="width: 10%;"></td> </tr> <tr> <td></td> <td></td> <td colspan="8" style="text-align: center;"> <table border="1" style="width: 100%; border-collapse: collapse; text-align: center;"> <tr> <td style="width: 10%;"></td> <td style="width: 10%;"></td> <td style="width: 10%;"></td> <td style="width: 10%;"></td> <td style="width: 10%;"></td> <td style="width: 10%;"></td> <td style="width: 10%;"></td> <td style="width: 10%;"></td> <td style="width: 10%;"></td> <td style="width: 10%;"></td> </tr> <tr> <td></td> <td></td> <td colspan="8" style="text-align: center;"> <table border="1" style="width: 100%; border-collapse: collapse; text-align: center;"> <tr> <td style="width: 10%;"></td> <td style="width: 10%;"></td> <td style="width: 10%;"></td> <td style="width: 10%;"></td> <td style="width: 10%;"></td> <td style="width: 10%;"></td> <td style="width: 10%;"></td> <td style="width: 10%;"></td> <td style="width: 10%;"></td> <td style="width: 10%;"></td> </tr> <tr> <td></td> <td></td> <td colspan="8" style="text-align: center;"> <table border="1" style="width: 100%; border-collapse: collapse; text-align: center;"> <tr> <td style="width: 10%;"></td> <td style="width: 10%;"></td> <td style="width: 10%;"></td> <td style="width: 10%;"></td> <td style="width: 10%;"></td> <td style="width: 10%;"></td> <td style="width: 10%;"></td> <td style="width: 10%;"></td> <td style="width: 10%;"></td> <td style="width: 10%;"></td> </tr> <tr> <td></td> <td></td> <td colspan="8" style="text-align: center;"> <table border="1" style="width: 100%; border-collapse: collapse; text-align: center;"> <tr> <td style="width: 10%;"></td> <td style="width: 10%;"></td> <td style="width: 10%;"></td> <td style="width: 10%;"></td> <td style="width: 10%;"></td> <td style="width: 10%;"></td> <td style="width: 10%;"></td> <td style="width: 10%;"></td> <td style="width: 10%;"></td> <td style="width: 10%;"></td> </tr> <tr> <td></td> <td></td> <td colspan="8" style="text-align: center;"> <table border="1" style="width: 100%; border-collapse: collapse; text-align: center;"> <tr> <td style="width: 10%;"></td> <td style="width: 10%;"></td> <td style="width: 10%;"></td> <td style="width: 10%;"></td> <td style="width: 10%;"></td> <td style="width: 10%;"></td> <td style="width: 10%;"></td> <td style="width: 10%;"></td> <td style="width: 10%;"></td> <td style="width: 10%;"></td> </tr> <tr> <td></td> <td></td> <td colspan="8" style="text-align: center;"> <table border="1" style="width: 100%; border-collapse: collapse; text-align: center;"> <tr> <td style="width: 10%;"></td> <td style="width: 10%;"></td> <td style="width: 10%;"></td> <td style="width: 10%;"></td> <td style="width: 10%;"></td> <td style="width: 10%;"></td> <td style="width: 10%;"></td> <td style="width: 10%;"></td> <td style="width: 10%;"></td> <td style="width: 10%;"></td> </tr> <tr> <td></td> <td></td> <td colspan="8" style="text-align: center;"> <table border="1" style="width: 100%; border-collapse: collapse; text-align: center;"> <tr> <td style="width: 10%;"></td> <td style="width: 10%;"></td> <td style="width: 10%;"></td> <td style="width: 10%;"></td> <td style="width: 10%;"></td> <td style="width: 10%;"></td> <td style="width: 10%;"></td> <td style="width: 10%;"></td> <td style="width: 10%;"></td> <td style="width: 10%;"></td> </tr> <tr> <td></td> <td></td> <td colspan="8" style="text-align: center;"> <table border="1" style="width: 100%; border-collapse: collapse; text-align: center;"> <tr> <td style="width: 10%;"></td> <td style="width: 10%;"></td> <td style="width: 10%;"></td> <td style="width: 10%;"></td> <td style="width: 10%;"></td> <td style="width: 10%;"></td> <td style="width: 10%;"></td> <td style="width: 10%;"></td> <td style="width: 10%;"></td> <td style="width: 10%;"></td> </tr> <tr> <td></td> <td></td> <td colspan="8" style="text-align: center;"> <table border="1" style="width: 100%; border-collapse: collapse; text-align: center;"> <tr> <td style="width: 10%;"></td> <td style="width: 10%;"></td> <td style="width: 10%;"></td> <td style="width: 10%;"></td> <td style="width: 10%;"></td> <td style="width: 10%;"></td> <td style="width: 10%;"></td> <td style="width: 10%;"></td> <td style="width: 10%;"></td> <td style="width: 10%;"></td> </tr> <tr> <td></td> <td></td> <td colspan="8" style="text-align: center;"> <table border="1" style="width: 100%; border-collapse: collapse; text-align: center;"> <tr> <td style="width: 10%;"></td> <td style="width: 10%;"></td> <td style="width: 10%;"></td> <td style="width: 10%;"></td> <td style="width: 10%;"></td> <td style="width: 10%;"></td> <td style="width: 10%;"></td> <td style="width: 10%;"></td> <td style="width: 10%;"></td> <td style="width: 10%;"></td> </tr> <tr> <td></td> <td></td> <td colspan="8" style="text-align: center;"> <table border="1" style="width: 100%; border-collapse: collapse; text-align: center;"> <tr> <td style="width: 10%;"></td> <td style="width: 10%;"></td> <td style="width: 10%;"></td> <td style="width: 10%;"></td> <td style="width: 10%;"></td> <td style="width: 10%;"></td> <td style="width: 10%;"></td> <td style="width: 10%;"></td> <td style="width: 10%;"></td> <td style="width: 10%;"></td> </tr> <tr> <td></td> <td></td> <td colspan="8" style="text-align: center;"> <table border="1" style="width: 100%; border-collapse: collapse; text-align: center;"> <tr> <td style="width: 10%;"></td> <td style="width: 10%;"></td> <td style="width: 10%;"></td> <td style="width: 10%;"></td> <td style="width: 10%;"></td> <td style="width: 10%;"></td> <td style="width: 10%;"></td> <td style="width: 10%;"></td> <td style="width: 10%;"></td> <td style="width: 10%;"></td> </tr> <tr> <td></td> <td></td> <td colspan="8" style="text-align: center;"> <table border="1" style="width: 100%; border-collapse: collapse; text-align: center;"> <tr> <td style="width: 10%;"></td> <td style="width: 10%;"></td> <td style="width: 10%;"></td> <td style="width: 10%;"></td> <td style="width: 10%;"></td> <td style="width: 10%;"></td> <td style="width: 10%;"></td> <td style="width: 10%;"></td> <td style="width: 10%;"></td> <td style="width: 10%;"></td> </tr> <tr> <td></td> <td></td> <td colspan="8" style="text-align: center;"> <table border="1" style="width: 100%; border-collapse: collapse; text-align: center;"> <tr> </tr></table></td></tr></table></td></tr></table></td></tr></table></td></tr></table></td></tr></table></td></tr></table></td></tr></table></td></tr></table></td></tr></table></td></tr></table></td></tr></table></td></tr></table></td></tr></table></td></tr></table> | | | | | | | | | | | | | | | | | | | | <table border="1" style="width: 100%; border-collapse:
collapse; text-align: center;"> <tr> <td style="width: 10%;"></td> <td style="width: 10%;"></td> <td style="width: 10%;"></td> <td style="width: 10%;"></td> <td style="width: 10%;"></td> <td style="width: 10%;"></td> <td style="width: 10%;"></td> <td style="width: 10%;"></td> <td style="width: 10%;"></td> <td style="width: 10%;"></td> </tr> <tr> <td></td> <td></td> <td colspan="8" style="text-align: center;"> <table border="1" style="width: 100%; border-collapse: collapse; text-align: center;"> <tr> <td style="width: 10%;"></td> <td style="width: 10%;"></td> <td style="width: 10%;"></td> <td style="width: 10%;"></td> <td style="width: 10%;"></td> <td style="width: 10%;"></td> <td style="width: 10%;"></td> <td style="width: 10%;"></td> <td style="width: 10%;"></td> <td style="width: 10%;"></td> </tr> <tr> <td></td> <td></td> <td colspan="8" style="text-align: center;"> <table border="1" style="width: 100%; border-collapse: collapse; text-align: center;"> <tr> <td style="width: 10%;"></td> <td style="width: 10%;"></td> <td style="width: 10%;"></td> <td style="width: 10%;"></td> <td style="width: 10%;"></td> <td style="width: 10%;"></td> <td style="width: 10%;"></td> <td style="width: 10%;"></td> <td style="width: 10%;"></td> <td style="width: 10%;"></td> </tr> <tr> <td></td> <td></td> <td colspan="8" style="text-align: center;"> <table border="1" style="width: 100%; border-collapse: collapse; text-align: center;"> <tr> <td style="width: 10%;"></td> <td style="width: 10%;"></td> <td style="width: 10%;"></td> <td style="width: 10%;"></td> <td style="width: 10%;"></td> <td style="width: 10%;"></td> <td style="width: 10%;"></td> <td style="width: 10%;"></td> <td style="width: 10%;"></td> <td style="width: 10%;"></td> </tr> <tr> <td></td> <td></td> <td colspan="8" style="text-align: center;"> <table border="1" style="width: 100%; border-collapse: collapse; text-align: center;"> <tr> <td style="width: 10%;"></td> <td style="width: 10%;"></td> <td style="width: 10%;"></td> <td style="width: 10%;"></td> <td style="width: 10%;"></td> <td style="width: 10%;"></td> <td style="width: 10%;"></td> <td style="width: 10%;"></td> <td style="width: 10%;"></td> <td style="width: 10%;"></td> </tr> <tr> <td></td> <td></td> <td colspan="8" style="text-align: center;"> <table border="1" style="width: 100%; border-collapse: collapse; text-align: center;"> <tr> <td style="width: 10%;"></td> <td style="width: 10%;"></td> <td style="width: 10%;"></td> <td style="width: 10%;"></td> <td style="width: 10%;"></td> <td style="width: 10%;"></td> <td style="width: 10%;"></td> <td style="width: 10%;"></td> <td style="width: 10%;"></td> <td style="width: 10%;"></td> </tr> <tr> <td></td> <td></td> <td colspan="8" style="text-align: center;"> <table border="1" style="width: 100%; border-collapse: collapse; text-align: center;"> <tr> <td style="width: 10%;"></td> <td style="width: 10%;"></td> <td style="width: 10%;"></td> <td style="width: 10%;"></td> <td style="width: 10%;"></td> <td style="width: 10%;"></td> <td style="width: 10%;"></td> <td style="width: 10%;"></td> <td style="width: 10%;"></td> <td style="width: 10%;"></td> </tr> <tr> <td></td> <td></td> <td colspan="8" style="text-align: center;"> <table border="1" style="width: 100%; border-collapse: collapse; text-align: center;"> <tr> <td style="width: 10%;"></td> <td style="width: 10%;"></td> <td style="width: 10%;"></td> <td style="width: 10%;"></td> <td style="width: 10%;"></td> <td style="width: 10%;"></td> <td style="width: 10%;"></td> <td style="width: 10%;"></td> <td style="width: 10%;"></td> <td style="width: 10%;"></td> </tr> <tr> <td></td> <td></td> <td colspan="8" style="text-align: center;"> <table border="1" style="width: 100%; border-collapse: collapse; text-align: center;"> <tr> <td style="width: 10%;"></td> <td style="width: 10%;"></td> <td style="width: 10%;"></td> <td style="width: 10%;"></td> <td style="width: 10%;"></td> <td style="width: 10%;"></td> <td style="width: 10%;"></td> <td style="width: 10%;"></td> <td style="width: 10%;"></td> <td style="width: 10%;"></td> </tr> <tr> <td></td> <td></td> <td colspan="8" style="text-align: center;"> <table border="1" style="width: 100%; border-collapse: collapse; text-align: center;"> <tr> <td style="width: 10%;"></td> <td style="width: 10%;"></td> <td style="width: 10%;"></td> <td style="width: 10%;"></td> <td style="width: 10%;"></td> <td style="width: 10%;"></td> <td style="width: 10%;"></td> <td style="width: 10%;"></td> <td style="width: 10%;"></td> <td style="width: 10%;"></td> </tr> <tr> <td></td> <td></td> <td colspan="8" style="text-align: center;"> <table border="1" style="width: 100%; border-collapse: collapse; text-align: center;"> <tr> <td style="width: 10%;"></td> <td style="width: 10%;"></td> <td style="width: 10%;"></td> <td style="width: 10%;"></td> <td style="width: 10%;"></td> <td style="width: 10%;"></td> <td style="width: 10%;"></td> <td style="width: 10%;"></td> <td style="width: 10%;"></td> <td style="width: 10%;"></td> </tr> <tr> <td></td> <td></td> <td colspan="8" style="text-align: center;"> <table border="1" style="width: 100%; border-collapse: collapse; text-align: center;"> <tr> <td style="width: 10%;"></td> <td style="width: 10%;"></td> <td style="width: 10%;"></td> <td style="width: 10%;"></td> <td style="width: 10%;"></td> <td style="width: 10%;"></td> <td style="width: 10%;"></td> <td style="width: 10%;"></td> <td style="width: 10%;"></td> <td style="width: 10%;"></td> </tr> <tr> <td></td> <td></td> <td colspan="8" style="text-align: center;"> <table border="1" style="width: 100%; border-collapse: collapse; text-align: center;"> <tr> <td style="width: 10%;"></td> <td style="width: 10%;"></td> <td style="width: 10%;"></td> <td style="width: 10%;"></td> <td style="width: 10%;"></td> <td style="width: 10%;"></td> <td style="width: 10%;"></td> <td style="width: 10%;"></td> <td style="width: 10%;"></td> <td style="width: 10%;"></td> </tr> <tr> <td></td> <td></td> <td colspan="8" style="text-align: center;"> <table border="1" style="width: 100%; border-collapse: collapse; text-align: center;"> <tr> </tr></table></td></tr></table></td></tr></table></td></tr></table></td></tr></table></td></tr></table></td></tr></table></td></tr></table></td></tr></table></td></tr></table></td></tr></table></td></tr></table></td></tr></table></td></tr></table> | | | | | | | | | | | | | | | | | | | | <table border="1" style="width: 100%; border-collapse: collapse; text-align: center;"> <tr> <td style="width: 10%;"></td> <td style="width: 10%;"></td> <td style="width: 10%;"></td> <td style="width: 10%;"></td> <td style="width: 10%;"></td> <td style="width: 10%;"></td> <td style="width: 10%;"></td> <td style="width: 10%;"></td> <td style="width: 10%;"></td> <td style="width: 10%;"></td> </tr> <tr> <td></td> <td></td> <td colspan="8" style="text-align: center;"> <table border="1" style="width: 100%; border-collapse: collapse; text-align: center;"> <tr> <td style="width: 10%;"></td> <td style="width: 10%;"></td> <td style="width: 10%;"></td> <td style="width: 10%;"></td> <td style="width: 10%;"></td> <td style="width: 10%;"></td> <td style="width: 10%;"></td> <td style="width: 10%;"></td> <td style="width: 10%;"></td> <td style="width: 10%;"></td> </tr> <tr> <td></td> <td></td> <td colspan="8" style="text-align: center;"> <table border="1" style="width: 100%; border-collapse: collapse; text-align: center;"> <tr> <td style="width: 10%;"></td> <td style="width: 10%;"></td> <td style="width: 10%;"></td> <td style="width: 10%;"></td> <td style="width: 10%;"></td> <td style="width: 10%;"></td> <td style="width: 10%;"></td> <td style="width: 10%;"></td> <td style="width: 10%;"></td> <td style="width: 10%;"></td> </tr> <tr> <td></td> <td></td> <td colspan="8" style="text-align: center;"> <table border="1" style="width: 100%; border-collapse: collapse; text-align: center;"> <tr> <td style="width: 10%;"></td> <td style="width: 10%;"></td> <td style="width: 10%;"></td> <td style="width: 10%;"></td> <td style="width: 10%;"></td> <td style="width: 10%;"></td> <td style="width: 10%;"></td> <td style="width: 10%;"></td> <td style="width: 10%;"></td> <td style="width: 10%;"></td> </tr> <tr> <td></td> <td></td> <td colspan="8" style="text-align: center;"> <table border="1" style="width: 100%; border-collapse: collapse; text-align: center;"> <tr> <td style="width: 10%;"></td> <td style="width: 10%;"></td> <td style="width: 10%;"></td> <td style="width: 10%;"></td> <td style="width: 10%;"></td> <td style="width: 10%;"></td> <td style="width: 10%;"></td> <td style="width: 10%;"></td> <td style="width: 10%;"></td> <td style="width: 10%;"></td> </tr> <tr> <td></td> <td></td> <td colspan="8" style="text-align: center;"> <table border="1" style="width: 100%; border-collapse: collapse; text-align: center;"> <tr> <td style="width: 10%;"></td> <td style="width: 10%;"></td> <td style="width: 10%;"></td> <td style="width: 10%;"></td> <td style="width: 10%;"></td> <td style="width: 10%;"></td> <td style="width: 10%;"></td> <td style="width: 10%;"></td> <td style="width: 10%;"></td> <td style="width: 10%;"></td> </tr> <tr> <td></td> <td></td> <td colspan="8" style="text-align: center;"> <table border="1" style="width: 100%; border-collapse: collapse; text-align: center;"> <tr> <td style="width: 10%;"></td> <td style="width: 10%;"></td> <td style="width: 10%;"></td> <td style="width: 10%;"></td> <td style="width: 10%;"></td> <td style="width: 10%;"></td> <td
style="width: 10%;"></td> <td style="width: 10%;"></td> <td style="width: 10%;"></td> <td style="width: 10%;"></td> </tr> <tr> <td></td> <td></td> <td colspan="8" style="text-align: center;"> <table border="1" style="width: 100%; border-collapse: collapse; text-align: center;"> <tr> <td style="width: 10%;"></td> <td style="width: 10%;"></td> <td style="width: 10%;"></td> <td style="width: 10%;"></td> <td style="width: 10%;"></td> <td style="width: 10%;"></td> <td style="width: 10%;"></td> <td style="width: 10%;"></td> <td style="width: 10%;"></td> <td style="width: 10%;"></td> </tr> <tr> <td></td> <td></td> <td colspan="8" style="text-align: center;"> <table border="1" style="width: 100%; border-collapse: collapse; text-align: center;"> <tr> <td style="width: 10%;"></td> <td style="width: 10%;"></td> <td style="width: 10%;"></td> <td style="width: 10%;"></td> <td style="width: 10%;"></td> <td style="width: 10%;"></td> <td style="width: 10%;"></td> <td style="width: 10%;"></td> <td style="width: 10%;"></td> <td style="width: 10%;"></td> </tr> <tr> <td></td> <td></td> <td colspan="8" style="text-align: center;"> <table border="1" style="width: 100%; border-collapse: collapse; text-align: center;"> <tr> <td style="width: 10%;"></td> <td style="width: 10%;"></td> <td style="width: 10%;"></td> <td style="width: 10%;"></td> <td style="width: 10%;"></td> <td style="width: 10%;"></td> <td style="width: 10%;"></td> <td style="width: 10%;"></td> <td style="width: 10%;"></td> <td style="width: 10%;"></td> </tr> <tr> <td></td> <td></td> <td colspan="8" style="text-align: center;"> <table border="1" style="width: 100%; border-collapse: collapse; text-align: center;"> <tr> <td style="width: 10%;"></td> <td style="width: 10%;"></td> <td style="width: 10%;"></td> <td style="width: 10%;"></td> <td style="width: 10%;"></td> <td style="width: 10%;"></td> <td style="width: 10%;"></td> <td style="width: 10%;"></td> <td style="width: 10%;"></td> <td style="width: 10%;"></td> </tr> <tr> <td></td> <td></td> <td colspan="8" style="text-align: center;"> <table border="1" style="width: 100%; border-collapse: collapse; text-align: center;"> <tr> <td style="width: 10%;"></td> <td style="width: 10%;"></td> <td style="width: 10%;"></td> <td style="width: 10%;"></td> <td style="width: 10%;"></td> <td style="width: 10%;"></td> <td style="width: 10%;"></td> <td style="width: 10%;"></td> <td style="width: 10%;"></td> <td style="width: 10%;"></td> </tr> <tr> <td></td> <td></td> <td colspan="8" style="text-align: center;"> <table border="1" style="width: 100%; border-collapse: collapse; text-align: center;"> <tr> </tr></table></td></tr></table></td></tr></table></td></tr></table></td></tr></table></td></tr></table></td></tr></table></td></tr></table></td></tr></table></td></tr></table></td></tr></table></td></tr></table></td></tr></table> | | | | | | | | | | | | | | | | | | | | <table border="1" style="width: 100%; border-collapse: collapse; text-align: center;"> <tr> <td style="width: 10%;"></td> <td style="width: 10%;"></td> <td style="width: 10%;"></td> <td style="width: 10%;"></td> <td style="width: 10%;"></td> <td style="width: 10%;"></td> <td style="width: 10%;"></td> <td style="width: 10%;"></td> <td style="width: 10%;"></td> <td style="width: 10%;"></td> </tr> <tr> <td></td> <td></td> <td colspan="8" style="text-align: center;"> <table border="1" style="width: 100%; border-collapse: collapse; text-align: center;"> <tr> <td style="width: 10%;"></td> <td style="width: 10%;"></td> <td style="width: 10%;"></td> <td style="width: 10%;"></td> <td style="width: 10%;"></td> <td style="width: 10%;"></td> <td style="width: 10%;"></td> <td style="width: 10%;"></td> <td style="width: 10%;"></td> <td style="width: 10%;"></td> </tr> <tr> <td></td> <td></td> <td colspan="8" style="text-align: center;"> <table border="1" style="width: 100%; border-collapse: collapse; text-align: center;"> <tr> <td style="width: 10%;"></td> <td style="width: 10%;"></td> <td style="width: 10%;"></td> <td style="width: 10%;"></td> <td style="width: 10%;"></td> <td style="width: 10%;"></td> <td style="width: 10%;"></td> <td style="width: 10%;"></td> <td style="width: 10%;"></td> <td style="width: 10%;"></td> </tr> <tr> <td></td> <td></td> <td colspan="8" style="text-align: center;"> <table border="1" style="width: 100%; border-collapse: collapse; text-align: center;"> <tr> <td style="width: 10%;"></td> <td style="width: 10%;"></td> <td style="width: 10%;"></td> <td style="width: 10%;"></td> <td style="width: 10%;"></td> <td style="width: 10%;"></td> <td style="width: 10%;"></td> <td style="width: 10%;"></td> <td style="width: 10%;"></td> <td style="width: 10%;"></td> </tr> <tr> <td></td> <td></td> <td colspan="8" style="text-align: center;"> <table border="1" style="width: 100%; border-collapse: collapse; text-align: center;"> <tr> <td style="width: 10%;"></td> <td style="width: 10%;"></td> <td style="width: 10%;"></td> <td style="width: 10%;"></td> <td style="width: 10%;"></td> <td style="width: 10%;"></td> <td style="width: 10%;"></td> <td style="width: 10%;"></td> <td style="width: 10%;"></td> <td style="width: 10%;"></td> </tr> <tr> <td></td> <td></td> <td colspan="8" style="text-align: center;"> <table border="1" style="width: 100%; border-collapse: collapse; text-align: center;"> <tr> <td style="width: 10%;"></td> <td style="width: 10%;"></td> <td style="width: 10%;"></td> <td style="width: 10%;"></td> <td style="width: 10%;"></td> <td style="width: 10%;"></td> <td style="width: 10%;"></td> <td style="width: 10%;"></td> <td style="width: 10%;"></td> <td style="width: 10%;"></td> </tr> <tr> <td></td> <td></td> <td colspan="8" style="text-align: center;"> <table border="1" style="width: 100%; border-collapse: collapse; text-align: center;"> <tr> <td style="width: 10%;"></td> <td style="width: 10%;"></td> <td style="width: 10%;"></td> <td style="width: 10%;"></td> <td style="width: 10%;"></td> <td style="width: 10%;"></td> <td style="width: 10%;"></td> <td style="width: 10%;"></td> <td style="width: 10%;"></td> <td style="width: 10%;"></td> </tr> <tr> <td></td> <td></td> <td colspan="8" style="text-align: center;"> <table border="1" style="width: 100%; border-collapse: collapse; text-align: center;"> <tr> <td style="width: 10%;"></td> <td style="width: 10%;"></td> <td style="width: 10%;"></td> <td style="width: 10%;"></td> <td style="width: 10%;"></td> <td style="width: 10%;"></td> <td style="width: 10%;"></td> <td style="width: 10%;"></td> <td style="width: 10%;"></td> <td style="width: 10%;"></td> </tr> <tr> <td></td> <td></td> <td colspan="8" style="text-align: center;"> <table border="1" style="width: 100%; border-collapse: collapse; text-align: center;"> <tr> <td style="width: 10%;"></td> <td style="width: 10%;"></td> <td style="width: 10%;"></td> <td style="width: 10%;"></td> <td style="width: 10%;"></td> <td style="width: 10%;"></td> <td style="width: 10%;"></td> <td style="width: 10%;"></td> <td style="width: 10%;"></td> <td style="width: 10%;"></td> </tr> <tr> <td></td> <td></td> <td colspan="8" style="text-align: center;"> <table border="1" style="width: 100%; border-collapse: collapse; text-align: center;"> <tr> <td style="width: 10%;"></td> <td style="width: 10%;"></td> <td style="width: 10%;"></td> <td style="width: 10%;"></td> <td style="width: 10%;"></td> <td style="width: 10%;"></td> <td style="width: 10%;"></td> <td style="width: 10%;"></td> <td style="width: 10%;"></td> <td style="width: 10%;"></td> </tr> <tr> <td></td> <td></td> <td colspan="8" style="text-align: center;"> <table border="1" style="width: 100%; border-collapse: collapse; text-align: center;"> <tr> <td style="width: 10%;"></td> <td style="width: 10%;"></td> <td style="width: 10%;"></td> <td style="width: 10%;"></td> <td style="width: 10%;"></td> <td style="width: 10%;"></td> <td style="width: 10%;"></td> <td style="width: 10%;"></td> <td style="width: 10%;"></td> <td style="width: 10%;"></td> </tr> <tr> <td></td> <td></td> <td colspan="8" style="text-align: center;"> <table border="1" style="width: 100%; border-collapse: collapse; text-align: center;"> <tr> </tr></table></td></tr></table></td></tr></table></td></tr></table></td></tr></table></td></tr></table></td></tr></table></td></tr></table></td></tr></table></td></tr></table></td></tr></table></td></tr></table> | | | | | | | | | | | | | | | | | | | | <table border="1" style="width: 100%; border-collapse: collapse; text-align: center;"> <tr> <td style="width: 10%;"></td> <td style="width: 10%;"></td> <td style="width: 10%;"></td> <td style="width: 10%;"></td> <td style="width: 10%;"></td> <td style="width: 10%;"></td> <td style="width: 10%;"></td> <td style="width: 10%;"></td> <td style="width: 10%;"></td> <td style="width: 10%;"></td> </tr> <tr> <td></td> <td></td> <td colspan="8" style="text-align: center;"> <table border="1" style="width: 100%; border-collapse: collapse; text-align: center;"> <tr> <td style="width: 10%;"></td> <td
style="width: 10%;"></td> <td style="width: 10%;"></td> <td style="width: 10%;"></td> <td style="width: 10%;"></td> <td style="width: 10%;"></td> <td style="width: 10%;"></td> <td style="width: 10%;"></td> <td style="width: 10%;"></td> <td style="width: 10%;"></td> </tr> <tr> <td></td> <td></td> <td colspan="8" style="text-align: center;"> <table border="1" style="width: 100%; border-collapse: collapse; text-align: center;"> <tr> <td style="width: 10%;"></td> <td style="width: 10%;"></td> <td style="width: 10%;"></td> <td style="width: 10%;"></td> <td style="width: 10%;"></td> <td style="width: 10%;"></td> <td style="width: 10%;"></td> <td style="width: 10%;"></td> <td style="width: 10%;"></td> <td style="width: 10%;"></td> </tr> <tr> <td></td> <td></td> <td colspan="8" style="text-align: center;"> <table border="1" style="width: 100%; border-collapse: collapse; text-align: center;"> <tr> <td style="width: 10%;"></td> <td style="width: 10%;"></td> <td style="width: 10%;"></td> <td style="width: 10%;"></td> <td style="width: 10%;"></td> <td style="width: 10%;"></td> <td style="width: 10%;"></td> <td style="width: 10%;"></td> <td style="width: 10%;"></td> <td style="width: 10%;"></td> </tr> <tr> <td></td> <td></td> <td colspan="8" style="text-align: center;"> <table border="1" style="width: 100%; border-collapse: collapse; text-align: center;"> <tr> <td style="width: 10%;"></td> <td style="width: 10%;"></td> <td style="width: 10%;"></td> <td style="width: 10%;"></td> <td style="width: 10%;"></td> <td style="width: 10%;"></td> <td style="width: 10%;"></td> <td style="width: 10%;"></td> <td style="width: 10%;"></td> <td style="width: 10%;"></td> </tr> <tr> <td></td> <td></td> <td colspan="8" style="text-align: center;"> <table border="1" style="width: 100%; border-collapse: collapse; text-align: center;"> <tr> <td style="width: 10%;"></td> <td style="width: 10%;"></td> <td style="width: 10%;"></td> <td style="width: 10%;"></td> <td style="width: 10%;"></td> <td style="width: 10%;"></td> <td style="width: 10%;"></td> <td style="width: 10%;"></td> <td style="width: 10%;"></td> <td style="width: 10%;"></td> </tr> <tr> <td></td> <td></td> <td colspan="8" style="text-align: center;"> <table border="1" style="width: 100%; border-collapse: collapse; text-align: center;"> <tr> <td style="width: 10%;"></td> <td style="width: 10%;"></td> <td style="width: 10%;"></td> <td style="width: 10%;"></td> <td style="width: 10%;"></td> <td style="width: 10%;"></td> <td style="width: 10%;"></td> <td style="width: 10%;"></td> <td style="width: 10%;"></td> <td style="width: 10%;"></td> </tr> <tr> <td></td> <td></td> <td colspan="8" style="text-align: center;"> <table border="1" style="width: 100%; border-collapse: collapse; text-align: center;"> <tr> <td style="width: 10%;"></td> <td style="width: 10%;"></td> <td style="width: 10%;"></td> <td style="width: 10%;"></td> <td style="width: 10%;"></td> <td style="width: 10%;"></td> <td style="width: 10%;"></td> <td style="width: 10%;"></td> <td style="width: 10%;"></td> <td style="width: 10%;"></td> </tr> <tr> <td></td> <td></td> <td colspan="8" style="text-align: center;"> <table border="1" style="width: 100%; border-collapse: collapse; text-align: center;"> <tr> <td style="width: 10%;"></td> <td style="width: 10%;"></td> <td style="width: 10%;"></td> <td style="width: 10%;"></td> <td style="width: 10%;"></td> <td style="width: 10%;"></td> <td style="width: 10%;"></td> <td style="width: 10%;"></td> <td style="width: 10%;"></td> <td style="width: 10%;"></td> </tr> <tr> <td></td> <td></td> <td colspan="8" style="text-align: center;"> <table border="1" style="width: 100%; border-collapse: collapse; text-align: center;"> <tr> <td style="width: 10%;"></td> <td style="width: 10%;"></td> <td style="width: 10%;"></td> <td style="width: 10%;"></td> <td style="width: 10%;"></td> <td style="width: 10%;"></td> <td style="width: 10%;"></td> <td style="width: 10%;"></td> <td style="width: 10%;"></td> <td style="width: 10%;"></td> </tr> <tr> <td></td> <td></td> <td colspan="8" style="text-align: center;"> <table border="1" style="width: 100%; border-collapse: collapse; text-align: center;"> <tr> </tr></table></td></tr></table></td></tr></table></td></tr></table></td></tr></table></td></tr></table></td></tr></table></td></tr></table></td></tr></table></td></tr></table></td></tr></table> | | | | | | | | | | | | | | | | | | | | <table border="1" style="width: 100%; border-collapse: collapse; text-align: center;"> <tr> <td style="width: 10%;"></td> <td style="width: 10%;"></td> <td style="width: 10%;"></td> <td style="width: 10%;"></td> <td style="width: 10%;"></td> <td style="width: 10%;"></td> <td style="width: 10%;"></td> <td style="width: 10%;"></td> <td style="width: 10%;"></td> <td style="width: 10%;"></td> </tr> <tr> <td></td> <td></td> <td colspan="8" style="text-align: center;"> <table border="1" style="width: 100%; border-collapse: collapse; text-align: center;"> <tr> <td style="width: 10%;"></td> <td style="width: 10%;"></td> <td style="width: 10%;"></td> <td style="width: 10%;"></td> <td style="width: 10%;"></td> <td style="width: 10%;"></td> <td style="width: 10%;"></td> <td style="width: 10%;"></td> <td style="width: 10%;"></td> <td style="width: 10%;"></td> </tr> <tr> <td></td> <td></td> <td colspan="8" style="text-align: center;"> <table border="1" style="width: 100%; border-collapse: collapse; text-align: center;"> <tr> <td style="width: 10%;"></td> <td style="width: 10%;"></td> <td style="width: 10%;"></td> <td style="width: 10%;"></td> <td style="width: 10%;"></td> <td style="width: 10%;"></td> <td style="width: 10%;"></td> <td style="width: 10%;"></td> <td style="width: 10%;"></td> <td style="width: 10%;"></td> </tr> <tr> <td></td> <td></td> <td colspan="8" style="text-align: center;"> <table border="1" style="width: 100%; border-collapse: collapse; text-align: center;"> <tr> <td style="width: 10%;"></td> <td style="width: 10%;"></td> <td style="width: 10%;"></td> <td style="width: 10%;"></td> <td style="width: 10%;"></td> <td style="width: 10%;"></td> <td style="width: 10%;"></td> <td style="width: 10%;"></td> <td style="width: 10%;"></td> <td style="width: 10%;"></td> </tr> <tr> <td></td> <td></td> <td colspan="8" style="text-align: center;"> <table border="1" style="width: 100%; border-collapse: collapse; text-align: center;"> <tr> <td style="width: 10%;"></td> <td style="width: 10%;"></td> <td style="width: 10%;"></td> <td style="width: 10%;"></td> <td style="width: 10%;"></td> <td style="width: 10%;"></td> <td style="width: 10%;"></td> <td style="width: 10%;"></td> <td style="width: 10%;"></td> <td style="width: 10%;"></td> </tr> <tr> <td></td> <td></td> <td colspan="8" style="text-align: center;"> <table border="1" style="width: 100%; border-collapse: collapse; text-align: center;"> <tr> <td style="width: 10%;"></td> <td style="width: 10%;"></td> <td style="width: 10%;"></td> <td style="width: 10%;"></td> <td style="width: 10%;"></td> <td style="width: 10%;"></td> <td style="width: 10%;"></td> <td style="width: 10%;"></td> <td style="width: 10%;"></td> <td style="width: 10%;"></td> </tr> <tr> <td></td> <td></td> <td colspan="8" style="text-align: center;"> <table border="1" style="width: 100%; border-collapse: collapse; text-align: center;"> <tr> <td style="width: 10%;"></td> <td style="width: 10%;"></td> <td style="width: 10%;"></td> <td style="width: 10%;"></td> <td style="width: 10%;"></td> <td style="width: 10%;"></td> <td style="width: 10%;"></td> <td style="width: 10%;"></td> <td style="width: 10%;"></td> <td style="width: 10%;"></td> </tr> <tr> <td></td> <td></td> <td colspan="8" style="text-align: center;"> <table border="1" style="width: 100%; border-collapse: collapse; text-align: center;"> <tr> <td style="width: 10%;"></td> <td style="width: 10%;"></td> <td style="width: 10%;"></td> <td style="width: 10%;"></td> <td style="width: 10%;"></td> <td style="width: 10%;"></td> <td style="width: 10%;"></td> <td style="width: 10%;"></td> <td style="width: 10%;"></td> <td style="width: 10%;"></td> </tr> <tr> <td></td> <td></td> <td colspan="8" style="text-align: center;"> <table border="1" style="width: 100%; border-collapse: collapse; text-align: center;"> <tr> <td style="width: 10%;"></td> <td style="width: 10%;"></td> <td style="width: 10%;"></td> <td style="width: 10%;"></td> <td style="width: 10%;"></td> <td style="width: 10%;"></td> <td style="width: 10%;"></td> <td style="width: 10%;"></td> <td style="width: 10%;"></td> <td style="width: 10%;"></td> </tr> <tr> <td></td> <td></td> <td colspan="8" style="text-align: center;"> <table border="1" style="width: 100%; border-collapse: collapse; text-align: center;"> <tr> </tr></table></td></tr></table></td></tr></table></td></tr></table></td></tr></table></td></tr></table></td></tr></table></td></tr></table></td></tr></table></td></tr></table> | | | | | | | | | | | | | | | | | | | | <table border="1" style="width: 100%; border-collapse:
collapse; text-align: center;"> <tr> <td style="width: 10%;"></td> <td style="width: 10%;"></td> <td style="width: 10%;"></td> <td style="width: 10%;"></td> <td style="width: 10%;"></td> <td style="width: 10%;"></td> <td style="width: 10%;"></td> <td style="width: 10%;"></td> <td style="width: 10%;"></td> <td style="width: 10%;"></td> </tr> <tr> <td></td> <td></td> <td colspan="8" style="text-align: center;"> <table border="1" style="width: 100%; border-collapse: collapse; text-align: center;"> <tr> <td style="width: 10%;"></td> <td style="width: 10%;"></td> <td style="width: 10%;"></td> <td style="width: 10%;"></td> <td style="width: 10%;"></td> <td style="width: 10%;"></td> <td style="width: 10%;"></td> <td style="width: 10%;"></td> <td style="width: 10%;"></td> <td style="width: 10%;"></td> </tr> <tr> <td></td> <td></td> <td colspan="8" style="text-align: center;"> <table border="1" style="width: 100%; border-collapse: collapse; text-align: center;"> <tr> <td style="width: 10%;"></td> <td style="width: 10%;"></td> <td style="width: 10%;"></td> <td style="width: 10%;"></td> <td style="width: 10%;"></td> <td style="width: 10%;"></td> <td style="width: 10%;"></td> <td style="width: 10%;"></td> <td style="width: 10%;"></td> <td style="width: 10%;"></td> </tr> <tr> <td></td> <td></td> <td colspan="8" style="text-align: center;"> <table border="1" style="width: 100%; border-collapse: collapse; text-align: center;"> <tr> <td style="width: 10%;"></td> <td style="width: 10%;"></td> <td style="width: 10%;"></td> <td style="width: 10%;"></td> <td style="width: 10%;"></td> <td style="width: 10%;"></td> <td style="width: 10%;"></td> <td style="width: 10%;"></td> <td style="width: 10%;"></td> <td style="width: 10%;"></td> </tr> <tr> <td></td> <td></td> <td colspan="8" style="text-align: center;"> <table border="1" style="width: 100%; border-collapse: collapse; text-align: center;"> <tr> <td style="width: 10%;"></td> <td style="width: 10%;"></td> <td style="width: 10%;"></td> <td style="width: 10%;"></td> <td style="width: 10%;"></td> <td style="width: 10%;"></td> <td style="width: 10%;"></td> <td style="width: 10%;"></td> <td style="width: 10%;"></td> <td style="width: 10%;"></td> </tr> <tr> <td></td> <td></td> <td colspan="8" style="text-align: center;"> <table border="1" style="width: 100%; border-collapse: collapse; text-align: center;"> <tr> <td style="width: 10%;"></td> <td style="width: 10%;"></td> <td style="width: 10%;"></td> <td style="width: 10%;"></td> <td style="width: 10%;"></td> <td style="width: 10%;"></td> <td style="width: 10%;"></td> <td style="width: 10%;"></td> <td style="width: 10%;"></td> <td style="width: 10%;"></td> </tr> <tr> <td></td> <td></td> <td colspan="8" style="text-align: center;"> <table border="1" style="width: 100%; border-collapse: collapse; text-align: center;"> <tr> <td style="width: 10%;"></td> <td style="width: 10%;"></td> <td style="width: 10%;"></td> <td style="width: 10%;"></td> <td style="width: 10%;"></td> <td style="width: 10%;"></td> <td style="width: 10%;"></td> <td style="width: 10%;"></td> <td style="width: 10%;"></td> <td style="width: 10%;"></td> </tr> <tr> <td></td> <td></td> <td colspan="8" style="text-align: center;"> <table border="1" style="width: 100%; border-collapse: collapse; text-align: center;"> <tr> <td style="width: 10%;"></td> <td style="width: 10%;"></td> <td style="width: 10%;"></td> <td style="width: 10%;"></td> <td style="width: 10%;"></td> <td style="width: 10%;"></td> <td style="width: 10%;"></td> <td style="width: 10%;"></td> <td style="width: 10%;"></td> <td style="width: 10%;"></td> </tr> <tr> <td></td> <td></td> <td colspan="8" style="text-align: center;"> <table border="1" style="width: 100%; border-collapse: collapse; text-align: center;"> <tr> </tr></table></td></tr></table></td></tr></table></td></tr></table></td></tr></table></td></tr></table></td></tr></table></td></tr></table></td></tr></table> | | | | | | | | | | | | | | | | | | | | <table border="1" style="width: 100%; border-collapse: collapse; text-align: center;"> <tr> <td style="width: 10%;"></td> <td style="width: 10%;"></td> <td style="width: 10%;"></td> <td style="width: 10%;"></td> <td style="width: 10%;"></td> <td style="width: 10%;"></td> <td style="width: 10%;"></td> <td style="width: 10%;"></td> <td style="width: 10%;"></td> <td style="width: 10%;"></td> </tr> <tr> <td></td> <td></td> <td colspan="8" style="text-align: center;"> <table border="1" style="width: 100%; border-collapse: collapse; text-align: center;"> <tr> <td style="width: 10%;"></td> <td style="width: 10%;"></td> <td style="width: 10%;"></td> <td style="width: 10%;"></td> <td style="width: 10%;"></td> <td style="width: 10%;"></td> <td style="width: 10%;"></td> <td style="width: 10%;"></td> <td style="width: 10%;"></td> <td style="width: 10%;"></td> </tr> <tr> <td></td> <td></td> <td colspan="8" style="text-align: center;"> <table border="1" style="width: 100%; border-collapse: collapse; text-align: center;"> <tr> <td style="width: 10%;"></td> <td style="width: 10%;"></td> <td style="width: 10%;"></td> <td style="width: 10%;"></td> <td style="width: 10%;"></td> <td style="width: 10%;"></td> <td style="width: 10%;"></td> <td style="width: 10%;"></td> <td style="width: 10%;"></td> <td style="width: 10%;"></td> </tr> <tr> <td></td> <td></td> <td colspan="8" style="text-align: center;"> <table border="1" style="width: 100%; border-collapse: collapse; text-align: center;"> <tr> <td style="width: 10%;"></td> <td style="width: 10%;"></td> <td style="width: 10%;"></td> <td style="width: 10%;"></td> <td style="width: 10%;"></td> <td style="width: 10%;"></td> <td style="width: 10%;"></td> <td style="width: 10%;"></td> <td style="width: 10%;"></td> <td style="width: 10%;"></td> </tr> <tr> <td></td> <td></td> <td colspan="8" style="text-align: center;"> <table border="1" style="width: 100%; border-collapse: collapse; text-align: center;"> <tr> <td style="width: 10%;"></td> <td style="width: 10%;"></td> <td style="width: 10%;"></td> <td style="width: 10%;"></td> <td style="width: 10%;"></td> <td style="width: 10%;"></td> <td style="width: 10%;"></td> <td style="width: 10%;"></td> <td style="width: 10%;"></td> <td style="width: 10%;"></td> </tr> <tr> <td></td> <td></td> <td colspan="8" style="text-align: center;"> <table border="1" style="width: 100%; border-collapse: collapse; text-align: center;"> <tr> <td style="width: 10%;"></td> <td style="width: 10%;"></td> <td style="width: 10%;"></td> <td style="width: 10%;"></td> <td style="width: 10%;"></td> <td style="width: 10%;"></td> <td style="width: 10%;"></td> <td style="width: 10%;"></td> <td style="width: 10%;"></td> <td style="width: 10%;"></td> </tr> <tr> <td></td> <td></td> <td colspan="8" style="text-align: center;"> <table border="1" style="width: 100%; border-collapse: collapse; text-align: center;"> <tr> <td style="width: 10%;"></td> <td style="width: 10%;"></td> <td style="width: 10%;"></td> <td style="width: 10%;"></td> <td style="width: 10%;"></td> <td style="width: 10%;"></td> <td style="width: 10%;"></td> <td style="width: 10%;"></td> <td style="width: 10%;"></td> <td style="width: 10%;"></td> </tr> <tr> <td></td> <td></td> <td colspan="8" style="text-align: center;"> <table border="1" style="width: 100%; border-collapse: collapse; text-align: center;"> <tr> </tr></table></td></tr></table></td></tr></table></td></tr></table></td></tr></table></td></tr></table></td></tr></table></td></tr></table> | | | | | | | | | | | | | | | | | | | | <table border="1" style="width: 100%; border-collapse: collapse; text-align: center;"> <tr> <td style="width: 10%;"></td> <td style="width: 10%;"></td> <td style="width: 10%;"></td> <td style="width: 10%;"></td> <td style="width: 10%;"></td> <td style="width: 10%;"></td> <td style="width: 10%;"></td> <td style="width: 10%;"></td> <td style="width: 10%;"></td> <td style="width: 10%;"></td> </tr> <tr> <td></td> <td></td> <td colspan="8" style="text-align: center;"> <table border="1" style="width: 100%; border-collapse: collapse; text-align: center;"> <tr> <td style="width: 10%;"></td> <td style="width: 10%;"></td> <td style="width: 10%;"></td> <td style="width: 10%;"></td> <td style="width: 10%;"></td> <td style="width: 10%;"></td> <td style="width: 10%;"></td> <td style="width: 10%;"></td> <td style="width: 10%;"></td> <td style="width: 10%;"></td> </tr> <tr> <td></td> <td></td> <td colspan="8" style="text-align: center;"> <table border="1" style="width: 100%; border-collapse: collapse; text-align: center;"> <tr> <td style="width: 10%;"></td> <td style="width: 10%;"></td> <td style="width: 10%;"></td> <td style="width: 10%;"></td> <td style="width: 10%;"></td> <td style="width: 10%;"></td> <td style="width: 10%;"></td> <td style="width: 10%;"></td> <td style="width: 10%;"></td> <td style="width: 10%;"></td> </tr> <tr> <td></td> <td></td> <td colspan="8" style="text-align: center;"> <table border="1" style="width: 100%; border-collapse:
collapse; text-align: center;"> <tr> <td style="width: 10%;"></td> <td style="width: 10%;"></td> <td style="width: 10%;"></td> <td style="width: 10%;"></td> <td style="width: 10%;"></td> <td style="width: 10%;"></td> <td style="width: 10%;"></td> <td style="width: 10%;"></td> <td style="width: 10%;"></td> <td style="width: 10%;"></td> </tr> <tr> <td></td> <td></td> <td colspan="8" style="text-align: center;"> <table border="1" style="width: 100%; border-collapse: collapse; text-align: center;"> <tr> <td style="width: 10%;"></td> <td style="width: 10%;"></td> <td style="width: 10%;"></td> <td style="width: 10%;"></td> <td style="width: 10%;"></td> <td style="width: 10%;"></td> <td style="width: 10%;"></td> <td style="width: 10%;"></td> <td style="width: 10%;"></td> <td style="width: 10%;"></td> </tr> <tr> <td></td> <td></td> <td colspan="8" style="text-align: center;"> <table border="1" style="width: 100%; border-collapse: collapse; text-align: center;"> <tr> <td style="width: 10%;"></td> <td style="width: 10%;"></td> <td style="width: 10%;"></td> <td style="width: 10%;"></td> <td style="width: 10%;"></td> <td style="width: 10%;"></td> <td style="width: 10%;"></td> <td style="width: 10%;"></td> <td style="width: 10%;"></td> <td style="width: 10%;"></td> </tr> <tr> <td></td> <td></td> <td colspan="8" style="text-align: center;"> <table border="1" style="width: 100%; border-collapse: collapse; text-align: center;"> <tr> </tr></table></td></tr></table></td></tr></table></td></tr></table></td></tr></table></td></tr></table></td></tr></table> | | | | | | | | | | | | | | | | | | | | <table border="1" style="width: 100%; border-collapse: collapse; text-align: center;"> <tr> <td style="width: 10%;"></td> <td style="width: 10%;"></td> <td style="width: 10%;"></td> <td style="width: 10%;"></td> <td style="width: 10%;"></td> <td style="width: 10%;"></td> <td style="width: 10%;"></td> <td style="width: 10%;"></td> <td style="width: 10%;"></td> <td style="width: 10%;"></td> </tr> <tr> <td></td> <td></td> <td colspan="8" style="text-align: center;"> <table border="1" style="width: 100%; border-collapse: collapse; text-align: center;"> <tr> <td style="width: 10%;"></td> <td style="width: 10%;"></td> <td style="width: 10%;"></td> <td style="width: 10%;"></td> <td style="width: 10%;"></td> <td style="width: 10%;"></td> <td style="width: 10%;"></td> <td style="width: 10%;"></td> <td style="width: 10%;"></td> <td style="width: 10%;"></td> </tr> <tr> <td></td> <td></td> <td colspan="8" style="text-align: center;"> <table border="1" style="width: 100%; border-collapse: collapse; text-align: center;"> <tr> <td style="width: 10%;"></td> <td style="width: 10%;"></td> <td style="width: 10%;"></td> <td style="width: 10%;"></td> <td style="width: 10%;"></td> <td style="width: 10%;"></td> <td style="width: 10%;"></td> <td style="width: 10%;"></td> <td style="width: 10%;"></td> <td style="width: 10%;"></td> </tr> <tr> <td></td> <td></td> <td colspan="8" style="text-align: center;"> <table border="1" style="width: 100%; border-collapse: collapse; text-align: center;"> <tr> <td style="width: 10%;"></td> <td style="width: 10%;"></td> <td style="width: 10%;"></td> <td style="width: 10%;"></td> <td style="width: 10%;"></td> <td style="width: 10%;"></td> <td style="width: 10%;"></td> <td style="width: 10%;"></td> <td style="width: 10%;"></td> <td style="width: 10%;"></td> </tr> <tr> <td></td> <td></td> <td colspan="8" style="text-align: center;"> <table border="1" style="width: 100%; border-collapse: collapse; text-align: center;"> <tr> <td style="width: 10%;"></td> <td style="width: 10%;"></td> <td style="width: 10%;"></td> <td style="width: 10%;"></td> <td style="width: 10%;"></td> <td style="width: 10%;"></td> <td style="width: 10%;"></td> <td style="width: 10%;"></td> <td style="width: 10%;"></td> <td style="width: 10%;"></td> </tr> <tr> <td></td> <td></td> <td colspan="8" style="text-align: center;"> <table border="1" style="width: 100%; border-collapse: collapse; text-align: center;"> <tr> </tr></table></td></tr></table></td></tr></table></td></tr></table></td></tr></table></td></tr></table> | | | | | | | | | | | | | | | | | | | | <table border="1" style="width: 100%; border-collapse: collapse; text-align: center;"> <tr> <td style="width: 10%;"></td> <td style="width: 10%;"></td> <td style="width: 10%;"></td> <td style="width: 10%;"></td> <td style="width: 10%;"></td> <td style="width: 10%;"></td> <td style="width: 10%;"></td> <td style="width: 10%;"></td> <td style="width: 10%;"></td> <td style="width: 10%;"></td> </tr> <tr> <td></td> <td></td> <td colspan="8" style="text-align: center;"> <table border="1" style="width: 100%; border-collapse: collapse; text-align: center;"> <tr> <td style="width: 10%;"></td> <td style="width: 10%;"></td> <td style="width: 10%;"></td> <td style="width: 10%;"></td> <td style="width: 10%;"></td> <td style="width: 10%;"></td> <td style="width: 10%;"></td> <td style="width: 10%;"></td> <td style="width: 10%;"></td> <td style="width: 10%;"></td> </tr> <tr> <td></td> <td></td> <td colspan="8" style="text-align: center;"> <table border="1" style="width: 100%; border-collapse: collapse; text-align: center;"> <tr> <td style="width: 10%;"></td> <td style="width: 10%;"></td> <td style="width: 10%;"></td> <td style="width: 10%;"></td> <td style="width: 10%;"></td> <td style="width: 10%;"></td> <td style="width: 10%;"></td> <td style="width: 10%;"></td> <td style="width: 10%;"></td> <td style="width: 10%;"></td> </tr> <tr> <td></td> <td></td> <td colspan="8" style="text-align: center;"> <table border="1" style="width: 100%; border-collapse: collapse; text-align: center;"> <tr> <td style="width: 10%;"></td> <td style="width: 10%;"></td> <td style="width: 10%;"></td> <td style="width: 10%;"></td> <td style="width: 10%;"></td> <td style="width: 10%;"></td> <td style="width: 10%;"></td> <td style="width: 10%;"></td> <td style="width: 10%;"></td> <td style="width: 10%;"></td> </tr> <tr> <td></td> <td></td> <td colspan="8" style="text-align: center;"> <table border="1" style="width: 100%; border-collapse: collapse; text-align: center;"> <tr> </tr></table></td></tr></table></td></tr></table></td></tr></table></td></tr></table> | | | | | | | | | | | | | | | | | | | | <table border="1" style="width: 100%; border-collapse: collapse; text-align: center;"> <tr> <td style="width: 10%;"></td> <td style="width: 10%;"></td> <td style="width: 10%;"></td> <td style="width: 10%;"></td> <td style="width: 10%;"></td> <td style="width: 10%;"></td> <td style="width: 10%;"></td> <td style="width: 10%;"></td> <td style="width: 10%;"></td> <td style="width: 10%;"></td> </tr> <tr> <td></td> <td></td> <td colspan="8" style="text-align: center;"> <table border="1" style="width: 100%; border-collapse: collapse; text-align: center;"> <tr> <td style="width: 10%;"></td> <td style="width: 10%;"></td> <td style="width: 10%;"></td> <td style="width: 10%;"></td> <td style="width: 10%;"></td> <td style="width: 10%;"></td> <td style="width: 10%;"></td> <td style="width: 10%;"></td> <td style="width: 10%;"></td> <td style="width: 10%;"></td> </tr> <tr> <td></td> <td></td> <td colspan="8" style="text-align: center;"> <table border="1" style="width: 100%; border-collapse: collapse; text-align: center;"> <tr> <td style="width: 10%;"></td> <td style="width: 10%;"></td> <td style="width: 10%;"></td> <td style="width: 10%;"></td> <td style="width: 10%;"></td> <td style="width: 10%;"></td> <td style="width: 10%;"></td> <td style="width: 10%;"></td> <td style="width: 10%;"></td> <td style="width: 10%;"></td> </tr> <tr> <td></td> <td></td> <td colspan="8" style="text-align: center;"> <table border="1" style="width: 100%; border-collapse: collapse; text-align: center;"> <tr> </tr></table></td></tr></table></td></tr></table></td></tr></table> | | | | | | | | | | | | | | | | | | | | <table border="1" style="width: 100%; border-collapse: collapse; text-align: center;"> <tr> <td
style="width: 10%;"></td> <td style="width: 10%;"></td> <td style="width: 10%;"></td> <td style="width: 10%;"></td> <td style="width: 10%;"></td> <td style="width: 10%;"></td> <td style="width: 10%;"></td> <td style="width: 10%;"></td> <td style="width: 10%;"></td> <td style="width: 10%;"></td> </tr> <tr> <td></td> <td></td> <td colspan="8" style="text-align: center;"> <table border="1" style="width: 100%; border-collapse: collapse; text-align: center;"> <tr> <td style="width: 10%;"></td> <td style="width: 10%;"></td> <td style="width: 10%;"></td> <td style="width: 10%;"></td> <td style="width: 10%;"></td> <td style="width: 10%;"></td> <td style="width: 10%;"></td> <td style="width: 10%;"></td> <td style="width: 10%;"></td> <td style="width: 10%;"></td> </tr> <tr> <td></td> <td></td> <td colspan="8" style="text-align: center;"> <table border="1" style="width: 100%; border-collapse: collapse; text-align: center;"> <tr> </tr></table></td></tr></table></td></tr></table> | | | | | | | | | | | | | | | | | | | | <table border="1" style="width: 100%; border-collapse: collapse; text-align: center;"> <tr> <td style="width: 10%;"></td> <td style="width: 10%;"></td> <td style="width: 10%;"></td> <td style="width: 10%;"></td> <td style="width: 10%;"></td> <td style="width: 10%;"></td> <td style="width: 10%;"></td> <td style="width: 10%;"></td> <td style="width: 10%;"></td> <td style="width: 10%;"></td> </tr> <tr> <td></td> <td></td> <td colspan="8" style="text-align: center;"> <table border="1" style="width: 100%; border-collapse: collapse; text-align: center;"> <tr> </tr></table></td></tr></table> | | | | | | | | | | | | | | | | | | | | <table border="1" style="width: 100%; border-collapse: collapse; text-align: center;"> <tr> </tr></table> | | | | | | | | | | | | | | | | | | | | | | | | | | | |
| | |

 | | | | | | | | | | | | | | | | | | | |

 | | | | | | | | | | | | | | | | | | | |

 | | | | | | | | | | | | | | | | | | | |

 | | | | | | | | | | | | | | | | | | | |

 | | | | | | | | | | | | | | | | | | | |

 | | | | | | | | | | | | | | | | | | | |

 | | | | | | | | | | | | | | | | | | | |

 | | | | | | | | | | | | | | | | | | | |

 | | | | | | | | | | | | | | | | | | | |

 | | | | | | | | | | | | | | | | | | | |

 | | | | | | | | | | | | | | | | | | | |

 | | | | | | | | | | | | | | | | | | | |

 | | | | | | | | | | | | | | | | | | | |

 | | | | | | | | | | | | | | | | | | | |

 | | | | | | | | | | | | | | | | | | | |

 | | | | | | | | | | | | | | | | | | | |

 | | | | | | | | | | | | | | | | | | | |

 | | | | | | | | | | | | | | | | | | | |

 | | | | | | | | | | | | | | | | | | | |

 | | | | | | | | | | | | | | | | | | | |

 | | | | | | | | | | | | | | | | | | | |

 | | | | | | | | | | | | | | | | | | | |

 | | | | | | | | | | | | | | | | | | | |

 | | | | | | | | | | | | | | | | | | | |

 | | | | | | | | | | | | | | | | | | | |

 | | | | | | | | | | | | | | | | | | | |

 | | | | | | | | | | | | | | | | | | | |

 | | | | | | | | | | | | | | | | | | | |
 | | | | | | | | | | | | | | | | | | | |

 | | | | | | | | | | | | | | | | | | | |

 | | | | | | | | | | | | | | | | | | | |
 | | | | | | | | | | | | | | | | | | | |

 | | | | | | | | | | | | | | | | | | | |

 | | | | | | | | | | | | | | | | | | | |
 | | | | | | | | | | | | | | | | | | | |
 | | | | | | | | | | | | | | | | | | | |

 | | | | | | | | | | | | | | | | | | | |
 | | | | | | | | | | | | | | | | | | | |
 | | | | | | | | | | | | | | | | | | | |

 | | | | | | | | | | | | | | | | | | | | | | | | | | | | | | | | | | | | | | | | | | | | | | | | | | | | | | | | | | | | | | | | | | | | | | | | | | | | | | | | | | | | | | | | | | | | | | | | | | | |
 | | | | | | | | | | | | | | | | | | | |
 | | | | | | | | | | | | | | | | | | | |
 | | | | | | | | | | | | | | | | | | | |
 | | | | | | | | | | | | | | | | | | | |
 | | | | | | | | | | | | | | | | | | | |
 | | | | | | | | | | | | | | | | | | | |
 | | | | | | | | | | | | | | | | | | | |
 | | | | | | | | | | | | | | | | | | | |
 | | | | | | | | | | | | | | | | | | | | | | | | | | | | | | | | | | | | | | | |
 | | | | | | | | | | | | | | | | | | | |
 | | | | | | | | | | | | | | | | | | | | | | | | | | | | | | | | | | | | | | | |
 | | | | | | | | | | | | | | | | | | | | | | | | | | | | | | | | | | | | | | | |
 | | | | | | | | | | | | | | | | | | | | | | | | | | | | | | | | | | | | | | | |
 | | | | | | | | | | | | | | | | | | | | | | | | | | | | | | | | | | | | | | | | | | | | | | | | | | | | | | | | | | | | | | | | | | | | | | | | | | | | | | | | | | | | | | | | | | | | | | | | | | | |
 | | | | | | | | | | | | | | | | | | | | | | | | | | | | | | | | | | | | | | | | | | | | | | | |
| | | <table border="1" style="width: 100%; border-collapse: collapse; text-align: center;"> <tr> <td style="width: 10%;"></td> <td style="width: 10%;"></td> <td style="width: 10%;"></td> <td style="width: 10%;"></td> <td style="width: 10%;"></td> <td style="width: 10%;"></td> <td style="width: 10%;"></td> <td style="width: 10%;"></td> <td style="width: 10%;"></td> <td style="width: 10%;"></td> </tr> <tr> <td></td> <td></td> <td colspan="8" style="text-align: center;"> <table border="1" style="width: 100%; border-collapse: collapse; text-align: center;"> <tr> <td style="width: 10%;"></td> <td style="width: 10%;"></td> <td style="width: 10%;"></td> <td style="width: 10%;"></td> <td style="width: 10%;"></td> <td style="width: 10%;"></td> <td style="width: 10%;"></td> <td style="width: 10%;"></td> <td style="width: 10%;"></td> <td style="width: 10%;"></td> </tr> <tr> <td></td> <td></td> <td colspan="8" style="text-align: center;"> <table border="1" style="width: 100%; border-collapse: collapse; text-align: center;"> <tr> <td style="width: 10%;"></td> <td style="width: 10%;"></td> <td style="width: 10%;"></td> <td style="width: 10%;"></td> <td style="width: 10%;"></td> <td style="width: 10%;"></td> <td style="width: 10%;"></td> <td style="width: 10%;"></td> <td style="width: 10%;"></td> <td style="width: 10%;"></td> </tr> <tr> <td></td> <td></td> <td colspan="8" style="text-align: center;"> <table border="1" style="width: 100%; border-collapse: collapse; text-align: center;"> <tr> <td style="width: 10%;"></td> <td style="width: 10%;"></td> <td style="width: 10%;"></td> <td style="width: 10%;"></td> <td style="width: 10%;"></td> <td style="width: 10%;"></td> <td style="width: 10%;"></td> <td style="width: 10%;"></td> <td style="width: 10%;"></td> <td style="width: 10%;"></td> </tr> <tr> <td></td> <td></td> <td colspan="8" style="text-align: center;"> <table border="1" style="width: 100%; border-collapse: collapse; text-align: center;"> <tr> <td style="width: 10%;"></td> <td style="width: 10%;"></td> <td style="width: 10%;"></td> <td style="width: 10%;"></td> <td style="width: 10%;"></td> <td style="width: 10%;"></td> <td style="width: 10%;"></td> <td style="width: 10%;"></td> <td style="width: 10%;"></td> <td style="width: 10%;"></td> </tr> <tr> <td></td> <td></td> <td colspan="8" style="text-align: center;"> <table border="1" style="width: 100%; border-collapse: collapse; text-align: center;"> <tr> <td style="width: 10%;"></td> <td style="width: 10%;"></td> <td style="width: 10%;"></td> <td style="width: 10%;"></td> <td style="width: 10%;"></td> <td style="width: 10%;"></td> <td style="width: 10%;"></td> <td style="width: 10%;"></td> <td style="width: 10%;"></td> <td style="width: 10%;"></td> </tr> <tr> <td></td> <td></td> <td colspan="8" style="text-align: center;"> <table border="1" style="width: 100%; border-collapse: collapse; text-align: center;"> <tr> <td style="width: 10%;"></td> <td style="width: 10%;"></td> <td style="width: 10%;"></td> <td style="width: 10%;"></td> <td style="width: 10%;"></td> <td style="width: 10%;"></td> <td style="width: 10%;"></td> <td style="width: 10%;"></td> <td style="width: 10%;"></td> <td style="width: 10%;"></td> </tr> <tr> <td></td> <td></td> <td colspan="8" style="text-align: center;"> <table border="1" style="width: 100%; border-collapse: collapse; text-align: center;"> <tr> <td style="width: 10%;"></td> <td style="width: 10%;"></td> <td style="width: 10%;"></td> <td style="width: 10%;"></td> <td style="width: 10%;"></td> <td style="width: 10%;"></td> <td style="width: 10%;"></td> <td style="width: 10%;"></td> <td style="width: 10%;"></td> <td style="width: 10%;"></td> </tr> <tr> <td></td> <td></td> <td colspan="8" style="text-align: center;"> <table border="1" style="width: 100%; border-collapse: collapse; text-align: center;"> <tr> <td style="width: 10%;"></td> <td style="width: 10%;"></td> <td style="width: 10%;"></td> <td style="width: 10%;"></td> <td style="width: 10%;"></td> <td style="width: 10%;"></td> <td style="width: 10%;"></td> <td style="width: 10%;"></td> <td style="width: 10%;"></td> <td style="width: 10%;"></td> </tr> <tr> <td></td> <td></td> <td colspan="8" style="text-align: center;"> <table border="1" style="width: 100%; border-collapse: collapse; text-align: center;"> <tr> <td style="width: 10%;"></td> <td style="width: 10%;"></td> <td style="width: 10%;"></td> <td style="width: 10%;"></td> <td style="width: 10%;"></td> <td style="width: 10%;"></td> <td style="width: 10%;"></td> <td style="width: 10%;"></td> <td style="width: 10%;"></td> <td style="width: 10%;"></td> </tr> <tr> <td></td> <td></td> <td colspan="8" style="text-align: center;"> <table border="1" style="width: 100%; border-collapse: collapse; text-align: center;"> <tr> <td style="width: 10%;"></td> <td style="width: 10%;"></td> <td style="width: 10%;"></td> <td style="width: 10%;"></td> <td style="width: 10%;"></td> <td style="width: 10%;"></td> <td style="width: 10%;"></td> <td style="width: 10%;"></td> <td style="width: 10%;"></td> <td style="width: 10%;"></td> </tr> <tr> <td></td> <td></td> <td colspan="8" style="text-align: center;"> <table border="1" style="width: 100%; border-collapse: collapse; text-align: center;"> <tr> <td style="width: 10%;"></td> <td style="width: 10%;"></td> <td style="width: 10%;"></td> <td style="width: 10%;"></td> <td style="width: 10%;"></td> <td style="width: 10%;"></td> <td style="width: 10%;"></td> <td style="width: 10%;"></td> <td style="width: 10%;"></td> <td style="width: 10%;"></td> </tr> <tr> <td></td> <td></td> <td colspan="8" style="text-align: center;"> <table border="1" style="width: 100%; border-collapse: collapse; text-align: center;"> <tr> <td style="width: 10%;"></td> <td style="width: 10%;"></td> <td style="width: 10%;"></td> <td style="width: 10%;"></td> <td style="width: 10%;"></td> <td style="width: 10%;"></td> <td style="width: 10%;"></td> <td style="width: 10%;"></td> <td style="width: 10%;"></td> <td style="width: 10%;"></td> </tr> <tr> <td></td> <td></td> <td colspan="8" style="text-align: center;"> <table border="1" style="width: 100%; border-collapse: collapse; text-align: center;"> <tr> <td style="width: 10%;"></td> <td style="width: 10%;"></td> <td style="width: 10%;"></td> <td style="width: 10%;"></td> <td style="width: 10%;"></td> <td style="width: 10%;"></td> <td style="width: 10%;"></td> <td style="width: 10%;"></td> <td style="width: 10%;"></td> <td style="width: 10%;"></td> </tr> <tr> <td></td> <td></td> <td colspan="8" style="text-align: center;"> <table border="1" style="width: 100%; border-collapse: collapse; text-align: center;"> <tr> <td style="width: 10%;"></td> <td style="width: 10%;"></td> <td style="width: 10%;"></td> <td style="width: 10%;"></td> <td style="width: 10%;"></td> <td style="width: 10%;"></td> <td style="width: 10%;"></td> <td style="width: 10%;"></td> <td style="width: 10%;"></td> <td style="width: 10%;"></td> </tr> <tr> <td></td> <td></td> <td colspan="8" style="text-align: center;"> <table border="1" style="width: 100%; border-collapse: collapse; text-align: center;"> <tr> <td style="width: 10%;"></td> <td style="width: 10%;"></td> <td style="width: 10%;"></td> <td style="width: 10%;"></td> <td style="width: 10%;"></td> <td style="width: 10%;"></td> <td style="width: 10%;"></td> <td style="width: 10%;"></td> <td style="width: 10%;"></td> <td style="width: 10%;"></td> </tr> <tr> <td></td> <td></td> <td colspan="8" style="text-align: center;"> <table border="1" style="width: 100%; border-collapse: collapse; text-align: center;"> <tr> <td style="width: 10%;"></td> <td style="width: 10%;"></td> <td style="width: 10%;"></td> <td style="width: 10%;"></td> <td style="width: 10%;"></td> <td style="width: 10%;"></td> <td style="width: 10%;"></td> <td style="width: 10%;"></td> <td style="width: 10%;"></td> <td style="width: 10%;"></td> </tr> <tr> <td></td> <td></td> <td colspan="8" style="text-align: center;"> <table border="1" style="width: 100%; border-collapse: collapse; text-align: center;"> <tr> <td style="width: 10%;"></td> <td style="width: 10%;"></td> <td style="width: 10%;"></td> <td style="width: 10%;"></td> <td style="width: 10%;"></td> <td style="width: 10%;"></td> <td style="width: 10%;"></td> <td style="width: 10%;"></td> <td style="width: 10%;"></td> <td style="width: 10%;"></td> </tr> <tr> <td></td> <td></td> <td colspan="8" style="text-align: center;"> <table border="1" style="width: 100%; border-collapse: collapse; text-align: center;"> <tr> <td style="width: 10%;"></td> <td style="width: 10%;"></td> <td style="width: 10%;"></td> <td style="width: 10%;"></td> <td style="width: 10%;"></td> <td style="width: 10%;"></td> <td style="width: 10%;"></td> <td style="width: 10%;"></td> <td style="width: 10%;"></td> <td style="width: 10%;"></td> </tr> <tr> <td></td> <td></td> <td colspan="8" style="text-align: center;"> <table border="1" style="width: 100%; border-collapse: collapse; text-align: center;"> <tr> <td style="width: 10%;"></td> <td style="width: 10%;"></td> <td style="width: 10%;"></td> <td style="width: 10%;"></td> <td style="width: 10%;"></td> <td style="width: 10%;"></td> <td style="width: 10%;"></td> <td style="width: 10%;"></td> <td style="width: 10%;"></td> <td style="width: 10%;"></td> </tr> <tr> <td></td> <td></td> <td colspan="8" style="text-align: center;"> <table border="1" style="width: 100%; border-collapse: collapse; text-align: center;"> <tr> <td style="width: 10%;"></td> <td style="width: 10%;"></td> <td style="width: 10%;"></td> <td style="width: 10%;"></td> <td style="width: 10%;"></td> <td style="width: 10%;"></td> <td style="width: 10%;"></td> <td style="width: 10%;"></td> <td style="width: 10%;"></td> <td style="width: 10%;"></td> </tr> <tr> <td></td> <td></td> <td colspan="8" style="text-align: center;"> <table border="1" style="width: 100%; border-collapse: collapse; text-align: center;"> <tr> <td style="width: 10%;"></td> <td style="width: 10%;"></td> <td
style="width: 10%;"></td> <td style="width: 10%;"></td> <td style="width: 10%;"></td> <td style="width: 10%;"></td> <td style="width: 10%;"></td> <td style="width: 10%;"></td> <td style="width: 10%;"></td> <td style="width: 10%;"></td> </tr> <tr> <td></td> <td></td> <td colspan="8" style="text-align: center;"> <table border="1" style="width: 100%; border-collapse: collapse; text-align: center;"> <tr> <td style="width: 10%;"></td> <td style="width: 10%;"></td> <td style="width: 10%;"></td> <td style="width: 10%;"></td> <td style="width: 10%;"></td> <td style="width: 10%;"></td> <td style="width: 10%;"></td> <td style="width: 10%;"></td> <td style="width: 10%;"></td> <td style="width: 10%;"></td> </tr> <tr> <td></td> <td></td> <td colspan="8" style="text-align: center;"> <table border="1" style="width: 100%; border-collapse: collapse; text-align: center;"> <tr> <td style="width: 10%;"></td> <td style="width: 10%;"></td> <td style="width: 10%;"></td> <td style="width: 10%;"></td> <td style="width: 10%;"></td> <td style="width: 10%;"></td> <td style="width: 10%;"></td> <td style="width: 10%;"></td> <td style="width: 10%;"></td> <td style="width: 10%;"></td> </tr> <tr> <td></td> <td></td> <td colspan="8" style="text-align: center;"> <table border="1" style="width: 100%; border-collapse: collapse; text-align: center;"> <tr> <td style="width: 10%;"></td> <td style="width: 10%;"></td> <td style="width: 10%;"></td> <td style="width: 10%;"></td> <td style="width: 10%;"></td> <td style="width: 10%;"></td> <td style="width: 10%;"></td> <td style="width: 10%;"></td> <td style="width: 10%;"></td> <td style="width: 10%;"></td> </tr> <tr> <td></td> <td></td> <td colspan="8" style="text-align: center;"> <table border="1" style="width: 100%; border-collapse: collapse; text-align: center;"> <tr> <td style="width: 10%;"></td> <td style="width: 10%;"></td> <td style="width: 10%;"></td> <td style="width: 10%;"></td> <td style="width: 10%;"></td> <td style="width: 10%;"></td> <td style="width: 10%;"></td> <td style="width: 10%;"></td> <td style="width: 10%;"></td> <td style="width: 10%;"></td> </tr> <tr> <td></td> <td></td> <td colspan="8" style="text-align: center;"> <table border="1" style="width: 100%; border-collapse: collapse; text-align: center;"> <tr> <td style="width: 10%;"></td> <td style="width: 10%;"></td> <td style="width: 10%;"></td> <td style="width: 10%;"></td> <td style="width: 10%;"></td> <td style="width: 10%;"></td> <td style="width: 10%;"></td> <td style="width: 10%;"></td> <td style="width: 10%;"></td> <td style="width: 10%;"></td> </tr> <tr> <td></td> <td></td> <td colspan="8" style="text-align: center;"> <table border="1" style="width: 100%; border-collapse: collapse; text-align: center;"> <tr> <td style="width: 10%;"></td> <td style="width: 10%;"></td> <td style="width: 10%;"></td> <td style="width: 10%;"></td> <td style="width: 10%;"></td> <td style="width: 10%;"></td> <td style="width: 10%;"></td> <td style="width: 10%;"></td> <td style="width: 10%;"></td> <td style="width: 10%;"></td> </tr> <tr> <td></td> <td></td> <td colspan="8" style="text-align: center;"> <table border="1" style="width: 100%; border-collapse: collapse; text-align: center;"> <tr> <td style="width: 10%;"></td> <td style="width: 10%;"></td> <td style="width: 10%;"></td> <td style="width: 10%;"></td> <td style="width: 10%;"></td> <td style="width: 10%;"></td> <td style="width: 10%;"></td> <td style="width: 10%;"></td> <td style="width: 10%;"></td> <td style="width: 10%;"></td> </tr> <tr> <td></td> <td></td> <td colspan="8" style="text-align: center;"> <table border="1" style="width: 100%; border-collapse: collapse; text-align: center;"> <tr> <td style="width: 10%;"></td> <td style="width: 10%;"></td> <td style="width: 10%;"></td> <td style="width: 10%;"></td> <td style="width: 10%;"></td> <td style="width: 10%;"></td> <td style="width: 10%;"></td> <td style="width: 10%;"></td> <td style="width: 10%;"></td> <td style="width: 10%;"></td> </tr> <tr> <td></td> <td></td> <td colspan="8" style="text-align: center;"> <table border="1" style="width: 100%; border-collapse: collapse; text-align: center;"> <tr> <td style="width: 10%;"></td> <td style="width: 10%;"></td> <td style="width: 10%;"></td> <td style="width: 10%;"></td> <td style="width: 10%;"></td> <td style="width: 10%;"></td> <td style="width: 10%;"></td> <td style="width: 10%;"></td> <td style="width: 10%;"></td> <td style="width: 10%;"></td> </tr> <tr> <td></td> <td></td> <td colspan="8" style="text-align: center;"> <table border="1" style="width: 100%; border-collapse: collapse; text-align: center;"> <tr> <td style="width: 10%;"></td> <td style="width: 10%;"></td> <td style="width: 10%;"></td> <td style="width: 10%;"></td> <td style="width: 10%;"></td> <td style="width: 10%;"></td> <td style="width: 10%;"></td> <td style="width: 10%;"></td> <td style="width: 10%;"></td> <td style="width: 10%;"></td> </tr> <tr> <td></td> <td></td> <td colspan="8" style="text-align: center;"> <table border="1" style="width: 100%; border-collapse: collapse; text-align: center;"> <tr> <td style="width: 10%;"></td> <td style="width: 10%;"></td> <td style="width: 10%;"></td> <td style="width: 10%;"></td> <td style="width: 10%;"></td> <td style="width: 10%;"></td> <td style="width: 10%;"></td> <td style="width: 10%;"></td> <td style="width: 10%;"></td> <td style="width: 10%;"></td> </tr> <tr> <td></td> <td></td> <td colspan="8" style="text-align: center;"> <table border="1" style="width: 100%; border-collapse: collapse; text-align: center;"> <tr> <td style="width: 10%;"></td> <td style="width: 10%;"></td> <td style="width: 10%;"></td> <td style="width: 10%;"></td> <td style="width: 10%;"></td> <td style="width: 10%;"></td> <td style="width: 10%;"></td> <td style="width: 10%;"></td> <td style="width: 10%;"></td> <td style="width: 10%;"></td> </tr> <tr> <td></td> <td></td> <td colspan="8" style="text-align: center;"> <table border="1" style="width: 100%; border-collapse: collapse; text-align: center;"> <tr> <td style="width: 10%;"></td> <td style="width: 10%;"></td> <td style="width: 10%;"></td> <td style="width: 10%;"></td> <td style="width: 10%;"></td> <td style="width: 10%;"></td> <td style="width: 10%;"></td> <td style="width: 10%;"></td> <td style="width: 10%;"></td> <td style="width: 10%;"></td> </tr> <tr> <td></td> <td></td> <td colspan="8" style="text-align: center;"> <table border="1" style="width: 100%; border-collapse: collapse; text-align: center;"> <tr> <td style="width: 10%;"></td> <td style="width: 10%;"></td> <td style="width: 10%;"></td> <td style="width: 10%;"></td> <td style="width: 10%;"></td> <td style="width: 10%;"></td> <td style="width: 10%;"></td> <td style="width: 10%;"></td> <td style="width: 10%;"></td> <td style="width: 10%;"></td> </tr> <tr> <td></td> <td></td> <td colspan="8" style="text-align: center;"> <table border="1" style="width: 100%; border-collapse: collapse; text-align: center;"> <tr> <td style="width: 10%;"></td> <td style="width: 10%;"></td> <td style="width: 10%;"></td> <td style="width: 10%;"></td> <td style="width: 10%;"></td> <td style="width: 10%;"></td> <td style="width: 10%;"></td> <td style="width: 10%;"></td> <td style="width: 10%;"></td> <td style="width: 10%;"></td> </tr> <tr> <td></td> <td></td> <td colspan="8" style="text-align: center;"> <table border="1" style="width: 100%; border-collapse: collapse; text-align: center;"> <tr> <td style="width: 10%;"></td> <td style="width: 10%;"></td> <td style="width: 10%;"></td> <td style="width: 10%;"></td> <td style="width: 10%;"></td> <td style="width: 10%;"></td> <td style="width: 10%;"></td> <td style="width: 10%;"></td> <td style="width: 10%;"></td> <td style="width: 10%;"></td> </tr> <tr> <td></td> <td></td> <td colspan="8" style="text-align: center;"> <table border="1" style="width: 100%; border-collapse: collapse; text-align: center;"> <tr> <td style="width: 10%;"></td> <td style="width: 10%;"></td> <td style="width: 10%;"></td> <td style="width: 10%;"></td> <td style="width: 10%;"></td> <td style="width: 10%;"></td> <td style="width: 10%;"></td> <td style="width: 10%;"></td> <td style="width: 10%;"></td> <td style="width: 10%;"></td> </tr> <tr> <td></td> <td></td> <td colspan="8" style="text-align: center;"> <table border="1" style="width: 100%; border-collapse: collapse; text-align: center;"> <tr> <td style="width: 10%;"></td> <td style="width: 10%;"></td> <td style="width: 10%;"></td> <td style="width: 10%;"></td> <td style="width: 10%;"></td> <td style="width: 10%;"></td> <td style="width: 10%;"></td> <td style="width: 10%;"></td> <td style="width: 10%;"></td> <td style="width: 10%;"></td> </tr> <tr> <td></td> <td></td> <td colspan="8" style="text-align: center;"> <table border="1" style="width: 100%; border-collapse: collapse; text-align: center;"> <tr> <td style="width: 10%;"></td> <td style="width: 10%;"></td> <td style="width: 10%;"></td> <td style="width: 10%;"></td> <td style="width: 10%;"></td> <td style="width: 10%;"></td> <td style="width: 10%;"></td> <td style="width: 10%;"></td> <td style="width: 10%;"></td> <td style="width: 10%;"></td> </tr> <tr> <td></td> <td></td> <td colspan="8" style="text-align: center;"> <table border="1" style="width: 100%; border-collapse: collapse; text-align: center;"> <tr> <td style="width: 10%;"></td> <td style="width: 10%;"></td> <td style="width: 10%;"></td> <td style="width: 10%;"></td> <td style="width: 10%;"></td> <td style="width: 10%;"></td> <td style="width: 10%;"></td> <td style="width: 10%;"></td> <td style="width: 10%;"></td> <td style="width: 10%;"></td> </tr> <tr> <td></td> <td></td> <td colspan="8" style="text-align: center;"> <table border="1" style="width: 100%; border-collapse: collapse; text-align: center;"> <tr> <td style="width: 10%;"></td> <td style="width: 10%;"></td> <td style="width: 10%;"></td> <td style="width: 10%;"></td> <td style="width: 10%;"></td> <td style="width: 10%;"></td> <td style="width: 10%;"></td> <td style="width:
10%;"></td> <td style="width: 10%;"></td> <td style="width: 10%;"></td> </tr> <tr> <td></td> <td></td> <td colspan="8" style="text-align: center;"> <table border="1" style="width: 100%; border-collapse: collapse; text-align: center;"> <tr> <td style="width: 10%;"></td> <td style="width: 10%;"></td> <td style="width: 10%;"></td> <td style="width: 10%;"></td> <td style="width: 10%;"></td> <td style="width: 10%;"></td> <td style="width: 10%;"></td> <td style="width: 10%;"></td> <td style="width: 10%;"></td> <td style="width: 10%;"></td> </tr> <tr> <td></td> <td></td> <td colspan="8" style="text-align: center;"> <table border="1" style="width: 100%; border-collapse: collapse; text-align: center;"> <tr> <td style="width: 10%;"></td> <td style="width: 10%;"></td> <td style="width: 10%;"></td> <td style="width: 10%;"></td> <td style="width: 10%;"></td> <td style="width: 10%;"></td> <td style="width: 10%;"></td> <td style="width: 10%;"></td> <td style="width: 10%;"></td> <td style="width: 10%;"></td> </tr> <tr> <td></td> <td></td> <td colspan="8" style="text-align: center;"> <table border="1" style="width: 100%; border-collapse: collapse; text-align: center;"> <tr> <td style="width: 10%;"></td> <td style="width: 10%;"></td> <td style="width: 10%;"></td> <td style="width: 10%;"></td> <td style="width: 10%;"></td> <td style="width: 10%;"></td> <td style="width: 10%;"></td> <td style="width: 10%;"></td> <td style="width: 10%;"></td> <td style="width: 10%;"></td> </tr> <tr> <td></td> <td></td> <td colspan="8" style="text-align: center;"> <table border="1" style="width: 100%; border-collapse: collapse; text-align: center;"> <tr> <td style="width: 10%;"></td> <td style="width: 10%;"></td> <td style="width: 10%;"></td> <td style="width: 10%;"></td> <td style="width: 10%;"></td> <td style="width: 10%;"></td> <td style="width: 10%;"></td> <td style="width: 10%;"></td> <td style="width: 10%;"></td> <td style="width: 10%;"></td> </tr> <tr> <td></td> <td></td> <td colspan="8" style="text-align: center;"> <table border="1" style="width: 100%; border-collapse: collapse; text-align: center;"> <tr> <td style="width: 10%;"></td> <td style="width: 10%;"></td> <td style="width: 10%;"></td> <td style="width: 10%;"></td> <td style="width: 10%;"></td> <td style="width: 10%;"></td> <td style="width: 10%;"></td> <td style="width: 10%;"></td> <td style="width: 10%;"></td> <td style="width: 10%;"></td> </tr> <tr> <td></td> <td></td> <td colspan="8" style="text-align: center;"> <table border="1" style="width: 100%; border-collapse: collapse; text-align: center;"> <tr> <td style="width: 10%;"></td> <td style="width: 10%;"></td> <td style="width: 10%;"></td> <td style="width: 10%;"></td> <td style="width: 10%;"></td> <td style="width: 10%;"></td> <td style="width: 10%;"></td> <td style="width: 10%;"></td> <td style="width: 10%;"></td> <td style="width: 10%;"></td> </tr> <tr> <td></td> <td></td> <td colspan="8" style="text-align: center;"> <table border="1" style="width: 100%; border-collapse: collapse; text-align: center;"> <tr> <td style="width: 10%;"></td> <td style="width: 10%;"></td> <td style="width: 10%;"></td> <td style="width: 10%;"></td> <td style="width: 10%;"></td> <td style="width: 10%;"></td> <td style="width: 10%;"></td> <td style="width: 10%;"></td> <td style="width: 10%;"></td> <td style="width: 10%;"></td> </tr> <tr> <td></td> <td></td> <td colspan="8" style="text-align: center;"> <table border="1" style="width: 100%; border-collapse: collapse; text-align: center;"> <tr> <td style="width: 10%;"></td> <td style="width: 10%;"></td> <td style="width: 10%;"></td> <td style="width: 10%;"></td> <td style="width: 10%;"></td> <td style="width: 10%;"></td> <td style="width: 10%;"></td> <td style="width: 10%;"></td> <td style="width: 10%;"></td> <td style="width: 10%;"></td> </tr> <tr> <td></td> <td></td> <td colspan="8" style="text-align: center;"> <table border="1" style="width: 100%; border-collapse: collapse; text-align: center;"> <tr> <td style="width: 10%;"></td> <td style="width: 10%;"></td> <td style="width: 10%;"></td> <td style="width: 10%;"></td> <td style="width: 10%;"></td> <td style="width: 10%;"></td> <td style="width: 10%;"></td> <td style="width: 10%;"></td> <td style="width: 10%;"></td> <td style="width: 10%;"></td> </tr> <tr> <td></td> <td></td> <td colspan="8" style="text-align: center;"> <table border="1" style="width: 100%; border-collapse: collapse; text-align: center;"> <tr> <td style="width: 10%;"></td> <td style="width: 10%;"></td> <td style="width: 10%;"></td> <td style="width: 10%;"></td> <td style="width: 10%;"></td> <td style="width: 10%;"></td> <td style="width: 10%;"></td> <td style="width: 10%;"></td> <td style="width: 10%;"></td> <td style="width: 10%;"></td> </tr> <tr> <td></td> <td></td> <td colspan="8" style="text-align: center;"> <table border="1" style="width: 100%; border-collapse: collapse; text-align: center;"> <tr> <td style="width: 10%;"></td> <td style="width: 10%;"></td> <td style="width: 10%;"></td> <td style="width: 10%;"></td> <td style="width: 10%;"></td> <td style="width: 10%;"></td> <td style="width: 10%;"></td> <td style="width: 10%;"></td> <td style="width: 10%;"></td> <td style="width: 10%;"></td> </tr> <tr> <td></td> <td></td> <td colspan="8" style="text-align: center;"> <table border="1" style="width: 100%; border-collapse: collapse; text-align: center;"> <tr> <td style="width: 10%;"></td> <td style="width: 10%;"></td> <td style="width: 10%;"></td> <td style="width: 10%;"></td> <td style="width: 10%;"></td> <td style="width: 10%;"></td> <td style="width: 10%;"></td> <td style="width: 10%;"></td> <td style="width: 10%;"></td> <td style="width: 10%;"></td> </tr> <tr> <td></td> <td></td> <td colspan="8" style="text-align: center;"> <table border="1" style="width: 100%; border-collapse: collapse; text-align: center;"> <tr> <td style="width: 10%;"></td> <td style="width: 10%;"></td> <td style="width: 10%;"></td> <td style="width: 10%;"></td> <td style="width: 10%;"></td> <td style="width: 10%;"></td> <td style="width: 10%;"></td> <td style="width: 10%;"></td> <td style="width: 10%;"></td> <td style="width: 10%;"></td> </tr> <tr> <td></td> <td></td> <td colspan="8" style="text-align: center;"> <table border="1" style="width: 100%; border-collapse: collapse; text-align: center;"> <tr> <td style="width: 10%;"></td> <td style="width: 10%;"></td> <td style="width: 10%;"></td> <td style="width: 10%;"></td> <td style="width: 10%;"></td> <td style="width: 10%;"></td> <td style="width: 10%;"></td> <td style="width: 10%;"></td> <td style="width: 10%;"></td> <td style="width: 10%;"></td> </tr> <tr> <td></td> <td></td> <td colspan="8" style="text-align: center;"> <table border="1" style="width: 100%; border-collapse: collapse; text-align: center;"> <tr> <td style="width: 10%;"></td> <td style="width: 10%;"></td> <td style="width: 10%;"></td> <td style="width: 10%;"></td> <td style="width: 10%;"></td> <td style="width: 10%;"></td> <td style="width: 10%;"></td> <td style="width: 10%;"></td> <td style="width: 10%;"></td> <td style="width: 10%;"></td> </tr> <tr> <td></td> <td></td> <td colspan="8" style="text-align: center;"> <table border="1" style="width: 100%; border-collapse: collapse; text-align: center;"> <tr> <td style="width: 10%;"></td> <td style="width: 10%;"></td> <td style="width: 10%;"></td> <td style="width: 10%;"></td> <td style="width: 10%;"></td> <td style="width: 10%;"></td> <td style="width: 10%;"></td> <td style="width: 10%;"></td> <td style="width: 10%;"></td> <td style="width: 10%;"></td> </tr> <tr> <td></td> <td></td> <td colspan="8" style="text-align: center;"> <table border="1" style="width: 100%; border-collapse: collapse; text-align: center;"> <tr> <td style="width: 10%;"></td> <td style="width: 10%;"></td> <td style="width: 10%;"></td> <td style="width: 10%;"></td> <td style="width: 10%;"></td> <td style="width: 10%;"></td> <td style="width: 10%;"></td> <td style="width: 10%;"></td> <td style="width: 10%;"></td> <td style="width: 10%;"></td> </tr> <tr> <td></td> <td></td> <td colspan="8" style="text-align: center;"> <table border="1" style="width: 100%; border-collapse: collapse; text-align: center;"> <tr> <td style="width: 10%;"></td> <td style="width: 10%;"></td> <td style="width: 10%;"></td> <td style="width: 10%;"></td> <td style="width: 10%;"></td> <td style="width: 10%;"></td> <td style="width: 10%;"></td> <td style="width: 10%;"></td> <td style="width: 10%;"></td> <td style="width: 10%;"></td> </tr> <tr> <td></td> <td></td> <td colspan="8" style="text-align: center;"> <table border="1" style="width: 100%; border-collapse: collapse; text-align: center;"> <tr> <td style="width: 10%;"></td> <td style="width: 10%;"></td> <td style="width: 10%;"></td> <td style="width: 10%;"></td> <td style="width: 10%;"></td> <td style="width: 10%;"></td> <td style="width: 10%;"></td> <td style="width: 10%;"></td> <td style="width: 10%;"></td> <td style="width: 10%;"></td> </tr> <tr> <td></td> <td></td> <td colspan="8" style="text-align: center;"> <table border="1" style="width: 100%; border-collapse: collapse; text-align: center;"> <tr>
</tr></table></td></tr></table></td></tr></table></td></tr></table></td></tr></table></td></tr></table></td></tr></table></td></tr></table></td></tr></table></td></tr></table></td></tr></table></td></tr></table></td></tr></table></td></tr></table></td></tr></table></td></tr></table></td></tr></table></td></tr></table></td></tr></table></td></tr></table></td></tr></table></td></tr></table></td></tr></table></td></tr></table></td></tr></table></td></tr></table></td></tr></table></td></tr></table></td></tr></table></td></tr></table></td></tr></table></td></tr></table></td></tr></table></td></tr></table></td></tr></table></td></tr></table></td></tr></table></td></tr></table></td></tr></table></td></tr></table></td></tr></table></td></tr></table></td></tr></table></td></tr></table></td></tr></table></td></tr></table></td></tr></table></td></tr></table></td></tr></table></td></tr></table></td></tr></table></td></tr></table></td></tr></table></td></tr></table></td></tr></table></td></tr></table></td></tr></table></td></tr></table></td></tr></table></td></tr></table></td></tr></table></td></tr></table></td></tr></table> | | | | | | | | | | | | | | | | | | | | <table border="1" style="width: 100%; border-collapse: collapse; text-align: center;"> <tr> <td style="width: 10%;"></td> <td style="width: 10%;"></td> <td style="width: 10%;"></td> <td style="width: 10%;"></td> <td style="width: 10%;"></td> <td style="width: 10%;"></td> <td style="width: 10%;"></td> <td style="width: 10%;"></td> <td style="width: 10%;"></td> <td style="width: 10%;"></td> </tr> <tr> <td></td> <td></td> <td colspan="8" style="text-align: center;"> <table border="1" style="width: 100%; border-collapse: collapse; text-align: center;"> <tr> <td style="width: 10%;"></td> <td style="width: 10%;"></td> <td style="width: 10%;"></td> <td style="width: 10%;"></td> <td style="width: 10%;"></td> <td style="width: 10%;"></td> <td style="width: 10%;"></td> <td style="width: 10%;"></td> <td style="width: 10%;"></td> <td style="width: 10%;"></td> </tr> <tr> <td></td> <td></td> <td colspan="8" style="text-align: center;"> <table border="1" style="width: 100%; border-collapse: collapse; text-align: center;"> <tr> <td style="width: 10%;"></td> <td style="width: 10%;"></td> <td style="width: 10%;"></td> <td style="width: 10%;"></td> <td style="width: 10%;"></td> <td style="width: 10%;"></td> <td style="width: 10%;"></td> <td style="width: 10%;"></td> <td style="width: 10%;"></td> <td style="width: 10%;"></td> </tr> <tr> <td></td> <td></td> <td colspan="8" style="text-align: center;"> <table border="1" style="width: 100%; border-collapse: collapse; text-align: center;"> <tr> <td style="width: 10%;"></td> <td style="width: 10%;"></td> <td style="width: 10%;"></td> <td style="width: 10%;"></td> <td style="width: 10%;"></td> <td style="width: 10%;"></td> <td style="width: 10%;"></td> <td style="width: 10%;"></td> <td style="width: 10%;"></td> <td style="width: 10%;"></td> </tr> <tr> <td></td> <td></td> <td colspan="8" style="text-align: center;"> <table border="1" style="width: 100%; border-collapse: collapse; text-align: center;"> <tr> <td style="width: 10%;"></td> <td style="width: 10%;"></td> <td style="width: 10%;"></td> <td style="width: 10%;"></td> <td style="width: 10%;"></td> <td style="width: 10%;"></td> <td style="width: 10%;"></td> <td style="width: 10%;"></td> <td style="width: 10%;"></td> <td style="width: 10%;"></td> </tr> <tr> <td></td> <td></td> <td colspan="8" style="text-align: center;"> <table border="1" style="width: 100%; border-collapse: collapse; text-align: center;"> <tr> <td style="width: 10%;"></td> <td style="width: 10%;"></td> <td style="width: 10%;"></td> <td style="width: 10%;"></td> <td style="width: 10%;"></td> <td style="width: 10%;"></td> <td style="width: 10%;"></td> <td style="width: 10%;"></td> <td style="width: 10%;"></td> <td style="width: 10%;"></td> </tr> <tr> <td></td> <td></td> <td colspan="8" style="text-align: center;"> <table border="1" style="width: 100%; border-collapse: collapse; text-align: center;"> <tr> <td style="width: 10%;"></td> <td style="width: 10%;"></td> <td style="width: 10%;"></td> <td style="width: 10%;"></td> <td style="width: 10%;"></td> <td style="width: 10%;"></td> <td style="width: 10%;"></td> <td style="width: 10%;"></td> <td style="width: 10%;"></td> <td style="width: 10%;"></td> </tr> <tr> <td></td> <td></td> <td colspan="8" style="text-align: center;"> <table border="1" style="width: 100%; border-collapse: collapse; text-align: center;"> <tr> <td style="width: 10%;"></td> <td style="width: 10%;"></td> <td style="width: 10%;"></td> <td style="width: 10%;"></td> <td style="width: 10%;"></td> <td style="width: 10%;"></td> <td style="width: 10%;"></td> <td style="width: 10%;"></td> <td style="width: 10%;"></td> <td style="width: 10%;"></td> </tr> <tr> <td></td> <td></td> <td colspan="8" style="text-align: center;"> <table border="1" style="width: 100%; border-collapse: collapse; text-align: center;"> <tr> <td style="width: 10%;"></td> <td style="width: 10%;"></td> <td style="width: 10%;"></td> <td style="width: 10%;"></td> <td style="width: 10%;"></td> <td style="width: 10%;"></td> <td style="width: 10%;"></td> <td style="width: 10%;"></td> <td style="width: 10%;"></td> <td style="width: 10%;"></td> </tr> <tr> <td></td> <td></td> <td colspan="8" style="text-align: center;"> <table border="1" style="width: 100%; border-collapse: collapse; text-align: center;"> <tr> <td style="width: 10%;"></td> <td style="width: 10%;"></td> <td style="width: 10%;"></td> <td style="width: 10%;"></td> <td style="width: 10%;"></td> <td style="width: 10%;"></td> <td style="width: 10%;"></td> <td style="width: 10%;"></td> <td style="width: 10%;"></td> <td style="width: 10%;"></td> </tr> <tr> <td></td> <td></td> <td colspan="8" style="text-align: center;"> <table border="1" style="width: 100%; border-collapse: collapse; text-align: center;"> <tr> <td style="width: 10%;"></td> <td style="width: 10%;"></td> <td style="width: 10%;"></td> <td style="width: 10%;"></td> <td style="width: 10%;"></td> <td style="width: 10%;"></td> <td style="width: 10%;"></td> <td style="width: 10%;"></td> <td style="width: 10%;"></td> <td style="width: 10%;"></td> </tr> <tr> <td></td> <td></td> <td colspan="8" style="text-align: center;"> <table border="1" style="width: 100%; border-collapse: collapse; text-align: center;"> <tr> <td style="width: 10%;"></td> <td style="width: 10%;"></td> <td style="width: 10%;"></td> <td style="width: 10%;"></td> <td style="width: 10%;"></td> <td style="width: 10%;"></td> <td style="width: 10%;"></td> <td style="width: 10%;"></td> <td style="width: 10%;"></td> <td style="width: 10%;"></td> </tr> <tr> <td></td> <td></td> <td colspan="8" style="text-align: center;"> <table border="1" style="width: 100%; border-collapse: collapse; text-align: center;"> <tr> <td style="width: 10%;"></td> <td style="width: 10%;"></td> <td style="width: 10%;"></td> <td style="width: 10%;"></td> <td style="width: 10%;"></td> <td style="width: 10%;"></td> <td style="width: 10%;"></td> <td style="width: 10%;"></td> <td style="width: 10%;"></td> <td style="width: 10%;"></td> </tr> <tr> <td></td> <td></td> <td colspan="8" style="text-align: center;"> <table border="1" style="width: 100%; border-collapse: collapse; text-align: center;"> <tr> <td style="width: 10%;"></td> <td style="width: 10%;"></td> <td style="width: 10%;"></td> <td style="width: 10%;"></td> <td style="width: 10%;"></td> <td style="width: 10%;"></td> <td style="width: 10%;"></td> <td style="width: 10%;"></td> <td style="width: 10%;"></td> <td style="width: 10%;"></td> </tr> <tr> <td></td> <td></td> <td colspan="8" style="text-align: center;"> <table border="1" style="width: 100%; border-collapse: collapse; text-align: center;"> <tr> <td style="width: 10%;"></td> <td style="width: 10%;"></td> <td style="width: 10%;"></td> <td style="width: 10%;"></td> <td style="width: 10%;"></td> <td style="width: 10%;"></td> <td style="width: 10%;"></td> <td style="width: 10%;"></td> <td style="width: 10%;"></td> <td style="width: 10%;"></td> </tr> <tr> <td></td> <td></td> <td colspan="8" style="text-align: center;"> <table border="1" style="width: 100%; border-collapse: collapse; text-align: center;"> <tr> <td style="width: 10%;"></td> <td style="width: 10%;"></td> <td style="width: 10%;"></td> <td style="width: 10%;"></td> <td style="width: 10%;"></td> <td style="width: 10%;"></td> <td style="width: 10%;"></td> <td style="width: 10%;"></td> <td style="width: 10%;"></td> <td style="width: 10%;"></td> </tr> <tr> <td></td> <td></td> <td colspan="8" style="text-align: center;"> <table border="1" style="width: 100%; border-collapse: collapse; text-align: center;"> <tr> <td style="width: 10%;"></td> <td style="width: 10%;"></td> <td style="width: 10%;"></td> <td style="width: 10%;"></td> <td style="width: 10%;"></td> <td style="width: 10%;"></td> <td style="width: 10%;"></td> <td style="width: 10%;"></td> <td
style="width: 10%;"></td> <td style="width: 10%;"></td> </tr> <tr> <td></td> <td></td> <td colspan="8" style="text-align: center;"> <table border="1" style="width: 100%; border-collapse: collapse; text-align: center;"> <tr> <td style="width: 10%;"></td> <td style="width: 10%;"></td> <td style="width: 10%;"></td> <td style="width: 10%;"></td> <td style="width: 10%;"></td> <td style="width: 10%;"></td> <td style="width: 10%;"></td> <td style="width: 10%;"></td> <td style="width: 10%;"></td> <td style="width: 10%;"></td> </tr> <tr> <td></td> <td></td> <td colspan="8" style="text-align: center;"> <table border="1" style="width: 100%; border-collapse: collapse; text-align: center;"> <tr> <td style="width: 10%;"></td> <td style="width: 10%;"></td> <td style="width: 10%;"></td> <td style="width: 10%;"></td> <td style="width: 10%;"></td> <td style="width: 10%;"></td> <td style="width: 10%;"></td> <td style="width: 10%;"></td> <td style="width: 10%;"></td> <td style="width: 10%;"></td> </tr> <tr> <td></td> <td></td> <td colspan="8" style="text-align: center;"> <table border="1" style="width: 100%; border-collapse: collapse; text-align: center;"> <tr> <td style="width: 10%;"></td> <td style="width: 10%;"></td> <td style="width: 10%;"></td> <td style="width: 10%;"></td> <td style="width: 10%;"></td> <td style="width: 10%;"></td> <td style="width: 10%;"></td> <td style="width: 10%;"></td> <td style="width: 10%;"></td> <td style="width: 10%;"></td> </tr> <tr> <td></td> <td></td> <td colspan="8" style="text-align: center;"> <table border="1" style="width: 100%; border-collapse: collapse; text-align: center;"> <tr> <td style="width: 10%;"></td> <td style="width: 10%;"></td> <td style="width: 10%;"></td> <td style="width: 10%;"></td> <td style="width: 10%;"></td> <td style="width: 10%;"></td> <td style="width: 10%;"></td> <td style="width: 10%;"></td> <td style="width: 10%;"></td> <td style="width: 10%;"></td> </tr> <tr> <td></td> <td></td> <td colspan="8" style="text-align: center;"> <table border="1" style="width: 100%; border-collapse: collapse; text-align: center;"> <tr> <td style="width: 10%;"></td> <td style="width: 10%;"></td> <td style="width: 10%;"></td> <td style="width: 10%;"></td> <td style="width: 10%;"></td> <td style="width: 10%;"></td> <td style="width: 10%;"></td> <td style="width: 10%;"></td> <td style="width: 10%;"></td> <td style="width: 10%;"></td> </tr> <tr> <td></td> <td></td> <td colspan="8" style="text-align: center;"> <table border="1" style="width: 100%; border-collapse: collapse; text-align: center;"> <tr> <td style="width: 10%;"></td> <td style="width: 10%;"></td> <td style="width: 10%;"></td> <td style="width: 10%;"></td> <td style="width: 10%;"></td> <td style="width: 10%;"></td> <td style="width: 10%;"></td> <td style="width: 10%;"></td> <td style="width: 10%;"></td> <td style="width: 10%;"></td> </tr> <tr> <td></td> <td></td> <td colspan="8" style="text-align: center;"> <table border="1" style="width: 100%; border-collapse: collapse; text-align: center;"> <tr> <td style="width: 10%;"></td> <td style="width: 10%;"></td> <td style="width: 10%;"></td> <td style="width: 10%;"></td> <td style="width: 10%;"></td> <td style="width: 10%;"></td> <td style="width: 10%;"></td> <td style="width: 10%;"></td> <td style="width: 10%;"></td> <td style="width: 10%;"></td> </tr> <tr> <td></td> <td></td> <td colspan="8" style="text-align: center;"> <table border="1" style="width: 100%; border-collapse: collapse; text-align: center;"> <tr> <td style="width: 10%;"></td> <td style="width: 10%;"></td> <td style="width: 10%;"></td> <td style="width: 10%;"></td> <td style="width: 10%;"></td> <td style="width: 10%;"></td> <td style="width: 10%;"></td> <td style="width: 10%;"></td> <td style="width: 10%;"></td> <td style="width: 10%;"></td> </tr> <tr> <td></td> <td></td> <td colspan="8" style="text-align: center;"> <table border="1" style="width: 100%; border-collapse: collapse; text-align: center;"> <tr> <td style="width: 10%;"></td> <td style="width: 10%;"></td> <td style="width: 10%;"></td> <td style="width: 10%;"></td> <td style="width: 10%;"></td> <td style="width: 10%;"></td> <td style="width: 10%;"></td> <td style="width: 10%;"></td> <td style="width: 10%;"></td> <td style="width: 10%;"></td> </tr> <tr> <td></td> <td></td> <td colspan="8" style="text-align: center;"> <table border="1" style="width: 100%; border-collapse: collapse; text-align: center;"> <tr> <td style="width: 10%;"></td> <td style="width: 10%;"></td> <td style="width: 10%;"></td> <td style="width: 10%;"></td> <td style="width: 10%;"></td> <td style="width: 10%;"></td> <td style="width: 10%;"></td> <td style="width: 10%;"></td> <td style="width: 10%;"></td> <td style="width: 10%;"></td> </tr> <tr> <td></td> <td></td> <td colspan="8" style="text-align: center;"> <table border="1" style="width: 100%; border-collapse: collapse; text-align: center;"> <tr> <td style="width: 10%;"></td> <td style="width: 10%;"></td> <td style="width: 10%;"></td> <td style="width: 10%;"></td> <td style="width: 10%;"></td> <td style="width: 10%;"></td> <td style="width: 10%;"></td> <td style="width: 10%;"></td> <td style="width: 10%;"></td> <td style="width: 10%;"></td> </tr> <tr> <td></td> <td></td> <td colspan="8" style="text-align: center;"> <table border="1" style="width: 100%; border-collapse: collapse; text-align: center;"> <tr> <td style="width: 10%;"></td> <td style="width: 10%;"></td> <td style="width: 10%;"></td> <td style="width: 10%;"></td> <td style="width: 10%;"></td> <td style="width: 10%;"></td> <td style="width: 10%;"></td> <td style="width: 10%;"></td> <td style="width: 10%;"></td> <td style="width: 10%;"></td> </tr> <tr> <td></td> <td></td> <td colspan="8" style="text-align: center;"> <table border="1" style="width: 100%; border-collapse: collapse; text-align: center;"> <tr> <td style="width: 10%;"></td> <td style="width: 10%;"></td> <td style="width: 10%;"></td> <td style="width: 10%;"></td> <td style="width: 10%;"></td> <td style="width: 10%;"></td> <td style="width: 10%;"></td> <td style="width: 10%;"></td> <td style="width: 10%;"></td> <td style="width: 10%;"></td> </tr> <tr> <td></td> <td></td> <td colspan="8" style="text-align: center;"> <table border="1" style="width: 100%; border-collapse: collapse; text-align: center;"> <tr> <td style="width: 10%;"></td> <td style="width: 10%;"></td> <td style="width: 10%;"></td> <td style="width: 10%;"></td> <td style="width: 10%;"></td> <td style="width: 10%;"></td> <td style="width: 10%;"></td> <td style="width: 10%;"></td> <td style="width: 10%;"></td> <td style="width: 10%;"></td> </tr> <tr> <td></td> <td></td> <td colspan="8" style="text-align: center;"> <table border="1" style="width: 100%; border-collapse: collapse; text-align: center;"> <tr> <td style="width: 10%;"></td> <td style="width: 10%;"></td> <td style="width: 10%;"></td> <td style="width: 10%;"></td> <td style="width: 10%;"></td> <td style="width: 10%;"></td> <td style="width: 10%;"></td> <td style="width: 10%;"></td> <td style="width: 10%;"></td> <td style="width: 10%;"></td> </tr> <tr> <td></td> <td></td> <td colspan="8" style="text-align: center;"> <table border="1" style="width: 100%; border-collapse: collapse; text-align: center;"> <tr> <td style="width: 10%;"></td> <td style="width: 10%;"></td> <td style="width: 10%;"></td> <td style="width: 10%;"></td> <td style="width: 10%;"></td> <td style="width: 10%;"></td> <td style="width: 10%;"></td> <td style="width: 10%;"></td> <td style="width: 10%;"></td> <td style="width: 10%;"></td> </tr> <tr> <td></td> <td></td> <td colspan="8" style="text-align: center;"> <table border="1" style="width: 100%; border-collapse: collapse; text-align: center;"> <tr> <td style="width: 10%;"></td> <td style="width: 10%;"></td> <td style="width: 10%;"></td> <td style="width: 10%;"></td> <td style="width: 10%;"></td> <td style="width: 10%;"></td> <td style="width: 10%;"></td> <td style="width: 10%;"></td> <td style="width: 10%;"></td> <td style="width: 10%;"></td> </tr> <tr> <td></td> <td></td> <td colspan="8" style="text-align: center;"> <table border="1" style="width: 100%; border-collapse: collapse; text-align: center;"> <tr> <td style="width: 10%;"></td> <td style="width: 10%;"></td> <td style="width: 10%;"></td> <td style="width: 10%;"></td> <td style="width: 10%;"></td> <td style="width: 10%;"></td> <td style="width: 10%;"></td> <td style="width: 10%;"></td> <td style="width: 10%;"></td> <td style="width: 10%;"></td> </tr> <tr> <td></td> <td></td> <td colspan="8" style="text-align: center;"> <table border="1" style="width: 100%; border-collapse: collapse; text-align: center;"> <tr> <td style="width: 10%;"></td> <td style="width: 10%;"></td> <td style="width: 10%;"></td> <td style="width: 10%;"></td> <td style="width: 10%;"></td> <td style="width: 10%;"></td> <td style="width: 10%;"></td> <td style="width: 10%;"></td> <td style="width: 10%;"></td> <td style="width: 10%;"></td> </tr> <tr> <td></td> <td></td> <td colspan="8" style="text-align: center;"> <table border="1" style="width: 100%; border-collapse: collapse; text-align: center;"> <tr> <td style="width: 10%;"></td> <td style="width: 10%;"></td> <td style="width: 10%;"></td> <td style="width: 10%;"></td> <td style="width: 10%;"></td> <td style="width: 10%;"></td> <td style="width: 10%;"></td> <td style="width: 10%;"></td> <td style="width: 10%;"></td> <td style="width: 10%;"></td> </tr> <tr> <td></td> <td></td> <td colspan="8" style="text-align: center;"> <table border="1" style="width: 100%; border-collapse: collapse; text-align: center;"> <tr> <td style="width: 10%;"></td> <td style="width: 10%;"></td> <td style="width: 10%;"></td> <td style="width: 10%;"></td> <td style="width: 10%;"></td> <td style="width: 10%;"></td> <td style="width: 10%;"></td> <td style="width: 10%;"></td> <td style="width: 10%;"></td> <td style="width: 10%;"></td> </tr> <tr> <td></td> <td></td> <td colspan="8" style="text-align: center;"> <table border="1" style="width: 100%;
border-collapse: collapse; text-align: center;"> <tr> <td style="width: 10%;"></td> <td style="width: 10%;"></td> <td style="width: 10%;"></td> <td style="width: 10%;"></td> <td style="width: 10%;"></td> <td style="width: 10%;"></td> <td style="width: 10%;"></td> <td style="width: 10%;"></td> <td style="width: 10%;"></td> <td style="width: 10%;"></td> </tr> <tr> <td></td> <td></td> <td colspan="8" style="text-align: center;"> <table border="1" style="width: 100%; border-collapse: collapse; text-align: center;"> <tr> <td style="width: 10%;"></td> <td style="width: 10%;"></td> <td style="width: 10%;"></td> <td style="width: 10%;"></td> <td style="width: 10%;"></td> <td style="width: 10%;"></td> <td style="width: 10%;"></td> <td style="width: 10%;"></td> <td style="width: 10%;"></td> <td style="width: 10%;"></td> </tr> <tr> <td></td> <td></td> <td colspan="8" style="text-align: center;"> <table border="1" style="width: 100%; border-collapse: collapse; text-align: center;"> <tr> <td style="width: 10%;"></td> <td style="width: 10%;"></td> <td style="width: 10%;"></td> <td style="width: 10%;"></td> <td style="width: 10%;"></td> <td style="width: 10%;"></td> <td style="width: 10%;"></td> <td style="width: 10%;"></td> <td style="width: 10%;"></td> <td style="width: 10%;"></td> </tr> <tr> <td></td> <td></td> <td colspan="8" style="text-align: center;"> <table border="1" style="width: 100%; border-collapse: collapse; text-align: center;"> <tr> <td style="width: 10%;"></td> <td style="width: 10%;"></td> <td style="width: 10%;"></td> <td style="width: 10%;"></td> <td style="width: 10%;"></td> <td style="width: 10%;"></td> <td style="width: 10%;"></td> <td style="width: 10%;"></td> <td style="width: 10%;"></td> <td style="width: 10%;"></td> </tr> <tr> <td></td> <td></td> <td colspan="8" style="text-align: center;"> <table border="1" style="width: 100%; border-collapse: collapse; text-align: center;"> <tr> <td style="width: 10%;"></td> <td style="width: 10%;"></td> <td style="width: 10%;"></td> <td style="width: 10%;"></td> <td style="width: 10%;"></td> <td style="width: 10%;"></td> <td style="width: 10%;"></td> <td style="width: 10%;"></td> <td style="width: 10%;"></td> <td style="width: 10%;"></td> </tr> <tr> <td></td> <td></td> <td colspan="8" style="text-align: center;"> <table border="1" style="width: 100%; border-collapse: collapse; text-align: center;"> <tr> <td style="width: 10%;"></td> <td style="width: 10%;"></td> <td style="width: 10%;"></td> <td style="width: 10%;"></td> <td style="width: 10%;"></td> <td style="width: 10%;"></td> <td style="width: 10%;"></td> <td style="width: 10%;"></td> <td style="width: 10%;"></td> <td style="width: 10%;"></td> </tr> <tr> <td></td> <td></td> <td colspan="8" style="text-align: center;"> <table border="1" style="width: 100%; border-collapse: collapse; text-align: center;"> <tr> <td style="width: 10%;"></td> <td style="width: 10%;"></td> <td style="width: 10%;"></td> <td style="width: 10%;"></td> <td style="width: 10%;"></td> <td style="width: 10%;"></td> <td style="width: 10%;"></td> <td style="width: 10%;"></td> <td style="width: 10%;"></td> <td style="width: 10%;"></td> </tr> <tr> <td></td> <td></td> <td colspan="8" style="text-align: center;"> <table border="1" style="width: 100%; border-collapse: collapse; text-align: center;"> <tr> <td style="width: 10%;"></td> <td style="width: 10%;"></td> <td style="width: 10%;"></td> <td style="width: 10%;"></td> <td style="width: 10%;"></td> <td style="width: 10%;"></td> <td style="width: 10%;"></td> <td style="width: 10%;"></td> <td style="width: 10%;"></td> <td style="width: 10%;"></td> </tr> <tr> <td></td> <td></td> <td colspan="8" style="text-align: center;"> <table border="1" style="width: 100%; border-collapse: collapse; text-align: center;"> <tr> <td style="width: 10%;"></td> <td style="width: 10%;"></td> <td style="width: 10%;"></td> <td style="width: 10%;"></td> <td style="width: 10%;"></td> <td style="width: 10%;"></td> <td style="width: 10%;"></td> <td style="width: 10%;"></td> <td style="width: 10%;"></td> <td style="width: 10%;"></td> </tr> <tr> <td></td> <td></td> <td colspan="8" style="text-align: center;"> <table border="1" style="width: 100%; border-collapse: collapse; text-align: center;"> <tr> <td style="width: 10%;"></td> <td style="width: 10%;"></td> <td style="width: 10%;"></td> <td style="width: 10%;"></td> <td style="width: 10%;"></td> <td style="width: 10%;"></td> <td style="width: 10%;"></td> <td style="width: 10%;"></td> <td style="width: 10%;"></td> <td style="width: 10%;"></td> </tr> <tr> <td></td> <td></td> <td colspan="8" style="text-align: center;"> <table border="1" style="width: 100%; border-collapse: collapse; text-align: center;"> <tr> <td style="width: 10%;"></td> <td style="width: 10%;"></td> <td style="width: 10%;"></td> <td style="width: 10%;"></td> <td style="width: 10%;"></td> <td style="width: 10%;"></td> <td style="width: 10%;"></td> <td style="width: 10%;"></td> <td style="width: 10%;"></td> <td style="width: 10%;"></td> </tr> <tr> <td></td> <td></td> <td colspan="8" style="text-align: center;"> <table border="1" style="width: 100%; border-collapse: collapse; text-align: center;"> <tr> <td style="width: 10%;"></td> <td style="width: 10%;"></td> <td style="width: 10%;"></td> <td style="width: 10%;"></td> <td style="width: 10%;"></td> <td style="width: 10%;"></td> <td style="width: 10%;"></td> <td style="width: 10%;"></td> <td style="width: 10%;"></td> <td style="width: 10%;"></td> </tr> <tr> <td></td> <td></td> <td colspan="8" style="text-align: center;"> <table border="1" style="width: 100%; border-collapse: collapse; text-align: center;"> <tr> <td style="width: 10%;"></td> <td style="width: 10%;"></td> <td style="width: 10%;"></td> <td style="width: 10%;"></td> <td style="width: 10%;"></td> <td style="width: 10%;"></td> <td style="width: 10%;"></td> <td style="width: 10%;"></td> <td style="width: 10%;"></td> <td style="width: 10%;"></td> </tr> <tr> <td></td> <td></td> <td colspan="8" style="text-align: center;"> <table border="1" style="width: 100%; border-collapse: collapse; text-align: center;"> <tr> <td style="width: 10%;"></td> <td style="width: 10%;"></td> <td style="width: 10%;"></td> <td style="width: 10%;"></td> <td style="width: 10%;"></td> <td style="width: 10%;"></td> <td style="width: 10%;"></td> <td style="width: 10%;"></td> <td style="width: 10%;"></td> <td style="width: 10%;"></td> </tr> <tr> <td></td> <td></td> <td colspan="8" style="text-align: center;"> <table border="1" style="width: 100%; border-collapse: collapse; text-align: center;"> <tr> <td style="width: 10%;"></td> <td style="width: 10%;"></td> <td style="width: 10%;"></td> <td style="width: 10%;"></td> <td style="width: 10%;"></td> <td style="width: 10%;"></td> <td style="width: 10%;"></td> <td style="width: 10%;"></td> <td style="width: 10%;"></td> <td style="width: 10%;"></td> </tr> <tr> <td></td> <td></td> <td colspan="8" style="text-align: center;"> <table border="1" style="width: 100%; border-collapse: collapse; text-align: center;"> <tr> <td style="width: 10%;"></td> <td style="width: 10%;"></td> <td style="width: 10%;"></td> <td style="width: 10%;"></td> <td style="width: 10%;"></td> <td style="width: 10%;"></td> <td style="width: 10%;"></td> <td style="width: 10%;"></td> <td style="width: 10%;"></td> <td style="width: 10%;"></td> </tr> <tr> <td></td> <td></td> <td colspan="8" style="text-align: center;"> <table border="1" style="width: 100%; border-collapse: collapse; text-align: center;"> <tr> <td style="width: 10%;"></td> <td style="width: 10%;"></td> <td style="width: 10%;"></td> <td style="width: 10%;"></td> <td style="width: 10%;"></td> <td style="width: 10%;"></td> <td style="width: 10%;"></td> <td style="width: 10%;"></td> <td style="width: 10%;"></td> <td style="width: 10%;"></td> </tr> <tr> <td></td> <td></td> <td colspan="8" style="text-align: center;"> <table border="1" style="width: 100%; border-collapse: collapse; text-align: center;"> <tr> <td style="width: 10%;"></td> <td style="width: 10%;"></td> <td style="width: 10%;"></td> <td style="width: 10%;"></td> <td style="width: 10%;"></td> <td style="width: 10%;"></td> <td style="width: 10%;"></td> <td style="width: 10%;"></td> <td style="width: 10%;"></td> <td style="width: 10%;"></td> </tr> <tr> <td></td> <td></td> <td colspan="8" style="text-align: center;"> <table border="1" style="width: 100%; border-collapse: collapse; text-align: center;"> <tr> <td style="width: 10%;"></td> <td style="width: 10%;"></td> <td style="width: 10%;"></td> <td style="width: 10%;"></td> <td style="width: 10%;"></td> <td style="width: 10%;"></td> <td style="width: 10%;"></td> <td style="width: 10%;"></td> <td style="width: 10%;"></td> <td style="width: 10%;"></td> </tr> <tr> <td></td> <td></td> <td colspan="8" style="text-align: center;"> <table border="1" style="width: 100%; border-collapse: collapse; text-align: center;"> <tr> <td style="width: 10%;"></td> <td style="width: 10%;"></td> <td style="width: 10%;"></td> <td style="width: 10%;"></td> <td style="width: 10%;"></td> <td style="width: 10%;"></td> <td style="width: 10%;"></td> <td style="width: 10%;"></td> <td style="width: 10%;"></td> <td style="width: 10%;"></td> </tr> <tr> <td></td> <td></td> <td colspan="8" style="text-align: center;"> <table border="1" style="width: 100%; border-collapse: collapse; text-align: center;"> <tr> <td style="width: 10%;"></td> <td style="width: 10%;"></td> <td style="width: 10%;"></td> <td style="width: 10%;"></td> <td style="width: 10%;"></td> <td style="width: 10%;"></td> <td style="width: 10%;"></td> <td style="width: 10%;"></td> <td style="width: 10%;"></td> <td style="width: 10%;"></td> </tr> <tr> <td></td> <td></td> <td colspan="8" style="text-align: center;"> <table border="1" style="width: 100%; border-collapse: collapse; text-align: center;"> <tr> <td style="width: 10%;"></td> <td style="width: 10%;"></td> <td style="width: 10%;"></td> <td style="width:
10%;"></td> <td style="width: 10%;"></td> <td style="width: 10%;"></td> <td style="width: 10%;"></td> <td style="width: 10%;"></td> <td style="width: 10%;"></td> <td style="width: 10%;"></td> </tr> <tr> <td></td> <td></td> <td colspan="8" style="text-align: center;"> <table border="1" style="width: 100%; border-collapse: collapse; text-align: center;"> <tr> <td style="width: 10%;"></td> <td style="width: 10%;"></td> <td style="width: 10%;"></td> <td style="width: 10%;"></td> <td style="width: 10%;"></td> <td style="width: 10%;"></td> <td style="width: 10%;"></td> <td style="width: 10%;"></td> <td style="width: 10%;"></td> <td style="width: 10%;"></td> </tr> <tr> <td></td> <td></td> <td colspan="8" style="text-align: center;"> <table border="1" style="width: 100%; border-collapse: collapse; text-align: center;"> <tr> </tr></table></td></tr></table></td></tr></table></td></tr></table></td></tr></table></td></tr></table></td></tr></table></td></tr></table></td></tr></table></td></tr></table></td></tr></table></td></tr></table></td></tr></table></td></tr></table></td></tr></table></td></tr></table></td></tr></table></td></tr></table></td></tr></table></td></tr></table></td></tr></table></td></tr></table></td></tr></table></td></tr></table></td></tr></table></td></tr></table></td></tr></table></td></tr></table></td></tr></table></td></tr></table></td></tr></table></td></tr></table></td></tr></table></td></tr></table></td></tr></table></td></tr></table></td></tr></table></td></tr></table></td></tr></table></td></tr></table></td></tr></table></td></tr></table></td></tr></table></td></tr></table></td></tr></table></td></tr></table></td></tr></table></td></tr></table></td></tr></table></td></tr></table></td></tr></table></td></tr></table></td></tr></table></td></tr></table></td></tr></table></td></tr></table></td></tr></table></td></tr></table></td></tr></table></td></tr></table></td></tr></table></td></tr></table> | | | | | | | | | | | | | | | | | | | | <table border="1" style="width: 100%; border-collapse: collapse; text-align: center;"> <tr> <td style="width: 10%;"></td> <td style="width: 10%;"></td> <td style="width: 10%;"></td> <td style="width: 10%;"></td> <td style="width: 10%;"></td> <td style="width: 10%;"></td> <td style="width: 10%;"></td> <td style="width: 10%;"></td> <td style="width: 10%;"></td> <td style="width: 10%;"></td> </tr> <tr> <td></td> <td></td> <td colspan="8" style="text-align: center;"> <table border="1" style="width: 100%; border-collapse: collapse; text-align: center;"> <tr> <td style="width: 10%;"></td> <td style="width: 10%;"></td> <td style="width: 10%;"></td> <td style="width: 10%;"></td> <td style="width: 10%;"></td> <td style="width: 10%;"></td> <td style="width: 10%;"></td> <td style="width: 10%;"></td> <td style="width: 10%;"></td> <td style="width: 10%;"></td> </tr> <tr> <td></td> <td></td> <td colspan="8" style="text-align: center;"> <table border="1" style="width: 100%; border-collapse: collapse; text-align: center;"> <tr> <td style="width: 10%;"></td> <td style="width: 10%;"></td> <td style="width: 10%;"></td> <td style="width: 10%;"></td> <td style="width: 10%;"></td> <td style="width: 10%;"></td> <td style="width: 10%;"></td> <td style="width: 10%;"></td> <td style="width: 10%;"></td> <td style="width: 10%;"></td> </tr> <tr> <td></td> <td></td> <td colspan="8" style="text-align: center;"> <table border="1" style="width: 100%; border-collapse: collapse; text-align: center;"> <tr> <td style="width: 10%;"></td> <td style="width: 10%;"></td> <td style="width: 10%;"></td> <td style="width: 10%;"></td> <td style="width: 10%;"></td> <td style="width: 10%;"></td> <td style="width: 10%;"></td> <td style="width: 10%;"></td> <td style="width: 10%;"></td> <td style="width: 10%;"></td> </tr> <tr> <td></td> <td></td> <td colspan="8" style="text-align: center;"> <table border="1" style="width: 100%; border-collapse: collapse; text-align: center;"> <tr> <td style="width: 10%;"></td> <td style="width: 10%;"></td> <td style="width: 10%;"></td> <td style="width: 10%;"></td> <td style="width: 10%;"></td> <td style="width: 10%;"></td> <td style="width: 10%;"></td> <td style="width: 10%;"></td> <td style="width: 10%;"></td> <td style="width: 10%;"></td> </tr> <tr> <td></td> <td></td> <td colspan="8" style="text-align: center;"> <table border="1" style="width: 100%; border-collapse: collapse; text-align: center;"> <tr> <td style="width: 10%;"></td> <td style="width: 10%;"></td> <td style="width: 10%;"></td> <td style="width: 10%;"></td> <td style="width: 10%;"></td> <td style="width: 10%;"></td> <td style="width: 10%;"></td> <td style="width: 10%;"></td> <td style="width: 10%;"></td> <td style="width: 10%;"></td> </tr> <tr> <td></td> <td></td> <td colspan="8" style="text-align: center;"> <table border="1" style="width: 100%; border-collapse: collapse; text-align: center;"> <tr> <td style="width: 10%;"></td> <td style="width: 10%;"></td> <td style="width: 10%;"></td> <td style="width: 10%;"></td> <td style="width: 10%;"></td> <td style="width: 10%;"></td> <td style="width: 10%;"></td> <td style="width: 10%;"></td> <td style="width: 10%;"></td> <td style="width: 10%;"></td> </tr> <tr> <td></td> <td></td> <td colspan="8" style="text-align: center;"> <table border="1" style="width: 100%; border-collapse: collapse; text-align: center;"> <tr> <td style="width: 10%;"></td> <td style="width: 10%;"></td> <td style="width: 10%;"></td> <td style="width: 10%;"></td> <td style="width: 10%;"></td> <td style="width: 10%;"></td> <td style="width: 10%;"></td> <td style="width: 10%;"></td> <td style="width: 10%;"></td> <td style="width: 10%;"></td> </tr> <tr> <td></td> <td></td> <td colspan="8" style="text-align: center;"> <table border="1" style="width: 100%; border-collapse: collapse; text-align: center;"> <tr> <td style="width: 10%;"></td> <td style="width: 10%;"></td> <td style="width: 10%;"></td> <td style="width: 10%;"></td> <td style="width: 10%;"></td> <td style="width: 10%;"></td> <td style="width: 10%;"></td> <td style="width: 10%;"></td> <td style="width: 10%;"></td> <td style="width: 10%;"></td> </tr> <tr> <td></td> <td></td> <td colspan="8" style="text-align: center;"> <table border="1" style="width: 100%; border-collapse: collapse; text-align: center;"> <tr> <td style="width: 10%;"></td> <td style="width: 10%;"></td> <td style="width: 10%;"></td> <td style="width: 10%;"></td> <td style="width: 10%;"></td> <td style="width: 10%;"></td> <td style="width: 10%;"></td> <td style="width: 10%;"></td> <td style="width: 10%;"></td> <td style="width: 10%;"></td> </tr> <tr> <td></td> <td></td> <td colspan="8" style="text-align: center;"> <table border="1" style="width: 100%; border-collapse: collapse; text-align: center;"> <tr> <td style="width: 10%;"></td> <td style="width: 10%;"></td> <td style="width: 10%;"></td> <td style="width: 10%;"></td> <td style="width: 10%;"></td> <td style="width: 10%;"></td> <td style="width: 10%;"></td> <td style="width: 10%;"></td> <td style="width: 10%;"></td> <td style="width: 10%;"></td> </tr> <tr> <td></td> <td></td> <td colspan="8" style="text-align: center;"> <table border="1" style="width: 100%; border-collapse: collapse; text-align: center;"> <tr> <td style="width: 10%;"></td> <td style="width: 10%;"></td> <td style="width: 10%;"></td> <td style="width: 10%;"></td> <td style="width: 10%;"></td> <td style="width: 10%;"></td> <td style="width: 10%;"></td> <td style="width: 10%;"></td> <td style="width: 10%;"></td> <td style="width: 10%;"></td> </tr> <tr> <td></td> <td></td> <td colspan="8" style="text-align: center;"> <table border="1" style="width: 100%; border-collapse: collapse; text-align: center;"> <tr> <td style="width: 10%;"></td> <td style="width: 10%;"></td> <td style="width: 10%;"></td> <td style="width: 10%;"></td> <td style="width: 10%;"></td> <td style="width: 10%;"></td> <td style="width: 10%;"></td> <td style="width: 10%;"></td> <td style="width: 10%;"></td> <td style="width: 10%;"></td> </tr> <tr> <td></td> <td></td> <td colspan="8" style="text-align: center;"> <table border="1" style="width: 100%; border-collapse: collapse; text-align: center;"> <tr> <td style="width: 10%;"></td> <td style="width: 10%;"></td> <td style="width: 10%;"></td> <td style="width: 10%;"></td> <td style="width: 10%;"></td> <td style="width: 10%;"></td> <td style="width: 10%;"></td> <td style="width: 10%;"></td> <td style="width: 10%;"></td> <td style="width: 10%;"></td> </tr> <tr> <td></td> <td></td> <td colspan="8" style="text-align: center;"> <table border="1" style="width: 100%; border-collapse: collapse; text-align: center;"> <tr> <td style="width: 10%;"></td> <td style="width: 10%;"></td> <td style="width: 10%;"></td> <td style="width: 10%;"></td> <td style="width: 10%;"></td> <td style="width: 10%;"></td> <td style="width: 10%;"></td> <td style="width: 10%;"></td> <td style="width: 10%;"></td> <td style="width: 10%;"></td> </tr> <tr> <td></td> <td></td> <td colspan="8" style="text-align: center;"> <table
border="1" style="width: 100%; border-collapse: collapse; text-align: center;"> <tr> <td style="width: 10%;"></td> <td style="width: 10%;"></td> <td style="width: 10%;"></td> <td style="width: 10%;"></td> <td style="width: 10%;"></td> <td style="width: 10%;"></td> <td style="width: 10%;"></td> <td style="width: 10%;"></td> <td style="width: 10%;"></td> <td style="width: 10%;"></td> </tr> <tr> <td></td> <td></td> <td colspan="8" style="text-align: center;"> <table border="1" style="width: 100%; border-collapse: collapse; text-align: center;"> <tr> <td style="width: 10%;"></td> <td style="width: 10%;"></td> <td style="width: 10%;"></td> <td style="width: 10%;"></td> <td style="width: 10%;"></td> <td style="width: 10%;"></td> <td style="width: 10%;"></td> <td style="width: 10%;"></td> <td style="width: 10%;"></td> <td style="width: 10%;"></td> </tr> <tr> <td></td> <td></td> <td colspan="8" style="text-align: center;"> <table border="1" style="width: 100%; border-collapse: collapse; text-align: center;"> <tr> <td style="width: 10%;"></td> <td style="width: 10%;"></td> <td style="width: 10%;"></td> <td style="width: 10%;"></td> <td style="width: 10%;"></td> <td style="width: 10%;"></td> <td style="width: 10%;"></td> <td style="width: 10%;"></td> <td style="width: 10%;"></td> <td style="width: 10%;"></td> </tr> <tr> <td></td> <td></td> <td colspan="8" style="text-align: center;"> <table border="1" style="width: 100%; border-collapse: collapse; text-align: center;"> <tr> <td style="width: 10%;"></td> <td style="width: 10%;"></td> <td style="width: 10%;"></td> <td style="width: 10%;"></td> <td style="width: 10%;"></td> <td style="width: 10%;"></td> <td style="width: 10%;"></td> <td style="width: 10%;"></td> <td style="width: 10%;"></td> <td style="width: 10%;"></td> </tr> <tr> <td></td> <td></td> <td colspan="8" style="text-align: center;"> <table border="1" style="width: 100%; border-collapse: collapse; text-align: center;"> <tr> <td style="width: 10%;"></td> <td style="width: 10%;"></td> <td style="width: 10%;"></td> <td style="width: 10%;"></td> <td style="width: 10%;"></td> <td style="width: 10%;"></td> <td style="width: 10%;"></td> <td style="width: 10%;"></td> <td style="width: 10%;"></td> <td style="width: 10%;"></td> </tr> <tr> <td></td> <td></td> <td colspan="8" style="text-align: center;"> <table border="1" style="width: 100%; border-collapse: collapse; text-align: center;"> <tr> <td style="width: 10%;"></td> <td style="width: 10%;"></td> <td style="width: 10%;"></td> <td style="width: 10%;"></td> <td style="width: 10%;"></td> <td style="width: 10%;"></td> <td style="width: 10%;"></td> <td style="width: 10%;"></td> <td style="width: 10%;"></td> <td style="width: 10%;"></td> </tr> <tr> <td></td> <td></td> <td colspan="8" style="text-align: center;"> <table border="1" style="width: 100%; border-collapse: collapse; text-align: center;"> <tr> <td style="width: 10%;"></td> <td style="width: 10%;"></td> <td style="width: 10%;"></td> <td style="width: 10%;"></td> <td style="width: 10%;"></td> <td style="width: 10%;"></td> <td style="width: 10%;"></td> <td style="width: 10%;"></td> <td style="width: 10%;"></td> <td style="width: 10%;"></td> </tr> <tr> <td></td> <td></td> <td colspan="8" style="text-align: center;"> <table border="1" style="width: 100%; border-collapse: collapse; text-align: center;"> <tr> <td style="width: 10%;"></td> <td style="width: 10%;"></td> <td style="width: 10%;"></td> <td style="width: 10%;"></td> <td style="width: 10%;"></td> <td style="width: 10%;"></td> <td style="width: 10%;"></td> <td style="width: 10%;"></td> <td style="width: 10%;"></td> <td style="width: 10%;"></td> </tr> <tr> <td></td> <td></td> <td colspan="8" style="text-align: center;"> <table border="1" style="width: 100%; border-collapse: collapse; text-align: center;"> <tr> <td style="width: 10%;"></td> <td style="width: 10%;"></td> <td style="width: 10%;"></td> <td style="width: 10%;"></td> <td style="width: 10%;"></td> <td style="width: 10%;"></td> <td style="width: 10%;"></td> <td style="width: 10%;"></td> <td style="width: 10%;"></td> <td style="width: 10%;"></td> </tr> <tr> <td></td> <td></td> <td colspan="8" style="text-align: center;"> <table border="1" style="width: 100%; border-collapse: collapse; text-align: center;"> <tr> <td style="width: 10%;"></td> <td style="width: 10%;"></td> <td style="width: 10%;"></td> <td style="width: 10%;"></td> <td style="width: 10%;"></td> <td style="width: 10%;"></td> <td style="width: 10%;"></td> <td style="width: 10%;"></td> <td style="width: 10%;"></td> <td style="width: 10%;"></td> </tr> <tr> <td></td> <td></td> <td colspan="8" style="text-align: center;"> <table border="1" style="width: 100%; border-collapse: collapse; text-align: center;"> <tr> <td style="width: 10%;"></td> <td style="width: 10%;"></td> <td style="width: 10%;"></td> <td style="width: 10%;"></td> <td style="width: 10%;"></td> <td style="width: 10%;"></td> <td style="width: 10%;"></td> <td style="width: 10%;"></td> <td style="width: 10%;"></td> <td style="width: 10%;"></td> </tr> <tr> <td></td> <td></td> <td colspan="8" style="text-align: center;"> <table border="1" style="width: 100%; border-collapse: collapse; text-align: center;"> <tr> <td style="width: 10%;"></td> <td style="width: 10%;"></td> <td style="width: 10%;"></td> <td style="width: 10%;"></td> <td style="width: 10%;"></td> <td style="width: 10%;"></td> <td style="width: 10%;"></td> <td style="width: 10%;"></td> <td style="width: 10%;"></td> <td style="width: 10%;"></td> </tr> <tr> <td></td> <td></td> <td colspan="8" style="text-align: center;"> <table border="1" style="width: 100%; border-collapse: collapse; text-align: center;"> <tr> <td style="width: 10%;"></td> <td style="width: 10%;"></td> <td style="width: 10%;"></td> <td style="width: 10%;"></td> <td style="width: 10%;"></td> <td style="width: 10%;"></td> <td style="width: 10%;"></td> <td style="width: 10%;"></td> <td style="width: 10%;"></td> <td style="width: 10%;"></td> </tr> <tr> <td></td> <td></td> <td colspan="8" style="text-align: center;"> <table border="1" style="width: 100%; border-collapse: collapse; text-align: center;"> <tr> <td style="width: 10%;"></td> <td style="width: 10%;"></td> <td style="width: 10%;"></td> <td style="width: 10%;"></td> <td style="width: 10%;"></td> <td style="width: 10%;"></td> <td style="width: 10%;"></td> <td style="width: 10%;"></td> <td style="width: 10%;"></td> <td style="width: 10%;"></td> </tr> <tr> <td></td> <td></td> <td colspan="8" style="text-align: center;"> <table border="1" style="width: 100%; border-collapse: collapse; text-align: center;"> <tr> <td style="width: 10%;"></td> <td style="width: 10%;"></td> <td style="width: 10%;"></td> <td style="width: 10%;"></td> <td style="width: 10%;"></td> <td style="width: 10%;"></td> <td style="width: 10%;"></td> <td style="width: 10%;"></td> <td style="width: 10%;"></td> <td style="width: 10%;"></td> </tr> <tr> <td></td> <td></td> <td colspan="8" style="text-align: center;"> <table border="1" style="width: 100%; border-collapse: collapse; text-align: center;"> <tr> <td style="width: 10%;"></td> <td style="width: 10%;"></td> <td style="width: 10%;"></td> <td style="width: 10%;"></td> <td style="width: 10%;"></td> <td style="width: 10%;"></td> <td style="width: 10%;"></td> <td style="width: 10%;"></td> <td style="width: 10%;"></td> <td style="width: 10%;"></td> </tr> <tr> <td></td> <td></td> <td colspan="8" style="text-align: center;"> <table border="1" style="width: 100%; border-collapse: collapse; text-align: center;"> <tr> <td style="width: 10%;"></td> <td style="width: 10%;"></td> <td style="width: 10%;"></td> <td style="width: 10%;"></td> <td style="width: 10%;"></td> <td style="width: 10%;"></td> <td style="width: 10%;"></td> <td style="width: 10%;"></td> <td style="width: 10%;"></td> <td style="width: 10%;"></td> </tr> <tr> <td></td> <td></td> <td colspan="8" style="text-align: center;"> <table border="1" style="width: 100%; border-collapse: collapse; text-align: center;"> <tr> <td style="width: 10%;"></td> <td style="width: 10%;"></td> <td style="width: 10%;"></td> <td style="width: 10%;"></td> <td style="width: 10%;"></td> <td style="width: 10%;"></td> <td style="width: 10%;"></td> <td style="width: 10%;"></td> <td style="width: 10%;"></td> <td style="width: 10%;"></td> </tr> <tr> <td></td> <td></td> <td colspan="8" style="text-align: center;"> <table border="1" style="width: 100%; border-collapse: collapse; text-align: center;"> <tr> <td style="width: 10%;"></td> <td style="width: 10%;"></td> <td style="width: 10%;"></td> <td style="width: 10%;"></td> <td style="width: 10%;"></td> <td style="width: 10%;"></td> <td style="width: 10%;"></td> <td style="width: 10%;"></td> <td style="width: 10%;"></td> <td style="width: 10%;"></td> </tr> <tr> <td></td> <td></td> <td colspan="8" style="text-align: center;"> <table border="1" style="width: 100%; border-collapse: collapse; text-align: center;"> <tr> <td style="width: 10%;"></td> <td style="width: 10%;"></td> <td style="width: 10%;"></td> <td style="width: 10%;"></td> <td style="width: 10%;"></td> <td style="width: 10%;"></td> <td style="width: 10%;"></td> <td style="width: 10%;"></td> <td style="width: 10%;"></td> <td style="width: 10%;"></td> </tr> <tr> <td></td> <td></td> <td colspan="8" style="text-align: center;"> <table border="1" style="width: 100%; border-collapse: collapse; text-align: center;"> <tr> <td style="width: 10%;"></td> <td style="width: 10%;"></td> <td style="width: 10%;"></td> <td style="width: 10%;"></td> <td style="width: 10%;"></td> <td style="width: 10%;"></td> <td style="width: 10%;"></td> <td style="width: 10%;"></td> <td style="width: 10%;"></td> <td style="width: 10%;"></td> </tr> <tr> <td></td> <td></td> <td colspan="8" style="text-align: center;"> <table border="1" style="width: 100%; border-collapse: collapse; text-align: center;"> <tr> <td style="width: 10%;"></td> <td style="width: 10%;"></td> <td style="width:
10%;"></td> <td style="width: 10%;"></td> <td style="width: 10%;"></td> <td style="width: 10%;"></td> <td style="width: 10%;"></td> <td style="width: 10%;"></td> <td style="width: 10%;"></td> <td style="width: 10%;"></td> </tr> <tr> <td></td> <td></td> <td colspan="8" style="text-align: center;"> <table border="1" style="width: 100%; border-collapse: collapse; text-align: center;"> <tr> <td style="width: 10%;"></td> <td style="width: 10%;"></td> <td style="width: 10%;"></td> <td style="width: 10%;"></td> <td style="width: 10%;"></td> <td style="width: 10%;"></td> <td style="width: 10%;"></td> <td style="width: 10%;"></td> <td style="width: 10%;"></td> <td style="width: 10%;"></td> </tr> <tr> <td></td> <td></td> <td colspan="8" style="text-align: center;"> <table border="1" style="width: 100%; border-collapse: collapse; text-align: center;"> <tr> <td style="width: 10%;"></td> <td style="width: 10%;"></td> <td style="width: 10%;"></td> <td style="width: 10%;"></td> <td style="width: 10%;"></td> <td style="width: 10%;"></td> <td style="width: 10%;"></td> <td style="width: 10%;"></td> <td style="width: 10%;"></td> <td style="width: 10%;"></td> </tr> <tr> <td></td> <td></td> <td colspan="8" style="text-align: center;"> <table border="1" style="width: 100%; border-collapse: collapse; text-align: center;"> <tr> <td style="width: 10%;"></td> <td style="width: 10%;"></td> <td style="width: 10%;"></td> <td style="width: 10%;"></td> <td style="width: 10%;"></td> <td style="width: 10%;"></td> <td style="width: 10%;"></td> <td style="width: 10%;"></td> <td style="width: 10%;"></td> <td style="width: 10%;"></td> </tr> <tr> <td></td> <td></td> <td colspan="8" style="text-align: center;"> <table border="1" style="width: 100%; border-collapse: collapse; text-align: center;"> <tr> <td style="width: 10%;"></td> <td style="width: 10%;"></td> <td style="width: 10%;"></td> <td style="width: 10%;"></td> <td style="width: 10%;"></td> <td style="width: 10%;"></td> <td style="width: 10%;"></td> <td style="width: 10%;"></td> <td style="width: 10%;"></td> <td style="width: 10%;"></td> </tr> <tr> <td></td> <td></td> <td colspan="8" style="text-align: center;"> <table border="1" style="width: 100%; border-collapse: collapse; text-align: center;"> <tr> <td style="width: 10%;"></td> <td style="width: 10%;"></td> <td style="width: 10%;"></td> <td style="width: 10%;"></td> <td style="width: 10%;"></td> <td style="width: 10%;"></td> <td style="width: 10%;"></td> <td style="width: 10%;"></td> <td style="width: 10%;"></td> <td style="width: 10%;"></td> </tr> <tr> <td></td> <td></td> <td colspan="8" style="text-align: center;"> <table border="1" style="width: 100%; border-collapse: collapse; text-align: center;"> <tr> <td style="width: 10%;"></td> <td style="width: 10%;"></td> <td style="width: 10%;"></td> <td style="width: 10%;"></td> <td style="width: 10%;"></td> <td style="width: 10%;"></td> <td style="width: 10%;"></td> <td style="width: 10%;"></td> <td style="width: 10%;"></td> <td style="width: 10%;"></td> </tr> <tr> <td></td> <td></td> <td colspan="8" style="text-align: center;"> <table border="1" style="width: 100%; border-collapse: collapse; text-align: center;"> <tr> <td style="width: 10%;"></td> <td style="width: 10%;"></td> <td style="width: 10%;"></td> <td style="width: 10%;"></td> <td style="width: 10%;"></td> <td style="width: 10%;"></td> <td style="width: 10%;"></td> <td style="width: 10%;"></td> <td style="width: 10%;"></td> <td style="width: 10%;"></td> </tr> <tr> <td></td> <td></td> <td colspan="8" style="text-align: center;"> <table border="1" style="width: 100%; border-collapse: collapse; text-align: center;"> <tr> <td style="width: 10%;"></td> <td style="width: 10%;"></td> <td style="width: 10%;"></td> <td style="width: 10%;"></td> <td style="width: 10%;"></td> <td style="width: 10%;"></td> <td style="width: 10%;"></td> <td style="width: 10%;"></td> <td style="width: 10%;"></td> <td style="width: 10%;"></td> </tr> <tr> <td></td> <td></td> <td colspan="8" style="text-align: center;"> <table border="1" style="width: 100%; border-collapse: collapse; text-align: center;"> <tr> <td style="width: 10%;"></td> <td style="width: 10%;"></td> <td style="width: 10%;"></td> <td style="width: 10%;"></td> <td style="width: 10%;"></td> <td style="width: 10%;"></td> <td style="width: 10%;"></td> <td style="width: 10%;"></td> <td style="width: 10%;"></td> <td style="width: 10%;"></td> </tr> <tr> <td></td> <td></td> <td colspan="8" style="text-align: center;"> <table border="1" style="width: 100%; border-collapse: collapse; text-align: center;"> <tr> <td style="width: 10%;"></td> <td style="width: 10%;"></td> <td style="width: 10%;"></td> <td style="width: 10%;"></td> <td style="width: 10%;"></td> <td style="width: 10%;"></td> <td style="width: 10%;"></td> <td style="width: 10%;"></td> <td style="width: 10%;"></td> <td style="width: 10%;"></td> </tr> <tr> <td></td> <td></td> <td colspan="8" style="text-align: center;"> <table border="1" style="width: 100%; border-collapse: collapse; text-align: center;"> <tr> <td style="width: 10%;"></td> <td style="width: 10%;"></td> <td style="width: 10%;"></td> <td style="width: 10%;"></td> <td style="width: 10%;"></td> <td style="width: 10%;"></td> <td style="width: 10%;"></td> <td style="width: 10%;"></td> <td style="width: 10%;"></td> <td style="width: 10%;"></td> </tr> <tr> <td></td> <td></td> <td colspan="8" style="text-align: center;"> <table border="1" style="width: 100%; border-collapse: collapse; text-align: center;"> <tr> <td style="width: 10%;"></td> <td style="width: 10%;"></td> <td style="width: 10%;"></td> <td style="width: 10%;"></td> <td style="width: 10%;"></td> <td style="width: 10%;"></td> <td style="width: 10%;"></td> <td style="width: 10%;"></td> <td style="width: 10%;"></td> <td style="width: 10%;"></td> </tr> <tr> <td></td> <td></td> <td colspan="8" style="text-align: center;"> <table border="1" style="width: 100%; border-collapse: collapse; text-align: center;"> <tr> <td style="width: 10%;"></td> <td style="width: 10%;"></td> <td style="width: 10%;"></td> <td style="width: 10%;"></td> <td style="width: 10%;"></td> <td style="width: 10%;"></td> <td style="width: 10%;"></td> <td style="width: 10%;"></td> <td style="width: 10%;"></td> <td style="width: 10%;"></td> </tr> <tr> <td></td> <td></td> <td colspan="8" style="text-align: center;"> <table border="1" style="width: 100%; border-collapse: collapse; text-align: center;"> <tr> <td style="width: 10%;"></td> <td style="width: 10%;"></td> <td style="width: 10%;"></td> <td style="width: 10%;"></td> <td style="width: 10%;"></td> <td style="width: 10%;"></td> <td style="width: 10%;"></td> <td style="width: 10%;"></td> <td style="width: 10%;"></td> <td style="width: 10%;"></td> </tr> <tr> <td></td> <td></td> <td colspan="8" style="text-align: center;"> <table border="1" style="width: 100%; border-collapse: collapse; text-align: center;"> <tr> <td style="width: 10%;"></td> <td style="width: 10%;"></td> <td style="width: 10%;"></td> <td style="width: 10%;"></td> <td style="width: 10%;"></td> <td style="width: 10%;"></td> <td style="width: 10%;"></td> <td style="width: 10%;"></td> <td style="width: 10%;"></td> <td style="width: 10%;"></td> </tr> <tr> <td></td> <td></td> <td colspan="8" style="text-align: center;"> <table border="1" style="width: 100%; border-collapse: collapse; text-align: center;"> <tr> <td style="width: 10%;"></td> <td style="width: 10%;"></td> <td style="width: 10%;"></td> <td style="width: 10%;"></td> <td style="width: 10%;"></td> <td style="width: 10%;"></td> <td style="width: 10%;"></td> <td style="width: 10%;"></td> <td style="width: 10%;"></td> <td style="width: 10%;"></td> </tr> <tr> <td></td> <td></td> <td colspan="8" style="text-align: center;"> <table border="1" style="width: 100%; border-collapse: collapse; text-align: center;"> <tr> <td style="width: 10%;"></td> <td style="width: 10%;"></td> <td style="width: 10%;"></td> <td style="width: 10%;"></td> <td style="width: 10%;"></td> <td style="width: 10%;"></td> <td style="width: 10%;"></td> <td style="width: 10%;"></td> <td style="width: 10%;"></td> <td style="width: 10%;"></td> </tr> <tr> <td></td> <td></td> <td colspan="8" style="text-align: center;"> <table border="1" style="width: 100%; border-collapse: collapse; text-align: center;"> <tr> <td style="width: 10%;"></td> <td style="width: 10%;"></td> <td style="width: 10%;"></td> <td style="width: 10%;"></td> <td style="width: 10%;"></td> <td style="width: 10%;"></td> <td style="width: 10%;"></td> <td style="width: 10%;"></td> <td style="width: 10%;"></td> <td style="width: 10%;"></td> </tr> <tr> <td></td> <td></td> <td colspan="8" style="text-align: center;"> <table border="1" style="width: 100%; border-collapse: collapse; text-align: center;"> <tr> <td style="width: 10%;"></td> <td style="width: 10%;"></td> <td style="width: 10%;"></td> <td style="width: 10%;"></td> <td style="width: 10%;"></td> <td style="width: 10%;"></td> <td style="width: 10%;"></td> <td style="width: 10%;"></td> <td style="width: 10%;"></td> <td style="width: 10%;"></td> </tr> <tr> <td></td> <td></td> <td colspan="8" style="text-align: center;"> <table border="1" style="width: 100%; border-collapse: collapse; text-align: center;"> <tr> <td style="width: 10%;"></td> <td style="width: 10%;"></td> <td style="width: 10%;"></td> <td style="width: 10%;"></td> <td style="width: 10%;"></td> <td style="width: 10%;"></td> <td style="width: 10%;"></td> <td style="width: 10%;"></td> <td style="width: 10%;"></td> <td style="width: 10%;"></td> </tr> <tr> <td></td> <td></td> <td colspan="8" style="text-align: center;"> <table border="1" style="width: 100%; border-collapse: collapse; text-align: center;"> <tr> <td style="width: 10%;"></td> <td style="width: 10%;"></td> <td style="width: 10%;"></td> <td style="width: 10%;"></td> <td style="width: 10%;"></td> <td style="width: 10%;"></td> <td style="width: 10%;"></td> <td style="width: 10%;"></td> <td
style="width: 10%;"></td> <td style="width: 10%;"></td> </tr> <tr> <td></td> <td></td> <td colspan="8" style="text-align: center;"> <table border="1" style="width: 100%; border-collapse: collapse; text-align: center;"> <tr> <td style="width: 10%;"></td> <td style="width: 10%;"></td> <td style="width: 10%;"></td> <td style="width: 10%;"></td> <td style="width: 10%;"></td> <td style="width: 10%;"></td> <td style="width: 10%;"></td> <td style="width: 10%;"></td> <td style="width: 10%;"></td> <td style="width: 10%;"></td> </tr> <tr> <td></td> <td></td> <td colspan="8" style="text-align: center;"> <table border="1" style="width: 100%; border-collapse: collapse; text-align: center;"> <tr> <td style="width: 10%;"></td> <td style="width: 10%;"></td> <td style="width: 10%;"></td> <td style="width: 10%;"></td> <td style="width: 10%;"></td> <td style="width: 10%;"></td> <td style="width: 10%;"></td> <td style="width: 10%;"></td> <td style="width: 10%;"></td> <td style="width: 10%;"></td> </tr> <tr> <td></td> <td></td> <td colspan="8" style="text-align: center;"> <table border="1" style="width: 100%; border-collapse: collapse; text-align: center;"> <tr> </tr></table></td></tr></table></td></tr></table></td></tr></table></td></tr></table></td></tr></table></td></tr></table></td></tr></table></td></tr></table></td></tr></table></td></tr></table></td></tr></table></td></tr></table></td></tr></table></td></tr></table></td></tr></table></td></tr></table></td></tr></table></td></tr></table></td></tr></table></td></tr></table></td></tr></table></td></tr></table></td></tr></table></td></tr></table></td></tr></table></td></tr></table></td></tr></table></td></tr></table></td></tr></table></td></tr></table></td></tr></table></td></tr></table></td></tr></table></td></tr></table></td></tr></table></td></tr></table></td></tr></table></td></tr></table></td></tr></table></td></tr></table></td></tr></table></td></tr></table></td></tr></table></td></tr></table></td></tr></table></td></tr></table></td></tr></table></td></tr></table></td></tr></table></td></tr></table></td></tr></table></td></tr></table></td></tr></table></td></tr></table></td></tr></table></td></tr></table></td></tr></table></td></tr></table></td></tr></table></td></tr></table> | | | | | | | | | | | | | | | | | | | | <table border="1" style="width: 100%; border-collapse: collapse; text-align: center;"> <tr> <td style="width: 10%;"></td> <td style="width: 10%;"></td> <td style="width: 10%;"></td> <td style="width: 10%;"></td> <td style="width: 10%;"></td> <td style="width: 10%;"></td> <td style="width: 10%;"></td> <td style="width: 10%;"></td> <td style="width: 10%;"></td> <td style="width: 10%;"></td> </tr> <tr> <td></td> <td></td> <td colspan="8" style="text-align: center;"> <table border="1" style="width: 100%; border-collapse: collapse; text-align: center;"> <tr> <td style="width: 10%;"></td> <td style="width: 10%;"></td> <td style="width: 10%;"></td> <td style="width: 10%;"></td> <td style="width: 10%;"></td> <td style="width: 10%;"></td> <td style="width: 10%;"></td> <td style="width: 10%;"></td> <td style="width: 10%;"></td> <td style="width: 10%;"></td> </tr> <tr> <td></td> <td></td> <td colspan="8" style="text-align: center;"> <table border="1" style="width: 100%; border-collapse: collapse; text-align: center;"> <tr> <td style="width: 10%;"></td> <td style="width: 10%;"></td> <td style="width: 10%;"></td> <td style="width: 10%;"></td> <td style="width: 10%;"></td> <td style="width: 10%;"></td> <td style="width: 10%;"></td> <td style="width: 10%;"></td> <td style="width: 10%;"></td> <td style="width: 10%;"></td> </tr> <tr> <td></td> <td></td> <td colspan="8" style="text-align: center;"> <table border="1" style="width: 100%; border-collapse: collapse; text-align: center;"> <tr> <td style="width: 10%;"></td> <td style="width: 10%;"></td> <td style="width: 10%;"></td> <td style="width: 10%;"></td> <td style="width: 10%;"></td> <td style="width: 10%;"></td> <td style="width: 10%;"></td> <td style="width: 10%;"></td> <td style="width: 10%;"></td> <td style="width: 10%;"></td> </tr> <tr> <td></td> <td></td> <td colspan="8" style="text-align: center;"> <table border="1" style="width: 100%; border-collapse: collapse; text-align: center;"> <tr> <td style="width: 10%;"></td> <td style="width: 10%;"></td> <td style="width: 10%;"></td> <td style="width: 10%;"></td> <td style="width: 10%;"></td> <td style="width: 10%;"></td> <td style="width: 10%;"></td> <td style="width: 10%;"></td> <td style="width: 10%;"></td> <td style="width: 10%;"></td> </tr> <tr> <td></td> <td></td> <td colspan="8" style="text-align: center;"> <table border="1" style="width: 100%; border-collapse: collapse; text-align: center;"> <tr> <td style="width: 10%;"></td> <td style="width: 10%;"></td> <td style="width: 10%;"></td> <td style="width: 10%;"></td> <td style="width: 10%;"></td> <td style="width: 10%;"></td> <td style="width: 10%;"></td> <td style="width: 10%;"></td> <td style="width: 10%;"></td> <td style="width: 10%;"></td> </tr> <tr> <td></td> <td></td> <td colspan="8" style="text-align: center;"> <table border="1" style="width: 100%; border-collapse: collapse; text-align: center;"> <tr> <td style="width: 10%;"></td> <td style="width: 10%;"></td> <td style="width: 10%;"></td> <td style="width: 10%;"></td> <td style="width: 10%;"></td> <td style="width: 10%;"></td> <td style="width: 10%;"></td> <td style="width: 10%;"></td> <td style="width: 10%;"></td> <td style="width: 10%;"></td> </tr> <tr> <td></td> <td></td> <td colspan="8" style="text-align: center;"> <table border="1" style="width: 100%; border-collapse: collapse; text-align: center;"> <tr> <td style="width: 10%;"></td> <td style="width: 10%;"></td> <td style="width: 10%;"></td> <td style="width: 10%;"></td> <td style="width: 10%;"></td> <td style="width: 10%;"></td> <td style="width: 10%;"></td> <td style="width: 10%;"></td> <td style="width: 10%;"></td> <td style="width: 10%;"></td> </tr> <tr> <td></td> <td></td> <td colspan="8" style="text-align: center;"> <table border="1" style="width: 100%; border-collapse: collapse; text-align: center;"> <tr> <td style="width: 10%;"></td> <td style="width: 10%;"></td> <td style="width: 10%;"></td> <td style="width: 10%;"></td> <td style="width: 10%;"></td> <td style="width: 10%;"></td> <td style="width: 10%;"></td> <td style="width: 10%;"></td> <td style="width: 10%;"></td> <td style="width: 10%;"></td> </tr> <tr> <td></td> <td></td> <td colspan="8" style="text-align: center;"> <table border="1" style="width: 100%; border-collapse: collapse; text-align: center;"> <tr> <td style="width: 10%;"></td> <td style="width: 10%;"></td> <td style="width: 10%;"></td> <td style="width: 10%;"></td> <td style="width: 10%;"></td> <td style="width: 10%;"></td> <td style="width: 10%;"></td> <td style="width: 10%;"></td> <td style="width: 10%;"></td> <td style="width: 10%;"></td> </tr> <tr> <td></td> <td></td> <td colspan="8" style="text-align: center;"> <table border="1" style="width: 100%; border-collapse: collapse; text-align: center;"> <tr> <td style="width: 10%;"></td> <td style="width: 10%;"></td> <td style="width: 10%;"></td> <td style="width: 10%;"></td> <td style="width: 10%;"></td> <td style="width: 10%;"></td> <td style="width: 10%;"></td> <td style="width: 10%;"></td> <td style="width: 10%;"></td> <td style="width: 10%;"></td> </tr> <tr> <td></td> <td></td> <td colspan="8" style="text-align: center;"> <table border="1" style="width: 100%; border-collapse: collapse; text-align: center;"> <tr> <td style="width: 10%;"></td> <td style="width: 10%;"></td> <td style="width: 10%;"></td> <td style="width: 10%;"></td> <td style="width: 10%;"></td> <td style="width: 10%;"></td> <td style="width: 10%;"></td> <td style="width: 10%;"></td> <td style="width: 10%;"></td> <td style="width: 10%;"></td> </tr> <tr> <td></td> <td></td> <td colspan="8" style="text-align: center;"> <table border="1" style="width: 100%; border-collapse: collapse; text-align: center;"> <tr> <td style="width: 10%;"></td> <td style="width: 10%;"></td> <td style="width: 10%;"></td> <td style="width: 10%;"></td> <td style="width: 10%;"></td> <td style="width: 10%;"></td> <td style="width: 10%;"></td> <td style="width: 10%;"></td> <td style="width: 10%;"></td> <td style="width: 10%;"></td> </tr> <tr> <td></td> <td></td> <td colspan="8" style="text-align: center;"> <table border="1" style="width: 100%; border-collapse: collapse; text-align: center;"> <tr> <td style="width: 10%;"></td> <td style="width: 10%;"></td> <td style="width: 10%;"></td> <td style="width: 10%;"></td> <td style="width: 10%;"></td> <td style="width: 10%;"></td> <td style="width: 10%;"></td> <td style="width: 10%;"></td> <td style="width: 10%;"></td> <td style="width: 10%;"></td> </tr> <tr> <td></td> <td></td> <td colspan="8" style="text-align: center;"> <table border="1" style="width: 100%; border-collapse: collapse; text-align: center;"> <tr> <td style="width: 10%;"></td> <td style="width: 10%;"></td> <td
style="width: 10%;"></td> <td style="width: 10%;"></td> <td style="width: 10%;"></td> <td style="width: 10%;"></td> <td style="width: 10%;"></td> <td style="width: 10%;"></td> <td style="width: 10%;"></td> <td style="width: 10%;"></td> </tr> <tr> <td></td> <td></td> <td colspan="8" style="text-align: center;"> <table border="1" style="width: 100%; border-collapse: collapse; text-align: center;"> <tr> <td style="width: 10%;"></td> <td style="width: 10%;"></td> <td style="width: 10%;"></td> <td style="width: 10%;"></td> <td style="width: 10%;"></td> <td style="width: 10%;"></td> <td style="width: 10%;"></td> <td style="width: 10%;"></td> <td style="width: 10%;"></td> <td style="width: 10%;"></td> </tr> <tr> <td></td> <td></td> <td colspan="8" style="text-align: center;"> <table border="1" style="width: 100%; border-collapse: collapse; text-align: center;"> <tr> <td style="width: 10%;"></td> <td style="width: 10%;"></td> <td style="width: 10%;"></td> <td style="width: 10%;"></td> <td style="width: 10%;"></td> <td style="width: 10%;"></td> <td style="width: 10%;"></td> <td style="width: 10%;"></td> <td style="width: 10%;"></td> <td style="width: 10%;"></td> </tr> <tr> <td></td> <td></td> <td colspan="8" style="text-align: center;"> <table border="1" style="width: 100%; border-collapse: collapse; text-align: center;"> <tr> <td style="width: 10%;"></td> <td style="width: 10%;"></td> <td style="width: 10%;"></td> <td style="width: 10%;"></td> <td style="width: 10%;"></td> <td style="width: 10%;"></td> <td style="width: 10%;"></td> <td style="width: 10%;"></td> <td style="width: 10%;"></td> <td style="width: 10%;"></td> </tr> <tr> <td></td> <td></td> <td colspan="8" style="text-align: center;"> <table border="1" style="width: 100%; border-collapse: collapse; text-align: center;"> <tr> <td style="width: 10%;"></td> <td style="width: 10%;"></td> <td style="width: 10%;"></td> <td style="width: 10%;"></td> <td style="width: 10%;"></td> <td style="width: 10%;"></td> <td style="width: 10%;"></td> <td style="width: 10%;"></td> <td style="width: 10%;"></td> <td style="width: 10%;"></td> </tr> <tr> <td></td> <td></td> <td colspan="8" style="text-align: center;"> <table border="1" style="width: 100%; border-collapse: collapse; text-align: center;"> <tr> <td style="width: 10%;"></td> <td style="width: 10%;"></td> <td style="width: 10%;"></td> <td style="width: 10%;"></td> <td style="width: 10%;"></td> <td style="width: 10%;"></td> <td style="width: 10%;"></td> <td style="width: 10%;"></td> <td style="width: 10%;"></td> <td style="width: 10%;"></td> </tr> <tr> <td></td> <td></td> <td colspan="8" style="text-align: center;"> <table border="1" style="width: 100%; border-collapse: collapse; text-align: center;"> <tr> <td style="width: 10%;"></td> <td style="width: 10%;"></td> <td style="width: 10%;"></td> <td style="width: 10%;"></td> <td style="width: 10%;"></td> <td style="width: 10%;"></td> <td style="width: 10%;"></td> <td style="width: 10%;"></td> <td style="width: 10%;"></td> <td style="width: 10%;"></td> </tr> <tr> <td></td> <td></td> <td colspan="8" style="text-align: center;"> <table border="1" style="width: 100%; border-collapse: collapse; text-align: center;"> <tr> <td style="width: 10%;"></td> <td style="width: 10%;"></td> <td style="width: 10%;"></td> <td style="width: 10%;"></td> <td style="width: 10%;"></td> <td style="width: 10%;"></td> <td style="width: 10%;"></td> <td style="width: 10%;"></td> <td style="width: 10%;"></td> <td style="width: 10%;"></td> </tr> <tr> <td></td> <td></td> <td colspan="8" style="text-align: center;"> <table border="1" style="width: 100%; border-collapse: collapse; text-align: center;"> <tr> <td style="width: 10%;"></td> <td style="width: 10%;"></td> <td style="width: 10%;"></td> <td style="width: 10%;"></td> <td style="width: 10%;"></td> <td style="width: 10%;"></td> <td style="width: 10%;"></td> <td style="width: 10%;"></td> <td style="width: 10%;"></td> <td style="width: 10%;"></td> </tr> <tr> <td></td> <td></td> <td colspan="8" style="text-align: center;"> <table border="1" style="width: 100%; border-collapse: collapse; text-align: center;"> <tr> <td style="width: 10%;"></td> <td style="width: 10%;"></td> <td style="width: 10%;"></td> <td style="width: 10%;"></td> <td style="width: 10%;"></td> <td style="width: 10%;"></td> <td style="width: 10%;"></td> <td style="width: 10%;"></td> <td style="width: 10%;"></td> <td style="width: 10%;"></td> </tr> <tr> <td></td> <td></td> <td colspan="8" style="text-align: center;"> <table border="1" style="width: 100%; border-collapse: collapse; text-align: center;"> <tr> <td style="width: 10%;"></td> <td style="width: 10%;"></td> <td style="width: 10%;"></td> <td style="width: 10%;"></td> <td style="width: 10%;"></td> <td style="width: 10%;"></td> <td style="width: 10%;"></td> <td style="width: 10%;"></td> <td style="width: 10%;"></td> <td style="width: 10%;"></td> </tr> <tr> <td></td> <td></td> <td colspan="8" style="text-align: center;"> <table border="1" style="width: 100%; border-collapse: collapse; text-align: center;"> <tr> <td style="width: 10%;"></td> <td style="width: 10%;"></td> <td style="width: 10%;"></td> <td style="width: 10%;"></td> <td style="width: 10%;"></td> <td style="width: 10%;"></td> <td style="width: 10%;"></td> <td style="width: 10%;"></td> <td style="width: 10%;"></td> <td style="width: 10%;"></td> </tr> <tr> <td></td> <td></td> <td colspan="8" style="text-align: center;"> <table border="1" style="width: 100%; border-collapse: collapse; text-align: center;"> <tr> <td style="width: 10%;"></td> <td style="width: 10%;"></td> <td style="width: 10%;"></td> <td style="width: 10%;"></td> <td style="width: 10%;"></td> <td style="width: 10%;"></td> <td style="width: 10%;"></td> <td style="width: 10%;"></td> <td style="width: 10%;"></td> <td style="width: 10%;"></td> </tr> <tr> <td></td> <td></td> <td colspan="8" style="text-align: center;"> <table border="1" style="width: 100%; border-collapse: collapse; text-align: center;"> <tr> <td style="width: 10%;"></td> <td style="width: 10%;"></td> <td style="width: 10%;"></td> <td style="width: 10%;"></td> <td style="width: 10%;"></td> <td style="width: 10%;"></td> <td style="width: 10%;"></td> <td style="width: 10%;"></td> <td style="width: 10%;"></td> <td style="width: 10%;"></td> </tr> <tr> <td></td> <td></td> <td colspan="8" style="text-align: center;"> <table border="1" style="width: 100%; border-collapse: collapse; text-align: center;"> <tr> <td style="width: 10%;"></td> <td style="width: 10%;"></td> <td style="width: 10%;"></td> <td style="width: 10%;"></td> <td style="width: 10%;"></td> <td style="width: 10%;"></td> <td style="width: 10%;"></td> <td style="width: 10%;"></td> <td style="width: 10%;"></td> <td style="width: 10%;"></td> </tr> <tr> <td></td> <td></td> <td colspan="8" style="text-align: center;"> <table border="1" style="width: 100%; border-collapse: collapse; text-align: center;"> <tr> <td style="width: 10%;"></td> <td style="width: 10%;"></td> <td style="width: 10%;"></td> <td style="width: 10%;"></td> <td style="width: 10%;"></td> <td style="width: 10%;"></td> <td style="width: 10%;"></td> <td style="width: 10%;"></td> <td style="width: 10%;"></td> <td style="width: 10%;"></td> </tr> <tr> <td></td> <td></td> <td colspan="8" style="text-align: center;"> <table border="1" style="width: 100%; border-collapse: collapse; text-align: center;"> <tr> <td style="width: 10%;"></td> <td style="width: 10%;"></td> <td style="width: 10%;"></td> <td style="width: 10%;"></td> <td style="width: 10%;"></td> <td style="width: 10%;"></td> <td style="width: 10%;"></td> <td style="width: 10%;"></td> <td style="width: 10%;"></td> <td style="width: 10%;"></td> </tr> <tr> <td></td> <td></td> <td colspan="8" style="text-align: center;"> <table border="1" style="width: 100%; border-collapse: collapse; text-align: center;"> <tr> <td style="width: 10%;"></td> <td style="width: 10%;"></td> <td style="width: 10%;"></td> <td style="width: 10%;"></td> <td style="width: 10%;"></td> <td style="width: 10%;"></td> <td style="width: 10%;"></td> <td style="width: 10%;"></td> <td style="width: 10%;"></td> <td style="width: 10%;"></td> </tr> <tr> <td></td> <td></td> <td colspan="8" style="text-align: center;"> <table border="1" style="width: 100%; border-collapse: collapse; text-align: center;"> <tr> <td style="width: 10%;"></td> <td style="width: 10%;"></td> <td style="width: 10%;"></td> <td style="width: 10%;"></td> <td style="width: 10%;"></td> <td style="width: 10%;"></td> <td style="width: 10%;"></td> <td style="width: 10%;"></td> <td style="width: 10%;"></td> <td style="width: 10%;"></td> </tr> <tr> <td></td> <td></td> <td colspan="8" style="text-align: center;"> <table border="1" style="width: 100%; border-collapse: collapse; text-align: center;"> <tr> <td style="width: 10%;"></td> <td style="width: 10%;"></td> <td style="width: 10%;"></td> <td style="width: 10%;"></td> <td style="width: 10%;"></td> <td style="width: 10%;"></td> <td style="width: 10%;"></td> <td style="width: 10%;"></td> <td style="width: 10%;"></td> <td style="width: 10%;"></td> </tr> <tr> <td></td> <td></td> <td colspan="8" style="text-align: center;"> <table border="1" style="width: 100%; border-collapse: collapse; text-align: center;"> <tr> <td style="width: 10%;"></td> <td style="width: 10%;"></td> <td style="width: 10%;"></td> <td style="width: 10%;"></td> <td style="width: 10%;"></td> <td style="width: 10%;"></td> <td style="width: 10%;"></td> <td style="width: 10%;"></td> <td style="width: 10%;"></td> <td style="width: 10%;"></td> </tr> <tr> <td></td> <td></td> <td colspan="8" style="text-align: center;"> <table border="1" style="width: 100%; border-collapse: collapse; text-align: center;"> <tr> <td style="width: 10%;"></td> <td style="width: 10%;"></td> <td style="width: 10%;"></td> <td style="width: 10%;"></td> <td style="width: 10%;"></td> <td style="width: 10%;"></td> <td style="width: 10%;"></td> <td style="width:
10%;"></td> <td style="width: 10%;"></td> <td style="width: 10%;"></td> </tr> <tr> <td></td> <td></td> <td colspan="8" style="text-align: center;"> <table border="1" style="width: 100%; border-collapse: collapse; text-align: center;"> <tr> <td style="width: 10%;"></td> <td style="width: 10%;"></td> <td style="width: 10%;"></td> <td style="width: 10%;"></td> <td style="width: 10%;"></td> <td style="width: 10%;"></td> <td style="width: 10%;"></td> <td style="width: 10%;"></td> <td style="width: 10%;"></td> <td style="width: 10%;"></td> </tr> <tr> <td></td> <td></td> <td colspan="8" style="text-align: center;"> <table border="1" style="width: 100%; border-collapse: collapse; text-align: center;"> <tr> <td style="width: 10%;"></td> <td style="width: 10%;"></td> <td style="width: 10%;"></td> <td style="width: 10%;"></td> <td style="width: 10%;"></td> <td style="width: 10%;"></td> <td style="width: 10%;"></td> <td style="width: 10%;"></td> <td style="width: 10%;"></td> <td style="width: 10%;"></td> </tr> <tr> <td></td> <td></td> <td colspan="8" style="text-align: center;"> <table border="1" style="width: 100%; border-collapse: collapse; text-align: center;"> <tr> <td style="width: 10%;"></td> <td style="width: 10%;"></td> <td style="width: 10%;"></td> <td style="width: 10%;"></td> <td style="width: 10%;"></td> <td style="width: 10%;"></td> <td style="width: 10%;"></td> <td style="width: 10%;"></td> <td style="width: 10%;"></td> <td style="width: 10%;"></td> </tr> <tr> <td></td> <td></td> <td colspan="8" style="text-align: center;"> <table border="1" style="width: 100%; border-collapse: collapse; text-align: center;"> <tr> <td style="width: 10%;"></td> <td style="width: 10%;"></td> <td style="width: 10%;"></td> <td style="width: 10%;"></td> <td style="width: 10%;"></td> <td style="width: 10%;"></td> <td style="width: 10%;"></td> <td style="width: 10%;"></td> <td style="width: 10%;"></td> <td style="width: 10%;"></td> </tr> <tr> <td></td> <td></td> <td colspan="8" style="text-align: center;"> <table border="1" style="width: 100%; border-collapse: collapse; text-align: center;"> <tr> <td style="width: 10%;"></td> <td style="width: 10%;"></td> <td style="width: 10%;"></td> <td style="width: 10%;"></td> <td style="width: 10%;"></td> <td style="width: 10%;"></td> <td style="width: 10%;"></td> <td style="width: 10%;"></td> <td style="width: 10%;"></td> <td style="width: 10%;"></td> </tr> <tr> <td></td> <td></td> <td colspan="8" style="text-align: center;"> <table border="1" style="width: 100%; border-collapse: collapse; text-align: center;"> <tr> <td style="width: 10%;"></td> <td style="width: 10%;"></td> <td style="width: 10%;"></td> <td style="width: 10%;"></td> <td style="width: 10%;"></td> <td style="width: 10%;"></td> <td style="width: 10%;"></td> <td style="width: 10%;"></td> <td style="width: 10%;"></td> <td style="width: 10%;"></td> </tr> <tr> <td></td> <td></td> <td colspan="8" style="text-align: center;"> <table border="1" style="width: 100%; border-collapse: collapse; text-align: center;"> <tr> <td style="width: 10%;"></td> <td style="width: 10%;"></td> <td style="width: 10%;"></td> <td style="width: 10%;"></td> <td style="width: 10%;"></td> <td style="width: 10%;"></td> <td style="width: 10%;"></td> <td style="width: 10%;"></td> <td style="width: 10%;"></td> <td style="width: 10%;"></td> </tr> <tr> <td></td> <td></td> <td colspan="8" style="text-align: center;"> <table border="1" style="width: 100%; border-collapse: collapse; text-align: center;"> <tr> <td style="width: 10%;"></td> <td style="width: 10%;"></td> <td style="width: 10%;"></td> <td style="width: 10%;"></td> <td style="width: 10%;"></td> <td style="width: 10%;"></td> <td style="width: 10%;"></td> <td style="width: 10%;"></td> <td style="width: 10%;"></td> <td style="width: 10%;"></td> </tr> <tr> <td></td> <td></td> <td colspan="8" style="text-align: center;"> <table border="1" style="width: 100%; border-collapse: collapse; text-align: center;"> <tr> <td style="width: 10%;"></td> <td style="width: 10%;"></td> <td style="width: 10%;"></td> <td style="width: 10%;"></td> <td style="width: 10%;"></td> <td style="width: 10%;"></td> <td style="width: 10%;"></td> <td style="width: 10%;"></td> <td style="width: 10%;"></td> <td style="width: 10%;"></td> </tr> <tr> <td></td> <td></td> <td colspan="8" style="text-align: center;"> <table border="1" style="width: 100%; border-collapse: collapse; text-align: center;"> <tr> <td style="width: 10%;"></td> <td style="width: 10%;"></td> <td style="width: 10%;"></td> <td style="width: 10%;"></td> <td style="width: 10%;"></td> <td style="width: 10%;"></td> <td style="width: 10%;"></td> <td style="width: 10%;"></td> <td style="width: 10%;"></td> <td style="width: 10%;"></td> </tr> <tr> <td></td> <td></td> <td colspan="8" style="text-align: center;"> <table border="1" style="width: 100%; border-collapse: collapse; text-align: center;"> <tr> <td style="width: 10%;"></td> <td style="width: 10%;"></td> <td style="width: 10%;"></td> <td style="width: 10%;"></td> <td style="width: 10%;"></td> <td style="width: 10%;"></td> <td style="width: 10%;"></td> <td style="width: 10%;"></td> <td style="width: 10%;"></td> <td style="width: 10%;"></td> </tr> <tr> <td></td> <td></td> <td colspan="8" style="text-align: center;"> <table border="1" style="width: 100%; border-collapse: collapse; text-align: center;"> <tr> <td style="width: 10%;"></td> <td style="width: 10%;"></td> <td style="width: 10%;"></td> <td style="width: 10%;"></td> <td style="width: 10%;"></td> <td style="width: 10%;"></td> <td style="width: 10%;"></td> <td style="width: 10%;"></td> <td style="width: 10%;"></td> <td style="width: 10%;"></td> </tr> <tr> <td></td> <td></td> <td colspan="8" style="text-align: center;"> <table border="1" style="width: 100%; border-collapse: collapse; text-align: center;"> <tr> <td style="width: 10%;"></td> <td style="width: 10%;"></td> <td style="width: 10%;"></td> <td style="width: 10%;"></td> <td style="width: 10%;"></td> <td style="width: 10%;"></td> <td style="width: 10%;"></td> <td style="width: 10%;"></td> <td style="width: 10%;"></td> <td style="width: 10%;"></td> </tr> <tr> <td></td> <td></td> <td colspan="8" style="text-align: center;"> <table border="1" style="width: 100%; border-collapse: collapse; text-align: center;"> <tr> <td style="width: 10%;"></td> <td style="width: 10%;"></td> <td style="width: 10%;"></td> <td style="width: 10%;"></td> <td style="width: 10%;"></td> <td style="width: 10%;"></td> <td style="width: 10%;"></td> <td style="width: 10%;"></td> <td style="width: 10%;"></td> <td style="width: 10%;"></td> </tr> <tr> <td></td> <td></td> <td colspan="8" style="text-align: center;"> <table border="1" style="width: 100%; border-collapse: collapse; text-align: center;"> <tr> <td style="width: 10%;"></td> <td style="width: 10%;"></td> <td style="width: 10%;"></td> <td style="width: 10%;"></td> <td style="width: 10%;"></td> <td style="width: 10%;"></td> <td style="width: 10%;"></td> <td style="width: 10%;"></td> <td style="width: 10%;"></td> <td style="width: 10%;"></td> </tr> <tr> <td></td> <td></td> <td colspan="8" style="text-align: center;"> <table border="1" style="width: 100%; border-collapse: collapse; text-align: center;"> <tr> <td style="width: 10%;"></td> <td style="width: 10%;"></td> <td style="width: 10%;"></td> <td style="width: 10%;"></td> <td style="width: 10%;"></td> <td style="width: 10%;"></td> <td style="width: 10%;"></td> <td style="width: 10%;"></td> <td style="width: 10%;"></td> <td style="width: 10%;"></td> </tr> <tr> <td></td> <td></td> <td colspan="8" style="text-align: center;"> <table border="1" style="width: 100%; border-collapse: collapse; text-align: center;"> <tr> <td style="width: 10%;"></td> <td style="width: 10%;"></td> <td style="width: 10%;"></td> <td style="width: 10%;"></td> <td style="width: 10%;"></td> <td style="width: 10%;"></td> <td style="width: 10%;"></td> <td style="width: 10%;"></td> <td style="width: 10%;"></td> <td style="width: 10%;"></td> </tr> <tr> <td></td> <td></td> <td colspan="8" style="text-align: center;"> <table border="1" style="width: 100%; border-collapse: collapse; text-align: center;"> <tr> <td style="width: 10%;"></td> <td style="width: 10%;"></td> <td style="width: 10%;"></td> <td style="width: 10%;"></td> <td style="width: 10%;"></td> <td style="width: 10%;"></td> <td style="width: 10%;"></td> <td style="width: 10%;"></td> <td style="width: 10%;"></td> <td style="width: 10%;"></td> </tr> <tr> <td></td> <td></td> <td colspan="8" style="text-align: center;"> <table border="1" style="width: 100%; border-collapse: collapse; text-align: center;"> <tr> <td style="width: 10%;"></td> <td style="width: 10%;"></td> <td style="width: 10%;"></td> <td style="width: 10%;"></td> <td style="width: 10%;"></td> <td style="width: 10%;"></td> <td style="width: 10%;"></td> <td style="width: 10%;"></td> <td style="width: 10%;"></td> <td style="width: 10%;"></td> </tr> <tr> <td></td> <td></td> <td colspan="8" style="text-align: center;"> <table border="1" style="width: 100%; border-collapse: collapse; text-align: center;"> <tr> <td style="width: 10%;"></td> <td style="width: 10%;"></td> <td style="width: 10%;"></td> <td style="width: 10%;"></td> <td style="width: 10%;"></td> <td style="width: 10%;"></td> <td style="width: 10%;"></td> <td style="width: 10%;"></td> <td style="width: 10%;"></td> <td style="width: 10%;"></td> </tr> <tr> <td></td> <td></td> <td colspan="8" style="text-align: center;"> <table border="1" style="width: 100%; border-collapse: collapse; text-align: center;"> <tr> <td style="width: 10%;"></td> <td style="width: 10%;"></td> <td style="width: 10%;"></td> <td style="width: 10%;"></td> <td style="width: 10%;"></td> <td style="width: 10%;"></td> <td style="width: 10%;"></td> <td style="width: 10%;"></td> <td style="width: 10%;"></td> <td style="width: 10%;"></td> </tr> <tr> <td></td> <td></td> <td colspan="8" style="text-align: center;"> <table border="1"
style="width: 100%; border-collapse: collapse; text-align: center;"> <tr> <td style="width: 10%;"></td> <td style="width: 10%;"></td> <td style="width: 10%;"></td> <td style="width: 10%;"></td> <td style="width: 10%;"></td> <td style="width: 10%;"></td> <td style="width: 10%;"></td> <td style="width: 10%;"></td> <td style="width: 10%;"></td> <td style="width: 10%;"></td> </tr> <tr> <td></td> <td></td> <td colspan="8" style="text-align: center;"> <table border="1" style="width: 100%; border-collapse: collapse; text-align: center;"> <tr> <td style="width: 10%;"></td> <td style="width: 10%;"></td> <td style="width: 10%;"></td> <td style="width: 10%;"></td> <td style="width: 10%;"></td> <td style="width: 10%;"></td> <td style="width: 10%;"></td> <td style="width: 10%;"></td> <td style="width: 10%;"></td> <td style="width: 10%;"></td> </tr> <tr> <td></td> <td></td> <td colspan="8" style="text-align: center;"> <table border="1" style="width: 100%; border-collapse: collapse; text-align: center;"> <tr> </tr></table></td></tr></table></td></tr></table></td></tr></table></td></tr></table></td></tr></table></td></tr></table></td></tr></table></td></tr></table></td></tr></table></td></tr></table></td></tr></table></td></tr></table></td></tr></table></td></tr></table></td></tr></table></td></tr></table></td></tr></table></td></tr></table></td></tr></table></td></tr></table></td></tr></table></td></tr></table></td></tr></table></td></tr></table></td></tr></table></td></tr></table></td></tr></table></td></tr></table></td></tr></table></td></tr></table></td></tr></table></td></tr></table></td></tr></table></td></tr></table></td></tr></table></td></tr></table></td></tr></table></td></tr></table></td></tr></table></td></tr></table></td></tr></table></td></tr></table></td></tr></table></td></tr></table></td></tr></table></td></tr></table></td></tr></table></td></tr></table></td></tr></table></td></tr></table></td></tr></table></td></tr></table></td></tr></table></td></tr></table></td></tr></table></td></tr></table></td></tr></table></td></tr></table></td></tr></table> | | | | | | | | | | | | | | | | | | | | <table border="1" style="width: 100%; border-collapse: collapse; text-align: center;"> <tr> <td style="width: 10%;"></td> <td style="width: 10%;"></td> <td style="width: 10%;"></td> <td style="width: 10%;"></td> <td style="width: 10%;"></td> <td style="width: 10%;"></td> <td style="width: 10%;"></td> <td style="width: 10%;"></td> <td style="width: 10%;"></td> <td style="width: 10%;"></td> </tr> <tr> <td></td> <td></td> <td colspan="8" style="text-align: center;"> <table border="1" style="width: 100%; border-collapse: collapse; text-align: center;"> <tr> <td style="width: 10%;"></td> <td style="width: 10%;"></td> <td style="width: 10%;"></td> <td style="width: 10%;"></td> <td style="width: 10%;"></td> <td style="width: 10%;"></td> <td style="width: 10%;"></td> <td style="width: 10%;"></td> <td style="width: 10%;"></td> <td style="width: 10%;"></td> </tr> <tr> <td></td> <td></td> <td colspan="8" style="text-align: center;"> <table border="1" style="width: 100%; border-collapse: collapse; text-align: center;"> <tr> <td style="width: 10%;"></td> <td style="width: 10%;"></td> <td style="width: 10%;"></td> <td style="width: 10%;"></td> <td style="width: 10%;"></td> <td style="width: 10%;"></td> <td style="width: 10%;"></td> <td style="width: 10%;"></td> <td style="width: 10%;"></td> <td style="width: 10%;"></td> </tr> <tr> <td></td> <td></td> <td colspan="8" style="text-align: center;"> <table border="1" style="width: 100%; border-collapse: collapse; text-align: center;"> <tr> <td style="width: 10%;"></td> <td style="width: 10%;"></td> <td style="width: 10%;"></td> <td style="width: 10%;"></td> <td style="width: 10%;"></td> <td style="width: 10%;"></td> <td style="width: 10%;"></td> <td style="width: 10%;"></td> <td style="width: 10%;"></td> <td style="width: 10%;"></td> </tr> <tr> <td></td> <td></td> <td colspan="8" style="text-align: center;"> <table border="1" style="width: 100%; border-collapse: collapse; text-align: center;"> <tr> <td style="width: 10%;"></td> <td style="width: 10%;"></td> <td style="width: 10%;"></td> <td style="width: 10%;"></td> <td style="width: 10%;"></td> <td style="width: 10%;"></td> <td style="width: 10%;"></td> <td style="width: 10%;"></td> <td style="width: 10%;"></td> <td style="width: 10%;"></td> </tr> <tr> <td></td> <td></td> <td colspan="8" style="text-align: center;"> <table border="1" style="width: 100%; border-collapse: collapse; text-align: center;"> <tr> <td style="width: 10%;"></td> <td style="width: 10%;"></td> <td style="width: 10%;"></td> <td style="width: 10%;"></td> <td style="width: 10%;"></td> <td style="width: 10%;"></td> <td style="width: 10%;"></td> <td style="width: 10%;"></td> <td style="width: 10%;"></td> <td style="width: 10%;"></td> </tr> <tr> <td></td> <td></td> <td colspan="8" style="text-align: center;"> <table border="1" style="width: 100%; border-collapse: collapse; text-align: center;"> <tr> <td style="width: 10%;"></td> <td style="width: 10%;"></td> <td style="width: 10%;"></td> <td style="width: 10%;"></td> <td style="width: 10%;"></td> <td style="width: 10%;"></td> <td style="width: 10%;"></td> <td style="width: 10%;"></td> <td style="width: 10%;"></td> <td style="width: 10%;"></td> </tr> <tr> <td></td> <td></td> <td colspan="8" style="text-align: center;"> <table border="1" style="width: 100%; border-collapse: collapse; text-align: center;"> <tr> <td style="width: 10%;"></td> <td style="width: 10%;"></td> <td style="width: 10%;"></td> <td style="width: 10%;"></td> <td style="width: 10%;"></td> <td style="width: 10%;"></td> <td style="width: 10%;"></td> <td style="width: 10%;"></td> <td style="width: 10%;"></td> <td style="width: 10%;"></td> </tr> <tr> <td></td> <td></td> <td colspan="8" style="text-align: center;"> <table border="1" style="width: 100%; border-collapse: collapse; text-align: center;"> <tr> <td style="width: 10%;"></td> <td style="width: 10%;"></td> <td style="width: 10%;"></td> <td style="width: 10%;"></td> <td style="width: 10%;"></td> <td style="width: 10%;"></td> <td style="width: 10%;"></td> <td style="width: 10%;"></td> <td style="width: 10%;"></td> <td style="width: 10%;"></td> </tr> <tr> <td></td> <td></td> <td colspan="8" style="text-align: center;"> <table border="1" style="width: 100%; border-collapse: collapse; text-align: center;"> <tr> <td style="width: 10%;"></td> <td style="width: 10%;"></td> <td style="width: 10%;"></td> <td style="width: 10%;"></td> <td style="width: 10%;"></td> <td style="width: 10%;"></td> <td style="width: 10%;"></td> <td style="width: 10%;"></td> <td style="width: 10%;"></td> <td style="width: 10%;"></td> </tr> <tr> <td></td> <td></td> <td colspan="8" style="text-align: center;"> <table border="1" style="width: 100%; border-collapse: collapse; text-align: center;"> <tr> <td style="width: 10%;"></td> <td style="width: 10%;"></td> <td style="width: 10%;"></td> <td style="width: 10%;"></td> <td style="width: 10%;"></td> <td style="width: 10%;"></td> <td style="width: 10%;"></td> <td style="width: 10%;"></td> <td style="width: 10%;"></td> <td style="width: 10%;"></td> </tr> <tr> <td></td> <td></td> <td colspan="8" style="text-align: center;"> <table border="1" style="width: 100%; border-collapse: collapse; text-align: center;"> <tr> <td style="width: 10%;"></td> <td style="width: 10%;"></td> <td style="width: 10%;"></td> <td style="width: 10%;"></td> <td style="width: 10%;"></td> <td style="width: 10%;"></td> <td style="width: 10%;"></td> <td style="width: 10%;"></td> <td style="width: 10%;"></td> <td style="width: 10%;"></td> </tr> <tr> <td></td> <td></td> <td colspan="8" style="text-align: center;"> <table border="1" style="width: 100%; border-collapse: collapse; text-align: center;"> <tr> <td style="width: 10%;"></td> <td style="width: 10%;"></td> <td style="width: 10%;"></td> <td style="width: 10%;"></td> <td style="width: 10%;"></td> <td style="width: 10%;"></td> <td style="width: 10%;"></td> <td style="width: 10%;"></td> <td style="width: 10%;"></td> <td style="width: 10%;"></td> </tr> <tr> <td></td> <td></td> <td colspan="8" style="text-align: center;"> <table border="1" style="width: 100%; border-collapse: collapse; text-align: center;"> <tr> <td style="width: 10%;"></td> <td style="width: 10%;"></td> <td style="width: 10%;"></td> <td style="width: 10%;"></td> <td style="width: 10%;"></td> <td style="width: 10%;"></td> <td style="width: 10%;"></td> <td style="width: 10%;"></td> <td style="width: 10%;"></td> <td style="width: 10%;"></td> </tr> <tr> <td></td> <td></td> <td colspan="8" style="text-align: center;"> <table border="1" style="width: 100%; border-collapse: collapse; text-align: center;"> <tr> <td style="width: 10%;"></td> <td style="width: 10%;"></td> <td style="width: 10%;"></td> <td style="width: 10%;"></td> <td style="width: 10%;"></td> <td style="width: 10%;"></td> <td style="width: 10%;"></td> <td style="width:
10%;"></td> <td style="width: 10%;"></td> <td style="width: 10%;"></td> </tr> <tr> <td></td> <td></td> <td colspan="8" style="text-align: center;"> <table border="1" style="width: 100%; border-collapse: collapse; text-align: center;"> <tr> <td style="width: 10%;"></td> <td style="width: 10%;"></td> <td style="width: 10%;"></td> <td style="width: 10%;"></td> <td style="width: 10%;"></td> <td style="width: 10%;"></td> <td style="width: 10%;"></td> <td style="width: 10%;"></td> <td style="width: 10%;"></td> <td style="width: 10%;"></td> </tr> <tr> <td></td> <td></td> <td colspan="8" style="text-align: center;"> <table border="1" style="width: 100%; border-collapse: collapse; text-align: center;"> <tr> <td style="width: 10%;"></td> <td style="width: 10%;"></td> <td style="width: 10%;"></td> <td style="width: 10%;"></td> <td style="width: 10%;"></td> <td style="width: 10%;"></td> <td style="width: 10%;"></td> <td style="width: 10%;"></td> <td style="width: 10%;"></td> <td style="width: 10%;"></td> </tr> <tr> <td></td> <td></td> <td colspan="8" style="text-align: center;"> <table border="1" style="width: 100%; border-collapse: collapse; text-align: center;"> <tr> <td style="width: 10%;"></td> <td style="width: 10%;"></td> <td style="width: 10%;"></td> <td style="width: 10%;"></td> <td style="width: 10%;"></td> <td style="width: 10%;"></td> <td style="width: 10%;"></td> <td style="width: 10%;"></td> <td style="width: 10%;"></td> <td style="width: 10%;"></td> </tr> <tr> <td></td> <td></td> <td colspan="8" style="text-align: center;"> <table border="1" style="width: 100%; border-collapse: collapse; text-align: center;"> <tr> <td style="width: 10%;"></td> <td style="width: 10%;"></td> <td style="width: 10%;"></td> <td style="width: 10%;"></td> <td style="width: 10%;"></td> <td style="width: 10%;"></td> <td style="width: 10%;"></td> <td style="width: 10%;"></td> <td style="width: 10%;"></td> <td style="width: 10%;"></td> </tr> <tr> <td></td> <td></td> <td colspan="8" style="text-align: center;"> <table border="1" style="width: 100%; border-collapse: collapse; text-align: center;"> <tr> <td style="width: 10%;"></td> <td style="width: 10%;"></td> <td style="width: 10%;"></td> <td style="width: 10%;"></td> <td style="width: 10%;"></td> <td style="width: 10%;"></td> <td style="width: 10%;"></td> <td style="width: 10%;"></td> <td style="width: 10%;"></td> <td style="width: 10%;"></td> </tr> <tr> <td></td> <td></td> <td colspan="8" style="text-align: center;"> <table border="1" style="width: 100%; border-collapse: collapse; text-align: center;"> <tr> <td style="width: 10%;"></td> <td style="width: 10%;"></td> <td style="width: 10%;"></td> <td style="width: 10%;"></td> <td style="width: 10%;"></td> <td style="width: 10%;"></td> <td style="width: 10%;"></td> <td style="width: 10%;"></td> <td style="width: 10%;"></td> <td style="width: 10%;"></td> </tr> <tr> <td></td> <td></td> <td colspan="8" style="text-align: center;"> <table border="1" style="width: 100%; border-collapse: collapse; text-align: center;"> <tr> <td style="width: 10%;"></td> <td style="width: 10%;"></td> <td style="width: 10%;"></td> <td style="width: 10%;"></td> <td style="width: 10%;"></td> <td style="width: 10%;"></td> <td style="width: 10%;"></td> <td style="width: 10%;"></td> <td style="width: 10%;"></td> <td style="width: 10%;"></td> </tr> <tr> <td></td> <td></td> <td colspan="8" style="text-align: center;"> <table border="1" style="width: 100%; border-collapse: collapse; text-align: center;"> <tr> <td style="width: 10%;"></td> <td style="width: 10%;"></td> <td style="width: 10%;"></td> <td style="width: 10%;"></td> <td style="width: 10%;"></td> <td style="width: 10%;"></td> <td style="width: 10%;"></td> <td style="width: 10%;"></td> <td style="width: 10%;"></td> <td style="width: 10%;"></td> </tr> <tr> <td></td> <td></td> <td colspan="8" style="text-align: center;"> <table border="1" style="width: 100%; border-collapse: collapse; text-align: center;"> <tr> <td style="width: 10%;"></td> <td style="width: 10%;"></td> <td style="width: 10%;"></td> <td style="width: 10%;"></td> <td style="width: 10%;"></td> <td style="width: 10%;"></td> <td style="width: 10%;"></td> <td style="width: 10%;"></td> <td style="width: 10%;"></td> <td style="width: 10%;"></td> </tr> <tr> <td></td> <td></td> <td colspan="8" style="text-align: center;"> <table border="1" style="width: 100%; border-collapse: collapse; text-align: center;"> <tr> <td style="width: 10%;"></td> <td style="width: 10%;"></td> <td style="width: 10%;"></td> <td style="width: 10%;"></td> <td style="width: 10%;"></td> <td style="width: 10%;"></td> <td style="width: 10%;"></td> <td style="width: 10%;"></td> <td style="width: 10%;"></td> <td style="width: 10%;"></td> </tr> <tr> <td></td> <td></td> <td colspan="8" style="text-align: center;"> <table border="1" style="width: 100%; border-collapse: collapse; text-align: center;"> <tr> <td style="width: 10%;"></td> <td style="width: 10%;"></td> <td style="width: 10%;"></td> <td style="width: 10%;"></td> <td style="width: 10%;"></td> <td style="width: 10%;"></td> <td style="width: 10%;"></td> <td style="width: 10%;"></td> <td style="width: 10%;"></td> <td style="width: 10%;"></td> </tr> <tr> <td></td> <td></td> <td colspan="8" style="text-align: center;"> <table border="1" style="width: 100%; border-collapse: collapse; text-align: center;"> <tr> <td style="width: 10%;"></td> <td style="width: 10%;"></td> <td style="width: 10%;"></td> <td style="width: 10%;"></td> <td style="width: 10%;"></td> <td style="width: 10%;"></td> <td style="width: 10%;"></td> <td style="width: 10%;"></td> <td style="width: 10%;"></td> <td style="width: 10%;"></td> </tr> <tr> <td></td> <td></td> <td colspan="8" style="text-align: center;"> <table border="1" style="width: 100%; border-collapse: collapse; text-align: center;"> <tr> <td style="width: 10%;"></td> <td style="width: 10%;"></td> <td style="width: 10%;"></td> <td style="width: 10%;"></td> <td style="width: 10%;"></td> <td style="width: 10%;"></td> <td style="width: 10%;"></td> <td style="width: 10%;"></td> <td style="width: 10%;"></td> <td style="width: 10%;"></td> </tr> <tr> <td></td> <td></td> <td colspan="8" style="text-align: center;"> <table border="1" style="width: 100%; border-collapse: collapse; text-align: center;"> <tr> <td style="width: 10%;"></td> <td style="width: 10%;"></td> <td style="width: 10%;"></td> <td style="width: 10%;"></td> <td style="width: 10%;"></td> <td style="width: 10%;"></td> <td style="width: 10%;"></td> <td style="width: 10%;"></td> <td style="width: 10%;"></td> <td style="width: 10%;"></td> </tr> <tr> <td></td> <td></td> <td colspan="8" style="text-align: center;"> <table border="1" style="width: 100%; border-collapse: collapse; text-align: center;"> <tr> <td style="width: 10%;"></td> <td style="width: 10%;"></td> <td style="width: 10%;"></td> <td style="width: 10%;"></td> <td style="width: 10%;"></td> <td style="width: 10%;"></td> <td style="width: 10%;"></td> <td style="width: 10%;"></td> <td style="width: 10%;"></td> <td style="width: 10%;"></td> </tr> <tr> <td></td> <td></td> <td colspan="8" style="text-align: center;"> <table border="1" style="width: 100%; border-collapse: collapse; text-align: center;"> <tr> <td style="width: 10%;"></td> <td style="width: 10%;"></td> <td style="width: 10%;"></td> <td style="width: 10%;"></td> <td style="width: 10%;"></td> <td style="width: 10%;"></td> <td style="width: 10%;"></td> <td style="width: 10%;"></td> <td style="width: 10%;"></td> <td style="width: 10%;"></td> </tr> <tr> <td></td> <td></td> <td colspan="8" style="text-align: center;"> <table border="1" style="width: 100%; border-collapse: collapse; text-align: center;"> <tr> <td style="width: 10%;"></td> <td style="width: 10%;"></td> <td style="width: 10%;"></td> <td style="width: 10%;"></td> <td style="width: 10%;"></td> <td style="width: 10%;"></td> <td style="width: 10%;"></td> <td style="width: 10%;"></td> <td style="width: 10%;"></td> <td style="width: 10%;"></td> </tr> <tr> <td></td> <td></td> <td colspan="8" style="text-align: center;"> <table border="1" style="width: 100%; border-collapse: collapse; text-align: center;"> <tr> <td style="width: 10%;"></td> <td style="width: 10%;"></td> <td style="width: 10%;"></td> <td style="width: 10%;"></td> <td style="width: 10%;"></td> <td style="width: 10%;"></td> <td style="width: 10%;"></td> <td style="width: 10%;"></td> <td style="width: 10%;"></td> <td style="width: 10%;"></td> </tr> <tr> <td></td> <td></td> <td colspan="8" style="text-align: center;"> <table border="1" style="width: 100%; border-collapse: collapse; text-align: center;"> <tr> <td style="width: 10%;"></td> <td style="width: 10%;"></td> <td style="width: 10%;"></td> <td style="width: 10%;"></td> <td style="width: 10%;"></td> <td style="width: 10%;"></td> <td style="width: 10%;"></td> <td style="width: 10%;"></td> <td style="width: 10%;"></td> <td style="width: 10%;"></td> </tr> <tr> <td></td> <td></td> <td colspan="8" style="text-align: center;"> <table border="1" style="width: 100%; border-collapse: collapse; text-align: center;"> <tr> <td style="width: 10%;"></td> <td style="width: 10%;"></td> <td style="width: 10%;"></td> <td style="width: 10%;"></td> <td style="width: 10%;"></td> <td style="width: 10%;"></td> <td style="width: 10%;"></td> <td style="width: 10%;"></td> <td style="width: 10%;"></td> <td style="width: 10%;"></td> </tr> <tr> <td></td> <td></td> <td colspan="8" style="text-align: center;"> <table border="1" style="width: 100%; border-collapse: collapse; text-align: center;"> <tr> <td style="width: 10%;"></td> <td style="width: 10%;"></td> <td style="width: 10%;"></td> <td style="width: 10%;"></td> <td style="width: 10%;"></td> <td style="width: 10%;"></td> <td style="width: 10%;"></td> <td style="width: 10%;"></td> <td style="width: 10%;"></td> <td style="width: 10%;"></td> </tr> <tr> <td></td> <td></td> <td colspan="8" style="text-align: center;"> <table border="1"
style="width: 100%; border-collapse: collapse; text-align: center;"> <tr> <td style="width: 10%;"></td> <td style="width: 10%;"></td> <td style="width: 10%;"></td> <td style="width: 10%;"></td> <td style="width: 10%;"></td> <td style="width: 10%;"></td> <td style="width: 10%;"></td> <td style="width: 10%;"></td> <td style="width: 10%;"></td> <td style="width: 10%;"></td> </tr> <tr> <td></td> <td></td> <td colspan="8" style="text-align: center;"> <table border="1" style="width: 100%; border-collapse: collapse; text-align: center;"> <tr> <td style="width: 10%;"></td> <td style="width: 10%;"></td> <td style="width: 10%;"></td> <td style="width: 10%;"></td> <td style="width: 10%;"></td> <td style="width: 10%;"></td> <td style="width: 10%;"></td> <td style="width: 10%;"></td> <td style="width: 10%;"></td> <td style="width: 10%;"></td> </tr> <tr> <td></td> <td></td> <td colspan="8" style="text-align: center;"> <table border="1" style="width: 100%; border-collapse: collapse; text-align: center;"> <tr> <td style="width: 10%;"></td> <td style="width: 10%;"></td> <td style="width: 10%;"></td> <td style="width: 10%;"></td> <td style="width: 10%;"></td> <td style="width: 10%;"></td> <td style="width: 10%;"></td> <td style="width: 10%;"></td> <td style="width: 10%;"></td> <td style="width: 10%;"></td> </tr> <tr> <td></td> <td></td> <td colspan="8" style="text-align: center;"> <table border="1" style="width: 100%; border-collapse: collapse; text-align: center;"> <tr> <td style="width: 10%;"></td> <td style="width: 10%;"></td> <td style="width: 10%;"></td> <td style="width: 10%;"></td> <td style="width: 10%;"></td> <td style="width: 10%;"></td> <td style="width: 10%;"></td> <td style="width: 10%;"></td> <td style="width: 10%;"></td> <td style="width: 10%;"></td> </tr> <tr> <td></td> <td></td> <td colspan="8" style="text-align: center;"> <table border="1" style="width: 100%; border-collapse: collapse; text-align: center;"> <tr> <td style="width: 10%;"></td> <td style="width: 10%;"></td> <td style="width: 10%;"></td> <td style="width: 10%;"></td> <td style="width: 10%;"></td> <td style="width: 10%;"></td> <td style="width: 10%;"></td> <td style="width: 10%;"></td> <td style="width: 10%;"></td> <td style="width: 10%;"></td> </tr> <tr> <td></td> <td></td> <td colspan="8" style="text-align: center;"> <table border="1" style="width: 100%; border-collapse: collapse; text-align: center;"> <tr> <td style="width: 10%;"></td> <td style="width: 10%;"></td> <td style="width: 10%;"></td> <td style="width: 10%;"></td> <td style="width: 10%;"></td> <td style="width: 10%;"></td> <td style="width: 10%;"></td> <td style="width: 10%;"></td> <td style="width: 10%;"></td> <td style="width: 10%;"></td> </tr> <tr> <td></td> <td></td> <td colspan="8" style="text-align: center;"> <table border="1" style="width: 100%; border-collapse: collapse; text-align: center;"> <tr> <td style="width: 10%;"></td> <td style="width: 10%;"></td> <td style="width: 10%;"></td> <td style="width: 10%;"></td> <td style="width: 10%;"></td> <td style="width: 10%;"></td> <td style="width: 10%;"></td> <td style="width: 10%;"></td> <td style="width: 10%;"></td> <td style="width: 10%;"></td> </tr> <tr> <td></td> <td></td> <td colspan="8" style="text-align: center;"> <table border="1" style="width: 100%; border-collapse: collapse; text-align: center;"> <tr> <td style="width: 10%;"></td> <td style="width: 10%;"></td> <td style="width: 10%;"></td> <td style="width: 10%;"></td> <td style="width: 10%;"></td> <td style="width: 10%;"></td> <td style="width: 10%;"></td> <td style="width: 10%;"></td> <td style="width: 10%;"></td> <td style="width: 10%;"></td> </tr> <tr> <td></td> <td></td> <td colspan="8" style="text-align: center;"> <table border="1" style="width: 100%; border-collapse: collapse; text-align: center;"> <tr> <td style="width: 10%;"></td> <td style="width: 10%;"></td> <td style="width: 10%;"></td> <td style="width: 10%;"></td> <td style="width: 10%;"></td> <td style="width: 10%;"></td> <td style="width: 10%;"></td> <td style="width: 10%;"></td> <td style="width: 10%;"></td> <td style="width: 10%;"></td> </tr> <tr> <td></td> <td></td> <td colspan="8" style="text-align: center;"> <table border="1" style="width: 100%; border-collapse: collapse; text-align: center;"> <tr> <td style="width: 10%;"></td> <td style="width: 10%;"></td> <td style="width: 10%;"></td> <td style="width: 10%;"></td> <td style="width: 10%;"></td> <td style="width: 10%;"></td> <td style="width: 10%;"></td> <td style="width: 10%;"></td> <td style="width: 10%;"></td> <td style="width: 10%;"></td> </tr> <tr> <td></td> <td></td> <td colspan="8" style="text-align: center;"> <table border="1" style="width: 100%; border-collapse: collapse; text-align: center;"> <tr> <td style="width: 10%;"></td> <td style="width: 10%;"></td> <td style="width: 10%;"></td> <td style="width: 10%;"></td> <td style="width: 10%;"></td> <td style="width: 10%;"></td> <td style="width: 10%;"></td> <td style="width: 10%;"></td> <td style="width: 10%;"></td> <td style="width: 10%;"></td> </tr> <tr> <td></td> <td></td> <td colspan="8" style="text-align: center;"> <table border="1" style="width: 100%; border-collapse: collapse; text-align: center;"> <tr> <td style="width: 10%;"></td> <td style="width: 10%;"></td> <td style="width: 10%;"></td> <td style="width: 10%;"></td> <td style="width: 10%;"></td> <td style="width: 10%;"></td> <td style="width: 10%;"></td> <td style="width: 10%;"></td> <td style="width: 10%;"></td> <td style="width: 10%;"></td> </tr> <tr> <td></td> <td></td> <td colspan="8" style="text-align: center;"> <table border="1" style="width: 100%; border-collapse: collapse; text-align: center;"> <tr> <td style="width: 10%;"></td> <td style="width: 10%;"></td> <td style="width: 10%;"></td> <td style="width: 10%;"></td> <td style="width: 10%;"></td> <td style="width: 10%;"></td> <td style="width: 10%;"></td> <td style="width: 10%;"></td> <td style="width: 10%;"></td> <td style="width: 10%;"></td> </tr> <tr> <td></td> <td></td> <td colspan="8" style="text-align: center;"> <table border="1" style="width: 100%; border-collapse: collapse; text-align: center;"> <tr> <td style="width: 10%;"></td> <td style="width: 10%;"></td> <td style="width: 10%;"></td> <td style="width: 10%;"></td> <td style="width: 10%;"></td> <td style="width: 10%;"></td> <td style="width: 10%;"></td> <td style="width: 10%;"></td> <td style="width: 10%;"></td> <td style="width: 10%;"></td> </tr> <tr> <td></td> <td></td> <td colspan="8" style="text-align: center;"> <table border="1" style="width: 100%; border-collapse: collapse; text-align: center;"> <tr> <td style="width: 10%;"></td> <td style="width: 10%;"></td> <td style="width: 10%;"></td> <td style="width: 10%;"></td> <td style="width: 10%;"></td> <td style="width: 10%;"></td> <td style="width: 10%;"></td> <td style="width: 10%;"></td> <td style="width: 10%;"></td> <td style="width: 10%;"></td> </tr> <tr> <td></td> <td></td> <td colspan="8" style="text-align: center;"> <table border="1" style="width: 100%; border-collapse: collapse; text-align: center;"> <tr> <td style="width: 10%;"></td> <td style="width: 10%;"></td> <td style="width: 10%;"></td> <td style="width: 10%;"></td> <td style="width: 10%;"></td> <td style="width: 10%;"></td> <td style="width: 10%;"></td> <td style="width: 10%;"></td> <td style="width: 10%;"></td> <td style="width: 10%;"></td> </tr> <tr> <td></td> <td></td> <td colspan="8" style="text-align: center;"> <table border="1" style="width: 100%; border-collapse: collapse; text-align: center;"> <tr> <td style="width: 10%;"></td> <td style="width: 10%;"></td> <td style="width: 10%;"></td> <td style="width: 10%;"></td> <td style="width: 10%;"></td> <td style="width: 10%;"></td> <td style="width: 10%;"></td> <td style="width: 10%;"></td> <td style="width: 10%;"></td> <td style="width: 10%;"></td> </tr> <tr> <td></td> <td></td> <td colspan="8" style="text-align: center;"> <table border="1" style="width: 100%; border-collapse: collapse; text-align: center;"> <tr> <td style="width: 10%;"></td> <td style="width: 10%;"></td> <td style="width: 10%;"></td> <td style="width: 10%;"></td> <td style="width: 10%;"></td> <td style="width: 10%;"></td> <td style="width: 10%;"></td> <td style="width: 10%;"></td> <td style="width: 10%;"></td> <td style="width: 10%;"></td> </tr> <tr> <td></td> <td></td> <td colspan="8" style="text-align: center;"> <table border="1" style="width: 100%; border-collapse: collapse; text-align: center;"> <tr> <td style="width: 10%;"></td> <td style="width: 10%;"></td> <td style="width: 10%;"></td> <td style="width: 10%;"></td> <td style="width: 10%;"></td> <td style="width: 10%;"></td> <td style="width: 10%;"></td> <td style="width: 10%;"></td> <td style="width: 10%;"></td> <td style="width: 10%;"></td> </tr> <tr> <td></td> <td></td> <td colspan="8" style="text-align: center;"> <table border="1" style="width: 100%; border-collapse: collapse; text-align: center;"> <tr> <td style="width: 10%;"></td> <td style="width: 10%;"></td> <td style="width: 10%;"></td> <td style="width: 10%;"></td> <td style="width: 10%;"></td> <td style="width: 10%;"></td> <td style="width: 10%;"></td> <td style="width: 10%;"></td> <td style="width: 10%;"></td> <td style="width: 10%;"></td> </tr> <tr> <td></td> <td></td> <td colspan="8" style="text-align: center;"> <table border="1" style="width: 100%; border-collapse: collapse; text-align: center;"> <tr> <td style="width: 10%;"></td> <td style="width: 10%;"></td> <td style="width: 10%;"></td> <td style="width: 10%;"></td> <td style="width: 10%;"></td> <td style="width: 10%;"></td> <td style="width: 10%;"></td> <td style="width: 10%;"></td> <td style="width: 10%;"></td> <td style="width: 10%;"></td> </tr> <tr> <td></td> <td></td> <td colspan="8" style="text-align: center;"> <table border="1" style="width: 100%; border-collapse: collapse; text-align: center;"> <tr> <td style="width: 10%;"></td> <td style="width: 10%;"></td> <td style="width: 10%;"></td> <td
style="width: 10%;"></td> <td style="width: 10%;"></td> <td style="width: 10%;"></td> <td style="width: 10%;"></td> <td style="width: 10%;"></td> <td style="width: 10%;"></td> <td style="width: 10%;"></td> </tr> <tr> <td></td> <td></td> <td colspan="8" style="text-align: center;"> <table border="1" style="width: 100%; border-collapse: collapse; text-align: center;"> <tr> </tr></table></td></tr></table></td></tr></table></td></tr></table></td></tr></table></td></tr></table></td></tr></table></td></tr></table></td></tr></table></td></tr></table></td></tr></table></td></tr></table></td></tr></table></td></tr></table></td></tr></table></td></tr></table></td></tr></table></td></tr></table></td></tr></table></td></tr></table></td></tr></table></td></tr></table></td></tr></table></td></tr></table></td></tr></table></td></tr></table></td></tr></table></td></tr></table></td></tr></table></td></tr></table></td></tr></table></td></tr></table></td></tr></table></td></tr></table></td></tr></table></td></tr></table></td></tr></table></td></tr></table></td></tr></table></td></tr></table></td></tr></table></td></tr></table></td></tr></table></td></tr></table></td></tr></table></td></tr></table></td></tr></table></td></tr></table></td></tr></table></td></tr></table></td></tr></table></td></tr></table></td></tr></table></td></tr></table></td></tr></table></td></tr></table></td></tr></table></td></tr></table></td></tr></table> | | | | | | | | | | | | | | | | | | | | <table border="1" style="width: 100%; border-collapse: collapse; text-align: center;"> <tr> <td style="width: 10%;"></td> <td style="width: 10%;"></td> <td style="width: 10%;"></td> <td style="width: 10%;"></td> <td style="width: 10%;"></td> <td style="width: 10%;"></td> <td style="width: 10%;"></td> <td style="width: 10%;"></td> <td style="width: 10%;"></td> <td style="width: 10%;"></td> </tr> <tr> <td></td> <td></td> <td colspan="8" style="text-align: center;"> <table border="1" style="width: 100%; border-collapse: collapse; text-align: center;"> <tr> <td style="width: 10%;"></td> <td style="width: 10%;"></td> <td style="width: 10%;"></td> <td style="width: 10%;"></td> <td style="width: 10%;"></td> <td style="width: 10%;"></td> <td style="width: 10%;"></td> <td style="width: 10%;"></td> <td style="width: 10%;"></td> <td style="width: 10%;"></td> </tr> <tr> <td></td> <td></td> <td colspan="8" style="text-align: center;"> <table border="1" style="width: 100%; border-collapse: collapse; text-align: center;"> <tr> <td style="width: 10%;"></td> <td style="width: 10%;"></td> <td style="width: 10%;"></td> <td style="width: 10%;"></td> <td style="width: 10%;"></td> <td style="width: 10%;"></td> <td style="width: 10%;"></td> <td style="width: 10%;"></td> <td style="width: 10%;"></td> <td style="width: 10%;"></td> </tr> <tr> <td></td> <td></td> <td colspan="8" style="text-align: center;"> <table border="1" style="width: 100%; border-collapse: collapse; text-align: center;"> <tr> <td style="width: 10%;"></td> <td style="width: 10%;"></td> <td style="width: 10%;"></td> <td style="width: 10%;"></td> <td style="width: 10%;"></td> <td style="width: 10%;"></td> <td style="width: 10%;"></td> <td style="width: 10%;"></td> <td style="width: 10%;"></td> <td style="width: 10%;"></td> </tr> <tr> <td></td> <td></td> <td colspan="8" style="text-align: center;"> <table border="1" style="width: 100%; border-collapse: collapse; text-align: center;"> <tr> <td style="width: 10%;"></td> <td style="width: 10%;"></td> <td style="width: 10%;"></td> <td style="width: 10%;"></td> <td style="width: 10%;"></td> <td style="width: 10%;"></td> <td style="width: 10%;"></td> <td style="width: 10%;"></td> <td style="width: 10%;"></td> <td style="width: 10%;"></td> </tr> <tr> <td></td> <td></td> <td colspan="8" style="text-align: center;"> <table border="1" style="width: 100%; border-collapse: collapse; text-align: center;"> <tr> <td style="width: 10%;"></td> <td style="width: 10%;"></td> <td style="width: 10%;"></td> <td style="width: 10%;"></td> <td style="width: 10%;"></td> <td style="width: 10%;"></td> <td style="width: 10%;"></td> <td style="width: 10%;"></td> <td style="width: 10%;"></td> <td style="width: 10%;"></td> </tr> <tr> <td></td> <td></td> <td colspan="8" style="text-align: center;"> <table border="1" style="width: 100%; border-collapse: collapse; text-align: center;"> <tr> <td style="width: 10%;"></td> <td style="width: 10%;"></td> <td style="width: 10%;"></td> <td style="width: 10%;"></td> <td style="width: 10%;"></td> <td style="width: 10%;"></td> <td style="width: 10%;"></td> <td style="width: 10%;"></td> <td style="width: 10%;"></td> <td style="width: 10%;"></td> </tr> <tr> <td></td> <td></td> <td colspan="8" style="text-align: center;"> <table border="1" style="width: 100%; border-collapse: collapse; text-align: center;"> <tr> <td style="width: 10%;"></td> <td style="width: 10%;"></td> <td style="width: 10%;"></td> <td style="width: 10%;"></td> <td style="width: 10%;"></td> <td style="width: 10%;"></td> <td style="width: 10%;"></td> <td style="width: 10%;"></td> <td style="width: 10%;"></td> <td style="width: 10%;"></td> </tr> <tr> <td></td> <td></td> <td colspan="8" style="text-align: center;"> <table border="1" style="width: 100%; border-collapse: collapse; text-align: center;"> <tr> <td style="width: 10%;"></td> <td style="width: 10%;"></td> <td style="width: 10%;"></td> <td style="width: 10%;"></td> <td style="width: 10%;"></td> <td style="width: 10%;"></td> <td style="width: 10%;"></td> <td style="width: 10%;"></td> <td style="width: 10%;"></td> <td style="width: 10%;"></td> </tr> <tr> <td></td> <td></td> <td colspan="8" style="text-align: center;"> <table border="1" style="width: 100%; border-collapse: collapse; text-align: center;"> <tr> <td style="width: 10%;"></td> <td style="width: 10%;"></td> <td style="width: 10%;"></td> <td style="width: 10%;"></td> <td style="width: 10%;"></td> <td style="width: 10%;"></td> <td style="width: 10%;"></td> <td style="width: 10%;"></td> <td style="width: 10%;"></td> <td style="width: 10%;"></td> </tr> <tr> <td></td> <td></td> <td colspan="8" style="text-align: center;"> <table border="1" style="width: 100%; border-collapse: collapse; text-align: center;"> <tr> <td style="width: 10%;"></td> <td style="width: 10%;"></td> <td style="width: 10%;"></td> <td style="width: 10%;"></td> <td style="width: 10%;"></td> <td style="width: 10%;"></td> <td style="width: 10%;"></td> <td style="width: 10%;"></td> <td style="width: 10%;"></td> <td style="width: 10%;"></td> </tr> <tr> <td></td> <td></td> <td colspan="8" style="text-align: center;"> <table border="1" style="width: 100%; border-collapse: collapse; text-align: center;"> <tr> <td style="width: 10%;"></td> <td style="width: 10%;"></td> <td style="width: 10%;"></td> <td style="width: 10%;"></td> <td style="width: 10%;"></td> <td style="width: 10%;"></td> <td style="width: 10%;"></td> <td style="width: 10%;"></td> <td style="width: 10%;"></td> <td style="width: 10%;"></td> </tr> <tr> <td></td> <td></td> <td colspan="8" style="text-align: center;"> <table border="1" style="width: 100%; border-collapse: collapse; text-align: center;"> <tr> <td style="width: 10%;"></td> <td style="width: 10%;"></td> <td style="width: 10%;"></td> <td style="width: 10%;"></td> <td style="width: 10%;"></td> <td style="width: 10%;"></td> <td style="width: 10%;"></td> <td style="width: 10%;"></td> <td style="width: 10%;"></td> <td style="width: 10%;"></td> </tr> <tr> <td></td> <td></td> <td colspan="8" style="text-align: center;"> <table border="1" style="width: 100%; border-collapse: collapse; text-align: center;"> <tr> <td style="width: 10%;"></td> <td style="width: 10%;"></td> <td style="width: 10%;"></td> <td style="width: 10%;"></td> <td style="width: 10%;"></td> <td style="width: 10%;"></td> <td style="width: 10%;"></td> <td style="width: 10%;"></td> <td style="width: 10%;"></td> <td style="width: 10%;"></td> </tr> <tr> <td></td> <td></td> <td colspan="8" style="text-align: center;"> <table border="1" style="width: 100%; border-collapse: collapse; text-align: center;"> <tr> <td style="width: 10%;"></td> <td style="width: 10%;"></td> <td style="width: 10%;"></td> <td style="width: 10%;"></td> <td style="width: 10%;"></td> <td style="width: 10%;"></td> <td style="width: 10%;"></td> <td style="width: 10%;"></td> <td style="width: 10%;"></td> <td style="width: 10%;"></td> </tr> <tr> <td></td> <td></td> <td colspan="8" style="text-align: center;"> <table border="1" style="width: 100%; border-collapse: collapse; text-align: center;"> <tr> <td style="width: 10%;"></td> <td style="width: 10%;"></td> <td style="width: 10%;"></td> <td style="width: 10%;"></td> <td style="width: 10%;"></td> <td style="width: 10%;"></td> <td style="width: 10%;"></td> <td style="width: 10%;"></td> <td style="width: 10%;"></td> <td style="width: 10%;"></td> </tr> <tr> <td></td> <td></td> <td colspan="8" style="text-align: center;"> <table border="1" style="width: 100%;
border-collapse: collapse; text-align: center;"> <tr> <td style="width: 10%;"></td> <td style="width: 10%;"></td> <td style="width: 10%;"></td> <td style="width: 10%;"></td> <td style="width: 10%;"></td> <td style="width: 10%;"></td> <td style="width: 10%;"></td> <td style="width: 10%;"></td> <td style="width: 10%;"></td> <td style="width: 10%;"></td> </tr> <tr> <td></td> <td></td> <td colspan="8" style="text-align: center;"> <table border="1" style="width: 100%; border-collapse: collapse; text-align: center;"> <tr> <td style="width: 10%;"></td> <td style="width: 10%;"></td> <td style="width: 10%;"></td> <td style="width: 10%;"></td> <td style="width: 10%;"></td> <td style="width: 10%;"></td> <td style="width: 10%;"></td> <td style="width: 10%;"></td> <td style="width: 10%;"></td> <td style="width: 10%;"></td> </tr> <tr> <td></td> <td></td> <td colspan="8" style="text-align: center;"> <table border="1" style="width: 100%; border-collapse: collapse; text-align: center;"> <tr> <td style="width: 10%;"></td> <td style="width: 10%;"></td> <td style="width: 10%;"></td> <td style="width: 10%;"></td> <td style="width: 10%;"></td> <td style="width: 10%;"></td> <td style="width: 10%;"></td> <td style="width: 10%;"></td> <td style="width: 10%;"></td> <td style="width: 10%;"></td> </tr> <tr> <td></td> <td></td> <td colspan="8" style="text-align: center;"> <table border="1" style="width: 100%; border-collapse: collapse; text-align: center;"> <tr> <td style="width: 10%;"></td> <td style="width: 10%;"></td> <td style="width: 10%;"></td> <td style="width: 10%;"></td> <td style="width: 10%;"></td> <td style="width: 10%;"></td> <td style="width: 10%;"></td> <td style="width: 10%;"></td> <td style="width: 10%;"></td> <td style="width: 10%;"></td> </tr> <tr> <td></td> <td></td> <td colspan="8" style="text-align: center;"> <table border="1" style="width: 100%; border-collapse: collapse; text-align: center;"> <tr> <td style="width: 10%;"></td> <td style="width: 10%;"></td> <td style="width: 10%;"></td> <td style="width: 10%;"></td> <td style="width: 10%;"></td> <td style="width: 10%;"></td> <td style="width: 10%;"></td> <td style="width: 10%;"></td> <td style="width: 10%;"></td> <td style="width: 10%;"></td> </tr> <tr> <td></td> <td></td> <td colspan="8" style="text-align: center;"> <table border="1" style="width: 100%; border-collapse: collapse; text-align: center;"> <tr> <td style="width: 10%;"></td> <td style="width: 10%;"></td> <td style="width: 10%;"></td> <td style="width: 10%;"></td> <td style="width: 10%;"></td> <td style="width: 10%;"></td> <td style="width: 10%;"></td> <td style="width: 10%;"></td> <td style="width: 10%;"></td> <td style="width: 10%;"></td> </tr> <tr> <td></td> <td></td> <td colspan="8" style="text-align: center;"> <table border="1" style="width: 100%; border-collapse: collapse; text-align: center;"> <tr> <td style="width: 10%;"></td> <td style="width: 10%;"></td> <td style="width: 10%;"></td> <td style="width: 10%;"></td> <td style="width: 10%;"></td> <td style="width: 10%;"></td> <td style="width: 10%;"></td> <td style="width: 10%;"></td> <td style="width: 10%;"></td> <td style="width: 10%;"></td> </tr> <tr> <td></td> <td></td> <td colspan="8" style="text-align: center;"> <table border="1" style="width: 100%; border-collapse: collapse; text-align: center;"> <tr> <td style="width: 10%;"></td> <td style="width: 10%;"></td> <td style="width: 10%;"></td> <td style="width: 10%;"></td> <td style="width: 10%;"></td> <td style="width: 10%;"></td> <td style="width: 10%;"></td> <td style="width: 10%;"></td> <td style="width: 10%;"></td> <td style="width: 10%;"></td> </tr> <tr> <td></td> <td></td> <td colspan="8" style="text-align: center;"> <table border="1" style="width: 100%; border-collapse: collapse; text-align: center;"> <tr> <td style="width: 10%;"></td> <td style="width: 10%;"></td> <td style="width: 10%;"></td> <td style="width: 10%;"></td> <td style="width: 10%;"></td> <td style="width: 10%;"></td> <td style="width: 10%;"></td> <td style="width: 10%;"></td> <td style="width: 10%;"></td> <td style="width: 10%;"></td> </tr> <tr> <td></td> <td></td> <td colspan="8" style="text-align: center;"> <table border="1" style="width: 100%; border-collapse: collapse; text-align: center;"> <tr> <td style="width: 10%;"></td> <td style="width: 10%;"></td> <td style="width: 10%;"></td> <td style="width: 10%;"></td> <td style="width: 10%;"></td> <td style="width: 10%;"></td> <td style="width: 10%;"></td> <td style="width: 10%;"></td> <td style="width: 10%;"></td> <td style="width: 10%;"></td> </tr> <tr> <td></td> <td></td> <td colspan="8" style="text-align: center;"> <table border="1" style="width: 100%; border-collapse: collapse; text-align: center;"> <tr> <td style="width: 10%;"></td> <td style="width: 10%;"></td> <td style="width: 10%;"></td> <td style="width: 10%;"></td> <td style="width: 10%;"></td> <td style="width: 10%;"></td> <td style="width: 10%;"></td> <td style="width: 10%;"></td> <td style="width: 10%;"></td> <td style="width: 10%;"></td> </tr> <tr> <td></td> <td></td> <td colspan="8" style="text-align: center;"> <table border="1" style="width: 100%; border-collapse: collapse; text-align: center;"> <tr> <td style="width: 10%;"></td> <td style="width: 10%;"></td> <td style="width: 10%;"></td> <td style="width: 10%;"></td> <td style="width: 10%;"></td> <td style="width: 10%;"></td> <td style="width: 10%;"></td> <td style="width: 10%;"></td> <td style="width: 10%;"></td> <td style="width: 10%;"></td> </tr> <tr> <td></td> <td></td> <td colspan="8" style="text-align: center;"> <table border="1" style="width: 100%; border-collapse: collapse; text-align: center;"> <tr> <td style="width: 10%;"></td> <td style="width: 10%;"></td> <td style="width: 10%;"></td> <td style="width: 10%;"></td> <td style="width: 10%;"></td> <td style="width: 10%;"></td> <td style="width: 10%;"></td> <td style="width: 10%;"></td> <td style="width: 10%;"></td> <td style="width: 10%;"></td> </tr> <tr> <td></td> <td></td> <td colspan="8" style="text-align: center;"> <table border="1" style="width: 100%; border-collapse: collapse; text-align: center;"> <tr> <td style="width: 10%;"></td> <td style="width: 10%;"></td> <td style="width: 10%;"></td> <td style="width: 10%;"></td> <td style="width: 10%;"></td> <td style="width: 10%;"></td> <td style="width: 10%;"></td> <td style="width: 10%;"></td> <td style="width: 10%;"></td> <td style="width: 10%;"></td> </tr> <tr> <td></td> <td></td> <td colspan="8" style="text-align: center;"> <table border="1" style="width: 100%; border-collapse: collapse; text-align: center;"> <tr> <td style="width: 10%;"></td> <td style="width: 10%;"></td> <td style="width: 10%;"></td> <td style="width: 10%;"></td> <td style="width: 10%;"></td> <td style="width: 10%;"></td> <td style="width: 10%;"></td> <td style="width: 10%;"></td> <td style="width: 10%;"></td> <td style="width: 10%;"></td> </tr> <tr> <td></td> <td></td> <td colspan="8" style="text-align: center;"> <table border="1" style="width: 100%; border-collapse: collapse; text-align: center;"> <tr> <td style="width: 10%;"></td> <td style="width: 10%;"></td> <td style="width: 10%;"></td> <td style="width: 10%;"></td> <td style="width: 10%;"></td> <td style="width: 10%;"></td> <td style="width: 10%;"></td> <td style="width: 10%;"></td> <td style="width: 10%;"></td> <td style="width: 10%;"></td> </tr> <tr> <td></td> <td></td> <td colspan="8" style="text-align: center;"> <table border="1" style="width: 100%; border-collapse: collapse; text-align: center;"> <tr> <td style="width: 10%;"></td> <td style="width: 10%;"></td> <td style="width: 10%;"></td> <td style="width: 10%;"></td> <td style="width: 10%;"></td> <td style="width: 10%;"></td> <td style="width: 10%;"></td> <td style="width: 10%;"></td> <td style="width: 10%;"></td> <td style="width: 10%;"></td> </tr> <tr> <td></td> <td></td> <td colspan="8" style="text-align: center;"> <table border="1" style="width: 100%; border-collapse: collapse; text-align: center;"> <tr> <td style="width: 10%;"></td> <td style="width: 10%;"></td> <td style="width: 10%;"></td> <td style="width: 10%;"></td> <td style="width: 10%;"></td> <td style="width: 10%;"></td> <td style="width: 10%;"></td> <td style="width: 10%;"></td> <td style="width: 10%;"></td> <td style="width: 10%;"></td> </tr> <tr> <td></td> <td></td> <td colspan="8" style="text-align: center;"> <table border="1" style="width: 100%; border-collapse: collapse; text-align: center;"> <tr> <td style="width: 10%;"></td> <td style="width: 10%;"></td> <td style="width: 10%;"></td> <td style="width: 10%;"></td> <td style="width: 10%;"></td> <td style="width: 10%;"></td> <td style="width: 10%;"></td> <td style="width: 10%;"></td> <td style="width: 10%;"></td> <td style="width: 10%;"></td> </tr> <tr> <td></td> <td></td> <td colspan="8" style="text-align: center;"> <table border="1" style="width: 100%; border-collapse: collapse; text-align: center;"> <tr> <td style="width: 10%;"></td> <td style="width: 10%;"></td> <td style="width: 10%;"></td> <td style="width: 10%;"></td> <td style="width: 10%;"></td> <td style="width: 10%;"></td> <td style="width: 10%;"></td> <td style="width: 10%;"></td> <td style="width: 10%;"></td> <td style="width: 10%;"></td> </tr> <tr> <td></td> <td></td> <td colspan="8" style="text-align: center;"> <table border="1" style="width: 100%; border-collapse: collapse; text-align: center;"> <tr> <td style="width: 10%;"></td> <td style="width: 10%;"></td> <td style="width: 10%;"></td> <td style="width: 10%;"></td> <td style="width: 10%;"></td> <td style="width: 10%;"></td> <td style="width: 10%;"></td> <td style="width: 10%;"></td> <td style="width: 10%;"></td> <td style="width: 10%;"></td> </tr> <tr> <td></td> <td></td> <td colspan="8" style="text-align: center;"> <table border="1" style="width: 100%; border-collapse: collapse; text-align: center;"> <tr> <td style="width: 10%;"></td> <td style="width: 10%;"></td> <td style="width: 10%;"></td> <td style="width:
10%;"></td> <td style="width: 10%;"></td> <td style="width: 10%;"></td> <td style="width: 10%;"></td> <td style="width: 10%;"></td> <td style="width: 10%;"></td> <td style="width: 10%;"></td> </tr> <tr> <td></td> <td></td> <td colspan="8" style="text-align: center;"> <table border="1" style="width: 100%; border-collapse: collapse; text-align: center;"> <tr> <td style="width: 10%;"></td> <td style="width: 10%;"></td> <td style="width: 10%;"></td> <td style="width: 10%;"></td> <td style="width: 10%;"></td> <td style="width: 10%;"></td> <td style="width: 10%;"></td> <td style="width: 10%;"></td> <td style="width: 10%;"></td> <td style="width: 10%;"></td> </tr> <tr> <td></td> <td></td> <td colspan="8" style="text-align: center;"> <table border="1" style="width: 100%; border-collapse: collapse; text-align: center;"> <tr> <td style="width: 10%;"></td> <td style="width: 10%;"></td> <td style="width: 10%;"></td> <td style="width: 10%;"></td> <td style="width: 10%;"></td> <td style="width: 10%;"></td> <td style="width: 10%;"></td> <td style="width: 10%;"></td> <td style="width: 10%;"></td> <td style="width: 10%;"></td> </tr> <tr> <td></td> <td></td> <td colspan="8" style="text-align: center;"> <table border="1" style="width: 100%; border-collapse: collapse; text-align: center;"> <tr> <td style="width: 10%;"></td> <td style="width: 10%;"></td> <td style="width: 10%;"></td> <td style="width: 10%;"></td> <td style="width: 10%;"></td> <td style="width: 10%;"></td> <td style="width: 10%;"></td> <td style="width: 10%;"></td> <td style="width: 10%;"></td> <td style="width: 10%;"></td> </tr> <tr> <td></td> <td></td> <td colspan="8" style="text-align: center;"> <table border="1" style="width: 100%; border-collapse: collapse; text-align: center;"> <tr> <td style="width: 10%;"></td> <td style="width: 10%;"></td> <td style="width: 10%;"></td> <td style="width: 10%;"></td> <td style="width: 10%;"></td> <td style="width: 10%;"></td> <td style="width: 10%;"></td> <td style="width: 10%;"></td> <td style="width: 10%;"></td> <td style="width: 10%;"></td> </tr> <tr> <td></td> <td></td> <td colspan="8" style="text-align: center;"> <table border="1" style="width: 100%; border-collapse: collapse; text-align: center;"> <tr> <td style="width: 10%;"></td> <td style="width: 10%;"></td> <td style="width: 10%;"></td> <td style="width: 10%;"></td> <td style="width: 10%;"></td> <td style="width: 10%;"></td> <td style="width: 10%;"></td> <td style="width: 10%;"></td> <td style="width: 10%;"></td> <td style="width: 10%;"></td> </tr> <tr> <td></td> <td></td> <td colspan="8" style="text-align: center;"> <table border="1" style="width: 100%; border-collapse: collapse; text-align: center;"> <tr> <td style="width: 10%;"></td> <td style="width: 10%;"></td> <td style="width: 10%;"></td> <td style="width: 10%;"></td> <td style="width: 10%;"></td> <td style="width: 10%;"></td> <td style="width: 10%;"></td> <td style="width: 10%;"></td> <td style="width: 10%;"></td> <td style="width: 10%;"></td> </tr> <tr> <td></td> <td></td> <td colspan="8" style="text-align: center;"> <table border="1" style="width: 100%; border-collapse: collapse; text-align: center;"> <tr> <td style="width: 10%;"></td> <td style="width: 10%;"></td> <td style="width: 10%;"></td> <td style="width: 10%;"></td> <td style="width: 10%;"></td> <td style="width: 10%;"></td> <td style="width: 10%;"></td> <td style="width: 10%;"></td> <td style="width: 10%;"></td> <td style="width: 10%;"></td> </tr> <tr> <td></td> <td></td> <td colspan="8" style="text-align: center;"> <table border="1" style="width: 100%; border-collapse: collapse; text-align: center;"> <tr> <td style="width: 10%;"></td> <td style="width: 10%;"></td> <td style="width: 10%;"></td> <td style="width: 10%;"></td> <td style="width: 10%;"></td> <td style="width: 10%;"></td> <td style="width: 10%;"></td> <td style="width: 10%;"></td> <td style="width: 10%;"></td> <td style="width: 10%;"></td> </tr> <tr> <td></td> <td></td> <td colspan="8" style="text-align: center;"> <table border="1" style="width: 100%; border-collapse: collapse; text-align: center;"> <tr> <td style="width: 10%;"></td> <td style="width: 10%;"></td> <td style="width: 10%;"></td> <td style="width: 10%;"></td> <td style="width: 10%;"></td> <td style="width: 10%;"></td> <td style="width: 10%;"></td> <td style="width: 10%;"></td> <td style="width: 10%;"></td> <td style="width: 10%;"></td> </tr> <tr> <td></td> <td></td> <td colspan="8" style="text-align: center;"> <table border="1" style="width: 100%; border-collapse: collapse; text-align: center;"> <tr> <td style="width: 10%;"></td> <td style="width: 10%;"></td> <td style="width: 10%;"></td> <td style="width: 10%;"></td> <td style="width: 10%;"></td> <td style="width: 10%;"></td> <td style="width: 10%;"></td> <td style="width: 10%;"></td> <td style="width: 10%;"></td> <td style="width: 10%;"></td> </tr> <tr> <td></td> <td></td> <td colspan="8" style="text-align: center;"> <table border="1" style="width: 100%; border-collapse: collapse; text-align: center;"> <tr> <td style="width: 10%;"></td> <td style="width: 10%;"></td> <td style="width: 10%;"></td> <td style="width: 10%;"></td> <td style="width: 10%;"></td> <td style="width: 10%;"></td> <td style="width: 10%;"></td> <td style="width: 10%;"></td> <td style="width: 10%;"></td> <td style="width: 10%;"></td> </tr> <tr> <td></td> <td></td> <td colspan="8" style="text-align: center;"> <table border="1" style="width: 100%; border-collapse: collapse; text-align: center;"> <tr> <td style="width: 10%;"></td> <td style="width: 10%;"></td> <td style="width: 10%;"></td> <td style="width: 10%;"></td> <td style="width: 10%;"></td> <td style="width: 10%;"></td> <td style="width: 10%;"></td> <td style="width: 10%;"></td> <td style="width: 10%;"></td> <td style="width: 10%;"></td> </tr> <tr> <td></td> <td></td> <td colspan="8" style="text-align: center;"> <table border="1" style="width: 100%; border-collapse: collapse; text-align: center;"> <tr> <td style="width: 10%;"></td> <td style="width: 10%;"></td> <td style="width: 10%;"></td> <td style="width: 10%;"></td> <td style="width: 10%;"></td> <td style="width: 10%;"></td> <td style="width: 10%;"></td> <td style="width: 10%;"></td> <td style="width: 10%;"></td> <td style="width: 10%;"></td> </tr> <tr> <td></td> <td></td> <td colspan="8" style="text-align: center;"> <table border="1" style="width: 100%; border-collapse: collapse; text-align: center;"> <tr> <td style="width: 10%;"></td> <td style="width: 10%;"></td> <td style="width: 10%;"></td> <td style="width: 10%;"></td> <td style="width: 10%;"></td> <td style="width: 10%;"></td> <td style="width: 10%;"></td> <td style="width: 10%;"></td> <td style="width: 10%;"></td> <td style="width: 10%;"></td> </tr> <tr> <td></td> <td></td> <td colspan="8" style="text-align: center;"> <table border="1" style="width: 100%; border-collapse: collapse; text-align: center;"> <tr> <td style="width: 10%;"></td> <td style="width: 10%;"></td> <td style="width: 10%;"></td> <td style="width: 10%;"></td> <td style="width: 10%;"></td> <td style="width: 10%;"></td> <td style="width: 10%;"></td> <td style="width: 10%;"></td> <td style="width: 10%;"></td> <td style="width: 10%;"></td> </tr> <tr> <td></td> <td></td> <td colspan="8" style="text-align: center;"> <table border="1" style="width: 100%; border-collapse: collapse; text-align: center;"> <tr> <td style="width: 10%;"></td> <td style="width: 10%;"></td> <td style="width: 10%;"></td> <td style="width: 10%;"></td> <td style="width: 10%;"></td> <td style="width: 10%;"></td> <td style="width: 10%;"></td> <td style="width: 10%;"></td> <td style="width: 10%;"></td> <td style="width: 10%;"></td> </tr> <tr> <td></td> <td></td> <td colspan="8" style="text-align: center;"> <table border="1" style="width: 100%; border-collapse: collapse; text-align: center;"> <tr> <td style="width: 10%;"></td> <td style="width: 10%;"></td> <td style="width: 10%;"></td> <td style="width: 10%;"></td> <td style="width: 10%;"></td> <td style="width: 10%;"></td> <td style="width: 10%;"></td> <td style="width: 10%;"></td> <td style="width: 10%;"></td> <td style="width: 10%;"></td> </tr> <tr> <td></td> <td></td> <td colspan="8" style="text-align: center;"> <table border="1" style="width: 100%; border-collapse: collapse; text-align: center;"> <tr> <td style="width: 10%;"></td> <td style="width: 10%;"></td> <td style="width: 10%;"></td> <td style="width: 10%;"></td> <td style="width: 10%;"></td> <td style="width: 10%;"></td> <td style="width: 10%;"></td> <td style="width: 10%;"></td> <td style="width: 10%;"></td> <td style="width: 10%;"></td> </tr> <tr> <td></td> <td></td> <td colspan="8" style="text-align: center;"> <table border="1" style="width: 100%; border-collapse: collapse; text-align: center;"> <tr> <td style="width: 10%;"></td> <td style="width: 10%;"></td> <td style="width: 10%;"></td> <td style="width: 10%;"></td> <td style="width: 10%;"></td> <td style="width: 10%;"></td> <td style="width: 10%;"></td> <td style="width: 10%;"></td> <td style="width: 10%;"></td> <td style="width: 10%;"></td> </tr> <tr> <td></td> <td></td> <td colspan="8" style="text-align: center;"> <table border="1" style="width: 100%; border-collapse: collapse; text-align: center;"> <tr>
</tr></table></td></tr></table></td></tr></table></td></tr></table></td></tr></table></td></tr></table></td></tr></table></td></tr></table></td></tr></table></td></tr></table></td></tr></table></td></tr></table></td></tr></table></td></tr></table></td></tr></table></td></tr></table></td></tr></table></td></tr></table></td></tr></table></td></tr></table></td></tr></table></td></tr></table></td></tr></table></td></tr></table></td></tr></table></td></tr></table></td></tr></table></td></tr></table></td></tr></table></td></tr></table></td></tr></table></td></tr></table></td></tr></table></td></tr></table></td></tr></table></td></tr></table></td></tr></table></td></tr></table></td></tr></table></td></tr></table></td></tr></table></td></tr></table></td></tr></table></td></tr></table></td></tr></table></td></tr></table></td></tr></table></td></tr></table></td></tr></table></td></tr></table></td></tr></table></td></tr></table></td></tr></table></td></tr></table></td></tr></table></td></tr></table></td></tr></table></td></tr></table> | | | | | | | | | | | | | | | | | | | | <table border="1" style="width: 100%; border-collapse: collapse; text-align: center;"> <tr> <td style="width: 10%;"></td> <td style="width: 10%;"></td> <td style="width: 10%;"></td> <td style="width: 10%;"></td> <td style="width: 10%;"></td> <td style="width: 10%;"></td> <td style="width: 10%;"></td> <td style="width: 10%;"></td> <td style="width: 10%;"></td> <td style="width: 10%;"></td> </tr> <tr> <td></td> <td></td> <td colspan="8" style="text-align: center;"> <table border="1" style="width: 100%; border-collapse: collapse; text-align: center;"> <tr> <td style="width: 10%;"></td> <td style="width: 10%;"></td> <td style="width: 10%;"></td> <td style="width: 10%;"></td> <td style="width: 10%;"></td> <td style="width: 10%;"></td> <td style="width: 10%;"></td> <td style="width: 10%;"></td> <td style="width: 10%;"></td> <td style="width: 10%;"></td> </tr> <tr> <td></td> <td></td> <td colspan="8" style="text-align: center;"> <table border="1" style="width: 100%; border-collapse: collapse; text-align: center;"> <tr> <td style="width: 10%;"></td> <td style="width: 10%;"></td> <td style="width: 10%;"></td> <td style="width: 10%;"></td> <td style="width: 10%;"></td> <td style="width: 10%;"></td> <td style="width: 10%;"></td> <td style="width: 10%;"></td> <td style="width: 10%;"></td> <td style="width: 10%;"></td> </tr> <tr> <td></td> <td></td> <td colspan="8" style="text-align: center;"> <table border="1" style="width: 100%; border-collapse: collapse; text-align: center;"> <tr> <td style="width: 10%;"></td> <td style="width: 10%;"></td> <td style="width: 10%;"></td> <td style="width: 10%;"></td> <td style="width: 10%;"></td> <td style="width: 10%;"></td> <td style="width: 10%;"></td> <td style="width: 10%;"></td> <td style="width: 10%;"></td> <td style="width: 10%;"></td> </tr> <tr> <td></td> <td></td> <td colspan="8" style="text-align: center;"> <table border="1" style="width: 100%; border-collapse: collapse; text-align: center;"> <tr> <td style="width: 10%;"></td> <td style="width: 10%;"></td> <td style="width: 10%;"></td> <td style="width: 10%;"></td> <td style="width: 10%;"></td> <td style="width: 10%;"></td> <td style="width: 10%;"></td> <td style="width: 10%;"></td> <td style="width: 10%;"></td> <td style="width: 10%;"></td> </tr> <tr> <td></td> <td></td> <td colspan="8" style="text-align: center;"> <table border="1" style="width: 100%; border-collapse: collapse; text-align: center;"> <tr> <td style="width: 10%;"></td> <td style="width: 10%;"></td> <td style="width: 10%;"></td> <td style="width: 10%;"></td> <td style="width: 10%;"></td> <td style="width: 10%;"></td> <td style="width: 10%;"></td> <td style="width: 10%;"></td> <td style="width: 10%;"></td> <td style="width: 10%;"></td> </tr> <tr> <td></td> <td></td> <td colspan="8" style="text-align: center;"> <table border="1" style="width: 100%; border-collapse: collapse; text-align: center;"> <tr> <td style="width: 10%;"></td> <td style="width: 10%;"></td> <td style="width: 10%;"></td> <td style="width: 10%;"></td> <td style="width: 10%;"></td> <td style="width: 10%;"></td> <td style="width: 10%;"></td> <td style="width: 10%;"></td> <td style="width: 10%;"></td> <td style="width: 10%;"></td> </tr> <tr> <td></td> <td></td> <td colspan="8" style="text-align: center;"> <table border="1" style="width: 100%; border-collapse: collapse; text-align: center;"> <tr> <td style="width: 10%;"></td> <td style="width: 10%;"></td> <td style="width: 10%;"></td> <td style="width: 10%;"></td> <td style="width: 10%;"></td> <td style="width: 10%;"></td> <td style="width: 10%;"></td> <td style="width: 10%;"></td> <td style="width: 10%;"></td> <td style="width: 10%;"></td> </tr> <tr> <td></td> <td></td> <td colspan="8" style="text-align: center;"> <table border="1" style="width: 100%; border-collapse: collapse; text-align: center;"> <tr> <td style="width: 10%;"></td> <td style="width: 10%;"></td> <td style="width: 10%;"></td> <td style="width: 10%;"></td> <td style="width: 10%;"></td> <td style="width: 10%;"></td> <td style="width: 10%;"></td> <td style="width: 10%;"></td> <td style="width: 10%;"></td> <td style="width: 10%;"></td> </tr> <tr> <td></td> <td></td> <td colspan="8" style="text-align: center;"> <table border="1" style="width: 100%; border-collapse: collapse; text-align: center;"> <tr> <td style="width: 10%;"></td> <td style="width: 10%;"></td> <td style="width: 10%;"></td> <td style="width: 10%;"></td> <td style="width: 10%;"></td> <td style="width: 10%;"></td> <td style="width: 10%;"></td> <td style="width: 10%;"></td> <td style="width: 10%;"></td> <td style="width: 10%;"></td> </tr> <tr> <td></td> <td></td> <td colspan="8" style="text-align: center;"> <table border="1" style="width: 100%; border-collapse: collapse; text-align: center;"> <tr> <td style="width: 10%;"></td> <td style="width: 10%;"></td> <td style="width: 10%;"></td> <td style="width: 10%;"></td> <td style="width: 10%;"></td> <td style="width: 10%;"></td> <td style="width: 10%;"></td> <td style="width: 10%;"></td> <td style="width: 10%;"></td> <td style="width: 10%;"></td> </tr> <tr> <td></td> <td></td> <td colspan="8" style="text-align: center;"> <table border="1" style="width: 100%; border-collapse: collapse; text-align: center;"> <tr> <td style="width: 10%;"></td> <td style="width: 10%;"></td> <td style="width: 10%;"></td> <td style="width: 10%;"></td> <td style="width: 10%;"></td> <td style="width: 10%;"></td> <td style="width: 10%;"></td> <td style="width: 10%;"></td> <td style="width: 10%;"></td> <td style="width: 10%;"></td> </tr> <tr> <td></td> <td></td> <td colspan="8" style="text-align: center;"> <table border="1" style="width: 100%; border-collapse: collapse; text-align: center;"> <tr> <td style="width: 10%;"></td> <td style="width: 10%;"></td> <td style="width: 10%;"></td> <td style="width: 10%;"></td> <td style="width: 10%;"></td> <td style="width: 10%;"></td> <td style="width: 10%;"></td> <td style="width: 10%;"></td> <td style="width: 10%;"></td> <td style="width: 10%;"></td> </tr> <tr> <td></td> <td></td> <td colspan="8" style="text-align: center;"> <table border="1" style="width: 100%; border-collapse: collapse; text-align: center;"> <tr> <td style="width: 10%;"></td> <td style="width: 10%;"></td> <td style="width: 10%;"></td> <td style="width: 10%;"></td> <td style="width: 10%;"></td> <td style="width: 10%;"></td> <td style="width: 10%;"></td> <td style="width: 10%;"></td> <td style="width: 10%;"></td> <td style="width: 10%;"></td> </tr> <tr> <td></td> <td></td> <td colspan="8" style="text-align: center;"> <table border="1" style="width: 100%; border-collapse: collapse; text-align: center;"> <tr> <td style="width: 10%;"></td> <td style="width: 10%;"></td> <td style="width: 10%;"></td> <td style="width: 10%;"></td> <td style="width: 10%;"></td> <td style="width: 10%;"></td> <td style="width: 10%;"></td> <td style="width: 10%;"></td> <td style="width: 10%;"></td> <td style="width: 10%;"></td> </tr> <tr> <td></td> <td></td> <td colspan="8" style="text-align: center;"> <table border="1" style="width: 100%; border-collapse: collapse; text-align: center;"> <tr> <td style="width: 10%;"></td> <td style="width: 10%;"></td> <td style="width: 10%;"></td> <td style="width: 10%;"></td> <td style="width: 10%;"></td> <td style="width: 10%;"></td> <td style="width: 10%;"></td> <td style="width: 10%;"></td> <td style="width: 10%;"></td> <td style="width: 10%;"></td> </tr> <tr> <td></td> <td></td> <td colspan="8" style="text-align: center;"> <table border="1" style="width: 100%; border-collapse: collapse; text-align: center;"> <tr> <td style="width: 10%;"></td> <td style="width: 10%;"></td> <td style="width: 10%;"></td> <td style="width: 10%;"></td> <td style="width: 10%;"></td> <td style="width: 10%;"></td> <td style="width: 10%;"></td> <td style="width: 10%;"></td> <td style="width: 10%;"></td> <td style="width: 10%;"></td> </tr> <tr> <td></td> <td></td> <td colspan="8"
style="text-align: center;"> <table border="1" style="width: 100%; border-collapse: collapse; text-align: center;"> <tr> <td style="width: 10%;"></td> <td style="width: 10%;"></td> <td style="width: 10%;"></td> <td style="width: 10%;"></td> <td style="width: 10%;"></td> <td style="width: 10%;"></td> <td style="width: 10%;"></td> <td style="width: 10%;"></td> <td style="width: 10%;"></td> <td style="width: 10%;"></td> </tr> <tr> <td></td> <td></td> <td colspan="8" style="text-align: center;"> <table border="1" style="width: 100%; border-collapse: collapse; text-align: center;"> <tr> <td style="width: 10%;"></td> <td style="width: 10%;"></td> <td style="width: 10%;"></td> <td style="width: 10%;"></td> <td style="width: 10%;"></td> <td style="width: 10%;"></td> <td style="width: 10%;"></td> <td style="width: 10%;"></td> <td style="width: 10%;"></td> <td style="width: 10%;"></td> </tr> <tr> <td></td> <td></td> <td colspan="8" style="text-align: center;"> <table border="1" style="width: 100%; border-collapse: collapse; text-align: center;"> <tr> <td style="width: 10%;"></td> <td style="width: 10%;"></td> <td style="width: 10%;"></td> <td style="width: 10%;"></td> <td style="width: 10%;"></td> <td style="width: 10%;"></td> <td style="width: 10%;"></td> <td style="width: 10%;"></td> <td style="width: 10%;"></td> <td style="width: 10%;"></td> </tr> <tr> <td></td> <td></td> <td colspan="8" style="text-align: center;"> <table border="1" style="width: 100%; border-collapse: collapse; text-align: center;"> <tr> <td style="width: 10%;"></td> <td style="width: 10%;"></td> <td style="width: 10%;"></td> <td style="width: 10%;"></td> <td style="width: 10%;"></td> <td style="width: 10%;"></td> <td style="width: 10%;"></td> <td style="width: 10%;"></td> <td style="width: 10%;"></td> <td style="width: 10%;"></td> </tr> <tr> <td></td> <td></td> <td colspan="8" style="text-align: center;"> <table border="1" style="width: 100%; border-collapse: collapse; text-align: center;"> <tr> <td style="width: 10%;"></td> <td style="width: 10%;"></td> <td style="width: 10%;"></td> <td style="width: 10%;"></td> <td style="width: 10%;"></td> <td style="width: 10%;"></td> <td style="width: 10%;"></td> <td style="width: 10%;"></td> <td style="width: 10%;"></td> <td style="width: 10%;"></td> </tr> <tr> <td></td> <td></td> <td colspan="8" style="text-align: center;"> <table border="1" style="width: 100%; border-collapse: collapse; text-align: center;"> <tr> <td style="width: 10%;"></td> <td style="width: 10%;"></td> <td style="width: 10%;"></td> <td style="width: 10%;"></td> <td style="width: 10%;"></td> <td style="width: 10%;"></td> <td style="width: 10%;"></td> <td style="width: 10%;"></td> <td style="width: 10%;"></td> <td style="width: 10%;"></td> </tr> <tr> <td></td> <td></td> <td colspan="8" style="text-align: center;"> <table border="1" style="width: 100%; border-collapse: collapse; text-align: center;"> <tr> <td style="width: 10%;"></td> <td style="width: 10%;"></td> <td style="width: 10%;"></td> <td style="width: 10%;"></td> <td style="width: 10%;"></td> <td style="width: 10%;"></td> <td style="width: 10%;"></td> <td style="width: 10%;"></td> <td style="width: 10%;"></td> <td style="width: 10%;"></td> </tr> <tr> <td></td> <td></td> <td colspan="8" style="text-align: center;"> <table border="1" style="width: 100%; border-collapse: collapse; text-align: center;"> <tr> <td style="width: 10%;"></td> <td style="width: 10%;"></td> <td style="width: 10%;"></td> <td style="width: 10%;"></td> <td style="width: 10%;"></td> <td style="width: 10%;"></td> <td style="width: 10%;"></td> <td style="width: 10%;"></td> <td style="width: 10%;"></td> <td style="width: 10%;"></td> </tr> <tr> <td></td> <td></td> <td colspan="8" style="text-align: center;"> <table border="1" style="width: 100%; border-collapse: collapse; text-align: center;"> <tr> <td style="width: 10%;"></td> <td style="width: 10%;"></td> <td style="width: 10%;"></td> <td style="width: 10%;"></td> <td style="width: 10%;"></td> <td style="width: 10%;"></td> <td style="width: 10%;"></td> <td style="width: 10%;"></td> <td style="width: 10%;"></td> <td style="width: 10%;"></td> </tr> <tr> <td></td> <td></td> <td colspan="8" style="text-align: center;"> <table border="1" style="width: 100%; border-collapse: collapse; text-align: center;"> <tr> <td style="width: 10%;"></td> <td style="width: 10%;"></td> <td style="width: 10%;"></td> <td style="width: 10%;"></td> <td style="width: 10%;"></td> <td style="width: 10%;"></td> <td style="width: 10%;"></td> <td style="width: 10%;"></td> <td style="width: 10%;"></td> <td style="width: 10%;"></td> </tr> <tr> <td></td> <td></td> <td colspan="8" style="text-align: center;"> <table border="1" style="width: 100%; border-collapse: collapse; text-align: center;"> <tr> <td style="width: 10%;"></td> <td style="width: 10%;"></td> <td style="width: 10%;"></td> <td style="width: 10%;"></td> <td style="width: 10%;"></td> <td style="width: 10%;"></td> <td style="width: 10%;"></td> <td style="width: 10%;"></td> <td style="width: 10%;"></td> <td style="width: 10%;"></td> </tr> <tr> <td></td> <td></td> <td colspan="8" style="text-align: center;"> <table border="1" style="width: 100%; border-collapse: collapse; text-align: center;"> <tr> <td style="width: 10%;"></td> <td style="width: 10%;"></td> <td style="width: 10%;"></td> <td style="width: 10%;"></td> <td style="width: 10%;"></td> <td style="width: 10%;"></td> <td style="width: 10%;"></td> <td style="width: 10%;"></td> <td style="width: 10%;"></td> <td style="width: 10%;"></td> </tr> <tr> <td></td> <td></td> <td colspan="8" style="text-align: center;"> <table border="1" style="width: 100%; border-collapse: collapse; text-align: center;"> <tr> <td style="width: 10%;"></td> <td style="width: 10%;"></td> <td style="width: 10%;"></td> <td style="width: 10%;"></td> <td style="width: 10%;"></td> <td style="width: 10%;"></td> <td style="width: 10%;"></td> <td style="width: 10%;"></td> <td style="width: 10%;"></td> <td style="width: 10%;"></td> </tr> <tr> <td></td> <td></td> <td colspan="8" style="text-align: center;"> <table border="1" style="width: 100%; border-collapse: collapse; text-align: center;"> <tr> <td style="width: 10%;"></td> <td style="width: 10%;"></td> <td style="width: 10%;"></td> <td style="width: 10%;"></td> <td style="width: 10%;"></td> <td style="width: 10%;"></td> <td style="width: 10%;"></td> <td style="width: 10%;"></td> <td style="width: 10%;"></td> <td style="width: 10%;"></td> </tr> <tr> <td></td> <td></td> <td colspan="8" style="text-align: center;"> <table border="1" style="width: 100%; border-collapse: collapse; text-align: center;"> <tr> <td style="width: 10%;"></td> <td style="width: 10%;"></td> <td style="width: 10%;"></td> <td style="width: 10%;"></td> <td style="width: 10%;"></td> <td style="width: 10%;"></td> <td style="width: 10%;"></td> <td style="width: 10%;"></td> <td style="width: 10%;"></td> <td style="width: 10%;"></td> </tr> <tr> <td></td> <td></td> <td colspan="8" style="text-align: center;"> <table border="1" style="width: 100%; border-collapse: collapse; text-align: center;"> <tr> <td style="width: 10%;"></td> <td style="width: 10%;"></td> <td style="width: 10%;"></td> <td style="width: 10%;"></td> <td style="width: 10%;"></td> <td style="width: 10%;"></td> <td style="width: 10%;"></td> <td style="width: 10%;"></td> <td style="width: 10%;"></td> <td style="width: 10%;"></td> </tr> <tr> <td></td> <td></td> <td colspan="8" style="text-align: center;"> <table border="1" style="width: 100%; border-collapse: collapse; text-align: center;"> <tr> <td style="width: 10%;"></td> <td style="width: 10%;"></td> <td style="width: 10%;"></td> <td style="width: 10%;"></td> <td style="width: 10%;"></td> <td style="width: 10%;"></td> <td style="width: 10%;"></td> <td style="width: 10%;"></td> <td style="width: 10%;"></td> <td style="width: 10%;"></td> </tr> <tr> <td></td> <td></td> <td colspan="8" style="text-align: center;"> <table border="1" style="width: 100%; border-collapse: collapse; text-align: center;"> <tr> <td style="width: 10%;"></td> <td style="width: 10%;"></td> <td style="width: 10%;"></td> <td style="width: 10%;"></td> <td style="width: 10%;"></td> <td style="width: 10%;"></td> <td style="width: 10%;"></td> <td style="width: 10%;"></td> <td style="width: 10%;"></td> <td style="width: 10%;"></td> </tr> <tr> <td></td> <td></td> <td colspan="8" style="text-align: center;"> <table border="1" style="width: 100%; border-collapse: collapse; text-align: center;"> <tr> <td style="width: 10%;"></td> <td style="width: 10%;"></td> <td style="width: 10%;"></td> <td style="width: 10%;"></td> <td style="width: 10%;"></td> <td style="width: 10%;"></td> <td style="width: 10%;"></td> <td style="width: 10%;"></td> <td style="width: 10%;"></td> <td style="width: 10%;"></td> </tr> <tr> <td></td> <td></td> <td colspan="8" style="text-align: center;"> <table border="1" style="width: 100%; border-collapse: collapse; text-align: center;"> <tr> <td style="width: 10%;"></td> <td style="width: 10%;"></td> <td style="width: 10%;"></td> <td style="width: 10%;"></td> <td style="width: 10%;"></td> <td style="width: 10%;"></td> <td style="width: 10%;"></td> <td style="width: 10%;"></td> <td style="width: 10%;"></td> <td style="width: 10%;"></td> </tr> <tr> <td></td> <td></td> <td colspan="8" style="text-align: center;"> <table border="1" style="width: 100%; border-collapse: collapse; text-align: center;"> <tr> <td style="width: 10%;"></td> <td style="width: 10%;"></td> <td style="width: 10%;"></td> <td style="width: 10%;"></td> <td style="width: 10%;"></td> <td style="width: 10%;"></td> <td style="width: 10%;"></td> <td style="width: 10%;"></td> <td style="width: 10%;"></td> <td style="width: 10%;"></td> </tr> <tr> <td></td> <td></td> <td colspan="8" style="text-align: center;"> <table border="1" style="width: 100%; border-collapse: collapse; text-align: center;"> <tr> <td style="width: 10%;"></td> <td style="width:
10%;"></td> <td style="width: 10%;"></td> <td style="width: 10%;"></td> <td style="width: 10%;"></td> <td style="width: 10%;"></td> <td style="width: 10%;"></td> <td style="width: 10%;"></td> <td style="width: 10%;"></td> <td style="width: 10%;"></td> </tr> <tr> <td></td> <td></td> <td colspan="8" style="text-align: center;"> <table border="1" style="width: 100%; border-collapse: collapse; text-align: center;"> <tr> <td style="width: 10%;"></td> <td style="width: 10%;"></td> <td style="width: 10%;"></td> <td style="width: 10%;"></td> <td style="width: 10%;"></td> <td style="width: 10%;"></td> <td style="width: 10%;"></td> <td style="width: 10%;"></td> <td style="width: 10%;"></td> <td style="width: 10%;"></td> </tr> <tr> <td></td> <td></td> <td colspan="8" style="text-align: center;"> <table border="1" style="width: 100%; border-collapse: collapse; text-align: center;"> <tr> <td style="width: 10%;"></td> <td style="width: 10%;"></td> <td style="width: 10%;"></td> <td style="width: 10%;"></td> <td style="width: 10%;"></td> <td style="width: 10%;"></td> <td style="width: 10%;"></td> <td style="width: 10%;"></td> <td style="width: 10%;"></td> <td style="width: 10%;"></td> </tr> <tr> <td></td> <td></td> <td colspan="8" style="text-align: center;"> <table border="1" style="width: 100%; border-collapse: collapse; text-align: center;"> <tr> <td style="width: 10%;"></td> <td style="width: 10%;"></td> <td style="width: 10%;"></td> <td style="width: 10%;"></td> <td style="width: 10%;"></td> <td style="width: 10%;"></td> <td style="width: 10%;"></td> <td style="width: 10%;"></td> <td style="width: 10%;"></td> <td style="width: 10%;"></td> </tr> <tr> <td></td> <td></td> <td colspan="8" style="text-align: center;"> <table border="1" style="width: 100%; border-collapse: collapse; text-align: center;"> <tr> <td style="width: 10%;"></td> <td style="width: 10%;"></td> <td style="width: 10%;"></td> <td style="width: 10%;"></td> <td style="width: 10%;"></td> <td style="width: 10%;"></td> <td style="width: 10%;"></td> <td style="width: 10%;"></td> <td style="width: 10%;"></td> <td style="width: 10%;"></td> </tr> <tr> <td></td> <td></td> <td colspan="8" style="text-align: center;"> <table border="1" style="width: 100%; border-collapse: collapse; text-align: center;"> <tr> <td style="width: 10%;"></td> <td style="width: 10%;"></td> <td style="width: 10%;"></td> <td style="width: 10%;"></td> <td style="width: 10%;"></td> <td style="width: 10%;"></td> <td style="width: 10%;"></td> <td style="width: 10%;"></td> <td style="width: 10%;"></td> <td style="width: 10%;"></td> </tr> <tr> <td></td> <td></td> <td colspan="8" style="text-align: center;"> <table border="1" style="width: 100%; border-collapse: collapse; text-align: center;"> <tr> <td style="width: 10%;"></td> <td style="width: 10%;"></td> <td style="width: 10%;"></td> <td style="width: 10%;"></td> <td style="width: 10%;"></td> <td style="width: 10%;"></td> <td style="width: 10%;"></td> <td style="width: 10%;"></td> <td style="width: 10%;"></td> <td style="width: 10%;"></td> </tr> <tr> <td></td> <td></td> <td colspan="8" style="text-align: center;"> <table border="1" style="width: 100%; border-collapse: collapse; text-align: center;"> <tr> <td style="width: 10%;"></td> <td style="width: 10%;"></td> <td style="width: 10%;"></td> <td style="width: 10%;"></td> <td style="width: 10%;"></td> <td style="width: 10%;"></td> <td style="width: 10%;"></td> <td style="width: 10%;"></td> <td style="width: 10%;"></td> <td style="width: 10%;"></td> </tr> <tr> <td></td> <td></td> <td colspan="8" style="text-align: center;"> <table border="1" style="width: 100%; border-collapse: collapse; text-align: center;"> <tr> <td style="width: 10%;"></td> <td style="width: 10%;"></td> <td style="width: 10%;"></td> <td style="width: 10%;"></td> <td style="width: 10%;"></td> <td style="width: 10%;"></td> <td style="width: 10%;"></td> <td style="width: 10%;"></td> <td style="width: 10%;"></td> <td style="width: 10%;"></td> </tr> <tr> <td></td> <td></td> <td colspan="8" style="text-align: center;"> <table border="1" style="width: 100%; border-collapse: collapse; text-align: center;"> <tr> <td style="width: 10%;"></td> <td style="width: 10%;"></td> <td style="width: 10%;"></td> <td style="width: 10%;"></td> <td style="width: 10%;"></td> <td style="width: 10%;"></td> <td style="width: 10%;"></td> <td style="width: 10%;"></td> <td style="width: 10%;"></td> <td style="width: 10%;"></td> </tr> <tr> <td></td> <td></td> <td colspan="8" style="text-align: center;"> <table border="1" style="width: 100%; border-collapse: collapse; text-align: center;"> <tr> <td style="width: 10%;"></td> <td style="width: 10%;"></td> <td style="width: 10%;"></td> <td style="width: 10%;"></td> <td style="width: 10%;"></td> <td style="width: 10%;"></td> <td style="width: 10%;"></td> <td style="width: 10%;"></td> <td style="width: 10%;"></td> <td style="width: 10%;"></td> </tr> <tr> <td></td> <td></td> <td colspan="8" style="text-align: center;"> <table border="1" style="width: 100%; border-collapse: collapse; text-align: center;"> <tr> <td style="width: 10%;"></td> <td style="width: 10%;"></td> <td style="width: 10%;"></td> <td style="width: 10%;"></td> <td style="width: 10%;"></td> <td style="width: 10%;"></td> <td style="width: 10%;"></td> <td style="width: 10%;"></td> <td style="width: 10%;"></td> <td style="width: 10%;"></td> </tr> <tr> <td></td> <td></td> <td colspan="8" style="text-align: center;"> <table border="1" style="width: 100%; border-collapse: collapse; text-align: center;"> <tr> <td style="width: 10%;"></td> <td style="width: 10%;"></td> <td style="width: 10%;"></td> <td style="width: 10%;"></td> <td style="width: 10%;"></td> <td style="width: 10%;"></td> <td style="width: 10%;"></td> <td style="width: 10%;"></td> <td style="width: 10%;"></td> <td style="width: 10%;"></td> </tr> <tr> <td></td> <td></td> <td colspan="8" style="text-align: center;"> <table border="1" style="width: 100%; border-collapse: collapse; text-align: center;"> <tr> <td style="width: 10%;"></td> <td style="width: 10%;"></td> <td style="width: 10%;"></td> <td style="width: 10%;"></td> <td style="width: 10%;"></td> <td style="width: 10%;"></td> <td style="width: 10%;"></td> <td style="width: 10%;"></td> <td style="width: 10%;"></td> <td style="width: 10%;"></td> </tr> <tr> <td></td> <td></td> <td colspan="8" style="text-align: center;"> <table border="1" style="width: 100%; border-collapse: collapse; text-align: center;"> <tr> <td style="width: 10%;"></td> <td style="width: 10%;"></td> <td style="width: 10%;"></td> <td style="width: 10%;"></td> <td style="width: 10%;"></td> <td style="width: 10%;"></td> <td style="width: 10%;"></td> <td style="width: 10%;"></td> <td style="width: 10%;"></td> <td style="width: 10%;"></td> </tr> <tr> <td></td> <td></td> <td colspan="8" style="text-align: center;"> <table border="1" style="width: 100%; border-collapse: collapse; text-align: center;"> <tr> <td style="width: 10%;"></td> <td style="width: 10%;"></td> <td style="width: 10%;"></td> <td style="width: 10%;"></td> <td style="width: 10%;"></td> <td style="width: 10%;"></td> <td style="width: 10%;"></td> <td style="width: 10%;"></td> <td style="width: 10%;"></td> <td style="width: 10%;"></td> </tr> <tr> <td></td> <td></td> <td colspan="8" style="text-align: center;"> <table border="1" style="width: 100%; border-collapse: collapse; text-align: center;"> <tr> <td style="width: 10%;"></td> <td style="width: 10%;"></td> <td style="width: 10%;"></td> <td style="width: 10%;"></td> <td style="width: 10%;"></td> <td style="width: 10%;"></td> <td style="width: 10%;"></td> <td style="width: 10%;"></td> <td style="width: 10%;"></td> <td style="width: 10%;"></td> </tr> <tr> <td></td> <td></td> <td colspan="8" style="text-align: center;"> <table border="1" style="width: 100%; border-collapse: collapse; text-align: center;"> <tr> <td style="width: 10%;"></td> <td style="width: 10%;"></td> <td style="width: 10%;"></td> <td style="width: 10%;"></td> <td style="width: 10%;"></td> <td style="width: 10%;"></td> <td style="width: 10%;"></td> <td style="width: 10%;"></td> <td style="width: 10%;"></td> <td style="width: 10%;"></td> </tr> <tr> <td></td> <td></td> <td colspan="8" style="text-align: center;"> <table border="1" style="width: 100%; border-collapse: collapse; text-align: center;"> <tr> </tr></table></td></tr></table></td></tr></table></td></tr></table></td></tr></table></td></tr></table></td></tr></table></td></tr></table></td></tr></table></td></tr></table></td></tr></table></td></tr></table></td></tr></table></td></tr></table></td></tr></table></td></tr></table></td></tr></table></td></tr></table></td></tr></table></td></tr></table></td></tr></table></td></tr></table></td></tr></table></td></tr></table></td></tr></table></td></tr></table></td></tr></table></td></tr></table></td></tr></table></td></tr></table></td></tr></table></td></tr></table></td></tr></table></td></tr></table></td></tr></table></td></tr></table></td></tr></table></td></tr></table></td></tr></table></td></tr></table></td></tr></table></td></tr></table></td></tr></table></td></tr></table></td></tr></table></td></tr></table></td></tr></table></td></tr></table></td></tr></table></td></tr></table></td></tr></table></td></tr></table></td></tr></table></td></tr></table></td></tr></table></td></tr></table></td></tr></table>
 | | | | | | | | | | | | | | | | | | | | <table border="1" style="width: 100%; border-collapse: collapse; text-align: center;"> <tr> <td style="width: 10%;"></td> <td style="width: 10%;"></td> <td style="width: 10%;"></td> <td style="width: 10%;"></td> <td style="width: 10%;"></td> <td style="width: 10%;"></td> <td style="width: 10%;"></td> <td style="width: 10%;"></td> <td style="width: 10%;"></td> <td style="width: 10%;"></td> </tr> <tr> <td></td> <td></td> <td colspan="8" style="text-align: center;"> <table border="1" style="width: 100%; border-collapse: collapse; text-align: center;"> <tr> <td style="width: 10%;"></td> <td style="width: 10%;"></td> <td style="width: 10%;"></td> <td style="width: 10%;"></td> <td style="width: 10%;"></td> <td style="width: 10%;"></td> <td style="width: 10%;"></td> <td style="width: 10%;"></td> <td style="width: 10%;"></td> <td style="width: 10%;"></td> </tr> <tr> <td></td> <td></td> <td colspan="8" style="text-align: center;"> <table border="1" style="width: 100%; border-collapse: collapse; text-align: center;"> <tr> <td style="width: 10%;"></td> <td style="width: 10%;"></td> <td style="width: 10%;"></td> <td style="width: 10%;"></td> <td style="width: 10%;"></td> <td style="width: 10%;"></td> <td style="width: 10%;"></td> <td style="width: 10%;"></td> <td style="width: 10%;"></td> <td style="width: 10%;"></td> </tr> <tr> <td></td> <td></td> <td colspan="8" style="text-align: center;"> <table border="1" style="width: 100%; border-collapse: collapse; text-align: center;"> <tr> <td style="width: 10%;"></td> <td style="width: 10%;"></td> <td style="width: 10%;"></td> <td style="width: 10%;"></td> <td style="width: 10%;"></td> <td style="width: 10%;"></td> <td style="width: 10%;"></td> <td style="width: 10%;"></td> <td style="width: 10%;"></td> <td style="width: 10%;"></td> </tr> <tr> <td></td> <td></td> <td colspan="8" style="text-align: center;"> <table border="1" style="width: 100%; border-collapse: collapse; text-align: center;"> <tr> <td style="width: 10%;"></td> <td style="width: 10%;"></td> <td style="width: 10%;"></td> <td style="width: 10%;"></td> <td style="width: 10%;"></td> <td style="width: 10%;"></td> <td style="width: 10%;"></td> <td style="width: 10%;"></td> <td style="width: 10%;"></td> <td style="width: 10%;"></td> </tr> <tr> <td></td> <td></td> <td colspan="8" style="text-align: center;"> <table border="1" style="width: 100%; border-collapse: collapse; text-align: center;"> <tr> <td style="width: 10%;"></td> <td style="width: 10%;"></td> <td style="width: 10%;"></td> <td style="width: 10%;"></td> <td style="width: 10%;"></td> <td style="width: 10%;"></td> <td style="width: 10%;"></td> <td style="width: 10%;"></td> <td style="width: 10%;"></td> <td style="width: 10%;"></td> </tr> <tr> <td></td> <td></td> <td colspan="8" style="text-align: center;"> <table border="1" style="width: 100%; border-collapse: collapse; text-align: center;"> <tr> <td style="width: 10%;"></td> <td style="width: 10%;"></td> <td style="width: 10%;"></td> <td style="width: 10%;"></td> <td style="width: 10%;"></td> <td style="width: 10%;"></td> <td style="width: 10%;"></td> <td style="width: 10%;"></td> <td style="width: 10%;"></td> <td style="width: 10%;"></td> </tr> <tr> <td></td> <td></td> <td colspan="8" style="text-align: center;"> <table border="1" style="width: 100%; border-collapse: collapse; text-align: center;"> <tr> <td style="width: 10%;"></td> <td style="width: 10%;"></td> <td style="width: 10%;"></td> <td style="width: 10%;"></td> <td style="width: 10%;"></td> <td style="width: 10%;"></td> <td style="width: 10%;"></td> <td style="width: 10%;"></td> <td style="width: 10%;"></td> <td style="width: 10%;"></td> </tr> <tr> <td></td> <td></td> <td colspan="8" style="text-align: center;"> <table border="1" style="width: 100%; border-collapse: collapse; text-align: center;"> <tr> <td style="width: 10%;"></td> <td style="width: 10%;"></td> <td style="width: 10%;"></td> <td style="width: 10%;"></td> <td style="width: 10%;"></td> <td style="width: 10%;"></td> <td style="width: 10%;"></td> <td style="width: 10%;"></td> <td style="width: 10%;"></td> <td style="width: 10%;"></td> </tr> <tr> <td></td> <td></td> <td colspan="8" style="text-align: center;"> <table border="1" style="width: 100%; border-collapse: collapse; text-align: center;"> <tr> <td style="width: 10%;"></td> <td style="width: 10%;"></td> <td style="width: 10%;"></td> <td style="width: 10%;"></td> <td style="width: 10%;"></td> <td style="width: 10%;"></td> <td style="width: 10%;"></td> <td style="width: 10%;"></td> <td style="width: 10%;"></td> <td style="width: 10%;"></td> </tr> <tr> <td></td> <td></td> <td colspan="8" style="text-align: center;"> <table border="1" style="width: 100%; border-collapse: collapse; text-align: center;"> <tr> <td style="width: 10%;"></td> <td style="width: 10%;"></td> <td style="width: 10%;"></td> <td style="width: 10%;"></td> <td style="width: 10%;"></td> <td style="width: 10%;"></td> <td style="width: 10%;"></td> <td style="width: 10%;"></td> <td style="width: 10%;"></td> <td style="width: 10%;"></td> </tr> <tr> <td></td> <td></td> <td colspan="8" style="text-align: center;"> <table border="1" style="width: 100%; border-collapse: collapse; text-align: center;"> <tr> <td style="width: 10%;"></td> <td style="width: 10%;"></td> <td style="width: 10%;"></td> <td style="width: 10%;"></td> <td style="width: 10%;"></td> <td style="width: 10%;"></td> <td style="width: 10%;"></td> <td style="width: 10%;"></td> <td style="width: 10%;"></td> <td style="width: 10%;"></td> </tr> <tr> <td></td> <td></td> <td colspan="8" style="text-align: center;"> <table border="1" style="width: 100%; border-collapse: collapse; text-align: center;"> <tr> <td style="width: 10%;"></td> <td style="width: 10%;"></td> <td style="width: 10%;"></td> <td style="width: 10%;"></td> <td style="width: 10%;"></td> <td style="width: 10%;"></td> <td style="width: 10%;"></td> <td style="width: 10%;"></td> <td style="width: 10%;"></td> <td style="width: 10%;"></td> </tr> <tr> <td></td> <td></td> <td colspan="8" style="text-align: center;"> <table border="1" style="width: 100%; border-collapse: collapse; text-align: center;"> <tr> <td style="width: 10%;"></td> <td style="width: 10%;"></td> <td style="width: 10%;"></td> <td style="width: 10%;"></td> <td style="width: 10%;"></td> <td style="width: 10%;"></td> <td style="width: 10%;"></td> <td style="width: 10%;"></td> <td style="width: 10%;"></td> <td style="width: 10%;"></td> </tr> <tr> <td></td> <td></td> <td colspan="8" style="text-align: center;"> <table border="1" style="width: 100%; border-collapse: collapse; text-align: center;"> <tr> <td style="width: 10%;"></td> <td style="width: 10%;"></td> <td style="width: 10%;"></td> <td style="width: 10%;"></td> <td style="width: 10%;"></td> <td style="width: 10%;"></td> <td style="width: 10%;"></td> <td style="width: 10%;"></td> <td style="width: 10%;"></td> <td style="width: 10%;"></td> </tr> <tr> <td></td> <td></td> <td colspan="8" style="text-align: center;"> <table border="1" style="width: 100%; border-collapse: collapse; text-align: center;"> <tr> <td style="width: 10%;"></td> <td style="width: 10%;"></td> <td style="width: 10%;"></td> <td style="width: 10%;"></td> <td style="width: 10%;"></td> <td style="width: 10%;"></td> <td style="width: 10%;"></td> <td style="width: 10%;"></td> <td style="width: 10%;"></td> <td style="width: 10%;"></td> </tr> <tr> <td></td> <td></td> <td colspan="8" style="text-align: center;"> <table border="1" style="width: 100%; border-collapse: collapse; text-align: center;"> <tr> <td style="width: 10%;"></td> <td style="width: 10%;"></td> <td style="width: 10%;"></td> <td style="width: 10%;"></td> <td style="width: 10%;"></td> <td style="width: 10%;"></td> <td style="width: 10%;"></td> <td style="width: 10%;"></td> <td style="width: 10%;"></td> <td style="width: 10%;"></td> </tr> <tr> <td></td> <td></td> <td colspan="8" style="text-align: center;"> <table border="1" style="width: 100%; border-collapse: collapse; text-align: center;"> <tr> <td style="width: 10%;"></td> <td style="width: 10%;"></td> <td style="width: 10%;"></td> <td style="width: 10%;"></td> <td style="width: 10%;"></td> <td style="width: 10%;"></td> <td style="width: 10%;"></td> <td style="width: 10%;"></td> <td style="width: 10%;"></td> <td style="width: 10%;"></td> </tr> <tr> <td></td> <td></td> <td colspan="8" style="text-align: center;"> <table border="1" style="width: 100%; border-collapse: collapse; text-align: center;"> <tr> <td style="width: 10%;"></td> <td style="width: 10%;"></td> <td style="width: 10%;"></td> <td style="width: 10%;"></td> <td style="width: 10%;"></td> <td style="width: 10%;"></td> <td style="width: 10%;"></td> <td style="width: 10%;"></td> <td style="width: 10%;"></td> <td style="width: 10%;"></td> </tr> <tr> <td></td> <td></td> <td colspan="8" style="text-align: center;"> <table border="1" style="width: 100%; border-collapse: collapse; text-align: center;"> <tr> <td style="width: 10%;"></td> <td style="width: 10%;"></td> <td style="width: 10%;"></td> <td style="width: 10%;"></td> <td style="width: 10%;"></td> <td style="width: 10%;"></td> <td style="width: 10%;"></td> <td style="width: 10%;"></td> <td style="width: 10%;"></td> <td style="width: 10%;"></td> </tr> <tr> <td></td> <td></td> <td colspan="8" style="text-align: center;"> <table border="1" style="width: 100%; border-collapse: collapse; text-align: center;"> <tr> <td style="width: 10%;"></td> <td style="width: 10%;"></td> <td style="width: 10%;"></td> <td style="width:
10%;"></td> <td style="width: 10%;"></td> <td style="width: 10%;"></td> <td style="width: 10%;"></td> <td style="width: 10%;"></td> <td style="width: 10%;"></td> <td style="width: 10%;"></td> </tr> <tr> <td></td> <td></td> <td colspan="8" style="text-align: center;"> <table border="1" style="width: 100%; border-collapse: collapse; text-align: center;"> <tr> <td style="width: 10%;"></td> <td style="width: 10%;"></td> <td style="width: 10%;"></td> <td style="width: 10%;"></td> <td style="width: 10%;"></td> <td style="width: 10%;"></td> <td style="width: 10%;"></td> <td style="width: 10%;"></td> <td style="width: 10%;"></td> <td style="width: 10%;"></td> </tr> <tr> <td></td> <td></td> <td colspan="8" style="text-align: center;"> <table border="1" style="width: 100%; border-collapse: collapse; text-align: center;"> <tr> <td style="width: 10%;"></td> <td style="width: 10%;"></td> <td style="width: 10%;"></td> <td style="width: 10%;"></td> <td style="width: 10%;"></td> <td style="width: 10%;"></td> <td style="width: 10%;"></td> <td style="width: 10%;"></td> <td style="width: 10%;"></td> <td style="width: 10%;"></td> </tr> <tr> <td></td> <td></td> <td colspan="8" style="text-align: center;"> <table border="1" style="width: 100%; border-collapse: collapse; text-align: center;"> <tr> <td style="width: 10%;"></td> <td style="width: 10%;"></td> <td style="width: 10%;"></td> <td style="width: 10%;"></td> <td style="width: 10%;"></td> <td style="width: 10%;"></td> <td style="width: 10%;"></td> <td style="width: 10%;"></td> <td style="width: 10%;"></td> <td style="width: 10%;"></td> </tr> <tr> <td></td> <td></td> <td colspan="8" style="text-align: center;"> <table border="1" style="width: 100%; border-collapse: collapse; text-align: center;"> <tr> <td style="width: 10%;"></td> <td style="width: 10%;"></td> <td style="width: 10%;"></td> <td style="width: 10%;"></td> <td style="width: 10%;"></td> <td style="width: 10%;"></td> <td style="width: 10%;"></td> <td style="width: 10%;"></td> <td style="width: 10%;"></td> <td style="width: 10%;"></td> </tr> <tr> <td></td> <td></td> <td colspan="8" style="text-align: center;"> <table border="1" style="width: 100%; border-collapse: collapse; text-align: center;"> <tr> <td style="width: 10%;"></td> <td style="width: 10%;"></td> <td style="width: 10%;"></td> <td style="width: 10%;"></td> <td style="width: 10%;"></td> <td style="width: 10%;"></td> <td style="width: 10%;"></td> <td style="width: 10%;"></td> <td style="width: 10%;"></td> <td style="width: 10%;"></td> </tr> <tr> <td></td> <td></td> <td colspan="8" style="text-align: center;"> <table border="1" style="width: 100%; border-collapse: collapse; text-align: center;"> <tr> <td style="width: 10%;"></td> <td style="width: 10%;"></td> <td style="width: 10%;"></td> <td style="width: 10%;"></td> <td style="width: 10%;"></td> <td style="width: 10%;"></td> <td style="width: 10%;"></td> <td style="width: 10%;"></td> <td style="width: 10%;"></td> <td style="width: 10%;"></td> </tr> <tr> <td></td> <td></td> <td colspan="8" style="text-align: center;"> <table border="1" style="width: 100%; border-collapse: collapse; text-align: center;"> <tr> <td style="width: 10%;"></td> <td style="width: 10%;"></td> <td style="width: 10%;"></td> <td style="width: 10%;"></td> <td style="width: 10%;"></td> <td style="width: 10%;"></td> <td style="width: 10%;"></td> <td style="width: 10%;"></td> <td style="width: 10%;"></td> <td style="width: 10%;"></td> </tr> <tr> <td></td> <td></td> <td colspan="8" style="text-align: center;"> <table border="1" style="width: 100%; border-collapse: collapse; text-align: center;"> <tr> <td style="width: 10%;"></td> <td style="width: 10%;"></td> <td style="width: 10%;"></td> <td style="width: 10%;"></td> <td style="width: 10%;"></td> <td style="width: 10%;"></td> <td style="width: 10%;"></td> <td style="width: 10%;"></td> <td style="width: 10%;"></td> <td style="width: 10%;"></td> </tr> <tr> <td></td> <td></td> <td colspan="8" style="text-align: center;"> <table border="1" style="width: 100%; border-collapse: collapse; text-align: center;"> <tr> <td style="width: 10%;"></td> <td style="width: 10%;"></td> <td style="width: 10%;"></td> <td style="width: 10%;"></td> <td style="width: 10%;"></td> <td style="width: 10%;"></td> <td style="width: 10%;"></td> <td style="width: 10%;"></td> <td style="width: 10%;"></td> <td style="width: 10%;"></td> </tr> <tr> <td></td> <td></td> <td colspan="8" style="text-align: center;"> <table border="1" style="width: 100%; border-collapse: collapse; text-align: center;"> <tr> <td style="width: 10%;"></td> <td style="width: 10%;"></td> <td style="width: 10%;"></td> <td style="width: 10%;"></td> <td style="width: 10%;"></td> <td style="width: 10%;"></td> <td style="width: 10%;"></td> <td style="width: 10%;"></td> <td style="width: 10%;"></td> <td style="width: 10%;"></td> </tr> <tr> <td></td> <td></td> <td colspan="8" style="text-align: center;"> <table border="1" style="width: 100%; border-collapse: collapse; text-align: center;"> <tr> <td style="width: 10%;"></td> <td style="width: 10%;"></td> <td style="width: 10%;"></td> <td style="width: 10%;"></td> <td style="width: 10%;"></td> <td style="width: 10%;"></td> <td style="width: 10%;"></td> <td style="width: 10%;"></td> <td style="width: 10%;"></td> <td style="width: 10%;"></td> </tr> <tr> <td></td> <td></td> <td colspan="8" style="text-align: center;"> <table border="1" style="width: 100%; border-collapse: collapse; text-align: center;"> <tr> <td style="width: 10%;"></td> <td style="width: 10%;"></td> <td style="width: 10%;"></td> <td style="width: 10%;"></td> <td style="width: 10%;"></td> <td style="width: 10%;"></td> <td style="width: 10%;"></td> <td style="width: 10%;"></td> <td style="width: 10%;"></td> <td style="width: 10%;"></td> </tr> <tr> <td></td> <td></td> <td colspan="8" style="text-align: center;"> <table border="1" style="width: 100%; border-collapse: collapse; text-align: center;"> <tr> <td style="width: 10%;"></td> <td style="width: 10%;"></td> <td style="width: 10%;"></td> <td style="width: 10%;"></td> <td style="width: 10%;"></td> <td style="width: 10%;"></td> <td style="width: 10%;"></td> <td style="width: 10%;"></td> <td style="width: 10%;"></td> <td style="width: 10%;"></td> </tr> <tr> <td></td> <td></td> <td colspan="8" style="text-align: center;"> <table border="1" style="width: 100%; border-collapse: collapse; text-align: center;"> <tr> <td style="width: 10%;"></td> <td style="width: 10%;"></td> <td style="width: 10%;"></td> <td style="width: 10%;"></td> <td style="width: 10%;"></td> <td style="width: 10%;"></td> <td style="width: 10%;"></td> <td style="width: 10%;"></td> <td style="width: 10%;"></td> <td style="width: 10%;"></td> </tr> <tr> <td></td> <td></td> <td colspan="8" style="text-align: center;"> <table border="1" style="width: 100%; border-collapse: collapse; text-align: center;"> <tr> <td style="width: 10%;"></td> <td style="width: 10%;"></td> <td style="width: 10%;"></td> <td style="width: 10%;"></td> <td style="width: 10%;"></td> <td style="width: 10%;"></td> <td style="width: 10%;"></td> <td style="width: 10%;"></td> <td style="width: 10%;"></td> <td style="width: 10%;"></td> </tr> <tr> <td></td> <td></td> <td colspan="8" style="text-align: center;"> <table border="1" style="width: 100%; border-collapse: collapse; text-align: center;"> <tr> <td style="width: 10%;"></td> <td style="width: 10%;"></td> <td style="width: 10%;"></td> <td style="width: 10%;"></td> <td style="width: 10%;"></td> <td style="width: 10%;"></td> <td style="width: 10%;"></td> <td style="width: 10%;"></td> <td style="width: 10%;"></td> <td style="width: 10%;"></td> </tr> <tr> <td></td> <td></td> <td colspan="8" style="text-align: center;"> <table border="1" style="width: 100%; border-collapse: collapse; text-align: center;"> <tr> <td style="width: 10%;"></td> <td style="width: 10%;"></td> <td style="width: 10%;"></td> <td style="width: 10%;"></td> <td style="width: 10%;"></td> <td style="width: 10%;"></td> <td style="width: 10%;"></td> <td style="width: 10%;"></td> <td style="width: 10%;"></td> <td style="width: 10%;"></td> </tr> <tr> <td></td> <td></td> <td colspan="8" style="text-align: center;"> <table border="1" style="width: 100%; border-collapse: collapse; text-align: center;"> <tr> <td style="width: 10%;"></td> <td style="width: 10%;"></td> <td style="width: 10%;"></td> <td style="width: 10%;"></td> <td style="width: 10%;"></td> <td style="width: 10%;"></td> <td style="width: 10%;"></td> <td style="width: 10%;"></td> <td style="width: 10%;"></td> <td style="width: 10%;"></td> </tr> <tr> <td></td> <td></td> <td colspan="8" style="text-align: center;"> <table border="1" style="width: 100%; border-collapse: collapse; text-align: center;"> <tr> <td style="width: 10%;"></td> <td style="width: 10%;"></td> <td style="width: 10%;"></td> <td style="width: 10%;"></td> <td style="width: 10%;"></td> <td style="width: 10%;"></td> <td style="width: 10%;"></td> <td style="width: 10%;"></td> <td style="width: 10%;"></td> <td style="width: 10%;"></td> </tr> <tr> <td></td> <td></td> <td colspan="8" style="text-align: center;"> <table border="1" style="width: 100%; border-collapse: collapse; text-align: center;"> <tr> <td style="width: 10%;"></td> <td style="width: 10%;"></td> <td style="width: 10%;"></td> <td style="width: 10%;"></td> <td style="width: 10%;"></td> <td style="width: 10%;"></td> <td style="width: 10%;"></td> <td style="width: 10%;"></td> <td style="width: 10%;"></td> <td style="width: 10%;"></td> </tr> <tr> <td></td> <td></td> <td colspan="8" style="text-align: center;"> <table border="1" style="width: 100%; border-collapse: collapse; text-align: center;"> <tr> <td style="width: 10%;"></td> <td style="width: 10%;"></td> <td style="width: 10%;"></td> <td style="width: 10%;"></td> <td style="width: 10%;"></td> <td style="width: 10%;"></td> <td style="width: 10%;"></td> <td style="width: 10%;"></td> <td style="width: 10%;"></td> <td
style="width: 10%;"></td> </tr> <tr> <td></td> <td></td> <td colspan="8" style="text-align: center;"> <table border="1" style="width: 100%; border-collapse: collapse; text-align: center;"> <tr> <td style="width: 10%;"></td> <td style="width: 10%;"></td> <td style="width: 10%;"></td> <td style="width: 10%;"></td> <td style="width: 10%;"></td> <td style="width: 10%;"></td> <td style="width: 10%;"></td> <td style="width: 10%;"></td> <td style="width: 10%;"></td> <td style="width: 10%;"></td> </tr> <tr> <td></td> <td></td> <td colspan="8" style="text-align: center;"> <table border="1" style="width: 100%; border-collapse: collapse; text-align: center;"> <tr> <td style="width: 10%;"></td> <td style="width: 10%;"></td> <td style="width: 10%;"></td> <td style="width: 10%;"></td> <td style="width: 10%;"></td> <td style="width: 10%;"></td> <td style="width: 10%;"></td> <td style="width: 10%;"></td> <td style="width: 10%;"></td> <td style="width: 10%;"></td> </tr> <tr> <td></td> <td></td> <td colspan="8" style="text-align: center;"> <table border="1" style="width: 100%; border-collapse: collapse; text-align: center;"> <tr> <td style="width: 10%;"></td> <td style="width: 10%;"></td> <td style="width: 10%;"></td> <td style="width: 10%;"></td> <td style="width: 10%;"></td> <td style="width: 10%;"></td> <td style="width: 10%;"></td> <td style="width: 10%;"></td> <td style="width: 10%;"></td> <td style="width: 10%;"></td> </tr> <tr> <td></td> <td></td> <td colspan="8" style="text-align: center;"> <table border="1" style="width: 100%; border-collapse: collapse; text-align: center;"> <tr> <td style="width: 10%;"></td> <td style="width: 10%;"></td> <td style="width: 10%;"></td> <td style="width: 10%;"></td> <td style="width: 10%;"></td> <td style="width: 10%;"></td> <td style="width: 10%;"></td> <td style="width: 10%;"></td> <td style="width: 10%;"></td> <td style="width: 10%;"></td> </tr> <tr> <td></td> <td></td> <td colspan="8" style="text-align: center;"> <table border="1" style="width: 100%; border-collapse: collapse; text-align: center;"> <tr> <td style="width: 10%;"></td> <td style="width: 10%;"></td> <td style="width: 10%;"></td> <td style="width: 10%;"></td> <td style="width: 10%;"></td> <td style="width: 10%;"></td> <td style="width: 10%;"></td> <td style="width: 10%;"></td> <td style="width: 10%;"></td> <td style="width: 10%;"></td> </tr> <tr> <td></td> <td></td> <td colspan="8" style="text-align: center;"> <table border="1" style="width: 100%; border-collapse: collapse; text-align: center;"> <tr> <td style="width: 10%;"></td> <td style="width: 10%;"></td> <td style="width: 10%;"></td> <td style="width: 10%;"></td> <td style="width: 10%;"></td> <td style="width: 10%;"></td> <td style="width: 10%;"></td> <td style="width: 10%;"></td> <td style="width: 10%;"></td> <td style="width: 10%;"></td> </tr> <tr> <td></td> <td></td> <td colspan="8" style="text-align: center;"> <table border="1" style="width: 100%; border-collapse: collapse; text-align: center;"> <tr> <td style="width: 10%;"></td> <td style="width: 10%;"></td> <td style="width: 10%;"></td> <td style="width: 10%;"></td> <td style="width: 10%;"></td> <td style="width: 10%;"></td> <td style="width: 10%;"></td> <td style="width: 10%;"></td> <td style="width: 10%;"></td> <td style="width: 10%;"></td> </tr> <tr> <td></td> <td></td> <td colspan="8" style="text-align: center;"> <table border="1" style="width: 100%; border-collapse: collapse; text-align: center;"> <tr> <td style="width: 10%;"></td> <td style="width: 10%;"></td> <td style="width: 10%;"></td> <td style="width: 10%;"></td> <td style="width: 10%;"></td> <td style="width: 10%;"></td> <td style="width: 10%;"></td> <td style="width: 10%;"></td> <td style="width: 10%;"></td> <td style="width: 10%;"></td> </tr> <tr> <td></td> <td></td> <td colspan="8" style="text-align: center;"> <table border="1" style="width: 100%; border-collapse: collapse; text-align: center;"> <tr> <td style="width: 10%;"></td> <td style="width: 10%;"></td> <td style="width: 10%;"></td> <td style="width: 10%;"></td> <td style="width: 10%;"></td> <td style="width: 10%;"></td> <td style="width: 10%;"></td> <td style="width: 10%;"></td> <td style="width: 10%;"></td> <td style="width: 10%;"></td> </tr> <tr> <td></td> <td></td> <td colspan="8" style="text-align: center;"> <table border="1" style="width: 100%; border-collapse: collapse; text-align: center;"> <tr> <td style="width: 10%;"></td> <td style="width: 10%;"></td> <td style="width: 10%;"></td> <td style="width: 10%;"></td> <td style="width: 10%;"></td> <td style="width: 10%;"></td> <td style="width: 10%;"></td> <td style="width: 10%;"></td> <td style="width: 10%;"></td> <td style="width: 10%;"></td> </tr> <tr> <td></td> <td></td> <td colspan="8" style="text-align: center;"> <table border="1" style="width: 100%; border-collapse: collapse; text-align: center;"> <tr> <td style="width: 10%;"></td> <td style="width: 10%;"></td> <td style="width: 10%;"></td> <td style="width: 10%;"></td> <td style="width: 10%;"></td> <td style="width: 10%;"></td> <td style="width: 10%;"></td> <td style="width: 10%;"></td> <td style="width: 10%;"></td> <td style="width: 10%;"></td> </tr> <tr> <td></td> <td></td> <td colspan="8" style="text-align: center;"> <table border="1" style="width: 100%; border-collapse: collapse; text-align: center;"> <tr> <td style="width: 10%;"></td> <td style="width: 10%;"></td> <td style="width: 10%;"></td> <td style="width: 10%;"></td> <td style="width: 10%;"></td> <td style="width: 10%;"></td> <td style="width: 10%;"></td> <td style="width: 10%;"></td> <td style="width: 10%;"></td> <td style="width: 10%;"></td> </tr> <tr> <td></td> <td></td> <td colspan="8" style="text-align: center;"> <table border="1" style="width: 100%; border-collapse: collapse; text-align: center;"> <tr> <td style="width: 10%;"></td> <td style="width: 10%;"></td> <td style="width: 10%;"></td> <td style="width: 10%;"></td> <td style="width: 10%;"></td> <td style="width: 10%;"></td> <td style="width: 10%;"></td> <td style="width: 10%;"></td> <td style="width: 10%;"></td> <td style="width: 10%;"></td> </tr> <tr> <td></td> <td></td> <td colspan="8" style="text-align: center;"> <table border="1" style="width: 100%; border-collapse: collapse; text-align: center;"> <tr> </tr></table></td></tr></table></td></tr></table></td></tr></table></td></tr></table></td></tr></table></td></tr></table></td></tr></table></td></tr></table></td></tr></table></td></tr></table></td></tr></table></td></tr></table></td></tr></table></td></tr></table></td></tr></table></td></tr></table></td></tr></table></td></tr></table></td></tr></table></td></tr></table></td></tr></table></td></tr></table></td></tr></table></td></tr></table></td></tr></table></td></tr></table></td></tr></table></td></tr></table></td></tr></table></td></tr></table></td></tr></table></td></tr></table></td></tr></table></td></tr></table></td></tr></table></td></tr></table></td></tr></table></td></tr></table></td></tr></table></td></tr></table></td></tr></table></td></tr></table></td></tr></table></td></tr></table></td></tr></table></td></tr></table></td></tr></table></td></tr></table></td></tr></table></td></tr></table></td></tr></table></td></tr></table></td></tr></table></td></tr></table></td></tr></table> | | | | | | | | | | | | | | | | | | | | <table border="1" style="width: 100%; border-collapse: collapse; text-align: center;"> <tr> <td style="width: 10%;"></td> <td style="width: 10%;"></td> <td style="width: 10%;"></td> <td style="width: 10%;"></td> <td style="width: 10%;"></td> <td style="width: 10%;"></td> <td style="width: 10%;"></td> <td style="width: 10%;"></td> <td style="width: 10%;"></td> <td style="width: 10%;"></td> </tr> <tr> <td></td> <td></td> <td colspan="8" style="text-align: center;"> <table border="1" style="width: 100%; border-collapse: collapse; text-align: center;"> <tr> <td style="width: 10%;"></td> <td style="width: 10%;"></td> <td style="width: 10%;"></td> <td style="width: 10%;"></td> <td style="width: 10%;"></td> <td style="width: 10%;"></td> <td style="width: 10%;"></td> <td style="width: 10%;"></td> <td style="width: 10%;"></td> <td style="width: 10%;"></td> </tr> <tr> <td></td> <td></td> <td colspan="8" style="text-align: center;"> <table border="1" style="width: 100%; border-collapse: collapse; text-align: center;"> <tr> <td style="width: 10%;"></td> <td style="width: 10%;"></td> <td style="width: 10%;"></td> <td style="width: 10%;"></td> <td style="width: 10%;"></td> <td style="width: 10%;"></td> <td style="width: 10%;"></td> <td style="width: 10%;"></td> <td style="width: 10%;"></td> <td style="width: 10%;"></td> </tr> <tr> <td></td> <td></td> <td colspan="8" style="text-align: center;"> <table border="1" style="width: 100%; border-collapse: collapse; text-align: center;"> <tr> <td style="width: 10%;"></td> <td style="width: 10%;"></td> <td style="width: 10%;"></td> <td style="width: 10%;"></td> <td style="width: 10%;"></td> <td style="width: 10%;"></td> <td
style="width: 10%;"></td> <td style="width: 10%;"></td> <td style="width: 10%;"></td> <td style="width: 10%;"></td> </tr> <tr> <td></td> <td></td> <td colspan="8" style="text-align: center;"> <table border="1" style="width: 100%; border-collapse: collapse; text-align: center;"> <tr> <td style="width: 10%;"></td> <td style="width: 10%;"></td> <td style="width: 10%;"></td> <td style="width: 10%;"></td> <td style="width: 10%;"></td> <td style="width: 10%;"></td> <td style="width: 10%;"></td> <td style="width: 10%;"></td> <td style="width: 10%;"></td> <td style="width: 10%;"></td> </tr> <tr> <td></td> <td></td> <td colspan="8" style="text-align: center;"> <table border="1" style="width: 100%; border-collapse: collapse; text-align: center;"> <tr> <td style="width: 10%;"></td> <td style="width: 10%;"></td> <td style="width: 10%;"></td> <td style="width: 10%;"></td> <td style="width: 10%;"></td> <td style="width: 10%;"></td> <td style="width: 10%;"></td> <td style="width: 10%;"></td> <td style="width: 10%;"></td> <td style="width: 10%;"></td> </tr> <tr> <td></td> <td></td> <td colspan="8" style="text-align: center;"> <table border="1" style="width: 100%; border-collapse: collapse; text-align: center;"> <tr> <td style="width: 10%;"></td> <td style="width: 10%;"></td> <td style="width: 10%;"></td> <td style="width: 10%;"></td> <td style="width: 10%;"></td> <td style="width: 10%;"></td> <td style="width: 10%;"></td> <td style="width: 10%;"></td> <td style="width: 10%;"></td> <td style="width: 10%;"></td> </tr> <tr> <td></td> <td></td> <td colspan="8" style="text-align: center;"> <table border="1" style="width: 100%; border-collapse: collapse; text-align: center;"> <tr> <td style="width: 10%;"></td> <td style="width: 10%;"></td> <td style="width: 10%;"></td> <td style="width: 10%;"></td> <td style="width: 10%;"></td> <td style="width: 10%;"></td> <td style="width: 10%;"></td> <td style="width: 10%;"></td> <td style="width: 10%;"></td> <td style="width: 10%;"></td> </tr> <tr> <td></td> <td></td> <td colspan="8" style="text-align: center;"> <table border="1" style="width: 100%; border-collapse: collapse; text-align: center;"> <tr> <td style="width: 10%;"></td> <td style="width: 10%;"></td> <td style="width: 10%;"></td> <td style="width: 10%;"></td> <td style="width: 10%;"></td> <td style="width: 10%;"></td> <td style="width: 10%;"></td> <td style="width: 10%;"></td> <td style="width: 10%;"></td> <td style="width: 10%;"></td> </tr> <tr> <td></td> <td></td> <td colspan="8" style="text-align: center;"> <table border="1" style="width: 100%; border-collapse: collapse; text-align: center;"> <tr> <td style="width: 10%;"></td> <td style="width: 10%;"></td> <td style="width: 10%;"></td> <td style="width: 10%;"></td> <td style="width: 10%;"></td> <td style="width: 10%;"></td> <td style="width: 10%;"></td> <td style="width: 10%;"></td> <td style="width: 10%;"></td> <td style="width: 10%;"></td> </tr> <tr> <td></td> <td></td> <td colspan="8" style="text-align: center;"> <table border="1" style="width: 100%; border-collapse: collapse; text-align: center;"> <tr> <td style="width: 10%;"></td> <td style="width: 10%;"></td> <td style="width: 10%;"></td> <td style="width: 10%;"></td> <td style="width: 10%;"></td> <td style="width: 10%;"></td> <td style="width: 10%;"></td> <td style="width: 10%;"></td> <td style="width: 10%;"></td> <td style="width: 10%;"></td> </tr> <tr> <td></td> <td></td> <td colspan="8" style="text-align: center;"> <table border="1" style="width: 100%; border-collapse: collapse; text-align: center;"> <tr> <td style="width: 10%;"></td> <td style="width: 10%;"></td> <td style="width: 10%;"></td> <td style="width: 10%;"></td> <td style="width: 10%;"></td> <td style="width: 10%;"></td> <td style="width: 10%;"></td> <td style="width: 10%;"></td> <td style="width: 10%;"></td> <td style="width: 10%;"></td> </tr> <tr> <td></td> <td></td> <td colspan="8" style="text-align: center;"> <table border="1" style="width: 100%; border-collapse: collapse; text-align: center;"> <tr> <td style="width: 10%;"></td> <td style="width: 10%;"></td> <td style="width: 10%;"></td> <td style="width: 10%;"></td> <td style="width: 10%;"></td> <td style="width: 10%;"></td> <td style="width: 10%;"></td> <td style="width: 10%;"></td> <td style="width: 10%;"></td> <td style="width: 10%;"></td> </tr> <tr> <td></td> <td></td> <td colspan="8" style="text-align: center;"> <table border="1" style="width: 100%; border-collapse: collapse; text-align: center;"> <tr> <td style="width: 10%;"></td> <td style="width: 10%;"></td> <td style="width: 10%;"></td> <td style="width: 10%;"></td> <td style="width: 10%;"></td> <td style="width: 10%;"></td> <td style="width: 10%;"></td> <td style="width: 10%;"></td> <td style="width: 10%;"></td> <td style="width: 10%;"></td> </tr> <tr> <td></td> <td></td> <td colspan="8" style="text-align: center;"> <table border="1" style="width: 100%; border-collapse: collapse; text-align: center;"> <tr> <td style="width: 10%;"></td> <td style="width: 10%;"></td> <td style="width: 10%;"></td> <td style="width: 10%;"></td> <td style="width: 10%;"></td> <td style="width: 10%;"></td> <td style="width: 10%;"></td> <td style="width: 10%;"></td> <td style="width: 10%;"></td> <td style="width: 10%;"></td> </tr> <tr> <td></td> <td></td> <td colspan="8" style="text-align: center;"> <table border="1" style="width: 100%; border-collapse: collapse; text-align: center;"> <tr> <td style="width: 10%;"></td> <td style="width: 10%;"></td> <td style="width: 10%;"></td> <td style="width: 10%;"></td> <td style="width: 10%;"></td> <td style="width: 10%;"></td> <td style="width: 10%;"></td> <td style="width: 10%;"></td> <td style="width: 10%;"></td> <td style="width: 10%;"></td> </tr> <tr> <td></td> <td></td> <td colspan="8" style="text-align: center;"> <table border="1" style="width: 100%; border-collapse: collapse; text-align: center;"> <tr> <td style="width: 10%;"></td> <td style="width: 10%;"></td> <td style="width: 10%;"></td> <td style="width: 10%;"></td> <td style="width: 10%;"></td> <td style="width: 10%;"></td> <td style="width: 10%;"></td> <td style="width: 10%;"></td> <td style="width: 10%;"></td> <td style="width: 10%;"></td> </tr> <tr> <td></td> <td></td> <td colspan="8" style="text-align: center;"> <table border="1" style="width: 100%; border-collapse: collapse; text-align: center;"> <tr> <td style="width: 10%;"></td> <td style="width: 10%;"></td> <td style="width: 10%;"></td> <td style="width: 10%;"></td> <td style="width: 10%;"></td> <td style="width: 10%;"></td> <td style="width: 10%;"></td> <td style="width: 10%;"></td> <td style="width: 10%;"></td> <td style="width: 10%;"></td> </tr> <tr> <td></td> <td></td> <td colspan="8" style="text-align: center;"> <table border="1" style="width: 100%; border-collapse: collapse; text-align: center;"> <tr> <td style="width: 10%;"></td> <td style="width: 10%;"></td> <td style="width: 10%;"></td> <td style="width: 10%;"></td> <td style="width: 10%;"></td> <td style="width: 10%;"></td> <td style="width: 10%;"></td> <td style="width: 10%;"></td> <td style="width: 10%;"></td> <td style="width: 10%;"></td> </tr> <tr> <td></td> <td></td> <td colspan="8" style="text-align: center;"> <table border="1" style="width: 100%; border-collapse: collapse; text-align: center;"> <tr> <td style="width: 10%;"></td> <td style="width: 10%;"></td> <td style="width: 10%;"></td> <td style="width: 10%;"></td> <td style="width: 10%;"></td> <td style="width: 10%;"></td> <td style="width: 10%;"></td> <td style="width: 10%;"></td> <td style="width: 10%;"></td> <td style="width: 10%;"></td> </tr> <tr> <td></td> <td></td> <td colspan="8" style="text-align: center;"> <table border="1" style="width: 100%; border-collapse: collapse; text-align: center;"> <tr> <td style="width: 10%;"></td> <td style="width: 10%;"></td> <td style="width: 10%;"></td> <td style="width: 10%;"></td> <td style="width: 10%;"></td> <td style="width: 10%;"></td> <td style="width: 10%;"></td> <td style="width: 10%;"></td> <td style="width: 10%;"></td> <td style="width: 10%;"></td> </tr> <tr> <td></td> <td></td> <td colspan="8" style="text-align: center;"> <table border="1" style="width: 100%; border-collapse: collapse; text-align: center;"> <tr> <td style="width: 10%;"></td> <td style="width: 10%;"></td> <td style="width: 10%;"></td> <td style="width: 10%;"></td> <td style="width: 10%;"></td> <td style="width: 10%;"></td> <td style="width: 10%;"></td> <td style="width: 10%;"></td> <td style="width: 10%;"></td> <td style="width: 10%;"></td> </tr> <tr> <td></td> <td></td> <td colspan="8" style="text-align: center;"> <table border="1" style="width: 100%; border-collapse: collapse; text-align: center;"> <tr> <td style="width: 10%;"></td> <td style="width: 10%;"></td> <td style="width: 10%;"></td> <td style="width: 10%;"></td> <td style="width: 10%;"></td> <td style="width: 10%;"></td> <td style="width: 10%;"></td> <td style="width: 10%;"></td> <td style="width: 10%;"></td> <td style="width: 10%;"></td> </tr> <tr> <td></td> <td></td> <td colspan="8" style="text-align: center;"> <table border="1" style="width: 100%; border-collapse: collapse; text-align: center;"> <tr> <td style="width: 10%;"></td> <td style="width: 10%;"></td> <td style="width: 10%;"></td> <td style="width: 10%;"></td> <td style="width: 10%;"></td> <td style="width: 10%;"></td> <td style="width: 10%;"></td> <td style="width: 10%;"></td> <td style="width: 10%;"></td> <td style="width: 10%;"></td> </tr> <tr> <td></td> <td></td> <td colspan="8" style="text-align: center;"> <table border="1" style="width: 100%; border-collapse: collapse; text-align: center;"> <tr> <td style="width: 10%;"></td> <td style="width: 10%;"></td> <td style="width: 10%;"></td> <td style="width: 10%;"></td> <td style="width: 10%;"></td> <td style="width: 10%;"></td> <td style="width: 10%;"></td> <td style="width: 10%;"></td> <td style="width: 10%;"></td> <td style="width: 10%;"></td> </tr> <tr> <td></td> <td></td> <td colspan="8"
style="text-align: center;"> <table border="1" style="width: 100%; border-collapse: collapse; text-align: center;"> <tr> <td style="width: 10%;"></td> <td style="width: 10%;"></td> <td style="width: 10%;"></td> <td style="width: 10%;"></td> <td style="width: 10%;"></td> <td style="width: 10%;"></td> <td style="width: 10%;"></td> <td style="width: 10%;"></td> <td style="width: 10%;"></td> <td style="width: 10%;"></td> </tr> <tr> <td></td> <td></td> <td colspan="8" style="text-align: center;"> <table border="1" style="width: 100%; border-collapse: collapse; text-align: center;"> <tr> <td style="width: 10%;"></td> <td style="width: 10%;"></td> <td style="width: 10%;"></td> <td style="width: 10%;"></td> <td style="width: 10%;"></td> <td style="width: 10%;"></td> <td style="width: 10%;"></td> <td style="width: 10%;"></td> <td style="width: 10%;"></td> <td style="width: 10%;"></td> </tr> <tr> <td></td> <td></td> <td colspan="8" style="text-align: center;"> <table border="1" style="width: 100%; border-collapse: collapse; text-align: center;"> <tr> <td style="width: 10%;"></td> <td style="width: 10%;"></td> <td style="width: 10%;"></td> <td style="width: 10%;"></td> <td style="width: 10%;"></td> <td style="width: 10%;"></td> <td style="width: 10%;"></td> <td style="width: 10%;"></td> <td style="width: 10%;"></td> <td style="width: 10%;"></td> </tr> <tr> <td></td> <td></td> <td colspan="8" style="text-align: center;"> <table border="1" style="width: 100%; border-collapse: collapse; text-align: center;"> <tr> <td style="width: 10%;"></td> <td style="width: 10%;"></td> <td style="width: 10%;"></td> <td style="width: 10%;"></td> <td style="width: 10%;"></td> <td style="width: 10%;"></td> <td style="width: 10%;"></td> <td style="width: 10%;"></td> <td style="width: 10%;"></td> <td style="width: 10%;"></td> </tr> <tr> <td></td> <td></td> <td colspan="8" style="text-align: center;"> <table border="1" style="width: 100%; border-collapse: collapse; text-align: center;"> <tr> <td style="width: 10%;"></td> <td style="width: 10%;"></td> <td style="width: 10%;"></td> <td style="width: 10%;"></td> <td style="width: 10%;"></td> <td style="width: 10%;"></td> <td style="width: 10%;"></td> <td style="width: 10%;"></td> <td style="width: 10%;"></td> <td style="width: 10%;"></td> </tr> <tr> <td></td> <td></td> <td colspan="8" style="text-align: center;"> <table border="1" style="width: 100%; border-collapse: collapse; text-align: center;"> <tr> <td style="width: 10%;"></td> <td style="width: 10%;"></td> <td style="width: 10%;"></td> <td style="width: 10%;"></td> <td style="width: 10%;"></td> <td style="width: 10%;"></td> <td style="width: 10%;"></td> <td style="width: 10%;"></td> <td style="width: 10%;"></td> <td style="width: 10%;"></td> </tr> <tr> <td></td> <td></td> <td colspan="8" style="text-align: center;"> <table border="1" style="width: 100%; border-collapse: collapse; text-align: center;"> <tr> <td style="width: 10%;"></td> <td style="width: 10%;"></td> <td style="width: 10%;"></td> <td style="width: 10%;"></td> <td style="width: 10%;"></td> <td style="width: 10%;"></td> <td style="width: 10%;"></td> <td style="width: 10%;"></td> <td style="width: 10%;"></td> <td style="width: 10%;"></td> </tr> <tr> <td></td> <td></td> <td colspan="8" style="text-align: center;"> <table border="1" style="width: 100%; border-collapse: collapse; text-align: center;"> <tr> <td style="width: 10%;"></td> <td style="width: 10%;"></td> <td style="width: 10%;"></td> <td style="width: 10%;"></td> <td style="width: 10%;"></td> <td style="width: 10%;"></td> <td style="width: 10%;"></td> <td style="width: 10%;"></td> <td style="width: 10%;"></td> <td style="width: 10%;"></td> </tr> <tr> <td></td> <td></td> <td colspan="8" style="text-align: center;"> <table border="1" style="width: 100%; border-collapse: collapse; text-align: center;"> <tr> <td style="width: 10%;"></td> <td style="width: 10%;"></td> <td style="width: 10%;"></td> <td style="width: 10%;"></td> <td style="width: 10%;"></td> <td style="width: 10%;"></td> <td style="width: 10%;"></td> <td style="width: 10%;"></td> <td style="width: 10%;"></td> <td style="width: 10%;"></td> </tr> <tr> <td></td> <td></td> <td colspan="8" style="text-align: center;"> <table border="1" style="width: 100%; border-collapse: collapse; text-align: center;"> <tr> <td style="width: 10%;"></td> <td style="width: 10%;"></td> <td style="width: 10%;"></td> <td style="width: 10%;"></td> <td style="width: 10%;"></td> <td style="width: 10%;"></td> <td style="width: 10%;"></td> <td style="width: 10%;"></td> <td style="width: 10%;"></td> <td style="width: 10%;"></td> </tr> <tr> <td></td> <td></td> <td colspan="8" style="text-align: center;"> <table border="1" style="width: 100%; border-collapse: collapse; text-align: center;"> <tr> <td style="width: 10%;"></td> <td style="width: 10%;"></td> <td style="width: 10%;"></td> <td style="width: 10%;"></td> <td style="width: 10%;"></td> <td style="width: 10%;"></td> <td style="width: 10%;"></td> <td style="width: 10%;"></td> <td style="width: 10%;"></td> <td style="width: 10%;"></td> </tr> <tr> <td></td> <td></td> <td colspan="8" style="text-align: center;"> <table border="1" style="width: 100%; border-collapse: collapse; text-align: center;"> <tr> <td style="width: 10%;"></td> <td style="width: 10%;"></td> <td style="width: 10%;"></td> <td style="width: 10%;"></td> <td style="width: 10%;"></td> <td style="width: 10%;"></td> <td style="width: 10%;"></td> <td style="width: 10%;"></td> <td style="width: 10%;"></td> <td style="width: 10%;"></td> </tr> <tr> <td></td> <td></td> <td colspan="8" style="text-align: center;"> <table border="1" style="width: 100%; border-collapse: collapse; text-align: center;"> <tr> <td style="width: 10%;"></td> <td style="width: 10%;"></td> <td style="width: 10%;"></td> <td style="width: 10%;"></td> <td style="width: 10%;"></td> <td style="width: 10%;"></td> <td style="width: 10%;"></td> <td style="width: 10%;"></td> <td style="width: 10%;"></td> <td style="width: 10%;"></td> </tr> <tr> <td></td> <td></td> <td colspan="8" style="text-align: center;"> <table border="1" style="width: 100%; border-collapse: collapse; text-align: center;"> <tr> <td style="width: 10%;"></td> <td style="width: 10%;"></td> <td style="width: 10%;"></td> <td style="width: 10%;"></td> <td style="width: 10%;"></td> <td style="width: 10%;"></td> <td style="width: 10%;"></td> <td style="width: 10%;"></td> <td style="width: 10%;"></td> <td style="width: 10%;"></td> </tr> <tr> <td></td> <td></td> <td colspan="8" style="text-align: center;"> <table border="1" style="width: 100%; border-collapse: collapse; text-align: center;"> <tr> <td style="width: 10%;"></td> <td style="width: 10%;"></td> <td style="width: 10%;"></td> <td style="width: 10%;"></td> <td style="width: 10%;"></td> <td style="width: 10%;"></td> <td style="width: 10%;"></td> <td style="width: 10%;"></td> <td style="width: 10%;"></td> <td style="width: 10%;"></td> </tr> <tr> <td></td> <td></td> <td colspan="8" style="text-align: center;"> <table border="1" style="width: 100%; border-collapse: collapse; text-align: center;"> <tr> <td style="width: 10%;"></td> <td style="width: 10%;"></td> <td style="width: 10%;"></td> <td style="width: 10%;"></td> <td style="width: 10%;"></td> <td style="width: 10%;"></td> <td style="width: 10%;"></td> <td style="width: 10%;"></td> <td style="width: 10%;"></td> <td style="width: 10%;"></td> </tr> <tr> <td></td> <td></td> <td colspan="8" style="text-align: center;"> <table border="1" style="width: 100%; border-collapse: collapse; text-align: center;"> <tr> <td style="width: 10%;"></td> <td style="width: 10%;"></td> <td style="width: 10%;"></td> <td style="width: 10%;"></td> <td style="width: 10%;"></td> <td style="width: 10%;"></td> <td style="width: 10%;"></td> <td style="width: 10%;"></td> <td style="width: 10%;"></td> <td style="width: 10%;"></td> </tr> <tr> <td></td> <td></td> <td colspan="8" style="text-align: center;"> <table border="1" style="width: 100%; border-collapse: collapse; text-align: center;"> <tr> <td style="width: 10%;"></td> <td style="width: 10%;"></td> <td style="width: 10%;"></td> <td style="width: 10%;"></td> <td style="width: 10%;"></td> <td style="width: 10%;"></td> <td style="width: 10%;"></td> <td style="width: 10%;"></td> <td style="width: 10%;"></td> <td style="width: 10%;"></td> </tr> <tr> <td></td> <td></td> <td colspan="8" style="text-align: center;"> <table border="1" style="width: 100%; border-collapse: collapse; text-align: center;"> <tr> <td style="width: 10%;"></td> <td style="width: 10%;"></td> <td style="width: 10%;"></td> <td style="width: 10%;"></td> <td style="width: 10%;"></td> <td style="width: 10%;"></td> <td style="width: 10%;"></td> <td style="width: 10%;"></td> <td style="width: 10%;"></td> <td style="width: 10%;"></td> </tr> <tr> <td></td> <td></td> <td colspan="8" style="text-align: center;"> <table border="1" style="width: 100%; border-collapse: collapse; text-align: center;"> <tr> <td style="width: 10%;"></td> <td style="width: 10%;"></td> <td style="width: 10%;"></td> <td style="width: 10%;"></td> <td style="width: 10%;"></td> <td style="width: 10%;"></td> <td style="width: 10%;"></td> <td style="width: 10%;"></td> <td style="width: 10%;"></td> <td style="width: 10%;"></td> </tr> <tr> <td></td> <td></td> <td colspan="8" style="text-align: center;"> <table border="1" style="width: 100%; border-collapse: collapse; text-align: center;"> <tr> <td style="width: 10%;"></td> <td style="width: 10%;"></td> <td style="width: 10%;"></td> <td style="width: 10%;"></td> <td style="width: 10%;"></td> <td style="width: 10%;"></td> <td style="width: 10%;"></td> <td style="width: 10%;"></td> <td style="width: 10%;"></td> <td style="width: 10%;"></td> </tr> <tr> <td></td> <td></td> <td colspan="8" style="text-align: center;"> <table border="1" style="width: 100%; border-collapse: collapse; text-align: center;"> <tr> <td style="width: 10%;"></td> <td style="width:
10%;"></td> <td style="width: 10%;"></td> <td style="width: 10%;"></td> <td style="width: 10%;"></td> <td style="width: 10%;"></td> <td style="width: 10%;"></td> <td style="width: 10%;"></td> <td style="width: 10%;"></td> <td style="width: 10%;"></td> </tr> <tr> <td></td> <td></td> <td colspan="8" style="text-align: center;"> <table border="1" style="width: 100%; border-collapse: collapse; text-align: center;"> <tr> <td style="width: 10%;"></td> <td style="width: 10%;"></td> <td style="width: 10%;"></td> <td style="width: 10%;"></td> <td style="width: 10%;"></td> <td style="width: 10%;"></td> <td style="width: 10%;"></td> <td style="width: 10%;"></td> <td style="width: 10%;"></td> <td style="width: 10%;"></td> </tr> <tr> <td></td> <td></td> <td colspan="8" style="text-align: center;"> <table border="1" style="width: 100%; border-collapse: collapse; text-align: center;"> <tr> <td style="width: 10%;"></td> <td style="width: 10%;"></td> <td style="width: 10%;"></td> <td style="width: 10%;"></td> <td style="width: 10%;"></td> <td style="width: 10%;"></td> <td style="width: 10%;"></td> <td style="width: 10%;"></td> <td style="width: 10%;"></td> <td style="width: 10%;"></td> </tr> <tr> <td></td> <td></td> <td colspan="8" style="text-align: center;"> <table border="1" style="width: 100%; border-collapse: collapse; text-align: center;"> <tr> <td style="width: 10%;"></td> <td style="width: 10%;"></td> <td style="width: 10%;"></td> <td style="width: 10%;"></td> <td style="width: 10%;"></td> <td style="width: 10%;"></td> <td style="width: 10%;"></td> <td style="width: 10%;"></td> <td style="width: 10%;"></td> <td style="width: 10%;"></td> </tr> <tr> <td></td> <td></td> <td colspan="8" style="text-align: center;"> <table border="1" style="width: 100%; border-collapse: collapse; text-align: center;"> <tr> <td style="width: 10%;"></td> <td style="width: 10%;"></td> <td style="width: 10%;"></td> <td style="width: 10%;"></td> <td style="width: 10%;"></td> <td style="width: 10%;"></td> <td style="width: 10%;"></td> <td style="width: 10%;"></td> <td style="width: 10%;"></td> <td style="width: 10%;"></td> </tr> <tr> <td></td> <td></td> <td colspan="8" style="text-align: center;"> <table border="1" style="width: 100%; border-collapse: collapse; text-align: center;"> <tr> <td style="width: 10%;"></td> <td style="width: 10%;"></td> <td style="width: 10%;"></td> <td style="width: 10%;"></td> <td style="width: 10%;"></td> <td style="width: 10%;"></td> <td style="width: 10%;"></td> <td style="width: 10%;"></td> <td style="width: 10%;"></td> <td style="width: 10%;"></td> </tr> <tr> <td></td> <td></td> <td colspan="8" style="text-align: center;"> <table border="1" style="width: 100%; border-collapse: collapse; text-align: center;"> <tr> <td style="width: 10%;"></td> <td style="width: 10%;"></td> <td style="width: 10%;"></td> <td style="width: 10%;"></td> <td style="width: 10%;"></td> <td style="width: 10%;"></td> <td style="width: 10%;"></td> <td style="width: 10%;"></td> <td style="width: 10%;"></td> <td style="width: 10%;"></td> </tr> <tr> <td></td> <td></td> <td colspan="8" style="text-align: center;"> <table border="1" style="width: 100%; border-collapse: collapse; text-align: center;"> <tr> <td style="width: 10%;"></td> <td style="width: 10%;"></td> <td style="width: 10%;"></td> <td style="width: 10%;"></td> <td style="width: 10%;"></td> <td style="width: 10%;"></td> <td style="width: 10%;"></td> <td style="width: 10%;"></td> <td style="width: 10%;"></td> <td style="width: 10%;"></td> </tr> <tr> <td></td> <td></td> <td colspan="8" style="text-align: center;"> <table border="1" style="width: 100%; border-collapse: collapse; text-align: center;"> <tr> </tr></table></td></tr></table></td></tr></table></td></tr></table></td></tr></table></td></tr></table></td></tr></table></td></tr></table></td></tr></table></td></tr></table></td></tr></table></td></tr></table></td></tr></table></td></tr></table></td></tr></table></td></tr></table></td></tr></table></td></tr></table></td></tr></table></td></tr></table></td></tr></table></td></tr></table></td></tr></table></td></tr></table></td></tr></table></td></tr></table></td></tr></table></td></tr></table></td></tr></table></td></tr></table></td></tr></table></td></tr></table></td></tr></table></td></tr></table></td></tr></table></td></tr></table></td></tr></table></td></tr></table></td></tr></table></td></tr></table></td></tr></table></td></tr></table></td></tr></table></td></tr></table></td></tr></table></td></tr></table></td></tr></table></td></tr></table></td></tr></table></td></tr></table></td></tr></table></td></tr></table></td></tr></table></td></tr></table></td></tr></table> | | | | | | | | | | | | | | | | | | | | <table border="1" style="width: 100%; border-collapse: collapse; text-align: center;"> <tr> <td style="width: 10%;"></td> <td style="width: 10%;"></td> <td style="width: 10%;"></td> <td style="width: 10%;"></td> <td style="width: 10%;"></td> <td style="width: 10%;"></td> <td style="width: 10%;"></td> <td style="width: 10%;"></td> <td style="width: 10%;"></td> <td style="width: 10%;"></td> </tr> <tr> <td></td> <td></td> <td colspan="8" style="text-align: center;"> <table border="1" style="width: 100%; border-collapse: collapse; text-align: center;"> <tr> <td style="width: 10%;"></td> <td style="width: 10%;"></td> <td style="width: 10%;"></td> <td style="width: 10%;"></td> <td style="width: 10%;"></td> <td style="width: 10%;"></td> <td style="width: 10%;"></td> <td style="width: 10%;"></td> <td style="width: 10%;"></td> <td style="width: 10%;"></td> </tr> <tr> <td></td> <td></td> <td colspan="8" style="text-align: center;"> <table border="1" style="width: 100%; border-collapse: collapse; text-align: center;"> <tr> <td style="width: 10%;"></td> <td style="width: 10%;"></td> <td style="width: 10%;"></td> <td style="width: 10%;"></td> <td style="width: 10%;"></td> <td style="width: 10%;"></td> <td style="width: 10%;"></td> <td style="width: 10%;"></td> <td style="width: 10%;"></td> <td style="width: 10%;"></td> </tr> <tr> <td></td> <td></td> <td colspan="8" style="text-align: center;"> <table border="1" style="width: 100%; border-collapse: collapse; text-align: center;"> <tr> <td style="width: 10%;"></td> <td style="width: 10%;"></td> <td style="width: 10%;"></td> <td style="width: 10%;"></td> <td style="width: 10%;"></td> <td style="width: 10%;"></td> <td style="width: 10%;"></td> <td style="width: 10%;"></td> <td style="width: 10%;"></td> <td style="width: 10%;"></td> </tr> <tr> <td></td> <td></td> <td colspan="8" style="text-align: center;"> <table border="1" style="width: 100%; border-collapse: collapse; text-align: center;"> <tr> <td style="width: 10%;"></td> <td style="width: 10%;"></td> <td style="width: 10%;"></td> <td style="width: 10%;"></td> <td style="width: 10%;"></td> <td style="width: 10%;"></td> <td style="width: 10%;"></td> <td style="width: 10%;"></td> <td style="width: 10%;"></td> <td style="width: 10%;"></td> </tr> <tr> <td></td> <td></td> <td colspan="8" style="text-align: center;"> <table border="1" style="width: 100%; border-collapse: collapse; text-align: center;"> <tr> <td style="width: 10%;"></td> <td style="width: 10%;"></td> <td style="width: 10%;"></td> <td style="width: 10%;"></td> <td style="width: 10%;"></td> <td style="width: 10%;"></td> <td style="width: 10%;"></td> <td style="width: 10%;"></td> <td style="width: 10%;"></td> <td style="width: 10%;"></td> </tr> <tr> <td></td> <td></td> <td colspan="8" style="text-align: center;"> <table border="1" style="width: 100%; border-collapse: collapse; text-align: center;"> <tr> <td style="width: 10%;"></td> <td style="width: 10%;"></td> <td style="width: 10%;"></td> <td style="width: 10%;"></td> <td style="width: 10%;"></td> <td style="width: 10%;"></td> <td style="width: 10%;"></td> <td style="width: 10%;"></td> <td style="width: 10%;"></td> <td style="width: 10%;"></td> </tr> <tr> <td></td> <td></td> <td colspan="8" style="text-align: center;"> <table border="1" style="width: 100%; border-collapse: collapse; text-align: center;"> <tr> <td style="width: 10%;"></td> <td style="width: 10%;"></td> <td style="width: 10%;"></td> <td style="width: 10%;"></td> <td style="width: 10%;"></td> <td style="width: 10%;"></td> <td style="width: 10%;"></td> <td style="width: 10%;"></td> <td style="width: 10%;"></td> <td style="width: 10%;"></td> </tr> <tr> <td></td> <td></td> <td colspan="8" style="text-align: center;"> <table border="1" style="width: 100%; border-collapse: collapse; text-align: center;"> <tr> <td style="width: 10%;"></td> <td style="width: 10%;"></td> <td style="width: 10%;"></td> <td style="width: 10%;"></td> <td style="width: 10%;"></td> <td style="width: 10%;"></td> <td style="width: 10%;"></td> <td style="width: 10%;"></td> <td style="width: 10%;"></td> <td style="width: 10%;"></td> </tr> <tr> <td></td> <td></td> <td colspan="8" style="text-align: center;"> <table border="1" style="width: 100%; border-collapse: collapse;
text-align: center;"> <tr> <td style="width: 10%;"></td> <td style="width: 10%;"></td> <td style="width: 10%;"></td> <td style="width: 10%;"></td> <td style="width: 10%;"></td> <td style="width: 10%;"></td> <td style="width: 10%;"></td> <td style="width: 10%;"></td> <td style="width: 10%;"></td> <td style="width: 10%;"></td> </tr> <tr> <td></td> <td></td> <td colspan="8" style="text-align: center;"> <table border="1" style="width: 100%; border-collapse: collapse; text-align: center;"> <tr> <td style="width: 10%;"></td> <td style="width: 10%;"></td> <td style="width: 10%;"></td> <td style="width: 10%;"></td> <td style="width: 10%;"></td> <td style="width: 10%;"></td> <td style="width: 10%;"></td> <td style="width: 10%;"></td> <td style="width: 10%;"></td> <td style="width: 10%;"></td> </tr> <tr> <td></td> <td></td> <td colspan="8" style="text-align: center;"> <table border="1" style="width: 100%; border-collapse: collapse; text-align: center;"> <tr> <td style="width: 10%;"></td> <td style="width: 10%;"></td> <td style="width: 10%;"></td> <td style="width: 10%;"></td> <td style="width: 10%;"></td> <td style="width: 10%;"></td> <td style="width: 10%;"></td> <td style="width: 10%;"></td> <td style="width: 10%;"></td> <td style="width: 10%;"></td> </tr> <tr> <td></td> <td></td> <td colspan="8" style="text-align: center;"> <table border="1" style="width: 100%; border-collapse: collapse; text-align: center;"> <tr> <td style="width: 10%;"></td> <td style="width: 10%;"></td> <td style="width: 10%;"></td> <td style="width: 10%;"></td> <td style="width: 10%;"></td> <td style="width: 10%;"></td> <td style="width: 10%;"></td> <td style="width: 10%;"></td> <td style="width: 10%;"></td> <td style="width: 10%;"></td> </tr> <tr> <td></td> <td></td> <td colspan="8" style="text-align: center;"> <table border="1" style="width: 100%; border-collapse: collapse; text-align: center;"> <tr> <td style="width: 10%;"></td> <td style="width: 10%;"></td> <td style="width: 10%;"></td> <td style="width: 10%;"></td> <td style="width: 10%;"></td> <td style="width: 10%;"></td> <td style="width: 10%;"></td> <td style="width: 10%;"></td> <td style="width: 10%;"></td> <td style="width: 10%;"></td> </tr> <tr> <td></td> <td></td> <td colspan="8" style="text-align: center;"> <table border="1" style="width: 100%; border-collapse: collapse; text-align: center;"> <tr> <td style="width: 10%;"></td> <td style="width: 10%;"></td> <td style="width: 10%;"></td> <td style="width: 10%;"></td> <td style="width: 10%;"></td> <td style="width: 10%;"></td> <td style="width: 10%;"></td> <td style="width: 10%;"></td> <td style="width: 10%;"></td> <td style="width: 10%;"></td> </tr> <tr> <td></td> <td></td> <td colspan="8" style="text-align: center;"> <table border="1" style="width: 100%; border-collapse: collapse; text-align: center;"> <tr> <td style="width: 10%;"></td> <td style="width: 10%;"></td> <td style="width: 10%;"></td> <td style="width: 10%;"></td> <td style="width: 10%;"></td> <td style="width: 10%;"></td> <td style="width: 10%;"></td> <td style="width: 10%;"></td> <td style="width: 10%;"></td> <td style="width: 10%;"></td> </tr> <tr> <td></td> <td></td> <td colspan="8" style="text-align: center;"> <table border="1" style="width: 100%; border-collapse: collapse; text-align: center;"> <tr> <td style="width: 10%;"></td> <td style="width: 10%;"></td> <td style="width: 10%;"></td> <td style="width: 10%;"></td> <td style="width: 10%;"></td> <td style="width: 10%;"></td> <td style="width: 10%;"></td> <td style="width: 10%;"></td> <td style="width: 10%;"></td> <td style="width: 10%;"></td> </tr> <tr> <td></td> <td></td> <td colspan="8" style="text-align: center;"> <table border="1" style="width: 100%; border-collapse: collapse; text-align: center;"> <tr> <td style="width: 10%;"></td> <td style="width: 10%;"></td> <td style="width: 10%;"></td> <td style="width: 10%;"></td> <td style="width: 10%;"></td> <td style="width: 10%;"></td> <td style="width: 10%;"></td> <td style="width: 10%;"></td> <td style="width: 10%;"></td> <td style="width: 10%;"></td> </tr> <tr> <td></td> <td></td> <td colspan="8" style="text-align: center;"> <table border="1" style="width: 100%; border-collapse: collapse; text-align: center;"> <tr> <td style="width: 10%;"></td> <td style="width: 10%;"></td> <td style="width: 10%;"></td> <td style="width: 10%;"></td> <td style="width: 10%;"></td> <td style="width: 10%;"></td> <td style="width: 10%;"></td> <td style="width: 10%;"></td> <td style="width: 10%;"></td> <td style="width: 10%;"></td> </tr> <tr> <td></td> <td></td> <td colspan="8" style="text-align: center;"> <table border="1" style="width: 100%; border-collapse: collapse; text-align: center;"> <tr> <td style="width: 10%;"></td> <td style="width: 10%;"></td> <td style="width: 10%;"></td> <td style="width: 10%;"></td> <td style="width: 10%;"></td> <td style="width: 10%;"></td> <td style="width: 10%;"></td> <td style="width: 10%;"></td> <td style="width: 10%;"></td> <td style="width: 10%;"></td> </tr> <tr> <td></td> <td></td> <td colspan="8" style="text-align: center;"> <table border="1" style="width: 100%; border-collapse: collapse; text-align: center;"> <tr> <td style="width: 10%;"></td> <td style="width: 10%;"></td> <td style="width: 10%;"></td> <td style="width: 10%;"></td> <td style="width: 10%;"></td> <td style="width: 10%;"></td> <td style="width: 10%;"></td> <td style="width: 10%;"></td> <td style="width: 10%;"></td> <td style="width: 10%;"></td> </tr> <tr> <td></td> <td></td> <td colspan="8" style="text-align: center;"> <table border="1" style="width: 100%; border-collapse: collapse; text-align: center;"> <tr> <td style="width: 10%;"></td> <td style="width: 10%;"></td> <td style="width: 10%;"></td> <td style="width: 10%;"></td> <td style="width: 10%;"></td> <td style="width: 10%;"></td> <td style="width: 10%;"></td> <td style="width: 10%;"></td> <td style="width: 10%;"></td> <td style="width: 10%;"></td> </tr> <tr> <td></td> <td></td> <td colspan="8" style="text-align: center;"> <table border="1" style="width: 100%; border-collapse: collapse; text-align: center;"> <tr> <td style="width: 10%;"></td> <td style="width: 10%;"></td> <td style="width: 10%;"></td> <td style="width: 10%;"></td> <td style="width: 10%;"></td> <td style="width: 10%;"></td> <td style="width: 10%;"></td> <td style="width: 10%;"></td> <td style="width: 10%;"></td> <td style="width: 10%;"></td> </tr> <tr> <td></td> <td></td> <td colspan="8" style="text-align: center;"> <table border="1" style="width: 100%; border-collapse: collapse; text-align: center;"> <tr> <td style="width: 10%;"></td> <td style="width: 10%;"></td> <td style="width: 10%;"></td> <td style="width: 10%;"></td> <td style="width: 10%;"></td> <td style="width: 10%;"></td> <td style="width: 10%;"></td> <td style="width: 10%;"></td> <td style="width: 10%;"></td> <td style="width: 10%;"></td> </tr> <tr> <td></td> <td></td> <td colspan="8" style="text-align: center;"> <table border="1" style="width: 100%; border-collapse: collapse; text-align: center;"> <tr> <td style="width: 10%;"></td> <td style="width: 10%;"></td> <td style="width: 10%;"></td> <td style="width: 10%;"></td> <td style="width: 10%;"></td> <td style="width: 10%;"></td> <td style="width: 10%;"></td> <td style="width: 10%;"></td> <td style="width: 10%;"></td> <td style="width: 10%;"></td> </tr> <tr> <td></td> <td></td> <td colspan="8" style="text-align: center;"> <table border="1" style="width: 100%; border-collapse: collapse; text-align: center;"> <tr> <td style="width: 10%;"></td> <td style="width: 10%;"></td> <td style="width: 10%;"></td> <td style="width: 10%;"></td> <td style="width: 10%;"></td> <td style="width: 10%;"></td> <td style="width: 10%;"></td> <td style="width: 10%;"></td> <td style="width: 10%;"></td> <td style="width: 10%;"></td> </tr> <tr> <td></td> <td></td> <td colspan="8" style="text-align: center;"> <table border="1" style="width: 100%; border-collapse: collapse; text-align: center;"> <tr> <td style="width: 10%;"></td> <td style="width: 10%;"></td> <td style="width: 10%;"></td> <td style="width: 10%;"></td> <td style="width: 10%;"></td> <td style="width: 10%;"></td> <td style="width: 10%;"></td> <td style="width: 10%;"></td> <td style="width: 10%;"></td> <td style="width: 10%;"></td> </tr> <tr> <td></td> <td></td> <td colspan="8" style="text-align: center;"> <table border="1" style="width: 100%; border-collapse: collapse; text-align: center;"> <tr> <td style="width: 10%;"></td> <td style="width: 10%;"></td> <td style="width: 10%;"></td> <td style="width: 10%;"></td> <td style="width: 10%;"></td> <td style="width: 10%;"></td> <td style="width: 10%;"></td> <td style="width: 10%;"></td> <td style="width: 10%;"></td> <td style="width: 10%;"></td> </tr> <tr> <td></td> <td></td> <td colspan="8" style="text-align: center;"> <table border="1" style="width: 100%; border-collapse: collapse; text-align: center;"> <tr> <td style="width: 10%;"></td> <td style="width: 10%;"></td> <td style="width: 10%;"></td> <td style="width: 10%;"></td> <td style="width: 10%;"></td> <td style="width: 10%;"></td> <td style="width: 10%;"></td> <td style="width: 10%;"></td> <td style="width: 10%;"></td> <td style="width: 10%;"></td> </tr> <tr> <td></td> <td></td> <td colspan="8" style="text-align: center;"> <table border="1" style="width: 100%; border-collapse: collapse; text-align: center;"> <tr> <td style="width: 10%;"></td> <td style="width: 10%;"></td> <td style="width: 10%;"></td> <td style="width: 10%;"></td> <td style="width: 10%;"></td> <td style="width: 10%;"></td> <td style="width: 10%;"></td> <td style="width: 10%;"></td> <td style="width: 10%;"></td> <td style="width: 10%;"></td> </tr> <tr> <td></td> <td></td> <td colspan="8" style="text-align: center;"> <table border="1" style="width: 100%; border-collapse: collapse; text-align: center;"> <tr> <td style="width: 10%;"></td> <td style="width: 10%;"></td> <td style="width: 10%;"></td> <td style="width: 10%;"></td> <td style="width:
10%;"></td> <td style="width: 10%;"></td> <td style="width: 10%;"></td> <td style="width: 10%;"></td> <td style="width: 10%;"></td> <td style="width: 10%;"></td> </tr> <tr> <td></td> <td></td> <td colspan="8" style="text-align: center;"> <table border="1" style="width: 100%; border-collapse: collapse; text-align: center;"> <tr> <td style="width: 10%;"></td> <td style="width: 10%;"></td> <td style="width: 10%;"></td> <td style="width: 10%;"></td> <td style="width: 10%;"></td> <td style="width: 10%;"></td> <td style="width: 10%;"></td> <td style="width: 10%;"></td> <td style="width: 10%;"></td> <td style="width: 10%;"></td> </tr> <tr> <td></td> <td></td> <td colspan="8" style="text-align: center;"> <table border="1" style="width: 100%; border-collapse: collapse; text-align: center;"> <tr> <td style="width: 10%;"></td> <td style="width: 10%;"></td> <td style="width: 10%;"></td> <td style="width: 10%;"></td> <td style="width: 10%;"></td> <td style="width: 10%;"></td> <td style="width: 10%;"></td> <td style="width: 10%;"></td> <td style="width: 10%;"></td> <td style="width: 10%;"></td> </tr> <tr> <td></td> <td></td> <td colspan="8" style="text-align: center;"> <table border="1" style="width: 100%; border-collapse: collapse; text-align: center;"> <tr> <td style="width: 10%;"></td> <td style="width: 10%;"></td> <td style="width: 10%;"></td> <td style="width: 10%;"></td> <td style="width: 10%;"></td> <td style="width: 10%;"></td> <td style="width: 10%;"></td> <td style="width: 10%;"></td> <td style="width: 10%;"></td> <td style="width: 10%;"></td> </tr> <tr> <td></td> <td></td> <td colspan="8" style="text-align: center;"> <table border="1" style="width: 100%; border-collapse: collapse; text-align: center;"> <tr> <td style="width: 10%;"></td> <td style="width: 10%;"></td> <td style="width: 10%;"></td> <td style="width: 10%;"></td> <td style="width: 10%;"></td> <td style="width: 10%;"></td> <td style="width: 10%;"></td> <td style="width: 10%;"></td> <td style="width: 10%;"></td> <td style="width: 10%;"></td> </tr> <tr> <td></td> <td></td> <td colspan="8" style="text-align: center;"> <table border="1" style="width: 100%; border-collapse: collapse; text-align: center;"> <tr> <td style="width: 10%;"></td> <td style="width: 10%;"></td> <td style="width: 10%;"></td> <td style="width: 10%;"></td> <td style="width: 10%;"></td> <td style="width: 10%;"></td> <td style="width: 10%;"></td> <td style="width: 10%;"></td> <td style="width: 10%;"></td> <td style="width: 10%;"></td> </tr> <tr> <td></td> <td></td> <td colspan="8" style="text-align: center;"> <table border="1" style="width: 100%; border-collapse: collapse; text-align: center;"> <tr> <td style="width: 10%;"></td> <td style="width: 10%;"></td> <td style="width: 10%;"></td> <td style="width: 10%;"></td> <td style="width: 10%;"></td> <td style="width: 10%;"></td> <td style="width: 10%;"></td> <td style="width: 10%;"></td> <td style="width: 10%;"></td> <td style="width: 10%;"></td> </tr> <tr> <td></td> <td></td> <td colspan="8" style="text-align: center;"> <table border="1" style="width: 100%; border-collapse: collapse; text-align: center;"> <tr> <td style="width: 10%;"></td> <td style="width: 10%;"></td> <td style="width: 10%;"></td> <td style="width: 10%;"></td> <td style="width: 10%;"></td> <td style="width: 10%;"></td> <td style="width: 10%;"></td> <td style="width: 10%;"></td> <td style="width: 10%;"></td> <td style="width: 10%;"></td> </tr> <tr> <td></td> <td></td> <td colspan="8" style="text-align: center;"> <table border="1" style="width: 100%; border-collapse: collapse; text-align: center;"> <tr> <td style="width: 10%;"></td> <td style="width: 10%;"></td> <td style="width: 10%;"></td> <td style="width: 10%;"></td> <td style="width: 10%;"></td> <td style="width: 10%;"></td> <td style="width: 10%;"></td> <td style="width: 10%;"></td> <td style="width: 10%;"></td> <td style="width: 10%;"></td> </tr> <tr> <td></td> <td></td> <td colspan="8" style="text-align: center;"> <table border="1" style="width: 100%; border-collapse: collapse; text-align: center;"> <tr> <td style="width: 10%;"></td> <td style="width: 10%;"></td> <td style="width: 10%;"></td> <td style="width: 10%;"></td> <td style="width: 10%;"></td> <td style="width: 10%;"></td> <td style="width: 10%;"></td> <td style="width: 10%;"></td> <td style="width: 10%;"></td> <td style="width: 10%;"></td> </tr> <tr> <td></td> <td></td> <td colspan="8" style="text-align: center;"> <table border="1" style="width: 100%; border-collapse: collapse; text-align: center;"> <tr> <td style="width: 10%;"></td> <td style="width: 10%;"></td> <td style="width: 10%;"></td> <td style="width: 10%;"></td> <td style="width: 10%;"></td> <td style="width: 10%;"></td> <td style="width: 10%;"></td> <td style="width: 10%;"></td> <td style="width: 10%;"></td> <td style="width: 10%;"></td> </tr> <tr> <td></td> <td></td> <td colspan="8" style="text-align: center;"> <table border="1" style="width: 100%; border-collapse: collapse; text-align: center;"> <tr> <td style="width: 10%;"></td> <td style="width: 10%;"></td> <td style="width: 10%;"></td> <td style="width: 10%;"></td> <td style="width: 10%;"></td> <td style="width: 10%;"></td> <td style="width: 10%;"></td> <td style="width: 10%;"></td> <td style="width: 10%;"></td> <td style="width: 10%;"></td> </tr> <tr> <td></td> <td></td> <td colspan="8" style="text-align: center;"> <table border="1" style="width: 100%; border-collapse: collapse; text-align: center;"> <tr> <td style="width: 10%;"></td> <td style="width: 10%;"></td> <td style="width: 10%;"></td> <td style="width: 10%;"></td> <td style="width: 10%;"></td> <td style="width: 10%;"></td> <td style="width: 10%;"></td> <td style="width: 10%;"></td> <td style="width: 10%;"></td> <td style="width: 10%;"></td> </tr> <tr> <td></td> <td></td> <td colspan="8" style="text-align: center;"> <table border="1" style="width: 100%; border-collapse: collapse; text-align: center;"> <tr> <td style="width: 10%;"></td> <td style="width: 10%;"></td> <td style="width: 10%;"></td> <td style="width: 10%;"></td> <td style="width: 10%;"></td> <td style="width: 10%;"></td> <td style="width: 10%;"></td> <td style="width: 10%;"></td> <td style="width: 10%;"></td> <td style="width: 10%;"></td> </tr> <tr> <td></td> <td></td> <td colspan="8" style="text-align: center;"> <table border="1" style="width: 100%; border-collapse: collapse; text-align: center;"> <tr> <td style="width: 10%;"></td> <td style="width: 10%;"></td> <td style="width: 10%;"></td> <td style="width: 10%;"></td> <td style="width: 10%;"></td> <td style="width: 10%;"></td> <td style="width: 10%;"></td> <td style="width: 10%;"></td> <td style="width: 10%;"></td> <td style="width: 10%;"></td> </tr> <tr> <td></td> <td></td> <td colspan="8" style="text-align: center;"> <table border="1" style="width: 100%; border-collapse: collapse; text-align: center;"> <tr> <td style="width: 10%;"></td> <td style="width: 10%;"></td> <td style="width: 10%;"></td> <td style="width: 10%;"></td> <td style="width: 10%;"></td> <td style="width: 10%;"></td> <td style="width: 10%;"></td> <td style="width: 10%;"></td> <td style="width: 10%;"></td> <td style="width: 10%;"></td> </tr> <tr> <td></td> <td></td> <td colspan="8" style="text-align: center;"> <table border="1" style="width: 100%; border-collapse: collapse; text-align: center;"> <tr> <td style="width: 10%;"></td> <td style="width: 10%;"></td> <td style="width: 10%;"></td> <td style="width: 10%;"></td> <td style="width: 10%;"></td> <td style="width: 10%;"></td> <td style="width: 10%;"></td> <td style="width: 10%;"></td> <td style="width: 10%;"></td> <td style="width: 10%;"></td> </tr> <tr> <td></td> <td></td> <td colspan="8" style="text-align: center;"> <table border="1" style="width: 100%; border-collapse: collapse; text-align: center;"> <tr> <td style="width: 10%;"></td> <td style="width: 10%;"></td> <td style="width: 10%;"></td> <td style="width: 10%;"></td> <td style="width: 10%;"></td> <td style="width: 10%;"></td> <td style="width: 10%;"></td> <td style="width: 10%;"></td> <td style="width: 10%;"></td> <td style="width: 10%;"></td> </tr> <tr> <td></td> <td></td> <td colspan="8" style="text-align: center;"> <table border="1" style="width: 100%; border-collapse: collapse; text-align: center;"> <tr> <td style="width: 10%;"></td> <td style="width: 10%;"></td> <td style="width: 10%;"></td> <td style="width: 10%;"></td> <td style="width: 10%;"></td> <td style="width: 10%;"></td> <td style="width: 10%;"></td> <td style="width: 10%;"></td> <td style="width: 10%;"></td> <td style="width: 10%;"></td> </tr> <tr> <td></td> <td></td> <td colspan="8" style="text-align: center;"> <table border="1" style="width: 100%; border-collapse: collapse; text-align: center;"> <tr> <td style="width: 10%;"></td> <td style="width: 10%;"></td> <td style="width: 10%;"></td> <td style="width: 10%;"></td> <td style="width: 10%;"></td> <td style="width: 10%;"></td> <td style="width: 10%;"></td> <td style="width: 10%;"></td> <td style="width: 10%;"></td> <td style="width: 10%;"></td> </tr> <tr> <td></td> <td></td> <td colspan="8" style="text-align: center;"> <table border="1" style="width: 100%; border-collapse: collapse; text-align: center;"> <tr> <td style="width: 10%;"></td> <td style="width: 10%;"></td> <td style="width: 10%;"></td> <td style="width: 10%;"></td> <td style="width: 10%;"></td> <td style="width: 10%;"></td> <td style="width: 10%;"></td> <td style="width: 10%;"></td> <td style="width: 10%;"></td> <td style="width: 10%;"></td> </tr> <tr> <td></td> <td></td> <td colspan="8" style="text-align: center;"> <table border="1" style="width: 100%; border-collapse: collapse; text-align: center;"> <tr> <td style="width: 10%;"></td> <td style="width: 10%;"></td> <td style="width: 10%;"></td> <td style="width: 10%;"></td> <td style="width: 10%;"></td> <td style="width: 10%;"></td> <td style="width: 10%;"></td> <td style="width: 10%;"></td> <td style="width: 10%;"></td> <td style="width: 10%;"></td> </tr>
<tr> <td></td> <td></td> <td colspan="8" style="text-align: center;"> <table border="1" style="width: 100%; border-collapse: collapse; text-align: center;"> <tr> <td style="width: 10%;"></td> <td style="width: 10%;"></td> <td style="width: 10%;"></td> <td style="width: 10%;"></td> <td style="width: 10%;"></td> <td style="width: 10%;"></td> <td style="width: 10%;"></td> <td style="width: 10%;"></td> <td style="width: 10%;"></td> <td style="width: 10%;"></td> </tr> <tr> <td></td> <td></td> <td colspan="8" style="text-align: center;"> <table border="1" style="width: 100%; border-collapse: collapse; text-align: center;"> <tr> </tr></table></td></tr></table></td></tr></table></td></tr></table></td></tr></table></td></tr></table></td></tr></table></td></tr></table></td></tr></table></td></tr></table></td></tr></table></td></tr></table></td></tr></table></td></tr></table></td></tr></table></td></tr></table></td></tr></table></td></tr></table></td></tr></table></td></tr></table></td></tr></table></td></tr></table></td></tr></table></td></tr></table></td></tr></table></td></tr></table></td></tr></table></td></tr></table></td></tr></table></td></tr></table></td></tr></table></td></tr></table></td></tr></table></td></tr></table></td></tr></table></td></tr></table></td></tr></table></td></tr></table></td></tr></table></td></tr></table></td></tr></table></td></tr></table></td></tr></table></td></tr></table></td></tr></table></td></tr></table></td></tr></table></td></tr></table></td></tr></table></td></tr></table></td></tr></table></td></tr></table></td></tr></table></td></tr></table> | | | | | | | | | | | | | | | | | | | | <table border="1" style="width: 100%; border-collapse: collapse; text-align: center;"> <tr> <td style="width: 10%;"></td> <td style="width: 10%;"></td> <td style="width: 10%;"></td> <td style="width: 10%;"></td> <td style="width: 10%;"></td> <td style="width: 10%;"></td> <td style="width: 10%;"></td> <td style="width: 10%;"></td> <td style="width: 10%;"></td> <td style="width: 10%;"></td> </tr> <tr> <td></td> <td></td> <td colspan="8" style="text-align: center;"> <table border="1" style="width: 100%; border-collapse: collapse; text-align: center;"> <tr> <td style="width: 10%;"></td> <td style="width: 10%;"></td> <td style="width: 10%;"></td> <td style="width: 10%;"></td> <td style="width: 10%;"></td> <td style="width: 10%;"></td> <td style="width: 10%;"></td> <td style="width: 10%;"></td> <td style="width: 10%;"></td> <td style="width: 10%;"></td> </tr> <tr> <td></td> <td></td> <td colspan="8" style="text-align: center;"> <table border="1" style="width: 100%; border-collapse: collapse; text-align: center;"> <tr> <td style="width: 10%;"></td> <td style="width: 10%;"></td> <td style="width: 10%;"></td> <td style="width: 10%;"></td> <td style="width: 10%;"></td> <td style="width: 10%;"></td> <td style="width: 10%;"></td> <td style="width: 10%;"></td> <td style="width: 10%;"></td> <td style="width: 10%;"></td> </tr> <tr> <td></td> <td></td> <td colspan="8" style="text-align: center;"> <table border="1" style="width: 100%; border-collapse: collapse; text-align: center;"> <tr> <td style="width: 10%;"></td> <td style="width: 10%;"></td> <td style="width: 10%;"></td> <td style="width: 10%;"></td> <td style="width: 10%;"></td> <td style="width: 10%;"></td> <td style="width: 10%;"></td> <td style="width: 10%;"></td> <td style="width: 10%;"></td> <td style="width: 10%;"></td> </tr> <tr> <td></td> <td></td> <td colspan="8" style="text-align: center;"> <table border="1" style="width: 100%; border-collapse: collapse; text-align: center;"> <tr> <td style="width: 10%;"></td> <td style="width: 10%;"></td> <td style="width: 10%;"></td> <td style="width: 10%;"></td> <td style="width: 10%;"></td> <td style="width: 10%;"></td> <td style="width: 10%;"></td> <td style="width: 10%;"></td> <td style="width: 10%;"></td> <td style="width: 10%;"></td> </tr> <tr> <td></td> <td></td> <td colspan="8" style="text-align: center;"> <table border="1" style="width: 100%; border-collapse: collapse; text-align: center;"> <tr> <td style="width: 10%;"></td> <td style="width: 10%;"></td> <td style="width: 10%;"></td> <td style="width: 10%;"></td> <td style="width: 10%;"></td> <td style="width: 10%;"></td> <td style="width: 10%;"></td> <td style="width: 10%;"></td> <td style="width: 10%;"></td> <td style="width: 10%;"></td> </tr> <tr> <td></td> <td></td> <td colspan="8" style="text-align: center;"> <table border="1" style="width: 100%; border-collapse: collapse; text-align: center;"> <tr> <td style="width: 10%;"></td> <td style="width: 10%;"></td> <td style="width: 10%;"></td> <td style="width: 10%;"></td> <td style="width: 10%;"></td> <td style="width: 10%;"></td> <td style="width: 10%;"></td> <td style="width: 10%;"></td> <td style="width: 10%;"></td> <td style="width: 10%;"></td> </tr> <tr> <td></td> <td></td> <td colspan="8" style="text-align: center;"> <table border="1" style="width: 100%; border-collapse: collapse; text-align: center;"> <tr> <td style="width: 10%;"></td> <td style="width: 10%;"></td> <td style="width: 10%;"></td> <td style="width: 10%;"></td> <td style="width: 10%;"></td> <td style="width: 10%;"></td> <td style="width: 10%;"></td> <td style="width: 10%;"></td> <td style="width: 10%;"></td> <td style="width: 10%;"></td> </tr> <tr> <td></td> <td></td> <td colspan="8" style="text-align: center;"> <table border="1" style="width: 100%; border-collapse: collapse; text-align: center;"> <tr> <td style="width: 10%;"></td> <td style="width: 10%;"></td> <td style="width: 10%;"></td> <td style="width: 10%;"></td> <td style="width: 10%;"></td> <td style="width: 10%;"></td> <td style="width: 10%;"></td> <td style="width: 10%;"></td> <td style="width: 10%;"></td> <td style="width: 10%;"></td> </tr> <tr> <td></td> <td></td> <td colspan="8" style="text-align: center;"> <table border="1" style="width: 100%; border-collapse: collapse; text-align: center;"> <tr> <td style="width: 10%;"></td> <td style="width: 10%;"></td> <td style="width: 10%;"></td> <td style="width: 10%;"></td> <td style="width: 10%;"></td> <td style="width: 10%;"></td> <td style="width: 10%;"></td> <td style="width: 10%;"></td> <td style="width: 10%;"></td> <td style="width: 10%;"></td> </tr> <tr> <td></td> <td></td> <td colspan="8" style="text-align: center;"> <table border="1" style="width: 100%; border-collapse: collapse; text-align: center;"> <tr> <td style="width: 10%;"></td> <td style="width: 10%;"></td> <td style="width: 10%;"></td> <td style="width: 10%;"></td> <td style="width: 10%;"></td> <td style="width: 10%;"></td> <td style="width: 10%;"></td> <td style="width: 10%;"></td> <td style="width: 10%;"></td> <td style="width: 10%;"></td> </tr> <tr> <td></td> <td></td> <td colspan="8" style="text-align: center;"> <table border="1" style="width: 100%; border-collapse: collapse; text-align: center;"> <tr> <td style="width: 10%;"></td> <td style="width: 10%;"></td> <td style="width: 10%;"></td> <td style="width: 10%;"></td> <td style="width: 10%;"></td> <td style="width: 10%;"></td> <td style="width: 10%;"></td> <td style="width: 10%;"></td> <td style="width: 10%;"></td> <td style="width: 10%;"></td> </tr> <tr> <td></td> <td></td> <td colspan="8" style="text-align: center;"> <table border="1" style="width: 100%; border-collapse: collapse; text-align: center;"> <tr> <td style="width: 10%;"></td> <td style="width: 10%;"></td> <td style="width: 10%;"></td> <td style="width: 10%;"></td> <td style="width: 10%;"></td> <td style="width: 10%;"></td> <td style="width: 10%;"></td> <td style="width: 10%;"></td> <td style="width: 10%;"></td> <td style="width: 10%;"></td> </tr> <tr> <td></td> <td></td> <td colspan="8" style="text-align: center;"> <table border="1" style="width: 100%; border-collapse: collapse; text-align: center;"> <tr> <td style="width: 10%;"></td> <td style="width: 10%;"></td> <td style="width: 10%;"></td> <td style="width: 10%;"></td> <td style="width: 10%;"></td> <td style="width: 10%;"></td> <td style="width: 10%;"></td> <td style="width: 10%;"></td> <td style="width: 10%;"></td> <td style="width: 10%;"></td> </tr> <tr> <td></td> <td></td> <td colspan="8" style="text-align: center;"> <table border="1" style="width: 100%; border-collapse: collapse; text-align: center;"> <tr> <td style="width: 10%;"></td> <td style="width: 10%;"></td> <td style="width: 10%;"></td> <td style="width: 10%;"></td> <td style="width: 10%;"></td> <td style="width: 10%;"></td> <td style="width: 10%;"></td> <td style="width: 10%;"></td> <td style="width: 10%;"></td> <td style="width: 10%;"></td> </tr> <tr> <td></td> <td></td> <td colspan="8" style="text-align: center;"> <table border="1" style="width: 100%; border-collapse: collapse; text-align: center;"> <tr> <td style="width: 10%;"></td> <td style="width: 10%;"></td> <td style="width: 10%;"></td> <td style="width: 10%;"></td> <td style="width: 10%;"></td> <td style="width: 10%;"></td> <td style="width: 10%;"></td> <td style="width: 10%;"></td> <td style="width:
10%;"></td> <td style="width: 10%;"></td> </tr> <tr> <td></td> <td></td> <td colspan="8" style="text-align: center;"> <table border="1" style="width: 100%; border-collapse: collapse; text-align: center;"> <tr> <td style="width: 10%;"></td> <td style="width: 10%;"></td> <td style="width: 10%;"></td> <td style="width: 10%;"></td> <td style="width: 10%;"></td> <td style="width: 10%;"></td> <td style="width: 10%;"></td> <td style="width: 10%;"></td> <td style="width: 10%;"></td> <td style="width: 10%;"></td> </tr> <tr> <td></td> <td></td> <td colspan="8" style="text-align: center;"> <table border="1" style="width: 100%; border-collapse: collapse; text-align: center;"> <tr> <td style="width: 10%;"></td> <td style="width: 10%;"></td> <td style="width: 10%;"></td> <td style="width: 10%;"></td> <td style="width: 10%;"></td> <td style="width: 10%;"></td> <td style="width: 10%;"></td> <td style="width: 10%;"></td> <td style="width: 10%;"></td> <td style="width: 10%;"></td> </tr> <tr> <td></td> <td></td> <td colspan="8" style="text-align: center;"> <table border="1" style="width: 100%; border-collapse: collapse; text-align: center;"> <tr> <td style="width: 10%;"></td> <td style="width: 10%;"></td> <td style="width: 10%;"></td> <td style="width: 10%;"></td> <td style="width: 10%;"></td> <td style="width: 10%;"></td> <td style="width: 10%;"></td> <td style="width: 10%;"></td> <td style="width: 10%;"></td> <td style="width: 10%;"></td> </tr> <tr> <td></td> <td></td> <td colspan="8" style="text-align: center;"> <table border="1" style="width: 100%; border-collapse: collapse; text-align: center;"> <tr> <td style="width: 10%;"></td> <td style="width: 10%;"></td> <td style="width: 10%;"></td> <td style="width: 10%;"></td> <td style="width: 10%;"></td> <td style="width: 10%;"></td> <td style="width: 10%;"></td> <td style="width: 10%;"></td> <td style="width: 10%;"></td> <td style="width: 10%;"></td> </tr> <tr> <td></td> <td></td> <td colspan="8" style="text-align: center;"> <table border="1" style="width: 100%; border-collapse: collapse; text-align: center;"> <tr> <td style="width: 10%;"></td> <td style="width: 10%;"></td> <td style="width: 10%;"></td> <td style="width: 10%;"></td> <td style="width: 10%;"></td> <td style="width: 10%;"></td> <td style="width: 10%;"></td> <td style="width: 10%;"></td> <td style="width: 10%;"></td> <td style="width: 10%;"></td> </tr> <tr> <td></td> <td></td> <td colspan="8" style="text-align: center;"> <table border="1" style="width: 100%; border-collapse: collapse; text-align: center;"> <tr> <td style="width: 10%;"></td> <td style="width: 10%;"></td> <td style="width: 10%;"></td> <td style="width: 10%;"></td> <td style="width: 10%;"></td> <td style="width: 10%;"></td> <td style="width: 10%;"></td> <td style="width: 10%;"></td> <td style="width: 10%;"></td> <td style="width: 10%;"></td> </tr> <tr> <td></td> <td></td> <td colspan="8" style="text-align: center;"> <table border="1" style="width: 100%; border-collapse: collapse; text-align: center;"> <tr> <td style="width: 10%;"></td> <td style="width: 10%;"></td> <td style="width: 10%;"></td> <td style="width: 10%;"></td> <td style="width: 10%;"></td> <td style="width: 10%;"></td> <td style="width: 10%;"></td> <td style="width: 10%;"></td> <td style="width: 10%;"></td> <td style="width: 10%;"></td> </tr> <tr> <td></td> <td></td> <td colspan="8" style="text-align: center;"> <table border="1" style="width: 100%; border-collapse: collapse; text-align: center;"> <tr> <td style="width: 10%;"></td> <td style="width: 10%;"></td> <td style="width: 10%;"></td> <td style="width: 10%;"></td> <td style="width: 10%;"></td> <td style="width: 10%;"></td> <td style="width: 10%;"></td> <td style="width: 10%;"></td> <td style="width: 10%;"></td> <td style="width: 10%;"></td> </tr> <tr> <td></td> <td></td> <td colspan="8" style="text-align: center;"> <table border="1" style="width: 100%; border-collapse: collapse; text-align: center;"> <tr> <td style="width: 10%;"></td> <td style="width: 10%;"></td> <td style="width: 10%;"></td> <td style="width: 10%;"></td> <td style="width: 10%;"></td> <td style="width: 10%;"></td> <td style="width: 10%;"></td> <td style="width: 10%;"></td> <td style="width: 10%;"></td> <td style="width: 10%;"></td> </tr> <tr> <td></td> <td></td> <td colspan="8" style="text-align: center;"> <table border="1" style="width: 100%; border-collapse: collapse; text-align: center;"> <tr> <td style="width: 10%;"></td> <td style="width: 10%;"></td> <td style="width: 10%;"></td> <td style="width: 10%;"></td> <td style="width: 10%;"></td> <td style="width: 10%;"></td> <td style="width: 10%;"></td> <td style="width: 10%;"></td> <td style="width: 10%;"></td> <td style="width: 10%;"></td> </tr> <tr> <td></td> <td></td> <td colspan="8" style="text-align: center;"> <table border="1" style="width: 100%; border-collapse: collapse; text-align: center;"> <tr> <td style="width: 10%;"></td> <td style="width: 10%;"></td> <td style="width: 10%;"></td> <td style="width: 10%;"></td> <td style="width: 10%;"></td> <td style="width: 10%;"></td> <td style="width: 10%;"></td> <td style="width: 10%;"></td> <td style="width: 10%;"></td> <td style="width: 10%;"></td> </tr> <tr> <td></td> <td></td> <td colspan="8" style="text-align: center;"> <table border="1" style="width: 100%; border-collapse: collapse; text-align: center;"> <tr> <td style="width: 10%;"></td> <td style="width: 10%;"></td> <td style="width: 10%;"></td> <td style="width: 10%;"></td> <td style="width: 10%;"></td> <td style="width: 10%;"></td> <td style="width: 10%;"></td> <td style="width: 10%;"></td> <td style="width: 10%;"></td> <td style="width: 10%;"></td> </tr> <tr> <td></td> <td></td> <td colspan="8" style="text-align: center;"> <table border="1" style="width: 100%; border-collapse: collapse; text-align: center;"> <tr> <td style="width: 10%;"></td> <td style="width: 10%;"></td> <td style="width: 10%;"></td> <td style="width: 10%;"></td> <td style="width: 10%;"></td> <td style="width: 10%;"></td> <td style="width: 10%;"></td> <td style="width: 10%;"></td> <td style="width: 10%;"></td> <td style="width: 10%;"></td> </tr> <tr> <td></td> <td></td> <td colspan="8" style="text-align: center;"> <table border="1" style="width: 100%; border-collapse: collapse; text-align: center;"> <tr> <td style="width: 10%;"></td> <td style="width: 10%;"></td> <td style="width: 10%;"></td> <td style="width: 10%;"></td> <td style="width: 10%;"></td> <td style="width: 10%;"></td> <td style="width: 10%;"></td> <td style="width: 10%;"></td> <td style="width: 10%;"></td> <td style="width: 10%;"></td> </tr> <tr> <td></td> <td></td> <td colspan="8" style="text-align: center;"> <table border="1" style="width: 100%; border-collapse: collapse; text-align: center;"> <tr> <td style="width: 10%;"></td> <td style="width: 10%;"></td> <td style="width: 10%;"></td> <td style="width: 10%;"></td> <td style="width: 10%;"></td> <td style="width: 10%;"></td> <td style="width: 10%;"></td> <td style="width: 10%;"></td> <td style="width: 10%;"></td> <td style="width: 10%;"></td> </tr> <tr> <td></td> <td></td> <td colspan="8" style="text-align: center;"> <table border="1" style="width: 100%; border-collapse: collapse; text-align: center;"> <tr> <td style="width: 10%;"></td> <td style="width: 10%;"></td> <td style="width: 10%;"></td> <td style="width: 10%;"></td> <td style="width: 10%;"></td> <td style="width: 10%;"></td> <td style="width: 10%;"></td> <td style="width: 10%;"></td> <td style="width: 10%;"></td> <td style="width: 10%;"></td> </tr> <tr> <td></td> <td></td> <td colspan="8" style="text-align: center;"> <table border="1" style="width: 100%; border-collapse: collapse; text-align: center;"> <tr> <td style="width: 10%;"></td> <td style="width: 10%;"></td> <td style="width: 10%;"></td> <td style="width: 10%;"></td> <td style="width: 10%;"></td> <td style="width: 10%;"></td> <td style="width: 10%;"></td> <td style="width: 10%;"></td> <td style="width: 10%;"></td> <td style="width: 10%;"></td> </tr> <tr> <td></td> <td></td> <td colspan="8" style="text-align: center;"> <table border="1" style="width: 100%; border-collapse: collapse; text-align: center;"> <tr> <td style="width: 10%;"></td> <td style="width: 10%;"></td> <td style="width: 10%;"></td> <td style="width: 10%;"></td> <td style="width: 10%;"></td> <td style="width: 10%;"></td> <td style="width: 10%;"></td> <td style="width: 10%;"></td> <td style="width: 10%;"></td> <td style="width: 10%;"></td> </tr> <tr> <td></td> <td></td> <td colspan="8" style="text-align: center;"> <table border="1" style="width: 100%; border-collapse: collapse; text-align: center;"> <tr> <td style="width: 10%;"></td> <td style="width: 10%;"></td> <td style="width: 10%;"></td> <td style="width: 10%;"></td> <td style="width: 10%;"></td> <td style="width: 10%;"></td> <td style="width: 10%;"></td> <td style="width: 10%;"></td> <td style="width: 10%;"></td> <td style="width: 10%;"></td> </tr> <tr> <td></td> <td></td> <td colspan="8" style="text-align: center;"> <table border="1" style="width: 100%; border-collapse: collapse; text-align: center;"> <tr> <td style="width: 10%;"></td> <td style="width: 10%;"></td> <td style="width: 10%;"></td> <td style="width: 10%;"></td> <td style="width: 10%;"></td> <td style="width: 10%;"></td> <td style="width: 10%;"></td> <td style="width: 10%;"></td> <td style="width: 10%;"></td> <td style="width: 10%;"></td> </tr> <tr> <td></td> <td></td> <td colspan="8" style="text-align: center;"> <table border="1" style="width: 100%; border-collapse: collapse; text-align: center;"> <tr> <td style="width: 10%;"></td> <td style="width: 10%;"></td> <td style="width: 10%;"></td> <td style="width: 10%;"></td> <td style="width: 10%;"></td> <td style="width: 10%;"></td> <td style="width: 10%;"></td> <td style="width: 10%;"></td> <td style="width: 10%;"></td> <td style="width: 10%;"></td> </tr> <tr> <td></td> <td></td> <td colspan="8" style="text-align: center;"> <table border="1" style="width: 100%;
border-collapse: collapse; text-align: center;"> <tr> <td style="width: 10%;"></td> <td style="width: 10%;"></td> <td style="width: 10%;"></td> <td style="width: 10%;"></td> <td style="width: 10%;"></td> <td style="width: 10%;"></td> <td style="width: 10%;"></td> <td style="width: 10%;"></td> <td style="width: 10%;"></td> <td style="width: 10%;"></td> </tr> <tr> <td></td> <td></td> <td colspan="8" style="text-align: center;"> <table border="1" style="width: 100%; border-collapse: collapse; text-align: center;"> <tr> <td style="width: 10%;"></td> <td style="width: 10%;"></td> <td style="width: 10%;"></td> <td style="width: 10%;"></td> <td style="width: 10%;"></td> <td style="width: 10%;"></td> <td style="width: 10%;"></td> <td style="width: 10%;"></td> <td style="width: 10%;"></td> <td style="width: 10%;"></td> </tr> <tr> <td></td> <td></td> <td colspan="8" style="text-align: center;"> <table border="1" style="width: 100%; border-collapse: collapse; text-align: center;"> <tr> <td style="width: 10%;"></td> <td style="width: 10%;"></td> <td style="width: 10%;"></td> <td style="width: 10%;"></td> <td style="width: 10%;"></td> <td style="width: 10%;"></td> <td style="width: 10%;"></td> <td style="width: 10%;"></td> <td style="width: 10%;"></td> <td style="width: 10%;"></td> </tr> <tr> <td></td> <td></td> <td colspan="8" style="text-align: center;"> <table border="1" style="width: 100%; border-collapse: collapse; text-align: center;"> <tr> <td style="width: 10%;"></td> <td style="width: 10%;"></td> <td style="width: 10%;"></td> <td style="width: 10%;"></td> <td style="width: 10%;"></td> <td style="width: 10%;"></td> <td style="width: 10%;"></td> <td style="width: 10%;"></td> <td style="width: 10%;"></td> <td style="width: 10%;"></td> </tr> <tr> <td></td> <td></td> <td colspan="8" style="text-align: center;"> <table border="1" style="width: 100%; border-collapse: collapse; text-align: center;"> <tr> <td style="width: 10%;"></td> <td style="width: 10%;"></td> <td style="width: 10%;"></td> <td style="width: 10%;"></td> <td style="width: 10%;"></td> <td style="width: 10%;"></td> <td style="width: 10%;"></td> <td style="width: 10%;"></td> <td style="width: 10%;"></td> <td style="width: 10%;"></td> </tr> <tr> <td></td> <td></td> <td colspan="8" style="text-align: center;"> <table border="1" style="width: 100%; border-collapse: collapse; text-align: center;"> <tr> <td style="width: 10%;"></td> <td style="width: 10%;"></td> <td style="width: 10%;"></td> <td style="width: 10%;"></td> <td style="width: 10%;"></td> <td style="width: 10%;"></td> <td style="width: 10%;"></td> <td style="width: 10%;"></td> <td style="width: 10%;"></td> <td style="width: 10%;"></td> </tr> <tr> <td></td> <td></td> <td colspan="8" style="text-align: center;"> <table border="1" style="width: 100%; border-collapse: collapse; text-align: center;"> <tr> <td style="width: 10%;"></td> <td style="width: 10%;"></td> <td style="width: 10%;"></td> <td style="width: 10%;"></td> <td style="width: 10%;"></td> <td style="width: 10%;"></td> <td style="width: 10%;"></td> <td style="width: 10%;"></td> <td style="width: 10%;"></td> <td style="width: 10%;"></td> </tr> <tr> <td></td> <td></td> <td colspan="8" style="text-align: center;"> <table border="1" style="width: 100%; border-collapse: collapse; text-align: center;"> <tr> <td style="width: 10%;"></td> <td style="width: 10%;"></td> <td style="width: 10%;"></td> <td style="width: 10%;"></td> <td style="width: 10%;"></td> <td style="width: 10%;"></td> <td style="width: 10%;"></td> <td style="width: 10%;"></td> <td style="width: 10%;"></td> <td style="width: 10%;"></td> </tr> <tr> <td></td> <td></td> <td colspan="8" style="text-align: center;"> <table border="1" style="width: 100%; border-collapse: collapse; text-align: center;"> <tr> <td style="width: 10%;"></td> <td style="width: 10%;"></td> <td style="width: 10%;"></td> <td style="width: 10%;"></td> <td style="width: 10%;"></td> <td style="width: 10%;"></td> <td style="width: 10%;"></td> <td style="width: 10%;"></td> <td style="width: 10%;"></td> <td style="width: 10%;"></td> </tr> <tr> <td></td> <td></td> <td colspan="8" style="text-align: center;"> <table border="1" style="width: 100%; border-collapse: collapse; text-align: center;"> <tr> <td style="width: 10%;"></td> <td style="width: 10%;"></td> <td style="width: 10%;"></td> <td style="width: 10%;"></td> <td style="width: 10%;"></td> <td style="width: 10%;"></td> <td style="width: 10%;"></td> <td style="width: 10%;"></td> <td style="width: 10%;"></td> <td style="width: 10%;"></td> </tr> <tr> <td></td> <td></td> <td colspan="8" style="text-align: center;"> <table border="1" style="width: 100%; border-collapse: collapse; text-align: center;"> <tr> <td style="width: 10%;"></td> <td style="width: 10%;"></td> <td style="width: 10%;"></td> <td style="width: 10%;"></td> <td style="width: 10%;"></td> <td style="width: 10%;"></td> <td style="width: 10%;"></td> <td style="width: 10%;"></td> <td style="width: 10%;"></td> <td style="width: 10%;"></td> </tr> <tr> <td></td> <td></td> <td colspan="8" style="text-align: center;"> <table border="1" style="width: 100%; border-collapse: collapse; text-align: center;"> <tr> <td style="width: 10%;"></td> <td style="width: 10%;"></td> <td style="width: 10%;"></td> <td style="width: 10%;"></td> <td style="width: 10%;"></td> <td style="width: 10%;"></td> <td style="width: 10%;"></td> <td style="width: 10%;"></td> <td style="width: 10%;"></td> <td style="width: 10%;"></td> </tr> <tr> <td></td> <td></td> <td colspan="8" style="text-align: center;"> <table border="1" style="width: 100%; border-collapse: collapse; text-align: center;"> <tr> <td style="width: 10%;"></td> <td style="width: 10%;"></td> <td style="width: 10%;"></td> <td style="width: 10%;"></td> <td style="width: 10%;"></td> <td style="width: 10%;"></td> <td style="width: 10%;"></td> <td style="width: 10%;"></td> <td style="width: 10%;"></td> <td style="width: 10%;"></td> </tr> <tr> <td></td> <td></td> <td colspan="8" style="text-align: center;"> <table border="1" style="width: 100%; border-collapse: collapse; text-align: center;"> <tr> <td style="width: 10%;"></td> <td style="width: 10%;"></td> <td style="width: 10%;"></td> <td style="width: 10%;"></td> <td style="width: 10%;"></td> <td style="width: 10%;"></td> <td style="width: 10%;"></td> <td style="width: 10%;"></td> <td style="width: 10%;"></td> <td style="width: 10%;"></td> </tr> <tr> <td></td> <td></td> <td colspan="8" style="text-align: center;"> <table border="1" style="width: 100%; border-collapse: collapse; text-align: center;"> <tr> <td style="width: 10%;"></td> <td style="width: 10%;"></td> <td style="width: 10%;"></td> <td style="width: 10%;"></td> <td style="width: 10%;"></td> <td style="width: 10%;"></td> <td style="width: 10%;"></td> <td style="width: 10%;"></td> <td style="width: 10%;"></td> <td style="width: 10%;"></td> </tr> <tr> <td></td> <td></td> <td colspan="8" style="text-align: center;"> <table border="1" style="width: 100%; border-collapse: collapse; text-align: center;"> <tr> </tr></table></td></tr></table></td></tr></table></td></tr></table></td></tr></table></td></tr></table></td></tr></table></td></tr></table></td></tr></table></td></tr></table></td></tr></table></td></tr></table></td></tr></table></td></tr></table></td></tr></table></td></tr></table></td></tr></table></td></tr></table></td></tr></table></td></tr></table></td></tr></table></td></tr></table></td></tr></table></td></tr></table></td></tr></table></td></tr></table></td></tr></table></td></tr></table></td></tr></table></td></tr></table></td></tr></table></td></tr></table></td></tr></table></td></tr></table></td></tr></table></td></tr></table></td></tr></table></td></tr></table></td></tr></table></td></tr></table></td></tr></table></td></tr></table></td></tr></table></td></tr></table></td></tr></table></td></tr></table></td></tr></table></td></tr></table></td></tr></table></td></tr></table></td></tr></table></td></tr></table></td></tr></table> | | | | | | | | | | | | | | | | | | | | <table border="1" style="width: 100%; border-collapse: collapse; text-align: center;"> <tr> <td style="width: 10%;"></td> <td style="width: 10%;"></td> <td style="width: 10%;"></td> <td style="width: 10%;"></td> <td style="width: 10%;"></td> <td style="width: 10%;"></td> <td style="width: 10%;"></td> <td style="width: 10%;"></td> <td style="width: 10%;"></td> <td style="width: 10%;"></td> </tr> <tr> <td></td> <td></td> <td colspan="8" style="text-align: center;"> <table border="1" style="width: 100%; border-collapse: collapse; text-align: center;"> <tr> <td style="width: 10%;"></td> <td style="width: 10%;"></td> <td style="width: 10%;"></td> <td style="width: 10%;"></td> <td style="width: 10%;"></td> <td style="width: 10%;"></td> <td style="width: 10%;"></td> <td style="width: 10%;"></td> <td style="width: 10%;"></td> <td style="width: 10%;"></td> </tr> <tr> <td></td> <td></td> <td colspan="8" style="text-align: center;"> <table
border="1" style="width: 100%; border-collapse: collapse; text-align: center;"> <tr> <td style="width: 10%;"></td> <td style="width: 10%;"></td> <td style="width: 10%;"></td> <td style="width: 10%;"></td> <td style="width: 10%;"></td> <td style="width: 10%;"></td> <td style="width: 10%;"></td> <td style="width: 10%;"></td> <td style="width: 10%;"></td> <td style="width: 10%;"></td> </tr> <tr> <td></td> <td></td> <td colspan="8" style="text-align: center;"> <table border="1" style="width: 100%; border-collapse: collapse; text-align: center;"> <tr> <td style="width: 10%;"></td> <td style="width: 10%;"></td> <td style="width: 10%;"></td> <td style="width: 10%;"></td> <td style="width: 10%;"></td> <td style="width: 10%;"></td> <td style="width: 10%;"></td> <td style="width: 10%;"></td> <td style="width: 10%;"></td> <td style="width: 10%;"></td> </tr> <tr> <td></td> <td></td> <td colspan="8" style="text-align: center;"> <table border="1" style="width: 100%; border-collapse: collapse; text-align: center;"> <tr> <td style="width: 10%;"></td> <td style="width: 10%;"></td> <td style="width: 10%;"></td> <td style="width: 10%;"></td> <td style="width: 10%;"></td> <td style="width: 10%;"></td> <td style="width: 10%;"></td> <td style="width: 10%;"></td> <td style="width: 10%;"></td> <td style="width: 10%;"></td> </tr> <tr> <td></td> <td></td> <td colspan="8" style="text-align: center;"> <table border="1" style="width: 100%; border-collapse: collapse; text-align: center;"> <tr> <td style="width: 10%;"></td> <td style="width: 10%;"></td> <td style="width: 10%;"></td> <td style="width: 10%;"></td> <td style="width: 10%;"></td> <td style="width: 10%;"></td> <td style="width: 10%;"></td> <td style="width: 10%;"></td> <td style="width: 10%;"></td> <td style="width: 10%;"></td> </tr> <tr> <td></td> <td></td> <td colspan="8" style="text-align: center;"> <table border="1" style="width: 100%; border-collapse: collapse; text-align: center;"> <tr> <td style="width: 10%;"></td> <td style="width: 10%;"></td> <td style="width: 10%;"></td> <td style="width: 10%;"></td> <td style="width: 10%;"></td> <td style="width: 10%;"></td> <td style="width: 10%;"></td> <td style="width: 10%;"></td> <td style="width: 10%;"></td> <td style="width: 10%;"></td> </tr> <tr> <td></td> <td></td> <td colspan="8" style="text-align: center;"> <table border="1" style="width: 100%; border-collapse: collapse; text-align: center;"> <tr> <td style="width: 10%;"></td> <td style="width: 10%;"></td> <td style="width: 10%;"></td> <td style="width: 10%;"></td> <td style="width: 10%;"></td> <td style="width: 10%;"></td> <td style="width: 10%;"></td> <td style="width: 10%;"></td> <td style="width: 10%;"></td> <td style="width: 10%;"></td> </tr> <tr> <td></td> <td></td> <td colspan="8" style="text-align: center;"> <table border="1" style="width: 100%; border-collapse: collapse; text-align: center;"> <tr> <td style="width: 10%;"></td> <td style="width: 10%;"></td> <td style="width: 10%;"></td> <td style="width: 10%;"></td> <td style="width: 10%;"></td> <td style="width: 10%;"></td> <td style="width: 10%;"></td> <td style="width: 10%;"></td> <td style="width: 10%;"></td> <td style="width: 10%;"></td> </tr> <tr> <td></td> <td></td> <td colspan="8" style="text-align: center;"> <table border="1" style="width: 100%; border-collapse: collapse; text-align: center;"> <tr> <td style="width: 10%;"></td> <td style="width: 10%;"></td> <td style="width: 10%;"></td> <td style="width: 10%;"></td> <td style="width: 10%;"></td> <td style="width: 10%;"></td> <td style="width: 10%;"></td> <td style="width: 10%;"></td> <td style="width: 10%;"></td> <td style="width: 10%;"></td> </tr> <tr> <td></td> <td></td> <td colspan="8" style="text-align: center;"> <table border="1" style="width: 100%; border-collapse: collapse; text-align: center;"> <tr> <td style="width: 10%;"></td> <td style="width: 10%;"></td> <td style="width: 10%;"></td> <td style="width: 10%;"></td> <td style="width: 10%;"></td> <td style="width: 10%;"></td> <td style="width: 10%;"></td> <td style="width: 10%;"></td> <td style="width: 10%;"></td> <td style="width: 10%;"></td> </tr> <tr> <td></td> <td></td> <td colspan="8" style="text-align: center;"> <table border="1" style="width: 100%; border-collapse: collapse; text-align: center;"> <tr> <td style="width: 10%;"></td> <td style="width: 10%;"></td> <td style="width: 10%;"></td> <td style="width: 10%;"></td> <td style="width: 10%;"></td> <td style="width: 10%;"></td> <td style="width: 10%;"></td> <td style="width: 10%;"></td> <td style="width: 10%;"></td> <td style="width: 10%;"></td> </tr> <tr> <td></td> <td></td> <td colspan="8" style="text-align: center;"> <table border="1" style="width: 100%; border-collapse: collapse; text-align: center;"> <tr> <td style="width: 10%;"></td> <td style="width: 10%;"></td> <td style="width: 10%;"></td> <td style="width: 10%;"></td> <td style="width: 10%;"></td> <td style="width: 10%;"></td> <td style="width: 10%;"></td> <td style="width: 10%;"></td> <td style="width: 10%;"></td> <td style="width: 10%;"></td> </tr> <tr> <td></td> <td></td> <td colspan="8" style="text-align: center;"> <table border="1" style="width: 100%; border-collapse: collapse; text-align: center;"> <tr> <td style="width: 10%;"></td> <td style="width: 10%;"></td> <td style="width: 10%;"></td> <td style="width: 10%;"></td> <td style="width: 10%;"></td> <td style="width: 10%;"></td> <td style="width: 10%;"></td> <td style="width: 10%;"></td> <td style="width: 10%;"></td> <td style="width: 10%;"></td> </tr> <tr> <td></td> <td></td> <td colspan="8" style="text-align: center;"> <table border="1" style="width: 100%; border-collapse: collapse; text-align: center;"> <tr> <td style="width: 10%;"></td> <td style="width: 10%;"></td> <td style="width: 10%;"></td> <td style="width: 10%;"></td> <td style="width: 10%;"></td> <td style="width: 10%;"></td> <td style="width: 10%;"></td> <td style="width: 10%;"></td> <td style="width: 10%;"></td> <td style="width: 10%;"></td> </tr> <tr> <td></td> <td></td> <td colspan="8" style="text-align: center;"> <table border="1" style="width: 100%; border-collapse: collapse; text-align: center;"> <tr> <td style="width: 10%;"></td> <td style="width: 10%;"></td> <td style="width: 10%;"></td> <td style="width: 10%;"></td> <td style="width: 10%;"></td> <td style="width: 10%;"></td> <td style="width: 10%;"></td> <td style="width: 10%;"></td> <td style="width: 10%;"></td> <td style="width: 10%;"></td> </tr> <tr> <td></td> <td></td> <td colspan="8" style="text-align: center;"> <table border="1" style="width: 100%; border-collapse: collapse; text-align: center;"> <tr> <td style="width: 10%;"></td> <td style="width: 10%;"></td> <td style="width: 10%;"></td> <td style="width: 10%;"></td> <td style="width: 10%;"></td> <td style="width: 10%;"></td> <td style="width: 10%;"></td> <td style="width: 10%;"></td> <td style="width: 10%;"></td> <td style="width: 10%;"></td> </tr> <tr> <td></td> <td></td> <td colspan="8" style="text-align: center;"> <table border="1" style="width: 100%; border-collapse: collapse; text-align: center;"> <tr> <td style="width: 10%;"></td> <td style="width: 10%;"></td> <td style="width: 10%;"></td> <td style="width: 10%;"></td> <td style="width: 10%;"></td> <td style="width: 10%;"></td> <td style="width: 10%;"></td> <td style="width: 10%;"></td> <td style="width: 10%;"></td> <td style="width: 10%;"></td> </tr> <tr> <td></td> <td></td> <td colspan="8" style="text-align: center;"> <table border="1" style="width: 100%; border-collapse: collapse; text-align: center;"> <tr> <td style="width: 10%;"></td> <td style="width: 10%;"></td> <td style="width: 10%;"></td> <td style="width: 10%;"></td> <td style="width: 10%;"></td> <td style="width: 10%;"></td> <td style="width: 10%;"></td> <td style="width: 10%;"></td> <td style="width: 10%;"></td> <td style="width: 10%;"></td> </tr> <tr> <td></td> <td></td> <td colspan="8" style="text-align: center;"> <table border="1" style="width: 100%; border-collapse: collapse; text-align: center;"> <tr> <td style="width: 10%;"></td> <td style="width: 10%;"></td> <td style="width: 10%;"></td> <td style="width: 10%;"></td> <td style="width: 10%;"></td> <td style="width: 10%;"></td> <td style="width: 10%;"></td> <td style="width: 10%;"></td> <td style="width: 10%;"></td> <td style="width: 10%;"></td> </tr> <tr> <td></td> <td></td> <td colspan="8" style="text-align: center;"> <table border="1" style="width: 100%; border-collapse: collapse; text-align: center;"> <tr> <td style="width: 10%;"></td> <td style="width: 10%;"></td> <td style="width: 10%;"></td> <td style="width: 10%;"></td> <td style="width: 10%;"></td> <td style="width: 10%;"></td> <td style="width: 10%;"></td> <td style="width: 10%;"></td> <td style="width: 10%;"></td> <td style="width: 10%;"></td> </tr> <tr> <td></td> <td></td> <td colspan="8" style="text-align: center;"> <table border="1" style="width: 100%; border-collapse: collapse; text-align: center;"> <tr> <td style="width: 10%;"></td> <td style="width: 10%;"></td> <td style="width: 10%;"></td> <td style="width: 10%;"></td> <td style="width: 10%;"></td> <td style="width: 10%;"></td> <td style="width: 10%;"></td> <td style="width: 10%;"></td> <td style="width: 10%;"></td> <td style="width: 10%;"></td> </tr> <tr> <td></td> <td></td> <td colspan="8" style="text-align: center;"> <table border="1" style="width: 100%; border-collapse: collapse; text-align: center;"> <tr> <td style="width: 10%;"></td> <td style="width: 10%;"></td> <td style="width: 10%;"></td> <td style="width: 10%;"></td> <td style="width: 10%;"></td> <td style="width: 10%;"></td> <td style="width: 10%;"></td> <td style="width: 10%;"></td> <td style="width: 10%;"></td> <td style="width: 10%;"></td> </tr> <tr> <td></td> <td></td> <td colspan="8" style="text-align: center;"> <table border="1" style="width: 100%; border-collapse: collapse; text-align: center;"> <tr> <td style="width: 10%;"></td> <td style="width: 10%;"></td> <td style="width:
10%;"></td> <td style="width: 10%;"></td> <td style="width: 10%;"></td> <td style="width: 10%;"></td> <td style="width: 10%;"></td> <td style="width: 10%;"></td> <td style="width: 10%;"></td> <td style="width: 10%;"></td> </tr> <tr> <td></td> <td></td> <td colspan="8" style="text-align: center;"> <table border="1" style="width: 100%; border-collapse: collapse; text-align: center;"> <tr> <td style="width: 10%;"></td> <td style="width: 10%;"></td> <td style="width: 10%;"></td> <td style="width: 10%;"></td> <td style="width: 10%;"></td> <td style="width: 10%;"></td> <td style="width: 10%;"></td> <td style="width: 10%;"></td> <td style="width: 10%;"></td> <td style="width: 10%;"></td> </tr> <tr> <td></td> <td></td> <td colspan="8" style="text-align: center;"> <table border="1" style="width: 100%; border-collapse: collapse; text-align: center;"> <tr> <td style="width: 10%;"></td> <td style="width: 10%;"></td> <td style="width: 10%;"></td> <td style="width: 10%;"></td> <td style="width: 10%;"></td> <td style="width: 10%;"></td> <td style="width: 10%;"></td> <td style="width: 10%;"></td> <td style="width: 10%;"></td> <td style="width: 10%;"></td> </tr> <tr> <td></td> <td></td> <td colspan="8" style="text-align: center;"> <table border="1" style="width: 100%; border-collapse: collapse; text-align: center;"> <tr> <td style="width: 10%;"></td> <td style="width: 10%;"></td> <td style="width: 10%;"></td> <td style="width: 10%;"></td> <td style="width: 10%;"></td> <td style="width: 10%;"></td> <td style="width: 10%;"></td> <td style="width: 10%;"></td> <td style="width: 10%;"></td> <td style="width: 10%;"></td> </tr> <tr> <td></td> <td></td> <td colspan="8" style="text-align: center;"> <table border="1" style="width: 100%; border-collapse: collapse; text-align: center;"> <tr> <td style="width: 10%;"></td> <td style="width: 10%;"></td> <td style="width: 10%;"></td> <td style="width: 10%;"></td> <td style="width: 10%;"></td> <td style="width: 10%;"></td> <td style="width: 10%;"></td> <td style="width: 10%;"></td> <td style="width: 10%;"></td> <td style="width: 10%;"></td> </tr> <tr> <td></td> <td></td> <td colspan="8" style="text-align: center;"> <table border="1" style="width: 100%; border-collapse: collapse; text-align: center;"> <tr> <td style="width: 10%;"></td> <td style="width: 10%;"></td> <td style="width: 10%;"></td> <td style="width: 10%;"></td> <td style="width: 10%;"></td> <td style="width: 10%;"></td> <td style="width: 10%;"></td> <td style="width: 10%;"></td> <td style="width: 10%;"></td> <td style="width: 10%;"></td> </tr> <tr> <td></td> <td></td> <td colspan="8" style="text-align: center;"> <table border="1" style="width: 100%; border-collapse: collapse; text-align: center;"> <tr> <td style="width: 10%;"></td> <td style="width: 10%;"></td> <td style="width: 10%;"></td> <td style="width: 10%;"></td> <td style="width: 10%;"></td> <td style="width: 10%;"></td> <td style="width: 10%;"></td> <td style="width: 10%;"></td> <td style="width: 10%;"></td> <td style="width: 10%;"></td> </tr> <tr> <td></td> <td></td> <td colspan="8" style="text-align: center;"> <table border="1" style="width: 100%; border-collapse: collapse; text-align: center;"> <tr> <td style="width: 10%;"></td> <td style="width: 10%;"></td> <td style="width: 10%;"></td> <td style="width: 10%;"></td> <td style="width: 10%;"></td> <td style="width: 10%;"></td> <td style="width: 10%;"></td> <td style="width: 10%;"></td> <td style="width: 10%;"></td> <td style="width: 10%;"></td> </tr> <tr> <td></td> <td></td> <td colspan="8" style="text-align: center;"> <table border="1" style="width: 100%; border-collapse: collapse; text-align: center;"> <tr> <td style="width: 10%;"></td> <td style="width: 10%;"></td> <td style="width: 10%;"></td> <td style="width: 10%;"></td> <td style="width: 10%;"></td> <td style="width: 10%;"></td> <td style="width: 10%;"></td> <td style="width: 10%;"></td> <td style="width: 10%;"></td> <td style="width: 10%;"></td> </tr> <tr> <td></td> <td></td> <td colspan="8" style="text-align: center;"> <table border="1" style="width: 100%; border-collapse: collapse; text-align: center;"> <tr> <td style="width: 10%;"></td> <td style="width: 10%;"></td> <td style="width: 10%;"></td> <td style="width: 10%;"></td> <td style="width: 10%;"></td> <td style="width: 10%;"></td> <td style="width: 10%;"></td> <td style="width: 10%;"></td> <td style="width: 10%;"></td> <td style="width: 10%;"></td> </tr> <tr> <td></td> <td></td> <td colspan="8" style="text-align: center;"> <table border="1" style="width: 100%; border-collapse: collapse; text-align: center;"> <tr> <td style="width: 10%;"></td> <td style="width: 10%;"></td> <td style="width: 10%;"></td> <td style="width: 10%;"></td> <td style="width: 10%;"></td> <td style="width: 10%;"></td> <td style="width: 10%;"></td> <td style="width: 10%;"></td> <td style="width: 10%;"></td> <td style="width: 10%;"></td> </tr> <tr> <td></td> <td></td> <td colspan="8" style="text-align: center;"> <table border="1" style="width: 100%; border-collapse: collapse; text-align: center;"> <tr> <td style="width: 10%;"></td> <td style="width: 10%;"></td> <td style="width: 10%;"></td> <td style="width: 10%;"></td> <td style="width: 10%;"></td> <td style="width: 10%;"></td> <td style="width: 10%;"></td> <td style="width: 10%;"></td> <td style="width: 10%;"></td> <td style="width: 10%;"></td> </tr> <tr> <td></td> <td></td> <td colspan="8" style="text-align: center;"> <table border="1" style="width: 100%; border-collapse: collapse; text-align: center;"> <tr> <td style="width: 10%;"></td> <td style="width: 10%;"></td> <td style="width: 10%;"></td> <td style="width: 10%;"></td> <td style="width: 10%;"></td> <td style="width: 10%;"></td> <td style="width: 10%;"></td> <td style="width: 10%;"></td> <td style="width: 10%;"></td> <td style="width: 10%;"></td> </tr> <tr> <td></td> <td></td> <td colspan="8" style="text-align: center;"> <table border="1" style="width: 100%; border-collapse: collapse; text-align: center;"> <tr> <td style="width: 10%;"></td> <td style="width: 10%;"></td> <td style="width: 10%;"></td> <td style="width: 10%;"></td> <td style="width: 10%;"></td> <td style="width: 10%;"></td> <td style="width: 10%;"></td> <td style="width: 10%;"></td> <td style="width: 10%;"></td> <td style="width: 10%;"></td> </tr> <tr> <td></td> <td></td> <td colspan="8" style="text-align: center;"> <table border="1" style="width: 100%; border-collapse: collapse; text-align: center;"> <tr> <td style="width: 10%;"></td> <td style="width: 10%;"></td> <td style="width: 10%;"></td> <td style="width: 10%;"></td> <td style="width: 10%;"></td> <td style="width: 10%;"></td> <td style="width: 10%;"></td> <td style="width: 10%;"></td> <td style="width: 10%;"></td> <td style="width: 10%;"></td> </tr> <tr> <td></td> <td></td> <td colspan="8" style="text-align: center;"> <table border="1" style="width: 100%; border-collapse: collapse; text-align: center;"> <tr> <td style="width: 10%;"></td> <td style="width: 10%;"></td> <td style="width: 10%;"></td> <td style="width: 10%;"></td> <td style="width: 10%;"></td> <td style="width: 10%;"></td> <td style="width: 10%;"></td> <td style="width: 10%;"></td> <td style="width: 10%;"></td> <td style="width: 10%;"></td> </tr> <tr> <td></td> <td></td> <td colspan="8" style="text-align: center;"> <table border="1" style="width: 100%; border-collapse: collapse; text-align: center;"> <tr> <td style="width: 10%;"></td> <td style="width: 10%;"></td> <td style="width: 10%;"></td> <td style="width: 10%;"></td> <td style="width: 10%;"></td> <td style="width: 10%;"></td> <td style="width: 10%;"></td> <td style="width: 10%;"></td> <td style="width: 10%;"></td> <td style="width: 10%;"></td> </tr> <tr> <td></td> <td></td> <td colspan="8" style="text-align: center;"> <table border="1" style="width: 100%; border-collapse: collapse; text-align: center;"> <tr> <td style="width: 10%;"></td> <td style="width: 10%;"></td> <td style="width: 10%;"></td> <td style="width: 10%;"></td> <td style="width: 10%;"></td> <td style="width: 10%;"></td> <td style="width: 10%;"></td> <td style="width: 10%;"></td> <td style="width: 10%;"></td> <td style="width: 10%;"></td> </tr> <tr> <td></td> <td></td> <td colspan="8" style="text-align: center;"> <table border="1" style="width: 100%; border-collapse: collapse; text-align: center;"> <tr> <td style="width: 10%;"></td> <td style="width: 10%;"></td> <td style="width: 10%;"></td> <td style="width: 10%;"></td> <td style="width: 10%;"></td> <td style="width: 10%;"></td> <td style="width: 10%;"></td> <td style="width: 10%;"></td> <td style="width: 10%;"></td> <td style="width: 10%;"></td> </tr> <tr> <td></td> <td></td> <td colspan="8" style="text-align: center;"> <table border="1" style="width: 100%; border-collapse: collapse; text-align: center;"> <tr> <td style="width: 10%;"></td> <td style="width: 10%;"></td> <td style="width: 10%;"></td> <td style="width: 10%;"></td> <td style="width: 10%;"></td> <td style="width: 10%;"></td> <td style="width: 10%;"></td> <td style="width: 10%;"></td> <td style="width: 10%;"></td> <td style="width: 10%;"></td> </tr> <tr> <td></td> <td></td> <td colspan="8" style="text-align: center;"> <table border="1" style="width: 100%; border-collapse: collapse; text-align: center;"> <tr> <td style="width: 10%;"></td> <td style="width: 10%;"></td> <td style="width: 10%;"></td> <td style="width: 10%;"></td> <td style="width: 10%;"></td> <td style="width: 10%;"></td> <td style="width: 10%;"></td> <td style="width: 10%;"></td> <td style="width: 10%;"></td> <td style="width: 10%;"></td> </tr> <tr> <td></td> <td></td> <td colspan="8" style="text-align: center;"> <table border="1" style="width: 100%; border-collapse: collapse; text-align: center;"> <tr> <td style="width: 10%;"></td> <td style="width: 10%;"></td> <td style="width: 10%;"></td> <td style="width: 10%;"></td> <td style="width: 10%;"></td> <td style="width: 10%;"></td> <td style="width: 10%;"></td> <td style="width: 10%;"></td> <td
style="width: 10%;"></td> <td style="width: 10%;"></td> </tr> <tr> <td></td> <td></td> <td colspan="8" style="text-align: center;"> <table border="1" style="width: 100%; border-collapse: collapse; text-align: center;"> <tr> <td style="width: 10%;"></td> <td style="width: 10%;"></td> <td style="width: 10%;"></td> <td style="width: 10%;"></td> <td style="width: 10%;"></td> <td style="width: 10%;"></td> <td style="width: 10%;"></td> <td style="width: 10%;"></td> <td style="width: 10%;"></td> <td style="width: 10%;"></td> </tr> <tr> <td></td> <td></td> <td colspan="8" style="text-align: center;"> <table border="1" style="width: 100%; border-collapse: collapse; text-align: center;"> <tr> <td style="width: 10%;"></td> <td style="width: 10%;"></td> <td style="width: 10%;"></td> <td style="width: 10%;"></td> <td style="width: 10%;"></td> <td style="width: 10%;"></td> <td style="width: 10%;"></td> <td style="width: 10%;"></td> <td style="width: 10%;"></td> <td style="width: 10%;"></td> </tr> <tr> <td></td> <td></td> <td colspan="8" style="text-align: center;"> <table border="1" style="width: 100%; border-collapse: collapse; text-align: center;"> <tr> <td style="width: 10%;"></td> <td style="width: 10%;"></td> <td style="width: 10%;"></td> <td style="width: 10%;"></td> <td style="width: 10%;"></td> <td style="width: 10%;"></td> <td style="width: 10%;"></td> <td style="width: 10%;"></td> <td style="width: 10%;"></td> <td style="width: 10%;"></td> </tr> <tr> <td></td> <td></td> <td colspan="8" style="text-align: center;"> <table border="1" style="width: 100%; border-collapse: collapse; text-align: center;"> <tr> <td style="width: 10%;"></td> <td style="width: 10%;"></td> <td style="width: 10%;"></td> <td style="width: 10%;"></td> <td style="width: 10%;"></td> <td style="width: 10%;"></td> <td style="width: 10%;"></td> <td style="width: 10%;"></td> <td style="width: 10%;"></td> <td style="width: 10%;"></td> </tr> <tr> <td></td> <td></td> <td colspan="8" style="text-align: center;"> <table border="1" style="width: 100%; border-collapse: collapse; text-align: center;"> <tr> <td style="width: 10%;"></td> <td style="width: 10%;"></td> <td style="width: 10%;"></td> <td style="width: 10%;"></td> <td style="width: 10%;"></td> <td style="width: 10%;"></td> <td style="width: 10%;"></td> <td style="width: 10%;"></td> <td style="width: 10%;"></td> <td style="width: 10%;"></td> </tr> <tr> <td></td> <td></td> <td colspan="8" style="text-align: center;"> <table border="1" style="width: 100%; border-collapse: collapse; text-align: center;"> <tr> <td style="width: 10%;"></td> <td style="width: 10%;"></td> <td style="width: 10%;"></td> <td style="width: 10%;"></td> <td style="width: 10%;"></td> <td style="width: 10%;"></td> <td style="width: 10%;"></td> <td style="width: 10%;"></td> <td style="width: 10%;"></td> <td style="width: 10%;"></td> </tr> <tr> <td></td> <td></td> <td colspan="8" style="text-align: center;"> <table border="1" style="width: 100%; border-collapse: collapse; text-align: center;"> <tr> </tr></table></td></tr></table></td></tr></table></td></tr></table></td></tr></table></td></tr></table></td></tr></table></td></tr></table></td></tr></table></td></tr></table></td></tr></table></td></tr></table></td></tr></table></td></tr></table></td></tr></table></td></tr></table></td></tr></table></td></tr></table></td></tr></table></td></tr></table></td></tr></table></td></tr></table></td></tr></table></td></tr></table></td></tr></table></td></tr></table></td></tr></table></td></tr></table></td></tr></table></td></tr></table></td></tr></table></td></tr></table></td></tr></table></td></tr></table></td></tr></table></td></tr></table></td></tr></table></td></tr></table></td></tr></table></td></tr></table></td></tr></table></td></tr></table></td></tr></table></td></tr></table></td></tr></table></td></tr></table></td></tr></table></td></tr></table></td></tr></table></td></tr></table></td></tr></table></td></tr></table> | | | | | | | | | | | | | | | | | | | | <table border="1" style="width: 100%; border-collapse: collapse; text-align: center;"> <tr> <td style="width: 10%;"></td> <td style="width: 10%;"></td> <td style="width: 10%;"></td> <td style="width: 10%;"></td> <td style="width: 10%;"></td> <td style="width: 10%;"></td> <td style="width: 10%;"></td> <td style="width: 10%;"></td> <td style="width: 10%;"></td> <td style="width: 10%;"></td> </tr> <tr> <td></td> <td></td> <td colspan="8" style="text-align: center;"> <table border="1" style="width: 100%; border-collapse: collapse; text-align: center;"> <tr> <td style="width: 10%;"></td> <td style="width: 10%;"></td> <td style="width: 10%;"></td> <td style="width: 10%;"></td> <td style="width: 10%;"></td> <td style="width: 10%;"></td> <td style="width: 10%;"></td> <td style="width: 10%;"></td> <td style="width: 10%;"></td> <td style="width: 10%;"></td> </tr> <tr> <td></td> <td></td> <td colspan="8" style="text-align: center;"> <table border="1" style="width: 100%; border-collapse: collapse; text-align: center;"> <tr> <td style="width: 10%;"></td> <td style="width: 10%;"></td> <td style="width: 10%;"></td> <td style="width: 10%;"></td> <td style="width: 10%;"></td> <td style="width: 10%;"></td> <td style="width: 10%;"></td> <td style="width: 10%;"></td> <td style="width: 10%;"></td> <td style="width: 10%;"></td> </tr> <tr> <td></td> <td></td> <td colspan="8" style="text-align: center;"> <table border="1" style="width: 100%; border-collapse: collapse; text-align: center;"> <tr> <td style="width: 10%;"></td> <td style="width: 10%;"></td> <td style="width: 10%;"></td> <td style="width: 10%;"></td> <td style="width: 10%;"></td> <td style="width: 10%;"></td> <td style="width: 10%;"></td> <td style="width: 10%;"></td> <td style="width: 10%;"></td> <td style="width: 10%;"></td> </tr> <tr> <td></td> <td></td> <td colspan="8" style="text-align: center;"> <table border="1" style="width: 100%; border-collapse: collapse; text-align: center;"> <tr> <td style="width: 10%;"></td> <td style="width: 10%;"></td> <td style="width: 10%;"></td> <td style="width: 10%;"></td> <td style="width: 10%;"></td> <td style="width: 10%;"></td> <td style="width: 10%;"></td> <td style="width: 10%;"></td> <td style="width: 10%;"></td> <td style="width: 10%;"></td> </tr> <tr> <td></td> <td></td> <td colspan="8" style="text-align: center;"> <table border="1" style="width: 100%; border-collapse: collapse; text-align: center;"> <tr> <td style="width: 10%;"></td> <td style="width: 10%;"></td> <td style="width: 10%;"></td> <td style="width: 10%;"></td> <td style="width: 10%;"></td> <td style="width: 10%;"></td> <td style="width: 10%;"></td> <td style="width: 10%;"></td> <td style="width: 10%;"></td> <td style="width: 10%;"></td> </tr> <tr> <td></td> <td></td> <td colspan="8" style="text-align: center;"> <table border="1" style="width: 100%; border-collapse: collapse; text-align: center;"> <tr> <td style="width: 10%;"></td> <td style="width: 10%;"></td> <td style="width: 10%;"></td> <td style="width: 10%;"></td> <td style="width: 10%;"></td> <td style="width: 10%;"></td> <td style="width: 10%;"></td> <td style="width: 10%;"></td> <td style="width: 10%;"></td> <td style="width: 10%;"></td> </tr> <tr> <td></td> <td></td> <td colspan="8" style="text-align: center;"> <table border="1" style="width: 100%; border-collapse: collapse; text-align: center;"> <tr> <td style="width: 10%;"></td> <td style="width: 10%;"></td> <td style="width: 10%;"></td> <td style="width: 10%;"></td> <td style="width: 10%;"></td> <td style="width: 10%;"></td> <td style="width: 10%;"></td> <td style="width: 10%;"></td> <td style="width: 10%;"></td> <td style="width: 10%;"></td> </tr> <tr> <td></td> <td></td> <td colspan="8" style="text-align: center;"> <table border="1" style="width: 100%; border-collapse: collapse; text-align: center;"> <tr> <td style="width: 10%;"></td> <td style="width: 10%;"></td> <td style="width: 10%;"></td> <td style="width: 10%;"></td> <td style="width: 10%;"></td> <td style="width: 10%;"></td> <td style="width: 10%;"></td> <td style="width: 10%;"></td> <td style="width: 10%;"></td> <td style="width: 10%;"></td> </tr> <tr> <td></td> <td></td> <td colspan="8" style="text-align: center;"> <table border="1" style="width: 100%; border-collapse: collapse; text-align: center;"> <tr> <td style="width: 10%;"></td> <td style="width: 10%;"></td> <td style="width: 10%;"></td> <td style="width: 10%;"></td> <td style="width: 10%;"></td> <td style="width: 10%;"></td> <td style="width: 10%;"></td> <td style="width: 10%;"></td> <td style="width: 10%;"></td> <td style="width: 10%;"></td> </tr> <tr> <td></td> <td></td> <td colspan="8" style="text-align: center;"> <table border="1" style="width: 100%; border-collapse: collapse; text-align: center;"> <tr> <td style="width: 10%;"></td> <td style="width: 10%;"></td> <td style="width: 10%;"></td> <td style="width: 10%;"></td> <td style="width: 10%;"></td> <td style="width: 10%;"></td> <td style="width: 10%;"></td> <td style="width:
10%;"></td> <td style="width: 10%;"></td> <td style="width: 10%;"></td> </tr> <tr> <td></td> <td></td> <td colspan="8" style="text-align: center;"> <table border="1" style="width: 100%; border-collapse: collapse; text-align: center;"> <tr> <td style="width: 10%;"></td> <td style="width: 10%;"></td> <td style="width: 10%;"></td> <td style="width: 10%;"></td> <td style="width: 10%;"></td> <td style="width: 10%;"></td> <td style="width: 10%;"></td> <td style="width: 10%;"></td> <td style="width: 10%;"></td> <td style="width: 10%;"></td> </tr> <tr> <td></td> <td></td> <td colspan="8" style="text-align: center;"> <table border="1" style="width: 100%; border-collapse: collapse; text-align: center;"> <tr> <td style="width: 10%;"></td> <td style="width: 10%;"></td> <td style="width: 10%;"></td> <td style="width: 10%;"></td> <td style="width: 10%;"></td> <td style="width: 10%;"></td> <td style="width: 10%;"></td> <td style="width: 10%;"></td> <td style="width: 10%;"></td> <td style="width: 10%;"></td> </tr> <tr> <td></td> <td></td> <td colspan="8" style="text-align: center;"> <table border="1" style="width: 100%; border-collapse: collapse; text-align: center;"> <tr> <td style="width: 10%;"></td> <td style="width: 10%;"></td> <td style="width: 10%;"></td> <td style="width: 10%;"></td> <td style="width: 10%;"></td> <td style="width: 10%;"></td> <td style="width: 10%;"></td> <td style="width: 10%;"></td> <td style="width: 10%;"></td> <td style="width: 10%;"></td> </tr> <tr> <td></td> <td></td> <td colspan="8" style="text-align: center;"> <table border="1" style="width: 100%; border-collapse: collapse; text-align: center;"> <tr> <td style="width: 10%;"></td> <td style="width: 10%;"></td> <td style="width: 10%;"></td> <td style="width: 10%;"></td> <td style="width: 10%;"></td> <td style="width: 10%;"></td> <td style="width: 10%;"></td> <td style="width: 10%;"></td> <td style="width: 10%;"></td> <td style="width: 10%;"></td> </tr> <tr> <td></td> <td></td> <td colspan="8" style="text-align: center;"> <table border="1" style="width: 100%; border-collapse: collapse; text-align: center;"> <tr> <td style="width: 10%;"></td> <td style="width: 10%;"></td> <td style="width: 10%;"></td> <td style="width: 10%;"></td> <td style="width: 10%;"></td> <td style="width: 10%;"></td> <td style="width: 10%;"></td> <td style="width: 10%;"></td> <td style="width: 10%;"></td> <td style="width: 10%;"></td> </tr> <tr> <td></td> <td></td> <td colspan="8" style="text-align: center;"> <table border="1" style="width: 100%; border-collapse: collapse; text-align: center;"> <tr> <td style="width: 10%;"></td> <td style="width: 10%;"></td> <td style="width: 10%;"></td> <td style="width: 10%;"></td> <td style="width: 10%;"></td> <td style="width: 10%;"></td> <td style="width: 10%;"></td> <td style="width: 10%;"></td> <td style="width: 10%;"></td> <td style="width: 10%;"></td> </tr> <tr> <td></td> <td></td> <td colspan="8" style="text-align: center;"> <table border="1" style="width: 100%; border-collapse: collapse; text-align: center;"> <tr> <td style="width: 10%;"></td> <td style="width: 10%;"></td> <td style="width: 10%;"></td> <td style="width: 10%;"></td> <td style="width: 10%;"></td> <td style="width: 10%;"></td> <td style="width: 10%;"></td> <td style="width: 10%;"></td> <td style="width: 10%;"></td> <td style="width: 10%;"></td> </tr> <tr> <td></td> <td></td> <td colspan="8" style="text-align: center;"> <table border="1" style="width: 100%; border-collapse: collapse; text-align: center;"> <tr> <td style="width: 10%;"></td> <td style="width: 10%;"></td> <td style="width: 10%;"></td> <td style="width: 10%;"></td> <td style="width: 10%;"></td> <td style="width: 10%;"></td> <td style="width: 10%;"></td> <td style="width: 10%;"></td> <td style="width: 10%;"></td> <td style="width: 10%;"></td> </tr> <tr> <td></td> <td></td> <td colspan="8" style="text-align: center;"> <table border="1" style="width: 100%; border-collapse: collapse; text-align: center;"> <tr> <td style="width: 10%;"></td> <td style="width: 10%;"></td> <td style="width: 10%;"></td> <td style="width: 10%;"></td> <td style="width: 10%;"></td> <td style="width: 10%;"></td> <td style="width: 10%;"></td> <td style="width: 10%;"></td> <td style="width: 10%;"></td> <td style="width: 10%;"></td> </tr> <tr> <td></td> <td></td> <td colspan="8" style="text-align: center;"> <table border="1" style="width: 100%; border-collapse: collapse; text-align: center;"> <tr> <td style="width: 10%;"></td> <td style="width: 10%;"></td> <td style="width: 10%;"></td> <td style="width: 10%;"></td> <td style="width: 10%;"></td> <td style="width: 10%;"></td> <td style="width: 10%;"></td> <td style="width: 10%;"></td> <td style="width: 10%;"></td> <td style="width: 10%;"></td> </tr> <tr> <td></td> <td></td> <td colspan="8" style="text-align: center;"> <table border="1" style="width: 100%; border-collapse: collapse; text-align: center;"> <tr> <td style="width: 10%;"></td> <td style="width: 10%;"></td> <td style="width: 10%;"></td> <td style="width: 10%;"></td> <td style="width: 10%;"></td> <td style="width: 10%;"></td> <td style="width: 10%;"></td> <td style="width: 10%;"></td> <td style="width: 10%;"></td> <td style="width: 10%;"></td> </tr> <tr> <td></td> <td></td> <td colspan="8" style="text-align: center;"> <table border="1" style="width: 100%; border-collapse: collapse; text-align: center;"> <tr> <td style="width: 10%;"></td> <td style="width: 10%;"></td> <td style="width: 10%;"></td> <td style="width: 10%;"></td> <td style="width: 10%;"></td> <td style="width: 10%;"></td> <td style="width: 10%;"></td> <td style="width: 10%;"></td> <td style="width: 10%;"></td> <td style="width: 10%;"></td> </tr> <tr> <td></td> <td></td> <td colspan="8" style="text-align: center;"> <table border="1" style="width: 100%; border-collapse: collapse; text-align: center;"> <tr> <td style="width: 10%;"></td> <td style="width: 10%;"></td> <td style="width: 10%;"></td> <td style="width: 10%;"></td> <td style="width: 10%;"></td> <td style="width: 10%;"></td> <td style="width: 10%;"></td> <td style="width: 10%;"></td> <td style="width: 10%;"></td> <td style="width: 10%;"></td> </tr> <tr> <td></td> <td></td> <td colspan="8" style="text-align: center;"> <table border="1" style="width: 100%; border-collapse: collapse; text-align: center;"> <tr> <td style="width: 10%;"></td> <td style="width: 10%;"></td> <td style="width: 10%;"></td> <td style="width: 10%;"></td> <td style="width: 10%;"></td> <td style="width: 10%;"></td> <td style="width: 10%;"></td> <td style="width: 10%;"></td> <td style="width: 10%;"></td> <td style="width: 10%;"></td> </tr> <tr> <td></td> <td></td> <td colspan="8" style="text-align: center;"> <table border="1" style="width: 100%; border-collapse: collapse; text-align: center;"> <tr> <td style="width: 10%;"></td> <td style="width: 10%;"></td> <td style="width: 10%;"></td> <td style="width: 10%;"></td> <td style="width: 10%;"></td> <td style="width: 10%;"></td> <td style="width: 10%;"></td> <td style="width: 10%;"></td> <td style="width: 10%;"></td> <td style="width: 10%;"></td> </tr> <tr> <td></td> <td></td> <td colspan="8" style="text-align: center;"> <table border="1" style="width: 100%; border-collapse: collapse; text-align: center;"> <tr> <td style="width: 10%;"></td> <td style="width: 10%;"></td> <td style="width: 10%;"></td> <td style="width: 10%;"></td> <td style="width: 10%;"></td> <td style="width: 10%;"></td> <td style="width: 10%;"></td> <td style="width: 10%;"></td> <td style="width: 10%;"></td> <td style="width: 10%;"></td> </tr> <tr> <td></td> <td></td> <td colspan="8" style="text-align: center;"> <table border="1" style="width: 100%; border-collapse: collapse; text-align: center;"> <tr> <td style="width: 10%;"></td> <td style="width: 10%;"></td> <td style="width: 10%;"></td> <td style="width: 10%;"></td> <td style="width: 10%;"></td> <td style="width: 10%;"></td> <td style="width: 10%;"></td> <td style="width: 10%;"></td> <td style="width: 10%;"></td> <td style="width: 10%;"></td> </tr> <tr> <td></td> <td></td> <td colspan="8" style="text-align: center;"> <table border="1" style="width: 100%; border-collapse: collapse; text-align: center;"> <tr> <td style="width: 10%;"></td> <td style="width: 10%;"></td> <td style="width: 10%;"></td> <td style="width: 10%;"></td> <td style="width: 10%;"></td> <td style="width: 10%;"></td> <td style="width: 10%;"></td> <td style="width: 10%;"></td> <td style="width: 10%;"></td> <td style="width: 10%;"></td> </tr> <tr> <td></td> <td></td> <td colspan="8" style="text-align: center;"> <table border="1" style="width: 100%; border-collapse: collapse; text-align: center;"> <tr> <td style="width: 10%;"></td> <td style="width: 10%;"></td> <td style="width: 10%;"></td> <td style="width: 10%;"></td> <td style="width: 10%;"></td> <td style="width: 10%;"></td> <td style="width: 10%;"></td> <td style="width: 10%;"></td> <td style="width: 10%;"></td> <td style="width: 10%;"></td> </tr> <tr> <td></td> <td></td> <td colspan="8" style="text-align: center;"> <table border="1" style="width: 100%; border-collapse: collapse; text-align: center;"> <tr> <td style="width: 10%;"></td> <td style="width: 10%;"></td> <td style="width: 10%;"></td> <td style="width: 10%;"></td> <td style="width: 10%;"></td> <td style="width: 10%;"></td> <td style="width: 10%;"></td> <td style="width: 10%;"></td> <td style="width: 10%;"></td> <td style="width: 10%;"></td> </tr> <tr> <td></td> <td></td> <td colspan="8" style="text-align: center;"> <table border="1" style="width: 100%; border-collapse: collapse; text-align: center;"> <tr> <td style="width: 10%;"></td> <td style="width: 10%;"></td> <td style="width: 10%;"></td> <td style="width: 10%;"></td> <td style="width: 10%;"></td> <td style="width: 10%;"></td> <td style="width: 10%;"></td> <td style="width: 10%;"></td> <td style="width: 10%;"></td> <td style="width: 10%;"></td> </tr> <tr> <td></td> <td></td> <td colspan="8" style="text-align: center;"> <table border="1"
style="width: 100%; border-collapse: collapse; text-align: center;"> <tr> <td style="width: 10%;"></td> <td style="width: 10%;"></td> <td style="width: 10%;"></td> <td style="width: 10%;"></td> <td style="width: 10%;"></td> <td style="width: 10%;"></td> <td style="width: 10%;"></td> <td style="width: 10%;"></td> <td style="width: 10%;"></td> <td style="width: 10%;"></td> </tr> <tr> <td></td> <td></td> <td colspan="8" style="text-align: center;"> <table border="1" style="width: 100%; border-collapse: collapse; text-align: center;"> <tr> <td style="width: 10%;"></td> <td style="width: 10%;"></td> <td style="width: 10%;"></td> <td style="width: 10%;"></td> <td style="width: 10%;"></td> <td style="width: 10%;"></td> <td style="width: 10%;"></td> <td style="width: 10%;"></td> <td style="width: 10%;"></td> <td style="width: 10%;"></td> </tr> <tr> <td></td> <td></td> <td colspan="8" style="text-align: center;"> <table border="1" style="width: 100%; border-collapse: collapse; text-align: center;"> <tr> <td style="width: 10%;"></td> <td style="width: 10%;"></td> <td style="width: 10%;"></td> <td style="width: 10%;"></td> <td style="width: 10%;"></td> <td style="width: 10%;"></td> <td style="width: 10%;"></td> <td style="width: 10%;"></td> <td style="width: 10%;"></td> <td style="width: 10%;"></td> </tr> <tr> <td></td> <td></td> <td colspan="8" style="text-align: center;"> <table border="1" style="width: 100%; border-collapse: collapse; text-align: center;"> <tr> <td style="width: 10%;"></td> <td style="width: 10%;"></td> <td style="width: 10%;"></td> <td style="width: 10%;"></td> <td style="width: 10%;"></td> <td style="width: 10%;"></td> <td style="width: 10%;"></td> <td style="width: 10%;"></td> <td style="width: 10%;"></td> <td style="width: 10%;"></td> </tr> <tr> <td></td> <td></td> <td colspan="8" style="text-align: center;"> <table border="1" style="width: 100%; border-collapse: collapse; text-align: center;"> <tr> <td style="width: 10%;"></td> <td style="width: 10%;"></td> <td style="width: 10%;"></td> <td style="width: 10%;"></td> <td style="width: 10%;"></td> <td style="width: 10%;"></td> <td style="width: 10%;"></td> <td style="width: 10%;"></td> <td style="width: 10%;"></td> <td style="width: 10%;"></td> </tr> <tr> <td></td> <td></td> <td colspan="8" style="text-align: center;"> <table border="1" style="width: 100%; border-collapse: collapse; text-align: center;"> <tr> <td style="width: 10%;"></td> <td style="width: 10%;"></td> <td style="width: 10%;"></td> <td style="width: 10%;"></td> <td style="width: 10%;"></td> <td style="width: 10%;"></td> <td style="width: 10%;"></td> <td style="width: 10%;"></td> <td style="width: 10%;"></td> <td style="width: 10%;"></td> </tr> <tr> <td></td> <td></td> <td colspan="8" style="text-align: center;"> <table border="1" style="width: 100%; border-collapse: collapse; text-align: center;"> <tr> <td style="width: 10%;"></td> <td style="width: 10%;"></td> <td style="width: 10%;"></td> <td style="width: 10%;"></td> <td style="width: 10%;"></td> <td style="width: 10%;"></td> <td style="width: 10%;"></td> <td style="width: 10%;"></td> <td style="width: 10%;"></td> <td style="width: 10%;"></td> </tr> <tr> <td></td> <td></td> <td colspan="8" style="text-align: center;"> <table border="1" style="width: 100%; border-collapse: collapse; text-align: center;"> <tr> <td style="width: 10%;"></td> <td style="width: 10%;"></td> <td style="width: 10%;"></td> <td style="width: 10%;"></td> <td style="width: 10%;"></td> <td style="width: 10%;"></td> <td style="width: 10%;"></td> <td style="width: 10%;"></td> <td style="width: 10%;"></td> <td style="width: 10%;"></td> </tr> <tr> <td></td> <td></td> <td colspan="8" style="text-align: center;"> <table border="1" style="width: 100%; border-collapse: collapse; text-align: center;"> <tr> <td style="width: 10%;"></td> <td style="width: 10%;"></td> <td style="width: 10%;"></td> <td style="width: 10%;"></td> <td style="width: 10%;"></td> <td style="width: 10%;"></td> <td style="width: 10%;"></td> <td style="width: 10%;"></td> <td style="width: 10%;"></td> <td style="width: 10%;"></td> </tr> <tr> <td></td> <td></td> <td colspan="8" style="text-align: center;"> <table border="1" style="width: 100%; border-collapse: collapse; text-align: center;"> <tr> <td style="width: 10%;"></td> <td style="width: 10%;"></td> <td style="width: 10%;"></td> <td style="width: 10%;"></td> <td style="width: 10%;"></td> <td style="width: 10%;"></td> <td style="width: 10%;"></td> <td style="width: 10%;"></td> <td style="width: 10%;"></td> <td style="width: 10%;"></td> </tr> <tr> <td></td> <td></td> <td colspan="8" style="text-align: center;"> <table border="1" style="width: 100%; border-collapse: collapse; text-align: center;"> <tr> <td style="width: 10%;"></td> <td style="width: 10%;"></td> <td style="width: 10%;"></td> <td style="width: 10%;"></td> <td style="width: 10%;"></td> <td style="width: 10%;"></td> <td style="width: 10%;"></td> <td style="width: 10%;"></td> <td style="width: 10%;"></td> <td style="width: 10%;"></td> </tr> <tr> <td></td> <td></td> <td colspan="8" style="text-align: center;"> <table border="1" style="width: 100%; border-collapse: collapse; text-align: center;"> <tr> <td style="width: 10%;"></td> <td style="width: 10%;"></td> <td style="width: 10%;"></td> <td style="width: 10%;"></td> <td style="width: 10%;"></td> <td style="width: 10%;"></td> <td style="width: 10%;"></td> <td style="width: 10%;"></td> <td style="width: 10%;"></td> <td style="width: 10%;"></td> </tr> <tr> <td></td> <td></td> <td colspan="8" style="text-align: center;"> <table border="1" style="width: 100%; border-collapse: collapse; text-align: center;"> <tr> <td style="width: 10%;"></td> <td style="width: 10%;"></td> <td style="width: 10%;"></td> <td style="width: 10%;"></td> <td style="width: 10%;"></td> <td style="width: 10%;"></td> <td style="width: 10%;"></td> <td style="width: 10%;"></td> <td style="width: 10%;"></td> <td style="width: 10%;"></td> </tr> <tr> <td></td> <td></td> <td colspan="8" style="text-align: center;"> <table border="1" style="width: 100%; border-collapse: collapse; text-align: center;"> <tr> <td style="width: 10%;"></td> <td style="width: 10%;"></td> <td style="width: 10%;"></td> <td style="width: 10%;"></td> <td style="width: 10%;"></td> <td style="width: 10%;"></td> <td style="width: 10%;"></td> <td style="width: 10%;"></td> <td style="width: 10%;"></td> <td style="width: 10%;"></td> </tr> <tr> <td></td> <td></td> <td colspan="8" style="text-align: center;"> <table border="1" style="width: 100%; border-collapse: collapse; text-align: center;"> <tr> <td style="width: 10%;"></td> <td style="width: 10%;"></td> <td style="width: 10%;"></td> <td style="width: 10%;"></td> <td style="width: 10%;"></td> <td style="width: 10%;"></td> <td style="width: 10%;"></td> <td style="width: 10%;"></td> <td style="width: 10%;"></td> <td style="width: 10%;"></td> </tr> <tr> <td></td> <td></td> <td colspan="8" style="text-align: center;"> <table border="1" style="width: 100%; border-collapse: collapse; text-align: center;"> <tr> <td style="width: 10%;"></td> <td style="width: 10%;"></td> <td style="width: 10%;"></td> <td style="width: 10%;"></td> <td style="width: 10%;"></td> <td style="width: 10%;"></td> <td style="width: 10%;"></td> <td style="width: 10%;"></td> <td style="width: 10%;"></td> <td style="width: 10%;"></td> </tr> <tr> <td></td> <td></td> <td colspan="8" style="text-align: center;"> <table border="1" style="width: 100%; border-collapse: collapse; text-align: center;"> <tr> <td style="width: 10%;"></td> <td style="width: 10%;"></td> <td style="width: 10%;"></td> <td style="width: 10%;"></td> <td style="width: 10%;"></td> <td style="width: 10%;"></td> <td style="width: 10%;"></td> <td style="width: 10%;"></td> <td style="width: 10%;"></td> <td style="width: 10%;"></td> </tr> <tr> <td></td> <td></td> <td colspan="8" style="text-align: center;"> <table border="1" style="width: 100%; border-collapse: collapse; text-align: center;"> <tr> <td style="width: 10%;"></td> <td style="width: 10%;"></td> <td style="width: 10%;"></td> <td style="width: 10%;"></td> <td style="width: 10%;"></td> <td style="width: 10%;"></td> <td style="width: 10%;"></td> <td style="width: 10%;"></td> <td style="width: 10%;"></td> <td style="width: 10%;"></td> </tr> <tr> <td></td> <td></td> <td colspan="8" style="text-align: center;"> <table border="1" style="width: 100%; border-collapse: collapse; text-align: center;"> <tr> </tr></table></td></tr></table></td></tr></table></td></tr></table></td></tr></table></td></tr></table></td></tr></table></td></tr></table></td></tr></table></td></tr></table></td></tr></table></td></tr></table></td></tr></table></td></tr></table></td></tr></table></td></tr></table></td></tr></table></td></tr></table></td></tr></table></td></tr></table></td></tr></table></td></tr></table></td></tr></table></td></tr></table></td></tr></table></td></tr></table></td></tr></table></td></tr></table></td></tr></table></td></tr></table></td></tr></table></td></tr></table></td></tr></table></td></tr></table></td></tr></table></td></tr></table></td></tr></table></td></tr></table></td></tr></table></td></tr></table></td></tr></table></td></tr></table></td></tr></table></td></tr></table></td></tr></table></td></tr></table></td></tr></table></td></tr></table></td></tr></table></td></tr></table></td></tr></table>
 | | | | | | | | | | | | | | | | | | | | <table border="1" style="width: 100%; border-collapse: collapse; text-align: center;"> <tr> <td style="width: 10%;"></td> <td style="width: 10%;"></td> <td style="width: 10%;"></td> <td style="width: 10%;"></td> <td style="width: 10%;"></td> <td style="width: 10%;"></td> <td style="width: 10%;"></td> <td style="width: 10%;"></td> <td style="width: 10%;"></td> <td style="width: 10%;"></td> </tr> <tr> <td></td> <td></td> <td colspan="8" style="text-align: center;"> <table border="1" style="width: 100%; border-collapse: collapse; text-align: center;"> <tr> <td style="width: 10%;"></td> <td style="width: 10%;"></td> <td style="width: 10%;"></td> <td style="width: 10%;"></td> <td style="width: 10%;"></td> <td style="width: 10%;"></td> <td style="width: 10%;"></td> <td style="width: 10%;"></td> <td style="width: 10%;"></td> <td style="width: 10%;"></td> </tr> <tr> <td></td> <td></td> <td colspan="8" style="text-align: center;"> <table border="1" style="width: 100%; border-collapse: collapse; text-align: center;"> <tr> <td style="width: 10%;"></td> <td style="width: 10%;"></td> <td style="width: 10%;"></td> <td style="width: 10%;"></td> <td style="width: 10%;"></td> <td style="width: 10%;"></td> <td style="width: 10%;"></td> <td style="width: 10%;"></td> <td style="width: 10%;"></td> <td style="width: 10%;"></td> </tr> <tr> <td></td> <td></td> <td colspan="8" style="text-align: center;"> <table border="1" style="width: 100%; border-collapse: collapse; text-align: center;"> <tr> <td style="width: 10%;"></td> <td style="width: 10%;"></td> <td style="width: 10%;"></td> <td style="width: 10%;"></td> <td style="width: 10%;"></td> <td style="width: 10%;"></td> <td style="width: 10%;"></td> <td style="width: 10%;"></td> <td style="width: 10%;"></td> <td style="width: 10%;"></td> </tr> <tr> <td></td> <td></td> <td colspan="8" style="text-align: center;"> <table border="1" style="width: 100%; border-collapse: collapse; text-align: center;"> <tr> <td style="width: 10%;"></td> <td style="width: 10%;"></td> <td style="width: 10%;"></td> <td style="width: 10%;"></td> <td style="width: 10%;"></td> <td style="width: 10%;"></td> <td style="width: 10%;"></td> <td style="width: 10%;"></td> <td style="width: 10%;"></td> <td style="width: 10%;"></td> </tr> <tr> <td></td> <td></td> <td colspan="8" style="text-align: center;"> <table border="1" style="width: 100%; border-collapse: collapse; text-align: center;"> <tr> <td style="width: 10%;"></td> <td style="width: 10%;"></td> <td style="width: 10%;"></td> <td style="width: 10%;"></td> <td style="width: 10%;"></td> <td style="width: 10%;"></td> <td style="width: 10%;"></td> <td style="width: 10%;"></td> <td style="width: 10%;"></td> <td style="width: 10%;"></td> </tr> <tr> <td></td> <td></td> <td colspan="8" style="text-align: center;"> <table border="1" style="width: 100%; border-collapse: collapse; text-align: center;"> <tr> <td style="width: 10%;"></td> <td style="width: 10%;"></td> <td style="width: 10%;"></td> <td style="width: 10%;"></td> <td style="width: 10%;"></td> <td style="width: 10%;"></td> <td style="width: 10%;"></td> <td style="width: 10%;"></td> <td style="width: 10%;"></td> <td style="width: 10%;"></td> </tr> <tr> <td></td> <td></td> <td colspan="8" style="text-align: center;"> <table border="1" style="width: 100%; border-collapse: collapse; text-align: center;"> <tr> <td style="width: 10%;"></td> <td style="width: 10%;"></td> <td style="width: 10%;"></td> <td style="width: 10%;"></td> <td style="width: 10%;"></td> <td style="width: 10%;"></td> <td style="width: 10%;"></td> <td style="width: 10%;"></td> <td style="width: 10%;"></td> <td style="width: 10%;"></td> </tr> <tr> <td></td> <td></td> <td colspan="8" style="text-align: center;"> <table border="1" style="width: 100%; border-collapse: collapse; text-align: center;"> <tr> <td style="width: 10%;"></td> <td style="width: 10%;"></td> <td style="width: 10%;"></td> <td style="width: 10%;"></td> <td style="width: 10%;"></td> <td style="width: 10%;"></td> <td style="width: 10%;"></td> <td style="width: 10%;"></td> <td style="width: 10%;"></td> <td style="width: 10%;"></td> </tr> <tr> <td></td> <td></td> <td colspan="8" style="text-align: center;"> <table border="1" style="width: 100%; border-collapse: collapse; text-align: center;"> <tr> <td style="width: 10%;"></td> <td style="width: 10%;"></td> <td style="width: 10%;"></td> <td style="width: 10%;"></td> <td style="width: 10%;"></td> <td style="width: 10%;"></td> <td style="width: 10%;"></td> <td style="width: 10%;"></td> <td style="width: 10%;"></td> <td style="width: 10%;"></td> </tr> <tr> <td></td> <td></td> <td colspan="8" style="text-align: center;"> <table border="1" style="width: 100%; border-collapse: collapse; text-align: center;"> <tr> <td style="width: 10%;"></td> <td style="width: 10%;"></td> <td style="width: 10%;"></td> <td style="width: 10%;"></td> <td style="width: 10%;"></td> <td style="width: 10%;"></td> <td style="width: 10%;"></td> <td style="width: 10%;"></td> <td style="width: 10%;"></td> <td style="width: 10%;"></td> </tr> <tr> <td></td> <td></td> <td colspan="8" style="text-align: center;"> <table border="1" style="width: 100%; border-collapse: collapse; text-align: center;"> <tr> <td style="width: 10%;"></td> <td style="width: 10%;"></td> <td style="width: 10%;"></td> <td style="width: 10%;"></td> <td style="width: 10%;"></td> <td style="width: 10%;"></td> <td style="width: 10%;"></td> <td style="width: 10%;"></td> <td style="width: 10%;"></td> <td style="width: 10%;"></td> </tr> <tr> <td></td> <td></td> <td colspan="8" style="text-align: center;"> <table border="1" style="width: 100%; border-collapse: collapse; text-align: center;"> <tr> <td style="width: 10%;"></td> <td style="width: 10%;"></td> <td style="width: 10%;"></td> <td style="width: 10%;"></td> <td style="width: 10%;"></td> <td style="width: 10%;"></td> <td style="width: 10%;"></td> <td style="width: 10%;"></td> <td style="width: 10%;"></td> <td style="width: 10%;"></td> </tr> <tr> <td></td> <td></td> <td colspan="8" style="text-align: center;"> <table border="1" style="width: 100%; border-collapse: collapse; text-align: center;"> <tr> <td style="width: 10%;"></td> <td style="width: 10%;"></td> <td style="width: 10%;"></td> <td style="width: 10%;"></td> <td style="width: 10%;"></td> <td style="width: 10%;"></td> <td style="width: 10%;"></td> <td style="width: 10%;"></td> <td style="width: 10%;"></td> <td style="width: 10%;"></td> </tr> <tr> <td></td> <td></td> <td colspan="8" style="text-align: center;"> <table border="1" style="width: 100%; border-collapse: collapse; text-align: center;"> <tr> <td style="width: 10%;"></td> <td style="width: 10%;"></td> <td style="width: 10%;"></td> <td style="width: 10%;"></td> <td style="width: 10%;"></td> <td style="width: 10%;"></td> <td style="width: 10%;"></td> <td style="width: 10%;"></td> <td style="width: 10%;"></td> <td style="width: 10%;"></td> </tr> <tr> <td></td> <td></td> <td colspan="8" style="text-align: center;"> <table border="1" style="width: 100%; border-collapse: collapse; text-align: center;"> <tr> <td style="width: 10%;"></td> <td style="width: 10%;"></td> <td style="width: 10%;"></td> <td style="width: 10%;"></td> <td style="width: 10%;"></td> <td style="width: 10%;"></td> <td style="width: 10%;"></td> <td style="width: 10%;"></td> <td style="width: 10%;"></td> <td style="width: 10%;"></td> </tr> <tr> <td></td> <td></td> <td colspan="8" style="text-align: center;"> <table border="1" style="width: 100%; border-collapse: collapse; text-align: center;"> <tr> <td style="width: 10%;"></td> <td style="width: 10%;"></td> <td style="width: 10%;"></td> <td style="width: 10%;"></td> <td style="width: 10%;"></td> <td style="width: 10%;"></td> <td style="width: 10%;"></td> <td style="width: 10%;"></td> <td style="width: 10%;"></td> <td style="width: 10%;"></td> </tr> <tr> <td></td> <td></td> <td colspan="8" style="text-align: center;"> <table border="1" style="width: 100%; border-collapse: collapse; text-align: center;"> <tr> <td style="width: 10%;"></td> <td style="width: 10%;"></td> <td style="width: 10%;"></td> <td style="width: 10%;"></td> <td style="width: 10%;"></td> <td style="width: 10%;"></td> <td style="width: 10%;"></td> <td style="width: 10%;"></td> <td style="width: 10%;"></td> <td style="width: 10%;"></td> </tr> <tr> <td></td> <td></td> <td colspan="8" style="text-align: center;"> <table border="1" style="width: 100%; border-collapse: collapse; text-align: center;"> <tr> <td style="width: 10%;"></td> <td style="width: 10%;"></td> <td style="width: 10%;"></td> <td style="width: 10%;"></td> <td style="width: 10%;"></td> <td style="width: 10%;"></td> <td style="width: 10%;"></td> <td style="width: 10%;"></td> <td style="width: 10%;"></td> <td style="width: 10%;"></td> </tr> <tr> <td></td> <td></td> <td colspan="8" style="text-align: center;"> <table border="1" style="width: 100%; border-collapse: collapse; text-align: center;"> <tr> <td style="width: 10%;"></td> <td style="width: 10%;"></td> <td style="width: 10%;"></td> <td style="width: 10%;"></td> <td style="width: 10%;"></td> <td style="width: 10%;"></td> <td style="width: 10%;"></td> <td style="width: 10%;"></td> <td style="width: 10%;"></td> <td style="width: 10%;"></td> </tr> <tr> <td></td> <td></td> <td colspan="8" style="text-align: center;"> <table border="1" style="width: 100%; border-collapse: collapse; text-align: center;"> <tr> <td style="width: 10%;"></td> <td style="width: 10%;"></td> <td style="width: 10%;"></td> <td
style="width: 10%;"></td> <td style="width: 10%;"></td> <td style="width: 10%;"></td> <td style="width: 10%;"></td> <td style="width: 10%;"></td> <td style="width: 10%;"></td> <td style="width: 10%;"></td> </tr> <tr> <td></td> <td></td> <td colspan="8" style="text-align: center;"> <table border="1" style="width: 100%; border-collapse: collapse; text-align: center;"> <tr> <td style="width: 10%;"></td> <td style="width: 10%;"></td> <td style="width: 10%;"></td> <td style="width: 10%;"></td> <td style="width: 10%;"></td> <td style="width: 10%;"></td> <td style="width: 10%;"></td> <td style="width: 10%;"></td> <td style="width: 10%;"></td> <td style="width: 10%;"></td> </tr> <tr> <td></td> <td></td> <td colspan="8" style="text-align: center;"> <table border="1" style="width: 100%; border-collapse: collapse; text-align: center;"> <tr> <td style="width: 10%;"></td> <td style="width: 10%;"></td> <td style="width: 10%;"></td> <td style="width: 10%;"></td> <td style="width: 10%;"></td> <td style="width: 10%;"></td> <td style="width: 10%;"></td> <td style="width: 10%;"></td> <td style="width: 10%;"></td> <td style="width: 10%;"></td> </tr> <tr> <td></td> <td></td> <td colspan="8" style="text-align: center;"> <table border="1" style="width: 100%; border-collapse: collapse; text-align: center;"> <tr> <td style="width: 10%;"></td> <td style="width: 10%;"></td> <td style="width: 10%;"></td> <td style="width: 10%;"></td> <td style="width: 10%;"></td> <td style="width: 10%;"></td> <td style="width: 10%;"></td> <td style="width: 10%;"></td> <td style="width: 10%;"></td> <td style="width: 10%;"></td> </tr> <tr> <td></td> <td></td> <td colspan="8" style="text-align: center;"> <table border="1" style="width: 100%; border-collapse: collapse; text-align: center;"> <tr> <td style="width: 10%;"></td> <td style="width: 10%;"></td> <td style="width: 10%;"></td> <td style="width: 10%;"></td> <td style="width: 10%;"></td> <td style="width: 10%;"></td> <td style="width: 10%;"></td> <td style="width: 10%;"></td> <td style="width: 10%;"></td> <td style="width: 10%;"></td> </tr> <tr> <td></td> <td></td> <td colspan="8" style="text-align: center;"> <table border="1" style="width: 100%; border-collapse: collapse; text-align: center;"> <tr> <td style="width: 10%;"></td> <td style="width: 10%;"></td> <td style="width: 10%;"></td> <td style="width: 10%;"></td> <td style="width: 10%;"></td> <td style="width: 10%;"></td> <td style="width: 10%;"></td> <td style="width: 10%;"></td> <td style="width: 10%;"></td> <td style="width: 10%;"></td> </tr> <tr> <td></td> <td></td> <td colspan="8" style="text-align: center;"> <table border="1" style="width: 100%; border-collapse: collapse; text-align: center;"> <tr> <td style="width: 10%;"></td> <td style="width: 10%;"></td> <td style="width: 10%;"></td> <td style="width: 10%;"></td> <td style="width: 10%;"></td> <td style="width: 10%;"></td> <td style="width: 10%;"></td> <td style="width: 10%;"></td> <td style="width: 10%;"></td> <td style="width: 10%;"></td> </tr> <tr> <td></td> <td></td> <td colspan="8" style="text-align: center;"> <table border="1" style="width: 100%; border-collapse: collapse; text-align: center;"> <tr> <td style="width: 10%;"></td> <td style="width: 10%;"></td> <td style="width: 10%;"></td> <td style="width: 10%;"></td> <td style="width: 10%;"></td> <td style="width: 10%;"></td> <td style="width: 10%;"></td> <td style="width: 10%;"></td> <td style="width: 10%;"></td> <td style="width: 10%;"></td> </tr> <tr> <td></td> <td></td> <td colspan="8" style="text-align: center;"> <table border="1" style="width: 100%; border-collapse: collapse; text-align: center;"> <tr> <td style="width: 10%;"></td> <td style="width: 10%;"></td> <td style="width: 10%;"></td> <td style="width: 10%;"></td> <td style="width: 10%;"></td> <td style="width: 10%;"></td> <td style="width: 10%;"></td> <td style="width: 10%;"></td> <td style="width: 10%;"></td> <td style="width: 10%;"></td> </tr> <tr> <td></td> <td></td> <td colspan="8" style="text-align: center;"> <table border="1" style="width: 100%; border-collapse: collapse; text-align: center;"> <tr> <td style="width: 10%;"></td> <td style="width: 10%;"></td> <td style="width: 10%;"></td> <td style="width: 10%;"></td> <td style="width: 10%;"></td> <td style="width: 10%;"></td> <td style="width: 10%;"></td> <td style="width: 10%;"></td> <td style="width: 10%;"></td> <td style="width: 10%;"></td> </tr> <tr> <td></td> <td></td> <td colspan="8" style="text-align: center;"> <table border="1" style="width: 100%; border-collapse: collapse; text-align: center;"> <tr> <td style="width: 10%;"></td> <td style="width: 10%;"></td> <td style="width: 10%;"></td> <td style="width: 10%;"></td> <td style="width: 10%;"></td> <td style="width: 10%;"></td> <td style="width: 10%;"></td> <td style="width: 10%;"></td> <td style="width: 10%;"></td> <td style="width: 10%;"></td> </tr> <tr> <td></td> <td></td> <td colspan="8" style="text-align: center;"> <table border="1" style="width: 100%; border-collapse: collapse; text-align: center;"> <tr> <td style="width: 10%;"></td> <td style="width: 10%;"></td> <td style="width: 10%;"></td> <td style="width: 10%;"></td> <td style="width: 10%;"></td> <td style="width: 10%;"></td> <td style="width: 10%;"></td> <td style="width: 10%;"></td> <td style="width: 10%;"></td> <td style="width: 10%;"></td> </tr> <tr> <td></td> <td></td> <td colspan="8" style="text-align: center;"> <table border="1" style="width: 100%; border-collapse: collapse; text-align: center;"> <tr> <td style="width: 10%;"></td> <td style="width: 10%;"></td> <td style="width: 10%;"></td> <td style="width: 10%;"></td> <td style="width: 10%;"></td> <td style="width: 10%;"></td> <td style="width: 10%;"></td> <td style="width: 10%;"></td> <td style="width: 10%;"></td> <td style="width: 10%;"></td> </tr> <tr> <td></td> <td></td> <td colspan="8" style="text-align: center;"> <table border="1" style="width: 100%; border-collapse: collapse; text-align: center;"> <tr> <td style="width: 10%;"></td> <td style="width: 10%;"></td> <td style="width: 10%;"></td> <td style="width: 10%;"></td> <td style="width: 10%;"></td> <td style="width: 10%;"></td> <td style="width: 10%;"></td> <td style="width: 10%;"></td> <td style="width: 10%;"></td> <td style="width: 10%;"></td> </tr> <tr> <td></td> <td></td> <td colspan="8" style="text-align: center;"> <table border="1" style="width: 100%; border-collapse: collapse; text-align: center;"> <tr> <td style="width: 10%;"></td> <td style="width: 10%;"></td> <td style="width: 10%;"></td> <td style="width: 10%;"></td> <td style="width: 10%;"></td> <td style="width: 10%;"></td> <td style="width: 10%;"></td> <td style="width: 10%;"></td> <td style="width: 10%;"></td> <td style="width: 10%;"></td> </tr> <tr> <td></td> <td></td> <td colspan="8" style="text-align: center;"> <table border="1" style="width: 100%; border-collapse: collapse; text-align: center;"> <tr> <td style="width: 10%;"></td> <td style="width: 10%;"></td> <td style="width: 10%;"></td> <td style="width: 10%;"></td> <td style="width: 10%;"></td> <td style="width: 10%;"></td> <td style="width: 10%;"></td> <td style="width: 10%;"></td> <td style="width: 10%;"></td> <td style="width: 10%;"></td> </tr> <tr> <td></td> <td></td> <td colspan="8" style="text-align: center;"> <table border="1" style="width: 100%; border-collapse: collapse; text-align: center;"> <tr> <td style="width: 10%;"></td> <td style="width: 10%;"></td> <td style="width: 10%;"></td> <td style="width: 10%;"></td> <td style="width: 10%;"></td> <td style="width: 10%;"></td> <td style="width: 10%;"></td> <td style="width: 10%;"></td> <td style="width: 10%;"></td> <td style="width: 10%;"></td> </tr> <tr> <td></td> <td></td> <td colspan="8" style="text-align: center;"> <table border="1" style="width: 100%; border-collapse: collapse; text-align: center;"> <tr> <td style="width: 10%;"></td> <td style="width: 10%;"></td> <td style="width: 10%;"></td> <td style="width: 10%;"></td> <td style="width: 10%;"></td> <td style="width: 10%;"></td> <td style="width: 10%;"></td> <td style="width: 10%;"></td> <td style="width: 10%;"></td> <td style="width: 10%;"></td> </tr> <tr> <td></td> <td></td> <td colspan="8" style="text-align: center;"> <table border="1" style="width: 100%; border-collapse: collapse; text-align: center;"> <tr> <td style="width: 10%;"></td> <td style="width: 10%;"></td> <td style="width: 10%;"></td> <td style="width: 10%;"></td> <td style="width: 10%;"></td> <td style="width: 10%;"></td> <td style="width: 10%;"></td> <td style="width: 10%;"></td> <td style="width: 10%;"></td> <td style="width: 10%;"></td> </tr> <tr> <td></td> <td></td> <td colspan="8" style="text-align: center;"> <table border="1" style="width: 100%; border-collapse: collapse; text-align: center;"> <tr> <td style="width: 10%;"></td> <td style="width: 10%;"></td> <td style="width: 10%;"></td> <td style="width: 10%;"></td> <td style="width: 10%;"></td> <td style="width: 10%;"></td> <td style="width: 10%;"></td> <td style="width: 10%;"></td> <td style="width: 10%;"></td> <td style="width: 10%;"></td> </tr> <tr> <td></td> <td></td> <td colspan="8" style="text-align: center;"> <table border="1" style="width: 100%; border-collapse: collapse; text-align: center;"> <tr> <td style="width: 10%;"></td> <td style="width: 10%;"></td> <td style="width: 10%;"></td> <td style="width: 10%;"></td> <td style="width: 10%;"></td> <td style="width: 10%;"></td> <td style="width: 10%;"></td> <td style="width: 10%;"></td> <td style="width: 10%;"></td> <td style="width: 10%;"></td> </tr> <tr> <td></td> <td></td> <td colspan="8" style="text-align: center;"> <table border="1" style="width: 100%; border-collapse: collapse; text-align: center;"> <tr> <td style="width: 10%;"></td> <td style="width: 10%;"></td> <td style="width: 10%;"></td> <td style="width: 10%;"></td> <td style="width: 10%;"></td> <td style="width: 10%;"></td> <td style="width: 10%;"></td> <td style="width: 10%;"></td> <td style="width:
10%;"></td> <td style="width: 10%;"></td> </tr> <tr> <td></td> <td></td> <td colspan="8" style="text-align: center;"> <table border="1" style="width: 100%; border-collapse: collapse; text-align: center;"> <tr> <td style="width: 10%;"></td> <td style="width: 10%;"></td> <td style="width: 10%;"></td> <td style="width: 10%;"></td> <td style="width: 10%;"></td> <td style="width: 10%;"></td> <td style="width: 10%;"></td> <td style="width: 10%;"></td> <td style="width: 10%;"></td> <td style="width: 10%;"></td> </tr> <tr> <td></td> <td></td> <td colspan="8" style="text-align: center;"> <table border="1" style="width: 100%; border-collapse: collapse; text-align: center;"> <tr> <td style="width: 10%;"></td> <td style="width: 10%;"></td> <td style="width: 10%;"></td> <td style="width: 10%;"></td> <td style="width: 10%;"></td> <td style="width: 10%;"></td> <td style="width: 10%;"></td> <td style="width: 10%;"></td> <td style="width: 10%;"></td> <td style="width: 10%;"></td> </tr> <tr> <td></td> <td></td> <td colspan="8" style="text-align: center;"> <table border="1" style="width: 100%; border-collapse: collapse; text-align: center;"> <tr> <td style="width: 10%;"></td> <td style="width: 10%;"></td> <td style="width: 10%;"></td> <td style="width: 10%;"></td> <td style="width: 10%;"></td> <td style="width: 10%;"></td> <td style="width: 10%;"></td> <td style="width: 10%;"></td> <td style="width: 10%;"></td> <td style="width: 10%;"></td> </tr> <tr> <td></td> <td></td> <td colspan="8" style="text-align: center;"> <table border="1" style="width: 100%; border-collapse: collapse; text-align: center;"> <tr> <td style="width: 10%;"></td> <td style="width: 10%;"></td> <td style="width: 10%;"></td> <td style="width: 10%;"></td> <td style="width: 10%;"></td> <td style="width: 10%;"></td> <td style="width: 10%;"></td> <td style="width: 10%;"></td> <td style="width: 10%;"></td> <td style="width: 10%;"></td> </tr> <tr> <td></td> <td></td> <td colspan="8" style="text-align: center;"> <table border="1" style="width: 100%; border-collapse: collapse; text-align: center;"> <tr> <td style="width: 10%;"></td> <td style="width: 10%;"></td> <td style="width: 10%;"></td> <td style="width: 10%;"></td> <td style="width: 10%;"></td> <td style="width: 10%;"></td> <td style="width: 10%;"></td> <td style="width: 10%;"></td> <td style="width: 10%;"></td> <td style="width: 10%;"></td> </tr> <tr> <td></td> <td></td> <td colspan="8" style="text-align: center;"> <table border="1" style="width: 100%; border-collapse: collapse; text-align: center;"> <tr> <td style="width: 10%;"></td> <td style="width: 10%;"></td> <td style="width: 10%;"></td> <td style="width: 10%;"></td> <td style="width: 10%;"></td> <td style="width: 10%;"></td> <td style="width: 10%;"></td> <td style="width: 10%;"></td> <td style="width: 10%;"></td> <td style="width: 10%;"></td> </tr> <tr> <td></td> <td></td> <td colspan="8" style="text-align: center;"> <table border="1" style="width: 100%; border-collapse: collapse; text-align: center;"> <tr> <td style="width: 10%;"></td> <td style="width: 10%;"></td> <td style="width: 10%;"></td> <td style="width: 10%;"></td> <td style="width: 10%;"></td> <td style="width: 10%;"></td> <td style="width: 10%;"></td> <td style="width: 10%;"></td> <td style="width: 10%;"></td> <td style="width: 10%;"></td> </tr> <tr> <td></td> <td></td> <td colspan="8" style="text-align: center;"> <table border="1" style="width: 100%; border-collapse: collapse; text-align: center;"> <tr> </tr></table></td></tr></table></td></tr></table></td></tr></table></td></tr></table></td></tr></table></td></tr></table></td></tr></table></td></tr></table></td></tr></table></td></tr></table></td></tr></table></td></tr></table></td></tr></table></td></tr></table></td></tr></table></td></tr></table></td></tr></table></td></tr></table></td></tr></table></td></tr></table></td></tr></table></td></tr></table></td></tr></table></td></tr></table></td></tr></table></td></tr></table></td></tr></table></td></tr></table></td></tr></table></td></tr></table></td></tr></table></td></tr></table></td></tr></table></td></tr></table></td></tr></table></td></tr></table></td></tr></table></td></tr></table></td></tr></table></td></tr></table></td></tr></table></td></tr></table></td></tr></table></td></tr></table></td></tr></table></td></tr></table></td></tr></table></td></tr></table></td></tr></table> | | | | | | | | | | | | | | | | | | | | <table border="1" style="width: 100%; border-collapse: collapse; text-align: center;"> <tr> <td style="width: 10%;"></td> <td style="width: 10%;"></td> <td style="width: 10%;"></td> <td style="width: 10%;"></td> <td style="width: 10%;"></td> <td style="width: 10%;"></td> <td style="width: 10%;"></td> <td style="width: 10%;"></td> <td style="width: 10%;"></td> <td style="width: 10%;"></td> </tr> <tr> <td></td> <td></td> <td colspan="8" style="text-align: center;"> <table border="1" style="width: 100%; border-collapse: collapse; text-align: center;"> <tr> <td style="width: 10%;"></td> <td style="width: 10%;"></td> <td style="width: 10%;"></td> <td style="width: 10%;"></td> <td style="width: 10%;"></td> <td style="width: 10%;"></td> <td style="width: 10%;"></td> <td style="width: 10%;"></td> <td style="width: 10%;"></td> <td style="width: 10%;"></td> </tr> <tr> <td></td> <td></td> <td colspan="8" style="text-align: center;"> <table border="1" style="width: 100%; border-collapse: collapse; text-align: center;"> <tr> <td style="width: 10%;"></td> <td style="width: 10%;"></td> <td style="width: 10%;"></td> <td style="width: 10%;"></td> <td style="width: 10%;"></td> <td style="width: 10%;"></td> <td style="width: 10%;"></td> <td style="width: 10%;"></td> <td style="width: 10%;"></td> <td style="width: 10%;"></td> </tr> <tr> <td></td> <td></td> <td colspan="8" style="text-align: center;"> <table border="1" style="width: 100%; border-collapse: collapse; text-align: center;"> <tr> <td style="width: 10%;"></td> <td style="width: 10%;"></td> <td style="width: 10%;"></td> <td style="width: 10%;"></td> <td style="width: 10%;"></td> <td style="width: 10%;"></td> <td style="width: 10%;"></td> <td style="width: 10%;"></td> <td style="width: 10%;"></td> <td style="width: 10%;"></td> </tr> <tr> <td></td> <td></td> <td colspan="8" style="text-align: center;"> <table border="1" style="width: 100%; border-collapse: collapse; text-align: center;"> <tr> <td style="width: 10%;"></td> <td style="width: 10%;"></td> <td style="width: 10%;"></td> <td style="width: 10%;"></td> <td style="width: 10%;"></td> <td style="width: 10%;"></td> <td style="width: 10%;"></td> <td style="width: 10%;"></td> <td style="width: 10%;"></td> <td style="width: 10%;"></td> </tr> <tr> <td></td> <td></td> <td colspan="8" style="text-align: center;"> <table border="1" style="width: 100%; border-collapse: collapse; text-align: center;"> <tr> <td style="width: 10%;"></td> <td style="width: 10%;"></td> <td style="width: 10%;"></td> <td style="width: 10%;"></td> <td style="width: 10%;"></td> <td style="width: 10%;"></td> <td style="width: 10%;"></td> <td style="width: 10%;"></td> <td style="width: 10%;"></td> <td style="width: 10%;"></td> </tr> <tr> <td></td> <td></td> <td colspan="8" style="text-align: center;"> <table border="1" style="width: 100%; border-collapse: collapse; text-align: center;"> <tr> <td style="width: 10%;"></td> <td style="width: 10%;"></td> <td style="width: 10%;"></td> <td style="width: 10%;"></td> <td style="width: 10%;"></td> <td style="width: 10%;"></td> <td style="width: 10%;"></td> <td style="width: 10%;"></td> <td style="width: 10%;"></td> <td style="width: 10%;"></td> </tr> <tr> <td></td> <td></td> <td colspan="8" style="text-align: center;"> <table border="1" style="width: 100%; border-collapse: collapse; text-align: center;"> <tr> <td style="width: 10%;"></td> <td style="width: 10%;"></td> <td style="width: 10%;"></td> <td style="width: 10%;"></td> <td style="width: 10%;"></td> <td style="width: 10%;"></td> <td style="width: 10%;"></td> <td style="width: 10%;"></td> <td style="width: 10%;"></td> <td style="width: 10%;"></td> </tr> <tr> <td></td> <td></td> <td colspan="8" style="text-align: center;"> <table border="1" style="width: 100%; border-collapse: collapse; text-align: center;"> <tr> <td style="width: 10%;"></td> <td style="width: 10%;"></td> <td style="width: 10%;"></td> <td style="width: 10%;"></td> <td style="width: 10%;"></td> <td style="width: 10%;"></td> <td style="width: 10%;"></td> <td style="width: 10%;"></td> <td style="width: 10%;"></td> <td style="width: 10%;"></td> </tr> <tr> <td></td> <td></td> <td colspan="8" style="text-align: center;"> <table border="1" style="width: 100%; border-collapse: collapse; text-align: center;"> <tr> <td style="width: 10%;"></td> <td style="width: 10%;"></td> <td style="width: 10%;"></td> <td style="width: 10%;"></td> <td style="width: 10%;"></td> <td style="width: 10%;"></td> <td style="width: 10%;"></td> <td style="width: 10%;"></td> <td style="width: 10%;"></td> <td
style="width: 10%;"></td> </tr> <tr> <td></td> <td></td> <td colspan="8" style="text-align: center;"> <table border="1" style="width: 100%; border-collapse: collapse; text-align: center;"> <tr> <td style="width: 10%;"></td> <td style="width: 10%;"></td> <td style="width: 10%;"></td> <td style="width: 10%;"></td> <td style="width: 10%;"></td> <td style="width: 10%;"></td> <td style="width: 10%;"></td> <td style="width: 10%;"></td> <td style="width: 10%;"></td> <td style="width: 10%;"></td> </tr> <tr> <td></td> <td></td> <td colspan="8" style="text-align: center;"> <table border="1" style="width: 100%; border-collapse: collapse; text-align: center;"> <tr> <td style="width: 10%;"></td> <td style="width: 10%;"></td> <td style="width: 10%;"></td> <td style="width: 10%;"></td> <td style="width: 10%;"></td> <td style="width: 10%;"></td> <td style="width: 10%;"></td> <td style="width: 10%;"></td> <td style="width: 10%;"></td> <td style="width: 10%;"></td> </tr> <tr> <td></td> <td></td> <td colspan="8" style="text-align: center;"> <table border="1" style="width: 100%; border-collapse: collapse; text-align: center;"> <tr> <td style="width: 10%;"></td> <td style="width: 10%;"></td> <td style="width: 10%;"></td> <td style="width: 10%;"></td> <td style="width: 10%;"></td> <td style="width: 10%;"></td> <td style="width: 10%;"></td> <td style="width: 10%;"></td> <td style="width: 10%;"></td> <td style="width: 10%;"></td> </tr> <tr> <td></td> <td></td> <td colspan="8" style="text-align: center;"> <table border="1" style="width: 100%; border-collapse: collapse; text-align: center;"> <tr> <td style="width: 10%;"></td> <td style="width: 10%;"></td> <td style="width: 10%;"></td> <td style="width: 10%;"></td> <td style="width: 10%;"></td> <td style="width: 10%;"></td> <td style="width: 10%;"></td> <td style="width: 10%;"></td> <td style="width: 10%;"></td> <td style="width: 10%;"></td> </tr> <tr> <td></td> <td></td> <td colspan="8" style="text-align: center;"> <table border="1" style="width: 100%; border-collapse: collapse; text-align: center;"> <tr> <td style="width: 10%;"></td> <td style="width: 10%;"></td> <td style="width: 10%;"></td> <td style="width: 10%;"></td> <td style="width: 10%;"></td> <td style="width: 10%;"></td> <td style="width: 10%;"></td> <td style="width: 10%;"></td> <td style="width: 10%;"></td> <td style="width: 10%;"></td> </tr> <tr> <td></td> <td></td> <td colspan="8" style="text-align: center;"> <table border="1" style="width: 100%; border-collapse: collapse; text-align: center;"> <tr> <td style="width: 10%;"></td> <td style="width: 10%;"></td> <td style="width: 10%;"></td> <td style="width: 10%;"></td> <td style="width: 10%;"></td> <td style="width: 10%;"></td> <td style="width: 10%;"></td> <td style="width: 10%;"></td> <td style="width: 10%;"></td> <td style="width: 10%;"></td> </tr> <tr> <td></td> <td></td> <td colspan="8" style="text-align: center;"> <table border="1" style="width: 100%; border-collapse: collapse; text-align: center;"> <tr> <td style="width: 10%;"></td> <td style="width: 10%;"></td> <td style="width: 10%;"></td> <td style="width: 10%;"></td> <td style="width: 10%;"></td> <td style="width: 10%;"></td> <td style="width: 10%;"></td> <td style="width: 10%;"></td> <td style="width: 10%;"></td> <td style="width: 10%;"></td> </tr> <tr> <td></td> <td></td> <td colspan="8" style="text-align: center;"> <table border="1" style="width: 100%; border-collapse: collapse; text-align: center;"> <tr> <td style="width: 10%;"></td> <td style="width: 10%;"></td> <td style="width: 10%;"></td> <td style="width: 10%;"></td> <td style="width: 10%;"></td> <td style="width: 10%;"></td> <td style="width: 10%;"></td> <td style="width: 10%;"></td> <td style="width: 10%;"></td> <td style="width: 10%;"></td> </tr> <tr> <td></td> <td></td> <td colspan="8" style="text-align: center;"> <table border="1" style="width: 100%; border-collapse: collapse; text-align: center;"> <tr> <td style="width: 10%;"></td> <td style="width: 10%;"></td> <td style="width: 10%;"></td> <td style="width: 10%;"></td> <td style="width: 10%;"></td> <td style="width: 10%;"></td> <td style="width: 10%;"></td> <td style="width: 10%;"></td> <td style="width: 10%;"></td> <td style="width: 10%;"></td> </tr> <tr> <td></td> <td></td> <td colspan="8" style="text-align: center;"> <table border="1" style="width: 100%; border-collapse: collapse; text-align: center;"> <tr> <td style="width: 10%;"></td> <td style="width: 10%;"></td> <td style="width: 10%;"></td> <td style="width: 10%;"></td> <td style="width: 10%;"></td> <td style="width: 10%;"></td> <td style="width: 10%;"></td> <td style="width: 10%;"></td> <td style="width: 10%;"></td> <td style="width: 10%;"></td> </tr> <tr> <td></td> <td></td> <td colspan="8" style="text-align: center;"> <table border="1" style="width: 100%; border-collapse: collapse; text-align: center;"> <tr> <td style="width: 10%;"></td> <td style="width: 10%;"></td> <td style="width: 10%;"></td> <td style="width: 10%;"></td> <td style="width: 10%;"></td> <td style="width: 10%;"></td> <td style="width: 10%;"></td> <td style="width: 10%;"></td> <td style="width: 10%;"></td> <td style="width: 10%;"></td> </tr> <tr> <td></td> <td></td> <td colspan="8" style="text-align: center;"> <table border="1" style="width: 100%; border-collapse: collapse; text-align: center;"> <tr> <td style="width: 10%;"></td> <td style="width: 10%;"></td> <td style="width: 10%;"></td> <td style="width: 10%;"></td> <td style="width: 10%;"></td> <td style="width: 10%;"></td> <td style="width: 10%;"></td> <td style="width: 10%;"></td> <td style="width: 10%;"></td> <td style="width: 10%;"></td> </tr> <tr> <td></td> <td></td> <td colspan="8" style="text-align: center;"> <table border="1" style="width: 100%; border-collapse: collapse; text-align: center;"> <tr> <td style="width: 10%;"></td> <td style="width: 10%;"></td> <td style="width: 10%;"></td> <td style="width: 10%;"></td> <td style="width: 10%;"></td> <td style="width: 10%;"></td> <td style="width: 10%;"></td> <td style="width: 10%;"></td> <td style="width: 10%;"></td> <td style="width: 10%;"></td> </tr> <tr> <td></td> <td></td> <td colspan="8" style="text-align: center;"> <table border="1" style="width: 100%; border-collapse: collapse; text-align: center;"> <tr> <td style="width: 10%;"></td> <td style="width: 10%;"></td> <td style="width: 10%;"></td> <td style="width: 10%;"></td> <td style="width: 10%;"></td> <td style="width: 10%;"></td> <td style="width: 10%;"></td> <td style="width: 10%;"></td> <td style="width: 10%;"></td> <td style="width: 10%;"></td> </tr> <tr> <td></td> <td></td> <td colspan="8" style="text-align: center;"> <table border="1" style="width: 100%; border-collapse: collapse; text-align: center;"> <tr> <td style="width: 10%;"></td> <td style="width: 10%;"></td> <td style="width: 10%;"></td> <td style="width: 10%;"></td> <td style="width: 10%;"></td> <td style="width: 10%;"></td> <td style="width: 10%;"></td> <td style="width: 10%;"></td> <td style="width: 10%;"></td> <td style="width: 10%;"></td> </tr> <tr> <td></td> <td></td> <td colspan="8" style="text-align: center;"> <table border="1" style="width: 100%; border-collapse: collapse; text-align: center;"> <tr> <td style="width: 10%;"></td> <td style="width: 10%;"></td> <td style="width: 10%;"></td> <td style="width: 10%;"></td> <td style="width: 10%;"></td> <td style="width: 10%;"></td> <td style="width: 10%;"></td> <td style="width: 10%;"></td> <td style="width: 10%;"></td> <td style="width: 10%;"></td> </tr> <tr> <td></td> <td></td> <td colspan="8" style="text-align: center;"> <table border="1" style="width: 100%; border-collapse: collapse; text-align: center;"> <tr> <td style="width: 10%;"></td> <td style="width: 10%;"></td> <td style="width: 10%;"></td> <td style="width: 10%;"></td> <td style="width: 10%;"></td> <td style="width: 10%;"></td> <td style="width: 10%;"></td> <td style="width: 10%;"></td> <td style="width: 10%;"></td> <td style="width: 10%;"></td> </tr> <tr> <td></td> <td></td> <td colspan="8" style="text-align: center;"> <table border="1" style="width: 100%; border-collapse: collapse; text-align: center;"> <tr> <td style="width: 10%;"></td> <td style="width: 10%;"></td> <td style="width: 10%;"></td> <td style="width: 10%;"></td> <td style="width: 10%;"></td> <td style="width: 10%;"></td> <td style="width: 10%;"></td> <td style="width: 10%;"></td> <td style="width: 10%;"></td> <td style="width: 10%;"></td> </tr> <tr> <td></td> <td></td> <td colspan="8" style="text-align: center;"> <table border="1" style="width: 100%; border-collapse: collapse; text-align: center;"> <tr> <td style="width: 10%;"></td> <td style="width: 10%;"></td> <td style="width: 10%;"></td> <td style="width: 10%;"></td> <td style="width: 10%;"></td> <td style="width: 10%;"></td> <td style="width: 10%;"></td> <td style="width: 10%;"></td> <td style="width: 10%;"></td> <td style="width: 10%;"></td> </tr> <tr> <td></td> <td></td> <td colspan="8" style="text-align: center;"> <table border="1" style="width: 100%; border-collapse: collapse; text-align: center;"> <tr> <td style="width: 10%;"></td> <td style="width: 10%;"></td> <td style="width: 10%;"></td> <td style="width: 10%;"></td> <td style="width: 10%;"></td> <td style="width: 10%;"></td> <td style="width: 10%;"></td> <td style="width: 10%;"></td> <td style="width: 10%;"></td> <td style="width: 10%;"></td> </tr> <tr> <td></td> <td></td> <td colspan="8" style="text-align: center;"> <table border="1" style="width: 100%; border-collapse: collapse; text-align: center;"> <tr> <td style="width: 10%;"></td> <td style="width: 10%;"></td> <td style="width: 10%;"></td> <td style="width: 10%;"></td> <td style="width: 10%;"></td> <td style="width: 10%;"></td> <td style="width: 10%;"></td> <td style="width: 10%;"></td> <td style="width: 10%;"></td> <td style="width: 10%;"></td> </tr> <tr> <td></td> <td></td> <td colspan="8" style="text-align: center;"> <table border="1" style="width: 100%; border-collapse: collapse;
text-align: center;"> <tr> <td style="width: 10%;"></td> <td style="width: 10%;"></td> <td style="width: 10%;"></td> <td style="width: 10%;"></td> <td style="width: 10%;"></td> <td style="width: 10%;"></td> <td style="width: 10%;"></td> <td style="width: 10%;"></td> <td style="width: 10%;"></td> <td style="width: 10%;"></td> </tr> <tr> <td></td> <td></td> <td colspan="8" style="text-align: center;"> <table border="1" style="width: 100%; border-collapse: collapse; text-align: center;"> <tr> <td style="width: 10%;"></td> <td style="width: 10%;"></td> <td style="width: 10%;"></td> <td style="width: 10%;"></td> <td style="width: 10%;"></td> <td style="width: 10%;"></td> <td style="width: 10%;"></td> <td style="width: 10%;"></td> <td style="width: 10%;"></td> <td style="width: 10%;"></td> </tr> <tr> <td></td> <td></td> <td colspan="8" style="text-align: center;"> <table border="1" style="width: 100%; border-collapse: collapse; text-align: center;"> <tr> <td style="width: 10%;"></td> <td style="width: 10%;"></td> <td style="width: 10%;"></td> <td style="width: 10%;"></td> <td style="width: 10%;"></td> <td style="width: 10%;"></td> <td style="width: 10%;"></td> <td style="width: 10%;"></td> <td style="width: 10%;"></td> <td style="width: 10%;"></td> </tr> <tr> <td></td> <td></td> <td colspan="8" style="text-align: center;"> <table border="1" style="width: 100%; border-collapse: collapse; text-align: center;"> <tr> <td style="width: 10%;"></td> <td style="width: 10%;"></td> <td style="width: 10%;"></td> <td style="width: 10%;"></td> <td style="width: 10%;"></td> <td style="width: 10%;"></td> <td style="width: 10%;"></td> <td style="width: 10%;"></td> <td style="width: 10%;"></td> <td style="width: 10%;"></td> </tr> <tr> <td></td> <td></td> <td colspan="8" style="text-align: center;"> <table border="1" style="width: 100%; border-collapse: collapse; text-align: center;"> <tr> <td style="width: 10%;"></td> <td style="width: 10%;"></td> <td style="width: 10%;"></td> <td style="width: 10%;"></td> <td style="width: 10%;"></td> <td style="width: 10%;"></td> <td style="width: 10%;"></td> <td style="width: 10%;"></td> <td style="width: 10%;"></td> <td style="width: 10%;"></td> </tr> <tr> <td></td> <td></td> <td colspan="8" style="text-align: center;"> <table border="1" style="width: 100%; border-collapse: collapse; text-align: center;"> <tr> <td style="width: 10%;"></td> <td style="width: 10%;"></td> <td style="width: 10%;"></td> <td style="width: 10%;"></td> <td style="width: 10%;"></td> <td style="width: 10%;"></td> <td style="width: 10%;"></td> <td style="width: 10%;"></td> <td style="width: 10%;"></td> <td style="width: 10%;"></td> </tr> <tr> <td></td> <td></td> <td colspan="8" style="text-align: center;"> <table border="1" style="width: 100%; border-collapse: collapse; text-align: center;"> <tr> <td style="width: 10%;"></td> <td style="width: 10%;"></td> <td style="width: 10%;"></td> <td style="width: 10%;"></td> <td style="width: 10%;"></td> <td style="width: 10%;"></td> <td style="width: 10%;"></td> <td style="width: 10%;"></td> <td style="width: 10%;"></td> <td style="width: 10%;"></td> </tr> <tr> <td></td> <td></td> <td colspan="8" style="text-align: center;"> <table border="1" style="width: 100%; border-collapse: collapse; text-align: center;"> <tr> <td style="width: 10%;"></td> <td style="width: 10%;"></td> <td style="width: 10%;"></td> <td style="width: 10%;"></td> <td style="width: 10%;"></td> <td style="width: 10%;"></td> <td style="width: 10%;"></td> <td style="width: 10%;"></td> <td style="width: 10%;"></td> <td style="width: 10%;"></td> </tr> <tr> <td></td> <td></td> <td colspan="8" style="text-align: center;"> <table border="1" style="width: 100%; border-collapse: collapse; text-align: center;"> <tr> <td style="width: 10%;"></td> <td style="width: 10%;"></td> <td style="width: 10%;"></td> <td style="width: 10%;"></td> <td style="width: 10%;"></td> <td style="width: 10%;"></td> <td style="width: 10%;"></td> <td style="width: 10%;"></td> <td style="width: 10%;"></td> <td style="width: 10%;"></td> </tr> <tr> <td></td> <td></td> <td colspan="8" style="text-align: center;"> <table border="1" style="width: 100%; border-collapse: collapse; text-align: center;"> <tr> <td style="width: 10%;"></td> <td style="width: 10%;"></td> <td style="width: 10%;"></td> <td style="width: 10%;"></td> <td style="width: 10%;"></td> <td style="width: 10%;"></td> <td style="width: 10%;"></td> <td style="width: 10%;"></td> <td style="width: 10%;"></td> <td style="width: 10%;"></td> </tr> <tr> <td></td> <td></td> <td colspan="8" style="text-align: center;"> <table border="1" style="width: 100%; border-collapse: collapse; text-align: center;"> <tr> <td style="width: 10%;"></td> <td style="width: 10%;"></td> <td style="width: 10%;"></td> <td style="width: 10%;"></td> <td style="width: 10%;"></td> <td style="width: 10%;"></td> <td style="width: 10%;"></td> <td style="width: 10%;"></td> <td style="width: 10%;"></td> <td style="width: 10%;"></td> </tr> <tr> <td></td> <td></td> <td colspan="8" style="text-align: center;"> <table border="1" style="width: 100%; border-collapse: collapse; text-align: center;"> <tr> <td style="width: 10%;"></td> <td style="width: 10%;"></td> <td style="width: 10%;"></td> <td style="width: 10%;"></td> <td style="width: 10%;"></td> <td style="width: 10%;"></td> <td style="width: 10%;"></td> <td style="width: 10%;"></td> <td style="width: 10%;"></td> <td style="width: 10%;"></td> </tr> <tr> <td></td> <td></td> <td colspan="8" style="text-align: center;"> <table border="1" style="width: 100%; border-collapse: collapse; text-align: center;"> <tr> <td style="width: 10%;"></td> <td style="width: 10%;"></td> <td style="width: 10%;"></td> <td style="width: 10%;"></td> <td style="width: 10%;"></td> <td style="width: 10%;"></td> <td style="width: 10%;"></td> <td style="width: 10%;"></td> <td style="width: 10%;"></td> <td style="width: 10%;"></td> </tr> <tr> <td></td> <td></td> <td colspan="8" style="text-align: center;"> <table border="1" style="width: 100%; border-collapse: collapse; text-align: center;"> <tr> <td style="width: 10%;"></td> <td style="width: 10%;"></td> <td style="width: 10%;"></td> <td style="width: 10%;"></td> <td style="width: 10%;"></td> <td style="width: 10%;"></td> <td style="width: 10%;"></td> <td style="width: 10%;"></td> <td style="width: 10%;"></td> <td style="width: 10%;"></td> </tr> <tr> <td></td> <td></td> <td colspan="8" style="text-align: center;"> <table border="1" style="width: 100%; border-collapse: collapse; text-align: center;"> <tr> <td style="width: 10%;"></td> <td style="width: 10%;"></td> <td style="width: 10%;"></td> <td style="width: 10%;"></td> <td style="width: 10%;"></td> <td style="width: 10%;"></td> <td style="width: 10%;"></td> <td style="width: 10%;"></td> <td style="width: 10%;"></td> <td style="width: 10%;"></td> </tr> <tr> <td></td> <td></td> <td colspan="8" style="text-align: center;"> <table border="1" style="width: 100%; border-collapse: collapse; text-align: center;"> <tr> <td style="width: 10%;"></td> <td style="width: 10%;"></td> <td style="width: 10%;"></td> <td style="width: 10%;"></td> <td style="width: 10%;"></td> <td style="width: 10%;"></td> <td style="width: 10%;"></td> <td style="width: 10%;"></td> <td style="width: 10%;"></td> <td style="width: 10%;"></td> </tr> <tr> <td></td> <td></td> <td colspan="8" style="text-align: center;"> <table border="1" style="width: 100%; border-collapse: collapse; text-align: center;"> <tr> <td style="width: 10%;"></td> <td style="width: 10%;"></td> <td style="width: 10%;"></td> <td style="width: 10%;"></td> <td style="width: 10%;"></td> <td style="width: 10%;"></td> <td style="width: 10%;"></td> <td style="width: 10%;"></td> <td style="width: 10%;"></td> <td style="width: 10%;"></td> </tr> <tr> <td></td> <td></td> <td colspan="8" style="text-align: center;"> <table border="1" style="width: 100%; border-collapse: collapse; text-align: center;"> <tr> </tr></table></td></tr></table></td></tr></table></td></tr></table></td></tr></table></td></tr></table></td></tr></table></td></tr></table></td></tr></table></td></tr></table></td></tr></table></td></tr></table></td></tr></table></td></tr></table></td></tr></table></td></tr></table></td></tr></table></td></tr></table></td></tr></table></td></tr></table></td></tr></table></td></tr></table></td></tr></table></td></tr></table></td></tr></table></td></tr></table></td></tr></table></td></tr></table></td></tr></table></td></tr></table></td></tr></table></td></tr></table></td></tr></table></td></tr></table></td></tr></table></td></tr></table></td></tr></table></td></tr></table></td></tr></table></td></tr></table></td></tr></table></td></tr></table></td></tr></table></td></tr></table></td></tr></table></td></tr></table></td></tr></table></td></tr></table></td></tr></table> | | | | | | | | | | | | | | | | | | | | <table border="1" style="width: 100%; border-collapse: collapse; text-align: center;"> <tr> <td
style="width: 10%;"></td> <td style="width: 10%;"></td> <td style="width: 10%;"></td> <td style="width: 10%;"></td> <td style="width: 10%;"></td> <td style="width: 10%;"></td> <td style="width: 10%;"></td> <td style="width: 10%;"></td> <td style="width: 10%;"></td> <td style="width: 10%;"></td> </tr> <tr> <td></td> <td></td> <td colspan="8" style="text-align: center;"> <table border="1" style="width: 100%; border-collapse: collapse; text-align: center;"> <tr> <td style="width: 10%;"></td> <td style="width: 10%;"></td> <td style="width: 10%;"></td> <td style="width: 10%;"></td> <td style="width: 10%;"></td> <td style="width: 10%;"></td> <td style="width: 10%;"></td> <td style="width: 10%;"></td> <td style="width: 10%;"></td> <td style="width: 10%;"></td> </tr> <tr> <td></td> <td></td> <td colspan="8" style="text-align: center;"> <table border="1" style="width: 100%; border-collapse: collapse; text-align: center;"> <tr> <td style="width: 10%;"></td> <td style="width: 10%;"></td> <td style="width: 10%;"></td> <td style="width: 10%;"></td> <td style="width: 10%;"></td> <td style="width: 10%;"></td> <td style="width: 10%;"></td> <td style="width: 10%;"></td> <td style="width: 10%;"></td> <td style="width: 10%;"></td> </tr> <tr> <td></td> <td></td> <td colspan="8" style="text-align: center;"> <table border="1" style="width: 100%; border-collapse: collapse; text-align: center;"> <tr> <td style="width: 10%;"></td> <td style="width: 10%;"></td> <td style="width: 10%;"></td> <td style="width: 10%;"></td> <td style="width: 10%;"></td> <td style="width: 10%;"></td> <td style="width: 10%;"></td> <td style="width: 10%;"></td> <td style="width: 10%;"></td> <td style="width: 10%;"></td> </tr> <tr> <td></td> <td></td> <td colspan="8" style="text-align: center;"> <table border="1" style="width: 100%; border-collapse: collapse; text-align: center;"> <tr> <td style="width: 10%;"></td> <td style="width: 10%;"></td> <td style="width: 10%;"></td> <td style="width: 10%;"></td> <td style="width: 10%;"></td> <td style="width: 10%;"></td> <td style="width: 10%;"></td> <td style="width: 10%;"></td> <td style="width: 10%;"></td> <td style="width: 10%;"></td> </tr> <tr> <td></td> <td></td> <td colspan="8" style="text-align: center;"> <table border="1" style="width: 100%; border-collapse: collapse; text-align: center;"> <tr> <td style="width: 10%;"></td> <td style="width: 10%;"></td> <td style="width: 10%;"></td> <td style="width: 10%;"></td> <td style="width: 10%;"></td> <td style="width: 10%;"></td> <td style="width: 10%;"></td> <td style="width: 10%;"></td> <td style="width: 10%;"></td> <td style="width: 10%;"></td> </tr> <tr> <td></td> <td></td> <td colspan="8" style="text-align: center;"> <table border="1" style="width: 100%; border-collapse: collapse; text-align: center;"> <tr> <td style="width: 10%;"></td> <td style="width: 10%;"></td> <td style="width: 10%;"></td> <td style="width: 10%;"></td> <td style="width: 10%;"></td> <td style="width: 10%;"></td> <td style="width: 10%;"></td> <td style="width: 10%;"></td> <td style="width: 10%;"></td> <td style="width: 10%;"></td> </tr> <tr> <td></td> <td></td> <td colspan="8" style="text-align: center;"> <table border="1" style="width: 100%; border-collapse: collapse; text-align: center;"> <tr> <td style="width: 10%;"></td> <td style="width: 10%;"></td> <td style="width: 10%;"></td> <td style="width: 10%;"></td> <td style="width: 10%;"></td> <td style="width: 10%;"></td> <td style="width: 10%;"></td> <td style="width: 10%;"></td> <td style="width: 10%;"></td> <td style="width: 10%;"></td> </tr> <tr> <td></td> <td></td> <td colspan="8" style="text-align: center;"> <table border="1" style="width: 100%; border-collapse: collapse; text-align: center;"> <tr> <td style="width: 10%;"></td> <td style="width: 10%;"></td> <td style="width: 10%;"></td> <td style="width: 10%;"></td> <td style="width: 10%;"></td> <td style="width: 10%;"></td> <td style="width: 10%;"></td> <td style="width: 10%;"></td> <td style="width: 10%;"></td> <td style="width: 10%;"></td> </tr> <tr> <td></td> <td></td> <td colspan="8" style="text-align: center;"> <table border="1" style="width: 100%; border-collapse: collapse; text-align: center;"> <tr> <td style="width: 10%;"></td> <td style="width: 10%;"></td> <td style="width: 10%;"></td> <td style="width: 10%;"></td> <td style="width: 10%;"></td> <td style="width: 10%;"></td> <td style="width: 10%;"></td> <td style="width: 10%;"></td> <td style="width: 10%;"></td> <td style="width: 10%;"></td> </tr> <tr> <td></td> <td></td> <td colspan="8" style="text-align: center;"> <table border="1" style="width: 100%; border-collapse: collapse; text-align: center;"> <tr> <td style="width: 10%;"></td> <td style="width: 10%;"></td> <td style="width: 10%;"></td> <td style="width: 10%;"></td> <td style="width: 10%;"></td> <td style="width: 10%;"></td> <td style="width: 10%;"></td> <td style="width: 10%;"></td> <td style="width: 10%;"></td> <td style="width: 10%;"></td> </tr> <tr> <td></td> <td></td> <td colspan="8" style="text-align: center;"> <table border="1" style="width: 100%; border-collapse: collapse; text-align: center;"> <tr> <td style="width: 10%;"></td> <td style="width: 10%;"></td> <td style="width: 10%;"></td> <td style="width: 10%;"></td> <td style="width: 10%;"></td> <td style="width: 10%;"></td> <td style="width: 10%;"></td> <td style="width: 10%;"></td> <td style="width: 10%;"></td> <td style="width: 10%;"></td> </tr> <tr> <td></td> <td></td> <td colspan="8" style="text-align: center;"> <table border="1" style="width: 100%; border-collapse: collapse; text-align: center;"> <tr> <td style="width: 10%;"></td> <td style="width: 10%;"></td> <td style="width: 10%;"></td> <td style="width: 10%;"></td> <td style="width: 10%;"></td> <td style="width: 10%;"></td> <td style="width: 10%;"></td> <td style="width: 10%;"></td> <td style="width: 10%;"></td> <td style="width: 10%;"></td> </tr> <tr> <td></td> <td></td> <td colspan="8" style="text-align: center;"> <table border="1" style="width: 100%; border-collapse: collapse; text-align: center;"> <tr> <td style="width: 10%;"></td> <td style="width: 10%;"></td> <td style="width: 10%;"></td> <td style="width: 10%;"></td> <td style="width: 10%;"></td> <td style="width: 10%;"></td> <td style="width: 10%;"></td> <td style="width: 10%;"></td> <td style="width: 10%;"></td> <td style="width: 10%;"></td> </tr> <tr> <td></td> <td></td> <td colspan="8" style="text-align: center;"> <table border="1" style="width: 100%; border-collapse: collapse; text-align: center;"> <tr> <td style="width: 10%;"></td> <td style="width: 10%;"></td> <td style="width: 10%;"></td> <td style="width: 10%;"></td> <td style="width: 10%;"></td> <td style="width: 10%;"></td> <td style="width: 10%;"></td> <td style="width: 10%;"></td> <td style="width: 10%;"></td> <td style="width: 10%;"></td> </tr> <tr> <td></td> <td></td> <td colspan="8" style="text-align: center;"> <table border="1" style="width: 100%; border-collapse: collapse; text-align: center;"> <tr> <td style="width: 10%;"></td> <td style="width: 10%;"></td> <td style="width: 10%;"></td> <td style="width: 10%;"></td> <td style="width: 10%;"></td> <td style="width: 10%;"></td> <td style="width: 10%;"></td> <td style="width: 10%;"></td> <td style="width: 10%;"></td> <td style="width: 10%;"></td> </tr> <tr> <td></td> <td></td> <td colspan="8" style="text-align: center;"> <table border="1" style="width: 100%; border-collapse: collapse; text-align: center;"> <tr> <td style="width: 10%;"></td> <td style="width: 10%;"></td> <td style="width: 10%;"></td> <td style="width: 10%;"></td> <td style="width: 10%;"></td> <td style="width: 10%;"></td> <td style="width: 10%;"></td> <td style="width: 10%;"></td> <td style="width: 10%;"></td> <td style="width: 10%;"></td> </tr> <tr> <td></td> <td></td> <td colspan="8" style="text-align: center;"> <table border="1" style="width: 100%; border-collapse: collapse; text-align: center;"> <tr> <td style="width: 10%;"></td> <td style="width: 10%;"></td> <td style="width: 10%;"></td> <td style="width: 10%;"></td> <td style="width: 10%;"></td> <td style="width: 10%;"></td> <td style="width: 10%;"></td> <td style="width: 10%;"></td> <td style="width: 10%;"></td> <td style="width: 10%;"></td> </tr> <tr> <td></td> <td></td> <td colspan="8" style="text-align: center;"> <table border="1" style="width: 100%; border-collapse: collapse; text-align: center;"> <tr> <td style="width: 10%;"></td> <td style="width: 10%;"></td> <td style="width: 10%;"></td> <td style="width: 10%;"></td> <td style="width: 10%;"></td> <td style="width: 10%;"></td> <td style="width: 10%;"></td> <td style="width: 10%;"></td> <td style="width: 10%;"></td> <td style="width: 10%;"></td> </tr> <tr> <td></td> <td></td> <td colspan="8" style="text-align: center;"> <table border="1" style="width: 100%; border-collapse: collapse; text-align: center;"> <tr> <td style="width: 10%;"></td> <td style="width: 10%;"></td> <td style="width: 10%;"></td> <td style="width: 10%;"></td> <td style="width: 10%;"></td> <td style="width: 10%;"></td> <td style="width: 10%;"></td> <td style="width: 10%;"></td> <td style="width: 10%;"></td> <td style="width: 10%;"></td> </tr> <tr> <td></td> <td></td> <td colspan="8" style="text-align: center;"> <table border="1" style="width: 100%; border-collapse: collapse; text-align: center;"> <tr> <td style="width: 10%;"></td> <td style="width: 10%;"></td> <td style="width: 10%;"></td> <td style="width: 10%;"></td> <td style="width: 10%;"></td> <td style="width: 10%;"></td> <td style="width: 10%;"></td> <td style="width: 10%;"></td> <td style="width: 10%;"></td> <td style="width: 10%;"></td> </tr> <tr> <td></td> <td></td> <td colspan="8" style="text-align: center;"> <table border="1" style="width: 100%; border-collapse: collapse; text-align: center;"> <tr> <td style="width: 10%;"></td> <td style="width: 10%;"></td> <td style="width: 10%;"></td> <td style="width: 10%;"></td> <td style="width: 10%;"></td> <td style="width:
10%;"></td> <td style="width: 10%;"></td> <td style="width: 10%;"></td> <td style="width: 10%;"></td> <td style="width: 10%;"></td> </tr> <tr> <td></td> <td></td> <td colspan="8" style="text-align: center;"> <table border="1" style="width: 100%; border-collapse: collapse; text-align: center;"> <tr> <td style="width: 10%;"></td> <td style="width: 10%;"></td> <td style="width: 10%;"></td> <td style="width: 10%;"></td> <td style="width: 10%;"></td> <td style="width: 10%;"></td> <td style="width: 10%;"></td> <td style="width: 10%;"></td> <td style="width: 10%;"></td> <td style="width: 10%;"></td> </tr> <tr> <td></td> <td></td> <td colspan="8" style="text-align: center;"> <table border="1" style="width: 100%; border-collapse: collapse; text-align: center;"> <tr> <td style="width: 10%;"></td> <td style="width: 10%;"></td> <td style="width: 10%;"></td> <td style="width: 10%;"></td> <td style="width: 10%;"></td> <td style="width: 10%;"></td> <td style="width: 10%;"></td> <td style="width: 10%;"></td> <td style="width: 10%;"></td> <td style="width: 10%;"></td> </tr> <tr> <td></td> <td></td> <td colspan="8" style="text-align: center;"> <table border="1" style="width: 100%; border-collapse: collapse; text-align: center;"> <tr> <td style="width: 10%;"></td> <td style="width: 10%;"></td> <td style="width: 10%;"></td> <td style="width: 10%;"></td> <td style="width: 10%;"></td> <td style="width: 10%;"></td> <td style="width: 10%;"></td> <td style="width: 10%;"></td> <td style="width: 10%;"></td> <td style="width: 10%;"></td> </tr> <tr> <td></td> <td></td> <td colspan="8" style="text-align: center;"> <table border="1" style="width: 100%; border-collapse: collapse; text-align: center;"> <tr> <td style="width: 10%;"></td> <td style="width: 10%;"></td> <td style="width: 10%;"></td> <td style="width: 10%;"></td> <td style="width: 10%;"></td> <td style="width: 10%;"></td> <td style="width: 10%;"></td> <td style="width: 10%;"></td> <td style="width: 10%;"></td> <td style="width: 10%;"></td> </tr> <tr> <td></td> <td></td> <td colspan="8" style="text-align: center;"> <table border="1" style="width: 100%; border-collapse: collapse; text-align: center;"> <tr> <td style="width: 10%;"></td> <td style="width: 10%;"></td> <td style="width: 10%;"></td> <td style="width: 10%;"></td> <td style="width: 10%;"></td> <td style="width: 10%;"></td> <td style="width: 10%;"></td> <td style="width: 10%;"></td> <td style="width: 10%;"></td> <td style="width: 10%;"></td> </tr> <tr> <td></td> <td></td> <td colspan="8" style="text-align: center;"> <table border="1" style="width: 100%; border-collapse: collapse; text-align: center;"> <tr> <td style="width: 10%;"></td> <td style="width: 10%;"></td> <td style="width: 10%;"></td> <td style="width: 10%;"></td> <td style="width: 10%;"></td> <td style="width: 10%;"></td> <td style="width: 10%;"></td> <td style="width: 10%;"></td> <td style="width: 10%;"></td> <td style="width: 10%;"></td> </tr> <tr> <td></td> <td></td> <td colspan="8" style="text-align: center;"> <table border="1" style="width: 100%; border-collapse: collapse; text-align: center;"> <tr> <td style="width: 10%;"></td> <td style="width: 10%;"></td> <td style="width: 10%;"></td> <td style="width: 10%;"></td> <td style="width: 10%;"></td> <td style="width: 10%;"></td> <td style="width: 10%;"></td> <td style="width: 10%;"></td> <td style="width: 10%;"></td> <td style="width: 10%;"></td> </tr> <tr> <td></td> <td></td> <td colspan="8" style="text-align: center;"> <table border="1" style="width: 100%; border-collapse: collapse; text-align: center;"> <tr> <td style="width: 10%;"></td> <td style="width: 10%;"></td> <td style="width: 10%;"></td> <td style="width: 10%;"></td> <td style="width: 10%;"></td> <td style="width: 10%;"></td> <td style="width: 10%;"></td> <td style="width: 10%;"></td> <td style="width: 10%;"></td> <td style="width: 10%;"></td> </tr> <tr> <td></td> <td></td> <td colspan="8" style="text-align: center;"> <table border="1" style="width: 100%; border-collapse: collapse; text-align: center;"> <tr> <td style="width: 10%;"></td> <td style="width: 10%;"></td> <td style="width: 10%;"></td> <td style="width: 10%;"></td> <td style="width: 10%;"></td> <td style="width: 10%;"></td> <td style="width: 10%;"></td> <td style="width: 10%;"></td> <td style="width: 10%;"></td> <td style="width: 10%;"></td> </tr> <tr> <td></td> <td></td> <td colspan="8" style="text-align: center;"> <table border="1" style="width: 100%; border-collapse: collapse; text-align: center;"> <tr> <td style="width: 10%;"></td> <td style="width: 10%;"></td> <td style="width: 10%;"></td> <td style="width: 10%;"></td> <td style="width: 10%;"></td> <td style="width: 10%;"></td> <td style="width: 10%;"></td> <td style="width: 10%;"></td> <td style="width: 10%;"></td> <td style="width: 10%;"></td> </tr> <tr> <td></td> <td></td> <td colspan="8" style="text-align: center;"> <table border="1" style="width: 100%; border-collapse: collapse; text-align: center;"> <tr> <td style="width: 10%;"></td> <td style="width: 10%;"></td> <td style="width: 10%;"></td> <td style="width: 10%;"></td> <td style="width: 10%;"></td> <td style="width: 10%;"></td> <td style="width: 10%;"></td> <td style="width: 10%;"></td> <td style="width: 10%;"></td> <td style="width: 10%;"></td> </tr> <tr> <td></td> <td></td> <td colspan="8" style="text-align: center;"> <table border="1" style="width: 100%; border-collapse: collapse; text-align: center;"> <tr> <td style="width: 10%;"></td> <td style="width: 10%;"></td> <td style="width: 10%;"></td> <td style="width: 10%;"></td> <td style="width: 10%;"></td> <td style="width: 10%;"></td> <td style="width: 10%;"></td> <td style="width: 10%;"></td> <td style="width: 10%;"></td> <td style="width: 10%;"></td> </tr> <tr> <td></td> <td></td> <td colspan="8" style="text-align: center;"> <table border="1" style="width: 100%; border-collapse: collapse; text-align: center;"> <tr> <td style="width: 10%;"></td> <td style="width: 10%;"></td> <td style="width: 10%;"></td> <td style="width: 10%;"></td> <td style="width: 10%;"></td> <td style="width: 10%;"></td> <td style="width: 10%;"></td> <td style="width: 10%;"></td> <td style="width: 10%;"></td> <td style="width: 10%;"></td> </tr> <tr> <td></td> <td></td> <td colspan="8" style="text-align: center;"> <table border="1" style="width: 100%; border-collapse: collapse; text-align: center;"> <tr> <td style="width: 10%;"></td> <td style="width: 10%;"></td> <td style="width: 10%;"></td> <td style="width: 10%;"></td> <td style="width: 10%;"></td> <td style="width: 10%;"></td> <td style="width: 10%;"></td> <td style="width: 10%;"></td> <td style="width: 10%;"></td> <td style="width: 10%;"></td> </tr> <tr> <td></td> <td></td> <td colspan="8" style="text-align: center;"> <table border="1" style="width: 100%; border-collapse: collapse; text-align: center;"> <tr> <td style="width: 10%;"></td> <td style="width: 10%;"></td> <td style="width: 10%;"></td> <td style="width: 10%;"></td> <td style="width: 10%;"></td> <td style="width: 10%;"></td> <td style="width: 10%;"></td> <td style="width: 10%;"></td> <td style="width: 10%;"></td> <td style="width: 10%;"></td> </tr> <tr> <td></td> <td></td> <td colspan="8" style="text-align: center;"> <table border="1" style="width: 100%; border-collapse: collapse; text-align: center;"> <tr> <td style="width: 10%;"></td> <td style="width: 10%;"></td> <td style="width: 10%;"></td> <td style="width: 10%;"></td> <td style="width: 10%;"></td> <td style="width: 10%;"></td> <td style="width: 10%;"></td> <td style="width: 10%;"></td> <td style="width: 10%;"></td> <td style="width: 10%;"></td> </tr> <tr> <td></td> <td></td> <td colspan="8" style="text-align: center;"> <table border="1" style="width: 100%; border-collapse: collapse; text-align: center;"> <tr> <td style="width: 10%;"></td> <td style="width: 10%;"></td> <td style="width: 10%;"></td> <td style="width: 10%;"></td> <td style="width: 10%;"></td> <td style="width: 10%;"></td> <td style="width: 10%;"></td> <td style="width: 10%;"></td> <td style="width: 10%;"></td> <td style="width: 10%;"></td> </tr> <tr> <td></td> <td></td> <td colspan="8" style="text-align: center;"> <table border="1" style="width: 100%; border-collapse: collapse; text-align: center;"> <tr> <td style="width: 10%;"></td> <td style="width: 10%;"></td> <td style="width: 10%;"></td> <td style="width: 10%;"></td> <td style="width: 10%;"></td> <td style="width: 10%;"></td> <td style="width: 10%;"></td> <td style="width: 10%;"></td> <td style="width: 10%;"></td> <td style="width: 10%;"></td> </tr> <tr> <td></td> <td></td> <td colspan="8" style="text-align: center;"> <table border="1" style="width: 100%; border-collapse: collapse; text-align: center;"> <tr> <td style="width: 10%;"></td> <td style="width: 10%;"></td> <td style="width: 10%;"></td> <td style="width: 10%;"></td> <td style="width: 10%;"></td> <td style="width: 10%;"></td> <td style="width: 10%;"></td> <td style="width: 10%;"></td> <td style="width: 10%;"></td> <td style="width: 10%;"></td> </tr> <tr> <td></td> <td></td> <td colspan="8" style="text-align: center;"> <table border="1" style="width: 100%; border-collapse: collapse; text-align: center;"> <tr> <td style="width: 10%;"></td> <td style="width: 10%;"></td> <td style="width: 10%;"></td> <td style="width: 10%;"></td> <td style="width: 10%;"></td> <td style="width: 10%;"></td> <td style="width: 10%;"></td> <td style="width: 10%;"></td> <td style="width: 10%;"></td> <td style="width: 10%;"></td> </tr> <tr> <td></td> <td></td> <td colspan="8" style="text-align: center;"> <table border="1" style="width: 100%; border-collapse: collapse; text-align: center;"> <tr> <td style="width: 10%;"></td> <td style="width: 10%;"></td> <td style="width: 10%;"></td> <td style="width: 10%;"></td> <td style="width: 10%;"></td> <td style="width: 10%;"></td> <td style="width: 10%;"></td> <td style="width: 10%;"></td> <td style="width: 10%;"></td> <td style="width: 10%;"></td> </tr> <tr> <td></td> <td></td> <td
colspan="8" style="text-align: center;"> <table border="1" style="width: 100%; border-collapse: collapse; text-align: center;"> <tr> <td style="width: 10%;"></td> <td style="width: 10%;"></td> <td style="width: 10%;"></td> <td style="width: 10%;"></td> <td style="width: 10%;"></td> <td style="width: 10%;"></td> <td style="width: 10%;"></td> <td style="width: 10%;"></td> <td style="width: 10%;"></td> <td style="width: 10%;"></td> </tr> <tr> <td></td> <td></td> <td colspan="8" style="text-align: center;"> <table border="1" style="width: 100%; border-collapse: collapse; text-align: center;"> <tr> <td style="width: 10%;"></td> <td style="width: 10%;"></td> <td style="width: 10%;"></td> <td style="width: 10%;"></td> <td style="width: 10%;"></td> <td style="width: 10%;"></td> <td style="width: 10%;"></td> <td style="width: 10%;"></td> <td style="width: 10%;"></td> <td style="width: 10%;"></td> </tr> <tr> <td></td> <td></td> <td colspan="8" style="text-align: center;"> <table border="1" style="width: 100%; border-collapse: collapse; text-align: center;"> <tr> <td style="width: 10%;"></td> <td style="width: 10%;"></td> <td style="width: 10%;"></td> <td style="width: 10%;"></td> <td style="width: 10%;"></td> <td style="width: 10%;"></td> <td style="width: 10%;"></td> <td style="width: 10%;"></td> <td style="width: 10%;"></td> <td style="width: 10%;"></td> </tr> <tr> <td></td> <td></td> <td colspan="8" style="text-align: center;"> <table border="1" style="width: 100%; border-collapse: collapse; text-align: center;"> <tr> <td style="width: 10%;"></td> <td style="width: 10%;"></td> <td style="width: 10%;"></td> <td style="width: 10%;"></td> <td style="width: 10%;"></td> <td style="width: 10%;"></td> <td style="width: 10%;"></td> <td style="width: 10%;"></td> <td style="width: 10%;"></td> <td style="width: 10%;"></td> </tr> <tr> <td></td> <td></td> <td colspan="8" style="text-align: center;"> <table border="1" style="width: 100%; border-collapse: collapse; text-align: center;"> <tr> </tr></table></td></tr></table></td></tr></table></td></tr></table></td></tr></table></td></tr></table></td></tr></table></td></tr></table></td></tr></table></td></tr></table></td></tr></table></td></tr></table></td></tr></table></td></tr></table></td></tr></table></td></tr></table></td></tr></table></td></tr></table></td></tr></table></td></tr></table></td></tr></table></td></tr></table></td></tr></table></td></tr></table></td></tr></table></td></tr></table></td></tr></table></td></tr></table></td></tr></table></td></tr></table></td></tr></table></td></tr></table></td></tr></table></td></tr></table></td></tr></table></td></tr></table></td></tr></table></td></tr></table></td></tr></table></td></tr></table></td></tr></table></td></tr></table></td></tr></table></td></tr></table></td></tr></table></td></tr></table></td></tr></table></td></tr></table> | | | | | | | | | | | | | | | | | | | | <table border="1" style="width: 100%; border-collapse: collapse; text-align: center;"> <tr> <td style="width: 10%;"></td> <td style="width: 10%;"></td> <td style="width: 10%;"></td> <td style="width: 10%;"></td> <td style="width: 10%;"></td> <td style="width: 10%;"></td> <td style="width: 10%;"></td> <td style="width: 10%;"></td> <td style="width: 10%;"></td> <td style="width: 10%;"></td> </tr> <tr> <td></td> <td></td> <td colspan="8" style="text-align: center;"> <table border="1" style="width: 100%; border-collapse: collapse; text-align: center;"> <tr> <td style="width: 10%;"></td> <td style="width: 10%;"></td> <td style="width: 10%;"></td> <td style="width: 10%;"></td> <td style="width: 10%;"></td> <td style="width: 10%;"></td> <td style="width: 10%;"></td> <td style="width: 10%;"></td> <td style="width: 10%;"></td> <td style="width: 10%;"></td> </tr> <tr> <td></td> <td></td> <td colspan="8" style="text-align: center;"> <table border="1" style="width: 100%; border-collapse: collapse; text-align: center;"> <tr> <td style="width: 10%;"></td> <td style="width: 10%;"></td> <td style="width: 10%;"></td> <td style="width: 10%;"></td> <td style="width: 10%;"></td> <td style="width: 10%;"></td> <td style="width: 10%;"></td> <td style="width: 10%;"></td> <td style="width: 10%;"></td> <td style="width: 10%;"></td> </tr> <tr> <td></td> <td></td> <td colspan="8" style="text-align: center;"> <table border="1" style="width: 100%; border-collapse: collapse; text-align: center;"> <tr> <td style="width: 10%;"></td> <td style="width: 10%;"></td> <td style="width: 10%;"></td> <td style="width: 10%;"></td> <td style="width: 10%;"></td> <td style="width: 10%;"></td> <td style="width: 10%;"></td> <td style="width: 10%;"></td> <td style="width: 10%;"></td> <td style="width: 10%;"></td> </tr> <tr> <td></td> <td></td> <td colspan="8" style="text-align: center;"> <table border="1" style="width: 100%; border-collapse: collapse; text-align: center;"> <tr> <td style="width: 10%;"></td> <td style="width: 10%;"></td> <td style="width: 10%;"></td> <td style="width: 10%;"></td> <td style="width: 10%;"></td> <td style="width: 10%;"></td> <td style="width: 10%;"></td> <td style="width: 10%;"></td> <td style="width: 10%;"></td> <td style="width: 10%;"></td> </tr> <tr> <td></td> <td></td> <td colspan="8" style="text-align: center;"> <table border="1" style="width: 100%; border-collapse: collapse; text-align: center;"> <tr> <td style="width: 10%;"></td> <td style="width: 10%;"></td> <td style="width: 10%;"></td> <td style="width: 10%;"></td> <td style="width: 10%;"></td> <td style="width: 10%;"></td> <td style="width: 10%;"></td> <td style="width: 10%;"></td> <td style="width: 10%;"></td> <td style="width: 10%;"></td> </tr> <tr> <td></td> <td></td> <td colspan="8" style="text-align: center;"> <table border="1" style="width: 100%; border-collapse: collapse; text-align: center;"> <tr> <td style="width: 10%;"></td> <td style="width: 10%;"></td> <td style="width: 10%;"></td> <td style="width: 10%;"></td> <td style="width: 10%;"></td> <td style="width: 10%;"></td> <td style="width: 10%;"></td> <td style="width: 10%;"></td> <td style="width: 10%;"></td> <td style="width: 10%;"></td> </tr> <tr> <td></td> <td></td> <td colspan="8" style="text-align: center;"> <table border="1" style="width: 100%; border-collapse: collapse; text-align: center;"> <tr> <td style="width: 10%;"></td> <td style="width: 10%;"></td> <td style="width: 10%;"></td> <td style="width: 10%;"></td> <td style="width: 10%;"></td> <td style="width: 10%;"></td> <td style="width: 10%;"></td> <td style="width: 10%;"></td> <td style="width: 10%;"></td> <td style="width: 10%;"></td> </tr> <tr> <td></td> <td></td> <td colspan="8" style="text-align: center;"> <table border="1" style="width: 100%; border-collapse: collapse; text-align: center;"> <tr> <td style="width: 10%;"></td> <td style="width: 10%;"></td> <td style="width: 10%;"></td> <td style="width: 10%;"></td> <td style="width: 10%;"></td> <td style="width: 10%;"></td> <td style="width: 10%;"></td> <td style="width: 10%;"></td> <td style="width: 10%;"></td> <td style="width: 10%;"></td> </tr> <tr> <td></td> <td></td> <td colspan="8" style="text-align: center;"> <table border="1" style="width: 100%; border-collapse: collapse; text-align: center;"> <tr> <td style="width: 10%;"></td> <td style="width: 10%;"></td> <td style="width: 10%;"></td> <td style="width: 10%;"></td> <td style="width: 10%;"></td> <td style="width: 10%;"></td> <td style="width: 10%;"></td> <td style="width: 10%;"></td> <td style="width: 10%;"></td> <td style="width: 10%;"></td> </tr> <tr> <td></td> <td></td> <td colspan="8" style="text-align: center;"> <table border="1" style="width: 100%; border-collapse: collapse; text-align: center;"> <tr> <td style="width: 10%;"></td> <td style="width: 10%;"></td> <td style="width: 10%;"></td> <td style="width: 10%;"></td> <td style="width: 10%;"></td> <td style="width: 10%;"></td> <td style="width: 10%;"></td> <td style="width: 10%;"></td> <td style="width: 10%;"></td> <td style="width: 10%;"></td> </tr> <tr> <td></td> <td></td> <td colspan="8" style="text-align: center;"> <table border="1" style="width: 100%; border-collapse: collapse; text-align: center;"> <tr> <td style="width: 10%;"></td> <td style="width: 10%;"></td> <td style="width: 10%;"></td> <td style="width: 10%;"></td> <td style="width: 10%;"></td> <td style="width: 10%;"></td> <td style="width: 10%;"></td> <td style="width: 10%;"></td> <td style="width: 10%;"></td> <td style="width: 10%;"></td> </tr> <tr> <td></td> <td></td> <td colspan="8" style="text-align: center;"> <table border="1" style="width: 100%; border-collapse: collapse; text-align: center;"> <tr> <td style="width: 10%;"></td> <td style="width: 10%;"></td> <td style="width: 10%;"></td> <td style="width: 10%;"></td> <td style="width: 10%;"></td> <td style="width: 10%;"></td> <td style="width: 10%;"></td> <td style="width: 10%;"></td> <td style="width: 10%;"></td> <td style="width: 10%;"></td> </tr> <tr> <td></td> <td></td> <td colspan="8" style="text-align: center;"> <table border="1"
style="width: 100%; border-collapse: collapse; text-align: center;"> <tr> <td style="width: 10%;"></td> <td style="width: 10%;"></td> <td style="width: 10%;"></td> <td style="width: 10%;"></td> <td style="width: 10%;"></td> <td style="width: 10%;"></td> <td style="width: 10%;"></td> <td style="width: 10%;"></td> <td style="width: 10%;"></td> <td style="width: 10%;"></td> </tr> <tr> <td></td> <td></td> <td colspan="8" style="text-align: center;"> <table border="1" style="width: 100%; border-collapse: collapse; text-align: center;"> <tr> <td style="width: 10%;"></td> <td style="width: 10%;"></td> <td style="width: 10%;"></td> <td style="width: 10%;"></td> <td style="width: 10%;"></td> <td style="width: 10%;"></td> <td style="width: 10%;"></td> <td style="width: 10%;"></td> <td style="width: 10%;"></td> <td style="width: 10%;"></td> </tr> <tr> <td></td> <td></td> <td colspan="8" style="text-align: center;"> <table border="1" style="width: 100%; border-collapse: collapse; text-align: center;"> <tr> <td style="width: 10%;"></td> <td style="width: 10%;"></td> <td style="width: 10%;"></td> <td style="width: 10%;"></td> <td style="width: 10%;"></td> <td style="width: 10%;"></td> <td style="width: 10%;"></td> <td style="width: 10%;"></td> <td style="width: 10%;"></td> <td style="width: 10%;"></td> </tr> <tr> <td></td> <td></td> <td colspan="8" style="text-align: center;"> <table border="1" style="width: 100%; border-collapse: collapse; text-align: center;"> <tr> <td style="width: 10%;"></td> <td style="width: 10%;"></td> <td style="width: 10%;"></td> <td style="width: 10%;"></td> <td style="width: 10%;"></td> <td style="width: 10%;"></td> <td style="width: 10%;"></td> <td style="width: 10%;"></td> <td style="width: 10%;"></td> <td style="width: 10%;"></td> </tr> <tr> <td></td> <td></td> <td colspan="8" style="text-align: center;"> <table border="1" style="width: 100%; border-collapse: collapse; text-align: center;"> <tr> <td style="width: 10%;"></td> <td style="width: 10%;"></td> <td style="width: 10%;"></td> <td style="width: 10%;"></td> <td style="width: 10%;"></td> <td style="width: 10%;"></td> <td style="width: 10%;"></td> <td style="width: 10%;"></td> <td style="width: 10%;"></td> <td style="width: 10%;"></td> </tr> <tr> <td></td> <td></td> <td colspan="8" style="text-align: center;"> <table border="1" style="width: 100%; border-collapse: collapse; text-align: center;"> <tr> <td style="width: 10%;"></td> <td style="width: 10%;"></td> <td style="width: 10%;"></td> <td style="width: 10%;"></td> <td style="width: 10%;"></td> <td style="width: 10%;"></td> <td style="width: 10%;"></td> <td style="width: 10%;"></td> <td style="width: 10%;"></td> <td style="width: 10%;"></td> </tr> <tr> <td></td> <td></td> <td colspan="8" style="text-align: center;"> <table border="1" style="width: 100%; border-collapse: collapse; text-align: center;"> <tr> <td style="width: 10%;"></td> <td style="width: 10%;"></td> <td style="width: 10%;"></td> <td style="width: 10%;"></td> <td style="width: 10%;"></td> <td style="width: 10%;"></td> <td style="width: 10%;"></td> <td style="width: 10%;"></td> <td style="width: 10%;"></td> <td style="width: 10%;"></td> </tr> <tr> <td></td> <td></td> <td colspan="8" style="text-align: center;"> <table border="1" style="width: 100%; border-collapse: collapse; text-align: center;"> <tr> <td style="width: 10%;"></td> <td style="width: 10%;"></td> <td style="width: 10%;"></td> <td style="width: 10%;"></td> <td style="width: 10%;"></td> <td style="width: 10%;"></td> <td style="width: 10%;"></td> <td style="width: 10%;"></td> <td style="width: 10%;"></td> <td style="width: 10%;"></td> </tr> <tr> <td></td> <td></td> <td colspan="8" style="text-align: center;"> <table border="1" style="width: 100%; border-collapse: collapse; text-align: center;"> <tr> <td style="width: 10%;"></td> <td style="width: 10%;"></td> <td style="width: 10%;"></td> <td style="width: 10%;"></td> <td style="width: 10%;"></td> <td style="width: 10%;"></td> <td style="width: 10%;"></td> <td style="width: 10%;"></td> <td style="width: 10%;"></td> <td style="width: 10%;"></td> </tr> <tr> <td></td> <td></td> <td colspan="8" style="text-align: center;"> <table border="1" style="width: 100%; border-collapse: collapse; text-align: center;"> <tr> <td style="width: 10%;"></td> <td style="width: 10%;"></td> <td style="width: 10%;"></td> <td style="width: 10%;"></td> <td style="width: 10%;"></td> <td style="width: 10%;"></td> <td style="width: 10%;"></td> <td style="width: 10%;"></td> <td style="width: 10%;"></td> <td style="width: 10%;"></td> </tr> <tr> <td></td> <td></td> <td colspan="8" style="text-align: center;"> <table border="1" style="width: 100%; border-collapse: collapse; text-align: center;"> <tr> <td style="width: 10%;"></td> <td style="width: 10%;"></td> <td style="width: 10%;"></td> <td style="width: 10%;"></td> <td style="width: 10%;"></td> <td style="width: 10%;"></td> <td style="width: 10%;"></td> <td style="width: 10%;"></td> <td style="width: 10%;"></td> <td style="width: 10%;"></td> </tr> <tr> <td></td> <td></td> <td colspan="8" style="text-align: center;"> <table border="1" style="width: 100%; border-collapse: collapse; text-align: center;"> <tr> <td style="width: 10%;"></td> <td style="width: 10%;"></td> <td style="width: 10%;"></td> <td style="width: 10%;"></td> <td style="width: 10%;"></td> <td style="width: 10%;"></td> <td style="width: 10%;"></td> <td style="width: 10%;"></td> <td style="width: 10%;"></td> <td style="width: 10%;"></td> </tr> <tr> <td></td> <td></td> <td colspan="8" style="text-align: center;"> <table border="1" style="width: 100%; border-collapse: collapse; text-align: center;"> <tr> <td style="width: 10%;"></td> <td style="width: 10%;"></td> <td style="width: 10%;"></td> <td style="width: 10%;"></td> <td style="width: 10%;"></td> <td style="width: 10%;"></td> <td style="width: 10%;"></td> <td style="width: 10%;"></td> <td style="width: 10%;"></td> <td style="width: 10%;"></td> </tr> <tr> <td></td> <td></td> <td colspan="8" style="text-align: center;"> <table border="1" style="width: 100%; border-collapse: collapse; text-align: center;"> <tr> <td style="width: 10%;"></td> <td style="width: 10%;"></td> <td style="width: 10%;"></td> <td style="width: 10%;"></td> <td style="width: 10%;"></td> <td style="width: 10%;"></td> <td style="width: 10%;"></td> <td style="width: 10%;"></td> <td style="width: 10%;"></td> <td style="width: 10%;"></td> </tr> <tr> <td></td> <td></td> <td colspan="8" style="text-align: center;"> <table border="1" style="width: 100%; border-collapse: collapse; text-align: center;"> <tr> <td style="width: 10%;"></td> <td style="width: 10%;"></td> <td style="width: 10%;"></td> <td style="width: 10%;"></td> <td style="width: 10%;"></td> <td style="width: 10%;"></td> <td style="width: 10%;"></td> <td style="width: 10%;"></td> <td style="width: 10%;"></td> <td style="width: 10%;"></td> </tr> <tr> <td></td> <td></td> <td colspan="8" style="text-align: center;"> <table border="1" style="width: 100%; border-collapse: collapse; text-align: center;"> <tr> <td style="width: 10%;"></td> <td style="width: 10%;"></td> <td style="width: 10%;"></td> <td style="width: 10%;"></td> <td style="width: 10%;"></td> <td style="width: 10%;"></td> <td style="width: 10%;"></td> <td style="width: 10%;"></td> <td style="width: 10%;"></td> <td style="width: 10%;"></td> </tr> <tr> <td></td> <td></td> <td colspan="8" style="text-align: center;"> <table border="1" style="width: 100%; border-collapse: collapse; text-align: center;"> <tr> <td style="width: 10%;"></td> <td style="width: 10%;"></td> <td style="width: 10%;"></td> <td style="width: 10%;"></td> <td style="width: 10%;"></td> <td style="width: 10%;"></td> <td style="width: 10%;"></td> <td style="width: 10%;"></td> <td style="width: 10%;"></td> <td style="width: 10%;"></td> </tr> <tr> <td></td> <td></td> <td colspan="8" style="text-align: center;"> <table border="1" style="width: 100%; border-collapse: collapse; text-align: center;"> <tr> <td style="width: 10%;"></td> <td style="width: 10%;"></td> <td style="width: 10%;"></td> <td style="width: 10%;"></td> <td style="width: 10%;"></td> <td style="width: 10%;"></td> <td style="width: 10%;"></td> <td style="width: 10%;"></td> <td style="width: 10%;"></td> <td style="width: 10%;"></td> </tr> <tr> <td></td> <td></td> <td colspan="8" style="text-align: center;"> <table border="1" style="width: 100%; border-collapse: collapse; text-align: center;"> <tr> <td style="width: 10%;"></td> <td style="width: 10%;"></td> <td style="width: 10%;"></td> <td style="width: 10%;"></td> <td style="width: 10%;"></td> <td style="width: 10%;"></td> <td style="width: 10%;"></td> <td style="width: 10%;"></td> <td style="width: 10%;"></td> <td style="width: 10%;"></td> </tr> <tr> <td></td> <td></td> <td colspan="8" style="text-align: center;"> <table border="1" style="width: 100%; border-collapse: collapse; text-align: center;"> <tr> <td style="width: 10%;"></td> <td style="width: 10%;"></td> <td style="width: 10%;"></td> <td style="width: 10%;"></td> <td style="width: 10%;"></td> <td style="width: 10%;"></td> <td style="width: 10%;"></td> <td style="width: 10%;"></td> <td style="width: 10%;"></td> <td style="width: 10%;"></td> </tr> <tr> <td></td> <td></td> <td colspan="8" style="text-align: center;"> <table border="1" style="width: 100%; border-collapse: collapse; text-align: center;"> <tr> <td style="width: 10%;"></td> <td style="width: 10%;"></td> <td style="width: 10%;"></td> <td style="width: 10%;"></td> <td style="width: 10%;"></td> <td style="width: 10%;"></td> <td style="width: 10%;"></td> <td style="width: 10%;"></td> <td style="width: 10%;"></td> <td style="width: 10%;"></td> </tr> <tr> <td></td> <td></td> <td colspan="8" style="text-align: center;"> <table border="1" style="width: 100%; border-collapse: collapse; text-align: center;"> <tr> <td style="width: 10%;"></td> <td style="width: 10%;"></td> <td style="width: 10%;"></td> <td
style="width: 10%;"></td> <td style="width: 10%;"></td> <td style="width: 10%;"></td> <td style="width: 10%;"></td> <td style="width: 10%;"></td> <td style="width: 10%;"></td> <td style="width: 10%;"></td> </tr> <tr> <td></td> <td></td> <td colspan="8" style="text-align: center;"> <table border="1" style="width: 100%; border-collapse: collapse; text-align: center;"> <tr> <td style="width: 10%;"></td> <td style="width: 10%;"></td> <td style="width: 10%;"></td> <td style="width: 10%;"></td> <td style="width: 10%;"></td> <td style="width: 10%;"></td> <td style="width: 10%;"></td> <td style="width: 10%;"></td> <td style="width: 10%;"></td> <td style="width: 10%;"></td> </tr> <tr> <td></td> <td></td> <td colspan="8" style="text-align: center;"> <table border="1" style="width: 100%; border-collapse: collapse; text-align: center;"> <tr> <td style="width: 10%;"></td> <td style="width: 10%;"></td> <td style="width: 10%;"></td> <td style="width: 10%;"></td> <td style="width: 10%;"></td> <td style="width: 10%;"></td> <td style="width: 10%;"></td> <td style="width: 10%;"></td> <td style="width: 10%;"></td> <td style="width: 10%;"></td> </tr> <tr> <td></td> <td></td> <td colspan="8" style="text-align: center;"> <table border="1" style="width: 100%; border-collapse: collapse; text-align: center;"> <tr> <td style="width: 10%;"></td> <td style="width: 10%;"></td> <td style="width: 10%;"></td> <td style="width: 10%;"></td> <td style="width: 10%;"></td> <td style="width: 10%;"></td> <td style="width: 10%;"></td> <td style="width: 10%;"></td> <td style="width: 10%;"></td> <td style="width: 10%;"></td> </tr> <tr> <td></td> <td></td> <td colspan="8" style="text-align: center;"> <table border="1" style="width: 100%; border-collapse: collapse; text-align: center;"> <tr> <td style="width: 10%;"></td> <td style="width: 10%;"></td> <td style="width: 10%;"></td> <td style="width: 10%;"></td> <td style="width: 10%;"></td> <td style="width: 10%;"></td> <td style="width: 10%;"></td> <td style="width: 10%;"></td> <td style="width: 10%;"></td> <td style="width: 10%;"></td> </tr> <tr> <td></td> <td></td> <td colspan="8" style="text-align: center;"> <table border="1" style="width: 100%; border-collapse: collapse; text-align: center;"> <tr> <td style="width: 10%;"></td> <td style="width: 10%;"></td> <td style="width: 10%;"></td> <td style="width: 10%;"></td> <td style="width: 10%;"></td> <td style="width: 10%;"></td> <td style="width: 10%;"></td> <td style="width: 10%;"></td> <td style="width: 10%;"></td> <td style="width: 10%;"></td> </tr> <tr> <td></td> <td></td> <td colspan="8" style="text-align: center;"> <table border="1" style="width: 100%; border-collapse: collapse; text-align: center;"> <tr> <td style="width: 10%;"></td> <td style="width: 10%;"></td> <td style="width: 10%;"></td> <td style="width: 10%;"></td> <td style="width: 10%;"></td> <td style="width: 10%;"></td> <td style="width: 10%;"></td> <td style="width: 10%;"></td> <td style="width: 10%;"></td> <td style="width: 10%;"></td> </tr> <tr> <td></td> <td></td> <td colspan="8" style="text-align: center;"> <table border="1" style="width: 100%; border-collapse: collapse; text-align: center;"> <tr> <td style="width: 10%;"></td> <td style="width: 10%;"></td> <td style="width: 10%;"></td> <td style="width: 10%;"></td> <td style="width: 10%;"></td> <td style="width: 10%;"></td> <td style="width: 10%;"></td> <td style="width: 10%;"></td> <td style="width: 10%;"></td> <td style="width: 10%;"></td> </tr> <tr> <td></td> <td></td> <td colspan="8" style="text-align: center;"> <table border="1" style="width: 100%; border-collapse: collapse; text-align: center;"> <tr> <td style="width: 10%;"></td> <td style="width: 10%;"></td> <td style="width: 10%;"></td> <td style="width: 10%;"></td> <td style="width: 10%;"></td> <td style="width: 10%;"></td> <td style="width: 10%;"></td> <td style="width: 10%;"></td> <td style="width: 10%;"></td> <td style="width: 10%;"></td> </tr> <tr> <td></td> <td></td> <td colspan="8" style="text-align: center;"> <table border="1" style="width: 100%; border-collapse: collapse; text-align: center;"> <tr> <td style="width: 10%;"></td> <td style="width: 10%;"></td> <td style="width: 10%;"></td> <td style="width: 10%;"></td> <td style="width: 10%;"></td> <td style="width: 10%;"></td> <td style="width: 10%;"></td> <td style="width: 10%;"></td> <td style="width: 10%;"></td> <td style="width: 10%;"></td> </tr> <tr> <td></td> <td></td> <td colspan="8" style="text-align: center;"> <table border="1" style="width: 100%; border-collapse: collapse; text-align: center;"> <tr> <td style="width: 10%;"></td> <td style="width: 10%;"></td> <td style="width: 10%;"></td> <td style="width: 10%;"></td> <td style="width: 10%;"></td> <td style="width: 10%;"></td> <td style="width: 10%;"></td> <td style="width: 10%;"></td> <td style="width: 10%;"></td> <td style="width: 10%;"></td> </tr> <tr> <td></td> <td></td> <td colspan="8" style="text-align: center;"> <table border="1" style="width: 100%; border-collapse: collapse; text-align: center;"> <tr> <td style="width: 10%;"></td> <td style="width: 10%;"></td> <td style="width: 10%;"></td> <td style="width: 10%;"></td> <td style="width: 10%;"></td> <td style="width: 10%;"></td> <td style="width: 10%;"></td> <td style="width: 10%;"></td> <td style="width: 10%;"></td> <td style="width: 10%;"></td> </tr> <tr> <td></td> <td></td> <td colspan="8" style="text-align: center;"> <table border="1" style="width: 100%; border-collapse: collapse; text-align: center;"> <tr> </tr></table></td></tr></table></td></tr></table></td></tr></table></td></tr></table></td></tr></table></td></tr></table></td></tr></table></td></tr></table></td></tr></table></td></tr></table></td></tr></table></td></tr></table></td></tr></table></td></tr></table></td></tr></table></td></tr></table></td></tr></table></td></tr></table></td></tr></table></td></tr></table></td></tr></table></td></tr></table></td></tr></table></td></tr></table></td></tr></table></td></tr></table></td></tr></table></td></tr></table></td></tr></table></td></tr></table></td></tr></table></td></tr></table></td></tr></table></td></tr></table></td></tr></table></td></tr></table></td></tr></table></td></tr></table></td></tr></table></td></tr></table></td></tr></table></td></tr></table></td></tr></table></td></tr></table></td></tr></table></td></tr></table> | | | | | | | | | | | | | | | | | | | | <table border="1" style="width: 100%; border-collapse: collapse; text-align: center;"> <tr> <td style="width: 10%;"></td> <td style="width: 10%;"></td> <td style="width: 10%;"></td> <td style="width: 10%;"></td> <td style="width: 10%;"></td> <td style="width: 10%;"></td> <td style="width: 10%;"></td> <td style="width: 10%;"></td> <td style="width: 10%;"></td> <td style="width: 10%;"></td> </tr> <tr> <td></td> <td></td> <td colspan="8" style="text-align: center;"> <table border="1" style="width: 100%; border-collapse: collapse; text-align: center;"> <tr> <td style="width: 10%;"></td> <td style="width: 10%;"></td> <td style="width: 10%;"></td> <td style="width: 10%;"></td> <td style="width: 10%;"></td> <td style="width: 10%;"></td> <td style="width: 10%;"></td> <td style="width: 10%;"></td> <td style="width: 10%;"></td> <td style="width: 10%;"></td> </tr> <tr> <td></td> <td></td> <td colspan="8" style="text-align: center;"> <table border="1" style="width: 100%; border-collapse: collapse; text-align: center;"> <tr> <td style="width: 10%;"></td> <td style="width: 10%;"></td> <td style="width: 10%;"></td> <td style="width: 10%;"></td> <td style="width: 10%;"></td> <td style="width: 10%;"></td> <td style="width: 10%;"></td> <td style="width: 10%;"></td> <td style="width: 10%;"></td> <td style="width: 10%;"></td> </tr> <tr> <td></td> <td></td> <td colspan="8" style="text-align: center;"> <table border="1" style="width: 100%; border-collapse: collapse; text-align: center;"> <tr> <td style="width: 10%;"></td> <td style="width: 10%;"></td> <td style="width: 10%;"></td> <td style="width: 10%;"></td> <td style="width: 10%;"></td> <td style="width: 10%;"></td> <td style="width: 10%;"></td> <td style="width: 10%;"></td> <td style="width: 10%;"></td> <td style="width: 10%;"></td> </tr> <tr> <td></td> <td></td> <td colspan="8" style="text-align: center;"> <table border="1" style="width: 100%; border-collapse: collapse; text-align: center;"> <tr> <td style="width: 10%;"></td> <td style="width: 10%;"></td> <td style="width: 10%;"></td> <td style="width: 10%;"></td> <td style="width: 10%;"></td> <td style="width: 10%;"></td> <td style="width: 10%;"></td> <td style="width: 10%;"></td> <td style="width: 10%;"></td> <td style="width: 10%;"></td> </tr> <tr> <td></td> <td></td> <td colspan="8" style="text-align: center;"> <table border="1" style="width: 100%; border-collapse: collapse; text-align: center;"> <tr> <td style="width: 10%;"></td> <td style="width: 10%;"></td> <td style="width: 10%;"></td> <td style="width: 10%;"></td> <td style="width: 10%;"></td> <td style="width:
10%;"></td> <td style="width: 10%;"></td> <td style="width: 10%;"></td> <td style="width: 10%;"></td> <td style="width: 10%;"></td> </tr> <tr> <td></td> <td></td> <td colspan="8" style="text-align: center;"> <table border="1" style="width: 100%; border-collapse: collapse; text-align: center;"> <tr> <td style="width: 10%;"></td> <td style="width: 10%;"></td> <td style="width: 10%;"></td> <td style="width: 10%;"></td> <td style="width: 10%;"></td> <td style="width: 10%;"></td> <td style="width: 10%;"></td> <td style="width: 10%;"></td> <td style="width: 10%;"></td> <td style="width: 10%;"></td> </tr> <tr> <td></td> <td></td> <td colspan="8" style="text-align: center;"> <table border="1" style="width: 100%; border-collapse: collapse; text-align: center;"> <tr> <td style="width: 10%;"></td> <td style="width: 10%;"></td> <td style="width: 10%;"></td> <td style="width: 10%;"></td> <td style="width: 10%;"></td> <td style="width: 10%;"></td> <td style="width: 10%;"></td> <td style="width: 10%;"></td> <td style="width: 10%;"></td> <td style="width: 10%;"></td> </tr> <tr> <td></td> <td></td> <td colspan="8" style="text-align: center;"> <table border="1" style="width: 100%; border-collapse: collapse; text-align: center;"> <tr> <td style="width: 10%;"></td> <td style="width: 10%;"></td> <td style="width: 10%;"></td> <td style="width: 10%;"></td> <td style="width: 10%;"></td> <td style="width: 10%;"></td> <td style="width: 10%;"></td> <td style="width: 10%;"></td> <td style="width: 10%;"></td> <td style="width: 10%;"></td> </tr> <tr> <td></td> <td></td> <td colspan="8" style="text-align: center;"> <table border="1" style="width: 100%; border-collapse: collapse; text-align: center;"> <tr> <td style="width: 10%;"></td> <td style="width: 10%;"></td> <td style="width: 10%;"></td> <td style="width: 10%;"></td> <td style="width: 10%;"></td> <td style="width: 10%;"></td> <td style="width: 10%;"></td> <td style="width: 10%;"></td> <td style="width: 10%;"></td> <td style="width: 10%;"></td> </tr> <tr> <td></td> <td></td> <td colspan="8" style="text-align: center;"> <table border="1" style="width: 100%; border-collapse: collapse; text-align: center;"> <tr> <td style="width: 10%;"></td> <td style="width: 10%;"></td> <td style="width: 10%;"></td> <td style="width: 10%;"></td> <td style="width: 10%;"></td> <td style="width: 10%;"></td> <td style="width: 10%;"></td> <td style="width: 10%;"></td> <td style="width: 10%;"></td> <td style="width: 10%;"></td> </tr> <tr> <td></td> <td></td> <td colspan="8" style="text-align: center;"> <table border="1" style="width: 100%; border-collapse: collapse; text-align: center;"> <tr> <td style="width: 10%;"></td> <td style="width: 10%;"></td> <td style="width: 10%;"></td> <td style="width: 10%;"></td> <td style="width: 10%;"></td> <td style="width: 10%;"></td> <td style="width: 10%;"></td> <td style="width: 10%;"></td> <td style="width: 10%;"></td> <td style="width: 10%;"></td> </tr> <tr> <td></td> <td></td> <td colspan="8" style="text-align: center;"> <table border="1" style="width: 100%; border-collapse: collapse; text-align: center;"> <tr> <td style="width: 10%;"></td> <td style="width: 10%;"></td> <td style="width: 10%;"></td> <td style="width: 10%;"></td> <td style="width: 10%;"></td> <td style="width: 10%;"></td> <td style="width: 10%;"></td> <td style="width: 10%;"></td> <td style="width: 10%;"></td> <td style="width: 10%;"></td> </tr> <tr> <td></td> <td></td> <td colspan="8" style="text-align: center;"> <table border="1" style="width: 100%; border-collapse: collapse; text-align: center;"> <tr> <td style="width: 10%;"></td> <td style="width: 10%;"></td> <td style="width: 10%;"></td> <td style="width: 10%;"></td> <td style="width: 10%;"></td> <td style="width: 10%;"></td> <td style="width: 10%;"></td> <td style="width: 10%;"></td> <td style="width: 10%;"></td> <td style="width: 10%;"></td> </tr> <tr> <td></td> <td></td> <td colspan="8" style="text-align: center;"> <table border="1" style="width: 100%; border-collapse: collapse; text-align: center;"> <tr> <td style="width: 10%;"></td> <td style="width: 10%;"></td> <td style="width: 10%;"></td> <td style="width: 10%;"></td> <td style="width: 10%;"></td> <td style="width: 10%;"></td> <td style="width: 10%;"></td> <td style="width: 10%;"></td> <td style="width: 10%;"></td> <td style="width: 10%;"></td> </tr> <tr> <td></td> <td></td> <td colspan="8" style="text-align: center;"> <table border="1" style="width: 100%; border-collapse: collapse; text-align: center;"> <tr> <td style="width: 10%;"></td> <td style="width: 10%;"></td> <td style="width: 10%;"></td> <td style="width: 10%;"></td> <td style="width: 10%;"></td> <td style="width: 10%;"></td> <td style="width: 10%;"></td> <td style="width: 10%;"></td> <td style="width: 10%;"></td> <td style="width: 10%;"></td> </tr> <tr> <td></td> <td></td> <td colspan="8" style="text-align: center;"> <table border="1" style="width: 100%; border-collapse: collapse; text-align: center;"> <tr> <td style="width: 10%;"></td> <td style="width: 10%;"></td> <td style="width: 10%;"></td> <td style="width: 10%;"></td> <td style="width: 10%;"></td> <td style="width: 10%;"></td> <td style="width: 10%;"></td> <td style="width: 10%;"></td> <td style="width: 10%;"></td> <td style="width: 10%;"></td> </tr> <tr> <td></td> <td></td> <td colspan="8" style="text-align: center;"> <table border="1" style="width: 100%; border-collapse: collapse; text-align: center;"> <tr> <td style="width: 10%;"></td> <td style="width: 10%;"></td> <td style="width: 10%;"></td> <td style="width: 10%;"></td> <td style="width: 10%;"></td> <td style="width: 10%;"></td> <td style="width: 10%;"></td> <td style="width: 10%;"></td> <td style="width: 10%;"></td> <td style="width: 10%;"></td> </tr> <tr> <td></td> <td></td> <td colspan="8" style="text-align: center;"> <table border="1" style="width: 100%; border-collapse: collapse; text-align: center;"> <tr> <td style="width: 10%;"></td> <td style="width: 10%;"></td> <td style="width: 10%;"></td> <td style="width: 10%;"></td> <td style="width: 10%;"></td> <td style="width: 10%;"></td> <td style="width: 10%;"></td> <td style="width: 10%;"></td> <td style="width: 10%;"></td> <td style="width: 10%;"></td> </tr> <tr> <td></td> <td></td> <td colspan="8" style="text-align: center;"> <table border="1" style="width: 100%; border-collapse: collapse; text-align: center;"> <tr> <td style="width: 10%;"></td> <td style="width: 10%;"></td> <td style="width: 10%;"></td> <td style="width: 10%;"></td> <td style="width: 10%;"></td> <td style="width: 10%;"></td> <td style="width: 10%;"></td> <td style="width: 10%;"></td> <td style="width: 10%;"></td> <td style="width: 10%;"></td> </tr> <tr> <td></td> <td></td> <td colspan="8" style="text-align: center;"> <table border="1" style="width: 100%; border-collapse: collapse; text-align: center;"> <tr> <td style="width: 10%;"></td> <td style="width: 10%;"></td> <td style="width: 10%;"></td> <td style="width: 10%;"></td> <td style="width: 10%;"></td> <td style="width: 10%;"></td> <td style="width: 10%;"></td> <td style="width: 10%;"></td> <td style="width: 10%;"></td> <td style="width: 10%;"></td> </tr> <tr> <td></td> <td></td> <td colspan="8" style="text-align: center;"> <table border="1" style="width: 100%; border-collapse: collapse; text-align: center;"> <tr> <td style="width: 10%;"></td> <td style="width: 10%;"></td> <td style="width: 10%;"></td> <td style="width: 10%;"></td> <td style="width: 10%;"></td> <td style="width: 10%;"></td> <td style="width: 10%;"></td> <td style="width: 10%;"></td> <td style="width: 10%;"></td> <td style="width: 10%;"></td> </tr> <tr> <td></td> <td></td> <td colspan="8" style="text-align: center;"> <table border="1" style="width: 100%; border-collapse: collapse; text-align: center;"> <tr> <td style="width: 10%;"></td> <td style="width: 10%;"></td> <td style="width: 10%;"></td> <td style="width: 10%;"></td> <td style="width: 10%;"></td> <td style="width: 10%;"></td> <td style="width: 10%;"></td> <td style="width: 10%;"></td> <td style="width: 10%;"></td> <td style="width: 10%;"></td> </tr> <tr> <td></td> <td></td> <td colspan="8" style="text-align: center;"> <table border="1" style="width: 100%; border-collapse: collapse; text-align: center;"> <tr> <td style="width: 10%;"></td> <td style="width: 10%;"></td> <td style="width: 10%;"></td> <td style="width: 10%;"></td> <td style="width: 10%;"></td> <td style="width: 10%;"></td> <td style="width: 10%;"></td> <td style="width: 10%;"></td> <td style="width: 10%;"></td> <td style="width: 10%;"></td> </tr> <tr> <td></td> <td></td> <td colspan="8" style="text-align: center;"> <table border="1" style="width: 100%; border-collapse: collapse; text-align: center;"> <tr> <td style="width: 10%;"></td> <td style="width: 10%;"></td> <td style="width: 10%;"></td> <td style="width: 10%;"></td> <td style="width: 10%;"></td> <td style="width: 10%;"></td> <td style="width: 10%;"></td> <td style="width: 10%;"></td> <td style="width: 10%;"></td> <td style="width: 10%;"></td> </tr> <tr> <td></td> <td></td> <td colspan="8" style="text-align: center;"> <table border="1" style="width: 100%; border-collapse: collapse; text-align: center;"> <tr> <td style="width: 10%;"></td> <td style="width: 10%;"></td> <td style="width: 10%;"></td> <td style="width: 10%;"></td> <td style="width: 10%;"></td> <td style="width: 10%;"></td> <td style="width: 10%;"></td> <td style="width: 10%;"></td> <td style="width: 10%;"></td> <td style="width: 10%;"></td> </tr> <tr> <td></td> <td></td> <td colspan="8" style="text-align: center;"> <table border="1" style="width: 100%; border-collapse: collapse; text-align: center;"> <tr> <td style="width: 10%;"></td> <td style="width: 10%;"></td> <td style="width: 10%;"></td> <td style="width: 10%;"></td> <td style="width: 10%;"></td> <td style="width: 10%;"></td> <td style="width: 10%;"></td> <td style="width: 10%;"></td> <td style="width: 10%;"></td> <td style="width: 10%;"></td> </tr> <tr> <td></td> <td></td> <td
colspan="8" style="text-align: center;"> <table border="1" style="width: 100%; border-collapse: collapse; text-align: center;"> <tr> <td style="width: 10%;"></td> <td style="width: 10%;"></td> <td style="width: 10%;"></td> <td style="width: 10%;"></td> <td style="width: 10%;"></td> <td style="width: 10%;"></td> <td style="width: 10%;"></td> <td style="width: 10%;"></td> <td style="width: 10%;"></td> <td style="width: 10%;"></td> </tr> <tr> <td></td> <td></td> <td colspan="8" style="text-align: center;"> <table border="1" style="width: 100%; border-collapse: collapse; text-align: center;"> <tr> <td style="width: 10%;"></td> <td style="width: 10%;"></td> <td style="width: 10%;"></td> <td style="width: 10%;"></td> <td style="width: 10%;"></td> <td style="width: 10%;"></td> <td style="width: 10%;"></td> <td style="width: 10%;"></td> <td style="width: 10%;"></td> <td style="width: 10%;"></td> </tr> <tr> <td></td> <td></td> <td colspan="8" style="text-align: center;"> <table border="1" style="width: 100%; border-collapse: collapse; text-align: center;"> <tr> <td style="width: 10%;"></td> <td style="width: 10%;"></td> <td style="width: 10%;"></td> <td style="width: 10%;"></td> <td style="width: 10%;"></td> <td style="width: 10%;"></td> <td style="width: 10%;"></td> <td style="width: 10%;"></td> <td style="width: 10%;"></td> <td style="width: 10%;"></td> </tr> <tr> <td></td> <td></td> <td colspan="8" style="text-align: center;"> <table border="1" style="width: 100%; border-collapse: collapse; text-align: center;"> <tr> <td style="width: 10%;"></td> <td style="width: 10%;"></td> <td style="width: 10%;"></td> <td style="width: 10%;"></td> <td style="width: 10%;"></td> <td style="width: 10%;"></td> <td style="width: 10%;"></td> <td style="width: 10%;"></td> <td style="width: 10%;"></td> <td style="width: 10%;"></td> </tr> <tr> <td></td> <td></td> <td colspan="8" style="text-align: center;"> <table border="1" style="width: 100%; border-collapse: collapse; text-align: center;"> <tr> <td style="width: 10%;"></td> <td style="width: 10%;"></td> <td style="width: 10%;"></td> <td style="width: 10%;"></td> <td style="width: 10%;"></td> <td style="width: 10%;"></td> <td style="width: 10%;"></td> <td style="width: 10%;"></td> <td style="width: 10%;"></td> <td style="width: 10%;"></td> </tr> <tr> <td></td> <td></td> <td colspan="8" style="text-align: center;"> <table border="1" style="width: 100%; border-collapse: collapse; text-align: center;"> <tr> <td style="width: 10%;"></td> <td style="width: 10%;"></td> <td style="width: 10%;"></td> <td style="width: 10%;"></td> <td style="width: 10%;"></td> <td style="width: 10%;"></td> <td style="width: 10%;"></td> <td style="width: 10%;"></td> <td style="width: 10%;"></td> <td style="width: 10%;"></td> </tr> <tr> <td></td> <td></td> <td colspan="8" style="text-align: center;"> <table border="1" style="width: 100%; border-collapse: collapse; text-align: center;"> <tr> <td style="width: 10%;"></td> <td style="width: 10%;"></td> <td style="width: 10%;"></td> <td style="width: 10%;"></td> <td style="width: 10%;"></td> <td style="width: 10%;"></td> <td style="width: 10%;"></td> <td style="width: 10%;"></td> <td style="width: 10%;"></td> <td style="width: 10%;"></td> </tr> <tr> <td></td> <td></td> <td colspan="8" style="text-align: center;"> <table border="1" style="width: 100%; border-collapse: collapse; text-align: center;"> <tr> <td style="width: 10%;"></td> <td style="width: 10%;"></td> <td style="width: 10%;"></td> <td style="width: 10%;"></td> <td style="width: 10%;"></td> <td style="width: 10%;"></td> <td style="width: 10%;"></td> <td style="width: 10%;"></td> <td style="width: 10%;"></td> <td style="width: 10%;"></td> </tr> <tr> <td></td> <td></td> <td colspan="8" style="text-align: center;"> <table border="1" style="width: 100%; border-collapse: collapse; text-align: center;"> <tr> <td style="width: 10%;"></td> <td style="width: 10%;"></td> <td style="width: 10%;"></td> <td style="width: 10%;"></td> <td style="width: 10%;"></td> <td style="width: 10%;"></td> <td style="width: 10%;"></td> <td style="width: 10%;"></td> <td style="width: 10%;"></td> <td style="width: 10%;"></td> </tr> <tr> <td></td> <td></td> <td colspan="8" style="text-align: center;"> <table border="1" style="width: 100%; border-collapse: collapse; text-align: center;"> <tr> <td style="width: 10%;"></td> <td style="width: 10%;"></td> <td style="width: 10%;"></td> <td style="width: 10%;"></td> <td style="width: 10%;"></td> <td style="width: 10%;"></td> <td style="width: 10%;"></td> <td style="width: 10%;"></td> <td style="width: 10%;"></td> <td style="width: 10%;"></td> </tr> <tr> <td></td> <td></td> <td colspan="8" style="text-align: center;"> <table border="1" style="width: 100%; border-collapse: collapse; text-align: center;"> <tr> <td style="width: 10%;"></td> <td style="width: 10%;"></td> <td style="width: 10%;"></td> <td style="width: 10%;"></td> <td style="width: 10%;"></td> <td style="width: 10%;"></td> <td style="width: 10%;"></td> <td style="width: 10%;"></td> <td style="width: 10%;"></td> <td style="width: 10%;"></td> </tr> <tr> <td></td> <td></td> <td colspan="8" style="text-align: center;"> <table border="1" style="width: 100%; border-collapse: collapse; text-align: center;"> <tr> <td style="width: 10%;"></td> <td style="width: 10%;"></td> <td style="width: 10%;"></td> <td style="width: 10%;"></td> <td style="width: 10%;"></td> <td style="width: 10%;"></td> <td style="width: 10%;"></td> <td style="width: 10%;"></td> <td style="width: 10%;"></td> <td style="width: 10%;"></td> </tr> <tr> <td></td> <td></td> <td colspan="8" style="text-align: center;"> <table border="1" style="width: 100%; border-collapse: collapse; text-align: center;"> <tr> <td style="width: 10%;"></td> <td style="width: 10%;"></td> <td style="width: 10%;"></td> <td style="width: 10%;"></td> <td style="width: 10%;"></td> <td style="width: 10%;"></td> <td style="width: 10%;"></td> <td style="width: 10%;"></td> <td style="width: 10%;"></td> <td style="width: 10%;"></td> </tr> <tr> <td></td> <td></td> <td colspan="8" style="text-align: center;"> <table border="1" style="width: 100%; border-collapse: collapse; text-align: center;"> <tr> <td style="width: 10%;"></td> <td style="width: 10%;"></td> <td style="width: 10%;"></td> <td style="width: 10%;"></td> <td style="width: 10%;"></td> <td style="width: 10%;"></td> <td style="width: 10%;"></td> <td style="width: 10%;"></td> <td style="width: 10%;"></td> <td style="width: 10%;"></td> </tr> <tr> <td></td> <td></td> <td colspan="8" style="text-align: center;"> <table border="1" style="width: 100%; border-collapse: collapse; text-align: center;"> <tr> <td style="width: 10%;"></td> <td style="width: 10%;"></td> <td style="width: 10%;"></td> <td style="width: 10%;"></td> <td style="width: 10%;"></td> <td style="width: 10%;"></td> <td style="width: 10%;"></td> <td style="width: 10%;"></td> <td style="width: 10%;"></td> <td style="width: 10%;"></td> </tr> <tr> <td></td> <td></td> <td colspan="8" style="text-align: center;"> <table border="1" style="width: 100%; border-collapse: collapse; text-align: center;"> <tr> <td style="width: 10%;"></td> <td style="width: 10%;"></td> <td style="width: 10%;"></td> <td style="width: 10%;"></td> <td style="width: 10%;"></td> <td style="width: 10%;"></td> <td style="width: 10%;"></td> <td style="width: 10%;"></td> <td style="width: 10%;"></td> <td style="width: 10%;"></td> </tr> <tr> <td></td> <td></td> <td colspan="8" style="text-align: center;"> <table border="1" style="width: 100%; border-collapse: collapse; text-align: center;"> <tr> <td style="width: 10%;"></td> <td style="width: 10%;"></td> <td style="width: 10%;"></td> <td style="width: 10%;"></td> <td style="width: 10%;"></td> <td style="width: 10%;"></td> <td style="width: 10%;"></td> <td style="width: 10%;"></td> <td style="width: 10%;"></td> <td style="width: 10%;"></td> </tr> <tr> <td></td> <td></td> <td colspan="8" style="text-align: center;"> <table border="1" style="width: 100%; border-collapse: collapse; text-align: center;"> <tr> <td style="width: 10%;"></td> <td style="width: 10%;"></td> <td style="width: 10%;"></td> <td style="width: 10%;"></td> <td style="width: 10%;"></td> <td style="width: 10%;"></td> <td style="width: 10%;"></td> <td style="width: 10%;"></td> <td style="width: 10%;"></td> <td style="width: 10%;"></td> </tr> <tr> <td></td> <td></td> <td colspan="8" style="text-align: center;"> <table border="1" style="width: 100%; border-collapse: collapse; text-align: center;"> <tr> </tr></table></td></tr></table></td></tr></table></td></tr></table></td></tr></table></td></tr></table></td></tr></table></td></tr></table></td></tr></table></td></tr></table></td></tr></table></td></tr></table></td></tr></table></td></tr></table></td></tr></table></td></tr></table></td></tr></table></td></tr></table></td></tr></table></td></tr></table></td></tr></table></td></tr></table></td></tr></table></td></tr></table></td></tr></table></td></tr></table></td></tr></table></td></tr></table></td></tr></table></td></tr></table></td></tr></table></td></tr></table></td></tr></table></td></tr></table></td></tr></table></td></tr></table></td></tr></table></td></tr></table></td></tr></table></td></tr></table></td></tr></table></td></tr></table></td></tr></table></td></tr></table></td></tr></table></td></tr></table>
 | | | | | | | | | | | | | | | | | | | | <table border="1" style="width: 100%; border-collapse: collapse; text-align: center;"> <tr> <td style="width: 10%;"></td> <td style="width: 10%;"></td> <td style="width: 10%;"></td> <td style="width: 10%;"></td> <td style="width: 10%;"></td> <td style="width: 10%;"></td> <td style="width: 10%;"></td> <td style="width: 10%;"></td> <td style="width: 10%;"></td> <td style="width: 10%;"></td> </tr> <tr> <td></td> <td></td> <td colspan="8" style="text-align: center;"> <table border="1" style="width: 100%; border-collapse: collapse; text-align: center;"> <tr> <td style="width: 10%;"></td> <td style="width: 10%;"></td> <td style="width: 10%;"></td> <td style="width: 10%;"></td> <td style="width: 10%;"></td> <td style="width: 10%;"></td> <td style="width: 10%;"></td> <td style="width: 10%;"></td> <td style="width: 10%;"></td> <td style="width: 10%;"></td> </tr> <tr> <td></td> <td></td> <td colspan="8" style="text-align: center;"> <table border="1" style="width: 100%; border-collapse: collapse; text-align: center;"> <tr> <td style="width: 10%;"></td> <td style="width: 10%;"></td> <td style="width: 10%;"></td> <td style="width: 10%;"></td> <td style="width: 10%;"></td> <td style="width: 10%;"></td> <td style="width: 10%;"></td> <td style="width: 10%;"></td> <td style="width: 10%;"></td> <td style="width: 10%;"></td> </tr> <tr> <td></td> <td></td> <td colspan="8" style="text-align: center;"> <table border="1" style="width: 100%; border-collapse: collapse; text-align: center;"> <tr> <td style="width: 10%;"></td> <td style="width: 10%;"></td> <td style="width: 10%;"></td> <td style="width: 10%;"></td> <td style="width: 10%;"></td> <td style="width: 10%;"></td> <td style="width: 10%;"></td> <td style="width: 10%;"></td> <td style="width: 10%;"></td> <td style="width: 10%;"></td> </tr> <tr> <td></td> <td></td> <td colspan="8" style="text-align: center;"> <table border="1" style="width: 100%; border-collapse: collapse; text-align: center;"> <tr> <td style="width: 10%;"></td> <td style="width: 10%;"></td> <td style="width: 10%;"></td> <td style="width: 10%;"></td> <td style="width: 10%;"></td> <td style="width: 10%;"></td> <td style="width: 10%;"></td> <td style="width: 10%;"></td> <td style="width: 10%;"></td> <td style="width: 10%;"></td> </tr> <tr> <td></td> <td></td> <td colspan="8" style="text-align: center;"> <table border="1" style="width: 100%; border-collapse: collapse; text-align: center;"> <tr> <td style="width: 10%;"></td> <td style="width: 10%;"></td> <td style="width: 10%;"></td> <td style="width: 10%;"></td> <td style="width: 10%;"></td> <td style="width: 10%;"></td> <td style="width: 10%;"></td> <td style="width: 10%;"></td> <td style="width: 10%;"></td> <td style="width: 10%;"></td> </tr> <tr> <td></td> <td></td> <td colspan="8" style="text-align: center;"> <table border="1" style="width: 100%; border-collapse: collapse; text-align: center;"> <tr> <td style="width: 10%;"></td> <td style="width: 10%;"></td> <td style="width: 10%;"></td> <td style="width: 10%;"></td> <td style="width: 10%;"></td> <td style="width: 10%;"></td> <td style="width: 10%;"></td> <td style="width: 10%;"></td> <td style="width: 10%;"></td> <td style="width: 10%;"></td> </tr> <tr> <td></td> <td></td> <td colspan="8" style="text-align: center;"> <table border="1" style="width: 100%; border-collapse: collapse; text-align: center;"> <tr> <td style="width: 10%;"></td> <td style="width: 10%;"></td> <td style="width: 10%;"></td> <td style="width: 10%;"></td> <td style="width: 10%;"></td> <td style="width: 10%;"></td> <td style="width: 10%;"></td> <td style="width: 10%;"></td> <td style="width: 10%;"></td> <td style="width: 10%;"></td> </tr> <tr> <td></td> <td></td> <td colspan="8" style="text-align: center;"> <table border="1" style="width: 100%; border-collapse: collapse; text-align: center;"> <tr> <td style="width: 10%;"></td> <td style="width: 10%;"></td> <td style="width: 10%;"></td> <td style="width: 10%;"></td> <td style="width: 10%;"></td> <td style="width: 10%;"></td> <td style="width: 10%;"></td> <td style="width: 10%;"></td> <td style="width: 10%;"></td> <td style="width: 10%;"></td> </tr> <tr> <td></td> <td></td> <td colspan="8" style="text-align: center;"> <table border="1" style="width: 100%; border-collapse: collapse; text-align: center;"> <tr> <td style="width: 10%;"></td> <td style="width: 10%;"></td> <td style="width: 10%;"></td> <td style="width: 10%;"></td> <td style="width: 10%;"></td> <td style="width: 10%;"></td> <td style="width: 10%;"></td> <td style="width: 10%;"></td> <td style="width: 10%;"></td> <td style="width: 10%;"></td> </tr> <tr> <td></td> <td></td> <td colspan="8" style="text-align: center;"> <table border="1" style="width: 100%; border-collapse: collapse; text-align: center;"> <tr> <td style="width: 10%;"></td> <td style="width: 10%;"></td> <td style="width: 10%;"></td> <td style="width: 10%;"></td> <td style="width: 10%;"></td> <td style="width: 10%;"></td> <td style="width: 10%;"></td> <td style="width: 10%;"></td> <td style="width: 10%;"></td> <td style="width: 10%;"></td> </tr> <tr> <td></td> <td></td> <td colspan="8" style="text-align: center;"> <table border="1" style="width: 100%; border-collapse: collapse; text-align: center;"> <tr> <td style="width: 10%;"></td> <td style="width: 10%;"></td> <td style="width: 10%;"></td> <td style="width: 10%;"></td> <td style="width: 10%;"></td> <td style="width: 10%;"></td> <td style="width: 10%;"></td> <td style="width: 10%;"></td> <td style="width: 10%;"></td> <td style="width: 10%;"></td> </tr> <tr> <td></td> <td></td> <td colspan="8" style="text-align: center;"> <table border="1" style="width: 100%; border-collapse: collapse; text-align: center;"> <tr> <td style="width: 10%;"></td> <td style="width: 10%;"></td> <td style="width: 10%;"></td> <td style="width: 10%;"></td> <td style="width: 10%;"></td> <td style="width: 10%;"></td> <td style="width: 10%;"></td> <td style="width: 10%;"></td> <td style="width: 10%;"></td> <td style="width: 10%;"></td> </tr> <tr> <td></td> <td></td> <td colspan="8" style="text-align: center;"> <table border="1" style="width: 100%; border-collapse: collapse; text-align: center;"> <tr> <td style="width: 10%;"></td> <td style="width: 10%;"></td> <td style="width: 10%;"></td> <td style="width: 10%;"></td> <td style="width: 10%;"></td> <td style="width: 10%;"></td> <td style="width: 10%;"></td> <td style="width: 10%;"></td> <td style="width: 10%;"></td> <td style="width: 10%;"></td> </tr> <tr> <td></td> <td></td> <td colspan="8" style="text-align: center;"> <table border="1" style="width: 100%; border-collapse: collapse; text-align: center;"> <tr> <td style="width: 10%;"></td> <td style="width: 10%;"></td> <td style="width: 10%;"></td> <td style="width: 10%;"></td> <td style="width: 10%;"></td> <td style="width: 10%;"></td> <td style="width: 10%;"></td> <td style="width: 10%;"></td> <td style="width: 10%;"></td> <td style="width: 10%;"></td> </tr> <tr> <td></td> <td></td> <td colspan="8" style="text-align: center;"> <table border="1" style="width: 100%; border-collapse: collapse; text-align: center;"> <tr> <td style="width: 10%;"></td> <td style="width: 10%;"></td> <td style="width: 10%;"></td> <td style="width: 10%;"></td> <td style="width: 10%;"></td> <td style="width: 10%;"></td> <td style="width: 10%;"></td> <td style="width: 10%;"></td> <td style="width: 10%;"></td> <td style="width: 10%;"></td> </tr> <tr> <td></td> <td></td> <td colspan="8" style="text-align: center;"> <table border="1" style="width: 100%; border-collapse: collapse; text-align: center;"> <tr> <td style="width: 10%;"></td> <td style="width: 10%;"></td> <td style="width: 10%;"></td> <td style="width: 10%;"></td> <td style="width: 10%;"></td> <td style="width: 10%;"></td> <td style="width: 10%;"></td> <td style="width: 10%;"></td> <td style="width: 10%;"></td> <td style="width: 10%;"></td> </tr> <tr> <td></td> <td></td> <td colspan="8" style="text-align: center;"> <table border="1" style="width: 100%; border-collapse: collapse; text-align: center;"> <tr> <td style="width: 10%;"></td> <td style="width: 10%;"></td> <td style="width: 10%;"></td> <td style="width: 10%;"></td> <td style="width: 10%;"></td> <td style="width: 10%;"></td> <td style="width: 10%;"></td> <td style="width: 10%;"></td> <td style="width: 10%;"></td> <td style="width: 10%;"></td> </tr> <tr> <td></td> <td></td> <td colspan="8" style="text-align: center;"> <table border="1" style="width: 100%; border-collapse: collapse; text-align: center;"> <tr> <td style="width: 10%;"></td> <td style="width: 10%;"></td> <td style="width: 10%;"></td> <td style="width: 10%;"></td> <td style="width: 10%;"></td> <td style="width: 10%;"></td> <td style="width: 10%;"></td> <td style="width: 10%;"></td> <td style="width: 10%;"></td> <td style="width: 10%;"></td> </tr> <tr> <td></td> <td></td> <td colspan="8" style="text-align: center;"> <table border="1" style="width: 100%; border-collapse: collapse; text-align: center;"> <tr> <td style="width: 10%;"></td> <td style="width: 10%;"></td> <td style="width: 10%;"></td> <td style="width: 10%;"></td> <td style="width: 10%;"></td> <td style="width: 10%;"></td> <td style="width: 10%;"></td> <td style="width: 10%;"></td> <td style="width: 10%;"></td> <td style="width: 10%;"></td> </tr> <tr> <td></td> <td></td> <td colspan="8" style="text-align: center;"> <table border="1" style="width: 100%; border-collapse: collapse; text-align: center;"> <tr> <td style="width: 10%;"></td> <td style="width: 10%;"></td> <td style="width: 10%;"></td> <td style="width: 10%;"></td> <td
style="width: 10%;"></td> <td style="width: 10%;"></td> <td style="width: 10%;"></td> <td style="width: 10%;"></td> <td style="width: 10%;"></td> <td style="width: 10%;"></td> </tr> <tr> <td></td> <td></td> <td colspan="8" style="text-align: center;"> <table border="1" style="width: 100%; border-collapse: collapse; text-align: center;"> <tr> <td style="width: 10%;"></td> <td style="width: 10%;"></td> <td style="width: 10%;"></td> <td style="width: 10%;"></td> <td style="width: 10%;"></td> <td style="width: 10%;"></td> <td style="width: 10%;"></td> <td style="width: 10%;"></td> <td style="width: 10%;"></td> <td style="width: 10%;"></td> </tr> <tr> <td></td> <td></td> <td colspan="8" style="text-align: center;"> <table border="1" style="width: 100%; border-collapse: collapse; text-align: center;"> <tr> <td style="width: 10%;"></td> <td style="width: 10%;"></td> <td style="width: 10%;"></td> <td style="width: 10%;"></td> <td style="width: 10%;"></td> <td style="width: 10%;"></td> <td style="width: 10%;"></td> <td style="width: 10%;"></td> <td style="width: 10%;"></td> <td style="width: 10%;"></td> </tr> <tr> <td></td> <td></td> <td colspan="8" style="text-align: center;"> <table border="1" style="width: 100%; border-collapse: collapse; text-align: center;"> <tr> <td style="width: 10%;"></td> <td style="width: 10%;"></td> <td style="width: 10%;"></td> <td style="width: 10%;"></td> <td style="width: 10%;"></td> <td style="width: 10%;"></td> <td style="width: 10%;"></td> <td style="width: 10%;"></td> <td style="width: 10%;"></td> <td style="width: 10%;"></td> </tr> <tr> <td></td> <td></td> <td colspan="8" style="text-align: center;"> <table border="1" style="width: 100%; border-collapse: collapse; text-align: center;"> <tr> <td style="width: 10%;"></td> <td style="width: 10%;"></td> <td style="width: 10%;"></td> <td style="width: 10%;"></td> <td style="width: 10%;"></td> <td style="width: 10%;"></td> <td style="width: 10%;"></td> <td style="width: 10%;"></td> <td style="width: 10%;"></td> <td style="width: 10%;"></td> </tr> <tr> <td></td> <td></td> <td colspan="8" style="text-align: center;"> <table border="1" style="width: 100%; border-collapse: collapse; text-align: center;"> <tr> <td style="width: 10%;"></td> <td style="width: 10%;"></td> <td style="width: 10%;"></td> <td style="width: 10%;"></td> <td style="width: 10%;"></td> <td style="width: 10%;"></td> <td style="width: 10%;"></td> <td style="width: 10%;"></td> <td style="width: 10%;"></td> <td style="width: 10%;"></td> </tr> <tr> <td></td> <td></td> <td colspan="8" style="text-align: center;"> <table border="1" style="width: 100%; border-collapse: collapse; text-align: center;"> <tr> <td style="width: 10%;"></td> <td style="width: 10%;"></td> <td style="width: 10%;"></td> <td style="width: 10%;"></td> <td style="width: 10%;"></td> <td style="width: 10%;"></td> <td style="width: 10%;"></td> <td style="width: 10%;"></td> <td style="width: 10%;"></td> <td style="width: 10%;"></td> </tr> <tr> <td></td> <td></td> <td colspan="8" style="text-align: center;"> <table border="1" style="width: 100%; border-collapse: collapse; text-align: center;"> <tr> <td style="width: 10%;"></td> <td style="width: 10%;"></td> <td style="width: 10%;"></td> <td style="width: 10%;"></td> <td style="width: 10%;"></td> <td style="width: 10%;"></td> <td style="width: 10%;"></td> <td style="width: 10%;"></td> <td style="width: 10%;"></td> <td style="width: 10%;"></td> </tr> <tr> <td></td> <td></td> <td colspan="8" style="text-align: center;"> <table border="1" style="width: 100%; border-collapse: collapse; text-align: center;"> <tr> <td style="width: 10%;"></td> <td style="width: 10%;"></td> <td style="width: 10%;"></td> <td style="width: 10%;"></td> <td style="width: 10%;"></td> <td style="width: 10%;"></td> <td style="width: 10%;"></td> <td style="width: 10%;"></td> <td style="width: 10%;"></td> <td style="width: 10%;"></td> </tr> <tr> <td></td> <td></td> <td colspan="8" style="text-align: center;"> <table border="1" style="width: 100%; border-collapse: collapse; text-align: center;"> <tr> <td style="width: 10%;"></td> <td style="width: 10%;"></td> <td style="width: 10%;"></td> <td style="width: 10%;"></td> <td style="width: 10%;"></td> <td style="width: 10%;"></td> <td style="width: 10%;"></td> <td style="width: 10%;"></td> <td style="width: 10%;"></td> <td style="width: 10%;"></td> </tr> <tr> <td></td> <td></td> <td colspan="8" style="text-align: center;"> <table border="1" style="width: 100%; border-collapse: collapse; text-align: center;"> <tr> <td style="width: 10%;"></td> <td style="width: 10%;"></td> <td style="width: 10%;"></td> <td style="width: 10%;"></td> <td style="width: 10%;"></td> <td style="width: 10%;"></td> <td style="width: 10%;"></td> <td style="width: 10%;"></td> <td style="width: 10%;"></td> <td style="width: 10%;"></td> </tr> <tr> <td></td> <td></td> <td colspan="8" style="text-align: center;"> <table border="1" style="width: 100%; border-collapse: collapse; text-align: center;"> <tr> <td style="width: 10%;"></td> <td style="width: 10%;"></td> <td style="width: 10%;"></td> <td style="width: 10%;"></td> <td style="width: 10%;"></td> <td style="width: 10%;"></td> <td style="width: 10%;"></td> <td style="width: 10%;"></td> <td style="width: 10%;"></td> <td style="width: 10%;"></td> </tr> <tr> <td></td> <td></td> <td colspan="8" style="text-align: center;"> <table border="1" style="width: 100%; border-collapse: collapse; text-align: center;"> <tr> <td style="width: 10%;"></td> <td style="width: 10%;"></td> <td style="width: 10%;"></td> <td style="width: 10%;"></td> <td style="width: 10%;"></td> <td style="width: 10%;"></td> <td style="width: 10%;"></td> <td style="width: 10%;"></td> <td style="width: 10%;"></td> <td style="width: 10%;"></td> </tr> <tr> <td></td> <td></td> <td colspan="8" style="text-align: center;"> <table border="1" style="width: 100%; border-collapse: collapse; text-align: center;"> <tr> <td style="width: 10%;"></td> <td style="width: 10%;"></td> <td style="width: 10%;"></td> <td style="width: 10%;"></td> <td style="width: 10%;"></td> <td style="width: 10%;"></td> <td style="width: 10%;"></td> <td style="width: 10%;"></td> <td style="width: 10%;"></td> <td style="width: 10%;"></td> </tr> <tr> <td></td> <td></td> <td colspan="8" style="text-align: center;"> <table border="1" style="width: 100%; border-collapse: collapse; text-align: center;"> <tr> <td style="width: 10%;"></td> <td style="width: 10%;"></td> <td style="width: 10%;"></td> <td style="width: 10%;"></td> <td style="width: 10%;"></td> <td style="width: 10%;"></td> <td style="width: 10%;"></td> <td style="width: 10%;"></td> <td style="width: 10%;"></td> <td style="width: 10%;"></td> </tr> <tr> <td></td> <td></td> <td colspan="8" style="text-align: center;"> <table border="1" style="width: 100%; border-collapse: collapse; text-align: center;"> <tr> <td style="width: 10%;"></td> <td style="width: 10%;"></td> <td style="width: 10%;"></td> <td style="width: 10%;"></td> <td style="width: 10%;"></td> <td style="width: 10%;"></td> <td style="width: 10%;"></td> <td style="width: 10%;"></td> <td style="width: 10%;"></td> <td style="width: 10%;"></td> </tr> <tr> <td></td> <td></td> <td colspan="8" style="text-align: center;"> <table border="1" style="width: 100%; border-collapse: collapse; text-align: center;"> <tr> <td style="width: 10%;"></td> <td style="width: 10%;"></td> <td style="width: 10%;"></td> <td style="width: 10%;"></td> <td style="width: 10%;"></td> <td style="width: 10%;"></td> <td style="width: 10%;"></td> <td style="width: 10%;"></td> <td style="width: 10%;"></td> <td style="width: 10%;"></td> </tr> <tr> <td></td> <td></td> <td colspan="8" style="text-align: center;"> <table border="1" style="width: 100%; border-collapse: collapse; text-align: center;"> <tr> <td style="width: 10%;"></td> <td style="width: 10%;"></td> <td style="width: 10%;"></td> <td style="width: 10%;"></td> <td style="width: 10%;"></td> <td style="width: 10%;"></td> <td style="width: 10%;"></td> <td style="width: 10%;"></td> <td style="width: 10%;"></td> <td style="width: 10%;"></td> </tr> <tr> <td></td> <td></td> <td colspan="8" style="text-align: center;"> <table border="1" style="width: 100%; border-collapse: collapse; text-align: center;"> <tr> <td style="width: 10%;"></td> <td style="width: 10%;"></td> <td style="width: 10%;"></td> <td style="width: 10%;"></td> <td style="width: 10%;"></td> <td style="width: 10%;"></td> <td style="width: 10%;"></td> <td style="width: 10%;"></td> <td style="width: 10%;"></td> <td style="width: 10%;"></td> </tr> <tr> <td></td> <td></td> <td colspan="8" style="text-align: center;"> <table border="1" style="width: 100%; border-collapse: collapse; text-align: center;"> <tr> <td style="width: 10%;"></td> <td style="width: 10%;"></td> <td style="width: 10%;"></td> <td style="width: 10%;"></td> <td style="width: 10%;"></td> <td style="width: 10%;"></td> <td style="width: 10%;"></td> <td style="width: 10%;"></td> <td style="width: 10%;"></td> <td style="width: 10%;"></td> </tr> <tr> <td></td> <td></td> <td colspan="8" style="text-align: center;"> <table border="1" style="width: 100%; border-collapse: collapse; text-align: center;"> <tr> <td style="width: 10%;"></td> <td style="width: 10%;"></td> <td style="width: 10%;"></td> <td style="width: 10%;"></td> <td style="width: 10%;"></td> <td style="width: 10%;"></td> <td style="width: 10%;"></td> <td style="width: 10%;"></td> <td style="width: 10%;"></td> <td style="width: 10%;"></td> </tr> <tr> <td></td> <td></td> <td colspan="8" style="text-align: center;"> <table border="1" style="width: 100%; border-collapse: collapse; text-align: center;"> <tr> <td style="width: 10%;"></td> <td style="width: 10%;"></td> <td style="width: 10%;"></td> <td style="width: 10%;"></td> <td style="width: 10%;"></td> <td style="width: 10%;"></td> <td style="width: 10%;"></td> <td style="width: 10%;"></td> <td style="width: 10%;"></td> <td style="width:
10%;"></td> </tr> <tr> <td></td> <td></td> <td colspan="8" style="text-align: center;"> <table border="1" style="width: 100%; border-collapse: collapse; text-align: center;"> <tr> <td style="width: 10%;"></td> <td style="width: 10%;"></td> <td style="width: 10%;"></td> <td style="width: 10%;"></td> <td style="width: 10%;"></td> <td style="width: 10%;"></td> <td style="width: 10%;"></td> <td style="width: 10%;"></td> <td style="width: 10%;"></td> <td style="width: 10%;"></td> </tr> <tr> <td></td> <td></td> <td colspan="8" style="text-align: center;"> <table border="1" style="width: 100%; border-collapse: collapse; text-align: center;"> <tr> <td style="width: 10%;"></td> <td style="width: 10%;"></td> <td style="width: 10%;"></td> <td style="width: 10%;"></td> <td style="width: 10%;"></td> <td style="width: 10%;"></td> <td style="width: 10%;"></td> <td style="width: 10%;"></td> <td style="width: 10%;"></td> <td style="width: 10%;"></td> </tr> <tr> <td></td> <td></td> <td colspan="8" style="text-align: center;"> <table border="1" style="width: 100%; border-collapse: collapse; text-align: center;"> <tr> </tr></table></td></tr></table></td></tr></table></td></tr></table></td></tr></table></td></tr></table></td></tr></table></td></tr></table></td></tr></table></td></tr></table></td></tr></table></td></tr></table></td></tr></table></td></tr></table></td></tr></table></td></tr></table></td></tr></table></td></tr></table></td></tr></table></td></tr></table></td></tr></table></td></tr></table></td></tr></table></td></tr></table></td></tr></table></td></tr></table></td></tr></table></td></tr></table></td></tr></table></td></tr></table></td></tr></table></td></tr></table></td></tr></table></td></tr></table></td></tr></table></td></tr></table></td></tr></table></td></tr></table></td></tr></table></td></tr></table></td></tr></table></td></tr></table></td></tr></table></td></tr></table></td></tr></table> | | | | | | | | | | | | | | | | | | | | <table border="1" style="width: 100%; border-collapse: collapse; text-align: center;"> <tr> <td style="width: 10%;"></td> <td style="width: 10%;"></td> <td style="width: 10%;"></td> <td style="width: 10%;"></td> <td style="width: 10%;"></td> <td style="width: 10%;"></td> <td style="width: 10%;"></td> <td style="width: 10%;"></td> <td style="width: 10%;"></td> <td style="width: 10%;"></td> </tr> <tr> <td></td> <td></td> <td colspan="8" style="text-align: center;"> <table border="1" style="width: 100%; border-collapse: collapse; text-align: center;"> <tr> <td style="width: 10%;"></td> <td style="width: 10%;"></td> <td style="width: 10%;"></td> <td style="width: 10%;"></td> <td style="width: 10%;"></td> <td style="width: 10%;"></td> <td style="width: 10%;"></td> <td style="width: 10%;"></td> <td style="width: 10%;"></td> <td style="width: 10%;"></td> </tr> <tr> <td></td> <td></td> <td colspan="8" style="text-align: center;"> <table border="1" style="width: 100%; border-collapse: collapse; text-align: center;"> <tr> <td style="width: 10%;"></td> <td style="width: 10%;"></td> <td style="width: 10%;"></td> <td style="width: 10%;"></td> <td style="width: 10%;"></td> <td style="width: 10%;"></td> <td style="width: 10%;"></td> <td style="width: 10%;"></td> <td style="width: 10%;"></td> <td style="width: 10%;"></td> </tr> <tr> <td></td> <td></td> <td colspan="8" style="text-align: center;"> <table border="1" style="width: 100%; border-collapse: collapse; text-align: center;"> <tr> <td style="width: 10%;"></td> <td style="width: 10%;"></td> <td style="width: 10%;"></td> <td style="width: 10%;"></td> <td style="width: 10%;"></td> <td style="width: 10%;"></td> <td style="width: 10%;"></td> <td style="width: 10%;"></td> <td style="width: 10%;"></td> <td style="width: 10%;"></td> </tr> <tr> <td></td> <td></td> <td colspan="8" style="text-align: center;"> <table border="1" style="width: 100%; border-collapse: collapse; text-align: center;"> <tr> <td style="width: 10%;"></td> <td style="width: 10%;"></td> <td style="width: 10%;"></td> <td style="width: 10%;"></td> <td style="width: 10%;"></td> <td style="width: 10%;"></td> <td style="width: 10%;"></td> <td style="width: 10%;"></td> <td style="width: 10%;"></td> <td style="width: 10%;"></td> </tr> <tr> <td></td> <td></td> <td colspan="8" style="text-align: center;"> <table border="1" style="width: 100%; border-collapse: collapse; text-align: center;"> <tr> <td style="width: 10%;"></td> <td style="width: 10%;"></td> <td style="width: 10%;"></td> <td style="width: 10%;"></td> <td style="width: 10%;"></td> <td style="width: 10%;"></td> <td style="width: 10%;"></td> <td style="width: 10%;"></td> <td style="width: 10%;"></td> <td style="width: 10%;"></td> </tr> <tr> <td></td> <td></td> <td colspan="8" style="text-align: center;"> <table border="1" style="width: 100%; border-collapse: collapse; text-align: center;"> <tr> <td style="width: 10%;"></td> <td style="width: 10%;"></td> <td style="width: 10%;"></td> <td style="width: 10%;"></td> <td style="width: 10%;"></td> <td style="width: 10%;"></td> <td style="width: 10%;"></td> <td style="width: 10%;"></td> <td style="width: 10%;"></td> <td style="width: 10%;"></td> </tr> <tr> <td></td> <td></td> <td colspan="8" style="text-align: center;"> <table border="1" style="width: 100%; border-collapse: collapse; text-align: center;"> <tr> <td style="width: 10%;"></td> <td style="width: 10%;"></td> <td style="width: 10%;"></td> <td style="width: 10%;"></td> <td style="width: 10%;"></td> <td style="width: 10%;"></td> <td style="width: 10%;"></td> <td style="width: 10%;"></td> <td style="width: 10%;"></td> <td style="width: 10%;"></td> </tr> <tr> <td></td> <td></td> <td colspan="8" style="text-align: center;"> <table border="1" style="width: 100%; border-collapse: collapse; text-align: center;"> <tr> <td style="width: 10%;"></td> <td style="width: 10%;"></td> <td style="width: 10%;"></td> <td style="width: 10%;"></td> <td style="width: 10%;"></td> <td style="width: 10%;"></td> <td style="width: 10%;"></td> <td style="width: 10%;"></td> <td style="width: 10%;"></td> <td style="width: 10%;"></td> </tr> <tr> <td></td> <td></td> <td colspan="8" style="text-align: center;"> <table border="1" style="width: 100%; border-collapse: collapse; text-align: center;"> <tr> <td style="width: 10%;"></td> <td style="width: 10%;"></td> <td style="width: 10%;"></td> <td style="width: 10%;"></td> <td style="width: 10%;"></td> <td style="width: 10%;"></td> <td style="width: 10%;"></td> <td style="width: 10%;"></td> <td style="width: 10%;"></td> <td style="width: 10%;"></td> </tr> <tr> <td></td> <td></td> <td colspan="8" style="text-align: center;"> <table border="1" style="width: 100%; border-collapse: collapse; text-align: center;"> <tr> <td style="width: 10%;"></td> <td style="width: 10%;"></td> <td style="width: 10%;"></td> <td style="width: 10%;"></td> <td style="width: 10%;"></td> <td style="width: 10%;"></td> <td style="width: 10%;"></td> <td style="width: 10%;"></td> <td style="width: 10%;"></td> <td style="width: 10%;"></td> </tr> <tr> <td></td> <td></td> <td colspan="8" style="text-align: center;"> <table border="1" style="width: 100%; border-collapse: collapse; text-align: center;"> <tr> <td style="width: 10%;"></td> <td style="width: 10%;"></td> <td style="width: 10%;"></td> <td style="width: 10%;"></td> <td style="width: 10%;"></td> <td style="width: 10%;"></td> <td style="width: 10%;"></td> <td style="width: 10%;"></td> <td style="width: 10%;"></td> <td style="width: 10%;"></td> </tr> <tr> <td></td> <td></td> <td colspan="8" style="text-align: center;"> <table border="1" style="width: 100%; border-collapse: collapse; text-align: center;"> <tr> <td style="width: 10%;"></td> <td style="width: 10%;"></td> <td style="width: 10%;"></td> <td style="width: 10%;"></td> <td style="width: 10%;"></td> <td style="width: 10%;"></td> <td style="width: 10%;"></td> <td style="width: 10%;"></td> <td style="width: 10%;"></td> <td style="width: 10%;"></td> </tr> <tr> <td></td> <td></td> <td colspan="8" style="text-align: center;"> <table border="1" style="width: 100%; border-collapse: collapse; text-align: center;"> <tr> <td style="width: 10%;"></td> <td style="width: 10%;"></td> <td style="width: 10%;"></td> <td style="width: 10%;"></td> <td style="width: 10%;"></td> <td style="width: 10%;"></td> <td style="width: 10%;"></td> <td style="width: 10%;"></td> <td style="width: 10%;"></td> <td style="width: 10%;"></td> </tr> <tr> <td></td> <td></td> <td colspan="8" style="text-align: center;"> <table border="1" style="width: 100%; border-collapse: collapse; text-align: center;"> <tr> <td style="width: 10%;"></td> <td style="width: 10%;"></td> <td style="width: 10%;"></td> <td style="width: 10%;"></td> <td style="width: 10%;"></td> <td style="width: 10%;"></td> <td style="width: 10%;"></td> <td style="width: 10%;"></td> <td style="width: 10%;"></td> <td style="width: 10%;"></td> </tr> <tr> <td></td> <td></td> <td colspan="8" style="text-align: center;"> <table border="1"
style="width: 100%; border-collapse: collapse; text-align: center;"> <tr> <td style="width: 10%;"></td> <td style="width: 10%;"></td> <td style="width: 10%;"></td> <td style="width: 10%;"></td> <td style="width: 10%;"></td> <td style="width: 10%;"></td> <td style="width: 10%;"></td> <td style="width: 10%;"></td> <td style="width: 10%;"></td> <td style="width: 10%;"></td> </tr> <tr> <td></td> <td></td> <td colspan="8" style="text-align: center;"> <table border="1" style="width: 100%; border-collapse: collapse; text-align: center;"> <tr> <td style="width: 10%;"></td> <td style="width: 10%;"></td> <td style="width: 10%;"></td> <td style="width: 10%;"></td> <td style="width: 10%;"></td> <td style="width: 10%;"></td> <td style="width: 10%;"></td> <td style="width: 10%;"></td> <td style="width: 10%;"></td> <td style="width: 10%;"></td> </tr> <tr> <td></td> <td></td> <td colspan="8" style="text-align: center;"> <table border="1" style="width: 100%; border-collapse: collapse; text-align: center;"> <tr> <td style="width: 10%;"></td> <td style="width: 10%;"></td> <td style="width: 10%;"></td> <td style="width: 10%;"></td> <td style="width: 10%;"></td> <td style="width: 10%;"></td> <td style="width: 10%;"></td> <td style="width: 10%;"></td> <td style="width: 10%;"></td> <td style="width: 10%;"></td> </tr> <tr> <td></td> <td></td> <td colspan="8" style="text-align: center;"> <table border="1" style="width: 100%; border-collapse: collapse; text-align: center;"> <tr> <td style="width: 10%;"></td> <td style="width: 10%;"></td> <td style="width: 10%;"></td> <td style="width: 10%;"></td> <td style="width: 10%;"></td> <td style="width: 10%;"></td> <td style="width: 10%;"></td> <td style="width: 10%;"></td> <td style="width: 10%;"></td> <td style="width: 10%;"></td> </tr> <tr> <td></td> <td></td> <td colspan="8" style="text-align: center;"> <table border="1" style="width: 100%; border-collapse: collapse; text-align: center;"> <tr> <td style="width: 10%;"></td> <td style="width: 10%;"></td> <td style="width: 10%;"></td> <td style="width: 10%;"></td> <td style="width: 10%;"></td> <td style="width: 10%;"></td> <td style="width: 10%;"></td> <td style="width: 10%;"></td> <td style="width: 10%;"></td> <td style="width: 10%;"></td> </tr> <tr> <td></td> <td></td> <td colspan="8" style="text-align: center;"> <table border="1" style="width: 100%; border-collapse: collapse; text-align: center;"> <tr> <td style="width: 10%;"></td> <td style="width: 10%;"></td> <td style="width: 10%;"></td> <td style="width: 10%;"></td> <td style="width: 10%;"></td> <td style="width: 10%;"></td> <td style="width: 10%;"></td> <td style="width: 10%;"></td> <td style="width: 10%;"></td> <td style="width: 10%;"></td> </tr> <tr> <td></td> <td></td> <td colspan="8" style="text-align: center;"> <table border="1" style="width: 100%; border-collapse: collapse; text-align: center;"> <tr> <td style="width: 10%;"></td> <td style="width: 10%;"></td> <td style="width: 10%;"></td> <td style="width: 10%;"></td> <td style="width: 10%;"></td> <td style="width: 10%;"></td> <td style="width: 10%;"></td> <td style="width: 10%;"></td> <td style="width: 10%;"></td> <td style="width: 10%;"></td> </tr> <tr> <td></td> <td></td> <td colspan="8" style="text-align: center;"> <table border="1" style="width: 100%; border-collapse: collapse; text-align: center;"> <tr> <td style="width: 10%;"></td> <td style="width: 10%;"></td> <td style="width: 10%;"></td> <td style="width: 10%;"></td> <td style="width: 10%;"></td> <td style="width: 10%;"></td> <td style="width: 10%;"></td> <td style="width: 10%;"></td> <td style="width: 10%;"></td> <td style="width: 10%;"></td> </tr> <tr> <td></td> <td></td> <td colspan="8" style="text-align: center;"> <table border="1" style="width: 100%; border-collapse: collapse; text-align: center;"> <tr> <td style="width: 10%;"></td> <td style="width: 10%;"></td> <td style="width: 10%;"></td> <td style="width: 10%;"></td> <td style="width: 10%;"></td> <td style="width: 10%;"></td> <td style="width: 10%;"></td> <td style="width: 10%;"></td> <td style="width: 10%;"></td> <td style="width: 10%;"></td> </tr> <tr> <td></td> <td></td> <td colspan="8" style="text-align: center;"> <table border="1" style="width: 100%; border-collapse: collapse; text-align: center;"> <tr> <td style="width: 10%;"></td> <td style="width: 10%;"></td> <td style="width: 10%;"></td> <td style="width: 10%;"></td> <td style="width: 10%;"></td> <td style="width: 10%;"></td> <td style="width: 10%;"></td> <td style="width: 10%;"></td> <td style="width: 10%;"></td> <td style="width: 10%;"></td> </tr> <tr> <td></td> <td></td> <td colspan="8" style="text-align: center;"> <table border="1" style="width: 100%; border-collapse: collapse; text-align: center;"> <tr> <td style="width: 10%;"></td> <td style="width: 10%;"></td> <td style="width: 10%;"></td> <td style="width: 10%;"></td> <td style="width: 10%;"></td> <td style="width: 10%;"></td> <td style="width: 10%;"></td> <td style="width: 10%;"></td> <td style="width: 10%;"></td> <td style="width: 10%;"></td> </tr> <tr> <td></td> <td></td> <td colspan="8" style="text-align: center;"> <table border="1" style="width: 100%; border-collapse: collapse; text-align: center;"> <tr> <td style="width: 10%;"></td> <td style="width: 10%;"></td> <td style="width: 10%;"></td> <td style="width: 10%;"></td> <td style="width: 10%;"></td> <td style="width: 10%;"></td> <td style="width: 10%;"></td> <td style="width: 10%;"></td> <td style="width: 10%;"></td> <td style="width: 10%;"></td> </tr> <tr> <td></td> <td></td> <td colspan="8" style="text-align: center;"> <table border="1" style="width: 100%; border-collapse: collapse; text-align: center;"> <tr> <td style="width: 10%;"></td> <td style="width: 10%;"></td> <td style="width: 10%;"></td> <td style="width: 10%;"></td> <td style="width: 10%;"></td> <td style="width: 10%;"></td> <td style="width: 10%;"></td> <td style="width: 10%;"></td> <td style="width: 10%;"></td> <td style="width: 10%;"></td> </tr> <tr> <td></td> <td></td> <td colspan="8" style="text-align: center;"> <table border="1" style="width: 100%; border-collapse: collapse; text-align: center;"> <tr> <td style="width: 10%;"></td> <td style="width: 10%;"></td> <td style="width: 10%;"></td> <td style="width: 10%;"></td> <td style="width: 10%;"></td> <td style="width: 10%;"></td> <td style="width: 10%;"></td> <td style="width: 10%;"></td> <td style="width: 10%;"></td> <td style="width: 10%;"></td> </tr> <tr> <td></td> <td></td> <td colspan="8" style="text-align: center;"> <table border="1" style="width: 100%; border-collapse: collapse; text-align: center;"> <tr> <td style="width: 10%;"></td> <td style="width: 10%;"></td> <td style="width: 10%;"></td> <td style="width: 10%;"></td> <td style="width: 10%;"></td> <td style="width: 10%;"></td> <td style="width: 10%;"></td> <td style="width: 10%;"></td> <td style="width: 10%;"></td> <td style="width: 10%;"></td> </tr> <tr> <td></td> <td></td> <td colspan="8" style="text-align: center;"> <table border="1" style="width: 100%; border-collapse: collapse; text-align: center;"> <tr> <td style="width: 10%;"></td> <td style="width: 10%;"></td> <td style="width: 10%;"></td> <td style="width: 10%;"></td> <td style="width: 10%;"></td> <td style="width: 10%;"></td> <td style="width: 10%;"></td> <td style="width: 10%;"></td> <td style="width: 10%;"></td> <td style="width: 10%;"></td> </tr> <tr> <td></td> <td></td> <td colspan="8" style="text-align: center;"> <table border="1" style="width: 100%; border-collapse: collapse; text-align: center;"> <tr> <td style="width: 10%;"></td> <td style="width: 10%;"></td> <td style="width: 10%;"></td> <td style="width: 10%;"></td> <td style="width: 10%;"></td> <td style="width: 10%;"></td> <td style="width: 10%;"></td> <td style="width: 10%;"></td> <td style="width: 10%;"></td> <td style="width: 10%;"></td> </tr> <tr> <td></td> <td></td> <td colspan="8" style="text-align: center;"> <table border="1" style="width: 100%; border-collapse: collapse; text-align: center;"> <tr> <td style="width: 10%;"></td> <td style="width: 10%;"></td> <td style="width: 10%;"></td> <td style="width: 10%;"></td> <td style="width: 10%;"></td> <td style="width: 10%;"></td> <td style="width: 10%;"></td> <td style="width: 10%;"></td> <td style="width: 10%;"></td> <td style="width: 10%;"></td> </tr> <tr> <td></td> <td></td> <td colspan="8" style="text-align: center;"> <table border="1" style="width: 100%; border-collapse: collapse; text-align: center;"> <tr> <td style="width: 10%;"></td> <td style="width: 10%;"></td> <td style="width: 10%;"></td> <td style="width: 10%;"></td> <td style="width: 10%;"></td> <td style="width: 10%;"></td> <td style="width: 10%;"></td> <td style="width: 10%;"></td> <td style="width: 10%;"></td> <td style="width: 10%;"></td> </tr> <tr> <td></td> <td></td> <td colspan="8" style="text-align: center;"> <table border="1" style="width: 100%; border-collapse: collapse; text-align: center;"> <tr> <td style="width: 10%;"></td> <td style="width: 10%;"></td> <td style="width: 10%;"></td> <td style="width: 10%;"></td> <td style="width: 10%;"></td> <td style="width: 10%;"></td> <td style="width: 10%;"></td> <td style="width: 10%;"></td> <td style="width: 10%;"></td> <td style="width: 10%;"></td> </tr> <tr> <td></td> <td></td> <td colspan="8" style="text-align: center;"> <table border="1" style="width: 100%; border-collapse: collapse; text-align: center;"> <tr> <td style="width: 10%;"></td> <td style="width: 10%;"></td> <td style="width: 10%;"></td> <td style="width: 10%;"></td> <td style="width: 10%;"></td> <td style="width: 10%;"></td> <td style="width: 10%;"></td> <td style="width: 10%;"></td> <td style="width: 10%;"></td> <td style="width: 10%;"></td> </tr> <tr> <td></td> <td></td> <td colspan="8" style="text-align: center;"> <table border="1" style="width: 100%; border-collapse: collapse; text-align: center;"> <tr> <td style="width: 10%;"></td> <td style="width: 10%;"></td> <td style="width: 10%;"></td> <td
style="width: 10%;"></td> <td style="width: 10%;"></td> <td style="width: 10%;"></td> <td style="width: 10%;"></td> <td style="width: 10%;"></td> <td style="width: 10%;"></td> <td style="width: 10%;"></td> </tr> <tr> <td></td> <td></td> <td colspan="8" style="text-align: center;"> <table border="1" style="width: 100%; border-collapse: collapse; text-align: center;"> <tr> <td style="width: 10%;"></td> <td style="width: 10%;"></td> <td style="width: 10%;"></td> <td style="width: 10%;"></td> <td style="width: 10%;"></td> <td style="width: 10%;"></td> <td style="width: 10%;"></td> <td style="width: 10%;"></td> <td style="width: 10%;"></td> <td style="width: 10%;"></td> </tr> <tr> <td></td> <td></td> <td colspan="8" style="text-align: center;"> <table border="1" style="width: 100%; border-collapse: collapse; text-align: center;"> <tr> <td style="width: 10%;"></td> <td style="width: 10%;"></td> <td style="width: 10%;"></td> <td style="width: 10%;"></td> <td style="width: 10%;"></td> <td style="width: 10%;"></td> <td style="width: 10%;"></td> <td style="width: 10%;"></td> <td style="width: 10%;"></td> <td style="width: 10%;"></td> </tr> <tr> <td></td> <td></td> <td colspan="8" style="text-align: center;"> <table border="1" style="width: 100%; border-collapse: collapse; text-align: center;"> <tr> <td style="width: 10%;"></td> <td style="width: 10%;"></td> <td style="width: 10%;"></td> <td style="width: 10%;"></td> <td style="width: 10%;"></td> <td style="width: 10%;"></td> <td style="width: 10%;"></td> <td style="width: 10%;"></td> <td style="width: 10%;"></td> <td style="width: 10%;"></td> </tr> <tr> <td></td> <td></td> <td colspan="8" style="text-align: center;"> <table border="1" style="width: 100%; border-collapse: collapse; text-align: center;"> <tr> <td style="width: 10%;"></td> <td style="width: 10%;"></td> <td style="width: 10%;"></td> <td style="width: 10%;"></td> <td style="width: 10%;"></td> <td style="width: 10%;"></td> <td style="width: 10%;"></td> <td style="width: 10%;"></td> <td style="width: 10%;"></td> <td style="width: 10%;"></td> </tr> <tr> <td></td> <td></td> <td colspan="8" style="text-align: center;"> <table border="1" style="width: 100%; border-collapse: collapse; text-align: center;"> <tr> <td style="width: 10%;"></td> <td style="width: 10%;"></td> <td style="width: 10%;"></td> <td style="width: 10%;"></td> <td style="width: 10%;"></td> <td style="width: 10%;"></td> <td style="width: 10%;"></td> <td style="width: 10%;"></td> <td style="width: 10%;"></td> <td style="width: 10%;"></td> </tr> <tr> <td></td> <td></td> <td colspan="8" style="text-align: center;"> <table border="1" style="width: 100%; border-collapse: collapse; text-align: center;"> <tr> <td style="width: 10%;"></td> <td style="width: 10%;"></td> <td style="width: 10%;"></td> <td style="width: 10%;"></td> <td style="width: 10%;"></td> <td style="width: 10%;"></td> <td style="width: 10%;"></td> <td style="width: 10%;"></td> <td style="width: 10%;"></td> <td style="width: 10%;"></td> </tr> <tr> <td></td> <td></td> <td colspan="8" style="text-align: center;"> <table border="1" style="width: 100%; border-collapse: collapse; text-align: center;"> <tr> </tr></table></td></tr></table></td></tr></table></td></tr></table></td></tr></table></td></tr></table></td></tr></table></td></tr></table></td></tr></table></td></tr></table></td></tr></table></td></tr></table></td></tr></table></td></tr></table></td></tr></table></td></tr></table></td></tr></table></td></tr></table></td></tr></table></td></tr></table></td></tr></table></td></tr></table></td></tr></table></td></tr></table></td></tr></table></td></tr></table></td></tr></table></td></tr></table></td></tr></table></td></tr></table></td></tr></table></td></tr></table></td></tr></table></td></tr></table></td></tr></table></td></tr></table></td></tr></table></td></tr></table></td></tr></table></td></tr></table></td></tr></table></td></tr></table></td></tr></table></td></tr></table> | | | | | | | | | | | | | | | | | | | | <table border="1" style="width: 100%; border-collapse: collapse; text-align: center;"> <tr> <td style="width: 10%;"></td> <td style="width: 10%;"></td> <td style="width: 10%;"></td> <td style="width: 10%;"></td> <td style="width: 10%;"></td> <td style="width: 10%;"></td> <td style="width: 10%;"></td> <td style="width: 10%;"></td> <td style="width: 10%;"></td> <td style="width: 10%;"></td> </tr> <tr> <td></td> <td></td> <td colspan="8" style="text-align: center;"> <table border="1" style="width: 100%; border-collapse: collapse; text-align: center;"> <tr> <td style="width: 10%;"></td> <td style="width: 10%;"></td> <td style="width: 10%;"></td> <td style="width: 10%;"></td> <td style="width: 10%;"></td> <td style="width: 10%;"></td> <td style="width: 10%;"></td> <td style="width: 10%;"></td> <td style="width: 10%;"></td> <td style="width: 10%;"></td> </tr> <tr> <td></td> <td></td> <td colspan="8" style="text-align: center;"> <table border="1" style="width: 100%; border-collapse: collapse; text-align: center;"> <tr> <td style="width: 10%;"></td> <td style="width: 10%;"></td> <td style="width: 10%;"></td> <td style="width: 10%;"></td> <td style="width: 10%;"></td> <td style="width: 10%;"></td> <td style="width: 10%;"></td> <td style="width: 10%;"></td> <td style="width: 10%;"></td> <td style="width: 10%;"></td> </tr> <tr> <td></td> <td></td> <td colspan="8" style="text-align: center;"> <table border="1" style="width: 100%; border-collapse: collapse; text-align: center;"> <tr> <td style="width: 10%;"></td> <td style="width: 10%;"></td> <td style="width: 10%;"></td> <td style="width: 10%;"></td> <td style="width: 10%;"></td> <td style="width: 10%;"></td> <td style="width: 10%;"></td> <td style="width: 10%;"></td> <td style="width: 10%;"></td> <td style="width: 10%;"></td> </tr> <tr> <td></td> <td></td> <td colspan="8" style="text-align: center;"> <table border="1" style="width: 100%; border-collapse: collapse; text-align: center;"> <tr> <td style="width: 10%;"></td> <td style="width: 10%;"></td> <td style="width: 10%;"></td> <td style="width: 10%;"></td> <td style="width: 10%;"></td> <td style="width: 10%;"></td> <td style="width: 10%;"></td> <td style="width: 10%;"></td> <td style="width: 10%;"></td> <td style="width: 10%;"></td> </tr> <tr> <td></td> <td></td> <td colspan="8" style="text-align: center;"> <table border="1" style="width: 100%; border-collapse: collapse; text-align: center;"> <tr> <td style="width: 10%;"></td> <td style="width: 10%;"></td> <td style="width: 10%;"></td> <td style="width: 10%;"></td> <td style="width: 10%;"></td> <td style="width: 10%;"></td> <td style="width: 10%;"></td> <td style="width: 10%;"></td> <td style="width: 10%;"></td> <td style="width: 10%;"></td> </tr> <tr> <td></td> <td></td> <td colspan="8" style="text-align: center;"> <table border="1" style="width: 100%; border-collapse: collapse; text-align: center;"> <tr> <td style="width: 10%;"></td> <td style="width: 10%;"></td> <td style="width: 10%;"></td> <td style="width: 10%;"></td> <td style="width: 10%;"></td> <td style="width: 10%;"></td> <td style="width: 10%;"></td> <td style="width: 10%;"></td> <td style="width: 10%;"></td> <td style="width: 10%;"></td> </tr> <tr> <td></td> <td></td> <td colspan="8" style="text-align: center;"> <table border="1" style="width: 100%; border-collapse: collapse; text-align: center;"> <tr> <td style="width: 10%;"></td> <td style="width: 10%;"></td> <td style="width: 10%;"></td> <td style="width: 10%;"></td> <td style="width: 10%;"></td> <td style="width: 10%;"></td> <td style="width: 10%;"></td> <td style="width: 10%;"></td> <td style="width: 10%;"></td> <td style="width: 10%;"></td> </tr> <tr> <td></td> <td></td> <td colspan="8" style="text-align: center;"> <table border="1" style="width: 100%; border-collapse: collapse; text-align: center;"> <tr> <td style="width: 10%;"></td> <td style="width: 10%;"></td> <td style="width: 10%;"></td> <td style="width: 10%;"></td> <td style="width: 10%;"></td> <td style="width: 10%;"></td> <td style="width: 10%;"></td> <td style="width: 10%;"></td> <td style="width: 10%;"></td> <td style="width: 10%;"></td> </tr> <tr> <td></td> <td></td> <td colspan="8" style="text-align: center;"> <table border="1" style="width: 100%; border-collapse: collapse; text-align: center;"> <tr> <td style="width: 10%;"></td> <td style="width: 10%;"></td> <td style="width: 10%;"></td> <td style="width: 10%;"></td> <td style="width: 10%;"></td> <td style="width: 10%;"></td> <td style="width: 10%;"></td> <td style="width: 10%;"></td> <td style="width: 10%;"></td> <td style="width: 10%;"></td> </tr> <tr> <td></td> <td></td> <td colspan="8" style="text-align: center;"> <table border="1" style="width: 100%; border-collapse: collapse; text-align: center;"> <tr> <td style="width: 10%;"></td> <td style="width: 10%;"></td> <td style="width: 10%;"></td> <td style="width: 10%;"></td> <td style="width: 10%;"></td> <td style="width: 10%;"></td> <td style="width: 10%;"></td> <td
style="width: 10%;"></td> <td style="width: 10%;"></td> <td style="width: 10%;"></td> </tr> <tr> <td></td> <td></td> <td colspan="8" style="text-align: center;"> <table border="1" style="width: 100%; border-collapse: collapse; text-align: center;"> <tr> <td style="width: 10%;"></td> <td style="width: 10%;"></td> <td style="width: 10%;"></td> <td style="width: 10%;"></td> <td style="width: 10%;"></td> <td style="width: 10%;"></td> <td style="width: 10%;"></td> <td style="width: 10%;"></td> <td style="width: 10%;"></td> <td style="width: 10%;"></td> </tr> <tr> <td></td> <td></td> <td colspan="8" style="text-align: center;"> <table border="1" style="width: 100%; border-collapse: collapse; text-align: center;"> <tr> <td style="width: 10%;"></td> <td style="width: 10%;"></td> <td style="width: 10%;"></td> <td style="width: 10%;"></td> <td style="width: 10%;"></td> <td style="width: 10%;"></td> <td style="width: 10%;"></td> <td style="width: 10%;"></td> <td style="width: 10%;"></td> <td style="width: 10%;"></td> </tr> <tr> <td></td> <td></td> <td colspan="8" style="text-align: center;"> <table border="1" style="width: 100%; border-collapse: collapse; text-align: center;"> <tr> <td style="width: 10%;"></td> <td style="width: 10%;"></td> <td style="width: 10%;"></td> <td style="width: 10%;"></td> <td style="width: 10%;"></td> <td style="width: 10%;"></td> <td style="width: 10%;"></td> <td style="width: 10%;"></td> <td style="width: 10%;"></td> <td style="width: 10%;"></td> </tr> <tr> <td></td> <td></td> <td colspan="8" style="text-align: center;"> <table border="1" style="width: 100%; border-collapse: collapse; text-align: center;"> <tr> <td style="width: 10%;"></td> <td style="width: 10%;"></td> <td style="width: 10%;"></td> <td style="width: 10%;"></td> <td style="width: 10%;"></td> <td style="width: 10%;"></td> <td style="width: 10%;"></td> <td style="width: 10%;"></td> <td style="width: 10%;"></td> <td style="width: 10%;"></td> </tr> <tr> <td></td> <td></td> <td colspan="8" style="text-align: center;"> <table border="1" style="width: 100%; border-collapse: collapse; text-align: center;"> <tr> <td style="width: 10%;"></td> <td style="width: 10%;"></td> <td style="width: 10%;"></td> <td style="width: 10%;"></td> <td style="width: 10%;"></td> <td style="width: 10%;"></td> <td style="width: 10%;"></td> <td style="width: 10%;"></td> <td style="width: 10%;"></td> <td style="width: 10%;"></td> </tr> <tr> <td></td> <td></td> <td colspan="8" style="text-align: center;"> <table border="1" style="width: 100%; border-collapse: collapse; text-align: center;"> <tr> <td style="width: 10%;"></td> <td style="width: 10%;"></td> <td style="width: 10%;"></td> <td style="width: 10%;"></td> <td style="width: 10%;"></td> <td style="width: 10%;"></td> <td style="width: 10%;"></td> <td style="width: 10%;"></td> <td style="width: 10%;"></td> <td style="width: 10%;"></td> </tr> <tr> <td></td> <td></td> <td colspan="8" style="text-align: center;"> <table border="1" style="width: 100%; border-collapse: collapse; text-align: center;"> <tr> <td style="width: 10%;"></td> <td style="width: 10%;"></td> <td style="width: 10%;"></td> <td style="width: 10%;"></td> <td style="width: 10%;"></td> <td style="width: 10%;"></td> <td style="width: 10%;"></td> <td style="width: 10%;"></td> <td style="width: 10%;"></td> <td style="width: 10%;"></td> </tr> <tr> <td></td> <td></td> <td colspan="8" style="text-align: center;"> <table border="1" style="width: 100%; border-collapse: collapse; text-align: center;"> <tr> <td style="width: 10%;"></td> <td style="width: 10%;"></td> <td style="width: 10%;"></td> <td style="width: 10%;"></td> <td style="width: 10%;"></td> <td style="width: 10%;"></td> <td style="width: 10%;"></td> <td style="width: 10%;"></td> <td style="width: 10%;"></td> <td style="width: 10%;"></td> </tr> <tr> <td></td> <td></td> <td colspan="8" style="text-align: center;"> <table border="1" style="width: 100%; border-collapse: collapse; text-align: center;"> <tr> <td style="width: 10%;"></td> <td style="width: 10%;"></td> <td style="width: 10%;"></td> <td style="width: 10%;"></td> <td style="width: 10%;"></td> <td style="width: 10%;"></td> <td style="width: 10%;"></td> <td style="width: 10%;"></td> <td style="width: 10%;"></td> <td style="width: 10%;"></td> </tr> <tr> <td></td> <td></td> <td colspan="8" style="text-align: center;"> <table border="1" style="width: 100%; border-collapse: collapse; text-align: center;"> <tr> <td style="width: 10%;"></td> <td style="width: 10%;"></td> <td style="width: 10%;"></td> <td style="width: 10%;"></td> <td style="width: 10%;"></td> <td style="width: 10%;"></td> <td style="width: 10%;"></td> <td style="width: 10%;"></td> <td style="width: 10%;"></td> <td style="width: 10%;"></td> </tr> <tr> <td></td> <td></td> <td colspan="8" style="text-align: center;"> <table border="1" style="width: 100%; border-collapse: collapse; text-align: center;"> <tr> <td style="width: 10%;"></td> <td style="width: 10%;"></td> <td style="width: 10%;"></td> <td style="width: 10%;"></td> <td style="width: 10%;"></td> <td style="width: 10%;"></td> <td style="width: 10%;"></td> <td style="width: 10%;"></td> <td style="width: 10%;"></td> <td style="width: 10%;"></td> </tr> <tr> <td></td> <td></td> <td colspan="8" style="text-align: center;"> <table border="1" style="width: 100%; border-collapse: collapse; text-align: center;"> <tr> <td style="width: 10%;"></td> <td style="width: 10%;"></td> <td style="width: 10%;"></td> <td style="width: 10%;"></td> <td style="width: 10%;"></td> <td style="width: 10%;"></td> <td style="width: 10%;"></td> <td style="width: 10%;"></td> <td style="width: 10%;"></td> <td style="width: 10%;"></td> </tr> <tr> <td></td> <td></td> <td colspan="8" style="text-align: center;"> <table border="1" style="width: 100%; border-collapse: collapse; text-align: center;"> <tr> <td style="width: 10%;"></td> <td style="width: 10%;"></td> <td style="width: 10%;"></td> <td style="width: 10%;"></td> <td style="width: 10%;"></td> <td style="width: 10%;"></td> <td style="width: 10%;"></td> <td style="width: 10%;"></td> <td style="width: 10%;"></td> <td style="width: 10%;"></td> </tr> <tr> <td></td> <td></td> <td colspan="8" style="text-align: center;"> <table border="1" style="width: 100%; border-collapse: collapse; text-align: center;"> <tr> <td style="width: 10%;"></td> <td style="width: 10%;"></td> <td style="width: 10%;"></td> <td style="width: 10%;"></td> <td style="width: 10%;"></td> <td style="width: 10%;"></td> <td style="width: 10%;"></td> <td style="width: 10%;"></td> <td style="width: 10%;"></td> <td style="width: 10%;"></td> </tr> <tr> <td></td> <td></td> <td colspan="8" style="text-align: center;"> <table border="1" style="width: 100%; border-collapse: collapse; text-align: center;"> <tr> <td style="width: 10%;"></td> <td style="width: 10%;"></td> <td style="width: 10%;"></td> <td style="width: 10%;"></td> <td style="width: 10%;"></td> <td style="width: 10%;"></td> <td style="width: 10%;"></td> <td style="width: 10%;"></td> <td style="width: 10%;"></td> <td style="width: 10%;"></td> </tr> <tr> <td></td> <td></td> <td colspan="8" style="text-align: center;"> <table border="1" style="width: 100%; border-collapse: collapse; text-align: center;"> <tr> <td style="width: 10%;"></td> <td style="width: 10%;"></td> <td style="width: 10%;"></td> <td style="width: 10%;"></td> <td style="width: 10%;"></td> <td style="width: 10%;"></td> <td style="width: 10%;"></td> <td style="width: 10%;"></td> <td style="width: 10%;"></td> <td style="width: 10%;"></td> </tr> <tr> <td></td> <td></td> <td colspan="8" style="text-align: center;"> <table border="1" style="width: 100%; border-collapse: collapse; text-align: center;"> <tr> <td style="width: 10%;"></td> <td style="width: 10%;"></td> <td style="width: 10%;"></td> <td style="width: 10%;"></td> <td style="width: 10%;"></td> <td style="width: 10%;"></td> <td style="width: 10%;"></td> <td style="width: 10%;"></td> <td style="width: 10%;"></td> <td style="width: 10%;"></td> </tr> <tr> <td></td> <td></td> <td colspan="8" style="text-align: center;"> <table border="1" style="width: 100%; border-collapse: collapse; text-align: center;"> <tr> <td style="width: 10%;"></td> <td style="width: 10%;"></td> <td style="width: 10%;"></td> <td style="width: 10%;"></td> <td style="width: 10%;"></td> <td style="width: 10%;"></td> <td style="width: 10%;"></td> <td style="width: 10%;"></td> <td style="width: 10%;"></td> <td style="width: 10%;"></td> </tr> <tr> <td></td> <td></td> <td colspan="8" style="text-align: center;"> <table border="1" style="width: 100%; border-collapse: collapse; text-align: center;"> <tr> <td style="width: 10%;"></td> <td style="width: 10%;"></td> <td style="width: 10%;"></td> <td style="width: 10%;"></td> <td style="width: 10%;"></td> <td style="width: 10%;"></td> <td style="width: 10%;"></td> <td style="width: 10%;"></td> <td style="width: 10%;"></td> <td style="width: 10%;"></td> </tr> <tr> <td></td> <td></td> <td colspan="8" style="text-align: center;"> <table border="1" style="width: 100%; border-collapse: collapse; text-align: center;"> <tr> <td style="width: 10%;"></td> <td style="width: 10%;"></td> <td style="width: 10%;"></td> <td style="width: 10%;"></td> <td style="width: 10%;"></td> <td style="width: 10%;"></td> <td style="width: 10%;"></td> <td style="width: 10%;"></td> <td style="width: 10%;"></td> <td style="width: 10%;"></td> </tr> <tr> <td></td> <td></td> <td colspan="8" style="text-align: center;"> <table border="1" style="width: 100%; border-collapse: collapse; text-align: center;"> <tr> <td style="width: 10%;"></td> <td style="width: 10%;"></td> <td style="width: 10%;"></td> <td style="width: 10%;"></td> <td style="width: 10%;"></td> <td style="width: 10%;"></td> <td style="width: 10%;"></td> <td style="width: 10%;"></td> <td style="width: 10%;"></td> <td style="width: 10%;"></td> </tr> <tr> <td></td> <td></td> <td colspan="8" style="text-align: center;"> <table
border="1" style="width: 100%; border-collapse: collapse; text-align: center;"> <tr> <td style="width: 10%;"></td> <td style="width: 10%;"></td> <td style="width: 10%;"></td> <td style="width: 10%;"></td> <td style="width: 10%;"></td> <td style="width: 10%;"></td> <td style="width: 10%;"></td> <td style="width: 10%;"></td> <td style="width: 10%;"></td> <td style="width: 10%;"></td> </tr> <tr> <td></td> <td></td> <td colspan="8" style="text-align: center;"> <table border="1" style="width: 100%; border-collapse: collapse; text-align: center;"> <tr> <td style="width: 10%;"></td> <td style="width: 10%;"></td> <td style="width: 10%;"></td> <td style="width: 10%;"></td> <td style="width: 10%;"></td> <td style="width: 10%;"></td> <td style="width: 10%;"></td> <td style="width: 10%;"></td> <td style="width: 10%;"></td> <td style="width: 10%;"></td> </tr> <tr> <td></td> <td></td> <td colspan="8" style="text-align: center;"> <table border="1" style="width: 100%; border-collapse: collapse; text-align: center;"> <tr> <td style="width: 10%;"></td> <td style="width: 10%;"></td> <td style="width: 10%;"></td> <td style="width: 10%;"></td> <td style="width: 10%;"></td> <td style="width: 10%;"></td> <td style="width: 10%;"></td> <td style="width: 10%;"></td> <td style="width: 10%;"></td> <td style="width: 10%;"></td> </tr> <tr> <td></td> <td></td> <td colspan="8" style="text-align: center;"> <table border="1" style="width: 100%; border-collapse: collapse; text-align: center;"> <tr> <td style="width: 10%;"></td> <td style="width: 10%;"></td> <td style="width: 10%;"></td> <td style="width: 10%;"></td> <td style="width: 10%;"></td> <td style="width: 10%;"></td> <td style="width: 10%;"></td> <td style="width: 10%;"></td> <td style="width: 10%;"></td> <td style="width: 10%;"></td> </tr> <tr> <td></td> <td></td> <td colspan="8" style="text-align: center;"> <table border="1" style="width: 100%; border-collapse: collapse; text-align: center;"> <tr> <td style="width: 10%;"></td> <td style="width: 10%;"></td> <td style="width: 10%;"></td> <td style="width: 10%;"></td> <td style="width: 10%;"></td> <td style="width: 10%;"></td> <td style="width: 10%;"></td> <td style="width: 10%;"></td> <td style="width: 10%;"></td> <td style="width: 10%;"></td> </tr> <tr> <td></td> <td></td> <td colspan="8" style="text-align: center;"> <table border="1" style="width: 100%; border-collapse: collapse; text-align: center;"> <tr> <td style="width: 10%;"></td> <td style="width: 10%;"></td> <td style="width: 10%;"></td> <td style="width: 10%;"></td> <td style="width: 10%;"></td> <td style="width: 10%;"></td> <td style="width: 10%;"></td> <td style="width: 10%;"></td> <td style="width: 10%;"></td> <td style="width: 10%;"></td> </tr> <tr> <td></td> <td></td> <td colspan="8" style="text-align: center;"> <table border="1" style="width: 100%; border-collapse: collapse; text-align: center;"> <tr> <td style="width: 10%;"></td> <td style="width: 10%;"></td> <td style="width: 10%;"></td> <td style="width: 10%;"></td> <td style="width: 10%;"></td> <td style="width: 10%;"></td> <td style="width: 10%;"></td> <td style="width: 10%;"></td> <td style="width: 10%;"></td> <td style="width: 10%;"></td> </tr> <tr> <td></td> <td></td> <td colspan="8" style="text-align: center;"> <table border="1" style="width: 100%; border-collapse: collapse; text-align: center;"> <tr> <td style="width: 10%;"></td> <td style="width: 10%;"></td> <td style="width: 10%;"></td> <td style="width: 10%;"></td> <td style="width: 10%;"></td> <td style="width: 10%;"></td> <td style="width: 10%;"></td> <td style="width: 10%;"></td> <td style="width: 10%;"></td> <td style="width: 10%;"></td> </tr> <tr> <td></td> <td></td> <td colspan="8" style="text-align: center;"> <table border="1" style="width: 100%; border-collapse: collapse; text-align: center;"> <tr> <td style="width: 10%;"></td> <td style="width: 10%;"></td> <td style="width: 10%;"></td> <td style="width: 10%;"></td> <td style="width: 10%;"></td> <td style="width: 10%;"></td> <td style="width: 10%;"></td> <td style="width: 10%;"></td> <td style="width: 10%;"></td> <td style="width: 10%;"></td> </tr> <tr> <td></td> <td></td> <td colspan="8" style="text-align: center;"> <table border="1" style="width: 100%; border-collapse: collapse; text-align: center;"> <tr> <td style="width: 10%;"></td> <td style="width: 10%;"></td> <td style="width: 10%;"></td> <td style="width: 10%;"></td> <td style="width: 10%;"></td> <td style="width: 10%;"></td> <td style="width: 10%;"></td> <td style="width: 10%;"></td> <td style="width: 10%;"></td> <td style="width: 10%;"></td> </tr> <tr> <td></td> <td></td> <td colspan="8" style="text-align: center;"> <table border="1" style="width: 100%; border-collapse: collapse; text-align: center;"> <tr> </tr></table></td></tr></table></td></tr></table></td></tr></table></td></tr></table></td></tr></table></td></tr></table></td></tr></table></td></tr></table></td></tr></table></td></tr></table></td></tr></table></td></tr></table></td></tr></table></td></tr></table></td></tr></table></td></tr></table></td></tr></table></td></tr></table></td></tr></table></td></tr></table></td></tr></table></td></tr></table></td></tr></table></td></tr></table></td></tr></table></td></tr></table></td></tr></table></td></tr></table></td></tr></table></td></tr></table></td></tr></table></td></tr></table></td></tr></table></td></tr></table></td></tr></table></td></tr></table></td></tr></table></td></tr></table></td></tr></table></td></tr></table></td></tr></table></td></tr></table> | | | | | | | | | | | | | | | | | | | | <table border="1" style="width: 100%; border-collapse: collapse; text-align: center;"> <tr> <td style="width: 10%;"></td> <td style="width: 10%;"></td> <td style="width: 10%;"></td> <td style="width: 10%;"></td> <td style="width: 10%;"></td> <td style="width: 10%;"></td> <td style="width: 10%;"></td> <td style="width: 10%;"></td> <td style="width: 10%;"></td> <td style="width: 10%;"></td> </tr> <tr> <td></td> <td></td> <td colspan="8" style="text-align: center;"> <table border="1" style="width: 100%; border-collapse: collapse; text-align: center;"> <tr> <td style="width: 10%;"></td> <td style="width: 10%;"></td> <td style="width: 10%;"></td> <td style="width: 10%;"></td> <td style="width: 10%;"></td> <td style="width: 10%;"></td> <td style="width: 10%;"></td> <td style="width: 10%;"></td> <td style="width: 10%;"></td> <td style="width: 10%;"></td> </tr> <tr> <td></td> <td></td> <td colspan="8" style="text-align: center;"> <table border="1" style="width: 100%; border-collapse: collapse; text-align: center;"> <tr> <td style="width: 10%;"></td> <td style="width: 10%;"></td> <td style="width: 10%;"></td> <td style="width: 10%;"></td> <td style="width: 10%;"></td> <td style="width: 10%;"></td> <td style="width: 10%;"></td> <td style="width: 10%;"></td> <td style="width: 10%;"></td> <td style="width: 10%;"></td> </tr> <tr> <td></td> <td></td> <td colspan="8" style="text-align: center;"> <table border="1" style="width: 100%; border-collapse: collapse; text-align: center;"> <tr> <td style="width: 10%;"></td> <td style="width: 10%;"></td> <td style="width: 10%;"></td> <td style="width: 10%;"></td> <td style="width: 10%;"></td> <td style="width: 10%;"></td> <td style="width: 10%;"></td> <td style="width: 10%;"></td> <td style="width: 10%;"></td> <td style="width: 10%;"></td> </tr> <tr> <td></td> <td></td> <td colspan="8" style="text-align: center;"> <table border="1" style="width: 100%; border-collapse: collapse; text-align: center;"> <tr> <td style="width: 10%;"></td> <td style="width: 10%;"></td> <td style="width: 10%;"></td> <td style="width: 10%;"></td> <td style="width: 10%;"></td> <td style="width: 10%;"></td> <td style="width: 10%;"></td> <td style="width: 10%;"></td> <td style="width: 10%;"></td> <td style="width: 10%;"></td> </tr> <tr> <td></td> <td></td> <td colspan="8" style="text-align: center;"> <table border="1" style="width: 100%; border-collapse: collapse; text-align: center;"> <tr> <td style="width: 10%;"></td> <td style="width: 10%;"></td> <td style="width: 10%;"></td> <td style="width: 10%;"></td> <td style="width: 10%;"></td> <td style="width: 10%;"></td> <td style="width: 10%;"></td> <td style="width: 10%;"></td> <td style="width: 10%;"></td> <td style="width: 10%;"></td> </tr> <tr> <td></td> <td></td> <td colspan="8" style="text-align: center;"> <table border="1" style="width: 100%; border-collapse: collapse; text-align: center;"> <tr> <td style="width: 10%;"></td> <td style="width: 10%;"></td> <td style="width: 10%;"></td> <td style="width: 10%;"></td> <td style="width: 10%;"></td> <td style="width: 10%;"></td> <td style="width: 10%;"></td> <td style="width: 10%;"></td> <td style="width: 10%;"></td> <td style="width: 10%;"></td> </tr> <tr> <td></td> <td></td> <td colspan="8" style="text-align: center;"> <table border="1" style="width: 100%; border-collapse: collapse; text-align: center;"> <tr> <td style="width: 10%;"></td> <td style="width: 10%;"></td> <td
style="width: 10%;"></td> <td style="width: 10%;"></td> <td style="width: 10%;"></td> <td style="width: 10%;"></td> <td style="width: 10%;"></td> <td style="width: 10%;"></td> <td style="width: 10%;"></td> <td style="width: 10%;"></td> </tr> <tr> <td></td> <td></td> <td colspan="8" style="text-align: center;"> <table border="1" style="width: 100%; border-collapse: collapse; text-align: center;"> <tr> <td style="width: 10%;"></td> <td style="width: 10%;"></td> <td style="width: 10%;"></td> <td style="width: 10%;"></td> <td style="width: 10%;"></td> <td style="width: 10%;"></td> <td style="width: 10%;"></td> <td style="width: 10%;"></td> <td style="width: 10%;"></td> <td style="width: 10%;"></td> </tr> <tr> <td></td> <td></td> <td colspan="8" style="text-align: center;"> <table border="1" style="width: 100%; border-collapse: collapse; text-align: center;"> <tr> <td style="width: 10%;"></td> <td style="width: 10%;"></td> <td style="width: 10%;"></td> <td style="width: 10%;"></td> <td style="width: 10%;"></td> <td style="width: 10%;"></td> <td style="width: 10%;"></td> <td style="width: 10%;"></td> <td style="width: 10%;"></td> <td style="width: 10%;"></td> </tr> <tr> <td></td> <td></td> <td colspan="8" style="text-align: center;"> <table border="1" style="width: 100%; border-collapse: collapse; text-align: center;"> <tr> <td style="width: 10%;"></td> <td style="width: 10%;"></td> <td style="width: 10%;"></td> <td style="width: 10%;"></td> <td style="width: 10%;"></td> <td style="width: 10%;"></td> <td style="width: 10%;"></td> <td style="width: 10%;"></td> <td style="width: 10%;"></td> <td style="width: 10%;"></td> </tr> <tr> <td></td> <td></td> <td colspan="8" style="text-align: center;"> <table border="1" style="width: 100%; border-collapse: collapse; text-align: center;"> <tr> <td style="width: 10%;"></td> <td style="width: 10%;"></td> <td style="width: 10%;"></td> <td style="width: 10%;"></td> <td style="width: 10%;"></td> <td style="width: 10%;"></td> <td style="width: 10%;"></td> <td style="width: 10%;"></td> <td style="width: 10%;"></td> <td style="width: 10%;"></td> </tr> <tr> <td></td> <td></td> <td colspan="8" style="text-align: center;"> <table border="1" style="width: 100%; border-collapse: collapse; text-align: center;"> <tr> <td style="width: 10%;"></td> <td style="width: 10%;"></td> <td style="width: 10%;"></td> <td style="width: 10%;"></td> <td style="width: 10%;"></td> <td style="width: 10%;"></td> <td style="width: 10%;"></td> <td style="width: 10%;"></td> <td style="width: 10%;"></td> <td style="width: 10%;"></td> </tr> <tr> <td></td> <td></td> <td colspan="8" style="text-align: center;"> <table border="1" style="width: 100%; border-collapse: collapse; text-align: center;"> <tr> <td style="width: 10%;"></td> <td style="width: 10%;"></td> <td style="width: 10%;"></td> <td style="width: 10%;"></td> <td style="width: 10%;"></td> <td style="width: 10%;"></td> <td style="width: 10%;"></td> <td style="width: 10%;"></td> <td style="width: 10%;"></td> <td style="width: 10%;"></td> </tr> <tr> <td></td> <td></td> <td colspan="8" style="text-align: center;"> <table border="1" style="width: 100%; border-collapse: collapse; text-align: center;"> <tr> <td style="width: 10%;"></td> <td style="width: 10%;"></td> <td style="width: 10%;"></td> <td style="width: 10%;"></td> <td style="width: 10%;"></td> <td style="width: 10%;"></td> <td style="width: 10%;"></td> <td style="width: 10%;"></td> <td style="width: 10%;"></td> <td style="width: 10%;"></td> </tr> <tr> <td></td> <td></td> <td colspan="8" style="text-align: center;"> <table border="1" style="width: 100%; border-collapse: collapse; text-align: center;"> <tr> <td style="width: 10%;"></td> <td style="width: 10%;"></td> <td style="width: 10%;"></td> <td style="width: 10%;"></td> <td style="width: 10%;"></td> <td style="width: 10%;"></td> <td style="width: 10%;"></td> <td style="width: 10%;"></td> <td style="width: 10%;"></td> <td style="width: 10%;"></td> </tr> <tr> <td></td> <td></td> <td colspan="8" style="text-align: center;"> <table border="1" style="width: 100%; border-collapse: collapse; text-align: center;"> <tr> <td style="width: 10%;"></td> <td style="width: 10%;"></td> <td style="width: 10%;"></td> <td style="width: 10%;"></td> <td style="width: 10%;"></td> <td style="width: 10%;"></td> <td style="width: 10%;"></td> <td style="width: 10%;"></td> <td style="width: 10%;"></td> <td style="width: 10%;"></td> </tr> <tr> <td></td> <td></td> <td colspan="8" style="text-align: center;"> <table border="1" style="width: 100%; border-collapse: collapse; text-align: center;"> <tr> <td style="width: 10%;"></td> <td style="width: 10%;"></td> <td style="width: 10%;"></td> <td style="width: 10%;"></td> <td style="width: 10%;"></td> <td style="width: 10%;"></td> <td style="width: 10%;"></td> <td style="width: 10%;"></td> <td style="width: 10%;"></td> <td style="width: 10%;"></td> </tr> <tr> <td></td> <td></td> <td colspan="8" style="text-align: center;"> <table border="1" style="width: 100%; border-collapse: collapse; text-align: center;"> <tr> <td style="width: 10%;"></td> <td style="width: 10%;"></td> <td style="width: 10%;"></td> <td style="width: 10%;"></td> <td style="width: 10%;"></td> <td style="width: 10%;"></td> <td style="width: 10%;"></td> <td style="width: 10%;"></td> <td style="width: 10%;"></td> <td style="width: 10%;"></td> </tr> <tr> <td></td> <td></td> <td colspan="8" style="text-align: center;"> <table border="1" style="width: 100%; border-collapse: collapse; text-align: center;"> <tr> <td style="width: 10%;"></td> <td style="width: 10%;"></td> <td style="width: 10%;"></td> <td style="width: 10%;"></td> <td style="width: 10%;"></td> <td style="width: 10%;"></td> <td style="width: 10%;"></td> <td style="width: 10%;"></td> <td style="width: 10%;"></td> <td style="width: 10%;"></td> </tr> <tr> <td></td> <td></td> <td colspan="8" style="text-align: center;"> <table border="1" style="width: 100%; border-collapse: collapse; text-align: center;"> <tr> <td style="width: 10%;"></td> <td style="width: 10%;"></td> <td style="width: 10%;"></td> <td style="width: 10%;"></td> <td style="width: 10%;"></td> <td style="width: 10%;"></td> <td style="width: 10%;"></td> <td style="width: 10%;"></td> <td style="width: 10%;"></td> <td style="width: 10%;"></td> </tr> <tr> <td></td> <td></td> <td colspan="8" style="text-align: center;"> <table border="1" style="width: 100%; border-collapse: collapse; text-align: center;"> <tr> <td style="width: 10%;"></td> <td style="width: 10%;"></td> <td style="width: 10%;"></td> <td style="width: 10%;"></td> <td style="width: 10%;"></td> <td style="width: 10%;"></td> <td style="width: 10%;"></td> <td style="width: 10%;"></td> <td style="width: 10%;"></td> <td style="width: 10%;"></td> </tr> <tr> <td></td> <td></td> <td colspan="8" style="text-align: center;"> <table border="1" style="width: 100%; border-collapse: collapse; text-align: center;"> <tr> <td style="width: 10%;"></td> <td style="width: 10%;"></td> <td style="width: 10%;"></td> <td style="width: 10%;"></td> <td style="width: 10%;"></td> <td style="width: 10%;"></td> <td style="width: 10%;"></td> <td style="width: 10%;"></td> <td style="width: 10%;"></td> <td style="width: 10%;"></td> </tr> <tr> <td></td> <td></td> <td colspan="8" style="text-align: center;"> <table border="1" style="width: 100%; border-collapse: collapse; text-align: center;"> <tr> <td style="width: 10%;"></td> <td style="width: 10%;"></td> <td style="width: 10%;"></td> <td style="width: 10%;"></td> <td style="width: 10%;"></td> <td style="width: 10%;"></td> <td style="width: 10%;"></td> <td style="width: 10%;"></td> <td style="width: 10%;"></td> <td style="width: 10%;"></td> </tr> <tr> <td></td> <td></td> <td colspan="8" style="text-align: center;"> <table border="1" style="width: 100%; border-collapse: collapse; text-align: center;"> <tr> <td style="width: 10%;"></td> <td style="width: 10%;"></td> <td style="width: 10%;"></td> <td style="width: 10%;"></td> <td style="width: 10%;"></td> <td style="width: 10%;"></td> <td style="width: 10%;"></td> <td style="width: 10%;"></td> <td style="width: 10%;"></td> <td style="width: 10%;"></td> </tr> <tr> <td></td> <td></td> <td colspan="8" style="text-align: center;"> <table border="1" style="width: 100%; border-collapse: collapse; text-align: center;"> <tr> <td style="width: 10%;"></td> <td style="width: 10%;"></td> <td style="width: 10%;"></td> <td style="width: 10%;"></td> <td style="width: 10%;"></td> <td style="width: 10%;"></td> <td style="width: 10%;"></td> <td style="width: 10%;"></td> <td style="width: 10%;"></td> <td style="width: 10%;"></td> </tr> <tr> <td></td> <td></td> <td colspan="8" style="text-align: center;"> <table border="1" style="width: 100%; border-collapse: collapse; text-align: center;"> <tr> <td style="width: 10%;"></td> <td style="width: 10%;"></td> <td style="width: 10%;"></td> <td style="width: 10%;"></td> <td style="width: 10%;"></td> <td style="width: 10%;"></td> <td style="width: 10%;"></td> <td style="width: 10%;"></td> <td style="width: 10%;"></td> <td style="width: 10%;"></td> </tr> <tr> <td></td> <td></td> <td colspan="8" style="text-align: center;"> <table border="1" style="width: 100%; border-collapse: collapse; text-align: center;"> <tr> <td style="width: 10%;"></td> <td style="width: 10%;"></td> <td style="width: 10%;"></td> <td style="width: 10%;"></td> <td style="width: 10%;"></td> <td style="width: 10%;"></td> <td style="width: 10%;"></td> <td style="width: 10%;"></td> <td style="width: 10%;"></td> <td style="width: 10%;"></td> </tr> <tr> <td></td> <td></td> <td colspan="8" style="text-align: center;"> <table border="1" style="width: 100%; border-collapse: collapse; text-align: center;"> <tr> <td style="width: 10%;"></td> <td style="width: 10%;"></td> <td style="width: 10%;"></td> <td style="width: 10%;"></td> <td style="width: 10%;"></td> <td style="width: 10%;"></td> <td style="width: 10%;"></td> <td style="width:
10%;"></td> <td style="width: 10%;"></td> <td style="width: 10%;"></td> </tr> <tr> <td></td> <td></td> <td colspan="8" style="text-align: center;"> <table border="1" style="width: 100%; border-collapse: collapse; text-align: center;"> <tr> <td style="width: 10%;"></td> <td style="width: 10%;"></td> <td style="width: 10%;"></td> <td style="width: 10%;"></td> <td style="width: 10%;"></td> <td style="width: 10%;"></td> <td style="width: 10%;"></td> <td style="width: 10%;"></td> <td style="width: 10%;"></td> <td style="width: 10%;"></td> </tr> <tr> <td></td> <td></td> <td colspan="8" style="text-align: center;"> <table border="1" style="width: 100%; border-collapse: collapse; text-align: center;"> <tr> <td style="width: 10%;"></td> <td style="width: 10%;"></td> <td style="width: 10%;"></td> <td style="width: 10%;"></td> <td style="width: 10%;"></td> <td style="width: 10%;"></td> <td style="width: 10%;"></td> <td style="width: 10%;"></td> <td style="width: 10%;"></td> <td style="width: 10%;"></td> </tr> <tr> <td></td> <td></td> <td colspan="8" style="text-align: center;"> <table border="1" style="width: 100%; border-collapse: collapse; text-align: center;"> <tr> <td style="width: 10%;"></td> <td style="width: 10%;"></td> <td style="width: 10%;"></td> <td style="width: 10%;"></td> <td style="width: 10%;"></td> <td style="width: 10%;"></td> <td style="width: 10%;"></td> <td style="width: 10%;"></td> <td style="width: 10%;"></td> <td style="width: 10%;"></td> </tr> <tr> <td></td> <td></td> <td colspan="8" style="text-align: center;"> <table border="1" style="width: 100%; border-collapse: collapse; text-align: center;"> <tr> <td style="width: 10%;"></td> <td style="width: 10%;"></td> <td style="width: 10%;"></td> <td style="width: 10%;"></td> <td style="width: 10%;"></td> <td style="width: 10%;"></td> <td style="width: 10%;"></td> <td style="width: 10%;"></td> <td style="width: 10%;"></td> <td style="width: 10%;"></td> </tr> <tr> <td></td> <td></td> <td colspan="8" style="text-align: center;"> <table border="1" style="width: 100%; border-collapse: collapse; text-align: center;"> <tr> <td style="width: 10%;"></td> <td style="width: 10%;"></td> <td style="width: 10%;"></td> <td style="width: 10%;"></td> <td style="width: 10%;"></td> <td style="width: 10%;"></td> <td style="width: 10%;"></td> <td style="width: 10%;"></td> <td style="width: 10%;"></td> <td style="width: 10%;"></td> </tr> <tr> <td></td> <td></td> <td colspan="8" style="text-align: center;"> <table border="1" style="width: 100%; border-collapse: collapse; text-align: center;"> <tr> <td style="width: 10%;"></td> <td style="width: 10%;"></td> <td style="width: 10%;"></td> <td style="width: 10%;"></td> <td style="width: 10%;"></td> <td style="width: 10%;"></td> <td style="width: 10%;"></td> <td style="width: 10%;"></td> <td style="width: 10%;"></td> <td style="width: 10%;"></td> </tr> <tr> <td></td> <td></td> <td colspan="8" style="text-align: center;"> <table border="1" style="width: 100%; border-collapse: collapse; text-align: center;"> <tr> <td style="width: 10%;"></td> <td style="width: 10%;"></td> <td style="width: 10%;"></td> <td style="width: 10%;"></td> <td style="width: 10%;"></td> <td style="width: 10%;"></td> <td style="width: 10%;"></td> <td style="width: 10%;"></td> <td style="width: 10%;"></td> <td style="width: 10%;"></td> </tr> <tr> <td></td> <td></td> <td colspan="8" style="text-align: center;"> <table border="1" style="width: 100%; border-collapse: collapse; text-align: center;"> <tr> <td style="width: 10%;"></td> <td style="width: 10%;"></td> <td style="width: 10%;"></td> <td style="width: 10%;"></td> <td style="width: 10%;"></td> <td style="width: 10%;"></td> <td style="width: 10%;"></td> <td style="width: 10%;"></td> <td style="width: 10%;"></td> <td style="width: 10%;"></td> </tr> <tr> <td></td> <td></td> <td colspan="8" style="text-align: center;"> <table border="1" style="width: 100%; border-collapse: collapse; text-align: center;"> <tr> <td style="width: 10%;"></td> <td style="width: 10%;"></td> <td style="width: 10%;"></td> <td style="width: 10%;"></td> <td style="width: 10%;"></td> <td style="width: 10%;"></td> <td style="width: 10%;"></td> <td style="width: 10%;"></td> <td style="width: 10%;"></td> <td style="width: 10%;"></td> </tr> <tr> <td></td> <td></td> <td colspan="8" style="text-align: center;"> <table border="1" style="width: 100%; border-collapse: collapse; text-align: center;"> <tr> <td style="width: 10%;"></td> <td style="width: 10%;"></td> <td style="width: 10%;"></td> <td style="width: 10%;"></td> <td style="width: 10%;"></td> <td style="width: 10%;"></td> <td style="width: 10%;"></td> <td style="width: 10%;"></td> <td style="width: 10%;"></td> <td style="width: 10%;"></td> </tr> <tr> <td></td> <td></td> <td colspan="8" style="text-align: center;"> <table border="1" style="width: 100%; border-collapse: collapse; text-align: center;"> <tr> <td style="width: 10%;"></td> <td style="width: 10%;"></td> <td style="width: 10%;"></td> <td style="width: 10%;"></td> <td style="width: 10%;"></td> <td style="width: 10%;"></td> <td style="width: 10%;"></td> <td style="width: 10%;"></td> <td style="width: 10%;"></td> <td style="width: 10%;"></td> </tr> <tr> <td></td> <td></td> <td colspan="8" style="text-align: center;"> <table border="1" style="width: 100%; border-collapse: collapse; text-align: center;"> <tr> <td style="width: 10%;"></td> <td style="width: 10%;"></td> <td style="width: 10%;"></td> <td style="width: 10%;"></td> <td style="width: 10%;"></td> <td style="width: 10%;"></td> <td style="width: 10%;"></td> <td style="width: 10%;"></td> <td style="width: 10%;"></td> <td style="width: 10%;"></td> </tr> <tr> <td></td> <td></td> <td colspan="8" style="text-align: center;"> <table border="1" style="width: 100%; border-collapse: collapse; text-align: center;"> <tr> </tr></table></td></tr></table></td></tr></table></td></tr></table></td></tr></table></td></tr></table></td></tr></table></td></tr></table></td></tr></table></td></tr></table></td></tr></table></td></tr></table></td></tr></table></td></tr></table></td></tr></table></td></tr></table></td></tr></table></td></tr></table></td></tr></table></td></tr></table></td></tr></table></td></tr></table></td></tr></table></td></tr></table></td></tr></table></td></tr></table></td></tr></table></td></tr></table></td></tr></table></td></tr></table></td></tr></table></td></tr></table></td></tr></table></td></tr></table></td></tr></table></td></tr></table></td></tr></table></td></tr></table></td></tr></table></td></tr></table></td></tr></table></td></tr></table> | | | | | | | | | | | | | | | | | | | | <table border="1" style="width: 100%; border-collapse: collapse; text-align: center;"> <tr> <td style="width: 10%;"></td> <td style="width: 10%;"></td> <td style="width: 10%;"></td> <td style="width: 10%;"></td> <td style="width: 10%;"></td> <td style="width: 10%;"></td> <td style="width: 10%;"></td> <td style="width: 10%;"></td> <td style="width: 10%;"></td> <td style="width: 10%;"></td> </tr> <tr> <td></td> <td></td> <td colspan="8" style="text-align: center;"> <table border="1" style="width: 100%; border-collapse: collapse; text-align: center;"> <tr> <td style="width: 10%;"></td> <td style="width: 10%;"></td> <td style="width: 10%;"></td> <td style="width: 10%;"></td> <td style="width: 10%;"></td> <td style="width: 10%;"></td> <td style="width: 10%;"></td> <td style="width: 10%;"></td> <td style="width: 10%;"></td> <td style="width: 10%;"></td> </tr> <tr> <td></td> <td></td> <td colspan="8" style="text-align: center;"> <table border="1" style="width: 100%; border-collapse: collapse; text-align: center;"> <tr> <td style="width: 10%;"></td> <td style="width: 10%;"></td> <td style="width: 10%;"></td> <td style="width: 10%;"></td> <td style="width: 10%;"></td> <td style="width: 10%;"></td> <td style="width: 10%;"></td> <td style="width: 10%;"></td> <td style="width: 10%;"></td> <td style="width: 10%;"></td> </tr> <tr> <td></td> <td></td> <td colspan="8" style="text-align: center;"> <table border="1" style="width: 100%; border-collapse: collapse; text-align: center;"> <tr> <td style="width: 10%;"></td> <td style="width: 10%;"></td> <td style="width: 10%;"></td> <td style="width: 10%;"></td> <td style="width: 10%;"></td> <td style="width: 10%;"></td> <td style="width: 10%;"></td> <td style="width: 10%;"></td> <td style="width: 10%;"></td> <td style="width: 10%;"></td> </tr> <tr> <td></td> <td></td> <td colspan="8" style="text-align: center;"> <table border="1" style="width: 100%; border-collapse: collapse; text-align: center;"> <tr> <td style="width: 10%;"></td> <td style="width: 10%;"></td> <td style="width: 10%;"></td> <td style="width: 10%;"></td> <td style="width: 10%;"></td> <td style="width: 10%;"></td> <td style="width: 10%;"></td> <td style="width: 10%;"></td> <td style="width: 10%;"></td> <td style="width: 10%;"></td> </tr> <tr> <td></td> <td></td> <td colspan="8" style="text-align: center;"> <table border="1"
style="width: 100%; border-collapse: collapse; text-align: center;"> <tr> <td style="width: 10%;"></td> <td style="width: 10%;"></td> <td style="width: 10%;"></td> <td style="width: 10%;"></td> <td style="width: 10%;"></td> <td style="width: 10%;"></td> <td style="width: 10%;"></td> <td style="width: 10%;"></td> <td style="width: 10%;"></td> <td style="width: 10%;"></td> </tr> <tr> <td></td> <td></td> <td colspan="8" style="text-align: center;"> <table border="1" style="width: 100%; border-collapse: collapse; text-align: center;"> <tr> <td style="width: 10%;"></td> <td style="width: 10%;"></td> <td style="width: 10%;"></td> <td style="width: 10%;"></td> <td style="width: 10%;"></td> <td style="width: 10%;"></td> <td style="width: 10%;"></td> <td style="width: 10%;"></td> <td style="width: 10%;"></td> <td style="width: 10%;"></td> </tr> <tr> <td></td> <td></td> <td colspan="8" style="text-align: center;"> <table border="1" style="width: 100%; border-collapse: collapse; text-align: center;"> <tr> <td style="width: 10%;"></td> <td style="width: 10%;"></td> <td style="width: 10%;"></td> <td style="width: 10%;"></td> <td style="width: 10%;"></td> <td style="width: 10%;"></td> <td style="width: 10%;"></td> <td style="width: 10%;"></td> <td style="width: 10%;"></td> <td style="width: 10%;"></td> </tr> <tr> <td></td> <td></td> <td colspan="8" style="text-align: center;"> <table border="1" style="width: 100%; border-collapse: collapse; text-align: center;"> <tr> <td style="width: 10%;"></td> <td style="width: 10%;"></td> <td style="width: 10%;"></td> <td style="width: 10%;"></td> <td style="width: 10%;"></td> <td style="width: 10%;"></td> <td style="width: 10%;"></td> <td style="width: 10%;"></td> <td style="width: 10%;"></td> <td style="width: 10%;"></td> </tr> <tr> <td></td> <td></td> <td colspan="8" style="text-align: center;"> <table border="1" style="width: 100%; border-collapse: collapse; text-align: center;"> <tr> <td style="width: 10%;"></td> <td style="width: 10%;"></td> <td style="width: 10%;"></td> <td style="width: 10%;"></td> <td style="width: 10%;"></td> <td style="width: 10%;"></td> <td style="width: 10%;"></td> <td style="width: 10%;"></td> <td style="width: 10%;"></td> <td style="width: 10%;"></td> </tr> <tr> <td></td> <td></td> <td colspan="8" style="text-align: center;"> <table border="1" style="width: 100%; border-collapse: collapse; text-align: center;"> <tr> <td style="width: 10%;"></td> <td style="width: 10%;"></td> <td style="width: 10%;"></td> <td style="width: 10%;"></td> <td style="width: 10%;"></td> <td style="width: 10%;"></td> <td style="width: 10%;"></td> <td style="width: 10%;"></td> <td style="width: 10%;"></td> <td style="width: 10%;"></td> </tr> <tr> <td></td> <td></td> <td colspan="8" style="text-align: center;"> <table border="1" style="width: 100%; border-collapse: collapse; text-align: center;"> <tr> <td style="width: 10%;"></td> <td style="width: 10%;"></td> <td style="width: 10%;"></td> <td style="width: 10%;"></td> <td style="width: 10%;"></td> <td style="width: 10%;"></td> <td style="width: 10%;"></td> <td style="width: 10%;"></td> <td style="width: 10%;"></td> <td style="width: 10%;"></td> </tr> <tr> <td></td> <td></td> <td colspan="8" style="text-align: center;"> <table border="1" style="width: 100%; border-collapse: collapse; text-align: center;"> <tr> <td style="width: 10%;"></td> <td style="width: 10%;"></td> <td style="width: 10%;"></td> <td style="width: 10%;"></td> <td style="width: 10%;"></td> <td style="width: 10%;"></td> <td style="width: 10%;"></td> <td style="width: 10%;"></td> <td style="width: 10%;"></td> <td style="width: 10%;"></td> </tr> <tr> <td></td> <td></td> <td colspan="8" style="text-align: center;"> <table border="1" style="width: 100%; border-collapse: collapse; text-align: center;"> <tr> <td style="width: 10%;"></td> <td style="width: 10%;"></td> <td style="width: 10%;"></td> <td style="width: 10%;"></td> <td style="width: 10%;"></td> <td style="width: 10%;"></td> <td style="width: 10%;"></td> <td style="width: 10%;"></td> <td style="width: 10%;"></td> <td style="width: 10%;"></td> </tr> <tr> <td></td> <td></td> <td colspan="8" style="text-align: center;"> <table border="1" style="width: 100%; border-collapse: collapse; text-align: center;"> <tr> <td style="width: 10%;"></td> <td style="width: 10%;"></td> <td style="width: 10%;"></td> <td style="width: 10%;"></td> <td style="width: 10%;"></td> <td style="width: 10%;"></td> <td style="width: 10%;"></td> <td style="width: 10%;"></td> <td style="width: 10%;"></td> <td style="width: 10%;"></td> </tr> <tr> <td></td> <td></td> <td colspan="8" style="text-align: center;"> <table border="1" style="width: 100%; border-collapse: collapse; text-align: center;"> <tr> <td style="width: 10%;"></td> <td style="width: 10%;"></td> <td style="width: 10%;"></td> <td style="width: 10%;"></td> <td style="width: 10%;"></td> <td style="width: 10%;"></td> <td style="width: 10%;"></td> <td style="width: 10%;"></td> <td style="width: 10%;"></td> <td style="width: 10%;"></td> </tr> <tr> <td></td> <td></td> <td colspan="8" style="text-align: center;"> <table border="1" style="width: 100%; border-collapse: collapse; text-align: center;"> <tr> <td style="width: 10%;"></td> <td style="width: 10%;"></td> <td style="width: 10%;"></td> <td style="width: 10%;"></td> <td style="width: 10%;"></td> <td style="width: 10%;"></td> <td style="width: 10%;"></td> <td style="width: 10%;"></td> <td style="width: 10%;"></td> <td style="width: 10%;"></td> </tr> <tr> <td></td> <td></td> <td colspan="8" style="text-align: center;"> <table border="1" style="width: 100%; border-collapse: collapse; text-align: center;"> <tr> <td style="width: 10%;"></td> <td style="width: 10%;"></td> <td style="width: 10%;"></td> <td style="width: 10%;"></td> <td style="width: 10%;"></td> <td style="width: 10%;"></td> <td style="width: 10%;"></td> <td style="width: 10%;"></td> <td style="width: 10%;"></td> <td style="width: 10%;"></td> </tr> <tr> <td></td> <td></td> <td colspan="8" style="text-align: center;"> <table border="1" style="width: 100%; border-collapse: collapse; text-align: center;"> <tr> <td style="width: 10%;"></td> <td style="width: 10%;"></td> <td style="width: 10%;"></td> <td style="width: 10%;"></td> <td style="width: 10%;"></td> <td style="width: 10%;"></td> <td style="width: 10%;"></td> <td style="width: 10%;"></td> <td style="width: 10%;"></td> <td style="width: 10%;"></td> </tr> <tr> <td></td> <td></td> <td colspan="8" style="text-align: center;"> <table border="1" style="width: 100%; border-collapse: collapse; text-align: center;"> <tr> <td style="width: 10%;"></td> <td style="width: 10%;"></td> <td style="width: 10%;"></td> <td style="width: 10%;"></td> <td style="width: 10%;"></td> <td style="width: 10%;"></td> <td style="width: 10%;"></td> <td style="width: 10%;"></td> <td style="width: 10%;"></td> <td style="width: 10%;"></td> </tr> <tr> <td></td> <td></td> <td colspan="8" style="text-align: center;"> <table border="1" style="width: 100%; border-collapse: collapse; text-align: center;"> <tr> <td style="width: 10%;"></td> <td style="width: 10%;"></td> <td style="width: 10%;"></td> <td style="width: 10%;"></td> <td style="width: 10%;"></td> <td style="width: 10%;"></td> <td style="width: 10%;"></td> <td style="width: 10%;"></td> <td style="width: 10%;"></td> <td style="width: 10%;"></td> </tr> <tr> <td></td> <td></td> <td colspan="8" style="text-align: center;"> <table border="1" style="width: 100%; border-collapse: collapse; text-align: center;"> <tr> <td style="width: 10%;"></td> <td style="width: 10%;"></td> <td style="width: 10%;"></td> <td style="width: 10%;"></td> <td style="width: 10%;"></td> <td style="width: 10%;"></td> <td style="width: 10%;"></td> <td style="width: 10%;"></td> <td style="width: 10%;"></td> <td style="width: 10%;"></td> </tr> <tr> <td></td> <td></td> <td colspan="8" style="text-align: center;"> <table border="1" style="width: 100%; border-collapse: collapse; text-align: center;"> <tr> <td style="width: 10%;"></td> <td style="width: 10%;"></td> <td style="width: 10%;"></td> <td style="width: 10%;"></td> <td style="width: 10%;"></td> <td style="width: 10%;"></td> <td style="width: 10%;"></td> <td style="width: 10%;"></td> <td style="width: 10%;"></td> <td style="width: 10%;"></td> </tr> <tr> <td></td> <td></td> <td colspan="8" style="text-align: center;"> <table border="1" style="width: 100%; border-collapse: collapse; text-align: center;"> <tr> <td style="width: 10%;"></td> <td style="width: 10%;"></td> <td style="width: 10%;"></td> <td style="width: 10%;"></td> <td style="width: 10%;"></td> <td style="width: 10%;"></td> <td style="width: 10%;"></td> <td style="width: 10%;"></td> <td style="width: 10%;"></td> <td style="width: 10%;"></td> </tr> <tr> <td></td> <td></td> <td colspan="8" style="text-align: center;"> <table border="1" style="width: 100%; border-collapse: collapse; text-align: center;"> <tr> <td style="width: 10%;"></td> <td style="width: 10%;"></td> <td style="width: 10%;"></td> <td style="width: 10%;"></td> <td style="width: 10%;"></td> <td style="width: 10%;"></td> <td style="width: 10%;"></td> <td style="width: 10%;"></td> <td style="width: 10%;"></td> <td style="width: 10%;"></td> </tr> <tr> <td></td> <td></td> <td colspan="8" style="text-align: center;"> <table border="1" style="width: 100%; border-collapse: collapse; text-align: center;"> <tr> <td style="width: 10%;"></td> <td style="width: 10%;"></td> <td style="width: 10%;"></td> <td style="width: 10%;"></td> <td style="width: 10%;"></td> <td style="width: 10%;"></td> <td style="width: 10%;"></td> <td style="width: 10%;"></td> <td style="width: 10%;"></td> <td style="width: 10%;"></td> </tr> <tr> <td></td> <td></td> <td colspan="8" style="text-align: center;"> <table border="1" style="width: 100%; border-collapse: collapse; text-align: center;"> <tr> <td style="width: 10%;"></td> <td style="width: 10%;"></td> <td style="width: 10%;"></td> <td
style="width: 10%;"></td> <td style="width: 10%;"></td> <td style="width: 10%;"></td> <td style="width: 10%;"></td> <td style="width: 10%;"></td> <td style="width: 10%;"></td> <td style="width: 10%;"></td> </tr> <tr> <td></td> <td></td> <td colspan="8" style="text-align: center;"> <table border="1" style="width: 100%; border-collapse: collapse; text-align: center;"> <tr> <td style="width: 10%;"></td> <td style="width: 10%;"></td> <td style="width: 10%;"></td> <td style="width: 10%;"></td> <td style="width: 10%;"></td> <td style="width: 10%;"></td> <td style="width: 10%;"></td> <td style="width: 10%;"></td> <td style="width: 10%;"></td> <td style="width: 10%;"></td> </tr> <tr> <td></td> <td></td> <td colspan="8" style="text-align: center;"> <table border="1" style="width: 100%; border-collapse: collapse; text-align: center;"> <tr> <td style="width: 10%;"></td> <td style="width: 10%;"></td> <td style="width: 10%;"></td> <td style="width: 10%;"></td> <td style="width: 10%;"></td> <td style="width: 10%;"></td> <td style="width: 10%;"></td> <td style="width: 10%;"></td> <td style="width: 10%;"></td> <td style="width: 10%;"></td> </tr> <tr> <td></td> <td></td> <td colspan="8" style="text-align: center;"> <table border="1" style="width: 100%; border-collapse: collapse; text-align: center;"> <tr> <td style="width: 10%;"></td> <td style="width: 10%;"></td> <td style="width: 10%;"></td> <td style="width: 10%;"></td> <td style="width: 10%;"></td> <td style="width: 10%;"></td> <td style="width: 10%;"></td> <td style="width: 10%;"></td> <td style="width: 10%;"></td> <td style="width: 10%;"></td> </tr> <tr> <td></td> <td></td> <td colspan="8" style="text-align: center;"> <table border="1" style="width: 100%; border-collapse: collapse; text-align: center;"> <tr> <td style="width: 10%;"></td> <td style="width: 10%;"></td> <td style="width: 10%;"></td> <td style="width: 10%;"></td> <td style="width: 10%;"></td> <td style="width: 10%;"></td> <td style="width: 10%;"></td> <td style="width: 10%;"></td> <td style="width: 10%;"></td> <td style="width: 10%;"></td> </tr> <tr> <td></td> <td></td> <td colspan="8" style="text-align: center;"> <table border="1" style="width: 100%; border-collapse: collapse; text-align: center;"> <tr> <td style="width: 10%;"></td> <td style="width: 10%;"></td> <td style="width: 10%;"></td> <td style="width: 10%;"></td> <td style="width: 10%;"></td> <td style="width: 10%;"></td> <td style="width: 10%;"></td> <td style="width: 10%;"></td> <td style="width: 10%;"></td> <td style="width: 10%;"></td> </tr> <tr> <td></td> <td></td> <td colspan="8" style="text-align: center;"> <table border="1" style="width: 100%; border-collapse: collapse; text-align: center;"> <tr> <td style="width: 10%;"></td> <td style="width: 10%;"></td> <td style="width: 10%;"></td> <td style="width: 10%;"></td> <td style="width: 10%;"></td> <td style="width: 10%;"></td> <td style="width: 10%;"></td> <td style="width: 10%;"></td> <td style="width: 10%;"></td> <td style="width: 10%;"></td> </tr> <tr> <td></td> <td></td> <td colspan="8" style="text-align: center;"> <table border="1" style="width: 100%; border-collapse: collapse; text-align: center;"> <tr> <td style="width: 10%;"></td> <td style="width: 10%;"></td> <td style="width: 10%;"></td> <td style="width: 10%;"></td> <td style="width: 10%;"></td> <td style="width: 10%;"></td> <td style="width: 10%;"></td> <td style="width: 10%;"></td> <td style="width: 10%;"></td> <td style="width: 10%;"></td> </tr> <tr> <td></td> <td></td> <td colspan="8" style="text-align: center;"> <table border="1" style="width: 100%; border-collapse: collapse; text-align: center;"> <tr> <td style="width: 10%;"></td> <td style="width: 10%;"></td> <td style="width: 10%;"></td> <td style="width: 10%;"></td> <td style="width: 10%;"></td> <td style="width: 10%;"></td> <td style="width: 10%;"></td> <td style="width: 10%;"></td> <td style="width: 10%;"></td> <td style="width: 10%;"></td> </tr> <tr> <td></td> <td></td> <td colspan="8" style="text-align: center;"> <table border="1" style="width: 100%; border-collapse: collapse; text-align: center;"> <tr> <td style="width: 10%;"></td> <td style="width: 10%;"></td> <td style="width: 10%;"></td> <td style="width: 10%;"></td> <td style="width: 10%;"></td> <td style="width: 10%;"></td> <td style="width: 10%;"></td> <td style="width: 10%;"></td> <td style="width: 10%;"></td> <td style="width: 10%;"></td> </tr> <tr> <td></td> <td></td> <td colspan="8" style="text-align: center;"> <table border="1" style="width: 100%; border-collapse: collapse; text-align: center;"> <tr> <td style="width: 10%;"></td> <td style="width: 10%;"></td> <td style="width: 10%;"></td> <td style="width: 10%;"></td> <td style="width: 10%;"></td> <td style="width: 10%;"></td> <td style="width: 10%;"></td> <td style="width: 10%;"></td> <td style="width: 10%;"></td> <td style="width: 10%;"></td> </tr> <tr> <td></td> <td></td> <td colspan="8" style="text-align: center;"> <table border="1" style="width: 100%; border-collapse: collapse; text-align: center;"> <tr> <td style="width: 10%;"></td> <td style="width: 10%;"></td> <td style="width: 10%;"></td> <td style="width: 10%;"></td> <td style="width: 10%;"></td> <td style="width: 10%;"></td> <td style="width: 10%;"></td> <td style="width: 10%;"></td> <td style="width: 10%;"></td> <td style="width: 10%;"></td> </tr> <tr> <td></td> <td></td> <td colspan="8" style="text-align: center;"> <table border="1" style="width: 100%; border-collapse: collapse; text-align: center;"> <tr> <td style="width: 10%;"></td> <td style="width: 10%;"></td> <td style="width: 10%;"></td> <td style="width: 10%;"></td> <td style="width: 10%;"></td> <td style="width: 10%;"></td> <td style="width: 10%;"></td> <td style="width: 10%;"></td> <td style="width: 10%;"></td> <td style="width: 10%;"></td> </tr> <tr> <td></td> <td></td> <td colspan="8" style="text-align: center;"> <table border="1" style="width: 100%; border-collapse: collapse; text-align: center;"> <tr> <td style="width: 10%;"></td> <td style="width: 10%;"></td> <td style="width: 10%;"></td> <td style="width: 10%;"></td> <td style="width: 10%;"></td> <td style="width: 10%;"></td> <td style="width: 10%;"></td> <td style="width: 10%;"></td> <td style="width: 10%;"></td> <td style="width: 10%;"></td> </tr> <tr> <td></td> <td></td> <td colspan="8" style="text-align: center;"> <table border="1" style="width: 100%; border-collapse: collapse; text-align: center;"> <tr> </tr></table></td></tr></table></td></tr></table></td></tr></table></td></tr></table></td></tr></table></td></tr></table></td></tr></table></td></tr></table></td></tr></table></td></tr></table></td></tr></table></td></tr></table></td></tr></table></td></tr></table></td></tr></table></td></tr></table></td></tr></table></td></tr></table></td></tr></table></td></tr></table></td></tr></table></td></tr></table></td></tr></table></td></tr></table></td></tr></table></td></tr></table></td></tr></table></td></tr></table></td></tr></table></td></tr></table></td></tr></table></td></tr></table></td></tr></table></td></tr></table></td></tr></table></td></tr></table></td></tr></table></td></tr></table></td></tr></table></td></tr></table> | | | | | | | | | | | | | | | | | | | | <table border="1" style="width: 100%; border-collapse: collapse; text-align: center;"> <tr> <td style="width: 10%;"></td> <td style="width: 10%;"></td> <td style="width: 10%;"></td> <td style="width: 10%;"></td> <td style="width: 10%;"></td> <td style="width: 10%;"></td> <td style="width: 10%;"></td> <td style="width: 10%;"></td> <td style="width: 10%;"></td> <td style="width: 10%;"></td> </tr> <tr> <td></td> <td></td> <td colspan="8" style="text-align: center;"> <table border="1" style="width: 100%; border-collapse: collapse; text-align: center;"> <tr> <td style="width: 10%;"></td> <td style="width: 10%;"></td> <td style="width: 10%;"></td> <td style="width: 10%;"></td> <td style="width: 10%;"></td> <td style="width: 10%;"></td> <td style="width: 10%;"></td> <td style="width: 10%;"></td> <td style="width: 10%;"></td> <td style="width: 10%;"></td> </tr> <tr> <td></td> <td></td> <td colspan="8" style="text-align: center;"> <table border="1" style="width: 100%; border-collapse: collapse; text-align: center;"> <tr> <td style="width: 10%;"></td> <td style="width: 10%;"></td> <td style="width: 10%;"></td> <td style="width: 10%;"></td> <td style="width: 10%;"></td> <td style="width: 10%;"></td> <td style="width: 10%;"></td> <td style="width: 10%;"></td> <td style="width: 10%;"></td> <td style="width: 10%;"></td> </tr> <tr> <td></td> <td></td> <td colspan="8" style="text-align: center;"> <table border="1" style="width: 100%; border-collapse: collapse; text-align: center;"> <tr> <td style="width: 10%;"></td> <td style="width: 10%;"></td> <td style="width: 10%;"></td> <td style="width: 10%;"></td> <td style="width: 10%;"></td> <td style="width: 10%;"></td> <td style="width: 10%;"></td> <td style="width: 10%;"></td> <td style="width: 10%;"></td> <td
style="width: 10%;"></td> </tr> <tr> <td></td> <td></td> <td colspan="8" style="text-align: center;"> <table border="1" style="width: 100%; border-collapse: collapse; text-align: center;"> <tr> <td style="width: 10%;"></td> <td style="width: 10%;"></td> <td style="width: 10%;"></td> <td style="width: 10%;"></td> <td style="width: 10%;"></td> <td style="width: 10%;"></td> <td style="width: 10%;"></td> <td style="width: 10%;"></td> <td style="width: 10%;"></td> <td style="width: 10%;"></td> </tr> <tr> <td></td> <td></td> <td colspan="8" style="text-align: center;"> <table border="1" style="width: 100%; border-collapse: collapse; text-align: center;"> <tr> <td style="width: 10%;"></td> <td style="width: 10%;"></td> <td style="width: 10%;"></td> <td style="width: 10%;"></td> <td style="width: 10%;"></td> <td style="width: 10%;"></td> <td style="width: 10%;"></td> <td style="width: 10%;"></td> <td style="width: 10%;"></td> <td style="width: 10%;"></td> </tr> <tr> <td></td> <td></td> <td colspan="8" style="text-align: center;"> <table border="1" style="width: 100%; border-collapse: collapse; text-align: center;"> <tr> <td style="width: 10%;"></td> <td style="width: 10%;"></td> <td style="width: 10%;"></td> <td style="width: 10%;"></td> <td style="width: 10%;"></td> <td style="width: 10%;"></td> <td style="width: 10%;"></td> <td style="width: 10%;"></td> <td style="width: 10%;"></td> <td style="width: 10%;"></td> </tr> <tr> <td></td> <td></td> <td colspan="8" style="text-align: center;"> <table border="1" style="width: 100%; border-collapse: collapse; text-align: center;"> <tr> <td style="width: 10%;"></td> <td style="width: 10%;"></td> <td style="width: 10%;"></td> <td style="width: 10%;"></td> <td style="width: 10%;"></td> <td style="width: 10%;"></td> <td style="width: 10%;"></td> <td style="width: 10%;"></td> <td style="width: 10%;"></td> <td style="width: 10%;"></td> </tr> <tr> <td></td> <td></td> <td colspan="8" style="text-align: center;"> <table border="1" style="width: 100%; border-collapse: collapse; text-align: center;"> <tr> <td style="width: 10%;"></td> <td style="width: 10%;"></td> <td style="width: 10%;"></td> <td style="width: 10%;"></td> <td style="width: 10%;"></td> <td style="width: 10%;"></td> <td style="width: 10%;"></td> <td style="width: 10%;"></td> <td style="width: 10%;"></td> <td style="width: 10%;"></td> </tr> <tr> <td></td> <td></td> <td colspan="8" style="text-align: center;"> <table border="1" style="width: 100%; border-collapse: collapse; text-align: center;"> <tr> <td style="width: 10%;"></td> <td style="width: 10%;"></td> <td style="width: 10%;"></td> <td style="width: 10%;"></td> <td style="width: 10%;"></td> <td style="width: 10%;"></td> <td style="width: 10%;"></td> <td style="width: 10%;"></td> <td style="width: 10%;"></td> <td style="width: 10%;"></td> </tr> <tr> <td></td> <td></td> <td colspan="8" style="text-align: center;"> <table border="1" style="width: 100%; border-collapse: collapse; text-align: center;"> <tr> <td style="width: 10%;"></td> <td style="width: 10%;"></td> <td style="width: 10%;"></td> <td style="width: 10%;"></td> <td style="width: 10%;"></td> <td style="width: 10%;"></td> <td style="width: 10%;"></td> <td style="width: 10%;"></td> <td style="width: 10%;"></td> <td style="width: 10%;"></td> </tr> <tr> <td></td> <td></td> <td colspan="8" style="text-align: center;"> <table border="1" style="width: 100%; border-collapse: collapse; text-align: center;"> <tr> <td style="width: 10%;"></td> <td style="width: 10%;"></td> <td style="width: 10%;"></td> <td style="width: 10%;"></td> <td style="width: 10%;"></td> <td style="width: 10%;"></td> <td style="width: 10%;"></td> <td style="width: 10%;"></td> <td style="width: 10%;"></td> <td style="width: 10%;"></td> </tr> <tr> <td></td> <td></td> <td colspan="8" style="text-align: center;"> <table border="1" style="width: 100%; border-collapse: collapse; text-align: center;"> <tr> <td style="width: 10%;"></td> <td style="width: 10%;"></td> <td style="width: 10%;"></td> <td style="width: 10%;"></td> <td style="width: 10%;"></td> <td style="width: 10%;"></td> <td style="width: 10%;"></td> <td style="width: 10%;"></td> <td style="width: 10%;"></td> <td style="width: 10%;"></td> </tr> <tr> <td></td> <td></td> <td colspan="8" style="text-align: center;"> <table border="1" style="width: 100%; border-collapse: collapse; text-align: center;"> <tr> <td style="width: 10%;"></td> <td style="width: 10%;"></td> <td style="width: 10%;"></td> <td style="width: 10%;"></td> <td style="width: 10%;"></td> <td style="width: 10%;"></td> <td style="width: 10%;"></td> <td style="width: 10%;"></td> <td style="width: 10%;"></td> <td style="width: 10%;"></td> </tr> <tr> <td></td> <td></td> <td colspan="8" style="text-align: center;"> <table border="1" style="width: 100%; border-collapse: collapse; text-align: center;"> <tr> <td style="width: 10%;"></td> <td style="width: 10%;"></td> <td style="width: 10%;"></td> <td style="width: 10%;"></td> <td style="width: 10%;"></td> <td style="width: 10%;"></td> <td style="width: 10%;"></td> <td style="width: 10%;"></td> <td style="width: 10%;"></td> <td style="width: 10%;"></td> </tr> <tr> <td></td> <td></td> <td colspan="8" style="text-align: center;"> <table border="1" style="width: 100%; border-collapse: collapse; text-align: center;"> <tr> <td style="width: 10%;"></td> <td style="width: 10%;"></td> <td style="width: 10%;"></td> <td style="width: 10%;"></td> <td style="width: 10%;"></td> <td style="width: 10%;"></td> <td style="width: 10%;"></td> <td style="width: 10%;"></td> <td style="width: 10%;"></td> <td style="width: 10%;"></td> </tr> <tr> <td></td> <td></td> <td colspan="8" style="text-align: center;"> <table border="1" style="width: 100%; border-collapse: collapse; text-align: center;"> <tr> <td style="width: 10%;"></td> <td style="width: 10%;"></td> <td style="width: 10%;"></td> <td style="width: 10%;"></td> <td style="width: 10%;"></td> <td style="width: 10%;"></td> <td style="width: 10%;"></td> <td style="width: 10%;"></td> <td style="width: 10%;"></td> <td style="width: 10%;"></td> </tr> <tr> <td></td> <td></td> <td colspan="8" style="text-align: center;"> <table border="1" style="width: 100%; border-collapse: collapse; text-align: center;"> <tr> <td style="width: 10%;"></td> <td style="width: 10%;"></td> <td style="width: 10%;"></td> <td style="width: 10%;"></td> <td style="width: 10%;"></td> <td style="width: 10%;"></td> <td style="width: 10%;"></td> <td style="width: 10%;"></td> <td style="width: 10%;"></td> <td style="width: 10%;"></td> </tr> <tr> <td></td> <td></td> <td colspan="8" style="text-align: center;"> <table border="1" style="width: 100%; border-collapse: collapse; text-align: center;"> <tr> <td style="width: 10%;"></td> <td style="width: 10%;"></td> <td style="width: 10%;"></td> <td style="width: 10%;"></td> <td style="width: 10%;"></td> <td style="width: 10%;"></td> <td style="width: 10%;"></td> <td style="width: 10%;"></td> <td style="width: 10%;"></td> <td style="width: 10%;"></td> </tr> <tr> <td></td> <td></td> <td colspan="8" style="text-align: center;"> <table border="1" style="width: 100%; border-collapse: collapse; text-align: center;"> <tr> <td style="width: 10%;"></td> <td style="width: 10%;"></td> <td style="width: 10%;"></td> <td style="width: 10%;"></td> <td style="width: 10%;"></td> <td style="width: 10%;"></td> <td style="width: 10%;"></td> <td style="width: 10%;"></td> <td style="width: 10%;"></td> <td style="width: 10%;"></td> </tr> <tr> <td></td> <td></td> <td colspan="8" style="text-align: center;"> <table border="1" style="width: 100%; border-collapse: collapse; text-align: center;"> <tr> <td style="width: 10%;"></td> <td style="width: 10%;"></td> <td style="width: 10%;"></td> <td style="width: 10%;"></td> <td style="width: 10%;"></td> <td style="width: 10%;"></td> <td style="width: 10%;"></td> <td style="width: 10%;"></td> <td style="width: 10%;"></td> <td style="width: 10%;"></td> </tr> <tr> <td></td> <td></td> <td colspan="8" style="text-align: center;"> <table border="1" style="width: 100%; border-collapse: collapse; text-align: center;"> <tr> <td style="width: 10%;"></td> <td style="width: 10%;"></td> <td style="width: 10%;"></td> <td style="width: 10%;"></td> <td style="width: 10%;"></td> <td style="width: 10%;"></td> <td style="width: 10%;"></td> <td style="width: 10%;"></td> <td style="width: 10%;"></td> <td style="width: 10%;"></td> </tr> <tr> <td></td> <td></td> <td colspan="8" style="text-align: center;"> <table border="1" style="width: 100%; border-collapse: collapse; text-align: center;"> <tr> <td style="width: 10%;"></td> <td style="width: 10%;"></td> <td style="width: 10%;"></td> <td style="width: 10%;"></td> <td style="width: 10%;"></td> <td style="width: 10%;"></td> <td style="width: 10%;"></td> <td style="width: 10%;"></td> <td style="width: 10%;"></td> <td style="width: 10%;"></td> </tr> <tr> <td></td> <td></td> <td colspan="8" style="text-align: center;"> <table border="1" style="width: 100%; border-collapse: collapse; text-align: center;"> <tr> <td style="width: 10%;"></td> <td style="width: 10%;"></td> <td style="width: 10%;"></td> <td style="width: 10%;"></td> <td style="width: 10%;"></td> <td style="width: 10%;"></td> <td style="width: 10%;"></td> <td style="width: 10%;"></td> <td style="width: 10%;"></td> <td style="width: 10%;"></td> </tr> <tr> <td></td> <td></td> <td colspan="8" style="text-align: center;"> <table border="1" style="width: 100%; border-collapse: collapse; text-align: center;"> <tr> <td style="width: 10%;"></td> <td style="width: 10%;"></td> <td style="width: 10%;"></td> <td style="width: 10%;"></td> <td style="width: 10%;"></td> <td style="width: 10%;"></td> <td style="width: 10%;"></td> <td style="width: 10%;"></td> <td style="width: 10%;"></td> <td style="width: 10%;"></td> </tr> <tr> <td></td> <td></td> <td colspan="8" style="text-align: center;"> <table border="1" style="width: 100%; border-collapse: collapse;
text-align: center;"> <tr> <td style="width: 10%;"></td> <td style="width: 10%;"></td> <td style="width: 10%;"></td> <td style="width: 10%;"></td> <td style="width: 10%;"></td> <td style="width: 10%;"></td> <td style="width: 10%;"></td> <td style="width: 10%;"></td> <td style="width: 10%;"></td> <td style="width: 10%;"></td> </tr> <tr> <td></td> <td></td> <td colspan="8" style="text-align: center;"> <table border="1" style="width: 100%; border-collapse: collapse; text-align: center;"> <tr> <td style="width: 10%;"></td> <td style="width: 10%;"></td> <td style="width: 10%;"></td> <td style="width: 10%;"></td> <td style="width: 10%;"></td> <td style="width: 10%;"></td> <td style="width: 10%;"></td> <td style="width: 10%;"></td> <td style="width: 10%;"></td> <td style="width: 10%;"></td> </tr> <tr> <td></td> <td></td> <td colspan="8" style="text-align: center;"> <table border="1" style="width: 100%; border-collapse: collapse; text-align: center;"> <tr> <td style="width: 10%;"></td> <td style="width: 10%;"></td> <td style="width: 10%;"></td> <td style="width: 10%;"></td> <td style="width: 10%;"></td> <td style="width: 10%;"></td> <td style="width: 10%;"></td> <td style="width: 10%;"></td> <td style="width: 10%;"></td> <td style="width: 10%;"></td> </tr> <tr> <td></td> <td></td> <td colspan="8" style="text-align: center;"> <table border="1" style="width: 100%; border-collapse: collapse; text-align: center;"> <tr> <td style="width: 10%;"></td> <td style="width: 10%;"></td> <td style="width: 10%;"></td> <td style="width: 10%;"></td> <td style="width: 10%;"></td> <td style="width: 10%;"></td> <td style="width: 10%;"></td> <td style="width: 10%;"></td> <td style="width: 10%;"></td> <td style="width: 10%;"></td> </tr> <tr> <td></td> <td></td> <td colspan="8" style="text-align: center;"> <table border="1" style="width: 100%; border-collapse: collapse; text-align: center;"> <tr> <td style="width: 10%;"></td> <td style="width: 10%;"></td> <td style="width: 10%;"></td> <td style="width: 10%;"></td> <td style="width: 10%;"></td> <td style="width: 10%;"></td> <td style="width: 10%;"></td> <td style="width: 10%;"></td> <td style="width: 10%;"></td> <td style="width: 10%;"></td> </tr> <tr> <td></td> <td></td> <td colspan="8" style="text-align: center;"> <table border="1" style="width: 100%; border-collapse: collapse; text-align: center;"> <tr> <td style="width: 10%;"></td> <td style="width: 10%;"></td> <td style="width: 10%;"></td> <td style="width: 10%;"></td> <td style="width: 10%;"></td> <td style="width: 10%;"></td> <td style="width: 10%;"></td> <td style="width: 10%;"></td> <td style="width: 10%;"></td> <td style="width: 10%;"></td> </tr> <tr> <td></td> <td></td> <td colspan="8" style="text-align: center;"> <table border="1" style="width: 100%; border-collapse: collapse; text-align: center;"> <tr> <td style="width: 10%;"></td> <td style="width: 10%;"></td> <td style="width: 10%;"></td> <td style="width: 10%;"></td> <td style="width: 10%;"></td> <td style="width: 10%;"></td> <td style="width: 10%;"></td> <td style="width: 10%;"></td> <td style="width: 10%;"></td> <td style="width: 10%;"></td> </tr> <tr> <td></td> <td></td> <td colspan="8" style="text-align: center;"> <table border="1" style="width: 100%; border-collapse: collapse; text-align: center;"> <tr> <td style="width: 10%;"></td> <td style="width: 10%;"></td> <td style="width: 10%;"></td> <td style="width: 10%;"></td> <td style="width: 10%;"></td> <td style="width: 10%;"></td> <td style="width: 10%;"></td> <td style="width: 10%;"></td> <td style="width: 10%;"></td> <td style="width: 10%;"></td> </tr> <tr> <td></td> <td></td> <td colspan="8" style="text-align: center;"> <table border="1" style="width: 100%; border-collapse: collapse; text-align: center;"> <tr> <td style="width: 10%;"></td> <td style="width: 10%;"></td> <td style="width: 10%;"></td> <td style="width: 10%;"></td> <td style="width: 10%;"></td> <td style="width: 10%;"></td> <td style="width: 10%;"></td> <td style="width: 10%;"></td> <td style="width: 10%;"></td> <td style="width: 10%;"></td> </tr> <tr> <td></td> <td></td> <td colspan="8" style="text-align: center;"> <table border="1" style="width: 100%; border-collapse: collapse; text-align: center;"> <tr> <td style="width: 10%;"></td> <td style="width: 10%;"></td> <td style="width: 10%;"></td> <td style="width: 10%;"></td> <td style="width: 10%;"></td> <td style="width: 10%;"></td> <td style="width: 10%;"></td> <td style="width: 10%;"></td> <td style="width: 10%;"></td> <td style="width: 10%;"></td> </tr> <tr> <td></td> <td></td> <td colspan="8" style="text-align: center;"> <table border="1" style="width: 100%; border-collapse: collapse; text-align: center;"> <tr> <td style="width: 10%;"></td> <td style="width: 10%;"></td> <td style="width: 10%;"></td> <td style="width: 10%;"></td> <td style="width: 10%;"></td> <td style="width: 10%;"></td> <td style="width: 10%;"></td> <td style="width: 10%;"></td> <td style="width: 10%;"></td> <td style="width: 10%;"></td> </tr> <tr> <td></td> <td></td> <td colspan="8" style="text-align: center;"> <table border="1" style="width: 100%; border-collapse: collapse; text-align: center;"> <tr> <td style="width: 10%;"></td> <td style="width: 10%;"></td> <td style="width: 10%;"></td> <td style="width: 10%;"></td> <td style="width: 10%;"></td> <td style="width: 10%;"></td> <td style="width: 10%;"></td> <td style="width: 10%;"></td> <td style="width: 10%;"></td> <td style="width: 10%;"></td> </tr> <tr> <td></td> <td></td> <td colspan="8" style="text-align: center;"> <table border="1" style="width: 100%; border-collapse: collapse; text-align: center;"> <tr> <td style="width: 10%;"></td> <td style="width: 10%;"></td> <td style="width: 10%;"></td> <td style="width: 10%;"></td> <td style="width: 10%;"></td> <td style="width: 10%;"></td> <td style="width: 10%;"></td> <td style="width: 10%;"></td> <td style="width: 10%;"></td> <td style="width: 10%;"></td> </tr> <tr> <td></td> <td></td> <td colspan="8" style="text-align: center;"> <table border="1" style="width: 100%; border-collapse: collapse; text-align: center;"> <tr> <td style="width: 10%;"></td> <td style="width: 10%;"></td> <td style="width: 10%;"></td> <td style="width: 10%;"></td> <td style="width: 10%;"></td> <td style="width: 10%;"></td> <td style="width: 10%;"></td> <td style="width: 10%;"></td> <td style="width: 10%;"></td> <td style="width: 10%;"></td> </tr> <tr> <td></td> <td></td> <td colspan="8" style="text-align: center;"> <table border="1" style="width: 100%; border-collapse: collapse; text-align: center;"> <tr> </tr></table></td></tr></table></td></tr></table></td></tr></table></td></tr></table></td></tr></table></td></tr></table></td></tr></table></td></tr></table></td></tr></table></td></tr></table></td></tr></table></td></tr></table></td></tr></table></td></tr></table></td></tr></table></td></tr></table></td></tr></table></td></tr></table></td></tr></table></td></tr></table></td></tr></table></td></tr></table></td></tr></table></td></tr></table></td></tr></table></td></tr></table></td></tr></table></td></tr></table></td></tr></table></td></tr></table></td></tr></table></td></tr></table></td></tr></table></td></tr></table></td></tr></table></td></tr></table></td></tr></table></td></tr></table></td></tr></table> | | | | | | | | | | | | | | | | | | | | <table border="1" style="width: 100%; border-collapse: collapse; text-align: center;"> <tr> <td style="width: 10%;"></td> <td style="width: 10%;"></td> <td style="width: 10%;"></td> <td style="width: 10%;"></td> <td style="width: 10%;"></td> <td style="width: 10%;"></td> <td style="width: 10%;"></td> <td style="width: 10%;"></td> <td style="width: 10%;"></td> <td style="width: 10%;"></td> </tr> <tr> <td></td> <td></td> <td colspan="8" style="text-align: center;"> <table border="1" style="width: 100%; border-collapse: collapse; text-align: center;"> <tr> <td style="width: 10%;"></td> <td style="width: 10%;"></td> <td style="width: 10%;"></td> <td style="width: 10%;"></td> <td style="width: 10%;"></td> <td style="width: 10%;"></td> <td style="width: 10%;"></td> <td style="width: 10%;"></td> <td style="width: 10%;"></td> <td style="width: 10%;"></td> </tr> <tr> <td></td> <td></td> <td colspan="8" style="text-align: center;"> <table border="1" style="width: 100%; border-collapse: collapse; text-align: center;"> <tr> <td style="width: 10%;"></td> <td style="width: 10%;"></td> <td style="width: 10%;"></td> <td style="width: 10%;"></td> <td style="width: 10%;"></td> <td style="width: 10%;"></td> <td style="width: 10%;"></td> <td style="width: 10%;"></td> <td style="width: 10%;"></td> <td style="width: 10%;"></td> </tr> <tr> <td></td> <td></td> <td colspan="8" style="text-align: center;"> <table border="1" style="width: 100%; border-collapse: collapse; text-align: center;"> <tr> <td style="width: 10%;"></td> <td style="width: 10%;"></td> <td style="width: 10%;"></td> <td style="width: 10%;"></td> <td style="width: 10%;"></td> <td style="width:
10%;"></td> <td style="width: 10%;"></td> <td style="width: 10%;"></td> <td style="width: 10%;"></td> <td style="width: 10%;"></td> </tr> <tr> <td></td> <td></td> <td colspan="8" style="text-align: center;"> <table border="1" style="width: 100%; border-collapse: collapse; text-align: center;"> <tr> <td style="width: 10%;"></td> <td style="width: 10%;"></td> <td style="width: 10%;"></td> <td style="width: 10%;"></td> <td style="width: 10%;"></td> <td style="width: 10%;"></td> <td style="width: 10%;"></td> <td style="width: 10%;"></td> <td style="width: 10%;"></td> <td style="width: 10%;"></td> </tr> <tr> <td></td> <td></td> <td colspan="8" style="text-align: center;"> <table border="1" style="width: 100%; border-collapse: collapse; text-align: center;"> <tr> <td style="width: 10%;"></td> <td style="width: 10%;"></td> <td style="width: 10%;"></td> <td style="width: 10%;"></td> <td style="width: 10%;"></td> <td style="width: 10%;"></td> <td style="width: 10%;"></td> <td style="width: 10%;"></td> <td style="width: 10%;"></td> <td style="width: 10%;"></td> </tr> <tr> <td></td> <td></td> <td colspan="8" style="text-align: center;"> <table border="1" style="width: 100%; border-collapse: collapse; text-align: center;"> <tr> <td style="width: 10%;"></td> <td style="width: 10%;"></td> <td style="width: 10%;"></td> <td style="width: 10%;"></td> <td style="width: 10%;"></td> <td style="width: 10%;"></td> <td style="width: 10%;"></td> <td style="width: 10%;"></td> <td style="width: 10%;"></td> <td style="width: 10%;"></td> </tr> <tr> <td></td> <td></td> <td colspan="8" style="text-align: center;"> <table border="1" style="width: 100%; border-collapse: collapse; text-align: center;"> <tr> <td style="width: 10%;"></td> <td style="width: 10%;"></td> <td style="width: 10%;"></td> <td style="width: 10%;"></td> <td style="width: 10%;"></td> <td style="width: 10%;"></td> <td style="width: 10%;"></td> <td style="width: 10%;"></td> <td style="width: 10%;"></td> <td style="width: 10%;"></td> </tr> <tr> <td></td> <td></td> <td colspan="8" style="text-align: center;"> <table border="1" style="width: 100%; border-collapse: collapse; text-align: center;"> <tr> <td style="width: 10%;"></td> <td style="width: 10%;"></td> <td style="width: 10%;"></td> <td style="width: 10%;"></td> <td style="width: 10%;"></td> <td style="width: 10%;"></td> <td style="width: 10%;"></td> <td style="width: 10%;"></td> <td style="width: 10%;"></td> <td style="width: 10%;"></td> </tr> <tr> <td></td> <td></td> <td colspan="8" style="text-align: center;"> <table border="1" style="width: 100%; border-collapse: collapse; text-align: center;"> <tr> <td style="width: 10%;"></td> <td style="width: 10%;"></td> <td style="width: 10%;"></td> <td style="width: 10%;"></td> <td style="width: 10%;"></td> <td style="width: 10%;"></td> <td style="width: 10%;"></td> <td style="width: 10%;"></td> <td style="width: 10%;"></td> <td style="width: 10%;"></td> </tr> <tr> <td></td> <td></td> <td colspan="8" style="text-align: center;"> <table border="1" style="width: 100%; border-collapse: collapse; text-align: center;"> <tr> <td style="width: 10%;"></td> <td style="width: 10%;"></td> <td style="width: 10%;"></td> <td style="width: 10%;"></td> <td style="width: 10%;"></td> <td style="width: 10%;"></td> <td style="width: 10%;"></td> <td style="width: 10%;"></td> <td style="width: 10%;"></td> <td style="width: 10%;"></td> </tr> <tr> <td></td> <td></td> <td colspan="8" style="text-align: center;"> <table border="1" style="width: 100%; border-collapse: collapse; text-align: center;"> <tr> <td style="width: 10%;"></td> <td style="width: 10%;"></td> <td style="width: 10%;"></td> <td style="width: 10%;"></td> <td style="width: 10%;"></td> <td style="width: 10%;"></td> <td style="width: 10%;"></td> <td style="width: 10%;"></td> <td style="width: 10%;"></td> <td style="width: 10%;"></td> </tr> <tr> <td></td> <td></td> <td colspan="8" style="text-align: center;"> <table border="1" style="width: 100%; border-collapse: collapse; text-align: center;"> <tr> <td style="width: 10%;"></td> <td style="width: 10%;"></td> <td style="width: 10%;"></td> <td style="width: 10%;"></td> <td style="width: 10%;"></td> <td style="width: 10%;"></td> <td style="width: 10%;"></td> <td style="width: 10%;"></td> <td style="width: 10%;"></td> <td style="width: 10%;"></td> </tr> <tr> <td></td> <td></td> <td colspan="8" style="text-align: center;"> <table border="1" style="width: 100%; border-collapse: collapse; text-align: center;"> <tr> <td style="width: 10%;"></td> <td style="width: 10%;"></td> <td style="width: 10%;"></td> <td style="width: 10%;"></td> <td style="width: 10%;"></td> <td style="width: 10%;"></td> <td style="width: 10%;"></td> <td style="width: 10%;"></td> <td style="width: 10%;"></td> <td style="width: 10%;"></td> </tr> <tr> <td></td> <td></td> <td colspan="8" style="text-align: center;"> <table border="1" style="width: 100%; border-collapse: collapse; text-align: center;"> <tr> <td style="width: 10%;"></td> <td style="width: 10%;"></td> <td style="width: 10%;"></td> <td style="width: 10%;"></td> <td style="width: 10%;"></td> <td style="width: 10%;"></td> <td style="width: 10%;"></td> <td style="width: 10%;"></td> <td style="width: 10%;"></td> <td style="width: 10%;"></td> </tr> <tr> <td></td> <td></td> <td colspan="8" style="text-align: center;"> <table border="1" style="width: 100%; border-collapse: collapse; text-align: center;"> <tr> <td style="width: 10%;"></td> <td style="width: 10%;"></td> <td style="width: 10%;"></td> <td style="width: 10%;"></td> <td style="width: 10%;"></td> <td style="width: 10%;"></td> <td style="width: 10%;"></td> <td style="width: 10%;"></td> <td style="width: 10%;"></td> <td style="width: 10%;"></td> </tr> <tr> <td></td> <td></td> <td colspan="8" style="text-align: center;"> <table border="1" style="width: 100%; border-collapse: collapse; text-align: center;"> <tr> <td style="width: 10%;"></td> <td style="width: 10%;"></td> <td style="width: 10%;"></td> <td style="width: 10%;"></td> <td style="width: 10%;"></td> <td style="width: 10%;"></td> <td style="width: 10%;"></td> <td style="width: 10%;"></td> <td style="width: 10%;"></td> <td style="width: 10%;"></td> </tr> <tr> <td></td> <td></td> <td colspan="8" style="text-align: center;"> <table border="1" style="width: 100%; border-collapse: collapse; text-align: center;"> <tr> <td style="width: 10%;"></td> <td style="width: 10%;"></td> <td style="width: 10%;"></td> <td style="width: 10%;"></td> <td style="width: 10%;"></td> <td style="width: 10%;"></td> <td style="width: 10%;"></td> <td style="width: 10%;"></td> <td style="width: 10%;"></td> <td style="width: 10%;"></td> </tr> <tr> <td></td> <td></td> <td colspan="8" style="text-align: center;"> <table border="1" style="width: 100%; border-collapse: collapse; text-align: center;"> <tr> <td style="width: 10%;"></td> <td style="width: 10%;"></td> <td style="width: 10%;"></td> <td style="width: 10%;"></td> <td style="width: 10%;"></td> <td style="width: 10%;"></td> <td style="width: 10%;"></td> <td style="width: 10%;"></td> <td style="width: 10%;"></td> <td style="width: 10%;"></td> </tr> <tr> <td></td> <td></td> <td colspan="8" style="text-align: center;"> <table border="1" style="width: 100%; border-collapse: collapse; text-align: center;"> <tr> <td style="width: 10%;"></td> <td style="width: 10%;"></td> <td style="width: 10%;"></td> <td style="width: 10%;"></td> <td style="width: 10%;"></td> <td style="width: 10%;"></td> <td style="width: 10%;"></td> <td style="width: 10%;"></td> <td style="width: 10%;"></td> <td style="width: 10%;"></td> </tr> <tr> <td></td> <td></td> <td colspan="8" style="text-align: center;"> <table border="1" style="width: 100%; border-collapse: collapse; text-align: center;"> <tr> <td style="width: 10%;"></td> <td style="width: 10%;"></td> <td style="width: 10%;"></td> <td style="width: 10%;"></td> <td style="width: 10%;"></td> <td style="width: 10%;"></td> <td style="width: 10%;"></td> <td style="width: 10%;"></td> <td style="width: 10%;"></td> <td style="width: 10%;"></td> </tr> <tr> <td></td> <td></td> <td colspan="8" style="text-align: center;"> <table border="1" style="width: 100%; border-collapse: collapse; text-align: center;"> <tr> <td style="width: 10%;"></td> <td style="width: 10%;"></td> <td style="width: 10%;"></td> <td style="width: 10%;"></td> <td style="width: 10%;"></td> <td style="width: 10%;"></td> <td style="width: 10%;"></td> <td style="width: 10%;"></td> <td style="width: 10%;"></td> <td style="width: 10%;"></td> </tr> <tr> <td></td> <td></td> <td colspan="8" style="text-align: center;"> <table border="1" style="width: 100%; border-collapse: collapse; text-align: center;"> <tr> <td style="width: 10%;"></td> <td style="width: 10%;"></td> <td style="width: 10%;"></td> <td style="width: 10%;"></td> <td style="width: 10%;"></td> <td style="width: 10%;"></td> <td style="width: 10%;"></td> <td style="width: 10%;"></td> <td style="width: 10%;"></td> <td style="width: 10%;"></td> </tr> <tr> <td></td> <td></td> <td colspan="8" style="text-align: center;"> <table border="1" style="width: 100%; border-collapse: collapse; text-align: center;"> <tr> <td style="width: 10%;"></td> <td style="width: 10%;"></td> <td style="width: 10%;"></td> <td style="width: 10%;"></td> <td style="width: 10%;"></td> <td style="width: 10%;"></td> <td style="width: 10%;"></td> <td style="width: 10%;"></td> <td style="width: 10%;"></td> <td style="width: 10%;"></td> </tr> <tr> <td></td> <td></td> <td colspan="8" style="text-align: center;"> <table border="1" style="width: 100%; border-collapse: collapse; text-align: center;"> <tr> <td style="width: 10%;"></td> <td style="width: 10%;"></td> <td style="width: 10%;"></td> <td style="width: 10%;"></td> <td style="width: 10%;"></td> <td style="width: 10%;"></td> <td style="width: 10%;"></td> <td style="width: 10%;"></td> <td style="width: 10%;"></td> <td style="width: 10%;"></td> </tr> <tr> <td></td> <td></td> <td
colspan="8" style="text-align: center;"> <table border="1" style="width: 100%; border-collapse: collapse; text-align: center;"> <tr> <td style="width: 10%;"></td> <td style="width: 10%;"></td> <td style="width: 10%;"></td> <td style="width: 10%;"></td> <td style="width: 10%;"></td> <td style="width: 10%;"></td> <td style="width: 10%;"></td> <td style="width: 10%;"></td> <td style="width: 10%;"></td> <td style="width: 10%;"></td> </tr> <tr> <td></td> <td></td> <td colspan="8" style="text-align: center;"> <table border="1" style="width: 100%; border-collapse: collapse; text-align: center;"> <tr> <td style="width: 10%;"></td> <td style="width: 10%;"></td> <td style="width: 10%;"></td> <td style="width: 10%;"></td> <td style="width: 10%;"></td> <td style="width: 10%;"></td> <td style="width: 10%;"></td> <td style="width: 10%;"></td> <td style="width: 10%;"></td> <td style="width: 10%;"></td> </tr> <tr> <td></td> <td></td> <td colspan="8" style="text-align: center;"> <table border="1" style="width: 100%; border-collapse: collapse; text-align: center;"> <tr> <td style="width: 10%;"></td> <td style="width: 10%;"></td> <td style="width: 10%;"></td> <td style="width: 10%;"></td> <td style="width: 10%;"></td> <td style="width: 10%;"></td> <td style="width: 10%;"></td> <td style="width: 10%;"></td> <td style="width: 10%;"></td> <td style="width: 10%;"></td> </tr> <tr> <td></td> <td></td> <td colspan="8" style="text-align: center;"> <table border="1" style="width: 100%; border-collapse: collapse; text-align: center;"> <tr> <td style="width: 10%;"></td> <td style="width: 10%;"></td> <td style="width: 10%;"></td> <td style="width: 10%;"></td> <td style="width: 10%;"></td> <td style="width: 10%;"></td> <td style="width: 10%;"></td> <td style="width: 10%;"></td> <td style="width: 10%;"></td> <td style="width: 10%;"></td> </tr> <tr> <td></td> <td></td> <td colspan="8" style="text-align: center;"> <table border="1" style="width: 100%; border-collapse: collapse; text-align: center;"> <tr> <td style="width: 10%;"></td> <td style="width: 10%;"></td> <td style="width: 10%;"></td> <td style="width: 10%;"></td> <td style="width: 10%;"></td> <td style="width: 10%;"></td> <td style="width: 10%;"></td> <td style="width: 10%;"></td> <td style="width: 10%;"></td> <td style="width: 10%;"></td> </tr> <tr> <td></td> <td></td> <td colspan="8" style="text-align: center;"> <table border="1" style="width: 100%; border-collapse: collapse; text-align: center;"> <tr> <td style="width: 10%;"></td> <td style="width: 10%;"></td> <td style="width: 10%;"></td> <td style="width: 10%;"></td> <td style="width: 10%;"></td> <td style="width: 10%;"></td> <td style="width: 10%;"></td> <td style="width: 10%;"></td> <td style="width: 10%;"></td> <td style="width: 10%;"></td> </tr> <tr> <td></td> <td></td> <td colspan="8" style="text-align: center;"> <table border="1" style="width: 100%; border-collapse: collapse; text-align: center;"> <tr> <td style="width: 10%;"></td> <td style="width: 10%;"></td> <td style="width: 10%;"></td> <td style="width: 10%;"></td> <td style="width: 10%;"></td> <td style="width: 10%;"></td> <td style="width: 10%;"></td> <td style="width: 10%;"></td> <td style="width: 10%;"></td> <td style="width: 10%;"></td> </tr> <tr> <td></td> <td></td> <td colspan="8" style="text-align: center;"> <table border="1" style="width: 100%; border-collapse: collapse; text-align: center;"> <tr> <td style="width: 10%;"></td> <td style="width: 10%;"></td> <td style="width: 10%;"></td> <td style="width: 10%;"></td> <td style="width: 10%;"></td> <td style="width: 10%;"></td> <td style="width: 10%;"></td> <td style="width: 10%;"></td> <td style="width: 10%;"></td> <td style="width: 10%;"></td> </tr> <tr> <td></td> <td></td> <td colspan="8" style="text-align: center;"> <table border="1" style="width: 100%; border-collapse: collapse; text-align: center;"> <tr> <td style="width: 10%;"></td> <td style="width: 10%;"></td> <td style="width: 10%;"></td> <td style="width: 10%;"></td> <td style="width: 10%;"></td> <td style="width: 10%;"></td> <td style="width: 10%;"></td> <td style="width: 10%;"></td> <td style="width: 10%;"></td> <td style="width: 10%;"></td> </tr> <tr> <td></td> <td></td> <td colspan="8" style="text-align: center;"> <table border="1" style="width: 100%; border-collapse: collapse; text-align: center;"> <tr> <td style="width: 10%;"></td> <td style="width: 10%;"></td> <td style="width: 10%;"></td> <td style="width: 10%;"></td> <td style="width: 10%;"></td> <td style="width: 10%;"></td> <td style="width: 10%;"></td> <td style="width: 10%;"></td> <td style="width: 10%;"></td> <td style="width: 10%;"></td> </tr> <tr> <td></td> <td></td> <td colspan="8" style="text-align: center;"> <table border="1" style="width: 100%; border-collapse: collapse; text-align: center;"> <tr> <td style="width: 10%;"></td> <td style="width: 10%;"></td> <td style="width: 10%;"></td> <td style="width: 10%;"></td> <td style="width: 10%;"></td> <td style="width: 10%;"></td> <td style="width: 10%;"></td> <td style="width: 10%;"></td> <td style="width: 10%;"></td> <td style="width: 10%;"></td> </tr> <tr> <td></td> <td></td> <td colspan="8" style="text-align: center;"> <table border="1" style="width: 100%; border-collapse: collapse; text-align: center;"> <tr> <td style="width: 10%;"></td> <td style="width: 10%;"></td> <td style="width: 10%;"></td> <td style="width: 10%;"></td> <td style="width: 10%;"></td> <td style="width: 10%;"></td> <td style="width: 10%;"></td> <td style="width: 10%;"></td> <td style="width: 10%;"></td> <td style="width: 10%;"></td> </tr> <tr> <td></td> <td></td> <td colspan="8" style="text-align: center;"> <table border="1" style="width: 100%; border-collapse: collapse; text-align: center;"> <tr> <td style="width: 10%;"></td> <td style="width: 10%;"></td> <td style="width: 10%;"></td> <td style="width: 10%;"></td> <td style="width: 10%;"></td> <td style="width: 10%;"></td> <td style="width: 10%;"></td> <td style="width: 10%;"></td> <td style="width: 10%;"></td> <td style="width: 10%;"></td> </tr> <tr> <td></td> <td></td> <td colspan="8" style="text-align: center;"> <table border="1" style="width: 100%; border-collapse: collapse; text-align: center;"> <tr> </tr></table></td></tr></table></td></tr></table></td></tr></table></td></tr></table></td></tr></table></td></tr></table></td></tr></table></td></tr></table></td></tr></table></td></tr></table></td></tr></table></td></tr></table></td></tr></table></td></tr></table></td></tr></table></td></tr></table></td></tr></table></td></tr></table></td></tr></table></td></tr></table></td></tr></table></td></tr></table></td></tr></table></td></tr></table></td></tr></table></td></tr></table></td></tr></table></td></tr></table></td></tr></table></td></tr></table></td></tr></table></td></tr></table></td></tr></table></td></tr></table></td></tr></table></td></tr></table></td></tr></table></td></tr></table> | | | | | | | | | | | | | | | | | | | | <table border="1" style="width: 100%; border-collapse: collapse; text-align: center;"> <tr> <td style="width: 10%;"></td> <td style="width: 10%;"></td> <td style="width: 10%;"></td> <td style="width: 10%;"></td> <td style="width: 10%;"></td> <td style="width: 10%;"></td> <td style="width: 10%;"></td> <td style="width: 10%;"></td> <td style="width: 10%;"></td> <td style="width: 10%;"></td> </tr> <tr> <td></td> <td></td> <td colspan="8" style="text-align: center;"> <table border="1" style="width: 100%; border-collapse: collapse; text-align: center;"> <tr> <td style="width: 10%;"></td> <td style="width: 10%;"></td> <td style="width: 10%;"></td> <td style="width: 10%;"></td> <td style="width: 10%;"></td> <td style="width: 10%;"></td> <td style="width: 10%;"></td> <td style="width: 10%;"></td> <td style="width: 10%;"></td> <td style="width: 10%;"></td> </tr> <tr> <td></td> <td></td> <td colspan="8" style="text-align: center;"> <table border="1" style="width: 100%; border-collapse: collapse; text-align: center;"> <tr> <td style="width: 10%;"></td> <td style="width: 10%;"></td> <td style="width: 10%;"></td> <td style="width: 10%;"></td> <td style="width: 10%;"></td> <td style="width: 10%;"></td> <td style="width: 10%;"></td> <td style="width: 10%;"></td> <td style="width: 10%;"></td> <td style="width: 10%;"></td> </tr> <tr> <td></td> <td></td> <td colspan="8" style="text-align: center;"> <table border="1" style="width: 100%; border-collapse: collapse; text-align: center;"> <tr> <td style="width: 10%;"></td> <td style="width: 10%;"></td> <td style="width: 10%;"></td> <td style="width: 10%;"></td> <td style="width: 10%;"></td> <td style="width: 10%;"></td> <td style="width: 10%;"></td> <td style="width: 10%;"></td> <td style="width: 10%;"></td> <td style="width: 10%;"></td> </tr> <tr> <td></td> <td></td> <td colspan="8" style="text-align: center;"> <table border="1" style="width: 100%; border-collapse: collapse; text-align: center;"> <tr> <td style="width: 10%;"></td> <td style="width: 10%;"></td> <td style="width: 10%;"></td>
<td style="width: 10%;"></td> <td style="width: 10%;"></td> <td style="width: 10%;"></td> <td style="width: 10%;"></td> <td style="width: 10%;"></td> <td style="width: 10%;"></td> <td style="width: 10%;"></td> </tr> <tr> <td></td> <td></td> <td colspan="8" style="text-align: center;"> <table border="1" style="width: 100%; border-collapse: collapse; text-align: center;"> <tr> <td style="width: 10%;"></td> <td style="width: 10%;"></td> <td style="width: 10%;"></td> <td style="width: 10%;"></td> <td style="width: 10%;"></td> <td style="width: 10%;"></td> <td style="width: 10%;"></td> <td style="width: 10%;"></td> <td style="width: 10%;"></td> <td style="width: 10%;"></td> </tr> <tr> <td></td> <td></td> <td colspan="8" style="text-align: center;"> <table border="1" style="width: 100%; border-collapse: collapse; text-align: center;"> <tr> <td style="width: 10%;"></td> <td style="width: 10%;"></td> <td style="width: 10%;"></td> <td style="width: 10%;"></td> <td style="width: 10%;"></td> <td style="width: 10%;"></td> <td style="width: 10%;"></td> <td style="width: 10%;"></td> <td style="width: 10%;"></td> <td style="width: 10%;"></td> </tr> <tr> <td></td> <td></td> <td colspan="8" style="text-align: center;"> <table border="1" style="width: 100%; border-collapse: collapse; text-align: center;"> <tr> <td style="width: 10%;"></td> <td style="width: 10%;"></td> <td style="width: 10%;"></td> <td style="width: 10%;"></td> <td style="width: 10%;"></td> <td style="width: 10%;"></td> <td style="width: 10%;"></td> <td style="width: 10%;"></td> <td style="width: 10%;"></td> <td style="width: 10%;"></td> </tr> <tr> <td></td> <td></td> <td colspan="8" style="text-align: center;"> <table border="1" style="width: 100%; border-collapse: collapse; text-align: center;"> <tr> <td style="width: 10%;"></td> <td style="width: 10%;"></td> <td style="width: 10%;"></td> <td style="width: 10%;"></td> <td style="width: 10%;"></td> <td style="width: 10%;"></td> <td style="width: 10%;"></td> <td style="width: 10%;"></td> <td style="width: 10%;"></td> <td style="width: 10%;"></td> </tr> <tr> <td></td> <td></td> <td colspan="8" style="text-align: center;"> <table border="1" style="width: 100%; border-collapse: collapse; text-align: center;"> <tr> <td style="width: 10%;"></td> <td style="width: 10%;"></td> <td style="width: 10%;"></td> <td style="width: 10%;"></td> <td style="width: 10%;"></td> <td style="width: 10%;"></td> <td style="width: 10%;"></td> <td style="width: 10%;"></td> <td style="width: 10%;"></td> <td style="width: 10%;"></td> </tr> <tr> <td></td> <td></td> <td colspan="8" style="text-align: center;"> <table border="1" style="width: 100%; border-collapse: collapse; text-align: center;"> <tr> <td style="width: 10%;"></td> <td style="width: 10%;"></td> <td style="width: 10%;"></td> <td style="width: 10%;"></td> <td style="width: 10%;"></td> <td style="width: 10%;"></td> <td style="width: 10%;"></td> <td style="width: 10%;"></td> <td style="width: 10%;"></td> <td style="width: 10%;"></td> </tr> <tr> <td></td> <td></td> <td colspan="8" style="text-align: center;"> <table border="1" style="width: 100%; border-collapse: collapse; text-align: center;"> <tr> <td style="width: 10%;"></td> <td style="width: 10%;"></td> <td style="width: 10%;"></td> <td style="width: 10%;"></td> <td style="width: 10%;"></td> <td style="width: 10%;"></td> <td style="width: 10%;"></td> <td style="width: 10%;"></td> <td style="width: 10%;"></td> <td style="width: 10%;"></td> </tr> <tr> <td></td> <td></td> <td colspan="8" style="text-align: center;"> <table border="1" style="width: 100%; border-collapse: collapse; text-align: center;"> <tr> <td style="width: 10%;"></td> <td style="width: 10%;"></td> <td style="width: 10%;"></td> <td style="width: 10%;"></td> <td style="width: 10%;"></td> <td style="width: 10%;"></td> <td style="width: 10%;"></td> <td style="width: 10%;"></td> <td style="width: 10%;"></td> <td style="width: 10%;"></td> </tr> <tr> <td></td> <td></td> <td colspan="8" style="text-align: center;"> <table border="1" style="width: 100%; border-collapse: collapse; text-align: center;"> <tr> <td style="width: 10%;"></td> <td style="width: 10%;"></td> <td style="width: 10%;"></td> <td style="width: 10%;"></td> <td style="width: 10%;"></td> <td style="width: 10%;"></td> <td style="width: 10%;"></td> <td style="width: 10%;"></td> <td style="width: 10%;"></td> <td style="width: 10%;"></td> </tr> <tr> <td></td> <td></td> <td colspan="8" style="text-align: center;"> <table border="1" style="width: 100%; border-collapse: collapse; text-align: center;"> <tr> <td style="width: 10%;"></td> <td style="width: 10%;"></td> <td style="width: 10%;"></td> <td style="width: 10%;"></td> <td style="width: 10%;"></td> <td style="width: 10%;"></td> <td style="width: 10%;"></td> <td style="width: 10%;"></td> <td style="width: 10%;"></td> <td style="width: 10%;"></td> </tr> <tr> <td></td> <td></td> <td colspan="8" style="text-align: center;"> <table border="1" style="width: 100%; border-collapse: collapse; text-align: center;"> <tr> <td style="width: 10%;"></td> <td style="width: 10%;"></td> <td style="width: 10%;"></td> <td style="width: 10%;"></td> <td style="width: 10%;"></td> <td style="width: 10%;"></td> <td style="width: 10%;"></td> <td style="width: 10%;"></td> <td style="width: 10%;"></td> <td style="width: 10%;"></td> </tr> <tr> <td></td> <td></td> <td colspan="8" style="text-align: center;"> <table border="1" style="width: 100%; border-collapse: collapse; text-align: center;"> <tr> <td style="width: 10%;"></td> <td style="width: 10%;"></td> <td style="width: 10%;"></td> <td style="width: 10%;"></td> <td style="width: 10%;"></td> <td style="width: 10%;"></td> <td style="width: 10%;"></td> <td style="width: 10%;"></td> <td style="width: 10%;"></td> <td style="width: 10%;"></td> </tr> <tr> <td></td> <td></td> <td colspan="8" style="text-align: center;"> <table border="1" style="width: 100%; border-collapse: collapse; text-align: center;"> <tr> <td style="width: 10%;"></td> <td style="width: 10%;"></td> <td style="width: 10%;"></td> <td style="width: 10%;"></td> <td style="width: 10%;"></td> <td style="width: 10%;"></td> <td style="width: 10%;"></td> <td style="width: 10%;"></td> <td style="width: 10%;"></td> <td style="width: 10%;"></td> </tr> <tr> <td></td> <td></td> <td colspan="8" style="text-align: center;"> <table border="1" style="width: 100%; border-collapse: collapse; text-align: center;"> <tr> <td style="width: 10%;"></td> <td style="width: 10%;"></td> <td style="width: 10%;"></td> <td style="width: 10%;"></td> <td style="width: 10%;"></td> <td style="width: 10%;"></td> <td style="width: 10%;"></td> <td style="width: 10%;"></td> <td style="width: 10%;"></td> <td style="width: 10%;"></td> </tr> <tr> <td></td> <td></td> <td colspan="8" style="text-align: center;"> <table border="1" style="width: 100%; border-collapse: collapse; text-align: center;"> <tr> <td style="width: 10%;"></td> <td style="width: 10%;"></td> <td style="width: 10%;"></td> <td style="width: 10%;"></td> <td style="width: 10%;"></td> <td style="width: 10%;"></td> <td style="width: 10%;"></td> <td style="width: 10%;"></td> <td style="width: 10%;"></td> <td style="width: 10%;"></td> </tr> <tr> <td></td> <td></td> <td colspan="8" style="text-align: center;"> <table border="1" style="width: 100%; border-collapse: collapse; text-align: center;"> <tr> <td style="width: 10%;"></td> <td style="width: 10%;"></td> <td style="width: 10%;"></td> <td style="width: 10%;"></td> <td style="width: 10%;"></td> <td style="width: 10%;"></td> <td style="width: 10%;"></td> <td style="width: 10%;"></td> <td style="width: 10%;"></td> <td style="width: 10%;"></td> </tr> <tr> <td></td> <td></td> <td colspan="8" style="text-align: center;"> <table border="1" style="width: 100%; border-collapse: collapse; text-align: center;"> <tr> <td style="width: 10%;"></td> <td style="width: 10%;"></td> <td style="width: 10%;"></td> <td style="width: 10%;"></td> <td style="width: 10%;"></td> <td style="width: 10%;"></td> <td style="width: 10%;"></td> <td style="width: 10%;"></td> <td style="width: 10%;"></td> <td style="width: 10%;"></td> </tr> <tr> <td></td> <td></td> <td colspan="8" style="text-align: center;"> <table border="1" style="width: 100%; border-collapse: collapse; text-align: center;"> <tr> <td style="width: 10%;"></td> <td style="width: 10%;"></td> <td style="width: 10%;"></td> <td style="width: 10%;"></td> <td style="width: 10%;"></td> <td style="width: 10%;"></td> <td style="width: 10%;"></td> <td style="width: 10%;"></td> <td style="width: 10%;"></td> <td style="width: 10%;"></td> </tr> <tr> <td></td> <td></td> <td colspan="8" style="text-align: center;"> <table border="1" style="width: 100%; border-collapse: collapse; text-align: center;"> <tr> <td style="width: 10%;"></td> <td style="width: 10%;"></td> <td style="width: 10%;"></td> <td style="width: 10%;"></td> <td style="width: 10%;"></td> <td style="width: 10%;"></td> <td style="width: 10%;"></td> <td style="width: 10%;"></td> <td style="width: 10%;"></td> <td style="width: 10%;"></td> </tr> <tr> <td></td> <td></td> <td colspan="8" style="text-align: center;"> <table border="1" style="width: 100%; border-collapse: collapse; text-align: center;"> <tr> <td style="width: 10%;"></td> <td style="width: 10%;"></td> <td style="width: 10%;"></td> <td style="width: 10%;"></td> <td style="width: 10%;"></td> <td style="width: 10%;"></td> <td style="width: 10%;"></td> <td style="width: 10%;"></td> <td style="width: 10%;"></td> <td style="width: 10%;"></td> </tr> <tr> <td></td> <td></td> <td colspan="8" style="text-align: center;"> <table border="1" style="width: 100%; border-collapse: collapse; text-align: center;"> <tr> <td style="width: 10%;"></td> <td style="width: 10%;"></td> <td style="width: 10%;"></td> <td style="width: 10%;"></td> <td style="width: 10%;"></td> <td style="width: 10%;"></td> <td style="width: 10%;"></td> <td style="width: 10%;"></td> <td style="width:
10%;"></td> <td style="width: 10%;"></td> </tr> <tr> <td></td> <td></td> <td colspan="8" style="text-align: center;"> <table border="1" style="width: 100%; border-collapse: collapse; text-align: center;"> <tr> <td style="width: 10%;"></td> <td style="width: 10%;"></td> <td style="width: 10%;"></td> <td style="width: 10%;"></td> <td style="width: 10%;"></td> <td style="width: 10%;"></td> <td style="width: 10%;"></td> <td style="width: 10%;"></td> <td style="width: 10%;"></td> <td style="width: 10%;"></td> </tr> <tr> <td></td> <td></td> <td colspan="8" style="text-align: center;"> <table border="1" style="width: 100%; border-collapse: collapse; text-align: center;"> <tr> <td style="width: 10%;"></td> <td style="width: 10%;"></td> <td style="width: 10%;"></td> <td style="width: 10%;"></td> <td style="width: 10%;"></td> <td style="width: 10%;"></td> <td style="width: 10%;"></td> <td style="width: 10%;"></td> <td style="width: 10%;"></td> <td style="width: 10%;"></td> </tr> <tr> <td></td> <td></td> <td colspan="8" style="text-align: center;"> <table border="1" style="width: 100%; border-collapse: collapse; text-align: center;"> <tr> <td style="width: 10%;"></td> <td style="width: 10%;"></td> <td style="width: 10%;"></td> <td style="width: 10%;"></td> <td style="width: 10%;"></td> <td style="width: 10%;"></td> <td style="width: 10%;"></td> <td style="width: 10%;"></td> <td style="width: 10%;"></td> <td style="width: 10%;"></td> </tr> <tr> <td></td> <td></td> <td colspan="8" style="text-align: center;"> <table border="1" style="width: 100%; border-collapse: collapse; text-align: center;"> <tr> <td style="width: 10%;"></td> <td style="width: 10%;"></td> <td style="width: 10%;"></td> <td style="width: 10%;"></td> <td style="width: 10%;"></td> <td style="width: 10%;"></td> <td style="width: 10%;"></td> <td style="width: 10%;"></td> <td style="width: 10%;"></td> <td style="width: 10%;"></td> </tr> <tr> <td></td> <td></td> <td colspan="8" style="text-align: center;"> <table border="1" style="width: 100%; border-collapse: collapse; text-align: center;"> <tr> <td style="width: 10%;"></td> <td style="width: 10%;"></td> <td style="width: 10%;"></td> <td style="width: 10%;"></td> <td style="width: 10%;"></td> <td style="width: 10%;"></td> <td style="width: 10%;"></td> <td style="width: 10%;"></td> <td style="width: 10%;"></td> <td style="width: 10%;"></td> </tr> <tr> <td></td> <td></td> <td colspan="8" style="text-align: center;"> <table border="1" style="width: 100%; border-collapse: collapse; text-align: center;"> <tr> <td style="width: 10%;"></td> <td style="width: 10%;"></td> <td style="width: 10%;"></td> <td style="width: 10%;"></td> <td style="width: 10%;"></td> <td style="width: 10%;"></td> <td style="width: 10%;"></td> <td style="width: 10%;"></td> <td style="width: 10%;"></td> <td style="width: 10%;"></td> </tr> <tr> <td></td> <td></td> <td colspan="8" style="text-align: center;"> <table border="1" style="width: 100%; border-collapse: collapse; text-align: center;"> <tr> <td style="width: 10%;"></td> <td style="width: 10%;"></td> <td style="width: 10%;"></td> <td style="width: 10%;"></td> <td style="width: 10%;"></td> <td style="width: 10%;"></td> <td style="width: 10%;"></td> <td style="width: 10%;"></td> <td style="width: 10%;"></td> <td style="width: 10%;"></td> </tr> <tr> <td></td> <td></td> <td colspan="8" style="text-align: center;"> <table border="1" style="width: 100%; border-collapse: collapse; text-align: center;"> <tr> <td style="width: 10%;"></td> <td style="width: 10%;"></td> <td style="width: 10%;"></td> <td style="width: 10%;"></td> <td style="width: 10%;"></td> <td style="width: 10%;"></td> <td style="width: 10%;"></td> <td style="width: 10%;"></td> <td style="width: 10%;"></td> <td style="width: 10%;"></td> </tr> <tr> <td></td> <td></td> <td colspan="8" style="text-align: center;"> <table border="1" style="width: 100%; border-collapse: collapse; text-align: center;"> <tr> <td style="width: 10%;"></td> <td style="width: 10%;"></td> <td style="width: 10%;"></td> <td style="width: 10%;"></td> <td style="width: 10%;"></td> <td style="width: 10%;"></td> <td style="width: 10%;"></td> <td style="width: 10%;"></td> <td style="width: 10%;"></td> <td style="width: 10%;"></td> </tr> <tr> <td></td> <td></td> <td colspan="8" style="text-align: center;"> <table border="1" style="width: 100%; border-collapse: collapse; text-align: center;"> <tr> <td style="width: 10%;"></td> <td style="width: 10%;"></td> <td style="width: 10%;"></td> <td style="width: 10%;"></td> <td style="width: 10%;"></td> <td style="width: 10%;"></td> <td style="width: 10%;"></td> <td style="width: 10%;"></td> <td style="width: 10%;"></td> <td style="width: 10%;"></td> </tr> <tr> <td></td> <td></td> <td colspan="8" style="text-align: center;"> <table border="1" style="width: 100%; border-collapse: collapse; text-align: center;"> <tr> <td style="width: 10%;"></td> <td style="width: 10%;"></td> <td style="width: 10%;"></td> <td style="width: 10%;"></td> <td style="width: 10%;"></td> <td style="width: 10%;"></td> <td style="width: 10%;"></td> <td style="width: 10%;"></td> <td style="width: 10%;"></td> <td style="width: 10%;"></td> </tr> <tr> <td></td> <td></td> <td colspan="8" style="text-align: center;"> <table border="1" style="width: 100%; border-collapse: collapse; text-align: center;"> <tr> </tr></table></td></tr></table></td></tr></table></td></tr></table></td></tr></table></td></tr></table></td></tr></table></td></tr></table></td></tr></table></td></tr></table></td></tr></table></td></tr></table></td></tr></table></td></tr></table></td></tr></table></td></tr></table></td></tr></table></td></tr></table></td></tr></table></td></tr></table></td></tr></table></td></tr></table></td></tr></table></td></tr></table></td></tr></table></td></tr></table></td></tr></table></td></tr></table></td></tr></table></td></tr></table></td></tr></table></td></tr></table></td></tr></table></td></tr></table></td></tr></table></td></tr></table></td></tr></table></td></tr></table> | | | | | | | | | | | | | | | | | | | | <table border="1" style="width: 100%; border-collapse: collapse; text-align: center;"> <tr> <td style="width: 10%;"></td> <td style="width: 10%;"></td> <td style="width: 10%;"></td> <td style="width: 10%;"></td> <td style="width: 10%;"></td> <td style="width: 10%;"></td> <td style="width: 10%;"></td> <td style="width: 10%;"></td> <td style="width: 10%;"></td> <td style="width: 10%;"></td> </tr> <tr> <td></td> <td></td> <td colspan="8" style="text-align: center;"> <table border="1" style="width: 100%; border-collapse: collapse; text-align: center;"> <tr> <td style="width: 10%;"></td> <td style="width: 10%;"></td> <td style="width: 10%;"></td> <td style="width: 10%;"></td> <td style="width: 10%;"></td> <td style="width: 10%;"></td> <td style="width: 10%;"></td> <td style="width: 10%;"></td> <td style="width: 10%;"></td> <td style="width: 10%;"></td> </tr> <tr> <td></td> <td></td> <td colspan="8" style="text-align: center;"> <table border="1" style="width: 100%; border-collapse: collapse; text-align: center;"> <tr> <td style="width: 10%;"></td> <td style="width: 10%;"></td> <td style="width: 10%;"></td> <td style="width: 10%;"></td> <td style="width: 10%;"></td> <td style="width: 10%;"></td> <td style="width: 10%;"></td> <td style="width: 10%;"></td> <td style="width: 10%;"></td> <td style="width: 10%;"></td> </tr> <tr> <td></td> <td></td> <td colspan="8" style="text-align: center;"> <table border="1" style="width: 100%; border-collapse: collapse; text-align: center;"> <tr> <td style="width: 10%;"></td> <td style="width: 10%;"></td> <td style="width: 10%;"></td> <td style="width: 10%;"></td> <td style="width: 10%;"></td> <td style="width: 10%;"></td> <td style="width: 10%;"></td> <td style="width: 10%;"></td> <td style="width: 10%;"></td> <td style="width: 10%;"></td> </tr> <tr> <td></td> <td></td> <td colspan="8" style="text-align: center;"> <table border="1" style="width: 100%; border-collapse: collapse; text-align: center;"> <tr> <td style="width: 10%;"></td> <td style="width: 10%;"></td> <td style="width: 10%;"></td> <td style="width: 10%;"></td> <td style="width: 10%;"></td> <td style="width: 10%;"></td> <td style="width: 10%;"></td> <td style="width: 10%;"></td> <td style="width: 10%;"></td> <td style="width: 10%;"></td> </tr> <tr> <td></td> <td></td> <td colspan="8" style="text-align: center;"> <table border="1" style="width: 100%; border-collapse: collapse; text-align: center;"> <tr> <td style="width: 10%;"></td> <td style="width: 10%;"></td> <td style="width: 10%;"></td> <td style="width: 10%;"></td> <td style="width: 10%;"></td> <td style="width: 10%;"></td> <td style="width: 10%;"></td> <td style="width: 10%;"></td> <td style="width: 10%;"></td> <td style="width: 10%;"></td> </tr> <tr> <td></td> <td></td> <td colspan="8" style="text-align: center;"> <table border="1" style="width: 100%; border-collapse: collapse; text-align: center;"> <tr> <td style="width: 10%;"></td>
<td style="width: 10%;"></td> <td style="width: 10%;"></td> <td style="width: 10%;"></td> <td style="width: 10%;"></td> <td style="width: 10%;"></td> <td style="width: 10%;"></td> <td style="width: 10%;"></td> <td style="width: 10%;"></td> <td style="width: 10%;"></td> </tr> <tr> <td></td> <td></td> <td colspan="8" style="text-align: center;"> <table border="1" style="width: 100%; border-collapse: collapse; text-align: center;"> <tr> <td style="width: 10%;"></td> <td style="width: 10%;"></td> <td style="width: 10%;"></td> <td style="width: 10%;"></td> <td style="width: 10%;"></td> <td style="width: 10%;"></td> <td style="width: 10%;"></td> <td style="width: 10%;"></td> <td style="width: 10%;"></td> <td style="width: 10%;"></td> </tr> <tr> <td></td> <td></td> <td colspan="8" style="text-align: center;"> <table border="1" style="width: 100%; border-collapse: collapse; text-align: center;"> <tr> <td style="width: 10%;"></td> <td style="width: 10%;"></td> <td style="width: 10%;"></td> <td style="width: 10%;"></td> <td style="width: 10%;"></td> <td style="width: 10%;"></td> <td style="width: 10%;"></td> <td style="width: 10%;"></td> <td style="width: 10%;"></td> <td style="width: 10%;"></td> </tr> <tr> <td></td> <td></td> <td colspan="8" style="text-align: center;"> <table border="1" style="width: 100%; border-collapse: collapse; text-align: center;"> <tr> <td style="width: 10%;"></td> <td style="width: 10%;"></td> <td style="width: 10%;"></td> <td style="width: 10%;"></td> <td style="width: 10%;"></td> <td style="width: 10%;"></td> <td style="width: 10%;"></td> <td style="width: 10%;"></td> <td style="width: 10%;"></td> <td style="width: 10%;"></td> </tr> <tr> <td></td> <td></td> <td colspan="8" style="text-align: center;"> <table border="1" style="width: 100%; border-collapse: collapse; text-align: center;"> <tr> <td style="width: 10%;"></td> <td style="width: 10%;"></td> <td style="width: 10%;"></td> <td style="width: 10%;"></td> <td style="width: 10%;"></td> <td style="width: 10%;"></td> <td style="width: 10%;"></td> <td style="width: 10%;"></td> <td style="width: 10%;"></td> <td style="width: 10%;"></td> </tr> <tr> <td></td> <td></td> <td colspan="8" style="text-align: center;"> <table border="1" style="width: 100%; border-collapse: collapse; text-align: center;"> <tr> <td style="width: 10%;"></td> <td style="width: 10%;"></td> <td style="width: 10%;"></td> <td style="width: 10%;"></td> <td style="width: 10%;"></td> <td style="width: 10%;"></td> <td style="width: 10%;"></td> <td style="width: 10%;"></td> <td style="width: 10%;"></td> <td style="width: 10%;"></td> </tr> <tr> <td></td> <td></td> <td colspan="8" style="text-align: center;"> <table border="1" style="width: 100%; border-collapse: collapse; text-align: center;"> <tr> <td style="width: 10%;"></td> <td style="width: 10%;"></td> <td style="width: 10%;"></td> <td style="width: 10%;"></td> <td style="width: 10%;"></td> <td style="width: 10%;"></td> <td style="width: 10%;"></td> <td style="width: 10%;"></td> <td style="width: 10%;"></td> <td style="width: 10%;"></td> </tr> <tr> <td></td> <td></td> <td colspan="8" style="text-align: center;"> <table border="1" style="width: 100%; border-collapse: collapse; text-align: center;"> <tr> <td style="width: 10%;"></td> <td style="width: 10%;"></td> <td style="width: 10%;"></td> <td style="width: 10%;"></td> <td style="width: 10%;"></td> <td style="width: 10%;"></td> <td style="width: 10%;"></td> <td style="width: 10%;"></td> <td style="width: 10%;"></td> <td style="width: 10%;"></td> </tr> <tr> <td></td> <td></td> <td colspan="8" style="text-align: center;"> <table border="1" style="width: 100%; border-collapse: collapse; text-align: center;"> <tr> <td style="width: 10%;"></td> <td style="width: 10%;"></td> <td style="width: 10%;"></td> <td style="width: 10%;"></td> <td style="width: 10%;"></td> <td style="width: 10%;"></td> <td style="width: 10%;"></td> <td style="width: 10%;"></td> <td style="width: 10%;"></td> <td style="width: 10%;"></td> </tr> <tr> <td></td> <td></td> <td colspan="8" style="text-align: center;"> <table border="1" style="width: 100%; border-collapse: collapse; text-align: center;"> <tr> <td style="width: 10%;"></td> <td style="width: 10%;"></td> <td style="width: 10%;"></td> <td style="width: 10%;"></td> <td style="width: 10%;"></td> <td style="width: 10%;"></td> <td style="width: 10%;"></td> <td style="width: 10%;"></td> <td style="width: 10%;"></td> <td style="width: 10%;"></td> </tr> <tr> <td></td> <td></td> <td colspan="8" style="text-align: center;"> <table border="1" style="width: 100%; border-collapse: collapse; text-align: center;"> <tr> <td style="width: 10%;"></td> <td style="width: 10%;"></td> <td style="width: 10%;"></td> <td style="width: 10%;"></td> <td style="width: 10%;"></td> <td style="width: 10%;"></td> <td style="width: 10%;"></td> <td style="width: 10%;"></td> <td style="width: 10%;"></td> <td style="width: 10%;"></td> </tr> <tr> <td></td> <td></td> <td colspan="8" style="text-align: center;"> <table border="1" style="width: 100%; border-collapse: collapse; text-align: center;"> <tr> <td style="width: 10%;"></td> <td style="width: 10%;"></td> <td style="width: 10%;"></td> <td style="width: 10%;"></td> <td style="width: 10%;"></td> <td style="width: 10%;"></td> <td style="width: 10%;"></td> <td style="width: 10%;"></td> <td style="width: 10%;"></td> <td style="width: 10%;"></td> </tr> <tr> <td></td> <td></td> <td colspan="8" style="text-align: center;"> <table border="1" style="width: 100%; border-collapse: collapse; text-align: center;"> <tr> <td style="width: 10%;"></td> <td style="width: 10%;"></td> <td style="width: 10%;"></td> <td style="width: 10%;"></td> <td style="width: 10%;"></td> <td style="width: 10%;"></td> <td style="width: 10%;"></td> <td style="width: 10%;"></td> <td style="width: 10%;"></td> <td style="width: 10%;"></td> </tr> <tr> <td></td> <td></td> <td colspan="8" style="text-align: center;"> <table border="1" style="width: 100%; border-collapse: collapse; text-align: center;"> <tr> <td style="width: 10%;"></td> <td style="width: 10%;"></td> <td style="width: 10%;"></td> <td style="width: 10%;"></td> <td style="width: 10%;"></td> <td style="width: 10%;"></td> <td style="width: 10%;"></td> <td style="width: 10%;"></td> <td style="width: 10%;"></td> <td style="width: 10%;"></td> </tr> <tr> <td></td> <td></td> <td colspan="8" style="text-align: center;"> <table border="1" style="width: 100%; border-collapse: collapse; text-align: center;"> <tr> <td style="width: 10%;"></td> <td style="width: 10%;"></td> <td style="width: 10%;"></td> <td style="width: 10%;"></td> <td style="width: 10%;"></td> <td style="width: 10%;"></td> <td style="width: 10%;"></td> <td style="width: 10%;"></td> <td style="width: 10%;"></td> <td style="width: 10%;"></td> </tr> <tr> <td></td> <td></td> <td colspan="8" style="text-align: center;"> <table border="1" style="width: 100%; border-collapse: collapse; text-align: center;"> <tr> <td style="width: 10%;"></td> <td style="width: 10%;"></td> <td style="width: 10%;"></td> <td style="width: 10%;"></td> <td style="width: 10%;"></td> <td style="width: 10%;"></td> <td style="width: 10%;"></td> <td style="width: 10%;"></td> <td style="width: 10%;"></td> <td style="width: 10%;"></td> </tr> <tr> <td></td> <td></td> <td colspan="8" style="text-align: center;"> <table border="1" style="width: 100%; border-collapse: collapse; text-align: center;"> <tr> <td style="width: 10%;"></td> <td style="width: 10%;"></td> <td style="width: 10%;"></td> <td style="width: 10%;"></td> <td style="width: 10%;"></td> <td style="width: 10%;"></td> <td style="width: 10%;"></td> <td style="width: 10%;"></td> <td style="width: 10%;"></td> <td style="width: 10%;"></td> </tr> <tr> <td></td> <td></td> <td colspan="8" style="text-align: center;"> <table border="1" style="width: 100%; border-collapse: collapse; text-align: center;"> <tr> <td style="width: 10%;"></td> <td style="width: 10%;"></td> <td style="width: 10%;"></td> <td style="width: 10%;"></td> <td style="width: 10%;"></td> <td style="width: 10%;"></td> <td style="width: 10%;"></td> <td style="width: 10%;"></td> <td style="width: 10%;"></td> <td style="width: 10%;"></td> </tr> <tr> <td></td> <td></td> <td colspan="8" style="text-align: center;"> <table border="1" style="width: 100%; border-collapse: collapse; text-align: center;"> <tr> <td style="width: 10%;"></td> <td style="width: 10%;"></td> <td style="width: 10%;"></td> <td style="width: 10%;"></td> <td style="width: 10%;"></td> <td style="width: 10%;"></td> <td style="width: 10%;"></td> <td style="width: 10%;"></td> <td style="width: 10%;"></td> <td style="width: 10%;"></td> </tr> <tr> <td></td> <td></td> <td colspan="8" style="text-align: center;"> <table border="1" style="width: 100%; border-collapse: collapse; text-align: center;"> <tr> <td style="width: 10%;"></td> <td style="width: 10%;"></td> <td style="width: 10%;"></td> <td style="width: 10%;"></td> <td style="width: 10%;"></td> <td style="width: 10%;"></td> <td style="width: 10%;"></td> <td style="width: 10%;"></td> <td style="width: 10%;"></td> <td style="width: 10%;"></td> </tr> <tr> <td></td> <td></td> <td colspan="8" style="text-align: center;"> <table border="1" style="width: 100%; border-collapse: collapse; text-align: center;"> <tr> <td style="width: 10%;"></td> <td style="width: 10%;"></td> <td style="width: 10%;"></td> <td style="width: 10%;"></td> <td style="width: 10%;"></td> <td style="width: 10%;"></td> <td style="width: 10%;"></td> <td style="width: 10%;"></td> <td style="width: 10%;"></td> <td style="width: 10%;"></td> </tr> <tr> <td></td> <td></td> <td colspan="8" style="text-align: center;"> <table border="1" style="width: 100%; border-collapse: collapse; text-align: center;"> <tr> <td style="width: 10%;"></td> <td style="width: 10%;"></td> <td style="width: 10%;"></td> <td style="width: 10%;"></td> <td style="width: 10%;"></td> <td style="width: 10%;"></td> <td style="width:
10%;"></td> <td style="width: 10%;"></td> <td style="width: 10%;"></td> <td style="width: 10%;"></td> </tr> <tr> <td></td> <td></td> <td colspan="8" style="text-align: center;"> <table border="1" style="width: 100%; border-collapse: collapse; text-align: center;"> <tr> <td style="width: 10%;"></td> <td style="width: 10%;"></td> <td style="width: 10%;"></td> <td style="width: 10%;"></td> <td style="width: 10%;"></td> <td style="width: 10%;"></td> <td style="width: 10%;"></td> <td style="width: 10%;"></td> <td style="width: 10%;"></td> <td style="width: 10%;"></td> </tr> <tr> <td></td> <td></td> <td colspan="8" style="text-align: center;"> <table border="1" style="width: 100%; border-collapse: collapse; text-align: center;"> <tr> <td style="width: 10%;"></td> <td style="width: 10%;"></td> <td style="width: 10%;"></td> <td style="width: 10%;"></td> <td style="width: 10%;"></td> <td style="width: 10%;"></td> <td style="width: 10%;"></td> <td style="width: 10%;"></td> <td style="width: 10%;"></td> <td style="width: 10%;"></td> </tr> <tr> <td></td> <td></td> <td colspan="8" style="text-align: center;"> <table border="1" style="width: 100%; border-collapse: collapse; text-align: center;"> <tr> <td style="width: 10%;"></td> <td style="width: 10%;"></td> <td style="width: 10%;"></td> <td style="width: 10%;"></td> <td style="width: 10%;"></td> <td style="width: 10%;"></td> <td style="width: 10%;"></td> <td style="width: 10%;"></td> <td style="width: 10%;"></td> <td style="width: 10%;"></td> </tr> <tr> <td></td> <td></td> <td colspan="8" style="text-align: center;"> <table border="1" style="width: 100%; border-collapse: collapse; text-align: center;"> <tr> <td style="width: 10%;"></td> <td style="width: 10%;"></td> <td style="width: 10%;"></td> <td style="width: 10%;"></td> <td style="width: 10%;"></td> <td style="width: 10%;"></td> <td style="width: 10%;"></td> <td style="width: 10%;"></td> <td style="width: 10%;"></td> <td style="width: 10%;"></td> </tr> <tr> <td></td> <td></td> <td colspan="8" style="text-align: center;"> <table border="1" style="width: 100%; border-collapse: collapse; text-align: center;"> <tr> <td style="width: 10%;"></td> <td style="width: 10%;"></td> <td style="width: 10%;"></td> <td style="width: 10%;"></td> <td style="width: 10%;"></td> <td style="width: 10%;"></td> <td style="width: 10%;"></td> <td style="width: 10%;"></td> <td style="width: 10%;"></td> <td style="width: 10%;"></td> </tr> <tr> <td></td> <td></td> <td colspan="8" style="text-align: center;"> <table border="1" style="width: 100%; border-collapse: collapse; text-align: center;"> <tr> <td style="width: 10%;"></td> <td style="width: 10%;"></td> <td style="width: 10%;"></td> <td style="width: 10%;"></td> <td style="width: 10%;"></td> <td style="width: 10%;"></td> <td style="width: 10%;"></td> <td style="width: 10%;"></td> <td style="width: 10%;"></td> <td style="width: 10%;"></td> </tr> <tr> <td></td> <td></td> <td colspan="8" style="text-align: center;"> <table border="1" style="width: 100%; border-collapse: collapse; text-align: center;"> <tr> <td style="width: 10%;"></td> <td style="width: 10%;"></td> <td style="width: 10%;"></td> <td style="width: 10%;"></td> <td style="width: 10%;"></td> <td style="width: 10%;"></td> <td style="width: 10%;"></td> <td style="width: 10%;"></td> <td style="width: 10%;"></td> <td style="width: 10%;"></td> </tr> <tr> <td></td> <td></td> <td colspan="8" style="text-align: center;"> <table border="1" style="width: 100%; border-collapse: collapse; text-align: center;"> <tr> <td style="width: 10%;"></td> <td style="width: 10%;"></td> <td style="width: 10%;"></td> <td style="width: 10%;"></td> <td style="width: 10%;"></td> <td style="width: 10%;"></td> <td style="width: 10%;"></td> <td style="width: 10%;"></td> <td style="width: 10%;"></td> <td style="width: 10%;"></td> </tr> <tr> <td></td> <td></td> <td colspan="8" style="text-align: center;"> <table border="1" style="width: 100%; border-collapse: collapse; text-align: center;"> <tr> </tr></table></td></tr></table></td></tr></table></td></tr></table></td></tr></table></td></tr></table></td></tr></table></td></tr></table></td></tr></table></td></tr></table></td></tr></table></td></tr></table></td></tr></table></td></tr></table></td></tr></table></td></tr></table></td></tr></table></td></tr></table></td></tr></table></td></tr></table></td></tr></table></td></tr></table></td></tr></table></td></tr></table></td></tr></table></td></tr></table></td></tr></table></td></tr></table></td></tr></table></td></tr></table></td></tr></table></td></tr></table></td></tr></table></td></tr></table></td></tr></table></td></tr></table></td></tr></table> | | | | | | | | | | | | | | | | | | | | <table border="1" style="width: 100%; border-collapse: collapse; text-align: center;"> <tr> <td style="width: 10%;"></td> <td style="width: 10%;"></td> <td style="width: 10%;"></td> <td style="width: 10%;"></td> <td style="width: 10%;"></td> <td style="width: 10%;"></td> <td style="width: 10%;"></td> <td style="width: 10%;"></td> <td style="width: 10%;"></td> <td style="width: 10%;"></td> </tr> <tr> <td></td> <td></td> <td colspan="8" style="text-align: center;"> <table border="1" style="width: 100%; border-collapse: collapse; text-align: center;"> <tr> <td style="width: 10%;"></td> <td style="width: 10%;"></td> <td style="width: 10%;"></td> <td style="width: 10%;"></td> <td style="width: 10%;"></td> <td style="width: 10%;"></td> <td style="width: 10%;"></td> <td style="width: 10%;"></td> <td style="width: 10%;"></td> <td style="width: 10%;"></td> </tr> <tr> <td></td> <td></td> <td colspan="8" style="text-align: center;"> <table border="1" style="width: 100%; border-collapse: collapse; text-align: center;"> <tr> <td style="width: 10%;"></td> <td style="width: 10%;"></td> <td style="width: 10%;"></td> <td style="width: 10%;"></td> <td style="width: 10%;"></td> <td style="width: 10%;"></td> <td style="width: 10%;"></td> <td style="width: 10%;"></td> <td style="width: 10%;"></td> <td style="width: 10%;"></td> </tr> <tr> <td></td> <td></td> <td colspan="8" style="text-align: center;"> <table border="1" style="width: 100%; border-collapse: collapse; text-align: center;"> <tr> <td style="width: 10%;"></td> <td style="width: 10%;"></td> <td style="width: 10%;"></td> <td style="width: 10%;"></td> <td style="width: 10%;"></td> <td style="width: 10%;"></td> <td style="width: 10%;"></td> <td style="width: 10%;"></td> <td style="width: 10%;"></td> <td style="width: 10%;"></td> </tr> <tr> <td></td> <td></td> <td colspan="8" style="text-align: center;"> <table border="1" style="width: 100%; border-collapse: collapse; text-align: center;"> <tr> <td style="width: 10%;"></td> <td style="width: 10%;"></td> <td style="width: 10%;"></td> <td style="width: 10%;"></td> <td style="width: 10%;"></td> <td style="width: 10%;"></td> <td style="width: 10%;"></td> <td style="width: 10%;"></td> <td style="width: 10%;"></td> <td style="width: 10%;"></td> </tr> <tr> <td></td> <td></td> <td colspan="8" style="text-align: center;"> <table border="1" style="width: 100%; border-collapse: collapse; text-align: center;"> <tr> <td style="width: 10%;"></td> <td style="width: 10%;"></td> <td style="width: 10%;"></td> <td style="width: 10%;"></td> <td style="width: 10%;"></td> <td style="width: 10%;"></td> <td style="width: 10%;"></td> <td style="width: 10%;"></td> <td style="width: 10%;"></td> <td style="width: 10%;"></td> </tr> <tr> <td></td> <td></td> <td colspan="8" style="text-align: center;"> <table border="1" style="width: 100%; border-collapse: collapse; text-align: center;"> <tr> <td style="width: 10%;"></td> <td style="width: 10%;"></td> <td style="width: 10%;"></td> <td style="width: 10%;"></td> <td style="width: 10%;"></td> <td style="width: 10%;"></td> <td style="width: 10%;"></td> <td style="width: 10%;"></td> <td style="width: 10%;"></td> <td style="width: 10%;"></td> </tr> <tr> <td></td> <td></td> <td colspan="8" style="text-align: center;"> <table border="1" style="width: 100%; border-collapse: collapse; text-align: center;"> <tr> <td style="width: 10%;"></td> <td style="width: 10%;"></td> <td style="width: 10%;"></td> <td style="width: 10%;"></td> <td style="width: 10%;"></td> <td style="width: 10%;"></td> <td style="width: 10%;"></td> <td style="width: 10%;"></td> <td style="width: 10%;"></td> <td style="width: 10%;"></td> </tr> <tr> <td></td> <td></td> <td colspan="8" style="text-align: center;"> <table border="1" style="width: 100%; border-collapse: collapse; text-align: center;"> <tr> <td style="width: 10%;"></td> <td style="width: 10%;"></td> <td style="width: 10%;"></td> <td style="width: 10%;"></td> <td style="width: 10%;"></td> <td style="width: 10%;"></td> <td style="width: 10%;"></td> <td style="width: 10%;"></td> <td style="width: 10%;"></td> <td style="width: 10%;"></td> </tr> <tr> <td></td> <td></td> <td colspan="8" style="text-align: center;"> <table border="1" style="width: 100%; border-collapse: collapse; text-align:
center;"> <tr> <td style="width: 10%;"></td> <td style="width: 10%;"></td> <td style="width: 10%;"></td> <td style="width: 10%;"></td> <td style="width: 10%;"></td> <td style="width: 10%;"></td> <td style="width: 10%;"></td> <td style="width: 10%;"></td> <td style="width: 10%;"></td> <td style="width: 10%;"></td> </tr> <tr> <td></td> <td></td> <td colspan="8" style="text-align: center;"> <table border="1" style="width: 100%; border-collapse: collapse; text-align: center;"> <tr> <td style="width: 10%;"></td> <td style="width: 10%;"></td> <td style="width: 10%;"></td> <td style="width: 10%;"></td> <td style="width: 10%;"></td> <td style="width: 10%;"></td> <td style="width: 10%;"></td> <td style="width: 10%;"></td> <td style="width: 10%;"></td> <td style="width: 10%;"></td> </tr> <tr> <td></td> <td></td> <td colspan="8" style="text-align: center;"> <table border="1" style="width: 100%; border-collapse: collapse; text-align: center;"> <tr> <td style="width: 10%;"></td> <td style="width: 10%;"></td> <td style="width: 10%;"></td> <td style="width: 10%;"></td> <td style="width: 10%;"></td> <td style="width: 10%;"></td> <td style="width: 10%;"></td> <td style="width: 10%;"></td> <td style="width: 10%;"></td> <td style="width: 10%;"></td> </tr> <tr> <td></td> <td></td> <td colspan="8" style="text-align: center;"> <table border="1" style="width: 100%; border-collapse: collapse; text-align: center;"> <tr> <td style="width: 10%;"></td> <td style="width: 10%;"></td> <td style="width: 10%;"></td> <td style="width: 10%;"></td> <td style="width: 10%;"></td> <td style="width: 10%;"></td> <td style="width: 10%;"></td> <td style="width: 10%;"></td> <td style="width: 10%;"></td> <td style="width: 10%;"></td> </tr> <tr> <td></td> <td></td> <td colspan="8" style="text-align: center;"> <table border="1" style="width: 100%; border-collapse: collapse; text-align: center;"> <tr> <td style="width: 10%;"></td> <td style="width: 10%;"></td> <td style="width: 10%;"></td> <td style="width: 10%;"></td> <td style="width: 10%;"></td> <td style="width: 10%;"></td> <td style="width: 10%;"></td> <td style="width: 10%;"></td> <td style="width: 10%;"></td> <td style="width: 10%;"></td> </tr> <tr> <td></td> <td></td> <td colspan="8" style="text-align: center;"> <table border="1" style="width: 100%; border-collapse: collapse; text-align: center;"> <tr> <td style="width: 10%;"></td> <td style="width: 10%;"></td> <td style="width: 10%;"></td> <td style="width: 10%;"></td> <td style="width: 10%;"></td> <td style="width: 10%;"></td> <td style="width: 10%;"></td> <td style="width: 10%;"></td> <td style="width: 10%;"></td> <td style="width: 10%;"></td> </tr> <tr> <td></td> <td></td> <td colspan="8" style="text-align: center;"> <table border="1" style="width: 100%; border-collapse: collapse; text-align: center;"> <tr> <td style="width: 10%;"></td> <td style="width: 10%;"></td> <td style="width: 10%;"></td> <td style="width: 10%;"></td> <td style="width: 10%;"></td> <td style="width: 10%;"></td> <td style="width: 10%;"></td> <td style="width: 10%;"></td> <td style="width: 10%;"></td> <td style="width: 10%;"></td> </tr> <tr> <td></td> <td></td> <td colspan="8" style="text-align: center;"> <table border="1" style="width: 100%; border-collapse: collapse; text-align: center;"> <tr> <td style="width: 10%;"></td> <td style="width: 10%;"></td> <td style="width: 10%;"></td> <td style="width: 10%;"></td> <td style="width: 10%;"></td> <td style="width: 10%;"></td> <td style="width: 10%;"></td> <td style="width: 10%;"></td> <td style="width: 10%;"></td> <td style="width: 10%;"></td> </tr> <tr> <td></td> <td></td> <td colspan="8" style="text-align: center;"> <table border="1" style="width: 100%; border-collapse: collapse; text-align: center;"> <tr> <td style="width: 10%;"></td> <td style="width: 10%;"></td> <td style="width: 10%;"></td> <td style="width: 10%;"></td> <td style="width: 10%;"></td> <td style="width: 10%;"></td> <td style="width: 10%;"></td> <td style="width: 10%;"></td> <td style="width: 10%;"></td> <td style="width: 10%;"></td> </tr> <tr> <td></td> <td></td> <td colspan="8" style="text-align: center;"> <table border="1" style="width: 100%; border-collapse: collapse; text-align: center;"> <tr> <td style="width: 10%;"></td> <td style="width: 10%;"></td> <td style="width: 10%;"></td> <td style="width: 10%;"></td> <td style="width: 10%;"></td> <td style="width: 10%;"></td> <td style="width: 10%;"></td> <td style="width: 10%;"></td> <td style="width: 10%;"></td> <td style="width: 10%;"></td> </tr> <tr> <td></td> <td></td> <td colspan="8" style="text-align: center;"> <table border="1" style="width: 100%; border-collapse: collapse; text-align: center;"> <tr> <td style="width: 10%;"></td> <td style="width: 10%;"></td> <td style="width: 10%;"></td> <td style="width: 10%;"></td> <td style="width: 10%;"></td> <td style="width: 10%;"></td> <td style="width: 10%;"></td> <td style="width: 10%;"></td> <td style="width: 10%;"></td> <td style="width: 10%;"></td> </tr> <tr> <td></td> <td></td> <td colspan="8" style="text-align: center;"> <table border="1" style="width: 100%; border-collapse: collapse; text-align: center;"> <tr> <td style="width: 10%;"></td> <td style="width: 10%;"></td> <td style="width: 10%;"></td> <td style="width: 10%;"></td> <td style="width: 10%;"></td> <td style="width: 10%;"></td> <td style="width: 10%;"></td> <td style="width: 10%;"></td> <td style="width: 10%;"></td> <td style="width: 10%;"></td> </tr> <tr> <td></td> <td></td> <td colspan="8" style="text-align: center;"> <table border="1" style="width: 100%; border-collapse: collapse; text-align: center;"> <tr> <td style="width: 10%;"></td> <td style="width: 10%;"></td> <td style="width: 10%;"></td> <td style="width: 10%;"></td> <td style="width: 10%;"></td> <td style="width: 10%;"></td> <td style="width: 10%;"></td> <td style="width: 10%;"></td> <td style="width: 10%;"></td> <td style="width: 10%;"></td> </tr> <tr> <td></td> <td></td> <td colspan="8" style="text-align: center;"> <table border="1" style="width: 100%; border-collapse: collapse; text-align: center;"> <tr> <td style="width: 10%;"></td> <td style="width: 10%;"></td> <td style="width: 10%;"></td> <td style="width: 10%;"></td> <td style="width: 10%;"></td> <td style="width: 10%;"></td> <td style="width: 10%;"></td> <td style="width: 10%;"></td> <td style="width: 10%;"></td> <td style="width: 10%;"></td> </tr> <tr> <td></td> <td></td> <td colspan="8" style="text-align: center;"> <table border="1" style="width: 100%; border-collapse: collapse; text-align: center;"> <tr> <td style="width: 10%;"></td> <td style="width: 10%;"></td> <td style="width: 10%;"></td> <td style="width: 10%;"></td> <td style="width: 10%;"></td> <td style="width: 10%;"></td> <td style="width: 10%;"></td> <td style="width: 10%;"></td> <td style="width: 10%;"></td> <td style="width: 10%;"></td> </tr> <tr> <td></td> <td></td> <td colspan="8" style="text-align: center;"> <table border="1" style="width: 100%; border-collapse: collapse; text-align: center;"> <tr> <td style="width: 10%;"></td> <td style="width: 10%;"></td> <td style="width: 10%;"></td> <td style="width: 10%;"></td> <td style="width: 10%;"></td> <td style="width: 10%;"></td> <td style="width: 10%;"></td> <td style="width: 10%;"></td> <td style="width: 10%;"></td> <td style="width: 10%;"></td> </tr> <tr> <td></td> <td></td> <td colspan="8" style="text-align: center;"> <table border="1" style="width: 100%; border-collapse: collapse; text-align: center;"> <tr> <td style="width: 10%;"></td> <td style="width: 10%;"></td> <td style="width: 10%;"></td> <td style="width: 10%;"></td> <td style="width: 10%;"></td> <td style="width: 10%;"></td> <td style="width: 10%;"></td> <td style="width: 10%;"></td> <td style="width: 10%;"></td> <td style="width: 10%;"></td> </tr> <tr> <td></td> <td></td> <td colspan="8" style="text-align: center;"> <table border="1" style="width: 100%; border-collapse: collapse; text-align: center;"> <tr> <td style="width: 10%;"></td> <td style="width: 10%;"></td> <td style="width: 10%;"></td> <td style="width: 10%;"></td> <td style="width: 10%;"></td> <td style="width: 10%;"></td> <td style="width: 10%;"></td> <td style="width: 10%;"></td> <td style="width: 10%;"></td> <td style="width: 10%;"></td> </tr> <tr> <td></td> <td></td> <td colspan="8" style="text-align: center;"> <table border="1" style="width: 100%; border-collapse: collapse; text-align: center;"> <tr> <td style="width: 10%;"></td> <td style="width: 10%;"></td> <td style="width: 10%;"></td> <td style="width: 10%;"></td> <td style="width: 10%;"></td> <td style="width: 10%;"></td> <td style="width: 10%;"></td> <td style="width: 10%;"></td> <td style="width: 10%;"></td> <td style="width: 10%;"></td> </tr> <tr> <td></td> <td></td> <td colspan="8" style="text-align: center;"> <table border="1" style="width: 100%; border-collapse: collapse; text-align: center;"> <tr> <td style="width: 10%;"></td> <td style="width: 10%;"></td> <td style="width: 10%;"></td> <td style="width: 10%;"></td> <td style="width: 10%;"></td> <td style="width: 10%;"></td> <td style="width: 10%;"></td> <td style="width: 10%;"></td> <td style="width: 10%;"></td> <td style="width: 10%;"></td> </tr> <tr> <td></td> <td></td> <td colspan="8" style="text-align: center;"> <table border="1" style="width: 100%; border-collapse: collapse; text-align: center;"> <tr> <td style="width: 10%;"></td> <td style="width: 10%;"></td> <td style="width: 10%;"></td> <td style="width: 10%;"></td> <td style="width: 10%;"></td> <td style="width: 10%;"></td> <td style="width: 10%;"></td> <td style="width: 10%;"></td> <td style="width: 10%;"></td> <td style="width: 10%;"></td> </tr> <tr> <td></td> <td></td> <td colspan="8" style="text-align: center;"> <table border="1" style="width: 100%; border-collapse: collapse; text-align: center;"> <tr> <td style="width: 10%;"></td> <td style="width: 10%;"></td> <td style="width: 10%;"></td> <td style="width: 10%;"></td> <td style="width: 10%;"></td> <td
style="width: 10%;"></td> <td style="width: 10%;"></td> <td style="width: 10%;"></td> <td style="width: 10%;"></td> <td style="width: 10%;"></td> </tr> <tr> <td></td> <td></td> <td colspan="8" style="text-align: center;"> <table border="1" style="width: 100%; border-collapse: collapse; text-align: center;"> <tr> <td style="width: 10%;"></td> <td style="width: 10%;"></td> <td style="width: 10%;"></td> <td style="width: 10%;"></td> <td style="width: 10%;"></td> <td style="width: 10%;"></td> <td style="width: 10%;"></td> <td style="width: 10%;"></td> <td style="width: 10%;"></td> <td style="width: 10%;"></td> </tr> <tr> <td></td> <td></td> <td colspan="8" style="text-align: center;"> <table border="1" style="width: 100%; border-collapse: collapse; text-align: center;"> <tr> <td style="width: 10%;"></td> <td style="width: 10%;"></td> <td style="width: 10%;"></td> <td style="width: 10%;"></td> <td style="width: 10%;"></td> <td style="width: 10%;"></td> <td style="width: 10%;"></td> <td style="width: 10%;"></td> <td style="width: 10%;"></td> <td style="width: 10%;"></td> </tr> <tr> <td></td> <td></td> <td colspan="8" style="text-align: center;"> <table border="1" style="width: 100%; border-collapse: collapse; text-align: center;"> <tr> <td style="width: 10%;"></td> <td style="width: 10%;"></td> <td style="width: 10%;"></td> <td style="width: 10%;"></td> <td style="width: 10%;"></td> <td style="width: 10%;"></td> <td style="width: 10%;"></td> <td style="width: 10%;"></td> <td style="width: 10%;"></td> <td style="width: 10%;"></td> </tr> <tr> <td></td> <td></td> <td colspan="8" style="text-align: center;"> <table border="1" style="width: 100%; border-collapse: collapse; text-align: center;"> <tr> <td style="width: 10%;"></td> <td style="width: 10%;"></td> <td style="width: 10%;"></td> <td style="width: 10%;"></td> <td style="width: 10%;"></td> <td style="width: 10%;"></td> <td style="width: 10%;"></td> <td style="width: 10%;"></td> <td style="width: 10%;"></td> <td style="width: 10%;"></td> </tr> <tr> <td></td> <td></td> <td colspan="8" style="text-align: center;"> <table border="1" style="width: 100%; border-collapse: collapse; text-align: center;"> <tr> </tr></table></td></tr></table></td></tr></table></td></tr></table></td></tr></table></td></tr></table></td></tr></table></td></tr></table></td></tr></table></td></tr></table></td></tr></table></td></tr></table></td></tr></table></td></tr></table></td></tr></table></td></tr></table></td></tr></table></td></tr></table></td></tr></table></td></tr></table></td></tr></table></td></tr></table></td></tr></table></td></tr></table></td></tr></table></td></tr></table></td></tr></table></td></tr></table></td></tr></table></td></tr></table></td></tr></table></td></tr></table></td></tr></table></td></tr></table></td></tr></table></td></tr></table> | | | | | | | | | | | | | | | | | | | | <table border="1" style="width: 100%; border-collapse: collapse; text-align: center;"> <tr> <td style="width: 10%;"></td> <td style="width: 10%;"></td> <td style="width: 10%;"></td> <td style="width: 10%;"></td> <td style="width: 10%;"></td> <td style="width: 10%;"></td> <td style="width: 10%;"></td> <td style="width: 10%;"></td> <td style="width: 10%;"></td> <td style="width: 10%;"></td> </tr> <tr> <td></td> <td></td> <td colspan="8" style="text-align: center;"> <table border="1" style="width: 100%; border-collapse: collapse; text-align: center;"> <tr> <td style="width: 10%;"></td> <td style="width: 10%;"></td> <td style="width: 10%;"></td> <td style="width: 10%;"></td> <td style="width: 10%;"></td> <td style="width: 10%;"></td> <td style="width: 10%;"></td> <td style="width: 10%;"></td> <td style="width: 10%;"></td> <td style="width: 10%;"></td> </tr> <tr> <td></td> <td></td> <td colspan="8" style="text-align: center;"> <table border="1" style="width: 100%; border-collapse: collapse; text-align: center;"> <tr> <td style="width: 10%;"></td> <td style="width: 10%;"></td> <td style="width: 10%;"></td> <td style="width: 10%;"></td> <td style="width: 10%;"></td> <td style="width: 10%;"></td> <td style="width: 10%;"></td> <td style="width: 10%;"></td> <td style="width: 10%;"></td> <td style="width: 10%;"></td> </tr> <tr> <td></td> <td></td> <td colspan="8" style="text-align: center;"> <table border="1" style="width: 100%; border-collapse: collapse; text-align: center;"> <tr> <td style="width: 10%;"></td> <td style="width: 10%;"></td> <td style="width: 10%;"></td> <td style="width: 10%;"></td> <td style="width: 10%;"></td> <td style="width: 10%;"></td> <td style="width: 10%;"></td> <td style="width: 10%;"></td> <td style="width: 10%;"></td> <td style="width: 10%;"></td> </tr> <tr> <td></td> <td></td> <td colspan="8" style="text-align: center;"> <table border="1" style="width: 100%; border-collapse: collapse; text-align: center;"> <tr> <td style="width: 10%;"></td> <td style="width: 10%;"></td> <td style="width: 10%;"></td> <td style="width: 10%;"></td> <td style="width: 10%;"></td> <td style="width: 10%;"></td> <td style="width: 10%;"></td> <td style="width: 10%;"></td> <td style="width: 10%;"></td> <td style="width: 10%;"></td> </tr> <tr> <td></td> <td></td> <td colspan="8" style="text-align: center;"> <table border="1" style="width: 100%; border-collapse: collapse; text-align: center;"> <tr> <td style="width: 10%;"></td> <td style="width: 10%;"></td> <td style="width: 10%;"></td> <td style="width: 10%;"></td> <td style="width: 10%;"></td> <td style="width: 10%;"></td> <td style="width: 10%;"></td> <td style="width: 10%;"></td> <td style="width: 10%;"></td> <td style="width: 10%;"></td> </tr> <tr> <td></td> <td></td> <td colspan="8" style="text-align: center;"> <table border="1" style="width: 100%; border-collapse: collapse; text-align: center;"> <tr> <td style="width: 10%;"></td> <td style="width: 10%;"></td> <td style="width: 10%;"></td> <td style="width: 10%;"></td> <td style="width: 10%;"></td> <td style="width: 10%;"></td> <td style="width: 10%;"></td> <td style="width: 10%;"></td> <td style="width: 10%;"></td> <td style="width: 10%;"></td> </tr> <tr> <td></td> <td></td> <td colspan="8" style="text-align: center;"> <table border="1" style="width: 100%; border-collapse: collapse; text-align: center;"> <tr> <td style="width: 10%;"></td> <td style="width: 10%;"></td> <td style="width: 10%;"></td> <td style="width: 10%;"></td> <td style="width: 10%;"></td> <td style="width: 10%;"></td> <td style="width: 10%;"></td> <td style="width: 10%;"></td> <td style="width: 10%;"></td> <td style="width: 10%;"></td> </tr> <tr> <td></td> <td></td> <td colspan="8" style="text-align: center;"> <table border="1" style="width: 100%; border-collapse: collapse; text-align: center;"> <tr> <td style="width: 10%;"></td> <td style="width: 10%;"></td> <td style="width: 10%;"></td> <td style="width: 10%;"></td> <td style="width: 10%;"></td> <td style="width: 10%;"></td> <td style="width: 10%;"></td> <td style="width: 10%;"></td> <td style="width: 10%;"></td> <td style="width: 10%;"></td> </tr> <tr> <td></td> <td></td> <td colspan="8" style="text-align: center;"> <table border="1" style="width: 100%; border-collapse: collapse; text-align: center;"> <tr> <td style="width: 10%;"></td> <td style="width: 10%;"></td> <td style="width: 10%;"></td> <td style="width: 10%;"></td> <td style="width: 10%;"></td> <td style="width: 10%;"></td> <td style="width: 10%;"></td> <td style="width: 10%;"></td> <td style="width: 10%;"></td> <td style="width: 10%;"></td> </tr> <tr> <td></td> <td></td> <td colspan="8" style="text-align: center;"> <table border="1" style="width: 100%; border-collapse: collapse; text-align: center;"> <tr> <td style="width: 10%;"></td> <td style="width: 10%;"></td> <td style="width: 10%;"></td> <td style="width: 10%;"></td> <td style="width: 10%;"></td> <td style="width: 10%;"></td> <td style="width: 10%;"></td> <td style="width: 10%;"></td> <td style="width: 10%;"></td> <td style="width: 10%;"></td> </tr> <tr> <td></td> <td></td> <td colspan="8" style="text-align: center;"> <table border="1" style="width: 100%; border-collapse: collapse; text-align: center;"> <tr> <td style="width: 10%;"></td> <td style="width: 10%;"></td> <td style="width: 10%;"></td> <td style="width: 10%;"></td> <td style="width: 10%;"></td> <td style="width: 10%;"></td> <td style="width: 10%;"></td> <td style="width: 10%;"></td> <td style="width: 10%;"></td> <td style="width: 10%;"></td> </tr> <tr> <td></td> <td></td> <td colspan="8" style="text-align: center;"> <table border="1" style="width: 100%; border-collapse: collapse; text-align: center;"> <tr> <td style="width: 10%;"></td> <td style="width: 10%;"></td> <td style="width: 10%;"></td> <td style="width: 10%;"></td> <td style="width: 10%;"></td> <td style="width: 10%;"></td> <td style="width: 10%;"></td> <td style="width: 10%;"></td> <td style="width: 10%;"></td> <td style="width: 10%;"></td> </tr> <tr> <td></td> <td></td> <td colspan="8" style="text-align: center;"> <table border="1" style="width: 100%; border-collapse:
collapse; text-align: center;"> <tr> <td style="width: 10%;"></td> <td style="width: 10%;"></td> <td style="width: 10%;"></td> <td style="width: 10%;"></td> <td style="width: 10%;"></td> <td style="width: 10%;"></td> <td style="width: 10%;"></td> <td style="width: 10%;"></td> <td style="width: 10%;"></td> <td style="width: 10%;"></td> </tr> <tr> <td></td> <td></td> <td colspan="8" style="text-align: center;"> <table border="1" style="width: 100%; border-collapse: collapse; text-align: center;"> <tr> <td style="width: 10%;"></td> <td style="width: 10%;"></td> <td style="width: 10%;"></td> <td style="width: 10%;"></td> <td style="width: 10%;"></td> <td style="width: 10%;"></td> <td style="width: 10%;"></td> <td style="width: 10%;"></td> <td style="width: 10%;"></td> <td style="width: 10%;"></td> </tr> <tr> <td></td> <td></td> <td colspan="8" style="text-align: center;"> <table border="1" style="width: 100%; border-collapse: collapse; text-align: center;"> <tr> <td style="width: 10%;"></td> <td style="width: 10%;"></td> <td style="width: 10%;"></td> <td style="width: 10%;"></td> <td style="width: 10%;"></td> <td style="width: 10%;"></td> <td style="width: 10%;"></td> <td style="width: 10%;"></td> <td style="width: 10%;"></td> <td style="width: 10%;"></td> </tr> <tr> <td></td> <td></td> <td colspan="8" style="text-align: center;"> <table border="1" style="width: 100%; border-collapse: collapse; text-align: center;"> <tr> <td style="width: 10%;"></td> <td style="width: 10%;"></td> <td style="width: 10%;"></td> <td style="width: 10%;"></td> <td style="width: 10%;"></td> <td style="width: 10%;"></td> <td style="width: 10%;"></td> <td style="width: 10%;"></td> <td style="width: 10%;"></td> <td style="width: 10%;"></td> </tr> <tr> <td></td> <td></td> <td colspan="8" style="text-align: center;"> <table border="1" style="width: 100%; border-collapse: collapse; text-align: center;"> <tr> <td style="width: 10%;"></td> <td style="width: 10%;"></td> <td style="width: 10%;"></td> <td style="width: 10%;"></td> <td style="width: 10%;"></td> <td style="width: 10%;"></td> <td style="width: 10%;"></td> <td style="width: 10%;"></td> <td style="width: 10%;"></td> <td style="width: 10%;"></td> </tr> <tr> <td></td> <td></td> <td colspan="8" style="text-align: center;"> <table border="1" style="width: 100%; border-collapse: collapse; text-align: center;"> <tr> <td style="width: 10%;"></td> <td style="width: 10%;"></td> <td style="width: 10%;"></td> <td style="width: 10%;"></td> <td style="width: 10%;"></td> <td style="width: 10%;"></td> <td style="width: 10%;"></td> <td style="width: 10%;"></td> <td style="width: 10%;"></td> <td style="width: 10%;"></td> </tr> <tr> <td></td> <td></td> <td colspan="8" style="text-align: center;"> <table border="1" style="width: 100%; border-collapse: collapse; text-align: center;"> <tr> <td style="width: 10%;"></td> <td style="width: 10%;"></td> <td style="width: 10%;"></td> <td style="width: 10%;"></td> <td style="width: 10%;"></td> <td style="width: 10%;"></td> <td style="width: 10%;"></td> <td style="width: 10%;"></td> <td style="width: 10%;"></td> <td style="width: 10%;"></td> </tr> <tr> <td></td> <td></td> <td colspan="8" style="text-align: center;"> <table border="1" style="width: 100%; border-collapse: collapse; text-align: center;"> <tr> <td style="width: 10%;"></td> <td style="width: 10%;"></td> <td style="width: 10%;"></td> <td style="width: 10%;"></td> <td style="width: 10%;"></td> <td style="width: 10%;"></td> <td style="width: 10%;"></td> <td style="width: 10%;"></td> <td style="width: 10%;"></td> <td style="width: 10%;"></td> </tr> <tr> <td></td> <td></td> <td colspan="8" style="text-align: center;"> <table border="1" style="width: 100%; border-collapse: collapse; text-align: center;"> <tr> <td style="width: 10%;"></td> <td style="width: 10%;"></td> <td style="width: 10%;"></td> <td style="width: 10%;"></td> <td style="width: 10%;"></td> <td style="width: 10%;"></td> <td style="width: 10%;"></td> <td style="width: 10%;"></td> <td style="width: 10%;"></td> <td style="width: 10%;"></td> </tr> <tr> <td></td> <td></td> <td colspan="8" style="text-align: center;"> <table border="1" style="width: 100%; border-collapse: collapse; text-align: center;"> <tr> <td style="width: 10%;"></td> <td style="width: 10%;"></td> <td style="width: 10%;"></td> <td style="width: 10%;"></td> <td style="width: 10%;"></td> <td style="width: 10%;"></td> <td style="width: 10%;"></td> <td style="width: 10%;"></td> <td style="width: 10%;"></td> <td style="width: 10%;"></td> </tr> <tr> <td></td> <td></td> <td colspan="8" style="text-align: center;"> <table border="1" style="width: 100%; border-collapse: collapse; text-align: center;"> <tr> <td style="width: 10%;"></td> <td style="width: 10%;"></td> <td style="width: 10%;"></td> <td style="width: 10%;"></td> <td style="width: 10%;"></td> <td style="width: 10%;"></td> <td style="width: 10%;"></td> <td style="width: 10%;"></td> <td style="width: 10%;"></td> <td style="width: 10%;"></td> </tr> <tr> <td></td> <td></td> <td colspan="8" style="text-align: center;"> <table border="1" style="width: 100%; border-collapse: collapse; text-align: center;"> <tr> <td style="width: 10%;"></td> <td style="width: 10%;"></td> <td style="width: 10%;"></td> <td style="width: 10%;"></td> <td style="width: 10%;"></td> <td style="width: 10%;"></td> <td style="width: 10%;"></td> <td style="width: 10%;"></td> <td style="width: 10%;"></td> <td style="width: 10%;"></td> </tr> <tr> <td></td> <td></td> <td colspan="8" style="text-align: center;"> <table border="1" style="width: 100%; border-collapse: collapse; text-align: center;"> <tr> <td style="width: 10%;"></td> <td style="width: 10%;"></td> <td style="width: 10%;"></td> <td style="width: 10%;"></td> <td style="width: 10%;"></td> <td style="width: 10%;"></td> <td style="width: 10%;"></td> <td style="width: 10%;"></td> <td style="width: 10%;"></td> <td style="width: 10%;"></td> </tr> <tr> <td></td> <td></td> <td colspan="8" style="text-align: center;"> <table border="1" style="width: 100%; border-collapse: collapse; text-align: center;"> <tr> <td style="width: 10%;"></td> <td style="width: 10%;"></td> <td style="width: 10%;"></td> <td style="width: 10%;"></td> <td style="width: 10%;"></td> <td style="width: 10%;"></td> <td style="width: 10%;"></td> <td style="width: 10%;"></td> <td style="width: 10%;"></td> <td style="width: 10%;"></td> </tr> <tr> <td></td> <td></td> <td colspan="8" style="text-align: center;"> <table border="1" style="width: 100%; border-collapse: collapse; text-align: center;"> <tr> <td style="width: 10%;"></td> <td style="width: 10%;"></td> <td style="width: 10%;"></td> <td style="width: 10%;"></td> <td style="width: 10%;"></td> <td style="width: 10%;"></td> <td style="width: 10%;"></td> <td style="width: 10%;"></td> <td style="width: 10%;"></td> <td style="width: 10%;"></td> </tr> <tr> <td></td> <td></td> <td colspan="8" style="text-align: center;"> <table border="1" style="width: 100%; border-collapse: collapse; text-align: center;"> <tr> <td style="width: 10%;"></td> <td style="width: 10%;"></td> <td style="width: 10%;"></td> <td style="width: 10%;"></td> <td style="width: 10%;"></td> <td style="width: 10%;"></td> <td style="width: 10%;"></td> <td style="width: 10%;"></td> <td style="width: 10%;"></td> <td style="width: 10%;"></td> </tr> <tr> <td></td> <td></td> <td colspan="8" style="text-align: center;"> <table border="1" style="width: 100%; border-collapse: collapse; text-align: center;"> <tr> <td style="width: 10%;"></td> <td style="width: 10%;"></td> <td style="width: 10%;"></td> <td style="width: 10%;"></td> <td style="width: 10%;"></td> <td style="width: 10%;"></td> <td style="width: 10%;"></td> <td style="width: 10%;"></td> <td style="width: 10%;"></td> <td style="width: 10%;"></td> </tr> <tr> <td></td> <td></td> <td colspan="8" style="text-align: center;"> <table border="1" style="width: 100%; border-collapse: collapse; text-align: center;"> <tr> <td style="width: 10%;"></td> <td style="width: 10%;"></td> <td style="width: 10%;"></td> <td style="width: 10%;"></td> <td style="width: 10%;"></td> <td style="width: 10%;"></td> <td style="width: 10%;"></td> <td style="width: 10%;"></td> <td style="width: 10%;"></td> <td style="width: 10%;"></td> </tr> <tr> <td></td> <td></td> <td colspan="8" style="text-align: center;"> <table border="1" style="width: 100%; border-collapse: collapse; text-align: center;"> <tr> <td style="width: 10%;"></td> <td style="width: 10%;"></td> <td style="width: 10%;"></td> <td style="width: 10%;"></td> <td style="width: 10%;"></td> <td style="width: 10%;"></td> <td style="width: 10%;"></td> <td style="width: 10%;"></td> <td style="width: 10%;"></td> <td style="width: 10%;"></td> </tr> <tr> <td></td> <td></td> <td colspan="8" style="text-align: center;"> <table border="1" style="width: 100%; border-collapse: collapse; text-align: center;"> <tr> <td style="width: 10%;"></td> <td style="width: 10%;"></td> <td style="width: 10%;"></td> <td style="width: 10%;"></td> <td style="width: 10%;"></td> <td style="width: 10%;"></td> <td style="width: 10%;"></td> <td style="width: 10%;"></td> <td style="width: 10%;"></td> <td style="width: 10%;"></td> </tr> <tr> <td></td> <td></td> <td colspan="8" style="text-align: center;"> <table border="1" style="width: 100%; border-collapse: collapse; text-align: center;"> <tr> <td style="width: 10%;"></td> <td style="width: 10%;"></td> <td style="width: 10%;"></td> <td style="width: 10%;"></td> <td style="width: 10%;"></td> <td style="width: 10%;"></td> <td style="width: 10%;"></td> <td style="width: 10%;"></td> <td style="width: 10%;"></td> <td style="width: 10%;"></td> </tr> <tr> <td></td> <td></td> <td colspan="8" style="text-align: center;"> <table border="1" style="width: 100%; border-collapse: collapse; text-align: center;"> <tr>
</tr></table></td></tr></table></td></tr></table></td></tr></table></td></tr></table></td></tr></table></td></tr></table></td></tr></table></td></tr></table></td></tr></table></td></tr></table></td></tr></table></td></tr></table></td></tr></table></td></tr></table></td></tr></table></td></tr></table></td></tr></table></td></tr></table></td></tr></table></td></tr></table></td></tr></table></td></tr></table></td></tr></table></td></tr></table></td></tr></table></td></tr></table></td></tr></table></td></tr></table></td></tr></table></td></tr></table></td></tr></table></td></tr></table></td></tr></table></td></tr></table> | | | | | | | | | | | | | | | | | | | | <table border="1" style="width: 100%; border-collapse: collapse; text-align: center;"> <tr> <td style="width: 10%;"></td> <td style="width: 10%;"></td> <td style="width: 10%;"></td> <td style="width: 10%;"></td> <td style="width: 10%;"></td> <td style="width: 10%;"></td> <td style="width: 10%;"></td> <td style="width: 10%;"></td> <td style="width: 10%;"></td> <td style="width: 10%;"></td> </tr> <tr> <td></td> <td></td> <td colspan="8" style="text-align: center;"> <table border="1" style="width: 100%; border-collapse: collapse; text-align: center;"> <tr> <td style="width: 10%;"></td> <td style="width: 10%;"></td> <td style="width: 10%;"></td> <td style="width: 10%;"></td> <td style="width: 10%;"></td> <td style="width: 10%;"></td> <td style="width: 10%;"></td> <td style="width: 10%;"></td> <td style="width: 10%;"></td> <td style="width: 10%;"></td> </tr> <tr> <td></td> <td></td> <td colspan="8" style="text-align: center;"> <table border="1" style="width: 100%; border-collapse: collapse; text-align: center;"> <tr> <td style="width: 10%;"></td> <td style="width: 10%;"></td> <td style="width: 10%;"></td> <td style="width: 10%;"></td> <td style="width: 10%;"></td> <td style="width: 10%;"></td> <td style="width: 10%;"></td> <td style="width: 10%;"></td> <td style="width: 10%;"></td> <td style="width: 10%;"></td> </tr> <tr> <td></td> <td></td> <td colspan="8" style="text-align: center;"> <table border="1" style="width: 100%; border-collapse: collapse; text-align: center;"> <tr> <td style="width: 10%;"></td> <td style="width: 10%;"></td> <td style="width: 10%;"></td> <td style="width: 10%;"></td> <td style="width: 10%;"></td> <td style="width: 10%;"></td> <td style="width: 10%;"></td> <td style="width: 10%;"></td> <td style="width: 10%;"></td> <td style="width: 10%;"></td> </tr> <tr> <td></td> <td></td> <td colspan="8" style="text-align: center;"> <table border="1" style="width: 100%; border-collapse: collapse; text-align: center;"> <tr> <td style="width: 10%;"></td> <td style="width: 10%;"></td> <td style="width: 10%;"></td> <td style="width: 10%;"></td> <td style="width: 10%;"></td> <td style="width: 10%;"></td> <td style="width: 10%;"></td> <td style="width: 10%;"></td> <td style="width: 10%;"></td> <td style="width: 10%;"></td> </tr> <tr> <td></td> <td></td> <td colspan="8" style="text-align: center;"> <table border="1" style="width: 100%; border-collapse: collapse; text-align: center;"> <tr> <td style="width: 10%;"></td> <td style="width: 10%;"></td> <td style="width: 10%;"></td> <td style="width: 10%;"></td> <td style="width: 10%;"></td> <td style="width: 10%;"></td> <td style="width: 10%;"></td> <td style="width: 10%;"></td> <td style="width: 10%;"></td> <td style="width: 10%;"></td> </tr> <tr> <td></td> <td></td> <td colspan="8" style="text-align: center;"> <table border="1" style="width: 100%; border-collapse: collapse; text-align: center;"> <tr> <td style="width: 10%;"></td> <td style="width: 10%;"></td> <td style="width: 10%;"></td> <td style="width: 10%;"></td> <td style="width: 10%;"></td> <td style="width: 10%;"></td> <td style="width: 10%;"></td> <td style="width: 10%;"></td> <td style="width: 10%;"></td> <td style="width: 10%;"></td> </tr> <tr> <td></td> <td></td> <td colspan="8" style="text-align: center;"> <table border="1" style="width: 100%; border-collapse: collapse; text-align: center;"> <tr> <td style="width: 10%;"></td> <td style="width: 10%;"></td> <td style="width: 10%;"></td> <td style="width: 10%;"></td> <td style="width: 10%;"></td> <td style="width: 10%;"></td> <td style="width: 10%;"></td> <td style="width: 10%;"></td> <td style="width: 10%;"></td> <td style="width: 10%;"></td> </tr> <tr> <td></td> <td></td> <td colspan="8" style="text-align: center;"> <table border="1" style="width: 100%; border-collapse: collapse; text-align: center;"> <tr> <td style="width: 10%;"></td> <td style="width: 10%;"></td> <td style="width: 10%;"></td> <td style="width: 10%;"></td> <td style="width: 10%;"></td> <td style="width: 10%;"></td> <td style="width: 10%;"></td> <td style="width: 10%;"></td> <td style="width: 10%;"></td> <td style="width: 10%;"></td> </tr> <tr> <td></td> <td></td> <td colspan="8" style="text-align: center;"> <table border="1" style="width: 100%; border-collapse: collapse; text-align: center;"> <tr> <td style="width: 10%;"></td> <td style="width: 10%;"></td> <td style="width: 10%;"></td> <td style="width: 10%;"></td> <td style="width: 10%;"></td> <td style="width: 10%;"></td> <td style="width: 10%;"></td> <td style="width: 10%;"></td> <td style="width: 10%;"></td> <td style="width: 10%;"></td> </tr> <tr> <td></td> <td></td> <td colspan="8" style="text-align: center;"> <table border="1" style="width: 100%; border-collapse: collapse; text-align: center;"> <tr> <td style="width: 10%;"></td> <td style="width: 10%;"></td> <td style="width: 10%;"></td> <td style="width: 10%;"></td> <td style="width: 10%;"></td> <td style="width: 10%;"></td> <td style="width: 10%;"></td> <td style="width: 10%;"></td> <td style="width: 10%;"></td> <td style="width: 10%;"></td> </tr> <tr> <td></td> <td></td> <td colspan="8" style="text-align: center;"> <table border="1" style="width: 100%; border-collapse: collapse; text-align: center;"> <tr> <td style="width: 10%;"></td> <td style="width: 10%;"></td> <td style="width: 10%;"></td> <td style="width: 10%;"></td> <td style="width: 10%;"></td> <td style="width: 10%;"></td> <td style="width: 10%;"></td> <td style="width: 10%;"></td> <td style="width: 10%;"></td> <td style="width: 10%;"></td> </tr> <tr> <td></td> <td></td> <td colspan="8" style="text-align: center;"> <table border="1" style="width: 100%; border-collapse: collapse; text-align: center;"> <tr> <td style="width: 10%;"></td> <td style="width: 10%;"></td> <td style="width: 10%;"></td> <td style="width: 10%;"></td> <td style="width: 10%;"></td> <td style="width: 10%;"></td> <td style="width: 10%;"></td> <td style="width: 10%;"></td> <td style="width: 10%;"></td> <td style="width: 10%;"></td> </tr> <tr> <td></td> <td></td> <td colspan="8" style="text-align: center;"> <table border="1" style="width: 100%; border-collapse: collapse; text-align: center;"> <tr> <td style="width: 10%;"></td> <td style="width: 10%;"></td> <td style="width: 10%;"></td> <td style="width: 10%;"></td> <td style="width: 10%;"></td> <td style="width: 10%;"></td> <td style="width: 10%;"></td> <td style="width: 10%;"></td> <td style="width: 10%;"></td> <td style="width: 10%;"></td> </tr> <tr> <td></td> <td></td> <td colspan="8" style="text-align: center;"> <table border="1" style="width: 100%; border-collapse: collapse; text-align: center;"> <tr> <td style="width: 10%;"></td> <td style="width: 10%;"></td> <td style="width: 10%;"></td> <td style="width: 10%;"></td> <td style="width: 10%;"></td> <td style="width: 10%;"></td> <td style="width: 10%;"></td> <td style="width: 10%;"></td> <td style="width: 10%;"></td> <td style="width: 10%;"></td> </tr> <tr> <td></td> <td></td> <td colspan="8" style="text-align: center;"> <table border="1" style="width: 100%; border-collapse: collapse; text-align: center;"> <tr> <td style="width: 10%;"></td> <td style="width: 10%;"></td> <td style="width: 10%;"></td> <td style="width: 10%;"></td> <td style="width: 10%;"></td> <td style="width: 10%;"></td> <td style="width: 10%;"></td> <td style="width: 10%;"></td> <td style="width: 10%;"></td> <td style="width: 10%;"></td> </tr> <tr> <td></td> <td></td> <td colspan="8" style="text-align: center;"> <table border="1" style="width: 100%; border-collapse: collapse; text-align: center;"> <tr> <td style="width: 10%;"></td> <td style="width: 10%;"></td> <td style="width: 10%;"></td> <td style="width: 10%;"></td> <td style="width: 10%;"></td> <td style="width: 10%;"></td> <td style="width: 10%;"></td> <td style="width: 10%;"></td> <td style="width: 10%;"></td> <td style="width: 10%;"></td> </tr> <tr> <td></td> <td></td> <td colspan="8" style="text-align: center;"> <table border="1" style="width: 100%; border-collapse: collapse; text-align: center;"> <tr> <td style="width: 10%;"></td> <td style="width: 10%;"></td> <td style="width: 10%;"></td> <td style="width: 10%;"></td> <td style="width: 10%;"></td> <td style="width: 10%;"></td> <td style="width: 10%;"></td> <td style="width: 10%;"></td> <td style="width: 10%;"></td> <td style="width:
10%;"></td> </tr> <tr> <td></td> <td></td> <td colspan="8" style="text-align: center;"> <table border="1" style="width: 100%; border-collapse: collapse; text-align: center;"> <tr> <td style="width: 10%;"></td> <td style="width: 10%;"></td> <td style="width: 10%;"></td> <td style="width: 10%;"></td> <td style="width: 10%;"></td> <td style="width: 10%;"></td> <td style="width: 10%;"></td> <td style="width: 10%;"></td> <td style="width: 10%;"></td> <td style="width: 10%;"></td> </tr> <tr> <td></td> <td></td> <td colspan="8" style="text-align: center;"> <table border="1" style="width: 100%; border-collapse: collapse; text-align: center;"> <tr> <td style="width: 10%;"></td> <td style="width: 10%;"></td> <td style="width: 10%;"></td> <td style="width: 10%;"></td> <td style="width: 10%;"></td> <td style="width: 10%;"></td> <td style="width: 10%;"></td> <td style="width: 10%;"></td> <td style="width: 10%;"></td> <td style="width: 10%;"></td> </tr> <tr> <td></td> <td></td> <td colspan="8" style="text-align: center;"> <table border="1" style="width: 100%; border-collapse: collapse; text-align: center;"> <tr> <td style="width: 10%;"></td> <td style="width: 10%;"></td> <td style="width: 10%;"></td> <td style="width: 10%;"></td> <td style="width: 10%;"></td> <td style="width: 10%;"></td> <td style="width: 10%;"></td> <td style="width: 10%;"></td> <td style="width: 10%;"></td> <td style="width: 10%;"></td> </tr> <tr> <td></td> <td></td> <td colspan="8" style="text-align: center;"> <table border="1" style="width: 100%; border-collapse: collapse; text-align: center;"> <tr> <td style="width: 10%;"></td> <td style="width: 10%;"></td> <td style="width: 10%;"></td> <td style="width: 10%;"></td> <td style="width: 10%;"></td> <td style="width: 10%;"></td> <td style="width: 10%;"></td> <td style="width: 10%;"></td> <td style="width: 10%;"></td> <td style="width: 10%;"></td> </tr> <tr> <td></td> <td></td> <td colspan="8" style="text-align: center;"> <table border="1" style="width: 100%; border-collapse: collapse; text-align: center;"> <tr> <td style="width: 10%;"></td> <td style="width: 10%;"></td> <td style="width: 10%;"></td> <td style="width: 10%;"></td> <td style="width: 10%;"></td> <td style="width: 10%;"></td> <td style="width: 10%;"></td> <td style="width: 10%;"></td> <td style="width: 10%;"></td> <td style="width: 10%;"></td> </tr> <tr> <td></td> <td></td> <td colspan="8" style="text-align: center;"> <table border="1" style="width: 100%; border-collapse: collapse; text-align: center;"> <tr> <td style="width: 10%;"></td> <td style="width: 10%;"></td> <td style="width: 10%;"></td> <td style="width: 10%;"></td> <td style="width: 10%;"></td> <td style="width: 10%;"></td> <td style="width: 10%;"></td> <td style="width: 10%;"></td> <td style="width: 10%;"></td> <td style="width: 10%;"></td> </tr> <tr> <td></td> <td></td> <td colspan="8" style="text-align: center;"> <table border="1" style="width: 100%; border-collapse: collapse; text-align: center;"> <tr> <td style="width: 10%;"></td> <td style="width: 10%;"></td> <td style="width: 10%;"></td> <td style="width: 10%;"></td> <td style="width: 10%;"></td> <td style="width: 10%;"></td> <td style="width: 10%;"></td> <td style="width: 10%;"></td> <td style="width: 10%;"></td> <td style="width: 10%;"></td> </tr> <tr> <td></td> <td></td> <td colspan="8" style="text-align: center;"> <table border="1" style="width: 100%; border-collapse: collapse; text-align: center;"> <tr> <td style="width: 10%;"></td> <td style="width: 10%;"></td> <td style="width: 10%;"></td> <td style="width: 10%;"></td> <td style="width: 10%;"></td> <td style="width: 10%;"></td> <td style="width: 10%;"></td> <td style="width: 10%;"></td> <td style="width: 10%;"></td> <td style="width: 10%;"></td> </tr> <tr> <td></td> <td></td> <td colspan="8" style="text-align: center;"> <table border="1" style="width: 100%; border-collapse: collapse; text-align: center;"> <tr> <td style="width: 10%;"></td> <td style="width: 10%;"></td> <td style="width: 10%;"></td> <td style="width: 10%;"></td> <td style="width: 10%;"></td> <td style="width: 10%;"></td> <td style="width: 10%;"></td> <td style="width: 10%;"></td> <td style="width: 10%;"></td> <td style="width: 10%;"></td> </tr> <tr> <td></td> <td></td> <td colspan="8" style="text-align: center;"> <table border="1" style="width: 100%; border-collapse: collapse; text-align: center;"> <tr> <td style="width: 10%;"></td> <td style="width: 10%;"></td> <td style="width: 10%;"></td> <td style="width: 10%;"></td> <td style="width: 10%;"></td> <td style="width: 10%;"></td> <td style="width: 10%;"></td> <td style="width: 10%;"></td> <td style="width: 10%;"></td> <td style="width: 10%;"></td> </tr> <tr> <td></td> <td></td> <td colspan="8" style="text-align: center;"> <table border="1" style="width: 100%; border-collapse: collapse; text-align: center;"> <tr> <td style="width: 10%;"></td> <td style="width: 10%;"></td> <td style="width: 10%;"></td> <td style="width: 10%;"></td> <td style="width: 10%;"></td> <td style="width: 10%;"></td> <td style="width: 10%;"></td> <td style="width: 10%;"></td> <td style="width: 10%;"></td> <td style="width: 10%;"></td> </tr> <tr> <td></td> <td></td> <td colspan="8" style="text-align: center;"> <table border="1" style="width: 100%; border-collapse: collapse; text-align: center;"> <tr> <td style="width: 10%;"></td> <td style="width: 10%;"></td> <td style="width: 10%;"></td> <td style="width: 10%;"></td> <td style="width: 10%;"></td> <td style="width: 10%;"></td> <td style="width: 10%;"></td> <td style="width: 10%;"></td> <td style="width: 10%;"></td> <td style="width: 10%;"></td> </tr> <tr> <td></td> <td></td> <td colspan="8" style="text-align: center;"> <table border="1" style="width: 100%; border-collapse: collapse; text-align: center;"> <tr> <td style="width: 10%;"></td> <td style="width: 10%;"></td> <td style="width: 10%;"></td> <td style="width: 10%;"></td> <td style="width: 10%;"></td> <td style="width: 10%;"></td> <td style="width: 10%;"></td> <td style="width: 10%;"></td> <td style="width: 10%;"></td> <td style="width: 10%;"></td> </tr> <tr> <td></td> <td></td> <td colspan="8" style="text-align: center;"> <table border="1" style="width: 100%; border-collapse: collapse; text-align: center;"> <tr> <td style="width: 10%;"></td> <td style="width: 10%;"></td> <td style="width: 10%;"></td> <td style="width: 10%;"></td> <td style="width: 10%;"></td> <td style="width: 10%;"></td> <td style="width: 10%;"></td> <td style="width: 10%;"></td> <td style="width: 10%;"></td> <td style="width: 10%;"></td> </tr> <tr> <td></td> <td></td> <td colspan="8" style="text-align: center;"> <table border="1" style="width: 100%; border-collapse: collapse; text-align: center;"> <tr> <td style="width: 10%;"></td> <td style="width: 10%;"></td> <td style="width: 10%;"></td> <td style="width: 10%;"></td> <td style="width: 10%;"></td> <td style="width: 10%;"></td> <td style="width: 10%;"></td> <td style="width: 10%;"></td> <td style="width: 10%;"></td> <td style="width: 10%;"></td> </tr> <tr> <td></td> <td></td> <td colspan="8" style="text-align: center;"> <table border="1" style="width: 100%; border-collapse: collapse; text-align: center;"> <tr> </tr></table></td></tr></table></td></tr></table></td></tr></table></td></tr></table></td></tr></table></td></tr></table></td></tr></table></td></tr></table></td></tr></table></td></tr></table></td></tr></table></td></tr></table></td></tr></table></td></tr></table></td></tr></table></td></tr></table></td></tr></table></td></tr></table></td></tr></table></td></tr></table></td></tr></table></td></tr></table></td></tr></table></td></tr></table></td></tr></table></td></tr></table></td></tr></table></td></tr></table></td></tr></table></td></tr></table></td></tr></table></td></tr></table></td></tr></table> | | | | | | | | | | | | | | | | | | | | <table border="1" style="width: 100%; border-collapse: collapse; text-align: center;"> <tr> <td style="width: 10%;"></td> <td style="width: 10%;"></td> <td style="width: 10%;"></td> <td style="width: 10%;"></td> <td style="width: 10%;"></td> <td style="width: 10%;"></td> <td style="width: 10%;"></td> <td style="width: 10%;"></td> <td style="width: 10%;"></td> <td style="width: 10%;"></td> </tr> <tr> <td></td> <td></td> <td colspan="8" style="text-align: center;"> <table border="1" style="width: 100%; border-collapse: collapse; text-align: center;"> <tr> <td style="width: 10%;"></td> <td style="width: 10%;"></td> <td style="width: 10%;"></td> <td style="width: 10%;"></td> <td style="width: 10%;"></td> <td style="width: 10%;"></td> <td style="width: 10%;"></td> <td style="width: 10%;"></td> <td style="width: 10%;"></td> <td style="width: 10%;"></td> </tr> <tr> <td></td> <td></td> <td colspan="8" style="text-align: center;"> <table border="1" style="width: 100%; border-collapse: collapse; text-align: center;"> <tr> <td style="width: 10%;"></td> <td style="width: 10%;"></td> <td style="width: 10%;"></td> <td style="width: 10%;"></td> <td
style="width: 10%;"></td> <td style="width: 10%;"></td> <td style="width: 10%;"></td> <td style="width: 10%;"></td> <td style="width: 10%;"></td> <td style="width: 10%;"></td> </tr> <tr> <td></td> <td></td> <td colspan="8" style="text-align: center;"> <table border="1" style="width: 100%; border-collapse: collapse; text-align: center;"> <tr> <td style="width: 10%;"></td> <td style="width: 10%;"></td> <td style="width: 10%;"></td> <td style="width: 10%;"></td> <td style="width: 10%;"></td> <td style="width: 10%;"></td> <td style="width: 10%;"></td> <td style="width: 10%;"></td> <td style="width: 10%;"></td> <td style="width: 10%;"></td> </tr> <tr> <td></td> <td></td> <td colspan="8" style="text-align: center;"> <table border="1" style="width: 100%; border-collapse: collapse; text-align: center;"> <tr> <td style="width: 10%;"></td> <td style="width: 10%;"></td> <td style="width: 10%;"></td> <td style="width: 10%;"></td> <td style="width: 10%;"></td> <td style="width: 10%;"></td> <td style="width: 10%;"></td> <td style="width: 10%;"></td> <td style="width: 10%;"></td> <td style="width: 10%;"></td> </tr> <tr> <td></td> <td></td> <td colspan="8" style="text-align: center;"> <table border="1" style="width: 100%; border-collapse: collapse; text-align: center;"> <tr> <td style="width: 10%;"></td> <td style="width: 10%;"></td> <td style="width: 10%;"></td> <td style="width: 10%;"></td> <td style="width: 10%;"></td> <td style="width: 10%;"></td> <td style="width: 10%;"></td> <td style="width: 10%;"></td> <td style="width: 10%;"></td> <td style="width: 10%;"></td> </tr> <tr> <td></td> <td></td> <td colspan="8" style="text-align: center;"> <table border="1" style="width: 100%; border-collapse: collapse; text-align: center;"> <tr> <td style="width: 10%;"></td> <td style="width: 10%;"></td> <td style="width: 10%;"></td> <td style="width: 10%;"></td> <td style="width: 10%;"></td> <td style="width: 10%;"></td> <td style="width: 10%;"></td> <td style="width: 10%;"></td> <td style="width: 10%;"></td> <td style="width: 10%;"></td> </tr> <tr> <td></td> <td></td> <td colspan="8" style="text-align: center;"> <table border="1" style="width: 100%; border-collapse: collapse; text-align: center;"> <tr> <td style="width: 10%;"></td> <td style="width: 10%;"></td> <td style="width: 10%;"></td> <td style="width: 10%;"></td> <td style="width: 10%;"></td> <td style="width: 10%;"></td> <td style="width: 10%;"></td> <td style="width: 10%;"></td> <td style="width: 10%;"></td> <td style="width: 10%;"></td> </tr> <tr> <td></td> <td></td> <td colspan="8" style="text-align: center;"> <table border="1" style="width: 100%; border-collapse: collapse; text-align: center;"> <tr> <td style="width: 10%;"></td> <td style="width: 10%;"></td> <td style="width: 10%;"></td> <td style="width: 10%;"></td> <td style="width: 10%;"></td> <td style="width: 10%;"></td> <td style="width: 10%;"></td> <td style="width: 10%;"></td> <td style="width: 10%;"></td> <td style="width: 10%;"></td> </tr> <tr> <td></td> <td></td> <td colspan="8" style="text-align: center;"> <table border="1" style="width: 100%; border-collapse: collapse; text-align: center;"> <tr> <td style="width: 10%;"></td> <td style="width: 10%;"></td> <td style="width: 10%;"></td> <td style="width: 10%;"></td> <td style="width: 10%;"></td> <td style="width: 10%;"></td> <td style="width: 10%;"></td> <td style="width: 10%;"></td> <td style="width: 10%;"></td> <td style="width: 10%;"></td> </tr> <tr> <td></td> <td></td> <td colspan="8" style="text-align: center;"> <table border="1" style="width: 100%; border-collapse: collapse; text-align: center;"> <tr> <td style="width: 10%;"></td> <td style="width: 10%;"></td> <td style="width: 10%;"></td> <td style="width: 10%;"></td> <td style="width: 10%;"></td> <td style="width: 10%;"></td> <td style="width: 10%;"></td> <td style="width: 10%;"></td> <td style="width: 10%;"></td> <td style="width: 10%;"></td> </tr> <tr> <td></td> <td></td> <td colspan="8" style="text-align: center;"> <table border="1" style="width: 100%; border-collapse: collapse; text-align: center;"> <tr> <td style="width: 10%;"></td> <td style="width: 10%;"></td> <td style="width: 10%;"></td> <td style="width: 10%;"></td> <td style="width: 10%;"></td> <td style="width: 10%;"></td> <td style="width: 10%;"></td> <td style="width: 10%;"></td> <td style="width: 10%;"></td> <td style="width: 10%;"></td> </tr> <tr> <td></td> <td></td> <td colspan="8" style="text-align: center;"> <table border="1" style="width: 100%; border-collapse: collapse; text-align: center;"> <tr> <td style="width: 10%;"></td> <td style="width: 10%;"></td> <td style="width: 10%;"></td> <td style="width: 10%;"></td> <td style="width: 10%;"></td> <td style="width: 10%;"></td> <td style="width: 10%;"></td> <td style="width: 10%;"></td> <td style="width: 10%;"></td> <td style="width: 10%;"></td> </tr> <tr> <td></td> <td></td> <td colspan="8" style="text-align: center;"> <table border="1" style="width: 100%; border-collapse: collapse; text-align: center;"> <tr> <td style="width: 10%;"></td> <td style="width: 10%;"></td> <td style="width: 10%;"></td> <td style="width: 10%;"></td> <td style="width: 10%;"></td> <td style="width: 10%;"></td> <td style="width: 10%;"></td> <td style="width: 10%;"></td> <td style="width: 10%;"></td> <td style="width: 10%;"></td> </tr> <tr> <td></td> <td></td> <td colspan="8" style="text-align: center;"> <table border="1" style="width: 100%; border-collapse: collapse; text-align: center;"> <tr> <td style="width: 10%;"></td> <td style="width: 10%;"></td> <td style="width: 10%;"></td> <td style="width: 10%;"></td> <td style="width: 10%;"></td> <td style="width: 10%;"></td> <td style="width: 10%;"></td> <td style="width: 10%;"></td> <td style="width: 10%;"></td> <td style="width: 10%;"></td> </tr> <tr> <td></td> <td></td> <td colspan="8" style="text-align: center;"> <table border="1" style="width: 100%; border-collapse: collapse; text-align: center;"> <tr> <td style="width: 10%;"></td> <td style="width: 10%;"></td> <td style="width: 10%;"></td> <td style="width: 10%;"></td> <td style="width: 10%;"></td> <td style="width: 10%;"></td> <td style="width: 10%;"></td> <td style="width: 10%;"></td> <td style="width: 10%;"></td> <td style="width: 10%;"></td> </tr> <tr> <td></td> <td></td> <td colspan="8" style="text-align: center;"> <table border="1" style="width: 100%; border-collapse: collapse; text-align: center;"> <tr> <td style="width: 10%;"></td> <td style="width: 10%;"></td> <td style="width: 10%;"></td> <td style="width: 10%;"></td> <td style="width: 10%;"></td> <td style="width: 10%;"></td> <td style="width: 10%;"></td> <td style="width: 10%;"></td> <td style="width: 10%;"></td> <td style="width: 10%;"></td> </tr> <tr> <td></td> <td></td> <td colspan="8" style="text-align: center;"> <table border="1" style="width: 100%; border-collapse: collapse; text-align: center;"> <tr> <td style="width: 10%;"></td> <td style="width: 10%;"></td> <td style="width: 10%;"></td> <td style="width: 10%;"></td> <td style="width: 10%;"></td> <td style="width: 10%;"></td> <td style="width: 10%;"></td> <td style="width: 10%;"></td> <td style="width: 10%;"></td> <td style="width: 10%;"></td> </tr> <tr> <td></td> <td></td> <td colspan="8" style="text-align: center;"> <table border="1" style="width: 100%; border-collapse: collapse; text-align: center;"> <tr> <td style="width: 10%;"></td> <td style="width: 10%;"></td> <td style="width: 10%;"></td> <td style="width: 10%;"></td> <td style="width: 10%;"></td> <td style="width: 10%;"></td> <td style="width: 10%;"></td> <td style="width: 10%;"></td> <td style="width: 10%;"></td> <td style="width: 10%;"></td> </tr> <tr> <td></td> <td></td> <td colspan="8" style="text-align: center;"> <table border="1" style="width: 100%; border-collapse: collapse; text-align: center;"> <tr> <td style="width: 10%;"></td> <td style="width: 10%;"></td> <td style="width: 10%;"></td> <td style="width: 10%;"></td> <td style="width: 10%;"></td> <td style="width: 10%;"></td> <td style="width: 10%;"></td> <td style="width: 10%;"></td> <td style="width: 10%;"></td> <td style="width: 10%;"></td> </tr> <tr> <td></td> <td></td> <td colspan="8" style="text-align: center;"> <table border="1" style="width: 100%; border-collapse: collapse; text-align: center;"> <tr> <td style="width: 10%;"></td> <td style="width: 10%;"></td> <td style="width: 10%;"></td> <td style="width: 10%;"></td> <td style="width: 10%;"></td> <td style="width: 10%;"></td> <td style="width: 10%;"></td> <td style="width: 10%;"></td> <td style="width: 10%;"></td> <td style="width: 10%;"></td> </tr> <tr> <td></td> <td></td> <td colspan="8" style="text-align: center;"> <table border="1" style="width: 100%; border-collapse: collapse; text-align: center;"> <tr> <td style="width: 10%;"></td> <td style="width: 10%;"></td> <td style="width: 10%;"></td> <td style="width: 10%;"></td> <td style="width: 10%;"></td> <td style="width: 10%;"></td> <td style="width: 10%;"></td> <td style="width: 10%;"></td> <td style="width: 10%;"></td> <td style="width: 10%;"></td> </tr> <tr> <td></td> <td></td> <td colspan="8" style="text-align: center;"> <table border="1" style="width: 100%; border-collapse: collapse; text-align: center;"> <tr> <td style="width: 10%;"></td> <td style="width: 10%;"></td> <td style="width: 10%;"></td> <td style="width: 10%;"></td> <td style="width: 10%;"></td> <td style="width: 10%;"></td> <td style="width: 10%;"></td> <td style="width: 10%;"></td> <td style="width: 10%;"></td> <td style="width: 10%;"></td> </tr> <tr> <td></td> <td></td> <td colspan="8" style="text-align: center;"> <table border="1" style="width: 100%; border-collapse: collapse; text-align: center;"> <tr> <td style="width: 10%;"></td> <td style="width: 10%;"></td> <td style="width: 10%;"></td> <td style="width: 10%;"></td> <td style="width: 10%;"></td> <td style="width: 10%;"></td> <td style="width: 10%;"></td> <td style="width: 10%;"></td> <td style="width: 10%;"></td> <td style="width:
10%;"></td> </tr> <tr> <td></td> <td></td> <td colspan="8" style="text-align: center;"> <table border="1" style="width: 100%; border-collapse: collapse; text-align: center;"> <tr> <td style="width: 10%;"></td> <td style="width: 10%;"></td> <td style="width: 10%;"></td> <td style="width: 10%;"></td> <td style="width: 10%;"></td> <td style="width: 10%;"></td> <td style="width: 10%;"></td> <td style="width: 10%;"></td> <td style="width: 10%;"></td> <td style="width: 10%;"></td> </tr> <tr> <td></td> <td></td> <td colspan="8" style="text-align: center;"> <table border="1" style="width: 100%; border-collapse: collapse; text-align: center;"> <tr> <td style="width: 10%;"></td> <td style="width: 10%;"></td> <td style="width: 10%;"></td> <td style="width: 10%;"></td> <td style="width: 10%;"></td> <td style="width: 10%;"></td> <td style="width: 10%;"></td> <td style="width: 10%;"></td> <td style="width: 10%;"></td> <td style="width: 10%;"></td> </tr> <tr> <td></td> <td></td> <td colspan="8" style="text-align: center;"> <table border="1" style="width: 100%; border-collapse: collapse; text-align: center;"> <tr> <td style="width: 10%;"></td> <td style="width: 10%;"></td> <td style="width: 10%;"></td> <td style="width: 10%;"></td> <td style="width: 10%;"></td> <td style="width: 10%;"></td> <td style="width: 10%;"></td> <td style="width: 10%;"></td> <td style="width: 10%;"></td> <td style="width: 10%;"></td> </tr> <tr> <td></td> <td></td> <td colspan="8" style="text-align: center;"> <table border="1" style="width: 100%; border-collapse: collapse; text-align: center;"> <tr> <td style="width: 10%;"></td> <td style="width: 10%;"></td> <td style="width: 10%;"></td> <td style="width: 10%;"></td> <td style="width: 10%;"></td> <td style="width: 10%;"></td> <td style="width: 10%;"></td> <td style="width: 10%;"></td> <td style="width: 10%;"></td> <td style="width: 10%;"></td> </tr> <tr> <td></td> <td></td> <td colspan="8" style="text-align: center;"> <table border="1" style="width: 100%; border-collapse: collapse; text-align: center;"> <tr> <td style="width: 10%;"></td> <td style="width: 10%;"></td> <td style="width: 10%;"></td> <td style="width: 10%;"></td> <td style="width: 10%;"></td> <td style="width: 10%;"></td> <td style="width: 10%;"></td> <td style="width: 10%;"></td> <td style="width: 10%;"></td> <td style="width: 10%;"></td> </tr> <tr> <td></td> <td></td> <td colspan="8" style="text-align: center;"> <table border="1" style="width: 100%; border-collapse: collapse; text-align: center;"> <tr> <td style="width: 10%;"></td> <td style="width: 10%;"></td> <td style="width: 10%;"></td> <td style="width: 10%;"></td> <td style="width: 10%;"></td> <td style="width: 10%;"></td> <td style="width: 10%;"></td> <td style="width: 10%;"></td> <td style="width: 10%;"></td> <td style="width: 10%;"></td> </tr> <tr> <td></td> <td></td> <td colspan="8" style="text-align: center;"> <table border="1" style="width: 100%; border-collapse: collapse; text-align: center;"> <tr> <td style="width: 10%;"></td> <td style="width: 10%;"></td> <td style="width: 10%;"></td> <td style="width: 10%;"></td> <td style="width: 10%;"></td> <td style="width: 10%;"></td> <td style="width: 10%;"></td> <td style="width: 10%;"></td> <td style="width: 10%;"></td> <td style="width: 10%;"></td> </tr> <tr> <td></td> <td></td> <td colspan="8" style="text-align: center;"> <table border="1" style="width: 100%; border-collapse: collapse; text-align: center;"> <tr> <td style="width: 10%;"></td> <td style="width: 10%;"></td> <td style="width: 10%;"></td> <td style="width: 10%;"></td> <td style="width: 10%;"></td> <td style="width: 10%;"></td> <td style="width: 10%;"></td> <td style="width: 10%;"></td> <td style="width: 10%;"></td> <td style="width: 10%;"></td> </tr> <tr> <td></td> <td></td> <td colspan="8" style="text-align: center;"> <table border="1" style="width: 100%; border-collapse: collapse; text-align: center;"> <tr> </tr></table></td></tr></table></td></tr></table></td></tr></table></td></tr></table></td></tr></table></td></tr></table></td></tr></table></td></tr></table></td></tr></table></td></tr></table></td></tr></table></td></tr></table></td></tr></table></td></tr></table></td></tr></table></td></tr></table></td></tr></table></td></tr></table></td></tr></table></td></tr></table></td></tr></table></td></tr></table></td></tr></table></td></tr></table></td></tr></table></td></tr></table></td></tr></table></td></tr></table></td></tr></table></td></tr></table></td></tr></table></td></tr></table> | | | | | | | | | | | | | | | | | | | | <table border="1" style="width: 100%; border-collapse: collapse; text-align: center;"> <tr> <td style="width: 10%;"></td> <td style="width: 10%;"></td> <td style="width: 10%;"></td> <td style="width: 10%;"></td> <td style="width: 10%;"></td> <td style="width: 10%;"></td> <td style="width: 10%;"></td> <td style="width: 10%;"></td> <td style="width: 10%;"></td> <td style="width: 10%;"></td> </tr> <tr> <td></td> <td></td> <td colspan="8" style="text-align: center;"> <table border="1" style="width: 100%; border-collapse: collapse; text-align: center;"> <tr> <td style="width: 10%;"></td> <td style="width: 10%;"></td> <td style="width: 10%;"></td> <td style="width: 10%;"></td> <td style="width: 10%;"></td> <td style="width: 10%;"></td> <td style="width: 10%;"></td> <td style="width: 10%;"></td> <td style="width: 10%;"></td> <td style="width: 10%;"></td> </tr> <tr> <td></td> <td></td> <td colspan="8" style="text-align: center;"> <table border="1" style="width: 100%; border-collapse: collapse; text-align: center;"> <tr> <td style="width: 10%;"></td> <td style="width: 10%;"></td> <td style="width: 10%;"></td> <td style="width: 10%;"></td> <td style="width: 10%;"></td> <td style="width: 10%;"></td> <td style="width: 10%;"></td> <td style="width: 10%;"></td> <td style="width: 10%;"></td> <td style="width: 10%;"></td> </tr> <tr> <td></td> <td></td> <td colspan="8" style="text-align: center;"> <table border="1" style="width: 100%; border-collapse: collapse; text-align: center;"> <tr> <td style="width: 10%;"></td> <td style="width: 10%;"></td> <td style="width: 10%;"></td> <td style="width: 10%;"></td> <td style="width: 10%;"></td> <td style="width: 10%;"></td> <td style="width: 10%;"></td> <td style="width: 10%;"></td> <td style="width: 10%;"></td> <td style="width: 10%;"></td> </tr> <tr> <td></td> <td></td> <td colspan="8" style="text-align: center;"> <table border="1" style="width: 100%; border-collapse: collapse; text-align: center;"> <tr> <td style="width: 10%;"></td> <td style="width: 10%;"></td> <td style="width: 10%;"></td> <td style="width: 10%;"></td> <td style="width: 10%;"></td> <td style="width: 10%;"></td> <td style="width: 10%;"></td> <td style="width: 10%;"></td> <td style="width: 10%;"></td> <td style="width: 10%;"></td> </tr> <tr> <td></td> <td></td> <td colspan="8" style="text-align: center;"> <table border="1" style="width: 100%; border-collapse: collapse; text-align: center;"> <tr> <td style="width: 10%;"></td> <td style="width: 10%;"></td> <td style="width: 10%;"></td> <td style="width: 10%;"></td> <td style="width: 10%;"></td> <td style="width: 10%;"></td> <td style="width: 10%;"></td> <td style="width: 10%;"></td> <td style="width: 10%;"></td> <td style="width: 10%;"></td> </tr> <tr> <td></td> <td></td> <td colspan="8" style="text-align: center;"> <table border="1" style="width: 100%; border-collapse: collapse; text-align: center;"> <tr> <td style="width: 10%;"></td> <td style="width: 10%;"></td> <td style="width: 10%;"></td> <td style="width: 10%;"></td> <td style="width: 10%;"></td> <td style="width: 10%;"></td> <td style="width: 10%;"></td> <td style="width: 10%;"></td> <td style="width: 10%;"></td> <td style="width: 10%;"></td> </tr> <tr> <td></td> <td></td> <td colspan="8" style="text-align: center;"> <table border="1" style="width: 100%; border-collapse: collapse; text-align: center;"> <tr> <td style="width: 10%;"></td> <td style="width: 10%;"></td> <td style="width: 10%;"></td> <td style="width: 10%;"></td> <td style="width: 10%;"></td> <td style="width: 10%;"></td> <td style="width: 10%;"></td> <td style="width: 10%;"></td> <td style="width: 10%;"></td> <td style="width: 10%;"></td> </tr> <tr> <td></td> <td></td> <td colspan="8" style="text-align: center;"> <table border="1" style="width: 100%; border-collapse: collapse; text-align: center;"> <tr> <td style="width: 10%;"></td> <td style="width: 10%;"></td> <td style="width: 10%;"></td> <td style="width: 10%;"></td> <td style="width: 10%;"></td> <td style="width: 10%;"></td> <td style="width: 10%;"></td> <td style="width: 10%;"></td> <td style="width: 10%;"></td> <td style="width: 10%;"></td> </tr> <tr> <td></td> <td></td> <td colspan="8" style="text-align: center;"> <table border="1" style="width: 100%; border-collapse: collapse; text-align: center;"> <tr> <td style="width: 10%;"></td> <td style="width: 10%;"></td> <td style="width: 10%;"></td> <td style="width: 10%;"></td> <td style="width: 10%;"></td>
<td style="width: 10%;"></td> <td style="width: 10%;"></td> <td style="width: 10%;"></td> <td style="width: 10%;"></td> <td style="width: 10%;"></td> </tr> <tr> <td></td> <td></td> <td colspan="8" style="text-align: center;"> <table border="1" style="width: 100%; border-collapse: collapse; text-align: center;"> <tr> <td style="width: 10%;"></td> <td style="width: 10%;"></td> <td style="width: 10%;"></td> <td style="width: 10%;"></td> <td style="width: 10%;"></td> <td style="width: 10%;"></td> <td style="width: 10%;"></td> <td style="width: 10%;"></td> <td style="width: 10%;"></td> <td style="width: 10%;"></td> </tr> <tr> <td></td> <td></td> <td colspan="8" style="text-align: center;"> <table border="1" style="width: 100%; border-collapse: collapse; text-align: center;"> <tr> <td style="width: 10%;"></td> <td style="width: 10%;"></td> <td style="width: 10%;"></td> <td style="width: 10%;"></td> <td style="width: 10%;"></td> <td style="width: 10%;"></td> <td style="width: 10%;"></td> <td style="width: 10%;"></td> <td style="width: 10%;"></td> <td style="width: 10%;"></td> </tr> <tr> <td></td> <td></td> <td colspan="8" style="text-align: center;"> <table border="1" style="width: 100%; border-collapse: collapse; text-align: center;"> <tr> <td style="width: 10%;"></td> <td style="width: 10%;"></td> <td style="width: 10%;"></td> <td style="width: 10%;"></td> <td style="width: 10%;"></td> <td style="width: 10%;"></td> <td style="width: 10%;"></td> <td style="width: 10%;"></td> <td style="width: 10%;"></td> <td style="width: 10%;"></td> </tr> <tr> <td></td> <td></td> <td colspan="8" style="text-align: center;"> <table border="1" style="width: 100%; border-collapse: collapse; text-align: center;"> <tr> <td style="width: 10%;"></td> <td style="width: 10%;"></td> <td style="width: 10%;"></td> <td style="width: 10%;"></td> <td style="width: 10%;"></td> <td style="width: 10%;"></td> <td style="width: 10%;"></td> <td style="width: 10%;"></td> <td style="width: 10%;"></td> <td style="width: 10%;"></td> </tr> <tr> <td></td> <td></td> <td colspan="8" style="text-align: center;"> <table border="1" style="width: 100%; border-collapse: collapse; text-align: center;"> <tr> <td style="width: 10%;"></td> <td style="width: 10%;"></td> <td style="width: 10%;"></td> <td style="width: 10%;"></td> <td style="width: 10%;"></td> <td style="width: 10%;"></td> <td style="width: 10%;"></td> <td style="width: 10%;"></td> <td style="width: 10%;"></td> <td style="width: 10%;"></td> </tr> <tr> <td></td> <td></td> <td colspan="8" style="text-align: center;"> <table border="1" style="width: 100%; border-collapse: collapse; text-align: center;"> <tr> <td style="width: 10%;"></td> <td style="width: 10%;"></td> <td style="width: 10%;"></td> <td style="width: 10%;"></td> <td style="width: 10%;"></td> <td style="width: 10%;"></td> <td style="width: 10%;"></td> <td style="width: 10%;"></td> <td style="width: 10%;"></td> <td style="width: 10%;"></td> </tr> <tr> <td></td> <td></td> <td colspan="8" style="text-align: center;"> <table border="1" style="width: 100%; border-collapse: collapse; text-align: center;"> <tr> <td style="width: 10%;"></td> <td style="width: 10%;"></td> <td style="width: 10%;"></td> <td style="width: 10%;"></td> <td style="width: 10%;"></td> <td style="width: 10%;"></td> <td style="width: 10%;"></td> <td style="width: 10%;"></td> <td style="width: 10%;"></td> <td style="width: 10%;"></td> </tr> <tr> <td></td> <td></td> <td colspan="8" style="text-align: center;"> <table border="1" style="width: 100%; border-collapse: collapse; text-align: center;"> <tr> <td style="width: 10%;"></td> <td style="width: 10%;"></td> <td style="width: 10%;"></td> <td style="width: 10%;"></td> <td style="width: 10%;"></td> <td style="width: 10%;"></td> <td style="width: 10%;"></td> <td style="width: 10%;"></td> <td style="width: 10%;"></td> <td style="width: 10%;"></td> </tr> <tr> <td></td> <td></td> <td colspan="8" style="text-align: center;"> <table border="1" style="width: 100%; border-collapse: collapse; text-align: center;"> <tr> <td style="width: 10%;"></td> <td style="width: 10%;"></td> <td style="width: 10%;"></td> <td style="width: 10%;"></td> <td style="width: 10%;"></td> <td style="width: 10%;"></td> <td style="width: 10%;"></td> <td style="width: 10%;"></td> <td style="width: 10%;"></td> <td style="width: 10%;"></td> </tr> <tr> <td></td> <td></td> <td colspan="8" style="text-align: center;"> <table border="1" style="width: 100%; border-collapse: collapse; text-align: center;"> <tr> <td style="width: 10%;"></td> <td style="width: 10%;"></td> <td style="width: 10%;"></td> <td style="width: 10%;"></td> <td style="width: 10%;"></td> <td style="width: 10%;"></td> <td style="width: 10%;"></td> <td style="width: 10%;"></td> <td style="width: 10%;"></td> <td style="width: 10%;"></td> </tr> <tr> <td></td> <td></td> <td colspan="8" style="text-align: center;"> <table border="1" style="width: 100%; border-collapse: collapse; text-align: center;"> <tr> <td style="width: 10%;"></td> <td style="width: 10%;"></td> <td style="width: 10%;"></td> <td style="width: 10%;"></td> <td style="width: 10%;"></td> <td style="width: 10%;"></td> <td style="width: 10%;"></td> <td style="width: 10%;"></td> <td style="width: 10%;"></td> <td style="width: 10%;"></td> </tr> <tr> <td></td> <td></td> <td colspan="8" style="text-align: center;"> <table border="1" style="width: 100%; border-collapse: collapse; text-align: center;"> <tr> <td style="width: 10%;"></td> <td style="width: 10%;"></td> <td style="width: 10%;"></td> <td style="width: 10%;"></td> <td style="width: 10%;"></td> <td style="width: 10%;"></td> <td style="width: 10%;"></td> <td style="width: 10%;"></td> <td style="width: 10%;"></td> <td style="width: 10%;"></td> </tr> <tr> <td></td> <td></td> <td colspan="8" style="text-align: center;"> <table border="1" style="width: 100%; border-collapse: collapse; text-align: center;"> <tr> <td style="width: 10%;"></td> <td style="width: 10%;"></td> <td style="width: 10%;"></td> <td style="width: 10%;"></td> <td style="width: 10%;"></td> <td style="width: 10%;"></td> <td style="width: 10%;"></td> <td style="width: 10%;"></td> <td style="width: 10%;"></td> <td style="width: 10%;"></td> </tr> <tr> <td></td> <td></td> <td colspan="8" style="text-align: center;"> <table border="1" style="width: 100%; border-collapse: collapse; text-align: center;"> <tr> <td style="width: 10%;"></td> <td style="width: 10%;"></td> <td style="width: 10%;"></td> <td style="width: 10%;"></td> <td style="width: 10%;"></td> <td style="width: 10%;"></td> <td style="width: 10%;"></td> <td style="width: 10%;"></td> <td style="width: 10%;"></td> <td style="width: 10%;"></td> </tr> <tr> <td></td> <td></td> <td colspan="8" style="text-align: center;"> <table border="1" style="width: 100%; border-collapse: collapse; text-align: center;"> <tr> <td style="width: 10%;"></td> <td style="width: 10%;"></td> <td style="width: 10%;"></td> <td style="width: 10%;"></td> <td style="width: 10%;"></td> <td style="width: 10%;"></td> <td style="width: 10%;"></td> <td style="width: 10%;"></td> <td style="width: 10%;"></td> <td style="width: 10%;"></td> </tr> <tr> <td></td> <td></td> <td colspan="8" style="text-align: center;"> <table border="1" style="width: 100%; border-collapse: collapse; text-align: center;"> <tr> <td style="width: 10%;"></td> <td style="width: 10%;"></td> <td style="width: 10%;"></td> <td style="width: 10%;"></td> <td style="width: 10%;"></td> <td style="width: 10%;"></td> <td style="width: 10%;"></td> <td style="width: 10%;"></td> <td style="width: 10%;"></td> <td style="width: 10%;"></td> </tr> <tr> <td></td> <td></td> <td colspan="8" style="text-align: center;"> <table border="1" style="width: 100%; border-collapse: collapse; text-align: center;"> <tr> <td style="width: 10%;"></td> <td style="width: 10%;"></td> <td style="width: 10%;"></td> <td style="width: 10%;"></td> <td style="width: 10%;"></td> <td style="width: 10%;"></td> <td style="width: 10%;"></td> <td style="width: 10%;"></td> <td style="width: 10%;"></td> <td style="width: 10%;"></td> </tr> <tr> <td></td> <td></td> <td colspan="8" style="text-align: center;"> <table border="1" style="width: 100%; border-collapse: collapse; text-align: center;"> <tr> <td style="width: 10%;"></td> <td style="width: 10%;"></td> <td style="width: 10%;"></td> <td style="width: 10%;"></td> <td style="width: 10%;"></td> <td style="width: 10%;"></td> <td style="width: 10%;"></td> <td style="width: 10%;"></td> <td style="width: 10%;"></td> <td style="width: 10%;"></td> </tr> <tr> <td></td> <td></td> <td colspan="8" style="text-align: center;"> <table border="1" style="width: 100%; border-collapse: collapse; text-align: center;"> <tr> <td style="width: 10%;"></td> <td style="width: 10%;"></td> <td style="width: 10%;"></td> <td style="width: 10%;"></td> <td style="width: 10%;"></td> <td style="width: 10%;"></td> <td style="width: 10%;"></td> <td style="width: 10%;"></td> <td style="width: 10%;"></td> <td style="width: 10%;"></td> </tr> <tr> <td></td> <td></td> <td colspan="8" style="text-align: center;"> <table border="1" style="width: 100%; border-collapse: collapse; text-align: center;"> <tr> <td style="width: 10%;"></td> <td style="width: 10%;"></td> <td style="width: 10%;"></td> <td style="width: 10%;"></td> <td style="width: 10%;"></td> <td style="width: 10%;"></td> <td style="width: 10%;"></td> <td style="width: 10%;"></td> <td style="width: 10%;"></td> <td style="width: 10%;"></td> </tr> <tr> <td></td> <td></td> <td colspan="8" style="text-align: center;"> <table border="1" style="width: 100%; border-collapse: collapse; text-align: center;"> <tr> <td style="width: 10%;"></td> <td style="width: 10%;"></td> <td style="width: 10%;"></td> <td style="width: 10%;"></td> <td style="width: 10%;"></td> <td style="width: 10%;"></td> <td style="width: 10%;"></td> <td style="width: 10%;"></td> <td style="width: 10%;"></td> <td style="width: 10%;"></td> </tr> <tr> <td></td>
<td></td> <td colspan="8" style="text-align: center;"> <table border="1" style="width: 100%; border-collapse: collapse; text-align: center;"> <tr> </tr></table></td></tr></table></td></tr></table></td></tr></table></td></tr></table></td></tr></table></td></tr></table></td></tr></table></td></tr></table></td></tr></table></td></tr></table></td></tr></table></td></tr></table></td></tr></table></td></tr></table></td></tr></table></td></tr></table></td></tr></table></td></tr></table></td></tr></table></td></tr></table></td></tr></table></td></tr></table></td></tr></table></td></tr></table></td></tr></table></td></tr></table></td></tr></table></td></tr></table></td></tr></table></td></tr></table></td></tr></table> | | | | | | | | | | | | | | | | | | | | <table border="1" style="width: 100%; border-collapse: collapse; text-align: center;"> <tr> <td style="width: 10%;"></td> <td style="width: 10%;"></td> <td style="width: 10%;"></td> <td style="width: 10%;"></td> <td style="width: 10%;"></td> <td style="width: 10%;"></td> <td style="width: 10%;"></td> <td style="width: 10%;"></td> <td style="width: 10%;"></td> <td style="width: 10%;"></td> </tr> <tr> <td></td> <td></td> <td colspan="8" style="text-align: center;"> <table border="1" style="width: 100%; border-collapse: collapse; text-align: center;"> <tr> <td style="width: 10%;"></td> <td style="width: 10%;"></td> <td style="width: 10%;"></td> <td style="width: 10%;"></td> <td style="width: 10%;"></td> <td style="width: 10%;"></td> <td style="width: 10%;"></td> <td style="width: 10%;"></td> <td style="width: 10%;"></td> <td style="width: 10%;"></td> </tr> <tr> <td></td> <td></td> <td colspan="8" style="text-align: center;"> <table border="1" style="width: 100%; border-collapse: collapse; text-align: center;"> <tr> <td style="width: 10%;"></td> <td style="width: 10%;"></td> <td style="width: 10%;"></td> <td style="width: 10%;"></td> <td style="width: 10%;"></td> <td style="width: 10%;"></td> <td style="width: 10%;"></td> <td style="width: 10%;"></td> <td style="width: 10%;"></td> <td style="width: 10%;"></td> </tr> <tr> <td></td> <td></td> <td colspan="8" style="text-align: center;"> <table border="1" style="width: 100%; border-collapse: collapse; text-align: center;"> <tr> <td style="width: 10%;"></td> <td style="width: 10%;"></td> <td style="width: 10%;"></td> <td style="width: 10%;"></td> <td style="width: 10%;"></td> <td style="width: 10%;"></td> <td style="width: 10%;"></td> <td style="width: 10%;"></td> <td style="width: 10%;"></td> <td style="width: 10%;"></td> </tr> <tr> <td></td> <td></td> <td colspan="8" style="text-align: center;"> <table border="1" style="width: 100%; border-collapse: collapse; text-align: center;"> <tr> <td style="width: 10%;"></td> <td style="width: 10%;"></td> <td style="width: 10%;"></td> <td style="width: 10%;"></td> <td style="width: 10%;"></td> <td style="width: 10%;"></td> <td style="width: 10%;"></td> <td style="width: 10%;"></td> <td style="width: 10%;"></td> <td style="width: 10%;"></td> </tr> <tr> <td></td> <td></td> <td colspan="8" style="text-align: center;"> <table border="1" style="width: 100%; border-collapse: collapse; text-align: center;"> <tr> <td style="width: 10%;"></td> <td style="width: 10%;"></td> <td style="width: 10%;"></td> <td style="width: 10%;"></td> <td style="width: 10%;"></td> <td style="width: 10%;"></td> <td style="width: 10%;"></td> <td style="width: 10%;"></td> <td style="width: 10%;"></td> <td style="width: 10%;"></td> </tr> <tr> <td></td> <td></td> <td colspan="8" style="text-align: center;"> <table border="1" style="width: 100%; border-collapse: collapse; text-align: center;"> <tr> <td style="width: 10%;"></td> <td style="width: 10%;"></td> <td style="width: 10%;"></td> <td style="width: 10%;"></td> <td style="width: 10%;"></td> <td style="width: 10%;"></td> <td style="width: 10%;"></td> <td style="width: 10%;"></td> <td style="width: 10%;"></td> <td style="width: 10%;"></td> </tr> <tr> <td></td> <td></td> <td colspan="8" style="text-align: center;"> <table border="1" style="width: 100%; border-collapse: collapse; text-align: center;"> <tr> <td style="width: 10%;"></td> <td style="width: 10%;"></td> <td style="width: 10%;"></td> <td style="width: 10%;"></td> <td style="width: 10%;"></td> <td style="width: 10%;"></td> <td style="width: 10%;"></td> <td style="width: 10%;"></td> <td style="width: 10%;"></td> <td style="width: 10%;"></td> </tr> <tr> <td></td> <td></td> <td colspan="8" style="text-align: center;"> <table border="1" style="width: 100%; border-collapse: collapse; text-align: center;"> <tr> <td style="width: 10%;"></td> <td style="width: 10%;"></td> <td style="width: 10%;"></td> <td style="width: 10%;"></td> <td style="width: 10%;"></td> <td style="width: 10%;"></td> <td style="width: 10%;"></td> <td style="width: 10%;"></td> <td style="width: 10%;"></td> <td style="width: 10%;"></td> </tr> <tr> <td></td> <td></td> <td colspan="8" style="text-align: center;"> <table border="1" style="width: 100%; border-collapse: collapse; text-align: center;"> <tr> <td style="width: 10%;"></td> <td style="width: 10%;"></td> <td style="width: 10%;"></td> <td style="width: 10%;"></td> <td style="width: 10%;"></td> <td style="width: 10%;"></td> <td style="width: 10%;"></td> <td style="width: 10%;"></td> <td style="width: 10%;"></td> <td style="width: 10%;"></td> </tr> <tr> <td></td> <td></td> <td colspan="8" style="text-align: center;"> <table border="1" style="width: 100%; border-collapse: collapse; text-align: center;"> <tr> <td style="width: 10%;"></td> <td style="width: 10%;"></td> <td style="width: 10%;"></td> <td style="width: 10%;"></td> <td style="width: 10%;"></td> <td style="width: 10%;"></td> <td style="width: 10%;"></td> <td style="width: 10%;"></td> <td style="width: 10%;"></td> <td style="width: 10%;"></td> </tr> <tr> <td></td> <td></td> <td colspan="8" style="text-align: center;"> <table border="1" style="width: 100%; border-collapse: collapse; text-align: center;"> <tr> <td style="width: 10%;"></td> <td style="width: 10%;"></td> <td style="width: 10%;"></td> <td style="width: 10%;"></td> <td style="width: 10%;"></td> <td style="width: 10%;"></td> <td style="width: 10%;"></td> <td style="width: 10%;"></td> <td style="width: 10%;"></td> <td style="width: 10%;"></td> </tr> <tr> <td></td> <td></td> <td colspan="8" style="text-align: center;"> <table border="1" style="width: 100%; border-collapse: collapse; text-align: center;"> <tr> <td style="width: 10%;"></td> <td style="width: 10%;"></td> <td style="width: 10%;"></td> <td style="width: 10%;"></td> <td style="width: 10%;"></td> <td style="width: 10%;"></td> <td style="width: 10%;"></td> <td style="width: 10%;"></td> <td style="width: 10%;"></td> <td style="width: 10%;"></td> </tr> <tr> <td></td> <td></td> <td colspan="8" style="text-align: center;"> <table border="1" style="width: 100%; border-collapse: collapse; text-align: center;"> <tr> <td style="width: 10%;"></td> <td style="width: 10%;"></td> <td style="width: 10%;"></td> <td style="width: 10%;"></td> <td style="width: 10%;"></td> <td style="width: 10%;"></td> <td style="width: 10%;"></td> <td style="width: 10%;"></td> <td style="width: 10%;"></td> <td style="width: 10%;"></td> </tr> <tr> <td></td> <td></td> <td colspan="8" style="text-align: center;"> <table border="1" style="width: 100%; border-collapse: collapse; text-align: center;"> <tr> <td style="width: 10%;"></td> <td style="width: 10%;"></td> <td style="width: 10%;"></td> <td style="width: 10%;"></td> <td style="width: 10%;"></td> <td style="width: 10%;"></td> <td style="width: 10%;"></td> <td style="width: 10%;"></td> <td style="width: 10%;"></td> <td style="width: 10%;"></td> </tr> <tr> <td></td> <td></td> <td colspan="8" style="text-align: center;"> <table border="1" style="width: 100%; border-collapse: collapse; text-align: center;"> <tr> <td style="width: 10%;"></td> <td style="width: 10%;"></td> <td style="width: 10%;"></td> <td style="width: 10%;"></td> <td style="width: 10%;"></td> <td style="width: 10%;"></td> <td style="width: 10%;"></td> <td style="width: 10%;"></td> <td style="width: 10%;"></td> <td style="width: 10%;"></td> </tr> <tr> <td></td> <td></td> <td colspan="8" style="text-align: center;"> <table border="1" style="width: 100%; border-collapse: collapse; text-align: center;"> <tr> <td style="width: 10%;"></td> <td style="width: 10%;"></td> <td style="width: 10%;"></td> <td style="width: 10%;"></td> <td style="width: 10%;"></td> <td style="width: 10%;"></td> <td style="width: 10%;"></td> <td style="width: 10%;"></td> <td style="width: 10%;"></td> <td style="width: 10%;"></td> </tr> <tr> <td></td> <td></td> <td colspan="8" style="text-align: center;"> <table border="1" style="width: 100%; border-collapse: collapse; text-align: center;"> <tr> <td style="width: 10%;"></td> <td style="width: 10%;"></td> <td style="width: 10%;"></td> <td style="width: 10%;"></td> <td style="width: 10%;"></td> <td style="width: 10%;"></td> <td style="width:
10%;"></td> <td style="width: 10%;"></td> <td style="width: 10%;"></td> <td style="width: 10%;"></td> </tr> <tr> <td></td> <td></td> <td colspan="8" style="text-align: center;"> <table border="1" style="width: 100%; border-collapse: collapse; text-align: center;"> <tr> <td style="width: 10%;"></td> <td style="width: 10%;"></td> <td style="width: 10%;"></td> <td style="width: 10%;"></td> <td style="width: 10%;"></td> <td style="width: 10%;"></td> <td style="width: 10%;"></td> <td style="width: 10%;"></td> <td style="width: 10%;"></td> <td style="width: 10%;"></td> </tr> <tr> <td></td> <td></td> <td colspan="8" style="text-align: center;"> <table border="1" style="width: 100%; border-collapse: collapse; text-align: center;"> <tr> <td style="width: 10%;"></td> <td style="width: 10%;"></td> <td style="width: 10%;"></td> <td style="width: 10%;"></td> <td style="width: 10%;"></td> <td style="width: 10%;"></td> <td style="width: 10%;"></td> <td style="width: 10%;"></td> <td style="width: 10%;"></td> <td style="width: 10%;"></td> </tr> <tr> <td></td> <td></td> <td colspan="8" style="text-align: center;"> <table border="1" style="width: 100%; border-collapse: collapse; text-align: center;"> <tr> <td style="width: 10%;"></td> <td style="width: 10%;"></td> <td style="width: 10%;"></td> <td style="width: 10%;"></td> <td style="width: 10%;"></td> <td style="width: 10%;"></td> <td style="width: 10%;"></td> <td style="width: 10%;"></td> <td style="width: 10%;"></td> <td style="width: 10%;"></td> </tr> <tr> <td></td> <td></td> <td colspan="8" style="text-align: center;"> <table border="1" style="width: 100%; border-collapse: collapse; text-align: center;"> <tr> <td style="width: 10%;"></td> <td style="width: 10%;"></td> <td style="width: 10%;"></td> <td style="width: 10%;"></td> <td style="width: 10%;"></td> <td style="width: 10%;"></td> <td style="width: 10%;"></td> <td style="width: 10%;"></td> <td style="width: 10%;"></td> <td style="width: 10%;"></td> </tr> <tr> <td></td> <td></td> <td colspan="8" style="text-align: center;"> <table border="1" style="width: 100%; border-collapse: collapse; text-align: center;"> <tr> <td style="width: 10%;"></td> <td style="width: 10%;"></td> <td style="width: 10%;"></td> <td style="width: 10%;"></td> <td style="width: 10%;"></td> <td style="width: 10%;"></td> <td style="width: 10%;"></td> <td style="width: 10%;"></td> <td style="width: 10%;"></td> <td style="width: 10%;"></td> </tr> <tr> <td></td> <td></td> <td colspan="8" style="text-align: center;"> <table border="1" style="width: 100%; border-collapse: collapse; text-align: center;"> <tr> <td style="width: 10%;"></td> <td style="width: 10%;"></td> <td style="width: 10%;"></td> <td style="width: 10%;"></td> <td style="width: 10%;"></td> <td style="width: 10%;"></td> <td style="width: 10%;"></td> <td style="width: 10%;"></td> <td style="width: 10%;"></td> <td style="width: 10%;"></td> </tr> <tr> <td></td> <td></td> <td colspan="8" style="text-align: center;"> <table border="1" style="width: 100%; border-collapse: collapse; text-align: center;"> <tr> <td style="width: 10%;"></td> <td style="width: 10%;"></td> <td style="width: 10%;"></td> <td style="width: 10%;"></td> <td style="width: 10%;"></td> <td style="width: 10%;"></td> <td style="width: 10%;"></td> <td style="width: 10%;"></td> <td style="width: 10%;"></td> <td style="width: 10%;"></td> </tr> <tr> <td></td> <td></td> <td colspan="8" style="text-align: center;"> <table border="1" style="width: 100%; border-collapse: collapse; text-align: center;"> <tr> <td style="width: 10%;"></td> <td style="width: 10%;"></td> <td style="width: 10%;"></td> <td style="width: 10%;"></td> <td style="width: 10%;"></td> <td style="width: 10%;"></td> <td style="width: 10%;"></td> <td style="width: 10%;"></td> <td style="width: 10%;"></td> <td style="width: 10%;"></td> </tr> <tr> <td></td> <td></td> <td colspan="8" style="text-align: center;"> <table border="1" style="width: 100%; border-collapse: collapse; text-align: center;"> <tr> <td style="width: 10%;"></td> <td style="width: 10%;"></td> <td style="width: 10%;"></td> <td style="width: 10%;"></td> <td style="width: 10%;"></td> <td style="width: 10%;"></td> <td style="width: 10%;"></td> <td style="width: 10%;"></td> <td style="width: 10%;"></td> <td style="width: 10%;"></td> </tr> <tr> <td></td> <td></td> <td colspan="8" style="text-align: center;"> <table border="1" style="width: 100%; border-collapse: collapse; text-align: center;"> <tr> <td style="width: 10%;"></td> <td style="width: 10%;"></td> <td style="width: 10%;"></td> <td style="width: 10%;"></td> <td style="width: 10%;"></td> <td style="width: 10%;"></td> <td style="width: 10%;"></td> <td style="width: 10%;"></td> <td style="width: 10%;"></td> <td style="width: 10%;"></td> </tr> <tr> <td></td> <td></td> <td colspan="8" style="text-align: center;"> <table border="1" style="width: 100%; border-collapse: collapse; text-align: center;"> <tr> <td style="width: 10%;"></td> <td style="width: 10%;"></td> <td style="width: 10%;"></td> <td style="width: 10%;"></td> <td style="width: 10%;"></td> <td style="width: 10%;"></td> <td style="width: 10%;"></td> <td style="width: 10%;"></td> <td style="width: 10%;"></td> <td style="width: 10%;"></td> </tr> <tr> <td></td> <td></td> <td colspan="8" style="text-align: center;"> <table border="1" style="width: 100%; border-collapse: collapse; text-align: center;"> <tr> <td style="width: 10%;"></td> <td style="width: 10%;"></td> <td style="width: 10%;"></td> <td style="width: 10%;"></td> <td style="width: 10%;"></td> <td style="width: 10%;"></td> <td style="width: 10%;"></td> <td style="width: 10%;"></td> <td style="width: 10%;"></td> <td style="width: 10%;"></td> </tr> <tr> <td></td> <td></td> <td colspan="8" style="text-align: center;"> <table border="1" style="width: 100%; border-collapse: collapse; text-align: center;"> <tr> </tr></table></td></tr></table></td></tr></table></td></tr></table></td></tr></table></td></tr></table></td></tr></table></td></tr></table></td></tr></table></td></tr></table></td></tr></table></td></tr></table></td></tr></table></td></tr></table></td></tr></table></td></tr></table></td></tr></table></td></tr></table></td></tr></table></td></tr></table></td></tr></table></td></tr></table></td></tr></table></td></tr></table></td></tr></table></td></tr></table></td></tr></table></td></tr></table></td></tr></table></td></tr></table></td></tr></table> | | | | | | | | | | | | | | | | | | | | <table border="1" style="width: 100%; border-collapse: collapse; text-align: center;"> <tr> <td style="width: 10%;"></td> <td style="width: 10%;"></td> <td style="width: 10%;"></td> <td style="width: 10%;"></td> <td style="width: 10%;"></td> <td style="width: 10%;"></td> <td style="width: 10%;"></td> <td style="width: 10%;"></td> <td style="width: 10%;"></td> <td style="width: 10%;"></td> </tr> <tr> <td></td> <td></td> <td colspan="8" style="text-align: center;"> <table border="1" style="width: 100%; border-collapse: collapse; text-align: center;"> <tr> <td style="width: 10%;"></td> <td style="width: 10%;"></td> <td style="width: 10%;"></td> <td style="width: 10%;"></td> <td style="width: 10%;"></td> <td style="width: 10%;"></td> <td style="width: 10%;"></td> <td style="width: 10%;"></td> <td style="width: 10%;"></td> <td style="width: 10%;"></td> </tr> <tr> <td></td> <td></td> <td colspan="8" style="text-align: center;"> <table border="1" style="width: 100%; border-collapse: collapse; text-align: center;"> <tr> <td style="width: 10%;"></td> <td style="width: 10%;"></td> <td style="width: 10%;"></td> <td style="width: 10%;"></td> <td style="width: 10%;"></td> <td style="width: 10%;"></td> <td style="width: 10%;"></td> <td style="width: 10%;"></td> <td style="width: 10%;"></td> <td style="width: 10%;"></td> </tr> <tr> <td></td> <td></td> <td colspan="8" style="text-align: center;"> <table border="1" style="width: 100%; border-collapse: collapse; text-align: center;"> <tr> <td style="width: 10%;"></td> <td style="width: 10%;"></td> <td style="width: 10%;"></td> <td style="width: 10%;"></td> <td style="width: 10%;"></td> <td style="width: 10%;"></td> <td style="width: 10%;"></td> <td style="width: 10%;"></td> <td style="width: 10%;"></td> <td style="width: 10%;"></td> </tr> <tr> <td></td> <td></td> <td colspan="8" style="text-align: center;"> <table border="1" style="width: 100%; border-collapse: collapse; text-align: center;"> <tr> <td style="width: 10%;"></td> <td style="width: 10%;"></td> <td style="width: 10%;"></td> <td style="width: 10%;"></td> <td style="width: 10%;"></td> <td style="width: 10%;"></td> <td style="width: 10%;"></td> <td style="width: 10%;"></td> <td style="width: 10%;"></td> <td style="width: 10%;"></td> </tr> <tr> <td></td> <td></td> <td colspan="8" style="text-align: center;"> <table border="1" style="width: 100%; border-collapse: collapse; text-align: center;"> <tr> <td style="width: 10%;"></td> <td style="width: 10%;"></td> <td style="width: 10%;"></td> <td
style="width: 10%;"></td> <td style="width: 10%;"></td> <td style="width: 10%;"></td> <td style="width: 10%;"></td> <td style="width: 10%;"></td> <td style="width: 10%;"></td> <td style="width: 10%;"></td> </tr> <tr> <td></td> <td></td> <td colspan="8" style="text-align: center;"> <table border="1" style="width: 100%; border-collapse: collapse; text-align: center;"> <tr> <td style="width: 10%;"></td> <td style="width: 10%;"></td> <td style="width: 10%;"></td> <td style="width: 10%;"></td> <td style="width: 10%;"></td> <td style="width: 10%;"></td> <td style="width: 10%;"></td> <td style="width: 10%;"></td> <td style="width: 10%;"></td> <td style="width: 10%;"></td> </tr> <tr> <td></td> <td></td> <td colspan="8" style="text-align: center;"> <table border="1" style="width: 100%; border-collapse: collapse; text-align: center;"> <tr> <td style="width: 10%;"></td> <td style="width: 10%;"></td> <td style="width: 10%;"></td> <td style="width: 10%;"></td> <td style="width: 10%;"></td> <td style="width: 10%;"></td> <td style="width: 10%;"></td> <td style="width: 10%;"></td> <td style="width: 10%;"></td> <td style="width: 10%;"></td> </tr> <tr> <td></td> <td></td> <td colspan="8" style="text-align: center;"> <table border="1" style="width: 100%; border-collapse: collapse; text-align: center;"> <tr> <td style="width: 10%;"></td> <td style="width: 10%;"></td> <td style="width: 10%;"></td> <td style="width: 10%;"></td> <td style="width: 10%;"></td> <td style="width: 10%;"></td> <td style="width: 10%;"></td> <td style="width: 10%;"></td> <td style="width: 10%;"></td> <td style="width: 10%;"></td> </tr> <tr> <td></td> <td></td> <td colspan="8" style="text-align: center;"> <table border="1" style="width: 100%; border-collapse: collapse; text-align: center;"> <tr> <td style="width: 10%;"></td> <td style="width: 10%;"></td> <td style="width: 10%;"></td> <td style="width: 10%;"></td> <td style="width: 10%;"></td> <td style="width: 10%;"></td> <td style="width: 10%;"></td> <td style="width: 10%;"></td> <td style="width: 10%;"></td> <td style="width: 10%;"></td> </tr> <tr> <td></td> <td></td> <td colspan="8" style="text-align: center;"> <table border="1" style="width: 100%; border-collapse: collapse; text-align: center;"> <tr> <td style="width: 10%;"></td> <td style="width: 10%;"></td> <td style="width: 10%;"></td> <td style="width: 10%;"></td> <td style="width: 10%;"></td> <td style="width: 10%;"></td> <td style="width: 10%;"></td> <td style="width: 10%;"></td> <td style="width: 10%;"></td> <td style="width: 10%;"></td> </tr> <tr> <td></td> <td></td> <td colspan="8" style="text-align: center;"> <table border="1" style="width: 100%; border-collapse: collapse; text-align: center;"> <tr> <td style="width: 10%;"></td> <td style="width: 10%;"></td> <td style="width: 10%;"></td> <td style="width: 10%;"></td> <td style="width: 10%;"></td> <td style="width: 10%;"></td> <td style="width: 10%;"></td> <td style="width: 10%;"></td> <td style="width: 10%;"></td> <td style="width: 10%;"></td> </tr> <tr> <td></td> <td></td> <td colspan="8" style="text-align: center;"> <table border="1" style="width: 100%; border-collapse: collapse; text-align: center;"> <tr> <td style="width: 10%;"></td> <td style="width: 10%;"></td> <td style="width: 10%;"></td> <td style="width: 10%;"></td> <td style="width: 10%;"></td> <td style="width: 10%;"></td> <td style="width: 10%;"></td> <td style="width: 10%;"></td> <td style="width: 10%;"></td> <td style="width: 10%;"></td> </tr> <tr> <td></td> <td></td> <td colspan="8" style="text-align: center;"> <table border="1" style="width: 100%; border-collapse: collapse; text-align: center;"> <tr> <td style="width: 10%;"></td> <td style="width: 10%;"></td> <td style="width: 10%;"></td> <td style="width: 10%;"></td> <td style="width: 10%;"></td> <td style="width: 10%;"></td> <td style="width: 10%;"></td> <td style="width: 10%;"></td> <td style="width: 10%;"></td> <td style="width: 10%;"></td> </tr> <tr> <td></td> <td></td> <td colspan="8" style="text-align: center;"> <table border="1" style="width: 100%; border-collapse: collapse; text-align: center;"> <tr> <td style="width: 10%;"></td> <td style="width: 10%;"></td> <td style="width: 10%;"></td> <td style="width: 10%;"></td> <td style="width: 10%;"></td> <td style="width: 10%;"></td> <td style="width: 10%;"></td> <td style="width: 10%;"></td> <td style="width: 10%;"></td> <td style="width: 10%;"></td> </tr> <tr> <td></td> <td></td> <td colspan="8" style="text-align: center;"> <table border="1" style="width: 100%; border-collapse: collapse; text-align: center;"> <tr> <td style="width: 10%;"></td> <td style="width: 10%;"></td> <td style="width: 10%;"></td> <td style="width: 10%;"></td> <td style="width: 10%;"></td> <td style="width: 10%;"></td> <td style="width: 10%;"></td> <td style="width: 10%;"></td> <td style="width: 10%;"></td> <td style="width: 10%;"></td> </tr> <tr> <td></td> <td></td> <td colspan="8" style="text-align: center;"> <table border="1" style="width: 100%; border-collapse: collapse; text-align: center;"> <tr> <td style="width: 10%;"></td> <td style="width: 10%;"></td> <td style="width: 10%;"></td> <td style="width: 10%;"></td> <td style="width: 10%;"></td> <td style="width: 10%;"></td> <td style="width: 10%;"></td> <td style="width: 10%;"></td> <td style="width: 10%;"></td> <td style="width: 10%;"></td> </tr> <tr> <td></td> <td></td> <td colspan="8" style="text-align: center;"> <table border="1" style="width: 100%; border-collapse: collapse; text-align: center;"> <tr> <td style="width: 10%;"></td> <td style="width: 10%;"></td> <td style="width: 10%;"></td> <td style="width: 10%;"></td> <td style="width: 10%;"></td> <td style="width: 10%;"></td> <td style="width: 10%;"></td> <td style="width: 10%;"></td> <td style="width: 10%;"></td> <td style="width: 10%;"></td> </tr> <tr> <td></td> <td></td> <td colspan="8" style="text-align: center;"> <table border="1" style="width: 100%; border-collapse: collapse; text-align: center;"> <tr> <td style="width: 10%;"></td> <td style="width: 10%;"></td> <td style="width: 10%;"></td> <td style="width: 10%;"></td> <td style="width: 10%;"></td> <td style="width: 10%;"></td> <td style="width: 10%;"></td> <td style="width: 10%;"></td> <td style="width: 10%;"></td> <td style="width: 10%;"></td> </tr> <tr> <td></td> <td></td> <td colspan="8" style="text-align: center;"> <table border="1" style="width: 100%; border-collapse: collapse; text-align: center;"> <tr> <td style="width: 10%;"></td> <td style="width: 10%;"></td> <td style="width: 10%;"></td> <td style="width: 10%;"></td> <td style="width: 10%;"></td> <td style="width: 10%;"></td> <td style="width: 10%;"></td> <td style="width: 10%;"></td> <td style="width: 10%;"></td> <td style="width: 10%;"></td> </tr> <tr> <td></td> <td></td> <td colspan="8" style="text-align: center;"> <table border="1" style="width: 100%; border-collapse: collapse; text-align: center;"> <tr> <td style="width: 10%;"></td> <td style="width: 10%;"></td> <td style="width: 10%;"></td> <td style="width: 10%;"></td> <td style="width: 10%;"></td> <td style="width: 10%;"></td> <td style="width: 10%;"></td> <td style="width: 10%;"></td> <td style="width: 10%;"></td> <td style="width: 10%;"></td> </tr> <tr> <td></td> <td></td> <td colspan="8" style="text-align: center;"> <table border="1" style="width: 100%; border-collapse: collapse; text-align: center;"> <tr> <td style="width: 10%;"></td> <td style="width: 10%;"></td> <td style="width: 10%;"></td> <td style="width: 10%;"></td> <td style="width: 10%;"></td> <td style="width: 10%;"></td> <td style="width: 10%;"></td> <td style="width: 10%;"></td> <td style="width: 10%;"></td> <td style="width: 10%;"></td> </tr> <tr> <td></td> <td></td> <td colspan="8" style="text-align: center;"> <table border="1" style="width: 100%; border-collapse: collapse; text-align: center;"> <tr> <td style="width: 10%;"></td> <td style="width: 10%;"></td> <td style="width: 10%;"></td> <td style="width: 10%;"></td> <td style="width: 10%;"></td> <td style="width: 10%;"></td> <td style="width: 10%;"></td> <td style="width: 10%;"></td> <td style="width: 10%;"></td> <td style="width: 10%;"></td> </tr> <tr> <td></td> <td></td> <td colspan="8" style="text-align: center;"> <table border="1" style="width: 100%; border-collapse: collapse; text-align: center;"> <tr> <td style="width: 10%;"></td> <td style="width: 10%;"></td> <td style="width: 10%;"></td> <td style="width: 10%;"></td> <td style="width: 10%;"></td> <td style="width: 10%;"></td> <td style="width: 10%;"></td> <td style="width: 10%;"></td> <td style="width: 10%;"></td> <td style="width: 10%;"></td> </tr> <tr> <td></td> <td></td> <td colspan="8" style="text-align: center;"> <table border="1" style="width: 100%; border-collapse: collapse; text-align: center;"> <tr> <td style="width: 10%;"></td> <td style="width: 10%;"></td> <td style="width: 10%;"></td> <td style="width: 10%;"></td> <td style="width: 10%;"></td> <td style="width: 10%;"></td> <td style="width: 10%;"></td> <td style="width: 10%;"></td> <td style="width: 10%;"></td> <td style="width: 10%;"></td> </tr> <tr> <td></td> <td></td> <td colspan="8" style="text-align: center;"> <table border="1" style="width: 100%; border-collapse: collapse; text-align: center;"> <tr> <td style="width: 10%;"></td> <td style="width: 10%;"></td> <td style="width: 10%;"></td> <td style="width: 10%;"></td> <td style="width: 10%;"></td> <td style="width: 10%;"></td> <td style="width: 10%;"></td> <td style="width: 10%;"></td> <td style="width: 10%;"></td> <td style="width: 10%;"></td> </tr> <tr> <td></td> <td></td> <td colspan="8" style="text-align: center;"> <table border="1" style="width: 100%; border-collapse: collapse; text-align: center;"> <tr> <td style="width: 10%;"></td> <td style="width: 10%;"></td> <td style="width: 10%;"></td> <td style="width: 10%;"></td> <td style="width: 10%;"></td> <td style="width: 10%;"></td> <td style="width: 10%;"></td> <td style="width: 10%;"></td> <td style="width:
10%;"></td> <td style="width: 10%;"></td> </tr> <tr> <td></td> <td></td> <td colspan="8" style="text-align: center;"> <table border="1" style="width: 100%; border-collapse: collapse; text-align: center;"> <tr> <td style="width: 10%;"></td> <td style="width: 10%;"></td> <td style="width: 10%;"></td> <td style="width: 10%;"></td> <td style="width: 10%;"></td> <td style="width: 10%;"></td> <td style="width: 10%;"></td> <td style="width: 10%;"></td> <td style="width: 10%;"></td> <td style="width: 10%;"></td> </tr> <tr> <td></td> <td></td> <td colspan="8" style="text-align: center;"> <table border="1" style="width: 100%; border-collapse: collapse; text-align: center;"> <tr> <td style="width: 10%;"></td> <td style="width: 10%;"></td> <td style="width: 10%;"></td> <td style="width: 10%;"></td> <td style="width: 10%;"></td> <td style="width: 10%;"></td> <td style="width: 10%;"></td> <td style="width: 10%;"></td> <td style="width: 10%;"></td> <td style="width: 10%;"></td> </tr> <tr> <td></td> <td></td> <td colspan="8" style="text-align: center;"> <table border="1" style="width: 100%; border-collapse: collapse; text-align: center;"> <tr> </tr></table></td></tr></table></td></tr></table></td></tr></table></td></tr></table></td></tr></table></td></tr></table></td></tr></table></td></tr></table></td></tr></table></td></tr></table></td></tr></table></td></tr></table></td></tr></table></td></tr></table></td></tr></table></td></tr></table></td></tr></table></td></tr></table></td></tr></table></td></tr></table></td></tr></table></td></tr></table></td></tr></table></td></tr></table></td></tr></table></td></tr></table></td></tr></table></td></tr></table></td></tr></table> | | | | | | | | | | | | | | | | | | | | <table border="1" style="width: 100%; border-collapse: collapse; text-align: center;"> <tr> <td style="width: 10%;"></td> <td style="width: 10%;"></td> <td style="width: 10%;"></td> <td style="width: 10%;"></td> <td style="width: 10%;"></td> <td style="width: 10%;"></td> <td style="width: 10%;"></td> <td style="width: 10%;"></td> <td style="width: 10%;"></td> <td style="width: 10%;"></td> </tr> <tr> <td></td> <td></td> <td colspan="8" style="text-align: center;"> <table border="1" style="width: 100%; border-collapse: collapse; text-align: center;"> <tr> <td style="width: 10%;"></td> <td style="width: 10%;"></td> <td style="width: 10%;"></td> <td style="width: 10%;"></td> <td style="width: 10%;"></td> <td style="width: 10%;"></td> <td style="width: 10%;"></td> <td style="width: 10%;"></td> <td style="width: 10%;"></td> <td style="width: 10%;"></td> </tr> <tr> <td></td> <td></td> <td colspan="8" style="text-align: center;"> <table border="1" style="width: 100%; border-collapse: collapse; text-align: center;"> <tr> <td style="width: 10%;"></td> <td style="width: 10%;"></td> <td style="width: 10%;"></td> <td style="width: 10%;"></td> <td style="width: 10%;"></td> <td style="width: 10%;"></td> <td style="width: 10%;"></td> <td style="width: 10%;"></td> <td style="width: 10%;"></td> <td style="width: 10%;"></td> </tr> <tr> <td></td> <td></td> <td colspan="8" style="text-align: center;"> <table border="1" style="width: 100%; border-collapse: collapse; text-align: center;"> <tr> <td style="width: 10%;"></td> <td style="width: 10%;"></td> <td style="width: 10%;"></td> <td style="width: 10%;"></td> <td style="width: 10%;"></td> <td style="width: 10%;"></td> <td style="width: 10%;"></td> <td style="width: 10%;"></td> <td style="width: 10%;"></td> <td style="width: 10%;"></td> </tr> <tr> <td></td> <td></td> <td colspan="8" style="text-align: center;"> <table border="1" style="width: 100%; border-collapse: collapse; text-align: center;"> <tr> <td style="width: 10%;"></td> <td style="width: 10%;"></td> <td style="width: 10%;"></td> <td style="width: 10%;"></td> <td style="width: 10%;"></td> <td style="width: 10%;"></td> <td style="width: 10%;"></td> <td style="width: 10%;"></td> <td style="width: 10%;"></td> <td style="width: 10%;"></td> </tr> <tr> <td></td> <td></td> <td colspan="8" style="text-align: center;"> <table border="1" style="width: 100%; border-collapse: collapse; text-align: center;"> <tr> <td style="width: 10%;"></td> <td style="width: 10%;"></td> <td style="width: 10%;"></td> <td style="width: 10%;"></td> <td style="width: 10%;"></td> <td style="width: 10%;"></td> <td style="width: 10%;"></td> <td style="width: 10%;"></td> <td style="width: 10%;"></td> <td style="width: 10%;"></td> </tr> <tr> <td></td> <td></td> <td colspan="8" style="text-align: center;"> <table border="1" style="width: 100%; border-collapse: collapse; text-align: center;"> <tr> <td style="width: 10%;"></td> <td style="width: 10%;"></td> <td style="width: 10%;"></td> <td style="width: 10%;"></td> <td style="width: 10%;"></td> <td style="width: 10%;"></td> <td style="width: 10%;"></td> <td style="width: 10%;"></td> <td style="width: 10%;"></td> <td style="width: 10%;"></td> </tr> <tr> <td></td> <td></td> <td colspan="8" style="text-align: center;"> <table border="1" style="width: 100%; border-collapse: collapse; text-align: center;"> <tr> <td style="width: 10%;"></td> <td style="width: 10%;"></td> <td style="width: 10%;"></td> <td style="width: 10%;"></td> <td style="width: 10%;"></td> <td style="width: 10%;"></td> <td style="width: 10%;"></td> <td style="width: 10%;"></td> <td style="width: 10%;"></td> <td style="width: 10%;"></td> </tr> <tr> <td></td> <td></td> <td colspan="8" style="text-align: center;"> <table border="1" style="width: 100%; border-collapse: collapse; text-align: center;"> <tr> <td style="width: 10%;"></td> <td style="width: 10%;"></td> <td style="width: 10%;"></td> <td style="width: 10%;"></td> <td style="width: 10%;"></td> <td style="width: 10%;"></td> <td style="width: 10%;"></td> <td style="width: 10%;"></td> <td style="width: 10%;"></td> <td style="width: 10%;"></td> </tr> <tr> <td></td> <td></td> <td colspan="8" style="text-align: center;"> <table border="1" style="width: 100%; border-collapse: collapse; text-align: center;"> <tr> <td style="width: 10%;"></td> <td style="width: 10%;"></td> <td style="width: 10%;"></td> <td style="width: 10%;"></td> <td style="width: 10%;"></td> <td style="width: 10%;"></td> <td style="width: 10%;"></td> <td style="width: 10%;"></td> <td style="width: 10%;"></td> <td style="width: 10%;"></td> </tr> <tr> <td></td> <td></td> <td colspan="8" style="text-align: center;"> <table border="1" style="width: 100%; border-collapse: collapse; text-align: center;"> <tr> <td style="width: 10%;"></td> <td style="width: 10%;"></td> <td style="width: 10%;"></td> <td style="width: 10%;"></td> <td style="width: 10%;"></td> <td style="width: 10%;"></td> <td style="width: 10%;"></td> <td style="width: 10%;"></td> <td style="width: 10%;"></td> <td style="width: 10%;"></td> </tr> <tr> <td></td> <td></td> <td colspan="8" style="text-align: center;"> <table border="1" style="width: 100%; border-collapse: collapse; text-align: center;"> <tr> <td style="width: 10%;"></td> <td style="width: 10%;"></td> <td style="width: 10%;"></td> <td style="width: 10%;"></td> <td style="width: 10%;"></td> <td style="width: 10%;"></td> <td style="width: 10%;"></td> <td style="width: 10%;"></td> <td style="width: 10%;"></td> <td style="width: 10%;"></td> </tr> <tr> <td></td> <td></td> <td colspan="8" style="text-align: center;"> <table border="1" style="width: 100%; border-collapse: collapse; text-align: center;"> <tr> <td style="width: 10%;"></td> <td style="width: 10%;"></td> <td style="width: 10%;"></td> <td style="width: 10%;"></td> <td style="width: 10%;"></td> <td style="width: 10%;"></td> <td style="width: 10%;"></td> <td style="width: 10%;"></td> <td style="width: 10%;"></td> <td style="width: 10%;"></td> </tr> <tr> <td></td> <td></td> <td colspan="8" style="text-align: center;"> <table border="1" style="width: 100%; border-collapse: collapse; text-align: center;"> <tr> <td style="width: 10%;"></td> <td style="width: 10%;"></td> <td style="width: 10%;"></td> <td style="width: 10%;"></td> <td style="width: 10%;"></td> <td style="width: 10%;"></td> <td style="width: 10%;"></td> <td style="width: 10%;"></td> <td style="width: 10%;"></td> <td style="width: 10%;"></td> </tr> <tr> <td></td> <td></td> <td colspan="8" style="text-align: center;"> <table border="1" style="width: 100%; border-collapse: collapse; text-align: center;"> <tr> <td style="width: 10%;"></td> <td style="width: 10%;"></td> <td style="width: 10%;"></td> <td style="width: 10%;"></td> <td style="width: 10%;"></td> <td style="width: 10%;"></td> <td style="width: 10%;"></td> <td style="width: 10%;"></td> <td style="width: 10%;"></td> <td style="width: 10%;"></td> </tr> <tr> <td></td> <td></td> <td colspan="8" style="text-align: center;"> <table border="1" style="width: 100%; border-collapse: collapse; text-align: center;"> <tr> <td style="width: 10%;"></td> <td style="width: 10%;"></td> <td style="width: 10%;"></td> <td style="width: 10%;"></td> <td style="width: 10%;"></td> <td style="width:
10%;"></td> <td style="width: 10%;"></td> <td style="width: 10%;"></td> <td style="width: 10%;"></td> <td style="width: 10%;"></td> </tr> <tr> <td></td> <td></td> <td colspan="8" style="text-align: center;"> <table border="1" style="width: 100%; border-collapse: collapse; text-align: center;"> <tr> <td style="width: 10%;"></td> <td style="width: 10%;"></td> <td style="width: 10%;"></td> <td style="width: 10%;"></td> <td style="width: 10%;"></td> <td style="width: 10%;"></td> <td style="width: 10%;"></td> <td style="width: 10%;"></td> <td style="width: 10%;"></td> <td style="width: 10%;"></td> </tr> <tr> <td></td> <td></td> <td colspan="8" style="text-align: center;"> <table border="1" style="width: 100%; border-collapse: collapse; text-align: center;"> <tr> <td style="width: 10%;"></td> <td style="width: 10%;"></td> <td style="width: 10%;"></td> <td style="width: 10%;"></td> <td style="width: 10%;"></td> <td style="width: 10%;"></td> <td style="width: 10%;"></td> <td style="width: 10%;"></td> <td style="width: 10%;"></td> <td style="width: 10%;"></td> </tr> <tr> <td></td> <td></td> <td colspan="8" style="text-align: center;"> <table border="1" style="width: 100%; border-collapse: collapse; text-align: center;"> <tr> <td style="width: 10%;"></td> <td style="width: 10%;"></td> <td style="width: 10%;"></td> <td style="width: 10%;"></td> <td style="width: 10%;"></td> <td style="width: 10%;"></td> <td style="width: 10%;"></td> <td style="width: 10%;"></td> <td style="width: 10%;"></td> <td style="width: 10%;"></td> </tr> <tr> <td></td> <td></td> <td colspan="8" style="text-align: center;"> <table border="1" style="width: 100%; border-collapse: collapse; text-align: center;"> <tr> <td style="width: 10%;"></td> <td style="width: 10%;"></td> <td style="width: 10%;"></td> <td style="width: 10%;"></td> <td style="width: 10%;"></td> <td style="width: 10%;"></td> <td style="width: 10%;"></td> <td style="width: 10%;"></td> <td style="width: 10%;"></td> <td style="width: 10%;"></td> </tr> <tr> <td></td> <td></td> <td colspan="8" style="text-align: center;"> <table border="1" style="width: 100%; border-collapse: collapse; text-align: center;"> <tr> <td style="width: 10%;"></td> <td style="width: 10%;"></td> <td style="width: 10%;"></td> <td style="width: 10%;"></td> <td style="width: 10%;"></td> <td style="width: 10%;"></td> <td style="width: 10%;"></td> <td style="width: 10%;"></td> <td style="width: 10%;"></td> <td style="width: 10%;"></td> </tr> <tr> <td></td> <td></td> <td colspan="8" style="text-align: center;"> <table border="1" style="width: 100%; border-collapse: collapse; text-align: center;"> <tr> <td style="width: 10%;"></td> <td style="width: 10%;"></td> <td style="width: 10%;"></td> <td style="width: 10%;"></td> <td style="width: 10%;"></td> <td style="width: 10%;"></td> <td style="width: 10%;"></td> <td style="width: 10%;"></td> <td style="width: 10%;"></td> <td style="width: 10%;"></td> </tr> <tr> <td></td> <td></td> <td colspan="8" style="text-align: center;"> <table border="1" style="width: 100%; border-collapse: collapse; text-align: center;"> <tr> <td style="width: 10%;"></td> <td style="width: 10%;"></td> <td style="width: 10%;"></td> <td style="width: 10%;"></td> <td style="width: 10%;"></td> <td style="width: 10%;"></td> <td style="width: 10%;"></td> <td style="width: 10%;"></td> <td style="width: 10%;"></td> <td style="width: 10%;"></td> </tr> <tr> <td></td> <td></td> <td colspan="8" style="text-align: center;"> <table border="1" style="width: 100%; border-collapse: collapse; text-align: center;"> <tr> <td style="width: 10%;"></td> <td style="width: 10%;"></td> <td style="width: 10%;"></td> <td style="width: 10%;"></td> <td style="width: 10%;"></td> <td style="width: 10%;"></td> <td style="width: 10%;"></td> <td style="width: 10%;"></td> <td style="width: 10%;"></td> <td style="width: 10%;"></td> </tr> <tr> <td></td> <td></td> <td colspan="8" style="text-align: center;"> <table border="1" style="width: 100%; border-collapse: collapse; text-align: center;"> <tr> <td style="width: 10%;"></td> <td style="width: 10%;"></td> <td style="width: 10%;"></td> <td style="width: 10%;"></td> <td style="width: 10%;"></td> <td style="width: 10%;"></td> <td style="width: 10%;"></td> <td style="width: 10%;"></td> <td style="width: 10%;"></td> <td style="width: 10%;"></td> </tr> <tr> <td></td> <td></td> <td colspan="8" style="text-align: center;"> <table border="1" style="width: 100%; border-collapse: collapse; text-align: center;"> <tr> <td style="width: 10%;"></td> <td style="width: 10%;"></td> <td style="width: 10%;"></td> <td style="width: 10%;"></td> <td style="width: 10%;"></td> <td style="width: 10%;"></td> <td style="width: 10%;"></td> <td style="width: 10%;"></td> <td style="width: 10%;"></td> <td style="width: 10%;"></td> </tr> <tr> <td></td> <td></td> <td colspan="8" style="text-align: center;"> <table border="1" style="width: 100%; border-collapse: collapse; text-align: center;"> <tr> <td style="width: 10%;"></td> <td style="width: 10%;"></td> <td style="width: 10%;"></td> <td style="width: 10%;"></td> <td style="width: 10%;"></td> <td style="width: 10%;"></td> <td style="width: 10%;"></td> <td style="width: 10%;"></td> <td style="width: 10%;"></td> <td style="width: 10%;"></td> </tr> <tr> <td></td> <td></td> <td colspan="8" style="text-align: center;"> <table border="1" style="width: 100%; border-collapse: collapse; text-align: center;"> <tr> <td style="width: 10%;"></td> <td style="width: 10%;"></td> <td style="width: 10%;"></td> <td style="width: 10%;"></td> <td style="width: 10%;"></td> <td style="width: 10%;"></td> <td style="width: 10%;"></td> <td style="width: 10%;"></td> <td style="width: 10%;"></td> <td style="width: 10%;"></td> </tr> <tr> <td></td> <td></td> <td colspan="8" style="text-align: center;"> <table border="1" style="width: 100%; border-collapse: collapse; text-align: center;"> <tr> </tr></table></td></tr></table></td></tr></table></td></tr></table></td></tr></table></td></tr></table></td></tr></table></td></tr></table></td></tr></table></td></tr></table></td></tr></table></td></tr></table></td></tr></table></td></tr></table></td></tr></table></td></tr></table></td></tr></table></td></tr></table></td></tr></table></td></tr></table></td></tr></table></td></tr></table></td></tr></table></td></tr></table></td></tr></table></td></tr></table></td></tr></table></td></tr></table></td></tr></table> | | | | | | | | | | | | | | | | | | | | <table border="1" style="width: 100%; border-collapse: collapse; text-align: center;"> <tr> <td style="width: 10%;"></td> <td style="width: 10%;"></td> <td style="width: 10%;"></td> <td style="width: 10%;"></td> <td style="width: 10%;"></td> <td style="width: 10%;"></td> <td style="width: 10%;"></td> <td style="width: 10%;"></td> <td style="width: 10%;"></td> <td style="width: 10%;"></td> </tr> <tr> <td></td> <td></td> <td colspan="8" style="text-align: center;"> <table border="1" style="width: 100%; border-collapse: collapse; text-align: center;"> <tr> <td style="width: 10%;"></td> <td style="width: 10%;"></td> <td style="width: 10%;"></td> <td style="width: 10%;"></td> <td style="width: 10%;"></td> <td style="width: 10%;"></td> <td style="width: 10%;"></td> <td style="width: 10%;"></td> <td style="width: 10%;"></td> <td style="width: 10%;"></td> </tr> <tr> <td></td> <td></td> <td colspan="8" style="text-align: center;"> <table border="1" style="width: 100%; border-collapse: collapse; text-align: center;"> <tr> <td style="width: 10%;"></td> <td style="width: 10%;"></td> <td style="width: 10%;"></td> <td style="width: 10%;"></td> <td style="width: 10%;"></td> <td style="width: 10%;"></td> <td style="width: 10%;"></td> <td style="width: 10%;"></td> <td style="width: 10%;"></td> <td style="width: 10%;"></td> </tr> <tr> <td></td> <td></td> <td colspan="8" style="text-align: center;"> <table border="1" style="width: 100%; border-collapse: collapse; text-align: center;"> <tr> <td style="width: 10%;"></td> <td style="width: 10%;"></td> <td style="width: 10%;"></td> <td style="width: 10%;"></td> <td style="width: 10%;"></td> <td style="width: 10%;"></td> <td style="width: 10%;"></td> <td style="width: 10%;"></td> <td style="width: 10%;"></td> <td style="width: 10%;"></td> </tr> <tr> <td></td> <td></td> <td colspan="8" style="text-align: center;"> <table border="1" style="width: 100%; border-collapse: collapse; text-align: center;"> <tr> <td style="width: 10%;"></td> <td style="width: 10%;"></td> <td style="width: 10%;"></td> <td style="width: 10%;"></td> <td style="width: 10%;"></td> <td style="width: 10%;"></td> <td style="width: 10%;"></td> <td style="width: 10%;"></td> <td style="width: 10%;"></td> <td style="width: 10%;"></td> </tr> <tr> <td></td> <td></td> <td colspan="8" style="text-align: center;"> <table border="1" style="width: 100%; border-collapse: collapse; text-align: center;"> <tr> <td style="width: 10%;"></td> <td style="width: 10%;"></td> <td style="width: 10%;"></td> <td
style="width: 10%;"></td> <td style="width: 10%;"></td> <td style="width: 10%;"></td> <td style="width: 10%;"></td> <td style="width: 10%;"></td> <td style="width: 10%;"></td> <td style="width: 10%;"></td> </tr> <tr> <td></td> <td></td> <td colspan="8" style="text-align: center;"> <table border="1" style="width: 100%; border-collapse: collapse; text-align: center;"> <tr> <td style="width: 10%;"></td> <td style="width: 10%;"></td> <td style="width: 10%;"></td> <td style="width: 10%;"></td> <td style="width: 10%;"></td> <td style="width: 10%;"></td> <td style="width: 10%;"></td> <td style="width: 10%;"></td> <td style="width: 10%;"></td> <td style="width: 10%;"></td> </tr> <tr> <td></td> <td></td> <td colspan="8" style="text-align: center;"> <table border="1" style="width: 100%; border-collapse: collapse; text-align: center;"> <tr> <td style="width: 10%;"></td> <td style="width: 10%;"></td> <td style="width: 10%;"></td> <td style="width: 10%;"></td> <td style="width: 10%;"></td> <td style="width: 10%;"></td> <td style="width: 10%;"></td> <td style="width: 10%;"></td> <td style="width: 10%;"></td> <td style="width: 10%;"></td> </tr> <tr> <td></td> <td></td> <td colspan="8" style="text-align: center;"> <table border="1" style="width: 100%; border-collapse: collapse; text-align: center;"> <tr> <td style="width: 10%;"></td> <td style="width: 10%;"></td> <td style="width: 10%;"></td> <td style="width: 10%;"></td> <td style="width: 10%;"></td> <td style="width: 10%;"></td> <td style="width: 10%;"></td> <td style="width: 10%;"></td> <td style="width: 10%;"></td> <td style="width: 10%;"></td> </tr> <tr> <td></td> <td></td> <td colspan="8" style="text-align: center;"> <table border="1" style="width: 100%; border-collapse: collapse; text-align: center;"> <tr> <td style="width: 10%;"></td> <td style="width: 10%;"></td> <td style="width: 10%;"></td> <td style="width: 10%;"></td> <td style="width: 10%;"></td> <td style="width: 10%;"></td> <td style="width: 10%;"></td> <td style="width: 10%;"></td> <td style="width: 10%;"></td> <td style="width: 10%;"></td> </tr> <tr> <td></td> <td></td> <td colspan="8" style="text-align: center;"> <table border="1" style="width: 100%; border-collapse: collapse; text-align: center;"> <tr> <td style="width: 10%;"></td> <td style="width: 10%;"></td> <td style="width: 10%;"></td> <td style="width: 10%;"></td> <td style="width: 10%;"></td> <td style="width: 10%;"></td> <td style="width: 10%;"></td> <td style="width: 10%;"></td> <td style="width: 10%;"></td> <td style="width: 10%;"></td> </tr> <tr> <td></td> <td></td> <td colspan="8" style="text-align: center;"> <table border="1" style="width: 100%; border-collapse: collapse; text-align: center;"> <tr> <td style="width: 10%;"></td> <td style="width: 10%;"></td> <td style="width: 10%;"></td> <td style="width: 10%;"></td> <td style="width: 10%;"></td> <td style="width: 10%;"></td> <td style="width: 10%;"></td> <td style="width: 10%;"></td> <td style="width: 10%;"></td> <td style="width: 10%;"></td> </tr> <tr> <td></td> <td></td> <td colspan="8" style="text-align: center;"> <table border="1" style="width: 100%; border-collapse: collapse; text-align: center;"> <tr> <td style="width: 10%;"></td> <td style="width: 10%;"></td> <td style="width: 10%;"></td> <td style="width: 10%;"></td> <td style="width: 10%;"></td> <td style="width: 10%;"></td> <td style="width: 10%;"></td> <td style="width: 10%;"></td> <td style="width: 10%;"></td> <td style="width: 10%;"></td> </tr> <tr> <td></td> <td></td> <td colspan="8" style="text-align: center;"> <table border="1" style="width: 100%; border-collapse: collapse; text-align: center;"> <tr> <td style="width: 10%;"></td> <td style="width: 10%;"></td> <td style="width: 10%;"></td> <td style="width: 10%;"></td> <td style="width: 10%;"></td> <td style="width: 10%;"></td> <td style="width: 10%;"></td> <td style="width: 10%;"></td> <td style="width: 10%;"></td> <td style="width: 10%;"></td> </tr> <tr> <td></td> <td></td> <td colspan="8" style="text-align: center;"> <table border="1" style="width: 100%; border-collapse: collapse; text-align: center;"> <tr> <td style="width: 10%;"></td> <td style="width: 10%;"></td> <td style="width: 10%;"></td> <td style="width: 10%;"></td> <td style="width: 10%;"></td> <td style="width: 10%;"></td> <td style="width: 10%;"></td> <td style="width: 10%;"></td> <td style="width: 10%;"></td> <td style="width: 10%;"></td> </tr> <tr> <td></td> <td></td> <td colspan="8" style="text-align: center;"> <table border="1" style="width: 100%; border-collapse: collapse; text-align: center;"> <tr> <td style="width: 10%;"></td> <td style="width: 10%;"></td> <td style="width: 10%;"></td> <td style="width: 10%;"></td> <td style="width: 10%;"></td> <td style="width: 10%;"></td> <td style="width: 10%;"></td> <td style="width: 10%;"></td> <td style="width: 10%;"></td> <td style="width: 10%;"></td> </tr> <tr> <td></td> <td></td> <td colspan="8" style="text-align: center;"> <table border="1" style="width: 100%; border-collapse: collapse; text-align: center;"> <tr> <td style="width: 10%;"></td> <td style="width: 10%;"></td> <td style="width: 10%;"></td> <td style="width: 10%;"></td> <td style="width: 10%;"></td> <td style="width: 10%;"></td> <td style="width: 10%;"></td> <td style="width: 10%;"></td> <td style="width: 10%;"></td> <td style="width: 10%;"></td> </tr> <tr> <td></td> <td></td> <td colspan="8" style="text-align: center;"> <table border="1" style="width: 100%; border-collapse: collapse; text-align: center;"> <tr> <td style="width: 10%;"></td> <td style="width: 10%;"></td> <td style="width: 10%;"></td> <td style="width: 10%;"></td> <td style="width: 10%;"></td> <td style="width: 10%;"></td> <td style="width: 10%;"></td> <td style="width: 10%;"></td> <td style="width: 10%;"></td> <td style="width: 10%;"></td> </tr> <tr> <td></td> <td></td> <td colspan="8" style="text-align: center;"> <table border="1" style="width: 100%; border-collapse: collapse; text-align: center;"> <tr> <td style="width: 10%;"></td> <td style="width: 10%;"></td> <td style="width: 10%;"></td> <td style="width: 10%;"></td> <td style="width: 10%;"></td> <td style="width: 10%;"></td> <td style="width: 10%;"></td> <td style="width: 10%;"></td> <td style="width: 10%;"></td> <td style="width: 10%;"></td> </tr> <tr> <td></td> <td></td> <td colspan="8" style="text-align: center;"> <table border="1" style="width: 100%; border-collapse: collapse; text-align: center;"> <tr> <td style="width: 10%;"></td> <td style="width: 10%;"></td> <td style="width: 10%;"></td> <td style="width: 10%;"></td> <td style="width: 10%;"></td> <td style="width: 10%;"></td> <td style="width: 10%;"></td> <td style="width: 10%;"></td> <td style="width: 10%;"></td> <td style="width: 10%;"></td> </tr> <tr> <td></td> <td></td> <td colspan="8" style="text-align: center;"> <table border="1" style="width: 100%; border-collapse: collapse; text-align: center;"> <tr> <td style="width: 10%;"></td> <td style="width: 10%;"></td> <td style="width: 10%;"></td> <td style="width: 10%;"></td> <td style="width: 10%;"></td> <td style="width: 10%;"></td> <td style="width: 10%;"></td> <td style="width: 10%;"></td> <td style="width: 10%;"></td> <td style="width: 10%;"></td> </tr> <tr> <td></td> <td></td> <td colspan="8" style="text-align: center;"> <table border="1" style="width: 100%; border-collapse: collapse; text-align: center;"> <tr> <td style="width: 10%;"></td> <td style="width: 10%;"></td> <td style="width: 10%;"></td> <td style="width: 10%;"></td> <td style="width: 10%;"></td> <td style="width: 10%;"></td> <td style="width: 10%;"></td> <td style="width: 10%;"></td> <td style="width: 10%;"></td> <td style="width: 10%;"></td> </tr> <tr> <td></td> <td></td> <td colspan="8" style="text-align: center;"> <table border="1" style="width: 100%; border-collapse: collapse; text-align: center;"> <tr> <td style="width: 10%;"></td> <td style="width: 10%;"></td> <td style="width: 10%;"></td> <td style="width: 10%;"></td> <td style="width: 10%;"></td> <td style="width: 10%;"></td> <td style="width: 10%;"></td> <td style="width: 10%;"></td> <td style="width: 10%;"></td> <td style="width: 10%;"></td> </tr> <tr> <td></td> <td></td> <td colspan="8" style="text-align: center;"> <table border="1" style="width: 100%; border-collapse: collapse; text-align: center;"> <tr> <td style="width: 10%;"></td> <td style="width: 10%;"></td> <td style="width: 10%;"></td> <td style="width: 10%;"></td> <td style="width: 10%;"></td> <td style="width: 10%;"></td> <td style="width: 10%;"></td> <td style="width: 10%;"></td> <td style="width: 10%;"></td> <td style="width: 10%;"></td> </tr> <tr> <td></td> <td></td> <td colspan="8" style="text-align: center;"> <table border="1" style="width: 100%; border-collapse: collapse; text-align: center;"> <tr> <td style="width: 10%;"></td> <td style="width: 10%;"></td> <td style="width: 10%;"></td> <td style="width: 10%;"></td> <td style="width: 10%;"></td> <td style="width: 10%;"></td> <td style="width: 10%;"></td> <td style="width: 10%;"></td> <td style="width: 10%;"></td> <td style="width: 10%;"></td> </tr> <tr> <td></td> <td></td> <td colspan="8" style="text-align: center;"> <table border="1" style="width: 100%; border-collapse: collapse; text-align: center;"> <tr> <td style="width: 10%;"></td> <td style="width: 10%;"></td> <td style="width: 10%;"></td> <td style="width: 10%;"></td> <td style="width: 10%;"></td> <td style="width: 10%;"></td> <td style="width: 10%;"></td> <td style="width: 10%;"></td> <td style="width: 10%;"></td> <td style="width: 10%;"></td> </tr> <tr> <td></td> <td></td> <td colspan="8" style="text-align: center;"> <table border="1" style="width: 100%; border-collapse: collapse; text-align: center;"> <tr> <td style="width: 10%;"></td> <td style="width: 10%;"></td> <td style="width: 10%;"></td> <td style="width: 10%;"></td> <td style="width: 10%;"></td> <td style="width: 10%;"></td> <td style="width: 10%;"></td> <td style="width: 10%;"></td> <td style="width:
10%;"></td> <td style="width: 10%;"></td> </tr> <tr> <td></td> <td></td> <td colspan="8" style="text-align: center;"> <table border="1" style="width: 100%; border-collapse: collapse; text-align: center;"> <tr> </tr></table></td></tr></table></td></tr></table></td></tr></table></td></tr></table></td></tr></table></td></tr></table></td></tr></table></td></tr></table></td></tr></table></td></tr></table></td></tr></table></td></tr></table></td></tr></table></td></tr></table></td></tr></table></td></tr></table></td></tr></table></td></tr></table></td></tr></table></td></tr></table></td></tr></table></td></tr></table></td></tr></table></td></tr></table></td></tr></table></td></tr></table></td></tr></table> | | | | | | | | | | | | | | | | | | | | <table border="1" style="width: 100%; border-collapse: collapse; text-align: center;"> <tr> <td style="width: 10%;"></td> <td style="width: 10%;"></td> <td style="width: 10%;"></td> <td style="width: 10%;"></td> <td style="width: 10%;"></td> <td style="width: 10%;"></td> <td style="width: 10%;"></td> <td style="width: 10%;"></td> <td style="width: 10%;"></td> <td style="width: 10%;"></td> </tr> <tr> <td></td> <td></td> <td colspan="8" style="text-align: center;"> <table border="1" style="width: 100%; border-collapse: collapse; text-align: center;"> <tr> <td style="width: 10%;"></td> <td style="width: 10%;"></td> <td style="width: 10%;"></td> <td style="width: 10%;"></td> <td style="width: 10%;"></td> <td style="width: 10%;"></td> <td style="width: 10%;"></td> <td style="width: 10%;"></td> <td style="width: 10%;"></td> <td style="width: 10%;"></td> </tr> <tr> <td></td> <td></td> <td colspan="8" style="text-align: center;"> <table border="1" style="width: 100%; border-collapse: collapse; text-align: center;"> <tr> <td style="width: 10%;"></td> <td style="width: 10%;"></td> <td style="width: 10%;"></td> <td style="width: 10%;"></td> <td style="width: 10%;"></td> <td style="width: 10%;"></td> <td style="width: 10%;"></td> <td style="width: 10%;"></td> <td style="width: 10%;"></td> <td style="width: 10%;"></td> </tr> <tr> <td></td> <td></td> <td colspan="8" style="text-align: center;"> <table border="1" style="width: 100%; border-collapse: collapse; text-align: center;"> <tr> <td style="width: 10%;"></td> <td style="width: 10%;"></td> <td style="width: 10%;"></td> <td style="width: 10%;"></td> <td style="width: 10%;"></td> <td style="width: 10%;"></td> <td style="width: 10%;"></td> <td style="width: 10%;"></td> <td style="width: 10%;"></td> <td style="width: 10%;"></td> </tr> <tr> <td></td> <td></td> <td colspan="8" style="text-align: center;"> <table border="1" style="width: 100%; border-collapse: collapse; text-align: center;"> <tr> <td style="width: 10%;"></td> <td style="width: 10%;"></td> <td style="width: 10%;"></td> <td style="width: 10%;"></td> <td style="width: 10%;"></td> <td style="width: 10%;"></td> <td style="width: 10%;"></td> <td style="width: 10%;"></td> <td style="width: 10%;"></td> <td style="width: 10%;"></td> </tr> <tr> <td></td> <td></td> <td colspan="8" style="text-align: center;"> <table border="1" style="width: 100%; border-collapse: collapse; text-align: center;"> <tr> <td style="width: 10%;"></td> <td style="width: 10%;"></td> <td style="width: 10%;"></td> <td style="width: 10%;"></td> <td style="width: 10%;"></td> <td style="width: 10%;"></td> <td style="width: 10%;"></td> <td style="width: 10%;"></td> <td style="width: 10%;"></td> <td style="width: 10%;"></td> </tr> <tr> <td></td> <td></td> <td colspan="8" style="text-align: center;"> <table border="1" style="width: 100%; border-collapse: collapse; text-align: center;"> <tr> <td style="width: 10%;"></td> <td style="width: 10%;"></td> <td style="width: 10%;"></td> <td style="width: 10%;"></td> <td style="width: 10%;"></td> <td style="width: 10%;"></td> <td style="width: 10%;"></td> <td style="width: 10%;"></td> <td style="width: 10%;"></td> <td style="width: 10%;"></td> </tr> <tr> <td></td> <td></td> <td colspan="8" style="text-align: center;"> <table border="1" style="width: 100%; border-collapse: collapse; text-align: center;"> <tr> <td style="width: 10%;"></td> <td style="width: 10%;"></td> <td style="width: 10%;"></td> <td style="width: 10%;"></td> <td style="width: 10%;"></td> <td style="width: 10%;"></td> <td style="width: 10%;"></td> <td style="width: 10%;"></td> <td style="width: 10%;"></td> <td style="width: 10%;"></td> </tr> <tr> <td></td> <td></td> <td colspan="8" style="text-align: center;"> <table border="1" style="width: 100%; border-collapse: collapse; text-align: center;"> <tr> <td style="width: 10%;"></td> <td style="width: 10%;"></td> <td style="width: 10%;"></td> <td style="width: 10%;"></td> <td style="width: 10%;"></td> <td style="width: 10%;"></td> <td style="width: 10%;"></td> <td style="width: 10%;"></td> <td style="width: 10%;"></td> <td style="width: 10%;"></td> </tr> <tr> <td></td> <td></td> <td colspan="8" style="text-align: center;"> <table border="1" style="width: 100%; border-collapse: collapse; text-align: center;"> <tr> <td style="width: 10%;"></td> <td style="width: 10%;"></td> <td style="width: 10%;"></td> <td style="width: 10%;"></td> <td style="width: 10%;"></td> <td style="width: 10%;"></td> <td style="width: 10%;"></td> <td style="width: 10%;"></td> <td style="width: 10%;"></td> <td style="width: 10%;"></td> </tr> <tr> <td></td> <td></td> <td colspan="8" style="text-align: center;"> <table border="1" style="width: 100%; border-collapse: collapse; text-align: center;"> <tr> <td style="width: 10%;"></td> <td style="width: 10%;"></td> <td style="width: 10%;"></td> <td style="width: 10%;"></td> <td style="width: 10%;"></td> <td style="width: 10%;"></td> <td style="width: 10%;"></td> <td style="width: 10%;"></td> <td style="width: 10%;"></td> <td style="width: 10%;"></td> </tr> <tr> <td></td> <td></td> <td colspan="8" style="text-align: center;"> <table border="1" style="width: 100%; border-collapse: collapse; text-align: center;"> <tr> <td style="width: 10%;"></td> <td style="width: 10%;"></td> <td style="width: 10%;"></td> <td style="width: 10%;"></td> <td style="width: 10%;"></td> <td style="width: 10%;"></td> <td style="width: 10%;"></td> <td style="width: 10%;"></td> <td style="width: 10%;"></td> <td style="width: 10%;"></td> </tr> <tr> <td></td> <td></td> <td colspan="8" style="text-align: center;"> <table border="1" style="width: 100%; border-collapse: collapse; text-align: center;"> <tr> <td style="width: 10%;"></td> <td style="width: 10%;"></td> <td style="width: 10%;"></td> <td style="width: 10%;"></td> <td style="width: 10%;"></td> <td style="width: 10%;"></td> <td style="width: 10%;"></td> <td style="width: 10%;"></td> <td style="width: 10%;"></td> <td style="width: 10%;"></td> </tr> <tr> <td></td> <td></td> <td colspan="8" style="text-align: center;"> <table border="1" style="width: 100%; border-collapse: collapse; text-align: center;"> <tr> <td style="width: 10%;"></td> <td style="width: 10%;"></td> <td style="width: 10%;"></td> <td style="width: 10%;"></td> <td style="width: 10%;"></td> <td style="width: 10%;"></td> <td style="width: 10%;"></td> <td style="width: 10%;"></td> <td style="width: 10%;"></td> <td style="width: 10%;"></td> </tr> <tr> <td></td> <td></td> <td colspan="8" style="text-align: center;"> <table border="1" style="width: 100%; border-collapse: collapse; text-align: center;"> <tr> <td style="width: 10%;"></td> <td style="width: 10%;"></td> <td style="width: 10%;"></td> <td style="width: 10%;"></td> <td style="width: 10%;"></td> <td style="width: 10%;"></td> <td style="width: 10%;"></td> <td style="width: 10%;"></td> <td style="width: 10%;"></td> <td style="width: 10%;"></td> </tr> <tr> <td></td> <td></td> <td colspan="8" style="text-align: center;"> <table border="1" style="width: 100%; border-collapse: collapse; text-align: center;"> <tr> <td style="width: 10%;"></td> <td style="width: 10%;"></td> <td style="width: 10%;"></td> <td style="width: 10%;"></td> <td style="width: 10%;"></td> <td style="width: 10%;"></td> <td style="width: 10%;"></td> <td style="width: 10%;"></td> <td style="width: 10%;"></td> <td style="width: 10%;"></td> </tr> <tr> <td></td> <td></td> <td colspan="8" style="text-align: center;"> <table border="1" style="width: 100%; border-collapse: collapse; text-align: center;"> <tr> <td style="width: 10%;"></td> <td style="width: 10%;"></td> <td style="width: 10%;"></td> <td style="width: 10%;"></td> <td style="width: 10%;"></td> <td style="width: 10%;"></td> <td style="width: 10%;"></td> <td style="width: 10%;"></td> <td style="width: 10%;"></td> <td style="width: 10%;"></td> </tr> <tr> <td></td> <td></td> <td colspan="8" style="text-align: center;"> <table border="1" style="width: 100%; border-collapse: collapse; text-align: center;"> <tr> <td style="width: 10%;"></td> <td style="width: 10%;"></td> <td style="width: 10%;"></td> <td style="width: 10%;"></td> <td style="width: 10%;"></td> <td style="width: 10%;"></td> <td style="width: 10%;"></td>
<td style="width: 10%;"></td> <td style="width: 10%;"></td> <td style="width: 10%;"></td> </tr> <tr> <td></td> <td></td> <td colspan="8" style="text-align: center;"> <table border="1" style="width: 100%; border-collapse: collapse; text-align: center;"> <tr> <td style="width: 10%;"></td> <td style="width: 10%;"></td> <td style="width: 10%;"></td> <td style="width: 10%;"></td> <td style="width: 10%;"></td> <td style="width: 10%;"></td> <td style="width: 10%;"></td> <td style="width: 10%;"></td> <td style="width: 10%;"></td> <td style="width: 10%;"></td> </tr> <tr> <td></td> <td></td> <td colspan="8" style="text-align: center;"> <table border="1" style="width: 100%; border-collapse: collapse; text-align: center;"> <tr> <td style="width: 10%;"></td> <td style="width: 10%;"></td> <td style="width: 10%;"></td> <td style="width: 10%;"></td> <td style="width: 10%;"></td> <td style="width: 10%;"></td> <td style="width: 10%;"></td> <td style="width: 10%;"></td> <td style="width: 10%;"></td> <td style="width: 10%;"></td> </tr> <tr> <td></td> <td></td> <td colspan="8" style="text-align: center;"> <table border="1" style="width: 100%; border-collapse: collapse; text-align: center;"> <tr> <td style="width: 10%;"></td> <td style="width: 10%;"></td> <td style="width: 10%;"></td> <td style="width: 10%;"></td> <td style="width: 10%;"></td> <td style="width: 10%;"></td> <td style="width: 10%;"></td> <td style="width: 10%;"></td> <td style="width: 10%;"></td> <td style="width: 10%;"></td> </tr> <tr> <td></td> <td></td> <td colspan="8" style="text-align: center;"> <table border="1" style="width: 100%; border-collapse: collapse; text-align: center;"> <tr> <td style="width: 10%;"></td> <td style="width: 10%;"></td> <td style="width: 10%;"></td> <td style="width: 10%;"></td> <td style="width: 10%;"></td> <td style="width: 10%;"></td> <td style="width: 10%;"></td> <td style="width: 10%;"></td> <td style="width: 10%;"></td> <td style="width: 10%;"></td> </tr> <tr> <td></td> <td></td> <td colspan="8" style="text-align: center;"> <table border="1" style="width: 100%; border-collapse: collapse; text-align: center;"> <tr> <td style="width: 10%;"></td> <td style="width: 10%;"></td> <td style="width: 10%;"></td> <td style="width: 10%;"></td> <td style="width: 10%;"></td> <td style="width: 10%;"></td> <td style="width: 10%;"></td> <td style="width: 10%;"></td> <td style="width: 10%;"></td> <td style="width: 10%;"></td> </tr> <tr> <td></td> <td></td> <td colspan="8" style="text-align: center;"> <table border="1" style="width: 100%; border-collapse: collapse; text-align: center;"> <tr> <td style="width: 10%;"></td> <td style="width: 10%;"></td> <td style="width: 10%;"></td> <td style="width: 10%;"></td> <td style="width: 10%;"></td> <td style="width: 10%;"></td> <td style="width: 10%;"></td> <td style="width: 10%;"></td> <td style="width: 10%;"></td> <td style="width: 10%;"></td> </tr> <tr> <td></td> <td></td> <td colspan="8" style="text-align: center;"> <table border="1" style="width: 100%; border-collapse: collapse; text-align: center;"> <tr> <td style="width: 10%;"></td> <td style="width: 10%;"></td> <td style="width: 10%;"></td> <td style="width: 10%;"></td> <td style="width: 10%;"></td> <td style="width: 10%;"></td> <td style="width: 10%;"></td> <td style="width: 10%;"></td> <td style="width: 10%;"></td> <td style="width: 10%;"></td> </tr> <tr> <td></td> <td></td> <td colspan="8" style="text-align: center;"> <table border="1" style="width: 100%; border-collapse: collapse; text-align: center;"> <tr> <td style="width: 10%;"></td> <td style="width: 10%;"></td> <td style="width: 10%;"></td> <td style="width: 10%;"></td> <td style="width: 10%;"></td> <td style="width: 10%;"></td> <td style="width: 10%;"></td> <td style="width: 10%;"></td> <td style="width: 10%;"></td> <td style="width: 10%;"></td> </tr> <tr> <td></td> <td></td> <td colspan="8" style="text-align: center;"> <table border="1" style="width: 100%; border-collapse: collapse; text-align: center;"> <tr> </tr></table></td></tr></table></td></tr></table></td></tr></table></td></tr></table></td></tr></table></td></tr></table></td></tr></table></td></tr></table></td></tr></table></td></tr></table></td></tr></table></td></tr></table></td></tr></table></td></tr></table></td></tr></table></td></tr></table></td></tr></table></td></tr></table></td></tr></table></td></tr></table></td></tr></table></td></tr></table></td></tr></table></td></tr></table></td></tr></table></td></tr></table> | | | | | | | | | | | | | | | | | | | | <table border="1" style="width: 100%; border-collapse: collapse; text-align: center;"> <tr> <td style="width: 10%;"></td> <td style="width: 10%;"></td> <td style="width: 10%;"></td> <td style="width: 10%;"></td> <td style="width: 10%;"></td> <td style="width: 10%;"></td> <td style="width: 10%;"></td> <td style="width: 10%;"></td> <td style="width: 10%;"></td> <td style="width: 10%;"></td> </tr> <tr> <td></td> <td></td> <td colspan="8" style="text-align: center;"> <table border="1" style="width: 100%; border-collapse: collapse; text-align: center;"> <tr> <td style="width: 10%;"></td> <td style="width: 10%;"></td> <td style="width: 10%;"></td> <td style="width: 10%;"></td> <td style="width: 10%;"></td> <td style="width: 10%;"></td> <td style="width: 10%;"></td> <td style="width: 10%;"></td> <td style="width: 10%;"></td> <td style="width: 10%;"></td> </tr> <tr> <td></td> <td></td> <td colspan="8" style="text-align: center;"> <table border="1" style="width: 100%; border-collapse: collapse; text-align: center;"> <tr> <td style="width: 10%;"></td> <td style="width: 10%;"></td> <td style="width: 10%;"></td> <td style="width: 10%;"></td> <td style="width: 10%;"></td> <td style="width: 10%;"></td> <td style="width: 10%;"></td> <td style="width: 10%;"></td> <td style="width: 10%;"></td> <td style="width: 10%;"></td> </tr> <tr> <td></td> <td></td> <td colspan="8" style="text-align: center;"> <table border="1" style="width: 100%; border-collapse: collapse; text-align: center;"> <tr> <td style="width: 10%;"></td> <td style="width: 10%;"></td> <td style="width: 10%;"></td> <td style="width: 10%;"></td> <td style="width: 10%;"></td> <td style="width: 10%;"></td> <td style="width: 10%;"></td> <td style="width: 10%;"></td> <td style="width: 10%;"></td> <td style="width: 10%;"></td> </tr> <tr> <td></td> <td></td> <td colspan="8" style="text-align: center;"> <table border="1" style="width: 100%; border-collapse: collapse; text-align: center;"> <tr> <td style="width: 10%;"></td> <td style="width: 10%;"></td> <td style="width: 10%;"></td> <td style="width: 10%;"></td> <td style="width: 10%;"></td> <td style="width: 10%;"></td> <td style="width: 10%;"></td> <td style="width: 10%;"></td> <td style="width: 10%;"></td> <td style="width: 10%;"></td> </tr> <tr> <td></td> <td></td> <td colspan="8" style="text-align: center;"> <table border="1" style="width: 100%; border-collapse: collapse; text-align: center;"> <tr> <td style="width: 10%;"></td> <td style="width: 10%;"></td> <td style="width: 10%;"></td> <td style="width: 10%;"></td> <td style="width: 10%;"></td> <td style="width: 10%;"></td> <td style="width: 10%;"></td> <td style="width: 10%;"></td> <td style="width: 10%;"></td> <td style="width: 10%;"></td> </tr> <tr> <td></td> <td></td> <td colspan="8" style="text-align: center;"> <table border="1" style="width: 100%; border-collapse: collapse; text-align: center;"> <tr> <td style="width: 10%;"></td> <td style="width: 10%;"></td> <td style="width: 10%;"></td> <td style="width: 10%;"></td> <td style="width: 10%;"></td> <td style="width: 10%;"></td> <td style="width: 10%;"></td> <td style="width: 10%;"></td> <td style="width: 10%;"></td> <td style="width: 10%;"></td> </tr> <tr> <td></td> <td></td> <td colspan="8" style="text-align: center;"> <table border="1" style="width: 100%; border-collapse: collapse; text-align: center;"> <tr> <td style="width: 10%;"></td> <td style="width: 10%;"></td> <td style="width: 10%;"></td> <td style="width: 10%;"></td> <td style="width: 10%;"></td> <td style="width: 10%;"></td> <td style="width: 10%;"></td> <td style="width: 10%;"></td> <td style="width: 10%;"></td> <td style="width: 10%;"></td> </tr> <tr> <td></td> <td></td> <td colspan="8" style="text-align: center;"> <table border="1" style="width: 100%; border-collapse: collapse; text-align: center;"> <tr> <td style="width: 10%;"></td> <td style="width: 10%;"></td> <td style="width: 10%;"></td> <td style="width: 10%;"></td> <td style="width: 10%;"></td> <td style="width: 10%;"></td> <td style="width: 10%;"></td> <td style="width: 10%;"></td> <td style="width: 10%;"></td> <td style="width: 10%;"></td> </tr> <tr> <td></td> <td></td> <td colspan="8" style="text-align: center;"> <table border="1" style="width: 100%; border-collapse: collapse; text-align: center;"> <tr> <td style="width: 10%;"></td> <td style="width: 10%;"></td> <td style="width: 10%;"></td> <td style="width: 10%;"></td> <td style="width: 10%;"></td> <td style="width: 10%;"></td>
<td style="width: 10%;"></td> <td style="width: 10%;"></td> <td style="width: 10%;"></td> <td style="width: 10%;"></td> </tr> <tr> <td></td> <td></td> <td colspan="8" style="text-align: center;"> <table border="1" style="width: 100%; border-collapse: collapse; text-align: center;"> <tr> <td style="width: 10%;"></td> <td style="width: 10%;"></td> <td style="width: 10%;"></td> <td style="width: 10%;"></td> <td style="width: 10%;"></td> <td style="width: 10%;"></td> <td style="width: 10%;"></td> <td style="width: 10%;"></td> <td style="width: 10%;"></td> <td style="width: 10%;"></td> </tr> <tr> <td></td> <td></td> <td colspan="8" style="text-align: center;"> <table border="1" style="width: 100%; border-collapse: collapse; text-align: center;"> <tr> <td style="width: 10%;"></td> <td style="width: 10%;"></td> <td style="width: 10%;"></td> <td style="width: 10%;"></td> <td style="width: 10%;"></td> <td style="width: 10%;"></td> <td style="width: 10%;"></td> <td style="width: 10%;"></td> <td style="width: 10%;"></td> <td style="width: 10%;"></td> </tr> <tr> <td></td> <td></td> <td colspan="8" style="text-align: center;"> <table border="1" style="width: 100%; border-collapse: collapse; text-align: center;"> <tr> <td style="width: 10%;"></td> <td style="width: 10%;"></td> <td style="width: 10%;"></td> <td style="width: 10%;"></td> <td style="width: 10%;"></td> <td style="width: 10%;"></td> <td style="width: 10%;"></td> <td style="width: 10%;"></td> <td style="width: 10%;"></td> <td style="width: 10%;"></td> </tr> <tr> <td></td> <td></td> <td colspan="8" style="text-align: center;"> <table border="1" style="width: 100%; border-collapse: collapse; text-align: center;"> <tr> <td style="width: 10%;"></td> <td style="width: 10%;"></td> <td style="width: 10%;"></td> <td style="width: 10%;"></td> <td style="width: 10%;"></td> <td style="width: 10%;"></td> <td style="width: 10%;"></td> <td style="width: 10%;"></td> <td style="width: 10%;"></td> <td style="width: 10%;"></td> </tr> <tr> <td></td> <td></td> <td colspan="8" style="text-align: center;"> <table border="1" style="width: 100%; border-collapse: collapse; text-align: center;"> <tr> <td style="width: 10%;"></td> <td style="width: 10%;"></td> <td style="width: 10%;"></td> <td style="width: 10%;"></td> <td style="width: 10%;"></td> <td style="width: 10%;"></td> <td style="width: 10%;"></td> <td style="width: 10%;"></td> <td style="width: 10%;"></td> <td style="width: 10%;"></td> </tr> <tr> <td></td> <td></td> <td colspan="8" style="text-align: center;"> <table border="1" style="width: 100%; border-collapse: collapse; text-align: center;"> <tr> <td style="width: 10%;"></td> <td style="width: 10%;"></td> <td style="width: 10%;"></td> <td style="width: 10%;"></td> <td style="width: 10%;"></td> <td style="width: 10%;"></td> <td style="width: 10%;"></td> <td style="width: 10%;"></td> <td style="width: 10%;"></td> <td style="width: 10%;"></td> </tr> <tr> <td></td> <td></td> <td colspan="8" style="text-align: center;"> <table border="1" style="width: 100%; border-collapse: collapse; text-align: center;"> <tr> <td style="width: 10%;"></td> <td style="width: 10%;"></td> <td style="width: 10%;"></td> <td style="width: 10%;"></td> <td style="width: 10%;"></td> <td style="width: 10%;"></td> <td style="width: 10%;"></td> <td style="width: 10%;"></td> <td style="width: 10%;"></td> <td style="width: 10%;"></td> </tr> <tr> <td></td> <td></td> <td colspan="8" style="text-align: center;"> <table border="1" style="width: 100%; border-collapse: collapse; text-align: center;"> <tr> <td style="width: 10%;"></td> <td style="width: 10%;"></td> <td style="width: 10%;"></td> <td style="width: 10%;"></td> <td style="width: 10%;"></td> <td style="width: 10%;"></td> <td style="width: 10%;"></td> <td style="width: 10%;"></td> <td style="width: 10%;"></td> <td style="width: 10%;"></td> </tr> <tr> <td></td> <td></td> <td colspan="8" style="text-align: center;"> <table border="1" style="width: 100%; border-collapse: collapse; text-align: center;"> <tr> <td style="width: 10%;"></td> <td style="width: 10%;"></td> <td style="width: 10%;"></td> <td style="width: 10%;"></td> <td style="width: 10%;"></td> <td style="width: 10%;"></td> <td style="width: 10%;"></td> <td style="width: 10%;"></td> <td style="width: 10%;"></td> <td style="width: 10%;"></td> </tr> <tr> <td></td> <td></td> <td colspan="8" style="text-align: center;"> <table border="1" style="width: 100%; border-collapse: collapse; text-align: center;"> <tr> <td style="width: 10%;"></td> <td style="width: 10%;"></td> <td style="width: 10%;"></td> <td style="width: 10%;"></td> <td style="width: 10%;"></td> <td style="width: 10%;"></td> <td style="width: 10%;"></td> <td style="width: 10%;"></td> <td style="width: 10%;"></td> <td style="width: 10%;"></td> </tr> <tr> <td></td> <td></td> <td colspan="8" style="text-align: center;"> <table border="1" style="width: 100%; border-collapse: collapse; text-align: center;"> <tr> <td style="width: 10%;"></td> <td style="width: 10%;"></td> <td style="width: 10%;"></td> <td style="width: 10%;"></td> <td style="width: 10%;"></td> <td style="width: 10%;"></td> <td style="width: 10%;"></td> <td style="width: 10%;"></td> <td style="width: 10%;"></td> <td style="width: 10%;"></td> </tr> <tr> <td></td> <td></td> <td colspan="8" style="text-align: center;"> <table border="1" style="width: 100%; border-collapse: collapse; text-align: center;"> <tr> <td style="width: 10%;"></td> <td style="width: 10%;"></td> <td style="width: 10%;"></td> <td style="width: 10%;"></td> <td style="width: 10%;"></td> <td style="width: 10%;"></td> <td style="width: 10%;"></td> <td style="width: 10%;"></td> <td style="width: 10%;"></td> <td style="width: 10%;"></td> </tr> <tr> <td></td> <td></td> <td colspan="8" style="text-align: center;"> <table border="1" style="width: 100%; border-collapse: collapse; text-align: center;"> <tr> <td style="width: 10%;"></td> <td style="width: 10%;"></td> <td style="width: 10%;"></td> <td style="width: 10%;"></td> <td style="width: 10%;"></td> <td style="width: 10%;"></td> <td style="width: 10%;"></td> <td style="width: 10%;"></td> <td style="width: 10%;"></td> <td style="width: 10%;"></td> </tr> <tr> <td></td> <td></td> <td colspan="8" style="text-align: center;"> <table border="1" style="width: 100%; border-collapse: collapse; text-align: center;"> <tr> <td style="width: 10%;"></td> <td style="width: 10%;"></td> <td style="width: 10%;"></td> <td style="width: 10%;"></td> <td style="width: 10%;"></td> <td style="width: 10%;"></td> <td style="width: 10%;"></td> <td style="width: 10%;"></td> <td style="width: 10%;"></td> <td style="width: 10%;"></td> </tr> <tr> <td></td> <td></td> <td colspan="8" style="text-align: center;"> <table border="1" style="width: 100%; border-collapse: collapse; text-align: center;"> <tr> <td style="width: 10%;"></td> <td style="width: 10%;"></td> <td style="width: 10%;"></td> <td style="width: 10%;"></td> <td style="width: 10%;"></td> <td style="width: 10%;"></td> <td style="width: 10%;"></td> <td style="width: 10%;"></td> <td style="width: 10%;"></td> <td style="width: 10%;"></td> </tr> <tr> <td></td> <td></td> <td colspan="8" style="text-align: center;"> <table border="1" style="width: 100%; border-collapse: collapse; text-align: center;"> <tr> </tr></table></td></tr></table></td></tr></table></td></tr></table></td></tr></table></td></tr></table></td></tr></table></td></tr></table></td></tr></table></td></tr></table></td></tr></table></td></tr></table></td></tr></table></td></tr></table></td></tr></table></td></tr></table></td></tr></table></td></tr></table></td></tr></table></td></tr></table></td></tr></table></td></tr></table></td></tr></table></td></tr></table></td></tr></table></td></tr></table> | | | | | | | | | | | | | | | | | | | | <table border="1" style="width: 100%; border-collapse: collapse; text-align: center;"> <tr> <td style="width: 10%;"></td> <td style="width: 10%;"></td> <td style="width: 10%;"></td> <td style="width: 10%;"></td> <td style="width: 10%;"></td> <td style="width: 10%;"></td> <td style="width: 10%;"></td> <td style="width: 10%;"></td> <td style="width: 10%;"></td> <td style="width: 10%;"></td> </tr> <tr> <td></td> <td></td> <td colspan="8" style="text-align: center;"> <table border="1" style="width: 100%; border-collapse: collapse; text-align: center;"> <tr> <td style="width: 10%;"></td> <td style="width: 10%;"></td> <td style="width: 10%;"></td> <td style="width: 10%;"></td> <td style="width: 10%;"></td> <td style="width: 10%;"></td> <td style="width: 10%;"></td> <td style="width: 10%;"></td> <td style="width: 10%;"></td> <td style="width: 10%;"></td> </tr> <tr> <td></td> <td></td> <td colspan="8" style="text-align: center;"> <table border="1" style="width: 100%; border-collapse: collapse; text-align: center;"> <tr> <td style="width: 10%;"></td> <td style="width: 10%;"></td> <td style="width: 10%;"></td> <td style="width: 10%;"></td> <td style="width: 10%;"></td> <td style="width:
10%;"></td> <td style="width: 10%;"></td> <td style="width: 10%;"></td> <td style="width: 10%;"></td> <td style="width: 10%;"></td> </tr> <tr> <td></td> <td></td> <td colspan="8" style="text-align: center;"> <table border="1" style="width: 100%; border-collapse: collapse; text-align: center;"> <tr> <td style="width: 10%;"></td> <td style="width: 10%;"></td> <td style="width: 10%;"></td> <td style="width: 10%;"></td> <td style="width: 10%;"></td> <td style="width: 10%;"></td> <td style="width: 10%;"></td> <td style="width: 10%;"></td> <td style="width: 10%;"></td> <td style="width: 10%;"></td> </tr> <tr> <td></td> <td></td> <td colspan="8" style="text-align: center;"> <table border="1" style="width: 100%; border-collapse: collapse; text-align: center;"> <tr> <td style="width: 10%;"></td> <td style="width: 10%;"></td> <td style="width: 10%;"></td> <td style="width: 10%;"></td> <td style="width: 10%;"></td> <td style="width: 10%;"></td> <td style="width: 10%;"></td> <td style="width: 10%;"></td> <td style="width: 10%;"></td> <td style="width: 10%;"></td> </tr> <tr> <td></td> <td></td> <td colspan="8" style="text-align: center;"> <table border="1" style="width: 100%; border-collapse: collapse; text-align: center;"> <tr> <td style="width: 10%;"></td> <td style="width: 10%;"></td> <td style="width: 10%;"></td> <td style="width: 10%;"></td> <td style="width: 10%;"></td> <td style="width: 10%;"></td> <td style="width: 10%;"></td> <td style="width: 10%;"></td> <td style="width: 10%;"></td> <td style="width: 10%;"></td> </tr> <tr> <td></td> <td></td> <td colspan="8" style="text-align: center;"> <table border="1" style="width: 100%; border-collapse: collapse; text-align: center;"> <tr> <td style="width: 10%;"></td> <td style="width: 10%;"></td> <td style="width: 10%;"></td> <td style="width: 10%;"></td> <td style="width: 10%;"></td> <td style="width: 10%;"></td> <td style="width: 10%;"></td> <td style="width: 10%;"></td> <td style="width: 10%;"></td> <td style="width: 10%;"></td> </tr> <tr> <td></td> <td></td> <td colspan="8" style="text-align: center;"> <table border="1" style="width: 100%; border-collapse: collapse; text-align: center;"> <tr> <td style="width: 10%;"></td> <td style="width: 10%;"></td> <td style="width: 10%;"></td> <td style="width: 10%;"></td> <td style="width: 10%;"></td> <td style="width: 10%;"></td> <td style="width: 10%;"></td> <td style="width: 10%;"></td> <td style="width: 10%;"></td> <td style="width: 10%;"></td> </tr> <tr> <td></td> <td></td> <td colspan="8" style="text-align: center;"> <table border="1" style="width: 100%; border-collapse: collapse; text-align: center;"> <tr> <td style="width: 10%;"></td> <td style="width: 10%;"></td> <td style="width: 10%;"></td> <td style="width: 10%;"></td> <td style="width: 10%;"></td> <td style="width: 10%;"></td> <td style="width: 10%;"></td> <td style="width: 10%;"></td> <td style="width: 10%;"></td> <td style="width: 10%;"></td> </tr> <tr> <td></td> <td></td> <td colspan="8" style="text-align: center;"> <table border="1" style="width: 100%; border-collapse: collapse; text-align: center;"> <tr> <td style="width: 10%;"></td> <td style="width: 10%;"></td> <td style="width: 10%;"></td> <td style="width: 10%;"></td> <td style="width: 10%;"></td> <td style="width: 10%;"></td> <td style="width: 10%;"></td> <td style="width: 10%;"></td> <td style="width: 10%;"></td> <td style="width: 10%;"></td> </tr> <tr> <td></td> <td></td> <td colspan="8" style="text-align: center;"> <table border="1" style="width: 100%; border-collapse: collapse; text-align: center;"> <tr> <td style="width: 10%;"></td> <td style="width: 10%;"></td> <td style="width: 10%;"></td> <td style="width: 10%;"></td> <td style="width: 10%;"></td> <td style="width: 10%;"></td> <td style="width: 10%;"></td> <td style="width: 10%;"></td> <td style="width: 10%;"></td> <td style="width: 10%;"></td> </tr> <tr> <td></td> <td></td> <td colspan="8" style="text-align: center;"> <table border="1" style="width: 100%; border-collapse: collapse; text-align: center;"> <tr> <td style="width: 10%;"></td> <td style="width: 10%;"></td> <td style="width: 10%;"></td> <td style="width: 10%;"></td> <td style="width: 10%;"></td> <td style="width: 10%;"></td> <td style="width: 10%;"></td> <td style="width: 10%;"></td> <td style="width: 10%;"></td> <td style="width: 10%;"></td> </tr> <tr> <td></td> <td></td> <td colspan="8" style="text-align: center;"> <table border="1" style="width: 100%; border-collapse: collapse; text-align: center;"> <tr> <td style="width: 10%;"></td> <td style="width: 10%;"></td> <td style="width: 10%;"></td> <td style="width: 10%;"></td> <td style="width: 10%;"></td> <td style="width: 10%;"></td> <td style="width: 10%;"></td> <td style="width: 10%;"></td> <td style="width: 10%;"></td> <td style="width: 10%;"></td> </tr> <tr> <td></td> <td></td> <td colspan="8" style="text-align: center;"> <table border="1" style="width: 100%; border-collapse: collapse; text-align: center;"> <tr> <td style="width: 10%;"></td> <td style="width: 10%;"></td> <td style="width: 10%;"></td> <td style="width: 10%;"></td> <td style="width: 10%;"></td> <td style="width: 10%;"></td> <td style="width: 10%;"></td> <td style="width: 10%;"></td> <td style="width: 10%;"></td> <td style="width: 10%;"></td> </tr> <tr> <td></td> <td></td> <td colspan="8" style="text-align: center;"> <table border="1" style="width: 100%; border-collapse: collapse; text-align: center;"> <tr> <td style="width: 10%;"></td> <td style="width: 10%;"></td> <td style="width: 10%;"></td> <td style="width: 10%;"></td> <td style="width: 10%;"></td> <td style="width: 10%;"></td> <td style="width: 10%;"></td> <td style="width: 10%;"></td> <td style="width: 10%;"></td> <td style="width: 10%;"></td> </tr> <tr> <td></td> <td></td> <td colspan="8" style="text-align: center;"> <table border="1" style="width: 100%; border-collapse: collapse; text-align: center;"> <tr> <td style="width: 10%;"></td> <td style="width: 10%;"></td> <td style="width: 10%;"></td> <td style="width: 10%;"></td> <td style="width: 10%;"></td> <td style="width: 10%;"></td> <td style="width: 10%;"></td> <td style="width: 10%;"></td> <td style="width: 10%;"></td> <td style="width: 10%;"></td> </tr> <tr> <td></td> <td></td> <td colspan="8" style="text-align: center;"> <table border="1" style="width: 100%; border-collapse: collapse; text-align: center;"> <tr> <td style="width: 10%;"></td> <td style="width: 10%;"></td> <td style="width: 10%;"></td> <td style="width: 10%;"></td> <td style="width: 10%;"></td> <td style="width: 10%;"></td> <td style="width: 10%;"></td> <td style="width: 10%;"></td> <td style="width: 10%;"></td> <td style="width: 10%;"></td> </tr> <tr> <td></td> <td></td> <td colspan="8" style="text-align: center;"> <table border="1" style="width: 100%; border-collapse: collapse; text-align: center;"> <tr> <td style="width: 10%;"></td> <td style="width: 10%;"></td> <td style="width: 10%;"></td> <td style="width: 10%;"></td> <td style="width: 10%;"></td> <td style="width: 10%;"></td> <td style="width: 10%;"></td> <td style="width: 10%;"></td> <td style="width: 10%;"></td> <td style="width: 10%;"></td> </tr> <tr> <td></td> <td></td> <td colspan="8" style="text-align: center;"> <table border="1" style="width: 100%; border-collapse: collapse; text-align: center;"> <tr> <td style="width: 10%;"></td> <td style="width: 10%;"></td> <td style="width: 10%;"></td> <td style="width: 10%;"></td> <td style="width: 10%;"></td> <td style="width: 10%;"></td> <td style="width: 10%;"></td> <td style="width: 10%;"></td> <td style="width: 10%;"></td> <td style="width: 10%;"></td> </tr> <tr> <td></td> <td></td> <td colspan="8" style="text-align: center;"> <table border="1" style="width: 100%; border-collapse: collapse; text-align: center;"> <tr> <td style="width: 10%;"></td> <td style="width: 10%;"></td> <td style="width: 10%;"></td> <td style="width: 10%;"></td> <td style="width: 10%;"></td> <td style="width: 10%;"></td> <td style="width: 10%;"></td> <td style="width: 10%;"></td> <td style="width: 10%;"></td> <td style="width: 10%;"></td> </tr> <tr> <td></td> <td></td> <td colspan="8" style="text-align: center;"> <table border="1" style="width: 100%; border-collapse: collapse; text-align: center;"> <tr> <td style="width: 10%;"></td> <td style="width: 10%;"></td> <td style="width: 10%;"></td> <td style="width: 10%;"></td> <td style="width: 10%;"></td> <td style="width: 10%;"></td> <td style="width: 10%;"></td> <td style="width: 10%;"></td> <td style="width: 10%;"></td> <td style="width: 10%;"></td> </tr> <tr> <td></td> <td></td> <td colspan="8" style="text-align: center;"> <table border="1" style="width: 100%; border-collapse: collapse; text-align: center;"> <tr> <td style="width: 10%;"></td> <td style="width: 10%;"></td> <td style="width: 10%;"></td> <td style="width: 10%;"></td> <td style="width: 10%;"></td> <td style="width: 10%;"></td> <td style="width: 10%;"></td> <td style="width: 10%;"></td> <td style="width: 10%;"></td> <td style="width: 10%;"></td> </tr> <tr> <td></td> <td></td> <td colspan="8" style="text-align: center;"> <table border="1" style="width: 100%; border-collapse: collapse; text-align: center;"> <tr> <td style="width: 10%;"></td> <td style="width: 10%;"></td> <td style="width: 10%;"></td> <td style="width: 10%;"></td> <td style="width: 10%;"></td> <td style="width: 10%;"></td> <td style="width: 10%;"></td> <td style="width: 10%;"></td> <td style="width: 10%;"></td> <td style="width: 10%;"></td> </tr> <tr> <td></td> <td></td> <td colspan="8" style="text-align: center;"> <table border="1" style="width: 100%; border-collapse: collapse; text-align: center;"> <tr> <td style="width: 10%;"></td> <td style="width: 10%;"></td> <td style="width: 10%;"></td> <td style="width: 10%;"></td> <td style="width: 10%;"></td> <td style="width: 10%;"></td> <td style="width: 10%;"></td> <td style="width: 10%;"></td> <td style="width: 10%;"></td> <td style="width: 10%;"></td> </tr> <tr> <td></td> <td></td> <td
colspan="8" style="text-align: center;"> <table border="1" style="width: 100%; border-collapse: collapse; text-align: center;"> <tr> </tr></table></td></tr></table></td></tr></table></td></tr></table></td></tr></table></td></tr></table></td></tr></table></td></tr></table></td></tr></table></td></tr></table></td></tr></table></td></tr></table></td></tr></table></td></tr></table></td></tr></table></td></tr></table></td></tr></table></td></tr></table></td></tr></table></td></tr></table></td></tr></table></td></tr></table></td></tr></table></td></tr></table></td></tr></table> | | | | | | | | | | | | | | | | | | | | <table border="1" style="width: 100%; border-collapse: collapse; text-align: center;"> <tr> <td style="width: 10%;"></td> <td style="width: 10%;"></td> <td style="width: 10%;"></td> <td style="width: 10%;"></td> <td style="width: 10%;"></td> <td style="width: 10%;"></td> <td style="width: 10%;"></td> <td style="width: 10%;"></td> <td style="width: 10%;"></td> <td style="width: 10%;"></td> </tr> <tr> <td></td> <td></td> <td colspan="8" style="text-align: center;"> <table border="1" style="width: 100%; border-collapse: collapse; text-align: center;"> <tr> <td style="width: 10%;"></td> <td style="width: 10%;"></td> <td style="width: 10%;"></td> <td style="width: 10%;"></td> <td style="width: 10%;"></td> <td style="width: 10%;"></td> <td style="width: 10%;"></td> <td style="width: 10%;"></td> <td style="width: 10%;"></td> <td style="width: 10%;"></td> </tr> <tr> <td></td> <td></td> <td colspan="8" style="text-align: center;"> <table border="1" style="width: 100%; border-collapse: collapse; text-align: center;"> <tr> <td style="width: 10%;"></td> <td style="width: 10%;"></td> <td style="width: 10%;"></td> <td style="width: 10%;"></td> <td style="width: 10%;"></td> <td style="width: 10%;"></td> <td style="width: 10%;"></td> <td style="width: 10%;"></td> <td style="width: 10%;"></td> <td style="width: 10%;"></td> </tr> <tr> <td></td> <td></td> <td colspan="8" style="text-align: center;"> <table border="1" style="width: 100%; border-collapse: collapse; text-align: center;"> <tr> <td style="width: 10%;"></td> <td style="width: 10%;"></td> <td style="width: 10%;"></td> <td style="width: 10%;"></td> <td style="width: 10%;"></td> <td style="width: 10%;"></td> <td style="width: 10%;"></td> <td style="width: 10%;"></td> <td style="width: 10%;"></td> <td style="width: 10%;"></td> </tr> <tr> <td></td> <td></td> <td colspan="8" style="text-align: center;"> <table border="1" style="width: 100%; border-collapse: collapse; text-align: center;"> <tr> <td style="width: 10%;"></td> <td style="width: 10%;"></td> <td style="width: 10%;"></td> <td style="width: 10%;"></td> <td style="width: 10%;"></td> <td style="width: 10%;"></td> <td style="width: 10%;"></td> <td style="width: 10%;"></td> <td style="width: 10%;"></td> <td style="width: 10%;"></td> </tr> <tr> <td></td> <td></td> <td colspan="8" style="text-align: center;"> <table border="1" style="width: 100%; border-collapse: collapse; text-align: center;"> <tr> <td style="width: 10%;"></td> <td style="width: 10%;"></td> <td style="width: 10%;"></td> <td style="width: 10%;"></td> <td style="width: 10%;"></td> <td style="width: 10%;"></td> <td style="width: 10%;"></td> <td style="width: 10%;"></td> <td style="width: 10%;"></td> <td style="width: 10%;"></td> </tr> <tr> <td></td> <td></td> <td colspan="8" style="text-align: center;"> <table border="1" style="width: 100%; border-collapse: collapse; text-align: center;"> <tr> <td style="width: 10%;"></td> <td style="width: 10%;"></td> <td style="width: 10%;"></td> <td style="width: 10%;"></td> <td style="width: 10%;"></td> <td style="width: 10%;"></td> <td style="width: 10%;"></td> <td style="width: 10%;"></td> <td style="width: 10%;"></td> <td style="width: 10%;"></td> </tr> <tr> <td></td> <td></td> <td colspan="8" style="text-align: center;"> <table border="1" style="width: 100%; border-collapse: collapse; text-align: center;"> <tr> <td style="width: 10%;"></td> <td style="width: 10%;"></td> <td style="width: 10%;"></td> <td style="width: 10%;"></td> <td style="width: 10%;"></td> <td style="width: 10%;"></td> <td style="width: 10%;"></td> <td style="width: 10%;"></td> <td style="width: 10%;"></td> <td style="width: 10%;"></td> </tr> <tr> <td></td> <td></td> <td colspan="8" style="text-align: center;"> <table border="1" style="width: 100%; border-collapse: collapse; text-align: center;"> <tr> <td style="width: 10%;"></td> <td style="width: 10%;"></td> <td style="width: 10%;"></td> <td style="width: 10%;"></td> <td style="width: 10%;"></td> <td style="width: 10%;"></td> <td style="width: 10%;"></td> <td style="width: 10%;"></td> <td style="width: 10%;"></td> <td style="width: 10%;"></td> </tr> <tr> <td></td> <td></td> <td colspan="8" style="text-align: center;"> <table border="1" style="width: 100%; border-collapse: collapse; text-align: center;"> <tr> <td style="width: 10%;"></td> <td style="width: 10%;"></td> <td style="width: 10%;"></td> <td style="width: 10%;"></td> <td style="width: 10%;"></td> <td style="width: 10%;"></td> <td style="width: 10%;"></td> <td style="width: 10%;"></td> <td style="width: 10%;"></td> <td style="width: 10%;"></td> </tr> <tr> <td></td> <td></td> <td colspan="8" style="text-align: center;"> <table border="1" style="width: 100%; border-collapse: collapse; text-align: center;"> <tr> <td style="width: 10%;"></td> <td style="width: 10%;"></td> <td style="width: 10%;"></td> <td style="width: 10%;"></td> <td style="width: 10%;"></td> <td style="width: 10%;"></td> <td style="width: 10%;"></td> <td style="width: 10%;"></td> <td style="width: 10%;"></td> <td style="width: 10%;"></td> </tr> <tr> <td></td> <td></td> <td colspan="8" style="text-align: center;"> <table border="1" style="width: 100%; border-collapse: collapse; text-align: center;"> <tr> <td style="width: 10%;"></td> <td style="width: 10%;"></td> <td style="width: 10%;"></td> <td style="width: 10%;"></td> <td style="width: 10%;"></td> <td style="width: 10%;"></td> <td style="width: 10%;"></td> <td style="width: 10%;"></td> <td style="width: 10%;"></td> <td style="width: 10%;"></td> </tr> <tr> <td></td> <td></td> <td colspan="8" style="text-align: center;"> <table border="1" style="width: 100%; border-collapse: collapse; text-align: center;"> <tr> <td style="width: 10%;"></td> <td style="width: 10%;"></td> <td style="width: 10%;"></td> <td style="width: 10%;"></td> <td style="width: 10%;"></td> <td style="width: 10%;"></td> <td style="width: 10%;"></td> <td style="width: 10%;"></td> <td style="width: 10%;"></td> <td style="width: 10%;"></td> </tr> <tr> <td></td> <td></td> <td colspan="8" style="text-align: center;"> <table border="1" style="width: 100%; border-collapse: collapse; text-align: center;"> <tr> <td style="width: 10%;"></td> <td style="width: 10%;"></td> <td style="width: 10%;"></td> <td style="width: 10%;"></td> <td style="width: 10%;"></td> <td style="width: 10%;"></td> <td style="width: 10%;"></td> <td style="width: 10%;"></td> <td style="width: 10%;"></td> <td style="width: 10%;"></td> </tr> <tr> <td></td> <td></td> <td colspan="8" style="text-align: center;"> <table border="1" style="width: 100%; border-collapse: collapse; text-align: center;"> <tr> <td style="width: 10%;"></td> <td style="width: 10%;"></td> <td style="width: 10%;"></td> <td style="width: 10%;"></td> <td style="width: 10%;"></td> <td style="width: 10%;"></td> <td style="width: 10%;"></td> <td style="width: 10%;"></td> <td style="width: 10%;"></td> <td style="width: 10%;"></td> </tr> <tr> <td></td> <td></td> <td colspan="8" style="text-align: center;"> <table border="1" style="width: 100%; border-collapse: collapse; text-align: center;"> <tr> <td style="width: 10%;"></td> <td style="width: 10%;"></td> <td style="width: 10%;"></td> <td style="width: 10%;"></td> <td style="width: 10%;"></td> <td style="width: 10%;"></td> <td style="width: 10%;"></td> <td style="width: 10%;"></td> <td style="width: 10%;"></td> <td style="width: 10%;"></td> </tr> <tr> <td></td> <td></td> <td colspan="8" style="text-align: center;"> <table border="1" style="width: 100%; border-collapse: collapse; text-align: center;"> <tr> <td style="width: 10%;"></td> <td style="width: 10%;"></td> <td style="width: 10%;"></td> <td style="width: 10%;"></td> <td style="width: 10%;"></td> <td style="width: 10%;"></td> <td style="width: 10%;"></td> <td style="width: 10%;"></td> <td style="width: 10%;"></td> <td style="width: 10%;"></td> </tr> <tr> <td></td> <td></td> <td colspan="8" style="text-align: center;"> <table border="1" style="width: 100%; border-collapse: collapse; text-align: center;"> <tr> <td style="width: 10%;"></td> <td style="width: 10%;"></td> <td style="width: 10%;"></td> <td style="width: 10%;"></td> <td style="width: 10%;"></td> <td style="width: 10%;"></td> <td style="width: 10%;"></td> <td style="width: 10%;"></td> <td style="width: 10%;"></td> <td style="width: 10%;"></td> </tr> <tr> <td></td> <td></td> <td
colspan="8" style="text-align: center;"> <table border="1" style="width: 100%; border-collapse: collapse; text-align: center;"> <tr> <td style="width: 10%;"></td> <td style="width: 10%;"></td> <td style="width: 10%;"></td> <td style="width: 10%;"></td> <td style="width: 10%;"></td> <td style="width: 10%;"></td> <td style="width: 10%;"></td> <td style="width: 10%;"></td> <td style="width: 10%;"></td> <td style="width: 10%;"></td> </tr> <tr> <td></td> <td></td> <td colspan="8" style="text-align: center;"> <table border="1" style="width: 100%; border-collapse: collapse; text-align: center;"> <tr> <td style="width: 10%;"></td> <td style="width: 10%;"></td> <td style="width: 10%;"></td> <td style="width: 10%;"></td> <td style="width: 10%;"></td> <td style="width: 10%;"></td> <td style="width: 10%;"></td> <td style="width: 10%;"></td> <td style="width: 10%;"></td> <td style="width: 10%;"></td> </tr> <tr> <td></td> <td></td> <td colspan="8" style="text-align: center;"> <table border="1" style="width: 100%; border-collapse: collapse; text-align: center;"> <tr> <td style="width: 10%;"></td> <td style="width: 10%;"></td> <td style="width: 10%;"></td> <td style="width: 10%;"></td> <td style="width: 10%;"></td> <td style="width: 10%;"></td> <td style="width: 10%;"></td> <td style="width: 10%;"></td> <td style="width: 10%;"></td> <td style="width: 10%;"></td> </tr> <tr> <td></td> <td></td> <td colspan="8" style="text-align: center;"> <table border="1" style="width: 100%; border-collapse: collapse; text-align: center;"> <tr> <td style="width: 10%;"></td> <td style="width: 10%;"></td> <td style="width: 10%;"></td> <td style="width: 10%;"></td> <td style="width: 10%;"></td> <td style="width: 10%;"></td> <td style="width: 10%;"></td> <td style="width: 10%;"></td> <td style="width: 10%;"></td> <td style="width: 10%;"></td> </tr> <tr> <td></td> <td></td> <td colspan="8" style="text-align: center;"> <table border="1" style="width: 100%; border-collapse: collapse; text-align: center;"> <tr> <td style="width: 10%;"></td> <td style="width: 10%;"></td> <td style="width: 10%;"></td> <td style="width: 10%;"></td> <td style="width: 10%;"></td> <td style="width: 10%;"></td> <td style="width: 10%;"></td> <td style="width: 10%;"></td> <td style="width: 10%;"></td> <td style="width: 10%;"></td> </tr> <tr> <td></td> <td></td> <td colspan="8" style="text-align: center;"> <table border="1" style="width: 100%; border-collapse: collapse; text-align: center;"> <tr> </tr></table></td></tr></table></td></tr></table></td></tr></table></td></tr></table></td></tr></table></td></tr></table></td></tr></table></td></tr></table></td></tr></table></td></tr></table></td></tr></table></td></tr></table></td></tr></table></td></tr></table></td></tr></table></td></tr></table></td></tr></table></td></tr></table></td></tr></table></td></tr></table></td></tr></table></td></tr></table></td></tr></table> | | | | | | | | | | | | | | | | | | | | <table border="1" style="width: 100%; border-collapse: collapse; text-align: center;"> <tr> <td style="width: 10%;"></td> <td style="width: 10%;"></td> <td style="width: 10%;"></td> <td style="width: 10%;"></td> <td style="width: 10%;"></td> <td style="width: 10%;"></td> <td style="width: 10%;"></td> <td style="width: 10%;"></td> <td style="width: 10%;"></td> <td style="width: 10%;"></td> </tr> <tr> <td></td> <td></td> <td colspan="8" style="text-align: center;"> <table border="1" style="width: 100%; border-collapse: collapse; text-align: center;"> <tr> <td style="width: 10%;"></td> <td style="width: 10%;"></td> <td style="width: 10%;"></td> <td style="width: 10%;"></td> <td style="width: 10%;"></td> <td style="width: 10%;"></td> <td style="width: 10%;"></td> <td style="width: 10%;"></td> <td style="width: 10%;"></td> <td style="width: 10%;"></td> </tr> <tr> <td></td> <td></td> <td colspan="8" style="text-align: center;"> <table border="1" style="width: 100%; border-collapse: collapse; text-align: center;"> <tr> <td style="width: 10%;"></td> <td style="width: 10%;"></td> <td style="width: 10%;"></td> <td style="width: 10%;"></td> <td style="width: 10%;"></td> <td style="width: 10%;"></td> <td style="width: 10%;"></td> <td style="width: 10%;"></td> <td style="width: 10%;"></td> <td style="width: 10%;"></td> </tr> <tr> <td></td> <td></td> <td colspan="8" style="text-align: center;"> <table border="1" style="width: 100%; border-collapse: collapse; text-align: center;"> <tr> <td style="width: 10%;"></td> <td style="width: 10%;"></td> <td style="width: 10%;"></td> <td style="width: 10%;"></td> <td style="width: 10%;"></td> <td style="width: 10%;"></td> <td style="width: 10%;"></td> <td style="width: 10%;"></td> <td style="width: 10%;"></td> <td style="width: 10%;"></td> </tr> <tr> <td></td> <td></td> <td colspan="8" style="text-align: center;"> <table border="1" style="width: 100%; border-collapse: collapse; text-align: center;"> <tr> <td style="width: 10%;"></td> <td style="width: 10%;"></td> <td style="width: 10%;"></td> <td style="width: 10%;"></td> <td style="width: 10%;"></td> <td style="width: 10%;"></td> <td style="width: 10%;"></td> <td style="width: 10%;"></td> <td style="width: 10%;"></td> <td style="width: 10%;"></td> </tr> <tr> <td></td> <td></td> <td colspan="8" style="text-align: center;"> <table border="1" style="width: 100%; border-collapse: collapse; text-align: center;"> <tr> <td style="width: 10%;"></td> <td style="width: 10%;"></td> <td style="width: 10%;"></td> <td style="width: 10%;"></td> <td style="width: 10%;"></td> <td style="width: 10%;"></td> <td style="width: 10%;"></td> <td style="width: 10%;"></td> <td style="width: 10%;"></td> <td style="width: 10%;"></td> </tr> <tr> <td></td> <td></td> <td colspan="8" style="text-align: center;"> <table border="1" style="width: 100%; border-collapse: collapse; text-align: center;"> <tr> <td style="width: 10%;"></td> <td style="width: 10%;"></td> <td style="width: 10%;"></td> <td style="width: 10%;"></td> <td style="width: 10%;"></td> <td style="width: 10%;"></td> <td style="width: 10%;"></td> <td style="width: 10%;"></td> <td style="width: 10%;"></td> <td style="width: 10%;"></td> </tr> <tr> <td></td> <td></td> <td colspan="8" style="text-align: center;"> <table border="1" style="width: 100%; border-collapse: collapse; text-align: center;"> <tr> <td style="width: 10%;"></td> <td style="width: 10%;"></td> <td style="width: 10%;"></td> <td style="width: 10%;"></td> <td style="width: 10%;"></td> <td style="width: 10%;"></td> <td style="width: 10%;"></td> <td style="width: 10%;"></td> <td style="width: 10%;"></td> <td style="width: 10%;"></td> </tr> <tr> <td></td> <td></td> <td colspan="8" style="text-align: center;"> <table border="1" style="width: 100%; border-collapse: collapse; text-align: center;"> <tr> <td style="width: 10%;"></td> <td style="width: 10%;"></td> <td style="width: 10%;"></td> <td style="width: 10%;"></td> <td style="width: 10%;"></td> <td style="width: 10%;"></td> <td style="width: 10%;"></td> <td style="width: 10%;"></td> <td style="width: 10%;"></td> <td style="width: 10%;"></td> </tr> <tr> <td></td> <td></td> <td colspan="8" style="text-align: center;"> <table border="1" style="width: 100%; border-collapse: collapse; text-align: center;"> <tr> <td style="width: 10%;"></td> <td style="width: 10%;"></td> <td style="width: 10%;"></td> <td style="width: 10%;"></td> <td style="width: 10%;"></td> <td style="width: 10%;"></td> <td style="width: 10%;"></td> <td style="width: 10%;"></td> <td style="width: 10%;"></td> <td style="width: 10%;"></td> </tr> <tr> <td></td> <td></td> <td colspan="8" style="text-align: center;"> <table border="1" style="width: 100%; border-collapse: collapse; text-align: center;"> <tr> <td style="width: 10%;"></td> <td style="width: 10%;"></td> <td style="width: 10%;"></td> <td style="width: 10%;"></td> <td style="width: 10%;"></td> <td style="width: 10%;"></td> <td style="width: 10%;"></td> <td style="width: 10%;"></td> <td style="width: 10%;"></td> <td style="width: 10%;"></td> </tr> <tr> <td></td> <td></td> <td colspan="8" style="text-align: center;"> <table border="1" style="width: 100%; border-collapse: collapse; text-align: center;"> <tr> <td style="width: 10%;"></td> <td style="width: 10%;"></td> <td style="width: 10%;"></td> <td style="width: 10%;"></td> <td style="width: 10%;"></td> <td style="width: 10%;"></td> <td style="width: 10%;"></td> <td style="width: 10%;"></td> <td style="width: 10%;"></td> <td style="width: 10%;"></td> </tr> <tr> <td></td> <td></td> <td colspan="8" style="text-align: center;"> <table border="1" style="width: 100%; border-collapse: collapse; text-align: center;"> <tr> <td style="width: 10%;"></td> <td style="width: 10%;"></td> <td style="width: 10%;"></td> <td style="width: 10%;"></td> <td style="width: 10%;"></td> <td style="width: 10%;"></td> <td style="width: 10%;"></td> <td style="width: 10%;"></td> <td style="width: 10%;"></td> <td style="width: 10%;"></td> </tr> <tr> <td></td> <td></td> <td colspan="8"
style="text-align: center;"> <table border="1" style="width: 100%; border-collapse: collapse; text-align: center;"> <tr> <td style="width: 10%;"></td> <td style="width: 10%;"></td> <td style="width: 10%;"></td> <td style="width: 10%;"></td> <td style="width: 10%;"></td> <td style="width: 10%;"></td> <td style="width: 10%;"></td> <td style="width: 10%;"></td> <td style="width: 10%;"></td> <td style="width: 10%;"></td> </tr> <tr> <td></td> <td></td> <td colspan="8" style="text-align: center;"> <table border="1" style="width: 100%; border-collapse: collapse; text-align: center;"> <tr> <td style="width: 10%;"></td> <td style="width: 10%;"></td> <td style="width: 10%;"></td> <td style="width: 10%;"></td> <td style="width: 10%;"></td> <td style="width: 10%;"></td> <td style="width: 10%;"></td> <td style="width: 10%;"></td> <td style="width: 10%;"></td> <td style="width: 10%;"></td> </tr> <tr> <td></td> <td></td> <td colspan="8" style="text-align: center;"> <table border="1" style="width: 100%; border-collapse: collapse; text-align: center;"> <tr> <td style="width: 10%;"></td> <td style="width: 10%;"></td> <td style="width: 10%;"></td> <td style="width: 10%;"></td> <td style="width: 10%;"></td> <td style="width: 10%;"></td> <td style="width: 10%;"></td> <td style="width: 10%;"></td> <td style="width: 10%;"></td> <td style="width: 10%;"></td> </tr> <tr> <td></td> <td></td> <td colspan="8" style="text-align: center;"> <table border="1" style="width: 100%; border-collapse: collapse; text-align: center;"> <tr> <td style="width: 10%;"></td> <td style="width: 10%;"></td> <td style="width: 10%;"></td> <td style="width: 10%;"></td> <td style="width: 10%;"></td> <td style="width: 10%;"></td> <td style="width: 10%;"></td> <td style="width: 10%;"></td> <td style="width: 10%;"></td> <td style="width: 10%;"></td> </tr> <tr> <td></td> <td></td> <td colspan="8" style="text-align: center;"> <table border="1" style="width: 100%; border-collapse: collapse; text-align: center;"> <tr> <td style="width: 10%;"></td> <td style="width: 10%;"></td> <td style="width: 10%;"></td> <td style="width: 10%;"></td> <td style="width: 10%;"></td> <td style="width: 10%;"></td> <td style="width: 10%;"></td> <td style="width: 10%;"></td> <td style="width: 10%;"></td> <td style="width: 10%;"></td> </tr> <tr> <td></td> <td></td> <td colspan="8" style="text-align: center;"> <table border="1" style="width: 100%; border-collapse: collapse; text-align: center;"> <tr> <td style="width: 10%;"></td> <td style="width: 10%;"></td> <td style="width: 10%;"></td> <td style="width: 10%;"></td> <td style="width: 10%;"></td> <td style="width: 10%;"></td> <td style="width: 10%;"></td> <td style="width: 10%;"></td> <td style="width: 10%;"></td> <td style="width: 10%;"></td> </tr> <tr> <td></td> <td></td> <td colspan="8" style="text-align: center;"> <table border="1" style="width: 100%; border-collapse: collapse; text-align: center;"> <tr> <td style="width: 10%;"></td> <td style="width: 10%;"></td> <td style="width: 10%;"></td> <td style="width: 10%;"></td> <td style="width: 10%;"></td> <td style="width: 10%;"></td> <td style="width: 10%;"></td> <td style="width: 10%;"></td> <td style="width: 10%;"></td> <td style="width: 10%;"></td> </tr> <tr> <td></td> <td></td> <td colspan="8" style="text-align: center;"> <table border="1" style="width: 100%; border-collapse: collapse; text-align: center;"> <tr> <td style="width: 10%;"></td> <td style="width: 10%;"></td> <td style="width: 10%;"></td> <td style="width: 10%;"></td> <td style="width: 10%;"></td> <td style="width: 10%;"></td> <td style="width: 10%;"></td> <td style="width: 10%;"></td> <td style="width: 10%;"></td> <td style="width: 10%;"></td> </tr> <tr> <td></td> <td></td> <td colspan="8" style="text-align: center;"> <table border="1" style="width: 100%; border-collapse: collapse; text-align: center;"> <tr> <td style="width: 10%;"></td> <td style="width: 10%;"></td> <td style="width: 10%;"></td> <td style="width: 10%;"></td> <td style="width: 10%;"></td> <td style="width: 10%;"></td> <td style="width: 10%;"></td> <td style="width: 10%;"></td> <td style="width: 10%;"></td> <td style="width: 10%;"></td> </tr> <tr> <td></td> <td></td> <td colspan="8" style="text-align: center;"> <table border="1" style="width: 100%; border-collapse: collapse; text-align: center;"> <tr> </tr></table></td></tr></table></td></tr></table></td></tr></table></td></tr></table></td></tr></table></td></tr></table></td></tr></table></td></tr></table></td></tr></table></td></tr></table></td></tr></table></td></tr></table></td></tr></table></td></tr></table></td></tr></table></td></tr></table></td></tr></table></td></tr></table></td></tr></table></td></tr></table></td></tr></table></td></tr></table> | | | | | | | | | | | | | | | | | | | | <table border="1" style="width: 100%; border-collapse: collapse; text-align: center;"> <tr> <td style="width: 10%;"></td> <td style="width: 10%;"></td> <td style="width: 10%;"></td> <td style="width: 10%;"></td> <td style="width: 10%;"></td> <td style="width: 10%;"></td> <td style="width: 10%;"></td> <td style="width: 10%;"></td> <td style="width: 10%;"></td> <td style="width: 10%;"></td> </tr> <tr> <td></td> <td></td> <td colspan="8" style="text-align: center;"> <table border="1" style="width: 100%; border-collapse: collapse; text-align: center;"> <tr> <td style="width: 10%;"></td> <td style="width: 10%;"></td> <td style="width: 10%;"></td> <td style="width: 10%;"></td> <td style="width: 10%;"></td> <td style="width: 10%;"></td> <td style="width: 10%;"></td> <td style="width: 10%;"></td> <td style="width: 10%;"></td> <td style="width: 10%;"></td> </tr> <tr> <td></td> <td></td> <td colspan="8" style="text-align: center;"> <table border="1" style="width: 100%; border-collapse: collapse; text-align: center;"> <tr> <td style="width: 10%;"></td> <td style="width: 10%;"></td> <td style="width: 10%;"></td> <td style="width: 10%;"></td> <td style="width: 10%;"></td> <td style="width: 10%;"></td> <td style="width: 10%;"></td> <td style="width: 10%;"></td> <td style="width: 10%;"></td> <td style="width: 10%;"></td> </tr> <tr> <td></td> <td></td> <td colspan="8" style="text-align: center;"> <table border="1" style="width: 100%; border-collapse: collapse; text-align: center;"> <tr> <td style="width: 10%;"></td> <td style="width: 10%;"></td> <td style="width: 10%;"></td> <td style="width: 10%;"></td> <td style="width: 10%;"></td> <td style="width: 10%;"></td> <td style="width: 10%;"></td> <td style="width: 10%;"></td> <td style="width: 10%;"></td> <td style="width: 10%;"></td> </tr> <tr> <td></td> <td></td> <td colspan="8" style="text-align: center;"> <table border="1" style="width: 100%; border-collapse: collapse; text-align: center;"> <tr> <td style="width: 10%;"></td> <td style="width: 10%;"></td> <td style="width: 10%;"></td> <td style="width: 10%;"></td> <td style="width: 10%;"></td> <td style="width: 10%;"></td> <td style="width: 10%;"></td> <td style="width: 10%;"></td> <td style="width: 10%;"></td> <td style="width: 10%;"></td> </tr> <tr> <td></td> <td></td> <td colspan="8" style="text-align: center;"> <table border="1" style="width: 100%; border-collapse: collapse; text-align: center;"> <tr> <td style="width: 10%;"></td> <td style="width: 10%;"></td> <td style="width: 10%;"></td> <td style="width: 10%;"></td> <td style="width: 10%;"></td> <td style="width: 10%;"></td> <td style="width: 10%;"></td> <td style="width: 10%;"></td> <td style="width: 10%;"></td> <td style="width: 10%;"></td> </tr> <tr> <td></td> <td></td> <td colspan="8" style="text-align: center;"> <table border="1" style="width: 100%; border-collapse: collapse; text-align: center;"> <tr> <td style="width: 10%;"></td> <td style="width: 10%;"></td> <td style="width: 10%;"></td> <td style="width: 10%;"></td> <td style="width: 10%;"></td> <td style="width: 10%;"></td> <td style="width: 10%;"></td> <td style="width: 10%;"></td> <td style="width: 10%;"></td> <td style="width: 10%;"></td> </tr> <tr> <td></td> <td></td> <td colspan="8" style="text-align: center;"> <table border="1" style="width: 100%; border-collapse: collapse; text-align: center;"> <tr> <td style="width: 10%;"></td> <td style="width: 10%;"></td> <td style="width: 10%;"></td> <td style="width: 10%;"></td> <td style="width: 10%;"></td> <td style="width: 10%;"></td> <td style="width: 10%;"></td> <td style="width: 10%;"></td> <td style="width: 10%;"></td> <td style="width: 10%;"></td> </tr> <tr> <td></td> <td></td> <td colspan="8" style="text-align: center;"> <table border="1" style="width: 100%; border-collapse: collapse; text-align: center;"> <tr> <td style="width: 10%;"></td> <td style="width: 10%;"></td> <td style="width: 10%;"></td> <td style="width: 10%;"></td> <td style="width: 10%;"></td> <td style="width: 10%;"></td> <td style="width: 10%;"></td> <td style="width: 10%;"></td> <td style="width: 10%;"></td> <td style="width: 10%;"></td> </tr> <tr> <td></td> <td></td> <td colspan="8" style="text-align: center;"> <table
border="1" style="width: 100%; border-collapse: collapse; text-align: center;"> <tr> <td style="width: 10%;"></td> <td style="width: 10%;"></td> <td style="width: 10%;"></td> <td style="width: 10%;"></td> <td style="width: 10%;"></td> <td style="width: 10%;"></td> <td style="width: 10%;"></td> <td style="width: 10%;"></td> <td style="width: 10%;"></td> <td style="width: 10%;"></td> </tr> <tr> <td></td> <td></td> <td colspan="8" style="text-align: center;"> <table border="1" style="width: 100%; border-collapse: collapse; text-align: center;"> <tr> <td style="width: 10%;"></td> <td style="width: 10%;"></td> <td style="width: 10%;"></td> <td style="width: 10%;"></td> <td style="width: 10%;"></td> <td style="width: 10%;"></td> <td style="width: 10%;"></td> <td style="width: 10%;"></td> <td style="width: 10%;"></td> <td style="width: 10%;"></td> </tr> <tr> <td></td> <td></td> <td colspan="8" style="text-align: center;"> <table border="1" style="width: 100%; border-collapse: collapse; text-align: center;"> <tr> <td style="width: 10%;"></td> <td style="width: 10%;"></td> <td style="width: 10%;"></td> <td style="width: 10%;"></td> <td style="width: 10%;"></td> <td style="width: 10%;"></td> <td style="width: 10%;"></td> <td style="width: 10%;"></td> <td style="width: 10%;"></td> <td style="width: 10%;"></td> </tr> <tr> <td></td> <td></td> <td colspan="8" style="text-align: center;"> <table border="1" style="width: 100%; border-collapse: collapse; text-align: center;"> <tr> <td style="width: 10%;"></td> <td style="width: 10%;"></td> <td style="width: 10%;"></td> <td style="width: 10%;"></td> <td style="width: 10%;"></td> <td style="width: 10%;"></td> <td style="width: 10%;"></td> <td style="width: 10%;"></td> <td style="width: 10%;"></td> <td style="width: 10%;"></td> </tr> <tr> <td></td> <td></td> <td colspan="8" style="text-align: center;"> <table border="1" style="width: 100%; border-collapse: collapse; text-align: center;"> <tr> <td style="width: 10%;"></td> <td style="width: 10%;"></td> <td style="width: 10%;"></td> <td style="width: 10%;"></td> <td style="width: 10%;"></td> <td style="width: 10%;"></td> <td style="width: 10%;"></td> <td style="width: 10%;"></td> <td style="width: 10%;"></td> <td style="width: 10%;"></td> </tr> <tr> <td></td> <td></td> <td colspan="8" style="text-align: center;"> <table border="1" style="width: 100%; border-collapse: collapse; text-align: center;"> <tr> <td style="width: 10%;"></td> <td style="width: 10%;"></td> <td style="width: 10%;"></td> <td style="width: 10%;"></td> <td style="width: 10%;"></td> <td style="width: 10%;"></td> <td style="width: 10%;"></td> <td style="width: 10%;"></td> <td style="width: 10%;"></td> <td style="width: 10%;"></td> </tr> <tr> <td></td> <td></td> <td colspan="8" style="text-align: center;"> <table border="1" style="width: 100%; border-collapse: collapse; text-align: center;"> <tr> <td style="width: 10%;"></td> <td style="width: 10%;"></td> <td style="width: 10%;"></td> <td style="width: 10%;"></td> <td style="width: 10%;"></td> <td style="width: 10%;"></td> <td style="width: 10%;"></td> <td style="width: 10%;"></td> <td style="width: 10%;"></td> <td style="width: 10%;"></td> </tr> <tr> <td></td> <td></td> <td colspan="8" style="text-align: center;"> <table border="1" style="width: 100%; border-collapse: collapse; text-align: center;"> <tr> <td style="width: 10%;"></td> <td style="width: 10%;"></td> <td style="width: 10%;"></td> <td style="width: 10%;"></td> <td style="width: 10%;"></td> <td style="width: 10%;"></td> <td style="width: 10%;"></td> <td style="width: 10%;"></td> <td style="width: 10%;"></td> <td style="width: 10%;"></td> </tr> <tr> <td></td> <td></td> <td colspan="8" style="text-align: center;"> <table border="1" style="width: 100%; border-collapse: collapse; text-align: center;"> <tr> <td style="width: 10%;"></td> <td style="width: 10%;"></td> <td style="width: 10%;"></td> <td style="width: 10%;"></td> <td style="width: 10%;"></td> <td style="width: 10%;"></td> <td style="width: 10%;"></td> <td style="width: 10%;"></td> <td style="width: 10%;"></td> <td style="width: 10%;"></td> </tr> <tr> <td></td> <td></td> <td colspan="8" style="text-align: center;"> <table border="1" style="width: 100%; border-collapse: collapse; text-align: center;"> <tr> <td style="width: 10%;"></td> <td style="width: 10%;"></td> <td style="width: 10%;"></td> <td style="width: 10%;"></td> <td style="width: 10%;"></td> <td style="width: 10%;"></td> <td style="width: 10%;"></td> <td style="width: 10%;"></td> <td style="width: 10%;"></td> <td style="width: 10%;"></td> </tr> <tr> <td></td> <td></td> <td colspan="8" style="text-align: center;"> <table border="1" style="width: 100%; border-collapse: collapse; text-align: center;"> <tr> <td style="width: 10%;"></td> <td style="width: 10%;"></td> <td style="width: 10%;"></td> <td style="width: 10%;"></td> <td style="width: 10%;"></td> <td style="width: 10%;"></td> <td style="width: 10%;"></td> <td style="width: 10%;"></td> <td style="width: 10%;"></td> <td style="width: 10%;"></td> </tr> <tr> <td></td> <td></td> <td colspan="8" style="text-align: center;"> <table border="1" style="width: 100%; border-collapse: collapse; text-align: center;"> <tr> <td style="width: 10%;"></td> <td style="width: 10%;"></td> <td style="width: 10%;"></td> <td style="width: 10%;"></td> <td style="width: 10%;"></td> <td style="width: 10%;"></td> <td style="width: 10%;"></td> <td style="width: 10%;"></td> <td style="width: 10%;"></td> <td style="width: 10%;"></td> </tr> <tr> <td></td> <td></td> <td colspan="8" style="text-align: center;"> <table border="1" style="width: 100%; border-collapse: collapse; text-align: center;"> <tr> </tr></table></td></tr></table></td></tr></table></td></tr></table></td></tr></table></td></tr></table></td></tr></table></td></tr></table></td></tr></table></td></tr></table></td></tr></table></td></tr></table></td></tr></table></td></tr></table></td></tr></table></td></tr></table></td></tr></table></td></tr></table></td></tr></table></td></tr></table></td></tr></table></td></tr></table> | | | | | | | | | | | | | | | | | | | | <table border="1" style="width: 100%; border-collapse: collapse; text-align: center;"> <tr> <td style="width: 10%;"></td> <td style="width: 10%;"></td> <td style="width: 10%;"></td> <td style="width: 10%;"></td> <td style="width: 10%;"></td> <td style="width: 10%;"></td> <td style="width: 10%;"></td> <td style="width: 10%;"></td> <td style="width: 10%;"></td> <td style="width: 10%;"></td> </tr> <tr> <td></td> <td></td> <td colspan="8" style="text-align: center;"> <table border="1" style="width: 100%; border-collapse: collapse; text-align: center;"> <tr> <td style="width: 10%;"></td> <td style="width: 10%;"></td> <td style="width: 10%;"></td> <td style="width: 10%;"></td> <td style="width: 10%;"></td> <td style="width: 10%;"></td> <td style="width: 10%;"></td> <td style="width: 10%;"></td> <td style="width: 10%;"></td> <td style="width: 10%;"></td> </tr> <tr> <td></td> <td></td> <td colspan="8" style="text-align: center;"> <table border="1" style="width: 100%; border-collapse: collapse; text-align: center;"> <tr> <td style="width: 10%;"></td> <td style="width: 10%;"></td> <td style="width: 10%;"></td> <td style="width: 10%;"></td> <td style="width: 10%;"></td> <td style="width: 10%;"></td> <td style="width: 10%;"></td> <td style="width: 10%;"></td> <td style="width: 10%;"></td> <td style="width: 10%;"></td> </tr> <tr> <td></td> <td></td> <td colspan="8" style="text-align: center;"> <table border="1" style="width: 100%; border-collapse: collapse; text-align: center;"> <tr> <td style="width: 10%;"></td> <td style="width: 10%;"></td> <td style="width: 10%;"></td> <td style="width: 10%;"></td> <td style="width: 10%;"></td> <td style="width: 10%;"></td> <td style="width: 10%;"></td> <td style="width: 10%;"></td> <td style="width: 10%;"></td> <td style="width: 10%;"></td> </tr> <tr> <td></td> <td></td> <td colspan="8" style="text-align: center;"> <table border="1" style="width: 100%; border-collapse: collapse; text-align: center;"> <tr> <td style="width: 10%;"></td> <td style="width: 10%;"></td> <td style="width: 10%;"></td> <td style="width: 10%;"></td> <td style="width: 10%;"></td> <td style="width: 10%;"></td> <td style="width: 10%;"></td> <td style="width: 10%;"></td> <td style="width: 10%;"></td> <td style="width: 10%;"></td> </tr> <tr> <td></td> <td></td> <td colspan="8" style="text-align: center;"> <table border="1" style="width: 100%; border-collapse: collapse; text-align: center;"> <tr> <td style="width: 10%;"></td> <td style="width: 10%;"></td> <td style="width: 10%;"></td> <td style="width: 10%;"></td> <td style="width: 10%;"></td> <td style="width: 10%;"></td> <td style="width: 10%;"></td> <td style="width: 10%;"></td> <td style="width: 10%;"></td> <td style="width: 10%;"></td> </tr> <tr> <td></td> <td></td> <td colspan="8" style="text-align: center;"> <table border="1" style="width: 100%; border-collapse: collapse;
text-align: center;"> <tr> <td style="width: 10%;"></td> <td style="width: 10%;"></td> <td style="width: 10%;"></td> <td style="width: 10%;"></td> <td style="width: 10%;"></td> <td style="width: 10%;"></td> <td style="width: 10%;"></td> <td style="width: 10%;"></td> <td style="width: 10%;"></td> <td style="width: 10%;"></td> </tr> <tr> <td></td> <td></td> <td colspan="8" style="text-align: center;"> <table border="1" style="width: 100%; border-collapse: collapse; text-align: center;"> <tr> <td style="width: 10%;"></td> <td style="width: 10%;"></td> <td style="width: 10%;"></td> <td style="width: 10%;"></td> <td style="width: 10%;"></td> <td style="width: 10%;"></td> <td style="width: 10%;"></td> <td style="width: 10%;"></td> <td style="width: 10%;"></td> <td style="width: 10%;"></td> </tr> <tr> <td></td> <td></td> <td colspan="8" style="text-align: center;"> <table border="1" style="width: 100%; border-collapse: collapse; text-align: center;"> <tr> <td style="width: 10%;"></td> <td style="width: 10%;"></td> <td style="width: 10%;"></td> <td style="width: 10%;"></td> <td style="width: 10%;"></td> <td style="width: 10%;"></td> <td style="width: 10%;"></td> <td style="width: 10%;"></td> <td style="width: 10%;"></td> <td style="width: 10%;"></td> </tr> <tr> <td></td> <td></td> <td colspan="8" style="text-align: center;"> <table border="1" style="width: 100%; border-collapse: collapse; text-align: center;"> <tr> <td style="width: 10%;"></td> <td style="width: 10%;"></td> <td style="width: 10%;"></td> <td style="width: 10%;"></td> <td style="width: 10%;"></td> <td style="width: 10%;"></td> <td style="width: 10%;"></td> <td style="width: 10%;"></td> <td style="width: 10%;"></td> <td style="width: 10%;"></td> </tr> <tr> <td></td> <td></td> <td colspan="8" style="text-align: center;"> <table border="1" style="width: 100%; border-collapse: collapse; text-align: center;"> <tr> <td style="width: 10%;"></td> <td style="width: 10%;"></td> <td style="width: 10%;"></td> <td style="width: 10%;"></td> <td style="width: 10%;"></td> <td style="width: 10%;"></td> <td style="width: 10%;"></td> <td style="width: 10%;"></td> <td style="width: 10%;"></td> <td style="width: 10%;"></td> </tr> <tr> <td></td> <td></td> <td colspan="8" style="text-align: center;"> <table border="1" style="width: 100%; border-collapse: collapse; text-align: center;"> <tr> <td style="width: 10%;"></td> <td style="width: 10%;"></td> <td style="width: 10%;"></td> <td style="width: 10%;"></td> <td style="width: 10%;"></td> <td style="width: 10%;"></td> <td style="width: 10%;"></td> <td style="width: 10%;"></td> <td style="width: 10%;"></td> <td style="width: 10%;"></td> </tr> <tr> <td></td> <td></td> <td colspan="8" style="text-align: center;"> <table border="1" style="width: 100%; border-collapse: collapse; text-align: center;"> <tr> <td style="width: 10%;"></td> <td style="width: 10%;"></td> <td style="width: 10%;"></td> <td style="width: 10%;"></td> <td style="width: 10%;"></td> <td style="width: 10%;"></td> <td style="width: 10%;"></td> <td style="width: 10%;"></td> <td style="width: 10%;"></td> <td style="width: 10%;"></td> </tr> <tr> <td></td> <td></td> <td colspan="8" style="text-align: center;"> <table border="1" style="width: 100%; border-collapse: collapse; text-align: center;"> <tr> <td style="width: 10%;"></td> <td style="width: 10%;"></td> <td style="width: 10%;"></td> <td style="width: 10%;"></td> <td style="width: 10%;"></td> <td style="width: 10%;"></td> <td style="width: 10%;"></td> <td style="width: 10%;"></td> <td style="width: 10%;"></td> <td style="width: 10%;"></td> </tr> <tr> <td></td> <td></td> <td colspan="8" style="text-align: center;"> <table border="1" style="width: 100%; border-collapse: collapse; text-align: center;"> <tr> <td style="width: 10%;"></td> <td style="width: 10%;"></td> <td style="width: 10%;"></td> <td style="width: 10%;"></td> <td style="width: 10%;"></td> <td style="width: 10%;"></td> <td style="width: 10%;"></td> <td style="width: 10%;"></td> <td style="width: 10%;"></td> <td style="width: 10%;"></td> </tr> <tr> <td></td> <td></td> <td colspan="8" style="text-align: center;"> <table border="1" style="width: 100%; border-collapse: collapse; text-align: center;"> <tr> <td style="width: 10%;"></td> <td style="width: 10%;"></td> <td style="width: 10%;"></td> <td style="width: 10%;"></td> <td style="width: 10%;"></td> <td style="width: 10%;"></td> <td style="width: 10%;"></td> <td style="width: 10%;"></td> <td style="width: 10%;"></td> <td style="width: 10%;"></td> </tr> <tr> <td></td> <td></td> <td colspan="8" style="text-align: center;"> <table border="1" style="width: 100%; border-collapse: collapse; text-align: center;"> <tr> <td style="width: 10%;"></td> <td style="width: 10%;"></td> <td style="width: 10%;"></td> <td style="width: 10%;"></td> <td style="width: 10%;"></td> <td style="width: 10%;"></td> <td style="width: 10%;"></td> <td style="width: 10%;"></td> <td style="width: 10%;"></td> <td style="width: 10%;"></td> </tr> <tr> <td></td> <td></td> <td colspan="8" style="text-align: center;"> <table border="1" style="width: 100%; border-collapse: collapse; text-align: center;"> <tr> <td style="width: 10%;"></td> <td style="width: 10%;"></td> <td style="width: 10%;"></td> <td style="width: 10%;"></td> <td style="width: 10%;"></td> <td style="width: 10%;"></td> <td style="width: 10%;"></td> <td style="width: 10%;"></td> <td style="width: 10%;"></td> <td style="width: 10%;"></td> </tr> <tr> <td></td> <td></td> <td colspan="8" style="text-align: center;"> <table border="1" style="width: 100%; border-collapse: collapse; text-align: center;"> <tr> <td style="width: 10%;"></td> <td style="width: 10%;"></td> <td style="width: 10%;"></td> <td style="width: 10%;"></td> <td style="width: 10%;"></td> <td style="width: 10%;"></td> <td style="width: 10%;"></td> <td style="width: 10%;"></td> <td style="width: 10%;"></td> <td style="width: 10%;"></td> </tr> <tr> <td></td> <td></td> <td colspan="8" style="text-align: center;"> <table border="1" style="width: 100%; border-collapse: collapse; text-align: center;"> <tr> <td style="width: 10%;"></td> <td style="width: 10%;"></td> <td style="width: 10%;"></td> <td style="width: 10%;"></td> <td style="width: 10%;"></td> <td style="width: 10%;"></td> <td style="width: 10%;"></td> <td style="width: 10%;"></td> <td style="width: 10%;"></td> <td style="width: 10%;"></td> </tr> <tr> <td></td> <td></td> <td colspan="8" style="text-align: center;"> <table border="1" style="width: 100%; border-collapse: collapse; text-align: center;"> <tr> </tr></table></td></tr></table></td></tr></table></td></tr></table></td></tr></table></td></tr></table></td></tr></table></td></tr></table></td></tr></table></td></tr></table></td></tr></table></td></tr></table></td></tr></table></td></tr></table></td></tr></table></td></tr></table></td></tr></table></td></tr></table></td></tr></table></td></tr></table></td></tr></table> | | | | | | | | | | | | | | | | | | | | <table border="1" style="width: 100%; border-collapse: collapse; text-align: center;"> <tr> <td style="width: 10%;"></td> <td style="width: 10%;"></td> <td style="width: 10%;"></td> <td style="width: 10%;"></td> <td style="width: 10%;"></td> <td style="width: 10%;"></td> <td style="width: 10%;"></td> <td style="width: 10%;"></td> <td style="width: 10%;"></td> <td style="width: 10%;"></td> </tr> <tr> <td></td> <td></td> <td colspan="8" style="text-align: center;"> <table border="1" style="width: 100%; border-collapse: collapse; text-align: center;"> <tr> <td style="width: 10%;"></td> <td style="width: 10%;"></td> <td style="width: 10%;"></td> <td style="width: 10%;"></td> <td style="width: 10%;"></td> <td style="width: 10%;"></td> <td style="width: 10%;"></td> <td style="width: 10%;"></td> <td style="width: 10%;"></td> <td style="width: 10%;"></td> </tr> <tr> <td></td> <td></td> <td colspan="8" style="text-align: center;"> <table border="1" style="width: 100%; border-collapse: collapse; text-align: center;"> <tr> <td style="width: 10%;"></td> <td style="width: 10%;"></td> <td style="width: 10%;"></td> <td style="width: 10%;"></td> <td style="width: 10%;"></td> <td style="width: 10%;"></td> <td style="width: 10%;"></td> <td style="width: 10%;"></td> <td style="width: 10%;"></td> <td style="width: 10%;"></td> </tr> <tr> <td></td> <td></td> <td colspan="8" style="text-align: center;"> <table border="1" style="width: 100%; border-collapse: collapse; text-align: center;"> <tr> <td style="width: 10%;"></td> <td style="width: 10%;"></td> <td style="width: 10%;"></td> <td style="width: 10%;"></td> <td style="width: 10%;"></td> <td style="width: 10%;"></td> <td style="width: 10%;"></td> <td style="width: 10%;"></td> <td style="width: 10%;"></td> <td style="width: 10%;"></td> </tr> <tr> <td></td> <td></td> <td colspan="8" style="text-align: center;"> <table border="1" style="width: 100%; border-collapse: collapse; text-align: center;"> <tr> <td style="width: 10%;"></td> <td style="width:
10%;"></td> <td style="width: 10%;"></td> <td style="width: 10%;"></td> <td style="width: 10%;"></td> <td style="width: 10%;"></td> <td style="width: 10%;"></td> <td style="width: 10%;"></td> <td style="width: 10%;"></td> <td style="width: 10%;"></td> </tr> <tr> <td></td> <td></td> <td colspan="8" style="text-align: center;"> <table border="1" style="width: 100%; border-collapse: collapse; text-align: center;"> <tr> <td style="width: 10%;"></td> <td style="width: 10%;"></td> <td style="width: 10%;"></td> <td style="width: 10%;"></td> <td style="width: 10%;"></td> <td style="width: 10%;"></td> <td style="width: 10%;"></td> <td style="width: 10%;"></td> <td style="width: 10%;"></td> <td style="width: 10%;"></td> </tr> <tr> <td></td> <td></td> <td colspan="8" style="text-align: center;"> <table border="1" style="width: 100%; border-collapse: collapse; text-align: center;"> <tr> <td style="width: 10%;"></td> <td style="width: 10%;"></td> <td style="width: 10%;"></td> <td style="width: 10%;"></td> <td style="width: 10%;"></td> <td style="width: 10%;"></td> <td style="width: 10%;"></td> <td style="width: 10%;"></td> <td style="width: 10%;"></td> <td style="width: 10%;"></td> </tr> <tr> <td></td> <td></td> <td colspan="8" style="text-align: center;"> <table border="1" style="width: 100%; border-collapse: collapse; text-align: center;"> <tr> <td style="width: 10%;"></td> <td style="width: 10%;"></td> <td style="width: 10%;"></td> <td style="width: 10%;"></td> <td style="width: 10%;"></td> <td style="width: 10%;"></td> <td style="width: 10%;"></td> <td style="width: 10%;"></td> <td style="width: 10%;"></td> <td style="width: 10%;"></td> </tr> <tr> <td></td> <td></td> <td colspan="8" style="text-align: center;"> <table border="1" style="width: 100%; border-collapse: collapse; text-align: center;"> <tr> <td style="width: 10%;"></td> <td style="width: 10%;"></td> <td style="width: 10%;"></td> <td style="width: 10%;"></td> <td style="width: 10%;"></td> <td style="width: 10%;"></td> <td style="width: 10%;"></td> <td style="width: 10%;"></td> <td style="width: 10%;"></td> <td style="width: 10%;"></td> </tr> <tr> <td></td> <td></td> <td colspan="8" style="text-align: center;"> <table border="1" style="width: 100%; border-collapse: collapse; text-align: center;"> <tr> <td style="width: 10%;"></td> <td style="width: 10%;"></td> <td style="width: 10%;"></td> <td style="width: 10%;"></td> <td style="width: 10%;"></td> <td style="width: 10%;"></td> <td style="width: 10%;"></td> <td style="width: 10%;"></td> <td style="width: 10%;"></td> <td style="width: 10%;"></td> </tr> <tr> <td></td> <td></td> <td colspan="8" style="text-align: center;"> <table border="1" style="width: 100%; border-collapse: collapse; text-align: center;"> <tr> <td style="width: 10%;"></td> <td style="width: 10%;"></td> <td style="width: 10%;"></td> <td style="width: 10%;"></td> <td style="width: 10%;"></td> <td style="width: 10%;"></td> <td style="width: 10%;"></td> <td style="width: 10%;"></td> <td style="width: 10%;"></td> <td style="width: 10%;"></td> </tr> <tr> <td></td> <td></td> <td colspan="8" style="text-align: center;"> <table border="1" style="width: 100%; border-collapse: collapse; text-align: center;"> <tr> <td style="width: 10%;"></td> <td style="width: 10%;"></td> <td style="width: 10%;"></td> <td style="width: 10%;"></td> <td style="width: 10%;"></td> <td style="width: 10%;"></td> <td style="width: 10%;"></td> <td style="width: 10%;"></td> <td style="width: 10%;"></td> <td style="width: 10%;"></td> </tr> <tr> <td></td> <td></td> <td colspan="8" style="text-align: center;"> <table border="1" style="width: 100%; border-collapse: collapse; text-align: center;"> <tr> <td style="width: 10%;"></td> <td style="width: 10%;"></td> <td style="width: 10%;"></td> <td style="width: 10%;"></td> <td style="width: 10%;"></td> <td style="width: 10%;"></td> <td style="width: 10%;"></td> <td style="width: 10%;"></td> <td style="width: 10%;"></td> <td style="width: 10%;"></td> </tr> <tr> <td></td> <td></td> <td colspan="8" style="text-align: center;"> <table border="1" style="width: 100%; border-collapse: collapse; text-align: center;"> <tr> <td style="width: 10%;"></td> <td style="width: 10%;"></td> <td style="width: 10%;"></td> <td style="width: 10%;"></td> <td style="width: 10%;"></td> <td style="width: 10%;"></td> <td style="width: 10%;"></td> <td style="width: 10%;"></td> <td style="width: 10%;"></td> <td style="width: 10%;"></td> </tr> <tr> <td></td> <td></td> <td colspan="8" style="text-align: center;"> <table border="1" style="width: 100%; border-collapse: collapse; text-align: center;"> <tr> <td style="width: 10%;"></td> <td style="width: 10%;"></td> <td style="width: 10%;"></td> <td style="width: 10%;"></td> <td style="width: 10%;"></td> <td style="width: 10%;"></td> <td style="width: 10%;"></td> <td style="width: 10%;"></td> <td style="width: 10%;"></td> <td style="width: 10%;"></td> </tr> <tr> <td></td> <td></td> <td colspan="8" style="text-align: center;"> <table border="1" style="width: 100%; border-collapse: collapse; text-align: center;"> <tr> <td style="width: 10%;"></td> <td style="width: 10%;"></td> <td style="width: 10%;"></td> <td style="width: 10%;"></td> <td style="width: 10%;"></td> <td style="width: 10%;"></td> <td style="width: 10%;"></td> <td style="width: 10%;"></td> <td style="width: 10%;"></td> <td style="width: 10%;"></td> </tr> <tr> <td></td> <td></td> <td colspan="8" style="text-align: center;"> <table border="1" style="width: 100%; border-collapse: collapse; text-align: center;"> <tr> <td style="width: 10%;"></td> <td style="width: 10%;"></td> <td style="width: 10%;"></td> <td style="width: 10%;"></td> <td style="width: 10%;"></td> <td style="width: 10%;"></td> <td style="width: 10%;"></td> <td style="width: 10%;"></td> <td style="width: 10%;"></td> <td style="width: 10%;"></td> </tr> <tr> <td></td> <td></td> <td colspan="8" style="text-align: center;"> <table border="1" style="width: 100%; border-collapse: collapse; text-align: center;"> <tr> <td style="width: 10%;"></td> <td style="width: 10%;"></td> <td style="width: 10%;"></td> <td style="width: 10%;"></td> <td style="width: 10%;"></td> <td style="width: 10%;"></td> <td style="width: 10%;"></td> <td style="width: 10%;"></td> <td style="width: 10%;"></td> <td style="width: 10%;"></td> </tr> <tr> <td></td> <td></td> <td colspan="8" style="text-align: center;"> <table border="1" style="width: 100%; border-collapse: collapse; text-align: center;"> <tr> <td style="width: 10%;"></td> <td style="width: 10%;"></td> <td style="width: 10%;"></td> <td style="width: 10%;"></td> <td style="width: 10%;"></td> <td style="width: 10%;"></td> <td style="width: 10%;"></td> <td style="width: 10%;"></td> <td style="width: 10%;"></td> <td style="width: 10%;"></td> </tr> <tr> <td></td> <td></td> <td colspan="8" style="text-align: center;"> <table border="1" style="width: 100%; border-collapse: collapse; text-align: center;"> <tr> </tr></table></td></tr></table></td></tr></table></td></tr></table></td></tr></table></td></tr></table></td></tr></table></td></tr></table></td></tr></table></td></tr></table></td></tr></table></td></tr></table></td></tr></table></td></tr></table></td></tr></table></td></tr></table></td></tr></table></td></tr></table></td></tr></table></td></tr></table> | | | | | | | | | | | | | | | | | | | | <table border="1" style="width: 100%; border-collapse: collapse; text-align: center;"> <tr> <td style="width: 10%;"></td> <td style="width: 10%;"></td> <td style="width: 10%;"></td> <td style="width: 10%;"></td> <td style="width: 10%;"></td> <td style="width: 10%;"></td> <td style="width: 10%;"></td> <td style="width: 10%;"></td> <td style="width: 10%;"></td> <td style="width: 10%;"></td> </tr> <tr> <td></td> <td></td> <td colspan="8" style="text-align: center;"> <table border="1" style="width: 100%; border-collapse: collapse; text-align: center;"> <tr> <td style="width: 10%;"></td> <td style="width: 10%;"></td> <td style="width: 10%;"></td> <td style="width: 10%;"></td> <td style="width: 10%;"></td> <td style="width: 10%;"></td> <td style="width: 10%;"></td> <td style="width: 10%;"></td> <td style="width: 10%;"></td> <td style="width: 10%;"></td> </tr> <tr> <td></td> <td></td> <td colspan="8" style="text-align: center;"> <table border="1" style="width: 100%; border-collapse: collapse; text-align: center;"> <tr> <td style="width: 10%;"></td> <td style="width: 10%;"></td> <td style="width: 10%;"></td> <td style="width: 10%;"></td> <td style="width: 10%;"></td> <td style="width: 10%;"></td> <td style="width: 10%;"></td> <td style="width: 10%;"></td> <td style="width: 10%;"></td> <td style="width: 10%;"></td> </tr> <tr> <td></td> <td></td> <td colspan="8" style="text-align: center;"> <table border="1" style="width: 100%; border-collapse: collapse; text-align: center;"> <tr> <td style="width: 10%;"></td> <td style="width: 10%;"></td> <td style="width: 10%;"></td> <td style="width: 10%;"></td> <td style="width:
10%;"></td> <td style="width: 10%;"></td> <td style="width: 10%;"></td> <td style="width: 10%;"></td> <td style="width: 10%;"></td> <td style="width: 10%;"></td> </tr> <tr> <td></td> <td></td> <td colspan="8" style="text-align: center;"> <table border="1" style="width: 100%; border-collapse: collapse; text-align: center;"> <tr> <td style="width: 10%;"></td> <td style="width: 10%;"></td> <td style="width: 10%;"></td> <td style="width: 10%;"></td> <td style="width: 10%;"></td> <td style="width: 10%;"></td> <td style="width: 10%;"></td> <td style="width: 10%;"></td> <td style="width: 10%;"></td> <td style="width: 10%;"></td> </tr> <tr> <td></td> <td></td> <td colspan="8" style="text-align: center;"> <table border="1" style="width: 100%; border-collapse: collapse; text-align: center;"> <tr> <td style="width: 10%;"></td> <td style="width: 10%;"></td> <td style="width: 10%;"></td> <td style="width: 10%;"></td> <td style="width: 10%;"></td> <td style="width: 10%;"></td> <td style="width: 10%;"></td> <td style="width: 10%;"></td> <td style="width: 10%;"></td> <td style="width: 10%;"></td> </tr> <tr> <td></td> <td></td> <td colspan="8" style="text-align: center;"> <table border="1" style="width: 100%; border-collapse: collapse; text-align: center;"> <tr> <td style="width: 10%;"></td> <td style="width: 10%;"></td> <td style="width: 10%;"></td> <td style="width: 10%;"></td> <td style="width: 10%;"></td> <td style="width: 10%;"></td> <td style="width: 10%;"></td> <td style="width: 10%;"></td> <td style="width: 10%;"></td> <td style="width: 10%;"></td> </tr> <tr> <td></td> <td></td> <td colspan="8" style="text-align: center;"> <table border="1" style="width: 100%; border-collapse: collapse; text-align: center;"> <tr> <td style="width: 10%;"></td> <td style="width: 10%;"></td> <td style="width: 10%;"></td> <td style="width: 10%;"></td> <td style="width: 10%;"></td> <td style="width: 10%;"></td> <td style="width: 10%;"></td> <td style="width: 10%;"></td> <td style="width: 10%;"></td> <td style="width: 10%;"></td> </tr> <tr> <td></td> <td></td> <td colspan="8" style="text-align: center;"> <table border="1" style="width: 100%; border-collapse: collapse; text-align: center;"> <tr> <td style="width: 10%;"></td> <td style="width: 10%;"></td> <td style="width: 10%;"></td> <td style="width: 10%;"></td> <td style="width: 10%;"></td> <td style="width: 10%;"></td> <td style="width: 10%;"></td> <td style="width: 10%;"></td> <td style="width: 10%;"></td> <td style="width: 10%;"></td> </tr> <tr> <td></td> <td></td> <td colspan="8" style="text-align: center;"> <table border="1" style="width: 100%; border-collapse: collapse; text-align: center;"> <tr> <td style="width: 10%;"></td> <td style="width: 10%;"></td> <td style="width: 10%;"></td> <td style="width: 10%;"></td> <td style="width: 10%;"></td> <td style="width: 10%;"></td> <td style="width: 10%;"></td> <td style="width: 10%;"></td> <td style="width: 10%;"></td> <td style="width: 10%;"></td> </tr> <tr> <td></td> <td></td> <td colspan="8" style="text-align: center;"> <table border="1" style="width: 100%; border-collapse: collapse; text-align: center;"> <tr> <td style="width: 10%;"></td> <td style="width: 10%;"></td> <td style="width: 10%;"></td> <td style="width: 10%;"></td> <td style="width: 10%;"></td> <td style="width: 10%;"></td> <td style="width: 10%;"></td> <td style="width: 10%;"></td> <td style="width: 10%;"></td> <td style="width: 10%;"></td> </tr> <tr> <td></td> <td></td> <td colspan="8" style="text-align: center;"> <table border="1" style="width: 100%; border-collapse: collapse; text-align: center;"> <tr> <td style="width: 10%;"></td> <td style="width: 10%;"></td> <td style="width: 10%;"></td> <td style="width: 10%;"></td> <td style="width: 10%;"></td> <td style="width: 10%;"></td> <td style="width: 10%;"></td> <td style="width: 10%;"></td> <td style="width: 10%;"></td> <td style="width: 10%;"></td> </tr> <tr> <td></td> <td></td> <td colspan="8" style="text-align: center;"> <table border="1" style="width: 100%; border-collapse: collapse; text-align: center;"> <tr> <td style="width: 10%;"></td> <td style="width: 10%;"></td> <td style="width: 10%;"></td> <td style="width: 10%;"></td> <td style="width: 10%;"></td> <td style="width: 10%;"></td> <td style="width: 10%;"></td> <td style="width: 10%;"></td> <td style="width: 10%;"></td> <td style="width: 10%;"></td> </tr> <tr> <td></td> <td></td> <td colspan="8" style="text-align: center;"> <table border="1" style="width: 100%; border-collapse: collapse; text-align: center;"> <tr> <td style="width: 10%;"></td> <td style="width: 10%;"></td> <td style="width: 10%;"></td> <td style="width: 10%;"></td> <td style="width: 10%;"></td> <td style="width: 10%;"></td> <td style="width: 10%;"></td> <td style="width: 10%;"></td> <td style="width: 10%;"></td> <td style="width: 10%;"></td> </tr> <tr> <td></td> <td></td> <td colspan="8" style="text-align: center;"> <table border="1" style="width: 100%; border-collapse: collapse; text-align: center;"> <tr> <td style="width: 10%;"></td> <td style="width: 10%;"></td> <td style="width: 10%;"></td> <td style="width: 10%;"></td> <td style="width: 10%;"></td> <td style="width: 10%;"></td> <td style="width: 10%;"></td> <td style="width: 10%;"></td> <td style="width: 10%;"></td> <td style="width: 10%;"></td> </tr> <tr> <td></td> <td></td> <td colspan="8" style="text-align: center;"> <table border="1" style="width: 100%; border-collapse: collapse; text-align: center;"> <tr> <td style="width: 10%;"></td> <td style="width: 10%;"></td> <td style="width: 10%;"></td> <td style="width: 10%;"></td> <td style="width: 10%;"></td> <td style="width: 10%;"></td> <td style="width: 10%;"></td> <td style="width: 10%;"></td> <td style="width: 10%;"></td> <td style="width: 10%;"></td> </tr> <tr> <td></td> <td></td> <td colspan="8" style="text-align: center;"> <table border="1" style="width: 100%; border-collapse: collapse; text-align: center;"> <tr> <td style="width: 10%;"></td> <td style="width: 10%;"></td> <td style="width: 10%;"></td> <td style="width: 10%;"></td> <td style="width: 10%;"></td> <td style="width: 10%;"></td> <td style="width: 10%;"></td> <td style="width: 10%;"></td> <td style="width: 10%;"></td> <td style="width: 10%;"></td> </tr> <tr> <td></td> <td></td> <td colspan="8" style="text-align: center;"> <table border="1" style="width: 100%; border-collapse: collapse; text-align: center;"> <tr> <td style="width: 10%;"></td> <td style="width: 10%;"></td> <td style="width: 10%;"></td> <td style="width: 10%;"></td> <td style="width: 10%;"></td> <td style="width: 10%;"></td> <td style="width: 10%;"></td> <td style="width: 10%;"></td> <td style="width: 10%;"></td> <td style="width: 10%;"></td> </tr> <tr> <td></td> <td></td> <td colspan="8" style="text-align: center;"> <table border="1" style="width: 100%; border-collapse: collapse; text-align: center;"> <tr> </tr></table></td></tr></table></td></tr></table></td></tr></table></td></tr></table></td></tr></table></td></tr></table></td></tr></table></td></tr></table></td></tr></table></td></tr></table></td></tr></table></td></tr></table></td></tr></table></td></tr></table></td></tr></table></td></tr></table></td></tr></table></td></tr></table> | | | | | | | | | | | | | | | | | | | | <table border="1" style="width: 100%; border-collapse: collapse; text-align: center;"> <tr> <td style="width: 10%;"></td> <td style="width: 10%;"></td> <td style="width: 10%;"></td> <td style="width: 10%;"></td> <td style="width: 10%;"></td> <td style="width: 10%;"></td> <td style="width: 10%;"></td> <td style="width: 10%;"></td> <td style="width: 10%;"></td> <td style="width: 10%;"></td> </tr> <tr> <td></td> <td></td> <td colspan="8" style="text-align: center;"> <table border="1" style="width: 100%; border-collapse: collapse; text-align: center;"> <tr> <td style="width: 10%;"></td> <td style="width: 10%;"></td> <td style="width: 10%;"></td> <td style="width: 10%;"></td> <td style="width: 10%;"></td> <td style="width: 10%;"></td> <td style="width: 10%;"></td> <td style="width: 10%;"></td> <td style="width: 10%;"></td> <td style="width: 10%;"></td> </tr> <tr> <td></td> <td></td> <td colspan="8" style="text-align: center;"> <table border="1" style="width: 100%; border-collapse: collapse; text-align: center;"> <tr> <td style="width: 10%;"></td> <td style="width: 10%;"></td> <td style="width: 10%;"></td> <td style="width: 10%;"></td> <td style="width: 10%;"></td> <td style="width: 10%;"></td> <td style="width: 10%;"></td> <td style="width: 10%;"></td> <td style="width: 10%;"></td> <td style="width: 10%;"></td> </tr> <tr> <td></td> <td></td> <td colspan="8" style="text-align: center;"> <table border="1" style="width: 100%; border-collapse: collapse; text-align: center;"> <tr> <td style="width: 10%;"></td> <td style="width: 10%;"></td> <td style="width: 10%;"></td> <td style="width: 10%;"></td> <td style="width: 10%;"></td> <td style="width: 10%;"></td> <td style="width: 10%;"></td> <td style="width: 10%;"></td> <td
style="width: 10%;"></td> <td style="width: 10%;"></td> </tr> <tr> <td></td> <td></td> <td colspan="8" style="text-align: center;"> <table border="1" style="width: 100%; border-collapse: collapse; text-align: center;"> <tr> <td style="width: 10%;"></td> <td style="width: 10%;"></td> <td style="width: 10%;"></td> <td style="width: 10%;"></td> <td style="width: 10%;"></td> <td style="width: 10%;"></td> <td style="width: 10%;"></td> <td style="width: 10%;"></td> <td style="width: 10%;"></td> <td style="width: 10%;"></td> </tr> <tr> <td></td> <td></td> <td colspan="8" style="text-align: center;"> <table border="1" style="width: 100%; border-collapse: collapse; text-align: center;"> <tr> <td style="width: 10%;"></td> <td style="width: 10%;"></td> <td style="width: 10%;"></td> <td style="width: 10%;"></td> <td style="width: 10%;"></td> <td style="width: 10%;"></td> <td style="width: 10%;"></td> <td style="width: 10%;"></td> <td style="width: 10%;"></td> <td style="width: 10%;"></td> </tr> <tr> <td></td> <td></td> <td colspan="8" style="text-align: center;"> <table border="1" style="width: 100%; border-collapse: collapse; text-align: center;"> <tr> <td style="width: 10%;"></td> <td style="width: 10%;"></td> <td style="width: 10%;"></td> <td style="width: 10%;"></td> <td style="width: 10%;"></td> <td style="width: 10%;"></td> <td style="width: 10%;"></td> <td style="width: 10%;"></td> <td style="width: 10%;"></td> <td style="width: 10%;"></td> </tr> <tr> <td></td> <td></td> <td colspan="8" style="text-align: center;"> <table border="1" style="width: 100%; border-collapse: collapse; text-align: center;"> <tr> <td style="width: 10%;"></td> <td style="width: 10%;"></td> <td style="width: 10%;"></td> <td style="width: 10%;"></td> <td style="width: 10%;"></td> <td style="width: 10%;"></td> <td style="width: 10%;"></td> <td style="width: 10%;"></td> <td style="width: 10%;"></td> <td style="width: 10%;"></td> </tr> <tr> <td></td> <td></td> <td colspan="8" style="text-align: center;"> <table border="1" style="width: 100%; border-collapse: collapse; text-align: center;"> <tr> <td style="width: 10%;"></td> <td style="width: 10%;"></td> <td style="width: 10%;"></td> <td style="width: 10%;"></td> <td style="width: 10%;"></td> <td style="width: 10%;"></td> <td style="width: 10%;"></td> <td style="width: 10%;"></td> <td style="width: 10%;"></td> <td style="width: 10%;"></td> </tr> <tr> <td></td> <td></td> <td colspan="8" style="text-align: center;"> <table border="1" style="width: 100%; border-collapse: collapse; text-align: center;"> <tr> <td style="width: 10%;"></td> <td style="width: 10%;"></td> <td style="width: 10%;"></td> <td style="width: 10%;"></td> <td style="width: 10%;"></td> <td style="width: 10%;"></td> <td style="width: 10%;"></td> <td style="width: 10%;"></td> <td style="width: 10%;"></td> <td style="width: 10%;"></td> </tr> <tr> <td></td> <td></td> <td colspan="8" style="text-align: center;"> <table border="1" style="width: 100%; border-collapse: collapse; text-align: center;"> <tr> <td style="width: 10%;"></td> <td style="width: 10%;"></td> <td style="width: 10%;"></td> <td style="width: 10%;"></td> <td style="width: 10%;"></td> <td style="width: 10%;"></td> <td style="width: 10%;"></td> <td style="width: 10%;"></td> <td style="width: 10%;"></td> <td style="width: 10%;"></td> </tr> <tr> <td></td> <td></td> <td colspan="8" style="text-align: center;"> <table border="1" style="width: 100%; border-collapse: collapse; text-align: center;"> <tr> <td style="width: 10%;"></td> <td style="width: 10%;"></td> <td style="width: 10%;"></td> <td style="width: 10%;"></td> <td style="width: 10%;"></td> <td style="width: 10%;"></td> <td style="width: 10%;"></td> <td style="width: 10%;"></td> <td style="width: 10%;"></td> <td style="width: 10%;"></td> </tr> <tr> <td></td> <td></td> <td colspan="8" style="text-align: center;"> <table border="1" style="width: 100%; border-collapse: collapse; text-align: center;"> <tr> <td style="width: 10%;"></td> <td style="width: 10%;"></td> <td style="width: 10%;"></td> <td style="width: 10%;"></td> <td style="width: 10%;"></td> <td style="width: 10%;"></td> <td style="width: 10%;"></td> <td style="width: 10%;"></td> <td style="width: 10%;"></td> <td style="width: 10%;"></td> </tr> <tr> <td></td> <td></td> <td colspan="8" style="text-align: center;"> <table border="1" style="width: 100%; border-collapse: collapse; text-align: center;"> <tr> <td style="width: 10%;"></td> <td style="width: 10%;"></td> <td style="width: 10%;"></td> <td style="width: 10%;"></td> <td style="width: 10%;"></td> <td style="width: 10%;"></td> <td style="width: 10%;"></td> <td style="width: 10%;"></td> <td style="width: 10%;"></td> <td style="width: 10%;"></td> </tr> <tr> <td></td> <td></td> <td colspan="8" style="text-align: center;"> <table border="1" style="width: 100%; border-collapse: collapse; text-align: center;"> <tr> <td style="width: 10%;"></td> <td style="width: 10%;"></td> <td style="width: 10%;"></td> <td style="width: 10%;"></td> <td style="width: 10%;"></td> <td style="width: 10%;"></td> <td style="width: 10%;"></td> <td style="width: 10%;"></td> <td style="width: 10%;"></td> <td style="width: 10%;"></td> </tr> <tr> <td></td> <td></td> <td colspan="8" style="text-align: center;"> <table border="1" style="width: 100%; border-collapse: collapse; text-align: center;"> <tr> <td style="width: 10%;"></td> <td style="width: 10%;"></td> <td style="width: 10%;"></td> <td style="width: 10%;"></td> <td style="width: 10%;"></td> <td style="width: 10%;"></td> <td style="width: 10%;"></td> <td style="width: 10%;"></td> <td style="width: 10%;"></td> <td style="width: 10%;"></td> </tr> <tr> <td></td> <td></td> <td colspan="8" style="text-align: center;"> <table border="1" style="width: 100%; border-collapse: collapse; text-align: center;"> <tr> <td style="width: 10%;"></td> <td style="width: 10%;"></td> <td style="width: 10%;"></td> <td style="width: 10%;"></td> <td style="width: 10%;"></td> <td style="width: 10%;"></td> <td style="width: 10%;"></td> <td style="width: 10%;"></td> <td style="width: 10%;"></td> <td style="width: 10%;"></td> </tr> <tr> <td></td> <td></td> <td colspan="8" style="text-align: center;"> <table border="1" style="width: 100%; border-collapse: collapse; text-align: center;"> <tr> </tr></table></td></tr></table></td></tr></table></td></tr></table></td></tr></table></td></tr></table></td></tr></table></td></tr></table></td></tr></table></td></tr></table></td></tr></table></td></tr></table></td></tr></table></td></tr></table></td></tr></table></td></tr></table></td></tr></table></td></tr></table> | | | | | | | | | | | | | | | | | | | | <table border="1" style="width: 100%; border-collapse: collapse; text-align: center;"> <tr> <td style="width: 10%;"></td> <td style="width: 10%;"></td> <td style="width: 10%;"></td> <td style="width: 10%;"></td> <td style="width: 10%;"></td> <td style="width: 10%;"></td> <td style="width: 10%;"></td> <td style="width: 10%;"></td> <td style="width: 10%;"></td> <td style="width: 10%;"></td> </tr> <tr> <td></td> <td></td> <td colspan="8" style="text-align: center;"> <table border="1" style="width: 100%; border-collapse: collapse; text-align: center;"> <tr> <td style="width: 10%;"></td> <td style="width: 10%;"></td> <td style="width: 10%;"></td> <td style="width: 10%;"></td> <td style="width: 10%;"></td> <td style="width: 10%;"></td> <td style="width: 10%;"></td> <td style="width: 10%;"></td> <td style="width: 10%;"></td> <td style="width: 10%;"></td> </tr> <tr> <td></td> <td></td> <td colspan="8" style="text-align: center;"> <table border="1" style="width: 100%; border-collapse: collapse; text-align: center;"> <tr> <td style="width: 10%;"></td> <td style="width: 10%;"></td> <td style="width: 10%;"></td> <td style="width: 10%;"></td> <td style="width: 10%;"></td> <td style="width: 10%;"></td> <td style="width: 10%;"></td> <td style="width: 10%;"></td> <td style="width: 10%;"></td> <td style="width: 10%;"></td> </tr> <tr> <td></td> <td></td> <td colspan="8" style="text-align: center;"> <table border="1" style="width: 100%; border-collapse: collapse; text-align: center;"> <tr> <td style="width: 10%;"></td> <td style="width: 10%;"></td> <td style="width: 10%;"></td> <td style="width: 10%;"></td> <td style="width: 10%;"></td> <td style="width: 10%;"></td> <td style="width: 10%;"></td> <td style="width: 10%;"></td> <td style="width: 10%;"></td> <td style="width: 10%;"></td> </tr> <tr> <td></td> <td></td> <td colspan="8" style="text-align: center;"> <table border="1" style="width: 100%; border-collapse: collapse; text-align: center;"> <tr> <td style="width: 10%;"></td> <td style="width: 10%;"></td> <td style="width: 10%;"></td> <td style="width: 10%;"></td> <td style="width: 10%;"></td> <td style="width: 10%;"></td> <td style="width: 10%;"></td> <td style="width: 10%;"></td> <td style="width: 10%;"></td> <td style="width: 10%;"></td> </tr> <tr> <td></td> <td></td> <td colspan="8" style="text-align: center;">
<table border="1" style="width: 100%; border-collapse: collapse; text-align: center;"> <tr> <td style="width: 10%;"></td> <td style="width: 10%;"></td> <td style="width: 10%;"></td> <td style="width: 10%;"></td> <td style="width: 10%;"></td> <td style="width: 10%;"></td> <td style="width: 10%;"></td> <td style="width: 10%;"></td> <td style="width: 10%;"></td> <td style="width: 10%;"></td> </tr> <tr> <td></td> <td></td> <td colspan="8" style="text-align: center;"> <table border="1" style="width: 100%; border-collapse: collapse; text-align: center;"> <tr> <td style="width: 10%;"></td> <td style="width: 10%;"></td> <td style="width: 10%;"></td> <td style="width: 10%;"></td> <td style="width: 10%;"></td> <td style="width: 10%;"></td> <td style="width: 10%;"></td> <td style="width: 10%;"></td> <td style="width: 10%;"></td> <td style="width: 10%;"></td> </tr> <tr> <td></td> <td></td> <td colspan="8" style="text-align: center;"> <table border="1" style="width: 100%; border-collapse: collapse; text-align: center;"> <tr> <td style="width: 10%;"></td> <td style="width: 10%;"></td> <td style="width: 10%;"></td> <td style="width: 10%;"></td> <td style="width: 10%;"></td> <td style="width: 10%;"></td> <td style="width: 10%;"></td> <td style="width: 10%;"></td> <td style="width: 10%;"></td> <td style="width: 10%;"></td> </tr> <tr> <td></td> <td></td> <td colspan="8" style="text-align: center;"> <table border="1" style="width: 100%; border-collapse: collapse; text-align: center;"> <tr> <td style="width: 10%;"></td> <td style="width: 10%;"></td> <td style="width: 10%;"></td> <td style="width: 10%;"></td> <td style="width: 10%;"></td> <td style="width: 10%;"></td> <td style="width: 10%;"></td> <td style="width: 10%;"></td> <td style="width: 10%;"></td> <td style="width: 10%;"></td> </tr> <tr> <td></td> <td></td> <td colspan="8" style="text-align: center;"> <table border="1" style="width: 100%; border-collapse: collapse; text-align: center;"> <tr> <td style="width: 10%;"></td> <td style="width: 10%;"></td> <td style="width: 10%;"></td> <td style="width: 10%;"></td> <td style="width: 10%;"></td> <td style="width: 10%;"></td> <td style="width: 10%;"></td> <td style="width: 10%;"></td> <td style="width: 10%;"></td> <td style="width: 10%;"></td> </tr> <tr> <td></td> <td></td> <td colspan="8" style="text-align: center;"> <table border="1" style="width: 100%; border-collapse: collapse; text-align: center;"> <tr> <td style="width: 10%;"></td> <td style="width: 10%;"></td> <td style="width: 10%;"></td> <td style="width: 10%;"></td> <td style="width: 10%;"></td> <td style="width: 10%;"></td> <td style="width: 10%;"></td> <td style="width: 10%;"></td> <td style="width: 10%;"></td> <td style="width: 10%;"></td> </tr> <tr> <td></td> <td></td> <td colspan="8" style="text-align: center;"> <table border="1" style="width: 100%; border-collapse: collapse; text-align: center;"> <tr> <td style="width: 10%;"></td> <td style="width: 10%;"></td> <td style="width: 10%;"></td> <td style="width: 10%;"></td> <td style="width: 10%;"></td> <td style="width: 10%;"></td> <td style="width: 10%;"></td> <td style="width: 10%;"></td> <td style="width: 10%;"></td> <td style="width: 10%;"></td> </tr> <tr> <td></td> <td></td> <td colspan="8" style="text-align: center;"> <table border="1" style="width: 100%; border-collapse: collapse; text-align: center;"> <tr> <td style="width: 10%;"></td> <td style="width: 10%;"></td> <td style="width: 10%;"></td> <td style="width: 10%;"></td> <td style="width: 10%;"></td> <td style="width: 10%;"></td> <td style="width: 10%;"></td> <td style="width: 10%;"></td> <td style="width: 10%;"></td> <td style="width: 10%;"></td> </tr> <tr> <td></td> <td></td> <td colspan="8" style="text-align: center;"> <table border="1" style="width: 100%; border-collapse: collapse; text-align: center;"> <tr> <td style="width: 10%;"></td> <td style="width: 10%;"></td> <td style="width: 10%;"></td> <td style="width: 10%;"></td> <td style="width: 10%;"></td> <td style="width: 10%;"></td> <td style="width: 10%;"></td> <td style="width: 10%;"></td> <td style="width: 10%;"></td> <td style="width: 10%;"></td> </tr> <tr> <td></td> <td></td> <td colspan="8" style="text-align: center;"> <table border="1" style="width: 100%; border-collapse: collapse; text-align: center;"> <tr> <td style="width: 10%;"></td> <td style="width: 10%;"></td> <td style="width: 10%;"></td> <td style="width: 10%;"></td> <td style="width: 10%;"></td> <td style="width: 10%;"></td> <td style="width: 10%;"></td> <td style="width: 10%;"></td> <td style="width: 10%;"></td> <td style="width: 10%;"></td> </tr> <tr> <td></td> <td></td> <td colspan="8" style="text-align: center;"> <table border="1" style="width: 100%; border-collapse: collapse; text-align: center;"> <tr> <td style="width: 10%;"></td> <td style="width: 10%;"></td> <td style="width: 10%;"></td> <td style="width: 10%;"></td> <td style="width: 10%;"></td> <td style="width: 10%;"></td> <td style="width: 10%;"></td> <td style="width: 10%;"></td> <td style="width: 10%;"></td> <td style="width: 10%;"></td> </tr> <tr> <td></td> <td></td> <td colspan="8" style="text-align: center;"> <table border="1" style="width: 100%; border-collapse: collapse; text-align: center;"> <tr> </tr></table></td></tr></table></td></tr></table></td></tr></table></td></tr></table></td></tr></table></td></tr></table></td></tr></table></td></tr></table></td></tr></table></td></tr></table></td></tr></table></td></tr></table></td></tr></table></td></tr></table></td></tr></table></td></tr></table> | | | | | | | | | | | | | | | | | | | | <table border="1" style="width: 100%; border-collapse: collapse; text-align: center;"> <tr> <td style="width: 10%;"></td> <td style="width: 10%;"></td> <td style="width: 10%;"></td> <td style="width: 10%;"></td> <td style="width: 10%;"></td> <td style="width: 10%;"></td> <td style="width: 10%;"></td> <td style="width: 10%;"></td> <td style="width: 10%;"></td> <td style="width: 10%;"></td> </tr> <tr> <td></td> <td></td> <td colspan="8" style="text-align: center;"> <table border="1" style="width: 100%; border-collapse: collapse; text-align: center;"> <tr> <td style="width: 10%;"></td> <td style="width: 10%;"></td> <td style="width: 10%;"></td> <td style="width: 10%;"></td> <td style="width: 10%;"></td> <td style="width: 10%;"></td> <td style="width: 10%;"></td> <td style="width: 10%;"></td> <td style="width: 10%;"></td> <td style="width: 10%;"></td> </tr> <tr> <td></td> <td></td> <td colspan="8" style="text-align: center;"> <table border="1" style="width: 100%; border-collapse: collapse; text-align: center;"> <tr> <td style="width: 10%;"></td> <td style="width: 10%;"></td> <td style="width: 10%;"></td> <td style="width: 10%;"></td> <td style="width: 10%;"></td> <td style="width: 10%;"></td> <td style="width: 10%;"></td> <td style="width: 10%;"></td> <td style="width: 10%;"></td> <td style="width: 10%;"></td> </tr> <tr> <td></td> <td></td> <td colspan="8" style="text-align: center;"> <table border="1" style="width: 100%; border-collapse: collapse; text-align: center;"> <tr> <td style="width: 10%;"></td> <td style="width: 10%;"></td> <td style="width: 10%;"></td> <td style="width: 10%;"></td> <td style="width: 10%;"></td> <td style="width: 10%;"></td> <td style="width: 10%;"></td> <td style="width: 10%;"></td> <td style="width: 10%;"></td> <td style="width: 10%;"></td> </tr> <tr> <td></td> <td></td> <td colspan="8" style="text-align: center;"> <table border="1" style="width: 100%; border-collapse: collapse; text-align: center;"> <tr> <td style="width: 10%;"></td> <td style="width: 10%;"></td> <td style="width: 10%;"></td> <td style="width: 10%;"></td> <td style="width: 10%;"></td> <td style="width: 10%;"></td> <td style="width: 10%;"></td> <td style="width: 10%;"></td> <td style="width: 10%;"></td> <td style="width: 10%;"></td> </tr> <tr> <td></td> <td></td> <td colspan="8" style="text-align: center;"> <table border="1" style="width: 100%; border-collapse: collapse; text-align: center;"> <tr> <td style="width: 10%;"></td> <td style="width: 10%;"></td> <td style="width: 10%;"></td> <td style="width: 10%;"></td> <td style="width: 10%;"></td> <td style="width: 10%;"></td> <td style="width: 10%;"></td> <td style="width: 10%;"></td> <td style="width: 10%;"></td> <td style="width: 10%;"></td> </tr> <tr> <td></td> <td></td> <td colspan="8" style="text-align: center;"> <table border="1" style="width: 100%; border-collapse: collapse; text-align: center;"> <tr> <td style="width: 10%;"></td> <td style="width: 10%;"></td> <td style="width: 10%;"></td> <td style="width: 10%;"></td> <td style="width: 10%;"></td> <td style="width: 10%;"></td> <td style="width: 10%;"></td> <td style="width: 10%;"></td> <td style="width: 10%;"></td> <td style="width: 10%;"></td> </tr> <tr> <td></td> <td></td> <td colspan="8" style="text-align: center;"> <table border="1" style="width: 100%; border-collapse: collapse; text-align: center;"> <tr> <td style="width: 10%;"></td> <td style="width:
10%;"></td> <td style="width: 10%;"></td> <td style="width: 10%;"></td> <td style="width: 10%;"></td> <td style="width: 10%;"></td> <td style="width: 10%;"></td> <td style="width: 10%;"></td> <td style="width: 10%;"></td> <td style="width: 10%;"></td> </tr> <tr> <td></td> <td></td> <td colspan="8" style="text-align: center;"> <table border="1" style="width: 100%; border-collapse: collapse; text-align: center;"> <tr> <td style="width: 10%;"></td> <td style="width: 10%;"></td> <td style="width: 10%;"></td> <td style="width: 10%;"></td> <td style="width: 10%;"></td> <td style="width: 10%;"></td> <td style="width: 10%;"></td> <td style="width: 10%;"></td> <td style="width: 10%;"></td> <td style="width: 10%;"></td> </tr> <tr> <td></td> <td></td> <td colspan="8" style="text-align: center;"> <table border="1" style="width: 100%; border-collapse: collapse; text-align: center;"> <tr> <td style="width: 10%;"></td> <td style="width: 10%;"></td> <td style="width: 10%;"></td> <td style="width: 10%;"></td> <td style="width: 10%;"></td> <td style="width: 10%;"></td> <td style="width: 10%;"></td> <td style="width: 10%;"></td> <td style="width: 10%;"></td> <td style="width: 10%;"></td> </tr> <tr> <td></td> <td></td> <td colspan="8" style="text-align: center;"> <table border="1" style="width: 100%; border-collapse: collapse; text-align: center;"> <tr> <td style="width: 10%;"></td> <td style="width: 10%;"></td> <td style="width: 10%;"></td> <td style="width: 10%;"></td> <td style="width: 10%;"></td> <td style="width: 10%;"></td> <td style="width: 10%;"></td> <td style="width: 10%;"></td> <td style="width: 10%;"></td> <td style="width: 10%;"></td> </tr> <tr> <td></td> <td></td> <td colspan="8" style="text-align: center;"> <table border="1" style="width: 100%; border-collapse: collapse; text-align: center;"> <tr> <td style="width: 10%;"></td> <td style="width: 10%;"></td> <td style="width: 10%;"></td> <td style="width: 10%;"></td> <td style="width: 10%;"></td> <td style="width: 10%;"></td> <td style="width: 10%;"></td> <td style="width: 10%;"></td> <td style="width: 10%;"></td> <td style="width: 10%;"></td> </tr> <tr> <td></td> <td></td> <td colspan="8" style="text-align: center;"> <table border="1" style="width: 100%; border-collapse: collapse; text-align: center;"> <tr> <td style="width: 10%;"></td> <td style="width: 10%;"></td> <td style="width: 10%;"></td> <td style="width: 10%;"></td> <td style="width: 10%;"></td> <td style="width: 10%;"></td> <td style="width: 10%;"></td> <td style="width: 10%;"></td> <td style="width: 10%;"></td> <td style="width: 10%;"></td> </tr> <tr> <td></td> <td></td> <td colspan="8" style="text-align: center;"> <table border="1" style="width: 100%; border-collapse: collapse; text-align: center;"> <tr> <td style="width: 10%;"></td> <td style="width: 10%;"></td> <td style="width: 10%;"></td> <td style="width: 10%;"></td> <td style="width: 10%;"></td> <td style="width: 10%;"></td> <td style="width: 10%;"></td> <td style="width: 10%;"></td> <td style="width: 10%;"></td> <td style="width: 10%;"></td> </tr> <tr> <td></td> <td></td> <td colspan="8" style="text-align: center;"> <table border="1" style="width: 100%; border-collapse: collapse; text-align: center;"> <tr> <td style="width: 10%;"></td> <td style="width: 10%;"></td> <td style="width: 10%;"></td> <td style="width: 10%;"></td> <td style="width: 10%;"></td> <td style="width: 10%;"></td> <td style="width: 10%;"></td> <td style="width: 10%;"></td> <td style="width: 10%;"></td> <td style="width: 10%;"></td> </tr> <tr> <td></td> <td></td> <td colspan="8" style="text-align: center;"> <table border="1" style="width: 100%; border-collapse: collapse; text-align: center;"> <tr> </tr></table></td></tr></table></td></tr></table></td></tr></table></td></tr></table></td></tr></table></td></tr></table></td></tr></table></td></tr></table></td></tr></table></td></tr></table></td></tr></table></td></tr></table></td></tr></table></td></tr></table></td></tr></table> | | | | | | | | | | | | | | | | | | | | <table border="1" style="width: 100%; border-collapse: collapse; text-align: center;"> <tr> <td style="width: 10%;"></td> <td style="width: 10%;"></td> <td style="width: 10%;"></td> <td style="width: 10%;"></td> <td style="width: 10%;"></td> <td style="width: 10%;"></td> <td style="width: 10%;"></td> <td style="width: 10%;"></td> <td style="width: 10%;"></td> <td style="width: 10%;"></td> </tr> <tr> <td></td> <td></td> <td colspan="8" style="text-align: center;"> <table border="1" style="width: 100%; border-collapse: collapse; text-align: center;"> <tr> <td style="width: 10%;"></td> <td style="width: 10%;"></td> <td style="width: 10%;"></td> <td style="width: 10%;"></td> <td style="width: 10%;"></td> <td style="width: 10%;"></td> <td style="width: 10%;"></td> <td style="width: 10%;"></td> <td style="width: 10%;"></td> <td style="width: 10%;"></td> </tr> <tr> <td></td> <td></td> <td colspan="8" style="text-align: center;"> <table border="1" style="width: 100%; border-collapse: collapse; text-align: center;"> <tr> <td style="width: 10%;"></td> <td style="width: 10%;"></td> <td style="width: 10%;"></td> <td style="width: 10%;"></td> <td style="width: 10%;"></td> <td style="width: 10%;"></td> <td style="width: 10%;"></td> <td style="width: 10%;"></td> <td style="width: 10%;"></td> <td style="width: 10%;"></td> </tr> <tr> <td></td> <td></td> <td colspan="8" style="text-align: center;"> <table border="1" style="width: 100%; border-collapse: collapse; text-align: center;"> <tr> <td style="width: 10%;"></td> <td style="width: 10%;"></td> <td style="width: 10%;"></td> <td style="width: 10%;"></td> <td style="width: 10%;"></td> <td style="width: 10%;"></td> <td style="width: 10%;"></td> <td style="width: 10%;"></td> <td style="width: 10%;"></td> <td style="width: 10%;"></td> </tr> <tr> <td></td> <td></td> <td colspan="8" style="text-align: center;"> <table border="1" style="width: 100%; border-collapse: collapse; text-align: center;"> <tr> <td style="width: 10%;"></td> <td style="width: 10%;"></td> <td style="width: 10%;"></td> <td style="width: 10%;"></td> <td style="width: 10%;"></td> <td style="width: 10%;"></td> <td style="width: 10%;"></td> <td style="width: 10%;"></td> <td style="width: 10%;"></td> <td style="width: 10%;"></td> </tr> <tr> <td></td> <td></td> <td colspan="8" style="text-align: center;"> <table border="1" style="width: 100%; border-collapse: collapse; text-align: center;"> <tr> <td style="width: 10%;"></td> <td style="width: 10%;"></td> <td style="width: 10%;"></td> <td style="width: 10%;"></td> <td style="width: 10%;"></td> <td style="width: 10%;"></td> <td style="width: 10%;"></td> <td style="width: 10%;"></td> <td style="width: 10%;"></td> <td style="width: 10%;"></td> </tr> <tr> <td></td> <td></td> <td colspan="8" style="text-align: center;"> <table border="1" style="width: 100%; border-collapse: collapse; text-align: center;"> <tr> <td style="width: 10%;"></td> <td style="width: 10%;"></td> <td style="width: 10%;"></td> <td style="width: 10%;"></td> <td style="width: 10%;"></td> <td style="width: 10%;"></td> <td style="width: 10%;"></td> <td style="width: 10%;"></td> <td style="width: 10%;"></td> <td style="width: 10%;"></td> </tr> <tr> <td></td> <td></td> <td colspan="8" style="text-align: center;"> <table border="1" style="width: 100%; border-collapse: collapse; text-align: center;"> <tr> <td style="width: 10%;"></td> <td style="width: 10%;"></td> <td style="width: 10%;"></td> <td style="width: 10%;"></td> <td style="width: 10%;"></td> <td style="width: 10%;"></td> <td style="width: 10%;"></td> <td style="width: 10%;"></td> <td style="width: 10%;"></td> <td style="width: 10%;"></td> </tr> <tr> <td></td> <td></td> <td colspan="8" style="text-align: center;"> <table border="1" style="width: 100%; border-collapse: collapse; text-align: center;"> <tr> <td style="width: 10%;"></td> <td style="width: 10%;"></td> <td style="width: 10%;"></td> <td style="width: 10%;"></td> <td style="width: 10%;"></td> <td style="width: 10%;"></td> <td style="width: 10%;"></td> <td style="width: 10%;"></td> <td style="width: 10%;"></td> <td style="width: 10%;"></td> </tr> <tr> <td></td> <td></td> <td colspan="8" style="text-align: center;"> <table border="1" style="width: 100%; border-collapse: collapse; text-align: center;"> <tr> <td style="width: 10%;"></td> <td style="width: 10%;"></td> <td style="width: 10%;"></td> <td style="width: 10%;"></td> <td style="width: 10%;"></td> <td style="width: 10%;"></td> <td style="width: 10%;"></td> <td style="width: 10%;"></td> <td style="width: 10%;"></td> <td style="width: 10%;"></td> </tr> <tr> <td></td> <td></td> <td colspan="8" style="text-align: center;"> <table border="1" style="width: 100%; border-collapse: collapse; text-align: center;"> <tr> <td style="width: 10%;"></td> <td style="width: 10%;"></td> <td style="width: 10%;"></td> <td style="width: 10%;"></td> <td style="width: 10%;"></td> <td style="width: 10%;"></td> <td style="width: 10%;"></td> <td
style="width: 10%;"></td> <td style="width: 10%;"></td> <td style="width: 10%;"></td> </tr> <tr> <td></td> <td></td> <td colspan="8" style="text-align: center;"> <table border="1" style="width: 100%; border-collapse: collapse; text-align: center;"> <tr> <td style="width: 10%;"></td> <td style="width: 10%;"></td> <td style="width: 10%;"></td> <td style="width: 10%;"></td> <td style="width: 10%;"></td> <td style="width: 10%;"></td> <td style="width: 10%;"></td> <td style="width: 10%;"></td> <td style="width: 10%;"></td> <td style="width: 10%;"></td> </tr> <tr> <td></td> <td></td> <td colspan="8" style="text-align: center;"> <table border="1" style="width: 100%; border-collapse: collapse; text-align: center;"> <tr> <td style="width: 10%;"></td> <td style="width: 10%;"></td> <td style="width: 10%;"></td> <td style="width: 10%;"></td> <td style="width: 10%;"></td> <td style="width: 10%;"></td> <td style="width: 10%;"></td> <td style="width: 10%;"></td> <td style="width: 10%;"></td> <td style="width: 10%;"></td> </tr> <tr> <td></td> <td></td> <td colspan="8" style="text-align: center;"> <table border="1" style="width: 100%; border-collapse: collapse; text-align: center;"> <tr> <td style="width: 10%;"></td> <td style="width: 10%;"></td> <td style="width: 10%;"></td> <td style="width: 10%;"></td> <td style="width: 10%;"></td> <td style="width: 10%;"></td> <td style="width: 10%;"></td> <td style="width: 10%;"></td> <td style="width: 10%;"></td> <td style="width: 10%;"></td> </tr> <tr> <td></td> <td></td> <td colspan="8" style="text-align: center;"> <table border="1" style="width: 100%; border-collapse: collapse; text-align: center;"> <tr> </tr></table></td></tr></table></td></tr></table></td></tr></table></td></tr></table></td></tr></table></td></tr></table></td></tr></table></td></tr></table></td></tr></table></td></tr></table></td></tr></table></td></tr></table></td></tr></table></td></tr></table> | | | | | | | | | | | | | | | | | | | | <table border="1" style="width: 100%; border-collapse: collapse; text-align: center;"> <tr> <td style="width: 10%;"></td> <td style="width: 10%;"></td> <td style="width: 10%;"></td> <td style="width: 10%;"></td> <td style="width: 10%;"></td> <td style="width: 10%;"></td> <td style="width: 10%;"></td> <td style="width: 10%;"></td> <td style="width: 10%;"></td> <td style="width: 10%;"></td> </tr> <tr> <td></td> <td></td> <td colspan="8" style="text-align: center;"> <table border="1" style="width: 100%; border-collapse: collapse; text-align: center;"> <tr> <td style="width: 10%;"></td> <td style="width: 10%;"></td> <td style="width: 10%;"></td> <td style="width: 10%;"></td> <td style="width: 10%;"></td> <td style="width: 10%;"></td> <td style="width: 10%;"></td> <td style="width: 10%;"></td> <td style="width: 10%;"></td> <td style="width: 10%;"></td> </tr> <tr> <td></td> <td></td> <td colspan="8" style="text-align: center;"> <table border="1" style="width: 100%; border-collapse: collapse; text-align: center;"> <tr> <td style="width: 10%;"></td> <td style="width: 10%;"></td> <td style="width: 10%;"></td> <td style="width: 10%;"></td> <td style="width: 10%;"></td> <td style="width: 10%;"></td> <td style="width: 10%;"></td> <td style="width: 10%;"></td> <td style="width: 10%;"></td> <td style="width: 10%;"></td> </tr> <tr> <td></td> <td></td> <td colspan="8" style="text-align: center;"> <table border="1" style="width: 100%; border-collapse: collapse; text-align: center;"> <tr> <td style="width: 10%;"></td> <td style="width: 10%;"></td> <td style="width: 10%;"></td> <td style="width: 10%;"></td> <td style="width: 10%;"></td> <td style="width: 10%;"></td> <td style="width: 10%;"></td> <td style="width: 10%;"></td> <td style="width: 10%;"></td> <td style="width: 10%;"></td> </tr> <tr> <td></td> <td></td> <td colspan="8" style="text-align: center;"> <table border="1" style="width: 100%; border-collapse: collapse; text-align: center;"> <tr> <td style="width: 10%;"></td> <td style="width: 10%;"></td> <td style="width: 10%;"></td> <td style="width: 10%;"></td> <td style="width: 10%;"></td> <td style="width: 10%;"></td> <td style="width: 10%;"></td> <td style="width: 10%;"></td> <td style="width: 10%;"></td> <td style="width: 10%;"></td> </tr> <tr> <td></td> <td></td> <td colspan="8" style="text-align: center;"> <table border="1" style="width: 100%; border-collapse: collapse; text-align: center;"> <tr> <td style="width: 10%;"></td> <td style="width: 10%;"></td> <td style="width: 10%;"></td> <td style="width: 10%;"></td> <td style="width: 10%;"></td> <td style="width: 10%;"></td> <td style="width: 10%;"></td> <td style="width: 10%;"></td> <td style="width: 10%;"></td> <td style="width: 10%;"></td> </tr> <tr> <td></td> <td></td> <td colspan="8" style="text-align: center;"> <table border="1" style="width: 100%; border-collapse: collapse; text-align: center;"> <tr> <td style="width: 10%;"></td> <td style="width: 10%;"></td> <td style="width: 10%;"></td> <td style="width: 10%;"></td> <td style="width: 10%;"></td> <td style="width: 10%;"></td> <td style="width: 10%;"></td> <td style="width: 10%;"></td> <td style="width: 10%;"></td> <td style="width: 10%;"></td> </tr> <tr> <td></td> <td></td> <td colspan="8" style="text-align: center;"> <table border="1" style="width: 100%; border-collapse: collapse; text-align: center;"> <tr> <td style="width: 10%;"></td> <td style="width: 10%;"></td> <td style="width: 10%;"></td> <td style="width: 10%;"></td> <td style="width: 10%;"></td> <td style="width: 10%;"></td> <td style="width: 10%;"></td> <td style="width: 10%;"></td> <td style="width: 10%;"></td> <td style="width: 10%;"></td> </tr> <tr> <td></td> <td></td> <td colspan="8" style="text-align: center;"> <table border="1" style="width: 100%; border-collapse: collapse; text-align: center;"> <tr> <td style="width: 10%;"></td> <td style="width: 10%;"></td> <td style="width: 10%;"></td> <td style="width: 10%;"></td> <td style="width: 10%;"></td> <td style="width: 10%;"></td> <td style="width: 10%;"></td> <td style="width: 10%;"></td> <td style="width: 10%;"></td> <td style="width: 10%;"></td> </tr> <tr> <td></td> <td></td> <td colspan="8" style="text-align: center;"> <table border="1" style="width: 100%; border-collapse: collapse; text-align: center;"> <tr> <td style="width: 10%;"></td> <td style="width: 10%;"></td> <td style="width: 10%;"></td> <td style="width: 10%;"></td> <td style="width: 10%;"></td> <td style="width: 10%;"></td> <td style="width: 10%;"></td> <td style="width: 10%;"></td> <td style="width: 10%;"></td> <td style="width: 10%;"></td> </tr> <tr> <td></td> <td></td> <td colspan="8" style="text-align: center;"> <table border="1" style="width: 100%; border-collapse: collapse; text-align: center;"> <tr> <td style="width: 10%;"></td> <td style="width: 10%;"></td> <td style="width: 10%;"></td> <td style="width: 10%;"></td> <td style="width: 10%;"></td> <td style="width: 10%;"></td> <td style="width: 10%;"></td> <td style="width: 10%;"></td> <td style="width: 10%;"></td> <td style="width: 10%;"></td> </tr> <tr> <td></td> <td></td> <td colspan="8" style="text-align: center;"> <table border="1" style="width: 100%; border-collapse: collapse; text-align: center;"> <tr> <td style="width: 10%;"></td> <td style="width: 10%;"></td> <td style="width: 10%;"></td> <td style="width: 10%;"></td> <td style="width: 10%;"></td> <td style="width: 10%;"></td> <td style="width: 10%;"></td> <td style="width: 10%;"></td> <td style="width: 10%;"></td> <td style="width: 10%;"></td> </tr> <tr> <td></td> <td></td> <td colspan="8" style="text-align: center;"> <table border="1" style="width: 100%; border-collapse: collapse; text-align: center;"> <tr> <td style="width: 10%;"></td> <td style="width: 10%;"></td> <td style="width: 10%;"></td> <td style="width: 10%;"></td> <td style="width: 10%;"></td> <td style="width: 10%;"></td> <td style="width: 10%;"></td> <td style="width: 10%;"></td> <td style="width: 10%;"></td> <td style="width: 10%;"></td> </tr> <tr> <td></td> <td></td> <td colspan="8" style="text-align: center;"> <table border="1" style="width: 100%; border-collapse: collapse; text-align: center;"> <tr> </tr></table></td></tr></table></td></tr></table></td></tr></table></td></tr></table></td></tr></table></td></tr></table></td></tr></table></td></tr></table></td></tr></table></td></tr></table></td></tr></table></td></tr></table></td></tr></table>
 | | | | | | | | | | | | | | | | | | | | <table border="1" style="width: 100%; border-collapse: collapse; text-align: center;"> <tr> <td style="width: 10%;"></td> <td style="width: 10%;"></td> <td style="width: 10%;"></td> <td style="width: 10%;"></td> <td style="width: 10%;"></td> <td style="width: 10%;"></td> <td style="width: 10%;"></td> <td style="width: 10%;"></td> <td style="width: 10%;"></td> <td style="width: 10%;"></td> </tr> <tr> <td></td> <td></td> <td colspan="8" style="text-align: center;"> <table border="1" style="width: 100%; border-collapse: collapse; text-align: center;"> <tr> <td style="width: 10%;"></td> <td style="width: 10%;"></td> <td style="width: 10%;"></td> <td style="width: 10%;"></td> <td style="width: 10%;"></td> <td style="width: 10%;"></td> <td style="width: 10%;"></td> <td style="width: 10%;"></td> <td style="width: 10%;"></td> <td style="width: 10%;"></td> </tr> <tr> <td></td> <td></td> <td colspan="8" style="text-align: center;"> <table border="1" style="width: 100%; border-collapse: collapse; text-align: center;"> <tr> <td style="width: 10%;"></td> <td style="width: 10%;"></td> <td style="width: 10%;"></td> <td style="width: 10%;"></td> <td style="width: 10%;"></td> <td style="width: 10%;"></td> <td style="width: 10%;"></td> <td style="width: 10%;"></td> <td style="width: 10%;"></td> <td style="width: 10%;"></td> </tr> <tr> <td></td> <td></td> <td colspan="8" style="text-align: center;"> <table border="1" style="width: 100%; border-collapse: collapse; text-align: center;"> <tr> <td style="width: 10%;"></td> <td style="width: 10%;"></td> <td style="width: 10%;"></td> <td style="width: 10%;"></td> <td style="width: 10%;"></td> <td style="width: 10%;"></td> <td style="width: 10%;"></td> <td style="width: 10%;"></td> <td style="width: 10%;"></td> <td style="width: 10%;"></td> </tr> <tr> <td></td> <td></td> <td colspan="8" style="text-align: center;"> <table border="1" style="width: 100%; border-collapse: collapse; text-align: center;"> <tr> <td style="width: 10%;"></td> <td style="width: 10%;"></td> <td style="width: 10%;"></td> <td style="width: 10%;"></td> <td style="width: 10%;"></td> <td style="width: 10%;"></td> <td style="width: 10%;"></td> <td style="width: 10%;"></td> <td style="width: 10%;"></td> <td style="width: 10%;"></td> </tr> <tr> <td></td> <td></td> <td colspan="8" style="text-align: center;"> <table border="1" style="width: 100%; border-collapse: collapse; text-align: center;"> <tr> <td style="width: 10%;"></td> <td style="width: 10%;"></td> <td style="width: 10%;"></td> <td style="width: 10%;"></td> <td style="width: 10%;"></td> <td style="width: 10%;"></td> <td style="width: 10%;"></td> <td style="width: 10%;"></td> <td style="width: 10%;"></td> <td style="width: 10%;"></td> </tr> <tr> <td></td> <td></td> <td colspan="8" style="text-align: center;"> <table border="1" style="width: 100%; border-collapse: collapse; text-align: center;"> <tr> <td style="width: 10%;"></td> <td style="width: 10%;"></td> <td style="width: 10%;"></td> <td style="width: 10%;"></td> <td style="width: 10%;"></td> <td style="width: 10%;"></td> <td style="width: 10%;"></td> <td style="width: 10%;"></td> <td style="width: 10%;"></td> <td style="width: 10%;"></td> </tr> <tr> <td></td> <td></td> <td colspan="8" style="text-align: center;"> <table border="1" style="width: 100%; border-collapse: collapse; text-align: center;"> <tr> <td style="width: 10%;"></td> <td style="width: 10%;"></td> <td style="width: 10%;"></td> <td style="width: 10%;"></td> <td style="width: 10%;"></td> <td style="width: 10%;"></td> <td style="width: 10%;"></td> <td style="width: 10%;"></td> <td style="width: 10%;"></td> <td style="width: 10%;"></td> </tr> <tr> <td></td> <td></td> <td colspan="8" style="text-align: center;"> <table border="1" style="width: 100%; border-collapse: collapse; text-align: center;"> <tr> <td style="width: 10%;"></td> <td style="width: 10%;"></td> <td style="width: 10%;"></td> <td style="width: 10%;"></td> <td style="width: 10%;"></td> <td style="width: 10%;"></td> <td style="width: 10%;"></td> <td style="width: 10%;"></td> <td style="width: 10%;"></td> <td style="width: 10%;"></td> </tr> <tr> <td></td> <td></td> <td colspan="8" style="text-align: center;"> <table border="1" style="width: 100%; border-collapse: collapse; text-align: center;"> <tr> <td style="width: 10%;"></td> <td style="width: 10%;"></td> <td style="width: 10%;"></td> <td style="width: 10%;"></td> <td style="width: 10%;"></td> <td style="width: 10%;"></td> <td style="width: 10%;"></td> <td style="width: 10%;"></td> <td style="width: 10%;"></td> <td style="width: 10%;"></td> </tr> <tr> <td></td> <td></td> <td colspan="8" style="text-align: center;"> <table border="1" style="width: 100%; border-collapse: collapse; text-align: center;"> <tr> <td style="width: 10%;"></td> <td style="width: 10%;"></td> <td style="width: 10%;"></td> <td style="width: 10%;"></td> <td style="width: 10%;"></td> <td style="width: 10%;"></td> <td style="width: 10%;"></td> <td style="width: 10%;"></td> <td style="width: 10%;"></td> <td style="width: 10%;"></td> </tr> <tr> <td></td> <td></td> <td colspan="8" style="text-align: center;"> <table border="1" style="width: 100%; border-collapse: collapse; text-align: center;"> <tr> <td style="width: 10%;"></td> <td style="width: 10%;"></td> <td style="width: 10%;"></td> <td style="width: 10%;"></td> <td style="width: 10%;"></td> <td style="width: 10%;"></td> <td style="width: 10%;"></td> <td style="width: 10%;"></td> <td style="width: 10%;"></td> <td style="width: 10%;"></td> </tr> <tr> <td></td> <td></td> <td colspan="8" style="text-align: center;"> <table border="1" style="width: 100%; border-collapse: collapse; text-align: center;"> <tr> </tr></table></td></tr></table></td></tr></table></td></tr></table></td></tr></table></td></tr></table></td></tr></table></td></tr></table></td></tr></table></td></tr></table></td></tr></table></td></tr></table></td></tr></table> | | | | | | | | | | | | | | | | | | | | <table border="1" style="width: 100%; border-collapse: collapse; text-align: center;"> <tr> <td style="width: 10%;"></td> <td style="width: 10%;"></td> <td style="width: 10%;"></td> <td style="width: 10%;"></td> <td style="width: 10%;"></td> <td style="width: 10%;"></td> <td style="width: 10%;"></td> <td style="width: 10%;"></td> <td style="width: 10%;"></td> <td style="width: 10%;"></td> </tr> <tr> <td></td> <td></td> <td colspan="8" style="text-align: center;"> <table border="1" style="width: 100%; border-collapse: collapse; text-align: center;"> <tr> <td style="width: 10%;"></td> <td style="width: 10%;"></td> <td style="width: 10%;"></td> <td style="width: 10%;"></td> <td style="width: 10%;"></td> <td style="width: 10%;"></td> <td style="width: 10%;"></td> <td style="width: 10%;"></td> <td style="width: 10%;"></td> <td style="width: 10%;"></td> </tr> <tr> <td></td> <td></td> <td colspan="8" style="text-align: center;"> <table border="1" style="width: 100%; border-collapse: collapse; text-align: center;"> <tr> <td style="width: 10%;"></td> <td style="width: 10%;"></td> <td style="width: 10%;"></td> <td style="width: 10%;"></td> <td style="width: 10%;"></td> <td style="width: 10%;"></td> <td style="width: 10%;"></td> <td style="width: 10%;"></td> <td style="width: 10%;"></td> <td style="width: 10%;"></td> </tr> <tr> <td></td> <td></td> <td colspan="8" style="text-align: center;"> <table border="1" style="width: 100%; border-collapse: collapse; text-align: center;"> <tr> <td style="width: 10%;"></td> <td style="width: 10%;"></td> <td style="width: 10%;"></td> <td style="width: 10%;"></td> <td style="width: 10%;"></td> <td style="width: 10%;"></td> <td style="width: 10%;"></td> <td style="width: 10%;"></td> <td style="width: 10%;"></td> <td style="width: 10%;"></td> </tr> <tr> <td></td> <td></td> <td colspan="8" style="text-align: center;"> <table border="1" style="width: 100%; border-collapse: collapse; text-align: center;"> <tr> <td style="width: 10%;"></td> <td style="width: 10%;"></td> <td style="width: 10%;"></td> <td style="width: 10%;"></td> <td style="width: 10%;"></td> <td style="width: 10%;"></td> <td style="width: 10%;"></td> <td style="width: 10%;"></td> <td style="width: 10%;"></td> <td style="width: 10%;"></td> </tr> <tr> <td></td> <td></td> <td colspan="8" style="text-align: center;"> <table border="1" style="width: 100%; border-collapse: collapse; text-align: center;"> <tr> <td style="width: 10%;"></td> <td style="width: 10%;"></td> <td style="width: 10%;"></td> <td style="width: 10%;"></td> <td style="width: 10%;"></td> <td style="width: 10%;"></td> <td
style="width: 10%;"></td> <td style="width: 10%;"></td> <td style="width: 10%;"></td> <td style="width: 10%;"></td> </tr> <tr> <td></td> <td></td> <td colspan="8" style="text-align: center;"> <table border="1" style="width: 100%; border-collapse: collapse; text-align: center;"> <tr> <td style="width: 10%;"></td> <td style="width: 10%;"></td> <td style="width: 10%;"></td> <td style="width: 10%;"></td> <td style="width: 10%;"></td> <td style="width: 10%;"></td> <td style="width: 10%;"></td> <td style="width: 10%;"></td> <td style="width: 10%;"></td> <td style="width: 10%;"></td> </tr> <tr> <td></td> <td></td> <td colspan="8" style="text-align: center;"> <table border="1" style="width: 100%; border-collapse: collapse; text-align: center;"> <tr> <td style="width: 10%;"></td> <td style="width: 10%;"></td> <td style="width: 10%;"></td> <td style="width: 10%;"></td> <td style="width: 10%;"></td> <td style="width: 10%;"></td> <td style="width: 10%;"></td> <td style="width: 10%;"></td> <td style="width: 10%;"></td> <td style="width: 10%;"></td> </tr> <tr> <td></td> <td></td> <td colspan="8" style="text-align: center;"> <table border="1" style="width: 100%; border-collapse: collapse; text-align: center;"> <tr> <td style="width: 10%;"></td> <td style="width: 10%;"></td> <td style="width: 10%;"></td> <td style="width: 10%;"></td> <td style="width: 10%;"></td> <td style="width: 10%;"></td> <td style="width: 10%;"></td> <td style="width: 10%;"></td> <td style="width: 10%;"></td> <td style="width: 10%;"></td> </tr> <tr> <td></td> <td></td> <td colspan="8" style="text-align: center;"> <table border="1" style="width: 100%; border-collapse: collapse; text-align: center;"> <tr> <td style="width: 10%;"></td> <td style="width: 10%;"></td> <td style="width: 10%;"></td> <td style="width: 10%;"></td> <td style="width: 10%;"></td> <td style="width: 10%;"></td> <td style="width: 10%;"></td> <td style="width: 10%;"></td> <td style="width: 10%;"></td> <td style="width: 10%;"></td> </tr> <tr> <td></td> <td></td> <td colspan="8" style="text-align: center;"> <table border="1" style="width: 100%; border-collapse: collapse; text-align: center;"> <tr> <td style="width: 10%;"></td> <td style="width: 10%;"></td> <td style="width: 10%;"></td> <td style="width: 10%;"></td> <td style="width: 10%;"></td> <td style="width: 10%;"></td> <td style="width: 10%;"></td> <td style="width: 10%;"></td> <td style="width: 10%;"></td> <td style="width: 10%;"></td> </tr> <tr> <td></td> <td></td> <td colspan="8" style="text-align: center;"> <table border="1" style="width: 100%; border-collapse: collapse; text-align: center;"> <tr> </tr></table></td></tr></table></td></tr></table></td></tr></table></td></tr></table></td></tr></table></td></tr></table></td></tr></table></td></tr></table></td></tr></table></td></tr></table></td></tr></table> | | | | | | | | | | | | | | | | | | | | <table border="1" style="width: 100%; border-collapse: collapse; text-align: center;"> <tr> <td style="width: 10%;"></td> <td style="width: 10%;"></td> <td style="width: 10%;"></td> <td style="width: 10%;"></td> <td style="width: 10%;"></td> <td style="width: 10%;"></td> <td style="width: 10%;"></td> <td style="width: 10%;"></td> <td style="width: 10%;"></td> <td style="width: 10%;"></td> </tr> <tr> <td></td> <td></td> <td colspan="8" style="text-align: center;"> <table border="1" style="width: 100%; border-collapse: collapse; text-align: center;"> <tr> <td style="width: 10%;"></td> <td style="width: 10%;"></td> <td style="width: 10%;"></td> <td style="width: 10%;"></td> <td style="width: 10%;"></td> <td style="width: 10%;"></td> <td style="width: 10%;"></td> <td style="width: 10%;"></td> <td style="width: 10%;"></td> <td style="width: 10%;"></td> </tr> <tr> <td></td> <td></td> <td colspan="8" style="text-align: center;"> <table border="1" style="width: 100%; border-collapse: collapse; text-align: center;"> <tr> <td style="width: 10%;"></td> <td style="width: 10%;"></td> <td style="width: 10%;"></td> <td style="width: 10%;"></td> <td style="width: 10%;"></td> <td style="width: 10%;"></td> <td style="width: 10%;"></td> <td style="width: 10%;"></td> <td style="width: 10%;"></td> <td style="width: 10%;"></td> </tr> <tr> <td></td> <td></td> <td colspan="8" style="text-align: center;"> <table border="1" style="width: 100%; border-collapse: collapse; text-align: center;"> <tr> <td style="width: 10%;"></td> <td style="width: 10%;"></td> <td style="width: 10%;"></td> <td style="width: 10%;"></td> <td style="width: 10%;"></td> <td style="width: 10%;"></td> <td style="width: 10%;"></td> <td style="width: 10%;"></td> <td style="width: 10%;"></td> <td style="width: 10%;"></td> </tr> <tr> <td></td> <td></td> <td colspan="8" style="text-align: center;"> <table border="1" style="width: 100%; border-collapse: collapse; text-align: center;"> <tr> <td style="width: 10%;"></td> <td style="width: 10%;"></td> <td style="width: 10%;"></td> <td style="width: 10%;"></td> <td style="width: 10%;"></td> <td style="width: 10%;"></td> <td style="width: 10%;"></td> <td style="width: 10%;"></td> <td style="width: 10%;"></td> <td style="width: 10%;"></td> </tr> <tr> <td></td> <td></td> <td colspan="8" style="text-align: center;"> <table border="1" style="width: 100%; border-collapse: collapse; text-align: center;"> <tr> <td style="width: 10%;"></td> <td style="width: 10%;"></td> <td style="width: 10%;"></td> <td style="width: 10%;"></td> <td style="width: 10%;"></td> <td style="width: 10%;"></td> <td style="width: 10%;"></td> <td style="width: 10%;"></td> <td style="width: 10%;"></td> <td style="width: 10%;"></td> </tr> <tr> <td></td> <td></td> <td colspan="8" style="text-align: center;"> <table border="1" style="width: 100%; border-collapse: collapse; text-align: center;"> <tr> <td style="width: 10%;"></td> <td style="width: 10%;"></td> <td style="width: 10%;"></td> <td style="width: 10%;"></td> <td style="width: 10%;"></td> <td style="width: 10%;"></td> <td style="width: 10%;"></td> <td style="width: 10%;"></td> <td style="width: 10%;"></td> <td style="width: 10%;"></td> </tr> <tr> <td></td> <td></td> <td colspan="8" style="text-align: center;"> <table border="1" style="width: 100%; border-collapse: collapse; text-align: center;"> <tr> <td style="width: 10%;"></td> <td style="width: 10%;"></td> <td style="width: 10%;"></td> <td style="width: 10%;"></td> <td style="width: 10%;"></td> <td style="width: 10%;"></td> <td style="width: 10%;"></td> <td style="width: 10%;"></td> <td style="width: 10%;"></td> <td style="width: 10%;"></td> </tr> <tr> <td></td> <td></td> <td colspan="8" style="text-align: center;"> <table border="1" style="width: 100%; border-collapse: collapse; text-align: center;"> <tr> <td style="width: 10%;"></td> <td style="width: 10%;"></td> <td style="width: 10%;"></td> <td style="width: 10%;"></td> <td style="width: 10%;"></td> <td style="width: 10%;"></td> <td style="width: 10%;"></td> <td style="width: 10%;"></td> <td style="width: 10%;"></td> <td style="width: 10%;"></td> </tr> <tr> <td></td> <td></td> <td colspan="8" style="text-align: center;"> <table border="1" style="width: 100%; border-collapse: collapse; text-align: center;"> <tr> <td style="width: 10%;"></td> <td style="width: 10%;"></td> <td style="width: 10%;"></td> <td style="width: 10%;"></td> <td style="width: 10%;"></td> <td style="width: 10%;"></td> <td style="width: 10%;"></td> <td style="width: 10%;"></td> <td style="width: 10%;"></td> <td style="width: 10%;"></td> </tr> <tr> <td></td> <td></td> <td colspan="8" style="text-align: center;"> <table border="1" style="width: 100%; border-collapse: collapse; text-align: center;"> <tr> </tr></table></td></tr></table></td></tr></table></td></tr></table></td></tr></table></td></tr></table></td></tr></table></td></tr></table></td></tr></table></td></tr></table></td></tr></table> | | | | | | | | | | | | | | | | | | | | <table border="1" style="width: 100%; border-collapse: collapse; text-align: center;"> <tr> <td style="width: 10%;"></td> <td
style="width: 10%;"></td> <td style="width: 10%;"></td> <td style="width: 10%;"></td> <td style="width: 10%;"></td> <td style="width: 10%;"></td> <td style="width: 10%;"></td> <td style="width: 10%;"></td> <td style="width: 10%;"></td> <td style="width: 10%;"></td> </tr> <tr> <td></td> <td></td> <td colspan="8" style="text-align: center;"> <table border="1" style="width: 100%; border-collapse: collapse; text-align: center;"> <tr> <td style="width: 10%;"></td> <td style="width: 10%;"></td> <td style="width: 10%;"></td> <td style="width: 10%;"></td> <td style="width: 10%;"></td> <td style="width: 10%;"></td> <td style="width: 10%;"></td> <td style="width: 10%;"></td> <td style="width: 10%;"></td> <td style="width: 10%;"></td> </tr> <tr> <td></td> <td></td> <td colspan="8" style="text-align: center;"> <table border="1" style="width: 100%; border-collapse: collapse; text-align: center;"> <tr> <td style="width: 10%;"></td> <td style="width: 10%;"></td> <td style="width: 10%;"></td> <td style="width: 10%;"></td> <td style="width: 10%;"></td> <td style="width: 10%;"></td> <td style="width: 10%;"></td> <td style="width: 10%;"></td> <td style="width: 10%;"></td> <td style="width: 10%;"></td> </tr> <tr> <td></td> <td></td> <td colspan="8" style="text-align: center;"> <table border="1" style="width: 100%; border-collapse: collapse; text-align: center;"> <tr> <td style="width: 10%;"></td> <td style="width: 10%;"></td> <td style="width: 10%;"></td> <td style="width: 10%;"></td> <td style="width: 10%;"></td> <td style="width: 10%;"></td> <td style="width: 10%;"></td> <td style="width: 10%;"></td> <td style="width: 10%;"></td> <td style="width: 10%;"></td> </tr> <tr> <td></td> <td></td> <td colspan="8" style="text-align: center;"> <table border="1" style="width: 100%; border-collapse: collapse; text-align: center;"> <tr> <td style="width: 10%;"></td> <td style="width: 10%;"></td> <td style="width: 10%;"></td> <td style="width: 10%;"></td> <td style="width: 10%;"></td> <td style="width: 10%;"></td> <td style="width: 10%;"></td> <td style="width: 10%;"></td> <td style="width: 10%;"></td> <td style="width: 10%;"></td> </tr> <tr> <td></td> <td></td> <td colspan="8" style="text-align: center;"> <table border="1" style="width: 100%; border-collapse: collapse; text-align: center;"> <tr> <td style="width: 10%;"></td> <td style="width: 10%;"></td> <td style="width: 10%;"></td> <td style="width: 10%;"></td> <td style="width: 10%;"></td> <td style="width: 10%;"></td> <td style="width: 10%;"></td> <td style="width: 10%;"></td> <td style="width: 10%;"></td> <td style="width: 10%;"></td> </tr> <tr> <td></td> <td></td> <td colspan="8" style="text-align: center;"> <table border="1" style="width: 100%; border-collapse: collapse; text-align: center;"> <tr> <td style="width: 10%;"></td> <td style="width: 10%;"></td> <td style="width: 10%;"></td> <td style="width: 10%;"></td> <td style="width: 10%;"></td> <td style="width: 10%;"></td> <td style="width: 10%;"></td> <td style="width: 10%;"></td> <td style="width: 10%;"></td> <td style="width: 10%;"></td> </tr> <tr> <td></td> <td></td> <td colspan="8" style="text-align: center;"> <table border="1" style="width: 100%; border-collapse: collapse; text-align: center;"> <tr> <td style="width: 10%;"></td> <td style="width: 10%;"></td> <td style="width: 10%;"></td> <td style="width: 10%;"></td> <td style="width: 10%;"></td> <td style="width: 10%;"></td> <td style="width: 10%;"></td> <td style="width: 10%;"></td> <td style="width: 10%;"></td> <td style="width: 10%;"></td> </tr> <tr> <td></td> <td></td> <td colspan="8" style="text-align: center;"> <table border="1" style="width: 100%; border-collapse: collapse; text-align: center;"> <tr> <td style="width: 10%;"></td> <td style="width: 10%;"></td> <td style="width: 10%;"></td> <td style="width: 10%;"></td> <td style="width: 10%;"></td> <td style="width: 10%;"></td> <td style="width: 10%;"></td> <td style="width: 10%;"></td> <td style="width: 10%;"></td> <td style="width: 10%;"></td> </tr> <tr> <td></td> <td></td> <td colspan="8" style="text-align: center;"> <table border="1" style="width: 100%; border-collapse: collapse; text-align: center;"> <tr> </tr></table></td></tr></table></td></tr></table></td></tr></table></td></tr></table></td></tr></table></td></tr></table></td></tr></table></td></tr></table></td></tr></table> | | | | | | | | | | | | | | | | | | | | <table border="1" style="width: 100%; border-collapse: collapse; text-align: center;"> <tr> <td style="width: 10%;"></td> <td style="width: 10%;"></td> <td style="width: 10%;"></td> <td style="width: 10%;"></td> <td style="width: 10%;"></td> <td style="width: 10%;"></td> <td style="width: 10%;"></td> <td style="width: 10%;"></td> <td style="width: 10%;"></td> <td style="width: 10%;"></td> </tr> <tr> <td></td> <td></td> <td colspan="8" style="text-align: center;"> <table border="1" style="width: 100%; border-collapse: collapse; text-align: center;"> <tr> <td style="width: 10%;"></td> <td style="width: 10%;"></td> <td style="width: 10%;"></td> <td style="width: 10%;"></td> <td style="width: 10%;"></td> <td style="width: 10%;"></td> <td style="width: 10%;"></td> <td style="width: 10%;"></td> <td style="width: 10%;"></td> <td style="width: 10%;"></td> </tr> <tr> <td></td> <td></td> <td colspan="8" style="text-align: center;"> <table border="1" style="width: 100%; border-collapse: collapse; text-align: center;"> <tr> <td style="width: 10%;"></td> <td style="width: 10%;"></td> <td style="width: 10%;"></td> <td style="width: 10%;"></td> <td style="width: 10%;"></td> <td style="width: 10%;"></td> <td style="width: 10%;"></td> <td style="width: 10%;"></td> <td style="width: 10%;"></td> <td style="width: 10%;"></td> </tr> <tr> <td></td> <td></td> <td colspan="8" style="text-align: center;"> <table border="1" style="width: 100%; border-collapse: collapse; text-align: center;"> <tr> <td style="width: 10%;"></td> <td style="width: 10%;"></td> <td style="width: 10%;"></td> <td style="width: 10%;"></td> <td style="width: 10%;"></td> <td style="width: 10%;"></td> <td style="width: 10%;"></td> <td style="width: 10%;"></td> <td style="width: 10%;"></td> <td style="width: 10%;"></td> </tr> <tr> <td></td> <td></td> <td colspan="8" style="text-align: center;"> <table border="1" style="width: 100%; border-collapse: collapse; text-align: center;"> <tr> <td style="width: 10%;"></td> <td style="width: 10%;"></td> <td style="width: 10%;"></td> <td style="width: 10%;"></td> <td style="width: 10%;"></td> <td style="width: 10%;"></td> <td style="width: 10%;"></td> <td style="width: 10%;"></td> <td style="width: 10%;"></td> <td style="width: 10%;"></td> </tr> <tr> <td></td> <td></td> <td colspan="8" style="text-align: center;"> <table border="1" style="width: 100%; border-collapse: collapse; text-align: center;"> <tr> <td style="width: 10%;"></td> <td style="width: 10%;"></td> <td style="width: 10%;"></td> <td style="width: 10%;"></td> <td style="width: 10%;"></td> <td style="width: 10%;"></td> <td style="width: 10%;"></td> <td style="width: 10%;"></td> <td style="width: 10%;"></td> <td style="width: 10%;"></td> </tr> <tr> <td></td> <td></td> <td colspan="8" style="text-align: center;"> <table border="1" style="width: 100%; border-collapse: collapse; text-align: center;"> <tr> <td style="width: 10%;"></td> <td style="width: 10%;"></td> <td style="width: 10%;"></td> <td style="width: 10%;"></td> <td style="width: 10%;"></td> <td style="width: 10%;"></td> <td style="width: 10%;"></td> <td style="width: 10%;"></td> <td style="width: 10%;"></td> <td style="width: 10%;"></td> </tr> <tr> <td></td> <td></td> <td colspan="8" style="text-align: center;"> <table border="1" style="width: 100%; border-collapse: collapse; text-align: center;"> <tr> <td style="width: 10%;"></td> <td style="width: 10%;"></td> <td style="width: 10%;"></td> <td style="width: 10%;"></td> <td style="width: 10%;"></td> <td style="width: 10%;"></td> <td style="width: 10%;"></td> <td style="width: 10%;"></td> <td style="width: 10%;"></td> <td style="width: 10%;"></td> </tr> <tr> <td></td> <td></td> <td colspan="8" style="text-align: center;"> <table border="1" style="width: 100%; border-collapse: collapse; text-align: center;"> <tr> </tr></table></td></tr></table></td></tr></table></td></tr></table></td></tr></table></td></tr></table></td></tr></table></td></tr></table></td></tr></table>
 | | | | | | | | | | | | | | | | | | | | <table border="1" style="width: 100%; border-collapse: collapse; text-align: center;"> <tr> <td style="width: 10%;"></td> <td style="width: 10%;"></td> <td style="width: 10%;"></td> <td style="width: 10%;"></td> <td style="width: 10%;"></td> <td style="width: 10%;"></td> <td style="width: 10%;"></td> <td style="width: 10%;"></td> <td style="width: 10%;"></td> <td style="width: 10%;"></td> </tr> <tr> <td></td> <td></td> <td colspan="8" style="text-align: center;"> <table border="1" style="width: 100%; border-collapse: collapse; text-align: center;"> <tr> <td style="width: 10%;"></td> <td style="width: 10%;"></td> <td style="width: 10%;"></td> <td style="width: 10%;"></td> <td style="width: 10%;"></td> <td style="width: 10%;"></td> <td style="width: 10%;"></td> <td style="width: 10%;"></td> <td style="width: 10%;"></td> <td style="width: 10%;"></td> </tr> <tr> <td></td> <td></td> <td colspan="8" style="text-align: center;"> <table border="1" style="width: 100%; border-collapse: collapse; text-align: center;"> <tr> <td style="width: 10%;"></td> <td style="width: 10%;"></td> <td style="width: 10%;"></td> <td style="width: 10%;"></td> <td style="width: 10%;"></td> <td style="width: 10%;"></td> <td style="width: 10%;"></td> <td style="width: 10%;"></td> <td style="width: 10%;"></td> <td style="width: 10%;"></td> </tr> <tr> <td></td> <td></td> <td colspan="8" style="text-align: center;"> <table border="1" style="width: 100%; border-collapse: collapse; text-align: center;"> <tr> <td style="width: 10%;"></td> <td style="width: 10%;"></td> <td style="width: 10%;"></td> <td style="width: 10%;"></td> <td style="width: 10%;"></td> <td style="width: 10%;"></td> <td style="width: 10%;"></td> <td style="width: 10%;"></td> <td style="width: 10%;"></td> <td style="width: 10%;"></td> </tr> <tr> <td></td> <td></td> <td colspan="8" style="text-align: center;"> <table border="1" style="width: 100%; border-collapse: collapse; text-align: center;"> <tr> <td style="width: 10%;"></td> <td style="width: 10%;"></td> <td style="width: 10%;"></td> <td style="width: 10%;"></td> <td style="width: 10%;"></td> <td style="width: 10%;"></td> <td style="width: 10%;"></td> <td style="width: 10%;"></td> <td style="width: 10%;"></td> <td style="width: 10%;"></td> </tr> <tr> <td></td> <td></td> <td colspan="8" style="text-align: center;"> <table border="1" style="width: 100%; border-collapse: collapse; text-align: center;"> <tr> <td style="width: 10%;"></td> <td style="width: 10%;"></td> <td style="width: 10%;"></td> <td style="width: 10%;"></td> <td style="width: 10%;"></td> <td style="width: 10%;"></td> <td style="width: 10%;"></td> <td style="width: 10%;"></td> <td style="width: 10%;"></td> <td style="width: 10%;"></td> </tr> <tr> <td></td> <td></td> <td colspan="8" style="text-align: center;"> <table border="1" style="width: 100%; border-collapse: collapse; text-align: center;"> <tr> <td style="width: 10%;"></td> <td style="width: 10%;"></td> <td style="width: 10%;"></td> <td style="width: 10%;"></td> <td style="width: 10%;"></td> <td style="width: 10%;"></td> <td style="width: 10%;"></td> <td style="width: 10%;"></td> <td style="width: 10%;"></td> <td style="width: 10%;"></td> </tr> <tr> <td></td> <td></td> <td colspan="8" style="text-align: center;"> <table border="1" style="width: 100%; border-collapse: collapse; text-align: center;"> <tr> </tr></table></td></tr></table></td></tr></table></td></tr></table></td></tr></table></td></tr></table></td></tr></table></td></tr></table> | | | | | | | | | | | | | | | | | | | | <table border="1" style="width: 100%; border-collapse: collapse; text-align: center;"> <tr> <td style="width: 10%;"></td> <td style="width: 10%;"></td> <td style="width: 10%;"></td> <td style="width: 10%;"></td> <td style="width: 10%;"></td> <td style="width: 10%;"></td> <td style="width: 10%;"></td> <td style="width: 10%;"></td> <td style="width: 10%;"></td> <td style="width: 10%;"></td> </tr> <tr> <td></td> <td></td> <td colspan="8" style="text-align: center;"> <table border="1" style="width: 100%; border-collapse: collapse; text-align: center;"> <tr> <td style="width: 10%;"></td> <td style="width: 10%;"></td> <td style="width: 10%;"></td> <td style="width: 10%;"></td> <td style="width: 10%;"></td> <td style="width: 10%;"></td> <td style="width: 10%;"></td> <td style="width: 10%;"></td> <td style="width: 10%;"></td> <td style="width: 10%;"></td> </tr> <tr> <td></td> <td></td> <td colspan="8" style="text-align: center;"> <table border="1" style="width: 100%; border-collapse: collapse; text-align: center;"> <tr> <td style="width: 10%;"></td> <td style="width: 10%;"></td> <td style="width: 10%;"></td> <td style="width: 10%;"></td> <td style="width: 10%;"></td> <td style="width: 10%;"></td> <td style="width: 10%;"></td> <td style="width: 10%;"></td> <td style="width: 10%;"></td> <td style="width: 10%;"></td> </tr> <tr> <td></td> <td></td> <td colspan="8" style="text-align: center;"> <table border="1" style="width: 100%; border-collapse: collapse; text-align: center;"> <tr> <td style="width: 10%;"></td> <td style="width: 10%;"></td> <td style="width: 10%;"></td> <td style="width: 10%;"></td> <td style="width: 10%;"></td> <td style="width: 10%;"></td> <td style="width: 10%;"></td> <td style="width: 10%;"></td> <td style="width: 10%;"></td> <td style="width: 10%;"></td> </tr> <tr> <td></td> <td></td> <td colspan="8" style="text-align: center;"> <table border="1" style="width: 100%; border-collapse: collapse; text-align: center;"> <tr> <td style="width: 10%;"></td> <td style="width: 10%;"></td> <td style="width: 10%;"></td> <td style="width: 10%;"></td> <td style="width: 10%;"></td> <td style="width: 10%;"></td> <td style="width: 10%;"></td> <td style="width: 10%;"></td> <td style="width: 10%;"></td> <td style="width: 10%;"></td> </tr> <tr> <td></td> <td></td> <td colspan="8" style="text-align: center;"> <table border="1" style="width: 100%; border-collapse: collapse; text-align: center;"> <tr> <td style="width: 10%;"></td> <td style="width: 10%;"></td> <td style="width: 10%;"></td> <td style="width: 10%;"></td> <td style="width: 10%;"></td> <td style="width: 10%;"></td> <td style="width: 10%;"></td> <td style="width: 10%;"></td> <td style="width: 10%;"></td> <td style="width: 10%;"></td> </tr> <tr> <td></td> <td></td> <td colspan="8" style="text-align: center;"> <table border="1" style="width: 100%; border-collapse: collapse; text-align: center;"> <tr> </tr></table></td></tr></table></td></tr></table></td></tr></table></td></tr></table></td></tr></table></td></tr></table> | | | | | | | | | | | | | | | | | | | | <table border="1" style="width: 100%; border-collapse: collapse; text-align: center;"> <tr> <td style="width: 10%;"></td> <td style="width: 10%;"></td> <td style="width: 10%;"></td> <td style="width: 10%;"></td> <td style="width: 10%;"></td> <td style="width: 10%;"></td> <td style="width: 10%;"></td> <td style="width: 10%;"></td> <td style="width: 10%;"></td> <td style="width: 10%;"></td> </tr> <tr> <td></td> <td></td> <td colspan="8" style="text-align: center;"> <table border="1" style="width: 100%; border-collapse: collapse; text-align: center;"> <tr> <td style="width: 10%;"></td> <td style="width: 10%;"></td> <td style="width: 10%;"></td> <td style="width: 10%;"></td> <td style="width: 10%;"></td> <td style="width: 10%;"></td> <td style="width: 10%;"></td> <td style="width: 10%;"></td> <td style="width: 10%;"></td> <td style="width: 10%;"></td> </tr> <tr> <td></td> <td></td> <td colspan="8" style="text-align: center;"> <table border="1" style="width: 100%; border-collapse:
collapse; text-align: center;"> <tr> <td style="width: 10%;"></td> <td style="width: 10%;"></td> <td style="width: 10%;"></td> <td style="width: 10%;"></td> <td style="width: 10%;"></td> <td style="width: 10%;"></td> <td style="width: 10%;"></td> <td style="width: 10%;"></td> <td style="width: 10%;"></td> <td style="width: 10%;"></td> </tr> <tr> <td></td> <td></td> <td colspan="8" style="text-align: center;"> <table border="1" style="width: 100%; border-collapse: collapse; text-align: center;"> <tr> <td style="width: 10%;"></td> <td style="width: 10%;"></td> <td style="width: 10%;"></td> <td style="width: 10%;"></td> <td style="width: 10%;"></td> <td style="width: 10%;"></td> <td style="width: 10%;"></td> <td style="width: 10%;"></td> <td style="width: 10%;"></td> <td style="width: 10%;"></td> </tr> <tr> <td></td> <td></td> <td colspan="8" style="text-align: center;"> <table border="1" style="width: 100%; border-collapse: collapse; text-align: center;"> <tr> <td style="width: 10%;"></td> <td style="width: 10%;"></td> <td style="width: 10%;"></td> <td style="width: 10%;"></td> <td style="width: 10%;"></td> <td style="width: 10%;"></td> <td style="width: 10%;"></td> <td style="width: 10%;"></td> <td style="width: 10%;"></td> <td style="width: 10%;"></td> </tr> <tr> <td></td> <td></td> <td colspan="8" style="text-align: center;"> <table border="1" style="width: 100%; border-collapse: collapse; text-align: center;"> <tr> </tr></table></td></tr></table></td></tr></table></td></tr></table></td></tr></table></td></tr></table> | | | | | | | | | | | | | | | | | | | | <table border="1" style="width: 100%; border-collapse: collapse; text-align: center;"> <tr> <td style="width: 10%;"></td> <td style="width: 10%;"></td> <td style="width: 10%;"></td> <td style="width: 10%;"></td> <td style="width: 10%;"></td> <td style="width: 10%;"></td> <td style="width: 10%;"></td> <td style="width: 10%;"></td> <td style="width: 10%;"></td> <td style="width: 10%;"></td> </tr> <tr> <td></td> <td></td> <td colspan="8" style="text-align: center;"> <table border="1" style="width: 100%; border-collapse: collapse; text-align: center;"> <tr> <td style="width: 10%;"></td> <td style="width: 10%;"></td> <td style="width: 10%;"></td> <td style="width: 10%;"></td> <td style="width: 10%;"></td> <td style="width: 10%;"></td> <td style="width: 10%;"></td> <td style="width: 10%;"></td> <td style="width: 10%;"></td> <td style="width: 10%;"></td> </tr> <tr> <td></td> <td></td> <td colspan="8" style="text-align: center;"> <table border="1" style="width: 100%; border-collapse: collapse; text-align: center;"> <tr> <td style="width: 10%;"></td> <td style="width: 10%;"></td> <td style="width: 10%;"></td> <td style="width: 10%;"></td> <td style="width: 10%;"></td> <td style="width: 10%;"></td> <td style="width: 10%;"></td> <td style="width: 10%;"></td> <td style="width: 10%;"></td> <td style="width: 10%;"></td> </tr> <tr> <td></td> <td></td> <td colspan="8" style="text-align: center;"> <table border="1" style="width: 100%; border-collapse: collapse; text-align: center;"> <tr> <td style="width: 10%;"></td> <td style="width: 10%;"></td> <td style="width: 10%;"></td> <td style="width: 10%;"></td> <td style="width: 10%;"></td> <td style="width: 10%;"></td> <td style="width: 10%;"></td> <td style="width: 10%;"></td> <td style="width: 10%;"></td> <td style="width: 10%;"></td> </tr> <tr> <td></td> <td></td> <td colspan="8" style="text-align: center;"> <table border="1" style="width: 100%; border-collapse: collapse; text-align: center;"> <tr> </tr></table></td></tr></table></td></tr></table></td></tr></table></td></tr></table> | | | | | | | | | | | | | | | | | | | | <table border="1" style="width: 100%; border-collapse: collapse; text-align: center;"> <tr> <td style="width: 10%;"></td> <td style="width: 10%;"></td> <td style="width: 10%;"></td> <td style="width: 10%;"></td> <td style="width: 10%;"></td> <td style="width: 10%;"></td> <td style="width: 10%;"></td> <td style="width: 10%;"></td> <td style="width: 10%;"></td> <td style="width: 10%;"></td> </tr> <tr> <td></td> <td></td> <td colspan="8" style="text-align: center;"> <table border="1" style="width: 100%; border-collapse: collapse; text-align: center;"> <tr> <td style="width: 10%;"></td> <td style="width: 10%;"></td> <td style="width: 10%;"></td> <td style="width: 10%;"></td> <td style="width: 10%;"></td> <td style="width: 10%;"></td> <td style="width: 10%;"></td> <td style="width: 10%;"></td> <td style="width: 10%;"></td> <td style="width: 10%;"></td> </tr> <tr> <td></td> <td></td> <td colspan="8" style="text-align: center;"> <table border="1" style="width: 100%; border-collapse: collapse; text-align: center;"> <tr> <td style="width: 10%;"></td> <td style="width: 10%;"></td> <td style="width: 10%;"></td> <td style="width: 10%;"></td> <td style="width: 10%;"></td> <td style="width: 10%;"></td> <td style="width: 10%;"></td> <td style="width: 10%;"></td> <td style="width: 10%;"></td> <td style="width: 10%;"></td> </tr> <tr> <td></td> <td></td> <td colspan="8" style="text-align: center;"> <table border="1" style="width: 100%; border-collapse: collapse; text-align: center;"> <tr> </tr></table></td></tr></table></td></tr></table></td></tr></table> | | | | | | | | | | | | | | | | | | | | <table border="1" style="width: 100%; border-collapse: collapse; text-align: center;"> <tr> <td style="width: 10%;"></td> <td style="width: 10%;"></td> <td style="width: 10%;"></td> <td style="width: 10%;"></td> <td style="width: 10%;"></td> <td style="width: 10%;"></td> <td style="width: 10%;"></td> <td style="width: 10%;"></td> <td style="width: 10%;"></td> <td style="width: 10%;"></td> </tr> <tr> <td></td> <td></td> <td colspan="8" style="text-align: center;"> <table border="1" style="width: 100%; border-collapse: collapse; text-align: center;"> <tr> <td style="width: 10%;"></td> <td style="width: 10%;"></td> <td style="width: 10%;"></td> <td style="width: 10%;"></td> <td style="width: 10%;"></td> <td style="width: 10%;"></td> <td style="width: 10%;"></td> <td style="width: 10%;"></td> <td style="width: 10%;"></td> <td style="width: 10%;"></td> </tr> <tr> <td></td> <td></td> <td colspan="8" style="text-align: center;"> <table border="1" style="width: 100%; border-collapse: collapse; text-align: center;"> <tr> </tr></table></td></tr></table></td></tr></table>
 | | | | | | | | | | | | | | | | | | | | <table border="1" style="width: 100%; border-collapse: collapse; text-align: center;"> <tr> <td style="width: 10%;"></td> <td style="width: 10%;"></td> <td style="width: 10%;"></td> <td style="width: 10%;"></td> <td style="width: 10%;"></td> <td style="width: 10%;"></td> <td style="width: 10%;"></td> <td style="width: 10%;"></td> <td style="width: 10%;"></td> <td style="width: 10%;"></td> </tr> <tr> <td></td> <td></td> <td colspan="8" style="text-align: center;"> <table border="1" style="width: 100%; border-collapse: collapse; text-align: center;"> <tr> </tr></table></td></tr></table> | | | | | | | | | | | | | | | | | | | | <table border="1" style="width: 100%; border-collapse: collapse; text-align: center;"> <tr> </tr></table> | | | | | | | | | | | | | | | | | | | | | | | | | | | | | | | | | | | | | | | | | | | | | | | |
| | |

 | | | | | | | | | | | | | | | | | | | |

 | | | | | | | | | | | | | | | | | | | |

 | | | | | | | | | | | | | | | | | | | |

 | | | | | | | | | | | | | | | | | | | |

 | | | | | | | | | | | | | | | | | | | |

 | | | | | | | | | | | | | | | | | | | |

 | | | | | | | | | | | | | | | | | | | |

 | | | | | | | | | | | | | | | | | | | |

 | | | | | | | | | | | | | | | | | | | |

 | | | | | | | | | | | | | | | | | | | |

 | | | | | | | | | | | | | | | | | | | |

 | | | | | | | | | | | | | | | | | | | |

 | | | | | | | | | | | | | | | | | | | |

 | | | | | | | | | | | | | | | | | | | |

 | | | | | | | | | | | | | | | | | | | |

 | | | | | | | | | | | | | | | | | | | |

 | | | | | | | | | | | | | | | | | | | |

 | | | | | | | | | | | | | | | | | | | |

 | | | | | | | | | | | | | | | | | | | |

 | | | | | | | | | | | | | | | | | | | |

 | | | | | | | | | | | | | | | | | | | |

 | | | | | | | | | | | | | | | | | | | |

 | | | | | | | | | | | | | | | | | | | |

 | | | | | | | | | | | | | | | | | | | |

 | | | | | | | | | | | | | | | | | | | |

 | | | | | | | | | | | | | | | | | | | |

 | | | | | | | | | | | | | | | | | | | |

 | | | | | | | | | | | | | | | | | | | |
 | | | | | | | | | | | | | | | | | | | |

 | | | | | | | | | | | | | | | | | | | |

 | | | | | | | | | | | | | | | | | | | |
 | | | | | | | | | | | | | | | | | | | |

 | | | | | | | | | | | | | | | | | | | |

 | | | | | | | | | | | | | | | | | | | |
 | | | | | | | | | | | | | | | | | | | |
 | | | | | | | | | | | | | | | | | | | |

 | | | | | | | | | | | | | | | | | | | |
 | | | | | | | | | | | | | | | | | | | |
 | | | | | | | | | | | | | | | | | | | |

 | | | | | | | | | | | | | | | | | | | | | | | | | | | | | | | | | | | | | | | | | | | | | | | | | | | | | | | | | | | | | | | | | | | | | | | | | | | | | | | | | | | | | | | | | | | | | | | | | | | |
 | | | | | | | | | | | | | | | | | | | |
 | | | | | | | | | | | | | | | | | | | |
 | | | | | | | | | | | | | | | | | | | |
 | | | | | | | | | | | | | | | | | | | |
 | | | | | | | | | | | | | | | | | | | |
 | | | | | | | | | | | | | | | | | | | |
 | | | | | | | | | | | | | | | | | | | |
 | | | | | | | | | | | | | | | | | | | |
 | | | | | | | | | | | | | | | | | | | | | | | | | | | | | | | | | | | | | | | |
 | | | | | | | | | | | | | | | | | | | |
 | | | | | | | | | | | | | | | | | | | | | | | | | | | | | | | | | | | | | | | |
 | | | | | | | | | | | | | | | | | | | | | | | | | | | | | | | | | | | | | | | |
 | | | | | | | | | | | | | | | | | | | | | | | | | | | | | | | | | | | | | | | |
 | | | | | | | | | | | | | | | | | | | | | | | | | | | | | | | | | | | | | | | | | | | | | | | | | | | | | | | | | | | | | | | | | | | | | | | | | | | | | | | | | | | | | | | | | | | | | | | | | | | |
 | | | | | | | | | | | | | | | | | | | | | | | | | | | | | | | | | | | | | | | | | | | | | | | |
| | | <table border="1" style="width: 100%; border-collapse: collapse; text-align: center;"> <tr> <td style="width: 10%;"></td> <td style="width: 10%;"></td> <td style="width: 10%;"></td> <td style="width: 10%;"></td> <td style="width: 10%;"></td> <td style="width: 10%;"></td> <td style="width: 10%;"></td> <td style="width: 10%;"></td> <td style="width: 10%;"></td> <td style="width: 10%;"></td> </tr> <tr> <td></td> <td></td> <td colspan="8" style="text-align: center;"> <table border="1" style="width: 100%; border-collapse: collapse; text-align: center;"> <tr> <td style="width: 10%;"></td> <td style="width: 10%;"></td> <td style="width: 10%;"></td> <td style="width: 10%;"></td> <td style="width: 10%;"></td> <td style="width: 10%;"></td> <td style="width: 10%;"></td> <td style="width: 10%;"></td> <td style="width: 10%;"></td> <td style="width: 10%;"></td> </tr> <tr> <td></td> <td></td> <td colspan="8" style="text-align: center;"> <table border="1" style="width: 100%; border-collapse: collapse; text-align: center;"> <tr> <td style="width: 10%;"></td> <td style="width: 10%;"></td> <td style="width: 10%;"></td> <td style="width: 10%;"></td> <td style="width: 10%;"></td> <td style="width: 10%;"></td> <td style="width: 10%;"></td> <td style="width: 10%;"></td> <td style="width: 10%;"></td> <td style="width: 10%;"></td> </tr> <tr> <td></td> <td></td> <td colspan="8" style="text-align: center;"> <table border="1" style="width: 100%; border-collapse: collapse; text-align: center;"> <tr> <td style="width: 10%;"></td> <td style="width: 10%;"></td> <td style="width: 10%;"></td> <td style="width: 10%;"></td> <td style="width: 10%;"></td> <td style="width: 10%;"></td> <td style="width: 10%;"></td> <td style="width: 10%;"></td> <td style="width: 10%;"></td> <td style="width: 10%;"></td> </tr> <tr> <td></td> <td></td> <td colspan="8" style="text-align: center;"> <table border="1" style="width: 100%; border-collapse: collapse; text-align: center;"> <tr> <td style="width: 10%;"></td> <td style="width: 10%;"></td> <td style="width: 10%;"></td> <td style="width: 10%;"></td> <td style="width: 10%;"></td> <td style="width: 10%;"></td> <td style="width: 10%;"></td> <td style="width: 10%;"></td> <td style="width: 10%;"></td> <td style="width: 10%;"></td> </tr> <tr> <td></td> <td></td> <td colspan="8" style="text-align: center;"> <table border="1" style="width: 100%; border-collapse: collapse; text-align: center;"> <tr> <td style="width: 10%;"></td> <td style="width: 10%;"></td> <td style="width: 10%;"></td> <td style="width: 10%;"></td> <td style="width: 10%;"></td> <td style="width: 10%;"></td> <td style="width: 10%;"></td> <td style="width: 10%;"></td> <td style="width: 10%;"></td> <td style="width: 10%;"></td> </tr> <tr> <td></td> <td></td> <td colspan="8" style="text-align: center;"> <table border="1" style="width: 100%; border-collapse: collapse; text-align: center;"> <tr> <td style="width: 10%;"></td> <td style="width: 10%;"></td> <td style="width: 10%;"></td> <td style="width: 10%;"></td> <td style="width: 10%;"></td> <td style="width: 10%;"></td> <td style="width: 10%;"></td> <td style="width: 10%;"></td> <td style="width: 10%;"></td> <td style="width: 10%;"></td> </tr> <tr> <td></td> <td></td> <td colspan="8" style="text-align: center;"> <table border="1" style="width: 100%; border-collapse: collapse; text-align: center;"> <tr> <td style="width: 10%;"></td> <td style="width: 10%;"></td> <td style="width: 10%;"></td> <td style="width: 10%;"></td> <td style="width: 10%;"></td> <td style="width: 10%;"></td> <td style="width: 10%;"></td> <td style="width: 10%;"></td> <td style="width: 10%;"></td> <td style="width: 10%;"></td> </tr> <tr> <td></td> <td></td> <td colspan="8" style="text-align: center;"> <table border="1" style="width: 100%; border-collapse: collapse; text-align: center;"> <tr> <td style="width: 10%;"></td> <td style="width: 10%;"></td> <td style="width: 10%;"></td> <td style="width: 10%;"></td> <td style="width: 10%;"></td> <td style="width: 10%;"></td> <td style="width: 10%;"></td> <td style="width: 10%;"></td> <td style="width: 10%;"></td> <td style="width: 10%;"></td> </tr> <tr> <td></td> <td></td> <td colspan="8" style="text-align: center;"> <table border="1" style="width: 100%; border-collapse: collapse; text-align: center;"> <tr> <td style="width: 10%;"></td> <td style="width: 10%;"></td> <td style="width: 10%;"></td> <td style="width: 10%;"></td> <td style="width: 10%;"></td> <td style="width: 10%;"></td> <td style="width: 10%;"></td> <td style="width: 10%;"></td> <td style="width: 10%;"></td> <td style="width: 10%;"></td> </tr> <tr> <td></td> <td></td> <td colspan="8" style="text-align: center;"> <table border="1" style="width: 100%; border-collapse: collapse; text-align: center;"> <tr> <td style="width: 10%;"></td> <td style="width: 10%;"></td> <td style="width: 10%;"></td> <td style="width: 10%;"></td> <td style="width: 10%;"></td> <td style="width: 10%;"></td> <td style="width: 10%;"></td> <td style="width: 10%;"></td> <td style="width: 10%;"></td> <td style="width: 10%;"></td> </tr> <tr> <td></td> <td></td> <td colspan="8" style="text-align: center;"> <table border="1" style="width: 100%; border-collapse: collapse; text-align: center;"> <tr> <td style="width: 10%;"></td> <td style="width: 10%;"></td> <td style="width: 10%;"></td> <td style="width: 10%;"></td> <td style="width: 10%;"></td> <td style="width: 10%;"></td> <td style="width: 10%;"></td> <td style="width: 10%;"></td> <td style="width: 10%;"></td> <td style="width: 10%;"></td> </tr> <tr> <td></td> <td></td> <td colspan="8" style="text-align: center;"> <table border="1" style="width: 100%; border-collapse: collapse; text-align: center;"> <tr> <td style="width: 10%;"></td> <td style="width: 10%;"></td> <td style="width: 10%;"></td> <td style="width: 10%;"></td> <td style="width: 10%;"></td> <td style="width: 10%;"></td> <td style="width: 10%;"></td> <td style="width: 10%;"></td> <td style="width: 10%;"></td> <td style="width: 10%;"></td> </tr> <tr> <td></td> <td></td> <td colspan="8" style="text-align: center;"> <table border="1" style="width: 100%; border-collapse: collapse; text-align: center;"> <tr> <td style="width: 10%;"></td> <td style="width: 10%;"></td> <td style="width: 10%;"></td> <td style="width: 10%;"></td> <td style="width: 10%;"></td> <td style="width: 10%;"></td> <td style="width: 10%;"></td> <td style="width: 10%;"></td> <td style="width: 10%;"></td> <td style="width: 10%;"></td> </tr> <tr> <td></td> <td></td> <td colspan="8" style="text-align: center;"> <table border="1" style="width: 100%; border-collapse: collapse; text-align: center;"> <tr> <td style="width: 10%;"></td> <td style="width: 10%;"></td> <td style="width: 10%;"></td> <td style="width: 10%;"></td> <td style="width: 10%;"></td> <td style="width: 10%;"></td> <td style="width: 10%;"></td> <td style="width: 10%;"></td> <td style="width: 10%;"></td> <td style="width: 10%;"></td> </tr> <tr> <td></td> <td></td> <td colspan="8" style="text-align: center;"> <table border="1" style="width: 100%; border-collapse: collapse; text-align: center;"> <tr> <td style="width: 10%;"></td> <td style="width: 10%;"></td> <td style="width: 10%;"></td> <td style="width: 10%;"></td> <td style="width: 10%;"></td> <td style="width: 10%;"></td> <td style="width: 10%;"></td> <td style="width: 10%;"></td> <td style="width: 10%;"></td> <td style="width: 10%;"></td> </tr> <tr> <td></td> <td></td> <td colspan="8" style="text-align: center;"> <table border="1" style="width: 100%; border-collapse: collapse; text-align: center;"> <tr> <td style="width: 10%;"></td> <td style="width: 10%;"></td> <td style="width: 10%;"></td> <td style="width: 10%;"></td> <td style="width: 10%;"></td> <td style="width: 10%;"></td> <td style="width: 10%;"></td> <td style="width: 10%;"></td> <td style="width: 10%;"></td> <td style="width: 10%;"></td> </tr> <tr> <td></td> <td></td> <td colspan="8" style="text-align: center;"> <table border="1" style="width: 100%; border-collapse: collapse; text-align: center;"> <tr> <td style="width: 10%;"></td> <td style="width: 10%;"></td> <td style="width: 10%;"></td> <td style="width: 10%;"></td> <td style="width: 10%;"></td> <td style="width: 10%;"></td> <td style="width: 10%;"></td> <td style="width: 10%;"></td> <td style="width: 10%;"></td> <td style="width: 10%;"></td> </tr> <tr> <td></td> <td></td> <td colspan="8" style="text-align: center;"> <table border="1" style="width: 100%; border-collapse: collapse; text-align: center;"> <tr> <td style="width: 10%;"></td> <td style="width: 10%;"></td> <td style="width: 10%;"></td> <td style="width: 10%;"></td> <td style="width: 10%;"></td> <td style="width: 10%;"></td> <td style="width: 10%;"></td> <td style="width: 10%;"></td> <td style="width: 10%;"></td> <td style="width: 10%;"></td> </tr> <tr> <td></td> <td></td> <td colspan="8" style="text-align: center;"> <table border="1" style="width: 100%; border-collapse: collapse; text-align: center;"> <tr> <td style="width: 10%;"></td> <td style="width: 10%;"></td> <td style="width: 10%;"></td> <td style="width: 10%;"></td> <td style="width: 10%;"></td> <td style="width: 10%;"></td> <td style="width: 10%;"></td> <td style="width: 10%;"></td> <td style="width: 10%;"></td> <td style="width: 10%;"></td> </tr> <tr> <td></td> <td></td> <td colspan="8" style="text-align: center;"> <table border="1" style="width: 100%; border-collapse: collapse; text-align: center;"> <tr> <td style="width: 10%;"></td> <td style="width: 10%;"></td> <td style="width: 10%;"></td> <td style="width: 10%;"></td> <td style="width: 10%;"></td> <td style="width: 10%;"></td> <td style="width: 10%;"></td> <td style="width: 10%;"></td> <td style="width: 10%;"></td> <td style="width: 10%;"></td> </tr> <tr> <td></td> <td></td> <td colspan="8" style="text-align: center;"> <table border="1" style="width: 100%; border-collapse: collapse; text-align: center;"> <tr> <td style="width: 10%;"></td> <td style="width: 10%;"></td> <td
style="width: 10%;"></td> <td style="width: 10%;"></td> <td style="width: 10%;"></td> <td style="width: 10%;"></td> <td style="width: 10%;"></td> <td style="width: 10%;"></td> <td style="width: 10%;"></td> <td style="width: 10%;"></td> </tr> <tr> <td></td> <td></td> <td colspan="8" style="text-align: center;"> <table border="1" style="width: 100%; border-collapse: collapse; text-align: center;"> <tr> <td style="width: 10%;"></td> <td style="width: 10%;"></td> <td style="width: 10%;"></td> <td style="width: 10%;"></td> <td style="width: 10%;"></td> <td style="width: 10%;"></td> <td style="width: 10%;"></td> <td style="width: 10%;"></td> <td style="width: 10%;"></td> <td style="width: 10%;"></td> </tr> <tr> <td></td> <td></td> <td colspan="8" style="text-align: center;"> <table border="1" style="width: 100%; border-collapse: collapse; text-align: center;"> <tr> <td style="width: 10%;"></td> <td style="width: 10%;"></td> <td style="width: 10%;"></td> <td style="width: 10%;"></td> <td style="width: 10%;"></td> <td style="width: 10%;"></td> <td style="width: 10%;"></td> <td style="width: 10%;"></td> <td style="width: 10%;"></td> <td style="width: 10%;"></td> </tr> <tr> <td></td> <td></td> <td colspan="8" style="text-align: center;"> <table border="1" style="width: 100%; border-collapse: collapse; text-align: center;"> <tr> <td style="width: 10%;"></td> <td style="width: 10%;"></td> <td style="width: 10%;"></td> <td style="width: 10%;"></td> <td style="width: 10%;"></td> <td style="width: 10%;"></td> <td style="width: 10%;"></td> <td style="width: 10%;"></td> <td style="width: 10%;"></td> <td style="width: 10%;"></td> </tr> <tr> <td></td> <td></td> <td colspan="8" style="text-align: center;"> <table border="1" style="width: 100%; border-collapse: collapse; text-align: center;"> <tr> <td style="width: 10%;"></td> <td style="width: 10%;"></td> <td style="width: 10%;"></td> <td style="width: 10%;"></td> <td style="width: 10%;"></td> <td style="width: 10%;"></td> <td style="width: 10%;"></td> <td style="width: 10%;"></td> <td style="width: 10%;"></td> <td style="width: 10%;"></td> </tr> <tr> <td></td> <td></td> <td colspan="8" style="text-align: center;"> <table border="1" style="width: 100%; border-collapse: collapse; text-align: center;"> <tr> <td style="width: 10%;"></td> <td style="width: 10%;"></td> <td style="width: 10%;"></td> <td style="width: 10%;"></td> <td style="width: 10%;"></td> <td style="width: 10%;"></td> <td style="width: 10%;"></td> <td style="width: 10%;"></td> <td style="width: 10%;"></td> <td style="width: 10%;"></td> </tr> <tr> <td></td> <td></td> <td colspan="8" style="text-align: center;"> <table border="1" style="width: 100%; border-collapse: collapse; text-align: center;"> <tr> <td style="width: 10%;"></td> <td style="width: 10%;"></td> <td style="width: 10%;"></td> <td style="width: 10%;"></td> <td style="width: 10%;"></td> <td style="width: 10%;"></td> <td style="width: 10%;"></td> <td style="width: 10%;"></td> <td style="width: 10%;"></td> <td style="width: 10%;"></td> </tr> <tr> <td></td> <td></td> <td colspan="8" style="text-align: center;"> <table border="1" style="width: 100%; border-collapse: collapse; text-align: center;"> <tr> <td style="width: 10%;"></td> <td style="width: 10%;"></td> <td style="width: 10%;"></td> <td style="width: 10%;"></td> <td style="width: 10%;"></td> <td style="width: 10%;"></td> <td style="width: 10%;"></td> <td style="width: 10%;"></td> <td style="width: 10%;"></td> <td style="width: 10%;"></td> </tr> <tr> <td></td> <td></td> <td colspan="8" style="text-align: center;"> <table border="1" style="width: 100%; border-collapse: collapse; text-align: center;"> <tr> <td style="width: 10%;"></td> <td style="width: 10%;"></td> <td style="width: 10%;"></td> <td style="width: 10%;"></td> <td style="width: 10%;"></td> <td style="width: 10%;"></td> <td style="width: 10%;"></td> <td style="width: 10%;"></td> <td style="width: 10%;"></td> <td style="width: 10%;"></td> </tr> <tr> <td></td> <td></td> <td colspan="8" style="text-align: center;"> <table border="1" style="width: 100%; border-collapse: collapse; text-align: center;"> <tr> <td style="width: 10%;"></td> <td style="width: 10%;"></td> <td style="width: 10%;"></td> <td style="width: 10%;"></td> <td style="width: 10%;"></td> <td style="width: 10%;"></td> <td style="width: 10%;"></td> <td style="width: 10%;"></td> <td style="width: 10%;"></td> <td style="width: 10%;"></td> </tr> <tr> <td></td> <td></td> <td colspan="8" style="text-align: center;"> <table border="1" style="width: 100%; border-collapse: collapse; text-align: center;"> <tr> <td style="width: 10%;"></td> <td style="width: 10%;"></td> <td style="width: 10%;"></td> <td style="width: 10%;"></td> <td style="width: 10%;"></td> <td style="width: 10%;"></td> <td style="width: 10%;"></td> <td style="width: 10%;"></td> <td style="width: 10%;"></td> <td style="width: 10%;"></td> </tr> <tr> <td></td> <td></td> <td colspan="8" style="text-align: center;"> <table border="1" style="width: 100%; border-collapse: collapse; text-align: center;"> <tr> <td style="width: 10%;"></td> <td style="width: 10%;"></td> <td style="width: 10%;"></td> <td style="width: 10%;"></td> <td style="width: 10%;"></td> <td style="width: 10%;"></td> <td style="width: 10%;"></td> <td style="width: 10%;"></td> <td style="width: 10%;"></td> <td style="width: 10%;"></td> </tr> <tr> <td></td> <td></td> <td colspan="8" style="text-align: center;"> <table border="1" style="width: 100%; border-collapse: collapse; text-align: center;"> <tr> <td style="width: 10%;"></td> <td style="width: 10%;"></td> <td style="width: 10%;"></td> <td style="width: 10%;"></td> <td style="width: 10%;"></td> <td style="width: 10%;"></td> <td style="width: 10%;"></td> <td style="width: 10%;"></td> <td style="width: 10%;"></td> <td style="width: 10%;"></td> </tr> <tr> <td></td> <td></td> <td colspan="8" style="text-align: center;"> <table border="1" style="width: 100%; border-collapse: collapse; text-align: center;"> <tr> <td style="width: 10%;"></td> <td style="width: 10%;"></td> <td style="width: 10%;"></td> <td style="width: 10%;"></td> <td style="width: 10%;"></td> <td style="width: 10%;"></td> <td style="width: 10%;"></td> <td style="width: 10%;"></td> <td style="width: 10%;"></td> <td style="width: 10%;"></td> </tr> <tr> <td></td> <td></td> <td colspan="8" style="text-align: center;"> <table border="1" style="width: 100%; border-collapse: collapse; text-align: center;"> <tr> <td style="width: 10%;"></td> <td style="width: 10%;"></td> <td style="width: 10%;"></td> <td style="width: 10%;"></td> <td style="width: 10%;"></td> <td style="width: 10%;"></td> <td style="width: 10%;"></td> <td style="width: 10%;"></td> <td style="width: 10%;"></td> <td style="width: 10%;"></td> </tr> <tr> <td></td> <td></td> <td colspan="8" style="text-align: center;"> <table border="1" style="width: 100%; border-collapse: collapse; text-align: center;"> <tr> <td style="width: 10%;"></td> <td style="width: 10%;"></td> <td style="width: 10%;"></td> <td style="width: 10%;"></td> <td style="width: 10%;"></td> <td style="width: 10%;"></td> <td style="width: 10%;"></td> <td style="width: 10%;"></td> <td style="width: 10%;"></td> <td style="width: 10%;"></td> </tr> <tr> <td></td> <td></td> <td colspan="8" style="text-align: center;"> <table border="1" style="width: 100%; border-collapse: collapse; text-align: center;"> <tr> <td style="width: 10%;"></td> <td style="width: 10%;"></td> <td style="width: 10%;"></td> <td style="width: 10%;"></td> <td style="width: 10%;"></td> <td style="width: 10%;"></td> <td style="width: 10%;"></td> <td style="width: 10%;"></td> <td style="width: 10%;"></td> <td style="width: 10%;"></td> </tr> <tr> <td></td> <td></td> <td colspan="8" style="text-align: center;"> <table border="1" style="width: 100%; border-collapse: collapse; text-align: center;"> <tr> <td style="width: 10%;"></td> <td style="width: 10%;"></td> <td style="width: 10%;"></td> <td style="width: 10%;"></td> <td style="width: 10%;"></td> <td style="width: 10%;"></td> <td style="width: 10%;"></td> <td style="width: 10%;"></td> <td style="width: 10%;"></td> <td style="width: 10%;"></td> </tr> <tr> <td></td> <td></td> <td colspan="8" style="text-align: center;"> <table border="1" style="width: 100%; border-collapse: collapse; text-align: center;"> <tr> <td style="width: 10%;"></td> <td style="width: 10%;"></td> <td style="width: 10%;"></td> <td style="width: 10%;"></td> <td style="width: 10%;"></td> <td style="width: 10%;"></td> <td style="width: 10%;"></td> <td style="width: 10%;"></td> <td style="width: 10%;"></td> <td style="width: 10%;"></td> </tr> <tr> <td></td> <td></td> <td colspan="8" style="text-align: center;"> <table border="1" style="width: 100%; border-collapse: collapse; text-align: center;"> <tr> <td style="width: 10%;"></td> <td style="width: 10%;"></td> <td style="width: 10%;"></td> <td style="width: 10%;"></td> <td style="width: 10%;"></td> <td style="width: 10%;"></td> <td style="width: 10%;"></td> <td style="width: 10%;"></td> <td style="width: 10%;"></td> <td style="width: 10%;"></td> </tr> <tr> <td></td> <td></td> <td colspan="8" style="text-align: center;"> <table border="1" style="width: 100%; border-collapse: collapse; text-align: center;"> <tr> <td style="width: 10%;"></td> <td style="width: 10%;"></td> <td style="width: 10%;"></td> <td style="width: 10%;"></td> <td style="width: 10%;"></td> <td style="width: 10%;"></td> <td style="width: 10%;"></td> <td style="width: 10%;"></td> <td style="width: 10%;"></td> <td style="width: 10%;"></td> </tr> <tr> <td></td> <td></td> <td colspan="8" style="text-align: center;"> <table border="1" style="width: 100%; border-collapse: collapse; text-align: center;"> <tr> <td style="width: 10%;"></td> <td style="width: 10%;"></td> <td style="width: 10%;"></td> <td style="width: 10%;"></td> <td style="width: 10%;"></td> <td style="width: 10%;"></td> <td style="width: 10%;"></td> <td style="width:
10%;"></td> <td style="width: 10%;"></td> <td style="width: 10%;"></td> </tr> <tr> <td></td> <td></td> <td colspan="8" style="text-align: center;"> <table border="1" style="width: 100%; border-collapse: collapse; text-align: center;"> <tr> <td style="width: 10%;"></td> <td style="width: 10%;"></td> <td style="width: 10%;"></td> <td style="width: 10%;"></td> <td style="width: 10%;"></td> <td style="width: 10%;"></td> <td style="width: 10%;"></td> <td style="width: 10%;"></td> <td style="width: 10%;"></td> <td style="width: 10%;"></td> </tr> <tr> <td></td> <td></td> <td colspan="8" style="text-align: center;"> <table border="1" style="width: 100%; border-collapse: collapse; text-align: center;"> <tr> <td style="width: 10%;"></td> <td style="width: 10%;"></td> <td style="width: 10%;"></td> <td style="width: 10%;"></td> <td style="width: 10%;"></td> <td style="width: 10%;"></td> <td style="width: 10%;"></td> <td style="width: 10%;"></td> <td style="width: 10%;"></td> <td style="width: 10%;"></td> </tr> <tr> <td></td> <td></td> <td colspan="8" style="text-align: center;"> <table border="1" style="width: 100%; border-collapse: collapse; text-align: center;"> <tr> <td style="width: 10%;"></td> <td style="width: 10%;"></td> <td style="width: 10%;"></td> <td style="width: 10%;"></td> <td style="width: 10%;"></td> <td style="width: 10%;"></td> <td style="width: 10%;"></td> <td style="width: 10%;"></td> <td style="width: 10%;"></td> <td style="width: 10%;"></td> </tr> <tr> <td></td> <td></td> <td colspan="8" style="text-align: center;"> <table border="1" style="width: 100%; border-collapse: collapse; text-align: center;"> <tr> <td style="width: 10%;"></td> <td style="width: 10%;"></td> <td style="width: 10%;"></td> <td style="width: 10%;"></td> <td style="width: 10%;"></td> <td style="width: 10%;"></td> <td style="width: 10%;"></td> <td style="width: 10%;"></td> <td style="width: 10%;"></td> <td style="width: 10%;"></td> </tr> <tr> <td></td> <td></td> <td colspan="8" style="text-align: center;"> <table border="1" style="width: 100%; border-collapse: collapse; text-align: center;"> <tr> <td style="width: 10%;"></td> <td style="width: 10%;"></td> <td style="width: 10%;"></td> <td style="width: 10%;"></td> <td style="width: 10%;"></td> <td style="width: 10%;"></td> <td style="width: 10%;"></td> <td style="width: 10%;"></td> <td style="width: 10%;"></td> <td style="width: 10%;"></td> </tr> <tr> <td></td> <td></td> <td colspan="8" style="text-align: center;"> <table border="1" style="width: 100%; border-collapse: collapse; text-align: center;"> <tr> <td style="width: 10%;"></td> <td style="width: 10%;"></td> <td style="width: 10%;"></td> <td style="width: 10%;"></td> <td style="width: 10%;"></td> <td style="width: 10%;"></td> <td style="width: 10%;"></td> <td style="width: 10%;"></td> <td style="width: 10%;"></td> <td style="width: 10%;"></td> </tr> <tr> <td></td> <td></td> <td colspan="8" style="text-align: center;"> <table border="1" style="width: 100%; border-collapse: collapse; text-align: center;"> <tr> <td style="width: 10%;"></td> <td style="width: 10%;"></td> <td style="width: 10%;"></td> <td style="width: 10%;"></td> <td style="width: 10%;"></td> <td style="width: 10%;"></td> <td style="width: 10%;"></td> <td style="width: 10%;"></td> <td style="width: 10%;"></td> <td style="width: 10%;"></td> </tr> <tr> <td></td> <td></td> <td colspan="8" style="text-align: center;"> <table border="1" style="width: 100%; border-collapse: collapse; text-align: center;"> <tr> <td style="width: 10%;"></td> <td style="width: 10%;"></td> <td style="width: 10%;"></td> <td style="width: 10%;"></td> <td style="width: 10%;"></td> <td style="width: 10%;"></td> <td style="width: 10%;"></td> <td style="width: 10%;"></td> <td style="width: 10%;"></td> <td style="width: 10%;"></td> </tr> <tr> <td></td> <td></td> <td colspan="8" style="text-align: center;"> <table border="1" style="width: 100%; border-collapse: collapse; text-align: center;"> <tr> <td style="width: 10%;"></td> <td style="width: 10%;"></td> <td style="width: 10%;"></td> <td style="width: 10%;"></td> <td style="width: 10%;"></td> <td style="width: 10%;"></td> <td style="width: 10%;"></td> <td style="width: 10%;"></td> <td style="width: 10%;"></td> <td style="width: 10%;"></td> </tr> <tr> <td></td> <td></td> <td colspan="8" style="text-align: center;"> <table border="1" style="width: 100%; border-collapse: collapse; text-align: center;"> <tr> <td style="width: 10%;"></td> <td style="width: 10%;"></td> <td style="width: 10%;"></td> <td style="width: 10%;"></td> <td style="width: 10%;"></td> <td style="width: 10%;"></td> <td style="width: 10%;"></td> <td style="width: 10%;"></td> <td style="width: 10%;"></td> <td style="width: 10%;"></td> </tr> <tr> <td></td> <td></td> <td colspan="8" style="text-align: center;"> <table border="1" style="width: 100%; border-collapse: collapse; text-align: center;"> <tr> <td style="width: 10%;"></td> <td style="width: 10%;"></td> <td style="width: 10%;"></td> <td style="width: 10%;"></td> <td style="width: 10%;"></td> <td style="width: 10%;"></td> <td style="width: 10%;"></td> <td style="width: 10%;"></td> <td style="width: 10%;"></td> <td style="width: 10%;"></td> </tr> <tr> <td></td> <td></td> <td colspan="8" style="text-align: center;"> <table border="1" style="width: 100%; border-collapse: collapse; text-align: center;"> <tr> <td style="width: 10%;"></td> <td style="width: 10%;"></td> <td style="width: 10%;"></td> <td style="width: 10%;"></td> <td style="width: 10%;"></td> <td style="width: 10%;"></td> <td style="width: 10%;"></td> <td style="width: 10%;"></td> <td style="width: 10%;"></td> <td style="width: 10%;"></td> </tr> <tr> <td></td> <td></td> <td colspan="8" style="text-align: center;"> <table border="1" style="width: 100%; border-collapse: collapse; text-align: center;"> <tr> <td style="width: 10%;"></td> <td style="width: 10%;"></td> <td style="width: 10%;"></td> <td style="width: 10%;"></td> <td style="width: 10%;"></td> <td style="width: 10%;"></td> <td style="width: 10%;"></td> <td style="width: 10%;"></td> <td style="width: 10%;"></td> <td style="width: 10%;"></td> </tr> <tr> <td></td> <td></td> <td colspan="8" style="text-align: center;"> <table border="1" style="width: 100%; border-collapse: collapse; text-align: center;"> <tr> <td style="width: 10%;"></td> <td style="width: 10%;"></td> <td style="width: 10%;"></td> <td style="width: 10%;"></td> <td style="width: 10%;"></td> <td style="width: 10%;"></td> <td style="width: 10%;"></td> <td style="width: 10%;"></td> <td style="width: 10%;"></td> <td style="width: 10%;"></td> </tr> <tr> <td></td> <td></td> <td colspan="8" style="text-align: center;"> <table border="1" style="width: 100%; border-collapse: collapse; text-align: center;"> <tr> <td style="width: 10%;"></td> <td style="width: 10%;"></td> <td style="width: 10%;"></td> <td style="width: 10%;"></td> <td style="width: 10%;"></td> <td style="width: 10%;"></td> <td style="width: 10%;"></td> <td style="width: 10%;"></td> <td style="width: 10%;"></td> <td style="width: 10%;"></td> </tr> <tr> <td></td> <td></td> <td colspan="8" style="text-align: center;"> <table border="1" style="width: 100%; border-collapse: collapse; text-align: center;"> <tr> <td style="width: 10%;"></td> <td style="width: 10%;"></td> <td style="width: 10%;"></td> <td style="width: 10%;"></td> <td style="width: 10%;"></td> <td style="width: 10%;"></td> <td style="width: 10%;"></td> <td style="width: 10%;"></td> <td style="width: 10%;"></td> <td style="width: 10%;"></td> </tr> <tr> <td></td> <td></td> <td colspan="8" style="text-align: center;"> <table border="1" style="width: 100%; border-collapse: collapse; text-align: center;"> <tr> <td style="width: 10%;"></td> <td style="width: 10%;"></td> <td style="width: 10%;"></td> <td style="width: 10%;"></td> <td style="width: 10%;"></td> <td style="width: 10%;"></td> <td style="width: 10%;"></td> <td style="width: 10%;"></td> <td style="width: 10%;"></td> <td style="width: 10%;"></td> </tr> <tr> <td></td> <td></td> <td colspan="8" style="text-align: center;"> <table border="1" style="width: 100%; border-collapse: collapse; text-align: center;"> <tr> <td style="width: 10%;"></td> <td style="width: 10%;"></td> <td style="width: 10%;"></td> <td style="width: 10%;"></td> <td style="width: 10%;"></td> <td style="width: 10%;"></td> <td style="width: 10%;"></td> <td style="width: 10%;"></td> <td style="width: 10%;"></td> <td style="width: 10%;"></td> </tr> <tr> <td></td> <td></td> <td colspan="8" style="text-align: center;"> <table border="1" style="width: 100%; border-collapse: collapse; text-align: center;"> <tr> </tr></table></td></tr></table></td></tr></table></td></tr></table></td></tr></table></td></tr></table></td></tr></table></td></tr></table></td></tr></table></td></tr></table></td></tr></table></td></tr></table></td></tr></table></td></tr></table></td></tr></table></td></tr></table></td></tr></table></td></tr></table></td></tr></table></td></tr></table></td></tr></table></td></tr></table></td></tr></table></td></tr></table></td></tr></table></td></tr></table></td></tr></table></td></tr></table></td></tr></table></td></tr></table></td></tr></table></td></tr></table></td></tr></table></td></tr></table></td></tr></table></td></tr></table></td></tr></table></td></tr></table></td></tr></table></td></tr></table></td></tr></table></td></tr></table></td></tr></table></td></tr></table></td></tr></table></td></tr></table></td></tr></table></td></tr></table></td></tr></table></td></tr></table></td></tr></table></td></tr></table></td></tr></table></td></tr></table></td></tr></table></td></tr></table></td></tr></table></td></tr></table></td></tr></table></td></tr></table></td></tr></table></td></tr></table>
 | | | | | | | | | | | | | | | | | | | | <table border="1" style="width: 100%; border-collapse: collapse; text-align: center;"> <tr> <td style="width: 10%;"></td> <td style="width: 10%;"></td> <td style="width: 10%;"></td> <td style="width: 10%;"></td> <td style="width: 10%;"></td> <td style="width: 10%;"></td> <td style="width: 10%;"></td> <td style="width: 10%;"></td> <td style="width: 10%;"></td> <td style="width: 10%;"></td> </tr> <tr> <td></td> <td></td> <td colspan="8" style="text-align: center;"> <table border="1" style="width: 100%; border-collapse: collapse; text-align: center;"> <tr> <td style="width: 10%;"></td> <td style="width: 10%;"></td> <td style="width: 10%;"></td> <td style="width: 10%;"></td> <td style="width: 10%;"></td> <td style="width: 10%;"></td> <td style="width: 10%;"></td> <td style="width: 10%;"></td> <td style="width: 10%;"></td> <td style="width: 10%;"></td> </tr> <tr> <td></td> <td></td> <td colspan="8" style="text-align: center;"> <table border="1" style="width: 100%; border-collapse: collapse; text-align: center;"> <tr> <td style="width: 10%;"></td> <td style="width: 10%;"></td> <td style="width: 10%;"></td> <td style="width: 10%;"></td> <td style="width: 10%;"></td> <td style="width: 10%;"></td> <td style="width: 10%;"></td> <td style="width: 10%;"></td> <td style="width: 10%;"></td> <td style="width: 10%;"></td> </tr> <tr> <td></td> <td></td> <td colspan="8" style="text-align: center;"> <table border="1" style="width: 100%; border-collapse: collapse; text-align: center;"> <tr> <td style="width: 10%;"></td> <td style="width: 10%;"></td> <td style="width: 10%;"></td> <td style="width: 10%;"></td> <td style="width: 10%;"></td> <td style="width: 10%;"></td> <td style="width: 10%;"></td> <td style="width: 10%;"></td> <td style="width: 10%;"></td> <td style="width: 10%;"></td> </tr> <tr> <td></td> <td></td> <td colspan="8" style="text-align: center;"> <table border="1" style="width: 100%; border-collapse: collapse; text-align: center;"> <tr> <td style="width: 10%;"></td> <td style="width: 10%;"></td> <td style="width: 10%;"></td> <td style="width: 10%;"></td> <td style="width: 10%;"></td> <td style="width: 10%;"></td> <td style="width: 10%;"></td> <td style="width: 10%;"></td> <td style="width: 10%;"></td> <td style="width: 10%;"></td> </tr> <tr> <td></td> <td></td> <td colspan="8" style="text-align: center;"> <table border="1" style="width: 100%; border-collapse: collapse; text-align: center;"> <tr> <td style="width: 10%;"></td> <td style="width: 10%;"></td> <td style="width: 10%;"></td> <td style="width: 10%;"></td> <td style="width: 10%;"></td> <td style="width: 10%;"></td> <td style="width: 10%;"></td> <td style="width: 10%;"></td> <td style="width: 10%;"></td> <td style="width: 10%;"></td> </tr> <tr> <td></td> <td></td> <td colspan="8" style="text-align: center;"> <table border="1" style="width: 100%; border-collapse: collapse; text-align: center;"> <tr> <td style="width: 10%;"></td> <td style="width: 10%;"></td> <td style="width: 10%;"></td> <td style="width: 10%;"></td> <td style="width: 10%;"></td> <td style="width: 10%;"></td> <td style="width: 10%;"></td> <td style="width: 10%;"></td> <td style="width: 10%;"></td> <td style="width: 10%;"></td> </tr> <tr> <td></td> <td></td> <td colspan="8" style="text-align: center;"> <table border="1" style="width: 100%; border-collapse: collapse; text-align: center;"> <tr> <td style="width: 10%;"></td> <td style="width: 10%;"></td> <td style="width: 10%;"></td> <td style="width: 10%;"></td> <td style="width: 10%;"></td> <td style="width: 10%;"></td> <td style="width: 10%;"></td> <td style="width: 10%;"></td> <td style="width: 10%;"></td> <td style="width: 10%;"></td> </tr> <tr> <td></td> <td></td> <td colspan="8" style="text-align: center;"> <table border="1" style="width: 100%; border-collapse: collapse; text-align: center;"> <tr> <td style="width: 10%;"></td> <td style="width: 10%;"></td> <td style="width: 10%;"></td> <td style="width: 10%;"></td> <td style="width: 10%;"></td> <td style="width: 10%;"></td> <td style="width: 10%;"></td> <td style="width: 10%;"></td> <td style="width: 10%;"></td> <td style="width: 10%;"></td> </tr> <tr> <td></td> <td></td> <td colspan="8" style="text-align: center;"> <table border="1" style="width: 100%; border-collapse: collapse; text-align: center;"> <tr> <td style="width: 10%;"></td> <td style="width: 10%;"></td> <td style="width: 10%;"></td> <td style="width: 10%;"></td> <td style="width: 10%;"></td> <td style="width: 10%;"></td> <td style="width: 10%;"></td> <td style="width: 10%;"></td> <td style="width: 10%;"></td> <td style="width: 10%;"></td> </tr> <tr> <td></td> <td></td> <td colspan="8" style="text-align: center;"> <table border="1" style="width: 100%; border-collapse: collapse; text-align: center;"> <tr> <td style="width: 10%;"></td> <td style="width: 10%;"></td> <td style="width: 10%;"></td> <td style="width: 10%;"></td> <td style="width: 10%;"></td> <td style="width: 10%;"></td> <td style="width: 10%;"></td> <td style="width: 10%;"></td> <td style="width: 10%;"></td> <td style="width: 10%;"></td> </tr> <tr> <td></td> <td></td> <td colspan="8" style="text-align: center;"> <table border="1" style="width: 100%; border-collapse: collapse; text-align: center;"> <tr> <td style="width: 10%;"></td> <td style="width: 10%;"></td> <td style="width: 10%;"></td> <td style="width: 10%;"></td> <td style="width: 10%;"></td> <td style="width: 10%;"></td> <td style="width: 10%;"></td> <td style="width: 10%;"></td> <td style="width: 10%;"></td> <td style="width: 10%;"></td> </tr> <tr> <td></td> <td></td> <td colspan="8" style="text-align: center;"> <table border="1" style="width: 100%; border-collapse: collapse; text-align: center;"> <tr> <td style="width: 10%;"></td> <td style="width: 10%;"></td> <td style="width: 10%;"></td> <td style="width: 10%;"></td> <td style="width: 10%;"></td> <td style="width: 10%;"></td> <td style="width: 10%;"></td> <td style="width: 10%;"></td> <td style="width: 10%;"></td> <td style="width: 10%;"></td> </tr> <tr> <td></td> <td></td> <td colspan="8" style="text-align: center;"> <table border="1" style="width: 100%; border-collapse: collapse; text-align: center;"> <tr> <td style="width: 10%;"></td> <td style="width: 10%;"></td> <td style="width: 10%;"></td> <td style="width: 10%;"></td> <td style="width: 10%;"></td> <td style="width: 10%;"></td> <td style="width: 10%;"></td> <td style="width: 10%;"></td> <td style="width: 10%;"></td> <td style="width: 10%;"></td> </tr> <tr> <td></td> <td></td> <td colspan="8" style="text-align: center;"> <table border="1" style="width: 100%; border-collapse: collapse; text-align: center;"> <tr> <td style="width: 10%;"></td> <td style="width: 10%;"></td> <td style="width: 10%;"></td> <td style="width: 10%;"></td> <td style="width: 10%;"></td> <td style="width: 10%;"></td> <td style="width: 10%;"></td> <td style="width: 10%;"></td> <td style="width: 10%;"></td> <td style="width: 10%;"></td> </tr> <tr> <td></td> <td></td> <td colspan="8" style="text-align: center;"> <table border="1" style="width: 100%; border-collapse: collapse; text-align: center;"> <tr> <td style="width: 10%;"></td> <td style="width: 10%;"></td> <td style="width: 10%;"></td> <td style="width: 10%;"></td> <td style="width: 10%;"></td> <td style="width: 10%;"></td> <td style="width: 10%;"></td> <td style="width: 10%;"></td> <td style="width: 10%;"></td> <td style="width: 10%;"></td> </tr> <tr> <td></td> <td></td> <td colspan="8" style="text-align: center;"> <table border="1" style="width: 100%; border-collapse: collapse; text-align: center;"> <tr> <td style="width: 10%;"></td> <td style="width: 10%;"></td> <td style="width: 10%;"></td> <td style="width: 10%;"></td> <td style="width: 10%;"></td> <td style="width: 10%;"></td> <td style="width: 10%;"></td> <td style="width: 10%;"></td> <td style="width: 10%;"></td> <td style="width: 10%;"></td> </tr> <tr> <td></td> <td></td> <td colspan="8" style="text-align: center;"> <table border="1" style="width: 100%; border-collapse: collapse; text-align: center;"> <tr> <td style="width: 10%;"></td> <td style="width: 10%;"></td> <td style="width: 10%;"></td> <td style="width: 10%;"></td> <td style="width: 10%;"></td> <td style="width: 10%;"></td> <td style="width: 10%;"></td> <td style="width: 10%;"></td> <td style="width: 10%;"></td> <td style="width: 10%;"></td> </tr> <tr> <td></td> <td></td> <td colspan="8" style="text-align: center;"> <table border="1" style="width: 100%; border-collapse: collapse; text-align: center;"> <tr> <td style="width: 10%;"></td> <td style="width: 10%;"></td> <td style="width: 10%;"></td> <td style="width: 10%;"></td> <td style="width: 10%;"></td> <td style="width:
10%;"></td> <td style="width: 10%;"></td> <td style="width: 10%;"></td> <td style="width: 10%;"></td> <td style="width: 10%;"></td> </tr> <tr> <td></td> <td></td> <td colspan="8" style="text-align: center;"> <table border="1" style="width: 100%; border-collapse: collapse; text-align: center;"> <tr> <td style="width: 10%;"></td> <td style="width: 10%;"></td> <td style="width: 10%;"></td> <td style="width: 10%;"></td> <td style="width: 10%;"></td> <td style="width: 10%;"></td> <td style="width: 10%;"></td> <td style="width: 10%;"></td> <td style="width: 10%;"></td> <td style="width: 10%;"></td> </tr> <tr> <td></td> <td></td> <td colspan="8" style="text-align: center;"> <table border="1" style="width: 100%; border-collapse: collapse; text-align: center;"> <tr> <td style="width: 10%;"></td> <td style="width: 10%;"></td> <td style="width: 10%;"></td> <td style="width: 10%;"></td> <td style="width: 10%;"></td> <td style="width: 10%;"></td> <td style="width: 10%;"></td> <td style="width: 10%;"></td> <td style="width: 10%;"></td> <td style="width: 10%;"></td> </tr> <tr> <td></td> <td></td> <td colspan="8" style="text-align: center;"> <table border="1" style="width: 100%; border-collapse: collapse; text-align: center;"> <tr> <td style="width: 10%;"></td> <td style="width: 10%;"></td> <td style="width: 10%;"></td> <td style="width: 10%;"></td> <td style="width: 10%;"></td> <td style="width: 10%;"></td> <td style="width: 10%;"></td> <td style="width: 10%;"></td> <td style="width: 10%;"></td> <td style="width: 10%;"></td> </tr> <tr> <td></td> <td></td> <td colspan="8" style="text-align: center;"> <table border="1" style="width: 100%; border-collapse: collapse; text-align: center;"> <tr> <td style="width: 10%;"></td> <td style="width: 10%;"></td> <td style="width: 10%;"></td> <td style="width: 10%;"></td> <td style="width: 10%;"></td> <td style="width: 10%;"></td> <td style="width: 10%;"></td> <td style="width: 10%;"></td> <td style="width: 10%;"></td> <td style="width: 10%;"></td> </tr> <tr> <td></td> <td></td> <td colspan="8" style="text-align: center;"> <table border="1" style="width: 100%; border-collapse: collapse; text-align: center;"> <tr> <td style="width: 10%;"></td> <td style="width: 10%;"></td> <td style="width: 10%;"></td> <td style="width: 10%;"></td> <td style="width: 10%;"></td> <td style="width: 10%;"></td> <td style="width: 10%;"></td> <td style="width: 10%;"></td> <td style="width: 10%;"></td> <td style="width: 10%;"></td> </tr> <tr> <td></td> <td></td> <td colspan="8" style="text-align: center;"> <table border="1" style="width: 100%; border-collapse: collapse; text-align: center;"> <tr> <td style="width: 10%;"></td> <td style="width: 10%;"></td> <td style="width: 10%;"></td> <td style="width: 10%;"></td> <td style="width: 10%;"></td> <td style="width: 10%;"></td> <td style="width: 10%;"></td> <td style="width: 10%;"></td> <td style="width: 10%;"></td> <td style="width: 10%;"></td> </tr> <tr> <td></td> <td></td> <td colspan="8" style="text-align: center;"> <table border="1" style="width: 100%; border-collapse: collapse; text-align: center;"> <tr> <td style="width: 10%;"></td> <td style="width: 10%;"></td> <td style="width: 10%;"></td> <td style="width: 10%;"></td> <td style="width: 10%;"></td> <td style="width: 10%;"></td> <td style="width: 10%;"></td> <td style="width: 10%;"></td> <td style="width: 10%;"></td> <td style="width: 10%;"></td> </tr> <tr> <td></td> <td></td> <td colspan="8" style="text-align: center;"> <table border="1" style="width: 100%; border-collapse: collapse; text-align: center;"> <tr> <td style="width: 10%;"></td> <td style="width: 10%;"></td> <td style="width: 10%;"></td> <td style="width: 10%;"></td> <td style="width: 10%;"></td> <td style="width: 10%;"></td> <td style="width: 10%;"></td> <td style="width: 10%;"></td> <td style="width: 10%;"></td> <td style="width: 10%;"></td> </tr> <tr> <td></td> <td></td> <td colspan="8" style="text-align: center;"> <table border="1" style="width: 100%; border-collapse: collapse; text-align: center;"> <tr> <td style="width: 10%;"></td> <td style="width: 10%;"></td> <td style="width: 10%;"></td> <td style="width: 10%;"></td> <td style="width: 10%;"></td> <td style="width: 10%;"></td> <td style="width: 10%;"></td> <td style="width: 10%;"></td> <td style="width: 10%;"></td> <td style="width: 10%;"></td> </tr> <tr> <td></td> <td></td> <td colspan="8" style="text-align: center;"> <table border="1" style="width: 100%; border-collapse: collapse; text-align: center;"> <tr> <td style="width: 10%;"></td> <td style="width: 10%;"></td> <td style="width: 10%;"></td> <td style="width: 10%;"></td> <td style="width: 10%;"></td> <td style="width: 10%;"></td> <td style="width: 10%;"></td> <td style="width: 10%;"></td> <td style="width: 10%;"></td> <td style="width: 10%;"></td> </tr> <tr> <td></td> <td></td> <td colspan="8" style="text-align: center;"> <table border="1" style="width: 100%; border-collapse: collapse; text-align: center;"> <tr> <td style="width: 10%;"></td> <td style="width: 10%;"></td> <td style="width: 10%;"></td> <td style="width: 10%;"></td> <td style="width: 10%;"></td> <td style="width: 10%;"></td> <td style="width: 10%;"></td> <td style="width: 10%;"></td> <td style="width: 10%;"></td> <td style="width: 10%;"></td> </tr> <tr> <td></td> <td></td> <td colspan="8" style="text-align: center;"> <table border="1" style="width: 100%; border-collapse: collapse; text-align: center;"> <tr> <td style="width: 10%;"></td> <td style="width: 10%;"></td> <td style="width: 10%;"></td> <td style="width: 10%;"></td> <td style="width: 10%;"></td> <td style="width: 10%;"></td> <td style="width: 10%;"></td> <td style="width: 10%;"></td> <td style="width: 10%;"></td> <td style="width: 10%;"></td> </tr> <tr> <td></td> <td></td> <td colspan="8" style="text-align: center;"> <table border="1" style="width: 100%; border-collapse: collapse; text-align: center;"> <tr> <td style="width: 10%;"></td> <td style="width: 10%;"></td> <td style="width: 10%;"></td> <td style="width: 10%;"></td> <td style="width: 10%;"></td> <td style="width: 10%;"></td> <td style="width: 10%;"></td> <td style="width: 10%;"></td> <td style="width: 10%;"></td> <td style="width: 10%;"></td> </tr> <tr> <td></td> <td></td> <td colspan="8" style="text-align: center;"> <table border="1" style="width: 100%; border-collapse: collapse; text-align: center;"> <tr> <td style="width: 10%;"></td> <td style="width: 10%;"></td> <td style="width: 10%;"></td> <td style="width: 10%;"></td> <td style="width: 10%;"></td> <td style="width: 10%;"></td> <td style="width: 10%;"></td> <td style="width: 10%;"></td> <td style="width: 10%;"></td> <td style="width: 10%;"></td> </tr> <tr> <td></td> <td></td> <td colspan="8" style="text-align: center;"> <table border="1" style="width: 100%; border-collapse: collapse; text-align: center;"> <tr> <td style="width: 10%;"></td> <td style="width: 10%;"></td> <td style="width: 10%;"></td> <td style="width: 10%;"></td> <td style="width: 10%;"></td> <td style="width: 10%;"></td> <td style="width: 10%;"></td> <td style="width: 10%;"></td> <td style="width: 10%;"></td> <td style="width: 10%;"></td> </tr> <tr> <td></td> <td></td> <td colspan="8" style="text-align: center;"> <table border="1" style="width: 100%; border-collapse: collapse; text-align: center;"> <tr> <td style="width: 10%;"></td> <td style="width: 10%;"></td> <td style="width: 10%;"></td> <td style="width: 10%;"></td> <td style="width: 10%;"></td> <td style="width: 10%;"></td> <td style="width: 10%;"></td> <td style="width: 10%;"></td> <td style="width: 10%;"></td> <td style="width: 10%;"></td> </tr> <tr> <td></td> <td></td> <td colspan="8" style="text-align: center;"> <table border="1" style="width: 100%; border-collapse: collapse; text-align: center;"> <tr> <td style="width: 10%;"></td> <td style="width: 10%;"></td> <td style="width: 10%;"></td> <td style="width: 10%;"></td> <td style="width: 10%;"></td> <td style="width: 10%;"></td> <td style="width: 10%;"></td> <td style="width: 10%;"></td> <td style="width: 10%;"></td> <td style="width: 10%;"></td> </tr> <tr> <td></td> <td></td> <td colspan="8" style="text-align: center;"> <table border="1" style="width: 100%; border-collapse: collapse; text-align: center;"> <tr> <td style="width: 10%;"></td> <td style="width: 10%;"></td> <td style="width: 10%;"></td> <td style="width: 10%;"></td> <td style="width: 10%;"></td> <td style="width: 10%;"></td> <td style="width: 10%;"></td> <td style="width: 10%;"></td> <td style="width: 10%;"></td> <td style="width: 10%;"></td> </tr> <tr> <td></td> <td></td> <td colspan="8" style="text-align: center;"> <table border="1" style="width: 100%; border-collapse: collapse; text-align: center;"> <tr> <td style="width: 10%;"></td> <td style="width: 10%;"></td> <td style="width: 10%;"></td> <td style="width: 10%;"></td> <td style="width: 10%;"></td> <td style="width: 10%;"></td> <td style="width: 10%;"></td> <td style="width: 10%;"></td> <td style="width: 10%;"></td> <td style="width: 10%;"></td> </tr> <tr> <td></td> <td></td> <td colspan="8" style="text-align: center;"> <table border="1" style="width: 100%; border-collapse: collapse; text-align: center;"> <tr> <td style="width: 10%;"></td> <td style="width: 10%;"></td> <td style="width: 10%;"></td> <td style="width: 10%;"></td> <td style="width: 10%;"></td> <td style="width: 10%;"></td> <td style="width: 10%;"></td> <td style="width: 10%;"></td> <td style="width: 10%;"></td> <td style="width: 10%;"></td> </tr> <tr> <td></td> <td></td> <td colspan="8" style="text-align: center;"> <table border="1" style="width: 100%; border-collapse: collapse; text-align: center;"> <tr> <td style="width: 10%;"></td> <td style="width: 10%;"></td> <td style="width: 10%;"></td> <td style="width: 10%;"></td> <td style="width: 10%;"></td> <td style="width: 10%;"></td> <td style="width: 10%;"></td> <td style="width: 10%;"></td> <td style="width: 10%;"></td> <td style="width: 10%;"></td> </tr> <tr> <td></td> <td></td> <td
colspan="8" style="text-align: center;"> <table border="1" style="width: 100%; border-collapse: collapse; text-align: center;"> <tr> <td style="width: 10%;"></td> <td style="width: 10%;"></td> <td style="width: 10%;"></td> <td style="width: 10%;"></td> <td style="width: 10%;"></td> <td style="width: 10%;"></td> <td style="width: 10%;"></td> <td style="width: 10%;"></td> <td style="width: 10%;"></td> <td style="width: 10%;"></td> </tr> <tr> <td></td> <td></td> <td colspan="8" style="text-align: center;"> <table border="1" style="width: 100%; border-collapse: collapse; text-align: center;"> <tr> <td style="width: 10%;"></td> <td style="width: 10%;"></td> <td style="width: 10%;"></td> <td style="width: 10%;"></td> <td style="width: 10%;"></td> <td style="width: 10%;"></td> <td style="width: 10%;"></td> <td style="width: 10%;"></td> <td style="width: 10%;"></td> <td style="width: 10%;"></td> </tr> <tr> <td></td> <td></td> <td colspan="8" style="text-align: center;"> <table border="1" style="width: 100%; border-collapse: collapse; text-align: center;"> <tr> <td style="width: 10%;"></td> <td style="width: 10%;"></td> <td style="width: 10%;"></td> <td style="width: 10%;"></td> <td style="width: 10%;"></td> <td style="width: 10%;"></td> <td style="width: 10%;"></td> <td style="width: 10%;"></td> <td style="width: 10%;"></td> <td style="width: 10%;"></td> </tr> <tr> <td></td> <td></td> <td colspan="8" style="text-align: center;"> <table border="1" style="width: 100%; border-collapse: collapse; text-align: center;"> <tr> <td style="width: 10%;"></td> <td style="width: 10%;"></td> <td style="width: 10%;"></td> <td style="width: 10%;"></td> <td style="width: 10%;"></td> <td style="width: 10%;"></td> <td style="width: 10%;"></td> <td style="width: 10%;"></td> <td style="width: 10%;"></td> <td style="width: 10%;"></td> </tr> <tr> <td></td> <td></td> <td colspan="8" style="text-align: center;"> <table border="1" style="width: 100%; border-collapse: collapse; text-align: center;"> <tr> <td style="width: 10%;"></td> <td style="width: 10%;"></td> <td style="width: 10%;"></td> <td style="width: 10%;"></td> <td style="width: 10%;"></td> <td style="width: 10%;"></td> <td style="width: 10%;"></td> <td style="width: 10%;"></td> <td style="width: 10%;"></td> <td style="width: 10%;"></td> </tr> <tr> <td></td> <td></td> <td colspan="8" style="text-align: center;"> <table border="1" style="width: 100%; border-collapse: collapse; text-align: center;"> <tr> <td style="width: 10%;"></td> <td style="width: 10%;"></td> <td style="width: 10%;"></td> <td style="width: 10%;"></td> <td style="width: 10%;"></td> <td style="width: 10%;"></td> <td style="width: 10%;"></td> <td style="width: 10%;"></td> <td style="width: 10%;"></td> <td style="width: 10%;"></td> </tr> <tr> <td></td> <td></td> <td colspan="8" style="text-align: center;"> <table border="1" style="width: 100%; border-collapse: collapse; text-align: center;"> <tr> <td style="width: 10%;"></td> <td style="width: 10%;"></td> <td style="width: 10%;"></td> <td style="width: 10%;"></td> <td style="width: 10%;"></td> <td style="width: 10%;"></td> <td style="width: 10%;"></td> <td style="width: 10%;"></td> <td style="width: 10%;"></td> <td style="width: 10%;"></td> </tr> <tr> <td></td> <td></td> <td colspan="8" style="text-align: center;"> <table border="1" style="width: 100%; border-collapse: collapse; text-align: center;"> <tr> <td style="width: 10%;"></td> <td style="width: 10%;"></td> <td style="width: 10%;"></td> <td style="width: 10%;"></td> <td style="width: 10%;"></td> <td style="width: 10%;"></td> <td style="width: 10%;"></td> <td style="width: 10%;"></td> <td style="width: 10%;"></td> <td style="width: 10%;"></td> </tr> <tr> <td></td> <td></td> <td colspan="8" style="text-align: center;"> <table border="1" style="width: 100%; border-collapse: collapse; text-align: center;"> <tr> <td style="width: 10%;"></td> <td style="width: 10%;"></td> <td style="width: 10%;"></td> <td style="width: 10%;"></td> <td style="width: 10%;"></td> <td style="width: 10%;"></td> <td style="width: 10%;"></td> <td style="width: 10%;"></td> <td style="width: 10%;"></td> <td style="width: 10%;"></td> </tr> <tr> <td></td> <td></td> <td colspan="8" style="text-align: center;"> <table border="1" style="width: 100%; border-collapse: collapse; text-align: center;"> <tr> <td style="width: 10%;"></td> <td style="width: 10%;"></td> <td style="width: 10%;"></td> <td style="width: 10%;"></td> <td style="width: 10%;"></td> <td style="width: 10%;"></td> <td style="width: 10%;"></td> <td style="width: 10%;"></td> <td style="width: 10%;"></td> <td style="width: 10%;"></td> </tr> <tr> <td></td> <td></td> <td colspan="8" style="text-align: center;"> <table border="1" style="width: 100%; border-collapse: collapse; text-align: center;"> <tr> <td style="width: 10%;"></td> <td style="width: 10%;"></td> <td style="width: 10%;"></td> <td style="width: 10%;"></td> <td style="width: 10%;"></td> <td style="width: 10%;"></td> <td style="width: 10%;"></td> <td style="width: 10%;"></td> <td style="width: 10%;"></td> <td style="width: 10%;"></td> </tr> <tr> <td></td> <td></td> <td colspan="8" style="text-align: center;"> <table border="1" style="width: 100%; border-collapse: collapse; text-align: center;"> <tr> <td style="width: 10%;"></td> <td style="width: 10%;"></td> <td style="width: 10%;"></td> <td style="width: 10%;"></td> <td style="width: 10%;"></td> <td style="width: 10%;"></td> <td style="width: 10%;"></td> <td style="width: 10%;"></td> <td style="width: 10%;"></td> <td style="width: 10%;"></td> </tr> <tr> <td></td> <td></td> <td colspan="8" style="text-align: center;"> <table border="1" style="width: 100%; border-collapse: collapse; text-align: center;"> <tr> <td style="width: 10%;"></td> <td style="width: 10%;"></td> <td style="width: 10%;"></td> <td style="width: 10%;"></td> <td style="width: 10%;"></td> <td style="width: 10%;"></td> <td style="width: 10%;"></td> <td style="width: 10%;"></td> <td style="width: 10%;"></td> <td style="width: 10%;"></td> </tr> <tr> <td></td> <td></td> <td colspan="8" style="text-align: center;"> <table border="1" style="width: 100%; border-collapse: collapse; text-align: center;"> <tr> <td style="width: 10%;"></td> <td style="width: 10%;"></td> <td style="width: 10%;"></td> <td style="width: 10%;"></td> <td style="width: 10%;"></td> <td style="width: 10%;"></td> <td style="width: 10%;"></td> <td style="width: 10%;"></td> <td style="width: 10%;"></td> <td style="width: 10%;"></td> </tr> <tr> <td></td> <td></td> <td colspan="8" style="text-align: center;"> <table border="1" style="width: 100%; border-collapse: collapse; text-align: center;"> <tr> <td style="width: 10%;"></td> <td style="width: 10%;"></td> <td style="width: 10%;"></td> <td style="width: 10%;"></td> <td style="width: 10%;"></td> <td style="width: 10%;"></td> <td style="width: 10%;"></td> <td style="width: 10%;"></td> <td style="width: 10%;"></td> <td style="width: 10%;"></td> </tr> <tr> <td></td> <td></td> <td colspan="8" style="text-align: center;"> <table border="1" style="width: 100%; border-collapse: collapse; text-align: center;"> <tr> <td style="width: 10%;"></td> <td style="width: 10%;"></td> <td style="width: 10%;"></td> <td style="width: 10%;"></td> <td style="width: 10%;"></td> <td style="width: 10%;"></td> <td style="width: 10%;"></td> <td style="width: 10%;"></td> <td style="width: 10%;"></td> <td style="width: 10%;"></td> </tr> <tr> <td></td> <td></td> <td colspan="8" style="text-align: center;"> <table border="1" style="width: 100%; border-collapse: collapse; text-align: center;"> <tr> <td style="width: 10%;"></td> <td style="width: 10%;"></td> <td style="width: 10%;"></td> <td style="width: 10%;"></td> <td style="width: 10%;"></td> <td style="width: 10%;"></td> <td style="width: 10%;"></td> <td style="width: 10%;"></td> <td style="width: 10%;"></td> <td style="width: 10%;"></td> </tr> <tr> <td></td> <td></td> <td colspan="8" style="text-align: center;"> <table border="1" style="width: 100%; border-collapse: collapse; text-align: center;"> <tr> <td style="width: 10%;"></td> <td style="width: 10%;"></td> <td style="width: 10%;"></td> <td style="width: 10%;"></td> <td style="width: 10%;"></td> <td style="width: 10%;"></td> <td style="width: 10%;"></td> <td style="width: 10%;"></td> <td style="width: 10%;"></td> <td style="width: 10%;"></td> </tr> <tr> <td></td> <td></td> <td colspan="8" style="text-align: center;"> <table border="1" style="width: 100%; border-collapse: collapse; text-align: center;"> <tr> <td style="width: 10%;"></td> <td style="width: 10%;"></td> <td style="width: 10%;"></td> <td style="width: 10%;"></td> <td style="width: 10%;"></td> <td style="width: 10%;"></td> <td style="width: 10%;"></td> <td style="width: 10%;"></td> <td style="width: 10%;"></td> <td style="width: 10%;"></td> </tr> <tr> <td></td> <td></td> <td colspan="8" style="text-align: center;"> <table border="1" style="width: 100%; border-collapse: collapse; text-align: center;"> <tr> <td style="width: 10%;"></td> <td style="width: 10%;"></td> <td style="width: 10%;"></td> <td style="width: 10%;"></td> <td style="width: 10%;"></td> <td style="width: 10%;"></td> <td style="width: 10%;"></td> <td style="width: 10%;"></td> <td style="width: 10%;"></td> <td style="width: 10%;"></td> </tr> <tr> <td></td> <td></td> <td colspan="8" style="text-align: center;"> <table border="1" style="width: 100%; border-collapse: collapse; text-align: center;"> <tr>
</tr></table></td></tr></table></td></tr></table></td></tr></table></td></tr></table></td></tr></table></td></tr></table></td></tr></table></td></tr></table></td></tr></table></td></tr></table></td></tr></table></td></tr></table></td></tr></table></td></tr></table></td></tr></table></td></tr></table></td></tr></table></td></tr></table></td></tr></table></td></tr></table></td></tr></table></td></tr></table></td></tr></table></td></tr></table></td></tr></table></td></tr></table></td></tr></table></td></tr></table></td></tr></table></td></tr></table></td></tr></table></td></tr></table></td></tr></table></td></tr></table></td></tr></table></td></tr></table></td></tr></table></td></tr></table></td></tr></table></td></tr></table></td></tr></table></td></tr></table></td></tr></table></td></tr></table></td></tr></table></td></tr></table></td></tr></table></td></tr></table></td></tr></table></td></tr></table></td></tr></table></td></tr></table></td></tr></table></td></tr></table></td></tr></table></td></tr></table></td></tr></table></td></tr></table></td></tr></table></td></tr></table> | | | | | | | | | | | | | | | | | | | | <table border="1" style="width: 100%; border-collapse: collapse; text-align: center;"> <tr> <td style="width: 10%;"></td> <td style="width: 10%;"></td> <td style="width: 10%;"></td> <td style="width: 10%;"></td> <td style="width: 10%;"></td> <td style="width: 10%;"></td> <td style="width: 10%;"></td> <td style="width: 10%;"></td> <td style="width: 10%;"></td> <td style="width: 10%;"></td> </tr> <tr> <td></td> <td></td> <td colspan="8" style="text-align: center;"> <table border="1" style="width: 100%; border-collapse: collapse; text-align: center;"> <tr> <td style="width: 10%;"></td> <td style="width: 10%;"></td> <td style="width: 10%;"></td> <td style="width: 10%;"></td> <td style="width: 10%;"></td> <td style="width: 10%;"></td> <td style="width: 10%;"></td> <td style="width: 10%;"></td> <td style="width: 10%;"></td> <td style="width: 10%;"></td> </tr> <tr> <td></td> <td></td> <td colspan="8" style="text-align: center;"> <table border="1" style="width: 100%; border-collapse: collapse; text-align: center;"> <tr> <td style="width: 10%;"></td> <td style="width: 10%;"></td> <td style="width: 10%;"></td> <td style="width: 10%;"></td> <td style="width: 10%;"></td> <td style="width: 10%;"></td> <td style="width: 10%;"></td> <td style="width: 10%;"></td> <td style="width: 10%;"></td> <td style="width: 10%;"></td> </tr> <tr> <td></td> <td></td> <td colspan="8" style="text-align: center;"> <table border="1" style="width: 100%; border-collapse: collapse; text-align: center;"> <tr> <td style="width: 10%;"></td> <td style="width: 10%;"></td> <td style="width: 10%;"></td> <td style="width: 10%;"></td> <td style="width: 10%;"></td> <td style="width: 10%;"></td> <td style="width: 10%;"></td> <td style="width: 10%;"></td> <td style="width: 10%;"></td> <td style="width: 10%;"></td> </tr> <tr> <td></td> <td></td> <td colspan="8" style="text-align: center;"> <table border="1" style="width: 100%; border-collapse: collapse; text-align: center;"> <tr> <td style="width: 10%;"></td> <td style="width: 10%;"></td> <td style="width: 10%;"></td> <td style="width: 10%;"></td> <td style="width: 10%;"></td> <td style="width: 10%;"></td> <td style="width: 10%;"></td> <td style="width: 10%;"></td> <td style="width: 10%;"></td> <td style="width: 10%;"></td> </tr> <tr> <td></td> <td></td> <td colspan="8" style="text-align: center;"> <table border="1" style="width: 100%; border-collapse: collapse; text-align: center;"> <tr> <td style="width: 10%;"></td> <td style="width: 10%;"></td> <td style="width: 10%;"></td> <td style="width: 10%;"></td> <td style="width: 10%;"></td> <td style="width: 10%;"></td> <td style="width: 10%;"></td> <td style="width: 10%;"></td> <td style="width: 10%;"></td> <td style="width: 10%;"></td> </tr> <tr> <td></td> <td></td> <td colspan="8" style="text-align: center;"> <table border="1" style="width: 100%; border-collapse: collapse; text-align: center;"> <tr> <td style="width: 10%;"></td> <td style="width: 10%;"></td> <td style="width: 10%;"></td> <td style="width: 10%;"></td> <td style="width: 10%;"></td> <td style="width: 10%;"></td> <td style="width: 10%;"></td> <td style="width: 10%;"></td> <td style="width: 10%;"></td> <td style="width: 10%;"></td> </tr> <tr> <td></td> <td></td> <td colspan="8" style="text-align: center;"> <table border="1" style="width: 100%; border-collapse: collapse; text-align: center;"> <tr> <td style="width: 10%;"></td> <td style="width: 10%;"></td> <td style="width: 10%;"></td> <td style="width: 10%;"></td> <td style="width: 10%;"></td> <td style="width: 10%;"></td> <td style="width: 10%;"></td> <td style="width: 10%;"></td> <td style="width: 10%;"></td> <td style="width: 10%;"></td> </tr> <tr> <td></td> <td></td> <td colspan="8" style="text-align: center;"> <table border="1" style="width: 100%; border-collapse: collapse; text-align: center;"> <tr> <td style="width: 10%;"></td> <td style="width: 10%;"></td> <td style="width: 10%;"></td> <td style="width: 10%;"></td> <td style="width: 10%;"></td> <td style="width: 10%;"></td> <td style="width: 10%;"></td> <td style="width: 10%;"></td> <td style="width: 10%;"></td> <td style="width: 10%;"></td> </tr> <tr> <td></td> <td></td> <td colspan="8" style="text-align: center;"> <table border="1" style="width: 100%; border-collapse: collapse; text-align: center;"> <tr> <td style="width: 10%;"></td> <td style="width: 10%;"></td> <td style="width: 10%;"></td> <td style="width: 10%;"></td> <td style="width: 10%;"></td> <td style="width: 10%;"></td> <td style="width: 10%;"></td> <td style="width: 10%;"></td> <td style="width: 10%;"></td> <td style="width: 10%;"></td> </tr> <tr> <td></td> <td></td> <td colspan="8" style="text-align: center;"> <table border="1" style="width: 100%; border-collapse: collapse; text-align: center;"> <tr> <td style="width: 10%;"></td> <td style="width: 10%;"></td> <td style="width: 10%;"></td> <td style="width: 10%;"></td> <td style="width: 10%;"></td> <td style="width: 10%;"></td> <td style="width: 10%;"></td> <td style="width: 10%;"></td> <td style="width: 10%;"></td> <td style="width: 10%;"></td> </tr> <tr> <td></td> <td></td> <td colspan="8" style="text-align: center;"> <table border="1" style="width: 100%; border-collapse: collapse; text-align: center;"> <tr> <td style="width: 10%;"></td> <td style="width: 10%;"></td> <td style="width: 10%;"></td> <td style="width: 10%;"></td> <td style="width: 10%;"></td> <td style="width: 10%;"></td> <td style="width: 10%;"></td> <td style="width: 10%;"></td> <td style="width: 10%;"></td> <td style="width: 10%;"></td> </tr> <tr> <td></td> <td></td> <td colspan="8" style="text-align: center;"> <table border="1" style="width: 100%; border-collapse: collapse; text-align: center;"> <tr> <td style="width: 10%;"></td> <td style="width: 10%;"></td> <td style="width: 10%;"></td> <td style="width: 10%;"></td> <td style="width: 10%;"></td> <td style="width: 10%;"></td> <td style="width: 10%;"></td> <td style="width: 10%;"></td> <td style="width: 10%;"></td> <td style="width: 10%;"></td> </tr> <tr> <td></td> <td></td> <td colspan="8" style="text-align: center;"> <table border="1" style="width: 100%; border-collapse: collapse; text-align: center;"> <tr> <td style="width: 10%;"></td> <td style="width: 10%;"></td> <td style="width: 10%;"></td> <td style="width: 10%;"></td> <td style="width: 10%;"></td> <td style="width: 10%;"></td> <td style="width: 10%;"></td> <td style="width: 10%;"></td> <td style="width: 10%;"></td> <td style="width: 10%;"></td> </tr> <tr> <td></td> <td></td> <td colspan="8" style="text-align: center;"> <table border="1" style="width: 100%; border-collapse: collapse; text-align: center;"> <tr> <td style="width: 10%;"></td> <td style="width: 10%;"></td> <td style="width: 10%;"></td> <td style="width: 10%;"></td> <td style="width: 10%;"></td> <td style="width: 10%;"></td> <td style="width: 10%;"></td> <td style="width: 10%;"></td> <td style="width: 10%;"></td> <td style="width: 10%;"></td> </tr> <tr> <td></td> <td></td> <td colspan="8" style="text-align: center;"> <table border="1" style="width: 100%; border-collapse: collapse; text-align: center;"> <tr> <td style="width: 10%;"></td> <td style="width: 10%;"></td> <td style="width: 10%;"></td> <td style="width: 10%;"></td> <td style="width: 10%;"></td> <td style="width: 10%;"></td> <td style="width: 10%;"></td> <td style="width: 10%;"></td> <td style="width: 10%;"></td> <td
style="width: 10%;"></td> </tr> <tr> <td></td> <td></td> <td colspan="8" style="text-align: center;"> <table border="1" style="width: 100%; border-collapse: collapse; text-align: center;"> <tr> <td style="width: 10%;"></td> <td style="width: 10%;"></td> <td style="width: 10%;"></td> <td style="width: 10%;"></td> <td style="width: 10%;"></td> <td style="width: 10%;"></td> <td style="width: 10%;"></td> <td style="width: 10%;"></td> <td style="width: 10%;"></td> <td style="width: 10%;"></td> </tr> <tr> <td></td> <td></td> <td colspan="8" style="text-align: center;"> <table border="1" style="width: 100%; border-collapse: collapse; text-align: center;"> <tr> <td style="width: 10%;"></td> <td style="width: 10%;"></td> <td style="width: 10%;"></td> <td style="width: 10%;"></td> <td style="width: 10%;"></td> <td style="width: 10%;"></td> <td style="width: 10%;"></td> <td style="width: 10%;"></td> <td style="width: 10%;"></td> <td style="width: 10%;"></td> </tr> <tr> <td></td> <td></td> <td colspan="8" style="text-align: center;"> <table border="1" style="width: 100%; border-collapse: collapse; text-align: center;"> <tr> <td style="width: 10%;"></td> <td style="width: 10%;"></td> <td style="width: 10%;"></td> <td style="width: 10%;"></td> <td style="width: 10%;"></td> <td style="width: 10%;"></td> <td style="width: 10%;"></td> <td style="width: 10%;"></td> <td style="width: 10%;"></td> <td style="width: 10%;"></td> </tr> <tr> <td></td> <td></td> <td colspan="8" style="text-align: center;"> <table border="1" style="width: 100%; border-collapse: collapse; text-align: center;"> <tr> <td style="width: 10%;"></td> <td style="width: 10%;"></td> <td style="width: 10%;"></td> <td style="width: 10%;"></td> <td style="width: 10%;"></td> <td style="width: 10%;"></td> <td style="width: 10%;"></td> <td style="width: 10%;"></td> <td style="width: 10%;"></td> <td style="width: 10%;"></td> </tr> <tr> <td></td> <td></td> <td colspan="8" style="text-align: center;"> <table border="1" style="width: 100%; border-collapse: collapse; text-align: center;"> <tr> <td style="width: 10%;"></td> <td style="width: 10%;"></td> <td style="width: 10%;"></td> <td style="width: 10%;"></td> <td style="width: 10%;"></td> <td style="width: 10%;"></td> <td style="width: 10%;"></td> <td style="width: 10%;"></td> <td style="width: 10%;"></td> <td style="width: 10%;"></td> </tr> <tr> <td></td> <td></td> <td colspan="8" style="text-align: center;"> <table border="1" style="width: 100%; border-collapse: collapse; text-align: center;"> <tr> <td style="width: 10%;"></td> <td style="width: 10%;"></td> <td style="width: 10%;"></td> <td style="width: 10%;"></td> <td style="width: 10%;"></td> <td style="width: 10%;"></td> <td style="width: 10%;"></td> <td style="width: 10%;"></td> <td style="width: 10%;"></td> <td style="width: 10%;"></td> </tr> <tr> <td></td> <td></td> <td colspan="8" style="text-align: center;"> <table border="1" style="width: 100%; border-collapse: collapse; text-align: center;"> <tr> <td style="width: 10%;"></td> <td style="width: 10%;"></td> <td style="width: 10%;"></td> <td style="width: 10%;"></td> <td style="width: 10%;"></td> <td style="width: 10%;"></td> <td style="width: 10%;"></td> <td style="width: 10%;"></td> <td style="width: 10%;"></td> <td style="width: 10%;"></td> </tr> <tr> <td></td> <td></td> <td colspan="8" style="text-align: center;"> <table border="1" style="width: 100%; border-collapse: collapse; text-align: center;"> <tr> <td style="width: 10%;"></td> <td style="width: 10%;"></td> <td style="width: 10%;"></td> <td style="width: 10%;"></td> <td style="width: 10%;"></td> <td style="width: 10%;"></td> <td style="width: 10%;"></td> <td style="width: 10%;"></td> <td style="width: 10%;"></td> <td style="width: 10%;"></td> </tr> <tr> <td></td> <td></td> <td colspan="8" style="text-align: center;"> <table border="1" style="width: 100%; border-collapse: collapse; text-align: center;"> <tr> <td style="width: 10%;"></td> <td style="width: 10%;"></td> <td style="width: 10%;"></td> <td style="width: 10%;"></td> <td style="width: 10%;"></td> <td style="width: 10%;"></td> <td style="width: 10%;"></td> <td style="width: 10%;"></td> <td style="width: 10%;"></td> <td style="width: 10%;"></td> </tr> <tr> <td></td> <td></td> <td colspan="8" style="text-align: center;"> <table border="1" style="width: 100%; border-collapse: collapse; text-align: center;"> <tr> <td style="width: 10%;"></td> <td style="width: 10%;"></td> <td style="width: 10%;"></td> <td style="width: 10%;"></td> <td style="width: 10%;"></td> <td style="width: 10%;"></td> <td style="width: 10%;"></td> <td style="width: 10%;"></td> <td style="width: 10%;"></td> <td style="width: 10%;"></td> </tr> <tr> <td></td> <td></td> <td colspan="8" style="text-align: center;"> <table border="1" style="width: 100%; border-collapse: collapse; text-align: center;"> <tr> <td style="width: 10%;"></td> <td style="width: 10%;"></td> <td style="width: 10%;"></td> <td style="width: 10%;"></td> <td style="width: 10%;"></td> <td style="width: 10%;"></td> <td style="width: 10%;"></td> <td style="width: 10%;"></td> <td style="width: 10%;"></td> <td style="width: 10%;"></td> </tr> <tr> <td></td> <td></td> <td colspan="8" style="text-align: center;"> <table border="1" style="width: 100%; border-collapse: collapse; text-align: center;"> <tr> <td style="width: 10%;"></td> <td style="width: 10%;"></td> <td style="width: 10%;"></td> <td style="width: 10%;"></td> <td style="width: 10%;"></td> <td style="width: 10%;"></td> <td style="width: 10%;"></td> <td style="width: 10%;"></td> <td style="width: 10%;"></td> <td style="width: 10%;"></td> </tr> <tr> <td></td> <td></td> <td colspan="8" style="text-align: center;"> <table border="1" style="width: 100%; border-collapse: collapse; text-align: center;"> <tr> <td style="width: 10%;"></td> <td style="width: 10%;"></td> <td style="width: 10%;"></td> <td style="width: 10%;"></td> <td style="width: 10%;"></td> <td style="width: 10%;"></td> <td style="width: 10%;"></td> <td style="width: 10%;"></td> <td style="width: 10%;"></td> <td style="width: 10%;"></td> </tr> <tr> <td></td> <td></td> <td colspan="8" style="text-align: center;"> <table border="1" style="width: 100%; border-collapse: collapse; text-align: center;"> <tr> <td style="width: 10%;"></td> <td style="width: 10%;"></td> <td style="width: 10%;"></td> <td style="width: 10%;"></td> <td style="width: 10%;"></td> <td style="width: 10%;"></td> <td style="width: 10%;"></td> <td style="width: 10%;"></td> <td style="width: 10%;"></td> <td style="width: 10%;"></td> </tr> <tr> <td></td> <td></td> <td colspan="8" style="text-align: center;"> <table border="1" style="width: 100%; border-collapse: collapse; text-align: center;"> <tr> <td style="width: 10%;"></td> <td style="width: 10%;"></td> <td style="width: 10%;"></td> <td style="width: 10%;"></td> <td style="width: 10%;"></td> <td style="width: 10%;"></td> <td style="width: 10%;"></td> <td style="width: 10%;"></td> <td style="width: 10%;"></td> <td style="width: 10%;"></td> </tr> <tr> <td></td> <td></td> <td colspan="8" style="text-align: center;"> <table border="1" style="width: 100%; border-collapse: collapse; text-align: center;"> <tr> <td style="width: 10%;"></td> <td style="width: 10%;"></td> <td style="width: 10%;"></td> <td style="width: 10%;"></td> <td style="width: 10%;"></td> <td style="width: 10%;"></td> <td style="width: 10%;"></td> <td style="width: 10%;"></td> <td style="width: 10%;"></td> <td style="width: 10%;"></td> </tr> <tr> <td></td> <td></td> <td colspan="8" style="text-align: center;"> <table border="1" style="width: 100%; border-collapse: collapse; text-align: center;"> <tr> <td style="width: 10%;"></td> <td style="width: 10%;"></td> <td style="width: 10%;"></td> <td style="width: 10%;"></td> <td style="width: 10%;"></td> <td style="width: 10%;"></td> <td style="width: 10%;"></td> <td style="width: 10%;"></td> <td style="width: 10%;"></td> <td style="width: 10%;"></td> </tr> <tr> <td></td> <td></td> <td colspan="8" style="text-align: center;"> <table border="1" style="width: 100%; border-collapse: collapse; text-align: center;"> <tr> <td style="width: 10%;"></td> <td style="width: 10%;"></td> <td style="width: 10%;"></td> <td style="width: 10%;"></td> <td style="width: 10%;"></td> <td style="width: 10%;"></td> <td style="width: 10%;"></td> <td style="width: 10%;"></td> <td style="width: 10%;"></td> <td style="width: 10%;"></td> </tr> <tr> <td></td> <td></td> <td colspan="8" style="text-align: center;"> <table border="1" style="width: 100%; border-collapse: collapse; text-align: center;"> <tr> <td style="width: 10%;"></td> <td style="width: 10%;"></td> <td style="width: 10%;"></td> <td style="width: 10%;"></td> <td style="width: 10%;"></td> <td style="width: 10%;"></td> <td style="width: 10%;"></td> <td style="width: 10%;"></td> <td style="width: 10%;"></td> <td style="width: 10%;"></td> </tr> <tr> <td></td> <td></td> <td colspan="8" style="text-align: center;"> <table border="1" style="width: 100%; border-collapse: collapse; text-align: center;"> <tr> <td style="width: 10%;"></td> <td style="width: 10%;"></td> <td style="width: 10%;"></td> <td style="width: 10%;"></td> <td style="width: 10%;"></td> <td style="width: 10%;"></td> <td style="width: 10%;"></td> <td style="width: 10%;"></td> <td style="width: 10%;"></td> <td style="width: 10%;"></td> </tr> <tr> <td></td> <td></td> <td colspan="8" style="text-align: center;"> <table border="1" style="width: 100%; border-collapse: collapse; text-align: center;"> <tr> <td style="width: 10%;"></td> <td style="width: 10%;"></td> <td style="width: 10%;"></td> <td style="width: 10%;"></td> <td style="width: 10%;"></td> <td style="width: 10%;"></td> <td style="width: 10%;"></td> <td style="width: 10%;"></td> <td style="width: 10%;"></td> <td style="width: 10%;"></td> </tr> <tr> <td></td> <td></td> <td colspan="8" style="text-align: center;"> <table border="1" style="width: 100%; border-collapse: collapse;
text-align: center;"> <tr> <td style="width: 10%;"></td> <td style="width: 10%;"></td> <td style="width: 10%;"></td> <td style="width: 10%;"></td> <td style="width: 10%;"></td> <td style="width: 10%;"></td> <td style="width: 10%;"></td> <td style="width: 10%;"></td> <td style="width: 10%;"></td> <td style="width: 10%;"></td> </tr> <tr> <td></td> <td></td> <td colspan="8" style="text-align: center;"> <table border="1" style="width: 100%; border-collapse: collapse; text-align: center;"> <tr> <td style="width: 10%;"></td> <td style="width: 10%;"></td> <td style="width: 10%;"></td> <td style="width: 10%;"></td> <td style="width: 10%;"></td> <td style="width: 10%;"></td> <td style="width: 10%;"></td> <td style="width: 10%;"></td> <td style="width: 10%;"></td> <td style="width: 10%;"></td> </tr> <tr> <td></td> <td></td> <td colspan="8" style="text-align: center;"> <table border="1" style="width: 100%; border-collapse: collapse; text-align: center;"> <tr> <td style="width: 10%;"></td> <td style="width: 10%;"></td> <td style="width: 10%;"></td> <td style="width: 10%;"></td> <td style="width: 10%;"></td> <td style="width: 10%;"></td> <td style="width: 10%;"></td> <td style="width: 10%;"></td> <td style="width: 10%;"></td> <td style="width: 10%;"></td> </tr> <tr> <td></td> <td></td> <td colspan="8" style="text-align: center;"> <table border="1" style="width: 100%; border-collapse: collapse; text-align: center;"> <tr> <td style="width: 10%;"></td> <td style="width: 10%;"></td> <td style="width: 10%;"></td> <td style="width: 10%;"></td> <td style="width: 10%;"></td> <td style="width: 10%;"></td> <td style="width: 10%;"></td> <td style="width: 10%;"></td> <td style="width: 10%;"></td> <td style="width: 10%;"></td> </tr> <tr> <td></td> <td></td> <td colspan="8" style="text-align: center;"> <table border="1" style="width: 100%; border-collapse: collapse; text-align: center;"> <tr> <td style="width: 10%;"></td> <td style="width: 10%;"></td> <td style="width: 10%;"></td> <td style="width: 10%;"></td> <td style="width: 10%;"></td> <td style="width: 10%;"></td> <td style="width: 10%;"></td> <td style="width: 10%;"></td> <td style="width: 10%;"></td> <td style="width: 10%;"></td> </tr> <tr> <td></td> <td></td> <td colspan="8" style="text-align: center;"> <table border="1" style="width: 100%; border-collapse: collapse; text-align: center;"> <tr> <td style="width: 10%;"></td> <td style="width: 10%;"></td> <td style="width: 10%;"></td> <td style="width: 10%;"></td> <td style="width: 10%;"></td> <td style="width: 10%;"></td> <td style="width: 10%;"></td> <td style="width: 10%;"></td> <td style="width: 10%;"></td> <td style="width: 10%;"></td> </tr> <tr> <td></td> <td></td> <td colspan="8" style="text-align: center;"> <table border="1" style="width: 100%; border-collapse: collapse; text-align: center;"> <tr> <td style="width: 10%;"></td> <td style="width: 10%;"></td> <td style="width: 10%;"></td> <td style="width: 10%;"></td> <td style="width: 10%;"></td> <td style="width: 10%;"></td> <td style="width: 10%;"></td> <td style="width: 10%;"></td> <td style="width: 10%;"></td> <td style="width: 10%;"></td> </tr> <tr> <td></td> <td></td> <td colspan="8" style="text-align: center;"> <table border="1" style="width: 100%; border-collapse: collapse; text-align: center;"> <tr> <td style="width: 10%;"></td> <td style="width: 10%;"></td> <td style="width: 10%;"></td> <td style="width: 10%;"></td> <td style="width: 10%;"></td> <td style="width: 10%;"></td> <td style="width: 10%;"></td> <td style="width: 10%;"></td> <td style="width: 10%;"></td> <td style="width: 10%;"></td> </tr> <tr> <td></td> <td></td> <td colspan="8" style="text-align: center;"> <table border="1" style="width: 100%; border-collapse: collapse; text-align: center;"> <tr> <td style="width: 10%;"></td> <td style="width: 10%;"></td> <td style="width: 10%;"></td> <td style="width: 10%;"></td> <td style="width: 10%;"></td> <td style="width: 10%;"></td> <td style="width: 10%;"></td> <td style="width: 10%;"></td> <td style="width: 10%;"></td> <td style="width: 10%;"></td> </tr> <tr> <td></td> <td></td> <td colspan="8" style="text-align: center;"> <table border="1" style="width: 100%; border-collapse: collapse; text-align: center;"> <tr> <td style="width: 10%;"></td> <td style="width: 10%;"></td> <td style="width: 10%;"></td> <td style="width: 10%;"></td> <td style="width: 10%;"></td> <td style="width: 10%;"></td> <td style="width: 10%;"></td> <td style="width: 10%;"></td> <td style="width: 10%;"></td> <td style="width: 10%;"></td> </tr> <tr> <td></td> <td></td> <td colspan="8" style="text-align: center;"> <table border="1" style="width: 100%; border-collapse: collapse; text-align: center;"> <tr> <td style="width: 10%;"></td> <td style="width: 10%;"></td> <td style="width: 10%;"></td> <td style="width: 10%;"></td> <td style="width: 10%;"></td> <td style="width: 10%;"></td> <td style="width: 10%;"></td> <td style="width: 10%;"></td> <td style="width: 10%;"></td> <td style="width: 10%;"></td> </tr> <tr> <td></td> <td></td> <td colspan="8" style="text-align: center;"> <table border="1" style="width: 100%; border-collapse: collapse; text-align: center;"> <tr> <td style="width: 10%;"></td> <td style="width: 10%;"></td> <td style="width: 10%;"></td> <td style="width: 10%;"></td> <td style="width: 10%;"></td> <td style="width: 10%;"></td> <td style="width: 10%;"></td> <td style="width: 10%;"></td> <td style="width: 10%;"></td> <td style="width: 10%;"></td> </tr> <tr> <td></td> <td></td> <td colspan="8" style="text-align: center;"> <table border="1" style="width: 100%; border-collapse: collapse; text-align: center;"> <tr> <td style="width: 10%;"></td> <td style="width: 10%;"></td> <td style="width: 10%;"></td> <td style="width: 10%;"></td> <td style="width: 10%;"></td> <td style="width: 10%;"></td> <td style="width: 10%;"></td> <td style="width: 10%;"></td> <td style="width: 10%;"></td> <td style="width: 10%;"></td> </tr> <tr> <td></td> <td></td> <td colspan="8" style="text-align: center;"> <table border="1" style="width: 100%; border-collapse: collapse; text-align: center;"> <tr> <td style="width: 10%;"></td> <td style="width: 10%;"></td> <td style="width: 10%;"></td> <td style="width: 10%;"></td> <td style="width: 10%;"></td> <td style="width: 10%;"></td> <td style="width: 10%;"></td> <td style="width: 10%;"></td> <td style="width: 10%;"></td> <td style="width: 10%;"></td> </tr> <tr> <td></td> <td></td> <td colspan="8" style="text-align: center;"> <table border="1" style="width: 100%; border-collapse: collapse; text-align: center;"> <tr> <td style="width: 10%;"></td> <td style="width: 10%;"></td> <td style="width: 10%;"></td> <td style="width: 10%;"></td> <td style="width: 10%;"></td> <td style="width: 10%;"></td> <td style="width: 10%;"></td> <td style="width: 10%;"></td> <td style="width: 10%;"></td> <td style="width: 10%;"></td> </tr> <tr> <td></td> <td></td> <td colspan="8" style="text-align: center;"> <table border="1" style="width: 100%; border-collapse: collapse; text-align: center;"> <tr> <td style="width: 10%;"></td> <td style="width: 10%;"></td> <td style="width: 10%;"></td> <td style="width: 10%;"></td> <td style="width: 10%;"></td> <td style="width: 10%;"></td> <td style="width: 10%;"></td> <td style="width: 10%;"></td> <td style="width: 10%;"></td> <td style="width: 10%;"></td> </tr> <tr> <td></td> <td></td> <td colspan="8" style="text-align: center;"> <table border="1" style="width: 100%; border-collapse: collapse; text-align: center;"> <tr> <td style="width: 10%;"></td> <td style="width: 10%;"></td> <td style="width: 10%;"></td> <td style="width: 10%;"></td> <td style="width: 10%;"></td> <td style="width: 10%;"></td> <td style="width: 10%;"></td> <td style="width: 10%;"></td> <td style="width: 10%;"></td> <td style="width: 10%;"></td> </tr> <tr> <td></td> <td></td> <td colspan="8" style="text-align: center;"> <table border="1" style="width: 100%; border-collapse: collapse; text-align: center;"> <tr> <td style="width: 10%;"></td> <td style="width: 10%;"></td> <td style="width: 10%;"></td> <td style="width: 10%;"></td> <td style="width: 10%;"></td> <td style="width: 10%;"></td> <td style="width: 10%;"></td> <td style="width: 10%;"></td> <td style="width: 10%;"></td> <td style="width: 10%;"></td> </tr> <tr> <td></td> <td></td> <td colspan="8" style="text-align: center;"> <table border="1" style="width: 100%; border-collapse: collapse; text-align: center;"> <tr> <td style="width: 10%;"></td> <td style="width: 10%;"></td> <td style="width: 10%;"></td> <td style="width: 10%;"></td> <td style="width: 10%;"></td> <td style="width: 10%;"></td> <td style="width: 10%;"></td> <td style="width: 10%;"></td> <td style="width: 10%;"></td> <td style="width: 10%;"></td> </tr> <tr> <td></td> <td></td> <td colspan="8" style="text-align: center;"> <table border="1" style="width: 100%; border-collapse: collapse; text-align: center;"> <tr> <td style="width: 10%;"></td> <td style="width: 10%;"></td> <td style="width: 10%;"></td> <td style="width: 10%;"></td> <td style="width: 10%;"></td> <td style="width: 10%;"></td> <td style="width: 10%;"></td> <td style="width: 10%;"></td> <td style="width: 10%;"></td> <td style="width: 10%;"></td> </tr> <tr> <td></td> <td></td> <td colspan="8" style="text-align: center;"> <table border="1" style="width: 100%; border-collapse: collapse; text-align: center;"> <tr> <td style="width: 10%;"></td> <td style="width: 10%;"></td> <td style="width: 10%;"></td> <td style="width: 10%;"></td> <td style="width: 10%;"></td> <td style="width: 10%;"></td> <td style="width: 10%;"></td> <td style="width: 10%;"></td> <td style="width: 10%;"></td> <td style="width: 10%;"></td> </tr> <tr> <td></td> <td></td> <td colspan="8" style="text-align: center;"> <table border="1" style="width: 100%; border-collapse: collapse; text-align: center;"> <tr> <td style="width: 10%;"></td> <td style="width: 10%;"></td> <td style="width: 10%;"></td> <td style="width: 10%;"></td> <td style="width:
10%;"></td> <td style="width: 10%;"></td> <td style="width: 10%;"></td> <td style="width: 10%;"></td> <td style="width: 10%;"></td> <td style="width: 10%;"></td> </tr> <tr> <td></td> <td></td> <td colspan="8" style="text-align: center;"> <table border="1" style="width: 100%; border-collapse: collapse; text-align: center;"> <tr> </tr></table></td></tr></table></td></tr></table></td></tr></table></td></tr></table></td></tr></table></td></tr></table></td></tr></table></td></tr></table></td></tr></table></td></tr></table></td></tr></table></td></tr></table></td></tr></table></td></tr></table></td></tr></table></td></tr></table></td></tr></table></td></tr></table></td></tr></table></td></tr></table></td></tr></table></td></tr></table></td></tr></table></td></tr></table></td></tr></table></td></tr></table></td></tr></table></td></tr></table></td></tr></table></td></tr></table></td></tr></table></td></tr></table></td></tr></table></td></tr></table></td></tr></table></td></tr></table></td></tr></table></td></tr></table></td></tr></table></td></tr></table></td></tr></table></td></tr></table></td></tr></table></td></tr></table></td></tr></table></td></tr></table></td></tr></table></td></tr></table></td></tr></table></td></tr></table></td></tr></table></td></tr></table></td></tr></table></td></tr></table></td></tr></table></td></tr></table></td></tr></table></td></tr></table></td></tr></table> | | | | | | | | | | | | | | | | | | | | <table border="1" style="width: 100%; border-collapse: collapse; text-align: center;"> <tr> <td style="width: 10%;"></td> <td style="width: 10%;"></td> <td style="width: 10%;"></td> <td style="width: 10%;"></td> <td style="width: 10%;"></td> <td style="width: 10%;"></td> <td style="width: 10%;"></td> <td style="width: 10%;"></td> <td style="width: 10%;"></td> <td style="width: 10%;"></td> </tr> <tr> <td></td> <td></td> <td colspan="8" style="text-align: center;"> <table border="1" style="width: 100%; border-collapse: collapse; text-align: center;"> <tr> <td style="width: 10%;"></td> <td style="width: 10%;"></td> <td style="width: 10%;"></td> <td style="width: 10%;"></td> <td style="width: 10%;"></td> <td style="width: 10%;"></td> <td style="width: 10%;"></td> <td style="width: 10%;"></td> <td style="width: 10%;"></td> <td style="width: 10%;"></td> </tr> <tr> <td></td> <td></td> <td colspan="8" style="text-align: center;"> <table border="1" style="width: 100%; border-collapse: collapse; text-align: center;"> <tr> <td style="width: 10%;"></td> <td style="width: 10%;"></td> <td style="width: 10%;"></td> <td style="width: 10%;"></td> <td style="width: 10%;"></td> <td style="width: 10%;"></td> <td style="width: 10%;"></td> <td style="width: 10%;"></td> <td style="width: 10%;"></td> <td style="width: 10%;"></td> </tr> <tr> <td></td> <td></td> <td colspan="8" style="text-align: center;"> <table border="1" style="width: 100%; border-collapse: collapse; text-align: center;"> <tr> <td style="width: 10%;"></td> <td style="width: 10%;"></td> <td style="width: 10%;"></td> <td style="width: 10%;"></td> <td style="width: 10%;"></td> <td style="width: 10%;"></td> <td style="width: 10%;"></td> <td style="width: 10%;"></td> <td style="width: 10%;"></td> <td style="width: 10%;"></td> </tr> <tr> <td></td> <td></td> <td colspan="8" style="text-align: center;"> <table border="1" style="width: 100%; border-collapse: collapse; text-align: center;"> <tr> <td style="width: 10%;"></td> <td style="width: 10%;"></td> <td style="width: 10%;"></td> <td style="width: 10%;"></td> <td style="width: 10%;"></td> <td style="width: 10%;"></td> <td style="width: 10%;"></td> <td style="width: 10%;"></td> <td style="width: 10%;"></td> <td style="width: 10%;"></td> </tr> <tr> <td></td> <td></td> <td colspan="8" style="text-align: center;"> <table border="1" style="width: 100%; border-collapse: collapse; text-align: center;"> <tr> <td style="width: 10%;"></td> <td style="width: 10%;"></td> <td style="width: 10%;"></td> <td style="width: 10%;"></td> <td style="width: 10%;"></td> <td style="width: 10%;"></td> <td style="width: 10%;"></td> <td style="width: 10%;"></td> <td style="width: 10%;"></td> <td style="width: 10%;"></td> </tr> <tr> <td></td> <td></td> <td colspan="8" style="text-align: center;"> <table border="1" style="width: 100%; border-collapse: collapse; text-align: center;"> <tr> <td style="width: 10%;"></td> <td style="width: 10%;"></td> <td style="width: 10%;"></td> <td style="width: 10%;"></td> <td style="width: 10%;"></td> <td style="width: 10%;"></td> <td style="width: 10%;"></td> <td style="width: 10%;"></td> <td style="width: 10%;"></td> <td style="width: 10%;"></td> </tr> <tr> <td></td> <td></td> <td colspan="8" style="text-align: center;"> <table border="1" style="width: 100%; border-collapse: collapse; text-align: center;"> <tr> <td style="width: 10%;"></td> <td style="width: 10%;"></td> <td style="width: 10%;"></td> <td style="width: 10%;"></td> <td style="width: 10%;"></td> <td style="width: 10%;"></td> <td style="width: 10%;"></td> <td style="width: 10%;"></td> <td style="width: 10%;"></td> <td style="width: 10%;"></td> </tr> <tr> <td></td> <td></td> <td colspan="8" style="text-align: center;"> <table border="1" style="width: 100%; border-collapse: collapse; text-align: center;"> <tr> <td style="width: 10%;"></td> <td style="width: 10%;"></td> <td style="width: 10%;"></td> <td style="width: 10%;"></td> <td style="width: 10%;"></td> <td style="width: 10%;"></td> <td style="width: 10%;"></td> <td style="width: 10%;"></td> <td style="width: 10%;"></td> <td style="width: 10%;"></td> </tr> <tr> <td></td> <td></td> <td colspan="8" style="text-align: center;"> <table border="1" style="width: 100%; border-collapse: collapse; text-align: center;"> <tr> <td style="width: 10%;"></td> <td style="width: 10%;"></td> <td style="width: 10%;"></td> <td style="width: 10%;"></td> <td style="width: 10%;"></td> <td style="width: 10%;"></td> <td style="width: 10%;"></td> <td style="width: 10%;"></td> <td style="width: 10%;"></td> <td style="width: 10%;"></td> </tr> <tr> <td></td> <td></td> <td colspan="8" style="text-align: center;"> <table border="1" style="width: 100%; border-collapse: collapse; text-align: center;"> <tr> <td style="width: 10%;"></td> <td style="width: 10%;"></td> <td style="width: 10%;"></td> <td style="width: 10%;"></td> <td style="width: 10%;"></td> <td style="width: 10%;"></td> <td style="width: 10%;"></td> <td style="width: 10%;"></td> <td style="width: 10%;"></td> <td style="width: 10%;"></td> </tr> <tr> <td></td> <td></td> <td colspan="8" style="text-align: center;"> <table border="1" style="width: 100%; border-collapse: collapse; text-align: center;"> <tr> <td style="width: 10%;"></td> <td style="width: 10%;"></td> <td style="width: 10%;"></td> <td style="width: 10%;"></td> <td style="width: 10%;"></td> <td style="width: 10%;"></td> <td style="width: 10%;"></td> <td style="width: 10%;"></td> <td style="width: 10%;"></td> <td style="width: 10%;"></td> </tr> <tr> <td></td> <td></td> <td colspan="8" style="text-align: center;"> <table border="1" style="width: 100%; border-collapse: collapse; text-align: center;"> <tr> <td style="width: 10%;"></td> <td style="width: 10%;"></td> <td style="width: 10%;"></td> <td style="width: 10%;"></td> <td style="width: 10%;"></td> <td style="width: 10%;"></td> <td style="width: 10%;"></td> <td style="width: 10%;"></td> <td style="width: 10%;"></td> <td style="width: 10%;"></td> </tr> <tr> <td></td> <td></td> <td colspan="8" style="text-align: center;"> <table border="1" style="width: 100%; border-collapse: collapse; text-align: center;"> <tr> <td style="width: 10%;"></td> <td style="width: 10%;"></td> <td style="width: 10%;"></td> <td style="width: 10%;"></td> <td style="width: 10%;"></td> <td style="width: 10%;"></td> <td style="width: 10%;"></td> <td style="width: 10%;"></td> <td style="width: 10%;"></td> <td style="width: 10%;"></td> </tr> <tr> <td></td> <td></td> <td colspan="8" style="text-align: center;"> <table border="1" style="width: 100%; border-collapse: collapse; text-align: center;"> <tr> <td style="width: 10%;"></td> <td style="width: 10%;"></td> <td style="width: 10%;"></td> <td style="width: 10%;"></td> <td style="width: 10%;"></td> <td style="width: 10%;"></td> <td style="width: 10%;"></td> <td style="width: 10%;"></td> <td style="width: 10%;"></td> <td style="width: 10%;"></td> </tr> <tr> <td></td> <td></td> <td colspan="8" style="text-align: center;"> <table border="1" style="width: 100%; border-collapse:
collapse; text-align: center;"> <tr> <td style="width: 10%;"></td> <td style="width: 10%;"></td> <td style="width: 10%;"></td> <td style="width: 10%;"></td> <td style="width: 10%;"></td> <td style="width: 10%;"></td> <td style="width: 10%;"></td> <td style="width: 10%;"></td> <td style="width: 10%;"></td> <td style="width: 10%;"></td> </tr> <tr> <td></td> <td></td> <td colspan="8" style="text-align: center;"> <table border="1" style="width: 100%; border-collapse: collapse; text-align: center;"> <tr> <td style="width: 10%;"></td> <td style="width: 10%;"></td> <td style="width: 10%;"></td> <td style="width: 10%;"></td> <td style="width: 10%;"></td> <td style="width: 10%;"></td> <td style="width: 10%;"></td> <td style="width: 10%;"></td> <td style="width: 10%;"></td> <td style="width: 10%;"></td> </tr> <tr> <td></td> <td></td> <td colspan="8" style="text-align: center;"> <table border="1" style="width: 100%; border-collapse: collapse; text-align: center;"> <tr> <td style="width: 10%;"></td> <td style="width: 10%;"></td> <td style="width: 10%;"></td> <td style="width: 10%;"></td> <td style="width: 10%;"></td> <td style="width: 10%;"></td> <td style="width: 10%;"></td> <td style="width: 10%;"></td> <td style="width: 10%;"></td> <td style="width: 10%;"></td> </tr> <tr> <td></td> <td></td> <td colspan="8" style="text-align: center;"> <table border="1" style="width: 100%; border-collapse: collapse; text-align: center;"> <tr> <td style="width: 10%;"></td> <td style="width: 10%;"></td> <td style="width: 10%;"></td> <td style="width: 10%;"></td> <td style="width: 10%;"></td> <td style="width: 10%;"></td> <td style="width: 10%;"></td> <td style="width: 10%;"></td> <td style="width: 10%;"></td> <td style="width: 10%;"></td> </tr> <tr> <td></td> <td></td> <td colspan="8" style="text-align: center;"> <table border="1" style="width: 100%; border-collapse: collapse; text-align: center;"> <tr> <td style="width: 10%;"></td> <td style="width: 10%;"></td> <td style="width: 10%;"></td> <td style="width: 10%;"></td> <td style="width: 10%;"></td> <td style="width: 10%;"></td> <td style="width: 10%;"></td> <td style="width: 10%;"></td> <td style="width: 10%;"></td> <td style="width: 10%;"></td> </tr> <tr> <td></td> <td></td> <td colspan="8" style="text-align: center;"> <table border="1" style="width: 100%; border-collapse: collapse; text-align: center;"> <tr> <td style="width: 10%;"></td> <td style="width: 10%;"></td> <td style="width: 10%;"></td> <td style="width: 10%;"></td> <td style="width: 10%;"></td> <td style="width: 10%;"></td> <td style="width: 10%;"></td> <td style="width: 10%;"></td> <td style="width: 10%;"></td> <td style="width: 10%;"></td> </tr> <tr> <td></td> <td></td> <td colspan="8" style="text-align: center;"> <table border="1" style="width: 100%; border-collapse: collapse; text-align: center;"> <tr> <td style="width: 10%;"></td> <td style="width: 10%;"></td> <td style="width: 10%;"></td> <td style="width: 10%;"></td> <td style="width: 10%;"></td> <td style="width: 10%;"></td> <td style="width: 10%;"></td> <td style="width: 10%;"></td> <td style="width: 10%;"></td> <td style="width: 10%;"></td> </tr> <tr> <td></td> <td></td> <td colspan="8" style="text-align: center;"> <table border="1" style="width: 100%; border-collapse: collapse; text-align: center;"> <tr> <td style="width: 10%;"></td> <td style="width: 10%;"></td> <td style="width: 10%;"></td> <td style="width: 10%;"></td> <td style="width: 10%;"></td> <td style="width: 10%;"></td> <td style="width: 10%;"></td> <td style="width: 10%;"></td> <td style="width: 10%;"></td> <td style="width: 10%;"></td> </tr> <tr> <td></td> <td></td> <td colspan="8" style="text-align: center;"> <table border="1" style="width: 100%; border-collapse: collapse; text-align: center;"> <tr> <td style="width: 10%;"></td> <td style="width: 10%;"></td> <td style="width: 10%;"></td> <td style="width: 10%;"></td> <td style="width: 10%;"></td> <td style="width: 10%;"></td> <td style="width: 10%;"></td> <td style="width: 10%;"></td> <td style="width: 10%;"></td> <td style="width: 10%;"></td> </tr> <tr> <td></td> <td></td> <td colspan="8" style="text-align: center;"> <table border="1" style="width: 100%; border-collapse: collapse; text-align: center;"> <tr> <td style="width: 10%;"></td> <td style="width: 10%;"></td> <td style="width: 10%;"></td> <td style="width: 10%;"></td> <td style="width: 10%;"></td> <td style="width: 10%;"></td> <td style="width: 10%;"></td> <td style="width: 10%;"></td> <td style="width: 10%;"></td> <td style="width: 10%;"></td> </tr> <tr> <td></td> <td></td> <td colspan="8" style="text-align: center;"> <table border="1" style="width: 100%; border-collapse: collapse; text-align: center;"> <tr> <td style="width: 10%;"></td> <td style="width: 10%;"></td> <td style="width: 10%;"></td> <td style="width: 10%;"></td> <td style="width: 10%;"></td> <td style="width: 10%;"></td> <td style="width: 10%;"></td> <td style="width: 10%;"></td> <td style="width: 10%;"></td> <td style="width: 10%;"></td> </tr> <tr> <td></td> <td></td> <td colspan="8" style="text-align: center;"> <table border="1" style="width: 100%; border-collapse: collapse; text-align: center;"> <tr> <td style="width: 10%;"></td> <td style="width: 10%;"></td> <td style="width: 10%;"></td> <td style="width: 10%;"></td> <td style="width: 10%;"></td> <td style="width: 10%;"></td> <td style="width: 10%;"></td> <td style="width: 10%;"></td> <td style="width: 10%;"></td> <td style="width: 10%;"></td> </tr> <tr> <td></td> <td></td> <td colspan="8" style="text-align: center;"> <table border="1" style="width: 100%; border-collapse: collapse; text-align: center;"> <tr> <td style="width: 10%;"></td> <td style="width: 10%;"></td> <td style="width: 10%;"></td> <td style="width: 10%;"></td> <td style="width: 10%;"></td> <td style="width: 10%;"></td> <td style="width: 10%;"></td> <td style="width: 10%;"></td> <td style="width: 10%;"></td> <td style="width: 10%;"></td> </tr> <tr> <td></td> <td></td> <td colspan="8" style="text-align: center;"> <table border="1" style="width: 100%; border-collapse: collapse; text-align: center;"> <tr> <td style="width: 10%;"></td> <td style="width: 10%;"></td> <td style="width: 10%;"></td> <td style="width: 10%;"></td> <td style="width: 10%;"></td> <td style="width: 10%;"></td> <td style="width: 10%;"></td> <td style="width: 10%;"></td> <td style="width: 10%;"></td> <td style="width: 10%;"></td> </tr> <tr> <td></td> <td></td> <td colspan="8" style="text-align: center;"> <table border="1" style="width: 100%; border-collapse: collapse; text-align: center;"> <tr> <td style="width: 10%;"></td> <td style="width: 10%;"></td> <td style="width: 10%;"></td> <td style="width: 10%;"></td> <td style="width: 10%;"></td> <td style="width: 10%;"></td> <td style="width: 10%;"></td> <td style="width: 10%;"></td> <td style="width: 10%;"></td> <td style="width: 10%;"></td> </tr> <tr> <td></td> <td></td> <td colspan="8" style="text-align: center;"> <table border="1" style="width: 100%; border-collapse: collapse; text-align: center;"> <tr> <td style="width: 10%;"></td> <td style="width: 10%;"></td> <td style="width: 10%;"></td> <td style="width: 10%;"></td> <td style="width: 10%;"></td> <td style="width: 10%;"></td> <td style="width: 10%;"></td> <td style="width: 10%;"></td> <td style="width: 10%;"></td> <td style="width: 10%;"></td> </tr> <tr> <td></td> <td></td> <td colspan="8" style="text-align: center;"> <table border="1" style="width: 100%; border-collapse: collapse; text-align: center;"> <tr> <td style="width: 10%;"></td> <td style="width: 10%;"></td> <td style="width: 10%;"></td> <td style="width: 10%;"></td> <td style="width: 10%;"></td> <td style="width: 10%;"></td> <td style="width: 10%;"></td> <td style="width: 10%;"></td> <td style="width: 10%;"></td> <td style="width: 10%;"></td> </tr> <tr> <td></td> <td></td> <td colspan="8" style="text-align: center;"> <table border="1" style="width: 100%; border-collapse: collapse; text-align: center;"> <tr> <td style="width: 10%;"></td> <td style="width: 10%;"></td> <td style="width: 10%;"></td> <td style="width: 10%;"></td> <td style="width: 10%;"></td> <td style="width: 10%;"></td> <td style="width: 10%;"></td> <td style="width: 10%;"></td> <td style="width: 10%;"></td> <td style="width: 10%;"></td> </tr> <tr> <td></td> <td></td> <td colspan="8" style="text-align: center;"> <table border="1" style="width: 100%; border-collapse: collapse; text-align: center;"> <tr> <td style="width: 10%;"></td> <td style="width: 10%;"></td> <td style="width: 10%;"></td> <td style="width: 10%;"></td> <td style="width: 10%;"></td> <td style="width: 10%;"></td> <td style="width: 10%;"></td> <td style="width: 10%;"></td> <td style="width: 10%;"></td> <td style="width: 10%;"></td> </tr> <tr> <td></td> <td></td> <td colspan="8" style="text-align: center;"> <table border="1" style="width: 100%; border-collapse: collapse; text-align: center;"> <tr> <td style="width: 10%;"></td> <td style="width: 10%;"></td> <td style="width: 10%;"></td> <td style="width: 10%;"></td> <td style="width: 10%;"></td> <td style="width: 10%;"></td> <td style="width: 10%;"></td> <td style="width: 10%;"></td> <td style="width: 10%;"></td> <td style="width: 10%;"></td> </tr> <tr> <td></td> <td></td> <td colspan="8" style="text-align: center;"> <table border="1" style="width: 100%; border-collapse: collapse; text-align: center;"> <tr> <td style="width: 10%;"></td> <td style="width: 10%;"></td> <td style="width: 10%;"></td> <td style="width: 10%;"></td> <td style="width: 10%;"></td> <td style="width: 10%;"></td> <td style="width: 10%;"></td> <td style="width: 10%;"></td> <td style="width: 10%;"></td> <td style="width: 10%;"></td> </tr> <tr> <td></td> <td></td> <td colspan="8" style="text-align: center;"> <table border="1" style="width: 100%; border-collapse: collapse; text-align: center;"> <tr> <td style="width: 10%;"></td> <td style="width: 10%;"></td> <td style="width: 10%;"></td> <td style="width: 10%;"></td> <td
style="width: 10%;"></td> <td style="width: 10%;"></td> <td style="width: 10%;"></td> <td style="width: 10%;"></td> <td style="width: 10%;"></td> <td style="width: 10%;"></td> </tr> <tr> <td></td> <td></td> <td colspan="8" style="text-align: center;"> <table border="1" style="width: 100%; border-collapse: collapse; text-align: center;"> <tr> <td style="width: 10%;"></td> <td style="width: 10%;"></td> <td style="width: 10%;"></td> <td style="width: 10%;"></td> <td style="width: 10%;"></td> <td style="width: 10%;"></td> <td style="width: 10%;"></td> <td style="width: 10%;"></td> <td style="width: 10%;"></td> <td style="width: 10%;"></td> </tr> <tr> <td></td> <td></td> <td colspan="8" style="text-align: center;"> <table border="1" style="width: 100%; border-collapse: collapse; text-align: center;"> <tr> <td style="width: 10%;"></td> <td style="width: 10%;"></td> <td style="width: 10%;"></td> <td style="width: 10%;"></td> <td style="width: 10%;"></td> <td style="width: 10%;"></td> <td style="width: 10%;"></td> <td style="width: 10%;"></td> <td style="width: 10%;"></td> <td style="width: 10%;"></td> </tr> <tr> <td></td> <td></td> <td colspan="8" style="text-align: center;"> <table border="1" style="width: 100%; border-collapse: collapse; text-align: center;"> <tr> <td style="width: 10%;"></td> <td style="width: 10%;"></td> <td style="width: 10%;"></td> <td style="width: 10%;"></td> <td style="width: 10%;"></td> <td style="width: 10%;"></td> <td style="width: 10%;"></td> <td style="width: 10%;"></td> <td style="width: 10%;"></td> <td style="width: 10%;"></td> </tr> <tr> <td></td> <td></td> <td colspan="8" style="text-align: center;"> <table border="1" style="width: 100%; border-collapse: collapse; text-align: center;"> <tr> <td style="width: 10%;"></td> <td style="width: 10%;"></td> <td style="width: 10%;"></td> <td style="width: 10%;"></td> <td style="width: 10%;"></td> <td style="width: 10%;"></td> <td style="width: 10%;"></td> <td style="width: 10%;"></td> <td style="width: 10%;"></td> <td style="width: 10%;"></td> </tr> <tr> <td></td> <td></td> <td colspan="8" style="text-align: center;"> <table border="1" style="width: 100%; border-collapse: collapse; text-align: center;"> <tr> <td style="width: 10%;"></td> <td style="width: 10%;"></td> <td style="width: 10%;"></td> <td style="width: 10%;"></td> <td style="width: 10%;"></td> <td style="width: 10%;"></td> <td style="width: 10%;"></td> <td style="width: 10%;"></td> <td style="width: 10%;"></td> <td style="width: 10%;"></td> </tr> <tr> <td></td> <td></td> <td colspan="8" style="text-align: center;"> <table border="1" style="width: 100%; border-collapse: collapse; text-align: center;"> <tr> <td style="width: 10%;"></td> <td style="width: 10%;"></td> <td style="width: 10%;"></td> <td style="width: 10%;"></td> <td style="width: 10%;"></td> <td style="width: 10%;"></td> <td style="width: 10%;"></td> <td style="width: 10%;"></td> <td style="width: 10%;"></td> <td style="width: 10%;"></td> </tr> <tr> <td></td> <td></td> <td colspan="8" style="text-align: center;"> <table border="1" style="width: 100%; border-collapse: collapse; text-align: center;"> <tr> <td style="width: 10%;"></td> <td style="width: 10%;"></td> <td style="width: 10%;"></td> <td style="width: 10%;"></td> <td style="width: 10%;"></td> <td style="width: 10%;"></td> <td style="width: 10%;"></td> <td style="width: 10%;"></td> <td style="width: 10%;"></td> <td style="width: 10%;"></td> </tr> <tr> <td></td> <td></td> <td colspan="8" style="text-align: center;"> <table border="1" style="width: 100%; border-collapse: collapse; text-align: center;"> <tr> <td style="width: 10%;"></td> <td style="width: 10%;"></td> <td style="width: 10%;"></td> <td style="width: 10%;"></td> <td style="width: 10%;"></td> <td style="width: 10%;"></td> <td style="width: 10%;"></td> <td style="width: 10%;"></td> <td style="width: 10%;"></td> <td style="width: 10%;"></td> </tr> <tr> <td></td> <td></td> <td colspan="8" style="text-align: center;"> <table border="1" style="width: 100%; border-collapse: collapse; text-align: center;"> <tr> <td style="width: 10%;"></td> <td style="width: 10%;"></td> <td style="width: 10%;"></td> <td style="width: 10%;"></td> <td style="width: 10%;"></td> <td style="width: 10%;"></td> <td style="width: 10%;"></td> <td style="width: 10%;"></td> <td style="width: 10%;"></td> <td style="width: 10%;"></td> </tr> <tr> <td></td> <td></td> <td colspan="8" style="text-align: center;"> <table border="1" style="width: 100%; border-collapse: collapse; text-align: center;"> <tr> <td style="width: 10%;"></td> <td style="width: 10%;"></td> <td style="width: 10%;"></td> <td style="width: 10%;"></td> <td style="width: 10%;"></td> <td style="width: 10%;"></td> <td style="width: 10%;"></td> <td style="width: 10%;"></td> <td style="width: 10%;"></td> <td style="width: 10%;"></td> </tr> <tr> <td></td> <td></td> <td colspan="8" style="text-align: center;"> <table border="1" style="width: 100%; border-collapse: collapse; text-align: center;"> <tr> <td style="width: 10%;"></td> <td style="width: 10%;"></td> <td style="width: 10%;"></td> <td style="width: 10%;"></td> <td style="width: 10%;"></td> <td style="width: 10%;"></td> <td style="width: 10%;"></td> <td style="width: 10%;"></td> <td style="width: 10%;"></td> <td style="width: 10%;"></td> </tr> <tr> <td></td> <td></td> <td colspan="8" style="text-align: center;"> <table border="1" style="width: 100%; border-collapse: collapse; text-align: center;"> <tr> <td style="width: 10%;"></td> <td style="width: 10%;"></td> <td style="width: 10%;"></td> <td style="width: 10%;"></td> <td style="width: 10%;"></td> <td style="width: 10%;"></td> <td style="width: 10%;"></td> <td style="width: 10%;"></td> <td style="width: 10%;"></td> <td style="width: 10%;"></td> </tr> <tr> <td></td> <td></td> <td colspan="8" style="text-align: center;"> <table border="1" style="width: 100%; border-collapse: collapse; text-align: center;"> <tr> <td style="width: 10%;"></td> <td style="width: 10%;"></td> <td style="width: 10%;"></td> <td style="width: 10%;"></td> <td style="width: 10%;"></td> <td style="width: 10%;"></td> <td style="width: 10%;"></td> <td style="width: 10%;"></td> <td style="width: 10%;"></td> <td style="width: 10%;"></td> </tr> <tr> <td></td> <td></td> <td colspan="8" style="text-align: center;"> <table border="1" style="width: 100%; border-collapse: collapse; text-align: center;"> <tr> <td style="width: 10%;"></td> <td style="width: 10%;"></td> <td style="width: 10%;"></td> <td style="width: 10%;"></td> <td style="width: 10%;"></td> <td style="width: 10%;"></td> <td style="width: 10%;"></td> <td style="width: 10%;"></td> <td style="width: 10%;"></td> <td style="width: 10%;"></td> </tr> <tr> <td></td> <td></td> <td colspan="8" style="text-align: center;"> <table border="1" style="width: 100%; border-collapse: collapse; text-align: center;"> <tr> <td style="width: 10%;"></td> <td style="width: 10%;"></td> <td style="width: 10%;"></td> <td style="width: 10%;"></td> <td style="width: 10%;"></td> <td style="width: 10%;"></td> <td style="width: 10%;"></td> <td style="width: 10%;"></td> <td style="width: 10%;"></td> <td style="width: 10%;"></td> </tr> <tr> <td></td> <td></td> <td colspan="8" style="text-align: center;"> <table border="1" style="width: 100%; border-collapse: collapse; text-align: center;"> <tr> <td style="width: 10%;"></td> <td style="width: 10%;"></td> <td style="width: 10%;"></td> <td style="width: 10%;"></td> <td style="width: 10%;"></td> <td style="width: 10%;"></td> <td style="width: 10%;"></td> <td style="width: 10%;"></td> <td style="width: 10%;"></td> <td style="width: 10%;"></td> </tr> <tr> <td></td> <td></td> <td colspan="8" style="text-align: center;"> <table border="1" style="width: 100%; border-collapse: collapse; text-align: center;"> <tr> <td style="width: 10%;"></td> <td style="width: 10%;"></td> <td style="width: 10%;"></td> <td style="width: 10%;"></td> <td style="width: 10%;"></td> <td style="width: 10%;"></td> <td style="width: 10%;"></td> <td style="width: 10%;"></td> <td style="width: 10%;"></td> <td style="width: 10%;"></td> </tr> <tr> <td></td> <td></td> <td colspan="8" style="text-align: center;"> <table border="1" style="width: 100%; border-collapse: collapse; text-align: center;"> <tr> <td style="width: 10%;"></td> <td style="width: 10%;"></td> <td style="width: 10%;"></td> <td style="width: 10%;"></td> <td style="width: 10%;"></td> <td style="width: 10%;"></td> <td style="width: 10%;"></td> <td style="width: 10%;"></td> <td style="width: 10%;"></td> <td style="width: 10%;"></td> </tr> <tr> <td></td> <td></td> <td colspan="8" style="text-align: center;"> <table border="1" style="width: 100%; border-collapse: collapse; text-align: center;"> <tr> <td style="width: 10%;"></td> <td style="width: 10%;"></td> <td style="width: 10%;"></td> <td style="width: 10%;"></td> <td style="width: 10%;"></td> <td style="width: 10%;"></td> <td style="width: 10%;"></td> <td style="width: 10%;"></td> <td style="width: 10%;"></td> <td style="width: 10%;"></td> </tr> <tr> <td></td> <td></td> <td colspan="8" style="text-align: center;"> <table border="1" style="width: 100%; border-collapse: collapse; text-align: center;"> <tr> <td style="width: 10%;"></td> <td style="width: 10%;"></td> <td style="width: 10%;"></td> <td style="width: 10%;"></td> <td style="width: 10%;"></td> <td style="width: 10%;"></td> <td style="width: 10%;"></td> <td style="width: 10%;"></td> <td style="width: 10%;"></td> <td style="width: 10%;"></td> </tr> <tr> <td></td> <td></td> <td colspan="8" style="text-align: center;"> <table border="1" style="width: 100%; border-collapse: collapse; text-align: center;"> <tr> <td style="width: 10%;"></td> <td style="width: 10%;"></td> <td style="width: 10%;"></td> <td style="width: 10%;"></td> <td style="width: 10%;"></td> <td style="width: 10%;"></td> <td style="width: 10%;"></td> <td style="width: 10%;"></td> <td style="width: 10%;"></td> <td style="width:
10%;"></td> </tr> <tr> <td></td> <td></td> <td colspan="8" style="text-align: center;"> <table border="1" style="width: 100%; border-collapse: collapse; text-align: center;"> <tr> </tr></table></td></tr></table></td></tr></table></td></tr></table></td></tr></table></td></tr></table></td></tr></table></td></tr></table></td></tr></table></td></tr></table></td></tr></table></td></tr></table></td></tr></table></td></tr></table></td></tr></table></td></tr></table></td></tr></table></td></tr></table></td></tr></table></td></tr></table></td></tr></table></td></tr></table></td></tr></table></td></tr></table></td></tr></table></td></tr></table></td></tr></table></td></tr></table></td></tr></table></td></tr></table></td></tr></table></td></tr></table></td></tr></table></td></tr></table></td></tr></table></td></tr></table></td></tr></table></td></tr></table></td></tr></table></td></tr></table></td></tr></table></td></tr></table></td></tr></table></td></tr></table></td></tr></table></td></tr></table></td></tr></table></td></tr></table></td></tr></table></td></tr></table></td></tr></table></td></tr></table></td></tr></table></td></tr></table></td></tr></table></td></tr></table></td></tr></table></td></tr></table></td></tr></table> | | | | | | | | | | | | | | | | | | | | <table border="1" style="width: 100%; border-collapse: collapse; text-align: center;"> <tr> <td style="width: 10%;"></td> <td style="width: 10%;"></td> <td style="width: 10%;"></td> <td style="width: 10%;"></td> <td style="width: 10%;"></td> <td style="width: 10%;"></td> <td style="width: 10%;"></td> <td style="width: 10%;"></td> <td style="width: 10%;"></td> <td style="width: 10%;"></td> </tr> <tr> <td></td> <td></td> <td colspan="8" style="text-align: center;"> <table border="1" style="width: 100%; border-collapse: collapse; text-align: center;"> <tr> <td style="width: 10%;"></td> <td style="width: 10%;"></td> <td style="width: 10%;"></td> <td style="width: 10%;"></td> <td style="width: 10%;"></td> <td style="width: 10%;"></td> <td style="width: 10%;"></td> <td style="width: 10%;"></td> <td style="width: 10%;"></td> <td style="width: 10%;"></td> </tr> <tr> <td></td> <td></td> <td colspan="8" style="text-align: center;"> <table border="1" style="width: 100%; border-collapse: collapse; text-align: center;"> <tr> <td style="width: 10%;"></td> <td style="width: 10%;"></td> <td style="width: 10%;"></td> <td style="width: 10%;"></td> <td style="width: 10%;"></td> <td style="width: 10%;"></td> <td style="width: 10%;"></td> <td style="width: 10%;"></td> <td style="width: 10%;"></td> <td style="width: 10%;"></td> </tr> <tr> <td></td> <td></td> <td colspan="8" style="text-align: center;"> <table border="1" style="width: 100%; border-collapse: collapse; text-align: center;"> <tr> <td style="width: 10%;"></td> <td style="width: 10%;"></td> <td style="width: 10%;"></td> <td style="width: 10%;"></td> <td style="width: 10%;"></td> <td style="width: 10%;"></td> <td style="width: 10%;"></td> <td style="width: 10%;"></td> <td style="width: 10%;"></td> <td style="width: 10%;"></td> </tr> <tr> <td></td> <td></td> <td colspan="8" style="text-align: center;"> <table border="1" style="width: 100%; border-collapse: collapse; text-align: center;"> <tr> <td style="width: 10%;"></td> <td style="width: 10%;"></td> <td style="width: 10%;"></td> <td style="width: 10%;"></td> <td style="width: 10%;"></td> <td style="width: 10%;"></td> <td style="width: 10%;"></td> <td style="width: 10%;"></td> <td style="width: 10%;"></td> <td style="width: 10%;"></td> </tr> <tr> <td></td> <td></td> <td colspan="8" style="text-align: center;"> <table border="1" style="width: 100%; border-collapse: collapse; text-align: center;"> <tr> <td style="width: 10%;"></td> <td style="width: 10%;"></td> <td style="width: 10%;"></td> <td style="width: 10%;"></td> <td style="width: 10%;"></td> <td style="width: 10%;"></td> <td style="width: 10%;"></td> <td style="width: 10%;"></td> <td style="width: 10%;"></td> <td style="width: 10%;"></td> </tr> <tr> <td></td> <td></td> <td colspan="8" style="text-align: center;"> <table border="1" style="width: 100%; border-collapse: collapse; text-align: center;"> <tr> <td style="width: 10%;"></td> <td style="width: 10%;"></td> <td style="width: 10%;"></td> <td style="width: 10%;"></td> <td style="width: 10%;"></td> <td style="width: 10%;"></td> <td style="width: 10%;"></td> <td style="width: 10%;"></td> <td style="width: 10%;"></td> <td style="width: 10%;"></td> </tr> <tr> <td></td> <td></td> <td colspan="8" style="text-align: center;"> <table border="1" style="width: 100%; border-collapse: collapse; text-align: center;"> <tr> <td style="width: 10%;"></td> <td style="width: 10%;"></td> <td style="width: 10%;"></td> <td style="width: 10%;"></td> <td style="width: 10%;"></td> <td style="width: 10%;"></td> <td style="width: 10%;"></td> <td style="width: 10%;"></td> <td style="width: 10%;"></td> <td style="width: 10%;"></td> </tr> <tr> <td></td> <td></td> <td colspan="8" style="text-align: center;"> <table border="1" style="width: 100%; border-collapse: collapse; text-align: center;"> <tr> <td style="width: 10%;"></td> <td style="width: 10%;"></td> <td style="width: 10%;"></td> <td style="width: 10%;"></td> <td style="width: 10%;"></td> <td style="width: 10%;"></td> <td style="width: 10%;"></td> <td style="width: 10%;"></td> <td style="width: 10%;"></td> <td style="width: 10%;"></td> </tr> <tr> <td></td> <td></td> <td colspan="8" style="text-align: center;"> <table border="1" style="width: 100%; border-collapse: collapse; text-align: center;"> <tr> <td style="width: 10%;"></td> <td style="width: 10%;"></td> <td style="width: 10%;"></td> <td style="width: 10%;"></td> <td style="width: 10%;"></td> <td style="width: 10%;"></td> <td style="width: 10%;"></td> <td style="width: 10%;"></td> <td style="width: 10%;"></td> <td style="width: 10%;"></td> </tr> <tr> <td></td> <td></td> <td colspan="8" style="text-align: center;"> <table border="1" style="width: 100%; border-collapse: collapse; text-align: center;"> <tr> <td style="width: 10%;"></td> <td style="width: 10%;"></td> <td style="width: 10%;"></td> <td style="width: 10%;"></td> <td style="width: 10%;"></td> <td style="width: 10%;"></td> <td style="width: 10%;"></td> <td style="width: 10%;"></td> <td style="width: 10%;"></td> <td style="width: 10%;"></td> </tr> <tr> <td></td> <td></td> <td colspan="8" style="text-align: center;"> <table border="1" style="width: 100%; border-collapse: collapse; text-align: center;"> <tr> <td style="width: 10%;"></td> <td style="width: 10%;"></td> <td style="width: 10%;"></td> <td style="width: 10%;"></td> <td style="width: 10%;"></td> <td style="width: 10%;"></td> <td style="width: 10%;"></td> <td style="width: 10%;"></td> <td style="width: 10%;"></td> <td style="width: 10%;"></td> </tr> <tr> <td></td> <td></td> <td colspan="8" style="text-align: center;"> <table border="1" style="width: 100%; border-collapse: collapse; text-align: center;"> <tr> <td style="width: 10%;"></td> <td style="width: 10%;"></td> <td style="width: 10%;"></td> <td style="width: 10%;"></td> <td style="width: 10%;"></td> <td style="width: 10%;"></td> <td style="width: 10%;"></td> <td style="width: 10%;"></td> <td style="width: 10%;"></td> <td style="width: 10%;"></td> </tr> <tr> <td></td> <td></td> <td colspan="8" style="text-align: center;"> <table border="1" style="width: 100%; border-collapse: collapse; text-align: center;"> <tr> <td style="width: 10%;"></td> <td style="width: 10%;"></td> <td style="width: 10%;"></td> <td style="width: 10%;"></td> <td style="width: 10%;"></td> <td style="width: 10%;"></td> <td style="width: 10%;"></td> <td style="width: 10%;"></td> <td style="width: 10%;"></td> <td style="width: 10%;"></td> </tr> <tr> <td></td> <td></td> <td colspan="8" style="text-align: center;"> <table border="1" style="width: 100%; border-collapse: collapse; text-align: center;"> <tr> <td style="width: 10%;"></td> <td style="width: 10%;"></td> <td style="width: 10%;"></td> <td style="width: 10%;"></td> <td style="width: 10%;"></td> <td style="width: 10%;"></td> <td style="width: 10%;"></td> <td style="width: 10%;"></td> <td style="width: 10%;"></td> <td style="width: 10%;"></td> </tr> <tr> <td></td> <td></td> <td colspan="8" style="text-align: center;"> <table border="1" style="width: 100%; border-collapse: collapse; text-align: center;"> <tr> <td style="width: 10%;"></td> <td style="width: 10%;"></td> <td style="width: 10%;"></td> <td style="width: 10%;"></td> <td
style="width: 10%;"></td> <td style="width: 10%;"></td> <td style="width: 10%;"></td> <td style="width: 10%;"></td> <td style="width: 10%;"></td> <td style="width: 10%;"></td> </tr> <tr> <td></td> <td></td> <td colspan="8" style="text-align: center;"> <table border="1" style="width: 100%; border-collapse: collapse; text-align: center;"> <tr> <td style="width: 10%;"></td> <td style="width: 10%;"></td> <td style="width: 10%;"></td> <td style="width: 10%;"></td> <td style="width: 10%;"></td> <td style="width: 10%;"></td> <td style="width: 10%;"></td> <td style="width: 10%;"></td> <td style="width: 10%;"></td> <td style="width: 10%;"></td> </tr> <tr> <td></td> <td></td> <td colspan="8" style="text-align: center;"> <table border="1" style="width: 100%; border-collapse: collapse; text-align: center;"> <tr> <td style="width: 10%;"></td> <td style="width: 10%;"></td> <td style="width: 10%;"></td> <td style="width: 10%;"></td> <td style="width: 10%;"></td> <td style="width: 10%;"></td> <td style="width: 10%;"></td> <td style="width: 10%;"></td> <td style="width: 10%;"></td> <td style="width: 10%;"></td> </tr> <tr> <td></td> <td></td> <td colspan="8" style="text-align: center;"> <table border="1" style="width: 100%; border-collapse: collapse; text-align: center;"> <tr> <td style="width: 10%;"></td> <td style="width: 10%;"></td> <td style="width: 10%;"></td> <td style="width: 10%;"></td> <td style="width: 10%;"></td> <td style="width: 10%;"></td> <td style="width: 10%;"></td> <td style="width: 10%;"></td> <td style="width: 10%;"></td> <td style="width: 10%;"></td> </tr> <tr> <td></td> <td></td> <td colspan="8" style="text-align: center;"> <table border="1" style="width: 100%; border-collapse: collapse; text-align: center;"> <tr> <td style="width: 10%;"></td> <td style="width: 10%;"></td> <td style="width: 10%;"></td> <td style="width: 10%;"></td> <td style="width: 10%;"></td> <td style="width: 10%;"></td> <td style="width: 10%;"></td> <td style="width: 10%;"></td> <td style="width: 10%;"></td> <td style="width: 10%;"></td> </tr> <tr> <td></td> <td></td> <td colspan="8" style="text-align: center;"> <table border="1" style="width: 100%; border-collapse: collapse; text-align: center;"> <tr> <td style="width: 10%;"></td> <td style="width: 10%;"></td> <td style="width: 10%;"></td> <td style="width: 10%;"></td> <td style="width: 10%;"></td> <td style="width: 10%;"></td> <td style="width: 10%;"></td> <td style="width: 10%;"></td> <td style="width: 10%;"></td> <td style="width: 10%;"></td> </tr> <tr> <td></td> <td></td> <td colspan="8" style="text-align: center;"> <table border="1" style="width: 100%; border-collapse: collapse; text-align: center;"> <tr> <td style="width: 10%;"></td> <td style="width: 10%;"></td> <td style="width: 10%;"></td> <td style="width: 10%;"></td> <td style="width: 10%;"></td> <td style="width: 10%;"></td> <td style="width: 10%;"></td> <td style="width: 10%;"></td> <td style="width: 10%;"></td> <td style="width: 10%;"></td> </tr> <tr> <td></td> <td></td> <td colspan="8" style="text-align: center;"> <table border="1" style="width: 100%; border-collapse: collapse; text-align: center;"> <tr> <td style="width: 10%;"></td> <td style="width: 10%;"></td> <td style="width: 10%;"></td> <td style="width: 10%;"></td> <td style="width: 10%;"></td> <td style="width: 10%;"></td> <td style="width: 10%;"></td> <td style="width: 10%;"></td> <td style="width: 10%;"></td> <td style="width: 10%;"></td> </tr> <tr> <td></td> <td></td> <td colspan="8" style="text-align: center;"> <table border="1" style="width: 100%; border-collapse: collapse; text-align: center;"> <tr> <td style="width: 10%;"></td> <td style="width: 10%;"></td> <td style="width: 10%;"></td> <td style="width: 10%;"></td> <td style="width: 10%;"></td> <td style="width: 10%;"></td> <td style="width: 10%;"></td> <td style="width: 10%;"></td> <td style="width: 10%;"></td> <td style="width: 10%;"></td> </tr> <tr> <td></td> <td></td> <td colspan="8" style="text-align: center;"> <table border="1" style="width: 100%; border-collapse: collapse; text-align: center;"> <tr> <td style="width: 10%;"></td> <td style="width: 10%;"></td> <td style="width: 10%;"></td> <td style="width: 10%;"></td> <td style="width: 10%;"></td> <td style="width: 10%;"></td> <td style="width: 10%;"></td> <td style="width: 10%;"></td> <td style="width: 10%;"></td> <td style="width: 10%;"></td> </tr> <tr> <td></td> <td></td> <td colspan="8" style="text-align: center;"> <table border="1" style="width: 100%; border-collapse: collapse; text-align: center;"> <tr> <td style="width: 10%;"></td> <td style="width: 10%;"></td> <td style="width: 10%;"></td> <td style="width: 10%;"></td> <td style="width: 10%;"></td> <td style="width: 10%;"></td> <td style="width: 10%;"></td> <td style="width: 10%;"></td> <td style="width: 10%;"></td> <td style="width: 10%;"></td> </tr> <tr> <td></td> <td></td> <td colspan="8" style="text-align: center;"> <table border="1" style="width: 100%; border-collapse: collapse; text-align: center;"> <tr> <td style="width: 10%;"></td> <td style="width: 10%;"></td> <td style="width: 10%;"></td> <td style="width: 10%;"></td> <td style="width: 10%;"></td> <td style="width: 10%;"></td> <td style="width: 10%;"></td> <td style="width: 10%;"></td> <td style="width: 10%;"></td> <td style="width: 10%;"></td> </tr> <tr> <td></td> <td></td> <td colspan="8" style="text-align: center;"> <table border="1" style="width: 100%; border-collapse: collapse; text-align: center;"> <tr> <td style="width: 10%;"></td> <td style="width: 10%;"></td> <td style="width: 10%;"></td> <td style="width: 10%;"></td> <td style="width: 10%;"></td> <td style="width: 10%;"></td> <td style="width: 10%;"></td> <td style="width: 10%;"></td> <td style="width: 10%;"></td> <td style="width: 10%;"></td> </tr> <tr> <td></td> <td></td> <td colspan="8" style="text-align: center;"> <table border="1" style="width: 100%; border-collapse: collapse; text-align: center;"> <tr> <td style="width: 10%;"></td> <td style="width: 10%;"></td> <td style="width: 10%;"></td> <td style="width: 10%;"></td> <td style="width: 10%;"></td> <td style="width: 10%;"></td> <td style="width: 10%;"></td> <td style="width: 10%;"></td> <td style="width: 10%;"></td> <td style="width: 10%;"></td> </tr> <tr> <td></td> <td></td> <td colspan="8" style="text-align: center;"> <table border="1" style="width: 100%; border-collapse: collapse; text-align: center;"> <tr> <td style="width: 10%;"></td> <td style="width: 10%;"></td> <td style="width: 10%;"></td> <td style="width: 10%;"></td> <td style="width: 10%;"></td> <td style="width: 10%;"></td> <td style="width: 10%;"></td> <td style="width: 10%;"></td> <td style="width: 10%;"></td> <td style="width: 10%;"></td> </tr> <tr> <td></td> <td></td> <td colspan="8" style="text-align: center;"> <table border="1" style="width: 100%; border-collapse: collapse; text-align: center;"> <tr> <td style="width: 10%;"></td> <td style="width: 10%;"></td> <td style="width: 10%;"></td> <td style="width: 10%;"></td> <td style="width: 10%;"></td> <td style="width: 10%;"></td> <td style="width: 10%;"></td> <td style="width: 10%;"></td> <td style="width: 10%;"></td> <td style="width: 10%;"></td> </tr> <tr> <td></td> <td></td> <td colspan="8" style="text-align: center;"> <table border="1" style="width: 100%; border-collapse: collapse; text-align: center;"> <tr> <td style="width: 10%;"></td> <td style="width: 10%;"></td> <td style="width: 10%;"></td> <td style="width: 10%;"></td> <td style="width: 10%;"></td> <td style="width: 10%;"></td> <td style="width: 10%;"></td> <td style="width: 10%;"></td> <td style="width: 10%;"></td> <td style="width: 10%;"></td> </tr> <tr> <td></td> <td></td> <td colspan="8" style="text-align: center;"> <table border="1" style="width: 100%; border-collapse: collapse; text-align: center;"> <tr> <td style="width: 10%;"></td> <td style="width: 10%;"></td> <td style="width: 10%;"></td> <td style="width: 10%;"></td> <td style="width: 10%;"></td> <td style="width: 10%;"></td> <td style="width: 10%;"></td> <td style="width: 10%;"></td> <td style="width: 10%;"></td> <td style="width: 10%;"></td> </tr> <tr> <td></td> <td></td> <td colspan="8" style="text-align: center;"> <table border="1" style="width: 100%; border-collapse: collapse; text-align: center;"> <tr> <td style="width: 10%;"></td> <td style="width: 10%;"></td> <td style="width: 10%;"></td> <td style="width: 10%;"></td> <td style="width: 10%;"></td> <td style="width: 10%;"></td> <td style="width: 10%;"></td> <td style="width: 10%;"></td> <td style="width: 10%;"></td> <td style="width: 10%;"></td> </tr> <tr> <td></td> <td></td> <td colspan="8" style="text-align: center;"> <table border="1" style="width: 100%; border-collapse: collapse; text-align: center;"> <tr> <td style="width: 10%;"></td> <td style="width: 10%;"></td> <td style="width: 10%;"></td> <td style="width: 10%;"></td> <td style="width: 10%;"></td> <td style="width: 10%;"></td> <td style="width: 10%;"></td> <td style="width: 10%;"></td> <td style="width: 10%;"></td> <td style="width: 10%;"></td> </tr> <tr> <td></td> <td></td> <td colspan="8" style="text-align: center;"> <table border="1" style="width: 100%; border-collapse: collapse; text-align: center;"> <tr> <td style="width: 10%;"></td> <td style="width: 10%;"></td> <td style="width: 10%;"></td> <td style="width: 10%;"></td> <td style="width: 10%;"></td> <td style="width: 10%;"></td> <td style="width: 10%;"></td> <td style="width: 10%;"></td> <td style="width: 10%;"></td> <td style="width: 10%;"></td> </tr> <tr> <td></td> <td></td> <td colspan="8" style="text-align: center;"> <table border="1" style="width: 100%; border-collapse: collapse; text-align: center;"> <tr> <td style="width: 10%;"></td> <td style="width: 10%;"></td> <td style="width: 10%;"></td> <td style="width: 10%;"></td> <td style="width: 10%;"></td> <td style="width: 10%;"></td> <td style="width: 10%;"></td> <td style="width: 10%;"></td> <td style="width: 10%;"></td> <td style="width:
10%;"></td> </tr> <tr> <td></td> <td></td> <td colspan="8" style="text-align: center;"> <table border="1" style="width: 100%; border-collapse: collapse; text-align: center;"> <tr> <td style="width: 10%;"></td> <td style="width: 10%;"></td> <td style="width: 10%;"></td> <td style="width: 10%;"></td> <td style="width: 10%;"></td> <td style="width: 10%;"></td> <td style="width: 10%;"></td> <td style="width: 10%;"></td> <td style="width: 10%;"></td> <td style="width: 10%;"></td> </tr> <tr> <td></td> <td></td> <td colspan="8" style="text-align: center;"> <table border="1" style="width: 100%; border-collapse: collapse; text-align: center;"> <tr> <td style="width: 10%;"></td> <td style="width: 10%;"></td> <td style="width: 10%;"></td> <td style="width: 10%;"></td> <td style="width: 10%;"></td> <td style="width: 10%;"></td> <td style="width: 10%;"></td> <td style="width: 10%;"></td> <td style="width: 10%;"></td> <td style="width: 10%;"></td> </tr> <tr> <td></td> <td></td> <td colspan="8" style="text-align: center;"> <table border="1" style="width: 100%; border-collapse: collapse; text-align: center;"> <tr> <td style="width: 10%;"></td> <td style="width: 10%;"></td> <td style="width: 10%;"></td> <td style="width: 10%;"></td> <td style="width: 10%;"></td> <td style="width: 10%;"></td> <td style="width: 10%;"></td> <td style="width: 10%;"></td> <td style="width: 10%;"></td> <td style="width: 10%;"></td> </tr> <tr> <td></td> <td></td> <td colspan="8" style="text-align: center;"> <table border="1" style="width: 100%; border-collapse: collapse; text-align: center;"> <tr> <td style="width: 10%;"></td> <td style="width: 10%;"></td> <td style="width: 10%;"></td> <td style="width: 10%;"></td> <td style="width: 10%;"></td> <td style="width: 10%;"></td> <td style="width: 10%;"></td> <td style="width: 10%;"></td> <td style="width: 10%;"></td> <td style="width: 10%;"></td> </tr> <tr> <td></td> <td></td> <td colspan="8" style="text-align: center;"> <table border="1" style="width: 100%; border-collapse: collapse; text-align: center;"> <tr> <td style="width: 10%;"></td> <td style="width: 10%;"></td> <td style="width: 10%;"></td> <td style="width: 10%;"></td> <td style="width: 10%;"></td> <td style="width: 10%;"></td> <td style="width: 10%;"></td> <td style="width: 10%;"></td> <td style="width: 10%;"></td> <td style="width: 10%;"></td> </tr> <tr> <td></td> <td></td> <td colspan="8" style="text-align: center;"> <table border="1" style="width: 100%; border-collapse: collapse; text-align: center;"> <tr> <td style="width: 10%;"></td> <td style="width: 10%;"></td> <td style="width: 10%;"></td> <td style="width: 10%;"></td> <td style="width: 10%;"></td> <td style="width: 10%;"></td> <td style="width: 10%;"></td> <td style="width: 10%;"></td> <td style="width: 10%;"></td> <td style="width: 10%;"></td> </tr> <tr> <td></td> <td></td> <td colspan="8" style="text-align: center;"> <table border="1" style="width: 100%; border-collapse: collapse; text-align: center;"> <tr> <td style="width: 10%;"></td> <td style="width: 10%;"></td> <td style="width: 10%;"></td> <td style="width: 10%;"></td> <td style="width: 10%;"></td> <td style="width: 10%;"></td> <td style="width: 10%;"></td> <td style="width: 10%;"></td> <td style="width: 10%;"></td> <td style="width: 10%;"></td> </tr> <tr> <td></td> <td></td> <td colspan="8" style="text-align: center;"> <table border="1" style="width: 100%; border-collapse: collapse; text-align: center;"> <tr> <td style="width: 10%;"></td> <td style="width: 10%;"></td> <td style="width: 10%;"></td> <td style="width: 10%;"></td> <td style="width: 10%;"></td> <td style="width: 10%;"></td> <td style="width: 10%;"></td> <td style="width: 10%;"></td> <td style="width: 10%;"></td> <td style="width: 10%;"></td> </tr> <tr> <td></td> <td></td> <td colspan="8" style="text-align: center;"> <table border="1" style="width: 100%; border-collapse: collapse; text-align: center;"> <tr> <td style="width: 10%;"></td> <td style="width: 10%;"></td> <td style="width: 10%;"></td> <td style="width: 10%;"></td> <td style="width: 10%;"></td> <td style="width: 10%;"></td> <td style="width: 10%;"></td> <td style="width: 10%;"></td> <td style="width: 10%;"></td> <td style="width: 10%;"></td> </tr> <tr> <td></td> <td></td> <td colspan="8" style="text-align: center;"> <table border="1" style="width: 100%; border-collapse: collapse; text-align: center;"> <tr> <td style="width: 10%;"></td> <td style="width: 10%;"></td> <td style="width: 10%;"></td> <td style="width: 10%;"></td> <td style="width: 10%;"></td> <td style="width: 10%;"></td> <td style="width: 10%;"></td> <td style="width: 10%;"></td> <td style="width: 10%;"></td> <td style="width: 10%;"></td> </tr> <tr> <td></td> <td></td> <td colspan="8" style="text-align: center;"> <table border="1" style="width: 100%; border-collapse: collapse; text-align: center;"> <tr> <td style="width: 10%;"></td> <td style="width: 10%;"></td> <td style="width: 10%;"></td> <td style="width: 10%;"></td> <td style="width: 10%;"></td> <td style="width: 10%;"></td> <td style="width: 10%;"></td> <td style="width: 10%;"></td> <td style="width: 10%;"></td> <td style="width: 10%;"></td> </tr> <tr> <td></td> <td></td> <td colspan="8" style="text-align: center;"> <table border="1" style="width: 100%; border-collapse: collapse; text-align: center;"> <tr> <td style="width: 10%;"></td> <td style="width: 10%;"></td> <td style="width: 10%;"></td> <td style="width: 10%;"></td> <td style="width: 10%;"></td> <td style="width: 10%;"></td> <td style="width: 10%;"></td> <td style="width: 10%;"></td> <td style="width: 10%;"></td> <td style="width: 10%;"></td> </tr> <tr> <td></td> <td></td> <td colspan="8" style="text-align: center;"> <table border="1" style="width: 100%; border-collapse: collapse; text-align: center;"> <tr> <td style="width: 10%;"></td> <td style="width: 10%;"></td> <td style="width: 10%;"></td> <td style="width: 10%;"></td> <td style="width: 10%;"></td> <td style="width: 10%;"></td> <td style="width: 10%;"></td> <td style="width: 10%;"></td> <td style="width: 10%;"></td> <td style="width: 10%;"></td> </tr> <tr> <td></td> <td></td> <td colspan="8" style="text-align: center;"> <table border="1" style="width: 100%; border-collapse: collapse; text-align: center;"> <tr> <td style="width: 10%;"></td> <td style="width: 10%;"></td> <td style="width: 10%;"></td> <td style="width: 10%;"></td> <td style="width: 10%;"></td> <td style="width: 10%;"></td> <td style="width: 10%;"></td> <td style="width: 10%;"></td> <td style="width: 10%;"></td> <td style="width: 10%;"></td> </tr> <tr> <td></td> <td></td> <td colspan="8" style="text-align: center;"> <table border="1" style="width: 100%; border-collapse: collapse; text-align: center;"> <tr> <td style="width: 10%;"></td> <td style="width: 10%;"></td> <td style="width: 10%;"></td> <td style="width: 10%;"></td> <td style="width: 10%;"></td> <td style="width: 10%;"></td> <td style="width: 10%;"></td> <td style="width: 10%;"></td> <td style="width: 10%;"></td> <td style="width: 10%;"></td> </tr> <tr> <td></td> <td></td> <td colspan="8" style="text-align: center;"> <table border="1" style="width: 100%; border-collapse: collapse; text-align: center;"> <tr> <td style="width: 10%;"></td> <td style="width: 10%;"></td> <td style="width: 10%;"></td> <td style="width: 10%;"></td> <td style="width: 10%;"></td> <td style="width: 10%;"></td> <td style="width: 10%;"></td> <td style="width: 10%;"></td> <td style="width: 10%;"></td> <td style="width: 10%;"></td> </tr> <tr> <td></td> <td></td> <td colspan="8" style="text-align: center;"> <table border="1" style="width: 100%; border-collapse: collapse; text-align: center;"> <tr> <td style="width: 10%;"></td> <td style="width: 10%;"></td> <td style="width: 10%;"></td> <td style="width: 10%;"></td> <td style="width: 10%;"></td> <td style="width: 10%;"></td> <td style="width: 10%;"></td> <td style="width: 10%;"></td> <td style="width: 10%;"></td> <td style="width: 10%;"></td> </tr> <tr> <td></td> <td></td> <td colspan="8" style="text-align: center;"> <table border="1" style="width: 100%; border-collapse: collapse; text-align: center;"> <tr> <td style="width: 10%;"></td> <td style="width: 10%;"></td> <td style="width: 10%;"></td> <td style="width: 10%;"></td> <td style="width: 10%;"></td> <td style="width: 10%;"></td> <td style="width: 10%;"></td> <td style="width: 10%;"></td> <td style="width: 10%;"></td> <td style="width: 10%;"></td> </tr> <tr> <td></td> <td></td> <td colspan="8" style="text-align: center;"> <table border="1" style="width: 100%; border-collapse: collapse; text-align: center;"> <tr> <td style="width: 10%;"></td> <td style="width: 10%;"></td> <td style="width: 10%;"></td> <td style="width: 10%;"></td> <td style="width: 10%;"></td> <td style="width: 10%;"></td> <td style="width: 10%;"></td> <td style="width: 10%;"></td> <td style="width: 10%;"></td> <td style="width: 10%;"></td> </tr> <tr> <td></td> <td></td> <td colspan="8" style="text-align: center;"> <table border="1" style="width: 100%; border-collapse: collapse; text-align: center;"> <tr> <td style="width: 10%;"></td> <td style="width: 10%;"></td> <td style="width: 10%;"></td> <td style="width: 10%;"></td> <td style="width: 10%;"></td> <td style="width: 10%;"></td> <td style="width: 10%;"></td> <td style="width: 10%;"></td> <td style="width: 10%;"></td> <td style="width: 10%;"></td> </tr> <tr> <td></td> <td></td> <td colspan="8" style="text-align: center;"> <table border="1" style="width: 100%; border-collapse: collapse; text-align: center;"> <tr>
</tr></table></td></tr></table></td></tr></table></td></tr></table></td></tr></table></td></tr></table></td></tr></table></td></tr></table></td></tr></table></td></tr></table></td></tr></table></td></tr></table></td></tr></table></td></tr></table></td></tr></table></td></tr></table></td></tr></table></td></tr></table></td></tr></table></td></tr></table></td></tr></table></td></tr></table></td></tr></table></td></tr></table></td></tr></table></td></tr></table></td></tr></table></td></tr></table></td></tr></table></td></tr></table></td></tr></table></td></tr></table></td></tr></table></td></tr></table></td></tr></table></td></tr></table></td></tr></table></td></tr></table></td></tr></table></td></tr></table></td></tr></table></td></tr></table></td></tr></table></td></tr></table></td></tr></table></td></tr></table></td></tr></table></td></tr></table></td></tr></table></td></tr></table></td></tr></table></td></tr></table></td></tr></table></td></tr></table></td></tr></table></td></tr></table></td></tr></table></td></tr></table> | | | | | | | | | | | | | | | | | | | | <table border="1" style="width: 100%; border-collapse: collapse; text-align: center;"> <tr> <td style="width: 10%;"></td> <td style="width: 10%;"></td> <td style="width: 10%;"></td> <td style="width: 10%;"></td> <td style="width: 10%;"></td> <td style="width: 10%;"></td> <td style="width: 10%;"></td> <td style="width: 10%;"></td> <td style="width: 10%;"></td> <td style="width: 10%;"></td> </tr> <tr> <td></td> <td></td> <td colspan="8" style="text-align: center;"> <table border="1" style="width: 100%; border-collapse: collapse; text-align: center;"> <tr> <td style="width: 10%;"></td> <td style="width: 10%;"></td> <td style="width: 10%;"></td> <td style="width: 10%;"></td> <td style="width: 10%;"></td> <td style="width: 10%;"></td> <td style="width: 10%;"></td> <td style="width: 10%;"></td> <td style="width: 10%;"></td> <td style="width: 10%;"></td> </tr> <tr> <td></td> <td></td> <td colspan="8" style="text-align: center;"> <table border="1" style="width: 100%; border-collapse: collapse; text-align: center;"> <tr> <td style="width: 10%;"></td> <td style="width: 10%;"></td> <td style="width: 10%;"></td> <td style="width: 10%;"></td> <td style="width: 10%;"></td> <td style="width: 10%;"></td> <td style="width: 10%;"></td> <td style="width: 10%;"></td> <td style="width: 10%;"></td> <td style="width: 10%;"></td> </tr> <tr> <td></td> <td></td> <td colspan="8" style="text-align: center;"> <table border="1" style="width: 100%; border-collapse: collapse; text-align: center;"> <tr> <td style="width: 10%;"></td> <td style="width: 10%;"></td> <td style="width: 10%;"></td> <td style="width: 10%;"></td> <td style="width: 10%;"></td> <td style="width: 10%;"></td> <td style="width: 10%;"></td> <td style="width: 10%;"></td> <td style="width: 10%;"></td> <td style="width: 10%;"></td> </tr> <tr> <td></td> <td></td> <td colspan="8" style="text-align: center;"> <table border="1" style="width: 100%; border-collapse: collapse; text-align: center;"> <tr> <td style="width: 10%;"></td> <td style="width: 10%;"></td> <td style="width: 10%;"></td> <td style="width: 10%;"></td> <td style="width: 10%;"></td> <td style="width: 10%;"></td> <td style="width: 10%;"></td> <td style="width: 10%;"></td> <td style="width: 10%;"></td> <td style="width: 10%;"></td> </tr> <tr> <td></td> <td></td> <td colspan="8" style="text-align: center;"> <table border="1" style="width: 100%; border-collapse: collapse; text-align: center;"> <tr> <td style="width: 10%;"></td> <td style="width: 10%;"></td> <td style="width: 10%;"></td> <td style="width: 10%;"></td> <td style="width: 10%;"></td> <td style="width: 10%;"></td> <td style="width: 10%;"></td> <td style="width: 10%;"></td> <td style="width: 10%;"></td> <td style="width: 10%;"></td> </tr> <tr> <td></td> <td></td> <td colspan="8" style="text-align: center;"> <table border="1" style="width: 100%; border-collapse: collapse; text-align: center;"> <tr> <td style="width: 10%;"></td> <td style="width: 10%;"></td> <td style="width: 10%;"></td> <td style="width: 10%;"></td> <td style="width: 10%;"></td> <td style="width: 10%;"></td> <td style="width: 10%;"></td> <td style="width: 10%;"></td> <td style="width: 10%;"></td> <td style="width: 10%;"></td> </tr> <tr> <td></td> <td></td> <td colspan="8" style="text-align: center;"> <table border="1" style="width: 100%; border-collapse: collapse; text-align: center;"> <tr> <td style="width: 10%;"></td> <td style="width: 10%;"></td> <td style="width: 10%;"></td> <td style="width: 10%;"></td> <td style="width: 10%;"></td> <td style="width: 10%;"></td> <td style="width: 10%;"></td> <td style="width: 10%;"></td> <td style="width: 10%;"></td> <td style="width: 10%;"></td> </tr> <tr> <td></td> <td></td> <td colspan="8" style="text-align: center;"> <table border="1" style="width: 100%; border-collapse: collapse; text-align: center;"> <tr> <td style="width: 10%;"></td> <td style="width: 10%;"></td> <td style="width: 10%;"></td> <td style="width: 10%;"></td> <td style="width: 10%;"></td> <td style="width: 10%;"></td> <td style="width: 10%;"></td> <td style="width: 10%;"></td> <td style="width: 10%;"></td> <td style="width: 10%;"></td> </tr> <tr> <td></td> <td></td> <td colspan="8" style="text-align: center;"> <table border="1" style="width: 100%; border-collapse: collapse; text-align: center;"> <tr> <td style="width: 10%;"></td> <td style="width: 10%;"></td> <td style="width: 10%;"></td> <td style="width: 10%;"></td> <td style="width: 10%;"></td> <td style="width: 10%;"></td> <td style="width: 10%;"></td> <td style="width: 10%;"></td> <td style="width: 10%;"></td> <td style="width: 10%;"></td> </tr> <tr> <td></td> <td></td> <td colspan="8" style="text-align: center;"> <table border="1" style="width: 100%; border-collapse: collapse; text-align: center;"> <tr> <td style="width: 10%;"></td> <td style="width: 10%;"></td> <td style="width: 10%;"></td> <td style="width: 10%;"></td> <td style="width: 10%;"></td> <td style="width: 10%;"></td> <td style="width: 10%;"></td> <td style="width: 10%;"></td> <td style="width: 10%;"></td> <td style="width: 10%;"></td> </tr> <tr> <td></td> <td></td> <td colspan="8" style="text-align: center;"> <table border="1" style="width: 100%; border-collapse: collapse; text-align: center;"> <tr> <td style="width: 10%;"></td> <td style="width: 10%;"></td> <td style="width: 10%;"></td> <td style="width: 10%;"></td> <td style="width: 10%;"></td> <td style="width: 10%;"></td> <td style="width: 10%;"></td> <td style="width: 10%;"></td> <td style="width: 10%;"></td> <td style="width: 10%;"></td> </tr> <tr> <td></td> <td></td> <td colspan="8" style="text-align: center;"> <table border="1" style="width: 100%; border-collapse: collapse; text-align: center;"> <tr> <td style="width: 10%;"></td> <td style="width: 10%;"></td> <td style="width: 10%;"></td> <td style="width: 10%;"></td> <td style="width: 10%;"></td> <td style="width: 10%;"></td> <td style="width: 10%;"></td> <td style="width: 10%;"></td> <td style="width: 10%;"></td> <td style="width: 10%;"></td> </tr> <tr> <td></td> <td></td> <td colspan="8" style="text-align: center;"> <table border="1" style="width: 100%; border-collapse: collapse; text-align: center;"> <tr> <td style="width: 10%;"></td> <td style="width: 10%;"></td> <td style="width: 10%;"></td> <td style="width: 10%;"></td> <td style="width: 10%;"></td> <td style="width: 10%;"></td> <td style="width: 10%;"></td> <td style="width: 10%;"></td> <td style="width: 10%;"></td> <td style="width: 10%;"></td> </tr> <tr> <td></td> <td></td> <td colspan="8" style="text-align: center;"> <table border="1" style="width: 100%; border-collapse: collapse; text-align: center;"> <tr> <td style="width: 10%;"></td> <td style="width: 10%;"></td> <td style="width: 10%;"></td> <td style="width: 10%;"></td> <td style="width: 10%;"></td> <td style="width: 10%;"></td> <td style="width: 10%;"></td> <td style="width: 10%;"></td> <td style="width: 10%;"></td> <td style="width: 10%;"></td> </tr> <tr> <td></td> <td></td> <td colspan="8" style="text-align: center;"> <table border="1" style="width: 100%; border-collapse: collapse; text-align: center;"> <tr> <td style="width: 10%;"></td> <td style="width: 10%;"></td> <td style="width: 10%;"></td> <td style="width: 10%;"></td> <td style="width: 10%;"></td> <td style="width: 10%;"></td> <td style="width: 10%;"></td> <td style="width: 10%;"></td> <td style="width: 10%;"></td> <td style="width: 10%;"></td> </tr> <tr> <td></td> <td></td>
<td colspan="8" style="text-align: center;"> <table border="1" style="width: 100%; border-collapse: collapse; text-align: center;"> <tr> <td style="width: 10%;"></td> <td style="width: 10%;"></td> <td style="width: 10%;"></td> <td style="width: 10%;"></td> <td style="width: 10%;"></td> <td style="width: 10%;"></td> <td style="width: 10%;"></td> <td style="width: 10%;"></td> <td style="width: 10%;"></td> <td style="width: 10%;"></td> </tr> <tr> <td></td> <td></td> <td colspan="8" style="text-align: center;"> <table border="1" style="width: 100%; border-collapse: collapse; text-align: center;"> <tr> <td style="width: 10%;"></td> <td style="width: 10%;"></td> <td style="width: 10%;"></td> <td style="width: 10%;"></td> <td style="width: 10%;"></td> <td style="width: 10%;"></td> <td style="width: 10%;"></td> <td style="width: 10%;"></td> <td style="width: 10%;"></td> <td style="width: 10%;"></td> </tr> <tr> <td></td> <td></td> <td colspan="8" style="text-align: center;"> <table border="1" style="width: 100%; border-collapse: collapse; text-align: center;"> <tr> <td style="width: 10%;"></td> <td style="width: 10%;"></td> <td style="width: 10%;"></td> <td style="width: 10%;"></td> <td style="width: 10%;"></td> <td style="width: 10%;"></td> <td style="width: 10%;"></td> <td style="width: 10%;"></td> <td style="width: 10%;"></td> <td style="width: 10%;"></td> </tr> <tr> <td></td> <td></td> <td colspan="8" style="text-align: center;"> <table border="1" style="width: 100%; border-collapse: collapse; text-align: center;"> <tr> <td style="width: 10%;"></td> <td style="width: 10%;"></td> <td style="width: 10%;"></td> <td style="width: 10%;"></td> <td style="width: 10%;"></td> <td style="width: 10%;"></td> <td style="width: 10%;"></td> <td style="width: 10%;"></td> <td style="width: 10%;"></td> <td style="width: 10%;"></td> </tr> <tr> <td></td> <td></td> <td colspan="8" style="text-align: center;"> <table border="1" style="width: 100%; border-collapse: collapse; text-align: center;"> <tr> <td style="width: 10%;"></td> <td style="width: 10%;"></td> <td style="width: 10%;"></td> <td style="width: 10%;"></td> <td style="width: 10%;"></td> <td style="width: 10%;"></td> <td style="width: 10%;"></td> <td style="width: 10%;"></td> <td style="width: 10%;"></td> <td style="width: 10%;"></td> </tr> <tr> <td></td> <td></td> <td colspan="8" style="text-align: center;"> <table border="1" style="width: 100%; border-collapse: collapse; text-align: center;"> <tr> <td style="width: 10%;"></td> <td style="width: 10%;"></td> <td style="width: 10%;"></td> <td style="width: 10%;"></td> <td style="width: 10%;"></td> <td style="width: 10%;"></td> <td style="width: 10%;"></td> <td style="width: 10%;"></td> <td style="width: 10%;"></td> <td style="width: 10%;"></td> </tr> <tr> <td></td> <td></td> <td colspan="8" style="text-align: center;"> <table border="1" style="width: 100%; border-collapse: collapse; text-align: center;"> <tr> <td style="width: 10%;"></td> <td style="width: 10%;"></td> <td style="width: 10%;"></td> <td style="width: 10%;"></td> <td style="width: 10%;"></td> <td style="width: 10%;"></td> <td style="width: 10%;"></td> <td style="width: 10%;"></td> <td style="width: 10%;"></td> <td style="width: 10%;"></td> </tr> <tr> <td></td> <td></td> <td colspan="8" style="text-align: center;"> <table border="1" style="width: 100%; border-collapse: collapse; text-align: center;"> <tr> <td style="width: 10%;"></td> <td style="width: 10%;"></td> <td style="width: 10%;"></td> <td style="width: 10%;"></td> <td style="width: 10%;"></td> <td style="width: 10%;"></td> <td style="width: 10%;"></td> <td style="width: 10%;"></td> <td style="width: 10%;"></td> <td style="width: 10%;"></td> </tr> <tr> <td></td> <td></td> <td colspan="8" style="text-align: center;"> <table border="1" style="width: 100%; border-collapse: collapse; text-align: center;"> <tr> <td style="width: 10%;"></td> <td style="width: 10%;"></td> <td style="width: 10%;"></td> <td style="width: 10%;"></td> <td style="width: 10%;"></td> <td style="width: 10%;"></td> <td style="width: 10%;"></td> <td style="width: 10%;"></td> <td style="width: 10%;"></td> <td style="width: 10%;"></td> </tr> <tr> <td></td> <td></td> <td colspan="8" style="text-align: center;"> <table border="1" style="width: 100%; border-collapse: collapse; text-align: center;"> <tr> <td style="width: 10%;"></td> <td style="width: 10%;"></td> <td style="width: 10%;"></td> <td style="width: 10%;"></td> <td style="width: 10%;"></td> <td style="width: 10%;"></td> <td style="width: 10%;"></td> <td style="width: 10%;"></td> <td style="width: 10%;"></td> <td style="width: 10%;"></td> </tr> <tr> <td></td> <td></td> <td colspan="8" style="text-align: center;"> <table border="1" style="width: 100%; border-collapse: collapse; text-align: center;"> <tr> <td style="width: 10%;"></td> <td style="width: 10%;"></td> <td style="width: 10%;"></td> <td style="width: 10%;"></td> <td style="width: 10%;"></td> <td style="width: 10%;"></td> <td style="width: 10%;"></td> <td style="width: 10%;"></td> <td style="width: 10%;"></td> <td style="width: 10%;"></td> </tr> <tr> <td></td> <td></td> <td colspan="8" style="text-align: center;"> <table border="1" style="width: 100%; border-collapse: collapse; text-align: center;"> <tr> <td style="width: 10%;"></td> <td style="width: 10%;"></td> <td style="width: 10%;"></td> <td style="width: 10%;"></td> <td style="width: 10%;"></td> <td style="width: 10%;"></td> <td style="width: 10%;"></td> <td style="width: 10%;"></td> <td style="width: 10%;"></td> <td style="width: 10%;"></td> </tr> <tr> <td></td> <td></td> <td colspan="8" style="text-align: center;"> <table border="1" style="width: 100%; border-collapse: collapse; text-align: center;"> <tr> <td style="width: 10%;"></td> <td style="width: 10%;"></td> <td style="width: 10%;"></td> <td style="width: 10%;"></td> <td style="width: 10%;"></td> <td style="width: 10%;"></td> <td style="width: 10%;"></td> <td style="width: 10%;"></td> <td style="width: 10%;"></td> <td style="width: 10%;"></td> </tr> <tr> <td></td> <td></td> <td colspan="8" style="text-align: center;"> <table border="1" style="width: 100%; border-collapse: collapse; text-align: center;"> <tr> <td style="width: 10%;"></td> <td style="width: 10%;"></td> <td style="width: 10%;"></td> <td style="width: 10%;"></td> <td style="width: 10%;"></td> <td style="width: 10%;"></td> <td style="width: 10%;"></td> <td style="width: 10%;"></td> <td style="width: 10%;"></td> <td style="width: 10%;"></td> </tr> <tr> <td></td> <td></td> <td colspan="8" style="text-align: center;"> <table border="1" style="width: 100%; border-collapse: collapse; text-align: center;"> <tr> <td style="width: 10%;"></td> <td style="width: 10%;"></td> <td style="width: 10%;"></td> <td style="width: 10%;"></td> <td style="width: 10%;"></td> <td style="width: 10%;"></td> <td style="width: 10%;"></td> <td style="width: 10%;"></td> <td style="width: 10%;"></td> <td style="width: 10%;"></td> </tr> <tr> <td></td> <td></td> <td colspan="8" style="text-align: center;"> <table border="1" style="width: 100%; border-collapse: collapse; text-align: center;"> <tr> <td style="width: 10%;"></td> <td style="width: 10%;"></td> <td style="width: 10%;"></td> <td style="width: 10%;"></td> <td style="width: 10%;"></td> <td style="width: 10%;"></td> <td style="width: 10%;"></td> <td style="width: 10%;"></td> <td style="width: 10%;"></td> <td style="width: 10%;"></td> </tr> <tr> <td></td> <td></td> <td colspan="8" style="text-align: center;"> <table border="1" style="width: 100%; border-collapse: collapse; text-align: center;"> <tr> <td style="width: 10%;"></td> <td style="width: 10%;"></td> <td style="width: 10%;"></td> <td style="width: 10%;"></td> <td style="width: 10%;"></td> <td style="width: 10%;"></td> <td style="width: 10%;"></td> <td style="width: 10%;"></td> <td style="width: 10%;"></td> <td style="width: 10%;"></td> </tr> <tr> <td></td> <td></td> <td colspan="8" style="text-align: center;"> <table border="1" style="width: 100%; border-collapse: collapse; text-align: center;"> <tr> <td style="width: 10%;"></td> <td style="width: 10%;"></td> <td style="width: 10%;"></td> <td style="width: 10%;"></td> <td style="width: 10%;"></td> <td style="width: 10%;"></td> <td style="width: 10%;"></td> <td style="width: 10%;"></td> <td style="width: 10%;"></td> <td style="width: 10%;"></td> </tr> <tr> <td></td> <td></td> <td colspan="8" style="text-align: center;"> <table border="1" style="width: 100%; border-collapse: collapse; text-align: center;"> <tr> <td style="width: 10%;"></td> <td style="width: 10%;"></td> <td style="width: 10%;"></td> <td style="width: 10%;"></td> <td style="width: 10%;"></td> <td style="width: 10%;"></td> <td style="width: 10%;"></td> <td style="width: 10%;"></td> <td style="width: 10%;"></td> <td style="width: 10%;"></td> </tr> <tr> <td></td> <td></td> <td colspan="8" style="text-align: center;"> <table border="1" style="width: 100%; border-collapse: collapse; text-align: center;"> <tr> <td style="width: 10%;"></td> <td style="width: 10%;"></td> <td style="width: 10%;"></td> <td style="width: 10%;"></td> <td style="width: 10%;"></td> <td style="width: 10%;"></td> <td style="width: 10%;"></td> <td style="width: 10%;"></td> <td style="width: 10%;"></td> <td style="width: 10%;"></td> </tr> <tr> <td></td> <td></td> <td colspan="8" style="text-align: center;"> <table border="1" style="width: 100%; border-collapse: collapse; text-align: center;"> <tr> <td style="width: 10%;"></td> <td style="width: 10%;"></td> <td style="width: 10%;"></td> <td style="width: 10%;"></td> <td style="width: 10%;"></td> <td style="width: 10%;"></td> <td style="width: 10%;"></td> <td style="width: 10%;"></td> <td style="width: 10%;"></td> <td style="width: 10%;"></td> </tr> <tr> <td></td> <td></td> <td colspan="8" style="text-align: center;"> <table border="1" style="width: 100%; border-collapse: collapse; text-align: center;"> <tr> <td style="width: 10%;"></td> <td
style="width: 10%;"></td> <td style="width: 10%;"></td> <td style="width: 10%;"></td> <td style="width: 10%;"></td> <td style="width: 10%;"></td> <td style="width: 10%;"></td> <td style="width: 10%;"></td> <td style="width: 10%;"></td> <td style="width: 10%;"></td> </tr> <tr> <td></td> <td></td> <td colspan="8" style="text-align: center;"> <table border="1" style="width: 100%; border-collapse: collapse; text-align: center;"> <tr> <td style="width: 10%;"></td> <td style="width: 10%;"></td> <td style="width: 10%;"></td> <td style="width: 10%;"></td> <td style="width: 10%;"></td> <td style="width: 10%;"></td> <td style="width: 10%;"></td> <td style="width: 10%;"></td> <td style="width: 10%;"></td> <td style="width: 10%;"></td> </tr> <tr> <td></td> <td></td> <td colspan="8" style="text-align: center;"> <table border="1" style="width: 100%; border-collapse: collapse; text-align: center;"> <tr> <td style="width: 10%;"></td> <td style="width: 10%;"></td> <td style="width: 10%;"></td> <td style="width: 10%;"></td> <td style="width: 10%;"></td> <td style="width: 10%;"></td> <td style="width: 10%;"></td> <td style="width: 10%;"></td> <td style="width: 10%;"></td> <td style="width: 10%;"></td> </tr> <tr> <td></td> <td></td> <td colspan="8" style="text-align: center;"> <table border="1" style="width: 100%; border-collapse: collapse; text-align: center;"> <tr> <td style="width: 10%;"></td> <td style="width: 10%;"></td> <td style="width: 10%;"></td> <td style="width: 10%;"></td> <td style="width: 10%;"></td> <td style="width: 10%;"></td> <td style="width: 10%;"></td> <td style="width: 10%;"></td> <td style="width: 10%;"></td> <td style="width: 10%;"></td> </tr> <tr> <td></td> <td></td> <td colspan="8" style="text-align: center;"> <table border="1" style="width: 100%; border-collapse: collapse; text-align: center;"> <tr> <td style="width: 10%;"></td> <td style="width: 10%;"></td> <td style="width: 10%;"></td> <td style="width: 10%;"></td> <td style="width: 10%;"></td> <td style="width: 10%;"></td> <td style="width: 10%;"></td> <td style="width: 10%;"></td> <td style="width: 10%;"></td> <td style="width: 10%;"></td> </tr> <tr> <td></td> <td></td> <td colspan="8" style="text-align: center;"> <table border="1" style="width: 100%; border-collapse: collapse; text-align: center;"> <tr> <td style="width: 10%;"></td> <td style="width: 10%;"></td> <td style="width: 10%;"></td> <td style="width: 10%;"></td> <td style="width: 10%;"></td> <td style="width: 10%;"></td> <td style="width: 10%;"></td> <td style="width: 10%;"></td> <td style="width: 10%;"></td> <td style="width: 10%;"></td> </tr> <tr> <td></td> <td></td> <td colspan="8" style="text-align: center;"> <table border="1" style="width: 100%; border-collapse: collapse; text-align: center;"> <tr> <td style="width: 10%;"></td> <td style="width: 10%;"></td> <td style="width: 10%;"></td> <td style="width: 10%;"></td> <td style="width: 10%;"></td> <td style="width: 10%;"></td> <td style="width: 10%;"></td> <td style="width: 10%;"></td> <td style="width: 10%;"></td> <td style="width: 10%;"></td> </tr> <tr> <td></td> <td></td> <td colspan="8" style="text-align: center;"> <table border="1" style="width: 100%; border-collapse: collapse; text-align: center;"> <tr> <td style="width: 10%;"></td> <td style="width: 10%;"></td> <td style="width: 10%;"></td> <td style="width: 10%;"></td> <td style="width: 10%;"></td> <td style="width: 10%;"></td> <td style="width: 10%;"></td> <td style="width: 10%;"></td> <td style="width: 10%;"></td> <td style="width: 10%;"></td> </tr> <tr> <td></td> <td></td> <td colspan="8" style="text-align: center;"> <table border="1" style="width: 100%; border-collapse: collapse; text-align: center;"> <tr> <td style="width: 10%;"></td> <td style="width: 10%;"></td> <td style="width: 10%;"></td> <td style="width: 10%;"></td> <td style="width: 10%;"></td> <td style="width: 10%;"></td> <td style="width: 10%;"></td> <td style="width: 10%;"></td> <td style="width: 10%;"></td> <td style="width: 10%;"></td> </tr> <tr> <td></td> <td></td> <td colspan="8" style="text-align: center;"> <table border="1" style="width: 100%; border-collapse: collapse; text-align: center;"> <tr> <td style="width: 10%;"></td> <td style="width: 10%;"></td> <td style="width: 10%;"></td> <td style="width: 10%;"></td> <td style="width: 10%;"></td> <td style="width: 10%;"></td> <td style="width: 10%;"></td> <td style="width: 10%;"></td> <td style="width: 10%;"></td> <td style="width: 10%;"></td> </tr> <tr> <td></td> <td></td> <td colspan="8" style="text-align: center;"> <table border="1" style="width: 100%; border-collapse: collapse; text-align: center;"> <tr> <td style="width: 10%;"></td> <td style="width: 10%;"></td> <td style="width: 10%;"></td> <td style="width: 10%;"></td> <td style="width: 10%;"></td> <td style="width: 10%;"></td> <td style="width: 10%;"></td> <td style="width: 10%;"></td> <td style="width: 10%;"></td> <td style="width: 10%;"></td> </tr> <tr> <td></td> <td></td> <td colspan="8" style="text-align: center;"> <table border="1" style="width: 100%; border-collapse: collapse; text-align: center;"> <tr> <td style="width: 10%;"></td> <td style="width: 10%;"></td> <td style="width: 10%;"></td> <td style="width: 10%;"></td> <td style="width: 10%;"></td> <td style="width: 10%;"></td> <td style="width: 10%;"></td> <td style="width: 10%;"></td> <td style="width: 10%;"></td> <td style="width: 10%;"></td> </tr> <tr> <td></td> <td></td> <td colspan="8" style="text-align: center;"> <table border="1" style="width: 100%; border-collapse: collapse; text-align: center;"> <tr> <td style="width: 10%;"></td> <td style="width: 10%;"></td> <td style="width: 10%;"></td> <td style="width: 10%;"></td> <td style="width: 10%;"></td> <td style="width: 10%;"></td> <td style="width: 10%;"></td> <td style="width: 10%;"></td> <td style="width: 10%;"></td> <td style="width: 10%;"></td> </tr> <tr> <td></td> <td></td> <td colspan="8" style="text-align: center;"> <table border="1" style="width: 100%; border-collapse: collapse; text-align: center;"> <tr> <td style="width: 10%;"></td> <td style="width: 10%;"></td> <td style="width: 10%;"></td> <td style="width: 10%;"></td> <td style="width: 10%;"></td> <td style="width: 10%;"></td> <td style="width: 10%;"></td> <td style="width: 10%;"></td> <td style="width: 10%;"></td> <td style="width: 10%;"></td> </tr> <tr> <td></td> <td></td> <td colspan="8" style="text-align: center;"> <table border="1" style="width: 100%; border-collapse: collapse; text-align: center;"> <tr> <td style="width: 10%;"></td> <td style="width: 10%;"></td> <td style="width: 10%;"></td> <td style="width: 10%;"></td> <td style="width: 10%;"></td> <td style="width: 10%;"></td> <td style="width: 10%;"></td> <td style="width: 10%;"></td> <td style="width: 10%;"></td> <td style="width: 10%;"></td> </tr> <tr> <td></td> <td></td> <td colspan="8" style="text-align: center;"> <table border="1" style="width: 100%; border-collapse: collapse; text-align: center;"> <tr> <td style="width: 10%;"></td> <td style="width: 10%;"></td> <td style="width: 10%;"></td> <td style="width: 10%;"></td> <td style="width: 10%;"></td> <td style="width: 10%;"></td> <td style="width: 10%;"></td> <td style="width: 10%;"></td> <td style="width: 10%;"></td> <td style="width: 10%;"></td> </tr> <tr> <td></td> <td></td> <td colspan="8" style="text-align: center;"> <table border="1" style="width: 100%; border-collapse: collapse; text-align: center;"> <tr> <td style="width: 10%;"></td> <td style="width: 10%;"></td> <td style="width: 10%;"></td> <td style="width: 10%;"></td> <td style="width: 10%;"></td> <td style="width: 10%;"></td> <td style="width: 10%;"></td> <td style="width: 10%;"></td> <td style="width: 10%;"></td> <td style="width: 10%;"></td> </tr> <tr> <td></td> <td></td> <td colspan="8" style="text-align: center;"> <table border="1" style="width: 100%; border-collapse: collapse; text-align: center;"> <tr> <td style="width: 10%;"></td> <td style="width: 10%;"></td> <td style="width: 10%;"></td> <td style="width: 10%;"></td> <td style="width: 10%;"></td> <td style="width: 10%;"></td> <td style="width: 10%;"></td> <td style="width: 10%;"></td> <td style="width: 10%;"></td> <td style="width: 10%;"></td> </tr> <tr> <td></td> <td></td> <td colspan="8" style="text-align: center;"> <table border="1" style="width: 100%; border-collapse: collapse; text-align: center;"> <tr> <td style="width: 10%;"></td> <td style="width: 10%;"></td> <td style="width: 10%;"></td> <td style="width: 10%;"></td> <td style="width: 10%;"></td> <td style="width: 10%;"></td> <td style="width: 10%;"></td> <td style="width: 10%;"></td> <td style="width: 10%;"></td> <td style="width: 10%;"></td> </tr> <tr> <td></td> <td></td> <td colspan="8" style="text-align: center;"> <table border="1" style="width: 100%; border-collapse: collapse; text-align: center;"> <tr> </tr></table></td></tr></table></td></tr></table></td></tr></table></td></tr></table></td></tr></table></td></tr></table></td></tr></table></td></tr></table></td></tr></table></td></tr></table></td></tr></table></td></tr></table></td></tr></table></td></tr></table></td></tr></table></td></tr></table></td></tr></table></td></tr></table></td></tr></table></td></tr></table></td></tr></table></td></tr></table></td></tr></table></td></tr></table></td></tr></table></td></tr></table></td></tr></table></td></tr></table></td></tr></table></td></tr></table></td></tr></table></td></tr></table></td></tr></table></td></tr></table></td></tr></table></td></tr></table></td></tr></table></td></tr></table></td></tr></table></td></tr></table></td></tr></table></td></tr></table></td></tr></table></td></tr></table></td></tr></table></td></tr></table></td></tr></table></td></tr></table></td></tr></table></td></tr></table></td></tr></table></td></tr></table></td></tr></table></td></tr></table></td></tr></table></td></tr></table>
 | | | | | | | | | | | | | | | | | | | | <table border="1" style="width: 100%; border-collapse: collapse; text-align: center;"> <tr> <td style="width: 10%;"></td> <td style="width: 10%;"></td> <td style="width: 10%;"></td> <td style="width: 10%;"></td> <td style="width: 10%;"></td> <td style="width: 10%;"></td> <td style="width: 10%;"></td> <td style="width: 10%;"></td> <td style="width: 10%;"></td> <td style="width: 10%;"></td> </tr> <tr> <td></td> <td></td> <td colspan="8" style="text-align: center;"> <table border="1" style="width: 100%; border-collapse: collapse; text-align: center;"> <tr> <td style="width: 10%;"></td> <td style="width: 10%;"></td> <td style="width: 10%;"></td> <td style="width: 10%;"></td> <td style="width: 10%;"></td> <td style="width: 10%;"></td> <td style="width: 10%;"></td> <td style="width: 10%;"></td> <td style="width: 10%;"></td> <td style="width: 10%;"></td> </tr> <tr> <td></td> <td></td> <td colspan="8" style="text-align: center;"> <table border="1" style="width: 100%; border-collapse: collapse; text-align: center;"> <tr> <td style="width: 10%;"></td> <td style="width: 10%;"></td> <td style="width: 10%;"></td> <td style="width: 10%;"></td> <td style="width: 10%;"></td> <td style="width: 10%;"></td> <td style="width: 10%;"></td> <td style="width: 10%;"></td> <td style="width: 10%;"></td> <td style="width: 10%;"></td> </tr> <tr> <td></td> <td></td> <td colspan="8" style="text-align: center;"> <table border="1" style="width: 100%; border-collapse: collapse; text-align: center;"> <tr> <td style="width: 10%;"></td> <td style="width: 10%;"></td> <td style="width: 10%;"></td> <td style="width: 10%;"></td> <td style="width: 10%;"></td> <td style="width: 10%;"></td> <td style="width: 10%;"></td> <td style="width: 10%;"></td> <td style="width: 10%;"></td> <td style="width: 10%;"></td> </tr> <tr> <td></td> <td></td> <td colspan="8" style="text-align: center;"> <table border="1" style="width: 100%; border-collapse: collapse; text-align: center;"> <tr> <td style="width: 10%;"></td> <td style="width: 10%;"></td> <td style="width: 10%;"></td> <td style="width: 10%;"></td> <td style="width: 10%;"></td> <td style="width: 10%;"></td> <td style="width: 10%;"></td> <td style="width: 10%;"></td> <td style="width: 10%;"></td> <td style="width: 10%;"></td> </tr> <tr> <td></td> <td></td> <td colspan="8" style="text-align: center;"> <table border="1" style="width: 100%; border-collapse: collapse; text-align: center;"> <tr> <td style="width: 10%;"></td> <td style="width: 10%;"></td> <td style="width: 10%;"></td> <td style="width: 10%;"></td> <td style="width: 10%;"></td> <td style="width: 10%;"></td> <td style="width: 10%;"></td> <td style="width: 10%;"></td> <td style="width: 10%;"></td> <td style="width: 10%;"></td> </tr> <tr> <td></td> <td></td> <td colspan="8" style="text-align: center;"> <table border="1" style="width: 100%; border-collapse: collapse; text-align: center;"> <tr> <td style="width: 10%;"></td> <td style="width: 10%;"></td> <td style="width: 10%;"></td> <td style="width: 10%;"></td> <td style="width: 10%;"></td> <td style="width: 10%;"></td> <td style="width: 10%;"></td> <td style="width: 10%;"></td> <td style="width: 10%;"></td> <td style="width: 10%;"></td> </tr> <tr> <td></td> <td></td> <td colspan="8" style="text-align: center;"> <table border="1" style="width: 100%; border-collapse: collapse; text-align: center;"> <tr> <td style="width: 10%;"></td> <td style="width: 10%;"></td> <td style="width: 10%;"></td> <td style="width: 10%;"></td> <td style="width: 10%;"></td> <td style="width: 10%;"></td> <td style="width: 10%;"></td> <td style="width: 10%;"></td> <td style="width: 10%;"></td> <td style="width: 10%;"></td> </tr> <tr> <td></td> <td></td> <td colspan="8" style="text-align: center;"> <table border="1" style="width: 100%; border-collapse: collapse; text-align: center;"> <tr> <td style="width: 10%;"></td> <td style="width: 10%;"></td> <td style="width: 10%;"></td> <td style="width: 10%;"></td> <td style="width: 10%;"></td> <td style="width: 10%;"></td> <td style="width: 10%;"></td> <td style="width: 10%;"></td> <td style="width: 10%;"></td> <td style="width: 10%;"></td> </tr> <tr> <td></td> <td></td> <td colspan="8" style="text-align: center;"> <table border="1" style="width: 100%; border-collapse: collapse; text-align: center;"> <tr> <td style="width: 10%;"></td> <td style="width: 10%;"></td> <td style="width: 10%;"></td> <td style="width: 10%;"></td> <td style="width: 10%;"></td> <td style="width: 10%;"></td> <td style="width: 10%;"></td> <td style="width: 10%;"></td> <td style="width: 10%;"></td> <td style="width: 10%;"></td> </tr> <tr> <td></td> <td></td> <td colspan="8" style="text-align: center;"> <table border="1" style="width: 100%; border-collapse: collapse; text-align: center;"> <tr> <td style="width: 10%;"></td> <td style="width: 10%;"></td> <td style="width: 10%;"></td> <td style="width: 10%;"></td> <td style="width: 10%;"></td> <td style="width: 10%;"></td> <td style="width: 10%;"></td> <td style="width: 10%;"></td> <td style="width: 10%;"></td> <td style="width: 10%;"></td> </tr> <tr> <td></td> <td></td> <td colspan="8" style="text-align: center;"> <table border="1" style="width: 100%; border-collapse: collapse; text-align: center;"> <tr> <td style="width: 10%;"></td> <td style="width: 10%;"></td> <td style="width: 10%;"></td> <td style="width: 10%;"></td> <td style="width: 10%;"></td> <td style="width: 10%;"></td> <td style="width: 10%;"></td> <td style="width: 10%;"></td> <td style="width: 10%;"></td> <td style="width: 10%;"></td> </tr> <tr> <td></td> <td></td> <td colspan="8" style="text-align: center;"> <table border="1" style="width: 100%; border-collapse: collapse; text-align: center;"> <tr> <td style="width: 10%;"></td> <td style="width: 10%;"></td> <td style="width: 10%;"></td> <td style="width: 10%;"></td> <td style="width: 10%;"></td> <td style="width: 10%;"></td> <td style="width: 10%;"></td> <td style="width: 10%;"></td> <td style="width: 10%;"></td> <td style="width: 10%;"></td> </tr> <tr> <td></td> <td></td> <td colspan="8" style="text-align: center;"> <table border="1" style="width: 100%; border-collapse: collapse; text-align: center;"> <tr> <td style="width: 10%;"></td> <td style="width: 10%;"></td> <td style="width: 10%;"></td> <td style="width: 10%;"></td> <td style="width: 10%;"></td> <td style="width: 10%;"></td> <td style="width: 10%;"></td> <td style="width: 10%;"></td> <td style="width: 10%;"></td> <td style="width: 10%;"></td> </tr> <tr> <td></td> <td></td> <td colspan="8" style="text-align: center;"> <table border="1" style="width: 100%; border-collapse: collapse; text-align: center;"> <tr> <td style="width: 10%;"></td> <td style="width: 10%;"></td> <td style="width: 10%;"></td> <td style="width: 10%;"></td> <td style="width: 10%;"></td> <td style="width: 10%;"></td> <td style="width: 10%;"></td> <td style="width: 10%;"></td> <td style="width: 10%;"></td> <td style="width: 10%;"></td> </tr> <tr> <td></td> <td></td> <td colspan="8" style="text-align: center;"> <table border="1" style="width: 100%; border-collapse: collapse; text-align: center;"> <tr> <td style="width: 10%;"></td> <td style="width: 10%;"></td> <td style="width: 10%;"></td> <td style="width: 10%;"></td> <td style="width: 10%;"></td> <td style="width: 10%;"></td> <td style="width: 10%;"></td> <td style="width: 10%;"></td> <td style="width: 10%;"></td> <td style="width: 10%;"></td> </tr> <tr> <td></td> <td></td> <td colspan="8" style="text-align: center;"> <table border="1" style="width: 100%; border-collapse: collapse; text-align: center;"> <tr> <td style="width: 10%;"></td> <td style="width: 10%;"></td> <td style="width: 10%;"></td> <td style="width: 10%;"></td> <td style="width: 10%;"></td> <td style="width: 10%;"></td> <td style="width: 10%;"></td> <td style="width: 10%;"></td> <td style="width: 10%;"></td> <td style="width: 10%;"></td> </tr> <tr> <td></td> <td></td> <td colspan="8" style="text-align: center;"> <table border="1" style="width: 100%; border-collapse: collapse; text-align: center;"> <tr> <td style="width: 10%;"></td> <td style="width: 10%;"></td> <td style="width: 10%;"></td> <td style="width: 10%;"></td> <td style="width: 10%;"></td> <td style="width: 10%;"></td> <td style="width: 10%;"></td> <td style="width: 10%;"></td> <td style="width: 10%;"></td> <td style="width: 10%;"></td> </tr> <tr> <td></td> <td></td> <td colspan="8" style="text-align: center;"> <table border="1" style="width: 100%; border-collapse: collapse; text-align: center;"> <tr> <td style="width: 10%;"></td> <td style="width: 10%;"></td> <td style="width:
10%;"></td> <td style="width: 10%;"></td> <td style="width: 10%;"></td> <td style="width: 10%;"></td> <td style="width: 10%;"></td> <td style="width: 10%;"></td> <td style="width: 10%;"></td> <td style="width: 10%;"></td> </tr> <tr> <td></td> <td></td> <td colspan="8" style="text-align: center;"> <table border="1" style="width: 100%; border-collapse: collapse; text-align: center;"> <tr> <td style="width: 10%;"></td> <td style="width: 10%;"></td> <td style="width: 10%;"></td> <td style="width: 10%;"></td> <td style="width: 10%;"></td> <td style="width: 10%;"></td> <td style="width: 10%;"></td> <td style="width: 10%;"></td> <td style="width: 10%;"></td> <td style="width: 10%;"></td> </tr> <tr> <td></td> <td></td> <td colspan="8" style="text-align: center;"> <table border="1" style="width: 100%; border-collapse: collapse; text-align: center;"> <tr> <td style="width: 10%;"></td> <td style="width: 10%;"></td> <td style="width: 10%;"></td> <td style="width: 10%;"></td> <td style="width: 10%;"></td> <td style="width: 10%;"></td> <td style="width: 10%;"></td> <td style="width: 10%;"></td> <td style="width: 10%;"></td> <td style="width: 10%;"></td> </tr> <tr> <td></td> <td></td> <td colspan="8" style="text-align: center;"> <table border="1" style="width: 100%; border-collapse: collapse; text-align: center;"> <tr> <td style="width: 10%;"></td> <td style="width: 10%;"></td> <td style="width: 10%;"></td> <td style="width: 10%;"></td> <td style="width: 10%;"></td> <td style="width: 10%;"></td> <td style="width: 10%;"></td> <td style="width: 10%;"></td> <td style="width: 10%;"></td> <td style="width: 10%;"></td> </tr> <tr> <td></td> <td></td> <td colspan="8" style="text-align: center;"> <table border="1" style="width: 100%; border-collapse: collapse; text-align: center;"> <tr> <td style="width: 10%;"></td> <td style="width: 10%;"></td> <td style="width: 10%;"></td> <td style="width: 10%;"></td> <td style="width: 10%;"></td> <td style="width: 10%;"></td> <td style="width: 10%;"></td> <td style="width: 10%;"></td> <td style="width: 10%;"></td> <td style="width: 10%;"></td> </tr> <tr> <td></td> <td></td> <td colspan="8" style="text-align: center;"> <table border="1" style="width: 100%; border-collapse: collapse; text-align: center;"> <tr> <td style="width: 10%;"></td> <td style="width: 10%;"></td> <td style="width: 10%;"></td> <td style="width: 10%;"></td> <td style="width: 10%;"></td> <td style="width: 10%;"></td> <td style="width: 10%;"></td> <td style="width: 10%;"></td> <td style="width: 10%;"></td> <td style="width: 10%;"></td> </tr> <tr> <td></td> <td></td> <td colspan="8" style="text-align: center;"> <table border="1" style="width: 100%; border-collapse: collapse; text-align: center;"> <tr> <td style="width: 10%;"></td> <td style="width: 10%;"></td> <td style="width: 10%;"></td> <td style="width: 10%;"></td> <td style="width: 10%;"></td> <td style="width: 10%;"></td> <td style="width: 10%;"></td> <td style="width: 10%;"></td> <td style="width: 10%;"></td> <td style="width: 10%;"></td> </tr> <tr> <td></td> <td></td> <td colspan="8" style="text-align: center;"> <table border="1" style="width: 100%; border-collapse: collapse; text-align: center;"> <tr> <td style="width: 10%;"></td> <td style="width: 10%;"></td> <td style="width: 10%;"></td> <td style="width: 10%;"></td> <td style="width: 10%;"></td> <td style="width: 10%;"></td> <td style="width: 10%;"></td> <td style="width: 10%;"></td> <td style="width: 10%;"></td> <td style="width: 10%;"></td> </tr> <tr> <td></td> <td></td> <td colspan="8" style="text-align: center;"> <table border="1" style="width: 100%; border-collapse: collapse; text-align: center;"> <tr> <td style="width: 10%;"></td> <td style="width: 10%;"></td> <td style="width: 10%;"></td> <td style="width: 10%;"></td> <td style="width: 10%;"></td> <td style="width: 10%;"></td> <td style="width: 10%;"></td> <td style="width: 10%;"></td> <td style="width: 10%;"></td> <td style="width: 10%;"></td> </tr> <tr> <td></td> <td></td> <td colspan="8" style="text-align: center;"> <table border="1" style="width: 100%; border-collapse: collapse; text-align: center;"> <tr> <td style="width: 10%;"></td> <td style="width: 10%;"></td> <td style="width: 10%;"></td> <td style="width: 10%;"></td> <td style="width: 10%;"></td> <td style="width: 10%;"></td> <td style="width: 10%;"></td> <td style="width: 10%;"></td> <td style="width: 10%;"></td> <td style="width: 10%;"></td> </tr> <tr> <td></td> <td></td> <td colspan="8" style="text-align: center;"> <table border="1" style="width: 100%; border-collapse: collapse; text-align: center;"> <tr> <td style="width: 10%;"></td> <td style="width: 10%;"></td> <td style="width: 10%;"></td> <td style="width: 10%;"></td> <td style="width: 10%;"></td> <td style="width: 10%;"></td> <td style="width: 10%;"></td> <td style="width: 10%;"></td> <td style="width: 10%;"></td> <td style="width: 10%;"></td> </tr> <tr> <td></td> <td></td> <td colspan="8" style="text-align: center;"> <table border="1" style="width: 100%; border-collapse: collapse; text-align: center;"> <tr> <td style="width: 10%;"></td> <td style="width: 10%;"></td> <td style="width: 10%;"></td> <td style="width: 10%;"></td> <td style="width: 10%;"></td> <td style="width: 10%;"></td> <td style="width: 10%;"></td> <td style="width: 10%;"></td> <td style="width: 10%;"></td> <td style="width: 10%;"></td> </tr> <tr> <td></td> <td></td> <td colspan="8" style="text-align: center;"> <table border="1" style="width: 100%; border-collapse: collapse; text-align: center;"> <tr> <td style="width: 10%;"></td> <td style="width: 10%;"></td> <td style="width: 10%;"></td> <td style="width: 10%;"></td> <td style="width: 10%;"></td> <td style="width: 10%;"></td> <td style="width: 10%;"></td> <td style="width: 10%;"></td> <td style="width: 10%;"></td> <td style="width: 10%;"></td> </tr> <tr> <td></td> <td></td> <td colspan="8" style="text-align: center;"> <table border="1" style="width: 100%; border-collapse: collapse; text-align: center;"> <tr> <td style="width: 10%;"></td> <td style="width: 10%;"></td> <td style="width: 10%;"></td> <td style="width: 10%;"></td> <td style="width: 10%;"></td> <td style="width: 10%;"></td> <td style="width: 10%;"></td> <td style="width: 10%;"></td> <td style="width: 10%;"></td> <td style="width: 10%;"></td> </tr> <tr> <td></td> <td></td> <td colspan="8" style="text-align: center;"> <table border="1" style="width: 100%; border-collapse: collapse; text-align: center;"> <tr> <td style="width: 10%;"></td> <td style="width: 10%;"></td> <td style="width: 10%;"></td> <td style="width: 10%;"></td> <td style="width: 10%;"></td> <td style="width: 10%;"></td> <td style="width: 10%;"></td> <td style="width: 10%;"></td> <td style="width: 10%;"></td> <td style="width: 10%;"></td> </tr> <tr> <td></td> <td></td> <td colspan="8" style="text-align: center;"> <table border="1" style="width: 100%; border-collapse: collapse; text-align: center;"> <tr> <td style="width: 10%;"></td> <td style="width: 10%;"></td> <td style="width: 10%;"></td> <td style="width: 10%;"></td> <td style="width: 10%;"></td> <td style="width: 10%;"></td> <td style="width: 10%;"></td> <td style="width: 10%;"></td> <td style="width: 10%;"></td> <td style="width: 10%;"></td> </tr> <tr> <td></td> <td></td> <td colspan="8" style="text-align: center;"> <table border="1" style="width: 100%; border-collapse: collapse; text-align: center;"> <tr> <td style="width: 10%;"></td> <td style="width: 10%;"></td> <td style="width: 10%;"></td> <td style="width: 10%;"></td> <td style="width: 10%;"></td> <td style="width: 10%;"></td> <td style="width: 10%;"></td> <td style="width: 10%;"></td> <td style="width: 10%;"></td> <td style="width: 10%;"></td> </tr> <tr> <td></td> <td></td> <td colspan="8" style="text-align: center;"> <table border="1" style="width: 100%; border-collapse: collapse; text-align: center;"> <tr> <td style="width: 10%;"></td> <td style="width: 10%;"></td> <td style="width: 10%;"></td> <td style="width: 10%;"></td> <td style="width: 10%;"></td> <td style="width: 10%;"></td> <td style="width: 10%;"></td> <td style="width: 10%;"></td> <td style="width: 10%;"></td> <td style="width: 10%;"></td> </tr> <tr> <td></td> <td></td> <td colspan="8" style="text-align: center;"> <table border="1" style="width: 100%; border-collapse: collapse; text-align: center;"> <tr> <td style="width: 10%;"></td> <td style="width: 10%;"></td> <td style="width: 10%;"></td> <td style="width: 10%;"></td> <td style="width: 10%;"></td> <td style="width: 10%;"></td> <td style="width: 10%;"></td> <td style="width: 10%;"></td> <td style="width: 10%;"></td> <td style="width: 10%;"></td> </tr> <tr> <td></td> <td></td> <td colspan="8" style="text-align: center;"> <table border="1" style="width: 100%; border-collapse: collapse; text-align: center;"> <tr> <td style="width: 10%;"></td> <td style="width: 10%;"></td> <td style="width: 10%;"></td> <td style="width: 10%;"></td> <td style="width: 10%;"></td> <td style="width: 10%;"></td> <td style="width: 10%;"></td> <td style="width: 10%;"></td> <td style="width: 10%;"></td> <td style="width: 10%;"></td> </tr> <tr> <td></td> <td></td> <td colspan="8" style="text-align: center;"> <table border="1" style="width: 100%; border-collapse: collapse; text-align: center;"> <tr> <td style="width: 10%;"></td> <td style="width: 10%;"></td> <td style="width: 10%;"></td> <td style="width: 10%;"></td> <td style="width: 10%;"></td> <td style="width: 10%;"></td> <td style="width: 10%;"></td> <td style="width: 10%;"></td> <td style="width: 10%;"></td> <td style="width: 10%;"></td> </tr> <tr> <td></td> <td></td> <td colspan="8" style="text-align: center;"> <table border="1" style="width: 100%; border-collapse: collapse; text-align: center;"> <tr> <td style="width: 10%;"></td> <td style="width: 10%;"></td> <td style="width: 10%;"></td> <td style="width: 10%;"></td> <td style="width: 10%;"></td> <td style="width: 10%;"></td> <td style="width: 10%;"></td> <td style="width: 10%;"></td> <td
style="width: 10%;"></td> <td style="width: 10%;"></td> </tr> <tr> <td></td> <td></td> <td colspan="8" style="text-align: center;"> <table border="1" style="width: 100%; border-collapse: collapse; text-align: center;"> <tr> <td style="width: 10%;"></td> <td style="width: 10%;"></td> <td style="width: 10%;"></td> <td style="width: 10%;"></td> <td style="width: 10%;"></td> <td style="width: 10%;"></td> <td style="width: 10%;"></td> <td style="width: 10%;"></td> <td style="width: 10%;"></td> <td style="width: 10%;"></td> </tr> <tr> <td></td> <td></td> <td colspan="8" style="text-align: center;"> <table border="1" style="width: 100%; border-collapse: collapse; text-align: center;"> <tr> <td style="width: 10%;"></td> <td style="width: 10%;"></td> <td style="width: 10%;"></td> <td style="width: 10%;"></td> <td style="width: 10%;"></td> <td style="width: 10%;"></td> <td style="width: 10%;"></td> <td style="width: 10%;"></td> <td style="width: 10%;"></td> <td style="width: 10%;"></td> </tr> <tr> <td></td> <td></td> <td colspan="8" style="text-align: center;"> <table border="1" style="width: 100%; border-collapse: collapse; text-align: center;"> <tr> <td style="width: 10%;"></td> <td style="width: 10%;"></td> <td style="width: 10%;"></td> <td style="width: 10%;"></td> <td style="width: 10%;"></td> <td style="width: 10%;"></td> <td style="width: 10%;"></td> <td style="width: 10%;"></td> <td style="width: 10%;"></td> <td style="width: 10%;"></td> </tr> <tr> <td></td> <td></td> <td colspan="8" style="text-align: center;"> <table border="1" style="width: 100%; border-collapse: collapse; text-align: center;"> <tr> <td style="width: 10%;"></td> <td style="width: 10%;"></td> <td style="width: 10%;"></td> <td style="width: 10%;"></td> <td style="width: 10%;"></td> <td style="width: 10%;"></td> <td style="width: 10%;"></td> <td style="width: 10%;"></td> <td style="width: 10%;"></td> <td style="width: 10%;"></td> </tr> <tr> <td></td> <td></td> <td colspan="8" style="text-align: center;"> <table border="1" style="width: 100%; border-collapse: collapse; text-align: center;"> <tr> <td style="width: 10%;"></td> <td style="width: 10%;"></td> <td style="width: 10%;"></td> <td style="width: 10%;"></td> <td style="width: 10%;"></td> <td style="width: 10%;"></td> <td style="width: 10%;"></td> <td style="width: 10%;"></td> <td style="width: 10%;"></td> <td style="width: 10%;"></td> </tr> <tr> <td></td> <td></td> <td colspan="8" style="text-align: center;"> <table border="1" style="width: 100%; border-collapse: collapse; text-align: center;"> <tr> <td style="width: 10%;"></td> <td style="width: 10%;"></td> <td style="width: 10%;"></td> <td style="width: 10%;"></td> <td style="width: 10%;"></td> <td style="width: 10%;"></td> <td style="width: 10%;"></td> <td style="width: 10%;"></td> <td style="width: 10%;"></td> <td style="width: 10%;"></td> </tr> <tr> <td></td> <td></td> <td colspan="8" style="text-align: center;"> <table border="1" style="width: 100%; border-collapse: collapse; text-align: center;"> <tr> <td style="width: 10%;"></td> <td style="width: 10%;"></td> <td style="width: 10%;"></td> <td style="width: 10%;"></td> <td style="width: 10%;"></td> <td style="width: 10%;"></td> <td style="width: 10%;"></td> <td style="width: 10%;"></td> <td style="width: 10%;"></td> <td style="width: 10%;"></td> </tr> <tr> <td></td> <td></td> <td colspan="8" style="text-align: center;"> <table border="1" style="width: 100%; border-collapse: collapse; text-align: center;"> <tr> <td style="width: 10%;"></td> <td style="width: 10%;"></td> <td style="width: 10%;"></td> <td style="width: 10%;"></td> <td style="width: 10%;"></td> <td style="width: 10%;"></td> <td style="width: 10%;"></td> <td style="width: 10%;"></td> <td style="width: 10%;"></td> <td style="width: 10%;"></td> </tr> <tr> <td></td> <td></td> <td colspan="8" style="text-align: center;"> <table border="1" style="width: 100%; border-collapse: collapse; text-align: center;"> <tr> <td style="width: 10%;"></td> <td style="width: 10%;"></td> <td style="width: 10%;"></td> <td style="width: 10%;"></td> <td style="width: 10%;"></td> <td style="width: 10%;"></td> <td style="width: 10%;"></td> <td style="width: 10%;"></td> <td style="width: 10%;"></td> <td style="width: 10%;"></td> </tr> <tr> <td></td> <td></td> <td colspan="8" style="text-align: center;"> <table border="1" style="width: 100%; border-collapse: collapse; text-align: center;"> <tr> <td style="width: 10%;"></td> <td style="width: 10%;"></td> <td style="width: 10%;"></td> <td style="width: 10%;"></td> <td style="width: 10%;"></td> <td style="width: 10%;"></td> <td style="width: 10%;"></td> <td style="width: 10%;"></td> <td style="width: 10%;"></td> <td style="width: 10%;"></td> </tr> <tr> <td></td> <td></td> <td colspan="8" style="text-align: center;"> <table border="1" style="width: 100%; border-collapse: collapse; text-align: center;"> <tr> <td style="width: 10%;"></td> <td style="width: 10%;"></td> <td style="width: 10%;"></td> <td style="width: 10%;"></td> <td style="width: 10%;"></td> <td style="width: 10%;"></td> <td style="width: 10%;"></td> <td style="width: 10%;"></td> <td style="width: 10%;"></td> <td style="width: 10%;"></td> </tr> <tr> <td></td> <td></td> <td colspan="8" style="text-align: center;"> <table border="1" style="width: 100%; border-collapse: collapse; text-align: center;"> <tr> <td style="width: 10%;"></td> <td style="width: 10%;"></td> <td style="width: 10%;"></td> <td style="width: 10%;"></td> <td style="width: 10%;"></td> <td style="width: 10%;"></td> <td style="width: 10%;"></td> <td style="width: 10%;"></td> <td style="width: 10%;"></td> <td style="width: 10%;"></td> </tr> <tr> <td></td> <td></td> <td colspan="8" style="text-align: center;"> <table border="1" style="width: 100%; border-collapse: collapse; text-align: center;"> <tr> <td style="width: 10%;"></td> <td style="width: 10%;"></td> <td style="width: 10%;"></td> <td style="width: 10%;"></td> <td style="width: 10%;"></td> <td style="width: 10%;"></td> <td style="width: 10%;"></td> <td style="width: 10%;"></td> <td style="width: 10%;"></td> <td style="width: 10%;"></td> </tr> <tr> <td></td> <td></td> <td colspan="8" style="text-align: center;"> <table border="1" style="width: 100%; border-collapse: collapse; text-align: center;"> <tr> <td style="width: 10%;"></td> <td style="width: 10%;"></td> <td style="width: 10%;"></td> <td style="width: 10%;"></td> <td style="width: 10%;"></td> <td style="width: 10%;"></td> <td style="width: 10%;"></td> <td style="width: 10%;"></td> <td style="width: 10%;"></td> <td style="width: 10%;"></td> </tr> <tr> <td></td> <td></td> <td colspan="8" style="text-align: center;"> <table border="1" style="width: 100%; border-collapse: collapse; text-align: center;"> <tr> <td style="width: 10%;"></td> <td style="width: 10%;"></td> <td style="width: 10%;"></td> <td style="width: 10%;"></td> <td style="width: 10%;"></td> <td style="width: 10%;"></td> <td style="width: 10%;"></td> <td style="width: 10%;"></td> <td style="width: 10%;"></td> <td style="width: 10%;"></td> </tr> <tr> <td></td> <td></td> <td colspan="8" style="text-align: center;"> <table border="1" style="width: 100%; border-collapse: collapse; text-align: center;"> <tr> </tr></table></td></tr></table></td></tr></table></td></tr></table></td></tr></table></td></tr></table></td></tr></table></td></tr></table></td></tr></table></td></tr></table></td></tr></table></td></tr></table></td></tr></table></td></tr></table></td></tr></table></td></tr></table></td></tr></table></td></tr></table></td></tr></table></td></tr></table></td></tr></table></td></tr></table></td></tr></table></td></tr></table></td></tr></table></td></tr></table></td></tr></table></td></tr></table></td></tr></table></td></tr></table></td></tr></table></td></tr></table></td></tr></table></td></tr></table></td></tr></table></td></tr></table></td></tr></table></td></tr></table></td></tr></table></td></tr></table></td></tr></table></td></tr></table></td></tr></table></td></tr></table></td></tr></table></td></tr></table></td></tr></table></td></tr></table></td></tr></table></td></tr></table></td></tr></table></td></tr></table></td></tr></table></td></tr></table></td></tr></table></td></tr></table> | | | | | | | | | | | | | | | | | | | | <table border="1" style="width: 100%; border-collapse: collapse; text-align: center;"> <tr> <td style="width: 10%;"></td> <td style="width: 10%;"></td> <td style="width: 10%;"></td> <td style="width: 10%;"></td> <td style="width:
10%;"></td> <td style="width: 10%;"></td> <td style="width: 10%;"></td> <td style="width: 10%;"></td> <td style="width: 10%;"></td> <td style="width: 10%;"></td> </tr> <tr> <td></td> <td></td> <td colspan="8" style="text-align: center;"> <table border="1" style="width: 100%; border-collapse: collapse; text-align: center;"> <tr> <td style="width: 10%;"></td> <td style="width: 10%;"></td> <td style="width: 10%;"></td> <td style="width: 10%;"></td> <td style="width: 10%;"></td> <td style="width: 10%;"></td> <td style="width: 10%;"></td> <td style="width: 10%;"></td> <td style="width: 10%;"></td> <td style="width: 10%;"></td> </tr> <tr> <td></td> <td></td> <td colspan="8" style="text-align: center;"> <table border="1" style="width: 100%; border-collapse: collapse; text-align: center;"> <tr> <td style="width: 10%;"></td> <td style="width: 10%;"></td> <td style="width: 10%;"></td> <td style="width: 10%;"></td> <td style="width: 10%;"></td> <td style="width: 10%;"></td> <td style="width: 10%;"></td> <td style="width: 10%;"></td> <td style="width: 10%;"></td> <td style="width: 10%;"></td> </tr> <tr> <td></td> <td></td> <td colspan="8" style="text-align: center;"> <table border="1" style="width: 100%; border-collapse: collapse; text-align: center;"> <tr> <td style="width: 10%;"></td> <td style="width: 10%;"></td> <td style="width: 10%;"></td> <td style="width: 10%;"></td> <td style="width: 10%;"></td> <td style="width: 10%;"></td> <td style="width: 10%;"></td> <td style="width: 10%;"></td> <td style="width: 10%;"></td> <td style="width: 10%;"></td> </tr> <tr> <td></td> <td></td> <td colspan="8" style="text-align: center;"> <table border="1" style="width: 100%; border-collapse: collapse; text-align: center;"> <tr> <td style="width: 10%;"></td> <td style="width: 10%;"></td> <td style="width: 10%;"></td> <td style="width: 10%;"></td> <td style="width: 10%;"></td> <td style="width: 10%;"></td> <td style="width: 10%;"></td> <td style="width: 10%;"></td> <td style="width: 10%;"></td> <td style="width: 10%;"></td> </tr> <tr> <td></td> <td></td> <td colspan="8" style="text-align: center;"> <table border="1" style="width: 100%; border-collapse: collapse; text-align: center;"> <tr> <td style="width: 10%;"></td> <td style="width: 10%;"></td> <td style="width: 10%;"></td> <td style="width: 10%;"></td> <td style="width: 10%;"></td> <td style="width: 10%;"></td> <td style="width: 10%;"></td> <td style="width: 10%;"></td> <td style="width: 10%;"></td> <td style="width: 10%;"></td> </tr> <tr> <td></td> <td></td> <td colspan="8" style="text-align: center;"> <table border="1" style="width: 100%; border-collapse: collapse; text-align: center;"> <tr> <td style="width: 10%;"></td> <td style="width: 10%;"></td> <td style="width: 10%;"></td> <td style="width: 10%;"></td> <td style="width: 10%;"></td> <td style="width: 10%;"></td> <td style="width: 10%;"></td> <td style="width: 10%;"></td> <td style="width: 10%;"></td> <td style="width: 10%;"></td> </tr> <tr> <td></td> <td></td> <td colspan="8" style="text-align: center;"> <table border="1" style="width: 100%; border-collapse: collapse; text-align: center;"> <tr> <td style="width: 10%;"></td> <td style="width: 10%;"></td> <td style="width: 10%;"></td> <td style="width: 10%;"></td> <td style="width: 10%;"></td> <td style="width: 10%;"></td> <td style="width: 10%;"></td> <td style="width: 10%;"></td> <td style="width: 10%;"></td> <td style="width: 10%;"></td> </tr> <tr> <td></td> <td></td> <td colspan="8" style="text-align: center;"> <table border="1" style="width: 100%; border-collapse: collapse; text-align: center;"> <tr> <td style="width: 10%;"></td> <td style="width: 10%;"></td> <td style="width: 10%;"></td> <td style="width: 10%;"></td> <td style="width: 10%;"></td> <td style="width: 10%;"></td> <td style="width: 10%;"></td> <td style="width: 10%;"></td> <td style="width: 10%;"></td> <td style="width: 10%;"></td> </tr> <tr> <td></td> <td></td> <td colspan="8" style="text-align: center;"> <table border="1" style="width: 100%; border-collapse: collapse; text-align: center;"> <tr> <td style="width: 10%;"></td> <td style="width: 10%;"></td> <td style="width: 10%;"></td> <td style="width: 10%;"></td> <td style="width: 10%;"></td> <td style="width: 10%;"></td> <td style="width: 10%;"></td> <td style="width: 10%;"></td> <td style="width: 10%;"></td> <td style="width: 10%;"></td> </tr> <tr> <td></td> <td></td> <td colspan="8" style="text-align: center;"> <table border="1" style="width: 100%; border-collapse: collapse; text-align: center;"> <tr> <td style="width: 10%;"></td> <td style="width: 10%;"></td> <td style="width: 10%;"></td> <td style="width: 10%;"></td> <td style="width: 10%;"></td> <td style="width: 10%;"></td> <td style="width: 10%;"></td> <td style="width: 10%;"></td> <td style="width: 10%;"></td> <td style="width: 10%;"></td> </tr> <tr> <td></td> <td></td> <td colspan="8" style="text-align: center;"> <table border="1" style="width: 100%; border-collapse: collapse; text-align: center;"> <tr> <td style="width: 10%;"></td> <td style="width: 10%;"></td> <td style="width: 10%;"></td> <td style="width: 10%;"></td> <td style="width: 10%;"></td> <td style="width: 10%;"></td> <td style="width: 10%;"></td> <td style="width: 10%;"></td> <td style="width: 10%;"></td> <td style="width: 10%;"></td> </tr> <tr> <td></td> <td></td> <td colspan="8" style="text-align: center;"> <table border="1" style="width: 100%; border-collapse: collapse; text-align: center;"> <tr> <td style="width: 10%;"></td> <td style="width: 10%;"></td> <td style="width: 10%;"></td> <td style="width: 10%;"></td> <td style="width: 10%;"></td> <td style="width: 10%;"></td> <td style="width: 10%;"></td> <td style="width: 10%;"></td> <td style="width: 10%;"></td> <td style="width: 10%;"></td> </tr> <tr> <td></td> <td></td> <td colspan="8" style="text-align: center;"> <table border="1" style="width: 100%; border-collapse: collapse; text-align: center;"> <tr> <td style="width: 10%;"></td> <td style="width: 10%;"></td> <td style="width: 10%;"></td> <td style="width: 10%;"></td> <td style="width: 10%;"></td> <td style="width: 10%;"></td> <td style="width: 10%;"></td> <td style="width: 10%;"></td> <td style="width: 10%;"></td> <td style="width: 10%;"></td> </tr> <tr> <td></td> <td></td> <td colspan="8" style="text-align: center;"> <table border="1" style="width: 100%; border-collapse: collapse; text-align: center;"> <tr> <td style="width: 10%;"></td> <td style="width: 10%;"></td> <td style="width: 10%;"></td> <td style="width: 10%;"></td> <td style="width: 10%;"></td> <td style="width: 10%;"></td> <td style="width: 10%;"></td> <td style="width: 10%;"></td> <td style="width: 10%;"></td> <td style="width: 10%;"></td> </tr> <tr> <td></td> <td></td> <td colspan="8" style="text-align: center;"> <table border="1" style="width: 100%; border-collapse: collapse; text-align: center;"> <tr> <td style="width: 10%;"></td> <td style="width: 10%;"></td> <td style="width: 10%;"></td> <td style="width: 10%;"></td> <td style="width: 10%;"></td> <td style="width: 10%;"></td> <td style="width: 10%;"></td> <td style="width: 10%;"></td> <td style="width: 10%;"></td> <td style="width: 10%;"></td> </tr> <tr> <td></td> <td></td> <td colspan="8" style="text-align: center;"> <table border="1" style="width: 100%; border-collapse: collapse; text-align: center;"> <tr> <td style="width: 10%;"></td> <td style="width: 10%;"></td> <td style="width: 10%;"></td> <td style="width: 10%;"></td> <td style="width: 10%;"></td> <td style="width: 10%;"></td> <td style="width: 10%;"></td> <td style="width: 10%;"></td> <td style="width: 10%;"></td> <td style="width: 10%;"></td> </tr> <tr> <td></td> <td></td> <td colspan="8" style="text-align: center;"> <table border="1" style="width: 100%; border-collapse: collapse; text-align: center;"> <tr> <td style="width: 10%;"></td> <td style="width: 10%;"></td> <td style="width: 10%;"></td> <td style="width: 10%;"></td> <td style="width: 10%;"></td> <td style="width: 10%;"></td> <td style="width: 10%;"></td> <td style="width: 10%;"></td> <td style="width: 10%;"></td> <td style="width: 10%;"></td> </tr> <tr> <td></td> <td></td> <td colspan="8" style="text-align: center;"> <table border="1" style="width: 100%; border-collapse: collapse; text-align: center;"> <tr> <td style="width: 10%;"></td> <td style="width: 10%;"></td> <td style="width: 10%;"></td> <td style="width: 10%;"></td> <td style="width: 10%;"></td> <td style="width: 10%;"></td> <td style="width: 10%;"></td> <td style="width: 10%;"></td> <td style="width: 10%;"></td> <td style="width: 10%;"></td> </tr> <tr> <td></td> <td></td> <td colspan="8" style="text-align: center;"> <table border="1" style="width: 100%; border-collapse: collapse; text-align: center;"> <tr> <td style="width: 10%;"></td> <td style="width: 10%;"></td> <td style="width: 10%;"></td> <td style="width: 10%;"></td> <td style="width: 10%;"></td> <td style="width: 10%;"></td> <td style="width: 10%;"></td> <td style="width: 10%;"></td> <td style="width: 10%;"></td> <td style="width: 10%;"></td> </tr> <tr> <td></td> <td></td> <td colspan="8" style="text-align: center;"> <table border="1" style="width: 100%; border-collapse: collapse; text-align: center;"> <tr> <td style="width: 10%;"></td> <td style="width: 10%;"></td> <td style="width: 10%;"></td> <td style="width: 10%;"></td> <td style="width: 10%;"></td> <td style="width: 10%;"></td> <td style="width: 10%;"></td> <td style="width: 10%;"></td> <td style="width: 10%;"></td> <td style="width: 10%;"></td> </tr> <tr> <td></td> <td></td> <td colspan="8" style="text-align: center;"> <table border="1" style="width: 100%; border-collapse: collapse; text-align: center;"> <tr> <td style="width: 10%;"></td> <td style="width: 10%;"></td> <td style="width: 10%;"></td> <td style="width: 10%;"></td> <td style="width: 10%;"></td> <td style="width: 10%;"></td> <td style="width: 10%;"></td> <td style="width: 10%;"></td> <td style="width: 10%;"></td> <td style="width: 10%;"></td> </tr>
<tr> <td></td> <td></td> <td colspan="8" style="text-align: center;"> <table border="1" style="width: 100%; border-collapse: collapse; text-align: center;"> <tr> <td style="width: 10%;"></td> <td style="width: 10%;"></td> <td style="width: 10%;"></td> <td style="width: 10%;"></td> <td style="width: 10%;"></td> <td style="width: 10%;"></td> <td style="width: 10%;"></td> <td style="width: 10%;"></td> <td style="width: 10%;"></td> <td style="width: 10%;"></td> </tr> <tr> <td></td> <td></td> <td colspan="8" style="text-align: center;"> <table border="1" style="width: 100%; border-collapse: collapse; text-align: center;"> <tr> <td style="width: 10%;"></td> <td style="width: 10%;"></td> <td style="width: 10%;"></td> <td style="width: 10%;"></td> <td style="width: 10%;"></td> <td style="width: 10%;"></td> <td style="width: 10%;"></td> <td style="width: 10%;"></td> <td style="width: 10%;"></td> <td style="width: 10%;"></td> </tr> <tr> <td></td> <td></td> <td colspan="8" style="text-align: center;"> <table border="1" style="width: 100%; border-collapse: collapse; text-align: center;"> <tr> <td style="width: 10%;"></td> <td style="width: 10%;"></td> <td style="width: 10%;"></td> <td style="width: 10%;"></td> <td style="width: 10%;"></td> <td style="width: 10%;"></td> <td style="width: 10%;"></td> <td style="width: 10%;"></td> <td style="width: 10%;"></td> <td style="width: 10%;"></td> </tr> <tr> <td></td> <td></td> <td colspan="8" style="text-align: center;"> <table border="1" style="width: 100%; border-collapse: collapse; text-align: center;"> <tr> <td style="width: 10%;"></td> <td style="width: 10%;"></td> <td style="width: 10%;"></td> <td style="width: 10%;"></td> <td style="width: 10%;"></td> <td style="width: 10%;"></td> <td style="width: 10%;"></td> <td style="width: 10%;"></td> <td style="width: 10%;"></td> <td style="width: 10%;"></td> </tr> <tr> <td></td> <td></td> <td colspan="8" style="text-align: center;"> <table border="1" style="width: 100%; border-collapse: collapse; text-align: center;"> <tr> <td style="width: 10%;"></td> <td style="width: 10%;"></td> <td style="width: 10%;"></td> <td style="width: 10%;"></td> <td style="width: 10%;"></td> <td style="width: 10%;"></td> <td style="width: 10%;"></td> <td style="width: 10%;"></td> <td style="width: 10%;"></td> <td style="width: 10%;"></td> </tr> <tr> <td></td> <td></td> <td colspan="8" style="text-align: center;"> <table border="1" style="width: 100%; border-collapse: collapse; text-align: center;"> <tr> <td style="width: 10%;"></td> <td style="width: 10%;"></td> <td style="width: 10%;"></td> <td style="width: 10%;"></td> <td style="width: 10%;"></td> <td style="width: 10%;"></td> <td style="width: 10%;"></td> <td style="width: 10%;"></td> <td style="width: 10%;"></td> <td style="width: 10%;"></td> </tr> <tr> <td></td> <td></td> <td colspan="8" style="text-align: center;"> <table border="1" style="width: 100%; border-collapse: collapse; text-align: center;"> <tr> <td style="width: 10%;"></td> <td style="width: 10%;"></td> <td style="width: 10%;"></td> <td style="width: 10%;"></td> <td style="width: 10%;"></td> <td style="width: 10%;"></td> <td style="width: 10%;"></td> <td style="width: 10%;"></td> <td style="width: 10%;"></td> <td style="width: 10%;"></td> </tr> <tr> <td></td> <td></td> <td colspan="8" style="text-align: center;"> <table border="1" style="width: 100%; border-collapse: collapse; text-align: center;"> <tr> <td style="width: 10%;"></td> <td style="width: 10%;"></td> <td style="width: 10%;"></td> <td style="width: 10%;"></td> <td style="width: 10%;"></td> <td style="width: 10%;"></td> <td style="width: 10%;"></td> <td style="width: 10%;"></td> <td style="width: 10%;"></td> <td style="width: 10%;"></td> </tr> <tr> <td></td> <td></td> <td colspan="8" style="text-align: center;"> <table border="1" style="width: 100%; border-collapse: collapse; text-align: center;"> <tr> <td style="width: 10%;"></td> <td style="width: 10%;"></td> <td style="width: 10%;"></td> <td style="width: 10%;"></td> <td style="width: 10%;"></td> <td style="width: 10%;"></td> <td style="width: 10%;"></td> <td style="width: 10%;"></td> <td style="width: 10%;"></td> <td style="width: 10%;"></td> </tr> <tr> <td></td> <td></td> <td colspan="8" style="text-align: center;"> <table border="1" style="width: 100%; border-collapse: collapse; text-align: center;"> <tr> <td style="width: 10%;"></td> <td style="width: 10%;"></td> <td style="width: 10%;"></td> <td style="width: 10%;"></td> <td style="width: 10%;"></td> <td style="width: 10%;"></td> <td style="width: 10%;"></td> <td style="width: 10%;"></td> <td style="width: 10%;"></td> <td style="width: 10%;"></td> </tr> <tr> <td></td> <td></td> <td colspan="8" style="text-align: center;"> <table border="1" style="width: 100%; border-collapse: collapse; text-align: center;"> <tr> <td style="width: 10%;"></td> <td style="width: 10%;"></td> <td style="width: 10%;"></td> <td style="width: 10%;"></td> <td style="width: 10%;"></td> <td style="width: 10%;"></td> <td style="width: 10%;"></td> <td style="width: 10%;"></td> <td style="width: 10%;"></td> <td style="width: 10%;"></td> </tr> <tr> <td></td> <td></td> <td colspan="8" style="text-align: center;"> <table border="1" style="width: 100%; border-collapse: collapse; text-align: center;"> <tr> <td style="width: 10%;"></td> <td style="width: 10%;"></td> <td style="width: 10%;"></td> <td style="width: 10%;"></td> <td style="width: 10%;"></td> <td style="width: 10%;"></td> <td style="width: 10%;"></td> <td style="width: 10%;"></td> <td style="width: 10%;"></td> <td style="width: 10%;"></td> </tr> <tr> <td></td> <td></td> <td colspan="8" style="text-align: center;"> <table border="1" style="width: 100%; border-collapse: collapse; text-align: center;"> <tr> <td style="width: 10%;"></td> <td style="width: 10%;"></td> <td style="width: 10%;"></td> <td style="width: 10%;"></td> <td style="width: 10%;"></td> <td style="width: 10%;"></td> <td style="width: 10%;"></td> <td style="width: 10%;"></td> <td style="width: 10%;"></td> <td style="width: 10%;"></td> </tr> <tr> <td></td> <td></td> <td colspan="8" style="text-align: center;"> <table border="1" style="width: 100%; border-collapse: collapse; text-align: center;"> <tr> <td style="width: 10%;"></td> <td style="width: 10%;"></td> <td style="width: 10%;"></td> <td style="width: 10%;"></td> <td style="width: 10%;"></td> <td style="width: 10%;"></td> <td style="width: 10%;"></td> <td style="width: 10%;"></td> <td style="width: 10%;"></td> <td style="width: 10%;"></td> </tr> <tr> <td></td> <td></td> <td colspan="8" style="text-align: center;"> <table border="1" style="width: 100%; border-collapse: collapse; text-align: center;"> <tr> <td style="width: 10%;"></td> <td style="width: 10%;"></td> <td style="width: 10%;"></td> <td style="width: 10%;"></td> <td style="width: 10%;"></td> <td style="width: 10%;"></td> <td style="width: 10%;"></td> <td style="width: 10%;"></td> <td style="width: 10%;"></td> <td style="width: 10%;"></td> </tr> <tr> <td></td> <td></td> <td colspan="8" style="text-align: center;"> <table border="1" style="width: 100%; border-collapse: collapse; text-align: center;"> <tr> <td style="width: 10%;"></td> <td style="width: 10%;"></td> <td style="width: 10%;"></td> <td style="width: 10%;"></td> <td style="width: 10%;"></td> <td style="width: 10%;"></td> <td style="width: 10%;"></td> <td style="width: 10%;"></td> <td style="width: 10%;"></td> <td style="width: 10%;"></td> </tr> <tr> <td></td> <td></td> <td colspan="8" style="text-align: center;"> <table border="1" style="width: 100%; border-collapse: collapse; text-align: center;"> <tr> <td style="width: 10%;"></td> <td style="width: 10%;"></td> <td style="width: 10%;"></td> <td style="width: 10%;"></td> <td style="width: 10%;"></td> <td style="width: 10%;"></td> <td style="width: 10%;"></td> <td style="width: 10%;"></td> <td style="width: 10%;"></td> <td style="width: 10%;"></td> </tr> <tr> <td></td> <td></td> <td colspan="8" style="text-align: center;"> <table border="1" style="width: 100%; border-collapse: collapse; text-align: center;"> <tr> <td style="width: 10%;"></td> <td style="width: 10%;"></td> <td style="width: 10%;"></td> <td style="width: 10%;"></td> <td style="width: 10%;"></td> <td style="width: 10%;"></td> <td style="width: 10%;"></td> <td style="width: 10%;"></td> <td style="width: 10%;"></td> <td style="width: 10%;"></td> </tr> <tr> <td></td> <td></td> <td colspan="8" style="text-align: center;"> <table border="1" style="width: 100%; border-collapse: collapse; text-align: center;"> <tr> <td style="width: 10%;"></td> <td style="width: 10%;"></td> <td style="width: 10%;"></td> <td style="width: 10%;"></td> <td style="width: 10%;"></td> <td style="width: 10%;"></td> <td style="width: 10%;"></td> <td style="width: 10%;"></td> <td style="width: 10%;"></td> <td style="width: 10%;"></td> </tr> <tr> <td></td> <td></td> <td colspan="8" style="text-align: center;"> <table border="1" style="width: 100%; border-collapse: collapse; text-align: center;"> <tr> <td style="width: 10%;"></td> <td style="width: 10%;"></td> <td style="width: 10%;"></td> <td style="width: 10%;"></td> <td style="width: 10%;"></td> <td style="width: 10%;"></td> <td style="width: 10%;"></td> <td style="width: 10%;"></td> <td style="width: 10%;"></td> <td style="width: 10%;"></td> </tr> <tr> <td></td> <td></td> <td colspan="8" style="text-align: center;"> <table border="1" style="width: 100%; border-collapse: collapse; text-align: center;"> <tr> <td style="width: 10%;"></td> <td style="width: 10%;"></td> <td style="width: 10%;"></td> <td style="width: 10%;"></td> <td style="width: 10%;"></td> <td style="width: 10%;"></td> <td style="width: 10%;"></td> <td style="width: 10%;"></td> <td style="width: 10%;"></td> <td style="width: 10%;"></td> </tr> <tr> <td></td> <td></td> <td colspan="8" style="text-align: center;"> <table border="1" style="width: 100%; border-collapse: collapse; text-align: center;"> <tr> <td
style="width: 10%;"></td> <td style="width: 10%;"></td> <td style="width: 10%;"></td> <td style="width: 10%;"></td> <td style="width: 10%;"></td> <td style="width: 10%;"></td> <td style="width: 10%;"></td> <td style="width: 10%;"></td> <td style="width: 10%;"></td> <td style="width: 10%;"></td> </tr> <tr> <td></td> <td></td> <td colspan="8" style="text-align: center;"> <table border="1" style="width: 100%; border-collapse: collapse; text-align: center;"> <tr> <td style="width: 10%;"></td> <td style="width: 10%;"></td> <td style="width: 10%;"></td> <td style="width: 10%;"></td> <td style="width: 10%;"></td> <td style="width: 10%;"></td> <td style="width: 10%;"></td> <td style="width: 10%;"></td> <td style="width: 10%;"></td> <td style="width: 10%;"></td> </tr> <tr> <td></td> <td></td> <td colspan="8" style="text-align: center;"> <table border="1" style="width: 100%; border-collapse: collapse; text-align: center;"> <tr> <td style="width: 10%;"></td> <td style="width: 10%;"></td> <td style="width: 10%;"></td> <td style="width: 10%;"></td> <td style="width: 10%;"></td> <td style="width: 10%;"></td> <td style="width: 10%;"></td> <td style="width: 10%;"></td> <td style="width: 10%;"></td> <td style="width: 10%;"></td> </tr> <tr> <td></td> <td></td> <td colspan="8" style="text-align: center;"> <table border="1" style="width: 100%; border-collapse: collapse; text-align: center;"> <tr> <td style="width: 10%;"></td> <td style="width: 10%;"></td> <td style="width: 10%;"></td> <td style="width: 10%;"></td> <td style="width: 10%;"></td> <td style="width: 10%;"></td> <td style="width: 10%;"></td> <td style="width: 10%;"></td> <td style="width: 10%;"></td> <td style="width: 10%;"></td> </tr> <tr> <td></td> <td></td> <td colspan="8" style="text-align: center;"> <table border="1" style="width: 100%; border-collapse: collapse; text-align: center;"> <tr> <td style="width: 10%;"></td> <td style="width: 10%;"></td> <td style="width: 10%;"></td> <td style="width: 10%;"></td> <td style="width: 10%;"></td> <td style="width: 10%;"></td> <td style="width: 10%;"></td> <td style="width: 10%;"></td> <td style="width: 10%;"></td> <td style="width: 10%;"></td> </tr> <tr> <td></td> <td></td> <td colspan="8" style="text-align: center;"> <table border="1" style="width: 100%; border-collapse: collapse; text-align: center;"> <tr> <td style="width: 10%;"></td> <td style="width: 10%;"></td> <td style="width: 10%;"></td> <td style="width: 10%;"></td> <td style="width: 10%;"></td> <td style="width: 10%;"></td> <td style="width: 10%;"></td> <td style="width: 10%;"></td> <td style="width: 10%;"></td> <td style="width: 10%;"></td> </tr> <tr> <td></td> <td></td> <td colspan="8" style="text-align: center;"> <table border="1" style="width: 100%; border-collapse: collapse; text-align: center;"> <tr> <td style="width: 10%;"></td> <td style="width: 10%;"></td> <td style="width: 10%;"></td> <td style="width: 10%;"></td> <td style="width: 10%;"></td> <td style="width: 10%;"></td> <td style="width: 10%;"></td> <td style="width: 10%;"></td> <td style="width: 10%;"></td> <td style="width: 10%;"></td> </tr> <tr> <td></td> <td></td> <td colspan="8" style="text-align: center;"> <table border="1" style="width: 100%; border-collapse: collapse; text-align: center;"> <tr> <td style="width: 10%;"></td> <td style="width: 10%;"></td> <td style="width: 10%;"></td> <td style="width: 10%;"></td> <td style="width: 10%;"></td> <td style="width: 10%;"></td> <td style="width: 10%;"></td> <td style="width: 10%;"></td> <td style="width: 10%;"></td> <td style="width: 10%;"></td> </tr> <tr> <td></td> <td></td> <td colspan="8" style="text-align: center;"> <table border="1" style="width: 100%; border-collapse: collapse; text-align: center;"> <tr> <td style="width: 10%;"></td> <td style="width: 10%;"></td> <td style="width: 10%;"></td> <td style="width: 10%;"></td> <td style="width: 10%;"></td> <td style="width: 10%;"></td> <td style="width: 10%;"></td> <td style="width: 10%;"></td> <td style="width: 10%;"></td> <td style="width: 10%;"></td> </tr> <tr> <td></td> <td></td> <td colspan="8" style="text-align: center;"> <table border="1" style="width: 100%; border-collapse: collapse; text-align: center;"> <tr> <td style="width: 10%;"></td> <td style="width: 10%;"></td> <td style="width: 10%;"></td> <td style="width: 10%;"></td> <td style="width: 10%;"></td> <td style="width: 10%;"></td> <td style="width: 10%;"></td> <td style="width: 10%;"></td> <td style="width: 10%;"></td> <td style="width: 10%;"></td> </tr> <tr> <td></td> <td></td> <td colspan="8" style="text-align: center;"> <table border="1" style="width: 100%; border-collapse: collapse; text-align: center;"> <tr> <td style="width: 10%;"></td> <td style="width: 10%;"></td> <td style="width: 10%;"></td> <td style="width: 10%;"></td> <td style="width: 10%;"></td> <td style="width: 10%;"></td> <td style="width: 10%;"></td> <td style="width: 10%;"></td> <td style="width: 10%;"></td> <td style="width: 10%;"></td> </tr> <tr> <td></td> <td></td> <td colspan="8" style="text-align: center;"> <table border="1" style="width: 100%; border-collapse: collapse; text-align: center;"> <tr> </tr></table></td></tr></table></td></tr></table></td></tr></table></td></tr></table></td></tr></table></td></tr></table></td></tr></table></td></tr></table></td></tr></table></td></tr></table></td></tr></table></td></tr></table></td></tr></table></td></tr></table></td></tr></table></td></tr></table></td></tr></table></td></tr></table></td></tr></table></td></tr></table></td></tr></table></td></tr></table></td></tr></table></td></tr></table></td></tr></table></td></tr></table></td></tr></table></td></tr></table></td></tr></table></td></tr></table></td></tr></table></td></tr></table></td></tr></table></td></tr></table></td></tr></table></td></tr></table></td></tr></table></td></tr></table></td></tr></table></td></tr></table></td></tr></table></td></tr></table></td></tr></table></td></tr></table></td></tr></table></td></tr></table></td></tr></table></td></tr></table></td></tr></table></td></tr></table></td></tr></table></td></tr></table></td></tr></table></td></tr></table> | | | | | | | | | | | | | | | | | | | | <table border="1" style="width: 100%; border-collapse: collapse; text-align: center;"> <tr> <td style="width: 10%;"></td> <td style="width: 10%;"></td> <td style="width: 10%;"></td> <td style="width: 10%;"></td> <td style="width: 10%;"></td> <td style="width: 10%;"></td> <td style="width: 10%;"></td> <td style="width: 10%;"></td> <td style="width: 10%;"></td> <td style="width: 10%;"></td> </tr> <tr> <td></td> <td></td> <td colspan="8" style="text-align: center;"> <table border="1" style="width: 100%; border-collapse: collapse; text-align: center;"> <tr> <td style="width: 10%;"></td> <td style="width: 10%;"></td> <td style="width: 10%;"></td> <td style="width: 10%;"></td> <td style="width: 10%;"></td> <td style="width: 10%;"></td> <td style="width: 10%;"></td> <td style="width: 10%;"></td> <td style="width: 10%;"></td> <td style="width: 10%;"></td> </tr> <tr> <td></td> <td></td> <td colspan="8" style="text-align: center;"> <table border="1" style="width: 100%; border-collapse: collapse; text-align: center;"> <tr> <td style="width: 10%;"></td> <td style="width: 10%;"></td> <td style="width: 10%;"></td> <td style="width: 10%;"></td> <td style="width: 10%;"></td> <td style="width: 10%;"></td> <td style="width: 10%;"></td> <td style="width: 10%;"></td> <td style="width: 10%;"></td> <td style="width: 10%;"></td> </tr> <tr> <td></td> <td></td> <td colspan="8" style="text-align: center;"> <table border="1" style="width: 100%; border-collapse: collapse; text-align: center;"> <tr> <td style="width: 10%;"></td> <td style="width: 10%;"></td> <td style="width: 10%;"></td> <td style="width: 10%;"></td> <td style="width: 10%;"></td> <td style="width: 10%;"></td> <td style="width: 10%;"></td> <td style="width: 10%;"></td> <td style="width: 10%;"></td> <td style="width: 10%;"></td> </tr> <tr> <td></td> <td></td> <td colspan="8" style="text-align: center;"> <table border="1" style="width: 100%; border-collapse: collapse; text-align: center;"> <tr> <td style="width: 10%;"></td> <td style="width: 10%;"></td> <td style="width: 10%;"></td> <td style="width: 10%;"></td> <td style="width: 10%;"></td> <td style="width: 10%;"></td> <td style="width: 10%;"></td> <td style="width: 10%;"></td> <td style="width: 10%;"></td> <td style="width: 10%;"></td> </tr> <tr> <td></td> <td></td> <td colspan="8" style="text-align: center;"> <table
border="1" style="width: 100%; border-collapse: collapse; text-align: center;"> <tr> <td style="width: 10%;"></td> <td style="width: 10%;"></td> <td style="width: 10%;"></td> <td style="width: 10%;"></td> <td style="width: 10%;"></td> <td style="width: 10%;"></td> <td style="width: 10%;"></td> <td style="width: 10%;"></td> <td style="width: 10%;"></td> <td style="width: 10%;"></td> </tr> <tr> <td></td> <td></td> <td colspan="8" style="text-align: center;"> <table border="1" style="width: 100%; border-collapse: collapse; text-align: center;"> <tr> <td style="width: 10%;"></td> <td style="width: 10%;"></td> <td style="width: 10%;"></td> <td style="width: 10%;"></td> <td style="width: 10%;"></td> <td style="width: 10%;"></td> <td style="width: 10%;"></td> <td style="width: 10%;"></td> <td style="width: 10%;"></td> <td style="width: 10%;"></td> </tr> <tr> <td></td> <td></td> <td colspan="8" style="text-align: center;"> <table border="1" style="width: 100%; border-collapse: collapse; text-align: center;"> <tr> <td style="width: 10%;"></td> <td style="width: 10%;"></td> <td style="width: 10%;"></td> <td style="width: 10%;"></td> <td style="width: 10%;"></td> <td style="width: 10%;"></td> <td style="width: 10%;"></td> <td style="width: 10%;"></td> <td style="width: 10%;"></td> <td style="width: 10%;"></td> </tr> <tr> <td></td> <td></td> <td colspan="8" style="text-align: center;"> <table border="1" style="width: 100%; border-collapse: collapse; text-align: center;"> <tr> <td style="width: 10%;"></td> <td style="width: 10%;"></td> <td style="width: 10%;"></td> <td style="width: 10%;"></td> <td style="width: 10%;"></td> <td style="width: 10%;"></td> <td style="width: 10%;"></td> <td style="width: 10%;"></td> <td style="width: 10%;"></td> <td style="width: 10%;"></td> </tr> <tr> <td></td> <td></td> <td colspan="8" style="text-align: center;"> <table border="1" style="width: 100%; border-collapse: collapse; text-align: center;"> <tr> <td style="width: 10%;"></td> <td style="width: 10%;"></td> <td style="width: 10%;"></td> <td style="width: 10%;"></td> <td style="width: 10%;"></td> <td style="width: 10%;"></td> <td style="width: 10%;"></td> <td style="width: 10%;"></td> <td style="width: 10%;"></td> <td style="width: 10%;"></td> </tr> <tr> <td></td> <td></td> <td colspan="8" style="text-align: center;"> <table border="1" style="width: 100%; border-collapse: collapse; text-align: center;"> <tr> <td style="width: 10%;"></td> <td style="width: 10%;"></td> <td style="width: 10%;"></td> <td style="width: 10%;"></td> <td style="width: 10%;"></td> <td style="width: 10%;"></td> <td style="width: 10%;"></td> <td style="width: 10%;"></td> <td style="width: 10%;"></td> <td style="width: 10%;"></td> </tr> <tr> <td></td> <td></td> <td colspan="8" style="text-align: center;"> <table border="1" style="width: 100%; border-collapse: collapse; text-align: center;"> <tr> <td style="width: 10%;"></td> <td style="width: 10%;"></td> <td style="width: 10%;"></td> <td style="width: 10%;"></td> <td style="width: 10%;"></td> <td style="width: 10%;"></td> <td style="width: 10%;"></td> <td style="width: 10%;"></td> <td style="width: 10%;"></td> <td style="width: 10%;"></td> </tr> <tr> <td></td> <td></td> <td colspan="8" style="text-align: center;"> <table border="1" style="width: 100%; border-collapse: collapse; text-align: center;"> <tr> <td style="width: 10%;"></td> <td style="width: 10%;"></td> <td style="width: 10%;"></td> <td style="width: 10%;"></td> <td style="width: 10%;"></td> <td style="width: 10%;"></td> <td style="width: 10%;"></td> <td style="width: 10%;"></td> <td style="width: 10%;"></td> <td style="width: 10%;"></td> </tr> <tr> <td></td> <td></td> <td colspan="8" style="text-align: center;"> <table border="1" style="width: 100%; border-collapse: collapse; text-align: center;"> <tr> <td style="width: 10%;"></td> <td style="width: 10%;"></td> <td style="width: 10%;"></td> <td style="width: 10%;"></td> <td style="width: 10%;"></td> <td style="width: 10%;"></td> <td style="width: 10%;"></td> <td style="width: 10%;"></td> <td style="width: 10%;"></td> <td style="width: 10%;"></td> </tr> <tr> <td></td> <td></td> <td colspan="8" style="text-align: center;"> <table border="1" style="width: 100%; border-collapse: collapse; text-align: center;"> <tr> <td style="width: 10%;"></td> <td style="width: 10%;"></td> <td style="width: 10%;"></td> <td style="width: 10%;"></td> <td style="width: 10%;"></td> <td style="width: 10%;"></td> <td style="width: 10%;"></td> <td style="width: 10%;"></td> <td style="width: 10%;"></td> <td style="width: 10%;"></td> </tr> <tr> <td></td> <td></td> <td colspan="8" style="text-align: center;"> <table border="1" style="width: 100%; border-collapse: collapse; text-align: center;"> <tr> <td style="width: 10%;"></td> <td style="width: 10%;"></td> <td style="width: 10%;"></td> <td style="width: 10%;"></td> <td style="width: 10%;"></td> <td style="width: 10%;"></td> <td style="width: 10%;"></td> <td style="width: 10%;"></td> <td style="width: 10%;"></td> <td style="width: 10%;"></td> </tr> <tr> <td></td> <td></td> <td colspan="8" style="text-align: center;"> <table border="1" style="width: 100%; border-collapse: collapse; text-align: center;"> <tr> <td style="width: 10%;"></td> <td style="width: 10%;"></td> <td style="width: 10%;"></td> <td style="width: 10%;"></td> <td style="width: 10%;"></td> <td style="width: 10%;"></td> <td style="width: 10%;"></td> <td style="width: 10%;"></td> <td style="width: 10%;"></td> <td style="width: 10%;"></td> </tr> <tr> <td></td> <td></td> <td colspan="8" style="text-align: center;"> <table border="1" style="width: 100%; border-collapse: collapse; text-align: center;"> <tr> <td style="width: 10%;"></td> <td style="width: 10%;"></td> <td style="width: 10%;"></td> <td style="width: 10%;"></td> <td style="width: 10%;"></td> <td style="width: 10%;"></td> <td style="width: 10%;"></td> <td style="width: 10%;"></td> <td style="width: 10%;"></td> <td style="width: 10%;"></td> </tr> <tr> <td></td> <td></td> <td colspan="8" style="text-align: center;"> <table border="1" style="width: 100%; border-collapse: collapse; text-align: center;"> <tr> <td style="width: 10%;"></td> <td style="width: 10%;"></td> <td style="width: 10%;"></td> <td style="width: 10%;"></td> <td style="width: 10%;"></td> <td style="width: 10%;"></td> <td style="width: 10%;"></td> <td style="width: 10%;"></td> <td style="width: 10%;"></td> <td style="width: 10%;"></td> </tr> <tr> <td></td> <td></td> <td colspan="8" style="text-align: center;"> <table border="1" style="width: 100%; border-collapse: collapse; text-align: center;"> <tr> <td style="width: 10%;"></td> <td style="width: 10%;"></td> <td style="width: 10%;"></td> <td style="width: 10%;"></td> <td style="width: 10%;"></td> <td style="width: 10%;"></td> <td style="width: 10%;"></td> <td style="width: 10%;"></td> <td style="width: 10%;"></td> <td style="width: 10%;"></td> </tr> <tr> <td></td> <td></td> <td colspan="8" style="text-align: center;"> <table border="1" style="width: 100%; border-collapse: collapse; text-align: center;"> <tr> <td style="width: 10%;"></td> <td style="width: 10%;"></td> <td style="width: 10%;"></td> <td style="width: 10%;"></td> <td style="width: 10%;"></td> <td style="width: 10%;"></td> <td style="width: 10%;"></td> <td style="width: 10%;"></td> <td style="width: 10%;"></td> <td style="width: 10%;"></td> </tr> <tr> <td></td> <td></td> <td colspan="8" style="text-align: center;"> <table border="1" style="width: 100%; border-collapse: collapse; text-align: center;"> <tr> <td style="width: 10%;"></td> <td style="width: 10%;"></td> <td style="width: 10%;"></td> <td style="width: 10%;"></td> <td style="width: 10%;"></td> <td style="width: 10%;"></td> <td style="width: 10%;"></td> <td style="width: 10%;"></td> <td style="width: 10%;"></td> <td style="width: 10%;"></td> </tr> <tr> <td></td> <td></td> <td colspan="8" style="text-align: center;"> <table border="1" style="width: 100%; border-collapse: collapse; text-align: center;"> <tr> <td style="width: 10%;"></td> <td style="width: 10%;"></td> <td style="width: 10%;"></td> <td style="width: 10%;"></td> <td style="width: 10%;"></td> <td style="width: 10%;"></td> <td style="width: 10%;"></td> <td style="width: 10%;"></td> <td style="width: 10%;"></td> <td style="width: 10%;"></td> </tr> <tr> <td></td> <td></td> <td colspan="8" style="text-align: center;"> <table border="1" style="width: 100%; border-collapse: collapse; text-align: center;"> <tr> <td style="width: 10%;"></td> <td style="width: 10%;"></td> <td style="width: 10%;"></td> <td style="width: 10%;"></td> <td style="width: 10%;"></td> <td style="width: 10%;"></td> <td style="width: 10%;"></td> <td style="width: 10%;"></td> <td style="width: 10%;"></td> <td style="width: 10%;"></td> </tr> <tr> <td></td> <td></td> <td colspan="8" style="text-align: center;"> <table border="1" style="width: 100%; border-collapse: collapse; text-align: center;"> <tr> <td style="width: 10%;"></td> <td style="width: 10%;"></td> <td style="width: 10%;"></td> <td style="width: 10%;"></td> <td style="width: 10%;"></td> <td style="width: 10%;"></td> <td style="width: 10%;"></td> <td style="width: 10%;"></td> <td style="width: 10%;"></td> <td style="width: 10%;"></td> </tr> <tr> <td></td> <td></td> <td colspan="8" style="text-align: center;"> <table border="1" style="width: 100%; border-collapse: collapse; text-align: center;"> <tr> <td style="width: 10%;"></td> <td style="width: 10%;"></td> <td style="width: 10%;"></td> <td style="width: 10%;"></td> <td style="width: 10%;"></td> <td style="width: 10%;"></td> <td style="width: 10%;"></td> <td style="width: 10%;"></td> <td style="width: 10%;"></td> <td style="width: 10%;"></td> </tr> <tr> <td></td> <td></td> <td colspan="8" style="text-align: center;"> <table border="1" style="width: 100%; border-collapse: collapse; text-align: center;"> <tr> <td style="width: 10%;"></td> <td style="width: 10%;"></td> <td style="width:
10%;"></td> <td style="width: 10%;"></td> <td style="width: 10%;"></td> <td style="width: 10%;"></td> <td style="width: 10%;"></td> <td style="width: 10%;"></td> <td style="width: 10%;"></td> <td style="width: 10%;"></td> </tr> <tr> <td></td> <td></td> <td colspan="8" style="text-align: center;"> <table border="1" style="width: 100%; border-collapse: collapse; text-align: center;"> <tr> <td style="width: 10%;"></td> <td style="width: 10%;"></td> <td style="width: 10%;"></td> <td style="width: 10%;"></td> <td style="width: 10%;"></td> <td style="width: 10%;"></td> <td style="width: 10%;"></td> <td style="width: 10%;"></td> <td style="width: 10%;"></td> <td style="width: 10%;"></td> </tr> <tr> <td></td> <td></td> <td colspan="8" style="text-align: center;"> <table border="1" style="width: 100%; border-collapse: collapse; text-align: center;"> <tr> <td style="width: 10%;"></td> <td style="width: 10%;"></td> <td style="width: 10%;"></td> <td style="width: 10%;"></td> <td style="width: 10%;"></td> <td style="width: 10%;"></td> <td style="width: 10%;"></td> <td style="width: 10%;"></td> <td style="width: 10%;"></td> <td style="width: 10%;"></td> </tr> <tr> <td></td> <td></td> <td colspan="8" style="text-align: center;"> <table border="1" style="width: 100%; border-collapse: collapse; text-align: center;"> <tr> <td style="width: 10%;"></td> <td style="width: 10%;"></td> <td style="width: 10%;"></td> <td style="width: 10%;"></td> <td style="width: 10%;"></td> <td style="width: 10%;"></td> <td style="width: 10%;"></td> <td style="width: 10%;"></td> <td style="width: 10%;"></td> <td style="width: 10%;"></td> </tr> <tr> <td></td> <td></td> <td colspan="8" style="text-align: center;"> <table border="1" style="width: 100%; border-collapse: collapse; text-align: center;"> <tr> <td style="width: 10%;"></td> <td style="width: 10%;"></td> <td style="width: 10%;"></td> <td style="width: 10%;"></td> <td style="width: 10%;"></td> <td style="width: 10%;"></td> <td style="width: 10%;"></td> <td style="width: 10%;"></td> <td style="width: 10%;"></td> <td style="width: 10%;"></td> </tr> <tr> <td></td> <td></td> <td colspan="8" style="text-align: center;"> <table border="1" style="width: 100%; border-collapse: collapse; text-align: center;"> <tr> <td style="width: 10%;"></td> <td style="width: 10%;"></td> <td style="width: 10%;"></td> <td style="width: 10%;"></td> <td style="width: 10%;"></td> <td style="width: 10%;"></td> <td style="width: 10%;"></td> <td style="width: 10%;"></td> <td style="width: 10%;"></td> <td style="width: 10%;"></td> </tr> <tr> <td></td> <td></td> <td colspan="8" style="text-align: center;"> <table border="1" style="width: 100%; border-collapse: collapse; text-align: center;"> <tr> <td style="width: 10%;"></td> <td style="width: 10%;"></td> <td style="width: 10%;"></td> <td style="width: 10%;"></td> <td style="width: 10%;"></td> <td style="width: 10%;"></td> <td style="width: 10%;"></td> <td style="width: 10%;"></td> <td style="width: 10%;"></td> <td style="width: 10%;"></td> </tr> <tr> <td></td> <td></td> <td colspan="8" style="text-align: center;"> <table border="1" style="width: 100%; border-collapse: collapse; text-align: center;"> <tr> <td style="width: 10%;"></td> <td style="width: 10%;"></td> <td style="width: 10%;"></td> <td style="width: 10%;"></td> <td style="width: 10%;"></td> <td style="width: 10%;"></td> <td style="width: 10%;"></td> <td style="width: 10%;"></td> <td style="width: 10%;"></td> <td style="width: 10%;"></td> </tr> <tr> <td></td> <td></td> <td colspan="8" style="text-align: center;"> <table border="1" style="width: 100%; border-collapse: collapse; text-align: center;"> <tr> <td style="width: 10%;"></td> <td style="width: 10%;"></td> <td style="width: 10%;"></td> <td style="width: 10%;"></td> <td style="width: 10%;"></td> <td style="width: 10%;"></td> <td style="width: 10%;"></td> <td style="width: 10%;"></td> <td style="width: 10%;"></td> <td style="width: 10%;"></td> </tr> <tr> <td></td> <td></td> <td colspan="8" style="text-align: center;"> <table border="1" style="width: 100%; border-collapse: collapse; text-align: center;"> <tr> <td style="width: 10%;"></td> <td style="width: 10%;"></td> <td style="width: 10%;"></td> <td style="width: 10%;"></td> <td style="width: 10%;"></td> <td style="width: 10%;"></td> <td style="width: 10%;"></td> <td style="width: 10%;"></td> <td style="width: 10%;"></td> <td style="width: 10%;"></td> </tr> <tr> <td></td> <td></td> <td colspan="8" style="text-align: center;"> <table border="1" style="width: 100%; border-collapse: collapse; text-align: center;"> <tr> <td style="width: 10%;"></td> <td style="width: 10%;"></td> <td style="width: 10%;"></td> <td style="width: 10%;"></td> <td style="width: 10%;"></td> <td style="width: 10%;"></td> <td style="width: 10%;"></td> <td style="width: 10%;"></td> <td style="width: 10%;"></td> <td style="width: 10%;"></td> </tr> <tr> <td></td> <td></td> <td colspan="8" style="text-align: center;"> <table border="1" style="width: 100%; border-collapse: collapse; text-align: center;"> <tr> <td style="width: 10%;"></td> <td style="width: 10%;"></td> <td style="width: 10%;"></td> <td style="width: 10%;"></td> <td style="width: 10%;"></td> <td style="width: 10%;"></td> <td style="width: 10%;"></td> <td style="width: 10%;"></td> <td style="width: 10%;"></td> <td style="width: 10%;"></td> </tr> <tr> <td></td> <td></td> <td colspan="8" style="text-align: center;"> <table border="1" style="width: 100%; border-collapse: collapse; text-align: center;"> <tr> <td style="width: 10%;"></td> <td style="width: 10%;"></td> <td style="width: 10%;"></td> <td style="width: 10%;"></td> <td style="width: 10%;"></td> <td style="width: 10%;"></td> <td style="width: 10%;"></td> <td style="width: 10%;"></td> <td style="width: 10%;"></td> <td style="width: 10%;"></td> </tr> <tr> <td></td> <td></td> <td colspan="8" style="text-align: center;"> <table border="1" style="width: 100%; border-collapse: collapse; text-align: center;"> <tr> <td style="width: 10%;"></td> <td style="width: 10%;"></td> <td style="width: 10%;"></td> <td style="width: 10%;"></td> <td style="width: 10%;"></td> <td style="width: 10%;"></td> <td style="width: 10%;"></td> <td style="width: 10%;"></td> <td style="width: 10%;"></td> <td style="width: 10%;"></td> </tr> <tr> <td></td> <td></td> <td colspan="8" style="text-align: center;"> <table border="1" style="width: 100%; border-collapse: collapse; text-align: center;"> <tr> <td style="width: 10%;"></td> <td style="width: 10%;"></td> <td style="width: 10%;"></td> <td style="width: 10%;"></td> <td style="width: 10%;"></td> <td style="width: 10%;"></td> <td style="width: 10%;"></td> <td style="width: 10%;"></td> <td style="width: 10%;"></td> <td style="width: 10%;"></td> </tr> <tr> <td></td> <td></td> <td colspan="8" style="text-align: center;"> <table border="1" style="width: 100%; border-collapse: collapse; text-align: center;"> <tr> <td style="width: 10%;"></td> <td style="width: 10%;"></td> <td style="width: 10%;"></td> <td style="width: 10%;"></td> <td style="width: 10%;"></td> <td style="width: 10%;"></td> <td style="width: 10%;"></td> <td style="width: 10%;"></td> <td style="width: 10%;"></td> <td style="width: 10%;"></td> </tr> <tr> <td></td> <td></td> <td colspan="8" style="text-align: center;"> <table border="1" style="width: 100%; border-collapse: collapse; text-align: center;"> <tr> <td style="width: 10%;"></td> <td style="width: 10%;"></td> <td style="width: 10%;"></td> <td style="width: 10%;"></td> <td style="width: 10%;"></td> <td style="width: 10%;"></td> <td style="width: 10%;"></td> <td style="width: 10%;"></td> <td style="width: 10%;"></td> <td style="width: 10%;"></td> </tr> <tr> <td></td> <td></td> <td colspan="8" style="text-align: center;"> <table border="1" style="width: 100%; border-collapse: collapse; text-align: center;"> <tr> <td style="width: 10%;"></td> <td style="width: 10%;"></td> <td style="width: 10%;"></td> <td style="width: 10%;"></td> <td style="width: 10%;"></td> <td style="width: 10%;"></td> <td style="width: 10%;"></td> <td style="width: 10%;"></td> <td style="width: 10%;"></td> <td style="width: 10%;"></td> </tr> <tr> <td></td> <td></td> <td colspan="8" style="text-align: center;"> <table border="1" style="width: 100%; border-collapse: collapse; text-align: center;"> <tr> <td style="width: 10%;"></td> <td style="width: 10%;"></td> <td style="width: 10%;"></td> <td style="width: 10%;"></td> <td style="width: 10%;"></td> <td style="width: 10%;"></td> <td style="width: 10%;"></td> <td style="width: 10%;"></td> <td style="width: 10%;"></td> <td style="width: 10%;"></td> </tr> <tr> <td></td> <td></td> <td colspan="8" style="text-align: center;"> <table border="1" style="width: 100%; border-collapse: collapse; text-align: center;"> <tr> <td style="width: 10%;"></td> <td style="width: 10%;"></td> <td style="width: 10%;"></td> <td style="width: 10%;"></td> <td style="width: 10%;"></td> <td style="width: 10%;"></td> <td style="width: 10%;"></td> <td style="width: 10%;"></td> <td style="width: 10%;"></td> <td style="width: 10%;"></td> </tr> <tr> <td></td> <td></td> <td colspan="8" style="text-align: center;"> <table border="1" style="width: 100%; border-collapse: collapse; text-align: center;"> <tr> <td style="width: 10%;"></td> <td style="width: 10%;"></td> <td style="width: 10%;"></td> <td style="width: 10%;"></td> <td style="width: 10%;"></td> <td style="width: 10%;"></td> <td style="width: 10%;"></td> <td style="width: 10%;"></td> <td style="width: 10%;"></td> <td style="width: 10%;"></td> </tr> <tr> <td></td> <td></td> <td colspan="8" style="text-align: center;"> <table border="1" style="width: 100%; border-collapse: collapse; text-align: center;"> <tr> <td style="width: 10%;"></td> <td style="width: 10%;"></td> <td style="width: 10%;"></td> <td style="width: 10%;"></td> <td style="width: 10%;"></td> <td style="width: 10%;"></td> <td style="width: 10%;"></td> <td style="width: 10%;"></td> <td
style="width: 10%;"></td> <td style="width: 10%;"></td> </tr> <tr> <td></td> <td></td> <td colspan="8" style="text-align: center;"> <table border="1" style="width: 100%; border-collapse: collapse; text-align: center;"> <tr> <td style="width: 10%;"></td> <td style="width: 10%;"></td> <td style="width: 10%;"></td> <td style="width: 10%;"></td> <td style="width: 10%;"></td> <td style="width: 10%;"></td> <td style="width: 10%;"></td> <td style="width: 10%;"></td> <td style="width: 10%;"></td> <td style="width: 10%;"></td> </tr> <tr> <td></td> <td></td> <td colspan="8" style="text-align: center;"> <table border="1" style="width: 100%; border-collapse: collapse; text-align: center;"> <tr> <td style="width: 10%;"></td> <td style="width: 10%;"></td> <td style="width: 10%;"></td> <td style="width: 10%;"></td> <td style="width: 10%;"></td> <td style="width: 10%;"></td> <td style="width: 10%;"></td> <td style="width: 10%;"></td> <td style="width: 10%;"></td> <td style="width: 10%;"></td> </tr> <tr> <td></td> <td></td> <td colspan="8" style="text-align: center;"> <table border="1" style="width: 100%; border-collapse: collapse; text-align: center;"> <tr> <td style="width: 10%;"></td> <td style="width: 10%;"></td> <td style="width: 10%;"></td> <td style="width: 10%;"></td> <td style="width: 10%;"></td> <td style="width: 10%;"></td> <td style="width: 10%;"></td> <td style="width: 10%;"></td> <td style="width: 10%;"></td> <td style="width: 10%;"></td> </tr> <tr> <td></td> <td></td> <td colspan="8" style="text-align: center;"> <table border="1" style="width: 100%; border-collapse: collapse; text-align: center;"> <tr> <td style="width: 10%;"></td> <td style="width: 10%;"></td> <td style="width: 10%;"></td> <td style="width: 10%;"></td> <td style="width: 10%;"></td> <td style="width: 10%;"></td> <td style="width: 10%;"></td> <td style="width: 10%;"></td> <td style="width: 10%;"></td> <td style="width: 10%;"></td> </tr> <tr> <td></td> <td></td> <td colspan="8" style="text-align: center;"> <table border="1" style="width: 100%; border-collapse: collapse; text-align: center;"> <tr> <td style="width: 10%;"></td> <td style="width: 10%;"></td> <td style="width: 10%;"></td> <td style="width: 10%;"></td> <td style="width: 10%;"></td> <td style="width: 10%;"></td> <td style="width: 10%;"></td> <td style="width: 10%;"></td> <td style="width: 10%;"></td> <td style="width: 10%;"></td> </tr> <tr> <td></td> <td></td> <td colspan="8" style="text-align: center;"> <table border="1" style="width: 100%; border-collapse: collapse; text-align: center;"> <tr> </tr></table></td></tr></table></td></tr></table></td></tr></table></td></tr></table></td></tr></table></td></tr></table></td></tr></table></td></tr></table></td></tr></table></td></tr></table></td></tr></table></td></tr></table></td></tr></table></td></tr></table></td></tr></table></td></tr></table></td></tr></table></td></tr></table></td></tr></table></td></tr></table></td></tr></table></td></tr></table></td></tr></table></td></tr></table></td></tr></table></td></tr></table></td></tr></table></td></tr></table></td></tr></table></td></tr></table></td></tr></table></td></tr></table></td></tr></table></td></tr></table></td></tr></table></td></tr></table></td></tr></table></td></tr></table></td></tr></table></td></tr></table></td></tr></table></td></tr></table></td></tr></table></td></tr></table></td></tr></table></td></tr></table></td></tr></table></td></tr></table></td></tr></table></td></tr></table></td></tr></table></td></tr></table></td></tr></table> | | | | | | | | | | | | | | | | | | | | <table border="1" style="width: 100%; border-collapse: collapse; text-align: center;"> <tr> <td style="width: 10%;"></td> <td style="width: 10%;"></td> <td style="width: 10%;"></td> <td style="width: 10%;"></td> <td style="width: 10%;"></td> <td style="width: 10%;"></td> <td style="width: 10%;"></td> <td style="width: 10%;"></td> <td style="width: 10%;"></td> <td style="width: 10%;"></td> </tr> <tr> <td></td> <td></td> <td colspan="8" style="text-align: center;"> <table border="1" style="width: 100%; border-collapse: collapse; text-align: center;"> <tr> <td style="width: 10%;"></td> <td style="width: 10%;"></td> <td style="width: 10%;"></td> <td style="width: 10%;"></td> <td style="width: 10%;"></td> <td style="width: 10%;"></td> <td style="width: 10%;"></td> <td style="width: 10%;"></td> <td style="width: 10%;"></td> <td style="width: 10%;"></td> </tr> <tr> <td></td> <td></td> <td colspan="8" style="text-align: center;"> <table border="1" style="width: 100%; border-collapse: collapse; text-align: center;"> <tr> <td style="width: 10%;"></td> <td style="width: 10%;"></td> <td style="width: 10%;"></td> <td style="width: 10%;"></td> <td style="width: 10%;"></td> <td style="width: 10%;"></td> <td style="width: 10%;"></td> <td style="width: 10%;"></td> <td style="width: 10%;"></td> <td style="width: 10%;"></td> </tr> <tr> <td></td> <td></td> <td colspan="8" style="text-align: center;"> <table border="1" style="width: 100%; border-collapse: collapse; text-align: center;"> <tr> <td style="width: 10%;"></td> <td style="width: 10%;"></td> <td style="width: 10%;"></td> <td style="width: 10%;"></td> <td style="width: 10%;"></td> <td style="width: 10%;"></td> <td style="width: 10%;"></td> <td style="width: 10%;"></td> <td style="width: 10%;"></td> <td style="width: 10%;"></td> </tr> <tr> <td></td> <td></td> <td colspan="8" style="text-align: center;"> <table border="1" style="width: 100%; border-collapse: collapse; text-align: center;"> <tr> <td style="width: 10%;"></td> <td style="width: 10%;"></td> <td style="width: 10%;"></td> <td style="width: 10%;"></td> <td style="width: 10%;"></td> <td style="width: 10%;"></td> <td style="width: 10%;"></td> <td style="width: 10%;"></td> <td style="width: 10%;"></td> <td style="width: 10%;"></td> </tr> <tr> <td></td> <td></td> <td colspan="8" style="text-align: center;"> <table border="1" style="width: 100%; border-collapse: collapse; text-align: center;"> <tr> <td style="width: 10%;"></td> <td style="width: 10%;"></td> <td style="width: 10%;"></td> <td style="width: 10%;"></td> <td style="width: 10%;"></td> <td style="width: 10%;"></td> <td style="width: 10%;"></td> <td style="width: 10%;"></td> <td style="width: 10%;"></td> <td style="width: 10%;"></td> </tr> <tr> <td></td> <td></td> <td colspan="8" style="text-align: center;"> <table border="1" style="width: 100%; border-collapse: collapse; text-align: center;"> <tr> <td style="width: 10%;"></td> <td style="width: 10%;"></td> <td style="width: 10%;"></td> <td style="width: 10%;"></td> <td style="width: 10%;"></td> <td style="width: 10%;"></td> <td style="width: 10%;"></td> <td style="width: 10%;"></td> <td style="width: 10%;"></td> <td style="width: 10%;"></td> </tr> <tr> <td></td> <td></td> <td colspan="8" style="text-align: center;"> <table border="1" style="width: 100%; border-collapse: collapse; text-align: center;"> <tr> <td style="width: 10%;"></td> <td style="width: 10%;"></td> <td style="width: 10%;"></td> <td style="width: 10%;"></td> <td style="width: 10%;"></td> <td style="width: 10%;"></td> <td style="width: 10%;"></td> <td style="width: 10%;"></td> <td style="width: 10%;"></td> <td style="width: 10%;"></td> </tr> <tr> <td></td> <td></td> <td colspan="8" style="text-align: center;"> <table border="1" style="width: 100%; border-collapse: collapse; text-align: center;"> <tr> <td style="width: 10%;"></td> <td style="width: 10%;"></td> <td style="width: 10%;"></td> <td style="width: 10%;"></td> <td style="width: 10%;"></td> <td style="width: 10%;"></td> <td style="width: 10%;"></td> <td style="width: 10%;"></td> <td style="width: 10%;"></td> <td style="width: 10%;"></td> </tr> <tr> <td></td> <td></td> <td colspan="8" style="text-align: center;"> <table border="1" style="width: 100%; border-collapse: collapse; text-align: center;"> <tr> <td style="width: 10%;"></td> <td style="width: 10%;"></td> <td style="width: 10%;"></td> <td style="width: 10%;"></td> <td style="width: 10%;"></td> <td style="width: 10%;"></td> <td style="width: 10%;"></td> <td style="width: 10%;"></td> <td style="width: 10%;"></td> <td style="width: 10%;"></td> </tr> <tr> <td></td> <td></td> <td colspan="8" style="text-align: center;"> <table border="1" style="width: 100%; border-collapse: collapse; text-align: center;"> <tr> <td style="width: 10%;"></td> <td style="width: 10%;"></td> <td style="width: 10%;"></td> <td style="width: 10%;"></td> <td style="width: 10%;"></td> <td style="width:
10%;"></td> <td style="width: 10%;"></td> <td style="width: 10%;"></td> <td style="width: 10%;"></td> <td style="width: 10%;"></td> </tr> <tr> <td></td> <td></td> <td colspan="8" style="text-align: center;"> <table border="1" style="width: 100%; border-collapse: collapse; text-align: center;"> <tr> <td style="width: 10%;"></td> <td style="width: 10%;"></td> <td style="width: 10%;"></td> <td style="width: 10%;"></td> <td style="width: 10%;"></td> <td style="width: 10%;"></td> <td style="width: 10%;"></td> <td style="width: 10%;"></td> <td style="width: 10%;"></td> <td style="width: 10%;"></td> </tr> <tr> <td></td> <td></td> <td colspan="8" style="text-align: center;"> <table border="1" style="width: 100%; border-collapse: collapse; text-align: center;"> <tr> <td style="width: 10%;"></td> <td style="width: 10%;"></td> <td style="width: 10%;"></td> <td style="width: 10%;"></td> <td style="width: 10%;"></td> <td style="width: 10%;"></td> <td style="width: 10%;"></td> <td style="width: 10%;"></td> <td style="width: 10%;"></td> <td style="width: 10%;"></td> </tr> <tr> <td></td> <td></td> <td colspan="8" style="text-align: center;"> <table border="1" style="width: 100%; border-collapse: collapse; text-align: center;"> <tr> <td style="width: 10%;"></td> <td style="width: 10%;"></td> <td style="width: 10%;"></td> <td style="width: 10%;"></td> <td style="width: 10%;"></td> <td style="width: 10%;"></td> <td style="width: 10%;"></td> <td style="width: 10%;"></td> <td style="width: 10%;"></td> <td style="width: 10%;"></td> </tr> <tr> <td></td> <td></td> <td colspan="8" style="text-align: center;"> <table border="1" style="width: 100%; border-collapse: collapse; text-align: center;"> <tr> <td style="width: 10%;"></td> <td style="width: 10%;"></td> <td style="width: 10%;"></td> <td style="width: 10%;"></td> <td style="width: 10%;"></td> <td style="width: 10%;"></td> <td style="width: 10%;"></td> <td style="width: 10%;"></td> <td style="width: 10%;"></td> <td style="width: 10%;"></td> </tr> <tr> <td></td> <td></td> <td colspan="8" style="text-align: center;"> <table border="1" style="width: 100%; border-collapse: collapse; text-align: center;"> <tr> <td style="width: 10%;"></td> <td style="width: 10%;"></td> <td style="width: 10%;"></td> <td style="width: 10%;"></td> <td style="width: 10%;"></td> <td style="width: 10%;"></td> <td style="width: 10%;"></td> <td style="width: 10%;"></td> <td style="width: 10%;"></td> <td style="width: 10%;"></td> </tr> <tr> <td></td> <td></td> <td colspan="8" style="text-align: center;"> <table border="1" style="width: 100%; border-collapse: collapse; text-align: center;"> <tr> <td style="width: 10%;"></td> <td style="width: 10%;"></td> <td style="width: 10%;"></td> <td style="width: 10%;"></td> <td style="width: 10%;"></td> <td style="width: 10%;"></td> <td style="width: 10%;"></td> <td style="width: 10%;"></td> <td style="width: 10%;"></td> <td style="width: 10%;"></td> </tr> <tr> <td></td> <td></td> <td colspan="8" style="text-align: center;"> <table border="1" style="width: 100%; border-collapse: collapse; text-align: center;"> <tr> <td style="width: 10%;"></td> <td style="width: 10%;"></td> <td style="width: 10%;"></td> <td style="width: 10%;"></td> <td style="width: 10%;"></td> <td style="width: 10%;"></td> <td style="width: 10%;"></td> <td style="width: 10%;"></td> <td style="width: 10%;"></td> <td style="width: 10%;"></td> </tr> <tr> <td></td> <td></td> <td colspan="8" style="text-align: center;"> <table border="1" style="width: 100%; border-collapse: collapse; text-align: center;"> <tr> <td style="width: 10%;"></td> <td style="width: 10%;"></td> <td style="width: 10%;"></td> <td style="width: 10%;"></td> <td style="width: 10%;"></td> <td style="width: 10%;"></td> <td style="width: 10%;"></td> <td style="width: 10%;"></td> <td style="width: 10%;"></td> <td style="width: 10%;"></td> </tr> <tr> <td></td> <td></td> <td colspan="8" style="text-align: center;"> <table border="1" style="width: 100%; border-collapse: collapse; text-align: center;"> <tr> <td style="width: 10%;"></td> <td style="width: 10%;"></td> <td style="width: 10%;"></td> <td style="width: 10%;"></td> <td style="width: 10%;"></td> <td style="width: 10%;"></td> <td style="width: 10%;"></td> <td style="width: 10%;"></td> <td style="width: 10%;"></td> <td style="width: 10%;"></td> </tr> <tr> <td></td> <td></td> <td colspan="8" style="text-align: center;"> <table border="1" style="width: 100%; border-collapse: collapse; text-align: center;"> <tr> <td style="width: 10%;"></td> <td style="width: 10%;"></td> <td style="width: 10%;"></td> <td style="width: 10%;"></td> <td style="width: 10%;"></td> <td style="width: 10%;"></td> <td style="width: 10%;"></td> <td style="width: 10%;"></td> <td style="width: 10%;"></td> <td style="width: 10%;"></td> </tr> <tr> <td></td> <td></td> <td colspan="8" style="text-align: center;"> <table border="1" style="width: 100%; border-collapse: collapse; text-align: center;"> <tr> <td style="width: 10%;"></td> <td style="width: 10%;"></td> <td style="width: 10%;"></td> <td style="width: 10%;"></td> <td style="width: 10%;"></td> <td style="width: 10%;"></td> <td style="width: 10%;"></td> <td style="width: 10%;"></td> <td style="width: 10%;"></td> <td style="width: 10%;"></td> </tr> <tr> <td></td> <td></td> <td colspan="8" style="text-align: center;"> <table border="1" style="width: 100%; border-collapse: collapse; text-align: center;"> <tr> <td style="width: 10%;"></td> <td style="width: 10%;"></td> <td style="width: 10%;"></td> <td style="width: 10%;"></td> <td style="width: 10%;"></td> <td style="width: 10%;"></td> <td style="width: 10%;"></td> <td style="width: 10%;"></td> <td style="width: 10%;"></td> <td style="width: 10%;"></td> </tr> <tr> <td></td> <td></td> <td colspan="8" style="text-align: center;"> <table border="1" style="width: 100%; border-collapse: collapse; text-align: center;"> <tr> <td style="width: 10%;"></td> <td style="width: 10%;"></td> <td style="width: 10%;"></td> <td style="width: 10%;"></td> <td style="width: 10%;"></td> <td style="width: 10%;"></td> <td style="width: 10%;"></td> <td style="width: 10%;"></td> <td style="width: 10%;"></td> <td style="width: 10%;"></td> </tr> <tr> <td></td> <td></td> <td colspan="8" style="text-align: center;"> <table border="1" style="width: 100%; border-collapse: collapse; text-align: center;"> <tr> <td style="width: 10%;"></td> <td style="width: 10%;"></td> <td style="width: 10%;"></td> <td style="width: 10%;"></td> <td style="width: 10%;"></td> <td style="width: 10%;"></td> <td style="width: 10%;"></td> <td style="width: 10%;"></td> <td style="width: 10%;"></td> <td style="width: 10%;"></td> </tr> <tr> <td></td> <td></td> <td colspan="8" style="text-align: center;"> <table border="1" style="width: 100%; border-collapse: collapse; text-align: center;"> <tr> <td style="width: 10%;"></td> <td style="width: 10%;"></td> <td style="width: 10%;"></td> <td style="width: 10%;"></td> <td style="width: 10%;"></td> <td style="width: 10%;"></td> <td style="width: 10%;"></td> <td style="width: 10%;"></td> <td style="width: 10%;"></td> <td style="width: 10%;"></td> </tr> <tr> <td></td> <td></td> <td colspan="8" style="text-align: center;"> <table border="1" style="width: 100%; border-collapse: collapse; text-align: center;"> <tr> <td style="width: 10%;"></td> <td style="width: 10%;"></td> <td style="width: 10%;"></td> <td style="width: 10%;"></td> <td style="width: 10%;"></td> <td style="width: 10%;"></td> <td style="width: 10%;"></td> <td style="width: 10%;"></td> <td style="width: 10%;"></td> <td style="width: 10%;"></td> </tr> <tr> <td></td> <td></td> <td colspan="8" style="text-align: center;"> <table border="1" style="width: 100%; border-collapse: collapse; text-align: center;"> <tr> <td style="width: 10%;"></td> <td style="width: 10%;"></td> <td style="width: 10%;"></td> <td style="width: 10%;"></td> <td style="width: 10%;"></td> <td style="width: 10%;"></td> <td style="width: 10%;"></td> <td style="width: 10%;"></td> <td style="width: 10%;"></td> <td style="width: 10%;"></td> </tr> <tr> <td></td> <td></td> <td colspan="8" style="text-align: center;"> <table border="1" style="width: 100%; border-collapse: collapse; text-align: center;"> <tr> <td style="width: 10%;"></td> <td style="width: 10%;"></td> <td style="width: 10%;"></td> <td style="width: 10%;"></td> <td style="width: 10%;"></td> <td style="width: 10%;"></td> <td style="width: 10%;"></td> <td style="width: 10%;"></td> <td style="width: 10%;"></td> <td style="width: 10%;"></td> </tr> <tr> <td></td> <td></td> <td colspan="8" style="text-align: center;"> <table border="1" style="width: 100%; border-collapse: collapse; text-align: center;"> <tr> <td style="width: 10%;"></td> <td style="width: 10%;"></td> <td style="width: 10%;"></td> <td style="width: 10%;"></td> <td style="width: 10%;"></td> <td style="width: 10%;"></td> <td style="width: 10%;"></td> <td style="width: 10%;"></td> <td style="width: 10%;"></td> <td style="width: 10%;"></td> </tr> <tr> <td></td> <td></td> <td colspan="8" style="text-align: center;"> <table border="1" style="width: 100%; border-collapse: collapse; text-align: center;"> <tr> <td style="width: 10%;"></td> <td style="width: 10%;"></td> <td style="width: 10%;"></td> <td style="width: 10%;"></td> <td style="width: 10%;"></td> <td style="width: 10%;"></td> <td style="width: 10%;"></td> <td style="width: 10%;"></td> <td style="width: 10%;"></td> <td style="width: 10%;"></td> </tr> <tr> <td></td> <td></td> <td colspan="8" style="text-align: center;"> <table border="1" style="width: 100%; border-collapse: collapse; text-align: center;"> <tr> <td style="width: 10%;"></td> <td style="width: 10%;"></td> <td style="width: 10%;"></td> <td style="width: 10%;"></td> <td style="width: 10%;"></td> <td style="width: 10%;"></td> <td style="width: 10%;"></td> <td style="width: 10%;"></td> <td style="width: 10%;"></td> <td style="width: 10%;"></td> </tr> <tr> <td></td> <td></td> <td
colspan="8" style="text-align: center;"> <table border="1" style="width: 100%; border-collapse: collapse; text-align: center;"> <tr> <td style="width: 10%;"></td> <td style="width: 10%;"></td> <td style="width: 10%;"></td> <td style="width: 10%;"></td> <td style="width: 10%;"></td> <td style="width: 10%;"></td> <td style="width: 10%;"></td> <td style="width: 10%;"></td> <td style="width: 10%;"></td> <td style="width: 10%;"></td> </tr> <tr> <td></td> <td></td> <td colspan="8" style="text-align: center;"> <table border="1" style="width: 100%; border-collapse: collapse; text-align: center;"> <tr> <td style="width: 10%;"></td> <td style="width: 10%;"></td> <td style="width: 10%;"></td> <td style="width: 10%;"></td> <td style="width: 10%;"></td> <td style="width: 10%;"></td> <td style="width: 10%;"></td> <td style="width: 10%;"></td> <td style="width: 10%;"></td> <td style="width: 10%;"></td> </tr> <tr> <td></td> <td></td> <td colspan="8" style="text-align: center;"> <table border="1" style="width: 100%; border-collapse: collapse; text-align: center;"> <tr> <td style="width: 10%;"></td> <td style="width: 10%;"></td> <td style="width: 10%;"></td> <td style="width: 10%;"></td> <td style="width: 10%;"></td> <td style="width: 10%;"></td> <td style="width: 10%;"></td> <td style="width: 10%;"></td> <td style="width: 10%;"></td> <td style="width: 10%;"></td> </tr> <tr> <td></td> <td></td> <td colspan="8" style="text-align: center;"> <table border="1" style="width: 100%; border-collapse: collapse; text-align: center;"> <tr> <td style="width: 10%;"></td> <td style="width: 10%;"></td> <td style="width: 10%;"></td> <td style="width: 10%;"></td> <td style="width: 10%;"></td> <td style="width: 10%;"></td> <td style="width: 10%;"></td> <td style="width: 10%;"></td> <td style="width: 10%;"></td> <td style="width: 10%;"></td> </tr> <tr> <td></td> <td></td> <td colspan="8" style="text-align: center;"> <table border="1" style="width: 100%; border-collapse: collapse; text-align: center;"> <tr> <td style="width: 10%;"></td> <td style="width: 10%;"></td> <td style="width: 10%;"></td> <td style="width: 10%;"></td> <td style="width: 10%;"></td> <td style="width: 10%;"></td> <td style="width: 10%;"></td> <td style="width: 10%;"></td> <td style="width: 10%;"></td> <td style="width: 10%;"></td> </tr> <tr> <td></td> <td></td> <td colspan="8" style="text-align: center;"> <table border="1" style="width: 100%; border-collapse: collapse; text-align: center;"> <tr> <td style="width: 10%;"></td> <td style="width: 10%;"></td> <td style="width: 10%;"></td> <td style="width: 10%;"></td> <td style="width: 10%;"></td> <td style="width: 10%;"></td> <td style="width: 10%;"></td> <td style="width: 10%;"></td> <td style="width: 10%;"></td> <td style="width: 10%;"></td> </tr> <tr> <td></td> <td></td> <td colspan="8" style="text-align: center;"> <table border="1" style="width: 100%; border-collapse: collapse; text-align: center;"> <tr> <td style="width: 10%;"></td> <td style="width: 10%;"></td> <td style="width: 10%;"></td> <td style="width: 10%;"></td> <td style="width: 10%;"></td> <td style="width: 10%;"></td> <td style="width: 10%;"></td> <td style="width: 10%;"></td> <td style="width: 10%;"></td> <td style="width: 10%;"></td> </tr> <tr> <td></td> <td></td> <td colspan="8" style="text-align: center;"> <table border="1" style="width: 100%; border-collapse: collapse; text-align: center;"> <tr> <td style="width: 10%;"></td> <td style="width: 10%;"></td> <td style="width: 10%;"></td> <td style="width: 10%;"></td> <td style="width: 10%;"></td> <td style="width: 10%;"></td> <td style="width: 10%;"></td> <td style="width: 10%;"></td> <td style="width: 10%;"></td> <td style="width: 10%;"></td> </tr> <tr> <td></td> <td></td> <td colspan="8" style="text-align: center;"> <table border="1" style="width: 100%; border-collapse: collapse; text-align: center;"> <tr> <td style="width: 10%;"></td> <td style="width: 10%;"></td> <td style="width: 10%;"></td> <td style="width: 10%;"></td> <td style="width: 10%;"></td> <td style="width: 10%;"></td> <td style="width: 10%;"></td> <td style="width: 10%;"></td> <td style="width: 10%;"></td> <td style="width: 10%;"></td> </tr> <tr> <td></td> <td></td> <td colspan="8" style="text-align: center;"> <table border="1" style="width: 100%; border-collapse: collapse; text-align: center;"> <tr> <td style="width: 10%;"></td> <td style="width: 10%;"></td> <td style="width: 10%;"></td> <td style="width: 10%;"></td> <td style="width: 10%;"></td> <td style="width: 10%;"></td> <td style="width: 10%;"></td> <td style="width: 10%;"></td> <td style="width: 10%;"></td> <td style="width: 10%;"></td> </tr> <tr> <td></td> <td></td> <td colspan="8" style="text-align: center;"> <table border="1" style="width: 100%; border-collapse: collapse; text-align: center;"> <tr> <td style="width: 10%;"></td> <td style="width: 10%;"></td> <td style="width: 10%;"></td> <td style="width: 10%;"></td> <td style="width: 10%;"></td> <td style="width: 10%;"></td> <td style="width: 10%;"></td> <td style="width: 10%;"></td> <td style="width: 10%;"></td> <td style="width: 10%;"></td> </tr> <tr> <td></td> <td></td> <td colspan="8" style="text-align: center;"> <table border="1" style="width: 100%; border-collapse: collapse; text-align: center;"> <tr> <td style="width: 10%;"></td> <td style="width: 10%;"></td> <td style="width: 10%;"></td> <td style="width: 10%;"></td> <td style="width: 10%;"></td> <td style="width: 10%;"></td> <td style="width: 10%;"></td> <td style="width: 10%;"></td> <td style="width: 10%;"></td> <td style="width: 10%;"></td> </tr> <tr> <td></td> <td></td> <td colspan="8" style="text-align: center;"> <table border="1" style="width: 100%; border-collapse: collapse; text-align: center;"> <tr> <td style="width: 10%;"></td> <td style="width: 10%;"></td> <td style="width: 10%;"></td> <td style="width: 10%;"></td> <td style="width: 10%;"></td> <td style="width: 10%;"></td> <td style="width: 10%;"></td> <td style="width: 10%;"></td> <td style="width: 10%;"></td> <td style="width: 10%;"></td> </tr> <tr> <td></td> <td></td> <td colspan="8" style="text-align: center;"> <table border="1" style="width: 100%; border-collapse: collapse; text-align: center;"> <tr> <td style="width: 10%;"></td> <td style="width: 10%;"></td> <td style="width: 10%;"></td> <td style="width: 10%;"></td> <td style="width: 10%;"></td> <td style="width: 10%;"></td> <td style="width: 10%;"></td> <td style="width: 10%;"></td> <td style="width: 10%;"></td> <td style="width: 10%;"></td> </tr> <tr> <td></td> <td></td> <td colspan="8" style="text-align: center;"> <table border="1" style="width: 100%; border-collapse: collapse; text-align: center;"> <tr> <td style="width: 10%;"></td> <td style="width: 10%;"></td> <td style="width: 10%;"></td> <td style="width: 10%;"></td> <td style="width: 10%;"></td> <td style="width: 10%;"></td> <td style="width: 10%;"></td> <td style="width: 10%;"></td> <td style="width: 10%;"></td> <td style="width: 10%;"></td> </tr> <tr> <td></td> <td></td> <td colspan="8" style="text-align: center;"> <table border="1" style="width: 100%; border-collapse: collapse; text-align: center;"> <tr> <td style="width: 10%;"></td> <td style="width: 10%;"></td> <td style="width: 10%;"></td> <td style="width: 10%;"></td> <td style="width: 10%;"></td> <td style="width: 10%;"></td> <td style="width: 10%;"></td> <td style="width: 10%;"></td> <td style="width: 10%;"></td> <td style="width: 10%;"></td> </tr> <tr> <td></td> <td></td> <td colspan="8" style="text-align: center;"> <table border="1" style="width: 100%; border-collapse: collapse; text-align: center;"> <tr> <td style="width: 10%;"></td> <td style="width: 10%;"></td> <td style="width: 10%;"></td> <td style="width: 10%;"></td> <td style="width: 10%;"></td> <td style="width: 10%;"></td> <td style="width: 10%;"></td> <td style="width: 10%;"></td> <td style="width: 10%;"></td> <td style="width: 10%;"></td> </tr> <tr> <td></td> <td></td> <td colspan="8" style="text-align: center;"> <table border="1" style="width: 100%; border-collapse: collapse; text-align: center;"> <tr> <td style="width: 10%;"></td> <td style="width: 10%;"></td> <td style="width: 10%;"></td> <td style="width: 10%;"></td> <td style="width: 10%;"></td> <td style="width: 10%;"></td> <td style="width: 10%;"></td> <td style="width: 10%;"></td> <td style="width: 10%;"></td> <td style="width: 10%;"></td> </tr> <tr> <td></td> <td></td> <td colspan="8" style="text-align: center;"> <table border="1" style="width: 100%; border-collapse: collapse; text-align: center;"> <tr> <td style="width: 10%;"></td> <td style="width: 10%;"></td> <td style="width: 10%;"></td> <td style="width: 10%;"></td> <td style="width: 10%;"></td> <td style="width: 10%;"></td> <td style="width: 10%;"></td> <td style="width: 10%;"></td> <td style="width: 10%;"></td> <td style="width: 10%;"></td> </tr> <tr> <td></td> <td></td> <td colspan="8" style="text-align: center;"> <table border="1" style="width: 100%; border-collapse: collapse; text-align: center;"> <tr> <td style="width: 10%;"></td> <td style="width: 10%;"></td> <td style="width: 10%;"></td> <td style="width: 10%;"></td> <td style="width: 10%;"></td> <td style="width: 10%;"></td> <td style="width: 10%;"></td> <td style="width: 10%;"></td> <td style="width: 10%;"></td> <td style="width: 10%;"></td> </tr> <tr> <td></td> <td></td> <td colspan="8" style="text-align: center;"> <table border="1" style="width: 100%; border-collapse: collapse; text-align: center;"> <tr>
</tr></table></td></tr></table></td></tr></table></td></tr></table></td></tr></table></td></tr></table></td></tr></table></td></tr></table></td></tr></table></td></tr></table></td></tr></table></td></tr></table></td></tr></table></td></tr></table></td></tr></table></td></tr></table></td></tr></table></td></tr></table></td></tr></table></td></tr></table></td></tr></table></td></tr></table></td></tr></table></td></tr></table></td></tr></table></td></tr></table></td></tr></table></td></tr></table></td></tr></table></td></tr></table></td></tr></table></td></tr></table></td></tr></table></td></tr></table></td></tr></table></td></tr></table></td></tr></table></td></tr></table></td></tr></table></td></tr></table></td></tr></table></td></tr></table></td></tr></table></td></tr></table></td></tr></table></td></tr></table></td></tr></table></td></tr></table></td></tr></table></td></tr></table></td></tr></table></td></tr></table></td></tr></table> | | | | | | | | | | | | | | | | | | | | <table border="1" style="width: 100%; border-collapse: collapse; text-align: center;"> <tr> <td style="width: 10%;"></td> <td style="width: 10%;"></td> <td style="width: 10%;"></td> <td style="width: 10%;"></td> <td style="width: 10%;"></td> <td style="width: 10%;"></td> <td style="width: 10%;"></td> <td style="width: 10%;"></td> <td style="width: 10%;"></td> <td style="width: 10%;"></td> </tr> <tr> <td></td> <td></td> <td colspan="8" style="text-align: center;"> <table border="1" style="width: 100%; border-collapse: collapse; text-align: center;"> <tr> <td style="width: 10%;"></td> <td style="width: 10%;"></td> <td style="width: 10%;"></td> <td style="width: 10%;"></td> <td style="width: 10%;"></td> <td style="width: 10%;"></td> <td style="width: 10%;"></td> <td style="width: 10%;"></td> <td style="width: 10%;"></td> <td style="width: 10%;"></td> </tr> <tr> <td></td> <td></td> <td colspan="8" style="text-align: center;"> <table border="1" style="width: 100%; border-collapse: collapse; text-align: center;"> <tr> <td style="width: 10%;"></td> <td style="width: 10%;"></td> <td style="width: 10%;"></td> <td style="width: 10%;"></td> <td style="width: 10%;"></td> <td style="width: 10%;"></td> <td style="width: 10%;"></td> <td style="width: 10%;"></td> <td style="width: 10%;"></td> <td style="width: 10%;"></td> </tr> <tr> <td></td> <td></td> <td colspan="8" style="text-align: center;"> <table border="1" style="width: 100%; border-collapse: collapse; text-align: center;"> <tr> <td style="width: 10%;"></td> <td style="width: 10%;"></td> <td style="width: 10%;"></td> <td style="width: 10%;"></td> <td style="width: 10%;"></td> <td style="width: 10%;"></td> <td style="width: 10%;"></td> <td style="width: 10%;"></td> <td style="width: 10%;"></td> <td style="width: 10%;"></td> </tr> <tr> <td></td> <td></td> <td colspan="8" style="text-align: center;"> <table border="1" style="width: 100%; border-collapse: collapse; text-align: center;"> <tr> <td style="width: 10%;"></td> <td style="width: 10%;"></td> <td style="width: 10%;"></td> <td style="width: 10%;"></td> <td style="width: 10%;"></td> <td style="width: 10%;"></td> <td style="width: 10%;"></td> <td style="width: 10%;"></td> <td style="width: 10%;"></td> <td style="width: 10%;"></td> </tr> <tr> <td></td> <td></td> <td colspan="8" style="text-align: center;"> <table border="1" style="width: 100%; border-collapse: collapse; text-align: center;"> <tr> <td style="width: 10%;"></td> <td style="width: 10%;"></td> <td style="width: 10%;"></td> <td style="width: 10%;"></td> <td style="width: 10%;"></td> <td style="width: 10%;"></td> <td style="width: 10%;"></td> <td style="width: 10%;"></td> <td style="width: 10%;"></td> <td style="width: 10%;"></td> </tr> <tr> <td></td> <td></td> <td colspan="8" style="text-align: center;"> <table border="1" style="width: 100%; border-collapse: collapse; text-align: center;"> <tr> <td style="width: 10%;"></td> <td style="width: 10%;"></td> <td style="width: 10%;"></td> <td style="width: 10%;"></td> <td style="width: 10%;"></td> <td style="width: 10%;"></td> <td style="width: 10%;"></td> <td style="width: 10%;"></td> <td style="width: 10%;"></td> <td style="width: 10%;"></td> </tr> <tr> <td></td> <td></td> <td colspan="8" style="text-align: center;"> <table border="1" style="width: 100%; border-collapse: collapse; text-align: center;"> <tr> <td style="width: 10%;"></td> <td style="width: 10%;"></td> <td style="width: 10%;"></td> <td style="width: 10%;"></td> <td style="width: 10%;"></td> <td style="width: 10%;"></td> <td style="width: 10%;"></td> <td style="width: 10%;"></td> <td style="width: 10%;"></td> <td style="width: 10%;"></td> </tr> <tr> <td></td> <td></td> <td colspan="8" style="text-align: center;"> <table border="1" style="width: 100%; border-collapse: collapse; text-align: center;"> <tr> <td style="width: 10%;"></td> <td style="width: 10%;"></td> <td style="width: 10%;"></td> <td style="width: 10%;"></td> <td style="width: 10%;"></td> <td style="width: 10%;"></td> <td style="width: 10%;"></td> <td style="width: 10%;"></td> <td style="width: 10%;"></td> <td style="width: 10%;"></td> </tr> <tr> <td></td> <td></td> <td colspan="8" style="text-align: center;"> <table border="1" style="width: 100%; border-collapse: collapse; text-align: center;"> <tr> <td style="width: 10%;"></td> <td style="width: 10%;"></td> <td style="width: 10%;"></td> <td style="width: 10%;"></td> <td style="width: 10%;"></td> <td style="width: 10%;"></td> <td style="width: 10%;"></td> <td style="width: 10%;"></td> <td style="width: 10%;"></td> <td style="width: 10%;"></td> </tr> <tr> <td></td> <td></td> <td colspan="8" style="text-align: center;"> <table border="1" style="width: 100%; border-collapse: collapse; text-align: center;"> <tr> <td style="width: 10%;"></td> <td style="width: 10%;"></td> <td style="width: 10%;"></td> <td style="width: 10%;"></td> <td style="width: 10%;"></td> <td style="width: 10%;"></td> <td style="width: 10%;"></td> <td style="width: 10%;"></td> <td style="width: 10%;"></td> <td style="width: 10%;"></td> </tr> <tr> <td></td> <td></td> <td colspan="8" style="text-align: center;"> <table border="1" style="width: 100%; border-collapse: collapse; text-align: center;"> <tr> <td style="width: 10%;"></td> <td style="width: 10%;"></td> <td style="width: 10%;"></td> <td style="width: 10%;"></td> <td style="width: 10%;"></td> <td style="width: 10%;"></td> <td style="width: 10%;"></td> <td style="width: 10%;"></td> <td style="width: 10%;"></td> <td style="width: 10%;"></td> </tr> <tr> <td></td> <td></td> <td colspan="8" style="text-align: center;"> <table border="1" style="width: 100%; border-collapse: collapse; text-align: center;"> <tr> <td style="width: 10%;"></td> <td style="width: 10%;"></td> <td style="width: 10%;"></td> <td style="width: 10%;"></td> <td style="width: 10%;"></td> <td style="width: 10%;"></td> <td style="width: 10%;"></td> <td style="width: 10%;"></td> <td style="width: 10%;"></td> <td style="width: 10%;"></td> </tr> <tr> <td></td> <td></td> <td colspan="8" style="text-align: center;"> <table border="1" style="width: 100%; border-collapse: collapse; text-align: center;"> <tr> <td style="width: 10%;"></td> <td style="width: 10%;"></td> <td style="width: 10%;"></td> <td style="width: 10%;"></td> <td style="width: 10%;"></td> <td style="width: 10%;"></td> <td style="width: 10%;"></td> <td style="width: 10%;"></td> <td style="width: 10%;"></td> <td style="width: 10%;"></td> </tr> <tr> <td></td> <td></td> <td colspan="8" style="text-align: center;"> <table border="1" style="width: 100%; border-collapse: collapse; text-align: center;"> <tr> <td style="width: 10%;"></td> <td style="width: 10%;"></td> <td style="width: 10%;"></td> <td style="width: 10%;"></td> <td style="width: 10%;"></td> <td style="width: 10%;"></td> <td style="width: 10%;"></td> <td style="width: 10%;"></td> <td style="width: 10%;"></td> <td style="width: 10%;"></td> </tr> <tr> <td></td> <td></td> <td colspan="8" style="text-align: center;"> <table border="1" style="width: 100%; border-collapse: collapse; text-align: center;"> <tr> <td style="width: 10%;"></td> <td style="width: 10%;"></td> <td style="width: 10%;"></td> <td style="width: 10%;"></td> <td style="width: 10%;"></td> <td style="width: 10%;"></td> <td style="width: 10%;"></td> <td style="width: 10%;"></td> <td style="width: 10%;"></td> <td style="width: 10%;"></td> </tr> <tr> <td></td> <td></td> <td colspan="8" style="text-align: center;"> <table border="1" style="width: 100%;
border-collapse: collapse; text-align: center;"> <tr> <td style="width: 10%;"></td> <td style="width: 10%;"></td> <td style="width: 10%;"></td> <td style="width: 10%;"></td> <td style="width: 10%;"></td> <td style="width: 10%;"></td> <td style="width: 10%;"></td> <td style="width: 10%;"></td> <td style="width: 10%;"></td> <td style="width: 10%;"></td> </tr> <tr> <td></td> <td></td> <td colspan="8" style="text-align: center;"> <table border="1" style="width: 100%; border-collapse: collapse; text-align: center;"> <tr> <td style="width: 10%;"></td> <td style="width: 10%;"></td> <td style="width: 10%;"></td> <td style="width: 10%;"></td> <td style="width: 10%;"></td> <td style="width: 10%;"></td> <td style="width: 10%;"></td> <td style="width: 10%;"></td> <td style="width: 10%;"></td> <td style="width: 10%;"></td> </tr> <tr> <td></td> <td></td> <td colspan="8" style="text-align: center;"> <table border="1" style="width: 100%; border-collapse: collapse; text-align: center;"> <tr> <td style="width: 10%;"></td> <td style="width: 10%;"></td> <td style="width: 10%;"></td> <td style="width: 10%;"></td> <td style="width: 10%;"></td> <td style="width: 10%;"></td> <td style="width: 10%;"></td> <td style="width: 10%;"></td> <td style="width: 10%;"></td> <td style="width: 10%;"></td> </tr> <tr> <td></td> <td></td> <td colspan="8" style="text-align: center;"> <table border="1" style="width: 100%; border-collapse: collapse; text-align: center;"> <tr> <td style="width: 10%;"></td> <td style="width: 10%;"></td> <td style="width: 10%;"></td> <td style="width: 10%;"></td> <td style="width: 10%;"></td> <td style="width: 10%;"></td> <td style="width: 10%;"></td> <td style="width: 10%;"></td> <td style="width: 10%;"></td> <td style="width: 10%;"></td> </tr> <tr> <td></td> <td></td> <td colspan="8" style="text-align: center;"> <table border="1" style="width: 100%; border-collapse: collapse; text-align: center;"> <tr> <td style="width: 10%;"></td> <td style="width: 10%;"></td> <td style="width: 10%;"></td> <td style="width: 10%;"></td> <td style="width: 10%;"></td> <td style="width: 10%;"></td> <td style="width: 10%;"></td> <td style="width: 10%;"></td> <td style="width: 10%;"></td> <td style="width: 10%;"></td> </tr> <tr> <td></td> <td></td> <td colspan="8" style="text-align: center;"> <table border="1" style="width: 100%; border-collapse: collapse; text-align: center;"> <tr> <td style="width: 10%;"></td> <td style="width: 10%;"></td> <td style="width: 10%;"></td> <td style="width: 10%;"></td> <td style="width: 10%;"></td> <td style="width: 10%;"></td> <td style="width: 10%;"></td> <td style="width: 10%;"></td> <td style="width: 10%;"></td> <td style="width: 10%;"></td> </tr> <tr> <td></td> <td></td> <td colspan="8" style="text-align: center;"> <table border="1" style="width: 100%; border-collapse: collapse; text-align: center;"> <tr> <td style="width: 10%;"></td> <td style="width: 10%;"></td> <td style="width: 10%;"></td> <td style="width: 10%;"></td> <td style="width: 10%;"></td> <td style="width: 10%;"></td> <td style="width: 10%;"></td> <td style="width: 10%;"></td> <td style="width: 10%;"></td> <td style="width: 10%;"></td> </tr> <tr> <td></td> <td></td> <td colspan="8" style="text-align: center;"> <table border="1" style="width: 100%; border-collapse: collapse; text-align: center;"> <tr> <td style="width: 10%;"></td> <td style="width: 10%;"></td> <td style="width: 10%;"></td> <td style="width: 10%;"></td> <td style="width: 10%;"></td> <td style="width: 10%;"></td> <td style="width: 10%;"></td> <td style="width: 10%;"></td> <td style="width: 10%;"></td> <td style="width: 10%;"></td> </tr> <tr> <td></td> <td></td> <td colspan="8" style="text-align: center;"> <table border="1" style="width: 100%; border-collapse: collapse; text-align: center;"> <tr> <td style="width: 10%;"></td> <td style="width: 10%;"></td> <td style="width: 10%;"></td> <td style="width: 10%;"></td> <td style="width: 10%;"></td> <td style="width: 10%;"></td> <td style="width: 10%;"></td> <td style="width: 10%;"></td> <td style="width: 10%;"></td> <td style="width: 10%;"></td> </tr> <tr> <td></td> <td></td> <td colspan="8" style="text-align: center;"> <table border="1" style="width: 100%; border-collapse: collapse; text-align: center;"> <tr> <td style="width: 10%;"></td> <td style="width: 10%;"></td> <td style="width: 10%;"></td> <td style="width: 10%;"></td> <td style="width: 10%;"></td> <td style="width: 10%;"></td> <td style="width: 10%;"></td> <td style="width: 10%;"></td> <td style="width: 10%;"></td> <td style="width: 10%;"></td> </tr> <tr> <td></td> <td></td> <td colspan="8" style="text-align: center;"> <table border="1" style="width: 100%; border-collapse: collapse; text-align: center;"> <tr> <td style="width: 10%;"></td> <td style="width: 10%;"></td> <td style="width: 10%;"></td> <td style="width: 10%;"></td> <td style="width: 10%;"></td> <td style="width: 10%;"></td> <td style="width: 10%;"></td> <td style="width: 10%;"></td> <td style="width: 10%;"></td> <td style="width: 10%;"></td> </tr> <tr> <td></td> <td></td> <td colspan="8" style="text-align: center;"> <table border="1" style="width: 100%; border-collapse: collapse; text-align: center;"> <tr> <td style="width: 10%;"></td> <td style="width: 10%;"></td> <td style="width: 10%;"></td> <td style="width: 10%;"></td> <td style="width: 10%;"></td> <td style="width: 10%;"></td> <td style="width: 10%;"></td> <td style="width: 10%;"></td> <td style="width: 10%;"></td> <td style="width: 10%;"></td> </tr> <tr> <td></td> <td></td> <td colspan="8" style="text-align: center;"> <table border="1" style="width: 100%; border-collapse: collapse; text-align: center;"> <tr> <td style="width: 10%;"></td> <td style="width: 10%;"></td> <td style="width: 10%;"></td> <td style="width: 10%;"></td> <td style="width: 10%;"></td> <td style="width: 10%;"></td> <td style="width: 10%;"></td> <td style="width: 10%;"></td> <td style="width: 10%;"></td> <td style="width: 10%;"></td> </tr> <tr> <td></td> <td></td> <td colspan="8" style="text-align: center;"> <table border="1" style="width: 100%; border-collapse: collapse; text-align: center;"> <tr> <td style="width: 10%;"></td> <td style="width: 10%;"></td> <td style="width: 10%;"></td> <td style="width: 10%;"></td> <td style="width: 10%;"></td> <td style="width: 10%;"></td> <td style="width: 10%;"></td> <td style="width: 10%;"></td> <td style="width: 10%;"></td> <td style="width: 10%;"></td> </tr> <tr> <td></td> <td></td> <td colspan="8" style="text-align: center;"> <table border="1" style="width: 100%; border-collapse: collapse; text-align: center;"> <tr> <td style="width: 10%;"></td> <td style="width: 10%;"></td> <td style="width: 10%;"></td> <td style="width: 10%;"></td> <td style="width: 10%;"></td> <td style="width: 10%;"></td> <td style="width: 10%;"></td> <td style="width: 10%;"></td> <td style="width: 10%;"></td> <td style="width: 10%;"></td> </tr> <tr> <td></td> <td></td> <td colspan="8" style="text-align: center;"> <table border="1" style="width: 100%; border-collapse: collapse; text-align: center;"> <tr> <td style="width: 10%;"></td> <td style="width: 10%;"></td> <td style="width: 10%;"></td> <td style="width: 10%;"></td> <td style="width: 10%;"></td> <td style="width: 10%;"></td> <td style="width: 10%;"></td> <td style="width: 10%;"></td> <td style="width: 10%;"></td> <td style="width: 10%;"></td> </tr> <tr> <td></td> <td></td> <td colspan="8" style="text-align: center;"> <table border="1" style="width: 100%; border-collapse: collapse; text-align: center;"> <tr> <td style="width: 10%;"></td> <td style="width: 10%;"></td> <td style="width: 10%;"></td> <td style="width: 10%;"></td> <td style="width: 10%;"></td> <td style="width: 10%;"></td> <td style="width: 10%;"></td> <td style="width: 10%;"></td> <td style="width: 10%;"></td> <td style="width: 10%;"></td> </tr> <tr> <td></td> <td></td> <td colspan="8" style="text-align: center;"> <table border="1" style="width: 100%; border-collapse: collapse; text-align: center;"> <tr> <td style="width: 10%;"></td> <td style="width: 10%;"></td> <td style="width: 10%;"></td> <td style="width: 10%;"></td> <td style="width: 10%;"></td> <td style="width: 10%;"></td> <td style="width: 10%;"></td> <td style="width: 10%;"></td> <td style="width: 10%;"></td> <td style="width: 10%;"></td> </tr> <tr> <td></td> <td></td> <td colspan="8" style="text-align: center;"> <table border="1" style="width: 100%; border-collapse: collapse; text-align: center;"> <tr> <td style="width: 10%;"></td> <td style="width: 10%;"></td> <td style="width: 10%;"></td> <td style="width: 10%;"></td> <td style="width: 10%;"></td> <td style="width: 10%;"></td> <td style="width: 10%;"></td> <td style="width: 10%;"></td> <td style="width: 10%;"></td> <td style="width: 10%;"></td> </tr> <tr> <td></td> <td></td> <td colspan="8" style="text-align: center;"> <table border="1" style="width: 100%; border-collapse: collapse; text-align: center;"> <tr> <td style="width: 10%;"></td> <td style="width: 10%;"></td> <td style="width: 10%;"></td> <td style="width: 10%;"></td> <td style="width: 10%;"></td> <td style="width: 10%;"></td> <td style="width: 10%;"></td> <td style="width: 10%;"></td> <td style="width: 10%;"></td> <td style="width: 10%;"></td> </tr> <tr> <td></td> <td></td> <td colspan="8" style="text-align: center;"> <table border="1" style="width: 100%; border-collapse: collapse; text-align: center;"> <tr> <td style="width: 10%;"></td> <td style="width: 10%;"></td> <td style="width: 10%;"></td> <td style="width: 10%;"></td> <td style="width: 10%;"></td> <td style="width: 10%;"></td> <td style="width: 10%;"></td> <td style="width: 10%;"></td> <td style="width: 10%;"></td> <td style="width: 10%;"></td> </tr> <tr> <td></td> <td></td> <td colspan="8" style="text-align: center;"> <table border="1" style="width: 100%; border-collapse: collapse; text-align: center;"> <tr> <td style="width: 10%;"></td> <td style="width: 10%;"></td> <td style="width: 10%;"></td> <td style="width:
10%;"></td> <td style="width: 10%;"></td> <td style="width: 10%;"></td> <td style="width: 10%;"></td> <td style="width: 10%;"></td> <td style="width: 10%;"></td> <td style="width: 10%;"></td> </tr> <tr> <td></td> <td></td> <td colspan="8" style="text-align: center;"> <table border="1" style="width: 100%; border-collapse: collapse; text-align: center;"> <tr> <td style="width: 10%;"></td> <td style="width: 10%;"></td> <td style="width: 10%;"></td> <td style="width: 10%;"></td> <td style="width: 10%;"></td> <td style="width: 10%;"></td> <td style="width: 10%;"></td> <td style="width: 10%;"></td> <td style="width: 10%;"></td> <td style="width: 10%;"></td> </tr> <tr> <td></td> <td></td> <td colspan="8" style="text-align: center;"> <table border="1" style="width: 100%; border-collapse: collapse; text-align: center;"> <tr> <td style="width: 10%;"></td> <td style="width: 10%;"></td> <td style="width: 10%;"></td> <td style="width: 10%;"></td> <td style="width: 10%;"></td> <td style="width: 10%;"></td> <td style="width: 10%;"></td> <td style="width: 10%;"></td> <td style="width: 10%;"></td> <td style="width: 10%;"></td> </tr> <tr> <td></td> <td></td> <td colspan="8" style="text-align: center;"> <table border="1" style="width: 100%; border-collapse: collapse; text-align: center;"> <tr> <td style="width: 10%;"></td> <td style="width: 10%;"></td> <td style="width: 10%;"></td> <td style="width: 10%;"></td> <td style="width: 10%;"></td> <td style="width: 10%;"></td> <td style="width: 10%;"></td> <td style="width: 10%;"></td> <td style="width: 10%;"></td> <td style="width: 10%;"></td> </tr> <tr> <td></td> <td></td> <td colspan="8" style="text-align: center;"> <table border="1" style="width: 100%; border-collapse: collapse; text-align: center;"> <tr> <td style="width: 10%;"></td> <td style="width: 10%;"></td> <td style="width: 10%;"></td> <td style="width: 10%;"></td> <td style="width: 10%;"></td> <td style="width: 10%;"></td> <td style="width: 10%;"></td> <td style="width: 10%;"></td> <td style="width: 10%;"></td> <td style="width: 10%;"></td> </tr> <tr> <td></td> <td></td> <td colspan="8" style="text-align: center;"> <table border="1" style="width: 100%; border-collapse: collapse; text-align: center;"> <tr> <td style="width: 10%;"></td> <td style="width: 10%;"></td> <td style="width: 10%;"></td> <td style="width: 10%;"></td> <td style="width: 10%;"></td> <td style="width: 10%;"></td> <td style="width: 10%;"></td> <td style="width: 10%;"></td> <td style="width: 10%;"></td> <td style="width: 10%;"></td> </tr> <tr> <td></td> <td></td> <td colspan="8" style="text-align: center;"> <table border="1" style="width: 100%; border-collapse: collapse; text-align: center;"> <tr> <td style="width: 10%;"></td> <td style="width: 10%;"></td> <td style="width: 10%;"></td> <td style="width: 10%;"></td> <td style="width: 10%;"></td> <td style="width: 10%;"></td> <td style="width: 10%;"></td> <td style="width: 10%;"></td> <td style="width: 10%;"></td> <td style="width: 10%;"></td> </tr> <tr> <td></td> <td></td> <td colspan="8" style="text-align: center;"> <table border="1" style="width: 100%; border-collapse: collapse; text-align: center;"> <tr> <td style="width: 10%;"></td> <td style="width: 10%;"></td> <td style="width: 10%;"></td> <td style="width: 10%;"></td> <td style="width: 10%;"></td> <td style="width: 10%;"></td> <td style="width: 10%;"></td> <td style="width: 10%;"></td> <td style="width: 10%;"></td> <td style="width: 10%;"></td> </tr> <tr> <td></td> <td></td> <td colspan="8" style="text-align: center;"> <table border="1" style="width: 100%; border-collapse: collapse; text-align: center;"> <tr> <td style="width: 10%;"></td> <td style="width: 10%;"></td> <td style="width: 10%;"></td> <td style="width: 10%;"></td> <td style="width: 10%;"></td> <td style="width: 10%;"></td> <td style="width: 10%;"></td> <td style="width: 10%;"></td> <td style="width: 10%;"></td> <td style="width: 10%;"></td> </tr> <tr> <td></td> <td></td> <td colspan="8" style="text-align: center;"> <table border="1" style="width: 100%; border-collapse: collapse; text-align: center;"> <tr> <td style="width: 10%;"></td> <td style="width: 10%;"></td> <td style="width: 10%;"></td> <td style="width: 10%;"></td> <td style="width: 10%;"></td> <td style="width: 10%;"></td> <td style="width: 10%;"></td> <td style="width: 10%;"></td> <td style="width: 10%;"></td> <td style="width: 10%;"></td> </tr> <tr> <td></td> <td></td> <td colspan="8" style="text-align: center;"> <table border="1" style="width: 100%; border-collapse: collapse; text-align: center;"> <tr> <td style="width: 10%;"></td> <td style="width: 10%;"></td> <td style="width: 10%;"></td> <td style="width: 10%;"></td> <td style="width: 10%;"></td> <td style="width: 10%;"></td> <td style="width: 10%;"></td> <td style="width: 10%;"></td> <td style="width: 10%;"></td> <td style="width: 10%;"></td> </tr> <tr> <td></td> <td></td> <td colspan="8" style="text-align: center;"> <table border="1" style="width: 100%; border-collapse: collapse; text-align: center;"> <tr> <td style="width: 10%;"></td> <td style="width: 10%;"></td> <td style="width: 10%;"></td> <td style="width: 10%;"></td> <td style="width: 10%;"></td> <td style="width: 10%;"></td> <td style="width: 10%;"></td> <td style="width: 10%;"></td> <td style="width: 10%;"></td> <td style="width: 10%;"></td> </tr> <tr> <td></td> <td></td> <td colspan="8" style="text-align: center;"> <table border="1" style="width: 100%; border-collapse: collapse; text-align: center;"> <tr> <td style="width: 10%;"></td> <td style="width: 10%;"></td> <td style="width: 10%;"></td> <td style="width: 10%;"></td> <td style="width: 10%;"></td> <td style="width: 10%;"></td> <td style="width: 10%;"></td> <td style="width: 10%;"></td> <td style="width: 10%;"></td> <td style="width: 10%;"></td> </tr> <tr> <td></td> <td></td> <td colspan="8" style="text-align: center;"> <table border="1" style="width: 100%; border-collapse: collapse; text-align: center;"> <tr> <td style="width: 10%;"></td> <td style="width: 10%;"></td> <td style="width: 10%;"></td> <td style="width: 10%;"></td> <td style="width: 10%;"></td> <td style="width: 10%;"></td> <td style="width: 10%;"></td> <td style="width: 10%;"></td> <td style="width: 10%;"></td> <td style="width: 10%;"></td> </tr> <tr> <td></td> <td></td> <td colspan="8" style="text-align: center;"> <table border="1" style="width: 100%; border-collapse: collapse; text-align: center;"> <tr> </tr></table></td></tr></table></td></tr></table></td></tr></table></td></tr></table></td></tr></table></td></tr></table></td></tr></table></td></tr></table></td></tr></table></td></tr></table></td></tr></table></td></tr></table></td></tr></table></td></tr></table></td></tr></table></td></tr></table></td></tr></table></td></tr></table></td></tr></table></td></tr></table></td></tr></table></td></tr></table></td></tr></table></td></tr></table></td></tr></table></td></tr></table></td></tr></table></td></tr></table></td></tr></table></td></tr></table></td></tr></table></td></tr></table></td></tr></table></td></tr></table></td></tr></table></td></tr></table></td></tr></table></td></tr></table></td></tr></table></td></tr></table></td></tr></table></td></tr></table></td></tr></table></td></tr></table></td></tr></table></td></tr></table></td></tr></table></td></tr></table></td></tr></table></td></tr></table></td></tr></table> | | | | | | | | | | | | | | | | | | | | <table border="1" style="width: 100%; border-collapse: collapse; text-align: center;"> <tr> <td style="width: 10%;"></td> <td style="width: 10%;"></td> <td style="width: 10%;"></td> <td style="width: 10%;"></td> <td style="width: 10%;"></td> <td style="width: 10%;"></td> <td style="width: 10%;"></td> <td style="width: 10%;"></td> <td style="width: 10%;"></td> <td style="width: 10%;"></td> </tr> <tr> <td></td> <td></td> <td colspan="8" style="text-align: center;"> <table border="1" style="width: 100%; border-collapse: collapse; text-align: center;"> <tr> <td style="width: 10%;"></td> <td style="width: 10%;"></td> <td style="width: 10%;"></td> <td style="width: 10%;"></td> <td style="width: 10%;"></td> <td style="width: 10%;"></td> <td style="width: 10%;"></td> <td style="width: 10%;"></td> <td style="width: 10%;"></td> <td style="width: 10%;"></td> </tr> <tr> <td></td> <td></td> <td colspan="8" style="text-align: center;"> <table border="1" style="width: 100%; border-collapse: collapse; text-align: center;"> <tr> <td style="width: 10%;"></td> <td style="width: 10%;"></td> <td style="width:
10%;"></td> <td style="width: 10%;"></td> <td style="width: 10%;"></td> <td style="width: 10%;"></td> <td style="width: 10%;"></td> <td style="width: 10%;"></td> <td style="width: 10%;"></td> <td style="width: 10%;"></td> </tr> <tr> <td></td> <td></td> <td colspan="8" style="text-align: center;"> <table border="1" style="width: 100%; border-collapse: collapse; text-align: center;"> <tr> <td style="width: 10%;"></td> <td style="width: 10%;"></td> <td style="width: 10%;"></td> <td style="width: 10%;"></td> <td style="width: 10%;"></td> <td style="width: 10%;"></td> <td style="width: 10%;"></td> <td style="width: 10%;"></td> <td style="width: 10%;"></td> <td style="width: 10%;"></td> </tr> <tr> <td></td> <td></td> <td colspan="8" style="text-align: center;"> <table border="1" style="width: 100%; border-collapse: collapse; text-align: center;"> <tr> <td style="width: 10%;"></td> <td style="width: 10%;"></td> <td style="width: 10%;"></td> <td style="width: 10%;"></td> <td style="width: 10%;"></td> <td style="width: 10%;"></td> <td style="width: 10%;"></td> <td style="width: 10%;"></td> <td style="width: 10%;"></td> <td style="width: 10%;"></td> </tr> <tr> <td></td> <td></td> <td colspan="8" style="text-align: center;"> <table border="1" style="width: 100%; border-collapse: collapse; text-align: center;"> <tr> <td style="width: 10%;"></td> <td style="width: 10%;"></td> <td style="width: 10%;"></td> <td style="width: 10%;"></td> <td style="width: 10%;"></td> <td style="width: 10%;"></td> <td style="width: 10%;"></td> <td style="width: 10%;"></td> <td style="width: 10%;"></td> <td style="width: 10%;"></td> </tr> <tr> <td></td> <td></td> <td colspan="8" style="text-align: center;"> <table border="1" style="width: 100%; border-collapse: collapse; text-align: center;"> <tr> <td style="width: 10%;"></td> <td style="width: 10%;"></td> <td style="width: 10%;"></td> <td style="width: 10%;"></td> <td style="width: 10%;"></td> <td style="width: 10%;"></td> <td style="width: 10%;"></td> <td style="width: 10%;"></td> <td style="width: 10%;"></td> <td style="width: 10%;"></td> </tr> <tr> <td></td> <td></td> <td colspan="8" style="text-align: center;"> <table border="1" style="width: 100%; border-collapse: collapse; text-align: center;"> <tr> <td style="width: 10%;"></td> <td style="width: 10%;"></td> <td style="width: 10%;"></td> <td style="width: 10%;"></td> <td style="width: 10%;"></td> <td style="width: 10%;"></td> <td style="width: 10%;"></td> <td style="width: 10%;"></td> <td style="width: 10%;"></td> <td style="width: 10%;"></td> </tr> <tr> <td></td> <td></td> <td colspan="8" style="text-align: center;"> <table border="1" style="width: 100%; border-collapse: collapse; text-align: center;"> <tr> <td style="width: 10%;"></td> <td style="width: 10%;"></td> <td style="width: 10%;"></td> <td style="width: 10%;"></td> <td style="width: 10%;"></td> <td style="width: 10%;"></td> <td style="width: 10%;"></td> <td style="width: 10%;"></td> <td style="width: 10%;"></td> <td style="width: 10%;"></td> </tr> <tr> <td></td> <td></td> <td colspan="8" style="text-align: center;"> <table border="1" style="width: 100%; border-collapse: collapse; text-align: center;"> <tr> <td style="width: 10%;"></td> <td style="width: 10%;"></td> <td style="width: 10%;"></td> <td style="width: 10%;"></td> <td style="width: 10%;"></td> <td style="width: 10%;"></td> <td style="width: 10%;"></td> <td style="width: 10%;"></td> <td style="width: 10%;"></td> <td style="width: 10%;"></td> </tr> <tr> <td></td> <td></td> <td colspan="8" style="text-align: center;"> <table border="1" style="width: 100%; border-collapse: collapse; text-align: center;"> <tr> <td style="width: 10%;"></td> <td style="width: 10%;"></td> <td style="width: 10%;"></td> <td style="width: 10%;"></td> <td style="width: 10%;"></td> <td style="width: 10%;"></td> <td style="width: 10%;"></td> <td style="width: 10%;"></td> <td style="width: 10%;"></td> <td style="width: 10%;"></td> </tr> <tr> <td></td> <td></td> <td colspan="8" style="text-align: center;"> <table border="1" style="width: 100%; border-collapse: collapse; text-align: center;"> <tr> <td style="width: 10%;"></td> <td style="width: 10%;"></td> <td style="width: 10%;"></td> <td style="width: 10%;"></td> <td style="width: 10%;"></td> <td style="width: 10%;"></td> <td style="width: 10%;"></td> <td style="width: 10%;"></td> <td style="width: 10%;"></td> <td style="width: 10%;"></td> </tr> <tr> <td></td> <td></td> <td colspan="8" style="text-align: center;"> <table border="1" style="width: 100%; border-collapse: collapse; text-align: center;"> <tr> <td style="width: 10%;"></td> <td style="width: 10%;"></td> <td style="width: 10%;"></td> <td style="width: 10%;"></td> <td style="width: 10%;"></td> <td style="width: 10%;"></td> <td style="width: 10%;"></td> <td style="width: 10%;"></td> <td style="width: 10%;"></td> <td style="width: 10%;"></td> </tr> <tr> <td></td> <td></td> <td colspan="8" style="text-align: center;"> <table border="1" style="width: 100%; border-collapse: collapse; text-align: center;"> <tr> <td style="width: 10%;"></td> <td style="width: 10%;"></td> <td style="width: 10%;"></td> <td style="width: 10%;"></td> <td style="width: 10%;"></td> <td style="width: 10%;"></td> <td style="width: 10%;"></td> <td style="width: 10%;"></td> <td style="width: 10%;"></td> <td style="width: 10%;"></td> </tr> <tr> <td></td> <td></td> <td colspan="8" style="text-align: center;"> <table border="1" style="width: 100%; border-collapse: collapse; text-align: center;"> <tr> <td style="width: 10%;"></td> <td style="width: 10%;"></td> <td style="width: 10%;"></td> <td style="width: 10%;"></td> <td style="width: 10%;"></td> <td style="width: 10%;"></td> <td style="width: 10%;"></td> <td style="width: 10%;"></td> <td style="width: 10%;"></td> <td style="width: 10%;"></td> </tr> <tr> <td></td> <td></td> <td colspan="8" style="text-align: center;"> <table border="1" style="width: 100%; border-collapse: collapse; text-align: center;"> <tr> <td style="width: 10%;"></td> <td style="width: 10%;"></td> <td style="width: 10%;"></td> <td style="width: 10%;"></td> <td style="width: 10%;"></td> <td style="width: 10%;"></td> <td style="width: 10%;"></td> <td style="width: 10%;"></td> <td style="width: 10%;"></td> <td style="width: 10%;"></td> </tr> <tr> <td></td> <td></td> <td colspan="8" style="text-align: center;"> <table border="1" style="width: 100%; border-collapse: collapse; text-align: center;"> <tr> <td style="width: 10%;"></td> <td style="width: 10%;"></td> <td style="width: 10%;"></td> <td style="width: 10%;"></td> <td style="width: 10%;"></td> <td style="width: 10%;"></td> <td style="width: 10%;"></td> <td style="width: 10%;"></td> <td style="width: 10%;"></td> <td style="width: 10%;"></td> </tr> <tr> <td></td> <td></td> <td colspan="8" style="text-align: center;"> <table border="1" style="width: 100%; border-collapse: collapse; text-align: center;"> <tr> <td style="width: 10%;"></td> <td style="width: 10%;"></td> <td style="width: 10%;"></td> <td style="width: 10%;"></td> <td style="width: 10%;"></td> <td style="width: 10%;"></td> <td style="width: 10%;"></td> <td style="width: 10%;"></td> <td style="width: 10%;"></td> <td style="width: 10%;"></td> </tr> <tr> <td></td> <td></td> <td colspan="8" style="text-align: center;"> <table border="1" style="width: 100%; border-collapse: collapse; text-align: center;"> <tr> <td style="width: 10%;"></td> <td style="width: 10%;"></td> <td style="width: 10%;"></td> <td style="width: 10%;"></td> <td style="width: 10%;"></td> <td style="width: 10%;"></td> <td style="width: 10%;"></td> <td style="width: 10%;"></td> <td style="width: 10%;"></td> <td style="width: 10%;"></td> </tr> <tr> <td></td> <td></td> <td colspan="8" style="text-align: center;"> <table border="1" style="width: 100%; border-collapse: collapse; text-align: center;"> <tr> <td style="width: 10%;"></td> <td style="width: 10%;"></td> <td style="width: 10%;"></td> <td style="width: 10%;"></td> <td style="width: 10%;"></td> <td style="width: 10%;"></td> <td style="width: 10%;"></td> <td style="width: 10%;"></td> <td style="width: 10%;"></td> <td style="width: 10%;"></td> </tr> <tr> <td></td> <td></td> <td colspan="8" style="text-align: center;"> <table border="1" style="width: 100%; border-collapse: collapse; text-align: center;"> <tr> <td style="width: 10%;"></td> <td style="width: 10%;"></td> <td style="width: 10%;"></td> <td style="width: 10%;"></td> <td style="width: 10%;"></td> <td style="width: 10%;"></td> <td style="width: 10%;"></td> <td style="width: 10%;"></td> <td style="width: 10%;"></td> <td style="width: 10%;"></td> </tr> <tr> <td></td> <td></td> <td colspan="8" style="text-align: center;"> <table border="1" style="width: 100%; border-collapse: collapse; text-align: center;"> <tr> <td style="width: 10%;"></td> <td style="width: 10%;"></td> <td style="width: 10%;"></td> <td style="width: 10%;"></td> <td style="width: 10%;"></td> <td style="width: 10%;"></td> <td style="width: 10%;"></td> <td style="width: 10%;"></td> <td style="width: 10%;"></td> <td style="width: 10%;"></td> </tr> <tr> <td></td> <td></td> <td colspan="8" style="text-align: center;"> <table border="1" style="width: 100%; border-collapse: collapse; text-align: center;"> <tr> <td style="width: 10%;"></td> <td style="width: 10%;"></td> <td style="width: 10%;"></td> <td style="width: 10%;"></td> <td style="width: 10%;"></td> <td style="width: 10%;"></td> <td style="width: 10%;"></td> <td style="width: 10%;"></td> <td style="width: 10%;"></td> <td style="width: 10%;"></td> </tr> <tr> <td></td> <td></td> <td colspan="8" style="text-align: center;"> <table border="1" style="width: 100%; border-collapse: collapse; text-align: center;"> <tr> <td style="width: 10%;"></td> <td style="width: 10%;"></td> <td style="width: 10%;"></td> <td style="width: 10%;"></td> <td style="width: 10%;"></td> <td style="width: 10%;"></td> <td style="width: 10%;"></td> <td style="width: 10%;"></td> <td
style="width: 10%;"></td> <td style="width: 10%;"></td> </tr> <tr> <td></td> <td></td> <td colspan="8" style="text-align: center;"> <table border="1" style="width: 100%; border-collapse: collapse; text-align: center;"> <tr> <td style="width: 10%;"></td> <td style="width: 10%;"></td> <td style="width: 10%;"></td> <td style="width: 10%;"></td> <td style="width: 10%;"></td> <td style="width: 10%;"></td> <td style="width: 10%;"></td> <td style="width: 10%;"></td> <td style="width: 10%;"></td> <td style="width: 10%;"></td> </tr> <tr> <td></td> <td></td> <td colspan="8" style="text-align: center;"> <table border="1" style="width: 100%; border-collapse: collapse; text-align: center;"> <tr> <td style="width: 10%;"></td> <td style="width: 10%;"></td> <td style="width: 10%;"></td> <td style="width: 10%;"></td> <td style="width: 10%;"></td> <td style="width: 10%;"></td> <td style="width: 10%;"></td> <td style="width: 10%;"></td> <td style="width: 10%;"></td> <td style="width: 10%;"></td> </tr> <tr> <td></td> <td></td> <td colspan="8" style="text-align: center;"> <table border="1" style="width: 100%; border-collapse: collapse; text-align: center;"> <tr> <td style="width: 10%;"></td> <td style="width: 10%;"></td> <td style="width: 10%;"></td> <td style="width: 10%;"></td> <td style="width: 10%;"></td> <td style="width: 10%;"></td> <td style="width: 10%;"></td> <td style="width: 10%;"></td> <td style="width: 10%;"></td> <td style="width: 10%;"></td> </tr> <tr> <td></td> <td></td> <td colspan="8" style="text-align: center;"> <table border="1" style="width: 100%; border-collapse: collapse; text-align: center;"> <tr> <td style="width: 10%;"></td> <td style="width: 10%;"></td> <td style="width: 10%;"></td> <td style="width: 10%;"></td> <td style="width: 10%;"></td> <td style="width: 10%;"></td> <td style="width: 10%;"></td> <td style="width: 10%;"></td> <td style="width: 10%;"></td> <td style="width: 10%;"></td> </tr> <tr> <td></td> <td></td> <td colspan="8" style="text-align: center;"> <table border="1" style="width: 100%; border-collapse: collapse; text-align: center;"> <tr> <td style="width: 10%;"></td> <td style="width: 10%;"></td> <td style="width: 10%;"></td> <td style="width: 10%;"></td> <td style="width: 10%;"></td> <td style="width: 10%;"></td> <td style="width: 10%;"></td> <td style="width: 10%;"></td> <td style="width: 10%;"></td> <td style="width: 10%;"></td> </tr> <tr> <td></td> <td></td> <td colspan="8" style="text-align: center;"> <table border="1" style="width: 100%; border-collapse: collapse; text-align: center;"> <tr> <td style="width: 10%;"></td> <td style="width: 10%;"></td> <td style="width: 10%;"></td> <td style="width: 10%;"></td> <td style="width: 10%;"></td> <td style="width: 10%;"></td> <td style="width: 10%;"></td> <td style="width: 10%;"></td> <td style="width: 10%;"></td> <td style="width: 10%;"></td> </tr> <tr> <td></td> <td></td> <td colspan="8" style="text-align: center;"> <table border="1" style="width: 100%; border-collapse: collapse; text-align: center;"> <tr> <td style="width: 10%;"></td> <td style="width: 10%;"></td> <td style="width: 10%;"></td> <td style="width: 10%;"></td> <td style="width: 10%;"></td> <td style="width: 10%;"></td> <td style="width: 10%;"></td> <td style="width: 10%;"></td> <td style="width: 10%;"></td> <td style="width: 10%;"></td> </tr> <tr> <td></td> <td></td> <td colspan="8" style="text-align: center;"> <table border="1" style="width: 100%; border-collapse: collapse; text-align: center;"> <tr> <td style="width: 10%;"></td> <td style="width: 10%;"></td> <td style="width: 10%;"></td> <td style="width: 10%;"></td> <td style="width: 10%;"></td> <td style="width: 10%;"></td> <td style="width: 10%;"></td> <td style="width: 10%;"></td> <td style="width: 10%;"></td> <td style="width: 10%;"></td> </tr> <tr> <td></td> <td></td> <td colspan="8" style="text-align: center;"> <table border="1" style="width: 100%; border-collapse: collapse; text-align: center;"> <tr> <td style="width: 10%;"></td> <td style="width: 10%;"></td> <td style="width: 10%;"></td> <td style="width: 10%;"></td> <td style="width: 10%;"></td> <td style="width: 10%;"></td> <td style="width: 10%;"></td> <td style="width: 10%;"></td> <td style="width: 10%;"></td> <td style="width: 10%;"></td> </tr> <tr> <td></td> <td></td> <td colspan="8" style="text-align: center;"> <table border="1" style="width: 100%; border-collapse: collapse; text-align: center;"> <tr> <td style="width: 10%;"></td> <td style="width: 10%;"></td> <td style="width: 10%;"></td> <td style="width: 10%;"></td> <td style="width: 10%;"></td> <td style="width: 10%;"></td> <td style="width: 10%;"></td> <td style="width: 10%;"></td> <td style="width: 10%;"></td> <td style="width: 10%;"></td> </tr> <tr> <td></td> <td></td> <td colspan="8" style="text-align: center;"> <table border="1" style="width: 100%; border-collapse: collapse; text-align: center;"> <tr> <td style="width: 10%;"></td> <td style="width: 10%;"></td> <td style="width: 10%;"></td> <td style="width: 10%;"></td> <td style="width: 10%;"></td> <td style="width: 10%;"></td> <td style="width: 10%;"></td> <td style="width: 10%;"></td> <td style="width: 10%;"></td> <td style="width: 10%;"></td> </tr> <tr> <td></td> <td></td> <td colspan="8" style="text-align: center;"> <table border="1" style="width: 100%; border-collapse: collapse; text-align: center;"> <tr> <td style="width: 10%;"></td> <td style="width: 10%;"></td> <td style="width: 10%;"></td> <td style="width: 10%;"></td> <td style="width: 10%;"></td> <td style="width: 10%;"></td> <td style="width: 10%;"></td> <td style="width: 10%;"></td> <td style="width: 10%;"></td> <td style="width: 10%;"></td> </tr> <tr> <td></td> <td></td> <td colspan="8" style="text-align: center;"> <table border="1" style="width: 100%; border-collapse: collapse; text-align: center;"> <tr> <td style="width: 10%;"></td> <td style="width: 10%;"></td> <td style="width: 10%;"></td> <td style="width: 10%;"></td> <td style="width: 10%;"></td> <td style="width: 10%;"></td> <td style="width: 10%;"></td> <td style="width: 10%;"></td> <td style="width: 10%;"></td> <td style="width: 10%;"></td> </tr> <tr> <td></td> <td></td> <td colspan="8" style="text-align: center;"> <table border="1" style="width: 100%; border-collapse: collapse; text-align: center;"> <tr> <td style="width: 10%;"></td> <td style="width: 10%;"></td> <td style="width: 10%;"></td> <td style="width: 10%;"></td> <td style="width: 10%;"></td> <td style="width: 10%;"></td> <td style="width: 10%;"></td> <td style="width: 10%;"></td> <td style="width: 10%;"></td> <td style="width: 10%;"></td> </tr> <tr> <td></td> <td></td> <td colspan="8" style="text-align: center;"> <table border="1" style="width: 100%; border-collapse: collapse; text-align: center;"> <tr> <td style="width: 10%;"></td> <td style="width: 10%;"></td> <td style="width: 10%;"></td> <td style="width: 10%;"></td> <td style="width: 10%;"></td> <td style="width: 10%;"></td> <td style="width: 10%;"></td> <td style="width: 10%;"></td> <td style="width: 10%;"></td> <td style="width: 10%;"></td> </tr> <tr> <td></td> <td></td> <td colspan="8" style="text-align: center;"> <table border="1" style="width: 100%; border-collapse: collapse; text-align: center;"> <tr> <td style="width: 10%;"></td> <td style="width: 10%;"></td> <td style="width: 10%;"></td> <td style="width: 10%;"></td> <td style="width: 10%;"></td> <td style="width: 10%;"></td> <td style="width: 10%;"></td> <td style="width: 10%;"></td> <td style="width: 10%;"></td> <td style="width: 10%;"></td> </tr> <tr> <td></td> <td></td> <td colspan="8" style="text-align: center;"> <table border="1" style="width: 100%; border-collapse: collapse; text-align: center;"> <tr> <td style="width: 10%;"></td> <td style="width: 10%;"></td> <td style="width: 10%;"></td> <td style="width: 10%;"></td> <td style="width: 10%;"></td> <td style="width: 10%;"></td> <td style="width: 10%;"></td> <td style="width: 10%;"></td> <td style="width: 10%;"></td> <td style="width: 10%;"></td> </tr> <tr> <td></td> <td></td> <td colspan="8" style="text-align: center;"> <table border="1" style="width: 100%; border-collapse: collapse; text-align: center;"> <tr> <td style="width: 10%;"></td> <td style="width: 10%;"></td> <td style="width: 10%;"></td> <td style="width: 10%;"></td> <td style="width: 10%;"></td> <td style="width: 10%;"></td> <td style="width: 10%;"></td> <td style="width: 10%;"></td> <td style="width: 10%;"></td> <td style="width: 10%;"></td> </tr> <tr> <td></td> <td></td> <td colspan="8" style="text-align: center;"> <table border="1" style="width: 100%; border-collapse: collapse; text-align: center;"> <tr> <td style="width: 10%;"></td> <td style="width: 10%;"></td> <td style="width: 10%;"></td> <td style="width: 10%;"></td> <td style="width: 10%;"></td> <td style="width: 10%;"></td> <td style="width: 10%;"></td> <td style="width: 10%;"></td> <td style="width: 10%;"></td> <td style="width: 10%;"></td> </tr> <tr> <td></td> <td></td> <td colspan="8" style="text-align: center;"> <table border="1" style="width: 100%; border-collapse: collapse; text-align: center;"> <tr> <td style="width: 10%;"></td> <td style="width: 10%;"></td> <td style="width: 10%;"></td> <td style="width: 10%;"></td> <td style="width: 10%;"></td> <td style="width: 10%;"></td> <td style="width: 10%;"></td> <td style="width: 10%;"></td> <td style="width: 10%;"></td> <td style="width: 10%;"></td> </tr> <tr> <td></td> <td></td> <td colspan="8" style="text-align: center;"> <table border="1" style="width: 100%; border-collapse: collapse; text-align: center;"> <tr> <td style="width: 10%;"></td> <td style="width: 10%;"></td> <td style="width: 10%;"></td> <td style="width: 10%;"></td> <td style="width: 10%;"></td> <td style="width: 10%;"></td> <td style="width: 10%;"></td> <td style="width: 10%;"></td> <td style="width: 10%;"></td> <td style="width: 10%;"></td> </tr> <tr> <td></td> <td></td> <td colspan="8" style="text-align: center;"> <table border="1" style="width: 100%;
border-collapse: collapse; text-align: center;"> <tr> <td style="width: 10%;"></td> <td style="width: 10%;"></td> <td style="width: 10%;"></td> <td style="width: 10%;"></td> <td style="width: 10%;"></td> <td style="width: 10%;"></td> <td style="width: 10%;"></td> <td style="width: 10%;"></td> <td style="width: 10%;"></td> <td style="width: 10%;"></td> </tr> <tr> <td></td> <td></td> <td colspan="8" style="text-align: center;"> <table border="1" style="width: 100%; border-collapse: collapse; text-align: center;"> <tr> <td style="width: 10%;"></td> <td style="width: 10%;"></td> <td style="width: 10%;"></td> <td style="width: 10%;"></td> <td style="width: 10%;"></td> <td style="width: 10%;"></td> <td style="width: 10%;"></td> <td style="width: 10%;"></td> <td style="width: 10%;"></td> <td style="width: 10%;"></td> </tr> <tr> <td></td> <td></td> <td colspan="8" style="text-align: center;"> <table border="1" style="width: 100%; border-collapse: collapse; text-align: center;"> <tr> <td style="width: 10%;"></td> <td style="width: 10%;"></td> <td style="width: 10%;"></td> <td style="width: 10%;"></td> <td style="width: 10%;"></td> <td style="width: 10%;"></td> <td style="width: 10%;"></td> <td style="width: 10%;"></td> <td style="width: 10%;"></td> <td style="width: 10%;"></td> </tr> <tr> <td></td> <td></td> <td colspan="8" style="text-align: center;"> <table border="1" style="width: 100%; border-collapse: collapse; text-align: center;"> <tr> <td style="width: 10%;"></td> <td style="width: 10%;"></td> <td style="width: 10%;"></td> <td style="width: 10%;"></td> <td style="width: 10%;"></td> <td style="width: 10%;"></td> <td style="width: 10%;"></td> <td style="width: 10%;"></td> <td style="width: 10%;"></td> <td style="width: 10%;"></td> </tr> <tr> <td></td> <td></td> <td colspan="8" style="text-align: center;"> <table border="1" style="width: 100%; border-collapse: collapse; text-align: center;"> <tr> <td style="width: 10%;"></td> <td style="width: 10%;"></td> <td style="width: 10%;"></td> <td style="width: 10%;"></td> <td style="width: 10%;"></td> <td style="width: 10%;"></td> <td style="width: 10%;"></td> <td style="width: 10%;"></td> <td style="width: 10%;"></td> <td style="width: 10%;"></td> </tr> <tr> <td></td> <td></td> <td colspan="8" style="text-align: center;"> <table border="1" style="width: 100%; border-collapse: collapse; text-align: center;"> <tr> </tr></table></td></tr></table></td></tr></table></td></tr></table></td></tr></table></td></tr></table></td></tr></table></td></tr></table></td></tr></table></td></tr></table></td></tr></table></td></tr></table></td></tr></table></td></tr></table></td></tr></table></td></tr></table></td></tr></table></td></tr></table></td></tr></table></td></tr></table></td></tr></table></td></tr></table></td></tr></table></td></tr></table></td></tr></table></td></tr></table></td></tr></table></td></tr></table></td></tr></table></td></tr></table></td></tr></table></td></tr></table></td></tr></table></td></tr></table></td></tr></table></td></tr></table></td></tr></table></td></tr></table></td></tr></table></td></tr></table></td></tr></table></td></tr></table></td></tr></table></td></tr></table></td></tr></table></td></tr></table></td></tr></table></td></tr></table></td></tr></table></td></tr></table></td></tr></table> | | | | | | | | | | | | | | | | | | | | <table border="1" style="width: 100%; border-collapse: collapse; text-align: center;"> <tr> <td style="width: 10%;"></td> <td style="width: 10%;"></td> <td style="width: 10%;"></td> <td style="width: 10%;"></td> <td style="width: 10%;"></td> <td style="width: 10%;"></td> <td style="width: 10%;"></td> <td style="width: 10%;"></td> <td style="width: 10%;"></td> <td style="width: 10%;"></td> </tr> <tr> <td></td> <td></td> <td colspan="8" style="text-align: center;"> <table border="1" style="width: 100%; border-collapse: collapse; text-align: center;"> <tr> <td style="width: 10%;"></td> <td style="width: 10%;"></td> <td style="width: 10%;"></td> <td style="width: 10%;"></td> <td style="width: 10%;"></td> <td style="width: 10%;"></td> <td style="width: 10%;"></td> <td style="width: 10%;"></td> <td style="width: 10%;"></td> <td style="width: 10%;"></td> </tr> <tr> <td></td> <td></td> <td colspan="8" style="text-align: center;"> <table border="1" style="width: 100%; border-collapse: collapse; text-align: center;"> <tr> <td style="width: 10%;"></td> <td style="width: 10%;"></td> <td style="width: 10%;"></td> <td style="width: 10%;"></td> <td style="width: 10%;"></td> <td style="width: 10%;"></td> <td style="width: 10%;"></td> <td style="width: 10%;"></td> <td style="width: 10%;"></td> <td style="width: 10%;"></td> </tr> <tr> <td></td> <td></td> <td colspan="8" style="text-align: center;"> <table border="1" style="width: 100%; border-collapse: collapse; text-align: center;"> <tr> <td style="width: 10%;"></td> <td style="width: 10%;"></td> <td style="width: 10%;"></td> <td style="width: 10%;"></td> <td style="width: 10%;"></td> <td style="width: 10%;"></td> <td style="width: 10%;"></td> <td style="width: 10%;"></td> <td style="width: 10%;"></td> <td style="width: 10%;"></td> </tr> <tr> <td></td> <td></td> <td colspan="8" style="text-align: center;"> <table border="1" style="width: 100%; border-collapse: collapse; text-align: center;"> <tr> <td style="width: 10%;"></td> <td style="width: 10%;"></td> <td style="width: 10%;"></td> <td style="width: 10%;"></td> <td style="width: 10%;"></td> <td style="width: 10%;"></td> <td style="width: 10%;"></td> <td style="width: 10%;"></td> <td style="width: 10%;"></td> <td style="width: 10%;"></td> </tr> <tr> <td></td> <td></td> <td colspan="8" style="text-align: center;"> <table border="1" style="width: 100%; border-collapse: collapse; text-align: center;"> <tr> <td style="width: 10%;"></td> <td style="width: 10%;"></td> <td style="width: 10%;"></td> <td style="width: 10%;"></td> <td style="width: 10%;"></td> <td style="width: 10%;"></td> <td style="width: 10%;"></td> <td style="width: 10%;"></td> <td style="width: 10%;"></td> <td style="width: 10%;"></td> </tr> <tr> <td></td> <td></td> <td colspan="8" style="text-align: center;"> <table border="1" style="width: 100%; border-collapse: collapse; text-align: center;"> <tr> <td style="width: 10%;"></td> <td style="width: 10%;"></td> <td style="width: 10%;"></td> <td style="width: 10%;"></td> <td style="width: 10%;"></td> <td style="width: 10%;"></td> <td style="width: 10%;"></td> <td style="width: 10%;"></td> <td style="width: 10%;"></td> <td style="width: 10%;"></td> </tr> <tr> <td></td> <td></td> <td colspan="8" style="text-align: center;"> <table border="1" style="width: 100%; border-collapse: collapse; text-align: center;"> <tr> <td style="width: 10%;"></td> <td style="width: 10%;"></td> <td style="width: 10%;"></td> <td style="width: 10%;"></td> <td style="width: 10%;"></td> <td style="width: 10%;"></td> <td style="width: 10%;"></td> <td style="width: 10%;"></td> <td style="width: 10%;"></td> <td style="width: 10%;"></td> </tr> <tr> <td></td> <td></td> <td colspan="8" style="text-align: center;"> <table border="1" style="width: 100%; border-collapse: collapse; text-align: center;"> <tr> <td style="width: 10%;"></td> <td style="width: 10%;"></td> <td style="width: 10%;"></td> <td style="width: 10%;"></td> <td style="width: 10%;"></td> <td style="width: 10%;"></td> <td style="width: 10%;"></td> <td style="width: 10%;"></td> <td style="width: 10%;"></td> <td style="width: 10%;"></td> </tr> <tr> <td></td> <td></td> <td colspan="8" style="text-align: center;"> <table border="1" style="width: 100%; border-collapse: collapse; text-align: center;"> <tr> <td style="width: 10%;"></td> <td style="width: 10%;"></td> <td style="width: 10%;"></td> <td style="width: 10%;"></td> <td style="width: 10%;"></td> <td style="width: 10%;"></td> <td style="width: 10%;"></td> <td style="width: 10%;"></td> <td style="width: 10%;"></td> <td style="width: 10%;"></td> </tr> <tr> <td></td> <td></td> <td colspan="8" style="text-align: center;"> <table border="1" style="width: 100%; border-collapse: collapse; text-align: center;"> <tr> <td style="width: 10%;"></td> <td style="width: 10%;"></td> <td style="width: 10%;"></td> <td style="width: 10%;"></td> <td style="width: 10%;"></td> <td style="width: 10%;"></td> <td style="width: 10%;"></td> <td style="width: 10%;"></td> <td style="width: 10%;"></td> <td style="width: 10%;"></td> </tr> <tr> <td></td> <td></td> <td colspan="8" style="text-align: center;"> <table border="1"
style="width: 100%; border-collapse: collapse; text-align: center;"> <tr> <td style="width: 10%;"></td> <td style="width: 10%;"></td> <td style="width: 10%;"></td> <td style="width: 10%;"></td> <td style="width: 10%;"></td> <td style="width: 10%;"></td> <td style="width: 10%;"></td> <td style="width: 10%;"></td> <td style="width: 10%;"></td> <td style="width: 10%;"></td> </tr> <tr> <td></td> <td></td> <td colspan="8" style="text-align: center;"> <table border="1" style="width: 100%; border-collapse: collapse; text-align: center;"> <tr> <td style="width: 10%;"></td> <td style="width: 10%;"></td> <td style="width: 10%;"></td> <td style="width: 10%;"></td> <td style="width: 10%;"></td> <td style="width: 10%;"></td> <td style="width: 10%;"></td> <td style="width: 10%;"></td> <td style="width: 10%;"></td> <td style="width: 10%;"></td> </tr> <tr> <td></td> <td></td> <td colspan="8" style="text-align: center;"> <table border="1" style="width: 100%; border-collapse: collapse; text-align: center;"> <tr> <td style="width: 10%;"></td> <td style="width: 10%;"></td> <td style="width: 10%;"></td> <td style="width: 10%;"></td> <td style="width: 10%;"></td> <td style="width: 10%;"></td> <td style="width: 10%;"></td> <td style="width: 10%;"></td> <td style="width: 10%;"></td> <td style="width: 10%;"></td> </tr> <tr> <td></td> <td></td> <td colspan="8" style="text-align: center;"> <table border="1" style="width: 100%; border-collapse: collapse; text-align: center;"> <tr> <td style="width: 10%;"></td> <td style="width: 10%;"></td> <td style="width: 10%;"></td> <td style="width: 10%;"></td> <td style="width: 10%;"></td> <td style="width: 10%;"></td> <td style="width: 10%;"></td> <td style="width: 10%;"></td> <td style="width: 10%;"></td> <td style="width: 10%;"></td> </tr> <tr> <td></td> <td></td> <td colspan="8" style="text-align: center;"> <table border="1" style="width: 100%; border-collapse: collapse; text-align: center;"> <tr> <td style="width: 10%;"></td> <td style="width: 10%;"></td> <td style="width: 10%;"></td> <td style="width: 10%;"></td> <td style="width: 10%;"></td> <td style="width: 10%;"></td> <td style="width: 10%;"></td> <td style="width: 10%;"></td> <td style="width: 10%;"></td> <td style="width: 10%;"></td> </tr> <tr> <td></td> <td></td> <td colspan="8" style="text-align: center;"> <table border="1" style="width: 100%; border-collapse: collapse; text-align: center;"> <tr> <td style="width: 10%;"></td> <td style="width: 10%;"></td> <td style="width: 10%;"></td> <td style="width: 10%;"></td> <td style="width: 10%;"></td> <td style="width: 10%;"></td> <td style="width: 10%;"></td> <td style="width: 10%;"></td> <td style="width: 10%;"></td> <td style="width: 10%;"></td> </tr> <tr> <td></td> <td></td> <td colspan="8" style="text-align: center;"> <table border="1" style="width: 100%; border-collapse: collapse; text-align: center;"> <tr> <td style="width: 10%;"></td> <td style="width: 10%;"></td> <td style="width: 10%;"></td> <td style="width: 10%;"></td> <td style="width: 10%;"></td> <td style="width: 10%;"></td> <td style="width: 10%;"></td> <td style="width: 10%;"></td> <td style="width: 10%;"></td> <td style="width: 10%;"></td> </tr> <tr> <td></td> <td></td> <td colspan="8" style="text-align: center;"> <table border="1" style="width: 100%; border-collapse: collapse; text-align: center;"> <tr> <td style="width: 10%;"></td> <td style="width: 10%;"></td> <td style="width: 10%;"></td> <td style="width: 10%;"></td> <td style="width: 10%;"></td> <td style="width: 10%;"></td> <td style="width: 10%;"></td> <td style="width: 10%;"></td> <td style="width: 10%;"></td> <td style="width: 10%;"></td> </tr> <tr> <td></td> <td></td> <td colspan="8" style="text-align: center;"> <table border="1" style="width: 100%; border-collapse: collapse; text-align: center;"> <tr> <td style="width: 10%;"></td> <td style="width: 10%;"></td> <td style="width: 10%;"></td> <td style="width: 10%;"></td> <td style="width: 10%;"></td> <td style="width: 10%;"></td> <td style="width: 10%;"></td> <td style="width: 10%;"></td> <td style="width: 10%;"></td> <td style="width: 10%;"></td> </tr> <tr> <td></td> <td></td> <td colspan="8" style="text-align: center;"> <table border="1" style="width: 100%; border-collapse: collapse; text-align: center;"> <tr> <td style="width: 10%;"></td> <td style="width: 10%;"></td> <td style="width: 10%;"></td> <td style="width: 10%;"></td> <td style="width: 10%;"></td> <td style="width: 10%;"></td> <td style="width: 10%;"></td> <td style="width: 10%;"></td> <td style="width: 10%;"></td> <td style="width: 10%;"></td> </tr> <tr> <td></td> <td></td> <td colspan="8" style="text-align: center;"> <table border="1" style="width: 100%; border-collapse: collapse; text-align: center;"> <tr> <td style="width: 10%;"></td> <td style="width: 10%;"></td> <td style="width: 10%;"></td> <td style="width: 10%;"></td> <td style="width: 10%;"></td> <td style="width: 10%;"></td> <td style="width: 10%;"></td> <td style="width: 10%;"></td> <td style="width: 10%;"></td> <td style="width: 10%;"></td> </tr> <tr> <td></td> <td></td> <td colspan="8" style="text-align: center;"> <table border="1" style="width: 100%; border-collapse: collapse; text-align: center;"> <tr> <td style="width: 10%;"></td> <td style="width: 10%;"></td> <td style="width: 10%;"></td> <td style="width: 10%;"></td> <td style="width: 10%;"></td> <td style="width: 10%;"></td> <td style="width: 10%;"></td> <td style="width: 10%;"></td> <td style="width: 10%;"></td> <td style="width: 10%;"></td> </tr> <tr> <td></td> <td></td> <td colspan="8" style="text-align: center;"> <table border="1" style="width: 100%; border-collapse: collapse; text-align: center;"> <tr> <td style="width: 10%;"></td> <td style="width: 10%;"></td> <td style="width: 10%;"></td> <td style="width: 10%;"></td> <td style="width: 10%;"></td> <td style="width: 10%;"></td> <td style="width: 10%;"></td> <td style="width: 10%;"></td> <td style="width: 10%;"></td> <td style="width: 10%;"></td> </tr> <tr> <td></td> <td></td> <td colspan="8" style="text-align: center;"> <table border="1" style="width: 100%; border-collapse: collapse; text-align: center;"> <tr> <td style="width: 10%;"></td> <td style="width: 10%;"></td> <td style="width: 10%;"></td> <td style="width: 10%;"></td> <td style="width: 10%;"></td> <td style="width: 10%;"></td> <td style="width: 10%;"></td> <td style="width: 10%;"></td> <td style="width: 10%;"></td> <td style="width: 10%;"></td> </tr> <tr> <td></td> <td></td> <td colspan="8" style="text-align: center;"> <table border="1" style="width: 100%; border-collapse: collapse; text-align: center;"> <tr> <td style="width: 10%;"></td> <td style="width: 10%;"></td> <td style="width: 10%;"></td> <td style="width: 10%;"></td> <td style="width: 10%;"></td> <td style="width: 10%;"></td> <td style="width: 10%;"></td> <td style="width: 10%;"></td> <td style="width: 10%;"></td> <td style="width: 10%;"></td> </tr> <tr> <td></td> <td></td> <td colspan="8" style="text-align: center;"> <table border="1" style="width: 100%; border-collapse: collapse; text-align: center;"> <tr> <td style="width: 10%;"></td> <td style="width: 10%;"></td> <td style="width: 10%;"></td> <td style="width: 10%;"></td> <td style="width: 10%;"></td> <td style="width: 10%;"></td> <td style="width: 10%;"></td> <td style="width: 10%;"></td> <td style="width: 10%;"></td> <td style="width: 10%;"></td> </tr> <tr> <td></td> <td></td> <td colspan="8" style="text-align: center;"> <table border="1" style="width: 100%; border-collapse: collapse; text-align: center;"> <tr> <td style="width: 10%;"></td> <td style="width: 10%;"></td> <td style="width: 10%;"></td> <td style="width: 10%;"></td> <td style="width: 10%;"></td> <td style="width: 10%;"></td> <td style="width: 10%;"></td> <td style="width: 10%;"></td> <td style="width: 10%;"></td> <td style="width: 10%;"></td> </tr> <tr> <td></td> <td></td> <td colspan="8" style="text-align: center;"> <table border="1" style="width: 100%; border-collapse: collapse; text-align: center;"> <tr> <td style="width: 10%;"></td> <td style="width: 10%;"></td> <td style="width: 10%;"></td> <td style="width: 10%;"></td> <td style="width: 10%;"></td> <td style="width: 10%;"></td> <td style="width: 10%;"></td> <td style="width: 10%;"></td> <td style="width: 10%;"></td> <td style="width: 10%;"></td> </tr> <tr> <td></td> <td></td> <td colspan="8" style="text-align: center;"> <table border="1" style="width: 100%; border-collapse: collapse; text-align: center;"> <tr> <td style="width: 10%;"></td> <td style="width: 10%;"></td> <td style="width: 10%;"></td> <td style="width: 10%;"></td> <td style="width: 10%;"></td> <td style="width: 10%;"></td> <td style="width: 10%;"></td> <td style="width: 10%;"></td> <td style="width: 10%;"></td> <td style="width: 10%;"></td> </tr> <tr> <td></td> <td></td> <td colspan="8" style="text-align: center;"> <table border="1" style="width: 100%; border-collapse: collapse; text-align: center;"> <tr> <td style="width: 10%;"></td> <td style="width: 10%;"></td> <td style="width: 10%;"></td> <td style="width: 10%;"></td> <td style="width: 10%;"></td> <td style="width: 10%;"></td> <td style="width: 10%;"></td> <td style="width: 10%;"></td> <td style="width: 10%;"></td> <td style="width: 10%;"></td> </tr> <tr> <td></td> <td></td> <td colspan="8" style="text-align: center;"> <table border="1" style="width: 100%; border-collapse: collapse; text-align: center;"> <tr> <td style="width: 10%;"></td> <td style="width: 10%;"></td> <td style="width: 10%;"></td> <td style="width: 10%;"></td> <td style="width: 10%;"></td> <td style="width: 10%;"></td> <td style="width: 10%;"></td> <td style="width: 10%;"></td> <td style="width: 10%;"></td> <td style="width: 10%;"></td> </tr> <tr> <td></td> <td></td> <td colspan="8" style="text-align: center;"> <table border="1" style="width: 100%; border-collapse: collapse; text-align: center;"> <tr> <td style="width: 10%;"></td> <td style="width: 10%;"></td> <td style="width: 10%;"></td> <td
style="width: 10%;"></td> <td style="width: 10%;"></td> <td style="width: 10%;"></td> <td style="width: 10%;"></td> <td style="width: 10%;"></td> <td style="width: 10%;"></td> <td style="width: 10%;"></td> </tr> <tr> <td></td> <td></td> <td colspan="8" style="text-align: center;"> <table border="1" style="width: 100%; border-collapse: collapse; text-align: center;"> <tr> <td style="width: 10%;"></td> <td style="width: 10%;"></td> <td style="width: 10%;"></td> <td style="width: 10%;"></td> <td style="width: 10%;"></td> <td style="width: 10%;"></td> <td style="width: 10%;"></td> <td style="width: 10%;"></td> <td style="width: 10%;"></td> <td style="width: 10%;"></td> </tr> <tr> <td></td> <td></td> <td colspan="8" style="text-align: center;"> <table border="1" style="width: 100%; border-collapse: collapse; text-align: center;"> <tr> <td style="width: 10%;"></td> <td style="width: 10%;"></td> <td style="width: 10%;"></td> <td style="width: 10%;"></td> <td style="width: 10%;"></td> <td style="width: 10%;"></td> <td style="width: 10%;"></td> <td style="width: 10%;"></td> <td style="width: 10%;"></td> <td style="width: 10%;"></td> </tr> <tr> <td></td> <td></td> <td colspan="8" style="text-align: center;"> <table border="1" style="width: 100%; border-collapse: collapse; text-align: center;"> <tr> <td style="width: 10%;"></td> <td style="width: 10%;"></td> <td style="width: 10%;"></td> <td style="width: 10%;"></td> <td style="width: 10%;"></td> <td style="width: 10%;"></td> <td style="width: 10%;"></td> <td style="width: 10%;"></td> <td style="width: 10%;"></td> <td style="width: 10%;"></td> </tr> <tr> <td></td> <td></td> <td colspan="8" style="text-align: center;"> <table border="1" style="width: 100%; border-collapse: collapse; text-align: center;"> <tr> <td style="width: 10%;"></td> <td style="width: 10%;"></td> <td style="width: 10%;"></td> <td style="width: 10%;"></td> <td style="width: 10%;"></td> <td style="width: 10%;"></td> <td style="width: 10%;"></td> <td style="width: 10%;"></td> <td style="width: 10%;"></td> <td style="width: 10%;"></td> </tr> <tr> <td></td> <td></td> <td colspan="8" style="text-align: center;"> <table border="1" style="width: 100%; border-collapse: collapse; text-align: center;"> <tr> <td style="width: 10%;"></td> <td style="width: 10%;"></td> <td style="width: 10%;"></td> <td style="width: 10%;"></td> <td style="width: 10%;"></td> <td style="width: 10%;"></td> <td style="width: 10%;"></td> <td style="width: 10%;"></td> <td style="width: 10%;"></td> <td style="width: 10%;"></td> </tr> <tr> <td></td> <td></td> <td colspan="8" style="text-align: center;"> <table border="1" style="width: 100%; border-collapse: collapse; text-align: center;"> <tr> <td style="width: 10%;"></td> <td style="width: 10%;"></td> <td style="width: 10%;"></td> <td style="width: 10%;"></td> <td style="width: 10%;"></td> <td style="width: 10%;"></td> <td style="width: 10%;"></td> <td style="width: 10%;"></td> <td style="width: 10%;"></td> <td style="width: 10%;"></td> </tr> <tr> <td></td> <td></td> <td colspan="8" style="text-align: center;"> <table border="1" style="width: 100%; border-collapse: collapse; text-align: center;"> <tr> <td style="width: 10%;"></td> <td style="width: 10%;"></td> <td style="width: 10%;"></td> <td style="width: 10%;"></td> <td style="width: 10%;"></td> <td style="width: 10%;"></td> <td style="width: 10%;"></td> <td style="width: 10%;"></td> <td style="width: 10%;"></td> <td style="width: 10%;"></td> </tr> <tr> <td></td> <td></td> <td colspan="8" style="text-align: center;"> <table border="1" style="width: 100%; border-collapse: collapse; text-align: center;"> <tr> <td style="width: 10%;"></td> <td style="width: 10%;"></td> <td style="width: 10%;"></td> <td style="width: 10%;"></td> <td style="width: 10%;"></td> <td style="width: 10%;"></td> <td style="width: 10%;"></td> <td style="width: 10%;"></td> <td style="width: 10%;"></td> <td style="width: 10%;"></td> </tr> <tr> <td></td> <td></td> <td colspan="8" style="text-align: center;"> <table border="1" style="width: 100%; border-collapse: collapse; text-align: center;"> <tr> <td style="width: 10%;"></td> <td style="width: 10%;"></td> <td style="width: 10%;"></td> <td style="width: 10%;"></td> <td style="width: 10%;"></td> <td style="width: 10%;"></td> <td style="width: 10%;"></td> <td style="width: 10%;"></td> <td style="width: 10%;"></td> <td style="width: 10%;"></td> </tr> <tr> <td></td> <td></td> <td colspan="8" style="text-align: center;"> <table border="1" style="width: 100%; border-collapse: collapse; text-align: center;"> <tr> <td style="width: 10%;"></td> <td style="width: 10%;"></td> <td style="width: 10%;"></td> <td style="width: 10%;"></td> <td style="width: 10%;"></td> <td style="width: 10%;"></td> <td style="width: 10%;"></td> <td style="width: 10%;"></td> <td style="width: 10%;"></td> <td style="width: 10%;"></td> </tr> <tr> <td></td> <td></td> <td colspan="8" style="text-align: center;"> <table border="1" style="width: 100%; border-collapse: collapse; text-align: center;"> <tr> <td style="width: 10%;"></td> <td style="width: 10%;"></td> <td style="width: 10%;"></td> <td style="width: 10%;"></td> <td style="width: 10%;"></td> <td style="width: 10%;"></td> <td style="width: 10%;"></td> <td style="width: 10%;"></td> <td style="width: 10%;"></td> <td style="width: 10%;"></td> </tr> <tr> <td></td> <td></td> <td colspan="8" style="text-align: center;"> <table border="1" style="width: 100%; border-collapse: collapse; text-align: center;"> <tr> <td style="width: 10%;"></td> <td style="width: 10%;"></td> <td style="width: 10%;"></td> <td style="width: 10%;"></td> <td style="width: 10%;"></td> <td style="width: 10%;"></td> <td style="width: 10%;"></td> <td style="width: 10%;"></td> <td style="width: 10%;"></td> <td style="width: 10%;"></td> </tr> <tr> <td></td> <td></td> <td colspan="8" style="text-align: center;"> <table border="1" style="width: 100%; border-collapse: collapse; text-align: center;"> <tr> <td style="width: 10%;"></td> <td style="width: 10%;"></td> <td style="width: 10%;"></td> <td style="width: 10%;"></td> <td style="width: 10%;"></td> <td style="width: 10%;"></td> <td style="width: 10%;"></td> <td style="width: 10%;"></td> <td style="width: 10%;"></td> <td style="width: 10%;"></td> </tr> <tr> <td></td> <td></td> <td colspan="8" style="text-align: center;"> <table border="1" style="width: 100%; border-collapse: collapse; text-align: center;"> <tr> <td style="width: 10%;"></td> <td style="width: 10%;"></td> <td style="width: 10%;"></td> <td style="width: 10%;"></td> <td style="width: 10%;"></td> <td style="width: 10%;"></td> <td style="width: 10%;"></td> <td style="width: 10%;"></td> <td style="width: 10%;"></td> <td style="width: 10%;"></td> </tr> <tr> <td></td> <td></td> <td colspan="8" style="text-align: center;"> <table border="1" style="width: 100%; border-collapse: collapse; text-align: center;"> <tr> <td style="width: 10%;"></td> <td style="width: 10%;"></td> <td style="width: 10%;"></td> <td style="width: 10%;"></td> <td style="width: 10%;"></td> <td style="width: 10%;"></td> <td style="width: 10%;"></td> <td style="width: 10%;"></td> <td style="width: 10%;"></td> <td style="width: 10%;"></td> </tr> <tr> <td></td> <td></td> <td colspan="8" style="text-align: center;"> <table border="1" style="width: 100%; border-collapse: collapse; text-align: center;"> <tr> <td style="width: 10%;"></td> <td style="width: 10%;"></td> <td style="width: 10%;"></td> <td style="width: 10%;"></td> <td style="width: 10%;"></td> <td style="width: 10%;"></td> <td style="width: 10%;"></td> <td style="width: 10%;"></td> <td style="width: 10%;"></td> <td style="width: 10%;"></td> </tr> <tr> <td></td> <td></td> <td colspan="8" style="text-align: center;"> <table border="1" style="width: 100%; border-collapse: collapse; text-align: center;"> <tr> </tr></table></td></tr></table></td></tr></table></td></tr></table></td></tr></table></td></tr></table></td></tr></table></td></tr></table></td></tr></table></td></tr></table></td></tr></table></td></tr></table></td></tr></table></td></tr></table></td></tr></table></td></tr></table></td></tr></table></td></tr></table></td></tr></table></td></tr></table></td></tr></table></td></tr></table></td></tr></table></td></tr></table></td></tr></table></td></tr></table></td></tr></table></td></tr></table></td></tr></table></td></tr></table></td></tr></table></td></tr></table></td></tr></table></td></tr></table></td></tr></table></td></tr></table></td></tr></table></td></tr></table></td></tr></table></td></tr></table></td></tr></table></td></tr></table></td></tr></table></td></tr></table></td></tr></table></td></tr></table></td></tr></table></td></tr></table></td></tr></table></td></tr></table>
 | | | | | | | | | | | | | | | | | | | | <table border="1" style="width: 100%; border-collapse: collapse; text-align: center;"> <tr> <td style="width: 10%;"></td> <td style="width: 10%;"></td> <td style="width: 10%;"></td> <td style="width: 10%;"></td> <td style="width: 10%;"></td> <td style="width: 10%;"></td> <td style="width: 10%;"></td> <td style="width: 10%;"></td> <td style="width: 10%;"></td> <td style="width: 10%;"></td> </tr> <tr> <td></td> <td></td> <td colspan="8" style="text-align: center;"> <table border="1" style="width: 100%; border-collapse: collapse; text-align: center;"> <tr> <td style="width: 10%;"></td> <td style="width: 10%;"></td> <td style="width: 10%;"></td> <td style="width: 10%;"></td> <td style="width: 10%;"></td> <td style="width: 10%;"></td> <td style="width: 10%;"></td> <td style="width: 10%;"></td> <td style="width: 10%;"></td> <td style="width: 10%;"></td> </tr> <tr> <td></td> <td></td> <td colspan="8" style="text-align: center;"> <table border="1" style="width: 100%; border-collapse: collapse; text-align: center;"> <tr> <td style="width: 10%;"></td> <td style="width: 10%;"></td> <td style="width: 10%;"></td> <td style="width: 10%;"></td> <td style="width: 10%;"></td> <td style="width: 10%;"></td> <td style="width: 10%;"></td> <td style="width: 10%;"></td> <td style="width: 10%;"></td> <td style="width: 10%;"></td> </tr> <tr> <td></td> <td></td> <td colspan="8" style="text-align: center;"> <table border="1" style="width: 100%; border-collapse: collapse; text-align: center;"> <tr> <td style="width: 10%;"></td> <td style="width: 10%;"></td> <td style="width: 10%;"></td> <td style="width: 10%;"></td> <td style="width: 10%;"></td> <td style="width: 10%;"></td> <td style="width: 10%;"></td> <td style="width: 10%;"></td> <td style="width: 10%;"></td> <td style="width: 10%;"></td> </tr> <tr> <td></td> <td></td> <td colspan="8" style="text-align: center;"> <table border="1" style="width: 100%; border-collapse: collapse; text-align: center;"> <tr> <td style="width: 10%;"></td> <td style="width: 10%;"></td> <td style="width: 10%;"></td> <td style="width: 10%;"></td> <td style="width: 10%;"></td> <td style="width: 10%;"></td> <td style="width: 10%;"></td> <td style="width: 10%;"></td> <td style="width: 10%;"></td> <td style="width: 10%;"></td> </tr> <tr> <td></td> <td></td> <td colspan="8" style="text-align: center;"> <table border="1" style="width: 100%; border-collapse: collapse; text-align: center;"> <tr> <td style="width: 10%;"></td> <td style="width: 10%;"></td> <td style="width: 10%;"></td> <td style="width: 10%;"></td> <td style="width: 10%;"></td> <td style="width: 10%;"></td> <td style="width: 10%;"></td> <td style="width: 10%;"></td> <td style="width: 10%;"></td> <td style="width: 10%;"></td> </tr> <tr> <td></td> <td></td> <td colspan="8" style="text-align: center;"> <table border="1" style="width: 100%; border-collapse: collapse; text-align: center;"> <tr> <td style="width: 10%;"></td> <td style="width: 10%;"></td> <td style="width: 10%;"></td> <td style="width: 10%;"></td> <td style="width: 10%;"></td> <td style="width: 10%;"></td> <td style="width: 10%;"></td> <td style="width: 10%;"></td> <td style="width: 10%;"></td> <td style="width: 10%;"></td> </tr> <tr> <td></td> <td></td> <td colspan="8" style="text-align: center;"> <table border="1" style="width: 100%; border-collapse: collapse; text-align: center;"> <tr> <td style="width: 10%;"></td> <td style="width: 10%;"></td> <td style="width: 10%;"></td> <td style="width: 10%;"></td> <td style="width: 10%;"></td> <td style="width: 10%;"></td> <td style="width: 10%;"></td> <td style="width: 10%;"></td> <td style="width: 10%;"></td> <td style="width: 10%;"></td> </tr> <tr> <td></td> <td></td> <td colspan="8" style="text-align: center;"> <table border="1" style="width: 100%; border-collapse: collapse; text-align: center;"> <tr> <td style="width: 10%;"></td> <td style="width: 10%;"></td> <td style="width: 10%;"></td> <td style="width: 10%;"></td> <td style="width: 10%;"></td> <td style="width: 10%;"></td> <td style="width: 10%;"></td> <td style="width: 10%;"></td> <td style="width: 10%;"></td> <td style="width: 10%;"></td> </tr> <tr> <td></td> <td></td> <td colspan="8" style="text-align: center;"> <table border="1" style="width: 100%; border-collapse: collapse; text-align: center;"> <tr> <td style="width: 10%;"></td> <td style="width: 10%;"></td> <td style="width: 10%;"></td> <td style="width: 10%;"></td> <td style="width: 10%;"></td> <td style="width: 10%;"></td> <td style="width: 10%;"></td> <td style="width: 10%;"></td> <td style="width: 10%;"></td> <td style="width: 10%;"></td> </tr> <tr> <td></td> <td></td> <td colspan="8" style="text-align: center;"> <table border="1" style="width: 100%; border-collapse: collapse; text-align: center;"> <tr> <td style="width: 10%;"></td> <td style="width: 10%;"></td> <td style="width: 10%;"></td> <td style="width: 10%;"></td> <td style="width: 10%;"></td> <td style="width: 10%;"></td> <td style="width: 10%;"></td> <td style="width: 10%;"></td> <td style="width: 10%;"></td> <td style="width: 10%;"></td> </tr> <tr> <td></td> <td></td> <td colspan="8" style="text-align: center;"> <table border="1" style="width: 100%; border-collapse: collapse; text-align: center;"> <tr> <td style="width: 10%;"></td> <td style="width: 10%;"></td> <td style="width: 10%;"></td> <td style="width: 10%;"></td> <td style="width: 10%;"></td> <td style="width: 10%;"></td> <td style="width: 10%;"></td> <td style="width: 10%;"></td> <td style="width: 10%;"></td> <td style="width: 10%;"></td> </tr> <tr> <td></td> <td></td> <td colspan="8" style="text-align: center;"> <table border="1" style="width: 100%; border-collapse: collapse; text-align: center;"> <tr> <td style="width: 10%;"></td> <td style="width: 10%;"></td> <td style="width: 10%;"></td> <td style="width: 10%;"></td> <td style="width: 10%;"></td> <td style="width: 10%;"></td> <td style="width: 10%;"></td> <td style="width: 10%;"></td> <td style="width: 10%;"></td> <td style="width: 10%;"></td> </tr> <tr> <td></td> <td></td> <td colspan="8" style="text-align: center;"> <table border="1" style="width: 100%; border-collapse: collapse; text-align: center;"> <tr> <td style="width: 10%;"></td> <td style="width: 10%;"></td> <td style="width: 10%;"></td> <td style="width: 10%;"></td> <td style="width: 10%;"></td> <td style="width: 10%;"></td> <td style="width: 10%;"></td> <td style="width: 10%;"></td> <td style="width: 10%;"></td> <td style="width: 10%;"></td> </tr> <tr> <td></td> <td></td> <td colspan="8" style="text-align: center;"> <table border="1" style="width: 100%; border-collapse: collapse; text-align: center;"> <tr> <td style="width: 10%;"></td> <td style="width: 10%;"></td> <td style="width: 10%;"></td> <td style="width: 10%;"></td> <td style="width: 10%;"></td> <td style="width: 10%;"></td> <td style="width: 10%;"></td> <td style="width: 10%;"></td> <td style="width: 10%;"></td> <td style="width: 10%;"></td> </tr> <tr> <td></td> <td></td> <td colspan="8" style="text-align: center;"> <table border="1" style="width: 100%; border-collapse: collapse; text-align: center;"> <tr> <td style="width: 10%;"></td> <td style="width: 10%;"></td> <td style="width: 10%;"></td> <td style="width: 10%;"></td> <td style="width: 10%;"></td> <td style="width: 10%;"></td> <td style="width: 10%;"></td> <td style="width: 10%;"></td> <td style="width: 10%;"></td> <td style="width: 10%;"></td> </tr> <tr> <td></td> <td></td> <td colspan="8" style="text-align: center;"> <table border="1" style="width: 100%; border-collapse: collapse; text-align: center;"> <tr> <td style="width: 10%;"></td> <td style="width: 10%;"></td> <td style="width: 10%;"></td> <td style="width: 10%;"></td> <td style="width: 10%;"></td> <td style="width: 10%;"></td> <td style="width: 10%;"></td> <td style="width: 10%;"></td> <td style="width: 10%;"></td> <td style="width: 10%;"></td> </tr> <tr> <td></td> <td></td> <td colspan="8" style="text-align: center;"> <table border="1" style="width: 100%; border-collapse: collapse; text-align: center;"> <tr> <td style="width: 10%;"></td> <td style="width: 10%;"></td> <td style="width: 10%;"></td> <td style="width: 10%;"></td> <td style="width: 10%;"></td> <td style="width: 10%;"></td> <td style="width: 10%;"></td> <td style="width: 10%;"></td> <td style="width: 10%;"></td> <td style="width: 10%;"></td> </tr> <tr> <td></td> <td></td> <td colspan="8" style="text-align: center;"> <table border="1" style="width: 100%; border-collapse: collapse; text-align: center;"> <tr> <td style="width: 10%;"></td> <td style="width: 10%;"></td> <td style="width: 10%;"></td> <td style="width: 10%;"></td> <td style="width: 10%;"></td> <td style="width: 10%;"></td> <td style="width: 10%;"></td> <td style="width: 10%;"></td> <td style="width: 10%;"></td> <td style="width: 10%;"></td> </tr> <tr> <td></td> <td></td> <td colspan="8" style="text-align: center;"> <table border="1" style="width: 100%; border-collapse: collapse; text-align: center;"> <tr> <td style="width: 10%;"></td> <td style="width: 10%;"></td> <td style="width: 10%;"></td> <td style="width: 10%;"></td> <td style="width: 10%;"></td> <td style="width: 10%;"></td> <td style="width: 10%;"></td> <td style="width: 10%;"></td> <td style="width: 10%;"></td> <td style="width: 10%;"></td> </tr> <tr> <td></td> <td></td> <td colspan="8" style="text-align: center;"> <table border="1" style="width: 100%; border-collapse: collapse; text-align: center;"> <tr> <td style="width: 10%;"></td> <td style="width: 10%;"></td> <td style="width: 10%;"></td> <td style="width: 10%;"></td> <td style="width: 10%;"></td> <td style="width: 10%;"></td> <td style="width: 10%;"></td> <td style="width: 10%;"></td> <td style="width: 10%;"></td>
<td style="width: 10%;"></td> </tr> <tr> <td></td> <td></td> <td colspan="8" style="text-align: center;"> <table border="1" style="width: 100%; border-collapse: collapse; text-align: center;"> <tr> <td style="width: 10%;"></td> <td style="width: 10%;"></td> <td style="width: 10%;"></td> <td style="width: 10%;"></td> <td style="width: 10%;"></td> <td style="width: 10%;"></td> <td style="width: 10%;"></td> <td style="width: 10%;"></td> <td style="width: 10%;"></td> <td style="width: 10%;"></td> </tr> <tr> <td></td> <td></td> <td colspan="8" style="text-align: center;"> <table border="1" style="width: 100%; border-collapse: collapse; text-align: center;"> <tr> <td style="width: 10%;"></td> <td style="width: 10%;"></td> <td style="width: 10%;"></td> <td style="width: 10%;"></td> <td style="width: 10%;"></td> <td style="width: 10%;"></td> <td style="width: 10%;"></td> <td style="width: 10%;"></td> <td style="width: 10%;"></td> <td style="width: 10%;"></td> </tr> <tr> <td></td> <td></td> <td colspan="8" style="text-align: center;"> <table border="1" style="width: 100%; border-collapse: collapse; text-align: center;"> <tr> <td style="width: 10%;"></td> <td style="width: 10%;"></td> <td style="width: 10%;"></td> <td style="width: 10%;"></td> <td style="width: 10%;"></td> <td style="width: 10%;"></td> <td style="width: 10%;"></td> <td style="width: 10%;"></td> <td style="width: 10%;"></td> <td style="width: 10%;"></td> </tr> <tr> <td></td> <td></td> <td colspan="8" style="text-align: center;"> <table border="1" style="width: 100%; border-collapse: collapse; text-align: center;"> <tr> <td style="width: 10%;"></td> <td style="width: 10%;"></td> <td style="width: 10%;"></td> <td style="width: 10%;"></td> <td style="width: 10%;"></td> <td style="width: 10%;"></td> <td style="width: 10%;"></td> <td style="width: 10%;"></td> <td style="width: 10%;"></td> <td style="width: 10%;"></td> </tr> <tr> <td></td> <td></td> <td colspan="8" style="text-align: center;"> <table border="1" style="width: 100%; border-collapse: collapse; text-align: center;"> <tr> <td style="width: 10%;"></td> <td style="width: 10%;"></td> <td style="width: 10%;"></td> <td style="width: 10%;"></td> <td style="width: 10%;"></td> <td style="width: 10%;"></td> <td style="width: 10%;"></td> <td style="width: 10%;"></td> <td style="width: 10%;"></td> <td style="width: 10%;"></td> </tr> <tr> <td></td> <td></td> <td colspan="8" style="text-align: center;"> <table border="1" style="width: 100%; border-collapse: collapse; text-align: center;"> <tr> <td style="width: 10%;"></td> <td style="width: 10%;"></td> <td style="width: 10%;"></td> <td style="width: 10%;"></td> <td style="width: 10%;"></td> <td style="width: 10%;"></td> <td style="width: 10%;"></td> <td style="width: 10%;"></td> <td style="width: 10%;"></td> <td style="width: 10%;"></td> </tr> <tr> <td></td> <td></td> <td colspan="8" style="text-align: center;"> <table border="1" style="width: 100%; border-collapse: collapse; text-align: center;"> <tr> <td style="width: 10%;"></td> <td style="width: 10%;"></td> <td style="width: 10%;"></td> <td style="width: 10%;"></td> <td style="width: 10%;"></td> <td style="width: 10%;"></td> <td style="width: 10%;"></td> <td style="width: 10%;"></td> <td style="width: 10%;"></td> <td style="width: 10%;"></td> </tr> <tr> <td></td> <td></td> <td colspan="8" style="text-align: center;"> <table border="1" style="width: 100%; border-collapse: collapse; text-align: center;"> <tr> <td style="width: 10%;"></td> <td style="width: 10%;"></td> <td style="width: 10%;"></td> <td style="width: 10%;"></td> <td style="width: 10%;"></td> <td style="width: 10%;"></td> <td style="width: 10%;"></td> <td style="width: 10%;"></td> <td style="width: 10%;"></td> <td style="width: 10%;"></td> </tr> <tr> <td></td> <td></td> <td colspan="8" style="text-align: center;"> <table border="1" style="width: 100%; border-collapse: collapse; text-align: center;"> <tr> <td style="width: 10%;"></td> <td style="width: 10%;"></td> <td style="width: 10%;"></td> <td style="width: 10%;"></td> <td style="width: 10%;"></td> <td style="width: 10%;"></td> <td style="width: 10%;"></td> <td style="width: 10%;"></td> <td style="width: 10%;"></td> <td style="width: 10%;"></td> </tr> <tr> <td></td> <td></td> <td colspan="8" style="text-align: center;"> <table border="1" style="width: 100%; border-collapse: collapse; text-align: center;"> <tr> <td style="width: 10%;"></td> <td style="width: 10%;"></td> <td style="width: 10%;"></td> <td style="width: 10%;"></td> <td style="width: 10%;"></td> <td style="width: 10%;"></td> <td style="width: 10%;"></td> <td style="width: 10%;"></td> <td style="width: 10%;"></td> <td style="width: 10%;"></td> </tr> <tr> <td></td> <td></td> <td colspan="8" style="text-align: center;"> <table border="1" style="width: 100%; border-collapse: collapse; text-align: center;"> <tr> <td style="width: 10%;"></td> <td style="width: 10%;"></td> <td style="width: 10%;"></td> <td style="width: 10%;"></td> <td style="width: 10%;"></td> <td style="width: 10%;"></td> <td style="width: 10%;"></td> <td style="width: 10%;"></td> <td style="width: 10%;"></td> <td style="width: 10%;"></td> </tr> <tr> <td></td> <td></td> <td colspan="8" style="text-align: center;"> <table border="1" style="width: 100%; border-collapse: collapse; text-align: center;"> <tr> <td style="width: 10%;"></td> <td style="width: 10%;"></td> <td style="width: 10%;"></td> <td style="width: 10%;"></td> <td style="width: 10%;"></td> <td style="width: 10%;"></td> <td style="width: 10%;"></td> <td style="width: 10%;"></td> <td style="width: 10%;"></td> <td style="width: 10%;"></td> </tr> <tr> <td></td> <td></td> <td colspan="8" style="text-align: center;"> <table border="1" style="width: 100%; border-collapse: collapse; text-align: center;"> <tr> <td style="width: 10%;"></td> <td style="width: 10%;"></td> <td style="width: 10%;"></td> <td style="width: 10%;"></td> <td style="width: 10%;"></td> <td style="width: 10%;"></td> <td style="width: 10%;"></td> <td style="width: 10%;"></td> <td style="width: 10%;"></td> <td style="width: 10%;"></td> </tr> <tr> <td></td> <td></td> <td colspan="8" style="text-align: center;"> <table border="1" style="width: 100%; border-collapse: collapse; text-align: center;"> <tr> <td style="width: 10%;"></td> <td style="width: 10%;"></td> <td style="width: 10%;"></td> <td style="width: 10%;"></td> <td style="width: 10%;"></td> <td style="width: 10%;"></td> <td style="width: 10%;"></td> <td style="width: 10%;"></td> <td style="width: 10%;"></td> <td style="width: 10%;"></td> </tr> <tr> <td></td> <td></td> <td colspan="8" style="text-align: center;"> <table border="1" style="width: 100%; border-collapse: collapse; text-align: center;"> <tr> <td style="width: 10%;"></td> <td style="width: 10%;"></td> <td style="width: 10%;"></td> <td style="width: 10%;"></td> <td style="width: 10%;"></td> <td style="width: 10%;"></td> <td style="width: 10%;"></td> <td style="width: 10%;"></td> <td style="width: 10%;"></td> <td style="width: 10%;"></td> </tr> <tr> <td></td> <td></td> <td colspan="8" style="text-align: center;"> <table border="1" style="width: 100%; border-collapse: collapse; text-align: center;"> <tr> <td style="width: 10%;"></td> <td style="width: 10%;"></td> <td style="width: 10%;"></td> <td style="width: 10%;"></td> <td style="width: 10%;"></td> <td style="width: 10%;"></td> <td style="width: 10%;"></td> <td style="width: 10%;"></td> <td style="width: 10%;"></td> <td style="width: 10%;"></td> </tr> <tr> <td></td> <td></td> <td colspan="8" style="text-align: center;"> <table border="1" style="width: 100%; border-collapse: collapse; text-align: center;"> <tr> <td style="width: 10%;"></td> <td style="width: 10%;"></td> <td style="width: 10%;"></td> <td style="width: 10%;"></td> <td style="width: 10%;"></td> <td style="width: 10%;"></td> <td style="width: 10%;"></td> <td style="width: 10%;"></td> <td style="width: 10%;"></td> <td style="width: 10%;"></td> </tr> <tr> <td></td> <td></td> <td colspan="8" style="text-align: center;"> <table border="1" style="width: 100%; border-collapse: collapse; text-align: center;"> <tr> <td style="width: 10%;"></td> <td style="width: 10%;"></td> <td style="width: 10%;"></td> <td style="width: 10%;"></td> <td style="width: 10%;"></td> <td style="width: 10%;"></td> <td style="width: 10%;"></td> <td style="width: 10%;"></td> <td style="width: 10%;"></td> <td style="width: 10%;"></td> </tr> <tr> <td></td> <td></td> <td colspan="8" style="text-align: center;"> <table border="1" style="width: 100%; border-collapse: collapse; text-align: center;"> <tr> <td style="width: 10%;"></td> <td style="width: 10%;"></td> <td style="width: 10%;"></td> <td style="width: 10%;"></td> <td style="width: 10%;"></td> <td style="width: 10%;"></td> <td style="width: 10%;"></td> <td style="width: 10%;"></td> <td style="width: 10%;"></td> <td style="width: 10%;"></td> </tr> <tr> <td></td> <td></td> <td colspan="8" style="text-align: center;"> <table border="1" style="width: 100%; border-collapse: collapse; text-align: center;"> <tr> <td style="width: 10%;"></td> <td style="width: 10%;"></td> <td style="width: 10%;"></td> <td style="width: 10%;"></td> <td style="width: 10%;"></td> <td style="width: 10%;"></td> <td style="width: 10%;"></td> <td style="width: 10%;"></td> <td style="width: 10%;"></td> <td style="width: 10%;"></td> </tr> <tr> <td></td> <td></td> <td colspan="8" style="text-align: center;"> <table border="1" style="width: 100%; border-collapse: collapse; text-align: center;"> <tr> <td style="width: 10%;"></td> <td style="width: 10%;"></td> <td style="width: 10%;"></td> <td style="width: 10%;"></td> <td style="width: 10%;"></td> <td style="width: 10%;"></td> <td style="width: 10%;"></td> <td style="width: 10%;"></td> <td style="width: 10%;"></td> <td style="width: 10%;"></td> </tr> <tr> <td></td> <td></td> <td colspan="8" style="text-align: center;"> <table border="1" style="width: 100%; border-collapse: collapse;
text-align: center;"> <tr> <td style="width: 10%;"></td> <td style="width: 10%;"></td> <td style="width: 10%;"></td> <td style="width: 10%;"></td> <td style="width: 10%;"></td> <td style="width: 10%;"></td> <td style="width: 10%;"></td> <td style="width: 10%;"></td> <td style="width: 10%;"></td> <td style="width: 10%;"></td> </tr> <tr> <td></td> <td></td> <td colspan="8" style="text-align: center;"> <table border="1" style="width: 100%; border-collapse: collapse; text-align: center;"> <tr> <td style="width: 10%;"></td> <td style="width: 10%;"></td> <td style="width: 10%;"></td> <td style="width: 10%;"></td> <td style="width: 10%;"></td> <td style="width: 10%;"></td> <td style="width: 10%;"></td> <td style="width: 10%;"></td> <td style="width: 10%;"></td> <td style="width: 10%;"></td> </tr> <tr> <td></td> <td></td> <td colspan="8" style="text-align: center;"> <table border="1" style="width: 100%; border-collapse: collapse; text-align: center;"> <tr> <td style="width: 10%;"></td> <td style="width: 10%;"></td> <td style="width: 10%;"></td> <td style="width: 10%;"></td> <td style="width: 10%;"></td> <td style="width: 10%;"></td> <td style="width: 10%;"></td> <td style="width: 10%;"></td> <td style="width: 10%;"></td> <td style="width: 10%;"></td> </tr> <tr> <td></td> <td></td> <td colspan="8" style="text-align: center;"> <table border="1" style="width: 100%; border-collapse: collapse; text-align: center;"> <tr> <td style="width: 10%;"></td> <td style="width: 10%;"></td> <td style="width: 10%;"></td> <td style="width: 10%;"></td> <td style="width: 10%;"></td> <td style="width: 10%;"></td> <td style="width: 10%;"></td> <td style="width: 10%;"></td> <td style="width: 10%;"></td> <td style="width: 10%;"></td> </tr> <tr> <td></td> <td></td> <td colspan="8" style="text-align: center;"> <table border="1" style="width: 100%; border-collapse: collapse; text-align: center;"> <tr> <td style="width: 10%;"></td> <td style="width: 10%;"></td> <td style="width: 10%;"></td> <td style="width: 10%;"></td> <td style="width: 10%;"></td> <td style="width: 10%;"></td> <td style="width: 10%;"></td> <td style="width: 10%;"></td> <td style="width: 10%;"></td> <td style="width: 10%;"></td> </tr> <tr> <td></td> <td></td> <td colspan="8" style="text-align: center;"> <table border="1" style="width: 100%; border-collapse: collapse; text-align: center;"> <tr> <td style="width: 10%;"></td> <td style="width: 10%;"></td> <td style="width: 10%;"></td> <td style="width: 10%;"></td> <td style="width: 10%;"></td> <td style="width: 10%;"></td> <td style="width: 10%;"></td> <td style="width: 10%;"></td> <td style="width: 10%;"></td> <td style="width: 10%;"></td> </tr> <tr> <td></td> <td></td> <td colspan="8" style="text-align: center;"> <table border="1" style="width: 100%; border-collapse: collapse; text-align: center;"> <tr> </tr></table></td></tr></table></td></tr></table></td></tr></table></td></tr></table></td></tr></table></td></tr></table></td></tr></table></td></tr></table></td></tr></table></td></tr></table></td></tr></table></td></tr></table></td></tr></table></td></tr></table></td></tr></table></td></tr></table></td></tr></table></td></tr></table></td></tr></table></td></tr></table></td></tr></table></td></tr></table></td></tr></table></td></tr></table></td></tr></table></td></tr></table></td></tr></table></td></tr></table></td></tr></table></td></tr></table></td></tr></table></td></tr></table></td></tr></table></td></tr></table></td></tr></table></td></tr></table></td></tr></table></td></tr></table></td></tr></table></td></tr></table></td></tr></table></td></tr></table></td></tr></table></td></tr></table></td></tr></table></td></tr></table></td></tr></table></td></tr></table> | | | | | | | | | | | | | | | | | | | | <table border="1" style="width: 100%; border-collapse: collapse; text-align: center;"> <tr> <td style="width: 10%;"></td> <td style="width: 10%;"></td> <td style="width: 10%;"></td> <td style="width: 10%;"></td> <td style="width: 10%;"></td> <td style="width: 10%;"></td> <td style="width: 10%;"></td> <td style="width: 10%;"></td> <td style="width: 10%;"></td> <td style="width: 10%;"></td> </tr> <tr> <td></td> <td></td> <td colspan="8" style="text-align: center;"> <table border="1" style="width: 100%; border-collapse: collapse; text-align: center;"> <tr> <td style="width: 10%;"></td> <td style="width: 10%;"></td> <td style="width: 10%;"></td> <td style="width: 10%;"></td> <td style="width: 10%;"></td> <td style="width: 10%;"></td> <td style="width: 10%;"></td> <td style="width: 10%;"></td> <td style="width: 10%;"></td> <td style="width: 10%;"></td> </tr> <tr> <td></td> <td></td> <td colspan="8" style="text-align: center;"> <table border="1" style="width: 100%; border-collapse: collapse; text-align: center;"> <tr> <td style="width: 10%;"></td> <td style="width: 10%;"></td> <td style="width: 10%;"></td> <td style="width: 10%;"></td> <td style="width: 10%;"></td> <td style="width: 10%;"></td> <td style="width: 10%;"></td> <td style="width: 10%;"></td> <td style="width: 10%;"></td> <td style="width: 10%;"></td> </tr> <tr> <td></td> <td></td> <td colspan="8" style="text-align: center;"> <table border="1" style="width: 100%; border-collapse: collapse; text-align: center;"> <tr> <td style="width: 10%;"></td> <td style="width: 10%;"></td> <td style="width: 10%;"></td> <td style="width: 10%;"></td> <td style="width: 10%;"></td> <td style="width: 10%;"></td> <td style="width: 10%;"></td> <td style="width: 10%;"></td> <td style="width: 10%;"></td> <td style="width: 10%;"></td> </tr> <tr> <td></td> <td></td> <td colspan="8" style="text-align: center;"> <table border="1" style="width: 100%; border-collapse: collapse; text-align: center;"> <tr> <td style="width: 10%;"></td> <td style="width: 10%;"></td> <td style="width: 10%;"></td> <td style="width: 10%;"></td> <td style="width: 10%;"></td> <td style="width: 10%;"></td> <td style="width: 10%;"></td> <td style="width: 10%;"></td> <td style="width: 10%;"></td> <td style="width: 10%;"></td> </tr> <tr> <td></td> <td></td> <td colspan="8" style="text-align: center;"> <table border="1" style="width: 100%; border-collapse: collapse; text-align: center;"> <tr> <td style="width: 10%;"></td> <td style="width: 10%;"></td> <td style="width: 10%;"></td> <td style="width: 10%;"></td> <td style="width: 10%;"></td> <td style="width: 10%;"></td> <td style="width: 10%;"></td> <td style="width: 10%;"></td> <td style="width: 10%;"></td> <td style="width: 10%;"></td> </tr> <tr> <td></td> <td></td> <td colspan="8" style="text-align: center;"> <table border="1" style="width: 100%; border-collapse: collapse; text-align: center;"> <tr> <td style="width: 10%;"></td> <td style="width: 10%;"></td> <td style="width: 10%;"></td> <td style="width: 10%;"></td> <td style="width: 10%;"></td> <td style="width: 10%;"></td> <td style="width: 10%;"></td> <td style="width: 10%;"></td> <td style="width: 10%;"></td> <td style="width: 10%;"></td> </tr> <tr> <td></td> <td></td> <td colspan="8" style="text-align: center;"> <table border="1" style="width: 100%; border-collapse: collapse; text-align: center;"> <tr> <td style="width: 10%;"></td> <td style="width: 10%;"></td> <td style="width: 10%;"></td> <td style="width: 10%;"></td> <td style="width: 10%;"></td> <td style="width: 10%;"></td> <td style="width: 10%;"></td> <td style="width: 10%;"></td> <td style="width: 10%;"></td> <td style="width: 10%;"></td> </tr> <tr> <td></td> <td></td> <td colspan="8" style="text-align: center;"> <table border="1" style="width: 100%; border-collapse: collapse; text-align: center;"> <tr> <td style="width: 10%;"></td> <td style="width: 10%;"></td> <td style="width: 10%;"></td> <td style="width: 10%;"></td> <td style="width: 10%;"></td> <td style="width: 10%;"></td> <td style="width: 10%;"></td> <td style="width: 10%;"></td> <td style="width: 10%;"></td> <td style="width: 10%;"></td> </tr> <tr> <td></td> <td></td> <td colspan="8" style="text-align: center;"> <table border="1" style="width: 100%; border-collapse: collapse; text-align: center;"> <tr> <td style="width: 10%;"></td> <td style="width: 10%;"></td> <td style="width: 10%;"></td> <td style="width: 10%;"></td> <td style="width: 10%;"></td> <td style="width: 10%;"></td> <td style="width: 10%;"></td> <td style="width: 10%;"></td> <td style="width: 10%;"></td> <td style="width: 10%;"></td> </tr> <tr> <td></td> <td></td> <td colspan="8" style="text-align: center;"> <table border="1" style="width: 100%; border-collapse: collapse; text-align: center;">
<tr> <td style="width: 10%;"></td> <td style="width: 10%;"></td> <td style="width: 10%;"></td> <td style="width: 10%;"></td> <td style="width: 10%;"></td> <td style="width: 10%;"></td> <td style="width: 10%;"></td> <td style="width: 10%;"></td> <td style="width: 10%;"></td> <td style="width: 10%;"></td> </tr> <tr> <td></td> <td></td> <td colspan="8" style="text-align: center;"> <table border="1" style="width: 100%; border-collapse: collapse; text-align: center;"> <tr> <td style="width: 10%;"></td> <td style="width: 10%;"></td> <td style="width: 10%;"></td> <td style="width: 10%;"></td> <td style="width: 10%;"></td> <td style="width: 10%;"></td> <td style="width: 10%;"></td> <td style="width: 10%;"></td> <td style="width: 10%;"></td> <td style="width: 10%;"></td> </tr> <tr> <td></td> <td></td> <td colspan="8" style="text-align: center;"> <table border="1" style="width: 100%; border-collapse: collapse; text-align: center;"> <tr> <td style="width: 10%;"></td> <td style="width: 10%;"></td> <td style="width: 10%;"></td> <td style="width: 10%;"></td> <td style="width: 10%;"></td> <td style="width: 10%;"></td> <td style="width: 10%;"></td> <td style="width: 10%;"></td> <td style="width: 10%;"></td> <td style="width: 10%;"></td> </tr> <tr> <td></td> <td></td> <td colspan="8" style="text-align: center;"> <table border="1" style="width: 100%; border-collapse: collapse; text-align: center;"> <tr> <td style="width: 10%;"></td> <td style="width: 10%;"></td> <td style="width: 10%;"></td> <td style="width: 10%;"></td> <td style="width: 10%;"></td> <td style="width: 10%;"></td> <td style="width: 10%;"></td> <td style="width: 10%;"></td> <td style="width: 10%;"></td> <td style="width: 10%;"></td> </tr> <tr> <td></td> <td></td> <td colspan="8" style="text-align: center;"> <table border="1" style="width: 100%; border-collapse: collapse; text-align: center;"> <tr> <td style="width: 10%;"></td> <td style="width: 10%;"></td> <td style="width: 10%;"></td> <td style="width: 10%;"></td> <td style="width: 10%;"></td> <td style="width: 10%;"></td> <td style="width: 10%;"></td> <td style="width: 10%;"></td> <td style="width: 10%;"></td> <td style="width: 10%;"></td> </tr> <tr> <td></td> <td></td> <td colspan="8" style="text-align: center;"> <table border="1" style="width: 100%; border-collapse: collapse; text-align: center;"> <tr> <td style="width: 10%;"></td> <td style="width: 10%;"></td> <td style="width: 10%;"></td> <td style="width: 10%;"></td> <td style="width: 10%;"></td> <td style="width: 10%;"></td> <td style="width: 10%;"></td> <td style="width: 10%;"></td> <td style="width: 10%;"></td> <td style="width: 10%;"></td> </tr> <tr> <td></td> <td></td> <td colspan="8" style="text-align: center;"> <table border="1" style="width: 100%; border-collapse: collapse; text-align: center;"> <tr> <td style="width: 10%;"></td> <td style="width: 10%;"></td> <td style="width: 10%;"></td> <td style="width: 10%;"></td> <td style="width: 10%;"></td> <td style="width: 10%;"></td> <td style="width: 10%;"></td> <td style="width: 10%;"></td> <td style="width: 10%;"></td> <td style="width: 10%;"></td> </tr> <tr> <td></td> <td></td> <td colspan="8" style="text-align: center;"> <table border="1" style="width: 100%; border-collapse: collapse; text-align: center;"> <tr> <td style="width: 10%;"></td> <td style="width: 10%;"></td> <td style="width: 10%;"></td> <td style="width: 10%;"></td> <td style="width: 10%;"></td> <td style="width: 10%;"></td> <td style="width: 10%;"></td> <td style="width: 10%;"></td> <td style="width: 10%;"></td> <td style="width: 10%;"></td> </tr> <tr> <td></td> <td></td> <td colspan="8" style="text-align: center;"> <table border="1" style="width: 100%; border-collapse: collapse; text-align: center;"> <tr> <td style="width: 10%;"></td> <td style="width: 10%;"></td> <td style="width: 10%;"></td> <td style="width: 10%;"></td> <td style="width: 10%;"></td> <td style="width: 10%;"></td> <td style="width: 10%;"></td> <td style="width: 10%;"></td> <td style="width: 10%;"></td> <td style="width: 10%;"></td> </tr> <tr> <td></td> <td></td> <td colspan="8" style="text-align: center;"> <table border="1" style="width: 100%; border-collapse: collapse; text-align: center;"> <tr> <td style="width: 10%;"></td> <td style="width: 10%;"></td> <td style="width: 10%;"></td> <td style="width: 10%;"></td> <td style="width: 10%;"></td> <td style="width: 10%;"></td> <td style="width: 10%;"></td> <td style="width: 10%;"></td> <td style="width: 10%;"></td> <td style="width: 10%;"></td> </tr> <tr> <td></td> <td></td> <td colspan="8" style="text-align: center;"> <table border="1" style="width: 100%; border-collapse: collapse; text-align: center;"> <tr> <td style="width: 10%;"></td> <td style="width: 10%;"></td> <td style="width: 10%;"></td> <td style="width: 10%;"></td> <td style="width: 10%;"></td> <td style="width: 10%;"></td> <td style="width: 10%;"></td> <td style="width: 10%;"></td> <td style="width: 10%;"></td> <td style="width: 10%;"></td> </tr> <tr> <td></td> <td></td> <td colspan="8" style="text-align: center;"> <table border="1" style="width: 100%; border-collapse: collapse; text-align: center;"> <tr> <td style="width: 10%;"></td> <td style="width: 10%;"></td> <td style="width: 10%;"></td> <td style="width: 10%;"></td> <td style="width: 10%;"></td> <td style="width: 10%;"></td> <td style="width: 10%;"></td> <td style="width: 10%;"></td> <td style="width: 10%;"></td> <td style="width: 10%;"></td> </tr> <tr> <td></td> <td></td> <td colspan="8" style="text-align: center;"> <table border="1" style="width: 100%; border-collapse: collapse; text-align: center;"> <tr> <td style="width: 10%;"></td> <td style="width: 10%;"></td> <td style="width: 10%;"></td> <td style="width: 10%;"></td> <td style="width: 10%;"></td> <td style="width: 10%;"></td> <td style="width: 10%;"></td> <td style="width: 10%;"></td> <td style="width: 10%;"></td> <td style="width: 10%;"></td> </tr> <tr> <td></td> <td></td> <td colspan="8" style="text-align: center;"> <table border="1" style="width: 100%; border-collapse: collapse; text-align: center;"> <tr> <td style="width: 10%;"></td> <td style="width: 10%;"></td> <td style="width: 10%;"></td> <td style="width: 10%;"></td> <td style="width: 10%;"></td> <td style="width: 10%;"></td> <td style="width: 10%;"></td> <td style="width: 10%;"></td> <td style="width: 10%;"></td> <td style="width: 10%;"></td> </tr> <tr> <td></td> <td></td> <td colspan="8" style="text-align: center;"> <table border="1" style="width: 100%; border-collapse: collapse; text-align: center;"> <tr> <td style="width: 10%;"></td> <td style="width: 10%;"></td> <td style="width: 10%;"></td> <td style="width: 10%;"></td> <td style="width: 10%;"></td> <td style="width: 10%;"></td> <td style="width: 10%;"></td> <td style="width: 10%;"></td> <td style="width: 10%;"></td> <td style="width: 10%;"></td> </tr> <tr> <td></td> <td></td> <td colspan="8" style="text-align: center;"> <table border="1" style="width: 100%; border-collapse: collapse; text-align: center;"> <tr> <td style="width: 10%;"></td> <td style="width: 10%;"></td> <td style="width: 10%;"></td> <td style="width: 10%;"></td> <td style="width: 10%;"></td> <td style="width: 10%;"></td> <td style="width: 10%;"></td> <td style="width: 10%;"></td> <td style="width: 10%;"></td> <td style="width: 10%;"></td> </tr> <tr> <td></td> <td></td> <td colspan="8" style="text-align: center;"> <table border="1" style="width: 100%; border-collapse: collapse; text-align: center;"> <tr> <td style="width: 10%;"></td> <td style="width: 10%;"></td> <td style="width: 10%;"></td> <td style="width: 10%;"></td> <td style="width: 10%;"></td> <td style="width: 10%;"></td> <td style="width: 10%;"></td> <td style="width: 10%;"></td> <td style="width: 10%;"></td> <td style="width: 10%;"></td> </tr> <tr> <td></td> <td></td> <td colspan="8" style="text-align: center;"> <table border="1" style="width: 100%; border-collapse: collapse; text-align: center;"> <tr> <td style="width: 10%;"></td> <td style="width: 10%;"></td> <td style="width: 10%;"></td> <td style="width: 10%;"></td> <td style="width: 10%;"></td> <td style="width: 10%;"></td> <td style="width: 10%;"></td> <td style="width: 10%;"></td> <td style="width: 10%;"></td> <td style="width: 10%;"></td> </tr> <tr> <td></td> <td></td> <td colspan="8" style="text-align: center;"> <table border="1" style="width: 100%; border-collapse: collapse; text-align: center;"> <tr> <td style="width: 10%;"></td> <td style="width: 10%;"></td> <td style="width: 10%;"></td> <td style="width: 10%;"></td> <td style="width: 10%;"></td> <td style="width: 10%;"></td> <td style="width: 10%;"></td> <td style="width: 10%;"></td> <td style="width: 10%;"></td> <td style="width: 10%;"></td> </tr> <tr> <td></td> <td></td> <td colspan="8" style="text-align: center;"> <table border="1" style="width: 100%; border-collapse: collapse; text-align: center;"> <tr> <td style="width: 10%;"></td> <td style="width: 10%;"></td> <td style="width: 10%;"></td> <td style="width: 10%;"></td> <td style="width: 10%;"></td> <td style="width: 10%;"></td> <td style="width: 10%;"></td> <td style="width: 10%;"></td> <td style="width: 10%;"></td> <td style="width: 10%;"></td> </tr> <tr> <td></td> <td></td> <td colspan="8" style="text-align: center;"> <table border="1" style="width: 100%; border-collapse: collapse; text-align: center;"> <tr> <td style="width: 10%;"></td> <td style="width: 10%;"></td> <td style="width: 10%;"></td> <td style="width: 10%;"></td> <td style="width: 10%;"></td> <td style="width: 10%;"></td> <td style="width: 10%;"></td> <td style="width: 10%;"></td> <td style="width: 10%;"></td> <td style="width: 10%;"></td> </tr> <tr> <td></td> <td></td> <td colspan="8" style="text-align: center;"> <table border="1" style="width: 100%; border-collapse: collapse; text-align: center;"> <tr> <td style="width: 10%;"></td> <td style="width: 10%;"></td> <td style="width: 10%;"></td> <td style="width: 10%;"></td> <td style="width: 10%;"></td> <td
style="width: 10%;"></td> <td style="width: 10%;"></td> <td style="width: 10%;"></td> <td style="width: 10%;"></td> <td style="width: 10%;"></td> </tr> <tr> <td></td> <td></td> <td colspan="8" style="text-align: center;"> <table border="1" style="width: 100%; border-collapse: collapse; text-align: center;"> <tr> <td style="width: 10%;"></td> <td style="width: 10%;"></td> <td style="width: 10%;"></td> <td style="width: 10%;"></td> <td style="width: 10%;"></td> <td style="width: 10%;"></td> <td style="width: 10%;"></td> <td style="width: 10%;"></td> <td style="width: 10%;"></td> <td style="width: 10%;"></td> </tr> <tr> <td></td> <td></td> <td colspan="8" style="text-align: center;"> <table border="1" style="width: 100%; border-collapse: collapse; text-align: center;"> <tr> <td style="width: 10%;"></td> <td style="width: 10%;"></td> <td style="width: 10%;"></td> <td style="width: 10%;"></td> <td style="width: 10%;"></td> <td style="width: 10%;"></td> <td style="width: 10%;"></td> <td style="width: 10%;"></td> <td style="width: 10%;"></td> <td style="width: 10%;"></td> </tr> <tr> <td></td> <td></td> <td colspan="8" style="text-align: center;"> <table border="1" style="width: 100%; border-collapse: collapse; text-align: center;"> <tr> <td style="width: 10%;"></td> <td style="width: 10%;"></td> <td style="width: 10%;"></td> <td style="width: 10%;"></td> <td style="width: 10%;"></td> <td style="width: 10%;"></td> <td style="width: 10%;"></td> <td style="width: 10%;"></td> <td style="width: 10%;"></td> <td style="width: 10%;"></td> </tr> <tr> <td></td> <td></td> <td colspan="8" style="text-align: center;"> <table border="1" style="width: 100%; border-collapse: collapse; text-align: center;"> <tr> <td style="width: 10%;"></td> <td style="width: 10%;"></td> <td style="width: 10%;"></td> <td style="width: 10%;"></td> <td style="width: 10%;"></td> <td style="width: 10%;"></td> <td style="width: 10%;"></td> <td style="width: 10%;"></td> <td style="width: 10%;"></td> <td style="width: 10%;"></td> </tr> <tr> <td></td> <td></td> <td colspan="8" style="text-align: center;"> <table border="1" style="width: 100%; border-collapse: collapse; text-align: center;"> <tr> <td style="width: 10%;"></td> <td style="width: 10%;"></td> <td style="width: 10%;"></td> <td style="width: 10%;"></td> <td style="width: 10%;"></td> <td style="width: 10%;"></td> <td style="width: 10%;"></td> <td style="width: 10%;"></td> <td style="width: 10%;"></td> <td style="width: 10%;"></td> </tr> <tr> <td></td> <td></td> <td colspan="8" style="text-align: center;"> <table border="1" style="width: 100%; border-collapse: collapse; text-align: center;"> <tr> <td style="width: 10%;"></td> <td style="width: 10%;"></td> <td style="width: 10%;"></td> <td style="width: 10%;"></td> <td style="width: 10%;"></td> <td style="width: 10%;"></td> <td style="width: 10%;"></td> <td style="width: 10%;"></td> <td style="width: 10%;"></td> <td style="width: 10%;"></td> </tr> <tr> <td></td> <td></td> <td colspan="8" style="text-align: center;"> <table border="1" style="width: 100%; border-collapse: collapse; text-align: center;"> <tr> <td style="width: 10%;"></td> <td style="width: 10%;"></td> <td style="width: 10%;"></td> <td style="width: 10%;"></td> <td style="width: 10%;"></td> <td style="width: 10%;"></td> <td style="width: 10%;"></td> <td style="width: 10%;"></td> <td style="width: 10%;"></td> <td style="width: 10%;"></td> </tr> <tr> <td></td> <td></td> <td colspan="8" style="text-align: center;"> <table border="1" style="width: 100%; border-collapse: collapse; text-align: center;"> <tr> <td style="width: 10%;"></td> <td style="width: 10%;"></td> <td style="width: 10%;"></td> <td style="width: 10%;"></td> <td style="width: 10%;"></td> <td style="width: 10%;"></td> <td style="width: 10%;"></td> <td style="width: 10%;"></td> <td style="width: 10%;"></td> <td style="width: 10%;"></td> </tr> <tr> <td></td> <td></td> <td colspan="8" style="text-align: center;"> <table border="1" style="width: 100%; border-collapse: collapse; text-align: center;"> <tr> <td style="width: 10%;"></td> <td style="width: 10%;"></td> <td style="width: 10%;"></td> <td style="width: 10%;"></td> <td style="width: 10%;"></td> <td style="width: 10%;"></td> <td style="width: 10%;"></td> <td style="width: 10%;"></td> <td style="width: 10%;"></td> <td style="width: 10%;"></td> </tr> <tr> <td></td> <td></td> <td colspan="8" style="text-align: center;"> <table border="1" style="width: 100%; border-collapse: collapse; text-align: center;"> <tr> <td style="width: 10%;"></td> <td style="width: 10%;"></td> <td style="width: 10%;"></td> <td style="width: 10%;"></td> <td style="width: 10%;"></td> <td style="width: 10%;"></td> <td style="width: 10%;"></td> <td style="width: 10%;"></td> <td style="width: 10%;"></td> <td style="width: 10%;"></td> </tr> <tr> <td></td> <td></td> <td colspan="8" style="text-align: center;"> <table border="1" style="width: 100%; border-collapse: collapse; text-align: center;"> <tr> <td style="width: 10%;"></td> <td style="width: 10%;"></td> <td style="width: 10%;"></td> <td style="width: 10%;"></td> <td style="width: 10%;"></td> <td style="width: 10%;"></td> <td style="width: 10%;"></td> <td style="width: 10%;"></td> <td style="width: 10%;"></td> <td style="width: 10%;"></td> </tr> <tr> <td></td> <td></td> <td colspan="8" style="text-align: center;"> <table border="1" style="width: 100%; border-collapse: collapse; text-align: center;"> <tr> <td style="width: 10%;"></td> <td style="width: 10%;"></td> <td style="width: 10%;"></td> <td style="width: 10%;"></td> <td style="width: 10%;"></td> <td style="width: 10%;"></td> <td style="width: 10%;"></td> <td style="width: 10%;"></td> <td style="width: 10%;"></td> <td style="width: 10%;"></td> </tr> <tr> <td></td> <td></td> <td colspan="8" style="text-align: center;"> <table border="1" style="width: 100%; border-collapse: collapse; text-align: center;"> <tr> <td style="width: 10%;"></td> <td style="width: 10%;"></td> <td style="width: 10%;"></td> <td style="width: 10%;"></td> <td style="width: 10%;"></td> <td style="width: 10%;"></td> <td style="width: 10%;"></td> <td style="width: 10%;"></td> <td style="width: 10%;"></td> <td style="width: 10%;"></td> </tr> <tr> <td></td> <td></td> <td colspan="8" style="text-align: center;"> <table border="1" style="width: 100%; border-collapse: collapse; text-align: center;"> <tr> <td style="width: 10%;"></td> <td style="width: 10%;"></td> <td style="width: 10%;"></td> <td style="width: 10%;"></td> <td style="width: 10%;"></td> <td style="width: 10%;"></td> <td style="width: 10%;"></td> <td style="width: 10%;"></td> <td style="width: 10%;"></td> <td style="width: 10%;"></td> </tr> <tr> <td></td> <td></td> <td colspan="8" style="text-align: center;"> <table border="1" style="width: 100%; border-collapse: collapse; text-align: center;"> <tr> <td style="width: 10%;"></td> <td style="width: 10%;"></td> <td style="width: 10%;"></td> <td style="width: 10%;"></td> <td style="width: 10%;"></td> <td style="width: 10%;"></td> <td style="width: 10%;"></td> <td style="width: 10%;"></td> <td style="width: 10%;"></td> <td style="width: 10%;"></td> </tr> <tr> <td></td> <td></td> <td colspan="8" style="text-align: center;"> <table border="1" style="width: 100%; border-collapse: collapse; text-align: center;"> <tr> </tr></table></td></tr></table></td></tr></table></td></tr></table></td></tr></table></td></tr></table></td></tr></table></td></tr></table></td></tr></table></td></tr></table></td></tr></table></td></tr></table></td></tr></table></td></tr></table></td></tr></table></td></tr></table></td></tr></table></td></tr></table></td></tr></table></td></tr></table></td></tr></table></td></tr></table></td></tr></table></td></tr></table></td></tr></table></td></tr></table></td></tr></table></td></tr></table></td></tr></table></td></tr></table></td></tr></table></td></tr></table></td></tr></table></td></tr></table></td></tr></table></td></tr></table></td></tr></table></td></tr></table></td></tr></table></td></tr></table></td></tr></table></td></tr></table></td></tr></table></td></tr></table></td></tr></table></td></tr></table></td></tr></table></td></tr></table> | | | | | | | | | | | | | | | | | | | | <table border="1" style="width: 100%; border-collapse: collapse; text-align: center;"> <tr> <td style="width: 10%;"></td> <td style="width: 10%;"></td> <td style="width: 10%;"></td> <td style="width: 10%;"></td> <td style="width: 10%;"></td> <td style="width: 10%;"></td> <td
style="width: 10%;"></td> <td style="width: 10%;"></td> <td style="width: 10%;"></td> <td style="width: 10%;"></td> </tr> <tr> <td></td> <td></td> <td colspan="8" style="text-align: center;"> <table border="1" style="width: 100%; border-collapse: collapse; text-align: center;"> <tr> <td style="width: 10%;"></td> <td style="width: 10%;"></td> <td style="width: 10%;"></td> <td style="width: 10%;"></td> <td style="width: 10%;"></td> <td style="width: 10%;"></td> <td style="width: 10%;"></td> <td style="width: 10%;"></td> <td style="width: 10%;"></td> <td style="width: 10%;"></td> </tr> <tr> <td></td> <td></td> <td colspan="8" style="text-align: center;"> <table border="1" style="width: 100%; border-collapse: collapse; text-align: center;"> <tr> <td style="width: 10%;"></td> <td style="width: 10%;"></td> <td style="width: 10%;"></td> <td style="width: 10%;"></td> <td style="width: 10%;"></td> <td style="width: 10%;"></td> <td style="width: 10%;"></td> <td style="width: 10%;"></td> <td style="width: 10%;"></td> <td style="width: 10%;"></td> </tr> <tr> <td></td> <td></td> <td colspan="8" style="text-align: center;"> <table border="1" style="width: 100%; border-collapse: collapse; text-align: center;"> <tr> <td style="width: 10%;"></td> <td style="width: 10%;"></td> <td style="width: 10%;"></td> <td style="width: 10%;"></td> <td style="width: 10%;"></td> <td style="width: 10%;"></td> <td style="width: 10%;"></td> <td style="width: 10%;"></td> <td style="width: 10%;"></td> <td style="width: 10%;"></td> </tr> <tr> <td></td> <td></td> <td colspan="8" style="text-align: center;"> <table border="1" style="width: 100%; border-collapse: collapse; text-align: center;"> <tr> <td style="width: 10%;"></td> <td style="width: 10%;"></td> <td style="width: 10%;"></td> <td style="width: 10%;"></td> <td style="width: 10%;"></td> <td style="width: 10%;"></td> <td style="width: 10%;"></td> <td style="width: 10%;"></td> <td style="width: 10%;"></td> <td style="width: 10%;"></td> </tr> <tr> <td></td> <td></td> <td colspan="8" style="text-align: center;"> <table border="1" style="width: 100%; border-collapse: collapse; text-align: center;"> <tr> <td style="width: 10%;"></td> <td style="width: 10%;"></td> <td style="width: 10%;"></td> <td style="width: 10%;"></td> <td style="width: 10%;"></td> <td style="width: 10%;"></td> <td style="width: 10%;"></td> <td style="width: 10%;"></td> <td style="width: 10%;"></td> <td style="width: 10%;"></td> </tr> <tr> <td></td> <td></td> <td colspan="8" style="text-align: center;"> <table border="1" style="width: 100%; border-collapse: collapse; text-align: center;"> <tr> <td style="width: 10%;"></td> <td style="width: 10%;"></td> <td style="width: 10%;"></td> <td style="width: 10%;"></td> <td style="width: 10%;"></td> <td style="width: 10%;"></td> <td style="width: 10%;"></td> <td style="width: 10%;"></td> <td style="width: 10%;"></td> <td style="width: 10%;"></td> </tr> <tr> <td></td> <td></td> <td colspan="8" style="text-align: center;"> <table border="1" style="width: 100%; border-collapse: collapse; text-align: center;"> <tr> <td style="width: 10%;"></td> <td style="width: 10%;"></td> <td style="width: 10%;"></td> <td style="width: 10%;"></td> <td style="width: 10%;"></td> <td style="width: 10%;"></td> <td style="width: 10%;"></td> <td style="width: 10%;"></td> <td style="width: 10%;"></td> <td style="width: 10%;"></td> </tr> <tr> <td></td> <td></td> <td colspan="8" style="text-align: center;"> <table border="1" style="width: 100%; border-collapse: collapse; text-align: center;"> <tr> <td style="width: 10%;"></td> <td style="width: 10%;"></td> <td style="width: 10%;"></td> <td style="width: 10%;"></td> <td style="width: 10%;"></td> <td style="width: 10%;"></td> <td style="width: 10%;"></td> <td style="width: 10%;"></td> <td style="width: 10%;"></td> <td style="width: 10%;"></td> </tr> <tr> <td></td> <td></td> <td colspan="8" style="text-align: center;"> <table border="1" style="width: 100%; border-collapse: collapse; text-align: center;"> <tr> <td style="width: 10%;"></td> <td style="width: 10%;"></td> <td style="width: 10%;"></td> <td style="width: 10%;"></td> <td style="width: 10%;"></td> <td style="width: 10%;"></td> <td style="width: 10%;"></td> <td style="width: 10%;"></td> <td style="width: 10%;"></td> <td style="width: 10%;"></td> </tr> <tr> <td></td> <td></td> <td colspan="8" style="text-align: center;"> <table border="1" style="width: 100%; border-collapse: collapse; text-align: center;"> <tr> <td style="width: 10%;"></td> <td style="width: 10%;"></td> <td style="width: 10%;"></td> <td style="width: 10%;"></td> <td style="width: 10%;"></td> <td style="width: 10%;"></td> <td style="width: 10%;"></td> <td style="width: 10%;"></td> <td style="width: 10%;"></td> <td style="width: 10%;"></td> </tr> <tr> <td></td> <td></td> <td colspan="8" style="text-align: center;"> <table border="1" style="width: 100%; border-collapse: collapse; text-align: center;"> <tr> <td style="width: 10%;"></td> <td style="width: 10%;"></td> <td style="width: 10%;"></td> <td style="width: 10%;"></td> <td style="width: 10%;"></td> <td style="width: 10%;"></td> <td style="width: 10%;"></td> <td style="width: 10%;"></td> <td style="width: 10%;"></td> <td style="width: 10%;"></td> </tr> <tr> <td></td> <td></td> <td colspan="8" style="text-align: center;"> <table border="1" style="width: 100%; border-collapse: collapse; text-align: center;"> <tr> <td style="width: 10%;"></td> <td style="width: 10%;"></td> <td style="width: 10%;"></td> <td style="width: 10%;"></td> <td style="width: 10%;"></td> <td style="width: 10%;"></td> <td style="width: 10%;"></td> <td style="width: 10%;"></td> <td style="width: 10%;"></td> <td style="width: 10%;"></td> </tr> <tr> <td></td> <td></td> <td colspan="8" style="text-align: center;"> <table border="1" style="width: 100%; border-collapse: collapse; text-align: center;"> <tr> <td style="width: 10%;"></td> <td style="width: 10%;"></td> <td style="width: 10%;"></td> <td style="width: 10%;"></td> <td style="width: 10%;"></td> <td style="width: 10%;"></td> <td style="width: 10%;"></td> <td style="width: 10%;"></td> <td style="width: 10%;"></td> <td style="width: 10%;"></td> </tr> <tr> <td></td> <td></td> <td colspan="8" style="text-align: center;"> <table border="1" style="width: 100%; border-collapse: collapse; text-align: center;"> <tr> <td style="width: 10%;"></td> <td style="width: 10%;"></td> <td style="width: 10%;"></td> <td style="width: 10%;"></td> <td style="width: 10%;"></td> <td style="width: 10%;"></td> <td style="width: 10%;"></td> <td style="width: 10%;"></td> <td style="width: 10%;"></td> <td style="width: 10%;"></td> </tr> <tr> <td></td> <td></td> <td colspan="8" style="text-align: center;"> <table border="1" style="width: 100%; border-collapse: collapse; text-align: center;"> <tr> <td style="width: 10%;"></td> <td style="width: 10%;"></td> <td style="width: 10%;"></td> <td style="width: 10%;"></td> <td style="width: 10%;"></td> <td style="width: 10%;"></td> <td style="width: 10%;"></td> <td style="width: 10%;"></td> <td style="width: 10%;"></td> <td style="width: 10%;"></td> </tr> <tr> <td></td> <td></td> <td colspan="8" style="text-align: center;"> <table border="1" style="width: 100%; border-collapse: collapse; text-align: center;"> <tr> <td style="width: 10%;"></td> <td style="width: 10%;"></td> <td style="width: 10%;"></td> <td style="width: 10%;"></td> <td style="width: 10%;"></td> <td style="width: 10%;"></td> <td style="width: 10%;"></td> <td style="width: 10%;"></td> <td style="width: 10%;"></td> <td style="width: 10%;"></td> </tr> <tr> <td></td> <td></td> <td colspan="8" style="text-align: center;"> <table border="1" style="width: 100%; border-collapse: collapse; text-align: center;"> <tr> <td style="width: 10%;"></td> <td style="width: 10%;"></td> <td style="width: 10%;"></td> <td style="width: 10%;"></td> <td style="width: 10%;"></td> <td style="width: 10%;"></td> <td style="width: 10%;"></td> <td style="width: 10%;"></td> <td style="width: 10%;"></td> <td style="width: 10%;"></td> </tr> <tr> <td></td> <td></td> <td colspan="8" style="text-align: center;"> <table border="1" style="width: 100%; border-collapse: collapse; text-align: center;"> <tr> <td style="width: 10%;"></td> <td style="width: 10%;"></td> <td style="width: 10%;"></td> <td style="width: 10%;"></td> <td style="width: 10%;"></td> <td style="width: 10%;"></td> <td style="width: 10%;"></td> <td style="width: 10%;"></td> <td style="width: 10%;"></td> <td style="width: 10%;"></td> </tr> <tr> <td></td> <td></td> <td colspan="8" style="text-align: center;"> <table border="1" style="width: 100%; border-collapse: collapse; text-align: center;"> <tr> <td style="width: 10%;"></td> <td style="width: 10%;"></td> <td style="width: 10%;"></td> <td style="width: 10%;"></td> <td style="width: 10%;"></td> <td style="width: 10%;"></td> <td style="width: 10%;"></td> <td style="width: 10%;"></td> <td style="width: 10%;"></td> <td style="width: 10%;"></td> </tr> <tr> <td></td> <td></td> <td colspan="8" style="text-align: center;"> <table border="1" style="width: 100%; border-collapse: collapse; text-align: center;"> <tr> <td style="width: 10%;"></td> <td style="width: 10%;"></td> <td style="width: 10%;"></td> <td style="width: 10%;"></td> <td style="width: 10%;"></td> <td style="width: 10%;"></td> <td style="width: 10%;"></td> <td style="width: 10%;"></td> <td style="width: 10%;"></td> <td style="width: 10%;"></td> </tr> <tr> <td></td> <td></td> <td colspan="8" style="text-align: center;"> <table border="1" style="width: 100%; border-collapse: collapse; text-align: center;"> <tr> <td style="width: 10%;"></td> <td style="width: 10%;"></td> <td style="width: 10%;"></td> <td style="width: 10%;"></td> <td style="width: 10%;"></td> <td style="width: 10%;"></td> <td style="width: 10%;"></td> <td style="width: 10%;"></td> <td style="width: 10%;"></td> <td style="width: 10%;"></td> </tr> <tr> <td></td> <td></td> <td colspan="8"
style="text-align: center;"> <table border="1" style="width: 100%; border-collapse: collapse; text-align: center;"> <tr> <td style="width: 10%;"></td> <td style="width: 10%;"></td> <td style="width: 10%;"></td> <td style="width: 10%;"></td> <td style="width: 10%;"></td> <td style="width: 10%;"></td> <td style="width: 10%;"></td> <td style="width: 10%;"></td> <td style="width: 10%;"></td> <td style="width: 10%;"></td> </tr> <tr> <td></td> <td></td> <td colspan="8" style="text-align: center;"> <table border="1" style="width: 100%; border-collapse: collapse; text-align: center;"> <tr> <td style="width: 10%;"></td> <td style="width: 10%;"></td> <td style="width: 10%;"></td> <td style="width: 10%;"></td> <td style="width: 10%;"></td> <td style="width: 10%;"></td> <td style="width: 10%;"></td> <td style="width: 10%;"></td> <td style="width: 10%;"></td> <td style="width: 10%;"></td> </tr> <tr> <td></td> <td></td> <td colspan="8" style="text-align: center;"> <table border="1" style="width: 100%; border-collapse: collapse; text-align: center;"> <tr> <td style="width: 10%;"></td> <td style="width: 10%;"></td> <td style="width: 10%;"></td> <td style="width: 10%;"></td> <td style="width: 10%;"></td> <td style="width: 10%;"></td> <td style="width: 10%;"></td> <td style="width: 10%;"></td> <td style="width: 10%;"></td> <td style="width: 10%;"></td> </tr> <tr> <td></td> <td></td> <td colspan="8" style="text-align: center;"> <table border="1" style="width: 100%; border-collapse: collapse; text-align: center;"> <tr> <td style="width: 10%;"></td> <td style="width: 10%;"></td> <td style="width: 10%;"></td> <td style="width: 10%;"></td> <td style="width: 10%;"></td> <td style="width: 10%;"></td> <td style="width: 10%;"></td> <td style="width: 10%;"></td> <td style="width: 10%;"></td> <td style="width: 10%;"></td> </tr> <tr> <td></td> <td></td> <td colspan="8" style="text-align: center;"> <table border="1" style="width: 100%; border-collapse: collapse; text-align: center;"> <tr> <td style="width: 10%;"></td> <td style="width: 10%;"></td> <td style="width: 10%;"></td> <td style="width: 10%;"></td> <td style="width: 10%;"></td> <td style="width: 10%;"></td> <td style="width: 10%;"></td> <td style="width: 10%;"></td> <td style="width: 10%;"></td> <td style="width: 10%;"></td> </tr> <tr> <td></td> <td></td> <td colspan="8" style="text-align: center;"> <table border="1" style="width: 100%; border-collapse: collapse; text-align: center;"> <tr> <td style="width: 10%;"></td> <td style="width: 10%;"></td> <td style="width: 10%;"></td> <td style="width: 10%;"></td> <td style="width: 10%;"></td> <td style="width: 10%;"></td> <td style="width: 10%;"></td> <td style="width: 10%;"></td> <td style="width: 10%;"></td> <td style="width: 10%;"></td> </tr> <tr> <td></td> <td></td> <td colspan="8" style="text-align: center;"> <table border="1" style="width: 100%; border-collapse: collapse; text-align: center;"> <tr> <td style="width: 10%;"></td> <td style="width: 10%;"></td> <td style="width: 10%;"></td> <td style="width: 10%;"></td> <td style="width: 10%;"></td> <td style="width: 10%;"></td> <td style="width: 10%;"></td> <td style="width: 10%;"></td> <td style="width: 10%;"></td> <td style="width: 10%;"></td> </tr> <tr> <td></td> <td></td> <td colspan="8" style="text-align: center;"> <table border="1" style="width: 100%; border-collapse: collapse; text-align: center;"> <tr> <td style="width: 10%;"></td> <td style="width: 10%;"></td> <td style="width: 10%;"></td> <td style="width: 10%;"></td> <td style="width: 10%;"></td> <td style="width: 10%;"></td> <td style="width: 10%;"></td> <td style="width: 10%;"></td> <td style="width: 10%;"></td> <td style="width: 10%;"></td> </tr> <tr> <td></td> <td></td> <td colspan="8" style="text-align: center;"> <table border="1" style="width: 100%; border-collapse: collapse; text-align: center;"> <tr> <td style="width: 10%;"></td> <td style="width: 10%;"></td> <td style="width: 10%;"></td> <td style="width: 10%;"></td> <td style="width: 10%;"></td> <td style="width: 10%;"></td> <td style="width: 10%;"></td> <td style="width: 10%;"></td> <td style="width: 10%;"></td> <td style="width: 10%;"></td> </tr> <tr> <td></td> <td></td> <td colspan="8" style="text-align: center;"> <table border="1" style="width: 100%; border-collapse: collapse; text-align: center;"> <tr> <td style="width: 10%;"></td> <td style="width: 10%;"></td> <td style="width: 10%;"></td> <td style="width: 10%;"></td> <td style="width: 10%;"></td> <td style="width: 10%;"></td> <td style="width: 10%;"></td> <td style="width: 10%;"></td> <td style="width: 10%;"></td> <td style="width: 10%;"></td> </tr> <tr> <td></td> <td></td> <td colspan="8" style="text-align: center;"> <table border="1" style="width: 100%; border-collapse: collapse; text-align: center;"> <tr> <td style="width: 10%;"></td> <td style="width: 10%;"></td> <td style="width: 10%;"></td> <td style="width: 10%;"></td> <td style="width: 10%;"></td> <td style="width: 10%;"></td> <td style="width: 10%;"></td> <td style="width: 10%;"></td> <td style="width: 10%;"></td> <td style="width: 10%;"></td> </tr> <tr> <td></td> <td></td> <td colspan="8" style="text-align: center;"> <table border="1" style="width: 100%; border-collapse: collapse; text-align: center;"> <tr> <td style="width: 10%;"></td> <td style="width: 10%;"></td> <td style="width: 10%;"></td> <td style="width: 10%;"></td> <td style="width: 10%;"></td> <td style="width: 10%;"></td> <td style="width: 10%;"></td> <td style="width: 10%;"></td> <td style="width: 10%;"></td> <td style="width: 10%;"></td> </tr> <tr> <td></td> <td></td> <td colspan="8" style="text-align: center;"> <table border="1" style="width: 100%; border-collapse: collapse; text-align: center;"> <tr> <td style="width: 10%;"></td> <td style="width: 10%;"></td> <td style="width: 10%;"></td> <td style="width: 10%;"></td> <td style="width: 10%;"></td> <td style="width: 10%;"></td> <td style="width: 10%;"></td> <td style="width: 10%;"></td> <td style="width: 10%;"></td> <td style="width: 10%;"></td> </tr> <tr> <td></td> <td></td> <td colspan="8" style="text-align: center;"> <table border="1" style="width: 100%; border-collapse: collapse; text-align: center;"> <tr> <td style="width: 10%;"></td> <td style="width: 10%;"></td> <td style="width: 10%;"></td> <td style="width: 10%;"></td> <td style="width: 10%;"></td> <td style="width: 10%;"></td> <td style="width: 10%;"></td> <td style="width: 10%;"></td> <td style="width: 10%;"></td> <td style="width: 10%;"></td> </tr> <tr> <td></td> <td></td> <td colspan="8" style="text-align: center;"> <table border="1" style="width: 100%; border-collapse: collapse; text-align: center;"> <tr> <td style="width: 10%;"></td> <td style="width: 10%;"></td> <td style="width: 10%;"></td> <td style="width: 10%;"></td> <td style="width: 10%;"></td> <td style="width: 10%;"></td> <td style="width: 10%;"></td> <td style="width: 10%;"></td> <td style="width: 10%;"></td> <td style="width: 10%;"></td> </tr> <tr> <td></td> <td></td> <td colspan="8" style="text-align: center;"> <table border="1" style="width: 100%; border-collapse: collapse; text-align: center;"> <tr> <td style="width: 10%;"></td> <td style="width: 10%;"></td> <td style="width: 10%;"></td> <td style="width: 10%;"></td> <td style="width: 10%;"></td> <td style="width: 10%;"></td> <td style="width: 10%;"></td> <td style="width: 10%;"></td> <td style="width: 10%;"></td> <td style="width: 10%;"></td> </tr> <tr> <td></td> <td></td> <td colspan="8" style="text-align: center;"> <table border="1" style="width: 100%; border-collapse: collapse; text-align: center;"> <tr> <td style="width: 10%;"></td> <td style="width: 10%;"></td> <td style="width: 10%;"></td> <td style="width: 10%;"></td> <td style="width: 10%;"></td> <td style="width: 10%;"></td> <td style="width: 10%;"></td> <td style="width: 10%;"></td> <td style="width: 10%;"></td> <td style="width: 10%;"></td> </tr> <tr> <td></td> <td></td> <td colspan="8" style="text-align: center;"> <table border="1" style="width: 100%; border-collapse: collapse; text-align: center;"> <tr> <td style="width: 10%;"></td> <td style="width: 10%;"></td> <td style="width: 10%;"></td> <td style="width: 10%;"></td> <td style="width: 10%;"></td> <td style="width: 10%;"></td> <td style="width: 10%;"></td> <td style="width: 10%;"></td> <td style="width: 10%;"></td> <td style="width: 10%;"></td> </tr> <tr> <td></td> <td></td> <td colspan="8" style="text-align: center;"> <table border="1" style="width: 100%; border-collapse: collapse; text-align: center;"> <tr> <td style="width: 10%;"></td> <td style="width: 10%;"></td> <td style="width: 10%;"></td> <td style="width: 10%;"></td> <td style="width: 10%;"></td> <td style="width: 10%;"></td> <td style="width: 10%;"></td> <td style="width: 10%;"></td> <td style="width: 10%;"></td> <td style="width: 10%;"></td> </tr> <tr> <td></td> <td></td> <td colspan="8" style="text-align: center;"> <table border="1" style="width: 100%; border-collapse: collapse; text-align: center;"> <tr> <td style="width: 10%;"></td> <td style="width: 10%;"></td> <td style="width: 10%;"></td> <td style="width: 10%;"></td> <td style="width: 10%;"></td> <td style="width: 10%;"></td> <td style="width: 10%;"></td> <td style="width: 10%;"></td> <td style="width: 10%;"></td> <td style="width: 10%;"></td> </tr> <tr> <td></td> <td></td> <td colspan="8" style="text-align: center;"> <table border="1" style="width: 100%; border-collapse: collapse; text-align: center;"> <tr> <td style="width: 10%;"></td> <td style="width: 10%;"></td> <td style="width: 10%;"></td> <td style="width: 10%;"></td> <td style="width: 10%;"></td> <td style="width: 10%;"></td> <td style="width: 10%;"></td> <td style="width: 10%;"></td> <td style="width: 10%;"></td> <td style="width: 10%;"></td> </tr> <tr> <td></td> <td></td> <td colspan="8" style="text-align: center;"> <table border="1" style="width: 100%; border-collapse: collapse; text-align: center;"> <tr> <td style="width: 10%;"></td> <td style="width:
10%;"></td> <td style="width: 10%;"></td> <td style="width: 10%;"></td> <td style="width: 10%;"></td> <td style="width: 10%;"></td> <td style="width: 10%;"></td> <td style="width: 10%;"></td> <td style="width: 10%;"></td> <td style="width: 10%;"></td> </tr> <tr> <td></td> <td></td> <td colspan="8" style="text-align: center;"> <table border="1" style="width: 100%; border-collapse: collapse; text-align: center;"> <tr> <td style="width: 10%;"></td> <td style="width: 10%;"></td> <td style="width: 10%;"></td> <td style="width: 10%;"></td> <td style="width: 10%;"></td> <td style="width: 10%;"></td> <td style="width: 10%;"></td> <td style="width: 10%;"></td> <td style="width: 10%;"></td> <td style="width: 10%;"></td> </tr> <tr> <td></td> <td></td> <td colspan="8" style="text-align: center;"> <table border="1" style="width: 100%; border-collapse: collapse; text-align: center;"> <tr> <td style="width: 10%;"></td> <td style="width: 10%;"></td> <td style="width: 10%;"></td> <td style="width: 10%;"></td> <td style="width: 10%;"></td> <td style="width: 10%;"></td> <td style="width: 10%;"></td> <td style="width: 10%;"></td> <td style="width: 10%;"></td> <td style="width: 10%;"></td> </tr> <tr> <td></td> <td></td> <td colspan="8" style="text-align: center;"> <table border="1" style="width: 100%; border-collapse: collapse; text-align: center;"> <tr> </tr></table></td></tr></table></td></tr></table></td></tr></table></td></tr></table></td></tr></table></td></tr></table></td></tr></table></td></tr></table></td></tr></table></td></tr></table></td></tr></table></td></tr></table></td></tr></table></td></tr></table></td></tr></table></td></tr></table></td></tr></table></td></tr></table></td></tr></table></td></tr></table></td></tr></table></td></tr></table></td></tr></table></td></tr></table></td></tr></table></td></tr></table></td></tr></table></td></tr></table></td></tr></table></td></tr></table></td></tr></table></td></tr></table></td></tr></table></td></tr></table></td></tr></table></td></tr></table></td></tr></table></td></tr></table></td></tr></table></td></tr></table></td></tr></table></td></tr></table></td></tr></table></td></tr></table></td></tr></table></td></tr></table> | | | | | | | | | | | | | | | | | | | | <table border="1" style="width: 100%; border-collapse: collapse; text-align: center;"> <tr> <td style="width: 10%;"></td> <td style="width: 10%;"></td> <td style="width: 10%;"></td> <td style="width: 10%;"></td> <td style="width: 10%;"></td> <td style="width: 10%;"></td> <td style="width: 10%;"></td> <td style="width: 10%;"></td> <td style="width: 10%;"></td> <td style="width: 10%;"></td> </tr> <tr> <td></td> <td></td> <td colspan="8" style="text-align: center;"> <table border="1" style="width: 100%; border-collapse: collapse; text-align: center;"> <tr> <td style="width: 10%;"></td> <td style="width: 10%;"></td> <td style="width: 10%;"></td> <td style="width: 10%;"></td> <td style="width: 10%;"></td> <td style="width: 10%;"></td> <td style="width: 10%;"></td> <td style="width: 10%;"></td> <td style="width: 10%;"></td> <td style="width: 10%;"></td> </tr> <tr> <td></td> <td></td> <td colspan="8" style="text-align: center;"> <table border="1" style="width: 100%; border-collapse: collapse; text-align: center;"> <tr> <td style="width: 10%;"></td> <td style="width: 10%;"></td> <td style="width: 10%;"></td> <td style="width: 10%;"></td> <td style="width: 10%;"></td> <td style="width: 10%;"></td> <td style="width: 10%;"></td> <td style="width: 10%;"></td> <td style="width: 10%;"></td> <td style="width: 10%;"></td> </tr> <tr> <td></td> <td></td> <td colspan="8" style="text-align: center;"> <table border="1" style="width: 100%; border-collapse: collapse; text-align: center;"> <tr> <td style="width: 10%;"></td> <td style="width: 10%;"></td> <td style="width: 10%;"></td> <td style="width: 10%;"></td> <td style="width: 10%;"></td> <td style="width: 10%;"></td> <td style="width: 10%;"></td> <td style="width: 10%;"></td> <td style="width: 10%;"></td> <td style="width: 10%;"></td> </tr> <tr> <td></td> <td></td> <td colspan="8" style="text-align: center;"> <table border="1" style="width: 100%; border-collapse: collapse; text-align: center;"> <tr> <td style="width: 10%;"></td> <td style="width: 10%;"></td> <td style="width: 10%;"></td> <td style="width: 10%;"></td> <td style="width: 10%;"></td> <td style="width: 10%;"></td> <td style="width: 10%;"></td> <td style="width: 10%;"></td> <td style="width: 10%;"></td> <td style="width: 10%;"></td> </tr> <tr> <td></td> <td></td> <td colspan="8" style="text-align: center;"> <table border="1" style="width: 100%; border-collapse: collapse; text-align: center;"> <tr> <td style="width: 10%;"></td> <td style="width: 10%;"></td> <td style="width: 10%;"></td> <td style="width: 10%;"></td> <td style="width: 10%;"></td> <td style="width: 10%;"></td> <td style="width: 10%;"></td> <td style="width: 10%;"></td> <td style="width: 10%;"></td> <td style="width: 10%;"></td> </tr> <tr> <td></td> <td></td> <td colspan="8" style="text-align: center;"> <table border="1" style="width: 100%; border-collapse: collapse; text-align: center;"> <tr> <td style="width: 10%;"></td> <td style="width: 10%;"></td> <td style="width: 10%;"></td> <td style="width: 10%;"></td> <td style="width: 10%;"></td> <td style="width: 10%;"></td> <td style="width: 10%;"></td> <td style="width: 10%;"></td> <td style="width: 10%;"></td> <td style="width: 10%;"></td> </tr> <tr> <td></td> <td></td> <td colspan="8" style="text-align: center;"> <table border="1" style="width: 100%; border-collapse: collapse; text-align: center;"> <tr> <td style="width: 10%;"></td> <td style="width: 10%;"></td> <td style="width: 10%;"></td> <td style="width: 10%;"></td> <td style="width: 10%;"></td> <td style="width: 10%;"></td> <td style="width: 10%;"></td> <td style="width: 10%;"></td> <td style="width: 10%;"></td> <td style="width: 10%;"></td> </tr> <tr> <td></td> <td></td> <td colspan="8" style="text-align: center;"> <table border="1" style="width: 100%; border-collapse: collapse; text-align: center;"> <tr> <td style="width: 10%;"></td> <td style="width: 10%;"></td> <td style="width: 10%;"></td> <td style="width: 10%;"></td> <td style="width: 10%;"></td> <td style="width: 10%;"></td> <td style="width: 10%;"></td> <td style="width: 10%;"></td> <td style="width: 10%;"></td> <td style="width: 10%;"></td> </tr> <tr> <td></td> <td></td> <td colspan="8" style="text-align: center;"> <table border="1" style="width: 100%; border-collapse: collapse; text-align: center;"> <tr> <td style="width: 10%;"></td> <td style="width: 10%;"></td> <td style="width: 10%;"></td> <td style="width: 10%;"></td> <td style="width: 10%;"></td> <td style="width: 10%;"></td> <td style="width: 10%;"></td> <td style="width: 10%;"></td> <td style="width: 10%;"></td> <td style="width: 10%;"></td> </tr> <tr> <td></td> <td></td> <td colspan="8" style="text-align: center;"> <table border="1" style="width: 100%; border-collapse: collapse; text-align: center;"> <tr> <td style="width: 10%;"></td> <td style="width: 10%;"></td> <td style="width: 10%;"></td> <td style="width: 10%;"></td> <td style="width: 10%;"></td> <td style="width: 10%;"></td> <td style="width: 10%;"></td> <td style="width: 10%;"></td> <td style="width: 10%;"></td> <td style="width: 10%;"></td> </tr> <tr> <td></td> <td></td> <td colspan="8" style="text-align: center;"> <table border="1" style="width: 100%; border-collapse: collapse; text-align: center;"> <tr> <td style="width: 10%;"></td> <td style="width: 10%;"></td> <td style="width: 10%;"></td> <td style="width: 10%;"></td> <td style="width: 10%;"></td> <td style="width: 10%;"></td> <td style="width: 10%;"></td> <td style="width: 10%;"></td> <td style="width: 10%;"></td> <td style="width: 10%;"></td> </tr> <tr> <td></td> <td></td> <td colspan="8" style="text-align: center;"> <table border="1" style="width: 100%; border-collapse: collapse; text-align: center;"> <tr> <td style="width: 10%;"></td> <td style="width: 10%;"></td> <td style="width: 10%;"></td> <td style="width: 10%;"></td> <td style="width: 10%;"></td> <td style="width: 10%;"></td> <td style="width: 10%;"></td> <td style="width: 10%;"></td> <td style="width: 10%;"></td> <td style="width: 10%;"></td> </tr> <tr> <td></td> <td></td> <td colspan="8" style="text-align: center;"> <table border="1" style="width: 100%; border-collapse: collapse; text-align: center;"> <tr> <td style="width: 10%;"></td> <td style="width: 10%;"></td> <td style="width: 10%;"></td> <td style="width:
10%;"></td> <td style="width: 10%;"></td> <td style="width: 10%;"></td> <td style="width: 10%;"></td> <td style="width: 10%;"></td> <td style="width: 10%;"></td> <td style="width: 10%;"></td> </tr> <tr> <td></td> <td></td> <td colspan="8" style="text-align: center;"> <table border="1" style="width: 100%; border-collapse: collapse; text-align: center;"> <tr> <td style="width: 10%;"></td> <td style="width: 10%;"></td> <td style="width: 10%;"></td> <td style="width: 10%;"></td> <td style="width: 10%;"></td> <td style="width: 10%;"></td> <td style="width: 10%;"></td> <td style="width: 10%;"></td> <td style="width: 10%;"></td> <td style="width: 10%;"></td> </tr> <tr> <td></td> <td></td> <td colspan="8" style="text-align: center;"> <table border="1" style="width: 100%; border-collapse: collapse; text-align: center;"> <tr> <td style="width: 10%;"></td> <td style="width: 10%;"></td> <td style="width: 10%;"></td> <td style="width: 10%;"></td> <td style="width: 10%;"></td> <td style="width: 10%;"></td> <td style="width: 10%;"></td> <td style="width: 10%;"></td> <td style="width: 10%;"></td> <td style="width: 10%;"></td> </tr> <tr> <td></td> <td></td> <td colspan="8" style="text-align: center;"> <table border="1" style="width: 100%; border-collapse: collapse; text-align: center;"> <tr> <td style="width: 10%;"></td> <td style="width: 10%;"></td> <td style="width: 10%;"></td> <td style="width: 10%;"></td> <td style="width: 10%;"></td> <td style="width: 10%;"></td> <td style="width: 10%;"></td> <td style="width: 10%;"></td> <td style="width: 10%;"></td> <td style="width: 10%;"></td> </tr> <tr> <td></td> <td></td> <td colspan="8" style="text-align: center;"> <table border="1" style="width: 100%; border-collapse: collapse; text-align: center;"> <tr> <td style="width: 10%;"></td> <td style="width: 10%;"></td> <td style="width: 10%;"></td> <td style="width: 10%;"></td> <td style="width: 10%;"></td> <td style="width: 10%;"></td> <td style="width: 10%;"></td> <td style="width: 10%;"></td> <td style="width: 10%;"></td> <td style="width: 10%;"></td> </tr> <tr> <td></td> <td></td> <td colspan="8" style="text-align: center;"> <table border="1" style="width: 100%; border-collapse: collapse; text-align: center;"> <tr> <td style="width: 10%;"></td> <td style="width: 10%;"></td> <td style="width: 10%;"></td> <td style="width: 10%;"></td> <td style="width: 10%;"></td> <td style="width: 10%;"></td> <td style="width: 10%;"></td> <td style="width: 10%;"></td> <td style="width: 10%;"></td> <td style="width: 10%;"></td> </tr> <tr> <td></td> <td></td> <td colspan="8" style="text-align: center;"> <table border="1" style="width: 100%; border-collapse: collapse; text-align: center;"> <tr> <td style="width: 10%;"></td> <td style="width: 10%;"></td> <td style="width: 10%;"></td> <td style="width: 10%;"></td> <td style="width: 10%;"></td> <td style="width: 10%;"></td> <td style="width: 10%;"></td> <td style="width: 10%;"></td> <td style="width: 10%;"></td> <td style="width: 10%;"></td> </tr> <tr> <td></td> <td></td> <td colspan="8" style="text-align: center;"> <table border="1" style="width: 100%; border-collapse: collapse; text-align: center;"> <tr> <td style="width: 10%;"></td> <td style="width: 10%;"></td> <td style="width: 10%;"></td> <td style="width: 10%;"></td> <td style="width: 10%;"></td> <td style="width: 10%;"></td> <td style="width: 10%;"></td> <td style="width: 10%;"></td> <td style="width: 10%;"></td> <td style="width: 10%;"></td> </tr> <tr> <td></td> <td></td> <td colspan="8" style="text-align: center;"> <table border="1" style="width: 100%; border-collapse: collapse; text-align: center;"> <tr> <td style="width: 10%;"></td> <td style="width: 10%;"></td> <td style="width: 10%;"></td> <td style="width: 10%;"></td> <td style="width: 10%;"></td> <td style="width: 10%;"></td> <td style="width: 10%;"></td> <td style="width: 10%;"></td> <td style="width: 10%;"></td> <td style="width: 10%;"></td> </tr> <tr> <td></td> <td></td> <td colspan="8" style="text-align: center;"> <table border="1" style="width: 100%; border-collapse: collapse; text-align: center;"> <tr> <td style="width: 10%;"></td> <td style="width: 10%;"></td> <td style="width: 10%;"></td> <td style="width: 10%;"></td> <td style="width: 10%;"></td> <td style="width: 10%;"></td> <td style="width: 10%;"></td> <td style="width: 10%;"></td> <td style="width: 10%;"></td> <td style="width: 10%;"></td> </tr> <tr> <td></td> <td></td> <td colspan="8" style="text-align: center;"> <table border="1" style="width: 100%; border-collapse: collapse; text-align: center;"> <tr> <td style="width: 10%;"></td> <td style="width: 10%;"></td> <td style="width: 10%;"></td> <td style="width: 10%;"></td> <td style="width: 10%;"></td> <td style="width: 10%;"></td> <td style="width: 10%;"></td> <td style="width: 10%;"></td> <td style="width: 10%;"></td> <td style="width: 10%;"></td> </tr> <tr> <td></td> <td></td> <td colspan="8" style="text-align: center;"> <table border="1" style="width: 100%; border-collapse: collapse; text-align: center;"> <tr> <td style="width: 10%;"></td> <td style="width: 10%;"></td> <td style="width: 10%;"></td> <td style="width: 10%;"></td> <td style="width: 10%;"></td> <td style="width: 10%;"></td> <td style="width: 10%;"></td> <td style="width: 10%;"></td> <td style="width: 10%;"></td> <td style="width: 10%;"></td> </tr> <tr> <td></td> <td></td> <td colspan="8" style="text-align: center;"> <table border="1" style="width: 100%; border-collapse: collapse; text-align: center;"> <tr> <td style="width: 10%;"></td> <td style="width: 10%;"></td> <td style="width: 10%;"></td> <td style="width: 10%;"></td> <td style="width: 10%;"></td> <td style="width: 10%;"></td> <td style="width: 10%;"></td> <td style="width: 10%;"></td> <td style="width: 10%;"></td> <td style="width: 10%;"></td> </tr> <tr> <td></td> <td></td> <td colspan="8" style="text-align: center;"> <table border="1" style="width: 100%; border-collapse: collapse; text-align: center;"> <tr> <td style="width: 10%;"></td> <td style="width: 10%;"></td> <td style="width: 10%;"></td> <td style="width: 10%;"></td> <td style="width: 10%;"></td> <td style="width: 10%;"></td> <td style="width: 10%;"></td> <td style="width: 10%;"></td> <td style="width: 10%;"></td> <td style="width: 10%;"></td> </tr> <tr> <td></td> <td></td> <td colspan="8" style="text-align: center;"> <table border="1" style="width: 100%; border-collapse: collapse; text-align: center;"> <tr> <td style="width: 10%;"></td> <td style="width: 10%;"></td> <td style="width: 10%;"></td> <td style="width: 10%;"></td> <td style="width: 10%;"></td> <td style="width: 10%;"></td> <td style="width: 10%;"></td> <td style="width: 10%;"></td> <td style="width: 10%;"></td> <td style="width: 10%;"></td> </tr> <tr> <td></td> <td></td> <td colspan="8" style="text-align: center;"> <table border="1" style="width: 100%; border-collapse: collapse; text-align: center;"> <tr> <td style="width: 10%;"></td> <td style="width: 10%;"></td> <td style="width: 10%;"></td> <td style="width: 10%;"></td> <td style="width: 10%;"></td> <td style="width: 10%;"></td> <td style="width: 10%;"></td> <td style="width: 10%;"></td> <td style="width: 10%;"></td> <td style="width: 10%;"></td> </tr> <tr> <td></td> <td></td> <td colspan="8" style="text-align: center;"> <table border="1" style="width: 100%; border-collapse: collapse; text-align: center;"> <tr> <td style="width: 10%;"></td> <td style="width: 10%;"></td> <td style="width: 10%;"></td> <td style="width: 10%;"></td> <td style="width: 10%;"></td> <td style="width: 10%;"></td> <td style="width: 10%;"></td> <td style="width: 10%;"></td> <td style="width: 10%;"></td> <td style="width: 10%;"></td> </tr> <tr> <td></td> <td></td> <td colspan="8" style="text-align: center;"> <table border="1" style="width: 100%; border-collapse: collapse; text-align: center;"> <tr> <td style="width: 10%;"></td> <td style="width: 10%;"></td> <td style="width: 10%;"></td> <td style="width: 10%;"></td> <td style="width: 10%;"></td> <td style="width: 10%;"></td> <td style="width: 10%;"></td> <td style="width: 10%;"></td> <td style="width: 10%;"></td> <td style="width: 10%;"></td> </tr> <tr> <td></td> <td></td> <td colspan="8" style="text-align: center;"> <table border="1" style="width: 100%; border-collapse: collapse; text-align: center;"> <tr> <td style="width: 10%;"></td> <td style="width: 10%;"></td> <td style="width: 10%;"></td> <td style="width: 10%;"></td> <td style="width: 10%;"></td> <td style="width: 10%;"></td> <td style="width: 10%;"></td> <td style="width: 10%;"></td> <td style="width: 10%;"></td> <td style="width: 10%;"></td> </tr> <tr> <td></td> <td></td> <td colspan="8" style="text-align: center;"> <table border="1" style="width: 100%; border-collapse: collapse; text-align: center;"> <tr> <td style="width: 10%;"></td> <td style="width: 10%;"></td> <td style="width: 10%;"></td> <td style="width: 10%;"></td> <td style="width: 10%;"></td> <td style="width: 10%;"></td> <td style="width: 10%;"></td> <td style="width: 10%;"></td> <td style="width: 10%;"></td> <td style="width: 10%;"></td> </tr> <tr> <td></td> <td></td> <td colspan="8" style="text-align: center;"> <table border="1" style="width: 100%; border-collapse: collapse; text-align: center;"> <tr> <td style="width: 10%;"></td> <td style="width: 10%;"></td> <td style="width: 10%;"></td> <td style="width: 10%;"></td> <td style="width: 10%;"></td> <td style="width: 10%;"></td> <td style="width: 10%;"></td> <td style="width: 10%;"></td> <td style="width: 10%;"></td> <td style="width: 10%;"></td> </tr> <tr> <td></td> <td></td> <td colspan="8" style="text-align: center;"> <table border="1" style="width: 100%; border-collapse: collapse; text-align: center;"> <tr> <td style="width: 10%;"></td> <td style="width: 10%;"></td> <td style="width: 10%;"></td> <td style="width: 10%;"></td> <td style="width: 10%;"></td> <td style="width: 10%;"></td> <td style="width: 10%;"></td> <td style="width: 10%;"></td> <td style="width: 10%;"></td> <td
style="width: 10%;"></td> </tr> <tr> <td></td> <td></td> <td colspan="8" style="text-align: center;"> <table border="1" style="width: 100%; border-collapse: collapse; text-align: center;"> <tr> <td style="width: 10%;"></td> <td style="width: 10%;"></td> <td style="width: 10%;"></td> <td style="width: 10%;"></td> <td style="width: 10%;"></td> <td style="width: 10%;"></td> <td style="width: 10%;"></td> <td style="width: 10%;"></td> <td style="width: 10%;"></td> <td style="width: 10%;"></td> </tr> <tr> <td></td> <td></td> <td colspan="8" style="text-align: center;"> <table border="1" style="width: 100%; border-collapse: collapse; text-align: center;"> <tr> <td style="width: 10%;"></td> <td style="width: 10%;"></td> <td style="width: 10%;"></td> <td style="width: 10%;"></td> <td style="width: 10%;"></td> <td style="width: 10%;"></td> <td style="width: 10%;"></td> <td style="width: 10%;"></td> <td style="width: 10%;"></td> <td style="width: 10%;"></td> </tr> <tr> <td></td> <td></td> <td colspan="8" style="text-align: center;"> <table border="1" style="width: 100%; border-collapse: collapse; text-align: center;"> <tr> <td style="width: 10%;"></td> <td style="width: 10%;"></td> <td style="width: 10%;"></td> <td style="width: 10%;"></td> <td style="width: 10%;"></td> <td style="width: 10%;"></td> <td style="width: 10%;"></td> <td style="width: 10%;"></td> <td style="width: 10%;"></td> <td style="width: 10%;"></td> </tr> <tr> <td></td> <td></td> <td colspan="8" style="text-align: center;"> <table border="1" style="width: 100%; border-collapse: collapse; text-align: center;"> <tr> <td style="width: 10%;"></td> <td style="width: 10%;"></td> <td style="width: 10%;"></td> <td style="width: 10%;"></td> <td style="width: 10%;"></td> <td style="width: 10%;"></td> <td style="width: 10%;"></td> <td style="width: 10%;"></td> <td style="width: 10%;"></td> <td style="width: 10%;"></td> </tr> <tr> <td></td> <td></td> <td colspan="8" style="text-align: center;"> <table border="1" style="width: 100%; border-collapse: collapse; text-align: center;"> <tr> <td style="width: 10%;"></td> <td style="width: 10%;"></td> <td style="width: 10%;"></td> <td style="width: 10%;"></td> <td style="width: 10%;"></td> <td style="width: 10%;"></td> <td style="width: 10%;"></td> <td style="width: 10%;"></td> <td style="width: 10%;"></td> <td style="width: 10%;"></td> </tr> <tr> <td></td> <td></td> <td colspan="8" style="text-align: center;"> <table border="1" style="width: 100%; border-collapse: collapse; text-align: center;"> <tr> <td style="width: 10%;"></td> <td style="width: 10%;"></td> <td style="width: 10%;"></td> <td style="width: 10%;"></td> <td style="width: 10%;"></td> <td style="width: 10%;"></td> <td style="width: 10%;"></td> <td style="width: 10%;"></td> <td style="width: 10%;"></td> <td style="width: 10%;"></td> </tr> <tr> <td></td> <td></td> <td colspan="8" style="text-align: center;"> <table border="1" style="width: 100%; border-collapse: collapse; text-align: center;"> <tr> <td style="width: 10%;"></td> <td style="width: 10%;"></td> <td style="width: 10%;"></td> <td style="width: 10%;"></td> <td style="width: 10%;"></td> <td style="width: 10%;"></td> <td style="width: 10%;"></td> <td style="width: 10%;"></td> <td style="width: 10%;"></td> <td style="width: 10%;"></td> </tr> <tr> <td></td> <td></td> <td colspan="8" style="text-align: center;"> <table border="1" style="width: 100%; border-collapse: collapse; text-align: center;"> <tr> <td style="width: 10%;"></td> <td style="width: 10%;"></td> <td style="width: 10%;"></td> <td style="width: 10%;"></td> <td style="width: 10%;"></td> <td style="width: 10%;"></td> <td style="width: 10%;"></td> <td style="width: 10%;"></td> <td style="width: 10%;"></td> <td style="width: 10%;"></td> </tr> <tr> <td></td> <td></td> <td colspan="8" style="text-align: center;"> <table border="1" style="width: 100%; border-collapse: collapse; text-align: center;"> <tr> <td style="width: 10%;"></td> <td style="width: 10%;"></td> <td style="width: 10%;"></td> <td style="width: 10%;"></td> <td style="width: 10%;"></td> <td style="width: 10%;"></td> <td style="width: 10%;"></td> <td style="width: 10%;"></td> <td style="width: 10%;"></td> <td style="width: 10%;"></td> </tr> <tr> <td></td> <td></td> <td colspan="8" style="text-align: center;"> <table border="1" style="width: 100%; border-collapse: collapse; text-align: center;"> <tr> <td style="width: 10%;"></td> <td style="width: 10%;"></td> <td style="width: 10%;"></td> <td style="width: 10%;"></td> <td style="width: 10%;"></td> <td style="width: 10%;"></td> <td style="width: 10%;"></td> <td style="width: 10%;"></td> <td style="width: 10%;"></td> <td style="width: 10%;"></td> </tr> <tr> <td></td> <td></td> <td colspan="8" style="text-align: center;"> <table border="1" style="width: 100%; border-collapse: collapse; text-align: center;"> <tr> </tr></table></td></tr></table></td></tr></table></td></tr></table></td></tr></table></td></tr></table></td></tr></table></td></tr></table></td></tr></table></td></tr></table></td></tr></table></td></tr></table></td></tr></table></td></tr></table></td></tr></table></td></tr></table></td></tr></table></td></tr></table></td></tr></table></td></tr></table></td></tr></table></td></tr></table></td></tr></table></td></tr></table></td></tr></table></td></tr></table></td></tr></table></td></tr></table></td></tr></table></td></tr></table></td></tr></table></td></tr></table></td></tr></table></td></tr></table></td></tr></table></td></tr></table></td></tr></table></td></tr></table></td></tr></table></td></tr></table></td></tr></table></td></tr></table></td></tr></table></td></tr></table></td></tr></table></td></tr></table> | | | | | | | | | | | | | | | | | | | | <table border="1" style="width: 100%; border-collapse: collapse; text-align: center;"> <tr> <td style="width: 10%;"></td> <td style="width: 10%;"></td> <td style="width: 10%;"></td> <td style="width: 10%;"></td> <td style="width: 10%;"></td> <td style="width: 10%;"></td> <td style="width: 10%;"></td> <td style="width: 10%;"></td> <td style="width: 10%;"></td> <td style="width: 10%;"></td> </tr> <tr> <td></td> <td></td> <td colspan="8" style="text-align: center;"> <table border="1" style="width: 100%; border-collapse: collapse; text-align: center;"> <tr> <td style="width: 10%;"></td> <td style="width: 10%;"></td> <td style="width: 10%;"></td> <td style="width: 10%;"></td> <td style="width: 10%;"></td> <td style="width: 10%;"></td> <td style="width: 10%;"></td> <td style="width: 10%;"></td> <td style="width: 10%;"></td> <td style="width: 10%;"></td> </tr> <tr> <td></td> <td></td> <td colspan="8" style="text-align: center;"> <table border="1" style="width: 100%; border-collapse: collapse; text-align: center;"> <tr> <td style="width: 10%;"></td> <td style="width: 10%;"></td> <td style="width: 10%;"></td> <td style="width: 10%;"></td> <td style="width: 10%;"></td> <td style="width: 10%;"></td> <td style="width: 10%;"></td> <td style="width: 10%;"></td> <td style="width: 10%;"></td> <td style="width: 10%;"></td> </tr> <tr> <td></td> <td></td> <td colspan="8" style="text-align: center;"> <table border="1" style="width: 100%; border-collapse: collapse; text-align: center;"> <tr> <td style="width: 10%;"></td> <td style="width: 10%;"></td> <td style="width: 10%;"></td> <td style="width: 10%;"></td> <td style="width: 10%;"></td> <td style="width: 10%;"></td> <td style="width: 10%;"></td> <td style="width: 10%;"></td> <td style="width: 10%;"></td> <td style="width: 10%;"></td> </tr> <tr> <td></td> <td></td> <td colspan="8" style="text-align: center;"> <table border="1" style="width: 100%; border-collapse: collapse; text-align: center;"> <tr> <td style="width: 10%;"></td> <td style="width: 10%;"></td> <td style="width: 10%;"></td> <td style="width: 10%;"></td> <td style="width: 10%;"></td> <td style="width: 10%;"></td> <td style="width: 10%;"></td> <td style="width: 10%;"></td> <td style="width: 10%;"></td> <td style="width: 10%;"></td> </tr> <tr> <td></td> <td></td> <td colspan="8" style="text-align: center;"> <table border="1" style="width: 100%; border-collapse: collapse; text-align: center;"> <tr> <td style="width: 10%;"></td> <td style="width: 10%;"></td> <td style="width: 10%;"></td> <td style="width: 10%;"></td> <td style="width: 10%;"></td> <td style="width: 10%;"></td> <td style="width: 10%;"></td> <td style="width: 10%;"></td> <td style="width: 10%;"></td> <td style="width: 10%;"></td> </tr> <tr> <td></td> <td></td> <td colspan="8"
style="text-align: center;"> <table border="1" style="width: 100%; border-collapse: collapse; text-align: center;"> <tr> <td style="width: 10%;"></td> <td style="width: 10%;"></td> <td style="width: 10%;"></td> <td style="width: 10%;"></td> <td style="width: 10%;"></td> <td style="width: 10%;"></td> <td style="width: 10%;"></td> <td style="width: 10%;"></td> <td style="width: 10%;"></td> <td style="width: 10%;"></td> </tr> <tr> <td></td> <td></td> <td colspan="8" style="text-align: center;"> <table border="1" style="width: 100%; border-collapse: collapse; text-align: center;"> <tr> <td style="width: 10%;"></td> <td style="width: 10%;"></td> <td style="width: 10%;"></td> <td style="width: 10%;"></td> <td style="width: 10%;"></td> <td style="width: 10%;"></td> <td style="width: 10%;"></td> <td style="width: 10%;"></td> <td style="width: 10%;"></td> <td style="width: 10%;"></td> </tr> <tr> <td></td> <td></td> <td colspan="8" style="text-align: center;"> <table border="1" style="width: 100%; border-collapse: collapse; text-align: center;"> <tr> <td style="width: 10%;"></td> <td style="width: 10%;"></td> <td style="width: 10%;"></td> <td style="width: 10%;"></td> <td style="width: 10%;"></td> <td style="width: 10%;"></td> <td style="width: 10%;"></td> <td style="width: 10%;"></td> <td style="width: 10%;"></td> <td style="width: 10%;"></td> </tr> <tr> <td></td> <td></td> <td colspan="8" style="text-align: center;"> <table border="1" style="width: 100%; border-collapse: collapse; text-align: center;"> <tr> <td style="width: 10%;"></td> <td style="width: 10%;"></td> <td style="width: 10%;"></td> <td style="width: 10%;"></td> <td style="width: 10%;"></td> <td style="width: 10%;"></td> <td style="width: 10%;"></td> <td style="width: 10%;"></td> <td style="width: 10%;"></td> <td style="width: 10%;"></td> </tr> <tr> <td></td> <td></td> <td colspan="8" style="text-align: center;"> <table border="1" style="width: 100%; border-collapse: collapse; text-align: center;"> <tr> <td style="width: 10%;"></td> <td style="width: 10%;"></td> <td style="width: 10%;"></td> <td style="width: 10%;"></td> <td style="width: 10%;"></td> <td style="width: 10%;"></td> <td style="width: 10%;"></td> <td style="width: 10%;"></td> <td style="width: 10%;"></td> <td style="width: 10%;"></td> </tr> <tr> <td></td> <td></td> <td colspan="8" style="text-align: center;"> <table border="1" style="width: 100%; border-collapse: collapse; text-align: center;"> <tr> <td style="width: 10%;"></td> <td style="width: 10%;"></td> <td style="width: 10%;"></td> <td style="width: 10%;"></td> <td style="width: 10%;"></td> <td style="width: 10%;"></td> <td style="width: 10%;"></td> <td style="width: 10%;"></td> <td style="width: 10%;"></td> <td style="width: 10%;"></td> </tr> <tr> <td></td> <td></td> <td colspan="8" style="text-align: center;"> <table border="1" style="width: 100%; border-collapse: collapse; text-align: center;"> <tr> <td style="width: 10%;"></td> <td style="width: 10%;"></td> <td style="width: 10%;"></td> <td style="width: 10%;"></td> <td style="width: 10%;"></td> <td style="width: 10%;"></td> <td style="width: 10%;"></td> <td style="width: 10%;"></td> <td style="width: 10%;"></td> <td style="width: 10%;"></td> </tr> <tr> <td></td> <td></td> <td colspan="8" style="text-align: center;"> <table border="1" style="width: 100%; border-collapse: collapse; text-align: center;"> <tr> <td style="width: 10%;"></td> <td style="width: 10%;"></td> <td style="width: 10%;"></td> <td style="width: 10%;"></td> <td style="width: 10%;"></td> <td style="width: 10%;"></td> <td style="width: 10%;"></td> <td style="width: 10%;"></td> <td style="width: 10%;"></td> <td style="width: 10%;"></td> </tr> <tr> <td></td> <td></td> <td colspan="8" style="text-align: center;"> <table border="1" style="width: 100%; border-collapse: collapse; text-align: center;"> <tr> <td style="width: 10%;"></td> <td style="width: 10%;"></td> <td style="width: 10%;"></td> <td style="width: 10%;"></td> <td style="width: 10%;"></td> <td style="width: 10%;"></td> <td style="width: 10%;"></td> <td style="width: 10%;"></td> <td style="width: 10%;"></td> <td style="width: 10%;"></td> </tr> <tr> <td></td> <td></td> <td colspan="8" style="text-align: center;"> <table border="1" style="width: 100%; border-collapse: collapse; text-align: center;"> <tr> <td style="width: 10%;"></td> <td style="width: 10%;"></td> <td style="width: 10%;"></td> <td style="width: 10%;"></td> <td style="width: 10%;"></td> <td style="width: 10%;"></td> <td style="width: 10%;"></td> <td style="width: 10%;"></td> <td style="width: 10%;"></td> <td style="width: 10%;"></td> </tr> <tr> <td></td> <td></td> <td colspan="8" style="text-align: center;"> <table border="1" style="width: 100%; border-collapse: collapse; text-align: center;"> <tr> <td style="width: 10%;"></td> <td style="width: 10%;"></td> <td style="width: 10%;"></td> <td style="width: 10%;"></td> <td style="width: 10%;"></td> <td style="width: 10%;"></td> <td style="width: 10%;"></td> <td style="width: 10%;"></td> <td style="width: 10%;"></td> <td style="width: 10%;"></td> </tr> <tr> <td></td> <td></td> <td colspan="8" style="text-align: center;"> <table border="1" style="width: 100%; border-collapse: collapse; text-align: center;"> <tr> <td style="width: 10%;"></td> <td style="width: 10%;"></td> <td style="width: 10%;"></td> <td style="width: 10%;"></td> <td style="width: 10%;"></td> <td style="width: 10%;"></td> <td style="width: 10%;"></td> <td style="width: 10%;"></td> <td style="width: 10%;"></td> <td style="width: 10%;"></td> </tr> <tr> <td></td> <td></td> <td colspan="8" style="text-align: center;"> <table border="1" style="width: 100%; border-collapse: collapse; text-align: center;"> <tr> <td style="width: 10%;"></td> <td style="width: 10%;"></td> <td style="width: 10%;"></td> <td style="width: 10%;"></td> <td style="width: 10%;"></td> <td style="width: 10%;"></td> <td style="width: 10%;"></td> <td style="width: 10%;"></td> <td style="width: 10%;"></td> <td style="width: 10%;"></td> </tr> <tr> <td></td> <td></td> <td colspan="8" style="text-align: center;"> <table border="1" style="width: 100%; border-collapse: collapse; text-align: center;"> <tr> <td style="width: 10%;"></td> <td style="width: 10%;"></td> <td style="width: 10%;"></td> <td style="width: 10%;"></td> <td style="width: 10%;"></td> <td style="width: 10%;"></td> <td style="width: 10%;"></td> <td style="width: 10%;"></td> <td style="width: 10%;"></td> <td style="width: 10%;"></td> </tr> <tr> <td></td> <td></td> <td colspan="8" style="text-align: center;"> <table border="1" style="width: 100%; border-collapse: collapse; text-align: center;"> <tr> <td style="width: 10%;"></td> <td style="width: 10%;"></td> <td style="width: 10%;"></td> <td style="width: 10%;"></td> <td style="width: 10%;"></td> <td style="width: 10%;"></td> <td style="width: 10%;"></td> <td style="width: 10%;"></td> <td style="width: 10%;"></td> <td style="width: 10%;"></td> </tr> <tr> <td></td> <td></td> <td colspan="8" style="text-align: center;"> <table border="1" style="width: 100%; border-collapse: collapse; text-align: center;"> <tr> <td style="width: 10%;"></td> <td style="width: 10%;"></td> <td style="width: 10%;"></td> <td style="width: 10%;"></td> <td style="width: 10%;"></td> <td style="width: 10%;"></td> <td style="width: 10%;"></td> <td style="width: 10%;"></td> <td style="width: 10%;"></td> <td style="width: 10%;"></td> </tr> <tr> <td></td> <td></td> <td colspan="8" style="text-align: center;"> <table border="1" style="width: 100%; border-collapse: collapse; text-align: center;"> <tr> <td style="width: 10%;"></td> <td style="width: 10%;"></td> <td style="width: 10%;"></td> <td style="width: 10%;"></td> <td style="width: 10%;"></td> <td style="width: 10%;"></td> <td style="width: 10%;"></td> <td style="width: 10%;"></td> <td style="width: 10%;"></td> <td style="width: 10%;"></td> </tr> <tr> <td></td> <td></td> <td colspan="8" style="text-align: center;"> <table border="1" style="width: 100%; border-collapse: collapse; text-align: center;"> <tr> <td style="width: 10%;"></td> <td style="width: 10%;"></td> <td style="width: 10%;"></td> <td style="width: 10%;"></td> <td style="width: 10%;"></td> <td style="width: 10%;"></td> <td style="width: 10%;"></td> <td style="width: 10%;"></td> <td style="width: 10%;"></td> <td style="width: 10%;"></td> </tr> <tr> <td></td> <td></td> <td colspan="8" style="text-align: center;"> <table border="1" style="width: 100%; border-collapse: collapse; text-align: center;"> <tr> <td style="width: 10%;"></td> <td style="width: 10%;"></td> <td style="width: 10%;"></td> <td style="width: 10%;"></td> <td style="width: 10%;"></td> <td style="width: 10%;"></td> <td style="width: 10%;"></td> <td style="width: 10%;"></td> <td style="width: 10%;"></td> <td style="width: 10%;"></td> </tr> <tr> <td></td> <td></td> <td colspan="8" style="text-align: center;"> <table border="1" style="width: 100%; border-collapse: collapse; text-align: center;"> <tr> <td style="width: 10%;"></td> <td style="width: 10%;"></td> <td style="width: 10%;"></td> <td style="width: 10%;"></td> <td style="width: 10%;"></td> <td style="width: 10%;"></td> <td style="width: 10%;"></td> <td style="width: 10%;"></td> <td style="width: 10%;"></td> <td style="width: 10%;"></td> </tr> <tr> <td></td> <td></td> <td colspan="8" style="text-align: center;"> <table border="1" style="width: 100%; border-collapse: collapse; text-align: center;"> <tr> <td style="width: 10%;"></td> <td style="width: 10%;"></td> <td style="width: 10%;"></td> <td style="width: 10%;"></td> <td style="width: 10%;"></td> <td style="width: 10%;"></td> <td style="width: 10%;"></td> <td style="width: 10%;"></td> <td style="width: 10%;"></td> <td style="width: 10%;"></td> </tr> <tr> <td></td> <td></td> <td colspan="8" style="text-align: center;"> <table border="1" style="width: 100%; border-collapse: collapse; text-align: center;"> <tr> <td style="width: 10%;"></td> <td style="width:
10%;"></td> <td style="width: 10%;"></td> <td style="width: 10%;"></td> <td style="width: 10%;"></td> <td style="width: 10%;"></td> <td style="width: 10%;"></td> <td style="width: 10%;"></td> <td style="width: 10%;"></td> <td style="width: 10%;"></td> </tr> <tr> <td></td> <td></td> <td colspan="8" style="text-align: center;"> <table border="1" style="width: 100%; border-collapse: collapse; text-align: center;"> <tr> <td style="width: 10%;"></td> <td style="width: 10%;"></td> <td style="width: 10%;"></td> <td style="width: 10%;"></td> <td style="width: 10%;"></td> <td style="width: 10%;"></td> <td style="width: 10%;"></td> <td style="width: 10%;"></td> <td style="width: 10%;"></td> <td style="width: 10%;"></td> </tr> <tr> <td></td> <td></td> <td colspan="8" style="text-align: center;"> <table border="1" style="width: 100%; border-collapse: collapse; text-align: center;"> <tr> <td style="width: 10%;"></td> <td style="width: 10%;"></td> <td style="width: 10%;"></td> <td style="width: 10%;"></td> <td style="width: 10%;"></td> <td style="width: 10%;"></td> <td style="width: 10%;"></td> <td style="width: 10%;"></td> <td style="width: 10%;"></td> <td style="width: 10%;"></td> </tr> <tr> <td></td> <td></td> <td colspan="8" style="text-align: center;"> <table border="1" style="width: 100%; border-collapse: collapse; text-align: center;"> <tr> <td style="width: 10%;"></td> <td style="width: 10%;"></td> <td style="width: 10%;"></td> <td style="width: 10%;"></td> <td style="width: 10%;"></td> <td style="width: 10%;"></td> <td style="width: 10%;"></td> <td style="width: 10%;"></td> <td style="width: 10%;"></td> <td style="width: 10%;"></td> </tr> <tr> <td></td> <td></td> <td colspan="8" style="text-align: center;"> <table border="1" style="width: 100%; border-collapse: collapse; text-align: center;"> <tr> <td style="width: 10%;"></td> <td style="width: 10%;"></td> <td style="width: 10%;"></td> <td style="width: 10%;"></td> <td style="width: 10%;"></td> <td style="width: 10%;"></td> <td style="width: 10%;"></td> <td style="width: 10%;"></td> <td style="width: 10%;"></td> <td style="width: 10%;"></td> </tr> <tr> <td></td> <td></td> <td colspan="8" style="text-align: center;"> <table border="1" style="width: 100%; border-collapse: collapse; text-align: center;"> <tr> <td style="width: 10%;"></td> <td style="width: 10%;"></td> <td style="width: 10%;"></td> <td style="width: 10%;"></td> <td style="width: 10%;"></td> <td style="width: 10%;"></td> <td style="width: 10%;"></td> <td style="width: 10%;"></td> <td style="width: 10%;"></td> <td style="width: 10%;"></td> </tr> <tr> <td></td> <td></td> <td colspan="8" style="text-align: center;"> <table border="1" style="width: 100%; border-collapse: collapse; text-align: center;"> <tr> <td style="width: 10%;"></td> <td style="width: 10%;"></td> <td style="width: 10%;"></td> <td style="width: 10%;"></td> <td style="width: 10%;"></td> <td style="width: 10%;"></td> <td style="width: 10%;"></td> <td style="width: 10%;"></td> <td style="width: 10%;"></td> <td style="width: 10%;"></td> </tr> <tr> <td></td> <td></td> <td colspan="8" style="text-align: center;"> <table border="1" style="width: 100%; border-collapse: collapse; text-align: center;"> <tr> <td style="width: 10%;"></td> <td style="width: 10%;"></td> <td style="width: 10%;"></td> <td style="width: 10%;"></td> <td style="width: 10%;"></td> <td style="width: 10%;"></td> <td style="width: 10%;"></td> <td style="width: 10%;"></td> <td style="width: 10%;"></td> <td style="width: 10%;"></td> </tr> <tr> <td></td> <td></td> <td colspan="8" style="text-align: center;"> <table border="1" style="width: 100%; border-collapse: collapse; text-align: center;"> <tr> <td style="width: 10%;"></td> <td style="width: 10%;"></td> <td style="width: 10%;"></td> <td style="width: 10%;"></td> <td style="width: 10%;"></td> <td style="width: 10%;"></td> <td style="width: 10%;"></td> <td style="width: 10%;"></td> <td style="width: 10%;"></td> <td style="width: 10%;"></td> </tr> <tr> <td></td> <td></td> <td colspan="8" style="text-align: center;"> <table border="1" style="width: 100%; border-collapse: collapse; text-align: center;"> <tr> <td style="width: 10%;"></td> <td style="width: 10%;"></td> <td style="width: 10%;"></td> <td style="width: 10%;"></td> <td style="width: 10%;"></td> <td style="width: 10%;"></td> <td style="width: 10%;"></td> <td style="width: 10%;"></td> <td style="width: 10%;"></td> <td style="width: 10%;"></td> </tr> <tr> <td></td> <td></td> <td colspan="8" style="text-align: center;"> <table border="1" style="width: 100%; border-collapse: collapse; text-align: center;"> <tr> <td style="width: 10%;"></td> <td style="width: 10%;"></td> <td style="width: 10%;"></td> <td style="width: 10%;"></td> <td style="width: 10%;"></td> <td style="width: 10%;"></td> <td style="width: 10%;"></td> <td style="width: 10%;"></td> <td style="width: 10%;"></td> <td style="width: 10%;"></td> </tr> <tr> <td></td> <td></td> <td colspan="8" style="text-align: center;"> <table border="1" style="width: 100%; border-collapse: collapse; text-align: center;"> <tr> <td style="width: 10%;"></td> <td style="width: 10%;"></td> <td style="width: 10%;"></td> <td style="width: 10%;"></td> <td style="width: 10%;"></td> <td style="width: 10%;"></td> <td style="width: 10%;"></td> <td style="width: 10%;"></td> <td style="width: 10%;"></td> <td style="width: 10%;"></td> </tr> <tr> <td></td> <td></td> <td colspan="8" style="text-align: center;"> <table border="1" style="width: 100%; border-collapse: collapse; text-align: center;"> <tr> <td style="width: 10%;"></td> <td style="width: 10%;"></td> <td style="width: 10%;"></td> <td style="width: 10%;"></td> <td style="width: 10%;"></td> <td style="width: 10%;"></td> <td style="width: 10%;"></td> <td style="width: 10%;"></td> <td style="width: 10%;"></td> <td style="width: 10%;"></td> </tr> <tr> <td></td> <td></td> <td colspan="8" style="text-align: center;"> <table border="1" style="width: 100%; border-collapse: collapse; text-align: center;"> <tr> <td style="width: 10%;"></td> <td style="width: 10%;"></td> <td style="width: 10%;"></td> <td style="width: 10%;"></td> <td style="width: 10%;"></td> <td style="width: 10%;"></td> <td style="width: 10%;"></td> <td style="width: 10%;"></td> <td style="width: 10%;"></td> <td style="width: 10%;"></td> </tr> <tr> <td></td> <td></td> <td colspan="8" style="text-align: center;"> <table border="1" style="width: 100%; border-collapse: collapse; text-align: center;"> <tr> <td style="width: 10%;"></td> <td style="width: 10%;"></td> <td style="width: 10%;"></td> <td style="width: 10%;"></td> <td style="width: 10%;"></td> <td style="width: 10%;"></td> <td style="width: 10%;"></td> <td style="width: 10%;"></td> <td style="width: 10%;"></td> <td style="width: 10%;"></td> </tr> <tr> <td></td> <td></td> <td colspan="8" style="text-align: center;"> <table border="1" style="width: 100%; border-collapse: collapse; text-align: center;"> <tr> <td style="width: 10%;"></td> <td style="width: 10%;"></td> <td style="width: 10%;"></td> <td style="width: 10%;"></td> <td style="width: 10%;"></td> <td style="width: 10%;"></td> <td style="width: 10%;"></td> <td style="width: 10%;"></td> <td style="width: 10%;"></td> <td style="width: 10%;"></td> </tr> <tr> <td></td> <td></td> <td colspan="8" style="text-align: center;"> <table border="1" style="width: 100%; border-collapse: collapse; text-align: center;"> <tr> <td style="width: 10%;"></td> <td style="width: 10%;"></td> <td style="width: 10%;"></td> <td style="width: 10%;"></td> <td style="width: 10%;"></td> <td style="width: 10%;"></td> <td style="width: 10%;"></td> <td style="width: 10%;"></td> <td style="width: 10%;"></td> <td style="width: 10%;"></td> </tr> <tr> <td></td> <td></td> <td colspan="8" style="text-align: center;"> <table border="1" style="width: 100%; border-collapse: collapse; text-align: center;"> <tr> </tr></table></td></tr></table></td></tr></table></td></tr></table></td></tr></table></td></tr></table></td></tr></table></td></tr></table></td></tr></table></td></tr></table></td></tr></table></td></tr></table></td></tr></table></td></tr></table></td></tr></table></td></tr></table></td></tr></table></td></tr></table></td></tr></table></td></tr></table></td></tr></table></td></tr></table></td></tr></table></td></tr></table></td></tr></table></td></tr></table></td></tr></table></td></tr></table></td></tr></table></td></tr></table></td></tr></table></td></tr></table></td></tr></table></td></tr></table></td></tr></table></td></tr></table></td></tr></table></td></tr></table></td></tr></table></td></tr></table></td></tr></table></td></tr></table></td></tr></table></td></tr></table></td></tr></table>
 | | | | | | | | | | | | | | | | | | | | <table border="1" style="width: 100%; border-collapse: collapse; text-align: center;"> <tr> <td style="width: 10%;"></td> <td style="width: 10%;"></td> <td style="width: 10%;"></td> <td style="width: 10%;"></td> <td style="width: 10%;"></td> <td style="width: 10%;"></td> <td style="width: 10%;"></td> <td style="width: 10%;"></td> <td style="width: 10%;"></td> <td style="width: 10%;"></td> </tr> <tr> <td></td> <td></td> <td colspan="8" style="text-align: center;"> <table border="1" style="width: 100%; border-collapse: collapse; text-align: center;"> <tr> <td style="width: 10%;"></td> <td style="width: 10%;"></td> <td style="width: 10%;"></td> <td style="width: 10%;"></td> <td style="width: 10%;"></td> <td style="width: 10%;"></td> <td style="width: 10%;"></td> <td style="width: 10%;"></td> <td style="width: 10%;"></td> <td style="width: 10%;"></td> </tr> <tr> <td></td> <td></td> <td colspan="8" style="text-align: center;"> <table border="1" style="width: 100%; border-collapse: collapse; text-align: center;"> <tr> <td style="width: 10%;"></td> <td style="width: 10%;"></td> <td style="width: 10%;"></td> <td style="width: 10%;"></td> <td style="width: 10%;"></td> <td style="width: 10%;"></td> <td style="width: 10%;"></td> <td style="width: 10%;"></td> <td style="width: 10%;"></td> <td style="width: 10%;"></td> </tr> <tr> <td></td> <td></td> <td colspan="8" style="text-align: center;"> <table border="1" style="width: 100%; border-collapse: collapse; text-align: center;"> <tr> <td style="width: 10%;"></td> <td style="width: 10%;"></td> <td style="width: 10%;"></td> <td style="width: 10%;"></td> <td style="width: 10%;"></td> <td style="width: 10%;"></td> <td style="width: 10%;"></td> <td style="width: 10%;"></td> <td style="width: 10%;"></td> <td style="width: 10%;"></td> </tr> <tr> <td></td> <td></td> <td colspan="8" style="text-align: center;"> <table border="1" style="width: 100%; border-collapse: collapse; text-align: center;"> <tr> <td style="width: 10%;"></td> <td style="width: 10%;"></td> <td style="width: 10%;"></td> <td style="width: 10%;"></td> <td style="width: 10%;"></td> <td style="width: 10%;"></td> <td style="width: 10%;"></td> <td style="width: 10%;"></td> <td style="width: 10%;"></td> <td style="width: 10%;"></td> </tr> <tr> <td></td> <td></td> <td colspan="8" style="text-align: center;"> <table border="1" style="width: 100%; border-collapse: collapse; text-align: center;"> <tr> <td style="width: 10%;"></td> <td style="width: 10%;"></td> <td style="width: 10%;"></td> <td style="width: 10%;"></td> <td style="width: 10%;"></td> <td style="width: 10%;"></td> <td style="width: 10%;"></td> <td style="width: 10%;"></td> <td style="width: 10%;"></td> <td style="width: 10%;"></td> </tr> <tr> <td></td> <td></td> <td colspan="8" style="text-align: center;"> <table border="1" style="width: 100%; border-collapse: collapse; text-align: center;"> <tr> <td style="width: 10%;"></td> <td style="width: 10%;"></td> <td style="width: 10%;"></td> <td style="width: 10%;"></td> <td style="width: 10%;"></td> <td style="width: 10%;"></td> <td style="width: 10%;"></td> <td style="width: 10%;"></td> <td style="width: 10%;"></td> <td style="width: 10%;"></td> </tr> <tr> <td></td> <td></td> <td colspan="8" style="text-align: center;"> <table border="1" style="width: 100%; border-collapse: collapse; text-align: center;"> <tr> <td style="width: 10%;"></td> <td style="width: 10%;"></td> <td style="width: 10%;"></td> <td style="width: 10%;"></td> <td style="width: 10%;"></td> <td style="width: 10%;"></td> <td style="width: 10%;"></td> <td style="width: 10%;"></td> <td style="width: 10%;"></td> <td style="width: 10%;"></td> </tr> <tr> <td></td> <td></td> <td colspan="8" style="text-align: center;"> <table border="1" style="width: 100%; border-collapse: collapse; text-align: center;"> <tr> <td style="width: 10%;"></td> <td style="width: 10%;"></td> <td style="width: 10%;"></td> <td style="width: 10%;"></td> <td style="width: 10%;"></td> <td style="width: 10%;"></td> <td style="width: 10%;"></td> <td style="width: 10%;"></td> <td style="width: 10%;"></td> <td style="width: 10%;"></td> </tr> <tr> <td></td> <td></td> <td colspan="8" style="text-align: center;"> <table border="1" style="width: 100%; border-collapse: collapse; text-align: center;"> <tr> <td style="width: 10%;"></td> <td style="width: 10%;"></td> <td style="width: 10%;"></td> <td style="width: 10%;"></td> <td style="width: 10%;"></td> <td style="width: 10%;"></td> <td style="width: 10%;"></td> <td style="width: 10%;"></td> <td style="width: 10%;"></td> <td style="width: 10%;"></td> </tr> <tr> <td></td> <td></td> <td colspan="8" style="text-align: center;"> <table border="1" style="width: 100%; border-collapse: collapse; text-align: center;"> <tr> <td style="width: 10%;"></td> <td style="width: 10%;"></td> <td style="width: 10%;"></td> <td style="width: 10%;"></td> <td style="width: 10%;"></td> <td style="width: 10%;"></td> <td style="width: 10%;"></td> <td style="width: 10%;"></td> <td style="width: 10%;"></td> <td style="width: 10%;"></td> </tr> <tr> <td></td> <td></td> <td colspan="8" style="text-align: center;"> <table border="1" style="width: 100%; border-collapse: collapse; text-align: center;"> <tr> <td style="width: 10%;"></td> <td style="width: 10%;"></td> <td style="width: 10%;"></td> <td style="width: 10%;"></td> <td style="width: 10%;"></td> <td style="width: 10%;"></td> <td style="width: 10%;"></td> <td style="width: 10%;"></td> <td style="width: 10%;"></td> <td style="width: 10%;"></td> </tr> <tr> <td></td> <td></td> <td colspan="8" style="text-align: center;"> <table border="1" style="width: 100%; border-collapse: collapse; text-align: center;"> <tr> <td style="width: 10%;"></td> <td style="width: 10%;"></td> <td style="width: 10%;"></td> <td style="width: 10%;"></td> <td style="width: 10%;"></td> <td style="width: 10%;"></td> <td style="width: 10%;"></td> <td style="width: 10%;"></td> <td style="width: 10%;"></td> <td style="width: 10%;"></td> </tr> <tr> <td></td> <td></td> <td colspan="8" style="text-align: center;"> <table border="1" style="width: 100%; border-collapse: collapse; text-align: center;"> <tr> <td style="width: 10%;"></td> <td style="width: 10%;"></td> <td style="width: 10%;"></td> <td style="width: 10%;"></td> <td style="width: 10%;"></td> <td style="width: 10%;"></td> <td style="width: 10%;"></td> <td style="width: 10%;"></td> <td style="width: 10%;"></td> <td style="width: 10%;"></td> </tr> <tr> <td></td> <td></td> <td colspan="8" style="text-align: center;"> <table border="1" style="width: 100%; border-collapse: collapse; text-align: center;"> <tr> <td style="width: 10%;"></td> <td style="width: 10%;"></td> <td style="width: 10%;"></td> <td style="width: 10%;"></td> <td style="width: 10%;"></td> <td style="width: 10%;"></td> <td style="width: 10%;"></td> <td style="width: 10%;"></td> <td style="width: 10%;"></td> <td style="width: 10%;"></td> </tr> <tr> <td></td> <td></td> <td colspan="8" style="text-align: center;"> <table border="1" style="width: 100%; border-collapse: collapse; text-align: center;"> <tr> <td style="width: 10%;"></td> <td style="width: 10%;"></td> <td style="width: 10%;"></td> <td style="width: 10%;"></td> <td style="width: 10%;"></td> <td style="width: 10%;"></td> <td style="width: 10%;"></td> <td style="width: 10%;"></td> <td style="width: 10%;"></td> <td style="width: 10%;"></td> </tr> <tr> <td></td> <td></td> <td colspan="8" style="text-align: center;"> <table border="1" style="width: 100%; border-collapse: collapse; text-align: center;"> <tr> <td style="width: 10%;"></td> <td style="width: 10%;"></td> <td style="width: 10%;"></td> <td style="width: 10%;"></td> <td style="width: 10%;"></td> <td style="width: 10%;"></td> <td style="width: 10%;"></td> <td style="width: 10%;"></td> <td style="width: 10%;"></td> <td style="width: 10%;"></td> </tr> <tr> <td></td> <td></td> <td colspan="8" style="text-align: center;"> <table border="1" style="width: 100%; border-collapse: collapse; text-align: center;"> <tr> <td style="width: 10%;"></td> <td style="width: 10%;"></td> <td style="width: 10%;"></td> <td style="width: 10%;"></td> <td style="width: 10%;"></td> <td style="width: 10%;"></td> <td style="width: 10%;"></td> <td style="width: 10%;"></td> <td style="width: 10%;"></td> <td style="width: 10%;"></td> </tr> <tr> <td></td> <td></td> <td colspan="8" style="text-align: center;"> <table border="1" style="width: 100%; border-collapse: collapse; text-align: center;"> <tr> <td style="width: 10%;"></td> <td style="width: 10%;"></td> <td style="width: 10%;"></td> <td style="width: 10%;"></td> <td style="width: 10%;"></td> <td style="width: 10%;"></td> <td style="width: 10%;"></td> <td style="width: 10%;"></td> <td style="width: 10%;"></td> <td style="width: 10%;"></td> </tr> <tr> <td></td> <td></td> <td colspan="8" style="text-align: center;"> <table border="1" style="width: 100%; border-collapse: collapse; text-align: center;"> <tr> <td style="width: 10%;"></td> <td style="width: 10%;"></td> <td style="width: 10%;"></td> <td style="width: 10%;"></td> <td style="width: 10%;"></td> <td style="width: 10%;"></td> <td style="width: 10%;"></td> <td style="width: 10%;"></td> <td style="width: 10%;"></td> <td style="width: 10%;"></td> </tr> <tr> <td></td> <td></td> <td colspan="8" style="text-align: center;"> <table border="1" style="width: 100%; border-collapse: collapse; text-align: center;"> <tr> <td style="width: 10%;"></td> <td style="width: 10%;"></td> <td style="width: 10%;"></td> <td style="width: 10%;"></td> <td style="width: 10%;"></td> <td style="width: 10%;"></td> <td style="width: 10%;"></td> <td style="width: 10%;"></td> <td style="width: 10%;"></td> <td style="width: 10%;"></td> </tr> <tr>
<td></td> <td></td> <td colspan="8" style="text-align: center;"> <table border="1" style="width: 100%; border-collapse: collapse; text-align: center;"> <tr> <td style="width: 10%;"></td> <td style="width: 10%;"></td> <td style="width: 10%;"></td> <td style="width: 10%;"></td> <td style="width: 10%;"></td> <td style="width: 10%;"></td> <td style="width: 10%;"></td> <td style="width: 10%;"></td> <td style="width: 10%;"></td> <td style="width: 10%;"></td> </tr> <tr> <td></td> <td></td> <td colspan="8" style="text-align: center;"> <table border="1" style="width: 100%; border-collapse: collapse; text-align: center;"> <tr> <td style="width: 10%;"></td> <td style="width: 10%;"></td> <td style="width: 10%;"></td> <td style="width: 10%;"></td> <td style="width: 10%;"></td> <td style="width: 10%;"></td> <td style="width: 10%;"></td> <td style="width: 10%;"></td> <td style="width: 10%;"></td> <td style="width: 10%;"></td> </tr> <tr> <td></td> <td></td> <td colspan="8" style="text-align: center;"> <table border="1" style="width: 100%; border-collapse: collapse; text-align: center;"> <tr> <td style="width: 10%;"></td> <td style="width: 10%;"></td> <td style="width: 10%;"></td> <td style="width: 10%;"></td> <td style="width: 10%;"></td> <td style="width: 10%;"></td> <td style="width: 10%;"></td> <td style="width: 10%;"></td> <td style="width: 10%;"></td> <td style="width: 10%;"></td> </tr> <tr> <td></td> <td></td> <td colspan="8" style="text-align: center;"> <table border="1" style="width: 100%; border-collapse: collapse; text-align: center;"> <tr> <td style="width: 10%;"></td> <td style="width: 10%;"></td> <td style="width: 10%;"></td> <td style="width: 10%;"></td> <td style="width: 10%;"></td> <td style="width: 10%;"></td> <td style="width: 10%;"></td> <td style="width: 10%;"></td> <td style="width: 10%;"></td> <td style="width: 10%;"></td> </tr> <tr> <td></td> <td></td> <td colspan="8" style="text-align: center;"> <table border="1" style="width: 100%; border-collapse: collapse; text-align: center;"> <tr> <td style="width: 10%;"></td> <td style="width: 10%;"></td> <td style="width: 10%;"></td> <td style="width: 10%;"></td> <td style="width: 10%;"></td> <td style="width: 10%;"></td> <td style="width: 10%;"></td> <td style="width: 10%;"></td> <td style="width: 10%;"></td> <td style="width: 10%;"></td> </tr> <tr> <td></td> <td></td> <td colspan="8" style="text-align: center;"> <table border="1" style="width: 100%; border-collapse: collapse; text-align: center;"> <tr> <td style="width: 10%;"></td> <td style="width: 10%;"></td> <td style="width: 10%;"></td> <td style="width: 10%;"></td> <td style="width: 10%;"></td> <td style="width: 10%;"></td> <td style="width: 10%;"></td> <td style="width: 10%;"></td> <td style="width: 10%;"></td> <td style="width: 10%;"></td> </tr> <tr> <td></td> <td></td> <td colspan="8" style="text-align: center;"> <table border="1" style="width: 100%; border-collapse: collapse; text-align: center;"> <tr> <td style="width: 10%;"></td> <td style="width: 10%;"></td> <td style="width: 10%;"></td> <td style="width: 10%;"></td> <td style="width: 10%;"></td> <td style="width: 10%;"></td> <td style="width: 10%;"></td> <td style="width: 10%;"></td> <td style="width: 10%;"></td> <td style="width: 10%;"></td> </tr> <tr> <td></td> <td></td> <td colspan="8" style="text-align: center;"> <table border="1" style="width: 100%; border-collapse: collapse; text-align: center;"> <tr> <td style="width: 10%;"></td> <td style="width: 10%;"></td> <td style="width: 10%;"></td> <td style="width: 10%;"></td> <td style="width: 10%;"></td> <td style="width: 10%;"></td> <td style="width: 10%;"></td> <td style="width: 10%;"></td> <td style="width: 10%;"></td> <td style="width: 10%;"></td> </tr> <tr> <td></td> <td></td> <td colspan="8" style="text-align: center;"> <table border="1" style="width: 100%; border-collapse: collapse; text-align: center;"> <tr> <td style="width: 10%;"></td> <td style="width: 10%;"></td> <td style="width: 10%;"></td> <td style="width: 10%;"></td> <td style="width: 10%;"></td> <td style="width: 10%;"></td> <td style="width: 10%;"></td> <td style="width: 10%;"></td> <td style="width: 10%;"></td> <td style="width: 10%;"></td> </tr> <tr> <td></td> <td></td> <td colspan="8" style="text-align: center;"> <table border="1" style="width: 100%; border-collapse: collapse; text-align: center;"> <tr> <td style="width: 10%;"></td> <td style="width: 10%;"></td> <td style="width: 10%;"></td> <td style="width: 10%;"></td> <td style="width: 10%;"></td> <td style="width: 10%;"></td> <td style="width: 10%;"></td> <td style="width: 10%;"></td> <td style="width: 10%;"></td> <td style="width: 10%;"></td> </tr> <tr> <td></td> <td></td> <td colspan="8" style="text-align: center;"> <table border="1" style="width: 100%; border-collapse: collapse; text-align: center;"> <tr> <td style="width: 10%;"></td> <td style="width: 10%;"></td> <td style="width: 10%;"></td> <td style="width: 10%;"></td> <td style="width: 10%;"></td> <td style="width: 10%;"></td> <td style="width: 10%;"></td> <td style="width: 10%;"></td> <td style="width: 10%;"></td> <td style="width: 10%;"></td> </tr> <tr> <td></td> <td></td> <td colspan="8" style="text-align: center;"> <table border="1" style="width: 100%; border-collapse: collapse; text-align: center;"> <tr> <td style="width: 10%;"></td> <td style="width: 10%;"></td> <td style="width: 10%;"></td> <td style="width: 10%;"></td> <td style="width: 10%;"></td> <td style="width: 10%;"></td> <td style="width: 10%;"></td> <td style="width: 10%;"></td> <td style="width: 10%;"></td> <td style="width: 10%;"></td> </tr> <tr> <td></td> <td></td> <td colspan="8" style="text-align: center;"> <table border="1" style="width: 100%; border-collapse: collapse; text-align: center;"> <tr> <td style="width: 10%;"></td> <td style="width: 10%;"></td> <td style="width: 10%;"></td> <td style="width: 10%;"></td> <td style="width: 10%;"></td> <td style="width: 10%;"></td> <td style="width: 10%;"></td> <td style="width: 10%;"></td> <td style="width: 10%;"></td> <td style="width: 10%;"></td> </tr> <tr> <td></td> <td></td> <td colspan="8" style="text-align: center;"> <table border="1" style="width: 100%; border-collapse: collapse; text-align: center;"> <tr> <td style="width: 10%;"></td> <td style="width: 10%;"></td> <td style="width: 10%;"></td> <td style="width: 10%;"></td> <td style="width: 10%;"></td> <td style="width: 10%;"></td> <td style="width: 10%;"></td> <td style="width: 10%;"></td> <td style="width: 10%;"></td> <td style="width: 10%;"></td> </tr> <tr> <td></td> <td></td> <td colspan="8" style="text-align: center;"> <table border="1" style="width: 100%; border-collapse: collapse; text-align: center;"> <tr> <td style="width: 10%;"></td> <td style="width: 10%;"></td> <td style="width: 10%;"></td> <td style="width: 10%;"></td> <td style="width: 10%;"></td> <td style="width: 10%;"></td> <td style="width: 10%;"></td> <td style="width: 10%;"></td> <td style="width: 10%;"></td> <td style="width: 10%;"></td> </tr> <tr> <td></td> <td></td> <td colspan="8" style="text-align: center;"> <table border="1" style="width: 100%; border-collapse: collapse; text-align: center;"> <tr> <td style="width: 10%;"></td> <td style="width: 10%;"></td> <td style="width: 10%;"></td> <td style="width: 10%;"></td> <td style="width: 10%;"></td> <td style="width: 10%;"></td> <td style="width: 10%;"></td> <td style="width: 10%;"></td> <td style="width: 10%;"></td> <td style="width: 10%;"></td> </tr> <tr> <td></td> <td></td> <td colspan="8" style="text-align: center;"> <table border="1" style="width: 100%; border-collapse: collapse; text-align: center;"> <tr> <td style="width: 10%;"></td> <td style="width: 10%;"></td> <td style="width: 10%;"></td> <td style="width: 10%;"></td> <td style="width: 10%;"></td> <td style="width: 10%;"></td> <td style="width: 10%;"></td> <td style="width: 10%;"></td> <td style="width: 10%;"></td> <td style="width: 10%;"></td> </tr> <tr> <td></td> <td></td> <td colspan="8" style="text-align: center;"> <table border="1" style="width: 100%; border-collapse: collapse; text-align: center;"> <tr> <td style="width: 10%;"></td> <td style="width: 10%;"></td> <td style="width: 10%;"></td> <td style="width: 10%;"></td> <td style="width: 10%;"></td> <td style="width: 10%;"></td> <td style="width: 10%;"></td> <td style="width: 10%;"></td> <td style="width: 10%;"></td> <td style="width: 10%;"></td> </tr> <tr> <td></td> <td></td> <td colspan="8" style="text-align: center;"> <table border="1" style="width: 100%; border-collapse: collapse; text-align: center;"> <tr> <td style="width: 10%;"></td> <td style="width: 10%;"></td> <td style="width: 10%;"></td> <td style="width: 10%;"></td> <td style="width: 10%;"></td> <td style="width: 10%;"></td> <td style="width: 10%;"></td> <td style="width: 10%;"></td> <td style="width: 10%;"></td> <td style="width: 10%;"></td> </tr> <tr> <td></td> <td></td> <td colspan="8" style="text-align: center;"> <table border="1" style="width: 100%; border-collapse: collapse; text-align: center;"> <tr> <td style="width: 10%;"></td> <td style="width: 10%;"></td> <td style="width: 10%;"></td> <td style="width: 10%;"></td> <td style="width: 10%;"></td> <td style="width: 10%;"></td> <td style="width: 10%;"></td> <td style="width: 10%;"></td> <td style="width: 10%;"></td> <td style="width: 10%;"></td> </tr> <tr> <td></td> <td></td> <td colspan="8" style="text-align: center;"> <table border="1" style="width: 100%; border-collapse: collapse; text-align: center;"> <tr> <td style="width: 10%;"></td> <td style="width: 10%;"></td> <td style="width: 10%;"></td> <td style="width: 10%;"></td> <td style="width: 10%;"></td> <td style="width: 10%;"></td> <td style="width: 10%;"></td> <td style="width: 10%;"></td> <td style="width: 10%;"></td> <td style="width: 10%;"></td> </tr> <tr> <td></td> <td></td> <td colspan="8" style="text-align: center;"> <table border="1" style="width: 100%; border-collapse: collapse; text-align: center;"> <tr> <td
style="width: 10%;"></td> <td style="width: 10%;"></td> <td style="width: 10%;"></td> <td style="width: 10%;"></td> <td style="width: 10%;"></td> <td style="width: 10%;"></td> <td style="width: 10%;"></td> <td style="width: 10%;"></td> <td style="width: 10%;"></td> <td style="width: 10%;"></td> </tr> <tr> <td></td> <td></td> <td colspan="8" style="text-align: center;"> <table border="1" style="width: 100%; border-collapse: collapse; text-align: center;"> <tr> </tr></table></td></tr></table></td></tr></table></td></tr></table></td></tr></table></td></tr></table></td></tr></table></td></tr></table></td></tr></table></td></tr></table></td></tr></table></td></tr></table></td></tr></table></td></tr></table></td></tr></table></td></tr></table></td></tr></table></td></tr></table></td></tr></table></td></tr></table></td></tr></table></td></tr></table></td></tr></table></td></tr></table></td></tr></table></td></tr></table></td></tr></table></td></tr></table></td></tr></table></td></tr></table></td></tr></table></td></tr></table></td></tr></table></td></tr></table></td></tr></table></td></tr></table></td></tr></table></td></tr></table></td></tr></table></td></tr></table></td></tr></table></td></tr></table></td></tr></table></td></tr></table> | | | | | | | | | | | | | | | | | | | | <table border="1" style="width: 100%; border-collapse: collapse; text-align: center;"> <tr> <td style="width: 10%;"></td> <td style="width: 10%;"></td> <td style="width: 10%;"></td> <td style="width: 10%;"></td> <td style="width: 10%;"></td> <td style="width: 10%;"></td> <td style="width: 10%;"></td> <td style="width: 10%;"></td> <td style="width: 10%;"></td> <td style="width: 10%;"></td> </tr> <tr> <td></td> <td></td> <td colspan="8" style="text-align: center;"> <table border="1" style="width: 100%; border-collapse: collapse; text-align: center;"> <tr> <td style="width: 10%;"></td> <td style="width: 10%;"></td> <td style="width: 10%;"></td> <td style="width: 10%;"></td> <td style="width: 10%;"></td> <td style="width: 10%;"></td> <td style="width: 10%;"></td> <td style="width: 10%;"></td> <td style="width: 10%;"></td> <td style="width: 10%;"></td> </tr> <tr> <td></td> <td></td> <td colspan="8" style="text-align: center;"> <table border="1" style="width: 100%; border-collapse: collapse; text-align: center;"> <tr> <td style="width: 10%;"></td> <td style="width: 10%;"></td> <td style="width: 10%;"></td> <td style="width: 10%;"></td> <td style="width: 10%;"></td> <td style="width: 10%;"></td> <td style="width: 10%;"></td> <td style="width: 10%;"></td> <td style="width: 10%;"></td> <td style="width: 10%;"></td> </tr> <tr> <td></td> <td></td> <td colspan="8" style="text-align: center;"> <table border="1" style="width: 100%; border-collapse: collapse; text-align: center;"> <tr> <td style="width: 10%;"></td> <td style="width: 10%;"></td> <td style="width: 10%;"></td> <td style="width: 10%;"></td> <td style="width: 10%;"></td> <td style="width: 10%;"></td> <td style="width: 10%;"></td> <td style="width: 10%;"></td> <td style="width: 10%;"></td> <td style="width: 10%;"></td> </tr> <tr> <td></td> <td></td> <td colspan="8" style="text-align: center;"> <table border="1" style="width: 100%; border-collapse: collapse; text-align: center;"> <tr> <td style="width: 10%;"></td> <td style="width: 10%;"></td> <td style="width: 10%;"></td> <td style="width: 10%;"></td> <td style="width: 10%;"></td> <td style="width: 10%;"></td> <td style="width: 10%;"></td> <td style="width: 10%;"></td> <td style="width: 10%;"></td> <td style="width: 10%;"></td> </tr> <tr> <td></td> <td></td> <td colspan="8" style="text-align: center;"> <table border="1" style="width: 100%; border-collapse: collapse; text-align: center;"> <tr> <td style="width: 10%;"></td> <td style="width: 10%;"></td> <td style="width: 10%;"></td> <td style="width: 10%;"></td> <td style="width: 10%;"></td> <td style="width: 10%;"></td> <td style="width: 10%;"></td> <td style="width: 10%;"></td> <td style="width: 10%;"></td> <td style="width: 10%;"></td> </tr> <tr> <td></td> <td></td> <td colspan="8" style="text-align: center;"> <table border="1" style="width: 100%; border-collapse: collapse; text-align: center;"> <tr> <td style="width: 10%;"></td> <td style="width: 10%;"></td> <td style="width: 10%;"></td> <td style="width: 10%;"></td> <td style="width: 10%;"></td> <td style="width: 10%;"></td> <td style="width: 10%;"></td> <td style="width: 10%;"></td> <td style="width: 10%;"></td> <td style="width: 10%;"></td> </tr> <tr> <td></td> <td></td> <td colspan="8" style="text-align: center;"> <table border="1" style="width: 100%; border-collapse: collapse; text-align: center;"> <tr> <td style="width: 10%;"></td> <td style="width: 10%;"></td> <td style="width: 10%;"></td> <td style="width: 10%;"></td> <td style="width: 10%;"></td> <td style="width: 10%;"></td> <td style="width: 10%;"></td> <td style="width: 10%;"></td> <td style="width: 10%;"></td> <td style="width: 10%;"></td> </tr> <tr> <td></td> <td></td> <td colspan="8" style="text-align: center;"> <table border="1" style="width: 100%; border-collapse: collapse; text-align: center;"> <tr> <td style="width: 10%;"></td> <td style="width: 10%;"></td> <td style="width: 10%;"></td> <td style="width: 10%;"></td> <td style="width: 10%;"></td> <td style="width: 10%;"></td> <td style="width: 10%;"></td> <td style="width: 10%;"></td> <td style="width: 10%;"></td> <td style="width: 10%;"></td> </tr> <tr> <td></td> <td></td> <td colspan="8" style="text-align: center;"> <table border="1" style="width: 100%; border-collapse: collapse; text-align: center;"> <tr> <td style="width: 10%;"></td> <td style="width: 10%;"></td> <td style="width: 10%;"></td> <td style="width: 10%;"></td> <td style="width: 10%;"></td> <td style="width: 10%;"></td> <td style="width: 10%;"></td> <td style="width: 10%;"></td> <td style="width: 10%;"></td> <td style="width: 10%;"></td> </tr> <tr> <td></td> <td></td> <td colspan="8" style="text-align: center;"> <table border="1" style="width: 100%; border-collapse: collapse; text-align: center;"> <tr> <td style="width: 10%;"></td> <td style="width: 10%;"></td> <td style="width: 10%;"></td> <td style="width: 10%;"></td> <td style="width: 10%;"></td> <td style="width: 10%;"></td> <td style="width: 10%;"></td> <td style="width: 10%;"></td> <td style="width: 10%;"></td> <td style="width: 10%;"></td> </tr> <tr> <td></td> <td></td> <td colspan="8" style="text-align: center;"> <table border="1" style="width: 100%; border-collapse: collapse; text-align: center;"> <tr> <td style="width: 10%;"></td> <td style="width: 10%;"></td> <td style="width: 10%;"></td> <td style="width: 10%;"></td> <td style="width: 10%;"></td> <td style="width: 10%;"></td> <td style="width: 10%;"></td> <td style="width: 10%;"></td> <td style="width: 10%;"></td> <td style="width: 10%;"></td> </tr> <tr> <td></td> <td></td> <td colspan="8" style="text-align: center;"> <table border="1" style="width: 100%; border-collapse: collapse; text-align: center;"> <tr> <td style="width: 10%;"></td> <td style="width: 10%;"></td> <td style="width: 10%;"></td> <td style="width: 10%;"></td> <td style="width: 10%;"></td> <td style="width: 10%;"></td> <td style="width: 10%;"></td> <td style="width: 10%;"></td> <td style="width: 10%;"></td> <td style="width: 10%;"></td> </tr> <tr> <td></td> <td></td> <td colspan="8" style="text-align: center;"> <table border="1" style="width: 100%; border-collapse: collapse; text-align: center;"> <tr> <td style="width: 10%;"></td> <td style="width: 10%;"></td> <td style="width: 10%;"></td> <td style="width: 10%;"></td> <td style="width: 10%;"></td> <td style="width: 10%;"></td> <td style="width: 10%;"></td> <td style="width: 10%;"></td> <td style="width: 10%;"></td> <td style="width: 10%;"></td> </tr> <tr> <td></td> <td></td> <td colspan="8" style="text-align: center;"> <table border="1" style="width: 100%; border-collapse: collapse; text-align: center;"> <tr> <td style="width: 10%;"></td> <td style="width: 10%;"></td> <td style="width: 10%;"></td> <td style="width: 10%;"></td> <td style="width: 10%;"></td> <td style="width: 10%;"></td> <td style="width: 10%;"></td> <td style="width: 10%;"></td> <td style="width: 10%;"></td> <td style="width: 10%;"></td> </tr> <tr> <td></td> <td></td> <td colspan="8" style="text-align: center;"> <table border="1" style="width: 100%; border-collapse: collapse; text-align: center;"> <tr> <td style="width: 10%;"></td> <td style="width: 10%;"></td> <td style="width: 10%;"></td> <td style="width:
10%;"></td> <td style="width: 10%;"></td> <td style="width: 10%;"></td> <td style="width: 10%;"></td> <td style="width: 10%;"></td> <td style="width: 10%;"></td> <td style="width: 10%;"></td> </tr> <tr> <td></td> <td></td> <td colspan="8" style="text-align: center;"> <table border="1" style="width: 100%; border-collapse: collapse; text-align: center;"> <tr> <td style="width: 10%;"></td> <td style="width: 10%;"></td> <td style="width: 10%;"></td> <td style="width: 10%;"></td> <td style="width: 10%;"></td> <td style="width: 10%;"></td> <td style="width: 10%;"></td> <td style="width: 10%;"></td> <td style="width: 10%;"></td> <td style="width: 10%;"></td> </tr> <tr> <td></td> <td></td> <td colspan="8" style="text-align: center;"> <table border="1" style="width: 100%; border-collapse: collapse; text-align: center;"> <tr> <td style="width: 10%;"></td> <td style="width: 10%;"></td> <td style="width: 10%;"></td> <td style="width: 10%;"></td> <td style="width: 10%;"></td> <td style="width: 10%;"></td> <td style="width: 10%;"></td> <td style="width: 10%;"></td> <td style="width: 10%;"></td> <td style="width: 10%;"></td> </tr> <tr> <td></td> <td></td> <td colspan="8" style="text-align: center;"> <table border="1" style="width: 100%; border-collapse: collapse; text-align: center;"> <tr> <td style="width: 10%;"></td> <td style="width: 10%;"></td> <td style="width: 10%;"></td> <td style="width: 10%;"></td> <td style="width: 10%;"></td> <td style="width: 10%;"></td> <td style="width: 10%;"></td> <td style="width: 10%;"></td> <td style="width: 10%;"></td> <td style="width: 10%;"></td> </tr> <tr> <td></td> <td></td> <td colspan="8" style="text-align: center;"> <table border="1" style="width: 100%; border-collapse: collapse; text-align: center;"> <tr> <td style="width: 10%;"></td> <td style="width: 10%;"></td> <td style="width: 10%;"></td> <td style="width: 10%;"></td> <td style="width: 10%;"></td> <td style="width: 10%;"></td> <td style="width: 10%;"></td> <td style="width: 10%;"></td> <td style="width: 10%;"></td> <td style="width: 10%;"></td> </tr> <tr> <td></td> <td></td> <td colspan="8" style="text-align: center;"> <table border="1" style="width: 100%; border-collapse: collapse; text-align: center;"> <tr> <td style="width: 10%;"></td> <td style="width: 10%;"></td> <td style="width: 10%;"></td> <td style="width: 10%;"></td> <td style="width: 10%;"></td> <td style="width: 10%;"></td> <td style="width: 10%;"></td> <td style="width: 10%;"></td> <td style="width: 10%;"></td> <td style="width: 10%;"></td> </tr> <tr> <td></td> <td></td> <td colspan="8" style="text-align: center;"> <table border="1" style="width: 100%; border-collapse: collapse; text-align: center;"> <tr> <td style="width: 10%;"></td> <td style="width: 10%;"></td> <td style="width: 10%;"></td> <td style="width: 10%;"></td> <td style="width: 10%;"></td> <td style="width: 10%;"></td> <td style="width: 10%;"></td> <td style="width: 10%;"></td> <td style="width: 10%;"></td> <td style="width: 10%;"></td> </tr> <tr> <td></td> <td></td> <td colspan="8" style="text-align: center;"> <table border="1" style="width: 100%; border-collapse: collapse; text-align: center;"> <tr> <td style="width: 10%;"></td> <td style="width: 10%;"></td> <td style="width: 10%;"></td> <td style="width: 10%;"></td> <td style="width: 10%;"></td> <td style="width: 10%;"></td> <td style="width: 10%;"></td> <td style="width: 10%;"></td> <td style="width: 10%;"></td> <td style="width: 10%;"></td> </tr> <tr> <td></td> <td></td> <td colspan="8" style="text-align: center;"> <table border="1" style="width: 100%; border-collapse: collapse; text-align: center;"> <tr> <td style="width: 10%;"></td> <td style="width: 10%;"></td> <td style="width: 10%;"></td> <td style="width: 10%;"></td> <td style="width: 10%;"></td> <td style="width: 10%;"></td> <td style="width: 10%;"></td> <td style="width: 10%;"></td> <td style="width: 10%;"></td> <td style="width: 10%;"></td> </tr> <tr> <td></td> <td></td> <td colspan="8" style="text-align: center;"> <table border="1" style="width: 100%; border-collapse: collapse; text-align: center;"> <tr> <td style="width: 10%;"></td> <td style="width: 10%;"></td> <td style="width: 10%;"></td> <td style="width: 10%;"></td> <td style="width: 10%;"></td> <td style="width: 10%;"></td> <td style="width: 10%;"></td> <td style="width: 10%;"></td> <td style="width: 10%;"></td> <td style="width: 10%;"></td> </tr> <tr> <td></td> <td></td> <td colspan="8" style="text-align: center;"> <table border="1" style="width: 100%; border-collapse: collapse; text-align: center;"> <tr> <td style="width: 10%;"></td> <td style="width: 10%;"></td> <td style="width: 10%;"></td> <td style="width: 10%;"></td> <td style="width: 10%;"></td> <td style="width: 10%;"></td> <td style="width: 10%;"></td> <td style="width: 10%;"></td> <td style="width: 10%;"></td> <td style="width: 10%;"></td> </tr> <tr> <td></td> <td></td> <td colspan="8" style="text-align: center;"> <table border="1" style="width: 100%; border-collapse: collapse; text-align: center;"> <tr> <td style="width: 10%;"></td> <td style="width: 10%;"></td> <td style="width: 10%;"></td> <td style="width: 10%;"></td> <td style="width: 10%;"></td> <td style="width: 10%;"></td> <td style="width: 10%;"></td> <td style="width: 10%;"></td> <td style="width: 10%;"></td> <td style="width: 10%;"></td> </tr> <tr> <td></td> <td></td> <td colspan="8" style="text-align: center;"> <table border="1" style="width: 100%; border-collapse: collapse; text-align: center;"> <tr> <td style="width: 10%;"></td> <td style="width: 10%;"></td> <td style="width: 10%;"></td> <td style="width: 10%;"></td> <td style="width: 10%;"></td> <td style="width: 10%;"></td> <td style="width: 10%;"></td> <td style="width: 10%;"></td> <td style="width: 10%;"></td> <td style="width: 10%;"></td> </tr> <tr> <td></td> <td></td> <td colspan="8" style="text-align: center;"> <table border="1" style="width: 100%; border-collapse: collapse; text-align: center;"> <tr> <td style="width: 10%;"></td> <td style="width: 10%;"></td> <td style="width: 10%;"></td> <td style="width: 10%;"></td> <td style="width: 10%;"></td> <td style="width: 10%;"></td> <td style="width: 10%;"></td> <td style="width: 10%;"></td> <td style="width: 10%;"></td> <td style="width: 10%;"></td> </tr> <tr> <td></td> <td></td> <td colspan="8" style="text-align: center;"> <table border="1" style="width: 100%; border-collapse: collapse; text-align: center;"> <tr> <td style="width: 10%;"></td> <td style="width: 10%;"></td> <td style="width: 10%;"></td> <td style="width: 10%;"></td> <td style="width: 10%;"></td> <td style="width: 10%;"></td> <td style="width: 10%;"></td> <td style="width: 10%;"></td> <td style="width: 10%;"></td> <td style="width: 10%;"></td> </tr> <tr> <td></td> <td></td> <td colspan="8" style="text-align: center;"> <table border="1" style="width: 100%; border-collapse: collapse; text-align: center;"> <tr> <td style="width: 10%;"></td> <td style="width: 10%;"></td> <td style="width: 10%;"></td> <td style="width: 10%;"></td> <td style="width: 10%;"></td> <td style="width: 10%;"></td> <td style="width: 10%;"></td> <td style="width: 10%;"></td> <td style="width: 10%;"></td> <td style="width: 10%;"></td> </tr> <tr> <td></td> <td></td> <td colspan="8" style="text-align: center;"> <table border="1" style="width: 100%; border-collapse: collapse; text-align: center;"> <tr> <td style="width: 10%;"></td> <td style="width: 10%;"></td> <td style="width: 10%;"></td> <td style="width: 10%;"></td> <td style="width: 10%;"></td> <td style="width: 10%;"></td> <td style="width: 10%;"></td> <td style="width: 10%;"></td> <td style="width: 10%;"></td> <td style="width: 10%;"></td> </tr> <tr> <td></td> <td></td> <td colspan="8" style="text-align: center;"> <table border="1" style="width: 100%; border-collapse: collapse; text-align: center;"> <tr> <td style="width: 10%;"></td> <td style="width: 10%;"></td> <td style="width: 10%;"></td> <td style="width: 10%;"></td> <td style="width: 10%;"></td> <td style="width: 10%;"></td> <td style="width: 10%;"></td> <td style="width: 10%;"></td> <td style="width: 10%;"></td> <td style="width: 10%;"></td> </tr> <tr> <td></td> <td></td> <td colspan="8" style="text-align: center;"> <table border="1" style="width: 100%; border-collapse: collapse; text-align: center;"> <tr> <td style="width: 10%;"></td> <td style="width: 10%;"></td> <td style="width: 10%;"></td> <td style="width: 10%;"></td> <td style="width: 10%;"></td> <td style="width: 10%;"></td> <td style="width: 10%;"></td> <td style="width: 10%;"></td> <td style="width: 10%;"></td> <td style="width: 10%;"></td> </tr> <tr> <td></td> <td></td> <td colspan="8" style="text-align: center;"> <table border="1" style="width: 100%; border-collapse: collapse; text-align: center;"> <tr> <td style="width: 10%;"></td> <td style="width: 10%;"></td> <td style="width: 10%;"></td> <td style="width: 10%;"></td> <td style="width: 10%;"></td> <td style="width: 10%;"></td> <td style="width: 10%;"></td> <td style="width: 10%;"></td> <td style="width: 10%;"></td> <td style="width: 10%;"></td> </tr> <tr> <td></td> <td></td> <td colspan="8" style="text-align: center;"> <table border="1" style="width: 100%; border-collapse: collapse; text-align: center;"> <tr> <td style="width: 10%;"></td> <td style="width: 10%;"></td> <td style="width: 10%;"></td> <td style="width: 10%;"></td> <td style="width: 10%;"></td> <td style="width: 10%;"></td> <td style="width: 10%;"></td> <td style="width: 10%;"></td> <td style="width: 10%;"></td> <td style="width: 10%;"></td> </tr> <tr> <td></td> <td></td> <td colspan="8" style="text-align: center;"> <table border="1" style="width: 100%; border-collapse: collapse; text-align: center;"> <tr> <td style="width: 10%;"></td> <td style="width: 10%;"></td> <td style="width: 10%;"></td> <td style="width: 10%;"></td> <td style="width: 10%;"></td> <td style="width: 10%;"></td> <td style="width: 10%;"></td> <td style="width: 10%;"></td> <td style="width: 10%;"></td> <td
style="width: 10%;"></td> </tr> <tr> <td></td> <td></td> <td colspan="8" style="text-align: center;"> <table border="1" style="width: 100%; border-collapse: collapse; text-align: center;"> <tr> <td style="width: 10%;"></td> <td style="width: 10%;"></td> <td style="width: 10%;"></td> <td style="width: 10%;"></td> <td style="width: 10%;"></td> <td style="width: 10%;"></td> <td style="width: 10%;"></td> <td style="width: 10%;"></td> <td style="width: 10%;"></td> <td style="width: 10%;"></td> </tr> <tr> <td></td> <td></td> <td colspan="8" style="text-align: center;"> <table border="1" style="width: 100%; border-collapse: collapse; text-align: center;"> <tr> <td style="width: 10%;"></td> <td style="width: 10%;"></td> <td style="width: 10%;"></td> <td style="width: 10%;"></td> <td style="width: 10%;"></td> <td style="width: 10%;"></td> <td style="width: 10%;"></td> <td style="width: 10%;"></td> <td style="width: 10%;"></td> <td style="width: 10%;"></td> </tr> <tr> <td></td> <td></td> <td colspan="8" style="text-align: center;"> <table border="1" style="width: 100%; border-collapse: collapse; text-align: center;"> <tr> <td style="width: 10%;"></td> <td style="width: 10%;"></td> <td style="width: 10%;"></td> <td style="width: 10%;"></td> <td style="width: 10%;"></td> <td style="width: 10%;"></td> <td style="width: 10%;"></td> <td style="width: 10%;"></td> <td style="width: 10%;"></td> <td style="width: 10%;"></td> </tr> <tr> <td></td> <td></td> <td colspan="8" style="text-align: center;"> <table border="1" style="width: 100%; border-collapse: collapse; text-align: center;"> <tr> <td style="width: 10%;"></td> <td style="width: 10%;"></td> <td style="width: 10%;"></td> <td style="width: 10%;"></td> <td style="width: 10%;"></td> <td style="width: 10%;"></td> <td style="width: 10%;"></td> <td style="width: 10%;"></td> <td style="width: 10%;"></td> <td style="width: 10%;"></td> </tr> <tr> <td></td> <td></td> <td colspan="8" style="text-align: center;"> <table border="1" style="width: 100%; border-collapse: collapse; text-align: center;"> <tr> <td style="width: 10%;"></td> <td style="width: 10%;"></td> <td style="width: 10%;"></td> <td style="width: 10%;"></td> <td style="width: 10%;"></td> <td style="width: 10%;"></td> <td style="width: 10%;"></td> <td style="width: 10%;"></td> <td style="width: 10%;"></td> <td style="width: 10%;"></td> </tr> <tr> <td></td> <td></td> <td colspan="8" style="text-align: center;"> <table border="1" style="width: 100%; border-collapse: collapse; text-align: center;"> <tr> </tr></table></td></tr></table></td></tr></table></td></tr></table></td></tr></table></td></tr></table></td></tr></table></td></tr></table></td></tr></table></td></tr></table></td></tr></table></td></tr></table></td></tr></table></td></tr></table></td></tr></table></td></tr></table></td></tr></table></td></tr></table></td></tr></table></td></tr></table></td></tr></table></td></tr></table></td></tr></table></td></tr></table></td></tr></table></td></tr></table></td></tr></table></td></tr></table></td></tr></table></td></tr></table></td></tr></table></td></tr></table></td></tr></table></td></tr></table></td></tr></table></td></tr></table></td></tr></table></td></tr></table></td></tr></table></td></tr></table></td></tr></table></td></tr></table></td></tr></table> | | | | | | | | | | | | | | | | | | | | <table border="1" style="width: 100%; border-collapse: collapse; text-align: center;"> <tr> <td style="width: 10%;"></td> <td style="width: 10%;"></td> <td style="width: 10%;"></td> <td style="width: 10%;"></td> <td style="width: 10%;"></td> <td style="width: 10%;"></td> <td style="width: 10%;"></td> <td style="width: 10%;"></td> <td style="width: 10%;"></td> <td style="width: 10%;"></td> </tr> <tr> <td></td> <td></td> <td colspan="8" style="text-align: center;"> <table border="1" style="width: 100%; border-collapse: collapse; text-align: center;"> <tr> <td style="width: 10%;"></td> <td style="width: 10%;"></td> <td style="width: 10%;"></td> <td style="width: 10%;"></td> <td style="width: 10%;"></td> <td style="width: 10%;"></td> <td style="width: 10%;"></td> <td style="width: 10%;"></td> <td style="width: 10%;"></td> <td style="width: 10%;"></td> </tr> <tr> <td></td> <td></td> <td colspan="8" style="text-align: center;"> <table border="1" style="width: 100%; border-collapse: collapse; text-align: center;"> <tr> <td style="width: 10%;"></td> <td style="width: 10%;"></td> <td style="width: 10%;"></td> <td style="width: 10%;"></td> <td style="width: 10%;"></td> <td style="width: 10%;"></td> <td style="width: 10%;"></td> <td style="width: 10%;"></td> <td style="width: 10%;"></td> <td style="width: 10%;"></td> </tr> <tr> <td></td> <td></td> <td colspan="8" style="text-align: center;"> <table border="1" style="width: 100%; border-collapse: collapse; text-align: center;"> <tr> <td style="width: 10%;"></td> <td style="width: 10%;"></td> <td style="width: 10%;"></td> <td style="width: 10%;"></td> <td style="width: 10%;"></td> <td style="width: 10%;"></td> <td style="width: 10%;"></td> <td style="width: 10%;"></td> <td style="width: 10%;"></td> <td style="width: 10%;"></td> </tr> <tr> <td></td> <td></td> <td colspan="8" style="text-align: center;"> <table border="1" style="width: 100%; border-collapse: collapse; text-align: center;"> <tr> <td style="width: 10%;"></td> <td style="width: 10%;"></td> <td style="width: 10%;"></td> <td style="width: 10%;"></td> <td style="width: 10%;"></td> <td style="width: 10%;"></td> <td style="width: 10%;"></td> <td style="width: 10%;"></td> <td style="width: 10%;"></td> <td style="width: 10%;"></td> </tr> <tr> <td></td> <td></td> <td colspan="8" style="text-align: center;"> <table border="1" style="width: 100%; border-collapse: collapse; text-align: center;"> <tr> <td style="width: 10%;"></td> <td style="width: 10%;"></td> <td style="width: 10%;"></td> <td style="width: 10%;"></td> <td style="width: 10%;"></td> <td style="width: 10%;"></td> <td style="width: 10%;"></td> <td style="width: 10%;"></td> <td style="width: 10%;"></td> <td style="width: 10%;"></td> </tr> <tr> <td></td> <td></td> <td colspan="8" style="text-align: center;"> <table border="1" style="width: 100%; border-collapse: collapse; text-align: center;"> <tr> <td style="width: 10%;"></td> <td style="width: 10%;"></td> <td style="width: 10%;"></td> <td style="width: 10%;"></td> <td style="width: 10%;"></td> <td style="width: 10%;"></td> <td style="width: 10%;"></td> <td style="width: 10%;"></td> <td style="width: 10%;"></td> <td style="width: 10%;"></td> </tr> <tr> <td></td> <td></td> <td colspan="8" style="text-align: center;"> <table border="1" style="width: 100%; border-collapse: collapse; text-align: center;"> <tr> <td style="width: 10%;"></td> <td style="width: 10%;"></td> <td style="width: 10%;"></td> <td style="width: 10%;"></td> <td style="width: 10%;"></td> <td style="width: 10%;"></td> <td style="width: 10%;"></td> <td style="width: 10%;"></td> <td style="width: 10%;"></td> <td style="width: 10%;"></td> </tr> <tr> <td></td> <td></td> <td colspan="8" style="text-align: center;"> <table border="1" style="width: 100%; border-collapse: collapse; text-align: center;"> <tr> <td style="width: 10%;"></td> <td style="width: 10%;"></td> <td style="width: 10%;"></td> <td style="width: 10%;"></td> <td style="width: 10%;"></td> <td style="width: 10%;"></td> <td style="width: 10%;"></td> <td style="width: 10%;"></td> <td style="width: 10%;"></td> <td style="width: 10%;"></td> </tr> <tr> <td></td> <td></td> <td colspan="8" style="text-align: center;"> <table border="1" style="width: 100%; border-collapse: collapse; text-align: center;"> <tr> <td style="width: 10%;"></td> <td style="width: 10%;"></td> <td style="width: 10%;"></td> <td style="width: 10%;"></td> <td style="width: 10%;"></td> <td style="width: 10%;"></td> <td style="width: 10%;"></td> <td style="width: 10%;"></td> <td style="width: 10%;"></td> <td style="width: 10%;"></td> </tr> <tr> <td></td> <td></td> <td colspan="8" style="text-align: center;"> <table border="1" style="width: 100%; border-collapse: collapse; text-align: center;"> <tr> <td style="width: 10%;"></td> <td style="width: 10%;"></td> <td style="width: 10%;"></td> <td style="width: 10%;"></td> <td style="width: 10%;"></td> <td style="width: 10%;"></td> <td style="width: 10%;"></td> <td style="width: 10%;"></td> <td style="width: 10%;"></td> <td style="width: 10%;"></td> </tr> <tr> <td></td> <td></td> <td colspan="8" style="text-align: center;"> <table border="1"
style="width: 100%; border-collapse: collapse; text-align: center;"> <tr> <td style="width: 10%;"></td> <td style="width: 10%;"></td> <td style="width: 10%;"></td> <td style="width: 10%;"></td> <td style="width: 10%;"></td> <td style="width: 10%;"></td> <td style="width: 10%;"></td> <td style="width: 10%;"></td> <td style="width: 10%;"></td> <td style="width: 10%;"></td> </tr> <tr> <td></td> <td></td> <td colspan="8" style="text-align: center;"> <table border="1" style="width: 100%; border-collapse: collapse; text-align: center;"> <tr> <td style="width: 10%;"></td> <td style="width: 10%;"></td> <td style="width: 10%;"></td> <td style="width: 10%;"></td> <td style="width: 10%;"></td> <td style="width: 10%;"></td> <td style="width: 10%;"></td> <td style="width: 10%;"></td> <td style="width: 10%;"></td> <td style="width: 10%;"></td> </tr> <tr> <td></td> <td></td> <td colspan="8" style="text-align: center;"> <table border="1" style="width: 100%; border-collapse: collapse; text-align: center;"> <tr> <td style="width: 10%;"></td> <td style="width: 10%;"></td> <td style="width: 10%;"></td> <td style="width: 10%;"></td> <td style="width: 10%;"></td> <td style="width: 10%;"></td> <td style="width: 10%;"></td> <td style="width: 10%;"></td> <td style="width: 10%;"></td> <td style="width: 10%;"></td> </tr> <tr> <td></td> <td></td> <td colspan="8" style="text-align: center;"> <table border="1" style="width: 100%; border-collapse: collapse; text-align: center;"> <tr> <td style="width: 10%;"></td> <td style="width: 10%;"></td> <td style="width: 10%;"></td> <td style="width: 10%;"></td> <td style="width: 10%;"></td> <td style="width: 10%;"></td> <td style="width: 10%;"></td> <td style="width: 10%;"></td> <td style="width: 10%;"></td> <td style="width: 10%;"></td> </tr> <tr> <td></td> <td></td> <td colspan="8" style="text-align: center;"> <table border="1" style="width: 100%; border-collapse: collapse; text-align: center;"> <tr> <td style="width: 10%;"></td> <td style="width: 10%;"></td> <td style="width: 10%;"></td> <td style="width: 10%;"></td> <td style="width: 10%;"></td> <td style="width: 10%;"></td> <td style="width: 10%;"></td> <td style="width: 10%;"></td> <td style="width: 10%;"></td> <td style="width: 10%;"></td> </tr> <tr> <td></td> <td></td> <td colspan="8" style="text-align: center;"> <table border="1" style="width: 100%; border-collapse: collapse; text-align: center;"> <tr> <td style="width: 10%;"></td> <td style="width: 10%;"></td> <td style="width: 10%;"></td> <td style="width: 10%;"></td> <td style="width: 10%;"></td> <td style="width: 10%;"></td> <td style="width: 10%;"></td> <td style="width: 10%;"></td> <td style="width: 10%;"></td> <td style="width: 10%;"></td> </tr> <tr> <td></td> <td></td> <td colspan="8" style="text-align: center;"> <table border="1" style="width: 100%; border-collapse: collapse; text-align: center;"> <tr> <td style="width: 10%;"></td> <td style="width: 10%;"></td> <td style="width: 10%;"></td> <td style="width: 10%;"></td> <td style="width: 10%;"></td> <td style="width: 10%;"></td> <td style="width: 10%;"></td> <td style="width: 10%;"></td> <td style="width: 10%;"></td> <td style="width: 10%;"></td> </tr> <tr> <td></td> <td></td> <td colspan="8" style="text-align: center;"> <table border="1" style="width: 100%; border-collapse: collapse; text-align: center;"> <tr> <td style="width: 10%;"></td> <td style="width: 10%;"></td> <td style="width: 10%;"></td> <td style="width: 10%;"></td> <td style="width: 10%;"></td> <td style="width: 10%;"></td> <td style="width: 10%;"></td> <td style="width: 10%;"></td> <td style="width: 10%;"></td> <td style="width: 10%;"></td> </tr> <tr> <td></td> <td></td> <td colspan="8" style="text-align: center;"> <table border="1" style="width: 100%; border-collapse: collapse; text-align: center;"> <tr> <td style="width: 10%;"></td> <td style="width: 10%;"></td> <td style="width: 10%;"></td> <td style="width: 10%;"></td> <td style="width: 10%;"></td> <td style="width: 10%;"></td> <td style="width: 10%;"></td> <td style="width: 10%;"></td> <td style="width: 10%;"></td> <td style="width: 10%;"></td> </tr> <tr> <td></td> <td></td> <td colspan="8" style="text-align: center;"> <table border="1" style="width: 100%; border-collapse: collapse; text-align: center;"> <tr> <td style="width: 10%;"></td> <td style="width: 10%;"></td> <td style="width: 10%;"></td> <td style="width: 10%;"></td> <td style="width: 10%;"></td> <td style="width: 10%;"></td> <td style="width: 10%;"></td> <td style="width: 10%;"></td> <td style="width: 10%;"></td> <td style="width: 10%;"></td> </tr> <tr> <td></td> <td></td> <td colspan="8" style="text-align: center;"> <table border="1" style="width: 100%; border-collapse: collapse; text-align: center;"> <tr> <td style="width: 10%;"></td> <td style="width: 10%;"></td> <td style="width: 10%;"></td> <td style="width: 10%;"></td> <td style="width: 10%;"></td> <td style="width: 10%;"></td> <td style="width: 10%;"></td> <td style="width: 10%;"></td> <td style="width: 10%;"></td> <td style="width: 10%;"></td> </tr> <tr> <td></td> <td></td> <td colspan="8" style="text-align: center;"> <table border="1" style="width: 100%; border-collapse: collapse; text-align: center;"> <tr> <td style="width: 10%;"></td> <td style="width: 10%;"></td> <td style="width: 10%;"></td> <td style="width: 10%;"></td> <td style="width: 10%;"></td> <td style="width: 10%;"></td> <td style="width: 10%;"></td> <td style="width: 10%;"></td> <td style="width: 10%;"></td> <td style="width: 10%;"></td> </tr> <tr> <td></td> <td></td> <td colspan="8" style="text-align: center;"> <table border="1" style="width: 100%; border-collapse: collapse; text-align: center;"> <tr> <td style="width: 10%;"></td> <td style="width: 10%;"></td> <td style="width: 10%;"></td> <td style="width: 10%;"></td> <td style="width: 10%;"></td> <td style="width: 10%;"></td> <td style="width: 10%;"></td> <td style="width: 10%;"></td> <td style="width: 10%;"></td> <td style="width: 10%;"></td> </tr> <tr> <td></td> <td></td> <td colspan="8" style="text-align: center;"> <table border="1" style="width: 100%; border-collapse: collapse; text-align: center;"> <tr> <td style="width: 10%;"></td> <td style="width: 10%;"></td> <td style="width: 10%;"></td> <td style="width: 10%;"></td> <td style="width: 10%;"></td> <td style="width: 10%;"></td> <td style="width: 10%;"></td> <td style="width: 10%;"></td> <td style="width: 10%;"></td> <td style="width: 10%;"></td> </tr> <tr> <td></td> <td></td> <td colspan="8" style="text-align: center;"> <table border="1" style="width: 100%; border-collapse: collapse; text-align: center;"> <tr> <td style="width: 10%;"></td> <td style="width: 10%;"></td> <td style="width: 10%;"></td> <td style="width: 10%;"></td> <td style="width: 10%;"></td> <td style="width: 10%;"></td> <td style="width: 10%;"></td> <td style="width: 10%;"></td> <td style="width: 10%;"></td> <td style="width: 10%;"></td> </tr> <tr> <td></td> <td></td> <td colspan="8" style="text-align: center;"> <table border="1" style="width: 100%; border-collapse: collapse; text-align: center;"> <tr> <td style="width: 10%;"></td> <td style="width: 10%;"></td> <td style="width: 10%;"></td> <td style="width: 10%;"></td> <td style="width: 10%;"></td> <td style="width: 10%;"></td> <td style="width: 10%;"></td> <td style="width: 10%;"></td> <td style="width: 10%;"></td> <td style="width: 10%;"></td> </tr> <tr> <td></td> <td></td> <td colspan="8" style="text-align: center;"> <table border="1" style="width: 100%; border-collapse: collapse; text-align: center;"> <tr> <td style="width: 10%;"></td> <td style="width: 10%;"></td> <td style="width: 10%;"></td> <td style="width: 10%;"></td> <td style="width: 10%;"></td> <td style="width: 10%;"></td> <td style="width: 10%;"></td> <td style="width: 10%;"></td> <td style="width: 10%;"></td> <td style="width: 10%;"></td> </tr> <tr> <td></td> <td></td> <td colspan="8" style="text-align: center;"> <table border="1" style="width: 100%; border-collapse: collapse; text-align: center;"> <tr> <td style="width: 10%;"></td> <td style="width: 10%;"></td> <td style="width: 10%;"></td> <td style="width: 10%;"></td> <td style="width: 10%;"></td> <td style="width: 10%;"></td> <td style="width: 10%;"></td> <td style="width: 10%;"></td> <td style="width: 10%;"></td> <td style="width: 10%;"></td> </tr> <tr> <td></td> <td></td> <td colspan="8" style="text-align: center;"> <table border="1" style="width: 100%; border-collapse: collapse; text-align: center;"> <tr> <td style="width: 10%;"></td> <td style="width: 10%;"></td> <td style="width: 10%;"></td> <td style="width: 10%;"></td> <td style="width: 10%;"></td> <td style="width: 10%;"></td> <td style="width: 10%;"></td> <td style="width: 10%;"></td> <td style="width: 10%;"></td> <td style="width: 10%;"></td> </tr> <tr> <td></td> <td></td> <td colspan="8" style="text-align: center;"> <table border="1" style="width: 100%; border-collapse: collapse; text-align: center;"> <tr> <td style="width: 10%;"></td> <td style="width: 10%;"></td> <td style="width: 10%;"></td> <td style="width: 10%;"></td> <td style="width: 10%;"></td> <td style="width: 10%;"></td> <td style="width: 10%;"></td> <td style="width: 10%;"></td> <td style="width: 10%;"></td> <td style="width: 10%;"></td> </tr> <tr> <td></td> <td></td> <td colspan="8" style="text-align: center;"> <table border="1" style="width: 100%; border-collapse: collapse; text-align: center;"> <tr> <td style="width: 10%;"></td> <td style="width: 10%;"></td> <td style="width: 10%;"></td> <td style="width: 10%;"></td> <td style="width: 10%;"></td> <td style="width: 10%;"></td> <td style="width: 10%;"></td> <td style="width: 10%;"></td> <td style="width: 10%;"></td> <td style="width: 10%;"></td> </tr> <tr> <td></td> <td></td> <td colspan="8" style="text-align: center;"> <table border="1" style="width: 100%; border-collapse: collapse; text-align: center;"> <tr> <td style="width: 10%;"></td> <td style="width: 10%;"></td> <td style="width: 10%;"></td> <td
style="width: 10%;"></td> <td style="width: 10%;"></td> <td style="width: 10%;"></td> <td style="width: 10%;"></td> <td style="width: 10%;"></td> <td style="width: 10%;"></td> <td style="width: 10%;"></td> </tr> <tr> <td></td> <td></td> <td colspan="8" style="text-align: center;"> <table border="1" style="width: 100%; border-collapse: collapse; text-align: center;"> <tr> <td style="width: 10%;"></td> <td style="width: 10%;"></td> <td style="width: 10%;"></td> <td style="width: 10%;"></td> <td style="width: 10%;"></td> <td style="width: 10%;"></td> <td style="width: 10%;"></td> <td style="width: 10%;"></td> <td style="width: 10%;"></td> <td style="width: 10%;"></td> </tr> <tr> <td></td> <td></td> <td colspan="8" style="text-align: center;"> <table border="1" style="width: 100%; border-collapse: collapse; text-align: center;"> <tr> <td style="width: 10%;"></td> <td style="width: 10%;"></td> <td style="width: 10%;"></td> <td style="width: 10%;"></td> <td style="width: 10%;"></td> <td style="width: 10%;"></td> <td style="width: 10%;"></td> <td style="width: 10%;"></td> <td style="width: 10%;"></td> <td style="width: 10%;"></td> </tr> <tr> <td></td> <td></td> <td colspan="8" style="text-align: center;"> <table border="1" style="width: 100%; border-collapse: collapse; text-align: center;"> <tr> <td style="width: 10%;"></td> <td style="width: 10%;"></td> <td style="width: 10%;"></td> <td style="width: 10%;"></td> <td style="width: 10%;"></td> <td style="width: 10%;"></td> <td style="width: 10%;"></td> <td style="width: 10%;"></td> <td style="width: 10%;"></td> <td style="width: 10%;"></td> </tr> <tr> <td></td> <td></td> <td colspan="8" style="text-align: center;"> <table border="1" style="width: 100%; border-collapse: collapse; text-align: center;"> <tr> <td style="width: 10%;"></td> <td style="width: 10%;"></td> <td style="width: 10%;"></td> <td style="width: 10%;"></td> <td style="width: 10%;"></td> <td style="width: 10%;"></td> <td style="width: 10%;"></td> <td style="width: 10%;"></td> <td style="width: 10%;"></td> <td style="width: 10%;"></td> </tr> <tr> <td></td> <td></td> <td colspan="8" style="text-align: center;"> <table border="1" style="width: 100%; border-collapse: collapse; text-align: center;"> <tr> <td style="width: 10%;"></td> <td style="width: 10%;"></td> <td style="width: 10%;"></td> <td style="width: 10%;"></td> <td style="width: 10%;"></td> <td style="width: 10%;"></td> <td style="width: 10%;"></td> <td style="width: 10%;"></td> <td style="width: 10%;"></td> <td style="width: 10%;"></td> </tr> <tr> <td></td> <td></td> <td colspan="8" style="text-align: center;"> <table border="1" style="width: 100%; border-collapse: collapse; text-align: center;"> <tr> <td style="width: 10%;"></td> <td style="width: 10%;"></td> <td style="width: 10%;"></td> <td style="width: 10%;"></td> <td style="width: 10%;"></td> <td style="width: 10%;"></td> <td style="width: 10%;"></td> <td style="width: 10%;"></td> <td style="width: 10%;"></td> <td style="width: 10%;"></td> </tr> <tr> <td></td> <td></td> <td colspan="8" style="text-align: center;"> <table border="1" style="width: 100%; border-collapse: collapse; text-align: center;"> <tr> <td style="width: 10%;"></td> <td style="width: 10%;"></td> <td style="width: 10%;"></td> <td style="width: 10%;"></td> <td style="width: 10%;"></td> <td style="width: 10%;"></td> <td style="width: 10%;"></td> <td style="width: 10%;"></td> <td style="width: 10%;"></td> <td style="width: 10%;"></td> </tr> <tr> <td></td> <td></td> <td colspan="8" style="text-align: center;"> <table border="1" style="width: 100%; border-collapse: collapse; text-align: center;"> <tr> <td style="width: 10%;"></td> <td style="width: 10%;"></td> <td style="width: 10%;"></td> <td style="width: 10%;"></td> <td style="width: 10%;"></td> <td style="width: 10%;"></td> <td style="width: 10%;"></td> <td style="width: 10%;"></td> <td style="width: 10%;"></td> <td style="width: 10%;"></td> </tr> <tr> <td></td> <td></td> <td colspan="8" style="text-align: center;"> <table border="1" style="width: 100%; border-collapse: collapse; text-align: center;"> <tr> </tr></table></td></tr></table></td></tr></table></td></tr></table></td></tr></table></td></tr></table></td></tr></table></td></tr></table></td></tr></table></td></tr></table></td></tr></table></td></tr></table></td></tr></table></td></tr></table></td></tr></table></td></tr></table></td></tr></table></td></tr></table></td></tr></table></td></tr></table></td></tr></table></td></tr></table></td></tr></table></td></tr></table></td></tr></table></td></tr></table></td></tr></table></td></tr></table></td></tr></table></td></tr></table></td></tr></table></td></tr></table></td></tr></table></td></tr></table></td></tr></table></td></tr></table></td></tr></table></td></tr></table></td></tr></table></td></tr></table></td></tr></table></td></tr></table> | | | | | | | | | | | | | | | | | | | | <table border="1" style="width: 100%; border-collapse: collapse; text-align: center;"> <tr> <td style="width: 10%;"></td> <td style="width: 10%;"></td> <td style="width: 10%;"></td> <td style="width: 10%;"></td> <td style="width: 10%;"></td> <td style="width: 10%;"></td> <td style="width: 10%;"></td> <td style="width: 10%;"></td> <td style="width: 10%;"></td> <td style="width: 10%;"></td> </tr> <tr> <td></td> <td></td> <td colspan="8" style="text-align: center;"> <table border="1" style="width: 100%; border-collapse: collapse; text-align: center;"> <tr> <td style="width: 10%;"></td> <td style="width: 10%;"></td> <td style="width: 10%;"></td> <td style="width: 10%;"></td> <td style="width: 10%;"></td> <td style="width: 10%;"></td> <td style="width: 10%;"></td> <td style="width: 10%;"></td> <td style="width: 10%;"></td> <td style="width: 10%;"></td> </tr> <tr> <td></td> <td></td> <td colspan="8" style="text-align: center;"> <table border="1" style="width: 100%; border-collapse: collapse; text-align: center;"> <tr> <td style="width: 10%;"></td> <td style="width: 10%;"></td> <td style="width: 10%;"></td> <td style="width: 10%;"></td> <td style="width: 10%;"></td> <td style="width: 10%;"></td> <td style="width: 10%;"></td> <td style="width: 10%;"></td> <td style="width: 10%;"></td> <td style="width: 10%;"></td> </tr> <tr> <td></td> <td></td> <td colspan="8" style="text-align: center;"> <table border="1" style="width: 100%; border-collapse: collapse; text-align: center;"> <tr> <td style="width: 10%;"></td> <td style="width: 10%;"></td> <td style="width: 10%;"></td> <td style="width: 10%;"></td> <td style="width: 10%;"></td> <td style="width: 10%;"></td> <td style="width: 10%;"></td> <td style="width: 10%;"></td> <td style="width: 10%;"></td> <td style="width: 10%;"></td> </tr> <tr> <td></td> <td></td> <td colspan="8" style="text-align: center;"> <table border="1" style="width: 100%; border-collapse: collapse; text-align: center;"> <tr> <td style="width: 10%;"></td> <td style="width: 10%;"></td> <td style="width: 10%;"></td> <td style="width: 10%;"></td> <td style="width: 10%;"></td> <td style="width: 10%;"></td> <td style="width: 10%;"></td> <td style="width: 10%;"></td> <td style="width: 10%;"></td> <td style="width: 10%;"></td> </tr> <tr> <td></td> <td></td> <td colspan="8" style="text-align: center;"> <table border="1" style="width: 100%; border-collapse: collapse; text-align: center;"> <tr> <td style="width: 10%;"></td> <td style="width: 10%;"></td> <td style="width: 10%;"></td> <td style="width: 10%;"></td> <td style="width: 10%;"></td> <td style="width: 10%;"></td> <td style="width: 10%;"></td> <td style="width: 10%;"></td> <td style="width: 10%;"></td> <td style="width: 10%;"></td> </tr> <tr> <td></td> <td></td> <td colspan="8" style="text-align: center;"> <table border="1" style="width: 100%; border-collapse: collapse; text-align: center;"> <tr> <td style="width: 10%;"></td> <td style="width: 10%;"></td> <td style="width: 10%;"></td> <td style="width: 10%;"></td> <td style="width: 10%;"></td> <td style="width: 10%;"></td> <td style="width: 10%;"></td> <td style="width: 10%;"></td> <td style="width: 10%;"></td> <td style="width: 10%;"></td> </tr> <tr> <td></td> <td></td> <td colspan="8" style="text-align: center;"> <table border="1" style="width: 100%; border-collapse: collapse; text-align: center;"> <tr> <td style="width: 10%;"></td> <td style="width: 10%;"></td> <td style="width: 10%;"></td> <td style="width: 10%;"></td> <td style="width: 10%;"></td> <td style="width: 10%;"></td> <td style="width: 10%;"></td> <td style="width: 10%;"></td> <td
style="width: 10%;"></td> <td style="width: 10%;"></td> </tr> <tr> <td></td> <td></td> <td colspan="8" style="text-align: center;"> <table border="1" style="width: 100%; border-collapse: collapse; text-align: center;"> <tr> <td style="width: 10%;"></td> <td style="width: 10%;"></td> <td style="width: 10%;"></td> <td style="width: 10%;"></td> <td style="width: 10%;"></td> <td style="width: 10%;"></td> <td style="width: 10%;"></td> <td style="width: 10%;"></td> <td style="width: 10%;"></td> <td style="width: 10%;"></td> </tr> <tr> <td></td> <td></td> <td colspan="8" style="text-align: center;"> <table border="1" style="width: 100%; border-collapse: collapse; text-align: center;"> <tr> <td style="width: 10%;"></td> <td style="width: 10%;"></td> <td style="width: 10%;"></td> <td style="width: 10%;"></td> <td style="width: 10%;"></td> <td style="width: 10%;"></td> <td style="width: 10%;"></td> <td style="width: 10%;"></td> <td style="width: 10%;"></td> <td style="width: 10%;"></td> </tr> <tr> <td></td> <td></td> <td colspan="8" style="text-align: center;"> <table border="1" style="width: 100%; border-collapse: collapse; text-align: center;"> <tr> <td style="width: 10%;"></td> <td style="width: 10%;"></td> <td style="width: 10%;"></td> <td style="width: 10%;"></td> <td style="width: 10%;"></td> <td style="width: 10%;"></td> <td style="width: 10%;"></td> <td style="width: 10%;"></td> <td style="width: 10%;"></td> <td style="width: 10%;"></td> </tr> <tr> <td></td> <td></td> <td colspan="8" style="text-align: center;"> <table border="1" style="width: 100%; border-collapse: collapse; text-align: center;"> <tr> <td style="width: 10%;"></td> <td style="width: 10%;"></td> <td style="width: 10%;"></td> <td style="width: 10%;"></td> <td style="width: 10%;"></td> <td style="width: 10%;"></td> <td style="width: 10%;"></td> <td style="width: 10%;"></td> <td style="width: 10%;"></td> <td style="width: 10%;"></td> </tr> <tr> <td></td> <td></td> <td colspan="8" style="text-align: center;"> <table border="1" style="width: 100%; border-collapse: collapse; text-align: center;"> <tr> <td style="width: 10%;"></td> <td style="width: 10%;"></td> <td style="width: 10%;"></td> <td style="width: 10%;"></td> <td style="width: 10%;"></td> <td style="width: 10%;"></td> <td style="width: 10%;"></td> <td style="width: 10%;"></td> <td style="width: 10%;"></td> <td style="width: 10%;"></td> </tr> <tr> <td></td> <td></td> <td colspan="8" style="text-align: center;"> <table border="1" style="width: 100%; border-collapse: collapse; text-align: center;"> <tr> <td style="width: 10%;"></td> <td style="width: 10%;"></td> <td style="width: 10%;"></td> <td style="width: 10%;"></td> <td style="width: 10%;"></td> <td style="width: 10%;"></td> <td style="width: 10%;"></td> <td style="width: 10%;"></td> <td style="width: 10%;"></td> <td style="width: 10%;"></td> </tr> <tr> <td></td> <td></td> <td colspan="8" style="text-align: center;"> <table border="1" style="width: 100%; border-collapse: collapse; text-align: center;"> <tr> <td style="width: 10%;"></td> <td style="width: 10%;"></td> <td style="width: 10%;"></td> <td style="width: 10%;"></td> <td style="width: 10%;"></td> <td style="width: 10%;"></td> <td style="width: 10%;"></td> <td style="width: 10%;"></td> <td style="width: 10%;"></td> <td style="width: 10%;"></td> </tr> <tr> <td></td> <td></td> <td colspan="8" style="text-align: center;"> <table border="1" style="width: 100%; border-collapse: collapse; text-align: center;"> <tr> <td style="width: 10%;"></td> <td style="width: 10%;"></td> <td style="width: 10%;"></td> <td style="width: 10%;"></td> <td style="width: 10%;"></td> <td style="width: 10%;"></td> <td style="width: 10%;"></td> <td style="width: 10%;"></td> <td style="width: 10%;"></td> <td style="width: 10%;"></td> </tr> <tr> <td></td> <td></td> <td colspan="8" style="text-align: center;"> <table border="1" style="width: 100%; border-collapse: collapse; text-align: center;"> <tr> <td style="width: 10%;"></td> <td style="width: 10%;"></td> <td style="width: 10%;"></td> <td style="width: 10%;"></td> <td style="width: 10%;"></td> <td style="width: 10%;"></td> <td style="width: 10%;"></td> <td style="width: 10%;"></td> <td style="width: 10%;"></td> <td style="width: 10%;"></td> </tr> <tr> <td></td> <td></td> <td colspan="8" style="text-align: center;"> <table border="1" style="width: 100%; border-collapse: collapse; text-align: center;"> <tr> <td style="width: 10%;"></td> <td style="width: 10%;"></td> <td style="width: 10%;"></td> <td style="width: 10%;"></td> <td style="width: 10%;"></td> <td style="width: 10%;"></td> <td style="width: 10%;"></td> <td style="width: 10%;"></td> <td style="width: 10%;"></td> <td style="width: 10%;"></td> </tr> <tr> <td></td> <td></td> <td colspan="8" style="text-align: center;"> <table border="1" style="width: 100%; border-collapse: collapse; text-align: center;"> <tr> <td style="width: 10%;"></td> <td style="width: 10%;"></td> <td style="width: 10%;"></td> <td style="width: 10%;"></td> <td style="width: 10%;"></td> <td style="width: 10%;"></td> <td style="width: 10%;"></td> <td style="width: 10%;"></td> <td style="width: 10%;"></td> <td style="width: 10%;"></td> </tr> <tr> <td></td> <td></td> <td colspan="8" style="text-align: center;"> <table border="1" style="width: 100%; border-collapse: collapse; text-align: center;"> <tr> <td style="width: 10%;"></td> <td style="width: 10%;"></td> <td style="width: 10%;"></td> <td style="width: 10%;"></td> <td style="width: 10%;"></td> <td style="width: 10%;"></td> <td style="width: 10%;"></td> <td style="width: 10%;"></td> <td style="width: 10%;"></td> <td style="width: 10%;"></td> </tr> <tr> <td></td> <td></td> <td colspan="8" style="text-align: center;"> <table border="1" style="width: 100%; border-collapse: collapse; text-align: center;"> <tr> <td style="width: 10%;"></td> <td style="width: 10%;"></td> <td style="width: 10%;"></td> <td style="width: 10%;"></td> <td style="width: 10%;"></td> <td style="width: 10%;"></td> <td style="width: 10%;"></td> <td style="width: 10%;"></td> <td style="width: 10%;"></td> <td style="width: 10%;"></td> </tr> <tr> <td></td> <td></td> <td colspan="8" style="text-align: center;"> <table border="1" style="width: 100%; border-collapse: collapse; text-align: center;"> <tr> <td style="width: 10%;"></td> <td style="width: 10%;"></td> <td style="width: 10%;"></td> <td style="width: 10%;"></td> <td style="width: 10%;"></td> <td style="width: 10%;"></td> <td style="width: 10%;"></td> <td style="width: 10%;"></td> <td style="width: 10%;"></td> <td style="width: 10%;"></td> </tr> <tr> <td></td> <td></td> <td colspan="8" style="text-align: center;"> <table border="1" style="width: 100%; border-collapse: collapse; text-align: center;"> <tr> <td style="width: 10%;"></td> <td style="width: 10%;"></td> <td style="width: 10%;"></td> <td style="width: 10%;"></td> <td style="width: 10%;"></td> <td style="width: 10%;"></td> <td style="width: 10%;"></td> <td style="width: 10%;"></td> <td style="width: 10%;"></td> <td style="width: 10%;"></td> </tr> <tr> <td></td> <td></td> <td colspan="8" style="text-align: center;"> <table border="1" style="width: 100%; border-collapse: collapse; text-align: center;"> <tr> <td style="width: 10%;"></td> <td style="width: 10%;"></td> <td style="width: 10%;"></td> <td style="width: 10%;"></td> <td style="width: 10%;"></td> <td style="width: 10%;"></td> <td style="width: 10%;"></td> <td style="width: 10%;"></td> <td style="width: 10%;"></td> <td style="width: 10%;"></td> </tr> <tr> <td></td> <td></td> <td colspan="8" style="text-align: center;"> <table border="1" style="width: 100%; border-collapse: collapse; text-align: center;"> <tr> <td style="width: 10%;"></td> <td style="width: 10%;"></td> <td style="width: 10%;"></td> <td style="width: 10%;"></td> <td style="width: 10%;"></td> <td style="width: 10%;"></td> <td style="width: 10%;"></td> <td style="width: 10%;"></td> <td style="width: 10%;"></td> <td style="width: 10%;"></td> </tr> <tr> <td></td> <td></td> <td colspan="8" style="text-align: center;"> <table border="1" style="width: 100%; border-collapse: collapse; text-align: center;"> <tr> <td style="width: 10%;"></td> <td style="width: 10%;"></td> <td style="width: 10%;"></td> <td style="width: 10%;"></td> <td style="width: 10%;"></td> <td style="width: 10%;"></td> <td style="width: 10%;"></td> <td style="width: 10%;"></td> <td style="width: 10%;"></td> <td style="width: 10%;"></td> </tr> <tr> <td></td> <td></td> <td colspan="8" style="text-align: center;"> <table border="1" style="width: 100%; border-collapse: collapse; text-align: center;"> <tr> <td style="width: 10%;"></td> <td style="width: 10%;"></td> <td style="width: 10%;"></td> <td style="width: 10%;"></td> <td style="width: 10%;"></td> <td style="width: 10%;"></td> <td style="width: 10%;"></td> <td style="width: 10%;"></td> <td style="width: 10%;"></td> <td style="width: 10%;"></td> </tr> <tr> <td></td> <td></td> <td colspan="8" style="text-align: center;"> <table border="1" style="width: 100%; border-collapse: collapse; text-align: center;"> <tr> <td style="width: 10%;"></td> <td style="width: 10%;"></td> <td style="width: 10%;"></td> <td style="width: 10%;"></td> <td style="width: 10%;"></td> <td style="width: 10%;"></td> <td style="width: 10%;"></td> <td style="width: 10%;"></td> <td style="width: 10%;"></td> <td style="width: 10%;"></td> </tr> <tr> <td></td> <td></td> <td colspan="8" style="text-align: center;"> <table border="1" style="width: 100%; border-collapse: collapse; text-align: center;"> <tr> <td style="width: 10%;"></td> <td style="width: 10%;"></td> <td style="width: 10%;"></td> <td style="width: 10%;"></td> <td style="width: 10%;"></td> <td style="width: 10%;"></td> <td style="width: 10%;"></td> <td style="width: 10%;"></td> <td style="width: 10%;"></td> <td style="width: 10%;"></td> </tr> <tr> <td></td> <td></td> <td colspan="8" style="text-align: center;"> <table border="1" style="width: 100%;
border-collapse: collapse; text-align: center;"> <tr> <td style="width: 10%;"></td> <td style="width: 10%;"></td> <td style="width: 10%;"></td> <td style="width: 10%;"></td> <td style="width: 10%;"></td> <td style="width: 10%;"></td> <td style="width: 10%;"></td> <td style="width: 10%;"></td> <td style="width: 10%;"></td> <td style="width: 10%;"></td> </tr> <tr> <td></td> <td></td> <td colspan="8" style="text-align: center;"> <table border="1" style="width: 100%; border-collapse: collapse; text-align: center;"> <tr> <td style="width: 10%;"></td> <td style="width: 10%;"></td> <td style="width: 10%;"></td> <td style="width: 10%;"></td> <td style="width: 10%;"></td> <td style="width: 10%;"></td> <td style="width: 10%;"></td> <td style="width: 10%;"></td> <td style="width: 10%;"></td> <td style="width: 10%;"></td> </tr> <tr> <td></td> <td></td> <td colspan="8" style="text-align: center;"> <table border="1" style="width: 100%; border-collapse: collapse; text-align: center;"> <tr> <td style="width: 10%;"></td> <td style="width: 10%;"></td> <td style="width: 10%;"></td> <td style="width: 10%;"></td> <td style="width: 10%;"></td> <td style="width: 10%;"></td> <td style="width: 10%;"></td> <td style="width: 10%;"></td> <td style="width: 10%;"></td> <td style="width: 10%;"></td> </tr> <tr> <td></td> <td></td> <td colspan="8" style="text-align: center;"> <table border="1" style="width: 100%; border-collapse: collapse; text-align: center;"> <tr> <td style="width: 10%;"></td> <td style="width: 10%;"></td> <td style="width: 10%;"></td> <td style="width: 10%;"></td> <td style="width: 10%;"></td> <td style="width: 10%;"></td> <td style="width: 10%;"></td> <td style="width: 10%;"></td> <td style="width: 10%;"></td> <td style="width: 10%;"></td> </tr> <tr> <td></td> <td></td> <td colspan="8" style="text-align: center;"> <table border="1" style="width: 100%; border-collapse: collapse; text-align: center;"> <tr> <td style="width: 10%;"></td> <td style="width: 10%;"></td> <td style="width: 10%;"></td> <td style="width: 10%;"></td> <td style="width: 10%;"></td> <td style="width: 10%;"></td> <td style="width: 10%;"></td> <td style="width: 10%;"></td> <td style="width: 10%;"></td> <td style="width: 10%;"></td> </tr> <tr> <td></td> <td></td> <td colspan="8" style="text-align: center;"> <table border="1" style="width: 100%; border-collapse: collapse; text-align: center;"> <tr> <td style="width: 10%;"></td> <td style="width: 10%;"></td> <td style="width: 10%;"></td> <td style="width: 10%;"></td> <td style="width: 10%;"></td> <td style="width: 10%;"></td> <td style="width: 10%;"></td> <td style="width: 10%;"></td> <td style="width: 10%;"></td> <td style="width: 10%;"></td> </tr> <tr> <td></td> <td></td> <td colspan="8" style="text-align: center;"> <table border="1" style="width: 100%; border-collapse: collapse; text-align: center;"> <tr> <td style="width: 10%;"></td> <td style="width: 10%;"></td> <td style="width: 10%;"></td> <td style="width: 10%;"></td> <td style="width: 10%;"></td> <td style="width: 10%;"></td> <td style="width: 10%;"></td> <td style="width: 10%;"></td> <td style="width: 10%;"></td> <td style="width: 10%;"></td> </tr> <tr> <td></td> <td></td> <td colspan="8" style="text-align: center;"> <table border="1" style="width: 100%; border-collapse: collapse; text-align: center;"> <tr> <td style="width: 10%;"></td> <td style="width: 10%;"></td> <td style="width: 10%;"></td> <td style="width: 10%;"></td> <td style="width: 10%;"></td> <td style="width: 10%;"></td> <td style="width: 10%;"></td> <td style="width: 10%;"></td> <td style="width: 10%;"></td> <td style="width: 10%;"></td> </tr> <tr> <td></td> <td></td> <td colspan="8" style="text-align: center;"> <table border="1" style="width: 100%; border-collapse: collapse; text-align: center;"> <tr> <td style="width: 10%;"></td> <td style="width: 10%;"></td> <td style="width: 10%;"></td> <td style="width: 10%;"></td> <td style="width: 10%;"></td> <td style="width: 10%;"></td> <td style="width: 10%;"></td> <td style="width: 10%;"></td> <td style="width: 10%;"></td> <td style="width: 10%;"></td> </tr> <tr> <td></td> <td></td> <td colspan="8" style="text-align: center;"> <table border="1" style="width: 100%; border-collapse: collapse; text-align: center;"> <tr> <td style="width: 10%;"></td> <td style="width: 10%;"></td> <td style="width: 10%;"></td> <td style="width: 10%;"></td> <td style="width: 10%;"></td> <td style="width: 10%;"></td> <td style="width: 10%;"></td> <td style="width: 10%;"></td> <td style="width: 10%;"></td> <td style="width: 10%;"></td> </tr> <tr> <td></td> <td></td> <td colspan="8" style="text-align: center;"> <table border="1" style="width: 100%; border-collapse: collapse; text-align: center;"> <tr> <td style="width: 10%;"></td> <td style="width: 10%;"></td> <td style="width: 10%;"></td> <td style="width: 10%;"></td> <td style="width: 10%;"></td> <td style="width: 10%;"></td> <td style="width: 10%;"></td> <td style="width: 10%;"></td> <td style="width: 10%;"></td> <td style="width: 10%;"></td> </tr> <tr> <td></td> <td></td> <td colspan="8" style="text-align: center;"> <table border="1" style="width: 100%; border-collapse: collapse; text-align: center;"> <tr> </tr></table></td></tr></table></td></tr></table></td></tr></table></td></tr></table></td></tr></table></td></tr></table></td></tr></table></td></tr></table></td></tr></table></td></tr></table></td></tr></table></td></tr></table></td></tr></table></td></tr></table></td></tr></table></td></tr></table></td></tr></table></td></tr></table></td></tr></table></td></tr></table></td></tr></table></td></tr></table></td></tr></table></td></tr></table></td></tr></table></td></tr></table></td></tr></table></td></tr></table></td></tr></table></td></tr></table></td></tr></table></td></tr></table></td></tr></table></td></tr></table></td></tr></table></td></tr></table></td></tr></table></td></tr></table></td></tr></table></td></tr></table> | | | | | | | | | | | | | | | | | | | | <table border="1" style="width: 100%; border-collapse: collapse; text-align: center;"> <tr> <td style="width: 10%;"></td> <td style="width: 10%;"></td> <td style="width: 10%;"></td> <td style="width: 10%;"></td> <td style="width: 10%;"></td> <td style="width: 10%;"></td> <td style="width: 10%;"></td> <td style="width: 10%;"></td> <td style="width: 10%;"></td> <td style="width: 10%;"></td> </tr> <tr> <td></td> <td></td> <td colspan="8" style="text-align: center;"> <table border="1" style="width: 100%; border-collapse: collapse; text-align: center;"> <tr> <td style="width: 10%;"></td> <td style="width: 10%;"></td> <td style="width: 10%;"></td> <td style="width: 10%;"></td> <td style="width: 10%;"></td> <td style="width: 10%;"></td> <td style="width: 10%;"></td> <td style="width: 10%;"></td> <td style="width: 10%;"></td> <td style="width: 10%;"></td> </tr> <tr> <td></td> <td></td> <td colspan="8" style="text-align: center;"> <table border="1" style="width: 100%; border-collapse: collapse; text-align: center;"> <tr> <td style="width: 10%;"></td> <td style="width: 10%;"></td> <td style="width: 10%;"></td> <td style="width: 10%;"></td> <td style="width: 10%;"></td> <td style="width: 10%;"></td> <td style="width: 10%;"></td> <td style="width: 10%;"></td> <td style="width: 10%;"></td> <td style="width: 10%;"></td> </tr> <tr> <td></td> <td></td> <td colspan="8" style="text-align: center;"> <table border="1" style="width: 100%; border-collapse: collapse; text-align: center;"> <tr> <td style="width: 10%;"></td> <td style="width: 10%;"></td> <td style="width: 10%;"></td> <td style="width: 10%;"></td> <td style="width: 10%;"></td> <td style="width: 10%;"></td> <td style="width: 10%;"></td> <td style="width: 10%;"></td> <td style="width: 10%;"></td> <td style="width: 10%;"></td> </tr> <tr> <td></td> <td></td> <td colspan="8" style="text-align: center;"> <table border="1" style="width: 100%; border-collapse: collapse; text-align: center;"> <tr> <td style="width: 10%;"></td> <td style="width: 10%;"></td> <td style="width: 10%;"></td> <td style="width: 10%;"></td> <td style="width: 10%;"></td> <td style="width: 10%;"></td> <td style="width: 10%;"></td> <td style="width: 10%;"></td> <td style="width: 10%;"></td> <td style="width: 10%;"></td> </tr> <tr> <td></td> <td></td> <td colspan="8" style="text-align: center;"> <table border="1" style="width: 100%; border-collapse: collapse; text-align: center;"> <tr> <td style="width: 10%;"></td> <td style="width: 10%;"></td> <td style="width: 10%;"></td> <td style="width:
10%;"></td> <td style="width: 10%;"></td> <td style="width: 10%;"></td> <td style="width: 10%;"></td> <td style="width: 10%;"></td> <td style="width: 10%;"></td> <td style="width: 10%;"></td> </tr> <tr> <td></td> <td></td> <td colspan="8" style="text-align: center;"> <table border="1" style="width: 100%; border-collapse: collapse; text-align: center;"> <tr> <td style="width: 10%;"></td> <td style="width: 10%;"></td> <td style="width: 10%;"></td> <td style="width: 10%;"></td> <td style="width: 10%;"></td> <td style="width: 10%;"></td> <td style="width: 10%;"></td> <td style="width: 10%;"></td> <td style="width: 10%;"></td> <td style="width: 10%;"></td> </tr> <tr> <td></td> <td></td> <td colspan="8" style="text-align: center;"> <table border="1" style="width: 100%; border-collapse: collapse; text-align: center;"> <tr> <td style="width: 10%;"></td> <td style="width: 10%;"></td> <td style="width: 10%;"></td> <td style="width: 10%;"></td> <td style="width: 10%;"></td> <td style="width: 10%;"></td> <td style="width: 10%;"></td> <td style="width: 10%;"></td> <td style="width: 10%;"></td> <td style="width: 10%;"></td> </tr> <tr> <td></td> <td></td> <td colspan="8" style="text-align: center;"> <table border="1" style="width: 100%; border-collapse: collapse; text-align: center;"> <tr> <td style="width: 10%;"></td> <td style="width: 10%;"></td> <td style="width: 10%;"></td> <td style="width: 10%;"></td> <td style="width: 10%;"></td> <td style="width: 10%;"></td> <td style="width: 10%;"></td> <td style="width: 10%;"></td> <td style="width: 10%;"></td> <td style="width: 10%;"></td> </tr> <tr> <td></td> <td></td> <td colspan="8" style="text-align: center;"> <table border="1" style="width: 100%; border-collapse: collapse; text-align: center;"> <tr> <td style="width: 10%;"></td> <td style="width: 10%;"></td> <td style="width: 10%;"></td> <td style="width: 10%;"></td> <td style="width: 10%;"></td> <td style="width: 10%;"></td> <td style="width: 10%;"></td> <td style="width: 10%;"></td> <td style="width: 10%;"></td> <td style="width: 10%;"></td> </tr> <tr> <td></td> <td></td> <td colspan="8" style="text-align: center;"> <table border="1" style="width: 100%; border-collapse: collapse; text-align: center;"> <tr> <td style="width: 10%;"></td> <td style="width: 10%;"></td> <td style="width: 10%;"></td> <td style="width: 10%;"></td> <td style="width: 10%;"></td> <td style="width: 10%;"></td> <td style="width: 10%;"></td> <td style="width: 10%;"></td> <td style="width: 10%;"></td> <td style="width: 10%;"></td> </tr> <tr> <td></td> <td></td> <td colspan="8" style="text-align: center;"> <table border="1" style="width: 100%; border-collapse: collapse; text-align: center;"> <tr> <td style="width: 10%;"></td> <td style="width: 10%;"></td> <td style="width: 10%;"></td> <td style="width: 10%;"></td> <td style="width: 10%;"></td> <td style="width: 10%;"></td> <td style="width: 10%;"></td> <td style="width: 10%;"></td> <td style="width: 10%;"></td> <td style="width: 10%;"></td> </tr> <tr> <td></td> <td></td> <td colspan="8" style="text-align: center;"> <table border="1" style="width: 100%; border-collapse: collapse; text-align: center;"> <tr> <td style="width: 10%;"></td> <td style="width: 10%;"></td> <td style="width: 10%;"></td> <td style="width: 10%;"></td> <td style="width: 10%;"></td> <td style="width: 10%;"></td> <td style="width: 10%;"></td> <td style="width: 10%;"></td> <td style="width: 10%;"></td> <td style="width: 10%;"></td> </tr> <tr> <td></td> <td></td> <td colspan="8" style="text-align: center;"> <table border="1" style="width: 100%; border-collapse: collapse; text-align: center;"> <tr> <td style="width: 10%;"></td> <td style="width: 10%;"></td> <td style="width: 10%;"></td> <td style="width: 10%;"></td> <td style="width: 10%;"></td> <td style="width: 10%;"></td> <td style="width: 10%;"></td> <td style="width: 10%;"></td> <td style="width: 10%;"></td> <td style="width: 10%;"></td> </tr> <tr> <td></td> <td></td> <td colspan="8" style="text-align: center;"> <table border="1" style="width: 100%; border-collapse: collapse; text-align: center;"> <tr> <td style="width: 10%;"></td> <td style="width: 10%;"></td> <td style="width: 10%;"></td> <td style="width: 10%;"></td> <td style="width: 10%;"></td> <td style="width: 10%;"></td> <td style="width: 10%;"></td> <td style="width: 10%;"></td> <td style="width: 10%;"></td> <td style="width: 10%;"></td> </tr> <tr> <td></td> <td></td> <td colspan="8" style="text-align: center;"> <table border="1" style="width: 100%; border-collapse: collapse; text-align: center;"> <tr> <td style="width: 10%;"></td> <td style="width: 10%;"></td> <td style="width: 10%;"></td> <td style="width: 10%;"></td> <td style="width: 10%;"></td> <td style="width: 10%;"></td> <td style="width: 10%;"></td> <td style="width: 10%;"></td> <td style="width: 10%;"></td> <td style="width: 10%;"></td> </tr> <tr> <td></td> <td></td> <td colspan="8" style="text-align: center;"> <table border="1" style="width: 100%; border-collapse: collapse; text-align: center;"> <tr> <td style="width: 10%;"></td> <td style="width: 10%;"></td> <td style="width: 10%;"></td> <td style="width: 10%;"></td> <td style="width: 10%;"></td> <td style="width: 10%;"></td> <td style="width: 10%;"></td> <td style="width: 10%;"></td> <td style="width: 10%;"></td> <td style="width: 10%;"></td> </tr> <tr> <td></td> <td></td> <td colspan="8" style="text-align: center;"> <table border="1" style="width: 100%; border-collapse: collapse; text-align: center;"> <tr> <td style="width: 10%;"></td> <td style="width: 10%;"></td> <td style="width: 10%;"></td> <td style="width: 10%;"></td> <td style="width: 10%;"></td> <td style="width: 10%;"></td> <td style="width: 10%;"></td> <td style="width: 10%;"></td> <td style="width: 10%;"></td> <td style="width: 10%;"></td> </tr> <tr> <td></td> <td></td> <td colspan="8" style="text-align: center;"> <table border="1" style="width: 100%; border-collapse: collapse; text-align: center;"> <tr> <td style="width: 10%;"></td> <td style="width: 10%;"></td> <td style="width: 10%;"></td> <td style="width: 10%;"></td> <td style="width: 10%;"></td> <td style="width: 10%;"></td> <td style="width: 10%;"></td> <td style="width: 10%;"></td> <td style="width: 10%;"></td> <td style="width: 10%;"></td> </tr> <tr> <td></td> <td></td> <td colspan="8" style="text-align: center;"> <table border="1" style="width: 100%; border-collapse: collapse; text-align: center;"> <tr> <td style="width: 10%;"></td> <td style="width: 10%;"></td> <td style="width: 10%;"></td> <td style="width: 10%;"></td> <td style="width: 10%;"></td> <td style="width: 10%;"></td> <td style="width: 10%;"></td> <td style="width: 10%;"></td> <td style="width: 10%;"></td> <td style="width: 10%;"></td> </tr> <tr> <td></td> <td></td> <td colspan="8" style="text-align: center;"> <table border="1" style="width: 100%; border-collapse: collapse; text-align: center;"> <tr> <td style="width: 10%;"></td> <td style="width: 10%;"></td> <td style="width: 10%;"></td> <td style="width: 10%;"></td> <td style="width: 10%;"></td> <td style="width: 10%;"></td> <td style="width: 10%;"></td> <td style="width: 10%;"></td> <td style="width: 10%;"></td> <td style="width: 10%;"></td> </tr> <tr> <td></td> <td></td> <td colspan="8" style="text-align: center;"> <table border="1" style="width: 100%; border-collapse: collapse; text-align: center;"> <tr> <td style="width: 10%;"></td> <td style="width: 10%;"></td> <td style="width: 10%;"></td> <td style="width: 10%;"></td> <td style="width: 10%;"></td> <td style="width: 10%;"></td> <td style="width: 10%;"></td> <td style="width: 10%;"></td> <td style="width: 10%;"></td> <td style="width: 10%;"></td> </tr> <tr> <td></td> <td></td> <td colspan="8" style="text-align: center;"> <table border="1" style="width: 100%; border-collapse: collapse; text-align: center;"> <tr> <td style="width: 10%;"></td> <td style="width: 10%;"></td> <td style="width: 10%;"></td> <td style="width: 10%;"></td> <td style="width: 10%;"></td> <td style="width: 10%;"></td> <td style="width: 10%;"></td> <td style="width: 10%;"></td> <td style="width: 10%;"></td> <td style="width: 10%;"></td> </tr> <tr> <td></td> <td></td> <td colspan="8" style="text-align: center;"> <table border="1" style="width: 100%; border-collapse: collapse; text-align: center;"> <tr> <td style="width: 10%;"></td> <td style="width: 10%;"></td> <td style="width: 10%;"></td> <td style="width: 10%;"></td> <td style="width: 10%;"></td> <td style="width: 10%;"></td> <td style="width: 10%;"></td> <td style="width: 10%;"></td> <td style="width: 10%;"></td> <td style="width: 10%;"></td> </tr> <tr> <td></td> <td></td> <td colspan="8" style="text-align: center;"> <table border="1" style="width: 100%; border-collapse: collapse; text-align: center;"> <tr> <td style="width: 10%;"></td> <td style="width: 10%;"></td> <td style="width: 10%;"></td> <td style="width: 10%;"></td> <td style="width: 10%;"></td> <td style="width: 10%;"></td> <td style="width: 10%;"></td> <td style="width: 10%;"></td> <td style="width: 10%;"></td> <td style="width: 10%;"></td> </tr> <tr> <td></td> <td></td> <td colspan="8" style="text-align: center;"> <table border="1" style="width: 100%; border-collapse: collapse; text-align: center;"> <tr> <td style="width: 10%;"></td> <td style="width: 10%;"></td> <td style="width: 10%;"></td> <td style="width: 10%;"></td> <td style="width: 10%;"></td> <td style="width: 10%;"></td> <td style="width: 10%;"></td> <td style="width: 10%;"></td> <td style="width: 10%;"></td> <td style="width: 10%;"></td> </tr> <tr> <td></td> <td></td> <td colspan="8" style="text-align: center;"> <table border="1" style="width: 100%; border-collapse: collapse; text-align: center;"> <tr> <td style="width: 10%;"></td> <td style="width: 10%;"></td> <td style="width: 10%;"></td> <td style="width: 10%;"></td> <td style="width: 10%;"></td> <td style="width: 10%;"></td> <td style="width: 10%;"></td> <td style="width: 10%;"></td> <td style="width: 10%;"></td> <td
style="width: 10%;"></td> </tr> <tr> <td></td> <td></td> <td colspan="8" style="text-align: center;"> <table border="1" style="width: 100%; border-collapse: collapse; text-align: center;"> <tr> <td style="width: 10%;"></td> <td style="width: 10%;"></td> <td style="width: 10%;"></td> <td style="width: 10%;"></td> <td style="width: 10%;"></td> <td style="width: 10%;"></td> <td style="width: 10%;"></td> <td style="width: 10%;"></td> <td style="width: 10%;"></td> <td style="width: 10%;"></td> </tr> <tr> <td></td> <td></td> <td colspan="8" style="text-align: center;"> <table border="1" style="width: 100%; border-collapse: collapse; text-align: center;"> <tr> <td style="width: 10%;"></td> <td style="width: 10%;"></td> <td style="width: 10%;"></td> <td style="width: 10%;"></td> <td style="width: 10%;"></td> <td style="width: 10%;"></td> <td style="width: 10%;"></td> <td style="width: 10%;"></td> <td style="width: 10%;"></td> <td style="width: 10%;"></td> </tr> <tr> <td></td> <td></td> <td colspan="8" style="text-align: center;"> <table border="1" style="width: 100%; border-collapse: collapse; text-align: center;"> <tr> <td style="width: 10%;"></td> <td style="width: 10%;"></td> <td style="width: 10%;"></td> <td style="width: 10%;"></td> <td style="width: 10%;"></td> <td style="width: 10%;"></td> <td style="width: 10%;"></td> <td style="width: 10%;"></td> <td style="width: 10%;"></td> <td style="width: 10%;"></td> </tr> <tr> <td></td> <td></td> <td colspan="8" style="text-align: center;"> <table border="1" style="width: 100%; border-collapse: collapse; text-align: center;"> <tr> <td style="width: 10%;"></td> <td style="width: 10%;"></td> <td style="width: 10%;"></td> <td style="width: 10%;"></td> <td style="width: 10%;"></td> <td style="width: 10%;"></td> <td style="width: 10%;"></td> <td style="width: 10%;"></td> <td style="width: 10%;"></td> <td style="width: 10%;"></td> </tr> <tr> <td></td> <td></td> <td colspan="8" style="text-align: center;"> <table border="1" style="width: 100%; border-collapse: collapse; text-align: center;"> <tr> <td style="width: 10%;"></td> <td style="width: 10%;"></td> <td style="width: 10%;"></td> <td style="width: 10%;"></td> <td style="width: 10%;"></td> <td style="width: 10%;"></td> <td style="width: 10%;"></td> <td style="width: 10%;"></td> <td style="width: 10%;"></td> <td style="width: 10%;"></td> </tr> <tr> <td></td> <td></td> <td colspan="8" style="text-align: center;"> <table border="1" style="width: 100%; border-collapse: collapse; text-align: center;"> <tr> <td style="width: 10%;"></td> <td style="width: 10%;"></td> <td style="width: 10%;"></td> <td style="width: 10%;"></td> <td style="width: 10%;"></td> <td style="width: 10%;"></td> <td style="width: 10%;"></td> <td style="width: 10%;"></td> <td style="width: 10%;"></td> <td style="width: 10%;"></td> </tr> <tr> <td></td> <td></td> <td colspan="8" style="text-align: center;"> <table border="1" style="width: 100%; border-collapse: collapse; text-align: center;"> <tr> <td style="width: 10%;"></td> <td style="width: 10%;"></td> <td style="width: 10%;"></td> <td style="width: 10%;"></td> <td style="width: 10%;"></td> <td style="width: 10%;"></td> <td style="width: 10%;"></td> <td style="width: 10%;"></td> <td style="width: 10%;"></td> <td style="width: 10%;"></td> </tr> <tr> <td></td> <td></td> <td colspan="8" style="text-align: center;"> <table border="1" style="width: 100%; border-collapse: collapse; text-align: center;"> <tr> <td style="width: 10%;"></td> <td style="width: 10%;"></td> <td style="width: 10%;"></td> <td style="width: 10%;"></td> <td style="width: 10%;"></td> <td style="width: 10%;"></td> <td style="width: 10%;"></td> <td style="width: 10%;"></td> <td style="width: 10%;"></td> <td style="width: 10%;"></td> </tr> <tr> <td></td> <td></td> <td colspan="8" style="text-align: center;"> <table border="1" style="width: 100%; border-collapse: collapse; text-align: center;"> <tr> <td style="width: 10%;"></td> <td style="width: 10%;"></td> <td style="width: 10%;"></td> <td style="width: 10%;"></td> <td style="width: 10%;"></td> <td style="width: 10%;"></td> <td style="width: 10%;"></td> <td style="width: 10%;"></td> <td style="width: 10%;"></td> <td style="width: 10%;"></td> </tr> <tr> <td></td> <td></td> <td colspan="8" style="text-align: center;"> <table border="1" style="width: 100%; border-collapse: collapse; text-align: center;"> <tr> <td style="width: 10%;"></td> <td style="width: 10%;"></td> <td style="width: 10%;"></td> <td style="width: 10%;"></td> <td style="width: 10%;"></td> <td style="width: 10%;"></td> <td style="width: 10%;"></td> <td style="width: 10%;"></td> <td style="width: 10%;"></td> <td style="width: 10%;"></td> </tr> <tr> <td></td> <td></td> <td colspan="8" style="text-align: center;"> <table border="1" style="width: 100%; border-collapse: collapse; text-align: center;"> <tr> <td style="width: 10%;"></td> <td style="width: 10%;"></td> <td style="width: 10%;"></td> <td style="width: 10%;"></td> <td style="width: 10%;"></td> <td style="width: 10%;"></td> <td style="width: 10%;"></td> <td style="width: 10%;"></td> <td style="width: 10%;"></td> <td style="width: 10%;"></td> </tr> <tr> <td></td> <td></td> <td colspan="8" style="text-align: center;"> <table border="1" style="width: 100%; border-collapse: collapse; text-align: center;"> <tr> <td style="width: 10%;"></td> <td style="width: 10%;"></td> <td style="width: 10%;"></td> <td style="width: 10%;"></td> <td style="width: 10%;"></td> <td style="width: 10%;"></td> <td style="width: 10%;"></td> <td style="width: 10%;"></td> <td style="width: 10%;"></td> <td style="width: 10%;"></td> </tr> <tr> <td></td> <td></td> <td colspan="8" style="text-align: center;"> <table border="1" style="width: 100%; border-collapse: collapse; text-align: center;"> <tr> </tr></table></td></tr></table></td></tr></table></td></tr></table></td></tr></table></td></tr></table></td></tr></table></td></tr></table></td></tr></table></td></tr></table></td></tr></table></td></tr></table></td></tr></table></td></tr></table></td></tr></table></td></tr></table></td></tr></table></td></tr></table></td></tr></table></td></tr></table></td></tr></table></td></tr></table></td></tr></table></td></tr></table></td></tr></table></td></tr></table></td></tr></table></td></tr></table></td></tr></table></td></tr></table></td></tr></table></td></tr></table></td></tr></table></td></tr></table></td></tr></table></td></tr></table></td></tr></table></td></tr></table></td></tr></table></td></tr></table> | | | | | | | | | | | | | | | | | | | | <table border="1" style="width: 100%; border-collapse: collapse; text-align: center;"> <tr> <td style="width: 10%;"></td> <td style="width: 10%;"></td> <td style="width: 10%;"></td> <td style="width: 10%;"></td> <td style="width: 10%;"></td> <td style="width: 10%;"></td> <td style="width: 10%;"></td> <td style="width: 10%;"></td> <td style="width: 10%;"></td> <td style="width: 10%;"></td> </tr> <tr> <td></td> <td></td> <td colspan="8" style="text-align: center;"> <table border="1" style="width: 100%; border-collapse: collapse; text-align: center;"> <tr> <td style="width: 10%;"></td> <td style="width: 10%;"></td> <td style="width: 10%;"></td> <td style="width: 10%;"></td> <td style="width: 10%;"></td> <td style="width: 10%;"></td> <td style="width: 10%;"></td> <td style="width: 10%;"></td> <td style="width: 10%;"></td> <td style="width: 10%;"></td> </tr> <tr> <td></td> <td></td> <td colspan="8" style="text-align: center;"> <table border="1" style="width: 100%; border-collapse: collapse; text-align: center;"> <tr> <td style="width: 10%;"></td> <td style="width: 10%;"></td> <td style="width: 10%;"></td> <td style="width: 10%;"></td> <td style="width: 10%;"></td> <td style="width: 10%;"></td> <td style="width: 10%;"></td> <td style="width: 10%;"></td> <td style="width: 10%;"></td> <td style="width: 10%;"></td> </tr> <tr> <td></td> <td></td> <td colspan="8" style="text-align: center;"> <table border="1" style="width: 100%; border-collapse: collapse; text-align: center;"> <tr> <td style="width: 10%;"></td> <td style="width: 10%;"></td> <td style="width: 10%;"></td> <td style="width: 10%;"></td> <td style="width: 10%;"></td> <td style="width: 10%;"></td> <td style="width: 10%;"></td> <td style="width: 10%;"></td> <td style="width: 10%;"></td> <td style="width: 10%;"></td> </tr> <tr> <td></td> <td></td> <td colspan="8" style="text-align: center;"> <table border="1" style="width: 100%; border-collapse: collapse; text-align:
center;"> <tr> <td style="width: 10%;"></td> <td style="width: 10%;"></td> <td style="width: 10%;"></td> <td style="width: 10%;"></td> <td style="width: 10%;"></td> <td style="width: 10%;"></td> <td style="width: 10%;"></td> <td style="width: 10%;"></td> <td style="width: 10%;"></td> <td style="width: 10%;"></td> </tr> <tr> <td></td> <td></td> <td colspan="8" style="text-align: center;"> <table border="1" style="width: 100%; border-collapse: collapse; text-align: center;"> <tr> <td style="width: 10%;"></td> <td style="width: 10%;"></td> <td style="width: 10%;"></td> <td style="width: 10%;"></td> <td style="width: 10%;"></td> <td style="width: 10%;"></td> <td style="width: 10%;"></td> <td style="width: 10%;"></td> <td style="width: 10%;"></td> <td style="width: 10%;"></td> </tr> <tr> <td></td> <td></td> <td colspan="8" style="text-align: center;"> <table border="1" style="width: 100%; border-collapse: collapse; text-align: center;"> <tr> <td style="width: 10%;"></td> <td style="width: 10%;"></td> <td style="width: 10%;"></td> <td style="width: 10%;"></td> <td style="width: 10%;"></td> <td style="width: 10%;"></td> <td style="width: 10%;"></td> <td style="width: 10%;"></td> <td style="width: 10%;"></td> <td style="width: 10%;"></td> </tr> <tr> <td></td> <td></td> <td colspan="8" style="text-align: center;"> <table border="1" style="width: 100%; border-collapse: collapse; text-align: center;"> <tr> <td style="width: 10%;"></td> <td style="width: 10%;"></td> <td style="width: 10%;"></td> <td style="width: 10%;"></td> <td style="width: 10%;"></td> <td style="width: 10%;"></td> <td style="width: 10%;"></td> <td style="width: 10%;"></td> <td style="width: 10%;"></td> <td style="width: 10%;"></td> </tr> <tr> <td></td> <td></td> <td colspan="8" style="text-align: center;"> <table border="1" style="width: 100%; border-collapse: collapse; text-align: center;"> <tr> <td style="width: 10%;"></td> <td style="width: 10%;"></td> <td style="width: 10%;"></td> <td style="width: 10%;"></td> <td style="width: 10%;"></td> <td style="width: 10%;"></td> <td style="width: 10%;"></td> <td style="width: 10%;"></td> <td style="width: 10%;"></td> <td style="width: 10%;"></td> </tr> <tr> <td></td> <td></td> <td colspan="8" style="text-align: center;"> <table border="1" style="width: 100%; border-collapse: collapse; text-align: center;"> <tr> <td style="width: 10%;"></td> <td style="width: 10%;"></td> <td style="width: 10%;"></td> <td style="width: 10%;"></td> <td style="width: 10%;"></td> <td style="width: 10%;"></td> <td style="width: 10%;"></td> <td style="width: 10%;"></td> <td style="width: 10%;"></td> <td style="width: 10%;"></td> </tr> <tr> <td></td> <td></td> <td colspan="8" style="text-align: center;"> <table border="1" style="width: 100%; border-collapse: collapse; text-align: center;"> <tr> <td style="width: 10%;"></td> <td style="width: 10%;"></td> <td style="width: 10%;"></td> <td style="width: 10%;"></td> <td style="width: 10%;"></td> <td style="width: 10%;"></td> <td style="width: 10%;"></td> <td style="width: 10%;"></td> <td style="width: 10%;"></td> <td style="width: 10%;"></td> </tr> <tr> <td></td> <td></td> <td colspan="8" style="text-align: center;"> <table border="1" style="width: 100%; border-collapse: collapse; text-align: center;"> <tr> <td style="width: 10%;"></td> <td style="width: 10%;"></td> <td style="width: 10%;"></td> <td style="width: 10%;"></td> <td style="width: 10%;"></td> <td style="width: 10%;"></td> <td style="width: 10%;"></td> <td style="width: 10%;"></td> <td style="width: 10%;"></td> <td style="width: 10%;"></td> </tr> <tr> <td></td> <td></td> <td colspan="8" style="text-align: center;"> <table border="1" style="width: 100%; border-collapse: collapse; text-align: center;"> <tr> <td style="width: 10%;"></td> <td style="width: 10%;"></td> <td style="width: 10%;"></td> <td style="width: 10%;"></td> <td style="width: 10%;"></td> <td style="width: 10%;"></td> <td style="width: 10%;"></td> <td style="width: 10%;"></td> <td style="width: 10%;"></td> <td style="width: 10%;"></td> </tr> <tr> <td></td> <td></td> <td colspan="8" style="text-align: center;"> <table border="1" style="width: 100%; border-collapse: collapse; text-align: center;"> <tr> <td style="width: 10%;"></td> <td style="width: 10%;"></td> <td style="width: 10%;"></td> <td style="width: 10%;"></td> <td style="width: 10%;"></td> <td style="width: 10%;"></td> <td style="width: 10%;"></td> <td style="width: 10%;"></td> <td style="width: 10%;"></td> <td style="width: 10%;"></td> </tr> <tr> <td></td> <td></td> <td colspan="8" style="text-align: center;"> <table border="1" style="width: 100%; border-collapse: collapse; text-align: center;"> <tr> <td style="width: 10%;"></td> <td style="width: 10%;"></td> <td style="width: 10%;"></td> <td style="width: 10%;"></td> <td style="width: 10%;"></td> <td style="width: 10%;"></td> <td style="width: 10%;"></td> <td style="width: 10%;"></td> <td style="width: 10%;"></td> <td style="width: 10%;"></td> </tr> <tr> <td></td> <td></td> <td colspan="8" style="text-align: center;"> <table border="1" style="width: 100%; border-collapse: collapse; text-align: center;"> <tr> <td style="width: 10%;"></td> <td style="width: 10%;"></td> <td style="width: 10%;"></td> <td style="width: 10%;"></td> <td style="width: 10%;"></td> <td style="width: 10%;"></td> <td style="width: 10%;"></td> <td style="width: 10%;"></td> <td style="width: 10%;"></td> <td style="width: 10%;"></td> </tr> <tr> <td></td> <td></td> <td colspan="8" style="text-align: center;"> <table border="1" style="width: 100%; border-collapse: collapse; text-align: center;"> <tr> <td style="width: 10%;"></td> <td style="width: 10%;"></td> <td style="width: 10%;"></td> <td style="width: 10%;"></td> <td style="width: 10%;"></td> <td style="width: 10%;"></td> <td style="width: 10%;"></td> <td style="width: 10%;"></td> <td style="width: 10%;"></td> <td style="width: 10%;"></td> </tr> <tr> <td></td> <td></td> <td colspan="8" style="text-align: center;"> <table border="1" style="width: 100%; border-collapse: collapse; text-align: center;"> <tr> <td style="width: 10%;"></td> <td style="width: 10%;"></td> <td style="width: 10%;"></td> <td style="width: 10%;"></td> <td style="width: 10%;"></td> <td style="width: 10%;"></td> <td style="width: 10%;"></td> <td style="width: 10%;"></td> <td style="width: 10%;"></td> <td style="width: 10%;"></td> </tr> <tr> <td></td> <td></td> <td colspan="8" style="text-align: center;"> <table border="1" style="width: 100%; border-collapse: collapse; text-align: center;"> <tr> <td style="width: 10%;"></td> <td style="width: 10%;"></td> <td style="width: 10%;"></td> <td style="width: 10%;"></td> <td style="width: 10%;"></td> <td style="width: 10%;"></td> <td style="width: 10%;"></td> <td style="width: 10%;"></td> <td style="width: 10%;"></td> <td style="width: 10%;"></td> </tr> <tr> <td></td> <td></td> <td colspan="8" style="text-align: center;"> <table border="1" style="width: 100%; border-collapse: collapse; text-align: center;"> <tr> <td style="width: 10%;"></td> <td style="width: 10%;"></td> <td style="width: 10%;"></td> <td style="width: 10%;"></td> <td style="width: 10%;"></td> <td style="width: 10%;"></td> <td style="width: 10%;"></td> <td style="width: 10%;"></td> <td style="width: 10%;"></td> <td style="width: 10%;"></td> </tr> <tr> <td></td> <td></td> <td colspan="8" style="text-align: center;"> <table border="1" style="width: 100%; border-collapse: collapse; text-align: center;"> <tr> <td style="width: 10%;"></td> <td style="width: 10%;"></td> <td style="width: 10%;"></td> <td style="width: 10%;"></td> <td style="width: 10%;"></td> <td style="width: 10%;"></td> <td style="width: 10%;"></td> <td style="width: 10%;"></td> <td style="width: 10%;"></td> <td style="width: 10%;"></td> </tr> <tr> <td></td> <td></td> <td colspan="8" style="text-align: center;"> <table border="1" style="width: 100%; border-collapse: collapse; text-align: center;"> <tr> <td style="width: 10%;"></td> <td style="width: 10%;"></td> <td style="width: 10%;"></td> <td style="width: 10%;"></td> <td style="width: 10%;"></td> <td style="width: 10%;"></td> <td style="width: 10%;"></td> <td style="width: 10%;"></td> <td style="width: 10%;"></td> <td style="width: 10%;"></td> </tr> <tr> <td></td> <td></td> <td colspan="8" style="text-align: center;"> <table border="1" style="width: 100%; border-collapse: collapse; text-align: center;"> <tr> <td style="width: 10%;"></td> <td style="width: 10%;"></td> <td style="width: 10%;"></td> <td style="width: 10%;"></td> <td style="width: 10%;"></td> <td style="width: 10%;"></td> <td style="width: 10%;"></td> <td style="width: 10%;"></td> <td style="width: 10%;"></td> <td style="width: 10%;"></td> </tr> <tr> <td></td> <td></td> <td colspan="8" style="text-align: center;"> <table border="1" style="width: 100%; border-collapse: collapse; text-align: center;"> <tr> <td style="width: 10%;"></td> <td style="width: 10%;"></td> <td style="width: 10%;"></td> <td style="width: 10%;"></td> <td style="width: 10%;"></td> <td style="width: 10%;"></td> <td style="width: 10%;"></td> <td style="width: 10%;"></td> <td style="width: 10%;"></td> <td style="width: 10%;"></td> </tr> <tr> <td></td> <td></td> <td colspan="8" style="text-align: center;"> <table border="1" style="width: 100%; border-collapse: collapse; text-align: center;"> <tr> <td style="width: 10%;"></td> <td style="width: 10%;"></td> <td style="width: 10%;"></td> <td style="width: 10%;"></td> <td style="width: 10%;"></td> <td style="width: 10%;"></td> <td style="width: 10%;"></td> <td style="width: 10%;"></td> <td style="width: 10%;"></td> <td style="width: 10%;"></td> </tr> <tr> <td></td> <td></td> <td colspan="8" style="text-align: center;"> <table border="1" style="width: 100%; border-collapse: collapse; text-align: center;"> <tr> <td style="width: 10%;"></td> <td style="width: 10%;"></td> <td style="width: 10%;"></td> <td style="width: 10%;"></td> <td style="width: 10%;"></td> <td
style="width: 10%;"></td> <td style="width: 10%;"></td> <td style="width: 10%;"></td> <td style="width: 10%;"></td> <td style="width: 10%;"></td> </tr> <tr> <td></td> <td></td> <td colspan="8" style="text-align: center;"> <table border="1" style="width: 100%; border-collapse: collapse; text-align: center;"> <tr> <td style="width: 10%;"></td> <td style="width: 10%;"></td> <td style="width: 10%;"></td> <td style="width: 10%;"></td> <td style="width: 10%;"></td> <td style="width: 10%;"></td> <td style="width: 10%;"></td> <td style="width: 10%;"></td> <td style="width: 10%;"></td> <td style="width: 10%;"></td> </tr> <tr> <td></td> <td></td> <td colspan="8" style="text-align: center;"> <table border="1" style="width: 100%; border-collapse: collapse; text-align: center;"> <tr> <td style="width: 10%;"></td> <td style="width: 10%;"></td> <td style="width: 10%;"></td> <td style="width: 10%;"></td> <td style="width: 10%;"></td> <td style="width: 10%;"></td> <td style="width: 10%;"></td> <td style="width: 10%;"></td> <td style="width: 10%;"></td> <td style="width: 10%;"></td> </tr> <tr> <td></td> <td></td> <td colspan="8" style="text-align: center;"> <table border="1" style="width: 100%; border-collapse: collapse; text-align: center;"> <tr> <td style="width: 10%;"></td> <td style="width: 10%;"></td> <td style="width: 10%;"></td> <td style="width: 10%;"></td> <td style="width: 10%;"></td> <td style="width: 10%;"></td> <td style="width: 10%;"></td> <td style="width: 10%;"></td> <td style="width: 10%;"></td> <td style="width: 10%;"></td> </tr> <tr> <td></td> <td></td> <td colspan="8" style="text-align: center;"> <table border="1" style="width: 100%; border-collapse: collapse; text-align: center;"> <tr> <td style="width: 10%;"></td> <td style="width: 10%;"></td> <td style="width: 10%;"></td> <td style="width: 10%;"></td> <td style="width: 10%;"></td> <td style="width: 10%;"></td> <td style="width: 10%;"></td> <td style="width: 10%;"></td> <td style="width: 10%;"></td> <td style="width: 10%;"></td> </tr> <tr> <td></td> <td></td> <td colspan="8" style="text-align: center;"> <table border="1" style="width: 100%; border-collapse: collapse; text-align: center;"> <tr> <td style="width: 10%;"></td> <td style="width: 10%;"></td> <td style="width: 10%;"></td> <td style="width: 10%;"></td> <td style="width: 10%;"></td> <td style="width: 10%;"></td> <td style="width: 10%;"></td> <td style="width: 10%;"></td> <td style="width: 10%;"></td> <td style="width: 10%;"></td> </tr> <tr> <td></td> <td></td> <td colspan="8" style="text-align: center;"> <table border="1" style="width: 100%; border-collapse: collapse; text-align: center;"> <tr> <td style="width: 10%;"></td> <td style="width: 10%;"></td> <td style="width: 10%;"></td> <td style="width: 10%;"></td> <td style="width: 10%;"></td> <td style="width: 10%;"></td> <td style="width: 10%;"></td> <td style="width: 10%;"></td> <td style="width: 10%;"></td> <td style="width: 10%;"></td> </tr> <tr> <td></td> <td></td> <td colspan="8" style="text-align: center;"> <table border="1" style="width: 100%; border-collapse: collapse; text-align: center;"> <tr> <td style="width: 10%;"></td> <td style="width: 10%;"></td> <td style="width: 10%;"></td> <td style="width: 10%;"></td> <td style="width: 10%;"></td> <td style="width: 10%;"></td> <td style="width: 10%;"></td> <td style="width: 10%;"></td> <td style="width: 10%;"></td> <td style="width: 10%;"></td> </tr> <tr> <td></td> <td></td> <td colspan="8" style="text-align: center;"> <table border="1" style="width: 100%; border-collapse: collapse; text-align: center;"> <tr> <td style="width: 10%;"></td> <td style="width: 10%;"></td> <td style="width: 10%;"></td> <td style="width: 10%;"></td> <td style="width: 10%;"></td> <td style="width: 10%;"></td> <td style="width: 10%;"></td> <td style="width: 10%;"></td> <td style="width: 10%;"></td> <td style="width: 10%;"></td> </tr> <tr> <td></td> <td></td> <td colspan="8" style="text-align: center;"> <table border="1" style="width: 100%; border-collapse: collapse; text-align: center;"> <tr> <td style="width: 10%;"></td> <td style="width: 10%;"></td> <td style="width: 10%;"></td> <td style="width: 10%;"></td> <td style="width: 10%;"></td> <td style="width: 10%;"></td> <td style="width: 10%;"></td> <td style="width: 10%;"></td> <td style="width: 10%;"></td> <td style="width: 10%;"></td> </tr> <tr> <td></td> <td></td> <td colspan="8" style="text-align: center;"> <table border="1" style="width: 100%; border-collapse: collapse; text-align: center;"> <tr> <td style="width: 10%;"></td> <td style="width: 10%;"></td> <td style="width: 10%;"></td> <td style="width: 10%;"></td> <td style="width: 10%;"></td> <td style="width: 10%;"></td> <td style="width: 10%;"></td> <td style="width: 10%;"></td> <td style="width: 10%;"></td> <td style="width: 10%;"></td> </tr> <tr> <td></td> <td></td> <td colspan="8" style="text-align: center;"> <table border="1" style="width: 100%; border-collapse: collapse; text-align: center;"> <tr> <td style="width: 10%;"></td> <td style="width: 10%;"></td> <td style="width: 10%;"></td> <td style="width: 10%;"></td> <td style="width: 10%;"></td> <td style="width: 10%;"></td> <td style="width: 10%;"></td> <td style="width: 10%;"></td> <td style="width: 10%;"></td> <td style="width: 10%;"></td> </tr> <tr> <td></td> <td></td> <td colspan="8" style="text-align: center;"> <table border="1" style="width: 100%; border-collapse: collapse; text-align: center;"> <tr> <td style="width: 10%;"></td> <td style="width: 10%;"></td> <td style="width: 10%;"></td> <td style="width: 10%;"></td> <td style="width: 10%;"></td> <td style="width: 10%;"></td> <td style="width: 10%;"></td> <td style="width: 10%;"></td> <td style="width: 10%;"></td> <td style="width: 10%;"></td> </tr> <tr> <td></td> <td></td> <td colspan="8" style="text-align: center;"> <table border="1" style="width: 100%; border-collapse: collapse; text-align: center;"> <tr> </tr></table></td></tr></table></td></tr></table></td></tr></table></td></tr></table></td></tr></table></td></tr></table></td></tr></table></td></tr></table></td></tr></table></td></tr></table></td></tr></table></td></tr></table></td></tr></table></td></tr></table></td></tr></table></td></tr></table></td></tr></table></td></tr></table></td></tr></table></td></tr></table></td></tr></table></td></tr></table></td></tr></table></td></tr></table></td></tr></table></td></tr></table></td></tr></table></td></tr></table></td></tr></table></td></tr></table></td></tr></table></td></tr></table></td></tr></table></td></tr></table></td></tr></table></td></tr></table></td></tr></table></td></tr></table> | | | | | | | | | | | | | | | | | | | | <table border="1" style="width: 100%; border-collapse: collapse; text-align: center;"> <tr> <td style="width: 10%;"></td> <td style="width: 10%;"></td> <td style="width: 10%;"></td> <td style="width: 10%;"></td> <td style="width: 10%;"></td> <td style="width: 10%;"></td> <td style="width: 10%;"></td> <td style="width: 10%;"></td> <td style="width: 10%;"></td> <td style="width: 10%;"></td> </tr> <tr> <td></td> <td></td> <td colspan="8" style="text-align: center;"> <table border="1" style="width: 100%; border-collapse: collapse; text-align: center;"> <tr> <td style="width: 10%;"></td> <td style="width: 10%;"></td> <td style="width: 10%;"></td> <td style="width: 10%;"></td> <td style="width: 10%;"></td> <td style="width: 10%;"></td> <td style="width: 10%;"></td> <td style="width: 10%;"></td> <td style="width: 10%;"></td> <td style="width: 10%;"></td> </tr> <tr> <td></td> <td></td> <td colspan="8" style="text-align: center;"> <table border="1" style="width: 100%; border-collapse: collapse; text-align: center;"> <tr> <td style="width: 10%;"></td> <td style="width: 10%;"></td> <td style="width: 10%;"></td> <td style="width: 10%;"></td> <td style="width: 10%;"></td> <td style="width: 10%;"></td> <td style="width: 10%;"></td> <td style="width: 10%;"></td> <td style="width: 10%;"></td> <td style="width: 10%;"></td> </tr> <tr> <td></td> <td></td> <td colspan="8" style="text-align: center;"> <table border="1" style="width: 100%; border-collapse: collapse; text-align: center;"> <tr> <td style="width: 10%;"></td> <td style="width: 10%;"></td> <td style="width: 10%;"></td> <td style="width: 10%;"></td> <td style="width: 10%;"></td> <td style="width: 10%;"></td> <td style="width: 10%;"></td> <td style="width: 10%;"></td> <td style="width: 10%;"></td> <td style="width: 10%;"></td> </tr> <tr> <td></td> <td></td> <td colspan="8"
style="text-align: center;"> <table border="1" style="width: 100%; border-collapse: collapse; text-align: center;"> <tr> <td style="width: 10%;"></td> <td style="width: 10%;"></td> <td style="width: 10%;"></td> <td style="width: 10%;"></td> <td style="width: 10%;"></td> <td style="width: 10%;"></td> <td style="width: 10%;"></td> <td style="width: 10%;"></td> <td style="width: 10%;"></td> <td style="width: 10%;"></td> </tr> <tr> <td></td> <td></td> <td colspan="8" style="text-align: center;"> <table border="1" style="width: 100%; border-collapse: collapse; text-align: center;"> <tr> <td style="width: 10%;"></td> <td style="width: 10%;"></td> <td style="width: 10%;"></td> <td style="width: 10%;"></td> <td style="width: 10%;"></td> <td style="width: 10%;"></td> <td style="width: 10%;"></td> <td style="width: 10%;"></td> <td style="width: 10%;"></td> <td style="width: 10%;"></td> </tr> <tr> <td></td> <td></td> <td colspan="8" style="text-align: center;"> <table border="1" style="width: 100%; border-collapse: collapse; text-align: center;"> <tr> <td style="width: 10%;"></td> <td style="width: 10%;"></td> <td style="width: 10%;"></td> <td style="width: 10%;"></td> <td style="width: 10%;"></td> <td style="width: 10%;"></td> <td style="width: 10%;"></td> <td style="width: 10%;"></td> <td style="width: 10%;"></td> <td style="width: 10%;"></td> </tr> <tr> <td></td> <td></td> <td colspan="8" style="text-align: center;"> <table border="1" style="width: 100%; border-collapse: collapse; text-align: center;"> <tr> <td style="width: 10%;"></td> <td style="width: 10%;"></td> <td style="width: 10%;"></td> <td style="width: 10%;"></td> <td style="width: 10%;"></td> <td style="width: 10%;"></td> <td style="width: 10%;"></td> <td style="width: 10%;"></td> <td style="width: 10%;"></td> <td style="width: 10%;"></td> </tr> <tr> <td></td> <td></td> <td colspan="8" style="text-align: center;"> <table border="1" style="width: 100%; border-collapse: collapse; text-align: center;"> <tr> <td style="width: 10%;"></td> <td style="width: 10%;"></td> <td style="width: 10%;"></td> <td style="width: 10%;"></td> <td style="width: 10%;"></td> <td style="width: 10%;"></td> <td style="width: 10%;"></td> <td style="width: 10%;"></td> <td style="width: 10%;"></td> <td style="width: 10%;"></td> </tr> <tr> <td></td> <td></td> <td colspan="8" style="text-align: center;"> <table border="1" style="width: 100%; border-collapse: collapse; text-align: center;"> <tr> <td style="width: 10%;"></td> <td style="width: 10%;"></td> <td style="width: 10%;"></td> <td style="width: 10%;"></td> <td style="width: 10%;"></td> <td style="width: 10%;"></td> <td style="width: 10%;"></td> <td style="width: 10%;"></td> <td style="width: 10%;"></td> <td style="width: 10%;"></td> </tr> <tr> <td></td> <td></td> <td colspan="8" style="text-align: center;"> <table border="1" style="width: 100%; border-collapse: collapse; text-align: center;"> <tr> <td style="width: 10%;"></td> <td style="width: 10%;"></td> <td style="width: 10%;"></td> <td style="width: 10%;"></td> <td style="width: 10%;"></td> <td style="width: 10%;"></td> <td style="width: 10%;"></td> <td style="width: 10%;"></td> <td style="width: 10%;"></td> <td style="width: 10%;"></td> </tr> <tr> <td></td> <td></td> <td colspan="8" style="text-align: center;"> <table border="1" style="width: 100%; border-collapse: collapse; text-align: center;"> <tr> <td style="width: 10%;"></td> <td style="width: 10%;"></td> <td style="width: 10%;"></td> <td style="width: 10%;"></td> <td style="width: 10%;"></td> <td style="width: 10%;"></td> <td style="width: 10%;"></td> <td style="width: 10%;"></td> <td style="width: 10%;"></td> <td style="width: 10%;"></td> </tr> <tr> <td></td> <td></td> <td colspan="8" style="text-align: center;"> <table border="1" style="width: 100%; border-collapse: collapse; text-align: center;"> <tr> <td style="width: 10%;"></td> <td style="width: 10%;"></td> <td style="width: 10%;"></td> <td style="width: 10%;"></td> <td style="width: 10%;"></td> <td style="width: 10%;"></td> <td style="width: 10%;"></td> <td style="width: 10%;"></td> <td style="width: 10%;"></td> <td style="width: 10%;"></td> </tr> <tr> <td></td> <td></td> <td colspan="8" style="text-align: center;"> <table border="1" style="width: 100%; border-collapse: collapse; text-align: center;"> <tr> <td style="width: 10%;"></td> <td style="width: 10%;"></td> <td style="width: 10%;"></td> <td style="width: 10%;"></td> <td style="width: 10%;"></td> <td style="width: 10%;"></td> <td style="width: 10%;"></td> <td style="width: 10%;"></td> <td style="width: 10%;"></td> <td style="width: 10%;"></td> </tr> <tr> <td></td> <td></td> <td colspan="8" style="text-align: center;"> <table border="1" style="width: 100%; border-collapse: collapse; text-align: center;"> <tr> <td style="width: 10%;"></td> <td style="width: 10%;"></td> <td style="width: 10%;"></td> <td style="width: 10%;"></td> <td style="width: 10%;"></td> <td style="width: 10%;"></td> <td style="width: 10%;"></td> <td style="width: 10%;"></td> <td style="width: 10%;"></td> <td style="width: 10%;"></td> </tr> <tr> <td></td> <td></td> <td colspan="8" style="text-align: center;"> <table border="1" style="width: 100%; border-collapse: collapse; text-align: center;"> <tr> <td style="width: 10%;"></td> <td style="width: 10%;"></td> <td style="width: 10%;"></td> <td style="width: 10%;"></td> <td style="width: 10%;"></td> <td style="width: 10%;"></td> <td style="width: 10%;"></td> <td style="width: 10%;"></td> <td style="width: 10%;"></td> <td style="width: 10%;"></td> </tr> <tr> <td></td> <td></td> <td colspan="8" style="text-align: center;"> <table border="1" style="width: 100%; border-collapse: collapse; text-align: center;"> <tr> <td style="width: 10%;"></td> <td style="width: 10%;"></td> <td style="width: 10%;"></td> <td style="width: 10%;"></td> <td style="width: 10%;"></td> <td style="width: 10%;"></td> <td style="width: 10%;"></td> <td style="width: 10%;"></td> <td style="width: 10%;"></td> <td style="width: 10%;"></td> </tr> <tr> <td></td> <td></td> <td colspan="8" style="text-align: center;"> <table border="1" style="width: 100%; border-collapse: collapse; text-align: center;"> <tr> <td style="width: 10%;"></td> <td style="width: 10%;"></td> <td style="width: 10%;"></td> <td style="width: 10%;"></td> <td style="width: 10%;"></td> <td style="width: 10%;"></td> <td style="width: 10%;"></td> <td style="width: 10%;"></td> <td style="width: 10%;"></td> <td style="width: 10%;"></td> </tr> <tr> <td></td> <td></td> <td colspan="8" style="text-align: center;"> <table border="1" style="width: 100%; border-collapse: collapse; text-align: center;"> <tr> <td style="width: 10%;"></td> <td style="width: 10%;"></td> <td style="width: 10%;"></td> <td style="width: 10%;"></td> <td style="width: 10%;"></td> <td style="width: 10%;"></td> <td style="width: 10%;"></td> <td style="width: 10%;"></td> <td style="width: 10%;"></td> <td style="width: 10%;"></td> </tr> <tr> <td></td> <td></td> <td colspan="8" style="text-align: center;"> <table border="1" style="width: 100%; border-collapse: collapse; text-align: center;"> <tr> <td style="width: 10%;"></td> <td style="width: 10%;"></td> <td style="width: 10%;"></td> <td style="width: 10%;"></td> <td style="width: 10%;"></td> <td style="width: 10%;"></td> <td style="width: 10%;"></td> <td style="width: 10%;"></td> <td style="width: 10%;"></td> <td style="width: 10%;"></td> </tr> <tr> <td></td> <td></td> <td colspan="8" style="text-align: center;"> <table border="1" style="width: 100%; border-collapse: collapse; text-align: center;"> <tr> <td style="width: 10%;"></td> <td style="width: 10%;"></td> <td style="width: 10%;"></td> <td style="width: 10%;"></td> <td style="width: 10%;"></td> <td style="width: 10%;"></td> <td style="width: 10%;"></td> <td style="width: 10%;"></td> <td style="width: 10%;"></td> <td style="width: 10%;"></td> </tr> <tr> <td></td> <td></td> <td colspan="8" style="text-align: center;"> <table border="1" style="width: 100%; border-collapse: collapse; text-align: center;"> <tr> <td style="width: 10%;"></td> <td style="width: 10%;"></td> <td style="width: 10%;"></td> <td style="width: 10%;"></td> <td style="width: 10%;"></td> <td style="width: 10%;"></td> <td style="width: 10%;"></td> <td style="width: 10%;"></td> <td style="width: 10%;"></td> <td style="width: 10%;"></td> </tr> <tr> <td></td> <td></td> <td colspan="8" style="text-align: center;"> <table border="1" style="width: 100%; border-collapse: collapse; text-align: center;"> <tr> <td style="width: 10%;"></td> <td style="width: 10%;"></td> <td style="width: 10%;"></td> <td style="width: 10%;"></td> <td style="width: 10%;"></td> <td style="width: 10%;"></td> <td style="width: 10%;"></td> <td style="width: 10%;"></td> <td style="width: 10%;"></td> <td style="width: 10%;"></td> </tr> <tr> <td></td> <td></td> <td colspan="8" style="text-align: center;"> <table border="1" style="width: 100%; border-collapse: collapse; text-align: center;"> <tr> <td style="width: 10%;"></td> <td style="width: 10%;"></td> <td style="width: 10%;"></td> <td style="width: 10%;"></td> <td style="width: 10%;"></td> <td style="width: 10%;"></td> <td style="width: 10%;"></td> <td style="width: 10%;"></td> <td style="width: 10%;"></td> <td style="width: 10%;"></td> </tr> <tr> <td></td> <td></td> <td colspan="8" style="text-align: center;"> <table border="1" style="width: 100%; border-collapse: collapse; text-align: center;"> <tr> <td style="width: 10%;"></td> <td style="width: 10%;"></td> <td style="width: 10%;"></td> <td style="width: 10%;"></td> <td style="width: 10%;"></td> <td style="width: 10%;"></td> <td style="width: 10%;"></td> <td style="width: 10%;"></td> <td style="width: 10%;"></td> <td style="width: 10%;"></td> </tr> <tr> <td></td> <td></td> <td colspan="8" style="text-align: center;"> <table border="1" style="width: 100%; border-collapse: collapse; text-align: center;"> <tr> <td style="width: 10%;"></td> <td style="width:
10%;"></td> <td style="width: 10%;"></td> <td style="width: 10%;"></td> <td style="width: 10%;"></td> <td style="width: 10%;"></td> <td style="width: 10%;"></td> <td style="width: 10%;"></td> <td style="width: 10%;"></td> <td style="width: 10%;"></td> </tr> <tr> <td></td> <td></td> <td colspan="8" style="text-align: center;"> <table border="1" style="width: 100%; border-collapse: collapse; text-align: center;"> <tr> <td style="width: 10%;"></td> <td style="width: 10%;"></td> <td style="width: 10%;"></td> <td style="width: 10%;"></td> <td style="width: 10%;"></td> <td style="width: 10%;"></td> <td style="width: 10%;"></td> <td style="width: 10%;"></td> <td style="width: 10%;"></td> <td style="width: 10%;"></td> </tr> <tr> <td></td> <td></td> <td colspan="8" style="text-align: center;"> <table border="1" style="width: 100%; border-collapse: collapse; text-align: center;"> <tr> <td style="width: 10%;"></td> <td style="width: 10%;"></td> <td style="width: 10%;"></td> <td style="width: 10%;"></td> <td style="width: 10%;"></td> <td style="width: 10%;"></td> <td style="width: 10%;"></td> <td style="width: 10%;"></td> <td style="width: 10%;"></td> <td style="width: 10%;"></td> </tr> <tr> <td></td> <td></td> <td colspan="8" style="text-align: center;"> <table border="1" style="width: 100%; border-collapse: collapse; text-align: center;"> <tr> <td style="width: 10%;"></td> <td style="width: 10%;"></td> <td style="width: 10%;"></td> <td style="width: 10%;"></td> <td style="width: 10%;"></td> <td style="width: 10%;"></td> <td style="width: 10%;"></td> <td style="width: 10%;"></td> <td style="width: 10%;"></td> <td style="width: 10%;"></td> </tr> <tr> <td></td> <td></td> <td colspan="8" style="text-align: center;"> <table border="1" style="width: 100%; border-collapse: collapse; text-align: center;"> <tr> <td style="width: 10%;"></td> <td style="width: 10%;"></td> <td style="width: 10%;"></td> <td style="width: 10%;"></td> <td style="width: 10%;"></td> <td style="width: 10%;"></td> <td style="width: 10%;"></td> <td style="width: 10%;"></td> <td style="width: 10%;"></td> <td style="width: 10%;"></td> </tr> <tr> <td></td> <td></td> <td colspan="8" style="text-align: center;"> <table border="1" style="width: 100%; border-collapse: collapse; text-align: center;"> <tr> <td style="width: 10%;"></td> <td style="width: 10%;"></td> <td style="width: 10%;"></td> <td style="width: 10%;"></td> <td style="width: 10%;"></td> <td style="width: 10%;"></td> <td style="width: 10%;"></td> <td style="width: 10%;"></td> <td style="width: 10%;"></td> <td style="width: 10%;"></td> </tr> <tr> <td></td> <td></td> <td colspan="8" style="text-align: center;"> <table border="1" style="width: 100%; border-collapse: collapse; text-align: center;"> <tr> <td style="width: 10%;"></td> <td style="width: 10%;"></td> <td style="width: 10%;"></td> <td style="width: 10%;"></td> <td style="width: 10%;"></td> <td style="width: 10%;"></td> <td style="width: 10%;"></td> <td style="width: 10%;"></td> <td style="width: 10%;"></td> <td style="width: 10%;"></td> </tr> <tr> <td></td> <td></td> <td colspan="8" style="text-align: center;"> <table border="1" style="width: 100%; border-collapse: collapse; text-align: center;"> <tr> <td style="width: 10%;"></td> <td style="width: 10%;"></td> <td style="width: 10%;"></td> <td style="width: 10%;"></td> <td style="width: 10%;"></td> <td style="width: 10%;"></td> <td style="width: 10%;"></td> <td style="width: 10%;"></td> <td style="width: 10%;"></td> <td style="width: 10%;"></td> </tr> <tr> <td></td> <td></td> <td colspan="8" style="text-align: center;"> <table border="1" style="width: 100%; border-collapse: collapse; text-align: center;"> <tr> <td style="width: 10%;"></td> <td style="width: 10%;"></td> <td style="width: 10%;"></td> <td style="width: 10%;"></td> <td style="width: 10%;"></td> <td style="width: 10%;"></td> <td style="width: 10%;"></td> <td style="width: 10%;"></td> <td style="width: 10%;"></td> <td style="width: 10%;"></td> </tr> <tr> <td></td> <td></td> <td colspan="8" style="text-align: center;"> <table border="1" style="width: 100%; border-collapse: collapse; text-align: center;"> <tr> <td style="width: 10%;"></td> <td style="width: 10%;"></td> <td style="width: 10%;"></td> <td style="width: 10%;"></td> <td style="width: 10%;"></td> <td style="width: 10%;"></td> <td style="width: 10%;"></td> <td style="width: 10%;"></td> <td style="width: 10%;"></td> <td style="width: 10%;"></td> </tr> <tr> <td></td> <td></td> <td colspan="8" style="text-align: center;"> <table border="1" style="width: 100%; border-collapse: collapse; text-align: center;"> <tr> <td style="width: 10%;"></td> <td style="width: 10%;"></td> <td style="width: 10%;"></td> <td style="width: 10%;"></td> <td style="width: 10%;"></td> <td style="width: 10%;"></td> <td style="width: 10%;"></td> <td style="width: 10%;"></td> <td style="width: 10%;"></td> <td style="width: 10%;"></td> </tr> <tr> <td></td> <td></td> <td colspan="8" style="text-align: center;"> <table border="1" style="width: 100%; border-collapse: collapse; text-align: center;"> <tr> <td style="width: 10%;"></td> <td style="width: 10%;"></td> <td style="width: 10%;"></td> <td style="width: 10%;"></td> <td style="width: 10%;"></td> <td style="width: 10%;"></td> <td style="width: 10%;"></td> <td style="width: 10%;"></td> <td style="width: 10%;"></td> <td style="width: 10%;"></td> </tr> <tr> <td></td> <td></td> <td colspan="8" style="text-align: center;"> <table border="1" style="width: 100%; border-collapse: collapse; text-align: center;"> <tr> </tr></table></td></tr></table></td></tr></table></td></tr></table></td></tr></table></td></tr></table></td></tr></table></td></tr></table></td></tr></table></td></tr></table></td></tr></table></td></tr></table></td></tr></table></td></tr></table></td></tr></table></td></tr></table></td></tr></table></td></tr></table></td></tr></table></td></tr></table></td></tr></table></td></tr></table></td></tr></table></td></tr></table></td></tr></table></td></tr></table></td></tr></table></td></tr></table></td></tr></table></td></tr></table></td></tr></table></td></tr></table></td></tr></table></td></tr></table></td></tr></table></td></tr></table></td></tr></table></td></tr></table> | | | | | | | | | | | | | | | | | | | | <table border="1" style="width: 100%; border-collapse: collapse; text-align: center;"> <tr> <td style="width: 10%;"></td> <td style="width: 10%;"></td> <td style="width: 10%;"></td> <td style="width: 10%;"></td> <td style="width: 10%;"></td> <td style="width: 10%;"></td> <td style="width: 10%;"></td> <td style="width: 10%;"></td> <td style="width: 10%;"></td> <td style="width: 10%;"></td> </tr> <tr> <td></td> <td></td> <td colspan="8" style="text-align: center;"> <table border="1" style="width: 100%; border-collapse: collapse; text-align: center;"> <tr> <td style="width: 10%;"></td> <td style="width: 10%;"></td> <td style="width: 10%;"></td> <td style="width: 10%;"></td> <td style="width: 10%;"></td> <td style="width: 10%;"></td> <td style="width: 10%;"></td> <td style="width: 10%;"></td> <td style="width: 10%;"></td> <td style="width: 10%;"></td> </tr> <tr> <td></td> <td></td> <td colspan="8" style="text-align: center;"> <table border="1" style="width: 100%; border-collapse: collapse; text-align: center;"> <tr> <td style="width: 10%;"></td> <td style="width: 10%;"></td> <td style="width: 10%;"></td> <td style="width: 10%;"></td> <td style="width: 10%;"></td> <td style="width: 10%;"></td> <td style="width: 10%;"></td> <td style="width: 10%;"></td> <td style="width: 10%;"></td> <td style="width: 10%;"></td> </tr> <tr> <td></td> <td></td> <td colspan="8" style="text-align: center;"> <table border="1" style="width: 100%; border-collapse: collapse; text-align: center;"> <tr> <td style="width: 10%;"></td> <td style="width: 10%;"></td> <td style="width: 10%;"></td> <td style="width: 10%;"></td> <td style="width: 10%;"></td> <td style="width: 10%;"></td> <td style="width: 10%;"></td> <td style="width: 10%;"></td> <td style="width: 10%;"></td> <td style="width: 10%;"></td> </tr> <tr> <td></td> <td></td> <td colspan="8" style="text-align: center;"> <table border="1" style="width: 100%; border-collapse: collapse; text-align: center;"> <tr> <td style="width: 10%;"></td> <td style="width: 10%;"></td> <td style="width: 10%;"></td> <td style="width: 10%;"></td> <td style="width: 10%;"></td> <td style="width: 10%;"></td> <td style="width: 10%;"></td> <td style="width: 10%;"></td> <td style="width: 10%;"></td>
<td style="width: 10%;"></td> </tr> <tr> <td></td> <td></td> <td colspan="8" style="text-align: center;"> <table border="1" style="width: 100%; border-collapse: collapse; text-align: center;"> <tr> <td style="width: 10%;"></td> <td style="width: 10%;"></td> <td style="width: 10%;"></td> <td style="width: 10%;"></td> <td style="width: 10%;"></td> <td style="width: 10%;"></td> <td style="width: 10%;"></td> <td style="width: 10%;"></td> <td style="width: 10%;"></td> <td style="width: 10%;"></td> </tr> <tr> <td></td> <td></td> <td colspan="8" style="text-align: center;"> <table border="1" style="width: 100%; border-collapse: collapse; text-align: center;"> <tr> <td style="width: 10%;"></td> <td style="width: 10%;"></td> <td style="width: 10%;"></td> <td style="width: 10%;"></td> <td style="width: 10%;"></td> <td style="width: 10%;"></td> <td style="width: 10%;"></td> <td style="width: 10%;"></td> <td style="width: 10%;"></td> <td style="width: 10%;"></td> </tr> <tr> <td></td> <td></td> <td colspan="8" style="text-align: center;"> <table border="1" style="width: 100%; border-collapse: collapse; text-align: center;"> <tr> <td style="width: 10%;"></td> <td style="width: 10%;"></td> <td style="width: 10%;"></td> <td style="width: 10%;"></td> <td style="width: 10%;"></td> <td style="width: 10%;"></td> <td style="width: 10%;"></td> <td style="width: 10%;"></td> <td style="width: 10%;"></td> <td style="width: 10%;"></td> </tr> <tr> <td></td> <td></td> <td colspan="8" style="text-align: center;"> <table border="1" style="width: 100%; border-collapse: collapse; text-align: center;"> <tr> <td style="width: 10%;"></td> <td style="width: 10%;"></td> <td style="width: 10%;"></td> <td style="width: 10%;"></td> <td style="width: 10%;"></td> <td style="width: 10%;"></td> <td style="width: 10%;"></td> <td style="width: 10%;"></td> <td style="width: 10%;"></td> <td style="width: 10%;"></td> </tr> <tr> <td></td> <td></td> <td colspan="8" style="text-align: center;"> <table border="1" style="width: 100%; border-collapse: collapse; text-align: center;"> <tr> <td style="width: 10%;"></td> <td style="width: 10%;"></td> <td style="width: 10%;"></td> <td style="width: 10%;"></td> <td style="width: 10%;"></td> <td style="width: 10%;"></td> <td style="width: 10%;"></td> <td style="width: 10%;"></td> <td style="width: 10%;"></td> <td style="width: 10%;"></td> </tr> <tr> <td></td> <td></td> <td colspan="8" style="text-align: center;"> <table border="1" style="width: 100%; border-collapse: collapse; text-align: center;"> <tr> <td style="width: 10%;"></td> <td style="width: 10%;"></td> <td style="width: 10%;"></td> <td style="width: 10%;"></td> <td style="width: 10%;"></td> <td style="width: 10%;"></td> <td style="width: 10%;"></td> <td style="width: 10%;"></td> <td style="width: 10%;"></td> <td style="width: 10%;"></td> </tr> <tr> <td></td> <td></td> <td colspan="8" style="text-align: center;"> <table border="1" style="width: 100%; border-collapse: collapse; text-align: center;"> <tr> <td style="width: 10%;"></td> <td style="width: 10%;"></td> <td style="width: 10%;"></td> <td style="width: 10%;"></td> <td style="width: 10%;"></td> <td style="width: 10%;"></td> <td style="width: 10%;"></td> <td style="width: 10%;"></td> <td style="width: 10%;"></td> <td style="width: 10%;"></td> </tr> <tr> <td></td> <td></td> <td colspan="8" style="text-align: center;"> <table border="1" style="width: 100%; border-collapse: collapse; text-align: center;"> <tr> <td style="width: 10%;"></td> <td style="width: 10%;"></td> <td style="width: 10%;"></td> <td style="width: 10%;"></td> <td style="width: 10%;"></td> <td style="width: 10%;"></td> <td style="width: 10%;"></td> <td style="width: 10%;"></td> <td style="width: 10%;"></td> <td style="width: 10%;"></td> </tr> <tr> <td></td> <td></td> <td colspan="8" style="text-align: center;"> <table border="1" style="width: 100%; border-collapse: collapse; text-align: center;"> <tr> <td style="width: 10%;"></td> <td style="width: 10%;"></td> <td style="width: 10%;"></td> <td style="width: 10%;"></td> <td style="width: 10%;"></td> <td style="width: 10%;"></td> <td style="width: 10%;"></td> <td style="width: 10%;"></td> <td style="width: 10%;"></td> <td style="width: 10%;"></td> </tr> <tr> <td></td> <td></td> <td colspan="8" style="text-align: center;"> <table border="1" style="width: 100%; border-collapse: collapse; text-align: center;"> <tr> <td style="width: 10%;"></td> <td style="width: 10%;"></td> <td style="width: 10%;"></td> <td style="width: 10%;"></td> <td style="width: 10%;"></td> <td style="width: 10%;"></td> <td style="width: 10%;"></td> <td style="width: 10%;"></td> <td style="width: 10%;"></td> <td style="width: 10%;"></td> </tr> <tr> <td></td> <td></td> <td colspan="8" style="text-align: center;"> <table border="1" style="width: 100%; border-collapse: collapse; text-align: center;"> <tr> <td style="width: 10%;"></td> <td style="width: 10%;"></td> <td style="width: 10%;"></td> <td style="width: 10%;"></td> <td style="width: 10%;"></td> <td style="width: 10%;"></td> <td style="width: 10%;"></td> <td style="width: 10%;"></td> <td style="width: 10%;"></td> <td style="width: 10%;"></td> </tr> <tr> <td></td> <td></td> <td colspan="8" style="text-align: center;"> <table border="1" style="width: 100%; border-collapse: collapse; text-align: center;"> <tr> <td style="width: 10%;"></td> <td style="width: 10%;"></td> <td style="width: 10%;"></td> <td style="width: 10%;"></td> <td style="width: 10%;"></td> <td style="width: 10%;"></td> <td style="width: 10%;"></td> <td style="width: 10%;"></td> <td style="width: 10%;"></td> <td style="width: 10%;"></td> </tr> <tr> <td></td> <td></td> <td colspan="8" style="text-align: center;"> <table border="1" style="width: 100%; border-collapse: collapse; text-align: center;"> <tr> <td style="width: 10%;"></td> <td style="width: 10%;"></td> <td style="width: 10%;"></td> <td style="width: 10%;"></td> <td style="width: 10%;"></td> <td style="width: 10%;"></td> <td style="width: 10%;"></td> <td style="width: 10%;"></td> <td style="width: 10%;"></td> <td style="width: 10%;"></td> </tr> <tr> <td></td> <td></td> <td colspan="8" style="text-align: center;"> <table border="1" style="width: 100%; border-collapse: collapse; text-align: center;"> <tr> <td style="width: 10%;"></td> <td style="width: 10%;"></td> <td style="width: 10%;"></td> <td style="width: 10%;"></td> <td style="width: 10%;"></td> <td style="width: 10%;"></td> <td style="width: 10%;"></td> <td style="width: 10%;"></td> <td style="width: 10%;"></td> <td style="width: 10%;"></td> </tr> <tr> <td></td> <td></td> <td colspan="8" style="text-align: center;"> <table border="1" style="width: 100%; border-collapse: collapse; text-align: center;"> <tr> <td style="width: 10%;"></td> <td style="width: 10%;"></td> <td style="width: 10%;"></td> <td style="width: 10%;"></td> <td style="width: 10%;"></td> <td style="width: 10%;"></td> <td style="width: 10%;"></td> <td style="width: 10%;"></td> <td style="width: 10%;"></td> <td style="width: 10%;"></td> </tr> <tr> <td></td> <td></td> <td colspan="8" style="text-align: center;"> <table border="1" style="width: 100%; border-collapse: collapse; text-align: center;"> <tr> <td style="width: 10%;"></td> <td style="width: 10%;"></td> <td style="width: 10%;"></td> <td style="width: 10%;"></td> <td style="width: 10%;"></td> <td style="width: 10%;"></td> <td style="width: 10%;"></td> <td style="width: 10%;"></td> <td style="width: 10%;"></td> <td style="width: 10%;"></td> </tr> <tr> <td></td> <td></td> <td colspan="8" style="text-align: center;"> <table border="1" style="width: 100%; border-collapse: collapse; text-align: center;"> <tr> <td style="width: 10%;"></td> <td style="width: 10%;"></td> <td style="width: 10%;"></td> <td style="width: 10%;"></td> <td style="width: 10%;"></td> <td style="width: 10%;"></td> <td style="width: 10%;"></td> <td style="width: 10%;"></td> <td style="width: 10%;"></td> <td style="width: 10%;"></td> </tr> <tr> <td></td> <td></td> <td colspan="8" style="text-align: center;"> <table border="1" style="width: 100%; border-collapse: collapse; text-align: center;"> <tr> <td style="width: 10%;"></td> <td style="width: 10%;"></td> <td style="width: 10%;"></td> <td style="width: 10%;"></td> <td style="width: 10%;"></td> <td style="width: 10%;"></td> <td style="width: 10%;"></td> <td style="width: 10%;"></td> <td style="width: 10%;"></td> <td style="width: 10%;"></td> </tr> <tr> <td></td> <td></td> <td colspan="8" style="text-align: center;"> <table border="1" style="width: 100%; border-collapse: collapse; text-align: center;"> <tr> <td style="width: 10%;"></td> <td style="width: 10%;"></td> <td style="width: 10%;"></td> <td style="width: 10%;"></td> <td style="width: 10%;"></td> <td style="width: 10%;"></td> <td style="width: 10%;"></td> <td style="width: 10%;"></td> <td style="width: 10%;"></td> <td style="width: 10%;"></td> </tr> <tr> <td></td> <td></td> <td colspan="8" style="text-align: center;"> <table border="1" style="width: 100%; border-collapse: collapse; text-align: center;"> <tr> <td style="width: 10%;"></td> <td style="width: 10%;"></td> <td style="width: 10%;"></td> <td style="width: 10%;"></td> <td style="width: 10%;"></td> <td style="width: 10%;"></td> <td style="width: 10%;"></td> <td style="width: 10%;"></td> <td style="width: 10%;"></td> <td style="width: 10%;"></td> </tr> <tr> <td></td> <td></td> <td colspan="8" style="text-align: center;"> <table border="1" style="width: 100%; border-collapse: collapse; text-align: center;"> <tr> <td style="width: 10%;"></td> <td style="width: 10%;"></td> <td style="width: 10%;"></td> <td style="width: 10%;"></td> <td style="width: 10%;"></td> <td style="width: 10%;"></td> <td style="width: 10%;"></td> <td style="width: 10%;"></td> <td style="width: 10%;"></td> <td style="width: 10%;"></td> </tr> <tr> <td></td> <td></td> <td colspan="8" style="text-align: center;"> <table border="1" style="width: 100%; border-collapse: collapse;
text-align: center;"> <tr> <td style="width: 10%;"></td> <td style="width: 10%;"></td> <td style="width: 10%;"></td> <td style="width: 10%;"></td> <td style="width: 10%;"></td> <td style="width: 10%;"></td> <td style="width: 10%;"></td> <td style="width: 10%;"></td> <td style="width: 10%;"></td> <td style="width: 10%;"></td> </tr> <tr> <td></td> <td></td> <td colspan="8" style="text-align: center;"> <table border="1" style="width: 100%; border-collapse: collapse; text-align: center;"> <tr> <td style="width: 10%;"></td> <td style="width: 10%;"></td> <td style="width: 10%;"></td> <td style="width: 10%;"></td> <td style="width: 10%;"></td> <td style="width: 10%;"></td> <td style="width: 10%;"></td> <td style="width: 10%;"></td> <td style="width: 10%;"></td> <td style="width: 10%;"></td> </tr> <tr> <td></td> <td></td> <td colspan="8" style="text-align: center;"> <table border="1" style="width: 100%; border-collapse: collapse; text-align: center;"> <tr> <td style="width: 10%;"></td> <td style="width: 10%;"></td> <td style="width: 10%;"></td> <td style="width: 10%;"></td> <td style="width: 10%;"></td> <td style="width: 10%;"></td> <td style="width: 10%;"></td> <td style="width: 10%;"></td> <td style="width: 10%;"></td> <td style="width: 10%;"></td> </tr> <tr> <td></td> <td></td> <td colspan="8" style="text-align: center;"> <table border="1" style="width: 100%; border-collapse: collapse; text-align: center;"> <tr> <td style="width: 10%;"></td> <td style="width: 10%;"></td> <td style="width: 10%;"></td> <td style="width: 10%;"></td> <td style="width: 10%;"></td> <td style="width: 10%;"></td> <td style="width: 10%;"></td> <td style="width: 10%;"></td> <td style="width: 10%;"></td> <td style="width: 10%;"></td> </tr> <tr> <td></td> <td></td> <td colspan="8" style="text-align: center;"> <table border="1" style="width: 100%; border-collapse: collapse; text-align: center;"> <tr> <td style="width: 10%;"></td> <td style="width: 10%;"></td> <td style="width: 10%;"></td> <td style="width: 10%;"></td> <td style="width: 10%;"></td> <td style="width: 10%;"></td> <td style="width: 10%;"></td> <td style="width: 10%;"></td> <td style="width: 10%;"></td> <td style="width: 10%;"></td> </tr> <tr> <td></td> <td></td> <td colspan="8" style="text-align: center;"> <table border="1" style="width: 100%; border-collapse: collapse; text-align: center;"> <tr> <td style="width: 10%;"></td> <td style="width: 10%;"></td> <td style="width: 10%;"></td> <td style="width: 10%;"></td> <td style="width: 10%;"></td> <td style="width: 10%;"></td> <td style="width: 10%;"></td> <td style="width: 10%;"></td> <td style="width: 10%;"></td> <td style="width: 10%;"></td> </tr> <tr> <td></td> <td></td> <td colspan="8" style="text-align: center;"> <table border="1" style="width: 100%; border-collapse: collapse; text-align: center;"> <tr> <td style="width: 10%;"></td> <td style="width: 10%;"></td> <td style="width: 10%;"></td> <td style="width: 10%;"></td> <td style="width: 10%;"></td> <td style="width: 10%;"></td> <td style="width: 10%;"></td> <td style="width: 10%;"></td> <td style="width: 10%;"></td> <td style="width: 10%;"></td> </tr> <tr> <td></td> <td></td> <td colspan="8" style="text-align: center;"> <table border="1" style="width: 100%; border-collapse: collapse; text-align: center;"> <tr> <td style="width: 10%;"></td> <td style="width: 10%;"></td> <td style="width: 10%;"></td> <td style="width: 10%;"></td> <td style="width: 10%;"></td> <td style="width: 10%;"></td> <td style="width: 10%;"></td> <td style="width: 10%;"></td> <td style="width: 10%;"></td> <td style="width: 10%;"></td> </tr> <tr> <td></td> <td></td> <td colspan="8" style="text-align: center;"> <table border="1" style="width: 100%; border-collapse: collapse; text-align: center;"> <tr> <td style="width: 10%;"></td> <td style="width: 10%;"></td> <td style="width: 10%;"></td> <td style="width: 10%;"></td> <td style="width: 10%;"></td> <td style="width: 10%;"></td> <td style="width: 10%;"></td> <td style="width: 10%;"></td> <td style="width: 10%;"></td> <td style="width: 10%;"></td> </tr> <tr> <td></td> <td></td> <td colspan="8" style="text-align: center;"> <table border="1" style="width: 100%; border-collapse: collapse; text-align: center;"> <tr> <td style="width: 10%;"></td> <td style="width: 10%;"></td> <td style="width: 10%;"></td> <td style="width: 10%;"></td> <td style="width: 10%;"></td> <td style="width: 10%;"></td> <td style="width: 10%;"></td> <td style="width: 10%;"></td> <td style="width: 10%;"></td> <td style="width: 10%;"></td> </tr> <tr> <td></td> <td></td> <td colspan="8" style="text-align: center;"> <table border="1" style="width: 100%; border-collapse: collapse; text-align: center;"> <tr> </tr></table></td></tr></table></td></tr></table></td></tr></table></td></tr></table></td></tr></table></td></tr></table></td></tr></table></td></tr></table></td></tr></table></td></tr></table></td></tr></table></td></tr></table></td></tr></table></td></tr></table></td></tr></table></td></tr></table></td></tr></table></td></tr></table></td></tr></table></td></tr></table></td></tr></table></td></tr></table></td></tr></table></td></tr></table></td></tr></table></td></tr></table></td></tr></table></td></tr></table></td></tr></table></td></tr></table></td></tr></table></td></tr></table></td></tr></table></td></tr></table></td></tr></table></td></tr></table> | | | | | | | | | | | | | | | | | | | | <table border="1" style="width: 100%; border-collapse: collapse; text-align: center;"> <tr> <td style="width: 10%;"></td> <td style="width: 10%;"></td> <td style="width: 10%;"></td> <td style="width: 10%;"></td> <td style="width: 10%;"></td> <td style="width: 10%;"></td> <td style="width: 10%;"></td> <td style="width: 10%;"></td> <td style="width: 10%;"></td> <td style="width: 10%;"></td> </tr> <tr> <td></td> <td></td> <td colspan="8" style="text-align: center;"> <table border="1" style="width: 100%; border-collapse: collapse; text-align: center;"> <tr> <td style="width: 10%;"></td> <td style="width: 10%;"></td> <td style="width: 10%;"></td> <td style="width: 10%;"></td> <td style="width: 10%;"></td> <td style="width: 10%;"></td> <td style="width: 10%;"></td> <td style="width: 10%;"></td> <td style="width: 10%;"></td> <td style="width: 10%;"></td> </tr> <tr> <td></td> <td></td> <td colspan="8" style="text-align: center;"> <table border="1" style="width: 100%; border-collapse: collapse; text-align: center;"> <tr> <td style="width: 10%;"></td> <td style="width: 10%;"></td> <td style="width: 10%;"></td> <td style="width: 10%;"></td> <td style="width: 10%;"></td> <td style="width: 10%;"></td> <td style="width: 10%;"></td> <td style="width: 10%;"></td> <td style="width: 10%;"></td> <td style="width: 10%;"></td> </tr> <tr> <td></td> <td></td> <td colspan="8" style="text-align: center;"> <table border="1" style="width: 100%; border-collapse: collapse; text-align: center;"> <tr> <td style="width: 10%;"></td> <td style="width: 10%;"></td> <td style="width: 10%;"></td> <td style="width: 10%;"></td> <td style="width: 10%;"></td> <td style="width: 10%;"></td> <td style="width: 10%;"></td> <td style="width: 10%;"></td> <td style="width: 10%;"></td> <td style="width: 10%;"></td> </tr> <tr> <td></td> <td></td> <td colspan="8" style="text-align: center;"> <table border="1" style="width: 100%; border-collapse: collapse; text-align: center;"> <tr> <td style="width: 10%;"></td> <td style="width: 10%;"></td> <td style="width: 10%;"></td> <td style="width: 10%;"></td> <td style="width: 10%;"></td> <td style="width: 10%;"></td> <td style="width: 10%;"></td> <td style="width: 10%;"></td> <td style="width: 10%;"></td> <td style="width: 10%;"></td> </tr> <tr> <td></td> <td></td> <td colspan="8" style="text-align: center;"> <table border="1" style="width: 100%; border-collapse: collapse; text-align: center;"> <tr> <td style="width: 10%;"></td> <td style="width: 10%;"></td> <td style="width: 10%;"></td> <td style="width: 10%;"></td> <td style="width: 10%;"></td> <td style="width: 10%;"></td> <td style="width: 10%;"></td> <td style="width: 10%;"></td> <td style="width: 10%;"></td> <td style="width: 10%;"></td> </tr> <tr> <td></td> <td></td> <td colspan="8" style="text-align: center;"> <table border="1" style="width: 100%; border-collapse: collapse; text-align: center;"> <tr> <td style="width: 10%;"></td> <td style="width: 10%;"></td> <td style="width: 10%;"></td> <td style="width: 10%;"></td> <td style="width: 10%;"></td> <td style="width: 10%;"></td> <td style="width: 10%;"></td> <td
style="width: 10%;"></td> <td style="width: 10%;"></td> <td style="width: 10%;"></td> </tr> <tr> <td></td> <td></td> <td colspan="8" style="text-align: center;"> <table border="1" style="width: 100%; border-collapse: collapse; text-align: center;"> <tr> <td style="width: 10%;"></td> <td style="width: 10%;"></td> <td style="width: 10%;"></td> <td style="width: 10%;"></td> <td style="width: 10%;"></td> <td style="width: 10%;"></td> <td style="width: 10%;"></td> <td style="width: 10%;"></td> <td style="width: 10%;"></td> <td style="width: 10%;"></td> </tr> <tr> <td></td> <td></td> <td colspan="8" style="text-align: center;"> <table border="1" style="width: 100%; border-collapse: collapse; text-align: center;"> <tr> <td style="width: 10%;"></td> <td style="width: 10%;"></td> <td style="width: 10%;"></td> <td style="width: 10%;"></td> <td style="width: 10%;"></td> <td style="width: 10%;"></td> <td style="width: 10%;"></td> <td style="width: 10%;"></td> <td style="width: 10%;"></td> <td style="width: 10%;"></td> </tr> <tr> <td></td> <td></td> <td colspan="8" style="text-align: center;"> <table border="1" style="width: 100%; border-collapse: collapse; text-align: center;"> <tr> <td style="width: 10%;"></td> <td style="width: 10%;"></td> <td style="width: 10%;"></td> <td style="width: 10%;"></td> <td style="width: 10%;"></td> <td style="width: 10%;"></td> <td style="width: 10%;"></td> <td style="width: 10%;"></td> <td style="width: 10%;"></td> <td style="width: 10%;"></td> </tr> <tr> <td></td> <td></td> <td colspan="8" style="text-align: center;"> <table border="1" style="width: 100%; border-collapse: collapse; text-align: center;"> <tr> <td style="width: 10%;"></td> <td style="width: 10%;"></td> <td style="width: 10%;"></td> <td style="width: 10%;"></td> <td style="width: 10%;"></td> <td style="width: 10%;"></td> <td style="width: 10%;"></td> <td style="width: 10%;"></td> <td style="width: 10%;"></td> <td style="width: 10%;"></td> </tr> <tr> <td></td> <td></td> <td colspan="8" style="text-align: center;"> <table border="1" style="width: 100%; border-collapse: collapse; text-align: center;"> <tr> <td style="width: 10%;"></td> <td style="width: 10%;"></td> <td style="width: 10%;"></td> <td style="width: 10%;"></td> <td style="width: 10%;"></td> <td style="width: 10%;"></td> <td style="width: 10%;"></td> <td style="width: 10%;"></td> <td style="width: 10%;"></td> <td style="width: 10%;"></td> </tr> <tr> <td></td> <td></td> <td colspan="8" style="text-align: center;"> <table border="1" style="width: 100%; border-collapse: collapse; text-align: center;"> <tr> <td style="width: 10%;"></td> <td style="width: 10%;"></td> <td style="width: 10%;"></td> <td style="width: 10%;"></td> <td style="width: 10%;"></td> <td style="width: 10%;"></td> <td style="width: 10%;"></td> <td style="width: 10%;"></td> <td style="width: 10%;"></td> <td style="width: 10%;"></td> </tr> <tr> <td></td> <td></td> <td colspan="8" style="text-align: center;"> <table border="1" style="width: 100%; border-collapse: collapse; text-align: center;"> <tr> <td style="width: 10%;"></td> <td style="width: 10%;"></td> <td style="width: 10%;"></td> <td style="width: 10%;"></td> <td style="width: 10%;"></td> <td style="width: 10%;"></td> <td style="width: 10%;"></td> <td style="width: 10%;"></td> <td style="width: 10%;"></td> <td style="width: 10%;"></td> </tr> <tr> <td></td> <td></td> <td colspan="8" style="text-align: center;"> <table border="1" style="width: 100%; border-collapse: collapse; text-align: center;"> <tr> <td style="width: 10%;"></td> <td style="width: 10%;"></td> <td style="width: 10%;"></td> <td style="width: 10%;"></td> <td style="width: 10%;"></td> <td style="width: 10%;"></td> <td style="width: 10%;"></td> <td style="width: 10%;"></td> <td style="width: 10%;"></td> <td style="width: 10%;"></td> </tr> <tr> <td></td> <td></td> <td colspan="8" style="text-align: center;"> <table border="1" style="width: 100%; border-collapse: collapse; text-align: center;"> <tr> <td style="width: 10%;"></td> <td style="width: 10%;"></td> <td style="width: 10%;"></td> <td style="width: 10%;"></td> <td style="width: 10%;"></td> <td style="width: 10%;"></td> <td style="width: 10%;"></td> <td style="width: 10%;"></td> <td style="width: 10%;"></td> <td style="width: 10%;"></td> </tr> <tr> <td></td> <td></td> <td colspan="8" style="text-align: center;"> <table border="1" style="width: 100%; border-collapse: collapse; text-align: center;"> <tr> <td style="width: 10%;"></td> <td style="width: 10%;"></td> <td style="width: 10%;"></td> <td style="width: 10%;"></td> <td style="width: 10%;"></td> <td style="width: 10%;"></td> <td style="width: 10%;"></td> <td style="width: 10%;"></td> <td style="width: 10%;"></td> <td style="width: 10%;"></td> </tr> <tr> <td></td> <td></td> <td colspan="8" style="text-align: center;"> <table border="1" style="width: 100%; border-collapse: collapse; text-align: center;"> <tr> <td style="width: 10%;"></td> <td style="width: 10%;"></td> <td style="width: 10%;"></td> <td style="width: 10%;"></td> <td style="width: 10%;"></td> <td style="width: 10%;"></td> <td style="width: 10%;"></td> <td style="width: 10%;"></td> <td style="width: 10%;"></td> <td style="width: 10%;"></td> </tr> <tr> <td></td> <td></td> <td colspan="8" style="text-align: center;"> <table border="1" style="width: 100%; border-collapse: collapse; text-align: center;"> <tr> <td style="width: 10%;"></td> <td style="width: 10%;"></td> <td style="width: 10%;"></td> <td style="width: 10%;"></td> <td style="width: 10%;"></td> <td style="width: 10%;"></td> <td style="width: 10%;"></td> <td style="width: 10%;"></td> <td style="width: 10%;"></td> <td style="width: 10%;"></td> </tr> <tr> <td></td> <td></td> <td colspan="8" style="text-align: center;"> <table border="1" style="width: 100%; border-collapse: collapse; text-align: center;"> <tr> <td style="width: 10%;"></td> <td style="width: 10%;"></td> <td style="width: 10%;"></td> <td style="width: 10%;"></td> <td style="width: 10%;"></td> <td style="width: 10%;"></td> <td style="width: 10%;"></td> <td style="width: 10%;"></td> <td style="width: 10%;"></td> <td style="width: 10%;"></td> </tr> <tr> <td></td> <td></td> <td colspan="8" style="text-align: center;"> <table border="1" style="width: 100%; border-collapse: collapse; text-align: center;"> <tr> <td style="width: 10%;"></td> <td style="width: 10%;"></td> <td style="width: 10%;"></td> <td style="width: 10%;"></td> <td style="width: 10%;"></td> <td style="width: 10%;"></td> <td style="width: 10%;"></td> <td style="width: 10%;"></td> <td style="width: 10%;"></td> <td style="width: 10%;"></td> </tr> <tr> <td></td> <td></td> <td colspan="8" style="text-align: center;"> <table border="1" style="width: 100%; border-collapse: collapse; text-align: center;"> <tr> <td style="width: 10%;"></td> <td style="width: 10%;"></td> <td style="width: 10%;"></td> <td style="width: 10%;"></td> <td style="width: 10%;"></td> <td style="width: 10%;"></td> <td style="width: 10%;"></td> <td style="width: 10%;"></td> <td style="width: 10%;"></td> <td style="width: 10%;"></td> </tr> <tr> <td></td> <td></td> <td colspan="8" style="text-align: center;"> <table border="1" style="width: 100%; border-collapse: collapse; text-align: center;"> <tr> <td style="width: 10%;"></td> <td style="width: 10%;"></td> <td style="width: 10%;"></td> <td style="width: 10%;"></td> <td style="width: 10%;"></td> <td style="width: 10%;"></td> <td style="width: 10%;"></td> <td style="width: 10%;"></td> <td style="width: 10%;"></td> <td style="width: 10%;"></td> </tr> <tr> <td></td> <td></td> <td colspan="8" style="text-align: center;"> <table border="1" style="width: 100%; border-collapse: collapse; text-align: center;"> <tr> <td style="width: 10%;"></td> <td style="width: 10%;"></td> <td style="width: 10%;"></td> <td style="width: 10%;"></td> <td style="width: 10%;"></td> <td style="width: 10%;"></td> <td style="width: 10%;"></td> <td style="width: 10%;"></td> <td style="width: 10%;"></td> <td style="width: 10%;"></td> </tr> <tr> <td></td> <td></td> <td colspan="8" style="text-align: center;"> <table border="1" style="width: 100%; border-collapse: collapse; text-align: center;"> <tr> <td style="width: 10%;"></td> <td style="width: 10%;"></td> <td style="width: 10%;"></td> <td style="width: 10%;"></td> <td style="width: 10%;"></td> <td style="width: 10%;"></td> <td style="width: 10%;"></td> <td style="width: 10%;"></td> <td style="width: 10%;"></td> <td style="width: 10%;"></td> </tr> <tr> <td></td> <td></td> <td colspan="8" style="text-align: center;"> <table border="1" style="width: 100%; border-collapse: collapse; text-align: center;"> <tr> <td style="width: 10%;"></td> <td style="width: 10%;"></td> <td style="width: 10%;"></td> <td style="width: 10%;"></td> <td style="width: 10%;"></td> <td style="width: 10%;"></td> <td style="width: 10%;"></td> <td style="width: 10%;"></td> <td style="width: 10%;"></td> <td style="width: 10%;"></td> </tr> <tr> <td></td> <td></td> <td colspan="8" style="text-align: center;"> <table border="1" style="width: 100%; border-collapse: collapse; text-align: center;"> <tr> <td style="width: 10%;"></td> <td style="width: 10%;"></td> <td style="width: 10%;"></td> <td style="width: 10%;"></td> <td style="width: 10%;"></td> <td style="width: 10%;"></td> <td style="width: 10%;"></td> <td style="width: 10%;"></td> <td style="width: 10%;"></td> <td style="width: 10%;"></td> </tr> <tr> <td></td> <td></td> <td colspan="8" style="text-align: center;"> <table border="1" style="width: 100%; border-collapse: collapse; text-align: center;"> <tr> <td style="width: 10%;"></td> <td style="width: 10%;"></td> <td style="width: 10%;"></td> <td style="width: 10%;"></td> <td style="width: 10%;"></td> <td style="width: 10%;"></td> <td style="width: 10%;"></td> <td style="width: 10%;"></td> <td style="width: 10%;"></td> <td style="width: 10%;"></td> </tr> <tr> <td></td> <td></td> <td colspan="8" style="text-align: center;"> <table
border="1" style="width: 100%; border-collapse: collapse; text-align: center;"> <tr> <td style="width: 10%;"></td> <td style="width: 10%;"></td> <td style="width: 10%;"></td> <td style="width: 10%;"></td> <td style="width: 10%;"></td> <td style="width: 10%;"></td> <td style="width: 10%;"></td> <td style="width: 10%;"></td> <td style="width: 10%;"></td> <td style="width: 10%;"></td> </tr> <tr> <td></td> <td></td> <td colspan="8" style="text-align: center;"> <table border="1" style="width: 100%; border-collapse: collapse; text-align: center;"> <tr> <td style="width: 10%;"></td> <td style="width: 10%;"></td> <td style="width: 10%;"></td> <td style="width: 10%;"></td> <td style="width: 10%;"></td> <td style="width: 10%;"></td> <td style="width: 10%;"></td> <td style="width: 10%;"></td> <td style="width: 10%;"></td> <td style="width: 10%;"></td> </tr> <tr> <td></td> <td></td> <td colspan="8" style="text-align: center;"> <table border="1" style="width: 100%; border-collapse: collapse; text-align: center;"> <tr> <td style="width: 10%;"></td> <td style="width: 10%;"></td> <td style="width: 10%;"></td> <td style="width: 10%;"></td> <td style="width: 10%;"></td> <td style="width: 10%;"></td> <td style="width: 10%;"></td> <td style="width: 10%;"></td> <td style="width: 10%;"></td> <td style="width: 10%;"></td> </tr> <tr> <td></td> <td></td> <td colspan="8" style="text-align: center;"> <table border="1" style="width: 100%; border-collapse: collapse; text-align: center;"> <tr> <td style="width: 10%;"></td> <td style="width: 10%;"></td> <td style="width: 10%;"></td> <td style="width: 10%;"></td> <td style="width: 10%;"></td> <td style="width: 10%;"></td> <td style="width: 10%;"></td> <td style="width: 10%;"></td> <td style="width: 10%;"></td> <td style="width: 10%;"></td> </tr> <tr> <td></td> <td></td> <td colspan="8" style="text-align: center;"> <table border="1" style="width: 100%; border-collapse: collapse; text-align: center;"> <tr> <td style="width: 10%;"></td> <td style="width: 10%;"></td> <td style="width: 10%;"></td> <td style="width: 10%;"></td> <td style="width: 10%;"></td> <td style="width: 10%;"></td> <td style="width: 10%;"></td> <td style="width: 10%;"></td> <td style="width: 10%;"></td> <td style="width: 10%;"></td> </tr> <tr> <td></td> <td></td> <td colspan="8" style="text-align: center;"> <table border="1" style="width: 100%; border-collapse: collapse; text-align: center;"> <tr> <td style="width: 10%;"></td> <td style="width: 10%;"></td> <td style="width: 10%;"></td> <td style="width: 10%;"></td> <td style="width: 10%;"></td> <td style="width: 10%;"></td> <td style="width: 10%;"></td> <td style="width: 10%;"></td> <td style="width: 10%;"></td> <td style="width: 10%;"></td> </tr> <tr> <td></td> <td></td> <td colspan="8" style="text-align: center;"> <table border="1" style="width: 100%; border-collapse: collapse; text-align: center;"> <tr> <td style="width: 10%;"></td> <td style="width: 10%;"></td> <td style="width: 10%;"></td> <td style="width: 10%;"></td> <td style="width: 10%;"></td> <td style="width: 10%;"></td> <td style="width: 10%;"></td> <td style="width: 10%;"></td> <td style="width: 10%;"></td> <td style="width: 10%;"></td> </tr> <tr> <td></td> <td></td> <td colspan="8" style="text-align: center;"> <table border="1" style="width: 100%; border-collapse: collapse; text-align: center;"> <tr> </tr></table></td></tr></table></td></tr></table></td></tr></table></td></tr></table></td></tr></table></td></tr></table></td></tr></table></td></tr></table></td></tr></table></td></tr></table></td></tr></table></td></tr></table></td></tr></table></td></tr></table></td></tr></table></td></tr></table></td></tr></table></td></tr></table></td></tr></table></td></tr></table></td></tr></table></td></tr></table></td></tr></table></td></tr></table></td></tr></table></td></tr></table></td></tr></table></td></tr></table></td></tr></table></td></tr></table></td></tr></table></td></tr></table></td></tr></table></td></tr></table></td></tr></table> | | | | | | | | | | | | | | | | | | | | <table border="1" style="width: 100%; border-collapse: collapse; text-align: center;"> <tr> <td style="width: 10%;"></td> <td style="width: 10%;"></td> <td style="width: 10%;"></td> <td style="width: 10%;"></td> <td style="width: 10%;"></td> <td style="width: 10%;"></td> <td style="width: 10%;"></td> <td style="width: 10%;"></td> <td style="width: 10%;"></td> <td style="width: 10%;"></td> </tr> <tr> <td></td> <td></td> <td colspan="8" style="text-align: center;"> <table border="1" style="width: 100%; border-collapse: collapse; text-align: center;"> <tr> <td style="width: 10%;"></td> <td style="width: 10%;"></td> <td style="width: 10%;"></td> <td style="width: 10%;"></td> <td style="width: 10%;"></td> <td style="width: 10%;"></td> <td style="width: 10%;"></td> <td style="width: 10%;"></td> <td style="width: 10%;"></td> <td style="width: 10%;"></td> </tr> <tr> <td></td> <td></td> <td colspan="8" style="text-align: center;"> <table border="1" style="width: 100%; border-collapse: collapse; text-align: center;"> <tr> <td style="width: 10%;"></td> <td style="width: 10%;"></td> <td style="width: 10%;"></td> <td style="width: 10%;"></td> <td style="width: 10%;"></td> <td style="width: 10%;"></td> <td style="width: 10%;"></td> <td style="width: 10%;"></td> <td style="width: 10%;"></td> <td style="width: 10%;"></td> </tr> <tr> <td></td> <td></td> <td colspan="8" style="text-align: center;"> <table border="1" style="width: 100%; border-collapse: collapse; text-align: center;"> <tr> <td style="width: 10%;"></td> <td style="width: 10%;"></td> <td style="width: 10%;"></td> <td style="width: 10%;"></td> <td style="width: 10%;"></td> <td style="width: 10%;"></td> <td style="width: 10%;"></td> <td style="width: 10%;"></td> <td style="width: 10%;"></td> <td style="width: 10%;"></td> </tr> <tr> <td></td> <td></td> <td colspan="8" style="text-align: center;"> <table border="1" style="width: 100%; border-collapse: collapse; text-align: center;"> <tr> <td style="width: 10%;"></td> <td style="width: 10%;"></td> <td style="width: 10%;"></td> <td style="width: 10%;"></td> <td style="width: 10%;"></td> <td style="width: 10%;"></td> <td style="width: 10%;"></td> <td style="width: 10%;"></td> <td style="width: 10%;"></td> <td style="width: 10%;"></td> </tr> <tr> <td></td> <td></td> <td colspan="8" style="text-align: center;"> <table border="1" style="width: 100%; border-collapse: collapse; text-align: center;"> <tr> <td style="width: 10%;"></td> <td style="width: 10%;"></td> <td style="width: 10%;"></td> <td style="width: 10%;"></td> <td style="width: 10%;"></td> <td style="width: 10%;"></td> <td style="width: 10%;"></td> <td style="width: 10%;"></td> <td style="width: 10%;"></td> <td style="width: 10%;"></td> </tr> <tr> <td></td> <td></td> <td colspan="8" style="text-align: center;"> <table border="1" style="width: 100%; border-collapse: collapse; text-align: center;"> <tr> <td style="width: 10%;"></td> <td style="width: 10%;"></td> <td style="width: 10%;"></td> <td style="width: 10%;"></td> <td style="width: 10%;"></td> <td style="width: 10%;"></td> <td style="width: 10%;"></td> <td style="width: 10%;"></td> <td style="width: 10%;"></td> <td style="width: 10%;"></td> </tr> <tr> <td></td> <td></td> <td colspan="8" style="text-align: center;"> <table border="1" style="width: 100%; border-collapse: collapse; text-align: center;"> <tr> <td style="width: 10%;"></td> <td style="width: 10%;"></td> <td style="width: 10%;"></td> <td style="width: 10%;"></td> <td style="width: 10%;"></td> <td style="width: 10%;"></td> <td style="width: 10%;"></td> <td style="width: 10%;"></td> <td style="width: 10%;"></td> <td style="width: 10%;"></td> </tr> <tr> <td></td> <td></td> <td colspan="8" style="text-align: center;"> <table border="1" style="width: 100%; border-collapse: collapse; text-align: center;"> <tr> <td style="width: 10%;"></td> <td style="width: 10%;"></td> <td style="width: 10%;"></td> <td style="width: 10%;"></td> <td style="width: 10%;"></td> <td style="width: 10%;"></td> <td style="width: 10%;"></td> <td style="width: 10%;"></td> <td style="width: 10%;"></td> <td style="width: 10%;"></td> </tr> <tr> <td></td> <td></td> <td colspan="8" style="text-align: center;"> <table border="1" style="width: 100%; border-collapse: collapse; text-align: center;"> <tr> <td style="width: 10%;"></td> <td style="width: 10%;"></td> <td style="width: 10%;"></td> <td style="width: 10%;"></td> <td style="width: 10%;"></td> <td style="width:
10%;"></td> <td style="width: 10%;"></td> <td style="width: 10%;"></td> <td style="width: 10%;"></td> <td style="width: 10%;"></td> </tr> <tr> <td></td> <td></td> <td colspan="8" style="text-align: center;"> <table border="1" style="width: 100%; border-collapse: collapse; text-align: center;"> <tr> <td style="width: 10%;"></td> <td style="width: 10%;"></td> <td style="width: 10%;"></td> <td style="width: 10%;"></td> <td style="width: 10%;"></td> <td style="width: 10%;"></td> <td style="width: 10%;"></td> <td style="width: 10%;"></td> <td style="width: 10%;"></td> <td style="width: 10%;"></td> </tr> <tr> <td></td> <td></td> <td colspan="8" style="text-align: center;"> <table border="1" style="width: 100%; border-collapse: collapse; text-align: center;"> <tr> <td style="width: 10%;"></td> <td style="width: 10%;"></td> <td style="width: 10%;"></td> <td style="width: 10%;"></td> <td style="width: 10%;"></td> <td style="width: 10%;"></td> <td style="width: 10%;"></td> <td style="width: 10%;"></td> <td style="width: 10%;"></td> <td style="width: 10%;"></td> </tr> <tr> <td></td> <td></td> <td colspan="8" style="text-align: center;"> <table border="1" style="width: 100%; border-collapse: collapse; text-align: center;"> <tr> <td style="width: 10%;"></td> <td style="width: 10%;"></td> <td style="width: 10%;"></td> <td style="width: 10%;"></td> <td style="width: 10%;"></td> <td style="width: 10%;"></td> <td style="width: 10%;"></td> <td style="width: 10%;"></td> <td style="width: 10%;"></td> <td style="width: 10%;"></td> </tr> <tr> <td></td> <td></td> <td colspan="8" style="text-align: center;"> <table border="1" style="width: 100%; border-collapse: collapse; text-align: center;"> <tr> <td style="width: 10%;"></td> <td style="width: 10%;"></td> <td style="width: 10%;"></td> <td style="width: 10%;"></td> <td style="width: 10%;"></td> <td style="width: 10%;"></td> <td style="width: 10%;"></td> <td style="width: 10%;"></td> <td style="width: 10%;"></td> <td style="width: 10%;"></td> </tr> <tr> <td></td> <td></td> <td colspan="8" style="text-align: center;"> <table border="1" style="width: 100%; border-collapse: collapse; text-align: center;"> <tr> <td style="width: 10%;"></td> <td style="width: 10%;"></td> <td style="width: 10%;"></td> <td style="width: 10%;"></td> <td style="width: 10%;"></td> <td style="width: 10%;"></td> <td style="width: 10%;"></td> <td style="width: 10%;"></td> <td style="width: 10%;"></td> <td style="width: 10%;"></td> </tr> <tr> <td></td> <td></td> <td colspan="8" style="text-align: center;"> <table border="1" style="width: 100%; border-collapse: collapse; text-align: center;"> <tr> <td style="width: 10%;"></td> <td style="width: 10%;"></td> <td style="width: 10%;"></td> <td style="width: 10%;"></td> <td style="width: 10%;"></td> <td style="width: 10%;"></td> <td style="width: 10%;"></td> <td style="width: 10%;"></td> <td style="width: 10%;"></td> <td style="width: 10%;"></td> </tr> <tr> <td></td> <td></td> <td colspan="8" style="text-align: center;"> <table border="1" style="width: 100%; border-collapse: collapse; text-align: center;"> <tr> <td style="width: 10%;"></td> <td style="width: 10%;"></td> <td style="width: 10%;"></td> <td style="width: 10%;"></td> <td style="width: 10%;"></td> <td style="width: 10%;"></td> <td style="width: 10%;"></td> <td style="width: 10%;"></td> <td style="width: 10%;"></td> <td style="width: 10%;"></td> </tr> <tr> <td></td> <td></td> <td colspan="8" style="text-align: center;"> <table border="1" style="width: 100%; border-collapse: collapse; text-align: center;"> <tr> <td style="width: 10%;"></td> <td style="width: 10%;"></td> <td style="width: 10%;"></td> <td style="width: 10%;"></td> <td style="width: 10%;"></td> <td style="width: 10%;"></td> <td style="width: 10%;"></td> <td style="width: 10%;"></td> <td style="width: 10%;"></td> <td style="width: 10%;"></td> </tr> <tr> <td></td> <td></td> <td colspan="8" style="text-align: center;"> <table border="1" style="width: 100%; border-collapse: collapse; text-align: center;"> <tr> <td style="width: 10%;"></td> <td style="width: 10%;"></td> <td style="width: 10%;"></td> <td style="width: 10%;"></td> <td style="width: 10%;"></td> <td style="width: 10%;"></td> <td style="width: 10%;"></td> <td style="width: 10%;"></td> <td style="width: 10%;"></td> <td style="width: 10%;"></td> </tr> <tr> <td></td> <td></td> <td colspan="8" style="text-align: center;"> <table border="1" style="width: 100%; border-collapse: collapse; text-align: center;"> <tr> <td style="width: 10%;"></td> <td style="width: 10%;"></td> <td style="width: 10%;"></td> <td style="width: 10%;"></td> <td style="width: 10%;"></td> <td style="width: 10%;"></td> <td style="width: 10%;"></td> <td style="width: 10%;"></td> <td style="width: 10%;"></td> <td style="width: 10%;"></td> </tr> <tr> <td></td> <td></td> <td colspan="8" style="text-align: center;"> <table border="1" style="width: 100%; border-collapse: collapse; text-align: center;"> <tr> <td style="width: 10%;"></td> <td style="width: 10%;"></td> <td style="width: 10%;"></td> <td style="width: 10%;"></td> <td style="width: 10%;"></td> <td style="width: 10%;"></td> <td style="width: 10%;"></td> <td style="width: 10%;"></td> <td style="width: 10%;"></td> <td style="width: 10%;"></td> </tr> <tr> <td></td> <td></td> <td colspan="8" style="text-align: center;"> <table border="1" style="width: 100%; border-collapse: collapse; text-align: center;"> <tr> <td style="width: 10%;"></td> <td style="width: 10%;"></td> <td style="width: 10%;"></td> <td style="width: 10%;"></td> <td style="width: 10%;"></td> <td style="width: 10%;"></td> <td style="width: 10%;"></td> <td style="width: 10%;"></td> <td style="width: 10%;"></td> <td style="width: 10%;"></td> </tr> <tr> <td></td> <td></td> <td colspan="8" style="text-align: center;"> <table border="1" style="width: 100%; border-collapse: collapse; text-align: center;"> <tr> <td style="width: 10%;"></td> <td style="width: 10%;"></td> <td style="width: 10%;"></td> <td style="width: 10%;"></td> <td style="width: 10%;"></td> <td style="width: 10%;"></td> <td style="width: 10%;"></td> <td style="width: 10%;"></td> <td style="width: 10%;"></td> <td style="width: 10%;"></td> </tr> <tr> <td></td> <td></td> <td colspan="8" style="text-align: center;"> <table border="1" style="width: 100%; border-collapse: collapse; text-align: center;"> <tr> <td style="width: 10%;"></td> <td style="width: 10%;"></td> <td style="width: 10%;"></td> <td style="width: 10%;"></td> <td style="width: 10%;"></td> <td style="width: 10%;"></td> <td style="width: 10%;"></td> <td style="width: 10%;"></td> <td style="width: 10%;"></td> <td style="width: 10%;"></td> </tr> <tr> <td></td> <td></td> <td colspan="8" style="text-align: center;"> <table border="1" style="width: 100%; border-collapse: collapse; text-align: center;"> <tr> <td style="width: 10%;"></td> <td style="width: 10%;"></td> <td style="width: 10%;"></td> <td style="width: 10%;"></td> <td style="width: 10%;"></td> <td style="width: 10%;"></td> <td style="width: 10%;"></td> <td style="width: 10%;"></td> <td style="width: 10%;"></td> <td style="width: 10%;"></td> </tr> <tr> <td></td> <td></td> <td colspan="8" style="text-align: center;"> <table border="1" style="width: 100%; border-collapse: collapse; text-align: center;"> <tr> <td style="width: 10%;"></td> <td style="width: 10%;"></td> <td style="width: 10%;"></td> <td style="width: 10%;"></td> <td style="width: 10%;"></td> <td style="width: 10%;"></td> <td style="width: 10%;"></td> <td style="width: 10%;"></td> <td style="width: 10%;"></td> <td style="width: 10%;"></td> </tr> <tr> <td></td> <td></td> <td colspan="8" style="text-align: center;"> <table border="1" style="width: 100%; border-collapse: collapse; text-align: center;"> <tr> <td style="width: 10%;"></td> <td style="width: 10%;"></td> <td style="width: 10%;"></td> <td style="width: 10%;"></td> <td style="width: 10%;"></td> <td style="width: 10%;"></td> <td style="width: 10%;"></td> <td style="width: 10%;"></td> <td style="width: 10%;"></td> <td style="width: 10%;"></td> </tr> <tr> <td></td> <td></td> <td colspan="8" style="text-align: center;"> <table border="1" style="width: 100%; border-collapse: collapse; text-align: center;"> <tr> <td style="width: 10%;"></td> <td style="width: 10%;"></td> <td style="width: 10%;"></td> <td style="width: 10%;"></td> <td style="width: 10%;"></td> <td style="width: 10%;"></td> <td style="width: 10%;"></td> <td style="width: 10%;"></td> <td style="width: 10%;"></td> <td style="width: 10%;"></td> </tr> <tr> <td></td> <td></td> <td colspan="8" style="text-align: center;"> <table border="1" style="width: 100%; border-collapse: collapse; text-align: center;"> <tr> <td style="width: 10%;"></td> <td style="width: 10%;"></td> <td style="width: 10%;"></td> <td style="width: 10%;"></td> <td style="width: 10%;"></td> <td style="width: 10%;"></td> <td style="width: 10%;"></td> <td style="width: 10%;"></td> <td style="width: 10%;"></td> <td style="width: 10%;"></td> </tr> <tr> <td></td> <td></td> <td colspan="8" style="text-align: center;"> <table border="1" style="width: 100%; border-collapse: collapse; text-align: center;"> <tr> <td style="width: 10%;"></td> <td style="width: 10%;"></td> <td style="width: 10%;"></td> <td style="width: 10%;"></td> <td style="width: 10%;"></td> <td style="width: 10%;"></td> <td style="width: 10%;"></td> <td style="width: 10%;"></td> <td style="width: 10%;"></td> <td style="width: 10%;"></td> </tr> <tr> <td></td> <td></td> <td colspan="8" style="text-align: center;"> <table border="1" style="width: 100%; border-collapse: collapse; text-align: center;"> <tr> <td style="width: 10%;"></td> <td style="width: 10%;"></td> <td style="width: 10%;"></td> <td style="width: 10%;"></td> <td style="width: 10%;"></td> <td style="width: 10%;"></td> <td style="width: 10%;"></td> <td style="width: 10%;"></td> <td style="width: 10%;"></td> <td style="width: 10%;"></td> </tr> <tr> <td></td> <td></td> <td
colspan="8" style="text-align: center;"> <table border="1" style="width: 100%; border-collapse: collapse; text-align: center;"> <tr> <td style="width: 10%;"></td> <td style="width: 10%;"></td> <td style="width: 10%;"></td> <td style="width: 10%;"></td> <td style="width: 10%;"></td> <td style="width: 10%;"></td> <td style="width: 10%;"></td> <td style="width: 10%;"></td> <td style="width: 10%;"></td> <td style="width: 10%;"></td> </tr> <tr> <td></td> <td></td> <td colspan="8" style="text-align: center;"> <table border="1" style="width: 100%; border-collapse: collapse; text-align: center;"> <tr> <td style="width: 10%;"></td> <td style="width: 10%;"></td> <td style="width: 10%;"></td> <td style="width: 10%;"></td> <td style="width: 10%;"></td> <td style="width: 10%;"></td> <td style="width: 10%;"></td> <td style="width: 10%;"></td> <td style="width: 10%;"></td> <td style="width: 10%;"></td> </tr> <tr> <td></td> <td></td> <td colspan="8" style="text-align: center;"> <table border="1" style="width: 100%; border-collapse: collapse; text-align: center;"> <tr> <td style="width: 10%;"></td> <td style="width: 10%;"></td> <td style="width: 10%;"></td> <td style="width: 10%;"></td> <td style="width: 10%;"></td> <td style="width: 10%;"></td> <td style="width: 10%;"></td> <td style="width: 10%;"></td> <td style="width: 10%;"></td> <td style="width: 10%;"></td> </tr> <tr> <td></td> <td></td> <td colspan="8" style="text-align: center;"> <table border="1" style="width: 100%; border-collapse: collapse; text-align: center;"> <tr> </tr></table></td></tr></table></td></tr></table></td></tr></table></td></tr></table></td></tr></table></td></tr></table></td></tr></table></td></tr></table></td></tr></table></td></tr></table></td></tr></table></td></tr></table></td></tr></table></td></tr></table></td></tr></table></td></tr></table></td></tr></table></td></tr></table></td></tr></table></td></tr></table></td></tr></table></td></tr></table></td></tr></table></td></tr></table></td></tr></table></td></tr></table></td></tr></table></td></tr></table></td></tr></table></td></tr></table></td></tr></table></td></tr></table></td></tr></table></td></tr></table> | | | | | | | | | | | | | | | | | | | | <table border="1" style="width: 100%; border-collapse: collapse; text-align: center;"> <tr> <td style="width: 10%;"></td> <td style="width: 10%;"></td> <td style="width: 10%;"></td> <td style="width: 10%;"></td> <td style="width: 10%;"></td> <td style="width: 10%;"></td> <td style="width: 10%;"></td> <td style="width: 10%;"></td> <td style="width: 10%;"></td> <td style="width: 10%;"></td> </tr> <tr> <td></td> <td></td> <td colspan="8" style="text-align: center;"> <table border="1" style="width: 100%; border-collapse: collapse; text-align: center;"> <tr> <td style="width: 10%;"></td> <td style="width: 10%;"></td> <td style="width: 10%;"></td> <td style="width: 10%;"></td> <td style="width: 10%;"></td> <td style="width: 10%;"></td> <td style="width: 10%;"></td> <td style="width: 10%;"></td> <td style="width: 10%;"></td> <td style="width: 10%;"></td> </tr> <tr> <td></td> <td></td> <td colspan="8" style="text-align: center;"> <table border="1" style="width: 100%; border-collapse: collapse; text-align: center;"> <tr> <td style="width: 10%;"></td> <td style="width: 10%;"></td> <td style="width: 10%;"></td> <td style="width: 10%;"></td> <td style="width: 10%;"></td> <td style="width: 10%;"></td> <td style="width: 10%;"></td> <td style="width: 10%;"></td> <td style="width: 10%;"></td> <td style="width: 10%;"></td> </tr> <tr> <td></td> <td></td> <td colspan="8" style="text-align: center;"> <table border="1" style="width: 100%; border-collapse: collapse; text-align: center;"> <tr> <td style="width: 10%;"></td> <td style="width: 10%;"></td> <td style="width: 10%;"></td> <td style="width: 10%;"></td> <td style="width: 10%;"></td> <td style="width: 10%;"></td> <td style="width: 10%;"></td> <td style="width: 10%;"></td> <td style="width: 10%;"></td> <td style="width: 10%;"></td> </tr> <tr> <td></td> <td></td> <td colspan="8" style="text-align: center;"> <table border="1" style="width: 100%; border-collapse: collapse; text-align: center;"> <tr> <td style="width: 10%;"></td> <td style="width: 10%;"></td> <td style="width: 10%;"></td> <td style="width: 10%;"></td> <td style="width: 10%;"></td> <td style="width: 10%;"></td> <td style="width: 10%;"></td> <td style="width: 10%;"></td> <td style="width: 10%;"></td> <td style="width: 10%;"></td> </tr> <tr> <td></td> <td></td> <td colspan="8" style="text-align: center;"> <table border="1" style="width: 100%; border-collapse: collapse; text-align: center;"> <tr> <td style="width: 10%;"></td> <td style="width: 10%;"></td> <td style="width: 10%;"></td> <td style="width: 10%;"></td> <td style="width: 10%;"></td> <td style="width: 10%;"></td> <td style="width: 10%;"></td> <td style="width: 10%;"></td> <td style="width: 10%;"></td> <td style="width: 10%;"></td> </tr> <tr> <td></td> <td></td> <td colspan="8" style="text-align: center;"> <table border="1" style="width: 100%; border-collapse: collapse; text-align: center;"> <tr> <td style="width: 10%;"></td> <td style="width: 10%;"></td> <td style="width: 10%;"></td> <td style="width: 10%;"></td> <td style="width: 10%;"></td> <td style="width: 10%;"></td> <td style="width: 10%;"></td> <td style="width: 10%;"></td> <td style="width: 10%;"></td> <td style="width: 10%;"></td> </tr> <tr> <td></td> <td></td> <td colspan="8" style="text-align: center;"> <table border="1" style="width: 100%; border-collapse: collapse; text-align: center;"> <tr> <td style="width: 10%;"></td> <td style="width: 10%;"></td> <td style="width: 10%;"></td> <td style="width: 10%;"></td> <td style="width: 10%;"></td> <td style="width: 10%;"></td> <td style="width: 10%;"></td> <td style="width: 10%;"></td> <td style="width: 10%;"></td> <td style="width: 10%;"></td> </tr> <tr> <td></td> <td></td> <td colspan="8" style="text-align: center;"> <table border="1" style="width: 100%; border-collapse: collapse; text-align: center;"> <tr> <td style="width: 10%;"></td> <td style="width: 10%;"></td> <td style="width: 10%;"></td> <td style="width: 10%;"></td> <td style="width: 10%;"></td> <td style="width: 10%;"></td> <td style="width: 10%;"></td> <td style="width: 10%;"></td> <td style="width: 10%;"></td> <td style="width: 10%;"></td> </tr> <tr> <td></td> <td></td> <td colspan="8" style="text-align: center;"> <table border="1" style="width: 100%; border-collapse: collapse; text-align: center;"> <tr> <td style="width: 10%;"></td> <td style="width: 10%;"></td> <td style="width: 10%;"></td> <td style="width: 10%;"></td> <td style="width: 10%;"></td> <td style="width: 10%;"></td> <td style="width: 10%;"></td> <td style="width: 10%;"></td> <td style="width: 10%;"></td> <td style="width: 10%;"></td> </tr> <tr> <td></td> <td></td> <td colspan="8" style="text-align: center;"> <table border="1" style="width: 100%; border-collapse: collapse; text-align: center;"> <tr> <td style="width: 10%;"></td> <td style="width: 10%;"></td> <td style="width: 10%;"></td> <td style="width: 10%;"></td> <td style="width: 10%;"></td> <td style="width: 10%;"></td> <td style="width: 10%;"></td> <td style="width: 10%;"></td> <td style="width: 10%;"></td> <td style="width: 10%;"></td> </tr> <tr> <td></td> <td></td> <td colspan="8" style="text-align: center;"> <table border="1" style="width: 100%; border-collapse: collapse; text-align: center;"> <tr> <td style="width: 10%;"></td> <td style="width: 10%;"></td> <td style="width: 10%;"></td> <td style="width: 10%;"></td> <td style="width: 10%;"></td> <td style="width: 10%;"></td> <td style="width: 10%;"></td> <td style="width: 10%;"></td> <td style="width: 10%;"></td> <td style="width: 10%;"></td> </tr> <tr> <td></td> <td></td> <td colspan="8" style="text-align: center;"> <table border="1" style="width: 100%; border-collapse: collapse; text-align: center;"> <tr> <td style="width: 10%;"></td> <td style="width: 10%;"></td> <td style="width: 10%;"></td> <td style="width: 10%;"></td> <td style="width: 10%;"></td> <td style="width: 10%;"></td> <td style="width: 10%;"></td> <td style="width: 10%;"></td> <td style="width: 10%;"></td> <td style="width: 10%;"></td> </tr> <tr> <td></td> <td></td> <td colspan="8" style="text-align: center;"> <table border="1" style="width: 100%; border-collapse: collapse; text-align: center;"> <tr> <td style="width: 10%;"></td> <td style="width: 10%;"></td> <td style="width: 10%;"></td> <td style="width: 10%;"></td> <td style="width:
10%;"></td> <td style="width: 10%;"></td> <td style="width: 10%;"></td> <td style="width: 10%;"></td> <td style="width: 10%;"></td> <td style="width: 10%;"></td> </tr> <tr> <td></td> <td></td> <td colspan="8" style="text-align: center;"> <table border="1" style="width: 100%; border-collapse: collapse; text-align: center;"> <tr> <td style="width: 10%;"></td> <td style="width: 10%;"></td> <td style="width: 10%;"></td> <td style="width: 10%;"></td> <td style="width: 10%;"></td> <td style="width: 10%;"></td> <td style="width: 10%;"></td> <td style="width: 10%;"></td> <td style="width: 10%;"></td> <td style="width: 10%;"></td> </tr> <tr> <td></td> <td></td> <td colspan="8" style="text-align: center;"> <table border="1" style="width: 100%; border-collapse: collapse; text-align: center;"> <tr> <td style="width: 10%;"></td> <td style="width: 10%;"></td> <td style="width: 10%;"></td> <td style="width: 10%;"></td> <td style="width: 10%;"></td> <td style="width: 10%;"></td> <td style="width: 10%;"></td> <td style="width: 10%;"></td> <td style="width: 10%;"></td> <td style="width: 10%;"></td> </tr> <tr> <td></td> <td></td> <td colspan="8" style="text-align: center;"> <table border="1" style="width: 100%; border-collapse: collapse; text-align: center;"> <tr> <td style="width: 10%;"></td> <td style="width: 10%;"></td> <td style="width: 10%;"></td> <td style="width: 10%;"></td> <td style="width: 10%;"></td> <td style="width: 10%;"></td> <td style="width: 10%;"></td> <td style="width: 10%;"></td> <td style="width: 10%;"></td> <td style="width: 10%;"></td> </tr> <tr> <td></td> <td></td> <td colspan="8" style="text-align: center;"> <table border="1" style="width: 100%; border-collapse: collapse; text-align: center;"> <tr> <td style="width: 10%;"></td> <td style="width: 10%;"></td> <td style="width: 10%;"></td> <td style="width: 10%;"></td> <td style="width: 10%;"></td> <td style="width: 10%;"></td> <td style="width: 10%;"></td> <td style="width: 10%;"></td> <td style="width: 10%;"></td> <td style="width: 10%;"></td> </tr> <tr> <td></td> <td></td> <td colspan="8" style="text-align: center;"> <table border="1" style="width: 100%; border-collapse: collapse; text-align: center;"> <tr> <td style="width: 10%;"></td> <td style="width: 10%;"></td> <td style="width: 10%;"></td> <td style="width: 10%;"></td> <td style="width: 10%;"></td> <td style="width: 10%;"></td> <td style="width: 10%;"></td> <td style="width: 10%;"></td> <td style="width: 10%;"></td> <td style="width: 10%;"></td> </tr> <tr> <td></td> <td></td> <td colspan="8" style="text-align: center;"> <table border="1" style="width: 100%; border-collapse: collapse; text-align: center;"> <tr> <td style="width: 10%;"></td> <td style="width: 10%;"></td> <td style="width: 10%;"></td> <td style="width: 10%;"></td> <td style="width: 10%;"></td> <td style="width: 10%;"></td> <td style="width: 10%;"></td> <td style="width: 10%;"></td> <td style="width: 10%;"></td> <td style="width: 10%;"></td> </tr> <tr> <td></td> <td></td> <td colspan="8" style="text-align: center;"> <table border="1" style="width: 100%; border-collapse: collapse; text-align: center;"> <tr> <td style="width: 10%;"></td> <td style="width: 10%;"></td> <td style="width: 10%;"></td> <td style="width: 10%;"></td> <td style="width: 10%;"></td> <td style="width: 10%;"></td> <td style="width: 10%;"></td> <td style="width: 10%;"></td> <td style="width: 10%;"></td> <td style="width: 10%;"></td> </tr> <tr> <td></td> <td></td> <td colspan="8" style="text-align: center;"> <table border="1" style="width: 100%; border-collapse: collapse; text-align: center;"> <tr> <td style="width: 10%;"></td> <td style="width: 10%;"></td> <td style="width: 10%;"></td> <td style="width: 10%;"></td> <td style="width: 10%;"></td> <td style="width: 10%;"></td> <td style="width: 10%;"></td> <td style="width: 10%;"></td> <td style="width: 10%;"></td> <td style="width: 10%;"></td> </tr> <tr> <td></td> <td></td> <td colspan="8" style="text-align: center;"> <table border="1" style="width: 100%; border-collapse: collapse; text-align: center;"> <tr> <td style="width: 10%;"></td> <td style="width: 10%;"></td> <td style="width: 10%;"></td> <td style="width: 10%;"></td> <td style="width: 10%;"></td> <td style="width: 10%;"></td> <td style="width: 10%;"></td> <td style="width: 10%;"></td> <td style="width: 10%;"></td> <td style="width: 10%;"></td> </tr> <tr> <td></td> <td></td> <td colspan="8" style="text-align: center;"> <table border="1" style="width: 100%; border-collapse: collapse; text-align: center;"> <tr> <td style="width: 10%;"></td> <td style="width: 10%;"></td> <td style="width: 10%;"></td> <td style="width: 10%;"></td> <td style="width: 10%;"></td> <td style="width: 10%;"></td> <td style="width: 10%;"></td> <td style="width: 10%;"></td> <td style="width: 10%;"></td> <td style="width: 10%;"></td> </tr> <tr> <td></td> <td></td> <td colspan="8" style="text-align: center;"> <table border="1" style="width: 100%; border-collapse: collapse; text-align: center;"> <tr> <td style="width: 10%;"></td> <td style="width: 10%;"></td> <td style="width: 10%;"></td> <td style="width: 10%;"></td> <td style="width: 10%;"></td> <td style="width: 10%;"></td> <td style="width: 10%;"></td> <td style="width: 10%;"></td> <td style="width: 10%;"></td> <td style="width: 10%;"></td> </tr> <tr> <td></td> <td></td> <td colspan="8" style="text-align: center;"> <table border="1" style="width: 100%; border-collapse: collapse; text-align: center;"> <tr> <td style="width: 10%;"></td> <td style="width: 10%;"></td> <td style="width: 10%;"></td> <td style="width: 10%;"></td> <td style="width: 10%;"></td> <td style="width: 10%;"></td> <td style="width: 10%;"></td> <td style="width: 10%;"></td> <td style="width: 10%;"></td> <td style="width: 10%;"></td> </tr> <tr> <td></td> <td></td> <td colspan="8" style="text-align: center;"> <table border="1" style="width: 100%; border-collapse: collapse; text-align: center;"> <tr> <td style="width: 10%;"></td> <td style="width: 10%;"></td> <td style="width: 10%;"></td> <td style="width: 10%;"></td> <td style="width: 10%;"></td> <td style="width: 10%;"></td> <td style="width: 10%;"></td> <td style="width: 10%;"></td> <td style="width: 10%;"></td> <td style="width: 10%;"></td> </tr> <tr> <td></td> <td></td> <td colspan="8" style="text-align: center;"> <table border="1" style="width: 100%; border-collapse: collapse; text-align: center;"> <tr> <td style="width: 10%;"></td> <td style="width: 10%;"></td> <td style="width: 10%;"></td> <td style="width: 10%;"></td> <td style="width: 10%;"></td> <td style="width: 10%;"></td> <td style="width: 10%;"></td> <td style="width: 10%;"></td> <td style="width: 10%;"></td> <td style="width: 10%;"></td> </tr> <tr> <td></td> <td></td> <td colspan="8" style="text-align: center;"> <table border="1" style="width: 100%; border-collapse: collapse; text-align: center;"> <tr> <td style="width: 10%;"></td> <td style="width: 10%;"></td> <td style="width: 10%;"></td> <td style="width: 10%;"></td> <td style="width: 10%;"></td> <td style="width: 10%;"></td> <td style="width: 10%;"></td> <td style="width: 10%;"></td> <td style="width: 10%;"></td> <td style="width: 10%;"></td> </tr> <tr> <td></td> <td></td> <td colspan="8" style="text-align: center;"> <table border="1" style="width: 100%; border-collapse: collapse; text-align: center;"> <tr> <td style="width: 10%;"></td> <td style="width: 10%;"></td> <td style="width: 10%;"></td> <td style="width: 10%;"></td> <td style="width: 10%;"></td> <td style="width: 10%;"></td> <td style="width: 10%;"></td> <td style="width: 10%;"></td> <td style="width: 10%;"></td> <td style="width: 10%;"></td> </tr> <tr> <td></td> <td></td> <td colspan="8" style="text-align: center;"> <table border="1" style="width: 100%; border-collapse: collapse; text-align: center;"> <tr> <td style="width: 10%;"></td> <td style="width: 10%;"></td> <td style="width: 10%;"></td> <td style="width: 10%;"></td> <td style="width: 10%;"></td> <td style="width: 10%;"></td> <td style="width: 10%;"></td> <td style="width: 10%;"></td> <td style="width: 10%;"></td> <td style="width: 10%;"></td> </tr> <tr> <td></td> <td></td> <td colspan="8" style="text-align: center;"> <table border="1" style="width: 100%; border-collapse: collapse; text-align: center;"> <tr> <td style="width: 10%;"></td> <td style="width: 10%;"></td> <td style="width: 10%;"></td> <td style="width: 10%;"></td> <td style="width: 10%;"></td> <td style="width: 10%;"></td> <td style="width: 10%;"></td> <td style="width: 10%;"></td> <td style="width: 10%;"></td> <td style="width: 10%;"></td> </tr> <tr> <td></td> <td></td> <td colspan="8" style="text-align: center;"> <table border="1" style="width: 100%; border-collapse: collapse; text-align: center;"> <tr> <td style="width: 10%;"></td> <td style="width: 10%;"></td> <td style="width: 10%;"></td> <td style="width: 10%;"></td> <td style="width: 10%;"></td> <td style="width: 10%;"></td> <td style="width: 10%;"></td> <td style="width: 10%;"></td> <td style="width: 10%;"></td> <td style="width: 10%;"></td> </tr> <tr> <td></td> <td></td> <td colspan="8" style="text-align: center;"> <table border="1" style="width: 100%; border-collapse: collapse; text-align: center;"> <tr> </tr></table></td></tr></table></td></tr></table></td></tr></table></td></tr></table></td></tr></table></td></tr></table></td></tr></table></td></tr></table></td></tr></table></td></tr></table></td></tr></table></td></tr></table></td></tr></table></td></tr></table></td></tr></table></td></tr></table></td></tr></table></td></tr></table></td></tr></table></td></tr></table></td></tr></table></td></tr></table></td></tr></table></td></tr></table></td></tr></table></td></tr></table></td></tr></table></td></tr></table></td></tr></table></td></tr></table></td></tr></table></td></tr></table></td></tr></table>
 | | | | | | | | | | | | | | | | | | | | <table border="1" style="width: 100%; border-collapse: collapse; text-align: center;"> <tr> <td style="width: 10%;"></td> <td style="width: 10%;"></td> <td style="width: 10%;"></td> <td style="width: 10%;"></td> <td style="width: 10%;"></td> <td style="width: 10%;"></td> <td style="width: 10%;"></td> <td style="width: 10%;"></td> <td style="width: 10%;"></td> <td style="width: 10%;"></td> </tr> <tr> <td></td> <td></td> <td colspan="8" style="text-align: center;"> <table border="1" style="width: 100%; border-collapse: collapse; text-align: center;"> <tr> <td style="width: 10%;"></td> <td style="width: 10%;"></td> <td style="width: 10%;"></td> <td style="width: 10%;"></td> <td style="width: 10%;"></td> <td style="width: 10%;"></td> <td style="width: 10%;"></td> <td style="width: 10%;"></td> <td style="width: 10%;"></td> <td style="width: 10%;"></td> </tr> <tr> <td></td> <td></td> <td colspan="8" style="text-align: center;"> <table border="1" style="width: 100%; border-collapse: collapse; text-align: center;"> <tr> <td style="width: 10%;"></td> <td style="width: 10%;"></td> <td style="width: 10%;"></td> <td style="width: 10%;"></td> <td style="width: 10%;"></td> <td style="width: 10%;"></td> <td style="width: 10%;"></td> <td style="width: 10%;"></td> <td style="width: 10%;"></td> <td style="width: 10%;"></td> </tr> <tr> <td></td> <td></td> <td colspan="8" style="text-align: center;"> <table border="1" style="width: 100%; border-collapse: collapse; text-align: center;"> <tr> <td style="width: 10%;"></td> <td style="width: 10%;"></td> <td style="width: 10%;"></td> <td style="width: 10%;"></td> <td style="width: 10%;"></td> <td style="width: 10%;"></td> <td style="width: 10%;"></td> <td style="width: 10%;"></td> <td style="width: 10%;"></td> <td style="width: 10%;"></td> </tr> <tr> <td></td> <td></td> <td colspan="8" style="text-align: center;"> <table border="1" style="width: 100%; border-collapse: collapse; text-align: center;"> <tr> <td style="width: 10%;"></td> <td style="width: 10%;"></td> <td style="width: 10%;"></td> <td style="width: 10%;"></td> <td style="width: 10%;"></td> <td style="width: 10%;"></td> <td style="width: 10%;"></td> <td style="width: 10%;"></td> <td style="width: 10%;"></td> <td style="width: 10%;"></td> </tr> <tr> <td></td> <td></td> <td colspan="8" style="text-align: center;"> <table border="1" style="width: 100%; border-collapse: collapse; text-align: center;"> <tr> <td style="width: 10%;"></td> <td style="width: 10%;"></td> <td style="width: 10%;"></td> <td style="width: 10%;"></td> <td style="width: 10%;"></td> <td style="width: 10%;"></td> <td style="width: 10%;"></td> <td style="width: 10%;"></td> <td style="width: 10%;"></td> <td style="width: 10%;"></td> </tr> <tr> <td></td> <td></td> <td colspan="8" style="text-align: center;"> <table border="1" style="width: 100%; border-collapse: collapse; text-align: center;"> <tr> <td style="width: 10%;"></td> <td style="width: 10%;"></td> <td style="width: 10%;"></td> <td style="width: 10%;"></td> <td style="width: 10%;"></td> <td style="width: 10%;"></td> <td style="width: 10%;"></td> <td style="width: 10%;"></td> <td style="width: 10%;"></td> <td style="width: 10%;"></td> </tr> <tr> <td></td> <td></td> <td colspan="8" style="text-align: center;"> <table border="1" style="width: 100%; border-collapse: collapse; text-align: center;"> <tr> <td style="width: 10%;"></td> <td style="width: 10%;"></td> <td style="width: 10%;"></td> <td style="width: 10%;"></td> <td style="width: 10%;"></td> <td style="width: 10%;"></td> <td style="width: 10%;"></td> <td style="width: 10%;"></td> <td style="width: 10%;"></td> <td style="width: 10%;"></td> </tr> <tr> <td></td> <td></td> <td colspan="8" style="text-align: center;"> <table border="1" style="width: 100%; border-collapse: collapse; text-align: center;"> <tr> <td style="width: 10%;"></td> <td style="width: 10%;"></td> <td style="width: 10%;"></td> <td style="width: 10%;"></td> <td style="width: 10%;"></td> <td style="width: 10%;"></td> <td style="width: 10%;"></td> <td style="width: 10%;"></td> <td style="width: 10%;"></td> <td style="width: 10%;"></td> </tr> <tr> <td></td> <td></td> <td colspan="8" style="text-align: center;"> <table border="1" style="width: 100%; border-collapse: collapse; text-align: center;"> <tr> <td style="width: 10%;"></td> <td style="width: 10%;"></td> <td style="width: 10%;"></td> <td style="width: 10%;"></td> <td style="width: 10%;"></td> <td style="width: 10%;"></td> <td style="width: 10%;"></td> <td style="width: 10%;"></td> <td style="width: 10%;"></td> <td style="width: 10%;"></td> </tr> <tr> <td></td> <td></td> <td colspan="8" style="text-align: center;"> <table border="1" style="width: 100%; border-collapse: collapse; text-align: center;"> <tr> <td style="width: 10%;"></td> <td style="width: 10%;"></td> <td style="width: 10%;"></td> <td style="width: 10%;"></td> <td style="width: 10%;"></td> <td style="width: 10%;"></td> <td style="width: 10%;"></td> <td style="width: 10%;"></td> <td style="width: 10%;"></td> <td style="width: 10%;"></td> </tr> <tr> <td></td> <td></td> <td colspan="8" style="text-align: center;"> <table border="1" style="width: 100%; border-collapse: collapse; text-align: center;"> <tr> <td style="width: 10%;"></td> <td style="width: 10%;"></td> <td style="width: 10%;"></td> <td style="width: 10%;"></td> <td style="width: 10%;"></td> <td style="width: 10%;"></td> <td style="width: 10%;"></td> <td style="width: 10%;"></td> <td style="width: 10%;"></td> <td style="width: 10%;"></td> </tr> <tr> <td></td> <td></td> <td colspan="8" style="text-align: center;"> <table border="1" style="width: 100%; border-collapse: collapse; text-align: center;"> <tr> <td style="width: 10%;"></td> <td style="width: 10%;"></td> <td style="width: 10%;"></td> <td style="width: 10%;"></td> <td style="width: 10%;"></td> <td style="width: 10%;"></td> <td style="width: 10%;"></td> <td style="width: 10%;"></td> <td style="width: 10%;"></td> <td style="width: 10%;"></td> </tr> <tr> <td></td> <td></td> <td colspan="8" style="text-align: center;"> <table border="1" style="width: 100%; border-collapse: collapse; text-align: center;"> <tr> <td style="width: 10%;"></td> <td style="width: 10%;"></td> <td style="width: 10%;"></td> <td style="width: 10%;"></td> <td style="width: 10%;"></td> <td style="width: 10%;"></td> <td style="width: 10%;"></td> <td style="width: 10%;"></td> <td style="width: 10%;"></td> <td style="width: 10%;"></td> </tr> <tr> <td></td> <td></td> <td colspan="8" style="text-align: center;"> <table border="1" style="width: 100%; border-collapse: collapse; text-align: center;"> <tr> <td style="width: 10%;"></td> <td style="width: 10%;"></td> <td style="width: 10%;"></td> <td style="width: 10%;"></td> <td style="width: 10%;"></td> <td style="width: 10%;"></td> <td style="width: 10%;"></td> <td style="width: 10%;"></td> <td style="width: 10%;"></td> <td style="width: 10%;"></td> </tr> <tr> <td></td> <td></td> <td colspan="8" style="text-align: center;"> <table border="1" style="width: 100%; border-collapse: collapse; text-align: center;"> <tr> <td style="width: 10%;"></td> <td style="width: 10%;"></td> <td style="width: 10%;"></td> <td style="width: 10%;"></td> <td style="width: 10%;"></td> <td style="width: 10%;"></td> <td style="width: 10%;"></td> <td style="width: 10%;"></td> <td style="width: 10%;"></td> <td style="width: 10%;"></td> </tr> <tr> <td></td> <td></td> <td colspan="8" style="text-align: center;"> <table border="1" style="width: 100%; border-collapse: collapse; text-align: center;"> <tr> <td style="width: 10%;"></td> <td style="width: 10%;"></td> <td style="width: 10%;"></td> <td style="width: 10%;"></td> <td style="width: 10%;"></td> <td style="width: 10%;"></td> <td style="width: 10%;"></td> <td style="width: 10%;"></td> <td style="width: 10%;"></td> <td style="width: 10%;"></td> </tr> <tr> <td></td> <td></td> <td colspan="8" style="text-align: center;"> <table border="1" style="width: 100%; border-collapse: collapse; text-align: center;"> <tr> <td style="width: 10%;"></td> <td style="width: 10%;"></td> <td style="width: 10%;"></td> <td style="width: 10%;"></td> <td style="width: 10%;"></td> <td style="width: 10%;"></td> <td style="width: 10%;"></td> <td style="width: 10%;"></td> <td style="width: 10%;"></td> <td style="width: 10%;"></td> </tr> <tr> <td></td> <td></td> <td colspan="8" style="text-align: center;"> <table border="1" style="width: 100%; border-collapse: collapse; text-align: center;"> <tr> <td style="width: 10%;"></td> <td style="width: 10%;"></td> <td style="width: 10%;"></td> <td style="width: 10%;"></td> <td
style="width: 10%;"></td> <td style="width: 10%;"></td> <td style="width: 10%;"></td> <td style="width: 10%;"></td> <td style="width: 10%;"></td> <td style="width: 10%;"></td> </tr> <tr> <td></td> <td></td> <td colspan="8" style="text-align: center;"> <table border="1" style="width: 100%; border-collapse: collapse; text-align: center;"> <tr> <td style="width: 10%;"></td> <td style="width: 10%;"></td> <td style="width: 10%;"></td> <td style="width: 10%;"></td> <td style="width: 10%;"></td> <td style="width: 10%;"></td> <td style="width: 10%;"></td> <td style="width: 10%;"></td> <td style="width: 10%;"></td> <td style="width: 10%;"></td> </tr> <tr> <td></td> <td></td> <td colspan="8" style="text-align: center;"> <table border="1" style="width: 100%; border-collapse: collapse; text-align: center;"> <tr> <td style="width: 10%;"></td> <td style="width: 10%;"></td> <td style="width: 10%;"></td> <td style="width: 10%;"></td> <td style="width: 10%;"></td> <td style="width: 10%;"></td> <td style="width: 10%;"></td> <td style="width: 10%;"></td> <td style="width: 10%;"></td> <td style="width: 10%;"></td> </tr> <tr> <td></td> <td></td> <td colspan="8" style="text-align: center;"> <table border="1" style="width: 100%; border-collapse: collapse; text-align: center;"> <tr> <td style="width: 10%;"></td> <td style="width: 10%;"></td> <td style="width: 10%;"></td> <td style="width: 10%;"></td> <td style="width: 10%;"></td> <td style="width: 10%;"></td> <td style="width: 10%;"></td> <td style="width: 10%;"></td> <td style="width: 10%;"></td> <td style="width: 10%;"></td> </tr> <tr> <td></td> <td></td> <td colspan="8" style="text-align: center;"> <table border="1" style="width: 100%; border-collapse: collapse; text-align: center;"> <tr> <td style="width: 10%;"></td> <td style="width: 10%;"></td> <td style="width: 10%;"></td> <td style="width: 10%;"></td> <td style="width: 10%;"></td> <td style="width: 10%;"></td> <td style="width: 10%;"></td> <td style="width: 10%;"></td> <td style="width: 10%;"></td> <td style="width: 10%;"></td> </tr> <tr> <td></td> <td></td> <td colspan="8" style="text-align: center;"> <table border="1" style="width: 100%; border-collapse: collapse; text-align: center;"> <tr> <td style="width: 10%;"></td> <td style="width: 10%;"></td> <td style="width: 10%;"></td> <td style="width: 10%;"></td> <td style="width: 10%;"></td> <td style="width: 10%;"></td> <td style="width: 10%;"></td> <td style="width: 10%;"></td> <td style="width: 10%;"></td> <td style="width: 10%;"></td> </tr> <tr> <td></td> <td></td> <td colspan="8" style="text-align: center;"> <table border="1" style="width: 100%; border-collapse: collapse; text-align: center;"> <tr> <td style="width: 10%;"></td> <td style="width: 10%;"></td> <td style="width: 10%;"></td> <td style="width: 10%;"></td> <td style="width: 10%;"></td> <td style="width: 10%;"></td> <td style="width: 10%;"></td> <td style="width: 10%;"></td> <td style="width: 10%;"></td> <td style="width: 10%;"></td> </tr> <tr> <td></td> <td></td> <td colspan="8" style="text-align: center;"> <table border="1" style="width: 100%; border-collapse: collapse; text-align: center;"> <tr> <td style="width: 10%;"></td> <td style="width: 10%;"></td> <td style="width: 10%;"></td> <td style="width: 10%;"></td> <td style="width: 10%;"></td> <td style="width: 10%;"></td> <td style="width: 10%;"></td> <td style="width: 10%;"></td> <td style="width: 10%;"></td> <td style="width: 10%;"></td> </tr> <tr> <td></td> <td></td> <td colspan="8" style="text-align: center;"> <table border="1" style="width: 100%; border-collapse: collapse; text-align: center;"> <tr> <td style="width: 10%;"></td> <td style="width: 10%;"></td> <td style="width: 10%;"></td> <td style="width: 10%;"></td> <td style="width: 10%;"></td> <td style="width: 10%;"></td> <td style="width: 10%;"></td> <td style="width: 10%;"></td> <td style="width: 10%;"></td> <td style="width: 10%;"></td> </tr> <tr> <td></td> <td></td> <td colspan="8" style="text-align: center;"> <table border="1" style="width: 100%; border-collapse: collapse; text-align: center;"> <tr> <td style="width: 10%;"></td> <td style="width: 10%;"></td> <td style="width: 10%;"></td> <td style="width: 10%;"></td> <td style="width: 10%;"></td> <td style="width: 10%;"></td> <td style="width: 10%;"></td> <td style="width: 10%;"></td> <td style="width: 10%;"></td> <td style="width: 10%;"></td> </tr> <tr> <td></td> <td></td> <td colspan="8" style="text-align: center;"> <table border="1" style="width: 100%; border-collapse: collapse; text-align: center;"> <tr> <td style="width: 10%;"></td> <td style="width: 10%;"></td> <td style="width: 10%;"></td> <td style="width: 10%;"></td> <td style="width: 10%;"></td> <td style="width: 10%;"></td> <td style="width: 10%;"></td> <td style="width: 10%;"></td> <td style="width: 10%;"></td> <td style="width: 10%;"></td> </tr> <tr> <td></td> <td></td> <td colspan="8" style="text-align: center;"> <table border="1" style="width: 100%; border-collapse: collapse; text-align: center;"> <tr> <td style="width: 10%;"></td> <td style="width: 10%;"></td> <td style="width: 10%;"></td> <td style="width: 10%;"></td> <td style="width: 10%;"></td> <td style="width: 10%;"></td> <td style="width: 10%;"></td> <td style="width: 10%;"></td> <td style="width: 10%;"></td> <td style="width: 10%;"></td> </tr> <tr> <td></td> <td></td> <td colspan="8" style="text-align: center;"> <table border="1" style="width: 100%; border-collapse: collapse; text-align: center;"> <tr> <td style="width: 10%;"></td> <td style="width: 10%;"></td> <td style="width: 10%;"></td> <td style="width: 10%;"></td> <td style="width: 10%;"></td> <td style="width: 10%;"></td> <td style="width: 10%;"></td> <td style="width: 10%;"></td> <td style="width: 10%;"></td> <td style="width: 10%;"></td> </tr> <tr> <td></td> <td></td> <td colspan="8" style="text-align: center;"> <table border="1" style="width: 100%; border-collapse: collapse; text-align: center;"> <tr> <td style="width: 10%;"></td> <td style="width: 10%;"></td> <td style="width: 10%;"></td> <td style="width: 10%;"></td> <td style="width: 10%;"></td> <td style="width: 10%;"></td> <td style="width: 10%;"></td> <td style="width: 10%;"></td> <td style="width: 10%;"></td> <td style="width: 10%;"></td> </tr> <tr> <td></td> <td></td> <td colspan="8" style="text-align: center;"> <table border="1" style="width: 100%; border-collapse: collapse; text-align: center;"> <tr> </tr></table></td></tr></table></td></tr></table></td></tr></table></td></tr></table></td></tr></table></td></tr></table></td></tr></table></td></tr></table></td></tr></table></td></tr></table></td></tr></table></td></tr></table></td></tr></table></td></tr></table></td></tr></table></td></tr></table></td></tr></table></td></tr></table></td></tr></table></td></tr></table></td></tr></table></td></tr></table></td></tr></table></td></tr></table></td></tr></table></td></tr></table></td></tr></table></td></tr></table></td></tr></table></td></tr></table></td></tr></table></td></tr></table> | | | | | | | | | | | | | | | | | | | | <table border="1" style="width: 100%; border-collapse: collapse; text-align: center;"> <tr> <td style="width: 10%;"></td> <td style="width: 10%;"></td> <td style="width: 10%;"></td> <td style="width: 10%;"></td> <td style="width: 10%;"></td> <td style="width: 10%;"></td> <td style="width: 10%;"></td> <td style="width: 10%;"></td> <td style="width: 10%;"></td> <td style="width: 10%;"></td> </tr> <tr> <td></td> <td></td> <td colspan="8" style="text-align: center;"> <table border="1" style="width: 100%; border-collapse: collapse; text-align: center;"> <tr> <td style="width: 10%;"></td> <td style="width: 10%;"></td> <td style="width: 10%;"></td> <td style="width: 10%;"></td> <td style="width: 10%;"></td> <td style="width: 10%;"></td> <td style="width: 10%;"></td> <td style="width: 10%;"></td> <td style="width: 10%;"></td> <td style="width: 10%;"></td> </tr> <tr> <td></td> <td></td> <td colspan="8" style="text-align: center;"> <table border="1" style="width: 100%; border-collapse: collapse; text-align: center;"> <tr> <td style="width: 10%;"></td> <td style="width: 10%;"></td> <td style="width: 10%;"></td> <td style="width: 10%;"></td> <td style="width: 10%;"></td> <td style="width: 10%;"></td> <td style="width: 10%;"></td> <td style="width: 10%;"></td> <td style="width: 10%;"></td> <td style="width: 10%;"></td> </tr> <tr> <td></td> <td></td> <td colspan="8" style="text-align: center;"> <table border="1" style="width: 100%; border-collapse:
collapse; text-align: center;"> <tr> <td style="width: 10%;"></td> <td style="width: 10%;"></td> <td style="width: 10%;"></td> <td style="width: 10%;"></td> <td style="width: 10%;"></td> <td style="width: 10%;"></td> <td style="width: 10%;"></td> <td style="width: 10%;"></td> <td style="width: 10%;"></td> <td style="width: 10%;"></td> </tr> <tr> <td></td> <td></td> <td colspan="8" style="text-align: center;"> <table border="1" style="width: 100%; border-collapse: collapse; text-align: center;"> <tr> <td style="width: 10%;"></td> <td style="width: 10%;"></td> <td style="width: 10%;"></td> <td style="width: 10%;"></td> <td style="width: 10%;"></td> <td style="width: 10%;"></td> <td style="width: 10%;"></td> <td style="width: 10%;"></td> <td style="width: 10%;"></td> <td style="width: 10%;"></td> </tr> <tr> <td></td> <td></td> <td colspan="8" style="text-align: center;"> <table border="1" style="width: 100%; border-collapse: collapse; text-align: center;"> <tr> <td style="width: 10%;"></td> <td style="width: 10%;"></td> <td style="width: 10%;"></td> <td style="width: 10%;"></td> <td style="width: 10%;"></td> <td style="width: 10%;"></td> <td style="width: 10%;"></td> <td style="width: 10%;"></td> <td style="width: 10%;"></td> <td style="width: 10%;"></td> </tr> <tr> <td></td> <td></td> <td colspan="8" style="text-align: center;"> <table border="1" style="width: 100%; border-collapse: collapse; text-align: center;"> <tr> <td style="width: 10%;"></td> <td style="width: 10%;"></td> <td style="width: 10%;"></td> <td style="width: 10%;"></td> <td style="width: 10%;"></td> <td style="width: 10%;"></td> <td style="width: 10%;"></td> <td style="width: 10%;"></td> <td style="width: 10%;"></td> <td style="width: 10%;"></td> </tr> <tr> <td></td> <td></td> <td colspan="8" style="text-align: center;"> <table border="1" style="width: 100%; border-collapse: collapse; text-align: center;"> <tr> <td style="width: 10%;"></td> <td style="width: 10%;"></td> <td style="width: 10%;"></td> <td style="width: 10%;"></td> <td style="width: 10%;"></td> <td style="width: 10%;"></td> <td style="width: 10%;"></td> <td style="width: 10%;"></td> <td style="width: 10%;"></td> <td style="width: 10%;"></td> </tr> <tr> <td></td> <td></td> <td colspan="8" style="text-align: center;"> <table border="1" style="width: 100%; border-collapse: collapse; text-align: center;"> <tr> <td style="width: 10%;"></td> <td style="width: 10%;"></td> <td style="width: 10%;"></td> <td style="width: 10%;"></td> <td style="width: 10%;"></td> <td style="width: 10%;"></td> <td style="width: 10%;"></td> <td style="width: 10%;"></td> <td style="width: 10%;"></td> <td style="width: 10%;"></td> </tr> <tr> <td></td> <td></td> <td colspan="8" style="text-align: center;"> <table border="1" style="width: 100%; border-collapse: collapse; text-align: center;"> <tr> <td style="width: 10%;"></td> <td style="width: 10%;"></td> <td style="width: 10%;"></td> <td style="width: 10%;"></td> <td style="width: 10%;"></td> <td style="width: 10%;"></td> <td style="width: 10%;"></td> <td style="width: 10%;"></td> <td style="width: 10%;"></td> <td style="width: 10%;"></td> </tr> <tr> <td></td> <td></td> <td colspan="8" style="text-align: center;"> <table border="1" style="width: 100%; border-collapse: collapse; text-align: center;"> <tr> <td style="width: 10%;"></td> <td style="width: 10%;"></td> <td style="width: 10%;"></td> <td style="width: 10%;"></td> <td style="width: 10%;"></td> <td style="width: 10%;"></td> <td style="width: 10%;"></td> <td style="width: 10%;"></td> <td style="width: 10%;"></td> <td style="width: 10%;"></td> </tr> <tr> <td></td> <td></td> <td colspan="8" style="text-align: center;"> <table border="1" style="width: 100%; border-collapse: collapse; text-align: center;"> <tr> <td style="width: 10%;"></td> <td style="width: 10%;"></td> <td style="width: 10%;"></td> <td style="width: 10%;"></td> <td style="width: 10%;"></td> <td style="width: 10%;"></td> <td style="width: 10%;"></td> <td style="width: 10%;"></td> <td style="width: 10%;"></td> <td style="width: 10%;"></td> </tr> <tr> <td></td> <td></td> <td colspan="8" style="text-align: center;"> <table border="1" style="width: 100%; border-collapse: collapse; text-align: center;"> <tr> <td style="width: 10%;"></td> <td style="width: 10%;"></td> <td style="width: 10%;"></td> <td style="width: 10%;"></td> <td style="width: 10%;"></td> <td style="width: 10%;"></td> <td style="width: 10%;"></td> <td style="width: 10%;"></td> <td style="width: 10%;"></td> <td style="width: 10%;"></td> </tr> <tr> <td></td> <td></td> <td colspan="8" style="text-align: center;"> <table border="1" style="width: 100%; border-collapse: collapse; text-align: center;"> <tr> <td style="width: 10%;"></td> <td style="width: 10%;"></td> <td style="width: 10%;"></td> <td style="width: 10%;"></td> <td style="width: 10%;"></td> <td style="width: 10%;"></td> <td style="width: 10%;"></td> <td style="width: 10%;"></td> <td style="width: 10%;"></td> <td style="width: 10%;"></td> </tr> <tr> <td></td> <td></td> <td colspan="8" style="text-align: center;"> <table border="1" style="width: 100%; border-collapse: collapse; text-align: center;"> <tr> <td style="width: 10%;"></td> <td style="width: 10%;"></td> <td style="width: 10%;"></td> <td style="width: 10%;"></td> <td style="width: 10%;"></td> <td style="width: 10%;"></td> <td style="width: 10%;"></td> <td style="width: 10%;"></td> <td style="width: 10%;"></td> <td style="width: 10%;"></td> </tr> <tr> <td></td> <td></td> <td colspan="8" style="text-align: center;"> <table border="1" style="width: 100%; border-collapse: collapse; text-align: center;"> <tr> <td style="width: 10%;"></td> <td style="width: 10%;"></td> <td style="width: 10%;"></td> <td style="width: 10%;"></td> <td style="width: 10%;"></td> <td style="width: 10%;"></td> <td style="width: 10%;"></td> <td style="width: 10%;"></td> <td style="width: 10%;"></td> <td style="width: 10%;"></td> </tr> <tr> <td></td> <td></td> <td colspan="8" style="text-align: center;"> <table border="1" style="width: 100%; border-collapse: collapse; text-align: center;"> <tr> <td style="width: 10%;"></td> <td style="width: 10%;"></td> <td style="width: 10%;"></td> <td style="width: 10%;"></td> <td style="width: 10%;"></td> <td style="width: 10%;"></td> <td style="width: 10%;"></td> <td style="width: 10%;"></td> <td style="width: 10%;"></td> <td style="width: 10%;"></td> </tr> <tr> <td></td> <td></td> <td colspan="8" style="text-align: center;"> <table border="1" style="width: 100%; border-collapse: collapse; text-align: center;"> <tr> <td style="width: 10%;"></td> <td style="width: 10%;"></td> <td style="width: 10%;"></td> <td style="width: 10%;"></td> <td style="width: 10%;"></td> <td style="width: 10%;"></td> <td style="width: 10%;"></td> <td style="width: 10%;"></td> <td style="width: 10%;"></td> <td style="width: 10%;"></td> </tr> <tr> <td></td> <td></td> <td colspan="8" style="text-align: center;"> <table border="1" style="width: 100%; border-collapse: collapse; text-align: center;"> <tr> <td style="width: 10%;"></td> <td style="width: 10%;"></td> <td style="width: 10%;"></td> <td style="width: 10%;"></td> <td style="width: 10%;"></td> <td style="width: 10%;"></td> <td style="width: 10%;"></td> <td style="width: 10%;"></td> <td style="width: 10%;"></td> <td style="width: 10%;"></td> </tr> <tr> <td></td> <td></td> <td colspan="8" style="text-align: center;"> <table border="1" style="width: 100%; border-collapse: collapse; text-align: center;"> <tr> <td style="width: 10%;"></td> <td style="width: 10%;"></td> <td style="width: 10%;"></td> <td style="width: 10%;"></td> <td style="width: 10%;"></td> <td style="width: 10%;"></td> <td style="width: 10%;"></td> <td style="width: 10%;"></td> <td style="width: 10%;"></td> <td style="width: 10%;"></td> </tr> <tr> <td></td> <td></td> <td colspan="8" style="text-align: center;"> <table border="1" style="width: 100%; border-collapse: collapse; text-align: center;"> <tr> <td style="width: 10%;"></td> <td style="width: 10%;"></td> <td style="width: 10%;"></td> <td style="width: 10%;"></td> <td style="width: 10%;"></td> <td style="width: 10%;"></td> <td style="width: 10%;"></td> <td style="width: 10%;"></td> <td style="width: 10%;"></td> <td style="width: 10%;"></td> </tr> <tr> <td></td> <td></td> <td colspan="8" style="text-align: center;"> <table border="1" style="width: 100%; border-collapse: collapse; text-align: center;"> <tr> <td style="width: 10%;"></td> <td style="width: 10%;"></td> <td style="width: 10%;"></td> <td style="width: 10%;"></td> <td style="width: 10%;"></td> <td style="width: 10%;"></td> <td style="width: 10%;"></td> <td style="width: 10%;"></td> <td style="width: 10%;"></td> <td style="width: 10%;"></td> </tr> <tr> <td></td> <td></td> <td colspan="8" style="text-align: center;"> <table border="1" style="width: 100%; border-collapse: collapse; text-align: center;"> <tr> <td style="width: 10%;"></td> <td style="width: 10%;"></td> <td style="width: 10%;"></td> <td style="width: 10%;"></td> <td style="width: 10%;"></td> <td style="width: 10%;"></td> <td style="width: 10%;"></td> <td style="width: 10%;"></td> <td style="width: 10%;"></td> <td style="width: 10%;"></td> </tr> <tr> <td></td> <td></td> <td colspan="8" style="text-align: center;"> <table border="1" style="width: 100%; border-collapse: collapse; text-align: center;"> <tr> <td style="width: 10%;"></td> <td style="width: 10%;"></td> <td style="width: 10%;"></td> <td style="width: 10%;"></td> <td style="width: 10%;"></td> <td style="width: 10%;"></td> <td style="width: 10%;"></td> <td style="width: 10%;"></td> <td style="width: 10%;"></td> <td style="width: 10%;"></td> </tr> <tr> <td></td> <td></td> <td colspan="8" style="text-align: center;"> <table border="1" style="width: 100%; border-collapse: collapse; text-align: center;"> <tr> <td style="width: 10%;"></td> <td style="width: 10%;"></td> <td style="width: 10%;"></td> <td style="width: 10%;"></td> <td
style="width: 10%;"></td> <td style="width: 10%;"></td> <td style="width: 10%;"></td> <td style="width: 10%;"></td> <td style="width: 10%;"></td> <td style="width: 10%;"></td> </tr> <tr> <td></td> <td></td> <td colspan="8" style="text-align: center;"> <table border="1" style="width: 100%; border-collapse: collapse; text-align: center;"> <tr> <td style="width: 10%;"></td> <td style="width: 10%;"></td> <td style="width: 10%;"></td> <td style="width: 10%;"></td> <td style="width: 10%;"></td> <td style="width: 10%;"></td> <td style="width: 10%;"></td> <td style="width: 10%;"></td> <td style="width: 10%;"></td> <td style="width: 10%;"></td> </tr> <tr> <td></td> <td></td> <td colspan="8" style="text-align: center;"> <table border="1" style="width: 100%; border-collapse: collapse; text-align: center;"> <tr> <td style="width: 10%;"></td> <td style="width: 10%;"></td> <td style="width: 10%;"></td> <td style="width: 10%;"></td> <td style="width: 10%;"></td> <td style="width: 10%;"></td> <td style="width: 10%;"></td> <td style="width: 10%;"></td> <td style="width: 10%;"></td> <td style="width: 10%;"></td> </tr> <tr> <td></td> <td></td> <td colspan="8" style="text-align: center;"> <table border="1" style="width: 100%; border-collapse: collapse; text-align: center;"> <tr> <td style="width: 10%;"></td> <td style="width: 10%;"></td> <td style="width: 10%;"></td> <td style="width: 10%;"></td> <td style="width: 10%;"></td> <td style="width: 10%;"></td> <td style="width: 10%;"></td> <td style="width: 10%;"></td> <td style="width: 10%;"></td> <td style="width: 10%;"></td> </tr> <tr> <td></td> <td></td> <td colspan="8" style="text-align: center;"> <table border="1" style="width: 100%; border-collapse: collapse; text-align: center;"> <tr> <td style="width: 10%;"></td> <td style="width: 10%;"></td> <td style="width: 10%;"></td> <td style="width: 10%;"></td> <td style="width: 10%;"></td> <td style="width: 10%;"></td> <td style="width: 10%;"></td> <td style="width: 10%;"></td> <td style="width: 10%;"></td> <td style="width: 10%;"></td> </tr> <tr> <td></td> <td></td> <td colspan="8" style="text-align: center;"> <table border="1" style="width: 100%; border-collapse: collapse; text-align: center;"> <tr> <td style="width: 10%;"></td> <td style="width: 10%;"></td> <td style="width: 10%;"></td> <td style="width: 10%;"></td> <td style="width: 10%;"></td> <td style="width: 10%;"></td> <td style="width: 10%;"></td> <td style="width: 10%;"></td> <td style="width: 10%;"></td> <td style="width: 10%;"></td> </tr> <tr> <td></td> <td></td> <td colspan="8" style="text-align: center;"> <table border="1" style="width: 100%; border-collapse: collapse; text-align: center;"> <tr> <td style="width: 10%;"></td> <td style="width: 10%;"></td> <td style="width: 10%;"></td> <td style="width: 10%;"></td> <td style="width: 10%;"></td> <td style="width: 10%;"></td> <td style="width: 10%;"></td> <td style="width: 10%;"></td> <td style="width: 10%;"></td> <td style="width: 10%;"></td> </tr> <tr> <td></td> <td></td> <td colspan="8" style="text-align: center;"> <table border="1" style="width: 100%; border-collapse: collapse; text-align: center;"> <tr> </tr></table></td></tr></table></td></tr></table></td></tr></table></td></tr></table></td></tr></table></td></tr></table></td></tr></table></td></tr></table></td></tr></table></td></tr></table></td></tr></table></td></tr></table></td></tr></table></td></tr></table></td></tr></table></td></tr></table></td></tr></table></td></tr></table></td></tr></table></td></tr></table></td></tr></table></td></tr></table></td></tr></table></td></tr></table></td></tr></table></td></tr></table></td></tr></table></td></tr></table></td></tr></table></td></tr></table></td></tr></table> | | | | | | | | | | | | | | | | | | | | <table border="1" style="width: 100%; border-collapse: collapse; text-align: center;"> <tr> <td style="width: 10%;"></td> <td style="width: 10%;"></td> <td style="width: 10%;"></td> <td style="width: 10%;"></td> <td style="width: 10%;"></td> <td style="width: 10%;"></td> <td style="width: 10%;"></td> <td style="width: 10%;"></td> <td style="width: 10%;"></td> <td style="width: 10%;"></td> </tr> <tr> <td></td> <td></td> <td colspan="8" style="text-align: center;"> <table border="1" style="width: 100%; border-collapse: collapse; text-align: center;"> <tr> <td style="width: 10%;"></td> <td style="width: 10%;"></td> <td style="width: 10%;"></td> <td style="width: 10%;"></td> <td style="width: 10%;"></td> <td style="width: 10%;"></td> <td style="width: 10%;"></td> <td style="width: 10%;"></td> <td style="width: 10%;"></td> <td style="width: 10%;"></td> </tr> <tr> <td></td> <td></td> <td colspan="8" style="text-align: center;"> <table border="1" style="width: 100%; border-collapse: collapse; text-align: center;"> <tr> <td style="width: 10%;"></td> <td style="width: 10%;"></td> <td style="width: 10%;"></td> <td style="width: 10%;"></td> <td style="width: 10%;"></td> <td style="width: 10%;"></td> <td style="width: 10%;"></td> <td style="width: 10%;"></td> <td style="width: 10%;"></td> <td style="width: 10%;"></td> </tr> <tr> <td></td> <td></td> <td colspan="8" style="text-align: center;"> <table border="1" style="width: 100%; border-collapse: collapse; text-align: center;"> <tr> <td style="width: 10%;"></td> <td style="width: 10%;"></td> <td style="width: 10%;"></td> <td style="width: 10%;"></td> <td style="width: 10%;"></td> <td style="width: 10%;"></td> <td style="width: 10%;"></td> <td style="width: 10%;"></td> <td style="width: 10%;"></td> <td style="width: 10%;"></td> </tr> <tr> <td></td> <td></td> <td colspan="8" style="text-align: center;"> <table border="1" style="width: 100%; border-collapse: collapse; text-align: center;"> <tr> <td style="width: 10%;"></td> <td style="width: 10%;"></td> <td style="width: 10%;"></td> <td style="width: 10%;"></td> <td style="width: 10%;"></td> <td style="width: 10%;"></td> <td style="width: 10%;"></td> <td style="width: 10%;"></td> <td style="width: 10%;"></td> <td style="width: 10%;"></td> </tr> <tr> <td></td> <td></td> <td colspan="8" style="text-align: center;"> <table border="1" style="width: 100%; border-collapse: collapse; text-align: center;"> <tr> <td style="width: 10%;"></td> <td style="width: 10%;"></td> <td style="width: 10%;"></td> <td style="width: 10%;"></td> <td style="width: 10%;"></td> <td style="width: 10%;"></td> <td style="width: 10%;"></td> <td style="width: 10%;"></td> <td style="width: 10%;"></td> <td style="width: 10%;"></td> </tr> <tr> <td></td> <td></td> <td colspan="8" style="text-align: center;"> <table border="1" style="width: 100%; border-collapse: collapse; text-align: center;"> <tr> <td style="width: 10%;"></td> <td style="width: 10%;"></td> <td style="width: 10%;"></td> <td style="width: 10%;"></td> <td style="width: 10%;"></td> <td style="width: 10%;"></td> <td style="width: 10%;"></td> <td style="width: 10%;"></td> <td style="width: 10%;"></td> <td style="width: 10%;"></td> </tr> <tr> <td></td> <td></td> <td colspan="8" style="text-align: center;"> <table border="1" style="width: 100%; border-collapse: collapse; text-align: center;"> <tr> <td style="width: 10%;"></td> <td style="width: 10%;"></td> <td style="width: 10%;"></td> <td style="width: 10%;"></td> <td style="width: 10%;"></td> <td style="width: 10%;"></td> <td style="width: 10%;"></td> <td style="width: 10%;"></td> <td style="width: 10%;"></td> <td style="width: 10%;"></td> </tr> <tr> <td></td> <td></td> <td colspan="8" style="text-align: center;"> <table border="1" style="width: 100%; border-collapse: collapse; text-align: center;"> <tr> <td style="width: 10%;"></td> <td style="width: 10%;"></td> <td style="width: 10%;"></td> <td style="width: 10%;"></td> <td style="width: 10%;"></td> <td style="width: 10%;"></td> <td style="width: 10%;"></td> <td style="width: 10%;"></td> <td style="width: 10%;"></td> <td style="width: 10%;"></td> </tr> <tr> <td></td> <td></td> <td colspan="8" style="text-align: center;"> <table border="1" style="width: 100%; border-collapse: collapse; text-align: center;"> <tr> <td style="width: 10%;"></td> <td style="width: 10%;"></td> <td style="width: 10%;"></td> <td style="width: 10%;"></td> <td style="width: 10%;"></td> <td style="width: 10%;"></td> <td style="width: 10%;"></td> <td style="width: 10%;"></td> <td style="width: 10%;"></td> <td style="width: 10%;"></td> </tr> <tr> <td></td> <td></td> <td colspan="8" style="text-align: center;"> <table border="1" style="width: 100%; border-collapse: collapse; text-align:
center;"> <tr> <td style="width: 10%;"></td> <td style="width: 10%;"></td> <td style="width: 10%;"></td> <td style="width: 10%;"></td> <td style="width: 10%;"></td> <td style="width: 10%;"></td> <td style="width: 10%;"></td> <td style="width: 10%;"></td> <td style="width: 10%;"></td> <td style="width: 10%;"></td> </tr> <tr> <td></td> <td></td> <td colspan="8" style="text-align: center;"> <table border="1" style="width: 100%; border-collapse: collapse; text-align: center;"> <tr> <td style="width: 10%;"></td> <td style="width: 10%;"></td> <td style="width: 10%;"></td> <td style="width: 10%;"></td> <td style="width: 10%;"></td> <td style="width: 10%;"></td> <td style="width: 10%;"></td> <td style="width: 10%;"></td> <td style="width: 10%;"></td> <td style="width: 10%;"></td> </tr> <tr> <td></td> <td></td> <td colspan="8" style="text-align: center;"> <table border="1" style="width: 100%; border-collapse: collapse; text-align: center;"> <tr> <td style="width: 10%;"></td> <td style="width: 10%;"></td> <td style="width: 10%;"></td> <td style="width: 10%;"></td> <td style="width: 10%;"></td> <td style="width: 10%;"></td> <td style="width: 10%;"></td> <td style="width: 10%;"></td> <td style="width: 10%;"></td> <td style="width: 10%;"></td> </tr> <tr> <td></td> <td></td> <td colspan="8" style="text-align: center;"> <table border="1" style="width: 100%; border-collapse: collapse; text-align: center;"> <tr> <td style="width: 10%;"></td> <td style="width: 10%;"></td> <td style="width: 10%;"></td> <td style="width: 10%;"></td> <td style="width: 10%;"></td> <td style="width: 10%;"></td> <td style="width: 10%;"></td> <td style="width: 10%;"></td> <td style="width: 10%;"></td> <td style="width: 10%;"></td> </tr> <tr> <td></td> <td></td> <td colspan="8" style="text-align: center;"> <table border="1" style="width: 100%; border-collapse: collapse; text-align: center;"> <tr> <td style="width: 10%;"></td> <td style="width: 10%;"></td> <td style="width: 10%;"></td> <td style="width: 10%;"></td> <td style="width: 10%;"></td> <td style="width: 10%;"></td> <td style="width: 10%;"></td> <td style="width: 10%;"></td> <td style="width: 10%;"></td> <td style="width: 10%;"></td> </tr> <tr> <td></td> <td></td> <td colspan="8" style="text-align: center;"> <table border="1" style="width: 100%; border-collapse: collapse; text-align: center;"> <tr> <td style="width: 10%;"></td> <td style="width: 10%;"></td> <td style="width: 10%;"></td> <td style="width: 10%;"></td> <td style="width: 10%;"></td> <td style="width: 10%;"></td> <td style="width: 10%;"></td> <td style="width: 10%;"></td> <td style="width: 10%;"></td> <td style="width: 10%;"></td> </tr> <tr> <td></td> <td></td> <td colspan="8" style="text-align: center;"> <table border="1" style="width: 100%; border-collapse: collapse; text-align: center;"> <tr> <td style="width: 10%;"></td> <td style="width: 10%;"></td> <td style="width: 10%;"></td> <td style="width: 10%;"></td> <td style="width: 10%;"></td> <td style="width: 10%;"></td> <td style="width: 10%;"></td> <td style="width: 10%;"></td> <td style="width: 10%;"></td> <td style="width: 10%;"></td> </tr> <tr> <td></td> <td></td> <td colspan="8" style="text-align: center;"> <table border="1" style="width: 100%; border-collapse: collapse; text-align: center;"> <tr> <td style="width: 10%;"></td> <td style="width: 10%;"></td> <td style="width: 10%;"></td> <td style="width: 10%;"></td> <td style="width: 10%;"></td> <td style="width: 10%;"></td> <td style="width: 10%;"></td> <td style="width: 10%;"></td> <td style="width: 10%;"></td> <td style="width: 10%;"></td> </tr> <tr> <td></td> <td></td> <td colspan="8" style="text-align: center;"> <table border="1" style="width: 100%; border-collapse: collapse; text-align: center;"> <tr> <td style="width: 10%;"></td> <td style="width: 10%;"></td> <td style="width: 10%;"></td> <td style="width: 10%;"></td> <td style="width: 10%;"></td> <td style="width: 10%;"></td> <td style="width: 10%;"></td> <td style="width: 10%;"></td> <td style="width: 10%;"></td> <td style="width: 10%;"></td> </tr> <tr> <td></td> <td></td> <td colspan="8" style="text-align: center;"> <table border="1" style="width: 100%; border-collapse: collapse; text-align: center;"> <tr> <td style="width: 10%;"></td> <td style="width: 10%;"></td> <td style="width: 10%;"></td> <td style="width: 10%;"></td> <td style="width: 10%;"></td> <td style="width: 10%;"></td> <td style="width: 10%;"></td> <td style="width: 10%;"></td> <td style="width: 10%;"></td> <td style="width: 10%;"></td> </tr> <tr> <td></td> <td></td> <td colspan="8" style="text-align: center;"> <table border="1" style="width: 100%; border-collapse: collapse; text-align: center;"> <tr> <td style="width: 10%;"></td> <td style="width: 10%;"></td> <td style="width: 10%;"></td> <td style="width: 10%;"></td> <td style="width: 10%;"></td> <td style="width: 10%;"></td> <td style="width: 10%;"></td> <td style="width: 10%;"></td> <td style="width: 10%;"></td> <td style="width: 10%;"></td> </tr> <tr> <td></td> <td></td> <td colspan="8" style="text-align: center;"> <table border="1" style="width: 100%; border-collapse: collapse; text-align: center;"> <tr> <td style="width: 10%;"></td> <td style="width: 10%;"></td> <td style="width: 10%;"></td> <td style="width: 10%;"></td> <td style="width: 10%;"></td> <td style="width: 10%;"></td> <td style="width: 10%;"></td> <td style="width: 10%;"></td> <td style="width: 10%;"></td> <td style="width: 10%;"></td> </tr> <tr> <td></td> <td></td> <td colspan="8" style="text-align: center;"> <table border="1" style="width: 100%; border-collapse: collapse; text-align: center;"> <tr> <td style="width: 10%;"></td> <td style="width: 10%;"></td> <td style="width: 10%;"></td> <td style="width: 10%;"></td> <td style="width: 10%;"></td> <td style="width: 10%;"></td> <td style="width: 10%;"></td> <td style="width: 10%;"></td> <td style="width: 10%;"></td> <td style="width: 10%;"></td> </tr> <tr> <td></td> <td></td> <td colspan="8" style="text-align: center;"> <table border="1" style="width: 100%; border-collapse: collapse; text-align: center;"> <tr> <td style="width: 10%;"></td> <td style="width: 10%;"></td> <td style="width: 10%;"></td> <td style="width: 10%;"></td> <td style="width: 10%;"></td> <td style="width: 10%;"></td> <td style="width: 10%;"></td> <td style="width: 10%;"></td> <td style="width: 10%;"></td> <td style="width: 10%;"></td> </tr> <tr> <td></td> <td></td> <td colspan="8" style="text-align: center;"> <table border="1" style="width: 100%; border-collapse: collapse; text-align: center;"> <tr> <td style="width: 10%;"></td> <td style="width: 10%;"></td> <td style="width: 10%;"></td> <td style="width: 10%;"></td> <td style="width: 10%;"></td> <td style="width: 10%;"></td> <td style="width: 10%;"></td> <td style="width: 10%;"></td> <td style="width: 10%;"></td> <td style="width: 10%;"></td> </tr> <tr> <td></td> <td></td> <td colspan="8" style="text-align: center;"> <table border="1" style="width: 100%; border-collapse: collapse; text-align: center;"> <tr> <td style="width: 10%;"></td> <td style="width: 10%;"></td> <td style="width: 10%;"></td> <td style="width: 10%;"></td> <td style="width: 10%;"></td> <td style="width: 10%;"></td> <td style="width: 10%;"></td> <td style="width: 10%;"></td> <td style="width: 10%;"></td> <td style="width: 10%;"></td> </tr> <tr> <td></td> <td></td> <td colspan="8" style="text-align: center;"> <table border="1" style="width: 100%; border-collapse: collapse; text-align: center;"> <tr> <td style="width: 10%;"></td> <td style="width: 10%;"></td> <td style="width: 10%;"></td> <td style="width: 10%;"></td> <td style="width: 10%;"></td> <td style="width: 10%;"></td> <td style="width: 10%;"></td> <td style="width: 10%;"></td> <td style="width: 10%;"></td> <td style="width: 10%;"></td> </tr> <tr> <td></td> <td></td> <td colspan="8" style="text-align: center;"> <table border="1" style="width: 100%; border-collapse: collapse; text-align: center;"> <tr> <td style="width: 10%;"></td> <td style="width: 10%;"></td> <td style="width: 10%;"></td> <td style="width: 10%;"></td> <td style="width: 10%;"></td> <td style="width: 10%;"></td> <td style="width: 10%;"></td> <td style="width: 10%;"></td> <td style="width: 10%;"></td> <td style="width: 10%;"></td> </tr> <tr> <td></td> <td></td> <td colspan="8" style="text-align: center;"> <table border="1" style="width: 100%; border-collapse: collapse; text-align: center;"> <tr> <td style="width: 10%;"></td> <td style="width: 10%;"></td> <td style="width: 10%;"></td> <td style="width: 10%;"></td> <td style="width: 10%;"></td> <td style="width: 10%;"></td> <td style="width: 10%;"></td> <td style="width: 10%;"></td> <td style="width: 10%;"></td> <td style="width: 10%;"></td> </tr> <tr> <td></td> <td></td> <td colspan="8" style="text-align: center;"> <table border="1" style="width: 100%; border-collapse: collapse; text-align: center;"> <tr> <td style="width: 10%;"></td> <td style="width: 10%;"></td> <td style="width: 10%;"></td> <td style="width: 10%;"></td> <td style="width: 10%;"></td> <td style="width: 10%;"></td> <td style="width: 10%;"></td> <td style="width: 10%;"></td> <td style="width: 10%;"></td> <td style="width: 10%;"></td> </tr> <tr> <td></td> <td></td> <td colspan="8" style="text-align: center;"> <table border="1" style="width: 100%; border-collapse: collapse; text-align: center;"> <tr> </tr></table></td></tr></table></td></tr></table></td></tr></table></td></tr></table></td></tr></table></td></tr></table></td></tr></table></td></tr></table></td></tr></table></td></tr></table></td></tr></table></td></tr></table></td></tr></table></td></tr></table></td></tr></table></td></tr></table></td></tr></table></td></tr></table></td></tr></table></td></tr></table></td></tr></table></td></tr></table></td></tr></table></td></tr></table></td></tr></table></td></tr></table></td></tr></table></td></tr></table></td></tr></table></td></tr></table>
 | | | | | | | | | | | | | | | | | | | | <table border="1" style="width: 100%; border-collapse: collapse; text-align: center;"> <tr> <td style="width: 10%;"></td> <td style="width: 10%;"></td> <td style="width: 10%;"></td> <td style="width: 10%;"></td> <td style="width: 10%;"></td> <td style="width: 10%;"></td> <td style="width: 10%;"></td> <td style="width: 10%;"></td> <td style="width: 10%;"></td> <td style="width: 10%;"></td> </tr> <tr> <td></td> <td></td> <td colspan="8" style="text-align: center;"> <table border="1" style="width: 100%; border-collapse: collapse; text-align: center;"> <tr> <td style="width: 10%;"></td> <td style="width: 10%;"></td> <td style="width: 10%;"></td> <td style="width: 10%;"></td> <td style="width: 10%;"></td> <td style="width: 10%;"></td> <td style="width: 10%;"></td> <td style="width: 10%;"></td> <td style="width: 10%;"></td> <td style="width: 10%;"></td> </tr> <tr> <td></td> <td></td> <td colspan="8" style="text-align: center;"> <table border="1" style="width: 100%; border-collapse: collapse; text-align: center;"> <tr> <td style="width: 10%;"></td> <td style="width: 10%;"></td> <td style="width: 10%;"></td> <td style="width: 10%;"></td> <td style="width: 10%;"></td> <td style="width: 10%;"></td> <td style="width: 10%;"></td> <td style="width: 10%;"></td> <td style="width: 10%;"></td> <td style="width: 10%;"></td> </tr> <tr> <td></td> <td></td> <td colspan="8" style="text-align: center;"> <table border="1" style="width: 100%; border-collapse: collapse; text-align: center;"> <tr> <td style="width: 10%;"></td> <td style="width: 10%;"></td> <td style="width: 10%;"></td> <td style="width: 10%;"></td> <td style="width: 10%;"></td> <td style="width: 10%;"></td> <td style="width: 10%;"></td> <td style="width: 10%;"></td> <td style="width: 10%;"></td> <td style="width: 10%;"></td> </tr> <tr> <td></td> <td></td> <td colspan="8" style="text-align: center;"> <table border="1" style="width: 100%; border-collapse: collapse; text-align: center;"> <tr> <td style="width: 10%;"></td> <td style="width: 10%;"></td> <td style="width: 10%;"></td> <td style="width: 10%;"></td> <td style="width: 10%;"></td> <td style="width: 10%;"></td> <td style="width: 10%;"></td> <td style="width: 10%;"></td> <td style="width: 10%;"></td> <td style="width: 10%;"></td> </tr> <tr> <td></td> <td></td> <td colspan="8" style="text-align: center;"> <table border="1" style="width: 100%; border-collapse: collapse; text-align: center;"> <tr> <td style="width: 10%;"></td> <td style="width: 10%;"></td> <td style="width: 10%;"></td> <td style="width: 10%;"></td> <td style="width: 10%;"></td> <td style="width: 10%;"></td> <td style="width: 10%;"></td> <td style="width: 10%;"></td> <td style="width: 10%;"></td> <td style="width: 10%;"></td> </tr> <tr> <td></td> <td></td> <td colspan="8" style="text-align: center;"> <table border="1" style="width: 100%; border-collapse: collapse; text-align: center;"> <tr> <td style="width: 10%;"></td> <td style="width: 10%;"></td> <td style="width: 10%;"></td> <td style="width: 10%;"></td> <td style="width: 10%;"></td> <td style="width: 10%;"></td> <td style="width: 10%;"></td> <td style="width: 10%;"></td> <td style="width: 10%;"></td> <td style="width: 10%;"></td> </tr> <tr> <td></td> <td></td> <td colspan="8" style="text-align: center;"> <table border="1" style="width: 100%; border-collapse: collapse; text-align: center;"> <tr> <td style="width: 10%;"></td> <td style="width: 10%;"></td> <td style="width: 10%;"></td> <td style="width: 10%;"></td> <td style="width: 10%;"></td> <td style="width: 10%;"></td> <td style="width: 10%;"></td> <td style="width: 10%;"></td> <td style="width: 10%;"></td> <td style="width: 10%;"></td> </tr> <tr> <td></td> <td></td> <td colspan="8" style="text-align: center;"> <table border="1" style="width: 100%; border-collapse: collapse; text-align: center;"> <tr> <td style="width: 10%;"></td> <td style="width: 10%;"></td> <td style="width: 10%;"></td> <td style="width: 10%;"></td> <td style="width: 10%;"></td> <td style="width: 10%;"></td> <td style="width: 10%;"></td> <td style="width: 10%;"></td> <td style="width: 10%;"></td> <td style="width: 10%;"></td> </tr> <tr> <td></td> <td></td> <td colspan="8" style="text-align: center;"> <table border="1" style="width: 100%; border-collapse: collapse; text-align: center;"> <tr> <td style="width: 10%;"></td> <td style="width: 10%;"></td> <td style="width: 10%;"></td> <td style="width: 10%;"></td> <td style="width: 10%;"></td> <td style="width: 10%;"></td> <td style="width: 10%;"></td> <td style="width: 10%;"></td> <td style="width: 10%;"></td> <td style="width: 10%;"></td> </tr> <tr> <td></td> <td></td> <td colspan="8" style="text-align: center;"> <table border="1" style="width: 100%; border-collapse: collapse; text-align: center;"> <tr> <td style="width: 10%;"></td> <td style="width: 10%;"></td> <td style="width: 10%;"></td> <td style="width: 10%;"></td> <td style="width: 10%;"></td> <td style="width: 10%;"></td> <td style="width: 10%;"></td> <td style="width: 10%;"></td> <td style="width: 10%;"></td> <td style="width: 10%;"></td> </tr> <tr> <td></td> <td></td> <td colspan="8" style="text-align: center;"> <table border="1" style="width: 100%; border-collapse: collapse; text-align: center;"> <tr> <td style="width: 10%;"></td> <td style="width: 10%;"></td> <td style="width: 10%;"></td> <td style="width: 10%;"></td> <td style="width: 10%;"></td> <td style="width: 10%;"></td> <td style="width: 10%;"></td> <td style="width: 10%;"></td> <td style="width: 10%;"></td> <td style="width: 10%;"></td> </tr> <tr> <td></td> <td></td> <td colspan="8" style="text-align: center;"> <table border="1" style="width: 100%; border-collapse: collapse; text-align: center;"> <tr> <td style="width: 10%;"></td> <td style="width: 10%;"></td> <td style="width: 10%;"></td> <td style="width: 10%;"></td> <td style="width: 10%;"></td> <td style="width: 10%;"></td> <td style="width: 10%;"></td> <td style="width: 10%;"></td> <td style="width: 10%;"></td> <td style="width: 10%;"></td> </tr> <tr> <td></td> <td></td> <td colspan="8" style="text-align: center;"> <table border="1" style="width: 100%; border-collapse: collapse; text-align: center;"> <tr> <td style="width: 10%;"></td> <td style="width: 10%;"></td> <td style="width: 10%;"></td> <td style="width: 10%;"></td> <td style="width: 10%;"></td> <td style="width: 10%;"></td> <td style="width: 10%;"></td> <td style="width: 10%;"></td> <td style="width: 10%;"></td> <td style="width: 10%;"></td> </tr> <tr> <td></td> <td></td> <td colspan="8" style="text-align: center;"> <table border="1" style="width: 100%; border-collapse: collapse; text-align: center;"> <tr> <td style="width: 10%;"></td> <td style="width: 10%;"></td> <td style="width: 10%;"></td> <td style="width: 10%;"></td> <td style="width: 10%;"></td> <td style="width: 10%;"></td> <td style="width: 10%;"></td> <td style="width: 10%;"></td> <td style="width: 10%;"></td> <td style="width: 10%;"></td> </tr> <tr> <td></td> <td></td> <td colspan="8" style="text-align: center;"> <table border="1" style="width: 100%; border-collapse: collapse; text-align: center;"> <tr> <td style="width: 10%;"></td> <td style="width: 10%;"></td> <td style="width: 10%;"></td> <td style="width: 10%;"></td> <td style="width: 10%;"></td> <td style="width: 10%;"></td> <td style="width: 10%;"></td> <td style="width: 10%;"></td> <td style="width: 10%;"></td> <td style="width: 10%;"></td> </tr> <tr> <td></td> <td></td> <td colspan="8" style="text-align: center;"> <table border="1" style="width: 100%; border-collapse: collapse; text-align: center;"> <tr> <td style="width: 10%;"></td> <td style="width: 10%;"></td> <td style="width: 10%;"></td> <td style="width: 10%;"></td> <td style="width: 10%;"></td> <td style="width: 10%;"></td> <td style="width: 10%;"></td> <td style="width: 10%;"></td> <td style="width: 10%;"></td> <td style="width: 10%;"></td> </tr> <tr> <td></td> <td></td> <td colspan="8" style="text-align: center;"> <table border="1" style="width: 100%; border-collapse: collapse; text-align: center;"> <tr> <td style="width: 10%;"></td> <td style="width: 10%;"></td> <td style="width: 10%;"></td> <td style="width: 10%;"></td> <td style="width: 10%;"></td> <td style="width: 10%;"></td> <td style="width: 10%;"></td> <td style="width: 10%;"></td> <td style="width: 10%;"></td> <td style="width: 10%;"></td> </tr> <tr> <td></td> <td></td> <td colspan="8" style="text-align: center;"> <table border="1" style="width: 100%; border-collapse: collapse; text-align: center;"> <tr> <td style="width: 10%;"></td> <td
style="width: 10%;"></td> <td style="width: 10%;"></td> <td style="width: 10%;"></td> <td style="width: 10%;"></td> <td style="width: 10%;"></td> <td style="width: 10%;"></td> <td style="width: 10%;"></td> <td style="width: 10%;"></td> <td style="width: 10%;"></td> </tr> <tr> <td></td> <td></td> <td colspan="8" style="text-align: center;"> <table border="1" style="width: 100%; border-collapse: collapse; text-align: center;"> <tr> <td style="width: 10%;"></td> <td style="width: 10%;"></td> <td style="width: 10%;"></td> <td style="width: 10%;"></td> <td style="width: 10%;"></td> <td style="width: 10%;"></td> <td style="width: 10%;"></td> <td style="width: 10%;"></td> <td style="width: 10%;"></td> <td style="width: 10%;"></td> </tr> <tr> <td></td> <td></td> <td colspan="8" style="text-align: center;"> <table border="1" style="width: 100%; border-collapse: collapse; text-align: center;"> <tr> <td style="width: 10%;"></td> <td style="width: 10%;"></td> <td style="width: 10%;"></td> <td style="width: 10%;"></td> <td style="width: 10%;"></td> <td style="width: 10%;"></td> <td style="width: 10%;"></td> <td style="width: 10%;"></td> <td style="width: 10%;"></td> <td style="width: 10%;"></td> </tr> <tr> <td></td> <td></td> <td colspan="8" style="text-align: center;"> <table border="1" style="width: 100%; border-collapse: collapse; text-align: center;"> <tr> <td style="width: 10%;"></td> <td style="width: 10%;"></td> <td style="width: 10%;"></td> <td style="width: 10%;"></td> <td style="width: 10%;"></td> <td style="width: 10%;"></td> <td style="width: 10%;"></td> <td style="width: 10%;"></td> <td style="width: 10%;"></td> <td style="width: 10%;"></td> </tr> <tr> <td></td> <td></td> <td colspan="8" style="text-align: center;"> <table border="1" style="width: 100%; border-collapse: collapse; text-align: center;"> <tr> <td style="width: 10%;"></td> <td style="width: 10%;"></td> <td style="width: 10%;"></td> <td style="width: 10%;"></td> <td style="width: 10%;"></td> <td style="width: 10%;"></td> <td style="width: 10%;"></td> <td style="width: 10%;"></td> <td style="width: 10%;"></td> <td style="width: 10%;"></td> </tr> <tr> <td></td> <td></td> <td colspan="8" style="text-align: center;"> <table border="1" style="width: 100%; border-collapse: collapse; text-align: center;"> <tr> <td style="width: 10%;"></td> <td style="width: 10%;"></td> <td style="width: 10%;"></td> <td style="width: 10%;"></td> <td style="width: 10%;"></td> <td style="width: 10%;"></td> <td style="width: 10%;"></td> <td style="width: 10%;"></td> <td style="width: 10%;"></td> <td style="width: 10%;"></td> </tr> <tr> <td></td> <td></td> <td colspan="8" style="text-align: center;"> <table border="1" style="width: 100%; border-collapse: collapse; text-align: center;"> <tr> <td style="width: 10%;"></td> <td style="width: 10%;"></td> <td style="width: 10%;"></td> <td style="width: 10%;"></td> <td style="width: 10%;"></td> <td style="width: 10%;"></td> <td style="width: 10%;"></td> <td style="width: 10%;"></td> <td style="width: 10%;"></td> <td style="width: 10%;"></td> </tr> <tr> <td></td> <td></td> <td colspan="8" style="text-align: center;"> <table border="1" style="width: 100%; border-collapse: collapse; text-align: center;"> <tr> <td style="width: 10%;"></td> <td style="width: 10%;"></td> <td style="width: 10%;"></td> <td style="width: 10%;"></td> <td style="width: 10%;"></td> <td style="width: 10%;"></td> <td style="width: 10%;"></td> <td style="width: 10%;"></td> <td style="width: 10%;"></td> <td style="width: 10%;"></td> </tr> <tr> <td></td> <td></td> <td colspan="8" style="text-align: center;"> <table border="1" style="width: 100%; border-collapse: collapse; text-align: center;"> <tr> <td style="width: 10%;"></td> <td style="width: 10%;"></td> <td style="width: 10%;"></td> <td style="width: 10%;"></td> <td style="width: 10%;"></td> <td style="width: 10%;"></td> <td style="width: 10%;"></td> <td style="width: 10%;"></td> <td style="width: 10%;"></td> <td style="width: 10%;"></td> </tr> <tr> <td></td> <td></td> <td colspan="8" style="text-align: center;"> <table border="1" style="width: 100%; border-collapse: collapse; text-align: center;"> <tr> <td style="width: 10%;"></td> <td style="width: 10%;"></td> <td style="width: 10%;"></td> <td style="width: 10%;"></td> <td style="width: 10%;"></td> <td style="width: 10%;"></td> <td style="width: 10%;"></td> <td style="width: 10%;"></td> <td style="width: 10%;"></td> <td style="width: 10%;"></td> </tr> <tr> <td></td> <td></td> <td colspan="8" style="text-align: center;"> <table border="1" style="width: 100%; border-collapse: collapse; text-align: center;"> <tr> <td style="width: 10%;"></td> <td style="width: 10%;"></td> <td style="width: 10%;"></td> <td style="width: 10%;"></td> <td style="width: 10%;"></td> <td style="width: 10%;"></td> <td style="width: 10%;"></td> <td style="width: 10%;"></td> <td style="width: 10%;"></td> <td style="width: 10%;"></td> </tr> <tr> <td></td> <td></td> <td colspan="8" style="text-align: center;"> <table border="1" style="width: 100%; border-collapse: collapse; text-align: center;"> <tr> </tr></table></td></tr></table></td></tr></table></td></tr></table></td></tr></table></td></tr></table></td></tr></table></td></tr></table></td></tr></table></td></tr></table></td></tr></table></td></tr></table></td></tr></table></td></tr></table></td></tr></table></td></tr></table></td></tr></table></td></tr></table></td></tr></table></td></tr></table></td></tr></table></td></tr></table></td></tr></table></td></tr></table></td></tr></table></td></tr></table></td></tr></table></td></tr></table></td></tr></table></td></tr></table> | | | | | | | | | | | | | | | | | | | | <table border="1" style="width: 100%; border-collapse: collapse; text-align: center;"> <tr> <td style="width: 10%;"></td> <td style="width: 10%;"></td> <td style="width: 10%;"></td> <td style="width: 10%;"></td> <td style="width: 10%;"></td> <td style="width: 10%;"></td> <td style="width: 10%;"></td> <td style="width: 10%;"></td> <td style="width: 10%;"></td> <td style="width: 10%;"></td> </tr> <tr> <td></td> <td></td> <td colspan="8" style="text-align: center;"> <table border="1" style="width: 100%; border-collapse: collapse; text-align: center;"> <tr> <td style="width: 10%;"></td> <td style="width: 10%;"></td> <td style="width: 10%;"></td> <td style="width: 10%;"></td> <td style="width: 10%;"></td> <td style="width: 10%;"></td> <td style="width: 10%;"></td> <td style="width: 10%;"></td> <td style="width: 10%;"></td> <td style="width: 10%;"></td> </tr> <tr> <td></td> <td></td> <td colspan="8" style="text-align: center;"> <table border="1" style="width: 100%; border-collapse: collapse; text-align: center;"> <tr> <td style="width: 10%;"></td> <td style="width: 10%;"></td> <td style="width: 10%;"></td> <td style="width: 10%;"></td> <td style="width: 10%;"></td> <td style="width: 10%;"></td> <td style="width: 10%;"></td> <td style="width: 10%;"></td> <td style="width: 10%;"></td> <td style="width: 10%;"></td> </tr> <tr> <td></td> <td></td> <td colspan="8" style="text-align: center;"> <table border="1" style="width: 100%; border-collapse: collapse; text-align: center;"> <tr> <td style="width: 10%;"></td> <td style="width: 10%;"></td> <td style="width: 10%;"></td> <td style="width: 10%;"></td> <td style="width: 10%;"></td> <td style="width: 10%;"></td> <td style="width: 10%;"></td> <td style="width: 10%;"></td> <td style="width: 10%;"></td> <td style="width: 10%;"></td> </tr> <tr> <td></td> <td></td> <td colspan="8" style="text-align: center;"> <table border="1" style="width: 100%; border-collapse: collapse; text-align: center;"> <tr> <td style="width: 10%;"></td> <td style="width: 10%;"></td> <td style="width: 10%;"></td> <td style="width: 10%;"></td> <td style="width: 10%;"></td> <td style="width: 10%;"></td> <td style="width: 10%;"></td> <td style="width: 10%;"></td> <td style="width: 10%;"></td> <td style="width: 10%;"></td> </tr> <tr> <td></td> <td></td> <td colspan="8" style="text-align: center;"> <table border="1" style="width: 100%; border-collapse: collapse; text-align: center;"> <tr> <td style="width: 10%;"></td> <td style="width: 10%;"></td> <td style="width: 10%;"></td> <td style="width: 10%;"></td> <td style="width: 10%;"></td> <td style="width: 10%;"></td> <td style="width: 10%;"></td> <td style="width: 10%;"></td> <td style="width: 10%;"></td> <td style="width: 10%;"></td> </tr> <tr> <td></td> <td></td> <td colspan="8" style="text-align: center;"> <table border="1"
style="width: 100%; border-collapse: collapse; text-align: center;"> <tr> <td style="width: 10%;"></td> <td style="width: 10%;"></td> <td style="width: 10%;"></td> <td style="width: 10%;"></td> <td style="width: 10%;"></td> <td style="width: 10%;"></td> <td style="width: 10%;"></td> <td style="width: 10%;"></td> <td style="width: 10%;"></td> <td style="width: 10%;"></td> </tr> <tr> <td></td> <td></td> <td colspan="8" style="text-align: center;"> <table border="1" style="width: 100%; border-collapse: collapse; text-align: center;"> <tr> <td style="width: 10%;"></td> <td style="width: 10%;"></td> <td style="width: 10%;"></td> <td style="width: 10%;"></td> <td style="width: 10%;"></td> <td style="width: 10%;"></td> <td style="width: 10%;"></td> <td style="width: 10%;"></td> <td style="width: 10%;"></td> <td style="width: 10%;"></td> </tr> <tr> <td></td> <td></td> <td colspan="8" style="text-align: center;"> <table border="1" style="width: 100%; border-collapse: collapse; text-align: center;"> <tr> <td style="width: 10%;"></td> <td style="width: 10%;"></td> <td style="width: 10%;"></td> <td style="width: 10%;"></td> <td style="width: 10%;"></td> <td style="width: 10%;"></td> <td style="width: 10%;"></td> <td style="width: 10%;"></td> <td style="width: 10%;"></td> <td style="width: 10%;"></td> </tr> <tr> <td></td> <td></td> <td colspan="8" style="text-align: center;"> <table border="1" style="width: 100%; border-collapse: collapse; text-align: center;"> <tr> <td style="width: 10%;"></td> <td style="width: 10%;"></td> <td style="width: 10%;"></td> <td style="width: 10%;"></td> <td style="width: 10%;"></td> <td style="width: 10%;"></td> <td style="width: 10%;"></td> <td style="width: 10%;"></td> <td style="width: 10%;"></td> <td style="width: 10%;"></td> </tr> <tr> <td></td> <td></td> <td colspan="8" style="text-align: center;"> <table border="1" style="width: 100%; border-collapse: collapse; text-align: center;"> <tr> <td style="width: 10%;"></td> <td style="width: 10%;"></td> <td style="width: 10%;"></td> <td style="width: 10%;"></td> <td style="width: 10%;"></td> <td style="width: 10%;"></td> <td style="width: 10%;"></td> <td style="width: 10%;"></td> <td style="width: 10%;"></td> <td style="width: 10%;"></td> </tr> <tr> <td></td> <td></td> <td colspan="8" style="text-align: center;"> <table border="1" style="width: 100%; border-collapse: collapse; text-align: center;"> <tr> <td style="width: 10%;"></td> <td style="width: 10%;"></td> <td style="width: 10%;"></td> <td style="width: 10%;"></td> <td style="width: 10%;"></td> <td style="width: 10%;"></td> <td style="width: 10%;"></td> <td style="width: 10%;"></td> <td style="width: 10%;"></td> <td style="width: 10%;"></td> </tr> <tr> <td></td> <td></td> <td colspan="8" style="text-align: center;"> <table border="1" style="width: 100%; border-collapse: collapse; text-align: center;"> <tr> <td style="width: 10%;"></td> <td style="width: 10%;"></td> <td style="width: 10%;"></td> <td style="width: 10%;"></td> <td style="width: 10%;"></td> <td style="width: 10%;"></td> <td style="width: 10%;"></td> <td style="width: 10%;"></td> <td style="width: 10%;"></td> <td style="width: 10%;"></td> </tr> <tr> <td></td> <td></td> <td colspan="8" style="text-align: center;"> <table border="1" style="width: 100%; border-collapse: collapse; text-align: center;"> <tr> <td style="width: 10%;"></td> <td style="width: 10%;"></td> <td style="width: 10%;"></td> <td style="width: 10%;"></td> <td style="width: 10%;"></td> <td style="width: 10%;"></td> <td style="width: 10%;"></td> <td style="width: 10%;"></td> <td style="width: 10%;"></td> <td style="width: 10%;"></td> </tr> <tr> <td></td> <td></td> <td colspan="8" style="text-align: center;"> <table border="1" style="width: 100%; border-collapse: collapse; text-align: center;"> <tr> <td style="width: 10%;"></td> <td style="width: 10%;"></td> <td style="width: 10%;"></td> <td style="width: 10%;"></td> <td style="width: 10%;"></td> <td style="width: 10%;"></td> <td style="width: 10%;"></td> <td style="width: 10%;"></td> <td style="width: 10%;"></td> <td style="width: 10%;"></td> </tr> <tr> <td></td> <td></td> <td colspan="8" style="text-align: center;"> <table border="1" style="width: 100%; border-collapse: collapse; text-align: center;"> <tr> <td style="width: 10%;"></td> <td style="width: 10%;"></td> <td style="width: 10%;"></td> <td style="width: 10%;"></td> <td style="width: 10%;"></td> <td style="width: 10%;"></td> <td style="width: 10%;"></td> <td style="width: 10%;"></td> <td style="width: 10%;"></td> <td style="width: 10%;"></td> </tr> <tr> <td></td> <td></td> <td colspan="8" style="text-align: center;"> <table border="1" style="width: 100%; border-collapse: collapse; text-align: center;"> <tr> <td style="width: 10%;"></td> <td style="width: 10%;"></td> <td style="width: 10%;"></td> <td style="width: 10%;"></td> <td style="width: 10%;"></td> <td style="width: 10%;"></td> <td style="width: 10%;"></td> <td style="width: 10%;"></td> <td style="width: 10%;"></td> <td style="width: 10%;"></td> </tr> <tr> <td></td> <td></td> <td colspan="8" style="text-align: center;"> <table border="1" style="width: 100%; border-collapse: collapse; text-align: center;"> <tr> <td style="width: 10%;"></td> <td style="width: 10%;"></td> <td style="width: 10%;"></td> <td style="width: 10%;"></td> <td style="width: 10%;"></td> <td style="width: 10%;"></td> <td style="width: 10%;"></td> <td style="width: 10%;"></td> <td style="width: 10%;"></td> <td style="width: 10%;"></td> </tr> <tr> <td></td> <td></td> <td colspan="8" style="text-align: center;"> <table border="1" style="width: 100%; border-collapse: collapse; text-align: center;"> <tr> <td style="width: 10%;"></td> <td style="width: 10%;"></td> <td style="width: 10%;"></td> <td style="width: 10%;"></td> <td style="width: 10%;"></td> <td style="width: 10%;"></td> <td style="width: 10%;"></td> <td style="width: 10%;"></td> <td style="width: 10%;"></td> <td style="width: 10%;"></td> </tr> <tr> <td></td> <td></td> <td colspan="8" style="text-align: center;"> <table border="1" style="width: 100%; border-collapse: collapse; text-align: center;"> <tr> <td style="width: 10%;"></td> <td style="width: 10%;"></td> <td style="width: 10%;"></td> <td style="width: 10%;"></td> <td style="width: 10%;"></td> <td style="width: 10%;"></td> <td style="width: 10%;"></td> <td style="width: 10%;"></td> <td style="width: 10%;"></td> <td style="width: 10%;"></td> </tr> <tr> <td></td> <td></td> <td colspan="8" style="text-align: center;"> <table border="1" style="width: 100%; border-collapse: collapse; text-align: center;"> <tr> <td style="width: 10%;"></td> <td style="width: 10%;"></td> <td style="width: 10%;"></td> <td style="width: 10%;"></td> <td style="width: 10%;"></td> <td style="width: 10%;"></td> <td style="width: 10%;"></td> <td style="width: 10%;"></td> <td style="width: 10%;"></td> <td style="width: 10%;"></td> </tr> <tr> <td></td> <td></td> <td colspan="8" style="text-align: center;"> <table border="1" style="width: 100%; border-collapse: collapse; text-align: center;"> <tr> <td style="width: 10%;"></td> <td style="width: 10%;"></td> <td style="width: 10%;"></td> <td style="width: 10%;"></td> <td style="width: 10%;"></td> <td style="width: 10%;"></td> <td style="width: 10%;"></td> <td style="width: 10%;"></td> <td style="width: 10%;"></td> <td style="width: 10%;"></td> </tr> <tr> <td></td> <td></td> <td colspan="8" style="text-align: center;"> <table border="1" style="width: 100%; border-collapse: collapse; text-align: center;"> <tr> <td style="width: 10%;"></td> <td style="width: 10%;"></td> <td style="width: 10%;"></td> <td style="width: 10%;"></td> <td style="width: 10%;"></td> <td style="width: 10%;"></td> <td style="width: 10%;"></td> <td style="width: 10%;"></td> <td style="width: 10%;"></td> <td style="width: 10%;"></td> </tr> <tr> <td></td> <td></td> <td colspan="8" style="text-align: center;"> <table border="1" style="width: 100%; border-collapse: collapse; text-align: center;"> <tr> <td style="width: 10%;"></td> <td style="width: 10%;"></td> <td style="width: 10%;"></td> <td style="width: 10%;"></td> <td style="width: 10%;"></td> <td style="width: 10%;"></td> <td style="width: 10%;"></td> <td style="width: 10%;"></td> <td style="width: 10%;"></td> <td style="width: 10%;"></td> </tr> <tr> <td></td> <td></td> <td colspan="8" style="text-align: center;"> <table border="1" style="width: 100%; border-collapse: collapse; text-align: center;"> <tr> <td style="width: 10%;"></td> <td style="width: 10%;"></td> <td style="width: 10%;"></td> <td style="width: 10%;"></td> <td style="width: 10%;"></td> <td style="width: 10%;"></td> <td style="width: 10%;"></td> <td style="width: 10%;"></td> <td style="width: 10%;"></td> <td style="width: 10%;"></td> </tr> <tr> <td></td> <td></td> <td colspan="8" style="text-align: center;"> <table border="1" style="width: 100%; border-collapse: collapse; text-align: center;"> <tr> <td style="width: 10%;"></td> <td style="width: 10%;"></td> <td style="width: 10%;"></td> <td style="width: 10%;"></td> <td style="width: 10%;"></td> <td style="width: 10%;"></td> <td style="width: 10%;"></td> <td style="width: 10%;"></td> <td style="width: 10%;"></td> <td style="width: 10%;"></td> </tr> <tr> <td></td> <td></td> <td colspan="8" style="text-align: center;"> <table border="1" style="width: 100%; border-collapse: collapse; text-align: center;"> <tr> <td style="width: 10%;"></td> <td style="width: 10%;"></td> <td style="width: 10%;"></td> <td style="width: 10%;"></td> <td style="width: 10%;"></td> <td style="width: 10%;"></td> <td style="width: 10%;"></td> <td style="width: 10%;"></td> <td style="width: 10%;"></td> <td style="width: 10%;"></td> </tr> <tr> <td></td> <td></td> <td colspan="8" style="text-align: center;"> <table border="1" style="width: 100%; border-collapse: collapse; text-align: center;"> <tr> <td style="width: 10%;"></td> <td style="width: 10%;"></td> <td style="width: 10%;"></td> <td
style="width: 10%;"></td> <td style="width: 10%;"></td> <td style="width: 10%;"></td> <td style="width: 10%;"></td> <td style="width: 10%;"></td> <td style="width: 10%;"></td> <td style="width: 10%;"></td> </tr> <tr> <td></td> <td></td> <td colspan="8" style="text-align: center;"> <table border="1" style="width: 100%; border-collapse: collapse; text-align: center;"> <tr> </tr></table></td></tr></table></td></tr></table></td></tr></table></td></tr></table></td></tr></table></td></tr></table></td></tr></table></td></tr></table></td></tr></table></td></tr></table></td></tr></table></td></tr></table></td></tr></table></td></tr></table></td></tr></table></td></tr></table></td></tr></table></td></tr></table></td></tr></table></td></tr></table></td></tr></table></td></tr></table></td></tr></table></td></tr></table></td></tr></table></td></tr></table></td></tr></table></td></tr></table> | | | | | | | | | | | | | | | | | | | | <table border="1" style="width: 100%; border-collapse: collapse; text-align: center;"> <tr> <td style="width: 10%;"></td> <td style="width: 10%;"></td> <td style="width: 10%;"></td> <td style="width: 10%;"></td> <td style="width: 10%;"></td> <td style="width: 10%;"></td> <td style="width: 10%;"></td> <td style="width: 10%;"></td> <td style="width: 10%;"></td> <td style="width: 10%;"></td> </tr> <tr> <td></td> <td></td> <td colspan="8" style="text-align: center;"> <table border="1" style="width: 100%; border-collapse: collapse; text-align: center;"> <tr> <td style="width: 10%;"></td> <td style="width: 10%;"></td> <td style="width: 10%;"></td> <td style="width: 10%;"></td> <td style="width: 10%;"></td> <td style="width: 10%;"></td> <td style="width: 10%;"></td> <td style="width: 10%;"></td> <td style="width: 10%;"></td> <td style="width: 10%;"></td> </tr> <tr> <td></td> <td></td> <td colspan="8" style="text-align: center;"> <table border="1" style="width: 100%; border-collapse: collapse; text-align: center;"> <tr> <td style="width: 10%;"></td> <td style="width: 10%;"></td> <td style="width: 10%;"></td> <td style="width: 10%;"></td> <td style="width: 10%;"></td> <td style="width: 10%;"></td> <td style="width: 10%;"></td> <td style="width: 10%;"></td> <td style="width: 10%;"></td> <td style="width: 10%;"></td> </tr> <tr> <td></td> <td></td> <td colspan="8" style="text-align: center;"> <table border="1" style="width: 100%; border-collapse: collapse; text-align: center;"> <tr> <td style="width: 10%;"></td> <td style="width: 10%;"></td> <td style="width: 10%;"></td> <td style="width: 10%;"></td> <td style="width: 10%;"></td> <td style="width: 10%;"></td> <td style="width: 10%;"></td> <td style="width: 10%;"></td> <td style="width: 10%;"></td> <td style="width: 10%;"></td> </tr> <tr> <td></td> <td></td> <td colspan="8" style="text-align: center;"> <table border="1" style="width: 100%; border-collapse: collapse; text-align: center;"> <tr> <td style="width: 10%;"></td> <td style="width: 10%;"></td> <td style="width: 10%;"></td> <td style="width: 10%;"></td> <td style="width: 10%;"></td> <td style="width: 10%;"></td> <td style="width: 10%;"></td> <td style="width: 10%;"></td> <td style="width: 10%;"></td> <td style="width: 10%;"></td> </tr> <tr> <td></td> <td></td> <td colspan="8" style="text-align: center;"> <table border="1" style="width: 100%; border-collapse: collapse; text-align: center;"> <tr> <td style="width: 10%;"></td> <td style="width: 10%;"></td> <td style="width: 10%;"></td> <td style="width: 10%;"></td> <td style="width: 10%;"></td> <td style="width: 10%;"></td> <td style="width: 10%;"></td> <td style="width: 10%;"></td> <td style="width: 10%;"></td> <td style="width: 10%;"></td> </tr> <tr> <td></td> <td></td> <td colspan="8" style="text-align: center;"> <table border="1" style="width: 100%; border-collapse: collapse; text-align: center;"> <tr> <td style="width: 10%;"></td> <td style="width: 10%;"></td> <td style="width: 10%;"></td> <td style="width: 10%;"></td> <td style="width: 10%;"></td> <td style="width: 10%;"></td> <td style="width: 10%;"></td> <td style="width: 10%;"></td> <td style="width: 10%;"></td> <td style="width: 10%;"></td> </tr> <tr> <td></td> <td></td> <td colspan="8" style="text-align: center;"> <table border="1" style="width: 100%; border-collapse: collapse; text-align: center;"> <tr> <td style="width: 10%;"></td> <td style="width: 10%;"></td> <td style="width: 10%;"></td> <td style="width: 10%;"></td> <td style="width: 10%;"></td> <td style="width: 10%;"></td> <td style="width: 10%;"></td> <td style="width: 10%;"></td> <td style="width: 10%;"></td> <td style="width: 10%;"></td> </tr> <tr> <td></td> <td></td> <td colspan="8" style="text-align: center;"> <table border="1" style="width: 100%; border-collapse: collapse; text-align: center;"> <tr> <td style="width: 10%;"></td> <td style="width: 10%;"></td> <td style="width: 10%;"></td> <td style="width: 10%;"></td> <td style="width: 10%;"></td> <td style="width: 10%;"></td> <td style="width: 10%;"></td> <td style="width: 10%;"></td> <td style="width: 10%;"></td> <td style="width: 10%;"></td> </tr> <tr> <td></td> <td></td> <td colspan="8" style="text-align: center;"> <table border="1" style="width: 100%; border-collapse: collapse; text-align: center;"> <tr> <td style="width: 10%;"></td> <td style="width: 10%;"></td> <td style="width: 10%;"></td> <td style="width: 10%;"></td> <td style="width: 10%;"></td> <td style="width: 10%;"></td> <td style="width: 10%;"></td> <td style="width: 10%;"></td> <td style="width: 10%;"></td> <td style="width: 10%;"></td> </tr> <tr> <td></td> <td></td> <td colspan="8" style="text-align: center;"> <table border="1" style="width: 100%; border-collapse: collapse; text-align: center;"> <tr> <td style="width: 10%;"></td> <td style="width: 10%;"></td> <td style="width: 10%;"></td> <td style="width: 10%;"></td> <td style="width: 10%;"></td> <td style="width: 10%;"></td> <td style="width: 10%;"></td> <td style="width: 10%;"></td> <td style="width: 10%;"></td> <td style="width: 10%;"></td> </tr> <tr> <td></td> <td></td> <td colspan="8" style="text-align: center;"> <table border="1" style="width: 100%; border-collapse: collapse; text-align: center;"> <tr> <td style="width: 10%;"></td> <td style="width: 10%;"></td> <td style="width: 10%;"></td> <td style="width: 10%;"></td> <td style="width: 10%;"></td> <td style="width: 10%;"></td> <td style="width: 10%;"></td> <td style="width: 10%;"></td> <td style="width: 10%;"></td> <td style="width: 10%;"></td> </tr> <tr> <td></td> <td></td> <td colspan="8" style="text-align: center;"> <table border="1" style="width: 100%; border-collapse: collapse; text-align: center;"> <tr> <td style="width: 10%;"></td> <td style="width: 10%;"></td> <td style="width: 10%;"></td> <td style="width: 10%;"></td> <td style="width: 10%;"></td> <td style="width: 10%;"></td> <td style="width: 10%;"></td> <td style="width: 10%;"></td> <td style="width: 10%;"></td> <td style="width: 10%;"></td> </tr> <tr> <td></td> <td></td> <td colspan="8" style="text-align: center;"> <table border="1" style="width: 100%; border-collapse: collapse; text-align: center;"> <tr> <td style="width: 10%;"></td> <td style="width: 10%;"></td> <td style="width: 10%;"></td> <td style="width: 10%;"></td> <td style="width: 10%;"></td> <td style="width: 10%;"></td> <td style="width: 10%;"></td> <td style="width: 10%;"></td> <td style="width: 10%;"></td> <td style="width: 10%;"></td> </tr> <tr> <td></td> <td></td> <td colspan="8" style="text-align: center;"> <table border="1" style="width: 100%; border-collapse: collapse; text-align: center;"> <tr> <td style="width: 10%;"></td> <td style="width: 10%;"></td> <td style="width: 10%;"></td> <td style="width: 10%;"></td> <td style="width: 10%;"></td> <td style="width: 10%;"></td> <td style="width: 10%;"></td> <td style="width: 10%;"></td> <td style="width: 10%;"></td> <td style="width: 10%;"></td> </tr> <tr> <td></td> <td></td> <td colspan="8" style="text-align: center;"> <table border="1" style="width: 100%; border-collapse: collapse; text-align: center;"> <tr> <td style="width: 10%;"></td> <td style="width: 10%;"></td> <td style="width: 10%;"></td> <td style="width: 10%;"></td> <td style="width: 10%;"></td> <td style="width: 10%;"></td> <td style="width: 10%;"></td> <td style="width: 10%;"></td> <td style="width: 10%;"></td> <td style="width: 10%;"></td> </tr> <tr> <td></td> <td></td> <td colspan="8" style="text-align: center;"> <table border="1" style="width: 100%; border-collapse: collapse; text-align: center;"> <tr> <td
style="width: 10%;"></td> <td style="width: 10%;"></td> <td style="width: 10%;"></td> <td style="width: 10%;"></td> <td style="width: 10%;"></td> <td style="width: 10%;"></td> <td style="width: 10%;"></td> <td style="width: 10%;"></td> <td style="width: 10%;"></td> <td style="width: 10%;"></td> </tr> <tr> <td></td> <td></td> <td colspan="8" style="text-align: center;"> <table border="1" style="width: 100%; border-collapse: collapse; text-align: center;"> <tr> <td style="width: 10%;"></td> <td style="width: 10%;"></td> <td style="width: 10%;"></td> <td style="width: 10%;"></td> <td style="width: 10%;"></td> <td style="width: 10%;"></td> <td style="width: 10%;"></td> <td style="width: 10%;"></td> <td style="width: 10%;"></td> <td style="width: 10%;"></td> </tr> <tr> <td></td> <td></td> <td colspan="8" style="text-align: center;"> <table border="1" style="width: 100%; border-collapse: collapse; text-align: center;"> <tr> <td style="width: 10%;"></td> <td style="width: 10%;"></td> <td style="width: 10%;"></td> <td style="width: 10%;"></td> <td style="width: 10%;"></td> <td style="width: 10%;"></td> <td style="width: 10%;"></td> <td style="width: 10%;"></td> <td style="width: 10%;"></td> <td style="width: 10%;"></td> </tr> <tr> <td></td> <td></td> <td colspan="8" style="text-align: center;"> <table border="1" style="width: 100%; border-collapse: collapse; text-align: center;"> <tr> <td style="width: 10%;"></td> <td style="width: 10%;"></td> <td style="width: 10%;"></td> <td style="width: 10%;"></td> <td style="width: 10%;"></td> <td style="width: 10%;"></td> <td style="width: 10%;"></td> <td style="width: 10%;"></td> <td style="width: 10%;"></td> <td style="width: 10%;"></td> </tr> <tr> <td></td> <td></td> <td colspan="8" style="text-align: center;"> <table border="1" style="width: 100%; border-collapse: collapse; text-align: center;"> <tr> <td style="width: 10%;"></td> <td style="width: 10%;"></td> <td style="width: 10%;"></td> <td style="width: 10%;"></td> <td style="width: 10%;"></td> <td style="width: 10%;"></td> <td style="width: 10%;"></td> <td style="width: 10%;"></td> <td style="width: 10%;"></td> <td style="width: 10%;"></td> </tr> <tr> <td></td> <td></td> <td colspan="8" style="text-align: center;"> <table border="1" style="width: 100%; border-collapse: collapse; text-align: center;"> <tr> <td style="width: 10%;"></td> <td style="width: 10%;"></td> <td style="width: 10%;"></td> <td style="width: 10%;"></td> <td style="width: 10%;"></td> <td style="width: 10%;"></td> <td style="width: 10%;"></td> <td style="width: 10%;"></td> <td style="width: 10%;"></td> <td style="width: 10%;"></td> </tr> <tr> <td></td> <td></td> <td colspan="8" style="text-align: center;"> <table border="1" style="width: 100%; border-collapse: collapse; text-align: center;"> <tr> <td style="width: 10%;"></td> <td style="width: 10%;"></td> <td style="width: 10%;"></td> <td style="width: 10%;"></td> <td style="width: 10%;"></td> <td style="width: 10%;"></td> <td style="width: 10%;"></td> <td style="width: 10%;"></td> <td style="width: 10%;"></td> <td style="width: 10%;"></td> </tr> <tr> <td></td> <td></td> <td colspan="8" style="text-align: center;"> <table border="1" style="width: 100%; border-collapse: collapse; text-align: center;"> <tr> <td style="width: 10%;"></td> <td style="width: 10%;"></td> <td style="width: 10%;"></td> <td style="width: 10%;"></td> <td style="width: 10%;"></td> <td style="width: 10%;"></td> <td style="width: 10%;"></td> <td style="width: 10%;"></td> <td style="width: 10%;"></td> <td style="width: 10%;"></td> </tr> <tr> <td></td> <td></td> <td colspan="8" style="text-align: center;"> <table border="1" style="width: 100%; border-collapse: collapse; text-align: center;"> <tr> <td style="width: 10%;"></td> <td style="width: 10%;"></td> <td style="width: 10%;"></td> <td style="width: 10%;"></td> <td style="width: 10%;"></td> <td style="width: 10%;"></td> <td style="width: 10%;"></td> <td style="width: 10%;"></td> <td style="width: 10%;"></td> <td style="width: 10%;"></td> </tr> <tr> <td></td> <td></td> <td colspan="8" style="text-align: center;"> <table border="1" style="width: 100%; border-collapse: collapse; text-align: center;"> <tr> <td style="width: 10%;"></td> <td style="width: 10%;"></td> <td style="width: 10%;"></td> <td style="width: 10%;"></td> <td style="width: 10%;"></td> <td style="width: 10%;"></td> <td style="width: 10%;"></td> <td style="width: 10%;"></td> <td style="width: 10%;"></td> <td style="width: 10%;"></td> </tr> <tr> <td></td> <td></td> <td colspan="8" style="text-align: center;"> <table border="1" style="width: 100%; border-collapse: collapse; text-align: center;"> <tr> <td style="width: 10%;"></td> <td style="width: 10%;"></td> <td style="width: 10%;"></td> <td style="width: 10%;"></td> <td style="width: 10%;"></td> <td style="width: 10%;"></td> <td style="width: 10%;"></td> <td style="width: 10%;"></td> <td style="width: 10%;"></td> <td style="width: 10%;"></td> </tr> <tr> <td></td> <td></td> <td colspan="8" style="text-align: center;"> <table border="1" style="width: 100%; border-collapse: collapse; text-align: center;"> <tr> </tr></table></td></tr></table></td></tr></table></td></tr></table></td></tr></table></td></tr></table></td></tr></table></td></tr></table></td></tr></table></td></tr></table></td></tr></table></td></tr></table></td></tr></table></td></tr></table></td></tr></table></td></tr></table></td></tr></table></td></tr></table></td></tr></table></td></tr></table></td></tr></table></td></tr></table></td></tr></table></td></tr></table></td></tr></table></td></tr></table></td></tr></table></td></tr></table> | | | | | | | | | | | | | | | | | | | | <table border="1" style="width: 100%; border-collapse: collapse; text-align: center;"> <tr> <td style="width: 10%;"></td> <td style="width: 10%;"></td> <td style="width: 10%;"></td> <td style="width: 10%;"></td> <td style="width: 10%;"></td> <td style="width: 10%;"></td> <td style="width: 10%;"></td> <td style="width: 10%;"></td> <td style="width: 10%;"></td> <td style="width: 10%;"></td> </tr> <tr> <td></td> <td></td> <td colspan="8" style="text-align: center;"> <table border="1" style="width: 100%; border-collapse: collapse; text-align: center;"> <tr> <td style="width: 10%;"></td> <td style="width: 10%;"></td> <td style="width: 10%;"></td> <td style="width: 10%;"></td> <td style="width: 10%;"></td> <td style="width: 10%;"></td> <td style="width: 10%;"></td> <td style="width: 10%;"></td> <td style="width: 10%;"></td> <td style="width: 10%;"></td> </tr> <tr> <td></td> <td></td> <td colspan="8" style="text-align: center;"> <table border="1" style="width: 100%; border-collapse: collapse; text-align: center;"> <tr> <td style="width: 10%;"></td> <td style="width: 10%;"></td> <td style="width: 10%;"></td> <td style="width: 10%;"></td> <td style="width: 10%;"></td> <td style="width: 10%;"></td> <td style="width: 10%;"></td> <td style="width: 10%;"></td> <td style="width: 10%;"></td> <td style="width: 10%;"></td> </tr> <tr> <td></td> <td></td> <td colspan="8" style="text-align: center;"> <table border="1" style="width: 100%; border-collapse: collapse; text-align: center;"> <tr> <td style="width: 10%;"></td> <td style="width: 10%;"></td> <td style="width: 10%;"></td> <td style="width: 10%;"></td> <td style="width: 10%;"></td> <td style="width: 10%;"></td> <td style="width: 10%;"></td> <td style="width: 10%;"></td> <td style="width: 10%;"></td> <td style="width: 10%;"></td> </tr> <tr> <td></td> <td></td> <td colspan="8" style="text-align: center;"> <table border="1" style="width: 100%; border-collapse: collapse; text-align: center;"> <tr> <td style="width: 10%;"></td> <td style="width: 10%;"></td> <td style="width: 10%;"></td> <td style="width: 10%;"></td> <td style="width: 10%;"></td> <td style="width: 10%;"></td> <td style="width: 10%;"></td> <td style="width: 10%;"></td> <td style="width: 10%;"></td> <td style="width: 10%;"></td> </tr> <tr> <td></td> <td></td> <td colspan="8" style="text-align: center;"> <table border="1" style="width: 100%; border-collapse: collapse; text-align: center;"> <tr> <td style="width: 10%;"></td> <td style="width: 10%;"></td> <td style="width: 10%;"></td> <td style="width: 10%;"></td> <td style="width: 10%;"></td> <td style="width: 10%;"></td> <td style="width: 10%;"></td> <td style="width: 10%;"></td> <td style="width: 10%;"></td> <td style="width: 10%;"></td> </tr> <tr> <td></td> <td></td> <td colspan="8" style="text-align: center;"> <table border="1"
style="width: 100%; border-collapse: collapse; text-align: center;"> <tr> <td style="width: 10%;"></td> <td style="width: 10%;"></td> <td style="width: 10%;"></td> <td style="width: 10%;"></td> <td style="width: 10%;"></td> <td style="width: 10%;"></td> <td style="width: 10%;"></td> <td style="width: 10%;"></td> <td style="width: 10%;"></td> <td style="width: 10%;"></td> </tr> <tr> <td></td> <td></td> <td colspan="8" style="text-align: center;"> <table border="1" style="width: 100%; border-collapse: collapse; text-align: center;"> <tr> <td style="width: 10%;"></td> <td style="width: 10%;"></td> <td style="width: 10%;"></td> <td style="width: 10%;"></td> <td style="width: 10%;"></td> <td style="width: 10%;"></td> <td style="width: 10%;"></td> <td style="width: 10%;"></td> <td style="width: 10%;"></td> <td style="width: 10%;"></td> </tr> <tr> <td></td> <td></td> <td colspan="8" style="text-align: center;"> <table border="1" style="width: 100%; border-collapse: collapse; text-align: center;"> <tr> <td style="width: 10%;"></td> <td style="width: 10%;"></td> <td style="width: 10%;"></td> <td style="width: 10%;"></td> <td style="width: 10%;"></td> <td style="width: 10%;"></td> <td style="width: 10%;"></td> <td style="width: 10%;"></td> <td style="width: 10%;"></td> <td style="width: 10%;"></td> </tr> <tr> <td></td> <td></td> <td colspan="8" style="text-align: center;"> <table border="1" style="width: 100%; border-collapse: collapse; text-align: center;"> <tr> <td style="width: 10%;"></td> <td style="width: 10%;"></td> <td style="width: 10%;"></td> <td style="width: 10%;"></td> <td style="width: 10%;"></td> <td style="width: 10%;"></td> <td style="width: 10%;"></td> <td style="width: 10%;"></td> <td style="width: 10%;"></td> <td style="width: 10%;"></td> </tr> <tr> <td></td> <td></td> <td colspan="8" style="text-align: center;"> <table border="1" style="width: 100%; border-collapse: collapse; text-align: center;"> <tr> <td style="width: 10%;"></td> <td style="width: 10%;"></td> <td style="width: 10%;"></td> <td style="width: 10%;"></td> <td style="width: 10%;"></td> <td style="width: 10%;"></td> <td style="width: 10%;"></td> <td style="width: 10%;"></td> <td style="width: 10%;"></td> <td style="width: 10%;"></td> </tr> <tr> <td></td> <td></td> <td colspan="8" style="text-align: center;"> <table border="1" style="width: 100%; border-collapse: collapse; text-align: center;"> <tr> <td style="width: 10%;"></td> <td style="width: 10%;"></td> <td style="width: 10%;"></td> <td style="width: 10%;"></td> <td style="width: 10%;"></td> <td style="width: 10%;"></td> <td style="width: 10%;"></td> <td style="width: 10%;"></td> <td style="width: 10%;"></td> <td style="width: 10%;"></td> </tr> <tr> <td></td> <td></td> <td colspan="8" style="text-align: center;"> <table border="1" style="width: 100%; border-collapse: collapse; text-align: center;"> <tr> <td style="width: 10%;"></td> <td style="width: 10%;"></td> <td style="width: 10%;"></td> <td style="width: 10%;"></td> <td style="width: 10%;"></td> <td style="width: 10%;"></td> <td style="width: 10%;"></td> <td style="width: 10%;"></td> <td style="width: 10%;"></td> <td style="width: 10%;"></td> </tr> <tr> <td></td> <td></td> <td colspan="8" style="text-align: center;"> <table border="1" style="width: 100%; border-collapse: collapse; text-align: center;"> <tr> <td style="width: 10%;"></td> <td style="width: 10%;"></td> <td style="width: 10%;"></td> <td style="width: 10%;"></td> <td style="width: 10%;"></td> <td style="width: 10%;"></td> <td style="width: 10%;"></td> <td style="width: 10%;"></td> <td style="width: 10%;"></td> <td style="width: 10%;"></td> </tr> <tr> <td></td> <td></td> <td colspan="8" style="text-align: center;"> <table border="1" style="width: 100%; border-collapse: collapse; text-align: center;"> <tr> <td style="width: 10%;"></td> <td style="width: 10%;"></td> <td style="width: 10%;"></td> <td style="width: 10%;"></td> <td style="width: 10%;"></td> <td style="width: 10%;"></td> <td style="width: 10%;"></td> <td style="width: 10%;"></td> <td style="width: 10%;"></td> <td style="width: 10%;"></td> </tr> <tr> <td></td> <td></td> <td colspan="8" style="text-align: center;"> <table border="1" style="width: 100%; border-collapse: collapse; text-align: center;"> <tr> <td style="width: 10%;"></td> <td style="width: 10%;"></td> <td style="width: 10%;"></td> <td style="width: 10%;"></td> <td style="width: 10%;"></td> <td style="width: 10%;"></td> <td style="width: 10%;"></td> <td style="width: 10%;"></td> <td style="width: 10%;"></td> <td style="width: 10%;"></td> </tr> <tr> <td></td> <td></td> <td colspan="8" style="text-align: center;"> <table border="1" style="width: 100%; border-collapse: collapse; text-align: center;"> <tr> <td style="width: 10%;"></td> <td style="width: 10%;"></td> <td style="width: 10%;"></td> <td style="width: 10%;"></td> <td style="width: 10%;"></td> <td style="width: 10%;"></td> <td style="width: 10%;"></td> <td style="width: 10%;"></td> <td style="width: 10%;"></td> <td style="width: 10%;"></td> </tr> <tr> <td></td> <td></td> <td colspan="8" style="text-align: center;"> <table border="1" style="width: 100%; border-collapse: collapse; text-align: center;"> <tr> <td style="width: 10%;"></td> <td style="width: 10%;"></td> <td style="width: 10%;"></td> <td style="width: 10%;"></td> <td style="width: 10%;"></td> <td style="width: 10%;"></td> <td style="width: 10%;"></td> <td style="width: 10%;"></td> <td style="width: 10%;"></td> <td style="width: 10%;"></td> </tr> <tr> <td></td> <td></td> <td colspan="8" style="text-align: center;"> <table border="1" style="width: 100%; border-collapse: collapse; text-align: center;"> <tr> <td style="width: 10%;"></td> <td style="width: 10%;"></td> <td style="width: 10%;"></td> <td style="width: 10%;"></td> <td style="width: 10%;"></td> <td style="width: 10%;"></td> <td style="width: 10%;"></td> <td style="width: 10%;"></td> <td style="width: 10%;"></td> <td style="width: 10%;"></td> </tr> <tr> <td></td> <td></td> <td colspan="8" style="text-align: center;"> <table border="1" style="width: 100%; border-collapse: collapse; text-align: center;"> <tr> <td style="width: 10%;"></td> <td style="width: 10%;"></td> <td style="width: 10%;"></td> <td style="width: 10%;"></td> <td style="width: 10%;"></td> <td style="width: 10%;"></td> <td style="width: 10%;"></td> <td style="width: 10%;"></td> <td style="width: 10%;"></td> <td style="width: 10%;"></td> </tr> <tr> <td></td> <td></td> <td colspan="8" style="text-align: center;"> <table border="1" style="width: 100%; border-collapse: collapse; text-align: center;"> <tr> <td style="width: 10%;"></td> <td style="width: 10%;"></td> <td style="width: 10%;"></td> <td style="width: 10%;"></td> <td style="width: 10%;"></td> <td style="width: 10%;"></td> <td style="width: 10%;"></td> <td style="width: 10%;"></td> <td style="width: 10%;"></td> <td style="width: 10%;"></td> </tr> <tr> <td></td> <td></td> <td colspan="8" style="text-align: center;"> <table border="1" style="width: 100%; border-collapse: collapse; text-align: center;"> <tr> <td style="width: 10%;"></td> <td style="width: 10%;"></td> <td style="width: 10%;"></td> <td style="width: 10%;"></td> <td style="width: 10%;"></td> <td style="width: 10%;"></td> <td style="width: 10%;"></td> <td style="width: 10%;"></td> <td style="width: 10%;"></td> <td style="width: 10%;"></td> </tr> <tr> <td></td> <td></td> <td colspan="8" style="text-align: center;"> <table border="1" style="width: 100%; border-collapse: collapse; text-align: center;"> <tr> <td style="width: 10%;"></td> <td style="width: 10%;"></td> <td style="width: 10%;"></td> <td style="width: 10%;"></td> <td style="width: 10%;"></td> <td style="width: 10%;"></td> <td style="width: 10%;"></td> <td style="width: 10%;"></td> <td style="width: 10%;"></td> <td style="width: 10%;"></td> </tr> <tr> <td></td> <td></td> <td colspan="8" style="text-align: center;"> <table border="1" style="width: 100%; border-collapse: collapse; text-align: center;"> <tr> <td style="width: 10%;"></td> <td style="width: 10%;"></td> <td style="width: 10%;"></td> <td style="width: 10%;"></td> <td style="width: 10%;"></td> <td style="width: 10%;"></td> <td style="width: 10%;"></td> <td style="width: 10%;"></td> <td style="width: 10%;"></td> <td style="width: 10%;"></td> </tr> <tr> <td></td> <td></td> <td colspan="8" style="text-align: center;"> <table border="1" style="width: 100%; border-collapse: collapse; text-align: center;"> <tr> <td style="width: 10%;"></td> <td style="width: 10%;"></td> <td style="width: 10%;"></td> <td style="width: 10%;"></td> <td style="width: 10%;"></td> <td style="width: 10%;"></td> <td style="width: 10%;"></td> <td style="width: 10%;"></td> <td style="width: 10%;"></td> <td style="width: 10%;"></td> </tr> <tr> <td></td> <td></td> <td colspan="8" style="text-align: center;"> <table border="1" style="width: 100%; border-collapse: collapse; text-align: center;"> <tr> <td style="width: 10%;"></td> <td style="width: 10%;"></td> <td style="width: 10%;"></td> <td style="width: 10%;"></td> <td style="width: 10%;"></td> <td style="width: 10%;"></td> <td style="width: 10%;"></td> <td style="width: 10%;"></td> <td style="width: 10%;"></td> <td style="width: 10%;"></td> </tr> <tr> <td></td> <td></td> <td colspan="8" style="text-align: center;"> <table border="1" style="width: 100%; border-collapse: collapse; text-align: center;"> <tr> </tr></table></td></tr></table></td></tr></table></td></tr></table></td></tr></table></td></tr></table></td></tr></table></td></tr></table></td></tr></table></td></tr></table></td></tr></table></td></tr></table></td></tr></table></td></tr></table></td></tr></table></td></tr></table></td></tr></table></td></tr></table></td></tr></table></td></tr></table></td></tr></table></td></tr></table></td></tr></table></td></tr></table></td></tr></table></td></tr></table></td></tr></table>
 | | | | | | | | | | | | | | | | | | | | <table border="1" style="width: 100%; border-collapse: collapse; text-align: center;"> <tr> <td style="width: 10%;"></td> <td style="width: 10%;"></td> <td style="width: 10%;"></td> <td style="width: 10%;"></td> <td style="width: 10%;"></td> <td style="width: 10%;"></td> <td style="width: 10%;"></td> <td style="width: 10%;"></td> <td style="width: 10%;"></td> <td style="width: 10%;"></td> </tr> <tr> <td></td> <td></td> <td colspan="8" style="text-align: center;"> <table border="1" style="width: 100%; border-collapse: collapse; text-align: center;"> <tr> <td style="width: 10%;"></td> <td style="width: 10%;"></td> <td style="width: 10%;"></td> <td style="width: 10%;"></td> <td style="width: 10%;"></td> <td style="width: 10%;"></td> <td style="width: 10%;"></td> <td style="width: 10%;"></td> <td style="width: 10%;"></td> <td style="width: 10%;"></td> </tr> <tr> <td></td> <td></td> <td colspan="8" style="text-align: center;"> <table border="1" style="width: 100%; border-collapse: collapse; text-align: center;"> <tr> <td style="width: 10%;"></td> <td style="width: 10%;"></td> <td style="width: 10%;"></td> <td style="width: 10%;"></td> <td style="width: 10%;"></td> <td style="width: 10%;"></td> <td style="width: 10%;"></td> <td style="width: 10%;"></td> <td style="width: 10%;"></td> <td style="width: 10%;"></td> </tr> <tr> <td></td> <td></td> <td colspan="8" style="text-align: center;"> <table border="1" style="width: 100%; border-collapse: collapse; text-align: center;"> <tr> <td style="width: 10%;"></td> <td style="width: 10%;"></td> <td style="width: 10%;"></td> <td style="width: 10%;"></td> <td style="width: 10%;"></td> <td style="width: 10%;"></td> <td style="width: 10%;"></td> <td style="width: 10%;"></td> <td style="width: 10%;"></td> <td style="width: 10%;"></td> </tr> <tr> <td></td> <td></td> <td colspan="8" style="text-align: center;"> <table border="1" style="width: 100%; border-collapse: collapse; text-align: center;"> <tr> <td style="width: 10%;"></td> <td style="width: 10%;"></td> <td style="width: 10%;"></td> <td style="width: 10%;"></td> <td style="width: 10%;"></td> <td style="width: 10%;"></td> <td style="width: 10%;"></td> <td style="width: 10%;"></td> <td style="width: 10%;"></td> <td style="width: 10%;"></td> </tr> <tr> <td></td> <td></td> <td colspan="8" style="text-align: center;"> <table border="1" style="width: 100%; border-collapse: collapse; text-align: center;"> <tr> <td style="width: 10%;"></td> <td style="width: 10%;"></td> <td style="width: 10%;"></td> <td style="width: 10%;"></td> <td style="width: 10%;"></td> <td style="width: 10%;"></td> <td style="width: 10%;"></td> <td style="width: 10%;"></td> <td style="width: 10%;"></td> <td style="width: 10%;"></td> </tr> <tr> <td></td> <td></td> <td colspan="8" style="text-align: center;"> <table border="1" style="width: 100%; border-collapse: collapse; text-align: center;"> <tr> <td style="width: 10%;"></td> <td style="width: 10%;"></td> <td style="width: 10%;"></td> <td style="width: 10%;"></td> <td style="width: 10%;"></td> <td style="width: 10%;"></td> <td style="width: 10%;"></td> <td style="width: 10%;"></td> <td style="width: 10%;"></td> <td style="width: 10%;"></td> </tr> <tr> <td></td> <td></td> <td colspan="8" style="text-align: center;"> <table border="1" style="width: 100%; border-collapse: collapse; text-align: center;"> <tr> <td style="width: 10%;"></td> <td style="width: 10%;"></td> <td style="width: 10%;"></td> <td style="width: 10%;"></td> <td style="width: 10%;"></td> <td style="width: 10%;"></td> <td style="width: 10%;"></td> <td style="width: 10%;"></td> <td style="width: 10%;"></td> <td style="width: 10%;"></td> </tr> <tr> <td></td> <td></td> <td colspan="8" style="text-align: center;"> <table border="1" style="width: 100%; border-collapse: collapse; text-align: center;"> <tr> <td style="width: 10%;"></td> <td style="width: 10%;"></td> <td style="width: 10%;"></td> <td style="width: 10%;"></td> <td style="width: 10%;"></td> <td style="width: 10%;"></td> <td style="width: 10%;"></td> <td style="width: 10%;"></td> <td style="width: 10%;"></td> <td style="width: 10%;"></td> </tr> <tr> <td></td> <td></td> <td colspan="8" style="text-align: center;"> <table border="1" style="width: 100%; border-collapse: collapse; text-align: center;"> <tr> <td style="width: 10%;"></td> <td style="width: 10%;"></td> <td style="width: 10%;"></td> <td style="width: 10%;"></td> <td style="width: 10%;"></td> <td style="width: 10%;"></td> <td style="width: 10%;"></td> <td style="width: 10%;"></td> <td style="width: 10%;"></td> <td style="width: 10%;"></td> </tr> <tr> <td></td> <td></td> <td colspan="8" style="text-align: center;"> <table border="1" style="width: 100%; border-collapse: collapse; text-align: center;"> <tr> <td style="width: 10%;"></td> <td style="width: 10%;"></td> <td style="width: 10%;"></td> <td style="width: 10%;"></td> <td style="width: 10%;"></td> <td style="width: 10%;"></td> <td style="width: 10%;"></td> <td style="width: 10%;"></td> <td style="width: 10%;"></td> <td style="width: 10%;"></td> </tr> <tr> <td></td> <td></td> <td colspan="8" style="text-align: center;"> <table border="1" style="width: 100%; border-collapse: collapse; text-align: center;"> <tr> <td style="width: 10%;"></td> <td style="width: 10%;"></td> <td style="width: 10%;"></td> <td style="width: 10%;"></td> <td style="width: 10%;"></td> <td style="width: 10%;"></td> <td style="width: 10%;"></td> <td style="width: 10%;"></td> <td style="width: 10%;"></td> <td style="width: 10%;"></td> </tr> <tr> <td></td> <td></td> <td colspan="8" style="text-align: center;"> <table border="1" style="width: 100%; border-collapse: collapse; text-align: center;"> <tr> <td style="width: 10%;"></td> <td style="width: 10%;"></td> <td style="width: 10%;"></td> <td style="width: 10%;"></td> <td style="width: 10%;"></td> <td style="width: 10%;"></td> <td style="width: 10%;"></td> <td style="width: 10%;"></td> <td style="width: 10%;"></td> <td style="width: 10%;"></td> </tr> <tr> <td></td> <td></td> <td colspan="8" style="text-align: center;"> <table border="1" style="width: 100%; border-collapse: collapse; text-align: center;"> <tr> <td style="width: 10%;"></td> <td style="width: 10%;"></td> <td style="width: 10%;"></td> <td style="width: 10%;"></td> <td style="width: 10%;"></td> <td style="width: 10%;"></td> <td style="width: 10%;"></td> <td style="width: 10%;"></td> <td style="width: 10%;"></td> <td style="width: 10%;"></td> </tr> <tr> <td></td> <td></td> <td colspan="8" style="text-align: center;"> <table border="1" style="width: 100%; border-collapse: collapse; text-align: center;"> <tr> <td style="width: 10%;"></td> <td style="width: 10%;"></td> <td style="width: 10%;"></td> <td style="width: 10%;"></td> <td style="width: 10%;"></td> <td style="width: 10%;"></td> <td style="width: 10%;"></td> <td style="width: 10%;"></td> <td style="width: 10%;"></td> <td style="width: 10%;"></td> </tr> <tr> <td></td> <td></td> <td colspan="8" style="text-align: center;"> <table border="1" style="width: 100%; border-collapse: collapse; text-align: center;"> <tr> <td style="width: 10%;"></td> <td style="width: 10%;"></td> <td style="width: 10%;"></td> <td style="width: 10%;"></td> <td style="width: 10%;"></td> <td style="width: 10%;"></td> <td style="width: 10%;"></td> <td style="width: 10%;"></td> <td style="width: 10%;"></td> <td style="width: 10%;"></td> </tr> <tr> <td></td> <td></td> <td colspan="8" style="text-align: center;"> <table border="1" style="width: 100%; border-collapse: collapse; text-align: center;"> <tr> <td style="width: 10%;"></td> <td style="width: 10%;"></td> <td style="width: 10%;"></td> <td style="width: 10%;"></td> <td style="width: 10%;"></td> <td style="width: 10%;"></td> <td style="width: 10%;"></td> <td style="width: 10%;"></td> <td style="width: 10%;"></td> <td style="width: 10%;"></td> </tr> <tr> <td></td> <td></td> <td colspan="8" style="text-align: center;"> <table border="1" style="width: 100%; border-collapse: collapse; text-align: center;"> <tr> <td style="width: 10%;"></td> <td style="width: 10%;"></td> <td style="width: 10%;"></td> <td style="width: 10%;"></td> <td style="width: 10%;"></td> <td style="width: 10%;"></td> <td style="width: 10%;"></td> <td style="width: 10%;"></td> <td style="width: 10%;"></td> <td style="width: 10%;"></td> </tr> <tr> <td></td> <td></td> <td colspan="8" style="text-align: center;"> <table border="1" style="width: 100%; border-collapse: collapse; text-align: center;"> <tr> <td style="width: 10%;"></td> <td style="width:
10%;"></td> <td style="width: 10%;"></td> <td style="width: 10%;"></td> <td style="width: 10%;"></td> <td style="width: 10%;"></td> <td style="width: 10%;"></td> <td style="width: 10%;"></td> <td style="width: 10%;"></td> <td style="width: 10%;"></td> </tr> <tr> <td></td> <td></td> <td colspan="8" style="text-align: center;"> <table border="1" style="width: 100%; border-collapse: collapse; text-align: center;"> <tr> <td style="width: 10%;"></td> <td style="width: 10%;"></td> <td style="width: 10%;"></td> <td style="width: 10%;"></td> <td style="width: 10%;"></td> <td style="width: 10%;"></td> <td style="width: 10%;"></td> <td style="width: 10%;"></td> <td style="width: 10%;"></td> <td style="width: 10%;"></td> </tr> <tr> <td></td> <td></td> <td colspan="8" style="text-align: center;"> <table border="1" style="width: 100%; border-collapse: collapse; text-align: center;"> <tr> <td style="width: 10%;"></td> <td style="width: 10%;"></td> <td style="width: 10%;"></td> <td style="width: 10%;"></td> <td style="width: 10%;"></td> <td style="width: 10%;"></td> <td style="width: 10%;"></td> <td style="width: 10%;"></td> <td style="width: 10%;"></td> <td style="width: 10%;"></td> </tr> <tr> <td></td> <td></td> <td colspan="8" style="text-align: center;"> <table border="1" style="width: 100%; border-collapse: collapse; text-align: center;"> <tr> <td style="width: 10%;"></td> <td style="width: 10%;"></td> <td style="width: 10%;"></td> <td style="width: 10%;"></td> <td style="width: 10%;"></td> <td style="width: 10%;"></td> <td style="width: 10%;"></td> <td style="width: 10%;"></td> <td style="width: 10%;"></td> <td style="width: 10%;"></td> </tr> <tr> <td></td> <td></td> <td colspan="8" style="text-align: center;"> <table border="1" style="width: 100%; border-collapse: collapse; text-align: center;"> <tr> <td style="width: 10%;"></td> <td style="width: 10%;"></td> <td style="width: 10%;"></td> <td style="width: 10%;"></td> <td style="width: 10%;"></td> <td style="width: 10%;"></td> <td style="width: 10%;"></td> <td style="width: 10%;"></td> <td style="width: 10%;"></td> <td style="width: 10%;"></td> </tr> <tr> <td></td> <td></td> <td colspan="8" style="text-align: center;"> <table border="1" style="width: 100%; border-collapse: collapse; text-align: center;"> <tr> <td style="width: 10%;"></td> <td style="width: 10%;"></td> <td style="width: 10%;"></td> <td style="width: 10%;"></td> <td style="width: 10%;"></td> <td style="width: 10%;"></td> <td style="width: 10%;"></td> <td style="width: 10%;"></td> <td style="width: 10%;"></td> <td style="width: 10%;"></td> </tr> <tr> <td></td> <td></td> <td colspan="8" style="text-align: center;"> <table border="1" style="width: 100%; border-collapse: collapse; text-align: center;"> <tr> <td style="width: 10%;"></td> <td style="width: 10%;"></td> <td style="width: 10%;"></td> <td style="width: 10%;"></td> <td style="width: 10%;"></td> <td style="width: 10%;"></td> <td style="width: 10%;"></td> <td style="width: 10%;"></td> <td style="width: 10%;"></td> <td style="width: 10%;"></td> </tr> <tr> <td></td> <td></td> <td colspan="8" style="text-align: center;"> <table border="1" style="width: 100%; border-collapse: collapse; text-align: center;"> <tr> </tr></table></td></tr></table></td></tr></table></td></tr></table></td></tr></table></td></tr></table></td></tr></table></td></tr></table></td></tr></table></td></tr></table></td></tr></table></td></tr></table></td></tr></table></td></tr></table></td></tr></table></td></tr></table></td></tr></table></td></tr></table></td></tr></table></td></tr></table></td></tr></table></td></tr></table></td></tr></table></td></tr></table></td></tr></table></td></tr></table> | | | | | | | | | | | | | | | | | | | | <table border="1" style="width: 100%; border-collapse: collapse; text-align: center;"> <tr> <td style="width: 10%;"></td> <td style="width: 10%;"></td> <td style="width: 10%;"></td> <td style="width: 10%;"></td> <td style="width: 10%;"></td> <td style="width: 10%;"></td> <td style="width: 10%;"></td> <td style="width: 10%;"></td> <td style="width: 10%;"></td> <td style="width: 10%;"></td> </tr> <tr> <td></td> <td></td> <td colspan="8" style="text-align: center;"> <table border="1" style="width: 100%; border-collapse: collapse; text-align: center;"> <tr> <td style="width: 10%;"></td> <td style="width: 10%;"></td> <td style="width: 10%;"></td> <td style="width: 10%;"></td> <td style="width: 10%;"></td> <td style="width: 10%;"></td> <td style="width: 10%;"></td> <td style="width: 10%;"></td> <td style="width: 10%;"></td> <td style="width: 10%;"></td> </tr> <tr> <td></td> <td></td> <td colspan="8" style="text-align: center;"> <table border="1" style="width: 100%; border-collapse: collapse; text-align: center;"> <tr> <td style="width: 10%;"></td> <td style="width: 10%;"></td> <td style="width: 10%;"></td> <td style="width: 10%;"></td> <td style="width: 10%;"></td> <td style="width: 10%;"></td> <td style="width: 10%;"></td> <td style="width: 10%;"></td> <td style="width: 10%;"></td> <td style="width: 10%;"></td> </tr> <tr> <td></td> <td></td> <td colspan="8" style="text-align: center;"> <table border="1" style="width: 100%; border-collapse: collapse; text-align: center;"> <tr> <td style="width: 10%;"></td> <td style="width: 10%;"></td> <td style="width: 10%;"></td> <td style="width: 10%;"></td> <td style="width: 10%;"></td> <td style="width: 10%;"></td> <td style="width: 10%;"></td> <td style="width: 10%;"></td> <td style="width: 10%;"></td> <td style="width: 10%;"></td> </tr> <tr> <td></td> <td></td> <td colspan="8" style="text-align: center;"> <table border="1" style="width: 100%; border-collapse: collapse; text-align: center;"> <tr> <td style="width: 10%;"></td> <td style="width: 10%;"></td> <td style="width: 10%;"></td> <td style="width: 10%;"></td> <td style="width: 10%;"></td> <td style="width: 10%;"></td> <td style="width: 10%;"></td> <td style="width: 10%;"></td> <td style="width: 10%;"></td> <td style="width: 10%;"></td> </tr> <tr> <td></td> <td></td> <td colspan="8" style="text-align: center;"> <table border="1" style="width: 100%; border-collapse: collapse; text-align: center;"> <tr> <td style="width: 10%;"></td> <td style="width: 10%;"></td> <td style="width: 10%;"></td> <td style="width: 10%;"></td> <td style="width: 10%;"></td> <td style="width: 10%;"></td> <td style="width: 10%;"></td> <td style="width: 10%;"></td> <td style="width: 10%;"></td> <td style="width: 10%;"></td> </tr> <tr> <td></td> <td></td> <td colspan="8" style="text-align: center;"> <table border="1" style="width: 100%; border-collapse: collapse; text-align: center;"> <tr> <td style="width: 10%;"></td> <td style="width: 10%;"></td> <td style="width: 10%;"></td> <td style="width: 10%;"></td> <td style="width: 10%;"></td> <td style="width: 10%;"></td> <td style="width: 10%;"></td> <td style="width: 10%;"></td> <td style="width: 10%;"></td> <td style="width: 10%;"></td> </tr> <tr> <td></td> <td></td> <td colspan="8" style="text-align: center;"> <table border="1" style="width: 100%; border-collapse: collapse; text-align: center;"> <tr> <td style="width: 10%;"></td> <td style="width: 10%;"></td> <td style="width: 10%;"></td> <td style="width: 10%;"></td> <td style="width: 10%;"></td> <td style="width: 10%;"></td> <td style="width: 10%;"></td> <td style="width: 10%;"></td> <td style="width: 10%;"></td> <td style="width: 10%;"></td> </tr> <tr> <td></td> <td></td> <td colspan="8" style="text-align: center;"> <table border="1" style="width: 100%; border-collapse: collapse; text-align: center;"> <tr> <td style="width: 10%;"></td> <td style="width: 10%;"></td> <td style="width: 10%;"></td> <td style="width: 10%;"></td> <td style="width: 10%;"></td> <td style="width: 10%;"></td> <td style="width: 10%;"></td> <td style="width: 10%;"></td> <td style="width: 10%;"></td> <td style="width: 10%;"></td> </tr> <tr> <td></td> <td></td> <td colspan="8" style="text-align: center;"> <table border="1" style="width: 100%; border-collapse: collapse; text-align: center;"> <tr> <td style="width: 10%;"></td> <td style="width: 10%;"></td> <td style="width: 10%;"></td> <td style="width: 10%;"></td> <td style="width: 10%;"></td> <td style="width: 10%;"></td> <td style="width: 10%;"></td> <td style="width: 10%;"></td> <td style="width: 10%;"></td> <td style="width: 10%;"></td> </tr> <tr> <td></td> <td></td> <td colspan="8" style="text-align: center;"> <table border="1" style="width: 100%; border-collapse: collapse; text-align: center;"> <tr> <td style="width:
10%;"></td> <td style="width: 10%;"></td> <td style="width: 10%;"></td> <td style="width: 10%;"></td> <td style="width: 10%;"></td> <td style="width: 10%;"></td> <td style="width: 10%;"></td> <td style="width: 10%;"></td> <td style="width: 10%;"></td> <td style="width: 10%;"></td> </tr> <tr> <td></td> <td></td> <td colspan="8" style="text-align: center;"> <table border="1" style="width: 100%; border-collapse: collapse; text-align: center;"> <tr> <td style="width: 10%;"></td> <td style="width: 10%;"></td> <td style="width: 10%;"></td> <td style="width: 10%;"></td> <td style="width: 10%;"></td> <td style="width: 10%;"></td> <td style="width: 10%;"></td> <td style="width: 10%;"></td> <td style="width: 10%;"></td> <td style="width: 10%;"></td> </tr> <tr> <td></td> <td></td> <td colspan="8" style="text-align: center;"> <table border="1" style="width: 100%; border-collapse: collapse; text-align: center;"> <tr> <td style="width: 10%;"></td> <td style="width: 10%;"></td> <td style="width: 10%;"></td> <td style="width: 10%;"></td> <td style="width: 10%;"></td> <td style="width: 10%;"></td> <td style="width: 10%;"></td> <td style="width: 10%;"></td> <td style="width: 10%;"></td> <td style="width: 10%;"></td> </tr> <tr> <td></td> <td></td> <td colspan="8" style="text-align: center;"> <table border="1" style="width: 100%; border-collapse: collapse; text-align: center;"> <tr> <td style="width: 10%;"></td> <td style="width: 10%;"></td> <td style="width: 10%;"></td> <td style="width: 10%;"></td> <td style="width: 10%;"></td> <td style="width: 10%;"></td> <td style="width: 10%;"></td> <td style="width: 10%;"></td> <td style="width: 10%;"></td> <td style="width: 10%;"></td> </tr> <tr> <td></td> <td></td> <td colspan="8" style="text-align: center;"> <table border="1" style="width: 100%; border-collapse: collapse; text-align: center;"> <tr> <td style="width: 10%;"></td> <td style="width: 10%;"></td> <td style="width: 10%;"></td> <td style="width: 10%;"></td> <td style="width: 10%;"></td> <td style="width: 10%;"></td> <td style="width: 10%;"></td> <td style="width: 10%;"></td> <td style="width: 10%;"></td> <td style="width: 10%;"></td> </tr> <tr> <td></td> <td></td> <td colspan="8" style="text-align: center;"> <table border="1" style="width: 100%; border-collapse: collapse; text-align: center;"> <tr> <td style="width: 10%;"></td> <td style="width: 10%;"></td> <td style="width: 10%;"></td> <td style="width: 10%;"></td> <td style="width: 10%;"></td> <td style="width: 10%;"></td> <td style="width: 10%;"></td> <td style="width: 10%;"></td> <td style="width: 10%;"></td> <td style="width: 10%;"></td> </tr> <tr> <td></td> <td></td> <td colspan="8" style="text-align: center;"> <table border="1" style="width: 100%; border-collapse: collapse; text-align: center;"> <tr> <td style="width: 10%;"></td> <td style="width: 10%;"></td> <td style="width: 10%;"></td> <td style="width: 10%;"></td> <td style="width: 10%;"></td> <td style="width: 10%;"></td> <td style="width: 10%;"></td> <td style="width: 10%;"></td> <td style="width: 10%;"></td> <td style="width: 10%;"></td> </tr> <tr> <td></td> <td></td> <td colspan="8" style="text-align: center;"> <table border="1" style="width: 100%; border-collapse: collapse; text-align: center;"> <tr> <td style="width: 10%;"></td> <td style="width: 10%;"></td> <td style="width: 10%;"></td> <td style="width: 10%;"></td> <td style="width: 10%;"></td> <td style="width: 10%;"></td> <td style="width: 10%;"></td> <td style="width: 10%;"></td> <td style="width: 10%;"></td> <td style="width: 10%;"></td> </tr> <tr> <td></td> <td></td> <td colspan="8" style="text-align: center;"> <table border="1" style="width: 100%; border-collapse: collapse; text-align: center;"> <tr> <td style="width: 10%;"></td> <td style="width: 10%;"></td> <td style="width: 10%;"></td> <td style="width: 10%;"></td> <td style="width: 10%;"></td> <td style="width: 10%;"></td> <td style="width: 10%;"></td> <td style="width: 10%;"></td> <td style="width: 10%;"></td> <td style="width: 10%;"></td> </tr> <tr> <td></td> <td></td> <td colspan="8" style="text-align: center;"> <table border="1" style="width: 100%; border-collapse: collapse; text-align: center;"> <tr> <td style="width: 10%;"></td> <td style="width: 10%;"></td> <td style="width: 10%;"></td> <td style="width: 10%;"></td> <td style="width: 10%;"></td> <td style="width: 10%;"></td> <td style="width: 10%;"></td> <td style="width: 10%;"></td> <td style="width: 10%;"></td> <td style="width: 10%;"></td> </tr> <tr> <td></td> <td></td> <td colspan="8" style="text-align: center;"> <table border="1" style="width: 100%; border-collapse: collapse; text-align: center;"> <tr> <td style="width: 10%;"></td> <td style="width: 10%;"></td> <td style="width: 10%;"></td> <td style="width: 10%;"></td> <td style="width: 10%;"></td> <td style="width: 10%;"></td> <td style="width: 10%;"></td> <td style="width: 10%;"></td> <td style="width: 10%;"></td> <td style="width: 10%;"></td> </tr> <tr> <td></td> <td></td> <td colspan="8" style="text-align: center;"> <table border="1" style="width: 100%; border-collapse: collapse; text-align: center;"> <tr> <td style="width: 10%;"></td> <td style="width: 10%;"></td> <td style="width: 10%;"></td> <td style="width: 10%;"></td> <td style="width: 10%;"></td> <td style="width: 10%;"></td> <td style="width: 10%;"></td> <td style="width: 10%;"></td> <td style="width: 10%;"></td> <td style="width: 10%;"></td> </tr> <tr> <td></td> <td></td> <td colspan="8" style="text-align: center;"> <table border="1" style="width: 100%; border-collapse: collapse; text-align: center;"> <tr> <td style="width: 10%;"></td> <td style="width: 10%;"></td> <td style="width: 10%;"></td> <td style="width: 10%;"></td> <td style="width: 10%;"></td> <td style="width: 10%;"></td> <td style="width: 10%;"></td> <td style="width: 10%;"></td> <td style="width: 10%;"></td> <td style="width: 10%;"></td> </tr> <tr> <td></td> <td></td> <td colspan="8" style="text-align: center;"> <table border="1" style="width: 100%; border-collapse: collapse; text-align: center;"> <tr> <td style="width: 10%;"></td> <td style="width: 10%;"></td> <td style="width: 10%;"></td> <td style="width: 10%;"></td> <td style="width: 10%;"></td> <td style="width: 10%;"></td> <td style="width: 10%;"></td> <td style="width: 10%;"></td> <td style="width: 10%;"></td> <td style="width: 10%;"></td> </tr> <tr> <td></td> <td></td> <td colspan="8" style="text-align: center;"> <table border="1" style="width: 100%; border-collapse: collapse; text-align: center;"> <tr> </tr></table></td></tr></table></td></tr></table></td></tr></table></td></tr></table></td></tr></table></td></tr></table></td></tr></table></td></tr></table></td></tr></table></td></tr></table></td></tr></table></td></tr></table></td></tr></table></td></tr></table></td></tr></table></td></tr></table></td></tr></table></td></tr></table></td></tr></table></td></tr></table></td></tr></table></td></tr></table></td></tr></table></td></tr></table> | | | | | | | | | | | | | | | | | | | | <table border="1" style="width: 100%; border-collapse: collapse; text-align: center;"> <tr> <td style="width: 10%;"></td> <td style="width: 10%;"></td> <td style="width: 10%;"></td> <td style="width: 10%;"></td> <td style="width: 10%;"></td> <td style="width: 10%;"></td> <td style="width: 10%;"></td> <td style="width: 10%;"></td> <td style="width: 10%;"></td> <td style="width: 10%;"></td> </tr> <tr> <td></td> <td></td> <td colspan="8" style="text-align: center;"> <table border="1" style="width: 100%; border-collapse: collapse; text-align: center;"> <tr> <td style="width: 10%;"></td> <td style="width: 10%;"></td> <td style="width: 10%;"></td> <td style="width: 10%;"></td> <td style="width: 10%;"></td> <td style="width: 10%;"></td> <td style="width: 10%;"></td> <td style="width: 10%;"></td> <td style="width: 10%;"></td> <td style="width: 10%;"></td> </tr> <tr> <td></td> <td></td> <td colspan="8" style="text-align: center;"> <table border="1" style="width: 100%; border-collapse: collapse; text-align: center;"> <tr> <td style="width: 10%;"></td> <td style="width: 10%;"></td> <td style="width: 10%;"></td> <td style="width: 10%;"></td> <td style="width: 10%;"></td> <td style="width: 10%;"></td> <td style="width: 10%;"></td> <td style="width: 10%;"></td> <td style="width: 10%;"></td> <td style="width: 10%;"></td> </tr> <tr> <td></td> <td></td> <td colspan="8" style="text-align: center;"> <table border="1" style="width: 100%; border-collapse: collapse; text-align: center;"> <tr> <td
style="width: 10%;"></td> <td style="width: 10%;"></td> <td style="width: 10%;"></td> <td style="width: 10%;"></td> <td style="width: 10%;"></td> <td style="width: 10%;"></td> <td style="width: 10%;"></td> <td style="width: 10%;"></td> <td style="width: 10%;"></td> <td style="width: 10%;"></td> </tr> <tr> <td></td> <td></td> <td colspan="8" style="text-align: center;"> <table border="1" style="width: 100%; border-collapse: collapse; text-align: center;"> <tr> <td style="width: 10%;"></td> <td style="width: 10%;"></td> <td style="width: 10%;"></td> <td style="width: 10%;"></td> <td style="width: 10%;"></td> <td style="width: 10%;"></td> <td style="width: 10%;"></td> <td style="width: 10%;"></td> <td style="width: 10%;"></td> <td style="width: 10%;"></td> </tr> <tr> <td></td> <td></td> <td colspan="8" style="text-align: center;"> <table border="1" style="width: 100%; border-collapse: collapse; text-align: center;"> <tr> <td style="width: 10%;"></td> <td style="width: 10%;"></td> <td style="width: 10%;"></td> <td style="width: 10%;"></td> <td style="width: 10%;"></td> <td style="width: 10%;"></td> <td style="width: 10%;"></td> <td style="width: 10%;"></td> <td style="width: 10%;"></td> <td style="width: 10%;"></td> </tr> <tr> <td></td> <td></td> <td colspan="8" style="text-align: center;"> <table border="1" style="width: 100%; border-collapse: collapse; text-align: center;"> <tr> <td style="width: 10%;"></td> <td style="width: 10%;"></td> <td style="width: 10%;"></td> <td style="width: 10%;"></td> <td style="width: 10%;"></td> <td style="width: 10%;"></td> <td style="width: 10%;"></td> <td style="width: 10%;"></td> <td style="width: 10%;"></td> <td style="width: 10%;"></td> </tr> <tr> <td></td> <td></td> <td colspan="8" style="text-align: center;"> <table border="1" style="width: 100%; border-collapse: collapse; text-align: center;"> <tr> <td style="width: 10%;"></td> <td style="width: 10%;"></td> <td style="width: 10%;"></td> <td style="width: 10%;"></td> <td style="width: 10%;"></td> <td style="width: 10%;"></td> <td style="width: 10%;"></td> <td style="width: 10%;"></td> <td style="width: 10%;"></td> <td style="width: 10%;"></td> </tr> <tr> <td></td> <td></td> <td colspan="8" style="text-align: center;"> <table border="1" style="width: 100%; border-collapse: collapse; text-align: center;"> <tr> <td style="width: 10%;"></td> <td style="width: 10%;"></td> <td style="width: 10%;"></td> <td style="width: 10%;"></td> <td style="width: 10%;"></td> <td style="width: 10%;"></td> <td style="width: 10%;"></td> <td style="width: 10%;"></td> <td style="width: 10%;"></td> <td style="width: 10%;"></td> </tr> <tr> <td></td> <td></td> <td colspan="8" style="text-align: center;"> <table border="1" style="width: 100%; border-collapse: collapse; text-align: center;"> <tr> <td style="width: 10%;"></td> <td style="width: 10%;"></td> <td style="width: 10%;"></td> <td style="width: 10%;"></td> <td style="width: 10%;"></td> <td style="width: 10%;"></td> <td style="width: 10%;"></td> <td style="width: 10%;"></td> <td style="width: 10%;"></td> <td style="width: 10%;"></td> </tr> <tr> <td></td> <td></td> <td colspan="8" style="text-align: center;"> <table border="1" style="width: 100%; border-collapse: collapse; text-align: center;"> <tr> <td style="width: 10%;"></td> <td style="width: 10%;"></td> <td style="width: 10%;"></td> <td style="width: 10%;"></td> <td style="width: 10%;"></td> <td style="width: 10%;"></td> <td style="width: 10%;"></td> <td style="width: 10%;"></td> <td style="width: 10%;"></td> <td style="width: 10%;"></td> </tr> <tr> <td></td> <td></td> <td colspan="8" style="text-align: center;"> <table border="1" style="width: 100%; border-collapse: collapse; text-align: center;"> <tr> <td style="width: 10%;"></td> <td style="width: 10%;"></td> <td style="width: 10%;"></td> <td style="width: 10%;"></td> <td style="width: 10%;"></td> <td style="width: 10%;"></td> <td style="width: 10%;"></td> <td style="width: 10%;"></td> <td style="width: 10%;"></td> <td style="width: 10%;"></td> </tr> <tr> <td></td> <td></td> <td colspan="8" style="text-align: center;"> <table border="1" style="width: 100%; border-collapse: collapse; text-align: center;"> <tr> <td style="width: 10%;"></td> <td style="width: 10%;"></td> <td style="width: 10%;"></td> <td style="width: 10%;"></td> <td style="width: 10%;"></td> <td style="width: 10%;"></td> <td style="width: 10%;"></td> <td style="width: 10%;"></td> <td style="width: 10%;"></td> <td style="width: 10%;"></td> </tr> <tr> <td></td> <td></td> <td colspan="8" style="text-align: center;"> <table border="1" style="width: 100%; border-collapse: collapse; text-align: center;"> <tr> <td style="width: 10%;"></td> <td style="width: 10%;"></td> <td style="width: 10%;"></td> <td style="width: 10%;"></td> <td style="width: 10%;"></td> <td style="width: 10%;"></td> <td style="width: 10%;"></td> <td style="width: 10%;"></td> <td style="width: 10%;"></td> <td style="width: 10%;"></td> </tr> <tr> <td></td> <td></td> <td colspan="8" style="text-align: center;"> <table border="1" style="width: 100%; border-collapse: collapse; text-align: center;"> <tr> <td style="width: 10%;"></td> <td style="width: 10%;"></td> <td style="width: 10%;"></td> <td style="width: 10%;"></td> <td style="width: 10%;"></td> <td style="width: 10%;"></td> <td style="width: 10%;"></td> <td style="width: 10%;"></td> <td style="width: 10%;"></td> <td style="width: 10%;"></td> </tr> <tr> <td></td> <td></td> <td colspan="8" style="text-align: center;"> <table border="1" style="width: 100%; border-collapse: collapse; text-align: center;"> <tr> <td style="width: 10%;"></td> <td style="width: 10%;"></td> <td style="width: 10%;"></td> <td style="width: 10%;"></td> <td style="width: 10%;"></td> <td style="width: 10%;"></td> <td style="width: 10%;"></td> <td style="width: 10%;"></td> <td style="width: 10%;"></td> <td style="width: 10%;"></td> </tr> <tr> <td></td> <td></td> <td colspan="8" style="text-align: center;"> <table border="1" style="width: 100%; border-collapse: collapse; text-align: center;"> <tr> <td style="width: 10%;"></td> <td style="width: 10%;"></td> <td style="width: 10%;"></td> <td style="width: 10%;"></td> <td style="width: 10%;"></td> <td style="width: 10%;"></td> <td style="width: 10%;"></td> <td style="width: 10%;"></td> <td style="width: 10%;"></td> <td style="width: 10%;"></td> </tr> <tr> <td></td> <td></td> <td colspan="8" style="text-align: center;"> <table border="1" style="width: 100%; border-collapse: collapse; text-align: center;"> <tr> <td style="width: 10%;"></td> <td style="width: 10%;"></td> <td style="width: 10%;"></td> <td style="width: 10%;"></td> <td style="width: 10%;"></td> <td style="width: 10%;"></td> <td style="width: 10%;"></td> <td style="width: 10%;"></td> <td style="width: 10%;"></td> <td style="width: 10%;"></td> </tr> <tr> <td></td> <td></td> <td colspan="8" style="text-align: center;"> <table border="1" style="width: 100%; border-collapse: collapse; text-align: center;"> <tr> <td style="width: 10%;"></td> <td style="width: 10%;"></td> <td style="width: 10%;"></td> <td style="width: 10%;"></td> <td style="width: 10%;"></td> <td style="width: 10%;"></td> <td style="width: 10%;"></td> <td style="width: 10%;"></td> <td style="width: 10%;"></td> <td style="width: 10%;"></td> </tr> <tr> <td></td> <td></td> <td colspan="8" style="text-align: center;"> <table border="1" style="width: 100%; border-collapse: collapse; text-align: center;"> <tr> <td style="width: 10%;"></td> <td style="width: 10%;"></td> <td style="width: 10%;"></td> <td style="width: 10%;"></td> <td style="width: 10%;"></td> <td style="width: 10%;"></td> <td style="width: 10%;"></td> <td style="width: 10%;"></td> <td style="width: 10%;"></td> <td style="width: 10%;"></td> </tr> <tr> <td></td> <td></td> <td colspan="8" style="text-align: center;"> <table border="1" style="width: 100%; border-collapse: collapse; text-align: center;"> <tr> <td style="width: 10%;"></td> <td style="width: 10%;"></td> <td style="width: 10%;"></td> <td style="width: 10%;"></td> <td style="width: 10%;"></td> <td style="width: 10%;"></td> <td style="width: 10%;"></td> <td style="width: 10%;"></td> <td style="width: 10%;"></td> <td style="width: 10%;"></td> </tr> <tr> <td></td> <td></td> <td colspan="8" style="text-align: center;"> <table border="1" style="width: 100%; border-collapse: collapse; text-align: center;"> <tr> <td style="width: 10%;"></td> <td style="width: 10%;"></td> <td style="width: 10%;"></td> <td style="width: 10%;"></td> <td style="width: 10%;"></td> <td style="width: 10%;"></td> <td style="width: 10%;"></td> <td style="width: 10%;"></td> <td style="width: 10%;"></td> <td style="width: 10%;"></td> </tr> <tr> <td></td> <td></td> <td colspan="8" style="text-align: center;"> <table border="1" style="width: 100%; border-collapse: collapse; text-align: center;"> <tr> <td style="width: 10%;"></td> <td style="width: 10%;"></td> <td style="width: 10%;"></td> <td style="width: 10%;"></td> <td style="width: 10%;"></td> <td style="width: 10%;"></td> <td style="width: 10%;"></td> <td style="width: 10%;"></td> <td style="width: 10%;"></td> <td style="width: 10%;"></td> </tr> <tr> <td></td> <td></td> <td colspan="8" style="text-align: center;"> <table border="1" style="width: 100%; border-collapse: collapse; text-align: center;"> <tr> </tr></table></td></tr></table></td></tr></table></td></tr></table></td></tr></table></td></tr></table></td></tr></table></td></tr></table></td></tr></table></td></tr></table></td></tr></table></td></tr></table></td></tr></table></td></tr></table></td></tr></table></td></tr></table></td></tr></table></td></tr></table></td></tr></table></td></tr></table></td></tr></table></td></tr></table></td></tr></table></td></tr></table>
 | | | | | | | | | | | | | | | | | | | | <table border="1" style="width: 100%; border-collapse: collapse; text-align: center;"> <tr> <td style="width: 10%;"></td> <td style="width: 10%;"></td> <td style="width: 10%;"></td> <td style="width: 10%;"></td> <td style="width: 10%;"></td> <td style="width: 10%;"></td> <td style="width: 10%;"></td> <td style="width: 10%;"></td> <td style="width: 10%;"></td> <td style="width: 10%;"></td> </tr> <tr> <td></td> <td></td> <td colspan="8" style="text-align: center;"> <table border="1" style="width: 100%; border-collapse: collapse; text-align: center;"> <tr> <td style="width: 10%;"></td> <td style="width: 10%;"></td> <td style="width: 10%;"></td> <td style="width: 10%;"></td> <td style="width: 10%;"></td> <td style="width: 10%;"></td> <td style="width: 10%;"></td> <td style="width: 10%;"></td> <td style="width: 10%;"></td> <td style="width: 10%;"></td> </tr> <tr> <td></td> <td></td> <td colspan="8" style="text-align: center;"> <table border="1" style="width: 100%; border-collapse: collapse; text-align: center;"> <tr> <td style="width: 10%;"></td> <td style="width: 10%;"></td> <td style="width: 10%;"></td> <td style="width: 10%;"></td> <td style="width: 10%;"></td> <td style="width: 10%;"></td> <td style="width: 10%;"></td> <td style="width: 10%;"></td> <td style="width: 10%;"></td> <td style="width: 10%;"></td> </tr> <tr> <td></td> <td></td> <td colspan="8" style="text-align: center;"> <table border="1" style="width: 100%; border-collapse: collapse; text-align: center;"> <tr> <td style="width: 10%;"></td> <td style="width: 10%;"></td> <td style="width: 10%;"></td> <td style="width: 10%;"></td> <td style="width: 10%;"></td> <td style="width: 10%;"></td> <td style="width: 10%;"></td> <td style="width: 10%;"></td> <td style="width: 10%;"></td> <td style="width: 10%;"></td> </tr> <tr> <td></td> <td></td> <td colspan="8" style="text-align: center;"> <table border="1" style="width: 100%; border-collapse: collapse; text-align: center;"> <tr> <td style="width: 10%;"></td> <td style="width: 10%;"></td> <td style="width: 10%;"></td> <td style="width: 10%;"></td> <td style="width: 10%;"></td> <td style="width: 10%;"></td> <td style="width: 10%;"></td> <td style="width: 10%;"></td> <td style="width: 10%;"></td> <td style="width: 10%;"></td> </tr> <tr> <td></td> <td></td> <td colspan="8" style="text-align: center;"> <table border="1" style="width: 100%; border-collapse: collapse; text-align: center;"> <tr> <td style="width: 10%;"></td> <td style="width: 10%;"></td> <td style="width: 10%;"></td> <td style="width: 10%;"></td> <td style="width: 10%;"></td> <td style="width: 10%;"></td> <td style="width: 10%;"></td> <td style="width: 10%;"></td> <td style="width: 10%;"></td> <td style="width: 10%;"></td> </tr> <tr> <td></td> <td></td> <td colspan="8" style="text-align: center;"> <table border="1" style="width: 100%; border-collapse: collapse; text-align: center;"> <tr> <td style="width: 10%;"></td> <td style="width: 10%;"></td> <td style="width: 10%;"></td> <td style="width: 10%;"></td> <td style="width: 10%;"></td> <td style="width: 10%;"></td> <td style="width: 10%;"></td> <td style="width: 10%;"></td> <td style="width: 10%;"></td> <td style="width: 10%;"></td> </tr> <tr> <td></td> <td></td> <td colspan="8" style="text-align: center;"> <table border="1" style="width: 100%; border-collapse: collapse; text-align: center;"> <tr> <td style="width: 10%;"></td> <td style="width: 10%;"></td> <td style="width: 10%;"></td> <td style="width: 10%;"></td> <td style="width: 10%;"></td> <td style="width: 10%;"></td> <td style="width: 10%;"></td> <td style="width: 10%;"></td> <td style="width: 10%;"></td> <td style="width: 10%;"></td> </tr> <tr> <td></td> <td></td> <td colspan="8" style="text-align: center;"> <table border="1" style="width: 100%; border-collapse: collapse; text-align: center;"> <tr> <td style="width: 10%;"></td> <td style="width: 10%;"></td> <td style="width: 10%;"></td> <td style="width: 10%;"></td> <td style="width: 10%;"></td> <td style="width: 10%;"></td> <td style="width: 10%;"></td> <td style="width: 10%;"></td> <td style="width: 10%;"></td> <td style="width: 10%;"></td> </tr> <tr> <td></td> <td></td> <td colspan="8" style="text-align: center;"> <table border="1" style="width: 100%; border-collapse: collapse; text-align: center;"> <tr> <td style="width: 10%;"></td> <td style="width: 10%;"></td> <td style="width: 10%;"></td> <td style="width: 10%;"></td> <td style="width: 10%;"></td> <td style="width: 10%;"></td> <td style="width: 10%;"></td> <td style="width: 10%;"></td> <td style="width: 10%;"></td> <td style="width: 10%;"></td> </tr> <tr> <td></td> <td></td> <td colspan="8" style="text-align: center;"> <table border="1" style="width: 100%; border-collapse: collapse; text-align: center;"> <tr> <td style="width: 10%;"></td> <td style="width: 10%;"></td> <td style="width: 10%;"></td> <td style="width: 10%;"></td> <td style="width: 10%;"></td> <td style="width: 10%;"></td> <td style="width: 10%;"></td> <td style="width: 10%;"></td> <td style="width: 10%;"></td> <td style="width: 10%;"></td> </tr> <tr> <td></td> <td></td> <td colspan="8" style="text-align: center;"> <table border="1" style="width: 100%; border-collapse: collapse; text-align: center;"> <tr> <td style="width: 10%;"></td> <td style="width: 10%;"></td> <td style="width: 10%;"></td> <td style="width: 10%;"></td> <td style="width: 10%;"></td> <td style="width: 10%;"></td> <td style="width: 10%;"></td> <td style="width: 10%;"></td> <td style="width: 10%;"></td> <td style="width: 10%;"></td> </tr> <tr> <td></td> <td></td> <td colspan="8" style="text-align: center;"> <table border="1" style="width: 100%; border-collapse: collapse; text-align: center;"> <tr> <td style="width: 10%;"></td> <td style="width: 10%;"></td> <td style="width: 10%;"></td> <td style="width: 10%;"></td> <td style="width: 10%;"></td> <td style="width: 10%;"></td> <td style="width: 10%;"></td> <td style="width: 10%;"></td> <td style="width: 10%;"></td> <td style="width: 10%;"></td> </tr> <tr> <td></td> <td></td> <td colspan="8" style="text-align: center;"> <table border="1" style="width: 100%; border-collapse: collapse; text-align: center;"> <tr> <td style="width: 10%;"></td> <td style="width: 10%;"></td> <td style="width: 10%;"></td> <td style="width: 10%;"></td> <td style="width: 10%;"></td> <td style="width: 10%;"></td> <td style="width: 10%;"></td> <td style="width: 10%;"></td> <td style="width: 10%;"></td> <td style="width: 10%;"></td> </tr> <tr> <td></td> <td></td> <td colspan="8" style="text-align: center;"> <table border="1" style="width: 100%; border-collapse: collapse; text-align: center;"> <tr> <td style="width: 10%;"></td> <td style="width: 10%;"></td> <td style="width: 10%;"></td> <td style="width: 10%;"></td> <td style="width: 10%;"></td> <td style="width: 10%;"></td> <td style="width: 10%;"></td> <td style="width: 10%;"></td> <td style="width: 10%;"></td> <td style="width: 10%;"></td> </tr> <tr> <td></td> <td></td> <td colspan="8" style="text-align: center;"> <table border="1" style="width: 100%; border-collapse: collapse; text-align: center;"> <tr> <td style="width: 10%;"></td> <td style="width: 10%;"></td> <td style="width: 10%;"></td> <td style="width: 10%;"></td> <td style="width: 10%;"></td> <td style="width: 10%;"></td> <td style="width: 10%;"></td> <td style="width: 10%;"></td> <td style="width: 10%;"></td> <td style="width: 10%;"></td> </tr> <tr> <td></td> <td></td> <td colspan="8" style="text-align: center;"> <table border="1" style="width: 100%; border-collapse: collapse; text-align: center;"> <tr> <td style="width: 10%;"></td> <td style="width: 10%;"></td> <td style="width: 10%;"></td> <td style="width: 10%;"></td> <td style="width: 10%;"></td> <td style="width: 10%;"></td> <td style="width: 10%;"></td> <td style="width: 10%;"></td> <td style="width: 10%;"></td> <td style="width: 10%;"></td> </tr> <tr> <td></td> <td></td> <td colspan="8" style="text-align: center;"> <table border="1" style="width: 100%; border-collapse: collapse; text-align: center;"> <tr> <td style="width: 10%;"></td> <td style="width: 10%;"></td> <td style="width: 10%;"></td> <td style="width: 10%;"></td> <td style="width: 10%;"></td> <td style="width: 10%;"></td> <td style="width: 10%;"></td> <td style="width: 10%;"></td> <td style="width: 10%;"></td> <td style="width: 10%;"></td> </tr> <tr> <td></td> <td></td> <td colspan="8" style="text-align: center;"> <table border="1" style="width: 100%; border-collapse: collapse; text-align: center;"> <tr> <td style="width: 10%;"></td> <td style="width: 10%;"></td> <td style="width: 10%;"></td> <td style="width: 10%;"></td> <td style="width: 10%;"></td> <td style="width: 10%;"></td>
<td style="width: 10%;"></td> <td style="width: 10%;"></td> <td style="width: 10%;"></td> <td style="width: 10%;"></td> </tr> <tr> <td></td> <td></td> <td colspan="8" style="text-align: center;"> <table border="1" style="width: 100%; border-collapse: collapse; text-align: center;"> <tr> <td style="width: 10%;"></td> <td style="width: 10%;"></td> <td style="width: 10%;"></td> <td style="width: 10%;"></td> <td style="width: 10%;"></td> <td style="width: 10%;"></td> <td style="width: 10%;"></td> <td style="width: 10%;"></td> <td style="width: 10%;"></td> <td style="width: 10%;"></td> </tr> <tr> <td></td> <td></td> <td colspan="8" style="text-align: center;"> <table border="1" style="width: 100%; border-collapse: collapse; text-align: center;"> <tr> <td style="width: 10%;"></td> <td style="width: 10%;"></td> <td style="width: 10%;"></td> <td style="width: 10%;"></td> <td style="width: 10%;"></td> <td style="width: 10%;"></td> <td style="width: 10%;"></td> <td style="width: 10%;"></td> <td style="width: 10%;"></td> <td style="width: 10%;"></td> </tr> <tr> <td></td> <td></td> <td colspan="8" style="text-align: center;"> <table border="1" style="width: 100%; border-collapse: collapse; text-align: center;"> <tr> <td style="width: 10%;"></td> <td style="width: 10%;"></td> <td style="width: 10%;"></td> <td style="width: 10%;"></td> <td style="width: 10%;"></td> <td style="width: 10%;"></td> <td style="width: 10%;"></td> <td style="width: 10%;"></td> <td style="width: 10%;"></td> <td style="width: 10%;"></td> </tr> <tr> <td></td> <td></td> <td colspan="8" style="text-align: center;"> <table border="1" style="width: 100%; border-collapse: collapse; text-align: center;"> <tr> </tr></table></td></tr></table></td></tr></table></td></tr></table></td></tr></table></td></tr></table></td></tr></table></td></tr></table></td></tr></table></td></tr></table></td></tr></table></td></tr></table></td></tr></table></td></tr></table></td></tr></table></td></tr></table></td></tr></table></td></tr></table></td></tr></table></td></tr></table></td></tr></table></td></tr></table></td></tr></table> | | | | | | | | | | | | | | | | | | | | <table border="1" style="width: 100%; border-collapse: collapse; text-align: center;"> <tr> <td style="width: 10%;"></td> <td style="width: 10%;"></td> <td style="width: 10%;"></td> <td style="width: 10%;"></td> <td style="width: 10%;"></td> <td style="width: 10%;"></td> <td style="width: 10%;"></td> <td style="width: 10%;"></td> <td style="width: 10%;"></td> <td style="width: 10%;"></td> </tr> <tr> <td></td> <td></td> <td colspan="8" style="text-align: center;"> <table border="1" style="width: 100%; border-collapse: collapse; text-align: center;"> <tr> <td style="width: 10%;"></td> <td style="width: 10%;"></td> <td style="width: 10%;"></td> <td style="width: 10%;"></td> <td style="width: 10%;"></td> <td style="width: 10%;"></td> <td style="width: 10%;"></td> <td style="width: 10%;"></td> <td style="width: 10%;"></td> <td style="width: 10%;"></td> </tr> <tr> <td></td> <td></td> <td colspan="8" style="text-align: center;"> <table border="1" style="width: 100%; border-collapse: collapse; text-align: center;"> <tr> <td style="width: 10%;"></td> <td style="width: 10%;"></td> <td style="width: 10%;"></td> <td style="width: 10%;"></td> <td style="width: 10%;"></td> <td style="width: 10%;"></td> <td style="width: 10%;"></td> <td style="width: 10%;"></td> <td style="width: 10%;"></td> <td style="width: 10%;"></td> </tr> <tr> <td></td> <td></td> <td colspan="8" style="text-align: center;"> <table border="1" style="width: 100%; border-collapse: collapse; text-align: center;"> <tr> <td style="width: 10%;"></td> <td style="width: 10%;"></td> <td style="width: 10%;"></td> <td style="width: 10%;"></td> <td style="width: 10%;"></td> <td style="width: 10%;"></td> <td style="width: 10%;"></td> <td style="width: 10%;"></td> <td style="width: 10%;"></td> <td style="width: 10%;"></td> </tr> <tr> <td></td> <td></td> <td colspan="8" style="text-align: center;"> <table border="1" style="width: 100%; border-collapse: collapse; text-align: center;"> <tr> <td style="width: 10%;"></td> <td style="width: 10%;"></td> <td style="width: 10%;"></td> <td style="width: 10%;"></td> <td style="width: 10%;"></td> <td style="width: 10%;"></td> <td style="width: 10%;"></td> <td style="width: 10%;"></td> <td style="width: 10%;"></td> <td style="width: 10%;"></td> </tr> <tr> <td></td> <td></td> <td colspan="8" style="text-align: center;"> <table border="1" style="width: 100%; border-collapse: collapse; text-align: center;"> <tr> <td style="width: 10%;"></td> <td style="width: 10%;"></td> <td style="width: 10%;"></td> <td style="width: 10%;"></td> <td style="width: 10%;"></td> <td style="width: 10%;"></td> <td style="width: 10%;"></td> <td style="width: 10%;"></td> <td style="width: 10%;"></td> <td style="width: 10%;"></td> </tr> <tr> <td></td> <td></td> <td colspan="8" style="text-align: center;"> <table border="1" style="width: 100%; border-collapse: collapse; text-align: center;"> <tr> <td style="width: 10%;"></td> <td style="width: 10%;"></td> <td style="width: 10%;"></td> <td style="width: 10%;"></td> <td style="width: 10%;"></td> <td style="width: 10%;"></td> <td style="width: 10%;"></td> <td style="width: 10%;"></td> <td style="width: 10%;"></td> <td style="width: 10%;"></td> </tr> <tr> <td></td> <td></td> <td colspan="8" style="text-align: center;"> <table border="1" style="width: 100%; border-collapse: collapse; text-align: center;"> <tr> <td style="width: 10%;"></td> <td style="width: 10%;"></td> <td style="width: 10%;"></td> <td style="width: 10%;"></td> <td style="width: 10%;"></td> <td style="width: 10%;"></td> <td style="width: 10%;"></td> <td style="width: 10%;"></td> <td style="width: 10%;"></td> <td style="width: 10%;"></td> </tr> <tr> <td></td> <td></td> <td colspan="8" style="text-align: center;"> <table border="1" style="width: 100%; border-collapse: collapse; text-align: center;"> <tr> <td style="width: 10%;"></td> <td style="width: 10%;"></td> <td style="width: 10%;"></td> <td style="width: 10%;"></td> <td style="width: 10%;"></td> <td style="width: 10%;"></td> <td style="width: 10%;"></td> <td style="width: 10%;"></td> <td style="width: 10%;"></td> <td style="width: 10%;"></td> </tr> <tr> <td></td> <td></td> <td colspan="8" style="text-align: center;"> <table border="1" style="width: 100%; border-collapse: collapse; text-align: center;"> <tr> <td style="width: 10%;"></td> <td style="width: 10%;"></td> <td style="width: 10%;"></td> <td style="width: 10%;"></td> <td style="width: 10%;"></td> <td style="width: 10%;"></td> <td style="width: 10%;"></td> <td style="width: 10%;"></td> <td style="width: 10%;"></td> <td style="width: 10%;"></td> </tr> <tr> <td></td> <td></td> <td colspan="8" style="text-align: center;"> <table border="1" style="width: 100%; border-collapse: collapse; text-align: center;"> <tr> <td style="width: 10%;"></td> <td style="width: 10%;"></td> <td style="width: 10%;"></td> <td style="width: 10%;"></td> <td style="width: 10%;"></td> <td style="width: 10%;"></td> <td style="width: 10%;"></td> <td style="width: 10%;"></td> <td style="width: 10%;"></td> <td style="width: 10%;"></td> </tr> <tr> <td></td> <td></td> <td colspan="8" style="text-align: center;"> <table border="1" style="width: 100%; border-collapse: collapse; text-align: center;"> <tr> <td style="width: 10%;"></td> <td style="width: 10%;"></td> <td style="width: 10%;"></td> <td style="width: 10%;"></td> <td style="width: 10%;"></td> <td style="width: 10%;"></td> <td style="width: 10%;"></td> <td style="width: 10%;"></td> <td style="width: 10%;"></td> <td style="width: 10%;"></td> </tr> <tr> <td></td> <td></td> <td colspan="8" style="text-align: center;"> <table border="1" style="width: 100%; border-collapse: collapse; text-align: center;"> <tr> <td style="width: 10%;"></td> <td style="width: 10%;"></td> <td style="width: 10%;"></td> <td style="width: 10%;"></td> <td style="width: 10%;"></td> <td style="width: 10%;"></td> <td style="width: 10%;"></td> <td style="width: 10%;"></td> <td style="width: 10%;"></td> <td style="width: 10%;"></td> </tr> <tr> <td></td> <td></td> <td colspan="8" style="text-align: center;"> <table border="1" style="width: 100%; border-collapse: collapse; text-align: center;"> <tr> <td style="width: 10%;"></td> <td style="width: 10%;"></td> <td style="width: 10%;"></td> <td style="width: 10%;"></td> <td style="width: 10%;"></td> <td style="width: 10%;"></td> <td style="width:
10%;"></td> <td style="width: 10%;"></td> <td style="width: 10%;"></td> <td style="width: 10%;"></td> </tr> <tr> <td></td> <td></td> <td colspan="8" style="text-align: center;"> <table border="1" style="width: 100%; border-collapse: collapse; text-align: center;"> <tr> <td style="width: 10%;"></td> <td style="width: 10%;"></td> <td style="width: 10%;"></td> <td style="width: 10%;"></td> <td style="width: 10%;"></td> <td style="width: 10%;"></td> <td style="width: 10%;"></td> <td style="width: 10%;"></td> <td style="width: 10%;"></td> <td style="width: 10%;"></td> </tr> <tr> <td></td> <td></td> <td colspan="8" style="text-align: center;"> <table border="1" style="width: 100%; border-collapse: collapse; text-align: center;"> <tr> <td style="width: 10%;"></td> <td style="width: 10%;"></td> <td style="width: 10%;"></td> <td style="width: 10%;"></td> <td style="width: 10%;"></td> <td style="width: 10%;"></td> <td style="width: 10%;"></td> <td style="width: 10%;"></td> <td style="width: 10%;"></td> <td style="width: 10%;"></td> </tr> <tr> <td></td> <td></td> <td colspan="8" style="text-align: center;"> <table border="1" style="width: 100%; border-collapse: collapse; text-align: center;"> <tr> <td style="width: 10%;"></td> <td style="width: 10%;"></td> <td style="width: 10%;"></td> <td style="width: 10%;"></td> <td style="width: 10%;"></td> <td style="width: 10%;"></td> <td style="width: 10%;"></td> <td style="width: 10%;"></td> <td style="width: 10%;"></td> <td style="width: 10%;"></td> </tr> <tr> <td></td> <td></td> <td colspan="8" style="text-align: center;"> <table border="1" style="width: 100%; border-collapse: collapse; text-align: center;"> <tr> <td style="width: 10%;"></td> <td style="width: 10%;"></td> <td style="width: 10%;"></td> <td style="width: 10%;"></td> <td style="width: 10%;"></td> <td style="width: 10%;"></td> <td style="width: 10%;"></td> <td style="width: 10%;"></td> <td style="width: 10%;"></td> <td style="width: 10%;"></td> </tr> <tr> <td></td> <td></td> <td colspan="8" style="text-align: center;"> <table border="1" style="width: 100%; border-collapse: collapse; text-align: center;"> <tr> <td style="width: 10%;"></td> <td style="width: 10%;"></td> <td style="width: 10%;"></td> <td style="width: 10%;"></td> <td style="width: 10%;"></td> <td style="width: 10%;"></td> <td style="width: 10%;"></td> <td style="width: 10%;"></td> <td style="width: 10%;"></td> <td style="width: 10%;"></td> </tr> <tr> <td></td> <td></td> <td colspan="8" style="text-align: center;"> <table border="1" style="width: 100%; border-collapse: collapse; text-align: center;"> <tr> <td style="width: 10%;"></td> <td style="width: 10%;"></td> <td style="width: 10%;"></td> <td style="width: 10%;"></td> <td style="width: 10%;"></td> <td style="width: 10%;"></td> <td style="width: 10%;"></td> <td style="width: 10%;"></td> <td style="width: 10%;"></td> <td style="width: 10%;"></td> </tr> <tr> <td></td> <td></td> <td colspan="8" style="text-align: center;"> <table border="1" style="width: 100%; border-collapse: collapse; text-align: center;"> <tr> <td style="width: 10%;"></td> <td style="width: 10%;"></td> <td style="width: 10%;"></td> <td style="width: 10%;"></td> <td style="width: 10%;"></td> <td style="width: 10%;"></td> <td style="width: 10%;"></td> <td style="width: 10%;"></td> <td style="width: 10%;"></td> <td style="width: 10%;"></td> </tr> <tr> <td></td> <td></td> <td colspan="8" style="text-align: center;"> <table border="1" style="width: 100%; border-collapse: collapse; text-align: center;"> <tr> </tr></table></td></tr></table></td></tr></table></td></tr></table></td></tr></table></td></tr></table></td></tr></table></td></tr></table></td></tr></table></td></tr></table></td></tr></table></td></tr></table></td></tr></table></td></tr></table></td></tr></table></td></tr></table></td></tr></table></td></tr></table></td></tr></table></td></tr></table></td></tr></table></td></tr></table> | | | | | | | | | | | | | | | | | | | | <table border="1" style="width: 100%; border-collapse: collapse; text-align: center;"> <tr> <td style="width: 10%;"></td> <td style="width: 10%;"></td> <td style="width: 10%;"></td> <td style="width: 10%;"></td> <td style="width: 10%;"></td> <td style="width: 10%;"></td> <td style="width: 10%;"></td> <td style="width: 10%;"></td> <td style="width: 10%;"></td> <td style="width: 10%;"></td> </tr> <tr> <td></td> <td></td> <td colspan="8" style="text-align: center;"> <table border="1" style="width: 100%; border-collapse: collapse; text-align: center;"> <tr> <td style="width: 10%;"></td> <td style="width: 10%;"></td> <td style="width: 10%;"></td> <td style="width: 10%;"></td> <td style="width: 10%;"></td> <td style="width: 10%;"></td> <td style="width: 10%;"></td> <td style="width: 10%;"></td> <td style="width: 10%;"></td> <td style="width: 10%;"></td> </tr> <tr> <td></td> <td></td> <td colspan="8" style="text-align: center;"> <table border="1" style="width: 100%; border-collapse: collapse; text-align: center;"> <tr> <td style="width: 10%;"></td> <td style="width: 10%;"></td> <td style="width: 10%;"></td> <td style="width: 10%;"></td> <td style="width: 10%;"></td> <td style="width: 10%;"></td> <td style="width: 10%;"></td> <td style="width: 10%;"></td> <td style="width: 10%;"></td> <td style="width: 10%;"></td> </tr> <tr> <td></td> <td></td> <td colspan="8" style="text-align: center;"> <table border="1" style="width: 100%; border-collapse: collapse; text-align: center;"> <tr> <td style="width: 10%;"></td> <td style="width: 10%;"></td> <td style="width: 10%;"></td> <td style="width: 10%;"></td> <td style="width: 10%;"></td> <td style="width: 10%;"></td> <td style="width: 10%;"></td> <td style="width: 10%;"></td> <td style="width: 10%;"></td> <td style="width: 10%;"></td> </tr> <tr> <td></td> <td></td> <td colspan="8" style="text-align: center;"> <table border="1" style="width: 100%; border-collapse: collapse; text-align: center;"> <tr> <td style="width: 10%;"></td> <td style="width: 10%;"></td> <td style="width: 10%;"></td> <td style="width: 10%;"></td> <td style="width: 10%;"></td> <td style="width: 10%;"></td> <td style="width: 10%;"></td> <td style="width: 10%;"></td> <td style="width: 10%;"></td> <td style="width: 10%;"></td> </tr> <tr> <td></td> <td></td> <td colspan="8" style="text-align: center;"> <table border="1" style="width: 100%; border-collapse: collapse; text-align: center;"> <tr> <td style="width: 10%;"></td> <td style="width: 10%;"></td> <td style="width: 10%;"></td> <td style="width: 10%;"></td> <td style="width: 10%;"></td> <td style="width: 10%;"></td> <td style="width: 10%;"></td> <td style="width: 10%;"></td> <td style="width: 10%;"></td> <td style="width: 10%;"></td> </tr> <tr> <td></td> <td></td> <td colspan="8" style="text-align: center;"> <table border="1" style="width: 100%; border-collapse: collapse; text-align: center;"> <tr> <td style="width: 10%;"></td> <td style="width: 10%;"></td> <td style="width: 10%;"></td> <td style="width: 10%;"></td> <td style="width: 10%;"></td> <td style="width: 10%;"></td> <td style="width: 10%;"></td> <td style="width: 10%;"></td> <td style="width: 10%;"></td> <td style="width: 10%;"></td> </tr> <tr> <td></td> <td></td> <td colspan="8" style="text-align: center;"> <table border="1" style="width: 100%; border-collapse: collapse; text-align: center;"> <tr> <td style="width: 10%;"></td> <td style="width: 10%;"></td> <td style="width: 10%;"></td> <td style="width: 10%;"></td> <td style="width: 10%;"></td> <td style="width: 10%;"></td> <td style="width: 10%;"></td> <td style="width: 10%;"></td> <td style="width: 10%;"></td> <td style="width: 10%;"></td> </tr> <tr> <td></td> <td></td> <td colspan="8" style="text-align: center;"> <table border="1" style="width: 100%; border-collapse: collapse; text-align: center;"> <tr> <td style="width: 10%;"></td> <td style="width: 10%;"></td> <td style="width: 10%;"></td> <td style="width: 10%;"></td> <td style="width: 10%;"></td> <td style="width: 10%;"></td> <td style="width: 10%;"></td> <td style="width: 10%;"></td> <td style="width: 10%;"></td> <td style="width: 10%;"></td> </tr> <tr> <td></td> <td></td> <td colspan="8" style="text-align: center;"> <table border="1" style="width: 100%; border-collapse: collapse; text-align: center;"> <tr> <td style="width: 10%;"></td> <td style="width: 10%;"></td> <td style="width: 10%;"></td> <td style="width: 10%;"></td> <td style="width: 10%;"></td> <td style="width: 10%;"></td> <td style="width: 10%;"></td> <td style="width: 10%;"></td>
<td style="width: 10%;"></td> <td style="width: 10%;"></td> </tr> <tr> <td></td> <td></td> <td colspan="8" style="text-align: center;"> <table border="1" style="width: 100%; border-collapse: collapse; text-align: center;"> <tr> <td style="width: 10%;"></td> <td style="width: 10%;"></td> <td style="width: 10%;"></td> <td style="width: 10%;"></td> <td style="width: 10%;"></td> <td style="width: 10%;"></td> <td style="width: 10%;"></td> <td style="width: 10%;"></td> <td style="width: 10%;"></td> <td style="width: 10%;"></td> </tr> <tr> <td></td> <td></td> <td colspan="8" style="text-align: center;"> <table border="1" style="width: 100%; border-collapse: collapse; text-align: center;"> <tr> <td style="width: 10%;"></td> <td style="width: 10%;"></td> <td style="width: 10%;"></td> <td style="width: 10%;"></td> <td style="width: 10%;"></td> <td style="width: 10%;"></td> <td style="width: 10%;"></td> <td style="width: 10%;"></td> <td style="width: 10%;"></td> <td style="width: 10%;"></td> </tr> <tr> <td></td> <td></td> <td colspan="8" style="text-align: center;"> <table border="1" style="width: 100%; border-collapse: collapse; text-align: center;"> <tr> <td style="width: 10%;"></td> <td style="width: 10%;"></td> <td style="width: 10%;"></td> <td style="width: 10%;"></td> <td style="width: 10%;"></td> <td style="width: 10%;"></td> <td style="width: 10%;"></td> <td style="width: 10%;"></td> <td style="width: 10%;"></td> <td style="width: 10%;"></td> </tr> <tr> <td></td> <td></td> <td colspan="8" style="text-align: center;"> <table border="1" style="width: 100%; border-collapse: collapse; text-align: center;"> <tr> <td style="width: 10%;"></td> <td style="width: 10%;"></td> <td style="width: 10%;"></td> <td style="width: 10%;"></td> <td style="width: 10%;"></td> <td style="width: 10%;"></td> <td style="width: 10%;"></td> <td style="width: 10%;"></td> <td style="width: 10%;"></td> <td style="width: 10%;"></td> </tr> <tr> <td></td> <td></td> <td colspan="8" style="text-align: center;"> <table border="1" style="width: 100%; border-collapse: collapse; text-align: center;"> <tr> <td style="width: 10%;"></td> <td style="width: 10%;"></td> <td style="width: 10%;"></td> <td style="width: 10%;"></td> <td style="width: 10%;"></td> <td style="width: 10%;"></td> <td style="width: 10%;"></td> <td style="width: 10%;"></td> <td style="width: 10%;"></td> <td style="width: 10%;"></td> </tr> <tr> <td></td> <td></td> <td colspan="8" style="text-align: center;"> <table border="1" style="width: 100%; border-collapse: collapse; text-align: center;"> <tr> <td style="width: 10%;"></td> <td style="width: 10%;"></td> <td style="width: 10%;"></td> <td style="width: 10%;"></td> <td style="width: 10%;"></td> <td style="width: 10%;"></td> <td style="width: 10%;"></td> <td style="width: 10%;"></td> <td style="width: 10%;"></td> <td style="width: 10%;"></td> </tr> <tr> <td></td> <td></td> <td colspan="8" style="text-align: center;"> <table border="1" style="width: 100%; border-collapse: collapse; text-align: center;"> <tr> <td style="width: 10%;"></td> <td style="width: 10%;"></td> <td style="width: 10%;"></td> <td style="width: 10%;"></td> <td style="width: 10%;"></td> <td style="width: 10%;"></td> <td style="width: 10%;"></td> <td style="width: 10%;"></td> <td style="width: 10%;"></td> <td style="width: 10%;"></td> </tr> <tr> <td></td> <td></td> <td colspan="8" style="text-align: center;"> <table border="1" style="width: 100%; border-collapse: collapse; text-align: center;"> <tr> <td style="width: 10%;"></td> <td style="width: 10%;"></td> <td style="width: 10%;"></td> <td style="width: 10%;"></td> <td style="width: 10%;"></td> <td style="width: 10%;"></td> <td style="width: 10%;"></td> <td style="width: 10%;"></td> <td style="width: 10%;"></td> <td style="width: 10%;"></td> </tr> <tr> <td></td> <td></td> <td colspan="8" style="text-align: center;"> <table border="1" style="width: 100%; border-collapse: collapse; text-align: center;"> <tr> <td style="width: 10%;"></td> <td style="width: 10%;"></td> <td style="width: 10%;"></td> <td style="width: 10%;"></td> <td style="width: 10%;"></td> <td style="width: 10%;"></td> <td style="width: 10%;"></td> <td style="width: 10%;"></td> <td style="width: 10%;"></td> <td style="width: 10%;"></td> </tr> <tr> <td></td> <td></td> <td colspan="8" style="text-align: center;"> <table border="1" style="width: 100%; border-collapse: collapse; text-align: center;"> <tr> <td style="width: 10%;"></td> <td style="width: 10%;"></td> <td style="width: 10%;"></td> <td style="width: 10%;"></td> <td style="width: 10%;"></td> <td style="width: 10%;"></td> <td style="width: 10%;"></td> <td style="width: 10%;"></td> <td style="width: 10%;"></td> <td style="width: 10%;"></td> </tr> <tr> <td></td> <td></td> <td colspan="8" style="text-align: center;"> <table border="1" style="width: 100%; border-collapse: collapse; text-align: center;"> <tr> </tr></table></td></tr></table></td></tr></table></td></tr></table></td></tr></table></td></tr></table></td></tr></table></td></tr></table></td></tr></table></td></tr></table></td></tr></table></td></tr></table></td></tr></table></td></tr></table></td></tr></table></td></tr></table></td></tr></table></td></tr></table></td></tr></table></td></tr></table></td></tr></table> | | | | | | | | | | | | | | | | | | | | <table border="1" style="width: 100%; border-collapse: collapse; text-align: center;"> <tr> <td style="width: 10%;"></td> <td style="width: 10%;"></td> <td style="width: 10%;"></td> <td style="width: 10%;"></td> <td style="width: 10%;"></td> <td style="width: 10%;"></td> <td style="width: 10%;"></td> <td style="width: 10%;"></td> <td style="width: 10%;"></td> <td style="width: 10%;"></td> </tr> <tr> <td></td> <td></td> <td colspan="8" style="text-align: center;"> <table border="1" style="width: 100%; border-collapse: collapse; text-align: center;"> <tr> <td style="width: 10%;"></td> <td style="width: 10%;"></td> <td style="width: 10%;"></td> <td style="width: 10%;"></td> <td style="width: 10%;"></td> <td style="width: 10%;"></td> <td style="width: 10%;"></td> <td style="width: 10%;"></td> <td style="width: 10%;"></td> <td style="width: 10%;"></td> </tr> <tr> <td></td> <td></td> <td colspan="8" style="text-align: center;"> <table border="1" style="width: 100%; border-collapse: collapse; text-align: center;"> <tr> <td style="width: 10%;"></td> <td style="width: 10%;"></td> <td style="width: 10%;"></td> <td style="width: 10%;"></td> <td style="width: 10%;"></td> <td style="width: 10%;"></td> <td style="width: 10%;"></td> <td style="width: 10%;"></td> <td style="width: 10%;"></td> <td style="width: 10%;"></td> </tr> <tr> <td></td> <td></td> <td colspan="8" style="text-align: center;"> <table border="1" style="width: 100%; border-collapse: collapse; text-align: center;"> <tr> <td style="width: 10%;"></td> <td style="width: 10%;"></td> <td style="width: 10%;"></td> <td style="width: 10%;"></td> <td style="width: 10%;"></td> <td style="width: 10%;"></td> <td style="width: 10%;"></td> <td style="width: 10%;"></td> <td style="width: 10%;"></td> <td style="width: 10%;"></td> </tr> <tr> <td></td> <td></td> <td colspan="8" style="text-align: center;"> <table border="1" style="width: 100%; border-collapse: collapse; text-align: center;"> <tr> <td style="width: 10%;"></td> <td style="width: 10%;"></td> <td style="width: 10%;"></td> <td style="width: 10%;"></td> <td style="width: 10%;"></td> <td style="width: 10%;"></td> <td style="width: 10%;"></td> <td style="width: 10%;"></td> <td style="width: 10%;"></td> <td style="width: 10%;"></td> </tr> <tr> <td></td> <td></td> <td colspan="8" style="text-align: center;"> <table border="1" style="width: 100%; border-collapse: collapse; text-align: center;"> <tr> <td style="width: 10%;"></td> <td style="width: 10%;"></td> <td style="width: 10%;"></td> <td style="width: 10%;"></td> <td style="width: 10%;"></td> <td style="width: 10%;"></td> <td style="width: 10%;"></td> <td style="width: 10%;"></td> <td style="width: 10%;"></td> <td style="width: 10%;"></td> </tr> <tr> <td></td> <td></td> <td colspan="8" style="text-align: center;"> <table border="1" style="width: 100%; border-collapse: collapse; text-align: center;"> <tr> <td style="width: 10%;"></td> <td style="width: 10%;"></td> <td style="width: 10%;"></td> <td style="width: 10%;"></td> <td style="width: 10%;"></td> <td style="width: 10%;"></td> <td style="width: 10%;"></td> <td style="width: 10%;"></td> <td style="width: 10%;"></td> <td style="width: 10%;"></td>
</tr> <tr> <td></td> <td></td> <td colspan="8" style="text-align: center;"> <table border="1" style="width: 100%; border-collapse: collapse; text-align: center;"> <tr> <td style="width: 10%;"></td> <td style="width: 10%;"></td> <td style="width: 10%;"></td> <td style="width: 10%;"></td> <td style="width: 10%;"></td> <td style="width: 10%;"></td> <td style="width: 10%;"></td> <td style="width: 10%;"></td> <td style="width: 10%;"></td> <td style="width: 10%;"></td> </tr> <tr> <td></td> <td></td> <td colspan="8" style="text-align: center;"> <table border="1" style="width: 100%; border-collapse: collapse; text-align: center;"> <tr> <td style="width: 10%;"></td> <td style="width: 10%;"></td> <td style="width: 10%;"></td> <td style="width: 10%;"></td> <td style="width: 10%;"></td> <td style="width: 10%;"></td> <td style="width: 10%;"></td> <td style="width: 10%;"></td> <td style="width: 10%;"></td> <td style="width: 10%;"></td> </tr> <tr> <td></td> <td></td> <td colspan="8" style="text-align: center;"> <table border="1" style="width: 100%; border-collapse: collapse; text-align: center;"> <tr> <td style="width: 10%;"></td> <td style="width: 10%;"></td> <td style="width: 10%;"></td> <td style="width: 10%;"></td> <td style="width: 10%;"></td> <td style="width: 10%;"></td> <td style="width: 10%;"></td> <td style="width: 10%;"></td> <td style="width: 10%;"></td> <td style="width: 10%;"></td> </tr> <tr> <td></td> <td></td> <td colspan="8" style="text-align: center;"> <table border="1" style="width: 100%; border-collapse: collapse; text-align: center;"> <tr> <td style="width: 10%;"></td> <td style="width: 10%;"></td> <td style="width: 10%;"></td> <td style="width: 10%;"></td> <td style="width: 10%;"></td> <td style="width: 10%;"></td> <td style="width: 10%;"></td> <td style="width: 10%;"></td> <td style="width: 10%;"></td> <td style="width: 10%;"></td> </tr> <tr> <td></td> <td></td> <td colspan="8" style="text-align: center;"> <table border="1" style="width: 100%; border-collapse: collapse; text-align: center;"> <tr> <td style="width: 10%;"></td> <td style="width: 10%;"></td> <td style="width: 10%;"></td> <td style="width: 10%;"></td> <td style="width: 10%;"></td> <td style="width: 10%;"></td> <td style="width: 10%;"></td> <td style="width: 10%;"></td> <td style="width: 10%;"></td> <td style="width: 10%;"></td> </tr> <tr> <td></td> <td></td> <td colspan="8" style="text-align: center;"> <table border="1" style="width: 100%; border-collapse: collapse; text-align: center;"> <tr> <td style="width: 10%;"></td> <td style="width: 10%;"></td> <td style="width: 10%;"></td> <td style="width: 10%;"></td> <td style="width: 10%;"></td> <td style="width: 10%;"></td> <td style="width: 10%;"></td> <td style="width: 10%;"></td> <td style="width: 10%;"></td> <td style="width: 10%;"></td> </tr> <tr> <td></td> <td></td> <td colspan="8" style="text-align: center;"> <table border="1" style="width: 100%; border-collapse: collapse; text-align: center;"> <tr> <td style="width: 10%;"></td> <td style="width: 10%;"></td> <td style="width: 10%;"></td> <td style="width: 10%;"></td> <td style="width: 10%;"></td> <td style="width: 10%;"></td> <td style="width: 10%;"></td> <td style="width: 10%;"></td> <td style="width: 10%;"></td> <td style="width: 10%;"></td> </tr> <tr> <td></td> <td></td> <td colspan="8" style="text-align: center;"> <table border="1" style="width: 100%; border-collapse: collapse; text-align: center;"> <tr> <td style="width: 10%;"></td> <td style="width: 10%;"></td> <td style="width: 10%;"></td> <td style="width: 10%;"></td> <td style="width: 10%;"></td> <td style="width: 10%;"></td> <td style="width: 10%;"></td> <td style="width: 10%;"></td> <td style="width: 10%;"></td> <td style="width: 10%;"></td> </tr> <tr> <td></td> <td></td> <td colspan="8" style="text-align: center;"> <table border="1" style="width: 100%; border-collapse: collapse; text-align: center;"> <tr> <td style="width: 10%;"></td> <td style="width: 10%;"></td> <td style="width: 10%;"></td> <td style="width: 10%;"></td> <td style="width: 10%;"></td> <td style="width: 10%;"></td> <td style="width: 10%;"></td> <td style="width: 10%;"></td> <td style="width: 10%;"></td> <td style="width: 10%;"></td> </tr> <tr> <td></td> <td></td> <td colspan="8" style="text-align: center;"> <table border="1" style="width: 100%; border-collapse: collapse; text-align: center;"> <tr> <td style="width: 10%;"></td> <td style="width: 10%;"></td> <td style="width: 10%;"></td> <td style="width: 10%;"></td> <td style="width: 10%;"></td> <td style="width: 10%;"></td> <td style="width: 10%;"></td> <td style="width: 10%;"></td> <td style="width: 10%;"></td> <td style="width: 10%;"></td> </tr> <tr> <td></td> <td></td> <td colspan="8" style="text-align: center;"> <table border="1" style="width: 100%; border-collapse: collapse; text-align: center;"> <tr> <td style="width: 10%;"></td> <td style="width: 10%;"></td> <td style="width: 10%;"></td> <td style="width: 10%;"></td> <td style="width: 10%;"></td> <td style="width: 10%;"></td> <td style="width: 10%;"></td> <td style="width: 10%;"></td> <td style="width: 10%;"></td> <td style="width: 10%;"></td> </tr> <tr> <td></td> <td></td> <td colspan="8" style="text-align: center;"> <table border="1" style="width: 100%; border-collapse: collapse; text-align: center;"> <tr> <td style="width: 10%;"></td> <td style="width: 10%;"></td> <td style="width: 10%;"></td> <td style="width: 10%;"></td> <td style="width: 10%;"></td> <td style="width: 10%;"></td> <td style="width: 10%;"></td> <td style="width: 10%;"></td> <td style="width: 10%;"></td> <td style="width: 10%;"></td> </tr> <tr> <td></td> <td></td> <td colspan="8" style="text-align: center;"> <table border="1" style="width: 100%; border-collapse: collapse; text-align: center;"> <tr> </tr></table></td></tr></table></td></tr></table></td></tr></table></td></tr></table></td></tr></table></td></tr></table></td></tr></table></td></tr></table></td></tr></table></td></tr></table></td></tr></table></td></tr></table></td></tr></table></td></tr></table></td></tr></table></td></tr></table></td></tr></table></td></tr></table></td></tr></table> | | | | | | | | | | | | | | | | | | | | <table border="1" style="width: 100%; border-collapse: collapse; text-align: center;"> <tr> <td style="width: 10%;"></td> <td style="width: 10%;"></td> <td style="width: 10%;"></td> <td style="width: 10%;"></td> <td style="width: 10%;"></td> <td style="width: 10%;"></td> <td style="width: 10%;"></td> <td style="width: 10%;"></td> <td style="width: 10%;"></td> <td style="width: 10%;"></td> </tr> <tr> <td></td> <td></td> <td colspan="8" style="text-align: center;"> <table border="1" style="width: 100%; border-collapse: collapse; text-align: center;"> <tr> <td style="width: 10%;"></td> <td style="width: 10%;"></td> <td style="width: 10%;"></td> <td style="width: 10%;"></td> <td style="width: 10%;"></td> <td style="width: 10%;"></td> <td style="width: 10%;"></td> <td style="width: 10%;"></td> <td style="width: 10%;"></td> <td style="width: 10%;"></td> </tr> <tr> <td></td> <td></td> <td colspan="8" style="text-align: center;"> <table border="1" style="width: 100%; border-collapse: collapse; text-align: center;"> <tr> <td style="width: 10%;"></td> <td style="width: 10%;"></td> <td style="width: 10%;"></td> <td style="width: 10%;"></td> <td style="width: 10%;"></td> <td style="width: 10%;"></td> <td style="width: 10%;"></td> <td style="width: 10%;"></td> <td style="width: 10%;"></td> <td style="width: 10%;"></td> </tr> <tr> <td></td> <td></td> <td colspan="8" style="text-align: center;"> <table border="1" style="width: 100%; border-collapse: collapse; text-align: center;"> <tr> <td style="width: 10%;"></td> <td style="width: 10%;"></td> <td style="width: 10%;"></td> <td style="width: 10%;"></td> <td style="width: 10%;"></td> <td style="width: 10%;"></td> <td style="width: 10%;"></td> <td style="width: 10%;"></td> <td style="width: 10%;"></td> <td style="width: 10%;"></td> </tr> <tr> <td></td> <td></td> <td colspan="8" style="text-align: center;"> <table border="1" style="width: 100%; border-collapse: collapse; text-align: center;"> <tr> <td style="width: 10%;"></td> <td style="width: 10%;"></td> <td style="width: 10%;"></td> <td style="width: 10%;"></td> <td style="width: 10%;"></td> <td style="width: 10%;"></td> <td style="width: 10%;"></td> <td style="width: 10%;"></td> <td style="width: 10%;"></td> <td style="width: 10%;"></td> </tr> <tr> <td></td> <td></td> <td colspan="8" style="text-align: center;">
<table border="1" style="width: 100%; border-collapse: collapse; text-align: center;"> <tr> <td style="width: 10%;"></td> <td style="width: 10%;"></td> <td style="width: 10%;"></td> <td style="width: 10%;"></td> <td style="width: 10%;"></td> <td style="width: 10%;"></td> <td style="width: 10%;"></td> <td style="width: 10%;"></td> <td style="width: 10%;"></td> <td style="width: 10%;"></td> </tr> <tr> <td></td> <td></td> <td colspan="8" style="text-align: center;"> <table border="1" style="width: 100%; border-collapse: collapse; text-align: center;"> <tr> <td style="width: 10%;"></td> <td style="width: 10%;"></td> <td style="width: 10%;"></td> <td style="width: 10%;"></td> <td style="width: 10%;"></td> <td style="width: 10%;"></td> <td style="width: 10%;"></td> <td style="width: 10%;"></td> <td style="width: 10%;"></td> <td style="width: 10%;"></td> </tr> <tr> <td></td> <td></td> <td colspan="8" style="text-align: center;"> <table border="1" style="width: 100%; border-collapse: collapse; text-align: center;"> <tr> <td style="width: 10%;"></td> <td style="width: 10%;"></td> <td style="width: 10%;"></td> <td style="width: 10%;"></td> <td style="width: 10%;"></td> <td style="width: 10%;"></td> <td style="width: 10%;"></td> <td style="width: 10%;"></td> <td style="width: 10%;"></td> <td style="width: 10%;"></td> </tr> <tr> <td></td> <td></td> <td colspan="8" style="text-align: center;"> <table border="1" style="width: 100%; border-collapse: collapse; text-align: center;"> <tr> <td style="width: 10%;"></td> <td style="width: 10%;"></td> <td style="width: 10%;"></td> <td style="width: 10%;"></td> <td style="width: 10%;"></td> <td style="width: 10%;"></td> <td style="width: 10%;"></td> <td style="width: 10%;"></td> <td style="width: 10%;"></td> <td style="width: 10%;"></td> </tr> <tr> <td></td> <td></td> <td colspan="8" style="text-align: center;"> <table border="1" style="width: 100%; border-collapse: collapse; text-align: center;"> <tr> <td style="width: 10%;"></td> <td style="width: 10%;"></td> <td style="width: 10%;"></td> <td style="width: 10%;"></td> <td style="width: 10%;"></td> <td style="width: 10%;"></td> <td style="width: 10%;"></td> <td style="width: 10%;"></td> <td style="width: 10%;"></td> <td style="width: 10%;"></td> </tr> <tr> <td></td> <td></td> <td colspan="8" style="text-align: center;"> <table border="1" style="width: 100%; border-collapse: collapse; text-align: center;"> <tr> <td style="width: 10%;"></td> <td style="width: 10%;"></td> <td style="width: 10%;"></td> <td style="width: 10%;"></td> <td style="width: 10%;"></td> <td style="width: 10%;"></td> <td style="width: 10%;"></td> <td style="width: 10%;"></td> <td style="width: 10%;"></td> <td style="width: 10%;"></td> </tr> <tr> <td></td> <td></td> <td colspan="8" style="text-align: center;"> <table border="1" style="width: 100%; border-collapse: collapse; text-align: center;"> <tr> <td style="width: 10%;"></td> <td style="width: 10%;"></td> <td style="width: 10%;"></td> <td style="width: 10%;"></td> <td style="width: 10%;"></td> <td style="width: 10%;"></td> <td style="width: 10%;"></td> <td style="width: 10%;"></td> <td style="width: 10%;"></td> <td style="width: 10%;"></td> </tr> <tr> <td></td> <td></td> <td colspan="8" style="text-align: center;"> <table border="1" style="width: 100%; border-collapse: collapse; text-align: center;"> <tr> <td style="width: 10%;"></td> <td style="width: 10%;"></td> <td style="width: 10%;"></td> <td style="width: 10%;"></td> <td style="width: 10%;"></td> <td style="width: 10%;"></td> <td style="width: 10%;"></td> <td style="width: 10%;"></td> <td style="width: 10%;"></td> <td style="width: 10%;"></td> </tr> <tr> <td></td> <td></td> <td colspan="8" style="text-align: center;"> <table border="1" style="width: 100%; border-collapse: collapse; text-align: center;"> <tr> <td style="width: 10%;"></td> <td style="width: 10%;"></td> <td style="width: 10%;"></td> <td style="width: 10%;"></td> <td style="width: 10%;"></td> <td style="width: 10%;"></td> <td style="width: 10%;"></td> <td style="width: 10%;"></td> <td style="width: 10%;"></td> <td style="width: 10%;"></td> </tr> <tr> <td></td> <td></td> <td colspan="8" style="text-align: center;"> <table border="1" style="width: 100%; border-collapse: collapse; text-align: center;"> <tr> <td style="width: 10%;"></td> <td style="width: 10%;"></td> <td style="width: 10%;"></td> <td style="width: 10%;"></td> <td style="width: 10%;"></td> <td style="width: 10%;"></td> <td style="width: 10%;"></td> <td style="width: 10%;"></td> <td style="width: 10%;"></td> <td style="width: 10%;"></td> </tr> <tr> <td></td> <td></td> <td colspan="8" style="text-align: center;"> <table border="1" style="width: 100%; border-collapse: collapse; text-align: center;"> <tr> <td style="width: 10%;"></td> <td style="width: 10%;"></td> <td style="width: 10%;"></td> <td style="width: 10%;"></td> <td style="width: 10%;"></td> <td style="width: 10%;"></td> <td style="width: 10%;"></td> <td style="width: 10%;"></td> <td style="width: 10%;"></td> <td style="width: 10%;"></td> </tr> <tr> <td></td> <td></td> <td colspan="8" style="text-align: center;"> <table border="1" style="width: 100%; border-collapse: collapse; text-align: center;"> <tr> <td style="width: 10%;"></td> <td style="width: 10%;"></td> <td style="width: 10%;"></td> <td style="width: 10%;"></td> <td style="width: 10%;"></td> <td style="width: 10%;"></td> <td style="width: 10%;"></td> <td style="width: 10%;"></td> <td style="width: 10%;"></td> <td style="width: 10%;"></td> </tr> <tr> <td></td> <td></td> <td colspan="8" style="text-align: center;"> <table border="1" style="width: 100%; border-collapse: collapse; text-align: center;"> <tr> <td style="width: 10%;"></td> <td style="width: 10%;"></td> <td style="width: 10%;"></td> <td style="width: 10%;"></td> <td style="width: 10%;"></td> <td style="width: 10%;"></td> <td style="width: 10%;"></td> <td style="width: 10%;"></td> <td style="width: 10%;"></td> <td style="width: 10%;"></td> </tr> <tr> <td></td> <td></td> <td colspan="8" style="text-align: center;"> <table border="1" style="width: 100%; border-collapse: collapse; text-align: center;"> <tr> </tr></table></td></tr></table></td></tr></table></td></tr></table></td></tr></table></td></tr></table></td></tr></table></td></tr></table></td></tr></table></td></tr></table></td></tr></table></td></tr></table></td></tr></table></td></tr></table></td></tr></table></td></tr></table></td></tr></table></td></tr></table></td></tr></table> | | | | | | | | | | | | | | | | | | | | <table border="1" style="width: 100%; border-collapse: collapse; text-align: center;"> <tr> <td style="width: 10%;"></td> <td style="width: 10%;"></td> <td style="width: 10%;"></td> <td style="width: 10%;"></td> <td style="width: 10%;"></td> <td style="width: 10%;"></td> <td style="width: 10%;"></td> <td style="width: 10%;"></td> <td style="width: 10%;"></td> <td style="width: 10%;"></td> </tr> <tr> <td></td> <td></td> <td colspan="8" style="text-align: center;"> <table border="1" style="width: 100%; border-collapse: collapse; text-align: center;"> <tr> <td style="width: 10%;"></td> <td style="width: 10%;"></td> <td style="width: 10%;"></td> <td style="width: 10%;"></td> <td style="width: 10%;"></td> <td style="width: 10%;"></td> <td style="width: 10%;"></td> <td style="width: 10%;"></td> <td style="width: 10%;"></td> <td style="width: 10%;"></td> </tr> <tr> <td></td> <td></td> <td colspan="8" style="text-align: center;"> <table border="1" style="width: 100%; border-collapse: collapse; text-align: center;"> <tr> <td style="width: 10%;"></td> <td style="width: 10%;"></td> <td style="width: 10%;"></td> <td style="width: 10%;"></td> <td style="width: 10%;"></td> <td style="width: 10%;"></td> <td style="width: 10%;"></td> <td style="width: 10%;"></td> <td style="width: 10%;"></td> <td style="width: 10%;"></td> </tr> <tr> <td></td> <td></td> <td colspan="8" style="text-align: center;"> <table border="1" style="width: 100%; border-collapse: collapse; text-align: center;"> <tr> <td style="width: 10%;"></td> <td style="width: 10%;"></td> <td style="width: 10%;"></td> <td style="width: 10%;"></td> <td style="width: 10%;"></td> <td style="width: 10%;"></td> <td style="width: 10%;"></td> <td style="width: 10%;"></td> <td style="width: 10%;"></td> <td style="width: 10%;"></td> </tr> <tr> <td></td> <td></td> <td colspan="8" style="text-align: center;"> <table border="1" style="width: 100%; border-collapse: collapse; text-align: center;"> <tr> <td
style="width: 10%;"></td> <td style="width: 10%;"></td> <td style="width: 10%;"></td> <td style="width: 10%;"></td> <td style="width: 10%;"></td> <td style="width: 10%;"></td> <td style="width: 10%;"></td> <td style="width: 10%;"></td> <td style="width: 10%;"></td> <td style="width: 10%;"></td> </tr> <tr> <td></td> <td></td> <td colspan="8" style="text-align: center;"> <table border="1" style="width: 100%; border-collapse: collapse; text-align: center;"> <tr> <td style="width: 10%;"></td> <td style="width: 10%;"></td> <td style="width: 10%;"></td> <td style="width: 10%;"></td> <td style="width: 10%;"></td> <td style="width: 10%;"></td> <td style="width: 10%;"></td> <td style="width: 10%;"></td> <td style="width: 10%;"></td> <td style="width: 10%;"></td> </tr> <tr> <td></td> <td></td> <td colspan="8" style="text-align: center;"> <table border="1" style="width: 100%; border-collapse: collapse; text-align: center;"> <tr> <td style="width: 10%;"></td> <td style="width: 10%;"></td> <td style="width: 10%;"></td> <td style="width: 10%;"></td> <td style="width: 10%;"></td> <td style="width: 10%;"></td> <td style="width: 10%;"></td> <td style="width: 10%;"></td> <td style="width: 10%;"></td> <td style="width: 10%;"></td> </tr> <tr> <td></td> <td></td> <td colspan="8" style="text-align: center;"> <table border="1" style="width: 100%; border-collapse: collapse; text-align: center;"> <tr> <td style="width: 10%;"></td> <td style="width: 10%;"></td> <td style="width: 10%;"></td> <td style="width: 10%;"></td> <td style="width: 10%;"></td> <td style="width: 10%;"></td> <td style="width: 10%;"></td> <td style="width: 10%;"></td> <td style="width: 10%;"></td> <td style="width: 10%;"></td> </tr> <tr> <td></td> <td></td> <td colspan="8" style="text-align: center;"> <table border="1" style="width: 100%; border-collapse: collapse; text-align: center;"> <tr> <td style="width: 10%;"></td> <td style="width: 10%;"></td> <td style="width: 10%;"></td> <td style="width: 10%;"></td> <td style="width: 10%;"></td> <td style="width: 10%;"></td> <td style="width: 10%;"></td> <td style="width: 10%;"></td> <td style="width: 10%;"></td> <td style="width: 10%;"></td> </tr> <tr> <td></td> <td></td> <td colspan="8" style="text-align: center;"> <table border="1" style="width: 100%; border-collapse: collapse; text-align: center;"> <tr> <td style="width: 10%;"></td> <td style="width: 10%;"></td> <td style="width: 10%;"></td> <td style="width: 10%;"></td> <td style="width: 10%;"></td> <td style="width: 10%;"></td> <td style="width: 10%;"></td> <td style="width: 10%;"></td> <td style="width: 10%;"></td> <td style="width: 10%;"></td> </tr> <tr> <td></td> <td></td> <td colspan="8" style="text-align: center;"> <table border="1" style="width: 100%; border-collapse: collapse; text-align: center;"> <tr> <td style="width: 10%;"></td> <td style="width: 10%;"></td> <td style="width: 10%;"></td> <td style="width: 10%;"></td> <td style="width: 10%;"></td> <td style="width: 10%;"></td> <td style="width: 10%;"></td> <td style="width: 10%;"></td> <td style="width: 10%;"></td> <td style="width: 10%;"></td> </tr> <tr> <td></td> <td></td> <td colspan="8" style="text-align: center;"> <table border="1" style="width: 100%; border-collapse: collapse; text-align: center;"> <tr> <td style="width: 10%;"></td> <td style="width: 10%;"></td> <td style="width: 10%;"></td> <td style="width: 10%;"></td> <td style="width: 10%;"></td> <td style="width: 10%;"></td> <td style="width: 10%;"></td> <td style="width: 10%;"></td> <td style="width: 10%;"></td> <td style="width: 10%;"></td> </tr> <tr> <td></td> <td></td> <td colspan="8" style="text-align: center;"> <table border="1" style="width: 100%; border-collapse: collapse; text-align: center;"> <tr> <td style="width: 10%;"></td> <td style="width: 10%;"></td> <td style="width: 10%;"></td> <td style="width: 10%;"></td> <td style="width: 10%;"></td> <td style="width: 10%;"></td> <td style="width: 10%;"></td> <td style="width: 10%;"></td> <td style="width: 10%;"></td> <td style="width: 10%;"></td> </tr> <tr> <td></td> <td></td> <td colspan="8" style="text-align: center;"> <table border="1" style="width: 100%; border-collapse: collapse; text-align: center;"> <tr> <td style="width: 10%;"></td> <td style="width: 10%;"></td> <td style="width: 10%;"></td> <td style="width: 10%;"></td> <td style="width: 10%;"></td> <td style="width: 10%;"></td> <td style="width: 10%;"></td> <td style="width: 10%;"></td> <td style="width: 10%;"></td> <td style="width: 10%;"></td> </tr> <tr> <td></td> <td></td> <td colspan="8" style="text-align: center;"> <table border="1" style="width: 100%; border-collapse: collapse; text-align: center;"> <tr> <td style="width: 10%;"></td> <td style="width: 10%;"></td> <td style="width: 10%;"></td> <td style="width: 10%;"></td> <td style="width: 10%;"></td> <td style="width: 10%;"></td> <td style="width: 10%;"></td> <td style="width: 10%;"></td> <td style="width: 10%;"></td> <td style="width: 10%;"></td> </tr> <tr> <td></td> <td></td> <td colspan="8" style="text-align: center;"> <table border="1" style="width: 100%; border-collapse: collapse; text-align: center;"> <tr> <td style="width: 10%;"></td> <td style="width: 10%;"></td> <td style="width: 10%;"></td> <td style="width: 10%;"></td> <td style="width: 10%;"></td> <td style="width: 10%;"></td> <td style="width: 10%;"></td> <td style="width: 10%;"></td> <td style="width: 10%;"></td> <td style="width: 10%;"></td> </tr> <tr> <td></td> <td></td> <td colspan="8" style="text-align: center;"> <table border="1" style="width: 100%; border-collapse: collapse; text-align: center;"> <tr> <td style="width: 10%;"></td> <td style="width: 10%;"></td> <td style="width: 10%;"></td> <td style="width: 10%;"></td> <td style="width: 10%;"></td> <td style="width: 10%;"></td> <td style="width: 10%;"></td> <td style="width: 10%;"></td> <td style="width: 10%;"></td> <td style="width: 10%;"></td> </tr> <tr> <td></td> <td></td> <td colspan="8" style="text-align: center;"> <table border="1" style="width: 100%; border-collapse: collapse; text-align: center;"> <tr> </tr></table></td></tr></table></td></tr></table></td></tr></table></td></tr></table></td></tr></table></td></tr></table></td></tr></table></td></tr></table></td></tr></table></td></tr></table></td></tr></table></td></tr></table></td></tr></table></td></tr></table></td></tr></table></td></tr></table></td></tr></table> | | | | | | | | | | | | | | | | | | | | <table border="1" style="width: 100%; border-collapse: collapse; text-align: center;"> <tr> <td style="width: 10%;"></td> <td style="width: 10%;"></td> <td style="width: 10%;"></td> <td style="width: 10%;"></td> <td style="width: 10%;"></td> <td style="width: 10%;"></td> <td style="width: 10%;"></td> <td style="width: 10%;"></td> <td style="width: 10%;"></td> <td style="width: 10%;"></td> </tr> <tr> <td></td> <td></td> <td colspan="8" style="text-align: center;"> <table border="1" style="width: 100%; border-collapse: collapse; text-align: center;"> <tr> <td style="width: 10%;"></td> <td style="width: 10%;"></td> <td style="width: 10%;"></td> <td style="width: 10%;"></td> <td style="width: 10%;"></td> <td style="width: 10%;"></td> <td style="width: 10%;"></td> <td style="width: 10%;"></td> <td style="width: 10%;"></td> <td style="width: 10%;"></td> </tr> <tr> <td></td> <td></td> <td colspan="8" style="text-align: center;"> <table border="1" style="width: 100%; border-collapse: collapse; text-align: center;"> <tr> <td style="width: 10%;"></td> <td style="width: 10%;"></td> <td style="width: 10%;"></td> <td style="width: 10%;"></td> <td style="width: 10%;"></td> <td style="width: 10%;"></td> <td style="width: 10%;"></td> <td style="width: 10%;"></td> <td style="width: 10%;"></td> <td style="width: 10%;"></td> </tr> <tr> <td></td> <td></td> <td colspan="8" style="text-align: center;"> <table border="1" style="width: 100%; border-collapse: collapse; text-align: center;"> <tr> <td style="width: 10%;"></td> <td style="width: 10%;"></td> <td style="width: 10%;"></td> <td style="width: 10%;"></td> <td style="width: 10%;"></td> <td style="width: 10%;"></td> <td style="width: 10%;"></td> <td style="width: 10%;"></td> <td style="width: 10%;"></td> <td style="width: 10%;"></td> </tr> <tr> <td></td> <td></td> <td colspan="8" style="text-align: center;"> <table border="1" style="width: 100%; border-collapse: collapse; text-align: center;"> <tr> <td style="width: 10%;"></td> <td style="width: 10%;"></td> <td style="width: 10%;"></td> <td style="width:
10%;"></td> <td style="width: 10%;"></td> <td style="width: 10%;"></td> <td style="width: 10%;"></td> <td style="width: 10%;"></td> <td style="width: 10%;"></td> <td style="width: 10%;"></td> </tr> <tr> <td></td> <td></td> <td colspan="8" style="text-align: center;"> <table border="1" style="width: 100%; border-collapse: collapse; text-align: center;"> <tr> <td style="width: 10%;"></td> <td style="width: 10%;"></td> <td style="width: 10%;"></td> <td style="width: 10%;"></td> <td style="width: 10%;"></td> <td style="width: 10%;"></td> <td style="width: 10%;"></td> <td style="width: 10%;"></td> <td style="width: 10%;"></td> <td style="width: 10%;"></td> </tr> <tr> <td></td> <td></td> <td colspan="8" style="text-align: center;"> <table border="1" style="width: 100%; border-collapse: collapse; text-align: center;"> <tr> <td style="width: 10%;"></td> <td style="width: 10%;"></td> <td style="width: 10%;"></td> <td style="width: 10%;"></td> <td style="width: 10%;"></td> <td style="width: 10%;"></td> <td style="width: 10%;"></td> <td style="width: 10%;"></td> <td style="width: 10%;"></td> <td style="width: 10%;"></td> </tr> <tr> <td></td> <td></td> <td colspan="8" style="text-align: center;"> <table border="1" style="width: 100%; border-collapse: collapse; text-align: center;"> <tr> <td style="width: 10%;"></td> <td style="width: 10%;"></td> <td style="width: 10%;"></td> <td style="width: 10%;"></td> <td style="width: 10%;"></td> <td style="width: 10%;"></td> <td style="width: 10%;"></td> <td style="width: 10%;"></td> <td style="width: 10%;"></td> <td style="width: 10%;"></td> </tr> <tr> <td></td> <td></td> <td colspan="8" style="text-align: center;"> <table border="1" style="width: 100%; border-collapse: collapse; text-align: center;"> <tr> <td style="width: 10%;"></td> <td style="width: 10%;"></td> <td style="width: 10%;"></td> <td style="width: 10%;"></td> <td style="width: 10%;"></td> <td style="width: 10%;"></td> <td style="width: 10%;"></td> <td style="width: 10%;"></td> <td style="width: 10%;"></td> <td style="width: 10%;"></td> </tr> <tr> <td></td> <td></td> <td colspan="8" style="text-align: center;"> <table border="1" style="width: 100%; border-collapse: collapse; text-align: center;"> <tr> <td style="width: 10%;"></td> <td style="width: 10%;"></td> <td style="width: 10%;"></td> <td style="width: 10%;"></td> <td style="width: 10%;"></td> <td style="width: 10%;"></td> <td style="width: 10%;"></td> <td style="width: 10%;"></td> <td style="width: 10%;"></td> <td style="width: 10%;"></td> </tr> <tr> <td></td> <td></td> <td colspan="8" style="text-align: center;"> <table border="1" style="width: 100%; border-collapse: collapse; text-align: center;"> <tr> <td style="width: 10%;"></td> <td style="width: 10%;"></td> <td style="width: 10%;"></td> <td style="width: 10%;"></td> <td style="width: 10%;"></td> <td style="width: 10%;"></td> <td style="width: 10%;"></td> <td style="width: 10%;"></td> <td style="width: 10%;"></td> <td style="width: 10%;"></td> </tr> <tr> <td></td> <td></td> <td colspan="8" style="text-align: center;"> <table border="1" style="width: 100%; border-collapse: collapse; text-align: center;"> <tr> <td style="width: 10%;"></td> <td style="width: 10%;"></td> <td style="width: 10%;"></td> <td style="width: 10%;"></td> <td style="width: 10%;"></td> <td style="width: 10%;"></td> <td style="width: 10%;"></td> <td style="width: 10%;"></td> <td style="width: 10%;"></td> <td style="width: 10%;"></td> </tr> <tr> <td></td> <td></td> <td colspan="8" style="text-align: center;"> <table border="1" style="width: 100%; border-collapse: collapse; text-align: center;"> <tr> <td style="width: 10%;"></td> <td style="width: 10%;"></td> <td style="width: 10%;"></td> <td style="width: 10%;"></td> <td style="width: 10%;"></td> <td style="width: 10%;"></td> <td style="width: 10%;"></td> <td style="width: 10%;"></td> <td style="width: 10%;"></td> <td style="width: 10%;"></td> </tr> <tr> <td></td> <td></td> <td colspan="8" style="text-align: center;"> <table border="1" style="width: 100%; border-collapse: collapse; text-align: center;"> <tr> <td style="width: 10%;"></td> <td style="width: 10%;"></td> <td style="width: 10%;"></td> <td style="width: 10%;"></td> <td style="width: 10%;"></td> <td style="width: 10%;"></td> <td style="width: 10%;"></td> <td style="width: 10%;"></td> <td style="width: 10%;"></td> <td style="width: 10%;"></td> </tr> <tr> <td></td> <td></td> <td colspan="8" style="text-align: center;"> <table border="1" style="width: 100%; border-collapse: collapse; text-align: center;"> <tr> <td style="width: 10%;"></td> <td style="width: 10%;"></td> <td style="width: 10%;"></td> <td style="width: 10%;"></td> <td style="width: 10%;"></td> <td style="width: 10%;"></td> <td style="width: 10%;"></td> <td style="width: 10%;"></td> <td style="width: 10%;"></td> <td style="width: 10%;"></td> </tr> <tr> <td></td> <td></td> <td colspan="8" style="text-align: center;"> <table border="1" style="width: 100%; border-collapse: collapse; text-align: center;"> <tr> <td style="width: 10%;"></td> <td style="width: 10%;"></td> <td style="width: 10%;"></td> <td style="width: 10%;"></td> <td style="width: 10%;"></td> <td style="width: 10%;"></td> <td style="width: 10%;"></td> <td style="width: 10%;"></td> <td style="width: 10%;"></td> <td style="width: 10%;"></td> </tr> <tr> <td></td> <td></td> <td colspan="8" style="text-align: center;"> <table border="1" style="width: 100%; border-collapse: collapse; text-align: center;"> <tr> </tr></table></td></tr></table></td></tr></table></td></tr></table></td></tr></table></td></tr></table></td></tr></table></td></tr></table></td></tr></table></td></tr></table></td></tr></table></td></tr></table></td></tr></table></td></tr></table></td></tr></table></td></tr></table></td></tr></table> | | | | | | | | | | | | | | | | | | | | <table border="1" style="width: 100%; border-collapse: collapse; text-align: center;"> <tr> <td style="width: 10%;"></td> <td style="width: 10%;"></td> <td style="width: 10%;"></td> <td style="width: 10%;"></td> <td style="width: 10%;"></td> <td style="width: 10%;"></td> <td style="width: 10%;"></td> <td style="width: 10%;"></td> <td style="width: 10%;"></td> <td style="width: 10%;"></td> </tr> <tr> <td></td> <td></td> <td colspan="8" style="text-align: center;"> <table border="1" style="width: 100%; border-collapse: collapse; text-align: center;"> <tr> <td style="width: 10%;"></td> <td style="width: 10%;"></td> <td style="width: 10%;"></td> <td style="width: 10%;"></td> <td style="width: 10%;"></td> <td style="width: 10%;"></td> <td style="width: 10%;"></td> <td style="width: 10%;"></td> <td style="width: 10%;"></td> <td style="width: 10%;"></td> </tr> <tr> <td></td> <td></td> <td colspan="8" style="text-align: center;"> <table border="1" style="width: 100%; border-collapse: collapse; text-align: center;"> <tr> <td style="width: 10%;"></td> <td style="width: 10%;"></td> <td style="width: 10%;"></td> <td style="width: 10%;"></td> <td style="width: 10%;"></td> <td style="width: 10%;"></td> <td style="width: 10%;"></td> <td style="width: 10%;"></td> <td style="width: 10%;"></td> <td style="width: 10%;"></td> </tr> <tr> <td></td> <td></td> <td colspan="8" style="text-align: center;"> <table border="1" style="width: 100%; border-collapse: collapse; text-align: center;"> <tr> <td style="width: 10%;"></td> <td style="width: 10%;"></td> <td style="width: 10%;"></td> <td style="width: 10%;"></td> <td style="width: 10%;"></td> <td style="width: 10%;"></td> <td style="width: 10%;"></td> <td style="width: 10%;"></td> <td style="width: 10%;"></td> <td style="width: 10%;"></td> </tr> <tr> <td></td> <td></td> <td colspan="8" style="text-align: center;"> <table border="1" style="width: 100%; border-collapse: collapse; text-align: center;"> <tr> <td style="width: 10%;"></td> <td style="width: 10%;"></td> <td style="width: 10%;"></td> <td style="width: 10%;"></td> <td style="width: 10%;"></td> <td style="width: 10%;"></td> <td style="width: 10%;"></td> <td style="width: 10%;"></td> <td style="width: 10%;"></td> <td style="width: 10%;"></td> </tr> <tr> <td></td> <td></td> <td colspan="8" style="text-align: center;"> <table border="1" style="width: 100%; border-collapse: collapse; text-align: center;"> <tr> <td style="width: 10%;"></td> <td style="width: 10%;"></td> <td style="width: 10%;"></td> <td style="width: 10%;"></td> <td style="width: 10%;"></td> <td style="width: 10%;"></td> <td style="width: 10%;"></td> <td style="width: 10%;"></td>
<td style="width: 10%;"></td> <td style="width: 10%;"></td> </tr> <tr> <td></td> <td></td> <td colspan="8" style="text-align: center;"> <table border="1" style="width: 100%; border-collapse: collapse; text-align: center;"> <tr> <td style="width: 10%;"></td> <td style="width: 10%;"></td> <td style="width: 10%;"></td> <td style="width: 10%;"></td> <td style="width: 10%;"></td> <td style="width: 10%;"></td> <td style="width: 10%;"></td> <td style="width: 10%;"></td> <td style="width: 10%;"></td> <td style="width: 10%;"></td> </tr> <tr> <td></td> <td></td> <td colspan="8" style="text-align: center;"> <table border="1" style="width: 100%; border-collapse: collapse; text-align: center;"> <tr> <td style="width: 10%;"></td> <td style="width: 10%;"></td> <td style="width: 10%;"></td> <td style="width: 10%;"></td> <td style="width: 10%;"></td> <td style="width: 10%;"></td> <td style="width: 10%;"></td> <td style="width: 10%;"></td> <td style="width: 10%;"></td> <td style="width: 10%;"></td> </tr> <tr> <td></td> <td></td> <td colspan="8" style="text-align: center;"> <table border="1" style="width: 100%; border-collapse: collapse; text-align: center;"> <tr> <td style="width: 10%;"></td> <td style="width: 10%;"></td> <td style="width: 10%;"></td> <td style="width: 10%;"></td> <td style="width: 10%;"></td> <td style="width: 10%;"></td> <td style="width: 10%;"></td> <td style="width: 10%;"></td> <td style="width: 10%;"></td> <td style="width: 10%;"></td> </tr> <tr> <td></td> <td></td> <td colspan="8" style="text-align: center;"> <table border="1" style="width: 100%; border-collapse: collapse; text-align: center;"> <tr> <td style="width: 10%;"></td> <td style="width: 10%;"></td> <td style="width: 10%;"></td> <td style="width: 10%;"></td> <td style="width: 10%;"></td> <td style="width: 10%;"></td> <td style="width: 10%;"></td> <td style="width: 10%;"></td> <td style="width: 10%;"></td> <td style="width: 10%;"></td> </tr> <tr> <td></td> <td></td> <td colspan="8" style="text-align: center;"> <table border="1" style="width: 100%; border-collapse: collapse; text-align: center;"> <tr> <td style="width: 10%;"></td> <td style="width: 10%;"></td> <td style="width: 10%;"></td> <td style="width: 10%;"></td> <td style="width: 10%;"></td> <td style="width: 10%;"></td> <td style="width: 10%;"></td> <td style="width: 10%;"></td> <td style="width: 10%;"></td> <td style="width: 10%;"></td> </tr> <tr> <td></td> <td></td> <td colspan="8" style="text-align: center;"> <table border="1" style="width: 100%; border-collapse: collapse; text-align: center;"> <tr> <td style="width: 10%;"></td> <td style="width: 10%;"></td> <td style="width: 10%;"></td> <td style="width: 10%;"></td> <td style="width: 10%;"></td> <td style="width: 10%;"></td> <td style="width: 10%;"></td> <td style="width: 10%;"></td> <td style="width: 10%;"></td> <td style="width: 10%;"></td> </tr> <tr> <td></td> <td></td> <td colspan="8" style="text-align: center;"> <table border="1" style="width: 100%; border-collapse: collapse; text-align: center;"> <tr> <td style="width: 10%;"></td> <td style="width: 10%;"></td> <td style="width: 10%;"></td> <td style="width: 10%;"></td> <td style="width: 10%;"></td> <td style="width: 10%;"></td> <td style="width: 10%;"></td> <td style="width: 10%;"></td> <td style="width: 10%;"></td> <td style="width: 10%;"></td> </tr> <tr> <td></td> <td></td> <td colspan="8" style="text-align: center;"> <table border="1" style="width: 100%; border-collapse: collapse; text-align: center;"> <tr> <td style="width: 10%;"></td> <td style="width: 10%;"></td> <td style="width: 10%;"></td> <td style="width: 10%;"></td> <td style="width: 10%;"></td> <td style="width: 10%;"></td> <td style="width: 10%;"></td> <td style="width: 10%;"></td> <td style="width: 10%;"></td> <td style="width: 10%;"></td> </tr> <tr> <td></td> <td></td> <td colspan="8" style="text-align: center;"> <table border="1" style="width: 100%; border-collapse: collapse; text-align: center;"> <tr> <td style="width: 10%;"></td> <td style="width: 10%;"></td> <td style="width: 10%;"></td> <td style="width: 10%;"></td> <td style="width: 10%;"></td> <td style="width: 10%;"></td> <td style="width: 10%;"></td> <td style="width: 10%;"></td> <td style="width: 10%;"></td> <td style="width: 10%;"></td> </tr> <tr> <td></td> <td></td> <td colspan="8" style="text-align: center;"> <table border="1" style="width: 100%; border-collapse: collapse; text-align: center;"> <tr> </tr></table></td></tr></table></td></tr></table></td></tr></table></td></tr></table></td></tr></table></td></tr></table></td></tr></table></td></tr></table></td></tr></table></td></tr></table></td></tr></table></td></tr></table></td></tr></table></td></tr></table></td></tr></table> | | | | | | | | | | | | | | | | | | | | <table border="1" style="width: 100%; border-collapse: collapse; text-align: center;"> <tr> <td style="width: 10%;"></td> <td style="width: 10%;"></td> <td style="width: 10%;"></td> <td style="width: 10%;"></td> <td style="width: 10%;"></td> <td style="width: 10%;"></td> <td style="width: 10%;"></td> <td style="width: 10%;"></td> <td style="width: 10%;"></td> <td style="width: 10%;"></td> </tr> <tr> <td></td> <td></td> <td colspan="8" style="text-align: center;"> <table border="1" style="width: 100%; border-collapse: collapse; text-align: center;"> <tr> <td style="width: 10%;"></td> <td style="width: 10%;"></td> <td style="width: 10%;"></td> <td style="width: 10%;"></td> <td style="width: 10%;"></td> <td style="width: 10%;"></td> <td style="width: 10%;"></td> <td style="width: 10%;"></td> <td style="width: 10%;"></td> <td style="width: 10%;"></td> </tr> <tr> <td></td> <td></td> <td colspan="8" style="text-align: center;"> <table border="1" style="width: 100%; border-collapse: collapse; text-align: center;"> <tr> <td style="width: 10%;"></td> <td style="width: 10%;"></td> <td style="width: 10%;"></td> <td style="width: 10%;"></td> <td style="width: 10%;"></td> <td style="width: 10%;"></td> <td style="width: 10%;"></td> <td style="width: 10%;"></td> <td style="width: 10%;"></td> <td style="width: 10%;"></td> </tr> <tr> <td></td> <td></td> <td colspan="8" style="text-align: center;"> <table border="1" style="width: 100%; border-collapse: collapse; text-align: center;"> <tr> <td style="width: 10%;"></td> <td style="width: 10%;"></td> <td style="width: 10%;"></td> <td style="width: 10%;"></td> <td style="width: 10%;"></td> <td style="width: 10%;"></td> <td style="width: 10%;"></td> <td style="width: 10%;"></td> <td style="width: 10%;"></td> <td style="width: 10%;"></td> </tr> <tr> <td></td> <td></td> <td colspan="8" style="text-align: center;"> <table border="1" style="width: 100%; border-collapse: collapse; text-align: center;"> <tr> <td style="width: 10%;"></td> <td style="width: 10%;"></td> <td style="width: 10%;"></td> <td style="width: 10%;"></td> <td style="width: 10%;"></td> <td style="width: 10%;"></td> <td style="width: 10%;"></td> <td style="width: 10%;"></td> <td style="width: 10%;"></td> <td style="width: 10%;"></td> </tr> <tr> <td></td> <td></td> <td colspan="8" style="text-align: center;"> <table border="1" style="width: 100%; border-collapse: collapse; text-align: center;"> <tr> <td style="width: 10%;"></td> <td style="width: 10%;"></td> <td style="width: 10%;"></td> <td style="width: 10%;"></td> <td style="width: 10%;"></td> <td style="width: 10%;"></td> <td style="width: 10%;"></td> <td style="width: 10%;"></td> <td style="width: 10%;"></td> <td style="width: 10%;"></td> </tr> <tr> <td></td> <td></td> <td colspan="8" style="text-align: center;"> <table border="1" style="width: 100%; border-collapse: collapse; text-align: center;"> <tr> <td style="width: 10%;"></td> <td style="width: 10%;"></td> <td style="width: 10%;"></td> <td style="width: 10%;"></td> <td style="width: 10%;"></td> <td style="width: 10%;"></td> <td style="width: 10%;"></td> <td style="width: 10%;"></td> <td style="width: 10%;"></td> <td style="width: 10%;"></td> </tr> <tr> <td></td> <td></td> <td colspan="8" style="text-align: center;"> <table border="1" style="width: 100%; border-collapse: collapse; text-align: center;"> <tr> <td style="width: 10%;"></td> <td style="width: 10%;"></td> <td style="width: 10%;"></td> <td style="width: 10%;"></td> <td style="width: 10%;"></td> <td style="width: 10%;"></td> <td style="width: 10%;"></td> <td style="width: 10%;"></td> <td style="width: 10%;"></td> <td style="width: 10%;"></td> </tr> <tr> <td></td> <td></td> <td colspan="8" style="text-align: center;"> <table
border="1" style="width: 100%; border-collapse: collapse; text-align: center;"> <tr> <td style="width: 10%;"></td> <td style="width: 10%;"></td> <td style="width: 10%;"></td> <td style="width: 10%;"></td> <td style="width: 10%;"></td> <td style="width: 10%;"></td> <td style="width: 10%;"></td> <td style="width: 10%;"></td> <td style="width: 10%;"></td> <td style="width: 10%;"></td> </tr> <tr> <td></td> <td></td> <td colspan="8" style="text-align: center;"> <table border="1" style="width: 100%; border-collapse: collapse; text-align: center;"> <tr> <td style="width: 10%;"></td> <td style="width: 10%;"></td> <td style="width: 10%;"></td> <td style="width: 10%;"></td> <td style="width: 10%;"></td> <td style="width: 10%;"></td> <td style="width: 10%;"></td> <td style="width: 10%;"></td> <td style="width: 10%;"></td> <td style="width: 10%;"></td> </tr> <tr> <td></td> <td></td> <td colspan="8" style="text-align: center;"> <table border="1" style="width: 100%; border-collapse: collapse; text-align: center;"> <tr> <td style="width: 10%;"></td> <td style="width: 10%;"></td> <td style="width: 10%;"></td> <td style="width: 10%;"></td> <td style="width: 10%;"></td> <td style="width: 10%;"></td> <td style="width: 10%;"></td> <td style="width: 10%;"></td> <td style="width: 10%;"></td> <td style="width: 10%;"></td> </tr> <tr> <td></td> <td></td> <td colspan="8" style="text-align: center;"> <table border="1" style="width: 100%; border-collapse: collapse; text-align: center;"> <tr> <td style="width: 10%;"></td> <td style="width: 10%;"></td> <td style="width: 10%;"></td> <td style="width: 10%;"></td> <td style="width: 10%;"></td> <td style="width: 10%;"></td> <td style="width: 10%;"></td> <td style="width: 10%;"></td> <td style="width: 10%;"></td> <td style="width: 10%;"></td> </tr> <tr> <td></td> <td></td> <td colspan="8" style="text-align: center;"> <table border="1" style="width: 100%; border-collapse: collapse; text-align: center;"> <tr> <td style="width: 10%;"></td> <td style="width: 10%;"></td> <td style="width: 10%;"></td> <td style="width: 10%;"></td> <td style="width: 10%;"></td> <td style="width: 10%;"></td> <td style="width: 10%;"></td> <td style="width: 10%;"></td> <td style="width: 10%;"></td> <td style="width: 10%;"></td> </tr> <tr> <td></td> <td></td> <td colspan="8" style="text-align: center;"> <table border="1" style="width: 100%; border-collapse: collapse; text-align: center;"> <tr> <td style="width: 10%;"></td> <td style="width: 10%;"></td> <td style="width: 10%;"></td> <td style="width: 10%;"></td> <td style="width: 10%;"></td> <td style="width: 10%;"></td> <td style="width: 10%;"></td> <td style="width: 10%;"></td> <td style="width: 10%;"></td> <td style="width: 10%;"></td> </tr> <tr> <td></td> <td></td> <td colspan="8" style="text-align: center;"> <table border="1" style="width: 100%; border-collapse: collapse; text-align: center;"> <tr> </tr></table></td></tr></table></td></tr></table></td></tr></table></td></tr></table></td></tr></table></td></tr></table></td></tr></table></td></tr></table></td></tr></table></td></tr></table></td></tr></table></td></tr></table></td></tr></table></td></tr></table> | | | | | | | | | | | | | | | | | | | | <table border="1" style="width: 100%; border-collapse: collapse; text-align: center;"> <tr> <td style="width: 10%;"></td> <td style="width: 10%;"></td> <td style="width: 10%;"></td> <td style="width: 10%;"></td> <td style="width: 10%;"></td> <td style="width: 10%;"></td> <td style="width: 10%;"></td> <td style="width: 10%;"></td> <td style="width: 10%;"></td> <td style="width: 10%;"></td> </tr> <tr> <td></td> <td></td> <td colspan="8" style="text-align: center;"> <table border="1" style="width: 100%; border-collapse: collapse; text-align: center;"> <tr> <td style="width: 10%;"></td> <td style="width: 10%;"></td> <td style="width: 10%;"></td> <td style="width: 10%;"></td> <td style="width: 10%;"></td> <td style="width: 10%;"></td> <td style="width: 10%;"></td> <td style="width: 10%;"></td> <td style="width: 10%;"></td> <td style="width: 10%;"></td> </tr> <tr> <td></td> <td></td> <td colspan="8" style="text-align: center;"> <table border="1" style="width: 100%; border-collapse: collapse; text-align: center;"> <tr> <td style="width: 10%;"></td> <td style="width: 10%;"></td> <td style="width: 10%;"></td> <td style="width: 10%;"></td> <td style="width: 10%;"></td> <td style="width: 10%;"></td> <td style="width: 10%;"></td> <td style="width: 10%;"></td> <td style="width: 10%;"></td> <td style="width: 10%;"></td> </tr> <tr> <td></td> <td></td> <td colspan="8" style="text-align: center;"> <table border="1" style="width: 100%; border-collapse: collapse; text-align: center;"> <tr> <td style="width: 10%;"></td> <td style="width: 10%;"></td> <td style="width: 10%;"></td> <td style="width: 10%;"></td> <td style="width: 10%;"></td> <td style="width: 10%;"></td> <td style="width: 10%;"></td> <td style="width: 10%;"></td> <td style="width: 10%;"></td> <td style="width: 10%;"></td> </tr> <tr> <td></td> <td></td> <td colspan="8" style="text-align: center;"> <table border="1" style="width: 100%; border-collapse: collapse; text-align: center;"> <tr> <td style="width: 10%;"></td> <td style="width: 10%;"></td> <td style="width: 10%;"></td> <td style="width: 10%;"></td> <td style="width: 10%;"></td> <td style="width: 10%;"></td> <td style="width: 10%;"></td> <td style="width: 10%;"></td> <td style="width: 10%;"></td> <td style="width: 10%;"></td> </tr> <tr> <td></td> <td></td> <td colspan="8" style="text-align: center;"> <table border="1" style="width: 100%; border-collapse: collapse; text-align: center;"> <tr> <td style="width: 10%;"></td> <td style="width: 10%;"></td> <td style="width: 10%;"></td> <td style="width: 10%;"></td> <td style="width: 10%;"></td> <td style="width: 10%;"></td> <td style="width: 10%;"></td> <td style="width: 10%;"></td> <td style="width: 10%;"></td> <td style="width: 10%;"></td> </tr> <tr> <td></td> <td></td> <td colspan="8" style="text-align: center;"> <table border="1" style="width: 100%; border-collapse: collapse; text-align: center;"> <tr> <td style="width: 10%;"></td> <td style="width: 10%;"></td> <td style="width: 10%;"></td> <td style="width: 10%;"></td> <td style="width: 10%;"></td> <td style="width: 10%;"></td> <td style="width: 10%;"></td> <td style="width: 10%;"></td> <td style="width: 10%;"></td> <td style="width: 10%;"></td> </tr> <tr> <td></td> <td></td> <td colspan="8" style="text-align: center;"> <table border="1" style="width: 100%; border-collapse: collapse; text-align: center;"> <tr> <td style="width: 10%;"></td> <td style="width: 10%;"></td> <td style="width: 10%;"></td> <td style="width: 10%;"></td> <td style="width: 10%;"></td> <td style="width: 10%;"></td> <td style="width: 10%;"></td> <td style="width: 10%;"></td> <td style="width: 10%;"></td> <td style="width: 10%;"></td> </tr> <tr> <td></td> <td></td> <td colspan="8" style="text-align: center;"> <table border="1" style="width: 100%; border-collapse: collapse; text-align: center;"> <tr> <td style="width: 10%;"></td> <td style="width: 10%;"></td> <td style="width: 10%;"></td> <td style="width: 10%;"></td> <td style="width: 10%;"></td> <td style="width: 10%;"></td> <td style="width: 10%;"></td> <td style="width: 10%;"></td> <td style="width: 10%;"></td> <td style="width: 10%;"></td> </tr> <tr> <td></td> <td></td> <td colspan="8" style="text-align: center;"> <table border="1" style="width: 100%; border-collapse: collapse; text-align: center;"> <tr> <td style="width: 10%;"></td> <td style="width: 10%;"></td> <td style="width: 10%;"></td> <td style="width: 10%;"></td> <td style="width: 10%;"></td> <td style="width: 10%;"></td> <td style="width: 10%;"></td> <td style="width: 10%;"></td> <td style="width: 10%;"></td> <td style="width: 10%;"></td> </tr> <tr> <td></td> <td></td> <td colspan="8" style="text-align: center;"> <table border="1" style="width: 100%; border-collapse: collapse; text-align: center;"> <tr> <td style="width: 10%;"></td> <td style="width: 10%;"></td> <td style="width: 10%;"></td> <td style="width: 10%;"></td> <td style="width: 10%;"></td> <td style="width: 10%;"></td> <td style="width: 10%;"></td> <td style="width: 10%;"></td> <td style="width: 10%;"></td> <td style="width: 10%;"></td> </tr> <tr> <td></td> <td></td> <td colspan="8" style="text-align: center;"> <table border="1" style="width: 100%; border-collapse: collapse; text-align: center;"> <tr> <td style="width: 10%;"></td> <td style="width: 10%;"></td> <td style="width:
10%;"></td> <td style="width: 10%;"></td> <td style="width: 10%;"></td> <td style="width: 10%;"></td> <td style="width: 10%;"></td> <td style="width: 10%;"></td> <td style="width: 10%;"></td> <td style="width: 10%;"></td> </tr> <tr> <td></td> <td></td> <td colspan="8" style="text-align: center;"> <table border="1" style="width: 100%; border-collapse: collapse; text-align: center;"> <tr> <td style="width: 10%;"></td> <td style="width: 10%;"></td> <td style="width: 10%;"></td> <td style="width: 10%;"></td> <td style="width: 10%;"></td> <td style="width: 10%;"></td> <td style="width: 10%;"></td> <td style="width: 10%;"></td> <td style="width: 10%;"></td> <td style="width: 10%;"></td> </tr> <tr> <td></td> <td></td> <td colspan="8" style="text-align: center;"> <table border="1" style="width: 100%; border-collapse: collapse; text-align: center;"> <tr> </tr></table></td></tr></table></td></tr></table></td></tr></table></td></tr></table></td></tr></table></td></tr></table></td></tr></table></td></tr></table></td></tr></table></td></tr></table></td></tr></table></td></tr></table></td></tr></table> | | | | | | | | | | | | | | | | | | | | <table border="1" style="width: 100%; border-collapse: collapse; text-align: center;"> <tr> <td style="width: 10%;"></td> <td style="width: 10%;"></td> <td style="width: 10%;"></td> <td style="width: 10%;"></td> <td style="width: 10%;"></td> <td style="width: 10%;"></td> <td style="width: 10%;"></td> <td style="width: 10%;"></td> <td style="width: 10%;"></td> <td style="width: 10%;"></td> </tr> <tr> <td></td> <td></td> <td colspan="8" style="text-align: center;"> <table border="1" style="width: 100%; border-collapse: collapse; text-align: center;"> <tr> <td style="width: 10%;"></td> <td style="width: 10%;"></td> <td style="width: 10%;"></td> <td style="width: 10%;"></td> <td style="width: 10%;"></td> <td style="width: 10%;"></td> <td style="width: 10%;"></td> <td style="width: 10%;"></td> <td style="width: 10%;"></td> <td style="width: 10%;"></td> </tr> <tr> <td></td> <td></td> <td colspan="8" style="text-align: center;"> <table border="1" style="width: 100%; border-collapse: collapse; text-align: center;"> <tr> <td style="width: 10%;"></td> <td style="width: 10%;"></td> <td style="width: 10%;"></td> <td style="width: 10%;"></td> <td style="width: 10%;"></td> <td style="width: 10%;"></td> <td style="width: 10%;"></td> <td style="width: 10%;"></td> <td style="width: 10%;"></td> <td style="width: 10%;"></td> </tr> <tr> <td></td> <td></td> <td colspan="8" style="text-align: center;"> <table border="1" style="width: 100%; border-collapse: collapse; text-align: center;"> <tr> <td style="width: 10%;"></td> <td style="width: 10%;"></td> <td style="width: 10%;"></td> <td style="width: 10%;"></td> <td style="width: 10%;"></td> <td style="width: 10%;"></td> <td style="width: 10%;"></td> <td style="width: 10%;"></td> <td style="width: 10%;"></td> <td style="width: 10%;"></td> </tr> <tr> <td></td> <td></td> <td colspan="8" style="text-align: center;"> <table border="1" style="width: 100%; border-collapse: collapse; text-align: center;"> <tr> <td style="width: 10%;"></td> <td style="width: 10%;"></td> <td style="width: 10%;"></td> <td style="width: 10%;"></td> <td style="width: 10%;"></td> <td style="width: 10%;"></td> <td style="width: 10%;"></td> <td style="width: 10%;"></td> <td style="width: 10%;"></td> <td style="width: 10%;"></td> </tr> <tr> <td></td> <td></td> <td colspan="8" style="text-align: center;"> <table border="1" style="width: 100%; border-collapse: collapse; text-align: center;"> <tr> <td style="width: 10%;"></td> <td style="width: 10%;"></td> <td style="width: 10%;"></td> <td style="width: 10%;"></td> <td style="width: 10%;"></td> <td style="width: 10%;"></td> <td style="width: 10%;"></td> <td style="width: 10%;"></td> <td style="width: 10%;"></td> <td style="width: 10%;"></td> </tr> <tr> <td></td> <td></td> <td colspan="8" style="text-align: center;"> <table border="1" style="width: 100%; border-collapse: collapse; text-align: center;"> <tr> <td style="width: 10%;"></td> <td style="width: 10%;"></td> <td style="width: 10%;"></td> <td style="width: 10%;"></td> <td style="width: 10%;"></td> <td style="width: 10%;"></td> <td style="width: 10%;"></td> <td style="width: 10%;"></td> <td style="width: 10%;"></td> <td style="width: 10%;"></td> </tr> <tr> <td></td> <td></td> <td colspan="8" style="text-align: center;"> <table border="1" style="width: 100%; border-collapse: collapse; text-align: center;"> <tr> <td style="width: 10%;"></td> <td style="width: 10%;"></td> <td style="width: 10%;"></td> <td style="width: 10%;"></td> <td style="width: 10%;"></td> <td style="width: 10%;"></td> <td style="width: 10%;"></td> <td style="width: 10%;"></td> <td style="width: 10%;"></td> <td style="width: 10%;"></td> </tr> <tr> <td></td> <td></td> <td colspan="8" style="text-align: center;"> <table border="1" style="width: 100%; border-collapse: collapse; text-align: center;"> <tr> <td style="width: 10%;"></td> <td style="width: 10%;"></td> <td style="width: 10%;"></td> <td style="width: 10%;"></td> <td style="width: 10%;"></td> <td style="width: 10%;"></td> <td style="width: 10%;"></td> <td style="width: 10%;"></td> <td style="width: 10%;"></td> <td style="width: 10%;"></td> </tr> <tr> <td></td> <td></td> <td colspan="8" style="text-align: center;"> <table border="1" style="width: 100%; border-collapse: collapse; text-align: center;"> <tr> <td style="width: 10%;"></td> <td style="width: 10%;"></td> <td style="width: 10%;"></td> <td style="width: 10%;"></td> <td style="width: 10%;"></td> <td style="width: 10%;"></td> <td style="width: 10%;"></td> <td style="width: 10%;"></td> <td style="width: 10%;"></td> <td style="width: 10%;"></td> </tr> <tr> <td></td> <td></td> <td colspan="8" style="text-align: center;"> <table border="1" style="width: 100%; border-collapse: collapse; text-align: center;"> <tr> <td style="width: 10%;"></td> <td style="width: 10%;"></td> <td style="width: 10%;"></td> <td style="width: 10%;"></td> <td style="width: 10%;"></td> <td style="width: 10%;"></td> <td style="width: 10%;"></td> <td style="width: 10%;"></td> <td style="width: 10%;"></td> <td style="width: 10%;"></td> </tr> <tr> <td></td> <td></td> <td colspan="8" style="text-align: center;"> <table border="1" style="width: 100%; border-collapse: collapse; text-align: center;"> <tr> <td style="width: 10%;"></td> <td style="width: 10%;"></td> <td style="width: 10%;"></td> <td style="width: 10%;"></td> <td style="width: 10%;"></td> <td style="width: 10%;"></td> <td style="width: 10%;"></td> <td style="width: 10%;"></td> <td style="width: 10%;"></td> <td style="width: 10%;"></td> </tr> <tr> <td></td> <td></td> <td colspan="8" style="text-align: center;"> <table border="1" style="width: 100%; border-collapse: collapse; text-align: center;"> <tr> </tr></table></td></tr></table></td></tr></table></td></tr></table></td></tr></table></td></tr></table></td></tr></table></td></tr></table></td></tr></table></td></tr></table></td></tr></table></td></tr></table></td></tr></table>
 | | | | | | | | | | | | | | | | | | | | <table border="1" style="width: 100%; border-collapse: collapse; text-align: center;"> <tr> <td style="width: 10%;"></td> <td style="width: 10%;"></td> <td style="width: 10%;"></td> <td style="width: 10%;"></td> <td style="width: 10%;"></td> <td style="width: 10%;"></td> <td style="width: 10%;"></td> <td style="width: 10%;"></td> <td style="width: 10%;"></td> <td style="width: 10%;"></td> </tr> <tr> <td></td> <td></td> <td colspan="8" style="text-align: center;"> <table border="1" style="width: 100%; border-collapse: collapse; text-align: center;"> <tr> <td style="width: 10%;"></td> <td style="width: 10%;"></td> <td style="width: 10%;"></td> <td style="width: 10%;"></td> <td style="width: 10%;"></td> <td style="width: 10%;"></td> <td style="width: 10%;"></td> <td style="width: 10%;"></td> <td style="width: 10%;"></td> <td style="width: 10%;"></td> </tr> <tr> <td></td> <td></td> <td colspan="8" style="text-align: center;"> <table border="1" style="width: 100%; border-collapse: collapse; text-align: center;"> <tr> <td style="width: 10%;"></td> <td style="width: 10%;"></td> <td style="width: 10%;"></td> <td style="width: 10%;"></td> <td style="width: 10%;"></td> <td style="width: 10%;"></td> <td style="width: 10%;"></td> <td style="width: 10%;"></td> <td style="width: 10%;"></td> <td style="width: 10%;"></td> </tr> <tr> <td></td> <td></td> <td colspan="8" style="text-align: center;"> <table border="1" style="width: 100%; border-collapse: collapse; text-align: center;"> <tr> <td style="width: 10%;"></td> <td style="width: 10%;"></td> <td style="width: 10%;"></td> <td style="width: 10%;"></td> <td style="width: 10%;"></td> <td style="width: 10%;"></td> <td style="width: 10%;"></td> <td style="width: 10%;"></td> <td style="width: 10%;"></td> <td style="width: 10%;"></td> </tr> <tr> <td></td> <td></td> <td colspan="8" style="text-align: center;"> <table border="1" style="width: 100%; border-collapse: collapse; text-align: center;"> <tr> <td style="width: 10%;"></td> <td style="width: 10%;"></td> <td style="width: 10%;"></td> <td style="width: 10%;"></td> <td style="width: 10%;"></td> <td style="width: 10%;"></td> <td style="width: 10%;"></td> <td style="width: 10%;"></td> <td style="width: 10%;"></td> <td style="width: 10%;"></td> </tr> <tr> <td></td> <td></td> <td colspan="8" style="text-align: center;"> <table border="1" style="width: 100%; border-collapse: collapse; text-align: center;"> <tr> <td style="width: 10%;"></td> <td style="width: 10%;"></td> <td style="width: 10%;"></td> <td style="width: 10%;"></td> <td style="width: 10%;"></td> <td style="width: 10%;"></td> <td style="width: 10%;"></td> <td style="width: 10%;"></td> <td style="width: 10%;"></td> <td style="width: 10%;"></td> </tr> <tr> <td></td> <td></td> <td colspan="8" style="text-align: center;"> <table border="1" style="width: 100%; border-collapse: collapse; text-align: center;"> <tr> <td style="width: 10%;"></td> <td style="width: 10%;"></td> <td style="width: 10%;"></td> <td style="width: 10%;"></td> <td style="width: 10%;"></td> <td style="width: 10%;"></td> <td style="width: 10%;"></td> <td style="width: 10%;"></td> <td style="width: 10%;"></td> <td style="width: 10%;"></td> </tr> <tr> <td></td> <td></td> <td colspan="8" style="text-align: center;"> <table border="1" style="width: 100%; border-collapse: collapse; text-align: center;"> <tr> <td style="width: 10%;"></td> <td style="width: 10%;"></td> <td style="width: 10%;"></td> <td style="width: 10%;"></td> <td style="width: 10%;"></td> <td style="width: 10%;"></td> <td style="width: 10%;"></td> <td style="width: 10%;"></td> <td style="width: 10%;"></td> <td style="width: 10%;"></td> </tr> <tr> <td></td> <td></td> <td colspan="8" style="text-align: center;"> <table border="1" style="width: 100%; border-collapse: collapse; text-align: center;"> <tr> <td style="width: 10%;"></td> <td style="width: 10%;"></td> <td style="width: 10%;"></td> <td style="width: 10%;"></td> <td style="width: 10%;"></td> <td style="width: 10%;"></td> <td style="width: 10%;"></td> <td style="width: 10%;"></td> <td style="width: 10%;"></td> <td style="width: 10%;"></td> </tr> <tr> <td></td> <td></td> <td colspan="8" style="text-align: center;"> <table border="1" style="width: 100%; border-collapse: collapse; text-align: center;"> <tr> <td style="width: 10%;"></td> <td style="width: 10%;"></td> <td style="width: 10%;"></td> <td style="width: 10%;"></td> <td style="width: 10%;"></td> <td style="width: 10%;"></td> <td style="width: 10%;"></td> <td style="width: 10%;"></td> <td style="width: 10%;"></td> <td style="width: 10%;"></td> </tr> <tr> <td></td> <td></td> <td colspan="8" style="text-align: center;"> <table border="1" style="width: 100%; border-collapse: collapse; text-align: center;"> <tr> <td style="width: 10%;"></td> <td style="width: 10%;"></td> <td style="width: 10%;"></td> <td style="width: 10%;"></td> <td style="width: 10%;"></td> <td style="width: 10%;"></td> <td style="width: 10%;"></td> <td style="width: 10%;"></td> <td style="width: 10%;"></td> <td style="width: 10%;"></td> </tr> <tr> <td></td> <td></td> <td colspan="8" style="text-align: center;"> <table border="1" style="width: 100%; border-collapse: collapse; text-align: center;"> <tr> </tr></table></td></tr></table></td></tr></table></td></tr></table></td></tr></table></td></tr></table></td></tr></table></td></tr></table></td></tr></table></td></tr></table></td></tr></table></td></tr></table> | | | | | | | | | | | | | | | | | | | | <table border="1" style="width: 100%; border-collapse: collapse; text-align: center;"> <tr> <td style="width: 10%;"></td> <td style="width: 10%;"></td> <td style="width: 10%;"></td> <td style="width: 10%;"></td> <td style="width: 10%;"></td> <td style="width: 10%;"></td> <td style="width: 10%;"></td> <td style="width: 10%;"></td> <td style="width: 10%;"></td> <td style="width: 10%;"></td> </tr> <tr> <td></td> <td></td> <td colspan="8" style="text-align: center;"> <table border="1" style="width: 100%; border-collapse: collapse; text-align: center;"> <tr> <td style="width: 10%;"></td> <td style="width: 10%;"></td> <td style="width: 10%;"></td> <td style="width: 10%;"></td> <td style="width: 10%;"></td> <td style="width: 10%;"></td> <td style="width: 10%;"></td> <td style="width: 10%;"></td> <td style="width: 10%;"></td> <td style="width: 10%;"></td> </tr> <tr> <td></td> <td></td> <td colspan="8" style="text-align: center;"> <table border="1" style="width: 100%; border-collapse: collapse; text-align: center;"> <tr> <td style="width: 10%;"></td> <td style="width: 10%;"></td> <td style="width: 10%;"></td> <td style="width: 10%;"></td> <td style="width: 10%;"></td> <td style="width: 10%;"></td> <td style="width: 10%;"></td> <td style="width: 10%;"></td> <td style="width: 10%;"></td> <td style="width: 10%;"></td> </tr> <tr> <td></td> <td></td> <td colspan="8" style="text-align: center;"> <table border="1" style="width: 100%; border-collapse: collapse; text-align: center;"> <tr> <td style="width: 10%;"></td> <td style="width: 10%;"></td> <td style="width: 10%;"></td> <td style="width: 10%;"></td> <td style="width: 10%;"></td> <td style="width: 10%;"></td> <td style="width: 10%;"></td> <td style="width: 10%;"></td> <td style="width: 10%;"></td> <td style="width: 10%;"></td> </tr> <tr> <td></td> <td></td> <td colspan="8" style="text-align: center;"> <table border="1" style="width: 100%; border-collapse: collapse; text-align: center;"> <tr> <td style="width: 10%;"></td> <td style="width: 10%;"></td> <td style="width: 10%;"></td> <td style="width: 10%;"></td> <td style="width: 10%;"></td> <td style="width: 10%;"></td> <td style="width: 10%;"></td> <td style="width: 10%;"></td> <td style="width: 10%;"></td> <td style="width: 10%;"></td> </tr> <tr> <td></td> <td></td> <td colspan="8" style="text-align: center;"> <table border="1" style="width: 100%; border-collapse: collapse; text-align: center;"> <tr> <td style="width: 10%;"></td> <td style="width: 10%;"></td> <td style="width: 10%;"></td> <td style="width: 10%;"></td> <td style="width: 10%;"></td> <td style="width: 10%;"></td> <td style="width: 10%;"></td> <td style="width: 10%;"></td> <td style="width: 10%;"></td> <td style="width: 10%;"></td> </tr> <tr> <td></td> <td></td> <td colspan="8" style="text-align: center;"> <table border="1" style="width: 100%; border-collapse: collapse; text-align: center;"> <tr> <td style="width: 10%;"></td> <td style="width:
10%;"></td> <td style="width: 10%;"></td> <td style="width: 10%;"></td> <td style="width: 10%;"></td> <td style="width: 10%;"></td> <td style="width: 10%;"></td> <td style="width: 10%;"></td> <td style="width: 10%;"></td> <td style="width: 10%;"></td> </tr> <tr> <td></td> <td></td> <td colspan="8" style="text-align: center;"> <table border="1" style="width: 100%; border-collapse: collapse; text-align: center;"> <tr> <td style="width: 10%;"></td> <td style="width: 10%;"></td> <td style="width: 10%;"></td> <td style="width: 10%;"></td> <td style="width: 10%;"></td> <td style="width: 10%;"></td> <td style="width: 10%;"></td> <td style="width: 10%;"></td> <td style="width: 10%;"></td> <td style="width: 10%;"></td> </tr> <tr> <td></td> <td></td> <td colspan="8" style="text-align: center;"> <table border="1" style="width: 100%; border-collapse: collapse; text-align: center;"> <tr> <td style="width: 10%;"></td> <td style="width: 10%;"></td> <td style="width: 10%;"></td> <td style="width: 10%;"></td> <td style="width: 10%;"></td> <td style="width: 10%;"></td> <td style="width: 10%;"></td> <td style="width: 10%;"></td> <td style="width: 10%;"></td> <td style="width: 10%;"></td> </tr> <tr> <td></td> <td></td> <td colspan="8" style="text-align: center;"> <table border="1" style="width: 100%; border-collapse: collapse; text-align: center;"> <tr> <td style="width: 10%;"></td> <td style="width: 10%;"></td> <td style="width: 10%;"></td> <td style="width: 10%;"></td> <td style="width: 10%;"></td> <td style="width: 10%;"></td> <td style="width: 10%;"></td> <td style="width: 10%;"></td> <td style="width: 10%;"></td> <td style="width: 10%;"></td> </tr> <tr> <td></td> <td></td> <td colspan="8" style="text-align: center;"> <table border="1" style="width: 100%; border-collapse: collapse; text-align: center;"> <tr> </tr></table></td></tr></table></td></tr></table></td></tr></table></td></tr></table></td></tr></table></td></tr></table></td></tr></table></td></tr></table></td></tr></table></td></tr></table> | | | | | | | | | | | | | | | | | | | | <table border="1" style="width: 100%; border-collapse: collapse; text-align: center;"> <tr> <td style="width: 10%;"></td> <td style="width: 10%;"></td> <td style="width: 10%;"></td> <td style="width: 10%;"></td> <td style="width: 10%;"></td> <td style="width: 10%;"></td> <td style="width: 10%;"></td> <td style="width: 10%;"></td> <td style="width: 10%;"></td> <td style="width: 10%;"></td> </tr> <tr> <td></td> <td></td> <td colspan="8" style="text-align: center;"> <table border="1" style="width: 100%; border-collapse: collapse; text-align: center;"> <tr> <td style="width: 10%;"></td> <td style="width: 10%;"></td> <td style="width: 10%;"></td> <td style="width: 10%;"></td> <td style="width: 10%;"></td> <td style="width: 10%;"></td> <td style="width: 10%;"></td> <td style="width: 10%;"></td> <td style="width: 10%;"></td> <td style="width: 10%;"></td> </tr> <tr> <td></td> <td></td> <td colspan="8" style="text-align: center;"> <table border="1" style="width: 100%; border-collapse: collapse; text-align: center;"> <tr> <td style="width: 10%;"></td> <td style="width: 10%;"></td> <td style="width: 10%;"></td> <td style="width: 10%;"></td> <td style="width: 10%;"></td> <td style="width: 10%;"></td> <td style="width: 10%;"></td> <td style="width: 10%;"></td> <td style="width: 10%;"></td> <td style="width: 10%;"></td> </tr> <tr> <td></td> <td></td> <td colspan="8" style="text-align: center;"> <table border="1" style="width: 100%; border-collapse: collapse; text-align: center;"> <tr> <td style="width: 10%;"></td> <td style="width: 10%;"></td> <td style="width: 10%;"></td> <td style="width: 10%;"></td> <td style="width: 10%;"></td> <td style="width: 10%;"></td> <td style="width: 10%;"></td> <td style="width: 10%;"></td> <td style="width: 10%;"></td> <td style="width: 10%;"></td> </tr> <tr> <td></td> <td></td> <td colspan="8" style="text-align: center;"> <table border="1" style="width: 100%; border-collapse: collapse; text-align: center;"> <tr> <td style="width: 10%;"></td> <td style="width: 10%;"></td> <td style="width: 10%;"></td> <td style="width: 10%;"></td> <td style="width: 10%;"></td> <td style="width: 10%;"></td> <td style="width: 10%;"></td> <td style="width: 10%;"></td> <td style="width: 10%;"></td> <td style="width: 10%;"></td> </tr> <tr> <td></td> <td></td> <td colspan="8" style="text-align: center;"> <table border="1" style="width: 100%; border-collapse: collapse; text-align: center;"> <tr> <td style="width: 10%;"></td> <td style="width: 10%;"></td> <td style="width: 10%;"></td> <td style="width: 10%;"></td> <td style="width: 10%;"></td> <td style="width: 10%;"></td> <td style="width: 10%;"></td> <td style="width: 10%;"></td> <td style="width: 10%;"></td> <td style="width: 10%;"></td> </tr> <tr> <td></td> <td></td> <td colspan="8" style="text-align: center;"> <table border="1" style="width: 100%; border-collapse: collapse; text-align: center;"> <tr> <td style="width: 10%;"></td> <td style="width: 10%;"></td> <td style="width: 10%;"></td> <td style="width: 10%;"></td> <td style="width: 10%;"></td> <td style="width: 10%;"></td> <td style="width: 10%;"></td> <td style="width: 10%;"></td> <td style="width: 10%;"></td> <td style="width: 10%;"></td> </tr> <tr> <td></td> <td></td> <td colspan="8" style="text-align: center;"> <table border="1" style="width: 100%; border-collapse: collapse; text-align: center;"> <tr> <td style="width: 10%;"></td> <td style="width: 10%;"></td> <td style="width: 10%;"></td> <td style="width: 10%;"></td> <td style="width: 10%;"></td> <td style="width: 10%;"></td> <td style="width: 10%;"></td> <td style="width: 10%;"></td> <td style="width: 10%;"></td> <td style="width: 10%;"></td> </tr> <tr> <td></td> <td></td> <td colspan="8" style="text-align: center;"> <table border="1" style="width: 100%; border-collapse: collapse; text-align: center;"> <tr> <td style="width: 10%;"></td> <td style="width: 10%;"></td> <td style="width: 10%;"></td> <td style="width: 10%;"></td> <td style="width: 10%;"></td> <td style="width: 10%;"></td> <td style="width: 10%;"></td> <td style="width: 10%;"></td> <td style="width: 10%;"></td> <td style="width: 10%;"></td> </tr> <tr> <td></td> <td></td> <td colspan="8" style="text-align: center;"> <table border="1" style="width: 100%; border-collapse: collapse; text-align: center;"> <tr> </tr></table></td></tr></table></td></tr></table></td></tr></table></td></tr></table></td></tr></table></td></tr></table></td></tr></table></td></tr></table></td></tr></table> | | | | | | | | | | | | | | | | | | | | <table border="1" style="width: 100%; border-collapse: collapse; text-align: center;"> <tr> <td style="width: 10%;"></td> <td style="width: 10%;"></td> <td style="width: 10%;"></td> <td style="width: 10%;"></td> <td style="width: 10%;"></td> <td style="width: 10%;"></td> <td style="width: 10%;"></td> <td style="width: 10%;"></td> <td style="width: 10%;"></td> <td style="width: 10%;"></td> </tr> <tr> <td></td> <td></td> <td colspan="8" style="text-align: center;">
<table border="1" style="width: 100%; border-collapse: collapse; text-align: center;"> <tr> <td style="width: 10%;"></td> <td style="width: 10%;"></td> <td style="width: 10%;"></td> <td style="width: 10%;"></td> <td style="width: 10%;"></td> <td style="width: 10%;"></td> <td style="width: 10%;"></td> <td style="width: 10%;"></td> <td style="width: 10%;"></td> <td style="width: 10%;"></td> </tr> <tr> <td></td> <td></td> <td colspan="8" style="text-align: center;"> <table border="1" style="width: 100%; border-collapse: collapse; text-align: center;"> <tr> <td style="width: 10%;"></td> <td style="width: 10%;"></td> <td style="width: 10%;"></td> <td style="width: 10%;"></td> <td style="width: 10%;"></td> <td style="width: 10%;"></td> <td style="width: 10%;"></td> <td style="width: 10%;"></td> <td style="width: 10%;"></td> <td style="width: 10%;"></td> </tr> <tr> <td></td> <td></td> <td colspan="8" style="text-align: center;"> <table border="1" style="width: 100%; border-collapse: collapse; text-align: center;"> <tr> <td style="width: 10%;"></td> <td style="width: 10%;"></td> <td style="width: 10%;"></td> <td style="width: 10%;"></td> <td style="width: 10%;"></td> <td style="width: 10%;"></td> <td style="width: 10%;"></td> <td style="width: 10%;"></td> <td style="width: 10%;"></td> <td style="width: 10%;"></td> </tr> <tr> <td></td> <td></td> <td colspan="8" style="text-align: center;"> <table border="1" style="width: 100%; border-collapse: collapse; text-align: center;"> <tr> <td style="width: 10%;"></td> <td style="width: 10%;"></td> <td style="width: 10%;"></td> <td style="width: 10%;"></td> <td style="width: 10%;"></td> <td style="width: 10%;"></td> <td style="width: 10%;"></td> <td style="width: 10%;"></td> <td style="width: 10%;"></td> <td style="width: 10%;"></td> </tr> <tr> <td></td> <td></td> <td colspan="8" style="text-align: center;"> <table border="1" style="width: 100%; border-collapse: collapse; text-align: center;"> <tr> <td style="width: 10%;"></td> <td style="width: 10%;"></td> <td style="width: 10%;"></td> <td style="width: 10%;"></td> <td style="width: 10%;"></td> <td style="width: 10%;"></td> <td style="width: 10%;"></td> <td style="width: 10%;"></td> <td style="width: 10%;"></td> <td style="width: 10%;"></td> </tr> <tr> <td></td> <td></td> <td colspan="8" style="text-align: center;"> <table border="1" style="width: 100%; border-collapse: collapse; text-align: center;"> <tr> <td style="width: 10%;"></td> <td style="width: 10%;"></td> <td style="width: 10%;"></td> <td style="width: 10%;"></td> <td style="width: 10%;"></td> <td style="width: 10%;"></td> <td style="width: 10%;"></td> <td style="width: 10%;"></td> <td style="width: 10%;"></td> <td style="width: 10%;"></td> </tr> <tr> <td></td> <td></td> <td colspan="8" style="text-align: center;"> <table border="1" style="width: 100%; border-collapse: collapse; text-align: center;"> <tr> <td style="width: 10%;"></td> <td style="width: 10%;"></td> <td style="width: 10%;"></td> <td style="width: 10%;"></td> <td style="width: 10%;"></td> <td style="width: 10%;"></td> <td style="width: 10%;"></td> <td style="width: 10%;"></td> <td style="width: 10%;"></td> <td style="width: 10%;"></td> </tr> <tr> <td></td> <td></td> <td colspan="8" style="text-align: center;"> <table border="1" style="width: 100%; border-collapse: collapse; text-align: center;"> <tr> </tr></table></td></tr></table></td></tr></table></td></tr></table></td></tr></table></td></tr></table></td></tr></table></td></tr></table></td></tr></table> | | | | | | | | | | | | | | | | | | | | <table border="1" style="width: 100%; border-collapse: collapse; text-align: center;"> <tr> <td style="width: 10%;"></td> <td style="width: 10%;"></td> <td style="width: 10%;"></td> <td style="width: 10%;"></td> <td style="width: 10%;"></td> <td style="width: 10%;"></td> <td style="width: 10%;"></td> <td style="width: 10%;"></td> <td style="width: 10%;"></td> <td style="width: 10%;"></td> </tr> <tr> <td></td> <td></td> <td colspan="8" style="text-align: center;"> <table border="1" style="width: 100%; border-collapse: collapse; text-align: center;"> <tr> <td style="width: 10%;"></td> <td style="width: 10%;"></td> <td style="width: 10%;"></td> <td style="width: 10%;"></td> <td style="width: 10%;"></td> <td style="width: 10%;"></td> <td style="width: 10%;"></td> <td style="width: 10%;"></td> <td style="width: 10%;"></td> <td style="width: 10%;"></td> </tr> <tr> <td></td> <td></td> <td colspan="8" style="text-align: center;"> <table border="1" style="width: 100%; border-collapse: collapse; text-align: center;"> <tr> <td style="width: 10%;"></td> <td style="width: 10%;"></td> <td style="width: 10%;"></td> <td style="width: 10%;"></td> <td style="width: 10%;"></td> <td style="width: 10%;"></td> <td style="width: 10%;"></td> <td style="width: 10%;"></td> <td style="width: 10%;"></td> <td style="width: 10%;"></td> </tr> <tr> <td></td> <td></td> <td colspan="8" style="text-align: center;"> <table border="1" style="width: 100%; border-collapse: collapse; text-align: center;"> <tr> <td style="width: 10%;"></td> <td style="width: 10%;"></td> <td style="width: 10%;"></td> <td style="width: 10%;"></td> <td style="width: 10%;"></td> <td style="width: 10%;"></td> <td style="width: 10%;"></td> <td style="width: 10%;"></td> <td style="width: 10%;"></td> <td style="width: 10%;"></td> </tr> <tr> <td></td> <td></td> <td colspan="8" style="text-align: center;"> <table border="1" style="width: 100%; border-collapse: collapse; text-align: center;"> <tr> <td style="width: 10%;"></td> <td style="width: 10%;"></td> <td style="width: 10%;"></td> <td style="width: 10%;"></td> <td style="width: 10%;"></td> <td style="width: 10%;"></td> <td style="width: 10%;"></td> <td style="width: 10%;"></td> <td style="width: 10%;"></td> <td style="width: 10%;"></td> </tr> <tr> <td></td> <td></td> <td colspan="8" style="text-align: center;"> <table border="1" style="width: 100%; border-collapse: collapse; text-align: center;"> <tr> <td style="width: 10%;"></td> <td style="width: 10%;"></td> <td style="width: 10%;"></td> <td style="width: 10%;"></td> <td style="width: 10%;"></td> <td style="width: 10%;"></td> <td style="width: 10%;"></td> <td style="width: 10%;"></td> <td style="width: 10%;"></td> <td style="width: 10%;"></td> </tr> <tr> <td></td> <td></td> <td colspan="8" style="text-align: center;"> <table border="1" style="width: 100%; border-collapse: collapse; text-align: center;"> <tr> <td style="width: 10%;"></td> <td style="width: 10%;"></td> <td style="width: 10%;"></td> <td style="width: 10%;"></td> <td style="width: 10%;"></td> <td style="width: 10%;"></td> <td style="width: 10%;"></td> <td style="width: 10%;"></td> <td style="width: 10%;"></td> <td style="width: 10%;"></td> </tr> <tr> <td></td> <td></td> <td colspan="8" style="text-align: center;"> <table border="1" style="width: 100%; border-collapse: collapse; text-align: center;"> <tr> </tr></table></td></tr></table></td></tr></table></td></tr></table></td></tr></table></td></tr></table></td></tr></table></td></tr></table>
 | | | | | | | | | | | | | | | | | | | | <table border="1" style="width: 100%; border-collapse: collapse; text-align: center;"> <tr> <td style="width: 10%;"></td> <td style="width: 10%;"></td> <td style="width: 10%;"></td> <td style="width: 10%;"></td> <td style="width: 10%;"></td> <td style="width: 10%;"></td> <td style="width: 10%;"></td> <td style="width: 10%;"></td> <td style="width: 10%;"></td> <td style="width: 10%;"></td> </tr> <tr> <td></td> <td></td> <td colspan="8" style="text-align: center;"> <table border="1" style="width: 100%; border-collapse: collapse; text-align: center;"> <tr> <td style="width: 10%;"></td> <td style="width: 10%;"></td> <td style="width: 10%;"></td> <td style="width: 10%;"></td> <td style="width: 10%;"></td> <td style="width: 10%;"></td> <td style="width: 10%;"></td> <td style="width: 10%;"></td> <td style="width: 10%;"></td> <td style="width: 10%;"></td> </tr> <tr> <td></td> <td></td> <td colspan="8" style="text-align: center;"> <table border="1" style="width: 100%; border-collapse: collapse; text-align: center;"> <tr> <td style="width: 10%;"></td> <td style="width: 10%;"></td> <td style="width: 10%;"></td> <td style="width: 10%;"></td> <td style="width: 10%;"></td> <td style="width: 10%;"></td> <td style="width: 10%;"></td> <td style="width: 10%;"></td> <td style="width: 10%;"></td> <td style="width: 10%;"></td> </tr> <tr> <td></td> <td></td> <td colspan="8" style="text-align: center;"> <table border="1" style="width: 100%; border-collapse: collapse; text-align: center;"> <tr> <td style="width: 10%;"></td> <td style="width: 10%;"></td> <td style="width: 10%;"></td> <td style="width: 10%;"></td> <td style="width: 10%;"></td> <td style="width: 10%;"></td> <td style="width: 10%;"></td> <td style="width: 10%;"></td> <td style="width: 10%;"></td> <td style="width: 10%;"></td> </tr> <tr> <td></td> <td></td> <td colspan="8" style="text-align: center;"> <table border="1" style="width: 100%; border-collapse: collapse; text-align: center;"> <tr> <td style="width: 10%;"></td> <td style="width: 10%;"></td> <td style="width: 10%;"></td> <td style="width: 10%;"></td> <td style="width: 10%;"></td> <td style="width: 10%;"></td> <td style="width: 10%;"></td> <td style="width: 10%;"></td> <td style="width: 10%;"></td> <td style="width: 10%;"></td> </tr> <tr> <td></td> <td></td> <td colspan="8" style="text-align: center;"> <table border="1" style="width: 100%; border-collapse: collapse; text-align: center;"> <tr> <td style="width: 10%;"></td> <td style="width: 10%;"></td> <td style="width: 10%;"></td> <td style="width: 10%;"></td> <td style="width: 10%;"></td> <td style="width: 10%;"></td> <td style="width: 10%;"></td> <td style="width: 10%;"></td> <td style="width: 10%;"></td> <td style="width: 10%;"></td> </tr> <tr> <td></td> <td></td> <td colspan="8" style="text-align: center;"> <table border="1" style="width: 100%; border-collapse: collapse; text-align: center;"> <tr> </tr></table></td></tr></table></td></tr></table></td></tr></table></td></tr></table></td></tr></table></td></tr></table> | | | | | | | | | | | | | | | | | | | | <table border="1" style="width: 100%; border-collapse: collapse; text-align: center;"> <tr> <td style="width: 10%;"></td> <td style="width: 10%;"></td> <td style="width: 10%;"></td> <td style="width: 10%;"></td> <td style="width: 10%;"></td> <td style="width: 10%;"></td> <td style="width: 10%;"></td> <td style="width: 10%;"></td> <td style="width: 10%;"></td> <td style="width: 10%;"></td> </tr> <tr> <td></td> <td></td> <td colspan="8" style="text-align: center;"> <table border="1" style="width: 100%; border-collapse: collapse; text-align: center;"> <tr> <td style="width: 10%;"></td> <td style="width: 10%;"></td> <td style="width: 10%;"></td> <td style="width: 10%;"></td> <td style="width: 10%;"></td> <td style="width: 10%;"></td> <td style="width: 10%;"></td> <td style="width: 10%;"></td> <td style="width: 10%;"></td> <td style="width: 10%;"></td> </tr> <tr> <td></td> <td></td> <td colspan="8" style="text-align: center;"> <table border="1" style="width: 100%; border-collapse: collapse; text-align: center;"> <tr> <td style="width: 10%;"></td> <td style="width: 10%;"></td> <td style="width: 10%;"></td> <td style="width: 10%;"></td> <td style="width: 10%;"></td> <td style="width: 10%;"></td> <td style="width: 10%;"></td> <td style="width: 10%;"></td> <td style="width: 10%;"></td> <td style="width: 10%;"></td> </tr> <tr> <td></td> <td></td> <td colspan="8" style="text-align: center;"> <table border="1" style="width: 100%; border-collapse: collapse; text-align: center;"> <tr> <td style="width: 10%;"></td> <td style="width: 10%;"></td> <td style="width: 10%;"></td> <td style="width: 10%;"></td> <td style="width: 10%;"></td> <td style="width: 10%;"></td> <td style="width: 10%;"></td> <td style="width: 10%;"></td> <td style="width: 10%;"></td> <td style="width: 10%;"></td> </tr> <tr> <td></td> <td></td> <td colspan="8" style="text-align: center;"> <table border="1" style="width: 100%; border-collapse: collapse; text-align: center;"> <tr> <td style="width: 10%;"></td> <td style="width: 10%;"></td> <td style="width: 10%;"></td> <td style="width: 10%;"></td> <td style="width: 10%;"></td> <td style="width: 10%;"></td> <td style="width: 10%;"></td> <td style="width: 10%;"></td> <td style="width: 10%;"></td> <td style="width: 10%;"></td> </tr> <tr> <td></td> <td></td> <td colspan="8" style="text-align: center;"> <table border="1" style="width: 100%; border-collapse: collapse; text-align: center;"> <tr> </tr></table></td></tr></table></td></tr></table></td></tr></table></td></tr></table></td></tr></table> | | | | | | | | | | | | | | | | | | | | <table border="1" style="width: 100%; border-collapse: collapse; text-align: center;"> <tr> <td style="width: 10%;"></td> <td style="width: 10%;"></td> <td style="width: 10%;"></td> <td style="width: 10%;"></td> <td style="width: 10%;"></td> <td style="width: 10%;"></td> <td style="width: 10%;"></td> <td style="width: 10%;"></td> <td style="width: 10%;"></td> <td style="width: 10%;"></td> </tr> <tr> <td></td> <td></td> <td colspan="8" style="text-align: center;"> <table border="1" style="width: 100%; border-collapse: collapse; text-align: center;"> <tr> <td style="width: 10%;"></td> <td style="width: 10%;"></td> <td style="width: 10%;"></td> <td style="width: 10%;"></td> <td style="width: 10%;"></td> <td style="width: 10%;"></td> <td style="width: 10%;"></td> <td style="width: 10%;"></td> <td style="width: 10%;"></td> <td style="width: 10%;"></td> </tr> <tr> <td></td> <td></td> <td colspan="8" style="text-align: center;"> <table border="1" style="width: 100%; border-collapse: collapse; text-align: center;"> <tr> <td style="width: 10%;"></td> <td style="width: 10%;"></td> <td style="width: 10%;"></td> <td style="width: 10%;"></td> <td style="width: 10%;"></td> <td style="width: 10%;"></td> <td style="width: 10%;"></td> <td style="width: 10%;"></td> <td style="width: 10%;"></td> <td style="width: 10%;"></td> </tr> <tr>
<td></td> <td></td> <td colspan="8" style="text-align: center;"> <table border="1" style="width: 100%; border-collapse: collapse; text-align: center;"> <tr> <td style="width: 10%;"></td> <td style="width: 10%;"></td> <td style="width: 10%;"></td> <td style="width: 10%;"></td> <td style="width: 10%;"></td> <td style="width: 10%;"></td> <td style="width: 10%;"></td> <td style="width: 10%;"></td> <td style="width: 10%;"></td> <td style="width: 10%;"></td> </tr> <tr> <td></td> <td></td> <td colspan="8" style="text-align: center;"> <table border="1" style="width: 100%; border-collapse: collapse; text-align: center;"> <tr> </tr></table></td></tr></table></td></tr></table></td></tr></table></td></tr></table> | | | | | | | | | | | | | | | | | | | | <table border="1" style="width: 100%; border-collapse: collapse; text-align: center;"> <tr> <td style="width: 10%;"></td> <td style="width: 10%;"></td> <td style="width: 10%;"></td> <td style="width: 10%;"></td> <td style="width: 10%;"></td> <td style="width: 10%;"></td> <td style="width: 10%;"></td> <td style="width: 10%;"></td> <td style="width: 10%;"></td> <td style="width: 10%;"></td> </tr> <tr> <td></td> <td></td> <td colspan="8" style="text-align: center;"> <table border="1" style="width: 100%; border-collapse: collapse; text-align: center;"> <tr> <td style="width: 10%;"></td> <td style="width: 10%;"></td> <td style="width: 10%;"></td> <td style="width: 10%;"></td> <td style="width: 10%;"></td> <td style="width: 10%;"></td> <td style="width: 10%;"></td> <td style="width: 10%;"></td> <td style="width: 10%;"></td> <td style="width: 10%;"></td> </tr> <tr> <td></td> <td></td> <td colspan="8" style="text-align: center;"> <table border="1" style="width: 100%; border-collapse: collapse; text-align: center;"> <tr> <td style="width: 10%;"></td> <td style="width: 10%;"></td> <td style="width: 10%;"></td> <td style="width: 10%;"></td> <td style="width: 10%;"></td> <td style="width: 10%;"></td> <td style="width: 10%;"></td> <td style="width: 10%;"></td> <td style="width: 10%;"></td> <td style="width: 10%;"></td> </tr> <tr> <td></td> <td></td> <td colspan="8" style="text-align: center;"> <table border="1" style="width: 100%; border-collapse: collapse; text-align: center;"> <tr> </tr></table></td></tr></table></td></tr></table></td></tr></table> | | | | | | | | | | | | | | | | | | | | <table border="1" style="width: 100%; border-collapse: collapse; text-align: center;"> <tr> <td style="width: 10%;"></td> <td style="width: 10%;"></td> <td style="width: 10%;"></td> <td style="width: 10%;"></td> <td style="width: 10%;"></td> <td style="width: 10%;"></td> <td style="width: 10%;"></td> <td style="width: 10%;"></td> <td style="width: 10%;"></td> <td style="width: 10%;"></td> </tr> <tr> <td></td> <td></td> <td colspan="8" style="text-align: center;"> <table border="1" style="width: 100%; border-collapse: collapse; text-align: center;"> <tr> <td style="width: 10%;"></td> <td style="width: 10%;"></td> <td style="width: 10%;"></td> <td style="width: 10%;"></td> <td style="width: 10%;"></td> <td style="width: 10%;"></td> <td style="width: 10%;"></td> <td style="width: 10%;"></td> <td style="width: 10%;"></td> <td style="width: 10%;"></td> </tr> <tr> <td></td> <td></td> <td colspan="8" style="text-align: center;"> <table border="1" style="width: 100%; border-collapse: collapse; text-align: center;"> <tr> </tr></table></td></tr></table></td></tr></table> | | | | | | | | | | | | | | | | | | | | <table border="1" style="width: 100%; border-collapse: collapse; text-align: center;"> <tr> <td style="width: 10%;"></td> <td style="width: 10%;"></td> <td style="width: 10%;"></td> <td style="width: 10%;"></td> <td style="width: 10%;"></td> <td style="width: 10%;"></td> <td style="width: 10%;"></td> <td style="width: 10%;"></td> <td style="width: 10%;"></td> <td style="width: 10%;"></td> </tr> <tr> <td></td> <td></td> <td colspan="8" style="text-align: center;"> <table border="1" style="width: 100%; border-collapse: collapse; text-align: center;"> <tr> </tr></table></td></tr></table> | | | | | | | | | | | | | | |
 | | | | <table border="1" style="width: 100%; border-collapse: collapse; text-align: center;"> <tr> </tr></table> | | | | | | | | | | | | | | | | | | | | | | | | | | | | | | | | | | | | | | | | | | | | | | | | | | | | | | | | | | | | | | | | | | | |
| | |

 | | | | | | | | | | | | | | | | | | | |

 | | | | | | | | | | | | | | | | | | | |

 | | | | | | | | | | | | | | | | | | | |

 | | | | | | | | | | | | | | | | | | | |

 | | | | | | | | | | | | | | | | | | | |

 | | | | | | | | | | | | | | | | | | | |

 | | | | | | | | | | | | | | | | | | | |

 | | | | | | | | | | | | | | | | | | | |

 | | | | | | | | | | | | | | | | | | | |

 | | | | | | | | | | | | | | | | | | | |

 | | | | | | | | | | | | | | | | | | | |

 | | | | | | | | | | | | | | | | | | | |

 | | | | | | | | | | | | | | | | | | | |

 | | | | | | | | | | | | | | | | | | | |

 | | | | | | | | | | | | | | | | | | | |

 | | | | | | | | | | | | | | | | | | | |

 | | | | | | | | | | | | | | | | | | | |

 | | | | | | | | | | | | | | | | | | | |

 | | | | | | | | | | | | | | | | | | | |

 | | | | | | | | | | | | | | | | | | | |

 | | | | | | | | | | | | | | | | | | | |

 | | | | | | | | | | | | | | | | | | | |

 | | | | | | | | | | | | | | | | | | | |

 | | | | | | | | | | | | | | | | | | | |

 | | | | | | | | | | | | | | | | | | | |

 | | | | | | | | | | | | | | | | | | | |

 | | | | | | | | | | | | | | | | | | | |

 | | | | | | | | | | | | | | | | | | | |
 | | | | | | | | | | | | | | | | | | | |

 | | | | | | | | | | | | | | | | | | | |

 | | | | | | | | | | | | | | | | | | | |
 | | | | | | | | | | | | | | | | | | | |

 | | | | | | | | | | | | | | | | | | | |

 | | | | | | | | | | | | | | | | | | | |
 | | | | | | | | | | | | | | | | | | | |
 | | | | | | | | | | | | | | | | | | | |

 | | | | | | | | | | | | | | | | | | | |
 | | | | | | | | | | | | | | | | | | | |
 | | | | | | | | | | | | | | | | | | | |

 | | | | | | | | | | | | | | | | | | | | | | | | | | | | | | | | | | | | | | | | | | | | | | | | | | | | | | | | | | | | | | | | | | | | | | | | | | | | | | | | | | | | | | | | | | | | | | | | | | | |
 | | | | | | | | | | | | | | | | | | | |
 | | | | | | | | | | | | | | | | | | | |
 | | | | | | | | | | | | | | | | | | | |
 | | | | | | | | | | | | | | | | | | | |
 | | | | | | | | | | | | | | | | | | | |
 | | | | | | | | | | | | | | | | | | | |
 | | | | | | | | | | | | | | | | | | | |
 | | | | | | | | | | | | | | | | | | | |
 | | | | | | | | | | | | | | | | | | | | | | | | | | | | | | | | | | | | | | | |
 | | | | | | | | | | | | | | | | | | | |
 | | | | | | | | | | | | | | | | | | | | | | | | | | | | | | | | | | | | | | | |
 | | | | | | | | | | | | | | | | | | | | | | | | | | | | | | | | | | | | | | | |
 | | | | | | | | | | | | | | | | | | | | | | | | | | | | | | | | | | | | | | | |
 | | | | | | | | | | | | | | | | | | | | | | | | | | | | | | | | | | | | | | | | | | | | | | | | | | | | | | | | | | | | | | | | | | | | | | | | | | | | | | | | | | | | | | | | | | | | | | | | | | | |
 | | | | | | | | | | | | | | | | | | | | | | | | | | | | | | | | | | | | | | | | | | | | | | | |
| | | <table border="1" style="width: 100%; border-collapse: collapse; text-align: center;"> <tr> <td style="width: 10%;"></td> <td style="width: 10%;"></td> <td style="width: 10%;"></td> <td style="width: 10%;"></td> <td style="width: 10%;"></td> <td style="width: 10%;"></td> <td style="width: 10%;"></td> <td style="width: 10%;"></td> <td style="width: 10%;"></td> <td style="width: 10%;"></td> </tr> <tr> <td></td> <td></td> <td colspan="8" style="text-align: center;"> <table border="1" style="width: 100%; border-collapse: collapse; text-align: center;"> <tr> <td style="width: 10%;"></td> <td style="width: 10%;"></td> <td style="width: 10%;"></td> <td style="width: 10%;"></td> <td style="width: 10%;"></td> <td style="width: 10%;"></td> <td style="width: 10%;"></td> <td style="width: 10%;"></td> <td style="width: 10%;"></td> <td style="width: 10%;"></td> </tr> <tr> <td></td> <td></td> <td colspan="8" style="text-align: center;"> <table border="1" style="width: 100%; border-collapse: collapse; text-align: center;"> <tr> <td style="width: 10%;"></td> <td style="width: 10%;"></td> <td style="width: 10%;"></td> <td style="width: 10%;"></td> <td style="width: 10%;"></td> <td style="width: 10%;"></td> <td style="width: 10%;"></td> <td style="width: 10%;"></td> <td style="width: 10%;"></td> <td style="width: 10%;"></td> </tr> <tr> <td></td> <td></td> <td colspan="8" style="text-align: center;"> <table border="1" style="width: 100%; border-collapse: collapse; text-align: center;"> <tr> <td style="width: 10%;"></td> <td style="width: 10%;"></td> <td style="width: 10%;"></td> <td style="width: 10%;"></td> <td style="width: 10%;"></td> <td style="width: 10%;"></td> <td style="width: 10%;"></td> <td style="width: 10%;"></td> <td style="width: 10%;"></td> <td style="width: 10%;"></td> </tr> <tr> <td></td> <td></td> <td colspan="8" style="text-align: center;"> <table border="1" style="width: 100%; border-collapse: collapse; text-align: center;"> <tr> <td style="width: 10%;"></td> <td style="width: 10%;"></td> <td style="width: 10%;"></td> <td style="width: 10%;"></td> <td style="width: 10%;"></td> <td style="width: 10%;"></td> <td style="width: 10%;"></td> <td style="width: 10%;"></td> <td style="width: 10%;"></td> <td style="width: 10%;"></td> </tr> <tr> <td></td> <td></td> <td colspan="8" style="text-align: center;"> <table border="1" style="width: 100%; border-collapse: collapse; text-align: center;"> <tr> <td style="width: 10%;"></td> <td style="width: 10%;"></td> <td style="width: 10%;"></td> <td style="width: 10%;"></td> <td style="width: 10%;"></td> <td style="width: 10%;"></td> <td style="width: 10%;"></td> <td style="width: 10%;"></td> <td style="width: 10%;"></td> <td style="width: 10%;"></td> </tr> <tr> <td></td> <td></td> <td colspan="8" style="text-align: center;"> <table border="1" style="width: 100%; border-collapse: collapse; text-align: center;"> <tr> <td style="width: 10%;"></td> <td style="width: 10%;"></td> <td style="width: 10%;"></td> <td style="width: 10%;"></td> <td style="width: 10%;"></td> <td style="width: 10%;"></td> <td style="width: 10%;"></td> <td style="width: 10%;"></td> <td style="width: 10%;"></td> <td style="width: 10%;"></td> </tr> <tr> <td></td> <td></td> <td colspan="8" style="text-align: center;"> <table border="1" style="width: 100%; border-collapse: collapse; text-align: center;"> <tr> <td style="width: 10%;"></td> <td style="width: 10%;"></td> <td style="width: 10%;"></td> <td style="width: 10%;"></td> <td style="width: 10%;"></td> <td style="width: 10%;"></td> <td style="width: 10%;"></td> <td style="width: 10%;"></td> <td style="width: 10%;"></td> <td style="width: 10%;"></td> </tr> <tr> <td></td> <td></td> <td colspan="8" style="text-align: center;"> <table border="1" style="width: 100%; border-collapse: collapse; text-align: center;"> <tr> <td style="width: 10%;"></td> <td style="width: 10%;"></td> <td style="width: 10%;"></td> <td style="width: 10%;"></td> <td style="width: 10%;"></td> <td style="width: 10%;"></td> <td style="width: 10%;"></td> <td style="width: 10%;"></td> <td style="width: 10%;"></td> <td style="width: 10%;"></td> </tr> <tr> <td></td> <td></td> <td colspan="8" style="text-align: center;"> <table border="1" style="width: 100%; border-collapse: collapse; text-align: center;"> <tr> <td style="width: 10%;"></td> <td style="width: 10%;"></td> <td style="width: 10%;"></td> <td style="width: 10%;"></td> <td style="width: 10%;"></td> <td style="width: 10%;"></td> <td style="width: 10%;"></td> <td style="width: 10%;"></td> <td style="width: 10%;"></td> <td style="width: 10%;"></td> </tr> <tr> <td></td> <td></td> <td colspan="8" style="text-align: center;"> <table border="1" style="width: 100%; border-collapse: collapse; text-align: center;"> <tr> <td style="width: 10%;"></td> <td style="width: 10%;"></td> <td style="width: 10%;"></td> <td style="width: 10%;"></td> <td style="width: 10%;"></td> <td style="width: 10%;"></td> <td style="width: 10%;"></td> <td style="width: 10%;"></td> <td style="width: 10%;"></td> <td style="width: 10%;"></td> </tr> <tr> <td></td> <td></td> <td colspan="8" style="text-align: center;"> <table border="1" style="width: 100%; border-collapse: collapse; text-align: center;"> <tr> <td style="width: 10%;"></td> <td style="width: 10%;"></td> <td style="width: 10%;"></td> <td style="width: 10%;"></td> <td style="width: 10%;"></td> <td style="width: 10%;"></td> <td style="width: 10%;"></td> <td style="width: 10%;"></td> <td style="width: 10%;"></td> <td style="width: 10%;"></td> </tr> <tr> <td></td> <td></td> <td colspan="8" style="text-align: center;"> <table border="1" style="width: 100%; border-collapse: collapse; text-align: center;"> <tr> <td style="width: 10%;"></td> <td style="width: 10%;"></td> <td style="width: 10%;"></td> <td style="width: 10%;"></td> <td style="width: 10%;"></td> <td style="width: 10%;"></td> <td style="width: 10%;"></td> <td style="width: 10%;"></td> <td style="width: 10%;"></td> <td style="width: 10%;"></td> </tr> <tr> <td></td> <td></td> <td colspan="8" style="text-align: center;"> <table border="1" style="width: 100%; border-collapse: collapse; text-align: center;"> <tr> <td style="width: 10%;"></td> <td style="width: 10%;"></td> <td style="width: 10%;"></td> <td style="width: 10%;"></td> <td style="width: 10%;"></td> <td style="width: 10%;"></td> <td style="width: 10%;"></td> <td style="width: 10%;"></td> <td style="width: 10%;"></td> <td style="width: 10%;"></td> </tr> <tr> <td></td> <td></td> <td colspan="8" style="text-align: center;"> <table border="1" style="width: 100%; border-collapse: collapse; text-align: center;"> <tr> <td style="width: 10%;"></td> <td style="width: 10%;"></td> <td style="width: 10%;"></td> <td style="width: 10%;"></td> <td style="width: 10%;"></td> <td style="width: 10%;"></td> <td style="width: 10%;"></td> <td style="width: 10%;"></td> <td style="width: 10%;"></td> <td style="width: 10%;"></td> </tr> <tr> <td></td> <td></td> <td colspan="8" style="text-align: center;"> <table border="1" style="width: 100%; border-collapse: collapse; text-align: center;"> <tr> <td style="width: 10%;"></td> <td style="width: 10%;"></td> <td style="width: 10%;"></td> <td style="width: 10%;"></td> <td style="width: 10%;"></td> <td style="width: 10%;"></td> <td style="width: 10%;"></td> <td style="width: 10%;"></td> <td style="width: 10%;"></td> <td style="width: 10%;"></td> </tr> <tr> <td></td> <td></td> <td colspan="8" style="text-align: center;"> <table border="1" style="width: 100%; border-collapse: collapse; text-align: center;"> <tr> <td style="width: 10%;"></td> <td style="width: 10%;"></td> <td style="width: 10%;"></td> <td style="width: 10%;"></td> <td style="width: 10%;"></td> <td style="width: 10%;"></td> <td style="width: 10%;"></td> <td style="width: 10%;"></td> <td style="width: 10%;"></td> <td style="width: 10%;"></td> </tr> <tr> <td></td> <td></td> <td colspan="8" style="text-align: center;"> <table border="1" style="width: 100%; border-collapse: collapse; text-align: center;"> <tr> <td style="width: 10%;"></td> <td style="width: 10%;"></td> <td style="width: 10%;"></td> <td style="width: 10%;"></td> <td style="width: 10%;"></td> <td style="width: 10%;"></td> <td style="width: 10%;"></td> <td style="width: 10%;"></td> <td style="width: 10%;"></td> <td style="width: 10%;"></td> </tr> <tr> <td></td> <td></td> <td colspan="8" style="text-align: center;"> <table border="1" style="width: 100%; border-collapse: collapse; text-align: center;"> <tr> <td style="width: 10%;"></td> <td style="width: 10%;"></td> <td style="width: 10%;"></td> <td style="width: 10%;"></td> <td style="width: 10%;"></td> <td style="width: 10%;"></td> <td style="width: 10%;"></td> <td style="width: 10%;"></td> <td style="width: 10%;"></td> <td style="width: 10%;"></td> </tr> <tr> <td></td> <td></td> <td colspan="8" style="text-align: center;"> <table border="1" style="width: 100%; border-collapse: collapse; text-align: center;"> <tr> <td style="width: 10%;"></td> <td style="width: 10%;"></td> <td style="width: 10%;"></td> <td style="width: 10%;"></td> <td style="width: 10%;"></td> <td style="width: 10%;"></td> <td style="width: 10%;"></td> <td style="width: 10%;"></td> <td style="width: 10%;"></td> <td style="width: 10%;"></td> </tr> <tr> <td></td> <td></td> <td colspan="8" style="text-align: center;"> <table border="1" style="width: 100%; border-collapse: collapse; text-align: center;"> <tr> <td style="width: 10%;"></td> <td style="width: 10%;"></td> <td style="width: 10%;"></td> <td style="width: 10%;"></td> <td style="width: 10%;"></td> <td style="width: 10%;"></td> <td style="width: 10%;"></td> <td style="width: 10%;"></td> <td style="width: 10%;"></td> <td style="width: 10%;"></td> </tr> <tr> <td></td> <td></td> <td colspan="8" style="text-align: center;"> <table border="1" style="width: 100%; border-collapse: collapse; text-align: center;"> <tr> <td style="width: 10%;"></td> <td style="width: 10%;"></td> <td
style="width: 10%;"></td> <td style="width: 10%;"></td> <td style="width: 10%;"></td> <td style="width: 10%;"></td> <td style="width: 10%;"></td> <td style="width: 10%;"></td> <td style="width: 10%;"></td> <td style="width: 10%;"></td> </tr> <tr> <td></td> <td></td> <td colspan="8" style="text-align: center;"> <table border="1" style="width: 100%; border-collapse: collapse; text-align: center;"> <tr> <td style="width: 10%;"></td> <td style="width: 10%;"></td> <td style="width: 10%;"></td> <td style="width: 10%;"></td> <td style="width: 10%;"></td> <td style="width: 10%;"></td> <td style="width: 10%;"></td> <td style="width: 10%;"></td> <td style="width: 10%;"></td> <td style="width: 10%;"></td> </tr> <tr> <td></td> <td></td> <td colspan="8" style="text-align: center;"> <table border="1" style="width: 100%; border-collapse: collapse; text-align: center;"> <tr> <td style="width: 10%;"></td> <td style="width: 10%;"></td> <td style="width: 10%;"></td> <td style="width: 10%;"></td> <td style="width: 10%;"></td> <td style="width: 10%;"></td> <td style="width: 10%;"></td> <td style="width: 10%;"></td> <td style="width: 10%;"></td> <td style="width: 10%;"></td> </tr> <tr> <td></td> <td></td> <td colspan="8" style="text-align: center;"> <table border="1" style="width: 100%; border-collapse: collapse; text-align: center;"> <tr> <td style="width: 10%;"></td> <td style="width: 10%;"></td> <td style="width: 10%;"></td> <td style="width: 10%;"></td> <td style="width: 10%;"></td> <td style="width: 10%;"></td> <td style="width: 10%;"></td> <td style="width: 10%;"></td> <td style="width: 10%;"></td> <td style="width: 10%;"></td> </tr> <tr> <td></td> <td></td> <td colspan="8" style="text-align: center;"> <table border="1" style="width: 100%; border-collapse: collapse; text-align: center;"> <tr> <td style="width: 10%;"></td> <td style="width: 10%;"></td> <td style="width: 10%;"></td> <td style="width: 10%;"></td> <td style="width: 10%;"></td> <td style="width: 10%;"></td> <td style="width: 10%;"></td> <td style="width: 10%;"></td> <td style="width: 10%;"></td> <td style="width: 10%;"></td> </tr> <tr> <td></td> <td></td> <td colspan="8" style="text-align: center;"> <table border="1" style="width: 100%; border-collapse: collapse; text-align: center;"> <tr> <td style="width: 10%;"></td> <td style="width: 10%;"></td> <td style="width: 10%;"></td> <td style="width: 10%;"></td> <td style="width: 10%;"></td> <td style="width: 10%;"></td> <td style="width: 10%;"></td> <td style="width: 10%;"></td> <td style="width: 10%;"></td> <td style="width: 10%;"></td> </tr> <tr> <td></td> <td></td> <td colspan="8" style="text-align: center;"> <table border="1" style="width: 100%; border-collapse: collapse; text-align: center;"> <tr> <td style="width: 10%;"></td> <td style="width: 10%;"></td> <td style="width: 10%;"></td> <td style="width: 10%;"></td> <td style="width: 10%;"></td> <td style="width: 10%;"></td> <td style="width: 10%;"></td> <td style="width: 10%;"></td> <td style="width: 10%;"></td> <td style="width: 10%;"></td> </tr> <tr> <td></td> <td></td> <td colspan="8" style="text-align: center;"> <table border="1" style="width: 100%; border-collapse: collapse; text-align: center;"> <tr> <td style="width: 10%;"></td> <td style="width: 10%;"></td> <td style="width: 10%;"></td> <td style="width: 10%;"></td> <td style="width: 10%;"></td> <td style="width: 10%;"></td> <td style="width: 10%;"></td> <td style="width: 10%;"></td> <td style="width: 10%;"></td> <td style="width: 10%;"></td> </tr> <tr> <td></td> <td></td> <td colspan="8" style="text-align: center;"> <table border="1" style="width: 100%; border-collapse: collapse; text-align: center;"> <tr> <td style="width: 10%;"></td> <td style="width: 10%;"></td> <td style="width: 10%;"></td> <td style="width: 10%;"></td> <td style="width: 10%;"></td> <td style="width: 10%;"></td> <td style="width: 10%;"></td> <td style="width: 10%;"></td> <td style="width: 10%;"></td> <td style="width: 10%;"></td> </tr> <tr> <td></td> <td></td> <td colspan="8" style="text-align: center;"> <table border="1" style="width: 100%; border-collapse: collapse; text-align: center;"> <tr> <td style="width: 10%;"></td> <td style="width: 10%;"></td> <td style="width: 10%;"></td> <td style="width: 10%;"></td> <td style="width: 10%;"></td> <td style="width: 10%;"></td> <td style="width: 10%;"></td> <td style="width: 10%;"></td> <td style="width: 10%;"></td> <td style="width: 10%;"></td> </tr> <tr> <td></td> <td></td> <td colspan="8" style="text-align: center;"> <table border="1" style="width: 100%; border-collapse: collapse; text-align: center;"> <tr> <td style="width: 10%;"></td> <td style="width: 10%;"></td> <td style="width: 10%;"></td> <td style="width: 10%;"></td> <td style="width: 10%;"></td> <td style="width: 10%;"></td> <td style="width: 10%;"></td> <td style="width: 10%;"></td> <td style="width: 10%;"></td> <td style="width: 10%;"></td> </tr> <tr> <td></td> <td></td> <td colspan="8" style="text-align: center;"> <table border="1" style="width: 100%; border-collapse: collapse; text-align: center;"> <tr> <td style="width: 10%;"></td> <td style="width: 10%;"></td> <td style="width: 10%;"></td> <td style="width: 10%;"></td> <td style="width: 10%;"></td> <td style="width: 10%;"></td> <td style="width: 10%;"></td> <td style="width: 10%;"></td> <td style="width: 10%;"></td> <td style="width: 10%;"></td> </tr> <tr> <td></td> <td></td> <td colspan="8" style="text-align: center;"> <table border="1" style="width: 100%; border-collapse: collapse; text-align: center;"> <tr> <td style="width: 10%;"></td> <td style="width: 10%;"></td> <td style="width: 10%;"></td> <td style="width: 10%;"></td> <td style="width: 10%;"></td> <td style="width: 10%;"></td> <td style="width: 10%;"></td> <td style="width: 10%;"></td> <td style="width: 10%;"></td> <td style="width: 10%;"></td> </tr> <tr> <td></td> <td></td> <td colspan="8" style="text-align: center;"> <table border="1" style="width: 100%; border-collapse: collapse; text-align: center;"> <tr> <td style="width: 10%;"></td> <td style="width: 10%;"></td> <td style="width: 10%;"></td> <td style="width: 10%;"></td> <td style="width: 10%;"></td> <td style="width: 10%;"></td> <td style="width: 10%;"></td> <td style="width: 10%;"></td> <td style="width: 10%;"></td> <td style="width: 10%;"></td> </tr> <tr> <td></td> <td></td> <td colspan="8" style="text-align: center;"> <table border="1" style="width: 100%; border-collapse: collapse; text-align: center;"> <tr> <td style="width: 10%;"></td> <td style="width: 10%;"></td> <td style="width: 10%;"></td> <td style="width: 10%;"></td> <td style="width: 10%;"></td> <td style="width: 10%;"></td> <td style="width: 10%;"></td> <td style="width: 10%;"></td> <td style="width: 10%;"></td> <td style="width: 10%;"></td> </tr> <tr> <td></td> <td></td> <td colspan="8" style="text-align: center;"> <table border="1" style="width: 100%; border-collapse: collapse; text-align: center;"> <tr> <td style="width: 10%;"></td> <td style="width: 10%;"></td> <td style="width: 10%;"></td> <td style="width: 10%;"></td> <td style="width: 10%;"></td> <td style="width: 10%;"></td> <td style="width: 10%;"></td> <td style="width: 10%;"></td> <td style="width: 10%;"></td> <td style="width: 10%;"></td> </tr> <tr> <td></td> <td></td> <td colspan="8" style="text-align: center;"> <table border="1" style="width: 100%; border-collapse: collapse; text-align: center;"> <tr> <td style="width: 10%;"></td> <td style="width: 10%;"></td> <td style="width: 10%;"></td> <td style="width: 10%;"></td> <td style="width: 10%;"></td> <td style="width: 10%;"></td> <td style="width: 10%;"></td> <td style="width: 10%;"></td> <td style="width: 10%;"></td> <td style="width: 10%;"></td> </tr> <tr> <td></td> <td></td> <td colspan="8" style="text-align: center;"> <table border="1" style="width: 100%; border-collapse: collapse; text-align: center;"> <tr> <td style="width: 10%;"></td> <td style="width: 10%;"></td> <td style="width: 10%;"></td> <td style="width: 10%;"></td> <td style="width: 10%;"></td> <td style="width: 10%;"></td> <td style="width: 10%;"></td> <td style="width: 10%;"></td> <td style="width: 10%;"></td> <td style="width: 10%;"></td> </tr> <tr> <td></td> <td></td> <td colspan="8" style="text-align: center;"> <table border="1" style="width: 100%; border-collapse: collapse; text-align: center;"> <tr> <td style="width: 10%;"></td> <td style="width: 10%;"></td> <td style="width: 10%;"></td> <td style="width: 10%;"></td> <td style="width: 10%;"></td> <td style="width: 10%;"></td> <td style="width: 10%;"></td> <td style="width: 10%;"></td> <td style="width: 10%;"></td> <td style="width: 10%;"></td> </tr> <tr> <td></td> <td></td> <td colspan="8" style="text-align: center;"> <table border="1" style="width: 100%; border-collapse: collapse; text-align: center;"> <tr> <td style="width: 10%;"></td> <td style="width: 10%;"></td> <td style="width: 10%;"></td> <td style="width: 10%;"></td> <td style="width: 10%;"></td> <td style="width: 10%;"></td> <td style="width: 10%;"></td> <td style="width: 10%;"></td> <td style="width: 10%;"></td> <td style="width: 10%;"></td> </tr> <tr> <td></td> <td></td> <td colspan="8" style="text-align: center;"> <table border="1" style="width: 100%; border-collapse: collapse; text-align: center;"> <tr> <td style="width: 10%;"></td> <td style="width: 10%;"></td> <td style="width: 10%;"></td> <td style="width: 10%;"></td> <td style="width: 10%;"></td> <td style="width: 10%;"></td> <td style="width: 10%;"></td> <td style="width: 10%;"></td> <td style="width: 10%;"></td> <td style="width: 10%;"></td> </tr> <tr> <td></td> <td></td> <td colspan="8" style="text-align: center;"> <table border="1" style="width: 100%; border-collapse: collapse; text-align: center;"> <tr> <td style="width: 10%;"></td> <td style="width: 10%;"></td> <td style="width: 10%;"></td> <td style="width: 10%;"></td> <td style="width: 10%;"></td> <td style="width: 10%;"></td> <td style="width: 10%;"></td> <td style="width:
10%;"></td> <td style="width: 10%;"></td> <td style="width: 10%;"></td> </tr> <tr> <td></td> <td></td> <td colspan="8" style="text-align: center;"> <table border="1" style="width: 100%; border-collapse: collapse; text-align: center;"> <tr> <td style="width: 10%;"></td> <td style="width: 10%;"></td> <td style="width: 10%;"></td> <td style="width: 10%;"></td> <td style="width: 10%;"></td> <td style="width: 10%;"></td> <td style="width: 10%;"></td> <td style="width: 10%;"></td> <td style="width: 10%;"></td> <td style="width: 10%;"></td> </tr> <tr> <td></td> <td></td> <td colspan="8" style="text-align: center;"> <table border="1" style="width: 100%; border-collapse: collapse; text-align: center;"> <tr> <td style="width: 10%;"></td> <td style="width: 10%;"></td> <td style="width: 10%;"></td> <td style="width: 10%;"></td> <td style="width: 10%;"></td> <td style="width: 10%;"></td> <td style="width: 10%;"></td> <td style="width: 10%;"></td> <td style="width: 10%;"></td> <td style="width: 10%;"></td> </tr> <tr> <td></td> <td></td> <td colspan="8" style="text-align: center;"> <table border="1" style="width: 100%; border-collapse: collapse; text-align: center;"> <tr> <td style="width: 10%;"></td> <td style="width: 10%;"></td> <td style="width: 10%;"></td> <td style="width: 10%;"></td> <td style="width: 10%;"></td> <td style="width: 10%;"></td> <td style="width: 10%;"></td> <td style="width: 10%;"></td> <td style="width: 10%;"></td> <td style="width: 10%;"></td> </tr> <tr> <td></td> <td></td> <td colspan="8" style="text-align: center;"> <table border="1" style="width: 100%; border-collapse: collapse; text-align: center;"> <tr> <td style="width: 10%;"></td> <td style="width: 10%;"></td> <td style="width: 10%;"></td> <td style="width: 10%;"></td> <td style="width: 10%;"></td> <td style="width: 10%;"></td> <td style="width: 10%;"></td> <td style="width: 10%;"></td> <td style="width: 10%;"></td> <td style="width: 10%;"></td> </tr> <tr> <td></td> <td></td> <td colspan="8" style="text-align: center;"> <table border="1" style="width: 100%; border-collapse: collapse; text-align: center;"> <tr> <td style="width: 10%;"></td> <td style="width: 10%;"></td> <td style="width: 10%;"></td> <td style="width: 10%;"></td> <td style="width: 10%;"></td> <td style="width: 10%;"></td> <td style="width: 10%;"></td> <td style="width: 10%;"></td> <td style="width: 10%;"></td> <td style="width: 10%;"></td> </tr> <tr> <td></td> <td></td> <td colspan="8" style="text-align: center;"> <table border="1" style="width: 100%; border-collapse: collapse; text-align: center;"> <tr> <td style="width: 10%;"></td> <td style="width: 10%;"></td> <td style="width: 10%;"></td> <td style="width: 10%;"></td> <td style="width: 10%;"></td> <td style="width: 10%;"></td> <td style="width: 10%;"></td> <td style="width: 10%;"></td> <td style="width: 10%;"></td> <td style="width: 10%;"></td> </tr> <tr> <td></td> <td></td> <td colspan="8" style="text-align: center;"> <table border="1" style="width: 100%; border-collapse: collapse; text-align: center;"> <tr> <td style="width: 10%;"></td> <td style="width: 10%;"></td> <td style="width: 10%;"></td> <td style="width: 10%;"></td> <td style="width: 10%;"></td> <td style="width: 10%;"></td> <td style="width: 10%;"></td> <td style="width: 10%;"></td> <td style="width: 10%;"></td> <td style="width: 10%;"></td> </tr> <tr> <td></td> <td></td> <td colspan="8" style="text-align: center;"> <table border="1" style="width: 100%; border-collapse: collapse; text-align: center;"> <tr> <td style="width: 10%;"></td> <td style="width: 10%;"></td> <td style="width: 10%;"></td> <td style="width: 10%;"></td> <td style="width: 10%;"></td> <td style="width: 10%;"></td> <td style="width: 10%;"></td> <td style="width: 10%;"></td> <td style="width: 10%;"></td> <td style="width: 10%;"></td> </tr> <tr> <td></td> <td></td> <td colspan="8" style="text-align: center;"> <table border="1" style="width: 100%; border-collapse: collapse; text-align: center;"> <tr> <td style="width: 10%;"></td> <td style="width: 10%;"></td> <td style="width: 10%;"></td> <td style="width: 10%;"></td> <td style="width: 10%;"></td> <td style="width: 10%;"></td> <td style="width: 10%;"></td> <td style="width: 10%;"></td> <td style="width: 10%;"></td> <td style="width: 10%;"></td> </tr> <tr> <td></td> <td></td> <td colspan="8" style="text-align: center;"> <table border="1" style="width: 100%; border-collapse: collapse; text-align: center;"> <tr> <td style="width: 10%;"></td> <td style="width: 10%;"></td> <td style="width: 10%;"></td> <td style="width: 10%;"></td> <td style="width: 10%;"></td> <td style="width: 10%;"></td> <td style="width: 10%;"></td> <td style="width: 10%;"></td> <td style="width: 10%;"></td> <td style="width: 10%;"></td> </tr> <tr> <td></td> <td></td> <td colspan="8" style="text-align: center;"> <table border="1" style="width: 100%; border-collapse: collapse; text-align: center;"> <tr> <td style="width: 10%;"></td> <td style="width: 10%;"></td> <td style="width: 10%;"></td> <td style="width: 10%;"></td> <td style="width: 10%;"></td> <td style="width: 10%;"></td> <td style="width: 10%;"></td> <td style="width: 10%;"></td> <td style="width: 10%;"></td> <td style="width: 10%;"></td> </tr> <tr> <td></td> <td></td> <td colspan="8" style="text-align: center;"> <table border="1" style="width: 100%; border-collapse: collapse; text-align: center;"> <tr> <td style="width: 10%;"></td> <td style="width: 10%;"></td> <td style="width: 10%;"></td> <td style="width: 10%;"></td> <td style="width: 10%;"></td> <td style="width: 10%;"></td> <td style="width: 10%;"></td> <td style="width: 10%;"></td> <td style="width: 10%;"></td> <td style="width: 10%;"></td> </tr> <tr> <td></td> <td></td> <td colspan="8" style="text-align: center;"> <table border="1" style="width: 100%; border-collapse: collapse; text-align: center;"> <tr> <td style="width: 10%;"></td> <td style="width: 10%;"></td> <td style="width: 10%;"></td> <td style="width: 10%;"></td> <td style="width: 10%;"></td> <td style="width: 10%;"></td> <td style="width: 10%;"></td> <td style="width: 10%;"></td> <td style="width: 10%;"></td> <td style="width: 10%;"></td> </tr> <tr> <td></td> <td></td> <td colspan="8" style="text-align: center;"> <table border="1" style="width: 100%; border-collapse: collapse; text-align: center;"> <tr> <td style="width: 10%;"></td> <td style="width: 10%;"></td> <td style="width: 10%;"></td> <td style="width: 10%;"></td> <td style="width: 10%;"></td> <td style="width: 10%;"></td> <td style="width: 10%;"></td> <td style="width: 10%;"></td> <td style="width: 10%;"></td> <td style="width: 10%;"></td> </tr> <tr> <td></td> <td></td> <td colspan="8" style="text-align: center;"> <table border="1" style="width: 100%; border-collapse: collapse; text-align: center;"> <tr> <td style="width: 10%;"></td> <td style="width: 10%;"></td> <td style="width: 10%;"></td> <td style="width: 10%;"></td> <td style="width: 10%;"></td> <td style="width: 10%;"></td> <td style="width: 10%;"></td> <td style="width: 10%;"></td> <td style="width: 10%;"></td> <td style="width: 10%;"></td> </tr> <tr> <td></td> <td></td> <td colspan="8" style="text-align: center;"> <table border="1" style="width: 100%; border-collapse: collapse; text-align: center;"> <tr> <td style="width: 10%;"></td> <td style="width: 10%;"></td> <td style="width: 10%;"></td> <td style="width: 10%;"></td> <td style="width: 10%;"></td> <td style="width: 10%;"></td> <td style="width: 10%;"></td> <td style="width: 10%;"></td> <td style="width: 10%;"></td> <td style="width: 10%;"></td> </tr> <tr> <td></td> <td></td> <td colspan="8" style="text-align: center;"> <table border="1" style="width: 100%; border-collapse: collapse; text-align: center;"> <tr> <td style="width: 10%;"></td> <td style="width: 10%;"></td> <td style="width: 10%;"></td> <td style="width: 10%;"></td> <td style="width: 10%;"></td> <td style="width: 10%;"></td> <td style="width: 10%;"></td> <td style="width: 10%;"></td> <td style="width: 10%;"></td> <td style="width: 10%;"></td> </tr> <tr> <td></td> <td></td> <td colspan="8" style="text-align: center;"> <table border="1" style="width: 100%; border-collapse: collapse; text-align: center;"> <tr> </tr></table></td></tr></table></td></tr></table></td></tr></table></td></tr></table></td></tr></table></td></tr></table></td></tr></table></td></tr></table></td></tr></table></td></tr></table></td></tr></table></td></tr></table></td></tr></table></td></tr></table></td></tr></table></td></tr></table></td></tr></table></td></tr></table></td></tr></table></td></tr></table></td></tr></table></td></tr></table></td></tr></table></td></tr></table></td></tr></table></td></tr></table></td></tr></table></td></tr></table></td></tr></table></td></tr></table></td></tr></table></td></tr></table></td></tr></table></td></tr></table></td></tr></table></td></tr></table></td></tr></table></td></tr></table></td></tr></table></td></tr></table></td></tr></table></td></tr></table></td></tr></table></td></tr></table></td></tr></table></td></tr></table></td></tr></table></td></tr></table></td></tr></table></td></tr></table></td></tr></table></td></tr></table></td></tr></table></td></tr></table></td></tr></table></td></tr></table></td></tr></table></td></tr></table></td></tr></table></td></tr></table>
 | | | | | | | | | | | | | | | | | | | | <table border="1" style="width: 100%; border-collapse: collapse; text-align: center;"> <tr> <td style="width: 10%;"></td> <td style="width: 10%;"></td> <td style="width: 10%;"></td> <td style="width: 10%;"></td> <td style="width: 10%;"></td> <td style="width: 10%;"></td> <td style="width: 10%;"></td> <td style="width: 10%;"></td> <td style="width: 10%;"></td> <td style="width: 10%;"></td> </tr> <tr> <td></td> <td></td> <td colspan="8" style="text-align: center;"> <table border="1" style="width: 100%; border-collapse: collapse; text-align: center;"> <tr> <td style="width: 10%;"></td> <td style="width: 10%;"></td> <td style="width: 10%;"></td> <td style="width: 10%;"></td> <td style="width: 10%;"></td> <td style="width: 10%;"></td> <td style="width: 10%;"></td> <td style="width: 10%;"></td> <td style="width: 10%;"></td> <td style="width: 10%;"></td> </tr> <tr> <td></td> <td></td> <td colspan="8" style="text-align: center;"> <table border="1" style="width: 100%; border-collapse: collapse; text-align: center;"> <tr> <td style="width: 10%;"></td> <td style="width: 10%;"></td> <td style="width: 10%;"></td> <td style="width: 10%;"></td> <td style="width: 10%;"></td> <td style="width: 10%;"></td> <td style="width: 10%;"></td> <td style="width: 10%;"></td> <td style="width: 10%;"></td> <td style="width: 10%;"></td> </tr> <tr> <td></td> <td></td> <td colspan="8" style="text-align: center;"> <table border="1" style="width: 100%; border-collapse: collapse; text-align: center;"> <tr> <td style="width: 10%;"></td> <td style="width: 10%;"></td> <td style="width: 10%;"></td> <td style="width: 10%;"></td> <td style="width: 10%;"></td> <td style="width: 10%;"></td> <td style="width: 10%;"></td> <td style="width: 10%;"></td> <td style="width: 10%;"></td> <td style="width: 10%;"></td> </tr> <tr> <td></td> <td></td> <td colspan="8" style="text-align: center;"> <table border="1" style="width: 100%; border-collapse: collapse; text-align: center;"> <tr> <td style="width: 10%;"></td> <td style="width: 10%;"></td> <td style="width: 10%;"></td> <td style="width: 10%;"></td> <td style="width: 10%;"></td> <td style="width: 10%;"></td> <td style="width: 10%;"></td> <td style="width: 10%;"></td> <td style="width: 10%;"></td> <td style="width: 10%;"></td> </tr> <tr> <td></td> <td></td> <td colspan="8" style="text-align: center;"> <table border="1" style="width: 100%; border-collapse: collapse; text-align: center;"> <tr> <td style="width: 10%;"></td> <td style="width: 10%;"></td> <td style="width: 10%;"></td> <td style="width: 10%;"></td> <td style="width: 10%;"></td> <td style="width: 10%;"></td> <td style="width: 10%;"></td> <td style="width: 10%;"></td> <td style="width: 10%;"></td> <td style="width: 10%;"></td> </tr> <tr> <td></td> <td></td> <td colspan="8" style="text-align: center;"> <table border="1" style="width: 100%; border-collapse: collapse; text-align: center;"> <tr> <td style="width: 10%;"></td> <td style="width: 10%;"></td> <td style="width: 10%;"></td> <td style="width: 10%;"></td> <td style="width: 10%;"></td> <td style="width: 10%;"></td> <td style="width: 10%;"></td> <td style="width: 10%;"></td> <td style="width: 10%;"></td> <td style="width: 10%;"></td> </tr> <tr> <td></td> <td></td> <td colspan="8" style="text-align: center;"> <table border="1" style="width: 100%; border-collapse: collapse; text-align: center;"> <tr> <td style="width: 10%;"></td> <td style="width: 10%;"></td> <td style="width: 10%;"></td> <td style="width: 10%;"></td> <td style="width: 10%;"></td> <td style="width: 10%;"></td> <td style="width: 10%;"></td> <td style="width: 10%;"></td> <td style="width: 10%;"></td> <td style="width: 10%;"></td> </tr> <tr> <td></td> <td></td> <td colspan="8" style="text-align: center;"> <table border="1" style="width: 100%; border-collapse: collapse; text-align: center;"> <tr> <td style="width: 10%;"></td> <td style="width: 10%;"></td> <td style="width: 10%;"></td> <td style="width: 10%;"></td> <td style="width: 10%;"></td> <td style="width: 10%;"></td> <td style="width: 10%;"></td> <td style="width: 10%;"></td> <td style="width: 10%;"></td> <td style="width: 10%;"></td> </tr> <tr> <td></td> <td></td> <td colspan="8" style="text-align: center;"> <table border="1" style="width: 100%; border-collapse: collapse; text-align: center;"> <tr> <td style="width: 10%;"></td> <td style="width: 10%;"></td> <td style="width: 10%;"></td> <td style="width: 10%;"></td> <td style="width: 10%;"></td> <td style="width: 10%;"></td> <td style="width: 10%;"></td> <td style="width: 10%;"></td> <td style="width: 10%;"></td> <td style="width: 10%;"></td> </tr> <tr> <td></td> <td></td> <td colspan="8" style="text-align: center;"> <table border="1" style="width: 100%; border-collapse: collapse; text-align: center;"> <tr> <td style="width: 10%;"></td> <td style="width: 10%;"></td> <td style="width: 10%;"></td> <td style="width: 10%;"></td> <td style="width: 10%;"></td> <td style="width: 10%;"></td> <td style="width: 10%;"></td> <td style="width: 10%;"></td> <td style="width: 10%;"></td> <td style="width: 10%;"></td> </tr> <tr> <td></td> <td></td> <td colspan="8" style="text-align: center;"> <table border="1" style="width: 100%; border-collapse: collapse; text-align: center;"> <tr> <td style="width: 10%;"></td> <td style="width: 10%;"></td> <td style="width: 10%;"></td> <td style="width: 10%;"></td> <td style="width: 10%;"></td> <td style="width: 10%;"></td> <td style="width: 10%;"></td> <td style="width: 10%;"></td> <td style="width: 10%;"></td> <td style="width: 10%;"></td> </tr> <tr> <td></td> <td></td> <td colspan="8" style="text-align: center;"> <table border="1" style="width: 100%; border-collapse: collapse; text-align: center;"> <tr> <td style="width: 10%;"></td> <td style="width: 10%;"></td> <td style="width: 10%;"></td> <td style="width: 10%;"></td> <td style="width: 10%;"></td> <td style="width: 10%;"></td> <td style="width: 10%;"></td> <td style="width: 10%;"></td> <td style="width: 10%;"></td> <td style="width: 10%;"></td> </tr> <tr> <td></td> <td></td> <td colspan="8" style="text-align: center;"> <table border="1" style="width: 100%; border-collapse: collapse; text-align: center;"> <tr> <td style="width: 10%;"></td> <td style="width: 10%;"></td> <td style="width: 10%;"></td> <td style="width: 10%;"></td> <td style="width: 10%;"></td> <td style="width: 10%;"></td> <td style="width: 10%;"></td> <td style="width: 10%;"></td> <td style="width: 10%;"></td> <td style="width: 10%;"></td> </tr> <tr> <td></td> <td></td> <td colspan="8" style="text-align: center;"> <table border="1" style="width: 100%; border-collapse: collapse; text-align: center;"> <tr> <td style="width: 10%;"></td> <td style="width: 10%;"></td> <td style="width: 10%;"></td> <td style="width: 10%;"></td> <td style="width: 10%;"></td> <td style="width: 10%;"></td> <td style="width: 10%;"></td> <td style="width: 10%;"></td> <td style="width: 10%;"></td> <td style="width: 10%;"></td> </tr> <tr> <td></td> <td></td> <td colspan="8" style="text-align: center;"> <table border="1" style="width: 100%; border-collapse: collapse; text-align: center;"> <tr> <td style="width: 10%;"></td> <td style="width: 10%;"></td> <td style="width: 10%;"></td> <td style="width: 10%;"></td> <td style="width: 10%;"></td> <td style="width: 10%;"></td> <td style="width: 10%;"></td> <td style="width: 10%;"></td> <td style="width: 10%;"></td> <td style="width: 10%;"></td> </tr> <tr> <td></td> <td></td> <td colspan="8" style="text-align: center;"> <table border="1" style="width: 100%; border-collapse: collapse; text-align: center;"> <tr> <td style="width: 10%;"></td> <td style="width: 10%;"></td> <td style="width: 10%;"></td> <td style="width: 10%;"></td> <td style="width: 10%;"></td> <td style="width: 10%;"></td> <td style="width: 10%;"></td> <td style="width: 10%;"></td> <td style="width: 10%;"></td> <td style="width: 10%;"></td> </tr> <tr> <td></td> <td></td> <td colspan="8" style="text-align: center;"> <table border="1" style="width: 100%; border-collapse: collapse; text-align: center;"> <tr> <td style="width: 10%;"></td> <td style="width: 10%;"></td> <td style="width: 10%;"></td> <td style="width: 10%;"></td> <td style="width: 10%;"></td> <td style="width: 10%;"></td> <td style="width: 10%;"></td> <td style="width: 10%;"></td> <td style="width: 10%;"></td> <td style="width: 10%;"></td> </tr> <tr> <td></td> <td></td> <td colspan="8" style="text-align: center;"> <table border="1" style="width: 100%; border-collapse: collapse; text-align: center;"> <tr> <td style="width: 10%;"></td> <td style="width: 10%;"></td> <td style="width: 10%;"></td> <td style="width: 10%;"></td> <td style="width: 10%;"></td> <td style="width:
10%;"></td> <td style="width: 10%;"></td> <td style="width: 10%;"></td> <td style="width: 10%;"></td> <td style="width: 10%;"></td> </tr> <tr> <td></td> <td></td> <td colspan="8" style="text-align: center;"> <table border="1" style="width: 100%; border-collapse: collapse; text-align: center;"> <tr> <td style="width: 10%;"></td> <td style="width: 10%;"></td> <td style="width: 10%;"></td> <td style="width: 10%;"></td> <td style="width: 10%;"></td> <td style="width: 10%;"></td> <td style="width: 10%;"></td> <td style="width: 10%;"></td> <td style="width: 10%;"></td> <td style="width: 10%;"></td> </tr> <tr> <td></td> <td></td> <td colspan="8" style="text-align: center;"> <table border="1" style="width: 100%; border-collapse: collapse; text-align: center;"> <tr> <td style="width: 10%;"></td> <td style="width: 10%;"></td> <td style="width: 10%;"></td> <td style="width: 10%;"></td> <td style="width: 10%;"></td> <td style="width: 10%;"></td> <td style="width: 10%;"></td> <td style="width: 10%;"></td> <td style="width: 10%;"></td> <td style="width: 10%;"></td> </tr> <tr> <td></td> <td></td> <td colspan="8" style="text-align: center;"> <table border="1" style="width: 100%; border-collapse: collapse; text-align: center;"> <tr> <td style="width: 10%;"></td> <td style="width: 10%;"></td> <td style="width: 10%;"></td> <td style="width: 10%;"></td> <td style="width: 10%;"></td> <td style="width: 10%;"></td> <td style="width: 10%;"></td> <td style="width: 10%;"></td> <td style="width: 10%;"></td> <td style="width: 10%;"></td> </tr> <tr> <td></td> <td></td> <td colspan="8" style="text-align: center;"> <table border="1" style="width: 100%; border-collapse: collapse; text-align: center;"> <tr> <td style="width: 10%;"></td> <td style="width: 10%;"></td> <td style="width: 10%;"></td> <td style="width: 10%;"></td> <td style="width: 10%;"></td> <td style="width: 10%;"></td> <td style="width: 10%;"></td> <td style="width: 10%;"></td> <td style="width: 10%;"></td> <td style="width: 10%;"></td> </tr> <tr> <td></td> <td></td> <td colspan="8" style="text-align: center;"> <table border="1" style="width: 100%; border-collapse: collapse; text-align: center;"> <tr> <td style="width: 10%;"></td> <td style="width: 10%;"></td> <td style="width: 10%;"></td> <td style="width: 10%;"></td> <td style="width: 10%;"></td> <td style="width: 10%;"></td> <td style="width: 10%;"></td> <td style="width: 10%;"></td> <td style="width: 10%;"></td> <td style="width: 10%;"></td> </tr> <tr> <td></td> <td></td> <td colspan="8" style="text-align: center;"> <table border="1" style="width: 100%; border-collapse: collapse; text-align: center;"> <tr> <td style="width: 10%;"></td> <td style="width: 10%;"></td> <td style="width: 10%;"></td> <td style="width: 10%;"></td> <td style="width: 10%;"></td> <td style="width: 10%;"></td> <td style="width: 10%;"></td> <td style="width: 10%;"></td> <td style="width: 10%;"></td> <td style="width: 10%;"></td> </tr> <tr> <td></td> <td></td> <td colspan="8" style="text-align: center;"> <table border="1" style="width: 100%; border-collapse: collapse; text-align: center;"> <tr> <td style="width: 10%;"></td> <td style="width: 10%;"></td> <td style="width: 10%;"></td> <td style="width: 10%;"></td> <td style="width: 10%;"></td> <td style="width: 10%;"></td> <td style="width: 10%;"></td> <td style="width: 10%;"></td> <td style="width: 10%;"></td> <td style="width: 10%;"></td> </tr> <tr> <td></td> <td></td> <td colspan="8" style="text-align: center;"> <table border="1" style="width: 100%; border-collapse: collapse; text-align: center;"> <tr> <td style="width: 10%;"></td> <td style="width: 10%;"></td> <td style="width: 10%;"></td> <td style="width: 10%;"></td> <td style="width: 10%;"></td> <td style="width: 10%;"></td> <td style="width: 10%;"></td> <td style="width: 10%;"></td> <td style="width: 10%;"></td> <td style="width: 10%;"></td> </tr> <tr> <td></td> <td></td> <td colspan="8" style="text-align: center;"> <table border="1" style="width: 100%; border-collapse: collapse; text-align: center;"> <tr> <td style="width: 10%;"></td> <td style="width: 10%;"></td> <td style="width: 10%;"></td> <td style="width: 10%;"></td> <td style="width: 10%;"></td> <td style="width: 10%;"></td> <td style="width: 10%;"></td> <td style="width: 10%;"></td> <td style="width: 10%;"></td> <td style="width: 10%;"></td> </tr> <tr> <td></td> <td></td> <td colspan="8" style="text-align: center;"> <table border="1" style="width: 100%; border-collapse: collapse; text-align: center;"> <tr> <td style="width: 10%;"></td> <td style="width: 10%;"></td> <td style="width: 10%;"></td> <td style="width: 10%;"></td> <td style="width: 10%;"></td> <td style="width: 10%;"></td> <td style="width: 10%;"></td> <td style="width: 10%;"></td> <td style="width: 10%;"></td> <td style="width: 10%;"></td> </tr> <tr> <td></td> <td></td> <td colspan="8" style="text-align: center;"> <table border="1" style="width: 100%; border-collapse: collapse; text-align: center;"> <tr> <td style="width: 10%;"></td> <td style="width: 10%;"></td> <td style="width: 10%;"></td> <td style="width: 10%;"></td> <td style="width: 10%;"></td> <td style="width: 10%;"></td> <td style="width: 10%;"></td> <td style="width: 10%;"></td> <td style="width: 10%;"></td> <td style="width: 10%;"></td> </tr> <tr> <td></td> <td></td> <td colspan="8" style="text-align: center;"> <table border="1" style="width: 100%; border-collapse: collapse; text-align: center;"> <tr> <td style="width: 10%;"></td> <td style="width: 10%;"></td> <td style="width: 10%;"></td> <td style="width: 10%;"></td> <td style="width: 10%;"></td> <td style="width: 10%;"></td> <td style="width: 10%;"></td> <td style="width: 10%;"></td> <td style="width: 10%;"></td> <td style="width: 10%;"></td> </tr> <tr> <td></td> <td></td> <td colspan="8" style="text-align: center;"> <table border="1" style="width: 100%; border-collapse: collapse; text-align: center;"> <tr> <td style="width: 10%;"></td> <td style="width: 10%;"></td> <td style="width: 10%;"></td> <td style="width: 10%;"></td> <td style="width: 10%;"></td> <td style="width: 10%;"></td> <td style="width: 10%;"></td> <td style="width: 10%;"></td> <td style="width: 10%;"></td> <td style="width: 10%;"></td> </tr> <tr> <td></td> <td></td> <td colspan="8" style="text-align: center;"> <table border="1" style="width: 100%; border-collapse: collapse; text-align: center;"> <tr> <td style="width: 10%;"></td> <td style="width: 10%;"></td> <td style="width: 10%;"></td> <td style="width: 10%;"></td> <td style="width: 10%;"></td> <td style="width: 10%;"></td> <td style="width: 10%;"></td> <td style="width: 10%;"></td> <td style="width: 10%;"></td> <td style="width: 10%;"></td> </tr> <tr> <td></td> <td></td> <td colspan="8" style="text-align: center;"> <table border="1" style="width: 100%; border-collapse: collapse; text-align: center;"> <tr> <td style="width: 10%;"></td> <td style="width: 10%;"></td> <td style="width: 10%;"></td> <td style="width: 10%;"></td> <td style="width: 10%;"></td> <td style="width: 10%;"></td> <td style="width: 10%;"></td> <td style="width: 10%;"></td> <td style="width: 10%;"></td> <td style="width: 10%;"></td> </tr> <tr> <td></td> <td></td> <td colspan="8" style="text-align: center;"> <table border="1" style="width: 100%; border-collapse: collapse; text-align: center;"> <tr> <td style="width: 10%;"></td> <td style="width: 10%;"></td> <td style="width: 10%;"></td> <td style="width: 10%;"></td> <td style="width: 10%;"></td> <td style="width: 10%;"></td> <td style="width: 10%;"></td> <td style="width: 10%;"></td> <td style="width: 10%;"></td> <td style="width: 10%;"></td> </tr> <tr> <td></td> <td></td> <td colspan="8" style="text-align: center;"> <table border="1" style="width: 100%; border-collapse: collapse; text-align: center;"> <tr> <td style="width: 10%;"></td> <td style="width: 10%;"></td> <td style="width: 10%;"></td> <td style="width: 10%;"></td> <td style="width: 10%;"></td> <td style="width: 10%;"></td> <td style="width: 10%;"></td> <td style="width: 10%;"></td> <td style="width: 10%;"></td> <td style="width: 10%;"></td> </tr> <tr> <td></td> <td></td> <td colspan="8" style="text-align: center;"> <table border="1" style="width: 100%; border-collapse: collapse; text-align: center;"> <tr> <td style="width: 10%;"></td> <td style="width: 10%;"></td> <td style="width: 10%;"></td> <td style="width: 10%;"></td> <td style="width: 10%;"></td> <td style="width: 10%;"></td> <td style="width: 10%;"></td> <td style="width: 10%;"></td> <td style="width: 10%;"></td> <td style="width: 10%;"></td> </tr> <tr> <td></td> <td></td> <td colspan="8" style="text-align: center;"> <table border="1" style="width: 100%; border-collapse: collapse; text-align: center;"> <tr> <td style="width: 10%;"></td> <td style="width: 10%;"></td> <td style="width: 10%;"></td> <td style="width: 10%;"></td> <td style="width: 10%;"></td> <td style="width: 10%;"></td> <td style="width: 10%;"></td> <td style="width: 10%;"></td> <td style="width: 10%;"></td> <td style="width: 10%;"></td> </tr> <tr> <td></td> <td></td> <td colspan="8" style="text-align: center;"> <table border="1" style="width: 100%; border-collapse: collapse; text-align: center;"> <tr> <td style="width: 10%;"></td> <td style="width: 10%;"></td> <td style="width: 10%;"></td> <td style="width: 10%;"></td> <td style="width: 10%;"></td> <td style="width: 10%;"></td> <td style="width: 10%;"></td> <td style="width: 10%;"></td> <td style="width: 10%;"></td> <td style="width: 10%;"></td> </tr> <tr> <td></td> <td></td> <td colspan="8" style="text-align: center;"> <table border="1" style="width: 100%; border-collapse: collapse; text-align: center;"> <tr> <td style="width: 10%;"></td> <td style="width: 10%;"></td> <td style="width: 10%;"></td> <td style="width: 10%;"></td> <td style="width: 10%;"></td> <td style="width: 10%;"></td> <td style="width: 10%;"></td> <td style="width: 10%;"></td> <td style="width: 10%;"></td> <td style="width: 10%;"></td> </tr> <tr> <td></td> <td></td> <td
colspan="8" style="text-align: center;"> <table border="1" style="width: 100%; border-collapse: collapse; text-align: center;"> <tr> <td style="width: 10%;"></td> <td style="width: 10%;"></td> <td style="width: 10%;"></td> <td style="width: 10%;"></td> <td style="width: 10%;"></td> <td style="width: 10%;"></td> <td style="width: 10%;"></td> <td style="width: 10%;"></td> <td style="width: 10%;"></td> <td style="width: 10%;"></td> </tr> <tr> <td></td> <td></td> <td colspan="8" style="text-align: center;"> <table border="1" style="width: 100%; border-collapse: collapse; text-align: center;"> <tr> <td style="width: 10%;"></td> <td style="width: 10%;"></td> <td style="width: 10%;"></td> <td style="width: 10%;"></td> <td style="width: 10%;"></td> <td style="width: 10%;"></td> <td style="width: 10%;"></td> <td style="width: 10%;"></td> <td style="width: 10%;"></td> <td style="width: 10%;"></td> </tr> <tr> <td></td> <td></td> <td colspan="8" style="text-align: center;"> <table border="1" style="width: 100%; border-collapse: collapse; text-align: center;"> <tr> <td style="width: 10%;"></td> <td style="width: 10%;"></td> <td style="width: 10%;"></td> <td style="width: 10%;"></td> <td style="width: 10%;"></td> <td style="width: 10%;"></td> <td style="width: 10%;"></td> <td style="width: 10%;"></td> <td style="width: 10%;"></td> <td style="width: 10%;"></td> </tr> <tr> <td></td> <td></td> <td colspan="8" style="text-align: center;"> <table border="1" style="width: 100%; border-collapse: collapse; text-align: center;"> <tr> <td style="width: 10%;"></td> <td style="width: 10%;"></td> <td style="width: 10%;"></td> <td style="width: 10%;"></td> <td style="width: 10%;"></td> <td style="width: 10%;"></td> <td style="width: 10%;"></td> <td style="width: 10%;"></td> <td style="width: 10%;"></td> <td style="width: 10%;"></td> </tr> <tr> <td></td> <td></td> <td colspan="8" style="text-align: center;"> <table border="1" style="width: 100%; border-collapse: collapse; text-align: center;"> <tr> <td style="width: 10%;"></td> <td style="width: 10%;"></td> <td style="width: 10%;"></td> <td style="width: 10%;"></td> <td style="width: 10%;"></td> <td style="width: 10%;"></td> <td style="width: 10%;"></td> <td style="width: 10%;"></td> <td style="width: 10%;"></td> <td style="width: 10%;"></td> </tr> <tr> <td></td> <td></td> <td colspan="8" style="text-align: center;"> <table border="1" style="width: 100%; border-collapse: collapse; text-align: center;"> <tr> <td style="width: 10%;"></td> <td style="width: 10%;"></td> <td style="width: 10%;"></td> <td style="width: 10%;"></td> <td style="width: 10%;"></td> <td style="width: 10%;"></td> <td style="width: 10%;"></td> <td style="width: 10%;"></td> <td style="width: 10%;"></td> <td style="width: 10%;"></td> </tr> <tr> <td></td> <td></td> <td colspan="8" style="text-align: center;"> <table border="1" style="width: 100%; border-collapse: collapse; text-align: center;"> <tr> <td style="width: 10%;"></td> <td style="width: 10%;"></td> <td style="width: 10%;"></td> <td style="width: 10%;"></td> <td style="width: 10%;"></td> <td style="width: 10%;"></td> <td style="width: 10%;"></td> <td style="width: 10%;"></td> <td style="width: 10%;"></td> <td style="width: 10%;"></td> </tr> <tr> <td></td> <td></td> <td colspan="8" style="text-align: center;"> <table border="1" style="width: 100%; border-collapse: collapse; text-align: center;"> <tr> <td style="width: 10%;"></td> <td style="width: 10%;"></td> <td style="width: 10%;"></td> <td style="width: 10%;"></td> <td style="width: 10%;"></td> <td style="width: 10%;"></td> <td style="width: 10%;"></td> <td style="width: 10%;"></td> <td style="width: 10%;"></td> <td style="width: 10%;"></td> </tr> <tr> <td></td> <td></td> <td colspan="8" style="text-align: center;"> <table border="1" style="width: 100%; border-collapse: collapse; text-align: center;"> <tr> <td style="width: 10%;"></td> <td style="width: 10%;"></td> <td style="width: 10%;"></td> <td style="width: 10%;"></td> <td style="width: 10%;"></td> <td style="width: 10%;"></td> <td style="width: 10%;"></td> <td style="width: 10%;"></td> <td style="width: 10%;"></td> <td style="width: 10%;"></td> </tr> <tr> <td></td> <td></td> <td colspan="8" style="text-align: center;"> <table border="1" style="width: 100%; border-collapse: collapse; text-align: center;"> <tr> <td style="width: 10%;"></td> <td style="width: 10%;"></td> <td style="width: 10%;"></td> <td style="width: 10%;"></td> <td style="width: 10%;"></td> <td style="width: 10%;"></td> <td style="width: 10%;"></td> <td style="width: 10%;"></td> <td style="width: 10%;"></td> <td style="width: 10%;"></td> </tr> <tr> <td></td> <td></td> <td colspan="8" style="text-align: center;"> <table border="1" style="width: 100%; border-collapse: collapse; text-align: center;"> <tr> <td style="width: 10%;"></td> <td style="width: 10%;"></td> <td style="width: 10%;"></td> <td style="width: 10%;"></td> <td style="width: 10%;"></td> <td style="width: 10%;"></td> <td style="width: 10%;"></td> <td style="width: 10%;"></td> <td style="width: 10%;"></td> <td style="width: 10%;"></td> </tr> <tr> <td></td> <td></td> <td colspan="8" style="text-align: center;"> <table border="1" style="width: 100%; border-collapse: collapse; text-align: center;"> <tr> <td style="width: 10%;"></td> <td style="width: 10%;"></td> <td style="width: 10%;"></td> <td style="width: 10%;"></td> <td style="width: 10%;"></td> <td style="width: 10%;"></td> <td style="width: 10%;"></td> <td style="width: 10%;"></td> <td style="width: 10%;"></td> <td style="width: 10%;"></td> </tr> <tr> <td></td> <td></td> <td colspan="8" style="text-align: center;"> <table border="1" style="width: 100%; border-collapse: collapse; text-align: center;"> <tr> <td style="width: 10%;"></td> <td style="width: 10%;"></td> <td style="width: 10%;"></td> <td style="width: 10%;"></td> <td style="width: 10%;"></td> <td style="width: 10%;"></td> <td style="width: 10%;"></td> <td style="width: 10%;"></td> <td style="width: 10%;"></td> <td style="width: 10%;"></td> </tr> <tr> <td></td> <td></td> <td colspan="8" style="text-align: center;"> <table border="1" style="width: 100%; border-collapse: collapse; text-align: center;"> <tr> <td style="width: 10%;"></td> <td style="width: 10%;"></td> <td style="width: 10%;"></td> <td style="width: 10%;"></td> <td style="width: 10%;"></td> <td style="width: 10%;"></td> <td style="width: 10%;"></td> <td style="width: 10%;"></td> <td style="width: 10%;"></td> <td style="width: 10%;"></td> </tr> <tr> <td></td> <td></td> <td colspan="8" style="text-align: center;"> <table border="1" style="width: 100%; border-collapse: collapse; text-align: center;"> <tr> <td style="width: 10%;"></td> <td style="width: 10%;"></td> <td style="width: 10%;"></td> <td style="width: 10%;"></td> <td style="width: 10%;"></td> <td style="width: 10%;"></td> <td style="width: 10%;"></td> <td style="width: 10%;"></td> <td style="width: 10%;"></td> <td style="width: 10%;"></td> </tr> <tr> <td></td> <td></td> <td colspan="8" style="text-align: center;"> <table border="1" style="width: 100%; border-collapse: collapse; text-align: center;"> <tr> <td style="width: 10%;"></td> <td style="width: 10%;"></td> <td style="width: 10%;"></td> <td style="width: 10%;"></td> <td style="width: 10%;"></td> <td style="width: 10%;"></td> <td style="width: 10%;"></td> <td style="width: 10%;"></td> <td style="width: 10%;"></td> <td style="width: 10%;"></td> </tr> <tr> <td></td> <td></td> <td colspan="8" style="text-align: center;"> <table border="1" style="width: 100%; border-collapse: collapse; text-align: center;"> <tr> <td style="width: 10%;"></td> <td style="width: 10%;"></td> <td style="width: 10%;"></td> <td style="width: 10%;"></td> <td style="width: 10%;"></td> <td style="width: 10%;"></td> <td style="width: 10%;"></td> <td style="width: 10%;"></td> <td style="width: 10%;"></td> <td style="width: 10%;"></td> </tr> <tr> <td></td> <td></td> <td colspan="8" style="text-align: center;"> <table border="1" style="width: 100%; border-collapse: collapse; text-align: center;"> <tr> <td style="width: 10%;"></td> <td style="width: 10%;"></td> <td style="width: 10%;"></td> <td style="width: 10%;"></td> <td style="width: 10%;"></td> <td style="width: 10%;"></td> <td style="width: 10%;"></td> <td style="width: 10%;"></td> <td style="width: 10%;"></td> <td style="width: 10%;"></td> </tr> <tr> <td></td> <td></td> <td colspan="8" style="text-align: center;"> <table border="1" style="width: 100%; border-collapse: collapse; text-align: center;"> <tr> <td style="width: 10%;"></td> <td style="width: 10%;"></td> <td style="width: 10%;"></td> <td style="width: 10%;"></td> <td style="width: 10%;"></td> <td style="width: 10%;"></td> <td style="width: 10%;"></td> <td style="width: 10%;"></td> <td style="width: 10%;"></td> <td style="width: 10%;"></td> </tr> <tr> <td></td> <td></td> <td colspan="8" style="text-align: center;"> <table border="1" style="width: 100%; border-collapse: collapse; text-align: center;"> <tr>
</tr></table></td></tr></table></td></tr></table></td></tr></table></td></tr></table></td></tr></table></td></tr></table></td></tr></table></td></tr></table></td></tr></table></td></tr></table></td></tr></table></td></tr></table></td></tr></table></td></tr></table></td></tr></table></td></tr></table></td></tr></table></td></tr></table></td></tr></table></td></tr></table></td></tr></table></td></tr></table></td></tr></table></td></tr></table></td></tr></table></td></tr></table></td></tr></table></td></tr></table></td></tr></table></td></tr></table></td></tr></table></td></tr></table></td></tr></table></td></tr></table></td></tr></table></td></tr></table></td></tr></table></td></tr></table></td></tr></table></td></tr></table></td></tr></table></td></tr></table></td></tr></table></td></tr></table></td></tr></table></td></tr></table></td></tr></table></td></tr></table></td></tr></table></td></tr></table></td></tr></table></td></tr></table></td></tr></table></td></tr></table></td></tr></table></td></tr></table></td></tr></table></td></tr></table></td></tr></table> | | | | | | | | | | | | | | | | | | | | <table border="1" style="width: 100%; border-collapse: collapse; text-align: center;"> <tr> <td style="width: 10%;"></td> <td style="width: 10%;"></td> <td style="width: 10%;"></td> <td style="width: 10%;"></td> <td style="width: 10%;"></td> <td style="width: 10%;"></td> <td style="width: 10%;"></td> <td style="width: 10%;"></td> <td style="width: 10%;"></td> <td style="width: 10%;"></td> </tr> <tr> <td></td> <td></td> <td colspan="8" style="text-align: center;"> <table border="1" style="width: 100%; border-collapse: collapse; text-align: center;"> <tr> <td style="width: 10%;"></td> <td style="width: 10%;"></td> <td style="width: 10%;"></td> <td style="width: 10%;"></td> <td style="width: 10%;"></td> <td style="width: 10%;"></td> <td style="width: 10%;"></td> <td style="width: 10%;"></td> <td style="width: 10%;"></td> <td style="width: 10%;"></td> </tr> <tr> <td></td> <td></td> <td colspan="8" style="text-align: center;"> <table border="1" style="width: 100%; border-collapse: collapse; text-align: center;"> <tr> <td style="width: 10%;"></td> <td style="width: 10%;"></td> <td style="width: 10%;"></td> <td style="width: 10%;"></td> <td style="width: 10%;"></td> <td style="width: 10%;"></td> <td style="width: 10%;"></td> <td style="width: 10%;"></td> <td style="width: 10%;"></td> <td style="width: 10%;"></td> </tr> <tr> <td></td> <td></td> <td colspan="8" style="text-align: center;"> <table border="1" style="width: 100%; border-collapse: collapse; text-align: center;"> <tr> <td style="width: 10%;"></td> <td style="width: 10%;"></td> <td style="width: 10%;"></td> <td style="width: 10%;"></td> <td style="width: 10%;"></td> <td style="width: 10%;"></td> <td style="width: 10%;"></td> <td style="width: 10%;"></td> <td style="width: 10%;"></td> <td style="width: 10%;"></td> </tr> <tr> <td></td> <td></td> <td colspan="8" style="text-align: center;"> <table border="1" style="width: 100%; border-collapse: collapse; text-align: center;"> <tr> <td style="width: 10%;"></td> <td style="width: 10%;"></td> <td style="width: 10%;"></td> <td style="width: 10%;"></td> <td style="width: 10%;"></td> <td style="width: 10%;"></td> <td style="width: 10%;"></td> <td style="width: 10%;"></td> <td style="width: 10%;"></td> <td style="width: 10%;"></td> </tr> <tr> <td></td> <td></td> <td colspan="8" style="text-align: center;"> <table border="1" style="width: 100%; border-collapse: collapse; text-align: center;"> <tr> <td style="width: 10%;"></td> <td style="width: 10%;"></td> <td style="width: 10%;"></td> <td style="width: 10%;"></td> <td style="width: 10%;"></td> <td style="width: 10%;"></td> <td style="width: 10%;"></td> <td style="width: 10%;"></td> <td style="width: 10%;"></td> <td style="width: 10%;"></td> </tr> <tr> <td></td> <td></td> <td colspan="8" style="text-align: center;"> <table border="1" style="width: 100%; border-collapse: collapse; text-align: center;"> <tr> <td style="width: 10%;"></td> <td style="width: 10%;"></td> <td style="width: 10%;"></td> <td style="width: 10%;"></td> <td style="width: 10%;"></td> <td style="width: 10%;"></td> <td style="width: 10%;"></td> <td style="width: 10%;"></td> <td style="width: 10%;"></td> <td style="width: 10%;"></td> </tr> <tr> <td></td> <td></td> <td colspan="8" style="text-align: center;"> <table border="1" style="width: 100%; border-collapse: collapse; text-align: center;"> <tr> <td style="width: 10%;"></td> <td style="width: 10%;"></td> <td style="width: 10%;"></td> <td style="width: 10%;"></td> <td style="width: 10%;"></td> <td style="width: 10%;"></td> <td style="width: 10%;"></td> <td style="width: 10%;"></td> <td style="width: 10%;"></td> <td style="width: 10%;"></td> </tr> <tr> <td></td> <td></td> <td colspan="8" style="text-align: center;"> <table border="1" style="width: 100%; border-collapse: collapse; text-align: center;"> <tr> <td style="width: 10%;"></td> <td style="width: 10%;"></td> <td style="width: 10%;"></td> <td style="width: 10%;"></td> <td style="width: 10%;"></td> <td style="width: 10%;"></td> <td style="width: 10%;"></td> <td style="width: 10%;"></td> <td style="width: 10%;"></td> <td style="width: 10%;"></td> </tr> <tr> <td></td> <td></td> <td colspan="8" style="text-align: center;"> <table border="1" style="width: 100%; border-collapse: collapse; text-align: center;"> <tr> <td style="width: 10%;"></td> <td style="width: 10%;"></td> <td style="width: 10%;"></td> <td style="width: 10%;"></td> <td style="width: 10%;"></td> <td style="width: 10%;"></td> <td style="width: 10%;"></td> <td style="width: 10%;"></td> <td style="width: 10%;"></td> <td style="width: 10%;"></td> </tr> <tr> <td></td> <td></td> <td colspan="8" style="text-align: center;"> <table border="1" style="width: 100%; border-collapse: collapse; text-align: center;"> <tr> <td style="width: 10%;"></td> <td style="width: 10%;"></td> <td style="width: 10%;"></td> <td style="width: 10%;"></td> <td style="width: 10%;"></td> <td style="width: 10%;"></td> <td style="width: 10%;"></td> <td style="width: 10%;"></td> <td style="width: 10%;"></td> <td style="width: 10%;"></td> </tr> <tr> <td></td> <td></td> <td colspan="8" style="text-align: center;"> <table border="1" style="width: 100%; border-collapse: collapse; text-align: center;"> <tr> <td style="width: 10%;"></td> <td style="width: 10%;"></td> <td style="width: 10%;"></td> <td style="width: 10%;"></td> <td style="width: 10%;"></td> <td style="width: 10%;"></td> <td style="width: 10%;"></td> <td style="width: 10%;"></td> <td style="width: 10%;"></td> <td style="width: 10%;"></td> </tr> <tr> <td></td> <td></td> <td colspan="8" style="text-align: center;"> <table border="1" style="width: 100%; border-collapse: collapse; text-align: center;"> <tr> <td style="width: 10%;"></td> <td style="width: 10%;"></td> <td style="width: 10%;"></td> <td style="width: 10%;"></td> <td style="width: 10%;"></td> <td style="width: 10%;"></td> <td style="width: 10%;"></td> <td style="width: 10%;"></td> <td style="width: 10%;"></td> <td style="width: 10%;"></td> </tr> <tr> <td></td> <td></td> <td colspan="8" style="text-align: center;"> <table border="1" style="width: 100%; border-collapse: collapse; text-align: center;"> <tr> <td style="width: 10%;"></td> <td style="width: 10%;"></td> <td style="width: 10%;"></td> <td style="width: 10%;"></td> <td style="width: 10%;"></td> <td style="width: 10%;"></td> <td style="width: 10%;"></td> <td style="width: 10%;"></td> <td style="width: 10%;"></td> <td style="width: 10%;"></td> </tr> <tr> <td></td> <td></td> <td colspan="8" style="text-align: center;"> <table border="1" style="width: 100%; border-collapse: collapse; text-align: center;"> <tr> <td style="width: 10%;"></td> <td style="width: 10%;"></td> <td style="width: 10%;"></td> <td style="width: 10%;"></td> <td style="width: 10%;"></td> <td style="width: 10%;"></td> <td style="width: 10%;"></td> <td style="width: 10%;"></td> <td style="width: 10%;"></td> <td
style="width: 10%;"></td> </tr> <tr> <td></td> <td></td> <td colspan="8" style="text-align: center;"> <table border="1" style="width: 100%; border-collapse: collapse; text-align: center;"> <tr> <td style="width: 10%;"></td> <td style="width: 10%;"></td> <td style="width: 10%;"></td> <td style="width: 10%;"></td> <td style="width: 10%;"></td> <td style="width: 10%;"></td> <td style="width: 10%;"></td> <td style="width: 10%;"></td> <td style="width: 10%;"></td> <td style="width: 10%;"></td> </tr> <tr> <td></td> <td></td> <td colspan="8" style="text-align: center;"> <table border="1" style="width: 100%; border-collapse: collapse; text-align: center;"> <tr> <td style="width: 10%;"></td> <td style="width: 10%;"></td> <td style="width: 10%;"></td> <td style="width: 10%;"></td> <td style="width: 10%;"></td> <td style="width: 10%;"></td> <td style="width: 10%;"></td> <td style="width: 10%;"></td> <td style="width: 10%;"></td> <td style="width: 10%;"></td> </tr> <tr> <td></td> <td></td> <td colspan="8" style="text-align: center;"> <table border="1" style="width: 100%; border-collapse: collapse; text-align: center;"> <tr> <td style="width: 10%;"></td> <td style="width: 10%;"></td> <td style="width: 10%;"></td> <td style="width: 10%;"></td> <td style="width: 10%;"></td> <td style="width: 10%;"></td> <td style="width: 10%;"></td> <td style="width: 10%;"></td> <td style="width: 10%;"></td> <td style="width: 10%;"></td> </tr> <tr> <td></td> <td></td> <td colspan="8" style="text-align: center;"> <table border="1" style="width: 100%; border-collapse: collapse; text-align: center;"> <tr> <td style="width: 10%;"></td> <td style="width: 10%;"></td> <td style="width: 10%;"></td> <td style="width: 10%;"></td> <td style="width: 10%;"></td> <td style="width: 10%;"></td> <td style="width: 10%;"></td> <td style="width: 10%;"></td> <td style="width: 10%;"></td> <td style="width: 10%;"></td> </tr> <tr> <td></td> <td></td> <td colspan="8" style="text-align: center;"> <table border="1" style="width: 100%; border-collapse: collapse; text-align: center;"> <tr> <td style="width: 10%;"></td> <td style="width: 10%;"></td> <td style="width: 10%;"></td> <td style="width: 10%;"></td> <td style="width: 10%;"></td> <td style="width: 10%;"></td> <td style="width: 10%;"></td> <td style="width: 10%;"></td> <td style="width: 10%;"></td> <td style="width: 10%;"></td> </tr> <tr> <td></td> <td></td> <td colspan="8" style="text-align: center;"> <table border="1" style="width: 100%; border-collapse: collapse; text-align: center;"> <tr> <td style="width: 10%;"></td> <td style="width: 10%;"></td> <td style="width: 10%;"></td> <td style="width: 10%;"></td> <td style="width: 10%;"></td> <td style="width: 10%;"></td> <td style="width: 10%;"></td> <td style="width: 10%;"></td> <td style="width: 10%;"></td> <td style="width: 10%;"></td> </tr> <tr> <td></td> <td></td> <td colspan="8" style="text-align: center;"> <table border="1" style="width: 100%; border-collapse: collapse; text-align: center;"> <tr> <td style="width: 10%;"></td> <td style="width: 10%;"></td> <td style="width: 10%;"></td> <td style="width: 10%;"></td> <td style="width: 10%;"></td> <td style="width: 10%;"></td> <td style="width: 10%;"></td> <td style="width: 10%;"></td> <td style="width: 10%;"></td> <td style="width: 10%;"></td> </tr> <tr> <td></td> <td></td> <td colspan="8" style="text-align: center;"> <table border="1" style="width: 100%; border-collapse: collapse; text-align: center;"> <tr> <td style="width: 10%;"></td> <td style="width: 10%;"></td> <td style="width: 10%;"></td> <td style="width: 10%;"></td> <td style="width: 10%;"></td> <td style="width: 10%;"></td> <td style="width: 10%;"></td> <td style="width: 10%;"></td> <td style="width: 10%;"></td> <td style="width: 10%;"></td> </tr> <tr> <td></td> <td></td> <td colspan="8" style="text-align: center;"> <table border="1" style="width: 100%; border-collapse: collapse; text-align: center;"> <tr> <td style="width: 10%;"></td> <td style="width: 10%;"></td> <td style="width: 10%;"></td> <td style="width: 10%;"></td> <td style="width: 10%;"></td> <td style="width: 10%;"></td> <td style="width: 10%;"></td> <td style="width: 10%;"></td> <td style="width: 10%;"></td> <td style="width: 10%;"></td> </tr> <tr> <td></td> <td></td> <td colspan="8" style="text-align: center;"> <table border="1" style="width: 100%; border-collapse: collapse; text-align: center;"> <tr> <td style="width: 10%;"></td> <td style="width: 10%;"></td> <td style="width: 10%;"></td> <td style="width: 10%;"></td> <td style="width: 10%;"></td> <td style="width: 10%;"></td> <td style="width: 10%;"></td> <td style="width: 10%;"></td> <td style="width: 10%;"></td> <td style="width: 10%;"></td> </tr> <tr> <td></td> <td></td> <td colspan="8" style="text-align: center;"> <table border="1" style="width: 100%; border-collapse: collapse; text-align: center;"> <tr> <td style="width: 10%;"></td> <td style="width: 10%;"></td> <td style="width: 10%;"></td> <td style="width: 10%;"></td> <td style="width: 10%;"></td> <td style="width: 10%;"></td> <td style="width: 10%;"></td> <td style="width: 10%;"></td> <td style="width: 10%;"></td> <td style="width: 10%;"></td> </tr> <tr> <td></td> <td></td> <td colspan="8" style="text-align: center;"> <table border="1" style="width: 100%; border-collapse: collapse; text-align: center;"> <tr> <td style="width: 10%;"></td> <td style="width: 10%;"></td> <td style="width: 10%;"></td> <td style="width: 10%;"></td> <td style="width: 10%;"></td> <td style="width: 10%;"></td> <td style="width: 10%;"></td> <td style="width: 10%;"></td> <td style="width: 10%;"></td> <td style="width: 10%;"></td> </tr> <tr> <td></td> <td></td> <td colspan="8" style="text-align: center;"> <table border="1" style="width: 100%; border-collapse: collapse; text-align: center;"> <tr> <td style="width: 10%;"></td> <td style="width: 10%;"></td> <td style="width: 10%;"></td> <td style="width: 10%;"></td> <td style="width: 10%;"></td> <td style="width: 10%;"></td> <td style="width: 10%;"></td> <td style="width: 10%;"></td> <td style="width: 10%;"></td> <td style="width: 10%;"></td> </tr> <tr> <td></td> <td></td> <td colspan="8" style="text-align: center;"> <table border="1" style="width: 100%; border-collapse: collapse; text-align: center;"> <tr> <td style="width: 10%;"></td> <td style="width: 10%;"></td> <td style="width: 10%;"></td> <td style="width: 10%;"></td> <td style="width: 10%;"></td> <td style="width: 10%;"></td> <td style="width: 10%;"></td> <td style="width: 10%;"></td> <td style="width: 10%;"></td> <td style="width: 10%;"></td> </tr> <tr> <td></td> <td></td> <td colspan="8" style="text-align: center;"> <table border="1" style="width: 100%; border-collapse: collapse; text-align: center;"> <tr> <td style="width: 10%;"></td> <td style="width: 10%;"></td> <td style="width: 10%;"></td> <td style="width: 10%;"></td> <td style="width: 10%;"></td> <td style="width: 10%;"></td> <td style="width: 10%;"></td> <td style="width: 10%;"></td> <td style="width: 10%;"></td> <td style="width: 10%;"></td> </tr> <tr> <td></td> <td></td> <td colspan="8" style="text-align: center;"> <table border="1" style="width: 100%; border-collapse: collapse; text-align: center;"> <tr> <td style="width: 10%;"></td> <td style="width: 10%;"></td> <td style="width: 10%;"></td> <td style="width: 10%;"></td> <td style="width: 10%;"></td> <td style="width: 10%;"></td> <td style="width: 10%;"></td> <td style="width: 10%;"></td> <td style="width: 10%;"></td> <td style="width: 10%;"></td> </tr> <tr> <td></td> <td></td> <td colspan="8" style="text-align: center;"> <table border="1" style="width: 100%; border-collapse: collapse; text-align: center;"> <tr> <td style="width: 10%;"></td> <td style="width: 10%;"></td> <td style="width: 10%;"></td> <td style="width: 10%;"></td> <td style="width: 10%;"></td> <td style="width: 10%;"></td> <td style="width: 10%;"></td> <td style="width: 10%;"></td> <td style="width: 10%;"></td> <td style="width: 10%;"></td> </tr> <tr> <td></td> <td></td> <td colspan="8" style="text-align: center;"> <table border="1" style="width: 100%; border-collapse: collapse; text-align: center;"> <tr> <td style="width: 10%;"></td> <td style="width: 10%;"></td> <td style="width: 10%;"></td> <td style="width: 10%;"></td> <td style="width: 10%;"></td> <td style="width: 10%;"></td> <td style="width: 10%;"></td> <td style="width: 10%;"></td> <td style="width: 10%;"></td> <td style="width: 10%;"></td> </tr> <tr> <td></td> <td></td> <td colspan="8" style="text-align: center;"> <table border="1" style="width: 100%; border-collapse: collapse; text-align: center;"> <tr> <td style="width: 10%;"></td> <td style="width: 10%;"></td> <td style="width: 10%;"></td> <td style="width: 10%;"></td> <td style="width: 10%;"></td> <td style="width: 10%;"></td> <td style="width: 10%;"></td> <td style="width: 10%;"></td> <td style="width: 10%;"></td> <td style="width: 10%;"></td> </tr> <tr> <td></td> <td></td> <td colspan="8" style="text-align: center;"> <table border="1" style="width: 100%; border-collapse: collapse; text-align: center;"> <tr> <td style="width: 10%;"></td> <td style="width: 10%;"></td> <td style="width: 10%;"></td> <td style="width: 10%;"></td> <td style="width: 10%;"></td> <td style="width: 10%;"></td> <td style="width: 10%;"></td> <td style="width: 10%;"></td> <td style="width: 10%;"></td> <td style="width: 10%;"></td> </tr> <tr> <td></td> <td></td> <td colspan="8" style="text-align: center;"> <table border="1" style="width: 100%; border-collapse: collapse; text-align: center;"> <tr> <td style="width: 10%;"></td> <td style="width: 10%;"></td> <td style="width: 10%;"></td> <td style="width: 10%;"></td> <td style="width: 10%;"></td> <td style="width: 10%;"></td> <td style="width: 10%;"></td> <td style="width: 10%;"></td> <td style="width: 10%;"></td> <td style="width: 10%;"></td> </tr> <tr> <td></td> <td></td> <td colspan="8" style="text-align: center;"> <table border="1" style="width: 100%; border-collapse: collapse;
text-align: center;"> <tr> <td style="width: 10%;"></td> <td style="width: 10%;"></td> <td style="width: 10%;"></td> <td style="width: 10%;"></td> <td style="width: 10%;"></td> <td style="width: 10%;"></td> <td style="width: 10%;"></td> <td style="width: 10%;"></td> <td style="width: 10%;"></td> <td style="width: 10%;"></td> </tr> <tr> <td></td> <td></td> <td colspan="8" style="text-align: center;"> <table border="1" style="width: 100%; border-collapse: collapse; text-align: center;"> <tr> <td style="width: 10%;"></td> <td style="width: 10%;"></td> <td style="width: 10%;"></td> <td style="width: 10%;"></td> <td style="width: 10%;"></td> <td style="width: 10%;"></td> <td style="width: 10%;"></td> <td style="width: 10%;"></td> <td style="width: 10%;"></td> <td style="width: 10%;"></td> </tr> <tr> <td></td> <td></td> <td colspan="8" style="text-align: center;"> <table border="1" style="width: 100%; border-collapse: collapse; text-align: center;"> <tr> <td style="width: 10%;"></td> <td style="width: 10%;"></td> <td style="width: 10%;"></td> <td style="width: 10%;"></td> <td style="width: 10%;"></td> <td style="width: 10%;"></td> <td style="width: 10%;"></td> <td style="width: 10%;"></td> <td style="width: 10%;"></td> <td style="width: 10%;"></td> </tr> <tr> <td></td> <td></td> <td colspan="8" style="text-align: center;"> <table border="1" style="width: 100%; border-collapse: collapse; text-align: center;"> <tr> <td style="width: 10%;"></td> <td style="width: 10%;"></td> <td style="width: 10%;"></td> <td style="width: 10%;"></td> <td style="width: 10%;"></td> <td style="width: 10%;"></td> <td style="width: 10%;"></td> <td style="width: 10%;"></td> <td style="width: 10%;"></td> <td style="width: 10%;"></td> </tr> <tr> <td></td> <td></td> <td colspan="8" style="text-align: center;"> <table border="1" style="width: 100%; border-collapse: collapse; text-align: center;"> <tr> <td style="width: 10%;"></td> <td style="width: 10%;"></td> <td style="width: 10%;"></td> <td style="width: 10%;"></td> <td style="width: 10%;"></td> <td style="width: 10%;"></td> <td style="width: 10%;"></td> <td style="width: 10%;"></td> <td style="width: 10%;"></td> <td style="width: 10%;"></td> </tr> <tr> <td></td> <td></td> <td colspan="8" style="text-align: center;"> <table border="1" style="width: 100%; border-collapse: collapse; text-align: center;"> <tr> <td style="width: 10%;"></td> <td style="width: 10%;"></td> <td style="width: 10%;"></td> <td style="width: 10%;"></td> <td style="width: 10%;"></td> <td style="width: 10%;"></td> <td style="width: 10%;"></td> <td style="width: 10%;"></td> <td style="width: 10%;"></td> <td style="width: 10%;"></td> </tr> <tr> <td></td> <td></td> <td colspan="8" style="text-align: center;"> <table border="1" style="width: 100%; border-collapse: collapse; text-align: center;"> <tr> <td style="width: 10%;"></td> <td style="width: 10%;"></td> <td style="width: 10%;"></td> <td style="width: 10%;"></td> <td style="width: 10%;"></td> <td style="width: 10%;"></td> <td style="width: 10%;"></td> <td style="width: 10%;"></td> <td style="width: 10%;"></td> <td style="width: 10%;"></td> </tr> <tr> <td></td> <td></td> <td colspan="8" style="text-align: center;"> <table border="1" style="width: 100%; border-collapse: collapse; text-align: center;"> <tr> <td style="width: 10%;"></td> <td style="width: 10%;"></td> <td style="width: 10%;"></td> <td style="width: 10%;"></td> <td style="width: 10%;"></td> <td style="width: 10%;"></td> <td style="width: 10%;"></td> <td style="width: 10%;"></td> <td style="width: 10%;"></td> <td style="width: 10%;"></td> </tr> <tr> <td></td> <td></td> <td colspan="8" style="text-align: center;"> <table border="1" style="width: 100%; border-collapse: collapse; text-align: center;"> <tr> <td style="width: 10%;"></td> <td style="width: 10%;"></td> <td style="width: 10%;"></td> <td style="width: 10%;"></td> <td style="width: 10%;"></td> <td style="width: 10%;"></td> <td style="width: 10%;"></td> <td style="width: 10%;"></td> <td style="width: 10%;"></td> <td style="width: 10%;"></td> </tr> <tr> <td></td> <td></td> <td colspan="8" style="text-align: center;"> <table border="1" style="width: 100%; border-collapse: collapse; text-align: center;"> <tr> <td style="width: 10%;"></td> <td style="width: 10%;"></td> <td style="width: 10%;"></td> <td style="width: 10%;"></td> <td style="width: 10%;"></td> <td style="width: 10%;"></td> <td style="width: 10%;"></td> <td style="width: 10%;"></td> <td style="width: 10%;"></td> <td style="width: 10%;"></td> </tr> <tr> <td></td> <td></td> <td colspan="8" style="text-align: center;"> <table border="1" style="width: 100%; border-collapse: collapse; text-align: center;"> <tr> <td style="width: 10%;"></td> <td style="width: 10%;"></td> <td style="width: 10%;"></td> <td style="width: 10%;"></td> <td style="width: 10%;"></td> <td style="width: 10%;"></td> <td style="width: 10%;"></td> <td style="width: 10%;"></td> <td style="width: 10%;"></td> <td style="width: 10%;"></td> </tr> <tr> <td></td> <td></td> <td colspan="8" style="text-align: center;"> <table border="1" style="width: 100%; border-collapse: collapse; text-align: center;"> <tr> <td style="width: 10%;"></td> <td style="width: 10%;"></td> <td style="width: 10%;"></td> <td style="width: 10%;"></td> <td style="width: 10%;"></td> <td style="width: 10%;"></td> <td style="width: 10%;"></td> <td style="width: 10%;"></td> <td style="width: 10%;"></td> <td style="width: 10%;"></td> </tr> <tr> <td></td> <td></td> <td colspan="8" style="text-align: center;"> <table border="1" style="width: 100%; border-collapse: collapse; text-align: center;"> <tr> <td style="width: 10%;"></td> <td style="width: 10%;"></td> <td style="width: 10%;"></td> <td style="width: 10%;"></td> <td style="width: 10%;"></td> <td style="width: 10%;"></td> <td style="width: 10%;"></td> <td style="width: 10%;"></td> <td style="width: 10%;"></td> <td style="width: 10%;"></td> </tr> <tr> <td></td> <td></td> <td colspan="8" style="text-align: center;"> <table border="1" style="width: 100%; border-collapse: collapse; text-align: center;"> <tr> <td style="width: 10%;"></td> <td style="width: 10%;"></td> <td style="width: 10%;"></td> <td style="width: 10%;"></td> <td style="width: 10%;"></td> <td style="width: 10%;"></td> <td style="width: 10%;"></td> <td style="width: 10%;"></td> <td style="width: 10%;"></td> <td style="width: 10%;"></td> </tr> <tr> <td></td> <td></td> <td colspan="8" style="text-align: center;"> <table border="1" style="width: 100%; border-collapse: collapse; text-align: center;"> <tr> <td style="width: 10%;"></td> <td style="width: 10%;"></td> <td style="width: 10%;"></td> <td style="width: 10%;"></td> <td style="width: 10%;"></td> <td style="width: 10%;"></td> <td style="width: 10%;"></td> <td style="width: 10%;"></td> <td style="width: 10%;"></td> <td style="width: 10%;"></td> </tr> <tr> <td></td> <td></td> <td colspan="8" style="text-align: center;"> <table border="1" style="width: 100%; border-collapse: collapse; text-align: center;"> <tr> <td style="width: 10%;"></td> <td style="width: 10%;"></td> <td style="width: 10%;"></td> <td style="width: 10%;"></td> <td style="width: 10%;"></td> <td style="width: 10%;"></td> <td style="width: 10%;"></td> <td style="width: 10%;"></td> <td style="width: 10%;"></td> <td style="width: 10%;"></td> </tr> <tr> <td></td> <td></td> <td colspan="8" style="text-align: center;"> <table border="1" style="width: 100%; border-collapse: collapse; text-align: center;"> <tr> <td style="width: 10%;"></td> <td style="width: 10%;"></td> <td style="width: 10%;"></td> <td style="width: 10%;"></td> <td style="width: 10%;"></td> <td style="width: 10%;"></td> <td style="width: 10%;"></td> <td style="width: 10%;"></td> <td style="width: 10%;"></td> <td style="width: 10%;"></td> </tr> <tr> <td></td> <td></td> <td colspan="8" style="text-align: center;"> <table border="1" style="width: 100%; border-collapse: collapse; text-align: center;"> <tr> <td style="width: 10%;"></td> <td style="width: 10%;"></td> <td style="width: 10%;"></td> <td style="width: 10%;"></td> <td style="width: 10%;"></td> <td style="width: 10%;"></td> <td style="width: 10%;"></td> <td style="width: 10%;"></td> <td style="width: 10%;"></td> <td style="width: 10%;"></td> </tr> <tr> <td></td> <td></td> <td colspan="8" style="text-align: center;"> <table border="1" style="width: 100%; border-collapse: collapse; text-align: center;"> <tr> <td style="width: 10%;"></td> <td style="width: 10%;"></td> <td style="width: 10%;"></td> <td style="width: 10%;"></td> <td style="width: 10%;"></td> <td style="width: 10%;"></td> <td style="width: 10%;"></td> <td style="width: 10%;"></td> <td style="width: 10%;"></td> <td style="width: 10%;"></td> </tr> <tr> <td></td> <td></td> <td colspan="8" style="text-align: center;"> <table border="1" style="width: 100%; border-collapse: collapse; text-align: center;"> <tr> <td style="width: 10%;"></td> <td style="width: 10%;"></td> <td style="width: 10%;"></td> <td style="width: 10%;"></td> <td style="width: 10%;"></td> <td style="width: 10%;"></td> <td style="width: 10%;"></td> <td style="width: 10%;"></td> <td style="width: 10%;"></td> <td style="width: 10%;"></td> </tr> <tr> <td></td> <td></td> <td colspan="8" style="text-align: center;"> <table border="1" style="width: 100%; border-collapse: collapse; text-align: center;"> <tr> <td style="width: 10%;"></td> <td style="width: 10%;"></td> <td style="width: 10%;"></td> <td style="width: 10%;"></td> <td style="width: 10%;"></td> <td style="width: 10%;"></td> <td style="width: 10%;"></td> <td style="width: 10%;"></td> <td style="width: 10%;"></td> <td style="width: 10%;"></td> </tr> <tr> <td></td> <td></td> <td colspan="8" style="text-align: center;"> <table border="1" style="width: 100%; border-collapse: collapse; text-align: center;"> <tr> <td style="width: 10%;"></td> <td style="width: 10%;"></td> <td style="width: 10%;"></td> <td style="width: 10%;"></td> <td style="width:
10%;"></td> <td style="width: 10%;"></td> <td style="width: 10%;"></td> <td style="width: 10%;"></td> <td style="width: 10%;"></td> <td style="width: 10%;"></td> </tr> <tr> <td></td> <td></td> <td colspan="8" style="text-align: center;"> <table border="1" style="width: 100%; border-collapse: collapse; text-align: center;"> <tr> </tr></table></td></tr></table></td></tr></table></td></tr></table></td></tr></table></td></tr></table></td></tr></table></td></tr></table></td></tr></table></td></tr></table></td></tr></table></td></tr></table></td></tr></table></td></tr></table></td></tr></table></td></tr></table></td></tr></table></td></tr></table></td></tr></table></td></tr></table></td></tr></table></td></tr></table></td></tr></table></td></tr></table></td></tr></table></td></tr></table></td></tr></table></td></tr></table></td></tr></table></td></tr></table></td></tr></table></td></tr></table></td></tr></table></td></tr></table></td></tr></table></td></tr></table></td></tr></table></td></tr></table></td></tr></table></td></tr></table></td></tr></table></td></tr></table></td></tr></table></td></tr></table></td></tr></table></td></tr></table></td></tr></table></td></tr></table></td></tr></table></td></tr></table></td></tr></table></td></tr></table></td></tr></table></td></tr></table></td></tr></table></td></tr></table></td></tr></table></td></tr></table></td></tr></table> | | | | | | | | | | | | | | | | | | | | <table border="1" style="width: 100%; border-collapse: collapse; text-align: center;"> <tr> <td style="width: 10%;"></td> <td style="width: 10%;"></td> <td style="width: 10%;"></td> <td style="width: 10%;"></td> <td style="width: 10%;"></td> <td style="width: 10%;"></td> <td style="width: 10%;"></td> <td style="width: 10%;"></td> <td style="width: 10%;"></td> <td style="width: 10%;"></td> </tr> <tr> <td></td> <td></td> <td colspan="8" style="text-align: center;"> <table border="1" style="width: 100%; border-collapse: collapse; text-align: center;"> <tr> <td style="width: 10%;"></td> <td style="width: 10%;"></td> <td style="width: 10%;"></td> <td style="width: 10%;"></td> <td style="width: 10%;"></td> <td style="width: 10%;"></td> <td style="width: 10%;"></td> <td style="width: 10%;"></td> <td style="width: 10%;"></td> <td style="width: 10%;"></td> </tr> <tr> <td></td> <td></td> <td colspan="8" style="text-align: center;"> <table border="1" style="width: 100%; border-collapse: collapse; text-align: center;"> <tr> <td style="width: 10%;"></td> <td style="width: 10%;"></td> <td style="width: 10%;"></td> <td style="width: 10%;"></td> <td style="width: 10%;"></td> <td style="width: 10%;"></td> <td style="width: 10%;"></td> <td style="width: 10%;"></td> <td style="width: 10%;"></td> <td style="width: 10%;"></td> </tr> <tr> <td></td> <td></td> <td colspan="8" style="text-align: center;"> <table border="1" style="width: 100%; border-collapse: collapse; text-align: center;"> <tr> <td style="width: 10%;"></td> <td style="width: 10%;"></td> <td style="width: 10%;"></td> <td style="width: 10%;"></td> <td style="width: 10%;"></td> <td style="width: 10%;"></td> <td style="width: 10%;"></td> <td style="width: 10%;"></td> <td style="width: 10%;"></td> <td style="width: 10%;"></td> </tr> <tr> <td></td> <td></td> <td colspan="8" style="text-align: center;"> <table border="1" style="width: 100%; border-collapse: collapse; text-align: center;"> <tr> <td style="width: 10%;"></td> <td style="width: 10%;"></td> <td style="width: 10%;"></td> <td style="width: 10%;"></td> <td style="width: 10%;"></td> <td style="width: 10%;"></td> <td style="width: 10%;"></td> <td style="width: 10%;"></td> <td style="width: 10%;"></td> <td style="width: 10%;"></td> </tr> <tr> <td></td> <td></td> <td colspan="8" style="text-align: center;"> <table border="1" style="width: 100%; border-collapse: collapse; text-align: center;"> <tr> <td style="width: 10%;"></td> <td style="width: 10%;"></td> <td style="width: 10%;"></td> <td style="width: 10%;"></td> <td style="width: 10%;"></td> <td style="width: 10%;"></td> <td style="width: 10%;"></td> <td style="width: 10%;"></td> <td style="width: 10%;"></td> <td style="width: 10%;"></td> </tr> <tr> <td></td> <td></td> <td colspan="8" style="text-align: center;"> <table border="1" style="width: 100%; border-collapse: collapse; text-align: center;"> <tr> <td style="width: 10%;"></td> <td style="width: 10%;"></td> <td style="width: 10%;"></td> <td style="width: 10%;"></td> <td style="width: 10%;"></td> <td style="width: 10%;"></td> <td style="width: 10%;"></td> <td style="width: 10%;"></td> <td style="width: 10%;"></td> <td style="width: 10%;"></td> </tr> <tr> <td></td> <td></td> <td colspan="8" style="text-align: center;"> <table border="1" style="width: 100%; border-collapse: collapse; text-align: center;"> <tr> <td style="width: 10%;"></td> <td style="width: 10%;"></td> <td style="width: 10%;"></td> <td style="width: 10%;"></td> <td style="width: 10%;"></td> <td style="width: 10%;"></td> <td style="width: 10%;"></td> <td style="width: 10%;"></td> <td style="width: 10%;"></td> <td style="width: 10%;"></td> </tr> <tr> <td></td> <td></td> <td colspan="8" style="text-align: center;"> <table border="1" style="width: 100%; border-collapse: collapse; text-align: center;"> <tr> <td style="width: 10%;"></td> <td style="width: 10%;"></td> <td style="width: 10%;"></td> <td style="width: 10%;"></td> <td style="width: 10%;"></td> <td style="width: 10%;"></td> <td style="width: 10%;"></td> <td style="width: 10%;"></td> <td style="width: 10%;"></td> <td style="width: 10%;"></td> </tr> <tr> <td></td> <td></td> <td colspan="8" style="text-align: center;"> <table border="1" style="width: 100%; border-collapse: collapse; text-align: center;"> <tr> <td style="width: 10%;"></td> <td style="width: 10%;"></td> <td style="width: 10%;"></td> <td style="width: 10%;"></td> <td style="width: 10%;"></td> <td style="width: 10%;"></td> <td style="width: 10%;"></td> <td style="width: 10%;"></td> <td style="width: 10%;"></td> <td style="width: 10%;"></td> </tr> <tr> <td></td> <td></td> <td colspan="8" style="text-align: center;"> <table border="1" style="width: 100%; border-collapse: collapse; text-align: center;"> <tr> <td style="width: 10%;"></td> <td style="width: 10%;"></td> <td style="width: 10%;"></td> <td style="width: 10%;"></td> <td style="width: 10%;"></td> <td style="width: 10%;"></td> <td style="width: 10%;"></td> <td style="width: 10%;"></td> <td style="width: 10%;"></td> <td style="width: 10%;"></td> </tr> <tr> <td></td> <td></td> <td colspan="8" style="text-align: center;"> <table border="1" style="width: 100%; border-collapse: collapse; text-align: center;"> <tr> <td style="width: 10%;"></td> <td style="width: 10%;"></td> <td style="width: 10%;"></td> <td style="width: 10%;"></td> <td style="width: 10%;"></td> <td style="width: 10%;"></td> <td style="width: 10%;"></td> <td style="width: 10%;"></td> <td style="width: 10%;"></td> <td style="width: 10%;"></td> </tr> <tr> <td></td> <td></td> <td colspan="8" style="text-align: center;"> <table border="1" style="width: 100%; border-collapse: collapse; text-align: center;"> <tr> <td style="width: 10%;"></td> <td style="width: 10%;"></td> <td style="width: 10%;"></td> <td style="width: 10%;"></td> <td style="width: 10%;"></td> <td style="width: 10%;"></td> <td style="width: 10%;"></td> <td style="width: 10%;"></td> <td style="width: 10%;"></td> <td style="width: 10%;"></td> </tr> <tr> <td></td> <td></td> <td colspan="8" style="text-align: center;"> <table border="1" style="width: 100%; border-collapse: collapse; text-align: center;"> <tr> <td style="width: 10%;"></td> <td style="width: 10%;"></td> <td style="width: 10%;"></td> <td style="width: 10%;"></td> <td style="width: 10%;"></td> <td style="width: 10%;"></td> <td style="width: 10%;"></td> <td style="width: 10%;"></td> <td style="width: 10%;"></td> <td style="width: 10%;"></td> </tr> <tr> <td></td> <td></td> <td colspan="8" style="text-align: center;"> <table border="1" style="width: 100%; border-collapse:
collapse; text-align: center;"> <tr> <td style="width: 10%;"></td> <td style="width: 10%;"></td> <td style="width: 10%;"></td> <td style="width: 10%;"></td> <td style="width: 10%;"></td> <td style="width: 10%;"></td> <td style="width: 10%;"></td> <td style="width: 10%;"></td> <td style="width: 10%;"></td> <td style="width: 10%;"></td> </tr> <tr> <td></td> <td></td> <td colspan="8" style="text-align: center;"> <table border="1" style="width: 100%; border-collapse: collapse; text-align: center;"> <tr> <td style="width: 10%;"></td> <td style="width: 10%;"></td> <td style="width: 10%;"></td> <td style="width: 10%;"></td> <td style="width: 10%;"></td> <td style="width: 10%;"></td> <td style="width: 10%;"></td> <td style="width: 10%;"></td> <td style="width: 10%;"></td> <td style="width: 10%;"></td> </tr> <tr> <td></td> <td></td> <td colspan="8" style="text-align: center;"> <table border="1" style="width: 100%; border-collapse: collapse; text-align: center;"> <tr> <td style="width: 10%;"></td> <td style="width: 10%;"></td> <td style="width: 10%;"></td> <td style="width: 10%;"></td> <td style="width: 10%;"></td> <td style="width: 10%;"></td> <td style="width: 10%;"></td> <td style="width: 10%;"></td> <td style="width: 10%;"></td> <td style="width: 10%;"></td> </tr> <tr> <td></td> <td></td> <td colspan="8" style="text-align: center;"> <table border="1" style="width: 100%; border-collapse: collapse; text-align: center;"> <tr> <td style="width: 10%;"></td> <td style="width: 10%;"></td> <td style="width: 10%;"></td> <td style="width: 10%;"></td> <td style="width: 10%;"></td> <td style="width: 10%;"></td> <td style="width: 10%;"></td> <td style="width: 10%;"></td> <td style="width: 10%;"></td> <td style="width: 10%;"></td> </tr> <tr> <td></td> <td></td> <td colspan="8" style="text-align: center;"> <table border="1" style="width: 100%; border-collapse: collapse; text-align: center;"> <tr> <td style="width: 10%;"></td> <td style="width: 10%;"></td> <td style="width: 10%;"></td> <td style="width: 10%;"></td> <td style="width: 10%;"></td> <td style="width: 10%;"></td> <td style="width: 10%;"></td> <td style="width: 10%;"></td> <td style="width: 10%;"></td> <td style="width: 10%;"></td> </tr> <tr> <td></td> <td></td> <td colspan="8" style="text-align: center;"> <table border="1" style="width: 100%; border-collapse: collapse; text-align: center;"> <tr> <td style="width: 10%;"></td> <td style="width: 10%;"></td> <td style="width: 10%;"></td> <td style="width: 10%;"></td> <td style="width: 10%;"></td> <td style="width: 10%;"></td> <td style="width: 10%;"></td> <td style="width: 10%;"></td> <td style="width: 10%;"></td> <td style="width: 10%;"></td> </tr> <tr> <td></td> <td></td> <td colspan="8" style="text-align: center;"> <table border="1" style="width: 100%; border-collapse: collapse; text-align: center;"> <tr> <td style="width: 10%;"></td> <td style="width: 10%;"></td> <td style="width: 10%;"></td> <td style="width: 10%;"></td> <td style="width: 10%;"></td> <td style="width: 10%;"></td> <td style="width: 10%;"></td> <td style="width: 10%;"></td> <td style="width: 10%;"></td> <td style="width: 10%;"></td> </tr> <tr> <td></td> <td></td> <td colspan="8" style="text-align: center;"> <table border="1" style="width: 100%; border-collapse: collapse; text-align: center;"> <tr> <td style="width: 10%;"></td> <td style="width: 10%;"></td> <td style="width: 10%;"></td> <td style="width: 10%;"></td> <td style="width: 10%;"></td> <td style="width: 10%;"></td> <td style="width: 10%;"></td> <td style="width: 10%;"></td> <td style="width: 10%;"></td> <td style="width: 10%;"></td> </tr> <tr> <td></td> <td></td> <td colspan="8" style="text-align: center;"> <table border="1" style="width: 100%; border-collapse: collapse; text-align: center;"> <tr> <td style="width: 10%;"></td> <td style="width: 10%;"></td> <td style="width: 10%;"></td> <td style="width: 10%;"></td> <td style="width: 10%;"></td> <td style="width: 10%;"></td> <td style="width: 10%;"></td> <td style="width: 10%;"></td> <td style="width: 10%;"></td> <td style="width: 10%;"></td> </tr> <tr> <td></td> <td></td> <td colspan="8" style="text-align: center;"> <table border="1" style="width: 100%; border-collapse: collapse; text-align: center;"> <tr> <td style="width: 10%;"></td> <td style="width: 10%;"></td> <td style="width: 10%;"></td> <td style="width: 10%;"></td> <td style="width: 10%;"></td> <td style="width: 10%;"></td> <td style="width: 10%;"></td> <td style="width: 10%;"></td> <td style="width: 10%;"></td> <td style="width: 10%;"></td> </tr> <tr> <td></td> <td></td> <td colspan="8" style="text-align: center;"> <table border="1" style="width: 100%; border-collapse: collapse; text-align: center;"> <tr> <td style="width: 10%;"></td> <td style="width: 10%;"></td> <td style="width: 10%;"></td> <td style="width: 10%;"></td> <td style="width: 10%;"></td> <td style="width: 10%;"></td> <td style="width: 10%;"></td> <td style="width: 10%;"></td> <td style="width: 10%;"></td> <td style="width: 10%;"></td> </tr> <tr> <td></td> <td></td> <td colspan="8" style="text-align: center;"> <table border="1" style="width: 100%; border-collapse: collapse; text-align: center;"> <tr> <td style="width: 10%;"></td> <td style="width: 10%;"></td> <td style="width: 10%;"></td> <td style="width: 10%;"></td> <td style="width: 10%;"></td> <td style="width: 10%;"></td> <td style="width: 10%;"></td> <td style="width: 10%;"></td> <td style="width: 10%;"></td> <td style="width: 10%;"></td> </tr> <tr> <td></td> <td></td> <td colspan="8" style="text-align: center;"> <table border="1" style="width: 100%; border-collapse: collapse; text-align: center;"> <tr> <td style="width: 10%;"></td> <td style="width: 10%;"></td> <td style="width: 10%;"></td> <td style="width: 10%;"></td> <td style="width: 10%;"></td> <td style="width: 10%;"></td> <td style="width: 10%;"></td> <td style="width: 10%;"></td> <td style="width: 10%;"></td> <td style="width: 10%;"></td> </tr> <tr> <td></td> <td></td> <td colspan="8" style="text-align: center;"> <table border="1" style="width: 100%; border-collapse: collapse; text-align: center;"> <tr> <td style="width: 10%;"></td> <td style="width: 10%;"></td> <td style="width: 10%;"></td> <td style="width: 10%;"></td> <td style="width: 10%;"></td> <td style="width: 10%;"></td> <td style="width: 10%;"></td> <td style="width: 10%;"></td> <td style="width: 10%;"></td> <td style="width: 10%;"></td> </tr> <tr> <td></td> <td></td> <td colspan="8" style="text-align: center;"> <table border="1" style="width: 100%; border-collapse: collapse; text-align: center;"> <tr> <td style="width: 10%;"></td> <td style="width: 10%;"></td> <td style="width: 10%;"></td> <td style="width: 10%;"></td> <td style="width: 10%;"></td> <td style="width: 10%;"></td> <td style="width: 10%;"></td> <td style="width: 10%;"></td> <td style="width: 10%;"></td> <td style="width: 10%;"></td> </tr> <tr> <td></td> <td></td> <td colspan="8" style="text-align: center;"> <table border="1" style="width: 100%; border-collapse: collapse; text-align: center;"> <tr> <td style="width: 10%;"></td> <td style="width: 10%;"></td> <td style="width: 10%;"></td> <td style="width: 10%;"></td> <td style="width: 10%;"></td> <td style="width: 10%;"></td> <td style="width: 10%;"></td> <td style="width: 10%;"></td> <td style="width: 10%;"></td> <td style="width: 10%;"></td> </tr> <tr> <td></td> <td></td> <td colspan="8" style="text-align: center;"> <table border="1" style="width: 100%; border-collapse: collapse; text-align: center;"> <tr> <td style="width: 10%;"></td> <td style="width: 10%;"></td> <td style="width: 10%;"></td> <td style="width: 10%;"></td> <td style="width: 10%;"></td> <td style="width: 10%;"></td> <td style="width: 10%;"></td> <td style="width: 10%;"></td> <td style="width: 10%;"></td> <td style="width: 10%;"></td> </tr> <tr> <td></td> <td></td> <td colspan="8" style="text-align: center;"> <table border="1" style="width: 100%; border-collapse: collapse; text-align: center;"> <tr> <td style="width: 10%;"></td> <td style="width: 10%;"></td> <td style="width: 10%;"></td> <td style="width: 10%;"></td> <td style="width: 10%;"></td> <td style="width: 10%;"></td> <td style="width: 10%;"></td> <td style="width: 10%;"></td> <td style="width: 10%;"></td> <td style="width: 10%;"></td> </tr> <tr> <td></td> <td></td> <td colspan="8" style="text-align: center;"> <table border="1" style="width: 100%; border-collapse: collapse; text-align: center;"> <tr> <td style="width: 10%;"></td> <td style="width: 10%;"></td> <td style="width: 10%;"></td> <td style="width: 10%;"></td> <td style="width: 10%;"></td> <td style="width: 10%;"></td> <td style="width: 10%;"></td> <td style="width: 10%;"></td> <td style="width: 10%;"></td> <td style="width: 10%;"></td> </tr> <tr> <td></td> <td></td> <td colspan="8" style="text-align: center;"> <table border="1" style="width: 100%; border-collapse: collapse; text-align: center;"> <tr> <td style="width: 10%;"></td> <td style="width: 10%;"></td> <td style="width: 10%;"></td> <td style="width: 10%;"></td> <td style="width: 10%;"></td> <td style="width: 10%;"></td> <td style="width: 10%;"></td> <td style="width: 10%;"></td> <td style="width: 10%;"></td> <td style="width: 10%;"></td> </tr> <tr> <td></td> <td></td> <td colspan="8" style="text-align: center;"> <table border="1" style="width: 100%; border-collapse: collapse; text-align: center;"> <tr> <td style="width: 10%;"></td> <td style="width: 10%;"></td> <td style="width: 10%;"></td> <td style="width: 10%;"></td> <td style="width: 10%;"></td> <td style="width: 10%;"></td> <td style="width: 10%;"></td> <td style="width: 10%;"></td> <td style="width: 10%;"></td> <td style="width: 10%;"></td> </tr> <tr> <td></td> <td></td> <td colspan="8" style="text-align: center;"> <table border="1" style="width: 100%; border-collapse: collapse; text-align: center;"> <tr> <td style="width: 10%;"></td> <td style="width: 10%;"></td> <td style="width: 10%;"></td> <td style="width: 10%;"></td> <td
style="width: 10%;"></td> <td style="width: 10%;"></td> <td style="width: 10%;"></td> <td style="width: 10%;"></td> <td style="width: 10%;"></td> <td style="width: 10%;"></td> </tr> <tr> <td></td> <td></td> <td colspan="8" style="text-align: center;"> <table border="1" style="width: 100%; border-collapse: collapse; text-align: center;"> <tr> <td style="width: 10%;"></td> <td style="width: 10%;"></td> <td style="width: 10%;"></td> <td style="width: 10%;"></td> <td style="width: 10%;"></td> <td style="width: 10%;"></td> <td style="width: 10%;"></td> <td style="width: 10%;"></td> <td style="width: 10%;"></td> <td style="width: 10%;"></td> </tr> <tr> <td></td> <td></td> <td colspan="8" style="text-align: center;"> <table border="1" style="width: 100%; border-collapse: collapse; text-align: center;"> <tr> <td style="width: 10%;"></td> <td style="width: 10%;"></td> <td style="width: 10%;"></td> <td style="width: 10%;"></td> <td style="width: 10%;"></td> <td style="width: 10%;"></td> <td style="width: 10%;"></td> <td style="width: 10%;"></td> <td style="width: 10%;"></td> <td style="width: 10%;"></td> </tr> <tr> <td></td> <td></td> <td colspan="8" style="text-align: center;"> <table border="1" style="width: 100%; border-collapse: collapse; text-align: center;"> <tr> <td style="width: 10%;"></td> <td style="width: 10%;"></td> <td style="width: 10%;"></td> <td style="width: 10%;"></td> <td style="width: 10%;"></td> <td style="width: 10%;"></td> <td style="width: 10%;"></td> <td style="width: 10%;"></td> <td style="width: 10%;"></td> <td style="width: 10%;"></td> </tr> <tr> <td></td> <td></td> <td colspan="8" style="text-align: center;"> <table border="1" style="width: 100%; border-collapse: collapse; text-align: center;"> <tr> <td style="width: 10%;"></td> <td style="width: 10%;"></td> <td style="width: 10%;"></td> <td style="width: 10%;"></td> <td style="width: 10%;"></td> <td style="width: 10%;"></td> <td style="width: 10%;"></td> <td style="width: 10%;"></td> <td style="width: 10%;"></td> <td style="width: 10%;"></td> </tr> <tr> <td></td> <td></td> <td colspan="8" style="text-align: center;"> <table border="1" style="width: 100%; border-collapse: collapse; text-align: center;"> <tr> <td style="width: 10%;"></td> <td style="width: 10%;"></td> <td style="width: 10%;"></td> <td style="width: 10%;"></td> <td style="width: 10%;"></td> <td style="width: 10%;"></td> <td style="width: 10%;"></td> <td style="width: 10%;"></td> <td style="width: 10%;"></td> <td style="width: 10%;"></td> </tr> <tr> <td></td> <td></td> <td colspan="8" style="text-align: center;"> <table border="1" style="width: 100%; border-collapse: collapse; text-align: center;"> <tr> <td style="width: 10%;"></td> <td style="width: 10%;"></td> <td style="width: 10%;"></td> <td style="width: 10%;"></td> <td style="width: 10%;"></td> <td style="width: 10%;"></td> <td style="width: 10%;"></td> <td style="width: 10%;"></td> <td style="width: 10%;"></td> <td style="width: 10%;"></td> </tr> <tr> <td></td> <td></td> <td colspan="8" style="text-align: center;"> <table border="1" style="width: 100%; border-collapse: collapse; text-align: center;"> <tr> <td style="width: 10%;"></td> <td style="width: 10%;"></td> <td style="width: 10%;"></td> <td style="width: 10%;"></td> <td style="width: 10%;"></td> <td style="width: 10%;"></td> <td style="width: 10%;"></td> <td style="width: 10%;"></td> <td style="width: 10%;"></td> <td style="width: 10%;"></td> </tr> <tr> <td></td> <td></td> <td colspan="8" style="text-align: center;"> <table border="1" style="width: 100%; border-collapse: collapse; text-align: center;"> <tr> <td style="width: 10%;"></td> <td style="width: 10%;"></td> <td style="width: 10%;"></td> <td style="width: 10%;"></td> <td style="width: 10%;"></td> <td style="width: 10%;"></td> <td style="width: 10%;"></td> <td style="width: 10%;"></td> <td style="width: 10%;"></td> <td style="width: 10%;"></td> </tr> <tr> <td></td> <td></td> <td colspan="8" style="text-align: center;"> <table border="1" style="width: 100%; border-collapse: collapse; text-align: center;"> <tr> <td style="width: 10%;"></td> <td style="width: 10%;"></td> <td style="width: 10%;"></td> <td style="width: 10%;"></td> <td style="width: 10%;"></td> <td style="width: 10%;"></td> <td style="width: 10%;"></td> <td style="width: 10%;"></td> <td style="width: 10%;"></td> <td style="width: 10%;"></td> </tr> <tr> <td></td> <td></td> <td colspan="8" style="text-align: center;"> <table border="1" style="width: 100%; border-collapse: collapse; text-align: center;"> <tr> <td style="width: 10%;"></td> <td style="width: 10%;"></td> <td style="width: 10%;"></td> <td style="width: 10%;"></td> <td style="width: 10%;"></td> <td style="width: 10%;"></td> <td style="width: 10%;"></td> <td style="width: 10%;"></td> <td style="width: 10%;"></td> <td style="width: 10%;"></td> </tr> <tr> <td></td> <td></td> <td colspan="8" style="text-align: center;"> <table border="1" style="width: 100%; border-collapse: collapse; text-align: center;"> <tr> <td style="width: 10%;"></td> <td style="width: 10%;"></td> <td style="width: 10%;"></td> <td style="width: 10%;"></td> <td style="width: 10%;"></td> <td style="width: 10%;"></td> <td style="width: 10%;"></td> <td style="width: 10%;"></td> <td style="width: 10%;"></td> <td style="width: 10%;"></td> </tr> <tr> <td></td> <td></td> <td colspan="8" style="text-align: center;"> <table border="1" style="width: 100%; border-collapse: collapse; text-align: center;"> <tr> <td style="width: 10%;"></td> <td style="width: 10%;"></td> <td style="width: 10%;"></td> <td style="width: 10%;"></td> <td style="width: 10%;"></td> <td style="width: 10%;"></td> <td style="width: 10%;"></td> <td style="width: 10%;"></td> <td style="width: 10%;"></td> <td style="width: 10%;"></td> </tr> <tr> <td></td> <td></td> <td colspan="8" style="text-align: center;"> <table border="1" style="width: 100%; border-collapse: collapse; text-align: center;"> <tr> <td style="width: 10%;"></td> <td style="width: 10%;"></td> <td style="width: 10%;"></td> <td style="width: 10%;"></td> <td style="width: 10%;"></td> <td style="width: 10%;"></td> <td style="width: 10%;"></td> <td style="width: 10%;"></td> <td style="width: 10%;"></td> <td style="width: 10%;"></td> </tr> <tr> <td></td> <td></td> <td colspan="8" style="text-align: center;"> <table border="1" style="width: 100%; border-collapse: collapse; text-align: center;"> <tr> <td style="width: 10%;"></td> <td style="width: 10%;"></td> <td style="width: 10%;"></td> <td style="width: 10%;"></td> <td style="width: 10%;"></td> <td style="width: 10%;"></td> <td style="width: 10%;"></td> <td style="width: 10%;"></td> <td style="width: 10%;"></td> <td style="width: 10%;"></td> </tr> <tr> <td></td> <td></td> <td colspan="8" style="text-align: center;"> <table border="1" style="width: 100%; border-collapse: collapse; text-align: center;"> <tr> <td style="width: 10%;"></td> <td style="width: 10%;"></td> <td style="width: 10%;"></td> <td style="width: 10%;"></td> <td style="width: 10%;"></td> <td style="width: 10%;"></td> <td style="width: 10%;"></td> <td style="width: 10%;"></td> <td style="width: 10%;"></td> <td style="width: 10%;"></td> </tr> <tr> <td></td> <td></td> <td colspan="8" style="text-align: center;"> <table border="1" style="width: 100%; border-collapse: collapse; text-align: center;"> <tr> <td style="width: 10%;"></td> <td style="width: 10%;"></td> <td style="width: 10%;"></td> <td style="width: 10%;"></td> <td style="width: 10%;"></td> <td style="width: 10%;"></td> <td style="width: 10%;"></td> <td style="width: 10%;"></td> <td style="width: 10%;"></td> <td style="width: 10%;"></td> </tr> <tr> <td></td> <td></td> <td colspan="8" style="text-align: center;"> <table border="1" style="width: 100%; border-collapse: collapse; text-align: center;"> <tr> <td style="width: 10%;"></td> <td style="width: 10%;"></td> <td style="width: 10%;"></td> <td style="width: 10%;"></td> <td style="width: 10%;"></td> <td style="width: 10%;"></td> <td style="width: 10%;"></td> <td style="width: 10%;"></td> <td style="width: 10%;"></td> <td style="width: 10%;"></td> </tr> <tr> <td></td> <td></td> <td colspan="8" style="text-align: center;"> <table border="1" style="width: 100%; border-collapse: collapse; text-align: center;"> <tr> <td style="width: 10%;"></td> <td style="width: 10%;"></td> <td style="width: 10%;"></td> <td style="width: 10%;"></td> <td style="width: 10%;"></td> <td style="width: 10%;"></td> <td style="width: 10%;"></td> <td style="width: 10%;"></td> <td style="width: 10%;"></td> <td style="width: 10%;"></td> </tr> <tr> <td></td> <td></td> <td colspan="8" style="text-align: center;"> <table border="1" style="width: 100%; border-collapse: collapse; text-align: center;"> <tr> <td style="width: 10%;"></td> <td style="width: 10%;"></td> <td style="width: 10%;"></td> <td style="width: 10%;"></td> <td style="width: 10%;"></td> <td style="width: 10%;"></td> <td style="width: 10%;"></td> <td style="width: 10%;"></td> <td style="width: 10%;"></td> <td style="width: 10%;"></td> </tr> <tr> <td></td> <td></td> <td colspan="8" style="text-align: center;"> <table border="1" style="width: 100%; border-collapse: collapse; text-align: center;"> <tr> <td style="width: 10%;"></td> <td style="width: 10%;"></td> <td style="width: 10%;"></td> <td style="width: 10%;"></td> <td style="width: 10%;"></td> <td style="width: 10%;"></td> <td style="width: 10%;"></td> <td style="width: 10%;"></td> <td style="width: 10%;"></td> <td style="width: 10%;"></td> </tr> <tr> <td></td> <td></td> <td colspan="8" style="text-align: center;"> <table border="1" style="width: 100%; border-collapse: collapse; text-align: center;"> <tr> <td style="width: 10%;"></td> <td style="width: 10%;"></td> <td style="width: 10%;"></td> <td style="width: 10%;"></td> <td style="width: 10%;"></td> <td style="width: 10%;"></td> <td style="width: 10%;"></td> <td style="width: 10%;"></td> <td style="width: 10%;"></td> <td style="width:
10%;"></td> </tr> <tr> <td></td> <td></td> <td colspan="8" style="text-align: center;"> <table border="1" style="width: 100%; border-collapse: collapse; text-align: center;"> <tr> </tr></table></td></tr></table></td></tr></table></td></tr></table></td></tr></table></td></tr></table></td></tr></table></td></tr></table></td></tr></table></td></tr></table></td></tr></table></td></tr></table></td></tr></table></td></tr></table></td></tr></table></td></tr></table></td></tr></table></td></tr></table></td></tr></table></td></tr></table></td></tr></table></td></tr></table></td></tr></table></td></tr></table></td></tr></table></td></tr></table></td></tr></table></td></tr></table></td></tr></table></td></tr></table></td></tr></table></td></tr></table></td></tr></table></td></tr></table></td></tr></table></td></tr></table></td></tr></table></td></tr></table></td></tr></table></td></tr></table></td></tr></table></td></tr></table></td></tr></table></td></tr></table></td></tr></table></td></tr></table></td></tr></table></td></tr></table></td></tr></table></td></tr></table></td></tr></table></td></tr></table></td></tr></table></td></tr></table></td></tr></table></td></tr></table></td></tr></table></td></tr></table> | | | | | | | | | | | | | | | | | | | | <table border="1" style="width: 100%; border-collapse: collapse; text-align: center;"> <tr> <td style="width: 10%;"></td> <td style="width: 10%;"></td> <td style="width: 10%;"></td> <td style="width: 10%;"></td> <td style="width: 10%;"></td> <td style="width: 10%;"></td> <td style="width: 10%;"></td> <td style="width: 10%;"></td> <td style="width: 10%;"></td> <td style="width: 10%;"></td> </tr> <tr> <td></td> <td></td> <td colspan="8" style="text-align: center;"> <table border="1" style="width: 100%; border-collapse: collapse; text-align: center;"> <tr> <td style="width: 10%;"></td> <td style="width: 10%;"></td> <td style="width: 10%;"></td> <td style="width: 10%;"></td> <td style="width: 10%;"></td> <td style="width: 10%;"></td> <td style="width: 10%;"></td> <td style="width: 10%;"></td> <td style="width: 10%;"></td> <td style="width: 10%;"></td> </tr> <tr> <td></td> <td></td> <td colspan="8" style="text-align: center;"> <table border="1" style="width: 100%; border-collapse: collapse; text-align: center;"> <tr> <td style="width: 10%;"></td> <td style="width: 10%;"></td> <td style="width: 10%;"></td> <td style="width: 10%;"></td> <td style="width: 10%;"></td> <td style="width: 10%;"></td> <td style="width: 10%;"></td> <td style="width: 10%;"></td> <td style="width: 10%;"></td> <td style="width: 10%;"></td> </tr> <tr> <td></td> <td></td> <td colspan="8" style="text-align: center;"> <table border="1" style="width: 100%; border-collapse: collapse; text-align: center;"> <tr> <td style="width: 10%;"></td> <td style="width: 10%;"></td> <td style="width: 10%;"></td> <td style="width: 10%;"></td> <td style="width: 10%;"></td> <td style="width: 10%;"></td> <td style="width: 10%;"></td> <td style="width: 10%;"></td> <td style="width: 10%;"></td> <td style="width: 10%;"></td> </tr> <tr> <td></td> <td></td> <td colspan="8" style="text-align: center;"> <table border="1" style="width: 100%; border-collapse: collapse; text-align: center;"> <tr> <td style="width: 10%;"></td> <td style="width: 10%;"></td> <td style="width: 10%;"></td> <td style="width: 10%;"></td> <td style="width: 10%;"></td> <td style="width: 10%;"></td> <td style="width: 10%;"></td> <td style="width: 10%;"></td> <td style="width: 10%;"></td> <td style="width: 10%;"></td> </tr> <tr> <td></td> <td></td> <td colspan="8" style="text-align: center;"> <table border="1" style="width: 100%; border-collapse: collapse; text-align: center;"> <tr> <td style="width: 10%;"></td> <td style="width: 10%;"></td> <td style="width: 10%;"></td> <td style="width: 10%;"></td> <td style="width: 10%;"></td> <td style="width: 10%;"></td> <td style="width: 10%;"></td> <td style="width: 10%;"></td> <td style="width: 10%;"></td> <td style="width: 10%;"></td> </tr> <tr> <td></td> <td></td> <td colspan="8" style="text-align: center;"> <table border="1" style="width: 100%; border-collapse: collapse; text-align: center;"> <tr> <td style="width: 10%;"></td> <td style="width: 10%;"></td> <td style="width: 10%;"></td> <td style="width: 10%;"></td> <td style="width: 10%;"></td> <td style="width: 10%;"></td> <td style="width: 10%;"></td> <td style="width: 10%;"></td> <td style="width: 10%;"></td> <td style="width: 10%;"></td> </tr> <tr> <td></td> <td></td> <td colspan="8" style="text-align: center;"> <table border="1" style="width: 100%; border-collapse: collapse; text-align: center;"> <tr> <td style="width: 10%;"></td> <td style="width: 10%;"></td> <td style="width: 10%;"></td> <td style="width: 10%;"></td> <td style="width: 10%;"></td> <td style="width: 10%;"></td> <td style="width: 10%;"></td> <td style="width: 10%;"></td> <td style="width: 10%;"></td> <td style="width: 10%;"></td> </tr> <tr> <td></td> <td></td> <td colspan="8" style="text-align: center;"> <table border="1" style="width: 100%; border-collapse: collapse; text-align: center;"> <tr> <td style="width: 10%;"></td> <td style="width: 10%;"></td> <td style="width: 10%;"></td> <td style="width: 10%;"></td> <td style="width: 10%;"></td> <td style="width: 10%;"></td> <td style="width: 10%;"></td> <td style="width: 10%;"></td> <td style="width: 10%;"></td> <td style="width: 10%;"></td> </tr> <tr> <td></td> <td></td> <td colspan="8" style="text-align: center;"> <table border="1" style="width: 100%; border-collapse: collapse; text-align: center;"> <tr> <td style="width: 10%;"></td> <td style="width: 10%;"></td> <td style="width: 10%;"></td> <td style="width: 10%;"></td> <td style="width: 10%;"></td> <td style="width: 10%;"></td> <td style="width: 10%;"></td> <td style="width: 10%;"></td> <td style="width: 10%;"></td> <td style="width: 10%;"></td> </tr> <tr> <td></td> <td></td> <td colspan="8" style="text-align: center;"> <table border="1" style="width: 100%; border-collapse: collapse; text-align: center;"> <tr> <td style="width: 10%;"></td> <td style="width: 10%;"></td> <td style="width: 10%;"></td> <td style="width: 10%;"></td> <td style="width: 10%;"></td> <td style="width: 10%;"></td> <td style="width: 10%;"></td> <td style="width: 10%;"></td> <td style="width: 10%;"></td> <td style="width: 10%;"></td> </tr> <tr> <td></td> <td></td> <td colspan="8" style="text-align: center;"> <table border="1" style="width: 100%; border-collapse: collapse; text-align: center;"> <tr> <td style="width: 10%;"></td> <td style="width: 10%;"></td> <td style="width: 10%;"></td> <td style="width: 10%;"></td> <td style="width: 10%;"></td> <td style="width: 10%;"></td> <td style="width: 10%;"></td> <td style="width: 10%;"></td> <td style="width: 10%;"></td> <td style="width: 10%;"></td> </tr> <tr> <td></td> <td></td> <td colspan="8" style="text-align: center;"> <table border="1" style="width: 100%; border-collapse: collapse; text-align: center;"> <tr> <td style="width: 10%;"></td> <td style="width: 10%;"></td> <td style="width: 10%;"></td> <td style="width: 10%;"></td> <td style="width: 10%;"></td> <td style="width: 10%;"></td> <td style="width: 10%;"></td> <td style="width: 10%;"></td> <td style="width: 10%;"></td> <td style="width: 10%;"></td> </tr> <tr> <td></td> <td></td> <td colspan="8" style="text-align: center;"> <table border="1" style="width: 100%; border-collapse: collapse; text-align: center;"> <tr> <td style="width: 10%;"></td> <td style="width: 10%;"></td> <td style="width: 10%;"></td> <td style="width: 10%;"></td> <td style="width: 10%;"></td> <td style="width: 10%;"></td> <td style="width: 10%;"></td> <td style="width: 10%;"></td> <td style="width: 10%;"></td> <td style="width: 10%;"></td> </tr> <tr> <td></td> <td></td> <td colspan="8" style="text-align: center;"> <table border="1" style="width: 100%; border-collapse: collapse; text-align: center;"> <tr> <td style="width: 10%;"></td> <td style="width: 10%;"></td> <td style="width: 10%;"></td> <td style="width: 10%;"></td> <td
style="width: 10%;"></td> <td style="width: 10%;"></td> <td style="width: 10%;"></td> <td style="width: 10%;"></td> <td style="width: 10%;"></td> <td style="width: 10%;"></td> </tr> <tr> <td></td> <td></td> <td colspan="8" style="text-align: center;"> <table border="1" style="width: 100%; border-collapse: collapse; text-align: center;"> <tr> <td style="width: 10%;"></td> <td style="width: 10%;"></td> <td style="width: 10%;"></td> <td style="width: 10%;"></td> <td style="width: 10%;"></td> <td style="width: 10%;"></td> <td style="width: 10%;"></td> <td style="width: 10%;"></td> <td style="width: 10%;"></td> <td style="width: 10%;"></td> </tr> <tr> <td></td> <td></td> <td colspan="8" style="text-align: center;"> <table border="1" style="width: 100%; border-collapse: collapse; text-align: center;"> <tr> <td style="width: 10%;"></td> <td style="width: 10%;"></td> <td style="width: 10%;"></td> <td style="width: 10%;"></td> <td style="width: 10%;"></td> <td style="width: 10%;"></td> <td style="width: 10%;"></td> <td style="width: 10%;"></td> <td style="width: 10%;"></td> <td style="width: 10%;"></td> </tr> <tr> <td></td> <td></td> <td colspan="8" style="text-align: center;"> <table border="1" style="width: 100%; border-collapse: collapse; text-align: center;"> <tr> <td style="width: 10%;"></td> <td style="width: 10%;"></td> <td style="width: 10%;"></td> <td style="width: 10%;"></td> <td style="width: 10%;"></td> <td style="width: 10%;"></td> <td style="width: 10%;"></td> <td style="width: 10%;"></td> <td style="width: 10%;"></td> <td style="width: 10%;"></td> </tr> <tr> <td></td> <td></td> <td colspan="8" style="text-align: center;"> <table border="1" style="width: 100%; border-collapse: collapse; text-align: center;"> <tr> <td style="width: 10%;"></td> <td style="width: 10%;"></td> <td style="width: 10%;"></td> <td style="width: 10%;"></td> <td style="width: 10%;"></td> <td style="width: 10%;"></td> <td style="width: 10%;"></td> <td style="width: 10%;"></td> <td style="width: 10%;"></td> <td style="width: 10%;"></td> </tr> <tr> <td></td> <td></td> <td colspan="8" style="text-align: center;"> <table border="1" style="width: 100%; border-collapse: collapse; text-align: center;"> <tr> <td style="width: 10%;"></td> <td style="width: 10%;"></td> <td style="width: 10%;"></td> <td style="width: 10%;"></td> <td style="width: 10%;"></td> <td style="width: 10%;"></td> <td style="width: 10%;"></td> <td style="width: 10%;"></td> <td style="width: 10%;"></td> <td style="width: 10%;"></td> </tr> <tr> <td></td> <td></td> <td colspan="8" style="text-align: center;"> <table border="1" style="width: 100%; border-collapse: collapse; text-align: center;"> <tr> <td style="width: 10%;"></td> <td style="width: 10%;"></td> <td style="width: 10%;"></td> <td style="width: 10%;"></td> <td style="width: 10%;"></td> <td style="width: 10%;"></td> <td style="width: 10%;"></td> <td style="width: 10%;"></td> <td style="width: 10%;"></td> <td style="width: 10%;"></td> </tr> <tr> <td></td> <td></td> <td colspan="8" style="text-align: center;"> <table border="1" style="width: 100%; border-collapse: collapse; text-align: center;"> <tr> <td style="width: 10%;"></td> <td style="width: 10%;"></td> <td style="width: 10%;"></td> <td style="width: 10%;"></td> <td style="width: 10%;"></td> <td style="width: 10%;"></td> <td style="width: 10%;"></td> <td style="width: 10%;"></td> <td style="width: 10%;"></td> <td style="width: 10%;"></td> </tr> <tr> <td></td> <td></td> <td colspan="8" style="text-align: center;"> <table border="1" style="width: 100%; border-collapse: collapse; text-align: center;"> <tr> <td style="width: 10%;"></td> <td style="width: 10%;"></td> <td style="width: 10%;"></td> <td style="width: 10%;"></td> <td style="width: 10%;"></td> <td style="width: 10%;"></td> <td style="width: 10%;"></td> <td style="width: 10%;"></td> <td style="width: 10%;"></td> <td style="width: 10%;"></td> </tr> <tr> <td></td> <td></td> <td colspan="8" style="text-align: center;"> <table border="1" style="width: 100%; border-collapse: collapse; text-align: center;"> <tr> <td style="width: 10%;"></td> <td style="width: 10%;"></td> <td style="width: 10%;"></td> <td style="width: 10%;"></td> <td style="width: 10%;"></td> <td style="width: 10%;"></td> <td style="width: 10%;"></td> <td style="width: 10%;"></td> <td style="width: 10%;"></td> <td style="width: 10%;"></td> </tr> <tr> <td></td> <td></td> <td colspan="8" style="text-align: center;"> <table border="1" style="width: 100%; border-collapse: collapse; text-align: center;"> <tr> <td style="width: 10%;"></td> <td style="width: 10%;"></td> <td style="width: 10%;"></td> <td style="width: 10%;"></td> <td style="width: 10%;"></td> <td style="width: 10%;"></td> <td style="width: 10%;"></td> <td style="width: 10%;"></td> <td style="width: 10%;"></td> <td style="width: 10%;"></td> </tr> <tr> <td></td> <td></td> <td colspan="8" style="text-align: center;"> <table border="1" style="width: 100%; border-collapse: collapse; text-align: center;"> <tr> <td style="width: 10%;"></td> <td style="width: 10%;"></td> <td style="width: 10%;"></td> <td style="width: 10%;"></td> <td style="width: 10%;"></td> <td style="width: 10%;"></td> <td style="width: 10%;"></td> <td style="width: 10%;"></td> <td style="width: 10%;"></td> <td style="width: 10%;"></td> </tr> <tr> <td></td> <td></td> <td colspan="8" style="text-align: center;"> <table border="1" style="width: 100%; border-collapse: collapse; text-align: center;"> <tr> <td style="width: 10%;"></td> <td style="width: 10%;"></td> <td style="width: 10%;"></td> <td style="width: 10%;"></td> <td style="width: 10%;"></td> <td style="width: 10%;"></td> <td style="width: 10%;"></td> <td style="width: 10%;"></td> <td style="width: 10%;"></td> <td style="width: 10%;"></td> </tr> <tr> <td></td> <td></td> <td colspan="8" style="text-align: center;"> <table border="1" style="width: 100%; border-collapse: collapse; text-align: center;"> <tr> <td style="width: 10%;"></td> <td style="width: 10%;"></td> <td style="width: 10%;"></td> <td style="width: 10%;"></td> <td style="width: 10%;"></td> <td style="width: 10%;"></td> <td style="width: 10%;"></td> <td style="width: 10%;"></td> <td style="width: 10%;"></td> <td style="width: 10%;"></td> </tr> <tr> <td></td> <td></td> <td colspan="8" style="text-align: center;"> <table border="1" style="width: 100%; border-collapse: collapse; text-align: center;"> <tr> <td style="width: 10%;"></td> <td style="width: 10%;"></td> <td style="width: 10%;"></td> <td style="width: 10%;"></td> <td style="width: 10%;"></td> <td style="width: 10%;"></td> <td style="width: 10%;"></td> <td style="width: 10%;"></td> <td style="width: 10%;"></td> <td style="width: 10%;"></td> </tr> <tr> <td></td> <td></td> <td colspan="8" style="text-align: center;"> <table border="1" style="width: 100%; border-collapse: collapse; text-align: center;"> <tr> <td style="width: 10%;"></td> <td style="width: 10%;"></td> <td style="width: 10%;"></td> <td style="width: 10%;"></td> <td style="width: 10%;"></td> <td style="width: 10%;"></td> <td style="width: 10%;"></td> <td style="width: 10%;"></td> <td style="width: 10%;"></td> <td style="width: 10%;"></td> </tr> <tr> <td></td> <td></td> <td colspan="8" style="text-align: center;"> <table border="1" style="width: 100%; border-collapse: collapse; text-align: center;"> <tr> <td style="width: 10%;"></td> <td style="width: 10%;"></td> <td style="width: 10%;"></td> <td style="width: 10%;"></td> <td style="width: 10%;"></td> <td style="width: 10%;"></td> <td style="width: 10%;"></td> <td style="width: 10%;"></td> <td style="width: 10%;"></td> <td style="width: 10%;"></td> </tr> <tr> <td></td> <td></td> <td colspan="8" style="text-align: center;"> <table border="1" style="width: 100%; border-collapse: collapse; text-align: center;"> <tr> <td style="width: 10%;"></td> <td style="width: 10%;"></td> <td style="width: 10%;"></td> <td style="width: 10%;"></td> <td style="width: 10%;"></td> <td style="width: 10%;"></td> <td style="width: 10%;"></td> <td style="width: 10%;"></td> <td style="width: 10%;"></td> <td style="width: 10%;"></td> </tr> <tr> <td></td> <td></td> <td colspan="8" style="text-align: center;"> <table border="1" style="width: 100%; border-collapse: collapse; text-align: center;"> <tr> <td style="width: 10%;"></td> <td style="width: 10%;"></td> <td style="width: 10%;"></td> <td style="width: 10%;"></td> <td style="width: 10%;"></td> <td style="width: 10%;"></td> <td style="width: 10%;"></td> <td style="width: 10%;"></td> <td style="width: 10%;"></td> <td style="width: 10%;"></td> </tr> <tr> <td></td> <td></td> <td colspan="8" style="text-align: center;"> <table border="1" style="width: 100%; border-collapse: collapse; text-align: center;"> <tr> <td style="width: 10%;"></td> <td style="width: 10%;"></td> <td style="width: 10%;"></td> <td style="width: 10%;"></td> <td style="width: 10%;"></td> <td style="width: 10%;"></td> <td style="width: 10%;"></td> <td style="width: 10%;"></td> <td style="width: 10%;"></td> <td style="width: 10%;"></td> </tr> <tr> <td></td> <td></td> <td colspan="8" style="text-align: center;"> <table border="1" style="width: 100%; border-collapse: collapse; text-align: center;"> <tr> <td style="width: 10%;"></td> <td style="width: 10%;"></td> <td style="width: 10%;"></td> <td style="width: 10%;"></td> <td style="width: 10%;"></td> <td style="width: 10%;"></td> <td style="width: 10%;"></td> <td style="width: 10%;"></td> <td style="width: 10%;"></td> <td style="width: 10%;"></td> </tr> <tr> <td></td> <td></td> <td colspan="8" style="text-align: center;"> <table border="1" style="width: 100%; border-collapse: collapse; text-align: center;"> <tr> <td style="width: 10%;"></td> <td style="width: 10%;"></td> <td style="width: 10%;"></td> <td style="width: 10%;"></td> <td style="width: 10%;"></td> <td style="width: 10%;"></td> <td style="width: 10%;"></td> <td style="width: 10%;"></td> <td style="width: 10%;"></td> <td style="width:
10%;"></td> </tr> <tr> <td></td> <td></td> <td colspan="8" style="text-align: center;"> <table border="1" style="width: 100%; border-collapse: collapse; text-align: center;"> <tr> <td style="width: 10%;"></td> <td style="width: 10%;"></td> <td style="width: 10%;"></td> <td style="width: 10%;"></td> <td style="width: 10%;"></td> <td style="width: 10%;"></td> <td style="width: 10%;"></td> <td style="width: 10%;"></td> <td style="width: 10%;"></td> <td style="width: 10%;"></td> </tr> <tr> <td></td> <td></td> <td colspan="8" style="text-align: center;"> <table border="1" style="width: 100%; border-collapse: collapse; text-align: center;"> <tr> <td style="width: 10%;"></td> <td style="width: 10%;"></td> <td style="width: 10%;"></td> <td style="width: 10%;"></td> <td style="width: 10%;"></td> <td style="width: 10%;"></td> <td style="width: 10%;"></td> <td style="width: 10%;"></td> <td style="width: 10%;"></td> <td style="width: 10%;"></td> </tr> <tr> <td></td> <td></td> <td colspan="8" style="text-align: center;"> <table border="1" style="width: 100%; border-collapse: collapse; text-align: center;"> <tr> <td style="width: 10%;"></td> <td style="width: 10%;"></td> <td style="width: 10%;"></td> <td style="width: 10%;"></td> <td style="width: 10%;"></td> <td style="width: 10%;"></td> <td style="width: 10%;"></td> <td style="width: 10%;"></td> <td style="width: 10%;"></td> <td style="width: 10%;"></td> </tr> <tr> <td></td> <td></td> <td colspan="8" style="text-align: center;"> <table border="1" style="width: 100%; border-collapse: collapse; text-align: center;"> <tr> <td style="width: 10%;"></td> <td style="width: 10%;"></td> <td style="width: 10%;"></td> <td style="width: 10%;"></td> <td style="width: 10%;"></td> <td style="width: 10%;"></td> <td style="width: 10%;"></td> <td style="width: 10%;"></td> <td style="width: 10%;"></td> <td style="width: 10%;"></td> </tr> <tr> <td></td> <td></td> <td colspan="8" style="text-align: center;"> <table border="1" style="width: 100%; border-collapse: collapse; text-align: center;"> <tr> <td style="width: 10%;"></td> <td style="width: 10%;"></td> <td style="width: 10%;"></td> <td style="width: 10%;"></td> <td style="width: 10%;"></td> <td style="width: 10%;"></td> <td style="width: 10%;"></td> <td style="width: 10%;"></td> <td style="width: 10%;"></td> <td style="width: 10%;"></td> </tr> <tr> <td></td> <td></td> <td colspan="8" style="text-align: center;"> <table border="1" style="width: 100%; border-collapse: collapse; text-align: center;"> <tr> <td style="width: 10%;"></td> <td style="width: 10%;"></td> <td style="width: 10%;"></td> <td style="width: 10%;"></td> <td style="width: 10%;"></td> <td style="width: 10%;"></td> <td style="width: 10%;"></td> <td style="width: 10%;"></td> <td style="width: 10%;"></td> <td style="width: 10%;"></td> </tr> <tr> <td></td> <td></td> <td colspan="8" style="text-align: center;"> <table border="1" style="width: 100%; border-collapse: collapse; text-align: center;"> <tr> <td style="width: 10%;"></td> <td style="width: 10%;"></td> <td style="width: 10%;"></td> <td style="width: 10%;"></td> <td style="width: 10%;"></td> <td style="width: 10%;"></td> <td style="width: 10%;"></td> <td style="width: 10%;"></td> <td style="width: 10%;"></td> <td style="width: 10%;"></td> </tr> <tr> <td></td> <td></td> <td colspan="8" style="text-align: center;"> <table border="1" style="width: 100%; border-collapse: collapse; text-align: center;"> <tr> <td style="width: 10%;"></td> <td style="width: 10%;"></td> <td style="width: 10%;"></td> <td style="width: 10%;"></td> <td style="width: 10%;"></td> <td style="width: 10%;"></td> <td style="width: 10%;"></td> <td style="width: 10%;"></td> <td style="width: 10%;"></td> <td style="width: 10%;"></td> </tr> <tr> <td></td> <td></td> <td colspan="8" style="text-align: center;"> <table border="1" style="width: 100%; border-collapse: collapse; text-align: center;"> <tr> <td style="width: 10%;"></td> <td style="width: 10%;"></td> <td style="width: 10%;"></td> <td style="width: 10%;"></td> <td style="width: 10%;"></td> <td style="width: 10%;"></td> <td style="width: 10%;"></td> <td style="width: 10%;"></td> <td style="width: 10%;"></td> <td style="width: 10%;"></td> </tr> <tr> <td></td> <td></td> <td colspan="8" style="text-align: center;"> <table border="1" style="width: 100%; border-collapse: collapse; text-align: center;"> <tr> <td style="width: 10%;"></td> <td style="width: 10%;"></td> <td style="width: 10%;"></td> <td style="width: 10%;"></td> <td style="width: 10%;"></td> <td style="width: 10%;"></td> <td style="width: 10%;"></td> <td style="width: 10%;"></td> <td style="width: 10%;"></td> <td style="width: 10%;"></td> </tr> <tr> <td></td> <td></td> <td colspan="8" style="text-align: center;"> <table border="1" style="width: 100%; border-collapse: collapse; text-align: center;"> <tr> <td style="width: 10%;"></td> <td style="width: 10%;"></td> <td style="width: 10%;"></td> <td style="width: 10%;"></td> <td style="width: 10%;"></td> <td style="width: 10%;"></td> <td style="width: 10%;"></td> <td style="width: 10%;"></td> <td style="width: 10%;"></td> <td style="width: 10%;"></td> </tr> <tr> <td></td> <td></td> <td colspan="8" style="text-align: center;"> <table border="1" style="width: 100%; border-collapse: collapse; text-align: center;"> <tr> <td style="width: 10%;"></td> <td style="width: 10%;"></td> <td style="width: 10%;"></td> <td style="width: 10%;"></td> <td style="width: 10%;"></td> <td style="width: 10%;"></td> <td style="width: 10%;"></td> <td style="width: 10%;"></td> <td style="width: 10%;"></td> <td style="width: 10%;"></td> </tr> <tr> <td></td> <td></td> <td colspan="8" style="text-align: center;"> <table border="1" style="width: 100%; border-collapse: collapse; text-align: center;"> <tr> <td style="width: 10%;"></td> <td style="width: 10%;"></td> <td style="width: 10%;"></td> <td style="width: 10%;"></td> <td style="width: 10%;"></td> <td style="width: 10%;"></td> <td style="width: 10%;"></td> <td style="width: 10%;"></td> <td style="width: 10%;"></td> <td style="width: 10%;"></td> </tr> <tr> <td></td> <td></td> <td colspan="8" style="text-align: center;"> <table border="1" style="width: 100%; border-collapse: collapse; text-align: center;"> <tr> <td style="width: 10%;"></td> <td style="width: 10%;"></td> <td style="width: 10%;"></td> <td style="width: 10%;"></td> <td style="width: 10%;"></td> <td style="width: 10%;"></td> <td style="width: 10%;"></td> <td style="width: 10%;"></td> <td style="width: 10%;"></td> <td style="width: 10%;"></td> </tr> <tr> <td></td> <td></td> <td colspan="8" style="text-align: center;"> <table border="1" style="width: 100%; border-collapse: collapse; text-align: center;"> <tr> <td style="width: 10%;"></td> <td style="width: 10%;"></td> <td style="width: 10%;"></td> <td style="width: 10%;"></td> <td style="width: 10%;"></td> <td style="width: 10%;"></td> <td style="width: 10%;"></td> <td style="width: 10%;"></td> <td style="width: 10%;"></td> <td style="width: 10%;"></td> </tr> <tr> <td></td> <td></td> <td colspan="8" style="text-align: center;"> <table border="1" style="width: 100%; border-collapse: collapse; text-align: center;"> <tr> <td style="width: 10%;"></td> <td style="width: 10%;"></td> <td style="width: 10%;"></td> <td style="width: 10%;"></td> <td style="width: 10%;"></td> <td style="width: 10%;"></td> <td style="width: 10%;"></td> <td style="width: 10%;"></td> <td style="width: 10%;"></td> <td style="width: 10%;"></td> </tr> <tr> <td></td> <td></td> <td colspan="8" style="text-align: center;"> <table border="1" style="width: 100%; border-collapse: collapse; text-align: center;"> <tr> <td style="width: 10%;"></td> <td style="width: 10%;"></td> <td style="width: 10%;"></td> <td style="width: 10%;"></td> <td style="width: 10%;"></td> <td style="width: 10%;"></td> <td style="width: 10%;"></td> <td style="width: 10%;"></td> <td style="width: 10%;"></td> <td style="width: 10%;"></td> </tr> <tr> <td></td> <td></td> <td colspan="8" style="text-align: center;"> <table border="1" style="width: 100%; border-collapse: collapse; text-align: center;"> <tr> <td style="width: 10%;"></td> <td style="width: 10%;"></td> <td style="width: 10%;"></td> <td style="width: 10%;"></td> <td style="width: 10%;"></td> <td style="width: 10%;"></td> <td style="width: 10%;"></td> <td style="width: 10%;"></td> <td style="width: 10%;"></td> <td style="width: 10%;"></td> </tr> <tr> <td></td> <td></td> <td colspan="8" style="text-align: center;"> <table border="1" style="width: 100%; border-collapse: collapse; text-align: center;"> <tr> <td style="width: 10%;"></td> <td style="width: 10%;"></td> <td style="width: 10%;"></td> <td style="width: 10%;"></td> <td style="width: 10%;"></td> <td style="width: 10%;"></td> <td style="width: 10%;"></td> <td style="width: 10%;"></td> <td style="width: 10%;"></td> <td style="width: 10%;"></td> </tr> <tr> <td></td> <td></td> <td colspan="8" style="text-align: center;"> <table border="1" style="width: 100%; border-collapse: collapse; text-align: center;"> <tr> <td style="width: 10%;"></td> <td style="width: 10%;"></td> <td style="width: 10%;"></td> <td style="width: 10%;"></td> <td style="width: 10%;"></td> <td style="width: 10%;"></td> <td style="width: 10%;"></td> <td style="width: 10%;"></td> <td style="width: 10%;"></td> <td style="width: 10%;"></td> </tr> <tr> <td></td> <td></td> <td colspan="8" style="text-align: center;"> <table border="1" style="width: 100%; border-collapse: collapse; text-align: center;"> <tr>
</tr></table></td></tr></table></td></tr></table></td></tr></table></td></tr></table></td></tr></table></td></tr></table></td></tr></table></td></tr></table></td></tr></table></td></tr></table></td></tr></table></td></tr></table></td></tr></table></td></tr></table></td></tr></table></td></tr></table></td></tr></table></td></tr></table></td></tr></table></td></tr></table></td></tr></table></td></tr></table></td></tr></table></td></tr></table></td></tr></table></td></tr></table></td></tr></table></td></tr></table></td></tr></table></td></tr></table></td></tr></table></td></tr></table></td></tr></table></td></tr></table></td></tr></table></td></tr></table></td></tr></table></td></tr></table></td></tr></table></td></tr></table></td></tr></table></td></tr></table></td></tr></table></td></tr></table></td></tr></table></td></tr></table></td></tr></table></td></tr></table></td></tr></table></td></tr></table></td></tr></table></td></tr></table></td></tr></table></td></tr></table></td></tr></table></td></tr></table> | | | | | | | | | | | | | | | | | | | | <table border="1" style="width: 100%; border-collapse: collapse; text-align: center;"> <tr> <td style="width: 10%;"></td> <td style="width: 10%;"></td> <td style="width: 10%;"></td> <td style="width: 10%;"></td> <td style="width: 10%;"></td> <td style="width: 10%;"></td> <td style="width: 10%;"></td> <td style="width: 10%;"></td> <td style="width: 10%;"></td> <td style="width: 10%;"></td> </tr> <tr> <td></td> <td></td> <td colspan="8" style="text-align: center;"> <table border="1" style="width: 100%; border-collapse: collapse; text-align: center;"> <tr> <td style="width: 10%;"></td> <td style="width: 10%;"></td> <td style="width: 10%;"></td> <td style="width: 10%;"></td> <td style="width: 10%;"></td> <td style="width: 10%;"></td> <td style="width: 10%;"></td> <td style="width: 10%;"></td> <td style="width: 10%;"></td> <td style="width: 10%;"></td> </tr> <tr> <td></td> <td></td> <td colspan="8" style="text-align: center;"> <table border="1" style="width: 100%; border-collapse: collapse; text-align: center;"> <tr> <td style="width: 10%;"></td> <td style="width: 10%;"></td> <td style="width: 10%;"></td> <td style="width: 10%;"></td> <td style="width: 10%;"></td> <td style="width: 10%;"></td> <td style="width: 10%;"></td> <td style="width: 10%;"></td> <td style="width: 10%;"></td> <td style="width: 10%;"></td> </tr> <tr> <td></td> <td></td> <td colspan="8" style="text-align: center;"> <table border="1" style="width: 100%; border-collapse: collapse; text-align: center;"> <tr> <td style="width: 10%;"></td> <td style="width: 10%;"></td> <td style="width: 10%;"></td> <td style="width: 10%;"></td> <td style="width: 10%;"></td> <td style="width: 10%;"></td> <td style="width: 10%;"></td> <td style="width: 10%;"></td> <td style="width: 10%;"></td> <td style="width: 10%;"></td> </tr> <tr> <td></td> <td></td> <td colspan="8" style="text-align: center;"> <table border="1" style="width: 100%; border-collapse: collapse; text-align: center;"> <tr> <td style="width: 10%;"></td> <td style="width: 10%;"></td> <td style="width: 10%;"></td> <td style="width: 10%;"></td> <td style="width: 10%;"></td> <td style="width: 10%;"></td> <td style="width: 10%;"></td> <td style="width: 10%;"></td> <td style="width: 10%;"></td> <td style="width: 10%;"></td> </tr> <tr> <td></td> <td></td> <td colspan="8" style="text-align: center;"> <table border="1" style="width: 100%; border-collapse: collapse; text-align: center;"> <tr> <td style="width: 10%;"></td> <td style="width: 10%;"></td> <td style="width: 10%;"></td> <td style="width: 10%;"></td> <td style="width: 10%;"></td> <td style="width: 10%;"></td> <td style="width: 10%;"></td> <td style="width: 10%;"></td> <td style="width: 10%;"></td> <td style="width: 10%;"></td> </tr> <tr> <td></td> <td></td> <td colspan="8" style="text-align: center;"> <table border="1" style="width: 100%; border-collapse: collapse; text-align: center;"> <tr> <td style="width: 10%;"></td> <td style="width: 10%;"></td> <td style="width: 10%;"></td> <td style="width: 10%;"></td> <td style="width: 10%;"></td> <td style="width: 10%;"></td> <td style="width: 10%;"></td> <td style="width: 10%;"></td> <td style="width: 10%;"></td> <td style="width: 10%;"></td> </tr> <tr> <td></td> <td></td> <td colspan="8" style="text-align: center;"> <table border="1" style="width: 100%; border-collapse: collapse; text-align: center;"> <tr> <td style="width: 10%;"></td> <td style="width: 10%;"></td> <td style="width: 10%;"></td> <td style="width: 10%;"></td> <td style="width: 10%;"></td> <td style="width: 10%;"></td> <td style="width: 10%;"></td> <td style="width: 10%;"></td> <td style="width: 10%;"></td> <td style="width: 10%;"></td> </tr> <tr> <td></td> <td></td> <td colspan="8" style="text-align: center;"> <table border="1" style="width: 100%; border-collapse: collapse; text-align: center;"> <tr> <td style="width: 10%;"></td> <td style="width: 10%;"></td> <td style="width: 10%;"></td> <td style="width: 10%;"></td> <td style="width: 10%;"></td> <td style="width: 10%;"></td> <td style="width: 10%;"></td> <td style="width: 10%;"></td> <td style="width: 10%;"></td> <td style="width: 10%;"></td> </tr> <tr> <td></td> <td></td> <td colspan="8" style="text-align: center;"> <table border="1" style="width: 100%; border-collapse: collapse; text-align: center;"> <tr> <td style="width: 10%;"></td> <td style="width: 10%;"></td> <td style="width: 10%;"></td> <td style="width: 10%;"></td> <td style="width: 10%;"></td> <td style="width: 10%;"></td> <td style="width: 10%;"></td> <td style="width: 10%;"></td> <td style="width: 10%;"></td> <td style="width: 10%;"></td> </tr> <tr> <td></td> <td></td> <td colspan="8" style="text-align: center;"> <table border="1" style="width: 100%; border-collapse: collapse; text-align: center;"> <tr> <td style="width: 10%;"></td> <td style="width: 10%;"></td> <td style="width: 10%;"></td> <td style="width: 10%;"></td> <td style="width: 10%;"></td> <td style="width: 10%;"></td> <td style="width: 10%;"></td> <td style="width: 10%;"></td> <td style="width: 10%;"></td> <td style="width: 10%;"></td> </tr> <tr> <td></td> <td></td> <td colspan="8" style="text-align: center;"> <table border="1" style="width: 100%; border-collapse: collapse; text-align: center;"> <tr> <td style="width: 10%;"></td> <td style="width: 10%;"></td> <td style="width: 10%;"></td> <td style="width: 10%;"></td> <td style="width: 10%;"></td> <td style="width: 10%;"></td> <td style="width: 10%;"></td> <td style="width: 10%;"></td> <td style="width: 10%;"></td> <td style="width: 10%;"></td> </tr> <tr> <td></td> <td></td> <td colspan="8" style="text-align: center;"> <table border="1" style="width: 100%; border-collapse: collapse; text-align: center;"> <tr> <td style="width: 10%;"></td> <td style="width: 10%;"></td> <td style="width: 10%;"></td> <td style="width: 10%;"></td> <td style="width: 10%;"></td> <td style="width: 10%;"></td> <td style="width: 10%;"></td> <td style="width: 10%;"></td> <td style="width: 10%;"></td> <td style="width: 10%;"></td> </tr> <tr> <td></td> <td></td> <td colspan="8" style="text-align: center;"> <table border="1" style="width: 100%; border-collapse: collapse; text-align: center;"> <tr> <td style="width: 10%;"></td> <td style="width: 10%;"></td> <td style="width: 10%;"></td> <td style="width: 10%;"></td> <td style="width: 10%;"></td> <td style="width: 10%;"></td> <td style="width: 10%;"></td> <td style="width: 10%;"></td> <td style="width: 10%;"></td> <td style="width: 10%;"></td> </tr> <tr> <td></td> <td></td> <td colspan="8" style="text-align: center;"> <table border="1" style="width: 100%; border-collapse: collapse; text-align: center;"> <tr> <td style="width: 10%;"></td> <td style="width: 10%;"></td> <td style="width: 10%;"></td> <td style="width: 10%;"></td> <td style="width: 10%;"></td> <td style="width: 10%;"></td> <td style="width: 10%;"></td> <td style="width: 10%;"></td> <td style="width: 10%;"></td> <td style="width: 10%;"></td> </tr> <tr> <td></td> <td></td>
<td colspan="8" style="text-align: center;"> <table border="1" style="width: 100%; border-collapse: collapse; text-align: center;"> <tr> <td style="width: 10%;"></td> <td style="width: 10%;"></td> <td style="width: 10%;"></td> <td style="width: 10%;"></td> <td style="width: 10%;"></td> <td style="width: 10%;"></td> <td style="width: 10%;"></td> <td style="width: 10%;"></td> <td style="width: 10%;"></td> <td style="width: 10%;"></td> </tr> <tr> <td></td> <td></td> <td colspan="8" style="text-align: center;"> <table border="1" style="width: 100%; border-collapse: collapse; text-align: center;"> <tr> <td style="width: 10%;"></td> <td style="width: 10%;"></td> <td style="width: 10%;"></td> <td style="width: 10%;"></td> <td style="width: 10%;"></td> <td style="width: 10%;"></td> <td style="width: 10%;"></td> <td style="width: 10%;"></td> <td style="width: 10%;"></td> <td style="width: 10%;"></td> </tr> <tr> <td></td> <td></td> <td colspan="8" style="text-align: center;"> <table border="1" style="width: 100%; border-collapse: collapse; text-align: center;"> <tr> <td style="width: 10%;"></td> <td style="width: 10%;"></td> <td style="width: 10%;"></td> <td style="width: 10%;"></td> <td style="width: 10%;"></td> <td style="width: 10%;"></td> <td style="width: 10%;"></td> <td style="width: 10%;"></td> <td style="width: 10%;"></td> <td style="width: 10%;"></td> </tr> <tr> <td></td> <td></td> <td colspan="8" style="text-align: center;"> <table border="1" style="width: 100%; border-collapse: collapse; text-align: center;"> <tr> <td style="width: 10%;"></td> <td style="width: 10%;"></td> <td style="width: 10%;"></td> <td style="width: 10%;"></td> <td style="width: 10%;"></td> <td style="width: 10%;"></td> <td style="width: 10%;"></td> <td style="width: 10%;"></td> <td style="width: 10%;"></td> <td style="width: 10%;"></td> </tr> <tr> <td></td> <td></td> <td colspan="8" style="text-align: center;"> <table border="1" style="width: 100%; border-collapse: collapse; text-align: center;"> <tr> <td style="width: 10%;"></td> <td style="width: 10%;"></td> <td style="width: 10%;"></td> <td style="width: 10%;"></td> <td style="width: 10%;"></td> <td style="width: 10%;"></td> <td style="width: 10%;"></td> <td style="width: 10%;"></td> <td style="width: 10%;"></td> <td style="width: 10%;"></td> </tr> <tr> <td></td> <td></td> <td colspan="8" style="text-align: center;"> <table border="1" style="width: 100%; border-collapse: collapse; text-align: center;"> <tr> <td style="width: 10%;"></td> <td style="width: 10%;"></td> <td style="width: 10%;"></td> <td style="width: 10%;"></td> <td style="width: 10%;"></td> <td style="width: 10%;"></td> <td style="width: 10%;"></td> <td style="width: 10%;"></td> <td style="width: 10%;"></td> <td style="width: 10%;"></td> </tr> <tr> <td></td> <td></td> <td colspan="8" style="text-align: center;"> <table border="1" style="width: 100%; border-collapse: collapse; text-align: center;"> <tr> <td style="width: 10%;"></td> <td style="width: 10%;"></td> <td style="width: 10%;"></td> <td style="width: 10%;"></td> <td style="width: 10%;"></td> <td style="width: 10%;"></td> <td style="width: 10%;"></td> <td style="width: 10%;"></td> <td style="width: 10%;"></td> <td style="width: 10%;"></td> </tr> <tr> <td></td> <td></td> <td colspan="8" style="text-align: center;"> <table border="1" style="width: 100%; border-collapse: collapse; text-align: center;"> <tr> <td style="width: 10%;"></td> <td style="width: 10%;"></td> <td style="width: 10%;"></td> <td style="width: 10%;"></td> <td style="width: 10%;"></td> <td style="width: 10%;"></td> <td style="width: 10%;"></td> <td style="width: 10%;"></td> <td style="width: 10%;"></td> <td style="width: 10%;"></td> </tr> <tr> <td></td> <td></td> <td colspan="8" style="text-align: center;"> <table border="1" style="width: 100%; border-collapse: collapse; text-align: center;"> <tr> <td style="width: 10%;"></td> <td style="width: 10%;"></td> <td style="width: 10%;"></td> <td style="width: 10%;"></td> <td style="width: 10%;"></td> <td style="width: 10%;"></td> <td style="width: 10%;"></td> <td style="width: 10%;"></td> <td style="width: 10%;"></td> <td style="width: 10%;"></td> </tr> <tr> <td></td> <td></td> <td colspan="8" style="text-align: center;"> <table border="1" style="width: 100%; border-collapse: collapse; text-align: center;"> <tr> <td style="width: 10%;"></td> <td style="width: 10%;"></td> <td style="width: 10%;"></td> <td style="width: 10%;"></td> <td style="width: 10%;"></td> <td style="width: 10%;"></td> <td style="width: 10%;"></td> <td style="width: 10%;"></td> <td style="width: 10%;"></td> <td style="width: 10%;"></td> </tr> <tr> <td></td> <td></td> <td colspan="8" style="text-align: center;"> <table border="1" style="width: 100%; border-collapse: collapse; text-align: center;"> <tr> <td style="width: 10%;"></td> <td style="width: 10%;"></td> <td style="width: 10%;"></td> <td style="width: 10%;"></td> <td style="width: 10%;"></td> <td style="width: 10%;"></td> <td style="width: 10%;"></td> <td style="width: 10%;"></td> <td style="width: 10%;"></td> <td style="width: 10%;"></td> </tr> <tr> <td></td> <td></td> <td colspan="8" style="text-align: center;"> <table border="1" style="width: 100%; border-collapse: collapse; text-align: center;"> <tr> <td style="width: 10%;"></td> <td style="width: 10%;"></td> <td style="width: 10%;"></td> <td style="width: 10%;"></td> <td style="width: 10%;"></td> <td style="width: 10%;"></td> <td style="width: 10%;"></td> <td style="width: 10%;"></td> <td style="width: 10%;"></td> <td style="width: 10%;"></td> </tr> <tr> <td></td> <td></td> <td colspan="8" style="text-align: center;"> <table border="1" style="width: 100%; border-collapse: collapse; text-align: center;"> <tr> <td style="width: 10%;"></td> <td style="width: 10%;"></td> <td style="width: 10%;"></td> <td style="width: 10%;"></td> <td style="width: 10%;"></td> <td style="width: 10%;"></td> <td style="width: 10%;"></td> <td style="width: 10%;"></td> <td style="width: 10%;"></td> <td style="width: 10%;"></td> </tr> <tr> <td></td> <td></td> <td colspan="8" style="text-align: center;"> <table border="1" style="width: 100%; border-collapse: collapse; text-align: center;"> <tr> <td style="width: 10%;"></td> <td style="width: 10%;"></td> <td style="width: 10%;"></td> <td style="width: 10%;"></td> <td style="width: 10%;"></td> <td style="width: 10%;"></td> <td style="width: 10%;"></td> <td style="width: 10%;"></td> <td style="width: 10%;"></td> <td style="width: 10%;"></td> </tr> <tr> <td></td> <td></td> <td colspan="8" style="text-align: center;"> <table border="1" style="width: 100%; border-collapse: collapse; text-align: center;"> <tr> <td style="width: 10%;"></td> <td style="width: 10%;"></td> <td style="width: 10%;"></td> <td style="width: 10%;"></td> <td style="width: 10%;"></td> <td style="width: 10%;"></td> <td style="width: 10%;"></td> <td style="width: 10%;"></td> <td style="width: 10%;"></td> <td style="width: 10%;"></td> </tr> <tr> <td></td> <td></td> <td colspan="8" style="text-align: center;"> <table border="1" style="width: 100%; border-collapse: collapse; text-align: center;"> <tr> <td style="width: 10%;"></td> <td style="width: 10%;"></td> <td style="width: 10%;"></td> <td style="width: 10%;"></td> <td style="width: 10%;"></td> <td style="width: 10%;"></td> <td style="width: 10%;"></td> <td style="width: 10%;"></td> <td style="width: 10%;"></td> <td style="width: 10%;"></td> </tr> <tr> <td></td> <td></td> <td colspan="8" style="text-align: center;"> <table border="1" style="width: 100%; border-collapse: collapse; text-align: center;"> <tr> <td style="width: 10%;"></td> <td style="width: 10%;"></td> <td style="width: 10%;"></td> <td style="width: 10%;"></td> <td style="width: 10%;"></td> <td style="width: 10%;"></td> <td style="width: 10%;"></td> <td style="width: 10%;"></td> <td style="width: 10%;"></td> <td style="width: 10%;"></td> </tr> <tr> <td></td> <td></td> <td colspan="8" style="text-align: center;"> <table border="1" style="width: 100%; border-collapse: collapse; text-align: center;"> <tr> <td style="width: 10%;"></td> <td style="width: 10%;"></td> <td style="width: 10%;"></td> <td style="width: 10%;"></td> <td style="width: 10%;"></td> <td style="width: 10%;"></td> <td style="width: 10%;"></td> <td style="width: 10%;"></td> <td style="width: 10%;"></td> <td style="width: 10%;"></td> </tr> <tr> <td></td> <td></td> <td colspan="8" style="text-align: center;"> <table border="1" style="width: 100%; border-collapse: collapse; text-align: center;"> <tr> <td style="width: 10%;"></td> <td style="width: 10%;"></td> <td style="width: 10%;"></td> <td style="width: 10%;"></td> <td style="width: 10%;"></td> <td style="width: 10%;"></td> <td style="width: 10%;"></td> <td style="width: 10%;"></td> <td style="width: 10%;"></td> <td style="width: 10%;"></td> </tr> <tr> <td></td> <td></td> <td colspan="8" style="text-align: center;"> <table border="1" style="width: 100%; border-collapse: collapse; text-align: center;"> <tr> <td style="width: 10%;"></td> <td style="width: 10%;"></td> <td style="width: 10%;"></td> <td style="width: 10%;"></td> <td style="width: 10%;"></td> <td style="width: 10%;"></td> <td style="width: 10%;"></td> <td style="width: 10%;"></td> <td style="width: 10%;"></td> <td style="width: 10%;"></td> </tr> <tr> <td></td> <td></td> <td colspan="8" style="text-align: center;"> <table border="1" style="width: 100%; border-collapse: collapse; text-align: center;"> <tr> <td style="width: 10%;"></td> <td style="width: 10%;"></td> <td style="width: 10%;"></td> <td style="width: 10%;"></td> <td style="width: 10%;"></td> <td style="width: 10%;"></td> <td style="width: 10%;"></td> <td style="width: 10%;"></td> <td style="width: 10%;"></td> <td style="width: 10%;"></td> </tr> <tr> <td></td> <td></td> <td colspan="8" style="text-align: center;"> <table border="1" style="width: 100%; border-collapse: collapse; text-align: center;"> <tr> <td style="width: 10%;"></td> <td
style="width: 10%;"></td> <td style="width: 10%;"></td> <td style="width: 10%;"></td> <td style="width: 10%;"></td> <td style="width: 10%;"></td> <td style="width: 10%;"></td> <td style="width: 10%;"></td> <td style="width: 10%;"></td> <td style="width: 10%;"></td> </tr> <tr> <td></td> <td></td> <td colspan="8" style="text-align: center;"> <table border="1" style="width: 100%; border-collapse: collapse; text-align: center;"> <tr> <td style="width: 10%;"></td> <td style="width: 10%;"></td> <td style="width: 10%;"></td> <td style="width: 10%;"></td> <td style="width: 10%;"></td> <td style="width: 10%;"></td> <td style="width: 10%;"></td> <td style="width: 10%;"></td> <td style="width: 10%;"></td> <td style="width: 10%;"></td> </tr> <tr> <td></td> <td></td> <td colspan="8" style="text-align: center;"> <table border="1" style="width: 100%; border-collapse: collapse; text-align: center;"> <tr> <td style="width: 10%;"></td> <td style="width: 10%;"></td> <td style="width: 10%;"></td> <td style="width: 10%;"></td> <td style="width: 10%;"></td> <td style="width: 10%;"></td> <td style="width: 10%;"></td> <td style="width: 10%;"></td> <td style="width: 10%;"></td> <td style="width: 10%;"></td> </tr> <tr> <td></td> <td></td> <td colspan="8" style="text-align: center;"> <table border="1" style="width: 100%; border-collapse: collapse; text-align: center;"> <tr> <td style="width: 10%;"></td> <td style="width: 10%;"></td> <td style="width: 10%;"></td> <td style="width: 10%;"></td> <td style="width: 10%;"></td> <td style="width: 10%;"></td> <td style="width: 10%;"></td> <td style="width: 10%;"></td> <td style="width: 10%;"></td> <td style="width: 10%;"></td> </tr> <tr> <td></td> <td></td> <td colspan="8" style="text-align: center;"> <table border="1" style="width: 100%; border-collapse: collapse; text-align: center;"> <tr> <td style="width: 10%;"></td> <td style="width: 10%;"></td> <td style="width: 10%;"></td> <td style="width: 10%;"></td> <td style="width: 10%;"></td> <td style="width: 10%;"></td> <td style="width: 10%;"></td> <td style="width: 10%;"></td> <td style="width: 10%;"></td> <td style="width: 10%;"></td> </tr> <tr> <td></td> <td></td> <td colspan="8" style="text-align: center;"> <table border="1" style="width: 100%; border-collapse: collapse; text-align: center;"> <tr> <td style="width: 10%;"></td> <td style="width: 10%;"></td> <td style="width: 10%;"></td> <td style="width: 10%;"></td> <td style="width: 10%;"></td> <td style="width: 10%;"></td> <td style="width: 10%;"></td> <td style="width: 10%;"></td> <td style="width: 10%;"></td> <td style="width: 10%;"></td> </tr> <tr> <td></td> <td></td> <td colspan="8" style="text-align: center;"> <table border="1" style="width: 100%; border-collapse: collapse; text-align: center;"> <tr> <td style="width: 10%;"></td> <td style="width: 10%;"></td> <td style="width: 10%;"></td> <td style="width: 10%;"></td> <td style="width: 10%;"></td> <td style="width: 10%;"></td> <td style="width: 10%;"></td> <td style="width: 10%;"></td> <td style="width: 10%;"></td> <td style="width: 10%;"></td> </tr> <tr> <td></td> <td></td> <td colspan="8" style="text-align: center;"> <table border="1" style="width: 100%; border-collapse: collapse; text-align: center;"> <tr> <td style="width: 10%;"></td> <td style="width: 10%;"></td> <td style="width: 10%;"></td> <td style="width: 10%;"></td> <td style="width: 10%;"></td> <td style="width: 10%;"></td> <td style="width: 10%;"></td> <td style="width: 10%;"></td> <td style="width: 10%;"></td> <td style="width: 10%;"></td> </tr> <tr> <td></td> <td></td> <td colspan="8" style="text-align: center;"> <table border="1" style="width: 100%; border-collapse: collapse; text-align: center;"> <tr> <td style="width: 10%;"></td> <td style="width: 10%;"></td> <td style="width: 10%;"></td> <td style="width: 10%;"></td> <td style="width: 10%;"></td> <td style="width: 10%;"></td> <td style="width: 10%;"></td> <td style="width: 10%;"></td> <td style="width: 10%;"></td> <td style="width: 10%;"></td> </tr> <tr> <td></td> <td></td> <td colspan="8" style="text-align: center;"> <table border="1" style="width: 100%; border-collapse: collapse; text-align: center;"> <tr> <td style="width: 10%;"></td> <td style="width: 10%;"></td> <td style="width: 10%;"></td> <td style="width: 10%;"></td> <td style="width: 10%;"></td> <td style="width: 10%;"></td> <td style="width: 10%;"></td> <td style="width: 10%;"></td> <td style="width: 10%;"></td> <td style="width: 10%;"></td> </tr> <tr> <td></td> <td></td> <td colspan="8" style="text-align: center;"> <table border="1" style="width: 100%; border-collapse: collapse; text-align: center;"> <tr> <td style="width: 10%;"></td> <td style="width: 10%;"></td> <td style="width: 10%;"></td> <td style="width: 10%;"></td> <td style="width: 10%;"></td> <td style="width: 10%;"></td> <td style="width: 10%;"></td> <td style="width: 10%;"></td> <td style="width: 10%;"></td> <td style="width: 10%;"></td> </tr> <tr> <td></td> <td></td> <td colspan="8" style="text-align: center;"> <table border="1" style="width: 100%; border-collapse: collapse; text-align: center;"> <tr> <td style="width: 10%;"></td> <td style="width: 10%;"></td> <td style="width: 10%;"></td> <td style="width: 10%;"></td> <td style="width: 10%;"></td> <td style="width: 10%;"></td> <td style="width: 10%;"></td> <td style="width: 10%;"></td> <td style="width: 10%;"></td> <td style="width: 10%;"></td> </tr> <tr> <td></td> <td></td> <td colspan="8" style="text-align: center;"> <table border="1" style="width: 100%; border-collapse: collapse; text-align: center;"> <tr> <td style="width: 10%;"></td> <td style="width: 10%;"></td> <td style="width: 10%;"></td> <td style="width: 10%;"></td> <td style="width: 10%;"></td> <td style="width: 10%;"></td> <td style="width: 10%;"></td> <td style="width: 10%;"></td> <td style="width: 10%;"></td> <td style="width: 10%;"></td> </tr> <tr> <td></td> <td></td> <td colspan="8" style="text-align: center;"> <table border="1" style="width: 100%; border-collapse: collapse; text-align: center;"> <tr> <td style="width: 10%;"></td> <td style="width: 10%;"></td> <td style="width: 10%;"></td> <td style="width: 10%;"></td> <td style="width: 10%;"></td> <td style="width: 10%;"></td> <td style="width: 10%;"></td> <td style="width: 10%;"></td> <td style="width: 10%;"></td> <td style="width: 10%;"></td> </tr> <tr> <td></td> <td></td> <td colspan="8" style="text-align: center;"> <table border="1" style="width: 100%; border-collapse: collapse; text-align: center;"> <tr> <td style="width: 10%;"></td> <td style="width: 10%;"></td> <td style="width: 10%;"></td> <td style="width: 10%;"></td> <td style="width: 10%;"></td> <td style="width: 10%;"></td> <td style="width: 10%;"></td> <td style="width: 10%;"></td> <td style="width: 10%;"></td> <td style="width: 10%;"></td> </tr> <tr> <td></td> <td></td> <td colspan="8" style="text-align: center;"> <table border="1" style="width: 100%; border-collapse: collapse; text-align: center;"> <tr> <td style="width: 10%;"></td> <td style="width: 10%;"></td> <td style="width: 10%;"></td> <td style="width: 10%;"></td> <td style="width: 10%;"></td> <td style="width: 10%;"></td> <td style="width: 10%;"></td> <td style="width: 10%;"></td> <td style="width: 10%;"></td> <td style="width: 10%;"></td> </tr> <tr> <td></td> <td></td> <td colspan="8" style="text-align: center;"> <table border="1" style="width: 100%; border-collapse: collapse; text-align: center;"> <tr> <td style="width: 10%;"></td> <td style="width: 10%;"></td> <td style="width: 10%;"></td> <td style="width: 10%;"></td> <td style="width: 10%;"></td> <td style="width: 10%;"></td> <td style="width: 10%;"></td> <td style="width: 10%;"></td> <td style="width: 10%;"></td> <td style="width: 10%;"></td> </tr> <tr> <td></td> <td></td> <td colspan="8" style="text-align: center;"> <table border="1" style="width: 100%; border-collapse: collapse; text-align: center;"> <tr> <td style="width: 10%;"></td> <td style="width: 10%;"></td> <td style="width: 10%;"></td> <td style="width: 10%;"></td> <td style="width: 10%;"></td> <td style="width: 10%;"></td> <td style="width: 10%;"></td> <td style="width: 10%;"></td> <td style="width: 10%;"></td> <td style="width: 10%;"></td> </tr> <tr> <td></td> <td></td> <td colspan="8" style="text-align: center;"> <table border="1" style="width: 100%; border-collapse: collapse; text-align: center;"> <tr> <td style="width: 10%;"></td> <td style="width: 10%;"></td> <td style="width: 10%;"></td> <td style="width: 10%;"></td> <td style="width: 10%;"></td> <td style="width: 10%;"></td> <td style="width: 10%;"></td> <td style="width: 10%;"></td> <td style="width: 10%;"></td> <td style="width: 10%;"></td> </tr> <tr> <td></td> <td></td> <td colspan="8" style="text-align: center;"> <table border="1" style="width: 100%; border-collapse: collapse; text-align: center;"> <tr> </tr></table></td></tr></table></td></tr></table></td></tr></table></td></tr></table></td></tr></table></td></tr></table></td></tr></table></td></tr></table></td></tr></table></td></tr></table></td></tr></table></td></tr></table></td></tr></table></td></tr></table></td></tr></table></td></tr></table></td></tr></table></td></tr></table></td></tr></table></td></tr></table></td></tr></table></td></tr></table></td></tr></table></td></tr></table></td></tr></table></td></tr></table></td></tr></table></td></tr></table></td></tr></table></td></tr></table></td></tr></table></td></tr></table></td></tr></table></td></tr></table></td></tr></table></td></tr></table></td></tr></table></td></tr></table></td></tr></table></td></tr></table></td></tr></table></td></tr></table></td></tr></table></td></tr></table></td></tr></table></td></tr></table></td></tr></table></td></tr></table></td></tr></table></td></tr></table></td></tr></table></td></tr></table></td></tr></table></td></tr></table></td></tr></table>
 | | | | | | | | | | | | | | | | | | | | <table border="1" style="width: 100%; border-collapse: collapse; text-align: center;"> <tr> <td style="width: 10%;"></td> <td style="width: 10%;"></td> <td style="width: 10%;"></td> <td style="width: 10%;"></td> <td style="width: 10%;"></td> <td style="width: 10%;"></td> <td style="width: 10%;"></td> <td style="width: 10%;"></td> <td style="width: 10%;"></td> <td style="width: 10%;"></td> </tr> <tr> <td></td> <td></td> <td colspan="8" style="text-align: center;"> <table border="1" style="width: 100%; border-collapse: collapse; text-align: center;"> <tr> <td style="width: 10%;"></td> <td style="width: 10%;"></td> <td style="width: 10%;"></td> <td style="width: 10%;"></td> <td style="width: 10%;"></td> <td style="width: 10%;"></td> <td style="width: 10%;"></td> <td style="width: 10%;"></td> <td style="width: 10%;"></td> <td style="width: 10%;"></td> </tr> <tr> <td></td> <td></td> <td colspan="8" style="text-align: center;"> <table border="1" style="width: 100%; border-collapse: collapse; text-align: center;"> <tr> <td style="width: 10%;"></td> <td style="width: 10%;"></td> <td style="width: 10%;"></td> <td style="width: 10%;"></td> <td style="width: 10%;"></td> <td style="width: 10%;"></td> <td style="width: 10%;"></td> <td style="width: 10%;"></td> <td style="width: 10%;"></td> <td style="width: 10%;"></td> </tr> <tr> <td></td> <td></td> <td colspan="8" style="text-align: center;"> <table border="1" style="width: 100%; border-collapse: collapse; text-align: center;"> <tr> <td style="width: 10%;"></td> <td style="width: 10%;"></td> <td style="width: 10%;"></td> <td style="width: 10%;"></td> <td style="width: 10%;"></td> <td style="width: 10%;"></td> <td style="width: 10%;"></td> <td style="width: 10%;"></td> <td style="width: 10%;"></td> <td style="width: 10%;"></td> </tr> <tr> <td></td> <td></td> <td colspan="8" style="text-align: center;"> <table border="1" style="width: 100%; border-collapse: collapse; text-align: center;"> <tr> <td style="width: 10%;"></td> <td style="width: 10%;"></td> <td style="width: 10%;"></td> <td style="width: 10%;"></td> <td style="width: 10%;"></td> <td style="width: 10%;"></td> <td style="width: 10%;"></td> <td style="width: 10%;"></td> <td style="width: 10%;"></td> <td style="width: 10%;"></td> </tr> <tr> <td></td> <td></td> <td colspan="8" style="text-align: center;"> <table border="1" style="width: 100%; border-collapse: collapse; text-align: center;"> <tr> <td style="width: 10%;"></td> <td style="width: 10%;"></td> <td style="width: 10%;"></td> <td style="width: 10%;"></td> <td style="width: 10%;"></td> <td style="width: 10%;"></td> <td style="width: 10%;"></td> <td style="width: 10%;"></td> <td style="width: 10%;"></td> <td style="width: 10%;"></td> </tr> <tr> <td></td> <td></td> <td colspan="8" style="text-align: center;"> <table border="1" style="width: 100%; border-collapse: collapse; text-align: center;"> <tr> <td style="width: 10%;"></td> <td style="width: 10%;"></td> <td style="width: 10%;"></td> <td style="width: 10%;"></td> <td style="width: 10%;"></td> <td style="width: 10%;"></td> <td style="width: 10%;"></td> <td style="width: 10%;"></td> <td style="width: 10%;"></td> <td style="width: 10%;"></td> </tr> <tr> <td></td> <td></td> <td colspan="8" style="text-align: center;"> <table border="1" style="width: 100%; border-collapse: collapse; text-align: center;"> <tr> <td style="width: 10%;"></td> <td style="width: 10%;"></td> <td style="width: 10%;"></td> <td style="width: 10%;"></td> <td style="width: 10%;"></td> <td style="width: 10%;"></td> <td style="width: 10%;"></td> <td style="width: 10%;"></td> <td style="width: 10%;"></td> <td style="width: 10%;"></td> </tr> <tr> <td></td> <td></td> <td colspan="8" style="text-align: center;"> <table border="1" style="width: 100%; border-collapse: collapse; text-align: center;"> <tr> <td style="width: 10%;"></td> <td style="width: 10%;"></td> <td style="width: 10%;"></td> <td style="width: 10%;"></td> <td style="width: 10%;"></td> <td style="width: 10%;"></td> <td style="width: 10%;"></td> <td style="width: 10%;"></td> <td style="width: 10%;"></td> <td style="width: 10%;"></td> </tr> <tr> <td></td> <td></td> <td colspan="8" style="text-align: center;"> <table border="1" style="width: 100%; border-collapse: collapse; text-align: center;"> <tr> <td style="width: 10%;"></td> <td style="width: 10%;"></td> <td style="width: 10%;"></td> <td style="width: 10%;"></td> <td style="width: 10%;"></td> <td style="width: 10%;"></td> <td style="width: 10%;"></td> <td style="width: 10%;"></td> <td style="width: 10%;"></td> <td style="width: 10%;"></td> </tr> <tr> <td></td> <td></td> <td colspan="8" style="text-align: center;"> <table border="1" style="width: 100%; border-collapse: collapse; text-align: center;"> <tr> <td style="width: 10%;"></td> <td style="width: 10%;"></td> <td style="width: 10%;"></td> <td style="width: 10%;"></td> <td style="width: 10%;"></td> <td style="width: 10%;"></td> <td style="width: 10%;"></td> <td style="width: 10%;"></td> <td style="width: 10%;"></td> <td style="width: 10%;"></td> </tr> <tr> <td></td> <td></td> <td colspan="8" style="text-align: center;"> <table border="1" style="width: 100%; border-collapse: collapse; text-align: center;"> <tr> <td style="width: 10%;"></td> <td style="width: 10%;"></td> <td style="width: 10%;"></td> <td style="width: 10%;"></td> <td style="width: 10%;"></td> <td style="width: 10%;"></td> <td style="width: 10%;"></td> <td style="width: 10%;"></td> <td style="width: 10%;"></td> <td style="width: 10%;"></td> </tr> <tr> <td></td> <td></td> <td colspan="8" style="text-align: center;"> <table border="1" style="width: 100%; border-collapse: collapse; text-align: center;"> <tr> <td style="width: 10%;"></td> <td style="width: 10%;"></td> <td style="width: 10%;"></td> <td style="width: 10%;"></td> <td style="width: 10%;"></td> <td style="width: 10%;"></td> <td style="width: 10%;"></td> <td style="width: 10%;"></td> <td style="width: 10%;"></td> <td style="width: 10%;"></td> </tr> <tr> <td></td> <td></td> <td colspan="8" style="text-align: center;"> <table border="1" style="width: 100%; border-collapse: collapse; text-align: center;"> <tr> <td style="width: 10%;"></td> <td style="width: 10%;"></td> <td style="width: 10%;"></td> <td style="width: 10%;"></td> <td style="width: 10%;"></td> <td style="width: 10%;"></td> <td style="width: 10%;"></td> <td style="width: 10%;"></td> <td style="width: 10%;"></td> <td style="width: 10%;"></td> </tr> <tr> <td></td> <td></td> <td colspan="8" style="text-align: center;"> <table border="1" style="width: 100%; border-collapse: collapse; text-align: center;"> <tr> <td style="width: 10%;"></td> <td style="width: 10%;"></td> <td style="width: 10%;"></td> <td style="width: 10%;"></td> <td style="width: 10%;"></td> <td style="width: 10%;"></td> <td style="width: 10%;"></td> <td style="width: 10%;"></td> <td style="width: 10%;"></td> <td style="width: 10%;"></td> </tr> <tr> <td></td> <td></td> <td colspan="8" style="text-align: center;"> <table border="1" style="width: 100%; border-collapse: collapse; text-align: center;"> <tr> <td style="width: 10%;"></td> <td style="width: 10%;"></td> <td style="width: 10%;"></td> <td style="width: 10%;"></td> <td style="width: 10%;"></td> <td style="width: 10%;"></td> <td style="width: 10%;"></td> <td style="width: 10%;"></td> <td style="width: 10%;"></td> <td style="width: 10%;"></td> </tr> <tr> <td></td> <td></td> <td colspan="8" style="text-align: center;"> <table border="1" style="width: 100%; border-collapse: collapse; text-align: center;"> <tr> <td style="width: 10%;"></td> <td style="width: 10%;"></td> <td style="width: 10%;"></td> <td style="width: 10%;"></td> <td style="width: 10%;"></td> <td style="width: 10%;"></td> <td style="width: 10%;"></td> <td style="width: 10%;"></td> <td style="width: 10%;"></td> <td style="width: 10%;"></td> </tr> <tr> <td></td> <td></td> <td colspan="8" style="text-align: center;"> <table border="1" style="width: 100%; border-collapse: collapse; text-align: center;"> <tr> <td style="width: 10%;"></td> <td style="width: 10%;"></td> <td style="width:
10%;"></td> <td style="width: 10%;"></td> <td style="width: 10%;"></td> <td style="width: 10%;"></td> <td style="width: 10%;"></td> <td style="width: 10%;"></td> <td style="width: 10%;"></td> <td style="width: 10%;"></td> </tr> <tr> <td></td> <td></td> <td colspan="8" style="text-align: center;"> <table border="1" style="width: 100%; border-collapse: collapse; text-align: center;"> <tr> <td style="width: 10%;"></td> <td style="width: 10%;"></td> <td style="width: 10%;"></td> <td style="width: 10%;"></td> <td style="width: 10%;"></td> <td style="width: 10%;"></td> <td style="width: 10%;"></td> <td style="width: 10%;"></td> <td style="width: 10%;"></td> <td style="width: 10%;"></td> </tr> <tr> <td></td> <td></td> <td colspan="8" style="text-align: center;"> <table border="1" style="width: 100%; border-collapse: collapse; text-align: center;"> <tr> <td style="width: 10%;"></td> <td style="width: 10%;"></td> <td style="width: 10%;"></td> <td style="width: 10%;"></td> <td style="width: 10%;"></td> <td style="width: 10%;"></td> <td style="width: 10%;"></td> <td style="width: 10%;"></td> <td style="width: 10%;"></td> <td style="width: 10%;"></td> </tr> <tr> <td></td> <td></td> <td colspan="8" style="text-align: center;"> <table border="1" style="width: 100%; border-collapse: collapse; text-align: center;"> <tr> <td style="width: 10%;"></td> <td style="width: 10%;"></td> <td style="width: 10%;"></td> <td style="width: 10%;"></td> <td style="width: 10%;"></td> <td style="width: 10%;"></td> <td style="width: 10%;"></td> <td style="width: 10%;"></td> <td style="width: 10%;"></td> <td style="width: 10%;"></td> </tr> <tr> <td></td> <td></td> <td colspan="8" style="text-align: center;"> <table border="1" style="width: 100%; border-collapse: collapse; text-align: center;"> <tr> <td style="width: 10%;"></td> <td style="width: 10%;"></td> <td style="width: 10%;"></td> <td style="width: 10%;"></td> <td style="width: 10%;"></td> <td style="width: 10%;"></td> <td style="width: 10%;"></td> <td style="width: 10%;"></td> <td style="width: 10%;"></td> <td style="width: 10%;"></td> </tr> <tr> <td></td> <td></td> <td colspan="8" style="text-align: center;"> <table border="1" style="width: 100%; border-collapse: collapse; text-align: center;"> <tr> <td style="width: 10%;"></td> <td style="width: 10%;"></td> <td style="width: 10%;"></td> <td style="width: 10%;"></td> <td style="width: 10%;"></td> <td style="width: 10%;"></td> <td style="width: 10%;"></td> <td style="width: 10%;"></td> <td style="width: 10%;"></td> <td style="width: 10%;"></td> </tr> <tr> <td></td> <td></td> <td colspan="8" style="text-align: center;"> <table border="1" style="width: 100%; border-collapse: collapse; text-align: center;"> <tr> <td style="width: 10%;"></td> <td style="width: 10%;"></td> <td style="width: 10%;"></td> <td style="width: 10%;"></td> <td style="width: 10%;"></td> <td style="width: 10%;"></td> <td style="width: 10%;"></td> <td style="width: 10%;"></td> <td style="width: 10%;"></td> <td style="width: 10%;"></td> </tr> <tr> <td></td> <td></td> <td colspan="8" style="text-align: center;"> <table border="1" style="width: 100%; border-collapse: collapse; text-align: center;"> <tr> <td style="width: 10%;"></td> <td style="width: 10%;"></td> <td style="width: 10%;"></td> <td style="width: 10%;"></td> <td style="width: 10%;"></td> <td style="width: 10%;"></td> <td style="width: 10%;"></td> <td style="width: 10%;"></td> <td style="width: 10%;"></td> <td style="width: 10%;"></td> </tr> <tr> <td></td> <td></td> <td colspan="8" style="text-align: center;"> <table border="1" style="width: 100%; border-collapse: collapse; text-align: center;"> <tr> <td style="width: 10%;"></td> <td style="width: 10%;"></td> <td style="width: 10%;"></td> <td style="width: 10%;"></td> <td style="width: 10%;"></td> <td style="width: 10%;"></td> <td style="width: 10%;"></td> <td style="width: 10%;"></td> <td style="width: 10%;"></td> <td style="width: 10%;"></td> </tr> <tr> <td></td> <td></td> <td colspan="8" style="text-align: center;"> <table border="1" style="width: 100%; border-collapse: collapse; text-align: center;"> <tr> <td style="width: 10%;"></td> <td style="width: 10%;"></td> <td style="width: 10%;"></td> <td style="width: 10%;"></td> <td style="width: 10%;"></td> <td style="width: 10%;"></td> <td style="width: 10%;"></td> <td style="width: 10%;"></td> <td style="width: 10%;"></td> <td style="width: 10%;"></td> </tr> <tr> <td></td> <td></td> <td colspan="8" style="text-align: center;"> <table border="1" style="width: 100%; border-collapse: collapse; text-align: center;"> <tr> <td style="width: 10%;"></td> <td style="width: 10%;"></td> <td style="width: 10%;"></td> <td style="width: 10%;"></td> <td style="width: 10%;"></td> <td style="width: 10%;"></td> <td style="width: 10%;"></td> <td style="width: 10%;"></td> <td style="width: 10%;"></td> <td style="width: 10%;"></td> </tr> <tr> <td></td> <td></td> <td colspan="8" style="text-align: center;"> <table border="1" style="width: 100%; border-collapse: collapse; text-align: center;"> <tr> <td style="width: 10%;"></td> <td style="width: 10%;"></td> <td style="width: 10%;"></td> <td style="width: 10%;"></td> <td style="width: 10%;"></td> <td style="width: 10%;"></td> <td style="width: 10%;"></td> <td style="width: 10%;"></td> <td style="width: 10%;"></td> <td style="width: 10%;"></td> </tr> <tr> <td></td> <td></td> <td colspan="8" style="text-align: center;"> <table border="1" style="width: 100%; border-collapse: collapse; text-align: center;"> <tr> <td style="width: 10%;"></td> <td style="width: 10%;"></td> <td style="width: 10%;"></td> <td style="width: 10%;"></td> <td style="width: 10%;"></td> <td style="width: 10%;"></td> <td style="width: 10%;"></td> <td style="width: 10%;"></td> <td style="width: 10%;"></td> <td style="width: 10%;"></td> </tr> <tr> <td></td> <td></td> <td colspan="8" style="text-align: center;"> <table border="1" style="width: 100%; border-collapse: collapse; text-align: center;"> <tr> <td style="width: 10%;"></td> <td style="width: 10%;"></td> <td style="width: 10%;"></td> <td style="width: 10%;"></td> <td style="width: 10%;"></td> <td style="width: 10%;"></td> <td style="width: 10%;"></td> <td style="width: 10%;"></td> <td style="width: 10%;"></td> <td style="width: 10%;"></td> </tr> <tr> <td></td> <td></td> <td colspan="8" style="text-align: center;"> <table border="1" style="width: 100%; border-collapse: collapse; text-align: center;"> <tr> <td style="width: 10%;"></td> <td style="width: 10%;"></td> <td style="width: 10%;"></td> <td style="width: 10%;"></td> <td style="width: 10%;"></td> <td style="width: 10%;"></td> <td style="width: 10%;"></td> <td style="width: 10%;"></td> <td style="width: 10%;"></td> <td style="width: 10%;"></td> </tr> <tr> <td></td> <td></td> <td colspan="8" style="text-align: center;"> <table border="1" style="width: 100%; border-collapse: collapse; text-align: center;"> <tr> <td style="width: 10%;"></td> <td style="width: 10%;"></td> <td style="width: 10%;"></td> <td style="width: 10%;"></td> <td style="width: 10%;"></td> <td style="width: 10%;"></td> <td style="width: 10%;"></td> <td style="width: 10%;"></td> <td style="width: 10%;"></td> <td style="width: 10%;"></td> </tr> <tr> <td></td> <td></td> <td colspan="8" style="text-align: center;"> <table border="1" style="width: 100%; border-collapse: collapse; text-align: center;"> <tr> <td style="width: 10%;"></td> <td style="width: 10%;"></td> <td style="width: 10%;"></td> <td style="width: 10%;"></td> <td style="width: 10%;"></td> <td style="width: 10%;"></td> <td style="width: 10%;"></td> <td style="width: 10%;"></td> <td style="width: 10%;"></td> <td style="width: 10%;"></td> </tr> <tr> <td></td> <td></td> <td colspan="8" style="text-align: center;"> <table border="1" style="width: 100%; border-collapse: collapse; text-align: center;"> <tr> <td style="width: 10%;"></td> <td style="width: 10%;"></td> <td style="width: 10%;"></td> <td style="width: 10%;"></td> <td style="width: 10%;"></td> <td style="width: 10%;"></td> <td style="width: 10%;"></td> <td style="width: 10%;"></td> <td style="width: 10%;"></td> <td style="width: 10%;"></td> </tr> <tr> <td></td> <td></td> <td colspan="8" style="text-align: center;"> <table border="1" style="width: 100%; border-collapse: collapse; text-align: center;"> <tr> <td style="width: 10%;"></td> <td style="width: 10%;"></td> <td style="width: 10%;"></td> <td style="width: 10%;"></td> <td style="width: 10%;"></td> <td style="width: 10%;"></td> <td style="width: 10%;"></td> <td style="width: 10%;"></td> <td style="width: 10%;"></td> <td style="width: 10%;"></td> </tr> <tr> <td></td> <td></td> <td colspan="8" style="text-align: center;"> <table border="1" style="width: 100%; border-collapse: collapse; text-align: center;"> <tr> <td style="width: 10%;"></td> <td style="width: 10%;"></td> <td style="width: 10%;"></td> <td style="width: 10%;"></td> <td style="width: 10%;"></td> <td style="width: 10%;"></td> <td style="width: 10%;"></td> <td style="width: 10%;"></td> <td style="width: 10%;"></td> <td style="width: 10%;"></td> </tr> <tr> <td></td> <td></td> <td colspan="8" style="text-align: center;"> <table border="1" style="width: 100%; border-collapse: collapse; text-align: center;"> <tr> <td style="width: 10%;"></td> <td style="width: 10%;"></td> <td style="width: 10%;"></td> <td style="width: 10%;"></td> <td style="width: 10%;"></td> <td style="width: 10%;"></td> <td style="width: 10%;"></td> <td style="width: 10%;"></td> <td style="width: 10%;"></td> <td style="width: 10%;"></td> </tr> <tr> <td></td> <td></td> <td colspan="8" style="text-align: center;"> <table border="1" style="width: 100%; border-collapse: collapse; text-align: center;"> <tr> <td style="width: 10%;"></td> <td style="width: 10%;"></td> <td style="width: 10%;"></td> <td style="width: 10%;"></td> <td style="width: 10%;"></td> <td style="width: 10%;"></td> <td style="width: 10%;"></td> <td style="width: 10%;"></td> <td
style="width: 10%;"></td> <td style="width: 10%;"></td> </tr> <tr> <td></td> <td></td> <td colspan="8" style="text-align: center;"> <table border="1" style="width: 100%; border-collapse: collapse; text-align: center;"> <tr> <td style="width: 10%;"></td> <td style="width: 10%;"></td> <td style="width: 10%;"></td> <td style="width: 10%;"></td> <td style="width: 10%;"></td> <td style="width: 10%;"></td> <td style="width: 10%;"></td> <td style="width: 10%;"></td> <td style="width: 10%;"></td> <td style="width: 10%;"></td> </tr> <tr> <td></td> <td></td> <td colspan="8" style="text-align: center;"> <table border="1" style="width: 100%; border-collapse: collapse; text-align: center;"> <tr> <td style="width: 10%;"></td> <td style="width: 10%;"></td> <td style="width: 10%;"></td> <td style="width: 10%;"></td> <td style="width: 10%;"></td> <td style="width: 10%;"></td> <td style="width: 10%;"></td> <td style="width: 10%;"></td> <td style="width: 10%;"></td> <td style="width: 10%;"></td> </tr> <tr> <td></td> <td></td> <td colspan="8" style="text-align: center;"> <table border="1" style="width: 100%; border-collapse: collapse; text-align: center;"> <tr> <td style="width: 10%;"></td> <td style="width: 10%;"></td> <td style="width: 10%;"></td> <td style="width: 10%;"></td> <td style="width: 10%;"></td> <td style="width: 10%;"></td> <td style="width: 10%;"></td> <td style="width: 10%;"></td> <td style="width: 10%;"></td> <td style="width: 10%;"></td> </tr> <tr> <td></td> <td></td> <td colspan="8" style="text-align: center;"> <table border="1" style="width: 100%; border-collapse: collapse; text-align: center;"> <tr> <td style="width: 10%;"></td> <td style="width: 10%;"></td> <td style="width: 10%;"></td> <td style="width: 10%;"></td> <td style="width: 10%;"></td> <td style="width: 10%;"></td> <td style="width: 10%;"></td> <td style="width: 10%;"></td> <td style="width: 10%;"></td> <td style="width: 10%;"></td> </tr> <tr> <td></td> <td></td> <td colspan="8" style="text-align: center;"> <table border="1" style="width: 100%; border-collapse: collapse; text-align: center;"> <tr> <td style="width: 10%;"></td> <td style="width: 10%;"></td> <td style="width: 10%;"></td> <td style="width: 10%;"></td> <td style="width: 10%;"></td> <td style="width: 10%;"></td> <td style="width: 10%;"></td> <td style="width: 10%;"></td> <td style="width: 10%;"></td> <td style="width: 10%;"></td> </tr> <tr> <td></td> <td></td> <td colspan="8" style="text-align: center;"> <table border="1" style="width: 100%; border-collapse: collapse; text-align: center;"> <tr> <td style="width: 10%;"></td> <td style="width: 10%;"></td> <td style="width: 10%;"></td> <td style="width: 10%;"></td> <td style="width: 10%;"></td> <td style="width: 10%;"></td> <td style="width: 10%;"></td> <td style="width: 10%;"></td> <td style="width: 10%;"></td> <td style="width: 10%;"></td> </tr> <tr> <td></td> <td></td> <td colspan="8" style="text-align: center;"> <table border="1" style="width: 100%; border-collapse: collapse; text-align: center;"> <tr> <td style="width: 10%;"></td> <td style="width: 10%;"></td> <td style="width: 10%;"></td> <td style="width: 10%;"></td> <td style="width: 10%;"></td> <td style="width: 10%;"></td> <td style="width: 10%;"></td> <td style="width: 10%;"></td> <td style="width: 10%;"></td> <td style="width: 10%;"></td> </tr> <tr> <td></td> <td></td> <td colspan="8" style="text-align: center;"> <table border="1" style="width: 100%; border-collapse: collapse; text-align: center;"> <tr> <td style="width: 10%;"></td> <td style="width: 10%;"></td> <td style="width: 10%;"></td> <td style="width: 10%;"></td> <td style="width: 10%;"></td> <td style="width: 10%;"></td> <td style="width: 10%;"></td> <td style="width: 10%;"></td> <td style="width: 10%;"></td> <td style="width: 10%;"></td> </tr> <tr> <td></td> <td></td> <td colspan="8" style="text-align: center;"> <table border="1" style="width: 100%; border-collapse: collapse; text-align: center;"> <tr> <td style="width: 10%;"></td> <td style="width: 10%;"></td> <td style="width: 10%;"></td> <td style="width: 10%;"></td> <td style="width: 10%;"></td> <td style="width: 10%;"></td> <td style="width: 10%;"></td> <td style="width: 10%;"></td> <td style="width: 10%;"></td> <td style="width: 10%;"></td> </tr> <tr> <td></td> <td></td> <td colspan="8" style="text-align: center;"> <table border="1" style="width: 100%; border-collapse: collapse; text-align: center;"> <tr> <td style="width: 10%;"></td> <td style="width: 10%;"></td> <td style="width: 10%;"></td> <td style="width: 10%;"></td> <td style="width: 10%;"></td> <td style="width: 10%;"></td> <td style="width: 10%;"></td> <td style="width: 10%;"></td> <td style="width: 10%;"></td> <td style="width: 10%;"></td> </tr> <tr> <td></td> <td></td> <td colspan="8" style="text-align: center;"> <table border="1" style="width: 100%; border-collapse: collapse; text-align: center;"> <tr> <td style="width: 10%;"></td> <td style="width: 10%;"></td> <td style="width: 10%;"></td> <td style="width: 10%;"></td> <td style="width: 10%;"></td> <td style="width: 10%;"></td> <td style="width: 10%;"></td> <td style="width: 10%;"></td> <td style="width: 10%;"></td> <td style="width: 10%;"></td> </tr> <tr> <td></td> <td></td> <td colspan="8" style="text-align: center;"> <table border="1" style="width: 100%; border-collapse: collapse; text-align: center;"> <tr> <td style="width: 10%;"></td> <td style="width: 10%;"></td> <td style="width: 10%;"></td> <td style="width: 10%;"></td> <td style="width: 10%;"></td> <td style="width: 10%;"></td> <td style="width: 10%;"></td> <td style="width: 10%;"></td> <td style="width: 10%;"></td> <td style="width: 10%;"></td> </tr> <tr> <td></td> <td></td> <td colspan="8" style="text-align: center;"> <table border="1" style="width: 100%; border-collapse: collapse; text-align: center;"> <tr> <td style="width: 10%;"></td> <td style="width: 10%;"></td> <td style="width: 10%;"></td> <td style="width: 10%;"></td> <td style="width: 10%;"></td> <td style="width: 10%;"></td> <td style="width: 10%;"></td> <td style="width: 10%;"></td> <td style="width: 10%;"></td> <td style="width: 10%;"></td> </tr> <tr> <td></td> <td></td> <td colspan="8" style="text-align: center;"> <table border="1" style="width: 100%; border-collapse: collapse; text-align: center;"> <tr> <td style="width: 10%;"></td> <td style="width: 10%;"></td> <td style="width: 10%;"></td> <td style="width: 10%;"></td> <td style="width: 10%;"></td> <td style="width: 10%;"></td> <td style="width: 10%;"></td> <td style="width: 10%;"></td> <td style="width: 10%;"></td> <td style="width: 10%;"></td> </tr> <tr> <td></td> <td></td> <td colspan="8" style="text-align: center;"> <table border="1" style="width: 100%; border-collapse: collapse; text-align: center;"> <tr> <td style="width: 10%;"></td> <td style="width: 10%;"></td> <td style="width: 10%;"></td> <td style="width: 10%;"></td> <td style="width: 10%;"></td> <td style="width: 10%;"></td> <td style="width: 10%;"></td> <td style="width: 10%;"></td> <td style="width: 10%;"></td> <td style="width: 10%;"></td> </tr> <tr> <td></td> <td></td> <td colspan="8" style="text-align: center;"> <table border="1" style="width: 100%; border-collapse: collapse; text-align: center;"> <tr> </tr></table></td></tr></table></td></tr></table></td></tr></table></td></tr></table></td></tr></table></td></tr></table></td></tr></table></td></tr></table></td></tr></table></td></tr></table></td></tr></table></td></tr></table></td></tr></table></td></tr></table></td></tr></table></td></tr></table></td></tr></table></td></tr></table></td></tr></table></td></tr></table></td></tr></table></td></tr></table></td></tr></table></td></tr></table></td></tr></table></td></tr></table></td></tr></table></td></tr></table></td></tr></table></td></tr></table></td></tr></table></td></tr></table></td></tr></table></td></tr></table></td></tr></table></td></tr></table></td></tr></table></td></tr></table></td></tr></table></td></tr></table></td></tr></table></td></tr></table></td></tr></table></td></tr></table></td></tr></table></td></tr></table></td></tr></table></td></tr></table></td></tr></table></td></tr></table></td></tr></table></td></tr></table></td></tr></table></td></tr></table>
 | | | | | | | | | | | | | | | | | | | | <table border="1" style="width: 100%; border-collapse: collapse; text-align: center;"> <tr> <td style="width: 10%;"></td> <td style="width: 10%;"></td> <td style="width: 10%;"></td> <td style="width: 10%;"></td> <td style="width: 10%;"></td> <td style="width: 10%;"></td> <td style="width: 10%;"></td> <td style="width: 10%;"></td> <td style="width: 10%;"></td> <td style="width: 10%;"></td> </tr> <tr> <td></td> <td></td> <td colspan="8" style="text-align: center;"> <table border="1" style="width: 100%; border-collapse: collapse; text-align: center;"> <tr> <td style="width: 10%;"></td> <td style="width: 10%;"></td> <td style="width: 10%;"></td> <td style="width: 10%;"></td> <td style="width: 10%;"></td> <td style="width: 10%;"></td> <td style="width: 10%;"></td> <td style="width: 10%;"></td> <td style="width: 10%;"></td> <td style="width: 10%;"></td> </tr> <tr> <td></td> <td></td> <td colspan="8" style="text-align: center;"> <table border="1" style="width: 100%; border-collapse: collapse; text-align: center;"> <tr> <td style="width: 10%;"></td> <td style="width: 10%;"></td> <td style="width: 10%;"></td> <td style="width: 10%;"></td> <td style="width: 10%;"></td> <td style="width: 10%;"></td> <td style="width: 10%;"></td> <td style="width: 10%;"></td> <td style="width: 10%;"></td> <td style="width: 10%;"></td> </tr> <tr> <td></td> <td></td> <td colspan="8" style="text-align: center;"> <table border="1" style="width: 100%; border-collapse: collapse; text-align: center;"> <tr> <td style="width: 10%;"></td> <td style="width: 10%;"></td> <td style="width: 10%;"></td> <td style="width: 10%;"></td> <td style="width: 10%;"></td> <td style="width: 10%;"></td> <td style="width: 10%;"></td> <td style="width: 10%;"></td> <td style="width: 10%;"></td> <td style="width: 10%;"></td> </tr> <tr> <td></td> <td></td> <td colspan="8" style="text-align: center;"> <table border="1" style="width: 100%; border-collapse: collapse; text-align: center;"> <tr> <td style="width: 10%;"></td> <td style="width: 10%;"></td> <td style="width: 10%;"></td> <td style="width: 10%;"></td> <td style="width: 10%;"></td> <td style="width: 10%;"></td> <td style="width: 10%;"></td> <td style="width: 10%;"></td> <td style="width: 10%;"></td> <td style="width: 10%;"></td> </tr> <tr> <td></td> <td></td> <td colspan="8" style="text-align: center;"> <table border="1" style="width: 100%; border-collapse: collapse; text-align: center;"> <tr> <td style="width: 10%;"></td> <td style="width: 10%;"></td> <td style="width: 10%;"></td> <td style="width: 10%;"></td> <td style="width: 10%;"></td> <td style="width: 10%;"></td> <td style="width: 10%;"></td> <td style="width: 10%;"></td> <td style="width: 10%;"></td> <td style="width: 10%;"></td> </tr> <tr> <td></td> <td></td> <td colspan="8" style="text-align: center;"> <table border="1" style="width: 100%; border-collapse: collapse; text-align: center;"> <tr> <td style="width: 10%;"></td> <td style="width: 10%;"></td> <td style="width: 10%;"></td> <td style="width: 10%;"></td> <td style="width: 10%;"></td> <td style="width: 10%;"></td> <td style="width: 10%;"></td> <td style="width: 10%;"></td> <td style="width: 10%;"></td> <td style="width: 10%;"></td> </tr> <tr> <td></td> <td></td> <td colspan="8" style="text-align: center;"> <table border="1" style="width: 100%; border-collapse: collapse; text-align: center;"> <tr> <td style="width: 10%;"></td> <td style="width: 10%;"></td> <td style="width: 10%;"></td> <td style="width: 10%;"></td> <td style="width: 10%;"></td> <td style="width: 10%;"></td> <td style="width: 10%;"></td> <td style="width: 10%;"></td> <td style="width: 10%;"></td> <td style="width: 10%;"></td> </tr> <tr> <td></td> <td></td> <td colspan="8" style="text-align: center;"> <table border="1" style="width: 100%; border-collapse: collapse; text-align: center;"> <tr> <td style="width: 10%;"></td> <td style="width: 10%;"></td> <td style="width: 10%;"></td> <td style="width: 10%;"></td> <td style="width: 10%;"></td> <td style="width: 10%;"></td> <td style="width: 10%;"></td> <td style="width: 10%;"></td> <td style="width: 10%;"></td> <td style="width: 10%;"></td> </tr> <tr> <td></td> <td></td> <td colspan="8" style="text-align: center;"> <table border="1" style="width: 100%; border-collapse: collapse; text-align: center;"> <tr> <td style="width: 10%;"></td> <td style="width: 10%;"></td> <td style="width: 10%;"></td> <td style="width: 10%;"></td> <td style="width: 10%;"></td> <td style="width: 10%;"></td> <td style="width: 10%;"></td> <td style="width: 10%;"></td> <td style="width: 10%;"></td> <td style="width: 10%;"></td> </tr> <tr> <td></td> <td></td> <td colspan="8" style="text-align: center;"> <table border="1" style="width: 100%; border-collapse: collapse; text-align: center;"> <tr> <td style="width: 10%;"></td> <td style="width: 10%;"></td> <td style="width: 10%;"></td> <td style="width: 10%;"></td> <td style="width: 10%;"></td> <td style="width: 10%;"></td> <td style="width: 10%;"></td> <td style="width: 10%;"></td> <td style="width: 10%;"></td> <td style="width: 10%;"></td> </tr> <tr> <td></td> <td></td> <td colspan="8" style="text-align: center;"> <table border="1" style="width: 100%; border-collapse: collapse; text-align: center;"> <tr> <td style="width: 10%;"></td> <td style="width: 10%;"></td> <td style="width: 10%;"></td> <td style="width: 10%;"></td> <td style="width: 10%;"></td> <td style="width: 10%;"></td> <td style="width: 10%;"></td> <td style="width: 10%;"></td> <td style="width: 10%;"></td> <td style="width: 10%;"></td> </tr> <tr> <td></td> <td></td> <td colspan="8" style="text-align: center;"> <table border="1" style="width: 100%; border-collapse: collapse; text-align: center;"> <tr> <td style="width: 10%;"></td> <td style="width: 10%;"></td> <td style="width: 10%;"></td> <td style="width: 10%;"></td> <td style="width: 10%;"></td> <td style="width: 10%;"></td> <td style="width: 10%;"></td> <td style="width: 10%;"></td> <td style="width: 10%;"></td> <td style="width: 10%;"></td> </tr> <tr> <td></td> <td></td> <td colspan="8" style="text-align: center;"> <table border="1" style="width: 100%; border-collapse: collapse; text-align: center;"> <tr> <td style="width: 10%;"></td> <td style="width: 10%;"></td> <td style="width: 10%;"></td> <td style="width: 10%;"></td> <td style="width: 10%;"></td> <td style="width: 10%;"></td> <td style="width: 10%;"></td> <td style="width: 10%;"></td> <td style="width: 10%;"></td> <td style="width: 10%;"></td> </tr> <tr> <td></td> <td></td> <td colspan="8" style="text-align: center;"> <table border="1" style="width: 100%; border-collapse: collapse; text-align: center;"> <tr> <td style="width: 10%;"></td> <td style="width: 10%;"></td> <td style="width: 10%;"></td> <td style="width: 10%;"></td> <td style="width: 10%;"></td> <td style="width: 10%;"></td> <td style="width: 10%;"></td> <td style="width: 10%;"></td> <td style="width: 10%;"></td> <td style="width: 10%;"></td> </tr> <tr> <td></td> <td></td> <td colspan="8" style="text-align: center;"> <table border="1" style="width: 100%; border-collapse: collapse; text-align: center;"> <tr> <td style="width: 10%;"></td> <td style="width: 10%;"></td> <td style="width: 10%;"></td> <td style="width: 10%;"></td> <td style="width: 10%;"></td> <td style="width: 10%;"></td> <td style="width: 10%;"></td> <td style="width: 10%;"></td> <td style="width: 10%;"></td> <td style="width: 10%;"></td> </tr> <tr> <td></td> <td></td> <td colspan="8" style="text-align: center;"> <table border="1" style="width: 100%; border-collapse: collapse; text-align: center;"> <tr> <td style="width: 10%;"></td> <td style="width: 10%;"></td> <td style="width: 10%;"></td> <td style="width: 10%;"></td> <td style="width: 10%;"></td> <td style="width: 10%;"></td> <td style="width: 10%;"></td> <td style="width: 10%;"></td> <td style="width: 10%;"></td> <td style="width: 10%;"></td> </tr> <tr> <td></td> <td></td> <td colspan="8" style="text-align: center;"> <table border="1" style="width: 100%; border-collapse: collapse; text-align: center;"> <tr> <td style="width: 10%;"></td> <td style="width: 10%;"></td> <td style="width: 10%;"></td> <td style="width: 10%;"></td> <td style="width: 10%;"></td> <td style="width: 10%;"></td> <td style="width: 10%;"></td> <td style="width: 10%;"></td> <td style="width: 10%;"></td> <td style="width: 10%;"></td> </tr> <tr> <td></td> <td></td> <td colspan="8" style="text-align: center;"> <table border="1" style="width: 100%; border-collapse: collapse; text-align: center;"> <tr> <td style="width: 10%;"></td> <td style="width: 10%;"></td> <td style="width: 10%;"></td> <td style="width: 10%;"></td> <td style="width: 10%;"></td> <td style="width: 10%;"></td> <td style="width: 10%;"></td> <td style="width: 10%;"></td> <td style="width: 10%;"></td> <td style="width: 10%;"></td> </tr> <tr> <td></td> <td></td> <td colspan="8" style="text-align: center;"> <table border="1" style="width: 100%; border-collapse: collapse; text-align: center;"> <tr> <td style="width: 10%;"></td> <td style="width: 10%;"></td> <td style="width: 10%;"></td> <td style="width: 10%;"></td> <td style="width: 10%;"></td> <td style="width: 10%;"></td> <td style="width: 10%;"></td> <td style="width: 10%;"></td> <td style="width: 10%;"></td> <td style="width: 10%;"></td> </tr> <tr> <td></td> <td></td> <td colspan="8" style="text-align: center;"> <table border="1" style="width: 100%; border-collapse: collapse; text-align: center;"> <tr> <td style="width: 10%;"></td> <td style="width: 10%;"></td> <td style="width: 10%;"></td> <td style="width: 10%;"></td> <td style="width: 10%;"></td> <td style="width: 10%;"></td> <td style="width: 10%;"></td> <td style="width: 10%;"></td> <td style="width: 10%;"></td> <td style="width: 10%;"></td> </tr> <tr>
<td></td> <td></td> <td colspan="8" style="text-align: center;"> <table border="1" style="width: 100%; border-collapse: collapse; text-align: center;"> <tr> <td style="width: 10%;"></td> <td style="width: 10%;"></td> <td style="width: 10%;"></td> <td style="width: 10%;"></td> <td style="width: 10%;"></td> <td style="width: 10%;"></td> <td style="width: 10%;"></td> <td style="width: 10%;"></td> <td style="width: 10%;"></td> <td style="width: 10%;"></td> </tr> <tr> <td></td> <td></td> <td colspan="8" style="text-align: center;"> <table border="1" style="width: 100%; border-collapse: collapse; text-align: center;"> <tr> <td style="width: 10%;"></td> <td style="width: 10%;"></td> <td style="width: 10%;"></td> <td style="width: 10%;"></td> <td style="width: 10%;"></td> <td style="width: 10%;"></td> <td style="width: 10%;"></td> <td style="width: 10%;"></td> <td style="width: 10%;"></td> <td style="width: 10%;"></td> </tr> <tr> <td></td> <td></td> <td colspan="8" style="text-align: center;"> <table border="1" style="width: 100%; border-collapse: collapse; text-align: center;"> <tr> <td style="width: 10%;"></td> <td style="width: 10%;"></td> <td style="width: 10%;"></td> <td style="width: 10%;"></td> <td style="width: 10%;"></td> <td style="width: 10%;"></td> <td style="width: 10%;"></td> <td style="width: 10%;"></td> <td style="width: 10%;"></td> <td style="width: 10%;"></td> </tr> <tr> <td></td> <td></td> <td colspan="8" style="text-align: center;"> <table border="1" style="width: 100%; border-collapse: collapse; text-align: center;"> <tr> <td style="width: 10%;"></td> <td style="width: 10%;"></td> <td style="width: 10%;"></td> <td style="width: 10%;"></td> <td style="width: 10%;"></td> <td style="width: 10%;"></td> <td style="width: 10%;"></td> <td style="width: 10%;"></td> <td style="width: 10%;"></td> <td style="width: 10%;"></td> </tr> <tr> <td></td> <td></td> <td colspan="8" style="text-align: center;"> <table border="1" style="width: 100%; border-collapse: collapse; text-align: center;"> <tr> <td style="width: 10%;"></td> <td style="width: 10%;"></td> <td style="width: 10%;"></td> <td style="width: 10%;"></td> <td style="width: 10%;"></td> <td style="width: 10%;"></td> <td style="width: 10%;"></td> <td style="width: 10%;"></td> <td style="width: 10%;"></td> <td style="width: 10%;"></td> </tr> <tr> <td></td> <td></td> <td colspan="8" style="text-align: center;"> <table border="1" style="width: 100%; border-collapse: collapse; text-align: center;"> <tr> <td style="width: 10%;"></td> <td style="width: 10%;"></td> <td style="width: 10%;"></td> <td style="width: 10%;"></td> <td style="width: 10%;"></td> <td style="width: 10%;"></td> <td style="width: 10%;"></td> <td style="width: 10%;"></td> <td style="width: 10%;"></td> <td style="width: 10%;"></td> </tr> <tr> <td></td> <td></td> <td colspan="8" style="text-align: center;"> <table border="1" style="width: 100%; border-collapse: collapse; text-align: center;"> <tr> <td style="width: 10%;"></td> <td style="width: 10%;"></td> <td style="width: 10%;"></td> <td style="width: 10%;"></td> <td style="width: 10%;"></td> <td style="width: 10%;"></td> <td style="width: 10%;"></td> <td style="width: 10%;"></td> <td style="width: 10%;"></td> <td style="width: 10%;"></td> </tr> <tr> <td></td> <td></td> <td colspan="8" style="text-align: center;"> <table border="1" style="width: 100%; border-collapse: collapse; text-align: center;"> <tr> <td style="width: 10%;"></td> <td style="width: 10%;"></td> <td style="width: 10%;"></td> <td style="width: 10%;"></td> <td style="width: 10%;"></td> <td style="width: 10%;"></td> <td style="width: 10%;"></td> <td style="width: 10%;"></td> <td style="width: 10%;"></td> <td style="width: 10%;"></td> </tr> <tr> <td></td> <td></td> <td colspan="8" style="text-align: center;"> <table border="1" style="width: 100%; border-collapse: collapse; text-align: center;"> <tr> <td style="width: 10%;"></td> <td style="width: 10%;"></td> <td style="width: 10%;"></td> <td style="width: 10%;"></td> <td style="width: 10%;"></td> <td style="width: 10%;"></td> <td style="width: 10%;"></td> <td style="width: 10%;"></td> <td style="width: 10%;"></td> <td style="width: 10%;"></td> </tr> <tr> <td></td> <td></td> <td colspan="8" style="text-align: center;"> <table border="1" style="width: 100%; border-collapse: collapse; text-align: center;"> <tr> <td style="width: 10%;"></td> <td style="width: 10%;"></td> <td style="width: 10%;"></td> <td style="width: 10%;"></td> <td style="width: 10%;"></td> <td style="width: 10%;"></td> <td style="width: 10%;"></td> <td style="width: 10%;"></td> <td style="width: 10%;"></td> <td style="width: 10%;"></td> </tr> <tr> <td></td> <td></td> <td colspan="8" style="text-align: center;"> <table border="1" style="width: 100%; border-collapse: collapse; text-align: center;"> <tr> <td style="width: 10%;"></td> <td style="width: 10%;"></td> <td style="width: 10%;"></td> <td style="width: 10%;"></td> <td style="width: 10%;"></td> <td style="width: 10%;"></td> <td style="width: 10%;"></td> <td style="width: 10%;"></td> <td style="width: 10%;"></td> <td style="width: 10%;"></td> </tr> <tr> <td></td> <td></td> <td colspan="8" style="text-align: center;"> <table border="1" style="width: 100%; border-collapse: collapse; text-align: center;"> <tr> <td style="width: 10%;"></td> <td style="width: 10%;"></td> <td style="width: 10%;"></td> <td style="width: 10%;"></td> <td style="width: 10%;"></td> <td style="width: 10%;"></td> <td style="width: 10%;"></td> <td style="width: 10%;"></td> <td style="width: 10%;"></td> <td style="width: 10%;"></td> </tr> <tr> <td></td> <td></td> <td colspan="8" style="text-align: center;"> <table border="1" style="width: 100%; border-collapse: collapse; text-align: center;"> <tr> <td style="width: 10%;"></td> <td style="width: 10%;"></td> <td style="width: 10%;"></td> <td style="width: 10%;"></td> <td style="width: 10%;"></td> <td style="width: 10%;"></td> <td style="width: 10%;"></td> <td style="width: 10%;"></td> <td style="width: 10%;"></td> <td style="width: 10%;"></td> </tr> <tr> <td></td> <td></td> <td colspan="8" style="text-align: center;"> <table border="1" style="width: 100%; border-collapse: collapse; text-align: center;"> <tr> <td style="width: 10%;"></td> <td style="width: 10%;"></td> <td style="width: 10%;"></td> <td style="width: 10%;"></td> <td style="width: 10%;"></td> <td style="width: 10%;"></td> <td style="width: 10%;"></td> <td style="width: 10%;"></td> <td style="width: 10%;"></td> <td style="width: 10%;"></td> </tr> <tr> <td></td> <td></td> <td colspan="8" style="text-align: center;"> <table border="1" style="width: 100%; border-collapse: collapse; text-align: center;"> <tr> <td style="width: 10%;"></td> <td style="width: 10%;"></td> <td style="width: 10%;"></td> <td style="width: 10%;"></td> <td style="width: 10%;"></td> <td style="width: 10%;"></td> <td style="width: 10%;"></td> <td style="width: 10%;"></td> <td style="width: 10%;"></td> <td style="width: 10%;"></td> </tr> <tr> <td></td> <td></td> <td colspan="8" style="text-align: center;"> <table border="1" style="width: 100%; border-collapse: collapse; text-align: center;"> <tr> <td style="width: 10%;"></td> <td style="width: 10%;"></td> <td style="width: 10%;"></td> <td style="width: 10%;"></td> <td style="width: 10%;"></td> <td style="width: 10%;"></td> <td style="width: 10%;"></td> <td style="width: 10%;"></td> <td style="width: 10%;"></td> <td style="width: 10%;"></td> </tr> <tr> <td></td> <td></td> <td colspan="8" style="text-align: center;"> <table border="1" style="width: 100%; border-collapse: collapse; text-align: center;"> <tr> <td style="width: 10%;"></td> <td style="width: 10%;"></td> <td style="width: 10%;"></td> <td style="width: 10%;"></td> <td style="width: 10%;"></td> <td style="width: 10%;"></td> <td style="width: 10%;"></td> <td style="width: 10%;"></td> <td style="width: 10%;"></td> <td style="width: 10%;"></td> </tr> <tr> <td></td> <td></td> <td colspan="8" style="text-align: center;"> <table border="1" style="width: 100%; border-collapse: collapse; text-align: center;"> <tr> <td style="width: 10%;"></td> <td style="width: 10%;"></td> <td style="width: 10%;"></td> <td style="width: 10%;"></td> <td style="width: 10%;"></td> <td style="width: 10%;"></td> <td style="width: 10%;"></td> <td style="width: 10%;"></td> <td style="width: 10%;"></td> <td style="width: 10%;"></td> </tr> <tr> <td></td> <td></td> <td colspan="8" style="text-align: center;"> <table border="1" style="width: 100%; border-collapse: collapse; text-align: center;"> <tr> <td style="width: 10%;"></td> <td style="width: 10%;"></td> <td style="width: 10%;"></td> <td style="width: 10%;"></td> <td style="width: 10%;"></td> <td style="width: 10%;"></td> <td style="width: 10%;"></td> <td style="width: 10%;"></td> <td style="width: 10%;"></td> <td style="width: 10%;"></td> </tr> <tr> <td></td> <td></td> <td colspan="8" style="text-align: center;"> <table border="1" style="width: 100%; border-collapse: collapse; text-align: center;"> <tr> <td style="width: 10%;"></td> <td style="width: 10%;"></td> <td style="width: 10%;"></td> <td style="width: 10%;"></td> <td style="width: 10%;"></td> <td style="width: 10%;"></td> <td style="width: 10%;"></td> <td style="width: 10%;"></td> <td style="width: 10%;"></td> <td style="width: 10%;"></td> </tr> <tr> <td></td> <td></td> <td colspan="8" style="text-align: center;"> <table border="1" style="width: 100%; border-collapse: collapse; text-align: center;"> <tr> <td style="width: 10%;"></td> <td style="width: 10%;"></td> <td style="width: 10%;"></td> <td style="width: 10%;"></td> <td style="width: 10%;"></td> <td style="width: 10%;"></td> <td style="width: 10%;"></td> <td style="width: 10%;"></td> <td style="width: 10%;"></td> <td style="width: 10%;"></td> </tr> <tr> <td></td> <td></td> <td colspan="8" style="text-align: center;"> <table border="1" style="width: 100%; border-collapse: collapse; text-align: center;"> <tr> <td
style="width: 10%;"></td> <td style="width: 10%;"></td> <td style="width: 10%;"></td> <td style="width: 10%;"></td> <td style="width: 10%;"></td> <td style="width: 10%;"></td> <td style="width: 10%;"></td> <td style="width: 10%;"></td> <td style="width: 10%;"></td> <td style="width: 10%;"></td> </tr> <tr> <td></td> <td></td> <td colspan="8" style="text-align: center;"> <table border="1" style="width: 100%; border-collapse: collapse; text-align: center;"> <tr> <td style="width: 10%;"></td> <td style="width: 10%;"></td> <td style="width: 10%;"></td> <td style="width: 10%;"></td> <td style="width: 10%;"></td> <td style="width: 10%;"></td> <td style="width: 10%;"></td> <td style="width: 10%;"></td> <td style="width: 10%;"></td> <td style="width: 10%;"></td> </tr> <tr> <td></td> <td></td> <td colspan="8" style="text-align: center;"> <table border="1" style="width: 100%; border-collapse: collapse; text-align: center;"> <tr> <td style="width: 10%;"></td> <td style="width: 10%;"></td> <td style="width: 10%;"></td> <td style="width: 10%;"></td> <td style="width: 10%;"></td> <td style="width: 10%;"></td> <td style="width: 10%;"></td> <td style="width: 10%;"></td> <td style="width: 10%;"></td> <td style="width: 10%;"></td> </tr> <tr> <td></td> <td></td> <td colspan="8" style="text-align: center;"> <table border="1" style="width: 100%; border-collapse: collapse; text-align: center;"> <tr> <td style="width: 10%;"></td> <td style="width: 10%;"></td> <td style="width: 10%;"></td> <td style="width: 10%;"></td> <td style="width: 10%;"></td> <td style="width: 10%;"></td> <td style="width: 10%;"></td> <td style="width: 10%;"></td> <td style="width: 10%;"></td> <td style="width: 10%;"></td> </tr> <tr> <td></td> <td></td> <td colspan="8" style="text-align: center;"> <table border="1" style="width: 100%; border-collapse: collapse; text-align: center;"> <tr> <td style="width: 10%;"></td> <td style="width: 10%;"></td> <td style="width: 10%;"></td> <td style="width: 10%;"></td> <td style="width: 10%;"></td> <td style="width: 10%;"></td> <td style="width: 10%;"></td> <td style="width: 10%;"></td> <td style="width: 10%;"></td> <td style="width: 10%;"></td> </tr> <tr> <td></td> <td></td> <td colspan="8" style="text-align: center;"> <table border="1" style="width: 100%; border-collapse: collapse; text-align: center;"> <tr> <td style="width: 10%;"></td> <td style="width: 10%;"></td> <td style="width: 10%;"></td> <td style="width: 10%;"></td> <td style="width: 10%;"></td> <td style="width: 10%;"></td> <td style="width: 10%;"></td> <td style="width: 10%;"></td> <td style="width: 10%;"></td> <td style="width: 10%;"></td> </tr> <tr> <td></td> <td></td> <td colspan="8" style="text-align: center;"> <table border="1" style="width: 100%; border-collapse: collapse; text-align: center;"> <tr> <td style="width: 10%;"></td> <td style="width: 10%;"></td> <td style="width: 10%;"></td> <td style="width: 10%;"></td> <td style="width: 10%;"></td> <td style="width: 10%;"></td> <td style="width: 10%;"></td> <td style="width: 10%;"></td> <td style="width: 10%;"></td> <td style="width: 10%;"></td> </tr> <tr> <td></td> <td></td> <td colspan="8" style="text-align: center;"> <table border="1" style="width: 100%; border-collapse: collapse; text-align: center;"> <tr> <td style="width: 10%;"></td> <td style="width: 10%;"></td> <td style="width: 10%;"></td> <td style="width: 10%;"></td> <td style="width: 10%;"></td> <td style="width: 10%;"></td> <td style="width: 10%;"></td> <td style="width: 10%;"></td> <td style="width: 10%;"></td> <td style="width: 10%;"></td> </tr> <tr> <td></td> <td></td> <td colspan="8" style="text-align: center;"> <table border="1" style="width: 100%; border-collapse: collapse; text-align: center;"> <tr> <td style="width: 10%;"></td> <td style="width: 10%;"></td> <td style="width: 10%;"></td> <td style="width: 10%;"></td> <td style="width: 10%;"></td> <td style="width: 10%;"></td> <td style="width: 10%;"></td> <td style="width: 10%;"></td> <td style="width: 10%;"></td> <td style="width: 10%;"></td> </tr> <tr> <td></td> <td></td> <td colspan="8" style="text-align: center;"> <table border="1" style="width: 100%; border-collapse: collapse; text-align: center;"> <tr> <td style="width: 10%;"></td> <td style="width: 10%;"></td> <td style="width: 10%;"></td> <td style="width: 10%;"></td> <td style="width: 10%;"></td> <td style="width: 10%;"></td> <td style="width: 10%;"></td> <td style="width: 10%;"></td> <td style="width: 10%;"></td> <td style="width: 10%;"></td> </tr> <tr> <td></td> <td></td> <td colspan="8" style="text-align: center;"> <table border="1" style="width: 100%; border-collapse: collapse; text-align: center;"> <tr> <td style="width: 10%;"></td> <td style="width: 10%;"></td> <td style="width: 10%;"></td> <td style="width: 10%;"></td> <td style="width: 10%;"></td> <td style="width: 10%;"></td> <td style="width: 10%;"></td> <td style="width: 10%;"></td> <td style="width: 10%;"></td> <td style="width: 10%;"></td> </tr> <tr> <td></td> <td></td> <td colspan="8" style="text-align: center;"> <table border="1" style="width: 100%; border-collapse: collapse; text-align: center;"> <tr> </tr></table></td></tr></table></td></tr></table></td></tr></table></td></tr></table></td></tr></table></td></tr></table></td></tr></table></td></tr></table></td></tr></table></td></tr></table></td></tr></table></td></tr></table></td></tr></table></td></tr></table></td></tr></table></td></tr></table></td></tr></table></td></tr></table></td></tr></table></td></tr></table></td></tr></table></td></tr></table></td></tr></table></td></tr></table></td></tr></table></td></tr></table></td></tr></table></td></tr></table></td></tr></table></td></tr></table></td></tr></table></td></tr></table></td></tr></table></td></tr></table></td></tr></table></td></tr></table></td></tr></table></td></tr></table></td></tr></table></td></tr></table></td></tr></table></td></tr></table></td></tr></table></td></tr></table></td></tr></table></td></tr></table></td></tr></table></td></tr></table></td></tr></table></td></tr></table></td></tr></table></td></tr></table></td></tr></table> | | | | | | | | | | | | | | | | | | | | <table border="1" style="width: 100%; border-collapse: collapse; text-align: center;"> <tr> <td style="width: 10%;"></td> <td style="width: 10%;"></td> <td style="width: 10%;"></td> <td style="width: 10%;"></td> <td style="width: 10%;"></td> <td style="width: 10%;"></td> <td style="width: 10%;"></td> <td style="width: 10%;"></td> <td style="width: 10%;"></td> <td style="width: 10%;"></td> </tr> <tr> <td></td> <td></td> <td colspan="8" style="text-align: center;"> <table border="1" style="width: 100%; border-collapse: collapse; text-align: center;"> <tr> <td style="width: 10%;"></td> <td style="width: 10%;"></td> <td style="width: 10%;"></td> <td style="width: 10%;"></td> <td style="width: 10%;"></td> <td style="width: 10%;"></td> <td style="width: 10%;"></td> <td style="width: 10%;"></td> <td style="width: 10%;"></td> <td style="width: 10%;"></td> </tr> <tr> <td></td> <td></td> <td colspan="8" style="text-align: center;"> <table border="1" style="width: 100%; border-collapse: collapse; text-align: center;"> <tr> <td style="width: 10%;"></td> <td style="width: 10%;"></td> <td style="width: 10%;"></td> <td style="width: 10%;"></td> <td style="width: 10%;"></td> <td style="width: 10%;"></td> <td style="width: 10%;"></td> <td style="width: 10%;"></td> <td style="width: 10%;"></td> <td style="width: 10%;"></td> </tr> <tr> <td></td> <td></td> <td colspan="8" style="text-align: center;"> <table border="1" style="width: 100%; border-collapse: collapse; text-align: center;"> <tr> <td style="width: 10%;"></td> <td style="width: 10%;"></td> <td style="width: 10%;"></td> <td style="width: 10%;"></td> <td style="width: 10%;"></td> <td style="width: 10%;"></td> <td style="width: 10%;"></td> <td style="width: 10%;"></td> <td style="width: 10%;"></td> <td style="width: 10%;"></td> </tr> <tr> <td></td> <td></td> <td colspan="8" style="text-align: center;"> <table
border="1" style="width: 100%; border-collapse: collapse; text-align: center;"> <tr> <td style="width: 10%;"></td> <td style="width: 10%;"></td> <td style="width: 10%;"></td> <td style="width: 10%;"></td> <td style="width: 10%;"></td> <td style="width: 10%;"></td> <td style="width: 10%;"></td> <td style="width: 10%;"></td> <td style="width: 10%;"></td> <td style="width: 10%;"></td> </tr> <tr> <td></td> <td></td> <td colspan="8" style="text-align: center;"> <table border="1" style="width: 100%; border-collapse: collapse; text-align: center;"> <tr> <td style="width: 10%;"></td> <td style="width: 10%;"></td> <td style="width: 10%;"></td> <td style="width: 10%;"></td> <td style="width: 10%;"></td> <td style="width: 10%;"></td> <td style="width: 10%;"></td> <td style="width: 10%;"></td> <td style="width: 10%;"></td> <td style="width: 10%;"></td> </tr> <tr> <td></td> <td></td> <td colspan="8" style="text-align: center;"> <table border="1" style="width: 100%; border-collapse: collapse; text-align: center;"> <tr> <td style="width: 10%;"></td> <td style="width: 10%;"></td> <td style="width: 10%;"></td> <td style="width: 10%;"></td> <td style="width: 10%;"></td> <td style="width: 10%;"></td> <td style="width: 10%;"></td> <td style="width: 10%;"></td> <td style="width: 10%;"></td> <td style="width: 10%;"></td> </tr> <tr> <td></td> <td></td> <td colspan="8" style="text-align: center;"> <table border="1" style="width: 100%; border-collapse: collapse; text-align: center;"> <tr> <td style="width: 10%;"></td> <td style="width: 10%;"></td> <td style="width: 10%;"></td> <td style="width: 10%;"></td> <td style="width: 10%;"></td> <td style="width: 10%;"></td> <td style="width: 10%;"></td> <td style="width: 10%;"></td> <td style="width: 10%;"></td> <td style="width: 10%;"></td> </tr> <tr> <td></td> <td></td> <td colspan="8" style="text-align: center;"> <table border="1" style="width: 100%; border-collapse: collapse; text-align: center;"> <tr> <td style="width: 10%;"></td> <td style="width: 10%;"></td> <td style="width: 10%;"></td> <td style="width: 10%;"></td> <td style="width: 10%;"></td> <td style="width: 10%;"></td> <td style="width: 10%;"></td> <td style="width: 10%;"></td> <td style="width: 10%;"></td> <td style="width: 10%;"></td> </tr> <tr> <td></td> <td></td> <td colspan="8" style="text-align: center;"> <table border="1" style="width: 100%; border-collapse: collapse; text-align: center;"> <tr> <td style="width: 10%;"></td> <td style="width: 10%;"></td> <td style="width: 10%;"></td> <td style="width: 10%;"></td> <td style="width: 10%;"></td> <td style="width: 10%;"></td> <td style="width: 10%;"></td> <td style="width: 10%;"></td> <td style="width: 10%;"></td> <td style="width: 10%;"></td> </tr> <tr> <td></td> <td></td> <td colspan="8" style="text-align: center;"> <table border="1" style="width: 100%; border-collapse: collapse; text-align: center;"> <tr> <td style="width: 10%;"></td> <td style="width: 10%;"></td> <td style="width: 10%;"></td> <td style="width: 10%;"></td> <td style="width: 10%;"></td> <td style="width: 10%;"></td> <td style="width: 10%;"></td> <td style="width: 10%;"></td> <td style="width: 10%;"></td> <td style="width: 10%;"></td> </tr> <tr> <td></td> <td></td> <td colspan="8" style="text-align: center;"> <table border="1" style="width: 100%; border-collapse: collapse; text-align: center;"> <tr> <td style="width: 10%;"></td> <td style="width: 10%;"></td> <td style="width: 10%;"></td> <td style="width: 10%;"></td> <td style="width: 10%;"></td> <td style="width: 10%;"></td> <td style="width: 10%;"></td> <td style="width: 10%;"></td> <td style="width: 10%;"></td> <td style="width: 10%;"></td> </tr> <tr> <td></td> <td></td> <td colspan="8" style="text-align: center;"> <table border="1" style="width: 100%; border-collapse: collapse; text-align: center;"> <tr> <td style="width: 10%;"></td> <td style="width: 10%;"></td> <td style="width: 10%;"></td> <td style="width: 10%;"></td> <td style="width: 10%;"></td> <td style="width: 10%;"></td> <td style="width: 10%;"></td> <td style="width: 10%;"></td> <td style="width: 10%;"></td> <td style="width: 10%;"></td> </tr> <tr> <td></td> <td></td> <td colspan="8" style="text-align: center;"> <table border="1" style="width: 100%; border-collapse: collapse; text-align: center;"> <tr> <td style="width: 10%;"></td> <td style="width: 10%;"></td> <td style="width: 10%;"></td> <td style="width: 10%;"></td> <td style="width: 10%;"></td> <td style="width: 10%;"></td> <td style="width: 10%;"></td> <td style="width: 10%;"></td> <td style="width: 10%;"></td> <td style="width: 10%;"></td> </tr> <tr> <td></td> <td></td> <td colspan="8" style="text-align: center;"> <table border="1" style="width: 100%; border-collapse: collapse; text-align: center;"> <tr> <td style="width: 10%;"></td> <td style="width: 10%;"></td> <td style="width: 10%;"></td> <td style="width: 10%;"></td> <td style="width: 10%;"></td> <td style="width: 10%;"></td> <td style="width: 10%;"></td> <td style="width: 10%;"></td> <td style="width: 10%;"></td> <td style="width: 10%;"></td> </tr> <tr> <td></td> <td></td> <td colspan="8" style="text-align: center;"> <table border="1" style="width: 100%; border-collapse: collapse; text-align: center;"> <tr> <td style="width: 10%;"></td> <td style="width: 10%;"></td> <td style="width: 10%;"></td> <td style="width: 10%;"></td> <td style="width: 10%;"></td> <td style="width: 10%;"></td> <td style="width: 10%;"></td> <td style="width: 10%;"></td> <td style="width: 10%;"></td> <td style="width: 10%;"></td> </tr> <tr> <td></td> <td></td> <td colspan="8" style="text-align: center;"> <table border="1" style="width: 100%; border-collapse: collapse; text-align: center;"> <tr> <td style="width: 10%;"></td> <td style="width: 10%;"></td> <td style="width: 10%;"></td> <td style="width: 10%;"></td> <td style="width: 10%;"></td> <td style="width: 10%;"></td> <td style="width: 10%;"></td> <td style="width: 10%;"></td> <td style="width: 10%;"></td> <td style="width: 10%;"></td> </tr> <tr> <td></td> <td></td> <td colspan="8" style="text-align: center;"> <table border="1" style="width: 100%; border-collapse: collapse; text-align: center;"> <tr> <td style="width: 10%;"></td> <td style="width: 10%;"></td> <td style="width: 10%;"></td> <td style="width: 10%;"></td> <td style="width: 10%;"></td> <td style="width: 10%;"></td> <td style="width: 10%;"></td> <td style="width: 10%;"></td> <td style="width: 10%;"></td> <td style="width: 10%;"></td> </tr> <tr> <td></td> <td></td> <td colspan="8" style="text-align: center;"> <table border="1" style="width: 100%; border-collapse: collapse; text-align: center;"> <tr> <td style="width: 10%;"></td> <td style="width: 10%;"></td> <td style="width: 10%;"></td> <td style="width: 10%;"></td> <td style="width: 10%;"></td> <td style="width: 10%;"></td> <td style="width: 10%;"></td> <td style="width: 10%;"></td> <td style="width: 10%;"></td> <td style="width: 10%;"></td> </tr> <tr> <td></td> <td></td> <td colspan="8" style="text-align: center;"> <table border="1" style="width: 100%; border-collapse: collapse; text-align: center;"> <tr> <td style="width: 10%;"></td> <td style="width: 10%;"></td> <td style="width: 10%;"></td> <td style="width: 10%;"></td> <td style="width: 10%;"></td> <td style="width: 10%;"></td> <td style="width: 10%;"></td> <td style="width: 10%;"></td> <td style="width: 10%;"></td> <td style="width: 10%;"></td> </tr> <tr> <td></td> <td></td> <td colspan="8" style="text-align: center;"> <table border="1" style="width: 100%; border-collapse: collapse; text-align: center;"> <tr> <td style="width: 10%;"></td> <td style="width: 10%;"></td> <td style="width: 10%;"></td> <td style="width: 10%;"></td> <td style="width: 10%;"></td> <td style="width: 10%;"></td> <td style="width: 10%;"></td> <td style="width: 10%;"></td> <td style="width: 10%;"></td> <td style="width: 10%;"></td> </tr> <tr> <td></td> <td></td> <td colspan="8" style="text-align: center;"> <table border="1" style="width: 100%; border-collapse: collapse; text-align: center;"> <tr> <td style="width: 10%;"></td> <td style="width: 10%;"></td> <td style="width: 10%;"></td> <td style="width: 10%;"></td> <td style="width: 10%;"></td> <td style="width: 10%;"></td> <td style="width: 10%;"></td> <td style="width: 10%;"></td> <td style="width: 10%;"></td> <td style="width: 10%;"></td> </tr> <tr> <td></td> <td></td> <td colspan="8" style="text-align: center;"> <table border="1" style="width: 100%; border-collapse: collapse; text-align: center;"> <tr> <td style="width: 10%;"></td> <td style="width: 10%;"></td> <td style="width: 10%;"></td> <td style="width: 10%;"></td> <td style="width: 10%;"></td> <td style="width: 10%;"></td> <td style="width: 10%;"></td> <td style="width: 10%;"></td> <td style="width: 10%;"></td> <td style="width: 10%;"></td> </tr> <tr> <td></td> <td></td> <td colspan="8" style="text-align: center;"> <table border="1" style="width: 100%; border-collapse: collapse; text-align: center;"> <tr> <td style="width: 10%;"></td> <td style="width: 10%;"></td> <td style="width: 10%;"></td> <td style="width: 10%;"></td> <td style="width: 10%;"></td> <td style="width: 10%;"></td> <td style="width: 10%;"></td> <td style="width: 10%;"></td> <td style="width: 10%;"></td> <td style="width: 10%;"></td> </tr> <tr> <td></td> <td></td> <td colspan="8" style="text-align: center;"> <table border="1" style="width: 100%; border-collapse: collapse; text-align: center;"> <tr> <td style="width: 10%;"></td> <td style="width: 10%;"></td> <td style="width: 10%;"></td> <td style="width: 10%;"></td> <td style="width: 10%;"></td> <td style="width: 10%;"></td> <td style="width: 10%;"></td> <td style="width: 10%;"></td> <td style="width: 10%;"></td> <td style="width: 10%;"></td> </tr> <tr> <td></td> <td></td> <td colspan="8" style="text-align: center;"> <table border="1" style="width: 100%; border-collapse: collapse; text-align: center;"> <tr> <td style="width: 10%;"></td> <td style="width: 10%;"></td> <td style="width:
10%;"></td> <td style="width: 10%;"></td> <td style="width: 10%;"></td> <td style="width: 10%;"></td> <td style="width: 10%;"></td> <td style="width: 10%;"></td> <td style="width: 10%;"></td> <td style="width: 10%;"></td> </tr> <tr> <td></td> <td></td> <td colspan="8" style="text-align: center;"> <table border="1" style="width: 100%; border-collapse: collapse; text-align: center;"> <tr> <td style="width: 10%;"></td> <td style="width: 10%;"></td> <td style="width: 10%;"></td> <td style="width: 10%;"></td> <td style="width: 10%;"></td> <td style="width: 10%;"></td> <td style="width: 10%;"></td> <td style="width: 10%;"></td> <td style="width: 10%;"></td> <td style="width: 10%;"></td> </tr> <tr> <td></td> <td></td> <td colspan="8" style="text-align: center;"> <table border="1" style="width: 100%; border-collapse: collapse; text-align: center;"> <tr> <td style="width: 10%;"></td> <td style="width: 10%;"></td> <td style="width: 10%;"></td> <td style="width: 10%;"></td> <td style="width: 10%;"></td> <td style="width: 10%;"></td> <td style="width: 10%;"></td> <td style="width: 10%;"></td> <td style="width: 10%;"></td> <td style="width: 10%;"></td> </tr> <tr> <td></td> <td></td> <td colspan="8" style="text-align: center;"> <table border="1" style="width: 100%; border-collapse: collapse; text-align: center;"> <tr> <td style="width: 10%;"></td> <td style="width: 10%;"></td> <td style="width: 10%;"></td> <td style="width: 10%;"></td> <td style="width: 10%;"></td> <td style="width: 10%;"></td> <td style="width: 10%;"></td> <td style="width: 10%;"></td> <td style="width: 10%;"></td> <td style="width: 10%;"></td> </tr> <tr> <td></td> <td></td> <td colspan="8" style="text-align: center;"> <table border="1" style="width: 100%; border-collapse: collapse; text-align: center;"> <tr> <td style="width: 10%;"></td> <td style="width: 10%;"></td> <td style="width: 10%;"></td> <td style="width: 10%;"></td> <td style="width: 10%;"></td> <td style="width: 10%;"></td> <td style="width: 10%;"></td> <td style="width: 10%;"></td> <td style="width: 10%;"></td> <td style="width: 10%;"></td> </tr> <tr> <td></td> <td></td> <td colspan="8" style="text-align: center;"> <table border="1" style="width: 100%; border-collapse: collapse; text-align: center;"> <tr> <td style="width: 10%;"></td> <td style="width: 10%;"></td> <td style="width: 10%;"></td> <td style="width: 10%;"></td> <td style="width: 10%;"></td> <td style="width: 10%;"></td> <td style="width: 10%;"></td> <td style="width: 10%;"></td> <td style="width: 10%;"></td> <td style="width: 10%;"></td> </tr> <tr> <td></td> <td></td> <td colspan="8" style="text-align: center;"> <table border="1" style="width: 100%; border-collapse: collapse; text-align: center;"> <tr> <td style="width: 10%;"></td> <td style="width: 10%;"></td> <td style="width: 10%;"></td> <td style="width: 10%;"></td> <td style="width: 10%;"></td> <td style="width: 10%;"></td> <td style="width: 10%;"></td> <td style="width: 10%;"></td> <td style="width: 10%;"></td> <td style="width: 10%;"></td> </tr> <tr> <td></td> <td></td> <td colspan="8" style="text-align: center;"> <table border="1" style="width: 100%; border-collapse: collapse; text-align: center;"> <tr> <td style="width: 10%;"></td> <td style="width: 10%;"></td> <td style="width: 10%;"></td> <td style="width: 10%;"></td> <td style="width: 10%;"></td> <td style="width: 10%;"></td> <td style="width: 10%;"></td> <td style="width: 10%;"></td> <td style="width: 10%;"></td> <td style="width: 10%;"></td> </tr> <tr> <td></td> <td></td> <td colspan="8" style="text-align: center;"> <table border="1" style="width: 100%; border-collapse: collapse; text-align: center;"> <tr> <td style="width: 10%;"></td> <td style="width: 10%;"></td> <td style="width: 10%;"></td> <td style="width: 10%;"></td> <td style="width: 10%;"></td> <td style="width: 10%;"></td> <td style="width: 10%;"></td> <td style="width: 10%;"></td> <td style="width: 10%;"></td> <td style="width: 10%;"></td> </tr> <tr> <td></td> <td></td> <td colspan="8" style="text-align: center;"> <table border="1" style="width: 100%; border-collapse: collapse; text-align: center;"> <tr> <td style="width: 10%;"></td> <td style="width: 10%;"></td> <td style="width: 10%;"></td> <td style="width: 10%;"></td> <td style="width: 10%;"></td> <td style="width: 10%;"></td> <td style="width: 10%;"></td> <td style="width: 10%;"></td> <td style="width: 10%;"></td> <td style="width: 10%;"></td> </tr> <tr> <td></td> <td></td> <td colspan="8" style="text-align: center;"> <table border="1" style="width: 100%; border-collapse: collapse; text-align: center;"> <tr> <td style="width: 10%;"></td> <td style="width: 10%;"></td> <td style="width: 10%;"></td> <td style="width: 10%;"></td> <td style="width: 10%;"></td> <td style="width: 10%;"></td> <td style="width: 10%;"></td> <td style="width: 10%;"></td> <td style="width: 10%;"></td> <td style="width: 10%;"></td> </tr> <tr> <td></td> <td></td> <td colspan="8" style="text-align: center;"> <table border="1" style="width: 100%; border-collapse: collapse; text-align: center;"> <tr> <td style="width: 10%;"></td> <td style="width: 10%;"></td> <td style="width: 10%;"></td> <td style="width: 10%;"></td> <td style="width: 10%;"></td> <td style="width: 10%;"></td> <td style="width: 10%;"></td> <td style="width: 10%;"></td> <td style="width: 10%;"></td> <td style="width: 10%;"></td> </tr> <tr> <td></td> <td></td> <td colspan="8" style="text-align: center;"> <table border="1" style="width: 100%; border-collapse: collapse; text-align: center;"> <tr> <td style="width: 10%;"></td> <td style="width: 10%;"></td> <td style="width: 10%;"></td> <td style="width: 10%;"></td> <td style="width: 10%;"></td> <td style="width: 10%;"></td> <td style="width: 10%;"></td> <td style="width: 10%;"></td> <td style="width: 10%;"></td> <td style="width: 10%;"></td> </tr> <tr> <td></td> <td></td> <td colspan="8" style="text-align: center;"> <table border="1" style="width: 100%; border-collapse: collapse; text-align: center;"> <tr> <td style="width: 10%;"></td> <td style="width: 10%;"></td> <td style="width: 10%;"></td> <td style="width: 10%;"></td> <td style="width: 10%;"></td> <td style="width: 10%;"></td> <td style="width: 10%;"></td> <td style="width: 10%;"></td> <td style="width: 10%;"></td> <td style="width: 10%;"></td> </tr> <tr> <td></td> <td></td> <td colspan="8" style="text-align: center;"> <table border="1" style="width: 100%; border-collapse: collapse; text-align: center;"> <tr> <td style="width: 10%;"></td> <td style="width: 10%;"></td> <td style="width: 10%;"></td> <td style="width: 10%;"></td> <td style="width: 10%;"></td> <td style="width: 10%;"></td> <td style="width: 10%;"></td> <td style="width: 10%;"></td> <td style="width: 10%;"></td> <td style="width: 10%;"></td> </tr> <tr> <td></td> <td></td> <td colspan="8" style="text-align: center;"> <table border="1" style="width: 100%; border-collapse: collapse; text-align: center;"> <tr> <td style="width: 10%;"></td> <td style="width: 10%;"></td> <td style="width: 10%;"></td> <td style="width: 10%;"></td> <td style="width: 10%;"></td> <td style="width: 10%;"></td> <td style="width: 10%;"></td> <td style="width: 10%;"></td> <td style="width: 10%;"></td> <td style="width: 10%;"></td> </tr> <tr> <td></td> <td></td> <td colspan="8" style="text-align: center;"> <table border="1" style="width: 100%; border-collapse: collapse; text-align: center;"> <tr> <td style="width: 10%;"></td> <td style="width: 10%;"></td> <td style="width: 10%;"></td> <td style="width: 10%;"></td> <td style="width: 10%;"></td> <td style="width: 10%;"></td> <td style="width: 10%;"></td> <td style="width: 10%;"></td> <td style="width: 10%;"></td> <td style="width: 10%;"></td> </tr> <tr> <td></td> <td></td> <td colspan="8" style="text-align: center;"> <table border="1" style="width: 100%; border-collapse: collapse; text-align: center;"> <tr> <td style="width: 10%;"></td> <td style="width: 10%;"></td> <td style="width: 10%;"></td> <td style="width: 10%;"></td> <td style="width: 10%;"></td> <td style="width: 10%;"></td> <td style="width: 10%;"></td> <td style="width: 10%;"></td> <td style="width: 10%;"></td> <td style="width: 10%;"></td> </tr> <tr> <td></td> <td></td> <td colspan="8" style="text-align: center;"> <table border="1" style="width: 100%; border-collapse: collapse; text-align: center;"> <tr> <td style="width: 10%;"></td> <td style="width: 10%;"></td> <td style="width: 10%;"></td> <td style="width: 10%;"></td> <td style="width: 10%;"></td> <td style="width: 10%;"></td> <td style="width: 10%;"></td> <td style="width: 10%;"></td> <td style="width: 10%;"></td> <td style="width: 10%;"></td> </tr> <tr> <td></td> <td></td> <td colspan="8" style="text-align: center;"> <table border="1" style="width: 100%; border-collapse: collapse; text-align: center;"> <tr> <td style="width: 10%;"></td> <td style="width: 10%;"></td> <td style="width: 10%;"></td> <td style="width: 10%;"></td> <td style="width: 10%;"></td> <td style="width: 10%;"></td> <td style="width: 10%;"></td> <td style="width: 10%;"></td> <td style="width: 10%;"></td> <td style="width: 10%;"></td> </tr> <tr> <td></td> <td></td> <td colspan="8" style="text-align: center;"> <table border="1" style="width: 100%; border-collapse: collapse; text-align: center;"> <tr> <td style="width: 10%;"></td> <td style="width: 10%;"></td> <td style="width: 10%;"></td> <td style="width: 10%;"></td> <td style="width: 10%;"></td> <td style="width: 10%;"></td> <td style="width: 10%;"></td> <td style="width: 10%;"></td> <td style="width: 10%;"></td> <td style="width: 10%;"></td> </tr> <tr> <td></td> <td></td> <td colspan="8" style="text-align: center;"> <table border="1" style="width: 100%; border-collapse: collapse; text-align: center;"> <tr> <td style="width: 10%;"></td> <td style="width: 10%;"></td> <td style="width: 10%;"></td> <td style="width: 10%;"></td> <td style="width: 10%;"></td> <td style="width: 10%;"></td> <td style="width: 10%;"></td> <td style="width: 10%;"></td> <td
style="width: 10%;"></td> <td style="width: 10%;"></td> </tr> <tr> <td></td> <td></td> <td colspan="8" style="text-align: center;"> <table border="1" style="width: 100%; border-collapse: collapse; text-align: center;"> <tr> <td style="width: 10%;"></td> <td style="width: 10%;"></td> <td style="width: 10%;"></td> <td style="width: 10%;"></td> <td style="width: 10%;"></td> <td style="width: 10%;"></td> <td style="width: 10%;"></td> <td style="width: 10%;"></td> <td style="width: 10%;"></td> <td style="width: 10%;"></td> </tr> <tr> <td></td> <td></td> <td colspan="8" style="text-align: center;"> <table border="1" style="width: 100%; border-collapse: collapse; text-align: center;"> <tr> <td style="width: 10%;"></td> <td style="width: 10%;"></td> <td style="width: 10%;"></td> <td style="width: 10%;"></td> <td style="width: 10%;"></td> <td style="width: 10%;"></td> <td style="width: 10%;"></td> <td style="width: 10%;"></td> <td style="width: 10%;"></td> <td style="width: 10%;"></td> </tr> <tr> <td></td> <td></td> <td colspan="8" style="text-align: center;"> <table border="1" style="width: 100%; border-collapse: collapse; text-align: center;"> <tr> <td style="width: 10%;"></td> <td style="width: 10%;"></td> <td style="width: 10%;"></td> <td style="width: 10%;"></td> <td style="width: 10%;"></td> <td style="width: 10%;"></td> <td style="width: 10%;"></td> <td style="width: 10%;"></td> <td style="width: 10%;"></td> <td style="width: 10%;"></td> </tr> <tr> <td></td> <td></td> <td colspan="8" style="text-align: center;"> <table border="1" style="width: 100%; border-collapse: collapse; text-align: center;"> <tr> <td style="width: 10%;"></td> <td style="width: 10%;"></td> <td style="width: 10%;"></td> <td style="width: 10%;"></td> <td style="width: 10%;"></td> <td style="width: 10%;"></td> <td style="width: 10%;"></td> <td style="width: 10%;"></td> <td style="width: 10%;"></td> <td style="width: 10%;"></td> </tr> <tr> <td></td> <td></td> <td colspan="8" style="text-align: center;"> <table border="1" style="width: 100%; border-collapse: collapse; text-align: center;"> <tr> <td style="width: 10%;"></td> <td style="width: 10%;"></td> <td style="width: 10%;"></td> <td style="width: 10%;"></td> <td style="width: 10%;"></td> <td style="width: 10%;"></td> <td style="width: 10%;"></td> <td style="width: 10%;"></td> <td style="width: 10%;"></td> <td style="width: 10%;"></td> </tr> <tr> <td></td> <td></td> <td colspan="8" style="text-align: center;"> <table border="1" style="width: 100%; border-collapse: collapse; text-align: center;"> <tr> </tr></table></td></tr></table></td></tr></table></td></tr></table></td></tr></table></td></tr></table></td></tr></table></td></tr></table></td></tr></table></td></tr></table></td></tr></table></td></tr></table></td></tr></table></td></tr></table></td></tr></table></td></tr></table></td></tr></table></td></tr></table></td></tr></table></td></tr></table></td></tr></table></td></tr></table></td></tr></table></td></tr></table></td></tr></table></td></tr></table></td></tr></table></td></tr></table></td></tr></table></td></tr></table></td></tr></table></td></tr></table></td></tr></table></td></tr></table></td></tr></table></td></tr></table></td></tr></table></td></tr></table></td></tr></table></td></tr></table></td></tr></table></td></tr></table></td></tr></table></td></tr></table></td></tr></table></td></tr></table></td></tr></table></td></tr></table></td></tr></table></td></tr></table></td></tr></table></td></tr></table></td></tr></table> | | | | | | | | | | | | | | | | | | | | <table border="1" style="width: 100%; border-collapse: collapse; text-align: center;"> <tr> <td style="width: 10%;"></td> <td style="width: 10%;"></td> <td style="width: 10%;"></td> <td style="width: 10%;"></td> <td style="width: 10%;"></td> <td style="width: 10%;"></td> <td style="width: 10%;"></td> <td style="width: 10%;"></td> <td style="width: 10%;"></td> <td style="width: 10%;"></td> </tr> <tr> <td></td> <td></td> <td colspan="8" style="text-align: center;"> <table border="1" style="width: 100%; border-collapse: collapse; text-align: center;"> <tr> <td style="width: 10%;"></td> <td style="width: 10%;"></td> <td style="width: 10%;"></td> <td style="width: 10%;"></td> <td style="width: 10%;"></td> <td style="width: 10%;"></td> <td style="width: 10%;"></td> <td style="width: 10%;"></td> <td style="width: 10%;"></td> <td style="width: 10%;"></td> </tr> <tr> <td></td> <td></td> <td colspan="8" style="text-align: center;"> <table border="1" style="width: 100%; border-collapse: collapse; text-align: center;"> <tr> <td style="width: 10%;"></td> <td style="width: 10%;"></td> <td style="width: 10%;"></td> <td style="width: 10%;"></td> <td style="width: 10%;"></td> <td style="width: 10%;"></td> <td style="width: 10%;"></td> <td style="width: 10%;"></td> <td style="width: 10%;"></td> <td style="width: 10%;"></td> </tr> <tr> <td></td> <td></td> <td colspan="8" style="text-align: center;"> <table border="1" style="width: 100%; border-collapse: collapse; text-align: center;"> <tr> <td style="width: 10%;"></td> <td style="width: 10%;"></td> <td style="width: 10%;"></td> <td style="width: 10%;"></td> <td style="width: 10%;"></td> <td style="width: 10%;"></td> <td style="width: 10%;"></td> <td style="width: 10%;"></td> <td style="width: 10%;"></td> <td style="width: 10%;"></td> </tr> <tr> <td></td> <td></td> <td colspan="8" style="text-align: center;"> <table border="1" style="width: 100%; border-collapse: collapse; text-align: center;"> <tr> <td style="width: 10%;"></td> <td style="width: 10%;"></td> <td style="width: 10%;"></td> <td style="width: 10%;"></td> <td style="width: 10%;"></td> <td style="width: 10%;"></td> <td style="width: 10%;"></td> <td style="width: 10%;"></td> <td style="width: 10%;"></td> <td style="width: 10%;"></td> </tr> <tr> <td></td> <td></td> <td colspan="8" style="text-align: center;"> <table border="1" style="width: 100%; border-collapse: collapse; text-align: center;"> <tr> <td style="width: 10%;"></td> <td style="width: 10%;"></td> <td style="width: 10%;"></td> <td style="width: 10%;"></td> <td style="width: 10%;"></td> <td style="width: 10%;"></td> <td style="width: 10%;"></td> <td style="width: 10%;"></td> <td style="width: 10%;"></td> <td style="width: 10%;"></td> </tr> <tr> <td></td> <td></td> <td colspan="8" style="text-align: center;"> <table border="1" style="width: 100%; border-collapse: collapse; text-align: center;"> <tr> <td style="width: 10%;"></td> <td style="width: 10%;"></td> <td style="width: 10%;"></td> <td style="width: 10%;"></td> <td style="width: 10%;"></td> <td style="width: 10%;"></td> <td style="width: 10%;"></td> <td style="width: 10%;"></td> <td style="width: 10%;"></td> <td style="width: 10%;"></td> </tr> <tr> <td></td> <td></td> <td colspan="8" style="text-align: center;"> <table border="1" style="width: 100%; border-collapse: collapse; text-align: center;"> <tr> <td style="width: 10%;"></td> <td style="width: 10%;"></td> <td style="width: 10%;"></td> <td style="width: 10%;"></td> <td style="width: 10%;"></td> <td style="width: 10%;"></td> <td style="width: 10%;"></td> <td style="width: 10%;"></td> <td style="width: 10%;"></td> <td style="width: 10%;"></td> </tr> <tr> <td></td> <td></td> <td colspan="8" style="text-align: center;"> <table border="1" style="width: 100%; border-collapse: collapse; text-align: center;"> <tr> <td style="width: 10%;"></td> <td style="width: 10%;"></td> <td style="width: 10%;"></td> <td style="width: 10%;"></td> <td style="width: 10%;"></td> <td style="width: 10%;"></td> <td style="width: 10%;"></td> <td style="width: 10%;"></td> <td style="width: 10%;"></td> <td style="width: 10%;"></td> </tr> <tr> <td></td> <td></td> <td colspan="8" style="text-align: center;"> <table border="1" style="width: 100%; border-collapse: collapse; text-align: center;"> <tr> <td style="width: 10%;"></td> <td style="width: 10%;"></td> <td style="width: 10%;"></td> <td style="width: 10%;"></td> <td style="width: 10%;"></td> <td style="width:
10%;"></td> <td style="width: 10%;"></td> <td style="width: 10%;"></td> <td style="width: 10%;"></td> <td style="width: 10%;"></td> </tr> <tr> <td></td> <td></td> <td colspan="8" style="text-align: center;"> <table border="1" style="width: 100%; border-collapse: collapse; text-align: center;"> <tr> <td style="width: 10%;"></td> <td style="width: 10%;"></td> <td style="width: 10%;"></td> <td style="width: 10%;"></td> <td style="width: 10%;"></td> <td style="width: 10%;"></td> <td style="width: 10%;"></td> <td style="width: 10%;"></td> <td style="width: 10%;"></td> <td style="width: 10%;"></td> </tr> <tr> <td></td> <td></td> <td colspan="8" style="text-align: center;"> <table border="1" style="width: 100%; border-collapse: collapse; text-align: center;"> <tr> <td style="width: 10%;"></td> <td style="width: 10%;"></td> <td style="width: 10%;"></td> <td style="width: 10%;"></td> <td style="width: 10%;"></td> <td style="width: 10%;"></td> <td style="width: 10%;"></td> <td style="width: 10%;"></td> <td style="width: 10%;"></td> <td style="width: 10%;"></td> </tr> <tr> <td></td> <td></td> <td colspan="8" style="text-align: center;"> <table border="1" style="width: 100%; border-collapse: collapse; text-align: center;"> <tr> <td style="width: 10%;"></td> <td style="width: 10%;"></td> <td style="width: 10%;"></td> <td style="width: 10%;"></td> <td style="width: 10%;"></td> <td style="width: 10%;"></td> <td style="width: 10%;"></td> <td style="width: 10%;"></td> <td style="width: 10%;"></td> <td style="width: 10%;"></td> </tr> <tr> <td></td> <td></td> <td colspan="8" style="text-align: center;"> <table border="1" style="width: 100%; border-collapse: collapse; text-align: center;"> <tr> <td style="width: 10%;"></td> <td style="width: 10%;"></td> <td style="width: 10%;"></td> <td style="width: 10%;"></td> <td style="width: 10%;"></td> <td style="width: 10%;"></td> <td style="width: 10%;"></td> <td style="width: 10%;"></td> <td style="width: 10%;"></td> <td style="width: 10%;"></td> </tr> <tr> <td></td> <td></td> <td colspan="8" style="text-align: center;"> <table border="1" style="width: 100%; border-collapse: collapse; text-align: center;"> <tr> <td style="width: 10%;"></td> <td style="width: 10%;"></td> <td style="width: 10%;"></td> <td style="width: 10%;"></td> <td style="width: 10%;"></td> <td style="width: 10%;"></td> <td style="width: 10%;"></td> <td style="width: 10%;"></td> <td style="width: 10%;"></td> <td style="width: 10%;"></td> </tr> <tr> <td></td> <td></td> <td colspan="8" style="text-align: center;"> <table border="1" style="width: 100%; border-collapse: collapse; text-align: center;"> <tr> <td style="width: 10%;"></td> <td style="width: 10%;"></td> <td style="width: 10%;"></td> <td style="width: 10%;"></td> <td style="width: 10%;"></td> <td style="width: 10%;"></td> <td style="width: 10%;"></td> <td style="width: 10%;"></td> <td style="width: 10%;"></td> <td style="width: 10%;"></td> </tr> <tr> <td></td> <td></td> <td colspan="8" style="text-align: center;"> <table border="1" style="width: 100%; border-collapse: collapse; text-align: center;"> <tr> <td style="width: 10%;"></td> <td style="width: 10%;"></td> <td style="width: 10%;"></td> <td style="width: 10%;"></td> <td style="width: 10%;"></td> <td style="width: 10%;"></td> <td style="width: 10%;"></td> <td style="width: 10%;"></td> <td style="width: 10%;"></td> <td style="width: 10%;"></td> </tr> <tr> <td></td> <td></td> <td colspan="8" style="text-align: center;"> <table border="1" style="width: 100%; border-collapse: collapse; text-align: center;"> <tr> <td style="width: 10%;"></td> <td style="width: 10%;"></td> <td style="width: 10%;"></td> <td style="width: 10%;"></td> <td style="width: 10%;"></td> <td style="width: 10%;"></td> <td style="width: 10%;"></td> <td style="width: 10%;"></td> <td style="width: 10%;"></td> <td style="width: 10%;"></td> </tr> <tr> <td></td> <td></td> <td colspan="8" style="text-align: center;"> <table border="1" style="width: 100%; border-collapse: collapse; text-align: center;"> <tr> <td style="width: 10%;"></td> <td style="width: 10%;"></td> <td style="width: 10%;"></td> <td style="width: 10%;"></td> <td style="width: 10%;"></td> <td style="width: 10%;"></td> <td style="width: 10%;"></td> <td style="width: 10%;"></td> <td style="width: 10%;"></td> <td style="width: 10%;"></td> </tr> <tr> <td></td> <td></td> <td colspan="8" style="text-align: center;"> <table border="1" style="width: 100%; border-collapse: collapse; text-align: center;"> <tr> <td style="width: 10%;"></td> <td style="width: 10%;"></td> <td style="width: 10%;"></td> <td style="width: 10%;"></td> <td style="width: 10%;"></td> <td style="width: 10%;"></td> <td style="width: 10%;"></td> <td style="width: 10%;"></td> <td style="width: 10%;"></td> <td style="width: 10%;"></td> </tr> <tr> <td></td> <td></td> <td colspan="8" style="text-align: center;"> <table border="1" style="width: 100%; border-collapse: collapse; text-align: center;"> <tr> <td style="width: 10%;"></td> <td style="width: 10%;"></td> <td style="width: 10%;"></td> <td style="width: 10%;"></td> <td style="width: 10%;"></td> <td style="width: 10%;"></td> <td style="width: 10%;"></td> <td style="width: 10%;"></td> <td style="width: 10%;"></td> <td style="width: 10%;"></td> </tr> <tr> <td></td> <td></td> <td colspan="8" style="text-align: center;"> <table border="1" style="width: 100%; border-collapse: collapse; text-align: center;"> <tr> <td style="width: 10%;"></td> <td style="width: 10%;"></td> <td style="width: 10%;"></td> <td style="width: 10%;"></td> <td style="width: 10%;"></td> <td style="width: 10%;"></td> <td style="width: 10%;"></td> <td style="width: 10%;"></td> <td style="width: 10%;"></td> <td style="width: 10%;"></td> </tr> <tr> <td></td> <td></td> <td colspan="8" style="text-align: center;"> <table border="1" style="width: 100%; border-collapse: collapse; text-align: center;"> <tr> <td style="width: 10%;"></td> <td style="width: 10%;"></td> <td style="width: 10%;"></td> <td style="width: 10%;"></td> <td style="width: 10%;"></td> <td style="width: 10%;"></td> <td style="width: 10%;"></td> <td style="width: 10%;"></td> <td style="width: 10%;"></td> <td style="width: 10%;"></td> </tr> <tr> <td></td> <td></td> <td colspan="8" style="text-align: center;"> <table border="1" style="width: 100%; border-collapse: collapse; text-align: center;"> <tr> <td style="width: 10%;"></td> <td style="width: 10%;"></td> <td style="width: 10%;"></td> <td style="width: 10%;"></td> <td style="width: 10%;"></td> <td style="width: 10%;"></td> <td style="width: 10%;"></td> <td style="width: 10%;"></td> <td style="width: 10%;"></td> <td style="width: 10%;"></td> </tr> <tr> <td></td> <td></td> <td colspan="8" style="text-align: center;"> <table border="1" style="width: 100%; border-collapse: collapse; text-align: center;"> <tr> <td style="width: 10%;"></td> <td style="width: 10%;"></td> <td style="width: 10%;"></td> <td style="width: 10%;"></td> <td style="width: 10%;"></td> <td style="width: 10%;"></td> <td style="width: 10%;"></td> <td style="width: 10%;"></td> <td style="width: 10%;"></td> <td style="width: 10%;"></td> </tr> <tr> <td></td> <td></td> <td colspan="8" style="text-align: center;"> <table border="1" style="width: 100%; border-collapse: collapse; text-align: center;"> <tr> <td style="width: 10%;"></td> <td style="width: 10%;"></td> <td style="width: 10%;"></td> <td style="width: 10%;"></td> <td style="width: 10%;"></td> <td style="width: 10%;"></td> <td style="width: 10%;"></td> <td style="width: 10%;"></td> <td style="width: 10%;"></td> <td style="width: 10%;"></td> </tr> <tr> <td></td> <td></td> <td colspan="8" style="text-align: center;"> <table border="1" style="width: 100%; border-collapse: collapse; text-align: center;"> <tr> <td style="width: 10%;"></td> <td style="width: 10%;"></td> <td style="width: 10%;"></td> <td style="width: 10%;"></td> <td style="width: 10%;"></td> <td style="width: 10%;"></td> <td style="width: 10%;"></td> <td style="width: 10%;"></td> <td style="width: 10%;"></td> <td style="width: 10%;"></td> </tr> <tr> <td></td> <td></td> <td colspan="8" style="text-align: center;"> <table border="1" style="width: 100%; border-collapse: collapse; text-align: center;"> <tr> <td style="width: 10%;"></td> <td style="width: 10%;"></td> <td style="width: 10%;"></td> <td style="width: 10%;"></td> <td style="width: 10%;"></td> <td style="width: 10%;"></td> <td style="width: 10%;"></td> <td style="width: 10%;"></td> <td style="width: 10%;"></td> <td style="width: 10%;"></td> </tr> <tr> <td></td> <td></td> <td colspan="8" style="text-align: center;"> <table border="1" style="width: 100%; border-collapse: collapse; text-align: center;"> <tr> <td style="width: 10%;"></td> <td style="width: 10%;"></td> <td style="width: 10%;"></td> <td style="width: 10%;"></td> <td style="width: 10%;"></td> <td style="width: 10%;"></td> <td style="width: 10%;"></td> <td style="width: 10%;"></td> <td style="width: 10%;"></td> <td style="width: 10%;"></td> </tr> <tr> <td></td> <td></td> <td colspan="8" style="text-align: center;"> <table border="1" style="width: 100%; border-collapse: collapse; text-align: center;"> <tr> <td style="width: 10%;"></td> <td style="width: 10%;"></td> <td style="width: 10%;"></td> <td style="width: 10%;"></td> <td style="width: 10%;"></td> <td style="width: 10%;"></td> <td style="width: 10%;"></td> <td style="width: 10%;"></td> <td style="width: 10%;"></td> <td style="width: 10%;"></td> </tr> <tr> <td></td> <td></td> <td colspan="8" style="text-align: center;"> <table border="1" style="width: 100%; border-collapse: collapse; text-align: center;"> <tr> <td style="width: 10%;"></td> <td style="width: 10%;"></td> <td style="width: 10%;"></td> <td style="width: 10%;"></td> <td style="width: 10%;"></td> <td style="width: 10%;"></td> <td style="width: 10%;"></td> <td style="width: 10%;"></td> <td style="width: 10%;"></td> <td style="width: 10%;"></td> </tr> <tr> <td></td> <td></td> <td
colspan="8" style="text-align: center;"> <table border="1" style="width: 100%; border-collapse: collapse; text-align: center;"> <tr> <td style="width: 10%;"></td> <td style="width: 10%;"></td> <td style="width: 10%;"></td> <td style="width: 10%;"></td> <td style="width: 10%;"></td> <td style="width: 10%;"></td> <td style="width: 10%;"></td> <td style="width: 10%;"></td> <td style="width: 10%;"></td> <td style="width: 10%;"></td> </tr> <tr> <td></td> <td></td> <td colspan="8" style="text-align: center;"> <table border="1" style="width: 100%; border-collapse: collapse; text-align: center;"> <tr> <td style="width: 10%;"></td> <td style="width: 10%;"></td> <td style="width: 10%;"></td> <td style="width: 10%;"></td> <td style="width: 10%;"></td> <td style="width: 10%;"></td> <td style="width: 10%;"></td> <td style="width: 10%;"></td> <td style="width: 10%;"></td> <td style="width: 10%;"></td> </tr> <tr> <td></td> <td></td> <td colspan="8" style="text-align: center;"> <table border="1" style="width: 100%; border-collapse: collapse; text-align: center;"> <tr> <td style="width: 10%;"></td> <td style="width: 10%;"></td> <td style="width: 10%;"></td> <td style="width: 10%;"></td> <td style="width: 10%;"></td> <td style="width: 10%;"></td> <td style="width: 10%;"></td> <td style="width: 10%;"></td> <td style="width: 10%;"></td> <td style="width: 10%;"></td> </tr> <tr> <td></td> <td></td> <td colspan="8" style="text-align: center;"> <table border="1" style="width: 100%; border-collapse: collapse; text-align: center;"> <tr> <td style="width: 10%;"></td> <td style="width: 10%;"></td> <td style="width: 10%;"></td> <td style="width: 10%;"></td> <td style="width: 10%;"></td> <td style="width: 10%;"></td> <td style="width: 10%;"></td> <td style="width: 10%;"></td> <td style="width: 10%;"></td> <td style="width: 10%;"></td> </tr> <tr> <td></td> <td></td> <td colspan="8" style="text-align: center;"> <table border="1" style="width: 100%; border-collapse: collapse; text-align: center;"> <tr> <td style="width: 10%;"></td> <td style="width: 10%;"></td> <td style="width: 10%;"></td> <td style="width: 10%;"></td> <td style="width: 10%;"></td> <td style="width: 10%;"></td> <td style="width: 10%;"></td> <td style="width: 10%;"></td> <td style="width: 10%;"></td> <td style="width: 10%;"></td> </tr> <tr> <td></td> <td></td> <td colspan="8" style="text-align: center;"> <table border="1" style="width: 100%; border-collapse: collapse; text-align: center;"> <tr> <td style="width: 10%;"></td> <td style="width: 10%;"></td> <td style="width: 10%;"></td> <td style="width: 10%;"></td> <td style="width: 10%;"></td> <td style="width: 10%;"></td> <td style="width: 10%;"></td> <td style="width: 10%;"></td> <td style="width: 10%;"></td> <td style="width: 10%;"></td> </tr> <tr> <td></td> <td></td> <td colspan="8" style="text-align: center;"> <table border="1" style="width: 100%; border-collapse: collapse; text-align: center;"> <tr> <td style="width: 10%;"></td> <td style="width: 10%;"></td> <td style="width: 10%;"></td> <td style="width: 10%;"></td> <td style="width: 10%;"></td> <td style="width: 10%;"></td> <td style="width: 10%;"></td> <td style="width: 10%;"></td> <td style="width: 10%;"></td> <td style="width: 10%;"></td> </tr> <tr> <td></td> <td></td> <td colspan="8" style="text-align: center;"> <table border="1" style="width: 100%; border-collapse: collapse; text-align: center;"> <tr> <td style="width: 10%;"></td> <td style="width: 10%;"></td> <td style="width: 10%;"></td> <td style="width: 10%;"></td> <td style="width: 10%;"></td> <td style="width: 10%;"></td> <td style="width: 10%;"></td> <td style="width: 10%;"></td> <td style="width: 10%;"></td> <td style="width: 10%;"></td> </tr> <tr> <td></td> <td></td> <td colspan="8" style="text-align: center;"> <table border="1" style="width: 100%; border-collapse: collapse; text-align: center;"> <tr> <td style="width: 10%;"></td> <td style="width: 10%;"></td> <td style="width: 10%;"></td> <td style="width: 10%;"></td> <td style="width: 10%;"></td> <td style="width: 10%;"></td> <td style="width: 10%;"></td> <td style="width: 10%;"></td> <td style="width: 10%;"></td> <td style="width: 10%;"></td> </tr> <tr> <td></td> <td></td> <td colspan="8" style="text-align: center;"> <table border="1" style="width: 100%; border-collapse: collapse; text-align: center;"> <tr> <td style="width: 10%;"></td> <td style="width: 10%;"></td> <td style="width: 10%;"></td> <td style="width: 10%;"></td> <td style="width: 10%;"></td> <td style="width: 10%;"></td> <td style="width: 10%;"></td> <td style="width: 10%;"></td> <td style="width: 10%;"></td> <td style="width: 10%;"></td> </tr> <tr> <td></td> <td></td> <td colspan="8" style="text-align: center;"> <table border="1" style="width: 100%; border-collapse: collapse; text-align: center;"> <tr> <td style="width: 10%;"></td> <td style="width: 10%;"></td> <td style="width: 10%;"></td> <td style="width: 10%;"></td> <td style="width: 10%;"></td> <td style="width: 10%;"></td> <td style="width: 10%;"></td> <td style="width: 10%;"></td> <td style="width: 10%;"></td> <td style="width: 10%;"></td> </tr> <tr> <td></td> <td></td> <td colspan="8" style="text-align: center;"> <table border="1" style="width: 100%; border-collapse: collapse; text-align: center;"> <tr> <td style="width: 10%;"></td> <td style="width: 10%;"></td> <td style="width: 10%;"></td> <td style="width: 10%;"></td> <td style="width: 10%;"></td> <td style="width: 10%;"></td> <td style="width: 10%;"></td> <td style="width: 10%;"></td> <td style="width: 10%;"></td> <td style="width: 10%;"></td> </tr> <tr> <td></td> <td></td> <td colspan="8" style="text-align: center;"> <table border="1" style="width: 100%; border-collapse: collapse; text-align: center;"> <tr> <td style="width: 10%;"></td> <td style="width: 10%;"></td> <td style="width: 10%;"></td> <td style="width: 10%;"></td> <td style="width: 10%;"></td> <td style="width: 10%;"></td> <td style="width: 10%;"></td> <td style="width: 10%;"></td> <td style="width: 10%;"></td> <td style="width: 10%;"></td> </tr> <tr> <td></td> <td></td> <td colspan="8" style="text-align: center;"> <table border="1" style="width: 100%; border-collapse: collapse; text-align: center;"> <tr> <td style="width: 10%;"></td> <td style="width: 10%;"></td> <td style="width: 10%;"></td> <td style="width: 10%;"></td> <td style="width: 10%;"></td> <td style="width: 10%;"></td> <td style="width: 10%;"></td> <td style="width: 10%;"></td> <td style="width: 10%;"></td> <td style="width: 10%;"></td> </tr> <tr> <td></td> <td></td> <td colspan="8" style="text-align: center;"> <table border="1" style="width: 100%; border-collapse: collapse; text-align: center;"> <tr> <td style="width: 10%;"></td> <td style="width: 10%;"></td> <td style="width: 10%;"></td> <td style="width: 10%;"></td> <td style="width: 10%;"></td> <td style="width: 10%;"></td> <td style="width: 10%;"></td> <td style="width: 10%;"></td> <td style="width: 10%;"></td> <td style="width: 10%;"></td> </tr> <tr> <td></td> <td></td> <td colspan="8" style="text-align: center;"> <table border="1" style="width: 100%; border-collapse: collapse; text-align: center;"> <tr> <td style="width: 10%;"></td> <td style="width: 10%;"></td> <td style="width: 10%;"></td> <td style="width: 10%;"></td> <td style="width: 10%;"></td> <td style="width: 10%;"></td> <td style="width: 10%;"></td> <td style="width: 10%;"></td> <td style="width: 10%;"></td> <td style="width: 10%;"></td> </tr> <tr> <td></td> <td></td> <td colspan="8" style="text-align: center;"> <table border="1" style="width: 100%; border-collapse: collapse; text-align: center;"> <tr> <td style="width: 10%;"></td> <td style="width: 10%;"></td> <td style="width: 10%;"></td> <td style="width: 10%;"></td> <td style="width: 10%;"></td> <td style="width: 10%;"></td> <td style="width: 10%;"></td> <td style="width: 10%;"></td> <td style="width: 10%;"></td> <td style="width: 10%;"></td> </tr> <tr> <td></td> <td></td> <td colspan="8" style="text-align: center;"> <table border="1" style="width: 100%; border-collapse: collapse; text-align: center;"> <tr> <td style="width: 10%;"></td> <td style="width: 10%;"></td> <td style="width: 10%;"></td> <td style="width: 10%;"></td> <td style="width: 10%;"></td> <td style="width: 10%;"></td> <td style="width: 10%;"></td> <td style="width: 10%;"></td> <td style="width: 10%;"></td> <td style="width: 10%;"></td> </tr> <tr> <td></td> <td></td> <td colspan="8" style="text-align: center;"> <table border="1" style="width: 100%; border-collapse: collapse; text-align: center;"> <tr> <td style="width: 10%;"></td> <td style="width: 10%;"></td> <td style="width: 10%;"></td> <td style="width: 10%;"></td> <td style="width: 10%;"></td> <td style="width: 10%;"></td> <td style="width: 10%;"></td> <td style="width: 10%;"></td> <td style="width: 10%;"></td> <td style="width: 10%;"></td> </tr> <tr> <td></td> <td></td> <td colspan="8" style="text-align: center;"> <table border="1" style="width: 100%; border-collapse: collapse; text-align: center;"> <tr> <td style="width: 10%;"></td> <td style="width: 10%;"></td> <td style="width: 10%;"></td> <td style="width: 10%;"></td> <td style="width: 10%;"></td> <td style="width: 10%;"></td> <td style="width: 10%;"></td> <td style="width: 10%;"></td> <td style="width: 10%;"></td> <td style="width: 10%;"></td> </tr> <tr> <td></td> <td></td> <td colspan="8" style="text-align: center;"> <table border="1" style="width: 100%; border-collapse: collapse; text-align: center;"> <tr>
</tr></table></td></tr></table></td></tr></table></td></tr></table></td></tr></table></td></tr></table></td></tr></table></td></tr></table></td></tr></table></td></tr></table></td></tr></table></td></tr></table></td></tr></table></td></tr></table></td></tr></table></td></tr></table></td></tr></table></td></tr></table></td></tr></table></td></tr></table></td></tr></table></td></tr></table></td></tr></table></td></tr></table></td></tr></table></td></tr></table></td></tr></table></td></tr></table></td></tr></table></td></tr></table></td></tr></table></td></tr></table></td></tr></table></td></tr></table></td></tr></table></td></tr></table></td></tr></table></td></tr></table></td></tr></table></td></tr></table></td></tr></table></td></tr></table></td></tr></table></td></tr></table></td></tr></table></td></tr></table></td></tr></table></td></tr></table></td></tr></table></td></tr></table></td></tr></table></td></tr></table> | | | | | | | | | | | | | | | | | | | | <table border="1" style="width: 100%; border-collapse: collapse; text-align: center;"> <tr> <td style="width: 10%;"></td> <td style="width: 10%;"></td> <td style="width: 10%;"></td> <td style="width: 10%;"></td> <td style="width: 10%;"></td> <td style="width: 10%;"></td> <td style="width: 10%;"></td> <td style="width: 10%;"></td> <td style="width: 10%;"></td> <td style="width: 10%;"></td> </tr> <tr> <td></td> <td></td> <td colspan="8" style="text-align: center;"> <table border="1" style="width: 100%; border-collapse: collapse; text-align: center;"> <tr> <td style="width: 10%;"></td> <td style="width: 10%;"></td> <td style="width: 10%;"></td> <td style="width: 10%;"></td> <td style="width: 10%;"></td> <td style="width: 10%;"></td> <td style="width: 10%;"></td> <td style="width: 10%;"></td> <td style="width: 10%;"></td> <td style="width: 10%;"></td> </tr> <tr> <td></td> <td></td> <td colspan="8" style="text-align: center;"> <table border="1" style="width: 100%; border-collapse: collapse; text-align: center;"> <tr> <td style="width: 10%;"></td> <td style="width: 10%;"></td> <td style="width: 10%;"></td> <td style="width: 10%;"></td> <td style="width: 10%;"></td> <td style="width: 10%;"></td> <td style="width: 10%;"></td> <td style="width: 10%;"></td> <td style="width: 10%;"></td> <td style="width: 10%;"></td> </tr> <tr> <td></td> <td></td> <td colspan="8" style="text-align: center;"> <table border="1" style="width: 100%; border-collapse: collapse; text-align: center;"> <tr> <td style="width: 10%;"></td> <td style="width: 10%;"></td> <td style="width: 10%;"></td> <td style="width: 10%;"></td> <td style="width: 10%;"></td> <td style="width: 10%;"></td> <td style="width: 10%;"></td> <td style="width: 10%;"></td> <td style="width: 10%;"></td> <td style="width: 10%;"></td> </tr> <tr> <td></td> <td></td> <td colspan="8" style="text-align: center;"> <table border="1" style="width: 100%; border-collapse: collapse; text-align: center;"> <tr> <td style="width: 10%;"></td> <td style="width: 10%;"></td> <td style="width: 10%;"></td> <td style="width: 10%;"></td> <td style="width: 10%;"></td> <td style="width: 10%;"></td> <td style="width: 10%;"></td> <td style="width: 10%;"></td> <td style="width: 10%;"></td> <td style="width: 10%;"></td> </tr> <tr> <td></td> <td></td> <td colspan="8" style="text-align: center;"> <table border="1" style="width: 100%; border-collapse: collapse; text-align: center;"> <tr> <td style="width: 10%;"></td> <td style="width: 10%;"></td> <td style="width: 10%;"></td> <td style="width: 10%;"></td> <td style="width: 10%;"></td> <td style="width: 10%;"></td> <td style="width: 10%;"></td> <td style="width: 10%;"></td> <td style="width: 10%;"></td> <td style="width: 10%;"></td> </tr> <tr> <td></td> <td></td> <td colspan="8" style="text-align: center;"> <table border="1" style="width: 100%; border-collapse: collapse; text-align: center;"> <tr> <td style="width: 10%;"></td> <td style="width: 10%;"></td> <td style="width: 10%;"></td> <td style="width: 10%;"></td> <td style="width: 10%;"></td> <td style="width: 10%;"></td> <td style="width: 10%;"></td> <td style="width: 10%;"></td> <td style="width: 10%;"></td> <td style="width: 10%;"></td> </tr> <tr> <td></td> <td></td> <td colspan="8" style="text-align: center;"> <table border="1" style="width: 100%; border-collapse: collapse; text-align: center;"> <tr> <td style="width: 10%;"></td> <td style="width: 10%;"></td> <td style="width: 10%;"></td> <td style="width: 10%;"></td> <td style="width: 10%;"></td> <td style="width: 10%;"></td> <td style="width: 10%;"></td> <td style="width: 10%;"></td> <td style="width: 10%;"></td> <td style="width: 10%;"></td> </tr> <tr> <td></td> <td></td> <td colspan="8" style="text-align: center;"> <table border="1" style="width: 100%; border-collapse: collapse; text-align: center;"> <tr> <td style="width: 10%;"></td> <td style="width: 10%;"></td> <td style="width: 10%;"></td> <td style="width: 10%;"></td> <td style="width: 10%;"></td> <td style="width: 10%;"></td> <td style="width: 10%;"></td> <td style="width: 10%;"></td> <td style="width: 10%;"></td> <td style="width: 10%;"></td> </tr> <tr> <td></td> <td></td> <td colspan="8" style="text-align: center;"> <table border="1" style="width: 100%; border-collapse: collapse; text-align: center;"> <tr> <td style="width: 10%;"></td> <td style="width: 10%;"></td> <td style="width: 10%;"></td> <td style="width: 10%;"></td> <td style="width: 10%;"></td> <td style="width: 10%;"></td> <td style="width: 10%;"></td> <td style="width: 10%;"></td> <td style="width: 10%;"></td> <td style="width: 10%;"></td> </tr> <tr> <td></td> <td></td> <td colspan="8" style="text-align: center;"> <table border="1" style="width: 100%; border-collapse: collapse; text-align: center;"> <tr> <td style="width: 10%;"></td> <td style="width: 10%;"></td> <td style="width: 10%;"></td> <td style="width: 10%;"></td> <td style="width: 10%;"></td> <td style="width: 10%;"></td> <td style="width: 10%;"></td> <td style="width: 10%;"></td> <td style="width: 10%;"></td> <td style="width: 10%;"></td> </tr> <tr> <td></td> <td></td> <td colspan="8" style="text-align: center;"> <table border="1" style="width: 100%; border-collapse: collapse; text-align: center;"> <tr> <td style="width: 10%;"></td> <td style="width: 10%;"></td> <td style="width: 10%;"></td> <td style="width: 10%;"></td> <td style="width: 10%;"></td> <td style="width: 10%;"></td> <td style="width: 10%;"></td> <td style="width: 10%;"></td> <td style="width: 10%;"></td> <td style="width: 10%;"></td> </tr> <tr> <td></td> <td></td> <td colspan="8" style="text-align: center;"> <table border="1" style="width: 100%; border-collapse: collapse; text-align: center;"> <tr> <td style="width: 10%;"></td> <td style="width: 10%;"></td> <td style="width: 10%;"></td> <td style="width: 10%;"></td> <td style="width: 10%;"></td> <td style="width: 10%;"></td> <td style="width: 10%;"></td> <td style="width: 10%;"></td> <td style="width: 10%;"></td> <td style="width: 10%;"></td> </tr> <tr> <td></td> <td></td> <td colspan="8" style="text-align: center;"> <table border="1" style="width: 100%; border-collapse: collapse; text-align: center;"> <tr> <td style="width: 10%;"></td> <td style="width: 10%;"></td> <td style="width: 10%;"></td> <td style="width: 10%;"></td> <td style="width: 10%;"></td> <td style="width: 10%;"></td> <td style="width: 10%;"></td> <td style="width: 10%;"></td> <td style="width: 10%;"></td> <td style="width: 10%;"></td> </tr> <tr> <td></td> <td></td> <td colspan="8" style="text-align: center;"> <table border="1" style="width: 100%; border-collapse: collapse; text-align: center;"> <tr> <td style="width: 10%;"></td> <td style="width: 10%;"></td> <td style="width: 10%;"></td> <td style="width: 10%;"></td> <td style="width: 10%;"></td> <td style="width: 10%;"></td> <td style="width: 10%;"></td> <td style="width: 10%;"></td> <td style="width: 10%;"></td> <td style="width: 10%;"></td> </tr> <tr> <td></td> <td></td> <td colspan="8" style="text-align: center;"> <table border="1" style="width: 100%;
border-collapse: collapse; text-align: center;"> <tr> <td style="width: 10%;"></td> <td style="width: 10%;"></td> <td style="width: 10%;"></td> <td style="width: 10%;"></td> <td style="width: 10%;"></td> <td style="width: 10%;"></td> <td style="width: 10%;"></td> <td style="width: 10%;"></td> <td style="width: 10%;"></td> <td style="width: 10%;"></td> </tr> <tr> <td></td> <td></td> <td colspan="8" style="text-align: center;"> <table border="1" style="width: 100%; border-collapse: collapse; text-align: center;"> <tr> <td style="width: 10%;"></td> <td style="width: 10%;"></td> <td style="width: 10%;"></td> <td style="width: 10%;"></td> <td style="width: 10%;"></td> <td style="width: 10%;"></td> <td style="width: 10%;"></td> <td style="width: 10%;"></td> <td style="width: 10%;"></td> <td style="width: 10%;"></td> </tr> <tr> <td></td> <td></td> <td colspan="8" style="text-align: center;"> <table border="1" style="width: 100%; border-collapse: collapse; text-align: center;"> <tr> <td style="width: 10%;"></td> <td style="width: 10%;"></td> <td style="width: 10%;"></td> <td style="width: 10%;"></td> <td style="width: 10%;"></td> <td style="width: 10%;"></td> <td style="width: 10%;"></td> <td style="width: 10%;"></td> <td style="width: 10%;"></td> <td style="width: 10%;"></td> </tr> <tr> <td></td> <td></td> <td colspan="8" style="text-align: center;"> <table border="1" style="width: 100%; border-collapse: collapse; text-align: center;"> <tr> <td style="width: 10%;"></td> <td style="width: 10%;"></td> <td style="width: 10%;"></td> <td style="width: 10%;"></td> <td style="width: 10%;"></td> <td style="width: 10%;"></td> <td style="width: 10%;"></td> <td style="width: 10%;"></td> <td style="width: 10%;"></td> <td style="width: 10%;"></td> </tr> <tr> <td></td> <td></td> <td colspan="8" style="text-align: center;"> <table border="1" style="width: 100%; border-collapse: collapse; text-align: center;"> <tr> <td style="width: 10%;"></td> <td style="width: 10%;"></td> <td style="width: 10%;"></td> <td style="width: 10%;"></td> <td style="width: 10%;"></td> <td style="width: 10%;"></td> <td style="width: 10%;"></td> <td style="width: 10%;"></td> <td style="width: 10%;"></td> <td style="width: 10%;"></td> </tr> <tr> <td></td> <td></td> <td colspan="8" style="text-align: center;"> <table border="1" style="width: 100%; border-collapse: collapse; text-align: center;"> <tr> <td style="width: 10%;"></td> <td style="width: 10%;"></td> <td style="width: 10%;"></td> <td style="width: 10%;"></td> <td style="width: 10%;"></td> <td style="width: 10%;"></td> <td style="width: 10%;"></td> <td style="width: 10%;"></td> <td style="width: 10%;"></td> <td style="width: 10%;"></td> </tr> <tr> <td></td> <td></td> <td colspan="8" style="text-align: center;"> <table border="1" style="width: 100%; border-collapse: collapse; text-align: center;"> <tr> <td style="width: 10%;"></td> <td style="width: 10%;"></td> <td style="width: 10%;"></td> <td style="width: 10%;"></td> <td style="width: 10%;"></td> <td style="width: 10%;"></td> <td style="width: 10%;"></td> <td style="width: 10%;"></td> <td style="width: 10%;"></td> <td style="width: 10%;"></td> </tr> <tr> <td></td> <td></td> <td colspan="8" style="text-align: center;"> <table border="1" style="width: 100%; border-collapse: collapse; text-align: center;"> <tr> <td style="width: 10%;"></td> <td style="width: 10%;"></td> <td style="width: 10%;"></td> <td style="width: 10%;"></td> <td style="width: 10%;"></td> <td style="width: 10%;"></td> <td style="width: 10%;"></td> <td style="width: 10%;"></td> <td style="width: 10%;"></td> <td style="width: 10%;"></td> </tr> <tr> <td></td> <td></td> <td colspan="8" style="text-align: center;"> <table border="1" style="width: 100%; border-collapse: collapse; text-align: center;"> <tr> <td style="width: 10%;"></td> <td style="width: 10%;"></td> <td style="width: 10%;"></td> <td style="width: 10%;"></td> <td style="width: 10%;"></td> <td style="width: 10%;"></td> <td style="width: 10%;"></td> <td style="width: 10%;"></td> <td style="width: 10%;"></td> <td style="width: 10%;"></td> </tr> <tr> <td></td> <td></td> <td colspan="8" style="text-align: center;"> <table border="1" style="width: 100%; border-collapse: collapse; text-align: center;"> <tr> <td style="width: 10%;"></td> <td style="width: 10%;"></td> <td style="width: 10%;"></td> <td style="width: 10%;"></td> <td style="width: 10%;"></td> <td style="width: 10%;"></td> <td style="width: 10%;"></td> <td style="width: 10%;"></td> <td style="width: 10%;"></td> <td style="width: 10%;"></td> </tr> <tr> <td></td> <td></td> <td colspan="8" style="text-align: center;"> <table border="1" style="width: 100%; border-collapse: collapse; text-align: center;"> <tr> <td style="width: 10%;"></td> <td style="width: 10%;"></td> <td style="width: 10%;"></td> <td style="width: 10%;"></td> <td style="width: 10%;"></td> <td style="width: 10%;"></td> <td style="width: 10%;"></td> <td style="width: 10%;"></td> <td style="width: 10%;"></td> <td style="width: 10%;"></td> </tr> <tr> <td></td> <td></td> <td colspan="8" style="text-align: center;"> <table border="1" style="width: 100%; border-collapse: collapse; text-align: center;"> <tr> <td style="width: 10%;"></td> <td style="width: 10%;"></td> <td style="width: 10%;"></td> <td style="width: 10%;"></td> <td style="width: 10%;"></td> <td style="width: 10%;"></td> <td style="width: 10%;"></td> <td style="width: 10%;"></td> <td style="width: 10%;"></td> <td style="width: 10%;"></td> </tr> <tr> <td></td> <td></td> <td colspan="8" style="text-align: center;"> <table border="1" style="width: 100%; border-collapse: collapse; text-align: center;"> <tr> <td style="width: 10%;"></td> <td style="width: 10%;"></td> <td style="width: 10%;"></td> <td style="width: 10%;"></td> <td style="width: 10%;"></td> <td style="width: 10%;"></td> <td style="width: 10%;"></td> <td style="width: 10%;"></td> <td style="width: 10%;"></td> <td style="width: 10%;"></td> </tr> <tr> <td></td> <td></td> <td colspan="8" style="text-align: center;"> <table border="1" style="width: 100%; border-collapse: collapse; text-align: center;"> <tr> <td style="width: 10%;"></td> <td style="width: 10%;"></td> <td style="width: 10%;"></td> <td style="width: 10%;"></td> <td style="width: 10%;"></td> <td style="width: 10%;"></td> <td style="width: 10%;"></td> <td style="width: 10%;"></td> <td style="width: 10%;"></td> <td style="width: 10%;"></td> </tr> <tr> <td></td> <td></td> <td colspan="8" style="text-align: center;"> <table border="1" style="width: 100%; border-collapse: collapse; text-align: center;"> <tr> <td style="width: 10%;"></td> <td style="width: 10%;"></td> <td style="width: 10%;"></td> <td style="width: 10%;"></td> <td style="width: 10%;"></td> <td style="width: 10%;"></td> <td style="width: 10%;"></td> <td style="width: 10%;"></td> <td style="width: 10%;"></td> <td style="width: 10%;"></td> </tr> <tr> <td></td> <td></td> <td colspan="8" style="text-align: center;"> <table border="1" style="width: 100%; border-collapse: collapse; text-align: center;"> <tr> <td style="width: 10%;"></td> <td style="width: 10%;"></td> <td style="width: 10%;"></td> <td style="width: 10%;"></td> <td style="width: 10%;"></td> <td style="width: 10%;"></td> <td style="width: 10%;"></td> <td style="width: 10%;"></td> <td style="width: 10%;"></td> <td style="width: 10%;"></td> </tr> <tr> <td></td> <td></td> <td colspan="8" style="text-align: center;"> <table border="1" style="width: 100%; border-collapse: collapse; text-align: center;"> <tr> <td style="width: 10%;"></td> <td style="width: 10%;"></td> <td style="width: 10%;"></td> <td style="width: 10%;"></td> <td style="width: 10%;"></td> <td style="width: 10%;"></td> <td style="width: 10%;"></td> <td style="width: 10%;"></td> <td style="width: 10%;"></td> <td style="width: 10%;"></td> </tr> <tr> <td></td> <td></td> <td colspan="8" style="text-align: center;"> <table border="1" style="width: 100%; border-collapse: collapse; text-align: center;"> <tr> <td style="width: 10%;"></td> <td style="width: 10%;"></td> <td style="width: 10%;"></td> <td style="width: 10%;"></td> <td style="width: 10%;"></td> <td style="width: 10%;"></td> <td style="width: 10%;"></td> <td style="width: 10%;"></td> <td style="width: 10%;"></td> <td style="width: 10%;"></td> </tr> <tr> <td></td> <td></td> <td colspan="8" style="text-align: center;"> <table border="1" style="width: 100%; border-collapse: collapse; text-align: center;"> <tr> <td style="width: 10%;"></td> <td style="width: 10%;"></td> <td style="width: 10%;"></td> <td style="width: 10%;"></td> <td style="width: 10%;"></td> <td style="width: 10%;"></td> <td style="width: 10%;"></td> <td style="width: 10%;"></td> <td style="width: 10%;"></td> <td style="width: 10%;"></td> </tr> <tr> <td></td> <td></td> <td colspan="8" style="text-align: center;"> <table border="1" style="width: 100%; border-collapse: collapse; text-align: center;"> <tr> <td style="width: 10%;"></td> <td style="width: 10%;"></td> <td style="width: 10%;"></td> <td style="width: 10%;"></td> <td style="width: 10%;"></td> <td style="width: 10%;"></td> <td style="width: 10%;"></td> <td style="width: 10%;"></td> <td style="width: 10%;"></td> <td style="width: 10%;"></td> </tr> <tr> <td></td> <td></td> <td colspan="8" style="text-align: center;"> <table border="1" style="width: 100%; border-collapse: collapse; text-align: center;"> <tr> <td style="width: 10%;"></td> <td style="width: 10%;"></td> <td style="width: 10%;"></td> <td style="width: 10%;"></td> <td style="width: 10%;"></td> <td style="width: 10%;"></td> <td style="width: 10%;"></td> <td style="width: 10%;"></td> <td style="width: 10%;"></td> <td style="width: 10%;"></td> </tr> <tr> <td></td> <td></td> <td colspan="8" style="text-align: center;"> <table border="1" style="width: 100%; border-collapse: collapse; text-align: center;"> <tr> <td style="width: 10%;"></td> <td style="width: 10%;"></td> <td style="width: 10%;"></td> <td style="width:
10%;"></td> <td style="width: 10%;"></td> <td style="width: 10%;"></td> <td style="width: 10%;"></td> <td style="width: 10%;"></td> <td style="width: 10%;"></td> <td style="width: 10%;"></td> </tr> <tr> <td></td> <td></td> <td colspan="8" style="text-align: center;"> <table border="1" style="width: 100%; border-collapse: collapse; text-align: center;"> <tr> <td style="width: 10%;"></td> <td style="width: 10%;"></td> <td style="width: 10%;"></td> <td style="width: 10%;"></td> <td style="width: 10%;"></td> <td style="width: 10%;"></td> <td style="width: 10%;"></td> <td style="width: 10%;"></td> <td style="width: 10%;"></td> <td style="width: 10%;"></td> </tr> <tr> <td></td> <td></td> <td colspan="8" style="text-align: center;"> <table border="1" style="width: 100%; border-collapse: collapse; text-align: center;"> <tr> <td style="width: 10%;"></td> <td style="width: 10%;"></td> <td style="width: 10%;"></td> <td style="width: 10%;"></td> <td style="width: 10%;"></td> <td style="width: 10%;"></td> <td style="width: 10%;"></td> <td style="width: 10%;"></td> <td style="width: 10%;"></td> <td style="width: 10%;"></td> </tr> <tr> <td></td> <td></td> <td colspan="8" style="text-align: center;"> <table border="1" style="width: 100%; border-collapse: collapse; text-align: center;"> <tr> <td style="width: 10%;"></td> <td style="width: 10%;"></td> <td style="width: 10%;"></td> <td style="width: 10%;"></td> <td style="width: 10%;"></td> <td style="width: 10%;"></td> <td style="width: 10%;"></td> <td style="width: 10%;"></td> <td style="width: 10%;"></td> <td style="width: 10%;"></td> </tr> <tr> <td></td> <td></td> <td colspan="8" style="text-align: center;"> <table border="1" style="width: 100%; border-collapse: collapse; text-align: center;"> <tr> <td style="width: 10%;"></td> <td style="width: 10%;"></td> <td style="width: 10%;"></td> <td style="width: 10%;"></td> <td style="width: 10%;"></td> <td style="width: 10%;"></td> <td style="width: 10%;"></td> <td style="width: 10%;"></td> <td style="width: 10%;"></td> <td style="width: 10%;"></td> </tr> <tr> <td></td> <td></td> <td colspan="8" style="text-align: center;"> <table border="1" style="width: 100%; border-collapse: collapse; text-align: center;"> <tr> <td style="width: 10%;"></td> <td style="width: 10%;"></td> <td style="width: 10%;"></td> <td style="width: 10%;"></td> <td style="width: 10%;"></td> <td style="width: 10%;"></td> <td style="width: 10%;"></td> <td style="width: 10%;"></td> <td style="width: 10%;"></td> <td style="width: 10%;"></td> </tr> <tr> <td></td> <td></td> <td colspan="8" style="text-align: center;"> <table border="1" style="width: 100%; border-collapse: collapse; text-align: center;"> <tr> <td style="width: 10%;"></td> <td style="width: 10%;"></td> <td style="width: 10%;"></td> <td style="width: 10%;"></td> <td style="width: 10%;"></td> <td style="width: 10%;"></td> <td style="width: 10%;"></td> <td style="width: 10%;"></td> <td style="width: 10%;"></td> <td style="width: 10%;"></td> </tr> <tr> <td></td> <td></td> <td colspan="8" style="text-align: center;"> <table border="1" style="width: 100%; border-collapse: collapse; text-align: center;"> <tr> <td style="width: 10%;"></td> <td style="width: 10%;"></td> <td style="width: 10%;"></td> <td style="width: 10%;"></td> <td style="width: 10%;"></td> <td style="width: 10%;"></td> <td style="width: 10%;"></td> <td style="width: 10%;"></td> <td style="width: 10%;"></td> <td style="width: 10%;"></td> </tr> <tr> <td></td> <td></td> <td colspan="8" style="text-align: center;"> <table border="1" style="width: 100%; border-collapse: collapse; text-align: center;"> <tr> <td style="width: 10%;"></td> <td style="width: 10%;"></td> <td style="width: 10%;"></td> <td style="width: 10%;"></td> <td style="width: 10%;"></td> <td style="width: 10%;"></td> <td style="width: 10%;"></td> <td style="width: 10%;"></td> <td style="width: 10%;"></td> <td style="width: 10%;"></td> </tr> <tr> <td></td> <td></td> <td colspan="8" style="text-align: center;"> <table border="1" style="width: 100%; border-collapse: collapse; text-align: center;"> <tr> <td style="width: 10%;"></td> <td style="width: 10%;"></td> <td style="width: 10%;"></td> <td style="width: 10%;"></td> <td style="width: 10%;"></td> <td style="width: 10%;"></td> <td style="width: 10%;"></td> <td style="width: 10%;"></td> <td style="width: 10%;"></td> <td style="width: 10%;"></td> </tr> <tr> <td></td> <td></td> <td colspan="8" style="text-align: center;"> <table border="1" style="width: 100%; border-collapse: collapse; text-align: center;"> <tr> <td style="width: 10%;"></td> <td style="width: 10%;"></td> <td style="width: 10%;"></td> <td style="width: 10%;"></td> <td style="width: 10%;"></td> <td style="width: 10%;"></td> <td style="width: 10%;"></td> <td style="width: 10%;"></td> <td style="width: 10%;"></td> <td style="width: 10%;"></td> </tr> <tr> <td></td> <td></td> <td colspan="8" style="text-align: center;"> <table border="1" style="width: 100%; border-collapse: collapse; text-align: center;"> <tr> <td style="width: 10%;"></td> <td style="width: 10%;"></td> <td style="width: 10%;"></td> <td style="width: 10%;"></td> <td style="width: 10%;"></td> <td style="width: 10%;"></td> <td style="width: 10%;"></td> <td style="width: 10%;"></td> <td style="width: 10%;"></td> <td style="width: 10%;"></td> </tr> <tr> <td></td> <td></td> <td colspan="8" style="text-align: center;"> <table border="1" style="width: 100%; border-collapse: collapse; text-align: center;"> <tr> <td style="width: 10%;"></td> <td style="width: 10%;"></td> <td style="width: 10%;"></td> <td style="width: 10%;"></td> <td style="width: 10%;"></td> <td style="width: 10%;"></td> <td style="width: 10%;"></td> <td style="width: 10%;"></td> <td style="width: 10%;"></td> <td style="width: 10%;"></td> </tr> <tr> <td></td> <td></td> <td colspan="8" style="text-align: center;"> <table border="1" style="width: 100%; border-collapse: collapse; text-align: center;"> <tr> <td style="width: 10%;"></td> <td style="width: 10%;"></td> <td style="width: 10%;"></td> <td style="width: 10%;"></td> <td style="width: 10%;"></td> <td style="width: 10%;"></td> <td style="width: 10%;"></td> <td style="width: 10%;"></td> <td style="width: 10%;"></td> <td style="width: 10%;"></td> </tr> <tr> <td></td> <td></td> <td colspan="8" style="text-align: center;"> <table border="1" style="width: 100%; border-collapse: collapse; text-align: center;"> <tr> </tr></table></td></tr></table></td></tr></table></td></tr></table></td></tr></table></td></tr></table></td></tr></table></td></tr></table></td></tr></table></td></tr></table></td></tr></table></td></tr></table></td></tr></table></td></tr></table></td></tr></table></td></tr></table></td></tr></table></td></tr></table></td></tr></table></td></tr></table></td></tr></table></td></tr></table></td></tr></table></td></tr></table></td></tr></table></td></tr></table></td></tr></table></td></tr></table></td></tr></table></td></tr></table></td></tr></table></td></tr></table></td></tr></table></td></tr></table></td></tr></table></td></tr></table></td></tr></table></td></tr></table></td></tr></table></td></tr></table></td></tr></table></td></tr></table></td></tr></table></td></tr></table></td></tr></table></td></tr></table></td></tr></table></td></tr></table></td></tr></table></td></tr></table></td></tr></table> | | | | | | | | | | | | | | | | | | | | <table border="1" style="width: 100%; border-collapse: collapse; text-align: center;"> <tr> <td style="width: 10%;"></td> <td style="width: 10%;"></td> <td style="width: 10%;"></td> <td style="width: 10%;"></td> <td style="width: 10%;"></td> <td style="width: 10%;"></td> <td style="width: 10%;"></td> <td style="width: 10%;"></td> <td style="width: 10%;"></td> <td style="width: 10%;"></td> </tr> <tr> <td></td> <td></td> <td colspan="8" style="text-align: center;"> <table border="1" style="width: 100%; border-collapse: collapse; text-align: center;"> <tr> <td style="width: 10%;"></td> <td style="width: 10%;"></td> <td style="width:
10%;"></td> <td style="width: 10%;"></td> <td style="width: 10%;"></td> <td style="width: 10%;"></td> <td style="width: 10%;"></td> <td style="width: 10%;"></td> <td style="width: 10%;"></td> <td style="width: 10%;"></td> </tr> <tr> <td></td> <td></td> <td colspan="8" style="text-align: center;"> <table border="1" style="width: 100%; border-collapse: collapse; text-align: center;"> <tr> <td style="width: 10%;"></td> <td style="width: 10%;"></td> <td style="width: 10%;"></td> <td style="width: 10%;"></td> <td style="width: 10%;"></td> <td style="width: 10%;"></td> <td style="width: 10%;"></td> <td style="width: 10%;"></td> <td style="width: 10%;"></td> <td style="width: 10%;"></td> </tr> <tr> <td></td> <td></td> <td colspan="8" style="text-align: center;"> <table border="1" style="width: 100%; border-collapse: collapse; text-align: center;"> <tr> <td style="width: 10%;"></td> <td style="width: 10%;"></td> <td style="width: 10%;"></td> <td style="width: 10%;"></td> <td style="width: 10%;"></td> <td style="width: 10%;"></td> <td style="width: 10%;"></td> <td style="width: 10%;"></td> <td style="width: 10%;"></td> <td style="width: 10%;"></td> </tr> <tr> <td></td> <td></td> <td colspan="8" style="text-align: center;"> <table border="1" style="width: 100%; border-collapse: collapse; text-align: center;"> <tr> <td style="width: 10%;"></td> <td style="width: 10%;"></td> <td style="width: 10%;"></td> <td style="width: 10%;"></td> <td style="width: 10%;"></td> <td style="width: 10%;"></td> <td style="width: 10%;"></td> <td style="width: 10%;"></td> <td style="width: 10%;"></td> <td style="width: 10%;"></td> </tr> <tr> <td></td> <td></td> <td colspan="8" style="text-align: center;"> <table border="1" style="width: 100%; border-collapse: collapse; text-align: center;"> <tr> <td style="width: 10%;"></td> <td style="width: 10%;"></td> <td style="width: 10%;"></td> <td style="width: 10%;"></td> <td style="width: 10%;"></td> <td style="width: 10%;"></td> <td style="width: 10%;"></td> <td style="width: 10%;"></td> <td style="width: 10%;"></td> <td style="width: 10%;"></td> </tr> <tr> <td></td> <td></td> <td colspan="8" style="text-align: center;"> <table border="1" style="width: 100%; border-collapse: collapse; text-align: center;"> <tr> <td style="width: 10%;"></td> <td style="width: 10%;"></td> <td style="width: 10%;"></td> <td style="width: 10%;"></td> <td style="width: 10%;"></td> <td style="width: 10%;"></td> <td style="width: 10%;"></td> <td style="width: 10%;"></td> <td style="width: 10%;"></td> <td style="width: 10%;"></td> </tr> <tr> <td></td> <td></td> <td colspan="8" style="text-align: center;"> <table border="1" style="width: 100%; border-collapse: collapse; text-align: center;"> <tr> <td style="width: 10%;"></td> <td style="width: 10%;"></td> <td style="width: 10%;"></td> <td style="width: 10%;"></td> <td style="width: 10%;"></td> <td style="width: 10%;"></td> <td style="width: 10%;"></td> <td style="width: 10%;"></td> <td style="width: 10%;"></td> <td style="width: 10%;"></td> </tr> <tr> <td></td> <td></td> <td colspan="8" style="text-align: center;"> <table border="1" style="width: 100%; border-collapse: collapse; text-align: center;"> <tr> <td style="width: 10%;"></td> <td style="width: 10%;"></td> <td style="width: 10%;"></td> <td style="width: 10%;"></td> <td style="width: 10%;"></td> <td style="width: 10%;"></td> <td style="width: 10%;"></td> <td style="width: 10%;"></td> <td style="width: 10%;"></td> <td style="width: 10%;"></td> </tr> <tr> <td></td> <td></td> <td colspan="8" style="text-align: center;"> <table border="1" style="width: 100%; border-collapse: collapse; text-align: center;"> <tr> <td style="width: 10%;"></td> <td style="width: 10%;"></td> <td style="width: 10%;"></td> <td style="width: 10%;"></td> <td style="width: 10%;"></td> <td style="width: 10%;"></td> <td style="width: 10%;"></td> <td style="width: 10%;"></td> <td style="width: 10%;"></td> <td style="width: 10%;"></td> </tr> <tr> <td></td> <td></td> <td colspan="8" style="text-align: center;"> <table border="1" style="width: 100%; border-collapse: collapse; text-align: center;"> <tr> <td style="width: 10%;"></td> <td style="width: 10%;"></td> <td style="width: 10%;"></td> <td style="width: 10%;"></td> <td style="width: 10%;"></td> <td style="width: 10%;"></td> <td style="width: 10%;"></td> <td style="width: 10%;"></td> <td style="width: 10%;"></td> <td style="width: 10%;"></td> </tr> <tr> <td></td> <td></td> <td colspan="8" style="text-align: center;"> <table border="1" style="width: 100%; border-collapse: collapse; text-align: center;"> <tr> <td style="width: 10%;"></td> <td style="width: 10%;"></td> <td style="width: 10%;"></td> <td style="width: 10%;"></td> <td style="width: 10%;"></td> <td style="width: 10%;"></td> <td style="width: 10%;"></td> <td style="width: 10%;"></td> <td style="width: 10%;"></td> <td style="width: 10%;"></td> </tr> <tr> <td></td> <td></td> <td colspan="8" style="text-align: center;"> <table border="1" style="width: 100%; border-collapse: collapse; text-align: center;"> <tr> <td style="width: 10%;"></td> <td style="width: 10%;"></td> <td style="width: 10%;"></td> <td style="width: 10%;"></td> <td style="width: 10%;"></td> <td style="width: 10%;"></td> <td style="width: 10%;"></td> <td style="width: 10%;"></td> <td style="width: 10%;"></td> <td style="width: 10%;"></td> </tr> <tr> <td></td> <td></td> <td colspan="8" style="text-align: center;"> <table border="1" style="width: 100%; border-collapse: collapse; text-align: center;"> <tr> <td style="width: 10%;"></td> <td style="width: 10%;"></td> <td style="width: 10%;"></td> <td style="width: 10%;"></td> <td style="width: 10%;"></td> <td style="width: 10%;"></td> <td style="width: 10%;"></td> <td style="width: 10%;"></td> <td style="width: 10%;"></td> <td style="width: 10%;"></td> </tr> <tr> <td></td> <td></td> <td colspan="8" style="text-align: center;"> <table border="1" style="width: 100%; border-collapse: collapse; text-align: center;"> <tr> <td style="width: 10%;"></td> <td style="width: 10%;"></td> <td style="width: 10%;"></td> <td style="width: 10%;"></td> <td style="width: 10%;"></td> <td style="width: 10%;"></td> <td style="width: 10%;"></td> <td style="width: 10%;"></td> <td style="width: 10%;"></td> <td style="width: 10%;"></td> </tr> <tr> <td></td> <td></td> <td colspan="8" style="text-align: center;"> <table border="1" style="width: 100%; border-collapse: collapse; text-align: center;"> <tr> <td style="width: 10%;"></td> <td style="width: 10%;"></td> <td style="width: 10%;"></td> <td style="width: 10%;"></td> <td style="width: 10%;"></td> <td style="width: 10%;"></td> <td style="width: 10%;"></td> <td style="width: 10%;"></td> <td style="width: 10%;"></td> <td style="width: 10%;"></td> </tr> <tr> <td></td> <td></td> <td colspan="8" style="text-align: center;"> <table border="1" style="width: 100%; border-collapse: collapse; text-align: center;"> <tr> <td style="width: 10%;"></td> <td style="width: 10%;"></td> <td style="width: 10%;"></td> <td style="width: 10%;"></td> <td style="width: 10%;"></td> <td style="width: 10%;"></td> <td style="width: 10%;"></td> <td style="width: 10%;"></td> <td style="width: 10%;"></td> <td style="width: 10%;"></td> </tr> <tr> <td></td> <td></td> <td colspan="8" style="text-align: center;"> <table border="1" style="width: 100%; border-collapse: collapse; text-align: center;"> <tr> <td style="width: 10%;"></td> <td style="width: 10%;"></td> <td style="width: 10%;"></td> <td style="width: 10%;"></td> <td style="width: 10%;"></td> <td style="width: 10%;"></td> <td style="width: 10%;"></td> <td style="width: 10%;"></td> <td style="width: 10%;"></td> <td style="width: 10%;"></td> </tr> <tr> <td></td> <td></td> <td colspan="8" style="text-align: center;"> <table border="1" style="width: 100%; border-collapse: collapse; text-align: center;"> <tr> <td style="width: 10%;"></td> <td style="width: 10%;"></td> <td style="width: 10%;"></td> <td style="width: 10%;"></td> <td style="width: 10%;"></td> <td style="width: 10%;"></td> <td style="width: 10%;"></td> <td style="width: 10%;"></td> <td style="width: 10%;"></td> <td style="width: 10%;"></td> </tr> <tr> <td></td> <td></td> <td colspan="8" style="text-align: center;"> <table border="1" style="width: 100%; border-collapse: collapse; text-align: center;"> <tr> <td style="width: 10%;"></td> <td style="width: 10%;"></td> <td style="width: 10%;"></td> <td style="width: 10%;"></td> <td style="width: 10%;"></td> <td style="width: 10%;"></td> <td style="width: 10%;"></td> <td style="width: 10%;"></td> <td style="width: 10%;"></td> <td style="width: 10%;"></td> </tr> <tr> <td></td> <td></td> <td colspan="8" style="text-align: center;"> <table border="1" style="width: 100%; border-collapse: collapse; text-align: center;"> <tr> <td style="width: 10%;"></td> <td style="width: 10%;"></td> <td style="width: 10%;"></td> <td style="width: 10%;"></td> <td style="width: 10%;"></td> <td style="width: 10%;"></td> <td style="width: 10%;"></td> <td style="width: 10%;"></td> <td style="width: 10%;"></td> <td style="width: 10%;"></td> </tr> <tr> <td></td> <td></td> <td colspan="8" style="text-align: center;"> <table border="1" style="width: 100%; border-collapse: collapse; text-align: center;"> <tr> <td style="width: 10%;"></td> <td style="width: 10%;"></td> <td style="width: 10%;"></td> <td style="width: 10%;"></td> <td style="width: 10%;"></td> <td style="width: 10%;"></td> <td style="width: 10%;"></td> <td style="width: 10%;"></td> <td style="width: 10%;"></td> <td style="width: 10%;"></td> </tr> <tr> <td></td> <td></td> <td colspan="8" style="text-align: center;"> <table border="1" style="width: 100%; border-collapse: collapse; text-align: center;"> <tr> <td style="width: 10%;"></td> <td style="width: 10%;"></td> <td style="width: 10%;"></td> <td style="width: 10%;"></td> <td style="width: 10%;"></td> <td style="width: 10%;"></td> <td style="width: 10%;"></td> <td style="width: 10%;"></td> <td
style="width: 10%;"></td> <td style="width: 10%;"></td> </tr> <tr> <td></td> <td></td> <td colspan="8" style="text-align: center;"> <table border="1" style="width: 100%; border-collapse: collapse; text-align: center;"> <tr> <td style="width: 10%;"></td> <td style="width: 10%;"></td> <td style="width: 10%;"></td> <td style="width: 10%;"></td> <td style="width: 10%;"></td> <td style="width: 10%;"></td> <td style="width: 10%;"></td> <td style="width: 10%;"></td> <td style="width: 10%;"></td> <td style="width: 10%;"></td> </tr> <tr> <td></td> <td></td> <td colspan="8" style="text-align: center;"> <table border="1" style="width: 100%; border-collapse: collapse; text-align: center;"> <tr> <td style="width: 10%;"></td> <td style="width: 10%;"></td> <td style="width: 10%;"></td> <td style="width: 10%;"></td> <td style="width: 10%;"></td> <td style="width: 10%;"></td> <td style="width: 10%;"></td> <td style="width: 10%;"></td> <td style="width: 10%;"></td> <td style="width: 10%;"></td> </tr> <tr> <td></td> <td></td> <td colspan="8" style="text-align: center;"> <table border="1" style="width: 100%; border-collapse: collapse; text-align: center;"> <tr> <td style="width: 10%;"></td> <td style="width: 10%;"></td> <td style="width: 10%;"></td> <td style="width: 10%;"></td> <td style="width: 10%;"></td> <td style="width: 10%;"></td> <td style="width: 10%;"></td> <td style="width: 10%;"></td> <td style="width: 10%;"></td> <td style="width: 10%;"></td> </tr> <tr> <td></td> <td></td> <td colspan="8" style="text-align: center;"> <table border="1" style="width: 100%; border-collapse: collapse; text-align: center;"> <tr> <td style="width: 10%;"></td> <td style="width: 10%;"></td> <td style="width: 10%;"></td> <td style="width: 10%;"></td> <td style="width: 10%;"></td> <td style="width: 10%;"></td> <td style="width: 10%;"></td> <td style="width: 10%;"></td> <td style="width: 10%;"></td> <td style="width: 10%;"></td> </tr> <tr> <td></td> <td></td> <td colspan="8" style="text-align: center;"> <table border="1" style="width: 100%; border-collapse: collapse; text-align: center;"> <tr> <td style="width: 10%;"></td> <td style="width: 10%;"></td> <td style="width: 10%;"></td> <td style="width: 10%;"></td> <td style="width: 10%;"></td> <td style="width: 10%;"></td> <td style="width: 10%;"></td> <td style="width: 10%;"></td> <td style="width: 10%;"></td> <td style="width: 10%;"></td> </tr> <tr> <td></td> <td></td> <td colspan="8" style="text-align: center;"> <table border="1" style="width: 100%; border-collapse: collapse; text-align: center;"> <tr> <td style="width: 10%;"></td> <td style="width: 10%;"></td> <td style="width: 10%;"></td> <td style="width: 10%;"></td> <td style="width: 10%;"></td> <td style="width: 10%;"></td> <td style="width: 10%;"></td> <td style="width: 10%;"></td> <td style="width: 10%;"></td> <td style="width: 10%;"></td> </tr> <tr> <td></td> <td></td> <td colspan="8" style="text-align: center;"> <table border="1" style="width: 100%; border-collapse: collapse; text-align: center;"> <tr> <td style="width: 10%;"></td> <td style="width: 10%;"></td> <td style="width: 10%;"></td> <td style="width: 10%;"></td> <td style="width: 10%;"></td> <td style="width: 10%;"></td> <td style="width: 10%;"></td> <td style="width: 10%;"></td> <td style="width: 10%;"></td> <td style="width: 10%;"></td> </tr> <tr> <td></td> <td></td> <td colspan="8" style="text-align: center;"> <table border="1" style="width: 100%; border-collapse: collapse; text-align: center;"> <tr> <td style="width: 10%;"></td> <td style="width: 10%;"></td> <td style="width: 10%;"></td> <td style="width: 10%;"></td> <td style="width: 10%;"></td> <td style="width: 10%;"></td> <td style="width: 10%;"></td> <td style="width: 10%;"></td> <td style="width: 10%;"></td> <td style="width: 10%;"></td> </tr> <tr> <td></td> <td></td> <td colspan="8" style="text-align: center;"> <table border="1" style="width: 100%; border-collapse: collapse; text-align: center;"> <tr> <td style="width: 10%;"></td> <td style="width: 10%;"></td> <td style="width: 10%;"></td> <td style="width: 10%;"></td> <td style="width: 10%;"></td> <td style="width: 10%;"></td> <td style="width: 10%;"></td> <td style="width: 10%;"></td> <td style="width: 10%;"></td> <td style="width: 10%;"></td> </tr> <tr> <td></td> <td></td> <td colspan="8" style="text-align: center;"> <table border="1" style="width: 100%; border-collapse: collapse; text-align: center;"> <tr> <td style="width: 10%;"></td> <td style="width: 10%;"></td> <td style="width: 10%;"></td> <td style="width: 10%;"></td> <td style="width: 10%;"></td> <td style="width: 10%;"></td> <td style="width: 10%;"></td> <td style="width: 10%;"></td> <td style="width: 10%;"></td> <td style="width: 10%;"></td> </tr> <tr> <td></td> <td></td> <td colspan="8" style="text-align: center;"> <table border="1" style="width: 100%; border-collapse: collapse; text-align: center;"> <tr> <td style="width: 10%;"></td> <td style="width: 10%;"></td> <td style="width: 10%;"></td> <td style="width: 10%;"></td> <td style="width: 10%;"></td> <td style="width: 10%;"></td> <td style="width: 10%;"></td> <td style="width: 10%;"></td> <td style="width: 10%;"></td> <td style="width: 10%;"></td> </tr> <tr> <td></td> <td></td> <td colspan="8" style="text-align: center;"> <table border="1" style="width: 100%; border-collapse: collapse; text-align: center;"> <tr> <td style="width: 10%;"></td> <td style="width: 10%;"></td> <td style="width: 10%;"></td> <td style="width: 10%;"></td> <td style="width: 10%;"></td> <td style="width: 10%;"></td> <td style="width: 10%;"></td> <td style="width: 10%;"></td> <td style="width: 10%;"></td> <td style="width: 10%;"></td> </tr> <tr> <td></td> <td></td> <td colspan="8" style="text-align: center;"> <table border="1" style="width: 100%; border-collapse: collapse; text-align: center;"> <tr> <td style="width: 10%;"></td> <td style="width: 10%;"></td> <td style="width: 10%;"></td> <td style="width: 10%;"></td> <td style="width: 10%;"></td> <td style="width: 10%;"></td> <td style="width: 10%;"></td> <td style="width: 10%;"></td> <td style="width: 10%;"></td> <td style="width: 10%;"></td> </tr> <tr> <td></td> <td></td> <td colspan="8" style="text-align: center;"> <table border="1" style="width: 100%; border-collapse: collapse; text-align: center;"> <tr> <td style="width: 10%;"></td> <td style="width: 10%;"></td> <td style="width: 10%;"></td> <td style="width: 10%;"></td> <td style="width: 10%;"></td> <td style="width: 10%;"></td> <td style="width: 10%;"></td> <td style="width: 10%;"></td> <td style="width: 10%;"></td> <td style="width: 10%;"></td> </tr> <tr> <td></td> <td></td> <td colspan="8" style="text-align: center;"> <table border="1" style="width: 100%; border-collapse: collapse; text-align: center;"> <tr> <td style="width: 10%;"></td> <td style="width: 10%;"></td> <td style="width: 10%;"></td> <td style="width: 10%;"></td> <td style="width: 10%;"></td> <td style="width: 10%;"></td> <td style="width: 10%;"></td> <td style="width: 10%;"></td> <td style="width: 10%;"></td> <td style="width: 10%;"></td> </tr> <tr> <td></td> <td></td> <td colspan="8" style="text-align: center;"> <table border="1" style="width: 100%; border-collapse: collapse; text-align: center;"> <tr> <td style="width: 10%;"></td> <td style="width: 10%;"></td> <td style="width: 10%;"></td> <td style="width: 10%;"></td> <td style="width: 10%;"></td> <td style="width: 10%;"></td> <td style="width: 10%;"></td> <td style="width: 10%;"></td> <td style="width: 10%;"></td> <td style="width: 10%;"></td> </tr> <tr> <td></td> <td></td> <td colspan="8" style="text-align: center;"> <table border="1" style="width: 100%; border-collapse: collapse; text-align: center;"> <tr> <td style="width: 10%;"></td> <td style="width: 10%;"></td> <td style="width: 10%;"></td> <td style="width: 10%;"></td> <td style="width: 10%;"></td> <td style="width: 10%;"></td> <td style="width: 10%;"></td> <td style="width: 10%;"></td> <td style="width: 10%;"></td> <td style="width: 10%;"></td> </tr> <tr> <td></td> <td></td> <td colspan="8" style="text-align: center;"> <table border="1" style="width: 100%; border-collapse: collapse; text-align: center;"> <tr> <td style="width: 10%;"></td> <td style="width: 10%;"></td> <td style="width: 10%;"></td> <td style="width: 10%;"></td> <td style="width: 10%;"></td> <td style="width: 10%;"></td> <td style="width: 10%;"></td> <td style="width: 10%;"></td> <td style="width: 10%;"></td> <td style="width: 10%;"></td> </tr> <tr> <td></td> <td></td> <td colspan="8" style="text-align: center;"> <table border="1" style="width: 100%; border-collapse: collapse; text-align: center;"> <tr> <td style="width: 10%;"></td> <td style="width: 10%;"></td> <td style="width: 10%;"></td> <td style="width: 10%;"></td> <td style="width: 10%;"></td> <td style="width: 10%;"></td> <td style="width: 10%;"></td> <td style="width: 10%;"></td> <td style="width: 10%;"></td> <td style="width: 10%;"></td> </tr> <tr> <td></td> <td></td> <td colspan="8" style="text-align: center;"> <table border="1" style="width: 100%; border-collapse: collapse; text-align: center;"> <tr> <td style="width: 10%;"></td> <td style="width: 10%;"></td> <td style="width: 10%;"></td> <td style="width: 10%;"></td> <td style="width: 10%;"></td> <td style="width: 10%;"></td> <td style="width: 10%;"></td> <td style="width: 10%;"></td> <td style="width: 10%;"></td> <td style="width: 10%;"></td> </tr> <tr> <td></td> <td></td> <td colspan="8" style="text-align: center;"> <table border="1" style="width: 100%; border-collapse: collapse; text-align: center;"> <tr> <td style="width: 10%;"></td> <td style="width: 10%;"></td> <td style="width: 10%;"></td> <td style="width: 10%;"></td> <td style="width: 10%;"></td> <td style="width: 10%;"></td> <td style="width: 10%;"></td> <td style="width: 10%;"></td> <td style="width: 10%;"></td> <td style="width: 10%;"></td> </tr> <tr> <td></td> <td></td> <td colspan="8" style="text-align: center;"> <table border="1" style="width: 100%;
border-collapse: collapse; text-align: center;"> <tr> <td style="width: 10%;"></td> <td style="width: 10%;"></td> <td style="width: 10%;"></td> <td style="width: 10%;"></td> <td style="width: 10%;"></td> <td style="width: 10%;"></td> <td style="width: 10%;"></td> <td style="width: 10%;"></td> <td style="width: 10%;"></td> <td style="width: 10%;"></td> </tr> <tr> <td></td> <td></td> <td colspan="8" style="text-align: center;"> <table border="1" style="width: 100%; border-collapse: collapse; text-align: center;"> <tr> <td style="width: 10%;"></td> <td style="width: 10%;"></td> <td style="width: 10%;"></td> <td style="width: 10%;"></td> <td style="width: 10%;"></td> <td style="width: 10%;"></td> <td style="width: 10%;"></td> <td style="width: 10%;"></td> <td style="width: 10%;"></td> <td style="width: 10%;"></td> </tr> <tr> <td></td> <td></td> <td colspan="8" style="text-align: center;"> <table border="1" style="width: 100%; border-collapse: collapse; text-align: center;"> <tr> <td style="width: 10%;"></td> <td style="width: 10%;"></td> <td style="width: 10%;"></td> <td style="width: 10%;"></td> <td style="width: 10%;"></td> <td style="width: 10%;"></td> <td style="width: 10%;"></td> <td style="width: 10%;"></td> <td style="width: 10%;"></td> <td style="width: 10%;"></td> </tr> <tr> <td></td> <td></td> <td colspan="8" style="text-align: center;"> <table border="1" style="width: 100%; border-collapse: collapse; text-align: center;"> <tr> <td style="width: 10%;"></td> <td style="width: 10%;"></td> <td style="width: 10%;"></td> <td style="width: 10%;"></td> <td style="width: 10%;"></td> <td style="width: 10%;"></td> <td style="width: 10%;"></td> <td style="width: 10%;"></td> <td style="width: 10%;"></td> <td style="width: 10%;"></td> </tr> <tr> <td></td> <td></td> <td colspan="8" style="text-align: center;"> <table border="1" style="width: 100%; border-collapse: collapse; text-align: center;"> <tr> <td style="width: 10%;"></td> <td style="width: 10%;"></td> <td style="width: 10%;"></td> <td style="width: 10%;"></td> <td style="width: 10%;"></td> <td style="width: 10%;"></td> <td style="width: 10%;"></td> <td style="width: 10%;"></td> <td style="width: 10%;"></td> <td style="width: 10%;"></td> </tr> <tr> <td></td> <td></td> <td colspan="8" style="text-align: center;"> <table border="1" style="width: 100%; border-collapse: collapse; text-align: center;"> <tr> </tr></table></td></tr></table></td></tr></table></td></tr></table></td></tr></table></td></tr></table></td></tr></table></td></tr></table></td></tr></table></td></tr></table></td></tr></table></td></tr></table></td></tr></table></td></tr></table></td></tr></table></td></tr></table></td></tr></table></td></tr></table></td></tr></table></td></tr></table></td></tr></table></td></tr></table></td></tr></table></td></tr></table></td></tr></table></td></tr></table></td></tr></table></td></tr></table></td></tr></table></td></tr></table></td></tr></table></td></tr></table></td></tr></table></td></tr></table></td></tr></table></td></tr></table></td></tr></table></td></tr></table></td></tr></table></td></tr></table></td></tr></table></td></tr></table></td></tr></table></td></tr></table></td></tr></table></td></tr></table></td></tr></table></td></tr></table></td></tr></table></td></tr></table> | | | | | | | | | | | | | | | | | | | | <table border="1" style="width: 100%; border-collapse: collapse; text-align: center;"> <tr> <td style="width: 10%;"></td> <td style="width: 10%;"></td> <td style="width: 10%;"></td> <td style="width: 10%;"></td> <td style="width: 10%;"></td> <td style="width: 10%;"></td> <td style="width: 10%;"></td> <td style="width: 10%;"></td> <td style="width: 10%;"></td> <td style="width: 10%;"></td> </tr> <tr> <td></td> <td></td> <td colspan="8" style="text-align: center;"> <table border="1" style="width: 100%; border-collapse: collapse; text-align: center;"> <tr> <td style="width: 10%;"></td> <td style="width: 10%;"></td> <td style="width: 10%;"></td> <td style="width: 10%;"></td> <td style="width: 10%;"></td> <td style="width: 10%;"></td> <td style="width: 10%;"></td> <td style="width: 10%;"></td> <td style="width: 10%;"></td> <td style="width: 10%;"></td> </tr> <tr> <td></td> <td></td> <td colspan="8" style="text-align: center;"> <table border="1" style="width: 100%; border-collapse: collapse; text-align: center;"> <tr> <td style="width: 10%;"></td> <td style="width: 10%;"></td> <td style="width: 10%;"></td> <td style="width: 10%;"></td> <td style="width: 10%;"></td> <td style="width: 10%;"></td> <td style="width: 10%;"></td> <td style="width: 10%;"></td> <td style="width: 10%;"></td> <td style="width: 10%;"></td> </tr> <tr> <td></td> <td></td> <td colspan="8" style="text-align: center;"> <table border="1" style="width: 100%; border-collapse: collapse; text-align: center;"> <tr> <td style="width: 10%;"></td> <td style="width: 10%;"></td> <td style="width: 10%;"></td> <td style="width: 10%;"></td> <td style="width: 10%;"></td> <td style="width: 10%;"></td> <td style="width: 10%;"></td> <td style="width: 10%;"></td> <td style="width: 10%;"></td> <td style="width: 10%;"></td> </tr> <tr> <td></td> <td></td> <td colspan="8" style="text-align: center;"> <table border="1" style="width: 100%; border-collapse: collapse; text-align: center;"> <tr> <td style="width: 10%;"></td> <td style="width: 10%;"></td> <td style="width: 10%;"></td> <td style="width: 10%;"></td> <td style="width: 10%;"></td> <td style="width: 10%;"></td> <td style="width: 10%;"></td> <td style="width: 10%;"></td> <td style="width: 10%;"></td> <td style="width: 10%;"></td> </tr> <tr> <td></td> <td></td> <td colspan="8" style="text-align: center;"> <table border="1" style="width: 100%; border-collapse: collapse; text-align: center;"> <tr> <td style="width: 10%;"></td> <td style="width: 10%;"></td> <td style="width: 10%;"></td> <td style="width: 10%;"></td> <td style="width: 10%;"></td> <td style="width: 10%;"></td> <td style="width: 10%;"></td> <td style="width: 10%;"></td> <td style="width: 10%;"></td> <td style="width: 10%;"></td> </tr> <tr> <td></td> <td></td> <td colspan="8" style="text-align: center;"> <table border="1" style="width: 100%; border-collapse: collapse; text-align: center;"> <tr> <td style="width: 10%;"></td> <td style="width: 10%;"></td> <td style="width: 10%;"></td> <td style="width: 10%;"></td> <td style="width: 10%;"></td> <td style="width: 10%;"></td> <td style="width: 10%;"></td> <td style="width: 10%;"></td> <td style="width: 10%;"></td> <td style="width: 10%;"></td> </tr> <tr> <td></td> <td></td> <td colspan="8" style="text-align: center;"> <table border="1" style="width: 100%; border-collapse: collapse; text-align: center;"> <tr> <td style="width: 10%;"></td> <td style="width: 10%;"></td> <td style="width: 10%;"></td> <td style="width: 10%;"></td> <td style="width: 10%;"></td> <td style="width: 10%;"></td> <td style="width: 10%;"></td> <td style="width: 10%;"></td> <td style="width: 10%;"></td> <td style="width: 10%;"></td> </tr> <tr> <td></td> <td></td> <td colspan="8" style="text-align: center;"> <table border="1" style="width: 100%; border-collapse: collapse; text-align: center;"> <tr> <td style="width: 10%;"></td> <td style="width: 10%;"></td> <td style="width: 10%;"></td> <td style="width: 10%;"></td> <td style="width: 10%;"></td> <td style="width: 10%;"></td> <td style="width: 10%;"></td> <td style="width: 10%;"></td> <td style="width: 10%;"></td> <td style="width: 10%;"></td> </tr> <tr> <td></td> <td></td> <td colspan="8" style="text-align: center;"> <table border="1" style="width: 100%; border-collapse: collapse; text-align: center;"> <tr> <td style="width: 10%;"></td> <td style="width: 10%;"></td> <td style="width: 10%;"></td> <td style="width: 10%;"></td> <td style="width: 10%;"></td> <td style="width: 10%;"></td> <td style="width: 10%;"></td> <td style="width: 10%;"></td> <td style="width: 10%;"></td> <td style="width: 10%;"></td> </tr> <tr> <td></td> <td></td> <td colspan="8" style="text-align: center;"> <table border="1"
style="width: 100%; border-collapse: collapse; text-align: center;"> <tr> <td style="width: 10%;"></td> <td style="width: 10%;"></td> <td style="width: 10%;"></td> <td style="width: 10%;"></td> <td style="width: 10%;"></td> <td style="width: 10%;"></td> <td style="width: 10%;"></td> <td style="width: 10%;"></td> <td style="width: 10%;"></td> <td style="width: 10%;"></td> </tr> <tr> <td></td> <td></td> <td colspan="8" style="text-align: center;"> <table border="1" style="width: 100%; border-collapse: collapse; text-align: center;"> <tr> <td style="width: 10%;"></td> <td style="width: 10%;"></td> <td style="width: 10%;"></td> <td style="width: 10%;"></td> <td style="width: 10%;"></td> <td style="width: 10%;"></td> <td style="width: 10%;"></td> <td style="width: 10%;"></td> <td style="width: 10%;"></td> <td style="width: 10%;"></td> </tr> <tr> <td></td> <td></td> <td colspan="8" style="text-align: center;"> <table border="1" style="width: 100%; border-collapse: collapse; text-align: center;"> <tr> <td style="width: 10%;"></td> <td style="width: 10%;"></td> <td style="width: 10%;"></td> <td style="width: 10%;"></td> <td style="width: 10%;"></td> <td style="width: 10%;"></td> <td style="width: 10%;"></td> <td style="width: 10%;"></td> <td style="width: 10%;"></td> <td style="width: 10%;"></td> </tr> <tr> <td></td> <td></td> <td colspan="8" style="text-align: center;"> <table border="1" style="width: 100%; border-collapse: collapse; text-align: center;"> <tr> <td style="width: 10%;"></td> <td style="width: 10%;"></td> <td style="width: 10%;"></td> <td style="width: 10%;"></td> <td style="width: 10%;"></td> <td style="width: 10%;"></td> <td style="width: 10%;"></td> <td style="width: 10%;"></td> <td style="width: 10%;"></td> <td style="width: 10%;"></td> </tr> <tr> <td></td> <td></td> <td colspan="8" style="text-align: center;"> <table border="1" style="width: 100%; border-collapse: collapse; text-align: center;"> <tr> <td style="width: 10%;"></td> <td style="width: 10%;"></td> <td style="width: 10%;"></td> <td style="width: 10%;"></td> <td style="width: 10%;"></td> <td style="width: 10%;"></td> <td style="width: 10%;"></td> <td style="width: 10%;"></td> <td style="width: 10%;"></td> <td style="width: 10%;"></td> </tr> <tr> <td></td> <td></td> <td colspan="8" style="text-align: center;"> <table border="1" style="width: 100%; border-collapse: collapse; text-align: center;"> <tr> <td style="width: 10%;"></td> <td style="width: 10%;"></td> <td style="width: 10%;"></td> <td style="width: 10%;"></td> <td style="width: 10%;"></td> <td style="width: 10%;"></td> <td style="width: 10%;"></td> <td style="width: 10%;"></td> <td style="width: 10%;"></td> <td style="width: 10%;"></td> </tr> <tr> <td></td> <td></td> <td colspan="8" style="text-align: center;"> <table border="1" style="width: 100%; border-collapse: collapse; text-align: center;"> <tr> <td style="width: 10%;"></td> <td style="width: 10%;"></td> <td style="width: 10%;"></td> <td style="width: 10%;"></td> <td style="width: 10%;"></td> <td style="width: 10%;"></td> <td style="width: 10%;"></td> <td style="width: 10%;"></td> <td style="width: 10%;"></td> <td style="width: 10%;"></td> </tr> <tr> <td></td> <td></td> <td colspan="8" style="text-align: center;"> <table border="1" style="width: 100%; border-collapse: collapse; text-align: center;"> <tr> <td style="width: 10%;"></td> <td style="width: 10%;"></td> <td style="width: 10%;"></td> <td style="width: 10%;"></td> <td style="width: 10%;"></td> <td style="width: 10%;"></td> <td style="width: 10%;"></td> <td style="width: 10%;"></td> <td style="width: 10%;"></td> <td style="width: 10%;"></td> </tr> <tr> <td></td> <td></td> <td colspan="8" style="text-align: center;"> <table border="1" style="width: 100%; border-collapse: collapse; text-align: center;"> <tr> <td style="width: 10%;"></td> <td style="width: 10%;"></td> <td style="width: 10%;"></td> <td style="width: 10%;"></td> <td style="width: 10%;"></td> <td style="width: 10%;"></td> <td style="width: 10%;"></td> <td style="width: 10%;"></td> <td style="width: 10%;"></td> <td style="width: 10%;"></td> </tr> <tr> <td></td> <td></td> <td colspan="8" style="text-align: center;"> <table border="1" style="width: 100%; border-collapse: collapse; text-align: center;"> <tr> <td style="width: 10%;"></td> <td style="width: 10%;"></td> <td style="width: 10%;"></td> <td style="width: 10%;"></td> <td style="width: 10%;"></td> <td style="width: 10%;"></td> <td style="width: 10%;"></td> <td style="width: 10%;"></td> <td style="width: 10%;"></td> <td style="width: 10%;"></td> </tr> <tr> <td></td> <td></td> <td colspan="8" style="text-align: center;"> <table border="1" style="width: 100%; border-collapse: collapse; text-align: center;"> <tr> <td style="width: 10%;"></td> <td style="width: 10%;"></td> <td style="width: 10%;"></td> <td style="width: 10%;"></td> <td style="width: 10%;"></td> <td style="width: 10%;"></td> <td style="width: 10%;"></td> <td style="width: 10%;"></td> <td style="width: 10%;"></td> <td style="width: 10%;"></td> </tr> <tr> <td></td> <td></td> <td colspan="8" style="text-align: center;"> <table border="1" style="width: 100%; border-collapse: collapse; text-align: center;"> <tr> <td style="width: 10%;"></td> <td style="width: 10%;"></td> <td style="width: 10%;"></td> <td style="width: 10%;"></td> <td style="width: 10%;"></td> <td style="width: 10%;"></td> <td style="width: 10%;"></td> <td style="width: 10%;"></td> <td style="width: 10%;"></td> <td style="width: 10%;"></td> </tr> <tr> <td></td> <td></td> <td colspan="8" style="text-align: center;"> <table border="1" style="width: 100%; border-collapse: collapse; text-align: center;"> <tr> <td style="width: 10%;"></td> <td style="width: 10%;"></td> <td style="width: 10%;"></td> <td style="width: 10%;"></td> <td style="width: 10%;"></td> <td style="width: 10%;"></td> <td style="width: 10%;"></td> <td style="width: 10%;"></td> <td style="width: 10%;"></td> <td style="width: 10%;"></td> </tr> <tr> <td></td> <td></td> <td colspan="8" style="text-align: center;"> <table border="1" style="width: 100%; border-collapse: collapse; text-align: center;"> <tr> <td style="width: 10%;"></td> <td style="width: 10%;"></td> <td style="width: 10%;"></td> <td style="width: 10%;"></td> <td style="width: 10%;"></td> <td style="width: 10%;"></td> <td style="width: 10%;"></td> <td style="width: 10%;"></td> <td style="width: 10%;"></td> <td style="width: 10%;"></td> </tr> <tr> <td></td> <td></td> <td colspan="8" style="text-align: center;"> <table border="1" style="width: 100%; border-collapse: collapse; text-align: center;"> <tr> <td style="width: 10%;"></td> <td style="width: 10%;"></td> <td style="width: 10%;"></td> <td style="width: 10%;"></td> <td style="width: 10%;"></td> <td style="width: 10%;"></td> <td style="width: 10%;"></td> <td style="width: 10%;"></td> <td style="width: 10%;"></td> <td style="width: 10%;"></td> </tr> <tr> <td></td> <td></td> <td colspan="8" style="text-align: center;"> <table border="1" style="width: 100%; border-collapse: collapse; text-align: center;"> <tr> <td style="width: 10%;"></td> <td style="width: 10%;"></td> <td style="width: 10%;"></td> <td style="width: 10%;"></td> <td style="width: 10%;"></td> <td style="width: 10%;"></td> <td style="width: 10%;"></td> <td style="width: 10%;"></td> <td style="width: 10%;"></td> <td style="width: 10%;"></td> </tr> <tr> <td></td> <td></td> <td colspan="8" style="text-align: center;"> <table border="1" style="width: 100%; border-collapse: collapse; text-align: center;"> <tr> <td style="width: 10%;"></td> <td style="width: 10%;"></td> <td style="width: 10%;"></td> <td style="width: 10%;"></td> <td style="width: 10%;"></td> <td style="width: 10%;"></td> <td style="width: 10%;"></td> <td style="width: 10%;"></td> <td style="width: 10%;"></td> <td style="width: 10%;"></td> </tr> <tr> <td></td> <td></td> <td colspan="8" style="text-align: center;"> <table border="1" style="width: 100%; border-collapse: collapse; text-align: center;"> <tr> <td style="width: 10%;"></td> <td style="width: 10%;"></td> <td style="width: 10%;"></td> <td style="width: 10%;"></td> <td style="width: 10%;"></td> <td style="width: 10%;"></td> <td style="width: 10%;"></td> <td style="width: 10%;"></td> <td style="width: 10%;"></td> <td style="width: 10%;"></td> </tr> <tr> <td></td> <td></td> <td colspan="8" style="text-align: center;"> <table border="1" style="width: 100%; border-collapse: collapse; text-align: center;"> <tr> <td style="width: 10%;"></td> <td style="width: 10%;"></td> <td style="width: 10%;"></td> <td style="width: 10%;"></td> <td style="width: 10%;"></td> <td style="width: 10%;"></td> <td style="width: 10%;"></td> <td style="width: 10%;"></td> <td style="width: 10%;"></td> <td style="width: 10%;"></td> </tr> <tr> <td></td> <td></td> <td colspan="8" style="text-align: center;"> <table border="1" style="width: 100%; border-collapse: collapse; text-align: center;"> <tr> <td style="width: 10%;"></td> <td style="width: 10%;"></td> <td style="width: 10%;"></td> <td style="width: 10%;"></td> <td style="width: 10%;"></td> <td style="width: 10%;"></td> <td style="width: 10%;"></td> <td style="width: 10%;"></td> <td style="width: 10%;"></td> <td style="width: 10%;"></td> </tr> <tr> <td></td> <td></td> <td colspan="8" style="text-align: center;"> <table border="1" style="width: 100%; border-collapse: collapse; text-align: center;"> <tr> <td style="width: 10%;"></td> <td style="width: 10%;"></td> <td style="width: 10%;"></td> <td style="width: 10%;"></td> <td style="width: 10%;"></td> <td style="width: 10%;"></td> <td style="width: 10%;"></td> <td style="width: 10%;"></td> <td style="width: 10%;"></td> <td style="width: 10%;"></td> </tr> <tr> <td></td> <td></td> <td colspan="8" style="text-align: center;"> <table border="1" style="width: 100%; border-collapse: collapse; text-align: center;"> <tr> <td style="width: 10%;"></td> <td style="width: 10%;"></td> <td style="width: 10%;"></td> <td
style="width: 10%;"></td> <td style="width: 10%;"></td> <td style="width: 10%;"></td> <td style="width: 10%;"></td> <td style="width: 10%;"></td> <td style="width: 10%;"></td> <td style="width: 10%;"></td> </tr> <tr> <td></td> <td></td> <td colspan="8" style="text-align: center;"> <table border="1" style="width: 100%; border-collapse: collapse; text-align: center;"> <tr> <td style="width: 10%;"></td> <td style="width: 10%;"></td> <td style="width: 10%;"></td> <td style="width: 10%;"></td> <td style="width: 10%;"></td> <td style="width: 10%;"></td> <td style="width: 10%;"></td> <td style="width: 10%;"></td> <td style="width: 10%;"></td> <td style="width: 10%;"></td> </tr> <tr> <td></td> <td></td> <td colspan="8" style="text-align: center;"> <table border="1" style="width: 100%; border-collapse: collapse; text-align: center;"> <tr> <td style="width: 10%;"></td> <td style="width: 10%;"></td> <td style="width: 10%;"></td> <td style="width: 10%;"></td> <td style="width: 10%;"></td> <td style="width: 10%;"></td> <td style="width: 10%;"></td> <td style="width: 10%;"></td> <td style="width: 10%;"></td> <td style="width: 10%;"></td> </tr> <tr> <td></td> <td></td> <td colspan="8" style="text-align: center;"> <table border="1" style="width: 100%; border-collapse: collapse; text-align: center;"> <tr> <td style="width: 10%;"></td> <td style="width: 10%;"></td> <td style="width: 10%;"></td> <td style="width: 10%;"></td> <td style="width: 10%;"></td> <td style="width: 10%;"></td> <td style="width: 10%;"></td> <td style="width: 10%;"></td> <td style="width: 10%;"></td> <td style="width: 10%;"></td> </tr> <tr> <td></td> <td></td> <td colspan="8" style="text-align: center;"> <table border="1" style="width: 100%; border-collapse: collapse; text-align: center;"> <tr> <td style="width: 10%;"></td> <td style="width: 10%;"></td> <td style="width: 10%;"></td> <td style="width: 10%;"></td> <td style="width: 10%;"></td> <td style="width: 10%;"></td> <td style="width: 10%;"></td> <td style="width: 10%;"></td> <td style="width: 10%;"></td> <td style="width: 10%;"></td> </tr> <tr> <td></td> <td></td> <td colspan="8" style="text-align: center;"> <table border="1" style="width: 100%; border-collapse: collapse; text-align: center;"> <tr> <td style="width: 10%;"></td> <td style="width: 10%;"></td> <td style="width: 10%;"></td> <td style="width: 10%;"></td> <td style="width: 10%;"></td> <td style="width: 10%;"></td> <td style="width: 10%;"></td> <td style="width: 10%;"></td> <td style="width: 10%;"></td> <td style="width: 10%;"></td> </tr> <tr> <td></td> <td></td> <td colspan="8" style="text-align: center;"> <table border="1" style="width: 100%; border-collapse: collapse; text-align: center;"> <tr> <td style="width: 10%;"></td> <td style="width: 10%;"></td> <td style="width: 10%;"></td> <td style="width: 10%;"></td> <td style="width: 10%;"></td> <td style="width: 10%;"></td> <td style="width: 10%;"></td> <td style="width: 10%;"></td> <td style="width: 10%;"></td> <td style="width: 10%;"></td> </tr> <tr> <td></td> <td></td> <td colspan="8" style="text-align: center;"> <table border="1" style="width: 100%; border-collapse: collapse; text-align: center;"> <tr> <td style="width: 10%;"></td> <td style="width: 10%;"></td> <td style="width: 10%;"></td> <td style="width: 10%;"></td> <td style="width: 10%;"></td> <td style="width: 10%;"></td> <td style="width: 10%;"></td> <td style="width: 10%;"></td> <td style="width: 10%;"></td> <td style="width: 10%;"></td> </tr> <tr> <td></td> <td></td> <td colspan="8" style="text-align: center;"> <table border="1" style="width: 100%; border-collapse: collapse; text-align: center;"> <tr> <td style="width: 10%;"></td> <td style="width: 10%;"></td> <td style="width: 10%;"></td> <td style="width: 10%;"></td> <td style="width: 10%;"></td> <td style="width: 10%;"></td> <td style="width: 10%;"></td> <td style="width: 10%;"></td> <td style="width: 10%;"></td> <td style="width: 10%;"></td> </tr> <tr> <td></td> <td></td> <td colspan="8" style="text-align: center;"> <table border="1" style="width: 100%; border-collapse: collapse; text-align: center;"> <tr> <td style="width: 10%;"></td> <td style="width: 10%;"></td> <td style="width: 10%;"></td> <td style="width: 10%;"></td> <td style="width: 10%;"></td> <td style="width: 10%;"></td> <td style="width: 10%;"></td> <td style="width: 10%;"></td> <td style="width: 10%;"></td> <td style="width: 10%;"></td> </tr> <tr> <td></td> <td></td> <td colspan="8" style="text-align: center;"> <table border="1" style="width: 100%; border-collapse: collapse; text-align: center;"> <tr> <td style="width: 10%;"></td> <td style="width: 10%;"></td> <td style="width: 10%;"></td> <td style="width: 10%;"></td> <td style="width: 10%;"></td> <td style="width: 10%;"></td> <td style="width: 10%;"></td> <td style="width: 10%;"></td> <td style="width: 10%;"></td> <td style="width: 10%;"></td> </tr> <tr> <td></td> <td></td> <td colspan="8" style="text-align: center;"> <table border="1" style="width: 100%; border-collapse: collapse; text-align: center;"> <tr> <td style="width: 10%;"></td> <td style="width: 10%;"></td> <td style="width: 10%;"></td> <td style="width: 10%;"></td> <td style="width: 10%;"></td> <td style="width: 10%;"></td> <td style="width: 10%;"></td> <td style="width: 10%;"></td> <td style="width: 10%;"></td> <td style="width: 10%;"></td> </tr> <tr> <td></td> <td></td> <td colspan="8" style="text-align: center;"> <table border="1" style="width: 100%; border-collapse: collapse; text-align: center;"> <tr> <td style="width: 10%;"></td> <td style="width: 10%;"></td> <td style="width: 10%;"></td> <td style="width: 10%;"></td> <td style="width: 10%;"></td> <td style="width: 10%;"></td> <td style="width: 10%;"></td> <td style="width: 10%;"></td> <td style="width: 10%;"></td> <td style="width: 10%;"></td> </tr> <tr> <td></td> <td></td> <td colspan="8" style="text-align: center;"> <table border="1" style="width: 100%; border-collapse: collapse; text-align: center;"> <tr> <td style="width: 10%;"></td> <td style="width: 10%;"></td> <td style="width: 10%;"></td> <td style="width: 10%;"></td> <td style="width: 10%;"></td> <td style="width: 10%;"></td> <td style="width: 10%;"></td> <td style="width: 10%;"></td> <td style="width: 10%;"></td> <td style="width: 10%;"></td> </tr> <tr> <td></td> <td></td> <td colspan="8" style="text-align: center;"> <table border="1" style="width: 100%; border-collapse: collapse; text-align: center;"> <tr> <td style="width: 10%;"></td> <td style="width: 10%;"></td> <td style="width: 10%;"></td> <td style="width: 10%;"></td> <td style="width: 10%;"></td> <td style="width: 10%;"></td> <td style="width: 10%;"></td> <td style="width: 10%;"></td> <td style="width: 10%;"></td> <td style="width: 10%;"></td> </tr> <tr> <td></td> <td></td> <td colspan="8" style="text-align: center;"> <table border="1" style="width: 100%; border-collapse: collapse; text-align: center;"> <tr> <td style="width: 10%;"></td> <td style="width: 10%;"></td> <td style="width: 10%;"></td> <td style="width: 10%;"></td> <td style="width: 10%;"></td> <td style="width: 10%;"></td> <td style="width: 10%;"></td> <td style="width: 10%;"></td> <td style="width: 10%;"></td> <td style="width: 10%;"></td> </tr> <tr> <td></td> <td></td> <td colspan="8" style="text-align: center;"> <table border="1" style="width: 100%; border-collapse: collapse; text-align: center;"> <tr> <td style="width: 10%;"></td> <td style="width: 10%;"></td> <td style="width: 10%;"></td> <td style="width: 10%;"></td> <td style="width: 10%;"></td> <td style="width: 10%;"></td> <td style="width: 10%;"></td> <td style="width: 10%;"></td> <td style="width: 10%;"></td> <td style="width: 10%;"></td> </tr> <tr> <td></td> <td></td> <td colspan="8" style="text-align: center;"> <table border="1" style="width: 100%; border-collapse: collapse; text-align: center;"> <tr> </tr></table></td></tr></table></td></tr></table></td></tr></table></td></tr></table></td></tr></table></td></tr></table></td></tr></table></td></tr></table></td></tr></table></td></tr></table></td></tr></table></td></tr></table></td></tr></table></td></tr></table></td></tr></table></td></tr></table></td></tr></table></td></tr></table></td></tr></table></td></tr></table></td></tr></table></td></tr></table></td></tr></table></td></tr></table></td></tr></table></td></tr></table></td></tr></table></td></tr></table></td></tr></table></td></tr></table></td></tr></table></td></tr></table></td></tr></table></td></tr></table></td></tr></table></td></tr></table></td></tr></table></td></tr></table></td></tr></table></td></tr></table></td></tr></table></td></tr></table></td></tr></table></td></tr></table></td></tr></table></td></tr></table></td></tr></table></td></tr></table>
 | | | | | | | | | | | | | | | | | | | | <table border="1" style="width: 100%; border-collapse: collapse; text-align: center;"> <tr> <td style="width: 10%;"></td> <td style="width: 10%;"></td> <td style="width: 10%;"></td> <td style="width: 10%;"></td> <td style="width: 10%;"></td> <td style="width: 10%;"></td> <td style="width: 10%;"></td> <td style="width: 10%;"></td> <td style="width: 10%;"></td> <td style="width: 10%;"></td> </tr> <tr> <td></td> <td></td> <td colspan="8" style="text-align: center;"> <table border="1" style="width: 100%; border-collapse: collapse; text-align: center;"> <tr> <td style="width: 10%;"></td> <td style="width: 10%;"></td> <td style="width: 10%;"></td> <td style="width: 10%;"></td> <td style="width: 10%;"></td> <td style="width: 10%;"></td> <td style="width: 10%;"></td> <td style="width: 10%;"></td> <td style="width: 10%;"></td> <td style="width: 10%;"></td> </tr> <tr> <td></td> <td></td> <td colspan="8" style="text-align: center;"> <table border="1" style="width: 100%; border-collapse: collapse; text-align: center;"> <tr> <td style="width: 10%;"></td> <td style="width: 10%;"></td> <td style="width: 10%;"></td> <td style="width: 10%;"></td> <td style="width: 10%;"></td> <td style="width: 10%;"></td> <td style="width: 10%;"></td> <td style="width: 10%;"></td> <td style="width: 10%;"></td> <td style="width: 10%;"></td> </tr> <tr> <td></td> <td></td> <td colspan="8" style="text-align: center;"> <table border="1" style="width: 100%; border-collapse: collapse; text-align: center;"> <tr> <td style="width: 10%;"></td> <td style="width: 10%;"></td> <td style="width: 10%;"></td> <td style="width: 10%;"></td> <td style="width: 10%;"></td> <td style="width: 10%;"></td> <td style="width: 10%;"></td> <td style="width: 10%;"></td> <td style="width: 10%;"></td> <td style="width: 10%;"></td> </tr> <tr> <td></td> <td></td> <td colspan="8" style="text-align: center;"> <table border="1" style="width: 100%; border-collapse: collapse; text-align: center;"> <tr> <td style="width: 10%;"></td> <td style="width: 10%;"></td> <td style="width: 10%;"></td> <td style="width: 10%;"></td> <td style="width: 10%;"></td> <td style="width: 10%;"></td> <td style="width: 10%;"></td> <td style="width: 10%;"></td> <td style="width: 10%;"></td> <td style="width: 10%;"></td> </tr> <tr> <td></td> <td></td> <td colspan="8" style="text-align: center;"> <table border="1" style="width: 100%; border-collapse: collapse; text-align: center;"> <tr> <td style="width: 10%;"></td> <td style="width: 10%;"></td> <td style="width: 10%;"></td> <td style="width: 10%;"></td> <td style="width: 10%;"></td> <td style="width: 10%;"></td> <td style="width: 10%;"></td> <td style="width: 10%;"></td> <td style="width: 10%;"></td> <td style="width: 10%;"></td> </tr> <tr> <td></td> <td></td> <td colspan="8" style="text-align: center;"> <table border="1" style="width: 100%; border-collapse: collapse; text-align: center;"> <tr> <td style="width: 10%;"></td> <td style="width: 10%;"></td> <td style="width: 10%;"></td> <td style="width: 10%;"></td> <td style="width: 10%;"></td> <td style="width: 10%;"></td> <td style="width: 10%;"></td> <td style="width: 10%;"></td> <td style="width: 10%;"></td> <td style="width: 10%;"></td> </tr> <tr> <td></td> <td></td> <td colspan="8" style="text-align: center;"> <table border="1" style="width: 100%; border-collapse: collapse; text-align: center;"> <tr> <td style="width: 10%;"></td> <td style="width: 10%;"></td> <td style="width: 10%;"></td> <td style="width: 10%;"></td> <td style="width: 10%;"></td> <td style="width: 10%;"></td> <td style="width: 10%;"></td> <td style="width: 10%;"></td> <td style="width: 10%;"></td> <td style="width: 10%;"></td> </tr> <tr> <td></td> <td></td> <td colspan="8" style="text-align: center;"> <table border="1" style="width: 100%; border-collapse: collapse; text-align: center;"> <tr> <td style="width: 10%;"></td> <td style="width: 10%;"></td> <td style="width: 10%;"></td> <td style="width: 10%;"></td> <td style="width: 10%;"></td> <td style="width: 10%;"></td> <td style="width: 10%;"></td> <td style="width: 10%;"></td> <td style="width: 10%;"></td> <td style="width: 10%;"></td> </tr> <tr> <td></td> <td></td> <td colspan="8" style="text-align: center;"> <table border="1" style="width: 100%; border-collapse: collapse; text-align: center;"> <tr> <td style="width: 10%;"></td> <td style="width: 10%;"></td> <td style="width: 10%;"></td> <td style="width: 10%;"></td> <td style="width: 10%;"></td> <td style="width: 10%;"></td> <td style="width: 10%;"></td> <td style="width: 10%;"></td> <td style="width: 10%;"></td> <td style="width: 10%;"></td> </tr> <tr> <td></td> <td></td> <td colspan="8" style="text-align: center;"> <table border="1" style="width: 100%; border-collapse: collapse; text-align: center;"> <tr> <td style="width: 10%;"></td> <td style="width: 10%;"></td> <td style="width: 10%;"></td> <td style="width: 10%;"></td> <td style="width: 10%;"></td> <td style="width: 10%;"></td> <td style="width: 10%;"></td> <td style="width: 10%;"></td> <td style="width: 10%;"></td> <td style="width: 10%;"></td> </tr> <tr> <td></td> <td></td> <td colspan="8" style="text-align: center;"> <table border="1" style="width: 100%; border-collapse: collapse; text-align: center;"> <tr> <td style="width: 10%;"></td> <td style="width: 10%;"></td> <td style="width: 10%;"></td> <td style="width: 10%;"></td> <td style="width: 10%;"></td> <td style="width: 10%;"></td> <td style="width: 10%;"></td> <td style="width: 10%;"></td> <td style="width: 10%;"></td> <td style="width: 10%;"></td> </tr> <tr> <td></td> <td></td> <td colspan="8" style="text-align: center;"> <table border="1" style="width: 100%; border-collapse: collapse; text-align: center;"> <tr> <td style="width: 10%;"></td> <td style="width: 10%;"></td> <td style="width: 10%;"></td> <td style="width: 10%;"></td> <td style="width: 10%;"></td> <td style="width: 10%;"></td> <td style="width: 10%;"></td> <td style="width: 10%;"></td> <td style="width: 10%;"></td> <td style="width: 10%;"></td> </tr> <tr> <td></td> <td></td> <td colspan="8" style="text-align: center;"> <table border="1" style="width: 100%; border-collapse: collapse; text-align: center;"> <tr> <td style="width: 10%;"></td> <td style="width: 10%;"></td> <td style="width: 10%;"></td> <td style="width: 10%;"></td> <td style="width: 10%;"></td> <td style="width: 10%;"></td> <td style="width: 10%;"></td> <td style="width: 10%;"></td> <td style="width: 10%;"></td> <td style="width: 10%;"></td> </tr> <tr> <td></td> <td></td> <td colspan="8" style="text-align: center;"> <table border="1" style="width: 100%; border-collapse: collapse; text-align: center;"> <tr> <td style="width: 10%;"></td> <td style="width: 10%;"></td> <td style="width: 10%;"></td> <td style="width: 10%;"></td> <td style="width: 10%;"></td> <td style="width: 10%;"></td> <td style="width: 10%;"></td> <td style="width: 10%;"></td> <td style="width: 10%;"></td> <td style="width: 10%;"></td> </tr> <tr> <td></td> <td></td> <td colspan="8" style="text-align: center;"> <table border="1" style="width: 100%; border-collapse: collapse; text-align: center;"> <tr> <td style="width: 10%;"></td> <td style="width: 10%;"></td> <td style="width: 10%;"></td> <td style="width: 10%;"></td> <td style="width: 10%;"></td> <td style="width: 10%;"></td> <td style="width: 10%;"></td> <td style="width: 10%;"></td> <td style="width: 10%;"></td> <td style="width: 10%;"></td> </tr> <tr> <td></td> <td></td> <td colspan="8" style="text-align: center;"> <table border="1" style="width: 100%; border-collapse: collapse; text-align: center;"> <tr> <td style="width: 10%;"></td> <td style="width: 10%;"></td> <td style="width: 10%;"></td> <td style="width: 10%;"></td> <td style="width: 10%;"></td> <td style="width: 10%;"></td> <td style="width: 10%;"></td> <td style="width: 10%;"></td> <td style="width: 10%;"></td> <td style="width: 10%;"></td> </tr> <tr> <td></td> <td></td> <td colspan="8" style="text-align: center;"> <table border="1" style="width: 100%; border-collapse: collapse; text-align: center;"> <tr> <td style="width: 10%;"></td> <td style="width: 10%;"></td> <td style="width: 10%;"></td> <td style="width: 10%;"></td> <td style="width: 10%;"></td> <td style="width: 10%;"></td> <td style="width: 10%;"></td> <td style="width: 10%;"></td> <td style="width: 10%;"></td> <td style="width: 10%;"></td> </tr> <tr> <td></td> <td></td> <td colspan="8" style="text-align: center;"> <table border="1" style="width: 100%; border-collapse: collapse; text-align: center;"> <tr> <td style="width: 10%;"></td> <td style="width: 10%;"></td> <td style="width: 10%;"></td> <td style="width: 10%;"></td> <td style="width: 10%;"></td> <td style="width: 10%;"></td> <td style="width: 10%;"></td> <td style="width: 10%;"></td> <td style="width: 10%;"></td> <td style="width: 10%;"></td> </tr> <tr> <td></td> <td></td> <td colspan="8" style="text-align: center;"> <table border="1" style="width: 100%; border-collapse: collapse; text-align: center;"> <tr> <td style="width: 10%;"></td> <td style="width: 10%;"></td> <td style="width: 10%;"></td> <td style="width: 10%;"></td> <td style="width: 10%;"></td> <td style="width: 10%;"></td> <td style="width: 10%;"></td> <td style="width: 10%;"></td> <td style="width: 10%;"></td>
<td style="width: 10%;"></td> </tr> <tr> <td></td> <td></td> <td colspan="8" style="text-align: center;"> <table border="1" style="width: 100%; border-collapse: collapse; text-align: center;"> <tr> <td style="width: 10%;"></td> <td style="width: 10%;"></td> <td style="width: 10%;"></td> <td style="width: 10%;"></td> <td style="width: 10%;"></td> <td style="width: 10%;"></td> <td style="width: 10%;"></td> <td style="width: 10%;"></td> <td style="width: 10%;"></td> <td style="width: 10%;"></td> </tr> <tr> <td></td> <td></td> <td colspan="8" style="text-align: center;"> <table border="1" style="width: 100%; border-collapse: collapse; text-align: center;"> <tr> <td style="width: 10%;"></td> <td style="width: 10%;"></td> <td style="width: 10%;"></td> <td style="width: 10%;"></td> <td style="width: 10%;"></td> <td style="width: 10%;"></td> <td style="width: 10%;"></td> <td style="width: 10%;"></td> <td style="width: 10%;"></td> <td style="width: 10%;"></td> </tr> <tr> <td></td> <td></td> <td colspan="8" style="text-align: center;"> <table border="1" style="width: 100%; border-collapse: collapse; text-align: center;"> <tr> <td style="width: 10%;"></td> <td style="width: 10%;"></td> <td style="width: 10%;"></td> <td style="width: 10%;"></td> <td style="width: 10%;"></td> <td style="width: 10%;"></td> <td style="width: 10%;"></td> <td style="width: 10%;"></td> <td style="width: 10%;"></td> <td style="width: 10%;"></td> </tr> <tr> <td></td> <td></td> <td colspan="8" style="text-align: center;"> <table border="1" style="width: 100%; border-collapse: collapse; text-align: center;"> <tr> <td style="width: 10%;"></td> <td style="width: 10%;"></td> <td style="width: 10%;"></td> <td style="width: 10%;"></td> <td style="width: 10%;"></td> <td style="width: 10%;"></td> <td style="width: 10%;"></td> <td style="width: 10%;"></td> <td style="width: 10%;"></td> <td style="width: 10%;"></td> </tr> <tr> <td></td> <td></td> <td colspan="8" style="text-align: center;"> <table border="1" style="width: 100%; border-collapse: collapse; text-align: center;"> <tr> <td style="width: 10%;"></td> <td style="width: 10%;"></td> <td style="width: 10%;"></td> <td style="width: 10%;"></td> <td style="width: 10%;"></td> <td style="width: 10%;"></td> <td style="width: 10%;"></td> <td style="width: 10%;"></td> <td style="width: 10%;"></td> <td style="width: 10%;"></td> </tr> <tr> <td></td> <td></td> <td colspan="8" style="text-align: center;"> <table border="1" style="width: 100%; border-collapse: collapse; text-align: center;"> <tr> <td style="width: 10%;"></td> <td style="width: 10%;"></td> <td style="width: 10%;"></td> <td style="width: 10%;"></td> <td style="width: 10%;"></td> <td style="width: 10%;"></td> <td style="width: 10%;"></td> <td style="width: 10%;"></td> <td style="width: 10%;"></td> <td style="width: 10%;"></td> </tr> <tr> <td></td> <td></td> <td colspan="8" style="text-align: center;"> <table border="1" style="width: 100%; border-collapse: collapse; text-align: center;"> <tr> <td style="width: 10%;"></td> <td style="width: 10%;"></td> <td style="width: 10%;"></td> <td style="width: 10%;"></td> <td style="width: 10%;"></td> <td style="width: 10%;"></td> <td style="width: 10%;"></td> <td style="width: 10%;"></td> <td style="width: 10%;"></td> <td style="width: 10%;"></td> </tr> <tr> <td></td> <td></td> <td colspan="8" style="text-align: center;"> <table border="1" style="width: 100%; border-collapse: collapse; text-align: center;"> <tr> <td style="width: 10%;"></td> <td style="width: 10%;"></td> <td style="width: 10%;"></td> <td style="width: 10%;"></td> <td style="width: 10%;"></td> <td style="width: 10%;"></td> <td style="width: 10%;"></td> <td style="width: 10%;"></td> <td style="width: 10%;"></td> <td style="width: 10%;"></td> </tr> <tr> <td></td> <td></td> <td colspan="8" style="text-align: center;"> <table border="1" style="width: 100%; border-collapse: collapse; text-align: center;"> <tr> <td style="width: 10%;"></td> <td style="width: 10%;"></td> <td style="width: 10%;"></td> <td style="width: 10%;"></td> <td style="width: 10%;"></td> <td style="width: 10%;"></td> <td style="width: 10%;"></td> <td style="width: 10%;"></td> <td style="width: 10%;"></td> <td style="width: 10%;"></td> </tr> <tr> <td></td> <td></td> <td colspan="8" style="text-align: center;"> <table border="1" style="width: 100%; border-collapse: collapse; text-align: center;"> <tr> <td style="width: 10%;"></td> <td style="width: 10%;"></td> <td style="width: 10%;"></td> <td style="width: 10%;"></td> <td style="width: 10%;"></td> <td style="width: 10%;"></td> <td style="width: 10%;"></td> <td style="width: 10%;"></td> <td style="width: 10%;"></td> <td style="width: 10%;"></td> </tr> <tr> <td></td> <td></td> <td colspan="8" style="text-align: center;"> <table border="1" style="width: 100%; border-collapse: collapse; text-align: center;"> <tr> <td style="width: 10%;"></td> <td style="width: 10%;"></td> <td style="width: 10%;"></td> <td style="width: 10%;"></td> <td style="width: 10%;"></td> <td style="width: 10%;"></td> <td style="width: 10%;"></td> <td style="width: 10%;"></td> <td style="width: 10%;"></td> <td style="width: 10%;"></td> </tr> <tr> <td></td> <td></td> <td colspan="8" style="text-align: center;"> <table border="1" style="width: 100%; border-collapse: collapse; text-align: center;"> <tr> <td style="width: 10%;"></td> <td style="width: 10%;"></td> <td style="width: 10%;"></td> <td style="width: 10%;"></td> <td style="width: 10%;"></td> <td style="width: 10%;"></td> <td style="width: 10%;"></td> <td style="width: 10%;"></td> <td style="width: 10%;"></td> <td style="width: 10%;"></td> </tr> <tr> <td></td> <td></td> <td colspan="8" style="text-align: center;"> <table border="1" style="width: 100%; border-collapse: collapse; text-align: center;"> <tr> <td style="width: 10%;"></td> <td style="width: 10%;"></td> <td style="width: 10%;"></td> <td style="width: 10%;"></td> <td style="width: 10%;"></td> <td style="width: 10%;"></td> <td style="width: 10%;"></td> <td style="width: 10%;"></td> <td style="width: 10%;"></td> <td style="width: 10%;"></td> </tr> <tr> <td></td> <td></td> <td colspan="8" style="text-align: center;"> <table border="1" style="width: 100%; border-collapse: collapse; text-align: center;"> <tr> <td style="width: 10%;"></td> <td style="width: 10%;"></td> <td style="width: 10%;"></td> <td style="width: 10%;"></td> <td style="width: 10%;"></td> <td style="width: 10%;"></td> <td style="width: 10%;"></td> <td style="width: 10%;"></td> <td style="width: 10%;"></td> <td style="width: 10%;"></td> </tr> <tr> <td></td> <td></td> <td colspan="8" style="text-align: center;"> <table border="1" style="width: 100%; border-collapse: collapse; text-align: center;"> <tr> <td style="width: 10%;"></td> <td style="width: 10%;"></td> <td style="width: 10%;"></td> <td style="width: 10%;"></td> <td style="width: 10%;"></td> <td style="width: 10%;"></td> <td style="width: 10%;"></td> <td style="width: 10%;"></td> <td style="width: 10%;"></td> <td style="width: 10%;"></td> </tr> <tr> <td></td> <td></td> <td colspan="8" style="text-align: center;"> <table border="1" style="width: 100%; border-collapse: collapse; text-align: center;"> <tr> <td style="width: 10%;"></td> <td style="width: 10%;"></td> <td style="width: 10%;"></td> <td style="width: 10%;"></td> <td style="width: 10%;"></td> <td style="width: 10%;"></td> <td style="width: 10%;"></td> <td style="width: 10%;"></td> <td style="width: 10%;"></td> <td style="width: 10%;"></td> </tr> <tr> <td></td> <td></td> <td colspan="8" style="text-align: center;"> <table border="1" style="width: 100%; border-collapse: collapse; text-align: center;"> <tr> <td style="width: 10%;"></td> <td style="width: 10%;"></td> <td style="width: 10%;"></td> <td style="width: 10%;"></td> <td style="width: 10%;"></td> <td style="width: 10%;"></td> <td style="width: 10%;"></td> <td style="width: 10%;"></td> <td style="width: 10%;"></td> <td style="width: 10%;"></td> </tr> <tr> <td></td> <td></td> <td colspan="8" style="text-align: center;"> <table border="1" style="width: 100%; border-collapse: collapse; text-align: center;"> <tr> <td style="width: 10%;"></td> <td style="width: 10%;"></td> <td style="width: 10%;"></td> <td style="width: 10%;"></td> <td style="width: 10%;"></td> <td style="width: 10%;"></td> <td style="width: 10%;"></td> <td style="width: 10%;"></td> <td style="width: 10%;"></td> <td style="width: 10%;"></td> </tr> <tr> <td></td> <td></td> <td colspan="8" style="text-align: center;"> <table border="1" style="width: 100%; border-collapse: collapse; text-align: center;"> <tr> <td style="width: 10%;"></td> <td style="width: 10%;"></td> <td style="width: 10%;"></td> <td style="width: 10%;"></td> <td style="width: 10%;"></td> <td style="width: 10%;"></td> <td style="width: 10%;"></td> <td style="width: 10%;"></td> <td style="width: 10%;"></td> <td style="width: 10%;"></td> </tr> <tr> <td></td> <td></td> <td colspan="8" style="text-align: center;"> <table border="1" style="width: 100%; border-collapse: collapse; text-align: center;"> <tr> <td style="width: 10%;"></td> <td style="width: 10%;"></td> <td style="width: 10%;"></td> <td style="width: 10%;"></td> <td style="width: 10%;"></td> <td style="width: 10%;"></td> <td style="width: 10%;"></td> <td style="width: 10%;"></td> <td style="width: 10%;"></td> <td style="width: 10%;"></td> </tr> <tr> <td></td> <td></td> <td colspan="8" style="text-align: center;"> <table border="1" style="width: 100%; border-collapse: collapse; text-align: center;"> <tr> <td style="width: 10%;"></td> <td style="width: 10%;"></td> <td style="width: 10%;"></td> <td style="width: 10%;"></td> <td style="width: 10%;"></td> <td style="width: 10%;"></td> <td style="width: 10%;"></td> <td style="width: 10%;"></td> <td style="width: 10%;"></td> <td style="width: 10%;"></td> </tr> <tr> <td></td> <td></td> <td colspan="8" style="text-align: center;"> <table border="1" style="width: 100%; border-collapse: collapse;
text-align: center;"> <tr> <td style="width: 10%;"></td> <td style="width: 10%;"></td> <td style="width: 10%;"></td> <td style="width: 10%;"></td> <td style="width: 10%;"></td> <td style="width: 10%;"></td> <td style="width: 10%;"></td> <td style="width: 10%;"></td> <td style="width: 10%;"></td> <td style="width: 10%;"></td> </tr> <tr> <td></td> <td></td> <td colspan="8" style="text-align: center;"> <table border="1" style="width: 100%; border-collapse: collapse; text-align: center;"> <tr> <td style="width: 10%;"></td> <td style="width: 10%;"></td> <td style="width: 10%;"></td> <td style="width: 10%;"></td> <td style="width: 10%;"></td> <td style="width: 10%;"></td> <td style="width: 10%;"></td> <td style="width: 10%;"></td> <td style="width: 10%;"></td> <td style="width: 10%;"></td> </tr> <tr> <td></td> <td></td> <td colspan="8" style="text-align: center;"> <table border="1" style="width: 100%; border-collapse: collapse; text-align: center;"> <tr> <td style="width: 10%;"></td> <td style="width: 10%;"></td> <td style="width: 10%;"></td> <td style="width: 10%;"></td> <td style="width: 10%;"></td> <td style="width: 10%;"></td> <td style="width: 10%;"></td> <td style="width: 10%;"></td> <td style="width: 10%;"></td> <td style="width: 10%;"></td> </tr> <tr> <td></td> <td></td> <td colspan="8" style="text-align: center;"> <table border="1" style="width: 100%; border-collapse: collapse; text-align: center;"> <tr> <td style="width: 10%;"></td> <td style="width: 10%;"></td> <td style="width: 10%;"></td> <td style="width: 10%;"></td> <td style="width: 10%;"></td> <td style="width: 10%;"></td> <td style="width: 10%;"></td> <td style="width: 10%;"></td> <td style="width: 10%;"></td> <td style="width: 10%;"></td> </tr> <tr> <td></td> <td></td> <td colspan="8" style="text-align: center;"> <table border="1" style="width: 100%; border-collapse: collapse; text-align: center;"> <tr> <td style="width: 10%;"></td> <td style="width: 10%;"></td> <td style="width: 10%;"></td> <td style="width: 10%;"></td> <td style="width: 10%;"></td> <td style="width: 10%;"></td> <td style="width: 10%;"></td> <td style="width: 10%;"></td> <td style="width: 10%;"></td> <td style="width: 10%;"></td> </tr> <tr> <td></td> <td></td> <td colspan="8" style="text-align: center;"> <table border="1" style="width: 100%; border-collapse: collapse; text-align: center;"> <tr> <td style="width: 10%;"></td> <td style="width: 10%;"></td> <td style="width: 10%;"></td> <td style="width: 10%;"></td> <td style="width: 10%;"></td> <td style="width: 10%;"></td> <td style="width: 10%;"></td> <td style="width: 10%;"></td> <td style="width: 10%;"></td> <td style="width: 10%;"></td> </tr> <tr> <td></td> <td></td> <td colspan="8" style="text-align: center;"> <table border="1" style="width: 100%; border-collapse: collapse; text-align: center;"> <tr> </tr></table></td></tr></table></td></tr></table></td></tr></table></td></tr></table></td></tr></table></td></tr></table></td></tr></table></td></tr></table></td></tr></table></td></tr></table></td></tr></table></td></tr></table></td></tr></table></td></tr></table></td></tr></table></td></tr></table></td></tr></table></td></tr></table></td></tr></table></td></tr></table></td></tr></table></td></tr></table></td></tr></table></td></tr></table></td></tr></table></td></tr></table></td></tr></table></td></tr></table></td></tr></table></td></tr></table></td></tr></table></td></tr></table></td></tr></table></td></tr></table></td></tr></table></td></tr></table></td></tr></table></td></tr></table></td></tr></table></td></tr></table></td></tr></table></td></tr></table></td></tr></table></td></tr></table></td></tr></table></td></tr></table></td></tr></table> | | | | | | | | | | | | | | | | | | | | <table border="1" style="width: 100%; border-collapse: collapse; text-align: center;"> <tr> <td style="width: 10%;"></td> <td style="width: 10%;"></td> <td style="width: 10%;"></td> <td style="width: 10%;"></td> <td style="width: 10%;"></td> <td style="width: 10%;"></td> <td style="width: 10%;"></td> <td style="width: 10%;"></td> <td style="width: 10%;"></td> <td style="width: 10%;"></td> </tr> <tr> <td></td> <td></td> <td colspan="8" style="text-align: center;"> <table border="1" style="width: 100%; border-collapse: collapse; text-align: center;"> <tr> <td style="width: 10%;"></td> <td style="width: 10%;"></td> <td style="width: 10%;"></td> <td style="width: 10%;"></td> <td style="width: 10%;"></td> <td style="width: 10%;"></td> <td style="width: 10%;"></td> <td style="width: 10%;"></td> <td style="width: 10%;"></td> <td style="width: 10%;"></td> </tr> <tr> <td></td> <td></td> <td colspan="8" style="text-align: center;"> <table border="1" style="width: 100%; border-collapse: collapse; text-align: center;"> <tr> <td style="width: 10%;"></td> <td style="width: 10%;"></td> <td style="width: 10%;"></td> <td style="width: 10%;"></td> <td style="width: 10%;"></td> <td style="width: 10%;"></td> <td style="width: 10%;"></td> <td style="width: 10%;"></td> <td style="width: 10%;"></td> <td style="width: 10%;"></td> </tr> <tr> <td></td> <td></td> <td colspan="8" style="text-align: center;"> <table border="1" style="width: 100%; border-collapse: collapse; text-align: center;"> <tr> <td style="width: 10%;"></td> <td style="width: 10%;"></td> <td style="width: 10%;"></td> <td style="width: 10%;"></td> <td style="width: 10%;"></td> <td style="width: 10%;"></td> <td style="width: 10%;"></td> <td style="width: 10%;"></td> <td style="width: 10%;"></td> <td style="width: 10%;"></td> </tr> <tr> <td></td> <td></td> <td colspan="8" style="text-align: center;"> <table border="1" style="width: 100%; border-collapse: collapse; text-align: center;"> <tr> <td style="width: 10%;"></td> <td style="width: 10%;"></td> <td style="width: 10%;"></td> <td style="width: 10%;"></td> <td style="width: 10%;"></td> <td style="width: 10%;"></td> <td style="width: 10%;"></td> <td style="width: 10%;"></td> <td style="width: 10%;"></td> <td style="width: 10%;"></td> </tr> <tr> <td></td> <td></td> <td colspan="8" style="text-align: center;"> <table border="1" style="width: 100%; border-collapse: collapse; text-align: center;"> <tr> <td style="width: 10%;"></td> <td style="width: 10%;"></td> <td style="width: 10%;"></td> <td style="width: 10%;"></td> <td style="width: 10%;"></td> <td style="width: 10%;"></td> <td style="width: 10%;"></td> <td style="width: 10%;"></td> <td style="width: 10%;"></td> <td style="width: 10%;"></td> </tr> <tr> <td></td> <td></td> <td colspan="8" style="text-align: center;"> <table border="1" style="width: 100%; border-collapse: collapse; text-align: center;"> <tr> <td style="width: 10%;"></td> <td style="width: 10%;"></td> <td style="width: 10%;"></td> <td style="width: 10%;"></td> <td style="width: 10%;"></td> <td style="width: 10%;"></td> <td style="width: 10%;"></td> <td style="width: 10%;"></td> <td style="width: 10%;"></td> <td style="width: 10%;"></td> </tr> <tr> <td></td> <td></td> <td colspan="8" style="text-align: center;"> <table border="1" style="width: 100%; border-collapse: collapse; text-align: center;"> <tr> <td style="width: 10%;"></td> <td style="width: 10%;"></td> <td style="width: 10%;"></td> <td style="width: 10%;"></td> <td style="width: 10%;"></td> <td style="width: 10%;"></td> <td style="width: 10%;"></td> <td style="width: 10%;"></td> <td style="width: 10%;"></td> <td style="width: 10%;"></td> </tr> <tr> <td></td> <td></td> <td colspan="8" style="text-align: center;"> <table border="1" style="width: 100%; border-collapse: collapse; text-align: center;"> <tr> <td style="width: 10%;"></td> <td style="width: 10%;"></td> <td style="width: 10%;"></td> <td style="width: 10%;"></td> <td style="width: 10%;"></td> <td style="width: 10%;"></td> <td style="width: 10%;"></td> <td style="width: 10%;"></td> <td style="width: 10%;"></td> <td style="width: 10%;"></td> </tr> <tr> <td></td> <td></td> <td colspan="8" style="text-align: center;"> <table border="1" style="width: 100%; border-collapse: collapse; text-align: center;">
<tr> <td style="width: 10%;"></td> <td style="width: 10%;"></td> <td style="width: 10%;"></td> <td style="width: 10%;"></td> <td style="width: 10%;"></td> <td style="width: 10%;"></td> <td style="width: 10%;"></td> <td style="width: 10%;"></td> <td style="width: 10%;"></td> <td style="width: 10%;"></td> </tr> <tr> <td></td> <td></td> <td colspan="8" style="text-align: center;"> <table border="1" style="width: 100%; border-collapse: collapse; text-align: center;"> <tr> <td style="width: 10%;"></td> <td style="width: 10%;"></td> <td style="width: 10%;"></td> <td style="width: 10%;"></td> <td style="width: 10%;"></td> <td style="width: 10%;"></td> <td style="width: 10%;"></td> <td style="width: 10%;"></td> <td style="width: 10%;"></td> <td style="width: 10%;"></td> </tr> <tr> <td></td> <td></td> <td colspan="8" style="text-align: center;"> <table border="1" style="width: 100%; border-collapse: collapse; text-align: center;"> <tr> <td style="width: 10%;"></td> <td style="width: 10%;"></td> <td style="width: 10%;"></td> <td style="width: 10%;"></td> <td style="width: 10%;"></td> <td style="width: 10%;"></td> <td style="width: 10%;"></td> <td style="width: 10%;"></td> <td style="width: 10%;"></td> <td style="width: 10%;"></td> </tr> <tr> <td></td> <td></td> <td colspan="8" style="text-align: center;"> <table border="1" style="width: 100%; border-collapse: collapse; text-align: center;"> <tr> <td style="width: 10%;"></td> <td style="width: 10%;"></td> <td style="width: 10%;"></td> <td style="width: 10%;"></td> <td style="width: 10%;"></td> <td style="width: 10%;"></td> <td style="width: 10%;"></td> <td style="width: 10%;"></td> <td style="width: 10%;"></td> <td style="width: 10%;"></td> </tr> <tr> <td></td> <td></td> <td colspan="8" style="text-align: center;"> <table border="1" style="width: 100%; border-collapse: collapse; text-align: center;"> <tr> <td style="width: 10%;"></td> <td style="width: 10%;"></td> <td style="width: 10%;"></td> <td style="width: 10%;"></td> <td style="width: 10%;"></td> <td style="width: 10%;"></td> <td style="width: 10%;"></td> <td style="width: 10%;"></td> <td style="width: 10%;"></td> <td style="width: 10%;"></td> </tr> <tr> <td></td> <td></td> <td colspan="8" style="text-align: center;"> <table border="1" style="width: 100%; border-collapse: collapse; text-align: center;"> <tr> <td style="width: 10%;"></td> <td style="width: 10%;"></td> <td style="width: 10%;"></td> <td style="width: 10%;"></td> <td style="width: 10%;"></td> <td style="width: 10%;"></td> <td style="width: 10%;"></td> <td style="width: 10%;"></td> <td style="width: 10%;"></td> <td style="width: 10%;"></td> </tr> <tr> <td></td> <td></td> <td colspan="8" style="text-align: center;"> <table border="1" style="width: 100%; border-collapse: collapse; text-align: center;"> <tr> <td style="width: 10%;"></td> <td style="width: 10%;"></td> <td style="width: 10%;"></td> <td style="width: 10%;"></td> <td style="width: 10%;"></td> <td style="width: 10%;"></td> <td style="width: 10%;"></td> <td style="width: 10%;"></td> <td style="width: 10%;"></td> <td style="width: 10%;"></td> </tr> <tr> <td></td> <td></td> <td colspan="8" style="text-align: center;"> <table border="1" style="width: 100%; border-collapse: collapse; text-align: center;"> <tr> <td style="width: 10%;"></td> <td style="width: 10%;"></td> <td style="width: 10%;"></td> <td style="width: 10%;"></td> <td style="width: 10%;"></td> <td style="width: 10%;"></td> <td style="width: 10%;"></td> <td style="width: 10%;"></td> <td style="width: 10%;"></td> <td style="width: 10%;"></td> </tr> <tr> <td></td> <td></td> <td colspan="8" style="text-align: center;"> <table border="1" style="width: 100%; border-collapse: collapse; text-align: center;"> <tr> <td style="width: 10%;"></td> <td style="width: 10%;"></td> <td style="width: 10%;"></td> <td style="width: 10%;"></td> <td style="width: 10%;"></td> <td style="width: 10%;"></td> <td style="width: 10%;"></td> <td style="width: 10%;"></td> <td style="width: 10%;"></td> <td style="width: 10%;"></td> </tr> <tr> <td></td> <td></td> <td colspan="8" style="text-align: center;"> <table border="1" style="width: 100%; border-collapse: collapse; text-align: center;"> <tr> <td style="width: 10%;"></td> <td style="width: 10%;"></td> <td style="width: 10%;"></td> <td style="width: 10%;"></td> <td style="width: 10%;"></td> <td style="width: 10%;"></td> <td style="width: 10%;"></td> <td style="width: 10%;"></td> <td style="width: 10%;"></td> <td style="width: 10%;"></td> </tr> <tr> <td></td> <td></td> <td colspan="8" style="text-align: center;"> <table border="1" style="width: 100%; border-collapse: collapse; text-align: center;"> <tr> <td style="width: 10%;"></td> <td style="width: 10%;"></td> <td style="width: 10%;"></td> <td style="width: 10%;"></td> <td style="width: 10%;"></td> <td style="width: 10%;"></td> <td style="width: 10%;"></td> <td style="width: 10%;"></td> <td style="width: 10%;"></td> <td style="width: 10%;"></td> </tr> <tr> <td></td> <td></td> <td colspan="8" style="text-align: center;"> <table border="1" style="width: 100%; border-collapse: collapse; text-align: center;"> <tr> <td style="width: 10%;"></td> <td style="width: 10%;"></td> <td style="width: 10%;"></td> <td style="width: 10%;"></td> <td style="width: 10%;"></td> <td style="width: 10%;"></td> <td style="width: 10%;"></td> <td style="width: 10%;"></td> <td style="width: 10%;"></td> <td style="width: 10%;"></td> </tr> <tr> <td></td> <td></td> <td colspan="8" style="text-align: center;"> <table border="1" style="width: 100%; border-collapse: collapse; text-align: center;"> <tr> <td style="width: 10%;"></td> <td style="width: 10%;"></td> <td style="width: 10%;"></td> <td style="width: 10%;"></td> <td style="width: 10%;"></td> <td style="width: 10%;"></td> <td style="width: 10%;"></td> <td style="width: 10%;"></td> <td style="width: 10%;"></td> <td style="width: 10%;"></td> </tr> <tr> <td></td> <td></td> <td colspan="8" style="text-align: center;"> <table border="1" style="width: 100%; border-collapse: collapse; text-align: center;"> <tr> <td style="width: 10%;"></td> <td style="width: 10%;"></td> <td style="width: 10%;"></td> <td style="width: 10%;"></td> <td style="width: 10%;"></td> <td style="width: 10%;"></td> <td style="width: 10%;"></td> <td style="width: 10%;"></td> <td style="width: 10%;"></td> <td style="width: 10%;"></td> </tr> <tr> <td></td> <td></td> <td colspan="8" style="text-align: center;"> <table border="1" style="width: 100%; border-collapse: collapse; text-align: center;"> <tr> <td style="width: 10%;"></td> <td style="width: 10%;"></td> <td style="width: 10%;"></td> <td style="width: 10%;"></td> <td style="width: 10%;"></td> <td style="width: 10%;"></td> <td style="width: 10%;"></td> <td style="width: 10%;"></td> <td style="width: 10%;"></td> <td style="width: 10%;"></td> </tr> <tr> <td></td> <td></td> <td colspan="8" style="text-align: center;"> <table border="1" style="width: 100%; border-collapse: collapse; text-align: center;"> <tr> <td style="width: 10%;"></td> <td style="width: 10%;"></td> <td style="width: 10%;"></td> <td style="width: 10%;"></td> <td style="width: 10%;"></td> <td style="width: 10%;"></td> <td style="width: 10%;"></td> <td style="width: 10%;"></td> <td style="width: 10%;"></td> <td style="width: 10%;"></td> </tr> <tr> <td></td> <td></td> <td colspan="8" style="text-align: center;"> <table border="1" style="width: 100%; border-collapse: collapse; text-align: center;"> <tr> <td style="width: 10%;"></td> <td style="width: 10%;"></td> <td style="width: 10%;"></td> <td style="width: 10%;"></td> <td style="width: 10%;"></td> <td style="width: 10%;"></td> <td style="width: 10%;"></td> <td style="width: 10%;"></td> <td style="width: 10%;"></td> <td style="width: 10%;"></td> </tr> <tr> <td></td> <td></td> <td colspan="8" style="text-align: center;"> <table border="1" style="width: 100%; border-collapse: collapse; text-align: center;"> <tr> <td style="width: 10%;"></td> <td style="width: 10%;"></td> <td style="width: 10%;"></td> <td style="width: 10%;"></td> <td style="width: 10%;"></td> <td style="width: 10%;"></td> <td style="width: 10%;"></td> <td style="width: 10%;"></td> <td style="width: 10%;"></td> <td style="width: 10%;"></td> </tr> <tr> <td></td> <td></td> <td colspan="8" style="text-align: center;"> <table border="1" style="width: 100%; border-collapse: collapse; text-align: center;"> <tr> <td style="width: 10%;"></td> <td style="width: 10%;"></td> <td style="width: 10%;"></td> <td style="width: 10%;"></td> <td style="width: 10%;"></td> <td style="width: 10%;"></td> <td style="width: 10%;"></td> <td style="width: 10%;"></td> <td style="width: 10%;"></td> <td style="width: 10%;"></td> </tr> <tr> <td></td> <td></td> <td colspan="8" style="text-align: center;"> <table border="1" style="width: 100%; border-collapse: collapse; text-align: center;"> <tr> <td style="width: 10%;"></td> <td style="width: 10%;"></td> <td style="width: 10%;"></td> <td style="width: 10%;"></td> <td style="width: 10%;"></td> <td style="width: 10%;"></td> <td style="width: 10%;"></td> <td style="width: 10%;"></td> <td style="width: 10%;"></td> <td style="width: 10%;"></td> </tr> <tr> <td></td> <td></td> <td colspan="8" style="text-align: center;"> <table border="1" style="width: 100%; border-collapse: collapse; text-align: center;"> <tr> <td style="width: 10%;"></td> <td style="width: 10%;"></td> <td style="width: 10%;"></td> <td style="width: 10%;"></td> <td style="width: 10%;"></td> <td style="width: 10%;"></td> <td style="width: 10%;"></td> <td style="width: 10%;"></td> <td style="width: 10%;"></td> <td style="width: 10%;"></td> </tr> <tr> <td></td> <td></td> <td colspan="8" style="text-align: center;"> <table border="1" style="width: 100%; border-collapse: collapse; text-align: center;"> <tr> <td style="width: 10%;"></td> <td style="width: 10%;"></td> <td style="width: 10%;"></td> <td style="width: 10%;"></td> <td style="width: 10%;"></td> <td
style="width: 10%;"></td> <td style="width: 10%;"></td> <td style="width: 10%;"></td> <td style="width: 10%;"></td> <td style="width: 10%;"></td> </tr> <tr> <td></td> <td></td> <td colspan="8" style="text-align: center;"> <table border="1" style="width: 100%; border-collapse: collapse; text-align: center;"> <tr> <td style="width: 10%;"></td> <td style="width: 10%;"></td> <td style="width: 10%;"></td> <td style="width: 10%;"></td> <td style="width: 10%;"></td> <td style="width: 10%;"></td> <td style="width: 10%;"></td> <td style="width: 10%;"></td> <td style="width: 10%;"></td> <td style="width: 10%;"></td> </tr> <tr> <td></td> <td></td> <td colspan="8" style="text-align: center;"> <table border="1" style="width: 100%; border-collapse: collapse; text-align: center;"> <tr> <td style="width: 10%;"></td> <td style="width: 10%;"></td> <td style="width: 10%;"></td> <td style="width: 10%;"></td> <td style="width: 10%;"></td> <td style="width: 10%;"></td> <td style="width: 10%;"></td> <td style="width: 10%;"></td> <td style="width: 10%;"></td> <td style="width: 10%;"></td> </tr> <tr> <td></td> <td></td> <td colspan="8" style="text-align: center;"> <table border="1" style="width: 100%; border-collapse: collapse; text-align: center;"> <tr> <td style="width: 10%;"></td> <td style="width: 10%;"></td> <td style="width: 10%;"></td> <td style="width: 10%;"></td> <td style="width: 10%;"></td> <td style="width: 10%;"></td> <td style="width: 10%;"></td> <td style="width: 10%;"></td> <td style="width: 10%;"></td> <td style="width: 10%;"></td> </tr> <tr> <td></td> <td></td> <td colspan="8" style="text-align: center;"> <table border="1" style="width: 100%; border-collapse: collapse; text-align: center;"> <tr> <td style="width: 10%;"></td> <td style="width: 10%;"></td> <td style="width: 10%;"></td> <td style="width: 10%;"></td> <td style="width: 10%;"></td> <td style="width: 10%;"></td> <td style="width: 10%;"></td> <td style="width: 10%;"></td> <td style="width: 10%;"></td> <td style="width: 10%;"></td> </tr> <tr> <td></td> <td></td> <td colspan="8" style="text-align: center;"> <table border="1" style="width: 100%; border-collapse: collapse; text-align: center;"> <tr> <td style="width: 10%;"></td> <td style="width: 10%;"></td> <td style="width: 10%;"></td> <td style="width: 10%;"></td> <td style="width: 10%;"></td> <td style="width: 10%;"></td> <td style="width: 10%;"></td> <td style="width: 10%;"></td> <td style="width: 10%;"></td> <td style="width: 10%;"></td> </tr> <tr> <td></td> <td></td> <td colspan="8" style="text-align: center;"> <table border="1" style="width: 100%; border-collapse: collapse; text-align: center;"> <tr> <td style="width: 10%;"></td> <td style="width: 10%;"></td> <td style="width: 10%;"></td> <td style="width: 10%;"></td> <td style="width: 10%;"></td> <td style="width: 10%;"></td> <td style="width: 10%;"></td> <td style="width: 10%;"></td> <td style="width: 10%;"></td> <td style="width: 10%;"></td> </tr> <tr> <td></td> <td></td> <td colspan="8" style="text-align: center;"> <table border="1" style="width: 100%; border-collapse: collapse; text-align: center;"> <tr> <td style="width: 10%;"></td> <td style="width: 10%;"></td> <td style="width: 10%;"></td> <td style="width: 10%;"></td> <td style="width: 10%;"></td> <td style="width: 10%;"></td> <td style="width: 10%;"></td> <td style="width: 10%;"></td> <td style="width: 10%;"></td> <td style="width: 10%;"></td> </tr> <tr> <td></td> <td></td> <td colspan="8" style="text-align: center;"> <table border="1" style="width: 100%; border-collapse: collapse; text-align: center;"> <tr> <td style="width: 10%;"></td> <td style="width: 10%;"></td> <td style="width: 10%;"></td> <td style="width: 10%;"></td> <td style="width: 10%;"></td> <td style="width: 10%;"></td> <td style="width: 10%;"></td> <td style="width: 10%;"></td> <td style="width: 10%;"></td> <td style="width: 10%;"></td> </tr> <tr> <td></td> <td></td> <td colspan="8" style="text-align: center;"> <table border="1" style="width: 100%; border-collapse: collapse; text-align: center;"> <tr> <td style="width: 10%;"></td> <td style="width: 10%;"></td> <td style="width: 10%;"></td> <td style="width: 10%;"></td> <td style="width: 10%;"></td> <td style="width: 10%;"></td> <td style="width: 10%;"></td> <td style="width: 10%;"></td> <td style="width: 10%;"></td> <td style="width: 10%;"></td> </tr> <tr> <td></td> <td></td> <td colspan="8" style="text-align: center;"> <table border="1" style="width: 100%; border-collapse: collapse; text-align: center;"> <tr> <td style="width: 10%;"></td> <td style="width: 10%;"></td> <td style="width: 10%;"></td> <td style="width: 10%;"></td> <td style="width: 10%;"></td> <td style="width: 10%;"></td> <td style="width: 10%;"></td> <td style="width: 10%;"></td> <td style="width: 10%;"></td> <td style="width: 10%;"></td> </tr> <tr> <td></td> <td></td> <td colspan="8" style="text-align: center;"> <table border="1" style="width: 100%; border-collapse: collapse; text-align: center;"> <tr> <td style="width: 10%;"></td> <td style="width: 10%;"></td> <td style="width: 10%;"></td> <td style="width: 10%;"></td> <td style="width: 10%;"></td> <td style="width: 10%;"></td> <td style="width: 10%;"></td> <td style="width: 10%;"></td> <td style="width: 10%;"></td> <td style="width: 10%;"></td> </tr> <tr> <td></td> <td></td> <td colspan="8" style="text-align: center;"> <table border="1" style="width: 100%; border-collapse: collapse; text-align: center;"> <tr> <td style="width: 10%;"></td> <td style="width: 10%;"></td> <td style="width: 10%;"></td> <td style="width: 10%;"></td> <td style="width: 10%;"></td> <td style="width: 10%;"></td> <td style="width: 10%;"></td> <td style="width: 10%;"></td> <td style="width: 10%;"></td> <td style="width: 10%;"></td> </tr> <tr> <td></td> <td></td> <td colspan="8" style="text-align: center;"> <table border="1" style="width: 100%; border-collapse: collapse; text-align: center;"> <tr> <td style="width: 10%;"></td> <td style="width: 10%;"></td> <td style="width: 10%;"></td> <td style="width: 10%;"></td> <td style="width: 10%;"></td> <td style="width: 10%;"></td> <td style="width: 10%;"></td> <td style="width: 10%;"></td> <td style="width: 10%;"></td> <td style="width: 10%;"></td> </tr> <tr> <td></td> <td></td> <td colspan="8" style="text-align: center;"> <table border="1" style="width: 100%; border-collapse: collapse; text-align: center;"> <tr> <td style="width: 10%;"></td> <td style="width: 10%;"></td> <td style="width: 10%;"></td> <td style="width: 10%;"></td> <td style="width: 10%;"></td> <td style="width: 10%;"></td> <td style="width: 10%;"></td> <td style="width: 10%;"></td> <td style="width: 10%;"></td> <td style="width: 10%;"></td> </tr> <tr> <td></td> <td></td> <td colspan="8" style="text-align: center;"> <table border="1" style="width: 100%; border-collapse: collapse; text-align: center;"> <tr> <td style="width: 10%;"></td> <td style="width: 10%;"></td> <td style="width: 10%;"></td> <td style="width: 10%;"></td> <td style="width: 10%;"></td> <td style="width: 10%;"></td> <td style="width: 10%;"></td> <td style="width: 10%;"></td> <td style="width: 10%;"></td> <td style="width: 10%;"></td> </tr> <tr> <td></td> <td></td> <td colspan="8" style="text-align: center;"> <table border="1" style="width: 100%; border-collapse: collapse; text-align: center;"> <tr> </tr></table></td></tr></table></td></tr></table></td></tr></table></td></tr></table></td></tr></table></td></tr></table></td></tr></table></td></tr></table></td></tr></table></td></tr></table></td></tr></table></td></tr></table></td></tr></table></td></tr></table></td></tr></table></td></tr></table></td></tr></table></td></tr></table></td></tr></table></td></tr></table></td></tr></table></td></tr></table></td></tr></table></td></tr></table></td></tr></table></td></tr></table></td></tr></table></td></tr></table></td></tr></table></td></tr></table></td></tr></table></td></tr></table></td></tr></table></td></tr></table></td></tr></table></td></tr></table></td></tr></table></td></tr></table></td></tr></table></td></tr></table></td></tr></table></td></tr></table></td></tr></table></td></tr></table></td></tr></table></td></tr></table>
 | | | | | | | | | | | | | | | | | | | | <table border="1" style="width: 100%; border-collapse: collapse; text-align: center;"> <tr> <td style="width: 10%;"></td> <td style="width: 10%;"></td> <td style="width: 10%;"></td> <td style="width: 10%;"></td> <td style="width: 10%;"></td> <td style="width: 10%;"></td> <td style="width: 10%;"></td> <td style="width: 10%;"></td> <td style="width: 10%;"></td> <td style="width: 10%;"></td> </tr> <tr> <td></td> <td></td> <td colspan="8" style="text-align: center;"> <table border="1" style="width: 100%; border-collapse: collapse; text-align: center;"> <tr> <td style="width: 10%;"></td> <td style="width: 10%;"></td> <td style="width: 10%;"></td> <td style="width: 10%;"></td> <td style="width: 10%;"></td> <td style="width: 10%;"></td> <td style="width: 10%;"></td> <td style="width: 10%;"></td> <td style="width: 10%;"></td> <td style="width: 10%;"></td> </tr> <tr> <td></td> <td></td> <td colspan="8" style="text-align: center;"> <table border="1" style="width: 100%; border-collapse: collapse; text-align: center;"> <tr> <td style="width: 10%;"></td> <td style="width: 10%;"></td> <td style="width: 10%;"></td> <td style="width: 10%;"></td> <td style="width: 10%;"></td> <td style="width: 10%;"></td> <td style="width: 10%;"></td> <td style="width: 10%;"></td> <td style="width: 10%;"></td> <td style="width: 10%;"></td> </tr> <tr> <td></td> <td></td> <td colspan="8" style="text-align: center;"> <table border="1" style="width: 100%; border-collapse: collapse; text-align: center;"> <tr> <td style="width: 10%;"></td> <td style="width: 10%;"></td> <td style="width: 10%;"></td> <td style="width: 10%;"></td> <td style="width: 10%;"></td> <td style="width: 10%;"></td> <td style="width: 10%;"></td> <td style="width: 10%;"></td> <td style="width: 10%;"></td> <td style="width: 10%;"></td> </tr> <tr> <td></td> <td></td> <td colspan="8" style="text-align: center;"> <table border="1" style="width: 100%; border-collapse: collapse; text-align: center;"> <tr> <td style="width: 10%;"></td> <td style="width: 10%;"></td> <td style="width: 10%;"></td> <td style="width: 10%;"></td> <td style="width: 10%;"></td> <td style="width: 10%;"></td> <td style="width: 10%;"></td> <td style="width: 10%;"></td> <td style="width: 10%;"></td> <td style="width: 10%;"></td> </tr> <tr> <td></td> <td></td> <td colspan="8" style="text-align: center;"> <table border="1" style="width: 100%; border-collapse: collapse; text-align: center;"> <tr> <td style="width: 10%;"></td> <td style="width: 10%;"></td> <td style="width: 10%;"></td> <td style="width: 10%;"></td> <td style="width: 10%;"></td> <td style="width: 10%;"></td> <td style="width: 10%;"></td> <td style="width: 10%;"></td> <td style="width: 10%;"></td> <td style="width: 10%;"></td> </tr> <tr> <td></td> <td></td> <td colspan="8" style="text-align: center;"> <table border="1" style="width: 100%; border-collapse: collapse; text-align: center;"> <tr> <td style="width: 10%;"></td> <td style="width: 10%;"></td> <td style="width: 10%;"></td> <td style="width: 10%;"></td> <td style="width: 10%;"></td> <td style="width: 10%;"></td> <td style="width: 10%;"></td> <td style="width: 10%;"></td> <td style="width: 10%;"></td> <td style="width: 10%;"></td> </tr> <tr> <td></td> <td></td> <td colspan="8" style="text-align: center;"> <table border="1" style="width: 100%; border-collapse: collapse; text-align: center;"> <tr> <td style="width: 10%;"></td> <td style="width: 10%;"></td> <td style="width: 10%;"></td> <td style="width: 10%;"></td> <td style="width: 10%;"></td> <td style="width: 10%;"></td> <td style="width: 10%;"></td> <td style="width: 10%;"></td> <td style="width: 10%;"></td> <td style="width: 10%;"></td> </tr> <tr> <td></td> <td></td> <td colspan="8" style="text-align: center;"> <table border="1" style="width: 100%; border-collapse: collapse; text-align: center;"> <tr> <td style="width: 10%;"></td> <td style="width: 10%;"></td> <td style="width: 10%;"></td> <td style="width: 10%;"></td> <td style="width: 10%;"></td> <td style="width: 10%;"></td> <td style="width: 10%;"></td> <td style="width: 10%;"></td> <td style="width: 10%;"></td> <td style="width: 10%;"></td> </tr> <tr> <td></td> <td></td> <td colspan="8" style="text-align: center;"> <table border="1" style="width: 100%; border-collapse: collapse; text-align: center;"> <tr> <td style="width: 10%;"></td> <td style="width: 10%;"></td> <td style="width: 10%;"></td> <td style="width: 10%;"></td> <td style="width: 10%;"></td> <td style="width: 10%;"></td> <td style="width: 10%;"></td> <td style="width: 10%;"></td> <td style="width: 10%;"></td> <td style="width: 10%;"></td> </tr> <tr> <td></td> <td></td> <td colspan="8" style="text-align: center;"> <table border="1" style="width: 100%; border-collapse: collapse; text-align: center;"> <tr> <td style="width: 10%;"></td> <td style="width: 10%;"></td> <td style="width: 10%;"></td> <td style="width: 10%;"></td> <td style="width: 10%;"></td> <td style="width: 10%;"></td> <td style="width: 10%;"></td> <td style="width: 10%;"></td> <td style="width: 10%;"></td> <td style="width: 10%;"></td> </tr> <tr> <td></td> <td></td> <td colspan="8" style="text-align: center;"> <table border="1" style="width: 100%; border-collapse: collapse; text-align: center;"> <tr> <td style="width: 10%;"></td> <td style="width: 10%;"></td> <td style="width: 10%;"></td> <td style="width: 10%;"></td> <td style="width: 10%;"></td> <td style="width: 10%;"></td> <td style="width: 10%;"></td> <td style="width: 10%;"></td> <td style="width: 10%;"></td> <td style="width: 10%;"></td> </tr> <tr> <td></td> <td></td> <td colspan="8" style="text-align: center;"> <table border="1" style="width: 100%; border-collapse: collapse; text-align: center;"> <tr> <td style="width: 10%;"></td> <td style="width: 10%;"></td> <td style="width: 10%;"></td> <td style="width: 10%;"></td> <td style="width: 10%;"></td> <td style="width: 10%;"></td> <td style="width: 10%;"></td> <td style="width: 10%;"></td> <td style="width: 10%;"></td> <td style="width: 10%;"></td> </tr> <tr> <td></td> <td></td> <td colspan="8" style="text-align: center;"> <table border="1" style="width: 100%; border-collapse: collapse; text-align: center;"> <tr> <td style="width: 10%;"></td> <td style="width: 10%;"></td> <td style="width: 10%;"></td> <td style="width: 10%;"></td> <td style="width: 10%;"></td> <td style="width: 10%;"></td> <td style="width: 10%;"></td> <td style="width: 10%;"></td> <td style="width: 10%;"></td> <td style="width: 10%;"></td> </tr> <tr> <td></td> <td></td> <td colspan="8" style="text-align: center;"> <table border="1" style="width: 100%; border-collapse: collapse; text-align: center;"> <tr> <td style="width: 10%;"></td> <td style="width: 10%;"></td> <td style="width: 10%;"></td> <td style="width: 10%;"></td> <td style="width: 10%;"></td> <td style="width: 10%;"></td> <td style="width: 10%;"></td> <td style="width: 10%;"></td> <td style="width: 10%;"></td> <td style="width: 10%;"></td> </tr> <tr> <td></td> <td></td> <td colspan="8" style="text-align: center;"> <table border="1" style="width: 100%; border-collapse: collapse; text-align: center;"> <tr> <td style="width: 10%;"></td> <td style="width: 10%;"></td> <td style="width: 10%;"></td> <td style="width: 10%;"></td> <td style="width: 10%;"></td> <td style="width: 10%;"></td> <td style="width: 10%;"></td> <td style="width: 10%;"></td> <td style="width: 10%;"></td> <td style="width: 10%;"></td> </tr> <tr> <td></td> <td></td> <td colspan="8" style="text-align: center;"> <table border="1" style="width: 100%; border-collapse: collapse; text-align: center;"> <tr> <td style="width: 10%;"></td> <td style="width: 10%;"></td> <td style="width: 10%;"></td> <td style="width: 10%;"></td> <td style="width: 10%;"></td> <td style="width: 10%;"></td> <td style="width: 10%;"></td> <td style="width: 10%;"></td> <td style="width: 10%;"></td> <td style="width: 10%;"></td> </tr> <tr> <td></td> <td></td> <td colspan="8" style="text-align: center;"> <table border="1" style="width: 100%; border-collapse: collapse; text-align: center;"> <tr> <td style="width: 10%;"></td> <td style="width: 10%;"></td> <td style="width: 10%;"></td> <td style="width: 10%;"></td> <td style="width: 10%;"></td> <td style="width: 10%;"></td> <td style="width: 10%;"></td> <td style="width: 10%;"></td> <td style="width: 10%;"></td> <td style="width: 10%;"></td> </tr> <tr> <td></td> <td></td> <td colspan="8" style="text-align: center;"> <table border="1" style="width: 100%; border-collapse: collapse; text-align: center;"> <tr> <td style="width: 10%;"></td> <td style="width: 10%;"></td> <td style="width: 10%;"></td> <td style="width: 10%;"></td> <td style="width: 10%;"></td> <td style="width: 10%;"></td> <td style="width: 10%;"></td> <td style="width: 10%;"></td> <td style="width: 10%;"></td> <td style="width: 10%;"></td> </tr> <tr> <td></td> <td></td> <td colspan="8" style="text-align: center;"> <table border="1" style="width: 100%; border-collapse: collapse; text-align: center;"> <tr> <td style="width: 10%;"></td> <td style="width: 10%;"></td> <td style="width: 10%;"></td> <td style="width: 10%;"></td> <td style="width: 10%;"></td> <td style="width: 10%;"></td> <td style="width: 10%;"></td> <td style="width: 10%;"></td> <td style="width: 10%;"></td> <td style="width: 10%;"></td> </tr> <tr> <td></td> <td></td> <td colspan="8" style="text-align: center;"> <table border="1" style="width: 100%; border-collapse: collapse; text-align: center;"> <tr> <td style="width: 10%;"></td> <td style="width: 10%;"></td> <td style="width: 10%;"></td> <td style="width: 10%;"></td> <td style="width: 10%;"></td> <td style="width: 10%;"></td> <td style="width: 10%;"></td> <td style="width: 10%;"></td> <td style="width: 10%;"></td> <td style="width: 10%;"></td> </tr> <tr> <td></td> <td></td> <td colspan="8" style="text-align:
center;"> <table border="1" style="width: 100%; border-collapse: collapse; text-align: center;"> <tr> <td style="width: 10%;"></td> <td style="width: 10%;"></td> <td style="width: 10%;"></td> <td style="width: 10%;"></td> <td style="width: 10%;"></td> <td style="width: 10%;"></td> <td style="width: 10%;"></td> <td style="width: 10%;"></td> <td style="width: 10%;"></td> <td style="width: 10%;"></td> </tr> <tr> <td></td> <td></td> <td colspan="8" style="text-align: center;"> <table border="1" style="width: 100%; border-collapse: collapse; text-align: center;"> <tr> <td style="width: 10%;"></td> <td style="width: 10%;"></td> <td style="width: 10%;"></td> <td style="width: 10%;"></td> <td style="width: 10%;"></td> <td style="width: 10%;"></td> <td style="width: 10%;"></td> <td style="width: 10%;"></td> <td style="width: 10%;"></td> <td style="width: 10%;"></td> </tr> <tr> <td></td> <td></td> <td colspan="8" style="text-align: center;"> <table border="1" style="width: 100%; border-collapse: collapse; text-align: center;"> <tr> <td style="width: 10%;"></td> <td style="width: 10%;"></td> <td style="width: 10%;"></td> <td style="width: 10%;"></td> <td style="width: 10%;"></td> <td style="width: 10%;"></td> <td style="width: 10%;"></td> <td style="width: 10%;"></td> <td style="width: 10%;"></td> <td style="width: 10%;"></td> </tr> <tr> <td></td> <td></td> <td colspan="8" style="text-align: center;"> <table border="1" style="width: 100%; border-collapse: collapse; text-align: center;"> <tr> <td style="width: 10%;"></td> <td style="width: 10%;"></td> <td style="width: 10%;"></td> <td style="width: 10%;"></td> <td style="width: 10%;"></td> <td style="width: 10%;"></td> <td style="width: 10%;"></td> <td style="width: 10%;"></td> <td style="width: 10%;"></td> <td style="width: 10%;"></td> </tr> <tr> <td></td> <td></td> <td colspan="8" style="text-align: center;"> <table border="1" style="width: 100%; border-collapse: collapse; text-align: center;"> <tr> <td style="width: 10%;"></td> <td style="width: 10%;"></td> <td style="width: 10%;"></td> <td style="width: 10%;"></td> <td style="width: 10%;"></td> <td style="width: 10%;"></td> <td style="width: 10%;"></td> <td style="width: 10%;"></td> <td style="width: 10%;"></td> <td style="width: 10%;"></td> </tr> <tr> <td></td> <td></td> <td colspan="8" style="text-align: center;"> <table border="1" style="width: 100%; border-collapse: collapse; text-align: center;"> <tr> <td style="width: 10%;"></td> <td style="width: 10%;"></td> <td style="width: 10%;"></td> <td style="width: 10%;"></td> <td style="width: 10%;"></td> <td style="width: 10%;"></td> <td style="width: 10%;"></td> <td style="width: 10%;"></td> <td style="width: 10%;"></td> <td style="width: 10%;"></td> </tr> <tr> <td></td> <td></td> <td colspan="8" style="text-align: center;"> <table border="1" style="width: 100%; border-collapse: collapse; text-align: center;"> <tr> <td style="width: 10%;"></td> <td style="width: 10%;"></td> <td style="width: 10%;"></td> <td style="width: 10%;"></td> <td style="width: 10%;"></td> <td style="width: 10%;"></td> <td style="width: 10%;"></td> <td style="width: 10%;"></td> <td style="width: 10%;"></td> <td style="width: 10%;"></td> </tr> <tr> <td></td> <td></td> <td colspan="8" style="text-align: center;"> <table border="1" style="width: 100%; border-collapse: collapse; text-align: center;"> <tr> <td style="width: 10%;"></td> <td style="width: 10%;"></td> <td style="width: 10%;"></td> <td style="width: 10%;"></td> <td style="width: 10%;"></td> <td style="width: 10%;"></td> <td style="width: 10%;"></td> <td style="width: 10%;"></td> <td style="width: 10%;"></td> <td style="width: 10%;"></td> </tr> <tr> <td></td> <td></td> <td colspan="8" style="text-align: center;"> <table border="1" style="width: 100%; border-collapse: collapse; text-align: center;"> <tr> <td style="width: 10%;"></td> <td style="width: 10%;"></td> <td style="width: 10%;"></td> <td style="width: 10%;"></td> <td style="width: 10%;"></td> <td style="width: 10%;"></td> <td style="width: 10%;"></td> <td style="width: 10%;"></td> <td style="width: 10%;"></td> <td style="width: 10%;"></td> </tr> <tr> <td></td> <td></td> <td colspan="8" style="text-align: center;"> <table border="1" style="width: 100%; border-collapse: collapse; text-align: center;"> <tr> <td style="width: 10%;"></td> <td style="width: 10%;"></td> <td style="width: 10%;"></td> <td style="width: 10%;"></td> <td style="width: 10%;"></td> <td style="width: 10%;"></td> <td style="width: 10%;"></td> <td style="width: 10%;"></td> <td style="width: 10%;"></td> <td style="width: 10%;"></td> </tr> <tr> <td></td> <td></td> <td colspan="8" style="text-align: center;"> <table border="1" style="width: 100%; border-collapse: collapse; text-align: center;"> <tr> <td style="width: 10%;"></td> <td style="width: 10%;"></td> <td style="width: 10%;"></td> <td style="width: 10%;"></td> <td style="width: 10%;"></td> <td style="width: 10%;"></td> <td style="width: 10%;"></td> <td style="width: 10%;"></td> <td style="width: 10%;"></td> <td style="width: 10%;"></td> </tr> <tr> <td></td> <td></td> <td colspan="8" style="text-align: center;"> <table border="1" style="width: 100%; border-collapse: collapse; text-align: center;"> <tr> <td style="width: 10%;"></td> <td style="width: 10%;"></td> <td style="width: 10%;"></td> <td style="width: 10%;"></td> <td style="width: 10%;"></td> <td style="width: 10%;"></td> <td style="width: 10%;"></td> <td style="width: 10%;"></td> <td style="width: 10%;"></td> <td style="width: 10%;"></td> </tr> <tr> <td></td> <td></td> <td colspan="8" style="text-align: center;"> <table border="1" style="width: 100%; border-collapse: collapse; text-align: center;"> <tr> <td style="width: 10%;"></td> <td style="width: 10%;"></td> <td style="width: 10%;"></td> <td style="width: 10%;"></td> <td style="width: 10%;"></td> <td style="width: 10%;"></td> <td style="width: 10%;"></td> <td style="width: 10%;"></td> <td style="width: 10%;"></td> <td style="width: 10%;"></td> </tr> <tr> <td></td> <td></td> <td colspan="8" style="text-align: center;"> <table border="1" style="width: 100%; border-collapse: collapse; text-align: center;"> <tr> <td style="width: 10%;"></td> <td style="width: 10%;"></td> <td style="width: 10%;"></td> <td style="width: 10%;"></td> <td style="width: 10%;"></td> <td style="width: 10%;"></td> <td style="width: 10%;"></td> <td style="width: 10%;"></td> <td style="width: 10%;"></td> <td style="width: 10%;"></td> </tr> <tr> <td></td> <td></td> <td colspan="8" style="text-align: center;"> <table border="1" style="width: 100%; border-collapse: collapse; text-align: center;"> <tr> <td style="width: 10%;"></td> <td style="width: 10%;"></td> <td style="width: 10%;"></td> <td style="width: 10%;"></td> <td style="width: 10%;"></td> <td style="width: 10%;"></td> <td style="width: 10%;"></td> <td style="width: 10%;"></td> <td style="width: 10%;"></td> <td style="width: 10%;"></td> </tr> <tr> <td></td> <td></td> <td colspan="8" style="text-align: center;"> <table border="1" style="width: 100%; border-collapse: collapse; text-align: center;"> <tr> <td style="width: 10%;"></td> <td style="width: 10%;"></td> <td style="width: 10%;"></td> <td style="width: 10%;"></td> <td style="width: 10%;"></td> <td style="width: 10%;"></td> <td style="width: 10%;"></td> <td style="width: 10%;"></td> <td style="width: 10%;"></td> <td style="width: 10%;"></td> </tr> <tr> <td></td> <td></td> <td colspan="8" style="text-align: center;"> <table border="1" style="width: 100%; border-collapse: collapse; text-align: center;"> <tr> <td style="width: 10%;"></td> <td style="width: 10%;"></td> <td style="width: 10%;"></td> <td style="width: 10%;"></td> <td style="width: 10%;"></td> <td style="width: 10%;"></td> <td style="width: 10%;"></td> <td style="width: 10%;"></td> <td style="width: 10%;"></td> <td style="width: 10%;"></td> </tr> <tr> <td></td> <td></td> <td colspan="8" style="text-align: center;"> <table border="1" style="width: 100%; border-collapse: collapse; text-align: center;"> <tr> <td style="width: 10%;"></td> <td style="width: 10%;"></td> <td style="width: 10%;"></td> <td style="width: 10%;"></td> <td style="width: 10%;"></td> <td style="width: 10%;"></td> <td style="width: 10%;"></td> <td style="width: 10%;"></td> <td style="width: 10%;"></td> <td style="width: 10%;"></td> </tr> <tr> <td></td> <td></td> <td colspan="8" style="text-align: center;"> <table border="1" style="width: 100%; border-collapse: collapse; text-align: center;"> <tr> <td style="width: 10%;"></td> <td style="width: 10%;"></td> <td style="width: 10%;"></td> <td style="width: 10%;"></td> <td style="width: 10%;"></td> <td style="width: 10%;"></td> <td style="width: 10%;"></td> <td style="width: 10%;"></td> <td style="width: 10%;"></td> <td style="width: 10%;"></td> </tr> <tr> <td></td> <td></td> <td colspan="8" style="text-align: center;"> <table border="1" style="width: 100%; border-collapse: collapse; text-align: center;"> <tr> <td style="width: 10%;"></td> <td style="width: 10%;"></td> <td style="width: 10%;"></td> <td style="width: 10%;"></td> <td style="width: 10%;"></td> <td style="width: 10%;"></td> <td style="width: 10%;"></td> <td style="width: 10%;"></td> <td style="width: 10%;"></td> <td style="width: 10%;"></td> </tr> <tr> <td></td> <td></td> <td colspan="8" style="text-align: center;"> <table border="1" style="width: 100%; border-collapse: collapse; text-align: center;"> <tr> <td style="width: 10%;"></td> <td style="width: 10%;"></td> <td style="width: 10%;"></td> <td style="width: 10%;"></td> <td style="width: 10%;"></td> <td style="width: 10%;"></td> <td style="width: 10%;"></td> <td style="width: 10%;"></td> <td style="width: 10%;"></td> <td style="width: 10%;"></td> </tr> <tr> <td></td> <td></td> <td colspan="8" style="text-align: center;"> <table border="1" style="width: 100%; border-collapse: collapse; text-align: center;"> <tr> <td style="width: 10%;"></td> <td style="width: 10%;"></td> <td
style="width: 10%;"></td> <td style="width: 10%;"></td> <td style="width: 10%;"></td> <td style="width: 10%;"></td> <td style="width: 10%;"></td> <td style="width: 10%;"></td> <td style="width: 10%;"></td> <td style="width: 10%;"></td> </tr> <tr> <td></td> <td></td> <td colspan="8" style="text-align: center;"> <table border="1" style="width: 100%; border-collapse: collapse; text-align: center;"> <tr> <td style="width: 10%;"></td> <td style="width: 10%;"></td> <td style="width: 10%;"></td> <td style="width: 10%;"></td> <td style="width: 10%;"></td> <td style="width: 10%;"></td> <td style="width: 10%;"></td> <td style="width: 10%;"></td> <td style="width: 10%;"></td> <td style="width: 10%;"></td> </tr> <tr> <td></td> <td></td> <td colspan="8" style="text-align: center;"> <table border="1" style="width: 100%; border-collapse: collapse; text-align: center;"> <tr> <td style="width: 10%;"></td> <td style="width: 10%;"></td> <td style="width: 10%;"></td> <td style="width: 10%;"></td> <td style="width: 10%;"></td> <td style="width: 10%;"></td> <td style="width: 10%;"></td> <td style="width: 10%;"></td> <td style="width: 10%;"></td> <td style="width: 10%;"></td> </tr> <tr> <td></td> <td></td> <td colspan="8" style="text-align: center;"> <table border="1" style="width: 100%; border-collapse: collapse; text-align: center;"> <tr> </tr></table></td></tr></table></td></tr></table></td></tr></table></td></tr></table></td></tr></table></td></tr></table></td></tr></table></td></tr></table></td></tr></table></td></tr></table></td></tr></table></td></tr></table></td></tr></table></td></tr></table></td></tr></table></td></tr></table></td></tr></table></td></tr></table></td></tr></table></td></tr></table></td></tr></table></td></tr></table></td></tr></table></td></tr></table></td></tr></table></td></tr></table></td></tr></table></td></tr></table></td></tr></table></td></tr></table></td></tr></table></td></tr></table></td></tr></table></td></tr></table></td></tr></table></td></tr></table></td></tr></table></td></tr></table></td></tr></table></td></tr></table></td></tr></table></td></tr></table></td></tr></table></td></tr></table></td></tr></table> | | | | | | | | | | | | | | | | | | | | <table border="1" style="width: 100%; border-collapse: collapse; text-align: center;"> <tr> <td style="width: 10%;"></td> <td style="width: 10%;"></td> <td style="width: 10%;"></td> <td style="width: 10%;"></td> <td style="width: 10%;"></td> <td style="width: 10%;"></td> <td style="width: 10%;"></td> <td style="width: 10%;"></td> <td style="width: 10%;"></td> <td style="width: 10%;"></td> </tr> <tr> <td></td> <td></td> <td colspan="8" style="text-align: center;"> <table border="1" style="width: 100%; border-collapse: collapse; text-align: center;"> <tr> <td style="width: 10%;"></td> <td style="width: 10%;"></td> <td style="width: 10%;"></td> <td style="width: 10%;"></td> <td style="width: 10%;"></td> <td style="width: 10%;"></td> <td style="width: 10%;"></td> <td style="width: 10%;"></td> <td style="width: 10%;"></td> <td style="width: 10%;"></td> </tr> <tr> <td></td> <td></td> <td colspan="8" style="text-align: center;"> <table border="1" style="width: 100%; border-collapse: collapse; text-align: center;"> <tr> <td style="width: 10%;"></td> <td style="width: 10%;"></td> <td style="width: 10%;"></td> <td style="width: 10%;"></td> <td style="width: 10%;"></td> <td style="width: 10%;"></td> <td style="width: 10%;"></td> <td style="width: 10%;"></td> <td style="width: 10%;"></td> <td style="width: 10%;"></td> </tr> <tr> <td></td> <td></td> <td colspan="8" style="text-align: center;"> <table border="1" style="width: 100%; border-collapse: collapse; text-align: center;"> <tr> <td style="width: 10%;"></td> <td style="width: 10%;"></td> <td style="width: 10%;"></td> <td style="width: 10%;"></td> <td style="width: 10%;"></td> <td style="width: 10%;"></td> <td style="width: 10%;"></td> <td style="width: 10%;"></td> <td style="width: 10%;"></td> <td style="width: 10%;"></td> </tr> <tr> <td></td> <td></td> <td colspan="8" style="text-align: center;"> <table border="1" style="width: 100%; border-collapse: collapse; text-align: center;"> <tr> <td style="width: 10%;"></td> <td style="width: 10%;"></td> <td style="width: 10%;"></td> <td style="width: 10%;"></td> <td style="width: 10%;"></td> <td style="width: 10%;"></td> <td style="width: 10%;"></td> <td style="width: 10%;"></td> <td style="width: 10%;"></td> <td style="width: 10%;"></td> </tr> <tr> <td></td> <td></td> <td colspan="8" style="text-align: center;"> <table border="1" style="width: 100%; border-collapse: collapse; text-align: center;"> <tr> <td style="width: 10%;"></td> <td style="width: 10%;"></td> <td style="width: 10%;"></td> <td style="width: 10%;"></td> <td style="width: 10%;"></td> <td style="width: 10%;"></td> <td style="width: 10%;"></td> <td style="width: 10%;"></td> <td style="width: 10%;"></td> <td style="width: 10%;"></td> </tr> <tr> <td></td> <td></td> <td colspan="8" style="text-align: center;"> <table border="1" style="width: 100%; border-collapse: collapse; text-align: center;"> <tr> <td style="width: 10%;"></td> <td style="width: 10%;"></td> <td style="width: 10%;"></td> <td style="width: 10%;"></td> <td style="width: 10%;"></td> <td style="width: 10%;"></td> <td style="width: 10%;"></td> <td style="width: 10%;"></td> <td style="width: 10%;"></td> <td style="width: 10%;"></td> </tr> <tr> <td></td> <td></td> <td colspan="8" style="text-align: center;"> <table border="1" style="width: 100%; border-collapse: collapse; text-align: center;"> <tr> <td style="width: 10%;"></td> <td style="width: 10%;"></td> <td style="width: 10%;"></td> <td style="width: 10%;"></td> <td style="width: 10%;"></td> <td style="width: 10%;"></td> <td style="width: 10%;"></td> <td style="width: 10%;"></td> <td style="width: 10%;"></td> <td style="width: 10%;"></td> </tr> <tr> <td></td> <td></td> <td colspan="8" style="text-align: center;"> <table border="1" style="width: 100%; border-collapse: collapse; text-align: center;"> <tr> <td style="width: 10%;"></td> <td style="width: 10%;"></td> <td style="width: 10%;"></td> <td style="width: 10%;"></td> <td style="width: 10%;"></td> <td style="width: 10%;"></td> <td style="width: 10%;"></td> <td style="width: 10%;"></td> <td style="width: 10%;"></td> <td style="width: 10%;"></td> </tr> <tr> <td></td> <td></td> <td colspan="8" style="text-align: center;"> <table border="1" style="width: 100%; border-collapse: collapse; text-align: center;"> <tr> <td style="width: 10%;"></td> <td style="width: 10%;"></td> <td style="width: 10%;"></td> <td style="width: 10%;"></td> <td style="width: 10%;"></td> <td style="width: 10%;"></td> <td style="width: 10%;"></td> <td style="width: 10%;"></td> <td style="width: 10%;"></td> <td style="width: 10%;"></td> </tr> <tr> <td></td> <td></td> <td colspan="8" style="text-align: center;"> <table border="1" style="width: 100%; border-collapse: collapse; text-align: center;"> <tr> <td style="width: 10%;"></td> <td style="width: 10%;"></td> <td style="width: 10%;"></td> <td style="width: 10%;"></td> <td style="width: 10%;"></td> <td style="width: 10%;"></td> <td style="width: 10%;"></td> <td style="width: 10%;"></td> <td style="width: 10%;"></td> <td style="width: 10%;"></td> </tr> <tr> <td></td> <td></td> <td colspan="8" style="text-align: center;"> <table border="1" style="width: 100%; border-collapse: collapse; text-align: center;"> <tr> <td style="width: 10%;"></td> <td style="width: 10%;"></td> <td style="width: 10%;"></td> <td style="width: 10%;"></td> <td style="width: 10%;"></td> <td style="width: 10%;"></td> <td style="width: 10%;"></td> <td style="width: 10%;"></td> <td style="width: 10%;"></td> <td style="width: 10%;"></td> </tr> <tr> <td></td> <td></td> <td colspan="8" style="text-align: center;"> <table border="1" style="width: 100%; border-collapse: collapse; text-align: center;"> <tr> <td style="width: 10%;"></td> <td style="width: 10%;"></td> <td style="width: 10%;"></td> <td style="width: 10%;"></td> <td
style="width: 10%;"></td> <td style="width: 10%;"></td> <td style="width: 10%;"></td> <td style="width: 10%;"></td> <td style="width: 10%;"></td> <td style="width: 10%;"></td> </tr> <tr> <td></td> <td></td> <td colspan="8" style="text-align: center;"> <table border="1" style="width: 100%; border-collapse: collapse; text-align: center;"> <tr> <td style="width: 10%;"></td> <td style="width: 10%;"></td> <td style="width: 10%;"></td> <td style="width: 10%;"></td> <td style="width: 10%;"></td> <td style="width: 10%;"></td> <td style="width: 10%;"></td> <td style="width: 10%;"></td> <td style="width: 10%;"></td> <td style="width: 10%;"></td> </tr> <tr> <td></td> <td></td> <td colspan="8" style="text-align: center;"> <table border="1" style="width: 100%; border-collapse: collapse; text-align: center;"> <tr> <td style="width: 10%;"></td> <td style="width: 10%;"></td> <td style="width: 10%;"></td> <td style="width: 10%;"></td> <td style="width: 10%;"></td> <td style="width: 10%;"></td> <td style="width: 10%;"></td> <td style="width: 10%;"></td> <td style="width: 10%;"></td> <td style="width: 10%;"></td> </tr> <tr> <td></td> <td></td> <td colspan="8" style="text-align: center;"> <table border="1" style="width: 100%; border-collapse: collapse; text-align: center;"> <tr> <td style="width: 10%;"></td> <td style="width: 10%;"></td> <td style="width: 10%;"></td> <td style="width: 10%;"></td> <td style="width: 10%;"></td> <td style="width: 10%;"></td> <td style="width: 10%;"></td> <td style="width: 10%;"></td> <td style="width: 10%;"></td> <td style="width: 10%;"></td> </tr> <tr> <td></td> <td></td> <td colspan="8" style="text-align: center;"> <table border="1" style="width: 100%; border-collapse: collapse; text-align: center;"> <tr> <td style="width: 10%;"></td> <td style="width: 10%;"></td> <td style="width: 10%;"></td> <td style="width: 10%;"></td> <td style="width: 10%;"></td> <td style="width: 10%;"></td> <td style="width: 10%;"></td> <td style="width: 10%;"></td> <td style="width: 10%;"></td> <td style="width: 10%;"></td> </tr> <tr> <td></td> <td></td> <td colspan="8" style="text-align: center;"> <table border="1" style="width: 100%; border-collapse: collapse; text-align: center;"> <tr> <td style="width: 10%;"></td> <td style="width: 10%;"></td> <td style="width: 10%;"></td> <td style="width: 10%;"></td> <td style="width: 10%;"></td> <td style="width: 10%;"></td> <td style="width: 10%;"></td> <td style="width: 10%;"></td> <td style="width: 10%;"></td> <td style="width: 10%;"></td> </tr> <tr> <td></td> <td></td> <td colspan="8" style="text-align: center;"> <table border="1" style="width: 100%; border-collapse: collapse; text-align: center;"> <tr> <td style="width: 10%;"></td> <td style="width: 10%;"></td> <td style="width: 10%;"></td> <td style="width: 10%;"></td> <td style="width: 10%;"></td> <td style="width: 10%;"></td> <td style="width: 10%;"></td> <td style="width: 10%;"></td> <td style="width: 10%;"></td> <td style="width: 10%;"></td> </tr> <tr> <td></td> <td></td> <td colspan="8" style="text-align: center;"> <table border="1" style="width: 100%; border-collapse: collapse; text-align: center;"> <tr> <td style="width: 10%;"></td> <td style="width: 10%;"></td> <td style="width: 10%;"></td> <td style="width: 10%;"></td> <td style="width: 10%;"></td> <td style="width: 10%;"></td> <td style="width: 10%;"></td> <td style="width: 10%;"></td> <td style="width: 10%;"></td> <td style="width: 10%;"></td> </tr> <tr> <td></td> <td></td> <td colspan="8" style="text-align: center;"> <table border="1" style="width: 100%; border-collapse: collapse; text-align: center;"> <tr> <td style="width: 10%;"></td> <td style="width: 10%;"></td> <td style="width: 10%;"></td> <td style="width: 10%;"></td> <td style="width: 10%;"></td> <td style="width: 10%;"></td> <td style="width: 10%;"></td> <td style="width: 10%;"></td> <td style="width: 10%;"></td> <td style="width: 10%;"></td> </tr> <tr> <td></td> <td></td> <td colspan="8" style="text-align: center;"> <table border="1" style="width: 100%; border-collapse: collapse; text-align: center;"> <tr> <td style="width: 10%;"></td> <td style="width: 10%;"></td> <td style="width: 10%;"></td> <td style="width: 10%;"></td> <td style="width: 10%;"></td> <td style="width: 10%;"></td> <td style="width: 10%;"></td> <td style="width: 10%;"></td> <td style="width: 10%;"></td> <td style="width: 10%;"></td> </tr> <tr> <td></td> <td></td> <td colspan="8" style="text-align: center;"> <table border="1" style="width: 100%; border-collapse: collapse; text-align: center;"> <tr> <td style="width: 10%;"></td> <td style="width: 10%;"></td> <td style="width: 10%;"></td> <td style="width: 10%;"></td> <td style="width: 10%;"></td> <td style="width: 10%;"></td> <td style="width: 10%;"></td> <td style="width: 10%;"></td> <td style="width: 10%;"></td> <td style="width: 10%;"></td> </tr> <tr> <td></td> <td></td> <td colspan="8" style="text-align: center;"> <table border="1" style="width: 100%; border-collapse: collapse; text-align: center;"> <tr> <td style="width: 10%;"></td> <td style="width: 10%;"></td> <td style="width: 10%;"></td> <td style="width: 10%;"></td> <td style="width: 10%;"></td> <td style="width: 10%;"></td> <td style="width: 10%;"></td> <td style="width: 10%;"></td> <td style="width: 10%;"></td> <td style="width: 10%;"></td> </tr> <tr> <td></td> <td></td> <td colspan="8" style="text-align: center;"> <table border="1" style="width: 100%; border-collapse: collapse; text-align: center;"> <tr> <td style="width: 10%;"></td> <td style="width: 10%;"></td> <td style="width: 10%;"></td> <td style="width: 10%;"></td> <td style="width: 10%;"></td> <td style="width: 10%;"></td> <td style="width: 10%;"></td> <td style="width: 10%;"></td> <td style="width: 10%;"></td> <td style="width: 10%;"></td> </tr> <tr> <td></td> <td></td> <td colspan="8" style="text-align: center;"> <table border="1" style="width: 100%; border-collapse: collapse; text-align: center;"> <tr> <td style="width: 10%;"></td> <td style="width: 10%;"></td> <td style="width: 10%;"></td> <td style="width: 10%;"></td> <td style="width: 10%;"></td> <td style="width: 10%;"></td> <td style="width: 10%;"></td> <td style="width: 10%;"></td> <td style="width: 10%;"></td> <td style="width: 10%;"></td> </tr> <tr> <td></td> <td></td> <td colspan="8" style="text-align: center;"> <table border="1" style="width: 100%; border-collapse: collapse; text-align: center;"> <tr> <td style="width: 10%;"></td> <td style="width: 10%;"></td> <td style="width: 10%;"></td> <td style="width: 10%;"></td> <td style="width: 10%;"></td> <td style="width: 10%;"></td> <td style="width: 10%;"></td> <td style="width: 10%;"></td> <td style="width: 10%;"></td> <td style="width: 10%;"></td> </tr> <tr> <td></td> <td></td> <td colspan="8" style="text-align: center;"> <table border="1" style="width: 100%; border-collapse: collapse; text-align: center;"> <tr> <td style="width: 10%;"></td> <td style="width: 10%;"></td> <td style="width: 10%;"></td> <td style="width: 10%;"></td> <td style="width: 10%;"></td> <td style="width: 10%;"></td> <td style="width: 10%;"></td> <td style="width: 10%;"></td> <td style="width: 10%;"></td> <td style="width: 10%;"></td> </tr> <tr> <td></td> <td></td> <td colspan="8" style="text-align: center;"> <table border="1" style="width: 100%; border-collapse: collapse; text-align: center;"> <tr> <td style="width: 10%;"></td> <td style="width: 10%;"></td> <td style="width: 10%;"></td> <td style="width: 10%;"></td> <td style="width: 10%;"></td> <td style="width: 10%;"></td> <td style="width: 10%;"></td> <td style="width: 10%;"></td> <td style="width: 10%;"></td> <td style="width: 10%;"></td> </tr> <tr> <td></td> <td></td> <td colspan="8" style="text-align: center;"> <table border="1" style="width: 100%; border-collapse: collapse; text-align: center;"> <tr> <td style="width: 10%;"></td> <td style="width: 10%;"></td> <td style="width: 10%;"></td> <td style="width: 10%;"></td> <td style="width: 10%;"></td> <td style="width: 10%;"></td> <td style="width: 10%;"></td> <td style="width: 10%;"></td> <td style="width: 10%;"></td> <td style="width: 10%;"></td> </tr> <tr> <td></td> <td></td> <td colspan="8" style="text-align: center;"> <table border="1" style="width: 100%; border-collapse: collapse; text-align: center;"> <tr> <td style="width: 10%;"></td> <td style="width: 10%;"></td> <td style="width: 10%;"></td> <td style="width: 10%;"></td> <td style="width: 10%;"></td> <td style="width: 10%;"></td> <td style="width: 10%;"></td> <td style="width: 10%;"></td> <td style="width: 10%;"></td> <td style="width: 10%;"></td> </tr> <tr> <td></td> <td></td> <td colspan="8" style="text-align: center;"> <table border="1" style="width: 100%; border-collapse: collapse; text-align: center;"> <tr> <td style="width: 10%;"></td> <td style="width: 10%;"></td> <td style="width: 10%;"></td> <td style="width: 10%;"></td> <td style="width: 10%;"></td> <td style="width: 10%;"></td> <td style="width: 10%;"></td> <td style="width: 10%;"></td> <td style="width: 10%;"></td> <td style="width: 10%;"></td> </tr> <tr> <td></td> <td></td> <td colspan="8" style="text-align: center;"> <table border="1" style="width: 100%; border-collapse: collapse; text-align: center;"> <tr> <td style="width: 10%;"></td> <td style="width: 10%;"></td> <td style="width: 10%;"></td> <td style="width: 10%;"></td> <td style="width: 10%;"></td> <td style="width: 10%;"></td> <td style="width: 10%;"></td> <td style="width: 10%;"></td> <td style="width: 10%;"></td> <td style="width: 10%;"></td> </tr> <tr> <td></td> <td></td> <td colspan="8" style="text-align: center;"> <table border="1" style="width: 100%; border-collapse: collapse; text-align: center;"> <tr> <td style="width: 10%;"></td> <td style="width: 10%;"></td> <td style="width: 10%;"></td> <td style="width: 10%;"></td> <td style="width: 10%;"></td> <td style="width: 10%;"></td> <td style="width: 10%;"></td> <td style="width: 10%;"></td> <td style="width: 10%;"></td> <td style="width:
10%;"></td> </tr> <tr> <td></td> <td></td> <td colspan="8" style="text-align: center;"> <table border="1" style="width: 100%; border-collapse: collapse; text-align: center;"> <tr> <td style="width: 10%;"></td> <td style="width: 10%;"></td> <td style="width: 10%;"></td> <td style="width: 10%;"></td> <td style="width: 10%;"></td> <td style="width: 10%;"></td> <td style="width: 10%;"></td> <td style="width: 10%;"></td> <td style="width: 10%;"></td> <td style="width: 10%;"></td> </tr> <tr> <td></td> <td></td> <td colspan="8" style="text-align: center;"> <table border="1" style="width: 100%; border-collapse: collapse; text-align: center;"> <tr> <td style="width: 10%;"></td> <td style="width: 10%;"></td> <td style="width: 10%;"></td> <td style="width: 10%;"></td> <td style="width: 10%;"></td> <td style="width: 10%;"></td> <td style="width: 10%;"></td> <td style="width: 10%;"></td> <td style="width: 10%;"></td> <td style="width: 10%;"></td> </tr> <tr> <td></td> <td></td> <td colspan="8" style="text-align: center;"> <table border="1" style="width: 100%; border-collapse: collapse; text-align: center;"> <tr> <td style="width: 10%;"></td> <td style="width: 10%;"></td> <td style="width: 10%;"></td> <td style="width: 10%;"></td> <td style="width: 10%;"></td> <td style="width: 10%;"></td> <td style="width: 10%;"></td> <td style="width: 10%;"></td> <td style="width: 10%;"></td> <td style="width: 10%;"></td> </tr> <tr> <td></td> <td></td> <td colspan="8" style="text-align: center;"> <table border="1" style="width: 100%; border-collapse: collapse; text-align: center;"> <tr> <td style="width: 10%;"></td> <td style="width: 10%;"></td> <td style="width: 10%;"></td> <td style="width: 10%;"></td> <td style="width: 10%;"></td> <td style="width: 10%;"></td> <td style="width: 10%;"></td> <td style="width: 10%;"></td> <td style="width: 10%;"></td> <td style="width: 10%;"></td> </tr> <tr> <td></td> <td></td> <td colspan="8" style="text-align: center;"> <table border="1" style="width: 100%; border-collapse: collapse; text-align: center;"> <tr> <td style="width: 10%;"></td> <td style="width: 10%;"></td> <td style="width: 10%;"></td> <td style="width: 10%;"></td> <td style="width: 10%;"></td> <td style="width: 10%;"></td> <td style="width: 10%;"></td> <td style="width: 10%;"></td> <td style="width: 10%;"></td> <td style="width: 10%;"></td> </tr> <tr> <td></td> <td></td> <td colspan="8" style="text-align: center;"> <table border="1" style="width: 100%; border-collapse: collapse; text-align: center;"> <tr> <td style="width: 10%;"></td> <td style="width: 10%;"></td> <td style="width: 10%;"></td> <td style="width: 10%;"></td> <td style="width: 10%;"></td> <td style="width: 10%;"></td> <td style="width: 10%;"></td> <td style="width: 10%;"></td> <td style="width: 10%;"></td> <td style="width: 10%;"></td> </tr> <tr> <td></td> <td></td> <td colspan="8" style="text-align: center;"> <table border="1" style="width: 100%; border-collapse: collapse; text-align: center;"> <tr> <td style="width: 10%;"></td> <td style="width: 10%;"></td> <td style="width: 10%;"></td> <td style="width: 10%;"></td> <td style="width: 10%;"></td> <td style="width: 10%;"></td> <td style="width: 10%;"></td> <td style="width: 10%;"></td> <td style="width: 10%;"></td> <td style="width: 10%;"></td> </tr> <tr> <td></td> <td></td> <td colspan="8" style="text-align: center;"> <table border="1" style="width: 100%; border-collapse: collapse; text-align: center;"> <tr> <td style="width: 10%;"></td> <td style="width: 10%;"></td> <td style="width: 10%;"></td> <td style="width: 10%;"></td> <td style="width: 10%;"></td> <td style="width: 10%;"></td> <td style="width: 10%;"></td> <td style="width: 10%;"></td> <td style="width: 10%;"></td> <td style="width: 10%;"></td> </tr> <tr> <td></td> <td></td> <td colspan="8" style="text-align: center;"> <table border="1" style="width: 100%; border-collapse: collapse; text-align: center;"> <tr> <td style="width: 10%;"></td> <td style="width: 10%;"></td> <td style="width: 10%;"></td> <td style="width: 10%;"></td> <td style="width: 10%;"></td> <td style="width: 10%;"></td> <td style="width: 10%;"></td> <td style="width: 10%;"></td> <td style="width: 10%;"></td> <td style="width: 10%;"></td> </tr> <tr> <td></td> <td></td> <td colspan="8" style="text-align: center;"> <table border="1" style="width: 100%; border-collapse: collapse; text-align: center;"> <tr> <td style="width: 10%;"></td> <td style="width: 10%;"></td> <td style="width: 10%;"></td> <td style="width: 10%;"></td> <td style="width: 10%;"></td> <td style="width: 10%;"></td> <td style="width: 10%;"></td> <td style="width: 10%;"></td> <td style="width: 10%;"></td> <td style="width: 10%;"></td> </tr> <tr> <td></td> <td></td> <td colspan="8" style="text-align: center;"> <table border="1" style="width: 100%; border-collapse: collapse; text-align: center;"> <tr> </tr></table></td></tr></table></td></tr></table></td></tr></table></td></tr></table></td></tr></table></td></tr></table></td></tr></table></td></tr></table></td></tr></table></td></tr></table></td></tr></table></td></tr></table></td></tr></table></td></tr></table></td></tr></table></td></tr></table></td></tr></table></td></tr></table></td></tr></table></td></tr></table></td></tr></table></td></tr></table></td></tr></table></td></tr></table></td></tr></table></td></tr></table></td></tr></table></td></tr></table></td></tr></table></td></tr></table></td></tr></table></td></tr></table></td></tr></table></td></tr></table></td></tr></table></td></tr></table></td></tr></table></td></tr></table></td></tr></table></td></tr></table></td></tr></table></td></tr></table></td></tr></table></td></tr></table> | | | | | | | | | | | | | | | | | | | | <table border="1" style="width: 100%; border-collapse: collapse; text-align: center;"> <tr> <td style="width: 10%;"></td> <td style="width: 10%;"></td> <td style="width: 10%;"></td> <td style="width: 10%;"></td> <td style="width: 10%;"></td> <td style="width: 10%;"></td> <td style="width: 10%;"></td> <td style="width: 10%;"></td> <td style="width: 10%;"></td> <td style="width: 10%;"></td> </tr> <tr> <td></td> <td></td> <td colspan="8" style="text-align: center;"> <table border="1" style="width: 100%; border-collapse: collapse; text-align: center;"> <tr> <td style="width: 10%;"></td> <td style="width: 10%;"></td> <td style="width: 10%;"></td> <td style="width: 10%;"></td> <td style="width: 10%;"></td> <td style="width: 10%;"></td> <td style="width: 10%;"></td> <td style="width: 10%;"></td> <td style="width: 10%;"></td> <td style="width: 10%;"></td> </tr> <tr> <td></td> <td></td> <td colspan="8" style="text-align: center;"> <table border="1" style="width: 100%; border-collapse: collapse; text-align: center;"> <tr> <td style="width: 10%;"></td> <td style="width: 10%;"></td> <td style="width: 10%;"></td> <td style="width: 10%;"></td> <td style="width: 10%;"></td> <td style="width: 10%;"></td> <td style="width: 10%;"></td> <td style="width: 10%;"></td> <td style="width: 10%;"></td> <td style="width: 10%;"></td> </tr> <tr> <td></td> <td></td> <td colspan="8" style="text-align: center;"> <table border="1" style="width: 100%; border-collapse: collapse; text-align: center;"> <tr> <td style="width: 10%;"></td> <td style="width: 10%;"></td> <td style="width: 10%;"></td> <td style="width: 10%;"></td> <td style="width: 10%;"></td> <td style="width: 10%;"></td> <td style="width: 10%;"></td> <td style="width: 10%;"></td> <td style="width: 10%;"></td> <td style="width: 10%;"></td> </tr> <tr> <td></td> <td></td> <td colspan="8" style="text-align: center;"> <table border="1" style="width: 100%; border-collapse: collapse; text-align: center;"> <tr> <td style="width: 10%;"></td> <td style="width: 10%;"></td> <td style="width: 10%;"></td> <td style="width: 10%;"></td> <td style="width: 10%;"></td> <td style="width: 10%;"></td> <td style="width: 10%;"></td> <td style="width: 10%;"></td> <td style="width: 10%;"></td> <td style="width: 10%;"></td> </tr> <tr> <td></td> <td></td> <td colspan="8" style="text-align:
center;"> <table border="1" style="width: 100%; border-collapse: collapse; text-align: center;"> <tr> <td style="width: 10%;"></td> <td style="width: 10%;"></td> <td style="width: 10%;"></td> <td style="width: 10%;"></td> <td style="width: 10%;"></td> <td style="width: 10%;"></td> <td style="width: 10%;"></td> <td style="width: 10%;"></td> <td style="width: 10%;"></td> <td style="width: 10%;"></td> </tr> <tr> <td></td> <td></td> <td colspan="8" style="text-align: center;"> <table border="1" style="width: 100%; border-collapse: collapse; text-align: center;"> <tr> <td style="width: 10%;"></td> <td style="width: 10%;"></td> <td style="width: 10%;"></td> <td style="width: 10%;"></td> <td style="width: 10%;"></td> <td style="width: 10%;"></td> <td style="width: 10%;"></td> <td style="width: 10%;"></td> <td style="width: 10%;"></td> <td style="width: 10%;"></td> </tr> <tr> <td></td> <td></td> <td colspan="8" style="text-align: center;"> <table border="1" style="width: 100%; border-collapse: collapse; text-align: center;"> <tr> <td style="width: 10%;"></td> <td style="width: 10%;"></td> <td style="width: 10%;"></td> <td style="width: 10%;"></td> <td style="width: 10%;"></td> <td style="width: 10%;"></td> <td style="width: 10%;"></td> <td style="width: 10%;"></td> <td style="width: 10%;"></td> <td style="width: 10%;"></td> </tr> <tr> <td></td> <td></td> <td colspan="8" style="text-align: center;"> <table border="1" style="width: 100%; border-collapse: collapse; text-align: center;"> <tr> <td style="width: 10%;"></td> <td style="width: 10%;"></td> <td style="width: 10%;"></td> <td style="width: 10%;"></td> <td style="width: 10%;"></td> <td style="width: 10%;"></td> <td style="width: 10%;"></td> <td style="width: 10%;"></td> <td style="width: 10%;"></td> <td style="width: 10%;"></td> </tr> <tr> <td></td> <td></td> <td colspan="8" style="text-align: center;"> <table border="1" style="width: 100%; border-collapse: collapse; text-align: center;"> <tr> <td style="width: 10%;"></td> <td style="width: 10%;"></td> <td style="width: 10%;"></td> <td style="width: 10%;"></td> <td style="width: 10%;"></td> <td style="width: 10%;"></td> <td style="width: 10%;"></td> <td style="width: 10%;"></td> <td style="width: 10%;"></td> <td style="width: 10%;"></td> </tr> <tr> <td></td> <td></td> <td colspan="8" style="text-align: center;"> <table border="1" style="width: 100%; border-collapse: collapse; text-align: center;"> <tr> <td style="width: 10%;"></td> <td style="width: 10%;"></td> <td style="width: 10%;"></td> <td style="width: 10%;"></td> <td style="width: 10%;"></td> <td style="width: 10%;"></td> <td style="width: 10%;"></td> <td style="width: 10%;"></td> <td style="width: 10%;"></td> <td style="width: 10%;"></td> </tr> <tr> <td></td> <td></td> <td colspan="8" style="text-align: center;"> <table border="1" style="width: 100%; border-collapse: collapse; text-align: center;"> <tr> <td style="width: 10%;"></td> <td style="width: 10%;"></td> <td style="width: 10%;"></td> <td style="width: 10%;"></td> <td style="width: 10%;"></td> <td style="width: 10%;"></td> <td style="width: 10%;"></td> <td style="width: 10%;"></td> <td style="width: 10%;"></td> <td style="width: 10%;"></td> </tr> <tr> <td></td> <td></td> <td colspan="8" style="text-align: center;"> <table border="1" style="width: 100%; border-collapse: collapse; text-align: center;"> <tr> <td style="width: 10%;"></td> <td style="width: 10%;"></td> <td style="width: 10%;"></td> <td style="width: 10%;"></td> <td style="width: 10%;"></td> <td style="width: 10%;"></td> <td style="width: 10%;"></td> <td style="width: 10%;"></td> <td style="width: 10%;"></td> <td style="width: 10%;"></td> </tr> <tr> <td></td> <td></td> <td colspan="8" style="text-align: center;"> <table border="1" style="width: 100%; border-collapse: collapse; text-align: center;"> <tr> <td style="width: 10%;"></td> <td style="width: 10%;"></td> <td style="width: 10%;"></td> <td style="width: 10%;"></td> <td style="width: 10%;"></td> <td style="width: 10%;"></td> <td style="width: 10%;"></td> <td style="width: 10%;"></td> <td style="width: 10%;"></td> <td style="width: 10%;"></td> </tr> <tr> <td></td> <td></td> <td colspan="8" style="text-align: center;"> <table border="1" style="width: 100%; border-collapse: collapse; text-align: center;"> <tr> <td style="width: 10%;"></td> <td style="width: 10%;"></td> <td style="width: 10%;"></td> <td style="width: 10%;"></td> <td style="width: 10%;"></td> <td style="width: 10%;"></td> <td style="width: 10%;"></td> <td style="width: 10%;"></td> <td style="width: 10%;"></td> <td style="width: 10%;"></td> </tr> <tr> <td></td> <td></td> <td colspan="8" style="text-align: center;"> <table border="1" style="width: 100%; border-collapse: collapse; text-align: center;"> <tr> <td style="width: 10%;"></td> <td style="width: 10%;"></td> <td style="width: 10%;"></td> <td style="width: 10%;"></td> <td style="width: 10%;"></td> <td style="width: 10%;"></td> <td style="width: 10%;"></td> <td style="width: 10%;"></td> <td style="width: 10%;"></td> <td style="width: 10%;"></td> </tr> <tr> <td></td> <td></td> <td colspan="8" style="text-align: center;"> <table border="1" style="width: 100%; border-collapse: collapse; text-align: center;"> <tr> <td style="width: 10%;"></td> <td style="width: 10%;"></td> <td style="width: 10%;"></td> <td style="width: 10%;"></td> <td style="width: 10%;"></td> <td style="width: 10%;"></td> <td style="width: 10%;"></td> <td style="width: 10%;"></td> <td style="width: 10%;"></td> <td style="width: 10%;"></td> </tr> <tr> <td></td> <td></td> <td colspan="8" style="text-align: center;"> <table border="1" style="width: 100%; border-collapse: collapse; text-align: center;"> <tr> <td style="width: 10%;"></td> <td style="width: 10%;"></td> <td style="width: 10%;"></td> <td style="width: 10%;"></td> <td style="width: 10%;"></td> <td style="width: 10%;"></td> <td style="width: 10%;"></td> <td style="width: 10%;"></td> <td style="width: 10%;"></td> <td style="width: 10%;"></td> </tr> <tr> <td></td> <td></td> <td colspan="8" style="text-align: center;"> <table border="1" style="width: 100%; border-collapse: collapse; text-align: center;"> <tr> <td style="width: 10%;"></td> <td style="width: 10%;"></td> <td style="width: 10%;"></td> <td style="width: 10%;"></td> <td style="width: 10%;"></td> <td style="width: 10%;"></td> <td style="width: 10%;"></td> <td style="width: 10%;"></td> <td style="width: 10%;"></td> <td style="width: 10%;"></td> </tr> <tr> <td></td> <td></td> <td colspan="8" style="text-align: center;"> <table border="1" style="width: 100%; border-collapse: collapse; text-align: center;"> <tr> <td style="width: 10%;"></td> <td style="width: 10%;"></td> <td style="width: 10%;"></td> <td style="width: 10%;"></td> <td style="width: 10%;"></td> <td style="width: 10%;"></td> <td style="width: 10%;"></td> <td style="width: 10%;"></td> <td style="width: 10%;"></td> <td style="width: 10%;"></td> </tr> <tr> <td></td> <td></td> <td colspan="8" style="text-align: center;"> <table border="1" style="width: 100%; border-collapse: collapse; text-align: center;"> <tr> <td style="width: 10%;"></td> <td style="width: 10%;"></td> <td style="width: 10%;"></td> <td style="width: 10%;"></td> <td style="width: 10%;"></td> <td style="width: 10%;"></td> <td style="width: 10%;"></td> <td style="width: 10%;"></td> <td style="width: 10%;"></td> <td style="width: 10%;"></td> </tr> <tr> <td></td> <td></td> <td colspan="8" style="text-align: center;"> <table border="1" style="width: 100%; border-collapse: collapse; text-align: center;"> <tr> <td style="width: 10%;"></td> <td style="width: 10%;"></td> <td style="width: 10%;"></td> <td style="width: 10%;"></td> <td style="width: 10%;"></td> <td style="width: 10%;"></td> <td style="width: 10%;"></td> <td style="width: 10%;"></td> <td style="width: 10%;"></td> <td style="width: 10%;"></td> </tr> <tr> <td></td> <td></td> <td colspan="8" style="text-align: center;"> <table border="1" style="width: 100%; border-collapse: collapse; text-align: center;"> <tr> <td style="width: 10%;"></td> <td style="width: 10%;"></td> <td style="width: 10%;"></td> <td style="width: 10%;"></td> <td style="width: 10%;"></td> <td style="width: 10%;"></td> <td style="width: 10%;"></td> <td style="width: 10%;"></td> <td style="width: 10%;"></td> <td style="width: 10%;"></td> </tr> <tr> <td></td> <td></td> <td colspan="8" style="text-align: center;"> <table border="1" style="width: 100%; border-collapse: collapse; text-align: center;"> <tr> <td style="width: 10%;"></td> <td style="width: 10%;"></td> <td style="width: 10%;"></td> <td style="width: 10%;"></td> <td style="width: 10%;"></td> <td style="width: 10%;"></td> <td style="width: 10%;"></td> <td style="width: 10%;"></td> <td style="width: 10%;"></td> <td style="width: 10%;"></td> </tr> <tr> <td></td> <td></td> <td colspan="8" style="text-align: center;"> <table border="1" style="width: 100%; border-collapse: collapse; text-align: center;"> <tr> <td style="width: 10%;"></td> <td style="width: 10%;"></td> <td style="width: 10%;"></td> <td style="width: 10%;"></td> <td style="width: 10%;"></td> <td style="width: 10%;"></td> <td style="width: 10%;"></td> <td style="width: 10%;"></td> <td style="width: 10%;"></td> <td style="width: 10%;"></td> </tr> <tr> <td></td> <td></td> <td colspan="8" style="text-align: center;"> <table border="1" style="width: 100%; border-collapse: collapse; text-align: center;"> <tr> <td style="width: 10%;"></td> <td style="width: 10%;"></td> <td style="width: 10%;"></td> <td style="width: 10%;"></td> <td style="width: 10%;"></td> <td style="width: 10%;"></td> <td style="width: 10%;"></td> <td style="width: 10%;"></td> <td style="width: 10%;"></td> <td style="width: 10%;"></td> </tr> <tr> <td></td> <td></td> <td colspan="8" style="text-align: center;"> <table border="1" style="width: 100%; border-collapse: collapse; text-align: center;"> <tr> <td style="width: 10%;"></td> <td style="width: 10%;"></td> <td
style="width: 10%;"></td> <td style="width: 10%;"></td> <td style="width: 10%;"></td> <td style="width: 10%;"></td> <td style="width: 10%;"></td> <td style="width: 10%;"></td> <td style="width: 10%;"></td> <td style="width: 10%;"></td> </tr> <tr> <td></td> <td></td> <td colspan="8" style="text-align: center;"> <table border="1" style="width: 100%; border-collapse: collapse; text-align: center;"> <tr> <td style="width: 10%;"></td> <td style="width: 10%;"></td> <td style="width: 10%;"></td> <td style="width: 10%;"></td> <td style="width: 10%;"></td> <td style="width: 10%;"></td> <td style="width: 10%;"></td> <td style="width: 10%;"></td> <td style="width: 10%;"></td> <td style="width: 10%;"></td> </tr> <tr> <td></td> <td></td> <td colspan="8" style="text-align: center;"> <table border="1" style="width: 100%; border-collapse: collapse; text-align: center;"> <tr> <td style="width: 10%;"></td> <td style="width: 10%;"></td> <td style="width: 10%;"></td> <td style="width: 10%;"></td> <td style="width: 10%;"></td> <td style="width: 10%;"></td> <td style="width: 10%;"></td> <td style="width: 10%;"></td> <td style="width: 10%;"></td> <td style="width: 10%;"></td> </tr> <tr> <td></td> <td></td> <td colspan="8" style="text-align: center;"> <table border="1" style="width: 100%; border-collapse: collapse; text-align: center;"> <tr> <td style="width: 10%;"></td> <td style="width: 10%;"></td> <td style="width: 10%;"></td> <td style="width: 10%;"></td> <td style="width: 10%;"></td> <td style="width: 10%;"></td> <td style="width: 10%;"></td> <td style="width: 10%;"></td> <td style="width: 10%;"></td> <td style="width: 10%;"></td> </tr> <tr> <td></td> <td></td> <td colspan="8" style="text-align: center;"> <table border="1" style="width: 100%; border-collapse: collapse; text-align: center;"> <tr> <td style="width: 10%;"></td> <td style="width: 10%;"></td> <td style="width: 10%;"></td> <td style="width: 10%;"></td> <td style="width: 10%;"></td> <td style="width: 10%;"></td> <td style="width: 10%;"></td> <td style="width: 10%;"></td> <td style="width: 10%;"></td> <td style="width: 10%;"></td> </tr> <tr> <td></td> <td></td> <td colspan="8" style="text-align: center;"> <table border="1" style="width: 100%; border-collapse: collapse; text-align: center;"> <tr> <td style="width: 10%;"></td> <td style="width: 10%;"></td> <td style="width: 10%;"></td> <td style="width: 10%;"></td> <td style="width: 10%;"></td> <td style="width: 10%;"></td> <td style="width: 10%;"></td> <td style="width: 10%;"></td> <td style="width: 10%;"></td> <td style="width: 10%;"></td> </tr> <tr> <td></td> <td></td> <td colspan="8" style="text-align: center;"> <table border="1" style="width: 100%; border-collapse: collapse; text-align: center;"> <tr> <td style="width: 10%;"></td> <td style="width: 10%;"></td> <td style="width: 10%;"></td> <td style="width: 10%;"></td> <td style="width: 10%;"></td> <td style="width: 10%;"></td> <td style="width: 10%;"></td> <td style="width: 10%;"></td> <td style="width: 10%;"></td> <td style="width: 10%;"></td> </tr> <tr> <td></td> <td></td> <td colspan="8" style="text-align: center;"> <table border="1" style="width: 100%; border-collapse: collapse; text-align: center;"> <tr> <td style="width: 10%;"></td> <td style="width: 10%;"></td> <td style="width: 10%;"></td> <td style="width: 10%;"></td> <td style="width: 10%;"></td> <td style="width: 10%;"></td> <td style="width: 10%;"></td> <td style="width: 10%;"></td> <td style="width: 10%;"></td> <td style="width: 10%;"></td> </tr> <tr> <td></td> <td></td> <td colspan="8" style="text-align: center;"> <table border="1" style="width: 100%; border-collapse: collapse; text-align: center;"> <tr> <td style="width: 10%;"></td> <td style="width: 10%;"></td> <td style="width: 10%;"></td> <td style="width: 10%;"></td> <td style="width: 10%;"></td> <td style="width: 10%;"></td> <td style="width: 10%;"></td> <td style="width: 10%;"></td> <td style="width: 10%;"></td> <td style="width: 10%;"></td> </tr> <tr> <td></td> <td></td> <td colspan="8" style="text-align: center;"> <table border="1" style="width: 100%; border-collapse: collapse; text-align: center;"> <tr> <td style="width: 10%;"></td> <td style="width: 10%;"></td> <td style="width: 10%;"></td> <td style="width: 10%;"></td> <td style="width: 10%;"></td> <td style="width: 10%;"></td> <td style="width: 10%;"></td> <td style="width: 10%;"></td> <td style="width: 10%;"></td> <td style="width: 10%;"></td> </tr> <tr> <td></td> <td></td> <td colspan="8" style="text-align: center;"> <table border="1" style="width: 100%; border-collapse: collapse; text-align: center;"> <tr> <td style="width: 10%;"></td> <td style="width: 10%;"></td> <td style="width: 10%;"></td> <td style="width: 10%;"></td> <td style="width: 10%;"></td> <td style="width: 10%;"></td> <td style="width: 10%;"></td> <td style="width: 10%;"></td> <td style="width: 10%;"></td> <td style="width: 10%;"></td> </tr> <tr> <td></td> <td></td> <td colspan="8" style="text-align: center;"> <table border="1" style="width: 100%; border-collapse: collapse; text-align: center;"> <tr> <td style="width: 10%;"></td> <td style="width: 10%;"></td> <td style="width: 10%;"></td> <td style="width: 10%;"></td> <td style="width: 10%;"></td> <td style="width: 10%;"></td> <td style="width: 10%;"></td> <td style="width: 10%;"></td> <td style="width: 10%;"></td> <td style="width: 10%;"></td> </tr> <tr> <td></td> <td></td> <td colspan="8" style="text-align: center;"> <table border="1" style="width: 100%; border-collapse: collapse; text-align: center;"> <tr> <td style="width: 10%;"></td> <td style="width: 10%;"></td> <td style="width: 10%;"></td> <td style="width: 10%;"></td> <td style="width: 10%;"></td> <td style="width: 10%;"></td> <td style="width: 10%;"></td> <td style="width: 10%;"></td> <td style="width: 10%;"></td> <td style="width: 10%;"></td> </tr> <tr> <td></td> <td></td> <td colspan="8" style="text-align: center;"> <table border="1" style="width: 100%; border-collapse: collapse; text-align: center;"> <tr> <td style="width: 10%;"></td> <td style="width: 10%;"></td> <td style="width: 10%;"></td> <td style="width: 10%;"></td> <td style="width: 10%;"></td> <td style="width: 10%;"></td> <td style="width: 10%;"></td> <td style="width: 10%;"></td> <td style="width: 10%;"></td> <td style="width: 10%;"></td> </tr> <tr> <td></td> <td></td> <td colspan="8" style="text-align: center;"> <table border="1" style="width: 100%; border-collapse: collapse; text-align: center;"> <tr> <td style="width: 10%;"></td> <td style="width: 10%;"></td> <td style="width: 10%;"></td> <td style="width: 10%;"></td> <td style="width: 10%;"></td> <td style="width: 10%;"></td> <td style="width: 10%;"></td> <td style="width: 10%;"></td> <td style="width: 10%;"></td> <td style="width: 10%;"></td> </tr> <tr> <td></td> <td></td> <td colspan="8" style="text-align: center;"> <table border="1" style="width: 100%; border-collapse: collapse; text-align: center;"> <tr> <td style="width: 10%;"></td> <td style="width: 10%;"></td> <td style="width: 10%;"></td> <td style="width: 10%;"></td> <td style="width: 10%;"></td> <td style="width: 10%;"></td> <td style="width: 10%;"></td> <td style="width: 10%;"></td> <td style="width: 10%;"></td> <td style="width: 10%;"></td> </tr> <tr> <td></td> <td></td> <td colspan="8" style="text-align: center;"> <table border="1" style="width: 100%; border-collapse: collapse; text-align: center;"> <tr> <td style="width: 10%;"></td> <td style="width: 10%;"></td> <td style="width: 10%;"></td> <td style="width: 10%;"></td> <td style="width: 10%;"></td> <td style="width: 10%;"></td> <td style="width: 10%;"></td> <td style="width: 10%;"></td> <td style="width: 10%;"></td> <td style="width: 10%;"></td> </tr> <tr> <td></td> <td></td> <td colspan="8" style="text-align: center;"> <table border="1" style="width: 100%; border-collapse: collapse; text-align: center;"> <tr> </tr></table></td></tr></table></td></tr></table></td></tr></table></td></tr></table></td></tr></table></td></tr></table></td></tr></table></td></tr></table></td></tr></table></td></tr></table></td></tr></table></td></tr></table></td></tr></table></td></tr></table></td></tr></table></td></tr></table></td></tr></table></td></tr></table></td></tr></table></td></tr></table></td></tr></table></td></tr></table></td></tr></table></td></tr></table></td></tr></table></td></tr></table></td></tr></table></td></tr></table></td></tr></table></td></tr></table></td></tr></table></td></tr></table></td></tr></table></td></tr></table></td></tr></table></td></tr></table></td></tr></table></td></tr></table></td></tr></table></td></tr></table></td></tr></table></td></tr></table></td></tr></table>
 | | | | | | | | | | | | | | | | | | | | <table border="1" style="width: 100%; border-collapse: collapse; text-align: center;"> <tr> <td style="width: 10%;"></td> <td style="width: 10%;"></td> <td style="width: 10%;"></td> <td style="width: 10%;"></td> <td style="width: 10%;"></td> <td style="width: 10%;"></td> <td style="width: 10%;"></td> <td style="width: 10%;"></td> <td style="width: 10%;"></td> <td style="width: 10%;"></td> </tr> <tr> <td></td> <td></td> <td colspan="8" style="text-align: center;"> <table border="1" style="width: 100%; border-collapse: collapse; text-align: center;"> <tr> <td style="width: 10%;"></td> <td style="width: 10%;"></td> <td style="width: 10%;"></td> <td style="width: 10%;"></td> <td style="width: 10%;"></td> <td style="width: 10%;"></td> <td style="width: 10%;"></td> <td style="width: 10%;"></td> <td style="width: 10%;"></td> <td style="width: 10%;"></td> </tr> <tr> <td></td> <td></td> <td colspan="8" style="text-align: center;"> <table border="1" style="width: 100%; border-collapse: collapse; text-align: center;"> <tr> <td style="width: 10%;"></td> <td style="width: 10%;"></td> <td style="width: 10%;"></td> <td style="width: 10%;"></td> <td style="width: 10%;"></td> <td style="width: 10%;"></td> <td style="width: 10%;"></td> <td style="width: 10%;"></td> <td style="width: 10%;"></td> <td style="width: 10%;"></td> </tr> <tr> <td></td> <td></td> <td colspan="8" style="text-align: center;"> <table border="1" style="width: 100%; border-collapse: collapse; text-align: center;"> <tr> <td style="width: 10%;"></td> <td style="width: 10%;"></td> <td style="width: 10%;"></td> <td style="width: 10%;"></td> <td style="width: 10%;"></td> <td style="width: 10%;"></td> <td style="width: 10%;"></td> <td style="width: 10%;"></td> <td style="width: 10%;"></td> <td style="width: 10%;"></td> </tr> <tr> <td></td> <td></td> <td colspan="8" style="text-align: center;"> <table border="1" style="width: 100%; border-collapse: collapse; text-align: center;"> <tr> <td style="width: 10%;"></td> <td style="width: 10%;"></td> <td style="width: 10%;"></td> <td style="width: 10%;"></td> <td style="width: 10%;"></td> <td style="width: 10%;"></td> <td style="width: 10%;"></td> <td style="width: 10%;"></td> <td style="width: 10%;"></td> <td style="width: 10%;"></td> </tr> <tr> <td></td> <td></td> <td colspan="8" style="text-align: center;"> <table border="1" style="width: 100%; border-collapse: collapse; text-align: center;"> <tr> <td style="width: 10%;"></td> <td style="width: 10%;"></td> <td style="width: 10%;"></td> <td style="width: 10%;"></td> <td style="width: 10%;"></td> <td style="width: 10%;"></td> <td style="width: 10%;"></td> <td style="width: 10%;"></td> <td style="width: 10%;"></td> <td style="width: 10%;"></td> </tr> <tr> <td></td> <td></td> <td colspan="8" style="text-align: center;"> <table border="1" style="width: 100%; border-collapse: collapse; text-align: center;"> <tr> <td style="width: 10%;"></td> <td style="width: 10%;"></td> <td style="width: 10%;"></td> <td style="width: 10%;"></td> <td style="width: 10%;"></td> <td style="width: 10%;"></td> <td style="width: 10%;"></td> <td style="width: 10%;"></td> <td style="width: 10%;"></td> <td style="width: 10%;"></td> </tr> <tr> <td></td> <td></td> <td colspan="8" style="text-align: center;"> <table border="1" style="width: 100%; border-collapse: collapse; text-align: center;"> <tr> <td style="width: 10%;"></td> <td style="width: 10%;"></td> <td style="width: 10%;"></td> <td style="width: 10%;"></td> <td style="width: 10%;"></td> <td style="width: 10%;"></td> <td style="width: 10%;"></td> <td style="width: 10%;"></td> <td style="width: 10%;"></td> <td style="width: 10%;"></td> </tr> <tr> <td></td> <td></td> <td colspan="8" style="text-align: center;"> <table border="1" style="width: 100%; border-collapse: collapse; text-align: center;"> <tr> <td style="width: 10%;"></td> <td style="width: 10%;"></td> <td style="width: 10%;"></td> <td style="width: 10%;"></td> <td style="width: 10%;"></td> <td style="width: 10%;"></td> <td style="width: 10%;"></td> <td style="width: 10%;"></td> <td style="width: 10%;"></td> <td style="width: 10%;"></td> </tr> <tr> <td></td> <td></td> <td colspan="8" style="text-align: center;"> <table border="1" style="width: 100%; border-collapse: collapse; text-align: center;"> <tr> <td style="width: 10%;"></td> <td style="width: 10%;"></td> <td style="width: 10%;"></td> <td style="width: 10%;"></td> <td style="width: 10%;"></td> <td style="width: 10%;"></td> <td style="width: 10%;"></td> <td style="width: 10%;"></td> <td style="width: 10%;"></td> <td style="width: 10%;"></td> </tr> <tr> <td></td> <td></td> <td colspan="8" style="text-align: center;"> <table border="1" style="width: 100%; border-collapse: collapse; text-align: center;"> <tr> <td style="width: 10%;"></td> <td style="width: 10%;"></td> <td style="width: 10%;"></td> <td style="width: 10%;"></td> <td style="width: 10%;"></td> <td style="width: 10%;"></td> <td style="width: 10%;"></td> <td style="width: 10%;"></td> <td style="width: 10%;"></td> <td style="width: 10%;"></td> </tr> <tr> <td></td> <td></td> <td colspan="8" style="text-align: center;"> <table border="1" style="width: 100%; border-collapse: collapse; text-align: center;"> <tr> <td style="width: 10%;"></td> <td style="width: 10%;"></td> <td style="width: 10%;"></td> <td style="width: 10%;"></td> <td style="width: 10%;"></td> <td style="width: 10%;"></td> <td style="width: 10%;"></td> <td style="width: 10%;"></td> <td style="width: 10%;"></td> <td style="width: 10%;"></td> </tr> <tr> <td></td> <td></td> <td colspan="8" style="text-align: center;"> <table border="1" style="width: 100%; border-collapse: collapse; text-align: center;"> <tr> <td style="width: 10%;"></td> <td style="width: 10%;"></td> <td style="width: 10%;"></td> <td style="width: 10%;"></td> <td style="width: 10%;"></td> <td style="width: 10%;"></td> <td style="width: 10%;"></td> <td style="width: 10%;"></td> <td style="width: 10%;"></td> <td style="width: 10%;"></td> </tr> <tr> <td></td> <td></td> <td colspan="8" style="text-align: center;"> <table border="1" style="width: 100%; border-collapse: collapse; text-align: center;"> <tr> <td style="width: 10%;"></td> <td style="width: 10%;"></td> <td style="width: 10%;"></td> <td style="width: 10%;"></td> <td style="width: 10%;"></td> <td style="width: 10%;"></td> <td style="width: 10%;"></td> <td style="width: 10%;"></td> <td style="width: 10%;"></td> <td style="width: 10%;"></td> </tr> <tr> <td></td> <td></td> <td colspan="8" style="text-align: center;"> <table border="1" style="width: 100%; border-collapse: collapse; text-align: center;"> <tr> <td style="width: 10%;"></td> <td style="width: 10%;"></td> <td style="width: 10%;"></td> <td style="width: 10%;"></td> <td style="width: 10%;"></td> <td style="width: 10%;"></td> <td style="width: 10%;"></td> <td style="width: 10%;"></td> <td style="width: 10%;"></td> <td style="width: 10%;"></td> </tr> <tr> <td></td> <td></td> <td colspan="8" style="text-align: center;"> <table border="1" style="width: 100%; border-collapse: collapse; text-align: center;"> <tr> <td style="width: 10%;"></td> <td style="width: 10%;"></td> <td style="width: 10%;"></td> <td style="width: 10%;"></td> <td style="width: 10%;"></td> <td style="width: 10%;"></td> <td style="width: 10%;"></td> <td style="width: 10%;"></td> <td style="width: 10%;"></td> <td style="width: 10%;"></td> </tr> <tr> <td></td> <td></td> <td colspan="8" style="text-align: center;"> <table border="1" style="width: 100%; border-collapse: collapse; text-align: center;"> <tr> <td style="width: 10%;"></td> <td style="width: 10%;"></td> <td style="width: 10%;"></td> <td style="width: 10%;"></td> <td style="width: 10%;"></td> <td style="width: 10%;"></td> <td style="width: 10%;"></td> <td style="width: 10%;"></td> <td style="width: 10%;"></td> <td style="width: 10%;"></td> </tr> <tr> <td></td> <td></td> <td colspan="8" style="text-align: center;"> <table border="1" style="width: 100%; border-collapse: collapse; text-align: center;"> <tr> <td style="width: 10%;"></td> <td style="width: 10%;"></td> <td style="width: 10%;"></td> <td style="width: 10%;"></td> <td style="width: 10%;"></td> <td style="width: 10%;"></td> <td style="width: 10%;"></td> <td style="width: 10%;"></td> <td style="width: 10%;"></td> <td style="width: 10%;"></td> </tr> <tr> <td></td> <td></td> <td colspan="8" style="text-align: center;"> <table border="1" style="width: 100%; border-collapse: collapse; text-align: center;"> <tr> <td style="width: 10%;"></td> <td style="width: 10%;"></td> <td style="width: 10%;"></td> <td style="width: 10%;"></td> <td style="width: 10%;"></td> <td style="width: 10%;"></td> <td style="width: 10%;"></td> <td style="width: 10%;"></td> <td style="width: 10%;"></td> <td style="width: 10%;"></td> </tr> <tr> <td></td> <td></td> <td colspan="8" style="text-align: center;"> <table border="1" style="width: 100%; border-collapse: collapse; text-align: center;"> <tr> <td style="width: 10%;"></td> <td style="width: 10%;"></td> <td style="width: 10%;"></td> <td style="width: 10%;"></td> <td style="width: 10%;"></td> <td style="width: 10%;"></td> <td style="width: 10%;"></td> <td style="width: 10%;"></td> <td style="width: 10%;"></td> <td style="width: 10%;"></td> </tr> <tr> <td></td> <td></td>
<td colspan="8" style="text-align: center;"> <table border="1" style="width: 100%; border-collapse: collapse; text-align: center;"> <tr> <td style="width: 10%;"></td> <td style="width: 10%;"></td> <td style="width: 10%;"></td> <td style="width: 10%;"></td> <td style="width: 10%;"></td> <td style="width: 10%;"></td> <td style="width: 10%;"></td> <td style="width: 10%;"></td> <td style="width: 10%;"></td> <td style="width: 10%;"></td> </tr> <tr> <td></td> <td></td> <td colspan="8" style="text-align: center;"> <table border="1" style="width: 100%; border-collapse: collapse; text-align: center;"> <tr> <td style="width: 10%;"></td> <td style="width: 10%;"></td> <td style="width: 10%;"></td> <td style="width: 10%;"></td> <td style="width: 10%;"></td> <td style="width: 10%;"></td> <td style="width: 10%;"></td> <td style="width: 10%;"></td> <td style="width: 10%;"></td> <td style="width: 10%;"></td> </tr> <tr> <td></td> <td></td> <td colspan="8" style="text-align: center;"> <table border="1" style="width: 100%; border-collapse: collapse; text-align: center;"> <tr> <td style="width: 10%;"></td> <td style="width: 10%;"></td> <td style="width: 10%;"></td> <td style="width: 10%;"></td> <td style="width: 10%;"></td> <td style="width: 10%;"></td> <td style="width: 10%;"></td> <td style="width: 10%;"></td> <td style="width: 10%;"></td> <td style="width: 10%;"></td> </tr> <tr> <td></td> <td></td> <td colspan="8" style="text-align: center;"> <table border="1" style="width: 100%; border-collapse: collapse; text-align: center;"> <tr> <td style="width: 10%;"></td> <td style="width: 10%;"></td> <td style="width: 10%;"></td> <td style="width: 10%;"></td> <td style="width: 10%;"></td> <td style="width: 10%;"></td> <td style="width: 10%;"></td> <td style="width: 10%;"></td> <td style="width: 10%;"></td> <td style="width: 10%;"></td> </tr> <tr> <td></td> <td></td> <td colspan="8" style="text-align: center;"> <table border="1" style="width: 100%; border-collapse: collapse; text-align: center;"> <tr> <td style="width: 10%;"></td> <td style="width: 10%;"></td> <td style="width: 10%;"></td> <td style="width: 10%;"></td> <td style="width: 10%;"></td> <td style="width: 10%;"></td> <td style="width: 10%;"></td> <td style="width: 10%;"></td> <td style="width: 10%;"></td> <td style="width: 10%;"></td> </tr> <tr> <td></td> <td></td> <td colspan="8" style="text-align: center;"> <table border="1" style="width: 100%; border-collapse: collapse; text-align: center;"> <tr> <td style="width: 10%;"></td> <td style="width: 10%;"></td> <td style="width: 10%;"></td> <td style="width: 10%;"></td> <td style="width: 10%;"></td> <td style="width: 10%;"></td> <td style="width: 10%;"></td> <td style="width: 10%;"></td> <td style="width: 10%;"></td> <td style="width: 10%;"></td> </tr> <tr> <td></td> <td></td> <td colspan="8" style="text-align: center;"> <table border="1" style="width: 100%; border-collapse: collapse; text-align: center;"> <tr> <td style="width: 10%;"></td> <td style="width: 10%;"></td> <td style="width: 10%;"></td> <td style="width: 10%;"></td> <td style="width: 10%;"></td> <td style="width: 10%;"></td> <td style="width: 10%;"></td> <td style="width: 10%;"></td> <td style="width: 10%;"></td> <td style="width: 10%;"></td> </tr> <tr> <td></td> <td></td> <td colspan="8" style="text-align: center;"> <table border="1" style="width: 100%; border-collapse: collapse; text-align: center;"> <tr> <td style="width: 10%;"></td> <td style="width: 10%;"></td> <td style="width: 10%;"></td> <td style="width: 10%;"></td> <td style="width: 10%;"></td> <td style="width: 10%;"></td> <td style="width: 10%;"></td> <td style="width: 10%;"></td> <td style="width: 10%;"></td> <td style="width: 10%;"></td> </tr> <tr> <td></td> <td></td> <td colspan="8" style="text-align: center;"> <table border="1" style="width: 100%; border-collapse: collapse; text-align: center;"> <tr> <td style="width: 10%;"></td> <td style="width: 10%;"></td> <td style="width: 10%;"></td> <td style="width: 10%;"></td> <td style="width: 10%;"></td> <td style="width: 10%;"></td> <td style="width: 10%;"></td> <td style="width: 10%;"></td> <td style="width: 10%;"></td> <td style="width: 10%;"></td> </tr> <tr> <td></td> <td></td> <td colspan="8" style="text-align: center;"> <table border="1" style="width: 100%; border-collapse: collapse; text-align: center;"> <tr> <td style="width: 10%;"></td> <td style="width: 10%;"></td> <td style="width: 10%;"></td> <td style="width: 10%;"></td> <td style="width: 10%;"></td> <td style="width: 10%;"></td> <td style="width: 10%;"></td> <td style="width: 10%;"></td> <td style="width: 10%;"></td> <td style="width: 10%;"></td> </tr> <tr> <td></td> <td></td> <td colspan="8" style="text-align: center;"> <table border="1" style="width: 100%; border-collapse: collapse; text-align: center;"> <tr> <td style="width: 10%;"></td> <td style="width: 10%;"></td> <td style="width: 10%;"></td> <td style="width: 10%;"></td> <td style="width: 10%;"></td> <td style="width: 10%;"></td> <td style="width: 10%;"></td> <td style="width: 10%;"></td> <td style="width: 10%;"></td> <td style="width: 10%;"></td> </tr> <tr> <td></td> <td></td> <td colspan="8" style="text-align: center;"> <table border="1" style="width: 100%; border-collapse: collapse; text-align: center;"> <tr> <td style="width: 10%;"></td> <td style="width: 10%;"></td> <td style="width: 10%;"></td> <td style="width: 10%;"></td> <td style="width: 10%;"></td> <td style="width: 10%;"></td> <td style="width: 10%;"></td> <td style="width: 10%;"></td> <td style="width: 10%;"></td> <td style="width: 10%;"></td> </tr> <tr> <td></td> <td></td> <td colspan="8" style="text-align: center;"> <table border="1" style="width: 100%; border-collapse: collapse; text-align: center;"> <tr> <td style="width: 10%;"></td> <td style="width: 10%;"></td> <td style="width: 10%;"></td> <td style="width: 10%;"></td> <td style="width: 10%;"></td> <td style="width: 10%;"></td> <td style="width: 10%;"></td> <td style="width: 10%;"></td> <td style="width: 10%;"></td> <td style="width: 10%;"></td> </tr> <tr> <td></td> <td></td> <td colspan="8" style="text-align: center;"> <table border="1" style="width: 100%; border-collapse: collapse; text-align: center;"> <tr> <td style="width: 10%;"></td> <td style="width: 10%;"></td> <td style="width: 10%;"></td> <td style="width: 10%;"></td> <td style="width: 10%;"></td> <td style="width: 10%;"></td> <td style="width: 10%;"></td> <td style="width: 10%;"></td> <td style="width: 10%;"></td> <td style="width: 10%;"></td> </tr> <tr> <td></td> <td></td> <td colspan="8" style="text-align: center;"> <table border="1" style="width: 100%; border-collapse: collapse; text-align: center;"> <tr> <td style="width: 10%;"></td> <td style="width: 10%;"></td> <td style="width: 10%;"></td> <td style="width: 10%;"></td> <td style="width: 10%;"></td> <td style="width: 10%;"></td> <td style="width: 10%;"></td> <td style="width: 10%;"></td> <td style="width: 10%;"></td> <td style="width: 10%;"></td> </tr> <tr> <td></td> <td></td> <td colspan="8" style="text-align: center;"> <table border="1" style="width: 100%; border-collapse: collapse; text-align: center;"> <tr> <td style="width: 10%;"></td> <td style="width: 10%;"></td> <td style="width: 10%;"></td> <td style="width: 10%;"></td> <td style="width: 10%;"></td> <td style="width: 10%;"></td> <td style="width: 10%;"></td> <td style="width: 10%;"></td> <td style="width: 10%;"></td> <td style="width: 10%;"></td> </tr> <tr> <td></td> <td></td> <td colspan="8" style="text-align: center;"> <table border="1" style="width: 100%; border-collapse: collapse; text-align: center;"> <tr> <td style="width: 10%;"></td> <td style="width: 10%;"></td> <td style="width: 10%;"></td> <td style="width: 10%;"></td> <td style="width: 10%;"></td> <td style="width: 10%;"></td> <td style="width: 10%;"></td> <td style="width: 10%;"></td> <td style="width: 10%;"></td> <td style="width: 10%;"></td> </tr> <tr> <td></td> <td></td> <td colspan="8" style="text-align: center;"> <table border="1" style="width: 100%; border-collapse: collapse; text-align: center;"> <tr> <td style="width: 10%;"></td> <td style="width: 10%;"></td> <td style="width: 10%;"></td> <td style="width: 10%;"></td> <td style="width: 10%;"></td> <td style="width: 10%;"></td> <td style="width: 10%;"></td> <td style="width: 10%;"></td> <td style="width: 10%;"></td> <td style="width: 10%;"></td> </tr> <tr> <td></td> <td></td> <td colspan="8" style="text-align: center;"> <table border="1" style="width: 100%; border-collapse: collapse; text-align: center;"> <tr> <td style="width: 10%;"></td> <td style="width: 10%;"></td> <td style="width: 10%;"></td> <td style="width: 10%;"></td> <td style="width: 10%;"></td> <td style="width: 10%;"></td> <td style="width: 10%;"></td> <td style="width: 10%;"></td> <td style="width: 10%;"></td> <td style="width: 10%;"></td> </tr> <tr> <td></td> <td></td> <td colspan="8" style="text-align: center;"> <table border="1" style="width: 100%; border-collapse: collapse; text-align: center;"> <tr> <td style="width: 10%;"></td> <td style="width: 10%;"></td> <td style="width: 10%;"></td> <td style="width: 10%;"></td> <td style="width: 10%;"></td> <td style="width: 10%;"></td> <td style="width: 10%;"></td> <td style="width: 10%;"></td> <td style="width: 10%;"></td> <td style="width: 10%;"></td> </tr> <tr> <td></td> <td></td> <td colspan="8" style="text-align: center;"> <table border="1" style="width: 100%; border-collapse: collapse; text-align: center;"> <tr> <td style="width: 10%;"></td> <td style="width: 10%;"></td> <td style="width: 10%;"></td> <td style="width: 10%;"></td> <td style="width: 10%;"></td> <td style="width: 10%;"></td> <td style="width: 10%;"></td> <td style="width: 10%;"></td> <td style="width: 10%;"></td> <td style="width: 10%;"></td> </tr> <tr> <td></td> <td></td> <td colspan="8" style="text-align: center;"> <table border="1" style="width: 100%; border-collapse: collapse; text-align: center;"> <tr> <td style="width: 10%;"></td> <td
style="width: 10%;"></td> <td style="width: 10%;"></td> <td style="width: 10%;"></td> <td style="width: 10%;"></td> <td style="width: 10%;"></td> <td style="width: 10%;"></td> <td style="width: 10%;"></td> <td style="width: 10%;"></td> <td style="width: 10%;"></td> </tr> <tr> <td></td> <td></td> <td colspan="8" style="text-align: center;"> <table border="1" style="width: 100%; border-collapse: collapse; text-align: center;"> <tr> </tr></table></td></tr></table></td></tr></table></td></tr></table></td></tr></table></td></tr></table></td></tr></table></td></tr></table></td></tr></table></td></tr></table></td></tr></table></td></tr></table></td></tr></table></td></tr></table></td></tr></table></td></tr></table></td></tr></table></td></tr></table></td></tr></table></td></tr></table></td></tr></table></td></tr></table></td></tr></table></td></tr></table></td></tr></table></td></tr></table></td></tr></table></td></tr></table></td></tr></table></td></tr></table></td></tr></table></td></tr></table></td></tr></table></td></tr></table></td></tr></table></td></tr></table></td></tr></table></td></tr></table></td></tr></table></td></tr></table></td></tr></table></td></tr></table></td></tr></table> | | | | | | | | | | | | | | | | | | | | <table border="1" style="width: 100%; border-collapse: collapse; text-align: center;"> <tr> <td style="width: 10%;"></td> <td style="width: 10%;"></td> <td style="width: 10%;"></td> <td style="width: 10%;"></td> <td style="width: 10%;"></td> <td style="width: 10%;"></td> <td style="width: 10%;"></td> <td style="width: 10%;"></td> <td style="width: 10%;"></td> <td style="width: 10%;"></td> </tr> <tr> <td></td> <td></td> <td colspan="8" style="text-align: center;"> <table border="1" style="width: 100%; border-collapse: collapse; text-align: center;"> <tr> <td style="width: 10%;"></td> <td style="width: 10%;"></td> <td style="width: 10%;"></td> <td style="width: 10%;"></td> <td style="width: 10%;"></td> <td style="width: 10%;"></td> <td style="width: 10%;"></td> <td style="width: 10%;"></td> <td style="width: 10%;"></td> <td style="width: 10%;"></td> </tr> <tr> <td></td> <td></td> <td colspan="8" style="text-align: center;"> <table border="1" style="width: 100%; border-collapse: collapse; text-align: center;"> <tr> <td style="width: 10%;"></td> <td style="width: 10%;"></td> <td style="width: 10%;"></td> <td style="width: 10%;"></td> <td style="width: 10%;"></td> <td style="width: 10%;"></td> <td style="width: 10%;"></td> <td style="width: 10%;"></td> <td style="width: 10%;"></td> <td style="width: 10%;"></td> </tr> <tr> <td></td> <td></td> <td colspan="8" style="text-align: center;"> <table border="1" style="width: 100%; border-collapse: collapse; text-align: center;"> <tr> <td style="width: 10%;"></td> <td style="width: 10%;"></td> <td style="width: 10%;"></td> <td style="width: 10%;"></td> <td style="width: 10%;"></td> <td style="width: 10%;"></td> <td style="width: 10%;"></td> <td style="width: 10%;"></td> <td style="width: 10%;"></td> <td style="width: 10%;"></td> </tr> <tr> <td></td> <td></td> <td colspan="8" style="text-align: center;"> <table border="1" style="width: 100%; border-collapse: collapse; text-align: center;"> <tr> <td style="width: 10%;"></td> <td style="width: 10%;"></td> <td style="width: 10%;"></td> <td style="width: 10%;"></td> <td style="width: 10%;"></td> <td style="width: 10%;"></td> <td style="width: 10%;"></td> <td style="width: 10%;"></td> <td style="width: 10%;"></td> <td style="width: 10%;"></td> </tr> <tr> <td></td> <td></td> <td colspan="8" style="text-align: center;"> <table border="1" style="width: 100%; border-collapse: collapse; text-align: center;"> <tr> <td style="width: 10%;"></td> <td style="width: 10%;"></td> <td style="width: 10%;"></td> <td style="width: 10%;"></td> <td style="width: 10%;"></td> <td style="width: 10%;"></td> <td style="width: 10%;"></td> <td style="width: 10%;"></td> <td style="width: 10%;"></td> <td style="width: 10%;"></td> </tr> <tr> <td></td> <td></td> <td colspan="8" style="text-align: center;"> <table border="1" style="width: 100%; border-collapse: collapse; text-align: center;"> <tr> <td style="width: 10%;"></td> <td style="width: 10%;"></td> <td style="width: 10%;"></td> <td style="width: 10%;"></td> <td style="width: 10%;"></td> <td style="width: 10%;"></td> <td style="width: 10%;"></td> <td style="width: 10%;"></td> <td style="width: 10%;"></td> <td style="width: 10%;"></td> </tr> <tr> <td></td> <td></td> <td colspan="8" style="text-align: center;"> <table border="1" style="width: 100%; border-collapse: collapse; text-align: center;"> <tr> <td style="width: 10%;"></td> <td style="width: 10%;"></td> <td style="width: 10%;"></td> <td style="width: 10%;"></td> <td style="width: 10%;"></td> <td style="width: 10%;"></td> <td style="width: 10%;"></td> <td style="width: 10%;"></td> <td style="width: 10%;"></td> <td style="width: 10%;"></td> </tr> <tr> <td></td> <td></td> <td colspan="8" style="text-align: center;"> <table border="1" style="width: 100%; border-collapse: collapse; text-align: center;"> <tr> <td style="width: 10%;"></td> <td style="width: 10%;"></td> <td style="width: 10%;"></td> <td style="width: 10%;"></td> <td style="width: 10%;"></td> <td style="width: 10%;"></td> <td style="width: 10%;"></td> <td style="width: 10%;"></td> <td style="width: 10%;"></td> <td style="width: 10%;"></td> </tr> <tr> <td></td> <td></td> <td colspan="8" style="text-align: center;"> <table border="1" style="width: 100%; border-collapse: collapse; text-align: center;"> <tr> <td style="width: 10%;"></td> <td style="width: 10%;"></td> <td style="width: 10%;"></td> <td style="width: 10%;"></td> <td style="width: 10%;"></td> <td style="width: 10%;"></td> <td style="width: 10%;"></td> <td style="width: 10%;"></td> <td style="width: 10%;"></td> <td style="width: 10%;"></td> </tr> <tr> <td></td> <td></td> <td colspan="8" style="text-align: center;"> <table border="1" style="width: 100%; border-collapse: collapse; text-align: center;"> <tr> <td style="width: 10%;"></td> <td style="width: 10%;"></td> <td style="width: 10%;"></td> <td style="width: 10%;"></td> <td style="width: 10%;"></td> <td style="width: 10%;"></td> <td style="width: 10%;"></td> <td style="width: 10%;"></td> <td style="width: 10%;"></td> <td style="width: 10%;"></td> </tr> <tr> <td></td> <td></td> <td colspan="8" style="text-align: center;"> <table border="1" style="width: 100%; border-collapse: collapse; text-align: center;"> <tr> <td style="width: 10%;"></td> <td style="width: 10%;"></td> <td style="width: 10%;"></td> <td style="width: 10%;"></td> <td style="width: 10%;"></td> <td style="width: 10%;"></td> <td style="width: 10%;"></td> <td style="width: 10%;"></td> <td style="width: 10%;"></td> <td style="width: 10%;"></td> </tr> <tr> <td></td> <td></td> <td colspan="8" style="text-align: center;"> <table border="1" style="width: 100%; border-collapse: collapse; text-align: center;"> <tr> <td style="width: 10%;"></td> <td style="width: 10%;"></td> <td style="width: 10%;"></td> <td style="width: 10%;"></td> <td style="width: 10%;"></td> <td style="width: 10%;"></td> <td style="width: 10%;"></td> <td style="width: 10%;"></td> <td style="width: 10%;"></td> <td style="width: 10%;"></td> </tr> <tr> <td></td> <td></td> <td colspan="8" style="text-align: center;"> <table border="1" style="width: 100%; border-collapse: collapse; text-align: center;"> <tr> <td style="width: 10%;"></td> <td style="width: 10%;"></td> <td style="width: 10%;"></td> <td style="width: 10%;"></td> <td style="width: 10%;"></td> <td style="width: 10%;"></td> <td style="width: 10%;"></td> <td style="width: 10%;"></td> <td style="width: 10%;"></td> <td style="width: 10%;"></td> </tr> <tr> <td></td> <td></td> <td colspan="8" style="text-align: center;"> <table border="1" style="width: 100%; border-collapse: collapse; text-align: center;"> <tr> <td style="width: 10%;"></td> <td style="width: 10%;"></td> <td style="width: 10%;"></td> <td style="width: 10%;"></td> <td style="width:
10%;"></td> <td style="width: 10%;"></td> <td style="width: 10%;"></td> <td style="width: 10%;"></td> <td style="width: 10%;"></td> <td style="width: 10%;"></td> </tr> <tr> <td></td> <td></td> <td colspan="8" style="text-align: center;"> <table border="1" style="width: 100%; border-collapse: collapse; text-align: center;"> <tr> <td style="width: 10%;"></td> <td style="width: 10%;"></td> <td style="width: 10%;"></td> <td style="width: 10%;"></td> <td style="width: 10%;"></td> <td style="width: 10%;"></td> <td style="width: 10%;"></td> <td style="width: 10%;"></td> <td style="width: 10%;"></td> <td style="width: 10%;"></td> </tr> <tr> <td></td> <td></td> <td colspan="8" style="text-align: center;"> <table border="1" style="width: 100%; border-collapse: collapse; text-align: center;"> <tr> <td style="width: 10%;"></td> <td style="width: 10%;"></td> <td style="width: 10%;"></td> <td style="width: 10%;"></td> <td style="width: 10%;"></td> <td style="width: 10%;"></td> <td style="width: 10%;"></td> <td style="width: 10%;"></td> <td style="width: 10%;"></td> <td style="width: 10%;"></td> </tr> <tr> <td></td> <td></td> <td colspan="8" style="text-align: center;"> <table border="1" style="width: 100%; border-collapse: collapse; text-align: center;"> <tr> <td style="width: 10%;"></td> <td style="width: 10%;"></td> <td style="width: 10%;"></td> <td style="width: 10%;"></td> <td style="width: 10%;"></td> <td style="width: 10%;"></td> <td style="width: 10%;"></td> <td style="width: 10%;"></td> <td style="width: 10%;"></td> <td style="width: 10%;"></td> </tr> <tr> <td></td> <td></td> <td colspan="8" style="text-align: center;"> <table border="1" style="width: 100%; border-collapse: collapse; text-align: center;"> <tr> <td style="width: 10%;"></td> <td style="width: 10%;"></td> <td style="width: 10%;"></td> <td style="width: 10%;"></td> <td style="width: 10%;"></td> <td style="width: 10%;"></td> <td style="width: 10%;"></td> <td style="width: 10%;"></td> <td style="width: 10%;"></td> <td style="width: 10%;"></td> </tr> <tr> <td></td> <td></td> <td colspan="8" style="text-align: center;"> <table border="1" style="width: 100%; border-collapse: collapse; text-align: center;"> <tr> <td style="width: 10%;"></td> <td style="width: 10%;"></td> <td style="width: 10%;"></td> <td style="width: 10%;"></td> <td style="width: 10%;"></td> <td style="width: 10%;"></td> <td style="width: 10%;"></td> <td style="width: 10%;"></td> <td style="width: 10%;"></td> <td style="width: 10%;"></td> </tr> <tr> <td></td> <td></td> <td colspan="8" style="text-align: center;"> <table border="1" style="width: 100%; border-collapse: collapse; text-align: center;"> <tr> <td style="width: 10%;"></td> <td style="width: 10%;"></td> <td style="width: 10%;"></td> <td style="width: 10%;"></td> <td style="width: 10%;"></td> <td style="width: 10%;"></td> <td style="width: 10%;"></td> <td style="width: 10%;"></td> <td style="width: 10%;"></td> <td style="width: 10%;"></td> </tr> <tr> <td></td> <td></td> <td colspan="8" style="text-align: center;"> <table border="1" style="width: 100%; border-collapse: collapse; text-align: center;"> <tr> <td style="width: 10%;"></td> <td style="width: 10%;"></td> <td style="width: 10%;"></td> <td style="width: 10%;"></td> <td style="width: 10%;"></td> <td style="width: 10%;"></td> <td style="width: 10%;"></td> <td style="width: 10%;"></td> <td style="width: 10%;"></td> <td style="width: 10%;"></td> </tr> <tr> <td></td> <td></td> <td colspan="8" style="text-align: center;"> <table border="1" style="width: 100%; border-collapse: collapse; text-align: center;"> <tr> <td style="width: 10%;"></td> <td style="width: 10%;"></td> <td style="width: 10%;"></td> <td style="width: 10%;"></td> <td style="width: 10%;"></td> <td style="width: 10%;"></td> <td style="width: 10%;"></td> <td style="width: 10%;"></td> <td style="width: 10%;"></td> <td style="width: 10%;"></td> </tr> <tr> <td></td> <td></td> <td colspan="8" style="text-align: center;"> <table border="1" style="width: 100%; border-collapse: collapse; text-align: center;"> <tr> <td style="width: 10%;"></td> <td style="width: 10%;"></td> <td style="width: 10%;"></td> <td style="width: 10%;"></td> <td style="width: 10%;"></td> <td style="width: 10%;"></td> <td style="width: 10%;"></td> <td style="width: 10%;"></td> <td style="width: 10%;"></td> <td style="width: 10%;"></td> </tr> <tr> <td></td> <td></td> <td colspan="8" style="text-align: center;"> <table border="1" style="width: 100%; border-collapse: collapse; text-align: center;"> <tr> <td style="width: 10%;"></td> <td style="width: 10%;"></td> <td style="width: 10%;"></td> <td style="width: 10%;"></td> <td style="width: 10%;"></td> <td style="width: 10%;"></td> <td style="width: 10%;"></td> <td style="width: 10%;"></td> <td style="width: 10%;"></td> <td style="width: 10%;"></td> </tr> <tr> <td></td> <td></td> <td colspan="8" style="text-align: center;"> <table border="1" style="width: 100%; border-collapse: collapse; text-align: center;"> <tr> <td style="width: 10%;"></td> <td style="width: 10%;"></td> <td style="width: 10%;"></td> <td style="width: 10%;"></td> <td style="width: 10%;"></td> <td style="width: 10%;"></td> <td style="width: 10%;"></td> <td style="width: 10%;"></td> <td style="width: 10%;"></td> <td style="width: 10%;"></td> </tr> <tr> <td></td> <td></td> <td colspan="8" style="text-align: center;"> <table border="1" style="width: 100%; border-collapse: collapse; text-align: center;"> <tr> <td style="width: 10%;"></td> <td style="width: 10%;"></td> <td style="width: 10%;"></td> <td style="width: 10%;"></td> <td style="width: 10%;"></td> <td style="width: 10%;"></td> <td style="width: 10%;"></td> <td style="width: 10%;"></td> <td style="width: 10%;"></td> <td style="width: 10%;"></td> </tr> <tr> <td></td> <td></td> <td colspan="8" style="text-align: center;"> <table border="1" style="width: 100%; border-collapse: collapse; text-align: center;"> <tr> <td style="width: 10%;"></td> <td style="width: 10%;"></td> <td style="width: 10%;"></td> <td style="width: 10%;"></td> <td style="width: 10%;"></td> <td style="width: 10%;"></td> <td style="width: 10%;"></td> <td style="width: 10%;"></td> <td style="width: 10%;"></td> <td style="width: 10%;"></td> </tr> <tr> <td></td> <td></td> <td colspan="8" style="text-align: center;"> <table border="1" style="width: 100%; border-collapse: collapse; text-align: center;"> <tr> <td style="width: 10%;"></td> <td style="width: 10%;"></td> <td style="width: 10%;"></td> <td style="width: 10%;"></td> <td style="width: 10%;"></td> <td style="width: 10%;"></td> <td style="width: 10%;"></td> <td style="width: 10%;"></td> <td style="width: 10%;"></td> <td style="width: 10%;"></td> </tr> <tr> <td></td> <td></td> <td colspan="8" style="text-align: center;"> <table border="1" style="width: 100%; border-collapse: collapse; text-align: center;"> <tr> <td style="width: 10%;"></td> <td style="width: 10%;"></td> <td style="width: 10%;"></td> <td style="width: 10%;"></td> <td style="width: 10%;"></td> <td style="width: 10%;"></td> <td style="width: 10%;"></td> <td style="width: 10%;"></td> <td style="width: 10%;"></td> <td style="width: 10%;"></td> </tr> <tr> <td></td> <td></td> <td colspan="8" style="text-align: center;"> <table border="1" style="width: 100%; border-collapse: collapse; text-align: center;"> <tr> <td style="width: 10%;"></td> <td style="width: 10%;"></td> <td style="width: 10%;"></td> <td style="width: 10%;"></td> <td style="width: 10%;"></td> <td style="width: 10%;"></td> <td style="width: 10%;"></td> <td style="width: 10%;"></td> <td style="width: 10%;"></td> <td style="width: 10%;"></td> </tr> <tr> <td></td> <td></td> <td colspan="8" style="text-align: center;"> <table border="1" style="width: 100%; border-collapse: collapse; text-align: center;"> <tr> <td style="width: 10%;"></td> <td style="width: 10%;"></td> <td style="width: 10%;"></td> <td style="width: 10%;"></td> <td style="width: 10%;"></td> <td style="width: 10%;"></td> <td style="width: 10%;"></td> <td style="width: 10%;"></td> <td style="width: 10%;"></td> <td style="width: 10%;"></td> </tr> <tr> <td></td> <td></td> <td colspan="8" style="text-align: center;"> <table border="1" style="width: 100%; border-collapse: collapse; text-align: center;"> <tr> <td style="width: 10%;"></td> <td style="width: 10%;"></td> <td style="width: 10%;"></td> <td style="width: 10%;"></td> <td style="width: 10%;"></td> <td style="width: 10%;"></td> <td style="width: 10%;"></td> <td style="width: 10%;"></td> <td style="width: 10%;"></td> <td style="width: 10%;"></td> </tr> <tr> <td></td> <td></td> <td colspan="8" style="text-align: center;"> <table border="1" style="width: 100%; border-collapse: collapse; text-align: center;"> <tr> <td style="width: 10%;"></td> <td style="width: 10%;"></td> <td style="width: 10%;"></td> <td style="width: 10%;"></td> <td style="width: 10%;"></td> <td style="width: 10%;"></td> <td style="width: 10%;"></td> <td style="width: 10%;"></td> <td style="width: 10%;"></td> <td style="width: 10%;"></td> </tr> <tr> <td></td> <td></td> <td colspan="8" style="text-align: center;"> <table border="1" style="width: 100%; border-collapse: collapse; text-align: center;"> <tr> <td style="width: 10%;"></td> <td style="width: 10%;"></td> <td style="width: 10%;"></td> <td style="width: 10%;"></td> <td style="width: 10%;"></td> <td style="width: 10%;"></td> <td style="width: 10%;"></td> <td style="width: 10%;"></td> <td style="width: 10%;"></td> <td style="width: 10%;"></td> </tr> <tr> <td></td> <td></td> <td colspan="8" style="text-align: center;"> <table border="1" style="width: 100%; border-collapse: collapse; text-align: center;"> <tr> <td style="width: 10%;"></td> <td style="width: 10%;"></td> <td style="width: 10%;"></td> <td style="width: 10%;"></td> <td style="width: 10%;"></td> <td style="width: 10%;"></td> <td style="width: 10%;"></td> <td style="width: 10%;"></td> <td style="width: 10%;"></td> <td style="width: 10%;"></td> </tr>
<tr> <td></td> <td></td> <td colspan="8" style="text-align: center;"> <table border="1" style="width: 100%; border-collapse: collapse; text-align: center;"> <tr> <td style="width: 10%;"></td> <td style="width: 10%;"></td> <td style="width: 10%;"></td> <td style="width: 10%;"></td> <td style="width: 10%;"></td> <td style="width: 10%;"></td> <td style="width: 10%;"></td> <td style="width: 10%;"></td> <td style="width: 10%;"></td> <td style="width: 10%;"></td> </tr> <tr> <td></td> <td></td> <td colspan="8" style="text-align: center;"> <table border="1" style="width: 100%; border-collapse: collapse; text-align: center;"> <tr> <td style="width: 10%;"></td> <td style="width: 10%;"></td> <td style="width: 10%;"></td> <td style="width: 10%;"></td> <td style="width: 10%;"></td> <td style="width: 10%;"></td> <td style="width: 10%;"></td> <td style="width: 10%;"></td> <td style="width: 10%;"></td> <td style="width: 10%;"></td> </tr> <tr> <td></td> <td></td> <td colspan="8" style="text-align: center;"> <table border="1" style="width: 100%; border-collapse: collapse; text-align: center;"> <tr> <td style="width: 10%;"></td> <td style="width: 10%;"></td> <td style="width: 10%;"></td> <td style="width: 10%;"></td> <td style="width: 10%;"></td> <td style="width: 10%;"></td> <td style="width: 10%;"></td> <td style="width: 10%;"></td> <td style="width: 10%;"></td> <td style="width: 10%;"></td> </tr> <tr> <td></td> <td></td> <td colspan="8" style="text-align: center;"> <table border="1" style="width: 100%; border-collapse: collapse; text-align: center;"> <tr> <td style="width: 10%;"></td> <td style="width: 10%;"></td> <td style="width: 10%;"></td> <td style="width: 10%;"></td> <td style="width: 10%;"></td> <td style="width: 10%;"></td> <td style="width: 10%;"></td> <td style="width: 10%;"></td> <td style="width: 10%;"></td> <td style="width: 10%;"></td> </tr> <tr> <td></td> <td></td> <td colspan="8" style="text-align: center;"> <table border="1" style="width: 100%; border-collapse: collapse; text-align: center;"> <tr> <td style="width: 10%;"></td> <td style="width: 10%;"></td> <td style="width: 10%;"></td> <td style="width: 10%;"></td> <td style="width: 10%;"></td> <td style="width: 10%;"></td> <td style="width: 10%;"></td> <td style="width: 10%;"></td> <td style="width: 10%;"></td> <td style="width: 10%;"></td> </tr> <tr> <td></td> <td></td> <td colspan="8" style="text-align: center;"> <table border="1" style="width: 100%; border-collapse: collapse; text-align: center;"> <tr> </tr></table></td></tr></table></td></tr></table></td></tr></table></td></tr></table></td></tr></table></td></tr></table></td></tr></table></td></tr></table></td></tr></table></td></tr></table></td></tr></table></td></tr></table></td></tr></table></td></tr></table></td></tr></table></td></tr></table></td></tr></table></td></tr></table></td></tr></table></td></tr></table></td></tr></table></td></tr></table></td></tr></table></td></tr></table></td></tr></table></td></tr></table></td></tr></table></td></tr></table></td></tr></table></td></tr></table></td></tr></table></td></tr></table></td></tr></table></td></tr></table></td></tr></table></td></tr></table></td></tr></table></td></tr></table></td></tr></table></td></tr></table></td></tr></table> | | | | | | | | | | | | | | | | | | | | <table border="1" style="width: 100%; border-collapse: collapse; text-align: center;"> <tr> <td style="width: 10%;"></td> <td style="width: 10%;"></td> <td style="width: 10%;"></td> <td style="width: 10%;"></td> <td style="width: 10%;"></td> <td style="width: 10%;"></td> <td style="width: 10%;"></td> <td style="width: 10%;"></td> <td style="width: 10%;"></td> <td style="width: 10%;"></td> </tr> <tr> <td></td> <td></td> <td colspan="8" style="text-align: center;"> <table border="1" style="width: 100%; border-collapse: collapse; text-align: center;"> <tr> <td style="width: 10%;"></td> <td style="width: 10%;"></td> <td style="width: 10%;"></td> <td style="width: 10%;"></td> <td style="width: 10%;"></td> <td style="width: 10%;"></td> <td style="width: 10%;"></td> <td style="width: 10%;"></td> <td style="width: 10%;"></td> <td style="width: 10%;"></td> </tr> <tr> <td></td> <td></td> <td colspan="8" style="text-align: center;"> <table border="1" style="width: 100%; border-collapse: collapse; text-align: center;"> <tr> <td style="width: 10%;"></td> <td style="width: 10%;"></td> <td style="width: 10%;"></td> <td style="width: 10%;"></td> <td style="width: 10%;"></td> <td style="width: 10%;"></td> <td style="width: 10%;"></td> <td style="width: 10%;"></td> <td style="width: 10%;"></td> <td style="width: 10%;"></td> </tr> <tr> <td></td> <td></td> <td colspan="8" style="text-align: center;"> <table border="1" style="width: 100%; border-collapse: collapse; text-align: center;"> <tr> <td style="width: 10%;"></td> <td style="width: 10%;"></td> <td style="width: 10%;"></td> <td style="width: 10%;"></td> <td style="width: 10%;"></td> <td style="width: 10%;"></td> <td style="width: 10%;"></td> <td style="width: 10%;"></td> <td style="width: 10%;"></td> <td style="width: 10%;"></td> </tr> <tr> <td></td> <td></td> <td colspan="8" style="text-align: center;"> <table border="1" style="width: 100%; border-collapse: collapse; text-align: center;"> <tr> <td style="width: 10%;"></td> <td style="width: 10%;"></td> <td style="width: 10%;"></td> <td style="width: 10%;"></td> <td style="width: 10%;"></td> <td style="width: 10%;"></td> <td style="width: 10%;"></td> <td style="width: 10%;"></td> <td style="width: 10%;"></td> <td style="width: 10%;"></td> </tr> <tr> <td></td> <td></td> <td colspan="8" style="text-align: center;"> <table border="1" style="width: 100%; border-collapse: collapse; text-align: center;"> <tr> <td style="width: 10%;"></td> <td style="width: 10%;"></td> <td style="width: 10%;"></td> <td style="width: 10%;"></td> <td style="width: 10%;"></td> <td style="width: 10%;"></td> <td style="width: 10%;"></td> <td style="width: 10%;"></td> <td style="width: 10%;"></td> <td style="width: 10%;"></td> </tr> <tr> <td></td> <td></td> <td colspan="8" style="text-align: center;"> <table border="1" style="width: 100%; border-collapse: collapse; text-align: center;"> <tr> <td style="width: 10%;"></td> <td style="width: 10%;"></td> <td style="width: 10%;"></td> <td style="width: 10%;"></td> <td style="width: 10%;"></td> <td style="width: 10%;"></td> <td style="width: 10%;"></td> <td style="width: 10%;"></td> <td style="width: 10%;"></td> <td style="width: 10%;"></td> </tr> <tr> <td></td> <td></td> <td colspan="8" style="text-align: center;"> <table border="1" style="width: 100%; border-collapse: collapse; text-align: center;"> <tr> <td style="width: 10%;"></td> <td style="width: 10%;"></td> <td style="width: 10%;"></td> <td style="width: 10%;"></td> <td style="width: 10%;"></td> <td style="width: 10%;"></td> <td style="width: 10%;"></td> <td style="width: 10%;"></td> <td style="width: 10%;"></td> <td style="width: 10%;"></td> </tr> <tr> <td></td> <td></td> <td colspan="8" style="text-align: center;"> <table border="1" style="width: 100%; border-collapse: collapse; text-align: center;"> <tr> <td style="width: 10%;"></td> <td style="width: 10%;"></td> <td style="width: 10%;"></td> <td style="width: 10%;"></td> <td style="width: 10%;"></td> <td style="width: 10%;"></td> <td style="width: 10%;"></td> <td style="width: 10%;"></td> <td style="width: 10%;"></td> <td style="width: 10%;"></td> </tr> <tr> <td></td> <td></td> <td colspan="8" style="text-align: center;"> <table border="1" style="width: 100%; border-collapse: collapse; text-align: center;"> <tr> <td style="width: 10%;"></td> <td style="width: 10%;"></td> <td style="width: 10%;"></td> <td style="width: 10%;"></td> <td style="width: 10%;"></td> <td style="width: 10%;"></td> <td style="width: 10%;"></td> <td style="width: 10%;"></td> <td style="width: 10%;"></td> <td style="width: 10%;"></td> </tr> <tr> <td></td> <td></td> <td colspan="8" style="text-align: center;"> <table border="1" style="width: 100%; border-collapse:
collapse; text-align: center;"> <tr> <td style="width: 10%;"></td> <td style="width: 10%;"></td> <td style="width: 10%;"></td> <td style="width: 10%;"></td> <td style="width: 10%;"></td> <td style="width: 10%;"></td> <td style="width: 10%;"></td> <td style="width: 10%;"></td> <td style="width: 10%;"></td> <td style="width: 10%;"></td> </tr> <tr> <td></td> <td></td> <td colspan="8" style="text-align: center;"> <table border="1" style="width: 100%; border-collapse: collapse; text-align: center;"> <tr> <td style="width: 10%;"></td> <td style="width: 10%;"></td> <td style="width: 10%;"></td> <td style="width: 10%;"></td> <td style="width: 10%;"></td> <td style="width: 10%;"></td> <td style="width: 10%;"></td> <td style="width: 10%;"></td> <td style="width: 10%;"></td> <td style="width: 10%;"></td> </tr> <tr> <td></td> <td></td> <td colspan="8" style="text-align: center;"> <table border="1" style="width: 100%; border-collapse: collapse; text-align: center;"> <tr> <td style="width: 10%;"></td> <td style="width: 10%;"></td> <td style="width: 10%;"></td> <td style="width: 10%;"></td> <td style="width: 10%;"></td> <td style="width: 10%;"></td> <td style="width: 10%;"></td> <td style="width: 10%;"></td> <td style="width: 10%;"></td> <td style="width: 10%;"></td> </tr> <tr> <td></td> <td></td> <td colspan="8" style="text-align: center;"> <table border="1" style="width: 100%; border-collapse: collapse; text-align: center;"> <tr> <td style="width: 10%;"></td> <td style="width: 10%;"></td> <td style="width: 10%;"></td> <td style="width: 10%;"></td> <td style="width: 10%;"></td> <td style="width: 10%;"></td> <td style="width: 10%;"></td> <td style="width: 10%;"></td> <td style="width: 10%;"></td> <td style="width: 10%;"></td> </tr> <tr> <td></td> <td></td> <td colspan="8" style="text-align: center;"> <table border="1" style="width: 100%; border-collapse: collapse; text-align: center;"> <tr> <td style="width: 10%;"></td> <td style="width: 10%;"></td> <td style="width: 10%;"></td> <td style="width: 10%;"></td> <td style="width: 10%;"></td> <td style="width: 10%;"></td> <td style="width: 10%;"></td> <td style="width: 10%;"></td> <td style="width: 10%;"></td> <td style="width: 10%;"></td> </tr> <tr> <td></td> <td></td> <td colspan="8" style="text-align: center;"> <table border="1" style="width: 100%; border-collapse: collapse; text-align: center;"> <tr> <td style="width: 10%;"></td> <td style="width: 10%;"></td> <td style="width: 10%;"></td> <td style="width: 10%;"></td> <td style="width: 10%;"></td> <td style="width: 10%;"></td> <td style="width: 10%;"></td> <td style="width: 10%;"></td> <td style="width: 10%;"></td> <td style="width: 10%;"></td> </tr> <tr> <td></td> <td></td> <td colspan="8" style="text-align: center;"> <table border="1" style="width: 100%; border-collapse: collapse; text-align: center;"> <tr> <td style="width: 10%;"></td> <td style="width: 10%;"></td> <td style="width: 10%;"></td> <td style="width: 10%;"></td> <td style="width: 10%;"></td> <td style="width: 10%;"></td> <td style="width: 10%;"></td> <td style="width: 10%;"></td> <td style="width: 10%;"></td> <td style="width: 10%;"></td> </tr> <tr> <td></td> <td></td> <td colspan="8" style="text-align: center;"> <table border="1" style="width: 100%; border-collapse: collapse; text-align: center;"> <tr> <td style="width: 10%;"></td> <td style="width: 10%;"></td> <td style="width: 10%;"></td> <td style="width: 10%;"></td> <td style="width: 10%;"></td> <td style="width: 10%;"></td> <td style="width: 10%;"></td> <td style="width: 10%;"></td> <td style="width: 10%;"></td> <td style="width: 10%;"></td> </tr> <tr> <td></td> <td></td> <td colspan="8" style="text-align: center;"> <table border="1" style="width: 100%; border-collapse: collapse; text-align: center;"> <tr> <td style="width: 10%;"></td> <td style="width: 10%;"></td> <td style="width: 10%;"></td> <td style="width: 10%;"></td> <td style="width: 10%;"></td> <td style="width: 10%;"></td> <td style="width: 10%;"></td> <td style="width: 10%;"></td> <td style="width: 10%;"></td> <td style="width: 10%;"></td> </tr> <tr> <td></td> <td></td> <td colspan="8" style="text-align: center;"> <table border="1" style="width: 100%; border-collapse: collapse; text-align: center;"> <tr> <td style="width: 10%;"></td> <td style="width: 10%;"></td> <td style="width: 10%;"></td> <td style="width: 10%;"></td> <td style="width: 10%;"></td> <td style="width: 10%;"></td> <td style="width: 10%;"></td> <td style="width: 10%;"></td> <td style="width: 10%;"></td> <td style="width: 10%;"></td> </tr> <tr> <td></td> <td></td> <td colspan="8" style="text-align: center;"> <table border="1" style="width: 100%; border-collapse: collapse; text-align: center;"> <tr> <td style="width: 10%;"></td> <td style="width: 10%;"></td> <td style="width: 10%;"></td> <td style="width: 10%;"></td> <td style="width: 10%;"></td> <td style="width: 10%;"></td> <td style="width: 10%;"></td> <td style="width: 10%;"></td> <td style="width: 10%;"></td> <td style="width: 10%;"></td> </tr> <tr> <td></td> <td></td> <td colspan="8" style="text-align: center;"> <table border="1" style="width: 100%; border-collapse: collapse; text-align: center;"> <tr> <td style="width: 10%;"></td> <td style="width: 10%;"></td> <td style="width: 10%;"></td> <td style="width: 10%;"></td> <td style="width: 10%;"></td> <td style="width: 10%;"></td> <td style="width: 10%;"></td> <td style="width: 10%;"></td> <td style="width: 10%;"></td> <td style="width: 10%;"></td> </tr> <tr> <td></td> <td></td> <td colspan="8" style="text-align: center;"> <table border="1" style="width: 100%; border-collapse: collapse; text-align: center;"> <tr> <td style="width: 10%;"></td> <td style="width: 10%;"></td> <td style="width: 10%;"></td> <td style="width: 10%;"></td> <td style="width: 10%;"></td> <td style="width: 10%;"></td> <td style="width: 10%;"></td> <td style="width: 10%;"></td> <td style="width: 10%;"></td> <td style="width: 10%;"></td> </tr> <tr> <td></td> <td></td> <td colspan="8" style="text-align: center;"> <table border="1" style="width: 100%; border-collapse: collapse; text-align: center;"> <tr> <td style="width: 10%;"></td> <td style="width: 10%;"></td> <td style="width: 10%;"></td> <td style="width: 10%;"></td> <td style="width: 10%;"></td> <td style="width: 10%;"></td> <td style="width: 10%;"></td> <td style="width: 10%;"></td> <td style="width: 10%;"></td> <td style="width: 10%;"></td> </tr> <tr> <td></td> <td></td> <td colspan="8" style="text-align: center;"> <table border="1" style="width: 100%; border-collapse: collapse; text-align: center;"> <tr> <td style="width: 10%;"></td> <td style="width: 10%;"></td> <td style="width: 10%;"></td> <td style="width: 10%;"></td> <td style="width: 10%;"></td> <td style="width: 10%;"></td> <td style="width: 10%;"></td> <td style="width: 10%;"></td> <td style="width: 10%;"></td> <td style="width: 10%;"></td> </tr> <tr> <td></td> <td></td> <td colspan="8" style="text-align: center;"> <table border="1" style="width: 100%; border-collapse: collapse; text-align: center;"> <tr> <td style="width: 10%;"></td> <td style="width: 10%;"></td> <td style="width: 10%;"></td> <td style="width: 10%;"></td> <td style="width: 10%;"></td> <td style="width: 10%;"></td> <td style="width: 10%;"></td> <td style="width: 10%;"></td> <td style="width: 10%;"></td> <td style="width: 10%;"></td> </tr> <tr> <td></td> <td></td> <td colspan="8" style="text-align: center;"> <table border="1" style="width: 100%; border-collapse: collapse; text-align: center;"> <tr> <td style="width: 10%;"></td> <td style="width: 10%;"></td> <td style="width: 10%;"></td> <td style="width: 10%;"></td> <td style="width: 10%;"></td> <td style="width: 10%;"></td> <td style="width: 10%;"></td> <td style="width: 10%;"></td> <td style="width: 10%;"></td> <td style="width: 10%;"></td> </tr> <tr> <td></td> <td></td> <td colspan="8" style="text-align: center;"> <table border="1" style="width: 100%; border-collapse: collapse; text-align: center;"> <tr> <td style="width: 10%;"></td> <td style="width: 10%;"></td> <td style="width: 10%;"></td> <td style="width: 10%;"></td> <td style="width: 10%;"></td> <td style="width: 10%;"></td> <td style="width: 10%;"></td> <td style="width: 10%;"></td> <td style="width: 10%;"></td> <td style="width: 10%;"></td> </tr> <tr> <td></td> <td></td> <td colspan="8" style="text-align: center;"> <table border="1" style="width: 100%; border-collapse: collapse; text-align: center;"> <tr> <td style="width: 10%;"></td> <td style="width: 10%;"></td> <td style="width: 10%;"></td> <td style="width: 10%;"></td> <td style="width: 10%;"></td> <td style="width: 10%;"></td> <td style="width: 10%;"></td> <td style="width: 10%;"></td> <td style="width: 10%;"></td> <td style="width: 10%;"></td> </tr> <tr> <td></td> <td></td> <td colspan="8" style="text-align: center;"> <table border="1" style="width: 100%; border-collapse: collapse; text-align: center;"> <tr> <td style="width: 10%;"></td> <td style="width: 10%;"></td> <td style="width: 10%;"></td> <td style="width: 10%;"></td> <td style="width: 10%;"></td> <td style="width: 10%;"></td> <td style="width: 10%;"></td> <td style="width: 10%;"></td> <td style="width: 10%;"></td> <td style="width: 10%;"></td> </tr> <tr> <td></td> <td></td> <td colspan="8" style="text-align: center;"> <table border="1" style="width: 100%; border-collapse: collapse; text-align: center;"> <tr> <td style="width: 10%;"></td> <td style="width: 10%;"></td> <td style="width: 10%;"></td> <td style="width: 10%;"></td> <td style="width: 10%;"></td> <td style="width: 10%;"></td> <td style="width: 10%;"></td> <td style="width: 10%;"></td> <td style="width: 10%;"></td> <td style="width: 10%;"></td> </tr> <tr> <td></td> <td></td> <td colspan="8" style="text-align: center;"> <table border="1" style="width: 100%; border-collapse: collapse; text-align: center;"> <tr> <td style="width: 10%;"></td> <td style="width: 10%;"></td> <td style="width: 10%;"></td> <td style="width: 10%;"></td> <td
style="width: 10%;"></td> <td style="width: 10%;"></td> <td style="width: 10%;"></td> <td style="width: 10%;"></td> <td style="width: 10%;"></td> <td style="width: 10%;"></td> </tr> <tr> <td></td> <td></td> <td colspan="8" style="text-align: center;"> <table border="1" style="width: 100%; border-collapse: collapse; text-align: center;"> <tr> <td style="width: 10%;"></td> <td style="width: 10%;"></td> <td style="width: 10%;"></td> <td style="width: 10%;"></td> <td style="width: 10%;"></td> <td style="width: 10%;"></td> <td style="width: 10%;"></td> <td style="width: 10%;"></td> <td style="width: 10%;"></td> <td style="width: 10%;"></td> </tr> <tr> <td></td> <td></td> <td colspan="8" style="text-align: center;"> <table border="1" style="width: 100%; border-collapse: collapse; text-align: center;"> <tr> <td style="width: 10%;"></td> <td style="width: 10%;"></td> <td style="width: 10%;"></td> <td style="width: 10%;"></td> <td style="width: 10%;"></td> <td style="width: 10%;"></td> <td style="width: 10%;"></td> <td style="width: 10%;"></td> <td style="width: 10%;"></td> <td style="width: 10%;"></td> </tr> <tr> <td></td> <td></td> <td colspan="8" style="text-align: center;"> <table border="1" style="width: 100%; border-collapse: collapse; text-align: center;"> <tr> <td style="width: 10%;"></td> <td style="width: 10%;"></td> <td style="width: 10%;"></td> <td style="width: 10%;"></td> <td style="width: 10%;"></td> <td style="width: 10%;"></td> <td style="width: 10%;"></td> <td style="width: 10%;"></td> <td style="width: 10%;"></td> <td style="width: 10%;"></td> </tr> <tr> <td></td> <td></td> <td colspan="8" style="text-align: center;"> <table border="1" style="width: 100%; border-collapse: collapse; text-align: center;"> <tr> <td style="width: 10%;"></td> <td style="width: 10%;"></td> <td style="width: 10%;"></td> <td style="width: 10%;"></td> <td style="width: 10%;"></td> <td style="width: 10%;"></td> <td style="width: 10%;"></td> <td style="width: 10%;"></td> <td style="width: 10%;"></td> <td style="width: 10%;"></td> </tr> <tr> <td></td> <td></td> <td colspan="8" style="text-align: center;"> <table border="1" style="width: 100%; border-collapse: collapse; text-align: center;"> <tr> <td style="width: 10%;"></td> <td style="width: 10%;"></td> <td style="width: 10%;"></td> <td style="width: 10%;"></td> <td style="width: 10%;"></td> <td style="width: 10%;"></td> <td style="width: 10%;"></td> <td style="width: 10%;"></td> <td style="width: 10%;"></td> <td style="width: 10%;"></td> </tr> <tr> <td></td> <td></td> <td colspan="8" style="text-align: center;"> <table border="1" style="width: 100%; border-collapse: collapse; text-align: center;"> <tr> <td style="width: 10%;"></td> <td style="width: 10%;"></td> <td style="width: 10%;"></td> <td style="width: 10%;"></td> <td style="width: 10%;"></td> <td style="width: 10%;"></td> <td style="width: 10%;"></td> <td style="width: 10%;"></td> <td style="width: 10%;"></td> <td style="width: 10%;"></td> </tr> <tr> <td></td> <td></td> <td colspan="8" style="text-align: center;"> <table border="1" style="width: 100%; border-collapse: collapse; text-align: center;"> <tr> <td style="width: 10%;"></td> <td style="width: 10%;"></td> <td style="width: 10%;"></td> <td style="width: 10%;"></td> <td style="width: 10%;"></td> <td style="width: 10%;"></td> <td style="width: 10%;"></td> <td style="width: 10%;"></td> <td style="width: 10%;"></td> <td style="width: 10%;"></td> </tr> <tr> <td></td> <td></td> <td colspan="8" style="text-align: center;"> <table border="1" style="width: 100%; border-collapse: collapse; text-align: center;"> <tr> <td style="width: 10%;"></td> <td style="width: 10%;"></td> <td style="width: 10%;"></td> <td style="width: 10%;"></td> <td style="width: 10%;"></td> <td style="width: 10%;"></td> <td style="width: 10%;"></td> <td style="width: 10%;"></td> <td style="width: 10%;"></td> <td style="width: 10%;"></td> </tr> <tr> <td></td> <td></td> <td colspan="8" style="text-align: center;"> <table border="1" style="width: 100%; border-collapse: collapse; text-align: center;"> <tr> </tr></table></td></tr></table></td></tr></table></td></tr></table></td></tr></table></td></tr></table></td></tr></table></td></tr></table></td></tr></table></td></tr></table></td></tr></table></td></tr></table></td></tr></table></td></tr></table></td></tr></table></td></tr></table></td></tr></table></td></tr></table></td></tr></table></td></tr></table></td></tr></table></td></tr></table></td></tr></table></td></tr></table></td></tr></table></td></tr></table></td></tr></table></td></tr></table></td></tr></table></td></tr></table></td></tr></table></td></tr></table></td></tr></table></td></tr></table></td></tr></table></td></tr></table></td></tr></table></td></tr></table></td></tr></table></td></tr></table></td></tr></table> | | | | | | | | | | | | | | | | | | | | <table border="1" style="width: 100%; border-collapse: collapse; text-align: center;"> <tr> <td style="width: 10%;"></td> <td style="width: 10%;"></td> <td style="width: 10%;"></td> <td style="width: 10%;"></td> <td style="width: 10%;"></td> <td style="width: 10%;"></td> <td style="width: 10%;"></td> <td style="width: 10%;"></td> <td style="width: 10%;"></td> <td style="width: 10%;"></td> </tr> <tr> <td></td> <td></td> <td colspan="8" style="text-align: center;"> <table border="1" style="width: 100%; border-collapse: collapse; text-align: center;"> <tr> <td style="width: 10%;"></td> <td style="width: 10%;"></td> <td style="width: 10%;"></td> <td style="width: 10%;"></td> <td style="width: 10%;"></td> <td style="width: 10%;"></td> <td style="width: 10%;"></td> <td style="width: 10%;"></td> <td style="width: 10%;"></td> <td style="width: 10%;"></td> </tr> <tr> <td></td> <td></td> <td colspan="8" style="text-align: center;"> <table border="1" style="width: 100%; border-collapse: collapse; text-align: center;"> <tr> <td style="width: 10%;"></td> <td style="width: 10%;"></td> <td style="width: 10%;"></td> <td style="width: 10%;"></td> <td style="width: 10%;"></td> <td style="width: 10%;"></td> <td style="width: 10%;"></td> <td style="width: 10%;"></td> <td style="width: 10%;"></td> <td style="width: 10%;"></td> </tr> <tr> <td></td> <td></td> <td colspan="8" style="text-align: center;"> <table border="1" style="width: 100%; border-collapse: collapse; text-align: center;"> <tr> <td style="width: 10%;"></td> <td style="width: 10%;"></td> <td style="width: 10%;"></td> <td style="width: 10%;"></td> <td style="width: 10%;"></td> <td style="width: 10%;"></td> <td style="width: 10%;"></td> <td style="width: 10%;"></td> <td style="width: 10%;"></td> <td style="width: 10%;"></td> </tr> <tr> <td></td> <td></td> <td colspan="8" style="text-align: center;"> <table border="1" style="width: 100%; border-collapse: collapse; text-align: center;"> <tr> <td style="width: 10%;"></td> <td style="width: 10%;"></td> <td style="width: 10%;"></td> <td style="width: 10%;"></td> <td style="width: 10%;"></td> <td style="width: 10%;"></td> <td style="width: 10%;"></td> <td style="width: 10%;"></td> <td style="width: 10%;"></td> <td style="width: 10%;"></td> </tr> <tr> <td></td> <td></td> <td colspan="8" style="text-align: center;"> <table border="1" style="width: 100%; border-collapse: collapse; text-align: center;"> <tr> <td style="width: 10%;"></td> <td style="width: 10%;"></td> <td style="width: 10%;"></td> <td style="width: 10%;"></td> <td style="width: 10%;"></td> <td style="width: 10%;"></td> <td style="width: 10%;"></td> <td style="width: 10%;"></td> <td style="width: 10%;"></td> <td style="width: 10%;"></td> </tr> <tr> <td></td> <td></td> <td colspan="8" style="text-align: center;"> <table border="1" style="width: 100%; border-collapse: collapse; text-align: center;"> <tr> <td style="width: 10%;"></td> <td style="width: 10%;"></td> <td style="width: 10%;"></td> <td style="width: 10%;"></td> <td style="width: 10%;"></td> <td style="width: 10%;"></td> <td style="width: 10%;"></td> <td style="width: 10%;"></td> <td style="width: 10%;"></td> <td
style="width: 10%;"></td> </tr> <tr> <td></td> <td></td> <td colspan="8" style="text-align: center;"> <table border="1" style="width: 100%; border-collapse: collapse; text-align: center;"> <tr> <td style="width: 10%;"></td> <td style="width: 10%;"></td> <td style="width: 10%;"></td> <td style="width: 10%;"></td> <td style="width: 10%;"></td> <td style="width: 10%;"></td> <td style="width: 10%;"></td> <td style="width: 10%;"></td> <td style="width: 10%;"></td> <td style="width: 10%;"></td> </tr> <tr> <td></td> <td></td> <td colspan="8" style="text-align: center;"> <table border="1" style="width: 100%; border-collapse: collapse; text-align: center;"> <tr> <td style="width: 10%;"></td> <td style="width: 10%;"></td> <td style="width: 10%;"></td> <td style="width: 10%;"></td> <td style="width: 10%;"></td> <td style="width: 10%;"></td> <td style="width: 10%;"></td> <td style="width: 10%;"></td> <td style="width: 10%;"></td> <td style="width: 10%;"></td> </tr> <tr> <td></td> <td></td> <td colspan="8" style="text-align: center;"> <table border="1" style="width: 100%; border-collapse: collapse; text-align: center;"> <tr> <td style="width: 10%;"></td> <td style="width: 10%;"></td> <td style="width: 10%;"></td> <td style="width: 10%;"></td> <td style="width: 10%;"></td> <td style="width: 10%;"></td> <td style="width: 10%;"></td> <td style="width: 10%;"></td> <td style="width: 10%;"></td> <td style="width: 10%;"></td> </tr> <tr> <td></td> <td></td> <td colspan="8" style="text-align: center;"> <table border="1" style="width: 100%; border-collapse: collapse; text-align: center;"> <tr> <td style="width: 10%;"></td> <td style="width: 10%;"></td> <td style="width: 10%;"></td> <td style="width: 10%;"></td> <td style="width: 10%;"></td> <td style="width: 10%;"></td> <td style="width: 10%;"></td> <td style="width: 10%;"></td> <td style="width: 10%;"></td> <td style="width: 10%;"></td> </tr> <tr> <td></td> <td></td> <td colspan="8" style="text-align: center;"> <table border="1" style="width: 100%; border-collapse: collapse; text-align: center;"> <tr> <td style="width: 10%;"></td> <td style="width: 10%;"></td> <td style="width: 10%;"></td> <td style="width: 10%;"></td> <td style="width: 10%;"></td> <td style="width: 10%;"></td> <td style="width: 10%;"></td> <td style="width: 10%;"></td> <td style="width: 10%;"></td> <td style="width: 10%;"></td> </tr> <tr> <td></td> <td></td> <td colspan="8" style="text-align: center;"> <table border="1" style="width: 100%; border-collapse: collapse; text-align: center;"> <tr> <td style="width: 10%;"></td> <td style="width: 10%;"></td> <td style="width: 10%;"></td> <td style="width: 10%;"></td> <td style="width: 10%;"></td> <td style="width: 10%;"></td> <td style="width: 10%;"></td> <td style="width: 10%;"></td> <td style="width: 10%;"></td> <td style="width: 10%;"></td> </tr> <tr> <td></td> <td></td> <td colspan="8" style="text-align: center;"> <table border="1" style="width: 100%; border-collapse: collapse; text-align: center;"> <tr> <td style="width: 10%;"></td> <td style="width: 10%;"></td> <td style="width: 10%;"></td> <td style="width: 10%;"></td> <td style="width: 10%;"></td> <td style="width: 10%;"></td> <td style="width: 10%;"></td> <td style="width: 10%;"></td> <td style="width: 10%;"></td> <td style="width: 10%;"></td> </tr> <tr> <td></td> <td></td> <td colspan="8" style="text-align: center;"> <table border="1" style="width: 100%; border-collapse: collapse; text-align: center;"> <tr> <td style="width: 10%;"></td> <td style="width: 10%;"></td> <td style="width: 10%;"></td> <td style="width: 10%;"></td> <td style="width: 10%;"></td> <td style="width: 10%;"></td> <td style="width: 10%;"></td> <td style="width: 10%;"></td> <td style="width: 10%;"></td> <td style="width: 10%;"></td> </tr> <tr> <td></td> <td></td> <td colspan="8" style="text-align: center;"> <table border="1" style="width: 100%; border-collapse: collapse; text-align: center;"> <tr> <td style="width: 10%;"></td> <td style="width: 10%;"></td> <td style="width: 10%;"></td> <td style="width: 10%;"></td> <td style="width: 10%;"></td> <td style="width: 10%;"></td> <td style="width: 10%;"></td> <td style="width: 10%;"></td> <td style="width: 10%;"></td> <td style="width: 10%;"></td> </tr> <tr> <td></td> <td></td> <td colspan="8" style="text-align: center;"> <table border="1" style="width: 100%; border-collapse: collapse; text-align: center;"> <tr> <td style="width: 10%;"></td> <td style="width: 10%;"></td> <td style="width: 10%;"></td> <td style="width: 10%;"></td> <td style="width: 10%;"></td> <td style="width: 10%;"></td> <td style="width: 10%;"></td> <td style="width: 10%;"></td> <td style="width: 10%;"></td> <td style="width: 10%;"></td> </tr> <tr> <td></td> <td></td> <td colspan="8" style="text-align: center;"> <table border="1" style="width: 100%; border-collapse: collapse; text-align: center;"> <tr> <td style="width: 10%;"></td> <td style="width: 10%;"></td> <td style="width: 10%;"></td> <td style="width: 10%;"></td> <td style="width: 10%;"></td> <td style="width: 10%;"></td> <td style="width: 10%;"></td> <td style="width: 10%;"></td> <td style="width: 10%;"></td> <td style="width: 10%;"></td> </tr> <tr> <td></td> <td></td> <td colspan="8" style="text-align: center;"> <table border="1" style="width: 100%; border-collapse: collapse; text-align: center;"> <tr> <td style="width: 10%;"></td> <td style="width: 10%;"></td> <td style="width: 10%;"></td> <td style="width: 10%;"></td> <td style="width: 10%;"></td> <td style="width: 10%;"></td> <td style="width: 10%;"></td> <td style="width: 10%;"></td> <td style="width: 10%;"></td> <td style="width: 10%;"></td> </tr> <tr> <td></td> <td></td> <td colspan="8" style="text-align: center;"> <table border="1" style="width: 100%; border-collapse: collapse; text-align: center;"> <tr> <td style="width: 10%;"></td> <td style="width: 10%;"></td> <td style="width: 10%;"></td> <td style="width: 10%;"></td> <td style="width: 10%;"></td> <td style="width: 10%;"></td> <td style="width: 10%;"></td> <td style="width: 10%;"></td> <td style="width: 10%;"></td> <td style="width: 10%;"></td> </tr> <tr> <td></td> <td></td> <td colspan="8" style="text-align: center;"> <table border="1" style="width: 100%; border-collapse: collapse; text-align: center;"> <tr> <td style="width: 10%;"></td> <td style="width: 10%;"></td> <td style="width: 10%;"></td> <td style="width: 10%;"></td> <td style="width: 10%;"></td> <td style="width: 10%;"></td> <td style="width: 10%;"></td> <td style="width: 10%;"></td> <td style="width: 10%;"></td> <td style="width: 10%;"></td> </tr> <tr> <td></td> <td></td> <td colspan="8" style="text-align: center;"> <table border="1" style="width: 100%; border-collapse: collapse; text-align: center;"> <tr> <td style="width: 10%;"></td> <td style="width: 10%;"></td> <td style="width: 10%;"></td> <td style="width: 10%;"></td> <td style="width: 10%;"></td> <td style="width: 10%;"></td> <td style="width: 10%;"></td> <td style="width: 10%;"></td> <td style="width: 10%;"></td> <td style="width: 10%;"></td> </tr> <tr> <td></td> <td></td> <td colspan="8" style="text-align: center;"> <table border="1" style="width: 100%; border-collapse: collapse; text-align: center;"> <tr> <td style="width: 10%;"></td> <td style="width: 10%;"></td> <td style="width: 10%;"></td> <td style="width: 10%;"></td> <td style="width: 10%;"></td> <td style="width: 10%;"></td> <td style="width: 10%;"></td> <td style="width: 10%;"></td> <td style="width: 10%;"></td> <td style="width: 10%;"></td> </tr> <tr> <td></td> <td></td> <td colspan="8" style="text-align: center;"> <table border="1" style="width: 100%; border-collapse: collapse; text-align: center;"> <tr> <td style="width: 10%;"></td> <td style="width: 10%;"></td> <td style="width: 10%;"></td> <td style="width: 10%;"></td> <td style="width: 10%;"></td> <td style="width: 10%;"></td> <td style="width: 10%;"></td> <td style="width: 10%;"></td> <td style="width: 10%;"></td> <td style="width: 10%;"></td> </tr> <tr> <td></td> <td></td> <td colspan="8" style="text-align: center;"> <table border="1" style="width: 100%; border-collapse: collapse; text-align: center;"> <tr> <td style="width: 10%;"></td> <td style="width: 10%;"></td> <td style="width: 10%;"></td> <td style="width: 10%;"></td> <td style="width: 10%;"></td> <td style="width: 10%;"></td> <td style="width: 10%;"></td> <td style="width: 10%;"></td> <td style="width: 10%;"></td> <td style="width: 10%;"></td> </tr> <tr> <td></td> <td></td> <td colspan="8" style="text-align: center;"> <table border="1" style="width: 100%; border-collapse: collapse; text-align: center;"> <tr> <td style="width: 10%;"></td> <td style="width: 10%;"></td> <td style="width: 10%;"></td> <td style="width: 10%;"></td> <td style="width: 10%;"></td> <td style="width: 10%;"></td> <td style="width: 10%;"></td> <td style="width: 10%;"></td> <td style="width: 10%;"></td> <td style="width: 10%;"></td> </tr> <tr> <td></td> <td></td> <td colspan="8" style="text-align: center;"> <table border="1" style="width: 100%; border-collapse: collapse; text-align: center;"> <tr> <td style="width: 10%;"></td> <td style="width: 10%;"></td> <td style="width: 10%;"></td> <td style="width: 10%;"></td> <td style="width: 10%;"></td> <td style="width: 10%;"></td> <td style="width: 10%;"></td> <td style="width: 10%;"></td> <td style="width: 10%;"></td> <td style="width: 10%;"></td> </tr> <tr> <td></td> <td></td> <td colspan="8" style="text-align: center;"> <table border="1" style="width: 100%; border-collapse: collapse; text-align: center;"> <tr> <td style="width: 10%;"></td> <td style="width: 10%;"></td> <td style="width: 10%;"></td> <td style="width: 10%;"></td> <td style="width: 10%;"></td> <td style="width: 10%;"></td> <td style="width: 10%;"></td> <td style="width: 10%;"></td> <td style="width: 10%;"></td> <td style="width: 10%;"></td> </tr> <tr> <td></td> <td></td> <td colspan="8" style="text-align: center;"> <table border="1" style="width: 100%; border-collapse: collapse;
text-align: center;"> <tr> <td style="width: 10%;"></td> <td style="width: 10%;"></td> <td style="width: 10%;"></td> <td style="width: 10%;"></td> <td style="width: 10%;"></td> <td style="width: 10%;"></td> <td style="width: 10%;"></td> <td style="width: 10%;"></td> <td style="width: 10%;"></td> <td style="width: 10%;"></td> </tr> <tr> <td></td> <td></td> <td colspan="8" style="text-align: center;"> <table border="1" style="width: 100%; border-collapse: collapse; text-align: center;"> <tr> <td style="width: 10%;"></td> <td style="width: 10%;"></td> <td style="width: 10%;"></td> <td style="width: 10%;"></td> <td style="width: 10%;"></td> <td style="width: 10%;"></td> <td style="width: 10%;"></td> <td style="width: 10%;"></td> <td style="width: 10%;"></td> <td style="width: 10%;"></td> </tr> <tr> <td></td> <td></td> <td colspan="8" style="text-align: center;"> <table border="1" style="width: 100%; border-collapse: collapse; text-align: center;"> <tr> <td style="width: 10%;"></td> <td style="width: 10%;"></td> <td style="width: 10%;"></td> <td style="width: 10%;"></td> <td style="width: 10%;"></td> <td style="width: 10%;"></td> <td style="width: 10%;"></td> <td style="width: 10%;"></td> <td style="width: 10%;"></td> <td style="width: 10%;"></td> </tr> <tr> <td></td> <td></td> <td colspan="8" style="text-align: center;"> <table border="1" style="width: 100%; border-collapse: collapse; text-align: center;"> <tr> <td style="width: 10%;"></td> <td style="width: 10%;"></td> <td style="width: 10%;"></td> <td style="width: 10%;"></td> <td style="width: 10%;"></td> <td style="width: 10%;"></td> <td style="width: 10%;"></td> <td style="width: 10%;"></td> <td style="width: 10%;"></td> <td style="width: 10%;"></td> </tr> <tr> <td></td> <td></td> <td colspan="8" style="text-align: center;"> <table border="1" style="width: 100%; border-collapse: collapse; text-align: center;"> <tr> <td style="width: 10%;"></td> <td style="width: 10%;"></td> <td style="width: 10%;"></td> <td style="width: 10%;"></td> <td style="width: 10%;"></td> <td style="width: 10%;"></td> <td style="width: 10%;"></td> <td style="width: 10%;"></td> <td style="width: 10%;"></td> <td style="width: 10%;"></td> </tr> <tr> <td></td> <td></td> <td colspan="8" style="text-align: center;"> <table border="1" style="width: 100%; border-collapse: collapse; text-align: center;"> <tr> <td style="width: 10%;"></td> <td style="width: 10%;"></td> <td style="width: 10%;"></td> <td style="width: 10%;"></td> <td style="width: 10%;"></td> <td style="width: 10%;"></td> <td style="width: 10%;"></td> <td style="width: 10%;"></td> <td style="width: 10%;"></td> <td style="width: 10%;"></td> </tr> <tr> <td></td> <td></td> <td colspan="8" style="text-align: center;"> <table border="1" style="width: 100%; border-collapse: collapse; text-align: center;"> <tr> <td style="width: 10%;"></td> <td style="width: 10%;"></td> <td style="width: 10%;"></td> <td style="width: 10%;"></td> <td style="width: 10%;"></td> <td style="width: 10%;"></td> <td style="width: 10%;"></td> <td style="width: 10%;"></td> <td style="width: 10%;"></td> <td style="width: 10%;"></td> </tr> <tr> <td></td> <td></td> <td colspan="8" style="text-align: center;"> <table border="1" style="width: 100%; border-collapse: collapse; text-align: center;"> <tr> <td style="width: 10%;"></td> <td style="width: 10%;"></td> <td style="width: 10%;"></td> <td style="width: 10%;"></td> <td style="width: 10%;"></td> <td style="width: 10%;"></td> <td style="width: 10%;"></td> <td style="width: 10%;"></td> <td style="width: 10%;"></td> <td style="width: 10%;"></td> </tr> <tr> <td></td> <td></td> <td colspan="8" style="text-align: center;"> <table border="1" style="width: 100%; border-collapse: collapse; text-align: center;"> <tr> <td style="width: 10%;"></td> <td style="width: 10%;"></td> <td style="width: 10%;"></td> <td style="width: 10%;"></td> <td style="width: 10%;"></td> <td style="width: 10%;"></td> <td style="width: 10%;"></td> <td style="width: 10%;"></td> <td style="width: 10%;"></td> <td style="width: 10%;"></td> </tr> <tr> <td></td> <td></td> <td colspan="8" style="text-align: center;"> <table border="1" style="width: 100%; border-collapse: collapse; text-align: center;"> <tr> <td style="width: 10%;"></td> <td style="width: 10%;"></td> <td style="width: 10%;"></td> <td style="width: 10%;"></td> <td style="width: 10%;"></td> <td style="width: 10%;"></td> <td style="width: 10%;"></td> <td style="width: 10%;"></td> <td style="width: 10%;"></td> <td style="width: 10%;"></td> </tr> <tr> <td></td> <td></td> <td colspan="8" style="text-align: center;"> <table border="1" style="width: 100%; border-collapse: collapse; text-align: center;"> <tr> <td style="width: 10%;"></td> <td style="width: 10%;"></td> <td style="width: 10%;"></td> <td style="width: 10%;"></td> <td style="width: 10%;"></td> <td style="width: 10%;"></td> <td style="width: 10%;"></td> <td style="width: 10%;"></td> <td style="width: 10%;"></td> <td style="width: 10%;"></td> </tr> <tr> <td></td> <td></td> <td colspan="8" style="text-align: center;"> <table border="1" style="width: 100%; border-collapse: collapse; text-align: center;"> <tr> </tr></table></td></tr></table></td></tr></table></td></tr></table></td></tr></table></td></tr></table></td></tr></table></td></tr></table></td></tr></table></td></tr></table></td></tr></table></td></tr></table></td></tr></table></td></tr></table></td></tr></table></td></tr></table></td></tr></table></td></tr></table></td></tr></table></td></tr></table></td></tr></table></td></tr></table></td></tr></table></td></tr></table></td></tr></table></td></tr></table></td></tr></table></td></tr></table></td></tr></table></td></tr></table></td></tr></table></td></tr></table></td></tr></table></td></tr></table></td></tr></table></td></tr></table></td></tr></table></td></tr></table></td></tr></table></td></tr></table> | | | | | | | | | | | | | | | | | | | | <table border="1" style="width: 100%; border-collapse: collapse; text-align: center;"> <tr> <td style="width: 10%;"></td> <td style="width: 10%;"></td> <td style="width: 10%;"></td> <td style="width: 10%;"></td> <td style="width: 10%;"></td> <td style="width: 10%;"></td> <td style="width: 10%;"></td> <td style="width: 10%;"></td> <td style="width: 10%;"></td> <td style="width: 10%;"></td> </tr> <tr> <td></td> <td></td> <td colspan="8" style="text-align: center;"> <table border="1" style="width: 100%; border-collapse: collapse; text-align: center;"> <tr> <td style="width: 10%;"></td> <td style="width: 10%;"></td> <td style="width: 10%;"></td> <td style="width: 10%;"></td> <td style="width: 10%;"></td> <td style="width: 10%;"></td> <td style="width: 10%;"></td> <td style="width: 10%;"></td> <td style="width: 10%;"></td> <td style="width: 10%;"></td> </tr> <tr> <td></td> <td></td> <td colspan="8" style="text-align: center;"> <table border="1" style="width: 100%; border-collapse: collapse; text-align: center;"> <tr> <td style="width: 10%;"></td> <td style="width: 10%;"></td> <td style="width: 10%;"></td> <td style="width: 10%;"></td> <td style="width: 10%;"></td> <td style="width: 10%;"></td> <td style="width: 10%;"></td> <td style="width: 10%;"></td> <td style="width: 10%;"></td> <td style="width: 10%;"></td> </tr> <tr> <td></td> <td></td> <td colspan="8" style="text-align: center;"> <table border="1" style="width: 100%; border-collapse: collapse; text-align: center;"> <tr> <td style="width: 10%;"></td> <td style="width: 10%;"></td> <td style="width: 10%;"></td> <td style="width: 10%;"></td> <td style="width: 10%;"></td> <td style="width: 10%;"></td> <td style="width: 10%;"></td> <td style="width: 10%;"></td> <td style="width: 10%;"></td> <td style="width: 10%;"></td> </tr> <tr> <td></td> <td></td> <td colspan="8" style="text-align: center;"> <table border="1" style="width: 100%; border-collapse: collapse; text-align: center;"> <tr> <td style="width: 10%;"></td> <td style="width: 10%;"></td> <td style="width: 10%;"></td> <td style="width: 10%;"></td> <td style="width:
10%;"></td> <td style="width: 10%;"></td> <td style="width: 10%;"></td> <td style="width: 10%;"></td> <td style="width: 10%;"></td> <td style="width: 10%;"></td> </tr> <tr> <td></td> <td></td> <td colspan="8" style="text-align: center;"> <table border="1" style="width: 100%; border-collapse: collapse; text-align: center;"> <tr> <td style="width: 10%;"></td> <td style="width: 10%;"></td> <td style="width: 10%;"></td> <td style="width: 10%;"></td> <td style="width: 10%;"></td> <td style="width: 10%;"></td> <td style="width: 10%;"></td> <td style="width: 10%;"></td> <td style="width: 10%;"></td> <td style="width: 10%;"></td> </tr> <tr> <td></td> <td></td> <td colspan="8" style="text-align: center;"> <table border="1" style="width: 100%; border-collapse: collapse; text-align: center;"> <tr> <td style="width: 10%;"></td> <td style="width: 10%;"></td> <td style="width: 10%;"></td> <td style="width: 10%;"></td> <td style="width: 10%;"></td> <td style="width: 10%;"></td> <td style="width: 10%;"></td> <td style="width: 10%;"></td> <td style="width: 10%;"></td> <td style="width: 10%;"></td> </tr> <tr> <td></td> <td></td> <td colspan="8" style="text-align: center;"> <table border="1" style="width: 100%; border-collapse: collapse; text-align: center;"> <tr> <td style="width: 10%;"></td> <td style="width: 10%;"></td> <td style="width: 10%;"></td> <td style="width: 10%;"></td> <td style="width: 10%;"></td> <td style="width: 10%;"></td> <td style="width: 10%;"></td> <td style="width: 10%;"></td> <td style="width: 10%;"></td> <td style="width: 10%;"></td> </tr> <tr> <td></td> <td></td> <td colspan="8" style="text-align: center;"> <table border="1" style="width: 100%; border-collapse: collapse; text-align: center;"> <tr> <td style="width: 10%;"></td> <td style="width: 10%;"></td> <td style="width: 10%;"></td> <td style="width: 10%;"></td> <td style="width: 10%;"></td> <td style="width: 10%;"></td> <td style="width: 10%;"></td> <td style="width: 10%;"></td> <td style="width: 10%;"></td> <td style="width: 10%;"></td> </tr> <tr> <td></td> <td></td> <td colspan="8" style="text-align: center;"> <table border="1" style="width: 100%; border-collapse: collapse; text-align: center;"> <tr> <td style="width: 10%;"></td> <td style="width: 10%;"></td> <td style="width: 10%;"></td> <td style="width: 10%;"></td> <td style="width: 10%;"></td> <td style="width: 10%;"></td> <td style="width: 10%;"></td> <td style="width: 10%;"></td> <td style="width: 10%;"></td> <td style="width: 10%;"></td> </tr> <tr> <td></td> <td></td> <td colspan="8" style="text-align: center;"> <table border="1" style="width: 100%; border-collapse: collapse; text-align: center;"> <tr> <td style="width: 10%;"></td> <td style="width: 10%;"></td> <td style="width: 10%;"></td> <td style="width: 10%;"></td> <td style="width: 10%;"></td> <td style="width: 10%;"></td> <td style="width: 10%;"></td> <td style="width: 10%;"></td> <td style="width: 10%;"></td> <td style="width: 10%;"></td> </tr> <tr> <td></td> <td></td> <td colspan="8" style="text-align: center;"> <table border="1" style="width: 100%; border-collapse: collapse; text-align: center;"> <tr> <td style="width: 10%;"></td> <td style="width: 10%;"></td> <td style="width: 10%;"></td> <td style="width: 10%;"></td> <td style="width: 10%;"></td> <td style="width: 10%;"></td> <td style="width: 10%;"></td> <td style="width: 10%;"></td> <td style="width: 10%;"></td> <td style="width: 10%;"></td> </tr> <tr> <td></td> <td></td> <td colspan="8" style="text-align: center;"> <table border="1" style="width: 100%; border-collapse: collapse; text-align: center;"> <tr> <td style="width: 10%;"></td> <td style="width: 10%;"></td> <td style="width: 10%;"></td> <td style="width: 10%;"></td> <td style="width: 10%;"></td> <td style="width: 10%;"></td> <td style="width: 10%;"></td> <td style="width: 10%;"></td> <td style="width: 10%;"></td> <td style="width: 10%;"></td> </tr> <tr> <td></td> <td></td> <td colspan="8" style="text-align: center;"> <table border="1" style="width: 100%; border-collapse: collapse; text-align: center;"> <tr> <td style="width: 10%;"></td> <td style="width: 10%;"></td> <td style="width: 10%;"></td> <td style="width: 10%;"></td> <td style="width: 10%;"></td> <td style="width: 10%;"></td> <td style="width: 10%;"></td> <td style="width: 10%;"></td> <td style="width: 10%;"></td> <td style="width: 10%;"></td> </tr> <tr> <td></td> <td></td> <td colspan="8" style="text-align: center;"> <table border="1" style="width: 100%; border-collapse: collapse; text-align: center;"> <tr> <td style="width: 10%;"></td> <td style="width: 10%;"></td> <td style="width: 10%;"></td> <td style="width: 10%;"></td> <td style="width: 10%;"></td> <td style="width: 10%;"></td> <td style="width: 10%;"></td> <td style="width: 10%;"></td> <td style="width: 10%;"></td> <td style="width: 10%;"></td> </tr> <tr> <td></td> <td></td> <td colspan="8" style="text-align: center;"> <table border="1" style="width: 100%; border-collapse: collapse; text-align: center;"> <tr> <td style="width: 10%;"></td> <td style="width: 10%;"></td> <td style="width: 10%;"></td> <td style="width: 10%;"></td> <td style="width: 10%;"></td> <td style="width: 10%;"></td> <td style="width: 10%;"></td> <td style="width: 10%;"></td> <td style="width: 10%;"></td> <td style="width: 10%;"></td> </tr> <tr> <td></td> <td></td> <td colspan="8" style="text-align: center;"> <table border="1" style="width: 100%; border-collapse: collapse; text-align: center;"> <tr> <td style="width: 10%;"></td> <td style="width: 10%;"></td> <td style="width: 10%;"></td> <td style="width: 10%;"></td> <td style="width: 10%;"></td> <td style="width: 10%;"></td> <td style="width: 10%;"></td> <td style="width: 10%;"></td> <td style="width: 10%;"></td> <td style="width: 10%;"></td> </tr> <tr> <td></td> <td></td> <td colspan="8" style="text-align: center;"> <table border="1" style="width: 100%; border-collapse: collapse; text-align: center;"> <tr> <td style="width: 10%;"></td> <td style="width: 10%;"></td> <td style="width: 10%;"></td> <td style="width: 10%;"></td> <td style="width: 10%;"></td> <td style="width: 10%;"></td> <td style="width: 10%;"></td> <td style="width: 10%;"></td> <td style="width: 10%;"></td> <td style="width: 10%;"></td> </tr> <tr> <td></td> <td></td> <td colspan="8" style="text-align: center;"> <table border="1" style="width: 100%; border-collapse: collapse; text-align: center;"> <tr> <td style="width: 10%;"></td> <td style="width: 10%;"></td> <td style="width: 10%;"></td> <td style="width: 10%;"></td> <td style="width: 10%;"></td> <td style="width: 10%;"></td> <td style="width: 10%;"></td> <td style="width: 10%;"></td> <td style="width: 10%;"></td> <td style="width: 10%;"></td> </tr> <tr> <td></td> <td></td> <td colspan="8" style="text-align: center;"> <table border="1" style="width: 100%; border-collapse: collapse; text-align: center;"> <tr> <td style="width: 10%;"></td> <td style="width: 10%;"></td> <td style="width: 10%;"></td> <td style="width: 10%;"></td> <td style="width: 10%;"></td> <td style="width: 10%;"></td> <td style="width: 10%;"></td> <td style="width: 10%;"></td> <td style="width: 10%;"></td> <td style="width: 10%;"></td> </tr> <tr> <td></td> <td></td> <td colspan="8" style="text-align: center;"> <table border="1" style="width: 100%; border-collapse: collapse; text-align: center;"> <tr> <td style="width: 10%;"></td> <td style="width: 10%;"></td> <td style="width: 10%;"></td> <td style="width: 10%;"></td> <td style="width: 10%;"></td> <td style="width: 10%;"></td> <td style="width: 10%;"></td> <td style="width: 10%;"></td> <td style="width: 10%;"></td> <td style="width: 10%;"></td> </tr> <tr> <td></td> <td></td> <td colspan="8" style="text-align: center;"> <table border="1" style="width: 100%; border-collapse: collapse; text-align: center;"> <tr> <td style="width: 10%;"></td> <td style="width: 10%;"></td> <td style="width: 10%;"></td> <td style="width: 10%;"></td> <td style="width: 10%;"></td> <td style="width: 10%;"></td> <td style="width: 10%;"></td> <td style="width: 10%;"></td> <td style="width: 10%;"></td> <td style="width: 10%;"></td> </tr> <tr> <td></td> <td></td> <td colspan="8" style="text-align: center;"> <table border="1" style="width: 100%; border-collapse: collapse; text-align: center;"> <tr> <td style="width: 10%;"></td> <td style="width: 10%;"></td> <td style="width: 10%;"></td> <td style="width: 10%;"></td> <td style="width: 10%;"></td> <td style="width: 10%;"></td> <td style="width: 10%;"></td> <td style="width: 10%;"></td> <td style="width: 10%;"></td> <td style="width: 10%;"></td> </tr> <tr> <td></td> <td></td> <td colspan="8" style="text-align: center;"> <table border="1" style="width: 100%; border-collapse: collapse; text-align: center;"> <tr> <td style="width: 10%;"></td> <td style="width: 10%;"></td> <td style="width: 10%;"></td> <td style="width: 10%;"></td> <td style="width: 10%;"></td> <td style="width: 10%;"></td> <td style="width: 10%;"></td> <td style="width: 10%;"></td> <td style="width: 10%;"></td> <td style="width: 10%;"></td> </tr> <tr> <td></td> <td></td> <td colspan="8" style="text-align: center;"> <table border="1" style="width: 100%; border-collapse: collapse; text-align: center;"> <tr> <td style="width: 10%;"></td> <td style="width: 10%;"></td> <td style="width: 10%;"></td> <td style="width: 10%;"></td> <td style="width: 10%;"></td> <td style="width: 10%;"></td> <td style="width: 10%;"></td> <td style="width: 10%;"></td> <td style="width: 10%;"></td> <td style="width: 10%;"></td> </tr> <tr> <td></td> <td></td> <td colspan="8" style="text-align: center;"> <table border="1" style="width: 100%; border-collapse: collapse; text-align: center;"> <tr> <td style="width: 10%;"></td> <td style="width: 10%;"></td> <td style="width: 10%;"></td> <td style="width: 10%;"></td> <td style="width: 10%;"></td> <td style="width: 10%;"></td> <td style="width: 10%;"></td> <td style="width: 10%;"></td> <td style="width: 10%;"></td> <td style="width: 10%;"></td> </tr>
<tr> <td></td> <td></td> <td colspan="8" style="text-align: center;"> <table border="1" style="width: 100%; border-collapse: collapse; text-align: center;"> <tr> <td style="width: 10%;"></td> <td style="width: 10%;"></td> <td style="width: 10%;"></td> <td style="width: 10%;"></td> <td style="width: 10%;"></td> <td style="width: 10%;"></td> <td style="width: 10%;"></td> <td style="width: 10%;"></td> <td style="width: 10%;"></td> <td style="width: 10%;"></td> </tr> <tr> <td></td> <td></td> <td colspan="8" style="text-align: center;"> <table border="1" style="width: 100%; border-collapse: collapse; text-align: center;"> <tr> <td style="width: 10%;"></td> <td style="width: 10%;"></td> <td style="width: 10%;"></td> <td style="width: 10%;"></td> <td style="width: 10%;"></td> <td style="width: 10%;"></td> <td style="width: 10%;"></td> <td style="width: 10%;"></td> <td style="width: 10%;"></td> <td style="width: 10%;"></td> </tr> <tr> <td></td> <td></td> <td colspan="8" style="text-align: center;"> <table border="1" style="width: 100%; border-collapse: collapse; text-align: center;"> <tr> <td style="width: 10%;"></td> <td style="width: 10%;"></td> <td style="width: 10%;"></td> <td style="width: 10%;"></td> <td style="width: 10%;"></td> <td style="width: 10%;"></td> <td style="width: 10%;"></td> <td style="width: 10%;"></td> <td style="width: 10%;"></td> <td style="width: 10%;"></td> </tr> <tr> <td></td> <td></td> <td colspan="8" style="text-align: center;"> <table border="1" style="width: 100%; border-collapse: collapse; text-align: center;"> <tr> <td style="width: 10%;"></td> <td style="width: 10%;"></td> <td style="width: 10%;"></td> <td style="width: 10%;"></td> <td style="width: 10%;"></td> <td style="width: 10%;"></td> <td style="width: 10%;"></td> <td style="width: 10%;"></td> <td style="width: 10%;"></td> <td style="width: 10%;"></td> </tr> <tr> <td></td> <td></td> <td colspan="8" style="text-align: center;"> <table border="1" style="width: 100%; border-collapse: collapse; text-align: center;"> <tr> <td style="width: 10%;"></td> <td style="width: 10%;"></td> <td style="width: 10%;"></td> <td style="width: 10%;"></td> <td style="width: 10%;"></td> <td style="width: 10%;"></td> <td style="width: 10%;"></td> <td style="width: 10%;"></td> <td style="width: 10%;"></td> <td style="width: 10%;"></td> </tr> <tr> <td></td> <td></td> <td colspan="8" style="text-align: center;"> <table border="1" style="width: 100%; border-collapse: collapse; text-align: center;"> <tr> <td style="width: 10%;"></td> <td style="width: 10%;"></td> <td style="width: 10%;"></td> <td style="width: 10%;"></td> <td style="width: 10%;"></td> <td style="width: 10%;"></td> <td style="width: 10%;"></td> <td style="width: 10%;"></td> <td style="width: 10%;"></td> <td style="width: 10%;"></td> </tr> <tr> <td></td> <td></td> <td colspan="8" style="text-align: center;"> <table border="1" style="width: 100%; border-collapse: collapse; text-align: center;"> <tr> <td style="width: 10%;"></td> <td style="width: 10%;"></td> <td style="width: 10%;"></td> <td style="width: 10%;"></td> <td style="width: 10%;"></td> <td style="width: 10%;"></td> <td style="width: 10%;"></td> <td style="width: 10%;"></td> <td style="width: 10%;"></td> <td style="width: 10%;"></td> </tr> <tr> <td></td> <td></td> <td colspan="8" style="text-align: center;"> <table border="1" style="width: 100%; border-collapse: collapse; text-align: center;"> <tr> <td style="width: 10%;"></td> <td style="width: 10%;"></td> <td style="width: 10%;"></td> <td style="width: 10%;"></td> <td style="width: 10%;"></td> <td style="width: 10%;"></td> <td style="width: 10%;"></td> <td style="width: 10%;"></td> <td style="width: 10%;"></td> <td style="width: 10%;"></td> </tr> <tr> <td></td> <td></td> <td colspan="8" style="text-align: center;"> <table border="1" style="width: 100%; border-collapse: collapse; text-align: center;"> <tr> <td style="width: 10%;"></td> <td style="width: 10%;"></td> <td style="width: 10%;"></td> <td style="width: 10%;"></td> <td style="width: 10%;"></td> <td style="width: 10%;"></td> <td style="width: 10%;"></td> <td style="width: 10%;"></td> <td style="width: 10%;"></td> <td style="width: 10%;"></td> </tr> <tr> <td></td> <td></td> <td colspan="8" style="text-align: center;"> <table border="1" style="width: 100%; border-collapse: collapse; text-align: center;"> <tr> <td style="width: 10%;"></td> <td style="width: 10%;"></td> <td style="width: 10%;"></td> <td style="width: 10%;"></td> <td style="width: 10%;"></td> <td style="width: 10%;"></td> <td style="width: 10%;"></td> <td style="width: 10%;"></td> <td style="width: 10%;"></td> <td style="width: 10%;"></td> </tr> <tr> <td></td> <td></td> <td colspan="8" style="text-align: center;"> <table border="1" style="width: 100%; border-collapse: collapse; text-align: center;"> <tr> <td style="width: 10%;"></td> <td style="width: 10%;"></td> <td style="width: 10%;"></td> <td style="width: 10%;"></td> <td style="width: 10%;"></td> <td style="width: 10%;"></td> <td style="width: 10%;"></td> <td style="width: 10%;"></td> <td style="width: 10%;"></td> <td style="width: 10%;"></td> </tr> <tr> <td></td> <td></td> <td colspan="8" style="text-align: center;"> <table border="1" style="width: 100%; border-collapse: collapse; text-align: center;"> <tr> <td style="width: 10%;"></td> <td style="width: 10%;"></td> <td style="width: 10%;"></td> <td style="width: 10%;"></td> <td style="width: 10%;"></td> <td style="width: 10%;"></td> <td style="width: 10%;"></td> <td style="width: 10%;"></td> <td style="width: 10%;"></td> <td style="width: 10%;"></td> </tr> <tr> <td></td> <td></td> <td colspan="8" style="text-align: center;"> <table border="1" style="width: 100%; border-collapse: collapse; text-align: center;"> <tr> </tr></table></td></tr></table></td></tr></table></td></tr></table></td></tr></table></td></tr></table></td></tr></table></td></tr></table></td></tr></table></td></tr></table></td></tr></table></td></tr></table></td></tr></table></td></tr></table></td></tr></table></td></tr></table></td></tr></table></td></tr></table></td></tr></table></td></tr></table></td></tr></table></td></tr></table></td></tr></table></td></tr></table></td></tr></table></td></tr></table></td></tr></table></td></tr></table></td></tr></table></td></tr></table></td></tr></table></td></tr></table></td></tr></table></td></tr></table></td></tr></table></td></tr></table></td></tr></table></td></tr></table></td></tr></table> | | | | | | | | | | | | | | | | | | | | <table border="1" style="width: 100%; border-collapse: collapse; text-align: center;"> <tr> <td style="width: 10%;"></td> <td style="width: 10%;"></td> <td style="width: 10%;"></td> <td style="width: 10%;"></td> <td style="width: 10%;"></td> <td style="width: 10%;"></td> <td style="width: 10%;"></td> <td style="width: 10%;"></td> <td style="width: 10%;"></td> <td style="width: 10%;"></td> </tr> <tr> <td></td> <td></td> <td colspan="8" style="text-align: center;"> <table border="1" style="width: 100%; border-collapse: collapse; text-align: center;"> <tr> <td style="width: 10%;"></td> <td style="width: 10%;"></td> <td style="width: 10%;"></td> <td style="width: 10%;"></td> <td style="width: 10%;"></td> <td style="width: 10%;"></td> <td style="width: 10%;"></td> <td style="width: 10%;"></td> <td style="width: 10%;"></td> <td style="width: 10%;"></td> </tr> <tr> <td></td> <td></td> <td colspan="8" style="text-align: center;"> <table border="1" style="width: 100%; border-collapse: collapse; text-align: center;"> <tr> <td style="width: 10%;"></td> <td style="width: 10%;"></td> <td style="width: 10%;"></td> <td style="width: 10%;"></td> <td style="width: 10%;"></td> <td style="width: 10%;"></td> <td style="width: 10%;"></td> <td style="width: 10%;"></td> <td style="width: 10%;"></td> <td style="width: 10%;"></td> </tr> <tr> <td></td> <td></td> <td colspan="8" style="text-align: center;"> <table border="1" style="width: 100%; border-collapse: collapse; text-align: center;"> <tr> <td style="width:
10%;"></td> <td style="width: 10%;"></td> <td style="width: 10%;"></td> <td style="width: 10%;"></td> <td style="width: 10%;"></td> <td style="width: 10%;"></td> <td style="width: 10%;"></td> <td style="width: 10%;"></td> <td style="width: 10%;"></td> <td style="width: 10%;"></td> </tr> <tr> <td></td> <td></td> <td colspan="8" style="text-align: center;"> <table border="1" style="width: 100%; border-collapse: collapse; text-align: center;"> <tr> <td style="width: 10%;"></td> <td style="width: 10%;"></td> <td style="width: 10%;"></td> <td style="width: 10%;"></td> <td style="width: 10%;"></td> <td style="width: 10%;"></td> <td style="width: 10%;"></td> <td style="width: 10%;"></td> <td style="width: 10%;"></td> <td style="width: 10%;"></td> </tr> <tr> <td></td> <td></td> <td colspan="8" style="text-align: center;"> <table border="1" style="width: 100%; border-collapse: collapse; text-align: center;"> <tr> <td style="width: 10%;"></td> <td style="width: 10%;"></td> <td style="width: 10%;"></td> <td style="width: 10%;"></td> <td style="width: 10%;"></td> <td style="width: 10%;"></td> <td style="width: 10%;"></td> <td style="width: 10%;"></td> <td style="width: 10%;"></td> <td style="width: 10%;"></td> </tr> <tr> <td></td> <td></td> <td colspan="8" style="text-align: center;"> <table border="1" style="width: 100%; border-collapse: collapse; text-align: center;"> <tr> <td style="width: 10%;"></td> <td style="width: 10%;"></td> <td style="width: 10%;"></td> <td style="width: 10%;"></td> <td style="width: 10%;"></td> <td style="width: 10%;"></td> <td style="width: 10%;"></td> <td style="width: 10%;"></td> <td style="width: 10%;"></td> <td style="width: 10%;"></td> </tr> <tr> <td></td> <td></td> <td colspan="8" style="text-align: center;"> <table border="1" style="width: 100%; border-collapse: collapse; text-align: center;"> <tr> <td style="width: 10%;"></td> <td style="width: 10%;"></td> <td style="width: 10%;"></td> <td style="width: 10%;"></td> <td style="width: 10%;"></td> <td style="width: 10%;"></td> <td style="width: 10%;"></td> <td style="width: 10%;"></td> <td style="width: 10%;"></td> <td style="width: 10%;"></td> </tr> <tr> <td></td> <td></td> <td colspan="8" style="text-align: center;"> <table border="1" style="width: 100%; border-collapse: collapse; text-align: center;"> <tr> <td style="width: 10%;"></td> <td style="width: 10%;"></td> <td style="width: 10%;"></td> <td style="width: 10%;"></td> <td style="width: 10%;"></td> <td style="width: 10%;"></td> <td style="width: 10%;"></td> <td style="width: 10%;"></td> <td style="width: 10%;"></td> <td style="width: 10%;"></td> </tr> <tr> <td></td> <td></td> <td colspan="8" style="text-align: center;"> <table border="1" style="width: 100%; border-collapse: collapse; text-align: center;"> <tr> <td style="width: 10%;"></td> <td style="width: 10%;"></td> <td style="width: 10%;"></td> <td style="width: 10%;"></td> <td style="width: 10%;"></td> <td style="width: 10%;"></td> <td style="width: 10%;"></td> <td style="width: 10%;"></td> <td style="width: 10%;"></td> <td style="width: 10%;"></td> </tr> <tr> <td></td> <td></td> <td colspan="8" style="text-align: center;"> <table border="1" style="width: 100%; border-collapse: collapse; text-align: center;"> <tr> <td style="width: 10%;"></td> <td style="width: 10%;"></td> <td style="width: 10%;"></td> <td style="width: 10%;"></td> <td style="width: 10%;"></td> <td style="width: 10%;"></td> <td style="width: 10%;"></td> <td style="width: 10%;"></td> <td style="width: 10%;"></td> <td style="width: 10%;"></td> </tr> <tr> <td></td> <td></td> <td colspan="8" style="text-align: center;"> <table border="1" style="width: 100%; border-collapse: collapse; text-align: center;"> <tr> <td style="width: 10%;"></td> <td style="width: 10%;"></td> <td style="width: 10%;"></td> <td style="width: 10%;"></td> <td style="width: 10%;"></td> <td style="width: 10%;"></td> <td style="width: 10%;"></td> <td style="width: 10%;"></td> <td style="width: 10%;"></td> <td style="width: 10%;"></td> </tr> <tr> <td></td> <td></td> <td colspan="8" style="text-align: center;"> <table border="1" style="width: 100%; border-collapse: collapse; text-align: center;"> <tr> <td style="width: 10%;"></td> <td style="width: 10%;"></td> <td style="width: 10%;"></td> <td style="width: 10%;"></td> <td style="width: 10%;"></td> <td style="width: 10%;"></td> <td style="width: 10%;"></td> <td style="width: 10%;"></td> <td style="width: 10%;"></td> <td style="width: 10%;"></td> </tr> <tr> <td></td> <td></td> <td colspan="8" style="text-align: center;"> <table border="1" style="width: 100%; border-collapse: collapse; text-align: center;"> <tr> <td style="width: 10%;"></td> <td style="width: 10%;"></td> <td style="width: 10%;"></td> <td style="width: 10%;"></td> <td style="width: 10%;"></td> <td style="width: 10%;"></td> <td style="width: 10%;"></td> <td style="width: 10%;"></td> <td style="width: 10%;"></td> <td style="width: 10%;"></td> </tr> <tr> <td></td> <td></td> <td colspan="8" style="text-align: center;"> <table border="1" style="width: 100%; border-collapse: collapse; text-align: center;"> <tr> <td style="width: 10%;"></td> <td style="width: 10%;"></td> <td style="width: 10%;"></td> <td style="width: 10%;"></td> <td style="width: 10%;"></td> <td style="width: 10%;"></td> <td style="width: 10%;"></td> <td style="width: 10%;"></td> <td style="width: 10%;"></td> <td style="width: 10%;"></td> </tr> <tr> <td></td> <td></td> <td colspan="8" style="text-align: center;"> <table border="1" style="width: 100%; border-collapse: collapse; text-align: center;"> <tr> <td style="width: 10%;"></td> <td style="width: 10%;"></td> <td style="width: 10%;"></td> <td style="width: 10%;"></td> <td style="width: 10%;"></td> <td style="width: 10%;"></td> <td style="width: 10%;"></td> <td style="width: 10%;"></td> <td style="width: 10%;"></td> <td style="width: 10%;"></td> </tr> <tr> <td></td> <td></td> <td colspan="8" style="text-align: center;"> <table border="1" style="width: 100%; border-collapse: collapse; text-align: center;"> <tr> <td style="width: 10%;"></td> <td style="width: 10%;"></td> <td style="width: 10%;"></td> <td style="width: 10%;"></td> <td style="width: 10%;"></td> <td style="width: 10%;"></td> <td style="width: 10%;"></td> <td style="width: 10%;"></td> <td style="width: 10%;"></td> <td style="width: 10%;"></td> </tr> <tr> <td></td> <td></td> <td colspan="8" style="text-align: center;"> <table border="1" style="width: 100%; border-collapse: collapse; text-align: center;"> <tr> <td style="width: 10%;"></td> <td style="width: 10%;"></td> <td style="width: 10%;"></td> <td style="width: 10%;"></td> <td style="width: 10%;"></td> <td style="width: 10%;"></td> <td style="width: 10%;"></td> <td style="width: 10%;"></td> <td style="width: 10%;"></td> <td style="width: 10%;"></td> </tr> <tr> <td></td> <td></td> <td colspan="8" style="text-align: center;"> <table border="1" style="width: 100%; border-collapse: collapse; text-align: center;"> <tr> <td style="width: 10%;"></td> <td style="width: 10%;"></td> <td style="width: 10%;"></td> <td style="width: 10%;"></td> <td style="width: 10%;"></td> <td style="width: 10%;"></td> <td style="width: 10%;"></td> <td style="width: 10%;"></td> <td style="width: 10%;"></td> <td style="width: 10%;"></td> </tr> <tr> <td></td> <td></td> <td colspan="8" style="text-align: center;"> <table border="1" style="width: 100%; border-collapse: collapse; text-align: center;"> <tr> <td style="width: 10%;"></td> <td style="width: 10%;"></td> <td style="width: 10%;"></td> <td style="width: 10%;"></td> <td style="width: 10%;"></td> <td style="width: 10%;"></td> <td style="width: 10%;"></td> <td style="width: 10%;"></td> <td style="width: 10%;"></td> <td style="width: 10%;"></td> </tr> <tr> <td></td> <td></td> <td colspan="8" style="text-align: center;"> <table border="1" style="width: 100%; border-collapse: collapse; text-align: center;"> <tr> <td style="width: 10%;"></td> <td style="width: 10%;"></td> <td style="width: 10%;"></td> <td style="width: 10%;"></td> <td style="width: 10%;"></td> <td style="width: 10%;"></td> <td style="width: 10%;"></td> <td style="width: 10%;"></td> <td style="width: 10%;"></td> <td style="width: 10%;"></td> </tr> <tr> <td></td> <td></td> <td colspan="8" style="text-align: center;"> <table border="1" style="width: 100%; border-collapse: collapse; text-align: center;"> <tr> <td style="width: 10%;"></td> <td style="width: 10%;"></td> <td style="width: 10%;"></td> <td style="width: 10%;"></td> <td style="width: 10%;"></td> <td style="width: 10%;"></td> <td style="width: 10%;"></td> <td style="width: 10%;"></td> <td style="width: 10%;"></td> <td style="width: 10%;"></td> </tr> <tr> <td></td> <td></td> <td colspan="8" style="text-align: center;"> <table border="1" style="width: 100%; border-collapse: collapse; text-align: center;"> <tr> <td style="width: 10%;"></td> <td style="width: 10%;"></td> <td style="width: 10%;"></td> <td style="width: 10%;"></td> <td style="width: 10%;"></td> <td style="width: 10%;"></td> <td style="width: 10%;"></td> <td style="width: 10%;"></td> <td style="width: 10%;"></td> <td style="width: 10%;"></td> </tr> <tr> <td></td> <td></td> <td colspan="8" style="text-align: center;"> <table border="1" style="width: 100%; border-collapse: collapse; text-align: center;"> <tr> <td style="width: 10%;"></td> <td style="width: 10%;"></td> <td style="width: 10%;"></td> <td style="width: 10%;"></td> <td style="width: 10%;"></td> <td style="width: 10%;"></td> <td style="width: 10%;"></td> <td style="width: 10%;"></td> <td style="width: 10%;"></td> <td style="width: 10%;"></td> </tr> <tr> <td></td> <td></td> <td colspan="8" style="text-align: center;"> <table border="1" style="width: 100%; border-collapse: collapse; text-align: center;"> <tr> <td style="width: 10%;"></td> <td style="width: 10%;"></td> <td style="width: 10%;"></td> <td style="width: 10%;"></td> <td style="width: 10%;"></td> <td style="width: 10%;"></td> <td
style="width: 10%;"></td> <td style="width: 10%;"></td> <td style="width: 10%;"></td> <td style="width: 10%;"></td> </tr> <tr> <td></td> <td></td> <td colspan="8" style="text-align: center;"> <table border="1" style="width: 100%; border-collapse: collapse; text-align: center;"> <tr> <td style="width: 10%;"></td> <td style="width: 10%;"></td> <td style="width: 10%;"></td> <td style="width: 10%;"></td> <td style="width: 10%;"></td> <td style="width: 10%;"></td> <td style="width: 10%;"></td> <td style="width: 10%;"></td> <td style="width: 10%;"></td> <td style="width: 10%;"></td> </tr> <tr> <td></td> <td></td> <td colspan="8" style="text-align: center;"> <table border="1" style="width: 100%; border-collapse: collapse; text-align: center;"> <tr> <td style="width: 10%;"></td> <td style="width: 10%;"></td> <td style="width: 10%;"></td> <td style="width: 10%;"></td> <td style="width: 10%;"></td> <td style="width: 10%;"></td> <td style="width: 10%;"></td> <td style="width: 10%;"></td> <td style="width: 10%;"></td> <td style="width: 10%;"></td> </tr> <tr> <td></td> <td></td> <td colspan="8" style="text-align: center;"> <table border="1" style="width: 100%; border-collapse: collapse; text-align: center;"> <tr> <td style="width: 10%;"></td> <td style="width: 10%;"></td> <td style="width: 10%;"></td> <td style="width: 10%;"></td> <td style="width: 10%;"></td> <td style="width: 10%;"></td> <td style="width: 10%;"></td> <td style="width: 10%;"></td> <td style="width: 10%;"></td> <td style="width: 10%;"></td> </tr> <tr> <td></td> <td></td> <td colspan="8" style="text-align: center;"> <table border="1" style="width: 100%; border-collapse: collapse; text-align: center;"> <tr> <td style="width: 10%;"></td> <td style="width: 10%;"></td> <td style="width: 10%;"></td> <td style="width: 10%;"></td> <td style="width: 10%;"></td> <td style="width: 10%;"></td> <td style="width: 10%;"></td> <td style="width: 10%;"></td> <td style="width: 10%;"></td> <td style="width: 10%;"></td> </tr> <tr> <td></td> <td></td> <td colspan="8" style="text-align: center;"> <table border="1" style="width: 100%; border-collapse: collapse; text-align: center;"> <tr> <td style="width: 10%;"></td> <td style="width: 10%;"></td> <td style="width: 10%;"></td> <td style="width: 10%;"></td> <td style="width: 10%;"></td> <td style="width: 10%;"></td> <td style="width: 10%;"></td> <td style="width: 10%;"></td> <td style="width: 10%;"></td> <td style="width: 10%;"></td> </tr> <tr> <td></td> <td></td> <td colspan="8" style="text-align: center;"> <table border="1" style="width: 100%; border-collapse: collapse; text-align: center;"> <tr> <td style="width: 10%;"></td> <td style="width: 10%;"></td> <td style="width: 10%;"></td> <td style="width: 10%;"></td> <td style="width: 10%;"></td> <td style="width: 10%;"></td> <td style="width: 10%;"></td> <td style="width: 10%;"></td> <td style="width: 10%;"></td> <td style="width: 10%;"></td> </tr> <tr> <td></td> <td></td> <td colspan="8" style="text-align: center;"> <table border="1" style="width: 100%; border-collapse: collapse; text-align: center;"> <tr> <td style="width: 10%;"></td> <td style="width: 10%;"></td> <td style="width: 10%;"></td> <td style="width: 10%;"></td> <td style="width: 10%;"></td> <td style="width: 10%;"></td> <td style="width: 10%;"></td> <td style="width: 10%;"></td> <td style="width: 10%;"></td> <td style="width: 10%;"></td> </tr> <tr> <td></td> <td></td> <td colspan="8" style="text-align: center;"> <table border="1" style="width: 100%; border-collapse: collapse; text-align: center;"> <tr> <td style="width: 10%;"></td> <td style="width: 10%;"></td> <td style="width: 10%;"></td> <td style="width: 10%;"></td> <td style="width: 10%;"></td> <td style="width: 10%;"></td> <td style="width: 10%;"></td> <td style="width: 10%;"></td> <td style="width: 10%;"></td> <td style="width: 10%;"></td> </tr> <tr> <td></td> <td></td> <td colspan="8" style="text-align: center;"> <table border="1" style="width: 100%; border-collapse: collapse; text-align: center;"> <tr> <td style="width: 10%;"></td> <td style="width: 10%;"></td> <td style="width: 10%;"></td> <td style="width: 10%;"></td> <td style="width: 10%;"></td> <td style="width: 10%;"></td> <td style="width: 10%;"></td> <td style="width: 10%;"></td> <td style="width: 10%;"></td> <td style="width: 10%;"></td> </tr> <tr> <td></td> <td></td> <td colspan="8" style="text-align: center;"> <table border="1" style="width: 100%; border-collapse: collapse; text-align: center;"> <tr> <td style="width: 10%;"></td> <td style="width: 10%;"></td> <td style="width: 10%;"></td> <td style="width: 10%;"></td> <td style="width: 10%;"></td> <td style="width: 10%;"></td> <td style="width: 10%;"></td> <td style="width: 10%;"></td> <td style="width: 10%;"></td> <td style="width: 10%;"></td> </tr> <tr> <td></td> <td></td> <td colspan="8" style="text-align: center;"> <table border="1" style="width: 100%; border-collapse: collapse; text-align: center;"> <tr> <td style="width: 10%;"></td> <td style="width: 10%;"></td> <td style="width: 10%;"></td> <td style="width: 10%;"></td> <td style="width: 10%;"></td> <td style="width: 10%;"></td> <td style="width: 10%;"></td> <td style="width: 10%;"></td> <td style="width: 10%;"></td> <td style="width: 10%;"></td> </tr> <tr> <td></td> <td></td> <td colspan="8" style="text-align: center;"> <table border="1" style="width: 100%; border-collapse: collapse; text-align: center;"> <tr> <td style="width: 10%;"></td> <td style="width: 10%;"></td> <td style="width: 10%;"></td> <td style="width: 10%;"></td> <td style="width: 10%;"></td> <td style="width: 10%;"></td> <td style="width: 10%;"></td> <td style="width: 10%;"></td> <td style="width: 10%;"></td> <td style="width: 10%;"></td> </tr> <tr> <td></td> <td></td> <td colspan="8" style="text-align: center;"> <table border="1" style="width: 100%; border-collapse: collapse; text-align: center;"> <tr> </tr></table></td></tr></table></td></tr></table></td></tr></table></td></tr></table></td></tr></table></td></tr></table></td></tr></table></td></tr></table></td></tr></table></td></tr></table></td></tr></table></td></tr></table></td></tr></table></td></tr></table></td></tr></table></td></tr></table></td></tr></table></td></tr></table></td></tr></table></td></tr></table></td></tr></table></td></tr></table></td></tr></table></td></tr></table></td></tr></table></td></tr></table></td></tr></table></td></tr></table></td></tr></table></td></tr></table></td></tr></table></td></tr></table></td></tr></table></td></tr></table></td></tr></table></td></tr></table></td></tr></table> | | | | | | | | | | | | | | | | | | | | <table border="1" style="width: 100%; border-collapse: collapse; text-align: center;"> <tr> <td style="width: 10%;"></td> <td style="width: 10%;"></td> <td style="width: 10%;"></td> <td style="width: 10%;"></td> <td style="width: 10%;"></td> <td style="width: 10%;"></td> <td style="width: 10%;"></td> <td style="width: 10%;"></td> <td style="width: 10%;"></td> <td style="width: 10%;"></td> </tr> <tr> <td></td> <td></td> <td colspan="8" style="text-align: center;"> <table border="1" style="width: 100%; border-collapse: collapse; text-align: center;"> <tr> <td style="width: 10%;"></td> <td style="width: 10%;"></td> <td style="width: 10%;"></td> <td style="width: 10%;"></td> <td style="width: 10%;"></td> <td style="width: 10%;"></td> <td style="width: 10%;"></td> <td style="width: 10%;"></td> <td style="width: 10%;"></td> <td style="width: 10%;"></td> </tr> <tr> <td></td> <td></td> <td colspan="8" style="text-align: center;"> <table border="1" style="width: 100%; border-collapse: collapse; text-align: center;"> <tr> <td style="width: 10%;"></td> <td style="width: 10%;"></td> <td style="width: 10%;"></td> <td style="width: 10%;"></td> <td style="width: 10%;"></td> <td style="width: 10%;"></td> <td style="width: 10%;"></td> <td style="width: 10%;"></td> <td style="width: 10%;"></td> <td style="width: 10%;"></td> </tr> <tr> <td></td> <td></td> <td colspan="8" style="text-align: center;"> <table
border="1" style="width: 100%; border-collapse: collapse; text-align: center;"> <tr> <td style="width: 10%;"></td> <td style="width: 10%;"></td> <td style="width: 10%;"></td> <td style="width: 10%;"></td> <td style="width: 10%;"></td> <td style="width: 10%;"></td> <td style="width: 10%;"></td> <td style="width: 10%;"></td> <td style="width: 10%;"></td> <td style="width: 10%;"></td> </tr> <tr> <td></td> <td></td> <td colspan="8" style="text-align: center;"> <table border="1" style="width: 100%; border-collapse: collapse; text-align: center;"> <tr> <td style="width: 10%;"></td> <td style="width: 10%;"></td> <td style="width: 10%;"></td> <td style="width: 10%;"></td> <td style="width: 10%;"></td> <td style="width: 10%;"></td> <td style="width: 10%;"></td> <td style="width: 10%;"></td> <td style="width: 10%;"></td> <td style="width: 10%;"></td> </tr> <tr> <td></td> <td></td> <td colspan="8" style="text-align: center;"> <table border="1" style="width: 100%; border-collapse: collapse; text-align: center;"> <tr> <td style="width: 10%;"></td> <td style="width: 10%;"></td> <td style="width: 10%;"></td> <td style="width: 10%;"></td> <td style="width: 10%;"></td> <td style="width: 10%;"></td> <td style="width: 10%;"></td> <td style="width: 10%;"></td> <td style="width: 10%;"></td> <td style="width: 10%;"></td> </tr> <tr> <td></td> <td></td> <td colspan="8" style="text-align: center;"> <table border="1" style="width: 100%; border-collapse: collapse; text-align: center;"> <tr> <td style="width: 10%;"></td> <td style="width: 10%;"></td> <td style="width: 10%;"></td> <td style="width: 10%;"></td> <td style="width: 10%;"></td> <td style="width: 10%;"></td> <td style="width: 10%;"></td> <td style="width: 10%;"></td> <td style="width: 10%;"></td> <td style="width: 10%;"></td> </tr> <tr> <td></td> <td></td> <td colspan="8" style="text-align: center;"> <table border="1" style="width: 100%; border-collapse: collapse; text-align: center;"> <tr> <td style="width: 10%;"></td> <td style="width: 10%;"></td> <td style="width: 10%;"></td> <td style="width: 10%;"></td> <td style="width: 10%;"></td> <td style="width: 10%;"></td> <td style="width: 10%;"></td> <td style="width: 10%;"></td> <td style="width: 10%;"></td> <td style="width: 10%;"></td> </tr> <tr> <td></td> <td></td> <td colspan="8" style="text-align: center;"> <table border="1" style="width: 100%; border-collapse: collapse; text-align: center;"> <tr> <td style="width: 10%;"></td> <td style="width: 10%;"></td> <td style="width: 10%;"></td> <td style="width: 10%;"></td> <td style="width: 10%;"></td> <td style="width: 10%;"></td> <td style="width: 10%;"></td> <td style="width: 10%;"></td> <td style="width: 10%;"></td> <td style="width: 10%;"></td> </tr> <tr> <td></td> <td></td> <td colspan="8" style="text-align: center;"> <table border="1" style="width: 100%; border-collapse: collapse; text-align: center;"> <tr> <td style="width: 10%;"></td> <td style="width: 10%;"></td> <td style="width: 10%;"></td> <td style="width: 10%;"></td> <td style="width: 10%;"></td> <td style="width: 10%;"></td> <td style="width: 10%;"></td> <td style="width: 10%;"></td> <td style="width: 10%;"></td> <td style="width: 10%;"></td> </tr> <tr> <td></td> <td></td> <td colspan="8" style="text-align: center;"> <table border="1" style="width: 100%; border-collapse: collapse; text-align: center;"> <tr> <td style="width: 10%;"></td> <td style="width: 10%;"></td> <td style="width: 10%;"></td> <td style="width: 10%;"></td> <td style="width: 10%;"></td> <td style="width: 10%;"></td> <td style="width: 10%;"></td> <td style="width: 10%;"></td> <td style="width: 10%;"></td> <td style="width: 10%;"></td> </tr> <tr> <td></td> <td></td> <td colspan="8" style="text-align: center;"> <table border="1" style="width: 100%; border-collapse: collapse; text-align: center;"> <tr> <td style="width: 10%;"></td> <td style="width: 10%;"></td> <td style="width: 10%;"></td> <td style="width: 10%;"></td> <td style="width: 10%;"></td> <td style="width: 10%;"></td> <td style="width: 10%;"></td> <td style="width: 10%;"></td> <td style="width: 10%;"></td> <td style="width: 10%;"></td> </tr> <tr> <td></td> <td></td> <td colspan="8" style="text-align: center;"> <table border="1" style="width: 100%; border-collapse: collapse; text-align: center;"> <tr> <td style="width: 10%;"></td> <td style="width: 10%;"></td> <td style="width: 10%;"></td> <td style="width: 10%;"></td> <td style="width: 10%;"></td> <td style="width: 10%;"></td> <td style="width: 10%;"></td> <td style="width: 10%;"></td> <td style="width: 10%;"></td> <td style="width: 10%;"></td> </tr> <tr> <td></td> <td></td> <td colspan="8" style="text-align: center;"> <table border="1" style="width: 100%; border-collapse: collapse; text-align: center;"> <tr> <td style="width: 10%;"></td> <td style="width: 10%;"></td> <td style="width: 10%;"></td> <td style="width: 10%;"></td> <td style="width: 10%;"></td> <td style="width: 10%;"></td> <td style="width: 10%;"></td> <td style="width: 10%;"></td> <td style="width: 10%;"></td> <td style="width: 10%;"></td> </tr> <tr> <td></td> <td></td> <td colspan="8" style="text-align: center;"> <table border="1" style="width: 100%; border-collapse: collapse; text-align: center;"> <tr> <td style="width: 10%;"></td> <td style="width: 10%;"></td> <td style="width: 10%;"></td> <td style="width: 10%;"></td> <td style="width: 10%;"></td> <td style="width: 10%;"></td> <td style="width: 10%;"></td> <td style="width: 10%;"></td> <td style="width: 10%;"></td> <td style="width: 10%;"></td> </tr> <tr> <td></td> <td></td> <td colspan="8" style="text-align: center;"> <table border="1" style="width: 100%; border-collapse: collapse; text-align: center;"> <tr> <td style="width: 10%;"></td> <td style="width: 10%;"></td> <td style="width: 10%;"></td> <td style="width: 10%;"></td> <td style="width: 10%;"></td> <td style="width: 10%;"></td> <td style="width: 10%;"></td> <td style="width: 10%;"></td> <td style="width: 10%;"></td> <td style="width: 10%;"></td> </tr> <tr> <td></td> <td></td> <td colspan="8" style="text-align: center;"> <table border="1" style="width: 100%; border-collapse: collapse; text-align: center;"> <tr> <td style="width: 10%;"></td> <td style="width: 10%;"></td> <td style="width: 10%;"></td> <td style="width: 10%;"></td> <td style="width: 10%;"></td> <td style="width: 10%;"></td> <td style="width: 10%;"></td> <td style="width: 10%;"></td> <td style="width: 10%;"></td> <td style="width: 10%;"></td> </tr> <tr> <td></td> <td></td> <td colspan="8" style="text-align: center;"> <table border="1" style="width: 100%; border-collapse: collapse; text-align: center;"> <tr> <td style="width: 10%;"></td> <td style="width: 10%;"></td> <td style="width: 10%;"></td> <td style="width: 10%;"></td> <td style="width: 10%;"></td> <td style="width: 10%;"></td> <td style="width: 10%;"></td> <td style="width: 10%;"></td> <td style="width: 10%;"></td> <td style="width: 10%;"></td> </tr> <tr> <td></td> <td></td> <td colspan="8" style="text-align: center;"> <table border="1" style="width: 100%; border-collapse: collapse; text-align: center;"> <tr> <td style="width: 10%;"></td> <td style="width: 10%;"></td> <td style="width: 10%;"></td> <td style="width: 10%;"></td> <td style="width: 10%;"></td> <td style="width: 10%;"></td> <td style="width: 10%;"></td> <td style="width: 10%;"></td> <td style="width: 10%;"></td> <td style="width: 10%;"></td> </tr> <tr> <td></td> <td></td> <td colspan="8" style="text-align: center;"> <table border="1" style="width: 100%; border-collapse: collapse; text-align: center;"> <tr> <td style="width: 10%;"></td> <td style="width: 10%;"></td> <td style="width: 10%;"></td> <td style="width: 10%;"></td> <td style="width: 10%;"></td> <td style="width: 10%;"></td> <td style="width: 10%;"></td> <td style="width: 10%;"></td> <td style="width: 10%;"></td> <td style="width: 10%;"></td> </tr> <tr> <td></td> <td></td> <td colspan="8" style="text-align: center;"> <table border="1" style="width: 100%; border-collapse: collapse; text-align: center;"> <tr> <td style="width: 10%;"></td> <td style="width: 10%;"></td> <td style="width: 10%;"></td> <td style="width: 10%;"></td> <td style="width: 10%;"></td> <td style="width: 10%;"></td> <td style="width: 10%;"></td> <td style="width: 10%;"></td> <td style="width: 10%;"></td> <td style="width: 10%;"></td> </tr> <tr> <td></td> <td></td> <td colspan="8" style="text-align: center;"> <table border="1" style="width: 100%; border-collapse: collapse; text-align: center;"> <tr> <td style="width: 10%;"></td> <td style="width: 10%;"></td> <td style="width: 10%;"></td> <td style="width: 10%;"></td> <td style="width: 10%;"></td> <td style="width: 10%;"></td> <td style="width: 10%;"></td> <td style="width: 10%;"></td> <td style="width: 10%;"></td> <td style="width: 10%;"></td> </tr> <tr> <td></td> <td></td> <td colspan="8" style="text-align: center;"> <table border="1" style="width: 100%; border-collapse: collapse; text-align: center;"> <tr> <td style="width: 10%;"></td> <td style="width: 10%;"></td> <td style="width: 10%;"></td> <td style="width: 10%;"></td> <td style="width: 10%;"></td> <td style="width: 10%;"></td> <td style="width: 10%;"></td> <td style="width: 10%;"></td> <td style="width: 10%;"></td> <td style="width: 10%;"></td> </tr> <tr> <td></td> <td></td> <td colspan="8" style="text-align: center;"> <table border="1" style="width: 100%; border-collapse: collapse; text-align: center;"> <tr> <td style="width: 10%;"></td> <td style="width: 10%;"></td> <td style="width: 10%;"></td> <td style="width: 10%;"></td> <td style="width: 10%;"></td> <td style="width: 10%;"></td> <td style="width: 10%;"></td> <td style="width: 10%;"></td> <td style="width: 10%;"></td> <td style="width: 10%;"></td> </tr> <tr> <td></td> <td></td> <td colspan="8" style="text-align: center;"> <table border="1" style="width: 100%; border-collapse: collapse; text-align: center;"> <tr> <td style="width: 10%;"></td> <td style="width: 10%;"></td> <td style="width:
10%;"></td> <td style="width: 10%;"></td> <td style="width: 10%;"></td> <td style="width: 10%;"></td> <td style="width: 10%;"></td> <td style="width: 10%;"></td> <td style="width: 10%;"></td> <td style="width: 10%;"></td> </tr> <tr> <td></td> <td></td> <td colspan="8" style="text-align: center;"> <table border="1" style="width: 100%; border-collapse: collapse; text-align: center;"> <tr> <td style="width: 10%;"></td> <td style="width: 10%;"></td> <td style="width: 10%;"></td> <td style="width: 10%;"></td> <td style="width: 10%;"></td> <td style="width: 10%;"></td> <td style="width: 10%;"></td> <td style="width: 10%;"></td> <td style="width: 10%;"></td> <td style="width: 10%;"></td> </tr> <tr> <td></td> <td></td> <td colspan="8" style="text-align: center;"> <table border="1" style="width: 100%; border-collapse: collapse; text-align: center;"> <tr> <td style="width: 10%;"></td> <td style="width: 10%;"></td> <td style="width: 10%;"></td> <td style="width: 10%;"></td> <td style="width: 10%;"></td> <td style="width: 10%;"></td> <td style="width: 10%;"></td> <td style="width: 10%;"></td> <td style="width: 10%;"></td> <td style="width: 10%;"></td> </tr> <tr> <td></td> <td></td> <td colspan="8" style="text-align: center;"> <table border="1" style="width: 100%; border-collapse: collapse; text-align: center;"> <tr> <td style="width: 10%;"></td> <td style="width: 10%;"></td> <td style="width: 10%;"></td> <td style="width: 10%;"></td> <td style="width: 10%;"></td> <td style="width: 10%;"></td> <td style="width: 10%;"></td> <td style="width: 10%;"></td> <td style="width: 10%;"></td> <td style="width: 10%;"></td> </tr> <tr> <td></td> <td></td> <td colspan="8" style="text-align: center;"> <table border="1" style="width: 100%; border-collapse: collapse; text-align: center;"> <tr> <td style="width: 10%;"></td> <td style="width: 10%;"></td> <td style="width: 10%;"></td> <td style="width: 10%;"></td> <td style="width: 10%;"></td> <td style="width: 10%;"></td> <td style="width: 10%;"></td> <td style="width: 10%;"></td> <td style="width: 10%;"></td> <td style="width: 10%;"></td> </tr> <tr> <td></td> <td></td> <td colspan="8" style="text-align: center;"> <table border="1" style="width: 100%; border-collapse: collapse; text-align: center;"> <tr> <td style="width: 10%;"></td> <td style="width: 10%;"></td> <td style="width: 10%;"></td> <td style="width: 10%;"></td> <td style="width: 10%;"></td> <td style="width: 10%;"></td> <td style="width: 10%;"></td> <td style="width: 10%;"></td> <td style="width: 10%;"></td> <td style="width: 10%;"></td> </tr> <tr> <td></td> <td></td> <td colspan="8" style="text-align: center;"> <table border="1" style="width: 100%; border-collapse: collapse; text-align: center;"> <tr> <td style="width: 10%;"></td> <td style="width: 10%;"></td> <td style="width: 10%;"></td> <td style="width: 10%;"></td> <td style="width: 10%;"></td> <td style="width: 10%;"></td> <td style="width: 10%;"></td> <td style="width: 10%;"></td> <td style="width: 10%;"></td> <td style="width: 10%;"></td> </tr> <tr> <td></td> <td></td> <td colspan="8" style="text-align: center;"> <table border="1" style="width: 100%; border-collapse: collapse; text-align: center;"> <tr> <td style="width: 10%;"></td> <td style="width: 10%;"></td> <td style="width: 10%;"></td> <td style="width: 10%;"></td> <td style="width: 10%;"></td> <td style="width: 10%;"></td> <td style="width: 10%;"></td> <td style="width: 10%;"></td> <td style="width: 10%;"></td> <td style="width: 10%;"></td> </tr> <tr> <td></td> <td></td> <td colspan="8" style="text-align: center;"> <table border="1" style="width: 100%; border-collapse: collapse; text-align: center;"> <tr> <td style="width: 10%;"></td> <td style="width: 10%;"></td> <td style="width: 10%;"></td> <td style="width: 10%;"></td> <td style="width: 10%;"></td> <td style="width: 10%;"></td> <td style="width: 10%;"></td> <td style="width: 10%;"></td> <td style="width: 10%;"></td> <td style="width: 10%;"></td> </tr> <tr> <td></td> <td></td> <td colspan="8" style="text-align: center;"> <table border="1" style="width: 100%; border-collapse: collapse; text-align: center;"> <tr> <td style="width: 10%;"></td> <td style="width: 10%;"></td> <td style="width: 10%;"></td> <td style="width: 10%;"></td> <td style="width: 10%;"></td> <td style="width: 10%;"></td> <td style="width: 10%;"></td> <td style="width: 10%;"></td> <td style="width: 10%;"></td> <td style="width: 10%;"></td> </tr> <tr> <td></td> <td></td> <td colspan="8" style="text-align: center;"> <table border="1" style="width: 100%; border-collapse: collapse; text-align: center;"> <tr> <td style="width: 10%;"></td> <td style="width: 10%;"></td> <td style="width: 10%;"></td> <td style="width: 10%;"></td> <td style="width: 10%;"></td> <td style="width: 10%;"></td> <td style="width: 10%;"></td> <td style="width: 10%;"></td> <td style="width: 10%;"></td> <td style="width: 10%;"></td> </tr> <tr> <td></td> <td></td> <td colspan="8" style="text-align: center;"> <table border="1" style="width: 100%; border-collapse: collapse; text-align: center;"> <tr> <td style="width: 10%;"></td> <td style="width: 10%;"></td> <td style="width: 10%;"></td> <td style="width: 10%;"></td> <td style="width: 10%;"></td> <td style="width: 10%;"></td> <td style="width: 10%;"></td> <td style="width: 10%;"></td> <td style="width: 10%;"></td> <td style="width: 10%;"></td> </tr> <tr> <td></td> <td></td> <td colspan="8" style="text-align: center;"> <table border="1" style="width: 100%; border-collapse: collapse; text-align: center;"> <tr> </tr></table></td></tr></table></td></tr></table></td></tr></table></td></tr></table></td></tr></table></td></tr></table></td></tr></table></td></tr></table></td></tr></table></td></tr></table></td></tr></table></td></tr></table></td></tr></table></td></tr></table></td></tr></table></td></tr></table></td></tr></table></td></tr></table></td></tr></table></td></tr></table></td></tr></table></td></tr></table></td></tr></table></td></tr></table></td></tr></table></td></tr></table></td></tr></table></td></tr></table></td></tr></table></td></tr></table></td></tr></table></td></tr></table></td></tr></table></td></tr></table></td></tr></table></td></tr></table> | | | | | | | | | | | | | | | | | | | | <table border="1" style="width: 100%; border-collapse: collapse; text-align: center;"> <tr> <td style="width: 10%;"></td> <td style="width: 10%;"></td> <td style="width: 10%;"></td> <td style="width: 10%;"></td> <td style="width: 10%;"></td> <td style="width: 10%;"></td> <td style="width: 10%;"></td> <td style="width: 10%;"></td> <td style="width: 10%;"></td> <td style="width: 10%;"></td> </tr> <tr> <td></td> <td></td> <td colspan="8" style="text-align: center;"> <table border="1" style="width: 100%; border-collapse: collapse; text-align: center;"> <tr> <td style="width: 10%;"></td> <td style="width: 10%;"></td> <td style="width: 10%;"></td> <td style="width: 10%;"></td> <td style="width: 10%;"></td> <td style="width: 10%;"></td> <td style="width: 10%;"></td> <td style="width: 10%;"></td> <td style="width: 10%;"></td> <td style="width: 10%;"></td> </tr> <tr> <td></td> <td></td> <td colspan="8" style="text-align: center;"> <table border="1" style="width: 100%; border-collapse: collapse; text-align: center;"> <tr> <td style="width: 10%;"></td> <td style="width: 10%;"></td> <td style="width: 10%;"></td> <td style="width: 10%;"></td> <td style="width: 10%;"></td> <td style="width: 10%;"></td> <td style="width: 10%;"></td> <td style="width: 10%;"></td> <td style="width: 10%;"></td> <td style="width: 10%;"></td> </tr> <tr> <td></td> <td></td> <td colspan="8" style="text-align: center;"> <table border="1" style="width: 100%; border-collapse: collapse; text-align: center;"> <tr> <td style="width: 10%;"></td> <td style="width: 10%;"></td> <td style="width: 10%;"></td> <td style="width: 10%;"></td> <td style="width: 10%;"></td> <td style="width: 10%;"></td> <td style="width: 10%;"></td> <td style="width: 10%;"></td> <td style="width: 10%;"></td> <td style="width: 10%;"></td>
</tr> <tr> <td></td> <td></td> <td colspan="8" style="text-align: center;"> <table border="1" style="width: 100%; border-collapse: collapse; text-align: center;"> <tr> <td style="width: 10%;"></td> <td style="width: 10%;"></td> <td style="width: 10%;"></td> <td style="width: 10%;"></td> <td style="width: 10%;"></td> <td style="width: 10%;"></td> <td style="width: 10%;"></td> <td style="width: 10%;"></td> <td style="width: 10%;"></td> <td style="width: 10%;"></td> </tr> <tr> <td></td> <td></td> <td colspan="8" style="text-align: center;"> <table border="1" style="width: 100%; border-collapse: collapse; text-align: center;"> <tr> <td style="width: 10%;"></td> <td style="width: 10%;"></td> <td style="width: 10%;"></td> <td style="width: 10%;"></td> <td style="width: 10%;"></td> <td style="width: 10%;"></td> <td style="width: 10%;"></td> <td style="width: 10%;"></td> <td style="width: 10%;"></td> <td style="width: 10%;"></td> </tr> <tr> <td></td> <td></td> <td colspan="8" style="text-align: center;"> <table border="1" style="width: 100%; border-collapse: collapse; text-align: center;"> <tr> <td style="width: 10%;"></td> <td style="width: 10%;"></td> <td style="width: 10%;"></td> <td style="width: 10%;"></td> <td style="width: 10%;"></td> <td style="width: 10%;"></td> <td style="width: 10%;"></td> <td style="width: 10%;"></td> <td style="width: 10%;"></td> <td style="width: 10%;"></td> </tr> <tr> <td></td> <td></td> <td colspan="8" style="text-align: center;"> <table border="1" style="width: 100%; border-collapse: collapse; text-align: center;"> <tr> <td style="width: 10%;"></td> <td style="width: 10%;"></td> <td style="width: 10%;"></td> <td style="width: 10%;"></td> <td style="width: 10%;"></td> <td style="width: 10%;"></td> <td style="width: 10%;"></td> <td style="width: 10%;"></td> <td style="width: 10%;"></td> <td style="width: 10%;"></td> </tr> <tr> <td></td> <td></td> <td colspan="8" style="text-align: center;"> <table border="1" style="width: 100%; border-collapse: collapse; text-align: center;"> <tr> <td style="width: 10%;"></td> <td style="width: 10%;"></td> <td style="width: 10%;"></td> <td style="width: 10%;"></td> <td style="width: 10%;"></td> <td style="width: 10%;"></td> <td style="width: 10%;"></td> <td style="width: 10%;"></td> <td style="width: 10%;"></td> <td style="width: 10%;"></td> </tr> <tr> <td></td> <td></td> <td colspan="8" style="text-align: center;"> <table border="1" style="width: 100%; border-collapse: collapse; text-align: center;"> <tr> <td style="width: 10%;"></td> <td style="width: 10%;"></td> <td style="width: 10%;"></td> <td style="width: 10%;"></td> <td style="width: 10%;"></td> <td style="width: 10%;"></td> <td style="width: 10%;"></td> <td style="width: 10%;"></td> <td style="width: 10%;"></td> <td style="width: 10%;"></td> </tr> <tr> <td></td> <td></td> <td colspan="8" style="text-align: center;"> <table border="1" style="width: 100%; border-collapse: collapse; text-align: center;"> <tr> <td style="width: 10%;"></td> <td style="width: 10%;"></td> <td style="width: 10%;"></td> <td style="width: 10%;"></td> <td style="width: 10%;"></td> <td style="width: 10%;"></td> <td style="width: 10%;"></td> <td style="width: 10%;"></td> <td style="width: 10%;"></td> <td style="width: 10%;"></td> </tr> <tr> <td></td> <td></td> <td colspan="8" style="text-align: center;"> <table border="1" style="width: 100%; border-collapse: collapse; text-align: center;"> <tr> <td style="width: 10%;"></td> <td style="width: 10%;"></td> <td style="width: 10%;"></td> <td style="width: 10%;"></td> <td style="width: 10%;"></td> <td style="width: 10%;"></td> <td style="width: 10%;"></td> <td style="width: 10%;"></td> <td style="width: 10%;"></td> <td style="width: 10%;"></td> </tr> <tr> <td></td> <td></td> <td colspan="8" style="text-align: center;"> <table border="1" style="width: 100%; border-collapse: collapse; text-align: center;"> <tr> <td style="width: 10%;"></td> <td style="width: 10%;"></td> <td style="width: 10%;"></td> <td style="width: 10%;"></td> <td style="width: 10%;"></td> <td style="width: 10%;"></td> <td style="width: 10%;"></td> <td style="width: 10%;"></td> <td style="width: 10%;"></td> <td style="width: 10%;"></td> </tr> <tr> <td></td> <td></td> <td colspan="8" style="text-align: center;"> <table border="1" style="width: 100%; border-collapse: collapse; text-align: center;"> <tr> <td style="width: 10%;"></td> <td style="width: 10%;"></td> <td style="width: 10%;"></td> <td style="width: 10%;"></td> <td style="width: 10%;"></td> <td style="width: 10%;"></td> <td style="width: 10%;"></td> <td style="width: 10%;"></td> <td style="width: 10%;"></td> <td style="width: 10%;"></td> </tr> <tr> <td></td> <td></td> <td colspan="8" style="text-align: center;"> <table border="1" style="width: 100%; border-collapse: collapse; text-align: center;"> <tr> <td style="width: 10%;"></td> <td style="width: 10%;"></td> <td style="width: 10%;"></td> <td style="width: 10%;"></td> <td style="width: 10%;"></td> <td style="width: 10%;"></td> <td style="width: 10%;"></td> <td style="width: 10%;"></td> <td style="width: 10%;"></td> <td style="width: 10%;"></td> </tr> <tr> <td></td> <td></td> <td colspan="8" style="text-align: center;"> <table border="1" style="width: 100%; border-collapse: collapse; text-align: center;"> <tr> <td style="width: 10%;"></td> <td style="width: 10%;"></td> <td style="width: 10%;"></td> <td style="width: 10%;"></td> <td style="width: 10%;"></td> <td style="width: 10%;"></td> <td style="width: 10%;"></td> <td style="width: 10%;"></td> <td style="width: 10%;"></td> <td style="width: 10%;"></td> </tr> <tr> <td></td> <td></td> <td colspan="8" style="text-align: center;"> <table border="1" style="width: 100%; border-collapse: collapse; text-align: center;"> <tr> <td style="width: 10%;"></td> <td style="width: 10%;"></td> <td style="width: 10%;"></td> <td style="width: 10%;"></td> <td style="width: 10%;"></td> <td style="width: 10%;"></td> <td style="width: 10%;"></td> <td style="width: 10%;"></td> <td style="width: 10%;"></td> <td style="width: 10%;"></td> </tr> <tr> <td></td> <td></td> <td colspan="8" style="text-align: center;"> <table border="1" style="width: 100%; border-collapse: collapse; text-align: center;"> <tr> <td style="width: 10%;"></td> <td style="width: 10%;"></td> <td style="width: 10%;"></td> <td style="width: 10%;"></td> <td style="width: 10%;"></td> <td style="width: 10%;"></td> <td style="width: 10%;"></td> <td style="width: 10%;"></td> <td style="width: 10%;"></td> <td style="width: 10%;"></td> </tr> <tr> <td></td> <td></td> <td colspan="8" style="text-align: center;"> <table border="1" style="width: 100%; border-collapse: collapse; text-align: center;"> <tr> <td style="width: 10%;"></td> <td style="width: 10%;"></td> <td style="width: 10%;"></td> <td style="width: 10%;"></td> <td style="width: 10%;"></td> <td style="width: 10%;"></td> <td style="width: 10%;"></td> <td style="width: 10%;"></td> <td style="width: 10%;"></td> <td style="width: 10%;"></td> </tr> <tr> <td></td> <td></td> <td colspan="8" style="text-align: center;"> <table border="1" style="width: 100%; border-collapse: collapse; text-align: center;"> <tr> <td style="width: 10%;"></td> <td style="width: 10%;"></td> <td style="width: 10%;"></td> <td style="width: 10%;"></td> <td style="width: 10%;"></td> <td style="width: 10%;"></td> <td style="width: 10%;"></td> <td style="width: 10%;"></td> <td style="width: 10%;"></td> <td style="width: 10%;"></td> </tr> <tr> <td></td> <td></td> <td colspan="8" style="text-align: center;"> <table border="1" style="width: 100%; border-collapse: collapse; text-align: center;"> <tr> <td style="width: 10%;"></td> <td style="width: 10%;"></td> <td style="width: 10%;"></td> <td style="width: 10%;"></td> <td style="width: 10%;"></td> <td style="width: 10%;"></td> <td style="width: 10%;"></td> <td style="width: 10%;"></td> <td style="width: 10%;"></td> <td style="width: 10%;"></td> </tr> <tr> <td></td> <td></td> <td colspan="8" style="text-align: center;"> <table border="1" style="width: 100%; border-collapse: collapse; text-align: center;"> <tr> <td style="width: 10%;"></td> <td style="width: 10%;"></td> <td style="width: 10%;"></td> <td style="width: 10%;"></td> <td style="width: 10%;"></td> <td style="width: 10%;"></td> <td style="width: 10%;"></td> <td style="width: 10%;"></td> <td style="width: 10%;"></td> <td style="width: 10%;"></td> </tr> <tr> <td></td> <td></td> <td colspan="8" style="text-align: center;"> <table border="1" style="width: 100%; border-collapse: collapse; text-align: center;"> <tr> <td style="width: 10%;"></td> <td style="width: 10%;"></td> <td style="width: 10%;"></td> <td style="width: 10%;"></td> <td style="width: 10%;"></td> <td style="width: 10%;"></td> <td style="width: 10%;"></td> <td style="width: 10%;"></td> <td style="width: 10%;"></td> <td style="width: 10%;"></td> </tr> <tr> <td></td> <td></td> <td colspan="8" style="text-align: center;"> <table border="1" style="width: 100%; border-collapse: collapse; text-align: center;"> <tr> <td style="width: 10%;"></td> <td style="width: 10%;"></td> <td style="width: 10%;"></td> <td style="width: 10%;"></td> <td style="width: 10%;"></td> <td style="width: 10%;"></td> <td style="width: 10%;"></td> <td style="width: 10%;"></td> <td style="width: 10%;"></td> <td style="width: 10%;"></td> </tr> <tr> <td></td> <td></td> <td colspan="8" style="text-align: center;"> <table border="1" style="width: 100%; border-collapse: collapse; text-align: center;"> <tr> <td style="width: 10%;"></td> <td style="width: 10%;"></td> <td style="width: 10%;"></td> <td style="width: 10%;"></td> <td style="width: 10%;"></td> <td style="width: 10%;"></td> <td style="width: 10%;"></td> <td style="width: 10%;"></td> <td style="width: 10%;"></td> <td style="width: 10%;"></td> </tr> <tr> <td></td> <td></td> <td colspan="8" style="text-align: center;"> <table border="1" style="width: 100%; border-collapse: collapse; text-align: center;"> <tr> <td
style="width: 10%;"></td> <td style="width: 10%;"></td> <td style="width: 10%;"></td> <td style="width: 10%;"></td> <td style="width: 10%;"></td> <td style="width: 10%;"></td> <td style="width: 10%;"></td> <td style="width: 10%;"></td> <td style="width: 10%;"></td> <td style="width: 10%;"></td> </tr> <tr> <td></td> <td></td> <td colspan="8" style="text-align: center;"> <table border="1" style="width: 100%; border-collapse: collapse; text-align: center;"> <tr> <td style="width: 10%;"></td> <td style="width: 10%;"></td> <td style="width: 10%;"></td> <td style="width: 10%;"></td> <td style="width: 10%;"></td> <td style="width: 10%;"></td> <td style="width: 10%;"></td> <td style="width: 10%;"></td> <td style="width: 10%;"></td> <td style="width: 10%;"></td> </tr> <tr> <td></td> <td></td> <td colspan="8" style="text-align: center;"> <table border="1" style="width: 100%; border-collapse: collapse; text-align: center;"> <tr> <td style="width: 10%;"></td> <td style="width: 10%;"></td> <td style="width: 10%;"></td> <td style="width: 10%;"></td> <td style="width: 10%;"></td> <td style="width: 10%;"></td> <td style="width: 10%;"></td> <td style="width: 10%;"></td> <td style="width: 10%;"></td> <td style="width: 10%;"></td> </tr> <tr> <td></td> <td></td> <td colspan="8" style="text-align: center;"> <table border="1" style="width: 100%; border-collapse: collapse; text-align: center;"> <tr> <td style="width: 10%;"></td> <td style="width: 10%;"></td> <td style="width: 10%;"></td> <td style="width: 10%;"></td> <td style="width: 10%;"></td> <td style="width: 10%;"></td> <td style="width: 10%;"></td> <td style="width: 10%;"></td> <td style="width: 10%;"></td> <td style="width: 10%;"></td> </tr> <tr> <td></td> <td></td> <td colspan="8" style="text-align: center;"> <table border="1" style="width: 100%; border-collapse: collapse; text-align: center;"> <tr> <td style="width: 10%;"></td> <td style="width: 10%;"></td> <td style="width: 10%;"></td> <td style="width: 10%;"></td> <td style="width: 10%;"></td> <td style="width: 10%;"></td> <td style="width: 10%;"></td> <td style="width: 10%;"></td> <td style="width: 10%;"></td> <td style="width: 10%;"></td> </tr> <tr> <td></td> <td></td> <td colspan="8" style="text-align: center;"> <table border="1" style="width: 100%; border-collapse: collapse; text-align: center;"> <tr> <td style="width: 10%;"></td> <td style="width: 10%;"></td> <td style="width: 10%;"></td> <td style="width: 10%;"></td> <td style="width: 10%;"></td> <td style="width: 10%;"></td> <td style="width: 10%;"></td> <td style="width: 10%;"></td> <td style="width: 10%;"></td> <td style="width: 10%;"></td> </tr> <tr> <td></td> <td></td> <td colspan="8" style="text-align: center;"> <table border="1" style="width: 100%; border-collapse: collapse; text-align: center;"> <tr> <td style="width: 10%;"></td> <td style="width: 10%;"></td> <td style="width: 10%;"></td> <td style="width: 10%;"></td> <td style="width: 10%;"></td> <td style="width: 10%;"></td> <td style="width: 10%;"></td> <td style="width: 10%;"></td> <td style="width: 10%;"></td> <td style="width: 10%;"></td> </tr> <tr> <td></td> <td></td> <td colspan="8" style="text-align: center;"> <table border="1" style="width: 100%; border-collapse: collapse; text-align: center;"> <tr> <td style="width: 10%;"></td> <td style="width: 10%;"></td> <td style="width: 10%;"></td> <td style="width: 10%;"></td> <td style="width: 10%;"></td> <td style="width: 10%;"></td> <td style="width: 10%;"></td> <td style="width: 10%;"></td> <td style="width: 10%;"></td> <td style="width: 10%;"></td> </tr> <tr> <td></td> <td></td> <td colspan="8" style="text-align: center;"> <table border="1" style="width: 100%; border-collapse: collapse; text-align: center;"> <tr> <td style="width: 10%;"></td> <td style="width: 10%;"></td> <td style="width: 10%;"></td> <td style="width: 10%;"></td> <td style="width: 10%;"></td> <td style="width: 10%;"></td> <td style="width: 10%;"></td> <td style="width: 10%;"></td> <td style="width: 10%;"></td> <td style="width: 10%;"></td> </tr> <tr> <td></td> <td></td> <td colspan="8" style="text-align: center;"> <table border="1" style="width: 100%; border-collapse: collapse; text-align: center;"> <tr> <td style="width: 10%;"></td> <td style="width: 10%;"></td> <td style="width: 10%;"></td> <td style="width: 10%;"></td> <td style="width: 10%;"></td> <td style="width: 10%;"></td> <td style="width: 10%;"></td> <td style="width: 10%;"></td> <td style="width: 10%;"></td> <td style="width: 10%;"></td> </tr> <tr> <td></td> <td></td> <td colspan="8" style="text-align: center;"> <table border="1" style="width: 100%; border-collapse: collapse; text-align: center;"> <tr> </tr></table></td></tr></table></td></tr></table></td></tr></table></td></tr></table></td></tr></table></td></tr></table></td></tr></table></td></tr></table></td></tr></table></td></tr></table></td></tr></table></td></tr></table></td></tr></table></td></tr></table></td></tr></table></td></tr></table></td></tr></table></td></tr></table></td></tr></table></td></tr></table></td></tr></table></td></tr></table></td></tr></table></td></tr></table></td></tr></table></td></tr></table></td></tr></table></td></tr></table></td></tr></table></td></tr></table></td></tr></table></td></tr></table></td></tr></table></td></tr></table></td></tr></table> | | | | | | | | | | | | | | | | | | | | <table border="1" style="width: 100%; border-collapse: collapse; text-align: center;"> <tr> <td style="width: 10%;"></td> <td style="width: 10%;"></td> <td style="width: 10%;"></td> <td style="width: 10%;"></td> <td style="width: 10%;"></td> <td style="width: 10%;"></td> <td style="width: 10%;"></td> <td style="width: 10%;"></td> <td style="width: 10%;"></td> <td style="width: 10%;"></td> </tr> <tr> <td></td> <td></td> <td colspan="8" style="text-align: center;"> <table border="1" style="width: 100%; border-collapse: collapse; text-align: center;"> <tr> <td style="width: 10%;"></td> <td style="width: 10%;"></td> <td style="width: 10%;"></td> <td style="width: 10%;"></td> <td style="width: 10%;"></td> <td style="width: 10%;"></td> <td style="width: 10%;"></td> <td style="width: 10%;"></td> <td style="width: 10%;"></td> <td style="width: 10%;"></td> </tr> <tr> <td></td> <td></td> <td colspan="8" style="text-align: center;"> <table border="1" style="width: 100%; border-collapse: collapse; text-align: center;"> <tr> <td style="width: 10%;"></td> <td style="width: 10%;"></td> <td style="width: 10%;"></td> <td style="width: 10%;"></td> <td style="width: 10%;"></td> <td style="width: 10%;"></td> <td style="width: 10%;"></td> <td style="width: 10%;"></td> <td style="width: 10%;"></td> <td style="width: 10%;"></td> </tr> <tr> <td></td> <td></td> <td colspan="8" style="text-align: center;"> <table border="1" style="width: 100%; border-collapse: collapse; text-align: center;"> <tr> <td style="width: 10%;"></td> <td style="width: 10%;"></td> <td style="width: 10%;"></td> <td style="width: 10%;"></td> <td style="width: 10%;"></td> <td style="width: 10%;"></td> <td style="width: 10%;"></td> <td style="width: 10%;"></td> <td style="width: 10%;"></td> <td style="width: 10%;"></td> </tr> <tr> <td></td> <td></td> <td colspan="8" style="text-align: center;"> <table border="1" style="width: 100%; border-collapse: collapse; text-align: center;"> <tr> <td style="width: 10%;"></td> <td style="width: 10%;"></td> <td style="width: 10%;"></td> <td style="width: 10%;"></td> <td style="width: 10%;"></td> <td style="width: 10%;"></td> <td style="width: 10%;"></td> <td style="width: 10%;"></td> <td style="width: 10%;"></td> <td style="width: 10%;"></td> </tr> <tr> <td></td> <td></td> <td colspan="8" style="text-align: center;"> <table border="1" style="width: 100%; border-collapse: collapse; text-align: center;"> <tr> <td style="width: 10%;"></td> <td style="width: 10%;"></td> <td style="width: 10%;"></td> <td style="width: 10%;"></td> <td style="width: 10%;"></td> <td style="width: 10%;"></td> <td style="width: 10%;"></td> <td style="width: 10%;"></td> <td
style="width: 10%;"></td> <td style="width: 10%;"></td> </tr> <tr> <td></td> <td></td> <td colspan="8" style="text-align: center;"> <table border="1" style="width: 100%; border-collapse: collapse; text-align: center;"> <tr> <td style="width: 10%;"></td> <td style="width: 10%;"></td> <td style="width: 10%;"></td> <td style="width: 10%;"></td> <td style="width: 10%;"></td> <td style="width: 10%;"></td> <td style="width: 10%;"></td> <td style="width: 10%;"></td> <td style="width: 10%;"></td> <td style="width: 10%;"></td> </tr> <tr> <td></td> <td></td> <td colspan="8" style="text-align: center;"> <table border="1" style="width: 100%; border-collapse: collapse; text-align: center;"> <tr> <td style="width: 10%;"></td> <td style="width: 10%;"></td> <td style="width: 10%;"></td> <td style="width: 10%;"></td> <td style="width: 10%;"></td> <td style="width: 10%;"></td> <td style="width: 10%;"></td> <td style="width: 10%;"></td> <td style="width: 10%;"></td> <td style="width: 10%;"></td> </tr> <tr> <td></td> <td></td> <td colspan="8" style="text-align: center;"> <table border="1" style="width: 100%; border-collapse: collapse; text-align: center;"> <tr> <td style="width: 10%;"></td> <td style="width: 10%;"></td> <td style="width: 10%;"></td> <td style="width: 10%;"></td> <td style="width: 10%;"></td> <td style="width: 10%;"></td> <td style="width: 10%;"></td> <td style="width: 10%;"></td> <td style="width: 10%;"></td> <td style="width: 10%;"></td> </tr> <tr> <td></td> <td></td> <td colspan="8" style="text-align: center;"> <table border="1" style="width: 100%; border-collapse: collapse; text-align: center;"> <tr> <td style="width: 10%;"></td> <td style="width: 10%;"></td> <td style="width: 10%;"></td> <td style="width: 10%;"></td> <td style="width: 10%;"></td> <td style="width: 10%;"></td> <td style="width: 10%;"></td> <td style="width: 10%;"></td> <td style="width: 10%;"></td> <td style="width: 10%;"></td> </tr> <tr> <td></td> <td></td> <td colspan="8" style="text-align: center;"> <table border="1" style="width: 100%; border-collapse: collapse; text-align: center;"> <tr> <td style="width: 10%;"></td> <td style="width: 10%;"></td> <td style="width: 10%;"></td> <td style="width: 10%;"></td> <td style="width: 10%;"></td> <td style="width: 10%;"></td> <td style="width: 10%;"></td> <td style="width: 10%;"></td> <td style="width: 10%;"></td> <td style="width: 10%;"></td> </tr> <tr> <td></td> <td></td> <td colspan="8" style="text-align: center;"> <table border="1" style="width: 100%; border-collapse: collapse; text-align: center;"> <tr> <td style="width: 10%;"></td> <td style="width: 10%;"></td> <td style="width: 10%;"></td> <td style="width: 10%;"></td> <td style="width: 10%;"></td> <td style="width: 10%;"></td> <td style="width: 10%;"></td> <td style="width: 10%;"></td> <td style="width: 10%;"></td> <td style="width: 10%;"></td> </tr> <tr> <td></td> <td></td> <td colspan="8" style="text-align: center;"> <table border="1" style="width: 100%; border-collapse: collapse; text-align: center;"> <tr> <td style="width: 10%;"></td> <td style="width: 10%;"></td> <td style="width: 10%;"></td> <td style="width: 10%;"></td> <td style="width: 10%;"></td> <td style="width: 10%;"></td> <td style="width: 10%;"></td> <td style="width: 10%;"></td> <td style="width: 10%;"></td> <td style="width: 10%;"></td> </tr> <tr> <td></td> <td></td> <td colspan="8" style="text-align: center;"> <table border="1" style="width: 100%; border-collapse: collapse; text-align: center;"> <tr> <td style="width: 10%;"></td> <td style="width: 10%;"></td> <td style="width: 10%;"></td> <td style="width: 10%;"></td> <td style="width: 10%;"></td> <td style="width: 10%;"></td> <td style="width: 10%;"></td> <td style="width: 10%;"></td> <td style="width: 10%;"></td> <td style="width: 10%;"></td> </tr> <tr> <td></td> <td></td> <td colspan="8" style="text-align: center;"> <table border="1" style="width: 100%; border-collapse: collapse; text-align: center;"> <tr> <td style="width: 10%;"></td> <td style="width: 10%;"></td> <td style="width: 10%;"></td> <td style="width: 10%;"></td> <td style="width: 10%;"></td> <td style="width: 10%;"></td> <td style="width: 10%;"></td> <td style="width: 10%;"></td> <td style="width: 10%;"></td> <td style="width: 10%;"></td> </tr> <tr> <td></td> <td></td> <td colspan="8" style="text-align: center;"> <table border="1" style="width: 100%; border-collapse: collapse; text-align: center;"> <tr> <td style="width: 10%;"></td> <td style="width: 10%;"></td> <td style="width: 10%;"></td> <td style="width: 10%;"></td> <td style="width: 10%;"></td> <td style="width: 10%;"></td> <td style="width: 10%;"></td> <td style="width: 10%;"></td> <td style="width: 10%;"></td> <td style="width: 10%;"></td> </tr> <tr> <td></td> <td></td> <td colspan="8" style="text-align: center;"> <table border="1" style="width: 100%; border-collapse: collapse; text-align: center;"> <tr> <td style="width: 10%;"></td> <td style="width: 10%;"></td> <td style="width: 10%;"></td> <td style="width: 10%;"></td> <td style="width: 10%;"></td> <td style="width: 10%;"></td> <td style="width: 10%;"></td> <td style="width: 10%;"></td> <td style="width: 10%;"></td> <td style="width: 10%;"></td> </tr> <tr> <td></td> <td></td> <td colspan="8" style="text-align: center;"> <table border="1" style="width: 100%; border-collapse: collapse; text-align: center;"> <tr> <td style="width: 10%;"></td> <td style="width: 10%;"></td> <td style="width: 10%;"></td> <td style="width: 10%;"></td> <td style="width: 10%;"></td> <td style="width: 10%;"></td> <td style="width: 10%;"></td> <td style="width: 10%;"></td> <td style="width: 10%;"></td> <td style="width: 10%;"></td> </tr> <tr> <td></td> <td></td> <td colspan="8" style="text-align: center;"> <table border="1" style="width: 100%; border-collapse: collapse; text-align: center;"> <tr> <td style="width: 10%;"></td> <td style="width: 10%;"></td> <td style="width: 10%;"></td> <td style="width: 10%;"></td> <td style="width: 10%;"></td> <td style="width: 10%;"></td> <td style="width: 10%;"></td> <td style="width: 10%;"></td> <td style="width: 10%;"></td> <td style="width: 10%;"></td> </tr> <tr> <td></td> <td></td> <td colspan="8" style="text-align: center;"> <table border="1" style="width: 100%; border-collapse: collapse; text-align: center;"> <tr> <td style="width: 10%;"></td> <td style="width: 10%;"></td> <td style="width: 10%;"></td> <td style="width: 10%;"></td> <td style="width: 10%;"></td> <td style="width: 10%;"></td> <td style="width: 10%;"></td> <td style="width: 10%;"></td> <td style="width: 10%;"></td> <td style="width: 10%;"></td> </tr> <tr> <td></td> <td></td> <td colspan="8" style="text-align: center;"> <table border="1" style="width: 100%; border-collapse: collapse; text-align: center;"> <tr> <td style="width: 10%;"></td> <td style="width: 10%;"></td> <td style="width: 10%;"></td> <td style="width: 10%;"></td> <td style="width: 10%;"></td> <td style="width: 10%;"></td> <td style="width: 10%;"></td> <td style="width: 10%;"></td> <td style="width: 10%;"></td> <td style="width: 10%;"></td> </tr> <tr> <td></td> <td></td> <td colspan="8" style="text-align: center;"> <table border="1" style="width: 100%; border-collapse: collapse; text-align: center;"> <tr> <td style="width: 10%;"></td> <td style="width: 10%;"></td> <td style="width: 10%;"></td> <td style="width: 10%;"></td> <td style="width: 10%;"></td> <td style="width: 10%;"></td> <td style="width: 10%;"></td> <td style="width: 10%;"></td> <td style="width: 10%;"></td> <td style="width: 10%;"></td> </tr> <tr> <td></td> <td></td> <td colspan="8" style="text-align: center;"> <table border="1" style="width: 100%; border-collapse: collapse; text-align: center;"> <tr> <td style="width: 10%;"></td> <td style="width: 10%;"></td> <td style="width: 10%;"></td> <td style="width: 10%;"></td> <td style="width: 10%;"></td> <td style="width: 10%;"></td> <td style="width: 10%;"></td> <td style="width: 10%;"></td> <td style="width: 10%;"></td> <td style="width: 10%;"></td> </tr> <tr> <td></td> <td></td> <td colspan="8" style="text-align: center;"> <table border="1" style="width: 100%; border-collapse: collapse; text-align: center;"> <tr> <td style="width: 10%;"></td> <td style="width: 10%;"></td> <td style="width: 10%;"></td> <td style="width: 10%;"></td> <td style="width: 10%;"></td> <td style="width: 10%;"></td> <td style="width: 10%;"></td> <td style="width: 10%;"></td> <td style="width: 10%;"></td> <td style="width: 10%;"></td> </tr> <tr> <td></td> <td></td> <td colspan="8" style="text-align: center;"> <table border="1" style="width: 100%; border-collapse: collapse; text-align: center;"> <tr> <td style="width: 10%;"></td> <td style="width: 10%;"></td> <td style="width: 10%;"></td> <td style="width: 10%;"></td> <td style="width: 10%;"></td> <td style="width: 10%;"></td> <td style="width: 10%;"></td> <td style="width: 10%;"></td> <td style="width: 10%;"></td> <td style="width: 10%;"></td> </tr> <tr> <td></td> <td></td> <td colspan="8" style="text-align: center;"> <table border="1" style="width: 100%; border-collapse: collapse; text-align: center;"> <tr> <td style="width: 10%;"></td> <td style="width: 10%;"></td> <td style="width: 10%;"></td> <td style="width: 10%;"></td> <td style="width: 10%;"></td> <td style="width: 10%;"></td> <td style="width: 10%;"></td> <td style="width: 10%;"></td> <td style="width: 10%;"></td> <td style="width: 10%;"></td> </tr> <tr> <td></td> <td></td> <td colspan="8" style="text-align: center;"> <table border="1" style="width: 100%; border-collapse: collapse; text-align: center;"> <tr> <td style="width: 10%;"></td> <td style="width: 10%;"></td> <td style="width: 10%;"></td> <td style="width: 10%;"></td> <td style="width: 10%;"></td> <td style="width: 10%;"></td> <td style="width: 10%;"></td> <td style="width: 10%;"></td> <td style="width: 10%;"></td> <td style="width: 10%;"></td> </tr> <tr> <td></td> <td></td> <td colspan="8" style="text-align: center;"> <table border="1" style="width: 100%;
border-collapse: collapse; text-align: center;"> <tr> <td style="width: 10%;"></td> <td style="width: 10%;"></td> <td style="width: 10%;"></td> <td style="width: 10%;"></td> <td style="width: 10%;"></td> <td style="width: 10%;"></td> <td style="width: 10%;"></td> <td style="width: 10%;"></td> <td style="width: 10%;"></td> <td style="width: 10%;"></td> </tr> <tr> <td></td> <td></td> <td colspan="8" style="text-align: center;"> <table border="1" style="width: 100%; border-collapse: collapse; text-align: center;"> <tr> <td style="width: 10%;"></td> <td style="width: 10%;"></td> <td style="width: 10%;"></td> <td style="width: 10%;"></td> <td style="width: 10%;"></td> <td style="width: 10%;"></td> <td style="width: 10%;"></td> <td style="width: 10%;"></td> <td style="width: 10%;"></td> <td style="width: 10%;"></td> </tr> <tr> <td></td> <td></td> <td colspan="8" style="text-align: center;"> <table border="1" style="width: 100%; border-collapse: collapse; text-align: center;"> <tr> <td style="width: 10%;"></td> <td style="width: 10%;"></td> <td style="width: 10%;"></td> <td style="width: 10%;"></td> <td style="width: 10%;"></td> <td style="width: 10%;"></td> <td style="width: 10%;"></td> <td style="width: 10%;"></td> <td style="width: 10%;"></td> <td style="width: 10%;"></td> </tr> <tr> <td></td> <td></td> <td colspan="8" style="text-align: center;"> <table border="1" style="width: 100%; border-collapse: collapse; text-align: center;"> <tr> <td style="width: 10%;"></td> <td style="width: 10%;"></td> <td style="width: 10%;"></td> <td style="width: 10%;"></td> <td style="width: 10%;"></td> <td style="width: 10%;"></td> <td style="width: 10%;"></td> <td style="width: 10%;"></td> <td style="width: 10%;"></td> <td style="width: 10%;"></td> </tr> <tr> <td></td> <td></td> <td colspan="8" style="text-align: center;"> <table border="1" style="width: 100%; border-collapse: collapse; text-align: center;"> <tr> <td style="width: 10%;"></td> <td style="width: 10%;"></td> <td style="width: 10%;"></td> <td style="width: 10%;"></td> <td style="width: 10%;"></td> <td style="width: 10%;"></td> <td style="width: 10%;"></td> <td style="width: 10%;"></td> <td style="width: 10%;"></td> <td style="width: 10%;"></td> </tr> <tr> <td></td> <td></td> <td colspan="8" style="text-align: center;"> <table border="1" style="width: 100%; border-collapse: collapse; text-align: center;"> <tr> <td style="width: 10%;"></td> <td style="width: 10%;"></td> <td style="width: 10%;"></td> <td style="width: 10%;"></td> <td style="width: 10%;"></td> <td style="width: 10%;"></td> <td style="width: 10%;"></td> <td style="width: 10%;"></td> <td style="width: 10%;"></td> <td style="width: 10%;"></td> </tr> <tr> <td></td> <td></td> <td colspan="8" style="text-align: center;"> <table border="1" style="width: 100%; border-collapse: collapse; text-align: center;"> <tr> <td style="width: 10%;"></td> <td style="width: 10%;"></td> <td style="width: 10%;"></td> <td style="width: 10%;"></td> <td style="width: 10%;"></td> <td style="width: 10%;"></td> <td style="width: 10%;"></td> <td style="width: 10%;"></td> <td style="width: 10%;"></td> <td style="width: 10%;"></td> </tr> <tr> <td></td> <td></td> <td colspan="8" style="text-align: center;"> <table border="1" style="width: 100%; border-collapse: collapse; text-align: center;"> <tr> </tr></table></td></tr></table></td></tr></table></td></tr></table></td></tr></table></td></tr></table></td></tr></table></td></tr></table></td></tr></table></td></tr></table></td></tr></table></td></tr></table></td></tr></table></td></tr></table></td></tr></table></td></tr></table></td></tr></table></td></tr></table></td></tr></table></td></tr></table></td></tr></table></td></tr></table></td></tr></table></td></tr></table></td></tr></table></td></tr></table></td></tr></table></td></tr></table></td></tr></table></td></tr></table></td></tr></table></td></tr></table></td></tr></table></td></tr></table></td></tr></table> | | | | | | | | | | | | | | | | | | | | <table border="1" style="width: 100%; border-collapse: collapse; text-align: center;"> <tr> <td style="width: 10%;"></td> <td style="width: 10%;"></td> <td style="width: 10%;"></td> <td style="width: 10%;"></td> <td style="width: 10%;"></td> <td style="width: 10%;"></td> <td style="width: 10%;"></td> <td style="width: 10%;"></td> <td style="width: 10%;"></td> <td style="width: 10%;"></td> </tr> <tr> <td></td> <td></td> <td colspan="8" style="text-align: center;"> <table border="1" style="width: 100%; border-collapse: collapse; text-align: center;"> <tr> <td style="width: 10%;"></td> <td style="width: 10%;"></td> <td style="width: 10%;"></td> <td style="width: 10%;"></td> <td style="width: 10%;"></td> <td style="width: 10%;"></td> <td style="width: 10%;"></td> <td style="width: 10%;"></td> <td style="width: 10%;"></td> <td style="width: 10%;"></td> </tr> <tr> <td></td> <td></td> <td colspan="8" style="text-align: center;"> <table border="1" style="width: 100%; border-collapse: collapse; text-align: center;"> <tr> <td style="width: 10%;"></td> <td style="width: 10%;"></td> <td style="width: 10%;"></td> <td style="width: 10%;"></td> <td style="width: 10%;"></td> <td style="width: 10%;"></td> <td style="width: 10%;"></td> <td style="width: 10%;"></td> <td style="width: 10%;"></td> <td style="width: 10%;"></td> </tr> <tr> <td></td> <td></td> <td colspan="8" style="text-align: center;"> <table border="1" style="width: 100%; border-collapse: collapse; text-align: center;"> <tr> <td style="width: 10%;"></td> <td style="width: 10%;"></td> <td style="width: 10%;"></td> <td style="width: 10%;"></td> <td style="width: 10%;"></td> <td style="width: 10%;"></td> <td style="width: 10%;"></td> <td style="width: 10%;"></td> <td style="width: 10%;"></td> <td style="width: 10%;"></td> </tr> <tr> <td></td> <td></td> <td colspan="8" style="text-align: center;"> <table border="1" style="width: 100%; border-collapse: collapse; text-align: center;"> <tr> <td style="width: 10%;"></td> <td style="width: 10%;"></td> <td style="width: 10%;"></td> <td style="width: 10%;"></td> <td style="width: 10%;"></td> <td style="width: 10%;"></td> <td style="width: 10%;"></td> <td style="width: 10%;"></td> <td style="width: 10%;"></td> <td style="width: 10%;"></td> </tr> <tr> <td></td> <td></td> <td colspan="8" style="text-align: center;"> <table border="1" style="width: 100%; border-collapse: collapse; text-align: center;"> <tr> <td style="width: 10%;"></td> <td style="width: 10%;"></td> <td style="width: 10%;"></td> <td style="width: 10%;"></td> <td style="width: 10%;"></td> <td style="width: 10%;"></td> <td style="width: 10%;"></td> <td style="width: 10%;"></td> <td style="width: 10%;"></td> <td style="width: 10%;"></td> </tr> <tr> <td></td> <td></td> <td colspan="8" style="text-align: center;"> <table border="1" style="width: 100%; border-collapse: collapse; text-align: center;"> <tr> <td style="width: 10%;"></td> <td style="width: 10%;"></td> <td style="width: 10%;"></td> <td style="width: 10%;"></td> <td style="width: 10%;"></td> <td style="width: 10%;"></td> <td style="width: 10%;"></td> <td style="width: 10%;"></td> <td style="width: 10%;"></td> <td style="width: 10%;"></td> </tr> <tr> <td></td> <td></td> <td colspan="8" style="text-align: center;"> <table border="1" style="width: 100%; border-collapse: collapse; text-align: center;"> <tr> <td style="width: 10%;"></td> <td style="width: 10%;"></td> <td style="width: 10%;"></td> <td style="width: 10%;"></td> <td style="width: 10%;"></td> <td style="width: 10%;"></td> <td style="width: 10%;"></td> <td style="width: 10%;"></td> <td style="width: 10%;"></td> <td style="width: 10%;"></td> </tr> <tr> <td></td> <td></td> <td colspan="8" style="text-align: center;"> <table border="1" style="width: 100%; border-collapse: collapse; text-align: center;"> <tr> <td style="width: 10%;"></td> <td style="width: 10%;"></td> <td style="width: 10%;"></td> <td style="width: 10%;"></td> <td style="width: 10%;"></td> <td style="width: 10%;"></td> <td style="width:
10%;"></td> <td style="width: 10%;"></td> <td style="width: 10%;"></td> <td style="width: 10%;"></td> </tr> <tr> <td></td> <td></td> <td colspan="8" style="text-align: center;"> <table border="1" style="width: 100%; border-collapse: collapse; text-align: center;"> <tr> <td style="width: 10%;"></td> <td style="width: 10%;"></td> <td style="width: 10%;"></td> <td style="width: 10%;"></td> <td style="width: 10%;"></td> <td style="width: 10%;"></td> <td style="width: 10%;"></td> <td style="width: 10%;"></td> <td style="width: 10%;"></td> <td style="width: 10%;"></td> </tr> <tr> <td></td> <td></td> <td colspan="8" style="text-align: center;"> <table border="1" style="width: 100%; border-collapse: collapse; text-align: center;"> <tr> <td style="width: 10%;"></td> <td style="width: 10%;"></td> <td style="width: 10%;"></td> <td style="width: 10%;"></td> <td style="width: 10%;"></td> <td style="width: 10%;"></td> <td style="width: 10%;"></td> <td style="width: 10%;"></td> <td style="width: 10%;"></td> <td style="width: 10%;"></td> </tr> <tr> <td></td> <td></td> <td colspan="8" style="text-align: center;"> <table border="1" style="width: 100%; border-collapse: collapse; text-align: center;"> <tr> <td style="width: 10%;"></td> <td style="width: 10%;"></td> <td style="width: 10%;"></td> <td style="width: 10%;"></td> <td style="width: 10%;"></td> <td style="width: 10%;"></td> <td style="width: 10%;"></td> <td style="width: 10%;"></td> <td style="width: 10%;"></td> <td style="width: 10%;"></td> </tr> <tr> <td></td> <td></td> <td colspan="8" style="text-align: center;"> <table border="1" style="width: 100%; border-collapse: collapse; text-align: center;"> <tr> <td style="width: 10%;"></td> <td style="width: 10%;"></td> <td style="width: 10%;"></td> <td style="width: 10%;"></td> <td style="width: 10%;"></td> <td style="width: 10%;"></td> <td style="width: 10%;"></td> <td style="width: 10%;"></td> <td style="width: 10%;"></td> <td style="width: 10%;"></td> </tr> <tr> <td></td> <td></td> <td colspan="8" style="text-align: center;"> <table border="1" style="width: 100%; border-collapse: collapse; text-align: center;"> <tr> <td style="width: 10%;"></td> <td style="width: 10%;"></td> <td style="width: 10%;"></td> <td style="width: 10%;"></td> <td style="width: 10%;"></td> <td style="width: 10%;"></td> <td style="width: 10%;"></td> <td style="width: 10%;"></td> <td style="width: 10%;"></td> <td style="width: 10%;"></td> </tr> <tr> <td></td> <td></td> <td colspan="8" style="text-align: center;"> <table border="1" style="width: 100%; border-collapse: collapse; text-align: center;"> <tr> <td style="width: 10%;"></td> <td style="width: 10%;"></td> <td style="width: 10%;"></td> <td style="width: 10%;"></td> <td style="width: 10%;"></td> <td style="width: 10%;"></td> <td style="width: 10%;"></td> <td style="width: 10%;"></td> <td style="width: 10%;"></td> <td style="width: 10%;"></td> </tr> <tr> <td></td> <td></td> <td colspan="8" style="text-align: center;"> <table border="1" style="width: 100%; border-collapse: collapse; text-align: center;"> <tr> <td style="width: 10%;"></td> <td style="width: 10%;"></td> <td style="width: 10%;"></td> <td style="width: 10%;"></td> <td style="width: 10%;"></td> <td style="width: 10%;"></td> <td style="width: 10%;"></td> <td style="width: 10%;"></td> <td style="width: 10%;"></td> <td style="width: 10%;"></td> </tr> <tr> <td></td> <td></td> <td colspan="8" style="text-align: center;"> <table border="1" style="width: 100%; border-collapse: collapse; text-align: center;"> <tr> <td style="width: 10%;"></td> <td style="width: 10%;"></td> <td style="width: 10%;"></td> <td style="width: 10%;"></td> <td style="width: 10%;"></td> <td style="width: 10%;"></td> <td style="width: 10%;"></td> <td style="width: 10%;"></td> <td style="width: 10%;"></td> <td style="width: 10%;"></td> </tr> <tr> <td></td> <td></td> <td colspan="8" style="text-align: center;"> <table border="1" style="width: 100%; border-collapse: collapse; text-align: center;"> <tr> <td style="width: 10%;"></td> <td style="width: 10%;"></td> <td style="width: 10%;"></td> <td style="width: 10%;"></td> <td style="width: 10%;"></td> <td style="width: 10%;"></td> <td style="width: 10%;"></td> <td style="width: 10%;"></td> <td style="width: 10%;"></td> <td style="width: 10%;"></td> </tr> <tr> <td></td> <td></td> <td colspan="8" style="text-align: center;"> <table border="1" style="width: 100%; border-collapse: collapse; text-align: center;"> <tr> <td style="width: 10%;"></td> <td style="width: 10%;"></td> <td style="width: 10%;"></td> <td style="width: 10%;"></td> <td style="width: 10%;"></td> <td style="width: 10%;"></td> <td style="width: 10%;"></td> <td style="width: 10%;"></td> <td style="width: 10%;"></td> <td style="width: 10%;"></td> </tr> <tr> <td></td> <td></td> <td colspan="8" style="text-align: center;"> <table border="1" style="width: 100%; border-collapse: collapse; text-align: center;"> <tr> <td style="width: 10%;"></td> <td style="width: 10%;"></td> <td style="width: 10%;"></td> <td style="width: 10%;"></td> <td style="width: 10%;"></td> <td style="width: 10%;"></td> <td style="width: 10%;"></td> <td style="width: 10%;"></td> <td style="width: 10%;"></td> <td style="width: 10%;"></td> </tr> <tr> <td></td> <td></td> <td colspan="8" style="text-align: center;"> <table border="1" style="width: 100%; border-collapse: collapse; text-align: center;"> <tr> <td style="width: 10%;"></td> <td style="width: 10%;"></td> <td style="width: 10%;"></td> <td style="width: 10%;"></td> <td style="width: 10%;"></td> <td style="width: 10%;"></td> <td style="width: 10%;"></td> <td style="width: 10%;"></td> <td style="width: 10%;"></td> <td style="width: 10%;"></td> </tr> <tr> <td></td> <td></td> <td colspan="8" style="text-align: center;"> <table border="1" style="width: 100%; border-collapse: collapse; text-align: center;"> <tr> <td style="width: 10%;"></td> <td style="width: 10%;"></td> <td style="width: 10%;"></td> <td style="width: 10%;"></td> <td style="width: 10%;"></td> <td style="width: 10%;"></td> <td style="width: 10%;"></td> <td style="width: 10%;"></td> <td style="width: 10%;"></td> <td style="width: 10%;"></td> </tr> <tr> <td></td> <td></td> <td colspan="8" style="text-align: center;"> <table border="1" style="width: 100%; border-collapse: collapse; text-align: center;"> <tr> <td style="width: 10%;"></td> <td style="width: 10%;"></td> <td style="width: 10%;"></td> <td style="width: 10%;"></td> <td style="width: 10%;"></td> <td style="width: 10%;"></td> <td style="width: 10%;"></td> <td style="width: 10%;"></td> <td style="width: 10%;"></td> <td style="width: 10%;"></td> </tr> <tr> <td></td> <td></td> <td colspan="8" style="text-align: center;"> <table border="1" style="width: 100%; border-collapse: collapse; text-align: center;"> <tr> <td style="width: 10%;"></td> <td style="width: 10%;"></td> <td style="width: 10%;"></td> <td style="width: 10%;"></td> <td style="width: 10%;"></td> <td style="width: 10%;"></td> <td style="width: 10%;"></td> <td style="width: 10%;"></td> <td style="width: 10%;"></td> <td style="width: 10%;"></td> </tr> <tr> <td></td> <td></td> <td colspan="8" style="text-align: center;"> <table border="1" style="width: 100%; border-collapse: collapse; text-align: center;"> <tr> <td style="width: 10%;"></td> <td style="width: 10%;"></td> <td style="width: 10%;"></td> <td style="width: 10%;"></td> <td style="width: 10%;"></td> <td style="width: 10%;"></td> <td style="width: 10%;"></td> <td style="width: 10%;"></td> <td style="width: 10%;"></td> <td style="width: 10%;"></td> </tr> <tr> <td></td> <td></td> <td colspan="8" style="text-align: center;"> <table border="1" style="width: 100%; border-collapse: collapse; text-align: center;"> <tr> <td style="width: 10%;"></td> <td style="width: 10%;"></td> <td style="width: 10%;"></td> <td style="width: 10%;"></td> <td style="width: 10%;"></td> <td style="width: 10%;"></td> <td style="width: 10%;"></td> <td style="width: 10%;"></td> <td style="width: 10%;"></td> <td style="width: 10%;"></td> </tr> <tr> <td></td> <td></td> <td colspan="8" style="text-align: center;"> <table border="1" style="width: 100%; border-collapse: collapse; text-align: center;"> <tr> <td style="width: 10%;"></td> <td style="width: 10%;"></td> <td style="width: 10%;"></td> <td style="width: 10%;"></td> <td style="width: 10%;"></td> <td style="width: 10%;"></td> <td style="width: 10%;"></td> <td style="width: 10%;"></td> <td style="width: 10%;"></td> <td style="width: 10%;"></td> </tr> <tr> <td></td> <td></td> <td colspan="8" style="text-align: center;"> <table border="1" style="width: 100%; border-collapse: collapse; text-align: center;"> <tr> <td style="width: 10%;"></td> <td style="width: 10%;"></td> <td style="width: 10%;"></td> <td style="width: 10%;"></td> <td style="width: 10%;"></td> <td style="width: 10%;"></td> <td style="width: 10%;"></td> <td style="width: 10%;"></td> <td style="width: 10%;"></td> <td style="width: 10%;"></td> </tr> <tr> <td></td> <td></td> <td colspan="8" style="text-align: center;"> <table border="1" style="width: 100%; border-collapse: collapse; text-align: center;"> <tr> <td style="width: 10%;"></td> <td style="width: 10%;"></td> <td style="width: 10%;"></td> <td style="width: 10%;"></td> <td style="width: 10%;"></td> <td style="width: 10%;"></td> <td style="width: 10%;"></td> <td style="width: 10%;"></td> <td style="width: 10%;"></td> <td style="width: 10%;"></td> </tr> <tr> <td></td> <td></td> <td colspan="8" style="text-align: center;"> <table border="1" style="width: 100%; border-collapse: collapse; text-align: center;"> <tr> <td style="width: 10%;"></td> <td style="width: 10%;"></td> <td style="width: 10%;"></td> <td style="width: 10%;"></td> <td style="width: 10%;"></td> <td style="width: 10%;"></td> <td style="width: 10%;"></td> <td style="width: 10%;"></td> <td style="width: 10%;"></td> <td style="width: 10%;"></td> </tr> <tr> <td></td> <td></td> <td colspan="8" style="text-align:
center;"> <table border="1" style="width: 100%; border-collapse: collapse; text-align: center;"> <tr> <td style="width: 10%;"></td> <td style="width: 10%;"></td> <td style="width: 10%;"></td> <td style="width: 10%;"></td> <td style="width: 10%;"></td> <td style="width: 10%;"></td> <td style="width: 10%;"></td> <td style="width: 10%;"></td> <td style="width: 10%;"></td> <td style="width: 10%;"></td> </tr> <tr> <td></td> <td></td> <td colspan="8" style="text-align: center;"> <table border="1" style="width: 100%; border-collapse: collapse; text-align: center;"> <tr> <td style="width: 10%;"></td> <td style="width: 10%;"></td> <td style="width: 10%;"></td> <td style="width: 10%;"></td> <td style="width: 10%;"></td> <td style="width: 10%;"></td> <td style="width: 10%;"></td> <td style="width: 10%;"></td> <td style="width: 10%;"></td> <td style="width: 10%;"></td> </tr> <tr> <td></td> <td></td> <td colspan="8" style="text-align: center;"> <table border="1" style="width: 100%; border-collapse: collapse; text-align: center;"> <tr> <td style="width: 10%;"></td> <td style="width: 10%;"></td> <td style="width: 10%;"></td> <td style="width: 10%;"></td> <td style="width: 10%;"></td> <td style="width: 10%;"></td> <td style="width: 10%;"></td> <td style="width: 10%;"></td> <td style="width: 10%;"></td> <td style="width: 10%;"></td> </tr> <tr> <td></td> <td></td> <td colspan="8" style="text-align: center;"> <table border="1" style="width: 100%; border-collapse: collapse; text-align: center;"> <tr> </tr></table></td></tr></table></td></tr></table></td></tr></table></td></tr></table></td></tr></table></td></tr></table></td></tr></table></td></tr></table></td></tr></table></td></tr></table></td></tr></table></td></tr></table></td></tr></table></td></tr></table></td></tr></table></td></tr></table></td></tr></table></td></tr></table></td></tr></table></td></tr></table></td></tr></table></td></tr></table></td></tr></table></td></tr></table></td></tr></table></td></tr></table></td></tr></table></td></tr></table></td></tr></table></td></tr></table></td></tr></table></td></tr></table></td></tr></table> | | | | | | | | | | | | | | | | | | | | <table border="1" style="width: 100%; border-collapse: collapse; text-align: center;"> <tr> <td style="width: 10%;"></td> <td style="width: 10%;"></td> <td style="width: 10%;"></td> <td style="width: 10%;"></td> <td style="width: 10%;"></td> <td style="width: 10%;"></td> <td style="width: 10%;"></td> <td style="width: 10%;"></td> <td style="width: 10%;"></td> <td style="width: 10%;"></td> </tr> <tr> <td></td> <td></td> <td colspan="8" style="text-align: center;"> <table border="1" style="width: 100%; border-collapse: collapse; text-align: center;"> <tr> <td style="width: 10%;"></td> <td style="width: 10%;"></td> <td style="width: 10%;"></td> <td style="width: 10%;"></td> <td style="width: 10%;"></td> <td style="width: 10%;"></td> <td style="width: 10%;"></td> <td style="width: 10%;"></td> <td style="width: 10%;"></td> <td style="width: 10%;"></td> </tr> <tr> <td></td> <td></td> <td colspan="8" style="text-align: center;"> <table border="1" style="width: 100%; border-collapse: collapse; text-align: center;"> <tr> <td style="width: 10%;"></td> <td style="width: 10%;"></td> <td style="width: 10%;"></td> <td style="width: 10%;"></td> <td style="width: 10%;"></td> <td style="width: 10%;"></td> <td style="width: 10%;"></td> <td style="width: 10%;"></td> <td style="width: 10%;"></td> <td style="width: 10%;"></td> </tr> <tr> <td></td> <td></td> <td colspan="8" style="text-align: center;"> <table border="1" style="width: 100%; border-collapse: collapse; text-align: center;"> <tr> <td style="width: 10%;"></td> <td style="width: 10%;"></td> <td style="width: 10%;"></td> <td style="width: 10%;"></td> <td style="width: 10%;"></td> <td style="width: 10%;"></td> <td style="width: 10%;"></td> <td style="width: 10%;"></td> <td style="width: 10%;"></td> <td style="width: 10%;"></td> </tr> <tr> <td></td> <td></td> <td colspan="8" style="text-align: center;"> <table border="1" style="width: 100%; border-collapse: collapse; text-align: center;"> <tr> <td style="width: 10%;"></td> <td style="width: 10%;"></td> <td style="width: 10%;"></td> <td style="width: 10%;"></td> <td style="width: 10%;"></td> <td style="width: 10%;"></td> <td style="width: 10%;"></td> <td style="width: 10%;"></td> <td style="width: 10%;"></td> <td style="width: 10%;"></td> </tr> <tr> <td></td> <td></td> <td colspan="8" style="text-align: center;"> <table border="1" style="width: 100%; border-collapse: collapse; text-align: center;"> <tr> <td style="width: 10%;"></td> <td style="width: 10%;"></td> <td style="width: 10%;"></td> <td style="width: 10%;"></td> <td style="width: 10%;"></td> <td style="width: 10%;"></td> <td style="width: 10%;"></td> <td style="width: 10%;"></td> <td style="width: 10%;"></td> <td style="width: 10%;"></td> </tr> <tr> <td></td> <td></td> <td colspan="8" style="text-align: center;"> <table border="1" style="width: 100%; border-collapse: collapse; text-align: center;"> <tr> <td style="width: 10%;"></td> <td style="width: 10%;"></td> <td style="width: 10%;"></td> <td style="width: 10%;"></td> <td style="width: 10%;"></td> <td style="width: 10%;"></td> <td style="width: 10%;"></td> <td style="width: 10%;"></td> <td style="width: 10%;"></td> <td style="width: 10%;"></td> </tr> <tr> <td></td> <td></td> <td colspan="8" style="text-align: center;"> <table border="1" style="width: 100%; border-collapse: collapse; text-align: center;"> <tr> <td style="width: 10%;"></td> <td style="width: 10%;"></td> <td style="width: 10%;"></td> <td style="width: 10%;"></td> <td style="width: 10%;"></td> <td style="width: 10%;"></td> <td style="width: 10%;"></td> <td style="width: 10%;"></td> <td style="width: 10%;"></td> <td style="width: 10%;"></td> </tr> <tr> <td></td> <td></td> <td colspan="8" style="text-align: center;"> <table border="1" style="width: 100%; border-collapse: collapse; text-align: center;"> <tr> <td style="width: 10%;"></td> <td style="width: 10%;"></td> <td style="width: 10%;"></td> <td style="width: 10%;"></td> <td style="width: 10%;"></td> <td style="width: 10%;"></td> <td style="width: 10%;"></td> <td style="width: 10%;"></td> <td style="width: 10%;"></td> <td style="width: 10%;"></td> </tr> <tr> <td></td> <td></td> <td colspan="8" style="text-align: center;"> <table border="1" style="width: 100%; border-collapse: collapse; text-align: center;"> <tr> <td style="width: 10%;"></td> <td style="width: 10%;"></td> <td style="width: 10%;"></td> <td style="width: 10%;"></td> <td style="width: 10%;"></td> <td style="width: 10%;"></td> <td style="width: 10%;"></td> <td style="width: 10%;"></td> <td style="width: 10%;"></td> <td style="width: 10%;"></td> </tr> <tr> <td></td> <td></td> <td colspan="8" style="text-align: center;"> <table border="1" style="width: 100%; border-collapse: collapse; text-align: center;"> <tr> <td style="width: 10%;"></td> <td style="width: 10%;"></td> <td style="width: 10%;"></td> <td style="width: 10%;"></td> <td style="width: 10%;"></td> <td style="width: 10%;"></td> <td style="width: 10%;"></td> <td style="width: 10%;"></td> <td style="width: 10%;"></td> <td style="width: 10%;"></td> </tr> <tr> <td></td> <td></td> <td colspan="8" style="text-align: center;"> <table border="1" style="width: 100%; border-collapse: collapse; text-align: center;"> <tr> <td style="width: 10%;"></td> <td style="width: 10%;"></td> <td style="width: 10%;"></td> <td style="width: 10%;"></td> <td style="width: 10%;"></td> <td style="width: 10%;"></td> <td style="width: 10%;"></td> <td style="width: 10%;"></td> <td style="width: 10%;"></td> <td style="width: 10%;"></td> </tr> <tr> <td></td> <td></td> <td colspan="8" style="text-align: center;"> <table border="1" style="width: 100%; border-collapse: collapse; text-align: center;"> <tr> <td style="width: 10%;"></td> <td style="width: 10%;"></td> <td style="width: 10%;"></td> <td style="width: 10%;"></td> <td style="width: 10%;"></td> <td style="width:
10%;"></td> <td style="width: 10%;"></td> <td style="width: 10%;"></td> <td style="width: 10%;"></td> <td style="width: 10%;"></td> </tr> <tr> <td></td> <td></td> <td colspan="8" style="text-align: center;"> <table border="1" style="width: 100%; border-collapse: collapse; text-align: center;"> <tr> <td style="width: 10%;"></td> <td style="width: 10%;"></td> <td style="width: 10%;"></td> <td style="width: 10%;"></td> <td style="width: 10%;"></td> <td style="width: 10%;"></td> <td style="width: 10%;"></td> <td style="width: 10%;"></td> <td style="width: 10%;"></td> <td style="width: 10%;"></td> </tr> <tr> <td></td> <td></td> <td colspan="8" style="text-align: center;"> <table border="1" style="width: 100%; border-collapse: collapse; text-align: center;"> <tr> <td style="width: 10%;"></td> <td style="width: 10%;"></td> <td style="width: 10%;"></td> <td style="width: 10%;"></td> <td style="width: 10%;"></td> <td style="width: 10%;"></td> <td style="width: 10%;"></td> <td style="width: 10%;"></td> <td style="width: 10%;"></td> <td style="width: 10%;"></td> </tr> <tr> <td></td> <td></td> <td colspan="8" style="text-align: center;"> <table border="1" style="width: 100%; border-collapse: collapse; text-align: center;"> <tr> <td style="width: 10%;"></td> <td style="width: 10%;"></td> <td style="width: 10%;"></td> <td style="width: 10%;"></td> <td style="width: 10%;"></td> <td style="width: 10%;"></td> <td style="width: 10%;"></td> <td style="width: 10%;"></td> <td style="width: 10%;"></td> <td style="width: 10%;"></td> </tr> <tr> <td></td> <td></td> <td colspan="8" style="text-align: center;"> <table border="1" style="width: 100%; border-collapse: collapse; text-align: center;"> <tr> <td style="width: 10%;"></td> <td style="width: 10%;"></td> <td style="width: 10%;"></td> <td style="width: 10%;"></td> <td style="width: 10%;"></td> <td style="width: 10%;"></td> <td style="width: 10%;"></td> <td style="width: 10%;"></td> <td style="width: 10%;"></td> <td style="width: 10%;"></td> </tr> <tr> <td></td> <td></td> <td colspan="8" style="text-align: center;"> <table border="1" style="width: 100%; border-collapse: collapse; text-align: center;"> <tr> <td style="width: 10%;"></td> <td style="width: 10%;"></td> <td style="width: 10%;"></td> <td style="width: 10%;"></td> <td style="width: 10%;"></td> <td style="width: 10%;"></td> <td style="width: 10%;"></td> <td style="width: 10%;"></td> <td style="width: 10%;"></td> <td style="width: 10%;"></td> </tr> <tr> <td></td> <td></td> <td colspan="8" style="text-align: center;"> <table border="1" style="width: 100%; border-collapse: collapse; text-align: center;"> <tr> <td style="width: 10%;"></td> <td style="width: 10%;"></td> <td style="width: 10%;"></td> <td style="width: 10%;"></td> <td style="width: 10%;"></td> <td style="width: 10%;"></td> <td style="width: 10%;"></td> <td style="width: 10%;"></td> <td style="width: 10%;"></td> <td style="width: 10%;"></td> </tr> <tr> <td></td> <td></td> <td colspan="8" style="text-align: center;"> <table border="1" style="width: 100%; border-collapse: collapse; text-align: center;"> <tr> <td style="width: 10%;"></td> <td style="width: 10%;"></td> <td style="width: 10%;"></td> <td style="width: 10%;"></td> <td style="width: 10%;"></td> <td style="width: 10%;"></td> <td style="width: 10%;"></td> <td style="width: 10%;"></td> <td style="width: 10%;"></td> <td style="width: 10%;"></td> </tr> <tr> <td></td> <td></td> <td colspan="8" style="text-align: center;"> <table border="1" style="width: 100%; border-collapse: collapse; text-align: center;"> <tr> <td style="width: 10%;"></td> <td style="width: 10%;"></td> <td style="width: 10%;"></td> <td style="width: 10%;"></td> <td style="width: 10%;"></td> <td style="width: 10%;"></td> <td style="width: 10%;"></td> <td style="width: 10%;"></td> <td style="width: 10%;"></td> <td style="width: 10%;"></td> </tr> <tr> <td></td> <td></td> <td colspan="8" style="text-align: center;"> <table border="1" style="width: 100%; border-collapse: collapse; text-align: center;"> <tr> <td style="width: 10%;"></td> <td style="width: 10%;"></td> <td style="width: 10%;"></td> <td style="width: 10%;"></td> <td style="width: 10%;"></td> <td style="width: 10%;"></td> <td style="width: 10%;"></td> <td style="width: 10%;"></td> <td style="width: 10%;"></td> <td style="width: 10%;"></td> </tr> <tr> <td></td> <td></td> <td colspan="8" style="text-align: center;"> <table border="1" style="width: 100%; border-collapse: collapse; text-align: center;"> <tr> <td style="width: 10%;"></td> <td style="width: 10%;"></td> <td style="width: 10%;"></td> <td style="width: 10%;"></td> <td style="width: 10%;"></td> <td style="width: 10%;"></td> <td style="width: 10%;"></td> <td style="width: 10%;"></td> <td style="width: 10%;"></td> <td style="width: 10%;"></td> </tr> <tr> <td></td> <td></td> <td colspan="8" style="text-align: center;"> <table border="1" style="width: 100%; border-collapse: collapse; text-align: center;"> <tr> <td style="width: 10%;"></td> <td style="width: 10%;"></td> <td style="width: 10%;"></td> <td style="width: 10%;"></td> <td style="width: 10%;"></td> <td style="width: 10%;"></td> <td style="width: 10%;"></td> <td style="width: 10%;"></td> <td style="width: 10%;"></td> <td style="width: 10%;"></td> </tr> <tr> <td></td> <td></td> <td colspan="8" style="text-align: center;"> <table border="1" style="width: 100%; border-collapse: collapse; text-align: center;"> <tr> <td style="width: 10%;"></td> <td style="width: 10%;"></td> <td style="width: 10%;"></td> <td style="width: 10%;"></td> <td style="width: 10%;"></td> <td style="width: 10%;"></td> <td style="width: 10%;"></td> <td style="width: 10%;"></td> <td style="width: 10%;"></td> <td style="width: 10%;"></td> </tr> <tr> <td></td> <td></td> <td colspan="8" style="text-align: center;"> <table border="1" style="width: 100%; border-collapse: collapse; text-align: center;"> <tr> <td style="width: 10%;"></td> <td style="width: 10%;"></td> <td style="width: 10%;"></td> <td style="width: 10%;"></td> <td style="width: 10%;"></td> <td style="width: 10%;"></td> <td style="width: 10%;"></td> <td style="width: 10%;"></td> <td style="width: 10%;"></td> <td style="width: 10%;"></td> </tr> <tr> <td></td> <td></td> <td colspan="8" style="text-align: center;"> <table border="1" style="width: 100%; border-collapse: collapse; text-align: center;"> <tr> <td style="width: 10%;"></td> <td style="width: 10%;"></td> <td style="width: 10%;"></td> <td style="width: 10%;"></td> <td style="width: 10%;"></td> <td style="width: 10%;"></td> <td style="width: 10%;"></td> <td style="width: 10%;"></td> <td style="width: 10%;"></td> <td style="width: 10%;"></td> </tr> <tr> <td></td> <td></td> <td colspan="8" style="text-align: center;"> <table border="1" style="width: 100%; border-collapse: collapse; text-align: center;"> <tr> <td style="width: 10%;"></td> <td style="width: 10%;"></td> <td style="width: 10%;"></td> <td style="width: 10%;"></td> <td style="width: 10%;"></td> <td style="width: 10%;"></td> <td style="width: 10%;"></td> <td style="width: 10%;"></td> <td style="width: 10%;"></td> <td style="width: 10%;"></td> </tr> <tr> <td></td> <td></td> <td colspan="8" style="text-align: center;"> <table border="1" style="width: 100%; border-collapse: collapse; text-align: center;"> <tr> <td style="width: 10%;"></td> <td style="width: 10%;"></td> <td style="width: 10%;"></td> <td style="width: 10%;"></td> <td style="width: 10%;"></td> <td style="width: 10%;"></td> <td style="width: 10%;"></td> <td style="width: 10%;"></td> <td style="width: 10%;"></td> <td style="width: 10%;"></td> </tr> <tr> <td></td> <td></td> <td colspan="8" style="text-align: center;"> <table border="1" style="width: 100%; border-collapse: collapse; text-align: center;"> <tr> <td style="width: 10%;"></td> <td style="width: 10%;"></td> <td style="width: 10%;"></td> <td style="width: 10%;"></td> <td style="width: 10%;"></td> <td style="width: 10%;"></td> <td style="width: 10%;"></td> <td style="width: 10%;"></td> <td style="width: 10%;"></td> <td style="width: 10%;"></td> </tr> <tr> <td></td> <td></td> <td colspan="8" style="text-align: center;"> <table border="1" style="width: 100%; border-collapse: collapse; text-align: center;"> <tr> <td style="width: 10%;"></td> <td style="width: 10%;"></td> <td style="width: 10%;"></td> <td style="width: 10%;"></td> <td style="width: 10%;"></td> <td style="width: 10%;"></td> <td style="width: 10%;"></td> <td style="width: 10%;"></td> <td style="width: 10%;"></td> <td style="width: 10%;"></td> </tr> <tr> <td></td> <td></td> <td colspan="8" style="text-align: center;"> <table border="1" style="width: 100%; border-collapse: collapse; text-align: center;"> <tr> <td style="width: 10%;"></td> <td style="width: 10%;"></td> <td style="width: 10%;"></td> <td style="width: 10%;"></td> <td style="width: 10%;"></td> <td style="width: 10%;"></td> <td style="width: 10%;"></td> <td style="width: 10%;"></td> <td style="width: 10%;"></td> <td style="width: 10%;"></td> </tr> <tr> <td></td> <td></td> <td colspan="8" style="text-align: center;"> <table border="1" style="width: 100%; border-collapse: collapse; text-align: center;"> <tr> </tr></table></td></tr></table></td></tr></table></td></tr></table></td></tr></table></td></tr></table></td></tr></table></td></tr></table></td></tr></table></td></tr></table></td></tr></table></td></tr></table></td></tr></table></td></tr></table></td></tr></table></td></tr></table></td></tr></table></td></tr></table></td></tr></table></td></tr></table></td></tr></table></td></tr></table></td></tr></table></td></tr></table></td></tr></table></td></tr></table></td></tr></table></td></tr></table></td></tr></table></td></tr></table></td></tr></table></td></tr></table></td></tr></table>
 | | | | | | | | | | | | | | | | | | | | <table border="1" style="width: 100%; border-collapse: collapse; text-align: center;"> <tr> <td style="width: 10%;"></td> <td style="width: 10%;"></td> <td style="width: 10%;"></td> <td style="width: 10%;"></td> <td style="width: 10%;"></td> <td style="width: 10%;"></td> <td style="width: 10%;"></td> <td style="width: 10%;"></td> <td style="width: 10%;"></td> <td style="width: 10%;"></td> </tr> <tr> <td></td> <td></td> <td colspan="8" style="text-align: center;"> <table border="1" style="width: 100%; border-collapse: collapse; text-align: center;"> <tr> <td style="width: 10%;"></td> <td style="width: 10%;"></td> <td style="width: 10%;"></td> <td style="width: 10%;"></td> <td style="width: 10%;"></td> <td style="width: 10%;"></td> <td style="width: 10%;"></td> <td style="width: 10%;"></td> <td style="width: 10%;"></td> <td style="width: 10%;"></td> </tr> <tr> <td></td> <td></td> <td colspan="8" style="text-align: center;"> <table border="1" style="width: 100%; border-collapse: collapse; text-align: center;"> <tr> <td style="width: 10%;"></td> <td style="width: 10%;"></td> <td style="width: 10%;"></td> <td style="width: 10%;"></td> <td style="width: 10%;"></td> <td style="width: 10%;"></td> <td style="width: 10%;"></td> <td style="width: 10%;"></td> <td style="width: 10%;"></td> <td style="width: 10%;"></td> </tr> <tr> <td></td> <td></td> <td colspan="8" style="text-align: center;"> <table border="1" style="width: 100%; border-collapse: collapse; text-align: center;"> <tr> <td style="width: 10%;"></td> <td style="width: 10%;"></td> <td style="width: 10%;"></td> <td style="width: 10%;"></td> <td style="width: 10%;"></td> <td style="width: 10%;"></td> <td style="width: 10%;"></td> <td style="width: 10%;"></td> <td style="width: 10%;"></td> <td style="width: 10%;"></td> </tr> <tr> <td></td> <td></td> <td colspan="8" style="text-align: center;"> <table border="1" style="width: 100%; border-collapse: collapse; text-align: center;"> <tr> <td style="width: 10%;"></td> <td style="width: 10%;"></td> <td style="width: 10%;"></td> <td style="width: 10%;"></td> <td style="width: 10%;"></td> <td style="width: 10%;"></td> <td style="width: 10%;"></td> <td style="width: 10%;"></td> <td style="width: 10%;"></td> <td style="width: 10%;"></td> </tr> <tr> <td></td> <td></td> <td colspan="8" style="text-align: center;"> <table border="1" style="width: 100%; border-collapse: collapse; text-align: center;"> <tr> <td style="width: 10%;"></td> <td style="width: 10%;"></td> <td style="width: 10%;"></td> <td style="width: 10%;"></td> <td style="width: 10%;"></td> <td style="width: 10%;"></td> <td style="width: 10%;"></td> <td style="width: 10%;"></td> <td style="width: 10%;"></td> <td style="width: 10%;"></td> </tr> <tr> <td></td> <td></td> <td colspan="8" style="text-align: center;"> <table border="1" style="width: 100%; border-collapse: collapse; text-align: center;"> <tr> <td style="width: 10%;"></td> <td style="width: 10%;"></td> <td style="width: 10%;"></td> <td style="width: 10%;"></td> <td style="width: 10%;"></td> <td style="width: 10%;"></td> <td style="width: 10%;"></td> <td style="width: 10%;"></td> <td style="width: 10%;"></td> <td style="width: 10%;"></td> </tr> <tr> <td></td> <td></td> <td colspan="8" style="text-align: center;"> <table border="1" style="width: 100%; border-collapse: collapse; text-align: center;"> <tr> <td style="width: 10%;"></td> <td style="width: 10%;"></td> <td style="width: 10%;"></td> <td style="width: 10%;"></td> <td style="width: 10%;"></td> <td style="width: 10%;"></td> <td style="width: 10%;"></td> <td style="width: 10%;"></td> <td style="width: 10%;"></td> <td style="width: 10%;"></td> </tr> <tr> <td></td> <td></td> <td colspan="8" style="text-align: center;"> <table border="1" style="width: 100%; border-collapse: collapse; text-align: center;"> <tr> <td style="width: 10%;"></td> <td style="width: 10%;"></td> <td style="width: 10%;"></td> <td style="width: 10%;"></td> <td style="width: 10%;"></td> <td style="width: 10%;"></td> <td style="width: 10%;"></td> <td style="width: 10%;"></td> <td style="width: 10%;"></td> <td style="width: 10%;"></td> </tr> <tr> <td></td> <td></td> <td colspan="8" style="text-align: center;"> <table border="1" style="width: 100%; border-collapse: collapse; text-align: center;"> <tr> <td style="width: 10%;"></td> <td style="width: 10%;"></td> <td style="width: 10%;"></td> <td style="width: 10%;"></td> <td style="width: 10%;"></td> <td style="width: 10%;"></td> <td style="width: 10%;"></td> <td style="width: 10%;"></td> <td style="width: 10%;"></td> <td style="width: 10%;"></td> </tr> <tr> <td></td> <td></td> <td colspan="8" style="text-align: center;"> <table border="1" style="width: 100%; border-collapse: collapse; text-align: center;"> <tr> <td style="width: 10%;"></td> <td style="width: 10%;"></td> <td style="width: 10%;"></td> <td style="width: 10%;"></td> <td style="width: 10%;"></td> <td style="width: 10%;"></td> <td style="width: 10%;"></td> <td style="width: 10%;"></td> <td style="width: 10%;"></td> <td style="width: 10%;"></td> </tr> <tr> <td></td> <td></td> <td colspan="8" style="text-align: center;"> <table border="1" style="width: 100%; border-collapse: collapse; text-align: center;"> <tr> <td style="width: 10%;"></td> <td style="width: 10%;"></td> <td style="width: 10%;"></td> <td style="width: 10%;"></td> <td style="width: 10%;"></td> <td style="width: 10%;"></td> <td style="width: 10%;"></td> <td style="width: 10%;"></td> <td style="width: 10%;"></td> <td style="width: 10%;"></td> </tr> <tr> <td></td> <td></td> <td colspan="8" style="text-align: center;"> <table border="1" style="width: 100%; border-collapse: collapse; text-align: center;"> <tr> <td style="width: 10%;"></td> <td style="width: 10%;"></td> <td style="width: 10%;"></td> <td style="width: 10%;"></td> <td style="width: 10%;"></td> <td style="width: 10%;"></td> <td style="width: 10%;"></td> <td style="width: 10%;"></td> <td style="width: 10%;"></td> <td style="width: 10%;"></td> </tr> <tr> <td></td> <td></td> <td colspan="8" style="text-align: center;"> <table border="1" style="width: 100%; border-collapse: collapse; text-align: center;"> <tr> <td style="width: 10%;"></td> <td style="width: 10%;"></td> <td style="width: 10%;"></td> <td style="width: 10%;"></td> <td style="width: 10%;"></td> <td style="width: 10%;"></td> <td style="width: 10%;"></td> <td style="width: 10%;"></td> <td style="width: 10%;"></td> <td style="width: 10%;"></td> </tr> <tr> <td></td> <td></td> <td colspan="8" style="text-align: center;"> <table border="1" style="width: 100%; border-collapse: collapse; text-align: center;"> <tr> <td style="width: 10%;"></td> <td style="width: 10%;"></td> <td style="width: 10%;"></td> <td style="width: 10%;"></td> <td style="width: 10%;"></td> <td style="width: 10%;"></td> <td style="width: 10%;"></td> <td style="width: 10%;"></td> <td style="width: 10%;"></td> <td style="width: 10%;"></td> </tr> <tr> <td></td> <td></td> <td colspan="8" style="text-align: center;"> <table border="1" style="width: 100%; border-collapse: collapse; text-align: center;"> <tr> <td style="width: 10%;"></td> <td style="width: 10%;"></td> <td style="width: 10%;"></td> <td style="width: 10%;"></td> <td style="width: 10%;"></td> <td style="width: 10%;"></td> <td style="width: 10%;"></td> <td style="width: 10%;"></td> <td style="width: 10%;"></td> <td style="width: 10%;"></td> </tr> <tr> <td></td> <td></td> <td colspan="8" style="text-align: center;"> <table border="1" style="width: 100%; border-collapse: collapse; text-align: center;"> <tr> <td style="width: 10%;"></td> <td style="width: 10%;"></td> <td style="width: 10%;"></td> <td style="width: 10%;"></td> <td style="width: 10%;"></td> <td style="width: 10%;"></td> <td style="width: 10%;"></td> <td style="width: 10%;"></td> <td style="width: 10%;"></td> <td style="width: 10%;"></td> </tr> <tr> <td></td> <td></td> <td colspan="8" style="text-align: center;"> <table border="1" style="width: 100%; border-collapse: collapse; text-align: center;"> <tr> <td style="width: 10%;"></td> <td style="width: 10%;"></td> <td style="width: 10%;"></td> <td style="width: 10%;"></td> <td style="width: 10%;"></td> <td
style="width: 10%;"></td> <td style="width: 10%;"></td> <td style="width: 10%;"></td> <td style="width: 10%;"></td> <td style="width: 10%;"></td> </tr> <tr> <td></td> <td></td> <td colspan="8" style="text-align: center;"> <table border="1" style="width: 100%; border-collapse: collapse; text-align: center;"> <tr> <td style="width: 10%;"></td> <td style="width: 10%;"></td> <td style="width: 10%;"></td> <td style="width: 10%;"></td> <td style="width: 10%;"></td> <td style="width: 10%;"></td> <td style="width: 10%;"></td> <td style="width: 10%;"></td> <td style="width: 10%;"></td> <td style="width: 10%;"></td> </tr> <tr> <td></td> <td></td> <td colspan="8" style="text-align: center;"> <table border="1" style="width: 100%; border-collapse: collapse; text-align: center;"> <tr> <td style="width: 10%;"></td> <td style="width: 10%;"></td> <td style="width: 10%;"></td> <td style="width: 10%;"></td> <td style="width: 10%;"></td> <td style="width: 10%;"></td> <td style="width: 10%;"></td> <td style="width: 10%;"></td> <td style="width: 10%;"></td> <td style="width: 10%;"></td> </tr> <tr> <td></td> <td></td> <td colspan="8" style="text-align: center;"> <table border="1" style="width: 100%; border-collapse: collapse; text-align: center;"> <tr> <td style="width: 10%;"></td> <td style="width: 10%;"></td> <td style="width: 10%;"></td> <td style="width: 10%;"></td> <td style="width: 10%;"></td> <td style="width: 10%;"></td> <td style="width: 10%;"></td> <td style="width: 10%;"></td> <td style="width: 10%;"></td> <td style="width: 10%;"></td> </tr> <tr> <td></td> <td></td> <td colspan="8" style="text-align: center;"> <table border="1" style="width: 100%; border-collapse: collapse; text-align: center;"> <tr> <td style="width: 10%;"></td> <td style="width: 10%;"></td> <td style="width: 10%;"></td> <td style="width: 10%;"></td> <td style="width: 10%;"></td> <td style="width: 10%;"></td> <td style="width: 10%;"></td> <td style="width: 10%;"></td> <td style="width: 10%;"></td> <td style="width: 10%;"></td> </tr> <tr> <td></td> <td></td> <td colspan="8" style="text-align: center;"> <table border="1" style="width: 100%; border-collapse: collapse; text-align: center;"> <tr> <td style="width: 10%;"></td> <td style="width: 10%;"></td> <td style="width: 10%;"></td> <td style="width: 10%;"></td> <td style="width: 10%;"></td> <td style="width: 10%;"></td> <td style="width: 10%;"></td> <td style="width: 10%;"></td> <td style="width: 10%;"></td> <td style="width: 10%;"></td> </tr> <tr> <td></td> <td></td> <td colspan="8" style="text-align: center;"> <table border="1" style="width: 100%; border-collapse: collapse; text-align: center;"> <tr> <td style="width: 10%;"></td> <td style="width: 10%;"></td> <td style="width: 10%;"></td> <td style="width: 10%;"></td> <td style="width: 10%;"></td> <td style="width: 10%;"></td> <td style="width: 10%;"></td> <td style="width: 10%;"></td> <td style="width: 10%;"></td> <td style="width: 10%;"></td> </tr> <tr> <td></td> <td></td> <td colspan="8" style="text-align: center;"> <table border="1" style="width: 100%; border-collapse: collapse; text-align: center;"> <tr> <td style="width: 10%;"></td> <td style="width: 10%;"></td> <td style="width: 10%;"></td> <td style="width: 10%;"></td> <td style="width: 10%;"></td> <td style="width: 10%;"></td> <td style="width: 10%;"></td> <td style="width: 10%;"></td> <td style="width: 10%;"></td> <td style="width: 10%;"></td> </tr> <tr> <td></td> <td></td> <td colspan="8" style="text-align: center;"> <table border="1" style="width: 100%; border-collapse: collapse; text-align: center;"> <tr> <td style="width: 10%;"></td> <td style="width: 10%;"></td> <td style="width: 10%;"></td> <td style="width: 10%;"></td> <td style="width: 10%;"></td> <td style="width: 10%;"></td> <td style="width: 10%;"></td> <td style="width: 10%;"></td> <td style="width: 10%;"></td> <td style="width: 10%;"></td> </tr> <tr> <td></td> <td></td> <td colspan="8" style="text-align: center;"> <table border="1" style="width: 100%; border-collapse: collapse; text-align: center;"> <tr> <td style="width: 10%;"></td> <td style="width: 10%;"></td> <td style="width: 10%;"></td> <td style="width: 10%;"></td> <td style="width: 10%;"></td> <td style="width: 10%;"></td> <td style="width: 10%;"></td> <td style="width: 10%;"></td> <td style="width: 10%;"></td> <td style="width: 10%;"></td> </tr> <tr> <td></td> <td></td> <td colspan="8" style="text-align: center;"> <table border="1" style="width: 100%; border-collapse: collapse; text-align: center;"> <tr> <td style="width: 10%;"></td> <td style="width: 10%;"></td> <td style="width: 10%;"></td> <td style="width: 10%;"></td> <td style="width: 10%;"></td> <td style="width: 10%;"></td> <td style="width: 10%;"></td> <td style="width: 10%;"></td> <td style="width: 10%;"></td> <td style="width: 10%;"></td> </tr> <tr> <td></td> <td></td> <td colspan="8" style="text-align: center;"> <table border="1" style="width: 100%; border-collapse: collapse; text-align: center;"> <tr> <td style="width: 10%;"></td> <td style="width: 10%;"></td> <td style="width: 10%;"></td> <td style="width: 10%;"></td> <td style="width: 10%;"></td> <td style="width: 10%;"></td> <td style="width: 10%;"></td> <td style="width: 10%;"></td> <td style="width: 10%;"></td> <td style="width: 10%;"></td> </tr> <tr> <td></td> <td></td> <td colspan="8" style="text-align: center;"> <table border="1" style="width: 100%; border-collapse: collapse; text-align: center;"> <tr> <td style="width: 10%;"></td> <td style="width: 10%;"></td> <td style="width: 10%;"></td> <td style="width: 10%;"></td> <td style="width: 10%;"></td> <td style="width: 10%;"></td> <td style="width: 10%;"></td> <td style="width: 10%;"></td> <td style="width: 10%;"></td> <td style="width: 10%;"></td> </tr> <tr> <td></td> <td></td> <td colspan="8" style="text-align: center;"> <table border="1" style="width: 100%; border-collapse: collapse; text-align: center;"> <tr> <td style="width: 10%;"></td> <td style="width: 10%;"></td> <td style="width: 10%;"></td> <td style="width: 10%;"></td> <td style="width: 10%;"></td> <td style="width: 10%;"></td> <td style="width: 10%;"></td> <td style="width: 10%;"></td> <td style="width: 10%;"></td> <td style="width: 10%;"></td> </tr> <tr> <td></td> <td></td> <td colspan="8" style="text-align: center;"> <table border="1" style="width: 100%; border-collapse: collapse; text-align: center;"> <tr> </tr></table></td></tr></table></td></tr></table></td></tr></table></td></tr></table></td></tr></table></td></tr></table></td></tr></table></td></tr></table></td></tr></table></td></tr></table></td></tr></table></td></tr></table></td></tr></table></td></tr></table></td></tr></table></td></tr></table></td></tr></table></td></tr></table></td></tr></table></td></tr></table></td></tr></table></td></tr></table></td></tr></table></td></tr></table></td></tr></table></td></tr></table></td></tr></table></td></tr></table></td></tr></table></td></tr></table></td></tr></table> | | | | | | | | | | | | | | | | | | | | <table border="1" style="width: 100%; border-collapse: collapse; text-align: center;"> <tr> <td style="width: 10%;"></td> <td style="width: 10%;"></td> <td style="width: 10%;"></td> <td style="width: 10%;"></td> <td style="width: 10%;"></td> <td style="width: 10%;"></td> <td style="width: 10%;"></td> <td style="width: 10%;"></td> <td style="width: 10%;"></td> <td style="width: 10%;"></td> </tr> <tr> <td></td> <td></td> <td colspan="8" style="text-align: center;"> <table border="1" style="width: 100%; border-collapse: collapse; text-align: center;"> <tr> <td style="width: 10%;"></td> <td style="width: 10%;"></td> <td style="width: 10%;"></td> <td style="width: 10%;"></td> <td style="width: 10%;"></td> <td style="width: 10%;"></td> <td style="width: 10%;"></td> <td style="width: 10%;"></td> <td style="width: 10%;"></td> <td style="width: 10%;"></td> </tr> <tr> <td></td> <td></td> <td colspan="8" style="text-align: center;"> <table border="1" style="width: 100%; border-collapse: collapse; text-align: center;">
<tr> <td style="width: 10%;"></td> <td style="width: 10%;"></td> <td style="width: 10%;"></td> <td style="width: 10%;"></td> <td style="width: 10%;"></td> <td style="width: 10%;"></td> <td style="width: 10%;"></td> <td style="width: 10%;"></td> <td style="width: 10%;"></td> <td style="width: 10%;"></td> </tr> <tr> <td></td> <td></td> <td colspan="8" style="text-align: center;"> <table border="1" style="width: 100%; border-collapse: collapse; text-align: center;"> <tr> <td style="width: 10%;"></td> <td style="width: 10%;"></td> <td style="width: 10%;"></td> <td style="width: 10%;"></td> <td style="width: 10%;"></td> <td style="width: 10%;"></td> <td style="width: 10%;"></td> <td style="width: 10%;"></td> <td style="width: 10%;"></td> <td style="width: 10%;"></td> </tr> <tr> <td></td> <td></td> <td colspan="8" style="text-align: center;"> <table border="1" style="width: 100%; border-collapse: collapse; text-align: center;"> <tr> <td style="width: 10%;"></td> <td style="width: 10%;"></td> <td style="width: 10%;"></td> <td style="width: 10%;"></td> <td style="width: 10%;"></td> <td style="width: 10%;"></td> <td style="width: 10%;"></td> <td style="width: 10%;"></td> <td style="width: 10%;"></td> <td style="width: 10%;"></td> </tr> <tr> <td></td> <td></td> <td colspan="8" style="text-align: center;"> <table border="1" style="width: 100%; border-collapse: collapse; text-align: center;"> <tr> <td style="width: 10%;"></td> <td style="width: 10%;"></td> <td style="width: 10%;"></td> <td style="width: 10%;"></td> <td style="width: 10%;"></td> <td style="width: 10%;"></td> <td style="width: 10%;"></td> <td style="width: 10%;"></td> <td style="width: 10%;"></td> <td style="width: 10%;"></td> </tr> <tr> <td></td> <td></td> <td colspan="8" style="text-align: center;"> <table border="1" style="width: 100%; border-collapse: collapse; text-align: center;"> <tr> <td style="width: 10%;"></td> <td style="width: 10%;"></td> <td style="width: 10%;"></td> <td style="width: 10%;"></td> <td style="width: 10%;"></td> <td style="width: 10%;"></td> <td style="width: 10%;"></td> <td style="width: 10%;"></td> <td style="width: 10%;"></td> <td style="width: 10%;"></td> </tr> <tr> <td></td> <td></td> <td colspan="8" style="text-align: center;"> <table border="1" style="width: 100%; border-collapse: collapse; text-align: center;"> <tr> <td style="width: 10%;"></td> <td style="width: 10%;"></td> <td style="width: 10%;"></td> <td style="width: 10%;"></td> <td style="width: 10%;"></td> <td style="width: 10%;"></td> <td style="width: 10%;"></td> <td style="width: 10%;"></td> <td style="width: 10%;"></td> <td style="width: 10%;"></td> </tr> <tr> <td></td> <td></td> <td colspan="8" style="text-align: center;"> <table border="1" style="width: 100%; border-collapse: collapse; text-align: center;"> <tr> <td style="width: 10%;"></td> <td style="width: 10%;"></td> <td style="width: 10%;"></td> <td style="width: 10%;"></td> <td style="width: 10%;"></td> <td style="width: 10%;"></td> <td style="width: 10%;"></td> <td style="width: 10%;"></td> <td style="width: 10%;"></td> <td style="width: 10%;"></td> </tr> <tr> <td></td> <td></td> <td colspan="8" style="text-align: center;"> <table border="1" style="width: 100%; border-collapse: collapse; text-align: center;"> <tr> <td style="width: 10%;"></td> <td style="width: 10%;"></td> <td style="width: 10%;"></td> <td style="width: 10%;"></td> <td style="width: 10%;"></td> <td style="width: 10%;"></td> <td style="width: 10%;"></td> <td style="width: 10%;"></td> <td style="width: 10%;"></td> <td style="width: 10%;"></td> </tr> <tr> <td></td> <td></td> <td colspan="8" style="text-align: center;"> <table border="1" style="width: 100%; border-collapse: collapse; text-align: center;"> <tr> <td style="width: 10%;"></td> <td style="width: 10%;"></td> <td style="width: 10%;"></td> <td style="width: 10%;"></td> <td style="width: 10%;"></td> <td style="width: 10%;"></td> <td style="width: 10%;"></td> <td style="width: 10%;"></td> <td style="width: 10%;"></td> <td style="width: 10%;"></td> </tr> <tr> <td></td> <td></td> <td colspan="8" style="text-align: center;"> <table border="1" style="width: 100%; border-collapse: collapse; text-align: center;"> <tr> <td style="width: 10%;"></td> <td style="width: 10%;"></td> <td style="width: 10%;"></td> <td style="width: 10%;"></td> <td style="width: 10%;"></td> <td style="width: 10%;"></td> <td style="width: 10%;"></td> <td style="width: 10%;"></td> <td style="width: 10%;"></td> <td style="width: 10%;"></td> </tr> <tr> <td></td> <td></td> <td colspan="8" style="text-align: center;"> <table border="1" style="width: 100%; border-collapse: collapse; text-align: center;"> <tr> <td style="width: 10%;"></td> <td style="width: 10%;"></td> <td style="width: 10%;"></td> <td style="width: 10%;"></td> <td style="width: 10%;"></td> <td style="width: 10%;"></td> <td style="width: 10%;"></td> <td style="width: 10%;"></td> <td style="width: 10%;"></td> <td style="width: 10%;"></td> </tr> <tr> <td></td> <td></td> <td colspan="8" style="text-align: center;"> <table border="1" style="width: 100%; border-collapse: collapse; text-align: center;"> <tr> <td style="width: 10%;"></td> <td style="width: 10%;"></td> <td style="width: 10%;"></td> <td style="width: 10%;"></td> <td style="width: 10%;"></td> <td style="width: 10%;"></td> <td style="width: 10%;"></td> <td style="width: 10%;"></td> <td style="width: 10%;"></td> <td style="width: 10%;"></td> </tr> <tr> <td></td> <td></td> <td colspan="8" style="text-align: center;"> <table border="1" style="width: 100%; border-collapse: collapse; text-align: center;"> <tr> <td style="width: 10%;"></td> <td style="width: 10%;"></td> <td style="width: 10%;"></td> <td style="width: 10%;"></td> <td style="width: 10%;"></td> <td style="width: 10%;"></td> <td style="width: 10%;"></td> <td style="width: 10%;"></td> <td style="width: 10%;"></td> <td style="width: 10%;"></td> </tr> <tr> <td></td> <td></td> <td colspan="8" style="text-align: center;"> <table border="1" style="width: 100%; border-collapse: collapse; text-align: center;"> <tr> <td style="width: 10%;"></td> <td style="width: 10%;"></td> <td style="width: 10%;"></td> <td style="width: 10%;"></td> <td style="width: 10%;"></td> <td style="width: 10%;"></td> <td style="width: 10%;"></td> <td style="width: 10%;"></td> <td style="width: 10%;"></td> <td style="width: 10%;"></td> </tr> <tr> <td></td> <td></td> <td colspan="8" style="text-align: center;"> <table border="1" style="width: 100%; border-collapse: collapse; text-align: center;"> <tr> <td style="width: 10%;"></td> <td style="width: 10%;"></td> <td style="width: 10%;"></td> <td style="width: 10%;"></td> <td style="width: 10%;"></td> <td style="width: 10%;"></td> <td style="width: 10%;"></td> <td style="width: 10%;"></td> <td style="width: 10%;"></td> <td style="width: 10%;"></td> </tr> <tr> <td></td> <td></td> <td colspan="8" style="text-align: center;"> <table border="1" style="width: 100%; border-collapse: collapse; text-align: center;"> <tr> <td style="width: 10%;"></td> <td style="width: 10%;"></td> <td style="width: 10%;"></td> <td style="width: 10%;"></td> <td style="width: 10%;"></td> <td style="width: 10%;"></td> <td style="width: 10%;"></td> <td style="width: 10%;"></td> <td style="width: 10%;"></td> <td style="width: 10%;"></td> </tr> <tr> <td></td> <td></td> <td colspan="8" style="text-align: center;"> <table border="1" style="width: 100%; border-collapse: collapse; text-align: center;"> <tr> <td style="width: 10%;"></td> <td style="width: 10%;"></td> <td style="width: 10%;"></td> <td style="width: 10%;"></td> <td style="width: 10%;"></td> <td style="width: 10%;"></td> <td style="width: 10%;"></td> <td style="width: 10%;"></td> <td style="width: 10%;"></td> <td style="width: 10%;"></td> </tr> <tr> <td></td> <td></td> <td colspan="8" style="text-align: center;"> <table border="1" style="width: 100%; border-collapse: collapse; text-align: center;"> <tr> <td style="width: 10%;"></td> <td style="width: 10%;"></td> <td style="width: 10%;"></td> <td style="width: 10%;"></td> <td style="width: 10%;"></td> <td style="width: 10%;"></td> <td style="width: 10%;"></td> <td style="width: 10%;"></td> <td style="width: 10%;"></td> <td style="width: 10%;"></td> </tr> <tr> <td></td> <td></td> <td colspan="8" style="text-align: center;"> <table border="1" style="width: 100%; border-collapse: collapse; text-align: center;"> <tr> <td style="width: 10%;"></td> <td style="width: 10%;"></td> <td style="width: 10%;"></td> <td style="width: 10%;"></td> <td style="width: 10%;"></td> <td style="width: 10%;"></td> <td style="width: 10%;"></td> <td style="width: 10%;"></td> <td style="width: 10%;"></td> <td style="width: 10%;"></td> </tr> <tr> <td></td> <td></td> <td colspan="8" style="text-align: center;"> <table border="1" style="width: 100%; border-collapse: collapse; text-align: center;"> <tr> <td style="width: 10%;"></td> <td style="width: 10%;"></td> <td style="width: 10%;"></td> <td style="width: 10%;"></td> <td style="width: 10%;"></td> <td style="width: 10%;"></td> <td style="width: 10%;"></td> <td style="width: 10%;"></td> <td style="width: 10%;"></td> <td style="width: 10%;"></td> </tr> <tr> <td></td> <td></td> <td colspan="8" style="text-align: center;"> <table border="1" style="width: 100%; border-collapse: collapse; text-align: center;"> <tr> <td style="width: 10%;"></td> <td style="width: 10%;"></td> <td style="width: 10%;"></td> <td style="width: 10%;"></td> <td style="width: 10%;"></td> <td style="width: 10%;"></td> <td style="width: 10%;"></td> <td style="width: 10%;"></td> <td style="width: 10%;"></td> <td style="width: 10%;"></td> </tr> <tr> <td></td> <td></td> <td colspan="8" style="text-align: center;"> <table border="1" style="width: 100%; border-collapse: collapse; text-align: center;"> <tr> <td style="width: 10%;"></td> <td style="width: 10%;"></td> <td style="width: 10%;"></td> <td style="width: 10%;"></td> <td style="width: 10%;"></td> <td
style="width: 10%;"></td> <td style="width: 10%;"></td> <td style="width: 10%;"></td> <td style="width: 10%;"></td> <td style="width: 10%;"></td> </tr> <tr> <td></td> <td></td> <td colspan="8" style="text-align: center;"> <table border="1" style="width: 100%; border-collapse: collapse; text-align: center;"> <tr> <td style="width: 10%;"></td> <td style="width: 10%;"></td> <td style="width: 10%;"></td> <td style="width: 10%;"></td> <td style="width: 10%;"></td> <td style="width: 10%;"></td> <td style="width: 10%;"></td> <td style="width: 10%;"></td> <td style="width: 10%;"></td> <td style="width: 10%;"></td> </tr> <tr> <td></td> <td></td> <td colspan="8" style="text-align: center;"> <table border="1" style="width: 100%; border-collapse: collapse; text-align: center;"> <tr> <td style="width: 10%;"></td> <td style="width: 10%;"></td> <td style="width: 10%;"></td> <td style="width: 10%;"></td> <td style="width: 10%;"></td> <td style="width: 10%;"></td> <td style="width: 10%;"></td> <td style="width: 10%;"></td> <td style="width: 10%;"></td> <td style="width: 10%;"></td> </tr> <tr> <td></td> <td></td> <td colspan="8" style="text-align: center;"> <table border="1" style="width: 100%; border-collapse: collapse; text-align: center;"> <tr> <td style="width: 10%;"></td> <td style="width: 10%;"></td> <td style="width: 10%;"></td> <td style="width: 10%;"></td> <td style="width: 10%;"></td> <td style="width: 10%;"></td> <td style="width: 10%;"></td> <td style="width: 10%;"></td> <td style="width: 10%;"></td> <td style="width: 10%;"></td> </tr> <tr> <td></td> <td></td> <td colspan="8" style="text-align: center;"> <table border="1" style="width: 100%; border-collapse: collapse; text-align: center;"> <tr> <td style="width: 10%;"></td> <td style="width: 10%;"></td> <td style="width: 10%;"></td> <td style="width: 10%;"></td> <td style="width: 10%;"></td> <td style="width: 10%;"></td> <td style="width: 10%;"></td> <td style="width: 10%;"></td> <td style="width: 10%;"></td> <td style="width: 10%;"></td> </tr> <tr> <td></td> <td></td> <td colspan="8" style="text-align: center;"> <table border="1" style="width: 100%; border-collapse: collapse; text-align: center;"> <tr> <td style="width: 10%;"></td> <td style="width: 10%;"></td> <td style="width: 10%;"></td> <td style="width: 10%;"></td> <td style="width: 10%;"></td> <td style="width: 10%;"></td> <td style="width: 10%;"></td> <td style="width: 10%;"></td> <td style="width: 10%;"></td> <td style="width: 10%;"></td> </tr> <tr> <td></td> <td></td> <td colspan="8" style="text-align: center;"> <table border="1" style="width: 100%; border-collapse: collapse; text-align: center;"> <tr> <td style="width: 10%;"></td> <td style="width: 10%;"></td> <td style="width: 10%;"></td> <td style="width: 10%;"></td> <td style="width: 10%;"></td> <td style="width: 10%;"></td> <td style="width: 10%;"></td> <td style="width: 10%;"></td> <td style="width: 10%;"></td> <td style="width: 10%;"></td> </tr> <tr> <td></td> <td></td> <td colspan="8" style="text-align: center;"> <table border="1" style="width: 100%; border-collapse: collapse; text-align: center;"> <tr> </tr></table></td></tr></table></td></tr></table></td></tr></table></td></tr></table></td></tr></table></td></tr></table></td></tr></table></td></tr></table></td></tr></table></td></tr></table></td></tr></table></td></tr></table></td></tr></table></td></tr></table></td></tr></table></td></tr></table></td></tr></table></td></tr></table></td></tr></table></td></tr></table></td></tr></table></td></tr></table></td></tr></table></td></tr></table></td></tr></table></td></tr></table></td></tr></table></td></tr></table></td></tr></table></td></tr></table> | | | | | | | | | | | | | | | | | | | | <table border="1" style="width: 100%; border-collapse: collapse; text-align: center;"> <tr> <td style="width: 10%;"></td> <td style="width: 10%;"></td> <td style="width: 10%;"></td> <td style="width: 10%;"></td> <td style="width: 10%;"></td> <td style="width: 10%;"></td> <td style="width: 10%;"></td> <td style="width: 10%;"></td> <td style="width: 10%;"></td> <td style="width: 10%;"></td> </tr> <tr> <td></td> <td></td> <td colspan="8" style="text-align: center;"> <table border="1" style="width: 100%; border-collapse: collapse; text-align: center;"> <tr> <td style="width: 10%;"></td> <td style="width: 10%;"></td> <td style="width: 10%;"></td> <td style="width: 10%;"></td> <td style="width: 10%;"></td> <td style="width: 10%;"></td> <td style="width: 10%;"></td> <td style="width: 10%;"></td> <td style="width: 10%;"></td> <td style="width: 10%;"></td> </tr> <tr> <td></td> <td></td> <td colspan="8" style="text-align: center;"> <table border="1" style="width: 100%; border-collapse: collapse; text-align: center;"> <tr> <td style="width: 10%;"></td> <td style="width: 10%;"></td> <td style="width: 10%;"></td> <td style="width: 10%;"></td> <td style="width: 10%;"></td> <td style="width: 10%;"></td> <td style="width: 10%;"></td> <td style="width: 10%;"></td> <td style="width: 10%;"></td> <td style="width: 10%;"></td> </tr> <tr> <td></td> <td></td> <td colspan="8" style="text-align: center;"> <table border="1" style="width: 100%; border-collapse: collapse; text-align: center;"> <tr> <td style="width: 10%;"></td> <td style="width: 10%;"></td> <td style="width: 10%;"></td> <td style="width: 10%;"></td> <td style="width: 10%;"></td> <td style="width: 10%;"></td> <td style="width: 10%;"></td> <td style="width: 10%;"></td> <td style="width: 10%;"></td> <td style="width: 10%;"></td> </tr> <tr> <td></td> <td></td> <td colspan="8" style="text-align: center;"> <table border="1" style="width: 100%; border-collapse: collapse; text-align: center;"> <tr> <td style="width: 10%;"></td> <td style="width: 10%;"></td> <td style="width: 10%;"></td> <td style="width: 10%;"></td> <td style="width: 10%;"></td> <td style="width: 10%;"></td> <td style="width: 10%;"></td> <td style="width: 10%;"></td> <td style="width: 10%;"></td> <td style="width: 10%;"></td> </tr> <tr> <td></td> <td></td> <td colspan="8" style="text-align: center;"> <table border="1" style="width: 100%; border-collapse: collapse; text-align: center;"> <tr> <td style="width: 10%;"></td> <td style="width: 10%;"></td> <td style="width: 10%;"></td> <td style="width: 10%;"></td> <td style="width: 10%;"></td> <td style="width: 10%;"></td> <td style="width: 10%;"></td> <td style="width: 10%;"></td> <td style="width: 10%;"></td> <td style="width: 10%;"></td> </tr> <tr> <td></td> <td></td> <td colspan="8" style="text-align: center;"> <table border="1" style="width: 100%; border-collapse: collapse; text-align: center;"> <tr> <td style="width: 10%;"></td> <td style="width: 10%;"></td> <td style="width: 10%;"></td> <td style="width: 10%;"></td> <td style="width: 10%;"></td> <td style="width: 10%;"></td> <td style="width: 10%;"></td> <td style="width: 10%;"></td> <td style="width: 10%;"></td> <td style="width: 10%;"></td> </tr> <tr> <td></td> <td></td> <td colspan="8" style="text-align: center;"> <table border="1" style="width: 100%; border-collapse: collapse; text-align: center;"> <tr> <td style="width: 10%;"></td> <td style="width: 10%;"></td> <td style="width: 10%;"></td> <td style="width: 10%;"></td> <td style="width: 10%;"></td> <td style="width: 10%;"></td> <td style="width: 10%;"></td> <td style="width: 10%;"></td> <td style="width: 10%;"></td> <td style="width: 10%;"></td> </tr> <tr> <td></td> <td></td> <td colspan="8" style="text-align: center;"> <table border="1" style="width: 100%; border-collapse: collapse; text-align: center;"> <tr> <td style="width: 10%;"></td> <td style="width: 10%;"></td> <td style="width: 10%;"></td> <td style="width: 10%;"></td> <td style="width: 10%;"></td> <td style="width: 10%;"></td> <td style="width: 10%;"></td> <td style="width: 10%;"></td> <td style="width: 10%;"></td> <td style="width: 10%;"></td> </tr> <tr> <td></td> <td></td> <td colspan="8" style="text-align: center;"> <table border="1" style="width: 100%; border-collapse: collapse; text-align: center;"> <tr> <td
style="width: 10%;"></td> <td style="width: 10%;"></td> <td style="width: 10%;"></td> <td style="width: 10%;"></td> <td style="width: 10%;"></td> <td style="width: 10%;"></td> <td style="width: 10%;"></td> <td style="width: 10%;"></td> <td style="width: 10%;"></td> <td style="width: 10%;"></td> </tr> <tr> <td></td> <td></td> <td colspan="8" style="text-align: center;"> <table border="1" style="width: 100%; border-collapse: collapse; text-align: center;"> <tr> <td style="width: 10%;"></td> <td style="width: 10%;"></td> <td style="width: 10%;"></td> <td style="width: 10%;"></td> <td style="width: 10%;"></td> <td style="width: 10%;"></td> <td style="width: 10%;"></td> <td style="width: 10%;"></td> <td style="width: 10%;"></td> <td style="width: 10%;"></td> </tr> <tr> <td></td> <td></td> <td colspan="8" style="text-align: center;"> <table border="1" style="width: 100%; border-collapse: collapse; text-align: center;"> <tr> <td style="width: 10%;"></td> <td style="width: 10%;"></td> <td style="width: 10%;"></td> <td style="width: 10%;"></td> <td style="width: 10%;"></td> <td style="width: 10%;"></td> <td style="width: 10%;"></td> <td style="width: 10%;"></td> <td style="width: 10%;"></td> <td style="width: 10%;"></td> </tr> <tr> <td></td> <td></td> <td colspan="8" style="text-align: center;"> <table border="1" style="width: 100%; border-collapse: collapse; text-align: center;"> <tr> <td style="width: 10%;"></td> <td style="width: 10%;"></td> <td style="width: 10%;"></td> <td style="width: 10%;"></td> <td style="width: 10%;"></td> <td style="width: 10%;"></td> <td style="width: 10%;"></td> <td style="width: 10%;"></td> <td style="width: 10%;"></td> <td style="width: 10%;"></td> </tr> <tr> <td></td> <td></td> <td colspan="8" style="text-align: center;"> <table border="1" style="width: 100%; border-collapse: collapse; text-align: center;"> <tr> <td style="width: 10%;"></td> <td style="width: 10%;"></td> <td style="width: 10%;"></td> <td style="width: 10%;"></td> <td style="width: 10%;"></td> <td style="width: 10%;"></td> <td style="width: 10%;"></td> <td style="width: 10%;"></td> <td style="width: 10%;"></td> <td style="width: 10%;"></td> </tr> <tr> <td></td> <td></td> <td colspan="8" style="text-align: center;"> <table border="1" style="width: 100%; border-collapse: collapse; text-align: center;"> <tr> <td style="width: 10%;"></td> <td style="width: 10%;"></td> <td style="width: 10%;"></td> <td style="width: 10%;"></td> <td style="width: 10%;"></td> <td style="width: 10%;"></td> <td style="width: 10%;"></td> <td style="width: 10%;"></td> <td style="width: 10%;"></td> <td style="width: 10%;"></td> </tr> <tr> <td></td> <td></td> <td colspan="8" style="text-align: center;"> <table border="1" style="width: 100%; border-collapse: collapse; text-align: center;"> <tr> <td style="width: 10%;"></td> <td style="width: 10%;"></td> <td style="width: 10%;"></td> <td style="width: 10%;"></td> <td style="width: 10%;"></td> <td style="width: 10%;"></td> <td style="width: 10%;"></td> <td style="width: 10%;"></td> <td style="width: 10%;"></td> <td style="width: 10%;"></td> </tr> <tr> <td></td> <td></td> <td colspan="8" style="text-align: center;"> <table border="1" style="width: 100%; border-collapse: collapse; text-align: center;"> <tr> <td style="width: 10%;"></td> <td style="width: 10%;"></td> <td style="width: 10%;"></td> <td style="width: 10%;"></td> <td style="width: 10%;"></td> <td style="width: 10%;"></td> <td style="width: 10%;"></td> <td style="width: 10%;"></td> <td style="width: 10%;"></td> <td style="width: 10%;"></td> </tr> <tr> <td></td> <td></td> <td colspan="8" style="text-align: center;"> <table border="1" style="width: 100%; border-collapse: collapse; text-align: center;"> <tr> <td style="width: 10%;"></td> <td style="width: 10%;"></td> <td style="width: 10%;"></td> <td style="width: 10%;"></td> <td style="width: 10%;"></td> <td style="width: 10%;"></td> <td style="width: 10%;"></td> <td style="width: 10%;"></td> <td style="width: 10%;"></td> <td style="width: 10%;"></td> </tr> <tr> <td></td> <td></td> <td colspan="8" style="text-align: center;"> <table border="1" style="width: 100%; border-collapse: collapse; text-align: center;"> <tr> <td style="width: 10%;"></td> <td style="width: 10%;"></td> <td style="width: 10%;"></td> <td style="width: 10%;"></td> <td style="width: 10%;"></td> <td style="width: 10%;"></td> <td style="width: 10%;"></td> <td style="width: 10%;"></td> <td style="width: 10%;"></td> <td style="width: 10%;"></td> </tr> <tr> <td></td> <td></td> <td colspan="8" style="text-align: center;"> <table border="1" style="width: 100%; border-collapse: collapse; text-align: center;"> <tr> <td style="width: 10%;"></td> <td style="width: 10%;"></td> <td style="width: 10%;"></td> <td style="width: 10%;"></td> <td style="width: 10%;"></td> <td style="width: 10%;"></td> <td style="width: 10%;"></td> <td style="width: 10%;"></td> <td style="width: 10%;"></td> <td style="width: 10%;"></td> </tr> <tr> <td></td> <td></td> <td colspan="8" style="text-align: center;"> <table border="1" style="width: 100%; border-collapse: collapse; text-align: center;"> <tr> <td style="width: 10%;"></td> <td style="width: 10%;"></td> <td style="width: 10%;"></td> <td style="width: 10%;"></td> <td style="width: 10%;"></td> <td style="width: 10%;"></td> <td style="width: 10%;"></td> <td style="width: 10%;"></td> <td style="width: 10%;"></td> <td style="width: 10%;"></td> </tr> <tr> <td></td> <td></td> <td colspan="8" style="text-align: center;"> <table border="1" style="width: 100%; border-collapse: collapse; text-align: center;"> <tr> <td style="width: 10%;"></td> <td style="width: 10%;"></td> <td style="width: 10%;"></td> <td style="width: 10%;"></td> <td style="width: 10%;"></td> <td style="width: 10%;"></td> <td style="width: 10%;"></td> <td style="width: 10%;"></td> <td style="width: 10%;"></td> <td style="width: 10%;"></td> </tr> <tr> <td></td> <td></td> <td colspan="8" style="text-align: center;"> <table border="1" style="width: 100%; border-collapse: collapse; text-align: center;"> <tr> <td style="width: 10%;"></td> <td style="width: 10%;"></td> <td style="width: 10%;"></td> <td style="width: 10%;"></td> <td style="width: 10%;"></td> <td style="width: 10%;"></td> <td style="width: 10%;"></td> <td style="width: 10%;"></td> <td style="width: 10%;"></td> <td style="width: 10%;"></td> </tr> <tr> <td></td> <td></td> <td colspan="8" style="text-align: center;"> <table border="1" style="width: 100%; border-collapse: collapse; text-align: center;"> <tr> <td style="width: 10%;"></td> <td style="width: 10%;"></td> <td style="width: 10%;"></td> <td style="width: 10%;"></td> <td style="width: 10%;"></td> <td style="width: 10%;"></td> <td style="width: 10%;"></td> <td style="width: 10%;"></td> <td style="width: 10%;"></td> <td style="width: 10%;"></td> </tr> <tr> <td></td> <td></td> <td colspan="8" style="text-align: center;"> <table border="1" style="width: 100%; border-collapse: collapse; text-align: center;"> <tr> <td style="width: 10%;"></td> <td style="width: 10%;"></td> <td style="width: 10%;"></td> <td style="width: 10%;"></td> <td style="width: 10%;"></td> <td style="width: 10%;"></td> <td style="width: 10%;"></td> <td style="width: 10%;"></td> <td style="width: 10%;"></td> <td style="width: 10%;"></td> </tr> <tr> <td></td> <td></td> <td colspan="8" style="text-align: center;"> <table border="1" style="width: 100%; border-collapse: collapse; text-align: center;"> <tr> <td style="width: 10%;"></td> <td style="width: 10%;"></td> <td style="width: 10%;"></td> <td style="width: 10%;"></td> <td style="width: 10%;"></td> <td style="width: 10%;"></td> <td style="width: 10%;"></td> <td style="width: 10%;"></td> <td style="width: 10%;"></td> <td style="width: 10%;"></td> </tr> <tr> <td></td> <td></td> <td colspan="8" style="text-align: center;"> <table border="1" style="width: 100%; border-collapse: collapse; text-align: center;"> <tr> <td style="width: 10%;"></td> <td style="width: 10%;"></td> <td style="width: 10%;"></td> <td style="width: 10%;"></td> <td style="width: 10%;"></td> <td style="width: 10%;"></td> <td style="width: 10%;"></td> <td style="width: 10%;"></td> <td style="width: 10%;"></td> <td style="width: 10%;"></td> </tr> <tr> <td></td> <td></td> <td colspan="8" style="text-align: center;"> <table border="1" style="width: 100%; border-collapse: collapse; text-align: center;"> <tr> <td style="width: 10%;"></td> <td style="width: 10%;"></td> <td style="width: 10%;"></td> <td style="width: 10%;"></td> <td style="width: 10%;"></td> <td style="width: 10%;"></td> <td style="width: 10%;"></td> <td style="width: 10%;"></td> <td style="width: 10%;"></td> <td style="width: 10%;"></td> </tr> <tr> <td></td> <td></td> <td colspan="8" style="text-align: center;"> <table border="1" style="width: 100%; border-collapse: collapse; text-align: center;"> <tr> <td style="width: 10%;"></td> <td style="width: 10%;"></td> <td style="width: 10%;"></td> <td style="width: 10%;"></td> <td style="width: 10%;"></td> <td style="width: 10%;"></td> <td style="width: 10%;"></td> <td style="width: 10%;"></td> <td style="width: 10%;"></td> <td style="width: 10%;"></td> </tr> <tr> <td></td> <td></td> <td colspan="8" style="text-align: center;"> <table border="1" style="width: 100%; border-collapse: collapse; text-align: center;"> <tr> </tr></table></td></tr></table></td></tr></table></td></tr></table></td></tr></table></td></tr></table></td></tr></table></td></tr></table></td></tr></table></td></tr></table></td></tr></table></td></tr></table></td></tr></table></td></tr></table></td></tr></table></td></tr></table></td></tr></table></td></tr></table></td></tr></table></td></tr></table></td></tr></table></td></tr></table></td></tr></table></td></tr></table></td></tr></table></td></tr></table></td></tr></table></td></tr></table></td></tr></table></td></tr></table>
 | | | | | | | | | | | | | | | | | | | | <table border="1" style="width: 100%; border-collapse: collapse; text-align: center;"> <tr> <td style="width: 10%;"></td> <td style="width: 10%;"></td> <td style="width: 10%;"></td> <td style="width: 10%;"></td> <td style="width: 10%;"></td> <td style="width: 10%;"></td> <td style="width: 10%;"></td> <td style="width: 10%;"></td> <td style="width: 10%;"></td> <td style="width: 10%;"></td> </tr> <tr> <td></td> <td></td> <td colspan="8" style="text-align: center;"> <table border="1" style="width: 100%; border-collapse: collapse; text-align: center;"> <tr> <td style="width: 10%;"></td> <td style="width: 10%;"></td> <td style="width: 10%;"></td> <td style="width: 10%;"></td> <td style="width: 10%;"></td> <td style="width: 10%;"></td> <td style="width: 10%;"></td> <td style="width: 10%;"></td> <td style="width: 10%;"></td> <td style="width: 10%;"></td> </tr> <tr> <td></td> <td></td> <td colspan="8" style="text-align: center;"> <table border="1" style="width: 100%; border-collapse: collapse; text-align: center;"> <tr> <td style="width: 10%;"></td> <td style="width: 10%;"></td> <td style="width: 10%;"></td> <td style="width: 10%;"></td> <td style="width: 10%;"></td> <td style="width: 10%;"></td> <td style="width: 10%;"></td> <td style="width: 10%;"></td> <td style="width: 10%;"></td> <td style="width: 10%;"></td> </tr> <tr> <td></td> <td></td> <td colspan="8" style="text-align: center;"> <table border="1" style="width: 100%; border-collapse: collapse; text-align: center;"> <tr> <td style="width: 10%;"></td> <td style="width: 10%;"></td> <td style="width: 10%;"></td> <td style="width: 10%;"></td> <td style="width: 10%;"></td> <td style="width: 10%;"></td> <td style="width: 10%;"></td> <td style="width: 10%;"></td> <td style="width: 10%;"></td> <td style="width: 10%;"></td> </tr> <tr> <td></td> <td></td> <td colspan="8" style="text-align: center;"> <table border="1" style="width: 100%; border-collapse: collapse; text-align: center;"> <tr> <td style="width: 10%;"></td> <td style="width: 10%;"></td> <td style="width: 10%;"></td> <td style="width: 10%;"></td> <td style="width: 10%;"></td> <td style="width: 10%;"></td> <td style="width: 10%;"></td> <td style="width: 10%;"></td> <td style="width: 10%;"></td> <td style="width: 10%;"></td> </tr> <tr> <td></td> <td></td> <td colspan="8" style="text-align: center;"> <table border="1" style="width: 100%; border-collapse: collapse; text-align: center;"> <tr> <td style="width: 10%;"></td> <td style="width: 10%;"></td> <td style="width: 10%;"></td> <td style="width: 10%;"></td> <td style="width: 10%;"></td> <td style="width: 10%;"></td> <td style="width: 10%;"></td> <td style="width: 10%;"></td> <td style="width: 10%;"></td> <td style="width: 10%;"></td> </tr> <tr> <td></td> <td></td> <td colspan="8" style="text-align: center;"> <table border="1" style="width: 100%; border-collapse: collapse; text-align: center;"> <tr> <td style="width: 10%;"></td> <td style="width: 10%;"></td> <td style="width: 10%;"></td> <td style="width: 10%;"></td> <td style="width: 10%;"></td> <td style="width: 10%;"></td> <td style="width: 10%;"></td> <td style="width: 10%;"></td> <td style="width: 10%;"></td> <td style="width: 10%;"></td> </tr> <tr> <td></td> <td></td> <td colspan="8" style="text-align: center;"> <table border="1" style="width: 100%; border-collapse: collapse; text-align: center;"> <tr> <td style="width: 10%;"></td> <td style="width: 10%;"></td> <td style="width: 10%;"></td> <td style="width: 10%;"></td> <td style="width: 10%;"></td> <td style="width: 10%;"></td> <td style="width: 10%;"></td> <td style="width: 10%;"></td> <td style="width: 10%;"></td> <td style="width: 10%;"></td> </tr> <tr> <td></td> <td></td> <td colspan="8" style="text-align: center;"> <table border="1" style="width: 100%; border-collapse: collapse; text-align: center;"> <tr> <td style="width: 10%;"></td> <td style="width: 10%;"></td> <td style="width: 10%;"></td> <td style="width: 10%;"></td> <td style="width: 10%;"></td> <td style="width: 10%;"></td> <td style="width: 10%;"></td> <td style="width: 10%;"></td> <td style="width: 10%;"></td> <td style="width: 10%;"></td> </tr> <tr> <td></td> <td></td> <td colspan="8" style="text-align: center;"> <table border="1" style="width: 100%; border-collapse: collapse; text-align: center;"> <tr> <td style="width: 10%;"></td> <td style="width: 10%;"></td> <td style="width: 10%;"></td> <td style="width: 10%;"></td> <td style="width: 10%;"></td> <td style="width: 10%;"></td> <td style="width: 10%;"></td> <td style="width: 10%;"></td> <td style="width: 10%;"></td> <td style="width: 10%;"></td> </tr> <tr> <td></td> <td></td> <td colspan="8" style="text-align: center;"> <table border="1" style="width: 100%; border-collapse: collapse; text-align: center;"> <tr> <td style="width: 10%;"></td> <td style="width: 10%;"></td> <td style="width: 10%;"></td> <td style="width: 10%;"></td> <td style="width: 10%;"></td> <td style="width: 10%;"></td> <td style="width: 10%;"></td> <td style="width: 10%;"></td> <td style="width: 10%;"></td> <td style="width: 10%;"></td> </tr> <tr> <td></td> <td></td> <td colspan="8" style="text-align: center;"> <table border="1" style="width: 100%; border-collapse: collapse; text-align: center;"> <tr> <td style="width: 10%;"></td> <td style="width: 10%;"></td> <td style="width: 10%;"></td> <td style="width: 10%;"></td> <td style="width: 10%;"></td> <td style="width: 10%;"></td> <td style="width: 10%;"></td> <td style="width: 10%;"></td> <td style="width: 10%;"></td> <td style="width: 10%;"></td> </tr> <tr> <td></td> <td></td> <td colspan="8" style="text-align: center;"> <table border="1" style="width: 100%; border-collapse: collapse; text-align: center;"> <tr> <td style="width: 10%;"></td> <td style="width: 10%;"></td> <td style="width: 10%;"></td> <td style="width: 10%;"></td> <td style="width: 10%;"></td> <td style="width: 10%;"></td> <td style="width: 10%;"></td> <td style="width: 10%;"></td> <td style="width: 10%;"></td> <td style="width: 10%;"></td> </tr> <tr> <td></td> <td></td> <td colspan="8" style="text-align: center;"> <table border="1" style="width: 100%; border-collapse: collapse; text-align: center;"> <tr> <td style="width: 10%;"></td> <td style="width: 10%;"></td> <td style="width: 10%;"></td> <td style="width: 10%;"></td> <td style="width: 10%;"></td> <td style="width: 10%;"></td> <td style="width: 10%;"></td> <td style="width: 10%;"></td> <td style="width: 10%;"></td> <td style="width: 10%;"></td> </tr> <tr> <td></td> <td></td> <td colspan="8" style="text-align: center;"> <table border="1" style="width: 100%; border-collapse: collapse; text-align: center;"> <tr> <td style="width: 10%;"></td> <td style="width: 10%;"></td> <td style="width: 10%;"></td> <td style="width: 10%;"></td> <td style="width: 10%;"></td> <td style="width: 10%;"></td> <td style="width: 10%;"></td> <td style="width: 10%;"></td> <td style="width: 10%;"></td> <td style="width: 10%;"></td> </tr> <tr> <td></td> <td></td> <td colspan="8" style="text-align: center;"> <table border="1" style="width: 100%; border-collapse: collapse; text-align: center;"> <tr> <td style="width: 10%;"></td> <td style="width: 10%;"></td> <td style="width: 10%;"></td> <td style="width: 10%;"></td> <td style="width: 10%;"></td> <td style="width: 10%;"></td> <td style="width: 10%;"></td> <td style="width: 10%;"></td> <td style="width: 10%;"></td> <td style="width: 10%;"></td> </tr> <tr> <td></td> <td></td> <td colspan="8" style="text-align: center;"> <table border="1" style="width: 100%; border-collapse: collapse; text-align: center;"> <tr> <td style="width: 10%;"></td> <td style="width: 10%;"></td> <td style="width: 10%;"></td> <td style="width: 10%;"></td> <td style="width: 10%;"></td> <td style="width: 10%;"></td> <td style="width: 10%;"></td> <td style="width: 10%;"></td> <td style="width: 10%;"></td> <td style="width: 10%;"></td> </tr> <tr> <td></td> <td></td> <td colspan="8" style="text-align: center;"> <table border="1" style="width: 100%; border-collapse: collapse; text-align: center;"> <tr> <td style="width: 10%;"></td> <td style="width:
10%;"></td> <td style="width: 10%;"></td> <td style="width: 10%;"></td> <td style="width: 10%;"></td> <td style="width: 10%;"></td> <td style="width: 10%;"></td> <td style="width: 10%;"></td> <td style="width: 10%;"></td> <td style="width: 10%;"></td> </tr> <tr> <td></td> <td></td> <td colspan="8" style="text-align: center;"> <table border="1" style="width: 100%; border-collapse: collapse; text-align: center;"> <tr> <td style="width: 10%;"></td> <td style="width: 10%;"></td> <td style="width: 10%;"></td> <td style="width: 10%;"></td> <td style="width: 10%;"></td> <td style="width: 10%;"></td> <td style="width: 10%;"></td> <td style="width: 10%;"></td> <td style="width: 10%;"></td> <td style="width: 10%;"></td> </tr> <tr> <td></td> <td></td> <td colspan="8" style="text-align: center;"> <table border="1" style="width: 100%; border-collapse: collapse; text-align: center;"> <tr> <td style="width: 10%;"></td> <td style="width: 10%;"></td> <td style="width: 10%;"></td> <td style="width: 10%;"></td> <td style="width: 10%;"></td> <td style="width: 10%;"></td> <td style="width: 10%;"></td> <td style="width: 10%;"></td> <td style="width: 10%;"></td> <td style="width: 10%;"></td> </tr> <tr> <td></td> <td></td> <td colspan="8" style="text-align: center;"> <table border="1" style="width: 100%; border-collapse: collapse; text-align: center;"> <tr> <td style="width: 10%;"></td> <td style="width: 10%;"></td> <td style="width: 10%;"></td> <td style="width: 10%;"></td> <td style="width: 10%;"></td> <td style="width: 10%;"></td> <td style="width: 10%;"></td> <td style="width: 10%;"></td> <td style="width: 10%;"></td> <td style="width: 10%;"></td> </tr> <tr> <td></td> <td></td> <td colspan="8" style="text-align: center;"> <table border="1" style="width: 100%; border-collapse: collapse; text-align: center;"> <tr> <td style="width: 10%;"></td> <td style="width: 10%;"></td> <td style="width: 10%;"></td> <td style="width: 10%;"></td> <td style="width: 10%;"></td> <td style="width: 10%;"></td> <td style="width: 10%;"></td> <td style="width: 10%;"></td> <td style="width: 10%;"></td> <td style="width: 10%;"></td> </tr> <tr> <td></td> <td></td> <td colspan="8" style="text-align: center;"> <table border="1" style="width: 100%; border-collapse: collapse; text-align: center;"> <tr> <td style="width: 10%;"></td> <td style="width: 10%;"></td> <td style="width: 10%;"></td> <td style="width: 10%;"></td> <td style="width: 10%;"></td> <td style="width: 10%;"></td> <td style="width: 10%;"></td> <td style="width: 10%;"></td> <td style="width: 10%;"></td> <td style="width: 10%;"></td> </tr> <tr> <td></td> <td></td> <td colspan="8" style="text-align: center;"> <table border="1" style="width: 100%; border-collapse: collapse; text-align: center;"> <tr> <td style="width: 10%;"></td> <td style="width: 10%;"></td> <td style="width: 10%;"></td> <td style="width: 10%;"></td> <td style="width: 10%;"></td> <td style="width: 10%;"></td> <td style="width: 10%;"></td> <td style="width: 10%;"></td> <td style="width: 10%;"></td> <td style="width: 10%;"></td> </tr> <tr> <td></td> <td></td> <td colspan="8" style="text-align: center;"> <table border="1" style="width: 100%; border-collapse: collapse; text-align: center;"> <tr> <td style="width: 10%;"></td> <td style="width: 10%;"></td> <td style="width: 10%;"></td> <td style="width: 10%;"></td> <td style="width: 10%;"></td> <td style="width: 10%;"></td> <td style="width: 10%;"></td> <td style="width: 10%;"></td> <td style="width: 10%;"></td> <td style="width: 10%;"></td> </tr> <tr> <td></td> <td></td> <td colspan="8" style="text-align: center;"> <table border="1" style="width: 100%; border-collapse: collapse; text-align: center;"> <tr> <td style="width: 10%;"></td> <td style="width: 10%;"></td> <td style="width: 10%;"></td> <td style="width: 10%;"></td> <td style="width: 10%;"></td> <td style="width: 10%;"></td> <td style="width: 10%;"></td> <td style="width: 10%;"></td> <td style="width: 10%;"></td> <td style="width: 10%;"></td> </tr> <tr> <td></td> <td></td> <td colspan="8" style="text-align: center;"> <table border="1" style="width: 100%; border-collapse: collapse; text-align: center;"> <tr> <td style="width: 10%;"></td> <td style="width: 10%;"></td> <td style="width: 10%;"></td> <td style="width: 10%;"></td> <td style="width: 10%;"></td> <td style="width: 10%;"></td> <td style="width: 10%;"></td> <td style="width: 10%;"></td> <td style="width: 10%;"></td> <td style="width: 10%;"></td> </tr> <tr> <td></td> <td></td> <td colspan="8" style="text-align: center;"> <table border="1" style="width: 100%; border-collapse: collapse; text-align: center;"> <tr> <td style="width: 10%;"></td> <td style="width: 10%;"></td> <td style="width: 10%;"></td> <td style="width: 10%;"></td> <td style="width: 10%;"></td> <td style="width: 10%;"></td> <td style="width: 10%;"></td> <td style="width: 10%;"></td> <td style="width: 10%;"></td> <td style="width: 10%;"></td> </tr> <tr> <td></td> <td></td> <td colspan="8" style="text-align: center;"> <table border="1" style="width: 100%; border-collapse: collapse; text-align: center;"> <tr> </tr></table></td></tr></table></td></tr></table></td></tr></table></td></tr></table></td></tr></table></td></tr></table></td></tr></table></td></tr></table></td></tr></table></td></tr></table></td></tr></table></td></tr></table></td></tr></table></td></tr></table></td></tr></table></td></tr></table></td></tr></table></td></tr></table></td></tr></table></td></tr></table></td></tr></table></td></tr></table></td></tr></table></td></tr></table></td></tr></table></td></tr></table></td></tr></table></td></tr></table> | | | | | | | | | | | | | | | | | | | | <table border="1" style="width: 100%; border-collapse: collapse; text-align: center;"> <tr> <td style="width: 10%;"></td> <td style="width: 10%;"></td> <td style="width: 10%;"></td> <td style="width: 10%;"></td> <td style="width: 10%;"></td> <td style="width: 10%;"></td> <td style="width: 10%;"></td> <td style="width: 10%;"></td> <td style="width: 10%;"></td> <td style="width: 10%;"></td> </tr> <tr> <td></td> <td></td> <td colspan="8" style="text-align: center;"> <table border="1" style="width: 100%; border-collapse: collapse; text-align: center;"> <tr> <td style="width: 10%;"></td> <td style="width: 10%;"></td> <td style="width: 10%;"></td> <td style="width: 10%;"></td> <td style="width: 10%;"></td> <td style="width: 10%;"></td> <td style="width: 10%;"></td> <td style="width: 10%;"></td> <td style="width: 10%;"></td> <td style="width: 10%;"></td> </tr> <tr> <td></td> <td></td> <td colspan="8" style="text-align: center;"> <table border="1" style="width: 100%; border-collapse: collapse; text-align: center;"> <tr> <td style="width: 10%;"></td> <td style="width: 10%;"></td> <td style="width: 10%;"></td> <td style="width: 10%;"></td> <td style="width: 10%;"></td> <td style="width: 10%;"></td> <td style="width: 10%;"></td> <td style="width: 10%;"></td> <td style="width: 10%;"></td> <td style="width: 10%;"></td> </tr> <tr> <td></td> <td></td> <td colspan="8" style="text-align: center;"> <table border="1" style="width: 100%; border-collapse: collapse; text-align: center;"> <tr> <td style="width: 10%;"></td> <td style="width: 10%;"></td> <td style="width: 10%;"></td> <td style="width: 10%;"></td> <td style="width: 10%;"></td> <td style="width: 10%;"></td> <td style="width: 10%;"></td> <td style="width: 10%;"></td> <td style="width: 10%;"></td> <td style="width: 10%;"></td> </tr> <tr> <td></td> <td></td> <td colspan="8" style="text-align: center;"> <table border="1" style="width: 100%; border-collapse: collapse; text-align: center;"> <tr> <td style="width: 10%;"></td> <td style="width: 10%;"></td> <td style="width: 10%;"></td> <td style="width: 10%;"></td> <td style="width: 10%;"></td> <td style="width: 10%;"></td> <td style="width: 10%;"></td> <td style="width: 10%;"></td> <td style="width: 10%;"></td> <td style="width: 10%;"></td> </tr> <tr> <td></td> <td></td> <td colspan="8" style="text-align: center;"> <table border="1" style="width: 100%;
border-collapse: collapse; text-align: center;"> <tr> <td style="width: 10%;"></td> <td style="width: 10%;"></td> <td style="width: 10%;"></td> <td style="width: 10%;"></td> <td style="width: 10%;"></td> <td style="width: 10%;"></td> <td style="width: 10%;"></td> <td style="width: 10%;"></td> <td style="width: 10%;"></td> <td style="width: 10%;"></td> </tr> <tr> <td></td> <td></td> <td colspan="8" style="text-align: center;"> <table border="1" style="width: 100%; border-collapse: collapse; text-align: center;"> <tr> <td style="width: 10%;"></td> <td style="width: 10%;"></td> <td style="width: 10%;"></td> <td style="width: 10%;"></td> <td style="width: 10%;"></td> <td style="width: 10%;"></td> <td style="width: 10%;"></td> <td style="width: 10%;"></td> <td style="width: 10%;"></td> <td style="width: 10%;"></td> </tr> <tr> <td></td> <td></td> <td colspan="8" style="text-align: center;"> <table border="1" style="width: 100%; border-collapse: collapse; text-align: center;"> <tr> <td style="width: 10%;"></td> <td style="width: 10%;"></td> <td style="width: 10%;"></td> <td style="width: 10%;"></td> <td style="width: 10%;"></td> <td style="width: 10%;"></td> <td style="width: 10%;"></td> <td style="width: 10%;"></td> <td style="width: 10%;"></td> <td style="width: 10%;"></td> </tr> <tr> <td></td> <td></td> <td colspan="8" style="text-align: center;"> <table border="1" style="width: 100%; border-collapse: collapse; text-align: center;"> <tr> <td style="width: 10%;"></td> <td style="width: 10%;"></td> <td style="width: 10%;"></td> <td style="width: 10%;"></td> <td style="width: 10%;"></td> <td style="width: 10%;"></td> <td style="width: 10%;"></td> <td style="width: 10%;"></td> <td style="width: 10%;"></td> <td style="width: 10%;"></td> </tr> <tr> <td></td> <td></td> <td colspan="8" style="text-align: center;"> <table border="1" style="width: 100%; border-collapse: collapse; text-align: center;"> <tr> <td style="width: 10%;"></td> <td style="width: 10%;"></td> <td style="width: 10%;"></td> <td style="width: 10%;"></td> <td style="width: 10%;"></td> <td style="width: 10%;"></td> <td style="width: 10%;"></td> <td style="width: 10%;"></td> <td style="width: 10%;"></td> <td style="width: 10%;"></td> </tr> <tr> <td></td> <td></td> <td colspan="8" style="text-align: center;"> <table border="1" style="width: 100%; border-collapse: collapse; text-align: center;"> <tr> <td style="width: 10%;"></td> <td style="width: 10%;"></td> <td style="width: 10%;"></td> <td style="width: 10%;"></td> <td style="width: 10%;"></td> <td style="width: 10%;"></td> <td style="width: 10%;"></td> <td style="width: 10%;"></td> <td style="width: 10%;"></td> <td style="width: 10%;"></td> </tr> <tr> <td></td> <td></td> <td colspan="8" style="text-align: center;"> <table border="1" style="width: 100%; border-collapse: collapse; text-align: center;"> <tr> <td style="width: 10%;"></td> <td style="width: 10%;"></td> <td style="width: 10%;"></td> <td style="width: 10%;"></td> <td style="width: 10%;"></td> <td style="width: 10%;"></td> <td style="width: 10%;"></td> <td style="width: 10%;"></td> <td style="width: 10%;"></td> <td style="width: 10%;"></td> </tr> <tr> <td></td> <td></td> <td colspan="8" style="text-align: center;"> <table border="1" style="width: 100%; border-collapse: collapse; text-align: center;"> <tr> <td style="width: 10%;"></td> <td style="width: 10%;"></td> <td style="width: 10%;"></td> <td style="width: 10%;"></td> <td style="width: 10%;"></td> <td style="width: 10%;"></td> <td style="width: 10%;"></td> <td style="width: 10%;"></td> <td style="width: 10%;"></td> <td style="width: 10%;"></td> </tr> <tr> <td></td> <td></td> <td colspan="8" style="text-align: center;"> <table border="1" style="width: 100%; border-collapse: collapse; text-align: center;"> <tr> <td style="width: 10%;"></td> <td style="width: 10%;"></td> <td style="width: 10%;"></td> <td style="width: 10%;"></td> <td style="width: 10%;"></td> <td style="width: 10%;"></td> <td style="width: 10%;"></td> <td style="width: 10%;"></td> <td style="width: 10%;"></td> <td style="width: 10%;"></td> </tr> <tr> <td></td> <td></td> <td colspan="8" style="text-align: center;"> <table border="1" style="width: 100%; border-collapse: collapse; text-align: center;"> <tr> <td style="width: 10%;"></td> <td style="width: 10%;"></td> <td style="width: 10%;"></td> <td style="width: 10%;"></td> <td style="width: 10%;"></td> <td style="width: 10%;"></td> <td style="width: 10%;"></td> <td style="width: 10%;"></td> <td style="width: 10%;"></td> <td style="width: 10%;"></td> </tr> <tr> <td></td> <td></td> <td colspan="8" style="text-align: center;"> <table border="1" style="width: 100%; border-collapse: collapse; text-align: center;"> <tr> <td style="width: 10%;"></td> <td style="width: 10%;"></td> <td style="width: 10%;"></td> <td style="width: 10%;"></td> <td style="width: 10%;"></td> <td style="width: 10%;"></td> <td style="width: 10%;"></td> <td style="width: 10%;"></td> <td style="width: 10%;"></td> <td style="width: 10%;"></td> </tr> <tr> <td></td> <td></td> <td colspan="8" style="text-align: center;"> <table border="1" style="width: 100%; border-collapse: collapse; text-align: center;"> <tr> <td style="width: 10%;"></td> <td style="width: 10%;"></td> <td style="width: 10%;"></td> <td style="width: 10%;"></td> <td style="width: 10%;"></td> <td style="width: 10%;"></td> <td style="width: 10%;"></td> <td style="width: 10%;"></td> <td style="width: 10%;"></td> <td style="width: 10%;"></td> </tr> <tr> <td></td> <td></td> <td colspan="8" style="text-align: center;"> <table border="1" style="width: 100%; border-collapse: collapse; text-align: center;"> <tr> <td style="width: 10%;"></td> <td style="width: 10%;"></td> <td style="width: 10%;"></td> <td style="width: 10%;"></td> <td style="width: 10%;"></td> <td style="width: 10%;"></td> <td style="width: 10%;"></td> <td style="width: 10%;"></td> <td style="width: 10%;"></td> <td style="width: 10%;"></td> </tr> <tr> <td></td> <td></td> <td colspan="8" style="text-align: center;"> <table border="1" style="width: 100%; border-collapse: collapse; text-align: center;"> <tr> <td style="width: 10%;"></td> <td style="width: 10%;"></td> <td style="width: 10%;"></td> <td style="width: 10%;"></td> <td style="width: 10%;"></td> <td style="width: 10%;"></td> <td style="width: 10%;"></td> <td style="width: 10%;"></td> <td style="width: 10%;"></td> <td style="width: 10%;"></td> </tr> <tr> <td></td> <td></td> <td colspan="8" style="text-align: center;"> <table border="1" style="width: 100%; border-collapse: collapse; text-align: center;"> <tr> <td style="width: 10%;"></td> <td style="width: 10%;"></td> <td style="width: 10%;"></td> <td style="width: 10%;"></td> <td style="width: 10%;"></td> <td style="width: 10%;"></td> <td style="width: 10%;"></td> <td style="width: 10%;"></td> <td style="width: 10%;"></td> <td style="width: 10%;"></td> </tr> <tr> <td></td> <td></td> <td colspan="8" style="text-align: center;"> <table border="1" style="width: 100%; border-collapse: collapse; text-align: center;"> <tr> <td style="width: 10%;"></td> <td style="width: 10%;"></td> <td style="width: 10%;"></td> <td style="width: 10%;"></td> <td style="width: 10%;"></td> <td style="width: 10%;"></td> <td style="width: 10%;"></td> <td style="width: 10%;"></td> <td style="width: 10%;"></td> <td style="width: 10%;"></td> </tr> <tr> <td></td> <td></td> <td colspan="8" style="text-align: center;"> <table border="1" style="width: 100%; border-collapse: collapse; text-align: center;"> <tr> <td style="width: 10%;"></td> <td style="width: 10%;"></td> <td style="width: 10%;"></td> <td style="width: 10%;"></td> <td style="width: 10%;"></td> <td style="width: 10%;"></td> <td style="width: 10%;"></td> <td style="width: 10%;"></td> <td style="width: 10%;"></td> <td style="width: 10%;"></td> </tr> <tr> <td></td> <td></td> <td colspan="8" style="text-align: center;"> <table border="1" style="width: 100%; border-collapse: collapse; text-align: center;"> <tr> <td style="width: 10%;"></td> <td style="width: 10%;"></td> <td style="width: 10%;"></td> <td style="width: 10%;"></td> <td style="width: 10%;"></td> <td style="width: 10%;"></td> <td style="width: 10%;"></td> <td style="width: 10%;"></td> <td style="width: 10%;"></td> <td style="width: 10%;"></td> </tr> <tr> <td></td> <td></td> <td colspan="8" style="text-align: center;"> <table border="1" style="width: 100%; border-collapse: collapse; text-align: center;"> <tr> <td style="width: 10%;"></td> <td style="width: 10%;"></td> <td style="width: 10%;"></td> <td style="width: 10%;"></td> <td style="width: 10%;"></td> <td style="width: 10%;"></td> <td style="width: 10%;"></td> <td style="width: 10%;"></td> <td style="width: 10%;"></td> <td style="width: 10%;"></td> </tr> <tr> <td></td> <td></td> <td colspan="8" style="text-align: center;"> <table border="1" style="width: 100%; border-collapse: collapse; text-align: center;"> <tr> <td style="width: 10%;"></td> <td style="width: 10%;"></td> <td style="width: 10%;"></td> <td style="width: 10%;"></td> <td style="width: 10%;"></td> <td style="width: 10%;"></td> <td style="width: 10%;"></td> <td style="width: 10%;"></td> <td style="width: 10%;"></td> <td style="width: 10%;"></td> </tr> <tr> <td></td> <td></td> <td colspan="8" style="text-align: center;"> <table border="1" style="width: 100%; border-collapse: collapse; text-align: center;"> <tr> <td style="width: 10%;"></td> <td style="width: 10%;"></td> <td style="width: 10%;"></td> <td style="width: 10%;"></td> <td style="width: 10%;"></td> <td style="width: 10%;"></td> <td style="width: 10%;"></td> <td style="width: 10%;"></td> <td style="width: 10%;"></td> <td style="width: 10%;"></td> </tr> <tr> <td></td> <td></td> <td colspan="8" style="text-align: center;"> <table border="1" style="width: 100%; border-collapse: collapse; text-align: center;"> <tr> <td style="width: 10%;"></td> <td style="width: 10%;"></td> <td style="width: 10%;"></td> <td style="width:
10%;"></td> <td style="width: 10%;"></td> <td style="width: 10%;"></td> <td style="width: 10%;"></td> <td style="width: 10%;"></td> <td style="width: 10%;"></td> <td style="width: 10%;"></td> </tr> <tr> <td></td> <td></td> <td colspan="8" style="text-align: center;"> <table border="1" style="width: 100%; border-collapse: collapse; text-align: center;"> <tr> </tr></table></td></tr></table></td></tr></table></td></tr></table></td></tr></table></td></tr></table></td></tr></table></td></tr></table></td></tr></table></td></tr></table></td></tr></table></td></tr></table></td></tr></table></td></tr></table></td></tr></table></td></tr></table></td></tr></table></td></tr></table></td></tr></table></td></tr></table></td></tr></table></td></tr></table></td></tr></table></td></tr></table></td></tr></table></td></tr></table></td></tr></table></td></tr></table> | | | | | | | | | | | | | | | | | | | | <table border="1" style="width: 100%; border-collapse: collapse; text-align: center;"> <tr> <td style="width: 10%;"></td> <td style="width: 10%;"></td> <td style="width: 10%;"></td> <td style="width: 10%;"></td> <td style="width: 10%;"></td> <td style="width: 10%;"></td> <td style="width: 10%;"></td> <td style="width: 10%;"></td> <td style="width: 10%;"></td> <td style="width: 10%;"></td> </tr> <tr> <td></td> <td></td> <td colspan="8" style="text-align: center;"> <table border="1" style="width: 100%; border-collapse: collapse; text-align: center;"> <tr> <td style="width: 10%;"></td> <td style="width: 10%;"></td> <td style="width: 10%;"></td> <td style="width: 10%;"></td> <td style="width: 10%;"></td> <td style="width: 10%;"></td> <td style="width: 10%;"></td> <td style="width: 10%;"></td> <td style="width: 10%;"></td> <td style="width: 10%;"></td> </tr> <tr> <td></td> <td></td> <td colspan="8" style="text-align: center;"> <table border="1" style="width: 100%; border-collapse: collapse; text-align: center;"> <tr> <td style="width: 10%;"></td> <td style="width: 10%;"></td> <td style="width: 10%;"></td> <td style="width: 10%;"></td> <td style="width: 10%;"></td> <td style="width: 10%;"></td> <td style="width: 10%;"></td> <td style="width: 10%;"></td> <td style="width: 10%;"></td> <td style="width: 10%;"></td> </tr> <tr> <td></td> <td></td> <td colspan="8" style="text-align: center;"> <table border="1" style="width: 100%; border-collapse: collapse; text-align: center;"> <tr> <td style="width: 10%;"></td> <td style="width: 10%;"></td> <td style="width: 10%;"></td> <td style="width: 10%;"></td> <td style="width: 10%;"></td> <td style="width: 10%;"></td> <td style="width: 10%;"></td> <td style="width: 10%;"></td> <td style="width: 10%;"></td> <td style="width: 10%;"></td> </tr> <tr> <td></td> <td></td> <td colspan="8" style="text-align: center;"> <table border="1" style="width: 100%; border-collapse: collapse; text-align: center;"> <tr> <td style="width: 10%;"></td> <td style="width: 10%;"></td> <td style="width: 10%;"></td> <td style="width: 10%;"></td> <td style="width: 10%;"></td> <td style="width: 10%;"></td> <td style="width: 10%;"></td> <td style="width: 10%;"></td> <td style="width: 10%;"></td> <td style="width: 10%;"></td> </tr> <tr> <td></td> <td></td> <td colspan="8" style="text-align: center;"> <table border="1" style="width: 100%; border-collapse: collapse; text-align: center;"> <tr> <td style="width: 10%;"></td> <td style="width: 10%;"></td> <td style="width: 10%;"></td> <td style="width: 10%;"></td> <td style="width: 10%;"></td> <td style="width: 10%;"></td> <td style="width: 10%;"></td> <td style="width: 10%;"></td> <td style="width: 10%;"></td> <td style="width: 10%;"></td> </tr> <tr> <td></td> <td></td> <td colspan="8" style="text-align: center;"> <table border="1" style="width: 100%; border-collapse: collapse; text-align: center;"> <tr> <td style="width: 10%;"></td> <td style="width: 10%;"></td> <td style="width: 10%;"></td> <td style="width: 10%;"></td> <td style="width: 10%;"></td> <td style="width: 10%;"></td> <td style="width: 10%;"></td> <td style="width: 10%;"></td> <td style="width: 10%;"></td> <td style="width: 10%;"></td> </tr> <tr> <td></td> <td></td> <td colspan="8" style="text-align: center;"> <table border="1" style="width: 100%; border-collapse: collapse; text-align: center;"> <tr> <td style="width: 10%;"></td> <td style="width: 10%;"></td> <td style="width: 10%;"></td> <td style="width: 10%;"></td> <td style="width: 10%;"></td> <td style="width: 10%;"></td> <td style="width: 10%;"></td> <td style="width: 10%;"></td> <td style="width: 10%;"></td> <td style="width: 10%;"></td> </tr> <tr> <td></td> <td></td> <td colspan="8" style="text-align: center;"> <table border="1" style="width: 100%; border-collapse: collapse; text-align: center;"> <tr> <td style="width: 10%;"></td> <td style="width: 10%;"></td> <td style="width: 10%;"></td> <td style="width: 10%;"></td> <td style="width: 10%;"></td> <td style="width: 10%;"></td> <td style="width: 10%;"></td> <td style="width: 10%;"></td> <td style="width: 10%;"></td> <td style="width: 10%;"></td> </tr> <tr> <td></td> <td></td> <td colspan="8" style="text-align: center;"> <table border="1" style="width: 100%; border-collapse: collapse; text-align: center;"> <tr> <td style="width: 10%;"></td> <td style="width: 10%;"></td> <td style="width: 10%;"></td> <td style="width: 10%;"></td> <td style="width: 10%;"></td> <td style="width: 10%;"></td> <td style="width: 10%;"></td> <td style="width: 10%;"></td> <td style="width: 10%;"></td> <td style="width: 10%;"></td> </tr> <tr> <td></td> <td></td> <td colspan="8" style="text-align: center;"> <table border="1" style="width: 100%; border-collapse: collapse; text-align: center;"> <tr> <td style="width: 10%;"></td> <td style="width: 10%;"></td> <td style="width: 10%;"></td> <td style="width: 10%;"></td> <td style="width: 10%;"></td> <td style="width: 10%;"></td> <td style="width: 10%;"></td> <td style="width: 10%;"></td> <td style="width: 10%;"></td> <td style="width: 10%;"></td> </tr> <tr> <td></td> <td></td> <td colspan="8" style="text-align: center;"> <table border="1" style="width: 100%; border-collapse: collapse; text-align: center;"> <tr> <td style="width: 10%;"></td> <td style="width: 10%;"></td> <td style="width: 10%;"></td> <td style="width: 10%;"></td> <td style="width: 10%;"></td> <td style="width: 10%;"></td> <td style="width: 10%;"></td> <td style="width: 10%;"></td> <td style="width: 10%;"></td> <td style="width: 10%;"></td> </tr> <tr> <td></td> <td></td> <td colspan="8" style="text-align: center;"> <table border="1" style="width: 100%; border-collapse: collapse; text-align: center;"> <tr> <td style="width: 10%;"></td> <td style="width: 10%;"></td> <td style="width: 10%;"></td> <td style="width: 10%;"></td> <td style="width: 10%;"></td> <td style="width: 10%;"></td> <td style="width: 10%;"></td> <td style="width: 10%;"></td> <td style="width: 10%;"></td> <td style="width: 10%;"></td> </tr> <tr> <td></td> <td></td> <td colspan="8" style="text-align: center;"> <table border="1" style="width: 100%; border-collapse: collapse; text-align: center;"> <tr> <td style="width: 10%;"></td> <td style="width: 10%;"></td> <td style="width: 10%;"></td> <td style="width: 10%;"></td> <td style="width: 10%;"></td> <td style="width: 10%;"></td> <td style="width: 10%;"></td> <td style="width: 10%;"></td> <td style="width: 10%;"></td> <td style="width: 10%;"></td> </tr> <tr> <td></td> <td></td> <td colspan="8" style="text-align: center;"> <table border="1" style="width: 100%; border-collapse: collapse; text-align: center;"> <tr> <td style="width: 10%;"></td> <td style="width: 10%;"></td> <td style="width: 10%;"></td> <td style="width: 10%;"></td> <td style="width: 10%;"></td> <td style="width: 10%;"></td> <td style="width: 10%;"></td> <td style="width: 10%;"></td> <td style="width: 10%;"></td> <td style="width: 10%;"></td> </tr> <tr> <td></td> <td></td> <td colspan="8" style="text-align: center;"> <table border="1" style="width: 100%; border-collapse: collapse; text-align: center;"> <tr> <td style="width:
10%;"></td> <td style="width: 10%;"></td> <td style="width: 10%;"></td> <td style="width: 10%;"></td> <td style="width: 10%;"></td> <td style="width: 10%;"></td> <td style="width: 10%;"></td> <td style="width: 10%;"></td> <td style="width: 10%;"></td> <td style="width: 10%;"></td> </tr> <tr> <td></td> <td></td> <td colspan="8" style="text-align: center;"> <table border="1" style="width: 100%; border-collapse: collapse; text-align: center;"> <tr> <td style="width: 10%;"></td> <td style="width: 10%;"></td> <td style="width: 10%;"></td> <td style="width: 10%;"></td> <td style="width: 10%;"></td> <td style="width: 10%;"></td> <td style="width: 10%;"></td> <td style="width: 10%;"></td> <td style="width: 10%;"></td> <td style="width: 10%;"></td> </tr> <tr> <td></td> <td></td> <td colspan="8" style="text-align: center;"> <table border="1" style="width: 100%; border-collapse: collapse; text-align: center;"> <tr> <td style="width: 10%;"></td> <td style="width: 10%;"></td> <td style="width: 10%;"></td> <td style="width: 10%;"></td> <td style="width: 10%;"></td> <td style="width: 10%;"></td> <td style="width: 10%;"></td> <td style="width: 10%;"></td> <td style="width: 10%;"></td> <td style="width: 10%;"></td> </tr> <tr> <td></td> <td></td> <td colspan="8" style="text-align: center;"> <table border="1" style="width: 100%; border-collapse: collapse; text-align: center;"> <tr> <td style="width: 10%;"></td> <td style="width: 10%;"></td> <td style="width: 10%;"></td> <td style="width: 10%;"></td> <td style="width: 10%;"></td> <td style="width: 10%;"></td> <td style="width: 10%;"></td> <td style="width: 10%;"></td> <td style="width: 10%;"></td> <td style="width: 10%;"></td> </tr> <tr> <td></td> <td></td> <td colspan="8" style="text-align: center;"> <table border="1" style="width: 100%; border-collapse: collapse; text-align: center;"> <tr> <td style="width: 10%;"></td> <td style="width: 10%;"></td> <td style="width: 10%;"></td> <td style="width: 10%;"></td> <td style="width: 10%;"></td> <td style="width: 10%;"></td> <td style="width: 10%;"></td> <td style="width: 10%;"></td> <td style="width: 10%;"></td> <td style="width: 10%;"></td> </tr> <tr> <td></td> <td></td> <td colspan="8" style="text-align: center;"> <table border="1" style="width: 100%; border-collapse: collapse; text-align: center;"> <tr> <td style="width: 10%;"></td> <td style="width: 10%;"></td> <td style="width: 10%;"></td> <td style="width: 10%;"></td> <td style="width: 10%;"></td> <td style="width: 10%;"></td> <td style="width: 10%;"></td> <td style="width: 10%;"></td> <td style="width: 10%;"></td> <td style="width: 10%;"></td> </tr> <tr> <td></td> <td></td> <td colspan="8" style="text-align: center;"> <table border="1" style="width: 100%; border-collapse: collapse; text-align: center;"> <tr> <td style="width: 10%;"></td> <td style="width: 10%;"></td> <td style="width: 10%;"></td> <td style="width: 10%;"></td> <td style="width: 10%;"></td> <td style="width: 10%;"></td> <td style="width: 10%;"></td> <td style="width: 10%;"></td> <td style="width: 10%;"></td> <td style="width: 10%;"></td> </tr> <tr> <td></td> <td></td> <td colspan="8" style="text-align: center;"> <table border="1" style="width: 100%; border-collapse: collapse; text-align: center;"> <tr> <td style="width: 10%;"></td> <td style="width: 10%;"></td> <td style="width: 10%;"></td> <td style="width: 10%;"></td> <td style="width: 10%;"></td> <td style="width: 10%;"></td> <td style="width: 10%;"></td> <td style="width: 10%;"></td> <td style="width: 10%;"></td> <td style="width: 10%;"></td> </tr> <tr> <td></td> <td></td> <td colspan="8" style="text-align: center;"> <table border="1" style="width: 100%; border-collapse: collapse; text-align: center;"> <tr> <td style="width: 10%;"></td> <td style="width: 10%;"></td> <td style="width: 10%;"></td> <td style="width: 10%;"></td> <td style="width: 10%;"></td> <td style="width: 10%;"></td> <td style="width: 10%;"></td> <td style="width: 10%;"></td> <td style="width: 10%;"></td> <td style="width: 10%;"></td> </tr> <tr> <td></td> <td></td> <td colspan="8" style="text-align: center;"> <table border="1" style="width: 100%; border-collapse: collapse; text-align: center;"> <tr> <td style="width: 10%;"></td> <td style="width: 10%;"></td> <td style="width: 10%;"></td> <td style="width: 10%;"></td> <td style="width: 10%;"></td> <td style="width: 10%;"></td> <td style="width: 10%;"></td> <td style="width: 10%;"></td> <td style="width: 10%;"></td> <td style="width: 10%;"></td> </tr> <tr> <td></td> <td></td> <td colspan="8" style="text-align: center;"> <table border="1" style="width: 100%; border-collapse: collapse; text-align: center;"> <tr> <td style="width: 10%;"></td> <td style="width: 10%;"></td> <td style="width: 10%;"></td> <td style="width: 10%;"></td> <td style="width: 10%;"></td> <td style="width: 10%;"></td> <td style="width: 10%;"></td> <td style="width: 10%;"></td> <td style="width: 10%;"></td> <td style="width: 10%;"></td> </tr> <tr> <td></td> <td></td> <td colspan="8" style="text-align: center;"> <table border="1" style="width: 100%; border-collapse: collapse; text-align: center;"> <tr> </tr></table></td></tr></table></td></tr></table></td></tr></table></td></tr></table></td></tr></table></td></tr></table></td></tr></table></td></tr></table></td></tr></table></td></tr></table></td></tr></table></td></tr></table></td></tr></table></td></tr></table></td></tr></table></td></tr></table></td></tr></table></td></tr></table></td></tr></table></td></tr></table></td></tr></table></td></tr></table></td></tr></table></td></tr></table></td></tr></table></td></tr></table> | | | | | | | | | | | | | | | | | | | | <table border="1" style="width: 100%; border-collapse: collapse; text-align: center;"> <tr> <td style="width: 10%;"></td> <td style="width: 10%;"></td> <td style="width: 10%;"></td> <td style="width: 10%;"></td> <td style="width: 10%;"></td> <td style="width: 10%;"></td> <td style="width: 10%;"></td> <td style="width: 10%;"></td> <td style="width: 10%;"></td> <td style="width: 10%;"></td> </tr> <tr> <td></td> <td></td> <td colspan="8" style="text-align: center;"> <table border="1" style="width: 100%; border-collapse: collapse; text-align: center;"> <tr> <td style="width: 10%;"></td> <td style="width: 10%;"></td> <td style="width: 10%;"></td> <td style="width: 10%;"></td> <td style="width: 10%;"></td> <td style="width: 10%;"></td> <td style="width: 10%;"></td> <td style="width: 10%;"></td> <td style="width: 10%;"></td> <td style="width: 10%;"></td> </tr> <tr> <td></td> <td></td> <td colspan="8" style="text-align: center;"> <table border="1" style="width: 100%; border-collapse: collapse; text-align: center;"> <tr> <td style="width: 10%;"></td> <td style="width: 10%;"></td> <td style="width: 10%;"></td> <td style="width: 10%;"></td> <td style="width: 10%;"></td> <td style="width: 10%;"></td> <td style="width: 10%;"></td> <td style="width: 10%;"></td> <td style="width: 10%;"></td> <td style="width: 10%;"></td> </tr> <tr> <td></td> <td></td> <td colspan="8" style="text-align: center;"> <table border="1" style="width: 100%; border-collapse: collapse; text-align: center;"> <tr> <td style="width: 10%;"></td> <td style="width: 10%;"></td> <td style="width: 10%;"></td> <td style="width: 10%;"></td> <td style="width: 10%;"></td> <td style="width: 10%;"></td> <td style="width: 10%;"></td> <td style="width: 10%;"></td> <td style="width: 10%;"></td> <td style="width: 10%;"></td> </tr> <tr> <td></td> <td></td> <td colspan="8" style="text-align: center;"> <table border="1" style="width: 100%; border-collapse: collapse; text-align: center;"> <tr> <td style="width: 10%;"></td> <td style="width: 10%;"></td> <td style="width: 10%;"></td> <td style="width: 10%;"></td> <td style="width: 10%;"></td> <td style="width: 10%;"></td> <td style="width: 10%;"></td> <td style="width: 10%;"></td> <td style="width: 10%;"></td> <td style="width: 10%;"></td> </tr> <tr> <td></td> <td></td> <td colspan="8" style="text-align: center;"> <table border="1" style="width: 100%;
border-collapse: collapse; text-align: center;"> <tr> <td style="width: 10%;"></td> <td style="width: 10%;"></td> <td style="width: 10%;"></td> <td style="width: 10%;"></td> <td style="width: 10%;"></td> <td style="width: 10%;"></td> <td style="width: 10%;"></td> <td style="width: 10%;"></td> <td style="width: 10%;"></td> <td style="width: 10%;"></td> </tr> <tr> <td></td> <td></td> <td colspan="8" style="text-align: center;"> <table border="1" style="width: 100%; border-collapse: collapse; text-align: center;"> <tr> <td style="width: 10%;"></td> <td style="width: 10%;"></td> <td style="width: 10%;"></td> <td style="width: 10%;"></td> <td style="width: 10%;"></td> <td style="width: 10%;"></td> <td style="width: 10%;"></td> <td style="width: 10%;"></td> <td style="width: 10%;"></td> <td style="width: 10%;"></td> </tr> <tr> <td></td> <td></td> <td colspan="8" style="text-align: center;"> <table border="1" style="width: 100%; border-collapse: collapse; text-align: center;"> <tr> <td style="width: 10%;"></td> <td style="width: 10%;"></td> <td style="width: 10%;"></td> <td style="width: 10%;"></td> <td style="width: 10%;"></td> <td style="width: 10%;"></td> <td style="width: 10%;"></td> <td style="width: 10%;"></td> <td style="width: 10%;"></td> <td style="width: 10%;"></td> </tr> <tr> <td></td> <td></td> <td colspan="8" style="text-align: center;"> <table border="1" style="width: 100%; border-collapse: collapse; text-align: center;"> <tr> <td style="width: 10%;"></td> <td style="width: 10%;"></td> <td style="width: 10%;"></td> <td style="width: 10%;"></td> <td style="width: 10%;"></td> <td style="width: 10%;"></td> <td style="width: 10%;"></td> <td style="width: 10%;"></td> <td style="width: 10%;"></td> <td style="width: 10%;"></td> </tr> <tr> <td></td> <td></td> <td colspan="8" style="text-align: center;"> <table border="1" style="width: 100%; border-collapse: collapse; text-align: center;"> <tr> <td style="width: 10%;"></td> <td style="width: 10%;"></td> <td style="width: 10%;"></td> <td style="width: 10%;"></td> <td style="width: 10%;"></td> <td style="width: 10%;"></td> <td style="width: 10%;"></td> <td style="width: 10%;"></td> <td style="width: 10%;"></td> <td style="width: 10%;"></td> </tr> <tr> <td></td> <td></td> <td colspan="8" style="text-align: center;"> <table border="1" style="width: 100%; border-collapse: collapse; text-align: center;"> <tr> <td style="width: 10%;"></td> <td style="width: 10%;"></td> <td style="width: 10%;"></td> <td style="width: 10%;"></td> <td style="width: 10%;"></td> <td style="width: 10%;"></td> <td style="width: 10%;"></td> <td style="width: 10%;"></td> <td style="width: 10%;"></td> <td style="width: 10%;"></td> </tr> <tr> <td></td> <td></td> <td colspan="8" style="text-align: center;"> <table border="1" style="width: 100%; border-collapse: collapse; text-align: center;"> <tr> <td style="width: 10%;"></td> <td style="width: 10%;"></td> <td style="width: 10%;"></td> <td style="width: 10%;"></td> <td style="width: 10%;"></td> <td style="width: 10%;"></td> <td style="width: 10%;"></td> <td style="width: 10%;"></td> <td style="width: 10%;"></td> <td style="width: 10%;"></td> </tr> <tr> <td></td> <td></td> <td colspan="8" style="text-align: center;"> <table border="1" style="width: 100%; border-collapse: collapse; text-align: center;"> <tr> <td style="width: 10%;"></td> <td style="width: 10%;"></td> <td style="width: 10%;"></td> <td style="width: 10%;"></td> <td style="width: 10%;"></td> <td style="width: 10%;"></td> <td style="width: 10%;"></td> <td style="width: 10%;"></td> <td style="width: 10%;"></td> <td style="width: 10%;"></td> </tr> <tr> <td></td> <td></td> <td colspan="8" style="text-align: center;"> <table border="1" style="width: 100%; border-collapse: collapse; text-align: center;"> <tr> <td style="width: 10%;"></td> <td style="width: 10%;"></td> <td style="width: 10%;"></td> <td style="width: 10%;"></td> <td style="width: 10%;"></td> <td style="width: 10%;"></td> <td style="width: 10%;"></td> <td style="width: 10%;"></td> <td style="width: 10%;"></td> <td style="width: 10%;"></td> </tr> <tr> <td></td> <td></td> <td colspan="8" style="text-align: center;"> <table border="1" style="width: 100%; border-collapse: collapse; text-align: center;"> <tr> <td style="width: 10%;"></td> <td style="width: 10%;"></td> <td style="width: 10%;"></td> <td style="width: 10%;"></td> <td style="width: 10%;"></td> <td style="width: 10%;"></td> <td style="width: 10%;"></td> <td style="width: 10%;"></td> <td style="width: 10%;"></td> <td style="width: 10%;"></td> </tr> <tr> <td></td> <td></td> <td colspan="8" style="text-align: center;"> <table border="1" style="width: 100%; border-collapse: collapse; text-align: center;"> <tr> <td style="width: 10%;"></td> <td style="width: 10%;"></td> <td style="width: 10%;"></td> <td style="width: 10%;"></td> <td style="width: 10%;"></td> <td style="width: 10%;"></td> <td style="width: 10%;"></td> <td style="width: 10%;"></td> <td style="width: 10%;"></td> <td style="width: 10%;"></td> </tr> <tr> <td></td> <td></td> <td colspan="8" style="text-align: center;"> <table border="1" style="width: 100%; border-collapse: collapse; text-align: center;"> <tr> <td style="width: 10%;"></td> <td style="width: 10%;"></td> <td style="width: 10%;"></td> <td style="width: 10%;"></td> <td style="width: 10%;"></td> <td style="width: 10%;"></td> <td style="width: 10%;"></td> <td style="width: 10%;"></td> <td style="width: 10%;"></td> <td style="width: 10%;"></td> </tr> <tr> <td></td> <td></td> <td colspan="8" style="text-align: center;"> <table border="1" style="width: 100%; border-collapse: collapse; text-align: center;"> <tr> <td style="width: 10%;"></td> <td style="width: 10%;"></td> <td style="width: 10%;"></td> <td style="width: 10%;"></td> <td style="width: 10%;"></td> <td style="width: 10%;"></td> <td style="width: 10%;"></td> <td style="width: 10%;"></td> <td style="width: 10%;"></td> <td style="width: 10%;"></td> </tr> <tr> <td></td> <td></td> <td colspan="8" style="text-align: center;"> <table border="1" style="width: 100%; border-collapse: collapse; text-align: center;"> <tr> <td style="width: 10%;"></td> <td style="width: 10%;"></td> <td style="width: 10%;"></td> <td style="width: 10%;"></td> <td style="width: 10%;"></td> <td style="width: 10%;"></td> <td style="width: 10%;"></td> <td style="width: 10%;"></td> <td style="width: 10%;"></td> <td style="width: 10%;"></td> </tr> <tr> <td></td> <td></td> <td colspan="8" style="text-align: center;"> <table border="1" style="width: 100%; border-collapse: collapse; text-align: center;"> <tr> <td style="width: 10%;"></td> <td style="width: 10%;"></td> <td style="width: 10%;"></td> <td style="width: 10%;"></td> <td style="width: 10%;"></td> <td style="width: 10%;"></td> <td style="width: 10%;"></td> <td style="width: 10%;"></td> <td style="width: 10%;"></td> <td style="width: 10%;"></td> </tr> <tr> <td></td> <td></td> <td colspan="8" style="text-align: center;"> <table border="1" style="width: 100%; border-collapse: collapse; text-align: center;"> <tr> <td style="width: 10%;"></td> <td style="width: 10%;"></td> <td style="width: 10%;"></td> <td style="width: 10%;"></td> <td style="width: 10%;"></td> <td style="width: 10%;"></td> <td style="width: 10%;"></td> <td style="width: 10%;"></td> <td style="width: 10%;"></td> <td style="width: 10%;"></td> </tr> <tr> <td></td> <td></td> <td colspan="8" style="text-align: center;"> <table border="1" style="width: 100%; border-collapse: collapse; text-align: center;"> <tr> <td style="width: 10%;"></td> <td style="width: 10%;"></td> <td style="width: 10%;"></td> <td style="width: 10%;"></td> <td style="width: 10%;"></td> <td style="width: 10%;"></td> <td style="width: 10%;"></td> <td style="width: 10%;"></td> <td style="width: 10%;"></td> <td style="width: 10%;"></td> </tr> <tr> <td></td> <td></td> <td colspan="8" style="text-align: center;"> <table border="1" style="width: 100%; border-collapse: collapse; text-align: center;"> <tr> <td style="width: 10%;"></td> <td style="width: 10%;"></td> <td style="width: 10%;"></td> <td style="width: 10%;"></td> <td style="width: 10%;"></td> <td style="width: 10%;"></td> <td style="width: 10%;"></td> <td style="width: 10%;"></td> <td style="width: 10%;"></td> <td style="width: 10%;"></td> </tr> <tr> <td></td> <td></td> <td colspan="8" style="text-align: center;"> <table border="1" style="width: 100%; border-collapse: collapse; text-align: center;"> <tr> <td style="width: 10%;"></td> <td style="width: 10%;"></td> <td style="width: 10%;"></td> <td style="width: 10%;"></td> <td style="width: 10%;"></td> <td style="width: 10%;"></td> <td style="width: 10%;"></td> <td style="width: 10%;"></td> <td style="width: 10%;"></td> <td style="width: 10%;"></td> </tr> <tr> <td></td> <td></td> <td colspan="8" style="text-align: center;"> <table border="1" style="width: 100%; border-collapse: collapse; text-align: center;"> <tr> <td style="width: 10%;"></td> <td style="width: 10%;"></td> <td style="width: 10%;"></td> <td style="width: 10%;"></td> <td style="width: 10%;"></td> <td style="width: 10%;"></td> <td style="width: 10%;"></td> <td style="width: 10%;"></td> <td style="width: 10%;"></td> <td style="width: 10%;"></td> </tr> <tr> <td></td> <td></td> <td colspan="8" style="text-align: center;"> <table border="1" style="width: 100%; border-collapse: collapse; text-align: center;"> <tr> </tr></table></td></tr></table></td></tr></table></td></tr></table></td></tr></table></td></tr></table></td></tr></table></td></tr></table></td></tr></table></td></tr></table></td></tr></table></td></tr></table></td></tr></table></td></tr></table></td></tr></table></td></tr></table></td></tr></table></td></tr></table></td></tr></table></td></tr></table></td></tr></table></td></tr></table></td></tr></table></td></tr></table></td></tr></table></td></tr></table>
 | | | | | | | | | | | | | | | | | | | | <table border="1" style="width: 100%; border-collapse: collapse; text-align: center;"> <tr> <td style="width: 10%;"></td> <td style="width: 10%;"></td> <td style="width: 10%;"></td> <td style="width: 10%;"></td> <td style="width: 10%;"></td> <td style="width: 10%;"></td> <td style="width: 10%;"></td> <td style="width: 10%;"></td> <td style="width: 10%;"></td> <td style="width: 10%;"></td> </tr> <tr> <td></td> <td></td> <td colspan="8" style="text-align: center;"> <table border="1" style="width: 100%; border-collapse: collapse; text-align: center;"> <tr> <td style="width: 10%;"></td> <td style="width: 10%;"></td> <td style="width: 10%;"></td> <td style="width: 10%;"></td> <td style="width: 10%;"></td> <td style="width: 10%;"></td> <td style="width: 10%;"></td> <td style="width: 10%;"></td> <td style="width: 10%;"></td> <td style="width: 10%;"></td> </tr> <tr> <td></td> <td></td> <td colspan="8" style="text-align: center;"> <table border="1" style="width: 100%; border-collapse: collapse; text-align: center;"> <tr> <td style="width: 10%;"></td> <td style="width: 10%;"></td> <td style="width: 10%;"></td> <td style="width: 10%;"></td> <td style="width: 10%;"></td> <td style="width: 10%;"></td> <td style="width: 10%;"></td> <td style="width: 10%;"></td> <td style="width: 10%;"></td> <td style="width: 10%;"></td> </tr> <tr> <td></td> <td></td> <td colspan="8" style="text-align: center;"> <table border="1" style="width: 100%; border-collapse: collapse; text-align: center;"> <tr> <td style="width: 10%;"></td> <td style="width: 10%;"></td> <td style="width: 10%;"></td> <td style="width: 10%;"></td> <td style="width: 10%;"></td> <td style="width: 10%;"></td> <td style="width: 10%;"></td> <td style="width: 10%;"></td> <td style="width: 10%;"></td> <td style="width: 10%;"></td> </tr> <tr> <td></td> <td></td> <td colspan="8" style="text-align: center;"> <table border="1" style="width: 100%; border-collapse: collapse; text-align: center;"> <tr> <td style="width: 10%;"></td> <td style="width: 10%;"></td> <td style="width: 10%;"></td> <td style="width: 10%;"></td> <td style="width: 10%;"></td> <td style="width: 10%;"></td> <td style="width: 10%;"></td> <td style="width: 10%;"></td> <td style="width: 10%;"></td> <td style="width: 10%;"></td> </tr> <tr> <td></td> <td></td> <td colspan="8" style="text-align: center;"> <table border="1" style="width: 100%; border-collapse: collapse; text-align: center;"> <tr> <td style="width: 10%;"></td> <td style="width: 10%;"></td> <td style="width: 10%;"></td> <td style="width: 10%;"></td> <td style="width: 10%;"></td> <td style="width: 10%;"></td> <td style="width: 10%;"></td> <td style="width: 10%;"></td> <td style="width: 10%;"></td> <td style="width: 10%;"></td> </tr> <tr> <td></td> <td></td> <td colspan="8" style="text-align: center;"> <table border="1" style="width: 100%; border-collapse: collapse; text-align: center;"> <tr> <td style="width: 10%;"></td> <td style="width: 10%;"></td> <td style="width: 10%;"></td> <td style="width: 10%;"></td> <td style="width: 10%;"></td> <td style="width: 10%;"></td> <td style="width: 10%;"></td> <td style="width: 10%;"></td> <td style="width: 10%;"></td> <td style="width: 10%;"></td> </tr> <tr> <td></td> <td></td> <td colspan="8" style="text-align: center;"> <table border="1" style="width: 100%; border-collapse: collapse; text-align: center;"> <tr> <td style="width: 10%;"></td> <td style="width: 10%;"></td> <td style="width: 10%;"></td> <td style="width: 10%;"></td> <td style="width: 10%;"></td> <td style="width: 10%;"></td> <td style="width: 10%;"></td> <td style="width: 10%;"></td> <td style="width: 10%;"></td> <td style="width: 10%;"></td> </tr> <tr> <td></td> <td></td> <td colspan="8" style="text-align: center;"> <table border="1" style="width: 100%; border-collapse: collapse; text-align: center;"> <tr> <td style="width: 10%;"></td> <td style="width: 10%;"></td> <td style="width: 10%;"></td> <td style="width: 10%;"></td> <td style="width: 10%;"></td> <td style="width: 10%;"></td> <td style="width: 10%;"></td> <td style="width: 10%;"></td> <td style="width: 10%;"></td> <td style="width: 10%;"></td> </tr> <tr> <td></td> <td></td> <td colspan="8" style="text-align: center;"> <table border="1" style="width: 100%; border-collapse: collapse; text-align: center;"> <tr> <td style="width: 10%;"></td> <td style="width: 10%;"></td> <td style="width: 10%;"></td> <td style="width: 10%;"></td> <td style="width: 10%;"></td> <td style="width: 10%;"></td> <td style="width: 10%;"></td> <td style="width: 10%;"></td> <td style="width: 10%;"></td> <td style="width: 10%;"></td> </tr> <tr> <td></td> <td></td> <td colspan="8" style="text-align: center;"> <table border="1" style="width: 100%; border-collapse: collapse; text-align: center;"> <tr> <td style="width: 10%;"></td> <td style="width: 10%;"></td> <td style="width: 10%;"></td> <td style="width: 10%;"></td> <td style="width: 10%;"></td> <td style="width: 10%;"></td> <td style="width: 10%;"></td> <td style="width: 10%;"></td> <td style="width: 10%;"></td> <td style="width: 10%;"></td> </tr> <tr> <td></td> <td></td> <td colspan="8" style="text-align: center;"> <table border="1" style="width: 100%; border-collapse: collapse; text-align: center;"> <tr> <td style="width: 10%;"></td> <td style="width: 10%;"></td> <td style="width: 10%;"></td> <td style="width: 10%;"></td> <td style="width: 10%;"></td> <td style="width: 10%;"></td> <td style="width: 10%;"></td> <td style="width: 10%;"></td> <td style="width: 10%;"></td> <td style="width: 10%;"></td> </tr> <tr> <td></td> <td></td> <td colspan="8" style="text-align: center;"> <table border="1" style="width: 100%; border-collapse: collapse; text-align: center;"> <tr> <td style="width: 10%;"></td> <td style="width: 10%;"></td> <td style="width: 10%;"></td> <td style="width: 10%;"></td> <td style="width: 10%;"></td> <td style="width: 10%;"></td> <td style="width: 10%;"></td> <td style="width: 10%;"></td> <td style="width: 10%;"></td> <td style="width: 10%;"></td> </tr> <tr> <td></td> <td></td> <td colspan="8" style="text-align: center;"> <table border="1" style="width: 100%; border-collapse: collapse; text-align: center;"> <tr> <td style="width: 10%;"></td> <td style="width: 10%;"></td> <td style="width: 10%;"></td> <td style="width: 10%;"></td> <td style="width: 10%;"></td> <td style="width: 10%;"></td> <td style="width: 10%;"></td> <td style="width: 10%;"></td> <td style="width: 10%;"></td> <td style="width: 10%;"></td> </tr> <tr> <td></td> <td></td> <td colspan="8" style="text-align: center;"> <table border="1" style="width: 100%; border-collapse: collapse; text-align: center;"> <tr> <td style="width: 10%;"></td> <td style="width: 10%;"></td> <td style="width: 10%;"></td> <td style="width: 10%;"></td> <td style="width: 10%;"></td> <td style="width: 10%;"></td> <td style="width: 10%;"></td> <td style="width: 10%;"></td> <td style="width: 10%;"></td> <td style="width: 10%;"></td> </tr> <tr> <td></td> <td></td> <td colspan="8" style="text-align: center;"> <table border="1" style="width: 100%; border-collapse: collapse; text-align: center;"> <tr> <td style="width: 10%;"></td> <td style="width: 10%;"></td> <td style="width: 10%;"></td> <td style="width: 10%;"></td> <td style="width: 10%;"></td> <td style="width: 10%;"></td> <td style="width: 10%;"></td> <td style="width: 10%;"></td> <td style="width: 10%;"></td> <td style="width: 10%;"></td> </tr> <tr> <td></td> <td></td> <td colspan="8" style="text-align: center;"> <table border="1" style="width: 100%; border-collapse: collapse; text-align: center;"> <tr> <td style="width: 10%;"></td> <td style="width: 10%;"></td> <td style="width: 10%;"></td> <td style="width: 10%;"></td> <td style="width: 10%;"></td> <td style="width: 10%;"></td> <td style="width: 10%;"></td> <td style="width: 10%;"></td> <td style="width: 10%;"></td> <td style="width: 10%;"></td> </tr> <tr> <td></td> <td></td> <td colspan="8" style="text-align: center;"> <table border="1" style="width: 100%; border-collapse: collapse; text-align: center;"> <tr> <td style="width: 10%;"></td> <td style="width: 10%;"></td> <td
style="width: 10%;"></td> <td style="width: 10%;"></td> <td style="width: 10%;"></td> <td style="width: 10%;"></td> <td style="width: 10%;"></td> <td style="width: 10%;"></td> <td style="width: 10%;"></td> <td style="width: 10%;"></td> </tr> <tr> <td></td> <td></td> <td colspan="8" style="text-align: center;"> <table border="1" style="width: 100%; border-collapse: collapse; text-align: center;"> <tr> <td style="width: 10%;"></td> <td style="width: 10%;"></td> <td style="width: 10%;"></td> <td style="width: 10%;"></td> <td style="width: 10%;"></td> <td style="width: 10%;"></td> <td style="width: 10%;"></td> <td style="width: 10%;"></td> <td style="width: 10%;"></td> <td style="width: 10%;"></td> </tr> <tr> <td></td> <td></td> <td colspan="8" style="text-align: center;"> <table border="1" style="width: 100%; border-collapse: collapse; text-align: center;"> <tr> <td style="width: 10%;"></td> <td style="width: 10%;"></td> <td style="width: 10%;"></td> <td style="width: 10%;"></td> <td style="width: 10%;"></td> <td style="width: 10%;"></td> <td style="width: 10%;"></td> <td style="width: 10%;"></td> <td style="width: 10%;"></td> <td style="width: 10%;"></td> </tr> <tr> <td></td> <td></td> <td colspan="8" style="text-align: center;"> <table border="1" style="width: 100%; border-collapse: collapse; text-align: center;"> <tr> <td style="width: 10%;"></td> <td style="width: 10%;"></td> <td style="width: 10%;"></td> <td style="width: 10%;"></td> <td style="width: 10%;"></td> <td style="width: 10%;"></td> <td style="width: 10%;"></td> <td style="width: 10%;"></td> <td style="width: 10%;"></td> <td style="width: 10%;"></td> </tr> <tr> <td></td> <td></td> <td colspan="8" style="text-align: center;"> <table border="1" style="width: 100%; border-collapse: collapse; text-align: center;"> <tr> <td style="width: 10%;"></td> <td style="width: 10%;"></td> <td style="width: 10%;"></td> <td style="width: 10%;"></td> <td style="width: 10%;"></td> <td style="width: 10%;"></td> <td style="width: 10%;"></td> <td style="width: 10%;"></td> <td style="width: 10%;"></td> <td style="width: 10%;"></td> </tr> <tr> <td></td> <td></td> <td colspan="8" style="text-align: center;"> <table border="1" style="width: 100%; border-collapse: collapse; text-align: center;"> <tr> <td style="width: 10%;"></td> <td style="width: 10%;"></td> <td style="width: 10%;"></td> <td style="width: 10%;"></td> <td style="width: 10%;"></td> <td style="width: 10%;"></td> <td style="width: 10%;"></td> <td style="width: 10%;"></td> <td style="width: 10%;"></td> <td style="width: 10%;"></td> </tr> <tr> <td></td> <td></td> <td colspan="8" style="text-align: center;"> <table border="1" style="width: 100%; border-collapse: collapse; text-align: center;"> <tr> <td style="width: 10%;"></td> <td style="width: 10%;"></td> <td style="width: 10%;"></td> <td style="width: 10%;"></td> <td style="width: 10%;"></td> <td style="width: 10%;"></td> <td style="width: 10%;"></td> <td style="width: 10%;"></td> <td style="width: 10%;"></td> <td style="width: 10%;"></td> </tr> <tr> <td></td> <td></td> <td colspan="8" style="text-align: center;"> <table border="1" style="width: 100%; border-collapse: collapse; text-align: center;"> <tr> </tr></table></td></tr></table></td></tr></table></td></tr></table></td></tr></table></td></tr></table></td></tr></table></td></tr></table></td></tr></table></td></tr></table></td></tr></table></td></tr></table></td></tr></table></td></tr></table></td></tr></table></td></tr></table></td></tr></table></td></tr></table></td></tr></table></td></tr></table></td></tr></table></td></tr></table></td></tr></table></td></tr></table></td></tr></table> | | | | | | | | | | | | | | | | | | | | <table border="1" style="width: 100%; border-collapse: collapse; text-align: center;"> <tr> <td style="width: 10%;"></td> <td style="width: 10%;"></td> <td style="width: 10%;"></td> <td style="width: 10%;"></td> <td style="width: 10%;"></td> <td style="width: 10%;"></td> <td style="width: 10%;"></td> <td style="width: 10%;"></td> <td style="width: 10%;"></td> <td style="width: 10%;"></td> </tr> <tr> <td></td> <td></td> <td colspan="8" style="text-align: center;"> <table border="1" style="width: 100%; border-collapse: collapse; text-align: center;"> <tr> <td style="width: 10%;"></td> <td style="width: 10%;"></td> <td style="width: 10%;"></td> <td style="width: 10%;"></td> <td style="width: 10%;"></td> <td style="width: 10%;"></td> <td style="width: 10%;"></td> <td style="width: 10%;"></td> <td style="width: 10%;"></td> <td style="width: 10%;"></td> </tr> <tr> <td></td> <td></td> <td colspan="8" style="text-align: center;"> <table border="1" style="width: 100%; border-collapse: collapse; text-align: center;"> <tr> <td style="width: 10%;"></td> <td style="width: 10%;"></td> <td style="width: 10%;"></td> <td style="width: 10%;"></td> <td style="width: 10%;"></td> <td style="width: 10%;"></td> <td style="width: 10%;"></td> <td style="width: 10%;"></td> <td style="width: 10%;"></td> <td style="width: 10%;"></td> </tr> <tr> <td></td> <td></td> <td colspan="8" style="text-align: center;"> <table border="1" style="width: 100%; border-collapse: collapse; text-align: center;"> <tr> <td style="width: 10%;"></td> <td style="width: 10%;"></td> <td style="width: 10%;"></td> <td style="width: 10%;"></td> <td style="width: 10%;"></td> <td style="width: 10%;"></td> <td style="width: 10%;"></td> <td style="width: 10%;"></td> <td style="width: 10%;"></td> <td style="width: 10%;"></td> </tr> <tr> <td></td> <td></td> <td colspan="8" style="text-align: center;"> <table border="1" style="width: 100%; border-collapse: collapse; text-align: center;"> <tr> <td style="width: 10%;"></td> <td style="width: 10%;"></td> <td style="width: 10%;"></td> <td style="width: 10%;"></td> <td style="width: 10%;"></td> <td style="width: 10%;"></td> <td style="width: 10%;"></td> <td style="width: 10%;"></td> <td style="width: 10%;"></td> <td style="width: 10%;"></td> </tr> <tr> <td></td> <td></td> <td colspan="8" style="text-align: center;"> <table border="1" style="width: 100%; border-collapse: collapse; text-align: center;"> <tr> <td style="width: 10%;"></td> <td style="width: 10%;"></td> <td style="width: 10%;"></td> <td style="width: 10%;"></td> <td style="width: 10%;"></td> <td style="width: 10%;"></td> <td style="width: 10%;"></td> <td style="width: 10%;"></td> <td style="width: 10%;"></td> <td style="width: 10%;"></td> </tr> <tr> <td></td> <td></td> <td colspan="8" style="text-align: center;"> <table border="1" style="width: 100%; border-collapse: collapse; text-align: center;"> <tr> <td style="width: 10%;"></td> <td style="width: 10%;"></td> <td style="width: 10%;"></td> <td style="width: 10%;"></td> <td style="width: 10%;"></td> <td style="width: 10%;"></td> <td style="width: 10%;"></td> <td style="width: 10%;"></td> <td style="width: 10%;"></td> <td style="width: 10%;"></td> </tr> <tr> <td></td> <td></td> <td colspan="8" style="text-align: center;"> <table border="1" style="width: 100%; border-collapse: collapse; text-align: center;"> <tr> <td style="width: 10%;"></td> <td style="width: 10%;"></td> <td style="width: 10%;"></td> <td style="width: 10%;"></td> <td style="width: 10%;"></td> <td style="width: 10%;"></td> <td style="width: 10%;"></td> <td style="width: 10%;"></td> <td style="width: 10%;"></td> <td style="width: 10%;"></td> </tr> <tr> <td></td> <td></td> <td colspan="8" style="text-align: center;"> <table border="1" style="width: 100%; border-collapse: collapse; text-align: center;"> <tr> <td style="width: 10%;"></td> <td style="width: 10%;"></td> <td style="width: 10%;"></td> <td style="width: 10%;"></td> <td style="width: 10%;"></td> <td style="width: 10%;"></td> <td style="width: 10%;"></td> <td style="width: 10%;"></td> <td style="width: 10%;"></td> <td style="width: 10%;"></td> </tr> <tr> <td></td> <td></td> <td colspan="8" style="text-align: center;"> <table border="1" style="width: 100%; border-collapse: collapse; text-align: center;"> <tr> <td style="width: 10%;"></td> <td
style="width: 10%;"></td> <td style="width: 10%;"></td> <td style="width: 10%;"></td> <td style="width: 10%;"></td> <td style="width: 10%;"></td> <td style="width: 10%;"></td> <td style="width: 10%;"></td> <td style="width: 10%;"></td> <td style="width: 10%;"></td> </tr> <tr> <td></td> <td></td> <td colspan="8" style="text-align: center;"> <table border="1" style="width: 100%; border-collapse: collapse; text-align: center;"> <tr> <td style="width: 10%;"></td> <td style="width: 10%;"></td> <td style="width: 10%;"></td> <td style="width: 10%;"></td> <td style="width: 10%;"></td> <td style="width: 10%;"></td> <td style="width: 10%;"></td> <td style="width: 10%;"></td> <td style="width: 10%;"></td> <td style="width: 10%;"></td> </tr> <tr> <td></td> <td></td> <td colspan="8" style="text-align: center;"> <table border="1" style="width: 100%; border-collapse: collapse; text-align: center;"> <tr> <td style="width: 10%;"></td> <td style="width: 10%;"></td> <td style="width: 10%;"></td> <td style="width: 10%;"></td> <td style="width: 10%;"></td> <td style="width: 10%;"></td> <td style="width: 10%;"></td> <td style="width: 10%;"></td> <td style="width: 10%;"></td> <td style="width: 10%;"></td> </tr> <tr> <td></td> <td></td> <td colspan="8" style="text-align: center;"> <table border="1" style="width: 100%; border-collapse: collapse; text-align: center;"> <tr> <td style="width: 10%;"></td> <td style="width: 10%;"></td> <td style="width: 10%;"></td> <td style="width: 10%;"></td> <td style="width: 10%;"></td> <td style="width: 10%;"></td> <td style="width: 10%;"></td> <td style="width: 10%;"></td> <td style="width: 10%;"></td> <td style="width: 10%;"></td> </tr> <tr> <td></td> <td></td> <td colspan="8" style="text-align: center;"> <table border="1" style="width: 100%; border-collapse: collapse; text-align: center;"> <tr> <td style="width: 10%;"></td> <td style="width: 10%;"></td> <td style="width: 10%;"></td> <td style="width: 10%;"></td> <td style="width: 10%;"></td> <td style="width: 10%;"></td> <td style="width: 10%;"></td> <td style="width: 10%;"></td> <td style="width: 10%;"></td> <td style="width: 10%;"></td> </tr> <tr> <td></td> <td></td> <td colspan="8" style="text-align: center;"> <table border="1" style="width: 100%; border-collapse: collapse; text-align: center;"> <tr> <td style="width: 10%;"></td> <td style="width: 10%;"></td> <td style="width: 10%;"></td> <td style="width: 10%;"></td> <td style="width: 10%;"></td> <td style="width: 10%;"></td> <td style="width: 10%;"></td> <td style="width: 10%;"></td> <td style="width: 10%;"></td> <td style="width: 10%;"></td> </tr> <tr> <td></td> <td></td> <td colspan="8" style="text-align: center;"> <table border="1" style="width: 100%; border-collapse: collapse; text-align: center;"> <tr> <td style="width: 10%;"></td> <td style="width: 10%;"></td> <td style="width: 10%;"></td> <td style="width: 10%;"></td> <td style="width: 10%;"></td> <td style="width: 10%;"></td> <td style="width: 10%;"></td> <td style="width: 10%;"></td> <td style="width: 10%;"></td> <td style="width: 10%;"></td> </tr> <tr> <td></td> <td></td> <td colspan="8" style="text-align: center;"> <table border="1" style="width: 100%; border-collapse: collapse; text-align: center;"> <tr> <td style="width: 10%;"></td> <td style="width: 10%;"></td> <td style="width: 10%;"></td> <td style="width: 10%;"></td> <td style="width: 10%;"></td> <td style="width: 10%;"></td> <td style="width: 10%;"></td> <td style="width: 10%;"></td> <td style="width: 10%;"></td> <td style="width: 10%;"></td> </tr> <tr> <td></td> <td></td> <td colspan="8" style="text-align: center;"> <table border="1" style="width: 100%; border-collapse: collapse; text-align: center;"> <tr> <td style="width: 10%;"></td> <td style="width: 10%;"></td> <td style="width: 10%;"></td> <td style="width: 10%;"></td> <td style="width: 10%;"></td> <td style="width: 10%;"></td> <td style="width: 10%;"></td> <td style="width: 10%;"></td> <td style="width: 10%;"></td> <td style="width: 10%;"></td> </tr> <tr> <td></td> <td></td> <td colspan="8" style="text-align: center;"> <table border="1" style="width: 100%; border-collapse: collapse; text-align: center;"> <tr> <td style="width: 10%;"></td> <td style="width: 10%;"></td> <td style="width: 10%;"></td> <td style="width: 10%;"></td> <td style="width: 10%;"></td> <td style="width: 10%;"></td> <td style="width: 10%;"></td> <td style="width: 10%;"></td> <td style="width: 10%;"></td> <td style="width: 10%;"></td> </tr> <tr> <td></td> <td></td> <td colspan="8" style="text-align: center;"> <table border="1" style="width: 100%; border-collapse: collapse; text-align: center;"> <tr> <td style="width: 10%;"></td> <td style="width: 10%;"></td> <td style="width: 10%;"></td> <td style="width: 10%;"></td> <td style="width: 10%;"></td> <td style="width: 10%;"></td> <td style="width: 10%;"></td> <td style="width: 10%;"></td> <td style="width: 10%;"></td> <td style="width: 10%;"></td> </tr> <tr> <td></td> <td></td> <td colspan="8" style="text-align: center;"> <table border="1" style="width: 100%; border-collapse: collapse; text-align: center;"> <tr> <td style="width: 10%;"></td> <td style="width: 10%;"></td> <td style="width: 10%;"></td> <td style="width: 10%;"></td> <td style="width: 10%;"></td> <td style="width: 10%;"></td> <td style="width: 10%;"></td> <td style="width: 10%;"></td> <td style="width: 10%;"></td> <td style="width: 10%;"></td> </tr> <tr> <td></td> <td></td> <td colspan="8" style="text-align: center;"> <table border="1" style="width: 100%; border-collapse: collapse; text-align: center;"> <tr> <td style="width: 10%;"></td> <td style="width: 10%;"></td> <td style="width: 10%;"></td> <td style="width: 10%;"></td> <td style="width: 10%;"></td> <td style="width: 10%;"></td> <td style="width: 10%;"></td> <td style="width: 10%;"></td> <td style="width: 10%;"></td> <td style="width: 10%;"></td> </tr> <tr> <td></td> <td></td> <td colspan="8" style="text-align: center;"> <table border="1" style="width: 100%; border-collapse: collapse; text-align: center;"> <tr> <td style="width: 10%;"></td> <td style="width: 10%;"></td> <td style="width: 10%;"></td> <td style="width: 10%;"></td> <td style="width: 10%;"></td> <td style="width: 10%;"></td> <td style="width: 10%;"></td> <td style="width: 10%;"></td> <td style="width: 10%;"></td> <td style="width: 10%;"></td> </tr> <tr> <td></td> <td></td> <td colspan="8" style="text-align: center;"> <table border="1" style="width: 100%; border-collapse: collapse; text-align: center;"> <tr> </tr></table></td></tr></table></td></tr></table></td></tr></table></td></tr></table></td></tr></table></td></tr></table></td></tr></table></td></tr></table></td></tr></table></td></tr></table></td></tr></table></td></tr></table></td></tr></table></td></tr></table></td></tr></table></td></tr></table></td></tr></table></td></tr></table></td></tr></table></td></tr></table></td></tr></table></td></tr></table></td></tr></table> | | | | | | | | | | | | | | | | | | | | <table border="1" style="width: 100%; border-collapse: collapse; text-align: center;"> <tr> <td style="width: 10%;"></td> <td style="width: 10%;"></td> <td style="width: 10%;"></td> <td style="width: 10%;"></td> <td style="width: 10%;"></td> <td style="width: 10%;"></td> <td style="width: 10%;"></td> <td style="width: 10%;"></td> <td style="width: 10%;"></td> <td style="width: 10%;"></td> </tr> <tr> <td></td> <td></td> <td colspan="8" style="text-align: center;"> <table border="1" style="width: 100%; border-collapse: collapse; text-align: center;"> <tr> <td style="width: 10%;"></td> <td style="width: 10%;"></td> <td style="width: 10%;"></td> <td style="width: 10%;"></td> <td style="width: 10%;"></td> <td style="width: 10%;"></td> <td style="width: 10%;"></td> <td style="width: 10%;"></td> <td style="width: 10%;"></td> <td style="width: 10%;"></td> </tr> <tr> <td></td> <td></td> <td colspan="8" style="text-align: center;"> <table border="1" style="width: 100%; border-collapse: collapse; text-align: center;"> <tr> <td style="width:
10%;"></td> <td style="width: 10%;"></td> <td style="width: 10%;"></td> <td style="width: 10%;"></td> <td style="width: 10%;"></td> <td style="width: 10%;"></td> <td style="width: 10%;"></td> <td style="width: 10%;"></td> <td style="width: 10%;"></td> <td style="width: 10%;"></td> </tr> <tr> <td></td> <td></td> <td colspan="8" style="text-align: center;"> <table border="1" style="width: 100%; border-collapse: collapse; text-align: center;"> <tr> <td style="width: 10%;"></td> <td style="width: 10%;"></td> <td style="width: 10%;"></td> <td style="width: 10%;"></td> <td style="width: 10%;"></td> <td style="width: 10%;"></td> <td style="width: 10%;"></td> <td style="width: 10%;"></td> <td style="width: 10%;"></td> <td style="width: 10%;"></td> </tr> <tr> <td></td> <td></td> <td colspan="8" style="text-align: center;"> <table border="1" style="width: 100%; border-collapse: collapse; text-align: center;"> <tr> <td style="width: 10%;"></td> <td style="width: 10%;"></td> <td style="width: 10%;"></td> <td style="width: 10%;"></td> <td style="width: 10%;"></td> <td style="width: 10%;"></td> <td style="width: 10%;"></td> <td style="width: 10%;"></td> <td style="width: 10%;"></td> <td style="width: 10%;"></td> </tr> <tr> <td></td> <td></td> <td colspan="8" style="text-align: center;"> <table border="1" style="width: 100%; border-collapse: collapse; text-align: center;"> <tr> <td style="width: 10%;"></td> <td style="width: 10%;"></td> <td style="width: 10%;"></td> <td style="width: 10%;"></td> <td style="width: 10%;"></td> <td style="width: 10%;"></td> <td style="width: 10%;"></td> <td style="width: 10%;"></td> <td style="width: 10%;"></td> <td style="width: 10%;"></td> </tr> <tr> <td></td> <td></td> <td colspan="8" style="text-align: center;"> <table border="1" style="width: 100%; border-collapse: collapse; text-align: center;"> <tr> <td style="width: 10%;"></td> <td style="width: 10%;"></td> <td style="width: 10%;"></td> <td style="width: 10%;"></td> <td style="width: 10%;"></td> <td style="width: 10%;"></td> <td style="width: 10%;"></td> <td style="width: 10%;"></td> <td style="width: 10%;"></td> <td style="width: 10%;"></td> </tr> <tr> <td></td> <td></td> <td colspan="8" style="text-align: center;"> <table border="1" style="width: 100%; border-collapse: collapse; text-align: center;"> <tr> <td style="width: 10%;"></td> <td style="width: 10%;"></td> <td style="width: 10%;"></td> <td style="width: 10%;"></td> <td style="width: 10%;"></td> <td style="width: 10%;"></td> <td style="width: 10%;"></td> <td style="width: 10%;"></td> <td style="width: 10%;"></td> <td style="width: 10%;"></td> </tr> <tr> <td></td> <td></td> <td colspan="8" style="text-align: center;"> <table border="1" style="width: 100%; border-collapse: collapse; text-align: center;"> <tr> <td style="width: 10%;"></td> <td style="width: 10%;"></td> <td style="width: 10%;"></td> <td style="width: 10%;"></td> <td style="width: 10%;"></td> <td style="width: 10%;"></td> <td style="width: 10%;"></td> <td style="width: 10%;"></td> <td style="width: 10%;"></td> <td style="width: 10%;"></td> </tr> <tr> <td></td> <td></td> <td colspan="8" style="text-align: center;"> <table border="1" style="width: 100%; border-collapse: collapse; text-align: center;"> <tr> <td style="width: 10%;"></td> <td style="width: 10%;"></td> <td style="width: 10%;"></td> <td style="width: 10%;"></td> <td style="width: 10%;"></td> <td style="width: 10%;"></td> <td style="width: 10%;"></td> <td style="width: 10%;"></td> <td style="width: 10%;"></td> <td style="width: 10%;"></td> </tr> <tr> <td></td> <td></td> <td colspan="8" style="text-align: center;"> <table border="1" style="width: 100%; border-collapse: collapse; text-align: center;"> <tr> <td style="width: 10%;"></td> <td style="width: 10%;"></td> <td style="width: 10%;"></td> <td style="width: 10%;"></td> <td style="width: 10%;"></td> <td style="width: 10%;"></td> <td style="width: 10%;"></td> <td style="width: 10%;"></td> <td style="width: 10%;"></td> <td style="width: 10%;"></td> </tr> <tr> <td></td> <td></td> <td colspan="8" style="text-align: center;"> <table border="1" style="width: 100%; border-collapse: collapse; text-align: center;"> <tr> <td style="width: 10%;"></td> <td style="width: 10%;"></td> <td style="width: 10%;"></td> <td style="width: 10%;"></td> <td style="width: 10%;"></td> <td style="width: 10%;"></td> <td style="width: 10%;"></td> <td style="width: 10%;"></td> <td style="width: 10%;"></td> <td style="width: 10%;"></td> </tr> <tr> <td></td> <td></td> <td colspan="8" style="text-align: center;"> <table border="1" style="width: 100%; border-collapse: collapse; text-align: center;"> <tr> <td style="width: 10%;"></td> <td style="width: 10%;"></td> <td style="width: 10%;"></td> <td style="width: 10%;"></td> <td style="width: 10%;"></td> <td style="width: 10%;"></td> <td style="width: 10%;"></td> <td style="width: 10%;"></td> <td style="width: 10%;"></td> <td style="width: 10%;"></td> </tr> <tr> <td></td> <td></td> <td colspan="8" style="text-align: center;"> <table border="1" style="width: 100%; border-collapse: collapse; text-align: center;"> <tr> <td style="width: 10%;"></td> <td style="width: 10%;"></td> <td style="width: 10%;"></td> <td style="width: 10%;"></td> <td style="width: 10%;"></td> <td style="width: 10%;"></td> <td style="width: 10%;"></td> <td style="width: 10%;"></td> <td style="width: 10%;"></td> <td style="width: 10%;"></td> </tr> <tr> <td></td> <td></td> <td colspan="8" style="text-align: center;"> <table border="1" style="width: 100%; border-collapse: collapse; text-align: center;"> <tr> <td style="width: 10%;"></td> <td style="width: 10%;"></td> <td style="width: 10%;"></td> <td style="width: 10%;"></td> <td style="width: 10%;"></td> <td style="width: 10%;"></td> <td style="width: 10%;"></td> <td style="width: 10%;"></td> <td style="width: 10%;"></td> <td style="width: 10%;"></td> </tr> <tr> <td></td> <td></td> <td colspan="8" style="text-align: center;"> <table border="1" style="width: 100%; border-collapse: collapse; text-align: center;"> <tr> <td style="width: 10%;"></td> <td style="width: 10%;"></td> <td style="width: 10%;"></td> <td style="width: 10%;"></td> <td style="width: 10%;"></td> <td style="width: 10%;"></td> <td style="width: 10%;"></td> <td style="width: 10%;"></td> <td style="width: 10%;"></td> <td style="width: 10%;"></td> </tr> <tr> <td></td> <td></td> <td colspan="8" style="text-align: center;"> <table border="1" style="width: 100%; border-collapse: collapse; text-align: center;"> <tr> <td style="width: 10%;"></td> <td style="width: 10%;"></td> <td style="width: 10%;"></td> <td style="width: 10%;"></td> <td style="width: 10%;"></td> <td style="width: 10%;"></td> <td style="width: 10%;"></td> <td style="width: 10%;"></td> <td style="width: 10%;"></td> <td style="width: 10%;"></td> </tr> <tr> <td></td> <td></td> <td colspan="8" style="text-align: center;"> <table border="1" style="width: 100%; border-collapse: collapse; text-align: center;"> <tr> <td style="width: 10%;"></td> <td style="width: 10%;"></td> <td style="width: 10%;"></td> <td style="width: 10%;"></td> <td style="width: 10%;"></td> <td style="width: 10%;"></td> <td style="width: 10%;"></td> <td style="width: 10%;"></td> <td style="width: 10%;"></td> <td style="width: 10%;"></td> </tr> <tr> <td></td> <td></td> <td colspan="8" style="text-align: center;"> <table border="1" style="width: 100%; border-collapse: collapse; text-align: center;"> <tr> <td style="width: 10%;"></td> <td style="width: 10%;"></td> <td style="width: 10%;"></td> <td style="width: 10%;"></td> <td style="width: 10%;"></td> <td style="width: 10%;"></td> <td style="width: 10%;"></td> <td style="width: 10%;"></td> <td style="width: 10%;"></td> <td style="width: 10%;"></td> </tr> <tr> <td></td> <td></td> <td colspan="8" style="text-align: center;"> <table border="1" style="width: 100%; border-collapse: collapse; text-align: center;"> <tr> <td style="width: 10%;"></td> <td style="width: 10%;"></td> <td style="width: 10%;"></td> <td style="width: 10%;"></td> <td style="width: 10%;"></td> <td style="width: 10%;"></td> <td style="width: 10%;"></td> <td style="width: 10%;"></td> <td style="width: 10%;"></td> <td style="width: 10%;"></td> </tr> <tr> <td></td> <td></td> <td colspan="8" style="text-align: center;"> <table border="1" style="width: 100%; border-collapse: collapse; text-align: center;"> <tr> <td style="width: 10%;"></td> <td style="width: 10%;"></td> <td style="width: 10%;"></td> <td style="width: 10%;"></td> <td style="width: 10%;"></td> <td style="width: 10%;"></td> <td style="width: 10%;"></td> <td style="width: 10%;"></td> <td style="width: 10%;"></td> <td style="width: 10%;"></td> </tr> <tr> <td></td> <td></td> <td colspan="8" style="text-align: center;"> <table border="1" style="width: 100%; border-collapse: collapse; text-align: center;"> <tr> <td style="width: 10%;"></td> <td style="width: 10%;"></td> <td style="width: 10%;"></td> <td style="width: 10%;"></td> <td style="width: 10%;"></td> <td style="width: 10%;"></td> <td style="width: 10%;"></td> <td style="width: 10%;"></td> <td style="width: 10%;"></td> <td style="width: 10%;"></td> </tr> <tr> <td></td> <td></td> <td colspan="8" style="text-align: center;"> <table border="1" style="width: 100%; border-collapse: collapse; text-align: center;"> <tr> </tr></table></td></tr></table></td></tr></table></td></tr></table></td></tr></table></td></tr></table></td></tr></table></td></tr></table></td></tr></table></td></tr></table></td></tr></table></td></tr></table></td></tr></table></td></tr></table></td></tr></table></td></tr></table></td></tr></table></td></tr></table></td></tr></table></td></tr></table></td></tr></table></td></tr></table></td></tr></table>
 | | | | | | | | | | | | | | | | | | | | <table border="1" style="width: 100%; border-collapse: collapse; text-align: center;"> <tr> <td style="width: 10%;"></td> <td style="width: 10%;"></td> <td style="width: 10%;"></td> <td style="width: 10%;"></td> <td style="width: 10%;"></td> <td style="width: 10%;"></td> <td style="width: 10%;"></td> <td style="width: 10%;"></td> <td style="width: 10%;"></td> <td style="width: 10%;"></td> </tr> <tr> <td></td> <td></td> <td colspan="8" style="text-align: center;"> <table border="1" style="width: 100%; border-collapse: collapse; text-align: center;"> <tr> <td style="width: 10%;"></td> <td style="width: 10%;"></td> <td style="width: 10%;"></td> <td style="width: 10%;"></td> <td style="width: 10%;"></td> <td style="width: 10%;"></td> <td style="width: 10%;"></td> <td style="width: 10%;"></td> <td style="width: 10%;"></td> <td style="width: 10%;"></td> </tr> <tr> <td></td> <td></td> <td colspan="8" style="text-align: center;"> <table border="1" style="width: 100%; border-collapse: collapse; text-align: center;"> <tr> <td style="width: 10%;"></td> <td style="width: 10%;"></td> <td style="width: 10%;"></td> <td style="width: 10%;"></td> <td style="width: 10%;"></td> <td style="width: 10%;"></td> <td style="width: 10%;"></td> <td style="width: 10%;"></td> <td style="width: 10%;"></td> <td style="width: 10%;"></td> </tr> <tr> <td></td> <td></td> <td colspan="8" style="text-align: center;"> <table border="1" style="width: 100%; border-collapse: collapse; text-align: center;"> <tr> <td style="width: 10%;"></td> <td style="width: 10%;"></td> <td style="width: 10%;"></td> <td style="width: 10%;"></td> <td style="width: 10%;"></td> <td style="width: 10%;"></td> <td style="width: 10%;"></td> <td style="width: 10%;"></td> <td style="width: 10%;"></td> <td style="width: 10%;"></td> </tr> <tr> <td></td> <td></td> <td colspan="8" style="text-align: center;"> <table border="1" style="width: 100%; border-collapse: collapse; text-align: center;"> <tr> <td style="width: 10%;"></td> <td style="width: 10%;"></td> <td style="width: 10%;"></td> <td style="width: 10%;"></td> <td style="width: 10%;"></td> <td style="width: 10%;"></td> <td style="width: 10%;"></td> <td style="width: 10%;"></td> <td style="width: 10%;"></td> <td style="width: 10%;"></td> </tr> <tr> <td></td> <td></td> <td colspan="8" style="text-align: center;"> <table border="1" style="width: 100%; border-collapse: collapse; text-align: center;"> <tr> <td style="width: 10%;"></td> <td style="width: 10%;"></td> <td style="width: 10%;"></td> <td style="width: 10%;"></td> <td style="width: 10%;"></td> <td style="width: 10%;"></td> <td style="width: 10%;"></td> <td style="width: 10%;"></td> <td style="width: 10%;"></td> <td style="width: 10%;"></td> </tr> <tr> <td></td> <td></td> <td colspan="8" style="text-align: center;"> <table border="1" style="width: 100%; border-collapse: collapse; text-align: center;"> <tr> <td style="width: 10%;"></td> <td style="width: 10%;"></td> <td style="width: 10%;"></td> <td style="width: 10%;"></td> <td style="width: 10%;"></td> <td style="width: 10%;"></td> <td style="width: 10%;"></td> <td style="width: 10%;"></td> <td style="width: 10%;"></td> <td style="width: 10%;"></td> </tr> <tr> <td></td> <td></td> <td colspan="8" style="text-align: center;"> <table border="1" style="width: 100%; border-collapse: collapse; text-align: center;"> <tr> <td style="width: 10%;"></td> <td style="width: 10%;"></td> <td style="width: 10%;"></td> <td style="width: 10%;"></td> <td style="width: 10%;"></td> <td style="width: 10%;"></td> <td style="width: 10%;"></td> <td style="width: 10%;"></td> <td style="width: 10%;"></td> <td style="width: 10%;"></td> </tr> <tr> <td></td> <td></td> <td colspan="8" style="text-align: center;"> <table border="1" style="width: 100%; border-collapse: collapse; text-align: center;"> <tr> <td style="width: 10%;"></td> <td style="width: 10%;"></td> <td style="width: 10%;"></td> <td style="width: 10%;"></td> <td style="width: 10%;"></td> <td style="width: 10%;"></td> <td style="width: 10%;"></td> <td style="width: 10%;"></td> <td style="width: 10%;"></td> <td style="width: 10%;"></td> </tr> <tr> <td></td> <td></td> <td colspan="8" style="text-align: center;"> <table border="1" style="width: 100%; border-collapse: collapse; text-align: center;"> <tr> <td style="width: 10%;"></td> <td style="width: 10%;"></td> <td style="width: 10%;"></td> <td style="width: 10%;"></td> <td style="width: 10%;"></td> <td style="width: 10%;"></td> <td style="width: 10%;"></td> <td style="width: 10%;"></td> <td style="width: 10%;"></td> <td style="width: 10%;"></td> </tr> <tr> <td></td> <td></td> <td colspan="8" style="text-align: center;"> <table border="1" style="width: 100%; border-collapse: collapse; text-align: center;"> <tr> <td style="width: 10%;"></td> <td style="width: 10%;"></td> <td style="width: 10%;"></td> <td style="width: 10%;"></td> <td style="width: 10%;"></td> <td style="width: 10%;"></td> <td style="width: 10%;"></td> <td style="width: 10%;"></td> <td style="width: 10%;"></td> <td style="width: 10%;"></td> </tr> <tr> <td></td> <td></td> <td colspan="8" style="text-align: center;"> <table border="1" style="width: 100%; border-collapse: collapse; text-align: center;"> <tr> <td style="width: 10%;"></td> <td style="width: 10%;"></td> <td style="width: 10%;"></td> <td style="width: 10%;"></td> <td style="width: 10%;"></td> <td style="width: 10%;"></td> <td style="width: 10%;"></td> <td style="width: 10%;"></td> <td style="width: 10%;"></td> <td style="width: 10%;"></td> </tr> <tr> <td></td> <td></td> <td colspan="8" style="text-align: center;"> <table border="1" style="width: 100%; border-collapse: collapse; text-align: center;"> <tr> <td style="width: 10%;"></td> <td style="width: 10%;"></td> <td style="width: 10%;"></td> <td style="width: 10%;"></td> <td style="width: 10%;"></td> <td style="width: 10%;"></td> <td style="width: 10%;"></td> <td style="width: 10%;"></td> <td style="width: 10%;"></td> <td style="width: 10%;"></td> </tr> <tr> <td></td> <td></td> <td colspan="8" style="text-align: center;"> <table border="1" style="width: 100%; border-collapse: collapse; text-align: center;"> <tr> <td style="width: 10%;"></td> <td style="width: 10%;"></td> <td style="width: 10%;"></td> <td style="width: 10%;"></td> <td style="width: 10%;"></td> <td style="width: 10%;"></td> <td style="width: 10%;"></td> <td style="width: 10%;"></td> <td style="width: 10%;"></td> <td style="width: 10%;"></td> </tr> <tr> <td></td> <td></td> <td colspan="8" style="text-align: center;"> <table border="1" style="width: 100%; border-collapse: collapse; text-align: center;"> <tr> <td style="width: 10%;"></td> <td style="width: 10%;"></td> <td style="width: 10%;"></td> <td style="width: 10%;"></td> <td style="width: 10%;"></td> <td style="width: 10%;"></td> <td style="width: 10%;"></td> <td style="width: 10%;"></td> <td style="width: 10%;"></td> <td style="width: 10%;"></td> </tr> <tr> <td></td> <td></td> <td colspan="8" style="text-align: center;"> <table border="1" style="width: 100%; border-collapse: collapse; text-align: center;"> <tr> <td style="width: 10%;"></td> <td style="width: 10%;"></td> <td style="width: 10%;"></td> <td style="width: 10%;"></td> <td style="width: 10%;"></td> <td style="width: 10%;"></td> <td style="width: 10%;"></td> <td style="width: 10%;"></td> <td style="width: 10%;"></td> <td style="width: 10%;"></td> </tr> <tr> <td></td> <td></td> <td colspan="8" style="text-align: center;"> <table border="1" style="width: 100%; border-collapse: collapse; text-align: center;"> <tr> <td style="width: 10%;"></td> <td style="width: 10%;"></td> <td style="width: 10%;"></td> <td style="width: 10%;"></td> <td style="width: 10%;"></td> <td style="width: 10%;"></td> <td style="width: 10%;"></td> <td style="width: 10%;"></td> <td style="width: 10%;"></td> <td style="width: 10%;"></td> </tr> <tr> <td></td> <td></td> <td colspan="8" style="text-align: center;"> <table border="1" style="width: 100%; border-collapse: collapse; text-align: center;"> <tr> <td style="width: 10%;"></td> <td style="width: 10%;"></td> <td style="width: 10%;"></td> <td style="width: 10%;"></td> <td style="width: 10%;"></td> <td style="width: 10%;"></td> <td
style="width: 10%;"></td> <td style="width: 10%;"></td> <td style="width: 10%;"></td> <td style="width: 10%;"></td> </tr> <tr> <td></td> <td></td> <td colspan="8" style="text-align: center;"> <table border="1" style="width: 100%; border-collapse: collapse; text-align: center;"> <tr> <td style="width: 10%;"></td> <td style="width: 10%;"></td> <td style="width: 10%;"></td> <td style="width: 10%;"></td> <td style="width: 10%;"></td> <td style="width: 10%;"></td> <td style="width: 10%;"></td> <td style="width: 10%;"></td> <td style="width: 10%;"></td> <td style="width: 10%;"></td> </tr> <tr> <td></td> <td></td> <td colspan="8" style="text-align: center;"> <table border="1" style="width: 100%; border-collapse: collapse; text-align: center;"> <tr> <td style="width: 10%;"></td> <td style="width: 10%;"></td> <td style="width: 10%;"></td> <td style="width: 10%;"></td> <td style="width: 10%;"></td> <td style="width: 10%;"></td> <td style="width: 10%;"></td> <td style="width: 10%;"></td> <td style="width: 10%;"></td> <td style="width: 10%;"></td> </tr> <tr> <td></td> <td></td> <td colspan="8" style="text-align: center;"> <table border="1" style="width: 100%; border-collapse: collapse; text-align: center;"> <tr> <td style="width: 10%;"></td> <td style="width: 10%;"></td> <td style="width: 10%;"></td> <td style="width: 10%;"></td> <td style="width: 10%;"></td> <td style="width: 10%;"></td> <td style="width: 10%;"></td> <td style="width: 10%;"></td> <td style="width: 10%;"></td> <td style="width: 10%;"></td> </tr> <tr> <td></td> <td></td> <td colspan="8" style="text-align: center;"> <table border="1" style="width: 100%; border-collapse: collapse; text-align: center;"> <tr> </tr></table></td></tr></table></td></tr></table></td></tr></table></td></tr></table></td></tr></table></td></tr></table></td></tr></table></td></tr></table></td></tr></table></td></tr></table></td></tr></table></td></tr></table></td></tr></table></td></tr></table></td></tr></table></td></tr></table></td></tr></table></td></tr></table></td></tr></table></td></tr></table></td></tr></table> | | | | | | | | | | | | | | | | | | | | <table border="1" style="width: 100%; border-collapse: collapse; text-align: center;"> <tr> <td style="width: 10%;"></td> <td style="width: 10%;"></td> <td style="width: 10%;"></td> <td style="width: 10%;"></td> <td style="width: 10%;"></td> <td style="width: 10%;"></td> <td style="width: 10%;"></td> <td style="width: 10%;"></td> <td style="width: 10%;"></td> <td style="width: 10%;"></td> </tr> <tr> <td></td> <td></td> <td colspan="8" style="text-align: center;"> <table border="1" style="width: 100%; border-collapse: collapse; text-align: center;"> <tr> <td style="width: 10%;"></td> <td style="width: 10%;"></td> <td style="width: 10%;"></td> <td style="width: 10%;"></td> <td style="width: 10%;"></td> <td style="width: 10%;"></td> <td style="width: 10%;"></td> <td style="width: 10%;"></td> <td style="width: 10%;"></td> <td style="width: 10%;"></td> </tr> <tr> <td></td> <td></td> <td colspan="8" style="text-align: center;"> <table border="1" style="width: 100%; border-collapse: collapse; text-align: center;"> <tr> <td style="width: 10%;"></td> <td style="width: 10%;"></td> <td style="width: 10%;"></td> <td style="width: 10%;"></td> <td style="width: 10%;"></td> <td style="width: 10%;"></td> <td style="width: 10%;"></td> <td style="width: 10%;"></td> <td style="width: 10%;"></td> <td style="width: 10%;"></td> </tr> <tr> <td></td> <td></td> <td colspan="8" style="text-align: center;"> <table border="1" style="width: 100%; border-collapse: collapse; text-align: center;"> <tr> <td style="width: 10%;"></td> <td style="width: 10%;"></td> <td style="width: 10%;"></td> <td style="width: 10%;"></td> <td style="width: 10%;"></td> <td style="width: 10%;"></td> <td style="width: 10%;"></td> <td style="width: 10%;"></td> <td style="width: 10%;"></td> <td style="width: 10%;"></td> </tr> <tr> <td></td> <td></td> <td colspan="8" style="text-align: center;"> <table border="1" style="width: 100%; border-collapse: collapse; text-align: center;"> <tr> <td style="width: 10%;"></td> <td style="width: 10%;"></td> <td style="width: 10%;"></td> <td style="width: 10%;"></td> <td style="width: 10%;"></td> <td style="width: 10%;"></td> <td style="width: 10%;"></td> <td style="width: 10%;"></td> <td style="width: 10%;"></td> <td style="width: 10%;"></td> </tr> <tr> <td></td> <td></td> <td colspan="8" style="text-align: center;"> <table border="1" style="width: 100%; border-collapse: collapse; text-align: center;"> <tr> <td style="width: 10%;"></td> <td style="width: 10%;"></td> <td style="width: 10%;"></td> <td style="width: 10%;"></td> <td style="width: 10%;"></td> <td style="width: 10%;"></td> <td style="width: 10%;"></td> <td style="width: 10%;"></td> <td style="width: 10%;"></td> <td style="width: 10%;"></td> </tr> <tr> <td></td> <td></td> <td colspan="8" style="text-align: center;"> <table border="1" style="width: 100%; border-collapse: collapse; text-align: center;"> <tr> <td style="width: 10%;"></td> <td style="width: 10%;"></td> <td style="width: 10%;"></td> <td style="width: 10%;"></td> <td style="width: 10%;"></td> <td style="width: 10%;"></td> <td style="width: 10%;"></td> <td style="width: 10%;"></td> <td style="width: 10%;"></td> <td style="width: 10%;"></td> </tr> <tr> <td></td> <td></td> <td colspan="8" style="text-align: center;"> <table border="1" style="width: 100%; border-collapse: collapse; text-align: center;"> <tr> <td style="width: 10%;"></td> <td style="width: 10%;"></td> <td style="width: 10%;"></td> <td style="width: 10%;"></td> <td style="width: 10%;"></td> <td style="width: 10%;"></td> <td style="width: 10%;"></td> <td style="width: 10%;"></td> <td style="width: 10%;"></td> <td style="width: 10%;"></td> </tr> <tr> <td></td> <td></td> <td colspan="8" style="text-align: center;"> <table border="1" style="width: 100%; border-collapse: collapse; text-align: center;"> <tr> <td style="width: 10%;"></td> <td style="width: 10%;"></td> <td style="width: 10%;"></td> <td style="width: 10%;"></td> <td style="width: 10%;"></td> <td style="width: 10%;"></td> <td style="width: 10%;"></td> <td style="width: 10%;"></td> <td style="width: 10%;"></td> <td style="width: 10%;"></td> </tr> <tr> <td></td> <td></td> <td colspan="8" style="text-align: center;"> <table border="1" style="width: 100%; border-collapse: collapse; text-align: center;"> <tr> <td style="width: 10%;"></td> <td style="width: 10%;"></td> <td style="width: 10%;"></td> <td style="width: 10%;"></td> <td style="width: 10%;"></td> <td style="width: 10%;"></td> <td style="width: 10%;"></td> <td style="width: 10%;"></td> <td style="width: 10%;"></td> <td style="width: 10%;"></td> </tr> <tr> <td></td> <td></td> <td colspan="8" style="text-align: center;"> <table border="1" style="width: 100%; border-collapse: collapse; text-align: center;"> <tr> <td style="width: 10%;"></td> <td style="width: 10%;"></td> <td style="width: 10%;"></td> <td style="width: 10%;"></td> <td style="width: 10%;"></td> <td style="width: 10%;"></td> <td style="width: 10%;"></td> <td style="width: 10%;"></td> <td style="width: 10%;"></td> <td style="width: 10%;"></td> </tr> <tr> <td></td> <td></td> <td colspan="8" style="text-align: center;"> <table border="1" style="width: 100%; border-collapse: collapse; text-align: center;"> <tr> <td style="width: 10%;"></td> <td style="width: 10%;"></td> <td style="width: 10%;"></td> <td style="width: 10%;"></td> <td style="width: 10%;"></td> <td style="width: 10%;"></td> <td style="width: 10%;"></td> <td style="width: 10%;"></td> <td style="width: 10%;"></td> <td style="width: 10%;"></td> </tr> <tr> <td></td> <td></td> <td colspan="8" style="text-align: center;"> <table border="1" style="width: 100%; border-collapse: collapse; text-align: center;"> <tr> <td style="width: 10%;"></td> <td style="width: 10%;"></td> <td style="width: 10%;"></td> <td style="width: 10%;"></td> <td style="width: 10%;"></td> <td style="width: 10%;"></td> <td style="width:
10%;"></td> <td style="width: 10%;"></td> <td style="width: 10%;"></td> <td style="width: 10%;"></td> </tr> <tr> <td></td> <td></td> <td colspan="8" style="text-align: center;"> <table border="1" style="width: 100%; border-collapse: collapse; text-align: center;"> <tr> <td style="width: 10%;"></td> <td style="width: 10%;"></td> <td style="width: 10%;"></td> <td style="width: 10%;"></td> <td style="width: 10%;"></td> <td style="width: 10%;"></td> <td style="width: 10%;"></td> <td style="width: 10%;"></td> <td style="width: 10%;"></td> <td style="width: 10%;"></td> </tr> <tr> <td></td> <td></td> <td colspan="8" style="text-align: center;"> <table border="1" style="width: 100%; border-collapse: collapse; text-align: center;"> <tr> <td style="width: 10%;"></td> <td style="width: 10%;"></td> <td style="width: 10%;"></td> <td style="width: 10%;"></td> <td style="width: 10%;"></td> <td style="width: 10%;"></td> <td style="width: 10%;"></td> <td style="width: 10%;"></td> <td style="width: 10%;"></td> <td style="width: 10%;"></td> </tr> <tr> <td></td> <td></td> <td colspan="8" style="text-align: center;"> <table border="1" style="width: 100%; border-collapse: collapse; text-align: center;"> <tr> <td style="width: 10%;"></td> <td style="width: 10%;"></td> <td style="width: 10%;"></td> <td style="width: 10%;"></td> <td style="width: 10%;"></td> <td style="width: 10%;"></td> <td style="width: 10%;"></td> <td style="width: 10%;"></td> <td style="width: 10%;"></td> <td style="width: 10%;"></td> </tr> <tr> <td></td> <td></td> <td colspan="8" style="text-align: center;"> <table border="1" style="width: 100%; border-collapse: collapse; text-align: center;"> <tr> <td style="width: 10%;"></td> <td style="width: 10%;"></td> <td style="width: 10%;"></td> <td style="width: 10%;"></td> <td style="width: 10%;"></td> <td style="width: 10%;"></td> <td style="width: 10%;"></td> <td style="width: 10%;"></td> <td style="width: 10%;"></td> <td style="width: 10%;"></td> </tr> <tr> <td></td> <td></td> <td colspan="8" style="text-align: center;"> <table border="1" style="width: 100%; border-collapse: collapse; text-align: center;"> <tr> <td style="width: 10%;"></td> <td style="width: 10%;"></td> <td style="width: 10%;"></td> <td style="width: 10%;"></td> <td style="width: 10%;"></td> <td style="width: 10%;"></td> <td style="width: 10%;"></td> <td style="width: 10%;"></td> <td style="width: 10%;"></td> <td style="width: 10%;"></td> </tr> <tr> <td></td> <td></td> <td colspan="8" style="text-align: center;"> <table border="1" style="width: 100%; border-collapse: collapse; text-align: center;"> <tr> <td style="width: 10%;"></td> <td style="width: 10%;"></td> <td style="width: 10%;"></td> <td style="width: 10%;"></td> <td style="width: 10%;"></td> <td style="width: 10%;"></td> <td style="width: 10%;"></td> <td style="width: 10%;"></td> <td style="width: 10%;"></td> <td style="width: 10%;"></td> </tr> <tr> <td></td> <td></td> <td colspan="8" style="text-align: center;"> <table border="1" style="width: 100%; border-collapse: collapse; text-align: center;"> <tr> <td style="width: 10%;"></td> <td style="width: 10%;"></td> <td style="width: 10%;"></td> <td style="width: 10%;"></td> <td style="width: 10%;"></td> <td style="width: 10%;"></td> <td style="width: 10%;"></td> <td style="width: 10%;"></td> <td style="width: 10%;"></td> <td style="width: 10%;"></td> </tr> <tr> <td></td> <td></td> <td colspan="8" style="text-align: center;"> <table border="1" style="width: 100%; border-collapse: collapse; text-align: center;"> <tr> </tr></table></td></tr></table></td></tr></table></td></tr></table></td></tr></table></td></tr></table></td></tr></table></td></tr></table></td></tr></table></td></tr></table></td></tr></table></td></tr></table></td></tr></table></td></tr></table></td></tr></table></td></tr></table></td></tr></table></td></tr></table></td></tr></table></td></tr></table></td></tr></table> | | | | | | | | | | | | | | | | | | | | <table border="1" style="width: 100%; border-collapse: collapse; text-align: center;"> <tr> <td style="width: 10%;"></td> <td style="width: 10%;"></td> <td style="width: 10%;"></td> <td style="width: 10%;"></td> <td style="width: 10%;"></td> <td style="width: 10%;"></td> <td style="width: 10%;"></td> <td style="width: 10%;"></td> <td style="width: 10%;"></td> <td style="width: 10%;"></td> </tr> <tr> <td></td> <td></td> <td colspan="8" style="text-align: center;"> <table border="1" style="width: 100%; border-collapse: collapse; text-align: center;"> <tr> <td style="width: 10%;"></td> <td style="width: 10%;"></td> <td style="width: 10%;"></td> <td style="width: 10%;"></td> <td style="width: 10%;"></td> <td style="width: 10%;"></td> <td style="width: 10%;"></td> <td style="width: 10%;"></td> <td style="width: 10%;"></td> <td style="width: 10%;"></td> </tr> <tr> <td></td> <td></td> <td colspan="8" style="text-align: center;"> <table border="1" style="width: 100%; border-collapse: collapse; text-align: center;"> <tr> <td style="width: 10%;"></td> <td style="width: 10%;"></td> <td style="width: 10%;"></td> <td style="width: 10%;"></td> <td style="width: 10%;"></td> <td style="width: 10%;"></td> <td style="width: 10%;"></td> <td style="width: 10%;"></td> <td style="width: 10%;"></td> <td style="width: 10%;"></td> </tr> <tr> <td></td> <td></td> <td colspan="8" style="text-align: center;"> <table border="1" style="width: 100%; border-collapse: collapse; text-align: center;"> <tr> <td style="width: 10%;"></td> <td style="width: 10%;"></td> <td style="width: 10%;"></td> <td style="width: 10%;"></td> <td style="width: 10%;"></td> <td style="width: 10%;"></td> <td style="width: 10%;"></td> <td style="width: 10%;"></td> <td style="width: 10%;"></td> <td style="width: 10%;"></td> </tr> <tr> <td></td> <td></td> <td colspan="8" style="text-align: center;"> <table border="1" style="width: 100%; border-collapse: collapse; text-align: center;"> <tr> <td style="width: 10%;"></td> <td style="width: 10%;"></td> <td style="width: 10%;"></td> <td style="width: 10%;"></td> <td style="width: 10%;"></td> <td style="width: 10%;"></td> <td style="width: 10%;"></td> <td style="width: 10%;"></td> <td style="width: 10%;"></td> <td style="width: 10%;"></td> </tr> <tr> <td></td> <td></td> <td colspan="8" style="text-align: center;"> <table border="1" style="width: 100%; border-collapse: collapse; text-align: center;"> <tr> <td style="width: 10%;"></td> <td style="width: 10%;"></td> <td style="width: 10%;"></td> <td style="width: 10%;"></td> <td style="width: 10%;"></td> <td style="width: 10%;"></td> <td style="width: 10%;"></td> <td style="width: 10%;"></td> <td style="width: 10%;"></td> <td style="width: 10%;"></td> </tr> <tr> <td></td> <td></td> <td colspan="8" style="text-align: center;"> <table border="1" style="width: 100%; border-collapse: collapse; text-align: center;"> <tr> <td style="width: 10%;"></td> <td style="width: 10%;"></td> <td style="width: 10%;"></td> <td style="width: 10%;"></td> <td style="width: 10%;"></td> <td style="width: 10%;"></td> <td style="width: 10%;"></td> <td style="width: 10%;"></td> <td style="width: 10%;"></td> <td style="width: 10%;"></td> </tr> <tr> <td></td> <td></td> <td colspan="8" style="text-align: center;"> <table border="1" style="width: 100%; border-collapse: collapse; text-align: center;"> <tr> <td style="width: 10%;"></td> <td style="width: 10%;"></td> <td style="width: 10%;"></td> <td style="width: 10%;"></td> <td style="width: 10%;"></td> <td style="width: 10%;"></td> <td style="width: 10%;"></td> <td style="width: 10%;"></td> <td style="width: 10%;"></td> <td style="width: 10%;"></td> </tr> <tr> <td></td> <td></td> <td colspan="8" style="text-align: center;"> <table border="1" style="width: 100%; border-collapse: collapse; text-align: center;"> <tr> <td style="width: 10%;"></td> <td style="width: 10%;"></td> <td style="width: 10%;"></td> <td style="width: 10%;"></td> <td style="width: 10%;"></td> <td style="width: 10%;"></td> <td style="width: 10%;"></td> <td style="width: 10%;"></td>
<td style="width: 10%;"></td> <td style="width: 10%;"></td> </tr> <tr> <td></td> <td></td> <td colspan="8" style="text-align: center;"> <table border="1" style="width: 100%; border-collapse: collapse; text-align: center;"> <tr> <td style="width: 10%;"></td> <td style="width: 10%;"></td> <td style="width: 10%;"></td> <td style="width: 10%;"></td> <td style="width: 10%;"></td> <td style="width: 10%;"></td> <td style="width: 10%;"></td> <td style="width: 10%;"></td> <td style="width: 10%;"></td> <td style="width: 10%;"></td> </tr> <tr> <td></td> <td></td> <td colspan="8" style="text-align: center;"> <table border="1" style="width: 100%; border-collapse: collapse; text-align: center;"> <tr> <td style="width: 10%;"></td> <td style="width: 10%;"></td> <td style="width: 10%;"></td> <td style="width: 10%;"></td> <td style="width: 10%;"></td> <td style="width: 10%;"></td> <td style="width: 10%;"></td> <td style="width: 10%;"></td> <td style="width: 10%;"></td> <td style="width: 10%;"></td> </tr> <tr> <td></td> <td></td> <td colspan="8" style="text-align: center;"> <table border="1" style="width: 100%; border-collapse: collapse; text-align: center;"> <tr> <td style="width: 10%;"></td> <td style="width: 10%;"></td> <td style="width: 10%;"></td> <td style="width: 10%;"></td> <td style="width: 10%;"></td> <td style="width: 10%;"></td> <td style="width: 10%;"></td> <td style="width: 10%;"></td> <td style="width: 10%;"></td> <td style="width: 10%;"></td> </tr> <tr> <td></td> <td></td> <td colspan="8" style="text-align: center;"> <table border="1" style="width: 100%; border-collapse: collapse; text-align: center;"> <tr> <td style="width: 10%;"></td> <td style="width: 10%;"></td> <td style="width: 10%;"></td> <td style="width: 10%;"></td> <td style="width: 10%;"></td> <td style="width: 10%;"></td> <td style="width: 10%;"></td> <td style="width: 10%;"></td> <td style="width: 10%;"></td> <td style="width: 10%;"></td> </tr> <tr> <td></td> <td></td> <td colspan="8" style="text-align: center;"> <table border="1" style="width: 100%; border-collapse: collapse; text-align: center;"> <tr> <td style="width: 10%;"></td> <td style="width: 10%;"></td> <td style="width: 10%;"></td> <td style="width: 10%;"></td> <td style="width: 10%;"></td> <td style="width: 10%;"></td> <td style="width: 10%;"></td> <td style="width: 10%;"></td> <td style="width: 10%;"></td> <td style="width: 10%;"></td> </tr> <tr> <td></td> <td></td> <td colspan="8" style="text-align: center;"> <table border="1" style="width: 100%; border-collapse: collapse; text-align: center;"> <tr> <td style="width: 10%;"></td> <td style="width: 10%;"></td> <td style="width: 10%;"></td> <td style="width: 10%;"></td> <td style="width: 10%;"></td> <td style="width: 10%;"></td> <td style="width: 10%;"></td> <td style="width: 10%;"></td> <td style="width: 10%;"></td> <td style="width: 10%;"></td> </tr> <tr> <td></td> <td></td> <td colspan="8" style="text-align: center;"> <table border="1" style="width: 100%; border-collapse: collapse; text-align: center;"> <tr> <td style="width: 10%;"></td> <td style="width: 10%;"></td> <td style="width: 10%;"></td> <td style="width: 10%;"></td> <td style="width: 10%;"></td> <td style="width: 10%;"></td> <td style="width: 10%;"></td> <td style="width: 10%;"></td> <td style="width: 10%;"></td> <td style="width: 10%;"></td> </tr> <tr> <td></td> <td></td> <td colspan="8" style="text-align: center;"> <table border="1" style="width: 100%; border-collapse: collapse; text-align: center;"> <tr> <td style="width: 10%;"></td> <td style="width: 10%;"></td> <td style="width: 10%;"></td> <td style="width: 10%;"></td> <td style="width: 10%;"></td> <td style="width: 10%;"></td> <td style="width: 10%;"></td> <td style="width: 10%;"></td> <td style="width: 10%;"></td> <td style="width: 10%;"></td> </tr> <tr> <td></td> <td></td> <td colspan="8" style="text-align: center;"> <table border="1" style="width: 100%; border-collapse: collapse; text-align: center;"> <tr> <td style="width: 10%;"></td> <td style="width: 10%;"></td> <td style="width: 10%;"></td> <td style="width: 10%;"></td> <td style="width: 10%;"></td> <td style="width: 10%;"></td> <td style="width: 10%;"></td> <td style="width: 10%;"></td> <td style="width: 10%;"></td> <td style="width: 10%;"></td> </tr> <tr> <td></td> <td></td> <td colspan="8" style="text-align: center;"> <table border="1" style="width: 100%; border-collapse: collapse; text-align: center;"> <tr> <td style="width: 10%;"></td> <td style="width: 10%;"></td> <td style="width: 10%;"></td> <td style="width: 10%;"></td> <td style="width: 10%;"></td> <td style="width: 10%;"></td> <td style="width: 10%;"></td> <td style="width: 10%;"></td> <td style="width: 10%;"></td> <td style="width: 10%;"></td> </tr> <tr> <td></td> <td></td> <td colspan="8" style="text-align: center;"> <table border="1" style="width: 100%; border-collapse: collapse; text-align: center;"> <tr> </tr></table></td></tr></table></td></tr></table></td></tr></table></td></tr></table></td></tr></table></td></tr></table></td></tr></table></td></tr></table></td></tr></table></td></tr></table></td></tr></table></td></tr></table></td></tr></table></td></tr></table></td></tr></table></td></tr></table></td></tr></table></td></tr></table></td></tr></table> | | | | | | | | | | | | | | | | | | | | <table border="1" style="width: 100%; border-collapse: collapse; text-align: center;"> <tr> <td style="width: 10%;"></td> <td style="width: 10%;"></td> <td style="width: 10%;"></td> <td style="width: 10%;"></td> <td style="width: 10%;"></td> <td style="width: 10%;"></td> <td style="width: 10%;"></td> <td style="width: 10%;"></td> <td style="width: 10%;"></td> <td style="width: 10%;"></td> </tr> <tr> <td></td> <td></td> <td colspan="8" style="text-align: center;"> <table border="1" style="width: 100%; border-collapse: collapse; text-align: center;"> <tr> <td style="width: 10%;"></td> <td style="width: 10%;"></td> <td style="width: 10%;"></td> <td style="width: 10%;"></td> <td style="width: 10%;"></td> <td style="width: 10%;"></td> <td style="width: 10%;"></td> <td style="width: 10%;"></td> <td style="width: 10%;"></td> <td style="width: 10%;"></td> </tr> <tr> <td></td> <td></td> <td colspan="8" style="text-align: center;"> <table border="1" style="width: 100%; border-collapse: collapse; text-align: center;"> <tr> <td style="width: 10%;"></td> <td style="width: 10%;"></td> <td style="width: 10%;"></td> <td style="width: 10%;"></td> <td style="width: 10%;"></td> <td style="width: 10%;"></td> <td style="width: 10%;"></td> <td style="width: 10%;"></td> <td style="width: 10%;"></td> <td style="width: 10%;"></td> </tr> <tr> <td></td> <td></td> <td colspan="8" style="text-align: center;"> <table border="1" style="width: 100%; border-collapse: collapse; text-align: center;"> <tr> <td style="width: 10%;"></td> <td style="width: 10%;"></td> <td style="width: 10%;"></td> <td style="width: 10%;"></td> <td style="width: 10%;"></td> <td style="width: 10%;"></td> <td style="width: 10%;"></td> <td style="width: 10%;"></td> <td style="width: 10%;"></td> <td style="width: 10%;"></td> </tr> <tr> <td></td> <td></td> <td colspan="8" style="text-align: center;"> <table border="1" style="width: 100%; border-collapse: collapse; text-align: center;"> <tr> <td style="width: 10%;"></td> <td style="width: 10%;"></td> <td style="width: 10%;"></td> <td style="width: 10%;"></td> <td style="width: 10%;"></td> <td style="width: 10%;"></td> <td style="width: 10%;"></td> <td style="width: 10%;"></td> <td style="width: 10%;"></td> <td style="width: 10%;"></td> </tr> <tr> <td></td> <td></td> <td colspan="8" style="text-align: center;"> <table border="1" style="width: 100%; border-collapse: collapse; text-align: center;"> <tr> <td style="width: 10%;"></td> <td style="width: 10%;"></td> <td style="width: 10%;"></td> <td style="width: 10%;"></td> <td style="width: 10%;"></td> <td style="width: 10%;"></td> <td style="width: 10%;"></td> <td style="width: 10%;"></td> <td style="width: 10%;"></td> <td style="width: 10%;"></td>
</tr> <tr> <td></td> <td></td> <td colspan="8" style="text-align: center;"> <table border="1" style="width: 100%; border-collapse: collapse; text-align: center;"> <tr> <td style="width: 10%;"></td> <td style="width: 10%;"></td> <td style="width: 10%;"></td> <td style="width: 10%;"></td> <td style="width: 10%;"></td> <td style="width: 10%;"></td> <td style="width: 10%;"></td> <td style="width: 10%;"></td> <td style="width: 10%;"></td> <td style="width: 10%;"></td> </tr> <tr> <td></td> <td></td> <td colspan="8" style="text-align: center;"> <table border="1" style="width: 100%; border-collapse: collapse; text-align: center;"> <tr> <td style="width: 10%;"></td> <td style="width: 10%;"></td> <td style="width: 10%;"></td> <td style="width: 10%;"></td> <td style="width: 10%;"></td> <td style="width: 10%;"></td> <td style="width: 10%;"></td> <td style="width: 10%;"></td> <td style="width: 10%;"></td> <td style="width: 10%;"></td> </tr> <tr> <td></td> <td></td> <td colspan="8" style="text-align: center;"> <table border="1" style="width: 100%; border-collapse: collapse; text-align: center;"> <tr> <td style="width: 10%;"></td> <td style="width: 10%;"></td> <td style="width: 10%;"></td> <td style="width: 10%;"></td> <td style="width: 10%;"></td> <td style="width: 10%;"></td> <td style="width: 10%;"></td> <td style="width: 10%;"></td> <td style="width: 10%;"></td> <td style="width: 10%;"></td> </tr> <tr> <td></td> <td></td> <td colspan="8" style="text-align: center;"> <table border="1" style="width: 100%; border-collapse: collapse; text-align: center;"> <tr> <td style="width: 10%;"></td> <td style="width: 10%;"></td> <td style="width: 10%;"></td> <td style="width: 10%;"></td> <td style="width: 10%;"></td> <td style="width: 10%;"></td> <td style="width: 10%;"></td> <td style="width: 10%;"></td> <td style="width: 10%;"></td> <td style="width: 10%;"></td> </tr> <tr> <td></td> <td></td> <td colspan="8" style="text-align: center;"> <table border="1" style="width: 100%; border-collapse: collapse; text-align: center;"> <tr> <td style="width: 10%;"></td> <td style="width: 10%;"></td> <td style="width: 10%;"></td> <td style="width: 10%;"></td> <td style="width: 10%;"></td> <td style="width: 10%;"></td> <td style="width: 10%;"></td> <td style="width: 10%;"></td> <td style="width: 10%;"></td> <td style="width: 10%;"></td> </tr> <tr> <td></td> <td></td> <td colspan="8" style="text-align: center;"> <table border="1" style="width: 100%; border-collapse: collapse; text-align: center;"> <tr> <td style="width: 10%;"></td> <td style="width: 10%;"></td> <td style="width: 10%;"></td> <td style="width: 10%;"></td> <td style="width: 10%;"></td> <td style="width: 10%;"></td> <td style="width: 10%;"></td> <td style="width: 10%;"></td> <td style="width: 10%;"></td> <td style="width: 10%;"></td> </tr> <tr> <td></td> <td></td> <td colspan="8" style="text-align: center;"> <table border="1" style="width: 100%; border-collapse: collapse; text-align: center;"> <tr> <td style="width: 10%;"></td> <td style="width: 10%;"></td> <td style="width: 10%;"></td> <td style="width: 10%;"></td> <td style="width: 10%;"></td> <td style="width: 10%;"></td> <td style="width: 10%;"></td> <td style="width: 10%;"></td> <td style="width: 10%;"></td> <td style="width: 10%;"></td> </tr> <tr> <td></td> <td></td> <td colspan="8" style="text-align: center;"> <table border="1" style="width: 100%; border-collapse: collapse; text-align: center;"> <tr> <td style="width: 10%;"></td> <td style="width: 10%;"></td> <td style="width: 10%;"></td> <td style="width: 10%;"></td> <td style="width: 10%;"></td> <td style="width: 10%;"></td> <td style="width: 10%;"></td> <td style="width: 10%;"></td> <td style="width: 10%;"></td> <td style="width: 10%;"></td> </tr> <tr> <td></td> <td></td> <td colspan="8" style="text-align: center;"> <table border="1" style="width: 100%; border-collapse: collapse; text-align: center;"> <tr> <td style="width: 10%;"></td> <td style="width: 10%;"></td> <td style="width: 10%;"></td> <td style="width: 10%;"></td> <td style="width: 10%;"></td> <td style="width: 10%;"></td> <td style="width: 10%;"></td> <td style="width: 10%;"></td> <td style="width: 10%;"></td> <td style="width: 10%;"></td> </tr> <tr> <td></td> <td></td> <td colspan="8" style="text-align: center;"> <table border="1" style="width: 100%; border-collapse: collapse; text-align: center;"> <tr> <td style="width: 10%;"></td> <td style="width: 10%;"></td> <td style="width: 10%;"></td> <td style="width: 10%;"></td> <td style="width: 10%;"></td> <td style="width: 10%;"></td> <td style="width: 10%;"></td> <td style="width: 10%;"></td> <td style="width: 10%;"></td> <td style="width: 10%;"></td> </tr> <tr> <td></td> <td></td> <td colspan="8" style="text-align: center;"> <table border="1" style="width: 100%; border-collapse: collapse; text-align: center;"> <tr> <td style="width: 10%;"></td> <td style="width: 10%;"></td> <td style="width: 10%;"></td> <td style="width: 10%;"></td> <td style="width: 10%;"></td> <td style="width: 10%;"></td> <td style="width: 10%;"></td> <td style="width: 10%;"></td> <td style="width: 10%;"></td> <td style="width: 10%;"></td> </tr> <tr> <td></td> <td></td> <td colspan="8" style="text-align: center;"> <table border="1" style="width: 100%; border-collapse: collapse; text-align: center;"> <tr> <td style="width: 10%;"></td> <td style="width: 10%;"></td> <td style="width: 10%;"></td> <td style="width: 10%;"></td> <td style="width: 10%;"></td> <td style="width: 10%;"></td> <td style="width: 10%;"></td> <td style="width: 10%;"></td> <td style="width: 10%;"></td> <td style="width: 10%;"></td> </tr> <tr> <td></td> <td></td> <td colspan="8" style="text-align: center;"> <table border="1" style="width: 100%; border-collapse: collapse; text-align: center;"> <tr> </tr></table></td></tr></table></td></tr></table></td></tr></table></td></tr></table></td></tr></table></td></tr></table></td></tr></table></td></tr></table></td></tr></table></td></tr></table></td></tr></table></td></tr></table></td></tr></table></td></tr></table></td></tr></table></td></tr></table></td></tr></table></td></tr></table> | | | | | | | | | | | | | | | | | | | | <table border="1" style="width: 100%; border-collapse: collapse; text-align: center;"> <tr> <td style="width: 10%;"></td> <td style="width: 10%;"></td> <td style="width: 10%;"></td> <td style="width: 10%;"></td> <td style="width: 10%;"></td> <td style="width: 10%;"></td> <td style="width: 10%;"></td> <td style="width: 10%;"></td> <td style="width: 10%;"></td> <td style="width: 10%;"></td> </tr> <tr> <td></td> <td></td> <td colspan="8" style="text-align: center;"> <table border="1" style="width: 100%; border-collapse: collapse; text-align: center;"> <tr> <td style="width: 10%;"></td> <td style="width: 10%;"></td> <td style="width: 10%;"></td> <td style="width: 10%;"></td> <td style="width: 10%;"></td> <td style="width: 10%;"></td> <td style="width: 10%;"></td> <td style="width: 10%;"></td> <td style="width: 10%;"></td> <td style="width: 10%;"></td> </tr> <tr> <td></td> <td></td> <td colspan="8" style="text-align: center;"> <table border="1" style="width: 100%; border-collapse: collapse; text-align: center;"> <tr> <td style="width: 10%;"></td> <td style="width: 10%;"></td> <td style="width: 10%;"></td> <td style="width: 10%;"></td> <td style="width: 10%;"></td> <td style="width: 10%;"></td> <td style="width: 10%;"></td> <td style="width: 10%;"></td> <td style="width: 10%;"></td> <td style="width: 10%;"></td> </tr> <tr> <td></td> <td></td> <td colspan="8" style="text-align: center;"> <table border="1" style="width: 100%; border-collapse: collapse; text-align: center;"> <tr> <td style="width: 10%;"></td> <td style="width: 10%;"></td> <td style="width: 10%;"></td> <td style="width: 10%;"></td> <td style="width: 10%;"></td> <td style="width: 10%;"></td> <td style="width: 10%;"></td> <td style="width: 10%;"></td> <td style="width: 10%;"></td> <td style="width: 10%;"></td> </tr> <tr> <td></td> <td></td> <td colspan="8" style="text-align: center;">
<table border="1" style="width: 100%; border-collapse: collapse; text-align: center;"> <tr> <td style="width: 10%;"></td> <td style="width: 10%;"></td> <td style="width: 10%;"></td> <td style="width: 10%;"></td> <td style="width: 10%;"></td> <td style="width: 10%;"></td> <td style="width: 10%;"></td> <td style="width: 10%;"></td> <td style="width: 10%;"></td> <td style="width: 10%;"></td> </tr> <tr> <td></td> <td></td> <td colspan="8" style="text-align: center;"> <table border="1" style="width: 100%; border-collapse: collapse; text-align: center;"> <tr> <td style="width: 10%;"></td> <td style="width: 10%;"></td> <td style="width: 10%;"></td> <td style="width: 10%;"></td> <td style="width: 10%;"></td> <td style="width: 10%;"></td> <td style="width: 10%;"></td> <td style="width: 10%;"></td> <td style="width: 10%;"></td> <td style="width: 10%;"></td> </tr> <tr> <td></td> <td></td> <td colspan="8" style="text-align: center;"> <table border="1" style="width: 100%; border-collapse: collapse; text-align: center;"> <tr> <td style="width: 10%;"></td> <td style="width: 10%;"></td> <td style="width: 10%;"></td> <td style="width: 10%;"></td> <td style="width: 10%;"></td> <td style="width: 10%;"></td> <td style="width: 10%;"></td> <td style="width: 10%;"></td> <td style="width: 10%;"></td> <td style="width: 10%;"></td> </tr> <tr> <td></td> <td></td> <td colspan="8" style="text-align: center;"> <table border="1" style="width: 100%; border-collapse: collapse; text-align: center;"> <tr> <td style="width: 10%;"></td> <td style="width: 10%;"></td> <td style="width: 10%;"></td> <td style="width: 10%;"></td> <td style="width: 10%;"></td> <td style="width: 10%;"></td> <td style="width: 10%;"></td> <td style="width: 10%;"></td> <td style="width: 10%;"></td> <td style="width: 10%;"></td> </tr> <tr> <td></td> <td></td> <td colspan="8" style="text-align: center;"> <table border="1" style="width: 100%; border-collapse: collapse; text-align: center;"> <tr> <td style="width: 10%;"></td> <td style="width: 10%;"></td> <td style="width: 10%;"></td> <td style="width: 10%;"></td> <td style="width: 10%;"></td> <td style="width: 10%;"></td> <td style="width: 10%;"></td> <td style="width: 10%;"></td> <td style="width: 10%;"></td> <td style="width: 10%;"></td> </tr> <tr> <td></td> <td></td> <td colspan="8" style="text-align: center;"> <table border="1" style="width: 100%; border-collapse: collapse; text-align: center;"> <tr> <td style="width: 10%;"></td> <td style="width: 10%;"></td> <td style="width: 10%;"></td> <td style="width: 10%;"></td> <td style="width: 10%;"></td> <td style="width: 10%;"></td> <td style="width: 10%;"></td> <td style="width: 10%;"></td> <td style="width: 10%;"></td> <td style="width: 10%;"></td> </tr> <tr> <td></td> <td></td> <td colspan="8" style="text-align: center;"> <table border="1" style="width: 100%; border-collapse: collapse; text-align: center;"> <tr> <td style="width: 10%;"></td> <td style="width: 10%;"></td> <td style="width: 10%;"></td> <td style="width: 10%;"></td> <td style="width: 10%;"></td> <td style="width: 10%;"></td> <td style="width: 10%;"></td> <td style="width: 10%;"></td> <td style="width: 10%;"></td> <td style="width: 10%;"></td> </tr> <tr> <td></td> <td></td> <td colspan="8" style="text-align: center;"> <table border="1" style="width: 100%; border-collapse: collapse; text-align: center;"> <tr> <td style="width: 10%;"></td> <td style="width: 10%;"></td> <td style="width: 10%;"></td> <td style="width: 10%;"></td> <td style="width: 10%;"></td> <td style="width: 10%;"></td> <td style="width: 10%;"></td> <td style="width: 10%;"></td> <td style="width: 10%;"></td> <td style="width: 10%;"></td> </tr> <tr> <td></td> <td></td> <td colspan="8" style="text-align: center;"> <table border="1" style="width: 100%; border-collapse: collapse; text-align: center;"> <tr> <td style="width: 10%;"></td> <td style="width: 10%;"></td> <td style="width: 10%;"></td> <td style="width: 10%;"></td> <td style="width: 10%;"></td> <td style="width: 10%;"></td> <td style="width: 10%;"></td> <td style="width: 10%;"></td> <td style="width: 10%;"></td> <td style="width: 10%;"></td> </tr> <tr> <td></td> <td></td> <td colspan="8" style="text-align: center;"> <table border="1" style="width: 100%; border-collapse: collapse; text-align: center;"> <tr> <td style="width: 10%;"></td> <td style="width: 10%;"></td> <td style="width: 10%;"></td> <td style="width: 10%;"></td> <td style="width: 10%;"></td> <td style="width: 10%;"></td> <td style="width: 10%;"></td> <td style="width: 10%;"></td> <td style="width: 10%;"></td> <td style="width: 10%;"></td> </tr> <tr> <td></td> <td></td> <td colspan="8" style="text-align: center;"> <table border="1" style="width: 100%; border-collapse: collapse; text-align: center;"> <tr> <td style="width: 10%;"></td> <td style="width: 10%;"></td> <td style="width: 10%;"></td> <td style="width: 10%;"></td> <td style="width: 10%;"></td> <td style="width: 10%;"></td> <td style="width: 10%;"></td> <td style="width: 10%;"></td> <td style="width: 10%;"></td> <td style="width: 10%;"></td> </tr> <tr> <td></td> <td></td> <td colspan="8" style="text-align: center;"> <table border="1" style="width: 100%; border-collapse: collapse; text-align: center;"> <tr> <td style="width: 10%;"></td> <td style="width: 10%;"></td> <td style="width: 10%;"></td> <td style="width: 10%;"></td> <td style="width: 10%;"></td> <td style="width: 10%;"></td> <td style="width: 10%;"></td> <td style="width: 10%;"></td> <td style="width: 10%;"></td> <td style="width: 10%;"></td> </tr> <tr> <td></td> <td></td> <td colspan="8" style="text-align: center;"> <table border="1" style="width: 100%; border-collapse: collapse; text-align: center;"> <tr> <td style="width: 10%;"></td> <td style="width: 10%;"></td> <td style="width: 10%;"></td> <td style="width: 10%;"></td> <td style="width: 10%;"></td> <td style="width: 10%;"></td> <td style="width: 10%;"></td> <td style="width: 10%;"></td> <td style="width: 10%;"></td> <td style="width: 10%;"></td> </tr> <tr> <td></td> <td></td> <td colspan="8" style="text-align: center;"> <table border="1" style="width: 100%; border-collapse: collapse; text-align: center;"> <tr> </tr></table></td></tr></table></td></tr></table></td></tr></table></td></tr></table></td></tr></table></td></tr></table></td></tr></table></td></tr></table></td></tr></table></td></tr></table></td></tr></table></td></tr></table></td></tr></table></td></tr></table></td></tr></table></td></tr></table></td></tr></table> | | | | | | | | | | | | | | | | | | | | <table border="1" style="width: 100%; border-collapse: collapse; text-align: center;"> <tr> <td style="width: 10%;"></td> <td style="width: 10%;"></td> <td style="width: 10%;"></td> <td style="width: 10%;"></td> <td style="width: 10%;"></td> <td style="width: 10%;"></td> <td style="width: 10%;"></td> <td style="width: 10%;"></td> <td style="width: 10%;"></td> <td style="width: 10%;"></td> </tr> <tr> <td></td> <td></td> <td colspan="8" style="text-align: center;"> <table border="1" style="width: 100%; border-collapse: collapse; text-align: center;"> <tr> <td style="width: 10%;"></td> <td style="width: 10%;"></td> <td style="width: 10%;"></td> <td style="width: 10%;"></td> <td style="width: 10%;"></td> <td style="width: 10%;"></td> <td style="width: 10%;"></td> <td style="width: 10%;"></td> <td style="width: 10%;"></td> <td style="width: 10%;"></td> </tr> <tr> <td></td> <td></td> <td colspan="8" style="text-align: center;"> <table border="1" style="width: 100%; border-collapse: collapse; text-align: center;"> <tr> <td style="width: 10%;"></td> <td style="width: 10%;"></td> <td style="width: 10%;"></td> <td style="width: 10%;"></td> <td style="width: 10%;"></td> <td style="width: 10%;"></td> <td style="width: 10%;"></td> <td style="width: 10%;"></td> <td style="width: 10%;"></td> <td style="width: 10%;"></td> </tr> <tr> <td></td> <td></td> <td colspan="8" style="text-align: center;"> <table border="1" style="width: 100%; border-collapse: collapse; text-align: center;"> <tr> <td
style="width: 10%;"></td> <td style="width: 10%;"></td> <td style="width: 10%;"></td> <td style="width: 10%;"></td> <td style="width: 10%;"></td> <td style="width: 10%;"></td> <td style="width: 10%;"></td> <td style="width: 10%;"></td> <td style="width: 10%;"></td> <td style="width: 10%;"></td> </tr> <tr> <td></td> <td></td> <td colspan="8" style="text-align: center;"> <table border="1" style="width: 100%; border-collapse: collapse; text-align: center;"> <tr> <td style="width: 10%;"></td> <td style="width: 10%;"></td> <td style="width: 10%;"></td> <td style="width: 10%;"></td> <td style="width: 10%;"></td> <td style="width: 10%;"></td> <td style="width: 10%;"></td> <td style="width: 10%;"></td> <td style="width: 10%;"></td> <td style="width: 10%;"></td> </tr> <tr> <td></td> <td></td> <td colspan="8" style="text-align: center;"> <table border="1" style="width: 100%; border-collapse: collapse; text-align: center;"> <tr> <td style="width: 10%;"></td> <td style="width: 10%;"></td> <td style="width: 10%;"></td> <td style="width: 10%;"></td> <td style="width: 10%;"></td> <td style="width: 10%;"></td> <td style="width: 10%;"></td> <td style="width: 10%;"></td> <td style="width: 10%;"></td> <td style="width: 10%;"></td> </tr> <tr> <td></td> <td></td> <td colspan="8" style="text-align: center;"> <table border="1" style="width: 100%; border-collapse: collapse; text-align: center;"> <tr> <td style="width: 10%;"></td> <td style="width: 10%;"></td> <td style="width: 10%;"></td> <td style="width: 10%;"></td> <td style="width: 10%;"></td> <td style="width: 10%;"></td> <td style="width: 10%;"></td> <td style="width: 10%;"></td> <td style="width: 10%;"></td> <td style="width: 10%;"></td> </tr> <tr> <td></td> <td></td> <td colspan="8" style="text-align: center;"> <table border="1" style="width: 100%; border-collapse: collapse; text-align: center;"> <tr> <td style="width: 10%;"></td> <td style="width: 10%;"></td> <td style="width: 10%;"></td> <td style="width: 10%;"></td> <td style="width: 10%;"></td> <td style="width: 10%;"></td> <td style="width: 10%;"></td> <td style="width: 10%;"></td> <td style="width: 10%;"></td> <td style="width: 10%;"></td> </tr> <tr> <td></td> <td></td> <td colspan="8" style="text-align: center;"> <table border="1" style="width: 100%; border-collapse: collapse; text-align: center;"> <tr> <td style="width: 10%;"></td> <td style="width: 10%;"></td> <td style="width: 10%;"></td> <td style="width: 10%;"></td> <td style="width: 10%;"></td> <td style="width: 10%;"></td> <td style="width: 10%;"></td> <td style="width: 10%;"></td> <td style="width: 10%;"></td> <td style="width: 10%;"></td> </tr> <tr> <td></td> <td></td> <td colspan="8" style="text-align: center;"> <table border="1" style="width: 100%; border-collapse: collapse; text-align: center;"> <tr> <td style="width: 10%;"></td> <td style="width: 10%;"></td> <td style="width: 10%;"></td> <td style="width: 10%;"></td> <td style="width: 10%;"></td> <td style="width: 10%;"></td> <td style="width: 10%;"></td> <td style="width: 10%;"></td> <td style="width: 10%;"></td> <td style="width: 10%;"></td> </tr> <tr> <td></td> <td></td> <td colspan="8" style="text-align: center;"> <table border="1" style="width: 100%; border-collapse: collapse; text-align: center;"> <tr> <td style="width: 10%;"></td> <td style="width: 10%;"></td> <td style="width: 10%;"></td> <td style="width: 10%;"></td> <td style="width: 10%;"></td> <td style="width: 10%;"></td> <td style="width: 10%;"></td> <td style="width: 10%;"></td> <td style="width: 10%;"></td> <td style="width: 10%;"></td> </tr> <tr> <td></td> <td></td> <td colspan="8" style="text-align: center;"> <table border="1" style="width: 100%; border-collapse: collapse; text-align: center;"> <tr> <td style="width: 10%;"></td> <td style="width: 10%;"></td> <td style="width: 10%;"></td> <td style="width: 10%;"></td> <td style="width: 10%;"></td> <td style="width: 10%;"></td> <td style="width: 10%;"></td> <td style="width: 10%;"></td> <td style="width: 10%;"></td> <td style="width: 10%;"></td> </tr> <tr> <td></td> <td></td> <td colspan="8" style="text-align: center;"> <table border="1" style="width: 100%; border-collapse: collapse; text-align: center;"> <tr> <td style="width: 10%;"></td> <td style="width: 10%;"></td> <td style="width: 10%;"></td> <td style="width: 10%;"></td> <td style="width: 10%;"></td> <td style="width: 10%;"></td> <td style="width: 10%;"></td> <td style="width: 10%;"></td> <td style="width: 10%;"></td> <td style="width: 10%;"></td> </tr> <tr> <td></td> <td></td> <td colspan="8" style="text-align: center;"> <table border="1" style="width: 100%; border-collapse: collapse; text-align: center;"> <tr> <td style="width: 10%;"></td> <td style="width: 10%;"></td> <td style="width: 10%;"></td> <td style="width: 10%;"></td> <td style="width: 10%;"></td> <td style="width: 10%;"></td> <td style="width: 10%;"></td> <td style="width: 10%;"></td> <td style="width: 10%;"></td> <td style="width: 10%;"></td> </tr> <tr> <td></td> <td></td> <td colspan="8" style="text-align: center;"> <table border="1" style="width: 100%; border-collapse: collapse; text-align: center;"> <tr> <td style="width: 10%;"></td> <td style="width: 10%;"></td> <td style="width: 10%;"></td> <td style="width: 10%;"></td> <td style="width: 10%;"></td> <td style="width: 10%;"></td> <td style="width: 10%;"></td> <td style="width: 10%;"></td> <td style="width: 10%;"></td> <td style="width: 10%;"></td> </tr> <tr> <td></td> <td></td> <td colspan="8" style="text-align: center;"> <table border="1" style="width: 100%; border-collapse: collapse; text-align: center;"> <tr> <td style="width: 10%;"></td> <td style="width: 10%;"></td> <td style="width: 10%;"></td> <td style="width: 10%;"></td> <td style="width: 10%;"></td> <td style="width: 10%;"></td> <td style="width: 10%;"></td> <td style="width: 10%;"></td> <td style="width: 10%;"></td> <td style="width: 10%;"></td> </tr> <tr> <td></td> <td></td> <td colspan="8" style="text-align: center;"> <table border="1" style="width: 100%; border-collapse: collapse; text-align: center;"> <tr> </tr></table></td></tr></table></td></tr></table></td></tr></table></td></tr></table></td></tr></table></td></tr></table></td></tr></table></td></tr></table></td></tr></table></td></tr></table></td></tr></table></td></tr></table></td></tr></table></td></tr></table></td></tr></table></td></tr></table> | | | | | | | | | | | | | | | | | | | | <table border="1" style="width: 100%; border-collapse: collapse; text-align: center;"> <tr> <td style="width: 10%;"></td> <td style="width: 10%;"></td> <td style="width: 10%;"></td> <td style="width: 10%;"></td> <td style="width: 10%;"></td> <td style="width: 10%;"></td> <td style="width: 10%;"></td> <td style="width: 10%;"></td> <td style="width: 10%;"></td> <td style="width: 10%;"></td> </tr> <tr> <td></td> <td></td> <td colspan="8" style="text-align: center;"> <table border="1" style="width: 100%; border-collapse: collapse; text-align: center;"> <tr> <td style="width: 10%;"></td> <td style="width: 10%;"></td> <td style="width: 10%;"></td> <td style="width: 10%;"></td> <td style="width: 10%;"></td> <td style="width: 10%;"></td> <td style="width: 10%;"></td> <td style="width: 10%;"></td> <td style="width: 10%;"></td> <td style="width: 10%;"></td> </tr> <tr> <td></td> <td></td> <td colspan="8" style="text-align: center;"> <table border="1" style="width: 100%; border-collapse: collapse; text-align: center;"> <tr> <td style="width: 10%;"></td> <td style="width: 10%;"></td> <td style="width: 10%;"></td> <td style="width: 10%;"></td> <td style="width: 10%;"></td> <td style="width: 10%;"></td> <td style="width: 10%;"></td> <td style="width: 10%;"></td> <td style="width: 10%;"></td> <td style="width: 10%;"></td> </tr> <tr> <td></td> <td></td> <td colspan="8" style="text-align: center;"> <table border="1" style="width: 100%; border-collapse: collapse; text-align: center;"> <tr> <td style="width: 10%;"></td> <td style="width: 10%;"></td> <td style="width: 10%;"></td> <td style="width:
10%;"></td> <td style="width: 10%;"></td> <td style="width: 10%;"></td> <td style="width: 10%;"></td> <td style="width: 10%;"></td> <td style="width: 10%;"></td> <td style="width: 10%;"></td> </tr> <tr> <td></td> <td></td> <td colspan="8" style="text-align: center;"> <table border="1" style="width: 100%; border-collapse: collapse; text-align: center;"> <tr> <td style="width: 10%;"></td> <td style="width: 10%;"></td> <td style="width: 10%;"></td> <td style="width: 10%;"></td> <td style="width: 10%;"></td> <td style="width: 10%;"></td> <td style="width: 10%;"></td> <td style="width: 10%;"></td> <td style="width: 10%;"></td> <td style="width: 10%;"></td> </tr> <tr> <td></td> <td></td> <td colspan="8" style="text-align: center;"> <table border="1" style="width: 100%; border-collapse: collapse; text-align: center;"> <tr> <td style="width: 10%;"></td> <td style="width: 10%;"></td> <td style="width: 10%;"></td> <td style="width: 10%;"></td> <td style="width: 10%;"></td> <td style="width: 10%;"></td> <td style="width: 10%;"></td> <td style="width: 10%;"></td> <td style="width: 10%;"></td> <td style="width: 10%;"></td> </tr> <tr> <td></td> <td></td> <td colspan="8" style="text-align: center;"> <table border="1" style="width: 100%; border-collapse: collapse; text-align: center;"> <tr> <td style="width: 10%;"></td> <td style="width: 10%;"></td> <td style="width: 10%;"></td> <td style="width: 10%;"></td> <td style="width: 10%;"></td> <td style="width: 10%;"></td> <td style="width: 10%;"></td> <td style="width: 10%;"></td> <td style="width: 10%;"></td> <td style="width: 10%;"></td> </tr> <tr> <td></td> <td></td> <td colspan="8" style="text-align: center;"> <table border="1" style="width: 100%; border-collapse: collapse; text-align: center;"> <tr> <td style="width: 10%;"></td> <td style="width: 10%;"></td> <td style="width: 10%;"></td> <td style="width: 10%;"></td> <td style="width: 10%;"></td> <td style="width: 10%;"></td> <td style="width: 10%;"></td> <td style="width: 10%;"></td> <td style="width: 10%;"></td> <td style="width: 10%;"></td> </tr> <tr> <td></td> <td></td> <td colspan="8" style="text-align: center;"> <table border="1" style="width: 100%; border-collapse: collapse; text-align: center;"> <tr> <td style="width: 10%;"></td> <td style="width: 10%;"></td> <td style="width: 10%;"></td> <td style="width: 10%;"></td> <td style="width: 10%;"></td> <td style="width: 10%;"></td> <td style="width: 10%;"></td> <td style="width: 10%;"></td> <td style="width: 10%;"></td> <td style="width: 10%;"></td> </tr> <tr> <td></td> <td></td> <td colspan="8" style="text-align: center;"> <table border="1" style="width: 100%; border-collapse: collapse; text-align: center;"> <tr> <td style="width: 10%;"></td> <td style="width: 10%;"></td> <td style="width: 10%;"></td> <td style="width: 10%;"></td> <td style="width: 10%;"></td> <td style="width: 10%;"></td> <td style="width: 10%;"></td> <td style="width: 10%;"></td> <td style="width: 10%;"></td> <td style="width: 10%;"></td> </tr> <tr> <td></td> <td></td> <td colspan="8" style="text-align: center;"> <table border="1" style="width: 100%; border-collapse: collapse; text-align: center;"> <tr> <td style="width: 10%;"></td> <td style="width: 10%;"></td> <td style="width: 10%;"></td> <td style="width: 10%;"></td> <td style="width: 10%;"></td> <td style="width: 10%;"></td> <td style="width: 10%;"></td> <td style="width: 10%;"></td> <td style="width: 10%;"></td> <td style="width: 10%;"></td> </tr> <tr> <td></td> <td></td> <td colspan="8" style="text-align: center;"> <table border="1" style="width: 100%; border-collapse: collapse; text-align: center;"> <tr> <td style="width: 10%;"></td> <td style="width: 10%;"></td> <td style="width: 10%;"></td> <td style="width: 10%;"></td> <td style="width: 10%;"></td> <td style="width: 10%;"></td> <td style="width: 10%;"></td> <td style="width: 10%;"></td> <td style="width: 10%;"></td> <td style="width: 10%;"></td> </tr> <tr> <td></td> <td></td> <td colspan="8" style="text-align: center;"> <table border="1" style="width: 100%; border-collapse: collapse; text-align: center;"> <tr> <td style="width: 10%;"></td> <td style="width: 10%;"></td> <td style="width: 10%;"></td> <td style="width: 10%;"></td> <td style="width: 10%;"></td> <td style="width: 10%;"></td> <td style="width: 10%;"></td> <td style="width: 10%;"></td> <td style="width: 10%;"></td> <td style="width: 10%;"></td> </tr> <tr> <td></td> <td></td> <td colspan="8" style="text-align: center;"> <table border="1" style="width: 100%; border-collapse: collapse; text-align: center;"> <tr> <td style="width: 10%;"></td> <td style="width: 10%;"></td> <td style="width: 10%;"></td> <td style="width: 10%;"></td> <td style="width: 10%;"></td> <td style="width: 10%;"></td> <td style="width: 10%;"></td> <td style="width: 10%;"></td> <td style="width: 10%;"></td> <td style="width: 10%;"></td> </tr> <tr> <td></td> <td></td> <td colspan="8" style="text-align: center;"> <table border="1" style="width: 100%; border-collapse: collapse; text-align: center;"> <tr> <td style="width: 10%;"></td> <td style="width: 10%;"></td> <td style="width: 10%;"></td> <td style="width: 10%;"></td> <td style="width: 10%;"></td> <td style="width: 10%;"></td> <td style="width: 10%;"></td> <td style="width: 10%;"></td> <td style="width: 10%;"></td> <td style="width: 10%;"></td> </tr> <tr> <td></td> <td></td> <td colspan="8" style="text-align: center;"> <table border="1" style="width: 100%; border-collapse: collapse; text-align: center;"> <tr> </tr></table></td></tr></table></td></tr></table></td></tr></table></td></tr></table></td></tr></table></td></tr></table></td></tr></table></td></tr></table></td></tr></table></td></tr></table></td></tr></table></td></tr></table></td></tr></table></td></tr></table></td></tr></table> | | | | | | | | | | | | | | | | | | | | <table border="1" style="width: 100%; border-collapse: collapse; text-align: center;"> <tr> <td style="width: 10%;"></td> <td style="width: 10%;"></td> <td style="width: 10%;"></td> <td style="width: 10%;"></td> <td style="width: 10%;"></td> <td style="width: 10%;"></td> <td style="width: 10%;"></td> <td style="width: 10%;"></td> <td style="width: 10%;"></td> <td style="width: 10%;"></td> </tr> <tr> <td></td> <td></td> <td colspan="8" style="text-align: center;"> <table border="1" style="width: 100%; border-collapse: collapse; text-align: center;"> <tr> <td style="width: 10%;"></td> <td style="width: 10%;"></td> <td style="width: 10%;"></td> <td style="width: 10%;"></td> <td style="width: 10%;"></td> <td style="width: 10%;"></td> <td style="width: 10%;"></td> <td style="width: 10%;"></td> <td style="width: 10%;"></td> <td style="width: 10%;"></td> </tr> <tr> <td></td> <td></td> <td colspan="8" style="text-align: center;"> <table border="1" style="width: 100%; border-collapse: collapse; text-align: center;"> <tr> <td style="width: 10%;"></td> <td style="width: 10%;"></td> <td style="width: 10%;"></td> <td style="width: 10%;"></td> <td style="width: 10%;"></td> <td style="width: 10%;"></td> <td style="width: 10%;"></td> <td style="width: 10%;"></td> <td style="width: 10%;"></td> <td style="width: 10%;"></td> </tr> <tr> <td></td> <td></td> <td colspan="8" style="text-align: center;"> <table border="1" style="width: 100%; border-collapse: collapse; text-align: center;"> <tr> <td style="width: 10%;"></td> <td style="width: 10%;"></td> <td style="width: 10%;"></td> <td style="width: 10%;"></td> <td style="width: 10%;"></td> <td style="width: 10%;"></td> <td style="width: 10%;"></td> <td style="width: 10%;"></td> <td style="width: 10%;"></td> <td style="width: 10%;"></td> </tr> <tr> <td></td> <td></td> <td colspan="8" style="text-align: center;"> <table border="1" style="width: 100%; border-collapse: collapse; text-align: center;"> <tr> <td style="width: 10%;"></td> <td style="width: 10%;"></td> <td style="width: 10%;"></td> <td style="width: 10%;"></td> <td style="width: 10%;"></td> <td style="width: 10%;"></td> <td style="width: 10%;"></td> <td style="width: 10%;"></td>
<td style="width: 10%;"></td> <td style="width: 10%;"></td> </tr> <tr> <td></td> <td></td> <td colspan="8" style="text-align: center;"> <table border="1" style="width: 100%; border-collapse: collapse; text-align: center;"> <tr> <td style="width: 10%;"></td> <td style="width: 10%;"></td> <td style="width: 10%;"></td> <td style="width: 10%;"></td> <td style="width: 10%;"></td> <td style="width: 10%;"></td> <td style="width: 10%;"></td> <td style="width: 10%;"></td> <td style="width: 10%;"></td> <td style="width: 10%;"></td> </tr> <tr> <td></td> <td></td> <td colspan="8" style="text-align: center;"> <table border="1" style="width: 100%; border-collapse: collapse; text-align: center;"> <tr> <td style="width: 10%;"></td> <td style="width: 10%;"></td> <td style="width: 10%;"></td> <td style="width: 10%;"></td> <td style="width: 10%;"></td> <td style="width: 10%;"></td> <td style="width: 10%;"></td> <td style="width: 10%;"></td> <td style="width: 10%;"></td> <td style="width: 10%;"></td> </tr> <tr> <td></td> <td></td> <td colspan="8" style="text-align: center;"> <table border="1" style="width: 100%; border-collapse: collapse; text-align: center;"> <tr> <td style="width: 10%;"></td> <td style="width: 10%;"></td> <td style="width: 10%;"></td> <td style="width: 10%;"></td> <td style="width: 10%;"></td> <td style="width: 10%;"></td> <td style="width: 10%;"></td> <td style="width: 10%;"></td> <td style="width: 10%;"></td> <td style="width: 10%;"></td> </tr> <tr> <td></td> <td></td> <td colspan="8" style="text-align: center;"> <table border="1" style="width: 100%; border-collapse: collapse; text-align: center;"> <tr> <td style="width: 10%;"></td> <td style="width: 10%;"></td> <td style="width: 10%;"></td> <td style="width: 10%;"></td> <td style="width: 10%;"></td> <td style="width: 10%;"></td> <td style="width: 10%;"></td> <td style="width: 10%;"></td> <td style="width: 10%;"></td> <td style="width: 10%;"></td> </tr> <tr> <td></td> <td></td> <td colspan="8" style="text-align: center;"> <table border="1" style="width: 100%; border-collapse: collapse; text-align: center;"> <tr> <td style="width: 10%;"></td> <td style="width: 10%;"></td> <td style="width: 10%;"></td> <td style="width: 10%;"></td> <td style="width: 10%;"></td> <td style="width: 10%;"></td> <td style="width: 10%;"></td> <td style="width: 10%;"></td> <td style="width: 10%;"></td> <td style="width: 10%;"></td> </tr> <tr> <td></td> <td></td> <td colspan="8" style="text-align: center;"> <table border="1" style="width: 100%; border-collapse: collapse; text-align: center;"> <tr> <td style="width: 10%;"></td> <td style="width: 10%;"></td> <td style="width: 10%;"></td> <td style="width: 10%;"></td> <td style="width: 10%;"></td> <td style="width: 10%;"></td> <td style="width: 10%;"></td> <td style="width: 10%;"></td> <td style="width: 10%;"></td> <td style="width: 10%;"></td> </tr> <tr> <td></td> <td></td> <td colspan="8" style="text-align: center;"> <table border="1" style="width: 100%; border-collapse: collapse; text-align: center;"> <tr> <td style="width: 10%;"></td> <td style="width: 10%;"></td> <td style="width: 10%;"></td> <td style="width: 10%;"></td> <td style="width: 10%;"></td> <td style="width: 10%;"></td> <td style="width: 10%;"></td> <td style="width: 10%;"></td> <td style="width: 10%;"></td> <td style="width: 10%;"></td> </tr> <tr> <td></td> <td></td> <td colspan="8" style="text-align: center;"> <table border="1" style="width: 100%; border-collapse: collapse; text-align: center;"> <tr> <td style="width: 10%;"></td> <td style="width: 10%;"></td> <td style="width: 10%;"></td> <td style="width: 10%;"></td> <td style="width: 10%;"></td> <td style="width: 10%;"></td> <td style="width: 10%;"></td> <td style="width: 10%;"></td> <td style="width: 10%;"></td> <td style="width: 10%;"></td> </tr> <tr> <td></td> <td></td> <td colspan="8" style="text-align: center;"> <table border="1" style="width: 100%; border-collapse: collapse; text-align: center;"> <tr> <td style="width: 10%;"></td> <td style="width: 10%;"></td> <td style="width: 10%;"></td> <td style="width: 10%;"></td> <td style="width: 10%;"></td> <td style="width: 10%;"></td> <td style="width: 10%;"></td> <td style="width: 10%;"></td> <td style="width: 10%;"></td> <td style="width: 10%;"></td> </tr> <tr> <td></td> <td></td> <td colspan="8" style="text-align: center;"> <table border="1" style="width: 100%; border-collapse: collapse; text-align: center;"> <tr> </tr></table></td></tr></table></td></tr></table></td></tr></table></td></tr></table></td></tr></table></td></tr></table></td></tr></table></td></tr></table></td></tr></table></td></tr></table></td></tr></table></td></tr></table></td></tr></table></td></tr></table> | | | | | | | | | | | | | | | | | | | | <table border="1" style="width: 100%; border-collapse: collapse; text-align: center;"> <tr> <td style="width: 10%;"></td> <td style="width: 10%;"></td> <td style="width: 10%;"></td> <td style="width: 10%;"></td> <td style="width: 10%;"></td> <td style="width: 10%;"></td> <td style="width: 10%;"></td> <td style="width: 10%;"></td> <td style="width: 10%;"></td> <td style="width: 10%;"></td> </tr> <tr> <td></td> <td></td> <td colspan="8" style="text-align: center;"> <table border="1" style="width: 100%; border-collapse: collapse; text-align: center;"> <tr> <td style="width: 10%;"></td> <td style="width: 10%;"></td> <td style="width: 10%;"></td> <td style="width: 10%;"></td> <td style="width: 10%;"></td> <td style="width: 10%;"></td> <td style="width: 10%;"></td> <td style="width: 10%;"></td> <td style="width: 10%;"></td> <td style="width: 10%;"></td> </tr> <tr> <td></td> <td></td> <td colspan="8" style="text-align: center;"> <table border="1" style="width: 100%; border-collapse: collapse; text-align: center;"> <tr> <td style="width: 10%;"></td> <td style="width: 10%;"></td> <td style="width: 10%;"></td> <td style="width: 10%;"></td> <td style="width: 10%;"></td> <td style="width: 10%;"></td> <td style="width: 10%;"></td> <td style="width: 10%;"></td> <td style="width: 10%;"></td> <td style="width: 10%;"></td> </tr> <tr> <td></td> <td></td> <td colspan="8" style="text-align: center;"> <table border="1" style="width: 100%; border-collapse: collapse; text-align: center;"> <tr> <td style="width: 10%;"></td> <td style="width: 10%;"></td> <td style="width: 10%;"></td> <td style="width: 10%;"></td> <td style="width: 10%;"></td> <td style="width: 10%;"></td> <td style="width: 10%;"></td> <td style="width: 10%;"></td> <td style="width: 10%;"></td> <td style="width: 10%;"></td> </tr> <tr> <td></td> <td></td> <td colspan="8" style="text-align: center;"> <table border="1" style="width: 100%; border-collapse: collapse; text-align: center;"> <tr> <td style="width: 10%;"></td> <td style="width: 10%;"></td> <td style="width: 10%;"></td> <td style="width: 10%;"></td> <td style="width: 10%;"></td> <td style="width: 10%;"></td> <td style="width: 10%;"></td> <td style="width: 10%;"></td> <td style="width: 10%;"></td> <td style="width: 10%;"></td> </tr> <tr> <td></td> <td></td> <td colspan="8" style="text-align: center;"> <table border="1" style="width: 100%; border-collapse: collapse; text-align: center;"> <tr> <td style="width: 10%;"></td> <td style="width: 10%;"></td> <td style="width: 10%;"></td> <td style="width: 10%;"></td> <td style="width: 10%;"></td> <td style="width: 10%;"></td> <td style="width: 10%;"></td> <td style="width: 10%;"></td> <td style="width: 10%;"></td> <td style="width: 10%;"></td> </tr> <tr> <td></td> <td></td> <td colspan="8" style="text-align: center;"> <table border="1" style="width: 100%; border-collapse: collapse; text-align: center;"> <tr> <td style="width: 10%;"></td> <td style="width: 10%;"></td> <td style="width: 10%;"></td> <td style="width: 10%;"></td> <td style="width: 10%;"></td> <td style="width: 10%;"></td> <td style="width: 10%;"></td> <td style="width: 10%;"></td> <td style="width: 10%;"></td> <td style="width: 10%;"></td> </tr> <tr> <td></td> <td></td> <td colspan="8" style="text-align: center;"> <table
border="1" style="width: 100%; border-collapse: collapse; text-align: center;"> <tr> <td style="width: 10%;"></td> <td style="width: 10%;"></td> <td style="width: 10%;"></td> <td style="width: 10%;"></td> <td style="width: 10%;"></td> <td style="width: 10%;"></td> <td style="width: 10%;"></td> <td style="width: 10%;"></td> <td style="width: 10%;"></td> <td style="width: 10%;"></td> </tr> <tr> <td></td> <td></td> <td colspan="8" style="text-align: center;"> <table border="1" style="width: 100%; border-collapse: collapse; text-align: center;"> <tr> <td style="width: 10%;"></td> <td style="width: 10%;"></td> <td style="width: 10%;"></td> <td style="width: 10%;"></td> <td style="width: 10%;"></td> <td style="width: 10%;"></td> <td style="width: 10%;"></td> <td style="width: 10%;"></td> <td style="width: 10%;"></td> <td style="width: 10%;"></td> </tr> <tr> <td></td> <td></td> <td colspan="8" style="text-align: center;"> <table border="1" style="width: 100%; border-collapse: collapse; text-align: center;"> <tr> <td style="width: 10%;"></td> <td style="width: 10%;"></td> <td style="width: 10%;"></td> <td style="width: 10%;"></td> <td style="width: 10%;"></td> <td style="width: 10%;"></td> <td style="width: 10%;"></td> <td style="width: 10%;"></td> <td style="width: 10%;"></td> <td style="width: 10%;"></td> </tr> <tr> <td></td> <td></td> <td colspan="8" style="text-align: center;"> <table border="1" style="width: 100%; border-collapse: collapse; text-align: center;"> <tr> <td style="width: 10%;"></td> <td style="width: 10%;"></td> <td style="width: 10%;"></td> <td style="width: 10%;"></td> <td style="width: 10%;"></td> <td style="width: 10%;"></td> <td style="width: 10%;"></td> <td style="width: 10%;"></td> <td style="width: 10%;"></td> <td style="width: 10%;"></td> </tr> <tr> <td></td> <td></td> <td colspan="8" style="text-align: center;"> <table border="1" style="width: 100%; border-collapse: collapse; text-align: center;"> <tr> <td style="width: 10%;"></td> <td style="width: 10%;"></td> <td style="width: 10%;"></td> <td style="width: 10%;"></td> <td style="width: 10%;"></td> <td style="width: 10%;"></td> <td style="width: 10%;"></td> <td style="width: 10%;"></td> <td style="width: 10%;"></td> <td style="width: 10%;"></td> </tr> <tr> <td></td> <td></td> <td colspan="8" style="text-align: center;"> <table border="1" style="width: 100%; border-collapse: collapse; text-align: center;"> <tr> <td style="width: 10%;"></td> <td style="width: 10%;"></td> <td style="width: 10%;"></td> <td style="width: 10%;"></td> <td style="width: 10%;"></td> <td style="width: 10%;"></td> <td style="width: 10%;"></td> <td style="width: 10%;"></td> <td style="width: 10%;"></td> <td style="width: 10%;"></td> </tr> <tr> <td></td> <td></td> <td colspan="8" style="text-align: center;"> <table border="1" style="width: 100%; border-collapse: collapse; text-align: center;"> <tr> </tr></table></td></tr></table></td></tr></table></td></tr></table></td></tr></table></td></tr></table></td></tr></table></td></tr></table></td></tr></table></td></tr></table></td></tr></table></td></tr></table></td></tr></table></td></tr></table> | | | | | | | | | | | | | | | | | | | | <table border="1" style="width: 100%; border-collapse: collapse; text-align: center;"> <tr> <td style="width: 10%;"></td> <td style="width: 10%;"></td> <td style="width: 10%;"></td> <td style="width: 10%;"></td> <td style="width: 10%;"></td> <td style="width: 10%;"></td> <td style="width: 10%;"></td> <td style="width: 10%;"></td> <td style="width: 10%;"></td> <td style="width: 10%;"></td> </tr> <tr> <td></td> <td></td> <td colspan="8" style="text-align: center;"> <table border="1" style="width: 100%; border-collapse: collapse; text-align: center;"> <tr> <td style="width: 10%;"></td> <td style="width: 10%;"></td> <td style="width: 10%;"></td> <td style="width: 10%;"></td> <td style="width: 10%;"></td> <td style="width: 10%;"></td> <td style="width: 10%;"></td> <td style="width: 10%;"></td> <td style="width: 10%;"></td> <td style="width: 10%;"></td> </tr> <tr> <td></td> <td></td> <td colspan="8" style="text-align: center;"> <table border="1" style="width: 100%; border-collapse: collapse; text-align: center;"> <tr> <td style="width: 10%;"></td> <td style="width: 10%;"></td> <td style="width: 10%;"></td> <td style="width: 10%;"></td> <td style="width: 10%;"></td> <td style="width: 10%;"></td> <td style="width: 10%;"></td> <td style="width: 10%;"></td> <td style="width: 10%;"></td> <td style="width: 10%;"></td> </tr> <tr> <td></td> <td></td> <td colspan="8" style="text-align: center;"> <table border="1" style="width: 100%; border-collapse: collapse; text-align: center;"> <tr> <td style="width: 10%;"></td> <td style="width: 10%;"></td> <td style="width: 10%;"></td> <td style="width: 10%;"></td> <td style="width: 10%;"></td> <td style="width: 10%;"></td> <td style="width: 10%;"></td> <td style="width: 10%;"></td> <td style="width: 10%;"></td> <td style="width: 10%;"></td> </tr> <tr> <td></td> <td></td> <td colspan="8" style="text-align: center;"> <table border="1" style="width: 100%; border-collapse: collapse; text-align: center;"> <tr> <td style="width: 10%;"></td> <td style="width: 10%;"></td> <td style="width: 10%;"></td> <td style="width: 10%;"></td> <td style="width: 10%;"></td> <td style="width: 10%;"></td> <td style="width: 10%;"></td> <td style="width: 10%;"></td> <td style="width: 10%;"></td> <td style="width: 10%;"></td> </tr> <tr> <td></td> <td></td> <td colspan="8" style="text-align: center;"> <table border="1" style="width: 100%; border-collapse: collapse; text-align: center;"> <tr> <td style="width: 10%;"></td> <td style="width: 10%;"></td> <td style="width: 10%;"></td> <td style="width: 10%;"></td> <td style="width: 10%;"></td> <td style="width: 10%;"></td> <td style="width: 10%;"></td> <td style="width: 10%;"></td> <td style="width: 10%;"></td> <td style="width: 10%;"></td> </tr> <tr> <td></td> <td></td> <td colspan="8" style="text-align: center;"> <table border="1" style="width: 100%; border-collapse: collapse; text-align: center;"> <tr> <td style="width: 10%;"></td> <td style="width: 10%;"></td> <td style="width: 10%;"></td> <td style="width: 10%;"></td> <td style="width: 10%;"></td> <td style="width: 10%;"></td> <td style="width: 10%;"></td> <td style="width: 10%;"></td> <td style="width: 10%;"></td> <td style="width: 10%;"></td> </tr> <tr> <td></td> <td></td> <td colspan="8" style="text-align: center;"> <table border="1" style="width: 100%; border-collapse: collapse; text-align: center;"> <tr> <td style="width: 10%;"></td> <td style="width: 10%;"></td> <td style="width: 10%;"></td> <td style="width: 10%;"></td> <td style="width: 10%;"></td> <td style="width: 10%;"></td> <td style="width: 10%;"></td> <td style="width: 10%;"></td> <td style="width: 10%;"></td> <td style="width: 10%;"></td> </tr> <tr> <td></td> <td></td> <td colspan="8" style="text-align: center;"> <table border="1" style="width: 100%; border-collapse: collapse; text-align: center;"> <tr> <td style="width: 10%;"></td> <td style="width: 10%;"></td> <td style="width: 10%;"></td> <td style="width: 10%;"></td> <td style="width: 10%;"></td> <td style="width: 10%;"></td> <td style="width: 10%;"></td> <td style="width: 10%;"></td> <td style="width: 10%;"></td> <td style="width: 10%;"></td> </tr> <tr> <td></td> <td></td> <td colspan="8" style="text-align: center;"> <table border="1" style="width: 100%; border-collapse: collapse; text-align: center;"> <tr> <td style="width: 10%;"></td> <td style="width: 10%;"></td> <td style="width: 10%;"></td> <td style="width: 10%;"></td> <td style="width: 10%;"></td> <td style="width: 10%;"></td> <td style="width: 10%;"></td> <td style="width: 10%;"></td> <td style="width: 10%;"></td> <td style="width: 10%;"></td> </tr> <tr> <td></td> <td></td> <td colspan="8" style="text-align: center;"> <table border="1" style="width: 100%; border-collapse: collapse; text-align: center;"> <tr> <td style="width: 10%;"></td> <td style="width: 10%;"></td> <td style="width:
10%;"></td> <td style="width: 10%;"></td> <td style="width: 10%;"></td> <td style="width: 10%;"></td> <td style="width: 10%;"></td> <td style="width: 10%;"></td> <td style="width: 10%;"></td> <td style="width: 10%;"></td> </tr> <tr> <td></td> <td></td> <td colspan="8" style="text-align: center;"> <table border="1" style="width: 100%; border-collapse: collapse; text-align: center;"> <tr> <td style="width: 10%;"></td> <td style="width: 10%;"></td> <td style="width: 10%;"></td> <td style="width: 10%;"></td> <td style="width: 10%;"></td> <td style="width: 10%;"></td> <td style="width: 10%;"></td> <td style="width: 10%;"></td> <td style="width: 10%;"></td> <td style="width: 10%;"></td> </tr> <tr> <td></td> <td></td> <td colspan="8" style="text-align: center;"> <table border="1" style="width: 100%; border-collapse: collapse; text-align: center;"> <tr> </tr></table></td></tr></table></td></tr></table></td></tr></table></td></tr></table></td></tr></table></td></tr></table></td></tr></table></td></tr></table></td></tr></table></td></tr></table></td></tr></table></td></tr></table> | | | | | | | | | | | | | | | | | | | | <table border="1" style="width: 100%; border-collapse: collapse; text-align: center;"> <tr> <td style="width: 10%;"></td> <td style="width: 10%;"></td> <td style="width: 10%;"></td> <td style="width: 10%;"></td> <td style="width: 10%;"></td> <td style="width: 10%;"></td> <td style="width: 10%;"></td> <td style="width: 10%;"></td> <td style="width: 10%;"></td> <td style="width: 10%;"></td> </tr> <tr> <td></td> <td></td> <td colspan="8" style="text-align: center;"> <table border="1" style="width: 100%; border-collapse: collapse; text-align: center;"> <tr> <td style="width: 10%;"></td> <td style="width: 10%;"></td> <td style="width: 10%;"></td> <td style="width: 10%;"></td> <td style="width: 10%;"></td> <td style="width: 10%;"></td> <td style="width: 10%;"></td> <td style="width: 10%;"></td> <td style="width: 10%;"></td> <td style="width: 10%;"></td> </tr> <tr> <td></td> <td></td> <td colspan="8" style="text-align: center;"> <table border="1" style="width: 100%; border-collapse: collapse; text-align: center;"> <tr> <td style="width: 10%;"></td> <td style="width: 10%;"></td> <td style="width: 10%;"></td> <td style="width: 10%;"></td> <td style="width: 10%;"></td> <td style="width: 10%;"></td> <td style="width: 10%;"></td> <td style="width: 10%;"></td> <td style="width: 10%;"></td> <td style="width: 10%;"></td> </tr> <tr> <td></td> <td></td> <td colspan="8" style="text-align: center;"> <table border="1" style="width: 100%; border-collapse: collapse; text-align: center;"> <tr> <td style="width: 10%;"></td> <td style="width: 10%;"></td> <td style="width: 10%;"></td> <td style="width: 10%;"></td> <td style="width: 10%;"></td> <td style="width: 10%;"></td> <td style="width: 10%;"></td> <td style="width: 10%;"></td> <td style="width: 10%;"></td> <td style="width: 10%;"></td> </tr> <tr> <td></td> <td></td> <td colspan="8" style="text-align: center;"> <table border="1" style="width: 100%; border-collapse: collapse; text-align: center;"> <tr> <td style="width: 10%;"></td> <td style="width: 10%;"></td> <td style="width: 10%;"></td> <td style="width: 10%;"></td> <td style="width: 10%;"></td> <td style="width: 10%;"></td> <td style="width: 10%;"></td> <td style="width: 10%;"></td> <td style="width: 10%;"></td> <td style="width: 10%;"></td> </tr> <tr> <td></td> <td></td> <td colspan="8" style="text-align: center;"> <table border="1" style="width: 100%; border-collapse: collapse; text-align: center;"> <tr> <td style="width: 10%;"></td> <td style="width: 10%;"></td> <td style="width: 10%;"></td> <td style="width: 10%;"></td> <td style="width: 10%;"></td> <td style="width: 10%;"></td> <td style="width: 10%;"></td> <td style="width: 10%;"></td> <td style="width: 10%;"></td> <td style="width: 10%;"></td> </tr> <tr> <td></td> <td></td> <td colspan="8" style="text-align: center;"> <table border="1" style="width: 100%; border-collapse: collapse; text-align: center;"> <tr> <td style="width: 10%;"></td> <td style="width: 10%;"></td> <td style="width: 10%;"></td> <td style="width: 10%;"></td> <td style="width: 10%;"></td> <td style="width: 10%;"></td> <td style="width: 10%;"></td> <td style="width: 10%;"></td> <td style="width: 10%;"></td> <td style="width: 10%;"></td> </tr> <tr> <td></td> <td></td> <td colspan="8" style="text-align: center;"> <table border="1" style="width: 100%; border-collapse: collapse; text-align: center;"> <tr> <td style="width: 10%;"></td> <td style="width: 10%;"></td> <td style="width: 10%;"></td> <td style="width: 10%;"></td> <td style="width: 10%;"></td> <td style="width: 10%;"></td> <td style="width: 10%;"></td> <td style="width: 10%;"></td> <td style="width: 10%;"></td> <td style="width: 10%;"></td> </tr> <tr> <td></td> <td></td> <td colspan="8" style="text-align: center;"> <table border="1" style="width: 100%; border-collapse: collapse; text-align: center;"> <tr> <td style="width: 10%;"></td> <td style="width: 10%;"></td> <td style="width: 10%;"></td> <td style="width: 10%;"></td> <td style="width: 10%;"></td> <td style="width: 10%;"></td> <td style="width: 10%;"></td> <td style="width: 10%;"></td> <td style="width: 10%;"></td> <td style="width: 10%;"></td> </tr> <tr> <td></td> <td></td> <td colspan="8" style="text-align: center;"> <table border="1" style="width: 100%; border-collapse: collapse; text-align: center;"> <tr> <td style="width: 10%;"></td> <td style="width: 10%;"></td> <td style="width: 10%;"></td> <td style="width: 10%;"></td> <td style="width: 10%;"></td> <td style="width: 10%;"></td> <td style="width: 10%;"></td> <td style="width: 10%;"></td> <td style="width: 10%;"></td> <td style="width: 10%;"></td> </tr> <tr> <td></td> <td></td> <td colspan="8" style="text-align: center;"> <table border="1" style="width: 100%; border-collapse: collapse; text-align: center;"> <tr> <td style="width: 10%;"></td> <td style="width: 10%;"></td> <td style="width: 10%;"></td> <td style="width: 10%;"></td> <td style="width: 10%;"></td> <td style="width: 10%;"></td> <td style="width: 10%;"></td> <td style="width: 10%;"></td> <td style="width: 10%;"></td> <td style="width: 10%;"></td> </tr> <tr> <td></td> <td></td> <td colspan="8" style="text-align: center;"> <table border="1" style="width: 100%; border-collapse: collapse; text-align: center;"> <tr> </tr></table></td></tr></table></td></tr></table></td></tr></table></td></tr></table></td></tr></table></td></tr></table></td></tr></table></td></tr></table></td></tr></table></td></tr></table></td></tr></table>
 | | | | | | | | | | | | | | | | | | | | <table border="1" style="width: 100%; border-collapse: collapse; text-align: center;"> <tr> <td style="width: 10%;"></td> <td style="width: 10%;"></td> <td style="width: 10%;"></td> <td style="width: 10%;"></td> <td style="width: 10%;"></td> <td style="width: 10%;"></td> <td style="width: 10%;"></td> <td style="width: 10%;"></td> <td style="width: 10%;"></td> <td style="width: 10%;"></td> </tr> <tr> <td></td> <td></td> <td colspan="8" style="text-align: center;"> <table border="1" style="width: 100%; border-collapse: collapse; text-align: center;"> <tr> <td style="width: 10%;"></td> <td style="width: 10%;"></td> <td style="width: 10%;"></td> <td style="width: 10%;"></td> <td style="width: 10%;"></td> <td style="width: 10%;"></td> <td style="width: 10%;"></td> <td style="width: 10%;"></td> <td style="width: 10%;"></td> <td style="width: 10%;"></td> </tr> <tr> <td></td> <td></td> <td colspan="8" style="text-align: center;"> <table border="1" style="width: 100%; border-collapse: collapse; text-align: center;"> <tr> <td style="width: 10%;"></td> <td style="width: 10%;"></td> <td style="width: 10%;"></td> <td style="width: 10%;"></td> <td style="width: 10%;"></td> <td style="width: 10%;"></td> <td style="width: 10%;"></td> <td style="width: 10%;"></td> <td style="width: 10%;"></td> <td style="width: 10%;"></td> </tr> <tr> <td></td> <td></td> <td colspan="8" style="text-align: center;"> <table border="1" style="width: 100%; border-collapse: collapse; text-align: center;"> <tr> <td style="width: 10%;"></td> <td style="width: 10%;"></td> <td style="width: 10%;"></td> <td style="width: 10%;"></td> <td style="width: 10%;"></td> <td style="width: 10%;"></td> <td style="width: 10%;"></td> <td style="width: 10%;"></td> <td style="width: 10%;"></td> <td style="width: 10%;"></td> </tr> <tr> <td></td> <td></td> <td colspan="8" style="text-align: center;"> <table border="1" style="width: 100%; border-collapse: collapse; text-align: center;"> <tr> <td style="width: 10%;"></td> <td style="width: 10%;"></td> <td style="width: 10%;"></td> <td style="width: 10%;"></td> <td style="width: 10%;"></td> <td style="width: 10%;"></td> <td style="width: 10%;"></td> <td style="width: 10%;"></td> <td style="width: 10%;"></td> <td style="width: 10%;"></td> </tr> <tr> <td></td> <td></td> <td colspan="8" style="text-align: center;"> <table border="1" style="width: 100%; border-collapse: collapse; text-align: center;"> <tr> <td style="width: 10%;"></td> <td style="width: 10%;"></td> <td style="width: 10%;"></td> <td style="width: 10%;"></td> <td style="width: 10%;"></td> <td style="width: 10%;"></td> <td style="width: 10%;"></td> <td style="width: 10%;"></td> <td style="width: 10%;"></td> <td style="width: 10%;"></td> </tr> <tr> <td></td> <td></td> <td colspan="8" style="text-align: center;"> <table border="1" style="width: 100%; border-collapse: collapse; text-align: center;"> <tr> <td style="width: 10%;"></td> <td style="width: 10%;"></td> <td style="width: 10%;"></td> <td style="width: 10%;"></td> <td style="width: 10%;"></td> <td style="width: 10%;"></td> <td style="width: 10%;"></td> <td style="width: 10%;"></td> <td style="width: 10%;"></td> <td style="width: 10%;"></td> </tr> <tr> <td></td> <td></td> <td colspan="8" style="text-align: center;"> <table border="1" style="width: 100%; border-collapse: collapse; text-align: center;"> <tr> <td style="width: 10%;"></td> <td style="width: 10%;"></td> <td style="width: 10%;"></td> <td style="width: 10%;"></td> <td style="width: 10%;"></td> <td style="width: 10%;"></td> <td style="width: 10%;"></td> <td style="width: 10%;"></td> <td style="width: 10%;"></td> <td style="width: 10%;"></td> </tr> <tr> <td></td> <td></td> <td colspan="8" style="text-align: center;"> <table border="1" style="width: 100%; border-collapse: collapse; text-align: center;"> <tr> <td style="width: 10%;"></td> <td style="width: 10%;"></td> <td style="width: 10%;"></td> <td style="width: 10%;"></td> <td style="width: 10%;"></td> <td style="width: 10%;"></td> <td style="width: 10%;"></td> <td style="width: 10%;"></td> <td style="width: 10%;"></td> <td style="width: 10%;"></td> </tr> <tr> <td></td> <td></td> <td colspan="8" style="text-align: center;"> <table border="1" style="width: 100%; border-collapse: collapse; text-align: center;"> <tr> <td style="width: 10%;"></td> <td style="width: 10%;"></td> <td style="width: 10%;"></td> <td style="width: 10%;"></td> <td style="width: 10%;"></td> <td style="width: 10%;"></td> <td style="width: 10%;"></td> <td style="width: 10%;"></td> <td style="width: 10%;"></td> <td style="width: 10%;"></td> </tr> <tr> <td></td> <td></td> <td colspan="8" style="text-align: center;"> <table border="1" style="width: 100%; border-collapse: collapse; text-align: center;"> <tr> </tr></table></td></tr></table></td></tr></table></td></tr></table></td></tr></table></td></tr></table></td></tr></table></td></tr></table></td></tr></table></td></tr></table></td></tr></table> | | | | | | | | | | | | | | | | | | | | <table border="1" style="width: 100%; border-collapse: collapse; text-align: center;"> <tr> <td style="width: 10%;"></td> <td style="width: 10%;"></td> <td style="width: 10%;"></td> <td style="width: 10%;"></td> <td style="width: 10%;"></td> <td style="width: 10%;"></td> <td style="width: 10%;"></td> <td style="width: 10%;"></td> <td style="width: 10%;"></td> <td style="width: 10%;"></td> </tr> <tr> <td></td> <td></td> <td colspan="8" style="text-align: center;"> <table border="1" style="width: 100%; border-collapse: collapse; text-align: center;"> <tr> <td style="width: 10%;"></td> <td style="width: 10%;"></td> <td style="width: 10%;"></td> <td style="width: 10%;"></td> <td style="width: 10%;"></td> <td style="width: 10%;"></td> <td style="width: 10%;"></td> <td style="width: 10%;"></td> <td style="width: 10%;"></td> <td style="width: 10%;"></td> </tr> <tr> <td></td> <td></td> <td colspan="8" style="text-align: center;"> <table border="1" style="width: 100%; border-collapse: collapse; text-align: center;"> <tr> <td style="width: 10%;"></td> <td style="width: 10%;"></td> <td style="width: 10%;"></td> <td style="width: 10%;"></td> <td style="width: 10%;"></td> <td style="width: 10%;"></td> <td style="width: 10%;"></td> <td style="width: 10%;"></td> <td style="width: 10%;"></td> <td style="width: 10%;"></td> </tr> <tr> <td></td> <td></td> <td colspan="8" style="text-align: center;"> <table border="1" style="width: 100%; border-collapse: collapse; text-align: center;"> <tr> <td style="width: 10%;"></td> <td style="width: 10%;"></td> <td style="width: 10%;"></td> <td style="width: 10%;"></td> <td style="width: 10%;"></td> <td style="width: 10%;"></td> <td style="width: 10%;"></td> <td style="width: 10%;"></td> <td style="width: 10%;"></td> <td style="width: 10%;"></td> </tr> <tr> <td></td> <td></td> <td colspan="8" style="text-align: center;"> <table border="1" style="width: 100%; border-collapse: collapse; text-align: center;"> <tr> <td style="width: 10%;"></td> <td style="width: 10%;"></td> <td style="width: 10%;"></td> <td style="width: 10%;"></td> <td style="width: 10%;"></td> <td style="width: 10%;"></td> <td style="width: 10%;"></td> <td style="width: 10%;"></td> <td style="width: 10%;"></td> <td style="width: 10%;"></td> </tr> <tr> <td></td> <td></td> <td colspan="8" style="text-align: center;"> <table border="1" style="width: 100%; border-collapse: collapse; text-align: center;"> <tr> <td style="width: 10%;"></td> <td style="width:
10%;"></td> <td style="width: 10%;"></td> <td style="width: 10%;"></td> <td style="width: 10%;"></td> <td style="width: 10%;"></td> <td style="width: 10%;"></td> <td style="width: 10%;"></td> <td style="width: 10%;"></td> <td style="width: 10%;"></td> </tr> <tr> <td></td> <td></td> <td colspan="8" style="text-align: center;"> <table border="1" style="width: 100%; border-collapse: collapse; text-align: center;"> <tr> <td style="width: 10%;"></td> <td style="width: 10%;"></td> <td style="width: 10%;"></td> <td style="width: 10%;"></td> <td style="width: 10%;"></td> <td style="width: 10%;"></td> <td style="width: 10%;"></td> <td style="width: 10%;"></td> <td style="width: 10%;"></td> <td style="width: 10%;"></td> </tr> <tr> <td></td> <td></td> <td colspan="8" style="text-align: center;"> <table border="1" style="width: 100%; border-collapse: collapse; text-align: center;"> <tr> <td style="width: 10%;"></td> <td style="width: 10%;"></td> <td style="width: 10%;"></td> <td style="width: 10%;"></td> <td style="width: 10%;"></td> <td style="width: 10%;"></td> <td style="width: 10%;"></td> <td style="width: 10%;"></td> <td style="width: 10%;"></td> <td style="width: 10%;"></td> </tr> <tr> <td></td> <td></td> <td colspan="8" style="text-align: center;"> <table border="1" style="width: 100%; border-collapse: collapse; text-align: center;"> <tr> <td style="width: 10%;"></td> <td style="width: 10%;"></td> <td style="width: 10%;"></td> <td style="width: 10%;"></td> <td style="width: 10%;"></td> <td style="width: 10%;"></td> <td style="width: 10%;"></td> <td style="width: 10%;"></td> <td style="width: 10%;"></td> <td style="width: 10%;"></td> </tr> <tr> <td></td> <td></td> <td colspan="8" style="text-align: center;"> <table border="1" style="width: 100%; border-collapse: collapse; text-align: center;"> <tr> </tr></table></td></tr></table></td></tr></table></td></tr></table></td></tr></table></td></tr></table></td></tr></table></td></tr></table></td></tr></table></td></tr></table> | | | | | | | | | | | | | | | | | | | | <table border="1" style="width: 100%; border-collapse: collapse; text-align: center;"> <tr> <td style="width: 10%;"></td> <td style="width: 10%;"></td> <td style="width: 10%;"></td> <td style="width: 10%;"></td> <td style="width: 10%;"></td> <td style="width: 10%;"></td> <td style="width: 10%;"></td> <td style="width: 10%;"></td> <td style="width: 10%;"></td> <td style="width: 10%;"></td> </tr> <tr> <td></td> <td></td> <td colspan="8" style="text-align: center;"> <table border="1" style="width: 100%; border-collapse: collapse; text-align: center;"> <tr> <td style="width: 10%;"></td> <td style="width: 10%;"></td> <td style="width: 10%;"></td> <td style="width: 10%;"></td> <td style="width: 10%;"></td> <td style="width: 10%;"></td> <td style="width: 10%;"></td> <td style="width: 10%;"></td> <td style="width: 10%;"></td> <td style="width: 10%;"></td> </tr> <tr> <td></td> <td></td> <td colspan="8" style="text-align: center;"> <table border="1" style="width: 100%; border-collapse: collapse; text-align: center;"> <tr> <td style="width: 10%;"></td> <td style="width: 10%;"></td> <td style="width: 10%;"></td> <td style="width: 10%;"></td> <td style="width: 10%;"></td> <td style="width: 10%;"></td> <td style="width: 10%;"></td> <td style="width: 10%;"></td> <td style="width: 10%;"></td> <td style="width: 10%;"></td> </tr> <tr> <td></td> <td></td> <td colspan="8" style="text-align: center;"> <table border="1" style="width: 100%; border-collapse: collapse; text-align: center;"> <tr> <td style="width: 10%;"></td> <td style="width: 10%;"></td> <td style="width: 10%;"></td> <td style="width: 10%;"></td> <td style="width: 10%;"></td> <td style="width: 10%;"></td> <td style="width: 10%;"></td> <td style="width: 10%;"></td> <td style="width: 10%;"></td> <td style="width: 10%;"></td> </tr> <tr> <td></td> <td></td> <td colspan="8" style="text-align: center;"> <table border="1" style="width: 100%; border-collapse: collapse; text-align: center;"> <tr> <td style="width: 10%;"></td> <td style="width: 10%;"></td> <td style="width: 10%;"></td> <td style="width: 10%;"></td> <td style="width: 10%;"></td> <td style="width: 10%;"></td> <td style="width: 10%;"></td> <td style="width: 10%;"></td> <td style="width: 10%;"></td> <td style="width: 10%;"></td> </tr> <tr> <td></td> <td></td> <td colspan="8" style="text-align: center;"> <table border="1" style="width: 100%; border-collapse: collapse; text-align: center;"> <tr> <td style="width: 10%;"></td> <td style="width: 10%;"></td> <td style="width: 10%;"></td> <td style="width: 10%;"></td> <td style="width: 10%;"></td> <td style="width: 10%;"></td> <td style="width: 10%;"></td> <td style="width: 10%;"></td> <td style="width: 10%;"></td> <td style="width: 10%;"></td> </tr> <tr> <td></td> <td></td> <td colspan="8" style="text-align: center;"> <table border="1" style="width: 100%; border-collapse: collapse; text-align: center;"> <tr> <td style="width: 10%;"></td> <td style="width: 10%;"></td> <td style="width: 10%;"></td> <td style="width: 10%;"></td> <td style="width: 10%;"></td> <td style="width: 10%;"></td> <td style="width: 10%;"></td> <td style="width: 10%;"></td> <td style="width: 10%;"></td> <td style="width: 10%;"></td> </tr> <tr> <td></td> <td></td> <td colspan="8" style="text-align: center;"> <table border="1" style="width: 100%; border-collapse: collapse; text-align: center;"> <tr> <td style="width: 10%;"></td> <td style="width: 10%;"></td> <td style="width: 10%;"></td> <td style="width: 10%;"></td> <td style="width: 10%;"></td> <td style="width: 10%;"></td> <td style="width: 10%;"></td> <td style="width: 10%;"></td> <td style="width: 10%;"></td> <td style="width: 10%;"></td> </tr> <tr> <td></td> <td></td> <td colspan="8" style="text-align: center;"> <table border="1" style="width: 100%; border-collapse: collapse; text-align: center;"> <tr> </tr></table></td></tr></table></td></tr></table></td></tr></table></td></tr></table></td></tr></table></td></tr></table></td></tr></table></td></tr></table> | | | | | | | | | | | | | | | | | | | |
<table border="1" style="width: 100%; border-collapse: collapse; text-align: center;"> <tr> <td style="width: 10%;"></td> <td style="width: 10%;"></td> <td style="width: 10%;"></td> <td style="width: 10%;"></td> <td style="width: 10%;"></td> <td style="width: 10%;"></td> <td style="width: 10%;"></td> <td style="width: 10%;"></td> <td style="width: 10%;"></td> <td style="width: 10%;"></td> </tr> <tr> <td></td> <td></td> <td colspan="8" style="text-align: center;"> <table border="1" style="width: 100%; border-collapse: collapse; text-align: center;"> <tr> <td style="width: 10%;"></td> <td style="width: 10%;"></td> <td style="width: 10%;"></td> <td style="width: 10%;"></td> <td style="width: 10%;"></td> <td style="width: 10%;"></td> <td style="width: 10%;"></td> <td style="width: 10%;"></td> <td style="width: 10%;"></td> <td style="width: 10%;"></td> </tr> <tr> <td></td> <td></td> <td colspan="8" style="text-align: center;"> <table border="1" style="width: 100%; border-collapse: collapse; text-align: center;"> <tr> <td style="width: 10%;"></td> <td style="width: 10%;"></td> <td style="width: 10%;"></td> <td style="width: 10%;"></td> <td style="width: 10%;"></td> <td style="width: 10%;"></td> <td style="width: 10%;"></td> <td style="width: 10%;"></td> <td style="width: 10%;"></td> <td style="width: 10%;"></td> </tr> <tr> <td></td> <td></td> <td colspan="8" style="text-align: center;"> <table border="1" style="width: 100%; border-collapse: collapse; text-align: center;"> <tr> <td style="width: 10%;"></td> <td style="width: 10%;"></td> <td style="width: 10%;"></td> <td style="width: 10%;"></td> <td style="width: 10%;"></td> <td style="width: 10%;"></td> <td style="width: 10%;"></td> <td style="width: 10%;"></td> <td style="width: 10%;"></td> <td style="width: 10%;"></td> </tr> <tr> <td></td> <td></td> <td colspan="8" style="text-align: center;"> <table border="1" style="width: 100%; border-collapse: collapse; text-align: center;"> <tr> <td style="width: 10%;"></td> <td style="width: 10%;"></td> <td style="width: 10%;"></td> <td style="width: 10%;"></td> <td style="width: 10%;"></td> <td style="width: 10%;"></td> <td style="width: 10%;"></td> <td style="width: 10%;"></td> <td style="width: 10%;"></td> <td style="width: 10%;"></td> </tr> <tr> <td></td> <td></td> <td colspan="8" style="text-align: center;"> <table border="1" style="width: 100%; border-collapse: collapse; text-align: center;"> <tr> <td style="width: 10%;"></td> <td style="width: 10%;"></td> <td style="width: 10%;"></td> <td style="width: 10%;"></td> <td style="width: 10%;"></td> <td style="width: 10%;"></td> <td style="width: 10%;"></td> <td style="width: 10%;"></td> <td style="width: 10%;"></td> <td style="width: 10%;"></td> </tr> <tr> <td></td> <td></td> <td colspan="8" style="text-align: center;"> <table border="1" style="width: 100%; border-collapse: collapse; text-align: center;"> <tr> <td style="width: 10%;"></td> <td style="width: 10%;"></td> <td style="width: 10%;"></td> <td style="width: 10%;"></td> <td style="width: 10%;"></td> <td style="width: 10%;"></td> <td style="width: 10%;"></td> <td style="width: 10%;"></td> <td style="width: 10%;"></td> <td style="width: 10%;"></td> </tr> <tr> <td></td> <td></td> <td colspan="8" style="text-align: center;"> <table border="1" style="width: 100%; border-collapse: collapse; text-align: center;"> <tr> </tr></table></td></tr></table></td></tr></table></td></tr></table></td></tr></table></td></tr></table></td></tr></table></td></tr></table> | | | | | | | | | | | | | | | | | | | | <table border="1" style="width: 100%; border-collapse: collapse; text-align: center;"> <tr> <td style="width: 10%;"></td> <td style="width: 10%;"></td> <td style="width: 10%;"></td> <td style="width: 10%;"></td> <td style="width: 10%;"></td> <td style="width: 10%;"></td> <td style="width: 10%;"></td> <td style="width: 10%;"></td> <td style="width: 10%;"></td> <td style="width: 10%;"></td> </tr> <tr> <td></td> <td></td> <td colspan="8" style="text-align: center;"> <table border="1" style="width: 100%; border-collapse: collapse; text-align: center;"> <tr> <td style="width: 10%;"></td> <td style="width: 10%;"></td> <td style="width: 10%;"></td> <td style="width: 10%;"></td> <td style="width: 10%;"></td> <td style="width: 10%;"></td> <td style="width: 10%;"></td> <td style="width: 10%;"></td> <td style="width: 10%;"></td> <td style="width: 10%;"></td> </tr> <tr> <td></td> <td></td> <td colspan="8" style="text-align: center;"> <table border="1" style="width: 100%; border-collapse: collapse; text-align: center;"> <tr> <td style="width: 10%;"></td> <td style="width: 10%;"></td> <td style="width: 10%;"></td> <td style="width: 10%;"></td> <td style="width: 10%;"></td> <td style="width: 10%;"></td> <td style="width: 10%;"></td> <td style="width: 10%;"></td> <td style="width: 10%;"></td> <td style="width: 10%;"></td> </tr> <tr> <td></td> <td></td> <td colspan="8" style="text-align: center;"> <table border="1" style="width: 100%; border-collapse: collapse; text-align: center;"> <tr> <td style="width: 10%;"></td> <td style="width: 10%;"></td> <td style="width: 10%;"></td> <td style="width: 10%;"></td> <td style="width: 10%;"></td> <td style="width: 10%;"></td> <td style="width: 10%;"></td> <td style="width: 10%;"></td> <td style="width: 10%;"></td> <td style="width: 10%;"></td> </tr> <tr> <td></td> <td></td> <td colspan="8" style="text-align: center;"> <table border="1" style="width: 100%; border-collapse: collapse; text-align: center;"> <tr> <td style="width: 10%;"></td> <td style="width: 10%;"></td> <td style="width: 10%;"></td> <td style="width: 10%;"></td> <td style="width: 10%;"></td> <td style="width: 10%;"></td> <td style="width: 10%;"></td> <td style="width: 10%;"></td> <td style="width: 10%;"></td> <td style="width: 10%;"></td> </tr> <tr> <td></td> <td></td> <td colspan="8" style="text-align: center;"> <table border="1" style="width: 100%; border-collapse: collapse; text-align: center;"> <tr> <td style="width: 10%;"></td> <td style="width: 10%;"></td> <td style="width: 10%;"></td> <td style="width: 10%;"></td> <td style="width: 10%;"></td> <td style="width: 10%;"></td> <td style="width: 10%;"></td> <td style="width: 10%;"></td> <td style="width: 10%;"></td> <td style="width: 10%;"></td> </tr> <tr> <td></td> <td></td> <td colspan="8" style="text-align: center;"> <table border="1" style="width: 100%; border-collapse: collapse; text-align: center;"> <tr> </tr></table></td></tr></table></td></tr></table></td></tr></table></td></tr></table></td></tr></table></td></tr></table>
 | | | | | | | | | | | | | | | | | | | | <table border="1" style="width: 100%; border-collapse: collapse; text-align: center;"> <tr> <td style="width: 10%;"></td> <td style="width: 10%;"></td> <td style="width: 10%;"></td> <td style="width: 10%;"></td> <td style="width: 10%;"></td> <td style="width: 10%;"></td> <td style="width: 10%;"></td> <td style="width: 10%;"></td> <td style="width: 10%;"></td> <td style="width: 10%;"></td> </tr> <tr> <td></td> <td></td> <td colspan="8" style="text-align: center;"> <table border="1" style="width: 100%; border-collapse: collapse; text-align: center;"> <tr> <td style="width: 10%;"></td> <td style="width: 10%;"></td> <td style="width: 10%;"></td> <td style="width: 10%;"></td> <td style="width: 10%;"></td> <td style="width: 10%;"></td> <td style="width: 10%;"></td> <td style="width: 10%;"></td> <td style="width: 10%;"></td> <td style="width: 10%;"></td> </tr> <tr> <td></td> <td></td> <td colspan="8" style="text-align: center;"> <table border="1" style="width: 100%; border-collapse: collapse; text-align: center;"> <tr> <td style="width: 10%;"></td> <td style="width: 10%;"></td> <td style="width: 10%;"></td> <td style="width: 10%;"></td> <td style="width: 10%;"></td> <td style="width: 10%;"></td> <td style="width: 10%;"></td> <td style="width: 10%;"></td> <td style="width: 10%;"></td> <td style="width: 10%;"></td> </tr> <tr> <td></td> <td></td> <td colspan="8" style="text-align: center;"> <table border="1" style="width: 100%; border-collapse: collapse; text-align: center;"> <tr> <td style="width: 10%;"></td> <td style="width: 10%;"></td> <td style="width: 10%;"></td> <td style="width: 10%;"></td> <td style="width: 10%;"></td> <td style="width: 10%;"></td> <td style="width: 10%;"></td> <td style="width: 10%;"></td> <td style="width: 10%;"></td> <td style="width: 10%;"></td> </tr> <tr> <td></td> <td></td> <td colspan="8" style="text-align: center;"> <table border="1" style="width: 100%; border-collapse: collapse; text-align: center;"> <tr> <td style="width: 10%;"></td> <td style="width: 10%;"></td> <td style="width: 10%;"></td> <td style="width: 10%;"></td> <td style="width: 10%;"></td> <td style="width: 10%;"></td> <td style="width: 10%;"></td> <td style="width: 10%;"></td> <td style="width: 10%;"></td> <td style="width: 10%;"></td> </tr> <tr> <td></td> <td></td> <td colspan="8" style="text-align: center;"> <table border="1" style="width: 100%; border-collapse: collapse; text-align: center;"> <tr> </tr></table></td></tr></table></td></tr></table></td></tr></table></td></tr></table></td></tr></table> | | | | | | | | | | | | | | | | | | | | <table border="1" style="width: 100%; border-collapse: collapse; text-align: center;"> <tr> <td style="width: 10%;"></td> <td style="width: 10%;"></td> <td style="width: 10%;"></td> <td style="width: 10%;"></td> <td style="width: 10%;"></td> <td style="width: 10%;"></td> <td style="width: 10%;"></td> <td style="width: 10%;"></td> <td style="width: 10%;"></td> <td style="width: 10%;"></td> </tr> <tr> <td></td> <td></td> <td colspan="8" style="text-align: center;"> <table border="1" style="width: 100%; border-collapse: collapse; text-align: center;"> <tr> <td style="width: 10%;"></td> <td style="width: 10%;"></td> <td style="width: 10%;"></td> <td style="width: 10%;"></td> <td style="width: 10%;"></td> <td style="width: 10%;"></td> <td style="width: 10%;"></td> <td style="width: 10%;"></td> <td style="width: 10%;"></td> <td style="width: 10%;"></td> </tr> <tr> <td></td> <td></td> <td colspan="8" style="text-align: center;"> <table border="1" style="width: 100%; border-collapse: collapse; text-align: center;"> <tr> <td style="width: 10%;"></td> <td style="width: 10%;"></td> <td style="width: 10%;"></td> <td style="width: 10%;"></td> <td style="width: 10%;"></td> <td style="width: 10%;"></td> <td style="width: 10%;"></td> <td style="width: 10%;"></td> <td style="width: 10%;"></td> <td style="width: 10%;"></td> </tr> <tr> <td></td> <td></td> <td colspan="8" style="text-align: center;"> <table border="1" style="width: 100%; border-collapse: collapse; text-align: center;"> <tr> <td style="width: 10%;"></td> <td style="width: 10%;"></td> <td style="width: 10%;"></td> <td style="width: 10%;"></td> <td style="width: 10%;"></td> <td style="width: 10%;"></td> <td style="width: 10%;"></td> <td style="width: 10%;"></td> <td style="width: 10%;"></td> <td style="width: 10%;"></td> </tr> <tr> <td></td> <td></td> <td colspan="8" style="text-align: center;"> <table border="1" style="width: 100%; border-collapse: collapse; text-align: center;"> <tr> </tr></table></td></tr></table></td></tr></table></td></tr></table></td></tr></table> | | | | | | | | | | | | | | | | | | | | <table border="1" style="width: 100%; border-collapse: collapse; text-align: center;"> <tr> <td style="width: 10%;"></td> <td style="width: 10%;"></td> <td style="width: 10%;"></td> <td style="width: 10%;"></td> <td style="width: 10%;"></td> <td style="width: 10%;"></td> <td style="width: 10%;"></td> <td style="width: 10%;"></td> <td style="width: 10%;"></td> <td style="width: 10%;"></td> </tr> <tr> <td></td> <td></td> <td colspan="8" style="text-align: center;"> <table border="1" style="width: 100%; border-collapse: collapse; text-align: center;"> <tr> <td style="width: 10%;"></td> <td style="width: 10%;"></td> <td style="width: 10%;"></td> <td style="width: 10%;"></td> <td style="width: 10%;"></td> <td style="width: 10%;"></td> <td style="width: 10%;"></td> <td style="width: 10%;"></td> <td style="width: 10%;"></td> <td style="width: 10%;"></td> </tr> <tr>
<td></td> <td></td> <td colspan="8" style="text-align: center;"> <table border="1" style="width: 100%; border-collapse: collapse; text-align: center;"> <tr> <td style="width: 10%;"></td> <td style="width: 10%;"></td> <td style="width: 10%;"></td> <td style="width: 10%;"></td> <td style="width: 10%;"></td> <td style="width: 10%;"></td> <td style="width: 10%;"></td> <td style="width: 10%;"></td> <td style="width: 10%;"></td> <td style="width: 10%;"></td> </tr> <tr> <td></td> <td></td> <td colspan="8" style="text-align: center;"> <table border="1" style="width: 100%; border-collapse: collapse; text-align: center;"> <tr> </tr></table></td></tr></table></td></tr></table></td></tr></table> | | | | | | | | | | | | | | | | | | | | <table border="1" style="width: 100%; border-collapse: collapse; text-align: center;"> <tr> <td style="width: 10%;"></td> <td style="width: 10%;"></td> <td style="width: 10%;"></td> <td style="width: 10%;"></td> <td style="width: 10%;"></td> <td style="width: 10%;"></td> <td style="width: 10%;"></td> <td style="width: 10%;"></td> <td style="width: 10%;"></td> <td style="width: 10%;"></td> </tr> <tr> <td></td> <td></td> <td colspan="8" style="text-align: center;"> <table border="1" style="width: 100%; border-collapse: collapse; text-align: center;"> <tr> <td style="width: 10%;"></td> <td style="width: 10%;"></td> <td style="width: 10%;"></td> <td style="width: 10%;"></td> <td style="width: 10%;"></td> <td style="width: 10%;"></td> <td style="width: 10%;"></td> <td style="width: 10%;"></td> <td style="width: 10%;"></td> <td style="width: 10%;"></td> </tr> <tr> <td></td> <td></td> <td colspan="8" style="text-align: center;"> <table border="1" style="width: 100%; border-collapse: collapse; text-align: center;"> <tr> </tr></table></td></tr></table></td></tr></table> | | | | | | | | | | | | | | | | | | | | <table border="1" style="width: 100%; border-collapse: collapse; text-align: center;"> <tr> <td style="width: 10%;"></td> <td style="width: 10%;"></td> <td style="width: 10%;"></td> <td style="width: 10%;"></td> <td style="width: 10%;"></td> <td style="width: 10%;"></td> <td style="width: 10%;"></td> <td style="width: 10%;"></td> <td style="width: 10%;"></td> <td style="width: 10%;"></td> </tr> <tr> <td></td> <td></td> <td colspan="8" style="text-align: center;"> <table border="1" style="width: 100%; border-collapse: collapse; text-align: center;"> <tr> </tr></table></td></tr></table> | | | | | | | | | | | | | | | | | | | | <table border="1" style="width: 100%; border-collapse: collapse; text-align: center;"> <tr> </tr></table>
 | | | | | | | | | | | | | | | | | | | | | | | | | | | | | | | | | | | | | | | | | | | | | | | | | | | | | | | | | | | | | | | | | | | | | | | | | | | | | | | | | | | | | | | |
| | |

 | | | | | | | | | | | | | | | | | | | |

 | | | | | | | | | | | | | | | | | | | |

 | | | | | | | | | | | | | | | | | | | |

 | | | | | | | | | | | | | | | | | | | |

 | | | | | | | | | | | | | | | | | | | |

 | | | | | | | | | | | | | | | | | | | |

 | | | | | | | | | | | | | | | | | | | |

 | | | | | | | | | | | | | | | | | | | |

 | | | | | | | | | | | | | | | | | | | |

 | | | | | | | | | | | | | | | | | | | |

 | | | | | | | | | | | | | | | | | | | |

 | | | | | | | | | | | | | | | | | | | |

 | | | | | | | | | | | | | | | | | | | |

 | | | | | | | | | | | | | | | | | | | |

 | | | | | | | | | | | | | | | | | | | |

 | | | | | | | | | | | | | | | | | | | |

 | | | | | | | | | | | | | | | | | | | |

 | | | | | | | | | | | | | | | | | | | |

 | | | | | | | | | | | | | | | | | | | |

 | | | | | | | | | | | | | | | | | | | |

 | | | | | | | | | | | | | | | | | | | |

 | | | | | | | | | | | | | | | | | | | |

 | | | | | | | | | | | | | | | | | | | |

 | | | | | | | | | | | | | | | | | | | |

 | | | | | | | | | | | | | | | | | | | |

 | | | | | | | | | | | | | | | | | | | |

 | | | | | | | | | | | | | | | | | | | |

 | | | | | | | | | | | | | | | | | | | |
 | | | | | | | | | | | | | | | | | | | |

 | | | | | | | | | | | | | | | | | | | |

 | | | | | | | | | | | | | | | | | | | |
 | | | | | | | | | | | | | | | | | | | |

 | | | | | | | | | | | | | | | | | | | |

 | | | | | | | | | | | | | | | | | | | |
 | | | | | | | | | | | | | | | | | | | |
 | | | | | | | | | | | | | | | | | | | |

 | | | | | | | | | | | | | | | | | | | |
 | | | | | | | | | | | | | | | | | | | |
 | | | | | | | | | | | | | | | | | | | |

 | | | | | | | | | | | | | | | | | | | | | | | | | | | | | | | | | | | | | | | | | | | | | | | | | | | | | | | | | | | | | | | | | | | | | | | | | | | | | | | | | | | | | | | | | | | | | | | | | | | |
 | | | | | | | | | | | | | | | | | | | |
 | | | | | | | | | | | | | | | | | | | |
 | | | | | | | | | | | | | | | | | | | |
 | | | | | | | | | | | | | | | | | | | |
 | | | | | | | | | | | | | | | | | | | |
 | | | | | | | | | | | | | | | | | | | |
 | | | | | | | | | | | | | | | | | | | |
 | | | | | | | | | | | | | | | | | | | |
 | | | | | | | | | | | | | | | | | | | | | | | | | | | | | | | | | | | | | | | |
 | | | | | | | | | | | | | | | | | | | |
 | | | | | | | | | | | | | | | | | | | | | | | | | | | | | | | | | | | | | | | |
 | | | | | | | | | | | | | | | | | | | | | | | | | | | | | | | | | | | | | | | |
 | | | | | | | | | | | | | | | | | | | | | | | | | | | | | | | | | | | | | | | |
 | | | | | | | | | | | | | | | | | | | | | | | | | | | | | | | | | | | | | | | | | | | | | | | | | | | | | | | | | | | | | | | | | | | | | | | | | | | | | | | | | | | | | | | | | | | | | | | | | | | |
 | | | | | | | | | | | | | | | | | | | | | | | | | | | | | | | | | | | | | | | | | | | | | | | |
| | | <table border="1" style="width: 100%; border-collapse: collapse; text-align: center;"> <tr> <td style="width: 10%;"></td> <td style="width: 10%;"></td> <td style="width: 10%;"></td> <td style="width: 10%;"></td> <td style="width: 10%;"></td> <td style="width: 10%;"></td> <td style="width: 10%;"></td> <td style="width: 10%;"></td> <td style="width: 10%;"></td> <td style="width: 10%;"></td> </tr> <tr> <td></td> <td></td> <td colspan="8" style="text-align: center;"> <table border="1" style="width: 100%; border-collapse: collapse; text-align: center;"> <tr> <td style="width: 10%;"></td> <td style="width: 10%;"></td> <td style="width: 10%;"></td> <td style="width: 10%;"></td> <td style="width: 10%;"></td> <td style="width: 10%;"></td> <td style="width: 10%;"></td> <td style="width: 10%;"></td> <td style="width: 10%;"></td> <td style="width: 10%;"></td> </tr> <tr> <td></td> <td></td> <td colspan="8" style="text-align: center;"> <table border="1" style="width: 100%; border-collapse: collapse; text-align: center;"> <tr> <td style="width: 10%;"></td> <td style="width: 10%;"></td> <td style="width: 10%;"></td> <td style="width: 10%;"></td> <td style="width: 10%;"></td> <td style="width: 10%;"></td> <td style="width: 10%;"></td> <td style="width: 10%;"></td> <td style="width: 10%;"></td> <td style="width: 10%;"></td> </tr> <tr> <td></td> <td></td> <td colspan="8" style="text-align: center;"> <table border="1" style="width: 100%; border-collapse: collapse; text-align: center;"> <tr> <td style="width: 10%;"></td> <td style="width: 10%;"></td> <td style="width: 10%;"></td> <td style="width: 10%;"></td> <td style="width: 10%;"></td> <td style="width: 10%;"></td> <td style="width: 10%;"></td> <td style="width: 10%;"></td> <td style="width: 10%;"></td> <td style="width: 10%;"></td> </tr> <tr> <td></td> <td></td> <td colspan="8" style="text-align: center;"> <table border="1" style="width: 100%; border-collapse: collapse; text-align: center;"> <tr> <td style="width: 10%;"></td> <td style="width: 10%;"></td> <td style="width: 10%;"></td> <td style="width: 10%;"></td> <td style="width: 10%;"></td> <td style="width: 10%;"></td> <td style="width: 10%;"></td> <td style="width: 10%;"></td> <td style="width: 10%;"></td> <td style="width: 10%;"></td> </tr> <tr> <td></td> <td></td> <td colspan="8" style="text-align: center;"> <table border="1" style="width: 100%; border-collapse: collapse; text-align: center;"> <tr> <td style="width: 10%;"></td> <td style="width: 10%;"></td> <td style="width: 10%;"></td> <td style="width: 10%;"></td> <td style="width: 10%;"></td> <td style="width: 10%;"></td> <td style="width: 10%;"></td> <td style="width: 10%;"></td> <td style="width: 10%;"></td> <td style="width: 10%;"></td> </tr> <tr> <td></td> <td></td> <td colspan="8" style="text-align: center;"> <table border="1" style="width: 100%; border-collapse: collapse; text-align: center;"> <tr> <td style="width: 10%;"></td> <td style="width: 10%;"></td> <td style="width: 10%;"></td> <td style="width: 10%;"></td> <td style="width: 10%;"></td> <td style="width: 10%;"></td> <td style="width: 10%;"></td> <td style="width: 10%;"></td> <td style="width: 10%;"></td> <td style="width: 10%;"></td> </tr> <tr> <td></td> <td></td> <td colspan="8" style="text-align: center;"> <table border="1" style="width: 100%; border-collapse: collapse; text-align: center;"> <tr> <td style="width: 10%;"></td> <td style="width: 10%;"></td> <td style="width: 10%;"></td> <td style="width: 10%;"></td> <td style="width: 10%;"></td> <td style="width: 10%;"></td> <td style="width: 10%;"></td> <td style="width: 10%;"></td> <td style="width: 10%;"></td> <td style="width: 10%;"></td> </tr> <tr> <td></td> <td></td> <td colspan="8" style="text-align: center;"> <table border="1" style="width: 100%; border-collapse: collapse; text-align: center;"> <tr> <td style="width: 10%;"></td> <td style="width: 10%;"></td> <td style="width: 10%;"></td> <td style="width: 10%;"></td> <td style="width: 10%;"></td> <td style="width: 10%;"></td> <td style="width: 10%;"></td> <td style="width: 10%;"></td> <td style="width: 10%;"></td> <td style="width: 10%;"></td> </tr> <tr> <td></td> <td></td> <td colspan="8" style="text-align: center;"> <table border="1" style="width: 100%; border-collapse: collapse; text-align: center;"> <tr> <td style="width: 10%;"></td> <td style="width: 10%;"></td> <td style="width: 10%;"></td> <td style="width: 10%;"></td> <td style="width: 10%;"></td> <td style="width: 10%;"></td> <td style="width: 10%;"></td> <td style="width: 10%;"></td> <td style="width: 10%;"></td> <td style="width: 10%;"></td> </tr> <tr> <td></td> <td></td> <td colspan="8" style="text-align: center;"> <table border="1" style="width: 100%; border-collapse: collapse; text-align: center;"> <tr> <td style="width: 10%;"></td> <td style="width: 10%;"></td> <td style="width: 10%;"></td> <td style="width: 10%;"></td> <td style="width: 10%;"></td> <td style="width: 10%;"></td> <td style="width: 10%;"></td> <td style="width: 10%;"></td> <td style="width: 10%;"></td> <td style="width: 10%;"></td> </tr> <tr> <td></td> <td></td> <td colspan="8" style="text-align: center;"> <table border="1" style="width: 100%; border-collapse: collapse; text-align: center;"> <tr> <td style="width: 10%;"></td> <td style="width: 10%;"></td> <td style="width: 10%;"></td> <td style="width: 10%;"></td> <td style="width: 10%;"></td> <td style="width: 10%;"></td> <td style="width: 10%;"></td> <td style="width: 10%;"></td> <td style="width: 10%;"></td> <td style="width: 10%;"></td> </tr> <tr> <td></td> <td></td> <td colspan="8" style="text-align: center;"> <table border="1" style="width: 100%; border-collapse: collapse; text-align: center;"> <tr> <td style="width: 10%;"></td> <td style="width: 10%;"></td> <td style="width: 10%;"></td> <td style="width: 10%;"></td> <td style="width: 10%;"></td> <td style="width: 10%;"></td> <td style="width: 10%;"></td> <td style="width: 10%;"></td> <td style="width: 10%;"></td> <td style="width: 10%;"></td> </tr> <tr> <td></td> <td></td> <td colspan="8" style="text-align: center;"> <table border="1" style="width: 100%; border-collapse: collapse; text-align: center;"> <tr> <td style="width: 10%;"></td> <td style="width: 10%;"></td> <td style="width: 10%;"></td> <td style="width: 10%;"></td> <td style="width: 10%;"></td> <td style="width: 10%;"></td> <td style="width: 10%;"></td> <td style="width: 10%;"></td> <td style="width: 10%;"></td> <td style="width: 10%;"></td> </tr> <tr> <td></td> <td></td> <td colspan="8" style="text-align: center;"> <table border="1" style="width: 100%; border-collapse: collapse; text-align: center;"> <tr> <td style="width: 10%;"></td> <td style="width: 10%;"></td> <td style="width: 10%;"></td> <td style="width: 10%;"></td> <td style="width: 10%;"></td> <td style="width: 10%;"></td> <td style="width: 10%;"></td> <td style="width: 10%;"></td> <td style="width: 10%;"></td> <td style="width: 10%;"></td> </tr> <tr> <td></td> <td></td> <td colspan="8" style="text-align: center;"> <table border="1" style="width: 100%; border-collapse: collapse; text-align: center;"> <tr> <td style="width: 10%;"></td> <td style="width: 10%;"></td> <td style="width: 10%;"></td> <td style="width: 10%;"></td> <td style="width: 10%;"></td> <td style="width: 10%;"></td> <td style="width: 10%;"></td> <td style="width: 10%;"></td> <td style="width: 10%;"></td> <td style="width: 10%;"></td> </tr> <tr> <td></td> <td></td> <td colspan="8" style="text-align: center;"> <table border="1" style="width: 100%; border-collapse: collapse; text-align: center;"> <tr> <td style="width: 10%;"></td> <td style="width: 10%;"></td> <td style="width: 10%;"></td> <td style="width: 10%;"></td> <td style="width: 10%;"></td> <td style="width: 10%;"></td> <td style="width: 10%;"></td> <td style="width: 10%;"></td> <td style="width: 10%;"></td> <td style="width: 10%;"></td> </tr> <tr> <td></td> <td></td> <td colspan="8" style="text-align: center;"> <table border="1" style="width: 100%; border-collapse: collapse; text-align: center;"> <tr> <td style="width: 10%;"></td> <td style="width: 10%;"></td> <td style="width: 10%;"></td> <td style="width: 10%;"></td> <td style="width: 10%;"></td> <td style="width: 10%;"></td> <td style="width: 10%;"></td> <td style="width: 10%;"></td> <td style="width: 10%;"></td> <td style="width: 10%;"></td> </tr> <tr> <td></td> <td></td> <td colspan="8" style="text-align: center;"> <table border="1" style="width: 100%; border-collapse: collapse; text-align: center;"> <tr> <td style="width: 10%;"></td> <td style="width: 10%;"></td> <td style="width: 10%;"></td> <td style="width: 10%;"></td> <td style="width: 10%;"></td> <td style="width: 10%;"></td> <td style="width: 10%;"></td> <td style="width: 10%;"></td> <td style="width: 10%;"></td> <td style="width: 10%;"></td> </tr> <tr> <td></td> <td></td> <td colspan="8" style="text-align: center;"> <table border="1" style="width: 100%; border-collapse: collapse; text-align: center;"> <tr> <td style="width: 10%;"></td> <td style="width: 10%;"></td> <td style="width: 10%;"></td> <td style="width: 10%;"></td> <td style="width: 10%;"></td> <td style="width: 10%;"></td> <td style="width: 10%;"></td> <td style="width: 10%;"></td> <td style="width: 10%;"></td> <td style="width: 10%;"></td> </tr> <tr> <td></td> <td></td> <td colspan="8" style="text-align: center;"> <table border="1" style="width: 100%; border-collapse: collapse; text-align: center;"> <tr> <td style="width: 10%;"></td> <td style="width: 10%;"></td> <td style="width: 10%;"></td> <td style="width: 10%;"></td> <td style="width: 10%;"></td> <td style="width: 10%;"></td> <td style="width: 10%;"></td> <td style="width: 10%;"></td> <td style="width: 10%;"></td> <td style="width: 10%;"></td> </tr> <tr> <td></td> <td></td> <td colspan="8" style="text-align: center;"> <table border="1" style="width: 100%; border-collapse: collapse; text-align: center;"> <tr> <td style="width: 10%;"></td> <td style="width: 10%;"></td> <td
style="width: 10%;"></td> <td style="width: 10%;"></td> <td style="width: 10%;"></td> <td style="width: 10%;"></td> <td style="width: 10%;"></td> <td style="width: 10%;"></td> <td style="width: 10%;"></td> <td style="width: 10%;"></td> </tr> <tr> <td></td> <td></td> <td colspan="8" style="text-align: center;"> <table border="1" style="width: 100%; border-collapse: collapse; text-align: center;"> <tr> <td style="width: 10%;"></td> <td style="width: 10%;"></td> <td style="width: 10%;"></td> <td style="width: 10%;"></td> <td style="width: 10%;"></td> <td style="width: 10%;"></td> <td style="width: 10%;"></td> <td style="width: 10%;"></td> <td style="width: 10%;"></td> <td style="width: 10%;"></td> </tr> <tr> <td></td> <td></td> <td colspan="8" style="text-align: center;"> <table border="1" style="width: 100%; border-collapse: collapse; text-align: center;"> <tr> <td style="width: 10%;"></td> <td style="width: 10%;"></td> <td style="width: 10%;"></td> <td style="width: 10%;"></td> <td style="width: 10%;"></td> <td style="width: 10%;"></td> <td style="width: 10%;"></td> <td style="width: 10%;"></td> <td style="width: 10%;"></td> <td style="width: 10%;"></td> </tr> <tr> <td></td> <td></td> <td colspan="8" style="text-align: center;"> <table border="1" style="width: 100%; border-collapse: collapse; text-align: center;"> <tr> <td style="width: 10%;"></td> <td style="width: 10%;"></td> <td style="width: 10%;"></td> <td style="width: 10%;"></td> <td style="width: 10%;"></td> <td style="width: 10%;"></td> <td style="width: 10%;"></td> <td style="width: 10%;"></td> <td style="width: 10%;"></td> <td style="width: 10%;"></td> </tr> <tr> <td></td> <td></td> <td colspan="8" style="text-align: center;"> <table border="1" style="width: 100%; border-collapse: collapse; text-align: center;"> <tr> <td style="width: 10%;"></td> <td style="width: 10%;"></td> <td style="width: 10%;"></td> <td style="width: 10%;"></td> <td style="width: 10%;"></td> <td style="width: 10%;"></td> <td style="width: 10%;"></td> <td style="width: 10%;"></td> <td style="width: 10%;"></td> <td style="width: 10%;"></td> </tr> <tr> <td></td> <td></td> <td colspan="8" style="text-align: center;"> <table border="1" style="width: 100%; border-collapse: collapse; text-align: center;"> <tr> <td style="width: 10%;"></td> <td style="width: 10%;"></td> <td style="width: 10%;"></td> <td style="width: 10%;"></td> <td style="width: 10%;"></td> <td style="width: 10%;"></td> <td style="width: 10%;"></td> <td style="width: 10%;"></td> <td style="width: 10%;"></td> <td style="width: 10%;"></td> </tr> <tr> <td></td> <td></td> <td colspan="8" style="text-align: center;"> <table border="1" style="width: 100%; border-collapse: collapse; text-align: center;"> <tr> <td style="width: 10%;"></td> <td style="width: 10%;"></td> <td style="width: 10%;"></td> <td style="width: 10%;"></td> <td style="width: 10%;"></td> <td style="width: 10%;"></td> <td style="width: 10%;"></td> <td style="width: 10%;"></td> <td style="width: 10%;"></td> <td style="width: 10%;"></td> </tr> <tr> <td></td> <td></td> <td colspan="8" style="text-align: center;"> <table border="1" style="width: 100%; border-collapse: collapse; text-align: center;"> <tr> <td style="width: 10%;"></td> <td style="width: 10%;"></td> <td style="width: 10%;"></td> <td style="width: 10%;"></td> <td style="width: 10%;"></td> <td style="width: 10%;"></td> <td style="width: 10%;"></td> <td style="width: 10%;"></td> <td style="width: 10%;"></td> <td style="width: 10%;"></td> </tr> <tr> <td></td> <td></td> <td colspan="8" style="text-align: center;"> <table border="1" style="width: 100%; border-collapse: collapse; text-align: center;"> <tr> <td style="width: 10%;"></td> <td style="width: 10%;"></td> <td style="width: 10%;"></td> <td style="width: 10%;"></td> <td style="width: 10%;"></td> <td style="width: 10%;"></td> <td style="width: 10%;"></td> <td style="width: 10%;"></td> <td style="width: 10%;"></td> <td style="width: 10%;"></td> </tr> <tr> <td></td> <td></td> <td colspan="8" style="text-align: center;"> <table border="1" style="width: 100%; border-collapse: collapse; text-align: center;"> <tr> <td style="width: 10%;"></td> <td style="width: 10%;"></td> <td style="width: 10%;"></td> <td style="width: 10%;"></td> <td style="width: 10%;"></td> <td style="width: 10%;"></td> <td style="width: 10%;"></td> <td style="width: 10%;"></td> <td style="width: 10%;"></td> <td style="width: 10%;"></td> </tr> <tr> <td></td> <td></td> <td colspan="8" style="text-align: center;"> <table border="1" style="width: 100%; border-collapse: collapse; text-align: center;"> <tr> <td style="width: 10%;"></td> <td style="width: 10%;"></td> <td style="width: 10%;"></td> <td style="width: 10%;"></td> <td style="width: 10%;"></td> <td style="width: 10%;"></td> <td style="width: 10%;"></td> <td style="width: 10%;"></td> <td style="width: 10%;"></td> <td style="width: 10%;"></td> </tr> <tr> <td></td> <td></td> <td colspan="8" style="text-align: center;"> <table border="1" style="width: 100%; border-collapse: collapse; text-align: center;"> <tr> <td style="width: 10%;"></td> <td style="width: 10%;"></td> <td style="width: 10%;"></td> <td style="width: 10%;"></td> <td style="width: 10%;"></td> <td style="width: 10%;"></td> <td style="width: 10%;"></td> <td style="width: 10%;"></td> <td style="width: 10%;"></td> <td style="width: 10%;"></td> </tr> <tr> <td></td> <td></td> <td colspan="8" style="text-align: center;"> <table border="1" style="width: 100%; border-collapse: collapse; text-align: center;"> <tr> <td style="width: 10%;"></td> <td style="width: 10%;"></td> <td style="width: 10%;"></td> <td style="width: 10%;"></td> <td style="width: 10%;"></td> <td style="width: 10%;"></td> <td style="width: 10%;"></td> <td style="width: 10%;"></td> <td style="width: 10%;"></td> <td style="width: 10%;"></td> </tr> <tr> <td></td> <td></td> <td colspan="8" style="text-align: center;"> <table border="1" style="width: 100%; border-collapse: collapse; text-align: center;"> <tr> <td style="width: 10%;"></td> <td style="width: 10%;"></td> <td style="width: 10%;"></td> <td style="width: 10%;"></td> <td style="width: 10%;"></td> <td style="width: 10%;"></td> <td style="width: 10%;"></td> <td style="width: 10%;"></td> <td style="width: 10%;"></td> <td style="width: 10%;"></td> </tr> <tr> <td></td> <td></td> <td colspan="8" style="text-align: center;"> <table border="1" style="width: 100%; border-collapse: collapse; text-align: center;"> <tr> <td style="width: 10%;"></td> <td style="width: 10%;"></td> <td style="width: 10%;"></td> <td style="width: 10%;"></td> <td style="width: 10%;"></td> <td style="width: 10%;"></td> <td style="width: 10%;"></td> <td style="width: 10%;"></td> <td style="width: 10%;"></td> <td style="width: 10%;"></td> </tr> <tr> <td></td> <td></td> <td colspan="8" style="text-align: center;"> <table border="1" style="width: 100%; border-collapse: collapse; text-align: center;"> <tr> <td style="width: 10%;"></td> <td style="width: 10%;"></td> <td style="width: 10%;"></td> <td style="width: 10%;"></td> <td style="width: 10%;"></td> <td style="width: 10%;"></td> <td style="width: 10%;"></td> <td style="width: 10%;"></td> <td style="width: 10%;"></td> <td style="width: 10%;"></td> </tr> <tr> <td></td> <td></td> <td colspan="8" style="text-align: center;"> <table border="1" style="width: 100%; border-collapse: collapse; text-align: center;"> <tr> <td style="width: 10%;"></td> <td style="width: 10%;"></td> <td style="width: 10%;"></td> <td style="width: 10%;"></td> <td style="width: 10%;"></td> <td style="width: 10%;"></td> <td style="width: 10%;"></td> <td style="width: 10%;"></td> <td style="width: 10%;"></td> <td style="width: 10%;"></td> </tr> <tr> <td></td> <td></td> <td colspan="8" style="text-align: center;"> <table border="1" style="width: 100%; border-collapse: collapse; text-align: center;"> <tr> <td style="width: 10%;"></td> <td style="width: 10%;"></td> <td style="width: 10%;"></td> <td style="width: 10%;"></td> <td style="width: 10%;"></td> <td style="width: 10%;"></td> <td style="width: 10%;"></td> <td style="width: 10%;"></td> <td style="width: 10%;"></td> <td style="width: 10%;"></td> </tr> <tr> <td></td> <td></td> <td colspan="8" style="text-align: center;"> <table border="1" style="width: 100%; border-collapse: collapse; text-align: center;"> <tr> <td style="width: 10%;"></td> <td style="width: 10%;"></td> <td style="width: 10%;"></td> <td style="width: 10%;"></td> <td style="width: 10%;"></td> <td style="width: 10%;"></td> <td style="width: 10%;"></td> <td style="width: 10%;"></td> <td style="width: 10%;"></td> <td style="width: 10%;"></td> </tr> <tr> <td></td> <td></td> <td colspan="8" style="text-align: center;"> <table border="1" style="width: 100%; border-collapse: collapse; text-align: center;"> <tr> <td style="width: 10%;"></td> <td style="width: 10%;"></td> <td style="width: 10%;"></td> <td style="width: 10%;"></td> <td style="width: 10%;"></td> <td style="width: 10%;"></td> <td style="width: 10%;"></td> <td style="width: 10%;"></td> <td style="width: 10%;"></td> <td style="width: 10%;"></td> </tr> <tr> <td></td> <td></td> <td colspan="8" style="text-align: center;"> <table border="1" style="width: 100%; border-collapse: collapse; text-align: center;"> <tr> <td style="width: 10%;"></td> <td style="width: 10%;"></td> <td style="width: 10%;"></td> <td style="width: 10%;"></td> <td style="width: 10%;"></td> <td style="width: 10%;"></td> <td style="width: 10%;"></td> <td style="width: 10%;"></td> <td style="width: 10%;"></td> <td style="width: 10%;"></td> </tr> <tr> <td></td> <td></td> <td colspan="8" style="text-align: center;"> <table border="1" style="width: 100%; border-collapse: collapse; text-align: center;"> <tr> <td style="width: 10%;"></td> <td style="width: 10%;"></td> <td style="width: 10%;"></td> <td style="width: 10%;"></td> <td style="width: 10%;"></td> <td style="width: 10%;"></td> <td style="width: 10%;"></td> <td style="width:
10%;"></td> <td style="width: 10%;"></td> <td style="width: 10%;"></td> </tr> <tr> <td></td> <td></td> <td colspan="8" style="text-align: center;"> <table border="1" style="width: 100%; border-collapse: collapse; text-align: center;"> <tr> <td style="width: 10%;"></td> <td style="width: 10%;"></td> <td style="width: 10%;"></td> <td style="width: 10%;"></td> <td style="width: 10%;"></td> <td style="width: 10%;"></td> <td style="width: 10%;"></td> <td style="width: 10%;"></td> <td style="width: 10%;"></td> <td style="width: 10%;"></td> </tr> <tr> <td></td> <td></td> <td colspan="8" style="text-align: center;"> <table border="1" style="width: 100%; border-collapse: collapse; text-align: center;"> <tr> <td style="width: 10%;"></td> <td style="width: 10%;"></td> <td style="width: 10%;"></td> <td style="width: 10%;"></td> <td style="width: 10%;"></td> <td style="width: 10%;"></td> <td style="width: 10%;"></td> <td style="width: 10%;"></td> <td style="width: 10%;"></td> <td style="width: 10%;"></td> </tr> <tr> <td></td> <td></td> <td colspan="8" style="text-align: center;"> <table border="1" style="width: 100%; border-collapse: collapse; text-align: center;"> <tr> <td style="width: 10%;"></td> <td style="width: 10%;"></td> <td style="width: 10%;"></td> <td style="width: 10%;"></td> <td style="width: 10%;"></td> <td style="width: 10%;"></td> <td style="width: 10%;"></td> <td style="width: 10%;"></td> <td style="width: 10%;"></td> <td style="width: 10%;"></td> </tr> <tr> <td></td> <td></td> <td colspan="8" style="text-align: center;"> <table border="1" style="width: 100%; border-collapse: collapse; text-align: center;"> <tr> <td style="width: 10%;"></td> <td style="width: 10%;"></td> <td style="width: 10%;"></td> <td style="width: 10%;"></td> <td style="width: 10%;"></td> <td style="width: 10%;"></td> <td style="width: 10%;"></td> <td style="width: 10%;"></td> <td style="width: 10%;"></td> <td style="width: 10%;"></td> </tr> <tr> <td></td> <td></td> <td colspan="8" style="text-align: center;"> <table border="1" style="width: 100%; border-collapse: collapse; text-align: center;"> <tr> <td style="width: 10%;"></td> <td style="width: 10%;"></td> <td style="width: 10%;"></td> <td style="width: 10%;"></td> <td style="width: 10%;"></td> <td style="width: 10%;"></td> <td style="width: 10%;"></td> <td style="width: 10%;"></td> <td style="width: 10%;"></td> <td style="width: 10%;"></td> </tr> <tr> <td></td> <td></td> <td colspan="8" style="text-align: center;"> <table border="1" style="width: 100%; border-collapse: collapse; text-align: center;"> <tr> <td style="width: 10%;"></td> <td style="width: 10%;"></td> <td style="width: 10%;"></td> <td style="width: 10%;"></td> <td style="width: 10%;"></td> <td style="width: 10%;"></td> <td style="width: 10%;"></td> <td style="width: 10%;"></td> <td style="width: 10%;"></td> <td style="width: 10%;"></td> </tr> <tr> <td></td> <td></td> <td colspan="8" style="text-align: center;"> <table border="1" style="width: 100%; border-collapse: collapse; text-align: center;"> <tr> <td style="width: 10%;"></td> <td style="width: 10%;"></td> <td style="width: 10%;"></td> <td style="width: 10%;"></td> <td style="width: 10%;"></td> <td style="width: 10%;"></td> <td style="width: 10%;"></td> <td style="width: 10%;"></td> <td style="width: 10%;"></td> <td style="width: 10%;"></td> </tr> <tr> <td></td> <td></td> <td colspan="8" style="text-align: center;"> <table border="1" style="width: 100%; border-collapse: collapse; text-align: center;"> <tr> <td style="width: 10%;"></td> <td style="width: 10%;"></td> <td style="width: 10%;"></td> <td style="width: 10%;"></td> <td style="width: 10%;"></td> <td style="width: 10%;"></td> <td style="width: 10%;"></td> <td style="width: 10%;"></td> <td style="width: 10%;"></td> <td style="width: 10%;"></td> </tr> <tr> <td></td> <td></td> <td colspan="8" style="text-align: center;"> <table border="1" style="width: 100%; border-collapse: collapse; text-align: center;"> <tr> <td style="width: 10%;"></td> <td style="width: 10%;"></td> <td style="width: 10%;"></td> <td style="width: 10%;"></td> <td style="width: 10%;"></td> <td style="width: 10%;"></td> <td style="width: 10%;"></td> <td style="width: 10%;"></td> <td style="width: 10%;"></td> <td style="width: 10%;"></td> </tr> <tr> <td></td> <td></td> <td colspan="8" style="text-align: center;"> <table border="1" style="width: 100%; border-collapse: collapse; text-align: center;"> <tr> <td style="width: 10%;"></td> <td style="width: 10%;"></td> <td style="width: 10%;"></td> <td style="width: 10%;"></td> <td style="width: 10%;"></td> <td style="width: 10%;"></td> <td style="width: 10%;"></td> <td style="width: 10%;"></td> <td style="width: 10%;"></td> <td style="width: 10%;"></td> </tr> <tr> <td></td> <td></td> <td colspan="8" style="text-align: center;"> <table border="1" style="width: 100%; border-collapse: collapse; text-align: center;"> <tr> <td style="width: 10%;"></td> <td style="width: 10%;"></td> <td style="width: 10%;"></td> <td style="width: 10%;"></td> <td style="width: 10%;"></td> <td style="width: 10%;"></td> <td style="width: 10%;"></td> <td style="width: 10%;"></td> <td style="width: 10%;"></td> <td style="width: 10%;"></td> </tr> <tr> <td></td> <td></td> <td colspan="8" style="text-align: center;"> <table border="1" style="width: 100%; border-collapse: collapse; text-align: center;"> <tr> <td style="width: 10%;"></td> <td style="width: 10%;"></td> <td style="width: 10%;"></td> <td style="width: 10%;"></td> <td style="width: 10%;"></td> <td style="width: 10%;"></td> <td style="width: 10%;"></td> <td style="width: 10%;"></td> <td style="width: 10%;"></td> <td style="width: 10%;"></td> </tr> <tr> <td></td> <td></td> <td colspan="8" style="text-align: center;"> <table border="1" style="width: 100%; border-collapse: collapse; text-align: center;"> <tr> <td style="width: 10%;"></td> <td style="width: 10%;"></td> <td style="width: 10%;"></td> <td style="width: 10%;"></td> <td style="width: 10%;"></td> <td style="width: 10%;"></td> <td style="width: 10%;"></td> <td style="width: 10%;"></td> <td style="width: 10%;"></td> <td style="width: 10%;"></td> </tr> <tr> <td></td> <td></td> <td colspan="8" style="text-align: center;"> <table border="1" style="width: 100%; border-collapse: collapse; text-align: center;"> <tr> <td style="width: 10%;"></td> <td style="width: 10%;"></td> <td style="width: 10%;"></td> <td style="width: 10%;"></td> <td style="width: 10%;"></td> <td style="width: 10%;"></td> <td style="width: 10%;"></td> <td style="width: 10%;"></td> <td style="width: 10%;"></td> <td style="width: 10%;"></td> </tr> <tr> <td></td> <td></td> <td colspan="8" style="text-align: center;"> <table border="1" style="width: 100%; border-collapse: collapse; text-align: center;"> <tr> <td style="width: 10%;"></td> <td style="width: 10%;"></td> <td style="width: 10%;"></td> <td style="width: 10%;"></td> <td style="width: 10%;"></td> <td style="width: 10%;"></td> <td style="width: 10%;"></td> <td style="width: 10%;"></td> <td style="width: 10%;"></td> <td style="width: 10%;"></td> </tr> <tr> <td></td> <td></td> <td colspan="8" style="text-align: center;"> <table border="1" style="width: 100%; border-collapse: collapse; text-align: center;"> <tr> <td style="width: 10%;"></td> <td style="width: 10%;"></td> <td style="width: 10%;"></td> <td style="width: 10%;"></td> <td style="width: 10%;"></td> <td style="width: 10%;"></td> <td style="width: 10%;"></td> <td style="width: 10%;"></td> <td style="width: 10%;"></td> <td style="width: 10%;"></td> </tr> <tr> <td></td> <td></td> <td colspan="8" style="text-align: center;"> <table border="1" style="width: 100%; border-collapse: collapse; text-align: center;"> <tr> </tr></table></td></tr></table></td></tr></table></td></tr></table></td></tr></table></td></tr></table></td></tr></table></td></tr></table></td></tr></table></td></tr></table></td></tr></table></td></tr></table></td></tr></table></td></tr></table></td></tr></table></td></tr></table></td></tr></table></td></tr></table></td></tr></table></td></tr></table></td></tr></table></td></tr></table></td></tr></table></td></tr></table></td></tr></table></td></tr></table></td></tr></table></td></tr></table></td></tr></table></td></tr></table></td></tr></table></td></tr></table></td></tr></table></td></tr></table></td></tr></table></td></tr></table></td></tr></table></td></tr></table></td></tr></table></td></tr></table></td></tr></table></td></tr></table></td></tr></table></td></tr></table></td></tr></table></td></tr></table></td></tr></table></td></tr></table></td></tr></table></td></tr></table></td></tr></table></td></tr></table></td></tr></table></td></tr></table></td></tr></table></td></tr></table></td></tr></table></td></tr></table></td></tr></table></td></tr></table>
 | | | | | | | | | | | | | | | | | | | | <table border="1" style="width: 100%; border-collapse: collapse; text-align: center;"> <tr> <td style="width: 10%;"></td> <td style="width: 10%;"></td> <td style="width: 10%;"></td> <td style="width: 10%;"></td> <td style="width: 10%;"></td> <td style="width: 10%;"></td> <td style="width: 10%;"></td> <td style="width: 10%;"></td> <td style="width: 10%;"></td> <td style="width: 10%;"></td> </tr> <tr> <td></td> <td></td> <td colspan="8" style="text-align: center;"> <table border="1" style="width: 100%; border-collapse: collapse; text-align: center;"> <tr> <td style="width: 10%;"></td> <td style="width: 10%;"></td> <td style="width: 10%;"></td> <td style="width: 10%;"></td> <td style="width: 10%;"></td> <td style="width: 10%;"></td> <td style="width: 10%;"></td> <td style="width: 10%;"></td> <td style="width: 10%;"></td> <td style="width: 10%;"></td> </tr> <tr> <td></td> <td></td> <td colspan="8" style="text-align: center;"> <table border="1" style="width: 100%; border-collapse: collapse; text-align: center;"> <tr> <td style="width: 10%;"></td> <td style="width: 10%;"></td> <td style="width: 10%;"></td> <td style="width: 10%;"></td> <td style="width: 10%;"></td> <td style="width: 10%;"></td> <td style="width: 10%;"></td> <td style="width: 10%;"></td> <td style="width: 10%;"></td> <td style="width: 10%;"></td> </tr> <tr> <td></td> <td></td> <td colspan="8" style="text-align: center;"> <table border="1" style="width: 100%; border-collapse: collapse; text-align: center;"> <tr> <td style="width: 10%;"></td> <td style="width: 10%;"></td> <td style="width: 10%;"></td> <td style="width: 10%;"></td> <td style="width: 10%;"></td> <td style="width: 10%;"></td> <td style="width: 10%;"></td> <td style="width: 10%;"></td> <td style="width: 10%;"></td> <td style="width: 10%;"></td> </tr> <tr> <td></td> <td></td> <td colspan="8" style="text-align: center;"> <table border="1" style="width: 100%; border-collapse: collapse; text-align: center;"> <tr> <td style="width: 10%;"></td> <td style="width: 10%;"></td> <td style="width: 10%;"></td> <td style="width: 10%;"></td> <td style="width: 10%;"></td> <td style="width: 10%;"></td> <td style="width: 10%;"></td> <td style="width: 10%;"></td> <td style="width: 10%;"></td> <td style="width: 10%;"></td> </tr> <tr> <td></td> <td></td> <td colspan="8" style="text-align: center;"> <table border="1" style="width: 100%; border-collapse: collapse; text-align: center;"> <tr> <td style="width: 10%;"></td> <td style="width: 10%;"></td> <td style="width: 10%;"></td> <td style="width: 10%;"></td> <td style="width: 10%;"></td> <td style="width: 10%;"></td> <td style="width: 10%;"></td> <td style="width: 10%;"></td> <td style="width: 10%;"></td> <td style="width: 10%;"></td> </tr> <tr> <td></td> <td></td> <td colspan="8" style="text-align: center;"> <table border="1" style="width: 100%; border-collapse: collapse; text-align: center;"> <tr> <td style="width: 10%;"></td> <td style="width: 10%;"></td> <td style="width: 10%;"></td> <td style="width: 10%;"></td> <td style="width: 10%;"></td> <td style="width: 10%;"></td> <td style="width: 10%;"></td> <td style="width: 10%;"></td> <td style="width: 10%;"></td> <td style="width: 10%;"></td> </tr> <tr> <td></td> <td></td> <td colspan="8" style="text-align: center;"> <table border="1" style="width: 100%; border-collapse: collapse; text-align: center;"> <tr> <td style="width: 10%;"></td> <td style="width: 10%;"></td> <td style="width: 10%;"></td> <td style="width: 10%;"></td> <td style="width: 10%;"></td> <td style="width: 10%;"></td> <td style="width: 10%;"></td> <td style="width: 10%;"></td> <td style="width: 10%;"></td> <td style="width: 10%;"></td> </tr> <tr> <td></td> <td></td> <td colspan="8" style="text-align: center;"> <table border="1" style="width: 100%; border-collapse: collapse; text-align: center;"> <tr> <td style="width: 10%;"></td> <td style="width: 10%;"></td> <td style="width: 10%;"></td> <td style="width: 10%;"></td> <td style="width: 10%;"></td> <td style="width: 10%;"></td> <td style="width: 10%;"></td> <td style="width: 10%;"></td> <td style="width: 10%;"></td> <td style="width: 10%;"></td> </tr> <tr> <td></td> <td></td> <td colspan="8" style="text-align: center;"> <table border="1" style="width: 100%; border-collapse: collapse; text-align: center;"> <tr> <td style="width: 10%;"></td> <td style="width: 10%;"></td> <td style="width: 10%;"></td> <td style="width: 10%;"></td> <td style="width: 10%;"></td> <td style="width: 10%;"></td> <td style="width: 10%;"></td> <td style="width: 10%;"></td> <td style="width: 10%;"></td> <td style="width: 10%;"></td> </tr> <tr> <td></td> <td></td> <td colspan="8" style="text-align: center;"> <table border="1" style="width: 100%; border-collapse: collapse; text-align: center;"> <tr> <td style="width: 10%;"></td> <td style="width: 10%;"></td> <td style="width: 10%;"></td> <td style="width: 10%;"></td> <td style="width: 10%;"></td> <td style="width: 10%;"></td> <td style="width: 10%;"></td> <td style="width: 10%;"></td> <td style="width: 10%;"></td> <td style="width: 10%;"></td> </tr> <tr> <td></td> <td></td> <td colspan="8" style="text-align: center;"> <table border="1" style="width: 100%; border-collapse: collapse; text-align: center;"> <tr> <td style="width: 10%;"></td> <td style="width: 10%;"></td> <td style="width: 10%;"></td> <td style="width: 10%;"></td> <td style="width: 10%;"></td> <td style="width: 10%;"></td> <td style="width: 10%;"></td> <td style="width: 10%;"></td> <td style="width: 10%;"></td> <td style="width: 10%;"></td> </tr> <tr> <td></td> <td></td> <td colspan="8" style="text-align: center;"> <table border="1" style="width: 100%; border-collapse: collapse; text-align: center;"> <tr> <td style="width: 10%;"></td> <td style="width: 10%;"></td> <td style="width: 10%;"></td> <td style="width: 10%;"></td> <td style="width: 10%;"></td> <td style="width: 10%;"></td> <td style="width: 10%;"></td> <td style="width: 10%;"></td> <td style="width: 10%;"></td> <td style="width: 10%;"></td> </tr> <tr> <td></td> <td></td> <td colspan="8" style="text-align: center;"> <table border="1" style="width: 100%; border-collapse: collapse; text-align: center;"> <tr> <td style="width: 10%;"></td> <td style="width: 10%;"></td> <td style="width: 10%;"></td> <td style="width: 10%;"></td> <td style="width: 10%;"></td> <td style="width: 10%;"></td> <td style="width: 10%;"></td> <td style="width: 10%;"></td> <td style="width: 10%;"></td> <td style="width: 10%;"></td> </tr> <tr> <td></td> <td></td> <td colspan="8" style="text-align: center;"> <table border="1" style="width: 100%; border-collapse: collapse; text-align: center;"> <tr> <td style="width: 10%;"></td> <td style="width: 10%;"></td> <td style="width: 10%;"></td> <td style="width: 10%;"></td> <td style="width: 10%;"></td> <td style="width: 10%;"></td> <td style="width: 10%;"></td> <td style="width: 10%;"></td> <td style="width: 10%;"></td> <td style="width: 10%;"></td> </tr> <tr> <td></td> <td></td> <td colspan="8" style="text-align: center;"> <table border="1" style="width: 100%; border-collapse: collapse; text-align: center;"> <tr> <td style="width: 10%;"></td> <td style="width: 10%;"></td> <td style="width: 10%;"></td> <td style="width: 10%;"></td> <td style="width: 10%;"></td> <td style="width: 10%;"></td> <td style="width: 10%;"></td> <td style="width: 10%;"></td> <td style="width: 10%;"></td> <td style="width: 10%;"></td> </tr> <tr> <td></td> <td></td> <td colspan="8" style="text-align: center;"> <table border="1" style="width: 100%; border-collapse: collapse; text-align: center;"> <tr> <td style="width: 10%;"></td> <td style="width: 10%;"></td> <td style="width: 10%;"></td> <td style="width: 10%;"></td> <td style="width: 10%;"></td> <td style="width: 10%;"></td> <td style="width: 10%;"></td> <td style="width: 10%;"></td> <td style="width: 10%;"></td> <td style="width: 10%;"></td> </tr> <tr> <td></td> <td></td> <td colspan="8" style="text-align: center;"> <table border="1" style="width: 100%; border-collapse: collapse; text-align: center;"> <tr> <td style="width: 10%;"></td> <td style="width: 10%;"></td> <td style="width: 10%;"></td> <td style="width: 10%;"></td> <td style="width: 10%;"></td> <td style="width: 10%;"></td> <td style="width: 10%;"></td> <td style="width: 10%;"></td> <td style="width: 10%;"></td> <td style="width: 10%;"></td> </tr> <tr> <td></td> <td></td> <td colspan="8" style="text-align: center;"> <table border="1" style="width: 100%; border-collapse: collapse; text-align: center;"> <tr> <td style="width: 10%;"></td> <td style="width: 10%;"></td> <td style="width: 10%;"></td> <td style="width: 10%;"></td> <td style="width: 10%;"></td> <td style="width:
10%;"></td> <td style="width: 10%;"></td> <td style="width: 10%;"></td> <td style="width: 10%;"></td> <td style="width: 10%;"></td> </tr> <tr> <td></td> <td></td> <td colspan="8" style="text-align: center;"> <table border="1" style="width: 100%; border-collapse: collapse; text-align: center;"> <tr> <td style="width: 10%;"></td> <td style="width: 10%;"></td> <td style="width: 10%;"></td> <td style="width: 10%;"></td> <td style="width: 10%;"></td> <td style="width: 10%;"></td> <td style="width: 10%;"></td> <td style="width: 10%;"></td> <td style="width: 10%;"></td> <td style="width: 10%;"></td> </tr> <tr> <td></td> <td></td> <td colspan="8" style="text-align: center;"> <table border="1" style="width: 100%; border-collapse: collapse; text-align: center;"> <tr> <td style="width: 10%;"></td> <td style="width: 10%;"></td> <td style="width: 10%;"></td> <td style="width: 10%;"></td> <td style="width: 10%;"></td> <td style="width: 10%;"></td> <td style="width: 10%;"></td> <td style="width: 10%;"></td> <td style="width: 10%;"></td> <td style="width: 10%;"></td> </tr> <tr> <td></td> <td></td> <td colspan="8" style="text-align: center;"> <table border="1" style="width: 100%; border-collapse: collapse; text-align: center;"> <tr> <td style="width: 10%;"></td> <td style="width: 10%;"></td> <td style="width: 10%;"></td> <td style="width: 10%;"></td> <td style="width: 10%;"></td> <td style="width: 10%;"></td> <td style="width: 10%;"></td> <td style="width: 10%;"></td> <td style="width: 10%;"></td> <td style="width: 10%;"></td> </tr> <tr> <td></td> <td></td> <td colspan="8" style="text-align: center;"> <table border="1" style="width: 100%; border-collapse: collapse; text-align: center;"> <tr> <td style="width: 10%;"></td> <td style="width: 10%;"></td> <td style="width: 10%;"></td> <td style="width: 10%;"></td> <td style="width: 10%;"></td> <td style="width: 10%;"></td> <td style="width: 10%;"></td> <td style="width: 10%;"></td> <td style="width: 10%;"></td> <td style="width: 10%;"></td> </tr> <tr> <td></td> <td></td> <td colspan="8" style="text-align: center;"> <table border="1" style="width: 100%; border-collapse: collapse; text-align: center;"> <tr> <td style="width: 10%;"></td> <td style="width: 10%;"></td> <td style="width: 10%;"></td> <td style="width: 10%;"></td> <td style="width: 10%;"></td> <td style="width: 10%;"></td> <td style="width: 10%;"></td> <td style="width: 10%;"></td> <td style="width: 10%;"></td> <td style="width: 10%;"></td> </tr> <tr> <td></td> <td></td> <td colspan="8" style="text-align: center;"> <table border="1" style="width: 100%; border-collapse: collapse; text-align: center;"> <tr> <td style="width: 10%;"></td> <td style="width: 10%;"></td> <td style="width: 10%;"></td> <td style="width: 10%;"></td> <td style="width: 10%;"></td> <td style="width: 10%;"></td> <td style="width: 10%;"></td> <td style="width: 10%;"></td> <td style="width: 10%;"></td> <td style="width: 10%;"></td> </tr> <tr> <td></td> <td></td> <td colspan="8" style="text-align: center;"> <table border="1" style="width: 100%; border-collapse: collapse; text-align: center;"> <tr> <td style="width: 10%;"></td> <td style="width: 10%;"></td> <td style="width: 10%;"></td> <td style="width: 10%;"></td> <td style="width: 10%;"></td> <td style="width: 10%;"></td> <td style="width: 10%;"></td> <td style="width: 10%;"></td> <td style="width: 10%;"></td> <td style="width: 10%;"></td> </tr> <tr> <td></td> <td></td> <td colspan="8" style="text-align: center;"> <table border="1" style="width: 100%; border-collapse: collapse; text-align: center;"> <tr> <td style="width: 10%;"></td> <td style="width: 10%;"></td> <td style="width: 10%;"></td> <td style="width: 10%;"></td> <td style="width: 10%;"></td> <td style="width: 10%;"></td> <td style="width: 10%;"></td> <td style="width: 10%;"></td> <td style="width: 10%;"></td> <td style="width: 10%;"></td> </tr> <tr> <td></td> <td></td> <td colspan="8" style="text-align: center;"> <table border="1" style="width: 100%; border-collapse: collapse; text-align: center;"> <tr> <td style="width: 10%;"></td> <td style="width: 10%;"></td> <td style="width: 10%;"></td> <td style="width: 10%;"></td> <td style="width: 10%;"></td> <td style="width: 10%;"></td> <td style="width: 10%;"></td> <td style="width: 10%;"></td> <td style="width: 10%;"></td> <td style="width: 10%;"></td> </tr> <tr> <td></td> <td></td> <td colspan="8" style="text-align: center;"> <table border="1" style="width: 100%; border-collapse: collapse; text-align: center;"> <tr> <td style="width: 10%;"></td> <td style="width: 10%;"></td> <td style="width: 10%;"></td> <td style="width: 10%;"></td> <td style="width: 10%;"></td> <td style="width: 10%;"></td> <td style="width: 10%;"></td> <td style="width: 10%;"></td> <td style="width: 10%;"></td> <td style="width: 10%;"></td> </tr> <tr> <td></td> <td></td> <td colspan="8" style="text-align: center;"> <table border="1" style="width: 100%; border-collapse: collapse; text-align: center;"> <tr> <td style="width: 10%;"></td> <td style="width: 10%;"></td> <td style="width: 10%;"></td> <td style="width: 10%;"></td> <td style="width: 10%;"></td> <td style="width: 10%;"></td> <td style="width: 10%;"></td> <td style="width: 10%;"></td> <td style="width: 10%;"></td> <td style="width: 10%;"></td> </tr> <tr> <td></td> <td></td> <td colspan="8" style="text-align: center;"> <table border="1" style="width: 100%; border-collapse: collapse; text-align: center;"> <tr> <td style="width: 10%;"></td> <td style="width: 10%;"></td> <td style="width: 10%;"></td> <td style="width: 10%;"></td> <td style="width: 10%;"></td> <td style="width: 10%;"></td> <td style="width: 10%;"></td> <td style="width: 10%;"></td> <td style="width: 10%;"></td> <td style="width: 10%;"></td> </tr> <tr> <td></td> <td></td> <td colspan="8" style="text-align: center;"> <table border="1" style="width: 100%; border-collapse: collapse; text-align: center;"> <tr> <td style="width: 10%;"></td> <td style="width: 10%;"></td> <td style="width: 10%;"></td> <td style="width: 10%;"></td> <td style="width: 10%;"></td> <td style="width: 10%;"></td> <td style="width: 10%;"></td> <td style="width: 10%;"></td> <td style="width: 10%;"></td> <td style="width: 10%;"></td> </tr> <tr> <td></td> <td></td> <td colspan="8" style="text-align: center;"> <table border="1" style="width: 100%; border-collapse: collapse; text-align: center;"> <tr> <td style="width: 10%;"></td> <td style="width: 10%;"></td> <td style="width: 10%;"></td> <td style="width: 10%;"></td> <td style="width: 10%;"></td> <td style="width: 10%;"></td> <td style="width: 10%;"></td> <td style="width: 10%;"></td> <td style="width: 10%;"></td> <td style="width: 10%;"></td> </tr> <tr> <td></td> <td></td> <td colspan="8" style="text-align: center;"> <table border="1" style="width: 100%; border-collapse: collapse; text-align: center;"> <tr> <td style="width: 10%;"></td> <td style="width: 10%;"></td> <td style="width: 10%;"></td> <td style="width: 10%;"></td> <td style="width: 10%;"></td> <td style="width: 10%;"></td> <td style="width: 10%;"></td> <td style="width: 10%;"></td> <td style="width: 10%;"></td> <td style="width: 10%;"></td> </tr> <tr> <td></td> <td></td> <td colspan="8" style="text-align: center;"> <table border="1" style="width: 100%; border-collapse: collapse; text-align: center;"> <tr> <td style="width: 10%;"></td> <td style="width: 10%;"></td> <td style="width: 10%;"></td> <td style="width: 10%;"></td> <td style="width: 10%;"></td> <td style="width: 10%;"></td> <td style="width: 10%;"></td> <td style="width: 10%;"></td> <td style="width: 10%;"></td> <td style="width: 10%;"></td> </tr> <tr> <td></td> <td></td> <td colspan="8" style="text-align: center;"> <table border="1" style="width: 100%; border-collapse: collapse; text-align: center;"> <tr> <td style="width: 10%;"></td> <td style="width: 10%;"></td> <td style="width: 10%;"></td> <td style="width: 10%;"></td> <td style="width: 10%;"></td> <td style="width: 10%;"></td> <td style="width: 10%;"></td> <td style="width: 10%;"></td> <td style="width: 10%;"></td> <td style="width: 10%;"></td> </tr> <tr> <td></td> <td></td> <td colspan="8" style="text-align: center;"> <table border="1" style="width: 100%; border-collapse: collapse; text-align: center;"> <tr> <td style="width: 10%;"></td> <td style="width: 10%;"></td> <td style="width: 10%;"></td> <td style="width: 10%;"></td> <td style="width: 10%;"></td> <td style="width: 10%;"></td> <td style="width: 10%;"></td> <td style="width: 10%;"></td> <td style="width: 10%;"></td> <td style="width: 10%;"></td> </tr> <tr> <td></td> <td></td> <td colspan="8" style="text-align: center;"> <table border="1" style="width: 100%; border-collapse: collapse; text-align: center;"> <tr> <td style="width: 10%;"></td> <td style="width: 10%;"></td> <td style="width: 10%;"></td> <td style="width: 10%;"></td> <td style="width: 10%;"></td> <td style="width: 10%;"></td> <td style="width: 10%;"></td> <td style="width: 10%;"></td> <td style="width: 10%;"></td> <td style="width: 10%;"></td> </tr> <tr> <td></td> <td></td> <td colspan="8" style="text-align: center;"> <table border="1" style="width: 100%; border-collapse: collapse; text-align: center;"> <tr> <td style="width: 10%;"></td> <td style="width: 10%;"></td> <td style="width: 10%;"></td> <td style="width: 10%;"></td> <td style="width: 10%;"></td> <td style="width: 10%;"></td> <td style="width: 10%;"></td> <td style="width: 10%;"></td> <td style="width: 10%;"></td> <td style="width: 10%;"></td> </tr> <tr> <td></td> <td></td> <td colspan="8" style="text-align: center;"> <table border="1" style="width: 100%; border-collapse: collapse; text-align: center;"> <tr> <td style="width: 10%;"></td> <td style="width: 10%;"></td> <td style="width: 10%;"></td> <td style="width: 10%;"></td> <td style="width: 10%;"></td> <td style="width: 10%;"></td> <td style="width: 10%;"></td> <td style="width: 10%;"></td> <td style="width: 10%;"></td> <td style="width: 10%;"></td> </tr> <tr> <td></td> <td></td> <td
colspan="8" style="text-align: center;"> <table border="1" style="width: 100%; border-collapse: collapse; text-align: center;"> <tr> <td style="width: 10%;"></td> <td style="width: 10%;"></td> <td style="width: 10%;"></td> <td style="width: 10%;"></td> <td style="width: 10%;"></td> <td style="width: 10%;"></td> <td style="width: 10%;"></td> <td style="width: 10%;"></td> <td style="width: 10%;"></td> <td style="width: 10%;"></td> </tr> <tr> <td></td> <td></td> <td colspan="8" style="text-align: center;"> <table border="1" style="width: 100%; border-collapse: collapse; text-align: center;"> <tr> <td style="width: 10%;"></td> <td style="width: 10%;"></td> <td style="width: 10%;"></td> <td style="width: 10%;"></td> <td style="width: 10%;"></td> <td style="width: 10%;"></td> <td style="width: 10%;"></td> <td style="width: 10%;"></td> <td style="width: 10%;"></td> <td style="width: 10%;"></td> </tr> <tr> <td></td> <td></td> <td colspan="8" style="text-align: center;"> <table border="1" style="width: 100%; border-collapse: collapse; text-align: center;"> <tr> <td style="width: 10%;"></td> <td style="width: 10%;"></td> <td style="width: 10%;"></td> <td style="width: 10%;"></td> <td style="width: 10%;"></td> <td style="width: 10%;"></td> <td style="width: 10%;"></td> <td style="width: 10%;"></td> <td style="width: 10%;"></td> <td style="width: 10%;"></td> </tr> <tr> <td></td> <td></td> <td colspan="8" style="text-align: center;"> <table border="1" style="width: 100%; border-collapse: collapse; text-align: center;"> <tr> <td style="width: 10%;"></td> <td style="width: 10%;"></td> <td style="width: 10%;"></td> <td style="width: 10%;"></td> <td style="width: 10%;"></td> <td style="width: 10%;"></td> <td style="width: 10%;"></td> <td style="width: 10%;"></td> <td style="width: 10%;"></td> <td style="width: 10%;"></td> </tr> <tr> <td></td> <td></td> <td colspan="8" style="text-align: center;"> <table border="1" style="width: 100%; border-collapse: collapse; text-align: center;"> <tr> <td style="width: 10%;"></td> <td style="width: 10%;"></td> <td style="width: 10%;"></td> <td style="width: 10%;"></td> <td style="width: 10%;"></td> <td style="width: 10%;"></td> <td style="width: 10%;"></td> <td style="width: 10%;"></td> <td style="width: 10%;"></td> <td style="width: 10%;"></td> </tr> <tr> <td></td> <td></td> <td colspan="8" style="text-align: center;"> <table border="1" style="width: 100%; border-collapse: collapse; text-align: center;"> <tr> <td style="width: 10%;"></td> <td style="width: 10%;"></td> <td style="width: 10%;"></td> <td style="width: 10%;"></td> <td style="width: 10%;"></td> <td style="width: 10%;"></td> <td style="width: 10%;"></td> <td style="width: 10%;"></td> <td style="width: 10%;"></td> <td style="width: 10%;"></td> </tr> <tr> <td></td> <td></td> <td colspan="8" style="text-align: center;"> <table border="1" style="width: 100%; border-collapse: collapse; text-align: center;"> <tr> <td style="width: 10%;"></td> <td style="width: 10%;"></td> <td style="width: 10%;"></td> <td style="width: 10%;"></td> <td style="width: 10%;"></td> <td style="width: 10%;"></td> <td style="width: 10%;"></td> <td style="width: 10%;"></td> <td style="width: 10%;"></td> <td style="width: 10%;"></td> </tr> <tr> <td></td> <td></td> <td colspan="8" style="text-align: center;"> <table border="1" style="width: 100%; border-collapse: collapse; text-align: center;"> <tr> <td style="width: 10%;"></td> <td style="width: 10%;"></td> <td style="width: 10%;"></td> <td style="width: 10%;"></td> <td style="width: 10%;"></td> <td style="width: 10%;"></td> <td style="width: 10%;"></td> <td style="width: 10%;"></td> <td style="width: 10%;"></td> <td style="width: 10%;"></td> </tr> <tr> <td></td> <td></td> <td colspan="8" style="text-align: center;"> <table border="1" style="width: 100%; border-collapse: collapse; text-align: center;"> <tr> <td style="width: 10%;"></td> <td style="width: 10%;"></td> <td style="width: 10%;"></td> <td style="width: 10%;"></td> <td style="width: 10%;"></td> <td style="width: 10%;"></td> <td style="width: 10%;"></td> <td style="width: 10%;"></td> <td style="width: 10%;"></td> <td style="width: 10%;"></td> </tr> <tr> <td></td> <td></td> <td colspan="8" style="text-align: center;"> <table border="1" style="width: 100%; border-collapse: collapse; text-align: center;"> <tr> <td style="width: 10%;"></td> <td style="width: 10%;"></td> <td style="width: 10%;"></td> <td style="width: 10%;"></td> <td style="width: 10%;"></td> <td style="width: 10%;"></td> <td style="width: 10%;"></td> <td style="width: 10%;"></td> <td style="width: 10%;"></td> <td style="width: 10%;"></td> </tr> <tr> <td></td> <td></td> <td colspan="8" style="text-align: center;"> <table border="1" style="width: 100%; border-collapse: collapse; text-align: center;"> <tr> <td style="width: 10%;"></td> <td style="width: 10%;"></td> <td style="width: 10%;"></td> <td style="width: 10%;"></td> <td style="width: 10%;"></td> <td style="width: 10%;"></td> <td style="width: 10%;"></td> <td style="width: 10%;"></td> <td style="width: 10%;"></td> <td style="width: 10%;"></td> </tr> <tr> <td></td> <td></td> <td colspan="8" style="text-align: center;"> <table border="1" style="width: 100%; border-collapse: collapse; text-align: center;"> <tr> <td style="width: 10%;"></td> <td style="width: 10%;"></td> <td style="width: 10%;"></td> <td style="width: 10%;"></td> <td style="width: 10%;"></td> <td style="width: 10%;"></td> <td style="width: 10%;"></td> <td style="width: 10%;"></td> <td style="width: 10%;"></td> <td style="width: 10%;"></td> </tr> <tr> <td></td> <td></td> <td colspan="8" style="text-align: center;"> <table border="1" style="width: 100%; border-collapse: collapse; text-align: center;"> <tr> <td style="width: 10%;"></td> <td style="width: 10%;"></td> <td style="width: 10%;"></td> <td style="width: 10%;"></td> <td style="width: 10%;"></td> <td style="width: 10%;"></td> <td style="width: 10%;"></td> <td style="width: 10%;"></td> <td style="width: 10%;"></td> <td style="width: 10%;"></td> </tr> <tr> <td></td> <td></td> <td colspan="8" style="text-align: center;"> <table border="1" style="width: 100%; border-collapse: collapse; text-align: center;"> <tr> <td style="width: 10%;"></td> <td style="width: 10%;"></td> <td style="width: 10%;"></td> <td style="width: 10%;"></td> <td style="width: 10%;"></td> <td style="width: 10%;"></td> <td style="width: 10%;"></td> <td style="width: 10%;"></td> <td style="width: 10%;"></td> <td style="width: 10%;"></td> </tr> <tr> <td></td> <td></td> <td colspan="8" style="text-align: center;"> <table border="1" style="width: 100%; border-collapse: collapse; text-align: center;"> <tr> <td style="width: 10%;"></td> <td style="width: 10%;"></td> <td style="width: 10%;"></td> <td style="width: 10%;"></td> <td style="width: 10%;"></td> <td style="width: 10%;"></td> <td style="width: 10%;"></td> <td style="width: 10%;"></td> <td style="width: 10%;"></td> <td style="width: 10%;"></td> </tr> <tr> <td></td> <td></td> <td colspan="8" style="text-align: center;"> <table border="1" style="width: 100%; border-collapse: collapse; text-align: center;"> <tr> <td style="width: 10%;"></td> <td style="width: 10%;"></td> <td style="width: 10%;"></td> <td style="width: 10%;"></td> <td style="width: 10%;"></td> <td style="width: 10%;"></td> <td style="width: 10%;"></td> <td style="width: 10%;"></td> <td style="width: 10%;"></td> <td style="width: 10%;"></td> </tr> <tr> <td></td> <td></td> <td colspan="8" style="text-align: center;"> <table border="1" style="width: 100%; border-collapse: collapse; text-align: center;"> <tr> <td style="width: 10%;"></td> <td style="width: 10%;"></td> <td style="width: 10%;"></td> <td style="width: 10%;"></td> <td style="width: 10%;"></td> <td style="width: 10%;"></td> <td style="width: 10%;"></td> <td style="width: 10%;"></td> <td style="width: 10%;"></td> <td style="width: 10%;"></td> </tr> <tr> <td></td> <td></td> <td colspan="8" style="text-align: center;"> <table border="1" style="width: 100%; border-collapse: collapse; text-align: center;"> <tr> <td style="width: 10%;"></td> <td style="width: 10%;"></td> <td style="width: 10%;"></td> <td style="width: 10%;"></td> <td style="width: 10%;"></td> <td style="width: 10%;"></td> <td style="width: 10%;"></td> <td style="width: 10%;"></td> <td style="width: 10%;"></td> <td style="width: 10%;"></td> </tr> <tr> <td></td> <td></td> <td colspan="8" style="text-align: center;"> <table border="1" style="width: 100%; border-collapse: collapse; text-align: center;"> <tr> </tr></table></td></tr></table></td></tr></table></td></tr></table></td></tr></table></td></tr></table></td></tr></table></td></tr></table></td></tr></table></td></tr></table></td></tr></table></td></tr></table></td></tr></table></td></tr></table></td></tr></table></td></tr></table></td></tr></table></td></tr></table></td></tr></table></td></tr></table></td></tr></table></td></tr></table></td></tr></table></td></tr></table></td></tr></table></td></tr></table></td></tr></table></td></tr></table></td></tr></table></td></tr></table></td></tr></table></td></tr></table></td></tr></table></td></tr></table></td></tr></table></td></tr></table></td></tr></table></td></tr></table></td></tr></table></td></tr></table></td></tr></table></td></tr></table></td></tr></table></td></tr></table></td></tr></table></td></tr></table></td></tr></table></td></tr></table></td></tr></table></td></tr></table></td></tr></table></td></tr></table></td></tr></table></td></tr></table></td></tr></table></td></tr></table></td></tr></table></td></tr></table></td></tr></table>
 | | | | | | | | | | | | | | | | | | | | <table border="1" style="width: 100%; border-collapse: collapse; text-align: center;"> <tr> <td style="width: 10%;"></td> <td style="width: 10%;"></td> <td style="width: 10%;"></td> <td style="width: 10%;"></td> <td style="width: 10%;"></td> <td style="width: 10%;"></td> <td style="width: 10%;"></td> <td style="width: 10%;"></td> <td style="width: 10%;"></td> <td style="width: 10%;"></td> </tr> <tr> <td></td> <td></td> <td colspan="8" style="text-align: center;"> <table border="1" style="width: 100%; border-collapse: collapse; text-align: center;"> <tr> <td style="width: 10%;"></td> <td style="width: 10%;"></td> <td style="width: 10%;"></td> <td style="width: 10%;"></td> <td style="width: 10%;"></td> <td style="width: 10%;"></td> <td style="width: 10%;"></td> <td style="width: 10%;"></td> <td style="width: 10%;"></td> <td style="width: 10%;"></td> </tr> <tr> <td></td> <td></td> <td colspan="8" style="text-align: center;"> <table border="1" style="width: 100%; border-collapse: collapse; text-align: center;"> <tr> <td style="width: 10%;"></td> <td style="width: 10%;"></td> <td style="width: 10%;"></td> <td style="width: 10%;"></td> <td style="width: 10%;"></td> <td style="width: 10%;"></td> <td style="width: 10%;"></td> <td style="width: 10%;"></td> <td style="width: 10%;"></td> <td style="width: 10%;"></td> </tr> <tr> <td></td> <td></td> <td colspan="8" style="text-align: center;"> <table border="1" style="width: 100%; border-collapse: collapse; text-align: center;"> <tr> <td style="width: 10%;"></td> <td style="width: 10%;"></td> <td style="width: 10%;"></td> <td style="width: 10%;"></td> <td style="width: 10%;"></td> <td style="width: 10%;"></td> <td style="width: 10%;"></td> <td style="width: 10%;"></td> <td style="width: 10%;"></td> <td style="width: 10%;"></td> </tr> <tr> <td></td> <td></td> <td colspan="8" style="text-align: center;"> <table border="1" style="width: 100%; border-collapse: collapse; text-align: center;"> <tr> <td style="width: 10%;"></td> <td style="width: 10%;"></td> <td style="width: 10%;"></td> <td style="width: 10%;"></td> <td style="width: 10%;"></td> <td style="width: 10%;"></td> <td style="width: 10%;"></td> <td style="width: 10%;"></td> <td style="width: 10%;"></td> <td style="width: 10%;"></td> </tr> <tr> <td></td> <td></td> <td colspan="8" style="text-align: center;"> <table border="1" style="width: 100%; border-collapse: collapse; text-align: center;"> <tr> <td style="width: 10%;"></td> <td style="width: 10%;"></td> <td style="width: 10%;"></td> <td style="width: 10%;"></td> <td style="width: 10%;"></td> <td style="width: 10%;"></td> <td style="width: 10%;"></td> <td style="width: 10%;"></td> <td style="width: 10%;"></td> <td style="width: 10%;"></td> </tr> <tr> <td></td> <td></td> <td colspan="8" style="text-align: center;"> <table border="1" style="width: 100%; border-collapse: collapse; text-align: center;"> <tr> <td style="width: 10%;"></td> <td style="width: 10%;"></td> <td style="width: 10%;"></td> <td style="width: 10%;"></td> <td style="width: 10%;"></td> <td style="width: 10%;"></td> <td style="width: 10%;"></td> <td style="width: 10%;"></td> <td style="width: 10%;"></td> <td style="width: 10%;"></td> </tr> <tr> <td></td> <td></td> <td colspan="8" style="text-align: center;"> <table border="1" style="width: 100%; border-collapse: collapse; text-align: center;"> <tr> <td style="width: 10%;"></td> <td style="width: 10%;"></td> <td style="width: 10%;"></td> <td style="width: 10%;"></td> <td style="width: 10%;"></td> <td style="width: 10%;"></td> <td style="width: 10%;"></td> <td style="width: 10%;"></td> <td style="width: 10%;"></td> <td style="width: 10%;"></td> </tr> <tr> <td></td> <td></td> <td colspan="8" style="text-align: center;"> <table border="1" style="width: 100%; border-collapse: collapse; text-align: center;"> <tr> <td style="width: 10%;"></td> <td style="width: 10%;"></td> <td style="width: 10%;"></td> <td style="width: 10%;"></td> <td style="width: 10%;"></td> <td style="width: 10%;"></td> <td style="width: 10%;"></td> <td style="width: 10%;"></td> <td style="width: 10%;"></td> <td style="width: 10%;"></td> </tr> <tr> <td></td> <td></td> <td colspan="8" style="text-align: center;"> <table border="1" style="width: 100%; border-collapse: collapse; text-align: center;"> <tr> <td style="width: 10%;"></td> <td style="width: 10%;"></td> <td style="width: 10%;"></td> <td style="width: 10%;"></td> <td style="width: 10%;"></td> <td style="width: 10%;"></td> <td style="width: 10%;"></td> <td style="width: 10%;"></td> <td style="width: 10%;"></td> <td style="width: 10%;"></td> </tr> <tr> <td></td> <td></td> <td colspan="8" style="text-align: center;"> <table border="1" style="width: 100%; border-collapse: collapse; text-align: center;"> <tr> <td style="width: 10%;"></td> <td style="width: 10%;"></td> <td style="width: 10%;"></td> <td style="width: 10%;"></td> <td style="width: 10%;"></td> <td style="width: 10%;"></td> <td style="width: 10%;"></td> <td style="width: 10%;"></td> <td style="width: 10%;"></td> <td style="width: 10%;"></td> </tr> <tr> <td></td> <td></td> <td colspan="8" style="text-align: center;"> <table border="1" style="width: 100%; border-collapse: collapse; text-align: center;"> <tr> <td style="width: 10%;"></td> <td style="width: 10%;"></td> <td style="width: 10%;"></td> <td style="width: 10%;"></td> <td style="width: 10%;"></td> <td style="width: 10%;"></td> <td style="width: 10%;"></td> <td style="width: 10%;"></td> <td style="width: 10%;"></td> <td style="width: 10%;"></td> </tr> <tr> <td></td> <td></td> <td colspan="8" style="text-align: center;"> <table border="1" style="width: 100%; border-collapse: collapse; text-align: center;"> <tr> <td style="width: 10%;"></td> <td style="width: 10%;"></td> <td style="width: 10%;"></td> <td style="width: 10%;"></td> <td style="width: 10%;"></td> <td style="width: 10%;"></td> <td style="width: 10%;"></td> <td style="width: 10%;"></td> <td style="width: 10%;"></td> <td style="width: 10%;"></td> </tr> <tr> <td></td> <td></td> <td colspan="8" style="text-align: center;"> <table border="1" style="width: 100%; border-collapse: collapse; text-align: center;"> <tr> <td style="width: 10%;"></td> <td style="width: 10%;"></td> <td style="width: 10%;"></td> <td style="width: 10%;"></td> <td style="width: 10%;"></td> <td style="width: 10%;"></td> <td style="width: 10%;"></td> <td style="width: 10%;"></td> <td style="width: 10%;"></td> <td style="width: 10%;"></td> </tr> <tr> <td></td> <td></td> <td colspan="8" style="text-align: center;"> <table border="1" style="width: 100%; border-collapse: collapse; text-align: center;"> <tr> <td style="width: 10%;"></td> <td style="width: 10%;"></td> <td style="width: 10%;"></td> <td style="width: 10%;"></td> <td style="width: 10%;"></td> <td style="width: 10%;"></td> <td style="width: 10%;"></td> <td style="width: 10%;"></td> <td style="width: 10%;"></td> <td style="width: 10%;"></td> </tr> <tr> <td></td> <td></td> <td colspan="8" style="text-align: center;"> <table border="1" style="width: 100%; border-collapse: collapse; text-align: center;"> <tr> <td style="width: 10%;"></td> <td style="width: 10%;"></td> <td style="width: 10%;"></td> <td style="width: 10%;"></td> <td style="width: 10%;"></td> <td style="width: 10%;"></td> <td style="width: 10%;"></td> <td style="width: 10%;"></td> <td style="width: 10%;"></td> <td style="width: 10%;"></td> </tr> <tr> <td></td> <td></td> <td colspan="8" style="text-align: center;"> <table border="1" style="width: 100%; border-collapse: collapse; text-align: center;"> <tr> <td style="width: 10%;"></td> <td style="width: 10%;"></td> <td style="width: 10%;"></td> <td style="width: 10%;"></td> <td style="width: 10%;"></td> <td style="width: 10%;"></td> <td style="width: 10%;"></td> <td style="width: 10%;"></td> <td style="width: 10%;"></td> <td style="width: 10%;"></td> </tr> <tr>
<td></td> <td></td> <td colspan="8" style="text-align: center;"> <table border="1" style="width: 100%; border-collapse: collapse; text-align: center;"> <tr> <td style="width: 10%;"></td> <td style="width: 10%;"></td> <td style="width: 10%;"></td> <td style="width: 10%;"></td> <td style="width: 10%;"></td> <td style="width: 10%;"></td> <td style="width: 10%;"></td> <td style="width: 10%;"></td> <td style="width: 10%;"></td> <td style="width: 10%;"></td> </tr> <tr> <td></td> <td></td> <td colspan="8" style="text-align: center;"> <table border="1" style="width: 100%; border-collapse: collapse; text-align: center;"> <tr> <td style="width: 10%;"></td> <td style="width: 10%;"></td> <td style="width: 10%;"></td> <td style="width: 10%;"></td> <td style="width: 10%;"></td> <td style="width: 10%;"></td> <td style="width: 10%;"></td> <td style="width: 10%;"></td> <td style="width: 10%;"></td> <td style="width: 10%;"></td> </tr> <tr> <td></td> <td></td> <td colspan="8" style="text-align: center;"> <table border="1" style="width: 100%; border-collapse: collapse; text-align: center;"> <tr> <td style="width: 10%;"></td> <td style="width: 10%;"></td> <td style="width: 10%;"></td> <td style="width: 10%;"></td> <td style="width: 10%;"></td> <td style="width: 10%;"></td> <td style="width: 10%;"></td> <td style="width: 10%;"></td> <td style="width: 10%;"></td> <td style="width: 10%;"></td> </tr> <tr> <td></td> <td></td> <td colspan="8" style="text-align: center;"> <table border="1" style="width: 100%; border-collapse: collapse; text-align: center;"> <tr> <td style="width: 10%;"></td> <td style="width: 10%;"></td> <td style="width: 10%;"></td> <td style="width: 10%;"></td> <td style="width: 10%;"></td> <td style="width: 10%;"></td> <td style="width: 10%;"></td> <td style="width: 10%;"></td> <td style="width: 10%;"></td> <td style="width: 10%;"></td> </tr> <tr> <td></td> <td></td> <td colspan="8" style="text-align: center;"> <table border="1" style="width: 100%; border-collapse: collapse; text-align: center;"> <tr> <td style="width: 10%;"></td> <td style="width: 10%;"></td> <td style="width: 10%;"></td> <td style="width: 10%;"></td> <td style="width: 10%;"></td> <td style="width: 10%;"></td> <td style="width: 10%;"></td> <td style="width: 10%;"></td> <td style="width: 10%;"></td> <td style="width: 10%;"></td> </tr> <tr> <td></td> <td></td> <td colspan="8" style="text-align: center;"> <table border="1" style="width: 100%; border-collapse: collapse; text-align: center;"> <tr> <td style="width: 10%;"></td> <td style="width: 10%;"></td> <td style="width: 10%;"></td> <td style="width: 10%;"></td> <td style="width: 10%;"></td> <td style="width: 10%;"></td> <td style="width: 10%;"></td> <td style="width: 10%;"></td> <td style="width: 10%;"></td> <td style="width: 10%;"></td> </tr> <tr> <td></td> <td></td> <td colspan="8" style="text-align: center;"> <table border="1" style="width: 100%; border-collapse: collapse; text-align: center;"> <tr> <td style="width: 10%;"></td> <td style="width: 10%;"></td> <td style="width: 10%;"></td> <td style="width: 10%;"></td> <td style="width: 10%;"></td> <td style="width: 10%;"></td> <td style="width: 10%;"></td> <td style="width: 10%;"></td> <td style="width: 10%;"></td> <td style="width: 10%;"></td> </tr> <tr> <td></td> <td></td> <td colspan="8" style="text-align: center;"> <table border="1" style="width: 100%; border-collapse: collapse; text-align: center;"> <tr> <td style="width: 10%;"></td> <td style="width: 10%;"></td> <td style="width: 10%;"></td> <td style="width: 10%;"></td> <td style="width: 10%;"></td> <td style="width: 10%;"></td> <td style="width: 10%;"></td> <td style="width: 10%;"></td> <td style="width: 10%;"></td> <td style="width: 10%;"></td> </tr> <tr> <td></td> <td></td> <td colspan="8" style="text-align: center;"> <table border="1" style="width: 100%; border-collapse: collapse; text-align: center;"> <tr> <td style="width: 10%;"></td> <td style="width: 10%;"></td> <td style="width: 10%;"></td> <td style="width: 10%;"></td> <td style="width: 10%;"></td> <td style="width: 10%;"></td> <td style="width: 10%;"></td> <td style="width: 10%;"></td> <td style="width: 10%;"></td> <td style="width: 10%;"></td> </tr> <tr> <td></td> <td></td> <td colspan="8" style="text-align: center;"> <table border="1" style="width: 100%; border-collapse: collapse; text-align: center;"> <tr> <td style="width: 10%;"></td> <td style="width: 10%;"></td> <td style="width: 10%;"></td> <td style="width: 10%;"></td> <td style="width: 10%;"></td> <td style="width: 10%;"></td> <td style="width: 10%;"></td> <td style="width: 10%;"></td> <td style="width: 10%;"></td> <td style="width: 10%;"></td> </tr> <tr> <td></td> <td></td> <td colspan="8" style="text-align: center;"> <table border="1" style="width: 100%; border-collapse: collapse; text-align: center;"> <tr> <td style="width: 10%;"></td> <td style="width: 10%;"></td> <td style="width: 10%;"></td> <td style="width: 10%;"></td> <td style="width: 10%;"></td> <td style="width: 10%;"></td> <td style="width: 10%;"></td> <td style="width: 10%;"></td> <td style="width: 10%;"></td> <td style="width: 10%;"></td> </tr> <tr> <td></td> <td></td> <td colspan="8" style="text-align: center;"> <table border="1" style="width: 100%; border-collapse: collapse; text-align: center;"> <tr> <td style="width: 10%;"></td> <td style="width: 10%;"></td> <td style="width: 10%;"></td> <td style="width: 10%;"></td> <td style="width: 10%;"></td> <td style="width: 10%;"></td> <td style="width: 10%;"></td> <td style="width: 10%;"></td> <td style="width: 10%;"></td> <td style="width: 10%;"></td> </tr> <tr> <td></td> <td></td> <td colspan="8" style="text-align: center;"> <table border="1" style="width: 100%; border-collapse: collapse; text-align: center;"> <tr> <td style="width: 10%;"></td> <td style="width: 10%;"></td> <td style="width: 10%;"></td> <td style="width: 10%;"></td> <td style="width: 10%;"></td> <td style="width: 10%;"></td> <td style="width: 10%;"></td> <td style="width: 10%;"></td> <td style="width: 10%;"></td> <td style="width: 10%;"></td> </tr> <tr> <td></td> <td></td> <td colspan="8" style="text-align: center;"> <table border="1" style="width: 100%; border-collapse: collapse; text-align: center;"> <tr> <td style="width: 10%;"></td> <td style="width: 10%;"></td> <td style="width: 10%;"></td> <td style="width: 10%;"></td> <td style="width: 10%;"></td> <td style="width: 10%;"></td> <td style="width: 10%;"></td> <td style="width: 10%;"></td> <td style="width: 10%;"></td> <td style="width: 10%;"></td> </tr> <tr> <td></td> <td></td> <td colspan="8" style="text-align: center;"> <table border="1" style="width: 100%; border-collapse: collapse; text-align: center;"> <tr> <td style="width: 10%;"></td> <td style="width: 10%;"></td> <td style="width: 10%;"></td> <td style="width: 10%;"></td> <td style="width: 10%;"></td> <td style="width: 10%;"></td> <td style="width: 10%;"></td> <td style="width: 10%;"></td> <td style="width: 10%;"></td> <td style="width: 10%;"></td> </tr> <tr> <td></td> <td></td> <td colspan="8" style="text-align: center;"> <table border="1" style="width: 100%; border-collapse: collapse; text-align: center;"> <tr> <td style="width: 10%;"></td> <td style="width: 10%;"></td> <td style="width: 10%;"></td> <td style="width: 10%;"></td> <td style="width: 10%;"></td> <td style="width: 10%;"></td> <td style="width: 10%;"></td> <td style="width: 10%;"></td> <td style="width: 10%;"></td> <td style="width: 10%;"></td> </tr> <tr> <td></td> <td></td> <td colspan="8" style="text-align: center;"> <table border="1" style="width: 100%; border-collapse: collapse; text-align: center;"> <tr> <td style="width: 10%;"></td> <td style="width: 10%;"></td> <td style="width: 10%;"></td> <td style="width: 10%;"></td> <td style="width: 10%;"></td> <td style="width: 10%;"></td> <td style="width: 10%;"></td> <td style="width: 10%;"></td> <td style="width: 10%;"></td> <td style="width: 10%;"></td> </tr> <tr> <td></td> <td></td> <td colspan="8" style="text-align: center;"> <table border="1" style="width: 100%; border-collapse: collapse; text-align: center;"> <tr> <td style="width: 10%;"></td> <td style="width: 10%;"></td> <td style="width: 10%;"></td> <td style="width: 10%;"></td> <td style="width: 10%;"></td> <td style="width: 10%;"></td> <td style="width: 10%;"></td> <td style="width: 10%;"></td> <td style="width: 10%;"></td> <td style="width: 10%;"></td> </tr> <tr> <td></td> <td></td> <td colspan="8" style="text-align: center;"> <table border="1" style="width: 100%; border-collapse: collapse; text-align: center;"> <tr> <td style="width: 10%;"></td> <td style="width: 10%;"></td> <td style="width: 10%;"></td> <td style="width: 10%;"></td> <td style="width: 10%;"></td> <td style="width: 10%;"></td> <td style="width: 10%;"></td> <td style="width: 10%;"></td> <td style="width: 10%;"></td> <td style="width: 10%;"></td> </tr> <tr> <td></td> <td></td> <td colspan="8" style="text-align: center;"> <table border="1" style="width: 100%; border-collapse: collapse; text-align: center;"> <tr> <td style="width: 10%;"></td> <td style="width: 10%;"></td> <td style="width: 10%;"></td> <td style="width: 10%;"></td> <td style="width: 10%;"></td> <td style="width: 10%;"></td> <td style="width: 10%;"></td> <td style="width: 10%;"></td> <td style="width: 10%;"></td> <td style="width: 10%;"></td> </tr> <tr> <td></td> <td></td> <td colspan="8" style="text-align: center;"> <table border="1" style="width: 100%; border-collapse: collapse; text-align: center;"> <tr> <td style="width: 10%;"></td> <td style="width: 10%;"></td> <td style="width: 10%;"></td> <td style="width: 10%;"></td> <td style="width: 10%;"></td> <td style="width: 10%;"></td> <td style="width: 10%;"></td> <td style="width: 10%;"></td> <td style="width: 10%;"></td> <td style="width: 10%;"></td> </tr> <tr> <td></td> <td></td> <td colspan="8" style="text-align: center;"> <table border="1" style="width: 100%; border-collapse: collapse; text-align: center;"> <tr> <td
style="width: 10%;"></td> <td style="width: 10%;"></td> <td style="width: 10%;"></td> <td style="width: 10%;"></td> <td style="width: 10%;"></td> <td style="width: 10%;"></td> <td style="width: 10%;"></td> <td style="width: 10%;"></td> <td style="width: 10%;"></td> <td style="width: 10%;"></td> </tr> <tr> <td></td> <td></td> <td colspan="8" style="text-align: center;"> <table border="1" style="width: 100%; border-collapse: collapse; text-align: center;"> <tr> <td style="width: 10%;"></td> <td style="width: 10%;"></td> <td style="width: 10%;"></td> <td style="width: 10%;"></td> <td style="width: 10%;"></td> <td style="width: 10%;"></td> <td style="width: 10%;"></td> <td style="width: 10%;"></td> <td style="width: 10%;"></td> <td style="width: 10%;"></td> </tr> <tr> <td></td> <td></td> <td colspan="8" style="text-align: center;"> <table border="1" style="width: 100%; border-collapse: collapse; text-align: center;"> <tr> <td style="width: 10%;"></td> <td style="width: 10%;"></td> <td style="width: 10%;"></td> <td style="width: 10%;"></td> <td style="width: 10%;"></td> <td style="width: 10%;"></td> <td style="width: 10%;"></td> <td style="width: 10%;"></td> <td style="width: 10%;"></td> <td style="width: 10%;"></td> </tr> <tr> <td></td> <td></td> <td colspan="8" style="text-align: center;"> <table border="1" style="width: 100%; border-collapse: collapse; text-align: center;"> <tr> <td style="width: 10%;"></td> <td style="width: 10%;"></td> <td style="width: 10%;"></td> <td style="width: 10%;"></td> <td style="width: 10%;"></td> <td style="width: 10%;"></td> <td style="width: 10%;"></td> <td style="width: 10%;"></td> <td style="width: 10%;"></td> <td style="width: 10%;"></td> </tr> <tr> <td></td> <td></td> <td colspan="8" style="text-align: center;"> <table border="1" style="width: 100%; border-collapse: collapse; text-align: center;"> <tr> <td style="width: 10%;"></td> <td style="width: 10%;"></td> <td style="width: 10%;"></td> <td style="width: 10%;"></td> <td style="width: 10%;"></td> <td style="width: 10%;"></td> <td style="width: 10%;"></td> <td style="width: 10%;"></td> <td style="width: 10%;"></td> <td style="width: 10%;"></td> </tr> <tr> <td></td> <td></td> <td colspan="8" style="text-align: center;"> <table border="1" style="width: 100%; border-collapse: collapse; text-align: center;"> <tr> <td style="width: 10%;"></td> <td style="width: 10%;"></td> <td style="width: 10%;"></td> <td style="width: 10%;"></td> <td style="width: 10%;"></td> <td style="width: 10%;"></td> <td style="width: 10%;"></td> <td style="width: 10%;"></td> <td style="width: 10%;"></td> <td style="width: 10%;"></td> </tr> <tr> <td></td> <td></td> <td colspan="8" style="text-align: center;"> <table border="1" style="width: 100%; border-collapse: collapse; text-align: center;"> <tr> <td style="width: 10%;"></td> <td style="width: 10%;"></td> <td style="width: 10%;"></td> <td style="width: 10%;"></td> <td style="width: 10%;"></td> <td style="width: 10%;"></td> <td style="width: 10%;"></td> <td style="width: 10%;"></td> <td style="width: 10%;"></td> <td style="width: 10%;"></td> </tr> <tr> <td></td> <td></td> <td colspan="8" style="text-align: center;"> <table border="1" style="width: 100%; border-collapse: collapse; text-align: center;"> <tr> <td style="width: 10%;"></td> <td style="width: 10%;"></td> <td style="width: 10%;"></td> <td style="width: 10%;"></td> <td style="width: 10%;"></td> <td style="width: 10%;"></td> <td style="width: 10%;"></td> <td style="width: 10%;"></td> <td style="width: 10%;"></td> <td style="width: 10%;"></td> </tr> <tr> <td></td> <td></td> <td colspan="8" style="text-align: center;"> <table border="1" style="width: 100%; border-collapse: collapse; text-align: center;"> <tr> <td style="width: 10%;"></td> <td style="width: 10%;"></td> <td style="width: 10%;"></td> <td style="width: 10%;"></td> <td style="width: 10%;"></td> <td style="width: 10%;"></td> <td style="width: 10%;"></td> <td style="width: 10%;"></td> <td style="width: 10%;"></td> <td style="width: 10%;"></td> </tr> <tr> <td></td> <td></td> <td colspan="8" style="text-align: center;"> <table border="1" style="width: 100%; border-collapse: collapse; text-align: center;"> <tr> <td style="width: 10%;"></td> <td style="width: 10%;"></td> <td style="width: 10%;"></td> <td style="width: 10%;"></td> <td style="width: 10%;"></td> <td style="width: 10%;"></td> <td style="width: 10%;"></td> <td style="width: 10%;"></td> <td style="width: 10%;"></td> <td style="width: 10%;"></td> </tr> <tr> <td></td> <td></td> <td colspan="8" style="text-align: center;"> <table border="1" style="width: 100%; border-collapse: collapse; text-align: center;"> <tr> <td style="width: 10%;"></td> <td style="width: 10%;"></td> <td style="width: 10%;"></td> <td style="width: 10%;"></td> <td style="width: 10%;"></td> <td style="width: 10%;"></td> <td style="width: 10%;"></td> <td style="width: 10%;"></td> <td style="width: 10%;"></td> <td style="width: 10%;"></td> </tr> <tr> <td></td> <td></td> <td colspan="8" style="text-align: center;"> <table border="1" style="width: 100%; border-collapse: collapse; text-align: center;"> <tr> <td style="width: 10%;"></td> <td style="width: 10%;"></td> <td style="width: 10%;"></td> <td style="width: 10%;"></td> <td style="width: 10%;"></td> <td style="width: 10%;"></td> <td style="width: 10%;"></td> <td style="width: 10%;"></td> <td style="width: 10%;"></td> <td style="width: 10%;"></td> </tr> <tr> <td></td> <td></td> <td colspan="8" style="text-align: center;"> <table border="1" style="width: 100%; border-collapse: collapse; text-align: center;"> <tr> <td style="width: 10%;"></td> <td style="width: 10%;"></td> <td style="width: 10%;"></td> <td style="width: 10%;"></td> <td style="width: 10%;"></td> <td style="width: 10%;"></td> <td style="width: 10%;"></td> <td style="width: 10%;"></td> <td style="width: 10%;"></td> <td style="width: 10%;"></td> </tr> <tr> <td></td> <td></td> <td colspan="8" style="text-align: center;"> <table border="1" style="width: 100%; border-collapse: collapse; text-align: center;"> <tr> <td style="width: 10%;"></td> <td style="width: 10%;"></td> <td style="width: 10%;"></td> <td style="width: 10%;"></td> <td style="width: 10%;"></td> <td style="width: 10%;"></td> <td style="width: 10%;"></td> <td style="width: 10%;"></td> <td style="width: 10%;"></td> <td style="width: 10%;"></td> </tr> <tr> <td></td> <td></td> <td colspan="8" style="text-align: center;"> <table border="1" style="width: 100%; border-collapse: collapse; text-align: center;"> <tr> <td style="width: 10%;"></td> <td style="width: 10%;"></td> <td style="width: 10%;"></td> <td style="width: 10%;"></td> <td style="width: 10%;"></td> <td style="width: 10%;"></td> <td style="width: 10%;"></td> <td style="width: 10%;"></td> <td style="width: 10%;"></td> <td style="width: 10%;"></td> </tr> <tr> <td></td> <td></td> <td colspan="8" style="text-align: center;"> <table border="1" style="width: 100%; border-collapse: collapse; text-align: center;"> <tr> <td style="width: 10%;"></td> <td style="width: 10%;"></td> <td style="width: 10%;"></td> <td style="width: 10%;"></td> <td style="width: 10%;"></td> <td style="width: 10%;"></td> <td style="width: 10%;"></td> <td style="width: 10%;"></td> <td style="width: 10%;"></td> <td style="width: 10%;"></td> </tr> <tr> <td></td> <td></td> <td colspan="8" style="text-align: center;"> <table border="1" style="width: 100%; border-collapse: collapse; text-align: center;"> <tr> <td style="width: 10%;"></td> <td style="width: 10%;"></td> <td style="width: 10%;"></td> <td style="width: 10%;"></td> <td style="width: 10%;"></td> <td style="width: 10%;"></td> <td style="width: 10%;"></td> <td style="width: 10%;"></td> <td style="width: 10%;"></td> <td style="width: 10%;"></td> </tr> <tr> <td></td> <td></td> <td colspan="8" style="text-align: center;"> <table border="1" style="width: 100%; border-collapse: collapse; text-align: center;"> <tr> <td style="width: 10%;"></td> <td style="width: 10%;"></td> <td style="width: 10%;"></td> <td style="width: 10%;"></td> <td style="width: 10%;"></td> <td style="width: 10%;"></td> <td style="width: 10%;"></td> <td style="width: 10%;"></td> <td style="width: 10%;"></td> <td style="width: 10%;"></td> </tr> <tr> <td></td> <td></td> <td colspan="8" style="text-align: center;"> <table border="1" style="width: 100%; border-collapse: collapse; text-align: center;"> <tr> <td style="width: 10%;"></td> <td style="width: 10%;"></td> <td style="width: 10%;"></td> <td style="width: 10%;"></td> <td style="width: 10%;"></td> <td style="width: 10%;"></td> <td style="width: 10%;"></td> <td style="width: 10%;"></td> <td style="width: 10%;"></td> <td style="width: 10%;"></td> </tr> <tr> <td></td> <td></td> <td colspan="8" style="text-align: center;"> <table border="1" style="width: 100%; border-collapse: collapse; text-align: center;"> <tr> </tr></table></td></tr></table></td></tr></table></td></tr></table></td></tr></table></td></tr></table></td></tr></table></td></tr></table></td></tr></table></td></tr></table></td></tr></table></td></tr></table></td></tr></table></td></tr></table></td></tr></table></td></tr></table></td></tr></table></td></tr></table></td></tr></table></td></tr></table></td></tr></table></td></tr></table></td></tr></table></td></tr></table></td></tr></table></td></tr></table></td></tr></table></td></tr></table></td></tr></table></td></tr></table></td></tr></table></td></tr></table></td></tr></table></td></tr></table></td></tr></table></td></tr></table></td></tr></table></td></tr></table></td></tr></table></td></tr></table></td></tr></table></td></tr></table></td></tr></table></td></tr></table></td></tr></table></td></tr></table></td></tr></table></td></tr></table></td></tr></table></td></tr></table></td></tr></table></td></tr></table></td></tr></table></td></tr></table></td></tr></table></td></tr></table></td></tr></table></td></tr></table>
 | | | | | | | | | | | | | | | | | | | | <table border="1" style="width: 100%; border-collapse: collapse; text-align: center;"> <tr> <td style="width: 10%;"></td> <td style="width: 10%;"></td> <td style="width: 10%;"></td> <td style="width: 10%;"></td> <td style="width: 10%;"></td> <td style="width: 10%;"></td> <td style="width: 10%;"></td> <td style="width: 10%;"></td> <td style="width: 10%;"></td> <td style="width: 10%;"></td> </tr> <tr> <td></td> <td></td> <td colspan="8" style="text-align: center;"> <table border="1" style="width: 100%; border-collapse: collapse; text-align: center;"> <tr> <td style="width: 10%;"></td> <td style="width: 10%;"></td> <td style="width: 10%;"></td> <td style="width: 10%;"></td> <td style="width: 10%;"></td> <td style="width: 10%;"></td> <td style="width: 10%;"></td> <td style="width: 10%;"></td> <td style="width: 10%;"></td> <td style="width: 10%;"></td> </tr> <tr> <td></td> <td></td> <td colspan="8" style="text-align: center;"> <table border="1" style="width: 100%; border-collapse: collapse; text-align: center;"> <tr> <td style="width: 10%;"></td> <td style="width: 10%;"></td> <td style="width: 10%;"></td> <td style="width: 10%;"></td> <td style="width: 10%;"></td> <td style="width: 10%;"></td> <td style="width: 10%;"></td> <td style="width: 10%;"></td> <td style="width: 10%;"></td> <td style="width: 10%;"></td> </tr> <tr> <td></td> <td></td> <td colspan="8" style="text-align: center;"> <table border="1" style="width: 100%; border-collapse: collapse; text-align: center;"> <tr> <td style="width: 10%;"></td> <td style="width: 10%;"></td> <td style="width: 10%;"></td> <td style="width: 10%;"></td> <td style="width: 10%;"></td> <td style="width: 10%;"></td> <td style="width: 10%;"></td> <td style="width: 10%;"></td> <td style="width: 10%;"></td> <td style="width: 10%;"></td> </tr> <tr> <td></td> <td></td> <td colspan="8" style="text-align: center;"> <table border="1" style="width: 100%; border-collapse: collapse; text-align: center;"> <tr> <td style="width: 10%;"></td> <td style="width: 10%;"></td> <td style="width: 10%;"></td> <td style="width: 10%;"></td> <td style="width: 10%;"></td> <td style="width: 10%;"></td> <td style="width: 10%;"></td> <td style="width: 10%;"></td> <td style="width: 10%;"></td> <td style="width: 10%;"></td> </tr> <tr> <td></td> <td></td> <td colspan="8" style="text-align: center;"> <table border="1" style="width: 100%; border-collapse: collapse; text-align: center;"> <tr> <td style="width: 10%;"></td> <td style="width: 10%;"></td> <td style="width: 10%;"></td> <td style="width: 10%;"></td> <td style="width: 10%;"></td> <td style="width: 10%;"></td> <td style="width: 10%;"></td> <td style="width: 10%;"></td> <td style="width: 10%;"></td> <td style="width: 10%;"></td> </tr> <tr> <td></td> <td></td> <td colspan="8" style="text-align: center;"> <table border="1" style="width: 100%; border-collapse: collapse; text-align: center;"> <tr> <td style="width: 10%;"></td> <td style="width: 10%;"></td> <td style="width: 10%;"></td> <td style="width: 10%;"></td> <td style="width: 10%;"></td> <td style="width: 10%;"></td> <td style="width: 10%;"></td> <td style="width: 10%;"></td> <td style="width: 10%;"></td> <td style="width: 10%;"></td> </tr> <tr> <td></td> <td></td> <td colspan="8" style="text-align: center;"> <table border="1" style="width: 100%; border-collapse: collapse; text-align: center;"> <tr> <td style="width: 10%;"></td> <td style="width: 10%;"></td> <td style="width: 10%;"></td> <td style="width: 10%;"></td> <td style="width: 10%;"></td> <td style="width: 10%;"></td> <td style="width: 10%;"></td> <td style="width: 10%;"></td> <td style="width: 10%;"></td> <td style="width: 10%;"></td> </tr> <tr> <td></td> <td></td> <td colspan="8" style="text-align: center;"> <table border="1" style="width: 100%; border-collapse: collapse; text-align: center;"> <tr> <td style="width: 10%;"></td> <td style="width: 10%;"></td> <td style="width: 10%;"></td> <td style="width: 10%;"></td> <td style="width: 10%;"></td> <td style="width: 10%;"></td> <td style="width: 10%;"></td> <td style="width: 10%;"></td> <td style="width: 10%;"></td> <td style="width: 10%;"></td> </tr> <tr> <td></td> <td></td> <td colspan="8" style="text-align: center;"> <table border="1" style="width: 100%; border-collapse: collapse; text-align: center;"> <tr> <td style="width: 10%;"></td> <td style="width: 10%;"></td> <td style="width: 10%;"></td> <td style="width: 10%;"></td> <td style="width: 10%;"></td> <td style="width: 10%;"></td> <td style="width: 10%;"></td> <td style="width: 10%;"></td> <td style="width: 10%;"></td> <td style="width: 10%;"></td> </tr> <tr> <td></td> <td></td> <td colspan="8" style="text-align: center;"> <table border="1" style="width: 100%; border-collapse: collapse; text-align: center;"> <tr> <td style="width: 10%;"></td> <td style="width: 10%;"></td> <td style="width: 10%;"></td> <td style="width: 10%;"></td> <td style="width: 10%;"></td> <td style="width: 10%;"></td> <td style="width: 10%;"></td> <td style="width: 10%;"></td> <td style="width: 10%;"></td> <td style="width: 10%;"></td> </tr> <tr> <td></td> <td></td> <td colspan="8" style="text-align: center;"> <table border="1" style="width: 100%; border-collapse: collapse; text-align: center;"> <tr> <td style="width: 10%;"></td> <td style="width: 10%;"></td> <td style="width: 10%;"></td> <td style="width: 10%;"></td> <td style="width: 10%;"></td> <td style="width: 10%;"></td> <td style="width: 10%;"></td> <td style="width: 10%;"></td> <td style="width: 10%;"></td> <td style="width: 10%;"></td> </tr> <tr> <td></td> <td></td> <td colspan="8" style="text-align: center;"> <table border="1" style="width: 100%; border-collapse: collapse; text-align: center;"> <tr> <td style="width: 10%;"></td> <td style="width: 10%;"></td> <td style="width: 10%;"></td> <td style="width: 10%;"></td> <td style="width: 10%;"></td> <td style="width: 10%;"></td> <td style="width: 10%;"></td> <td style="width: 10%;"></td> <td style="width: 10%;"></td> <td style="width: 10%;"></td> </tr> <tr> <td></td> <td></td> <td colspan="8" style="text-align: center;"> <table border="1" style="width: 100%; border-collapse: collapse; text-align: center;"> <tr> <td style="width: 10%;"></td> <td style="width: 10%;"></td> <td style="width: 10%;"></td> <td style="width: 10%;"></td> <td style="width: 10%;"></td> <td style="width: 10%;"></td> <td style="width: 10%;"></td> <td style="width: 10%;"></td> <td style="width: 10%;"></td> <td style="width: 10%;"></td> </tr> <tr> <td></td> <td></td> <td colspan="8" style="text-align: center;"> <table border="1" style="width: 100%; border-collapse: collapse; text-align: center;"> <tr> <td style="width: 10%;"></td> <td style="width: 10%;"></td> <td style="width: 10%;"></td> <td style="width: 10%;"></td> <td style="width: 10%;"></td> <td style="width: 10%;"></td> <td style="width: 10%;"></td> <td style="width: 10%;"></td> <td style="width: 10%;"></td> <td style="width: 10%;"></td> </tr> <tr> <td></td> <td></td> <td colspan="8" style="text-align: center;"> <table border="1" style="width: 100%; border-collapse: collapse; text-align: center;"> <tr> <td style="width: 10%;"></td> <td style="width: 10%;"></td> <td style="width: 10%;"></td> <td style="width: 10%;"></td> <td style="width: 10%;"></td> <td style="width: 10%;"></td> <td style="width: 10%;"></td> <td style="width: 10%;"></td> <td style="width: 10%;"></td> <td style="width: 10%;"></td> </tr> <tr> <td></td> <td></td> <td colspan="8" style="text-align: center;"> <table border="1" style="width: 100%; border-collapse: collapse; text-align: center;"> <tr>
<td style="width: 10%;"></td> <td style="width: 10%;"></td> <td style="width: 10%;"></td> <td style="width: 10%;"></td> <td style="width: 10%;"></td> <td style="width: 10%;"></td> <td style="width: 10%;"></td> <td style="width: 10%;"></td> <td style="width: 10%;"></td> <td style="width: 10%;"></td> </tr> <tr> <td></td> <td></td> <td colspan="8" style="text-align: center;"> <table border="1" style="width: 100%; border-collapse: collapse; text-align: center;"> <tr> <td style="width: 10%;"></td> <td style="width: 10%;"></td> <td style="width: 10%;"></td> <td style="width: 10%;"></td> <td style="width: 10%;"></td> <td style="width: 10%;"></td> <td style="width: 10%;"></td> <td style="width: 10%;"></td> <td style="width: 10%;"></td> <td style="width: 10%;"></td> </tr> <tr> <td></td> <td></td> <td colspan="8" style="text-align: center;"> <table border="1" style="width: 100%; border-collapse: collapse; text-align: center;"> <tr> <td style="width: 10%;"></td> <td style="width: 10%;"></td> <td style="width: 10%;"></td> <td style="width: 10%;"></td> <td style="width: 10%;"></td> <td style="width: 10%;"></td> <td style="width: 10%;"></td> <td style="width: 10%;"></td> <td style="width: 10%;"></td> <td style="width: 10%;"></td> </tr> <tr> <td></td> <td></td> <td colspan="8" style="text-align: center;"> <table border="1" style="width: 100%; border-collapse: collapse; text-align: center;"> <tr> <td style="width: 10%;"></td> <td style="width: 10%;"></td> <td style="width: 10%;"></td> <td style="width: 10%;"></td> <td style="width: 10%;"></td> <td style="width: 10%;"></td> <td style="width: 10%;"></td> <td style="width: 10%;"></td> <td style="width: 10%;"></td> <td style="width: 10%;"></td> </tr> <tr> <td></td> <td></td> <td colspan="8" style="text-align: center;"> <table border="1" style="width: 100%; border-collapse: collapse; text-align: center;"> <tr> <td style="width: 10%;"></td> <td style="width: 10%;"></td> <td style="width: 10%;"></td> <td style="width: 10%;"></td> <td style="width: 10%;"></td> <td style="width: 10%;"></td> <td style="width: 10%;"></td> <td style="width: 10%;"></td> <td style="width: 10%;"></td> <td style="width: 10%;"></td> </tr> <tr> <td></td> <td></td> <td colspan="8" style="text-align: center;"> <table border="1" style="width: 100%; border-collapse: collapse; text-align: center;"> <tr> <td style="width: 10%;"></td> <td style="width: 10%;"></td> <td style="width: 10%;"></td> <td style="width: 10%;"></td> <td style="width: 10%;"></td> <td style="width: 10%;"></td> <td style="width: 10%;"></td> <td style="width: 10%;"></td> <td style="width: 10%;"></td> <td style="width: 10%;"></td> </tr> <tr> <td></td> <td></td> <td colspan="8" style="text-align: center;"> <table border="1" style="width: 100%; border-collapse: collapse; text-align: center;"> <tr> <td style="width: 10%;"></td> <td style="width: 10%;"></td> <td style="width: 10%;"></td> <td style="width: 10%;"></td> <td style="width: 10%;"></td> <td style="width: 10%;"></td> <td style="width: 10%;"></td> <td style="width: 10%;"></td> <td style="width: 10%;"></td> <td style="width: 10%;"></td> </tr> <tr> <td></td> <td></td> <td colspan="8" style="text-align: center;"> <table border="1" style="width: 100%; border-collapse: collapse; text-align: center;"> <tr> <td style="width: 10%;"></td> <td style="width: 10%;"></td> <td style="width: 10%;"></td> <td style="width: 10%;"></td> <td style="width: 10%;"></td> <td style="width: 10%;"></td> <td style="width: 10%;"></td> <td style="width: 10%;"></td> <td style="width: 10%;"></td> <td style="width: 10%;"></td> </tr> <tr> <td></td> <td></td> <td colspan="8" style="text-align: center;"> <table border="1" style="width: 100%; border-collapse: collapse; text-align: center;"> <tr> <td style="width: 10%;"></td> <td style="width: 10%;"></td> <td style="width: 10%;"></td> <td style="width: 10%;"></td> <td style="width: 10%;"></td> <td style="width: 10%;"></td> <td style="width: 10%;"></td> <td style="width: 10%;"></td> <td style="width: 10%;"></td> <td style="width: 10%;"></td> </tr> <tr> <td></td> <td></td> <td colspan="8" style="text-align: center;"> <table border="1" style="width: 100%; border-collapse: collapse; text-align: center;"> <tr> <td style="width: 10%;"></td> <td style="width: 10%;"></td> <td style="width: 10%;"></td> <td style="width: 10%;"></td> <td style="width: 10%;"></td> <td style="width: 10%;"></td> <td style="width: 10%;"></td> <td style="width: 10%;"></td> <td style="width: 10%;"></td> <td style="width: 10%;"></td> </tr> <tr> <td></td> <td></td> <td colspan="8" style="text-align: center;"> <table border="1" style="width: 100%; border-collapse: collapse; text-align: center;"> <tr> <td style="width: 10%;"></td> <td style="width: 10%;"></td> <td style="width: 10%;"></td> <td style="width: 10%;"></td> <td style="width: 10%;"></td> <td style="width: 10%;"></td> <td style="width: 10%;"></td> <td style="width: 10%;"></td> <td style="width: 10%;"></td> <td style="width: 10%;"></td> </tr> <tr> <td></td> <td></td> <td colspan="8" style="text-align: center;"> <table border="1" style="width: 100%; border-collapse: collapse; text-align: center;"> <tr> <td style="width: 10%;"></td> <td style="width: 10%;"></td> <td style="width: 10%;"></td> <td style="width: 10%;"></td> <td style="width: 10%;"></td> <td style="width: 10%;"></td> <td style="width: 10%;"></td> <td style="width: 10%;"></td> <td style="width: 10%;"></td> <td style="width: 10%;"></td> </tr> <tr> <td></td> <td></td> <td colspan="8" style="text-align: center;"> <table border="1" style="width: 100%; border-collapse: collapse; text-align: center;"> <tr> <td style="width: 10%;"></td> <td style="width: 10%;"></td> <td style="width: 10%;"></td> <td style="width: 10%;"></td> <td style="width: 10%;"></td> <td style="width: 10%;"></td> <td style="width: 10%;"></td> <td style="width: 10%;"></td> <td style="width: 10%;"></td> <td style="width: 10%;"></td> </tr> <tr> <td></td> <td></td> <td colspan="8" style="text-align: center;"> <table border="1" style="width: 100%; border-collapse: collapse; text-align: center;"> <tr> <td style="width: 10%;"></td> <td style="width: 10%;"></td> <td style="width: 10%;"></td> <td style="width: 10%;"></td> <td style="width: 10%;"></td> <td style="width: 10%;"></td> <td style="width: 10%;"></td> <td style="width: 10%;"></td> <td style="width: 10%;"></td> <td style="width: 10%;"></td> </tr> <tr> <td></td> <td></td> <td colspan="8" style="text-align: center;"> <table border="1" style="width: 100%; border-collapse: collapse; text-align: center;"> <tr> <td style="width: 10%;"></td> <td style="width: 10%;"></td> <td style="width: 10%;"></td> <td style="width: 10%;"></td> <td style="width: 10%;"></td> <td style="width: 10%;"></td> <td style="width: 10%;"></td> <td style="width: 10%;"></td> <td style="width: 10%;"></td> <td style="width: 10%;"></td> </tr> <tr> <td></td> <td></td> <td colspan="8" style="text-align: center;"> <table border="1" style="width: 100%; border-collapse: collapse; text-align: center;"> <tr> <td style="width: 10%;"></td> <td style="width: 10%;"></td> <td style="width: 10%;"></td> <td style="width: 10%;"></td> <td style="width: 10%;"></td> <td style="width: 10%;"></td> <td style="width: 10%;"></td> <td style="width: 10%;"></td> <td style="width: 10%;"></td> <td style="width: 10%;"></td> </tr> <tr> <td></td> <td></td> <td colspan="8" style="text-align: center;"> <table border="1" style="width: 100%; border-collapse: collapse; text-align: center;"> <tr> <td style="width: 10%;"></td> <td style="width: 10%;"></td> <td style="width: 10%;"></td> <td style="width: 10%;"></td> <td style="width: 10%;"></td> <td style="width: 10%;"></td> <td style="width: 10%;"></td> <td style="width: 10%;"></td> <td style="width: 10%;"></td> <td style="width: 10%;"></td> </tr> <tr> <td></td> <td></td> <td colspan="8" style="text-align: center;"> <table border="1" style="width: 100%; border-collapse: collapse; text-align: center;"> <tr> <td style="width: 10%;"></td> <td style="width: 10%;"></td> <td style="width: 10%;"></td> <td style="width: 10%;"></td> <td style="width: 10%;"></td> <td style="width: 10%;"></td> <td style="width: 10%;"></td> <td style="width: 10%;"></td> <td style="width: 10%;"></td> <td style="width: 10%;"></td> </tr> <tr> <td></td> <td></td> <td colspan="8" style="text-align: center;"> <table border="1" style="width: 100%; border-collapse: collapse; text-align: center;"> <tr> <td style="width: 10%;"></td> <td style="width: 10%;"></td> <td style="width: 10%;"></td> <td style="width: 10%;"></td> <td style="width: 10%;"></td> <td style="width: 10%;"></td> <td style="width: 10%;"></td> <td style="width: 10%;"></td> <td style="width: 10%;"></td> <td style="width: 10%;"></td> </tr> <tr> <td></td> <td></td> <td colspan="8" style="text-align: center;"> <table border="1" style="width: 100%; border-collapse: collapse; text-align: center;"> <tr> <td style="width: 10%;"></td> <td style="width: 10%;"></td> <td style="width: 10%;"></td> <td style="width: 10%;"></td> <td style="width: 10%;"></td> <td style="width: 10%;"></td> <td style="width: 10%;"></td> <td style="width: 10%;"></td> <td style="width: 10%;"></td> <td style="width: 10%;"></td> </tr> <tr> <td></td> <td></td> <td colspan="8" style="text-align: center;"> <table border="1" style="width: 100%; border-collapse: collapse; text-align: center;"> <tr> <td style="width: 10%;"></td> <td style="width: 10%;"></td> <td style="width: 10%;"></td> <td style="width: 10%;"></td> <td style="width: 10%;"></td> <td style="width: 10%;"></td> <td style="width: 10%;"></td> <td style="width: 10%;"></td> <td style="width: 10%;"></td> <td style="width: 10%;"></td> </tr> <tr> <td></td> <td></td> <td colspan="8" style="text-align: center;"> <table border="1" style="width: 100%; border-collapse: collapse; text-align: center;"> <tr> <td style="width: 10%;"></td> <td style="width: 10%;"></td> <td style="width: 10%;"></td> <td style="width: 10%;"></td> <td style="width: 10%;"></td> <td style="width:
10%;"></td> <td style="width: 10%;"></td> <td style="width: 10%;"></td> <td style="width: 10%;"></td> <td style="width: 10%;"></td> </tr> <tr> <td></td> <td></td> <td colspan="8" style="text-align: center;"> <table border="1" style="width: 100%; border-collapse: collapse; text-align: center;"> <tr> <td style="width: 10%;"></td> <td style="width: 10%;"></td> <td style="width: 10%;"></td> <td style="width: 10%;"></td> <td style="width: 10%;"></td> <td style="width: 10%;"></td> <td style="width: 10%;"></td> <td style="width: 10%;"></td> <td style="width: 10%;"></td> <td style="width: 10%;"></td> </tr> <tr> <td></td> <td></td> <td colspan="8" style="text-align: center;"> <table border="1" style="width: 100%; border-collapse: collapse; text-align: center;"> <tr> <td style="width: 10%;"></td> <td style="width: 10%;"></td> <td style="width: 10%;"></td> <td style="width: 10%;"></td> <td style="width: 10%;"></td> <td style="width: 10%;"></td> <td style="width: 10%;"></td> <td style="width: 10%;"></td> <td style="width: 10%;"></td> <td style="width: 10%;"></td> </tr> <tr> <td></td> <td></td> <td colspan="8" style="text-align: center;"> <table border="1" style="width: 100%; border-collapse: collapse; text-align: center;"> <tr> <td style="width: 10%;"></td> <td style="width: 10%;"></td> <td style="width: 10%;"></td> <td style="width: 10%;"></td> <td style="width: 10%;"></td> <td style="width: 10%;"></td> <td style="width: 10%;"></td> <td style="width: 10%;"></td> <td style="width: 10%;"></td> <td style="width: 10%;"></td> </tr> <tr> <td></td> <td></td> <td colspan="8" style="text-align: center;"> <table border="1" style="width: 100%; border-collapse: collapse; text-align: center;"> <tr> <td style="width: 10%;"></td> <td style="width: 10%;"></td> <td style="width: 10%;"></td> <td style="width: 10%;"></td> <td style="width: 10%;"></td> <td style="width: 10%;"></td> <td style="width: 10%;"></td> <td style="width: 10%;"></td> <td style="width: 10%;"></td> <td style="width: 10%;"></td> </tr> <tr> <td></td> <td></td> <td colspan="8" style="text-align: center;"> <table border="1" style="width: 100%; border-collapse: collapse; text-align: center;"> <tr> <td style="width: 10%;"></td> <td style="width: 10%;"></td> <td style="width: 10%;"></td> <td style="width: 10%;"></td> <td style="width: 10%;"></td> <td style="width: 10%;"></td> <td style="width: 10%;"></td> <td style="width: 10%;"></td> <td style="width: 10%;"></td> <td style="width: 10%;"></td> </tr> <tr> <td></td> <td></td> <td colspan="8" style="text-align: center;"> <table border="1" style="width: 100%; border-collapse: collapse; text-align: center;"> <tr> <td style="width: 10%;"></td> <td style="width: 10%;"></td> <td style="width: 10%;"></td> <td style="width: 10%;"></td> <td style="width: 10%;"></td> <td style="width: 10%;"></td> <td style="width: 10%;"></td> <td style="width: 10%;"></td> <td style="width: 10%;"></td> <td style="width: 10%;"></td> </tr> <tr> <td></td> <td></td> <td colspan="8" style="text-align: center;"> <table border="1" style="width: 100%; border-collapse: collapse; text-align: center;"> <tr> <td style="width: 10%;"></td> <td style="width: 10%;"></td> <td style="width: 10%;"></td> <td style="width: 10%;"></td> <td style="width: 10%;"></td> <td style="width: 10%;"></td> <td style="width: 10%;"></td> <td style="width: 10%;"></td> <td style="width: 10%;"></td> <td style="width: 10%;"></td> </tr> <tr> <td></td> <td></td> <td colspan="8" style="text-align: center;"> <table border="1" style="width: 100%; border-collapse: collapse; text-align: center;"> <tr> <td style="width: 10%;"></td> <td style="width: 10%;"></td> <td style="width: 10%;"></td> <td style="width: 10%;"></td> <td style="width: 10%;"></td> <td style="width: 10%;"></td> <td style="width: 10%;"></td> <td style="width: 10%;"></td> <td style="width: 10%;"></td> <td style="width: 10%;"></td> </tr> <tr> <td></td> <td></td> <td colspan="8" style="text-align: center;"> <table border="1" style="width: 100%; border-collapse: collapse; text-align: center;"> <tr> <td style="width: 10%;"></td> <td style="width: 10%;"></td> <td style="width: 10%;"></td> <td style="width: 10%;"></td> <td style="width: 10%;"></td> <td style="width: 10%;"></td> <td style="width: 10%;"></td> <td style="width: 10%;"></td> <td style="width: 10%;"></td> <td style="width: 10%;"></td> </tr> <tr> <td></td> <td></td> <td colspan="8" style="text-align: center;"> <table border="1" style="width: 100%; border-collapse: collapse; text-align: center;"> <tr> <td style="width: 10%;"></td> <td style="width: 10%;"></td> <td style="width: 10%;"></td> <td style="width: 10%;"></td> <td style="width: 10%;"></td> <td style="width: 10%;"></td> <td style="width: 10%;"></td> <td style="width: 10%;"></td> <td style="width: 10%;"></td> <td style="width: 10%;"></td> </tr> <tr> <td></td> <td></td> <td colspan="8" style="text-align: center;"> <table border="1" style="width: 100%; border-collapse: collapse; text-align: center;"> <tr> <td style="width: 10%;"></td> <td style="width: 10%;"></td> <td style="width: 10%;"></td> <td style="width: 10%;"></td> <td style="width: 10%;"></td> <td style="width: 10%;"></td> <td style="width: 10%;"></td> <td style="width: 10%;"></td> <td style="width: 10%;"></td> <td style="width: 10%;"></td> </tr> <tr> <td></td> <td></td> <td colspan="8" style="text-align: center;"> <table border="1" style="width: 100%; border-collapse: collapse; text-align: center;"> <tr> <td style="width: 10%;"></td> <td style="width: 10%;"></td> <td style="width: 10%;"></td> <td style="width: 10%;"></td> <td style="width: 10%;"></td> <td style="width: 10%;"></td> <td style="width: 10%;"></td> <td style="width: 10%;"></td> <td style="width: 10%;"></td> <td style="width: 10%;"></td> </tr> <tr> <td></td> <td></td> <td colspan="8" style="text-align: center;"> <table border="1" style="width: 100%; border-collapse: collapse; text-align: center;"> <tr> <td style="width: 10%;"></td> <td style="width: 10%;"></td> <td style="width: 10%;"></td> <td style="width: 10%;"></td> <td style="width: 10%;"></td> <td style="width: 10%;"></td> <td style="width: 10%;"></td> <td style="width: 10%;"></td> <td style="width: 10%;"></td> <td style="width: 10%;"></td> </tr> <tr> <td></td> <td></td> <td colspan="8" style="text-align: center;"> <table border="1" style="width: 100%; border-collapse: collapse; text-align: center;"> <tr> <td style="width: 10%;"></td> <td style="width: 10%;"></td> <td style="width: 10%;"></td> <td style="width: 10%;"></td> <td style="width: 10%;"></td> <td style="width: 10%;"></td> <td style="width: 10%;"></td> <td style="width: 10%;"></td> <td style="width: 10%;"></td> <td style="width: 10%;"></td> </tr> <tr> <td></td> <td></td> <td colspan="8" style="text-align: center;"> <table border="1" style="width: 100%; border-collapse: collapse; text-align: center;"> <tr> <td style="width: 10%;"></td> <td style="width: 10%;"></td> <td style="width: 10%;"></td> <td style="width: 10%;"></td> <td style="width: 10%;"></td> <td style="width: 10%;"></td> <td style="width: 10%;"></td> <td style="width: 10%;"></td> <td style="width: 10%;"></td> <td style="width: 10%;"></td> </tr> <tr> <td></td> <td></td> <td colspan="8" style="text-align: center;"> <table border="1" style="width: 100%; border-collapse: collapse; text-align: center;"> <tr> <td style="width: 10%;"></td> <td style="width: 10%;"></td> <td style="width: 10%;"></td> <td style="width: 10%;"></td> <td style="width: 10%;"></td> <td style="width: 10%;"></td> <td style="width: 10%;"></td> <td style="width: 10%;"></td> <td style="width: 10%;"></td> <td style="width: 10%;"></td> </tr> <tr> <td></td> <td></td> <td colspan="8" style="text-align: center;"> <table border="1" style="width: 100%; border-collapse: collapse; text-align: center;"> <tr> <td style="width: 10%;"></td> <td style="width: 10%;"></td> <td style="width: 10%;"></td> <td style="width: 10%;"></td> <td style="width: 10%;"></td> <td style="width: 10%;"></td> <td style="width: 10%;"></td> <td style="width: 10%;"></td> <td style="width: 10%;"></td> <td style="width: 10%;"></td> </tr> <tr> <td></td> <td></td> <td colspan="8" style="text-align: center;"> <table border="1" style="width: 100%; border-collapse: collapse; text-align: center;"> <tr> <td style="width: 10%;"></td> <td style="width: 10%;"></td> <td style="width: 10%;"></td> <td style="width: 10%;"></td> <td style="width: 10%;"></td> <td style="width: 10%;"></td> <td style="width: 10%;"></td> <td style="width: 10%;"></td> <td style="width: 10%;"></td> <td style="width: 10%;"></td> </tr> <tr> <td></td> <td></td> <td colspan="8" style="text-align: center;"> <table border="1" style="width: 100%; border-collapse: collapse; text-align: center;"> <tr> </tr></table></td></tr></table></td></tr></table></td></tr></table></td></tr></table></td></tr></table></td></tr></table></td></tr></table></td></tr></table></td></tr></table></td></tr></table></td></tr></table></td></tr></table></td></tr></table></td></tr></table></td></tr></table></td></tr></table></td></tr></table></td></tr></table></td></tr></table></td></tr></table></td></tr></table></td></tr></table></td></tr></table></td></tr></table></td></tr></table></td></tr></table></td></tr></table></td></tr></table></td></tr></table></td></tr></table></td></tr></table></td></tr></table></td></tr></table></td></tr></table></td></tr></table></td></tr></table></td></tr></table></td></tr></table></td></tr></table></td></tr></table></td></tr></table></td></tr></table></td></tr></table></td></tr></table></td></tr></table></td></tr></table></td></tr></table></td></tr></table></td></tr></table></td></tr></table></td></tr></table></td></tr></table></td></tr></table></td></tr></table></td></tr></table></td></tr></table>
 | | | | | | | | | | | | | | | | | | | | <table border="1" style="width: 100%; border-collapse: collapse; text-align: center;"> <tr> <td style="width: 10%;"></td> <td style="width: 10%;"></td> <td style="width: 10%;"></td> <td style="width: 10%;"></td> <td style="width: 10%;"></td> <td style="width: 10%;"></td> <td style="width: 10%;"></td> <td style="width: 10%;"></td> <td style="width: 10%;"></td> <td style="width: 10%;"></td> </tr> <tr> <td></td> <td></td> <td colspan="8" style="text-align: center;"> <table border="1" style="width: 100%; border-collapse: collapse; text-align: center;"> <tr> <td style="width: 10%;"></td> <td style="width: 10%;"></td> <td style="width: 10%;"></td> <td style="width: 10%;"></td> <td style="width: 10%;"></td> <td style="width: 10%;"></td> <td style="width: 10%;"></td> <td style="width: 10%;"></td> <td style="width: 10%;"></td> <td style="width: 10%;"></td> </tr> <tr> <td></td> <td></td> <td colspan="8" style="text-align: center;"> <table border="1" style="width: 100%; border-collapse: collapse; text-align: center;"> <tr> <td style="width: 10%;"></td> <td style="width: 10%;"></td> <td style="width: 10%;"></td> <td style="width: 10%;"></td> <td style="width: 10%;"></td> <td style="width: 10%;"></td> <td style="width: 10%;"></td> <td style="width: 10%;"></td> <td style="width: 10%;"></td> <td style="width: 10%;"></td> </tr> <tr> <td></td> <td></td> <td colspan="8" style="text-align: center;"> <table border="1" style="width: 100%; border-collapse: collapse; text-align: center;"> <tr> <td style="width: 10%;"></td> <td style="width: 10%;"></td> <td style="width: 10%;"></td> <td style="width: 10%;"></td> <td style="width: 10%;"></td> <td style="width: 10%;"></td> <td style="width: 10%;"></td> <td style="width: 10%;"></td> <td style="width: 10%;"></td> <td style="width: 10%;"></td> </tr> <tr> <td></td> <td></td> <td colspan="8" style="text-align: center;"> <table border="1" style="width: 100%; border-collapse: collapse; text-align: center;"> <tr> <td style="width: 10%;"></td> <td style="width: 10%;"></td> <td style="width: 10%;"></td> <td style="width: 10%;"></td> <td style="width: 10%;"></td> <td style="width: 10%;"></td> <td style="width: 10%;"></td> <td style="width: 10%;"></td> <td style="width: 10%;"></td> <td style="width: 10%;"></td> </tr> <tr> <td></td> <td></td> <td colspan="8" style="text-align: center;"> <table border="1" style="width: 100%; border-collapse: collapse; text-align: center;"> <tr> <td style="width: 10%;"></td> <td style="width: 10%;"></td> <td style="width: 10%;"></td> <td style="width: 10%;"></td> <td style="width: 10%;"></td> <td style="width: 10%;"></td> <td style="width: 10%;"></td> <td style="width: 10%;"></td> <td style="width: 10%;"></td> <td style="width: 10%;"></td> </tr> <tr> <td></td> <td></td> <td colspan="8" style="text-align: center;"> <table border="1" style="width: 100%; border-collapse: collapse; text-align: center;"> <tr> <td style="width: 10%;"></td> <td style="width: 10%;"></td> <td style="width: 10%;"></td> <td style="width: 10%;"></td> <td style="width: 10%;"></td> <td style="width: 10%;"></td> <td style="width: 10%;"></td> <td style="width: 10%;"></td> <td style="width: 10%;"></td> <td style="width: 10%;"></td> </tr> <tr> <td></td> <td></td> <td colspan="8" style="text-align: center;"> <table border="1" style="width: 100%; border-collapse: collapse; text-align: center;"> <tr> <td style="width: 10%;"></td> <td style="width: 10%;"></td> <td style="width: 10%;"></td> <td style="width: 10%;"></td> <td style="width: 10%;"></td> <td style="width: 10%;"></td> <td style="width: 10%;"></td> <td style="width: 10%;"></td> <td style="width: 10%;"></td> <td style="width: 10%;"></td> </tr> <tr> <td></td> <td></td> <td colspan="8" style="text-align: center;"> <table border="1" style="width: 100%; border-collapse: collapse; text-align: center;"> <tr> <td style="width: 10%;"></td> <td style="width: 10%;"></td> <td style="width: 10%;"></td> <td style="width: 10%;"></td> <td style="width: 10%;"></td> <td style="width: 10%;"></td> <td style="width: 10%;"></td> <td style="width: 10%;"></td> <td style="width: 10%;"></td> <td style="width: 10%;"></td> </tr> <tr> <td></td> <td></td> <td colspan="8" style="text-align: center;"> <table border="1" style="width: 100%; border-collapse: collapse; text-align: center;"> <tr> <td style="width: 10%;"></td> <td style="width: 10%;"></td> <td style="width: 10%;"></td> <td style="width: 10%;"></td> <td style="width: 10%;"></td> <td style="width: 10%;"></td> <td style="width: 10%;"></td> <td style="width: 10%;"></td> <td style="width: 10%;"></td> <td style="width: 10%;"></td> </tr> <tr> <td></td> <td></td> <td colspan="8" style="text-align: center;"> <table border="1" style="width: 100%; border-collapse: collapse; text-align: center;"> <tr> <td style="width: 10%;"></td> <td style="width: 10%;"></td> <td style="width: 10%;"></td> <td style="width: 10%;"></td> <td style="width: 10%;"></td> <td style="width: 10%;"></td> <td style="width: 10%;"></td> <td style="width: 10%;"></td> <td style="width: 10%;"></td> <td style="width: 10%;"></td> </tr> <tr> <td></td> <td></td> <td colspan="8" style="text-align: center;"> <table border="1" style="width: 100%; border-collapse: collapse; text-align: center;"> <tr> <td style="width: 10%;"></td> <td style="width: 10%;"></td> <td style="width: 10%;"></td> <td style="width: 10%;"></td> <td style="width: 10%;"></td> <td style="width: 10%;"></td> <td style="width: 10%;"></td> <td style="width: 10%;"></td> <td style="width: 10%;"></td> <td style="width: 10%;"></td> </tr> <tr> <td></td> <td></td> <td colspan="8" style="text-align: center;"> <table border="1" style="width: 100%; border-collapse: collapse; text-align: center;"> <tr> <td style="width: 10%;"></td> <td style="width: 10%;"></td> <td style="width: 10%;"></td> <td style="width: 10%;"></td> <td style="width: 10%;"></td> <td style="width: 10%;"></td> <td style="width: 10%;"></td> <td style="width: 10%;"></td> <td style="width: 10%;"></td> <td style="width: 10%;"></td> </tr> <tr> <td></td> <td></td> <td colspan="8" style="text-align: center;"> <table border="1" style="width: 100%; border-collapse: collapse; text-align: center;"> <tr> <td style="width: 10%;"></td> <td style="width: 10%;"></td> <td style="width: 10%;"></td> <td style="width: 10%;"></td> <td style="width: 10%;"></td> <td style="width: 10%;"></td> <td style="width: 10%;"></td> <td style="width: 10%;"></td> <td style="width: 10%;"></td> <td style="width: 10%;"></td> </tr> <tr> <td></td> <td></td> <td colspan="8" style="text-align: center;"> <table border="1" style="width: 100%; border-collapse: collapse; text-align: center;"> <tr> <td style="width: 10%;"></td> <td style="width: 10%;"></td> <td style="width: 10%;"></td> <td style="width: 10%;"></td> <td style="width: 10%;"></td> <td style="width: 10%;"></td> <td style="width: 10%;"></td> <td style="width: 10%;"></td> <td style="width: 10%;"></td> <td style="width: 10%;"></td> </tr> <tr> <td></td> <td></td> <td colspan="8" style="text-align: center;"> <table border="1" style="width: 100%; border-collapse: collapse; text-align: center;"> <tr> <td style="width: 10%;"></td> <td style="width: 10%;"></td> <td style="width: 10%;"></td> <td style="width: 10%;"></td> <td style="width: 10%;"></td> <td style="width: 10%;"></td> <td style="width: 10%;"></td> <td style="width: 10%;"></td> <td style="width: 10%;"></td> <td style="width: 10%;"></td> </tr> <tr> <td></td> <td></td> <td colspan="8" style="text-align: center;"> <table border="1" style="width: 100%; border-collapse: collapse; text-align: center;"> <tr> <td style="width: 10%;"></td> <td style="width: 10%;"></td> <td style="width: 10%;"></td> <td style="width: 10%;"></td> <td style="width: 10%;"></td> <td style="width: 10%;"></td> <td
style="width: 10%;"></td> <td style="width: 10%;"></td> <td style="width: 10%;"></td> <td style="width: 10%;"></td> </tr> <tr> <td></td> <td></td> <td colspan="8" style="text-align: center;"> <table border="1" style="width: 100%; border-collapse: collapse; text-align: center;"> <tr> <td style="width: 10%;"></td> <td style="width: 10%;"></td> <td style="width: 10%;"></td> <td style="width: 10%;"></td> <td style="width: 10%;"></td> <td style="width: 10%;"></td> <td style="width: 10%;"></td> <td style="width: 10%;"></td> <td style="width: 10%;"></td> <td style="width: 10%;"></td> </tr> <tr> <td></td> <td></td> <td colspan="8" style="text-align: center;"> <table border="1" style="width: 100%; border-collapse: collapse; text-align: center;"> <tr> <td style="width: 10%;"></td> <td style="width: 10%;"></td> <td style="width: 10%;"></td> <td style="width: 10%;"></td> <td style="width: 10%;"></td> <td style="width: 10%;"></td> <td style="width: 10%;"></td> <td style="width: 10%;"></td> <td style="width: 10%;"></td> <td style="width: 10%;"></td> </tr> <tr> <td></td> <td></td> <td colspan="8" style="text-align: center;"> <table border="1" style="width: 100%; border-collapse: collapse; text-align: center;"> <tr> <td style="width: 10%;"></td> <td style="width: 10%;"></td> <td style="width: 10%;"></td> <td style="width: 10%;"></td> <td style="width: 10%;"></td> <td style="width: 10%;"></td> <td style="width: 10%;"></td> <td style="width: 10%;"></td> <td style="width: 10%;"></td> <td style="width: 10%;"></td> </tr> <tr> <td></td> <td></td> <td colspan="8" style="text-align: center;"> <table border="1" style="width: 100%; border-collapse: collapse; text-align: center;"> <tr> <td style="width: 10%;"></td> <td style="width: 10%;"></td> <td style="width: 10%;"></td> <td style="width: 10%;"></td> <td style="width: 10%;"></td> <td style="width: 10%;"></td> <td style="width: 10%;"></td> <td style="width: 10%;"></td> <td style="width: 10%;"></td> <td style="width: 10%;"></td> </tr> <tr> <td></td> <td></td> <td colspan="8" style="text-align: center;"> <table border="1" style="width: 100%; border-collapse: collapse; text-align: center;"> <tr> <td style="width: 10%;"></td> <td style="width: 10%;"></td> <td style="width: 10%;"></td> <td style="width: 10%;"></td> <td style="width: 10%;"></td> <td style="width: 10%;"></td> <td style="width: 10%;"></td> <td style="width: 10%;"></td> <td style="width: 10%;"></td> <td style="width: 10%;"></td> </tr> <tr> <td></td> <td></td> <td colspan="8" style="text-align: center;"> <table border="1" style="width: 100%; border-collapse: collapse; text-align: center;"> <tr> <td style="width: 10%;"></td> <td style="width: 10%;"></td> <td style="width: 10%;"></td> <td style="width: 10%;"></td> <td style="width: 10%;"></td> <td style="width: 10%;"></td> <td style="width: 10%;"></td> <td style="width: 10%;"></td> <td style="width: 10%;"></td> <td style="width: 10%;"></td> </tr> <tr> <td></td> <td></td> <td colspan="8" style="text-align: center;"> <table border="1" style="width: 100%; border-collapse: collapse; text-align: center;"> <tr> <td style="width: 10%;"></td> <td style="width: 10%;"></td> <td style="width: 10%;"></td> <td style="width: 10%;"></td> <td style="width: 10%;"></td> <td style="width: 10%;"></td> <td style="width: 10%;"></td> <td style="width: 10%;"></td> <td style="width: 10%;"></td> <td style="width: 10%;"></td> </tr> <tr> <td></td> <td></td> <td colspan="8" style="text-align: center;"> <table border="1" style="width: 100%; border-collapse: collapse; text-align: center;"> <tr> <td style="width: 10%;"></td> <td style="width: 10%;"></td> <td style="width: 10%;"></td> <td style="width: 10%;"></td> <td style="width: 10%;"></td> <td style="width: 10%;"></td> <td style="width: 10%;"></td> <td style="width: 10%;"></td> <td style="width: 10%;"></td> <td style="width: 10%;"></td> </tr> <tr> <td></td> <td></td> <td colspan="8" style="text-align: center;"> <table border="1" style="width: 100%; border-collapse: collapse; text-align: center;"> <tr> <td style="width: 10%;"></td> <td style="width: 10%;"></td> <td style="width: 10%;"></td> <td style="width: 10%;"></td> <td style="width: 10%;"></td> <td style="width: 10%;"></td> <td style="width: 10%;"></td> <td style="width: 10%;"></td> <td style="width: 10%;"></td> <td style="width: 10%;"></td> </tr> <tr> <td></td> <td></td> <td colspan="8" style="text-align: center;"> <table border="1" style="width: 100%; border-collapse: collapse; text-align: center;"> <tr> <td style="width: 10%;"></td> <td style="width: 10%;"></td> <td style="width: 10%;"></td> <td style="width: 10%;"></td> <td style="width: 10%;"></td> <td style="width: 10%;"></td> <td style="width: 10%;"></td> <td style="width: 10%;"></td> <td style="width: 10%;"></td> <td style="width: 10%;"></td> </tr> <tr> <td></td> <td></td> <td colspan="8" style="text-align: center;"> <table border="1" style="width: 100%; border-collapse: collapse; text-align: center;"> <tr> <td style="width: 10%;"></td> <td style="width: 10%;"></td> <td style="width: 10%;"></td> <td style="width: 10%;"></td> <td style="width: 10%;"></td> <td style="width: 10%;"></td> <td style="width: 10%;"></td> <td style="width: 10%;"></td> <td style="width: 10%;"></td> <td style="width: 10%;"></td> </tr> <tr> <td></td> <td></td> <td colspan="8" style="text-align: center;"> <table border="1" style="width: 100%; border-collapse: collapse; text-align: center;"> <tr> <td style="width: 10%;"></td> <td style="width: 10%;"></td> <td style="width: 10%;"></td> <td style="width: 10%;"></td> <td style="width: 10%;"></td> <td style="width: 10%;"></td> <td style="width: 10%;"></td> <td style="width: 10%;"></td> <td style="width: 10%;"></td> <td style="width: 10%;"></td> </tr> <tr> <td></td> <td></td> <td colspan="8" style="text-align: center;"> <table border="1" style="width: 100%; border-collapse: collapse; text-align: center;"> <tr> <td style="width: 10%;"></td> <td style="width: 10%;"></td> <td style="width: 10%;"></td> <td style="width: 10%;"></td> <td style="width: 10%;"></td> <td style="width: 10%;"></td> <td style="width: 10%;"></td> <td style="width: 10%;"></td> <td style="width: 10%;"></td> <td style="width: 10%;"></td> </tr> <tr> <td></td> <td></td> <td colspan="8" style="text-align: center;"> <table border="1" style="width: 100%; border-collapse: collapse; text-align: center;"> <tr> <td style="width: 10%;"></td> <td style="width: 10%;"></td> <td style="width: 10%;"></td> <td style="width: 10%;"></td> <td style="width: 10%;"></td> <td style="width: 10%;"></td> <td style="width: 10%;"></td> <td style="width: 10%;"></td> <td style="width: 10%;"></td> <td style="width: 10%;"></td> </tr> <tr> <td></td> <td></td> <td colspan="8" style="text-align: center;"> <table border="1" style="width: 100%; border-collapse: collapse; text-align: center;"> <tr> <td style="width: 10%;"></td> <td style="width: 10%;"></td> <td style="width: 10%;"></td> <td style="width: 10%;"></td> <td style="width: 10%;"></td> <td style="width: 10%;"></td> <td style="width: 10%;"></td> <td style="width: 10%;"></td> <td style="width: 10%;"></td> <td style="width: 10%;"></td> </tr> <tr> <td></td> <td></td> <td colspan="8" style="text-align: center;"> <table border="1" style="width: 100%; border-collapse: collapse; text-align: center;"> <tr> <td style="width: 10%;"></td> <td style="width: 10%;"></td> <td style="width: 10%;"></td> <td style="width: 10%;"></td> <td style="width: 10%;"></td> <td style="width: 10%;"></td> <td style="width: 10%;"></td> <td style="width: 10%;"></td> <td style="width: 10%;"></td> <td style="width: 10%;"></td> </tr> <tr> <td></td> <td></td> <td colspan="8" style="text-align: center;"> <table border="1" style="width: 100%; border-collapse: collapse; text-align: center;"> <tr> <td style="width: 10%;"></td> <td style="width: 10%;"></td> <td style="width: 10%;"></td> <td style="width: 10%;"></td> <td style="width: 10%;"></td> <td style="width: 10%;"></td> <td style="width: 10%;"></td> <td style="width: 10%;"></td> <td style="width: 10%;"></td> <td style="width: 10%;"></td> </tr> <tr> <td></td> <td></td> <td colspan="8" style="text-align: center;"> <table border="1" style="width: 100%; border-collapse: collapse; text-align: center;"> <tr> <td style="width: 10%;"></td> <td style="width: 10%;"></td> <td style="width: 10%;"></td> <td style="width: 10%;"></td> <td style="width: 10%;"></td> <td style="width: 10%;"></td> <td style="width: 10%;"></td> <td style="width: 10%;"></td> <td style="width: 10%;"></td> <td style="width: 10%;"></td> </tr> <tr> <td></td> <td></td> <td colspan="8" style="text-align: center;"> <table border="1" style="width: 100%; border-collapse: collapse; text-align: center;"> <tr> <td style="width: 10%;"></td> <td style="width: 10%;"></td> <td style="width: 10%;"></td> <td style="width: 10%;"></td> <td style="width: 10%;"></td> <td style="width: 10%;"></td> <td style="width: 10%;"></td> <td style="width: 10%;"></td> <td style="width: 10%;"></td> <td style="width: 10%;"></td> </tr> <tr> <td></td> <td></td> <td colspan="8" style="text-align: center;"> <table border="1" style="width: 100%; border-collapse: collapse; text-align: center;"> <tr> <td style="width: 10%;"></td> <td style="width: 10%;"></td> <td style="width: 10%;"></td> <td style="width: 10%;"></td> <td style="width: 10%;"></td> <td style="width: 10%;"></td> <td style="width: 10%;"></td> <td style="width: 10%;"></td> <td style="width: 10%;"></td> <td style="width: 10%;"></td> </tr> <tr> <td></td> <td></td> <td colspan="8" style="text-align: center;"> <table border="1" style="width: 100%; border-collapse: collapse; text-align: center;"> <tr> <td style="width: 10%;"></td> <td style="width: 10%;"></td> <td style="width: 10%;"></td> <td style="width: 10%;"></td> <td style="width: 10%;"></td> <td style="width: 10%;"></td> <td style="width: 10%;"></td> <td style="width: 10%;"></td> <td style="width: 10%;"></td> <td style="width: 10%;"></td> </tr> <tr> <td></td> <td></td> <td colspan="8"
style="text-align: center;"> <table border="1" style="width: 100%; border-collapse: collapse; text-align: center;"> <tr> <td style="width: 10%;"></td> <td style="width: 10%;"></td> <td style="width: 10%;"></td> <td style="width: 10%;"></td> <td style="width: 10%;"></td> <td style="width: 10%;"></td> <td style="width: 10%;"></td> <td style="width: 10%;"></td> <td style="width: 10%;"></td> <td style="width: 10%;"></td> </tr> <tr> <td></td> <td></td> <td colspan="8" style="text-align: center;"> <table border="1" style="width: 100%; border-collapse: collapse; text-align: center;"> <tr> <td style="width: 10%;"></td> <td style="width: 10%;"></td> <td style="width: 10%;"></td> <td style="width: 10%;"></td> <td style="width: 10%;"></td> <td style="width: 10%;"></td> <td style="width: 10%;"></td> <td style="width: 10%;"></td> <td style="width: 10%;"></td> <td style="width: 10%;"></td> </tr> <tr> <td></td> <td></td> <td colspan="8" style="text-align: center;"> <table border="1" style="width: 100%; border-collapse: collapse; text-align: center;"> <tr> <td style="width: 10%;"></td> <td style="width: 10%;"></td> <td style="width: 10%;"></td> <td style="width: 10%;"></td> <td style="width: 10%;"></td> <td style="width: 10%;"></td> <td style="width: 10%;"></td> <td style="width: 10%;"></td> <td style="width: 10%;"></td> <td style="width: 10%;"></td> </tr> <tr> <td></td> <td></td> <td colspan="8" style="text-align: center;"> <table border="1" style="width: 100%; border-collapse: collapse; text-align: center;"> <tr> <td style="width: 10%;"></td> <td style="width: 10%;"></td> <td style="width: 10%;"></td> <td style="width: 10%;"></td> <td style="width: 10%;"></td> <td style="width: 10%;"></td> <td style="width: 10%;"></td> <td style="width: 10%;"></td> <td style="width: 10%;"></td> <td style="width: 10%;"></td> </tr> <tr> <td></td> <td></td> <td colspan="8" style="text-align: center;"> <table border="1" style="width: 100%; border-collapse: collapse; text-align: center;"> <tr> <td style="width: 10%;"></td> <td style="width: 10%;"></td> <td style="width: 10%;"></td> <td style="width: 10%;"></td> <td style="width: 10%;"></td> <td style="width: 10%;"></td> <td style="width: 10%;"></td> <td style="width: 10%;"></td> <td style="width: 10%;"></td> <td style="width: 10%;"></td> </tr> <tr> <td></td> <td></td> <td colspan="8" style="text-align: center;"> <table border="1" style="width: 100%; border-collapse: collapse; text-align: center;"> <tr> <td style="width: 10%;"></td> <td style="width: 10%;"></td> <td style="width: 10%;"></td> <td style="width: 10%;"></td> <td style="width: 10%;"></td> <td style="width: 10%;"></td> <td style="width: 10%;"></td> <td style="width: 10%;"></td> <td style="width: 10%;"></td> <td style="width: 10%;"></td> </tr> <tr> <td></td> <td></td> <td colspan="8" style="text-align: center;"> <table border="1" style="width: 100%; border-collapse: collapse; text-align: center;"> <tr> <td style="width: 10%;"></td> <td style="width: 10%;"></td> <td style="width: 10%;"></td> <td style="width: 10%;"></td> <td style="width: 10%;"></td> <td style="width: 10%;"></td> <td style="width: 10%;"></td> <td style="width: 10%;"></td> <td style="width: 10%;"></td> <td style="width: 10%;"></td> </tr> <tr> <td></td> <td></td> <td colspan="8" style="text-align: center;"> <table border="1" style="width: 100%; border-collapse: collapse; text-align: center;"> <tr> <td style="width: 10%;"></td> <td style="width: 10%;"></td> <td style="width: 10%;"></td> <td style="width: 10%;"></td> <td style="width: 10%;"></td> <td style="width: 10%;"></td> <td style="width: 10%;"></td> <td style="width: 10%;"></td> <td style="width: 10%;"></td> <td style="width: 10%;"></td> </tr> <tr> <td></td> <td></td> <td colspan="8" style="text-align: center;"> <table border="1" style="width: 100%; border-collapse: collapse; text-align: center;"> <tr> <td style="width: 10%;"></td> <td style="width: 10%;"></td> <td style="width: 10%;"></td> <td style="width: 10%;"></td> <td style="width: 10%;"></td> <td style="width: 10%;"></td> <td style="width: 10%;"></td> <td style="width: 10%;"></td> <td style="width: 10%;"></td> <td style="width: 10%;"></td> </tr> <tr> <td></td> <td></td> <td colspan="8" style="text-align: center;"> <table border="1" style="width: 100%; border-collapse: collapse; text-align: center;"> <tr> <td style="width: 10%;"></td> <td style="width: 10%;"></td> <td style="width: 10%;"></td> <td style="width: 10%;"></td> <td style="width: 10%;"></td> <td style="width: 10%;"></td> <td style="width: 10%;"></td> <td style="width: 10%;"></td> <td style="width: 10%;"></td> <td style="width: 10%;"></td> </tr> <tr> <td></td> <td></td> <td colspan="8" style="text-align: center;"> <table border="1" style="width: 100%; border-collapse: collapse; text-align: center;"> <tr> <td style="width: 10%;"></td> <td style="width: 10%;"></td> <td style="width: 10%;"></td> <td style="width: 10%;"></td> <td style="width: 10%;"></td> <td style="width: 10%;"></td> <td style="width: 10%;"></td> <td style="width: 10%;"></td> <td style="width: 10%;"></td> <td style="width: 10%;"></td> </tr> <tr> <td></td> <td></td> <td colspan="8" style="text-align: center;"> <table border="1" style="width: 100%; border-collapse: collapse; text-align: center;"> <tr> <td style="width: 10%;"></td> <td style="width: 10%;"></td> <td style="width: 10%;"></td> <td style="width: 10%;"></td> <td style="width: 10%;"></td> <td style="width: 10%;"></td> <td style="width: 10%;"></td> <td style="width: 10%;"></td> <td style="width: 10%;"></td> <td style="width: 10%;"></td> </tr> <tr> <td></td> <td></td> <td colspan="8" style="text-align: center;"> <table border="1" style="width: 100%; border-collapse: collapse; text-align: center;"> <tr> <td style="width: 10%;"></td> <td style="width: 10%;"></td> <td style="width: 10%;"></td> <td style="width: 10%;"></td> <td style="width: 10%;"></td> <td style="width: 10%;"></td> <td style="width: 10%;"></td> <td style="width: 10%;"></td> <td style="width: 10%;"></td> <td style="width: 10%;"></td> </tr> <tr> <td></td> <td></td> <td colspan="8" style="text-align: center;"> <table border="1" style="width: 100%; border-collapse: collapse; text-align: center;"> <tr> <td style="width: 10%;"></td> <td style="width: 10%;"></td> <td style="width: 10%;"></td> <td style="width: 10%;"></td> <td style="width: 10%;"></td> <td style="width: 10%;"></td> <td style="width: 10%;"></td> <td style="width: 10%;"></td> <td style="width: 10%;"></td> <td style="width: 10%;"></td> </tr> <tr> <td></td> <td></td> <td colspan="8" style="text-align: center;"> <table border="1" style="width: 100%; border-collapse: collapse; text-align: center;"> <tr> <td style="width: 10%;"></td> <td style="width: 10%;"></td> <td style="width: 10%;"></td> <td style="width: 10%;"></td> <td style="width: 10%;"></td> <td style="width: 10%;"></td> <td style="width: 10%;"></td> <td style="width: 10%;"></td> <td style="width: 10%;"></td> <td style="width: 10%;"></td> </tr> <tr> <td></td> <td></td> <td colspan="8" style="text-align: center;"> <table border="1" style="width: 100%; border-collapse: collapse; text-align: center;"> <tr> <td style="width: 10%;"></td> <td style="width: 10%;"></td> <td style="width: 10%;"></td> <td style="width: 10%;"></td> <td style="width: 10%;"></td> <td style="width: 10%;"></td> <td style="width: 10%;"></td> <td style="width: 10%;"></td> <td style="width: 10%;"></td> <td style="width: 10%;"></td> </tr> <tr> <td></td> <td></td> <td colspan="8" style="text-align: center;"> <table border="1" style="width: 100%; border-collapse: collapse; text-align: center;"> <tr> <td style="width: 10%;"></td> <td style="width: 10%;"></td> <td style="width: 10%;"></td> <td style="width: 10%;"></td> <td style="width: 10%;"></td> <td style="width: 10%;"></td> <td style="width: 10%;"></td> <td style="width: 10%;"></td> <td style="width: 10%;"></td> <td style="width: 10%;"></td> </tr> <tr> <td></td> <td></td> <td colspan="8" style="text-align: center;"> <table border="1" style="width: 100%; border-collapse: collapse; text-align: center;"> <tr> </tr></table></td></tr></table></td></tr></table></td></tr></table></td></tr></table></td></tr></table></td></tr></table></td></tr></table></td></tr></table></td></tr></table></td></tr></table></td></tr></table></td></tr></table></td></tr></table></td></tr></table></td></tr></table></td></tr></table></td></tr></table></td></tr></table></td></tr></table></td></tr></table></td></tr></table></td></tr></table></td></tr></table></td></tr></table></td></tr></table></td></tr></table></td></tr></table></td></tr></table></td></tr></table></td></tr></table></td></tr></table></td></tr></table></td></tr></table></td></tr></table></td></tr></table></td></tr></table></td></tr></table></td></tr></table></td></tr></table></td></tr></table></td></tr></table></td></tr></table></td></tr></table></td></tr></table></td></tr></table></td></tr></table></td></tr></table></td></tr></table></td></tr></table></td></tr></table></td></tr></table></td></tr></table></td></tr></table></td></tr></table></td></tr></table>
 | | | | | | | | | | | | | | | | | | | | <table border="1" style="width: 100%; border-collapse: collapse; text-align: center;"> <tr> <td style="width: 10%;"></td> <td style="width: 10%;"></td> <td style="width: 10%;"></td> <td style="width: 10%;"></td> <td style="width: 10%;"></td> <td style="width: 10%;"></td> <td style="width: 10%;"></td> <td style="width: 10%;"></td> <td style="width: 10%;"></td> <td style="width: 10%;"></td> </tr> <tr> <td></td> <td></td> <td colspan="8" style="text-align: center;"> <table border="1" style="width: 100%; border-collapse: collapse; text-align: center;"> <tr> <td style="width: 10%;"></td> <td style="width: 10%;"></td> <td style="width: 10%;"></td> <td style="width: 10%;"></td> <td style="width: 10%;"></td> <td style="width: 10%;"></td> <td style="width: 10%;"></td> <td style="width: 10%;"></td> <td style="width: 10%;"></td> <td style="width: 10%;"></td> </tr> <tr> <td></td> <td></td> <td colspan="8" style="text-align: center;"> <table border="1" style="width: 100%; border-collapse: collapse; text-align: center;"> <tr> <td style="width: 10%;"></td> <td style="width: 10%;"></td> <td style="width: 10%;"></td> <td style="width: 10%;"></td> <td style="width: 10%;"></td> <td style="width: 10%;"></td> <td style="width: 10%;"></td> <td style="width: 10%;"></td> <td style="width: 10%;"></td> <td style="width: 10%;"></td> </tr> <tr> <td></td> <td></td> <td colspan="8" style="text-align: center;"> <table border="1" style="width: 100%; border-collapse: collapse; text-align: center;"> <tr> <td style="width: 10%;"></td> <td style="width: 10%;"></td> <td style="width: 10%;"></td> <td style="width: 10%;"></td> <td style="width: 10%;"></td> <td style="width: 10%;"></td> <td style="width: 10%;"></td> <td style="width: 10%;"></td> <td style="width: 10%;"></td> <td style="width: 10%;"></td> </tr> <tr> <td></td> <td></td> <td colspan="8" style="text-align: center;"> <table border="1" style="width: 100%; border-collapse: collapse; text-align: center;"> <tr> <td style="width: 10%;"></td> <td style="width: 10%;"></td> <td style="width: 10%;"></td> <td style="width: 10%;"></td> <td style="width: 10%;"></td> <td style="width: 10%;"></td> <td style="width: 10%;"></td> <td style="width: 10%;"></td> <td style="width: 10%;"></td> <td style="width: 10%;"></td> </tr> <tr> <td></td> <td></td> <td colspan="8" style="text-align: center;"> <table border="1" style="width: 100%; border-collapse: collapse; text-align: center;"> <tr> <td style="width: 10%;"></td> <td style="width: 10%;"></td> <td style="width: 10%;"></td> <td style="width: 10%;"></td> <td style="width: 10%;"></td> <td style="width: 10%;"></td> <td style="width: 10%;"></td> <td style="width: 10%;"></td> <td style="width: 10%;"></td> <td style="width: 10%;"></td> </tr> <tr> <td></td> <td></td> <td colspan="8" style="text-align: center;"> <table border="1" style="width: 100%; border-collapse: collapse; text-align: center;"> <tr> <td style="width: 10%;"></td> <td style="width: 10%;"></td> <td style="width: 10%;"></td> <td style="width: 10%;"></td> <td style="width: 10%;"></td> <td style="width: 10%;"></td> <td style="width: 10%;"></td> <td style="width: 10%;"></td> <td style="width: 10%;"></td> <td style="width: 10%;"></td> </tr> <tr> <td></td> <td></td> <td colspan="8" style="text-align: center;"> <table border="1" style="width: 100%; border-collapse: collapse; text-align: center;"> <tr> <td style="width: 10%;"></td> <td style="width: 10%;"></td> <td style="width: 10%;"></td> <td style="width: 10%;"></td> <td style="width: 10%;"></td> <td style="width: 10%;"></td> <td style="width: 10%;"></td> <td style="width: 10%;"></td> <td style="width: 10%;"></td> <td style="width: 10%;"></td> </tr> <tr> <td></td> <td></td> <td colspan="8" style="text-align: center;"> <table border="1" style="width: 100%; border-collapse: collapse; text-align: center;"> <tr> <td style="width: 10%;"></td> <td style="width: 10%;"></td> <td style="width: 10%;"></td> <td style="width: 10%;"></td> <td style="width: 10%;"></td> <td style="width: 10%;"></td> <td style="width: 10%;"></td> <td style="width: 10%;"></td> <td style="width: 10%;"></td> <td style="width: 10%;"></td> </tr> <tr> <td></td> <td></td> <td colspan="8" style="text-align: center;"> <table border="1" style="width: 100%; border-collapse: collapse; text-align: center;"> <tr> <td style="width: 10%;"></td> <td style="width: 10%;"></td> <td style="width: 10%;"></td> <td style="width: 10%;"></td> <td style="width: 10%;"></td> <td style="width: 10%;"></td> <td style="width: 10%;"></td> <td style="width: 10%;"></td> <td style="width: 10%;"></td> <td style="width: 10%;"></td> </tr> <tr> <td></td> <td></td> <td colspan="8" style="text-align: center;"> <table border="1" style="width: 100%; border-collapse: collapse; text-align: center;"> <tr> <td style="width: 10%;"></td> <td style="width: 10%;"></td> <td style="width: 10%;"></td> <td style="width: 10%;"></td> <td style="width: 10%;"></td> <td style="width: 10%;"></td> <td style="width: 10%;"></td> <td style="width: 10%;"></td> <td style="width: 10%;"></td> <td style="width: 10%;"></td> </tr> <tr> <td></td> <td></td> <td colspan="8" style="text-align: center;"> <table border="1" style="width: 100%; border-collapse: collapse; text-align: center;"> <tr> <td style="width: 10%;"></td> <td style="width: 10%;"></td> <td style="width: 10%;"></td> <td style="width: 10%;"></td> <td style="width: 10%;"></td> <td style="width: 10%;"></td> <td style="width: 10%;"></td> <td style="width: 10%;"></td> <td style="width: 10%;"></td> <td style="width: 10%;"></td> </tr> <tr> <td></td> <td></td> <td colspan="8" style="text-align: center;"> <table border="1" style="width: 100%; border-collapse: collapse; text-align: center;"> <tr> <td style="width: 10%;"></td> <td style="width: 10%;"></td> <td style="width: 10%;"></td> <td style="width: 10%;"></td> <td style="width: 10%;"></td> <td style="width: 10%;"></td> <td style="width: 10%;"></td> <td style="width: 10%;"></td> <td style="width: 10%;"></td> <td style="width: 10%;"></td> </tr> <tr> <td></td> <td></td> <td colspan="8" style="text-align: center;"> <table border="1" style="width: 100%; border-collapse: collapse; text-align: center;"> <tr> <td style="width: 10%;"></td> <td style="width: 10%;"></td> <td style="width: 10%;"></td> <td style="width: 10%;"></td> <td style="width: 10%;"></td> <td style="width: 10%;"></td> <td style="width: 10%;"></td> <td style="width: 10%;"></td> <td style="width: 10%;"></td> <td style="width: 10%;"></td> </tr> <tr> <td></td> <td></td> <td colspan="8" style="text-align: center;"> <table border="1" style="width: 100%; border-collapse: collapse; text-align: center;"> <tr> <td style="width: 10%;"></td> <td style="width: 10%;"></td> <td style="width: 10%;"></td> <td style="width: 10%;"></td> <td style="width: 10%;"></td> <td style="width: 10%;"></td> <td style="width: 10%;"></td> <td style="width: 10%;"></td> <td style="width: 10%;"></td> <td style="width: 10%;"></td> </tr> <tr> <td></td> <td></td> <td colspan="8" style="text-align: center;"> <table border="1" style="width: 100%; border-collapse: collapse; text-align: center;"> <tr> <td style="width: 10%;"></td> <td style="width: 10%;"></td> <td style="width: 10%;"></td> <td style="width: 10%;"></td> <td style="width: 10%;"></td> <td style="width: 10%;"></td> <td style="width: 10%;"></td> <td style="width: 10%;"></td> <td style="width: 10%;"></td> <td style="width: 10%;"></td> </tr> <tr> <td></td> <td></td> <td colspan="8" style="text-align: center;"> <table border="1" style="width: 100%; border-collapse: collapse; text-align: center;"> <tr> <td style="width: 10%;"></td> <td style="width: 10%;"></td> <td style="width: 10%;"></td> <td style="width: 10%;"></td> <td style="width: 10%;"></td> <td style="width: 10%;"></td> <td style="width: 10%;"></td> <td style="width: 10%;"></td> <td style="width: 10%;"></td> <td style="width: 10%;"></td> </tr> <tr> <td></td> <td></td> <td colspan="8" style="text-align: center;"> <table border="1" style="width: 100%; border-collapse: collapse; text-align: center;"> <tr> <td style="width: 10%;"></td> <td style="width: 10%;"></td> <td style="width: 10%;"></td> <td style="width: 10%;"></td> <td style="width: 10%;"></td> <td style="width: 10%;"></td> <td style="width: 10%;"></td> <td style="width: 10%;"></td> <td style="width: 10%;"></td> <td style="width: 10%;"></td> </tr> <tr> <td></td> <td></td> <td colspan="8" style="text-align: center;">
<table border="1" style="width: 100%; border-collapse: collapse; text-align: center;"> <tr> <td style="width: 10%;"></td> <td style="width: 10%;"></td> <td style="width: 10%;"></td> <td style="width: 10%;"></td> <td style="width: 10%;"></td> <td style="width: 10%;"></td> <td style="width: 10%;"></td> <td style="width: 10%;"></td> <td style="width: 10%;"></td> <td style="width: 10%;"></td> </tr> <tr> <td></td> <td></td> <td colspan="8" style="text-align: center;"> <table border="1" style="width: 100%; border-collapse: collapse; text-align: center;"> <tr> <td style="width: 10%;"></td> <td style="width: 10%;"></td> <td style="width: 10%;"></td> <td style="width: 10%;"></td> <td style="width: 10%;"></td> <td style="width: 10%;"></td> <td style="width: 10%;"></td> <td style="width: 10%;"></td> <td style="width: 10%;"></td> <td style="width: 10%;"></td> </tr> <tr> <td></td> <td></td> <td colspan="8" style="text-align: center;"> <table border="1" style="width: 100%; border-collapse: collapse; text-align: center;"> <tr> <td style="width: 10%;"></td> <td style="width: 10%;"></td> <td style="width: 10%;"></td> <td style="width: 10%;"></td> <td style="width: 10%;"></td> <td style="width: 10%;"></td> <td style="width: 10%;"></td> <td style="width: 10%;"></td> <td style="width: 10%;"></td> <td style="width: 10%;"></td> </tr> <tr> <td></td> <td></td> <td colspan="8" style="text-align: center;"> <table border="1" style="width: 100%; border-collapse: collapse; text-align: center;"> <tr> <td style="width: 10%;"></td> <td style="width: 10%;"></td> <td style="width: 10%;"></td> <td style="width: 10%;"></td> <td style="width: 10%;"></td> <td style="width: 10%;"></td> <td style="width: 10%;"></td> <td style="width: 10%;"></td> <td style="width: 10%;"></td> <td style="width: 10%;"></td> </tr> <tr> <td></td> <td></td> <td colspan="8" style="text-align: center;"> <table border="1" style="width: 100%; border-collapse: collapse; text-align: center;"> <tr> <td style="width: 10%;"></td> <td style="width: 10%;"></td> <td style="width: 10%;"></td> <td style="width: 10%;"></td> <td style="width: 10%;"></td> <td style="width: 10%;"></td> <td style="width: 10%;"></td> <td style="width: 10%;"></td> <td style="width: 10%;"></td> <td style="width: 10%;"></td> </tr> <tr> <td></td> <td></td> <td colspan="8" style="text-align: center;"> <table border="1" style="width: 100%; border-collapse: collapse; text-align: center;"> <tr> <td style="width: 10%;"></td> <td style="width: 10%;"></td> <td style="width: 10%;"></td> <td style="width: 10%;"></td> <td style="width: 10%;"></td> <td style="width: 10%;"></td> <td style="width: 10%;"></td> <td style="width: 10%;"></td> <td style="width: 10%;"></td> <td style="width: 10%;"></td> </tr> <tr> <td></td> <td></td> <td colspan="8" style="text-align: center;"> <table border="1" style="width: 100%; border-collapse: collapse; text-align: center;"> <tr> <td style="width: 10%;"></td> <td style="width: 10%;"></td> <td style="width: 10%;"></td> <td style="width: 10%;"></td> <td style="width: 10%;"></td> <td style="width: 10%;"></td> <td style="width: 10%;"></td> <td style="width: 10%;"></td> <td style="width: 10%;"></td> <td style="width: 10%;"></td> </tr> <tr> <td></td> <td></td> <td colspan="8" style="text-align: center;"> <table border="1" style="width: 100%; border-collapse: collapse; text-align: center;"> <tr> <td style="width: 10%;"></td> <td style="width: 10%;"></td> <td style="width: 10%;"></td> <td style="width: 10%;"></td> <td style="width: 10%;"></td> <td style="width: 10%;"></td> <td style="width: 10%;"></td> <td style="width: 10%;"></td> <td style="width: 10%;"></td> <td style="width: 10%;"></td> </tr> <tr> <td></td> <td></td> <td colspan="8" style="text-align: center;"> <table border="1" style="width: 100%; border-collapse: collapse; text-align: center;"> <tr> <td style="width: 10%;"></td> <td style="width: 10%;"></td> <td style="width: 10%;"></td> <td style="width: 10%;"></td> <td style="width: 10%;"></td> <td style="width: 10%;"></td> <td style="width: 10%;"></td> <td style="width: 10%;"></td> <td style="width: 10%;"></td> <td style="width: 10%;"></td> </tr> <tr> <td></td> <td></td> <td colspan="8" style="text-align: center;"> <table border="1" style="width: 100%; border-collapse: collapse; text-align: center;"> <tr> <td style="width: 10%;"></td> <td style="width: 10%;"></td> <td style="width: 10%;"></td> <td style="width: 10%;"></td> <td style="width: 10%;"></td> <td style="width: 10%;"></td> <td style="width: 10%;"></td> <td style="width: 10%;"></td> <td style="width: 10%;"></td> <td style="width: 10%;"></td> </tr> <tr> <td></td> <td></td> <td colspan="8" style="text-align: center;"> <table border="1" style="width: 100%; border-collapse: collapse; text-align: center;"> <tr> <td style="width: 10%;"></td> <td style="width: 10%;"></td> <td style="width: 10%;"></td> <td style="width: 10%;"></td> <td style="width: 10%;"></td> <td style="width: 10%;"></td> <td style="width: 10%;"></td> <td style="width: 10%;"></td> <td style="width: 10%;"></td> <td style="width: 10%;"></td> </tr> <tr> <td></td> <td></td> <td colspan="8" style="text-align: center;"> <table border="1" style="width: 100%; border-collapse: collapse; text-align: center;"> <tr> <td style="width: 10%;"></td> <td style="width: 10%;"></td> <td style="width: 10%;"></td> <td style="width: 10%;"></td> <td style="width: 10%;"></td> <td style="width: 10%;"></td> <td style="width: 10%;"></td> <td style="width: 10%;"></td> <td style="width: 10%;"></td> <td style="width: 10%;"></td> </tr> <tr> <td></td> <td></td> <td colspan="8" style="text-align: center;"> <table border="1" style="width: 100%; border-collapse: collapse; text-align: center;"> <tr> <td style="width: 10%;"></td> <td style="width: 10%;"></td> <td style="width: 10%;"></td> <td style="width: 10%;"></td> <td style="width: 10%;"></td> <td style="width: 10%;"></td> <td style="width: 10%;"></td> <td style="width: 10%;"></td> <td style="width: 10%;"></td> <td style="width: 10%;"></td> </tr> <tr> <td></td> <td></td> <td colspan="8" style="text-align: center;"> <table border="1" style="width: 100%; border-collapse: collapse; text-align: center;"> <tr> <td style="width: 10%;"></td> <td style="width: 10%;"></td> <td style="width: 10%;"></td> <td style="width: 10%;"></td> <td style="width: 10%;"></td> <td style="width: 10%;"></td> <td style="width: 10%;"></td> <td style="width: 10%;"></td> <td style="width: 10%;"></td> <td style="width: 10%;"></td> </tr> <tr> <td></td> <td></td> <td colspan="8" style="text-align: center;"> <table border="1" style="width: 100%; border-collapse: collapse; text-align: center;"> <tr> <td style="width: 10%;"></td> <td style="width: 10%;"></td> <td style="width: 10%;"></td> <td style="width: 10%;"></td> <td style="width: 10%;"></td> <td style="width: 10%;"></td> <td style="width: 10%;"></td> <td style="width: 10%;"></td> <td style="width: 10%;"></td> <td style="width: 10%;"></td> </tr> <tr> <td></td> <td></td> <td colspan="8" style="text-align: center;"> <table border="1" style="width: 100%; border-collapse: collapse; text-align: center;"> <tr> <td style="width: 10%;"></td> <td style="width: 10%;"></td> <td style="width: 10%;"></td> <td style="width: 10%;"></td> <td style="width: 10%;"></td> <td style="width: 10%;"></td> <td style="width: 10%;"></td> <td style="width: 10%;"></td> <td style="width: 10%;"></td> <td style="width: 10%;"></td> </tr> <tr> <td></td> <td></td> <td colspan="8" style="text-align: center;"> <table border="1" style="width: 100%; border-collapse: collapse; text-align: center;"> <tr> <td style="width: 10%;"></td> <td style="width: 10%;"></td> <td style="width: 10%;"></td> <td style="width: 10%;"></td> <td style="width: 10%;"></td> <td style="width: 10%;"></td> <td style="width: 10%;"></td> <td style="width: 10%;"></td> <td style="width: 10%;"></td> <td style="width: 10%;"></td> </tr> <tr> <td></td> <td></td> <td colspan="8" style="text-align: center;"> <table border="1" style="width: 100%; border-collapse: collapse; text-align: center;"> <tr> <td style="width: 10%;"></td> <td style="width: 10%;"></td> <td style="width: 10%;"></td> <td style="width: 10%;"></td> <td style="width: 10%;"></td> <td style="width: 10%;"></td> <td style="width: 10%;"></td> <td style="width: 10%;"></td> <td style="width: 10%;"></td> <td style="width: 10%;"></td> </tr> <tr> <td></td> <td></td> <td colspan="8" style="text-align: center;"> <table border="1" style="width: 100%; border-collapse: collapse; text-align: center;"> <tr> <td style="width: 10%;"></td> <td style="width: 10%;"></td> <td style="width: 10%;"></td> <td style="width: 10%;"></td> <td style="width: 10%;"></td> <td style="width: 10%;"></td> <td style="width: 10%;"></td> <td style="width: 10%;"></td> <td style="width: 10%;"></td> <td style="width: 10%;"></td> </tr> <tr> <td></td> <td></td> <td colspan="8" style="text-align: center;"> <table border="1" style="width: 100%; border-collapse: collapse; text-align: center;"> <tr> <td style="width: 10%;"></td> <td style="width: 10%;"></td> <td style="width: 10%;"></td> <td style="width: 10%;"></td> <td style="width: 10%;"></td> <td style="width: 10%;"></td> <td style="width: 10%;"></td> <td style="width: 10%;"></td> <td style="width: 10%;"></td> <td style="width: 10%;"></td> </tr> <tr> <td></td> <td></td> <td colspan="8" style="text-align: center;"> <table border="1" style="width: 100%; border-collapse: collapse; text-align: center;"> <tr> <td style="width: 10%;"></td> <td style="width: 10%;"></td> <td style="width: 10%;"></td> <td style="width: 10%;"></td> <td style="width: 10%;"></td> <td style="width: 10%;"></td> <td style="width: 10%;"></td> <td style="width: 10%;"></td> <td style="width: 10%;"></td> <td style="width: 10%;"></td> </tr> <tr> <td></td> <td></td> <td colspan="8" style="text-align: center;"> <table border="1" style="width: 100%; border-collapse: collapse; text-align: center;"> <tr> <td style="width: 10%;"></td> <td style="width: 10%;"></td> <td style="width:
10%;"></td> <td style="width: 10%;"></td> <td style="width: 10%;"></td> <td style="width: 10%;"></td> <td style="width: 10%;"></td> <td style="width: 10%;"></td> <td style="width: 10%;"></td> <td style="width: 10%;"></td> </tr> <tr> <td></td> <td></td> <td colspan="8" style="text-align: center;"> <table border="1" style="width: 100%; border-collapse: collapse; text-align: center;"> <tr> <td style="width: 10%;"></td> <td style="width: 10%;"></td> <td style="width: 10%;"></td> <td style="width: 10%;"></td> <td style="width: 10%;"></td> <td style="width: 10%;"></td> <td style="width: 10%;"></td> <td style="width: 10%;"></td> <td style="width: 10%;"></td> <td style="width: 10%;"></td> </tr> <tr> <td></td> <td></td> <td colspan="8" style="text-align: center;"> <table border="1" style="width: 100%; border-collapse: collapse; text-align: center;"> <tr> <td style="width: 10%;"></td> <td style="width: 10%;"></td> <td style="width: 10%;"></td> <td style="width: 10%;"></td> <td style="width: 10%;"></td> <td style="width: 10%;"></td> <td style="width: 10%;"></td> <td style="width: 10%;"></td> <td style="width: 10%;"></td> <td style="width: 10%;"></td> </tr> <tr> <td></td> <td></td> <td colspan="8" style="text-align: center;"> <table border="1" style="width: 100%; border-collapse: collapse; text-align: center;"> <tr> <td style="width: 10%;"></td> <td style="width: 10%;"></td> <td style="width: 10%;"></td> <td style="width: 10%;"></td> <td style="width: 10%;"></td> <td style="width: 10%;"></td> <td style="width: 10%;"></td> <td style="width: 10%;"></td> <td style="width: 10%;"></td> <td style="width: 10%;"></td> </tr> <tr> <td></td> <td></td> <td colspan="8" style="text-align: center;"> <table border="1" style="width: 100%; border-collapse: collapse; text-align: center;"> <tr> <td style="width: 10%;"></td> <td style="width: 10%;"></td> <td style="width: 10%;"></td> <td style="width: 10%;"></td> <td style="width: 10%;"></td> <td style="width: 10%;"></td> <td style="width: 10%;"></td> <td style="width: 10%;"></td> <td style="width: 10%;"></td> <td style="width: 10%;"></td> </tr> <tr> <td></td> <td></td> <td colspan="8" style="text-align: center;"> <table border="1" style="width: 100%; border-collapse: collapse; text-align: center;"> <tr> <td style="width: 10%;"></td> <td style="width: 10%;"></td> <td style="width: 10%;"></td> <td style="width: 10%;"></td> <td style="width: 10%;"></td> <td style="width: 10%;"></td> <td style="width: 10%;"></td> <td style="width: 10%;"></td> <td style="width: 10%;"></td> <td style="width: 10%;"></td> </tr> <tr> <td></td> <td></td> <td colspan="8" style="text-align: center;"> <table border="1" style="width: 100%; border-collapse: collapse; text-align: center;"> <tr> <td style="width: 10%;"></td> <td style="width: 10%;"></td> <td style="width: 10%;"></td> <td style="width: 10%;"></td> <td style="width: 10%;"></td> <td style="width: 10%;"></td> <td style="width: 10%;"></td> <td style="width: 10%;"></td> <td style="width: 10%;"></td> <td style="width: 10%;"></td> </tr> <tr> <td></td> <td></td> <td colspan="8" style="text-align: center;"> <table border="1" style="width: 100%; border-collapse: collapse; text-align: center;"> <tr> <td style="width: 10%;"></td> <td style="width: 10%;"></td> <td style="width: 10%;"></td> <td style="width: 10%;"></td> <td style="width: 10%;"></td> <td style="width: 10%;"></td> <td style="width: 10%;"></td> <td style="width: 10%;"></td> <td style="width: 10%;"></td> <td style="width: 10%;"></td> </tr> <tr> <td></td> <td></td> <td colspan="8" style="text-align: center;"> <table border="1" style="width: 100%; border-collapse: collapse; text-align: center;"> <tr> <td style="width: 10%;"></td> <td style="width: 10%;"></td> <td style="width: 10%;"></td> <td style="width: 10%;"></td> <td style="width: 10%;"></td> <td style="width: 10%;"></td> <td style="width: 10%;"></td> <td style="width: 10%;"></td> <td style="width: 10%;"></td> <td style="width: 10%;"></td> </tr> <tr> <td></td> <td></td> <td colspan="8" style="text-align: center;"> <table border="1" style="width: 100%; border-collapse: collapse; text-align: center;"> <tr> <td style="width: 10%;"></td> <td style="width: 10%;"></td> <td style="width: 10%;"></td> <td style="width: 10%;"></td> <td style="width: 10%;"></td> <td style="width: 10%;"></td> <td style="width: 10%;"></td> <td style="width: 10%;"></td> <td style="width: 10%;"></td> <td style="width: 10%;"></td> </tr> <tr> <td></td> <td></td> <td colspan="8" style="text-align: center;"> <table border="1" style="width: 100%; border-collapse: collapse; text-align: center;"> <tr> <td style="width: 10%;"></td> <td style="width: 10%;"></td> <td style="width: 10%;"></td> <td style="width: 10%;"></td> <td style="width: 10%;"></td> <td style="width: 10%;"></td> <td style="width: 10%;"></td> <td style="width: 10%;"></td> <td style="width: 10%;"></td> <td style="width: 10%;"></td> </tr> <tr> <td></td> <td></td> <td colspan="8" style="text-align: center;"> <table border="1" style="width: 100%; border-collapse: collapse; text-align: center;"> <tr> <td style="width: 10%;"></td> <td style="width: 10%;"></td> <td style="width: 10%;"></td> <td style="width: 10%;"></td> <td style="width: 10%;"></td> <td style="width: 10%;"></td> <td style="width: 10%;"></td> <td style="width: 10%;"></td> <td style="width: 10%;"></td> <td style="width: 10%;"></td> </tr> <tr> <td></td> <td></td> <td colspan="8" style="text-align: center;"> <table border="1" style="width: 100%; border-collapse: collapse; text-align: center;"> <tr> <td style="width: 10%;"></td> <td style="width: 10%;"></td> <td style="width: 10%;"></td> <td style="width: 10%;"></td> <td style="width: 10%;"></td> <td style="width: 10%;"></td> <td style="width: 10%;"></td> <td style="width: 10%;"></td> <td style="width: 10%;"></td> <td style="width: 10%;"></td> </tr> <tr> <td></td> <td></td> <td colspan="8" style="text-align: center;"> <table border="1" style="width: 100%; border-collapse: collapse; text-align: center;"> <tr> <td style="width: 10%;"></td> <td style="width: 10%;"></td> <td style="width: 10%;"></td> <td style="width: 10%;"></td> <td style="width: 10%;"></td> <td style="width: 10%;"></td> <td style="width: 10%;"></td> <td style="width: 10%;"></td> <td style="width: 10%;"></td> <td style="width: 10%;"></td> </tr> <tr> <td></td> <td></td> <td colspan="8" style="text-align: center;"> <table border="1" style="width: 100%; border-collapse: collapse; text-align: center;"> <tr> <td style="width: 10%;"></td> <td style="width: 10%;"></td> <td style="width: 10%;"></td> <td style="width: 10%;"></td> <td style="width: 10%;"></td> <td style="width: 10%;"></td> <td style="width: 10%;"></td> <td style="width: 10%;"></td> <td style="width: 10%;"></td> <td style="width: 10%;"></td> </tr> <tr> <td></td> <td></td> <td colspan="8" style="text-align: center;"> <table border="1" style="width: 100%; border-collapse: collapse; text-align: center;"> <tr> </tr></table></td></tr></table></td></tr></table></td></tr></table></td></tr></table></td></tr></table></td></tr></table></td></tr></table></td></tr></table></td></tr></table></td></tr></table></td></tr></table></td></tr></table></td></tr></table></td></tr></table></td></tr></table></td></tr></table></td></tr></table></td></tr></table></td></tr></table></td></tr></table></td></tr></table></td></tr></table></td></tr></table></td></tr></table></td></tr></table></td></tr></table></td></tr></table></td></tr></table></td></tr></table></td></tr></table></td></tr></table></td></tr></table></td></tr></table></td></tr></table></td></tr></table></td></tr></table></td></tr></table></td></tr></table></td></tr></table></td></tr></table></td></tr></table></td></tr></table></td></tr></table></td></tr></table></td></tr></table></td></tr></table></td></tr></table></td></tr></table></td></tr></table></td></tr></table></td></tr></table></td></tr></table></td></tr></table></td></tr></table>
 | | | | | | | | | | | | | | | | | | | | <table border="1" style="width: 100%; border-collapse: collapse; text-align: center;"> <tr> <td style="width: 10%;"></td> <td style="width: 10%;"></td> <td style="width: 10%;"></td> <td style="width: 10%;"></td> <td style="width: 10%;"></td> <td style="width: 10%;"></td> <td style="width: 10%;"></td> <td style="width: 10%;"></td> <td style="width: 10%;"></td> <td style="width: 10%;"></td> </tr> <tr> <td></td> <td></td> <td colspan="8" style="text-align: center;"> <table border="1" style="width: 100%; border-collapse: collapse; text-align: center;"> <tr> <td style="width: 10%;"></td> <td style="width: 10%;"></td> <td style="width: 10%;"></td> <td style="width: 10%;"></td> <td style="width: 10%;"></td> <td style="width: 10%;"></td> <td style="width: 10%;"></td> <td style="width: 10%;"></td> <td style="width: 10%;"></td> <td style="width: 10%;"></td> </tr> <tr> <td></td> <td></td> <td colspan="8" style="text-align: center;"> <table border="1" style="width: 100%; border-collapse: collapse; text-align: center;"> <tr> <td style="width: 10%;"></td> <td style="width: 10%;"></td> <td style="width: 10%;"></td> <td style="width: 10%;"></td> <td style="width: 10%;"></td> <td style="width: 10%;"></td> <td style="width: 10%;"></td> <td style="width: 10%;"></td> <td style="width: 10%;"></td> <td style="width: 10%;"></td> </tr> <tr> <td></td> <td></td> <td colspan="8" style="text-align: center;"> <table border="1" style="width: 100%; border-collapse: collapse; text-align: center;"> <tr> <td style="width: 10%;"></td> <td style="width: 10%;"></td> <td style="width: 10%;"></td> <td style="width: 10%;"></td> <td style="width: 10%;"></td> <td style="width: 10%;"></td> <td style="width: 10%;"></td> <td style="width: 10%;"></td> <td style="width: 10%;"></td> <td style="width: 10%;"></td> </tr> <tr> <td></td> <td></td> <td colspan="8" style="text-align: center;"> <table border="1" style="width: 100%; border-collapse: collapse; text-align: center;"> <tr> <td style="width: 10%;"></td> <td style="width: 10%;"></td> <td style="width: 10%;"></td> <td style="width: 10%;"></td> <td style="width: 10%;"></td> <td style="width: 10%;"></td> <td style="width: 10%;"></td> <td style="width: 10%;"></td> <td style="width: 10%;"></td> <td style="width: 10%;"></td> </tr> <tr> <td></td> <td></td> <td colspan="8" style="text-align: center;"> <table border="1" style="width: 100%; border-collapse: collapse; text-align: center;"> <tr> <td style="width: 10%;"></td> <td style="width: 10%;"></td> <td style="width: 10%;"></td> <td style="width: 10%;"></td> <td style="width: 10%;"></td> <td style="width: 10%;"></td> <td style="width: 10%;"></td> <td style="width: 10%;"></td> <td style="width: 10%;"></td> <td style="width: 10%;"></td> </tr> <tr> <td></td> <td></td> <td colspan="8" style="text-align: center;"> <table border="1" style="width: 100%; border-collapse: collapse; text-align: center;"> <tr> <td style="width: 10%;"></td> <td style="width: 10%;"></td> <td style="width: 10%;"></td> <td style="width: 10%;"></td> <td style="width: 10%;"></td> <td style="width: 10%;"></td> <td style="width: 10%;"></td> <td style="width: 10%;"></td> <td style="width: 10%;"></td> <td style="width: 10%;"></td> </tr> <tr> <td></td> <td></td> <td colspan="8" style="text-align: center;"> <table border="1" style="width: 100%; border-collapse: collapse; text-align: center;"> <tr> <td style="width: 10%;"></td> <td style="width: 10%;"></td> <td style="width: 10%;"></td> <td style="width: 10%;"></td> <td style="width: 10%;"></td> <td style="width: 10%;"></td> <td style="width: 10%;"></td> <td style="width: 10%;"></td> <td style="width: 10%;"></td> <td style="width: 10%;"></td> </tr> <tr> <td></td> <td></td> <td colspan="8" style="text-align: center;"> <table border="1" style="width: 100%; border-collapse: collapse; text-align: center;"> <tr> <td style="width: 10%;"></td> <td style="width: 10%;"></td> <td style="width: 10%;"></td> <td style="width: 10%;"></td> <td style="width: 10%;"></td> <td style="width: 10%;"></td> <td style="width: 10%;"></td> <td style="width: 10%;"></td> <td style="width: 10%;"></td> <td style="width: 10%;"></td> </tr> <tr> <td></td> <td></td> <td colspan="8" style="text-align: center;"> <table border="1" style="width: 100%; border-collapse: collapse; text-align: center;"> <tr> <td style="width: 10%;"></td> <td style="width: 10%;"></td> <td style="width: 10%;"></td> <td style="width: 10%;"></td> <td style="width: 10%;"></td> <td style="width: 10%;"></td> <td style="width: 10%;"></td> <td style="width: 10%;"></td> <td style="width: 10%;"></td> <td style="width: 10%;"></td> </tr> <tr> <td></td> <td></td> <td colspan="8" style="text-align: center;"> <table border="1" style="width: 100%; border-collapse: collapse; text-align: center;"> <tr> <td style="width: 10%;"></td> <td style="width: 10%;"></td> <td style="width: 10%;"></td> <td style="width: 10%;"></td> <td style="width: 10%;"></td> <td style="width: 10%;"></td> <td style="width: 10%;"></td> <td style="width: 10%;"></td> <td style="width: 10%;"></td> <td style="width: 10%;"></td> </tr> <tr> <td></td> <td></td> <td colspan="8" style="text-align: center;"> <table border="1" style="width: 100%; border-collapse: collapse; text-align: center;"> <tr> <td style="width: 10%;"></td> <td style="width: 10%;"></td> <td style="width: 10%;"></td> <td style="width: 10%;"></td> <td style="width: 10%;"></td> <td style="width: 10%;"></td> <td style="width: 10%;"></td> <td style="width: 10%;"></td> <td style="width: 10%;"></td> <td style="width: 10%;"></td> </tr> <tr> <td></td> <td></td> <td colspan="8" style="text-align: center;"> <table border="1" style="width: 100%; border-collapse: collapse; text-align: center;"> <tr> <td style="width: 10%;"></td> <td style="width: 10%;"></td> <td style="width: 10%;"></td> <td style="width: 10%;"></td> <td style="width: 10%;"></td> <td style="width: 10%;"></td> <td style="width: 10%;"></td> <td style="width: 10%;"></td> <td style="width: 10%;"></td> <td style="width: 10%;"></td> </tr> <tr> <td></td> <td></td> <td colspan="8" style="text-align: center;"> <table border="1" style="width: 100%; border-collapse: collapse; text-align: center;"> <tr> <td style="width: 10%;"></td> <td style="width: 10%;"></td> <td style="width: 10%;"></td> <td style="width: 10%;"></td> <td style="width: 10%;"></td> <td style="width: 10%;"></td> <td style="width: 10%;"></td> <td style="width: 10%;"></td> <td style="width: 10%;"></td> <td style="width: 10%;"></td> </tr> <tr> <td></td> <td></td> <td colspan="8" style="text-align: center;"> <table border="1" style="width: 100%; border-collapse: collapse; text-align: center;"> <tr> <td style="width: 10%;"></td> <td style="width: 10%;"></td> <td style="width: 10%;"></td> <td style="width: 10%;"></td> <td style="width: 10%;"></td> <td style="width: 10%;"></td> <td style="width: 10%;"></td> <td style="width: 10%;"></td> <td style="width: 10%;"></td> <td style="width: 10%;"></td> </tr> <tr> <td></td> <td></td> <td colspan="8" style="text-align: center;"> <table border="1" style="width: 100%; border-collapse: collapse; text-align: center;"> <tr> <td style="width: 10%;"></td> <td style="width: 10%;"></td> <td style="width: 10%;"></td> <td style="width: 10%;"></td> <td style="width: 10%;"></td> <td style="width: 10%;"></td> <td style="width: 10%;"></td> <td style="width: 10%;"></td> <td style="width: 10%;"></td> <td style="width: 10%;"></td> </tr> <tr> <td></td> <td></td> <td colspan="8" style="text-align: center;"> <table border="1" style="width: 100%; border-collapse: collapse; text-align: center;"> <tr> <td style="width: 10%;"></td> <td style="width: 10%;"></td> <td style="width: 10%;"></td> <td style="width: 10%;"></td> <td style="width: 10%;"></td> <td style="width: 10%;"></td> <td style="width: 10%;"></td> <td style="width: 10%;"></td> <td style="width: 10%;"></td> <td style="width: 10%;"></td> </tr> <tr> <td></td> <td></td> <td colspan="8" style="text-align: center;"> <table border="1" style="width: 100%; border-collapse: collapse; text-align: center;"> <tr> <td style="width: 10%;"></td> <td style="width: 10%;"></td> <td style="width: 10%;"></td> <td style="width: 10%;"></td> <td style="width: 10%;"></td> <td style="width: 10%;"></td> <td style="width: 10%;"></td> <td style="width: 10%;"></td> <td style="width: 10%;"></td> <td style="width: 10%;"></td> </tr> <tr> <td></td> <td></td> <td colspan="8" style="text-align: center;"> <table border="1" style="width: 100%; border-collapse: collapse; text-align: center;"> <tr> <td style="width: 10%;"></td> <td style="width: 10%;"></td> <td style="width: 10%;"></td> <td style="width: 10%;"></td> <td style="width: 10%;"></td> <td style="width: 10%;"></td> <td style="width: 10%;"></td> <td style="width: 10%;"></td> <td style="width: 10%;"></td> <td style="width: 10%;"></td> </tr> <tr> <td></td> <td></td> <td colspan="8" style="text-align: center;"> <table border="1" style="width: 100%; border-collapse: collapse; text-align: center;"> <tr> <td style="width: 10%;"></td> <td style="width: 10%;"></td> <td style="width: 10%;"></td> <td style="width: 10%;"></td> <td style="width: 10%;"></td> <td style="width: 10%;"></td> <td style="width: 10%;"></td> <td style="width: 10%;"></td> <td style="width: 10%;"></td> <td style="width: 10%;"></td> </tr> <tr> <td></td> <td></td> <td colspan="8" style="text-align: center;"> <table border="1" style="width: 100%; border-collapse: collapse; text-align: center;"> <tr> <td style="width: 10%;"></td> <td style="width: 10%;"></td> <td style="width: 10%;"></td> <td style="width: 10%;"></td> <td
style="width: 10%;"></td> <td style="width: 10%;"></td> <td style="width: 10%;"></td> <td style="width: 10%;"></td> <td style="width: 10%;"></td> <td style="width: 10%;"></td> </tr> <tr> <td></td> <td></td> <td colspan="8" style="text-align: center;"> <table border="1" style="width: 100%; border-collapse: collapse; text-align: center;"> <tr> <td style="width: 10%;"></td> <td style="width: 10%;"></td> <td style="width: 10%;"></td> <td style="width: 10%;"></td> <td style="width: 10%;"></td> <td style="width: 10%;"></td> <td style="width: 10%;"></td> <td style="width: 10%;"></td> <td style="width: 10%;"></td> <td style="width: 10%;"></td> </tr> <tr> <td></td> <td></td> <td colspan="8" style="text-align: center;"> <table border="1" style="width: 100%; border-collapse: collapse; text-align: center;"> <tr> <td style="width: 10%;"></td> <td style="width: 10%;"></td> <td style="width: 10%;"></td> <td style="width: 10%;"></td> <td style="width: 10%;"></td> <td style="width: 10%;"></td> <td style="width: 10%;"></td> <td style="width: 10%;"></td> <td style="width: 10%;"></td> <td style="width: 10%;"></td> </tr> <tr> <td></td> <td></td> <td colspan="8" style="text-align: center;"> <table border="1" style="width: 100%; border-collapse: collapse; text-align: center;"> <tr> <td style="width: 10%;"></td> <td style="width: 10%;"></td> <td style="width: 10%;"></td> <td style="width: 10%;"></td> <td style="width: 10%;"></td> <td style="width: 10%;"></td> <td style="width: 10%;"></td> <td style="width: 10%;"></td> <td style="width: 10%;"></td> <td style="width: 10%;"></td> </tr> <tr> <td></td> <td></td> <td colspan="8" style="text-align: center;"> <table border="1" style="width: 100%; border-collapse: collapse; text-align: center;"> <tr> <td style="width: 10%;"></td> <td style="width: 10%;"></td> <td style="width: 10%;"></td> <td style="width: 10%;"></td> <td style="width: 10%;"></td> <td style="width: 10%;"></td> <td style="width: 10%;"></td> <td style="width: 10%;"></td> <td style="width: 10%;"></td> <td style="width: 10%;"></td> </tr> <tr> <td></td> <td></td> <td colspan="8" style="text-align: center;"> <table border="1" style="width: 100%; border-collapse: collapse; text-align: center;"> <tr> <td style="width: 10%;"></td> <td style="width: 10%;"></td> <td style="width: 10%;"></td> <td style="width: 10%;"></td> <td style="width: 10%;"></td> <td style="width: 10%;"></td> <td style="width: 10%;"></td> <td style="width: 10%;"></td> <td style="width: 10%;"></td> <td style="width: 10%;"></td> </tr> <tr> <td></td> <td></td> <td colspan="8" style="text-align: center;"> <table border="1" style="width: 100%; border-collapse: collapse; text-align: center;"> <tr> <td style="width: 10%;"></td> <td style="width: 10%;"></td> <td style="width: 10%;"></td> <td style="width: 10%;"></td> <td style="width: 10%;"></td> <td style="width: 10%;"></td> <td style="width: 10%;"></td> <td style="width: 10%;"></td> <td style="width: 10%;"></td> <td style="width: 10%;"></td> </tr> <tr> <td></td> <td></td> <td colspan="8" style="text-align: center;"> <table border="1" style="width: 100%; border-collapse: collapse; text-align: center;"> <tr> <td style="width: 10%;"></td> <td style="width: 10%;"></td> <td style="width: 10%;"></td> <td style="width: 10%;"></td> <td style="width: 10%;"></td> <td style="width: 10%;"></td> <td style="width: 10%;"></td> <td style="width: 10%;"></td> <td style="width: 10%;"></td> <td style="width: 10%;"></td> </tr> <tr> <td></td> <td></td> <td colspan="8" style="text-align: center;"> <table border="1" style="width: 100%; border-collapse: collapse; text-align: center;"> <tr> <td style="width: 10%;"></td> <td style="width: 10%;"></td> <td style="width: 10%;"></td> <td style="width: 10%;"></td> <td style="width: 10%;"></td> <td style="width: 10%;"></td> <td style="width: 10%;"></td> <td style="width: 10%;"></td> <td style="width: 10%;"></td> <td style="width: 10%;"></td> </tr> <tr> <td></td> <td></td> <td colspan="8" style="text-align: center;"> <table border="1" style="width: 100%; border-collapse: collapse; text-align: center;"> <tr> <td style="width: 10%;"></td> <td style="width: 10%;"></td> <td style="width: 10%;"></td> <td style="width: 10%;"></td> <td style="width: 10%;"></td> <td style="width: 10%;"></td> <td style="width: 10%;"></td> <td style="width: 10%;"></td> <td style="width: 10%;"></td> <td style="width: 10%;"></td> </tr> <tr> <td></td> <td></td> <td colspan="8" style="text-align: center;"> <table border="1" style="width: 100%; border-collapse: collapse; text-align: center;"> <tr> <td style="width: 10%;"></td> <td style="width: 10%;"></td> <td style="width: 10%;"></td> <td style="width: 10%;"></td> <td style="width: 10%;"></td> <td style="width: 10%;"></td> <td style="width: 10%;"></td> <td style="width: 10%;"></td> <td style="width: 10%;"></td> <td style="width: 10%;"></td> </tr> <tr> <td></td> <td></td> <td colspan="8" style="text-align: center;"> <table border="1" style="width: 100%; border-collapse: collapse; text-align: center;"> <tr> <td style="width: 10%;"></td> <td style="width: 10%;"></td> <td style="width: 10%;"></td> <td style="width: 10%;"></td> <td style="width: 10%;"></td> <td style="width: 10%;"></td> <td style="width: 10%;"></td> <td style="width: 10%;"></td> <td style="width: 10%;"></td> <td style="width: 10%;"></td> </tr> <tr> <td></td> <td></td> <td colspan="8" style="text-align: center;"> <table border="1" style="width: 100%; border-collapse: collapse; text-align: center;"> <tr> <td style="width: 10%;"></td> <td style="width: 10%;"></td> <td style="width: 10%;"></td> <td style="width: 10%;"></td> <td style="width: 10%;"></td> <td style="width: 10%;"></td> <td style="width: 10%;"></td> <td style="width: 10%;"></td> <td style="width: 10%;"></td> <td style="width: 10%;"></td> </tr> <tr> <td></td> <td></td> <td colspan="8" style="text-align: center;"> <table border="1" style="width: 100%; border-collapse: collapse; text-align: center;"> <tr> <td style="width: 10%;"></td> <td style="width: 10%;"></td> <td style="width: 10%;"></td> <td style="width: 10%;"></td> <td style="width: 10%;"></td> <td style="width: 10%;"></td> <td style="width: 10%;"></td> <td style="width: 10%;"></td> <td style="width: 10%;"></td> <td style="width: 10%;"></td> </tr> <tr> <td></td> <td></td> <td colspan="8" style="text-align: center;"> <table border="1" style="width: 100%; border-collapse: collapse; text-align: center;"> <tr> <td style="width: 10%;"></td> <td style="width: 10%;"></td> <td style="width: 10%;"></td> <td style="width: 10%;"></td> <td style="width: 10%;"></td> <td style="width: 10%;"></td> <td style="width: 10%;"></td> <td style="width: 10%;"></td> <td style="width: 10%;"></td> <td style="width: 10%;"></td> </tr> <tr> <td></td> <td></td> <td colspan="8" style="text-align: center;"> <table border="1" style="width: 100%; border-collapse: collapse; text-align: center;"> <tr> <td style="width: 10%;"></td> <td style="width: 10%;"></td> <td style="width: 10%;"></td> <td style="width: 10%;"></td> <td style="width: 10%;"></td> <td style="width: 10%;"></td> <td style="width: 10%;"></td> <td style="width: 10%;"></td> <td style="width: 10%;"></td> <td style="width: 10%;"></td> </tr> <tr> <td></td> <td></td> <td colspan="8" style="text-align: center;"> <table border="1" style="width: 100%; border-collapse: collapse; text-align: center;"> <tr> <td style="width: 10%;"></td> <td style="width: 10%;"></td> <td style="width: 10%;"></td> <td style="width: 10%;"></td> <td style="width: 10%;"></td> <td style="width: 10%;"></td> <td style="width: 10%;"></td> <td style="width: 10%;"></td> <td style="width: 10%;"></td> <td style="width: 10%;"></td> </tr> <tr> <td></td> <td></td> <td colspan="8" style="text-align: center;"> <table border="1" style="width: 100%; border-collapse: collapse; text-align: center;"> <tr> <td style="width: 10%;"></td> <td style="width: 10%;"></td> <td style="width: 10%;"></td> <td style="width: 10%;"></td> <td style="width: 10%;"></td> <td style="width: 10%;"></td> <td style="width: 10%;"></td> <td style="width: 10%;"></td> <td style="width: 10%;"></td> <td style="width: 10%;"></td> </tr> <tr> <td></td> <td></td> <td colspan="8" style="text-align: center;"> <table border="1" style="width: 100%; border-collapse: collapse; text-align: center;"> <tr> <td style="width: 10%;"></td> <td style="width: 10%;"></td> <td style="width: 10%;"></td> <td style="width: 10%;"></td> <td style="width: 10%;"></td> <td style="width: 10%;"></td> <td style="width: 10%;"></td> <td style="width: 10%;"></td> <td style="width: 10%;"></td> <td style="width: 10%;"></td> </tr> <tr> <td></td> <td></td> <td colspan="8" style="text-align: center;"> <table border="1" style="width: 100%; border-collapse: collapse; text-align: center;"> <tr> <td style="width: 10%;"></td> <td style="width: 10%;"></td> <td style="width: 10%;"></td> <td style="width: 10%;"></td> <td style="width: 10%;"></td> <td style="width: 10%;"></td> <td style="width: 10%;"></td> <td style="width: 10%;"></td> <td style="width: 10%;"></td> <td style="width: 10%;"></td> </tr> <tr> <td></td> <td></td> <td colspan="8" style="text-align: center;"> <table border="1" style="width: 100%; border-collapse: collapse; text-align: center;"> <tr> <td style="width: 10%;"></td> <td style="width: 10%;"></td> <td style="width: 10%;"></td> <td style="width: 10%;"></td> <td style="width: 10%;"></td> <td style="width: 10%;"></td> <td style="width: 10%;"></td> <td style="width: 10%;"></td> <td style="width: 10%;"></td> <td style="width: 10%;"></td> </tr> <tr> <td></td> <td></td> <td colspan="8" style="text-align: center;"> <table border="1" style="width: 100%; border-collapse: collapse; text-align: center;"> <tr> <td style="width: 10%;"></td> <td style="width: 10%;"></td> <td style="width: 10%;"></td> <td style="width: 10%;"></td> <td style="width: 10%;"></td> <td style="width: 10%;"></td> <td style="width: 10%;"></td> <td style="width: 10%;"></td> <td style="width: 10%;"></td> <td style="width:
10%;"></td> </tr> <tr> <td></td> <td></td> <td colspan="8" style="text-align: center;"> <table border="1" style="width: 100%; border-collapse: collapse; text-align: center;"> <tr> <td style="width: 10%;"></td> <td style="width: 10%;"></td> <td style="width: 10%;"></td> <td style="width: 10%;"></td> <td style="width: 10%;"></td> <td style="width: 10%;"></td> <td style="width: 10%;"></td> <td style="width: 10%;"></td> <td style="width: 10%;"></td> <td style="width: 10%;"></td> </tr> <tr> <td></td> <td></td> <td colspan="8" style="text-align: center;"> <table border="1" style="width: 100%; border-collapse: collapse; text-align: center;"> <tr> <td style="width: 10%;"></td> <td style="width: 10%;"></td> <td style="width: 10%;"></td> <td style="width: 10%;"></td> <td style="width: 10%;"></td> <td style="width: 10%;"></td> <td style="width: 10%;"></td> <td style="width: 10%;"></td> <td style="width: 10%;"></td> <td style="width: 10%;"></td> </tr> <tr> <td></td> <td></td> <td colspan="8" style="text-align: center;"> <table border="1" style="width: 100%; border-collapse: collapse; text-align: center;"> <tr> <td style="width: 10%;"></td> <td style="width: 10%;"></td> <td style="width: 10%;"></td> <td style="width: 10%;"></td> <td style="width: 10%;"></td> <td style="width: 10%;"></td> <td style="width: 10%;"></td> <td style="width: 10%;"></td> <td style="width: 10%;"></td> <td style="width: 10%;"></td> </tr> <tr> <td></td> <td></td> <td colspan="8" style="text-align: center;"> <table border="1" style="width: 100%; border-collapse: collapse; text-align: center;"> <tr> <td style="width: 10%;"></td> <td style="width: 10%;"></td> <td style="width: 10%;"></td> <td style="width: 10%;"></td> <td style="width: 10%;"></td> <td style="width: 10%;"></td> <td style="width: 10%;"></td> <td style="width: 10%;"></td> <td style="width: 10%;"></td> <td style="width: 10%;"></td> </tr> <tr> <td></td> <td></td> <td colspan="8" style="text-align: center;"> <table border="1" style="width: 100%; border-collapse: collapse; text-align: center;"> <tr> <td style="width: 10%;"></td> <td style="width: 10%;"></td> <td style="width: 10%;"></td> <td style="width: 10%;"></td> <td style="width: 10%;"></td> <td style="width: 10%;"></td> <td style="width: 10%;"></td> <td style="width: 10%;"></td> <td style="width: 10%;"></td> <td style="width: 10%;"></td> </tr> <tr> <td></td> <td></td> <td colspan="8" style="text-align: center;"> <table border="1" style="width: 100%; border-collapse: collapse; text-align: center;"> <tr> <td style="width: 10%;"></td> <td style="width: 10%;"></td> <td style="width: 10%;"></td> <td style="width: 10%;"></td> <td style="width: 10%;"></td> <td style="width: 10%;"></td> <td style="width: 10%;"></td> <td style="width: 10%;"></td> <td style="width: 10%;"></td> <td style="width: 10%;"></td> </tr> <tr> <td></td> <td></td> <td colspan="8" style="text-align: center;"> <table border="1" style="width: 100%; border-collapse: collapse; text-align: center;"> <tr> <td style="width: 10%;"></td> <td style="width: 10%;"></td> <td style="width: 10%;"></td> <td style="width: 10%;"></td> <td style="width: 10%;"></td> <td style="width: 10%;"></td> <td style="width: 10%;"></td> <td style="width: 10%;"></td> <td style="width: 10%;"></td> <td style="width: 10%;"></td> </tr> <tr> <td></td> <td></td> <td colspan="8" style="text-align: center;"> <table border="1" style="width: 100%; border-collapse: collapse; text-align: center;"> <tr> <td style="width: 10%;"></td> <td style="width: 10%;"></td> <td style="width: 10%;"></td> <td style="width: 10%;"></td> <td style="width: 10%;"></td> <td style="width: 10%;"></td> <td style="width: 10%;"></td> <td style="width: 10%;"></td> <td style="width: 10%;"></td> <td style="width: 10%;"></td> </tr> <tr> <td></td> <td></td> <td colspan="8" style="text-align: center;"> <table border="1" style="width: 100%; border-collapse: collapse; text-align: center;"> <tr> <td style="width: 10%;"></td> <td style="width: 10%;"></td> <td style="width: 10%;"></td> <td style="width: 10%;"></td> <td style="width: 10%;"></td> <td style="width: 10%;"></td> <td style="width: 10%;"></td> <td style="width: 10%;"></td> <td style="width: 10%;"></td> <td style="width: 10%;"></td> </tr> <tr> <td></td> <td></td> <td colspan="8" style="text-align: center;"> <table border="1" style="width: 100%; border-collapse: collapse; text-align: center;"> <tr> <td style="width: 10%;"></td> <td style="width: 10%;"></td> <td style="width: 10%;"></td> <td style="width: 10%;"></td> <td style="width: 10%;"></td> <td style="width: 10%;"></td> <td style="width: 10%;"></td> <td style="width: 10%;"></td> <td style="width: 10%;"></td> <td style="width: 10%;"></td> </tr> <tr> <td></td> <td></td> <td colspan="8" style="text-align: center;"> <table border="1" style="width: 100%; border-collapse: collapse; text-align: center;"> <tr> <td style="width: 10%;"></td> <td style="width: 10%;"></td> <td style="width: 10%;"></td> <td style="width: 10%;"></td> <td style="width: 10%;"></td> <td style="width: 10%;"></td> <td style="width: 10%;"></td> <td style="width: 10%;"></td> <td style="width: 10%;"></td> <td style="width: 10%;"></td> </tr> <tr> <td></td> <td></td> <td colspan="8" style="text-align: center;"> <table border="1" style="width: 100%; border-collapse: collapse; text-align: center;"> <tr> </tr></table></td></tr></table></td></tr></table></td></tr></table></td></tr></table></td></tr></table></td></tr></table></td></tr></table></td></tr></table></td></tr></table></td></tr></table></td></tr></table></td></tr></table></td></tr></table></td></tr></table></td></tr></table></td></tr></table></td></tr></table></td></tr></table></td></tr></table></td></tr></table></td></tr></table></td></tr></table></td></tr></table></td></tr></table></td></tr></table></td></tr></table></td></tr></table></td></tr></table></td></tr></table></td></tr></table></td></tr></table></td></tr></table></td></tr></table></td></tr></table></td></tr></table></td></tr></table></td></tr></table></td></tr></table></td></tr></table></td></tr></table></td></tr></table></td></tr></table></td></tr></table></td></tr></table></td></tr></table></td></tr></table></td></tr></table></td></tr></table></td></tr></table></td></tr></table></td></tr></table></td></tr></table></td></tr></table> | | | | | | | | | | | | | | | | | | | | <table border="1" style="width: 100%; border-collapse: collapse; text-align: center;"> <tr> <td style="width: 10%;"></td> <td style="width: 10%;"></td> <td style="width: 10%;"></td> <td style="width: 10%;"></td> <td style="width: 10%;"></td> <td style="width: 10%;"></td> <td style="width: 10%;"></td> <td style="width: 10%;"></td> <td style="width: 10%;"></td> <td style="width: 10%;"></td> </tr> <tr> <td></td> <td></td> <td colspan="8" style="text-align: center;"> <table border="1" style="width: 100%; border-collapse: collapse; text-align: center;"> <tr> <td style="width: 10%;"></td> <td style="width: 10%;"></td> <td style="width: 10%;"></td> <td style="width: 10%;"></td> <td style="width: 10%;"></td> <td style="width: 10%;"></td> <td style="width: 10%;"></td> <td style="width: 10%;"></td> <td style="width: 10%;"></td> <td style="width: 10%;"></td> </tr> <tr> <td></td> <td></td> <td colspan="8" style="text-align: center;"> <table border="1" style="width: 100%; border-collapse: collapse; text-align: center;"> <tr> <td style="width: 10%;"></td> <td style="width: 10%;"></td> <td style="width: 10%;"></td> <td style="width: 10%;"></td> <td style="width: 10%;"></td> <td style="width: 10%;"></td> <td
style="width: 10%;"></td> <td style="width: 10%;"></td> <td style="width: 10%;"></td> <td style="width: 10%;"></td> </tr> <tr> <td></td> <td></td> <td colspan="8" style="text-align: center;"> <table border="1" style="width: 100%; border-collapse: collapse; text-align: center;"> <tr> <td style="width: 10%;"></td> <td style="width: 10%;"></td> <td style="width: 10%;"></td> <td style="width: 10%;"></td> <td style="width: 10%;"></td> <td style="width: 10%;"></td> <td style="width: 10%;"></td> <td style="width: 10%;"></td> <td style="width: 10%;"></td> <td style="width: 10%;"></td> </tr> <tr> <td></td> <td></td> <td colspan="8" style="text-align: center;"> <table border="1" style="width: 100%; border-collapse: collapse; text-align: center;"> <tr> <td style="width: 10%;"></td> <td style="width: 10%;"></td> <td style="width: 10%;"></td> <td style="width: 10%;"></td> <td style="width: 10%;"></td> <td style="width: 10%;"></td> <td style="width: 10%;"></td> <td style="width: 10%;"></td> <td style="width: 10%;"></td> <td style="width: 10%;"></td> </tr> <tr> <td></td> <td></td> <td colspan="8" style="text-align: center;"> <table border="1" style="width: 100%; border-collapse: collapse; text-align: center;"> <tr> <td style="width: 10%;"></td> <td style="width: 10%;"></td> <td style="width: 10%;"></td> <td style="width: 10%;"></td> <td style="width: 10%;"></td> <td style="width: 10%;"></td> <td style="width: 10%;"></td> <td style="width: 10%;"></td> <td style="width: 10%;"></td> <td style="width: 10%;"></td> </tr> <tr> <td></td> <td></td> <td colspan="8" style="text-align: center;"> <table border="1" style="width: 100%; border-collapse: collapse; text-align: center;"> <tr> <td style="width: 10%;"></td> <td style="width: 10%;"></td> <td style="width: 10%;"></td> <td style="width: 10%;"></td> <td style="width: 10%;"></td> <td style="width: 10%;"></td> <td style="width: 10%;"></td> <td style="width: 10%;"></td> <td style="width: 10%;"></td> <td style="width: 10%;"></td> </tr> <tr> <td></td> <td></td> <td colspan="8" style="text-align: center;"> <table border="1" style="width: 100%; border-collapse: collapse; text-align: center;"> <tr> <td style="width: 10%;"></td> <td style="width: 10%;"></td> <td style="width: 10%;"></td> <td style="width: 10%;"></td> <td style="width: 10%;"></td> <td style="width: 10%;"></td> <td style="width: 10%;"></td> <td style="width: 10%;"></td> <td style="width: 10%;"></td> <td style="width: 10%;"></td> </tr> <tr> <td></td> <td></td> <td colspan="8" style="text-align: center;"> <table border="1" style="width: 100%; border-collapse: collapse; text-align: center;"> <tr> <td style="width: 10%;"></td> <td style="width: 10%;"></td> <td style="width: 10%;"></td> <td style="width: 10%;"></td> <td style="width: 10%;"></td> <td style="width: 10%;"></td> <td style="width: 10%;"></td> <td style="width: 10%;"></td> <td style="width: 10%;"></td> <td style="width: 10%;"></td> </tr> <tr> <td></td> <td></td> <td colspan="8" style="text-align: center;"> <table border="1" style="width: 100%; border-collapse: collapse; text-align: center;"> <tr> <td style="width: 10%;"></td> <td style="width: 10%;"></td> <td style="width: 10%;"></td> <td style="width: 10%;"></td> <td style="width: 10%;"></td> <td style="width: 10%;"></td> <td style="width: 10%;"></td> <td style="width: 10%;"></td> <td style="width: 10%;"></td> <td style="width: 10%;"></td> </tr> <tr> <td></td> <td></td> <td colspan="8" style="text-align: center;"> <table border="1" style="width: 100%; border-collapse: collapse; text-align: center;"> <tr> <td style="width: 10%;"></td> <td style="width: 10%;"></td> <td style="width: 10%;"></td> <td style="width: 10%;"></td> <td style="width: 10%;"></td> <td style="width: 10%;"></td> <td style="width: 10%;"></td> <td style="width: 10%;"></td> <td style="width: 10%;"></td> <td style="width: 10%;"></td> </tr> <tr> <td></td> <td></td> <td colspan="8" style="text-align: center;"> <table border="1" style="width: 100%; border-collapse: collapse; text-align: center;"> <tr> <td style="width: 10%;"></td> <td style="width: 10%;"></td> <td style="width: 10%;"></td> <td style="width: 10%;"></td> <td style="width: 10%;"></td> <td style="width: 10%;"></td> <td style="width: 10%;"></td> <td style="width: 10%;"></td> <td style="width: 10%;"></td> <td style="width: 10%;"></td> </tr> <tr> <td></td> <td></td> <td colspan="8" style="text-align: center;"> <table border="1" style="width: 100%; border-collapse: collapse; text-align: center;"> <tr> <td style="width: 10%;"></td> <td style="width: 10%;"></td> <td style="width: 10%;"></td> <td style="width: 10%;"></td> <td style="width: 10%;"></td> <td style="width: 10%;"></td> <td style="width: 10%;"></td> <td style="width: 10%;"></td> <td style="width: 10%;"></td> <td style="width: 10%;"></td> </tr> <tr> <td></td> <td></td> <td colspan="8" style="text-align: center;"> <table border="1" style="width: 100%; border-collapse: collapse; text-align: center;"> <tr> <td style="width: 10%;"></td> <td style="width: 10%;"></td> <td style="width: 10%;"></td> <td style="width: 10%;"></td> <td style="width: 10%;"></td> <td style="width: 10%;"></td> <td style="width: 10%;"></td> <td style="width: 10%;"></td> <td style="width: 10%;"></td> <td style="width: 10%;"></td> </tr> <tr> <td></td> <td></td> <td colspan="8" style="text-align: center;"> <table border="1" style="width: 100%; border-collapse: collapse; text-align: center;"> <tr> <td style="width: 10%;"></td> <td style="width: 10%;"></td> <td style="width: 10%;"></td> <td style="width: 10%;"></td> <td style="width: 10%;"></td> <td style="width: 10%;"></td> <td style="width: 10%;"></td> <td style="width: 10%;"></td> <td style="width: 10%;"></td> <td style="width: 10%;"></td> </tr> <tr> <td></td> <td></td> <td colspan="8" style="text-align: center;"> <table border="1" style="width: 100%; border-collapse: collapse; text-align: center;"> <tr> <td style="width: 10%;"></td> <td style="width: 10%;"></td> <td style="width: 10%;"></td> <td style="width: 10%;"></td> <td style="width: 10%;"></td> <td style="width: 10%;"></td> <td style="width: 10%;"></td> <td style="width: 10%;"></td> <td style="width: 10%;"></td> <td style="width: 10%;"></td> </tr> <tr> <td></td> <td></td> <td colspan="8" style="text-align: center;"> <table border="1" style="width: 100%; border-collapse: collapse; text-align: center;"> <tr> <td style="width: 10%;"></td> <td style="width: 10%;"></td> <td style="width: 10%;"></td> <td style="width: 10%;"></td> <td style="width: 10%;"></td> <td style="width: 10%;"></td> <td style="width: 10%;"></td> <td style="width: 10%;"></td> <td style="width: 10%;"></td> <td style="width: 10%;"></td> </tr> <tr> <td></td> <td></td> <td colspan="8" style="text-align: center;"> <table border="1" style="width: 100%; border-collapse: collapse; text-align: center;"> <tr> <td style="width: 10%;"></td> <td style="width: 10%;"></td> <td style="width: 10%;"></td> <td style="width: 10%;"></td> <td style="width: 10%;"></td> <td style="width: 10%;"></td> <td style="width: 10%;"></td> <td style="width: 10%;"></td> <td style="width: 10%;"></td> <td style="width: 10%;"></td> </tr> <tr> <td></td> <td></td> <td colspan="8" style="text-align: center;"> <table border="1" style="width: 100%; border-collapse: collapse; text-align: center;"> <tr> <td style="width: 10%;"></td> <td style="width: 10%;"></td> <td style="width: 10%;"></td> <td style="width: 10%;"></td> <td style="width: 10%;"></td> <td style="width: 10%;"></td> <td style="width: 10%;"></td> <td style="width: 10%;"></td> <td style="width: 10%;"></td> <td style="width: 10%;"></td> </tr> <tr> <td></td> <td></td> <td colspan="8" style="text-align: center;"> <table border="1" style="width: 100%; border-collapse: collapse; text-align: center;"> <tr> <td style="width: 10%;"></td> <td style="width: 10%;"></td> <td style="width: 10%;"></td> <td style="width: 10%;"></td> <td style="width: 10%;"></td> <td style="width: 10%;"></td> <td style="width: 10%;"></td> <td style="width: 10%;"></td> <td style="width: 10%;"></td> <td style="width: 10%;"></td> </tr> <tr> <td></td> <td></td> <td colspan="8" style="text-align: center;"> <table border="1" style="width: 100%; border-collapse: collapse; text-align: center;"> <tr> <td style="width: 10%;"></td> <td style="width: 10%;"></td> <td style="width: 10%;"></td> <td style="width: 10%;"></td> <td style="width: 10%;"></td> <td style="width: 10%;"></td> <td style="width: 10%;"></td> <td style="width: 10%;"></td> <td style="width: 10%;"></td> <td style="width: 10%;"></td> </tr> <tr> <td></td> <td></td> <td colspan="8" style="text-align: center;"> <table border="1" style="width: 100%; border-collapse: collapse; text-align: center;"> <tr> <td style="width: 10%;"></td> <td style="width: 10%;"></td> <td style="width: 10%;"></td> <td style="width: 10%;"></td> <td style="width: 10%;"></td> <td style="width: 10%;"></td> <td style="width: 10%;"></td> <td style="width: 10%;"></td> <td style="width: 10%;"></td> <td style="width: 10%;"></td> </tr> <tr> <td></td> <td></td> <td colspan="8" style="text-align: center;"> <table border="1" style="width: 100%; border-collapse: collapse; text-align: center;"> <tr> <td style="width: 10%;"></td> <td style="width: 10%;"></td> <td style="width: 10%;"></td> <td style="width: 10%;"></td> <td style="width: 10%;"></td> <td style="width: 10%;"></td> <td style="width: 10%;"></td> <td style="width: 10%;"></td> <td style="width: 10%;"></td> <td style="width: 10%;"></td> </tr> <tr> <td></td> <td></td> <td colspan="8" style="text-align: center;"> <table border="1" style="width: 100%; border-collapse: collapse; text-align: center;"> <tr> <td style="width: 10%;"></td> <td style="width: 10%;"></td> <td style="width: 10%;"></td> <td style="width: 10%;"></td> <td style="width: 10%;"></td> <td style="width: 10%;"></td> <td style="width: 10%;"></td> <td style="width: 10%;"></td> <td style="width: 10%;"></td> <td style="width: 10%;"></td> </tr> <tr> <td></td> <td></td> <td colspan="8"
style="text-align: center;"> <table border="1" style="width: 100%; border-collapse: collapse; text-align: center;"> <tr> <td style="width: 10%;"></td> <td style="width: 10%;"></td> <td style="width: 10%;"></td> <td style="width: 10%;"></td> <td style="width: 10%;"></td> <td style="width: 10%;"></td> <td style="width: 10%;"></td> <td style="width: 10%;"></td> <td style="width: 10%;"></td> <td style="width: 10%;"></td> </tr> <tr> <td></td> <td></td> <td colspan="8" style="text-align: center;"> <table border="1" style="width: 100%; border-collapse: collapse; text-align: center;"> <tr> <td style="width: 10%;"></td> <td style="width: 10%;"></td> <td style="width: 10%;"></td> <td style="width: 10%;"></td> <td style="width: 10%;"></td> <td style="width: 10%;"></td> <td style="width: 10%;"></td> <td style="width: 10%;"></td> <td style="width: 10%;"></td> <td style="width: 10%;"></td> </tr> <tr> <td></td> <td></td> <td colspan="8" style="text-align: center;"> <table border="1" style="width: 100%; border-collapse: collapse; text-align: center;"> <tr> <td style="width: 10%;"></td> <td style="width: 10%;"></td> <td style="width: 10%;"></td> <td style="width: 10%;"></td> <td style="width: 10%;"></td> <td style="width: 10%;"></td> <td style="width: 10%;"></td> <td style="width: 10%;"></td> <td style="width: 10%;"></td> <td style="width: 10%;"></td> </tr> <tr> <td></td> <td></td> <td colspan="8" style="text-align: center;"> <table border="1" style="width: 100%; border-collapse: collapse; text-align: center;"> <tr> <td style="width: 10%;"></td> <td style="width: 10%;"></td> <td style="width: 10%;"></td> <td style="width: 10%;"></td> <td style="width: 10%;"></td> <td style="width: 10%;"></td> <td style="width: 10%;"></td> <td style="width: 10%;"></td> <td style="width: 10%;"></td> <td style="width: 10%;"></td> </tr> <tr> <td></td> <td></td> <td colspan="8" style="text-align: center;"> <table border="1" style="width: 100%; border-collapse: collapse; text-align: center;"> <tr> <td style="width: 10%;"></td> <td style="width: 10%;"></td> <td style="width: 10%;"></td> <td style="width: 10%;"></td> <td style="width: 10%;"></td> <td style="width: 10%;"></td> <td style="width: 10%;"></td> <td style="width: 10%;"></td> <td style="width: 10%;"></td> <td style="width: 10%;"></td> </tr> <tr> <td></td> <td></td> <td colspan="8" style="text-align: center;"> <table border="1" style="width: 100%; border-collapse: collapse; text-align: center;"> <tr> <td style="width: 10%;"></td> <td style="width: 10%;"></td> <td style="width: 10%;"></td> <td style="width: 10%;"></td> <td style="width: 10%;"></td> <td style="width: 10%;"></td> <td style="width: 10%;"></td> <td style="width: 10%;"></td> <td style="width: 10%;"></td> <td style="width: 10%;"></td> </tr> <tr> <td></td> <td></td> <td colspan="8" style="text-align: center;"> <table border="1" style="width: 100%; border-collapse: collapse; text-align: center;"> <tr> <td style="width: 10%;"></td> <td style="width: 10%;"></td> <td style="width: 10%;"></td> <td style="width: 10%;"></td> <td style="width: 10%;"></td> <td style="width: 10%;"></td> <td style="width: 10%;"></td> <td style="width: 10%;"></td> <td style="width: 10%;"></td> <td style="width: 10%;"></td> </tr> <tr> <td></td> <td></td> <td colspan="8" style="text-align: center;"> <table border="1" style="width: 100%; border-collapse: collapse; text-align: center;"> <tr> <td style="width: 10%;"></td> <td style="width: 10%;"></td> <td style="width: 10%;"></td> <td style="width: 10%;"></td> <td style="width: 10%;"></td> <td style="width: 10%;"></td> <td style="width: 10%;"></td> <td style="width: 10%;"></td> <td style="width: 10%;"></td> <td style="width: 10%;"></td> </tr> <tr> <td></td> <td></td> <td colspan="8" style="text-align: center;"> <table border="1" style="width: 100%; border-collapse: collapse; text-align: center;"> <tr> <td style="width: 10%;"></td> <td style="width: 10%;"></td> <td style="width: 10%;"></td> <td style="width: 10%;"></td> <td style="width: 10%;"></td> <td style="width: 10%;"></td> <td style="width: 10%;"></td> <td style="width: 10%;"></td> <td style="width: 10%;"></td> <td style="width: 10%;"></td> </tr> <tr> <td></td> <td></td> <td colspan="8" style="text-align: center;"> <table border="1" style="width: 100%; border-collapse: collapse; text-align: center;"> <tr> <td style="width: 10%;"></td> <td style="width: 10%;"></td> <td style="width: 10%;"></td> <td style="width: 10%;"></td> <td style="width: 10%;"></td> <td style="width: 10%;"></td> <td style="width: 10%;"></td> <td style="width: 10%;"></td> <td style="width: 10%;"></td> <td style="width: 10%;"></td> </tr> <tr> <td></td> <td></td> <td colspan="8" style="text-align: center;"> <table border="1" style="width: 100%; border-collapse: collapse; text-align: center;"> <tr> <td style="width: 10%;"></td> <td style="width: 10%;"></td> <td style="width: 10%;"></td> <td style="width: 10%;"></td> <td style="width: 10%;"></td> <td style="width: 10%;"></td> <td style="width: 10%;"></td> <td style="width: 10%;"></td> <td style="width: 10%;"></td> <td style="width: 10%;"></td> </tr> <tr> <td></td> <td></td> <td colspan="8" style="text-align: center;"> <table border="1" style="width: 100%; border-collapse: collapse; text-align: center;"> <tr> <td style="width: 10%;"></td> <td style="width: 10%;"></td> <td style="width: 10%;"></td> <td style="width: 10%;"></td> <td style="width: 10%;"></td> <td style="width: 10%;"></td> <td style="width: 10%;"></td> <td style="width: 10%;"></td> <td style="width: 10%;"></td> <td style="width: 10%;"></td> </tr> <tr> <td></td> <td></td> <td colspan="8" style="text-align: center;"> <table border="1" style="width: 100%; border-collapse: collapse; text-align: center;"> <tr> <td style="width: 10%;"></td> <td style="width: 10%;"></td> <td style="width: 10%;"></td> <td style="width: 10%;"></td> <td style="width: 10%;"></td> <td style="width: 10%;"></td> <td style="width: 10%;"></td> <td style="width: 10%;"></td> <td style="width: 10%;"></td> <td style="width: 10%;"></td> </tr> <tr> <td></td> <td></td> <td colspan="8" style="text-align: center;"> <table border="1" style="width: 100%; border-collapse: collapse; text-align: center;"> <tr> <td style="width: 10%;"></td> <td style="width: 10%;"></td> <td style="width: 10%;"></td> <td style="width: 10%;"></td> <td style="width: 10%;"></td> <td style="width: 10%;"></td> <td style="width: 10%;"></td> <td style="width: 10%;"></td> <td style="width: 10%;"></td> <td style="width: 10%;"></td> </tr> <tr> <td></td> <td></td> <td colspan="8" style="text-align: center;"> <table border="1" style="width: 100%; border-collapse: collapse; text-align: center;"> <tr> <td style="width: 10%;"></td> <td style="width: 10%;"></td> <td style="width: 10%;"></td> <td style="width: 10%;"></td> <td style="width: 10%;"></td> <td style="width: 10%;"></td> <td style="width: 10%;"></td> <td style="width: 10%;"></td> <td style="width: 10%;"></td> <td style="width: 10%;"></td> </tr> <tr> <td></td> <td></td> <td colspan="8" style="text-align: center;"> <table border="1" style="width: 100%; border-collapse: collapse; text-align: center;"> <tr> <td style="width: 10%;"></td> <td style="width: 10%;"></td> <td style="width: 10%;"></td> <td style="width: 10%;"></td> <td style="width: 10%;"></td> <td style="width: 10%;"></td> <td style="width: 10%;"></td> <td style="width: 10%;"></td> <td style="width: 10%;"></td> <td style="width: 10%;"></td> </tr> <tr> <td></td> <td></td> <td colspan="8" style="text-align: center;"> <table border="1" style="width: 100%; border-collapse: collapse; text-align: center;"> <tr> <td style="width: 10%;"></td> <td style="width: 10%;"></td> <td style="width: 10%;"></td> <td style="width: 10%;"></td> <td style="width: 10%;"></td> <td style="width: 10%;"></td> <td style="width: 10%;"></td> <td style="width: 10%;"></td> <td style="width: 10%;"></td> <td style="width: 10%;"></td> </tr> <tr> <td></td> <td></td> <td colspan="8" style="text-align: center;"> <table border="1" style="width: 100%; border-collapse: collapse; text-align: center;"> <tr> <td style="width: 10%;"></td> <td style="width: 10%;"></td> <td style="width: 10%;"></td> <td style="width: 10%;"></td> <td style="width: 10%;"></td> <td style="width: 10%;"></td> <td style="width: 10%;"></td> <td style="width: 10%;"></td> <td style="width: 10%;"></td> <td style="width: 10%;"></td> </tr> <tr> <td></td> <td></td> <td colspan="8" style="text-align: center;"> <table border="1" style="width: 100%; border-collapse: collapse; text-align: center;"> <tr> <td style="width: 10%;"></td> <td style="width: 10%;"></td> <td style="width: 10%;"></td> <td style="width: 10%;"></td> <td style="width: 10%;"></td> <td style="width: 10%;"></td> <td style="width: 10%;"></td> <td style="width: 10%;"></td> <td style="width: 10%;"></td> <td style="width: 10%;"></td> </tr> <tr> <td></td> <td></td> <td colspan="8" style="text-align: center;"> <table border="1" style="width: 100%; border-collapse: collapse; text-align: center;"> <tr> <td style="width: 10%;"></td> <td style="width: 10%;"></td> <td style="width: 10%;"></td> <td style="width: 10%;"></td> <td style="width: 10%;"></td> <td style="width: 10%;"></td> <td style="width: 10%;"></td> <td style="width: 10%;"></td> <td style="width: 10%;"></td> <td style="width: 10%;"></td> </tr> <tr> <td></td> <td></td> <td colspan="8" style="text-align: center;"> <table border="1" style="width: 100%; border-collapse: collapse; text-align: center;"> <tr> <td style="width: 10%;"></td> <td style="width: 10%;"></td> <td style="width: 10%;"></td> <td style="width: 10%;"></td> <td style="width: 10%;"></td> <td style="width: 10%;"></td> <td style="width: 10%;"></td> <td style="width: 10%;"></td> <td style="width: 10%;"></td> <td style="width: 10%;"></td> </tr> <tr> <td></td> <td></td> <td colspan="8" style="text-align: center;"> <table border="1" style="width: 100%; border-collapse: collapse; text-align: center;"> <tr> <td style="width: 10%;"></td> <td style="width:
10%;"></td> <td style="width: 10%;"></td> <td style="width: 10%;"></td> <td style="width: 10%;"></td> <td style="width: 10%;"></td> <td style="width: 10%;"></td> <td style="width: 10%;"></td> <td style="width: 10%;"></td> <td style="width: 10%;"></td> </tr> <tr> <td></td> <td></td> <td colspan="8" style="text-align: center;"> <table border="1" style="width: 100%; border-collapse: collapse; text-align: center;"> <tr> <td style="width: 10%;"></td> <td style="width: 10%;"></td> <td style="width: 10%;"></td> <td style="width: 10%;"></td> <td style="width: 10%;"></td> <td style="width: 10%;"></td> <td style="width: 10%;"></td> <td style="width: 10%;"></td> <td style="width: 10%;"></td> <td style="width: 10%;"></td> </tr> <tr> <td></td> <td></td> <td colspan="8" style="text-align: center;"> <table border="1" style="width: 100%; border-collapse: collapse; text-align: center;"> <tr> <td style="width: 10%;"></td> <td style="width: 10%;"></td> <td style="width: 10%;"></td> <td style="width: 10%;"></td> <td style="width: 10%;"></td> <td style="width: 10%;"></td> <td style="width: 10%;"></td> <td style="width: 10%;"></td> <td style="width: 10%;"></td> <td style="width: 10%;"></td> </tr> <tr> <td></td> <td></td> <td colspan="8" style="text-align: center;"> <table border="1" style="width: 100%; border-collapse: collapse; text-align: center;"> <tr> <td style="width: 10%;"></td> <td style="width: 10%;"></td> <td style="width: 10%;"></td> <td style="width: 10%;"></td> <td style="width: 10%;"></td> <td style="width: 10%;"></td> <td style="width: 10%;"></td> <td style="width: 10%;"></td> <td style="width: 10%;"></td> <td style="width: 10%;"></td> </tr> <tr> <td></td> <td></td> <td colspan="8" style="text-align: center;"> <table border="1" style="width: 100%; border-collapse: collapse; text-align: center;"> <tr> <td style="width: 10%;"></td> <td style="width: 10%;"></td> <td style="width: 10%;"></td> <td style="width: 10%;"></td> <td style="width: 10%;"></td> <td style="width: 10%;"></td> <td style="width: 10%;"></td> <td style="width: 10%;"></td> <td style="width: 10%;"></td> <td style="width: 10%;"></td> </tr> <tr> <td></td> <td></td> <td colspan="8" style="text-align: center;"> <table border="1" style="width: 100%; border-collapse: collapse; text-align: center;"> <tr> <td style="width: 10%;"></td> <td style="width: 10%;"></td> <td style="width: 10%;"></td> <td style="width: 10%;"></td> <td style="width: 10%;"></td> <td style="width: 10%;"></td> <td style="width: 10%;"></td> <td style="width: 10%;"></td> <td style="width: 10%;"></td> <td style="width: 10%;"></td> </tr> <tr> <td></td> <td></td> <td colspan="8" style="text-align: center;"> <table border="1" style="width: 100%; border-collapse: collapse; text-align: center;"> <tr> <td style="width: 10%;"></td> <td style="width: 10%;"></td> <td style="width: 10%;"></td> <td style="width: 10%;"></td> <td style="width: 10%;"></td> <td style="width: 10%;"></td> <td style="width: 10%;"></td> <td style="width: 10%;"></td> <td style="width: 10%;"></td> <td style="width: 10%;"></td> </tr> <tr> <td></td> <td></td> <td colspan="8" style="text-align: center;"> <table border="1" style="width: 100%; border-collapse: collapse; text-align: center;"> <tr> </tr></table></td></tr></table></td></tr></table></td></tr></table></td></tr></table></td></tr></table></td></tr></table></td></tr></table></td></tr></table></td></tr></table></td></tr></table></td></tr></table></td></tr></table></td></tr></table></td></tr></table></td></tr></table></td></tr></table></td></tr></table></td></tr></table></td></tr></table></td></tr></table></td></tr></table></td></tr></table></td></tr></table></td></tr></table></td></tr></table></td></tr></table></td></tr></table></td></tr></table></td></tr></table></td></tr></table></td></tr></table></td></tr></table></td></tr></table></td></tr></table></td></tr></table></td></tr></table></td></tr></table></td></tr></table></td></tr></table></td></tr></table></td></tr></table></td></tr></table></td></tr></table></td></tr></table></td></tr></table></td></tr></table></td></tr></table></td></tr></table></td></tr></table></td></tr></table></td></tr></table></td></tr></table> | | | | | | | | | | | | | | | | | | | | <table border="1" style="width: 100%; border-collapse: collapse; text-align: center;"> <tr> <td style="width: 10%;"></td> <td style="width: 10%;"></td> <td style="width: 10%;"></td> <td style="width: 10%;"></td> <td style="width: 10%;"></td> <td style="width: 10%;"></td> <td style="width: 10%;"></td> <td style="width: 10%;"></td> <td style="width: 10%;"></td> <td style="width: 10%;"></td> </tr> <tr> <td></td> <td></td> <td colspan="8" style="text-align: center;"> <table border="1" style="width: 100%; border-collapse: collapse; text-align: center;"> <tr> <td style="width: 10%;"></td> <td style="width: 10%;"></td> <td style="width: 10%;"></td> <td style="width: 10%;"></td> <td style="width: 10%;"></td> <td style="width: 10%;"></td> <td style="width: 10%;"></td> <td style="width: 10%;"></td> <td style="width: 10%;"></td> <td style="width: 10%;"></td> </tr> <tr> <td></td> <td></td> <td colspan="8" style="text-align: center;"> <table border="1" style="width: 100%; border-collapse: collapse; text-align: center;"> <tr> <td style="width: 10%;"></td> <td style="width: 10%;"></td> <td style="width: 10%;"></td> <td style="width: 10%;"></td> <td style="width: 10%;"></td> <td style="width: 10%;"></td> <td style="width: 10%;"></td> <td style="width: 10%;"></td> <td style="width: 10%;"></td> <td style="width: 10%;"></td> </tr> <tr> <td></td> <td></td> <td colspan="8" style="text-align: center;"> <table border="1" style="width: 100%; border-collapse: collapse; text-align: center;"> <tr> <td style="width: 10%;"></td> <td style="width: 10%;"></td> <td style="width: 10%;"></td> <td style="width: 10%;"></td> <td style="width: 10%;"></td> <td style="width: 10%;"></td> <td style="width: 10%;"></td> <td style="width: 10%;"></td> <td style="width: 10%;"></td> <td style="width: 10%;"></td> </tr> <tr> <td></td> <td></td> <td colspan="8" style="text-align: center;"> <table border="1" style="width: 100%; border-collapse: collapse; text-align: center;"> <tr> <td style="width: 10%;"></td> <td style="width: 10%;"></td> <td style="width: 10%;"></td> <td style="width: 10%;"></td> <td style="width: 10%;"></td> <td style="width: 10%;"></td> <td style="width: 10%;"></td> <td style="width: 10%;"></td> <td style="width: 10%;"></td> <td style="width: 10%;"></td> </tr> <tr> <td></td> <td></td> <td colspan="8" style="text-align: center;"> <table border="1" style="width: 100%; border-collapse: collapse; text-align: center;"> <tr> <td style="width: 10%;"></td> <td style="width: 10%;"></td> <td style="width: 10%;"></td> <td style="width: 10%;"></td> <td style="width: 10%;"></td> <td style="width: 10%;"></td> <td style="width: 10%;"></td> <td style="width: 10%;"></td> <td style="width: 10%;"></td> <td style="width: 10%;"></td> </tr> <tr> <td></td> <td></td> <td colspan="8" style="text-align: center;"> <table border="1" style="width: 100%; border-collapse: collapse; text-align: center;"> <tr> <td style="width: 10%;"></td> <td style="width: 10%;"></td> <td style="width: 10%;"></td> <td style="width: 10%;"></td> <td style="width: 10%;"></td> <td style="width: 10%;"></td> <td style="width: 10%;"></td> <td style="width: 10%;"></td> <td style="width: 10%;"></td> <td style="width: 10%;"></td> </tr> <tr> <td></td> <td></td> <td colspan="8" style="text-align: center;"> <table border="1" style="width: 100%; border-collapse:
collapse; text-align: center;"> <tr> <td style="width: 10%;"></td> <td style="width: 10%;"></td> <td style="width: 10%;"></td> <td style="width: 10%;"></td> <td style="width: 10%;"></td> <td style="width: 10%;"></td> <td style="width: 10%;"></td> <td style="width: 10%;"></td> <td style="width: 10%;"></td> <td style="width: 10%;"></td> </tr> <tr> <td></td> <td></td> <td colspan="8" style="text-align: center;"> <table border="1" style="width: 100%; border-collapse: collapse; text-align: center;"> <tr> <td style="width: 10%;"></td> <td style="width: 10%;"></td> <td style="width: 10%;"></td> <td style="width: 10%;"></td> <td style="width: 10%;"></td> <td style="width: 10%;"></td> <td style="width: 10%;"></td> <td style="width: 10%;"></td> <td style="width: 10%;"></td> <td style="width: 10%;"></td> </tr> <tr> <td></td> <td></td> <td colspan="8" style="text-align: center;"> <table border="1" style="width: 100%; border-collapse: collapse; text-align: center;"> <tr> <td style="width: 10%;"></td> <td style="width: 10%;"></td> <td style="width: 10%;"></td> <td style="width: 10%;"></td> <td style="width: 10%;"></td> <td style="width: 10%;"></td> <td style="width: 10%;"></td> <td style="width: 10%;"></td> <td style="width: 10%;"></td> <td style="width: 10%;"></td> </tr> <tr> <td></td> <td></td> <td colspan="8" style="text-align: center;"> <table border="1" style="width: 100%; border-collapse: collapse; text-align: center;"> <tr> <td style="width: 10%;"></td> <td style="width: 10%;"></td> <td style="width: 10%;"></td> <td style="width: 10%;"></td> <td style="width: 10%;"></td> <td style="width: 10%;"></td> <td style="width: 10%;"></td> <td style="width: 10%;"></td> <td style="width: 10%;"></td> <td style="width: 10%;"></td> </tr> <tr> <td></td> <td></td> <td colspan="8" style="text-align: center;"> <table border="1" style="width: 100%; border-collapse: collapse; text-align: center;"> <tr> <td style="width: 10%;"></td> <td style="width: 10%;"></td> <td style="width: 10%;"></td> <td style="width: 10%;"></td> <td style="width: 10%;"></td> <td style="width: 10%;"></td> <td style="width: 10%;"></td> <td style="width: 10%;"></td> <td style="width: 10%;"></td> <td style="width: 10%;"></td> </tr> <tr> <td></td> <td></td> <td colspan="8" style="text-align: center;"> <table border="1" style="width: 100%; border-collapse: collapse; text-align: center;"> <tr> <td style="width: 10%;"></td> <td style="width: 10%;"></td> <td style="width: 10%;"></td> <td style="width: 10%;"></td> <td style="width: 10%;"></td> <td style="width: 10%;"></td> <td style="width: 10%;"></td> <td style="width: 10%;"></td> <td style="width: 10%;"></td> <td style="width: 10%;"></td> </tr> <tr> <td></td> <td></td> <td colspan="8" style="text-align: center;"> <table border="1" style="width: 100%; border-collapse: collapse; text-align: center;"> <tr> <td style="width: 10%;"></td> <td style="width: 10%;"></td> <td style="width: 10%;"></td> <td style="width: 10%;"></td> <td style="width: 10%;"></td> <td style="width: 10%;"></td> <td style="width: 10%;"></td> <td style="width: 10%;"></td> <td style="width: 10%;"></td> <td style="width: 10%;"></td> </tr> <tr> <td></td> <td></td> <td colspan="8" style="text-align: center;"> <table border="1" style="width: 100%; border-collapse: collapse; text-align: center;"> <tr> <td style="width: 10%;"></td> <td style="width: 10%;"></td> <td style="width: 10%;"></td> <td style="width: 10%;"></td> <td style="width: 10%;"></td> <td style="width: 10%;"></td> <td style="width: 10%;"></td> <td style="width: 10%;"></td> <td style="width: 10%;"></td> <td style="width: 10%;"></td> </tr> <tr> <td></td> <td></td> <td colspan="8" style="text-align: center;"> <table border="1" style="width: 100%; border-collapse: collapse; text-align: center;"> <tr> <td style="width: 10%;"></td> <td style="width: 10%;"></td> <td style="width: 10%;"></td> <td style="width: 10%;"></td> <td style="width: 10%;"></td> <td style="width: 10%;"></td> <td style="width: 10%;"></td> <td style="width: 10%;"></td> <td style="width: 10%;"></td> <td style="width: 10%;"></td> </tr> <tr> <td></td> <td></td> <td colspan="8" style="text-align: center;"> <table border="1" style="width: 100%; border-collapse: collapse; text-align: center;"> <tr> <td style="width: 10%;"></td> <td style="width: 10%;"></td> <td style="width: 10%;"></td> <td style="width: 10%;"></td> <td style="width: 10%;"></td> <td style="width: 10%;"></td> <td style="width: 10%;"></td> <td style="width: 10%;"></td> <td style="width: 10%;"></td> <td style="width: 10%;"></td> </tr> <tr> <td></td> <td></td> <td colspan="8" style="text-align: center;"> <table border="1" style="width: 100%; border-collapse: collapse; text-align: center;"> <tr> <td style="width: 10%;"></td> <td style="width: 10%;"></td> <td style="width: 10%;"></td> <td style="width: 10%;"></td> <td style="width: 10%;"></td> <td style="width: 10%;"></td> <td style="width: 10%;"></td> <td style="width: 10%;"></td> <td style="width: 10%;"></td> <td style="width: 10%;"></td> </tr> <tr> <td></td> <td></td> <td colspan="8" style="text-align: center;"> <table border="1" style="width: 100%; border-collapse: collapse; text-align: center;"> <tr> <td style="width: 10%;"></td> <td style="width: 10%;"></td> <td style="width: 10%;"></td> <td style="width: 10%;"></td> <td style="width: 10%;"></td> <td style="width: 10%;"></td> <td style="width: 10%;"></td> <td style="width: 10%;"></td> <td style="width: 10%;"></td> <td style="width: 10%;"></td> </tr> <tr> <td></td> <td></td> <td colspan="8" style="text-align: center;"> <table border="1" style="width: 100%; border-collapse: collapse; text-align: center;"> <tr> <td style="width: 10%;"></td> <td style="width: 10%;"></td> <td style="width: 10%;"></td> <td style="width: 10%;"></td> <td style="width: 10%;"></td> <td style="width: 10%;"></td> <td style="width: 10%;"></td> <td style="width: 10%;"></td> <td style="width: 10%;"></td> <td style="width: 10%;"></td> </tr> <tr> <td></td> <td></td> <td colspan="8" style="text-align: center;"> <table border="1" style="width: 100%; border-collapse: collapse; text-align: center;"> <tr> <td style="width: 10%;"></td> <td style="width: 10%;"></td> <td style="width: 10%;"></td> <td style="width: 10%;"></td> <td style="width: 10%;"></td> <td style="width: 10%;"></td> <td style="width: 10%;"></td> <td style="width: 10%;"></td> <td style="width: 10%;"></td> <td style="width: 10%;"></td> </tr> <tr> <td></td> <td></td> <td colspan="8" style="text-align: center;"> <table border="1" style="width: 100%; border-collapse: collapse; text-align: center;"> <tr> <td style="width: 10%;"></td> <td style="width: 10%;"></td> <td style="width: 10%;"></td> <td style="width: 10%;"></td> <td style="width: 10%;"></td> <td style="width: 10%;"></td> <td style="width: 10%;"></td> <td style="width: 10%;"></td> <td style="width: 10%;"></td> <td style="width: 10%;"></td> </tr> <tr> <td></td> <td></td> <td colspan="8" style="text-align: center;"> <table border="1" style="width: 100%; border-collapse: collapse; text-align: center;"> <tr> <td style="width: 10%;"></td> <td style="width: 10%;"></td> <td style="width: 10%;"></td> <td style="width: 10%;"></td> <td style="width: 10%;"></td> <td style="width: 10%;"></td> <td style="width: 10%;"></td> <td style="width: 10%;"></td> <td style="width: 10%;"></td> <td style="width: 10%;"></td> </tr> <tr> <td></td> <td></td> <td colspan="8" style="text-align: center;"> <table border="1" style="width: 100%; border-collapse: collapse; text-align: center;"> <tr> <td style="width: 10%;"></td> <td style="width: 10%;"></td> <td style="width: 10%;"></td> <td style="width: 10%;"></td> <td style="width: 10%;"></td> <td style="width: 10%;"></td> <td style="width: 10%;"></td> <td style="width: 10%;"></td> <td style="width: 10%;"></td> <td style="width: 10%;"></td> </tr> <tr> <td></td> <td></td> <td colspan="8" style="text-align: center;"> <table border="1" style="width: 100%; border-collapse: collapse; text-align: center;"> <tr> <td style="width: 10%;"></td> <td style="width: 10%;"></td> <td style="width: 10%;"></td> <td style="width: 10%;"></td> <td style="width: 10%;"></td> <td style="width: 10%;"></td> <td style="width: 10%;"></td> <td style="width: 10%;"></td> <td style="width: 10%;"></td> <td style="width: 10%;"></td> </tr> <tr> <td></td> <td></td> <td colspan="8" style="text-align: center;"> <table border="1" style="width: 100%; border-collapse: collapse; text-align: center;"> <tr> <td style="width: 10%;"></td> <td style="width: 10%;"></td> <td style="width: 10%;"></td> <td style="width: 10%;"></td> <td style="width: 10%;"></td> <td style="width: 10%;"></td> <td style="width: 10%;"></td> <td style="width: 10%;"></td> <td style="width: 10%;"></td> <td style="width: 10%;"></td> </tr> <tr> <td></td> <td></td> <td colspan="8" style="text-align: center;"> <table border="1" style="width: 100%; border-collapse: collapse; text-align: center;"> <tr> <td style="width: 10%;"></td> <td style="width: 10%;"></td> <td style="width: 10%;"></td> <td style="width: 10%;"></td> <td style="width: 10%;"></td> <td style="width: 10%;"></td> <td style="width: 10%;"></td> <td style="width: 10%;"></td> <td style="width: 10%;"></td> <td style="width: 10%;"></td> </tr> <tr> <td></td> <td></td> <td colspan="8" style="text-align: center;"> <table border="1" style="width: 100%; border-collapse: collapse; text-align: center;"> <tr> <td style="width: 10%;"></td> <td style="width: 10%;"></td> <td style="width: 10%;"></td> <td style="width: 10%;"></td> <td style="width: 10%;"></td> <td style="width: 10%;"></td> <td style="width: 10%;"></td> <td style="width: 10%;"></td> <td style="width: 10%;"></td> <td style="width: 10%;"></td> </tr> <tr> <td></td> <td></td> <td colspan="8" style="text-align: center;"> <table border="1" style="width: 100%; border-collapse: collapse; text-align: center;"> <tr> <td style="width: 10%;"></td> <td style="width: 10%;"></td> <td style="width: 10%;"></td> <td style="width: 10%;"></td> <td
style="width: 10%;"></td> <td style="width: 10%;"></td> <td style="width: 10%;"></td> <td style="width: 10%;"></td> <td style="width: 10%;"></td> <td style="width: 10%;"></td> </tr> <tr> <td></td> <td></td> <td colspan="8" style="text-align: center;"> <table border="1" style="width: 100%; border-collapse: collapse; text-align: center;"> <tr> <td style="width: 10%;"></td> <td style="width: 10%;"></td> <td style="width: 10%;"></td> <td style="width: 10%;"></td> <td style="width: 10%;"></td> <td style="width: 10%;"></td> <td style="width: 10%;"></td> <td style="width: 10%;"></td> <td style="width: 10%;"></td> <td style="width: 10%;"></td> </tr> <tr> <td></td> <td></td> <td colspan="8" style="text-align: center;"> <table border="1" style="width: 100%; border-collapse: collapse; text-align: center;"> <tr> <td style="width: 10%;"></td> <td style="width: 10%;"></td> <td style="width: 10%;"></td> <td style="width: 10%;"></td> <td style="width: 10%;"></td> <td style="width: 10%;"></td> <td style="width: 10%;"></td> <td style="width: 10%;"></td> <td style="width: 10%;"></td> <td style="width: 10%;"></td> </tr> <tr> <td></td> <td></td> <td colspan="8" style="text-align: center;"> <table border="1" style="width: 100%; border-collapse: collapse; text-align: center;"> <tr> <td style="width: 10%;"></td> <td style="width: 10%;"></td> <td style="width: 10%;"></td> <td style="width: 10%;"></td> <td style="width: 10%;"></td> <td style="width: 10%;"></td> <td style="width: 10%;"></td> <td style="width: 10%;"></td> <td style="width: 10%;"></td> <td style="width: 10%;"></td> </tr> <tr> <td></td> <td></td> <td colspan="8" style="text-align: center;"> <table border="1" style="width: 100%; border-collapse: collapse; text-align: center;"> <tr> <td style="width: 10%;"></td> <td style="width: 10%;"></td> <td style="width: 10%;"></td> <td style="width: 10%;"></td> <td style="width: 10%;"></td> <td style="width: 10%;"></td> <td style="width: 10%;"></td> <td style="width: 10%;"></td> <td style="width: 10%;"></td> <td style="width: 10%;"></td> </tr> <tr> <td></td> <td></td> <td colspan="8" style="text-align: center;"> <table border="1" style="width: 100%; border-collapse: collapse; text-align: center;"> <tr> <td style="width: 10%;"></td> <td style="width: 10%;"></td> <td style="width: 10%;"></td> <td style="width: 10%;"></td> <td style="width: 10%;"></td> <td style="width: 10%;"></td> <td style="width: 10%;"></td> <td style="width: 10%;"></td> <td style="width: 10%;"></td> <td style="width: 10%;"></td> </tr> <tr> <td></td> <td></td> <td colspan="8" style="text-align: center;"> <table border="1" style="width: 100%; border-collapse: collapse; text-align: center;"> <tr> <td style="width: 10%;"></td> <td style="width: 10%;"></td> <td style="width: 10%;"></td> <td style="width: 10%;"></td> <td style="width: 10%;"></td> <td style="width: 10%;"></td> <td style="width: 10%;"></td> <td style="width: 10%;"></td> <td style="width: 10%;"></td> <td style="width: 10%;"></td> </tr> <tr> <td></td> <td></td> <td colspan="8" style="text-align: center;"> <table border="1" style="width: 100%; border-collapse: collapse; text-align: center;"> <tr> <td style="width: 10%;"></td> <td style="width: 10%;"></td> <td style="width: 10%;"></td> <td style="width: 10%;"></td> <td style="width: 10%;"></td> <td style="width: 10%;"></td> <td style="width: 10%;"></td> <td style="width: 10%;"></td> <td style="width: 10%;"></td> <td style="width: 10%;"></td> </tr> <tr> <td></td> <td></td> <td colspan="8" style="text-align: center;"> <table border="1" style="width: 100%; border-collapse: collapse; text-align: center;"> <tr> <td style="width: 10%;"></td> <td style="width: 10%;"></td> <td style="width: 10%;"></td> <td style="width: 10%;"></td> <td style="width: 10%;"></td> <td style="width: 10%;"></td> <td style="width: 10%;"></td> <td style="width: 10%;"></td> <td style="width: 10%;"></td> <td style="width: 10%;"></td> </tr> <tr> <td></td> <td></td> <td colspan="8" style="text-align: center;"> <table border="1" style="width: 100%; border-collapse: collapse; text-align: center;"> <tr> <td style="width: 10%;"></td> <td style="width: 10%;"></td> <td style="width: 10%;"></td> <td style="width: 10%;"></td> <td style="width: 10%;"></td> <td style="width: 10%;"></td> <td style="width: 10%;"></td> <td style="width: 10%;"></td> <td style="width: 10%;"></td> <td style="width: 10%;"></td> </tr> <tr> <td></td> <td></td> <td colspan="8" style="text-align: center;"> <table border="1" style="width: 100%; border-collapse: collapse; text-align: center;"> <tr> <td style="width: 10%;"></td> <td style="width: 10%;"></td> <td style="width: 10%;"></td> <td style="width: 10%;"></td> <td style="width: 10%;"></td> <td style="width: 10%;"></td> <td style="width: 10%;"></td> <td style="width: 10%;"></td> <td style="width: 10%;"></td> <td style="width: 10%;"></td> </tr> <tr> <td></td> <td></td> <td colspan="8" style="text-align: center;"> <table border="1" style="width: 100%; border-collapse: collapse; text-align: center;"> <tr> <td style="width: 10%;"></td> <td style="width: 10%;"></td> <td style="width: 10%;"></td> <td style="width: 10%;"></td> <td style="width: 10%;"></td> <td style="width: 10%;"></td> <td style="width: 10%;"></td> <td style="width: 10%;"></td> <td style="width: 10%;"></td> <td style="width: 10%;"></td> </tr> <tr> <td></td> <td></td> <td colspan="8" style="text-align: center;"> <table border="1" style="width: 100%; border-collapse: collapse; text-align: center;"> <tr> <td style="width: 10%;"></td> <td style="width: 10%;"></td> <td style="width: 10%;"></td> <td style="width: 10%;"></td> <td style="width: 10%;"></td> <td style="width: 10%;"></td> <td style="width: 10%;"></td> <td style="width: 10%;"></td> <td style="width: 10%;"></td> <td style="width: 10%;"></td> </tr> <tr> <td></td> <td></td> <td colspan="8" style="text-align: center;"> <table border="1" style="width: 100%; border-collapse: collapse; text-align: center;"> <tr> <td style="width: 10%;"></td> <td style="width: 10%;"></td> <td style="width: 10%;"></td> <td style="width: 10%;"></td> <td style="width: 10%;"></td> <td style="width: 10%;"></td> <td style="width: 10%;"></td> <td style="width: 10%;"></td> <td style="width: 10%;"></td> <td style="width: 10%;"></td> </tr> <tr> <td></td> <td></td> <td colspan="8" style="text-align: center;"> <table border="1" style="width: 100%; border-collapse: collapse; text-align: center;"> <tr> <td style="width: 10%;"></td> <td style="width: 10%;"></td> <td style="width: 10%;"></td> <td style="width: 10%;"></td> <td style="width: 10%;"></td> <td style="width: 10%;"></td> <td style="width: 10%;"></td> <td style="width: 10%;"></td> <td style="width: 10%;"></td> <td style="width: 10%;"></td> </tr> <tr> <td></td> <td></td> <td colspan="8" style="text-align: center;"> <table border="1" style="width: 100%; border-collapse: collapse; text-align: center;"> <tr> <td style="width: 10%;"></td> <td style="width: 10%;"></td> <td style="width: 10%;"></td> <td style="width: 10%;"></td> <td style="width: 10%;"></td> <td style="width: 10%;"></td> <td style="width: 10%;"></td> <td style="width: 10%;"></td> <td style="width: 10%;"></td> <td style="width: 10%;"></td> </tr> <tr> <td></td> <td></td> <td colspan="8" style="text-align: center;"> <table border="1" style="width: 100%; border-collapse: collapse; text-align: center;"> <tr> <td style="width: 10%;"></td> <td style="width: 10%;"></td> <td style="width: 10%;"></td> <td style="width: 10%;"></td> <td style="width: 10%;"></td> <td style="width: 10%;"></td> <td style="width: 10%;"></td> <td style="width: 10%;"></td> <td style="width: 10%;"></td> <td style="width: 10%;"></td> </tr> <tr> <td></td> <td></td> <td colspan="8" style="text-align: center;"> <table border="1" style="width: 100%; border-collapse: collapse; text-align: center;"> <tr> <td style="width: 10%;"></td> <td style="width: 10%;"></td> <td style="width: 10%;"></td> <td style="width: 10%;"></td> <td style="width: 10%;"></td> <td style="width: 10%;"></td> <td style="width: 10%;"></td> <td style="width: 10%;"></td> <td style="width: 10%;"></td> <td style="width: 10%;"></td> </tr> <tr> <td></td> <td></td> <td colspan="8" style="text-align: center;"> <table border="1" style="width: 100%; border-collapse: collapse; text-align: center;"> <tr> <td style="width: 10%;"></td> <td style="width: 10%;"></td> <td style="width: 10%;"></td> <td style="width: 10%;"></td> <td style="width: 10%;"></td> <td style="width: 10%;"></td> <td style="width: 10%;"></td> <td style="width: 10%;"></td> <td style="width: 10%;"></td> <td style="width: 10%;"></td> </tr> <tr> <td></td> <td></td> <td colspan="8" style="text-align: center;"> <table border="1" style="width: 100%; border-collapse: collapse; text-align: center;"> <tr> <td style="width: 10%;"></td> <td style="width: 10%;"></td> <td style="width: 10%;"></td> <td style="width: 10%;"></td> <td style="width: 10%;"></td> <td style="width: 10%;"></td> <td style="width: 10%;"></td> <td style="width: 10%;"></td> <td style="width: 10%;"></td> <td style="width: 10%;"></td> </tr> <tr> <td></td> <td></td> <td colspan="8" style="text-align: center;"> <table border="1" style="width: 100%; border-collapse: collapse; text-align: center;"> <tr> <td style="width: 10%;"></td> <td style="width: 10%;"></td> <td style="width: 10%;"></td> <td style="width: 10%;"></td> <td style="width: 10%;"></td> <td style="width: 10%;"></td> <td style="width: 10%;"></td> <td style="width: 10%;"></td> <td style="width: 10%;"></td> <td style="width: 10%;"></td> </tr> <tr> <td></td> <td></td> <td colspan="8" style="text-align: center;"> <table border="1" style="width: 100%; border-collapse: collapse; text-align: center;"> <tr> <td style="width: 10%;"></td> <td style="width: 10%;"></td> <td style="width: 10%;"></td> <td style="width: 10%;"></td> <td style="width: 10%;"></td> <td style="width: 10%;"></td> <td style="width: 10%;"></td> <td style="width: 10%;"></td> <td style="width: 10%;"></td> <td style="width:
10%;"></td> </tr> <tr> <td></td> <td></td> <td colspan="8" style="text-align: center;"> <table border="1" style="width: 100%; border-collapse: collapse; text-align: center;"> <tr> <td style="width: 10%;"></td> <td style="width: 10%;"></td> <td style="width: 10%;"></td> <td style="width: 10%;"></td> <td style="width: 10%;"></td> <td style="width: 10%;"></td> <td style="width: 10%;"></td> <td style="width: 10%;"></td> <td style="width: 10%;"></td> <td style="width: 10%;"></td> </tr> <tr> <td></td> <td></td> <td colspan="8" style="text-align: center;"> <table border="1" style="width: 100%; border-collapse: collapse; text-align: center;"> <tr> </tr></table></td></tr></table></td></tr></table></td></tr></table></td></tr></table></td></tr></table></td></tr></table></td></tr></table></td></tr></table></td></tr></table></td></tr></table></td></tr></table></td></tr></table></td></tr></table></td></tr></table></td></tr></table></td></tr></table></td></tr></table></td></tr></table></td></tr></table></td></tr></table></td></tr></table></td></tr></table></td></tr></table></td></tr></table></td></tr></table></td></tr></table></td></tr></table></td></tr></table></td></tr></table></td></tr></table></td></tr></table></td></tr></table></td></tr></table></td></tr></table></td></tr></table></td></tr></table></td></tr></table></td></tr></table></td></tr></table></td></tr></table></td></tr></table></td></tr></table></td></tr></table></td></tr></table></td></tr></table></td></tr></table></td></tr></table></td></tr></table></td></tr></table></td></tr></table></td></tr></table> | | | | | | | | | | | | | | | | | | | | <table border="1" style="width: 100%; border-collapse: collapse; text-align: center;"> <tr> <td style="width: 10%;"></td> <td style="width: 10%;"></td> <td style="width: 10%;"></td> <td style="width: 10%;"></td> <td style="width: 10%;"></td> <td style="width: 10%;"></td> <td style="width: 10%;"></td> <td style="width: 10%;"></td> <td style="width: 10%;"></td> <td style="width: 10%;"></td> </tr> <tr> <td></td> <td></td> <td colspan="8" style="text-align: center;"> <table border="1" style="width: 100%; border-collapse: collapse; text-align: center;"> <tr> <td style="width: 10%;"></td> <td style="width: 10%;"></td> <td style="width: 10%;"></td> <td style="width: 10%;"></td> <td style="width: 10%;"></td> <td style="width: 10%;"></td> <td style="width: 10%;"></td> <td style="width: 10%;"></td> <td style="width: 10%;"></td> <td style="width: 10%;"></td> </tr> <tr> <td></td> <td></td> <td colspan="8" style="text-align: center;"> <table border="1" style="width: 100%; border-collapse: collapse; text-align: center;"> <tr> <td style="width: 10%;"></td> <td style="width: 10%;"></td> <td style="width: 10%;"></td> <td style="width: 10%;"></td> <td style="width: 10%;"></td> <td style="width: 10%;"></td> <td style="width: 10%;"></td> <td style="width: 10%;"></td> <td style="width: 10%;"></td> <td style="width: 10%;"></td> </tr> <tr> <td></td> <td></td> <td colspan="8" style="text-align: center;"> <table border="1" style="width: 100%; border-collapse: collapse; text-align: center;"> <tr> <td style="width: 10%;"></td> <td style="width: 10%;"></td> <td style="width: 10%;"></td> <td style="width: 10%;"></td> <td style="width: 10%;"></td> <td style="width: 10%;"></td> <td style="width: 10%;"></td> <td style="width: 10%;"></td> <td style="width: 10%;"></td> <td style="width: 10%;"></td> </tr> <tr> <td></td> <td></td> <td colspan="8" style="text-align: center;"> <table border="1" style="width: 100%; border-collapse: collapse; text-align: center;"> <tr> <td style="width: 10%;"></td> <td style="width: 10%;"></td> <td style="width: 10%;"></td> <td style="width: 10%;"></td> <td style="width: 10%;"></td> <td style="width: 10%;"></td> <td style="width: 10%;"></td> <td style="width: 10%;"></td> <td style="width: 10%;"></td> <td style="width: 10%;"></td> </tr> <tr> <td></td> <td></td> <td colspan="8" style="text-align: center;"> <table border="1" style="width: 100%; border-collapse: collapse; text-align: center;"> <tr> <td style="width: 10%;"></td> <td style="width: 10%;"></td> <td style="width: 10%;"></td> <td style="width: 10%;"></td> <td style="width: 10%;"></td> <td style="width: 10%;"></td> <td style="width: 10%;"></td> <td style="width: 10%;"></td> <td style="width: 10%;"></td> <td style="width: 10%;"></td> </tr> <tr> <td></td> <td></td> <td colspan="8" style="text-align: center;"> <table border="1" style="width: 100%; border-collapse: collapse; text-align: center;"> <tr> <td style="width: 10%;"></td> <td style="width: 10%;"></td> <td style="width: 10%;"></td> <td style="width: 10%;"></td> <td style="width: 10%;"></td> <td style="width: 10%;"></td> <td style="width: 10%;"></td> <td style="width: 10%;"></td> <td style="width: 10%;"></td> <td style="width: 10%;"></td> </tr> <tr> <td></td> <td></td> <td colspan="8" style="text-align: center;"> <table border="1" style="width: 100%; border-collapse: collapse; text-align: center;"> <tr> <td style="width: 10%;"></td> <td style="width: 10%;"></td> <td style="width: 10%;"></td> <td style="width: 10%;"></td> <td style="width: 10%;"></td> <td style="width: 10%;"></td> <td style="width: 10%;"></td> <td style="width: 10%;"></td> <td style="width: 10%;"></td> <td style="width: 10%;"></td> </tr> <tr> <td></td> <td></td> <td colspan="8" style="text-align: center;"> <table border="1" style="width: 100%; border-collapse: collapse; text-align: center;"> <tr> <td style="width: 10%;"></td> <td style="width: 10%;"></td> <td style="width: 10%;"></td> <td style="width: 10%;"></td> <td style="width: 10%;"></td> <td style="width: 10%;"></td> <td style="width: 10%;"></td> <td style="width: 10%;"></td> <td style="width: 10%;"></td> <td style="width: 10%;"></td> </tr> <tr> <td></td> <td></td> <td colspan="8" style="text-align: center;"> <table border="1" style="width: 100%; border-collapse: collapse; text-align: center;"> <tr> <td style="width: 10%;"></td> <td style="width: 10%;"></td> <td style="width: 10%;"></td> <td style="width: 10%;"></td> <td style="width: 10%;"></td> <td style="width: 10%;"></td> <td style="width: 10%;"></td> <td style="width: 10%;"></td> <td style="width: 10%;"></td> <td style="width: 10%;"></td> </tr> <tr> <td></td> <td></td> <td colspan="8" style="text-align: center;"> <table border="1" style="width: 100%; border-collapse: collapse; text-align: center;"> <tr> <td style="width: 10%;"></td> <td style="width: 10%;"></td> <td style="width: 10%;"></td> <td style="width: 10%;"></td> <td style="width: 10%;"></td> <td style="width: 10%;"></td> <td style="width: 10%;"></td> <td style="width: 10%;"></td> <td style="width: 10%;"></td> <td style="width: 10%;"></td> </tr> <tr> <td></td> <td></td> <td colspan="8" style="text-align: center;"> <table border="1" style="width: 100%; border-collapse: collapse; text-align: center;"> <tr> <td style="width: 10%;"></td> <td style="width: 10%;"></td> <td style="width: 10%;"></td> <td style="width: 10%;"></td> <td style="width: 10%;"></td> <td style="width: 10%;"></td> <td style="width: 10%;"></td> <td style="width: 10%;"></td> <td style="width: 10%;"></td> <td style="width: 10%;"></td> </tr> <tr> <td></td> <td></td> <td colspan="8" style="text-align: center;"> <table border="1" style="width: 100%; border-collapse: collapse; text-align: center;"> <tr> <td style="width: 10%;"></td> <td style="width: 10%;"></td> <td style="width: 10%;"></td> <td style="width: 10%;"></td> <td style="width: 10%;"></td> <td style="width: 10%;"></td> <td style="width: 10%;"></td> <td
style="width: 10%;"></td> <td style="width: 10%;"></td> <td style="width: 10%;"></td> </tr> <tr> <td></td> <td></td> <td colspan="8" style="text-align: center;"> <table border="1" style="width: 100%; border-collapse: collapse; text-align: center;"> <tr> <td style="width: 10%;"></td> <td style="width: 10%;"></td> <td style="width: 10%;"></td> <td style="width: 10%;"></td> <td style="width: 10%;"></td> <td style="width: 10%;"></td> <td style="width: 10%;"></td> <td style="width: 10%;"></td> <td style="width: 10%;"></td> <td style="width: 10%;"></td> </tr> <tr> <td></td> <td></td> <td colspan="8" style="text-align: center;"> <table border="1" style="width: 100%; border-collapse: collapse; text-align: center;"> <tr> <td style="width: 10%;"></td> <td style="width: 10%;"></td> <td style="width: 10%;"></td> <td style="width: 10%;"></td> <td style="width: 10%;"></td> <td style="width: 10%;"></td> <td style="width: 10%;"></td> <td style="width: 10%;"></td> <td style="width: 10%;"></td> <td style="width: 10%;"></td> </tr> <tr> <td></td> <td></td> <td colspan="8" style="text-align: center;"> <table border="1" style="width: 100%; border-collapse: collapse; text-align: center;"> <tr> <td style="width: 10%;"></td> <td style="width: 10%;"></td> <td style="width: 10%;"></td> <td style="width: 10%;"></td> <td style="width: 10%;"></td> <td style="width: 10%;"></td> <td style="width: 10%;"></td> <td style="width: 10%;"></td> <td style="width: 10%;"></td> <td style="width: 10%;"></td> </tr> <tr> <td></td> <td></td> <td colspan="8" style="text-align: center;"> <table border="1" style="width: 100%; border-collapse: collapse; text-align: center;"> <tr> <td style="width: 10%;"></td> <td style="width: 10%;"></td> <td style="width: 10%;"></td> <td style="width: 10%;"></td> <td style="width: 10%;"></td> <td style="width: 10%;"></td> <td style="width: 10%;"></td> <td style="width: 10%;"></td> <td style="width: 10%;"></td> <td style="width: 10%;"></td> </tr> <tr> <td></td> <td></td> <td colspan="8" style="text-align: center;"> <table border="1" style="width: 100%; border-collapse: collapse; text-align: center;"> <tr> <td style="width: 10%;"></td> <td style="width: 10%;"></td> <td style="width: 10%;"></td> <td style="width: 10%;"></td> <td style="width: 10%;"></td> <td style="width: 10%;"></td> <td style="width: 10%;"></td> <td style="width: 10%;"></td> <td style="width: 10%;"></td> <td style="width: 10%;"></td> </tr> <tr> <td></td> <td></td> <td colspan="8" style="text-align: center;"> <table border="1" style="width: 100%; border-collapse: collapse; text-align: center;"> <tr> <td style="width: 10%;"></td> <td style="width: 10%;"></td> <td style="width: 10%;"></td> <td style="width: 10%;"></td> <td style="width: 10%;"></td> <td style="width: 10%;"></td> <td style="width: 10%;"></td> <td style="width: 10%;"></td> <td style="width: 10%;"></td> <td style="width: 10%;"></td> </tr> <tr> <td></td> <td></td> <td colspan="8" style="text-align: center;"> <table border="1" style="width: 100%; border-collapse: collapse; text-align: center;"> <tr> <td style="width: 10%;"></td> <td style="width: 10%;"></td> <td style="width: 10%;"></td> <td style="width: 10%;"></td> <td style="width: 10%;"></td> <td style="width: 10%;"></td> <td style="width: 10%;"></td> <td style="width: 10%;"></td> <td style="width: 10%;"></td> <td style="width: 10%;"></td> </tr> <tr> <td></td> <td></td> <td colspan="8" style="text-align: center;"> <table border="1" style="width: 100%; border-collapse: collapse; text-align: center;"> <tr> <td style="width: 10%;"></td> <td style="width: 10%;"></td> <td style="width: 10%;"></td> <td style="width: 10%;"></td> <td style="width: 10%;"></td> <td style="width: 10%;"></td> <td style="width: 10%;"></td> <td style="width: 10%;"></td> <td style="width: 10%;"></td> <td style="width: 10%;"></td> </tr> <tr> <td></td> <td></td> <td colspan="8" style="text-align: center;"> <table border="1" style="width: 100%; border-collapse: collapse; text-align: center;"> <tr> <td style="width: 10%;"></td> <td style="width: 10%;"></td> <td style="width: 10%;"></td> <td style="width: 10%;"></td> <td style="width: 10%;"></td> <td style="width: 10%;"></td> <td style="width: 10%;"></td> <td style="width: 10%;"></td> <td style="width: 10%;"></td> <td style="width: 10%;"></td> </tr> <tr> <td></td> <td></td> <td colspan="8" style="text-align: center;"> <table border="1" style="width: 100%; border-collapse: collapse; text-align: center;"> <tr> <td style="width: 10%;"></td> <td style="width: 10%;"></td> <td style="width: 10%;"></td> <td style="width: 10%;"></td> <td style="width: 10%;"></td> <td style="width: 10%;"></td> <td style="width: 10%;"></td> <td style="width: 10%;"></td> <td style="width: 10%;"></td> <td style="width: 10%;"></td> </tr> <tr> <td></td> <td></td> <td colspan="8" style="text-align: center;"> <table border="1" style="width: 100%; border-collapse: collapse; text-align: center;"> <tr> <td style="width: 10%;"></td> <td style="width: 10%;"></td> <td style="width: 10%;"></td> <td style="width: 10%;"></td> <td style="width: 10%;"></td> <td style="width: 10%;"></td> <td style="width: 10%;"></td> <td style="width: 10%;"></td> <td style="width: 10%;"></td> <td style="width: 10%;"></td> </tr> <tr> <td></td> <td></td> <td colspan="8" style="text-align: center;"> <table border="1" style="width: 100%; border-collapse: collapse; text-align: center;"> <tr> <td style="width: 10%;"></td> <td style="width: 10%;"></td> <td style="width: 10%;"></td> <td style="width: 10%;"></td> <td style="width: 10%;"></td> <td style="width: 10%;"></td> <td style="width: 10%;"></td> <td style="width: 10%;"></td> <td style="width: 10%;"></td> <td style="width: 10%;"></td> </tr> <tr> <td></td> <td></td> <td colspan="8" style="text-align: center;"> <table border="1" style="width: 100%; border-collapse: collapse; text-align: center;"> <tr> <td style="width: 10%;"></td> <td style="width: 10%;"></td> <td style="width: 10%;"></td> <td style="width: 10%;"></td> <td style="width: 10%;"></td> <td style="width: 10%;"></td> <td style="width: 10%;"></td> <td style="width: 10%;"></td> <td style="width: 10%;"></td> <td style="width: 10%;"></td> </tr> <tr> <td></td> <td></td> <td colspan="8" style="text-align: center;"> <table border="1" style="width: 100%; border-collapse: collapse; text-align: center;"> <tr> <td style="width: 10%;"></td> <td style="width: 10%;"></td> <td style="width: 10%;"></td> <td style="width: 10%;"></td> <td style="width: 10%;"></td> <td style="width: 10%;"></td> <td style="width: 10%;"></td> <td style="width: 10%;"></td> <td style="width: 10%;"></td> <td style="width: 10%;"></td> </tr> <tr> <td></td> <td></td> <td colspan="8" style="text-align: center;"> <table border="1" style="width: 100%; border-collapse: collapse; text-align: center;"> <tr> <td style="width: 10%;"></td> <td style="width: 10%;"></td> <td style="width: 10%;"></td> <td style="width: 10%;"></td> <td style="width: 10%;"></td> <td style="width: 10%;"></td> <td style="width: 10%;"></td> <td style="width: 10%;"></td> <td style="width: 10%;"></td> <td style="width: 10%;"></td> </tr> <tr> <td></td> <td></td> <td colspan="8" style="text-align: center;"> <table border="1" style="width: 100%; border-collapse: collapse; text-align: center;"> <tr> <td style="width: 10%;"></td> <td style="width: 10%;"></td> <td style="width: 10%;"></td> <td style="width: 10%;"></td> <td style="width: 10%;"></td> <td style="width: 10%;"></td> <td style="width: 10%;"></td> <td style="width: 10%;"></td> <td style="width: 10%;"></td> <td style="width: 10%;"></td> </tr> <tr> <td></td> <td></td> <td colspan="8" style="text-align: center;"> <table border="1" style="width: 100%; border-collapse: collapse; text-align: center;"> <tr> <td style="width: 10%;"></td> <td style="width: 10%;"></td> <td style="width: 10%;"></td> <td style="width: 10%;"></td> <td style="width: 10%;"></td> <td style="width: 10%;"></td> <td style="width: 10%;"></td> <td style="width: 10%;"></td> <td style="width: 10%;"></td> <td style="width: 10%;"></td> </tr> <tr> <td></td> <td></td> <td colspan="8" style="text-align: center;"> <table border="1" style="width: 100%; border-collapse: collapse; text-align: center;"> <tr> <td style="width: 10%;"></td> <td style="width: 10%;"></td> <td style="width: 10%;"></td> <td style="width: 10%;"></td> <td style="width: 10%;"></td> <td style="width: 10%;"></td> <td style="width: 10%;"></td> <td style="width: 10%;"></td> <td style="width: 10%;"></td> <td style="width: 10%;"></td> </tr> <tr> <td></td> <td></td> <td colspan="8" style="text-align: center;"> <table border="1" style="width: 100%; border-collapse: collapse; text-align: center;"> <tr> <td style="width: 10%;"></td> <td style="width: 10%;"></td> <td style="width: 10%;"></td> <td style="width: 10%;"></td> <td style="width: 10%;"></td> <td style="width: 10%;"></td> <td style="width: 10%;"></td> <td style="width: 10%;"></td> <td style="width: 10%;"></td> <td style="width: 10%;"></td> </tr> <tr> <td></td> <td></td> <td colspan="8" style="text-align: center;"> <table border="1" style="width: 100%; border-collapse: collapse; text-align: center;"> <tr> <td style="width: 10%;"></td> <td style="width: 10%;"></td> <td style="width: 10%;"></td> <td style="width: 10%;"></td> <td style="width: 10%;"></td> <td style="width: 10%;"></td> <td style="width: 10%;"></td> <td style="width: 10%;"></td> <td style="width: 10%;"></td> <td style="width: 10%;"></td> </tr> <tr> <td></td> <td></td> <td colspan="8" style="text-align: center;"> <table border="1" style="width: 100%; border-collapse: collapse; text-align: center;"> <tr> <td style="width: 10%;"></td> <td style="width: 10%;"></td> <td style="width: 10%;"></td> <td style="width: 10%;"></td> <td style="width: 10%;"></td> <td style="width: 10%;"></td> <td style="width: 10%;"></td> <td style="width: 10%;"></td> <td style="width: 10%;"></td> <td style="width: 10%;"></td> </tr> <tr> <td></td> <td></td> <td colspan="8" style="text-align: center;"> <table
border="1" style="width: 100%; border-collapse: collapse; text-align: center;"> <tr> <td style="width: 10%;"></td> <td style="width: 10%;"></td> <td style="width: 10%;"></td> <td style="width: 10%;"></td> <td style="width: 10%;"></td> <td style="width: 10%;"></td> <td style="width: 10%;"></td> <td style="width: 10%;"></td> <td style="width: 10%;"></td> <td style="width: 10%;"></td> </tr> <tr> <td></td> <td></td> <td colspan="8" style="text-align: center;"> <table border="1" style="width: 100%; border-collapse: collapse; text-align: center;"> <tr> <td style="width: 10%;"></td> <td style="width: 10%;"></td> <td style="width: 10%;"></td> <td style="width: 10%;"></td> <td style="width: 10%;"></td> <td style="width: 10%;"></td> <td style="width: 10%;"></td> <td style="width: 10%;"></td> <td style="width: 10%;"></td> <td style="width: 10%;"></td> </tr> <tr> <td></td> <td></td> <td colspan="8" style="text-align: center;"> <table border="1" style="width: 100%; border-collapse: collapse; text-align: center;"> <tr> <td style="width: 10%;"></td> <td style="width: 10%;"></td> <td style="width: 10%;"></td> <td style="width: 10%;"></td> <td style="width: 10%;"></td> <td style="width: 10%;"></td> <td style="width: 10%;"></td> <td style="width: 10%;"></td> <td style="width: 10%;"></td> <td style="width: 10%;"></td> </tr> <tr> <td></td> <td></td> <td colspan="8" style="text-align: center;"> <table border="1" style="width: 100%; border-collapse: collapse; text-align: center;"> <tr> <td style="width: 10%;"></td> <td style="width: 10%;"></td> <td style="width: 10%;"></td> <td style="width: 10%;"></td> <td style="width: 10%;"></td> <td style="width: 10%;"></td> <td style="width: 10%;"></td> <td style="width: 10%;"></td> <td style="width: 10%;"></td> <td style="width: 10%;"></td> </tr> <tr> <td></td> <td></td> <td colspan="8" style="text-align: center;"> <table border="1" style="width: 100%; border-collapse: collapse; text-align: center;"> <tr> <td style="width: 10%;"></td> <td style="width: 10%;"></td> <td style="width: 10%;"></td> <td style="width: 10%;"></td> <td style="width: 10%;"></td> <td style="width: 10%;"></td> <td style="width: 10%;"></td> <td style="width: 10%;"></td> <td style="width: 10%;"></td> <td style="width: 10%;"></td> </tr> <tr> <td></td> <td></td> <td colspan="8" style="text-align: center;"> <table border="1" style="width: 100%; border-collapse: collapse; text-align: center;"> <tr> <td style="width: 10%;"></td> <td style="width: 10%;"></td> <td style="width: 10%;"></td> <td style="width: 10%;"></td> <td style="width: 10%;"></td> <td style="width: 10%;"></td> <td style="width: 10%;"></td> <td style="width: 10%;"></td> <td style="width: 10%;"></td> <td style="width: 10%;"></td> </tr> <tr> <td></td> <td></td> <td colspan="8" style="text-align: center;"> <table border="1" style="width: 100%; border-collapse: collapse; text-align: center;"> <tr> <td style="width: 10%;"></td> <td style="width: 10%;"></td> <td style="width: 10%;"></td> <td style="width: 10%;"></td> <td style="width: 10%;"></td> <td style="width: 10%;"></td> <td style="width: 10%;"></td> <td style="width: 10%;"></td> <td style="width: 10%;"></td> <td style="width: 10%;"></td> </tr> <tr> <td></td> <td></td> <td colspan="8" style="text-align: center;"> <table border="1" style="width: 100%; border-collapse: collapse; text-align: center;"> <tr> <td style="width: 10%;"></td> <td style="width: 10%;"></td> <td style="width: 10%;"></td> <td style="width: 10%;"></td> <td style="width: 10%;"></td> <td style="width: 10%;"></td> <td style="width: 10%;"></td> <td style="width: 10%;"></td> <td style="width: 10%;"></td> <td style="width: 10%;"></td> </tr> <tr> <td></td> <td></td> <td colspan="8" style="text-align: center;"> <table border="1" style="width: 100%; border-collapse: collapse; text-align: center;"> <tr> <td style="width: 10%;"></td> <td style="width: 10%;"></td> <td style="width: 10%;"></td> <td style="width: 10%;"></td> <td style="width: 10%;"></td> <td style="width: 10%;"></td> <td style="width: 10%;"></td> <td style="width: 10%;"></td> <td style="width: 10%;"></td> <td style="width: 10%;"></td> </tr> <tr> <td></td> <td></td> <td colspan="8" style="text-align: center;"> <table border="1" style="width: 100%; border-collapse: collapse; text-align: center;"> <tr> <td style="width: 10%;"></td> <td style="width: 10%;"></td> <td style="width: 10%;"></td> <td style="width: 10%;"></td> <td style="width: 10%;"></td> <td style="width: 10%;"></td> <td style="width: 10%;"></td> <td style="width: 10%;"></td> <td style="width: 10%;"></td> <td style="width: 10%;"></td> </tr> <tr> <td></td> <td></td> <td colspan="8" style="text-align: center;"> <table border="1" style="width: 100%; border-collapse: collapse; text-align: center;"> <tr> <td style="width: 10%;"></td> <td style="width: 10%;"></td> <td style="width: 10%;"></td> <td style="width: 10%;"></td> <td style="width: 10%;"></td> <td style="width: 10%;"></td> <td style="width: 10%;"></td> <td style="width: 10%;"></td> <td style="width: 10%;"></td> <td style="width: 10%;"></td> </tr> <tr> <td></td> <td></td> <td colspan="8" style="text-align: center;"> <table border="1" style="width: 100%; border-collapse: collapse; text-align: center;"> <tr> <td style="width: 10%;"></td> <td style="width: 10%;"></td> <td style="width: 10%;"></td> <td style="width: 10%;"></td> <td style="width: 10%;"></td> <td style="width: 10%;"></td> <td style="width: 10%;"></td> <td style="width: 10%;"></td> <td style="width: 10%;"></td> <td style="width: 10%;"></td> </tr> <tr> <td></td> <td></td> <td colspan="8" style="text-align: center;"> <table border="1" style="width: 100%; border-collapse: collapse; text-align: center;"> <tr> <td style="width: 10%;"></td> <td style="width: 10%;"></td> <td style="width: 10%;"></td> <td style="width: 10%;"></td> <td style="width: 10%;"></td> <td style="width: 10%;"></td> <td style="width: 10%;"></td> <td style="width: 10%;"></td> <td style="width: 10%;"></td> <td style="width: 10%;"></td> </tr> <tr> <td></td> <td></td> <td colspan="8" style="text-align: center;"> <table border="1" style="width: 100%; border-collapse: collapse; text-align: center;"> <tr> <td style="width: 10%;"></td> <td style="width: 10%;"></td> <td style="width: 10%;"></td> <td style="width: 10%;"></td> <td style="width: 10%;"></td> <td style="width: 10%;"></td> <td style="width: 10%;"></td> <td style="width: 10%;"></td> <td style="width: 10%;"></td> <td style="width: 10%;"></td> </tr> <tr> <td></td> <td></td> <td colspan="8" style="text-align: center;"> <table border="1" style="width: 100%; border-collapse: collapse; text-align: center;"> <tr> <td style="width: 10%;"></td> <td style="width: 10%;"></td> <td style="width: 10%;"></td> <td style="width: 10%;"></td> <td style="width: 10%;"></td> <td style="width: 10%;"></td> <td style="width: 10%;"></td> <td style="width: 10%;"></td> <td style="width: 10%;"></td> <td style="width: 10%;"></td> </tr> <tr> <td></td> <td></td> <td colspan="8" style="text-align: center;"> <table border="1" style="width: 100%; border-collapse: collapse; text-align: center;"> <tr> <td style="width: 10%;"></td> <td style="width: 10%;"></td> <td style="width: 10%;"></td> <td style="width: 10%;"></td> <td style="width: 10%;"></td> <td style="width: 10%;"></td> <td style="width: 10%;"></td> <td style="width: 10%;"></td> <td style="width: 10%;"></td> <td style="width: 10%;"></td> </tr> <tr> <td></td> <td></td> <td colspan="8" style="text-align: center;"> <table border="1" style="width: 100%; border-collapse: collapse; text-align: center;"> <tr> </tr></table></td></tr></table></td></tr></table></td></tr></table></td></tr></table></td></tr></table></td></tr></table></td></tr></table></td></tr></table></td></tr></table></td></tr></table></td></tr></table></td></tr></table></td></tr></table></td></tr></table></td></tr></table></td></tr></table></td></tr></table></td></tr></table></td></tr></table></td></tr></table></td></tr></table></td></tr></table></td></tr></table></td></tr></table></td></tr></table></td></tr></table></td></tr></table></td></tr></table></td></tr></table></td></tr></table></td></tr></table></td></tr></table></td></tr></table></td></tr></table></td></tr></table></td></tr></table></td></tr></table></td></tr></table></td></tr></table></td></tr></table></td></tr></table></td></tr></table></td></tr></table></td></tr></table></td></tr></table></td></tr></table></td></tr></table></td></tr></table></td></tr></table></td></tr></table>
 | | | | | | | | | | | | | | | | | | | | <table border="1" style="width: 100%; border-collapse: collapse; text-align: center;"> <tr> <td style="width: 10%;"></td> <td style="width: 10%;"></td> <td style="width: 10%;"></td> <td style="width: 10%;"></td> <td style="width: 10%;"></td> <td style="width: 10%;"></td> <td style="width: 10%;"></td> <td style="width: 10%;"></td> <td style="width: 10%;"></td> <td style="width: 10%;"></td> </tr> <tr> <td></td> <td></td> <td colspan="8" style="text-align: center;"> <table border="1" style="width: 100%; border-collapse: collapse; text-align: center;"> <tr> <td style="width: 10%;"></td> <td style="width: 10%;"></td> <td style="width: 10%;"></td> <td style="width: 10%;"></td> <td style="width: 10%;"></td> <td style="width: 10%;"></td> <td style="width: 10%;"></td> <td style="width: 10%;"></td> <td style="width: 10%;"></td> <td style="width: 10%;"></td> </tr> <tr> <td></td> <td></td> <td colspan="8" style="text-align: center;"> <table border="1" style="width: 100%; border-collapse: collapse; text-align: center;"> <tr> <td style="width: 10%;"></td> <td style="width: 10%;"></td> <td style="width: 10%;"></td> <td style="width: 10%;"></td> <td style="width: 10%;"></td> <td style="width: 10%;"></td> <td style="width: 10%;"></td> <td style="width: 10%;"></td> <td style="width: 10%;"></td> <td style="width: 10%;"></td> </tr> <tr> <td></td> <td></td> <td colspan="8" style="text-align: center;"> <table border="1" style="width: 100%; border-collapse: collapse; text-align: center;"> <tr> <td style="width: 10%;"></td> <td style="width: 10%;"></td> <td style="width: 10%;"></td> <td style="width: 10%;"></td> <td style="width: 10%;"></td> <td style="width: 10%;"></td> <td style="width: 10%;"></td> <td style="width: 10%;"></td> <td style="width: 10%;"></td> <td style="width: 10%;"></td> </tr> <tr> <td></td> <td></td> <td colspan="8" style="text-align: center;"> <table border="1" style="width: 100%; border-collapse: collapse; text-align: center;"> <tr> <td style="width: 10%;"></td> <td style="width: 10%;"></td> <td style="width: 10%;"></td> <td style="width: 10%;"></td> <td style="width: 10%;"></td> <td style="width: 10%;"></td> <td style="width: 10%;"></td> <td style="width: 10%;"></td> <td style="width: 10%;"></td> <td style="width: 10%;"></td> </tr> <tr> <td></td> <td></td> <td colspan="8" style="text-align: center;"> <table border="1" style="width: 100%; border-collapse: collapse; text-align: center;"> <tr> <td style="width: 10%;"></td> <td style="width: 10%;"></td> <td style="width: 10%;"></td> <td style="width: 10%;"></td> <td style="width: 10%;"></td> <td style="width: 10%;"></td> <td style="width: 10%;"></td> <td style="width: 10%;"></td> <td style="width: 10%;"></td> <td style="width: 10%;"></td> </tr> <tr> <td></td> <td></td> <td colspan="8" style="text-align: center;"> <table border="1" style="width: 100%; border-collapse: collapse; text-align: center;"> <tr> <td style="width: 10%;"></td> <td style="width: 10%;"></td> <td style="width: 10%;"></td> <td style="width: 10%;"></td> <td style="width: 10%;"></td> <td style="width: 10%;"></td> <td style="width: 10%;"></td> <td style="width: 10%;"></td> <td style="width: 10%;"></td> <td style="width: 10%;"></td> </tr> <tr> <td></td> <td></td> <td colspan="8" style="text-align: center;"> <table border="1" style="width: 100%; border-collapse: collapse; text-align: center;"> <tr> <td style="width: 10%;"></td> <td style="width: 10%;"></td> <td style="width: 10%;"></td> <td style="width: 10%;"></td> <td style="width: 10%;"></td> <td style="width: 10%;"></td> <td style="width: 10%;"></td> <td style="width: 10%;"></td> <td style="width: 10%;"></td> <td style="width: 10%;"></td> </tr> <tr> <td></td> <td></td> <td colspan="8" style="text-align: center;"> <table border="1" style="width: 100%; border-collapse: collapse; text-align: center;"> <tr> <td style="width: 10%;"></td> <td style="width: 10%;"></td> <td style="width: 10%;"></td> <td style="width: 10%;"></td> <td style="width: 10%;"></td> <td style="width: 10%;"></td> <td style="width: 10%;"></td> <td style="width: 10%;"></td> <td style="width: 10%;"></td> <td style="width: 10%;"></td> </tr> <tr> <td></td> <td></td> <td colspan="8" style="text-align: center;"> <table border="1" style="width: 100%; border-collapse: collapse; text-align: center;"> <tr> <td style="width: 10%;"></td> <td style="width: 10%;"></td> <td style="width: 10%;"></td> <td style="width: 10%;"></td> <td style="width: 10%;"></td> <td style="width: 10%;"></td> <td style="width: 10%;"></td> <td style="width: 10%;"></td> <td style="width: 10%;"></td> <td style="width: 10%;"></td> </tr> <tr> <td></td> <td></td> <td colspan="8" style="text-align: center;"> <table border="1" style="width: 100%; border-collapse: collapse; text-align: center;"> <tr> <td style="width: 10%;"></td> <td style="width: 10%;"></td> <td style="width: 10%;"></td> <td style="width: 10%;"></td> <td style="width: 10%;"></td> <td style="width: 10%;"></td> <td style="width: 10%;"></td> <td style="width: 10%;"></td> <td style="width: 10%;"></td> <td style="width: 10%;"></td> </tr> <tr> <td></td> <td></td> <td colspan="8" style="text-align: center;"> <table border="1" style="width: 100%; border-collapse: collapse; text-align: center;"> <tr> <td style="width: 10%;"></td> <td style="width: 10%;"></td> <td style="width: 10%;"></td> <td style="width: 10%;"></td> <td style="width: 10%;"></td> <td style="width: 10%;"></td> <td style="width: 10%;"></td> <td style="width: 10%;"></td> <td style="width: 10%;"></td> <td style="width: 10%;"></td> </tr> <tr> <td></td> <td></td> <td colspan="8" style="text-align: center;"> <table border="1" style="width: 100%; border-collapse: collapse; text-align: center;"> <tr> <td style="width: 10%;"></td> <td style="width: 10%;"></td> <td style="width: 10%;"></td> <td style="width: 10%;"></td> <td style="width: 10%;"></td> <td style="width: 10%;"></td> <td style="width: 10%;"></td> <td style="width: 10%;"></td> <td style="width: 10%;"></td> <td style="width: 10%;"></td> </tr> <tr> <td></td> <td></td> <td colspan="8" style="text-align: center;"> <table border="1" style="width: 100%; border-collapse: collapse; text-align: center;"> <tr> <td style="width: 10%;"></td> <td style="width: 10%;"></td> <td style="width: 10%;"></td> <td style="width: 10%;"></td> <td style="width: 10%;"></td> <td style="width: 10%;"></td> <td style="width: 10%;"></td> <td style="width: 10%;"></td> <td style="width: 10%;"></td> <td style="width: 10%;"></td> </tr> <tr> <td></td> <td></td> <td colspan="8" style="text-align: center;"> <table border="1" style="width: 100%; border-collapse: collapse; text-align: center;"> <tr> <td style="width: 10%;"></td> <td style="width: 10%;"></td> <td style="width: 10%;"></td> <td style="width: 10%;"></td> <td style="width: 10%;"></td> <td style="width: 10%;"></td> <td style="width: 10%;"></td> <td style="width: 10%;"></td> <td style="width: 10%;"></td> <td style="width: 10%;"></td> </tr> <tr> <td></td> <td></td> <td colspan="8" style="text-align: center;"> <table border="1" style="width: 100%; border-collapse: collapse; text-align: center;"> <tr> <td style="width: 10%;"></td> <td style="width: 10%;"></td> <td style="width: 10%;"></td> <td style="width: 10%;"></td> <td style="width: 10%;"></td> <td style="width: 10%;"></td> <td style="width: 10%;"></td> <td style="width: 10%;"></td> <td style="width: 10%;"></td> <td style="width: 10%;"></td> </tr> <tr> <td></td> <td></td> <td colspan="8" style="text-align: center;"> <table border="1" style="width: 100%; border-collapse: collapse; text-align: center;"> <tr> <td style="width: 10%;"></td> <td style="width: 10%;"></td> <td style="width: 10%;"></td> <td style="width: 10%;"></td> <td style="width: 10%;"></td> <td style="width: 10%;"></td> <td style="width: 10%;"></td> <td style="width: 10%;"></td> <td style="width: 10%;"></td> <td style="width: 10%;"></td> </tr> <tr> <td></td> <td></td> <td colspan="8" style="text-align: center;"> <table border="1" style="width: 100%; border-collapse: collapse; text-align: center;"> <tr> <td style="width: 10%;"></td> <td style="width: 10%;"></td> <td style="width: 10%;"></td> <td style="width: 10%;"></td> <td style="width: 10%;"></td> <td style="width: 10%;"></td> <td style="width: 10%;"></td> <td style="width: 10%;"></td> <td style="width: 10%;"></td> <td style="width: 10%;"></td> </tr> <tr> <td></td> <td></td> <td colspan="8" style="text-align: center;"> <table border="1" style="width: 100%; border-collapse: collapse; text-align: center;"> <tr> <td style="width: 10%;"></td> <td style="width: 10%;"></td> <td style="width: 10%;"></td> <td style="width: 10%;"></td> <td style="width: 10%;"></td> <td style="width: 10%;"></td> <td style="width: 10%;"></td> <td style="width: 10%;"></td> <td style="width: 10%;"></td> <td style="width: 10%;"></td> </tr> <tr> <td></td> <td></td> <td colspan="8" style="text-align: center;"> <table border="1" style="width: 100%; border-collapse: collapse; text-align: center;"> <tr> <td style="width: 10%;"></td> <td
style="width: 10%;"></td> <td style="width: 10%;"></td> <td style="width: 10%;"></td> <td style="width: 10%;"></td> <td style="width: 10%;"></td> <td style="width: 10%;"></td> <td style="width: 10%;"></td> <td style="width: 10%;"></td> <td style="width: 10%;"></td> </tr> <tr> <td></td> <td></td> <td colspan="8" style="text-align: center;"> <table border="1" style="width: 100%; border-collapse: collapse; text-align: center;"> <tr> <td style="width: 10%;"></td> <td style="width: 10%;"></td> <td style="width: 10%;"></td> <td style="width: 10%;"></td> <td style="width: 10%;"></td> <td style="width: 10%;"></td> <td style="width: 10%;"></td> <td style="width: 10%;"></td> <td style="width: 10%;"></td> <td style="width: 10%;"></td> </tr> <tr> <td></td> <td></td> <td colspan="8" style="text-align: center;"> <table border="1" style="width: 100%; border-collapse: collapse; text-align: center;"> <tr> <td style="width: 10%;"></td> <td style="width: 10%;"></td> <td style="width: 10%;"></td> <td style="width: 10%;"></td> <td style="width: 10%;"></td> <td style="width: 10%;"></td> <td style="width: 10%;"></td> <td style="width: 10%;"></td> <td style="width: 10%;"></td> <td style="width: 10%;"></td> </tr> <tr> <td></td> <td></td> <td colspan="8" style="text-align: center;"> <table border="1" style="width: 100%; border-collapse: collapse; text-align: center;"> <tr> <td style="width: 10%;"></td> <td style="width: 10%;"></td> <td style="width: 10%;"></td> <td style="width: 10%;"></td> <td style="width: 10%;"></td> <td style="width: 10%;"></td> <td style="width: 10%;"></td> <td style="width: 10%;"></td> <td style="width: 10%;"></td> <td style="width: 10%;"></td> </tr> <tr> <td></td> <td></td> <td colspan="8" style="text-align: center;"> <table border="1" style="width: 100%; border-collapse: collapse; text-align: center;"> <tr> <td style="width: 10%;"></td> <td style="width: 10%;"></td> <td style="width: 10%;"></td> <td style="width: 10%;"></td> <td style="width: 10%;"></td> <td style="width: 10%;"></td> <td style="width: 10%;"></td> <td style="width: 10%;"></td> <td style="width: 10%;"></td> <td style="width: 10%;"></td> </tr> <tr> <td></td> <td></td> <td colspan="8" style="text-align: center;"> <table border="1" style="width: 100%; border-collapse: collapse; text-align: center;"> <tr> <td style="width: 10%;"></td> <td style="width: 10%;"></td> <td style="width: 10%;"></td> <td style="width: 10%;"></td> <td style="width: 10%;"></td> <td style="width: 10%;"></td> <td style="width: 10%;"></td> <td style="width: 10%;"></td> <td style="width: 10%;"></td> <td style="width: 10%;"></td> </tr> <tr> <td></td> <td></td> <td colspan="8" style="text-align: center;"> <table border="1" style="width: 100%; border-collapse: collapse; text-align: center;"> <tr> <td style="width: 10%;"></td> <td style="width: 10%;"></td> <td style="width: 10%;"></td> <td style="width: 10%;"></td> <td style="width: 10%;"></td> <td style="width: 10%;"></td> <td style="width: 10%;"></td> <td style="width: 10%;"></td> <td style="width: 10%;"></td> <td style="width: 10%;"></td> </tr> <tr> <td></td> <td></td> <td colspan="8" style="text-align: center;"> <table border="1" style="width: 100%; border-collapse: collapse; text-align: center;"> <tr> <td style="width: 10%;"></td> <td style="width: 10%;"></td> <td style="width: 10%;"></td> <td style="width: 10%;"></td> <td style="width: 10%;"></td> <td style="width: 10%;"></td> <td style="width: 10%;"></td> <td style="width: 10%;"></td> <td style="width: 10%;"></td> <td style="width: 10%;"></td> </tr> <tr> <td></td> <td></td> <td colspan="8" style="text-align: center;"> <table border="1" style="width: 100%; border-collapse: collapse; text-align: center;"> <tr> <td style="width: 10%;"></td> <td style="width: 10%;"></td> <td style="width: 10%;"></td> <td style="width: 10%;"></td> <td style="width: 10%;"></td> <td style="width: 10%;"></td> <td style="width: 10%;"></td> <td style="width: 10%;"></td> <td style="width: 10%;"></td> <td style="width: 10%;"></td> </tr> <tr> <td></td> <td></td> <td colspan="8" style="text-align: center;"> <table border="1" style="width: 100%; border-collapse: collapse; text-align: center;"> <tr> <td style="width: 10%;"></td> <td style="width: 10%;"></td> <td style="width: 10%;"></td> <td style="width: 10%;"></td> <td style="width: 10%;"></td> <td style="width: 10%;"></td> <td style="width: 10%;"></td> <td style="width: 10%;"></td> <td style="width: 10%;"></td> <td style="width: 10%;"></td> </tr> <tr> <td></td> <td></td> <td colspan="8" style="text-align: center;"> <table border="1" style="width: 100%; border-collapse: collapse; text-align: center;"> <tr> <td style="width: 10%;"></td> <td style="width: 10%;"></td> <td style="width: 10%;"></td> <td style="width: 10%;"></td> <td style="width: 10%;"></td> <td style="width: 10%;"></td> <td style="width: 10%;"></td> <td style="width: 10%;"></td> <td style="width: 10%;"></td> <td style="width: 10%;"></td> </tr> <tr> <td></td> <td></td> <td colspan="8" style="text-align: center;"> <table border="1" style="width: 100%; border-collapse: collapse; text-align: center;"> <tr> <td style="width: 10%;"></td> <td style="width: 10%;"></td> <td style="width: 10%;"></td> <td style="width: 10%;"></td> <td style="width: 10%;"></td> <td style="width: 10%;"></td> <td style="width: 10%;"></td> <td style="width: 10%;"></td> <td style="width: 10%;"></td> <td style="width: 10%;"></td> </tr> <tr> <td></td> <td></td> <td colspan="8" style="text-align: center;"> <table border="1" style="width: 100%; border-collapse: collapse; text-align: center;"> <tr> <td style="width: 10%;"></td> <td style="width: 10%;"></td> <td style="width: 10%;"></td> <td style="width: 10%;"></td> <td style="width: 10%;"></td> <td style="width: 10%;"></td> <td style="width: 10%;"></td> <td style="width: 10%;"></td> <td style="width: 10%;"></td> <td style="width: 10%;"></td> </tr> <tr> <td></td> <td></td> <td colspan="8" style="text-align: center;"> <table border="1" style="width: 100%; border-collapse: collapse; text-align: center;"> <tr> <td style="width: 10%;"></td> <td style="width: 10%;"></td> <td style="width: 10%;"></td> <td style="width: 10%;"></td> <td style="width: 10%;"></td> <td style="width: 10%;"></td> <td style="width: 10%;"></td> <td style="width: 10%;"></td> <td style="width: 10%;"></td> <td style="width: 10%;"></td> </tr> <tr> <td></td> <td></td> <td colspan="8" style="text-align: center;"> <table border="1" style="width: 100%; border-collapse: collapse; text-align: center;"> <tr> <td style="width: 10%;"></td> <td style="width: 10%;"></td> <td style="width: 10%;"></td> <td style="width: 10%;"></td> <td style="width: 10%;"></td> <td style="width: 10%;"></td> <td style="width: 10%;"></td> <td style="width: 10%;"></td> <td style="width: 10%;"></td> <td style="width: 10%;"></td> </tr> <tr> <td></td> <td></td> <td colspan="8" style="text-align: center;"> <table border="1" style="width: 100%; border-collapse: collapse; text-align: center;"> <tr> <td style="width: 10%;"></td> <td style="width: 10%;"></td> <td style="width: 10%;"></td> <td style="width: 10%;"></td> <td style="width: 10%;"></td> <td style="width: 10%;"></td> <td style="width: 10%;"></td> <td style="width: 10%;"></td> <td style="width: 10%;"></td> <td style="width: 10%;"></td> </tr> <tr> <td></td> <td></td> <td colspan="8" style="text-align: center;"> <table border="1" style="width: 100%; border-collapse: collapse; text-align: center;"> <tr> <td style="width: 10%;"></td> <td style="width: 10%;"></td> <td style="width: 10%;"></td> <td style="width: 10%;"></td> <td style="width: 10%;"></td> <td style="width: 10%;"></td> <td style="width: 10%;"></td> <td style="width: 10%;"></td> <td style="width: 10%;"></td> <td style="width: 10%;"></td> </tr> <tr> <td></td> <td></td> <td colspan="8" style="text-align: center;"> <table border="1" style="width: 100%; border-collapse: collapse; text-align: center;"> <tr> <td style="width: 10%;"></td> <td style="width: 10%;"></td> <td style="width: 10%;"></td> <td style="width: 10%;"></td> <td style="width: 10%;"></td> <td style="width: 10%;"></td> <td style="width: 10%;"></td> <td style="width: 10%;"></td> <td style="width: 10%;"></td> <td style="width: 10%;"></td> </tr> <tr> <td></td> <td></td> <td colspan="8" style="text-align: center;"> <table border="1" style="width: 100%; border-collapse: collapse; text-align: center;"> <tr> <td style="width: 10%;"></td> <td style="width: 10%;"></td> <td style="width: 10%;"></td> <td style="width: 10%;"></td> <td style="width: 10%;"></td> <td style="width: 10%;"></td> <td style="width: 10%;"></td> <td style="width: 10%;"></td> <td style="width: 10%;"></td> <td style="width: 10%;"></td> </tr> <tr> <td></td> <td></td> <td colspan="8" style="text-align: center;"> <table border="1" style="width: 100%; border-collapse: collapse; text-align: center;"> <tr> <td style="width: 10%;"></td> <td style="width: 10%;"></td> <td style="width: 10%;"></td> <td style="width: 10%;"></td> <td style="width: 10%;"></td> <td style="width: 10%;"></td> <td style="width: 10%;"></td> <td style="width: 10%;"></td> <td style="width: 10%;"></td> <td style="width: 10%;"></td> </tr> <tr> <td></td> <td></td> <td colspan="8" style="text-align: center;"> <table border="1" style="width: 100%; border-collapse: collapse; text-align: center;"> <tr> <td style="width: 10%;"></td> <td style="width: 10%;"></td> <td style="width: 10%;"></td> <td style="width: 10%;"></td> <td style="width: 10%;"></td> <td style="width: 10%;"></td> <td style="width: 10%;"></td> <td style="width: 10%;"></td> <td style="width: 10%;"></td> <td style="width: 10%;"></td> </tr> <tr> <td></td> <td></td> <td colspan="8" style="text-align: center;"> <table border="1" style="width: 100%; border-collapse: collapse; text-align: center;"> <tr> <td style="width: 10%;"></td> <td style="width: 10%;"></td> <td style="width: 10%;"></td> <td style="width: 10%;"></td> <td style="width: 10%;"></td> <td style="width: 10%;"></td> <td style="width:
10%;"></td> <td style="width: 10%;"></td> <td style="width: 10%;"></td> <td style="width: 10%;"></td> </tr> <tr> <td></td> <td></td> <td colspan="8" style="text-align: center;"> <table border="1" style="width: 100%; border-collapse: collapse; text-align: center;"> <tr> <td style="width: 10%;"></td> <td style="width: 10%;"></td> <td style="width: 10%;"></td> <td style="width: 10%;"></td> <td style="width: 10%;"></td> <td style="width: 10%;"></td> <td style="width: 10%;"></td> <td style="width: 10%;"></td> <td style="width: 10%;"></td> <td style="width: 10%;"></td> </tr> <tr> <td></td> <td></td> <td colspan="8" style="text-align: center;"> <table border="1" style="width: 100%; border-collapse: collapse; text-align: center;"> <tr> <td style="width: 10%;"></td> <td style="width: 10%;"></td> <td style="width: 10%;"></td> <td style="width: 10%;"></td> <td style="width: 10%;"></td> <td style="width: 10%;"></td> <td style="width: 10%;"></td> <td style="width: 10%;"></td> <td style="width: 10%;"></td> <td style="width: 10%;"></td> </tr> <tr> <td></td> <td></td> <td colspan="8" style="text-align: center;"> <table border="1" style="width: 100%; border-collapse: collapse; text-align: center;"> <tr> <td style="width: 10%;"></td> <td style="width: 10%;"></td> <td style="width: 10%;"></td> <td style="width: 10%;"></td> <td style="width: 10%;"></td> <td style="width: 10%;"></td> <td style="width: 10%;"></td> <td style="width: 10%;"></td> <td style="width: 10%;"></td> <td style="width: 10%;"></td> </tr> <tr> <td></td> <td></td> <td colspan="8" style="text-align: center;"> <table border="1" style="width: 100%; border-collapse: collapse; text-align: center;"> <tr> <td style="width: 10%;"></td> <td style="width: 10%;"></td> <td style="width: 10%;"></td> <td style="width: 10%;"></td> <td style="width: 10%;"></td> <td style="width: 10%;"></td> <td style="width: 10%;"></td> <td style="width: 10%;"></td> <td style="width: 10%;"></td> <td style="width: 10%;"></td> </tr> <tr> <td></td> <td></td> <td colspan="8" style="text-align: center;"> <table border="1" style="width: 100%; border-collapse: collapse; text-align: center;"> <tr> <td style="width: 10%;"></td> <td style="width: 10%;"></td> <td style="width: 10%;"></td> <td style="width: 10%;"></td> <td style="width: 10%;"></td> <td style="width: 10%;"></td> <td style="width: 10%;"></td> <td style="width: 10%;"></td> <td style="width: 10%;"></td> <td style="width: 10%;"></td> </tr> <tr> <td></td> <td></td> <td colspan="8" style="text-align: center;"> <table border="1" style="width: 100%; border-collapse: collapse; text-align: center;"> <tr> <td style="width: 10%;"></td> <td style="width: 10%;"></td> <td style="width: 10%;"></td> <td style="width: 10%;"></td> <td style="width: 10%;"></td> <td style="width: 10%;"></td> <td style="width: 10%;"></td> <td style="width: 10%;"></td> <td style="width: 10%;"></td> <td style="width: 10%;"></td> </tr> <tr> <td></td> <td></td> <td colspan="8" style="text-align: center;"> <table border="1" style="width: 100%; border-collapse: collapse; text-align: center;"> <tr> <td style="width: 10%;"></td> <td style="width: 10%;"></td> <td style="width: 10%;"></td> <td style="width: 10%;"></td> <td style="width: 10%;"></td> <td style="width: 10%;"></td> <td style="width: 10%;"></td> <td style="width: 10%;"></td> <td style="width: 10%;"></td> <td style="width: 10%;"></td> </tr> <tr> <td></td> <td></td> <td colspan="8" style="text-align: center;"> <table border="1" style="width: 100%; border-collapse: collapse; text-align: center;"> <tr> <td style="width: 10%;"></td> <td style="width: 10%;"></td> <td style="width: 10%;"></td> <td style="width: 10%;"></td> <td style="width: 10%;"></td> <td style="width: 10%;"></td> <td style="width: 10%;"></td> <td style="width: 10%;"></td> <td style="width: 10%;"></td> <td style="width: 10%;"></td> </tr> <tr> <td></td> <td></td> <td colspan="8" style="text-align: center;"> <table border="1" style="width: 100%; border-collapse: collapse; text-align: center;"> <tr> </tr></table></td></tr></table></td></tr></table></td></tr></table></td></tr></table></td></tr></table></td></tr></table></td></tr></table></td></tr></table></td></tr></table></td></tr></table></td></tr></table></td></tr></table></td></tr></table></td></tr></table></td></tr></table></td></tr></table></td></tr></table></td></tr></table></td></tr></table></td></tr></table></td></tr></table></td></tr></table></td></tr></table></td></tr></table></td></tr></table></td></tr></table></td></tr></table></td></tr></table></td></tr></table></td></tr></table></td></tr></table></td></tr></table></td></tr></table></td></tr></table></td></tr></table></td></tr></table></td></tr></table></td></tr></table></td></tr></table></td></tr></table></td></tr></table></td></tr></table></td></tr></table></td></tr></table></td></tr></table></td></tr></table></td></tr></table></td></tr></table></td></tr></table> | | | | | | | | | | | | | | | | | | | | <table border="1" style="width: 100%; border-collapse: collapse; text-align: center;"> <tr> <td style="width: 10%;"></td> <td style="width: 10%;"></td> <td style="width: 10%;"></td> <td style="width: 10%;"></td> <td style="width: 10%;"></td> <td style="width: 10%;"></td> <td style="width: 10%;"></td> <td style="width: 10%;"></td> <td style="width: 10%;"></td> <td style="width: 10%;"></td> </tr> <tr> <td></td> <td></td> <td colspan="8" style="text-align: center;"> <table border="1" style="width: 100%; border-collapse: collapse; text-align: center;"> <tr> <td style="width: 10%;"></td> <td style="width: 10%;"></td> <td style="width: 10%;"></td> <td style="width: 10%;"></td> <td style="width: 10%;"></td> <td style="width: 10%;"></td> <td style="width: 10%;"></td> <td style="width: 10%;"></td> <td style="width: 10%;"></td> <td style="width: 10%;"></td> </tr> <tr> <td></td> <td></td> <td colspan="8" style="text-align: center;"> <table border="1" style="width: 100%; border-collapse: collapse; text-align: center;"> <tr> <td style="width: 10%;"></td> <td style="width: 10%;"></td> <td style="width: 10%;"></td> <td style="width: 10%;"></td> <td style="width: 10%;"></td> <td style="width: 10%;"></td> <td style="width: 10%;"></td> <td style="width: 10%;"></td> <td style="width: 10%;"></td> <td style="width: 10%;"></td> </tr> <tr> <td></td> <td></td> <td colspan="8" style="text-align: center;"> <table border="1" style="width: 100%; border-collapse: collapse; text-align: center;"> <tr> <td style="width: 10%;"></td> <td style="width: 10%;"></td> <td style="width: 10%;"></td> <td style="width: 10%;"></td> <td style="width: 10%;"></td> <td style="width: 10%;"></td> <td style="width: 10%;"></td> <td style="width: 10%;"></td> <td style="width: 10%;"></td> <td style="width: 10%;"></td> </tr> <tr> <td></td> <td></td> <td colspan="8" style="text-align: center;"> <table border="1" style="width: 100%; border-collapse: collapse; text-align: center;"> <tr> <td style="width: 10%;"></td> <td style="width: 10%;"></td> <td style="width: 10%;"></td> <td style="width: 10%;"></td> <td style="width: 10%;"></td> <td style="width: 10%;"></td> <td style="width: 10%;"></td> <td style="width: 10%;"></td> <td style="width: 10%;"></td> <td style="width: 10%;"></td> </tr> <tr> <td></td> <td></td> <td colspan="8" style="text-align: center;"> <table border="1" style="width: 100%; border-collapse: collapse; text-align: center;"> <tr> <td style="width: 10%;"></td> <td style="width: 10%;"></td> <td style="width: 10%;"></td> <td style="width: 10%;"></td> <td style="width: 10%;"></td> <td style="width:
10%;"></td> <td style="width: 10%;"></td> <td style="width: 10%;"></td> <td style="width: 10%;"></td> <td style="width: 10%;"></td> </tr> <tr> <td></td> <td></td> <td colspan="8" style="text-align: center;"> <table border="1" style="width: 100%; border-collapse: collapse; text-align: center;"> <tr> <td style="width: 10%;"></td> <td style="width: 10%;"></td> <td style="width: 10%;"></td> <td style="width: 10%;"></td> <td style="width: 10%;"></td> <td style="width: 10%;"></td> <td style="width: 10%;"></td> <td style="width: 10%;"></td> <td style="width: 10%;"></td> <td style="width: 10%;"></td> </tr> <tr> <td></td> <td></td> <td colspan="8" style="text-align: center;"> <table border="1" style="width: 100%; border-collapse: collapse; text-align: center;"> <tr> <td style="width: 10%;"></td> <td style="width: 10%;"></td> <td style="width: 10%;"></td> <td style="width: 10%;"></td> <td style="width: 10%;"></td> <td style="width: 10%;"></td> <td style="width: 10%;"></td> <td style="width: 10%;"></td> <td style="width: 10%;"></td> <td style="width: 10%;"></td> </tr> <tr> <td></td> <td></td> <td colspan="8" style="text-align: center;"> <table border="1" style="width: 100%; border-collapse: collapse; text-align: center;"> <tr> <td style="width: 10%;"></td> <td style="width: 10%;"></td> <td style="width: 10%;"></td> <td style="width: 10%;"></td> <td style="width: 10%;"></td> <td style="width: 10%;"></td> <td style="width: 10%;"></td> <td style="width: 10%;"></td> <td style="width: 10%;"></td> <td style="width: 10%;"></td> </tr> <tr> <td></td> <td></td> <td colspan="8" style="text-align: center;"> <table border="1" style="width: 100%; border-collapse: collapse; text-align: center;"> <tr> <td style="width: 10%;"></td> <td style="width: 10%;"></td> <td style="width: 10%;"></td> <td style="width: 10%;"></td> <td style="width: 10%;"></td> <td style="width: 10%;"></td> <td style="width: 10%;"></td> <td style="width: 10%;"></td> <td style="width: 10%;"></td> <td style="width: 10%;"></td> </tr> <tr> <td></td> <td></td> <td colspan="8" style="text-align: center;"> <table border="1" style="width: 100%; border-collapse: collapse; text-align: center;"> <tr> <td style="width: 10%;"></td> <td style="width: 10%;"></td> <td style="width: 10%;"></td> <td style="width: 10%;"></td> <td style="width: 10%;"></td> <td style="width: 10%;"></td> <td style="width: 10%;"></td> <td style="width: 10%;"></td> <td style="width: 10%;"></td> <td style="width: 10%;"></td> </tr> <tr> <td></td> <td></td> <td colspan="8" style="text-align: center;"> <table border="1" style="width: 100%; border-collapse: collapse; text-align: center;"> <tr> <td style="width: 10%;"></td> <td style="width: 10%;"></td> <td style="width: 10%;"></td> <td style="width: 10%;"></td> <td style="width: 10%;"></td> <td style="width: 10%;"></td> <td style="width: 10%;"></td> <td style="width: 10%;"></td> <td style="width: 10%;"></td> <td style="width: 10%;"></td> </tr> <tr> <td></td> <td></td> <td colspan="8" style="text-align: center;"> <table border="1" style="width: 100%; border-collapse: collapse; text-align: center;"> <tr> <td style="width: 10%;"></td> <td style="width: 10%;"></td> <td style="width: 10%;"></td> <td style="width: 10%;"></td> <td style="width: 10%;"></td> <td style="width: 10%;"></td> <td style="width: 10%;"></td> <td style="width: 10%;"></td> <td style="width: 10%;"></td> <td style="width: 10%;"></td> </tr> <tr> <td></td> <td></td> <td colspan="8" style="text-align: center;"> <table border="1" style="width: 100%; border-collapse: collapse; text-align: center;"> <tr> <td style="width: 10%;"></td> <td style="width: 10%;"></td> <td style="width: 10%;"></td> <td style="width: 10%;"></td> <td style="width: 10%;"></td> <td style="width: 10%;"></td> <td style="width: 10%;"></td> <td style="width: 10%;"></td> <td style="width: 10%;"></td> <td style="width: 10%;"></td> </tr> <tr> <td></td> <td></td> <td colspan="8" style="text-align: center;"> <table border="1" style="width: 100%; border-collapse: collapse; text-align: center;"> <tr> <td style="width: 10%;"></td> <td style="width: 10%;"></td> <td style="width: 10%;"></td> <td style="width: 10%;"></td> <td style="width: 10%;"></td> <td style="width: 10%;"></td> <td style="width: 10%;"></td> <td style="width: 10%;"></td> <td style="width: 10%;"></td> <td style="width: 10%;"></td> </tr> <tr> <td></td> <td></td> <td colspan="8" style="text-align: center;"> <table border="1" style="width: 100%; border-collapse: collapse; text-align: center;"> <tr> <td style="width: 10%;"></td> <td style="width: 10%;"></td> <td style="width: 10%;"></td> <td style="width: 10%;"></td> <td style="width: 10%;"></td> <td style="width: 10%;"></td> <td style="width: 10%;"></td> <td style="width: 10%;"></td> <td style="width: 10%;"></td> <td style="width: 10%;"></td> </tr> <tr> <td></td> <td></td> <td colspan="8" style="text-align: center;"> <table border="1" style="width: 100%; border-collapse: collapse; text-align: center;"> <tr> <td style="width: 10%;"></td> <td style="width: 10%;"></td> <td style="width: 10%;"></td> <td style="width: 10%;"></td> <td style="width: 10%;"></td> <td style="width: 10%;"></td> <td style="width: 10%;"></td> <td style="width: 10%;"></td> <td style="width: 10%;"></td> <td style="width: 10%;"></td> </tr> <tr> <td></td> <td></td> <td colspan="8" style="text-align: center;"> <table border="1" style="width: 100%; border-collapse: collapse; text-align: center;"> <tr> <td style="width: 10%;"></td> <td style="width: 10%;"></td> <td style="width: 10%;"></td> <td style="width: 10%;"></td> <td style="width: 10%;"></td> <td style="width: 10%;"></td> <td style="width: 10%;"></td> <td style="width: 10%;"></td> <td style="width: 10%;"></td> <td style="width: 10%;"></td> </tr> <tr> <td></td> <td></td> <td colspan="8" style="text-align: center;"> <table border="1" style="width: 100%; border-collapse: collapse; text-align: center;"> <tr> <td style="width: 10%;"></td> <td style="width: 10%;"></td> <td style="width: 10%;"></td> <td style="width: 10%;"></td> <td style="width: 10%;"></td> <td style="width: 10%;"></td> <td style="width: 10%;"></td> <td style="width: 10%;"></td> <td style="width: 10%;"></td> <td style="width: 10%;"></td> </tr> <tr> <td></td> <td></td> <td colspan="8" style="text-align: center;"> <table border="1" style="width: 100%; border-collapse: collapse; text-align: center;"> <tr> <td style="width: 10%;"></td> <td style="width: 10%;"></td> <td style="width: 10%;"></td> <td style="width: 10%;"></td> <td style="width: 10%;"></td> <td style="width: 10%;"></td> <td style="width: 10%;"></td> <td style="width: 10%;"></td> <td style="width: 10%;"></td> <td style="width: 10%;"></td> </tr> <tr> <td></td> <td></td> <td colspan="8" style="text-align: center;"> <table border="1" style="width: 100%; border-collapse: collapse; text-align: center;"> <tr> <td style="width: 10%;"></td> <td style="width: 10%;"></td> <td style="width: 10%;"></td> <td style="width: 10%;"></td> <td style="width: 10%;"></td> <td style="width: 10%;"></td> <td style="width: 10%;"></td> <td style="width: 10%;"></td> <td style="width: 10%;"></td> <td style="width: 10%;"></td> </tr> <tr> <td></td> <td></td> <td colspan="8" style="text-align: center;"> <table border="1" style="width: 100%; border-collapse: collapse; text-align: center;"> <tr> <td style="width: 10%;"></td> <td style="width: 10%;"></td> <td style="width: 10%;"></td> <td style="width: 10%;"></td> <td style="width: 10%;"></td> <td style="width: 10%;"></td> <td style="width: 10%;"></td> <td style="width: 10%;"></td> <td style="width: 10%;"></td> <td style="width: 10%;"></td> </tr> <tr> <td></td> <td></td> <td colspan="8" style="text-align: center;"> <table border="1" style="width: 100%; border-collapse: collapse; text-align: center;"> <tr> <td style="width: 10%;"></td> <td style="width: 10%;"></td> <td style="width: 10%;"></td> <td style="width: 10%;"></td> <td style="width: 10%;"></td> <td style="width: 10%;"></td> <td style="width: 10%;"></td> <td style="width: 10%;"></td> <td style="width: 10%;"></td> <td style="width: 10%;"></td> </tr> <tr> <td></td> <td></td> <td colspan="8" style="text-align: center;"> <table border="1" style="width: 100%; border-collapse: collapse; text-align: center;"> <tr> <td style="width: 10%;"></td> <td style="width: 10%;"></td> <td style="width: 10%;"></td> <td style="width: 10%;"></td> <td style="width: 10%;"></td> <td style="width: 10%;"></td> <td style="width: 10%;"></td> <td style="width: 10%;"></td> <td style="width: 10%;"></td> <td style="width: 10%;"></td> </tr> <tr> <td></td> <td></td> <td colspan="8" style="text-align: center;"> <table border="1" style="width: 100%; border-collapse: collapse; text-align: center;"> <tr> <td style="width: 10%;"></td> <td style="width: 10%;"></td> <td style="width: 10%;"></td> <td style="width: 10%;"></td> <td style="width: 10%;"></td> <td style="width: 10%;"></td> <td style="width: 10%;"></td> <td style="width: 10%;"></td> <td style="width: 10%;"></td> <td style="width: 10%;"></td> </tr> <tr> <td></td> <td></td> <td colspan="8" style="text-align: center;"> <table border="1" style="width: 100%; border-collapse: collapse; text-align: center;"> <tr> <td style="width: 10%;"></td> <td style="width: 10%;"></td> <td style="width: 10%;"></td> <td style="width: 10%;"></td> <td style="width: 10%;"></td> <td style="width: 10%;"></td> <td style="width: 10%;"></td> <td style="width: 10%;"></td> <td style="width: 10%;"></td> <td style="width: 10%;"></td> </tr> <tr> <td></td> <td></td> <td colspan="8" style="text-align: center;"> <table border="1" style="width: 100%; border-collapse: collapse; text-align: center;"> <tr> <td style="width: 10%;"></td> <td style="width: 10%;"></td> <td style="width: 10%;"></td> <td style="width: 10%;"></td> <td style="width: 10%;"></td> <td style="width: 10%;"></td> <td style="width: 10%;"></td> <td style="width: 10%;"></td> <td style="width: 10%;"></td> <td style="width: 10%;"></td> </tr> <tr> <td></td> <td></td> <td
colspan="8" style="text-align: center;"> <table border="1" style="width: 100%; border-collapse: collapse; text-align: center;"> <tr> <td style="width: 10%;"></td> <td style="width: 10%;"></td> <td style="width: 10%;"></td> <td style="width: 10%;"></td> <td style="width: 10%;"></td> <td style="width: 10%;"></td> <td style="width: 10%;"></td> <td style="width: 10%;"></td> <td style="width: 10%;"></td> <td style="width: 10%;"></td> </tr> <tr> <td></td> <td></td> <td colspan="8" style="text-align: center;"> <table border="1" style="width: 100%; border-collapse: collapse; text-align: center;"> <tr> <td style="width: 10%;"></td> <td style="width: 10%;"></td> <td style="width: 10%;"></td> <td style="width: 10%;"></td> <td style="width: 10%;"></td> <td style="width: 10%;"></td> <td style="width: 10%;"></td> <td style="width: 10%;"></td> <td style="width: 10%;"></td> <td style="width: 10%;"></td> </tr> <tr> <td></td> <td></td> <td colspan="8" style="text-align: center;"> <table border="1" style="width: 100%; border-collapse: collapse; text-align: center;"> <tr> <td style="width: 10%;"></td> <td style="width: 10%;"></td> <td style="width: 10%;"></td> <td style="width: 10%;"></td> <td style="width: 10%;"></td> <td style="width: 10%;"></td> <td style="width: 10%;"></td> <td style="width: 10%;"></td> <td style="width: 10%;"></td> <td style="width: 10%;"></td> </tr> <tr> <td></td> <td></td> <td colspan="8" style="text-align: center;"> <table border="1" style="width: 100%; border-collapse: collapse; text-align: center;"> <tr> <td style="width: 10%;"></td> <td style="width: 10%;"></td> <td style="width: 10%;"></td> <td style="width: 10%;"></td> <td style="width: 10%;"></td> <td style="width: 10%;"></td> <td style="width: 10%;"></td> <td style="width: 10%;"></td> <td style="width: 10%;"></td> <td style="width: 10%;"></td> </tr> <tr> <td></td> <td></td> <td colspan="8" style="text-align: center;"> <table border="1" style="width: 100%; border-collapse: collapse; text-align: center;"> <tr> <td style="width: 10%;"></td> <td style="width: 10%;"></td> <td style="width: 10%;"></td> <td style="width: 10%;"></td> <td style="width: 10%;"></td> <td style="width: 10%;"></td> <td style="width: 10%;"></td> <td style="width: 10%;"></td> <td style="width: 10%;"></td> <td style="width: 10%;"></td> </tr> <tr> <td></td> <td></td> <td colspan="8" style="text-align: center;"> <table border="1" style="width: 100%; border-collapse: collapse; text-align: center;"> <tr> <td style="width: 10%;"></td> <td style="width: 10%;"></td> <td style="width: 10%;"></td> <td style="width: 10%;"></td> <td style="width: 10%;"></td> <td style="width: 10%;"></td> <td style="width: 10%;"></td> <td style="width: 10%;"></td> <td style="width: 10%;"></td> <td style="width: 10%;"></td> </tr> <tr> <td></td> <td></td> <td colspan="8" style="text-align: center;"> <table border="1" style="width: 100%; border-collapse: collapse; text-align: center;"> <tr> <td style="width: 10%;"></td> <td style="width: 10%;"></td> <td style="width: 10%;"></td> <td style="width: 10%;"></td> <td style="width: 10%;"></td> <td style="width: 10%;"></td> <td style="width: 10%;"></td> <td style="width: 10%;"></td> <td style="width: 10%;"></td> <td style="width: 10%;"></td> </tr> <tr> <td></td> <td></td> <td colspan="8" style="text-align: center;"> <table border="1" style="width: 100%; border-collapse: collapse; text-align: center;"> <tr> <td style="width: 10%;"></td> <td style="width: 10%;"></td> <td style="width: 10%;"></td> <td style="width: 10%;"></td> <td style="width: 10%;"></td> <td style="width: 10%;"></td> <td style="width: 10%;"></td> <td style="width: 10%;"></td> <td style="width: 10%;"></td> <td style="width: 10%;"></td> </tr> <tr> <td></td> <td></td> <td colspan="8" style="text-align: center;"> <table border="1" style="width: 100%; border-collapse: collapse; text-align: center;"> <tr> <td style="width: 10%;"></td> <td style="width: 10%;"></td> <td style="width: 10%;"></td> <td style="width: 10%;"></td> <td style="width: 10%;"></td> <td style="width: 10%;"></td> <td style="width: 10%;"></td> <td style="width: 10%;"></td> <td style="width: 10%;"></td> <td style="width: 10%;"></td> </tr> <tr> <td></td> <td></td> <td colspan="8" style="text-align: center;"> <table border="1" style="width: 100%; border-collapse: collapse; text-align: center;"> <tr> <td style="width: 10%;"></td> <td style="width: 10%;"></td> <td style="width: 10%;"></td> <td style="width: 10%;"></td> <td style="width: 10%;"></td> <td style="width: 10%;"></td> <td style="width: 10%;"></td> <td style="width: 10%;"></td> <td style="width: 10%;"></td> <td style="width: 10%;"></td> </tr> <tr> <td></td> <td></td> <td colspan="8" style="text-align: center;"> <table border="1" style="width: 100%; border-collapse: collapse; text-align: center;"> <tr> <td style="width: 10%;"></td> <td style="width: 10%;"></td> <td style="width: 10%;"></td> <td style="width: 10%;"></td> <td style="width: 10%;"></td> <td style="width: 10%;"></td> <td style="width: 10%;"></td> <td style="width: 10%;"></td> <td style="width: 10%;"></td> <td style="width: 10%;"></td> </tr> <tr> <td></td> <td></td> <td colspan="8" style="text-align: center;"> <table border="1" style="width: 100%; border-collapse: collapse; text-align: center;"> <tr> <td style="width: 10%;"></td> <td style="width: 10%;"></td> <td style="width: 10%;"></td> <td style="width: 10%;"></td> <td style="width: 10%;"></td> <td style="width: 10%;"></td> <td style="width: 10%;"></td> <td style="width: 10%;"></td> <td style="width: 10%;"></td> <td style="width: 10%;"></td> </tr> <tr> <td></td> <td></td> <td colspan="8" style="text-align: center;"> <table border="1" style="width: 100%; border-collapse: collapse; text-align: center;"> <tr> <td style="width: 10%;"></td> <td style="width: 10%;"></td> <td style="width: 10%;"></td> <td style="width: 10%;"></td> <td style="width: 10%;"></td> <td style="width: 10%;"></td> <td style="width: 10%;"></td> <td style="width: 10%;"></td> <td style="width: 10%;"></td> <td style="width: 10%;"></td> </tr> <tr> <td></td> <td></td> <td colspan="8" style="text-align: center;"> <table border="1" style="width: 100%; border-collapse: collapse; text-align: center;"> <tr> <td style="width: 10%;"></td> <td style="width: 10%;"></td> <td style="width: 10%;"></td> <td style="width: 10%;"></td> <td style="width: 10%;"></td> <td style="width: 10%;"></td> <td style="width: 10%;"></td> <td style="width: 10%;"></td> <td style="width: 10%;"></td> <td style="width: 10%;"></td> </tr> <tr> <td></td> <td></td> <td colspan="8" style="text-align: center;"> <table border="1" style="width: 100%; border-collapse: collapse; text-align: center;"> <tr> <td style="width: 10%;"></td> <td style="width: 10%;"></td> <td style="width: 10%;"></td> <td style="width: 10%;"></td> <td style="width: 10%;"></td> <td style="width: 10%;"></td> <td style="width: 10%;"></td> <td style="width: 10%;"></td> <td style="width: 10%;"></td> <td style="width: 10%;"></td> </tr> <tr> <td></td> <td></td> <td colspan="8" style="text-align: center;"> <table border="1" style="width: 100%; border-collapse: collapse; text-align: center;"> <tr> <td style="width: 10%;"></td> <td style="width: 10%;"></td> <td style="width: 10%;"></td> <td style="width: 10%;"></td> <td style="width: 10%;"></td> <td style="width: 10%;"></td> <td style="width: 10%;"></td> <td style="width: 10%;"></td> <td style="width: 10%;"></td> <td style="width: 10%;"></td> </tr> <tr> <td></td> <td></td> <td colspan="8" style="text-align: center;"> <table border="1" style="width: 100%; border-collapse: collapse; text-align: center;"> <tr> <td style="width: 10%;"></td> <td style="width: 10%;"></td> <td style="width: 10%;"></td> <td style="width: 10%;"></td> <td style="width: 10%;"></td> <td style="width: 10%;"></td> <td style="width: 10%;"></td> <td style="width: 10%;"></td> <td style="width: 10%;"></td> <td style="width: 10%;"></td> </tr> <tr> <td></td> <td></td> <td colspan="8" style="text-align: center;"> <table border="1" style="width: 100%; border-collapse: collapse; text-align: center;"> <tr> <td style="width: 10%;"></td> <td style="width: 10%;"></td> <td style="width: 10%;"></td> <td style="width: 10%;"></td> <td style="width: 10%;"></td> <td style="width: 10%;"></td> <td style="width: 10%;"></td> <td style="width: 10%;"></td> <td style="width: 10%;"></td> <td style="width: 10%;"></td> </tr> <tr> <td></td> <td></td> <td colspan="8" style="text-align: center;"> <table border="1" style="width: 100%; border-collapse: collapse; text-align: center;"> <tr> <td style="width: 10%;"></td> <td style="width: 10%;"></td> <td style="width: 10%;"></td> <td style="width: 10%;"></td> <td style="width: 10%;"></td> <td style="width: 10%;"></td> <td style="width: 10%;"></td> <td style="width: 10%;"></td> <td style="width: 10%;"></td> <td style="width: 10%;"></td> </tr> <tr> <td></td> <td></td> <td colspan="8" style="text-align: center;"> <table border="1" style="width: 100%; border-collapse: collapse; text-align: center;"> <tr> <td style="width: 10%;"></td> <td style="width: 10%;"></td> <td style="width: 10%;"></td> <td style="width: 10%;"></td> <td style="width: 10%;"></td> <td style="width: 10%;"></td> <td style="width: 10%;"></td> <td style="width: 10%;"></td> <td style="width: 10%;"></td> <td style="width: 10%;"></td> </tr> <tr> <td></td> <td></td> <td colspan="8" style="text-align: center;"> <table border="1" style="width: 100%; border-collapse: collapse; text-align: center;"> <tr> <td style="width: 10%;"></td> <td style="width: 10%;"></td> <td style="width: 10%;"></td> <td style="width: 10%;"></td> <td style="width: 10%;"></td> <td style="width: 10%;"></td> <td style="width: 10%;"></td> <td style="width: 10%;"></td> <td style="width: 10%;"></td> <td style="width: 10%;"></td> </tr> <tr> <td></td> <td></td> <td colspan="8" style="text-align: center;"> <table border="1" style="width: 100%; border-collapse: collapse; text-align: center;"> <tr>
</tr></table></td></tr></table></td></tr></table></td></tr></table></td></tr></table></td></tr></table></td></tr></table></td></tr></table></td></tr></table></td></tr></table></td></tr></table></td></tr></table></td></tr></table></td></tr></table></td></tr></table></td></tr></table></td></tr></table></td></tr></table></td></tr></table></td></tr></table></td></tr></table></td></tr></table></td></tr></table></td></tr></table></td></tr></table></td></tr></table></td></tr></table></td></tr></table></td></tr></table></td></tr></table></td></tr></table></td></tr></table></td></tr></table></td></tr></table></td></tr></table></td></tr></table></td></tr></table></td></tr></table></td></tr></table></td></tr></table></td></tr></table></td></tr></table></td></tr></table></td></tr></table></td></tr></table></td></tr></table></td></tr></table></td></tr></table></td></tr></table> | | | | | | | | | | | | | | | | | | | | <table border="1" style="width: 100%; border-collapse: collapse; text-align: center;"> <tr> <td style="width: 10%;"></td> <td style="width: 10%;"></td> <td style="width: 10%;"></td> <td style="width: 10%;"></td> <td style="width: 10%;"></td> <td style="width: 10%;"></td> <td style="width: 10%;"></td> <td style="width: 10%;"></td> <td style="width: 10%;"></td> <td style="width: 10%;"></td> </tr> <tr> <td></td> <td></td> <td colspan="8" style="text-align: center;"> <table border="1" style="width: 100%; border-collapse: collapse; text-align: center;"> <tr> <td style="width: 10%;"></td> <td style="width: 10%;"></td> <td style="width: 10%;"></td> <td style="width: 10%;"></td> <td style="width: 10%;"></td> <td style="width: 10%;"></td> <td style="width: 10%;"></td> <td style="width: 10%;"></td> <td style="width: 10%;"></td> <td style="width: 10%;"></td> </tr> <tr> <td></td> <td></td> <td colspan="8" style="text-align: center;"> <table border="1" style="width: 100%; border-collapse: collapse; text-align: center;"> <tr> <td style="width: 10%;"></td> <td style="width: 10%;"></td> <td style="width: 10%;"></td> <td style="width: 10%;"></td> <td style="width: 10%;"></td> <td style="width: 10%;"></td> <td style="width: 10%;"></td> <td style="width: 10%;"></td> <td style="width: 10%;"></td> <td style="width: 10%;"></td> </tr> <tr> <td></td> <td></td> <td colspan="8" style="text-align: center;"> <table border="1" style="width: 100%; border-collapse: collapse; text-align: center;"> <tr> <td style="width: 10%;"></td> <td style="width: 10%;"></td> <td style="width: 10%;"></td> <td style="width: 10%;"></td> <td style="width: 10%;"></td> <td style="width: 10%;"></td> <td style="width: 10%;"></td> <td style="width: 10%;"></td> <td style="width: 10%;"></td> <td style="width: 10%;"></td> </tr> <tr> <td></td> <td></td> <td colspan="8" style="text-align: center;"> <table border="1" style="width: 100%; border-collapse: collapse; text-align: center;"> <tr> <td style="width: 10%;"></td> <td style="width: 10%;"></td> <td style="width: 10%;"></td> <td style="width: 10%;"></td> <td style="width: 10%;"></td> <td style="width: 10%;"></td> <td style="width: 10%;"></td> <td style="width: 10%;"></td> <td style="width: 10%;"></td> <td style="width: 10%;"></td> </tr> <tr> <td></td> <td></td> <td colspan="8" style="text-align: center;"> <table border="1" style="width: 100%; border-collapse: collapse; text-align: center;"> <tr> <td style="width: 10%;"></td> <td style="width: 10%;"></td> <td style="width: 10%;"></td> <td style="width: 10%;"></td> <td style="width: 10%;"></td> <td style="width: 10%;"></td> <td style="width: 10%;"></td> <td style="width: 10%;"></td> <td style="width: 10%;"></td> <td style="width: 10%;"></td> </tr> <tr> <td></td> <td></td> <td colspan="8" style="text-align: center;"> <table border="1" style="width: 100%; border-collapse: collapse; text-align: center;"> <tr> <td style="width: 10%;"></td> <td style="width: 10%;"></td> <td style="width: 10%;"></td> <td style="width: 10%;"></td> <td style="width: 10%;"></td> <td style="width: 10%;"></td> <td style="width: 10%;"></td> <td style="width: 10%;"></td> <td style="width: 10%;"></td> <td style="width: 10%;"></td> </tr> <tr> <td></td> <td></td> <td colspan="8" style="text-align: center;"> <table border="1" style="width: 100%; border-collapse: collapse; text-align: center;"> <tr> <td style="width: 10%;"></td> <td style="width: 10%;"></td> <td style="width: 10%;"></td> <td style="width: 10%;"></td> <td style="width: 10%;"></td> <td style="width: 10%;"></td> <td style="width: 10%;"></td> <td style="width: 10%;"></td> <td style="width: 10%;"></td> <td style="width: 10%;"></td> </tr> <tr> <td></td> <td></td> <td colspan="8" style="text-align: center;"> <table border="1" style="width: 100%; border-collapse: collapse; text-align: center;"> <tr> <td style="width: 10%;"></td> <td style="width: 10%;"></td> <td style="width: 10%;"></td> <td style="width: 10%;"></td> <td style="width: 10%;"></td> <td style="width: 10%;"></td> <td style="width: 10%;"></td> <td style="width: 10%;"></td> <td style="width: 10%;"></td> <td style="width: 10%;"></td> </tr> <tr> <td></td> <td></td> <td colspan="8" style="text-align: center;"> <table border="1" style="width: 100%; border-collapse: collapse; text-align: center;"> <tr> <td style="width: 10%;"></td> <td style="width: 10%;"></td> <td style="width: 10%;"></td> <td style="width: 10%;"></td> <td style="width: 10%;"></td> <td style="width: 10%;"></td> <td style="width: 10%;"></td> <td style="width: 10%;"></td> <td style="width: 10%;"></td> <td style="width: 10%;"></td> </tr> <tr> <td></td> <td></td> <td colspan="8" style="text-align: center;"> <table border="1" style="width: 100%; border-collapse: collapse; text-align: center;"> <tr> <td style="width: 10%;"></td> <td style="width: 10%;"></td> <td style="width: 10%;"></td> <td style="width: 10%;"></td> <td style="width: 10%;"></td> <td style="width: 10%;"></td> <td style="width: 10%;"></td> <td style="width: 10%;"></td> <td style="width: 10%;"></td> <td style="width: 10%;"></td> </tr> <tr> <td></td> <td></td> <td colspan="8" style="text-align: center;"> <table border="1" style="width: 100%; border-collapse: collapse; text-align: center;"> <tr> <td style="width: 10%;"></td> <td style="width: 10%;"></td> <td style="width: 10%;"></td> <td style="width: 10%;"></td> <td style="width: 10%;"></td> <td style="width: 10%;"></td> <td style="width: 10%;"></td> <td style="width: 10%;"></td> <td style="width: 10%;"></td> <td style="width: 10%;"></td> </tr> <tr> <td></td> <td></td> <td colspan="8" style="text-align: center;"> <table border="1" style="width: 100%; border-collapse: collapse; text-align: center;"> <tr> <td style="width: 10%;"></td> <td style="width: 10%;"></td> <td style="width: 10%;"></td> <td style="width: 10%;"></td> <td style="width: 10%;"></td> <td style="width: 10%;"></td> <td style="width: 10%;"></td> <td style="width: 10%;"></td> <td style="width: 10%;"></td> <td style="width: 10%;"></td> </tr> <tr> <td></td> <td></td> <td colspan="8" style="text-align: center;"> <table border="1" style="width: 100%; border-collapse: collapse; text-align: center;"> <tr> <td style="width: 10%;"></td> <td style="width: 10%;"></td> <td style="width: 10%;"></td> <td style="width: 10%;"></td> <td style="width: 10%;"></td> <td style="width: 10%;"></td> <td style="width: 10%;"></td> <td style="width: 10%;"></td> <td style="width: 10%;"></td> <td style="width: 10%;"></td> </tr> <tr> <td></td> <td></td> <td colspan="8" style="text-align: center;"> <table border="1" style="width: 100%; border-collapse: collapse; text-align:
center;"> <tr> <td style="width: 10%;"></td> <td style="width: 10%;"></td> <td style="width: 10%;"></td> <td style="width: 10%;"></td> <td style="width: 10%;"></td> <td style="width: 10%;"></td> <td style="width: 10%;"></td> <td style="width: 10%;"></td> <td style="width: 10%;"></td> <td style="width: 10%;"></td> </tr> <tr> <td></td> <td></td> <td colspan="8" style="text-align: center;"> <table border="1" style="width: 100%; border-collapse: collapse; text-align: center;"> <tr> <td style="width: 10%;"></td> <td style="width: 10%;"></td> <td style="width: 10%;"></td> <td style="width: 10%;"></td> <td style="width: 10%;"></td> <td style="width: 10%;"></td> <td style="width: 10%;"></td> <td style="width: 10%;"></td> <td style="width: 10%;"></td> <td style="width: 10%;"></td> </tr> <tr> <td></td> <td></td> <td colspan="8" style="text-align: center;"> <table border="1" style="width: 100%; border-collapse: collapse; text-align: center;"> <tr> <td style="width: 10%;"></td> <td style="width: 10%;"></td> <td style="width: 10%;"></td> <td style="width: 10%;"></td> <td style="width: 10%;"></td> <td style="width: 10%;"></td> <td style="width: 10%;"></td> <td style="width: 10%;"></td> <td style="width: 10%;"></td> <td style="width: 10%;"></td> </tr> <tr> <td></td> <td></td> <td colspan="8" style="text-align: center;"> <table border="1" style="width: 100%; border-collapse: collapse; text-align: center;"> <tr> <td style="width: 10%;"></td> <td style="width: 10%;"></td> <td style="width: 10%;"></td> <td style="width: 10%;"></td> <td style="width: 10%;"></td> <td style="width: 10%;"></td> <td style="width: 10%;"></td> <td style="width: 10%;"></td> <td style="width: 10%;"></td> <td style="width: 10%;"></td> </tr> <tr> <td></td> <td></td> <td colspan="8" style="text-align: center;"> <table border="1" style="width: 100%; border-collapse: collapse; text-align: center;"> <tr> <td style="width: 10%;"></td> <td style="width: 10%;"></td> <td style="width: 10%;"></td> <td style="width: 10%;"></td> <td style="width: 10%;"></td> <td style="width: 10%;"></td> <td style="width: 10%;"></td> <td style="width: 10%;"></td> <td style="width: 10%;"></td> <td style="width: 10%;"></td> </tr> <tr> <td></td> <td></td> <td colspan="8" style="text-align: center;"> <table border="1" style="width: 100%; border-collapse: collapse; text-align: center;"> <tr> <td style="width: 10%;"></td> <td style="width: 10%;"></td> <td style="width: 10%;"></td> <td style="width: 10%;"></td> <td style="width: 10%;"></td> <td style="width: 10%;"></td> <td style="width: 10%;"></td> <td style="width: 10%;"></td> <td style="width: 10%;"></td> <td style="width: 10%;"></td> </tr> <tr> <td></td> <td></td> <td colspan="8" style="text-align: center;"> <table border="1" style="width: 100%; border-collapse: collapse; text-align: center;"> <tr> <td style="width: 10%;"></td> <td style="width: 10%;"></td> <td style="width: 10%;"></td> <td style="width: 10%;"></td> <td style="width: 10%;"></td> <td style="width: 10%;"></td> <td style="width: 10%;"></td> <td style="width: 10%;"></td> <td style="width: 10%;"></td> <td style="width: 10%;"></td> </tr> <tr> <td></td> <td></td> <td colspan="8" style="text-align: center;"> <table border="1" style="width: 100%; border-collapse: collapse; text-align: center;"> <tr> <td style="width: 10%;"></td> <td style="width: 10%;"></td> <td style="width: 10%;"></td> <td style="width: 10%;"></td> <td style="width: 10%;"></td> <td style="width: 10%;"></td> <td style="width: 10%;"></td> <td style="width: 10%;"></td> <td style="width: 10%;"></td> <td style="width: 10%;"></td> </tr> <tr> <td></td> <td></td> <td colspan="8" style="text-align: center;"> <table border="1" style="width: 100%; border-collapse: collapse; text-align: center;"> <tr> <td style="width: 10%;"></td> <td style="width: 10%;"></td> <td style="width: 10%;"></td> <td style="width: 10%;"></td> <td style="width: 10%;"></td> <td style="width: 10%;"></td> <td style="width: 10%;"></td> <td style="width: 10%;"></td> <td style="width: 10%;"></td> <td style="width: 10%;"></td> </tr> <tr> <td></td> <td></td> <td colspan="8" style="text-align: center;"> <table border="1" style="width: 100%; border-collapse: collapse; text-align: center;"> <tr> <td style="width: 10%;"></td> <td style="width: 10%;"></td> <td style="width: 10%;"></td> <td style="width: 10%;"></td> <td style="width: 10%;"></td> <td style="width: 10%;"></td> <td style="width: 10%;"></td> <td style="width: 10%;"></td> <td style="width: 10%;"></td> <td style="width: 10%;"></td> </tr> <tr> <td></td> <td></td> <td colspan="8" style="text-align: center;"> <table border="1" style="width: 100%; border-collapse: collapse; text-align: center;"> <tr> <td style="width: 10%;"></td> <td style="width: 10%;"></td> <td style="width: 10%;"></td> <td style="width: 10%;"></td> <td style="width: 10%;"></td> <td style="width: 10%;"></td> <td style="width: 10%;"></td> <td style="width: 10%;"></td> <td style="width: 10%;"></td> <td style="width: 10%;"></td> </tr> <tr> <td></td> <td></td> <td colspan="8" style="text-align: center;"> <table border="1" style="width: 100%; border-collapse: collapse; text-align: center;"> <tr> <td style="width: 10%;"></td> <td style="width: 10%;"></td> <td style="width: 10%;"></td> <td style="width: 10%;"></td> <td style="width: 10%;"></td> <td style="width: 10%;"></td> <td style="width: 10%;"></td> <td style="width: 10%;"></td> <td style="width: 10%;"></td> <td style="width: 10%;"></td> </tr> <tr> <td></td> <td></td> <td colspan="8" style="text-align: center;"> <table border="1" style="width: 100%; border-collapse: collapse; text-align: center;"> <tr> <td style="width: 10%;"></td> <td style="width: 10%;"></td> <td style="width: 10%;"></td> <td style="width: 10%;"></td> <td style="width: 10%;"></td> <td style="width: 10%;"></td> <td style="width: 10%;"></td> <td style="width: 10%;"></td> <td style="width: 10%;"></td> <td style="width: 10%;"></td> </tr> <tr> <td></td> <td></td> <td colspan="8" style="text-align: center;"> <table border="1" style="width: 100%; border-collapse: collapse; text-align: center;"> <tr> <td style="width: 10%;"></td> <td style="width: 10%;"></td> <td style="width: 10%;"></td> <td style="width: 10%;"></td> <td style="width: 10%;"></td> <td style="width: 10%;"></td> <td style="width: 10%;"></td> <td style="width: 10%;"></td> <td style="width: 10%;"></td> <td style="width: 10%;"></td> </tr> <tr> <td></td> <td></td> <td colspan="8" style="text-align: center;"> <table border="1" style="width: 100%; border-collapse: collapse; text-align: center;"> <tr> <td style="width: 10%;"></td> <td style="width: 10%;"></td> <td style="width: 10%;"></td> <td style="width: 10%;"></td> <td style="width: 10%;"></td> <td style="width: 10%;"></td> <td style="width: 10%;"></td> <td style="width: 10%;"></td> <td style="width: 10%;"></td> <td style="width: 10%;"></td> </tr> <tr> <td></td> <td></td> <td colspan="8" style="text-align: center;"> <table border="1" style="width: 100%; border-collapse: collapse; text-align: center;"> <tr> <td style="width: 10%;"></td> <td style="width: 10%;"></td> <td style="width: 10%;"></td> <td style="width: 10%;"></td> <td style="width: 10%;"></td> <td style="width: 10%;"></td> <td style="width: 10%;"></td> <td style="width: 10%;"></td> <td style="width: 10%;"></td> <td style="width: 10%;"></td> </tr> <tr> <td></td> <td></td> <td colspan="8" style="text-align: center;"> <table border="1" style="width: 100%; border-collapse: collapse; text-align: center;"> <tr> <td style="width: 10%;"></td> <td style="width: 10%;"></td> <td style="width: 10%;"></td> <td style="width: 10%;"></td> <td style="width: 10%;"></td> <td style="width: 10%;"></td> <td style="width: 10%;"></td> <td style="width: 10%;"></td> <td style="width: 10%;"></td> <td style="width: 10%;"></td> </tr> <tr> <td></td> <td></td> <td colspan="8" style="text-align: center;"> <table border="1" style="width: 100%; border-collapse: collapse; text-align: center;"> <tr> <td style="width: 10%;"></td> <td style="width: 10%;"></td> <td style="width: 10%;"></td> <td style="width: 10%;"></td> <td style="width: 10%;"></td> <td style="width: 10%;"></td> <td style="width: 10%;"></td> <td style="width: 10%;"></td> <td style="width: 10%;"></td> <td style="width: 10%;"></td> </tr> <tr> <td></td> <td></td> <td colspan="8" style="text-align: center;"> <table border="1" style="width: 100%; border-collapse: collapse; text-align: center;"> <tr> <td style="width: 10%;"></td> <td style="width: 10%;"></td> <td style="width: 10%;"></td> <td style="width: 10%;"></td> <td style="width: 10%;"></td> <td style="width: 10%;"></td> <td style="width: 10%;"></td> <td style="width: 10%;"></td> <td style="width: 10%;"></td> <td style="width: 10%;"></td> </tr> <tr> <td></td> <td></td> <td colspan="8" style="text-align: center;"> <table border="1" style="width: 100%; border-collapse: collapse; text-align: center;"> <tr> <td style="width: 10%;"></td> <td style="width: 10%;"></td> <td style="width: 10%;"></td> <td style="width: 10%;"></td> <td style="width: 10%;"></td> <td style="width: 10%;"></td> <td style="width: 10%;"></td> <td style="width: 10%;"></td> <td style="width: 10%;"></td> <td style="width: 10%;"></td> </tr> <tr> <td></td> <td></td> <td colspan="8" style="text-align: center;"> <table border="1" style="width: 100%; border-collapse: collapse; text-align: center;"> <tr> <td style="width: 10%;"></td> <td style="width: 10%;"></td> <td style="width: 10%;"></td> <td style="width: 10%;"></td> <td style="width: 10%;"></td> <td style="width: 10%;"></td> <td style="width: 10%;"></td> <td style="width: 10%;"></td> <td style="width: 10%;"></td> <td style="width: 10%;"></td> </tr> <tr> <td></td> <td></td> <td colspan="8" style="text-align: center;"> <table border="1" style="width: 100%; border-collapse: collapse; text-align: center;"> <tr> <td style="width: 10%;"></td> <td style="width: 10%;"></td> <td style="width: 10%;"></td> <td style="width: 10%;"></td> <td style="width: 10%;"></td> <td
style="width: 10%;"></td> <td style="width: 10%;"></td> <td style="width: 10%;"></td> <td style="width: 10%;"></td> <td style="width: 10%;"></td> </tr> <tr> <td></td> <td></td> <td colspan="8" style="text-align: center;"> <table border="1" style="width: 100%; border-collapse: collapse; text-align: center;"> <tr> <td style="width: 10%;"></td> <td style="width: 10%;"></td> <td style="width: 10%;"></td> <td style="width: 10%;"></td> <td style="width: 10%;"></td> <td style="width: 10%;"></td> <td style="width: 10%;"></td> <td style="width: 10%;"></td> <td style="width: 10%;"></td> <td style="width: 10%;"></td> </tr> <tr> <td></td> <td></td> <td colspan="8" style="text-align: center;"> <table border="1" style="width: 100%; border-collapse: collapse; text-align: center;"> <tr> <td style="width: 10%;"></td> <td style="width: 10%;"></td> <td style="width: 10%;"></td> <td style="width: 10%;"></td> <td style="width: 10%;"></td> <td style="width: 10%;"></td> <td style="width: 10%;"></td> <td style="width: 10%;"></td> <td style="width: 10%;"></td> <td style="width: 10%;"></td> </tr> <tr> <td></td> <td></td> <td colspan="8" style="text-align: center;"> <table border="1" style="width: 100%; border-collapse: collapse; text-align: center;"> <tr> <td style="width: 10%;"></td> <td style="width: 10%;"></td> <td style="width: 10%;"></td> <td style="width: 10%;"></td> <td style="width: 10%;"></td> <td style="width: 10%;"></td> <td style="width: 10%;"></td> <td style="width: 10%;"></td> <td style="width: 10%;"></td> <td style="width: 10%;"></td> </tr> <tr> <td></td> <td></td> <td colspan="8" style="text-align: center;"> <table border="1" style="width: 100%; border-collapse: collapse; text-align: center;"> <tr> <td style="width: 10%;"></td> <td style="width: 10%;"></td> <td style="width: 10%;"></td> <td style="width: 10%;"></td> <td style="width: 10%;"></td> <td style="width: 10%;"></td> <td style="width: 10%;"></td> <td style="width: 10%;"></td> <td style="width: 10%;"></td> <td style="width: 10%;"></td> </tr> <tr> <td></td> <td></td> <td colspan="8" style="text-align: center;"> <table border="1" style="width: 100%; border-collapse: collapse; text-align: center;"> <tr> <td style="width: 10%;"></td> <td style="width: 10%;"></td> <td style="width: 10%;"></td> <td style="width: 10%;"></td> <td style="width: 10%;"></td> <td style="width: 10%;"></td> <td style="width: 10%;"></td> <td style="width: 10%;"></td> <td style="width: 10%;"></td> <td style="width: 10%;"></td> </tr> <tr> <td></td> <td></td> <td colspan="8" style="text-align: center;"> <table border="1" style="width: 100%; border-collapse: collapse; text-align: center;"> <tr> <td style="width: 10%;"></td> <td style="width: 10%;"></td> <td style="width: 10%;"></td> <td style="width: 10%;"></td> <td style="width: 10%;"></td> <td style="width: 10%;"></td> <td style="width: 10%;"></td> <td style="width: 10%;"></td> <td style="width: 10%;"></td> <td style="width: 10%;"></td> </tr> <tr> <td></td> <td></td> <td colspan="8" style="text-align: center;"> <table border="1" style="width: 100%; border-collapse: collapse; text-align: center;"> <tr> <td style="width: 10%;"></td> <td style="width: 10%;"></td> <td style="width: 10%;"></td> <td style="width: 10%;"></td> <td style="width: 10%;"></td> <td style="width: 10%;"></td> <td style="width: 10%;"></td> <td style="width: 10%;"></td> <td style="width: 10%;"></td> <td style="width: 10%;"></td> </tr> <tr> <td></td> <td></td> <td colspan="8" style="text-align: center;"> <table border="1" style="width: 100%; border-collapse: collapse; text-align: center;"> <tr> <td style="width: 10%;"></td> <td style="width: 10%;"></td> <td style="width: 10%;"></td> <td style="width: 10%;"></td> <td style="width: 10%;"></td> <td style="width: 10%;"></td> <td style="width: 10%;"></td> <td style="width: 10%;"></td> <td style="width: 10%;"></td> <td style="width: 10%;"></td> </tr> <tr> <td></td> <td></td> <td colspan="8" style="text-align: center;"> <table border="1" style="width: 100%; border-collapse: collapse; text-align: center;"> <tr> <td style="width: 10%;"></td> <td style="width: 10%;"></td> <td style="width: 10%;"></td> <td style="width: 10%;"></td> <td style="width: 10%;"></td> <td style="width: 10%;"></td> <td style="width: 10%;"></td> <td style="width: 10%;"></td> <td style="width: 10%;"></td> <td style="width: 10%;"></td> </tr> <tr> <td></td> <td></td> <td colspan="8" style="text-align: center;"> <table border="1" style="width: 100%; border-collapse: collapse; text-align: center;"> <tr> <td style="width: 10%;"></td> <td style="width: 10%;"></td> <td style="width: 10%;"></td> <td style="width: 10%;"></td> <td style="width: 10%;"></td> <td style="width: 10%;"></td> <td style="width: 10%;"></td> <td style="width: 10%;"></td> <td style="width: 10%;"></td> <td style="width: 10%;"></td> </tr> <tr> <td></td> <td></td> <td colspan="8" style="text-align: center;"> <table border="1" style="width: 100%; border-collapse: collapse; text-align: center;"> <tr> <td style="width: 10%;"></td> <td style="width: 10%;"></td> <td style="width: 10%;"></td> <td style="width: 10%;"></td> <td style="width: 10%;"></td> <td style="width: 10%;"></td> <td style="width: 10%;"></td> <td style="width: 10%;"></td> <td style="width: 10%;"></td> <td style="width: 10%;"></td> </tr> <tr> <td></td> <td></td> <td colspan="8" style="text-align: center;"> <table border="1" style="width: 100%; border-collapse: collapse; text-align: center;"> <tr> </tr></table></td></tr></table></td></tr></table></td></tr></table></td></tr></table></td></tr></table></td></tr></table></td></tr></table></td></tr></table></td></tr></table></td></tr></table></td></tr></table></td></tr></table></td></tr></table></td></tr></table></td></tr></table></td></tr></table></td></tr></table></td></tr></table></td></tr></table></td></tr></table></td></tr></table></td></tr></table></td></tr></table></td></tr></table></td></tr></table></td></tr></table></td></tr></table></td></tr></table></td></tr></table></td></tr></table></td></tr></table></td></tr></table></td></tr></table></td></tr></table></td></tr></table></td></tr></table></td></tr></table></td></tr></table></td></tr></table></td></tr></table></td></tr></table></td></tr></table></td></tr></table></td></tr></table></td></tr></table></td></tr></table></td></tr></table> | | | | | | | | | | | | | | | | | | | | <table border="1" style="width: 100%; border-collapse: collapse; text-align: center;"> <tr> <td style="width: 10%;"></td> <td style="width: 10%;"></td> <td style="width: 10%;"></td> <td style="width: 10%;"></td> <td style="width: 10%;"></td> <td style="width: 10%;"></td> <td style="width: 10%;"></td> <td style="width: 10%;"></td> <td style="width: 10%;"></td> <td style="width: 10%;"></td> </tr> <tr> <td></td> <td></td> <td colspan="8" style="text-align: center;"> <table border="1" style="width: 100%; border-collapse: collapse; text-align: center;"> <tr> <td style="width: 10%;"></td> <td style="width: 10%;"></td> <td style="width: 10%;"></td> <td style="width: 10%;"></td> <td style="width: 10%;"></td> <td style="width: 10%;"></td> <td style="width: 10%;"></td> <td style="width: 10%;"></td> <td style="width: 10%;"></td> <td style="width: 10%;"></td> </tr> <tr> <td></td> <td></td> <td colspan="8" style="text-align: center;"> <table border="1" style="width: 100%; border-collapse: collapse; text-align: center;"> <tr> <td style="width: 10%;"></td> <td style="width: 10%;"></td> <td style="width: 10%;"></td> <td style="width: 10%;"></td> <td style="width: 10%;"></td> <td
style="width: 10%;"></td> <td style="width: 10%;"></td> <td style="width: 10%;"></td> <td style="width: 10%;"></td> <td style="width: 10%;"></td> </tr> <tr> <td></td> <td></td> <td colspan="8" style="text-align: center;"> <table border="1" style="width: 100%; border-collapse: collapse; text-align: center;"> <tr> <td style="width: 10%;"></td> <td style="width: 10%;"></td> <td style="width: 10%;"></td> <td style="width: 10%;"></td> <td style="width: 10%;"></td> <td style="width: 10%;"></td> <td style="width: 10%;"></td> <td style="width: 10%;"></td> <td style="width: 10%;"></td> <td style="width: 10%;"></td> </tr> <tr> <td></td> <td></td> <td colspan="8" style="text-align: center;"> <table border="1" style="width: 100%; border-collapse: collapse; text-align: center;"> <tr> <td style="width: 10%;"></td> <td style="width: 10%;"></td> <td style="width: 10%;"></td> <td style="width: 10%;"></td> <td style="width: 10%;"></td> <td style="width: 10%;"></td> <td style="width: 10%;"></td> <td style="width: 10%;"></td> <td style="width: 10%;"></td> <td style="width: 10%;"></td> </tr> <tr> <td></td> <td></td> <td colspan="8" style="text-align: center;"> <table border="1" style="width: 100%; border-collapse: collapse; text-align: center;"> <tr> <td style="width: 10%;"></td> <td style="width: 10%;"></td> <td style="width: 10%;"></td> <td style="width: 10%;"></td> <td style="width: 10%;"></td> <td style="width: 10%;"></td> <td style="width: 10%;"></td> <td style="width: 10%;"></td> <td style="width: 10%;"></td> <td style="width: 10%;"></td> </tr> <tr> <td></td> <td></td> <td colspan="8" style="text-align: center;"> <table border="1" style="width: 100%; border-collapse: collapse; text-align: center;"> <tr> <td style="width: 10%;"></td> <td style="width: 10%;"></td> <td style="width: 10%;"></td> <td style="width: 10%;"></td> <td style="width: 10%;"></td> <td style="width: 10%;"></td> <td style="width: 10%;"></td> <td style="width: 10%;"></td> <td style="width: 10%;"></td> <td style="width: 10%;"></td> </tr> <tr> <td></td> <td></td> <td colspan="8" style="text-align: center;"> <table border="1" style="width: 100%; border-collapse: collapse; text-align: center;"> <tr> <td style="width: 10%;"></td> <td style="width: 10%;"></td> <td style="width: 10%;"></td> <td style="width: 10%;"></td> <td style="width: 10%;"></td> <td style="width: 10%;"></td> <td style="width: 10%;"></td> <td style="width: 10%;"></td> <td style="width: 10%;"></td> <td style="width: 10%;"></td> </tr> <tr> <td></td> <td></td> <td colspan="8" style="text-align: center;"> <table border="1" style="width: 100%; border-collapse: collapse; text-align: center;"> <tr> <td style="width: 10%;"></td> <td style="width: 10%;"></td> <td style="width: 10%;"></td> <td style="width: 10%;"></td> <td style="width: 10%;"></td> <td style="width: 10%;"></td> <td style="width: 10%;"></td> <td style="width: 10%;"></td> <td style="width: 10%;"></td> <td style="width: 10%;"></td> </tr> <tr> <td></td> <td></td> <td colspan="8" style="text-align: center;"> <table border="1" style="width: 100%; border-collapse: collapse; text-align: center;"> <tr> <td style="width: 10%;"></td> <td style="width: 10%;"></td> <td style="width: 10%;"></td> <td style="width: 10%;"></td> <td style="width: 10%;"></td> <td style="width: 10%;"></td> <td style="width: 10%;"></td> <td style="width: 10%;"></td> <td style="width: 10%;"></td> <td style="width: 10%;"></td> </tr> <tr> <td></td> <td></td> <td colspan="8" style="text-align: center;"> <table border="1" style="width: 100%; border-collapse: collapse; text-align: center;"> <tr> <td style="width: 10%;"></td> <td style="width: 10%;"></td> <td style="width: 10%;"></td> <td style="width: 10%;"></td> <td style="width: 10%;"></td> <td style="width: 10%;"></td> <td style="width: 10%;"></td> <td style="width: 10%;"></td> <td style="width: 10%;"></td> <td style="width: 10%;"></td> </tr> <tr> <td></td> <td></td> <td colspan="8" style="text-align: center;"> <table border="1" style="width: 100%; border-collapse: collapse; text-align: center;"> <tr> <td style="width: 10%;"></td> <td style="width: 10%;"></td> <td style="width: 10%;"></td> <td style="width: 10%;"></td> <td style="width: 10%;"></td> <td style="width: 10%;"></td> <td style="width: 10%;"></td> <td style="width: 10%;"></td> <td style="width: 10%;"></td> <td style="width: 10%;"></td> </tr> <tr> <td></td> <td></td> <td colspan="8" style="text-align: center;"> <table border="1" style="width: 100%; border-collapse: collapse; text-align: center;"> <tr> <td style="width: 10%;"></td> <td style="width: 10%;"></td> <td style="width: 10%;"></td> <td style="width: 10%;"></td> <td style="width: 10%;"></td> <td style="width: 10%;"></td> <td style="width: 10%;"></td> <td style="width: 10%;"></td> <td style="width: 10%;"></td> <td style="width: 10%;"></td> </tr> <tr> <td></td> <td></td> <td colspan="8" style="text-align: center;"> <table border="1" style="width: 100%; border-collapse: collapse; text-align: center;"> <tr> <td style="width: 10%;"></td> <td style="width: 10%;"></td> <td style="width: 10%;"></td> <td style="width: 10%;"></td> <td style="width: 10%;"></td> <td style="width: 10%;"></td> <td style="width: 10%;"></td> <td style="width: 10%;"></td> <td style="width: 10%;"></td> <td style="width: 10%;"></td> </tr> <tr> <td></td> <td></td> <td colspan="8" style="text-align: center;"> <table border="1" style="width: 100%; border-collapse: collapse; text-align: center;"> <tr> <td style="width: 10%;"></td> <td style="width: 10%;"></td> <td style="width: 10%;"></td> <td style="width: 10%;"></td> <td style="width: 10%;"></td> <td style="width: 10%;"></td> <td style="width: 10%;"></td> <td style="width: 10%;"></td> <td style="width: 10%;"></td> <td style="width: 10%;"></td> </tr> <tr> <td></td> <td></td> <td colspan="8" style="text-align: center;"> <table border="1" style="width: 100%; border-collapse: collapse; text-align: center;"> <tr> <td style="width: 10%;"></td> <td style="width: 10%;"></td> <td style="width: 10%;"></td> <td style="width: 10%;"></td> <td style="width: 10%;"></td> <td style="width: 10%;"></td> <td style="width: 10%;"></td> <td style="width: 10%;"></td> <td style="width: 10%;"></td> <td style="width: 10%;"></td> </tr> <tr> <td></td> <td></td> <td colspan="8" style="text-align: center;"> <table border="1" style="width: 100%; border-collapse: collapse; text-align: center;"> <tr> <td style="width: 10%;"></td> <td style="width: 10%;"></td> <td style="width: 10%;"></td> <td style="width: 10%;"></td> <td style="width: 10%;"></td> <td style="width: 10%;"></td> <td style="width: 10%;"></td> <td style="width: 10%;"></td> <td style="width: 10%;"></td> <td style="width: 10%;"></td> </tr> <tr> <td></td> <td></td> <td colspan="8" style="text-align: center;"> <table border="1" style="width: 100%; border-collapse: collapse; text-align: center;"> <tr> <td style="width: 10%;"></td> <td style="width: 10%;"></td> <td style="width: 10%;"></td> <td style="width: 10%;"></td> <td style="width: 10%;"></td> <td style="width: 10%;"></td> <td style="width: 10%;"></td> <td style="width: 10%;"></td> <td style="width: 10%;"></td> <td style="width: 10%;"></td> </tr> <tr> <td></td> <td></td> <td colspan="8" style="text-align: center;"> <table border="1" style="width: 100%; border-collapse: collapse; text-align: center;"> <tr> <td style="width: 10%;"></td> <td style="width: 10%;"></td> <td style="width: 10%;"></td> <td style="width: 10%;"></td> <td style="width: 10%;"></td> <td style="width: 10%;"></td> <td style="width: 10%;"></td> <td style="width: 10%;"></td> <td style="width: 10%;"></td> <td style="width: 10%;"></td> </tr> <tr> <td></td> <td></td> <td colspan="8" style="text-align: center;"> <table border="1" style="width: 100%; border-collapse: collapse; text-align: center;"> <tr> <td style="width: 10%;"></td> <td style="width: 10%;"></td> <td style="width: 10%;"></td> <td style="width: 10%;"></td> <td style="width: 10%;"></td> <td style="width: 10%;"></td> <td style="width: 10%;"></td> <td style="width: 10%;"></td> <td style="width: 10%;"></td> <td style="width: 10%;"></td> </tr> <tr> <td></td> <td></td> <td colspan="8" style="text-align: center;"> <table border="1" style="width: 100%; border-collapse: collapse; text-align: center;"> <tr> <td style="width: 10%;"></td> <td style="width: 10%;"></td> <td style="width: 10%;"></td> <td style="width: 10%;"></td> <td style="width: 10%;"></td> <td style="width: 10%;"></td> <td style="width: 10%;"></td> <td style="width: 10%;"></td> <td style="width: 10%;"></td> <td style="width: 10%;"></td> </tr> <tr> <td></td> <td></td> <td colspan="8" style="text-align: center;"> <table border="1" style="width: 100%; border-collapse: collapse; text-align: center;"> <tr> <td style="width: 10%;"></td> <td style="width: 10%;"></td> <td style="width: 10%;"></td> <td style="width: 10%;"></td> <td style="width: 10%;"></td> <td style="width: 10%;"></td> <td style="width: 10%;"></td> <td style="width: 10%;"></td> <td style="width: 10%;"></td> <td style="width: 10%;"></td> </tr> <tr> <td></td> <td></td> <td colspan="8" style="text-align: center;"> <table border="1" style="width: 100%; border-collapse: collapse; text-align: center;"> <tr> <td style="width: 10%;"></td> <td style="width: 10%;"></td> <td style="width: 10%;"></td> <td style="width: 10%;"></td> <td style="width: 10%;"></td> <td style="width: 10%;"></td> <td style="width: 10%;"></td> <td style="width: 10%;"></td> <td style="width: 10%;"></td> <td style="width: 10%;"></td> </tr> <tr> <td></td> <td></td> <td colspan="8" style="text-align: center;"> <table border="1" style="width: 100%; border-collapse: collapse; text-align: center;"> <tr> <td style="width: 10%;"></td> <td style="width: 10%;"></td> <td style="width: 10%;"></td> <td style="width: 10%;"></td> <td style="width: 10%;"></td> <td style="width: 10%;"></td> <td style="width: 10%;"></td> <td style="width: 10%;"></td> <td style="width: 10%;"></td> <td style="width: 10%;"></td> </tr> <tr> <td></td>
<td></td> <td colspan="8" style="text-align: center;"> <table border="1" style="width: 100%; border-collapse: collapse; text-align: center;"> <tr> <td style="width: 10%;"></td> <td style="width: 10%;"></td> <td style="width: 10%;"></td> <td style="width: 10%;"></td> <td style="width: 10%;"></td> <td style="width: 10%;"></td> <td style="width: 10%;"></td> <td style="width: 10%;"></td> <td style="width: 10%;"></td> <td style="width: 10%;"></td> </tr> <tr> <td></td> <td></td> <td colspan="8" style="text-align: center;"> <table border="1" style="width: 100%; border-collapse: collapse; text-align: center;"> <tr> <td style="width: 10%;"></td> <td style="width: 10%;"></td> <td style="width: 10%;"></td> <td style="width: 10%;"></td> <td style="width: 10%;"></td> <td style="width: 10%;"></td> <td style="width: 10%;"></td> <td style="width: 10%;"></td> <td style="width: 10%;"></td> <td style="width: 10%;"></td> </tr> <tr> <td></td> <td></td> <td colspan="8" style="text-align: center;"> <table border="1" style="width: 100%; border-collapse: collapse; text-align: center;"> <tr> <td style="width: 10%;"></td> <td style="width: 10%;"></td> <td style="width: 10%;"></td> <td style="width: 10%;"></td> <td style="width: 10%;"></td> <td style="width: 10%;"></td> <td style="width: 10%;"></td> <td style="width: 10%;"></td> <td style="width: 10%;"></td> <td style="width: 10%;"></td> </tr> <tr> <td></td> <td></td> <td colspan="8" style="text-align: center;"> <table border="1" style="width: 100%; border-collapse: collapse; text-align: center;"> <tr> <td style="width: 10%;"></td> <td style="width: 10%;"></td> <td style="width: 10%;"></td> <td style="width: 10%;"></td> <td style="width: 10%;"></td> <td style="width: 10%;"></td> <td style="width: 10%;"></td> <td style="width: 10%;"></td> <td style="width: 10%;"></td> <td style="width: 10%;"></td> </tr> <tr> <td></td> <td></td> <td colspan="8" style="text-align: center;"> <table border="1" style="width: 100%; border-collapse: collapse; text-align: center;"> <tr> <td style="width: 10%;"></td> <td style="width: 10%;"></td> <td style="width: 10%;"></td> <td style="width: 10%;"></td> <td style="width: 10%;"></td> <td style="width: 10%;"></td> <td style="width: 10%;"></td> <td style="width: 10%;"></td> <td style="width: 10%;"></td> <td style="width: 10%;"></td> </tr> <tr> <td></td> <td></td> <td colspan="8" style="text-align: center;"> <table border="1" style="width: 100%; border-collapse: collapse; text-align: center;"> <tr> <td style="width: 10%;"></td> <td style="width: 10%;"></td> <td style="width: 10%;"></td> <td style="width: 10%;"></td> <td style="width: 10%;"></td> <td style="width: 10%;"></td> <td style="width: 10%;"></td> <td style="width: 10%;"></td> <td style="width: 10%;"></td> <td style="width: 10%;"></td> </tr> <tr> <td></td> <td></td> <td colspan="8" style="text-align: center;"> <table border="1" style="width: 100%; border-collapse: collapse; text-align: center;"> <tr> <td style="width: 10%;"></td> <td style="width: 10%;"></td> <td style="width: 10%;"></td> <td style="width: 10%;"></td> <td style="width: 10%;"></td> <td style="width: 10%;"></td> <td style="width: 10%;"></td> <td style="width: 10%;"></td> <td style="width: 10%;"></td> <td style="width: 10%;"></td> </tr> <tr> <td></td> <td></td> <td colspan="8" style="text-align: center;"> <table border="1" style="width: 100%; border-collapse: collapse; text-align: center;"> <tr> <td style="width: 10%;"></td> <td style="width: 10%;"></td> <td style="width: 10%;"></td> <td style="width: 10%;"></td> <td style="width: 10%;"></td> <td style="width: 10%;"></td> <td style="width: 10%;"></td> <td style="width: 10%;"></td> <td style="width: 10%;"></td> <td style="width: 10%;"></td> </tr> <tr> <td></td> <td></td> <td colspan="8" style="text-align: center;"> <table border="1" style="width: 100%; border-collapse: collapse; text-align: center;"> <tr> <td style="width: 10%;"></td> <td style="width: 10%;"></td> <td style="width: 10%;"></td> <td style="width: 10%;"></td> <td style="width: 10%;"></td> <td style="width: 10%;"></td> <td style="width: 10%;"></td> <td style="width: 10%;"></td> <td style="width: 10%;"></td> <td style="width: 10%;"></td> </tr> <tr> <td></td> <td></td> <td colspan="8" style="text-align: center;"> <table border="1" style="width: 100%; border-collapse: collapse; text-align: center;"> <tr> <td style="width: 10%;"></td> <td style="width: 10%;"></td> <td style="width: 10%;"></td> <td style="width: 10%;"></td> <td style="width: 10%;"></td> <td style="width: 10%;"></td> <td style="width: 10%;"></td> <td style="width: 10%;"></td> <td style="width: 10%;"></td> <td style="width: 10%;"></td> </tr> <tr> <td></td> <td></td> <td colspan="8" style="text-align: center;"> <table border="1" style="width: 100%; border-collapse: collapse; text-align: center;"> <tr> <td style="width: 10%;"></td> <td style="width: 10%;"></td> <td style="width: 10%;"></td> <td style="width: 10%;"></td> <td style="width: 10%;"></td> <td style="width: 10%;"></td> <td style="width: 10%;"></td> <td style="width: 10%;"></td> <td style="width: 10%;"></td> <td style="width: 10%;"></td> </tr> <tr> <td></td> <td></td> <td colspan="8" style="text-align: center;"> <table border="1" style="width: 100%; border-collapse: collapse; text-align: center;"> <tr> <td style="width: 10%;"></td> <td style="width: 10%;"></td> <td style="width: 10%;"></td> <td style="width: 10%;"></td> <td style="width: 10%;"></td> <td style="width: 10%;"></td> <td style="width: 10%;"></td> <td style="width: 10%;"></td> <td style="width: 10%;"></td> <td style="width: 10%;"></td> </tr> <tr> <td></td> <td></td> <td colspan="8" style="text-align: center;"> <table border="1" style="width: 100%; border-collapse: collapse; text-align: center;"> <tr> <td style="width: 10%;"></td> <td style="width: 10%;"></td> <td style="width: 10%;"></td> <td style="width: 10%;"></td> <td style="width: 10%;"></td> <td style="width: 10%;"></td> <td style="width: 10%;"></td> <td style="width: 10%;"></td> <td style="width: 10%;"></td> <td style="width: 10%;"></td> </tr> <tr> <td></td> <td></td> <td colspan="8" style="text-align: center;"> <table border="1" style="width: 100%; border-collapse: collapse; text-align: center;"> <tr> <td style="width: 10%;"></td> <td style="width: 10%;"></td> <td style="width: 10%;"></td> <td style="width: 10%;"></td> <td style="width: 10%;"></td> <td style="width: 10%;"></td> <td style="width: 10%;"></td> <td style="width: 10%;"></td> <td style="width: 10%;"></td> <td style="width: 10%;"></td> </tr> <tr> <td></td> <td></td> <td colspan="8" style="text-align: center;"> <table border="1" style="width: 100%; border-collapse: collapse; text-align: center;"> <tr> <td style="width: 10%;"></td> <td style="width: 10%;"></td> <td style="width: 10%;"></td> <td style="width: 10%;"></td> <td style="width: 10%;"></td> <td style="width: 10%;"></td> <td style="width: 10%;"></td> <td style="width: 10%;"></td> <td style="width: 10%;"></td> <td style="width: 10%;"></td> </tr> <tr> <td></td> <td></td> <td colspan="8" style="text-align: center;"> <table border="1" style="width: 100%; border-collapse: collapse; text-align: center;"> <tr> <td style="width: 10%;"></td> <td style="width: 10%;"></td> <td style="width: 10%;"></td> <td style="width: 10%;"></td> <td style="width: 10%;"></td> <td style="width: 10%;"></td> <td style="width: 10%;"></td> <td style="width: 10%;"></td> <td style="width: 10%;"></td> <td style="width: 10%;"></td> </tr> <tr> <td></td> <td></td> <td colspan="8" style="text-align: center;"> <table border="1" style="width: 100%; border-collapse: collapse; text-align: center;"> <tr> <td style="width: 10%;"></td> <td style="width: 10%;"></td> <td style="width: 10%;"></td> <td style="width: 10%;"></td> <td style="width: 10%;"></td> <td style="width: 10%;"></td> <td style="width: 10%;"></td> <td style="width: 10%;"></td> <td style="width: 10%;"></td> <td style="width: 10%;"></td> </tr> <tr> <td></td> <td></td> <td colspan="8" style="text-align: center;"> <table border="1" style="width: 100%; border-collapse: collapse; text-align: center;"> <tr> <td style="width: 10%;"></td> <td style="width: 10%;"></td> <td style="width: 10%;"></td> <td style="width: 10%;"></td> <td style="width: 10%;"></td> <td style="width: 10%;"></td> <td style="width: 10%;"></td> <td style="width: 10%;"></td> <td style="width: 10%;"></td> <td style="width: 10%;"></td> </tr> <tr> <td></td> <td></td> <td colspan="8" style="text-align: center;"> <table border="1" style="width: 100%; border-collapse: collapse; text-align: center;"> <tr> <td style="width: 10%;"></td> <td style="width: 10%;"></td> <td style="width: 10%;"></td> <td style="width: 10%;"></td> <td style="width: 10%;"></td> <td style="width: 10%;"></td> <td style="width: 10%;"></td> <td style="width: 10%;"></td> <td style="width: 10%;"></td> <td style="width: 10%;"></td> </tr> <tr> <td></td> <td></td> <td colspan="8" style="text-align: center;"> <table border="1" style="width: 100%; border-collapse: collapse; text-align: center;"> <tr> <td style="width: 10%;"></td> <td style="width: 10%;"></td> <td style="width: 10%;"></td> <td style="width: 10%;"></td> <td style="width: 10%;"></td> <td style="width: 10%;"></td> <td style="width: 10%;"></td> <td style="width: 10%;"></td> <td style="width: 10%;"></td> <td style="width: 10%;"></td> </tr> <tr> <td></td> <td></td> <td colspan="8" style="text-align: center;"> <table border="1" style="width: 100%; border-collapse: collapse; text-align: center;"> <tr> <td style="width: 10%;"></td> <td style="width: 10%;"></td> <td style="width: 10%;"></td> <td style="width: 10%;"></td> <td style="width: 10%;"></td> <td style="width: 10%;"></td> <td style="width: 10%;"></td> <td style="width: 10%;"></td> <td style="width: 10%;"></td> <td style="width: 10%;"></td> </tr> <tr> <td></td> <td></td> <td colspan="8" style="text-align: center;"> <table border="1" style="width: 100%; border-collapse: collapse; text-align: center;"> <tr> <td style="width:
10%;"></td> <td style="width: 10%;"></td> <td style="width: 10%;"></td> <td style="width: 10%;"></td> <td style="width: 10%;"></td> <td style="width: 10%;"></td> <td style="width: 10%;"></td> <td style="width: 10%;"></td> <td style="width: 10%;"></td> <td style="width: 10%;"></td> </tr> <tr> <td></td> <td></td> <td colspan="8" style="text-align: center;"> <table border="1" style="width: 100%; border-collapse: collapse; text-align: center;"> <tr> </tr></table></td></tr></table></td></tr></table></td></tr></table></td></tr></table></td></tr></table></td></tr></table></td></tr></table></td></tr></table></td></tr></table></td></tr></table></td></tr></table></td></tr></table></td></tr></table></td></tr></table></td></tr></table></td></tr></table></td></tr></table></td></tr></table></td></tr></table></td></tr></table></td></tr></table></td></tr></table></td></tr></table></td></tr></table></td></tr></table></td></tr></table></td></tr></table></td></tr></table></td></tr></table></td></tr></table></td></tr></table></td></tr></table></td></tr></table></td></tr></table></td></tr></table></td></tr></table></td></tr></table></td></tr></table></td></tr></table></td></tr></table></td></tr></table></td></tr></table></td></tr></table></td></tr></table></td></tr></table></td></tr></table> | | | | | | | | | | | | | | | | | | | | <table border="1" style="width: 100%; border-collapse: collapse; text-align: center;"> <tr> <td style="width: 10%;"></td> <td style="width: 10%;"></td> <td style="width: 10%;"></td> <td style="width: 10%;"></td> <td style="width: 10%;"></td> <td style="width: 10%;"></td> <td style="width: 10%;"></td> <td style="width: 10%;"></td> <td style="width: 10%;"></td> <td style="width: 10%;"></td> </tr> <tr> <td></td> <td></td> <td colspan="8" style="text-align: center;"> <table border="1" style="width: 100%; border-collapse: collapse; text-align: center;"> <tr> <td style="width: 10%;"></td> <td style="width: 10%;"></td> <td style="width: 10%;"></td> <td style="width: 10%;"></td> <td style="width: 10%;"></td> <td style="width: 10%;"></td> <td style="width: 10%;"></td> <td style="width: 10%;"></td> <td style="width: 10%;"></td> <td style="width: 10%;"></td> </tr> <tr> <td></td> <td></td> <td colspan="8" style="text-align: center;"> <table border="1" style="width: 100%; border-collapse: collapse; text-align: center;"> <tr> <td style="width: 10%;"></td> <td style="width: 10%;"></td> <td style="width: 10%;"></td> <td style="width: 10%;"></td> <td style="width: 10%;"></td> <td style="width: 10%;"></td> <td style="width: 10%;"></td> <td style="width: 10%;"></td> <td style="width: 10%;"></td> <td style="width: 10%;"></td> </tr> <tr> <td></td> <td></td> <td colspan="8" style="text-align: center;"> <table border="1" style="width: 100%; border-collapse: collapse; text-align: center;"> <tr> <td style="width: 10%;"></td> <td style="width: 10%;"></td> <td style="width: 10%;"></td> <td style="width: 10%;"></td> <td style="width: 10%;"></td> <td style="width: 10%;"></td> <td style="width: 10%;"></td> <td style="width: 10%;"></td> <td style="width: 10%;"></td> <td style="width: 10%;"></td> </tr> <tr> <td></td> <td></td> <td colspan="8" style="text-align: center;"> <table border="1" style="width: 100%; border-collapse: collapse; text-align: center;"> <tr> <td style="width: 10%;"></td> <td style="width: 10%;"></td> <td style="width: 10%;"></td> <td style="width: 10%;"></td> <td style="width: 10%;"></td> <td style="width: 10%;"></td> <td style="width: 10%;"></td> <td style="width: 10%;"></td> <td style="width: 10%;"></td> <td style="width: 10%;"></td> </tr> <tr> <td></td> <td></td> <td colspan="8" style="text-align: center;"> <table border="1" style="width: 100%; border-collapse: collapse; text-align: center;"> <tr> <td style="width: 10%;"></td> <td style="width: 10%;"></td> <td style="width: 10%;"></td> <td style="width: 10%;"></td> <td style="width: 10%;"></td> <td style="width: 10%;"></td> <td style="width: 10%;"></td> <td style="width: 10%;"></td> <td style="width: 10%;"></td> <td style="width: 10%;"></td> </tr> <tr> <td></td> <td></td> <td colspan="8" style="text-align: center;"> <table border="1" style="width: 100%; border-collapse: collapse; text-align: center;"> <tr> <td style="width: 10%;"></td> <td style="width: 10%;"></td> <td style="width: 10%;"></td> <td style="width: 10%;"></td> <td style="width: 10%;"></td> <td style="width: 10%;"></td> <td style="width: 10%;"></td> <td style="width: 10%;"></td> <td style="width: 10%;"></td> <td style="width: 10%;"></td> </tr> <tr> <td></td> <td></td> <td colspan="8" style="text-align: center;"> <table border="1" style="width: 100%; border-collapse: collapse; text-align: center;"> <tr> <td style="width: 10%;"></td> <td style="width: 10%;"></td> <td style="width: 10%;"></td> <td style="width: 10%;"></td> <td style="width: 10%;"></td> <td style="width: 10%;"></td> <td style="width: 10%;"></td> <td style="width: 10%;"></td> <td style="width: 10%;"></td> <td style="width: 10%;"></td> </tr> <tr> <td></td> <td></td> <td colspan="8" style="text-align: center;"> <table border="1" style="width: 100%; border-collapse: collapse; text-align: center;"> <tr> <td style="width: 10%;"></td> <td style="width: 10%;"></td> <td style="width: 10%;"></td> <td style="width: 10%;"></td> <td style="width: 10%;"></td> <td style="width: 10%;"></td> <td style="width: 10%;"></td> <td style="width: 10%;"></td> <td style="width: 10%;"></td> <td style="width: 10%;"></td> </tr> <tr> <td></td> <td></td> <td colspan="8" style="text-align: center;"> <table border="1" style="width: 100%; border-collapse: collapse; text-align: center;"> <tr> <td style="width: 10%;"></td> <td style="width: 10%;"></td> <td style="width: 10%;"></td> <td style="width: 10%;"></td> <td style="width: 10%;"></td> <td style="width: 10%;"></td> <td style="width: 10%;"></td> <td style="width: 10%;"></td> <td style="width: 10%;"></td> <td style="width: 10%;"></td> </tr> <tr> <td></td> <td></td> <td colspan="8" style="text-align: center;"> <table border="1" style="width: 100%; border-collapse: collapse; text-align: center;"> <tr> <td style="width: 10%;"></td> <td style="width: 10%;"></td> <td style="width: 10%;"></td> <td style="width: 10%;"></td> <td style="width: 10%;"></td> <td style="width: 10%;"></td> <td style="width: 10%;"></td> <td style="width: 10%;"></td> <td style="width: 10%;"></td> <td style="width: 10%;"></td> </tr> <tr> <td></td> <td></td> <td colspan="8" style="text-align: center;"> <table border="1" style="width: 100%; border-collapse: collapse; text-align: center;"> <tr> <td style="width: 10%;"></td> <td style="width: 10%;"></td> <td style="width: 10%;"></td> <td style="width: 10%;"></td> <td style="width: 10%;"></td> <td style="width: 10%;"></td> <td style="width: 10%;"></td> <td style="width: 10%;"></td> <td style="width: 10%;"></td> <td style="width: 10%;"></td> </tr> <tr> <td></td> <td></td> <td colspan="8" style="text-align: center;"> <table border="1" style="width: 100%; border-collapse: collapse; text-align: center;"> <tr> <td style="width: 10%;"></td> <td style="width: 10%;"></td> <td style="width: 10%;"></td> <td style="width: 10%;"></td> <td style="width: 10%;"></td> <td style="width: 10%;"></td> <td style="width: 10%;"></td> <td style="width: 10%;"></td> <td style="width: 10%;"></td> <td style="width: 10%;"></td> </tr> <tr> <td></td> <td></td> <td colspan="8" style="text-align: center;"> <table border="1" style="width: 100%; border-collapse: collapse; text-align: center;"> <tr> <td style="width: 10%;"></td> <td
style="width: 10%;"></td> <td style="width: 10%;"></td> <td style="width: 10%;"></td> <td style="width: 10%;"></td> <td style="width: 10%;"></td> <td style="width: 10%;"></td> <td style="width: 10%;"></td> <td style="width: 10%;"></td> <td style="width: 10%;"></td> </tr> <tr> <td></td> <td></td> <td colspan="8" style="text-align: center;"> <table border="1" style="width: 100%; border-collapse: collapse; text-align: center;"> <tr> <td style="width: 10%;"></td> <td style="width: 10%;"></td> <td style="width: 10%;"></td> <td style="width: 10%;"></td> <td style="width: 10%;"></td> <td style="width: 10%;"></td> <td style="width: 10%;"></td> <td style="width: 10%;"></td> <td style="width: 10%;"></td> <td style="width: 10%;"></td> </tr> <tr> <td></td> <td></td> <td colspan="8" style="text-align: center;"> <table border="1" style="width: 100%; border-collapse: collapse; text-align: center;"> <tr> <td style="width: 10%;"></td> <td style="width: 10%;"></td> <td style="width: 10%;"></td> <td style="width: 10%;"></td> <td style="width: 10%;"></td> <td style="width: 10%;"></td> <td style="width: 10%;"></td> <td style="width: 10%;"></td> <td style="width: 10%;"></td> <td style="width: 10%;"></td> </tr> <tr> <td></td> <td></td> <td colspan="8" style="text-align: center;"> <table border="1" style="width: 100%; border-collapse: collapse; text-align: center;"> <tr> <td style="width: 10%;"></td> <td style="width: 10%;"></td> <td style="width: 10%;"></td> <td style="width: 10%;"></td> <td style="width: 10%;"></td> <td style="width: 10%;"></td> <td style="width: 10%;"></td> <td style="width: 10%;"></td> <td style="width: 10%;"></td> <td style="width: 10%;"></td> </tr> <tr> <td></td> <td></td> <td colspan="8" style="text-align: center;"> <table border="1" style="width: 100%; border-collapse: collapse; text-align: center;"> <tr> <td style="width: 10%;"></td> <td style="width: 10%;"></td> <td style="width: 10%;"></td> <td style="width: 10%;"></td> <td style="width: 10%;"></td> <td style="width: 10%;"></td> <td style="width: 10%;"></td> <td style="width: 10%;"></td> <td style="width: 10%;"></td> <td style="width: 10%;"></td> </tr> <tr> <td></td> <td></td> <td colspan="8" style="text-align: center;"> <table border="1" style="width: 100%; border-collapse: collapse; text-align: center;"> <tr> <td style="width: 10%;"></td> <td style="width: 10%;"></td> <td style="width: 10%;"></td> <td style="width: 10%;"></td> <td style="width: 10%;"></td> <td style="width: 10%;"></td> <td style="width: 10%;"></td> <td style="width: 10%;"></td> <td style="width: 10%;"></td> <td style="width: 10%;"></td> </tr> <tr> <td></td> <td></td> <td colspan="8" style="text-align: center;"> <table border="1" style="width: 100%; border-collapse: collapse; text-align: center;"> <tr> <td style="width: 10%;"></td> <td style="width: 10%;"></td> <td style="width: 10%;"></td> <td style="width: 10%;"></td> <td style="width: 10%;"></td> <td style="width: 10%;"></td> <td style="width: 10%;"></td> <td style="width: 10%;"></td> <td style="width: 10%;"></td> <td style="width: 10%;"></td> </tr> <tr> <td></td> <td></td> <td colspan="8" style="text-align: center;"> <table border="1" style="width: 100%; border-collapse: collapse; text-align: center;"> <tr> <td style="width: 10%;"></td> <td style="width: 10%;"></td> <td style="width: 10%;"></td> <td style="width: 10%;"></td> <td style="width: 10%;"></td> <td style="width: 10%;"></td> <td style="width: 10%;"></td> <td style="width: 10%;"></td> <td style="width: 10%;"></td> <td style="width: 10%;"></td> </tr> <tr> <td></td> <td></td> <td colspan="8" style="text-align: center;"> <table border="1" style="width: 100%; border-collapse: collapse; text-align: center;"> <tr> <td style="width: 10%;"></td> <td style="width: 10%;"></td> <td style="width: 10%;"></td> <td style="width: 10%;"></td> <td style="width: 10%;"></td> <td style="width: 10%;"></td> <td style="width: 10%;"></td> <td style="width: 10%;"></td> <td style="width: 10%;"></td> <td style="width: 10%;"></td> </tr> <tr> <td></td> <td></td> <td colspan="8" style="text-align: center;"> <table border="1" style="width: 100%; border-collapse: collapse; text-align: center;"> <tr> <td style="width: 10%;"></td> <td style="width: 10%;"></td> <td style="width: 10%;"></td> <td style="width: 10%;"></td> <td style="width: 10%;"></td> <td style="width: 10%;"></td> <td style="width: 10%;"></td> <td style="width: 10%;"></td> <td style="width: 10%;"></td> <td style="width: 10%;"></td> </tr> <tr> <td></td> <td></td> <td colspan="8" style="text-align: center;"> <table border="1" style="width: 100%; border-collapse: collapse; text-align: center;"> <tr> <td style="width: 10%;"></td> <td style="width: 10%;"></td> <td style="width: 10%;"></td> <td style="width: 10%;"></td> <td style="width: 10%;"></td> <td style="width: 10%;"></td> <td style="width: 10%;"></td> <td style="width: 10%;"></td> <td style="width: 10%;"></td> <td style="width: 10%;"></td> </tr> <tr> <td></td> <td></td> <td colspan="8" style="text-align: center;"> <table border="1" style="width: 100%; border-collapse: collapse; text-align: center;"> <tr> <td style="width: 10%;"></td> <td style="width: 10%;"></td> <td style="width: 10%;"></td> <td style="width: 10%;"></td> <td style="width: 10%;"></td> <td style="width: 10%;"></td> <td style="width: 10%;"></td> <td style="width: 10%;"></td> <td style="width: 10%;"></td> <td style="width: 10%;"></td> </tr> <tr> <td></td> <td></td> <td colspan="8" style="text-align: center;"> <table border="1" style="width: 100%; border-collapse: collapse; text-align: center;"> <tr> <td style="width: 10%;"></td> <td style="width: 10%;"></td> <td style="width: 10%;"></td> <td style="width: 10%;"></td> <td style="width: 10%;"></td> <td style="width: 10%;"></td> <td style="width: 10%;"></td> <td style="width: 10%;"></td> <td style="width: 10%;"></td> <td style="width: 10%;"></td> </tr> <tr> <td></td> <td></td> <td colspan="8" style="text-align: center;"> <table border="1" style="width: 100%; border-collapse: collapse; text-align: center;"> <tr> <td style="width: 10%;"></td> <td style="width: 10%;"></td> <td style="width: 10%;"></td> <td style="width: 10%;"></td> <td style="width: 10%;"></td> <td style="width: 10%;"></td> <td style="width: 10%;"></td> <td style="width: 10%;"></td> <td style="width: 10%;"></td> <td style="width: 10%;"></td> </tr> <tr> <td></td> <td></td> <td colspan="8" style="text-align: center;"> <table border="1" style="width: 100%; border-collapse: collapse; text-align: center;"> <tr> <td style="width: 10%;"></td> <td style="width: 10%;"></td> <td style="width: 10%;"></td> <td style="width: 10%;"></td> <td style="width: 10%;"></td> <td style="width: 10%;"></td> <td style="width: 10%;"></td> <td style="width: 10%;"></td> <td style="width: 10%;"></td> <td style="width: 10%;"></td> </tr> <tr> <td></td> <td></td> <td colspan="8" style="text-align: center;"> <table border="1" style="width: 100%; border-collapse: collapse; text-align: center;"> <tr> <td style="width: 10%;"></td> <td style="width: 10%;"></td> <td style="width: 10%;"></td> <td style="width: 10%;"></td> <td style="width: 10%;"></td> <td style="width: 10%;"></td> <td style="width: 10%;"></td> <td style="width: 10%;"></td> <td style="width: 10%;"></td> <td style="width: 10%;"></td> </tr> <tr> <td></td> <td></td> <td colspan="8" style="text-align: center;"> <table border="1" style="width: 100%; border-collapse: collapse; text-align: center;"> <tr> <td style="width: 10%;"></td> <td style="width: 10%;"></td> <td style="width: 10%;"></td> <td style="width: 10%;"></td> <td style="width: 10%;"></td> <td style="width: 10%;"></td> <td style="width: 10%;"></td> <td style="width: 10%;"></td> <td style="width: 10%;"></td> <td style="width: 10%;"></td> </tr> <tr> <td></td> <td></td> <td colspan="8" style="text-align: center;"> <table border="1" style="width: 100%; border-collapse: collapse; text-align: center;"> <tr> <td style="width: 10%;"></td> <td style="width: 10%;"></td> <td style="width: 10%;"></td> <td style="width: 10%;"></td> <td style="width: 10%;"></td> <td style="width: 10%;"></td> <td style="width: 10%;"></td> <td style="width: 10%;"></td> <td style="width: 10%;"></td> <td style="width: 10%;"></td> </tr> <tr> <td></td> <td></td> <td colspan="8" style="text-align: center;"> <table border="1" style="width: 100%; border-collapse: collapse; text-align: center;"> <tr> <td style="width: 10%;"></td> <td style="width: 10%;"></td> <td style="width: 10%;"></td> <td style="width: 10%;"></td> <td style="width: 10%;"></td> <td style="width: 10%;"></td> <td style="width: 10%;"></td> <td style="width: 10%;"></td> <td style="width: 10%;"></td> <td style="width: 10%;"></td> </tr> <tr> <td></td> <td></td> <td colspan="8" style="text-align: center;"> <table border="1" style="width: 100%; border-collapse: collapse; text-align: center;"> <tr> <td style="width: 10%;"></td> <td style="width: 10%;"></td> <td style="width: 10%;"></td> <td style="width: 10%;"></td> <td style="width: 10%;"></td> <td style="width: 10%;"></td> <td style="width: 10%;"></td> <td style="width: 10%;"></td> <td style="width: 10%;"></td> <td style="width: 10%;"></td> </tr> <tr> <td></td> <td></td> <td colspan="8" style="text-align: center;"> <table border="1" style="width: 100%; border-collapse: collapse; text-align: center;"> <tr> <td style="width: 10%;"></td> <td style="width: 10%;"></td> <td style="width: 10%;"></td> <td style="width: 10%;"></td> <td style="width: 10%;"></td> <td style="width: 10%;"></td> <td style="width: 10%;"></td> <td style="width: 10%;"></td> <td style="width: 10%;"></td> <td style="width: 10%;"></td> </tr> <tr> <td></td> <td></td> <td colspan="8" style="text-align: center;"> <table border="1" style="width: 100%; border-collapse: collapse; text-align: center;"> <tr> <td style="width: 10%;"></td> <td style="width: 10%;"></td> <td style="width: 10%;"></td> <td style="width: 10%;"></td> <td style="width: 10%;"></td> <td style="width: 10%;"></td> <td style="width:
10%;"></td> <td style="width: 10%;"></td> <td style="width: 10%;"></td> <td style="width: 10%;"></td> </tr> <tr> <td></td> <td></td> <td colspan="8" style="text-align: center;"> <table border="1" style="width: 100%; border-collapse: collapse; text-align: center;"> <tr> <td style="width: 10%;"></td> <td style="width: 10%;"></td> <td style="width: 10%;"></td> <td style="width: 10%;"></td> <td style="width: 10%;"></td> <td style="width: 10%;"></td> <td style="width: 10%;"></td> <td style="width: 10%;"></td> <td style="width: 10%;"></td> <td style="width: 10%;"></td> </tr> <tr> <td></td> <td></td> <td colspan="8" style="text-align: center;"> <table border="1" style="width: 100%; border-collapse: collapse; text-align: center;"> <tr> <td style="width: 10%;"></td> <td style="width: 10%;"></td> <td style="width: 10%;"></td> <td style="width: 10%;"></td> <td style="width: 10%;"></td> <td style="width: 10%;"></td> <td style="width: 10%;"></td> <td style="width: 10%;"></td> <td style="width: 10%;"></td> <td style="width: 10%;"></td> </tr> <tr> <td></td> <td></td> <td colspan="8" style="text-align: center;"> <table border="1" style="width: 100%; border-collapse: collapse; text-align: center;"> <tr> <td style="width: 10%;"></td> <td style="width: 10%;"></td> <td style="width: 10%;"></td> <td style="width: 10%;"></td> <td style="width: 10%;"></td> <td style="width: 10%;"></td> <td style="width: 10%;"></td> <td style="width: 10%;"></td> <td style="width: 10%;"></td> <td style="width: 10%;"></td> </tr> <tr> <td></td> <td></td> <td colspan="8" style="text-align: center;"> <table border="1" style="width: 100%; border-collapse: collapse; text-align: center;"> <tr> <td style="width: 10%;"></td> <td style="width: 10%;"></td> <td style="width: 10%;"></td> <td style="width: 10%;"></td> <td style="width: 10%;"></td> <td style="width: 10%;"></td> <td style="width: 10%;"></td> <td style="width: 10%;"></td> <td style="width: 10%;"></td> <td style="width: 10%;"></td> </tr> <tr> <td></td> <td></td> <td colspan="8" style="text-align: center;"> <table border="1" style="width: 100%; border-collapse: collapse; text-align: center;"> <tr> <td style="width: 10%;"></td> <td style="width: 10%;"></td> <td style="width: 10%;"></td> <td style="width: 10%;"></td> <td style="width: 10%;"></td> <td style="width: 10%;"></td> <td style="width: 10%;"></td> <td style="width: 10%;"></td> <td style="width: 10%;"></td> <td style="width: 10%;"></td> </tr> <tr> <td></td> <td></td> <td colspan="8" style="text-align: center;"> <table border="1" style="width: 100%; border-collapse: collapse; text-align: center;"> <tr> <td style="width: 10%;"></td> <td style="width: 10%;"></td> <td style="width: 10%;"></td> <td style="width: 10%;"></td> <td style="width: 10%;"></td> <td style="width: 10%;"></td> <td style="width: 10%;"></td> <td style="width: 10%;"></td> <td style="width: 10%;"></td> <td style="width: 10%;"></td> </tr> <tr> <td></td> <td></td> <td colspan="8" style="text-align: center;"> <table border="1" style="width: 100%; border-collapse: collapse; text-align: center;"> <tr> <td style="width: 10%;"></td> <td style="width: 10%;"></td> <td style="width: 10%;"></td> <td style="width: 10%;"></td> <td style="width: 10%;"></td> <td style="width: 10%;"></td> <td style="width: 10%;"></td> <td style="width: 10%;"></td> <td style="width: 10%;"></td> <td style="width: 10%;"></td> </tr> <tr> <td></td> <td></td> <td colspan="8" style="text-align: center;"> <table border="1" style="width: 100%; border-collapse: collapse; text-align: center;"> <tr> <td style="width: 10%;"></td> <td style="width: 10%;"></td> <td style="width: 10%;"></td> <td style="width: 10%;"></td> <td style="width: 10%;"></td> <td style="width: 10%;"></td> <td style="width: 10%;"></td> <td style="width: 10%;"></td> <td style="width: 10%;"></td> <td style="width: 10%;"></td> </tr> <tr> <td></td> <td></td> <td colspan="8" style="text-align: center;"> <table border="1" style="width: 100%; border-collapse: collapse; text-align: center;"> <tr> <td style="width: 10%;"></td> <td style="width: 10%;"></td> <td style="width: 10%;"></td> <td style="width: 10%;"></td> <td style="width: 10%;"></td> <td style="width: 10%;"></td> <td style="width: 10%;"></td> <td style="width: 10%;"></td> <td style="width: 10%;"></td> <td style="width: 10%;"></td> </tr> <tr> <td></td> <td></td> <td colspan="8" style="text-align: center;"> <table border="1" style="width: 100%; border-collapse: collapse; text-align: center;"> <tr> <td style="width: 10%;"></td> <td style="width: 10%;"></td> <td style="width: 10%;"></td> <td style="width: 10%;"></td> <td style="width: 10%;"></td> <td style="width: 10%;"></td> <td style="width: 10%;"></td> <td style="width: 10%;"></td> <td style="width: 10%;"></td> <td style="width: 10%;"></td> </tr> <tr> <td></td> <td></td> <td colspan="8" style="text-align: center;"> <table border="1" style="width: 100%; border-collapse: collapse; text-align: center;"> <tr> </tr></table></td></tr></table></td></tr></table></td></tr></table></td></tr></table></td></tr></table></td></tr></table></td></tr></table></td></tr></table></td></tr></table></td></tr></table></td></tr></table></td></tr></table></td></tr></table></td></tr></table></td></tr></table></td></tr></table></td></tr></table></td></tr></table></td></tr></table></td></tr></table></td></tr></table></td></tr></table></td></tr></table></td></tr></table></td></tr></table></td></tr></table></td></tr></table></td></tr></table></td></tr></table></td></tr></table></td></tr></table></td></tr></table></td></tr></table></td></tr></table></td></tr></table></td></tr></table></td></tr></table></td></tr></table></td></tr></table></td></tr></table></td></tr></table></td></tr></table></td></tr></table></td></tr></table></td></tr></table> | | | | | | | | | | | | | | | | | | | | <table border="1" style="width: 100%; border-collapse: collapse; text-align: center;"> <tr> <td style="width: 10%;"></td> <td style="width: 10%;"></td> <td style="width: 10%;"></td> <td style="width: 10%;"></td> <td style="width: 10%;"></td> <td style="width: 10%;"></td> <td style="width: 10%;"></td> <td style="width: 10%;"></td> <td style="width: 10%;"></td> <td style="width: 10%;"></td> </tr> <tr> <td></td> <td></td> <td colspan="8" style="text-align: center;"> <table border="1" style="width: 100%; border-collapse: collapse; text-align: center;"> <tr> <td style="width: 10%;"></td> <td style="width: 10%;"></td> <td style="width: 10%;"></td> <td style="width: 10%;"></td> <td style="width: 10%;"></td> <td style="width: 10%;"></td> <td style="width: 10%;"></td> <td style="width: 10%;"></td> <td style="width: 10%;"></td> <td style="width: 10%;"></td> </tr> <tr> <td></td> <td></td> <td colspan="8" style="text-align: center;"> <table border="1" style="width: 100%; border-collapse: collapse; text-align: center;"> <tr> <td style="width: 10%;"></td> <td style="width: 10%;"></td> <td style="width: 10%;"></td> <td style="width: 10%;"></td> <td style="width: 10%;"></td> <td style="width: 10%;"></td> <td style="width: 10%;"></td> <td style="width: 10%;"></td> <td style="width: 10%;"></td> <td style="width: 10%;"></td> </tr> <tr> <td></td> <td></td> <td colspan="8" style="text-align: center;"> <table border="1" style="width: 100%; border-collapse: collapse; text-align: center;"> <tr> <td style="width: 10%;"></td> <td style="width: 10%;"></td> <td style="width: 10%;"></td> <td style="width: 10%;"></td> <td style="width: 10%;"></td> <td style="width: 10%;"></td> <td style="width: 10%;"></td> <td style="width: 10%;"></td>
<td style="width: 10%;"></td> <td style="width: 10%;"></td> </tr> <tr> <td></td> <td></td> <td colspan="8" style="text-align: center;"> <table border="1" style="width: 100%; border-collapse: collapse; text-align: center;"> <tr> <td style="width: 10%;"></td> <td style="width: 10%;"></td> <td style="width: 10%;"></td> <td style="width: 10%;"></td> <td style="width: 10%;"></td> <td style="width: 10%;"></td> <td style="width: 10%;"></td> <td style="width: 10%;"></td> <td style="width: 10%;"></td> <td style="width: 10%;"></td> </tr> <tr> <td></td> <td></td> <td colspan="8" style="text-align: center;"> <table border="1" style="width: 100%; border-collapse: collapse; text-align: center;"> <tr> <td style="width: 10%;"></td> <td style="width: 10%;"></td> <td style="width: 10%;"></td> <td style="width: 10%;"></td> <td style="width: 10%;"></td> <td style="width: 10%;"></td> <td style="width: 10%;"></td> <td style="width: 10%;"></td> <td style="width: 10%;"></td> <td style="width: 10%;"></td> </tr> <tr> <td></td> <td></td> <td colspan="8" style="text-align: center;"> <table border="1" style="width: 100%; border-collapse: collapse; text-align: center;"> <tr> <td style="width: 10%;"></td> <td style="width: 10%;"></td> <td style="width: 10%;"></td> <td style="width: 10%;"></td> <td style="width: 10%;"></td> <td style="width: 10%;"></td> <td style="width: 10%;"></td> <td style="width: 10%;"></td> <td style="width: 10%;"></td> <td style="width: 10%;"></td> </tr> <tr> <td></td> <td></td> <td colspan="8" style="text-align: center;"> <table border="1" style="width: 100%; border-collapse: collapse; text-align: center;"> <tr> <td style="width: 10%;"></td> <td style="width: 10%;"></td> <td style="width: 10%;"></td> <td style="width: 10%;"></td> <td style="width: 10%;"></td> <td style="width: 10%;"></td> <td style="width: 10%;"></td> <td style="width: 10%;"></td> <td style="width: 10%;"></td> <td style="width: 10%;"></td> </tr> <tr> <td></td> <td></td> <td colspan="8" style="text-align: center;"> <table border="1" style="width: 100%; border-collapse: collapse; text-align: center;"> <tr> <td style="width: 10%;"></td> <td style="width: 10%;"></td> <td style="width: 10%;"></td> <td style="width: 10%;"></td> <td style="width: 10%;"></td> <td style="width: 10%;"></td> <td style="width: 10%;"></td> <td style="width: 10%;"></td> <td style="width: 10%;"></td> <td style="width: 10%;"></td> </tr> <tr> <td></td> <td></td> <td colspan="8" style="text-align: center;"> <table border="1" style="width: 100%; border-collapse: collapse; text-align: center;"> <tr> <td style="width: 10%;"></td> <td style="width: 10%;"></td> <td style="width: 10%;"></td> <td style="width: 10%;"></td> <td style="width: 10%;"></td> <td style="width: 10%;"></td> <td style="width: 10%;"></td> <td style="width: 10%;"></td> <td style="width: 10%;"></td> <td style="width: 10%;"></td> </tr> <tr> <td></td> <td></td> <td colspan="8" style="text-align: center;"> <table border="1" style="width: 100%; border-collapse: collapse; text-align: center;"> <tr> <td style="width: 10%;"></td> <td style="width: 10%;"></td> <td style="width: 10%;"></td> <td style="width: 10%;"></td> <td style="width: 10%;"></td> <td style="width: 10%;"></td> <td style="width: 10%;"></td> <td style="width: 10%;"></td> <td style="width: 10%;"></td> <td style="width: 10%;"></td> </tr> <tr> <td></td> <td></td> <td colspan="8" style="text-align: center;"> <table border="1" style="width: 100%; border-collapse: collapse; text-align: center;"> <tr> <td style="width: 10%;"></td> <td style="width: 10%;"></td> <td style="width: 10%;"></td> <td style="width: 10%;"></td> <td style="width: 10%;"></td> <td style="width: 10%;"></td> <td style="width: 10%;"></td> <td style="width: 10%;"></td> <td style="width: 10%;"></td> <td style="width: 10%;"></td> </tr> <tr> <td></td> <td></td> <td colspan="8" style="text-align: center;"> <table border="1" style="width: 100%; border-collapse: collapse; text-align: center;"> <tr> <td style="width: 10%;"></td> <td style="width: 10%;"></td> <td style="width: 10%;"></td> <td style="width: 10%;"></td> <td style="width: 10%;"></td> <td style="width: 10%;"></td> <td style="width: 10%;"></td> <td style="width: 10%;"></td> <td style="width: 10%;"></td> <td style="width: 10%;"></td> </tr> <tr> <td></td> <td></td> <td colspan="8" style="text-align: center;"> <table border="1" style="width: 100%; border-collapse: collapse; text-align: center;"> <tr> <td style="width: 10%;"></td> <td style="width: 10%;"></td> <td style="width: 10%;"></td> <td style="width: 10%;"></td> <td style="width: 10%;"></td> <td style="width: 10%;"></td> <td style="width: 10%;"></td> <td style="width: 10%;"></td> <td style="width: 10%;"></td> <td style="width: 10%;"></td> </tr> <tr> <td></td> <td></td> <td colspan="8" style="text-align: center;"> <table border="1" style="width: 100%; border-collapse: collapse; text-align: center;"> <tr> <td style="width: 10%;"></td> <td style="width: 10%;"></td> <td style="width: 10%;"></td> <td style="width: 10%;"></td> <td style="width: 10%;"></td> <td style="width: 10%;"></td> <td style="width: 10%;"></td> <td style="width: 10%;"></td> <td style="width: 10%;"></td> <td style="width: 10%;"></td> </tr> <tr> <td></td> <td></td> <td colspan="8" style="text-align: center;"> <table border="1" style="width: 100%; border-collapse: collapse; text-align: center;"> <tr> <td style="width: 10%;"></td> <td style="width: 10%;"></td> <td style="width: 10%;"></td> <td style="width: 10%;"></td> <td style="width: 10%;"></td> <td style="width: 10%;"></td> <td style="width: 10%;"></td> <td style="width: 10%;"></td> <td style="width: 10%;"></td> <td style="width: 10%;"></td> </tr> <tr> <td></td> <td></td> <td colspan="8" style="text-align: center;"> <table border="1" style="width: 100%; border-collapse: collapse; text-align: center;"> <tr> <td style="width: 10%;"></td> <td style="width: 10%;"></td> <td style="width: 10%;"></td> <td style="width: 10%;"></td> <td style="width: 10%;"></td> <td style="width: 10%;"></td> <td style="width: 10%;"></td> <td style="width: 10%;"></td> <td style="width: 10%;"></td> <td style="width: 10%;"></td> </tr> <tr> <td></td> <td></td> <td colspan="8" style="text-align: center;"> <table border="1" style="width: 100%; border-collapse: collapse; text-align: center;"> <tr> <td style="width: 10%;"></td> <td style="width: 10%;"></td> <td style="width: 10%;"></td> <td style="width: 10%;"></td> <td style="width: 10%;"></td> <td style="width: 10%;"></td> <td style="width: 10%;"></td> <td style="width: 10%;"></td> <td style="width: 10%;"></td> <td style="width: 10%;"></td> </tr> <tr> <td></td> <td></td> <td colspan="8" style="text-align: center;"> <table border="1" style="width: 100%; border-collapse: collapse; text-align: center;"> <tr> <td style="width: 10%;"></td> <td style="width: 10%;"></td> <td style="width: 10%;"></td> <td style="width: 10%;"></td> <td style="width: 10%;"></td> <td style="width: 10%;"></td> <td style="width: 10%;"></td> <td style="width: 10%;"></td> <td style="width: 10%;"></td> <td style="width: 10%;"></td> </tr> <tr> <td></td> <td></td> <td colspan="8" style="text-align: center;"> <table border="1" style="width: 100%; border-collapse: collapse; text-align: center;"> <tr> <td style="width: 10%;"></td> <td style="width: 10%;"></td> <td style="width: 10%;"></td> <td style="width: 10%;"></td> <td style="width: 10%;"></td> <td style="width: 10%;"></td> <td style="width: 10%;"></td> <td style="width: 10%;"></td> <td style="width: 10%;"></td> <td style="width: 10%;"></td> </tr> <tr> <td></td> <td></td> <td colspan="8" style="text-align: center;"> <table border="1" style="width: 100%; border-collapse: collapse; text-align: center;"> <tr> <td style="width: 10%;"></td> <td style="width: 10%;"></td> <td style="width: 10%;"></td> <td style="width: 10%;"></td> <td style="width: 10%;"></td> <td style="width: 10%;"></td> <td style="width: 10%;"></td> <td style="width: 10%;"></td> <td style="width: 10%;"></td> <td style="width: 10%;"></td> </tr> <tr> <td></td> <td></td> <td colspan="8" style="text-align: center;"> <table border="1" style="width: 100%; border-collapse: collapse; text-align: center;"> <tr> <td style="width: 10%;"></td> <td style="width: 10%;"></td> <td style="width: 10%;"></td> <td style="width: 10%;"></td> <td style="width: 10%;"></td> <td style="width: 10%;"></td> <td style="width: 10%;"></td> <td style="width: 10%;"></td> <td style="width: 10%;"></td> <td style="width: 10%;"></td> </tr> <tr> <td></td> <td></td> <td colspan="8" style="text-align: center;"> <table border="1" style="width: 100%; border-collapse: collapse; text-align: center;"> <tr> <td style="width: 10%;"></td> <td style="width: 10%;"></td> <td style="width: 10%;"></td> <td style="width: 10%;"></td> <td style="width: 10%;"></td> <td style="width: 10%;"></td> <td style="width: 10%;"></td> <td style="width: 10%;"></td> <td style="width: 10%;"></td> <td style="width: 10%;"></td> </tr> <tr> <td></td> <td></td> <td colspan="8" style="text-align: center;"> <table border="1" style="width: 100%; border-collapse: collapse; text-align: center;"> <tr> <td style="width: 10%;"></td> <td style="width: 10%;"></td> <td style="width: 10%;"></td> <td style="width: 10%;"></td> <td style="width: 10%;"></td> <td style="width: 10%;"></td> <td style="width: 10%;"></td> <td style="width: 10%;"></td> <td style="width: 10%;"></td> <td style="width: 10%;"></td> </tr> <tr> <td></td> <td></td> <td colspan="8" style="text-align: center;"> <table border="1" style="width: 100%; border-collapse: collapse; text-align: center;"> <tr> <td style="width: 10%;"></td> <td style="width: 10%;"></td> <td style="width: 10%;"></td> <td style="width: 10%;"></td> <td style="width: 10%;"></td> <td style="width: 10%;"></td> <td style="width: 10%;"></td> <td style="width: 10%;"></td> <td style="width: 10%;"></td> <td style="width: 10%;"></td> </tr> <tr> <td></td> <td></td> <td colspan="8" style="text-align: center;"> <table border="1" style="width:
100%; border-collapse: collapse; text-align: center;"> <tr> <td style="width: 10%;"></td> <td style="width: 10%;"></td> <td style="width: 10%;"></td> <td style="width: 10%;"></td> <td style="width: 10%;"></td> <td style="width: 10%;"></td> <td style="width: 10%;"></td> <td style="width: 10%;"></td> <td style="width: 10%;"></td> <td style="width: 10%;"></td> </tr> <tr> <td></td> <td></td> <td colspan="8" style="text-align: center;"> <table border="1" style="width: 100%; border-collapse: collapse; text-align: center;"> <tr> <td style="width: 10%;"></td> <td style="width: 10%;"></td> <td style="width: 10%;"></td> <td style="width: 10%;"></td> <td style="width: 10%;"></td> <td style="width: 10%;"></td> <td style="width: 10%;"></td> <td style="width: 10%;"></td> <td style="width: 10%;"></td> <td style="width: 10%;"></td> </tr> <tr> <td></td> <td></td> <td colspan="8" style="text-align: center;"> <table border="1" style="width: 100%; border-collapse: collapse; text-align: center;"> <tr> <td style="width: 10%;"></td> <td style="width: 10%;"></td> <td style="width: 10%;"></td> <td style="width: 10%;"></td> <td style="width: 10%;"></td> <td style="width: 10%;"></td> <td style="width: 10%;"></td> <td style="width: 10%;"></td> <td style="width: 10%;"></td> <td style="width: 10%;"></td> </tr> <tr> <td></td> <td></td> <td colspan="8" style="text-align: center;"> <table border="1" style="width: 100%; border-collapse: collapse; text-align: center;"> <tr> <td style="width: 10%;"></td> <td style="width: 10%;"></td> <td style="width: 10%;"></td> <td style="width: 10%;"></td> <td style="width: 10%;"></td> <td style="width: 10%;"></td> <td style="width: 10%;"></td> <td style="width: 10%;"></td> <td style="width: 10%;"></td> <td style="width: 10%;"></td> </tr> <tr> <td></td> <td></td> <td colspan="8" style="text-align: center;"> <table border="1" style="width: 100%; border-collapse: collapse; text-align: center;"> <tr> <td style="width: 10%;"></td> <td style="width: 10%;"></td> <td style="width: 10%;"></td> <td style="width: 10%;"></td> <td style="width: 10%;"></td> <td style="width: 10%;"></td> <td style="width: 10%;"></td> <td style="width: 10%;"></td> <td style="width: 10%;"></td> <td style="width: 10%;"></td> </tr> <tr> <td></td> <td></td> <td colspan="8" style="text-align: center;"> <table border="1" style="width: 100%; border-collapse: collapse; text-align: center;"> <tr> <td style="width: 10%;"></td> <td style="width: 10%;"></td> <td style="width: 10%;"></td> <td style="width: 10%;"></td> <td style="width: 10%;"></td> <td style="width: 10%;"></td> <td style="width: 10%;"></td> <td style="width: 10%;"></td> <td style="width: 10%;"></td> <td style="width: 10%;"></td> </tr> <tr> <td></td> <td></td> <td colspan="8" style="text-align: center;"> <table border="1" style="width: 100%; border-collapse: collapse; text-align: center;"> <tr> <td style="width: 10%;"></td> <td style="width: 10%;"></td> <td style="width: 10%;"></td> <td style="width: 10%;"></td> <td style="width: 10%;"></td> <td style="width: 10%;"></td> <td style="width: 10%;"></td> <td style="width: 10%;"></td> <td style="width: 10%;"></td> <td style="width: 10%;"></td> </tr> <tr> <td></td> <td></td> <td colspan="8" style="text-align: center;"> <table border="1" style="width: 100%; border-collapse: collapse; text-align: center;"> <tr> <td style="width: 10%;"></td> <td style="width: 10%;"></td> <td style="width: 10%;"></td> <td style="width: 10%;"></td> <td style="width: 10%;"></td> <td style="width: 10%;"></td> <td style="width: 10%;"></td> <td style="width: 10%;"></td> <td style="width: 10%;"></td> <td style="width: 10%;"></td> </tr> <tr> <td></td> <td></td> <td colspan="8" style="text-align: center;"> <table border="1" style="width: 100%; border-collapse: collapse; text-align: center;"> <tr> <td style="width: 10%;"></td> <td style="width: 10%;"></td> <td style="width: 10%;"></td> <td style="width: 10%;"></td> <td style="width: 10%;"></td> <td style="width: 10%;"></td> <td style="width: 10%;"></td> <td style="width: 10%;"></td> <td style="width: 10%;"></td> <td style="width: 10%;"></td> </tr> <tr> <td></td> <td></td> <td colspan="8" style="text-align: center;"> <table border="1" style="width: 100%; border-collapse: collapse; text-align: center;"> <tr> <td style="width: 10%;"></td> <td style="width: 10%;"></td> <td style="width: 10%;"></td> <td style="width: 10%;"></td> <td style="width: 10%;"></td> <td style="width: 10%;"></td> <td style="width: 10%;"></td> <td style="width: 10%;"></td> <td style="width: 10%;"></td> <td style="width: 10%;"></td> </tr> <tr> <td></td> <td></td> <td colspan="8" style="text-align: center;"> <table border="1" style="width: 100%; border-collapse: collapse; text-align: center;"> <tr> <td style="width: 10%;"></td> <td style="width: 10%;"></td> <td style="width: 10%;"></td> <td style="width: 10%;"></td> <td style="width: 10%;"></td> <td style="width: 10%;"></td> <td style="width: 10%;"></td> <td style="width: 10%;"></td> <td style="width: 10%;"></td> <td style="width: 10%;"></td> </tr> <tr> <td></td> <td></td> <td colspan="8" style="text-align: center;"> <table border="1" style="width: 100%; border-collapse: collapse; text-align: center;"> <tr> <td style="width: 10%;"></td> <td style="width: 10%;"></td> <td style="width: 10%;"></td> <td style="width: 10%;"></td> <td style="width: 10%;"></td> <td style="width: 10%;"></td> <td style="width: 10%;"></td> <td style="width: 10%;"></td> <td style="width: 10%;"></td> <td style="width: 10%;"></td> </tr> <tr> <td></td> <td></td> <td colspan="8" style="text-align: center;"> <table border="1" style="width: 100%; border-collapse: collapse; text-align: center;"> <tr> <td style="width: 10%;"></td> <td style="width: 10%;"></td> <td style="width: 10%;"></td> <td style="width: 10%;"></td> <td style="width: 10%;"></td> <td style="width: 10%;"></td> <td style="width: 10%;"></td> <td style="width: 10%;"></td> <td style="width: 10%;"></td> <td style="width: 10%;"></td> </tr> <tr> <td></td> <td></td> <td colspan="8" style="text-align: center;"> <table border="1" style="width: 100%; border-collapse: collapse; text-align: center;"> <tr> <td style="width: 10%;"></td> <td style="width: 10%;"></td> <td style="width: 10%;"></td> <td style="width: 10%;"></td> <td style="width: 10%;"></td> <td style="width: 10%;"></td> <td style="width: 10%;"></td> <td style="width: 10%;"></td> <td style="width: 10%;"></td> <td style="width: 10%;"></td> </tr> <tr> <td></td> <td></td> <td colspan="8" style="text-align: center;"> <table border="1" style="width: 100%; border-collapse: collapse; text-align: center;"> <tr> <td style="width: 10%;"></td> <td style="width: 10%;"></td> <td style="width: 10%;"></td> <td style="width: 10%;"></td> <td style="width: 10%;"></td> <td style="width: 10%;"></td> <td style="width: 10%;"></td> <td style="width: 10%;"></td> <td style="width: 10%;"></td> <td style="width: 10%;"></td> </tr> <tr> <td></td> <td></td> <td colspan="8" style="text-align: center;"> <table border="1" style="width: 100%; border-collapse: collapse; text-align: center;"> <tr> <td style="width: 10%;"></td> <td style="width: 10%;"></td> <td style="width: 10%;"></td> <td style="width: 10%;"></td> <td style="width: 10%;"></td> <td style="width: 10%;"></td> <td style="width: 10%;"></td> <td style="width: 10%;"></td> <td style="width: 10%;"></td> <td style="width: 10%;"></td> </tr> <tr> <td></td> <td></td> <td colspan="8" style="text-align: center;"> <table border="1" style="width: 100%; border-collapse: collapse; text-align: center;"> <tr> <td style="width: 10%;"></td> <td style="width: 10%;"></td> <td style="width: 10%;"></td> <td style="width: 10%;"></td> <td style="width: 10%;"></td> <td style="width: 10%;"></td> <td style="width: 10%;"></td> <td style="width: 10%;"></td> <td style="width: 10%;"></td> <td style="width: 10%;"></td> </tr> <tr> <td></td> <td></td> <td colspan="8" style="text-align: center;"> <table border="1" style="width: 100%; border-collapse: collapse; text-align: center;"> <tr> <td style="width: 10%;"></td> <td style="width: 10%;"></td> <td style="width: 10%;"></td> <td style="width: 10%;"></td> <td style="width: 10%;"></td> <td style="width: 10%;"></td> <td style="width: 10%;"></td> <td style="width: 10%;"></td> <td style="width: 10%;"></td> <td style="width: 10%;"></td> </tr> <tr> <td></td> <td></td> <td colspan="8" style="text-align: center;"> <table border="1" style="width: 100%; border-collapse: collapse; text-align: center;"> <tr> <td style="width: 10%;"></td> <td style="width: 10%;"></td> <td style="width: 10%;"></td> <td style="width: 10%;"></td> <td style="width: 10%;"></td> <td style="width: 10%;"></td> <td style="width: 10%;"></td> <td style="width: 10%;"></td> <td style="width: 10%;"></td> <td style="width: 10%;"></td> </tr> <tr> <td></td> <td></td> <td colspan="8" style="text-align: center;"> <table border="1" style="width: 100%; border-collapse: collapse; text-align: center;"> <tr> </tr></table></td></tr></table></td></tr></table></td></tr></table></td></tr></table></td></tr></table></td></tr></table></td></tr></table></td></tr></table></td></tr></table></td></tr></table></td></tr></table></td></tr></table></td></tr></table></td></tr></table></td></tr></table></td></tr></table></td></tr></table></td></tr></table></td></tr></table></td></tr></table></td></tr></table></td></tr></table></td></tr></table></td></tr></table></td></tr></table></td></tr></table></td></tr></table></td></tr></table></td></tr></table></td></tr></table></td></tr></table></td></tr></table></td></tr></table></td></tr></table></td></tr></table></td></tr></table></td></tr></table></td></tr></table></td></tr></table></td></tr></table></td></tr></table></td></tr></table></td></tr></table></td></tr></table>
 | | | | | | | | | | | | | | | | | | | | <table border="1" style="width: 100%; border-collapse: collapse; text-align: center;"> <tr> <td style="width: 10%;"></td> <td style="width: 10%;"></td> <td style="width: 10%;"></td> <td style="width: 10%;"></td> <td style="width: 10%;"></td> <td style="width: 10%;"></td> <td style="width: 10%;"></td> <td style="width: 10%;"></td> <td style="width: 10%;"></td> <td style="width: 10%;"></td> </tr> <tr> <td></td> <td></td> <td colspan="8" style="text-align: center;"> <table border="1" style="width: 100%; border-collapse: collapse; text-align: center;"> <tr> <td style="width: 10%;"></td> <td style="width: 10%;"></td> <td style="width: 10%;"></td> <td style="width: 10%;"></td> <td style="width: 10%;"></td> <td style="width: 10%;"></td> <td style="width: 10%;"></td> <td style="width: 10%;"></td> <td style="width: 10%;"></td> <td style="width: 10%;"></td> </tr> <tr> <td></td> <td></td> <td colspan="8" style="text-align: center;"> <table border="1" style="width: 100%; border-collapse: collapse; text-align: center;"> <tr> <td style="width: 10%;"></td> <td style="width: 10%;"></td> <td style="width: 10%;"></td> <td style="width: 10%;"></td> <td style="width: 10%;"></td> <td style="width: 10%;"></td> <td style="width: 10%;"></td> <td style="width: 10%;"></td> <td style="width: 10%;"></td> <td style="width: 10%;"></td> </tr> <tr> <td></td> <td></td> <td colspan="8" style="text-align: center;"> <table border="1" style="width: 100%; border-collapse: collapse; text-align: center;"> <tr> <td style="width: 10%;"></td> <td style="width: 10%;"></td> <td style="width: 10%;"></td> <td style="width: 10%;"></td> <td style="width: 10%;"></td> <td style="width: 10%;"></td> <td style="width: 10%;"></td> <td style="width: 10%;"></td> <td style="width: 10%;"></td> <td style="width: 10%;"></td> </tr> <tr> <td></td> <td></td> <td colspan="8" style="text-align: center;"> <table border="1" style="width: 100%; border-collapse: collapse; text-align: center;"> <tr> <td style="width: 10%;"></td> <td style="width: 10%;"></td> <td style="width: 10%;"></td> <td style="width: 10%;"></td> <td style="width: 10%;"></td> <td style="width: 10%;"></td> <td style="width: 10%;"></td> <td style="width: 10%;"></td> <td style="width: 10%;"></td> <td style="width: 10%;"></td> </tr> <tr> <td></td> <td></td> <td colspan="8" style="text-align: center;"> <table border="1" style="width: 100%; border-collapse: collapse; text-align: center;"> <tr> <td style="width: 10%;"></td> <td style="width: 10%;"></td> <td style="width: 10%;"></td> <td style="width: 10%;"></td> <td style="width: 10%;"></td> <td style="width: 10%;"></td> <td style="width: 10%;"></td> <td style="width: 10%;"></td> <td style="width: 10%;"></td> <td style="width: 10%;"></td> </tr> <tr> <td></td> <td></td> <td colspan="8" style="text-align: center;"> <table border="1" style="width: 100%; border-collapse: collapse; text-align: center;"> <tr> <td style="width: 10%;"></td> <td style="width: 10%;"></td> <td style="width: 10%;"></td> <td style="width: 10%;"></td> <td style="width: 10%;"></td> <td style="width: 10%;"></td> <td style="width: 10%;"></td> <td style="width: 10%;"></td> <td style="width: 10%;"></td> <td style="width: 10%;"></td> </tr> <tr> <td></td> <td></td> <td colspan="8" style="text-align: center;"> <table border="1" style="width: 100%; border-collapse: collapse; text-align: center;"> <tr> <td style="width: 10%;"></td> <td style="width: 10%;"></td> <td style="width: 10%;"></td> <td style="width: 10%;"></td> <td style="width: 10%;"></td> <td style="width: 10%;"></td> <td style="width: 10%;"></td> <td style="width: 10%;"></td> <td style="width: 10%;"></td> <td style="width: 10%;"></td> </tr> <tr> <td></td> <td></td> <td colspan="8" style="text-align: center;"> <table border="1" style="width: 100%; border-collapse: collapse; text-align: center;"> <tr> <td style="width: 10%;"></td> <td style="width: 10%;"></td> <td style="width: 10%;"></td> <td style="width: 10%;"></td> <td style="width: 10%;"></td> <td style="width: 10%;"></td> <td style="width: 10%;"></td> <td style="width: 10%;"></td> <td style="width: 10%;"></td> <td style="width: 10%;"></td> </tr> <tr> <td></td> <td></td> <td colspan="8" style="text-align: center;"> <table border="1" style="width: 100%; border-collapse: collapse; text-align: center;"> <tr> <td style="width: 10%;"></td> <td style="width: 10%;"></td> <td style="width: 10%;"></td> <td style="width: 10%;"></td> <td style="width: 10%;"></td> <td style="width: 10%;"></td> <td style="width: 10%;"></td> <td style="width: 10%;"></td> <td style="width: 10%;"></td> <td style="width: 10%;"></td> </tr> <tr> <td></td> <td></td> <td colspan="8" style="text-align: center;"> <table border="1" style="width: 100%; border-collapse: collapse; text-align: center;"> <tr> <td style="width: 10%;"></td> <td style="width: 10%;"></td> <td style="width: 10%;"></td> <td style="width: 10%;"></td> <td style="width: 10%;"></td> <td style="width: 10%;"></td> <td style="width: 10%;"></td> <td style="width: 10%;"></td> <td style="width: 10%;"></td> <td style="width: 10%;"></td> </tr> <tr> <td></td> <td></td> <td colspan="8" style="text-align: center;"> <table border="1" style="width: 100%; border-collapse: collapse; text-align: center;"> <tr> <td style="width: 10%;"></td> <td style="width: 10%;"></td> <td style="width: 10%;"></td> <td style="width: 10%;"></td> <td style="width: 10%;"></td> <td style="width: 10%;"></td> <td style="width: 10%;"></td> <td style="width: 10%;"></td> <td style="width: 10%;"></td> <td style="width: 10%;"></td> </tr> <tr> <td></td> <td></td> <td colspan="8" style="text-align: center;"> <table border="1" style="width: 100%; border-collapse: collapse; text-align: center;"> <tr> <td style="width: 10%;"></td> <td style="width: 10%;"></td> <td style="width: 10%;"></td> <td style="width: 10%;"></td> <td style="width: 10%;"></td> <td style="width: 10%;"></td> <td style="width: 10%;"></td> <td style="width: 10%;"></td> <td style="width: 10%;"></td> <td style="width: 10%;"></td> </tr> <tr> <td></td> <td></td> <td colspan="8" style="text-align: center;"> <table border="1" style="width: 100%; border-collapse: collapse; text-align: center;"> <tr> <td style="width: 10%;"></td> <td style="width: 10%;"></td> <td style="width: 10%;"></td> <td style="width: 10%;"></td> <td style="width: 10%;"></td> <td style="width: 10%;"></td> <td style="width: 10%;"></td> <td style="width: 10%;"></td> <td style="width: 10%;"></td> <td style="width: 10%;"></td> </tr> <tr> <td></td> <td></td> <td colspan="8" style="text-align: center;"> <table border="1" style="width: 100%; border-collapse: collapse; text-align: center;"> <tr> <td style="width: 10%;"></td> <td style="width: 10%;"></td> <td style="width: 10%;"></td> <td style="width: 10%;"></td> <td style="width: 10%;"></td> <td style="width: 10%;"></td> <td style="width: 10%;"></td> <td style="width: 10%;"></td> <td style="width: 10%;"></td> <td style="width: 10%;"></td> </tr> <tr> <td></td> <td></td> <td colspan="8" style="text-align: center;"> <table border="1" style="width: 100%; border-collapse: collapse; text-align: center;"> <tr> <td style="width: 10%;"></td> <td style="width: 10%;"></td> <td style="width: 10%;"></td> <td style="width: 10%;"></td> <td style="width: 10%;"></td> <td style="width: 10%;"></td> <td style="width: 10%;"></td> <td style="width: 10%;"></td> <td style="width: 10%;"></td> <td style="width: 10%;"></td> </tr> <tr> <td></td> <td></td> <td colspan="8" style="text-align: center;"> <table border="1" style="width: 100%; border-collapse: collapse; text-align: center;"> <tr> <td style="width: 10%;"></td> <td style="width: 10%;"></td> <td style="width: 10%;"></td> <td style="width: 10%;"></td> <td style="width: 10%;"></td> <td style="width:
10%;"></td> <td style="width: 10%;"></td> <td style="width: 10%;"></td> <td style="width: 10%;"></td> <td style="width: 10%;"></td> </tr> <tr> <td></td> <td></td> <td colspan="8" style="text-align: center;"> <table border="1" style="width: 100%; border-collapse: collapse; text-align: center;"> <tr> <td style="width: 10%;"></td> <td style="width: 10%;"></td> <td style="width: 10%;"></td> <td style="width: 10%;"></td> <td style="width: 10%;"></td> <td style="width: 10%;"></td> <td style="width: 10%;"></td> <td style="width: 10%;"></td> <td style="width: 10%;"></td> <td style="width: 10%;"></td> </tr> <tr> <td></td> <td></td> <td colspan="8" style="text-align: center;"> <table border="1" style="width: 100%; border-collapse: collapse; text-align: center;"> <tr> <td style="width: 10%;"></td> <td style="width: 10%;"></td> <td style="width: 10%;"></td> <td style="width: 10%;"></td> <td style="width: 10%;"></td> <td style="width: 10%;"></td> <td style="width: 10%;"></td> <td style="width: 10%;"></td> <td style="width: 10%;"></td> <td style="width: 10%;"></td> </tr> <tr> <td></td> <td></td> <td colspan="8" style="text-align: center;"> <table border="1" style="width: 100%; border-collapse: collapse; text-align: center;"> <tr> <td style="width: 10%;"></td> <td style="width: 10%;"></td> <td style="width: 10%;"></td> <td style="width: 10%;"></td> <td style="width: 10%;"></td> <td style="width: 10%;"></td> <td style="width: 10%;"></td> <td style="width: 10%;"></td> <td style="width: 10%;"></td> <td style="width: 10%;"></td> </tr> <tr> <td></td> <td></td> <td colspan="8" style="text-align: center;"> <table border="1" style="width: 100%; border-collapse: collapse; text-align: center;"> <tr> <td style="width: 10%;"></td> <td style="width: 10%;"></td> <td style="width: 10%;"></td> <td style="width: 10%;"></td> <td style="width: 10%;"></td> <td style="width: 10%;"></td> <td style="width: 10%;"></td> <td style="width: 10%;"></td> <td style="width: 10%;"></td> <td style="width: 10%;"></td> </tr> <tr> <td></td> <td></td> <td colspan="8" style="text-align: center;"> <table border="1" style="width: 100%; border-collapse: collapse; text-align: center;"> <tr> <td style="width: 10%;"></td> <td style="width: 10%;"></td> <td style="width: 10%;"></td> <td style="width: 10%;"></td> <td style="width: 10%;"></td> <td style="width: 10%;"></td> <td style="width: 10%;"></td> <td style="width: 10%;"></td> <td style="width: 10%;"></td> <td style="width: 10%;"></td> </tr> <tr> <td></td> <td></td> <td colspan="8" style="text-align: center;"> <table border="1" style="width: 100%; border-collapse: collapse; text-align: center;"> <tr> <td style="width: 10%;"></td> <td style="width: 10%;"></td> <td style="width: 10%;"></td> <td style="width: 10%;"></td> <td style="width: 10%;"></td> <td style="width: 10%;"></td> <td style="width: 10%;"></td> <td style="width: 10%;"></td> <td style="width: 10%;"></td> <td style="width: 10%;"></td> </tr> <tr> <td></td> <td></td> <td colspan="8" style="text-align: center;"> <table border="1" style="width: 100%; border-collapse: collapse; text-align: center;"> <tr> <td style="width: 10%;"></td> <td style="width: 10%;"></td> <td style="width: 10%;"></td> <td style="width: 10%;"></td> <td style="width: 10%;"></td> <td style="width: 10%;"></td> <td style="width: 10%;"></td> <td style="width: 10%;"></td> <td style="width: 10%;"></td> <td style="width: 10%;"></td> </tr> <tr> <td></td> <td></td> <td colspan="8" style="text-align: center;"> <table border="1" style="width: 100%; border-collapse: collapse; text-align: center;"> <tr> <td style="width: 10%;"></td> <td style="width: 10%;"></td> <td style="width: 10%;"></td> <td style="width: 10%;"></td> <td style="width: 10%;"></td> <td style="width: 10%;"></td> <td style="width: 10%;"></td> <td style="width: 10%;"></td> <td style="width: 10%;"></td> <td style="width: 10%;"></td> </tr> <tr> <td></td> <td></td> <td colspan="8" style="text-align: center;"> <table border="1" style="width: 100%; border-collapse: collapse; text-align: center;"> <tr> <td style="width: 10%;"></td> <td style="width: 10%;"></td> <td style="width: 10%;"></td> <td style="width: 10%;"></td> <td style="width: 10%;"></td> <td style="width: 10%;"></td> <td style="width: 10%;"></td> <td style="width: 10%;"></td> <td style="width: 10%;"></td> <td style="width: 10%;"></td> </tr> <tr> <td></td> <td></td> <td colspan="8" style="text-align: center;"> <table border="1" style="width: 100%; border-collapse: collapse; text-align: center;"> <tr> <td style="width: 10%;"></td> <td style="width: 10%;"></td> <td style="width: 10%;"></td> <td style="width: 10%;"></td> <td style="width: 10%;"></td> <td style="width: 10%;"></td> <td style="width: 10%;"></td> <td style="width: 10%;"></td> <td style="width: 10%;"></td> <td style="width: 10%;"></td> </tr> <tr> <td></td> <td></td> <td colspan="8" style="text-align: center;"> <table border="1" style="width: 100%; border-collapse: collapse; text-align: center;"> <tr> <td style="width: 10%;"></td> <td style="width: 10%;"></td> <td style="width: 10%;"></td> <td style="width: 10%;"></td> <td style="width: 10%;"></td> <td style="width: 10%;"></td> <td style="width: 10%;"></td> <td style="width: 10%;"></td> <td style="width: 10%;"></td> <td style="width: 10%;"></td> </tr> <tr> <td></td> <td></td> <td colspan="8" style="text-align: center;"> <table border="1" style="width: 100%; border-collapse: collapse; text-align: center;"> <tr> <td style="width: 10%;"></td> <td style="width: 10%;"></td> <td style="width: 10%;"></td> <td style="width: 10%;"></td> <td style="width: 10%;"></td> <td style="width: 10%;"></td> <td style="width: 10%;"></td> <td style="width: 10%;"></td> <td style="width: 10%;"></td> <td style="width: 10%;"></td> </tr> <tr> <td></td> <td></td> <td colspan="8" style="text-align: center;"> <table border="1" style="width: 100%; border-collapse: collapse; text-align: center;"> <tr> <td style="width: 10%;"></td> <td style="width: 10%;"></td> <td style="width: 10%;"></td> <td style="width: 10%;"></td> <td style="width: 10%;"></td> <td style="width: 10%;"></td> <td style="width: 10%;"></td> <td style="width: 10%;"></td> <td style="width: 10%;"></td> <td style="width: 10%;"></td> </tr> <tr> <td></td> <td></td> <td colspan="8" style="text-align: center;"> <table border="1" style="width: 100%; border-collapse: collapse; text-align: center;"> <tr> <td style="width: 10%;"></td> <td style="width: 10%;"></td> <td style="width: 10%;"></td> <td style="width: 10%;"></td> <td style="width: 10%;"></td> <td style="width: 10%;"></td> <td style="width: 10%;"></td> <td style="width: 10%;"></td> <td style="width: 10%;"></td> <td style="width: 10%;"></td> </tr> <tr> <td></td> <td></td> <td colspan="8" style="text-align: center;"> <table border="1" style="width: 100%; border-collapse: collapse; text-align: center;"> <tr> <td style="width: 10%;"></td> <td style="width: 10%;"></td> <td style="width: 10%;"></td> <td style="width: 10%;"></td> <td style="width: 10%;"></td> <td style="width: 10%;"></td> <td style="width: 10%;"></td> <td style="width: 10%;"></td> <td style="width: 10%;"></td> <td style="width: 10%;"></td> </tr> <tr> <td></td> <td></td> <td colspan="8" style="text-align: center;"> <table border="1" style="width: 100%; border-collapse: collapse; text-align: center;"> <tr> <td style="width: 10%;"></td> <td style="width: 10%;"></td> <td style="width: 10%;"></td> <td style="width: 10%;"></td> <td style="width: 10%;"></td> <td style="width: 10%;"></td> <td style="width: 10%;"></td> <td style="width: 10%;"></td> <td style="width: 10%;"></td> <td style="width: 10%;"></td> </tr> <tr> <td></td> <td></td> <td colspan="8" style="text-align: center;"> <table border="1" style="width: 100%; border-collapse: collapse; text-align: center;"> <tr> <td style="width: 10%;"></td> <td style="width: 10%;"></td> <td style="width: 10%;"></td> <td style="width: 10%;"></td> <td style="width: 10%;"></td> <td style="width: 10%;"></td> <td style="width: 10%;"></td> <td style="width: 10%;"></td> <td style="width: 10%;"></td> <td style="width: 10%;"></td> </tr> <tr> <td></td> <td></td> <td colspan="8" style="text-align: center;"> <table border="1" style="width: 100%; border-collapse: collapse; text-align: center;"> <tr> <td style="width: 10%;"></td> <td style="width: 10%;"></td> <td style="width: 10%;"></td> <td style="width: 10%;"></td> <td style="width: 10%;"></td> <td style="width: 10%;"></td> <td style="width: 10%;"></td> <td style="width: 10%;"></td> <td style="width: 10%;"></td> <td style="width: 10%;"></td> </tr> <tr> <td></td> <td></td> <td colspan="8" style="text-align: center;"> <table border="1" style="width: 100%; border-collapse: collapse; text-align: center;"> <tr> <td style="width: 10%;"></td> <td style="width: 10%;"></td> <td style="width: 10%;"></td> <td style="width: 10%;"></td> <td style="width: 10%;"></td> <td style="width: 10%;"></td> <td style="width: 10%;"></td> <td style="width: 10%;"></td> <td style="width: 10%;"></td> <td style="width: 10%;"></td> </tr> <tr> <td></td> <td></td> <td colspan="8" style="text-align: center;"> <table border="1" style="width: 100%; border-collapse: collapse; text-align: center;"> <tr> <td style="width: 10%;"></td> <td style="width: 10%;"></td> <td style="width: 10%;"></td> <td style="width: 10%;"></td> <td style="width: 10%;"></td> <td style="width: 10%;"></td> <td style="width: 10%;"></td> <td style="width: 10%;"></td> <td style="width: 10%;"></td> <td style="width: 10%;"></td> </tr> <tr> <td></td> <td></td> <td colspan="8" style="text-align: center;"> <table border="1" style="width: 100%; border-collapse: collapse; text-align: center;"> <tr> <td style="width: 10%;"></td> <td style="width: 10%;"></td> <td style="width: 10%;"></td> <td style="width: 10%;"></td> <td style="width: 10%;"></td> <td style="width: 10%;"></td> <td style="width: 10%;"></td> <td style="width: 10%;"></td> <td style="width: 10%;"></td> <td style="width: 10%;"></td> </tr> <tr> <td></td> <td></td> <td
colspan="8" style="text-align: center;"> <table border="1" style="width: 100%; border-collapse: collapse; text-align: center;"> <tr> <td style="width: 10%;"></td> <td style="width: 10%;"></td> <td style="width: 10%;"></td> <td style="width: 10%;"></td> <td style="width: 10%;"></td> <td style="width: 10%;"></td> <td style="width: 10%;"></td> <td style="width: 10%;"></td> <td style="width: 10%;"></td> <td style="width: 10%;"></td> </tr> <tr> <td></td> <td></td> <td colspan="8" style="text-align: center;"> <table border="1" style="width: 100%; border-collapse: collapse; text-align: center;"> <tr> <td style="width: 10%;"></td> <td style="width: 10%;"></td> <td style="width: 10%;"></td> <td style="width: 10%;"></td> <td style="width: 10%;"></td> <td style="width: 10%;"></td> <td style="width: 10%;"></td> <td style="width: 10%;"></td> <td style="width: 10%;"></td> <td style="width: 10%;"></td> </tr> <tr> <td></td> <td></td> <td colspan="8" style="text-align: center;"> <table border="1" style="width: 100%; border-collapse: collapse; text-align: center;"> <tr> <td style="width: 10%;"></td> <td style="width: 10%;"></td> <td style="width: 10%;"></td> <td style="width: 10%;"></td> <td style="width: 10%;"></td> <td style="width: 10%;"></td> <td style="width: 10%;"></td> <td style="width: 10%;"></td> <td style="width: 10%;"></td> <td style="width: 10%;"></td> </tr> <tr> <td></td> <td></td> <td colspan="8" style="text-align: center;"> <table border="1" style="width: 100%; border-collapse: collapse; text-align: center;"> <tr> <td style="width: 10%;"></td> <td style="width: 10%;"></td> <td style="width: 10%;"></td> <td style="width: 10%;"></td> <td style="width: 10%;"></td> <td style="width: 10%;"></td> <td style="width: 10%;"></td> <td style="width: 10%;"></td> <td style="width: 10%;"></td> <td style="width: 10%;"></td> </tr> <tr> <td></td> <td></td> <td colspan="8" style="text-align: center;"> <table border="1" style="width: 100%; border-collapse: collapse; text-align: center;"> <tr> <td style="width: 10%;"></td> <td style="width: 10%;"></td> <td style="width: 10%;"></td> <td style="width: 10%;"></td> <td style="width: 10%;"></td> <td style="width: 10%;"></td> <td style="width: 10%;"></td> <td style="width: 10%;"></td> <td style="width: 10%;"></td> <td style="width: 10%;"></td> </tr> <tr> <td></td> <td></td> <td colspan="8" style="text-align: center;"> <table border="1" style="width: 100%; border-collapse: collapse; text-align: center;"> <tr> </tr></table></td></tr></table></td></tr></table></td></tr></table></td></tr></table></td></tr></table></td></tr></table></td></tr></table></td></tr></table></td></tr></table></td></tr></table></td></tr></table></td></tr></table></td></tr></table></td></tr></table></td></tr></table></td></tr></table></td></tr></table></td></tr></table></td></tr></table></td></tr></table></td></tr></table></td></tr></table></td></tr></table></td></tr></table></td></tr></table></td></tr></table></td></tr></table></td></tr></table></td></tr></table></td></tr></table></td></tr></table></td></tr></table></td></tr></table></td></tr></table></td></tr></table></td></tr></table></td></tr></table></td></tr></table></td></tr></table></td></tr></table></td></tr></table></td></tr></table></td></tr></table> | | | | | | | | | | | | | | | | | | | | <table border="1" style="width: 100%; border-collapse: collapse; text-align: center;"> <tr> <td style="width: 10%;"></td> <td style="width: 10%;"></td> <td style="width: 10%;"></td> <td style="width: 10%;"></td> <td style="width: 10%;"></td> <td style="width: 10%;"></td> <td style="width: 10%;"></td> <td style="width: 10%;"></td> <td style="width: 10%;"></td> <td style="width: 10%;"></td> </tr> <tr> <td></td> <td></td> <td colspan="8" style="text-align: center;"> <table border="1" style="width: 100%; border-collapse: collapse; text-align: center;"> <tr> <td style="width: 10%;"></td> <td style="width: 10%;"></td> <td style="width: 10%;"></td> <td style="width: 10%;"></td> <td style="width: 10%;"></td> <td style="width: 10%;"></td> <td style="width: 10%;"></td> <td style="width: 10%;"></td> <td style="width: 10%;"></td> <td style="width: 10%;"></td> </tr> <tr> <td></td> <td></td> <td colspan="8" style="text-align: center;"> <table border="1" style="width: 100%; border-collapse: collapse; text-align: center;"> <tr> <td style="width: 10%;"></td> <td style="width: 10%;"></td> <td style="width: 10%;"></td> <td style="width: 10%;"></td> <td style="width: 10%;"></td> <td style="width: 10%;"></td> <td style="width: 10%;"></td> <td style="width: 10%;"></td> <td style="width: 10%;"></td> <td style="width: 10%;"></td> </tr> <tr> <td></td> <td></td> <td colspan="8" style="text-align: center;"> <table border="1" style="width: 100%; border-collapse: collapse; text-align: center;"> <tr> <td style="width: 10%;"></td> <td style="width: 10%;"></td> <td style="width: 10%;"></td> <td style="width: 10%;"></td> <td style="width: 10%;"></td> <td style="width: 10%;"></td> <td style="width: 10%;"></td> <td style="width: 10%;"></td> <td style="width: 10%;"></td> <td style="width: 10%;"></td> </tr> <tr> <td></td> <td></td> <td colspan="8" style="text-align: center;"> <table border="1" style="width: 100%; border-collapse: collapse; text-align: center;"> <tr> <td style="width: 10%;"></td> <td style="width: 10%;"></td> <td style="width: 10%;"></td> <td style="width: 10%;"></td> <td style="width: 10%;"></td> <td style="width: 10%;"></td> <td style="width: 10%;"></td> <td style="width: 10%;"></td> <td style="width: 10%;"></td> <td style="width: 10%;"></td> </tr> <tr> <td></td> <td></td> <td colspan="8" style="text-align: center;"> <table border="1" style="width: 100%; border-collapse: collapse; text-align: center;"> <tr> <td style="width: 10%;"></td> <td style="width: 10%;"></td> <td style="width: 10%;"></td> <td style="width: 10%;"></td> <td style="width: 10%;"></td> <td style="width: 10%;"></td> <td style="width: 10%;"></td> <td style="width: 10%;"></td> <td style="width: 10%;"></td> <td style="width: 10%;"></td> </tr> <tr> <td></td> <td></td> <td colspan="8" style="text-align: center;"> <table border="1" style="width: 100%; border-collapse: collapse; text-align: center;"> <tr> <td style="width: 10%;"></td> <td style="width: 10%;"></td> <td style="width: 10%;"></td> <td style="width: 10%;"></td> <td style="width: 10%;"></td> <td style="width: 10%;"></td> <td style="width: 10%;"></td> <td style="width: 10%;"></td> <td style="width: 10%;"></td> <td style="width: 10%;"></td> </tr> <tr> <td></td> <td></td> <td colspan="8" style="text-align: center;"> <table border="1" style="width: 100%; border-collapse: collapse; text-align: center;"> <tr> <td style="width: 10%;"></td> <td style="width: 10%;"></td> <td style="width: 10%;"></td> <td style="width: 10%;"></td> <td style="width: 10%;"></td> <td style="width: 10%;"></td> <td style="width: 10%;"></td> <td style="width: 10%;"></td> <td style="width: 10%;"></td> <td style="width: 10%;"></td> </tr> <tr> <td></td> <td></td> <td colspan="8" style="text-align: center;"> <table border="1" style="width: 100%; border-collapse: collapse; text-align: center;"> <tr> <td style="width: 10%;"></td> <td style="width: 10%;"></td> <td style="width: 10%;"></td> <td style="width: 10%;"></td> <td style="width: 10%;"></td> <td style="width: 10%;"></td> <td style="width: 10%;"></td> <td style="width: 10%;"></td> <td style="width: 10%;"></td> <td style="width: 10%;"></td> </tr> <tr> <td></td> <td></td> <td colspan="8" style="text-align: center;"> <table border="1" style="width: 100%;
border-collapse: collapse; text-align: center;"> <tr> <td style="width: 10%;"></td> <td style="width: 10%;"></td> <td style="width: 10%;"></td> <td style="width: 10%;"></td> <td style="width: 10%;"></td> <td style="width: 10%;"></td> <td style="width: 10%;"></td> <td style="width: 10%;"></td> <td style="width: 10%;"></td> <td style="width: 10%;"></td> </tr> <tr> <td></td> <td></td> <td colspan="8" style="text-align: center;"> <table border="1" style="width: 100%; border-collapse: collapse; text-align: center;"> <tr> <td style="width: 10%;"></td> <td style="width: 10%;"></td> <td style="width: 10%;"></td> <td style="width: 10%;"></td> <td style="width: 10%;"></td> <td style="width: 10%;"></td> <td style="width: 10%;"></td> <td style="width: 10%;"></td> <td style="width: 10%;"></td> <td style="width: 10%;"></td> </tr> <tr> <td></td> <td></td> <td colspan="8" style="text-align: center;"> <table border="1" style="width: 100%; border-collapse: collapse; text-align: center;"> <tr> <td style="width: 10%;"></td> <td style="width: 10%;"></td> <td style="width: 10%;"></td> <td style="width: 10%;"></td> <td style="width: 10%;"></td> <td style="width: 10%;"></td> <td style="width: 10%;"></td> <td style="width: 10%;"></td> <td style="width: 10%;"></td> <td style="width: 10%;"></td> </tr> <tr> <td></td> <td></td> <td colspan="8" style="text-align: center;"> <table border="1" style="width: 100%; border-collapse: collapse; text-align: center;"> <tr> <td style="width: 10%;"></td> <td style="width: 10%;"></td> <td style="width: 10%;"></td> <td style="width: 10%;"></td> <td style="width: 10%;"></td> <td style="width: 10%;"></td> <td style="width: 10%;"></td> <td style="width: 10%;"></td> <td style="width: 10%;"></td> <td style="width: 10%;"></td> </tr> <tr> <td></td> <td></td> <td colspan="8" style="text-align: center;"> <table border="1" style="width: 100%; border-collapse: collapse; text-align: center;"> <tr> <td style="width: 10%;"></td> <td style="width: 10%;"></td> <td style="width: 10%;"></td> <td style="width: 10%;"></td> <td style="width: 10%;"></td> <td style="width: 10%;"></td> <td style="width: 10%;"></td> <td style="width: 10%;"></td> <td style="width: 10%;"></td> <td style="width: 10%;"></td> </tr> <tr> <td></td> <td></td> <td colspan="8" style="text-align: center;"> <table border="1" style="width: 100%; border-collapse: collapse; text-align: center;"> <tr> <td style="width: 10%;"></td> <td style="width: 10%;"></td> <td style="width: 10%;"></td> <td style="width: 10%;"></td> <td style="width: 10%;"></td> <td style="width: 10%;"></td> <td style="width: 10%;"></td> <td style="width: 10%;"></td> <td style="width: 10%;"></td> <td style="width: 10%;"></td> </tr> <tr> <td></td> <td></td> <td colspan="8" style="text-align: center;"> <table border="1" style="width: 100%; border-collapse: collapse; text-align: center;"> <tr> <td style="width: 10%;"></td> <td style="width: 10%;"></td> <td style="width: 10%;"></td> <td style="width: 10%;"></td> <td style="width: 10%;"></td> <td style="width: 10%;"></td> <td style="width: 10%;"></td> <td style="width: 10%;"></td> <td style="width: 10%;"></td> <td style="width: 10%;"></td> </tr> <tr> <td></td> <td></td> <td colspan="8" style="text-align: center;"> <table border="1" style="width: 100%; border-collapse: collapse; text-align: center;"> <tr> <td style="width: 10%;"></td> <td style="width: 10%;"></td> <td style="width: 10%;"></td> <td style="width: 10%;"></td> <td style="width: 10%;"></td> <td style="width: 10%;"></td> <td style="width: 10%;"></td> <td style="width: 10%;"></td> <td style="width: 10%;"></td> <td style="width: 10%;"></td> </tr> <tr> <td></td> <td></td> <td colspan="8" style="text-align: center;"> <table border="1" style="width: 100%; border-collapse: collapse; text-align: center;"> <tr> <td style="width: 10%;"></td> <td style="width: 10%;"></td> <td style="width: 10%;"></td> <td style="width: 10%;"></td> <td style="width: 10%;"></td> <td style="width: 10%;"></td> <td style="width: 10%;"></td> <td style="width: 10%;"></td> <td style="width: 10%;"></td> <td style="width: 10%;"></td> </tr> <tr> <td></td> <td></td> <td colspan="8" style="text-align: center;"> <table border="1" style="width: 100%; border-collapse: collapse; text-align: center;"> <tr> <td style="width: 10%;"></td> <td style="width: 10%;"></td> <td style="width: 10%;"></td> <td style="width: 10%;"></td> <td style="width: 10%;"></td> <td style="width: 10%;"></td> <td style="width: 10%;"></td> <td style="width: 10%;"></td> <td style="width: 10%;"></td> <td style="width: 10%;"></td> </tr> <tr> <td></td> <td></td> <td colspan="8" style="text-align: center;"> <table border="1" style="width: 100%; border-collapse: collapse; text-align: center;"> <tr> <td style="width: 10%;"></td> <td style="width: 10%;"></td> <td style="width: 10%;"></td> <td style="width: 10%;"></td> <td style="width: 10%;"></td> <td style="width: 10%;"></td> <td style="width: 10%;"></td> <td style="width: 10%;"></td> <td style="width: 10%;"></td> <td style="width: 10%;"></td> </tr> <tr> <td></td> <td></td> <td colspan="8" style="text-align: center;"> <table border="1" style="width: 100%; border-collapse: collapse; text-align: center;"> <tr> <td style="width: 10%;"></td> <td style="width: 10%;"></td> <td style="width: 10%;"></td> <td style="width: 10%;"></td> <td style="width: 10%;"></td> <td style="width: 10%;"></td> <td style="width: 10%;"></td> <td style="width: 10%;"></td> <td style="width: 10%;"></td> <td style="width: 10%;"></td> </tr> <tr> <td></td> <td></td> <td colspan="8" style="text-align: center;"> <table border="1" style="width: 100%; border-collapse: collapse; text-align: center;"> <tr> <td style="width: 10%;"></td> <td style="width: 10%;"></td> <td style="width: 10%;"></td> <td style="width: 10%;"></td> <td style="width: 10%;"></td> <td style="width: 10%;"></td> <td style="width: 10%;"></td> <td style="width: 10%;"></td> <td style="width: 10%;"></td> <td style="width: 10%;"></td> </tr> <tr> <td></td> <td></td> <td colspan="8" style="text-align: center;"> <table border="1" style="width: 100%; border-collapse: collapse; text-align: center;"> <tr> <td style="width: 10%;"></td> <td style="width: 10%;"></td> <td style="width: 10%;"></td> <td style="width: 10%;"></td> <td style="width: 10%;"></td> <td style="width: 10%;"></td> <td style="width: 10%;"></td> <td style="width: 10%;"></td> <td style="width: 10%;"></td> <td style="width: 10%;"></td> </tr> <tr> <td></td> <td></td> <td colspan="8" style="text-align: center;"> <table border="1" style="width: 100%; border-collapse: collapse; text-align: center;"> <tr> <td style="width: 10%;"></td> <td style="width: 10%;"></td> <td style="width: 10%;"></td> <td style="width: 10%;"></td> <td style="width: 10%;"></td> <td style="width: 10%;"></td> <td style="width: 10%;"></td> <td style="width: 10%;"></td> <td style="width: 10%;"></td> <td style="width: 10%;"></td> </tr> <tr> <td></td> <td></td> <td colspan="8" style="text-align: center;"> <table border="1" style="width: 100%; border-collapse: collapse; text-align: center;"> <tr> <td style="width: 10%;"></td> <td style="width: 10%;"></td> <td style="width: 10%;"></td> <td style="width: 10%;"></td> <td style="width: 10%;"></td> <td style="width: 10%;"></td> <td style="width: 10%;"></td> <td style="width: 10%;"></td> <td style="width: 10%;"></td> <td style="width: 10%;"></td> </tr> <tr> <td></td> <td></td> <td colspan="8" style="text-align: center;"> <table border="1" style="width: 100%; border-collapse: collapse; text-align: center;"> <tr> <td style="width: 10%;"></td> <td style="width: 10%;"></td> <td style="width: 10%;"></td> <td style="width: 10%;"></td> <td style="width: 10%;"></td> <td style="width: 10%;"></td> <td style="width: 10%;"></td> <td style="width: 10%;"></td> <td style="width: 10%;"></td> <td style="width: 10%;"></td> </tr> <tr> <td></td> <td></td> <td colspan="8" style="text-align: center;"> <table border="1" style="width: 100%; border-collapse: collapse; text-align: center;"> <tr> <td style="width: 10%;"></td> <td style="width: 10%;"></td> <td style="width: 10%;"></td> <td style="width: 10%;"></td> <td style="width: 10%;"></td> <td style="width: 10%;"></td> <td style="width: 10%;"></td> <td style="width: 10%;"></td> <td style="width: 10%;"></td> <td style="width: 10%;"></td> </tr> <tr> <td></td> <td></td> <td colspan="8" style="text-align: center;"> <table border="1" style="width: 100%; border-collapse: collapse; text-align: center;"> <tr> <td style="width: 10%;"></td> <td style="width: 10%;"></td> <td style="width: 10%;"></td> <td style="width: 10%;"></td> <td style="width: 10%;"></td> <td style="width: 10%;"></td> <td style="width: 10%;"></td> <td style="width: 10%;"></td> <td style="width: 10%;"></td> <td style="width: 10%;"></td> </tr> <tr> <td></td> <td></td> <td colspan="8" style="text-align: center;"> <table border="1" style="width: 100%; border-collapse: collapse; text-align: center;"> <tr> <td style="width: 10%;"></td> <td style="width: 10%;"></td> <td style="width: 10%;"></td> <td style="width: 10%;"></td> <td style="width: 10%;"></td> <td style="width: 10%;"></td> <td style="width: 10%;"></td> <td style="width: 10%;"></td> <td style="width: 10%;"></td> <td style="width: 10%;"></td> </tr> <tr> <td></td> <td></td> <td colspan="8" style="text-align: center;"> <table border="1" style="width: 100%; border-collapse: collapse; text-align: center;"> <tr> <td style="width: 10%;"></td> <td style="width: 10%;"></td> <td style="width: 10%;"></td> <td style="width: 10%;"></td> <td style="width: 10%;"></td> <td style="width: 10%;"></td> <td style="width: 10%;"></td> <td style="width: 10%;"></td> <td style="width: 10%;"></td> <td style="width: 10%;"></td> </tr> <tr> <td></td> <td></td> <td colspan="8" style="text-align: center;"> <table border="1" style="width: 100%; border-collapse: collapse; text-align: center;"> <tr> <td style="width: 10%;"></td> <td style="width: 10%;"></td> <td style="width: 10%;"></td> <td style="width:
10%;"></td> <td style="width: 10%;"></td> <td style="width: 10%;"></td> <td style="width: 10%;"></td> <td style="width: 10%;"></td> <td style="width: 10%;"></td> <td style="width: 10%;"></td> </tr> <tr> <td></td> <td></td> <td colspan="8" style="text-align: center;"> <table border="1" style="width: 100%; border-collapse: collapse; text-align: center;"> <tr> <td style="width: 10%;"></td> <td style="width: 10%;"></td> <td style="width: 10%;"></td> <td style="width: 10%;"></td> <td style="width: 10%;"></td> <td style="width: 10%;"></td> <td style="width: 10%;"></td> <td style="width: 10%;"></td> <td style="width: 10%;"></td> <td style="width: 10%;"></td> </tr> <tr> <td></td> <td></td> <td colspan="8" style="text-align: center;"> <table border="1" style="width: 100%; border-collapse: collapse; text-align: center;"> <tr> <td style="width: 10%;"></td> <td style="width: 10%;"></td> <td style="width: 10%;"></td> <td style="width: 10%;"></td> <td style="width: 10%;"></td> <td style="width: 10%;"></td> <td style="width: 10%;"></td> <td style="width: 10%;"></td> <td style="width: 10%;"></td> <td style="width: 10%;"></td> </tr> <tr> <td></td> <td></td> <td colspan="8" style="text-align: center;"> <table border="1" style="width: 100%; border-collapse: collapse; text-align: center;"> <tr> <td style="width: 10%;"></td> <td style="width: 10%;"></td> <td style="width: 10%;"></td> <td style="width: 10%;"></td> <td style="width: 10%;"></td> <td style="width: 10%;"></td> <td style="width: 10%;"></td> <td style="width: 10%;"></td> <td style="width: 10%;"></td> <td style="width: 10%;"></td> </tr> <tr> <td></td> <td></td> <td colspan="8" style="text-align: center;"> <table border="1" style="width: 100%; border-collapse: collapse; text-align: center;"> <tr> <td style="width: 10%;"></td> <td style="width: 10%;"></td> <td style="width: 10%;"></td> <td style="width: 10%;"></td> <td style="width: 10%;"></td> <td style="width: 10%;"></td> <td style="width: 10%;"></td> <td style="width: 10%;"></td> <td style="width: 10%;"></td> <td style="width: 10%;"></td> </tr> <tr> <td></td> <td></td> <td colspan="8" style="text-align: center;"> <table border="1" style="width: 100%; border-collapse: collapse; text-align: center;"> <tr> <td style="width: 10%;"></td> <td style="width: 10%;"></td> <td style="width: 10%;"></td> <td style="width: 10%;"></td> <td style="width: 10%;"></td> <td style="width: 10%;"></td> <td style="width: 10%;"></td> <td style="width: 10%;"></td> <td style="width: 10%;"></td> <td style="width: 10%;"></td> </tr> <tr> <td></td> <td></td> <td colspan="8" style="text-align: center;"> <table border="1" style="width: 100%; border-collapse: collapse; text-align: center;"> <tr> <td style="width: 10%;"></td> <td style="width: 10%;"></td> <td style="width: 10%;"></td> <td style="width: 10%;"></td> <td style="width: 10%;"></td> <td style="width: 10%;"></td> <td style="width: 10%;"></td> <td style="width: 10%;"></td> <td style="width: 10%;"></td> <td style="width: 10%;"></td> </tr> <tr> <td></td> <td></td> <td colspan="8" style="text-align: center;"> <table border="1" style="width: 100%; border-collapse: collapse; text-align: center;"> <tr> <td style="width: 10%;"></td> <td style="width: 10%;"></td> <td style="width: 10%;"></td> <td style="width: 10%;"></td> <td style="width: 10%;"></td> <td style="width: 10%;"></td> <td style="width: 10%;"></td> <td style="width: 10%;"></td> <td style="width: 10%;"></td> <td style="width: 10%;"></td> </tr> <tr> <td></td> <td></td> <td colspan="8" style="text-align: center;"> <table border="1" style="width: 100%; border-collapse: collapse; text-align: center;"> <tr> <td style="width: 10%;"></td> <td style="width: 10%;"></td> <td style="width: 10%;"></td> <td style="width: 10%;"></td> <td style="width: 10%;"></td> <td style="width: 10%;"></td> <td style="width: 10%;"></td> <td style="width: 10%;"></td> <td style="width: 10%;"></td> <td style="width: 10%;"></td> </tr> <tr> <td></td> <td></td> <td colspan="8" style="text-align: center;"> <table border="1" style="width: 100%; border-collapse: collapse; text-align: center;"> <tr> <td style="width: 10%;"></td> <td style="width: 10%;"></td> <td style="width: 10%;"></td> <td style="width: 10%;"></td> <td style="width: 10%;"></td> <td style="width: 10%;"></td> <td style="width: 10%;"></td> <td style="width: 10%;"></td> <td style="width: 10%;"></td> <td style="width: 10%;"></td> </tr> <tr> <td></td> <td></td> <td colspan="8" style="text-align: center;"> <table border="1" style="width: 100%; border-collapse: collapse; text-align: center;"> <tr> <td style="width: 10%;"></td> <td style="width: 10%;"></td> <td style="width: 10%;"></td> <td style="width: 10%;"></td> <td style="width: 10%;"></td> <td style="width: 10%;"></td> <td style="width: 10%;"></td> <td style="width: 10%;"></td> <td style="width: 10%;"></td> <td style="width: 10%;"></td> </tr> <tr> <td></td> <td></td> <td colspan="8" style="text-align: center;"> <table border="1" style="width: 100%; border-collapse: collapse; text-align: center;"> <tr> <td style="width: 10%;"></td> <td style="width: 10%;"></td> <td style="width: 10%;"></td> <td style="width: 10%;"></td> <td style="width: 10%;"></td> <td style="width: 10%;"></td> <td style="width: 10%;"></td> <td style="width: 10%;"></td> <td style="width: 10%;"></td> <td style="width: 10%;"></td> </tr> <tr> <td></td> <td></td> <td colspan="8" style="text-align: center;"> <table border="1" style="width: 100%; border-collapse: collapse; text-align: center;"> <tr> </tr></table></td></tr></table></td></tr></table></td></tr></table></td></tr></table></td></tr></table></td></tr></table></td></tr></table></td></tr></table></td></tr></table></td></tr></table></td></tr></table></td></tr></table></td></tr></table></td></tr></table></td></tr></table></td></tr></table></td></tr></table></td></tr></table></td></tr></table></td></tr></table></td></tr></table></td></tr></table></td></tr></table></td></tr></table></td></tr></table></td></tr></table></td></tr></table></td></tr></table></td></tr></table></td></tr></table></td></tr></table></td></tr></table></td></tr></table></td></tr></table></td></tr></table></td></tr></table></td></tr></table></td></tr></table></td></tr></table></td></tr></table></td></tr></table></td></tr></table> | | | | | | | | | | | | | | | | | | | | <table border="1" style="width: 100%; border-collapse: collapse; text-align: center;"> <tr> <td style="width: 10%;"></td> <td style="width: 10%;"></td> <td style="width: 10%;"></td> <td style="width: 10%;"></td> <td style="width: 10%;"></td> <td style="width: 10%;"></td> <td style="width: 10%;"></td> <td style="width: 10%;"></td> <td style="width: 10%;"></td> <td style="width: 10%;"></td> </tr> <tr> <td></td> <td></td> <td colspan="8" style="text-align: center;"> <table border="1" style="width: 100%; border-collapse: collapse; text-align: center;"> <tr> <td style="width: 10%;"></td> <td style="width: 10%;"></td> <td style="width: 10%;"></td> <td style="width: 10%;"></td> <td style="width: 10%;"></td> <td style="width: 10%;"></td> <td style="width: 10%;"></td> <td style="width: 10%;"></td> <td style="width: 10%;"></td> <td style="width: 10%;"></td> </tr> <tr> <td></td> <td></td> <td colspan="8" style="text-align: center;"> <table border="1" style="width: 100%; border-collapse: collapse; text-align: center;"> <tr> <td style="width: 10%;"></td> <td style="width: 10%;"></td> <td style="width: 10%;"></td> <td style="width: 10%;"></td> <td style="width: 10%;"></td> <td style="width: 10%;"></td> <td style="width:
10%;"></td> <td style="width: 10%;"></td> <td style="width: 10%;"></td> <td style="width: 10%;"></td> </tr> <tr> <td></td> <td></td> <td colspan="8" style="text-align: center;"> <table border="1" style="width: 100%; border-collapse: collapse; text-align: center;"> <tr> <td style="width: 10%;"></td> <td style="width: 10%;"></td> <td style="width: 10%;"></td> <td style="width: 10%;"></td> <td style="width: 10%;"></td> <td style="width: 10%;"></td> <td style="width: 10%;"></td> <td style="width: 10%;"></td> <td style="width: 10%;"></td> <td style="width: 10%;"></td> </tr> <tr> <td></td> <td></td> <td colspan="8" style="text-align: center;"> <table border="1" style="width: 100%; border-collapse: collapse; text-align: center;"> <tr> <td style="width: 10%;"></td> <td style="width: 10%;"></td> <td style="width: 10%;"></td> <td style="width: 10%;"></td> <td style="width: 10%;"></td> <td style="width: 10%;"></td> <td style="width: 10%;"></td> <td style="width: 10%;"></td> <td style="width: 10%;"></td> <td style="width: 10%;"></td> </tr> <tr> <td></td> <td></td> <td colspan="8" style="text-align: center;"> <table border="1" style="width: 100%; border-collapse: collapse; text-align: center;"> <tr> <td style="width: 10%;"></td> <td style="width: 10%;"></td> <td style="width: 10%;"></td> <td style="width: 10%;"></td> <td style="width: 10%;"></td> <td style="width: 10%;"></td> <td style="width: 10%;"></td> <td style="width: 10%;"></td> <td style="width: 10%;"></td> <td style="width: 10%;"></td> </tr> <tr> <td></td> <td></td> <td colspan="8" style="text-align: center;"> <table border="1" style="width: 100%; border-collapse: collapse; text-align: center;"> <tr> <td style="width: 10%;"></td> <td style="width: 10%;"></td> <td style="width: 10%;"></td> <td style="width: 10%;"></td> <td style="width: 10%;"></td> <td style="width: 10%;"></td> <td style="width: 10%;"></td> <td style="width: 10%;"></td> <td style="width: 10%;"></td> <td style="width: 10%;"></td> </tr> <tr> <td></td> <td></td> <td colspan="8" style="text-align: center;"> <table border="1" style="width: 100%; border-collapse: collapse; text-align: center;"> <tr> <td style="width: 10%;"></td> <td style="width: 10%;"></td> <td style="width: 10%;"></td> <td style="width: 10%;"></td> <td style="width: 10%;"></td> <td style="width: 10%;"></td> <td style="width: 10%;"></td> <td style="width: 10%;"></td> <td style="width: 10%;"></td> <td style="width: 10%;"></td> </tr> <tr> <td></td> <td></td> <td colspan="8" style="text-align: center;"> <table border="1" style="width: 100%; border-collapse: collapse; text-align: center;"> <tr> <td style="width: 10%;"></td> <td style="width: 10%;"></td> <td style="width: 10%;"></td> <td style="width: 10%;"></td> <td style="width: 10%;"></td> <td style="width: 10%;"></td> <td style="width: 10%;"></td> <td style="width: 10%;"></td> <td style="width: 10%;"></td> <td style="width: 10%;"></td> </tr> <tr> <td></td> <td></td> <td colspan="8" style="text-align: center;"> <table border="1" style="width: 100%; border-collapse: collapse; text-align: center;"> <tr> <td style="width: 10%;"></td> <td style="width: 10%;"></td> <td style="width: 10%;"></td> <td style="width: 10%;"></td> <td style="width: 10%;"></td> <td style="width: 10%;"></td> <td style="width: 10%;"></td> <td style="width: 10%;"></td> <td style="width: 10%;"></td> <td style="width: 10%;"></td> </tr> <tr> <td></td> <td></td> <td colspan="8" style="text-align: center;"> <table border="1" style="width: 100%; border-collapse: collapse; text-align: center;"> <tr> <td style="width: 10%;"></td> <td style="width: 10%;"></td> <td style="width: 10%;"></td> <td style="width: 10%;"></td> <td style="width: 10%;"></td> <td style="width: 10%;"></td> <td style="width: 10%;"></td> <td style="width: 10%;"></td> <td style="width: 10%;"></td> <td style="width: 10%;"></td> </tr> <tr> <td></td> <td></td> <td colspan="8" style="text-align: center;"> <table border="1" style="width: 100%; border-collapse: collapse; text-align: center;"> <tr> <td style="width: 10%;"></td> <td style="width: 10%;"></td> <td style="width: 10%;"></td> <td style="width: 10%;"></td> <td style="width: 10%;"></td> <td style="width: 10%;"></td> <td style="width: 10%;"></td> <td style="width: 10%;"></td> <td style="width: 10%;"></td> <td style="width: 10%;"></td> </tr> <tr> <td></td> <td></td> <td colspan="8" style="text-align: center;"> <table border="1" style="width: 100%; border-collapse: collapse; text-align: center;"> <tr> <td style="width: 10%;"></td> <td style="width: 10%;"></td> <td style="width: 10%;"></td> <td style="width: 10%;"></td> <td style="width: 10%;"></td> <td style="width: 10%;"></td> <td style="width: 10%;"></td> <td style="width: 10%;"></td> <td style="width: 10%;"></td> <td style="width: 10%;"></td> </tr> <tr> <td></td> <td></td> <td colspan="8" style="text-align: center;"> <table border="1" style="width: 100%; border-collapse: collapse; text-align: center;"> <tr> <td style="width: 10%;"></td> <td style="width: 10%;"></td> <td style="width: 10%;"></td> <td style="width: 10%;"></td> <td style="width: 10%;"></td> <td style="width: 10%;"></td> <td style="width: 10%;"></td> <td style="width: 10%;"></td> <td style="width: 10%;"></td> <td style="width: 10%;"></td> </tr> <tr> <td></td> <td></td> <td colspan="8" style="text-align: center;"> <table border="1" style="width: 100%; border-collapse: collapse; text-align: center;"> <tr> <td style="width: 10%;"></td> <td style="width: 10%;"></td> <td style="width: 10%;"></td> <td style="width: 10%;"></td> <td style="width: 10%;"></td> <td style="width: 10%;"></td> <td style="width: 10%;"></td> <td style="width: 10%;"></td> <td style="width: 10%;"></td> <td style="width: 10%;"></td> </tr> <tr> <td></td> <td></td> <td colspan="8" style="text-align: center;"> <table border="1" style="width: 100%; border-collapse: collapse; text-align: center;"> <tr> <td style="width: 10%;"></td> <td style="width: 10%;"></td> <td style="width: 10%;"></td> <td style="width: 10%;"></td> <td style="width: 10%;"></td> <td style="width: 10%;"></td> <td style="width: 10%;"></td> <td style="width: 10%;"></td> <td style="width: 10%;"></td> <td style="width: 10%;"></td> </tr> <tr> <td></td> <td></td> <td colspan="8" style="text-align: center;"> <table border="1" style="width: 100%; border-collapse: collapse; text-align: center;"> <tr> <td style="width: 10%;"></td> <td style="width: 10%;"></td> <td style="width: 10%;"></td> <td style="width: 10%;"></td> <td style="width: 10%;"></td> <td style="width: 10%;"></td> <td style="width: 10%;"></td> <td style="width: 10%;"></td> <td style="width: 10%;"></td> <td style="width: 10%;"></td> </tr> <tr> <td></td> <td></td> <td colspan="8" style="text-align: center;"> <table border="1" style="width: 100%; border-collapse: collapse; text-align: center;"> <tr> <td style="width: 10%;"></td> <td style="width: 10%;"></td> <td style="width: 10%;"></td> <td style="width: 10%;"></td> <td style="width: 10%;"></td> <td style="width: 10%;"></td> <td style="width: 10%;"></td> <td style="width: 10%;"></td> <td style="width: 10%;"></td> <td style="width: 10%;"></td> </tr> <tr> <td></td> <td></td> <td colspan="8" style="text-align: center;"> <table border="1" style="width: 100%; border-collapse: collapse; text-align: center;"> <tr> <td style="width: 10%;"></td> <td style="width: 10%;"></td> <td style="width: 10%;"></td> <td style="width: 10%;"></td> <td style="width: 10%;"></td> <td style="width: 10%;"></td> <td style="width: 10%;"></td> <td style="width: 10%;"></td> <td style="width: 10%;"></td> <td style="width: 10%;"></td> </tr> <tr> <td></td> <td></td> <td colspan="8" style="text-align: center;"> <table border="1" style="width: 100%; border-collapse: collapse; text-align: center;"> <tr> <td style="width: 10%;"></td> <td style="width: 10%;"></td> <td style="width: 10%;"></td> <td style="width: 10%;"></td> <td style="width: 10%;"></td> <td style="width: 10%;"></td> <td style="width: 10%;"></td> <td style="width: 10%;"></td> <td style="width: 10%;"></td> <td style="width: 10%;"></td> </tr> <tr> <td></td> <td></td> <td colspan="8" style="text-align: center;"> <table border="1" style="width: 100%; border-collapse: collapse; text-align: center;"> <tr> <td style="width: 10%;"></td> <td style="width: 10%;"></td> <td style="width: 10%;"></td> <td style="width: 10%;"></td> <td style="width: 10%;"></td> <td style="width: 10%;"></td> <td style="width: 10%;"></td> <td style="width: 10%;"></td> <td style="width: 10%;"></td> <td style="width: 10%;"></td> </tr> <tr> <td></td> <td></td> <td colspan="8" style="text-align: center;"> <table border="1" style="width: 100%; border-collapse: collapse; text-align: center;"> <tr> <td style="width: 10%;"></td> <td style="width: 10%;"></td> <td style="width: 10%;"></td> <td style="width: 10%;"></td> <td style="width: 10%;"></td> <td style="width: 10%;"></td> <td style="width: 10%;"></td> <td style="width: 10%;"></td> <td style="width: 10%;"></td> <td style="width: 10%;"></td> </tr> <tr> <td></td> <td></td> <td colspan="8" style="text-align: center;"> <table border="1" style="width: 100%; border-collapse: collapse; text-align: center;"> <tr> <td style="width: 10%;"></td> <td style="width: 10%;"></td> <td style="width: 10%;"></td> <td style="width: 10%;"></td> <td style="width: 10%;"></td> <td style="width: 10%;"></td> <td style="width: 10%;"></td> <td style="width: 10%;"></td> <td style="width: 10%;"></td> <td style="width: 10%;"></td> </tr> <tr> <td></td> <td></td> <td colspan="8" style="text-align: center;"> <table border="1" style="width: 100%; border-collapse: collapse; text-align: center;"> <tr> <td style="width: 10%;"></td> <td style="width: 10%;"></td> <td style="width: 10%;"></td> <td style="width: 10%;"></td> <td style="width: 10%;"></td> <td style="width: 10%;"></td> <td style="width: 10%;"></td> <td style="width: 10%;"></td> <td style="width: 10%;"></td> <td style="width: 10%;"></td> </tr> <tr> <td></td> <td></td> <td colspan="8" style="text-align:
center;"> <table border="1" style="width: 100%; border-collapse: collapse; text-align: center;"> <tr> <td style="width: 10%;"></td> <td style="width: 10%;"></td> <td style="width: 10%;"></td> <td style="width: 10%;"></td> <td style="width: 10%;"></td> <td style="width: 10%;"></td> <td style="width: 10%;"></td> <td style="width: 10%;"></td> <td style="width: 10%;"></td> <td style="width: 10%;"></td> </tr> <tr> <td></td> <td></td> <td colspan="8" style="text-align: center;"> <table border="1" style="width: 100%; border-collapse: collapse; text-align: center;"> <tr> <td style="width: 10%;"></td> <td style="width: 10%;"></td> <td style="width: 10%;"></td> <td style="width: 10%;"></td> <td style="width: 10%;"></td> <td style="width: 10%;"></td> <td style="width: 10%;"></td> <td style="width: 10%;"></td> <td style="width: 10%;"></td> <td style="width: 10%;"></td> </tr> <tr> <td></td> <td></td> <td colspan="8" style="text-align: center;"> <table border="1" style="width: 100%; border-collapse: collapse; text-align: center;"> <tr> <td style="width: 10%;"></td> <td style="width: 10%;"></td> <td style="width: 10%;"></td> <td style="width: 10%;"></td> <td style="width: 10%;"></td> <td style="width: 10%;"></td> <td style="width: 10%;"></td> <td style="width: 10%;"></td> <td style="width: 10%;"></td> <td style="width: 10%;"></td> </tr> <tr> <td></td> <td></td> <td colspan="8" style="text-align: center;"> <table border="1" style="width: 100%; border-collapse: collapse; text-align: center;"> <tr> <td style="width: 10%;"></td> <td style="width: 10%;"></td> <td style="width: 10%;"></td> <td style="width: 10%;"></td> <td style="width: 10%;"></td> <td style="width: 10%;"></td> <td style="width: 10%;"></td> <td style="width: 10%;"></td> <td style="width: 10%;"></td> <td style="width: 10%;"></td> </tr> <tr> <td></td> <td></td> <td colspan="8" style="text-align: center;"> <table border="1" style="width: 100%; border-collapse: collapse; text-align: center;"> <tr> <td style="width: 10%;"></td> <td style="width: 10%;"></td> <td style="width: 10%;"></td> <td style="width: 10%;"></td> <td style="width: 10%;"></td> <td style="width: 10%;"></td> <td style="width: 10%;"></td> <td style="width: 10%;"></td> <td style="width: 10%;"></td> <td style="width: 10%;"></td> </tr> <tr> <td></td> <td></td> <td colspan="8" style="text-align: center;"> <table border="1" style="width: 100%; border-collapse: collapse; text-align: center;"> <tr> <td style="width: 10%;"></td> <td style="width: 10%;"></td> <td style="width: 10%;"></td> <td style="width: 10%;"></td> <td style="width: 10%;"></td> <td style="width: 10%;"></td> <td style="width: 10%;"></td> <td style="width: 10%;"></td> <td style="width: 10%;"></td> <td style="width: 10%;"></td> </tr> <tr> <td></td> <td></td> <td colspan="8" style="text-align: center;"> <table border="1" style="width: 100%; border-collapse: collapse; text-align: center;"> <tr> <td style="width: 10%;"></td> <td style="width: 10%;"></td> <td style="width: 10%;"></td> <td style="width: 10%;"></td> <td style="width: 10%;"></td> <td style="width: 10%;"></td> <td style="width: 10%;"></td> <td style="width: 10%;"></td> <td style="width: 10%;"></td> <td style="width: 10%;"></td> </tr> <tr> <td></td> <td></td> <td colspan="8" style="text-align: center;"> <table border="1" style="width: 100%; border-collapse: collapse; text-align: center;"> <tr> <td style="width: 10%;"></td> <td style="width: 10%;"></td> <td style="width: 10%;"></td> <td style="width: 10%;"></td> <td style="width: 10%;"></td> <td style="width: 10%;"></td> <td style="width: 10%;"></td> <td style="width: 10%;"></td> <td style="width: 10%;"></td> <td style="width: 10%;"></td> </tr> <tr> <td></td> <td></td> <td colspan="8" style="text-align: center;"> <table border="1" style="width: 100%; border-collapse: collapse; text-align: center;"> <tr> <td style="width: 10%;"></td> <td style="width: 10%;"></td> <td style="width: 10%;"></td> <td style="width: 10%;"></td> <td style="width: 10%;"></td> <td style="width: 10%;"></td> <td style="width: 10%;"></td> <td style="width: 10%;"></td> <td style="width: 10%;"></td> <td style="width: 10%;"></td> </tr> <tr> <td></td> <td></td> <td colspan="8" style="text-align: center;"> <table border="1" style="width: 100%; border-collapse: collapse; text-align: center;"> <tr> <td style="width: 10%;"></td> <td style="width: 10%;"></td> <td style="width: 10%;"></td> <td style="width: 10%;"></td> <td style="width: 10%;"></td> <td style="width: 10%;"></td> <td style="width: 10%;"></td> <td style="width: 10%;"></td> <td style="width: 10%;"></td> <td style="width: 10%;"></td> </tr> <tr> <td></td> <td></td> <td colspan="8" style="text-align: center;"> <table border="1" style="width: 100%; border-collapse: collapse; text-align: center;"> <tr> <td style="width: 10%;"></td> <td style="width: 10%;"></td> <td style="width: 10%;"></td> <td style="width: 10%;"></td> <td style="width: 10%;"></td> <td style="width: 10%;"></td> <td style="width: 10%;"></td> <td style="width: 10%;"></td> <td style="width: 10%;"></td> <td style="width: 10%;"></td> </tr> <tr> <td></td> <td></td> <td colspan="8" style="text-align: center;"> <table border="1" style="width: 100%; border-collapse: collapse; text-align: center;"> <tr> <td style="width: 10%;"></td> <td style="width: 10%;"></td> <td style="width: 10%;"></td> <td style="width: 10%;"></td> <td style="width: 10%;"></td> <td style="width: 10%;"></td> <td style="width: 10%;"></td> <td style="width: 10%;"></td> <td style="width: 10%;"></td> <td style="width: 10%;"></td> </tr> <tr> <td></td> <td></td> <td colspan="8" style="text-align: center;"> <table border="1" style="width: 100%; border-collapse: collapse; text-align: center;"> <tr> <td style="width: 10%;"></td> <td style="width: 10%;"></td> <td style="width: 10%;"></td> <td style="width: 10%;"></td> <td style="width: 10%;"></td> <td style="width: 10%;"></td> <td style="width: 10%;"></td> <td style="width: 10%;"></td> <td style="width: 10%;"></td> <td style="width: 10%;"></td> </tr> <tr> <td></td> <td></td> <td colspan="8" style="text-align: center;"> <table border="1" style="width: 100%; border-collapse: collapse; text-align: center;"> <tr> <td style="width: 10%;"></td> <td style="width: 10%;"></td> <td style="width: 10%;"></td> <td style="width: 10%;"></td> <td style="width: 10%;"></td> <td style="width: 10%;"></td> <td style="width: 10%;"></td> <td style="width: 10%;"></td> <td style="width: 10%;"></td> <td style="width: 10%;"></td> </tr> <tr> <td></td> <td></td> <td colspan="8" style="text-align: center;"> <table border="1" style="width: 100%; border-collapse: collapse; text-align: center;"> <tr> <td style="width: 10%;"></td> <td style="width: 10%;"></td> <td style="width: 10%;"></td> <td style="width: 10%;"></td> <td style="width: 10%;"></td> <td style="width: 10%;"></td> <td style="width: 10%;"></td> <td style="width: 10%;"></td> <td style="width: 10%;"></td> <td style="width: 10%;"></td> </tr> <tr> <td></td> <td></td> <td colspan="8" style="text-align: center;"> <table border="1" style="width: 100%; border-collapse: collapse; text-align: center;"> <tr> <td style="width: 10%;"></td> <td style="width: 10%;"></td> <td style="width: 10%;"></td> <td style="width: 10%;"></td> <td style="width: 10%;"></td> <td style="width: 10%;"></td> <td style="width: 10%;"></td> <td style="width: 10%;"></td> <td style="width: 10%;"></td> <td style="width: 10%;"></td> </tr> <tr> <td></td> <td></td> <td colspan="8" style="text-align: center;"> <table border="1" style="width: 100%; border-collapse: collapse; text-align: center;"> <tr> <td style="width: 10%;"></td> <td style="width: 10%;"></td> <td style="width: 10%;"></td> <td style="width: 10%;"></td> <td style="width: 10%;"></td> <td style="width: 10%;"></td> <td style="width: 10%;"></td> <td style="width: 10%;"></td> <td style="width: 10%;"></td> <td style="width: 10%;"></td> </tr> <tr> <td></td> <td></td> <td colspan="8" style="text-align: center;"> <table border="1" style="width: 100%; border-collapse: collapse; text-align: center;"> <tr> </tr></table></td></tr></table></td></tr></table></td></tr></table></td></tr></table></td></tr></table></td></tr></table></td></tr></table></td></tr></table></td></tr></table></td></tr></table></td></tr></table></td></tr></table></td></tr></table></td></tr></table></td></tr></table></td></tr></table></td></tr></table></td></tr></table></td></tr></table></td></tr></table></td></tr></table></td></tr></table></td></tr></table></td></tr></table></td></tr></table></td></tr></table></td></tr></table></td></tr></table></td></tr></table></td></tr></table></td></tr></table></td></tr></table></td></tr></table></td></tr></table></td></tr></table></td></tr></table></td></tr></table></td></tr></table></td></tr></table></td></tr></table></td></tr></table>
 | | | | | | | | | | | | | | | | | | | | <table border="1" style="width: 100%; border-collapse: collapse; text-align: center;"> <tr> <td style="width: 10%;"></td> <td style="width: 10%;"></td> <td style="width: 10%;"></td> <td style="width: 10%;"></td> <td style="width: 10%;"></td> <td style="width: 10%;"></td> <td style="width: 10%;"></td> <td style="width: 10%;"></td> <td style="width: 10%;"></td> <td style="width: 10%;"></td> </tr> <tr> <td></td> <td></td> <td colspan="8" style="text-align: center;"> <table border="1" style="width: 100%; border-collapse: collapse; text-align: center;"> <tr> <td style="width: 10%;"></td> <td style="width: 10%;"></td> <td style="width: 10%;"></td> <td style="width: 10%;"></td> <td style="width: 10%;"></td> <td style="width: 10%;"></td> <td style="width: 10%;"></td> <td style="width: 10%;"></td> <td style="width: 10%;"></td> <td style="width: 10%;"></td> </tr> <tr> <td></td> <td></td> <td colspan="8" style="text-align: center;"> <table border="1" style="width: 100%; border-collapse: collapse; text-align: center;"> <tr> <td style="width: 10%;"></td> <td style="width: 10%;"></td> <td style="width: 10%;"></td> <td style="width: 10%;"></td> <td style="width: 10%;"></td> <td style="width: 10%;"></td> <td style="width: 10%;"></td> <td style="width: 10%;"></td> <td style="width: 10%;"></td> <td style="width: 10%;"></td> </tr> <tr> <td></td> <td></td> <td colspan="8" style="text-align: center;"> <table border="1" style="width: 100%; border-collapse: collapse; text-align: center;"> <tr> <td style="width: 10%;"></td> <td style="width: 10%;"></td> <td style="width: 10%;"></td> <td style="width: 10%;"></td> <td style="width: 10%;"></td> <td style="width: 10%;"></td> <td style="width: 10%;"></td> <td style="width: 10%;"></td> <td style="width: 10%;"></td> <td style="width: 10%;"></td> </tr> <tr> <td></td> <td></td> <td colspan="8" style="text-align: center;"> <table border="1" style="width: 100%; border-collapse: collapse; text-align: center;"> <tr> <td style="width: 10%;"></td> <td style="width: 10%;"></td> <td style="width: 10%;"></td> <td style="width: 10%;"></td> <td style="width: 10%;"></td> <td style="width: 10%;"></td> <td style="width: 10%;"></td> <td style="width: 10%;"></td> <td style="width: 10%;"></td> <td style="width: 10%;"></td> </tr> <tr> <td></td> <td></td> <td colspan="8" style="text-align: center;"> <table border="1" style="width: 100%; border-collapse: collapse; text-align: center;"> <tr> <td style="width: 10%;"></td> <td style="width: 10%;"></td> <td style="width: 10%;"></td> <td style="width: 10%;"></td> <td style="width: 10%;"></td> <td style="width: 10%;"></td> <td style="width: 10%;"></td> <td style="width: 10%;"></td> <td style="width: 10%;"></td> <td style="width: 10%;"></td> </tr> <tr> <td></td> <td></td> <td colspan="8" style="text-align: center;"> <table border="1" style="width: 100%; border-collapse: collapse; text-align: center;"> <tr> <td style="width: 10%;"></td> <td style="width: 10%;"></td> <td style="width: 10%;"></td> <td style="width: 10%;"></td> <td style="width: 10%;"></td> <td style="width: 10%;"></td> <td style="width: 10%;"></td> <td style="width: 10%;"></td> <td style="width: 10%;"></td> <td style="width: 10%;"></td> </tr> <tr> <td></td> <td></td> <td colspan="8" style="text-align: center;"> <table border="1" style="width: 100%; border-collapse: collapse; text-align: center;"> <tr> <td style="width: 10%;"></td> <td style="width: 10%;"></td> <td style="width: 10%;"></td> <td style="width: 10%;"></td> <td style="width: 10%;"></td> <td style="width: 10%;"></td> <td style="width: 10%;"></td> <td style="width: 10%;"></td> <td style="width: 10%;"></td> <td style="width: 10%;"></td> </tr> <tr> <td></td> <td></td> <td colspan="8" style="text-align: center;"> <table border="1" style="width: 100%; border-collapse: collapse; text-align: center;"> <tr> <td style="width: 10%;"></td> <td style="width: 10%;"></td> <td style="width: 10%;"></td> <td style="width: 10%;"></td> <td style="width: 10%;"></td> <td style="width: 10%;"></td> <td style="width: 10%;"></td> <td style="width: 10%;"></td> <td style="width: 10%;"></td> <td style="width: 10%;"></td> </tr> <tr> <td></td> <td></td> <td colspan="8" style="text-align: center;"> <table border="1" style="width: 100%; border-collapse: collapse; text-align: center;"> <tr> <td style="width: 10%;"></td> <td style="width: 10%;"></td> <td style="width: 10%;"></td> <td style="width: 10%;"></td> <td style="width: 10%;"></td> <td style="width: 10%;"></td> <td style="width: 10%;"></td> <td style="width: 10%;"></td> <td style="width: 10%;"></td> <td style="width: 10%;"></td> </tr> <tr> <td></td> <td></td> <td colspan="8" style="text-align: center;"> <table border="1" style="width: 100%; border-collapse: collapse; text-align: center;"> <tr> <td style="width: 10%;"></td> <td style="width: 10%;"></td> <td style="width: 10%;"></td> <td style="width: 10%;"></td> <td style="width: 10%;"></td> <td style="width: 10%;"></td> <td style="width: 10%;"></td> <td style="width: 10%;"></td> <td style="width: 10%;"></td> <td style="width: 10%;"></td> </tr> <tr> <td></td> <td></td> <td colspan="8" style="text-align: center;"> <table border="1" style="width: 100%; border-collapse: collapse; text-align: center;"> <tr> <td style="width: 10%;"></td> <td style="width: 10%;"></td> <td style="width: 10%;"></td> <td style="width: 10%;"></td> <td style="width: 10%;"></td> <td style="width: 10%;"></td> <td style="width: 10%;"></td> <td style="width: 10%;"></td> <td style="width: 10%;"></td> <td style="width: 10%;"></td> </tr> <tr> <td></td> <td></td> <td colspan="8" style="text-align: center;"> <table border="1" style="width: 100%; border-collapse: collapse; text-align: center;"> <tr> <td style="width: 10%;"></td> <td style="width: 10%;"></td> <td style="width: 10%;"></td> <td style="width: 10%;"></td> <td style="width: 10%;"></td> <td style="width: 10%;"></td> <td style="width: 10%;"></td> <td style="width: 10%;"></td> <td style="width: 10%;"></td> <td style="width: 10%;"></td> </tr> <tr> <td></td> <td></td> <td colspan="8" style="text-align: center;"> <table border="1" style="width: 100%; border-collapse: collapse; text-align: center;"> <tr> <td style="width: 10%;"></td> <td style="width: 10%;"></td> <td style="width: 10%;"></td> <td style="width: 10%;"></td> <td style="width: 10%;"></td> <td style="width: 10%;"></td> <td style="width: 10%;"></td> <td style="width: 10%;"></td> <td style="width: 10%;"></td> <td style="width: 10%;"></td> </tr> <tr> <td></td> <td></td> <td colspan="8" style="text-align: center;"> <table border="1" style="width: 100%; border-collapse: collapse; text-align: center;"> <tr> <td style="width: 10%;"></td> <td style="width: 10%;"></td> <td style="width: 10%;"></td> <td style="width: 10%;"></td> <td style="width: 10%;"></td> <td style="width: 10%;"></td> <td style="width: 10%;"></td> <td style="width: 10%;"></td> <td style="width: 10%;"></td> <td style="width: 10%;"></td> </tr> <tr> <td></td> <td></td> <td colspan="8" style="text-align: center;"> <table border="1" style="width: 100%; border-collapse: collapse; text-align: center;"> <tr> <td style="width: 10%;"></td> <td style="width: 10%;"></td> <td style="width: 10%;"></td> <td style="width: 10%;"></td> <td style="width: 10%;"></td> <td style="width: 10%;"></td> <td style="width: 10%;"></td> <td style="width: 10%;"></td> <td style="width: 10%;"></td> <td style="width: 10%;"></td> </tr> <tr> <td></td> <td></td> <td colspan="8" style="text-align: center;"> <table border="1" style="width: 100%; border-collapse: collapse; text-align: center;"> <tr> <td style="width: 10%;"></td> <td style="width: 10%;"></td> <td style="width: 10%;"></td> <td style="width: 10%;"></td> <td style="width: 10%;"></td> <td style="width: 10%;"></td> <td style="width: 10%;"></td> <td style="width: 10%;"></td> <td style="width: 10%;"></td> <td style="width: 10%;"></td> </tr> <tr> <td></td> <td></td> <td colspan="8" style="text-align: center;"> <table border="1" style="width: 100%; border-collapse: collapse; text-align: center;"> <tr> <td style="width: 10%;"></td> <td style="width: 10%;"></td> <td style="width: 10%;"></td> <td style="width: 10%;"></td> <td style="width: 10%;"></td> <td style="width: 10%;"></td> <td style="width: 10%;"></td> <td style="width: 10%;"></td> <td style="width: 10%;"></td> <td style="width: 10%;"></td> </tr> <tr> <td></td> <td></td> <td colspan="8" style="text-align: center;"> <table border="1" style="width: 100%; border-collapse: collapse; text-align: center;"> <tr> <td style="width: 10%;"></td> <td style="width: 10%;"></td> <td style="width: 10%;"></td> <td style="width: 10%;"></td> <td style="width: 10%;"></td> <td style="width: 10%;"></td> <td
style="width: 10%;"></td> <td style="width: 10%;"></td> <td style="width: 10%;"></td> <td style="width: 10%;"></td> </tr> <tr> <td></td> <td></td> <td colspan="8" style="text-align: center;"> <table border="1" style="width: 100%; border-collapse: collapse; text-align: center;"> <tr> <td style="width: 10%;"></td> <td style="width: 10%;"></td> <td style="width: 10%;"></td> <td style="width: 10%;"></td> <td style="width: 10%;"></td> <td style="width: 10%;"></td> <td style="width: 10%;"></td> <td style="width: 10%;"></td> <td style="width: 10%;"></td> <td style="width: 10%;"></td> </tr> <tr> <td></td> <td></td> <td colspan="8" style="text-align: center;"> <table border="1" style="width: 100%; border-collapse: collapse; text-align: center;"> <tr> <td style="width: 10%;"></td> <td style="width: 10%;"></td> <td style="width: 10%;"></td> <td style="width: 10%;"></td> <td style="width: 10%;"></td> <td style="width: 10%;"></td> <td style="width: 10%;"></td> <td style="width: 10%;"></td> <td style="width: 10%;"></td> <td style="width: 10%;"></td> </tr> <tr> <td></td> <td></td> <td colspan="8" style="text-align: center;"> <table border="1" style="width: 100%; border-collapse: collapse; text-align: center;"> <tr> <td style="width: 10%;"></td> <td style="width: 10%;"></td> <td style="width: 10%;"></td> <td style="width: 10%;"></td> <td style="width: 10%;"></td> <td style="width: 10%;"></td> <td style="width: 10%;"></td> <td style="width: 10%;"></td> <td style="width: 10%;"></td> <td style="width: 10%;"></td> </tr> <tr> <td></td> <td></td> <td colspan="8" style="text-align: center;"> <table border="1" style="width: 100%; border-collapse: collapse; text-align: center;"> <tr> <td style="width: 10%;"></td> <td style="width: 10%;"></td> <td style="width: 10%;"></td> <td style="width: 10%;"></td> <td style="width: 10%;"></td> <td style="width: 10%;"></td> <td style="width: 10%;"></td> <td style="width: 10%;"></td> <td style="width: 10%;"></td> <td style="width: 10%;"></td> </tr> <tr> <td></td> <td></td> <td colspan="8" style="text-align: center;"> <table border="1" style="width: 100%; border-collapse: collapse; text-align: center;"> <tr> <td style="width: 10%;"></td> <td style="width: 10%;"></td> <td style="width: 10%;"></td> <td style="width: 10%;"></td> <td style="width: 10%;"></td> <td style="width: 10%;"></td> <td style="width: 10%;"></td> <td style="width: 10%;"></td> <td style="width: 10%;"></td> <td style="width: 10%;"></td> </tr> <tr> <td></td> <td></td> <td colspan="8" style="text-align: center;"> <table border="1" style="width: 100%; border-collapse: collapse; text-align: center;"> <tr> <td style="width: 10%;"></td> <td style="width: 10%;"></td> <td style="width: 10%;"></td> <td style="width: 10%;"></td> <td style="width: 10%;"></td> <td style="width: 10%;"></td> <td style="width: 10%;"></td> <td style="width: 10%;"></td> <td style="width: 10%;"></td> <td style="width: 10%;"></td> </tr> <tr> <td></td> <td></td> <td colspan="8" style="text-align: center;"> <table border="1" style="width: 100%; border-collapse: collapse; text-align: center;"> <tr> <td style="width: 10%;"></td> <td style="width: 10%;"></td> <td style="width: 10%;"></td> <td style="width: 10%;"></td> <td style="width: 10%;"></td> <td style="width: 10%;"></td> <td style="width: 10%;"></td> <td style="width: 10%;"></td> <td style="width: 10%;"></td> <td style="width: 10%;"></td> </tr> <tr> <td></td> <td></td> <td colspan="8" style="text-align: center;"> <table border="1" style="width: 100%; border-collapse: collapse; text-align: center;"> <tr> <td style="width: 10%;"></td> <td style="width: 10%;"></td> <td style="width: 10%;"></td> <td style="width: 10%;"></td> <td style="width: 10%;"></td> <td style="width: 10%;"></td> <td style="width: 10%;"></td> <td style="width: 10%;"></td> <td style="width: 10%;"></td> <td style="width: 10%;"></td> </tr> <tr> <td></td> <td></td> <td colspan="8" style="text-align: center;"> <table border="1" style="width: 100%; border-collapse: collapse; text-align: center;"> <tr> <td style="width: 10%;"></td> <td style="width: 10%;"></td> <td style="width: 10%;"></td> <td style="width: 10%;"></td> <td style="width: 10%;"></td> <td style="width: 10%;"></td> <td style="width: 10%;"></td> <td style="width: 10%;"></td> <td style="width: 10%;"></td> <td style="width: 10%;"></td> </tr> <tr> <td></td> <td></td> <td colspan="8" style="text-align: center;"> <table border="1" style="width: 100%; border-collapse: collapse; text-align: center;"> <tr> <td style="width: 10%;"></td> <td style="width: 10%;"></td> <td style="width: 10%;"></td> <td style="width: 10%;"></td> <td style="width: 10%;"></td> <td style="width: 10%;"></td> <td style="width: 10%;"></td> <td style="width: 10%;"></td> <td style="width: 10%;"></td> <td style="width: 10%;"></td> </tr> <tr> <td></td> <td></td> <td colspan="8" style="text-align: center;"> <table border="1" style="width: 100%; border-collapse: collapse; text-align: center;"> <tr> <td style="width: 10%;"></td> <td style="width: 10%;"></td> <td style="width: 10%;"></td> <td style="width: 10%;"></td> <td style="width: 10%;"></td> <td style="width: 10%;"></td> <td style="width: 10%;"></td> <td style="width: 10%;"></td> <td style="width: 10%;"></td> <td style="width: 10%;"></td> </tr> <tr> <td></td> <td></td> <td colspan="8" style="text-align: center;"> <table border="1" style="width: 100%; border-collapse: collapse; text-align: center;"> <tr> <td style="width: 10%;"></td> <td style="width: 10%;"></td> <td style="width: 10%;"></td> <td style="width: 10%;"></td> <td style="width: 10%;"></td> <td style="width: 10%;"></td> <td style="width: 10%;"></td> <td style="width: 10%;"></td> <td style="width: 10%;"></td> <td style="width: 10%;"></td> </tr> <tr> <td></td> <td></td> <td colspan="8" style="text-align: center;"> <table border="1" style="width: 100%; border-collapse: collapse; text-align: center;"> <tr> <td style="width: 10%;"></td> <td style="width: 10%;"></td> <td style="width: 10%;"></td> <td style="width: 10%;"></td> <td style="width: 10%;"></td> <td style="width: 10%;"></td> <td style="width: 10%;"></td> <td style="width: 10%;"></td> <td style="width: 10%;"></td> <td style="width: 10%;"></td> </tr> <tr> <td></td> <td></td> <td colspan="8" style="text-align: center;"> <table border="1" style="width: 100%; border-collapse: collapse; text-align: center;"> <tr> <td style="width: 10%;"></td> <td style="width: 10%;"></td> <td style="width: 10%;"></td> <td style="width: 10%;"></td> <td style="width: 10%;"></td> <td style="width: 10%;"></td> <td style="width: 10%;"></td> <td style="width: 10%;"></td> <td style="width: 10%;"></td> <td style="width: 10%;"></td> </tr> <tr> <td></td> <td></td> <td colspan="8" style="text-align: center;"> <table border="1" style="width: 100%; border-collapse: collapse; text-align: center;"> <tr> <td style="width: 10%;"></td> <td style="width: 10%;"></td> <td style="width: 10%;"></td> <td style="width: 10%;"></td> <td style="width: 10%;"></td> <td style="width: 10%;"></td> <td style="width: 10%;"></td> <td style="width: 10%;"></td> <td style="width: 10%;"></td> <td style="width: 10%;"></td> </tr> <tr> <td></td> <td></td> <td colspan="8" style="text-align: center;"> <table border="1" style="width: 100%; border-collapse: collapse; text-align: center;"> <tr> <td style="width: 10%;"></td> <td style="width: 10%;"></td> <td style="width: 10%;"></td> <td style="width: 10%;"></td> <td style="width: 10%;"></td> <td style="width: 10%;"></td> <td style="width: 10%;"></td> <td style="width: 10%;"></td> <td style="width: 10%;"></td> <td style="width: 10%;"></td> </tr> <tr> <td></td> <td></td> <td colspan="8" style="text-align: center;"> <table border="1" style="width: 100%; border-collapse: collapse; text-align: center;"> <tr> <td style="width: 10%;"></td> <td style="width: 10%;"></td> <td style="width: 10%;"></td> <td style="width: 10%;"></td> <td style="width: 10%;"></td> <td style="width: 10%;"></td> <td style="width: 10%;"></td> <td style="width: 10%;"></td> <td style="width: 10%;"></td> <td style="width: 10%;"></td> </tr> <tr> <td></td> <td></td> <td colspan="8" style="text-align: center;"> <table border="1" style="width: 100%; border-collapse: collapse; text-align: center;"> <tr> <td style="width: 10%;"></td> <td style="width: 10%;"></td> <td style="width: 10%;"></td> <td style="width: 10%;"></td> <td style="width: 10%;"></td> <td style="width: 10%;"></td> <td style="width: 10%;"></td> <td style="width: 10%;"></td> <td style="width: 10%;"></td> <td style="width: 10%;"></td> </tr> <tr> <td></td> <td></td> <td colspan="8" style="text-align: center;"> <table border="1" style="width: 100%; border-collapse: collapse; text-align: center;"> <tr> <td style="width: 10%;"></td> <td style="width: 10%;"></td> <td style="width: 10%;"></td> <td style="width: 10%;"></td> <td style="width: 10%;"></td> <td style="width: 10%;"></td> <td style="width: 10%;"></td> <td style="width: 10%;"></td> <td style="width: 10%;"></td> <td style="width: 10%;"></td> </tr> <tr> <td></td> <td></td> <td colspan="8" style="text-align: center;"> <table border="1" style="width: 100%; border-collapse: collapse; text-align: center;"> <tr> <td style="width: 10%;"></td> <td style="width: 10%;"></td> <td style="width: 10%;"></td> <td style="width: 10%;"></td> <td style="width: 10%;"></td> <td style="width: 10%;"></td> <td style="width: 10%;"></td> <td style="width: 10%;"></td> <td style="width: 10%;"></td> <td style="width: 10%;"></td> </tr> <tr> <td></td> <td></td> <td colspan="8" style="text-align: center;"> <table border="1" style="width: 100%; border-collapse: collapse; text-align: center;"> <tr> <td style="width: 10%;"></td> <td style="width: 10%;"></td> <td style="width: 10%;"></td> <td style="width: 10%;"></td> <td style="width: 10%;"></td> <td style="width: 10%;"></td> <td style="width: 10%;"></td> <td style="width: 10%;"></td> <td style="width: 10%;"></td> <td style="width: 10%;"></td> </tr> <tr> <td></td> <td></td> <td colspan="8"
style="text-align: center;"> <table border="1" style="width: 100%; border-collapse: collapse; text-align: center;"> <tr> </tr></table></td></tr></table></td></tr></table></td></tr></table></td></tr></table></td></tr></table></td></tr></table></td></tr></table></td></tr></table></td></tr></table></td></tr></table></td></tr></table></td></tr></table></td></tr></table></td></tr></table></td></tr></table></td></tr></table></td></tr></table></td></tr></table></td></tr></table></td></tr></table></td></tr></table></td></tr></table></td></tr></table></td></tr></table></td></tr></table></td></tr></table></td></tr></table></td></tr></table></td></tr></table></td></tr></table></td></tr></table></td></tr></table></td></tr></table></td></tr></table></td></tr></table></td></tr></table></td></tr></table></td></tr></table></td></tr></table></td></tr></table> | | | | | | | | | | | | | | | | | | | | <table border="1" style="width: 100%; border-collapse: collapse; text-align: center;"> <tr> <td style="width: 10%;"></td> <td style="width: 10%;"></td> <td style="width: 10%;"></td> <td style="width: 10%;"></td> <td style="width: 10%;"></td> <td style="width: 10%;"></td> <td style="width: 10%;"></td> <td style="width: 10%;"></td> <td style="width: 10%;"></td> <td style="width: 10%;"></td> </tr> <tr> <td></td> <td></td> <td colspan="8" style="text-align: center;"> <table border="1" style="width: 100%; border-collapse: collapse; text-align: center;"> <tr> <td style="width: 10%;"></td> <td style="width: 10%;"></td> <td style="width: 10%;"></td> <td style="width: 10%;"></td> <td style="width: 10%;"></td> <td style="width: 10%;"></td> <td style="width: 10%;"></td> <td style="width: 10%;"></td> <td style="width: 10%;"></td> <td style="width: 10%;"></td> </tr> <tr> <td></td> <td></td> <td colspan="8" style="text-align: center;"> <table border="1" style="width: 100%; border-collapse: collapse; text-align: center;"> <tr> <td style="width: 10%;"></td> <td style="width: 10%;"></td> <td style="width: 10%;"></td> <td style="width: 10%;"></td> <td style="width: 10%;"></td> <td style="width: 10%;"></td> <td style="width: 10%;"></td> <td style="width: 10%;"></td> <td style="width: 10%;"></td> <td style="width: 10%;"></td> </tr> <tr> <td></td> <td></td> <td colspan="8" style="text-align: center;"> <table border="1" style="width: 100%; border-collapse: collapse; text-align: center;"> <tr> <td style="width: 10%;"></td> <td style="width: 10%;"></td> <td style="width: 10%;"></td> <td style="width: 10%;"></td> <td style="width: 10%;"></td> <td style="width: 10%;"></td> <td style="width: 10%;"></td> <td style="width: 10%;"></td> <td style="width: 10%;"></td> <td style="width: 10%;"></td> </tr> <tr> <td></td> <td></td> <td colspan="8" style="text-align: center;"> <table border="1" style="width: 100%; border-collapse: collapse; text-align: center;"> <tr> <td style="width: 10%;"></td> <td style="width: 10%;"></td> <td style="width: 10%;"></td> <td style="width: 10%;"></td> <td style="width: 10%;"></td> <td style="width: 10%;"></td> <td style="width: 10%;"></td> <td style="width: 10%;"></td> <td style="width: 10%;"></td> <td style="width: 10%;"></td> </tr> <tr> <td></td> <td></td> <td colspan="8" style="text-align: center;"> <table border="1" style="width: 100%; border-collapse: collapse; text-align: center;"> <tr> <td style="width: 10%;"></td> <td style="width: 10%;"></td> <td style="width: 10%;"></td> <td style="width: 10%;"></td> <td style="width: 10%;"></td> <td style="width: 10%;"></td> <td style="width: 10%;"></td> <td style="width: 10%;"></td> <td style="width: 10%;"></td> <td style="width: 10%;"></td> </tr> <tr> <td></td> <td></td> <td colspan="8" style="text-align: center;"> <table border="1" style="width: 100%; border-collapse: collapse; text-align: center;"> <tr> <td style="width: 10%;"></td> <td style="width: 10%;"></td> <td style="width: 10%;"></td> <td style="width: 10%;"></td> <td style="width: 10%;"></td> <td style="width: 10%;"></td> <td style="width: 10%;"></td> <td style="width: 10%;"></td> <td style="width: 10%;"></td> <td style="width: 10%;"></td> </tr> <tr> <td></td> <td></td> <td colspan="8" style="text-align: center;"> <table border="1" style="width: 100%; border-collapse: collapse; text-align: center;"> <tr> <td style="width: 10%;"></td> <td style="width: 10%;"></td> <td style="width: 10%;"></td> <td style="width: 10%;"></td> <td style="width: 10%;"></td> <td style="width: 10%;"></td> <td style="width: 10%;"></td> <td style="width: 10%;"></td> <td style="width: 10%;"></td> <td style="width: 10%;"></td> </tr> <tr> <td></td> <td></td> <td colspan="8" style="text-align: center;"> <table border="1" style="width: 100%; border-collapse: collapse; text-align: center;"> <tr> <td style="width: 10%;"></td> <td style="width: 10%;"></td> <td style="width: 10%;"></td> <td style="width: 10%;"></td> <td style="width: 10%;"></td> <td style="width: 10%;"></td> <td style="width: 10%;"></td> <td style="width: 10%;"></td> <td style="width: 10%;"></td> <td style="width: 10%;"></td> </tr> <tr> <td></td> <td></td> <td colspan="8" style="text-align: center;"> <table border="1" style="width: 100%; border-collapse: collapse; text-align: center;"> <tr> <td style="width: 10%;"></td> <td style="width: 10%;"></td> <td style="width: 10%;"></td> <td style="width: 10%;"></td> <td style="width: 10%;"></td> <td style="width: 10%;"></td> <td style="width: 10%;"></td> <td style="width: 10%;"></td> <td style="width: 10%;"></td> <td style="width: 10%;"></td> </tr> <tr> <td></td> <td></td> <td colspan="8" style="text-align: center;"> <table border="1" style="width: 100%; border-collapse: collapse; text-align: center;"> <tr> <td style="width: 10%;"></td> <td style="width: 10%;"></td> <td style="width: 10%;"></td> <td style="width: 10%;"></td> <td style="width: 10%;"></td> <td style="width: 10%;"></td> <td style="width: 10%;"></td> <td style="width: 10%;"></td> <td style="width: 10%;"></td> <td style="width: 10%;"></td> </tr> <tr> <td></td> <td></td> <td colspan="8" style="text-align: center;"> <table border="1" style="width: 100%; border-collapse: collapse; text-align: center;"> <tr> <td style="width: 10%;"></td> <td style="width: 10%;"></td> <td style="width: 10%;"></td> <td style="width: 10%;"></td> <td style="width: 10%;"></td> <td style="width: 10%;"></td> <td style="width: 10%;"></td> <td style="width: 10%;"></td> <td style="width: 10%;"></td> <td style="width: 10%;"></td> </tr> <tr> <td></td> <td></td> <td colspan="8" style="text-align: center;"> <table border="1" style="width: 100%; border-collapse: collapse; text-align: center;"> <tr> <td style="width: 10%;"></td> <td style="width: 10%;"></td> <td style="width: 10%;"></td> <td style="width: 10%;"></td> <td style="width: 10%;"></td> <td style="width: 10%;"></td> <td style="width: 10%;"></td> <td style="width: 10%;"></td> <td style="width: 10%;"></td> <td style="width: 10%;"></td> </tr> <tr> <td></td> <td></td> <td colspan="8" style="text-align: center;"> <table border="1" style="width: 100%; border-collapse: collapse; text-align: center;"> <tr> <td style="width: 10%;"></td> <td style="width: 10%;"></td> <td style="width: 10%;"></td> <td style="width: 10%;"></td> <td style="width: 10%;"></td> <td style="width: 10%;"></td> <td style="width: 10%;"></td> <td style="width: 10%;"></td> <td style="width: 10%;"></td> <td style="width: 10%;"></td> </tr> <tr> <td></td> <td></td> <td colspan="8" style="text-align: center;"> <table border="1" style="width: 100%; border-collapse: collapse; text-align: center;"> <tr> <td
style="width: 10%;"></td> <td style="width: 10%;"></td> <td style="width: 10%;"></td> <td style="width: 10%;"></td> <td style="width: 10%;"></td> <td style="width: 10%;"></td> <td style="width: 10%;"></td> <td style="width: 10%;"></td> <td style="width: 10%;"></td> <td style="width: 10%;"></td> </tr> <tr> <td></td> <td></td> <td colspan="8" style="text-align: center;"> <table border="1" style="width: 100%; border-collapse: collapse; text-align: center;"> <tr> <td style="width: 10%;"></td> <td style="width: 10%;"></td> <td style="width: 10%;"></td> <td style="width: 10%;"></td> <td style="width: 10%;"></td> <td style="width: 10%;"></td> <td style="width: 10%;"></td> <td style="width: 10%;"></td> <td style="width: 10%;"></td> <td style="width: 10%;"></td> </tr> <tr> <td></td> <td></td> <td colspan="8" style="text-align: center;"> <table border="1" style="width: 100%; border-collapse: collapse; text-align: center;"> <tr> <td style="width: 10%;"></td> <td style="width: 10%;"></td> <td style="width: 10%;"></td> <td style="width: 10%;"></td> <td style="width: 10%;"></td> <td style="width: 10%;"></td> <td style="width: 10%;"></td> <td style="width: 10%;"></td> <td style="width: 10%;"></td> <td style="width: 10%;"></td> </tr> <tr> <td></td> <td></td> <td colspan="8" style="text-align: center;"> <table border="1" style="width: 100%; border-collapse: collapse; text-align: center;"> <tr> <td style="width: 10%;"></td> <td style="width: 10%;"></td> <td style="width: 10%;"></td> <td style="width: 10%;"></td> <td style="width: 10%;"></td> <td style="width: 10%;"></td> <td style="width: 10%;"></td> <td style="width: 10%;"></td> <td style="width: 10%;"></td> <td style="width: 10%;"></td> </tr> <tr> <td></td> <td></td> <td colspan="8" style="text-align: center;"> <table border="1" style="width: 100%; border-collapse: collapse; text-align: center;"> <tr> <td style="width: 10%;"></td> <td style="width: 10%;"></td> <td style="width: 10%;"></td> <td style="width: 10%;"></td> <td style="width: 10%;"></td> <td style="width: 10%;"></td> <td style="width: 10%;"></td> <td style="width: 10%;"></td> <td style="width: 10%;"></td> <td style="width: 10%;"></td> </tr> <tr> <td></td> <td></td> <td colspan="8" style="text-align: center;"> <table border="1" style="width: 100%; border-collapse: collapse; text-align: center;"> <tr> <td style="width: 10%;"></td> <td style="width: 10%;"></td> <td style="width: 10%;"></td> <td style="width: 10%;"></td> <td style="width: 10%;"></td> <td style="width: 10%;"></td> <td style="width: 10%;"></td> <td style="width: 10%;"></td> <td style="width: 10%;"></td> <td style="width: 10%;"></td> </tr> <tr> <td></td> <td></td> <td colspan="8" style="text-align: center;"> <table border="1" style="width: 100%; border-collapse: collapse; text-align: center;"> <tr> <td style="width: 10%;"></td> <td style="width: 10%;"></td> <td style="width: 10%;"></td> <td style="width: 10%;"></td> <td style="width: 10%;"></td> <td style="width: 10%;"></td> <td style="width: 10%;"></td> <td style="width: 10%;"></td> <td style="width: 10%;"></td> <td style="width: 10%;"></td> </tr> <tr> <td></td> <td></td> <td colspan="8" style="text-align: center;"> <table border="1" style="width: 100%; border-collapse: collapse; text-align: center;"> <tr> <td style="width: 10%;"></td> <td style="width: 10%;"></td> <td style="width: 10%;"></td> <td style="width: 10%;"></td> <td style="width: 10%;"></td> <td style="width: 10%;"></td> <td style="width: 10%;"></td> <td style="width: 10%;"></td> <td style="width: 10%;"></td> <td style="width: 10%;"></td> </tr> <tr> <td></td> <td></td> <td colspan="8" style="text-align: center;"> <table border="1" style="width: 100%; border-collapse: collapse; text-align: center;"> <tr> <td style="width: 10%;"></td> <td style="width: 10%;"></td> <td style="width: 10%;"></td> <td style="width: 10%;"></td> <td style="width: 10%;"></td> <td style="width: 10%;"></td> <td style="width: 10%;"></td> <td style="width: 10%;"></td> <td style="width: 10%;"></td> <td style="width: 10%;"></td> </tr> <tr> <td></td> <td></td> <td colspan="8" style="text-align: center;"> <table border="1" style="width: 100%; border-collapse: collapse; text-align: center;"> <tr> <td style="width: 10%;"></td> <td style="width: 10%;"></td> <td style="width: 10%;"></td> <td style="width: 10%;"></td> <td style="width: 10%;"></td> <td style="width: 10%;"></td> <td style="width: 10%;"></td> <td style="width: 10%;"></td> <td style="width: 10%;"></td> <td style="width: 10%;"></td> </tr> <tr> <td></td> <td></td> <td colspan="8" style="text-align: center;"> <table border="1" style="width: 100%; border-collapse: collapse; text-align: center;"> <tr> <td style="width: 10%;"></td> <td style="width: 10%;"></td> <td style="width: 10%;"></td> <td style="width: 10%;"></td> <td style="width: 10%;"></td> <td style="width: 10%;"></td> <td style="width: 10%;"></td> <td style="width: 10%;"></td> <td style="width: 10%;"></td> <td style="width: 10%;"></td> </tr> <tr> <td></td> <td></td> <td colspan="8" style="text-align: center;"> <table border="1" style="width: 100%; border-collapse: collapse; text-align: center;"> <tr> <td style="width: 10%;"></td> <td style="width: 10%;"></td> <td style="width: 10%;"></td> <td style="width: 10%;"></td> <td style="width: 10%;"></td> <td style="width: 10%;"></td> <td style="width: 10%;"></td> <td style="width: 10%;"></td> <td style="width: 10%;"></td> <td style="width: 10%;"></td> </tr> <tr> <td></td> <td></td> <td colspan="8" style="text-align: center;"> <table border="1" style="width: 100%; border-collapse: collapse; text-align: center;"> <tr> <td style="width: 10%;"></td> <td style="width: 10%;"></td> <td style="width: 10%;"></td> <td style="width: 10%;"></td> <td style="width: 10%;"></td> <td style="width: 10%;"></td> <td style="width: 10%;"></td> <td style="width: 10%;"></td> <td style="width: 10%;"></td> <td style="width: 10%;"></td> </tr> <tr> <td></td> <td></td> <td colspan="8" style="text-align: center;"> <table border="1" style="width: 100%; border-collapse: collapse; text-align: center;"> <tr> <td style="width: 10%;"></td> <td style="width: 10%;"></td> <td style="width: 10%;"></td> <td style="width: 10%;"></td> <td style="width: 10%;"></td> <td style="width: 10%;"></td> <td style="width: 10%;"></td> <td style="width: 10%;"></td> <td style="width: 10%;"></td> <td style="width: 10%;"></td> </tr> <tr> <td></td> <td></td> <td colspan="8" style="text-align: center;"> <table border="1" style="width: 100%; border-collapse: collapse; text-align: center;"> <tr> <td style="width: 10%;"></td> <td style="width: 10%;"></td> <td style="width: 10%;"></td> <td style="width: 10%;"></td> <td style="width: 10%;"></td> <td style="width: 10%;"></td> <td style="width: 10%;"></td> <td style="width: 10%;"></td> <td style="width: 10%;"></td> <td style="width: 10%;"></td> </tr> <tr> <td></td> <td></td> <td colspan="8" style="text-align: center;"> <table border="1" style="width: 100%; border-collapse: collapse; text-align: center;"> <tr> <td style="width: 10%;"></td> <td style="width: 10%;"></td> <td style="width: 10%;"></td> <td style="width: 10%;"></td> <td style="width: 10%;"></td> <td style="width: 10%;"></td> <td style="width: 10%;"></td> <td style="width: 10%;"></td> <td style="width: 10%;"></td> <td style="width: 10%;"></td> </tr> <tr> <td></td> <td></td> <td colspan="8" style="text-align: center;"> <table border="1" style="width: 100%; border-collapse: collapse; text-align: center;"> <tr> <td style="width: 10%;"></td> <td style="width: 10%;"></td> <td style="width: 10%;"></td> <td style="width: 10%;"></td> <td style="width: 10%;"></td> <td style="width: 10%;"></td> <td style="width: 10%;"></td> <td style="width: 10%;"></td> <td style="width: 10%;"></td> <td style="width: 10%;"></td> </tr> <tr> <td></td> <td></td> <td colspan="8" style="text-align: center;"> <table border="1" style="width: 100%; border-collapse: collapse; text-align: center;"> <tr> <td style="width: 10%;"></td> <td style="width: 10%;"></td> <td style="width: 10%;"></td> <td style="width: 10%;"></td> <td style="width: 10%;"></td> <td style="width: 10%;"></td> <td style="width: 10%;"></td> <td style="width: 10%;"></td> <td style="width: 10%;"></td> <td style="width: 10%;"></td> </tr> <tr> <td></td> <td></td> <td colspan="8" style="text-align: center;"> <table border="1" style="width: 100%; border-collapse: collapse; text-align: center;"> <tr> <td style="width: 10%;"></td> <td style="width: 10%;"></td> <td style="width: 10%;"></td> <td style="width: 10%;"></td> <td style="width: 10%;"></td> <td style="width: 10%;"></td> <td style="width: 10%;"></td> <td style="width: 10%;"></td> <td style="width: 10%;"></td> <td style="width: 10%;"></td> </tr> <tr> <td></td> <td></td> <td colspan="8" style="text-align: center;"> <table border="1" style="width: 100%; border-collapse: collapse; text-align: center;"> <tr> <td style="width: 10%;"></td> <td style="width: 10%;"></td> <td style="width: 10%;"></td> <td style="width: 10%;"></td> <td style="width: 10%;"></td> <td style="width: 10%;"></td> <td style="width: 10%;"></td> <td style="width: 10%;"></td> <td style="width: 10%;"></td> <td style="width: 10%;"></td> </tr> <tr> <td></td> <td></td> <td colspan="8" style="text-align: center;"> <table border="1" style="width: 100%; border-collapse: collapse; text-align: center;"> <tr> <td style="width: 10%;"></td> <td style="width: 10%;"></td> <td style="width: 10%;"></td> <td style="width: 10%;"></td> <td style="width: 10%;"></td> <td style="width: 10%;"></td> <td style="width: 10%;"></td> <td style="width: 10%;"></td> <td style="width: 10%;"></td> <td style="width: 10%;"></td> </tr> <tr> <td></td> <td></td> <td colspan="8" style="text-align: center;"> <table border="1" style="width: 100%; border-collapse: collapse; text-align: center;"> <tr> <td style="width: 10%;"></td> <td style="width: 10%;"></td> <td style="width: 10%;"></td> <td style="width: 10%;"></td> <td style="width: 10%;"></td> <td style="width:
10%;"></td> <td style="width: 10%;"></td> <td style="width: 10%;"></td> <td style="width: 10%;"></td> <td style="width: 10%;"></td> </tr> <tr> <td></td> <td></td> <td colspan="8" style="text-align: center;"> <table border="1" style="width: 100%; border-collapse: collapse; text-align: center;"> <tr> <td style="width: 10%;"></td> <td style="width: 10%;"></td> <td style="width: 10%;"></td> <td style="width: 10%;"></td> <td style="width: 10%;"></td> <td style="width: 10%;"></td> <td style="width: 10%;"></td> <td style="width: 10%;"></td> <td style="width: 10%;"></td> <td style="width: 10%;"></td> </tr> <tr> <td></td> <td></td> <td colspan="8" style="text-align: center;"> <table border="1" style="width: 100%; border-collapse: collapse; text-align: center;"> <tr> <td style="width: 10%;"></td> <td style="width: 10%;"></td> <td style="width: 10%;"></td> <td style="width: 10%;"></td> <td style="width: 10%;"></td> <td style="width: 10%;"></td> <td style="width: 10%;"></td> <td style="width: 10%;"></td> <td style="width: 10%;"></td> <td style="width: 10%;"></td> </tr> <tr> <td></td> <td></td> <td colspan="8" style="text-align: center;"> <table border="1" style="width: 100%; border-collapse: collapse; text-align: center;"> <tr> <td style="width: 10%;"></td> <td style="width: 10%;"></td> <td style="width: 10%;"></td> <td style="width: 10%;"></td> <td style="width: 10%;"></td> <td style="width: 10%;"></td> <td style="width: 10%;"></td> <td style="width: 10%;"></td> <td style="width: 10%;"></td> <td style="width: 10%;"></td> </tr> <tr> <td></td> <td></td> <td colspan="8" style="text-align: center;"> <table border="1" style="width: 100%; border-collapse: collapse; text-align: center;"> <tr> </tr></table></td></tr></table></td></tr></table></td></tr></table></td></tr></table></td></tr></table></td></tr></table></td></tr></table></td></tr></table></td></tr></table></td></tr></table></td></tr></table></td></tr></table></td></tr></table></td></tr></table></td></tr></table></td></tr></table></td></tr></table></td></tr></table></td></tr></table></td></tr></table></td></tr></table></td></tr></table></td></tr></table></td></tr></table></td></tr></table></td></tr></table></td></tr></table></td></tr></table></td></tr></table></td></tr></table></td></tr></table></td></tr></table></td></tr></table></td></tr></table></td></tr></table></td></tr></table></td></tr></table></td></tr></table></td></tr></table> | | | | | | | | | | | | | | | | | | | | <table border="1" style="width: 100%; border-collapse: collapse; text-align: center;"> <tr> <td style="width: 10%;"></td> <td style="width: 10%;"></td> <td style="width: 10%;"></td> <td style="width: 10%;"></td> <td style="width: 10%;"></td> <td style="width: 10%;"></td> <td style="width: 10%;"></td> <td style="width: 10%;"></td> <td style="width: 10%;"></td> <td style="width: 10%;"></td> </tr> <tr> <td></td> <td></td> <td colspan="8" style="text-align: center;"> <table border="1" style="width: 100%; border-collapse: collapse; text-align: center;"> <tr> <td style="width: 10%;"></td> <td style="width: 10%;"></td> <td style="width: 10%;"></td> <td style="width: 10%;"></td> <td style="width: 10%;"></td> <td style="width: 10%;"></td> <td style="width: 10%;"></td> <td style="width: 10%;"></td> <td style="width: 10%;"></td> <td style="width: 10%;"></td> </tr> <tr> <td></td> <td></td> <td colspan="8" style="text-align: center;"> <table border="1" style="width: 100%; border-collapse: collapse; text-align: center;"> <tr> <td style="width: 10%;"></td> <td style="width: 10%;"></td> <td style="width: 10%;"></td> <td style="width: 10%;"></td> <td style="width: 10%;"></td> <td style="width: 10%;"></td> <td style="width: 10%;"></td> <td style="width: 10%;"></td> <td style="width: 10%;"></td> <td style="width: 10%;"></td> </tr> <tr> <td></td> <td></td> <td colspan="8" style="text-align: center;"> <table border="1" style="width: 100%; border-collapse: collapse; text-align: center;"> <tr> <td style="width: 10%;"></td> <td style="width: 10%;"></td> <td style="width: 10%;"></td> <td style="width: 10%;"></td> <td style="width: 10%;"></td> <td style="width: 10%;"></td> <td style="width: 10%;"></td> <td style="width: 10%;"></td> <td style="width: 10%;"></td> <td style="width: 10%;"></td> </tr> <tr> <td></td> <td></td> <td colspan="8" style="text-align: center;"> <table border="1" style="width: 100%; border-collapse: collapse; text-align: center;"> <tr> <td style="width: 10%;"></td> <td style="width: 10%;"></td> <td style="width: 10%;"></td> <td style="width: 10%;"></td> <td style="width: 10%;"></td> <td style="width: 10%;"></td> <td style="width: 10%;"></td> <td style="width: 10%;"></td> <td style="width: 10%;"></td> <td style="width: 10%;"></td> </tr> <tr> <td></td> <td></td> <td colspan="8" style="text-align: center;"> <table border="1" style="width: 100%; border-collapse: collapse; text-align: center;"> <tr> <td style="width: 10%;"></td> <td style="width: 10%;"></td> <td style="width: 10%;"></td> <td style="width: 10%;"></td> <td style="width: 10%;"></td> <td style="width: 10%;"></td> <td style="width: 10%;"></td> <td style="width: 10%;"></td> <td style="width: 10%;"></td> <td style="width: 10%;"></td> </tr> <tr> <td></td> <td></td> <td colspan="8" style="text-align: center;"> <table border="1" style="width: 100%; border-collapse: collapse; text-align: center;"> <tr> <td style="width: 10%;"></td> <td style="width: 10%;"></td> <td style="width: 10%;"></td> <td style="width: 10%;"></td> <td style="width: 10%;"></td> <td style="width: 10%;"></td> <td style="width: 10%;"></td> <td style="width: 10%;"></td> <td style="width: 10%;"></td> <td style="width: 10%;"></td> </tr> <tr> <td></td> <td></td> <td colspan="8" style="text-align: center;"> <table border="1" style="width: 100%; border-collapse: collapse; text-align: center;"> <tr> <td style="width: 10%;"></td> <td style="width: 10%;"></td> <td style="width: 10%;"></td> <td style="width: 10%;"></td> <td style="width: 10%;"></td> <td style="width: 10%;"></td> <td style="width: 10%;"></td> <td style="width: 10%;"></td> <td style="width: 10%;"></td> <td style="width: 10%;"></td> </tr> <tr> <td></td> <td></td> <td colspan="8" style="text-align: center;"> <table border="1" style="width: 100%; border-collapse: collapse; text-align: center;"> <tr> <td style="width: 10%;"></td> <td style="width: 10%;"></td> <td style="width: 10%;"></td> <td style="width: 10%;"></td> <td style="width: 10%;"></td> <td style="width: 10%;"></td> <td style="width: 10%;"></td> <td style="width: 10%;"></td> <td style="width: 10%;"></td> <td style="width: 10%;"></td> </tr> <tr> <td></td> <td></td> <td colspan="8" style="text-align: center;"> <table border="1" style="width: 100%; border-collapse: collapse; text-align: center;"> <tr> <td style="width: 10%;"></td> <td style="width: 10%;"></td> <td style="width: 10%;"></td> <td style="width: 10%;"></td> <td style="width: 10%;"></td> <td style="width: 10%;"></td> <td style="width: 10%;"></td> <td style="width: 10%;"></td> <td style="width: 10%;"></td> <td style="width: 10%;"></td> </tr> <tr> <td></td> <td></td> <td colspan="8" style="text-align: center;"> <table border="1" style="width: 100%; border-collapse: collapse; text-align: center;"> <tr> <td style="width: 10%;"></td> <td style="width: 10%;"></td> <td style="width: 10%;"></td> <td style="width: 10%;"></td> <td style="width: 10%;"></td> <td style="width: 10%;"></td> <td style="width: 10%;"></td> <td style="width: 10%;"></td> <td style="width: 10%;"></td> <td style="width: 10%;"></td> </tr> <tr>
<td></td> <td></td> <td colspan="8" style="text-align: center;"> <table border="1" style="width: 100%; border-collapse: collapse; text-align: center;"> <tr> <td style="width: 10%;"></td> <td style="width: 10%;"></td> <td style="width: 10%;"></td> <td style="width: 10%;"></td> <td style="width: 10%;"></td> <td style="width: 10%;"></td> <td style="width: 10%;"></td> <td style="width: 10%;"></td> <td style="width: 10%;"></td> <td style="width: 10%;"></td> </tr> <tr> <td></td> <td></td> <td colspan="8" style="text-align: center;"> <table border="1" style="width: 100%; border-collapse: collapse; text-align: center;"> <tr> <td style="width: 10%;"></td> <td style="width: 10%;"></td> <td style="width: 10%;"></td> <td style="width: 10%;"></td> <td style="width: 10%;"></td> <td style="width: 10%;"></td> <td style="width: 10%;"></td> <td style="width: 10%;"></td> <td style="width: 10%;"></td> <td style="width: 10%;"></td> </tr> <tr> <td></td> <td></td> <td colspan="8" style="text-align: center;"> <table border="1" style="width: 100%; border-collapse: collapse; text-align: center;"> <tr> <td style="width: 10%;"></td> <td style="width: 10%;"></td> <td style="width: 10%;"></td> <td style="width: 10%;"></td> <td style="width: 10%;"></td> <td style="width: 10%;"></td> <td style="width: 10%;"></td> <td style="width: 10%;"></td> <td style="width: 10%;"></td> <td style="width: 10%;"></td> </tr> <tr> <td></td> <td></td> <td colspan="8" style="text-align: center;"> <table border="1" style="width: 100%; border-collapse: collapse; text-align: center;"> <tr> <td style="width: 10%;"></td> <td style="width: 10%;"></td> <td style="width: 10%;"></td> <td style="width: 10%;"></td> <td style="width: 10%;"></td> <td style="width: 10%;"></td> <td style="width: 10%;"></td> <td style="width: 10%;"></td> <td style="width: 10%;"></td> <td style="width: 10%;"></td> </tr> <tr> <td></td> <td></td> <td colspan="8" style="text-align: center;"> <table border="1" style="width: 100%; border-collapse: collapse; text-align: center;"> <tr> <td style="width: 10%;"></td> <td style="width: 10%;"></td> <td style="width: 10%;"></td> <td style="width: 10%;"></td> <td style="width: 10%;"></td> <td style="width: 10%;"></td> <td style="width: 10%;"></td> <td style="width: 10%;"></td> <td style="width: 10%;"></td> <td style="width: 10%;"></td> </tr> <tr> <td></td> <td></td> <td colspan="8" style="text-align: center;"> <table border="1" style="width: 100%; border-collapse: collapse; text-align: center;"> <tr> <td style="width: 10%;"></td> <td style="width: 10%;"></td> <td style="width: 10%;"></td> <td style="width: 10%;"></td> <td style="width: 10%;"></td> <td style="width: 10%;"></td> <td style="width: 10%;"></td> <td style="width: 10%;"></td> <td style="width: 10%;"></td> <td style="width: 10%;"></td> </tr> <tr> <td></td> <td></td> <td colspan="8" style="text-align: center;"> <table border="1" style="width: 100%; border-collapse: collapse; text-align: center;"> <tr> <td style="width: 10%;"></td> <td style="width: 10%;"></td> <td style="width: 10%;"></td> <td style="width: 10%;"></td> <td style="width: 10%;"></td> <td style="width: 10%;"></td> <td style="width: 10%;"></td> <td style="width: 10%;"></td> <td style="width: 10%;"></td> <td style="width: 10%;"></td> </tr> <tr> <td></td> <td></td> <td colspan="8" style="text-align: center;"> <table border="1" style="width: 100%; border-collapse: collapse; text-align: center;"> <tr> <td style="width: 10%;"></td> <td style="width: 10%;"></td> <td style="width: 10%;"></td> <td style="width: 10%;"></td> <td style="width: 10%;"></td> <td style="width: 10%;"></td> <td style="width: 10%;"></td> <td style="width: 10%;"></td> <td style="width: 10%;"></td> <td style="width: 10%;"></td> </tr> <tr> <td></td> <td></td> <td colspan="8" style="text-align: center;"> <table border="1" style="width: 100%; border-collapse: collapse; text-align: center;"> <tr> <td style="width: 10%;"></td> <td style="width: 10%;"></td> <td style="width: 10%;"></td> <td style="width: 10%;"></td> <td style="width: 10%;"></td> <td style="width: 10%;"></td> <td style="width: 10%;"></td> <td style="width: 10%;"></td> <td style="width: 10%;"></td> <td style="width: 10%;"></td> </tr> <tr> <td></td> <td></td> <td colspan="8" style="text-align: center;"> <table border="1" style="width: 100%; border-collapse: collapse; text-align: center;"> <tr> <td style="width: 10%;"></td> <td style="width: 10%;"></td> <td style="width: 10%;"></td> <td style="width: 10%;"></td> <td style="width: 10%;"></td> <td style="width: 10%;"></td> <td style="width: 10%;"></td> <td style="width: 10%;"></td> <td style="width: 10%;"></td> <td style="width: 10%;"></td> </tr> <tr> <td></td> <td></td> <td colspan="8" style="text-align: center;"> <table border="1" style="width: 100%; border-collapse: collapse; text-align: center;"> <tr> <td style="width: 10%;"></td> <td style="width: 10%;"></td> <td style="width: 10%;"></td> <td style="width: 10%;"></td> <td style="width: 10%;"></td> <td style="width: 10%;"></td> <td style="width: 10%;"></td> <td style="width: 10%;"></td> <td style="width: 10%;"></td> <td style="width: 10%;"></td> </tr> <tr> <td></td> <td></td> <td colspan="8" style="text-align: center;"> <table border="1" style="width: 100%; border-collapse: collapse; text-align: center;"> <tr> <td style="width: 10%;"></td> <td style="width: 10%;"></td> <td style="width: 10%;"></td> <td style="width: 10%;"></td> <td style="width: 10%;"></td> <td style="width: 10%;"></td> <td style="width: 10%;"></td> <td style="width: 10%;"></td> <td style="width: 10%;"></td> <td style="width: 10%;"></td> </tr> <tr> <td></td> <td></td> <td colspan="8" style="text-align: center;"> <table border="1" style="width: 100%; border-collapse: collapse; text-align: center;"> <tr> <td style="width: 10%;"></td> <td style="width: 10%;"></td> <td style="width: 10%;"></td> <td style="width: 10%;"></td> <td style="width: 10%;"></td> <td style="width: 10%;"></td> <td style="width: 10%;"></td> <td style="width: 10%;"></td> <td style="width: 10%;"></td> <td style="width: 10%;"></td> </tr> <tr> <td></td> <td></td> <td colspan="8" style="text-align: center;"> <table border="1" style="width: 100%; border-collapse: collapse; text-align: center;"> <tr> <td style="width: 10%;"></td> <td style="width: 10%;"></td> <td style="width: 10%;"></td> <td style="width: 10%;"></td> <td style="width: 10%;"></td> <td style="width: 10%;"></td> <td style="width: 10%;"></td> <td style="width: 10%;"></td> <td style="width: 10%;"></td> <td style="width: 10%;"></td> </tr> <tr> <td></td> <td></td> <td colspan="8" style="text-align: center;"> <table border="1" style="width: 100%; border-collapse: collapse; text-align: center;"> <tr> <td style="width: 10%;"></td> <td style="width: 10%;"></td> <td style="width: 10%;"></td> <td style="width: 10%;"></td> <td style="width: 10%;"></td> <td style="width: 10%;"></td> <td style="width: 10%;"></td> <td style="width: 10%;"></td> <td style="width: 10%;"></td> <td style="width: 10%;"></td> </tr> <tr> <td></td> <td></td> <td colspan="8" style="text-align: center;"> <table border="1" style="width: 100%; border-collapse: collapse; text-align: center;"> <tr> <td style="width: 10%;"></td> <td style="width: 10%;"></td> <td style="width: 10%;"></td> <td style="width: 10%;"></td> <td style="width: 10%;"></td> <td style="width: 10%;"></td> <td style="width: 10%;"></td> <td style="width: 10%;"></td> <td style="width: 10%;"></td> <td style="width: 10%;"></td> </tr> <tr> <td></td> <td></td> <td colspan="8" style="text-align: center;"> <table border="1" style="width: 100%; border-collapse: collapse; text-align: center;"> <tr> <td style="width: 10%;"></td> <td style="width: 10%;"></td> <td style="width: 10%;"></td> <td style="width: 10%;"></td> <td style="width: 10%;"></td> <td style="width: 10%;"></td> <td style="width: 10%;"></td> <td style="width: 10%;"></td> <td style="width: 10%;"></td> <td style="width: 10%;"></td> </tr> <tr> <td></td> <td></td> <td colspan="8" style="text-align: center;"> <table border="1" style="width: 100%; border-collapse: collapse; text-align: center;"> <tr> <td style="width: 10%;"></td> <td style="width: 10%;"></td> <td style="width: 10%;"></td> <td style="width: 10%;"></td> <td style="width: 10%;"></td> <td style="width: 10%;"></td> <td style="width: 10%;"></td> <td style="width: 10%;"></td> <td style="width: 10%;"></td> <td style="width: 10%;"></td> </tr> <tr> <td></td> <td></td> <td colspan="8" style="text-align: center;"> <table border="1" style="width: 100%; border-collapse: collapse; text-align: center;"> <tr> <td style="width: 10%;"></td> <td style="width: 10%;"></td> <td style="width: 10%;"></td> <td style="width: 10%;"></td> <td style="width: 10%;"></td> <td style="width: 10%;"></td> <td style="width: 10%;"></td> <td style="width: 10%;"></td> <td style="width: 10%;"></td> <td style="width: 10%;"></td> </tr> <tr> <td></td> <td></td> <td colspan="8" style="text-align: center;"> <table border="1" style="width: 100%; border-collapse: collapse; text-align: center;"> <tr> <td style="width: 10%;"></td> <td style="width: 10%;"></td> <td style="width: 10%;"></td> <td style="width: 10%;"></td> <td style="width: 10%;"></td> <td style="width: 10%;"></td> <td style="width: 10%;"></td> <td style="width: 10%;"></td> <td style="width: 10%;"></td> <td style="width: 10%;"></td> </tr> <tr> <td></td> <td></td> <td colspan="8" style="text-align: center;"> <table border="1" style="width: 100%; border-collapse: collapse; text-align: center;"> <tr> <td style="width: 10%;"></td> <td style="width: 10%;"></td> <td style="width: 10%;"></td> <td style="width: 10%;"></td> <td style="width: 10%;"></td> <td style="width: 10%;"></td> <td style="width: 10%;"></td> <td style="width: 10%;"></td> <td style="width: 10%;"></td> <td style="width: 10%;"></td> </tr> <tr> <td></td> <td></td> <td colspan="8" style="text-align: center;"> <table border="1" style="width: 100%; border-collapse: collapse; text-align: center;"> <tr> <td
style="width: 10%;"></td> <td style="width: 10%;"></td> <td style="width: 10%;"></td> <td style="width: 10%;"></td> <td style="width: 10%;"></td> <td style="width: 10%;"></td> <td style="width: 10%;"></td> <td style="width: 10%;"></td> <td style="width: 10%;"></td> <td style="width: 10%;"></td> </tr> <tr> <td></td> <td></td> <td colspan="8" style="text-align: center;"> <table border="1" style="width: 100%; border-collapse: collapse; text-align: center;"> <tr> <td style="width: 10%;"></td> <td style="width: 10%;"></td> <td style="width: 10%;"></td> <td style="width: 10%;"></td> <td style="width: 10%;"></td> <td style="width: 10%;"></td> <td style="width: 10%;"></td> <td style="width: 10%;"></td> <td style="width: 10%;"></td> <td style="width: 10%;"></td> </tr> <tr> <td></td> <td></td> <td colspan="8" style="text-align: center;"> <table border="1" style="width: 100%; border-collapse: collapse; text-align: center;"> <tr> <td style="width: 10%;"></td> <td style="width: 10%;"></td> <td style="width: 10%;"></td> <td style="width: 10%;"></td> <td style="width: 10%;"></td> <td style="width: 10%;"></td> <td style="width: 10%;"></td> <td style="width: 10%;"></td> <td style="width: 10%;"></td> <td style="width: 10%;"></td> </tr> <tr> <td></td> <td></td> <td colspan="8" style="text-align: center;"> <table border="1" style="width: 100%; border-collapse: collapse; text-align: center;"> <tr> <td style="width: 10%;"></td> <td style="width: 10%;"></td> <td style="width: 10%;"></td> <td style="width: 10%;"></td> <td style="width: 10%;"></td> <td style="width: 10%;"></td> <td style="width: 10%;"></td> <td style="width: 10%;"></td> <td style="width: 10%;"></td> <td style="width: 10%;"></td> </tr> <tr> <td></td> <td></td> <td colspan="8" style="text-align: center;"> <table border="1" style="width: 100%; border-collapse: collapse; text-align: center;"> <tr> <td style="width: 10%;"></td> <td style="width: 10%;"></td> <td style="width: 10%;"></td> <td style="width: 10%;"></td> <td style="width: 10%;"></td> <td style="width: 10%;"></td> <td style="width: 10%;"></td> <td style="width: 10%;"></td> <td style="width: 10%;"></td> <td style="width: 10%;"></td> </tr> <tr> <td></td> <td></td> <td colspan="8" style="text-align: center;"> <table border="1" style="width: 100%; border-collapse: collapse; text-align: center;"> <tr> <td style="width: 10%;"></td> <td style="width: 10%;"></td> <td style="width: 10%;"></td> <td style="width: 10%;"></td> <td style="width: 10%;"></td> <td style="width: 10%;"></td> <td style="width: 10%;"></td> <td style="width: 10%;"></td> <td style="width: 10%;"></td> <td style="width: 10%;"></td> </tr> <tr> <td></td> <td></td> <td colspan="8" style="text-align: center;"> <table border="1" style="width: 100%; border-collapse: collapse; text-align: center;"> <tr> </tr></table></td></tr></table></td></tr></table></td></tr></table></td></tr></table></td></tr></table></td></tr></table></td></tr></table></td></tr></table></td></tr></table></td></tr></table></td></tr></table></td></tr></table></td></tr></table></td></tr></table></td></tr></table></td></tr></table></td></tr></table></td></tr></table></td></tr></table></td></tr></table></td></tr></table></td></tr></table></td></tr></table></td></tr></table></td></tr></table></td></tr></table></td></tr></table></td></tr></table></td></tr></table></td></tr></table></td></tr></table></td></tr></table></td></tr></table></td></tr></table></td></tr></table></td></tr></table></td></tr></table></td></tr></table> | | | | | | | | | | | | | | | | | | | | <table border="1" style="width: 100%; border-collapse: collapse; text-align: center;"> <tr> <td style="width: 10%;"></td> <td style="width: 10%;"></td> <td style="width: 10%;"></td> <td style="width: 10%;"></td> <td style="width: 10%;"></td> <td style="width: 10%;"></td> <td style="width: 10%;"></td> <td style="width: 10%;"></td> <td style="width: 10%;"></td> <td style="width: 10%;"></td> </tr> <tr> <td></td> <td></td> <td colspan="8" style="text-align: center;"> <table border="1" style="width: 100%; border-collapse: collapse; text-align: center;"> <tr> <td style="width: 10%;"></td> <td style="width: 10%;"></td> <td style="width: 10%;"></td> <td style="width: 10%;"></td> <td style="width: 10%;"></td> <td style="width: 10%;"></td> <td style="width: 10%;"></td> <td style="width: 10%;"></td> <td style="width: 10%;"></td> <td style="width: 10%;"></td> </tr> <tr> <td></td> <td></td> <td colspan="8" style="text-align: center;"> <table border="1" style="width: 100%; border-collapse: collapse; text-align: center;"> <tr> <td style="width: 10%;"></td> <td style="width: 10%;"></td> <td style="width: 10%;"></td> <td style="width: 10%;"></td> <td style="width: 10%;"></td> <td style="width: 10%;"></td> <td style="width: 10%;"></td> <td style="width: 10%;"></td> <td style="width: 10%;"></td> <td style="width: 10%;"></td> </tr> <tr> <td></td> <td></td> <td colspan="8" style="text-align: center;"> <table border="1" style="width: 100%; border-collapse: collapse; text-align: center;"> <tr> <td style="width: 10%;"></td> <td style="width: 10%;"></td> <td style="width: 10%;"></td> <td style="width: 10%;"></td> <td style="width: 10%;"></td> <td style="width: 10%;"></td> <td style="width: 10%;"></td> <td style="width: 10%;"></td> <td style="width: 10%;"></td> <td style="width: 10%;"></td> </tr> <tr> <td></td> <td></td> <td colspan="8" style="text-align: center;"> <table border="1" style="width: 100%; border-collapse: collapse; text-align: center;"> <tr> <td style="width: 10%;"></td> <td style="width: 10%;"></td> <td style="width: 10%;"></td> <td style="width: 10%;"></td> <td style="width: 10%;"></td> <td style="width: 10%;"></td> <td style="width: 10%;"></td> <td style="width: 10%;"></td> <td style="width: 10%;"></td> <td style="width: 10%;"></td> </tr> <tr> <td></td> <td></td> <td colspan="8" style="text-align: center;"> <table border="1" style="width: 100%; border-collapse: collapse; text-align: center;"> <tr> <td style="width: 10%;"></td> <td style="width: 10%;"></td> <td style="width: 10%;"></td> <td style="width: 10%;"></td> <td style="width: 10%;"></td> <td style="width: 10%;"></td> <td style="width: 10%;"></td> <td style="width: 10%;"></td> <td style="width: 10%;"></td> <td style="width: 10%;"></td> </tr> <tr> <td></td> <td></td> <td colspan="8" style="text-align: center;"> <table border="1" style="width: 100%; border-collapse: collapse; text-align: center;"> <tr> <td style="width: 10%;"></td> <td style="width: 10%;"></td> <td style="width: 10%;"></td> <td style="width: 10%;"></td> <td style="width: 10%;"></td> <td style="width: 10%;"></td> <td style="width: 10%;"></td> <td style="width: 10%;"></td> <td style="width: 10%;"></td> <td style="width: 10%;"></td> </tr> <tr> <td></td> <td></td> <td colspan="8" style="text-align: center;"> <table border="1" style="width: 100%; border-collapse: collapse; text-align: center;"> <tr> <td style="width: 10%;"></td> <td style="width: 10%;"></td> <td style="width: 10%;"></td> <td style="width: 10%;"></td> <td style="width: 10%;"></td> <td style="width: 10%;"></td> <td style="width: 10%;"></td> <td style="width: 10%;"></td> <td style="width: 10%;"></td> <td style="width: 10%;"></td> </tr> <tr> <td></td> <td></td> <td colspan="8" style="text-align: center;"> <table border="1" style="width: 100%; border-collapse: collapse; text-align: center;"> <tr> <td style="width: 10%;"></td> <td style="width: 10%;"></td> <td style="width: 10%;"></td> <td style="width: 10%;"></td> <td style="width: 10%;"></td> <td style="width:
10%;"></td> <td style="width: 10%;"></td> <td style="width: 10%;"></td> <td style="width: 10%;"></td> <td style="width: 10%;"></td> </tr> <tr> <td></td> <td></td> <td colspan="8" style="text-align: center;"> <table border="1" style="width: 100%; border-collapse: collapse; text-align: center;"> <tr> <td style="width: 10%;"></td> <td style="width: 10%;"></td> <td style="width: 10%;"></td> <td style="width: 10%;"></td> <td style="width: 10%;"></td> <td style="width: 10%;"></td> <td style="width: 10%;"></td> <td style="width: 10%;"></td> <td style="width: 10%;"></td> <td style="width: 10%;"></td> </tr> <tr> <td></td> <td></td> <td colspan="8" style="text-align: center;"> <table border="1" style="width: 100%; border-collapse: collapse; text-align: center;"> <tr> <td style="width: 10%;"></td> <td style="width: 10%;"></td> <td style="width: 10%;"></td> <td style="width: 10%;"></td> <td style="width: 10%;"></td> <td style="width: 10%;"></td> <td style="width: 10%;"></td> <td style="width: 10%;"></td> <td style="width: 10%;"></td> <td style="width: 10%;"></td> </tr> <tr> <td></td> <td></td> <td colspan="8" style="text-align: center;"> <table border="1" style="width: 100%; border-collapse: collapse; text-align: center;"> <tr> <td style="width: 10%;"></td> <td style="width: 10%;"></td> <td style="width: 10%;"></td> <td style="width: 10%;"></td> <td style="width: 10%;"></td> <td style="width: 10%;"></td> <td style="width: 10%;"></td> <td style="width: 10%;"></td> <td style="width: 10%;"></td> <td style="width: 10%;"></td> </tr> <tr> <td></td> <td></td> <td colspan="8" style="text-align: center;"> <table border="1" style="width: 100%; border-collapse: collapse; text-align: center;"> <tr> <td style="width: 10%;"></td> <td style="width: 10%;"></td> <td style="width: 10%;"></td> <td style="width: 10%;"></td> <td style="width: 10%;"></td> <td style="width: 10%;"></td> <td style="width: 10%;"></td> <td style="width: 10%;"></td> <td style="width: 10%;"></td> <td style="width: 10%;"></td> </tr> <tr> <td></td> <td></td> <td colspan="8" style="text-align: center;"> <table border="1" style="width: 100%; border-collapse: collapse; text-align: center;"> <tr> <td style="width: 10%;"></td> <td style="width: 10%;"></td> <td style="width: 10%;"></td> <td style="width: 10%;"></td> <td style="width: 10%;"></td> <td style="width: 10%;"></td> <td style="width: 10%;"></td> <td style="width: 10%;"></td> <td style="width: 10%;"></td> <td style="width: 10%;"></td> </tr> <tr> <td></td> <td></td> <td colspan="8" style="text-align: center;"> <table border="1" style="width: 100%; border-collapse: collapse; text-align: center;"> <tr> <td style="width: 10%;"></td> <td style="width: 10%;"></td> <td style="width: 10%;"></td> <td style="width: 10%;"></td> <td style="width: 10%;"></td> <td style="width: 10%;"></td> <td style="width: 10%;"></td> <td style="width: 10%;"></td> <td style="width: 10%;"></td> <td style="width: 10%;"></td> </tr> <tr> <td></td> <td></td> <td colspan="8" style="text-align: center;"> <table border="1" style="width: 100%; border-collapse: collapse; text-align: center;"> <tr> <td style="width: 10%;"></td> <td style="width: 10%;"></td> <td style="width: 10%;"></td> <td style="width: 10%;"></td> <td style="width: 10%;"></td> <td style="width: 10%;"></td> <td style="width: 10%;"></td> <td style="width: 10%;"></td> <td style="width: 10%;"></td> <td style="width: 10%;"></td> </tr> <tr> <td></td> <td></td> <td colspan="8" style="text-align: center;"> <table border="1" style="width: 100%; border-collapse: collapse; text-align: center;"> <tr> <td style="width: 10%;"></td> <td style="width: 10%;"></td> <td style="width: 10%;"></td> <td style="width: 10%;"></td> <td style="width: 10%;"></td> <td style="width: 10%;"></td> <td style="width: 10%;"></td> <td style="width: 10%;"></td> <td style="width: 10%;"></td> <td style="width: 10%;"></td> </tr> <tr> <td></td> <td></td> <td colspan="8" style="text-align: center;"> <table border="1" style="width: 100%; border-collapse: collapse; text-align: center;"> <tr> <td style="width: 10%;"></td> <td style="width: 10%;"></td> <td style="width: 10%;"></td> <td style="width: 10%;"></td> <td style="width: 10%;"></td> <td style="width: 10%;"></td> <td style="width: 10%;"></td> <td style="width: 10%;"></td> <td style="width: 10%;"></td> <td style="width: 10%;"></td> </tr> <tr> <td></td> <td></td> <td colspan="8" style="text-align: center;"> <table border="1" style="width: 100%; border-collapse: collapse; text-align: center;"> <tr> <td style="width: 10%;"></td> <td style="width: 10%;"></td> <td style="width: 10%;"></td> <td style="width: 10%;"></td> <td style="width: 10%;"></td> <td style="width: 10%;"></td> <td style="width: 10%;"></td> <td style="width: 10%;"></td> <td style="width: 10%;"></td> <td style="width: 10%;"></td> </tr> <tr> <td></td> <td></td> <td colspan="8" style="text-align: center;"> <table border="1" style="width: 100%; border-collapse: collapse; text-align: center;"> <tr> <td style="width: 10%;"></td> <td style="width: 10%;"></td> <td style="width: 10%;"></td> <td style="width: 10%;"></td> <td style="width: 10%;"></td> <td style="width: 10%;"></td> <td style="width: 10%;"></td> <td style="width: 10%;"></td> <td style="width: 10%;"></td> <td style="width: 10%;"></td> </tr> <tr> <td></td> <td></td> <td colspan="8" style="text-align: center;"> <table border="1" style="width: 100%; border-collapse: collapse; text-align: center;"> <tr> <td style="width: 10%;"></td> <td style="width: 10%;"></td> <td style="width: 10%;"></td> <td style="width: 10%;"></td> <td style="width: 10%;"></td> <td style="width: 10%;"></td> <td style="width: 10%;"></td> <td style="width: 10%;"></td> <td style="width: 10%;"></td> <td style="width: 10%;"></td> </tr> <tr> <td></td> <td></td> <td colspan="8" style="text-align: center;"> <table border="1" style="width: 100%; border-collapse: collapse; text-align: center;"> <tr> <td style="width: 10%;"></td> <td style="width: 10%;"></td> <td style="width: 10%;"></td> <td style="width: 10%;"></td> <td style="width: 10%;"></td> <td style="width: 10%;"></td> <td style="width: 10%;"></td> <td style="width: 10%;"></td> <td style="width: 10%;"></td> <td style="width: 10%;"></td> </tr> <tr> <td></td> <td></td> <td colspan="8" style="text-align: center;"> <table border="1" style="width: 100%; border-collapse: collapse; text-align: center;"> <tr> <td style="width: 10%;"></td> <td style="width: 10%;"></td> <td style="width: 10%;"></td> <td style="width: 10%;"></td> <td style="width: 10%;"></td> <td style="width: 10%;"></td> <td style="width: 10%;"></td> <td style="width: 10%;"></td> <td style="width: 10%;"></td> <td style="width: 10%;"></td> </tr> <tr> <td></td> <td></td> <td colspan="8" style="text-align: center;"> <table border="1" style="width: 100%; border-collapse: collapse; text-align: center;"> <tr> <td style="width: 10%;"></td> <td style="width: 10%;"></td> <td style="width: 10%;"></td> <td style="width: 10%;"></td> <td style="width: 10%;"></td> <td style="width: 10%;"></td> <td style="width: 10%;"></td> <td style="width: 10%;"></td> <td style="width: 10%;"></td> <td style="width: 10%;"></td> </tr> <tr> <td></td> <td></td> <td colspan="8" style="text-align: center;"> <table border="1" style="width: 100%; border-collapse: collapse; text-align: center;"> <tr> <td style="width: 10%;"></td> <td style="width: 10%;"></td> <td style="width: 10%;"></td> <td style="width: 10%;"></td> <td style="width: 10%;"></td> <td style="width: 10%;"></td> <td style="width: 10%;"></td> <td style="width: 10%;"></td> <td style="width: 10%;"></td> <td style="width: 10%;"></td> </tr> <tr> <td></td> <td></td> <td colspan="8" style="text-align: center;"> <table border="1" style="width: 100%; border-collapse: collapse; text-align: center;"> <tr> <td style="width: 10%;"></td> <td style="width: 10%;"></td> <td style="width: 10%;"></td> <td style="width: 10%;"></td> <td style="width: 10%;"></td> <td style="width: 10%;"></td> <td style="width: 10%;"></td> <td style="width: 10%;"></td> <td style="width: 10%;"></td> <td style="width: 10%;"></td> </tr> <tr> <td></td> <td></td> <td colspan="8" style="text-align: center;"> <table border="1" style="width: 100%; border-collapse: collapse; text-align: center;"> <tr> <td style="width: 10%;"></td> <td style="width: 10%;"></td> <td style="width: 10%;"></td> <td style="width: 10%;"></td> <td style="width: 10%;"></td> <td style="width: 10%;"></td> <td style="width: 10%;"></td> <td style="width: 10%;"></td> <td style="width: 10%;"></td> <td style="width: 10%;"></td> </tr> <tr> <td></td> <td></td> <td colspan="8" style="text-align: center;"> <table border="1" style="width: 100%; border-collapse: collapse; text-align: center;"> <tr> <td style="width: 10%;"></td> <td style="width: 10%;"></td> <td style="width: 10%;"></td> <td style="width: 10%;"></td> <td style="width: 10%;"></td> <td style="width: 10%;"></td> <td style="width: 10%;"></td> <td style="width: 10%;"></td> <td style="width: 10%;"></td> <td style="width: 10%;"></td> </tr> <tr> <td></td> <td></td> <td colspan="8" style="text-align: center;"> <table border="1" style="width: 100%; border-collapse: collapse; text-align: center;"> <tr> <td style="width: 10%;"></td> <td style="width: 10%;"></td> <td style="width: 10%;"></td> <td style="width: 10%;"></td> <td style="width: 10%;"></td> <td style="width: 10%;"></td> <td style="width: 10%;"></td> <td style="width: 10%;"></td> <td style="width: 10%;"></td> <td style="width: 10%;"></td> </tr> <tr> <td></td> <td></td> <td colspan="8" style="text-align: center;"> <table border="1" style="width: 100%; border-collapse: collapse; text-align: center;"> <tr> <td style="width: 10%;"></td> <td style="width: 10%;"></td> <td style="width: 10%;"></td> <td style="width: 10%;"></td> <td style="width: 10%;"></td> <td style="width: 10%;"></td> <td style="width: 10%;"></td> <td style="width: 10%;"></td> <td style="width: 10%;"></td> <td style="width: 10%;"></td> </tr> <tr> <td></td> <td></td> <td
colspan="8" style="text-align: center;"> <table border="1" style="width: 100%; border-collapse: collapse; text-align: center;"> <tr> <td style="width: 10%;"></td> <td style="width: 10%;"></td> <td style="width: 10%;"></td> <td style="width: 10%;"></td> <td style="width: 10%;"></td> <td style="width: 10%;"></td> <td style="width: 10%;"></td> <td style="width: 10%;"></td> <td style="width: 10%;"></td> <td style="width: 10%;"></td> </tr> <tr> <td></td> <td></td> <td colspan="8" style="text-align: center;"> <table border="1" style="width: 100%; border-collapse: collapse; text-align: center;"> <tr> <td style="width: 10%;"></td> <td style="width: 10%;"></td> <td style="width: 10%;"></td> <td style="width: 10%;"></td> <td style="width: 10%;"></td> <td style="width: 10%;"></td> <td style="width: 10%;"></td> <td style="width: 10%;"></td> <td style="width: 10%;"></td> <td style="width: 10%;"></td> </tr> <tr> <td></td> <td></td> <td colspan="8" style="text-align: center;"> <table border="1" style="width: 100%; border-collapse: collapse; text-align: center;"> <tr> <td style="width: 10%;"></td> <td style="width: 10%;"></td> <td style="width: 10%;"></td> <td style="width: 10%;"></td> <td style="width: 10%;"></td> <td style="width: 10%;"></td> <td style="width: 10%;"></td> <td style="width: 10%;"></td> <td style="width: 10%;"></td> <td style="width: 10%;"></td> </tr> <tr> <td></td> <td></td> <td colspan="8" style="text-align: center;"> <table border="1" style="width: 100%; border-collapse: collapse; text-align: center;"> <tr> <td style="width: 10%;"></td> <td style="width: 10%;"></td> <td style="width: 10%;"></td> <td style="width: 10%;"></td> <td style="width: 10%;"></td> <td style="width: 10%;"></td> <td style="width: 10%;"></td> <td style="width: 10%;"></td> <td style="width: 10%;"></td> <td style="width: 10%;"></td> </tr> <tr> <td></td> <td></td> <td colspan="8" style="text-align: center;"> <table border="1" style="width: 100%; border-collapse: collapse; text-align: center;"> <tr> <td style="width: 10%;"></td> <td style="width: 10%;"></td> <td style="width: 10%;"></td> <td style="width: 10%;"></td> <td style="width: 10%;"></td> <td style="width: 10%;"></td> <td style="width: 10%;"></td> <td style="width: 10%;"></td> <td style="width: 10%;"></td> <td style="width: 10%;"></td> </tr> <tr> <td></td> <td></td> <td colspan="8" style="text-align: center;"> <table border="1" style="width: 100%; border-collapse: collapse; text-align: center;"> <tr> <td style="width: 10%;"></td> <td style="width: 10%;"></td> <td style="width: 10%;"></td> <td style="width: 10%;"></td> <td style="width: 10%;"></td> <td style="width: 10%;"></td> <td style="width: 10%;"></td> <td style="width: 10%;"></td> <td style="width: 10%;"></td> <td style="width: 10%;"></td> </tr> <tr> <td></td> <td></td> <td colspan="8" style="text-align: center;"> <table border="1" style="width: 100%; border-collapse: collapse; text-align: center;"> <tr> <td style="width: 10%;"></td> <td style="width: 10%;"></td> <td style="width: 10%;"></td> <td style="width: 10%;"></td> <td style="width: 10%;"></td> <td style="width: 10%;"></td> <td style="width: 10%;"></td> <td style="width: 10%;"></td> <td style="width: 10%;"></td> <td style="width: 10%;"></td> </tr> <tr> <td></td> <td></td> <td colspan="8" style="text-align: center;"> <table border="1" style="width: 100%; border-collapse: collapse; text-align: center;"> <tr> </tr></table></td></tr></table></td></tr></table></td></tr></table></td></tr></table></td></tr></table></td></tr></table></td></tr></table></td></tr></table></td></tr></table></td></tr></table></td></tr></table></td></tr></table></td></tr></table></td></tr></table></td></tr></table></td></tr></table></td></tr></table></td></tr></table></td></tr></table></td></tr></table></td></tr></table></td></tr></table></td></tr></table></td></tr></table></td></tr></table></td></tr></table></td></tr></table></td></tr></table></td></tr></table></td></tr></table></td></tr></table></td></tr></table></td></tr></table></td></tr></table></td></tr></table></td></tr></table></td></tr></table> | | | | | | | | | | | | | | | | | | | | <table border="1" style="width: 100%; border-collapse: collapse; text-align: center;"> <tr> <td style="width: 10%;"></td> <td style="width: 10%;"></td> <td style="width: 10%;"></td> <td style="width: 10%;"></td> <td style="width: 10%;"></td> <td style="width: 10%;"></td> <td style="width: 10%;"></td> <td style="width: 10%;"></td> <td style="width: 10%;"></td> <td style="width: 10%;"></td> </tr> <tr> <td></td> <td></td> <td colspan="8" style="text-align: center;"> <table border="1" style="width: 100%; border-collapse: collapse; text-align: center;"> <tr> <td style="width: 10%;"></td> <td style="width: 10%;"></td> <td style="width: 10%;"></td> <td style="width: 10%;"></td> <td style="width: 10%;"></td> <td style="width: 10%;"></td> <td style="width: 10%;"></td> <td style="width: 10%;"></td> <td style="width: 10%;"></td> <td style="width: 10%;"></td> </tr> <tr> <td></td> <td></td> <td colspan="8" style="text-align: center;"> <table border="1" style="width: 100%; border-collapse: collapse; text-align: center;"> <tr> <td style="width: 10%;"></td> <td style="width: 10%;"></td> <td style="width: 10%;"></td> <td style="width: 10%;"></td> <td style="width: 10%;"></td> <td style="width: 10%;"></td> <td style="width: 10%;"></td> <td style="width: 10%;"></td> <td style="width: 10%;"></td> <td style="width: 10%;"></td> </tr> <tr> <td></td> <td></td> <td colspan="8" style="text-align: center;"> <table border="1" style="width: 100%; border-collapse: collapse; text-align: center;"> <tr> <td style="width: 10%;"></td> <td style="width: 10%;"></td> <td style="width: 10%;"></td> <td style="width: 10%;"></td> <td style="width: 10%;"></td> <td style="width: 10%;"></td> <td style="width: 10%;"></td> <td style="width: 10%;"></td> <td style="width: 10%;"></td> <td style="width: 10%;"></td> </tr> <tr> <td></td> <td></td> <td colspan="8" style="text-align: center;"> <table border="1" style="width: 100%; border-collapse: collapse; text-align: center;"> <tr> <td style="width: 10%;"></td> <td style="width: 10%;"></td> <td style="width: 10%;"></td> <td style="width: 10%;"></td> <td style="width: 10%;"></td> <td style="width: 10%;"></td> <td style="width: 10%;"></td> <td style="width: 10%;"></td> <td style="width: 10%;"></td> <td style="width: 10%;"></td> </tr> <tr> <td></td> <td></td> <td colspan="8" style="text-align: center;"> <table border="1" style="width: 100%; border-collapse: collapse; text-align: center;"> <tr> <td style="width: 10%;"></td> <td style="width: 10%;"></td> <td style="width: 10%;"></td> <td style="width: 10%;"></td> <td style="width: 10%;"></td> <td style="width: 10%;"></td> <td style="width: 10%;"></td> <td style="width: 10%;"></td> <td style="width: 10%;"></td> <td style="width: 10%;"></td> </tr> <tr> <td></td> <td></td> <td colspan="8" style="text-align: center;"> <table border="1" style="width: 100%; border-collapse: collapse; text-align: center;"> <tr> <td style="width: 10%;"></td> <td style="width: 10%;"></td> <td style="width: 10%;"></td> <td style="width: 10%;"></td> <td style="width: 10%;"></td> <td style="width: 10%;"></td> <td style="width: 10%;"></td> <td style="width: 10%;"></td> <td style="width: 10%;"></td> <td style="width: 10%;"></td> </tr> <tr> <td></td> <td></td> <td colspan="8" style="text-align: center;"> <table border="1" style="width: 100%; border-collapse: collapse; text-align: center;"> <tr> <td style="width: 10%;"></td> <td style="width:
10%;"></td> <td style="width: 10%;"></td> <td style="width: 10%;"></td> <td style="width: 10%;"></td> <td style="width: 10%;"></td> <td style="width: 10%;"></td> <td style="width: 10%;"></td> <td style="width: 10%;"></td> <td style="width: 10%;"></td> </tr> <tr> <td></td> <td></td> <td colspan="8" style="text-align: center;"> <table border="1" style="width: 100%; border-collapse: collapse; text-align: center;"> <tr> <td style="width: 10%;"></td> <td style="width: 10%;"></td> <td style="width: 10%;"></td> <td style="width: 10%;"></td> <td style="width: 10%;"></td> <td style="width: 10%;"></td> <td style="width: 10%;"></td> <td style="width: 10%;"></td> <td style="width: 10%;"></td> <td style="width: 10%;"></td> </tr> <tr> <td></td> <td></td> <td colspan="8" style="text-align: center;"> <table border="1" style="width: 100%; border-collapse: collapse; text-align: center;"> <tr> <td style="width: 10%;"></td> <td style="width: 10%;"></td> <td style="width: 10%;"></td> <td style="width: 10%;"></td> <td style="width: 10%;"></td> <td style="width: 10%;"></td> <td style="width: 10%;"></td> <td style="width: 10%;"></td> <td style="width: 10%;"></td> <td style="width: 10%;"></td> </tr> <tr> <td></td> <td></td> <td colspan="8" style="text-align: center;"> <table border="1" style="width: 100%; border-collapse: collapse; text-align: center;"> <tr> <td style="width: 10%;"></td> <td style="width: 10%;"></td> <td style="width: 10%;"></td> <td style="width: 10%;"></td> <td style="width: 10%;"></td> <td style="width: 10%;"></td> <td style="width: 10%;"></td> <td style="width: 10%;"></td> <td style="width: 10%;"></td> <td style="width: 10%;"></td> </tr> <tr> <td></td> <td></td> <td colspan="8" style="text-align: center;"> <table border="1" style="width: 100%; border-collapse: collapse; text-align: center;"> <tr> <td style="width: 10%;"></td> <td style="width: 10%;"></td> <td style="width: 10%;"></td> <td style="width: 10%;"></td> <td style="width: 10%;"></td> <td style="width: 10%;"></td> <td style="width: 10%;"></td> <td style="width: 10%;"></td> <td style="width: 10%;"></td> <td style="width: 10%;"></td> </tr> <tr> <td></td> <td></td> <td colspan="8" style="text-align: center;"> <table border="1" style="width: 100%; border-collapse: collapse; text-align: center;"> <tr> <td style="width: 10%;"></td> <td style="width: 10%;"></td> <td style="width: 10%;"></td> <td style="width: 10%;"></td> <td style="width: 10%;"></td> <td style="width: 10%;"></td> <td style="width: 10%;"></td> <td style="width: 10%;"></td> <td style="width: 10%;"></td> <td style="width: 10%;"></td> </tr> <tr> <td></td> <td></td> <td colspan="8" style="text-align: center;"> <table border="1" style="width: 100%; border-collapse: collapse; text-align: center;"> <tr> <td style="width: 10%;"></td> <td style="width: 10%;"></td> <td style="width: 10%;"></td> <td style="width: 10%;"></td> <td style="width: 10%;"></td> <td style="width: 10%;"></td> <td style="width: 10%;"></td> <td style="width: 10%;"></td> <td style="width: 10%;"></td> <td style="width: 10%;"></td> </tr> <tr> <td></td> <td></td> <td colspan="8" style="text-align: center;"> <table border="1" style="width: 100%; border-collapse: collapse; text-align: center;"> <tr> <td style="width: 10%;"></td> <td style="width: 10%;"></td> <td style="width: 10%;"></td> <td style="width: 10%;"></td> <td style="width: 10%;"></td> <td style="width: 10%;"></td> <td style="width: 10%;"></td> <td style="width: 10%;"></td> <td style="width: 10%;"></td> <td style="width: 10%;"></td> </tr> <tr> <td></td> <td></td> <td colspan="8" style="text-align: center;"> <table border="1" style="width: 100%; border-collapse: collapse; text-align: center;"> <tr> <td style="width: 10%;"></td> <td style="width: 10%;"></td> <td style="width: 10%;"></td> <td style="width: 10%;"></td> <td style="width: 10%;"></td> <td style="width: 10%;"></td> <td style="width: 10%;"></td> <td style="width: 10%;"></td> <td style="width: 10%;"></td> <td style="width: 10%;"></td> </tr> <tr> <td></td> <td></td> <td colspan="8" style="text-align: center;"> <table border="1" style="width: 100%; border-collapse: collapse; text-align: center;"> <tr> <td style="width: 10%;"></td> <td style="width: 10%;"></td> <td style="width: 10%;"></td> <td style="width: 10%;"></td> <td style="width: 10%;"></td> <td style="width: 10%;"></td> <td style="width: 10%;"></td> <td style="width: 10%;"></td> <td style="width: 10%;"></td> <td style="width: 10%;"></td> </tr> <tr> <td></td> <td></td> <td colspan="8" style="text-align: center;"> <table border="1" style="width: 100%; border-collapse: collapse; text-align: center;"> <tr> <td style="width: 10%;"></td> <td style="width: 10%;"></td> <td style="width: 10%;"></td> <td style="width: 10%;"></td> <td style="width: 10%;"></td> <td style="width: 10%;"></td> <td style="width: 10%;"></td> <td style="width: 10%;"></td> <td style="width: 10%;"></td> <td style="width: 10%;"></td> </tr> <tr> <td></td> <td></td> <td colspan="8" style="text-align: center;"> <table border="1" style="width: 100%; border-collapse: collapse; text-align: center;"> <tr> <td style="width: 10%;"></td> <td style="width: 10%;"></td> <td style="width: 10%;"></td> <td style="width: 10%;"></td> <td style="width: 10%;"></td> <td style="width: 10%;"></td> <td style="width: 10%;"></td> <td style="width: 10%;"></td> <td style="width: 10%;"></td> <td style="width: 10%;"></td> </tr> <tr> <td></td> <td></td> <td colspan="8" style="text-align: center;"> <table border="1" style="width: 100%; border-collapse: collapse; text-align: center;"> <tr> <td style="width: 10%;"></td> <td style="width: 10%;"></td> <td style="width: 10%;"></td> <td style="width: 10%;"></td> <td style="width: 10%;"></td> <td style="width: 10%;"></td> <td style="width: 10%;"></td> <td style="width: 10%;"></td> <td style="width: 10%;"></td> <td style="width: 10%;"></td> </tr> <tr> <td></td> <td></td> <td colspan="8" style="text-align: center;"> <table border="1" style="width: 100%; border-collapse: collapse; text-align: center;"> <tr> <td style="width: 10%;"></td> <td style="width: 10%;"></td> <td style="width: 10%;"></td> <td style="width: 10%;"></td> <td style="width: 10%;"></td> <td style="width: 10%;"></td> <td style="width: 10%;"></td> <td style="width: 10%;"></td> <td style="width: 10%;"></td> <td style="width: 10%;"></td> </tr> <tr> <td></td> <td></td> <td colspan="8" style="text-align: center;"> <table border="1" style="width: 100%; border-collapse: collapse; text-align: center;"> <tr> <td style="width: 10%;"></td> <td style="width: 10%;"></td> <td style="width: 10%;"></td> <td style="width: 10%;"></td> <td style="width: 10%;"></td> <td style="width: 10%;"></td> <td style="width: 10%;"></td> <td style="width: 10%;"></td> <td style="width: 10%;"></td> <td style="width: 10%;"></td> </tr> <tr> <td></td> <td></td> <td colspan="8" style="text-align: center;"> <table border="1" style="width: 100%; border-collapse: collapse; text-align: center;"> <tr> <td style="width: 10%;"></td> <td style="width: 10%;"></td> <td style="width: 10%;"></td> <td style="width: 10%;"></td> <td style="width: 10%;"></td> <td style="width: 10%;"></td> <td style="width: 10%;"></td> <td style="width: 10%;"></td> <td style="width: 10%;"></td> <td style="width: 10%;"></td> </tr> <tr> <td></td> <td></td> <td colspan="8" style="text-align: center;"> <table border="1" style="width: 100%; border-collapse: collapse; text-align: center;"> <tr> <td style="width: 10%;"></td> <td style="width: 10%;"></td> <td style="width: 10%;"></td> <td style="width: 10%;"></td> <td style="width: 10%;"></td> <td style="width: 10%;"></td> <td style="width: 10%;"></td> <td style="width: 10%;"></td> <td style="width: 10%;"></td> <td style="width: 10%;"></td> </tr> <tr> <td></td> <td></td> <td colspan="8" style="text-align: center;"> <table border="1" style="width: 100%; border-collapse: collapse; text-align: center;"> <tr> <td style="width: 10%;"></td> <td style="width: 10%;"></td> <td style="width: 10%;"></td> <td style="width: 10%;"></td> <td style="width: 10%;"></td> <td style="width: 10%;"></td> <td style="width: 10%;"></td> <td style="width: 10%;"></td> <td style="width: 10%;"></td> <td style="width: 10%;"></td> </tr> <tr> <td></td> <td></td> <td colspan="8" style="text-align: center;"> <table border="1" style="width: 100%; border-collapse: collapse; text-align: center;"> <tr> <td style="width: 10%;"></td> <td style="width: 10%;"></td> <td style="width: 10%;"></td> <td style="width: 10%;"></td> <td style="width: 10%;"></td> <td style="width: 10%;"></td> <td style="width: 10%;"></td> <td style="width: 10%;"></td> <td style="width: 10%;"></td> <td style="width: 10%;"></td> </tr> <tr> <td></td> <td></td> <td colspan="8" style="text-align: center;"> <table border="1" style="width: 100%; border-collapse: collapse; text-align: center;"> <tr> <td style="width: 10%;"></td> <td style="width: 10%;"></td> <td style="width: 10%;"></td> <td style="width: 10%;"></td> <td style="width: 10%;"></td> <td style="width: 10%;"></td> <td style="width: 10%;"></td> <td style="width: 10%;"></td> <td style="width: 10%;"></td> <td style="width: 10%;"></td> </tr> <tr> <td></td> <td></td> <td colspan="8" style="text-align: center;"> <table border="1" style="width: 100%; border-collapse: collapse; text-align: center;"> <tr> <td style="width: 10%;"></td> <td style="width: 10%;"></td> <td style="width: 10%;"></td> <td style="width: 10%;"></td> <td style="width: 10%;"></td> <td style="width: 10%;"></td> <td style="width: 10%;"></td> <td style="width: 10%;"></td> <td style="width: 10%;"></td> <td style="width: 10%;"></td> </tr> <tr> <td></td> <td></td> <td colspan="8" style="text-align: center;"> <table border="1" style="width: 100%; border-collapse: collapse; text-align: center;"> <tr> <td style="width: 10%;"></td> <td style="width: 10%;"></td> <td style="width: 10%;"></td> <td style="width: 10%;"></td> <td style="width: 10%;"></td> <td style="width: 10%;"></td> <td style="width: 10%;"></td> <td
style="width: 10%;"></td> <td style="width: 10%;"></td> <td style="width: 10%;"></td> </tr> <tr> <td></td> <td></td> <td colspan="8" style="text-align: center;"> <table border="1" style="width: 100%; border-collapse: collapse; text-align: center;"> <tr> <td style="width: 10%;"></td> <td style="width: 10%;"></td> <td style="width: 10%;"></td> <td style="width: 10%;"></td> <td style="width: 10%;"></td> <td style="width: 10%;"></td> <td style="width: 10%;"></td> <td style="width: 10%;"></td> <td style="width: 10%;"></td> <td style="width: 10%;"></td> </tr> <tr> <td></td> <td></td> <td colspan="8" style="text-align: center;"> <table border="1" style="width: 100%; border-collapse: collapse; text-align: center;"> <tr> <td style="width: 10%;"></td> <td style="width: 10%;"></td> <td style="width: 10%;"></td> <td style="width: 10%;"></td> <td style="width: 10%;"></td> <td style="width: 10%;"></td> <td style="width: 10%;"></td> <td style="width: 10%;"></td> <td style="width: 10%;"></td> <td style="width: 10%;"></td> </tr> <tr> <td></td> <td></td> <td colspan="8" style="text-align: center;"> <table border="1" style="width: 100%; border-collapse: collapse; text-align: center;"> <tr> <td style="width: 10%;"></td> <td style="width: 10%;"></td> <td style="width: 10%;"></td> <td style="width: 10%;"></td> <td style="width: 10%;"></td> <td style="width: 10%;"></td> <td style="width: 10%;"></td> <td style="width: 10%;"></td> <td style="width: 10%;"></td> <td style="width: 10%;"></td> </tr> <tr> <td></td> <td></td> <td colspan="8" style="text-align: center;"> <table border="1" style="width: 100%; border-collapse: collapse; text-align: center;"> <tr> <td style="width: 10%;"></td> <td style="width: 10%;"></td> <td style="width: 10%;"></td> <td style="width: 10%;"></td> <td style="width: 10%;"></td> <td style="width: 10%;"></td> <td style="width: 10%;"></td> <td style="width: 10%;"></td> <td style="width: 10%;"></td> <td style="width: 10%;"></td> </tr> <tr> <td></td> <td></td> <td colspan="8" style="text-align: center;"> <table border="1" style="width: 100%; border-collapse: collapse; text-align: center;"> <tr> <td style="width: 10%;"></td> <td style="width: 10%;"></td> <td style="width: 10%;"></td> <td style="width: 10%;"></td> <td style="width: 10%;"></td> <td style="width: 10%;"></td> <td style="width: 10%;"></td> <td style="width: 10%;"></td> <td style="width: 10%;"></td> <td style="width: 10%;"></td> </tr> <tr> <td></td> <td></td> <td colspan="8" style="text-align: center;"> <table border="1" style="width: 100%; border-collapse: collapse; text-align: center;"> <tr> <td style="width: 10%;"></td> <td style="width: 10%;"></td> <td style="width: 10%;"></td> <td style="width: 10%;"></td> <td style="width: 10%;"></td> <td style="width: 10%;"></td> <td style="width: 10%;"></td> <td style="width: 10%;"></td> <td style="width: 10%;"></td> <td style="width: 10%;"></td> </tr> <tr> <td></td> <td></td> <td colspan="8" style="text-align: center;"> <table border="1" style="width: 100%; border-collapse: collapse; text-align: center;"> <tr> <td style="width: 10%;"></td> <td style="width: 10%;"></td> <td style="width: 10%;"></td> <td style="width: 10%;"></td> <td style="width: 10%;"></td> <td style="width: 10%;"></td> <td style="width: 10%;"></td> <td style="width: 10%;"></td> <td style="width: 10%;"></td> <td style="width: 10%;"></td> </tr> <tr> <td></td> <td></td> <td colspan="8" style="text-align: center;"> <table border="1" style="width: 100%; border-collapse: collapse; text-align: center;"> <tr> </tr></table></td></tr></table></td></tr></table></td></tr></table></td></tr></table></td></tr></table></td></tr></table></td></tr></table></td></tr></table></td></tr></table></td></tr></table></td></tr></table></td></tr></table></td></tr></table></td></tr></table></td></tr></table></td></tr></table></td></tr></table></td></tr></table></td></tr></table></td></tr></table></td></tr></table></td></tr></table></td></tr></table></td></tr></table></td></tr></table></td></tr></table></td></tr></table></td></tr></table></td></tr></table></td></tr></table></td></tr></table></td></tr></table></td></tr></table></td></tr></table></td></tr></table></td></tr></table> | | | | | | | | | | | | | | | | | | | | <table border="1" style="width: 100%; border-collapse: collapse; text-align: center;"> <tr> <td style="width: 10%;"></td> <td style="width: 10%;"></td> <td style="width: 10%;"></td> <td style="width: 10%;"></td> <td style="width: 10%;"></td> <td style="width: 10%;"></td> <td style="width: 10%;"></td> <td style="width: 10%;"></td> <td style="width: 10%;"></td> <td style="width: 10%;"></td> </tr> <tr> <td></td> <td></td> <td colspan="8" style="text-align: center;"> <table border="1" style="width: 100%; border-collapse: collapse; text-align: center;"> <tr> <td style="width: 10%;"></td> <td style="width: 10%;"></td> <td style="width: 10%;"></td> <td style="width: 10%;"></td> <td style="width: 10%;"></td> <td style="width: 10%;"></td> <td style="width: 10%;"></td> <td style="width: 10%;"></td> <td style="width: 10%;"></td> <td style="width: 10%;"></td> </tr> <tr> <td></td> <td></td> <td colspan="8" style="text-align: center;"> <table border="1" style="width: 100%; border-collapse: collapse; text-align: center;"> <tr> <td style="width: 10%;"></td> <td style="width: 10%;"></td> <td style="width: 10%;"></td> <td style="width: 10%;"></td> <td style="width: 10%;"></td> <td style="width: 10%;"></td> <td style="width: 10%;"></td> <td style="width: 10%;"></td> <td style="width: 10%;"></td> <td style="width: 10%;"></td> </tr> <tr> <td></td> <td></td> <td colspan="8" style="text-align: center;"> <table border="1" style="width: 100%; border-collapse: collapse; text-align: center;"> <tr> <td style="width: 10%;"></td> <td style="width: 10%;"></td> <td style="width: 10%;"></td> <td style="width: 10%;"></td> <td style="width: 10%;"></td> <td style="width: 10%;"></td> <td style="width: 10%;"></td> <td style="width: 10%;"></td> <td style="width: 10%;"></td> <td style="width: 10%;"></td> </tr> <tr> <td></td> <td></td> <td colspan="8" style="text-align: center;"> <table border="1" style="width: 100%; border-collapse: collapse; text-align: center;"> <tr> <td style="width: 10%;"></td> <td style="width: 10%;"></td> <td style="width: 10%;"></td> <td style="width: 10%;"></td> <td style="width: 10%;"></td> <td style="width: 10%;"></td> <td style="width: 10%;"></td> <td style="width: 10%;"></td> <td style="width: 10%;"></td> <td style="width: 10%;"></td> </tr> <tr> <td></td> <td></td> <td colspan="8" style="text-align: center;"> <table border="1" style="width: 100%; border-collapse: collapse; text-align: center;"> <tr> <td style="width: 10%;"></td> <td style="width: 10%;"></td> <td style="width: 10%;"></td> <td style="width: 10%;"></td> <td style="width: 10%;"></td> <td style="width: 10%;"></td> <td style="width: 10%;"></td> <td style="width: 10%;"></td> <td style="width: 10%;"></td> <td style="width: 10%;"></td> </tr> <tr> <td></td> <td></td> <td colspan="8" style="text-align: center;"> <table border="1" style="width: 100%; border-collapse: collapse; text-align: center;"> <tr> <td style="width: 10%;"></td> <td style="width: 10%;"></td> <td style="width: 10%;"></td> <td style="width: 10%;"></td> <td style="width: 10%;"></td> <td style="width: 10%;"></td> <td style="width: 10%;"></td> <td style="width: 10%;"></td> <td style="width: 10%;"></td> <td style="width: 10%;"></td> </tr> <tr> <td></td> <td></td> <td colspan="8" style="text-align: center;"> <table border="1" style="width: 100%;
border-collapse: collapse; text-align: center;"> <tr> <td style="width: 10%;"></td> <td style="width: 10%;"></td> <td style="width: 10%;"></td> <td style="width: 10%;"></td> <td style="width: 10%;"></td> <td style="width: 10%;"></td> <td style="width: 10%;"></td> <td style="width: 10%;"></td> <td style="width: 10%;"></td> <td style="width: 10%;"></td> </tr> <tr> <td></td> <td></td> <td colspan="8" style="text-align: center;"> <table border="1" style="width: 100%; border-collapse: collapse; text-align: center;"> <tr> <td style="width: 10%;"></td> <td style="width: 10%;"></td> <td style="width: 10%;"></td> <td style="width: 10%;"></td> <td style="width: 10%;"></td> <td style="width: 10%;"></td> <td style="width: 10%;"></td> <td style="width: 10%;"></td> <td style="width: 10%;"></td> <td style="width: 10%;"></td> </tr> <tr> <td></td> <td></td> <td colspan="8" style="text-align: center;"> <table border="1" style="width: 100%; border-collapse: collapse; text-align: center;"> <tr> <td style="width: 10%;"></td> <td style="width: 10%;"></td> <td style="width: 10%;"></td> <td style="width: 10%;"></td> <td style="width: 10%;"></td> <td style="width: 10%;"></td> <td style="width: 10%;"></td> <td style="width: 10%;"></td> <td style="width: 10%;"></td> <td style="width: 10%;"></td> </tr> <tr> <td></td> <td></td> <td colspan="8" style="text-align: center;"> <table border="1" style="width: 100%; border-collapse: collapse; text-align: center;"> <tr> <td style="width: 10%;"></td> <td style="width: 10%;"></td> <td style="width: 10%;"></td> <td style="width: 10%;"></td> <td style="width: 10%;"></td> <td style="width: 10%;"></td> <td style="width: 10%;"></td> <td style="width: 10%;"></td> <td style="width: 10%;"></td> <td style="width: 10%;"></td> </tr> <tr> <td></td> <td></td> <td colspan="8" style="text-align: center;"> <table border="1" style="width: 100%; border-collapse: collapse; text-align: center;"> <tr> <td style="width: 10%;"></td> <td style="width: 10%;"></td> <td style="width: 10%;"></td> <td style="width: 10%;"></td> <td style="width: 10%;"></td> <td style="width: 10%;"></td> <td style="width: 10%;"></td> <td style="width: 10%;"></td> <td style="width: 10%;"></td> <td style="width: 10%;"></td> </tr> <tr> <td></td> <td></td> <td colspan="8" style="text-align: center;"> <table border="1" style="width: 100%; border-collapse: collapse; text-align: center;"> <tr> <td style="width: 10%;"></td> <td style="width: 10%;"></td> <td style="width: 10%;"></td> <td style="width: 10%;"></td> <td style="width: 10%;"></td> <td style="width: 10%;"></td> <td style="width: 10%;"></td> <td style="width: 10%;"></td> <td style="width: 10%;"></td> <td style="width: 10%;"></td> </tr> <tr> <td></td> <td></td> <td colspan="8" style="text-align: center;"> <table border="1" style="width: 100%; border-collapse: collapse; text-align: center;"> <tr> <td style="width: 10%;"></td> <td style="width: 10%;"></td> <td style="width: 10%;"></td> <td style="width: 10%;"></td> <td style="width: 10%;"></td> <td style="width: 10%;"></td> <td style="width: 10%;"></td> <td style="width: 10%;"></td> <td style="width: 10%;"></td> <td style="width: 10%;"></td> </tr> <tr> <td></td> <td></td> <td colspan="8" style="text-align: center;"> <table border="1" style="width: 100%; border-collapse: collapse; text-align: center;"> <tr> <td style="width: 10%;"></td> <td style="width: 10%;"></td> <td style="width: 10%;"></td> <td style="width: 10%;"></td> <td style="width: 10%;"></td> <td style="width: 10%;"></td> <td style="width: 10%;"></td> <td style="width: 10%;"></td> <td style="width: 10%;"></td> <td style="width: 10%;"></td> </tr> <tr> <td></td> <td></td> <td colspan="8" style="text-align: center;"> <table border="1" style="width: 100%; border-collapse: collapse; text-align: center;"> <tr> <td style="width: 10%;"></td> <td style="width: 10%;"></td> <td style="width: 10%;"></td> <td style="width: 10%;"></td> <td style="width: 10%;"></td> <td style="width: 10%;"></td> <td style="width: 10%;"></td> <td style="width: 10%;"></td> <td style="width: 10%;"></td> <td style="width: 10%;"></td> </tr> <tr> <td></td> <td></td> <td colspan="8" style="text-align: center;"> <table border="1" style="width: 100%; border-collapse: collapse; text-align: center;"> <tr> <td style="width: 10%;"></td> <td style="width: 10%;"></td> <td style="width: 10%;"></td> <td style="width: 10%;"></td> <td style="width: 10%;"></td> <td style="width: 10%;"></td> <td style="width: 10%;"></td> <td style="width: 10%;"></td> <td style="width: 10%;"></td> <td style="width: 10%;"></td> </tr> <tr> <td></td> <td></td> <td colspan="8" style="text-align: center;"> <table border="1" style="width: 100%; border-collapse: collapse; text-align: center;"> <tr> <td style="width: 10%;"></td> <td style="width: 10%;"></td> <td style="width: 10%;"></td> <td style="width: 10%;"></td> <td style="width: 10%;"></td> <td style="width: 10%;"></td> <td style="width: 10%;"></td> <td style="width: 10%;"></td> <td style="width: 10%;"></td> <td style="width: 10%;"></td> </tr> <tr> <td></td> <td></td> <td colspan="8" style="text-align: center;"> <table border="1" style="width: 100%; border-collapse: collapse; text-align: center;"> <tr> <td style="width: 10%;"></td> <td style="width: 10%;"></td> <td style="width: 10%;"></td> <td style="width: 10%;"></td> <td style="width: 10%;"></td> <td style="width: 10%;"></td> <td style="width: 10%;"></td> <td style="width: 10%;"></td> <td style="width: 10%;"></td> <td style="width: 10%;"></td> </tr> <tr> <td></td> <td></td> <td colspan="8" style="text-align: center;"> <table border="1" style="width: 100%; border-collapse: collapse; text-align: center;"> <tr> <td style="width: 10%;"></td> <td style="width: 10%;"></td> <td style="width: 10%;"></td> <td style="width: 10%;"></td> <td style="width: 10%;"></td> <td style="width: 10%;"></td> <td style="width: 10%;"></td> <td style="width: 10%;"></td> <td style="width: 10%;"></td> <td style="width: 10%;"></td> </tr> <tr> <td></td> <td></td> <td colspan="8" style="text-align: center;"> <table border="1" style="width: 100%; border-collapse: collapse; text-align: center;"> <tr> <td style="width: 10%;"></td> <td style="width: 10%;"></td> <td style="width: 10%;"></td> <td style="width: 10%;"></td> <td style="width: 10%;"></td> <td style="width: 10%;"></td> <td style="width: 10%;"></td> <td style="width: 10%;"></td> <td style="width: 10%;"></td> <td style="width: 10%;"></td> </tr> <tr> <td></td> <td></td> <td colspan="8" style="text-align: center;"> <table border="1" style="width: 100%; border-collapse: collapse; text-align: center;"> <tr> <td style="width: 10%;"></td> <td style="width: 10%;"></td> <td style="width: 10%;"></td> <td style="width: 10%;"></td> <td style="width: 10%;"></td> <td style="width: 10%;"></td> <td style="width: 10%;"></td> <td style="width: 10%;"></td> <td style="width: 10%;"></td> <td style="width: 10%;"></td> </tr> <tr> <td></td> <td></td> <td colspan="8" style="text-align: center;"> <table border="1" style="width: 100%; border-collapse: collapse; text-align: center;"> <tr> <td style="width: 10%;"></td> <td style="width: 10%;"></td> <td style="width: 10%;"></td> <td style="width: 10%;"></td> <td style="width: 10%;"></td> <td style="width: 10%;"></td> <td style="width: 10%;"></td> <td style="width: 10%;"></td> <td style="width: 10%;"></td> <td style="width: 10%;"></td> </tr> <tr> <td></td> <td></td> <td colspan="8" style="text-align: center;"> <table border="1" style="width: 100%; border-collapse: collapse; text-align: center;"> <tr> <td style="width: 10%;"></td> <td style="width: 10%;"></td> <td style="width: 10%;"></td> <td style="width: 10%;"></td> <td style="width: 10%;"></td> <td style="width: 10%;"></td> <td style="width: 10%;"></td> <td style="width: 10%;"></td> <td style="width: 10%;"></td> <td style="width: 10%;"></td> </tr> <tr> <td></td> <td></td> <td colspan="8" style="text-align: center;"> <table border="1" style="width: 100%; border-collapse: collapse; text-align: center;"> <tr> <td style="width: 10%;"></td> <td style="width: 10%;"></td> <td style="width: 10%;"></td> <td style="width: 10%;"></td> <td style="width: 10%;"></td> <td style="width: 10%;"></td> <td style="width: 10%;"></td> <td style="width: 10%;"></td> <td style="width: 10%;"></td> <td style="width: 10%;"></td> </tr> <tr> <td></td> <td></td> <td colspan="8" style="text-align: center;"> <table border="1" style="width: 100%; border-collapse: collapse; text-align: center;"> <tr> <td style="width: 10%;"></td> <td style="width: 10%;"></td> <td style="width: 10%;"></td> <td style="width: 10%;"></td> <td style="width: 10%;"></td> <td style="width: 10%;"></td> <td style="width: 10%;"></td> <td style="width: 10%;"></td> <td style="width: 10%;"></td> <td style="width: 10%;"></td> </tr> <tr> <td></td> <td></td> <td colspan="8" style="text-align: center;"> <table border="1" style="width: 100%; border-collapse: collapse; text-align: center;"> <tr> <td style="width: 10%;"></td> <td style="width: 10%;"></td> <td style="width: 10%;"></td> <td style="width: 10%;"></td> <td style="width: 10%;"></td> <td style="width: 10%;"></td> <td style="width: 10%;"></td> <td style="width: 10%;"></td> <td style="width: 10%;"></td> <td style="width: 10%;"></td> </tr> <tr> <td></td> <td></td> <td colspan="8" style="text-align: center;"> <table border="1" style="width: 100%; border-collapse: collapse; text-align: center;"> <tr> <td style="width: 10%;"></td> <td style="width: 10%;"></td> <td style="width: 10%;"></td> <td style="width: 10%;"></td> <td style="width: 10%;"></td> <td style="width: 10%;"></td> <td style="width: 10%;"></td> <td style="width: 10%;"></td> <td style="width: 10%;"></td> <td style="width: 10%;"></td> </tr> <tr> <td></td> <td></td> <td colspan="8" style="text-align: center;"> <table border="1" style="width: 100%; border-collapse: collapse; text-align: center;"> <tr> <td style="width: 10%;"></td> <td style="width: 10%;"></td> <td style="width: 10%;"></td> <td style="width:
10%;"></td> <td style="width: 10%;"></td> <td style="width: 10%;"></td> <td style="width: 10%;"></td> <td style="width: 10%;"></td> <td style="width: 10%;"></td> <td style="width: 10%;"></td> </tr> <tr> <td></td> <td></td> <td colspan="8" style="text-align: center;"> <table border="1" style="width: 100%; border-collapse: collapse; text-align: center;"> <tr> <td style="width: 10%;"></td> <td style="width: 10%;"></td> <td style="width: 10%;"></td> <td style="width: 10%;"></td> <td style="width: 10%;"></td> <td style="width: 10%;"></td> <td style="width: 10%;"></td> <td style="width: 10%;"></td> <td style="width: 10%;"></td> <td style="width: 10%;"></td> </tr> <tr> <td></td> <td></td> <td colspan="8" style="text-align: center;"> <table border="1" style="width: 100%; border-collapse: collapse; text-align: center;"> <tr> <td style="width: 10%;"></td> <td style="width: 10%;"></td> <td style="width: 10%;"></td> <td style="width: 10%;"></td> <td style="width: 10%;"></td> <td style="width: 10%;"></td> <td style="width: 10%;"></td> <td style="width: 10%;"></td> <td style="width: 10%;"></td> <td style="width: 10%;"></td> </tr> <tr> <td></td> <td></td> <td colspan="8" style="text-align: center;"> <table border="1" style="width: 100%; border-collapse: collapse; text-align: center;"> <tr> <td style="width: 10%;"></td> <td style="width: 10%;"></td> <td style="width: 10%;"></td> <td style="width: 10%;"></td> <td style="width: 10%;"></td> <td style="width: 10%;"></td> <td style="width: 10%;"></td> <td style="width: 10%;"></td> <td style="width: 10%;"></td> <td style="width: 10%;"></td> </tr> <tr> <td></td> <td></td> <td colspan="8" style="text-align: center;"> <table border="1" style="width: 100%; border-collapse: collapse; text-align: center;"> <tr> <td style="width: 10%;"></td> <td style="width: 10%;"></td> <td style="width: 10%;"></td> <td style="width: 10%;"></td> <td style="width: 10%;"></td> <td style="width: 10%;"></td> <td style="width: 10%;"></td> <td style="width: 10%;"></td> <td style="width: 10%;"></td> <td style="width: 10%;"></td> </tr> <tr> <td></td> <td></td> <td colspan="8" style="text-align: center;"> <table border="1" style="width: 100%; border-collapse: collapse; text-align: center;"> <tr> <td style="width: 10%;"></td> <td style="width: 10%;"></td> <td style="width: 10%;"></td> <td style="width: 10%;"></td> <td style="width: 10%;"></td> <td style="width: 10%;"></td> <td style="width: 10%;"></td> <td style="width: 10%;"></td> <td style="width: 10%;"></td> <td style="width: 10%;"></td> </tr> <tr> <td></td> <td></td> <td colspan="8" style="text-align: center;"> <table border="1" style="width: 100%; border-collapse: collapse; text-align: center;"> <tr> <td style="width: 10%;"></td> <td style="width: 10%;"></td> <td style="width: 10%;"></td> <td style="width: 10%;"></td> <td style="width: 10%;"></td> <td style="width: 10%;"></td> <td style="width: 10%;"></td> <td style="width: 10%;"></td> <td style="width: 10%;"></td> <td style="width: 10%;"></td> </tr> <tr> <td></td> <td></td> <td colspan="8" style="text-align: center;"> <table border="1" style="width: 100%; border-collapse: collapse; text-align: center;"> <tr> </tr></table></td></tr></table></td></tr></table></td></tr></table></td></tr></table></td></tr></table></td></tr></table></td></tr></table></td></tr></table></td></tr></table></td></tr></table></td></tr></table></td></tr></table></td></tr></table></td></tr></table></td></tr></table></td></tr></table></td></tr></table></td></tr></table></td></tr></table></td></tr></table></td></tr></table></td></tr></table></td></tr></table></td></tr></table></td></tr></table></td></tr></table></td></tr></table></td></tr></table></td></tr></table></td></tr></table></td></tr></table></td></tr></table></td></tr></table></td></tr></table></td></tr></table> | | | | | | | | | | | | | | | | | | | | <table border="1" style="width: 100%; border-collapse: collapse; text-align: center;"> <tr> <td style="width: 10%;"></td> <td style="width: 10%;"></td> <td style="width: 10%;"></td> <td style="width: 10%;"></td> <td style="width: 10%;"></td> <td style="width: 10%;"></td> <td style="width: 10%;"></td> <td style="width: 10%;"></td> <td style="width: 10%;"></td> <td style="width: 10%;"></td> </tr> <tr> <td></td> <td></td> <td colspan="8" style="text-align: center;"> <table border="1" style="width: 100%; border-collapse: collapse; text-align: center;"> <tr> <td style="width: 10%;"></td> <td style="width: 10%;"></td> <td style="width: 10%;"></td> <td style="width: 10%;"></td> <td style="width: 10%;"></td> <td style="width: 10%;"></td> <td style="width: 10%;"></td> <td style="width: 10%;"></td> <td style="width: 10%;"></td> <td style="width: 10%;"></td> </tr> <tr> <td></td> <td></td> <td colspan="8" style="text-align: center;"> <table border="1" style="width: 100%; border-collapse: collapse; text-align: center;"> <tr> <td style="width: 10%;"></td> <td style="width: 10%;"></td> <td style="width: 10%;"></td> <td style="width: 10%;"></td> <td style="width: 10%;"></td> <td style="width: 10%;"></td> <td style="width: 10%;"></td> <td style="width: 10%;"></td> <td style="width: 10%;"></td> <td style="width: 10%;"></td> </tr> <tr> <td></td> <td></td> <td colspan="8" style="text-align: center;"> <table border="1" style="width: 100%; border-collapse: collapse; text-align: center;"> <tr> <td style="width: 10%;"></td> <td style="width: 10%;"></td> <td style="width: 10%;"></td> <td style="width: 10%;"></td> <td style="width: 10%;"></td> <td style="width: 10%;"></td> <td style="width: 10%;"></td> <td style="width: 10%;"></td> <td style="width: 10%;"></td> <td style="width: 10%;"></td> </tr> <tr> <td></td> <td></td> <td colspan="8" style="text-align: center;"> <table border="1" style="width: 100%; border-collapse: collapse; text-align: center;"> <tr> <td style="width: 10%;"></td> <td style="width: 10%;"></td> <td style="width: 10%;"></td> <td style="width: 10%;"></td> <td style="width: 10%;"></td> <td style="width: 10%;"></td> <td style="width: 10%;"></td> <td style="width: 10%;"></td> <td style="width: 10%;"></td> <td style="width: 10%;"></td> </tr> <tr> <td></td> <td></td> <td colspan="8" style="text-align: center;"> <table border="1" style="width: 100%; border-collapse: collapse; text-align: center;"> <tr> <td style="width: 10%;"></td> <td style="width: 10%;"></td> <td style="width: 10%;"></td> <td style="width: 10%;"></td> <td style="width: 10%;"></td> <td style="width: 10%;"></td> <td style="width: 10%;"></td> <td style="width: 10%;"></td> <td style="width: 10%;"></td> <td style="width: 10%;"></td> </tr> <tr> <td></td> <td></td> <td colspan="8" style="text-align: center;"> <table border="1" style="width: 100%; border-collapse: collapse; text-align: center;"> <tr> <td style="width: 10%;"></td> <td style="width: 10%;"></td> <td style="width: 10%;"></td> <td style="width: 10%;"></td> <td style="width: 10%;"></td> <td style="width: 10%;"></td> <td style="width: 10%;"></td> <td style="width: 10%;"></td> <td style="width: 10%;"></td> <td style="width: 10%;"></td> </tr> <tr> <td></td> <td></td> <td colspan="8" style="text-align: center;"> <table border="1" style="width: 100%; border-collapse: collapse; text-align: center;"> <tr> <td style="width: 10%;"></td> <td style="width: 10%;"></td> <td style="width: 10%;"></td> <td style="width: 10%;"></td> <td style="width: 10%;"></td> <td style="width: 10%;"></td> <td style="width: 10%;"></td> <td style="width: 10%;"></td> <td style="width: 10%;"></td> <td style="width: 10%;"></td> </tr> <tr> <td></td> <td></td>
<td colspan="8" style="text-align: center;"> <table border="1" style="width: 100%; border-collapse: collapse; text-align: center;"> <tr> <td style="width: 10%;"></td> <td style="width: 10%;"></td> <td style="width: 10%;"></td> <td style="width: 10%;"></td> <td style="width: 10%;"></td> <td style="width: 10%;"></td> <td style="width: 10%;"></td> <td style="width: 10%;"></td> <td style="width: 10%;"></td> <td style="width: 10%;"></td> </tr> <tr> <td></td> <td></td> <td colspan="8" style="text-align: center;"> <table border="1" style="width: 100%; border-collapse: collapse; text-align: center;"> <tr> <td style="width: 10%;"></td> <td style="width: 10%;"></td> <td style="width: 10%;"></td> <td style="width: 10%;"></td> <td style="width: 10%;"></td> <td style="width: 10%;"></td> <td style="width: 10%;"></td> <td style="width: 10%;"></td> <td style="width: 10%;"></td> <td style="width: 10%;"></td> </tr> <tr> <td></td> <td></td> <td colspan="8" style="text-align: center;"> <table border="1" style="width: 100%; border-collapse: collapse; text-align: center;"> <tr> <td style="width: 10%;"></td> <td style="width: 10%;"></td> <td style="width: 10%;"></td> <td style="width: 10%;"></td> <td style="width: 10%;"></td> <td style="width: 10%;"></td> <td style="width: 10%;"></td> <td style="width: 10%;"></td> <td style="width: 10%;"></td> <td style="width: 10%;"></td> </tr> <tr> <td></td> <td></td> <td colspan="8" style="text-align: center;"> <table border="1" style="width: 100%; border-collapse: collapse; text-align: center;"> <tr> <td style="width: 10%;"></td> <td style="width: 10%;"></td> <td style="width: 10%;"></td> <td style="width: 10%;"></td> <td style="width: 10%;"></td> <td style="width: 10%;"></td> <td style="width: 10%;"></td> <td style="width: 10%;"></td> <td style="width: 10%;"></td> <td style="width: 10%;"></td> </tr> <tr> <td></td> <td></td> <td colspan="8" style="text-align: center;"> <table border="1" style="width: 100%; border-collapse: collapse; text-align: center;"> <tr> <td style="width: 10%;"></td> <td style="width: 10%;"></td> <td style="width: 10%;"></td> <td style="width: 10%;"></td> <td style="width: 10%;"></td> <td style="width: 10%;"></td> <td style="width: 10%;"></td> <td style="width: 10%;"></td> <td style="width: 10%;"></td> <td style="width: 10%;"></td> </tr> <tr> <td></td> <td></td> <td colspan="8" style="text-align: center;"> <table border="1" style="width: 100%; border-collapse: collapse; text-align: center;"> <tr> <td style="width: 10%;"></td> <td style="width: 10%;"></td> <td style="width: 10%;"></td> <td style="width: 10%;"></td> <td style="width: 10%;"></td> <td style="width: 10%;"></td> <td style="width: 10%;"></td> <td style="width: 10%;"></td> <td style="width: 10%;"></td> <td style="width: 10%;"></td> </tr> <tr> <td></td> <td></td> <td colspan="8" style="text-align: center;"> <table border="1" style="width: 100%; border-collapse: collapse; text-align: center;"> <tr> <td style="width: 10%;"></td> <td style="width: 10%;"></td> <td style="width: 10%;"></td> <td style="width: 10%;"></td> <td style="width: 10%;"></td> <td style="width: 10%;"></td> <td style="width: 10%;"></td> <td style="width: 10%;"></td> <td style="width: 10%;"></td> <td style="width: 10%;"></td> </tr> <tr> <td></td> <td></td> <td colspan="8" style="text-align: center;"> <table border="1" style="width: 100%; border-collapse: collapse; text-align: center;"> <tr> <td style="width: 10%;"></td> <td style="width: 10%;"></td> <td style="width: 10%;"></td> <td style="width: 10%;"></td> <td style="width: 10%;"></td> <td style="width: 10%;"></td> <td style="width: 10%;"></td> <td style="width: 10%;"></td> <td style="width: 10%;"></td> <td style="width: 10%;"></td> </tr> <tr> <td></td> <td></td> <td colspan="8" style="text-align: center;"> <table border="1" style="width: 100%; border-collapse: collapse; text-align: center;"> <tr> <td style="width: 10%;"></td> <td style="width: 10%;"></td> <td style="width: 10%;"></td> <td style="width: 10%;"></td> <td style="width: 10%;"></td> <td style="width: 10%;"></td> <td style="width: 10%;"></td> <td style="width: 10%;"></td> <td style="width: 10%;"></td> <td style="width: 10%;"></td> </tr> <tr> <td></td> <td></td> <td colspan="8" style="text-align: center;"> <table border="1" style="width: 100%; border-collapse: collapse; text-align: center;"> <tr> <td style="width: 10%;"></td> <td style="width: 10%;"></td> <td style="width: 10%;"></td> <td style="width: 10%;"></td> <td style="width: 10%;"></td> <td style="width: 10%;"></td> <td style="width: 10%;"></td> <td style="width: 10%;"></td> <td style="width: 10%;"></td> <td style="width: 10%;"></td> </tr> <tr> <td></td> <td></td> <td colspan="8" style="text-align: center;"> <table border="1" style="width: 100%; border-collapse: collapse; text-align: center;"> <tr> <td style="width: 10%;"></td> <td style="width: 10%;"></td> <td style="width: 10%;"></td> <td style="width: 10%;"></td> <td style="width: 10%;"></td> <td style="width: 10%;"></td> <td style="width: 10%;"></td> <td style="width: 10%;"></td> <td style="width: 10%;"></td> <td style="width: 10%;"></td> </tr> <tr> <td></td> <td></td> <td colspan="8" style="text-align: center;"> <table border="1" style="width: 100%; border-collapse: collapse; text-align: center;"> <tr> <td style="width: 10%;"></td> <td style="width: 10%;"></td> <td style="width: 10%;"></td> <td style="width: 10%;"></td> <td style="width: 10%;"></td> <td style="width: 10%;"></td> <td style="width: 10%;"></td> <td style="width: 10%;"></td> <td style="width: 10%;"></td> <td style="width: 10%;"></td> </tr> <tr> <td></td> <td></td> <td colspan="8" style="text-align: center;"> <table border="1" style="width: 100%; border-collapse: collapse; text-align: center;"> <tr> <td style="width: 10%;"></td> <td style="width: 10%;"></td> <td style="width: 10%;"></td> <td style="width: 10%;"></td> <td style="width: 10%;"></td> <td style="width: 10%;"></td> <td style="width: 10%;"></td> <td style="width: 10%;"></td> <td style="width: 10%;"></td> <td style="width: 10%;"></td> </tr> <tr> <td></td> <td></td> <td colspan="8" style="text-align: center;"> <table border="1" style="width: 100%; border-collapse: collapse; text-align: center;"> <tr> <td style="width: 10%;"></td> <td style="width: 10%;"></td> <td style="width: 10%;"></td> <td style="width: 10%;"></td> <td style="width: 10%;"></td> <td style="width: 10%;"></td> <td style="width: 10%;"></td> <td style="width: 10%;"></td> <td style="width: 10%;"></td> <td style="width: 10%;"></td> </tr> <tr> <td></td> <td></td> <td colspan="8" style="text-align: center;"> <table border="1" style="width: 100%; border-collapse: collapse; text-align: center;"> <tr> <td style="width: 10%;"></td> <td style="width: 10%;"></td> <td style="width: 10%;"></td> <td style="width: 10%;"></td> <td style="width: 10%;"></td> <td style="width: 10%;"></td> <td style="width: 10%;"></td> <td style="width: 10%;"></td> <td style="width: 10%;"></td> <td style="width: 10%;"></td> </tr> <tr> <td></td> <td></td> <td colspan="8" style="text-align: center;"> <table border="1" style="width: 100%; border-collapse: collapse; text-align: center;"> <tr> <td style="width: 10%;"></td> <td style="width: 10%;"></td> <td style="width: 10%;"></td> <td style="width: 10%;"></td> <td style="width: 10%;"></td> <td style="width: 10%;"></td> <td style="width: 10%;"></td> <td style="width: 10%;"></td> <td style="width: 10%;"></td> <td style="width: 10%;"></td> </tr> <tr> <td></td> <td></td> <td colspan="8" style="text-align: center;"> <table border="1" style="width: 100%; border-collapse: collapse; text-align: center;"> <tr> <td style="width: 10%;"></td> <td style="width: 10%;"></td> <td style="width: 10%;"></td> <td style="width: 10%;"></td> <td style="width: 10%;"></td> <td style="width: 10%;"></td> <td style="width: 10%;"></td> <td style="width: 10%;"></td> <td style="width: 10%;"></td> <td style="width: 10%;"></td> </tr> <tr> <td></td> <td></td> <td colspan="8" style="text-align: center;"> <table border="1" style="width: 100%; border-collapse: collapse; text-align: center;"> <tr> <td style="width: 10%;"></td> <td style="width: 10%;"></td> <td style="width: 10%;"></td> <td style="width: 10%;"></td> <td style="width: 10%;"></td> <td style="width: 10%;"></td> <td style="width: 10%;"></td> <td style="width: 10%;"></td> <td style="width: 10%;"></td> <td style="width: 10%;"></td> </tr> <tr> <td></td> <td></td> <td colspan="8" style="text-align: center;"> <table border="1" style="width: 100%; border-collapse: collapse; text-align: center;"> <tr> <td style="width: 10%;"></td> <td style="width: 10%;"></td> <td style="width: 10%;"></td> <td style="width: 10%;"></td> <td style="width: 10%;"></td> <td style="width: 10%;"></td> <td style="width: 10%;"></td> <td style="width: 10%;"></td> <td style="width: 10%;"></td> <td style="width: 10%;"></td> </tr> <tr> <td></td> <td></td> <td colspan="8" style="text-align: center;"> <table border="1" style="width: 100%; border-collapse: collapse; text-align: center;"> <tr> <td style="width: 10%;"></td> <td style="width: 10%;"></td> <td style="width: 10%;"></td> <td style="width: 10%;"></td> <td style="width: 10%;"></td> <td style="width: 10%;"></td> <td style="width: 10%;"></td> <td style="width: 10%;"></td> <td style="width: 10%;"></td> <td style="width: 10%;"></td> </tr> <tr> <td></td> <td></td> <td colspan="8" style="text-align: center;"> <table border="1" style="width: 100%; border-collapse: collapse; text-align: center;"> <tr> <td style="width: 10%;"></td> <td style="width: 10%;"></td> <td style="width: 10%;"></td> <td style="width: 10%;"></td> <td style="width: 10%;"></td> <td style="width: 10%;"></td> <td style="width: 10%;"></td> <td style="width: 10%;"></td> <td style="width: 10%;"></td> <td style="width: 10%;"></td> </tr> <tr> <td></td> <td></td> <td colspan="8" style="text-align: center;"> <table border="1" style="width: 100%; border-collapse: collapse; text-align: center;"> <tr> <td style="width: 10%;"></td> <td
style="width: 10%;"></td> <td style="width: 10%;"></td> <td style="width: 10%;"></td> <td style="width: 10%;"></td> <td style="width: 10%;"></td> <td style="width: 10%;"></td> <td style="width: 10%;"></td> <td style="width: 10%;"></td> <td style="width: 10%;"></td> </tr> <tr> <td></td> <td></td> <td colspan="8" style="text-align: center;"> <table border="1" style="width: 100%; border-collapse: collapse; text-align: center;"> <tr> <td style="width: 10%;"></td> <td style="width: 10%;"></td> <td style="width: 10%;"></td> <td style="width: 10%;"></td> <td style="width: 10%;"></td> <td style="width: 10%;"></td> <td style="width: 10%;"></td> <td style="width: 10%;"></td> <td style="width: 10%;"></td> <td style="width: 10%;"></td> </tr> <tr> <td></td> <td></td> <td colspan="8" style="text-align: center;"> <table border="1" style="width: 100%; border-collapse: collapse; text-align: center;"> <tr> <td style="width: 10%;"></td> <td style="width: 10%;"></td> <td style="width: 10%;"></td> <td style="width: 10%;"></td> <td style="width: 10%;"></td> <td style="width: 10%;"></td> <td style="width: 10%;"></td> <td style="width: 10%;"></td> <td style="width: 10%;"></td> <td style="width: 10%;"></td> </tr> <tr> <td></td> <td></td> <td colspan="8" style="text-align: center;"> <table border="1" style="width: 100%; border-collapse: collapse; text-align: center;"> <tr> <td style="width: 10%;"></td> <td style="width: 10%;"></td> <td style="width: 10%;"></td> <td style="width: 10%;"></td> <td style="width: 10%;"></td> <td style="width: 10%;"></td> <td style="width: 10%;"></td> <td style="width: 10%;"></td> <td style="width: 10%;"></td> <td style="width: 10%;"></td> </tr> <tr> <td></td> <td></td> <td colspan="8" style="text-align: center;"> <table border="1" style="width: 100%; border-collapse: collapse; text-align: center;"> <tr> <td style="width: 10%;"></td> <td style="width: 10%;"></td> <td style="width: 10%;"></td> <td style="width: 10%;"></td> <td style="width: 10%;"></td> <td style="width: 10%;"></td> <td style="width: 10%;"></td> <td style="width: 10%;"></td> <td style="width: 10%;"></td> <td style="width: 10%;"></td> </tr> <tr> <td></td> <td></td> <td colspan="8" style="text-align: center;"> <table border="1" style="width: 100%; border-collapse: collapse; text-align: center;"> <tr> </tr></table></td></tr></table></td></tr></table></td></tr></table></td></tr></table></td></tr></table></td></tr></table></td></tr></table></td></tr></table></td></tr></table></td></tr></table></td></tr></table></td></tr></table></td></tr></table></td></tr></table></td></tr></table></td></tr></table></td></tr></table></td></tr></table></td></tr></table></td></tr></table></td></tr></table></td></tr></table></td></tr></table></td></tr></table></td></tr></table></td></tr></table></td></tr></table></td></tr></table></td></tr></table></td></tr></table></td></tr></table></td></tr></table></td></tr></table></td></tr></table> | | | | | | | | | | | | | | | | | | | | <table border="1" style="width: 100%; border-collapse: collapse; text-align: center;"> <tr> <td style="width: 10%;"></td> <td style="width: 10%;"></td> <td style="width: 10%;"></td> <td style="width: 10%;"></td> <td style="width: 10%;"></td> <td style="width: 10%;"></td> <td style="width: 10%;"></td> <td style="width: 10%;"></td> <td style="width: 10%;"></td> <td style="width: 10%;"></td> </tr> <tr> <td></td> <td></td> <td colspan="8" style="text-align: center;"> <table border="1" style="width: 100%; border-collapse: collapse; text-align: center;"> <tr> <td style="width: 10%;"></td> <td style="width: 10%;"></td> <td style="width: 10%;"></td> <td style="width: 10%;"></td> <td style="width: 10%;"></td> <td style="width: 10%;"></td> <td style="width: 10%;"></td> <td style="width: 10%;"></td> <td style="width: 10%;"></td> <td style="width: 10%;"></td> </tr> <tr> <td></td> <td></td> <td colspan="8" style="text-align: center;"> <table border="1" style="width: 100%; border-collapse: collapse; text-align: center;"> <tr> <td style="width: 10%;"></td> <td style="width: 10%;"></td> <td style="width: 10%;"></td> <td style="width: 10%;"></td> <td style="width: 10%;"></td> <td style="width: 10%;"></td> <td style="width: 10%;"></td> <td style="width: 10%;"></td> <td style="width: 10%;"></td> <td style="width: 10%;"></td> </tr> <tr> <td></td> <td></td> <td colspan="8" style="text-align: center;"> <table border="1" style="width: 100%; border-collapse: collapse; text-align: center;"> <tr> <td style="width: 10%;"></td> <td style="width: 10%;"></td> <td style="width: 10%;"></td> <td style="width: 10%;"></td> <td style="width: 10%;"></td> <td style="width: 10%;"></td> <td style="width: 10%;"></td> <td style="width: 10%;"></td> <td style="width: 10%;"></td> <td style="width: 10%;"></td> </tr> <tr> <td></td> <td></td> <td colspan="8" style="text-align: center;"> <table border="1" style="width: 100%; border-collapse: collapse; text-align: center;"> <tr> <td style="width: 10%;"></td> <td style="width: 10%;"></td> <td style="width: 10%;"></td> <td style="width: 10%;"></td> <td style="width: 10%;"></td> <td style="width: 10%;"></td> <td style="width: 10%;"></td> <td style="width: 10%;"></td> <td style="width: 10%;"></td> <td style="width: 10%;"></td> </tr> <tr> <td></td> <td></td> <td colspan="8" style="text-align: center;"> <table border="1" style="width: 100%; border-collapse: collapse; text-align: center;"> <tr> <td style="width: 10%;"></td> <td style="width: 10%;"></td> <td style="width: 10%;"></td> <td style="width: 10%;"></td> <td style="width: 10%;"></td> <td style="width: 10%;"></td> <td style="width: 10%;"></td> <td style="width: 10%;"></td> <td style="width: 10%;"></td> <td style="width: 10%;"></td> </tr> <tr> <td></td> <td></td> <td colspan="8" style="text-align: center;"> <table border="1" style="width: 100%; border-collapse: collapse; text-align: center;"> <tr> <td style="width: 10%;"></td> <td style="width: 10%;"></td> <td style="width: 10%;"></td> <td style="width: 10%;"></td> <td style="width: 10%;"></td> <td style="width: 10%;"></td> <td style="width: 10%;"></td> <td style="width: 10%;"></td> <td style="width: 10%;"></td> <td style="width: 10%;"></td> </tr> <tr> <td></td> <td></td> <td colspan="8" style="text-align: center;"> <table border="1" style="width: 100%; border-collapse: collapse; text-align: center;"> <tr> <td style="width: 10%;"></td> <td style="width: 10%;"></td> <td style="width: 10%;"></td> <td style="width: 10%;"></td> <td style="width: 10%;"></td> <td style="width: 10%;"></td> <td style="width: 10%;"></td> <td style="width: 10%;"></td> <td style="width: 10%;"></td> <td style="width: 10%;"></td> </tr> <tr> <td></td> <td></td> <td colspan="8" style="text-align: center;"> <table border="1" style="width: 100%; border-collapse: collapse; text-align: center;"> <tr> <td style="width: 10%;"></td> <td style="width: 10%;"></td> <td style="width: 10%;"></td> <td style="width: 10%;"></td> <td style="width: 10%;"></td> <td style="width: 10%;"></td> <td style="width: 10%;"></td> <td style="width: 10%;"></td> <td style="width: 10%;"></td> <td style="width: 10%;"></td> </tr> <tr> <td></td> <td></td> <td colspan="8" style="text-align: center;"> <table border="1" style="width: 100%; border-collapse: collapse; text-align: center;"> <tr> <td style="width: 10%;"></td> <td style="width: 10%;"></td> <td style="width: 10%;"></td> <td style="width: 10%;"></td> <td style="width: 10%;"></td> <td style="width: 10%;"></td> <td style="width: 10%;"></td> <td style="width: 10%;"></td> <td style="width: 10%;"></td> <td
style="width: 10%;"></td> </tr> <tr> <td></td> <td></td> <td colspan="8" style="text-align: center;"> <table border="1" style="width: 100%; border-collapse: collapse; text-align: center;"> <tr> <td style="width: 10%;"></td> <td style="width: 10%;"></td> <td style="width: 10%;"></td> <td style="width: 10%;"></td> <td style="width: 10%;"></td> <td style="width: 10%;"></td> <td style="width: 10%;"></td> <td style="width: 10%;"></td> <td style="width: 10%;"></td> <td style="width: 10%;"></td> </tr> <tr> <td></td> <td></td> <td colspan="8" style="text-align: center;"> <table border="1" style="width: 100%; border-collapse: collapse; text-align: center;"> <tr> <td style="width: 10%;"></td> <td style="width: 10%;"></td> <td style="width: 10%;"></td> <td style="width: 10%;"></td> <td style="width: 10%;"></td> <td style="width: 10%;"></td> <td style="width: 10%;"></td> <td style="width: 10%;"></td> <td style="width: 10%;"></td> <td style="width: 10%;"></td> </tr> <tr> <td></td> <td></td> <td colspan="8" style="text-align: center;"> <table border="1" style="width: 100%; border-collapse: collapse; text-align: center;"> <tr> <td style="width: 10%;"></td> <td style="width: 10%;"></td> <td style="width: 10%;"></td> <td style="width: 10%;"></td> <td style="width: 10%;"></td> <td style="width: 10%;"></td> <td style="width: 10%;"></td> <td style="width: 10%;"></td> <td style="width: 10%;"></td> <td style="width: 10%;"></td> </tr> <tr> <td></td> <td></td> <td colspan="8" style="text-align: center;"> <table border="1" style="width: 100%; border-collapse: collapse; text-align: center;"> <tr> <td style="width: 10%;"></td> <td style="width: 10%;"></td> <td style="width: 10%;"></td> <td style="width: 10%;"></td> <td style="width: 10%;"></td> <td style="width: 10%;"></td> <td style="width: 10%;"></td> <td style="width: 10%;"></td> <td style="width: 10%;"></td> <td style="width: 10%;"></td> </tr> <tr> <td></td> <td></td> <td colspan="8" style="text-align: center;"> <table border="1" style="width: 100%; border-collapse: collapse; text-align: center;"> <tr> <td style="width: 10%;"></td> <td style="width: 10%;"></td> <td style="width: 10%;"></td> <td style="width: 10%;"></td> <td style="width: 10%;"></td> <td style="width: 10%;"></td> <td style="width: 10%;"></td> <td style="width: 10%;"></td> <td style="width: 10%;"></td> <td style="width: 10%;"></td> </tr> <tr> <td></td> <td></td> <td colspan="8" style="text-align: center;"> <table border="1" style="width: 100%; border-collapse: collapse; text-align: center;"> <tr> <td style="width: 10%;"></td> <td style="width: 10%;"></td> <td style="width: 10%;"></td> <td style="width: 10%;"></td> <td style="width: 10%;"></td> <td style="width: 10%;"></td> <td style="width: 10%;"></td> <td style="width: 10%;"></td> <td style="width: 10%;"></td> <td style="width: 10%;"></td> </tr> <tr> <td></td> <td></td> <td colspan="8" style="text-align: center;"> <table border="1" style="width: 100%; border-collapse: collapse; text-align: center;"> <tr> <td style="width: 10%;"></td> <td style="width: 10%;"></td> <td style="width: 10%;"></td> <td style="width: 10%;"></td> <td style="width: 10%;"></td> <td style="width: 10%;"></td> <td style="width: 10%;"></td> <td style="width: 10%;"></td> <td style="width: 10%;"></td> <td style="width: 10%;"></td> </tr> <tr> <td></td> <td></td> <td colspan="8" style="text-align: center;"> <table border="1" style="width: 100%; border-collapse: collapse; text-align: center;"> <tr> <td style="width: 10%;"></td> <td style="width: 10%;"></td> <td style="width: 10%;"></td> <td style="width: 10%;"></td> <td style="width: 10%;"></td> <td style="width: 10%;"></td> <td style="width: 10%;"></td> <td style="width: 10%;"></td> <td style="width: 10%;"></td> <td style="width: 10%;"></td> </tr> <tr> <td></td> <td></td> <td colspan="8" style="text-align: center;"> <table border="1" style="width: 100%; border-collapse: collapse; text-align: center;"> <tr> <td style="width: 10%;"></td> <td style="width: 10%;"></td> <td style="width: 10%;"></td> <td style="width: 10%;"></td> <td style="width: 10%;"></td> <td style="width: 10%;"></td> <td style="width: 10%;"></td> <td style="width: 10%;"></td> <td style="width: 10%;"></td> <td style="width: 10%;"></td> </tr> <tr> <td></td> <td></td> <td colspan="8" style="text-align: center;"> <table border="1" style="width: 100%; border-collapse: collapse; text-align: center;"> <tr> <td style="width: 10%;"></td> <td style="width: 10%;"></td> <td style="width: 10%;"></td> <td style="width: 10%;"></td> <td style="width: 10%;"></td> <td style="width: 10%;"></td> <td style="width: 10%;"></td> <td style="width: 10%;"></td> <td style="width: 10%;"></td> <td style="width: 10%;"></td> </tr> <tr> <td></td> <td></td> <td colspan="8" style="text-align: center;"> <table border="1" style="width: 100%; border-collapse: collapse; text-align: center;"> <tr> <td style="width: 10%;"></td> <td style="width: 10%;"></td> <td style="width: 10%;"></td> <td style="width: 10%;"></td> <td style="width: 10%;"></td> <td style="width: 10%;"></td> <td style="width: 10%;"></td> <td style="width: 10%;"></td> <td style="width: 10%;"></td> <td style="width: 10%;"></td> </tr> <tr> <td></td> <td></td> <td colspan="8" style="text-align: center;"> <table border="1" style="width: 100%; border-collapse: collapse; text-align: center;"> <tr> <td style="width: 10%;"></td> <td style="width: 10%;"></td> <td style="width: 10%;"></td> <td style="width: 10%;"></td> <td style="width: 10%;"></td> <td style="width: 10%;"></td> <td style="width: 10%;"></td> <td style="width: 10%;"></td> <td style="width: 10%;"></td> <td style="width: 10%;"></td> </tr> <tr> <td></td> <td></td> <td colspan="8" style="text-align: center;"> <table border="1" style="width: 100%; border-collapse: collapse; text-align: center;"> <tr> <td style="width: 10%;"></td> <td style="width: 10%;"></td> <td style="width: 10%;"></td> <td style="width: 10%;"></td> <td style="width: 10%;"></td> <td style="width: 10%;"></td> <td style="width: 10%;"></td> <td style="width: 10%;"></td> <td style="width: 10%;"></td> <td style="width: 10%;"></td> </tr> <tr> <td></td> <td></td> <td colspan="8" style="text-align: center;"> <table border="1" style="width: 100%; border-collapse: collapse; text-align: center;"> <tr> <td style="width: 10%;"></td> <td style="width: 10%;"></td> <td style="width: 10%;"></td> <td style="width: 10%;"></td> <td style="width: 10%;"></td> <td style="width: 10%;"></td> <td style="width: 10%;"></td> <td style="width: 10%;"></td> <td style="width: 10%;"></td> <td style="width: 10%;"></td> </tr> <tr> <td></td> <td></td> <td colspan="8" style="text-align: center;"> <table border="1" style="width: 100%; border-collapse: collapse; text-align: center;"> <tr> <td style="width: 10%;"></td> <td style="width: 10%;"></td> <td style="width: 10%;"></td> <td style="width: 10%;"></td> <td style="width: 10%;"></td> <td style="width: 10%;"></td> <td style="width: 10%;"></td> <td style="width: 10%;"></td> <td style="width: 10%;"></td> <td style="width: 10%;"></td> </tr> <tr> <td></td> <td></td> <td colspan="8" style="text-align: center;"> <table border="1" style="width: 100%; border-collapse: collapse; text-align: center;"> <tr> <td style="width: 10%;"></td> <td style="width: 10%;"></td> <td style="width: 10%;"></td> <td style="width: 10%;"></td> <td style="width: 10%;"></td> <td style="width: 10%;"></td> <td style="width: 10%;"></td> <td style="width: 10%;"></td> <td style="width: 10%;"></td> <td style="width: 10%;"></td> </tr> <tr> <td></td> <td></td> <td colspan="8" style="text-align: center;"> <table border="1" style="width: 100%; border-collapse: collapse; text-align: center;"> <tr> <td style="width: 10%;"></td> <td style="width: 10%;"></td> <td style="width: 10%;"></td> <td style="width: 10%;"></td> <td style="width: 10%;"></td> <td style="width: 10%;"></td> <td style="width: 10%;"></td> <td style="width: 10%;"></td> <td style="width: 10%;"></td> <td style="width: 10%;"></td> </tr> <tr> <td></td> <td></td> <td colspan="8" style="text-align: center;"> <table border="1" style="width: 100%; border-collapse: collapse; text-align: center;"> <tr> <td style="width: 10%;"></td> <td style="width: 10%;"></td> <td style="width: 10%;"></td> <td style="width: 10%;"></td> <td style="width: 10%;"></td> <td style="width: 10%;"></td> <td style="width: 10%;"></td> <td style="width: 10%;"></td> <td style="width: 10%;"></td> <td style="width: 10%;"></td> </tr> <tr> <td></td> <td></td> <td colspan="8" style="text-align: center;"> <table border="1" style="width: 100%; border-collapse: collapse; text-align: center;"> <tr> <td style="width: 10%;"></td> <td style="width: 10%;"></td> <td style="width: 10%;"></td> <td style="width: 10%;"></td> <td style="width: 10%;"></td> <td style="width: 10%;"></td> <td style="width: 10%;"></td> <td style="width: 10%;"></td> <td style="width: 10%;"></td> <td style="width: 10%;"></td> </tr> <tr> <td></td> <td></td> <td colspan="8" style="text-align: center;"> <table border="1" style="width: 100%; border-collapse: collapse; text-align: center;"> <tr> <td style="width: 10%;"></td> <td style="width: 10%;"></td> <td style="width: 10%;"></td> <td style="width: 10%;"></td> <td style="width: 10%;"></td> <td style="width: 10%;"></td> <td style="width: 10%;"></td> <td style="width: 10%;"></td> <td style="width: 10%;"></td> <td style="width: 10%;"></td> </tr> <tr> <td></td> <td></td> <td colspan="8" style="text-align: center;"> <table border="1" style="width: 100%; border-collapse: collapse; text-align: center;"> <tr> <td style="width: 10%;"></td> <td style="width: 10%;"></td> <td style="width: 10%;"></td> <td style="width: 10%;"></td> <td style="width: 10%;"></td> <td style="width: 10%;"></td> <td style="width: 10%;"></td> <td style="width: 10%;"></td> <td style="width: 10%;"></td> <td style="width: 10%;"></td> </tr> <tr> <td></td> <td></td> <td colspan="8" style="text-align: center;"> <table border="1" style="width: 100%; border-collapse: collapse;
text-align: center;"> <tr> <td style="width: 10%;"></td> <td style="width: 10%;"></td> <td style="width: 10%;"></td> <td style="width: 10%;"></td> <td style="width: 10%;"></td> <td style="width: 10%;"></td> <td style="width: 10%;"></td> <td style="width: 10%;"></td> <td style="width: 10%;"></td> <td style="width: 10%;"></td> </tr> <tr> <td></td> <td></td> <td colspan="8" style="text-align: center;"> <table border="1" style="width: 100%; border-collapse: collapse; text-align: center;"> <tr> <td style="width: 10%;"></td> <td style="width: 10%;"></td> <td style="width: 10%;"></td> <td style="width: 10%;"></td> <td style="width: 10%;"></td> <td style="width: 10%;"></td> <td style="width: 10%;"></td> <td style="width: 10%;"></td> <td style="width: 10%;"></td> <td style="width: 10%;"></td> </tr> <tr> <td></td> <td></td> <td colspan="8" style="text-align: center;"> <table border="1" style="width: 100%; border-collapse: collapse; text-align: center;"> <tr> </tr></table></td></tr></table></td></tr></table></td></tr></table></td></tr></table></td></tr></table></td></tr></table></td></tr></table></td></tr></table></td></tr></table></td></tr></table></td></tr></table></td></tr></table></td></tr></table></td></tr></table></td></tr></table></td></tr></table></td></tr></table></td></tr></table></td></tr></table></td></tr></table></td></tr></table></td></tr></table></td></tr></table></td></tr></table></td></tr></table></td></tr></table></td></tr></table></td></tr></table></td></tr></table></td></tr></table></td></tr></table></td></tr></table></td></tr></table> | | | | | | | | | | | | | | | | | | | | <table border="1" style="width: 100%; border-collapse: collapse; text-align: center;"> <tr> <td style="width: 10%;"></td> <td style="width: 10%;"></td> <td style="width: 10%;"></td> <td style="width: 10%;"></td> <td style="width: 10%;"></td> <td style="width: 10%;"></td> <td style="width: 10%;"></td> <td style="width: 10%;"></td> <td style="width: 10%;"></td> <td style="width: 10%;"></td> </tr> <tr> <td></td> <td></td> <td colspan="8" style="text-align: center;"> <table border="1" style="width: 100%; border-collapse: collapse; text-align: center;"> <tr> <td style="width: 10%;"></td> <td style="width: 10%;"></td> <td style="width: 10%;"></td> <td style="width: 10%;"></td> <td style="width: 10%;"></td> <td style="width: 10%;"></td> <td style="width: 10%;"></td> <td style="width: 10%;"></td> <td style="width: 10%;"></td> <td style="width: 10%;"></td> </tr> <tr> <td></td> <td></td> <td colspan="8" style="text-align: center;"> <table border="1" style="width: 100%; border-collapse: collapse; text-align: center;"> <tr> <td style="width: 10%;"></td> <td style="width: 10%;"></td> <td style="width: 10%;"></td> <td style="width: 10%;"></td> <td style="width: 10%;"></td> <td style="width: 10%;"></td> <td style="width: 10%;"></td> <td style="width: 10%;"></td> <td style="width: 10%;"></td> <td style="width: 10%;"></td> </tr> <tr> <td></td> <td></td> <td colspan="8" style="text-align: center;"> <table border="1" style="width: 100%; border-collapse: collapse; text-align: center;"> <tr> <td style="width: 10%;"></td> <td style="width: 10%;"></td> <td style="width: 10%;"></td> <td style="width: 10%;"></td> <td style="width: 10%;"></td> <td style="width: 10%;"></td> <td style="width: 10%;"></td> <td style="width: 10%;"></td> <td style="width: 10%;"></td> <td style="width: 10%;"></td> </tr> <tr> <td></td> <td></td> <td colspan="8" style="text-align: center;"> <table border="1" style="width: 100%; border-collapse: collapse; text-align: center;"> <tr> <td style="width: 10%;"></td> <td style="width: 10%;"></td> <td style="width: 10%;"></td> <td style="width: 10%;"></td> <td style="width: 10%;"></td> <td style="width: 10%;"></td> <td style="width: 10%;"></td> <td style="width: 10%;"></td> <td style="width: 10%;"></td> <td style="width: 10%;"></td> </tr> <tr> <td></td> <td></td> <td colspan="8" style="text-align: center;"> <table border="1" style="width: 100%; border-collapse: collapse; text-align: center;"> <tr> <td style="width: 10%;"></td> <td style="width: 10%;"></td> <td style="width: 10%;"></td> <td style="width: 10%;"></td> <td style="width: 10%;"></td> <td style="width: 10%;"></td> <td style="width: 10%;"></td> <td style="width: 10%;"></td> <td style="width: 10%;"></td> <td style="width: 10%;"></td> </tr> <tr> <td></td> <td></td> <td colspan="8" style="text-align: center;"> <table border="1" style="width: 100%; border-collapse: collapse; text-align: center;"> <tr> <td style="width: 10%;"></td> <td style="width: 10%;"></td> <td style="width: 10%;"></td> <td style="width: 10%;"></td> <td style="width: 10%;"></td> <td style="width: 10%;"></td> <td style="width: 10%;"></td> <td style="width: 10%;"></td> <td style="width: 10%;"></td> <td style="width: 10%;"></td> </tr> <tr> <td></td> <td></td> <td colspan="8" style="text-align: center;"> <table border="1" style="width: 100%; border-collapse: collapse; text-align: center;"> <tr> <td style="width: 10%;"></td> <td style="width: 10%;"></td> <td style="width: 10%;"></td> <td style="width: 10%;"></td> <td style="width: 10%;"></td> <td style="width: 10%;"></td> <td style="width: 10%;"></td> <td style="width: 10%;"></td> <td style="width: 10%;"></td> <td style="width: 10%;"></td> </tr> <tr> <td></td> <td></td> <td colspan="8" style="text-align: center;"> <table border="1" style="width: 100%; border-collapse: collapse; text-align: center;"> <tr> <td style="width: 10%;"></td> <td style="width: 10%;"></td> <td style="width: 10%;"></td> <td style="width: 10%;"></td> <td style="width: 10%;"></td> <td style="width: 10%;"></td> <td style="width: 10%;"></td> <td style="width: 10%;"></td> <td style="width: 10%;"></td> <td style="width: 10%;"></td> </tr> <tr> <td></td> <td></td> <td colspan="8" style="text-align: center;"> <table border="1" style="width: 100%; border-collapse: collapse; text-align: center;"> <tr> <td style="width: 10%;"></td> <td style="width: 10%;"></td> <td style="width: 10%;"></td> <td style="width: 10%;"></td> <td style="width: 10%;"></td> <td style="width: 10%;"></td> <td style="width: 10%;"></td> <td style="width: 10%;"></td> <td style="width: 10%;"></td> <td style="width: 10%;"></td> </tr> <tr> <td></td> <td></td> <td colspan="8" style="text-align: center;"> <table border="1" style="width: 100%; border-collapse: collapse; text-align: center;"> <tr> <td style="width: 10%;"></td> <td style="width: 10%;"></td> <td style="width: 10%;"></td> <td style="width: 10%;"></td> <td style="width: 10%;"></td> <td style="width: 10%;"></td> <td style="width: 10%;"></td> <td style="width: 10%;"></td> <td style="width: 10%;"></td> <td style="width: 10%;"></td> </tr> <tr> <td></td> <td></td> <td colspan="8" style="text-align: center;"> <table border="1" style="width: 100%; border-collapse: collapse; text-align: center;"> <tr> <td style="width: 10%;"></td> <td style="width: 10%;"></td> <td style="width: 10%;"></td> <td style="width: 10%;"></td> <td style="width: 10%;"></td> <td style="width: 10%;"></td> <td style="width: 10%;"></td> <td style="width: 10%;"></td> <td style="width: 10%;"></td> <td style="width: 10%;"></td> </tr> <tr> <td></td> <td></td> <td colspan="8" style="text-align: center;"> <table border="1" style="width: 100%; border-collapse: collapse; text-align: center;"> <tr> <td style="width: 10%;"></td> <td style="width: 10%;"></td> <td style="width: 10%;"></td> <td style="width: 10%;"></td> <td style="width: 10%;"></td> <td style="width: 10%;"></td> <td style="width: 10%;"></td> <td style="width:
10%;"></td> <td style="width: 10%;"></td> <td style="width: 10%;"></td> </tr> <tr> <td></td> <td></td> <td colspan="8" style="text-align: center;"> <table border="1" style="width: 100%; border-collapse: collapse; text-align: center;"> <tr> <td style="width: 10%;"></td> <td style="width: 10%;"></td> <td style="width: 10%;"></td> <td style="width: 10%;"></td> <td style="width: 10%;"></td> <td style="width: 10%;"></td> <td style="width: 10%;"></td> <td style="width: 10%;"></td> <td style="width: 10%;"></td> <td style="width: 10%;"></td> </tr> <tr> <td></td> <td></td> <td colspan="8" style="text-align: center;"> <table border="1" style="width: 100%; border-collapse: collapse; text-align: center;"> <tr> <td style="width: 10%;"></td> <td style="width: 10%;"></td> <td style="width: 10%;"></td> <td style="width: 10%;"></td> <td style="width: 10%;"></td> <td style="width: 10%;"></td> <td style="width: 10%;"></td> <td style="width: 10%;"></td> <td style="width: 10%;"></td> <td style="width: 10%;"></td> </tr> <tr> <td></td> <td></td> <td colspan="8" style="text-align: center;"> <table border="1" style="width: 100%; border-collapse: collapse; text-align: center;"> <tr> <td style="width: 10%;"></td> <td style="width: 10%;"></td> <td style="width: 10%;"></td> <td style="width: 10%;"></td> <td style="width: 10%;"></td> <td style="width: 10%;"></td> <td style="width: 10%;"></td> <td style="width: 10%;"></td> <td style="width: 10%;"></td> <td style="width: 10%;"></td> </tr> <tr> <td></td> <td></td> <td colspan="8" style="text-align: center;"> <table border="1" style="width: 100%; border-collapse: collapse; text-align: center;"> <tr> <td style="width: 10%;"></td> <td style="width: 10%;"></td> <td style="width: 10%;"></td> <td style="width: 10%;"></td> <td style="width: 10%;"></td> <td style="width: 10%;"></td> <td style="width: 10%;"></td> <td style="width: 10%;"></td> <td style="width: 10%;"></td> <td style="width: 10%;"></td> </tr> <tr> <td></td> <td></td> <td colspan="8" style="text-align: center;"> <table border="1" style="width: 100%; border-collapse: collapse; text-align: center;"> <tr> <td style="width: 10%;"></td> <td style="width: 10%;"></td> <td style="width: 10%;"></td> <td style="width: 10%;"></td> <td style="width: 10%;"></td> <td style="width: 10%;"></td> <td style="width: 10%;"></td> <td style="width: 10%;"></td> <td style="width: 10%;"></td> <td style="width: 10%;"></td> </tr> <tr> <td></td> <td></td> <td colspan="8" style="text-align: center;"> <table border="1" style="width: 100%; border-collapse: collapse; text-align: center;"> <tr> <td style="width: 10%;"></td> <td style="width: 10%;"></td> <td style="width: 10%;"></td> <td style="width: 10%;"></td> <td style="width: 10%;"></td> <td style="width: 10%;"></td> <td style="width: 10%;"></td> <td style="width: 10%;"></td> <td style="width: 10%;"></td> <td style="width: 10%;"></td> </tr> <tr> <td></td> <td></td> <td colspan="8" style="text-align: center;"> <table border="1" style="width: 100%; border-collapse: collapse; text-align: center;"> <tr> <td style="width: 10%;"></td> <td style="width: 10%;"></td> <td style="width: 10%;"></td> <td style="width: 10%;"></td> <td style="width: 10%;"></td> <td style="width: 10%;"></td> <td style="width: 10%;"></td> <td style="width: 10%;"></td> <td style="width: 10%;"></td> <td style="width: 10%;"></td> </tr> <tr> <td></td> <td></td> <td colspan="8" style="text-align: center;"> <table border="1" style="width: 100%; border-collapse: collapse; text-align: center;"> <tr> <td style="width: 10%;"></td> <td style="width: 10%;"></td> <td style="width: 10%;"></td> <td style="width: 10%;"></td> <td style="width: 10%;"></td> <td style="width: 10%;"></td> <td style="width: 10%;"></td> <td style="width: 10%;"></td> <td style="width: 10%;"></td> <td style="width: 10%;"></td> </tr> <tr> <td></td> <td></td> <td colspan="8" style="text-align: center;"> <table border="1" style="width: 100%; border-collapse: collapse; text-align: center;"> <tr> <td style="width: 10%;"></td> <td style="width: 10%;"></td> <td style="width: 10%;"></td> <td style="width: 10%;"></td> <td style="width: 10%;"></td> <td style="width: 10%;"></td> <td style="width: 10%;"></td> <td style="width: 10%;"></td> <td style="width: 10%;"></td> <td style="width: 10%;"></td> </tr> <tr> <td></td> <td></td> <td colspan="8" style="text-align: center;"> <table border="1" style="width: 100%; border-collapse: collapse; text-align: center;"> <tr> <td style="width: 10%;"></td> <td style="width: 10%;"></td> <td style="width: 10%;"></td> <td style="width: 10%;"></td> <td style="width: 10%;"></td> <td style="width: 10%;"></td> <td style="width: 10%;"></td> <td style="width: 10%;"></td> <td style="width: 10%;"></td> <td style="width: 10%;"></td> </tr> <tr> <td></td> <td></td> <td colspan="8" style="text-align: center;"> <table border="1" style="width: 100%; border-collapse: collapse; text-align: center;"> <tr> <td style="width: 10%;"></td> <td style="width: 10%;"></td> <td style="width: 10%;"></td> <td style="width: 10%;"></td> <td style="width: 10%;"></td> <td style="width: 10%;"></td> <td style="width: 10%;"></td> <td style="width: 10%;"></td> <td style="width: 10%;"></td> <td style="width: 10%;"></td> </tr> <tr> <td></td> <td></td> <td colspan="8" style="text-align: center;"> <table border="1" style="width: 100%; border-collapse: collapse; text-align: center;"> <tr> <td style="width: 10%;"></td> <td style="width: 10%;"></td> <td style="width: 10%;"></td> <td style="width: 10%;"></td> <td style="width: 10%;"></td> <td style="width: 10%;"></td> <td style="width: 10%;"></td> <td style="width: 10%;"></td> <td style="width: 10%;"></td> <td style="width: 10%;"></td> </tr> <tr> <td></td> <td></td> <td colspan="8" style="text-align: center;"> <table border="1" style="width: 100%; border-collapse: collapse; text-align: center;"> <tr> <td style="width: 10%;"></td> <td style="width: 10%;"></td> <td style="width: 10%;"></td> <td style="width: 10%;"></td> <td style="width: 10%;"></td> <td style="width: 10%;"></td> <td style="width: 10%;"></td> <td style="width: 10%;"></td> <td style="width: 10%;"></td> <td style="width: 10%;"></td> </tr> <tr> <td></td> <td></td> <td colspan="8" style="text-align: center;"> <table border="1" style="width: 100%; border-collapse: collapse; text-align: center;"> <tr> <td style="width: 10%;"></td> <td style="width: 10%;"></td> <td style="width: 10%;"></td> <td style="width: 10%;"></td> <td style="width: 10%;"></td> <td style="width: 10%;"></td> <td style="width: 10%;"></td> <td style="width: 10%;"></td> <td style="width: 10%;"></td> <td style="width: 10%;"></td> </tr> <tr> <td></td> <td></td> <td colspan="8" style="text-align: center;"> <table border="1" style="width: 100%; border-collapse: collapse; text-align: center;"> <tr> <td style="width: 10%;"></td> <td style="width: 10%;"></td> <td style="width: 10%;"></td> <td style="width: 10%;"></td> <td style="width: 10%;"></td> <td style="width: 10%;"></td> <td style="width: 10%;"></td> <td style="width: 10%;"></td> <td style="width: 10%;"></td> <td style="width: 10%;"></td> </tr> <tr> <td></td> <td></td> <td colspan="8" style="text-align: center;"> <table border="1" style="width: 100%; border-collapse: collapse; text-align: center;"> <tr> <td style="width: 10%;"></td> <td style="width: 10%;"></td> <td style="width: 10%;"></td> <td style="width: 10%;"></td> <td style="width: 10%;"></td> <td style="width: 10%;"></td> <td style="width: 10%;"></td> <td style="width: 10%;"></td> <td style="width: 10%;"></td> <td style="width: 10%;"></td> </tr> <tr> <td></td> <td></td> <td colspan="8" style="text-align: center;"> <table border="1" style="width: 100%; border-collapse: collapse; text-align: center;"> <tr> <td style="width: 10%;"></td> <td style="width: 10%;"></td> <td style="width: 10%;"></td> <td style="width: 10%;"></td> <td style="width: 10%;"></td> <td style="width: 10%;"></td> <td style="width: 10%;"></td> <td style="width: 10%;"></td> <td style="width: 10%;"></td> <td style="width: 10%;"></td> </tr> <tr> <td></td> <td></td> <td colspan="8" style="text-align: center;"> <table border="1" style="width: 100%; border-collapse: collapse; text-align: center;"> <tr> <td style="width: 10%;"></td> <td style="width: 10%;"></td> <td style="width: 10%;"></td> <td style="width: 10%;"></td> <td style="width: 10%;"></td> <td style="width: 10%;"></td> <td style="width: 10%;"></td> <td style="width: 10%;"></td> <td style="width: 10%;"></td> <td style="width: 10%;"></td> </tr> <tr> <td></td> <td></td> <td colspan="8" style="text-align: center;"> <table border="1" style="width: 100%; border-collapse: collapse; text-align: center;"> <tr> <td style="width: 10%;"></td> <td style="width: 10%;"></td> <td style="width: 10%;"></td> <td style="width: 10%;"></td> <td style="width: 10%;"></td> <td style="width: 10%;"></td> <td style="width: 10%;"></td> <td style="width: 10%;"></td> <td style="width: 10%;"></td> <td style="width: 10%;"></td> </tr> <tr> <td></td> <td></td> <td colspan="8" style="text-align: center;"> <table border="1" style="width: 100%; border-collapse: collapse; text-align: center;"> <tr> </tr></table></td></tr></table></td></tr></table></td></tr></table></td></tr></table></td></tr></table></td></tr></table></td></tr></table></td></tr></table></td></tr></table></td></tr></table></td></tr></table></td></tr></table></td></tr></table></td></tr></table></td></tr></table></td></tr></table></td></tr></table></td></tr></table></td></tr></table></td></tr></table></td></tr></table></td></tr></table></td></tr></table></td></tr></table></td></tr></table></td></tr></table></td></tr></table></td></tr></table></td></tr></table></td></tr></table></td></tr></table></td></tr></table>
 | | | | | | | | | | | | | | | | | | | | <table border="1" style="width: 100%; border-collapse: collapse; text-align: center;"> <tr> <td style="width: 10%;"></td> <td style="width: 10%;"></td> <td style="width: 10%;"></td> <td style="width: 10%;"></td> <td style="width: 10%;"></td> <td style="width: 10%;"></td> <td style="width: 10%;"></td> <td style="width: 10%;"></td> <td style="width: 10%;"></td> <td style="width: 10%;"></td> </tr> <tr> <td></td> <td></td> <td colspan="8" style="text-align: center;"> <table border="1" style="width: 100%; border-collapse: collapse; text-align: center;"> <tr> <td style="width: 10%;"></td> <td style="width: 10%;"></td> <td style="width: 10%;"></td> <td style="width: 10%;"></td> <td style="width: 10%;"></td> <td style="width: 10%;"></td> <td style="width: 10%;"></td> <td style="width: 10%;"></td> <td style="width: 10%;"></td> <td style="width: 10%;"></td> </tr> <tr> <td></td> <td></td> <td colspan="8" style="text-align: center;"> <table border="1" style="width: 100%; border-collapse: collapse; text-align: center;"> <tr> <td style="width: 10%;"></td> <td style="width: 10%;"></td> <td style="width: 10%;"></td> <td style="width: 10%;"></td> <td style="width: 10%;"></td> <td style="width: 10%;"></td> <td style="width: 10%;"></td> <td style="width: 10%;"></td> <td style="width: 10%;"></td> <td style="width: 10%;"></td> </tr> <tr> <td></td> <td></td> <td colspan="8" style="text-align: center;"> <table border="1" style="width: 100%; border-collapse: collapse; text-align: center;"> <tr> <td style="width: 10%;"></td> <td style="width: 10%;"></td> <td style="width: 10%;"></td> <td style="width: 10%;"></td> <td style="width: 10%;"></td> <td style="width: 10%;"></td> <td style="width: 10%;"></td> <td style="width: 10%;"></td> <td style="width: 10%;"></td> <td style="width: 10%;"></td> </tr> <tr> <td></td> <td></td> <td colspan="8" style="text-align: center;"> <table border="1" style="width: 100%; border-collapse: collapse; text-align: center;"> <tr> <td style="width: 10%;"></td> <td style="width: 10%;"></td> <td style="width: 10%;"></td> <td style="width: 10%;"></td> <td style="width: 10%;"></td> <td style="width: 10%;"></td> <td style="width: 10%;"></td> <td style="width: 10%;"></td> <td style="width: 10%;"></td> <td style="width: 10%;"></td> </tr> <tr> <td></td> <td></td> <td colspan="8" style="text-align: center;"> <table border="1" style="width: 100%; border-collapse: collapse; text-align: center;"> <tr> <td style="width: 10%;"></td> <td style="width: 10%;"></td> <td style="width: 10%;"></td> <td style="width: 10%;"></td> <td style="width: 10%;"></td> <td style="width: 10%;"></td> <td style="width: 10%;"></td> <td style="width: 10%;"></td> <td style="width: 10%;"></td> <td style="width: 10%;"></td> </tr> <tr> <td></td> <td></td> <td colspan="8" style="text-align: center;"> <table border="1" style="width: 100%; border-collapse: collapse; text-align: center;"> <tr> <td style="width: 10%;"></td> <td style="width: 10%;"></td> <td style="width: 10%;"></td> <td style="width: 10%;"></td> <td style="width: 10%;"></td> <td style="width: 10%;"></td> <td style="width: 10%;"></td> <td style="width: 10%;"></td> <td style="width: 10%;"></td> <td style="width: 10%;"></td> </tr> <tr> <td></td> <td></td> <td colspan="8" style="text-align: center;"> <table border="1" style="width: 100%; border-collapse: collapse; text-align: center;"> <tr> <td style="width: 10%;"></td> <td style="width: 10%;"></td> <td style="width: 10%;"></td> <td style="width: 10%;"></td> <td style="width: 10%;"></td> <td style="width: 10%;"></td> <td style="width: 10%;"></td> <td style="width: 10%;"></td> <td style="width: 10%;"></td> <td style="width: 10%;"></td> </tr> <tr> <td></td> <td></td> <td colspan="8" style="text-align: center;"> <table border="1" style="width: 100%; border-collapse: collapse; text-align: center;"> <tr> <td style="width: 10%;"></td> <td style="width: 10%;"></td> <td style="width: 10%;"></td> <td style="width: 10%;"></td> <td style="width: 10%;"></td> <td style="width: 10%;"></td> <td style="width: 10%;"></td> <td style="width: 10%;"></td> <td style="width: 10%;"></td> <td style="width: 10%;"></td> </tr> <tr> <td></td> <td></td> <td colspan="8" style="text-align: center;"> <table border="1" style="width: 100%; border-collapse: collapse; text-align: center;"> <tr> <td style="width: 10%;"></td> <td style="width: 10%;"></td> <td style="width: 10%;"></td> <td style="width: 10%;"></td> <td style="width: 10%;"></td> <td style="width: 10%;"></td> <td style="width: 10%;"></td> <td style="width: 10%;"></td> <td style="width: 10%;"></td> <td style="width: 10%;"></td> </tr> <tr> <td></td> <td></td> <td colspan="8" style="text-align: center;"> <table border="1" style="width: 100%; border-collapse: collapse; text-align: center;"> <tr> <td style="width: 10%;"></td> <td style="width: 10%;"></td> <td style="width: 10%;"></td> <td style="width: 10%;"></td> <td style="width: 10%;"></td> <td style="width: 10%;"></td> <td style="width: 10%;"></td> <td style="width: 10%;"></td> <td style="width: 10%;"></td> <td style="width: 10%;"></td> </tr> <tr> <td></td> <td></td> <td colspan="8" style="text-align: center;"> <table border="1" style="width: 100%; border-collapse: collapse; text-align: center;"> <tr> <td style="width: 10%;"></td> <td style="width: 10%;"></td> <td style="width: 10%;"></td> <td style="width: 10%;"></td> <td style="width: 10%;"></td> <td style="width: 10%;"></td> <td style="width: 10%;"></td> <td style="width: 10%;"></td> <td style="width: 10%;"></td> <td style="width: 10%;"></td> </tr> <tr> <td></td> <td></td> <td colspan="8" style="text-align: center;"> <table border="1" style="width: 100%; border-collapse: collapse; text-align: center;"> <tr> <td style="width: 10%;"></td> <td style="width: 10%;"></td> <td style="width: 10%;"></td> <td style="width: 10%;"></td> <td style="width: 10%;"></td> <td style="width: 10%;"></td> <td style="width: 10%;"></td> <td style="width: 10%;"></td> <td style="width: 10%;"></td> <td style="width: 10%;"></td> </tr> <tr> <td></td> <td></td> <td colspan="8" style="text-align: center;"> <table border="1" style="width: 100%; border-collapse: collapse; text-align: center;"> <tr> <td style="width: 10%;"></td> <td style="width: 10%;"></td> <td style="width: 10%;"></td> <td style="width: 10%;"></td> <td style="width: 10%;"></td> <td style="width: 10%;"></td> <td style="width: 10%;"></td> <td style="width: 10%;"></td> <td style="width: 10%;"></td> <td style="width: 10%;"></td> </tr> <tr> <td></td> <td></td> <td colspan="8" style="text-align: center;"> <table border="1" style="width: 100%; border-collapse: collapse; text-align: center;"> <tr> <td style="width: 10%;"></td> <td style="width: 10%;"></td> <td style="width: 10%;"></td> <td style="width: 10%;"></td> <td style="width: 10%;"></td> <td style="width: 10%;"></td> <td style="width: 10%;"></td> <td style="width: 10%;"></td> <td style="width: 10%;"></td> <td style="width: 10%;"></td> </tr> <tr> <td></td> <td></td> <td colspan="8" style="text-align: center;"> <table border="1" style="width: 100%; border-collapse: collapse; text-align: center;"> <tr> <td style="width: 10%;"></td> <td style="width: 10%;"></td> <td style="width: 10%;"></td> <td style="width: 10%;"></td> <td style="width: 10%;"></td> <td style="width: 10%;"></td> <td style="width: 10%;"></td> <td style="width: 10%;"></td> <td style="width: 10%;"></td> <td style="width: 10%;"></td> </tr> <tr> <td></td> <td></td> <td colspan="8" style="text-align: center;"> <table border="1" style="width: 100%; border-collapse: collapse; text-align: center;"> <tr> <td style="width: 10%;"></td> <td style="width: 10%;"></td> <td style="width: 10%;"></td> <td style="width: 10%;"></td> <td style="width: 10%;"></td> <td style="width: 10%;"></td> <td style="width:
10%;"></td> <td style="width: 10%;"></td> <td style="width: 10%;"></td> <td style="width: 10%;"></td> </tr> <tr> <td></td> <td></td> <td colspan="8" style="text-align: center;"> <table border="1" style="width: 100%; border-collapse: collapse; text-align: center;"> <tr> <td style="width: 10%;"></td> <td style="width: 10%;"></td> <td style="width: 10%;"></td> <td style="width: 10%;"></td> <td style="width: 10%;"></td> <td style="width: 10%;"></td> <td style="width: 10%;"></td> <td style="width: 10%;"></td> <td style="width: 10%;"></td> <td style="width: 10%;"></td> </tr> <tr> <td></td> <td></td> <td colspan="8" style="text-align: center;"> <table border="1" style="width: 100%; border-collapse: collapse; text-align: center;"> <tr> <td style="width: 10%;"></td> <td style="width: 10%;"></td> <td style="width: 10%;"></td> <td style="width: 10%;"></td> <td style="width: 10%;"></td> <td style="width: 10%;"></td> <td style="width: 10%;"></td> <td style="width: 10%;"></td> <td style="width: 10%;"></td> <td style="width: 10%;"></td> </tr> <tr> <td></td> <td></td> <td colspan="8" style="text-align: center;"> <table border="1" style="width: 100%; border-collapse: collapse; text-align: center;"> <tr> <td style="width: 10%;"></td> <td style="width: 10%;"></td> <td style="width: 10%;"></td> <td style="width: 10%;"></td> <td style="width: 10%;"></td> <td style="width: 10%;"></td> <td style="width: 10%;"></td> <td style="width: 10%;"></td> <td style="width: 10%;"></td> <td style="width: 10%;"></td> </tr> <tr> <td></td> <td></td> <td colspan="8" style="text-align: center;"> <table border="1" style="width: 100%; border-collapse: collapse; text-align: center;"> <tr> <td style="width: 10%;"></td> <td style="width: 10%;"></td> <td style="width: 10%;"></td> <td style="width: 10%;"></td> <td style="width: 10%;"></td> <td style="width: 10%;"></td> <td style="width: 10%;"></td> <td style="width: 10%;"></td> <td style="width: 10%;"></td> <td style="width: 10%;"></td> </tr> <tr> <td></td> <td></td> <td colspan="8" style="text-align: center;"> <table border="1" style="width: 100%; border-collapse: collapse; text-align: center;"> <tr> <td style="width: 10%;"></td> <td style="width: 10%;"></td> <td style="width: 10%;"></td> <td style="width: 10%;"></td> <td style="width: 10%;"></td> <td style="width: 10%;"></td> <td style="width: 10%;"></td> <td style="width: 10%;"></td> <td style="width: 10%;"></td> <td style="width: 10%;"></td> </tr> <tr> <td></td> <td></td> <td colspan="8" style="text-align: center;"> <table border="1" style="width: 100%; border-collapse: collapse; text-align: center;"> <tr> <td style="width: 10%;"></td> <td style="width: 10%;"></td> <td style="width: 10%;"></td> <td style="width: 10%;"></td> <td style="width: 10%;"></td> <td style="width: 10%;"></td> <td style="width: 10%;"></td> <td style="width: 10%;"></td> <td style="width: 10%;"></td> <td style="width: 10%;"></td> </tr> <tr> <td></td> <td></td> <td colspan="8" style="text-align: center;"> <table border="1" style="width: 100%; border-collapse: collapse; text-align: center;"> <tr> <td style="width: 10%;"></td> <td style="width: 10%;"></td> <td style="width: 10%;"></td> <td style="width: 10%;"></td> <td style="width: 10%;"></td> <td style="width: 10%;"></td> <td style="width: 10%;"></td> <td style="width: 10%;"></td> <td style="width: 10%;"></td> <td style="width: 10%;"></td> </tr> <tr> <td></td> <td></td> <td colspan="8" style="text-align: center;"> <table border="1" style="width: 100%; border-collapse: collapse; text-align: center;"> <tr> <td style="width: 10%;"></td> <td style="width: 10%;"></td> <td style="width: 10%;"></td> <td style="width: 10%;"></td> <td style="width: 10%;"></td> <td style="width: 10%;"></td> <td style="width: 10%;"></td> <td style="width: 10%;"></td> <td style="width: 10%;"></td> <td style="width: 10%;"></td> </tr> <tr> <td></td> <td></td> <td colspan="8" style="text-align: center;"> <table border="1" style="width: 100%; border-collapse: collapse; text-align: center;"> <tr> <td style="width: 10%;"></td> <td style="width: 10%;"></td> <td style="width: 10%;"></td> <td style="width: 10%;"></td> <td style="width: 10%;"></td> <td style="width: 10%;"></td> <td style="width: 10%;"></td> <td style="width: 10%;"></td> <td style="width: 10%;"></td> <td style="width: 10%;"></td> </tr> <tr> <td></td> <td></td> <td colspan="8" style="text-align: center;"> <table border="1" style="width: 100%; border-collapse: collapse; text-align: center;"> <tr> <td style="width: 10%;"></td> <td style="width: 10%;"></td> <td style="width: 10%;"></td> <td style="width: 10%;"></td> <td style="width: 10%;"></td> <td style="width: 10%;"></td> <td style="width: 10%;"></td> <td style="width: 10%;"></td> <td style="width: 10%;"></td> <td style="width: 10%;"></td> </tr> <tr> <td></td> <td></td> <td colspan="8" style="text-align: center;"> <table border="1" style="width: 100%; border-collapse: collapse; text-align: center;"> <tr> <td style="width: 10%;"></td> <td style="width: 10%;"></td> <td style="width: 10%;"></td> <td style="width: 10%;"></td> <td style="width: 10%;"></td> <td style="width: 10%;"></td> <td style="width: 10%;"></td> <td style="width: 10%;"></td> <td style="width: 10%;"></td> <td style="width: 10%;"></td> </tr> <tr> <td></td> <td></td> <td colspan="8" style="text-align: center;"> <table border="1" style="width: 100%; border-collapse: collapse; text-align: center;"> <tr> <td style="width: 10%;"></td> <td style="width: 10%;"></td> <td style="width: 10%;"></td> <td style="width: 10%;"></td> <td style="width: 10%;"></td> <td style="width: 10%;"></td> <td style="width: 10%;"></td> <td style="width: 10%;"></td> <td style="width: 10%;"></td> <td style="width: 10%;"></td> </tr> <tr> <td></td> <td></td> <td colspan="8" style="text-align: center;"> <table border="1" style="width: 100%; border-collapse: collapse; text-align: center;"> <tr> <td style="width: 10%;"></td> <td style="width: 10%;"></td> <td style="width: 10%;"></td> <td style="width: 10%;"></td> <td style="width: 10%;"></td> <td style="width: 10%;"></td> <td style="width: 10%;"></td> <td style="width: 10%;"></td> <td style="width: 10%;"></td> <td style="width: 10%;"></td> </tr> <tr> <td></td> <td></td> <td colspan="8" style="text-align: center;"> <table border="1" style="width: 100%; border-collapse: collapse; text-align: center;"> <tr> <td style="width: 10%;"></td> <td style="width: 10%;"></td> <td style="width: 10%;"></td> <td style="width: 10%;"></td> <td style="width: 10%;"></td> <td style="width: 10%;"></td> <td style="width: 10%;"></td> <td style="width: 10%;"></td> <td style="width: 10%;"></td> <td style="width: 10%;"></td> </tr> <tr> <td></td> <td></td> <td colspan="8" style="text-align: center;"> <table border="1" style="width: 100%; border-collapse: collapse; text-align: center;"> <tr> </tr></table></td></tr></table></td></tr></table></td></tr></table></td></tr></table></td></tr></table></td></tr></table></td></tr></table></td></tr></table></td></tr></table></td></tr></table></td></tr></table></td></tr></table></td></tr></table></td></tr></table></td></tr></table></td></tr></table></td></tr></table></td></tr></table></td></tr></table></td></tr></table></td></tr></table></td></tr></table></td></tr></table></td></tr></table></td></tr></table></td></tr></table></td></tr></table></td></tr></table></td></tr></table></td></tr></table></td></tr></table> | | | | | | | | | | | | | | | | | | | | <table border="1" style="width: 100%; border-collapse: collapse; text-align: center;"> <tr> <td style="width:
10%;"></td> <td style="width: 10%;"></td> <td style="width: 10%;"></td> <td style="width: 10%;"></td> <td style="width: 10%;"></td> <td style="width: 10%;"></td> <td style="width: 10%;"></td> <td style="width: 10%;"></td> <td style="width: 10%;"></td> <td style="width: 10%;"></td> </tr> <tr> <td></td> <td></td> <td colspan="8" style="text-align: center;"> <table border="1" style="width: 100%; border-collapse: collapse; text-align: center;"> <tr> <td style="width: 10%;"></td> <td style="width: 10%;"></td> <td style="width: 10%;"></td> <td style="width: 10%;"></td> <td style="width: 10%;"></td> <td style="width: 10%;"></td> <td style="width: 10%;"></td> <td style="width: 10%;"></td> <td style="width: 10%;"></td> <td style="width: 10%;"></td> </tr> <tr> <td></td> <td></td> <td colspan="8" style="text-align: center;"> <table border="1" style="width: 100%; border-collapse: collapse; text-align: center;"> <tr> <td style="width: 10%;"></td> <td style="width: 10%;"></td> <td style="width: 10%;"></td> <td style="width: 10%;"></td> <td style="width: 10%;"></td> <td style="width: 10%;"></td> <td style="width: 10%;"></td> <td style="width: 10%;"></td> <td style="width: 10%;"></td> <td style="width: 10%;"></td> </tr> <tr> <td></td> <td></td> <td colspan="8" style="text-align: center;"> <table border="1" style="width: 100%; border-collapse: collapse; text-align: center;"> <tr> <td style="width: 10%;"></td> <td style="width: 10%;"></td> <td style="width: 10%;"></td> <td style="width: 10%;"></td> <td style="width: 10%;"></td> <td style="width: 10%;"></td> <td style="width: 10%;"></td> <td style="width: 10%;"></td> <td style="width: 10%;"></td> <td style="width: 10%;"></td> </tr> <tr> <td></td> <td></td> <td colspan="8" style="text-align: center;"> <table border="1" style="width: 100%; border-collapse: collapse; text-align: center;"> <tr> <td style="width: 10%;"></td> <td style="width: 10%;"></td> <td style="width: 10%;"></td> <td style="width: 10%;"></td> <td style="width: 10%;"></td> <td style="width: 10%;"></td> <td style="width: 10%;"></td> <td style="width: 10%;"></td> <td style="width: 10%;"></td> <td style="width: 10%;"></td> </tr> <tr> <td></td> <td></td> <td colspan="8" style="text-align: center;"> <table border="1" style="width: 100%; border-collapse: collapse; text-align: center;"> <tr> <td style="width: 10%;"></td> <td style="width: 10%;"></td> <td style="width: 10%;"></td> <td style="width: 10%;"></td> <td style="width: 10%;"></td> <td style="width: 10%;"></td> <td style="width: 10%;"></td> <td style="width: 10%;"></td> <td style="width: 10%;"></td> <td style="width: 10%;"></td> </tr> <tr> <td></td> <td></td> <td colspan="8" style="text-align: center;"> <table border="1" style="width: 100%; border-collapse: collapse; text-align: center;"> <tr> <td style="width: 10%;"></td> <td style="width: 10%;"></td> <td style="width: 10%;"></td> <td style="width: 10%;"></td> <td style="width: 10%;"></td> <td style="width: 10%;"></td> <td style="width: 10%;"></td> <td style="width: 10%;"></td> <td style="width: 10%;"></td> <td style="width: 10%;"></td> </tr> <tr> <td></td> <td></td> <td colspan="8" style="text-align: center;"> <table border="1" style="width: 100%; border-collapse: collapse; text-align: center;"> <tr> <td style="width: 10%;"></td> <td style="width: 10%;"></td> <td style="width: 10%;"></td> <td style="width: 10%;"></td> <td style="width: 10%;"></td> <td style="width: 10%;"></td> <td style="width: 10%;"></td> <td style="width: 10%;"></td> <td style="width: 10%;"></td> <td style="width: 10%;"></td> </tr> <tr> <td></td> <td></td> <td colspan="8" style="text-align: center;"> <table border="1" style="width: 100%; border-collapse: collapse; text-align: center;"> <tr> <td style="width: 10%;"></td> <td style="width: 10%;"></td> <td style="width: 10%;"></td> <td style="width: 10%;"></td> <td style="width: 10%;"></td> <td style="width: 10%;"></td> <td style="width: 10%;"></td> <td style="width: 10%;"></td> <td style="width: 10%;"></td> <td style="width: 10%;"></td> </tr> <tr> <td></td> <td></td> <td colspan="8" style="text-align: center;"> <table border="1" style="width: 100%; border-collapse: collapse; text-align: center;"> <tr> <td style="width: 10%;"></td> <td style="width: 10%;"></td> <td style="width: 10%;"></td> <td style="width: 10%;"></td> <td style="width: 10%;"></td> <td style="width: 10%;"></td> <td style="width: 10%;"></td> <td style="width: 10%;"></td> <td style="width: 10%;"></td> <td style="width: 10%;"></td> </tr> <tr> <td></td> <td></td> <td colspan="8" style="text-align: center;"> <table border="1" style="width: 100%; border-collapse: collapse; text-align: center;"> <tr> <td style="width: 10%;"></td> <td style="width: 10%;"></td> <td style="width: 10%;"></td> <td style="width: 10%;"></td> <td style="width: 10%;"></td> <td style="width: 10%;"></td> <td style="width: 10%;"></td> <td style="width: 10%;"></td> <td style="width: 10%;"></td> <td style="width: 10%;"></td> </tr> <tr> <td></td> <td></td> <td colspan="8" style="text-align: center;"> <table border="1" style="width: 100%; border-collapse: collapse; text-align: center;"> <tr> <td style="width: 10%;"></td> <td style="width: 10%;"></td> <td style="width: 10%;"></td> <td style="width: 10%;"></td> <td style="width: 10%;"></td> <td style="width: 10%;"></td> <td style="width: 10%;"></td> <td style="width: 10%;"></td> <td style="width: 10%;"></td> <td style="width: 10%;"></td> </tr> <tr> <td></td> <td></td> <td colspan="8" style="text-align: center;"> <table border="1" style="width: 100%; border-collapse: collapse; text-align: center;"> <tr> <td style="width: 10%;"></td> <td style="width: 10%;"></td> <td style="width: 10%;"></td> <td style="width: 10%;"></td> <td style="width: 10%;"></td> <td style="width: 10%;"></td> <td style="width: 10%;"></td> <td style="width: 10%;"></td> <td style="width: 10%;"></td> <td style="width: 10%;"></td> </tr> <tr> <td></td> <td></td> <td colspan="8" style="text-align: center;"> <table border="1" style="width: 100%; border-collapse: collapse; text-align: center;"> <tr> <td style="width: 10%;"></td> <td style="width: 10%;"></td> <td style="width: 10%;"></td> <td style="width: 10%;"></td> <td style="width: 10%;"></td> <td style="width: 10%;"></td> <td style="width: 10%;"></td> <td style="width: 10%;"></td> <td style="width: 10%;"></td> <td style="width: 10%;"></td> </tr> <tr> <td></td> <td></td> <td colspan="8" style="text-align: center;"> <table border="1" style="width: 100%; border-collapse: collapse; text-align: center;"> <tr> <td style="width: 10%;"></td> <td style="width: 10%;"></td> <td style="width: 10%;"></td> <td style="width: 10%;"></td> <td style="width: 10%;"></td> <td style="width: 10%;"></td> <td style="width: 10%;"></td> <td style="width: 10%;"></td> <td style="width: 10%;"></td> <td style="width: 10%;"></td> </tr> <tr> <td></td> <td></td> <td colspan="8" style="text-align: center;"> <table border="1" style="width: 100%; border-collapse: collapse; text-align: center;"> <tr> <td style="width: 10%;"></td> <td style="width: 10%;"></td> <td style="width: 10%;"></td> <td style="width: 10%;"></td> <td style="width: 10%;"></td> <td style="width: 10%;"></td> <td style="width: 10%;"></td> <td style="width: 10%;"></td> <td style="width: 10%;"></td> <td style="width: 10%;"></td> </tr> <tr> <td></td> <td></td> <td colspan="8" style="text-align: center;"> <table border="1" style="width: 100%; border-collapse: collapse; text-align: center;"> <tr> <td style="width: 10%;"></td> <td style="width: 10%;"></td> <td style="width: 10%;"></td> <td style="width: 10%;"></td> <td style="width: 10%;"></td> <td style="width: 10%;"></td> <td style="width: 10%;"></td> <td style="width: 10%;"></td> <td style="width: 10%;"></td> <td style="width: 10%;"></td> </tr> <tr> <td></td> <td></td> <td colspan="8" style="text-align: center;"> <table border="1" style="width: 100%; border-collapse: collapse; text-align: center;"> <tr> <td style="width: 10%;"></td> <td style="width: 10%;"></td> <td style="width: 10%;"></td> <td style="width: 10%;"></td> <td style="width: 10%;"></td> <td style="width: 10%;"></td> <td style="width: 10%;"></td> <td style="width: 10%;"></td> <td style="width: 10%;"></td> <td style="width: 10%;"></td> </tr> <tr> <td></td> <td></td> <td colspan="8" style="text-align: center;"> <table border="1" style="width: 100%; border-collapse: collapse; text-align: center;"> <tr> <td style="width: 10%;"></td> <td style="width: 10%;"></td> <td style="width: 10%;"></td> <td style="width: 10%;"></td> <td style="width: 10%;"></td> <td style="width: 10%;"></td> <td style="width: 10%;"></td> <td style="width: 10%;"></td> <td style="width: 10%;"></td> <td style="width: 10%;"></td> </tr> <tr> <td></td> <td></td> <td colspan="8" style="text-align: center;"> <table border="1" style="width: 100%; border-collapse: collapse; text-align: center;"> <tr> <td style="width: 10%;"></td> <td style="width: 10%;"></td> <td style="width: 10%;"></td> <td style="width: 10%;"></td> <td style="width: 10%;"></td> <td style="width: 10%;"></td> <td style="width: 10%;"></td> <td style="width: 10%;"></td> <td style="width: 10%;"></td> <td style="width: 10%;"></td> </tr> <tr> <td></td> <td></td> <td colspan="8" style="text-align: center;"> <table border="1" style="width: 100%; border-collapse: collapse; text-align: center;"> <tr> <td style="width: 10%;"></td> <td style="width: 10%;"></td> <td style="width: 10%;"></td> <td style="width: 10%;"></td> <td style="width: 10%;"></td> <td style="width: 10%;"></td> <td style="width: 10%;"></td> <td style="width: 10%;"></td> <td style="width: 10%;"></td> <td style="width: 10%;"></td> </tr> <tr> <td></td> <td></td> <td colspan="8" style="text-align: center;"> <table border="1" style="width: 100%; border-collapse: collapse; text-align: center;"> <tr> <td style="width: 10%;"></td> <td style="width: 10%;"></td> <td style="width: 10%;"></td> <td style="width: 10%;"></td> <td style="width: 10%;"></td> <td style="width: 10%;"></td> <td
style="width: 10%;"></td> <td style="width: 10%;"></td> <td style="width: 10%;"></td> <td style="width: 10%;"></td> </tr> <tr> <td></td> <td></td> <td colspan="8" style="text-align: center;"> <table border="1" style="width: 100%; border-collapse: collapse; text-align: center;"> <tr> <td style="width: 10%;"></td> <td style="width: 10%;"></td> <td style="width: 10%;"></td> <td style="width: 10%;"></td> <td style="width: 10%;"></td> <td style="width: 10%;"></td> <td style="width: 10%;"></td> <td style="width: 10%;"></td> <td style="width: 10%;"></td> <td style="width: 10%;"></td> </tr> <tr> <td></td> <td></td> <td colspan="8" style="text-align: center;"> <table border="1" style="width: 100%; border-collapse: collapse; text-align: center;"> <tr> <td style="width: 10%;"></td> <td style="width: 10%;"></td> <td style="width: 10%;"></td> <td style="width: 10%;"></td> <td style="width: 10%;"></td> <td style="width: 10%;"></td> <td style="width: 10%;"></td> <td style="width: 10%;"></td> <td style="width: 10%;"></td> <td style="width: 10%;"></td> </tr> <tr> <td></td> <td></td> <td colspan="8" style="text-align: center;"> <table border="1" style="width: 100%; border-collapse: collapse; text-align: center;"> <tr> <td style="width: 10%;"></td> <td style="width: 10%;"></td> <td style="width: 10%;"></td> <td style="width: 10%;"></td> <td style="width: 10%;"></td> <td style="width: 10%;"></td> <td style="width: 10%;"></td> <td style="width: 10%;"></td> <td style="width: 10%;"></td> <td style="width: 10%;"></td> </tr> <tr> <td></td> <td></td> <td colspan="8" style="text-align: center;"> <table border="1" style="width: 100%; border-collapse: collapse; text-align: center;"> <tr> <td style="width: 10%;"></td> <td style="width: 10%;"></td> <td style="width: 10%;"></td> <td style="width: 10%;"></td> <td style="width: 10%;"></td> <td style="width: 10%;"></td> <td style="width: 10%;"></td> <td style="width: 10%;"></td> <td style="width: 10%;"></td> <td style="width: 10%;"></td> </tr> <tr> <td></td> <td></td> <td colspan="8" style="text-align: center;"> <table border="1" style="width: 100%; border-collapse: collapse; text-align: center;"> <tr> <td style="width: 10%;"></td> <td style="width: 10%;"></td> <td style="width: 10%;"></td> <td style="width: 10%;"></td> <td style="width: 10%;"></td> <td style="width: 10%;"></td> <td style="width: 10%;"></td> <td style="width: 10%;"></td> <td style="width: 10%;"></td> <td style="width: 10%;"></td> </tr> <tr> <td></td> <td></td> <td colspan="8" style="text-align: center;"> <table border="1" style="width: 100%; border-collapse: collapse; text-align: center;"> <tr> <td style="width: 10%;"></td> <td style="width: 10%;"></td> <td style="width: 10%;"></td> <td style="width: 10%;"></td> <td style="width: 10%;"></td> <td style="width: 10%;"></td> <td style="width: 10%;"></td> <td style="width: 10%;"></td> <td style="width: 10%;"></td> <td style="width: 10%;"></td> </tr> <tr> <td></td> <td></td> <td colspan="8" style="text-align: center;"> <table border="1" style="width: 100%; border-collapse: collapse; text-align: center;"> <tr> <td style="width: 10%;"></td> <td style="width: 10%;"></td> <td style="width: 10%;"></td> <td style="width: 10%;"></td> <td style="width: 10%;"></td> <td style="width: 10%;"></td> <td style="width: 10%;"></td> <td style="width: 10%;"></td> <td style="width: 10%;"></td> <td style="width: 10%;"></td> </tr> <tr> <td></td> <td></td> <td colspan="8" style="text-align: center;"> <table border="1" style="width: 100%; border-collapse: collapse; text-align: center;"> <tr> <td style="width: 10%;"></td> <td style="width: 10%;"></td> <td style="width: 10%;"></td> <td style="width: 10%;"></td> <td style="width: 10%;"></td> <td style="width: 10%;"></td> <td style="width: 10%;"></td> <td style="width: 10%;"></td> <td style="width: 10%;"></td> <td style="width: 10%;"></td> </tr> <tr> <td></td> <td></td> <td colspan="8" style="text-align: center;"> <table border="1" style="width: 100%; border-collapse: collapse; text-align: center;"> <tr> </tr></table></td></tr></table></td></tr></table></td></tr></table></td></tr></table></td></tr></table></td></tr></table></td></tr></table></td></tr></table></td></tr></table></td></tr></table></td></tr></table></td></tr></table></td></tr></table></td></tr></table></td></tr></table></td></tr></table></td></tr></table></td></tr></table></td></tr></table></td></tr></table></td></tr></table></td></tr></table></td></tr></table></td></tr></table></td></tr></table></td></tr></table></td></tr></table></td></tr></table></td></tr></table></td></tr></table> | | | | | | | | | | | | | | | | | | | | <table border="1" style="width: 100%; border-collapse: collapse; text-align: center;"> <tr> <td style="width: 10%;"></td> <td style="width: 10%;"></td> <td style="width: 10%;"></td> <td style="width: 10%;"></td> <td style="width: 10%;"></td> <td style="width: 10%;"></td> <td style="width: 10%;"></td> <td style="width: 10%;"></td> <td style="width: 10%;"></td> <td style="width: 10%;"></td> </tr> <tr> <td></td> <td></td> <td colspan="8" style="text-align: center;"> <table border="1" style="width: 100%; border-collapse: collapse; text-align: center;"> <tr> <td style="width: 10%;"></td> <td style="width: 10%;"></td> <td style="width: 10%;"></td> <td style="width: 10%;"></td> <td style="width: 10%;"></td> <td style="width: 10%;"></td> <td style="width: 10%;"></td> <td style="width: 10%;"></td> <td style="width: 10%;"></td> <td style="width: 10%;"></td> </tr> <tr> <td></td> <td></td> <td colspan="8" style="text-align: center;"> <table border="1" style="width: 100%; border-collapse: collapse; text-align: center;"> <tr> <td style="width: 10%;"></td> <td style="width: 10%;"></td> <td style="width: 10%;"></td> <td style="width: 10%;"></td> <td style="width: 10%;"></td> <td style="width: 10%;"></td> <td style="width: 10%;"></td> <td style="width: 10%;"></td> <td style="width: 10%;"></td> <td style="width: 10%;"></td> </tr> <tr> <td></td> <td></td> <td colspan="8" style="text-align: center;"> <table border="1" style="width: 100%; border-collapse: collapse; text-align: center;"> <tr> <td style="width: 10%;"></td> <td style="width: 10%;"></td> <td style="width: 10%;"></td> <td style="width: 10%;"></td> <td style="width: 10%;"></td> <td style="width: 10%;"></td> <td style="width: 10%;"></td> <td style="width: 10%;"></td> <td style="width: 10%;"></td> <td style="width: 10%;"></td> </tr> <tr> <td></td> <td></td> <td colspan="8" style="text-align: center;"> <table border="1" style="width: 100%; border-collapse: collapse; text-align: center;"> <tr> <td style="width: 10%;"></td> <td style="width: 10%;"></td> <td style="width: 10%;"></td> <td style="width: 10%;"></td> <td style="width: 10%;"></td> <td style="width: 10%;"></td> <td style="width: 10%;"></td> <td style="width: 10%;"></td> <td style="width: 10%;"></td> <td style="width: 10%;"></td> </tr> <tr> <td></td> <td></td> <td colspan="8" style="text-align: center;"> <table border="1" style="width: 100%; border-collapse: collapse; text-align: center;"> <tr> <td style="width: 10%;"></td> <td style="width: 10%;"></td> <td style="width: 10%;"></td> <td style="width: 10%;"></td> <td style="width: 10%;"></td> <td style="width: 10%;"></td> <td style="width: 10%;"></td> <td style="width: 10%;"></td> <td style="width: 10%;"></td> <td style="width: 10%;"></td> </tr> <tr> <td></td> <td></td> <td colspan="8" style="text-align: center;"> <table border="1" style="width: 100%; border-collapse: collapse; text-align: center;"> <tr> <td style="width:
10%;"></td> <td style="width: 10%;"></td> <td style="width: 10%;"></td> <td style="width: 10%;"></td> <td style="width: 10%;"></td> <td style="width: 10%;"></td> <td style="width: 10%;"></td> <td style="width: 10%;"></td> <td style="width: 10%;"></td> <td style="width: 10%;"></td> </tr> <tr> <td></td> <td></td> <td colspan="8" style="text-align: center;"> <table border="1" style="width: 100%; border-collapse: collapse; text-align: center;"> <tr> <td style="width: 10%;"></td> <td style="width: 10%;"></td> <td style="width: 10%;"></td> <td style="width: 10%;"></td> <td style="width: 10%;"></td> <td style="width: 10%;"></td> <td style="width: 10%;"></td> <td style="width: 10%;"></td> <td style="width: 10%;"></td> <td style="width: 10%;"></td> </tr> <tr> <td></td> <td></td> <td colspan="8" style="text-align: center;"> <table border="1" style="width: 100%; border-collapse: collapse; text-align: center;"> <tr> <td style="width: 10%;"></td> <td style="width: 10%;"></td> <td style="width: 10%;"></td> <td style="width: 10%;"></td> <td style="width: 10%;"></td> <td style="width: 10%;"></td> <td style="width: 10%;"></td> <td style="width: 10%;"></td> <td style="width: 10%;"></td> <td style="width: 10%;"></td> </tr> <tr> <td></td> <td></td> <td colspan="8" style="text-align: center;"> <table border="1" style="width: 100%; border-collapse: collapse; text-align: center;"> <tr> <td style="width: 10%;"></td> <td style="width: 10%;"></td> <td style="width: 10%;"></td> <td style="width: 10%;"></td> <td style="width: 10%;"></td> <td style="width: 10%;"></td> <td style="width: 10%;"></td> <td style="width: 10%;"></td> <td style="width: 10%;"></td> <td style="width: 10%;"></td> </tr> <tr> <td></td> <td></td> <td colspan="8" style="text-align: center;"> <table border="1" style="width: 100%; border-collapse: collapse; text-align: center;"> <tr> <td style="width: 10%;"></td> <td style="width: 10%;"></td> <td style="width: 10%;"></td> <td style="width: 10%;"></td> <td style="width: 10%;"></td> <td style="width: 10%;"></td> <td style="width: 10%;"></td> <td style="width: 10%;"></td> <td style="width: 10%;"></td> <td style="width: 10%;"></td> </tr> <tr> <td></td> <td></td> <td colspan="8" style="text-align: center;"> <table border="1" style="width: 100%; border-collapse: collapse; text-align: center;"> <tr> <td style="width: 10%;"></td> <td style="width: 10%;"></td> <td style="width: 10%;"></td> <td style="width: 10%;"></td> <td style="width: 10%;"></td> <td style="width: 10%;"></td> <td style="width: 10%;"></td> <td style="width: 10%;"></td> <td style="width: 10%;"></td> <td style="width: 10%;"></td> </tr> <tr> <td></td> <td></td> <td colspan="8" style="text-align: center;"> <table border="1" style="width: 100%; border-collapse: collapse; text-align: center;"> <tr> <td style="width: 10%;"></td> <td style="width: 10%;"></td> <td style="width: 10%;"></td> <td style="width: 10%;"></td> <td style="width: 10%;"></td> <td style="width: 10%;"></td> <td style="width: 10%;"></td> <td style="width: 10%;"></td> <td style="width: 10%;"></td> <td style="width: 10%;"></td> </tr> <tr> <td></td> <td></td> <td colspan="8" style="text-align: center;"> <table border="1" style="width: 100%; border-collapse: collapse; text-align: center;"> <tr> <td style="width: 10%;"></td> <td style="width: 10%;"></td> <td style="width: 10%;"></td> <td style="width: 10%;"></td> <td style="width: 10%;"></td> <td style="width: 10%;"></td> <td style="width: 10%;"></td> <td style="width: 10%;"></td> <td style="width: 10%;"></td> <td style="width: 10%;"></td> </tr> <tr> <td></td> <td></td> <td colspan="8" style="text-align: center;"> <table border="1" style="width: 100%; border-collapse: collapse; text-align: center;"> <tr> <td style="width: 10%;"></td> <td style="width: 10%;"></td> <td style="width: 10%;"></td> <td style="width: 10%;"></td> <td style="width: 10%;"></td> <td style="width: 10%;"></td> <td style="width: 10%;"></td> <td style="width: 10%;"></td> <td style="width: 10%;"></td> <td style="width: 10%;"></td> </tr> <tr> <td></td> <td></td> <td colspan="8" style="text-align: center;"> <table border="1" style="width: 100%; border-collapse: collapse; text-align: center;"> <tr> <td style="width: 10%;"></td> <td style="width: 10%;"></td> <td style="width: 10%;"></td> <td style="width: 10%;"></td> <td style="width: 10%;"></td> <td style="width: 10%;"></td> <td style="width: 10%;"></td> <td style="width: 10%;"></td> <td style="width: 10%;"></td> <td style="width: 10%;"></td> </tr> <tr> <td></td> <td></td> <td colspan="8" style="text-align: center;"> <table border="1" style="width: 100%; border-collapse: collapse; text-align: center;"> <tr> <td style="width: 10%;"></td> <td style="width: 10%;"></td> <td style="width: 10%;"></td> <td style="width: 10%;"></td> <td style="width: 10%;"></td> <td style="width: 10%;"></td> <td style="width: 10%;"></td> <td style="width: 10%;"></td> <td style="width: 10%;"></td> <td style="width: 10%;"></td> </tr> <tr> <td></td> <td></td> <td colspan="8" style="text-align: center;"> <table border="1" style="width: 100%; border-collapse: collapse; text-align: center;"> <tr> <td style="width: 10%;"></td> <td style="width: 10%;"></td> <td style="width: 10%;"></td> <td style="width: 10%;"></td> <td style="width: 10%;"></td> <td style="width: 10%;"></td> <td style="width: 10%;"></td> <td style="width: 10%;"></td> <td style="width: 10%;"></td> <td style="width: 10%;"></td> </tr> <tr> <td></td> <td></td> <td colspan="8" style="text-align: center;"> <table border="1" style="width: 100%; border-collapse: collapse; text-align: center;"> <tr> <td style="width: 10%;"></td> <td style="width: 10%;"></td> <td style="width: 10%;"></td> <td style="width: 10%;"></td> <td style="width: 10%;"></td> <td style="width: 10%;"></td> <td style="width: 10%;"></td> <td style="width: 10%;"></td> <td style="width: 10%;"></td> <td style="width: 10%;"></td> </tr> <tr> <td></td> <td></td> <td colspan="8" style="text-align: center;"> <table border="1" style="width: 100%; border-collapse: collapse; text-align: center;"> <tr> <td style="width: 10%;"></td> <td style="width: 10%;"></td> <td style="width: 10%;"></td> <td style="width: 10%;"></td> <td style="width: 10%;"></td> <td style="width: 10%;"></td> <td style="width: 10%;"></td> <td style="width: 10%;"></td> <td style="width: 10%;"></td> <td style="width: 10%;"></td> </tr> <tr> <td></td> <td></td> <td colspan="8" style="text-align: center;"> <table border="1" style="width: 100%; border-collapse: collapse; text-align: center;"> <tr> <td style="width: 10%;"></td> <td style="width: 10%;"></td> <td style="width: 10%;"></td> <td style="width: 10%;"></td> <td style="width: 10%;"></td> <td style="width: 10%;"></td> <td style="width: 10%;"></td> <td style="width: 10%;"></td> <td style="width: 10%;"></td> <td style="width: 10%;"></td> </tr> <tr> <td></td> <td></td> <td colspan="8" style="text-align: center;"> <table border="1" style="width: 100%; border-collapse: collapse; text-align: center;"> <tr> <td style="width: 10%;"></td> <td style="width: 10%;"></td> <td style="width: 10%;"></td> <td style="width: 10%;"></td> <td style="width: 10%;"></td> <td style="width: 10%;"></td> <td style="width: 10%;"></td> <td style="width: 10%;"></td> <td style="width: 10%;"></td> <td style="width: 10%;"></td> </tr> <tr> <td></td> <td></td> <td colspan="8" style="text-align: center;"> <table border="1" style="width: 100%; border-collapse: collapse; text-align: center;"> <tr> <td style="width: 10%;"></td> <td style="width: 10%;"></td> <td style="width: 10%;"></td> <td style="width: 10%;"></td> <td style="width: 10%;"></td> <td style="width: 10%;"></td> <td style="width: 10%;"></td> <td style="width: 10%;"></td> <td style="width: 10%;"></td> <td style="width: 10%;"></td> </tr> <tr> <td></td> <td></td> <td colspan="8" style="text-align: center;"> <table border="1" style="width: 100%; border-collapse: collapse; text-align: center;"> <tr> <td style="width: 10%;"></td> <td style="width: 10%;"></td> <td style="width: 10%;"></td> <td style="width: 10%;"></td> <td style="width: 10%;"></td> <td style="width: 10%;"></td> <td style="width: 10%;"></td> <td style="width: 10%;"></td> <td style="width: 10%;"></td> <td style="width: 10%;"></td> </tr> <tr> <td></td> <td></td> <td colspan="8" style="text-align: center;"> <table border="1" style="width: 100%; border-collapse: collapse; text-align: center;"> <tr> <td style="width: 10%;"></td> <td style="width: 10%;"></td> <td style="width: 10%;"></td> <td style="width: 10%;"></td> <td style="width: 10%;"></td> <td style="width: 10%;"></td> <td style="width: 10%;"></td> <td style="width: 10%;"></td> <td style="width: 10%;"></td> <td style="width: 10%;"></td> </tr> <tr> <td></td> <td></td> <td colspan="8" style="text-align: center;"> <table border="1" style="width: 100%; border-collapse: collapse; text-align: center;"> <tr> <td style="width: 10%;"></td> <td style="width: 10%;"></td> <td style="width: 10%;"></td> <td style="width: 10%;"></td> <td style="width: 10%;"></td> <td style="width: 10%;"></td> <td style="width: 10%;"></td> <td style="width: 10%;"></td> <td style="width: 10%;"></td> <td style="width: 10%;"></td> </tr> <tr> <td></td> <td></td> <td colspan="8" style="text-align: center;"> <table border="1" style="width: 100%; border-collapse: collapse; text-align: center;"> <tr> <td style="width: 10%;"></td> <td style="width: 10%;"></td> <td style="width: 10%;"></td> <td style="width: 10%;"></td> <td style="width: 10%;"></td> <td style="width: 10%;"></td> <td style="width: 10%;"></td> <td style="width: 10%;"></td> <td style="width: 10%;"></td> <td style="width: 10%;"></td> </tr> <tr> <td></td> <td></td> <td colspan="8" style="text-align: center;"> <table border="1" style="width: 100%; border-collapse: collapse; text-align: center;"> <tr> <td style="width: 10%;"></td> <td style="width: 10%;"></td> <td style="width: 10%;"></td> <td style="width: 10%;"></td> <td style="width: 10%;"></td> <td style="width: 10%;"></td> <td
style="width: 10%;"></td> <td style="width: 10%;"></td> <td style="width: 10%;"></td> <td style="width: 10%;"></td> </tr> <tr> <td></td> <td></td> <td colspan="8" style="text-align: center;"> <table border="1" style="width: 100%; border-collapse: collapse; text-align: center;"> <tr> <td style="width: 10%;"></td> <td style="width: 10%;"></td> <td style="width: 10%;"></td> <td style="width: 10%;"></td> <td style="width: 10%;"></td> <td style="width: 10%;"></td> <td style="width: 10%;"></td> <td style="width: 10%;"></td> <td style="width: 10%;"></td> <td style="width: 10%;"></td> </tr> <tr> <td></td> <td></td> <td colspan="8" style="text-align: center;"> <table border="1" style="width: 100%; border-collapse: collapse; text-align: center;"> <tr> </tr></table></td></tr></table></td></tr></table></td></tr></table></td></tr></table></td></tr></table></td></tr></table></td></tr></table></td></tr></table></td></tr></table></td></tr></table></td></tr></table></td></tr></table></td></tr></table></td></tr></table></td></tr></table></td></tr></table></td></tr></table></td></tr></table></td></tr></table></td></tr></table></td></tr></table></td></tr></table></td></tr></table></td></tr></table></td></tr></table></td></tr></table></td></tr></table></td></tr></table></td></tr></table> | | | | | | | | | | | | | | | | | | | | <table border="1" style="width: 100%; border-collapse: collapse; text-align: center;"> <tr> <td style="width: 10%;"></td> <td style="width: 10%;"></td> <td style="width: 10%;"></td> <td style="width: 10%;"></td> <td style="width: 10%;"></td> <td style="width: 10%;"></td> <td style="width: 10%;"></td> <td style="width: 10%;"></td> <td style="width: 10%;"></td> <td style="width: 10%;"></td> </tr> <tr> <td></td> <td></td> <td colspan="8" style="text-align: center;"> <table border="1" style="width: 100%; border-collapse: collapse; text-align: center;"> <tr> <td style="width: 10%;"></td> <td style="width: 10%;"></td> <td style="width: 10%;"></td> <td style="width: 10%;"></td> <td style="width: 10%;"></td> <td style="width: 10%;"></td> <td style="width: 10%;"></td> <td style="width: 10%;"></td> <td style="width: 10%;"></td> <td style="width: 10%;"></td> </tr> <tr> <td></td> <td></td> <td colspan="8" style="text-align: center;"> <table border="1" style="width: 100%; border-collapse: collapse; text-align: center;"> <tr> <td style="width: 10%;"></td> <td style="width: 10%;"></td> <td style="width: 10%;"></td> <td style="width: 10%;"></td> <td style="width: 10%;"></td> <td style="width: 10%;"></td> <td style="width: 10%;"></td> <td style="width: 10%;"></td> <td style="width: 10%;"></td> <td style="width: 10%;"></td> </tr> <tr> <td></td> <td></td> <td colspan="8" style="text-align: center;"> <table border="1" style="width: 100%; border-collapse: collapse; text-align: center;"> <tr> <td style="width: 10%;"></td> <td style="width: 10%;"></td> <td style="width: 10%;"></td> <td style="width: 10%;"></td> <td style="width: 10%;"></td> <td style="width: 10%;"></td> <td style="width: 10%;"></td> <td style="width: 10%;"></td> <td style="width: 10%;"></td> <td style="width: 10%;"></td> </tr> <tr> <td></td> <td></td> <td colspan="8" style="text-align: center;"> <table border="1" style="width: 100%; border-collapse: collapse; text-align: center;"> <tr> <td style="width: 10%;"></td> <td style="width: 10%;"></td> <td style="width: 10%;"></td> <td style="width: 10%;"></td> <td style="width: 10%;"></td> <td style="width: 10%;"></td> <td style="width: 10%;"></td> <td style="width: 10%;"></td> <td style="width: 10%;"></td> <td style="width: 10%;"></td> </tr> <tr> <td></td> <td></td> <td colspan="8" style="text-align: center;"> <table border="1" style="width: 100%; border-collapse: collapse; text-align: center;"> <tr> <td style="width: 10%;"></td> <td style="width: 10%;"></td> <td style="width: 10%;"></td> <td style="width: 10%;"></td> <td style="width: 10%;"></td> <td style="width: 10%;"></td> <td style="width: 10%;"></td> <td style="width: 10%;"></td> <td style="width: 10%;"></td> <td style="width: 10%;"></td> </tr> <tr> <td></td> <td></td> <td colspan="8" style="text-align: center;"> <table border="1" style="width: 100%; border-collapse: collapse; text-align: center;"> <tr> <td style="width: 10%;"></td> <td style="width: 10%;"></td> <td style="width: 10%;"></td> <td style="width: 10%;"></td> <td style="width: 10%;"></td> <td style="width: 10%;"></td> <td style="width: 10%;"></td> <td style="width: 10%;"></td> <td style="width: 10%;"></td> <td style="width: 10%;"></td> </tr> <tr> <td></td> <td></td> <td colspan="8" style="text-align: center;"> <table border="1" style="width: 100%; border-collapse: collapse; text-align: center;"> <tr> <td style="width: 10%;"></td> <td style="width: 10%;"></td> <td style="width: 10%;"></td> <td style="width: 10%;"></td> <td style="width: 10%;"></td> <td style="width: 10%;"></td> <td style="width: 10%;"></td> <td style="width: 10%;"></td> <td style="width: 10%;"></td> <td style="width: 10%;"></td> </tr> <tr> <td></td> <td></td> <td colspan="8" style="text-align: center;"> <table border="1" style="width: 100%; border-collapse: collapse; text-align: center;"> <tr> <td style="width: 10%;"></td> <td style="width: 10%;"></td> <td style="width: 10%;"></td> <td style="width: 10%;"></td> <td style="width: 10%;"></td> <td style="width: 10%;"></td> <td style="width: 10%;"></td> <td style="width: 10%;"></td> <td style="width: 10%;"></td> <td style="width: 10%;"></td> </tr> <tr> <td></td> <td></td> <td colspan="8" style="text-align: center;"> <table border="1" style="width: 100%; border-collapse: collapse; text-align: center;"> <tr> <td style="width: 10%;"></td> <td style="width: 10%;"></td> <td style="width: 10%;"></td> <td style="width: 10%;"></td> <td style="width: 10%;"></td> <td style="width: 10%;"></td> <td style="width: 10%;"></td> <td style="width: 10%;"></td> <td style="width: 10%;"></td> <td style="width: 10%;"></td> </tr> <tr> <td></td> <td></td> <td colspan="8" style="text-align: center;"> <table border="1" style="width: 100%; border-collapse: collapse; text-align: center;"> <tr> <td style="width: 10%;"></td> <td style="width: 10%;"></td> <td style="width: 10%;"></td> <td style="width: 10%;"></td> <td style="width: 10%;"></td> <td style="width: 10%;"></td> <td style="width: 10%;"></td> <td style="width: 10%;"></td> <td style="width: 10%;"></td> <td style="width: 10%;"></td> </tr> <tr> <td></td> <td></td> <td colspan="8" style="text-align: center;"> <table border="1" style="width: 100%; border-collapse: collapse; text-align: center;"> <tr> <td style="width: 10%;"></td> <td style="width: 10%;"></td> <td style="width: 10%;"></td> <td style="width: 10%;"></td> <td style="width: 10%;"></td> <td style="width: 10%;"></td> <td style="width: 10%;"></td> <td style="width: 10%;"></td> <td style="width: 10%;"></td> <td style="width: 10%;"></td> </tr> <tr> <td></td> <td></td> <td colspan="8" style="text-align: center;"> <table border="1" style="width: 100%; border-collapse: collapse; text-align: center;"> <tr> <td style="width: 10%;"></td> <td style="width: 10%;"></td> <td style="width: 10%;"></td> <td style="width: 10%;"></td> <td style="width: 10%;"></td> <td style="width: 10%;"></td> <td style="width: 10%;"></td> <td style="width: 10%;"></td> <td style="width: 10%;"></td> <td style="width: 10%;"></td> </tr> <tr> <td></td> <td></td> <td colspan="8" style="text-align: center;"> <table border="1" style="width: 100%; border-collapse: collapse; text-align: center;"> <tr> <td style="width: 10%;"></td> <td
style="width: 10%;"></td> <td style="width: 10%;"></td> <td style="width: 10%;"></td> <td style="width: 10%;"></td> <td style="width: 10%;"></td> <td style="width: 10%;"></td> <td style="width: 10%;"></td> <td style="width: 10%;"></td> <td style="width: 10%;"></td> </tr> <tr> <td></td> <td></td> <td colspan="8" style="text-align: center;"> <table border="1" style="width: 100%; border-collapse: collapse; text-align: center;"> <tr> <td style="width: 10%;"></td> <td style="width: 10%;"></td> <td style="width: 10%;"></td> <td style="width: 10%;"></td> <td style="width: 10%;"></td> <td style="width: 10%;"></td> <td style="width: 10%;"></td> <td style="width: 10%;"></td> <td style="width: 10%;"></td> <td style="width: 10%;"></td> </tr> <tr> <td></td> <td></td> <td colspan="8" style="text-align: center;"> <table border="1" style="width: 100%; border-collapse: collapse; text-align: center;"> <tr> <td style="width: 10%;"></td> <td style="width: 10%;"></td> <td style="width: 10%;"></td> <td style="width: 10%;"></td> <td style="width: 10%;"></td> <td style="width: 10%;"></td> <td style="width: 10%;"></td> <td style="width: 10%;"></td> <td style="width: 10%;"></td> <td style="width: 10%;"></td> </tr> <tr> <td></td> <td></td> <td colspan="8" style="text-align: center;"> <table border="1" style="width: 100%; border-collapse: collapse; text-align: center;"> <tr> <td style="width: 10%;"></td> <td style="width: 10%;"></td> <td style="width: 10%;"></td> <td style="width: 10%;"></td> <td style="width: 10%;"></td> <td style="width: 10%;"></td> <td style="width: 10%;"></td> <td style="width: 10%;"></td> <td style="width: 10%;"></td> <td style="width: 10%;"></td> </tr> <tr> <td></td> <td></td> <td colspan="8" style="text-align: center;"> <table border="1" style="width: 100%; border-collapse: collapse; text-align: center;"> <tr> <td style="width: 10%;"></td> <td style="width: 10%;"></td> <td style="width: 10%;"></td> <td style="width: 10%;"></td> <td style="width: 10%;"></td> <td style="width: 10%;"></td> <td style="width: 10%;"></td> <td style="width: 10%;"></td> <td style="width: 10%;"></td> <td style="width: 10%;"></td> </tr> <tr> <td></td> <td></td> <td colspan="8" style="text-align: center;"> <table border="1" style="width: 100%; border-collapse: collapse; text-align: center;"> <tr> <td style="width: 10%;"></td> <td style="width: 10%;"></td> <td style="width: 10%;"></td> <td style="width: 10%;"></td> <td style="width: 10%;"></td> <td style="width: 10%;"></td> <td style="width: 10%;"></td> <td style="width: 10%;"></td> <td style="width: 10%;"></td> <td style="width: 10%;"></td> </tr> <tr> <td></td> <td></td> <td colspan="8" style="text-align: center;"> <table border="1" style="width: 100%; border-collapse: collapse; text-align: center;"> <tr> <td style="width: 10%;"></td> <td style="width: 10%;"></td> <td style="width: 10%;"></td> <td style="width: 10%;"></td> <td style="width: 10%;"></td> <td style="width: 10%;"></td> <td style="width: 10%;"></td> <td style="width: 10%;"></td> <td style="width: 10%;"></td> <td style="width: 10%;"></td> </tr> <tr> <td></td> <td></td> <td colspan="8" style="text-align: center;"> <table border="1" style="width: 100%; border-collapse: collapse; text-align: center;"> <tr> <td style="width: 10%;"></td> <td style="width: 10%;"></td> <td style="width: 10%;"></td> <td style="width: 10%;"></td> <td style="width: 10%;"></td> <td style="width: 10%;"></td> <td style="width: 10%;"></td> <td style="width: 10%;"></td> <td style="width: 10%;"></td> <td style="width: 10%;"></td> </tr> <tr> <td></td> <td></td> <td colspan="8" style="text-align: center;"> <table border="1" style="width: 100%; border-collapse: collapse; text-align: center;"> <tr> <td style="width: 10%;"></td> <td style="width: 10%;"></td> <td style="width: 10%;"></td> <td style="width: 10%;"></td> <td style="width: 10%;"></td> <td style="width: 10%;"></td> <td style="width: 10%;"></td> <td style="width: 10%;"></td> <td style="width: 10%;"></td> <td style="width: 10%;"></td> </tr> <tr> <td></td> <td></td> <td colspan="8" style="text-align: center;"> <table border="1" style="width: 100%; border-collapse: collapse; text-align: center;"> <tr> <td style="width: 10%;"></td> <td style="width: 10%;"></td> <td style="width: 10%;"></td> <td style="width: 10%;"></td> <td style="width: 10%;"></td> <td style="width: 10%;"></td> <td style="width: 10%;"></td> <td style="width: 10%;"></td> <td style="width: 10%;"></td> <td style="width: 10%;"></td> </tr> <tr> <td></td> <td></td> <td colspan="8" style="text-align: center;"> <table border="1" style="width: 100%; border-collapse: collapse; text-align: center;"> <tr> <td style="width: 10%;"></td> <td style="width: 10%;"></td> <td style="width: 10%;"></td> <td style="width: 10%;"></td> <td style="width: 10%;"></td> <td style="width: 10%;"></td> <td style="width: 10%;"></td> <td style="width: 10%;"></td> <td style="width: 10%;"></td> <td style="width: 10%;"></td> </tr> <tr> <td></td> <td></td> <td colspan="8" style="text-align: center;"> <table border="1" style="width: 100%; border-collapse: collapse; text-align: center;"> <tr> <td style="width: 10%;"></td> <td style="width: 10%;"></td> <td style="width: 10%;"></td> <td style="width: 10%;"></td> <td style="width: 10%;"></td> <td style="width: 10%;"></td> <td style="width: 10%;"></td> <td style="width: 10%;"></td> <td style="width: 10%;"></td> <td style="width: 10%;"></td> </tr> <tr> <td></td> <td></td> <td colspan="8" style="text-align: center;"> <table border="1" style="width: 100%; border-collapse: collapse; text-align: center;"> <tr> <td style="width: 10%;"></td> <td style="width: 10%;"></td> <td style="width: 10%;"></td> <td style="width: 10%;"></td> <td style="width: 10%;"></td> <td style="width: 10%;"></td> <td style="width: 10%;"></td> <td style="width: 10%;"></td> <td style="width: 10%;"></td> <td style="width: 10%;"></td> </tr> <tr> <td></td> <td></td> <td colspan="8" style="text-align: center;"> <table border="1" style="width: 100%; border-collapse: collapse; text-align: center;"> <tr> <td style="width: 10%;"></td> <td style="width: 10%;"></td> <td style="width: 10%;"></td> <td style="width: 10%;"></td> <td style="width: 10%;"></td> <td style="width: 10%;"></td> <td style="width: 10%;"></td> <td style="width: 10%;"></td> <td style="width: 10%;"></td> <td style="width: 10%;"></td> </tr> <tr> <td></td> <td></td> <td colspan="8" style="text-align: center;"> <table border="1" style="width: 100%; border-collapse: collapse; text-align: center;"> <tr> <td style="width: 10%;"></td> <td style="width: 10%;"></td> <td style="width: 10%;"></td> <td style="width: 10%;"></td> <td style="width: 10%;"></td> <td style="width: 10%;"></td> <td style="width: 10%;"></td> <td style="width: 10%;"></td> <td style="width: 10%;"></td> <td style="width: 10%;"></td> </tr> <tr> <td></td> <td></td> <td colspan="8" style="text-align: center;"> <table border="1" style="width: 100%; border-collapse: collapse; text-align: center;"> <tr> </tr></table></td></tr></table></td></tr></table></td></tr></table></td></tr></table></td></tr></table></td></tr></table></td></tr></table></td></tr></table></td></tr></table></td></tr></table></td></tr></table></td></tr></table></td></tr></table></td></tr></table></td></tr></table></td></tr></table></td></tr></table></td></tr></table></td></tr></table></td></tr></table></td></tr></table></td></tr></table></td></tr></table></td></tr></table></td></tr></table></td></tr></table></td></tr></table></td></tr></table> | | | | | | | | | | | | | | | | | | | | <table
border="1" style="width: 100%; border-collapse: collapse; text-align: center;"> <tr> <td style="width: 10%;"></td> <td style="width: 10%;"></td> <td style="width: 10%;"></td> <td style="width: 10%;"></td> <td style="width: 10%;"></td> <td style="width: 10%;"></td> <td style="width: 10%;"></td> <td style="width: 10%;"></td> <td style="width: 10%;"></td> <td style="width: 10%;"></td> </tr> <tr> <td></td> <td></td> <td colspan="8" style="text-align: center;"> <table border="1" style="width: 100%; border-collapse: collapse; text-align: center;"> <tr> <td style="width: 10%;"></td> <td style="width: 10%;"></td> <td style="width: 10%;"></td> <td style="width: 10%;"></td> <td style="width: 10%;"></td> <td style="width: 10%;"></td> <td style="width: 10%;"></td> <td style="width: 10%;"></td> <td style="width: 10%;"></td> <td style="width: 10%;"></td> </tr> <tr> <td></td> <td></td> <td colspan="8" style="text-align: center;"> <table border="1" style="width: 100%; border-collapse: collapse; text-align: center;"> <tr> <td style="width: 10%;"></td> <td style="width: 10%;"></td> <td style="width: 10%;"></td> <td style="width: 10%;"></td> <td style="width: 10%;"></td> <td style="width: 10%;"></td> <td style="width: 10%;"></td> <td style="width: 10%;"></td> <td style="width: 10%;"></td> <td style="width: 10%;"></td> </tr> <tr> <td></td> <td></td> <td colspan="8" style="text-align: center;"> <table border="1" style="width: 100%; border-collapse: collapse; text-align: center;"> <tr> <td style="width: 10%;"></td> <td style="width: 10%;"></td> <td style="width: 10%;"></td> <td style="width: 10%;"></td> <td style="width: 10%;"></td> <td style="width: 10%;"></td> <td style="width: 10%;"></td> <td style="width: 10%;"></td> <td style="width: 10%;"></td> <td style="width: 10%;"></td> </tr> <tr> <td></td> <td></td> <td colspan="8" style="text-align: center;"> <table border="1" style="width: 100%; border-collapse: collapse; text-align: center;"> <tr> <td style="width: 10%;"></td> <td style="width: 10%;"></td> <td style="width: 10%;"></td> <td style="width: 10%;"></td> <td style="width: 10%;"></td> <td style="width: 10%;"></td> <td style="width: 10%;"></td> <td style="width: 10%;"></td> <td style="width: 10%;"></td> <td style="width: 10%;"></td> </tr> <tr> <td></td> <td></td> <td colspan="8" style="text-align: center;"> <table border="1" style="width: 100%; border-collapse: collapse; text-align: center;"> <tr> <td style="width: 10%;"></td> <td style="width: 10%;"></td> <td style="width: 10%;"></td> <td style="width: 10%;"></td> <td style="width: 10%;"></td> <td style="width: 10%;"></td> <td style="width: 10%;"></td> <td style="width: 10%;"></td> <td style="width: 10%;"></td> <td style="width: 10%;"></td> </tr> <tr> <td></td> <td></td> <td colspan="8" style="text-align: center;"> <table border="1" style="width: 100%; border-collapse: collapse; text-align: center;"> <tr> <td style="width: 10%;"></td> <td style="width: 10%;"></td> <td style="width: 10%;"></td> <td style="width: 10%;"></td> <td style="width: 10%;"></td> <td style="width: 10%;"></td> <td style="width: 10%;"></td> <td style="width: 10%;"></td> <td style="width: 10%;"></td> <td style="width: 10%;"></td> </tr> <tr> <td></td> <td></td> <td colspan="8" style="text-align: center;"> <table border="1" style="width: 100%; border-collapse: collapse; text-align: center;"> <tr> <td style="width: 10%;"></td> <td style="width: 10%;"></td> <td style="width: 10%;"></td> <td style="width: 10%;"></td> <td style="width: 10%;"></td> <td style="width: 10%;"></td> <td style="width: 10%;"></td> <td style="width: 10%;"></td> <td style="width: 10%;"></td> <td style="width: 10%;"></td> </tr> <tr> <td></td> <td></td> <td colspan="8" style="text-align: center;"> <table border="1" style="width: 100%; border-collapse: collapse; text-align: center;"> <tr> <td style="width: 10%;"></td> <td style="width: 10%;"></td> <td style="width: 10%;"></td> <td style="width: 10%;"></td> <td style="width: 10%;"></td> <td style="width: 10%;"></td> <td style="width: 10%;"></td> <td style="width: 10%;"></td> <td style="width: 10%;"></td> <td style="width: 10%;"></td> </tr> <tr> <td></td> <td></td> <td colspan="8" style="text-align: center;"> <table border="1" style="width: 100%; border-collapse: collapse; text-align: center;"> <tr> <td style="width: 10%;"></td> <td style="width: 10%;"></td> <td style="width: 10%;"></td> <td style="width: 10%;"></td> <td style="width: 10%;"></td> <td style="width: 10%;"></td> <td style="width: 10%;"></td> <td style="width: 10%;"></td> <td style="width: 10%;"></td> <td style="width: 10%;"></td> </tr> <tr> <td></td> <td></td> <td colspan="8" style="text-align: center;"> <table border="1" style="width: 100%; border-collapse: collapse; text-align: center;"> <tr> <td style="width: 10%;"></td> <td style="width: 10%;"></td> <td style="width: 10%;"></td> <td style="width: 10%;"></td> <td style="width: 10%;"></td> <td style="width: 10%;"></td> <td style="width: 10%;"></td> <td style="width: 10%;"></td> <td style="width: 10%;"></td> <td style="width: 10%;"></td> </tr> <tr> <td></td> <td></td> <td colspan="8" style="text-align: center;"> <table border="1" style="width: 100%; border-collapse: collapse; text-align: center;"> <tr> <td style="width: 10%;"></td> <td style="width: 10%;"></td> <td style="width: 10%;"></td> <td style="width: 10%;"></td> <td style="width: 10%;"></td> <td style="width: 10%;"></td> <td style="width: 10%;"></td> <td style="width: 10%;"></td> <td style="width: 10%;"></td> <td style="width: 10%;"></td> </tr> <tr> <td></td> <td></td> <td colspan="8" style="text-align: center;"> <table border="1" style="width: 100%; border-collapse: collapse; text-align: center;"> <tr> <td style="width: 10%;"></td> <td style="width: 10%;"></td> <td style="width: 10%;"></td> <td style="width: 10%;"></td> <td style="width: 10%;"></td> <td style="width: 10%;"></td> <td style="width: 10%;"></td> <td style="width: 10%;"></td> <td style="width: 10%;"></td> <td style="width: 10%;"></td> </tr> <tr> <td></td> <td></td> <td colspan="8" style="text-align: center;"> <table border="1" style="width: 100%; border-collapse: collapse; text-align: center;"> <tr> <td style="width: 10%;"></td> <td style="width: 10%;"></td> <td style="width: 10%;"></td> <td style="width: 10%;"></td> <td style="width: 10%;"></td> <td style="width: 10%;"></td> <td style="width: 10%;"></td> <td style="width: 10%;"></td> <td style="width: 10%;"></td> <td style="width: 10%;"></td> </tr> <tr> <td></td> <td></td> <td colspan="8" style="text-align: center;"> <table border="1" style="width: 100%; border-collapse: collapse; text-align: center;"> <tr> <td style="width: 10%;"></td> <td style="width: 10%;"></td> <td style="width: 10%;"></td> <td style="width: 10%;"></td> <td style="width: 10%;"></td> <td style="width: 10%;"></td> <td style="width: 10%;"></td> <td style="width: 10%;"></td> <td style="width: 10%;"></td> <td style="width: 10%;"></td> </tr> <tr> <td></td> <td></td> <td colspan="8" style="text-align: center;"> <table border="1" style="width: 100%; border-collapse: collapse; text-align: center;"> <tr> <td style="width: 10%;"></td> <td style="width: 10%;"></td> <td style="width: 10%;"></td> <td style="width: 10%;"></td> <td style="width: 10%;"></td> <td style="width: 10%;"></td> <td style="width: 10%;"></td> <td style="width: 10%;"></td> <td style="width: 10%;"></td> <td style="width: 10%;"></td> </tr> <tr> <td></td> <td></td> <td colspan="8" style="text-align: center;"> <table border="1" style="width: 100%; border-collapse: collapse; text-align: center;"> <tr> <td style="width: 10%;"></td> <td style="width: 10%;"></td> <td style="width: 10%;"></td> <td style="width: 10%;"></td> <td style="width: 10%;"></td> <td style="width: 10%;"></td> <td style="width: 10%;"></td> <td style="width: 10%;"></td> <td style="width: 10%;"></td> <td style="width: 10%;"></td> </tr> <tr> <td></td> <td></td> <td colspan="8" style="text-align: center;"> <table border="1" style="width: 100%; border-collapse: collapse; text-align: center;"> <tr> <td style="width: 10%;"></td> <td style="width: 10%;"></td> <td style="width: 10%;"></td> <td style="width: 10%;"></td> <td style="width: 10%;"></td> <td style="width: 10%;"></td> <td style="width: 10%;"></td> <td style="width: 10%;"></td> <td style="width: 10%;"></td> <td style="width: 10%;"></td> </tr> <tr> <td></td> <td></td> <td colspan="8" style="text-align: center;"> <table border="1" style="width: 100%; border-collapse: collapse; text-align: center;"> <tr> <td style="width: 10%;"></td> <td style="width: 10%;"></td> <td style="width: 10%;"></td> <td style="width: 10%;"></td> <td style="width: 10%;"></td> <td style="width: 10%;"></td> <td style="width: 10%;"></td> <td style="width: 10%;"></td> <td style="width: 10%;"></td> <td style="width: 10%;"></td> </tr> <tr> <td></td> <td></td> <td colspan="8" style="text-align: center;"> <table border="1" style="width: 100%; border-collapse: collapse; text-align: center;"> <tr> <td style="width: 10%;"></td> <td style="width: 10%;"></td> <td style="width: 10%;"></td> <td style="width: 10%;"></td> <td style="width: 10%;"></td> <td style="width: 10%;"></td> <td style="width: 10%;"></td> <td style="width: 10%;"></td> <td style="width: 10%;"></td> <td style="width: 10%;"></td> </tr> <tr> <td></td> <td></td> <td colspan="8" style="text-align: center;"> <table border="1" style="width: 100%; border-collapse: collapse; text-align: center;"> <tr> <td style="width: 10%;"></td> <td style="width: 10%;"></td> <td style="width: 10%;"></td> <td style="width: 10%;"></td> <td style="width: 10%;"></td> <td style="width: 10%;"></td> <td style="width: 10%;"></td> <td style="width: 10%;"></td> <td style="width: 10%;"></td> <td style="width: 10%;"></td> </tr> <tr> <td></td> <td></td> <td colspan="8" style="text-align: center;"> <table border="1" style="width: 100%; border-collapse: collapse; text-align: center;"> <tr> <td style="width: 10%;"></td> <td style="width: 10%;"></td> <td style="width:
10%;"></td> <td style="width: 10%;"></td> <td style="width: 10%;"></td> <td style="width: 10%;"></td> <td style="width: 10%;"></td> <td style="width: 10%;"></td> <td style="width: 10%;"></td> <td style="width: 10%;"></td> </tr> <tr> <td></td> <td></td> <td colspan="8" style="text-align: center;"> <table border="1" style="width: 100%; border-collapse: collapse; text-align: center;"> <tr> <td style="width: 10%;"></td> <td style="width: 10%;"></td> <td style="width: 10%;"></td> <td style="width: 10%;"></td> <td style="width: 10%;"></td> <td style="width: 10%;"></td> <td style="width: 10%;"></td> <td style="width: 10%;"></td> <td style="width: 10%;"></td> <td style="width: 10%;"></td> </tr> <tr> <td></td> <td></td> <td colspan="8" style="text-align: center;"> <table border="1" style="width: 100%; border-collapse: collapse; text-align: center;"> <tr> <td style="width: 10%;"></td> <td style="width: 10%;"></td> <td style="width: 10%;"></td> <td style="width: 10%;"></td> <td style="width: 10%;"></td> <td style="width: 10%;"></td> <td style="width: 10%;"></td> <td style="width: 10%;"></td> <td style="width: 10%;"></td> <td style="width: 10%;"></td> </tr> <tr> <td></td> <td></td> <td colspan="8" style="text-align: center;"> <table border="1" style="width: 100%; border-collapse: collapse; text-align: center;"> <tr> <td style="width: 10%;"></td> <td style="width: 10%;"></td> <td style="width: 10%;"></td> <td style="width: 10%;"></td> <td style="width: 10%;"></td> <td style="width: 10%;"></td> <td style="width: 10%;"></td> <td style="width: 10%;"></td> <td style="width: 10%;"></td> <td style="width: 10%;"></td> </tr> <tr> <td></td> <td></td> <td colspan="8" style="text-align: center;"> <table border="1" style="width: 100%; border-collapse: collapse; text-align: center;"> <tr> <td style="width: 10%;"></td> <td style="width: 10%;"></td> <td style="width: 10%;"></td> <td style="width: 10%;"></td> <td style="width: 10%;"></td> <td style="width: 10%;"></td> <td style="width: 10%;"></td> <td style="width: 10%;"></td> <td style="width: 10%;"></td> <td style="width: 10%;"></td> </tr> <tr> <td></td> <td></td> <td colspan="8" style="text-align: center;"> <table border="1" style="width: 100%; border-collapse: collapse; text-align: center;"> <tr> <td style="width: 10%;"></td> <td style="width: 10%;"></td> <td style="width: 10%;"></td> <td style="width: 10%;"></td> <td style="width: 10%;"></td> <td style="width: 10%;"></td> <td style="width: 10%;"></td> <td style="width: 10%;"></td> <td style="width: 10%;"></td> <td style="width: 10%;"></td> </tr> <tr> <td></td> <td></td> <td colspan="8" style="text-align: center;"> <table border="1" style="width: 100%; border-collapse: collapse; text-align: center;"> <tr> </tr></table></td></tr></table></td></tr></table></td></tr></table></td></tr></table></td></tr></table></td></tr></table></td></tr></table></td></tr></table></td></tr></table></td></tr></table></td></tr></table></td></tr></table></td></tr></table></td></tr></table></td></tr></table></td></tr></table></td></tr></table></td></tr></table></td></tr></table></td></tr></table></td></tr></table></td></tr></table></td></tr></table></td></tr></table></td></tr></table></td></tr></table></td></tr></table> | | | | | | | | | | | | | | | | | | | | <table border="1" style="width: 100%; border-collapse: collapse; text-align: center;"> <tr> <td style="width: 10%;"></td> <td style="width: 10%;"></td> <td style="width: 10%;"></td> <td style="width: 10%;"></td> <td style="width: 10%;"></td> <td style="width: 10%;"></td> <td style="width: 10%;"></td> <td style="width: 10%;"></td> <td style="width: 10%;"></td> <td style="width: 10%;"></td> </tr> <tr> <td></td> <td></td> <td colspan="8" style="text-align: center;"> <table border="1" style="width: 100%; border-collapse: collapse; text-align: center;"> <tr> <td style="width: 10%;"></td> <td style="width: 10%;"></td> <td style="width: 10%;"></td> <td style="width: 10%;"></td> <td style="width: 10%;"></td> <td style="width: 10%;"></td> <td style="width: 10%;"></td> <td style="width: 10%;"></td> <td style="width: 10%;"></td> <td style="width: 10%;"></td> </tr> <tr> <td></td> <td></td> <td colspan="8" style="text-align: center;"> <table border="1" style="width: 100%; border-collapse: collapse; text-align: center;"> <tr> <td style="width: 10%;"></td> <td style="width: 10%;"></td> <td style="width: 10%;"></td> <td style="width: 10%;"></td> <td style="width: 10%;"></td> <td style="width: 10%;"></td> <td style="width: 10%;"></td> <td style="width: 10%;"></td> <td style="width: 10%;"></td> <td style="width: 10%;"></td> </tr> <tr> <td></td> <td></td> <td colspan="8" style="text-align: center;"> <table border="1" style="width: 100%; border-collapse: collapse; text-align: center;"> <tr> <td style="width: 10%;"></td> <td style="width: 10%;"></td> <td style="width: 10%;"></td> <td style="width: 10%;"></td> <td style="width: 10%;"></td> <td style="width: 10%;"></td> <td style="width: 10%;"></td> <td style="width: 10%;"></td> <td style="width: 10%;"></td> <td style="width: 10%;"></td> </tr> <tr> <td></td> <td></td> <td colspan="8" style="text-align: center;"> <table border="1" style="width: 100%; border-collapse: collapse; text-align: center;"> <tr> <td style="width: 10%;"></td> <td style="width: 10%;"></td> <td style="width: 10%;"></td> <td style="width: 10%;"></td> <td style="width: 10%;"></td> <td style="width: 10%;"></td> <td style="width: 10%;"></td> <td style="width: 10%;"></td> <td style="width: 10%;"></td> <td style="width: 10%;"></td> </tr> <tr> <td></td> <td></td> <td colspan="8" style="text-align: center;"> <table border="1" style="width: 100%; border-collapse: collapse; text-align: center;"> <tr> <td style="width: 10%;"></td> <td style="width: 10%;"></td> <td style="width: 10%;"></td> <td style="width: 10%;"></td> <td style="width: 10%;"></td> <td style="width: 10%;"></td> <td style="width: 10%;"></td> <td style="width: 10%;"></td> <td style="width: 10%;"></td> <td style="width: 10%;"></td> </tr> <tr> <td></td> <td></td> <td colspan="8" style="text-align: center;"> <table border="1" style="width: 100%; border-collapse: collapse; text-align: center;"> <tr> <td style="width: 10%;"></td> <td style="width: 10%;"></td> <td style="width: 10%;"></td> <td style="width: 10%;"></td> <td style="width: 10%;"></td> <td style="width: 10%;"></td> <td style="width: 10%;"></td> <td style="width: 10%;"></td> <td style="width: 10%;"></td> <td style="width: 10%;"></td> </tr> <tr> <td></td> <td></td> <td colspan="8" style="text-align: center;"> <table border="1" style="width: 100%; border-collapse: collapse; text-align: center;"> <tr> <td style="width: 10%;"></td> <td style="width: 10%;"></td> <td style="width: 10%;"></td> <td style="width: 10%;"></td> <td style="width: 10%;"></td> <td style="width: 10%;"></td> <td style="width: 10%;"></td> <td style="width: 10%;"></td> <td style="width: 10%;"></td> <td style="width: 10%;"></td> </tr> <tr> <td></td> <td></td> <td colspan="8" style="text-align: center;"> <table border="1" style="width: 100%; border-collapse: collapse; text-align: center;"> <tr> <td style="width: 10%;"></td> <td style="width: 10%;"></td> <td style="width: 10%;"></td> <td style="width: 10%;"></td> <td style="width: 10%;"></td> <td style="width: 10%;"></td> <td style="width: 10%;"></td> <td style="width: 10%;"></td> <td style="width: 10%;"></td> <td style="width: 10%;"></td> </tr> <tr> <td></td> <td></td> <td colspan="8" style="text-align: center;"> <table border="1" style="width: 100%; border-collapse: collapse;
text-align: center;"> <tr> <td style="width: 10%;"></td> <td style="width: 10%;"></td> <td style="width: 10%;"></td> <td style="width: 10%;"></td> <td style="width: 10%;"></td> <td style="width: 10%;"></td> <td style="width: 10%;"></td> <td style="width: 10%;"></td> <td style="width: 10%;"></td> <td style="width: 10%;"></td> </tr> <tr> <td></td> <td></td> <td colspan="8" style="text-align: center;"> <table border="1" style="width: 100%; border-collapse: collapse; text-align: center;"> <tr> <td style="width: 10%;"></td> <td style="width: 10%;"></td> <td style="width: 10%;"></td> <td style="width: 10%;"></td> <td style="width: 10%;"></td> <td style="width: 10%;"></td> <td style="width: 10%;"></td> <td style="width: 10%;"></td> <td style="width: 10%;"></td> <td style="width: 10%;"></td> </tr> <tr> <td></td> <td></td> <td colspan="8" style="text-align: center;"> <table border="1" style="width: 100%; border-collapse: collapse; text-align: center;"> <tr> <td style="width: 10%;"></td> <td style="width: 10%;"></td> <td style="width: 10%;"></td> <td style="width: 10%;"></td> <td style="width: 10%;"></td> <td style="width: 10%;"></td> <td style="width: 10%;"></td> <td style="width: 10%;"></td> <td style="width: 10%;"></td> <td style="width: 10%;"></td> </tr> <tr> <td></td> <td></td> <td colspan="8" style="text-align: center;"> <table border="1" style="width: 100%; border-collapse: collapse; text-align: center;"> <tr> <td style="width: 10%;"></td> <td style="width: 10%;"></td> <td style="width: 10%;"></td> <td style="width: 10%;"></td> <td style="width: 10%;"></td> <td style="width: 10%;"></td> <td style="width: 10%;"></td> <td style="width: 10%;"></td> <td style="width: 10%;"></td> <td style="width: 10%;"></td> </tr> <tr> <td></td> <td></td> <td colspan="8" style="text-align: center;"> <table border="1" style="width: 100%; border-collapse: collapse; text-align: center;"> <tr> <td style="width: 10%;"></td> <td style="width: 10%;"></td> <td style="width: 10%;"></td> <td style="width: 10%;"></td> <td style="width: 10%;"></td> <td style="width: 10%;"></td> <td style="width: 10%;"></td> <td style="width: 10%;"></td> <td style="width: 10%;"></td> <td style="width: 10%;"></td> </tr> <tr> <td></td> <td></td> <td colspan="8" style="text-align: center;"> <table border="1" style="width: 100%; border-collapse: collapse; text-align: center;"> <tr> <td style="width: 10%;"></td> <td style="width: 10%;"></td> <td style="width: 10%;"></td> <td style="width: 10%;"></td> <td style="width: 10%;"></td> <td style="width: 10%;"></td> <td style="width: 10%;"></td> <td style="width: 10%;"></td> <td style="width: 10%;"></td> <td style="width: 10%;"></td> </tr> <tr> <td></td> <td></td> <td colspan="8" style="text-align: center;"> <table border="1" style="width: 100%; border-collapse: collapse; text-align: center;"> <tr> <td style="width: 10%;"></td> <td style="width: 10%;"></td> <td style="width: 10%;"></td> <td style="width: 10%;"></td> <td style="width: 10%;"></td> <td style="width: 10%;"></td> <td style="width: 10%;"></td> <td style="width: 10%;"></td> <td style="width: 10%;"></td> <td style="width: 10%;"></td> </tr> <tr> <td></td> <td></td> <td colspan="8" style="text-align: center;"> <table border="1" style="width: 100%; border-collapse: collapse; text-align: center;"> <tr> <td style="width: 10%;"></td> <td style="width: 10%;"></td> <td style="width: 10%;"></td> <td style="width: 10%;"></td> <td style="width: 10%;"></td> <td style="width: 10%;"></td> <td style="width: 10%;"></td> <td style="width: 10%;"></td> <td style="width: 10%;"></td> <td style="width: 10%;"></td> </tr> <tr> <td></td> <td></td> <td colspan="8" style="text-align: center;"> <table border="1" style="width: 100%; border-collapse: collapse; text-align: center;"> <tr> <td style="width: 10%;"></td> <td style="width: 10%;"></td> <td style="width: 10%;"></td> <td style="width: 10%;"></td> <td style="width: 10%;"></td> <td style="width: 10%;"></td> <td style="width: 10%;"></td> <td style="width: 10%;"></td> <td style="width: 10%;"></td> <td style="width: 10%;"></td> </tr> <tr> <td></td> <td></td> <td colspan="8" style="text-align: center;"> <table border="1" style="width: 100%; border-collapse: collapse; text-align: center;"> <tr> <td style="width: 10%;"></td> <td style="width: 10%;"></td> <td style="width: 10%;"></td> <td style="width: 10%;"></td> <td style="width: 10%;"></td> <td style="width: 10%;"></td> <td style="width: 10%;"></td> <td style="width: 10%;"></td> <td style="width: 10%;"></td> <td style="width: 10%;"></td> </tr> <tr> <td></td> <td></td> <td colspan="8" style="text-align: center;"> <table border="1" style="width: 100%; border-collapse: collapse; text-align: center;"> <tr> <td style="width: 10%;"></td> <td style="width: 10%;"></td> <td style="width: 10%;"></td> <td style="width: 10%;"></td> <td style="width: 10%;"></td> <td style="width: 10%;"></td> <td style="width: 10%;"></td> <td style="width: 10%;"></td> <td style="width: 10%;"></td> <td style="width: 10%;"></td> </tr> <tr> <td></td> <td></td> <td colspan="8" style="text-align: center;"> <table border="1" style="width: 100%; border-collapse: collapse; text-align: center;"> <tr> <td style="width: 10%;"></td> <td style="width: 10%;"></td> <td style="width: 10%;"></td> <td style="width: 10%;"></td> <td style="width: 10%;"></td> <td style="width: 10%;"></td> <td style="width: 10%;"></td> <td style="width: 10%;"></td> <td style="width: 10%;"></td> <td style="width: 10%;"></td> </tr> <tr> <td></td> <td></td> <td colspan="8" style="text-align: center;"> <table border="1" style="width: 100%; border-collapse: collapse; text-align: center;"> <tr> <td style="width: 10%;"></td> <td style="width: 10%;"></td> <td style="width: 10%;"></td> <td style="width: 10%;"></td> <td style="width: 10%;"></td> <td style="width: 10%;"></td> <td style="width: 10%;"></td> <td style="width: 10%;"></td> <td style="width: 10%;"></td> <td style="width: 10%;"></td> </tr> <tr> <td></td> <td></td> <td colspan="8" style="text-align: center;"> <table border="1" style="width: 100%; border-collapse: collapse; text-align: center;"> <tr> <td style="width: 10%;"></td> <td style="width: 10%;"></td> <td style="width: 10%;"></td> <td style="width: 10%;"></td> <td style="width: 10%;"></td> <td style="width: 10%;"></td> <td style="width: 10%;"></td> <td style="width: 10%;"></td> <td style="width: 10%;"></td> <td style="width: 10%;"></td> </tr> <tr> <td></td> <td></td> <td colspan="8" style="text-align: center;"> <table border="1" style="width: 100%; border-collapse: collapse; text-align: center;"> <tr> <td style="width: 10%;"></td> <td style="width: 10%;"></td> <td style="width: 10%;"></td> <td style="width: 10%;"></td> <td style="width: 10%;"></td> <td style="width: 10%;"></td> <td style="width: 10%;"></td> <td style="width: 10%;"></td> <td style="width: 10%;"></td> <td style="width: 10%;"></td> </tr> <tr> <td></td> <td></td> <td colspan="8" style="text-align: center;"> <table border="1" style="width: 100%; border-collapse: collapse; text-align: center;"> <tr> <td style="width: 10%;"></td> <td style="width: 10%;"></td> <td style="width: 10%;"></td> <td style="width: 10%;"></td> <td style="width: 10%;"></td> <td style="width: 10%;"></td> <td style="width: 10%;"></td> <td style="width: 10%;"></td> <td style="width: 10%;"></td> <td style="width: 10%;"></td> </tr> <tr> <td></td> <td></td> <td colspan="8" style="text-align: center;"> <table border="1" style="width: 100%; border-collapse: collapse; text-align: center;"> <tr> <td style="width: 10%;"></td> <td style="width: 10%;"></td> <td style="width: 10%;"></td> <td style="width: 10%;"></td> <td style="width: 10%;"></td> <td style="width: 10%;"></td> <td style="width: 10%;"></td> <td style="width: 10%;"></td> <td style="width: 10%;"></td> <td style="width: 10%;"></td> </tr> <tr> <td></td> <td></td> <td colspan="8" style="text-align: center;"> <table border="1" style="width: 100%; border-collapse: collapse; text-align: center;"> <tr> </tr></table></td></tr></table></td></tr></table></td></tr></table></td></tr></table></td></tr></table></td></tr></table></td></tr></table></td></tr></table></td></tr></table></td></tr></table></td></tr></table></td></tr></table></td></tr></table></td></tr></table></td></tr></table></td></tr></table></td></tr></table></td></tr></table></td></tr></table></td></tr></table></td></tr></table></td></tr></table></td></tr></table></td></tr></table></td></tr></table></td></tr></table>
 | | | | | | | | | | | | | | | | | | | | <table border="1" style="width: 100%; border-collapse: collapse; text-align: center;"> <tr> <td style="width: 10%;"></td> <td style="width: 10%;"></td> <td style="width: 10%;"></td> <td style="width: 10%;"></td> <td style="width: 10%;"></td> <td style="width: 10%;"></td> <td style="width: 10%;"></td> <td style="width: 10%;"></td> <td style="width: 10%;"></td> <td style="width: 10%;"></td> </tr> <tr> <td></td> <td></td> <td colspan="8" style="text-align: center;"> <table border="1" style="width: 100%; border-collapse: collapse; text-align: center;"> <tr> <td style="width: 10%;"></td> <td style="width: 10%;"></td> <td style="width: 10%;"></td> <td style="width: 10%;"></td> <td style="width: 10%;"></td> <td style="width: 10%;"></td> <td style="width: 10%;"></td> <td style="width: 10%;"></td> <td style="width: 10%;"></td> <td style="width: 10%;"></td> </tr> <tr> <td></td> <td></td> <td colspan="8" style="text-align: center;"> <table border="1" style="width: 100%; border-collapse: collapse; text-align: center;"> <tr> <td style="width: 10%;"></td> <td style="width: 10%;"></td> <td style="width: 10%;"></td> <td style="width: 10%;"></td> <td style="width: 10%;"></td> <td style="width: 10%;"></td> <td style="width: 10%;"></td> <td style="width: 10%;"></td> <td style="width: 10%;"></td> <td style="width: 10%;"></td> </tr> <tr> <td></td> <td></td> <td colspan="8" style="text-align: center;"> <table border="1" style="width: 100%; border-collapse: collapse; text-align: center;"> <tr> <td style="width: 10%;"></td> <td style="width: 10%;"></td> <td style="width: 10%;"></td> <td style="width: 10%;"></td> <td style="width: 10%;"></td> <td style="width: 10%;"></td> <td style="width: 10%;"></td> <td style="width: 10%;"></td> <td style="width: 10%;"></td> <td style="width: 10%;"></td> </tr> <tr> <td></td> <td></td> <td colspan="8" style="text-align: center;"> <table border="1" style="width: 100%; border-collapse: collapse; text-align: center;"> <tr> <td style="width: 10%;"></td> <td style="width: 10%;"></td> <td style="width: 10%;"></td> <td style="width: 10%;"></td> <td style="width: 10%;"></td> <td style="width: 10%;"></td> <td style="width: 10%;"></td> <td style="width: 10%;"></td> <td style="width: 10%;"></td> <td style="width: 10%;"></td> </tr> <tr> <td></td> <td></td> <td colspan="8" style="text-align: center;"> <table border="1" style="width: 100%; border-collapse: collapse; text-align: center;"> <tr> <td style="width: 10%;"></td> <td style="width: 10%;"></td> <td style="width: 10%;"></td> <td style="width: 10%;"></td> <td style="width: 10%;"></td> <td style="width: 10%;"></td> <td style="width: 10%;"></td> <td style="width: 10%;"></td> <td style="width: 10%;"></td> <td style="width: 10%;"></td> </tr> <tr> <td></td> <td></td> <td colspan="8" style="text-align: center;"> <table border="1" style="width: 100%; border-collapse: collapse; text-align: center;"> <tr> <td style="width: 10%;"></td> <td style="width: 10%;"></td> <td style="width: 10%;"></td> <td style="width: 10%;"></td> <td style="width: 10%;"></td> <td style="width: 10%;"></td> <td style="width: 10%;"></td> <td style="width: 10%;"></td> <td style="width: 10%;"></td> <td style="width: 10%;"></td> </tr> <tr> <td></td> <td></td> <td colspan="8" style="text-align: center;"> <table border="1" style="width: 100%; border-collapse: collapse; text-align: center;"> <tr> <td style="width: 10%;"></td> <td style="width: 10%;"></td> <td style="width: 10%;"></td> <td style="width: 10%;"></td> <td style="width: 10%;"></td> <td style="width: 10%;"></td> <td style="width: 10%;"></td> <td style="width: 10%;"></td> <td style="width: 10%;"></td> <td style="width: 10%;"></td> </tr> <tr> <td></td> <td></td> <td colspan="8" style="text-align: center;"> <table border="1" style="width: 100%; border-collapse: collapse; text-align: center;"> <tr> <td style="width: 10%;"></td> <td style="width: 10%;"></td> <td style="width: 10%;"></td> <td style="width: 10%;"></td> <td style="width: 10%;"></td> <td style="width: 10%;"></td> <td style="width: 10%;"></td> <td style="width: 10%;"></td> <td style="width: 10%;"></td> <td style="width: 10%;"></td> </tr> <tr> <td></td> <td></td> <td colspan="8" style="text-align: center;"> <table border="1" style="width: 100%; border-collapse: collapse; text-align: center;"> <tr> <td style="width: 10%;"></td> <td style="width: 10%;"></td> <td style="width: 10%;"></td> <td style="width: 10%;"></td> <td style="width: 10%;"></td> <td style="width: 10%;"></td> <td style="width: 10%;"></td> <td style="width: 10%;"></td> <td style="width: 10%;"></td> <td style="width: 10%;"></td> </tr> <tr> <td></td> <td></td> <td colspan="8" style="text-align: center;"> <table border="1" style="width: 100%; border-collapse: collapse; text-align: center;"> <tr> <td style="width: 10%;"></td> <td style="width: 10%;"></td> <td style="width: 10%;"></td> <td style="width: 10%;"></td> <td style="width: 10%;"></td> <td style="width: 10%;"></td> <td style="width: 10%;"></td> <td style="width: 10%;"></td> <td style="width: 10%;"></td> <td style="width: 10%;"></td> </tr> <tr> <td></td> <td></td> <td colspan="8" style="text-align: center;"> <table border="1" style="width: 100%; border-collapse: collapse; text-align: center;"> <tr> <td style="width: 10%;"></td> <td style="width: 10%;"></td> <td style="width: 10%;"></td> <td style="width: 10%;"></td> <td style="width: 10%;"></td> <td style="width: 10%;"></td> <td style="width: 10%;"></td> <td style="width: 10%;"></td> <td style="width: 10%;"></td> <td style="width: 10%;"></td> </tr> <tr> <td></td> <td></td> <td colspan="8" style="text-align: center;"> <table border="1" style="width: 100%; border-collapse: collapse; text-align: center;"> <tr> <td style="width: 10%;"></td> <td style="width: 10%;"></td> <td style="width: 10%;"></td> <td style="width: 10%;"></td> <td style="width: 10%;"></td> <td style="width: 10%;"></td> <td style="width: 10%;"></td> <td style="width: 10%;"></td> <td style="width: 10%;"></td> <td style="width: 10%;"></td> </tr> <tr> <td></td> <td></td> <td colspan="8" style="text-align: center;"> <table border="1" style="width: 100%; border-collapse: collapse; text-align: center;"> <tr> <td style="width: 10%;"></td> <td style="width: 10%;"></td> <td style="width: 10%;"></td> <td style="width: 10%;"></td> <td style="width: 10%;"></td> <td style="width: 10%;"></td> <td style="width: 10%;"></td> <td style="width: 10%;"></td> <td style="width: 10%;"></td> <td style="width: 10%;"></td> </tr> <tr> <td></td> <td></td> <td colspan="8" style="text-align: center;"> <table border="1" style="width: 100%; border-collapse: collapse; text-align: center;"> <tr> <td style="width: 10%;"></td> <td style="width: 10%;"></td> <td style="width: 10%;"></td> <td style="width: 10%;"></td> <td style="width: 10%;"></td> <td style="width: 10%;"></td> <td style="width: 10%;"></td> <td style="width: 10%;"></td> <td style="width: 10%;"></td> <td style="width: 10%;"></td> </tr> <tr> <td></td> <td></td> <td colspan="8" style="text-align: center;"> <table border="1" style="width: 100%; border-collapse: collapse; text-align: center;"> <tr> <td style="width: 10%;"></td> <td style="width: 10%;"></td> <td style="width: 10%;"></td> <td style="width: 10%;"></td> <td style="width: 10%;"></td> <td style="width: 10%;"></td> <td style="width: 10%;"></td> <td style="width: 10%;"></td> <td style="width: 10%;"></td> <td style="width: 10%;"></td> </tr> <tr> <td></td> <td></td> <td colspan="8" style="text-align: center;"> <table border="1" style="width: 100%; border-collapse: collapse; text-align: center;"> <tr> <td style="width: 10%;"></td> <td style="width: 10%;"></td> <td style="width: 10%;"></td> <td style="width: 10%;"></td> <td style="width: 10%;"></td> <td style="width: 10%;"></td> <td style="width: 10%;"></td> <td style="width: 10%;"></td> <td style="width: 10%;"></td> <td style="width: 10%;"></td> </tr> <tr> <td></td> <td></td> <td colspan="8" style="text-align: center;"> <table border="1" style="width: 100%; border-collapse: collapse; text-align: center;"> <tr> <td style="width: 10%;"></td> <td style="width: 10%;"></td> <td style="width: 10%;"></td> <td style="width: 10%;"></td> <td style="width: 10%;"></td> <td style="width: 10%;"></td> <td style="width: 10%;"></td> <td style="width: 10%;"></td> <td style="width: 10%;"></td> <td style="width: 10%;"></td> </tr> <tr> <td></td> <td></td> <td colspan="8" style="text-align: center;"> <table border="1" style="width: 100%; border-collapse: collapse; text-align: center;"> <tr> <td style="width: 10%;"></td> <td style="width: 10%;"></td> <td style="width: 10%;"></td> <td style="width: 10%;"></td> <td style="width: 10%;"></td> <td style="width: 10%;"></td> <td style="width: 10%;"></td> <td style="width: 10%;"></td> <td style="width: 10%;"></td> <td style="width: 10%;"></td> </tr> <tr> <td></td> <td></td> <td colspan="8" style="text-align: center;"> <table border="1" style="width: 100%; border-collapse: collapse; text-align: center;"> <tr> <td style="width: 10%;"></td> <td style="width: 10%;"></td>
<td style="width: 10%;"></td> <td style="width: 10%;"></td> <td style="width: 10%;"></td> <td style="width: 10%;"></td> <td style="width: 10%;"></td> <td style="width: 10%;"></td> <td style="width: 10%;"></td> <td style="width: 10%;"></td> </tr> <tr> <td></td> <td></td> <td colspan="8" style="text-align: center;"> <table border="1" style="width: 100%; border-collapse: collapse; text-align: center;"> <tr> <td style="width: 10%;"></td> <td style="width: 10%;"></td> <td style="width: 10%;"></td> <td style="width: 10%;"></td> <td style="width: 10%;"></td> <td style="width: 10%;"></td> <td style="width: 10%;"></td> <td style="width: 10%;"></td> <td style="width: 10%;"></td> <td style="width: 10%;"></td> </tr> <tr> <td></td> <td></td> <td colspan="8" style="text-align: center;"> <table border="1" style="width: 100%; border-collapse: collapse; text-align: center;"> <tr> <td style="width: 10%;"></td> <td style="width: 10%;"></td> <td style="width: 10%;"></td> <td style="width: 10%;"></td> <td style="width: 10%;"></td> <td style="width: 10%;"></td> <td style="width: 10%;"></td> <td style="width: 10%;"></td> <td style="width: 10%;"></td> <td style="width: 10%;"></td> </tr> <tr> <td></td> <td></td> <td colspan="8" style="text-align: center;"> <table border="1" style="width: 100%; border-collapse: collapse; text-align: center;"> <tr> <td style="width: 10%;"></td> <td style="width: 10%;"></td> <td style="width: 10%;"></td> <td style="width: 10%;"></td> <td style="width: 10%;"></td> <td style="width: 10%;"></td> <td style="width: 10%;"></td> <td style="width: 10%;"></td> <td style="width: 10%;"></td> <td style="width: 10%;"></td> </tr> <tr> <td></td> <td></td> <td colspan="8" style="text-align: center;"> <table border="1" style="width: 100%; border-collapse: collapse; text-align: center;"> <tr> <td style="width: 10%;"></td> <td style="width: 10%;"></td> <td style="width: 10%;"></td> <td style="width: 10%;"></td> <td style="width: 10%;"></td> <td style="width: 10%;"></td> <td style="width: 10%;"></td> <td style="width: 10%;"></td> <td style="width: 10%;"></td> <td style="width: 10%;"></td> </tr> <tr> <td></td> <td></td> <td colspan="8" style="text-align: center;"> <table border="1" style="width: 100%; border-collapse: collapse; text-align: center;"> <tr> <td style="width: 10%;"></td> <td style="width: 10%;"></td> <td style="width: 10%;"></td> <td style="width: 10%;"></td> <td style="width: 10%;"></td> <td style="width: 10%;"></td> <td style="width: 10%;"></td> <td style="width: 10%;"></td> <td style="width: 10%;"></td> <td style="width: 10%;"></td> </tr> <tr> <td></td> <td></td> <td colspan="8" style="text-align: center;"> <table border="1" style="width: 100%; border-collapse: collapse; text-align: center;"> <tr> </tr></table></td></tr></table></td></tr></table></td></tr></table></td></tr></table></td></tr></table></td></tr></table></td></tr></table></td></tr></table></td></tr></table></td></tr></table></td></tr></table></td></tr></table></td></tr></table></td></tr></table></td></tr></table></td></tr></table></td></tr></table></td></tr></table></td></tr></table></td></tr></table></td></tr></table></td></tr></table></td></tr></table></td></tr></table></td></tr></table> | | | | | | | | | | | | | | | | | | | | <table border="1" style="width: 100%; border-collapse: collapse; text-align: center;"> <tr> <td style="width: 10%;"></td> <td style="width: 10%;"></td> <td style="width: 10%;"></td> <td style="width: 10%;"></td> <td style="width: 10%;"></td> <td style="width: 10%;"></td> <td style="width: 10%;"></td> <td style="width: 10%;"></td> <td style="width: 10%;"></td> <td style="width: 10%;"></td> </tr> <tr> <td></td> <td></td> <td colspan="8" style="text-align: center;"> <table border="1" style="width: 100%; border-collapse: collapse; text-align: center;"> <tr> <td style="width: 10%;"></td> <td style="width: 10%;"></td> <td style="width: 10%;"></td> <td style="width: 10%;"></td> <td style="width: 10%;"></td> <td style="width: 10%;"></td> <td style="width: 10%;"></td> <td style="width: 10%;"></td> <td style="width: 10%;"></td> <td style="width: 10%;"></td> </tr> <tr> <td></td> <td></td> <td colspan="8" style="text-align: center;"> <table border="1" style="width: 100%; border-collapse: collapse; text-align: center;"> <tr> <td style="width: 10%;"></td> <td style="width: 10%;"></td> <td style="width: 10%;"></td> <td style="width: 10%;"></td> <td style="width: 10%;"></td> <td style="width: 10%;"></td> <td style="width: 10%;"></td> <td style="width: 10%;"></td> <td style="width: 10%;"></td> <td style="width: 10%;"></td> </tr> <tr> <td></td> <td></td> <td colspan="8" style="text-align: center;"> <table border="1" style="width: 100%; border-collapse: collapse; text-align: center;"> <tr> <td style="width: 10%;"></td> <td style="width: 10%;"></td> <td style="width: 10%;"></td> <td style="width: 10%;"></td> <td style="width: 10%;"></td> <td style="width: 10%;"></td> <td style="width: 10%;"></td> <td style="width: 10%;"></td> <td style="width: 10%;"></td> <td style="width: 10%;"></td> </tr> <tr> <td></td> <td></td> <td colspan="8" style="text-align: center;"> <table border="1" style="width: 100%; border-collapse: collapse; text-align: center;"> <tr> <td style="width: 10%;"></td> <td style="width: 10%;"></td> <td style="width: 10%;"></td> <td style="width: 10%;"></td> <td style="width: 10%;"></td> <td style="width: 10%;"></td> <td style="width: 10%;"></td> <td style="width: 10%;"></td> <td style="width: 10%;"></td> <td style="width: 10%;"></td> </tr> <tr> <td></td> <td></td> <td colspan="8" style="text-align: center;"> <table border="1" style="width: 100%; border-collapse: collapse; text-align: center;"> <tr> <td style="width: 10%;"></td> <td style="width: 10%;"></td> <td style="width: 10%;"></td> <td style="width: 10%;"></td> <td style="width: 10%;"></td> <td style="width: 10%;"></td> <td style="width: 10%;"></td> <td style="width: 10%;"></td> <td style="width: 10%;"></td> <td style="width: 10%;"></td> </tr> <tr> <td></td> <td></td> <td colspan="8" style="text-align: center;"> <table border="1" style="width: 100%; border-collapse: collapse; text-align: center;"> <tr> <td style="width: 10%;"></td> <td style="width: 10%;"></td> <td style="width: 10%;"></td> <td style="width: 10%;"></td> <td style="width: 10%;"></td> <td style="width: 10%;"></td> <td style="width: 10%;"></td> <td style="width: 10%;"></td> <td style="width: 10%;"></td> <td style="width: 10%;"></td> </tr> <tr> <td></td> <td></td> <td colspan="8" style="text-align: center;"> <table border="1" style="width: 100%; border-collapse: collapse; text-align: center;"> <tr> <td style="width: 10%;"></td> <td style="width: 10%;"></td> <td style="width: 10%;"></td> <td style="width: 10%;"></td> <td style="width: 10%;"></td> <td style="width: 10%;"></td> <td style="width: 10%;"></td> <td style="width: 10%;"></td> <td style="width: 10%;"></td> <td style="width: 10%;"></td> </tr> <tr> <td></td> <td></td> <td colspan="8" style="text-align: center;"> <table border="1" style="width: 100%; border-collapse: collapse; text-align: center;"> <tr> <td style="width: 10%;"></td> <td style="width: 10%;"></td> <td style="width: 10%;"></td> <td style="width: 10%;"></td> <td style="width: 10%;"></td> <td style="width: 10%;"></td> <td style="width: 10%;"></td> <td style="width: 10%;"></td> <td style="width: 10%;"></td> <td style="width: 10%;"></td> </tr> <tr> <td></td> <td></td> <td colspan="8" style="text-align: center;"> <table border="1" style="width: 100%; border-collapse: collapse; text-align: center;">
<tr> <td style="width: 10%;"></td> <td style="width: 10%;"></td> <td style="width: 10%;"></td> <td style="width: 10%;"></td> <td style="width: 10%;"></td> <td style="width: 10%;"></td> <td style="width: 10%;"></td> <td style="width: 10%;"></td> <td style="width: 10%;"></td> <td style="width: 10%;"></td> </tr> <tr> <td></td> <td></td> <td colspan="8" style="text-align: center;"> <table border="1" style="width: 100%; border-collapse: collapse; text-align: center;"> <tr> <td style="width: 10%;"></td> <td style="width: 10%;"></td> <td style="width: 10%;"></td> <td style="width: 10%;"></td> <td style="width: 10%;"></td> <td style="width: 10%;"></td> <td style="width: 10%;"></td> <td style="width: 10%;"></td> <td style="width: 10%;"></td> <td style="width: 10%;"></td> </tr> <tr> <td></td> <td></td> <td colspan="8" style="text-align: center;"> <table border="1" style="width: 100%; border-collapse: collapse; text-align: center;"> <tr> <td style="width: 10%;"></td> <td style="width: 10%;"></td> <td style="width: 10%;"></td> <td style="width: 10%;"></td> <td style="width: 10%;"></td> <td style="width: 10%;"></td> <td style="width: 10%;"></td> <td style="width: 10%;"></td> <td style="width: 10%;"></td> <td style="width: 10%;"></td> </tr> <tr> <td></td> <td></td> <td colspan="8" style="text-align: center;"> <table border="1" style="width: 100%; border-collapse: collapse; text-align: center;"> <tr> <td style="width: 10%;"></td> <td style="width: 10%;"></td> <td style="width: 10%;"></td> <td style="width: 10%;"></td> <td style="width: 10%;"></td> <td style="width: 10%;"></td> <td style="width: 10%;"></td> <td style="width: 10%;"></td> <td style="width: 10%;"></td> <td style="width: 10%;"></td> </tr> <tr> <td></td> <td></td> <td colspan="8" style="text-align: center;"> <table border="1" style="width: 100%; border-collapse: collapse; text-align: center;"> <tr> <td style="width: 10%;"></td> <td style="width: 10%;"></td> <td style="width: 10%;"></td> <td style="width: 10%;"></td> <td style="width: 10%;"></td> <td style="width: 10%;"></td> <td style="width: 10%;"></td> <td style="width: 10%;"></td> <td style="width: 10%;"></td> <td style="width: 10%;"></td> </tr> <tr> <td></td> <td></td> <td colspan="8" style="text-align: center;"> <table border="1" style="width: 100%; border-collapse: collapse; text-align: center;"> <tr> <td style="width: 10%;"></td> <td style="width: 10%;"></td> <td style="width: 10%;"></td> <td style="width: 10%;"></td> <td style="width: 10%;"></td> <td style="width: 10%;"></td> <td style="width: 10%;"></td> <td style="width: 10%;"></td> <td style="width: 10%;"></td> <td style="width: 10%;"></td> </tr> <tr> <td></td> <td></td> <td colspan="8" style="text-align: center;"> <table border="1" style="width: 100%; border-collapse: collapse; text-align: center;"> <tr> <td style="width: 10%;"></td> <td style="width: 10%;"></td> <td style="width: 10%;"></td> <td style="width: 10%;"></td> <td style="width: 10%;"></td> <td style="width: 10%;"></td> <td style="width: 10%;"></td> <td style="width: 10%;"></td> <td style="width: 10%;"></td> <td style="width: 10%;"></td> </tr> <tr> <td></td> <td></td> <td colspan="8" style="text-align: center;"> <table border="1" style="width: 100%; border-collapse: collapse; text-align: center;"> <tr> <td style="width: 10%;"></td> <td style="width: 10%;"></td> <td style="width: 10%;"></td> <td style="width: 10%;"></td> <td style="width: 10%;"></td> <td style="width: 10%;"></td> <td style="width: 10%;"></td> <td style="width: 10%;"></td> <td style="width: 10%;"></td> <td style="width: 10%;"></td> </tr> <tr> <td></td> <td></td> <td colspan="8" style="text-align: center;"> <table border="1" style="width: 100%; border-collapse: collapse; text-align: center;"> <tr> <td style="width: 10%;"></td> <td style="width: 10%;"></td> <td style="width: 10%;"></td> <td style="width: 10%;"></td> <td style="width: 10%;"></td> <td style="width: 10%;"></td> <td style="width: 10%;"></td> <td style="width: 10%;"></td> <td style="width: 10%;"></td> <td style="width: 10%;"></td> </tr> <tr> <td></td> <td></td> <td colspan="8" style="text-align: center;"> <table border="1" style="width: 100%; border-collapse: collapse; text-align: center;"> <tr> <td style="width: 10%;"></td> <td style="width: 10%;"></td> <td style="width: 10%;"></td> <td style="width: 10%;"></td> <td style="width: 10%;"></td> <td style="width: 10%;"></td> <td style="width: 10%;"></td> <td style="width: 10%;"></td> <td style="width: 10%;"></td> <td style="width: 10%;"></td> </tr> <tr> <td></td> <td></td> <td colspan="8" style="text-align: center;"> <table border="1" style="width: 100%; border-collapse: collapse; text-align: center;"> <tr> <td style="width: 10%;"></td> <td style="width: 10%;"></td> <td style="width: 10%;"></td> <td style="width: 10%;"></td> <td style="width: 10%;"></td> <td style="width: 10%;"></td> <td style="width: 10%;"></td> <td style="width: 10%;"></td> <td style="width: 10%;"></td> <td style="width: 10%;"></td> </tr> <tr> <td></td> <td></td> <td colspan="8" style="text-align: center;"> <table border="1" style="width: 100%; border-collapse: collapse; text-align: center;"> <tr> <td style="width: 10%;"></td> <td style="width: 10%;"></td> <td style="width: 10%;"></td> <td style="width: 10%;"></td> <td style="width: 10%;"></td> <td style="width: 10%;"></td> <td style="width: 10%;"></td> <td style="width: 10%;"></td> <td style="width: 10%;"></td> <td style="width: 10%;"></td> </tr> <tr> <td></td> <td></td> <td colspan="8" style="text-align: center;"> <table border="1" style="width: 100%; border-collapse: collapse; text-align: center;"> <tr> <td style="width: 10%;"></td> <td style="width: 10%;"></td> <td style="width: 10%;"></td> <td style="width: 10%;"></td> <td style="width: 10%;"></td> <td style="width: 10%;"></td> <td style="width: 10%;"></td> <td style="width: 10%;"></td> <td style="width: 10%;"></td> <td style="width: 10%;"></td> </tr> <tr> <td></td> <td></td> <td colspan="8" style="text-align: center;"> <table border="1" style="width: 100%; border-collapse: collapse; text-align: center;"> <tr> <td style="width: 10%;"></td> <td style="width: 10%;"></td> <td style="width: 10%;"></td> <td style="width: 10%;"></td> <td style="width: 10%;"></td> <td style="width: 10%;"></td> <td style="width: 10%;"></td> <td style="width: 10%;"></td> <td style="width: 10%;"></td> <td style="width: 10%;"></td> </tr> <tr> <td></td> <td></td> <td colspan="8" style="text-align: center;"> <table border="1" style="width: 100%; border-collapse: collapse; text-align: center;"> <tr> <td style="width: 10%;"></td> <td style="width: 10%;"></td> <td style="width: 10%;"></td> <td style="width: 10%;"></td> <td style="width: 10%;"></td> <td style="width: 10%;"></td> <td style="width: 10%;"></td> <td style="width: 10%;"></td> <td style="width: 10%;"></td> <td style="width: 10%;"></td> </tr> <tr> <td></td> <td></td> <td colspan="8" style="text-align: center;"> <table border="1" style="width: 100%; border-collapse: collapse; text-align: center;"> <tr> </tr></table></td></tr></table></td></tr></table></td></tr></table></td></tr></table></td></tr></table></td></tr></table></td></tr></table></td></tr></table></td></tr></table></td></tr></table></td></tr></table></td></tr></table></td></tr></table></td></tr></table></td></tr></table></td></tr></table></td></tr></table></td></tr></table></td></tr></table></td></tr></table></td></tr></table></td></tr></table></td></tr></table></td></tr></table> | | | | | | | | | | | | | | | | | | | | <table border="1" style="width: 100%;
border-collapse: collapse; text-align: center;"> <tr> <td style="width: 10%;"></td> <td style="width: 10%;"></td> <td style="width: 10%;"></td> <td style="width: 10%;"></td> <td style="width: 10%;"></td> <td style="width: 10%;"></td> <td style="width: 10%;"></td> <td style="width: 10%;"></td> <td style="width: 10%;"></td> <td style="width: 10%;"></td> </tr> <tr> <td></td> <td></td> <td colspan="8" style="text-align: center;"> <table border="1" style="width: 100%; border-collapse: collapse; text-align: center;"> <tr> <td style="width: 10%;"></td> <td style="width: 10%;"></td> <td style="width: 10%;"></td> <td style="width: 10%;"></td> <td style="width: 10%;"></td> <td style="width: 10%;"></td> <td style="width: 10%;"></td> <td style="width: 10%;"></td> <td style="width: 10%;"></td> <td style="width: 10%;"></td> </tr> <tr> <td></td> <td></td> <td colspan="8" style="text-align: center;"> <table border="1" style="width: 100%; border-collapse: collapse; text-align: center;"> <tr> <td style="width: 10%;"></td> <td style="width: 10%;"></td> <td style="width: 10%;"></td> <td style="width: 10%;"></td> <td style="width: 10%;"></td> <td style="width: 10%;"></td> <td style="width: 10%;"></td> <td style="width: 10%;"></td> <td style="width: 10%;"></td> <td style="width: 10%;"></td> </tr> <tr> <td></td> <td></td> <td colspan="8" style="text-align: center;"> <table border="1" style="width: 100%; border-collapse: collapse; text-align: center;"> <tr> <td style="width: 10%;"></td> <td style="width: 10%;"></td> <td style="width: 10%;"></td> <td style="width: 10%;"></td> <td style="width: 10%;"></td> <td style="width: 10%;"></td> <td style="width: 10%;"></td> <td style="width: 10%;"></td> <td style="width: 10%;"></td> <td style="width: 10%;"></td> </tr> <tr> <td></td> <td></td> <td colspan="8" style="text-align: center;"> <table border="1" style="width: 100%; border-collapse: collapse; text-align: center;"> <tr> <td style="width: 10%;"></td> <td style="width: 10%;"></td> <td style="width: 10%;"></td> <td style="width: 10%;"></td> <td style="width: 10%;"></td> <td style="width: 10%;"></td> <td style="width: 10%;"></td> <td style="width: 10%;"></td> <td style="width: 10%;"></td> <td style="width: 10%;"></td> </tr> <tr> <td></td> <td></td> <td colspan="8" style="text-align: center;"> <table border="1" style="width: 100%; border-collapse: collapse; text-align: center;"> <tr> <td style="width: 10%;"></td> <td style="width: 10%;"></td> <td style="width: 10%;"></td> <td style="width: 10%;"></td> <td style="width: 10%;"></td> <td style="width: 10%;"></td> <td style="width: 10%;"></td> <td style="width: 10%;"></td> <td style="width: 10%;"></td> <td style="width: 10%;"></td> </tr> <tr> <td></td> <td></td> <td colspan="8" style="text-align: center;"> <table border="1" style="width: 100%; border-collapse: collapse; text-align: center;"> <tr> <td style="width: 10%;"></td> <td style="width: 10%;"></td> <td style="width: 10%;"></td> <td style="width: 10%;"></td> <td style="width: 10%;"></td> <td style="width: 10%;"></td> <td style="width: 10%;"></td> <td style="width: 10%;"></td> <td style="width: 10%;"></td> <td style="width: 10%;"></td> </tr> <tr> <td></td> <td></td> <td colspan="8" style="text-align: center;"> <table border="1" style="width: 100%; border-collapse: collapse; text-align: center;"> <tr> <td style="width: 10%;"></td> <td style="width: 10%;"></td> <td style="width: 10%;"></td> <td style="width: 10%;"></td> <td style="width: 10%;"></td> <td style="width: 10%;"></td> <td style="width: 10%;"></td> <td style="width: 10%;"></td> <td style="width: 10%;"></td> <td style="width: 10%;"></td> </tr> <tr> <td></td> <td></td> <td colspan="8" style="text-align: center;"> <table border="1" style="width: 100%; border-collapse: collapse; text-align: center;"> <tr> <td style="width: 10%;"></td> <td style="width: 10%;"></td> <td style="width: 10%;"></td> <td style="width: 10%;"></td> <td style="width: 10%;"></td> <td style="width: 10%;"></td> <td style="width: 10%;"></td> <td style="width: 10%;"></td> <td style="width: 10%;"></td> <td style="width: 10%;"></td> </tr> <tr> <td></td> <td></td> <td colspan="8" style="text-align: center;"> <table border="1" style="width: 100%; border-collapse: collapse; text-align: center;"> <tr> <td style="width: 10%;"></td> <td style="width: 10%;"></td> <td style="width: 10%;"></td> <td style="width: 10%;"></td> <td style="width: 10%;"></td> <td style="width: 10%;"></td> <td style="width: 10%;"></td> <td style="width: 10%;"></td> <td style="width: 10%;"></td> <td style="width: 10%;"></td> </tr> <tr> <td></td> <td></td> <td colspan="8" style="text-align: center;"> <table border="1" style="width: 100%; border-collapse: collapse; text-align: center;"> <tr> <td style="width: 10%;"></td> <td style="width: 10%;"></td> <td style="width: 10%;"></td> <td style="width: 10%;"></td> <td style="width: 10%;"></td> <td style="width: 10%;"></td> <td style="width: 10%;"></td> <td style="width: 10%;"></td> <td style="width: 10%;"></td> <td style="width: 10%;"></td> </tr> <tr> <td></td> <td></td> <td colspan="8" style="text-align: center;"> <table border="1" style="width: 100%; border-collapse: collapse; text-align: center;"> <tr> <td style="width: 10%;"></td> <td style="width: 10%;"></td> <td style="width: 10%;"></td> <td style="width: 10%;"></td> <td style="width: 10%;"></td> <td style="width: 10%;"></td> <td style="width: 10%;"></td> <td style="width: 10%;"></td> <td style="width: 10%;"></td> <td style="width: 10%;"></td> </tr> <tr> <td></td> <td></td> <td colspan="8" style="text-align: center;"> <table border="1" style="width: 100%; border-collapse: collapse; text-align: center;"> <tr> <td style="width: 10%;"></td> <td style="width: 10%;"></td> <td style="width: 10%;"></td> <td style="width: 10%;"></td> <td style="width: 10%;"></td> <td style="width: 10%;"></td> <td style="width: 10%;"></td> <td style="width: 10%;"></td> <td style="width: 10%;"></td> <td style="width: 10%;"></td> </tr> <tr> <td></td> <td></td> <td colspan="8" style="text-align: center;"> <table border="1" style="width: 100%; border-collapse: collapse; text-align: center;"> <tr> <td style="width: 10%;"></td> <td style="width: 10%;"></td> <td style="width: 10%;"></td> <td style="width: 10%;"></td> <td style="width: 10%;"></td> <td style="width: 10%;"></td> <td style="width: 10%;"></td> <td style="width: 10%;"></td> <td style="width: 10%;"></td> <td style="width: 10%;"></td> </tr> <tr> <td></td> <td></td> <td colspan="8" style="text-align: center;"> <table border="1" style="width: 100%; border-collapse: collapse; text-align: center;"> <tr> <td style="width: 10%;"></td> <td style="width: 10%;"></td> <td style="width: 10%;"></td> <td style="width: 10%;"></td> <td style="width: 10%;"></td> <td style="width: 10%;"></td> <td style="width: 10%;"></td> <td style="width: 10%;"></td> <td style="width: 10%;"></td> <td style="width: 10%;"></td> </tr> <tr> <td></td> <td></td> <td colspan="8" style="text-align: center;"> <table border="1" style="width: 100%; border-collapse: collapse; text-align: center;"> <tr> <td style="width: 10%;"></td> <td style="width: 10%;"></td> <td style="width: 10%;"></td> <td style="width: 10%;"></td> <td style="width: 10%;"></td> <td style="width: 10%;"></td> <td style="width: 10%;"></td> <td style="width: 10%;"></td> <td style="width: 10%;"></td> <td style="width: 10%;"></td> </tr> <tr> <td></td> <td></td> <td colspan="8" style="text-align: center;"> <table border="1" style="width: 100%; border-collapse: collapse; text-align: center;"> <tr> <td style="width: 10%;"></td> <td style="width: 10%;"></td> <td style="width: 10%;"></td> <td style="width: 10%;"></td> <td style="width: 10%;"></td> <td style="width: 10%;"></td> <td style="width: 10%;"></td> <td style="width: 10%;"></td> <td style="width: 10%;"></td> <td style="width: 10%;"></td> </tr> <tr> <td></td> <td></td> <td colspan="8" style="text-align: center;"> <table border="1" style="width: 100%; border-collapse: collapse; text-align: center;"> <tr> <td style="width: 10%;"></td> <td style="width: 10%;"></td> <td style="width: 10%;"></td> <td style="width: 10%;"></td> <td style="width: 10%;"></td> <td style="width: 10%;"></td> <td style="width: 10%;"></td> <td style="width: 10%;"></td> <td style="width: 10%;"></td> <td style="width: 10%;"></td> </tr> <tr> <td></td> <td></td> <td colspan="8" style="text-align: center;"> <table border="1" style="width: 100%; border-collapse: collapse; text-align: center;"> <tr> <td style="width: 10%;"></td> <td style="width: 10%;"></td> <td style="width: 10%;"></td> <td style="width: 10%;"></td> <td style="width: 10%;"></td> <td style="width: 10%;"></td> <td style="width: 10%;"></td> <td style="width: 10%;"></td> <td style="width: 10%;"></td> <td style="width: 10%;"></td> </tr> <tr> <td></td> <td></td> <td colspan="8" style="text-align: center;"> <table border="1" style="width: 100%; border-collapse: collapse; text-align: center;"> <tr> <td style="width: 10%;"></td> <td style="width: 10%;"></td> <td style="width: 10%;"></td> <td style="width: 10%;"></td> <td style="width: 10%;"></td> <td style="width: 10%;"></td> <td style="width: 10%;"></td> <td style="width: 10%;"></td> <td style="width: 10%;"></td> <td style="width: 10%;"></td> </tr> <tr> <td></td> <td></td> <td colspan="8" style="text-align: center;"> <table border="1" style="width: 100%; border-collapse: collapse; text-align: center;"> <tr> <td style="width: 10%;"></td> <td style="width: 10%;"></td> <td style="width: 10%;"></td> <td style="width: 10%;"></td> <td style="width: 10%;"></td> <td style="width: 10%;"></td> <td style="width: 10%;"></td> <td style="width: 10%;"></td> <td style="width: 10%;"></td> <td style="width: 10%;"></td> </tr> <tr> <td></td> <td></td> <td colspan="8" style="text-align: center;"> <table border="1" style="width: 100%; border-collapse: collapse; text-align: center;"> <tr> <td style="width: 10%;"></td> <td style="width: 10%;"></td> <td style="width: 10%;"></td> <td style="width:
10%;"></td> <td style="width: 10%;"></td> <td style="width: 10%;"></td> <td style="width: 10%;"></td> <td style="width: 10%;"></td> <td style="width: 10%;"></td> <td style="width: 10%;"></td> </tr> <tr> <td></td> <td></td> <td colspan="8" style="text-align: center;"> <table border="1" style="width: 100%; border-collapse: collapse; text-align: center;"> <tr> <td style="width: 10%;"></td> <td style="width: 10%;"></td> <td style="width: 10%;"></td> <td style="width: 10%;"></td> <td style="width: 10%;"></td> <td style="width: 10%;"></td> <td style="width: 10%;"></td> <td style="width: 10%;"></td> <td style="width: 10%;"></td> <td style="width: 10%;"></td> </tr> <tr> <td></td> <td></td> <td colspan="8" style="text-align: center;"> <table border="1" style="width: 100%; border-collapse: collapse; text-align: center;"> <tr> </tr></table></td></tr></table></td></tr></table></td></tr></table></td></tr></table></td></tr></table></td></tr></table></td></tr></table></td></tr></table></td></tr></table></td></tr></table></td></tr></table></td></tr></table></td></tr></table></td></tr></table></td></tr></table></td></tr></table></td></tr></table></td></tr></table></td></tr></table></td></tr></table></td></tr></table></td></tr></table></td></tr></table> | | | | | | | | | | | | | | | | | | | | <table border="1" style="width: 100%; border-collapse: collapse; text-align: center;"> <tr> <td style="width: 10%;"></td> <td style="width: 10%;"></td> <td style="width: 10%;"></td> <td style="width: 10%;"></td> <td style="width: 10%;"></td> <td style="width: 10%;"></td> <td style="width: 10%;"></td> <td style="width: 10%;"></td> <td style="width: 10%;"></td> <td style="width: 10%;"></td> </tr> <tr> <td></td> <td></td> <td colspan="8" style="text-align: center;"> <table border="1" style="width: 100%; border-collapse: collapse; text-align: center;"> <tr> <td style="width: 10%;"></td> <td style="width: 10%;"></td> <td style="width: 10%;"></td> <td style="width: 10%;"></td> <td style="width: 10%;"></td> <td style="width: 10%;"></td> <td style="width: 10%;"></td> <td style="width: 10%;"></td> <td style="width: 10%;"></td> <td style="width: 10%;"></td> </tr> <tr> <td></td> <td></td> <td colspan="8" style="text-align: center;"> <table border="1" style="width: 100%; border-collapse: collapse; text-align: center;"> <tr> <td style="width: 10%;"></td> <td style="width: 10%;"></td> <td style="width: 10%;"></td> <td style="width: 10%;"></td> <td style="width: 10%;"></td> <td style="width: 10%;"></td> <td style="width: 10%;"></td> <td style="width: 10%;"></td> <td style="width: 10%;"></td> <td style="width: 10%;"></td> </tr> <tr> <td></td> <td></td> <td colspan="8" style="text-align: center;"> <table border="1" style="width: 100%; border-collapse: collapse; text-align: center;"> <tr> <td style="width: 10%;"></td> <td style="width: 10%;"></td> <td style="width: 10%;"></td> <td style="width: 10%;"></td> <td style="width: 10%;"></td> <td style="width: 10%;"></td> <td style="width: 10%;"></td> <td style="width: 10%;"></td> <td style="width: 10%;"></td> <td style="width: 10%;"></td> </tr> <tr> <td></td> <td></td> <td colspan="8" style="text-align: center;"> <table border="1" style="width: 100%; border-collapse: collapse; text-align: center;"> <tr> <td style="width: 10%;"></td> <td style="width: 10%;"></td> <td style="width: 10%;"></td> <td style="width: 10%;"></td> <td style="width: 10%;"></td> <td style="width: 10%;"></td> <td style="width: 10%;"></td> <td style="width: 10%;"></td> <td style="width: 10%;"></td> <td style="width: 10%;"></td> </tr> <tr> <td></td> <td></td> <td colspan="8" style="text-align: center;"> <table border="1" style="width: 100%; border-collapse: collapse; text-align: center;"> <tr> <td style="width: 10%;"></td> <td style="width: 10%;"></td> <td style="width: 10%;"></td> <td style="width: 10%;"></td> <td style="width: 10%;"></td> <td style="width: 10%;"></td> <td style="width: 10%;"></td> <td style="width: 10%;"></td> <td style="width: 10%;"></td> <td style="width: 10%;"></td> </tr> <tr> <td></td> <td></td> <td colspan="8" style="text-align: center;"> <table border="1" style="width: 100%; border-collapse: collapse; text-align: center;"> <tr> <td style="width: 10%;"></td> <td style="width: 10%;"></td> <td style="width: 10%;"></td> <td style="width: 10%;"></td> <td style="width: 10%;"></td> <td style="width: 10%;"></td> <td style="width: 10%;"></td> <td style="width: 10%;"></td> <td style="width: 10%;"></td> <td style="width: 10%;"></td> </tr> <tr> <td></td> <td></td> <td colspan="8" style="text-align: center;"> <table border="1" style="width: 100%; border-collapse: collapse; text-align: center;"> <tr> <td style="width: 10%;"></td> <td style="width: 10%;"></td> <td style="width: 10%;"></td> <td style="width: 10%;"></td> <td style="width: 10%;"></td> <td style="width: 10%;"></td> <td style="width: 10%;"></td> <td style="width: 10%;"></td> <td style="width: 10%;"></td> <td style="width: 10%;"></td> </tr> <tr> <td></td> <td></td> <td colspan="8" style="text-align: center;"> <table border="1" style="width: 100%; border-collapse: collapse; text-align: center;"> <tr> <td style="width: 10%;"></td> <td style="width: 10%;"></td> <td style="width: 10%;"></td> <td style="width: 10%;"></td> <td style="width: 10%;"></td> <td style="width: 10%;"></td> <td style="width: 10%;"></td> <td style="width: 10%;"></td> <td style="width: 10%;"></td> <td style="width: 10%;"></td> </tr> <tr> <td></td> <td></td> <td colspan="8" style="text-align: center;"> <table border="1" style="width: 100%; border-collapse: collapse; text-align: center;"> <tr> <td style="width: 10%;"></td> <td style="width: 10%;"></td> <td style="width: 10%;"></td> <td style="width: 10%;"></td> <td style="width: 10%;"></td> <td style="width: 10%;"></td> <td style="width: 10%;"></td> <td style="width: 10%;"></td> <td style="width: 10%;"></td> <td style="width: 10%;"></td> </tr> <tr> <td></td> <td></td> <td colspan="8" style="text-align: center;"> <table border="1" style="width: 100%; border-collapse: collapse; text-align: center;"> <tr> <td style="width: 10%;"></td> <td style="width: 10%;"></td> <td style="width: 10%;"></td> <td style="width: 10%;"></td> <td style="width: 10%;"></td> <td style="width: 10%;"></td> <td style="width: 10%;"></td> <td style="width: 10%;"></td> <td style="width: 10%;"></td> <td style="width: 10%;"></td> </tr> <tr> <td></td> <td></td> <td colspan="8" style="text-align: center;"> <table border="1" style="width: 100%; border-collapse: collapse; text-align: center;"> <tr> <td style="width: 10%;"></td> <td style="width: 10%;"></td> <td style="width: 10%;"></td> <td style="width: 10%;"></td> <td style="width: 10%;"></td> <td style="width: 10%;"></td> <td style="width: 10%;"></td> <td style="width: 10%;"></td> <td style="width: 10%;"></td> <td style="width: 10%;"></td> </tr> <tr> <td></td> <td></td> <td colspan="8" style="text-align: center;"> <table border="1" style="width: 100%; border-collapse: collapse; text-align: center;"> <tr> <td style="width: 10%;"></td> <td style="width: 10%;"></td> <td style="width: 10%;"></td> <td style="width: 10%;"></td> <td style="width: 10%;"></td> <td style="width: 10%;"></td> <td style="width: 10%;"></td> <td style="width: 10%;"></td> <td style="width: 10%;"></td> <td style="width: 10%;"></td> </tr> <tr> <td></td> <td></td> <td colspan="8" style="text-align: center;"> <table border="1" style="width: 100%; border-collapse: collapse; text-align: center;"> <tr> <td style="width: 10%;"></td> <td style="width: 10%;"></td> <td style="width:
10%;"></td> <td style="width: 10%;"></td> <td style="width: 10%;"></td> <td style="width: 10%;"></td> <td style="width: 10%;"></td> <td style="width: 10%;"></td> <td style="width: 10%;"></td> <td style="width: 10%;"></td> </tr> <tr> <td></td> <td></td> <td colspan="8" style="text-align: center;"> <table border="1" style="width: 100%; border-collapse: collapse; text-align: center;"> <tr> <td style="width: 10%;"></td> <td style="width: 10%;"></td> <td style="width: 10%;"></td> <td style="width: 10%;"></td> <td style="width: 10%;"></td> <td style="width: 10%;"></td> <td style="width: 10%;"></td> <td style="width: 10%;"></td> <td style="width: 10%;"></td> <td style="width: 10%;"></td> </tr> <tr> <td></td> <td></td> <td colspan="8" style="text-align: center;"> <table border="1" style="width: 100%; border-collapse: collapse; text-align: center;"> <tr> <td style="width: 10%;"></td> <td style="width: 10%;"></td> <td style="width: 10%;"></td> <td style="width: 10%;"></td> <td style="width: 10%;"></td> <td style="width: 10%;"></td> <td style="width: 10%;"></td> <td style="width: 10%;"></td> <td style="width: 10%;"></td> <td style="width: 10%;"></td> </tr> <tr> <td></td> <td></td> <td colspan="8" style="text-align: center;"> <table border="1" style="width: 100%; border-collapse: collapse; text-align: center;"> <tr> <td style="width: 10%;"></td> <td style="width: 10%;"></td> <td style="width: 10%;"></td> <td style="width: 10%;"></td> <td style="width: 10%;"></td> <td style="width: 10%;"></td> <td style="width: 10%;"></td> <td style="width: 10%;"></td> <td style="width: 10%;"></td> <td style="width: 10%;"></td> </tr> <tr> <td></td> <td></td> <td colspan="8" style="text-align: center;"> <table border="1" style="width: 100%; border-collapse: collapse; text-align: center;"> <tr> <td style="width: 10%;"></td> <td style="width: 10%;"></td> <td style="width: 10%;"></td> <td style="width: 10%;"></td> <td style="width: 10%;"></td> <td style="width: 10%;"></td> <td style="width: 10%;"></td> <td style="width: 10%;"></td> <td style="width: 10%;"></td> <td style="width: 10%;"></td> </tr> <tr> <td></td> <td></td> <td colspan="8" style="text-align: center;"> <table border="1" style="width: 100%; border-collapse: collapse; text-align: center;"> <tr> <td style="width: 10%;"></td> <td style="width: 10%;"></td> <td style="width: 10%;"></td> <td style="width: 10%;"></td> <td style="width: 10%;"></td> <td style="width: 10%;"></td> <td style="width: 10%;"></td> <td style="width: 10%;"></td> <td style="width: 10%;"></td> <td style="width: 10%;"></td> </tr> <tr> <td></td> <td></td> <td colspan="8" style="text-align: center;"> <table border="1" style="width: 100%; border-collapse: collapse; text-align: center;"> <tr> <td style="width: 10%;"></td> <td style="width: 10%;"></td> <td style="width: 10%;"></td> <td style="width: 10%;"></td> <td style="width: 10%;"></td> <td style="width: 10%;"></td> <td style="width: 10%;"></td> <td style="width: 10%;"></td> <td style="width: 10%;"></td> <td style="width: 10%;"></td> </tr> <tr> <td></td> <td></td> <td colspan="8" style="text-align: center;"> <table border="1" style="width: 100%; border-collapse: collapse; text-align: center;"> <tr> <td style="width: 10%;"></td> <td style="width: 10%;"></td> <td style="width: 10%;"></td> <td style="width: 10%;"></td> <td style="width: 10%;"></td> <td style="width: 10%;"></td> <td style="width: 10%;"></td> <td style="width: 10%;"></td> <td style="width: 10%;"></td> <td style="width: 10%;"></td> </tr> <tr> <td></td> <td></td> <td colspan="8" style="text-align: center;"> <table border="1" style="width: 100%; border-collapse: collapse; text-align: center;"> <tr> <td style="width: 10%;"></td> <td style="width: 10%;"></td> <td style="width: 10%;"></td> <td style="width: 10%;"></td> <td style="width: 10%;"></td> <td style="width: 10%;"></td> <td style="width: 10%;"></td> <td style="width: 10%;"></td> <td style="width: 10%;"></td> <td style="width: 10%;"></td> </tr> <tr> <td></td> <td></td> <td colspan="8" style="text-align: center;"> <table border="1" style="width: 100%; border-collapse: collapse; text-align: center;"> <tr> </tr></table></td></tr></table></td></tr></table></td></tr></table></td></tr></table></td></tr></table></td></tr></table></td></tr></table></td></tr></table></td></tr></table></td></tr></table></td></tr></table></td></tr></table></td></tr></table></td></tr></table></td></tr></table></td></tr></table></td></tr></table></td></tr></table></td></tr></table></td></tr></table></td></tr></table></td></tr></table> | | | | | | | | | | | | | | | | | | | | <table border="1" style="width: 100%; border-collapse: collapse; text-align: center;"> <tr> <td style="width: 10%;"></td> <td style="width: 10%;"></td> <td style="width: 10%;"></td> <td style="width: 10%;"></td> <td style="width: 10%;"></td> <td style="width: 10%;"></td> <td style="width: 10%;"></td> <td style="width: 10%;"></td> <td style="width: 10%;"></td> <td style="width: 10%;"></td> </tr> <tr> <td></td> <td></td> <td colspan="8" style="text-align: center;"> <table border="1" style="width: 100%; border-collapse: collapse; text-align: center;"> <tr> <td style="width: 10%;"></td> <td style="width: 10%;"></td> <td style="width: 10%;"></td> <td style="width: 10%;"></td> <td style="width: 10%;"></td> <td style="width: 10%;"></td> <td style="width: 10%;"></td> <td style="width: 10%;"></td> <td style="width: 10%;"></td> <td style="width: 10%;"></td> </tr> <tr> <td></td> <td></td> <td colspan="8" style="text-align: center;"> <table border="1" style="width: 100%; border-collapse: collapse; text-align: center;"> <tr> <td style="width: 10%;"></td> <td style="width: 10%;"></td> <td style="width: 10%;"></td> <td style="width: 10%;"></td> <td style="width: 10%;"></td> <td style="width: 10%;"></td> <td style="width: 10%;"></td> <td style="width: 10%;"></td> <td style="width: 10%;"></td> <td style="width: 10%;"></td> </tr> <tr> <td></td> <td></td> <td colspan="8" style="text-align: center;"> <table border="1" style="width: 100%; border-collapse: collapse; text-align: center;"> <tr> <td style="width: 10%;"></td> <td style="width: 10%;"></td> <td style="width: 10%;"></td> <td style="width: 10%;"></td> <td style="width: 10%;"></td> <td style="width: 10%;"></td> <td style="width: 10%;"></td> <td style="width: 10%;"></td> <td style="width: 10%;"></td> <td style="width: 10%;"></td> </tr> <tr> <td></td> <td></td> <td colspan="8" style="text-align: center;"> <table border="1" style="width: 100%; border-collapse: collapse; text-align: center;"> <tr> <td style="width: 10%;"></td> <td style="width: 10%;"></td> <td style="width: 10%;"></td> <td style="width: 10%;"></td> <td style="width: 10%;"></td> <td style="width: 10%;"></td> <td style="width: 10%;"></td> <td style="width: 10%;"></td> <td style="width: 10%;"></td> <td style="width: 10%;"></td> </tr> <tr> <td></td> <td></td> <td colspan="8" style="text-align: center;"> <table border="1" style="width: 100%; border-collapse: collapse; text-align: center;"> <tr> <td style="width: 10%;"></td> <td style="width: 10%;"></td> <td style="width: 10%;"></td> <td style="width: 10%;"></td> <td style="width: 10%;"></td> <td style="width: 10%;"></td> <td style="width: 10%;"></td> <td style="width: 10%;"></td> <td style="width: 10%;"></td> <td style="width: 10%;"></td> </tr> <tr> <td></td> <td></td> <td colspan="8" style="text-align: center;"> <table border="1" style="width: 100%; border-collapse: collapse; text-align: center;"> <tr> <td style="width: 10%;"></td> <td style="width: 10%;"></td> <td
style="width: 10%;"></td> <td style="width: 10%;"></td> <td style="width: 10%;"></td> <td style="width: 10%;"></td> <td style="width: 10%;"></td> <td style="width: 10%;"></td> <td style="width: 10%;"></td> <td style="width: 10%;"></td> </tr> <tr> <td></td> <td></td> <td colspan="8" style="text-align: center;"> <table border="1" style="width: 100%; border-collapse: collapse; text-align: center;"> <tr> <td style="width: 10%;"></td> <td style="width: 10%;"></td> <td style="width: 10%;"></td> <td style="width: 10%;"></td> <td style="width: 10%;"></td> <td style="width: 10%;"></td> <td style="width: 10%;"></td> <td style="width: 10%;"></td> <td style="width: 10%;"></td> <td style="width: 10%;"></td> </tr> <tr> <td></td> <td></td> <td colspan="8" style="text-align: center;"> <table border="1" style="width: 100%; border-collapse: collapse; text-align: center;"> <tr> <td style="width: 10%;"></td> <td style="width: 10%;"></td> <td style="width: 10%;"></td> <td style="width: 10%;"></td> <td style="width: 10%;"></td> <td style="width: 10%;"></td> <td style="width: 10%;"></td> <td style="width: 10%;"></td> <td style="width: 10%;"></td> <td style="width: 10%;"></td> </tr> <tr> <td></td> <td></td> <td colspan="8" style="text-align: center;"> <table border="1" style="width: 100%; border-collapse: collapse; text-align: center;"> <tr> <td style="width: 10%;"></td> <td style="width: 10%;"></td> <td style="width: 10%;"></td> <td style="width: 10%;"></td> <td style="width: 10%;"></td> <td style="width: 10%;"></td> <td style="width: 10%;"></td> <td style="width: 10%;"></td> <td style="width: 10%;"></td> <td style="width: 10%;"></td> </tr> <tr> <td></td> <td></td> <td colspan="8" style="text-align: center;"> <table border="1" style="width: 100%; border-collapse: collapse; text-align: center;"> <tr> <td style="width: 10%;"></td> <td style="width: 10%;"></td> <td style="width: 10%;"></td> <td style="width: 10%;"></td> <td style="width: 10%;"></td> <td style="width: 10%;"></td> <td style="width: 10%;"></td> <td style="width: 10%;"></td> <td style="width: 10%;"></td> <td style="width: 10%;"></td> </tr> <tr> <td></td> <td></td> <td colspan="8" style="text-align: center;"> <table border="1" style="width: 100%; border-collapse: collapse; text-align: center;"> <tr> <td style="width: 10%;"></td> <td style="width: 10%;"></td> <td style="width: 10%;"></td> <td style="width: 10%;"></td> <td style="width: 10%;"></td> <td style="width: 10%;"></td> <td style="width: 10%;"></td> <td style="width: 10%;"></td> <td style="width: 10%;"></td> <td style="width: 10%;"></td> </tr> <tr> <td></td> <td></td> <td colspan="8" style="text-align: center;"> <table border="1" style="width: 100%; border-collapse: collapse; text-align: center;"> <tr> <td style="width: 10%;"></td> <td style="width: 10%;"></td> <td style="width: 10%;"></td> <td style="width: 10%;"></td> <td style="width: 10%;"></td> <td style="width: 10%;"></td> <td style="width: 10%;"></td> <td style="width: 10%;"></td> <td style="width: 10%;"></td> <td style="width: 10%;"></td> </tr> <tr> <td></td> <td></td> <td colspan="8" style="text-align: center;"> <table border="1" style="width: 100%; border-collapse: collapse; text-align: center;"> <tr> <td style="width: 10%;"></td> <td style="width: 10%;"></td> <td style="width: 10%;"></td> <td style="width: 10%;"></td> <td style="width: 10%;"></td> <td style="width: 10%;"></td> <td style="width: 10%;"></td> <td style="width: 10%;"></td> <td style="width: 10%;"></td> <td style="width: 10%;"></td> </tr> <tr> <td></td> <td></td> <td colspan="8" style="text-align: center;"> <table border="1" style="width: 100%; border-collapse: collapse; text-align: center;"> <tr> <td style="width: 10%;"></td> <td style="width: 10%;"></td> <td style="width: 10%;"></td> <td style="width: 10%;"></td> <td style="width: 10%;"></td> <td style="width: 10%;"></td> <td style="width: 10%;"></td> <td style="width: 10%;"></td> <td style="width: 10%;"></td> <td style="width: 10%;"></td> </tr> <tr> <td></td> <td></td> <td colspan="8" style="text-align: center;"> <table border="1" style="width: 100%; border-collapse: collapse; text-align: center;"> <tr> <td style="width: 10%;"></td> <td style="width: 10%;"></td> <td style="width: 10%;"></td> <td style="width: 10%;"></td> <td style="width: 10%;"></td> <td style="width: 10%;"></td> <td style="width: 10%;"></td> <td style="width: 10%;"></td> <td style="width: 10%;"></td> <td style="width: 10%;"></td> </tr> <tr> <td></td> <td></td> <td colspan="8" style="text-align: center;"> <table border="1" style="width: 100%; border-collapse: collapse; text-align: center;"> <tr> <td style="width: 10%;"></td> <td style="width: 10%;"></td> <td style="width: 10%;"></td> <td style="width: 10%;"></td> <td style="width: 10%;"></td> <td style="width: 10%;"></td> <td style="width: 10%;"></td> <td style="width: 10%;"></td> <td style="width: 10%;"></td> <td style="width: 10%;"></td> </tr> <tr> <td></td> <td></td> <td colspan="8" style="text-align: center;"> <table border="1" style="width: 100%; border-collapse: collapse; text-align: center;"> <tr> <td style="width: 10%;"></td> <td style="width: 10%;"></td> <td style="width: 10%;"></td> <td style="width: 10%;"></td> <td style="width: 10%;"></td> <td style="width: 10%;"></td> <td style="width: 10%;"></td> <td style="width: 10%;"></td> <td style="width: 10%;"></td> <td style="width: 10%;"></td> </tr> <tr> <td></td> <td></td> <td colspan="8" style="text-align: center;"> <table border="1" style="width: 100%; border-collapse: collapse; text-align: center;"> <tr> <td style="width: 10%;"></td> <td style="width: 10%;"></td> <td style="width: 10%;"></td> <td style="width: 10%;"></td> <td style="width: 10%;"></td> <td style="width: 10%;"></td> <td style="width: 10%;"></td> <td style="width: 10%;"></td> <td style="width: 10%;"></td> <td style="width: 10%;"></td> </tr> <tr> <td></td> <td></td> <td colspan="8" style="text-align: center;"> <table border="1" style="width: 100%; border-collapse: collapse; text-align: center;"> <tr> <td style="width: 10%;"></td> <td style="width: 10%;"></td> <td style="width: 10%;"></td> <td style="width: 10%;"></td> <td style="width: 10%;"></td> <td style="width: 10%;"></td> <td style="width: 10%;"></td> <td style="width: 10%;"></td> <td style="width: 10%;"></td> <td style="width: 10%;"></td> </tr> <tr> <td></td> <td></td> <td colspan="8" style="text-align: center;"> <table border="1" style="width: 100%; border-collapse: collapse; text-align: center;"> <tr> <td style="width: 10%;"></td> <td style="width: 10%;"></td> <td style="width: 10%;"></td> <td style="width: 10%;"></td> <td style="width: 10%;"></td> <td style="width: 10%;"></td> <td style="width: 10%;"></td> <td style="width: 10%;"></td> <td style="width: 10%;"></td> <td style="width: 10%;"></td> </tr> <tr> <td></td> <td></td> <td colspan="8" style="text-align: center;"> <table border="1" style="width: 100%; border-collapse: collapse; text-align: center;"> <tr> </tr></table></td></tr></table></td></tr></table></td></tr></table></td></tr></table></td></tr></table></td></tr></table></td></tr></table></td></tr></table></td></tr></table></td></tr></table></td></tr></table></td></tr></table></td></tr></table></td></tr></table></td></tr></table></td></tr></table></td></tr></table></td></tr></table></td></tr></table></td></tr></table></td></tr></table> | | | | | | | | | | | | | | | | | | | | <table border="1" style="width: 100%; border-collapse: collapse; text-align: center;"> <tr> <td style="width: 10%;"></td> <td style="width: 10%;"></td> <td
style="width: 10%;"></td> <td style="width: 10%;"></td> <td style="width: 10%;"></td> <td style="width: 10%;"></td> <td style="width: 10%;"></td> <td style="width: 10%;"></td> <td style="width: 10%;"></td> <td style="width: 10%;"></td> </tr> <tr> <td></td> <td></td> <td colspan="8" style="text-align: center;"> <table border="1" style="width: 100%; border-collapse: collapse; text-align: center;"> <tr> <td style="width: 10%;"></td> <td style="width: 10%;"></td> <td style="width: 10%;"></td> <td style="width: 10%;"></td> <td style="width: 10%;"></td> <td style="width: 10%;"></td> <td style="width: 10%;"></td> <td style="width: 10%;"></td> <td style="width: 10%;"></td> <td style="width: 10%;"></td> </tr> <tr> <td></td> <td></td> <td colspan="8" style="text-align: center;"> <table border="1" style="width: 100%; border-collapse: collapse; text-align: center;"> <tr> <td style="width: 10%;"></td> <td style="width: 10%;"></td> <td style="width: 10%;"></td> <td style="width: 10%;"></td> <td style="width: 10%;"></td> <td style="width: 10%;"></td> <td style="width: 10%;"></td> <td style="width: 10%;"></td> <td style="width: 10%;"></td> <td style="width: 10%;"></td> </tr> <tr> <td></td> <td></td> <td colspan="8" style="text-align: center;"> <table border="1" style="width: 100%; border-collapse: collapse; text-align: center;"> <tr> <td style="width: 10%;"></td> <td style="width: 10%;"></td> <td style="width: 10%;"></td> <td style="width: 10%;"></td> <td style="width: 10%;"></td> <td style="width: 10%;"></td> <td style="width: 10%;"></td> <td style="width: 10%;"></td> <td style="width: 10%;"></td> <td style="width: 10%;"></td> </tr> <tr> <td></td> <td></td> <td colspan="8" style="text-align: center;"> <table border="1" style="width: 100%; border-collapse: collapse; text-align: center;"> <tr> <td style="width: 10%;"></td> <td style="width: 10%;"></td> <td style="width: 10%;"></td> <td style="width: 10%;"></td> <td style="width: 10%;"></td> <td style="width: 10%;"></td> <td style="width: 10%;"></td> <td style="width: 10%;"></td> <td style="width: 10%;"></td> <td style="width: 10%;"></td> </tr> <tr> <td></td> <td></td> <td colspan="8" style="text-align: center;"> <table border="1" style="width: 100%; border-collapse: collapse; text-align: center;"> <tr> <td style="width: 10%;"></td> <td style="width: 10%;"></td> <td style="width: 10%;"></td> <td style="width: 10%;"></td> <td style="width: 10%;"></td> <td style="width: 10%;"></td> <td style="width: 10%;"></td> <td style="width: 10%;"></td> <td style="width: 10%;"></td> <td style="width: 10%;"></td> </tr> <tr> <td></td> <td></td> <td colspan="8" style="text-align: center;"> <table border="1" style="width: 100%; border-collapse: collapse; text-align: center;"> <tr> <td style="width: 10%;"></td> <td style="width: 10%;"></td> <td style="width: 10%;"></td> <td style="width: 10%;"></td> <td style="width: 10%;"></td> <td style="width: 10%;"></td> <td style="width: 10%;"></td> <td style="width: 10%;"></td> <td style="width: 10%;"></td> <td style="width: 10%;"></td> </tr> <tr> <td></td> <td></td> <td colspan="8" style="text-align: center;"> <table border="1" style="width: 100%; border-collapse: collapse; text-align: center;"> <tr> <td style="width: 10%;"></td> <td style="width: 10%;"></td> <td style="width: 10%;"></td> <td style="width: 10%;"></td> <td style="width: 10%;"></td> <td style="width: 10%;"></td> <td style="width: 10%;"></td> <td style="width: 10%;"></td> <td style="width: 10%;"></td> <td style="width: 10%;"></td> </tr> <tr> <td></td> <td></td> <td colspan="8" style="text-align: center;"> <table border="1" style="width: 100%; border-collapse: collapse; text-align: center;"> <tr> <td style="width: 10%;"></td> <td style="width: 10%;"></td> <td style="width: 10%;"></td> <td style="width: 10%;"></td> <td style="width: 10%;"></td> <td style="width: 10%;"></td> <td style="width: 10%;"></td> <td style="width: 10%;"></td> <td style="width: 10%;"></td> <td style="width: 10%;"></td> </tr> <tr> <td></td> <td></td> <td colspan="8" style="text-align: center;"> <table border="1" style="width: 100%; border-collapse: collapse; text-align: center;"> <tr> <td style="width: 10%;"></td> <td style="width: 10%;"></td> <td style="width: 10%;"></td> <td style="width: 10%;"></td> <td style="width: 10%;"></td> <td style="width: 10%;"></td> <td style="width: 10%;"></td> <td style="width: 10%;"></td> <td style="width: 10%;"></td> <td style="width: 10%;"></td> </tr> <tr> <td></td> <td></td> <td colspan="8" style="text-align: center;"> <table border="1" style="width: 100%; border-collapse: collapse; text-align: center;"> <tr> <td style="width: 10%;"></td> <td style="width: 10%;"></td> <td style="width: 10%;"></td> <td style="width: 10%;"></td> <td style="width: 10%;"></td> <td style="width: 10%;"></td> <td style="width: 10%;"></td> <td style="width: 10%;"></td> <td style="width: 10%;"></td> <td style="width: 10%;"></td> </tr> <tr> <td></td> <td></td> <td colspan="8" style="text-align: center;"> <table border="1" style="width: 100%; border-collapse: collapse; text-align: center;"> <tr> <td style="width: 10%;"></td> <td style="width: 10%;"></td> <td style="width: 10%;"></td> <td style="width: 10%;"></td> <td style="width: 10%;"></td> <td style="width: 10%;"></td> <td style="width: 10%;"></td> <td style="width: 10%;"></td> <td style="width: 10%;"></td> <td style="width: 10%;"></td> </tr> <tr> <td></td> <td></td> <td colspan="8" style="text-align: center;"> <table border="1" style="width: 100%; border-collapse: collapse; text-align: center;"> <tr> <td style="width: 10%;"></td> <td style="width: 10%;"></td> <td style="width: 10%;"></td> <td style="width: 10%;"></td> <td style="width: 10%;"></td> <td style="width: 10%;"></td> <td style="width: 10%;"></td> <td style="width: 10%;"></td> <td style="width: 10%;"></td> <td style="width: 10%;"></td> </tr> <tr> <td></td> <td></td> <td colspan="8" style="text-align: center;"> <table border="1" style="width: 100%; border-collapse: collapse; text-align: center;"> <tr> <td style="width: 10%;"></td> <td style="width: 10%;"></td> <td style="width: 10%;"></td> <td style="width: 10%;"></td> <td style="width: 10%;"></td> <td style="width: 10%;"></td> <td style="width: 10%;"></td> <td style="width: 10%;"></td> <td style="width: 10%;"></td> <td style="width: 10%;"></td> </tr> <tr> <td></td> <td></td> <td colspan="8" style="text-align: center;"> <table border="1" style="width: 100%; border-collapse: collapse; text-align: center;"> <tr> <td style="width: 10%;"></td> <td style="width: 10%;"></td> <td style="width: 10%;"></td> <td style="width: 10%;"></td> <td style="width: 10%;"></td> <td style="width: 10%;"></td> <td style="width: 10%;"></td> <td style="width: 10%;"></td> <td style="width: 10%;"></td> <td style="width: 10%;"></td> </tr> <tr> <td></td> <td></td> <td colspan="8" style="text-align: center;"> <table border="1" style="width: 100%; border-collapse: collapse; text-align: center;"> <tr> <td style="width: 10%;"></td> <td style="width: 10%;"></td> <td style="width: 10%;"></td> <td style="width: 10%;"></td> <td style="width: 10%;"></td> <td style="width: 10%;"></td> <td style="width: 10%;"></td> <td style="width: 10%;"></td> <td style="width: 10%;"></td> <td style="width: 10%;"></td> </tr> <tr> <td></td> <td></td> <td colspan="8" style="text-align: center;"> <table border="1" style="width: 100%; border-collapse: collapse; text-align: center;"> <tr> <td style="width: 10%;"></td> <td style="width: 10%;"></td> <td style="width: 10%;"></td> <td style="width: 10%;"></td> <td style="width: 10%;"></td> <td style="width: 10%;"></td> <td style="width: 10%;"></td> <td style="width: 10%;"></td> <td style="width: 10%;"></td> <td style="width: 10%;"></td> </tr> <tr> <td></td> <td></td> <td colspan="8" style="text-align: center;"> <table border="1" style="width: 100%; border-collapse: collapse; text-align: center;"> <tr> <td style="width: 10%;"></td> <td style="width: 10%;"></td> <td style="width: 10%;"></td> <td style="width: 10%;"></td> <td style="width: 10%;"></td> <td style="width: 10%;"></td> <td style="width: 10%;"></td> <td style="width: 10%;"></td> <td style="width: 10%;"></td> <td style="width: 10%;"></td> </tr> <tr> <td></td> <td></td> <td colspan="8" style="text-align: center;"> <table border="1" style="width: 100%; border-collapse: collapse; text-align: center;"> <tr> <td style="width: 10%;"></td> <td style="width: 10%;"></td> <td style="width: 10%;"></td> <td style="width: 10%;"></td> <td style="width: 10%;"></td> <td style="width: 10%;"></td> <td style="width: 10%;"></td> <td style="width: 10%;"></td> <td style="width: 10%;"></td> <td style="width: 10%;"></td> </tr> <tr> <td></td> <td></td> <td colspan="8" style="text-align: center;"> <table border="1" style="width: 100%; border-collapse: collapse; text-align: center;"> <tr> <td style="width: 10%;"></td> <td style="width: 10%;"></td> <td style="width: 10%;"></td> <td style="width: 10%;"></td> <td style="width: 10%;"></td> <td style="width: 10%;"></td> <td style="width: 10%;"></td> <td style="width: 10%;"></td> <td style="width: 10%;"></td> <td style="width: 10%;"></td> </tr> <tr> <td></td> <td></td> <td colspan="8" style="text-align: center;"> <table border="1" style="width: 100%; border-collapse: collapse; text-align: center;"> <tr> </tr></table></td></tr></table></td></tr></table></td></tr></table></td></tr></table></td></tr></table></td></tr></table></td></tr></table></td></tr></table></td></tr></table></td></tr></table></td></tr></table></td></tr></table></td></tr></table></td></tr></table></td></tr></table></td></tr></table></td></tr></table></td></tr></table></td></tr></table></td></tr></table>
 | | | | | | | | | | | | | | | | | | | | <table border="1" style="width: 100%; border-collapse: collapse; text-align: center;"> <tr> <td style="width: 10%;"></td> <td style="width: 10%;"></td> <td style="width: 10%;"></td> <td style="width: 10%;"></td> <td style="width: 10%;"></td> <td style="width: 10%;"></td> <td style="width: 10%;"></td> <td style="width: 10%;"></td> <td style="width: 10%;"></td> <td style="width: 10%;"></td> </tr> <tr> <td></td> <td></td> <td colspan="8" style="text-align: center;"> <table border="1" style="width: 100%; border-collapse: collapse; text-align: center;"> <tr> <td style="width: 10%;"></td> <td style="width: 10%;"></td> <td style="width: 10%;"></td> <td style="width: 10%;"></td> <td style="width: 10%;"></td> <td style="width: 10%;"></td> <td style="width: 10%;"></td> <td style="width: 10%;"></td> <td style="width: 10%;"></td> <td style="width: 10%;"></td> </tr> <tr> <td></td> <td></td> <td colspan="8" style="text-align: center;"> <table border="1" style="width: 100%; border-collapse: collapse; text-align: center;"> <tr> <td style="width: 10%;"></td> <td style="width: 10%;"></td> <td style="width: 10%;"></td> <td style="width: 10%;"></td> <td style="width: 10%;"></td> <td style="width: 10%;"></td> <td style="width: 10%;"></td> <td style="width: 10%;"></td> <td style="width: 10%;"></td> <td style="width: 10%;"></td> </tr> <tr> <td></td> <td></td> <td colspan="8" style="text-align: center;"> <table border="1" style="width: 100%; border-collapse: collapse; text-align: center;"> <tr> <td style="width: 10%;"></td> <td style="width: 10%;"></td> <td style="width: 10%;"></td> <td style="width: 10%;"></td> <td style="width: 10%;"></td> <td style="width: 10%;"></td> <td style="width: 10%;"></td> <td style="width: 10%;"></td> <td style="width: 10%;"></td> <td style="width: 10%;"></td> </tr> <tr> <td></td> <td></td> <td colspan="8" style="text-align: center;"> <table border="1" style="width: 100%; border-collapse: collapse; text-align: center;"> <tr> <td style="width: 10%;"></td> <td style="width: 10%;"></td> <td style="width: 10%;"></td> <td style="width: 10%;"></td> <td style="width: 10%;"></td> <td style="width: 10%;"></td> <td style="width: 10%;"></td> <td style="width: 10%;"></td> <td style="width: 10%;"></td> <td style="width: 10%;"></td> </tr> <tr> <td></td> <td></td> <td colspan="8" style="text-align: center;"> <table border="1" style="width: 100%; border-collapse: collapse; text-align: center;"> <tr> <td style="width: 10%;"></td> <td style="width: 10%;"></td> <td style="width: 10%;"></td> <td style="width: 10%;"></td> <td style="width: 10%;"></td> <td style="width: 10%;"></td> <td style="width: 10%;"></td> <td style="width: 10%;"></td> <td style="width: 10%;"></td> <td style="width: 10%;"></td> </tr> <tr> <td></td> <td></td> <td colspan="8" style="text-align: center;"> <table border="1" style="width: 100%; border-collapse: collapse; text-align: center;"> <tr> <td style="width: 10%;"></td> <td style="width: 10%;"></td> <td style="width: 10%;"></td> <td style="width: 10%;"></td> <td style="width: 10%;"></td> <td style="width: 10%;"></td> <td style="width: 10%;"></td> <td style="width: 10%;"></td> <td style="width: 10%;"></td> <td style="width: 10%;"></td> </tr> <tr> <td></td> <td></td> <td colspan="8" style="text-align: center;"> <table border="1" style="width: 100%; border-collapse: collapse; text-align: center;"> <tr> <td style="width: 10%;"></td> <td style="width: 10%;"></td> <td style="width: 10%;"></td> <td style="width: 10%;"></td> <td style="width: 10%;"></td> <td style="width: 10%;"></td> <td style="width: 10%;"></td> <td style="width: 10%;"></td> <td style="width: 10%;"></td> <td style="width: 10%;"></td> </tr> <tr> <td></td> <td></td> <td colspan="8" style="text-align: center;"> <table border="1" style="width: 100%; border-collapse: collapse; text-align: center;"> <tr> <td style="width: 10%;"></td> <td style="width: 10%;"></td> <td style="width: 10%;"></td> <td style="width: 10%;"></td> <td style="width: 10%;"></td> <td style="width: 10%;"></td> <td style="width: 10%;"></td> <td style="width: 10%;"></td> <td style="width: 10%;"></td> <td style="width: 10%;"></td> </tr> <tr> <td></td> <td></td> <td colspan="8" style="text-align: center;"> <table border="1" style="width: 100%; border-collapse: collapse; text-align: center;"> <tr> <td style="width: 10%;"></td> <td style="width: 10%;"></td> <td style="width: 10%;"></td> <td style="width: 10%;"></td> <td style="width: 10%;"></td> <td style="width: 10%;"></td> <td style="width: 10%;"></td> <td style="width: 10%;"></td> <td style="width: 10%;"></td> <td style="width: 10%;"></td> </tr> <tr> <td></td> <td></td> <td colspan="8" style="text-align: center;"> <table border="1" style="width: 100%; border-collapse: collapse; text-align: center;"> <tr> <td style="width: 10%;"></td> <td style="width: 10%;"></td> <td style="width: 10%;"></td> <td style="width: 10%;"></td> <td style="width: 10%;"></td> <td style="width: 10%;"></td> <td style="width: 10%;"></td> <td style="width: 10%;"></td> <td style="width: 10%;"></td> <td style="width: 10%;"></td> </tr> <tr> <td></td> <td></td> <td colspan="8" style="text-align: center;"> <table border="1" style="width: 100%; border-collapse: collapse; text-align: center;"> <tr> <td style="width: 10%;"></td> <td style="width: 10%;"></td> <td style="width: 10%;"></td> <td style="width: 10%;"></td> <td style="width: 10%;"></td> <td style="width: 10%;"></td> <td style="width: 10%;"></td> <td style="width: 10%;"></td> <td style="width: 10%;"></td> <td style="width: 10%;"></td> </tr> <tr> <td></td> <td></td> <td colspan="8" style="text-align: center;"> <table border="1" style="width: 100%; border-collapse: collapse; text-align: center;"> <tr> <td style="width: 10%;"></td> <td style="width: 10%;"></td> <td style="width: 10%;"></td> <td style="width: 10%;"></td> <td style="width: 10%;"></td> <td style="width: 10%;"></td> <td style="width: 10%;"></td> <td style="width: 10%;"></td> <td style="width: 10%;"></td> <td style="width: 10%;"></td> </tr> <tr> <td></td> <td></td> <td colspan="8" style="text-align: center;"> <table border="1" style="width: 100%; border-collapse: collapse; text-align: center;"> <tr> <td style="width: 10%;"></td> <td style="width: 10%;"></td> <td style="width: 10%;"></td> <td style="width: 10%;"></td> <td style="width: 10%;"></td> <td style="width: 10%;"></td> <td style="width: 10%;"></td> <td style="width: 10%;"></td> <td style="width: 10%;"></td> <td style="width: 10%;"></td> </tr> <tr> <td></td> <td></td> <td colspan="8" style="text-align: center;"> <table border="1" style="width: 100%; border-collapse: collapse; text-align: center;"> <tr> <td style="width: 10%;"></td> <td style="width: 10%;"></td> <td style="width: 10%;"></td> <td style="width: 10%;"></td> <td style="width: 10%;"></td> <td style="width: 10%;"></td> <td style="width: 10%;"></td> <td style="width: 10%;"></td> <td style="width: 10%;"></td> <td style="width: 10%;"></td> </tr> <tr> <td></td> <td></td> <td colspan="8" style="text-align: center;"> <table border="1" style="width: 100%; border-collapse: collapse; text-align: center;"> <tr> <td style="width: 10%;"></td> <td style="width: 10%;"></td> <td style="width: 10%;"></td> <td style="width: 10%;"></td> <td style="width: 10%;"></td> <td style="width: 10%;"></td> <td style="width: 10%;"></td> <td style="width: 10%;"></td> <td style="width: 10%;"></td> <td style="width: 10%;"></td> </tr> <tr> <td></td> <td></td> <td colspan="8" style="text-align: center;"> <table border="1" style="width: 100%; border-collapse: collapse; text-align: center;"> <tr> <td style="width: 10%;"></td> <td style="width: 10%;"></td> <td style="width: 10%;"></td> <td style="width: 10%;"></td> <td style="width: 10%;"></td> <td style="width: 10%;"></td> <td style="width: 10%;"></td> <td style="width: 10%;"></td> <td style="width:
10%;"></td> <td style="width: 10%;"></td> </tr> <tr> <td></td> <td></td> <td colspan="8" style="text-align: center;"> <table border="1" style="width: 100%; border-collapse: collapse; text-align: center;"> <tr> <td style="width: 10%;"></td> <td style="width: 10%;"></td> <td style="width: 10%;"></td> <td style="width: 10%;"></td> <td style="width: 10%;"></td> <td style="width: 10%;"></td> <td style="width: 10%;"></td> <td style="width: 10%;"></td> <td style="width: 10%;"></td> <td style="width: 10%;"></td> </tr> <tr> <td></td> <td></td> <td colspan="8" style="text-align: center;"> <table border="1" style="width: 100%; border-collapse: collapse; text-align: center;"> <tr> <td style="width: 10%;"></td> <td style="width: 10%;"></td> <td style="width: 10%;"></td> <td style="width: 10%;"></td> <td style="width: 10%;"></td> <td style="width: 10%;"></td> <td style="width: 10%;"></td> <td style="width: 10%;"></td> <td style="width: 10%;"></td> <td style="width: 10%;"></td> </tr> <tr> <td></td> <td></td> <td colspan="8" style="text-align: center;"> <table border="1" style="width: 100%; border-collapse: collapse; text-align: center;"> <tr> </tr></table></td></tr></table></td></tr></table></td></tr></table></td></tr></table></td></tr></table></td></tr></table></td></tr></table></td></tr></table></td></tr></table></td></tr></table></td></tr></table></td></tr></table></td></tr></table></td></tr></table></td></tr></table></td></tr></table></td></tr></table></td></tr></table></td></tr></table> | | | | | | | | | | | | | | | | | | | | <table border="1" style="width: 100%; border-collapse: collapse; text-align: center;"> <tr> <td style="width: 10%;"></td> <td style="width: 10%;"></td> <td style="width: 10%;"></td> <td style="width: 10%;"></td> <td style="width: 10%;"></td> <td style="width: 10%;"></td> <td style="width: 10%;"></td> <td style="width: 10%;"></td> <td style="width: 10%;"></td> <td style="width: 10%;"></td> </tr> <tr> <td></td> <td></td> <td colspan="8" style="text-align: center;"> <table border="1" style="width: 100%; border-collapse: collapse; text-align: center;"> <tr> <td style="width: 10%;"></td> <td style="width: 10%;"></td> <td style="width: 10%;"></td> <td style="width: 10%;"></td> <td style="width: 10%;"></td> <td style="width: 10%;"></td> <td style="width: 10%;"></td> <td style="width: 10%;"></td> <td style="width: 10%;"></td> <td style="width: 10%;"></td> </tr> <tr> <td></td> <td></td> <td colspan="8" style="text-align: center;"> <table border="1" style="width: 100%; border-collapse: collapse; text-align: center;"> <tr> <td style="width: 10%;"></td> <td style="width: 10%;"></td> <td style="width: 10%;"></td> <td style="width: 10%;"></td> <td style="width: 10%;"></td> <td style="width: 10%;"></td> <td style="width: 10%;"></td> <td style="width: 10%;"></td> <td style="width: 10%;"></td> <td style="width: 10%;"></td> </tr> <tr> <td></td> <td></td> <td colspan="8" style="text-align: center;"> <table border="1" style="width: 100%; border-collapse: collapse; text-align: center;"> <tr> <td style="width: 10%;"></td> <td style="width: 10%;"></td> <td style="width: 10%;"></td> <td style="width: 10%;"></td> <td style="width: 10%;"></td> <td style="width: 10%;"></td> <td style="width: 10%;"></td> <td style="width: 10%;"></td> <td style="width: 10%;"></td> <td style="width: 10%;"></td> </tr> <tr> <td></td> <td></td> <td colspan="8" style="text-align: center;"> <table border="1" style="width: 100%; border-collapse: collapse; text-align: center;"> <tr> <td style="width: 10%;"></td> <td style="width: 10%;"></td> <td style="width: 10%;"></td> <td style="width: 10%;"></td> <td style="width: 10%;"></td> <td style="width: 10%;"></td> <td style="width: 10%;"></td> <td style="width: 10%;"></td> <td style="width: 10%;"></td> <td style="width: 10%;"></td> </tr> <tr> <td></td> <td></td> <td colspan="8" style="text-align: center;"> <table border="1" style="width: 100%; border-collapse: collapse; text-align: center;"> <tr> <td style="width: 10%;"></td> <td style="width: 10%;"></td> <td style="width: 10%;"></td> <td style="width: 10%;"></td> <td style="width: 10%;"></td> <td style="width: 10%;"></td> <td style="width: 10%;"></td> <td style="width: 10%;"></td> <td style="width: 10%;"></td> <td style="width: 10%;"></td> </tr> <tr> <td></td> <td></td> <td colspan="8" style="text-align: center;"> <table border="1" style="width: 100%; border-collapse: collapse; text-align: center;"> <tr> <td style="width: 10%;"></td> <td style="width: 10%;"></td> <td style="width: 10%;"></td> <td style="width: 10%;"></td> <td style="width: 10%;"></td> <td style="width: 10%;"></td> <td style="width: 10%;"></td> <td style="width: 10%;"></td> <td style="width: 10%;"></td> <td style="width: 10%;"></td> </tr> <tr> <td></td> <td></td> <td colspan="8" style="text-align: center;"> <table border="1" style="width: 100%; border-collapse: collapse; text-align: center;"> <tr> <td style="width: 10%;"></td> <td style="width: 10%;"></td> <td style="width: 10%;"></td> <td style="width: 10%;"></td> <td style="width: 10%;"></td> <td style="width: 10%;"></td> <td style="width: 10%;"></td> <td style="width: 10%;"></td> <td style="width: 10%;"></td> <td style="width: 10%;"></td> </tr> <tr> <td></td> <td></td> <td colspan="8" style="text-align: center;"> <table border="1" style="width: 100%; border-collapse: collapse; text-align: center;"> <tr> <td style="width: 10%;"></td> <td style="width: 10%;"></td> <td style="width: 10%;"></td> <td style="width: 10%;"></td> <td style="width: 10%;"></td> <td style="width: 10%;"></td> <td style="width: 10%;"></td> <td style="width: 10%;"></td> <td style="width: 10%;"></td> <td style="width: 10%;"></td> </tr> <tr> <td></td> <td></td> <td colspan="8" style="text-align: center;"> <table border="1" style="width: 100%; border-collapse: collapse; text-align: center;"> <tr> <td style="width: 10%;"></td> <td style="width: 10%;"></td> <td style="width: 10%;"></td> <td style="width: 10%;"></td> <td style="width: 10%;"></td> <td style="width: 10%;"></td> <td style="width: 10%;"></td> <td style="width: 10%;"></td> <td style="width: 10%;"></td> <td style="width: 10%;"></td> </tr> <tr> <td></td> <td></td> <td colspan="8" style="text-align: center;"> <table border="1" style="width: 100%; border-collapse: collapse; text-align: center;"> <tr> <td style="width: 10%;"></td> <td style="width: 10%;"></td> <td style="width: 10%;"></td> <td style="width: 10%;"></td> <td style="width: 10%;"></td> <td style="width: 10%;"></td> <td style="width: 10%;"></td> <td style="width: 10%;"></td> <td style="width: 10%;"></td> <td style="width: 10%;"></td> </tr> <tr> <td></td> <td></td> <td colspan="8" style="text-align: center;"> <table border="1" style="width: 100%; border-collapse: collapse; text-align: center;"> <tr> <td style="width: 10%;"></td> <td style="width: 10%;"></td> <td style="width: 10%;"></td> <td style="width: 10%;"></td> <td style="width: 10%;"></td> <td style="width: 10%;"></td> <td style="width: 10%;"></td> <td style="width: 10%;"></td> <td style="width: 10%;"></td> <td style="width: 10%;"></td> </tr> <tr> <td></td> <td></td> <td colspan="8" style="text-align: center;"> <table border="1" style="width: 100%; border-collapse: collapse; text-align: center;"> <tr> <td style="width: 10%;"></td> <td style="width: 10%;"></td> <td style="width: 10%;"></td> <td style="width: 10%;"></td> <td style="width: 10%;"></td> <td style="width: 10%;"></td> <td style="width: 10%;"></td> <td style="width: 10%;"></td> <td style="width: 10%;"></td> <td style="width: 10%;"></td>
</tr> <tr> <td></td> <td></td> <td colspan="8" style="text-align: center;"> <table border="1" style="width: 100%; border-collapse: collapse; text-align: center;"> <tr> <td style="width: 10%;"></td> <td style="width: 10%;"></td> <td style="width: 10%;"></td> <td style="width: 10%;"></td> <td style="width: 10%;"></td> <td style="width: 10%;"></td> <td style="width: 10%;"></td> <td style="width: 10%;"></td> <td style="width: 10%;"></td> <td style="width: 10%;"></td> </tr> <tr> <td></td> <td></td> <td colspan="8" style="text-align: center;"> <table border="1" style="width: 100%; border-collapse: collapse; text-align: center;"> <tr> <td style="width: 10%;"></td> <td style="width: 10%;"></td> <td style="width: 10%;"></td> <td style="width: 10%;"></td> <td style="width: 10%;"></td> <td style="width: 10%;"></td> <td style="width: 10%;"></td> <td style="width: 10%;"></td> <td style="width: 10%;"></td> <td style="width: 10%;"></td> </tr> <tr> <td></td> <td></td> <td colspan="8" style="text-align: center;"> <table border="1" style="width: 100%; border-collapse: collapse; text-align: center;"> <tr> <td style="width: 10%;"></td> <td style="width: 10%;"></td> <td style="width: 10%;"></td> <td style="width: 10%;"></td> <td style="width: 10%;"></td> <td style="width: 10%;"></td> <td style="width: 10%;"></td> <td style="width: 10%;"></td> <td style="width: 10%;"></td> <td style="width: 10%;"></td> </tr> <tr> <td></td> <td></td> <td colspan="8" style="text-align: center;"> <table border="1" style="width: 100%; border-collapse: collapse; text-align: center;"> <tr> <td style="width: 10%;"></td> <td style="width: 10%;"></td> <td style="width: 10%;"></td> <td style="width: 10%;"></td> <td style="width: 10%;"></td> <td style="width: 10%;"></td> <td style="width: 10%;"></td> <td style="width: 10%;"></td> <td style="width: 10%;"></td> <td style="width: 10%;"></td> </tr> <tr> <td></td> <td></td> <td colspan="8" style="text-align: center;"> <table border="1" style="width: 100%; border-collapse: collapse; text-align: center;"> <tr> <td style="width: 10%;"></td> <td style="width: 10%;"></td> <td style="width: 10%;"></td> <td style="width: 10%;"></td> <td style="width: 10%;"></td> <td style="width: 10%;"></td> <td style="width: 10%;"></td> <td style="width: 10%;"></td> <td style="width: 10%;"></td> <td style="width: 10%;"></td> </tr> <tr> <td></td> <td></td> <td colspan="8" style="text-align: center;"> <table border="1" style="width: 100%; border-collapse: collapse; text-align: center;"> <tr> </tr></table></td></tr></table></td></tr></table></td></tr></table></td></tr></table></td></tr></table></td></tr></table></td></tr></table></td></tr></table></td></tr></table></td></tr></table></td></tr></table></td></tr></table></td></tr></table></td></tr></table></td></tr></table></td></tr></table></td></tr></table></td></tr></table> | | | | | | | | | | | | | | | | | | | | <table border="1" style="width: 100%; border-collapse: collapse; text-align: center;"> <tr> <td style="width: 10%;"></td> <td style="width: 10%;"></td> <td style="width: 10%;"></td> <td style="width: 10%;"></td> <td style="width: 10%;"></td> <td style="width: 10%;"></td> <td style="width: 10%;"></td> <td style="width: 10%;"></td> <td style="width: 10%;"></td> <td style="width: 10%;"></td> </tr> <tr> <td></td> <td></td> <td colspan="8" style="text-align: center;"> <table border="1" style="width: 100%; border-collapse: collapse; text-align: center;"> <tr> <td style="width: 10%;"></td> <td style="width: 10%;"></td> <td style="width: 10%;"></td> <td style="width: 10%;"></td> <td style="width: 10%;"></td> <td style="width: 10%;"></td> <td style="width: 10%;"></td> <td style="width: 10%;"></td> <td style="width: 10%;"></td> <td style="width: 10%;"></td> </tr> <tr> <td></td> <td></td> <td colspan="8" style="text-align: center;"> <table border="1" style="width: 100%; border-collapse: collapse; text-align: center;"> <tr> <td style="width: 10%;"></td> <td style="width: 10%;"></td> <td style="width: 10%;"></td> <td style="width: 10%;"></td> <td style="width: 10%;"></td> <td style="width: 10%;"></td> <td style="width: 10%;"></td> <td style="width: 10%;"></td> <td style="width: 10%;"></td> <td style="width: 10%;"></td> </tr> <tr> <td></td> <td></td> <td colspan="8" style="text-align: center;"> <table border="1" style="width: 100%; border-collapse: collapse; text-align: center;"> <tr> <td style="width: 10%;"></td> <td style="width: 10%;"></td> <td style="width: 10%;"></td> <td style="width: 10%;"></td> <td style="width: 10%;"></td> <td style="width: 10%;"></td> <td style="width: 10%;"></td> <td style="width: 10%;"></td> <td style="width: 10%;"></td> <td style="width: 10%;"></td> </tr> <tr> <td></td> <td></td> <td colspan="8" style="text-align: center;"> <table border="1" style="width: 100%; border-collapse: collapse; text-align: center;"> <tr> <td style="width: 10%;"></td> <td style="width: 10%;"></td> <td style="width: 10%;"></td> <td style="width: 10%;"></td> <td style="width: 10%;"></td> <td style="width: 10%;"></td> <td style="width: 10%;"></td> <td style="width: 10%;"></td> <td style="width: 10%;"></td> <td style="width: 10%;"></td> </tr> <tr> <td></td> <td></td> <td colspan="8" style="text-align: center;"> <table border="1" style="width: 100%; border-collapse: collapse; text-align: center;"> <tr> <td style="width: 10%;"></td> <td style="width: 10%;"></td> <td style="width: 10%;"></td> <td style="width: 10%;"></td> <td style="width: 10%;"></td> <td style="width: 10%;"></td> <td style="width: 10%;"></td> <td style="width: 10%;"></td> <td style="width: 10%;"></td> <td style="width: 10%;"></td> </tr> <tr> <td></td> <td></td> <td colspan="8" style="text-align: center;"> <table border="1" style="width: 100%; border-collapse: collapse; text-align: center;"> <tr> <td style="width: 10%;"></td> <td style="width: 10%;"></td> <td style="width: 10%;"></td> <td style="width: 10%;"></td> <td style="width: 10%;"></td> <td style="width: 10%;"></td> <td style="width: 10%;"></td> <td style="width: 10%;"></td> <td style="width: 10%;"></td> <td style="width: 10%;"></td> </tr> <tr> <td></td> <td></td> <td colspan="8" style="text-align: center;"> <table border="1" style="width: 100%; border-collapse: collapse; text-align: center;"> <tr> <td style="width: 10%;"></td> <td style="width: 10%;"></td> <td style="width: 10%;"></td> <td style="width: 10%;"></td> <td style="width: 10%;"></td> <td style="width: 10%;"></td> <td style="width: 10%;"></td> <td style="width: 10%;"></td> <td style="width: 10%;"></td> <td style="width: 10%;"></td> </tr> <tr> <td></td> <td></td> <td colspan="8" style="text-align: center;"> <table border="1" style="width: 100%; border-collapse: collapse; text-align: center;"> <tr> <td style="width: 10%;"></td> <td style="width: 10%;"></td> <td style="width: 10%;"></td> <td style="width: 10%;"></td> <td style="width: 10%;"></td> <td style="width: 10%;"></td> <td style="width: 10%;"></td> <td style="width: 10%;"></td> <td style="width: 10%;"></td> <td style="width: 10%;"></td> </tr> <tr> <td></td> <td></td> <td colspan="8" style="text-align: center;"> <table border="1" style="width: 100%; border-collapse: collapse; text-align: center;"> <tr> <td style="width: 10%;"></td> <td style="width: 10%;"></td> <td style="width: 10%;"></td> <td style="width: 10%;"></td> <td style="width: 10%;"></td> <td style="width: 10%;"></td> <td style="width: 10%;"></td> <td style="width: 10%;"></td> <td style="width: 10%;"></td> <td style="width: 10%;"></td> </tr> <tr> <td></td> <td></td> <td colspan="8"
style="text-align: center;"> <table border="1" style="width: 100%; border-collapse: collapse; text-align: center;"> <tr> <td style="width: 10%;"></td> <td style="width: 10%;"></td> <td style="width: 10%;"></td> <td style="width: 10%;"></td> <td style="width: 10%;"></td> <td style="width: 10%;"></td> <td style="width: 10%;"></td> <td style="width: 10%;"></td> <td style="width: 10%;"></td> <td style="width: 10%;"></td> </tr> <tr> <td></td> <td></td> <td colspan="8" style="text-align: center;"> <table border="1" style="width: 100%; border-collapse: collapse; text-align: center;"> <tr> <td style="width: 10%;"></td> <td style="width: 10%;"></td> <td style="width: 10%;"></td> <td style="width: 10%;"></td> <td style="width: 10%;"></td> <td style="width: 10%;"></td> <td style="width: 10%;"></td> <td style="width: 10%;"></td> <td style="width: 10%;"></td> <td style="width: 10%;"></td> </tr> <tr> <td></td> <td></td> <td colspan="8" style="text-align: center;"> <table border="1" style="width: 100%; border-collapse: collapse; text-align: center;"> <tr> <td style="width: 10%;"></td> <td style="width: 10%;"></td> <td style="width: 10%;"></td> <td style="width: 10%;"></td> <td style="width: 10%;"></td> <td style="width: 10%;"></td> <td style="width: 10%;"></td> <td style="width: 10%;"></td> <td style="width: 10%;"></td> <td style="width: 10%;"></td> </tr> <tr> <td></td> <td></td> <td colspan="8" style="text-align: center;"> <table border="1" style="width: 100%; border-collapse: collapse; text-align: center;"> <tr> <td style="width: 10%;"></td> <td style="width: 10%;"></td> <td style="width: 10%;"></td> <td style="width: 10%;"></td> <td style="width: 10%;"></td> <td style="width: 10%;"></td> <td style="width: 10%;"></td> <td style="width: 10%;"></td> <td style="width: 10%;"></td> <td style="width: 10%;"></td> </tr> <tr> <td></td> <td></td> <td colspan="8" style="text-align: center;"> <table border="1" style="width: 100%; border-collapse: collapse; text-align: center;"> <tr> <td style="width: 10%;"></td> <td style="width: 10%;"></td> <td style="width: 10%;"></td> <td style="width: 10%;"></td> <td style="width: 10%;"></td> <td style="width: 10%;"></td> <td style="width: 10%;"></td> <td style="width: 10%;"></td> <td style="width: 10%;"></td> <td style="width: 10%;"></td> </tr> <tr> <td></td> <td></td> <td colspan="8" style="text-align: center;"> <table border="1" style="width: 100%; border-collapse: collapse; text-align: center;"> <tr> <td style="width: 10%;"></td> <td style="width: 10%;"></td> <td style="width: 10%;"></td> <td style="width: 10%;"></td> <td style="width: 10%;"></td> <td style="width: 10%;"></td> <td style="width: 10%;"></td> <td style="width: 10%;"></td> <td style="width: 10%;"></td> <td style="width: 10%;"></td> </tr> <tr> <td></td> <td></td> <td colspan="8" style="text-align: center;"> <table border="1" style="width: 100%; border-collapse: collapse; text-align: center;"> <tr> <td style="width: 10%;"></td> <td style="width: 10%;"></td> <td style="width: 10%;"></td> <td style="width: 10%;"></td> <td style="width: 10%;"></td> <td style="width: 10%;"></td> <td style="width: 10%;"></td> <td style="width: 10%;"></td> <td style="width: 10%;"></td> <td style="width: 10%;"></td> </tr> <tr> <td></td> <td></td> <td colspan="8" style="text-align: center;"> <table border="1" style="width: 100%; border-collapse: collapse; text-align: center;"> <tr> </tr></table></td></tr></table></td></tr></table></td></tr></table></td></tr></table></td></tr></table></td></tr></table></td></tr></table></td></tr></table></td></tr></table></td></tr></table></td></tr></table></td></tr></table></td></tr></table></td></tr></table></td></tr></table></td></tr></table></td></tr></table> | | | | | | | | | | | | | | | | | | | | <table border="1" style="width: 100%; border-collapse: collapse; text-align: center;"> <tr> <td style="width: 10%;"></td> <td style="width: 10%;"></td> <td style="width: 10%;"></td> <td style="width: 10%;"></td> <td style="width: 10%;"></td> <td style="width: 10%;"></td> <td style="width: 10%;"></td> <td style="width: 10%;"></td> <td style="width: 10%;"></td> <td style="width: 10%;"></td> </tr> <tr> <td></td> <td></td> <td colspan="8" style="text-align: center;"> <table border="1" style="width: 100%; border-collapse: collapse; text-align: center;"> <tr> <td style="width: 10%;"></td> <td style="width: 10%;"></td> <td style="width: 10%;"></td> <td style="width: 10%;"></td> <td style="width: 10%;"></td> <td style="width: 10%;"></td> <td style="width: 10%;"></td> <td style="width: 10%;"></td> <td style="width: 10%;"></td> <td style="width: 10%;"></td> </tr> <tr> <td></td> <td></td> <td colspan="8" style="text-align: center;"> <table border="1" style="width: 100%; border-collapse: collapse; text-align: center;"> <tr> <td style="width: 10%;"></td> <td style="width: 10%;"></td> <td style="width: 10%;"></td> <td style="width: 10%;"></td> <td style="width: 10%;"></td> <td style="width: 10%;"></td> <td style="width: 10%;"></td> <td style="width: 10%;"></td> <td style="width: 10%;"></td> <td style="width: 10%;"></td> </tr> <tr> <td></td> <td></td> <td colspan="8" style="text-align: center;"> <table border="1" style="width: 100%; border-collapse: collapse; text-align: center;"> <tr> <td style="width: 10%;"></td> <td style="width: 10%;"></td> <td style="width: 10%;"></td> <td style="width: 10%;"></td> <td style="width: 10%;"></td> <td style="width: 10%;"></td> <td style="width: 10%;"></td> <td style="width: 10%;"></td> <td style="width: 10%;"></td> <td style="width: 10%;"></td> </tr> <tr> <td></td> <td></td> <td colspan="8" style="text-align: center;"> <table border="1" style="width: 100%; border-collapse: collapse; text-align: center;"> <tr> <td style="width: 10%;"></td> <td style="width: 10%;"></td> <td style="width: 10%;"></td> <td style="width: 10%;"></td> <td style="width: 10%;"></td> <td style="width: 10%;"></td> <td style="width: 10%;"></td> <td style="width: 10%;"></td> <td style="width: 10%;"></td> <td style="width: 10%;"></td> </tr> <tr> <td></td> <td></td> <td colspan="8" style="text-align: center;"> <table border="1" style="width: 100%; border-collapse: collapse; text-align: center;"> <tr> <td style="width: 10%;"></td> <td style="width: 10%;"></td> <td style="width: 10%;"></td> <td style="width: 10%;"></td> <td style="width: 10%;"></td> <td style="width: 10%;"></td> <td style="width: 10%;"></td> <td style="width: 10%;"></td> <td style="width: 10%;"></td> <td style="width: 10%;"></td> </tr> <tr> <td></td> <td></td> <td colspan="8" style="text-align: center;"> <table border="1" style="width: 100%; border-collapse: collapse; text-align: center;"> <tr> <td style="width: 10%;"></td> <td style="width: 10%;"></td> <td style="width: 10%;"></td> <td style="width: 10%;"></td> <td style="width: 10%;"></td> <td style="width: 10%;"></td> <td style="width: 10%;"></td> <td style="width: 10%;"></td> <td style="width: 10%;"></td> <td style="width: 10%;"></td> </tr> <tr> <td></td> <td></td> <td colspan="8" style="text-align: center;"> <table border="1" style="width: 100%; border-collapse: collapse; text-align: center;"> <tr> <td style="width: 10%;"></td> <td style="width: 10%;"></td> <td style="width: 10%;"></td> <td style="width: 10%;"></td> <td style="width: 10%;"></td> <td style="width: 10%;"></td> <td style="width: 10%;"></td> <td style="width: 10%;"></td> <td style="width: 10%;"></td> <td style="width: 10%;"></td> </tr> <tr> <td></td> <td></td> <td colspan="8" style="text-align: center;"> <table border="1" style="width: 100%;
border-collapse: collapse; text-align: center;"> <tr> <td style="width: 10%;"></td> <td style="width: 10%;"></td> <td style="width: 10%;"></td> <td style="width: 10%;"></td> <td style="width: 10%;"></td> <td style="width: 10%;"></td> <td style="width: 10%;"></td> <td style="width: 10%;"></td> <td style="width: 10%;"></td> <td style="width: 10%;"></td> </tr> <tr> <td></td> <td></td> <td colspan="8" style="text-align: center;"> <table border="1" style="width: 100%; border-collapse: collapse; text-align: center;"> <tr> <td style="width: 10%;"></td> <td style="width: 10%;"></td> <td style="width: 10%;"></td> <td style="width: 10%;"></td> <td style="width: 10%;"></td> <td style="width: 10%;"></td> <td style="width: 10%;"></td> <td style="width: 10%;"></td> <td style="width: 10%;"></td> <td style="width: 10%;"></td> </tr> <tr> <td></td> <td></td> <td colspan="8" style="text-align: center;"> <table border="1" style="width: 100%; border-collapse: collapse; text-align: center;"> <tr> <td style="width: 10%;"></td> <td style="width: 10%;"></td> <td style="width: 10%;"></td> <td style="width: 10%;"></td> <td style="width: 10%;"></td> <td style="width: 10%;"></td> <td style="width: 10%;"></td> <td style="width: 10%;"></td> <td style="width: 10%;"></td> <td style="width: 10%;"></td> </tr> <tr> <td></td> <td></td> <td colspan="8" style="text-align: center;"> <table border="1" style="width: 100%; border-collapse: collapse; text-align: center;"> <tr> <td style="width: 10%;"></td> <td style="width: 10%;"></td> <td style="width: 10%;"></td> <td style="width: 10%;"></td> <td style="width: 10%;"></td> <td style="width: 10%;"></td> <td style="width: 10%;"></td> <td style="width: 10%;"></td> <td style="width: 10%;"></td> <td style="width: 10%;"></td> </tr> <tr> <td></td> <td></td> <td colspan="8" style="text-align: center;"> <table border="1" style="width: 100%; border-collapse: collapse; text-align: center;"> <tr> <td style="width: 10%;"></td> <td style="width: 10%;"></td> <td style="width: 10%;"></td> <td style="width: 10%;"></td> <td style="width: 10%;"></td> <td style="width: 10%;"></td> <td style="width: 10%;"></td> <td style="width: 10%;"></td> <td style="width: 10%;"></td> <td style="width: 10%;"></td> </tr> <tr> <td></td> <td></td> <td colspan="8" style="text-align: center;"> <table border="1" style="width: 100%; border-collapse: collapse; text-align: center;"> <tr> <td style="width: 10%;"></td> <td style="width: 10%;"></td> <td style="width: 10%;"></td> <td style="width: 10%;"></td> <td style="width: 10%;"></td> <td style="width: 10%;"></td> <td style="width: 10%;"></td> <td style="width: 10%;"></td> <td style="width: 10%;"></td> <td style="width: 10%;"></td> </tr> <tr> <td></td> <td></td> <td colspan="8" style="text-align: center;"> <table border="1" style="width: 100%; border-collapse: collapse; text-align: center;"> <tr> <td style="width: 10%;"></td> <td style="width: 10%;"></td> <td style="width: 10%;"></td> <td style="width: 10%;"></td> <td style="width: 10%;"></td> <td style="width: 10%;"></td> <td style="width: 10%;"></td> <td style="width: 10%;"></td> <td style="width: 10%;"></td> <td style="width: 10%;"></td> </tr> <tr> <td></td> <td></td> <td colspan="8" style="text-align: center;"> <table border="1" style="width: 100%; border-collapse: collapse; text-align: center;"> <tr> <td style="width: 10%;"></td> <td style="width: 10%;"></td> <td style="width: 10%;"></td> <td style="width: 10%;"></td> <td style="width: 10%;"></td> <td style="width: 10%;"></td> <td style="width: 10%;"></td> <td style="width: 10%;"></td> <td style="width: 10%;"></td> <td style="width: 10%;"></td> </tr> <tr> <td></td> <td></td> <td colspan="8" style="text-align: center;"> <table border="1" style="width: 100%; border-collapse: collapse; text-align: center;"> <tr> </tr></table></td></tr></table></td></tr></table></td></tr></table></td></tr></table></td></tr></table></td></tr></table></td></tr></table></td></tr></table></td></tr></table></td></tr></table></td></tr></table></td></tr></table></td></tr></table></td></tr></table></td></tr></table></td></tr></table> | | | | | | | | | | | | | | | | | | | | <table border="1" style="width: 100%; border-collapse: collapse; text-align: center;"> <tr> <td style="width: 10%;"></td> <td style="width: 10%;"></td> <td style="width: 10%;"></td> <td style="width: 10%;"></td> <td style="width: 10%;"></td> <td style="width: 10%;"></td> <td style="width: 10%;"></td> <td style="width: 10%;"></td> <td style="width: 10%;"></td> <td style="width: 10%;"></td> </tr> <tr> <td></td> <td></td> <td colspan="8" style="text-align: center;"> <table border="1" style="width: 100%; border-collapse: collapse; text-align: center;"> <tr> <td style="width: 10%;"></td> <td style="width: 10%;"></td> <td style="width: 10%;"></td> <td style="width: 10%;"></td> <td style="width: 10%;"></td> <td style="width: 10%;"></td> <td style="width: 10%;"></td> <td style="width: 10%;"></td> <td style="width: 10%;"></td> <td style="width: 10%;"></td> </tr> <tr> <td></td> <td></td> <td colspan="8" style="text-align: center;"> <table border="1" style="width: 100%; border-collapse: collapse; text-align: center;"> <tr> <td style="width: 10%;"></td> <td style="width: 10%;"></td> <td style="width: 10%;"></td> <td style="width: 10%;"></td> <td style="width: 10%;"></td> <td style="width: 10%;"></td> <td style="width: 10%;"></td> <td style="width: 10%;"></td> <td style="width: 10%;"></td> <td style="width: 10%;"></td> </tr> <tr> <td></td> <td></td> <td colspan="8" style="text-align: center;"> <table border="1" style="width: 100%; border-collapse: collapse; text-align: center;"> <tr> <td style="width: 10%;"></td> <td style="width: 10%;"></td> <td style="width: 10%;"></td> <td style="width: 10%;"></td> <td style="width: 10%;"></td> <td style="width: 10%;"></td> <td style="width: 10%;"></td> <td style="width: 10%;"></td> <td style="width: 10%;"></td> <td style="width: 10%;"></td> </tr> <tr> <td></td> <td></td> <td colspan="8" style="text-align: center;"> <table border="1" style="width: 100%; border-collapse: collapse; text-align: center;"> <tr> <td style="width: 10%;"></td> <td style="width: 10%;"></td> <td style="width: 10%;"></td> <td style="width: 10%;"></td> <td style="width: 10%;"></td> <td style="width: 10%;"></td> <td style="width: 10%;"></td> <td style="width: 10%;"></td> <td style="width: 10%;"></td> <td style="width: 10%;"></td> </tr> <tr> <td></td> <td></td> <td colspan="8" style="text-align: center;"> <table border="1" style="width: 100%; border-collapse: collapse; text-align: center;"> <tr> <td style="width: 10%;"></td> <td style="width: 10%;"></td> <td style="width: 10%;"></td> <td style="width: 10%;"></td> <td style="width: 10%;"></td> <td style="width: 10%;"></td> <td style="width: 10%;"></td> <td style="width: 10%;"></td> <td style="width: 10%;"></td> <td style="width: 10%;"></td> </tr> <tr> <td></td> <td></td> <td colspan="8" style="text-align: center;"> <table border="1" style="width: 100%; border-collapse: collapse; text-align: center;"> <tr> <td style="width: 10%;"></td> <td style="width: 10%;"></td> <td style="width: 10%;"></td> <td style="width: 10%;"></td> <td style="width: 10%;"></td> <td style="width: 10%;"></td> <td style="width: 10%;"></td> <td style="width: 10%;"></td> <td style="width: 10%;"></td> <td style="width: 10%;"></td> </tr> <tr> <td></td> <td></td> <td colspan="8" style="text-align: center;"> <table border="1" style="width: 100%; border-collapse: collapse; text-align: center;"> <tr> <td style="width: 10%;"></td> <td
style="width: 10%;"></td> <td style="width: 10%;"></td> <td style="width: 10%;"></td> <td style="width: 10%;"></td> <td style="width: 10%;"></td> <td style="width: 10%;"></td> <td style="width: 10%;"></td> <td style="width: 10%;"></td> <td style="width: 10%;"></td> </tr> <tr> <td></td> <td></td> <td colspan="8" style="text-align: center;"> <table border="1" style="width: 100%; border-collapse: collapse; text-align: center;"> <tr> <td style="width: 10%;"></td> <td style="width: 10%;"></td> <td style="width: 10%;"></td> <td style="width: 10%;"></td> <td style="width: 10%;"></td> <td style="width: 10%;"></td> <td style="width: 10%;"></td> <td style="width: 10%;"></td> <td style="width: 10%;"></td> <td style="width: 10%;"></td> </tr> <tr> <td></td> <td></td> <td colspan="8" style="text-align: center;"> <table border="1" style="width: 100%; border-collapse: collapse; text-align: center;"> <tr> <td style="width: 10%;"></td> <td style="width: 10%;"></td> <td style="width: 10%;"></td> <td style="width: 10%;"></td> <td style="width: 10%;"></td> <td style="width: 10%;"></td> <td style="width: 10%;"></td> <td style="width: 10%;"></td> <td style="width: 10%;"></td> <td style="width: 10%;"></td> </tr> <tr> <td></td> <td></td> <td colspan="8" style="text-align: center;"> <table border="1" style="width: 100%; border-collapse: collapse; text-align: center;"> <tr> <td style="width: 10%;"></td> <td style="width: 10%;"></td> <td style="width: 10%;"></td> <td style="width: 10%;"></td> <td style="width: 10%;"></td> <td style="width: 10%;"></td> <td style="width: 10%;"></td> <td style="width: 10%;"></td> <td style="width: 10%;"></td> <td style="width: 10%;"></td> </tr> <tr> <td></td> <td></td> <td colspan="8" style="text-align: center;"> <table border="1" style="width: 100%; border-collapse: collapse; text-align: center;"> <tr> <td style="width: 10%;"></td> <td style="width: 10%;"></td> <td style="width: 10%;"></td> <td style="width: 10%;"></td> <td style="width: 10%;"></td> <td style="width: 10%;"></td> <td style="width: 10%;"></td> <td style="width: 10%;"></td> <td style="width: 10%;"></td> <td style="width: 10%;"></td> </tr> <tr> <td></td> <td></td> <td colspan="8" style="text-align: center;"> <table border="1" style="width: 100%; border-collapse: collapse; text-align: center;"> <tr> <td style="width: 10%;"></td> <td style="width: 10%;"></td> <td style="width: 10%;"></td> <td style="width: 10%;"></td> <td style="width: 10%;"></td> <td style="width: 10%;"></td> <td style="width: 10%;"></td> <td style="width: 10%;"></td> <td style="width: 10%;"></td> <td style="width: 10%;"></td> </tr> <tr> <td></td> <td></td> <td colspan="8" style="text-align: center;"> <table border="1" style="width: 100%; border-collapse: collapse; text-align: center;"> <tr> <td style="width: 10%;"></td> <td style="width: 10%;"></td> <td style="width: 10%;"></td> <td style="width: 10%;"></td> <td style="width: 10%;"></td> <td style="width: 10%;"></td> <td style="width: 10%;"></td> <td style="width: 10%;"></td> <td style="width: 10%;"></td> <td style="width: 10%;"></td> </tr> <tr> <td></td> <td></td> <td colspan="8" style="text-align: center;"> <table border="1" style="width: 100%; border-collapse: collapse; text-align: center;"> <tr> <td style="width: 10%;"></td> <td style="width: 10%;"></td> <td style="width: 10%;"></td> <td style="width: 10%;"></td> <td style="width: 10%;"></td> <td style="width: 10%;"></td> <td style="width: 10%;"></td> <td style="width: 10%;"></td> <td style="width: 10%;"></td> <td style="width: 10%;"></td> </tr> <tr> <td></td> <td></td> <td colspan="8" style="text-align: center;"> <table border="1" style="width: 100%; border-collapse: collapse; text-align: center;"> <tr> </tr></table></td></tr></table></td></tr></table></td></tr></table></td></tr></table></td></tr></table></td></tr></table></td></tr></table></td></tr></table></td></tr></table></td></tr></table></td></tr></table></td></tr></table></td></tr></table></td></tr></table></td></tr></table> | | | | | | | | | | | | | | | | | | | | <table border="1" style="width: 100%; border-collapse: collapse; text-align: center;"> <tr> <td style="width: 10%;"></td> <td style="width: 10%;"></td> <td style="width: 10%;"></td> <td style="width: 10%;"></td> <td style="width: 10%;"></td> <td style="width: 10%;"></td> <td style="width: 10%;"></td> <td style="width: 10%;"></td> <td style="width: 10%;"></td> <td style="width: 10%;"></td> </tr> <tr> <td></td> <td></td> <td colspan="8" style="text-align: center;"> <table border="1" style="width: 100%; border-collapse: collapse; text-align: center;"> <tr> <td style="width: 10%;"></td> <td style="width: 10%;"></td> <td style="width: 10%;"></td> <td style="width: 10%;"></td> <td style="width: 10%;"></td> <td style="width: 10%;"></td> <td style="width: 10%;"></td> <td style="width: 10%;"></td> <td style="width: 10%;"></td> <td style="width: 10%;"></td> </tr> <tr> <td></td> <td></td> <td colspan="8" style="text-align: center;"> <table border="1" style="width: 100%; border-collapse: collapse; text-align: center;"> <tr> <td style="width: 10%;"></td> <td style="width: 10%;"></td> <td style="width: 10%;"></td> <td style="width: 10%;"></td> <td style="width: 10%;"></td> <td style="width: 10%;"></td> <td style="width: 10%;"></td> <td style="width: 10%;"></td> <td style="width: 10%;"></td> <td style="width: 10%;"></td> </tr> <tr> <td></td> <td></td> <td colspan="8" style="text-align: center;"> <table border="1" style="width: 100%; border-collapse: collapse; text-align: center;"> <tr> <td style="width: 10%;"></td> <td style="width: 10%;"></td> <td style="width: 10%;"></td> <td style="width: 10%;"></td> <td style="width: 10%;"></td> <td style="width: 10%;"></td> <td style="width: 10%;"></td> <td style="width: 10%;"></td> <td style="width: 10%;"></td> <td style="width: 10%;"></td> </tr> <tr> <td></td> <td></td> <td colspan="8" style="text-align: center;"> <table border="1" style="width: 100%; border-collapse: collapse; text-align: center;"> <tr> <td style="width: 10%;"></td> <td style="width: 10%;"></td> <td style="width: 10%;"></td> <td style="width: 10%;"></td> <td style="width: 10%;"></td> <td style="width: 10%;"></td> <td style="width: 10%;"></td> <td style="width: 10%;"></td> <td style="width: 10%;"></td> <td style="width: 10%;"></td> </tr> <tr> <td></td> <td></td> <td colspan="8" style="text-align: center;"> <table border="1" style="width: 100%; border-collapse: collapse; text-align: center;"> <tr> <td style="width: 10%;"></td> <td style="width: 10%;"></td> <td style="width: 10%;"></td> <td style="width: 10%;"></td> <td style="width: 10%;"></td> <td style="width: 10%;"></td> <td style="width: 10%;"></td> <td style="width: 10%;"></td> <td style="width: 10%;"></td> <td style="width: 10%;"></td> </tr> <tr> <td></td> <td></td> <td colspan="8" style="text-align: center;"> <table border="1" style="width: 100%; border-collapse: collapse; text-align: center;"> <tr> <td style="width: 10%;"></td> <td style="width: 10%;"></td> <td style="width: 10%;"></td> <td style="width: 10%;"></td> <td style="width: 10%;"></td> <td style="width: 10%;"></td> <td style="width: 10%;"></td> <td style="width: 10%;"></td> <td style="width: 10%;"></td> <td style="width: 10%;"></td> </tr> <tr> <td></td> <td></td> <td colspan="8" style="text-align: center;"> <table border="1" style="width: 100%; border-collapse: collapse; text-align: center;"> <tr> <td style="width: 10%;"></td> <td style="width: 10%;"></td> <td style="width: 10%;"></td> <td style="width: 10%;"></td> <td style="width:
10%;"></td> <td style="width: 10%;"></td> <td style="width: 10%;"></td> <td style="width: 10%;"></td> <td style="width: 10%;"></td> <td style="width: 10%;"></td> </tr> <tr> <td></td> <td></td> <td colspan="8" style="text-align: center;"> <table border="1" style="width: 100%; border-collapse: collapse; text-align: center;"> <tr> <td style="width: 10%;"></td> <td style="width: 10%;"></td> <td style="width: 10%;"></td> <td style="width: 10%;"></td> <td style="width: 10%;"></td> <td style="width: 10%;"></td> <td style="width: 10%;"></td> <td style="width: 10%;"></td> <td style="width: 10%;"></td> <td style="width: 10%;"></td> </tr> <tr> <td></td> <td></td> <td colspan="8" style="text-align: center;"> <table border="1" style="width: 100%; border-collapse: collapse; text-align: center;"> <tr> <td style="width: 10%;"></td> <td style="width: 10%;"></td> <td style="width: 10%;"></td> <td style="width: 10%;"></td> <td style="width: 10%;"></td> <td style="width: 10%;"></td> <td style="width: 10%;"></td> <td style="width: 10%;"></td> <td style="width: 10%;"></td> <td style="width: 10%;"></td> </tr> <tr> <td></td> <td></td> <td colspan="8" style="text-align: center;"> <table border="1" style="width: 100%; border-collapse: collapse; text-align: center;"> <tr> <td style="width: 10%;"></td> <td style="width: 10%;"></td> <td style="width: 10%;"></td> <td style="width: 10%;"></td> <td style="width: 10%;"></td> <td style="width: 10%;"></td> <td style="width: 10%;"></td> <td style="width: 10%;"></td> <td style="width: 10%;"></td> <td style="width: 10%;"></td> </tr> <tr> <td></td> <td></td> <td colspan="8" style="text-align: center;"> <table border="1" style="width: 100%; border-collapse: collapse; text-align: center;"> <tr> <td style="width: 10%;"></td> <td style="width: 10%;"></td> <td style="width: 10%;"></td> <td style="width: 10%;"></td> <td style="width: 10%;"></td> <td style="width: 10%;"></td> <td style="width: 10%;"></td> <td style="width: 10%;"></td> <td style="width: 10%;"></td> <td style="width: 10%;"></td> </tr> <tr> <td></td> <td></td> <td colspan="8" style="text-align: center;"> <table border="1" style="width: 100%; border-collapse: collapse; text-align: center;"> <tr> <td style="width: 10%;"></td> <td style="width: 10%;"></td> <td style="width: 10%;"></td> <td style="width: 10%;"></td> <td style="width: 10%;"></td> <td style="width: 10%;"></td> <td style="width: 10%;"></td> <td style="width: 10%;"></td> <td style="width: 10%;"></td> <td style="width: 10%;"></td> </tr> <tr> <td></td> <td></td> <td colspan="8" style="text-align: center;"> <table border="1" style="width: 100%; border-collapse: collapse; text-align: center;"> <tr> <td style="width: 10%;"></td> <td style="width: 10%;"></td> <td style="width: 10%;"></td> <td style="width: 10%;"></td> <td style="width: 10%;"></td> <td style="width: 10%;"></td> <td style="width: 10%;"></td> <td style="width: 10%;"></td> <td style="width: 10%;"></td> <td style="width: 10%;"></td> </tr> <tr> <td></td> <td></td> <td colspan="8" style="text-align: center;"> <table border="1" style="width: 100%; border-collapse: collapse; text-align: center;"> <tr> </tr></table></td></tr></table></td></tr></table></td></tr></table></td></tr></table></td></tr></table></td></tr></table></td></tr></table></td></tr></table></td></tr></table></td></tr></table></td></tr></table></td></tr></table></td></tr></table></td></tr></table> | | | | | | | | | | | | | | | | | | | | <table border="1" style="width: 100%; border-collapse: collapse; text-align: center;"> <tr> <td style="width: 10%;"></td> <td style="width: 10%;"></td> <td style="width: 10%;"></td> <td style="width: 10%;"></td> <td style="width: 10%;"></td> <td style="width: 10%;"></td> <td style="width: 10%;"></td> <td style="width: 10%;"></td> <td style="width: 10%;"></td> <td style="width: 10%;"></td> </tr> <tr> <td></td> <td></td> <td colspan="8" style="text-align: center;"> <table border="1" style="width: 100%; border-collapse: collapse; text-align: center;"> <tr> <td style="width: 10%;"></td> <td style="width: 10%;"></td> <td style="width: 10%;"></td> <td style="width: 10%;"></td> <td style="width: 10%;"></td> <td style="width: 10%;"></td> <td style="width: 10%;"></td> <td style="width: 10%;"></td> <td style="width: 10%;"></td> <td style="width: 10%;"></td> </tr> <tr> <td></td> <td></td> <td colspan="8" style="text-align: center;"> <table border="1" style="width: 100%; border-collapse: collapse; text-align: center;"> <tr> <td style="width: 10%;"></td> <td style="width: 10%;"></td> <td style="width: 10%;"></td> <td style="width: 10%;"></td> <td style="width: 10%;"></td> <td style="width: 10%;"></td> <td style="width: 10%;"></td> <td style="width: 10%;"></td> <td style="width: 10%;"></td> <td style="width: 10%;"></td> </tr> <tr> <td></td> <td></td> <td colspan="8" style="text-align: center;"> <table border="1" style="width: 100%; border-collapse: collapse; text-align: center;"> <tr> <td style="width: 10%;"></td> <td style="width: 10%;"></td> <td style="width: 10%;"></td> <td style="width: 10%;"></td> <td style="width: 10%;"></td> <td style="width: 10%;"></td> <td style="width: 10%;"></td> <td style="width: 10%;"></td> <td style="width: 10%;"></td> <td style="width: 10%;"></td> </tr> <tr> <td></td> <td></td> <td colspan="8" style="text-align: center;"> <table border="1" style="width: 100%; border-collapse: collapse; text-align: center;"> <tr> <td style="width: 10%;"></td> <td style="width: 10%;"></td> <td style="width: 10%;"></td> <td style="width: 10%;"></td> <td style="width: 10%;"></td> <td style="width: 10%;"></td> <td style="width: 10%;"></td> <td style="width: 10%;"></td> <td style="width: 10%;"></td> <td style="width: 10%;"></td> </tr> <tr> <td></td> <td></td> <td colspan="8" style="text-align: center;"> <table border="1" style="width: 100%; border-collapse: collapse; text-align: center;"> <tr> <td style="width: 10%;"></td> <td style="width: 10%;"></td> <td style="width: 10%;"></td> <td style="width: 10%;"></td> <td style="width: 10%;"></td> <td style="width: 10%;"></td> <td style="width: 10%;"></td> <td style="width: 10%;"></td> <td style="width: 10%;"></td> <td style="width: 10%;"></td> </tr> <tr> <td></td> <td></td> <td colspan="8" style="text-align: center;"> <table border="1" style="width: 100%; border-collapse: collapse; text-align: center;"> <tr> <td style="width: 10%;"></td> <td style="width: 10%;"></td> <td style="width: 10%;"></td> <td style="width: 10%;"></td> <td style="width: 10%;"></td> <td style="width: 10%;"></td> <td style="width: 10%;"></td> <td style="width: 10%;"></td> <td style="width: 10%;"></td> <td style="width: 10%;"></td> </tr> <tr> <td></td> <td></td> <td colspan="8" style="text-align: center;"> <table border="1" style="width: 100%; border-collapse: collapse; text-align: center;"> <tr> <td style="width: 10%;"></td> <td style="width: 10%;"></td> <td style="width: 10%;"></td> <td style="width: 10%;"></td> <td style="width: 10%;"></td> <td style="width: 10%;"></td> <td style="width: 10%;"></td> <td style="width: 10%;"></td> <td style="width: 10%;"></td> <td style="width: 10%;"></td> </tr> <tr> <td></td> <td></td> <td colspan="8" style="text-align: center;"> <table border="1" style="width: 100%; border-collapse: collapse; text-align: center;"> <tr> <td style="width: 10%;"></td> <td style="width: 10%;"></td> <td style="width: 10%;"></td> <td style="width: 10%;"></td> <td style="width: 10%;"></td> <td style="width: 10%;"></td> <td style="width: 10%;"></td> <td style="width: 10%;"></td> <td style="width: 10%;"></td>
<td style="width: 10%;"></td> </tr> <tr> <td></td> <td></td> <td colspan="8" style="text-align: center;"> <table border="1" style="width: 100%; border-collapse: collapse; text-align: center;"> <tr> <td style="width: 10%;"></td> <td style="width: 10%;"></td> <td style="width: 10%;"></td> <td style="width: 10%;"></td> <td style="width: 10%;"></td> <td style="width: 10%;"></td> <td style="width: 10%;"></td> <td style="width: 10%;"></td> <td style="width: 10%;"></td> <td style="width: 10%;"></td> </tr> <tr> <td></td> <td></td> <td colspan="8" style="text-align: center;"> <table border="1" style="width: 100%; border-collapse: collapse; text-align: center;"> <tr> <td style="width: 10%;"></td> <td style="width: 10%;"></td> <td style="width: 10%;"></td> <td style="width: 10%;"></td> <td style="width: 10%;"></td> <td style="width: 10%;"></td> <td style="width: 10%;"></td> <td style="width: 10%;"></td> <td style="width: 10%;"></td> <td style="width: 10%;"></td> </tr> <tr> <td></td> <td></td> <td colspan="8" style="text-align: center;"> <table border="1" style="width: 100%; border-collapse: collapse; text-align: center;"> <tr> <td style="width: 10%;"></td> <td style="width: 10%;"></td> <td style="width: 10%;"></td> <td style="width: 10%;"></td> <td style="width: 10%;"></td> <td style="width: 10%;"></td> <td style="width: 10%;"></td> <td style="width: 10%;"></td> <td style="width: 10%;"></td> <td style="width: 10%;"></td> </tr> <tr> <td></td> <td></td> <td colspan="8" style="text-align: center;"> <table border="1" style="width: 100%; border-collapse: collapse; text-align: center;"> <tr> <td style="width: 10%;"></td> <td style="width: 10%;"></td> <td style="width: 10%;"></td> <td style="width: 10%;"></td> <td style="width: 10%;"></td> <td style="width: 10%;"></td> <td style="width: 10%;"></td> <td style="width: 10%;"></td> <td style="width: 10%;"></td> <td style="width: 10%;"></td> </tr> <tr> <td></td> <td></td> <td colspan="8" style="text-align: center;"> <table border="1" style="width: 100%; border-collapse: collapse; text-align: center;"> <tr> </tr></table></td></tr></table></td></tr></table></td></tr></table></td></tr></table></td></tr></table></td></tr></table></td></tr></table></td></tr></table></td></tr></table></td></tr></table></td></tr></table></td></tr></table></td></tr></table> | | | | | | | | | | | | | | | | | | | | <table border="1" style="width: 100%; border-collapse: collapse; text-align: center;"> <tr> <td style="width: 10%;"></td> <td style="width: 10%;"></td> <td style="width: 10%;"></td> <td style="width: 10%;"></td> <td style="width: 10%;"></td> <td style="width: 10%;"></td> <td style="width: 10%;"></td> <td style="width: 10%;"></td> <td style="width: 10%;"></td> <td style="width: 10%;"></td> </tr> <tr> <td></td> <td></td> <td colspan="8" style="text-align: center;"> <table border="1" style="width: 100%; border-collapse: collapse; text-align: center;"> <tr> <td style="width: 10%;"></td> <td style="width: 10%;"></td> <td style="width: 10%;"></td> <td style="width: 10%;"></td> <td style="width: 10%;"></td> <td style="width: 10%;"></td> <td style="width: 10%;"></td> <td style="width: 10%;"></td> <td style="width: 10%;"></td> <td style="width: 10%;"></td> </tr> <tr> <td></td> <td></td> <td colspan="8" style="text-align: center;"> <table border="1" style="width: 100%; border-collapse: collapse; text-align: center;"> <tr> <td style="width: 10%;"></td> <td style="width: 10%;"></td> <td style="width: 10%;"></td> <td style="width: 10%;"></td> <td style="width: 10%;"></td> <td style="width: 10%;"></td> <td style="width: 10%;"></td> <td style="width: 10%;"></td> <td style="width: 10%;"></td> <td style="width: 10%;"></td> </tr> <tr> <td></td> <td></td> <td colspan="8" style="text-align: center;"> <table border="1" style="width: 100%; border-collapse: collapse; text-align: center;"> <tr> <td style="width: 10%;"></td> <td style="width: 10%;"></td> <td style="width: 10%;"></td> <td style="width: 10%;"></td> <td style="width: 10%;"></td> <td style="width: 10%;"></td> <td style="width: 10%;"></td> <td style="width: 10%;"></td> <td style="width: 10%;"></td> <td style="width: 10%;"></td> </tr> <tr> <td></td> <td></td> <td colspan="8" style="text-align: center;"> <table border="1" style="width: 100%; border-collapse: collapse; text-align: center;"> <tr> <td style="width: 10%;"></td> <td style="width: 10%;"></td> <td style="width: 10%;"></td> <td style="width: 10%;"></td> <td style="width: 10%;"></td> <td style="width: 10%;"></td> <td style="width: 10%;"></td> <td style="width: 10%;"></td> <td style="width: 10%;"></td> <td style="width: 10%;"></td> </tr> <tr> <td></td> <td></td> <td colspan="8" style="text-align: center;"> <table border="1" style="width: 100%; border-collapse: collapse; text-align: center;"> <tr> <td style="width: 10%;"></td> <td style="width: 10%;"></td> <td style="width: 10%;"></td> <td style="width: 10%;"></td> <td style="width: 10%;"></td> <td style="width: 10%;"></td> <td style="width: 10%;"></td> <td style="width: 10%;"></td> <td style="width: 10%;"></td> <td style="width: 10%;"></td> </tr> <tr> <td></td> <td></td> <td colspan="8" style="text-align: center;"> <table border="1" style="width: 100%; border-collapse: collapse; text-align: center;"> <tr> <td style="width: 10%;"></td> <td style="width: 10%;"></td> <td style="width: 10%;"></td> <td style="width: 10%;"></td> <td style="width: 10%;"></td> <td style="width: 10%;"></td> <td style="width: 10%;"></td> <td style="width: 10%;"></td> <td style="width: 10%;"></td> <td style="width: 10%;"></td> </tr> <tr> <td></td> <td></td> <td colspan="8" style="text-align: center;"> <table border="1" style="width: 100%; border-collapse: collapse; text-align: center;"> <tr> <td style="width: 10%;"></td> <td style="width: 10%;"></td> <td style="width: 10%;"></td> <td style="width: 10%;"></td> <td style="width: 10%;"></td> <td style="width: 10%;"></td> <td style="width: 10%;"></td> <td style="width: 10%;"></td> <td style="width: 10%;"></td> <td style="width: 10%;"></td> </tr> <tr> <td></td> <td></td> <td colspan="8" style="text-align: center;"> <table border="1" style="width: 100%; border-collapse: collapse; text-align: center;"> <tr> <td style="width: 10%;"></td> <td style="width: 10%;"></td> <td style="width: 10%;"></td> <td style="width: 10%;"></td> <td style="width: 10%;"></td> <td style="width: 10%;"></td> <td style="width: 10%;"></td> <td style="width: 10%;"></td> <td style="width: 10%;"></td> <td style="width: 10%;"></td> </tr> <tr> <td></td> <td></td> <td colspan="8" style="text-align: center;"> <table border="1" style="width: 100%; border-collapse: collapse; text-align: center;"> <tr> <td style="width: 10%;"></td> <td style="width: 10%;"></td> <td style="width: 10%;"></td> <td style="width: 10%;"></td> <td style="width: 10%;"></td> <td style="width: 10%;"></td> <td style="width: 10%;"></td> <td style="width: 10%;"></td> <td style="width: 10%;"></td> <td style="width: 10%;"></td> </tr> <tr> <td></td> <td></td> <td colspan="8" style="text-align: center;"> <table border="1" style="width: 100%; border-collapse: collapse; text-align: center;"> <tr> <td style="width: 10%;"></td> <td style="width: 10%;"></td> <td style="width: 10%;"></td> <td style="width: 10%;"></td> <td style="width: 10%;"></td> <td style="width: 10%;"></td> <td style="width: 10%;"></td> <td style="width: 10%;"></td> <td style="width: 10%;"></td> <td style="width: 10%;"></td> </tr> <tr> <td></td> <td></td> <td colspan="8" style="text-align: center;"> <table border="1" style="width: 100%;
border-collapse: collapse; text-align: center;"> <tr> <td style="width: 10%;"></td> <td style="width: 10%;"></td> <td style="width: 10%;"></td> <td style="width: 10%;"></td> <td style="width: 10%;"></td> <td style="width: 10%;"></td> <td style="width: 10%;"></td> <td style="width: 10%;"></td> <td style="width: 10%;"></td> <td style="width: 10%;"></td> </tr> <tr> <td></td> <td></td> <td colspan="8" style="text-align: center;"> <table border="1" style="width: 100%; border-collapse: collapse; text-align: center;"> <tr> </tr></table></td></tr></table></td></tr></table></td></tr></table></td></tr></table></td></tr></table></td></tr></table></td></tr></table></td></tr></table></td></tr></table></td></tr></table></td></tr></table></td></tr></table> | | | | | | | | | | | | | | | | | | | | <table border="1" style="width: 100%; border-collapse: collapse; text-align: center;"> <tr> <td style="width: 10%;"></td> <td style="width: 10%;"></td> <td style="width: 10%;"></td> <td style="width: 10%;"></td> <td style="width: 10%;"></td> <td style="width: 10%;"></td> <td style="width: 10%;"></td> <td style="width: 10%;"></td> <td style="width: 10%;"></td> <td style="width: 10%;"></td> </tr> <tr> <td></td> <td></td> <td colspan="8" style="text-align: center;"> <table border="1" style="width: 100%; border-collapse: collapse; text-align: center;"> <tr> <td style="width: 10%;"></td> <td style="width: 10%;"></td> <td style="width: 10%;"></td> <td style="width: 10%;"></td> <td style="width: 10%;"></td> <td style="width: 10%;"></td> <td style="width: 10%;"></td> <td style="width: 10%;"></td> <td style="width: 10%;"></td> <td style="width: 10%;"></td> </tr> <tr> <td></td> <td></td> <td colspan="8" style="text-align: center;"> <table border="1" style="width: 100%; border-collapse: collapse; text-align: center;"> <tr> <td style="width: 10%;"></td> <td style="width: 10%;"></td> <td style="width: 10%;"></td> <td style="width: 10%;"></td> <td style="width: 10%;"></td> <td style="width: 10%;"></td> <td style="width: 10%;"></td> <td style="width: 10%;"></td> <td style="width: 10%;"></td> <td style="width: 10%;"></td> </tr> <tr> <td></td> <td></td> <td colspan="8" style="text-align: center;"> <table border="1" style="width: 100%; border-collapse: collapse; text-align: center;"> <tr> <td style="width: 10%;"></td> <td style="width: 10%;"></td> <td style="width: 10%;"></td> <td style="width: 10%;"></td> <td style="width: 10%;"></td> <td style="width: 10%;"></td> <td style="width: 10%;"></td> <td style="width: 10%;"></td> <td style="width: 10%;"></td> <td style="width: 10%;"></td> </tr> <tr> <td></td> <td></td> <td colspan="8" style="text-align: center;"> <table border="1" style="width: 100%; border-collapse: collapse; text-align: center;"> <tr> <td style="width: 10%;"></td> <td style="width: 10%;"></td> <td style="width: 10%;"></td> <td style="width: 10%;"></td> <td style="width: 10%;"></td> <td style="width: 10%;"></td> <td style="width: 10%;"></td> <td style="width: 10%;"></td> <td style="width: 10%;"></td> <td style="width: 10%;"></td> </tr> <tr> <td></td> <td></td> <td colspan="8" style="text-align: center;"> <table border="1" style="width: 100%; border-collapse: collapse; text-align: center;"> <tr> <td style="width: 10%;"></td> <td style="width: 10%;"></td> <td style="width: 10%;"></td> <td style="width: 10%;"></td> <td style="width: 10%;"></td> <td style="width: 10%;"></td> <td style="width: 10%;"></td> <td style="width: 10%;"></td> <td style="width: 10%;"></td> <td style="width: 10%;"></td> </tr> <tr> <td></td> <td></td> <td colspan="8" style="text-align: center;"> <table border="1" style="width: 100%; border-collapse: collapse; text-align: center;"> <tr> <td style="width: 10%;"></td> <td style="width: 10%;"></td> <td style="width: 10%;"></td> <td style="width: 10%;"></td> <td style="width: 10%;"></td> <td style="width: 10%;"></td> <td style="width: 10%;"></td> <td style="width: 10%;"></td> <td style="width: 10%;"></td> <td style="width: 10%;"></td> </tr> <tr> <td></td> <td></td> <td colspan="8" style="text-align: center;"> <table border="1" style="width: 100%; border-collapse: collapse; text-align: center;"> <tr> <td style="width: 10%;"></td> <td style="width: 10%;"></td> <td style="width: 10%;"></td> <td style="width: 10%;"></td> <td style="width: 10%;"></td> <td style="width: 10%;"></td> <td style="width: 10%;"></td> <td style="width: 10%;"></td> <td style="width: 10%;"></td> <td style="width: 10%;"></td> </tr> <tr> <td></td> <td></td> <td colspan="8" style="text-align: center;"> <table border="1" style="width: 100%; border-collapse: collapse; text-align: center;"> <tr> <td style="width: 10%;"></td> <td style="width: 10%;"></td> <td style="width: 10%;"></td> <td style="width: 10%;"></td> <td style="width: 10%;"></td> <td style="width: 10%;"></td> <td style="width: 10%;"></td> <td style="width: 10%;"></td> <td style="width: 10%;"></td> <td style="width: 10%;"></td> </tr> <tr> <td></td> <td></td> <td colspan="8" style="text-align: center;"> <table border="1" style="width: 100%; border-collapse: collapse; text-align: center;"> <tr> <td style="width: 10%;"></td> <td style="width: 10%;"></td> <td style="width: 10%;"></td> <td style="width: 10%;"></td> <td style="width: 10%;"></td> <td style="width: 10%;"></td> <td style="width: 10%;"></td> <td style="width: 10%;"></td> <td style="width: 10%;"></td> <td style="width: 10%;"></td> </tr> <tr> <td></td> <td></td> <td colspan="8" style="text-align: center;"> <table border="1" style="width: 100%; border-collapse: collapse; text-align: center;"> <tr> <td style="width: 10%;"></td> <td style="width: 10%;"></td> <td style="width: 10%;"></td> <td style="width: 10%;"></td> <td style="width: 10%;"></td> <td style="width: 10%;"></td> <td style="width: 10%;"></td> <td style="width: 10%;"></td> <td style="width: 10%;"></td> <td style="width: 10%;"></td> </tr> <tr> <td></td> <td></td> <td colspan="8" style="text-align: center;"> <table border="1" style="width: 100%; border-collapse: collapse; text-align: center;"> <tr> </tr></table></td></tr></table></td></tr></table></td></tr></table></td></tr></table></td></tr></table></td></tr></table></td></tr></table></td></tr></table></td></tr></table></td></tr></table></td></tr></table>
 | | | | | | | | | | | | | | | | | | | | <table border="1" style="width: 100%; border-collapse: collapse; text-align: center;"> <tr> <td style="width: 10%;"></td> <td style="width: 10%;"></td> <td style="width: 10%;"></td> <td style="width: 10%;"></td> <td style="width: 10%;"></td> <td style="width: 10%;"></td> <td style="width: 10%;"></td> <td style="width: 10%;"></td> <td style="width: 10%;"></td> <td style="width: 10%;"></td> </tr> <tr> <td></td> <td></td> <td colspan="8" style="text-align: center;"> <table border="1" style="width: 100%; border-collapse: collapse; text-align: center;"> <tr> <td style="width: 10%;"></td> <td style="width: 10%;"></td> <td style="width: 10%;"></td> <td style="width: 10%;"></td> <td style="width: 10%;"></td> <td style="width: 10%;"></td> <td style="width: 10%;"></td> <td style="width: 10%;"></td> <td style="width: 10%;"></td> <td style="width: 10%;"></td> </tr> <tr> <td></td> <td></td> <td colspan="8" style="text-align: center;"> <table border="1" style="width: 100%; border-collapse: collapse; text-align: center;"> <tr> <td style="width: 10%;"></td> <td style="width: 10%;"></td> <td style="width: 10%;"></td> <td style="width: 10%;"></td> <td style="width: 10%;"></td> <td style="width: 10%;"></td> <td style="width: 10%;"></td> <td style="width: 10%;"></td> <td style="width: 10%;"></td> <td style="width: 10%;"></td> </tr> <tr> <td></td> <td></td> <td colspan="8" style="text-align: center;"> <table border="1" style="width: 100%; border-collapse: collapse; text-align: center;"> <tr> <td style="width: 10%;"></td> <td style="width: 10%;"></td> <td style="width: 10%;"></td> <td style="width: 10%;"></td> <td style="width: 10%;"></td> <td style="width: 10%;"></td> <td style="width: 10%;"></td> <td style="width: 10%;"></td> <td style="width: 10%;"></td> <td style="width: 10%;"></td> </tr> <tr> <td></td> <td></td> <td colspan="8" style="text-align: center;"> <table border="1" style="width: 100%; border-collapse: collapse; text-align: center;"> <tr> <td style="width: 10%;"></td> <td style="width: 10%;"></td> <td style="width: 10%;"></td> <td style="width: 10%;"></td> <td style="width: 10%;"></td> <td style="width: 10%;"></td> <td style="width: 10%;"></td> <td style="width: 10%;"></td> <td style="width: 10%;"></td> <td style="width: 10%;"></td> </tr> <tr> <td></td> <td></td> <td colspan="8" style="text-align: center;"> <table border="1" style="width: 100%; border-collapse: collapse; text-align: center;"> <tr> <td style="width: 10%;"></td> <td style="width: 10%;"></td> <td style="width: 10%;"></td> <td style="width: 10%;"></td> <td style="width: 10%;"></td> <td style="width: 10%;"></td> <td style="width: 10%;"></td> <td style="width: 10%;"></td> <td style="width: 10%;"></td> <td style="width: 10%;"></td> </tr> <tr> <td></td> <td></td> <td colspan="8" style="text-align: center;"> <table border="1" style="width: 100%; border-collapse: collapse; text-align: center;"> <tr> <td style="width: 10%;"></td> <td style="width: 10%;"></td> <td style="width: 10%;"></td> <td style="width: 10%;"></td> <td style="width: 10%;"></td> <td style="width: 10%;"></td> <td style="width: 10%;"></td> <td style="width: 10%;"></td> <td style="width: 10%;"></td> <td style="width: 10%;"></td> </tr> <tr> <td></td> <td></td> <td colspan="8" style="text-align: center;"> <table border="1" style="width: 100%; border-collapse: collapse; text-align: center;"> <tr> <td style="width: 10%;"></td> <td style="width: 10%;"></td> <td style="width: 10%;"></td> <td style="width: 10%;"></td> <td style="width: 10%;"></td> <td style="width: 10%;"></td> <td style="width: 10%;"></td> <td style="width: 10%;"></td> <td style="width: 10%;"></td> <td style="width: 10%;"></td> </tr> <tr> <td></td> <td></td> <td colspan="8" style="text-align: center;"> <table border="1" style="width: 100%; border-collapse: collapse; text-align: center;"> <tr> <td style="width: 10%;"></td> <td style="width: 10%;"></td> <td style="width: 10%;"></td> <td style="width: 10%;"></td> <td style="width: 10%;"></td> <td style="width: 10%;"></td> <td style="width: 10%;"></td> <td style="width: 10%;"></td> <td style="width: 10%;"></td> <td style="width: 10%;"></td> </tr> <tr> <td></td> <td></td> <td colspan="8" style="text-align: center;"> <table border="1" style="width: 100%; border-collapse: collapse; text-align: center;"> <tr> <td style="width: 10%;"></td> <td style="width: 10%;"></td> <td style="width: 10%;"></td> <td style="width: 10%;"></td> <td style="width: 10%;"></td> <td style="width: 10%;"></td> <td style="width: 10%;"></td> <td style="width: 10%;"></td> <td style="width: 10%;"></td> <td style="width: 10%;"></td> </tr> <tr> <td></td> <td></td> <td colspan="8" style="text-align: center;"> <table border="1" style="width: 100%; border-collapse: collapse; text-align: center;"> <tr> </tr></table></td></tr></table></td></tr></table></td></tr></table></td></tr></table></td></tr></table></td></tr></table></td></tr></table></td></tr></table></td></tr></table></td></tr></table> | | | | | | | | | | | | | | | | | | | | <table border="1" style="width: 100%; border-collapse: collapse; text-align: center;"> <tr> <td style="width: 10%;"></td> <td style="width: 10%;"></td> <td style="width: 10%;"></td> <td style="width: 10%;"></td> <td style="width: 10%;"></td> <td style="width: 10%;"></td> <td style="width: 10%;"></td> <td style="width: 10%;"></td> <td style="width: 10%;"></td> <td style="width: 10%;"></td> </tr> <tr> <td></td> <td></td> <td colspan="8" style="text-align: center;"> <table border="1" style="width: 100%; border-collapse: collapse; text-align: center;"> <tr> <td style="width: 10%;"></td> <td style="width: 10%;"></td> <td style="width: 10%;"></td> <td style="width: 10%;"></td> <td style="width: 10%;"></td> <td style="width: 10%;"></td> <td style="width: 10%;"></td> <td style="width: 10%;"></td> <td style="width: 10%;"></td> <td style="width: 10%;"></td> </tr> <tr> <td></td> <td></td> <td colspan="8" style="text-align: center;"> <table border="1" style="width: 100%; border-collapse: collapse; text-align: center;"> <tr> <td style="width: 10%;"></td> <td style="width: 10%;"></td> <td style="width: 10%;"></td> <td style="width: 10%;"></td> <td style="width: 10%;"></td> <td style="width: 10%;"></td> <td style="width: 10%;"></td> <td style="width: 10%;"></td> <td style="width: 10%;"></td> <td style="width: 10%;"></td> </tr> <tr> <td></td> <td></td> <td
colspan="8" style="text-align: center;"> <table border="1" style="width: 100%; border-collapse: collapse; text-align: center;"> <tr> <td style="width: 10%;"></td> <td style="width: 10%;"></td> <td style="width: 10%;"></td> <td style="width: 10%;"></td> <td style="width: 10%;"></td> <td style="width: 10%;"></td> <td style="width: 10%;"></td> <td style="width: 10%;"></td> <td style="width: 10%;"></td> <td style="width: 10%;"></td> </tr> <tr> <td></td> <td></td> <td colspan="8" style="text-align: center;"> <table border="1" style="width: 100%; border-collapse: collapse; text-align: center;"> <tr> <td style="width: 10%;"></td> <td style="width: 10%;"></td> <td style="width: 10%;"></td> <td style="width: 10%;"></td> <td style="width: 10%;"></td> <td style="width: 10%;"></td> <td style="width: 10%;"></td> <td style="width: 10%;"></td> <td style="width: 10%;"></td> <td style="width: 10%;"></td> </tr> <tr> <td></td> <td></td> <td colspan="8" style="text-align: center;"> <table border="1" style="width: 100%; border-collapse: collapse; text-align: center;"> <tr> <td style="width: 10%;"></td> <td style="width: 10%;"></td> <td style="width: 10%;"></td> <td style="width: 10%;"></td> <td style="width: 10%;"></td> <td style="width: 10%;"></td> <td style="width: 10%;"></td> <td style="width: 10%;"></td> <td style="width: 10%;"></td> <td style="width: 10%;"></td> </tr> <tr> <td></td> <td></td> <td colspan="8" style="text-align: center;"> <table border="1" style="width: 100%; border-collapse: collapse; text-align: center;"> <tr> <td style="width: 10%;"></td> <td style="width: 10%;"></td> <td style="width: 10%;"></td> <td style="width: 10%;"></td> <td style="width: 10%;"></td> <td style="width: 10%;"></td> <td style="width: 10%;"></td> <td style="width: 10%;"></td> <td style="width: 10%;"></td> <td style="width: 10%;"></td> </tr> <tr> <td></td> <td></td> <td colspan="8" style="text-align: center;"> <table border="1" style="width: 100%; border-collapse: collapse; text-align: center;"> <tr> <td style="width: 10%;"></td> <td style="width: 10%;"></td> <td style="width: 10%;"></td> <td style="width: 10%;"></td> <td style="width: 10%;"></td> <td style="width: 10%;"></td> <td style="width: 10%;"></td> <td style="width: 10%;"></td> <td style="width: 10%;"></td> <td style="width: 10%;"></td> </tr> <tr> <td></td> <td></td> <td colspan="8" style="text-align: center;"> <table border="1" style="width: 100%; border-collapse: collapse; text-align: center;"> <tr> <td style="width: 10%;"></td> <td style="width: 10%;"></td> <td style="width: 10%;"></td> <td style="width: 10%;"></td> <td style="width: 10%;"></td> <td style="width: 10%;"></td> <td style="width: 10%;"></td> <td style="width: 10%;"></td> <td style="width: 10%;"></td> <td style="width: 10%;"></td> </tr> <tr> <td></td> <td></td> <td colspan="8" style="text-align: center;"> <table border="1" style="width: 100%; border-collapse: collapse; text-align: center;"> <tr> </tr></table></td></tr></table></td></tr></table></td></tr></table></td></tr></table></td></tr></table></td></tr></table></td></tr></table></td></tr></table></td></tr></table> | | | | | | | | | | | | | | | | | | | | <table border="1" style="width: 100%; border-collapse: collapse; text-align: center;"> <tr> <td style="width: 10%;"></td> <td style="width: 10%;"></td> <td style="width: 10%;"></td> <td style="width: 10%;"></td> <td style="width: 10%;"></td> <td style="width: 10%;"></td> <td style="width: 10%;"></td> <td style="width: 10%;"></td> <td style="width: 10%;"></td> <td style="width: 10%;"></td> </tr> <tr> <td></td> <td></td> <td colspan="8" style="text-align: center;"> <table border="1" style="width: 100%; border-collapse: collapse; text-align: center;"> <tr> <td style="width: 10%;"></td> <td style="width: 10%;"></td> <td style="width: 10%;"></td> <td style="width: 10%;"></td> <td style="width: 10%;"></td> <td style="width: 10%;"></td> <td style="width: 10%;"></td> <td style="width: 10%;"></td> <td style="width: 10%;"></td> <td style="width: 10%;"></td> </tr> <tr> <td></td> <td></td> <td colspan="8" style="text-align: center;"> <table border="1" style="width: 100%; border-collapse: collapse; text-align: center;"> <tr> <td style="width: 10%;"></td> <td style="width: 10%;"></td> <td style="width: 10%;"></td> <td style="width: 10%;"></td> <td style="width: 10%;"></td> <td style="width: 10%;"></td> <td style="width: 10%;"></td> <td style="width: 10%;"></td> <td style="width: 10%;"></td> <td style="width: 10%;"></td> </tr> <tr> <td></td> <td></td> <td colspan="8" style="text-align: center;"> <table border="1" style="width: 100%; border-collapse: collapse; text-align: center;"> <tr> <td style="width: 10%;"></td> <td style="width: 10%;"></td> <td style="width: 10%;"></td> <td style="width: 10%;"></td> <td style="width: 10%;"></td> <td style="width: 10%;"></td> <td style="width: 10%;"></td> <td style="width: 10%;"></td> <td style="width: 10%;"></td> <td style="width: 10%;"></td> </tr> <tr> <td></td> <td></td> <td colspan="8" style="text-align: center;"> <table border="1" style="width: 100%; border-collapse: collapse; text-align: center;"> <tr> <td style="width: 10%;"></td> <td style="width: 10%;"></td> <td style="width: 10%;"></td> <td style="width: 10%;"></td> <td style="width: 10%;"></td> <td style="width: 10%;"></td> <td style="width: 10%;"></td> <td style="width: 10%;"></td> <td style="width: 10%;"></td> <td style="width: 10%;"></td> </tr> <tr> <td></td> <td></td> <td colspan="8" style="text-align: center;"> <table border="1" style="width: 100%; border-collapse: collapse; text-align: center;"> <tr> <td style="width: 10%;"></td> <td style="width: 10%;"></td> <td style="width: 10%;"></td> <td style="width: 10%;"></td> <td style="width: 10%;"></td> <td style="width: 10%;"></td> <td style="width: 10%;"></td> <td style="width: 10%;"></td> <td style="width: 10%;"></td> <td style="width: 10%;"></td> </tr> <tr> <td></td> <td></td> <td colspan="8" style="text-align: center;"> <table border="1" style="width: 100%; border-collapse: collapse; text-align: center;"> <tr> <td style="width: 10%;"></td> <td style="width: 10%;"></td> <td style="width: 10%;"></td> <td style="width: 10%;"></td> <td style="width: 10%;"></td> <td style="width: 10%;"></td> <td style="width: 10%;"></td> <td style="width: 10%;"></td> <td style="width: 10%;"></td> <td style="width: 10%;"></td> </tr> <tr> <td></td> <td></td> <td colspan="8" style="text-align: center;"> <table border="1" style="width: 100%; border-collapse: collapse; text-align: center;"> <tr> <td style="width: 10%;"></td> <td style="width: 10%;"></td> <td style="width: 10%;"></td> <td style="width: 10%;"></td> <td style="width: 10%;"></td> <td style="width: 10%;"></td> <td style="width: 10%;"></td> <td style="width: 10%;"></td> <td style="width: 10%;"></td> <td style="width: 10%;"></td> </tr> <tr> <td></td> <td></td> <td colspan="8" style="text-align: center;"> <table border="1" style="width: 100%; border-collapse: collapse; text-align: center;"> <tr> </tr></table></td></tr></table></td></tr></table></td></tr></table></td></tr></table></td></tr></table></td></tr></table></td></tr></table></td></tr></table>
 | | | | | | | | | | | | | | | | | | | | <table border="1" style="width: 100%; border-collapse: collapse; text-align: center;"> <tr> <td style="width: 10%;"></td> <td style="width: 10%;"></td> <td style="width: 10%;"></td> <td style="width: 10%;"></td> <td style="width: 10%;"></td> <td style="width: 10%;"></td> <td style="width: 10%;"></td> <td style="width: 10%;"></td> <td style="width: 10%;"></td> <td style="width: 10%;"></td> </tr> <tr> <td></td> <td></td> <td colspan="8" style="text-align: center;"> <table border="1" style="width: 100%; border-collapse: collapse; text-align: center;"> <tr> <td style="width: 10%;"></td> <td style="width: 10%;"></td> <td style="width: 10%;"></td> <td style="width: 10%;"></td> <td style="width: 10%;"></td> <td style="width: 10%;"></td> <td style="width: 10%;"></td> <td style="width: 10%;"></td> <td style="width: 10%;"></td> <td style="width: 10%;"></td> </tr> <tr> <td></td> <td></td> <td colspan="8" style="text-align: center;"> <table border="1" style="width: 100%; border-collapse: collapse; text-align: center;"> <tr> <td style="width: 10%;"></td> <td style="width: 10%;"></td> <td style="width: 10%;"></td> <td style="width: 10%;"></td> <td style="width: 10%;"></td> <td style="width: 10%;"></td> <td style="width: 10%;"></td> <td style="width: 10%;"></td> <td style="width: 10%;"></td> <td style="width: 10%;"></td> </tr> <tr> <td></td> <td></td> <td colspan="8" style="text-align: center;"> <table border="1" style="width: 100%; border-collapse: collapse; text-align: center;"> <tr> <td style="width: 10%;"></td> <td style="width: 10%;"></td> <td style="width: 10%;"></td> <td style="width: 10%;"></td> <td style="width: 10%;"></td> <td style="width: 10%;"></td> <td style="width: 10%;"></td> <td style="width: 10%;"></td> <td style="width: 10%;"></td> <td style="width: 10%;"></td> </tr> <tr> <td></td> <td></td> <td colspan="8" style="text-align: center;"> <table border="1" style="width: 100%; border-collapse: collapse; text-align: center;"> <tr> <td style="width: 10%;"></td> <td style="width: 10%;"></td> <td style="width: 10%;"></td> <td style="width: 10%;"></td> <td style="width: 10%;"></td> <td style="width: 10%;"></td> <td style="width: 10%;"></td> <td style="width: 10%;"></td> <td style="width: 10%;"></td> <td style="width: 10%;"></td> </tr> <tr> <td></td> <td></td> <td colspan="8" style="text-align: center;"> <table border="1" style="width: 100%; border-collapse: collapse; text-align: center;"> <tr> <td style="width: 10%;"></td> <td style="width: 10%;"></td> <td style="width: 10%;"></td> <td style="width: 10%;"></td> <td style="width: 10%;"></td> <td style="width: 10%;"></td> <td style="width: 10%;"></td> <td style="width: 10%;"></td> <td style="width: 10%;"></td> <td style="width: 10%;"></td> </tr> <tr> <td></td> <td></td> <td colspan="8" style="text-align: center;"> <table border="1" style="width: 100%; border-collapse: collapse; text-align: center;"> <tr> <td style="width: 10%;"></td> <td style="width: 10%;"></td> <td style="width: 10%;"></td> <td style="width: 10%;"></td> <td style="width: 10%;"></td> <td style="width: 10%;"></td> <td style="width: 10%;"></td> <td style="width: 10%;"></td> <td style="width: 10%;"></td> <td style="width: 10%;"></td> </tr> <tr> <td></td> <td></td> <td colspan="8" style="text-align: center;"> <table border="1" style="width: 100%; border-collapse: collapse; text-align: center;"> <tr> </tr></table></td></tr></table></td></tr></table></td></tr></table></td></tr></table></td></tr></table></td></tr></table></td></tr></table> | | | | | | | | | | | | | | | | | | | | <table border="1" style="width: 100%; border-collapse: collapse; text-align: center;"> <tr> <td style="width: 10%;"></td> <td style="width: 10%;"></td> <td style="width: 10%;"></td> <td style="width: 10%;"></td> <td style="width: 10%;"></td> <td style="width: 10%;"></td> <td style="width: 10%;"></td> <td style="width: 10%;"></td> <td style="width: 10%;"></td> <td style="width: 10%;"></td> </tr> <tr> <td></td> <td></td> <td colspan="8" style="text-align: center;"> <table border="1" style="width: 100%; border-collapse: collapse; text-align: center;"> <tr> <td style="width: 10%;"></td> <td style="width: 10%;"></td> <td style="width: 10%;"></td> <td style="width: 10%;"></td> <td style="width: 10%;"></td> <td style="width: 10%;"></td> <td style="width: 10%;"></td> <td style="width: 10%;"></td> <td style="width: 10%;"></td> <td style="width: 10%;"></td> </tr> <tr> <td></td> <td></td> <td colspan="8" style="text-align: center;"> <table border="1" style="width: 100%; border-collapse: collapse; text-align: center;"> <tr> <td style="width: 10%;"></td> <td style="width: 10%;"></td> <td style="width: 10%;"></td> <td style="width: 10%;"></td> <td style="width: 10%;"></td> <td style="width: 10%;"></td> <td style="width: 10%;"></td> <td style="width: 10%;"></td> <td style="width: 10%;"></td> <td style="width: 10%;"></td> </tr> <tr> <td></td> <td></td> <td colspan="8" style="text-align: center;"> <table border="1" style="width: 100%; border-collapse: collapse; text-align: center;"> <tr> <td style="width: 10%;"></td> <td style="width: 10%;"></td> <td style="width: 10%;"></td> <td style="width: 10%;"></td> <td style="width: 10%;"></td> <td style="width: 10%;"></td> <td style="width: 10%;"></td> <td style="width: 10%;"></td> <td style="width: 10%;"></td> <td style="width: 10%;"></td> </tr> <tr> <td></td> <td></td> <td colspan="8" style="text-align: center;"> <table border="1" style="width: 100%;
border-collapse: collapse; text-align: center;"> <tr> <td style="width: 10%;"></td> <td style="width: 10%;"></td> <td style="width: 10%;"></td> <td style="width: 10%;"></td> <td style="width: 10%;"></td> <td style="width: 10%;"></td> <td style="width: 10%;"></td> <td style="width: 10%;"></td> <td style="width: 10%;"></td> <td style="width: 10%;"></td> </tr> <tr> <td></td> <td></td> <td colspan="8" style="text-align: center;"> <table border="1" style="width: 100%; border-collapse: collapse; text-align: center;"> <tr> <td style="width: 10%;"></td> <td style="width: 10%;"></td> <td style="width: 10%;"></td> <td style="width: 10%;"></td> <td style="width: 10%;"></td> <td style="width: 10%;"></td> <td style="width: 10%;"></td> <td style="width: 10%;"></td> <td style="width: 10%;"></td> <td style="width: 10%;"></td> </tr> <tr> <td></td> <td></td> <td colspan="8" style="text-align: center;"> <table border="1" style="width: 100%; border-collapse: collapse; text-align: center;"> <tr> </tr></table></td></tr></table></td></tr></table></td></tr></table></td></tr></table></td></tr></table></td></tr></table> | | | | | | | | | | | | | | | | | | | | <table border="1" style="width: 100%; border-collapse: collapse; text-align: center;"> <tr> <td style="width: 10%;"></td> <td style="width: 10%;"></td> <td style="width: 10%;"></td> <td style="width: 10%;"></td> <td style="width: 10%;"></td> <td style="width: 10%;"></td> <td style="width: 10%;"></td> <td style="width: 10%;"></td> <td style="width: 10%;"></td> <td style="width: 10%;"></td> </tr> <tr> <td></td> <td></td> <td colspan="8" style="text-align: center;"> <table border="1" style="width: 100%; border-collapse: collapse; text-align: center;"> <tr> <td style="width: 10%;"></td> <td style="width: 10%;"></td> <td style="width: 10%;"></td> <td style="width: 10%;"></td> <td style="width: 10%;"></td> <td style="width: 10%;"></td> <td style="width: 10%;"></td> <td style="width: 10%;"></td> <td style="width: 10%;"></td> <td style="width: 10%;"></td> </tr> <tr> <td></td> <td></td> <td colspan="8" style="text-align: center;"> <table border="1" style="width: 100%; border-collapse: collapse; text-align: center;"> <tr> <td style="width: 10%;"></td> <td style="width: 10%;"></td> <td style="width: 10%;"></td> <td style="width: 10%;"></td> <td style="width: 10%;"></td> <td style="width: 10%;"></td> <td style="width: 10%;"></td> <td style="width: 10%;"></td> <td style="width: 10%;"></td> <td style="width: 10%;"></td> </tr> <tr> <td></td> <td></td> <td colspan="8" style="text-align: center;"> <table border="1" style="width: 100%; border-collapse: collapse; text-align: center;"> <tr> <td style="width: 10%;"></td> <td style="width: 10%;"></td> <td style="width: 10%;"></td> <td style="width: 10%;"></td> <td style="width: 10%;"></td> <td style="width: 10%;"></td> <td style="width: 10%;"></td> <td style="width: 10%;"></td> <td style="width: 10%;"></td> <td style="width: 10%;"></td> </tr> <tr> <td></td> <td></td> <td colspan="8" style="text-align: center;"> <table border="1" style="width: 100%; border-collapse: collapse; text-align: center;"> <tr> <td style="width: 10%;"></td> <td style="width: 10%;"></td> <td style="width: 10%;"></td> <td style="width: 10%;"></td> <td style="width: 10%;"></td> <td style="width: 10%;"></td> <td style="width: 10%;"></td> <td style="width: 10%;"></td> <td style="width: 10%;"></td> <td style="width: 10%;"></td> </tr> <tr> <td></td> <td></td> <td colspan="8" style="text-align: center;"> <table border="1" style="width: 100%; border-collapse: collapse; text-align: center;"> <tr> </tr></table></td></tr></table></td></tr></table></td></tr></table></td></tr></table></td></tr></table> | | | | | | | | | | | | | | | | | | | | <table border="1" style="width: 100%; border-collapse: collapse; text-align: center;"> <tr> <td style="width: 10%;"></td> <td style="width: 10%;"></td> <td style="width: 10%;"></td> <td style="width: 10%;"></td> <td style="width: 10%;"></td> <td style="width: 10%;"></td> <td style="width: 10%;"></td> <td style="width: 10%;"></td> <td style="width: 10%;"></td> <td style="width: 10%;"></td> </tr> <tr> <td></td> <td></td> <td colspan="8" style="text-align: center;"> <table border="1" style="width: 100%; border-collapse: collapse; text-align: center;"> <tr> <td style="width: 10%;"></td> <td style="width: 10%;"></td> <td style="width: 10%;"></td> <td style="width: 10%;"></td> <td style="width: 10%;"></td> <td style="width: 10%;"></td> <td style="width: 10%;"></td> <td style="width: 10%;"></td> <td style="width: 10%;"></td> <td style="width: 10%;"></td> </tr> <tr> <td></td> <td></td> <td colspan="8" style="text-align: center;"> <table border="1" style="width: 100%; border-collapse: collapse; text-align: center;"> <tr> <td style="width: 10%;"></td> <td style="width: 10%;"></td> <td style="width: 10%;"></td> <td style="width: 10%;"></td> <td style="width: 10%;"></td> <td style="width: 10%;"></td> <td style="width: 10%;"></td> <td style="width: 10%;"></td> <td style="width: 10%;"></td> <td style="width: 10%;"></td> </tr> <tr> <td></td> <td></td> <td
colspan="8" style="text-align: center;"> <table border="1" style="width: 100%; border-collapse: collapse; text-align: center;"> <tr> <td style="width: 10%;"></td> <td style="width: 10%;"></td> <td style="width: 10%;"></td> <td style="width: 10%;"></td> <td style="width: 10%;"></td> <td style="width: 10%;"></td> <td style="width: 10%;"></td> <td style="width: 10%;"></td> <td style="width: 10%;"></td> <td style="width: 10%;"></td> </tr> <tr> <td></td> <td></td> <td colspan="8" style="text-align: center;"> <table border="1" style="width: 100%; border-collapse: collapse; text-align: center;"> <tr> </tr></table></td></tr></table></td></tr></table></td></tr></table></td></tr></table> | | | | | | | | | | | | | | | | | | | | <table border="1" style="width: 100%; border-collapse: collapse; text-align: center;"> <tr> <td style="width: 10%;"></td> <td style="width: 10%;"></td> <td style="width: 10%;"></td> <td style="width: 10%;"></td> <td style="width: 10%;"></td> <td style="width: 10%;"></td> <td style="width: 10%;"></td> <td style="width: 10%;"></td> <td style="width: 10%;"></td> <td style="width: 10%;"></td> </tr> <tr> <td></td> <td></td> <td colspan="8" style="text-align: center;"> <table border="1" style="width: 100%; border-collapse: collapse; text-align: center;"> <tr> <td style="width: 10%;"></td> <td style="width: 10%;"></td> <td style="width: 10%;"></td> <td style="width: 10%;"></td> <td style="width: 10%;"></td> <td style="width: 10%;"></td> <td style="width: 10%;"></td> <td style="width: 10%;"></td> <td style="width: 10%;"></td> <td style="width: 10%;"></td> </tr> <tr> <td></td> <td></td> <td colspan="8" style="text-align: center;"> <table border="1" style="width: 100%; border-collapse: collapse; text-align: center;"> <tr> <td style="width: 10%;"></td> <td style="width: 10%;"></td> <td style="width: 10%;"></td> <td style="width: 10%;"></td> <td style="width: 10%;"></td> <td style="width: 10%;"></td> <td style="width: 10%;"></td> <td style="width: 10%;"></td> <td style="width: 10%;"></td> <td style="width: 10%;"></td> </tr> <tr> <td></td> <td></td> <td colspan="8" style="text-align: center;"> <table border="1" style="width: 100%; border-collapse: collapse; text-align: center;"> <tr> </tr></table></td></tr></table></td></tr></table></td></tr></table> | | | | | | | | | | | | | | | | | | | | <table border="1" style="width: 100%; border-collapse: collapse; text-align: center;"> <tr> <td style="width: 10%;"></td> <td style="width: 10%;"></td> <td style="width: 10%;"></td> <td style="width: 10%;"></td> <td style="width: 10%;"></td> <td style="width: 10%;"></td> <td style="width: 10%;"></td> <td style="width: 10%;"></td> <td style="width: 10%;"></td> <td style="width: 10%;"></td> </tr> <tr> <td></td> <td></td> <td colspan="8" style="text-align: center;"> <table border="1" style="width: 100%; border-collapse: collapse; text-align: center;"> <tr> <td style="width: 10%;"></td> <td style="width: 10%;"></td> <td style="width: 10%;"></td> <td style="width: 10%;"></td> <td style="width: 10%;"></td> <td style="width: 10%;"></td> <td style="width: 10%;"></td> <td style="width: 10%;"></td> <td style="width: 10%;"></td> <td style="width: 10%;"></td> </tr> <tr> <td></td> <td></td> <td colspan="8" style="text-align: center;"> <table border="1" style="width: 100%; border-collapse: collapse; text-align: center;"> <tr> </tr></table></td></tr></table></td></tr></table>
 | | | | | | | | | | | | | | | | | | | | <table border="1" style="width: 100%; border-collapse: collapse; text-align: center;"> <tr> <td style="width: 10%;"></td> <td style="width: 10%;"></td> <td style="width: 10%;"></td> <td style="width: 10%;"></td> <td style="width: 10%;"></td> <td style="width: 10%;"></td> <td style="width: 10%;"></td> <td style="width: 10%;"></td> <td style="width: 10%;"></td> <td style="width: 10%;"></td> </tr> <tr> <td></td> <td></td> <td colspan="8" style="text-align: center;"> <table border="1" style="width: 100%; border-collapse: collapse; text-align: center;"> <tr> </tr></table></td></tr></table> | | | | | | | | | | | | | | | | | | | | <table border="1" style="width: 100%; border-collapse: collapse; text-align: center;"> <tr> </tr></table> | | | | | | | | | | | | | | | | | | | | | | | | | | | | | | | | | | | | | | | |
 | | | | | | | | | | | | | | | | | | | | | | | | | | | | | | | | | | | | | | | | | | | | | | | | | | | | | | | | | | | | | | | | | | | |
| | |

 | | | | | | | | | | | | | | | | | | | |

 | | | | | | | | | | | | | | | | | | | |

 | | | | | | | | | | | | | | | | | | | |

 | | | | | | | | | | | | | | | | | | | |

 | | | | | | | | | | | | | | | | | | | |

 | | | | | | | | | | | | | | | | | | | |

 | | | | | | | | | | | | | | | | | | | |

 | | | | | | | | | | | | | | | | | | | |

 | | | | | | | | | | | | | | | | | | | |

 | | | | | | | | | | | | | | | | | | | |

 | | | | | | | | | | | | | | | | | | | |

 | | | | | | | | | | | | | | | | | | | |

 | | | | | | | | | | | | | | | | | | | |

 | | | | | | | | | | | | | | | | | | | |

 | | | | | | | | | | | | | | | | | | | |

 | | | | | | | | | | | | | | | | | | | |

 | | | | | | | | | | | | | | | | | | | |

 | | | | | | | | | | | | | | | | | | | |

 | | | | | | | | | | | | | | | | | | | |

 | | | | | | | | | | | | | | | | | | | |

 | | | | | | | | | | | | | | | | | | | |

 | | | | | | | | | | | | | | | | | | | |

 | | | | | | | | | | | | | | | | | | | |

 | | | | | | | | | | | | | | | | | | | |

 | | | | | | | | | | | | | | | | | | | |

 | | | | | | | | | | | | | | | | | | | |

 | | | | | | | | | | | | | | | | | | | |

 | | | | | | | | | | | | | | | | | | | |
 | | | | | | | | | | | | | | | | | | | |

 | | | | | | | | | | | | | | | | | | | |

 | | | | | | | | | | | | | | | | | | | |
 | | | | | | | | | | | | | | | | | | | |

 | | | | | | | | | | | | | | | | | | | |

 | | | | | | | | | | | | | | | | | | | |
 | | | | | | | | | | | | | | | | | | | |
 | | | | | | | | | | | | | | | | | | | |

 | | | | | | | | | | | | | | | | | | | |
 | | | | | | | | | | | | | | | | | | | |
 | | | | | | | | | | | | | | | | | | | |

 | | | | | | | | | | | | | | | | | | | | | | | | | | | | | | | | | | | | | | | | | | | | | | | | | | | | | | | | | | | | | | | | | | | | | | | | | | | | | | | | | | | | | | | | | | | | | | | | | | | |
 | | | | | | | | | | | | | | | | | | | |
 | | | | | | | | | | | | | | | | | | | |
 | | | | | | | | | | | | | | | | | | | |
 | | | | | | | | | | | | | | | | | | | |
 | | | | | | | | | | | | | | | | | | | |
 | | | | | | | | | | | | | | | | | | | |
 | | | | | | | | | | | | | | | | | | | |
 | | | | | | | | | | | | | | | | | | | |
 | | | | | | | | | | | | | | | | | | | | | | | | | | | | | | | | | | | | | | | |
 | | | | | | | | | | | | | | | | | | | |
 | | | | | | | | | | | | | | | | | | | | | | | | | | | | | | | | | | | | | | | |
 | | | | | | | | | | | | | | | | | | | | | | | | | | | | | | | | | | | | | | | |
 | | | | | | | | | | | | | | | | | | | | | | | | | | | | | | | | | | | | | | | |
 | | | | | | | | | | | | | | | | | | | | | | | | | | | | | | | | | | | | | | | | | | | | | | | | | | | | | | | | | | | | | | | | | | | | | | | | | | | | | | | | | | | | | | | | | | | | | | | | | | | |
 | | | | | | | | | | | | | | | | | | | | | | | | | | | | | | | | | | | | | | | | | | | | | | | |
| | | <table border="1" style="width: 100%; border-collapse: collapse; text-align: center;"> <tr> <td style="width: 10%;"></td> <td style="width: 10%;"></td> <td style="width: 10%;"></td> <td style="width: 10%;"></td> <td style="width: 10%;"></td> <td style="width: 10%;"></td> <td style="width: 10%;"></td> <td style="width: 10%;"></td> <td style="width: 10%;"></td> <td style="width: 10%;"></td> </tr> <tr> <td></td> <td></td> <td colspan="8" style="text-align: center;"> <table border="1" style="width: 100%; border-collapse: collapse; text-align: center;"> <tr> <td style="width: 10%;"></td> <td style="width: 10%;"></td> <td style="width: 10%;"></td> <td style="width: 10%;"></td> <td style="width: 10%;"></td> <td style="width: 10%;"></td> <td style="width: 10%;"></td> <td style="width: 10%;"></td> <td style="width: 10%;"></td> <td style="width: 10%;"></td> </tr> <tr> <td></td> <td></td> <td colspan="8" style="text-align: center;"> <table border="1" style="width: 100%; border-collapse: collapse; text-align: center;"> <tr> <td style="width: 10%;"></td> <td style="width: 10%;"></td> <td style="width: 10%;"></td> <td style="width: 10%;"></td> <td style="width: 10%;"></td> <td style="width: 10%;"></td> <td style="width: 10%;"></td> <td style="width: 10%;"></td> <td style="width: 10%;"></td> <td style="width: 10%;"></td> </tr> <tr> <td></td> <td></td> <td colspan="8" style="text-align: center;"> <table border="1" style="width: 100%; border-collapse: collapse; text-align: center;"> <tr> <td style="width: 10%;"></td> <td style="width: 10%;"></td> <td style="width: 10%;"></td> <td style="width: 10%;"></td> <td style="width: 10%;"></td> <td style="width: 10%;"></td> <td style="width: 10%;"></td> <td style="width: 10%;"></td> <td style="width: 10%;"></td> <td style="width: 10%;"></td> </tr> <tr> <td></td> <td></td> <td colspan="8" style="text-align: center;"> <table border="1" style="width: 100%; border-collapse: collapse; text-align: center;"> <tr> <td style="width: 10%;"></td> <td style="width: 10%;"></td> <td style="width: 10%;"></td> <td style="width: 10%;"></td> <td style="width: 10%;"></td> <td style="width: 10%;"></td> <td style="width: 10%;"></td> <td style="width: 10%;"></td> <td style="width: 10%;"></td> <td style="width: 10%;"></td> </tr> <tr> <td></td> <td></td> <td colspan="8" style="text-align: center;"> <table border="1" style="width: 100%; border-collapse: collapse; text-align: center;"> <tr> <td style="width: 10%;"></td> <td style="width: 10%;"></td> <td style="width: 10%;"></td> <td style="width: 10%;"></td> <td style="width: 10%;"></td> <td style="width: 10%;"></td> <td style="width: 10%;"></td> <td style="width: 10%;"></td> <td style="width: 10%;"></td> <td style="width: 10%;"></td> </tr> <tr> <td></td> <td></td> <td colspan="8" style="text-align: center;"> <table border="1" style="width: 100%; border-collapse: collapse; text-align: center;"> <tr> <td style="width: 10%;"></td> <td style="width: 10%;"></td> <td style="width: 10%;"></td> <td style="width: 10%;"></td> <td style="width: 10%;"></td> <td style="width: 10%;"></td> <td style="width: 10%;"></td> <td style="width: 10%;"></td> <td style="width: 10%;"></td> <td style="width: 10%;"></td> </tr> <tr> <td></td> <td></td> <td colspan="8" style="text-align: center;"> <table border="1" style="width: 100%; border-collapse: collapse; text-align: center;"> <tr> <td style="width: 10%;"></td> <td style="width: 10%;"></td> <td style="width: 10%;"></td> <td style="width: 10%;"></td> <td style="width: 10%;"></td> <td style="width: 10%;"></td> <td style="width: 10%;"></td> <td style="width: 10%;"></td> <td style="width: 10%;"></td> <td style="width: 10%;"></td> </tr> <tr> <td></td> <td></td> <td colspan="8" style="text-align: center;"> <table border="1" style="width: 100%; border-collapse: collapse; text-align: center;"> <tr> <td style="width: 10%;"></td> <td style="width: 10%;"></td> <td style="width: 10%;"></td> <td style="width: 10%;"></td> <td style="width: 10%;"></td> <td style="width: 10%;"></td> <td style="width: 10%;"></td> <td style="width: 10%;"></td> <td style="width: 10%;"></td> <td style="width: 10%;"></td> </tr> <tr> <td></td> <td></td> <td colspan="8" style="text-align: center;"> <table border="1" style="width: 100%; border-collapse: collapse; text-align: center;"> <tr> <td style="width: 10%;"></td> <td style="width: 10%;"></td> <td style="width: 10%;"></td> <td style="width: 10%;"></td> <td style="width: 10%;"></td> <td style="width: 10%;"></td> <td style="width: 10%;"></td> <td style="width: 10%;"></td> <td style="width: 10%;"></td> <td style="width: 10%;"></td> </tr> <tr> <td></td> <td></td> <td colspan="8" style="text-align: center;"> <table border="1" style="width: 100%; border-collapse: collapse; text-align: center;"> <tr> <td style="width: 10%;"></td> <td style="width: 10%;"></td> <td style="width: 10%;"></td> <td style="width: 10%;"></td> <td style="width: 10%;"></td> <td style="width: 10%;"></td> <td style="width: 10%;"></td> <td style="width: 10%;"></td> <td style="width: 10%;"></td> <td style="width: 10%;"></td> </tr> <tr> <td></td> <td></td> <td colspan="8" style="text-align: center;"> <table border="1" style="width: 100%; border-collapse: collapse; text-align: center;"> <tr> <td style="width: 10%;"></td> <td style="width: 10%;"></td> <td style="width: 10%;"></td> <td style="width: 10%;"></td> <td style="width: 10%;"></td> <td style="width: 10%;"></td> <td style="width: 10%;"></td> <td style="width: 10%;"></td> <td style="width: 10%;"></td> <td style="width: 10%;"></td> </tr> <tr> <td></td> <td></td> <td colspan="8" style="text-align: center;"> <table border="1" style="width: 100%; border-collapse: collapse; text-align: center;"> <tr> <td style="width: 10%;"></td> <td style="width: 10%;"></td> <td style="width: 10%;"></td> <td style="width: 10%;"></td> <td style="width: 10%;"></td> <td style="width: 10%;"></td> <td style="width: 10%;"></td> <td style="width: 10%;"></td> <td style="width: 10%;"></td> <td style="width: 10%;"></td> </tr> <tr> <td></td> <td></td> <td colspan="8" style="text-align: center;"> <table border="1" style="width: 100%; border-collapse: collapse; text-align: center;"> <tr> <td style="width: 10%;"></td> <td style="width: 10%;"></td> <td style="width: 10%;"></td> <td style="width: 10%;"></td> <td style="width: 10%;"></td> <td style="width: 10%;"></td> <td style="width: 10%;"></td> <td style="width: 10%;"></td> <td style="width: 10%;"></td> <td style="width: 10%;"></td> </tr> <tr> <td></td> <td></td> <td colspan="8" style="text-align: center;"> <table border="1" style="width: 100%; border-collapse: collapse; text-align: center;"> <tr> <td style="width: 10%;"></td> <td style="width: 10%;"></td> <td style="width: 10%;"></td> <td style="width: 10%;"></td> <td style="width: 10%;"></td> <td style="width: 10%;"></td> <td style="width: 10%;"></td> <td style="width: 10%;"></td> <td style="width: 10%;"></td> <td style="width: 10%;"></td> </tr> <tr> <td></td> <td></td> <td colspan="8" style="text-align: center;"> <table border="1" style="width: 100%; border-collapse: collapse; text-align: center;"> <tr> <td style="width: 10%;"></td> <td style="width: 10%;"></td> <td style="width: 10%;"></td> <td style="width: 10%;"></td> <td style="width: 10%;"></td> <td style="width: 10%;"></td> <td style="width: 10%;"></td> <td style="width: 10%;"></td> <td style="width: 10%;"></td> <td style="width: 10%;"></td> </tr> <tr> <td></td> <td></td> <td colspan="8" style="text-align: center;"> <table border="1" style="width: 100%; border-collapse: collapse; text-align: center;"> <tr> <td style="width: 10%;"></td> <td style="width: 10%;"></td> <td style="width: 10%;"></td> <td style="width: 10%;"></td> <td style="width: 10%;"></td> <td style="width: 10%;"></td> <td style="width: 10%;"></td> <td style="width: 10%;"></td> <td style="width: 10%;"></td> <td style="width: 10%;"></td> </tr> <tr> <td></td> <td></td> <td colspan="8" style="text-align: center;"> <table border="1" style="width: 100%; border-collapse: collapse; text-align: center;"> <tr> <td style="width: 10%;"></td> <td style="width: 10%;"></td> <td style="width: 10%;"></td> <td style="width: 10%;"></td> <td style="width: 10%;"></td> <td style="width: 10%;"></td> <td style="width: 10%;"></td> <td style="width: 10%;"></td> <td style="width: 10%;"></td> <td style="width: 10%;"></td> </tr> <tr> <td></td> <td></td> <td colspan="8" style="text-align: center;"> <table border="1" style="width: 100%; border-collapse: collapse; text-align: center;"> <tr> <td style="width: 10%;"></td> <td style="width: 10%;"></td> <td style="width: 10%;"></td> <td style="width: 10%;"></td> <td style="width: 10%;"></td> <td style="width: 10%;"></td> <td style="width: 10%;"></td> <td style="width: 10%;"></td> <td style="width: 10%;"></td> <td style="width: 10%;"></td> </tr> <tr> <td></td> <td></td> <td colspan="8" style="text-align: center;"> <table border="1" style="width: 100%; border-collapse: collapse; text-align: center;"> <tr> <td style="width: 10%;"></td> <td style="width: 10%;"></td> <td style="width: 10%;"></td> <td style="width: 10%;"></td> <td style="width: 10%;"></td> <td style="width: 10%;"></td> <td style="width: 10%;"></td> <td style="width: 10%;"></td> <td style="width: 10%;"></td> <td style="width: 10%;"></td> </tr> <tr> <td></td> <td></td> <td colspan="8" style="text-align: center;"> <table border="1" style="width: 100%; border-collapse: collapse; text-align: center;"> <tr> <td style="width: 10%;"></td> <td style="width: 10%;"></td> <td style="width: 10%;"></td> <td style="width: 10%;"></td> <td style="width: 10%;"></td> <td style="width: 10%;"></td> <td style="width: 10%;"></td> <td style="width: 10%;"></td> <td style="width: 10%;"></td> <td style="width: 10%;"></td> </tr> <tr> <td></td> <td></td> <td colspan="8" style="text-align: center;"> <table border="1" style="width: 100%; border-collapse: collapse; text-align: center;"> <tr> <td style="width: 10%;"></td> <td style="width: 10%;"></td> <td
style="width: 10%;"></td> <td style="width: 10%;"></td> <td style="width: 10%;"></td> <td style="width: 10%;"></td> <td style="width: 10%;"></td> <td style="width: 10%;"></td> <td style="width: 10%;"></td> <td style="width: 10%;"></td> </tr> <tr> <td></td> <td></td> <td colspan="8" style="text-align: center;"> <table border="1" style="width: 100%; border-collapse: collapse; text-align: center;"> <tr> <td style="width: 10%;"></td> <td style="width: 10%;"></td> <td style="width: 10%;"></td> <td style="width: 10%;"></td> <td style="width: 10%;"></td> <td style="width: 10%;"></td> <td style="width: 10%;"></td> <td style="width: 10%;"></td> <td style="width: 10%;"></td> <td style="width: 10%;"></td> </tr> <tr> <td></td> <td></td> <td colspan="8" style="text-align: center;"> <table border="1" style="width: 100%; border-collapse: collapse; text-align: center;"> <tr> <td style="width: 10%;"></td> <td style="width: 10%;"></td> <td style="width: 10%;"></td> <td style="width: 10%;"></td> <td style="width: 10%;"></td> <td style="width: 10%;"></td> <td style="width: 10%;"></td> <td style="width: 10%;"></td> <td style="width: 10%;"></td> <td style="width: 10%;"></td> </tr> <tr> <td></td> <td></td> <td colspan="8" style="text-align: center;"> <table border="1" style="width: 100%; border-collapse: collapse; text-align: center;"> <tr> <td style="width: 10%;"></td> <td style="width: 10%;"></td> <td style="width: 10%;"></td> <td style="width: 10%;"></td> <td style="width: 10%;"></td> <td style="width: 10%;"></td> <td style="width: 10%;"></td> <td style="width: 10%;"></td> <td style="width: 10%;"></td> <td style="width: 10%;"></td> </tr> <tr> <td></td> <td></td> <td colspan="8" style="text-align: center;"> <table border="1" style="width: 100%; border-collapse: collapse; text-align: center;"> <tr> <td style="width: 10%;"></td> <td style="width: 10%;"></td> <td style="width: 10%;"></td> <td style="width: 10%;"></td> <td style="width: 10%;"></td> <td style="width: 10%;"></td> <td style="width: 10%;"></td> <td style="width: 10%;"></td> <td style="width: 10%;"></td> <td style="width: 10%;"></td> </tr> <tr> <td></td> <td></td> <td colspan="8" style="text-align: center;"> <table border="1" style="width: 100%; border-collapse: collapse; text-align: center;"> <tr> <td style="width: 10%;"></td> <td style="width: 10%;"></td> <td style="width: 10%;"></td> <td style="width: 10%;"></td> <td style="width: 10%;"></td> <td style="width: 10%;"></td> <td style="width: 10%;"></td> <td style="width: 10%;"></td> <td style="width: 10%;"></td> <td style="width: 10%;"></td> </tr> <tr> <td></td> <td></td> <td colspan="8" style="text-align: center;"> <table border="1" style="width: 100%; border-collapse: collapse; text-align: center;"> <tr> <td style="width: 10%;"></td> <td style="width: 10%;"></td> <td style="width: 10%;"></td> <td style="width: 10%;"></td> <td style="width: 10%;"></td> <td style="width: 10%;"></td> <td style="width: 10%;"></td> <td style="width: 10%;"></td> <td style="width: 10%;"></td> <td style="width: 10%;"></td> </tr> <tr> <td></td> <td></td> <td colspan="8" style="text-align: center;"> <table border="1" style="width: 100%; border-collapse: collapse; text-align: center;"> <tr> <td style="width: 10%;"></td> <td style="width: 10%;"></td> <td style="width: 10%;"></td> <td style="width: 10%;"></td> <td style="width: 10%;"></td> <td style="width: 10%;"></td> <td style="width: 10%;"></td> <td style="width: 10%;"></td> <td style="width: 10%;"></td> <td style="width: 10%;"></td> </tr> <tr> <td></td> <td></td> <td colspan="8" style="text-align: center;"> <table border="1" style="width: 100%; border-collapse: collapse; text-align: center;"> <tr> <td style="width: 10%;"></td> <td style="width: 10%;"></td> <td style="width: 10%;"></td> <td style="width: 10%;"></td> <td style="width: 10%;"></td> <td style="width: 10%;"></td> <td style="width: 10%;"></td> <td style="width: 10%;"></td> <td style="width: 10%;"></td> <td style="width: 10%;"></td> </tr> <tr> <td></td> <td></td> <td colspan="8" style="text-align: center;"> <table border="1" style="width: 100%; border-collapse: collapse; text-align: center;"> <tr> <td style="width: 10%;"></td> <td style="width: 10%;"></td> <td style="width: 10%;"></td> <td style="width: 10%;"></td> <td style="width: 10%;"></td> <td style="width: 10%;"></td> <td style="width: 10%;"></td> <td style="width: 10%;"></td> <td style="width: 10%;"></td> <td style="width: 10%;"></td> </tr> <tr> <td></td> <td></td> <td colspan="8" style="text-align: center;"> <table border="1" style="width: 100%; border-collapse: collapse; text-align: center;"> <tr> <td style="width: 10%;"></td> <td style="width: 10%;"></td> <td style="width: 10%;"></td> <td style="width: 10%;"></td> <td style="width: 10%;"></td> <td style="width: 10%;"></td> <td style="width: 10%;"></td> <td style="width: 10%;"></td> <td style="width: 10%;"></td> <td style="width: 10%;"></td> </tr> <tr> <td></td> <td></td> <td colspan="8" style="text-align: center;"> <table border="1" style="width: 100%; border-collapse: collapse; text-align: center;"> <tr> <td style="width: 10%;"></td> <td style="width: 10%;"></td> <td style="width: 10%;"></td> <td style="width: 10%;"></td> <td style="width: 10%;"></td> <td style="width: 10%;"></td> <td style="width: 10%;"></td> <td style="width: 10%;"></td> <td style="width: 10%;"></td> <td style="width: 10%;"></td> </tr> <tr> <td></td> <td></td> <td colspan="8" style="text-align: center;"> <table border="1" style="width: 100%; border-collapse: collapse; text-align: center;"> <tr> <td style="width: 10%;"></td> <td style="width: 10%;"></td> <td style="width: 10%;"></td> <td style="width: 10%;"></td> <td style="width: 10%;"></td> <td style="width: 10%;"></td> <td style="width: 10%;"></td> <td style="width: 10%;"></td> <td style="width: 10%;"></td> <td style="width: 10%;"></td> </tr> <tr> <td></td> <td></td> <td colspan="8" style="text-align: center;"> <table border="1" style="width: 100%; border-collapse: collapse; text-align: center;"> <tr> <td style="width: 10%;"></td> <td style="width: 10%;"></td> <td style="width: 10%;"></td> <td style="width: 10%;"></td> <td style="width: 10%;"></td> <td style="width: 10%;"></td> <td style="width: 10%;"></td> <td style="width: 10%;"></td> <td style="width: 10%;"></td> <td style="width: 10%;"></td> </tr> <tr> <td></td> <td></td> <td colspan="8" style="text-align: center;"> <table border="1" style="width: 100%; border-collapse: collapse; text-align: center;"> <tr> <td style="width: 10%;"></td> <td style="width: 10%;"></td> <td style="width: 10%;"></td> <td style="width: 10%;"></td> <td style="width: 10%;"></td> <td style="width: 10%;"></td> <td style="width: 10%;"></td> <td style="width: 10%;"></td> <td style="width: 10%;"></td> <td style="width: 10%;"></td> </tr> <tr> <td></td> <td></td> <td colspan="8" style="text-align: center;"> <table border="1" style="width: 100%; border-collapse: collapse; text-align: center;"> <tr> <td style="width: 10%;"></td> <td style="width: 10%;"></td> <td style="width: 10%;"></td> <td style="width: 10%;"></td> <td style="width: 10%;"></td> <td style="width: 10%;"></td> <td style="width: 10%;"></td> <td style="width: 10%;"></td> <td style="width: 10%;"></td> <td style="width: 10%;"></td> </tr> <tr> <td></td> <td></td> <td colspan="8" style="text-align: center;"> <table border="1" style="width: 100%; border-collapse: collapse; text-align: center;"> <tr> <td style="width: 10%;"></td> <td style="width: 10%;"></td> <td style="width: 10%;"></td> <td style="width: 10%;"></td> <td style="width: 10%;"></td> <td style="width: 10%;"></td> <td style="width: 10%;"></td> <td style="width: 10%;"></td> <td style="width: 10%;"></td> <td style="width: 10%;"></td> </tr> <tr> <td></td> <td></td> <td colspan="8" style="text-align: center;"> <table border="1" style="width: 100%; border-collapse: collapse; text-align: center;"> <tr> <td style="width: 10%;"></td> <td style="width: 10%;"></td> <td style="width: 10%;"></td> <td style="width: 10%;"></td> <td style="width: 10%;"></td> <td style="width: 10%;"></td> <td style="width: 10%;"></td> <td style="width: 10%;"></td> <td style="width: 10%;"></td> <td style="width: 10%;"></td> </tr> <tr> <td></td> <td></td> <td colspan="8" style="text-align: center;"> <table border="1" style="width: 100%; border-collapse: collapse; text-align: center;"> <tr> <td style="width: 10%;"></td> <td style="width: 10%;"></td> <td style="width: 10%;"></td> <td style="width: 10%;"></td> <td style="width: 10%;"></td> <td style="width: 10%;"></td> <td style="width: 10%;"></td> <td style="width: 10%;"></td> <td style="width: 10%;"></td> <td style="width: 10%;"></td> </tr> <tr> <td></td> <td></td> <td colspan="8" style="text-align: center;"> <table border="1" style="width: 100%; border-collapse: collapse; text-align: center;"> <tr> <td style="width: 10%;"></td> <td style="width: 10%;"></td> <td style="width: 10%;"></td> <td style="width: 10%;"></td> <td style="width: 10%;"></td> <td style="width: 10%;"></td> <td style="width: 10%;"></td> <td style="width: 10%;"></td> <td style="width: 10%;"></td> <td style="width: 10%;"></td> </tr> <tr> <td></td> <td></td> <td colspan="8" style="text-align: center;"> <table border="1" style="width: 100%; border-collapse: collapse; text-align: center;"> <tr> <td style="width: 10%;"></td> <td style="width: 10%;"></td> <td style="width: 10%;"></td> <td style="width: 10%;"></td> <td style="width: 10%;"></td> <td style="width: 10%;"></td> <td style="width: 10%;"></td> <td style="width: 10%;"></td> <td style="width: 10%;"></td> <td style="width: 10%;"></td> </tr> <tr> <td></td> <td></td> <td colspan="8" style="text-align: center;"> <table border="1" style="width: 100%; border-collapse: collapse; text-align: center;"> <tr> <td style="width: 10%;"></td> <td style="width: 10%;"></td> <td style="width: 10%;"></td> <td style="width: 10%;"></td> <td style="width: 10%;"></td> <td style="width: 10%;"></td> <td style="width: 10%;"></td> <td style="width:
10%;"></td> <td style="width: 10%;"></td> <td style="width: 10%;"></td> </tr> <tr> <td></td> <td></td> <td colspan="8" style="text-align: center;"> <table border="1" style="width: 100%; border-collapse: collapse; text-align: center;"> <tr> <td style="width: 10%;"></td> <td style="width: 10%;"></td> <td style="width: 10%;"></td> <td style="width: 10%;"></td> <td style="width: 10%;"></td> <td style="width: 10%;"></td> <td style="width: 10%;"></td> <td style="width: 10%;"></td> <td style="width: 10%;"></td> <td style="width: 10%;"></td> </tr> <tr> <td></td> <td></td> <td colspan="8" style="text-align: center;"> <table border="1" style="width: 100%; border-collapse: collapse; text-align: center;"> <tr> <td style="width: 10%;"></td> <td style="width: 10%;"></td> <td style="width: 10%;"></td> <td style="width: 10%;"></td> <td style="width: 10%;"></td> <td style="width: 10%;"></td> <td style="width: 10%;"></td> <td style="width: 10%;"></td> <td style="width: 10%;"></td> <td style="width: 10%;"></td> </tr> <tr> <td></td> <td></td> <td colspan="8" style="text-align: center;"> <table border="1" style="width: 100%; border-collapse: collapse; text-align: center;"> <tr> <td style="width: 10%;"></td> <td style="width: 10%;"></td> <td style="width: 10%;"></td> <td style="width: 10%;"></td> <td style="width: 10%;"></td> <td style="width: 10%;"></td> <td style="width: 10%;"></td> <td style="width: 10%;"></td> <td style="width: 10%;"></td> <td style="width: 10%;"></td> </tr> <tr> <td></td> <td></td> <td colspan="8" style="text-align: center;"> <table border="1" style="width: 100%; border-collapse: collapse; text-align: center;"> <tr> <td style="width: 10%;"></td> <td style="width: 10%;"></td> <td style="width: 10%;"></td> <td style="width: 10%;"></td> <td style="width: 10%;"></td> <td style="width: 10%;"></td> <td style="width: 10%;"></td> <td style="width: 10%;"></td> <td style="width: 10%;"></td> <td style="width: 10%;"></td> </tr> <tr> <td></td> <td></td> <td colspan="8" style="text-align: center;"> <table border="1" style="width: 100%; border-collapse: collapse; text-align: center;"> <tr> <td style="width: 10%;"></td> <td style="width: 10%;"></td> <td style="width: 10%;"></td> <td style="width: 10%;"></td> <td style="width: 10%;"></td> <td style="width: 10%;"></td> <td style="width: 10%;"></td> <td style="width: 10%;"></td> <td style="width: 10%;"></td> <td style="width: 10%;"></td> </tr> <tr> <td></td> <td></td> <td colspan="8" style="text-align: center;"> <table border="1" style="width: 100%; border-collapse: collapse; text-align: center;"> <tr> <td style="width: 10%;"></td> <td style="width: 10%;"></td> <td style="width: 10%;"></td> <td style="width: 10%;"></td> <td style="width: 10%;"></td> <td style="width: 10%;"></td> <td style="width: 10%;"></td> <td style="width: 10%;"></td> <td style="width: 10%;"></td> <td style="width: 10%;"></td> </tr> <tr> <td></td> <td></td> <td colspan="8" style="text-align: center;"> <table border="1" style="width: 100%; border-collapse: collapse; text-align: center;"> <tr> <td style="width: 10%;"></td> <td style="width: 10%;"></td> <td style="width: 10%;"></td> <td style="width: 10%;"></td> <td style="width: 10%;"></td> <td style="width: 10%;"></td> <td style="width: 10%;"></td> <td style="width: 10%;"></td> <td style="width: 10%;"></td> <td style="width: 10%;"></td> </tr> <tr> <td></td> <td></td> <td colspan="8" style="text-align: center;"> <table border="1" style="width: 100%; border-collapse: collapse; text-align: center;"> <tr> <td style="width: 10%;"></td> <td style="width: 10%;"></td> <td style="width: 10%;"></td> <td style="width: 10%;"></td> <td style="width: 10%;"></td> <td style="width: 10%;"></td> <td style="width: 10%;"></td> <td style="width: 10%;"></td> <td style="width: 10%;"></td> <td style="width: 10%;"></td> </tr> <tr> <td></td> <td></td> <td colspan="8" style="text-align: center;"> <table border="1" style="width: 100%; border-collapse: collapse; text-align: center;"> <tr> <td style="width: 10%;"></td> <td style="width: 10%;"></td> <td style="width: 10%;"></td> <td style="width: 10%;"></td> <td style="width: 10%;"></td> <td style="width: 10%;"></td> <td style="width: 10%;"></td> <td style="width: 10%;"></td> <td style="width: 10%;"></td> <td style="width: 10%;"></td> </tr> <tr> <td></td> <td></td> <td colspan="8" style="text-align: center;"> <table border="1" style="width: 100%; border-collapse: collapse; text-align: center;"> <tr> <td style="width: 10%;"></td> <td style="width: 10%;"></td> <td style="width: 10%;"></td> <td style="width: 10%;"></td> <td style="width: 10%;"></td> <td style="width: 10%;"></td> <td style="width: 10%;"></td> <td style="width: 10%;"></td> <td style="width: 10%;"></td> <td style="width: 10%;"></td> </tr> <tr> <td></td> <td></td> <td colspan="8" style="text-align: center;"> <table border="1" style="width: 100%; border-collapse: collapse; text-align: center;"> <tr> <td style="width: 10%;"></td> <td style="width: 10%;"></td> <td style="width: 10%;"></td> <td style="width: 10%;"></td> <td style="width: 10%;"></td> <td style="width: 10%;"></td> <td style="width: 10%;"></td> <td style="width: 10%;"></td> <td style="width: 10%;"></td> <td style="width: 10%;"></td> </tr> <tr> <td></td> <td></td> <td colspan="8" style="text-align: center;"> <table border="1" style="width: 100%; border-collapse: collapse; text-align: center;"> <tr> <td style="width: 10%;"></td> <td style="width: 10%;"></td> <td style="width: 10%;"></td> <td style="width: 10%;"></td> <td style="width: 10%;"></td> <td style="width: 10%;"></td> <td style="width: 10%;"></td> <td style="width: 10%;"></td> <td style="width: 10%;"></td> <td style="width: 10%;"></td> </tr> <tr> <td></td> <td></td> <td colspan="8" style="text-align: center;"> <table border="1" style="width: 100%; border-collapse: collapse; text-align: center;"> <tr> <td style="width: 10%;"></td> <td style="width: 10%;"></td> <td style="width: 10%;"></td> <td style="width: 10%;"></td> <td style="width: 10%;"></td> <td style="width: 10%;"></td> <td style="width: 10%;"></td> <td style="width: 10%;"></td> <td style="width: 10%;"></td> <td style="width: 10%;"></td> </tr> <tr> <td></td> <td></td> <td colspan="8" style="text-align: center;"> <table border="1" style="width: 100%; border-collapse: collapse; text-align: center;"> <tr> <td style="width: 10%;"></td> <td style="width: 10%;"></td> <td style="width: 10%;"></td> <td style="width: 10%;"></td> <td style="width: 10%;"></td> <td style="width: 10%;"></td> <td style="width: 10%;"></td> <td style="width: 10%;"></td> <td style="width: 10%;"></td> <td style="width: 10%;"></td> </tr> <tr> <td></td> <td></td> <td colspan="8" style="text-align: center;"> <table border="1" style="width: 100%; border-collapse: collapse; text-align: center;"> <tr> <td style="width: 10%;"></td> <td style="width: 10%;"></td> <td style="width: 10%;"></td> <td style="width: 10%;"></td> <td style="width: 10%;"></td> <td style="width: 10%;"></td> <td style="width: 10%;"></td> <td style="width: 10%;"></td> <td style="width: 10%;"></td> <td style="width: 10%;"></td> </tr> <tr> <td></td> <td></td> <td colspan="8" style="text-align: center;"> <table border="1" style="width: 100%; border-collapse: collapse; text-align: center;"> <tr> </tr></table></td></tr></table></td></tr></table></td></tr></table></td></tr></table></td></tr></table></td></tr></table></td></tr></table></td></tr></table></td></tr></table></td></tr></table></td></tr></table></td></tr></table></td></tr></table></td></tr></table></td></tr></table></td></tr></table></td></tr></table></td></tr></table></td></tr></table></td></tr></table></td></tr></table></td></tr></table></td></tr></table></td></tr></table></td></tr></table></td></tr></table></td></tr></table></td></tr></table></td></tr></table></td></tr></table></td></tr></table></td></tr></table></td></tr></table></td></tr></table></td></tr></table></td></tr></table></td></tr></table></td></tr></table></td></tr></table></td></tr></table></td></tr></table></td></tr></table></td></tr></table></td></tr></table></td></tr></table></td></tr></table></td></tr></table></td></tr></table></td></tr></table></td></tr></table></td></tr></table></td></tr></table></td></tr></table></td></tr></table></td></tr></table></td></tr></table></td></tr></table></td></tr></table>
 | | | | | | | | | | | | | | | | | | | | <table border="1" style="width: 100%; border-collapse: collapse; text-align: center;"> <tr> <td style="width: 10%;"></td> <td style="width: 10%;"></td> <td style="width: 10%;"></td> <td style="width: 10%;"></td> <td style="width: 10%;"></td> <td style="width: 10%;"></td> <td style="width: 10%;"></td> <td style="width: 10%;"></td> <td style="width: 10%;"></td> <td style="width: 10%;"></td> </tr> <tr> <td></td> <td></td> <td colspan="8" style="text-align: center;"> <table border="1" style="width: 100%; border-collapse: collapse; text-align: center;"> <tr> <td style="width: 10%;"></td> <td style="width: 10%;"></td> <td style="width: 10%;"></td> <td style="width: 10%;"></td> <td style="width: 10%;"></td> <td style="width: 10%;"></td> <td style="width: 10%;"></td> <td style="width: 10%;"></td> <td style="width: 10%;"></td> <td style="width: 10%;"></td> </tr> <tr> <td></td> <td></td> <td colspan="8" style="text-align: center;"> <table border="1" style="width: 100%; border-collapse: collapse; text-align: center;"> <tr> <td style="width: 10%;"></td> <td style="width: 10%;"></td> <td style="width: 10%;"></td> <td style="width: 10%;"></td> <td style="width: 10%;"></td> <td style="width: 10%;"></td> <td style="width: 10%;"></td> <td style="width: 10%;"></td> <td style="width: 10%;"></td> <td style="width: 10%;"></td> </tr> <tr> <td></td> <td></td> <td colspan="8" style="text-align: center;"> <table border="1" style="width: 100%; border-collapse: collapse; text-align: center;"> <tr> <td style="width: 10%;"></td> <td style="width: 10%;"></td> <td style="width: 10%;"></td> <td style="width: 10%;"></td> <td style="width: 10%;"></td> <td style="width: 10%;"></td> <td style="width: 10%;"></td> <td style="width: 10%;"></td> <td style="width: 10%;"></td> <td style="width: 10%;"></td> </tr> <tr> <td></td> <td></td> <td colspan="8" style="text-align: center;"> <table border="1" style="width: 100%; border-collapse: collapse; text-align: center;"> <tr> <td style="width: 10%;"></td> <td style="width: 10%;"></td> <td style="width: 10%;"></td> <td style="width: 10%;"></td> <td style="width: 10%;"></td> <td style="width: 10%;"></td> <td style="width: 10%;"></td> <td style="width: 10%;"></td> <td style="width: 10%;"></td> <td style="width: 10%;"></td> </tr> <tr> <td></td> <td></td> <td colspan="8" style="text-align: center;"> <table border="1" style="width: 100%; border-collapse: collapse; text-align: center;"> <tr> <td style="width: 10%;"></td> <td style="width: 10%;"></td> <td style="width: 10%;"></td> <td style="width: 10%;"></td> <td style="width: 10%;"></td> <td style="width: 10%;"></td> <td style="width: 10%;"></td> <td style="width: 10%;"></td> <td style="width: 10%;"></td> <td style="width: 10%;"></td> </tr> <tr> <td></td> <td></td> <td colspan="8" style="text-align: center;"> <table border="1" style="width: 100%; border-collapse: collapse; text-align: center;"> <tr> <td style="width: 10%;"></td> <td style="width: 10%;"></td> <td style="width: 10%;"></td> <td style="width: 10%;"></td> <td style="width: 10%;"></td> <td style="width: 10%;"></td> <td style="width: 10%;"></td> <td style="width: 10%;"></td> <td style="width: 10%;"></td> <td style="width: 10%;"></td> </tr> <tr> <td></td> <td></td> <td colspan="8" style="text-align: center;"> <table border="1" style="width: 100%; border-collapse: collapse; text-align: center;"> <tr> <td style="width: 10%;"></td> <td style="width: 10%;"></td> <td style="width: 10%;"></td> <td style="width: 10%;"></td> <td style="width: 10%;"></td> <td style="width: 10%;"></td> <td style="width: 10%;"></td> <td style="width: 10%;"></td> <td style="width: 10%;"></td> <td style="width: 10%;"></td> </tr> <tr> <td></td> <td></td> <td colspan="8" style="text-align: center;"> <table border="1" style="width: 100%; border-collapse: collapse; text-align: center;"> <tr> <td style="width: 10%;"></td> <td style="width: 10%;"></td> <td style="width: 10%;"></td> <td style="width: 10%;"></td> <td style="width: 10%;"></td> <td style="width: 10%;"></td> <td style="width: 10%;"></td> <td style="width: 10%;"></td> <td style="width: 10%;"></td> <td style="width: 10%;"></td> </tr> <tr> <td></td> <td></td> <td colspan="8" style="text-align: center;"> <table border="1" style="width: 100%; border-collapse: collapse; text-align: center;"> <tr> <td style="width: 10%;"></td> <td style="width: 10%;"></td> <td style="width: 10%;"></td> <td style="width: 10%;"></td> <td style="width: 10%;"></td> <td style="width: 10%;"></td> <td style="width: 10%;"></td> <td style="width: 10%;"></td> <td style="width: 10%;"></td> <td style="width: 10%;"></td> </tr> <tr> <td></td> <td></td> <td colspan="8" style="text-align: center;"> <table border="1" style="width: 100%; border-collapse: collapse; text-align: center;"> <tr> <td style="width: 10%;"></td> <td style="width: 10%;"></td> <td style="width: 10%;"></td> <td style="width: 10%;"></td> <td style="width: 10%;"></td> <td style="width: 10%;"></td> <td style="width: 10%;"></td> <td style="width: 10%;"></td> <td style="width: 10%;"></td> <td style="width: 10%;"></td> </tr> <tr> <td></td> <td></td> <td colspan="8" style="text-align: center;"> <table border="1" style="width: 100%; border-collapse: collapse; text-align: center;"> <tr> <td style="width: 10%;"></td> <td style="width: 10%;"></td> <td style="width: 10%;"></td> <td style="width: 10%;"></td> <td style="width: 10%;"></td> <td style="width: 10%;"></td> <td style="width: 10%;"></td> <td style="width: 10%;"></td> <td style="width: 10%;"></td> <td style="width: 10%;"></td> </tr> <tr> <td></td> <td></td> <td colspan="8" style="text-align: center;"> <table border="1" style="width: 100%; border-collapse: collapse; text-align: center;"> <tr> <td style="width: 10%;"></td> <td style="width: 10%;"></td> <td style="width: 10%;"></td> <td style="width: 10%;"></td> <td style="width: 10%;"></td> <td style="width: 10%;"></td> <td style="width: 10%;"></td> <td style="width: 10%;"></td> <td style="width: 10%;"></td> <td style="width: 10%;"></td> </tr> <tr> <td></td> <td></td> <td colspan="8" style="text-align: center;"> <table border="1" style="width: 100%; border-collapse: collapse; text-align: center;"> <tr> <td style="width: 10%;"></td> <td style="width: 10%;"></td> <td style="width: 10%;"></td> <td style="width: 10%;"></td> <td style="width: 10%;"></td> <td style="width: 10%;"></td> <td style="width: 10%;"></td> <td style="width: 10%;"></td> <td style="width: 10%;"></td> <td style="width: 10%;"></td> </tr> <tr> <td></td> <td></td> <td colspan="8" style="text-align: center;"> <table border="1" style="width: 100%; border-collapse: collapse; text-align: center;"> <tr> <td style="width: 10%;"></td> <td style="width: 10%;"></td> <td style="width: 10%;"></td> <td style="width: 10%;"></td> <td style="width: 10%;"></td> <td style="width: 10%;"></td> <td style="width: 10%;"></td> <td style="width: 10%;"></td> <td style="width: 10%;"></td> <td style="width: 10%;"></td> </tr> <tr> <td></td> <td></td> <td colspan="8" style="text-align: center;"> <table border="1" style="width: 100%; border-collapse: collapse; text-align: center;"> <tr> <td style="width: 10%;"></td> <td style="width: 10%;"></td> <td style="width: 10%;"></td> <td style="width: 10%;"></td> <td style="width: 10%;"></td> <td style="width: 10%;"></td> <td style="width: 10%;"></td> <td style="width: 10%;"></td> <td style="width: 10%;"></td> <td style="width: 10%;"></td> </tr> <tr> <td></td> <td></td> <td colspan="8" style="text-align: center;"> <table border="1" style="width: 100%; border-collapse: collapse; text-align: center;"> <tr> <td style="width: 10%;"></td> <td style="width: 10%;"></td> <td style="width: 10%;"></td> <td style="width: 10%;"></td> <td style="width: 10%;"></td> <td style="width: 10%;"></td> <td style="width: 10%;"></td> <td style="width: 10%;"></td> <td style="width: 10%;"></td> <td style="width: 10%;"></td> </tr> <tr> <td></td> <td></td> <td colspan="8" style="text-align: center;"> <table border="1" style="width: 100%; border-collapse: collapse; text-align: center;"> <tr> <td style="width: 10%;"></td> <td style="width: 10%;"></td> <td style="width: 10%;"></td> <td style="width: 10%;"></td> <td style="width: 10%;"></td> <td style="width: 10%;"></td> <td style="width: 10%;"></td> <td style="width: 10%;"></td> <td style="width: 10%;"></td> <td style="width: 10%;"></td> </tr> <tr> <td></td> <td></td> <td colspan="8" style="text-align: center;"> <table border="1" style="width: 100%; border-collapse: collapse; text-align: center;"> <tr> <td style="width: 10%;"></td> <td style="width: 10%;"></td> <td style="width: 10%;"></td> <td style="width: 10%;"></td> <td style="width: 10%;"></td> <td style="width:
10%;"></td> <td style="width: 10%;"></td> <td style="width: 10%;"></td> <td style="width: 10%;"></td> <td style="width: 10%;"></td> </tr> <tr> <td></td> <td></td> <td colspan="8" style="text-align: center;"> <table border="1" style="width: 100%; border-collapse: collapse; text-align: center;"> <tr> <td style="width: 10%;"></td> <td style="width: 10%;"></td> <td style="width: 10%;"></td> <td style="width: 10%;"></td> <td style="width: 10%;"></td> <td style="width: 10%;"></td> <td style="width: 10%;"></td> <td style="width: 10%;"></td> <td style="width: 10%;"></td> <td style="width: 10%;"></td> </tr> <tr> <td></td> <td></td> <td colspan="8" style="text-align: center;"> <table border="1" style="width: 100%; border-collapse: collapse; text-align: center;"> <tr> <td style="width: 10%;"></td> <td style="width: 10%;"></td> <td style="width: 10%;"></td> <td style="width: 10%;"></td> <td style="width: 10%;"></td> <td style="width: 10%;"></td> <td style="width: 10%;"></td> <td style="width: 10%;"></td> <td style="width: 10%;"></td> <td style="width: 10%;"></td> </tr> <tr> <td></td> <td></td> <td colspan="8" style="text-align: center;"> <table border="1" style="width: 100%; border-collapse: collapse; text-align: center;"> <tr> <td style="width: 10%;"></td> <td style="width: 10%;"></td> <td style="width: 10%;"></td> <td style="width: 10%;"></td> <td style="width: 10%;"></td> <td style="width: 10%;"></td> <td style="width: 10%;"></td> <td style="width: 10%;"></td> <td style="width: 10%;"></td> <td style="width: 10%;"></td> </tr> <tr> <td></td> <td></td> <td colspan="8" style="text-align: center;"> <table border="1" style="width: 100%; border-collapse: collapse; text-align: center;"> <tr> <td style="width: 10%;"></td> <td style="width: 10%;"></td> <td style="width: 10%;"></td> <td style="width: 10%;"></td> <td style="width: 10%;"></td> <td style="width: 10%;"></td> <td style="width: 10%;"></td> <td style="width: 10%;"></td> <td style="width: 10%;"></td> <td style="width: 10%;"></td> </tr> <tr> <td></td> <td></td> <td colspan="8" style="text-align: center;"> <table border="1" style="width: 100%; border-collapse: collapse; text-align: center;"> <tr> <td style="width: 10%;"></td> <td style="width: 10%;"></td> <td style="width: 10%;"></td> <td style="width: 10%;"></td> <td style="width: 10%;"></td> <td style="width: 10%;"></td> <td style="width: 10%;"></td> <td style="width: 10%;"></td> <td style="width: 10%;"></td> <td style="width: 10%;"></td> </tr> <tr> <td></td> <td></td> <td colspan="8" style="text-align: center;"> <table border="1" style="width: 100%; border-collapse: collapse; text-align: center;"> <tr> <td style="width: 10%;"></td> <td style="width: 10%;"></td> <td style="width: 10%;"></td> <td style="width: 10%;"></td> <td style="width: 10%;"></td> <td style="width: 10%;"></td> <td style="width: 10%;"></td> <td style="width: 10%;"></td> <td style="width: 10%;"></td> <td style="width: 10%;"></td> </tr> <tr> <td></td> <td></td> <td colspan="8" style="text-align: center;"> <table border="1" style="width: 100%; border-collapse: collapse; text-align: center;"> <tr> <td style="width: 10%;"></td> <td style="width: 10%;"></td> <td style="width: 10%;"></td> <td style="width: 10%;"></td> <td style="width: 10%;"></td> <td style="width: 10%;"></td> <td style="width: 10%;"></td> <td style="width: 10%;"></td> <td style="width: 10%;"></td> <td style="width: 10%;"></td> </tr> <tr> <td></td> <td></td> <td colspan="8" style="text-align: center;"> <table border="1" style="width: 100%; border-collapse: collapse; text-align: center;"> <tr> <td style="width: 10%;"></td> <td style="width: 10%;"></td> <td style="width: 10%;"></td> <td style="width: 10%;"></td> <td style="width: 10%;"></td> <td style="width: 10%;"></td> <td style="width: 10%;"></td> <td style="width: 10%;"></td> <td style="width: 10%;"></td> <td style="width: 10%;"></td> </tr> <tr> <td></td> <td></td> <td colspan="8" style="text-align: center;"> <table border="1" style="width: 100%; border-collapse: collapse; text-align: center;"> <tr> <td style="width: 10%;"></td> <td style="width: 10%;"></td> <td style="width: 10%;"></td> <td style="width: 10%;"></td> <td style="width: 10%;"></td> <td style="width: 10%;"></td> <td style="width: 10%;"></td> <td style="width: 10%;"></td> <td style="width: 10%;"></td> <td style="width: 10%;"></td> </tr> <tr> <td></td> <td></td> <td colspan="8" style="text-align: center;"> <table border="1" style="width: 100%; border-collapse: collapse; text-align: center;"> <tr> <td style="width: 10%;"></td> <td style="width: 10%;"></td> <td style="width: 10%;"></td> <td style="width: 10%;"></td> <td style="width: 10%;"></td> <td style="width: 10%;"></td> <td style="width: 10%;"></td> <td style="width: 10%;"></td> <td style="width: 10%;"></td> <td style="width: 10%;"></td> </tr> <tr> <td></td> <td></td> <td colspan="8" style="text-align: center;"> <table border="1" style="width: 100%; border-collapse: collapse; text-align: center;"> <tr> <td style="width: 10%;"></td> <td style="width: 10%;"></td> <td style="width: 10%;"></td> <td style="width: 10%;"></td> <td style="width: 10%;"></td> <td style="width: 10%;"></td> <td style="width: 10%;"></td> <td style="width: 10%;"></td> <td style="width: 10%;"></td> <td style="width: 10%;"></td> </tr> <tr> <td></td> <td></td> <td colspan="8" style="text-align: center;"> <table border="1" style="width: 100%; border-collapse: collapse; text-align: center;"> <tr> <td style="width: 10%;"></td> <td style="width: 10%;"></td> <td style="width: 10%;"></td> <td style="width: 10%;"></td> <td style="width: 10%;"></td> <td style="width: 10%;"></td> <td style="width: 10%;"></td> <td style="width: 10%;"></td> <td style="width: 10%;"></td> <td style="width: 10%;"></td> </tr> <tr> <td></td> <td></td> <td colspan="8" style="text-align: center;"> <table border="1" style="width: 100%; border-collapse: collapse; text-align: center;"> <tr> <td style="width: 10%;"></td> <td style="width: 10%;"></td> <td style="width: 10%;"></td> <td style="width: 10%;"></td> <td style="width: 10%;"></td> <td style="width: 10%;"></td> <td style="width: 10%;"></td> <td style="width: 10%;"></td> <td style="width: 10%;"></td> <td style="width: 10%;"></td> </tr> <tr> <td></td> <td></td> <td colspan="8" style="text-align: center;"> <table border="1" style="width: 100%; border-collapse: collapse; text-align: center;"> <tr> <td style="width: 10%;"></td> <td style="width: 10%;"></td> <td style="width: 10%;"></td> <td style="width: 10%;"></td> <td style="width: 10%;"></td> <td style="width: 10%;"></td> <td style="width: 10%;"></td> <td style="width: 10%;"></td> <td style="width: 10%;"></td> <td style="width: 10%;"></td> </tr> <tr> <td></td> <td></td> <td colspan="8" style="text-align: center;"> <table border="1" style="width: 100%; border-collapse: collapse; text-align: center;"> <tr> <td style="width: 10%;"></td> <td style="width: 10%;"></td> <td style="width: 10%;"></td> <td style="width: 10%;"></td> <td style="width: 10%;"></td> <td style="width: 10%;"></td> <td style="width: 10%;"></td> <td style="width: 10%;"></td> <td style="width: 10%;"></td> <td style="width: 10%;"></td> </tr> <tr> <td></td> <td></td> <td colspan="8" style="text-align: center;"> <table border="1" style="width: 100%; border-collapse: collapse; text-align: center;"> <tr> <td style="width: 10%;"></td> <td style="width: 10%;"></td> <td style="width: 10%;"></td> <td style="width: 10%;"></td> <td style="width: 10%;"></td> <td style="width: 10%;"></td> <td style="width: 10%;"></td> <td style="width: 10%;"></td> <td style="width: 10%;"></td> <td style="width: 10%;"></td> </tr> <tr> <td></td> <td></td> <td colspan="8" style="text-align: center;"> <table border="1" style="width: 100%; border-collapse: collapse; text-align: center;"> <tr> <td style="width: 10%;"></td> <td style="width: 10%;"></td> <td style="width: 10%;"></td> <td style="width: 10%;"></td> <td style="width: 10%;"></td> <td style="width: 10%;"></td> <td style="width: 10%;"></td> <td style="width: 10%;"></td> <td style="width: 10%;"></td> <td style="width: 10%;"></td> </tr> <tr> <td></td> <td></td> <td colspan="8" style="text-align: center;"> <table border="1" style="width: 100%; border-collapse: collapse; text-align: center;"> <tr> <td style="width: 10%;"></td> <td style="width: 10%;"></td> <td style="width: 10%;"></td> <td style="width: 10%;"></td> <td style="width: 10%;"></td> <td style="width: 10%;"></td> <td style="width: 10%;"></td> <td style="width: 10%;"></td> <td style="width: 10%;"></td> <td style="width: 10%;"></td> </tr> <tr> <td></td> <td></td> <td colspan="8" style="text-align: center;"> <table border="1" style="width: 100%; border-collapse: collapse; text-align: center;"> <tr> <td style="width: 10%;"></td> <td style="width: 10%;"></td> <td style="width: 10%;"></td> <td style="width: 10%;"></td> <td style="width: 10%;"></td> <td style="width: 10%;"></td> <td style="width: 10%;"></td> <td style="width: 10%;"></td> <td style="width: 10%;"></td> <td style="width: 10%;"></td> </tr> <tr> <td></td> <td></td> <td colspan="8" style="text-align: center;"> <table border="1" style="width: 100%; border-collapse: collapse; text-align: center;"> <tr> <td style="width: 10%;"></td> <td style="width: 10%;"></td> <td style="width: 10%;"></td> <td style="width: 10%;"></td> <td style="width: 10%;"></td> <td style="width: 10%;"></td> <td style="width: 10%;"></td> <td style="width: 10%;"></td> <td style="width: 10%;"></td> <td style="width: 10%;"></td> </tr> <tr> <td></td> <td></td> <td colspan="8" style="text-align: center;"> <table border="1" style="width: 100%; border-collapse: collapse; text-align: center;"> <tr> <td style="width: 10%;"></td> <td style="width: 10%;"></td> <td style="width: 10%;"></td> <td style="width: 10%;"></td> <td style="width: 10%;"></td> <td style="width: 10%;"></td> <td style="width: 10%;"></td> <td style="width: 10%;"></td> <td style="width: 10%;"></td> <td style="width: 10%;"></td> </tr> <tr> <td></td> <td></td> <td
colspan="8" style="text-align: center;"> <table border="1" style="width: 100%; border-collapse: collapse; text-align: center;"> <tr> <td style="width: 10%;"></td> <td style="width: 10%;"></td> <td style="width: 10%;"></td> <td style="width: 10%;"></td> <td style="width: 10%;"></td> <td style="width: 10%;"></td> <td style="width: 10%;"></td> <td style="width: 10%;"></td> <td style="width: 10%;"></td> <td style="width: 10%;"></td> </tr> <tr> <td></td> <td></td> <td colspan="8" style="text-align: center;"> <table border="1" style="width: 100%; border-collapse: collapse; text-align: center;"> <tr> <td style="width: 10%;"></td> <td style="width: 10%;"></td> <td style="width: 10%;"></td> <td style="width: 10%;"></td> <td style="width: 10%;"></td> <td style="width: 10%;"></td> <td style="width: 10%;"></td> <td style="width: 10%;"></td> <td style="width: 10%;"></td> <td style="width: 10%;"></td> </tr> <tr> <td></td> <td></td> <td colspan="8" style="text-align: center;"> <table border="1" style="width: 100%; border-collapse: collapse; text-align: center;"> <tr> <td style="width: 10%;"></td> <td style="width: 10%;"></td> <td style="width: 10%;"></td> <td style="width: 10%;"></td> <td style="width: 10%;"></td> <td style="width: 10%;"></td> <td style="width: 10%;"></td> <td style="width: 10%;"></td> <td style="width: 10%;"></td> <td style="width: 10%;"></td> </tr> <tr> <td></td> <td></td> <td colspan="8" style="text-align: center;"> <table border="1" style="width: 100%; border-collapse: collapse; text-align: center;"> <tr> <td style="width: 10%;"></td> <td style="width: 10%;"></td> <td style="width: 10%;"></td> <td style="width: 10%;"></td> <td style="width: 10%;"></td> <td style="width: 10%;"></td> <td style="width: 10%;"></td> <td style="width: 10%;"></td> <td style="width: 10%;"></td> <td style="width: 10%;"></td> </tr> <tr> <td></td> <td></td> <td colspan="8" style="text-align: center;"> <table border="1" style="width: 100%; border-collapse: collapse; text-align: center;"> <tr> <td style="width: 10%;"></td> <td style="width: 10%;"></td> <td style="width: 10%;"></td> <td style="width: 10%;"></td> <td style="width: 10%;"></td> <td style="width: 10%;"></td> <td style="width: 10%;"></td> <td style="width: 10%;"></td> <td style="width: 10%;"></td> <td style="width: 10%;"></td> </tr> <tr> <td></td> <td></td> <td colspan="8" style="text-align: center;"> <table border="1" style="width: 100%; border-collapse: collapse; text-align: center;"> <tr> <td style="width: 10%;"></td> <td style="width: 10%;"></td> <td style="width: 10%;"></td> <td style="width: 10%;"></td> <td style="width: 10%;"></td> <td style="width: 10%;"></td> <td style="width: 10%;"></td> <td style="width: 10%;"></td> <td style="width: 10%;"></td> <td style="width: 10%;"></td> </tr> <tr> <td></td> <td></td> <td colspan="8" style="text-align: center;"> <table border="1" style="width: 100%; border-collapse: collapse; text-align: center;"> <tr> <td style="width: 10%;"></td> <td style="width: 10%;"></td> <td style="width: 10%;"></td> <td style="width: 10%;"></td> <td style="width: 10%;"></td> <td style="width: 10%;"></td> <td style="width: 10%;"></td> <td style="width: 10%;"></td> <td style="width: 10%;"></td> <td style="width: 10%;"></td> </tr> <tr> <td></td> <td></td> <td colspan="8" style="text-align: center;"> <table border="1" style="width: 100%; border-collapse: collapse; text-align: center;"> <tr> <td style="width: 10%;"></td> <td style="width: 10%;"></td> <td style="width: 10%;"></td> <td style="width: 10%;"></td> <td style="width: 10%;"></td> <td style="width: 10%;"></td> <td style="width: 10%;"></td> <td style="width: 10%;"></td> <td style="width: 10%;"></td> <td style="width: 10%;"></td> </tr> <tr> <td></td> <td></td> <td colspan="8" style="text-align: center;"> <table border="1" style="width: 100%; border-collapse: collapse; text-align: center;"> <tr> <td style="width: 10%;"></td> <td style="width: 10%;"></td> <td style="width: 10%;"></td> <td style="width: 10%;"></td> <td style="width: 10%;"></td> <td style="width: 10%;"></td> <td style="width: 10%;"></td> <td style="width: 10%;"></td> <td style="width: 10%;"></td> <td style="width: 10%;"></td> </tr> <tr> <td></td> <td></td> <td colspan="8" style="text-align: center;"> <table border="1" style="width: 100%; border-collapse: collapse; text-align: center;"> <tr> <td style="width: 10%;"></td> <td style="width: 10%;"></td> <td style="width: 10%;"></td> <td style="width: 10%;"></td> <td style="width: 10%;"></td> <td style="width: 10%;"></td> <td style="width: 10%;"></td> <td style="width: 10%;"></td> <td style="width: 10%;"></td> <td style="width: 10%;"></td> </tr> <tr> <td></td> <td></td> <td colspan="8" style="text-align: center;"> <table border="1" style="width: 100%; border-collapse: collapse; text-align: center;"> <tr> <td style="width: 10%;"></td> <td style="width: 10%;"></td> <td style="width: 10%;"></td> <td style="width: 10%;"></td> <td style="width: 10%;"></td> <td style="width: 10%;"></td> <td style="width: 10%;"></td> <td style="width: 10%;"></td> <td style="width: 10%;"></td> <td style="width: 10%;"></td> </tr> <tr> <td></td> <td></td> <td colspan="8" style="text-align: center;"> <table border="1" style="width: 100%; border-collapse: collapse; text-align: center;"> <tr> <td style="width: 10%;"></td> <td style="width: 10%;"></td> <td style="width: 10%;"></td> <td style="width: 10%;"></td> <td style="width: 10%;"></td> <td style="width: 10%;"></td> <td style="width: 10%;"></td> <td style="width: 10%;"></td> <td style="width: 10%;"></td> <td style="width: 10%;"></td> </tr> <tr> <td></td> <td></td> <td colspan="8" style="text-align: center;"> <table border="1" style="width: 100%; border-collapse: collapse; text-align: center;"> <tr> <td style="width: 10%;"></td> <td style="width: 10%;"></td> <td style="width: 10%;"></td> <td style="width: 10%;"></td> <td style="width: 10%;"></td> <td style="width: 10%;"></td> <td style="width: 10%;"></td> <td style="width: 10%;"></td> <td style="width: 10%;"></td> <td style="width: 10%;"></td> </tr> <tr> <td></td> <td></td> <td colspan="8" style="text-align: center;"> <table border="1" style="width: 100%; border-collapse: collapse; text-align: center;"> <tr> <td style="width: 10%;"></td> <td style="width: 10%;"></td> <td style="width: 10%;"></td> <td style="width: 10%;"></td> <td style="width: 10%;"></td> <td style="width: 10%;"></td> <td style="width: 10%;"></td> <td style="width: 10%;"></td> <td style="width: 10%;"></td> <td style="width: 10%;"></td> </tr> <tr> <td></td> <td></td> <td colspan="8" style="text-align: center;"> <table border="1" style="width: 100%; border-collapse: collapse; text-align: center;"> <tr> <td style="width: 10%;"></td> <td style="width: 10%;"></td> <td style="width: 10%;"></td> <td style="width: 10%;"></td> <td style="width: 10%;"></td> <td style="width: 10%;"></td> <td style="width: 10%;"></td> <td style="width: 10%;"></td> <td style="width: 10%;"></td> <td style="width: 10%;"></td> </tr> <tr> <td></td> <td></td> <td colspan="8" style="text-align: center;"> <table border="1" style="width: 100%; border-collapse: collapse; text-align: center;"> <tr> <td style="width: 10%;"></td> <td style="width: 10%;"></td> <td style="width: 10%;"></td> <td style="width: 10%;"></td> <td style="width: 10%;"></td> <td style="width: 10%;"></td> <td style="width: 10%;"></td> <td style="width: 10%;"></td> <td style="width: 10%;"></td> <td style="width: 10%;"></td> </tr> <tr> <td></td> <td></td> <td colspan="8" style="text-align: center;"> <table border="1" style="width: 100%; border-collapse: collapse; text-align: center;"> <tr> <td style="width: 10%;"></td> <td style="width: 10%;"></td> <td style="width: 10%;"></td> <td style="width: 10%;"></td> <td style="width: 10%;"></td> <td style="width: 10%;"></td> <td style="width: 10%;"></td> <td style="width: 10%;"></td> <td style="width: 10%;"></td> <td style="width: 10%;"></td> </tr> <tr> <td></td> <td></td> <td colspan="8" style="text-align: center;"> <table border="1" style="width: 100%; border-collapse: collapse; text-align: center;"> <tr> </tr></table></td></tr></table></td></tr></table></td></tr></table></td></tr></table></td></tr></table></td></tr></table></td></tr></table></td></tr></table></td></tr></table></td></tr></table></td></tr></table></td></tr></table></td></tr></table></td></tr></table></td></tr></table></td></tr></table></td></tr></table></td></tr></table></td></tr></table></td></tr></table></td></tr></table></td></tr></table></td></tr></table></td></tr></table></td></tr></table></td></tr></table></td></tr></table></td></tr></table></td></tr></table></td></tr></table></td></tr></table></td></tr></table></td></tr></table></td></tr></table></td></tr></table></td></tr></table></td></tr></table></td></tr></table></td></tr></table></td></tr></table></td></tr></table></td></tr></table></td></tr></table></td></tr></table></td></tr></table></td></tr></table></td></tr></table></td></tr></table></td></tr></table></td></tr></table></td></tr></table></td></tr></table></td></tr></table></td></tr></table></td></tr></table></td></tr></table></td></tr></table>
 | | | | | | | | | | | | | | | | | | | | <table border="1" style="width: 100%; border-collapse: collapse; text-align: center;"> <tr> <td style="width: 10%;"></td> <td style="width: 10%;"></td> <td style="width: 10%;"></td> <td style="width: 10%;"></td> <td style="width: 10%;"></td> <td style="width: 10%;"></td> <td style="width: 10%;"></td> <td style="width: 10%;"></td> <td style="width: 10%;"></td> <td style="width: 10%;"></td> </tr> <tr> <td></td> <td></td> <td colspan="8" style="text-align: center;"> <table border="1" style="width: 100%; border-collapse: collapse; text-align: center;"> <tr> <td style="width: 10%;"></td> <td style="width: 10%;"></td> <td style="width: 10%;"></td> <td style="width: 10%;"></td> <td style="width: 10%;"></td> <td style="width: 10%;"></td> <td style="width: 10%;"></td> <td style="width: 10%;"></td> <td style="width: 10%;"></td> <td style="width: 10%;"></td> </tr> <tr> <td></td> <td></td> <td colspan="8" style="text-align: center;"> <table border="1" style="width: 100%; border-collapse: collapse; text-align: center;"> <tr> <td style="width: 10%;"></td> <td style="width: 10%;"></td> <td style="width: 10%;"></td> <td style="width: 10%;"></td> <td style="width: 10%;"></td> <td style="width: 10%;"></td> <td style="width: 10%;"></td> <td style="width: 10%;"></td> <td style="width: 10%;"></td> <td style="width: 10%;"></td> </tr> <tr> <td></td> <td></td> <td colspan="8" style="text-align: center;"> <table border="1" style="width: 100%; border-collapse: collapse; text-align: center;"> <tr> <td style="width: 10%;"></td> <td style="width: 10%;"></td> <td style="width: 10%;"></td> <td style="width: 10%;"></td> <td style="width: 10%;"></td> <td style="width: 10%;"></td> <td style="width: 10%;"></td> <td style="width: 10%;"></td> <td style="width: 10%;"></td> <td style="width: 10%;"></td> </tr> <tr> <td></td> <td></td> <td colspan="8" style="text-align: center;"> <table border="1" style="width: 100%; border-collapse: collapse; text-align: center;"> <tr> <td style="width: 10%;"></td> <td style="width: 10%;"></td> <td style="width: 10%;"></td> <td style="width: 10%;"></td> <td style="width: 10%;"></td> <td style="width: 10%;"></td> <td style="width: 10%;"></td> <td style="width: 10%;"></td> <td style="width: 10%;"></td> <td style="width: 10%;"></td> </tr> <tr> <td></td> <td></td> <td colspan="8" style="text-align: center;"> <table border="1" style="width: 100%; border-collapse: collapse; text-align: center;"> <tr> <td style="width: 10%;"></td> <td style="width: 10%;"></td> <td style="width: 10%;"></td> <td style="width: 10%;"></td> <td style="width: 10%;"></td> <td style="width: 10%;"></td> <td style="width: 10%;"></td> <td style="width: 10%;"></td> <td style="width: 10%;"></td> <td style="width: 10%;"></td> </tr> <tr> <td></td> <td></td> <td colspan="8" style="text-align: center;"> <table border="1" style="width: 100%; border-collapse: collapse; text-align: center;"> <tr> <td style="width: 10%;"></td> <td style="width: 10%;"></td> <td style="width: 10%;"></td> <td style="width: 10%;"></td> <td style="width: 10%;"></td> <td style="width: 10%;"></td> <td style="width: 10%;"></td> <td style="width: 10%;"></td> <td style="width: 10%;"></td> <td style="width: 10%;"></td> </tr> <tr> <td></td> <td></td> <td colspan="8" style="text-align: center;"> <table border="1" style="width: 100%; border-collapse: collapse; text-align: center;"> <tr> <td style="width: 10%;"></td> <td style="width: 10%;"></td> <td style="width: 10%;"></td> <td style="width: 10%;"></td> <td style="width: 10%;"></td> <td style="width: 10%;"></td> <td style="width: 10%;"></td> <td style="width: 10%;"></td> <td style="width: 10%;"></td> <td style="width: 10%;"></td> </tr> <tr> <td></td> <td></td> <td colspan="8" style="text-align: center;"> <table border="1" style="width: 100%; border-collapse: collapse; text-align: center;"> <tr> <td style="width: 10%;"></td> <td style="width: 10%;"></td> <td style="width: 10%;"></td> <td style="width: 10%;"></td> <td style="width: 10%;"></td> <td style="width: 10%;"></td> <td style="width: 10%;"></td> <td style="width: 10%;"></td> <td style="width: 10%;"></td> <td style="width: 10%;"></td> </tr> <tr> <td></td> <td></td> <td colspan="8" style="text-align: center;"> <table border="1" style="width: 100%; border-collapse: collapse; text-align: center;"> <tr> <td style="width: 10%;"></td> <td style="width: 10%;"></td> <td style="width: 10%;"></td> <td style="width: 10%;"></td> <td style="width: 10%;"></td> <td style="width: 10%;"></td> <td style="width: 10%;"></td> <td style="width: 10%;"></td> <td style="width: 10%;"></td> <td style="width: 10%;"></td> </tr> <tr> <td></td> <td></td> <td colspan="8" style="text-align: center;"> <table border="1" style="width: 100%; border-collapse: collapse; text-align: center;"> <tr> <td style="width: 10%;"></td> <td style="width: 10%;"></td> <td style="width: 10%;"></td> <td style="width: 10%;"></td> <td style="width: 10%;"></td> <td style="width: 10%;"></td> <td style="width: 10%;"></td> <td style="width: 10%;"></td> <td style="width: 10%;"></td> <td style="width: 10%;"></td> </tr> <tr> <td></td> <td></td> <td colspan="8" style="text-align: center;"> <table border="1" style="width: 100%; border-collapse: collapse; text-align: center;"> <tr> <td style="width: 10%;"></td> <td style="width: 10%;"></td> <td style="width: 10%;"></td> <td style="width: 10%;"></td> <td style="width: 10%;"></td> <td style="width: 10%;"></td> <td style="width: 10%;"></td> <td style="width: 10%;"></td> <td style="width: 10%;"></td> <td style="width: 10%;"></td> </tr> <tr> <td></td> <td></td> <td colspan="8" style="text-align: center;"> <table border="1" style="width: 100%; border-collapse: collapse; text-align: center;"> <tr> <td style="width: 10%;"></td> <td style="width: 10%;"></td> <td style="width: 10%;"></td> <td style="width: 10%;"></td> <td style="width: 10%;"></td> <td style="width: 10%;"></td> <td style="width: 10%;"></td> <td style="width: 10%;"></td> <td style="width: 10%;"></td> <td style="width: 10%;"></td> </tr> <tr> <td></td> <td></td> <td colspan="8" style="text-align: center;"> <table border="1" style="width: 100%; border-collapse: collapse; text-align: center;"> <tr> <td style="width: 10%;"></td> <td style="width: 10%;"></td> <td style="width: 10%;"></td> <td style="width: 10%;"></td> <td style="width: 10%;"></td> <td style="width: 10%;"></td> <td style="width: 10%;"></td> <td style="width: 10%;"></td> <td style="width: 10%;"></td> <td style="width: 10%;"></td> </tr> <tr> <td></td> <td></td> <td colspan="8" style="text-align: center;"> <table border="1" style="width: 100%; border-collapse: collapse; text-align: center;"> <tr> <td style="width: 10%;"></td> <td style="width: 10%;"></td> <td style="width: 10%;"></td> <td style="width: 10%;"></td> <td style="width: 10%;"></td> <td style="width: 10%;"></td> <td style="width: 10%;"></td> <td style="width: 10%;"></td> <td style="width: 10%;"></td> <td style="width: 10%;"></td> </tr> <tr> <td></td> <td></td> <td colspan="8" style="text-align: center;"> <table border="1" style="width: 100%; border-collapse: collapse; text-align: center;"> <tr> <td style="width: 10%;"></td> <td style="width: 10%;"></td> <td style="width: 10%;"></td> <td style="width: 10%;"></td> <td style="width: 10%;"></td> <td style="width: 10%;"></td> <td style="width: 10%;"></td> <td style="width: 10%;"></td> <td style="width: 10%;"></td> <td style="width: 10%;"></td> </tr> <tr> <td></td> <td></td> <td colspan="8" style="text-align: center;"> <table border="1" style="width: 100%; border-collapse: collapse; text-align: center;"> <tr> <td style="width: 10%;"></td> <td style="width: 10%;"></td> <td style="width: 10%;"></td> <td style="width: 10%;"></td> <td style="width: 10%;"></td> <td style="width: 10%;"></td> <td style="width: 10%;"></td> <td style="width: 10%;"></td> <td style="width: 10%;"></td> <td style="width: 10%;"></td> </tr> <tr>
<td></td> <td></td> <td colspan="8" style="text-align: center;"> <table border="1" style="width: 100%; border-collapse: collapse; text-align: center;"> <tr> <td style="width: 10%;"></td> <td style="width: 10%;"></td> <td style="width: 10%;"></td> <td style="width: 10%;"></td> <td style="width: 10%;"></td> <td style="width: 10%;"></td> <td style="width: 10%;"></td> <td style="width: 10%;"></td> <td style="width: 10%;"></td> <td style="width: 10%;"></td> </tr> <tr> <td></td> <td></td> <td colspan="8" style="text-align: center;"> <table border="1" style="width: 100%; border-collapse: collapse; text-align: center;"> <tr> <td style="width: 10%;"></td> <td style="width: 10%;"></td> <td style="width: 10%;"></td> <td style="width: 10%;"></td> <td style="width: 10%;"></td> <td style="width: 10%;"></td> <td style="width: 10%;"></td> <td style="width: 10%;"></td> <td style="width: 10%;"></td> <td style="width: 10%;"></td> </tr> <tr> <td></td> <td></td> <td colspan="8" style="text-align: center;"> <table border="1" style="width: 100%; border-collapse: collapse; text-align: center;"> <tr> <td style="width: 10%;"></td> <td style="width: 10%;"></td> <td style="width: 10%;"></td> <td style="width: 10%;"></td> <td style="width: 10%;"></td> <td style="width: 10%;"></td> <td style="width: 10%;"></td> <td style="width: 10%;"></td> <td style="width: 10%;"></td> <td style="width: 10%;"></td> </tr> <tr> <td></td> <td></td> <td colspan="8" style="text-align: center;"> <table border="1" style="width: 100%; border-collapse: collapse; text-align: center;"> <tr> <td style="width: 10%;"></td> <td style="width: 10%;"></td> <td style="width: 10%;"></td> <td style="width: 10%;"></td> <td style="width: 10%;"></td> <td style="width: 10%;"></td> <td style="width: 10%;"></td> <td style="width: 10%;"></td> <td style="width: 10%;"></td> <td style="width: 10%;"></td> </tr> <tr> <td></td> <td></td> <td colspan="8" style="text-align: center;"> <table border="1" style="width: 100%; border-collapse: collapse; text-align: center;"> <tr> <td style="width: 10%;"></td> <td style="width: 10%;"></td> <td style="width: 10%;"></td> <td style="width: 10%;"></td> <td style="width: 10%;"></td> <td style="width: 10%;"></td> <td style="width: 10%;"></td> <td style="width: 10%;"></td> <td style="width: 10%;"></td> <td style="width: 10%;"></td> </tr> <tr> <td></td> <td></td> <td colspan="8" style="text-align: center;"> <table border="1" style="width: 100%; border-collapse: collapse; text-align: center;"> <tr> <td style="width: 10%;"></td> <td style="width: 10%;"></td> <td style="width: 10%;"></td> <td style="width: 10%;"></td> <td style="width: 10%;"></td> <td style="width: 10%;"></td> <td style="width: 10%;"></td> <td style="width: 10%;"></td> <td style="width: 10%;"></td> <td style="width: 10%;"></td> </tr> <tr> <td></td> <td></td> <td colspan="8" style="text-align: center;"> <table border="1" style="width: 100%; border-collapse: collapse; text-align: center;"> <tr> <td style="width: 10%;"></td> <td style="width: 10%;"></td> <td style="width: 10%;"></td> <td style="width: 10%;"></td> <td style="width: 10%;"></td> <td style="width: 10%;"></td> <td style="width: 10%;"></td> <td style="width: 10%;"></td> <td style="width: 10%;"></td> <td style="width: 10%;"></td> </tr> <tr> <td></td> <td></td> <td colspan="8" style="text-align: center;"> <table border="1" style="width: 100%; border-collapse: collapse; text-align: center;"> <tr> <td style="width: 10%;"></td> <td style="width: 10%;"></td> <td style="width: 10%;"></td> <td style="width: 10%;"></td> <td style="width: 10%;"></td> <td style="width: 10%;"></td> <td style="width: 10%;"></td> <td style="width: 10%;"></td> <td style="width: 10%;"></td> <td style="width: 10%;"></td> </tr> <tr> <td></td> <td></td> <td colspan="8" style="text-align: center;"> <table border="1" style="width: 100%; border-collapse: collapse; text-align: center;"> <tr> <td style="width: 10%;"></td> <td style="width: 10%;"></td> <td style="width: 10%;"></td> <td style="width: 10%;"></td> <td style="width: 10%;"></td> <td style="width: 10%;"></td> <td style="width: 10%;"></td> <td style="width: 10%;"></td> <td style="width: 10%;"></td> <td style="width: 10%;"></td> </tr> <tr> <td></td> <td></td> <td colspan="8" style="text-align: center;"> <table border="1" style="width: 100%; border-collapse: collapse; text-align: center;"> <tr> <td style="width: 10%;"></td> <td style="width: 10%;"></td> <td style="width: 10%;"></td> <td style="width: 10%;"></td> <td style="width: 10%;"></td> <td style="width: 10%;"></td> <td style="width: 10%;"></td> <td style="width: 10%;"></td> <td style="width: 10%;"></td> <td style="width: 10%;"></td> </tr> <tr> <td></td> <td></td> <td colspan="8" style="text-align: center;"> <table border="1" style="width: 100%; border-collapse: collapse; text-align: center;"> <tr> <td style="width: 10%;"></td> <td style="width: 10%;"></td> <td style="width: 10%;"></td> <td style="width: 10%;"></td> <td style="width: 10%;"></td> <td style="width: 10%;"></td> <td style="width: 10%;"></td> <td style="width: 10%;"></td> <td style="width: 10%;"></td> <td style="width: 10%;"></td> </tr> <tr> <td></td> <td></td> <td colspan="8" style="text-align: center;"> <table border="1" style="width: 100%; border-collapse: collapse; text-align: center;"> <tr> <td style="width: 10%;"></td> <td style="width: 10%;"></td> <td style="width: 10%;"></td> <td style="width: 10%;"></td> <td style="width: 10%;"></td> <td style="width: 10%;"></td> <td style="width: 10%;"></td> <td style="width: 10%;"></td> <td style="width: 10%;"></td> <td style="width: 10%;"></td> </tr> <tr> <td></td> <td></td> <td colspan="8" style="text-align: center;"> <table border="1" style="width: 100%; border-collapse: collapse; text-align: center;"> <tr> <td style="width: 10%;"></td> <td style="width: 10%;"></td> <td style="width: 10%;"></td> <td style="width: 10%;"></td> <td style="width: 10%;"></td> <td style="width: 10%;"></td> <td style="width: 10%;"></td> <td style="width: 10%;"></td> <td style="width: 10%;"></td> <td style="width: 10%;"></td> </tr> <tr> <td></td> <td></td> <td colspan="8" style="text-align: center;"> <table border="1" style="width: 100%; border-collapse: collapse; text-align: center;"> <tr> <td style="width: 10%;"></td> <td style="width: 10%;"></td> <td style="width: 10%;"></td> <td style="width: 10%;"></td> <td style="width: 10%;"></td> <td style="width: 10%;"></td> <td style="width: 10%;"></td> <td style="width: 10%;"></td> <td style="width: 10%;"></td> <td style="width: 10%;"></td> </tr> <tr> <td></td> <td></td> <td colspan="8" style="text-align: center;"> <table border="1" style="width: 100%; border-collapse: collapse; text-align: center;"> <tr> <td style="width: 10%;"></td> <td style="width: 10%;"></td> <td style="width: 10%;"></td> <td style="width: 10%;"></td> <td style="width: 10%;"></td> <td style="width: 10%;"></td> <td style="width: 10%;"></td> <td style="width: 10%;"></td> <td style="width: 10%;"></td> <td style="width: 10%;"></td> </tr> <tr> <td></td> <td></td> <td colspan="8" style="text-align: center;"> <table border="1" style="width: 100%; border-collapse: collapse; text-align: center;"> <tr> <td style="width: 10%;"></td> <td style="width: 10%;"></td> <td style="width: 10%;"></td> <td style="width: 10%;"></td> <td style="width: 10%;"></td> <td style="width: 10%;"></td> <td style="width: 10%;"></td> <td style="width: 10%;"></td> <td style="width: 10%;"></td> <td style="width: 10%;"></td> </tr> <tr> <td></td> <td></td> <td colspan="8" style="text-align: center;"> <table border="1" style="width: 100%; border-collapse: collapse; text-align: center;"> <tr> <td style="width: 10%;"></td> <td style="width: 10%;"></td> <td style="width: 10%;"></td> <td style="width: 10%;"></td> <td style="width: 10%;"></td> <td style="width: 10%;"></td> <td style="width: 10%;"></td> <td style="width: 10%;"></td> <td style="width: 10%;"></td> <td style="width: 10%;"></td> </tr> <tr> <td></td> <td></td> <td colspan="8" style="text-align: center;"> <table border="1" style="width: 100%; border-collapse: collapse; text-align: center;"> <tr> <td style="width: 10%;"></td> <td style="width: 10%;"></td> <td style="width: 10%;"></td> <td style="width: 10%;"></td> <td style="width: 10%;"></td> <td style="width: 10%;"></td> <td style="width: 10%;"></td> <td style="width: 10%;"></td> <td style="width: 10%;"></td> <td style="width: 10%;"></td> </tr> <tr> <td></td> <td></td> <td colspan="8" style="text-align: center;"> <table border="1" style="width: 100%; border-collapse: collapse; text-align: center;"> <tr> <td style="width: 10%;"></td> <td style="width: 10%;"></td> <td style="width: 10%;"></td> <td style="width: 10%;"></td> <td style="width: 10%;"></td> <td style="width: 10%;"></td> <td style="width: 10%;"></td> <td style="width: 10%;"></td> <td style="width: 10%;"></td> <td style="width: 10%;"></td> </tr> <tr> <td></td> <td></td> <td colspan="8" style="text-align: center;"> <table border="1" style="width: 100%; border-collapse: collapse; text-align: center;"> <tr> <td style="width: 10%;"></td> <td style="width: 10%;"></td> <td style="width: 10%;"></td> <td style="width: 10%;"></td> <td style="width: 10%;"></td> <td style="width: 10%;"></td> <td style="width: 10%;"></td> <td style="width: 10%;"></td> <td style="width: 10%;"></td> <td style="width: 10%;"></td> </tr> <tr> <td></td> <td></td> <td colspan="8" style="text-align: center;"> <table border="1" style="width: 100%; border-collapse: collapse; text-align: center;"> <tr> <td style="width: 10%;"></td> <td style="width: 10%;"></td> <td style="width: 10%;"></td> <td style="width: 10%;"></td> <td style="width: 10%;"></td> <td style="width: 10%;"></td> <td style="width: 10%;"></td> <td style="width: 10%;"></td> <td style="width: 10%;"></td> <td style="width: 10%;"></td> </tr> <tr> <td></td> <td></td> <td colspan="8" style="text-align: center;"> <table border="1" style="width: 100%; border-collapse: collapse; text-align: center;"> <tr> <td
style="width: 10%;"></td> <td style="width: 10%;"></td> <td style="width: 10%;"></td> <td style="width: 10%;"></td> <td style="width: 10%;"></td> <td style="width: 10%;"></td> <td style="width: 10%;"></td> <td style="width: 10%;"></td> <td style="width: 10%;"></td> <td style="width: 10%;"></td> </tr> <tr> <td></td> <td></td> <td colspan="8" style="text-align: center;"> <table border="1" style="width: 100%; border-collapse: collapse; text-align: center;"> <tr> <td style="width: 10%;"></td> <td style="width: 10%;"></td> <td style="width: 10%;"></td> <td style="width: 10%;"></td> <td style="width: 10%;"></td> <td style="width: 10%;"></td> <td style="width: 10%;"></td> <td style="width: 10%;"></td> <td style="width: 10%;"></td> <td style="width: 10%;"></td> </tr> <tr> <td></td> <td></td> <td colspan="8" style="text-align: center;"> <table border="1" style="width: 100%; border-collapse: collapse; text-align: center;"> <tr> <td style="width: 10%;"></td> <td style="width: 10%;"></td> <td style="width: 10%;"></td> <td style="width: 10%;"></td> <td style="width: 10%;"></td> <td style="width: 10%;"></td> <td style="width: 10%;"></td> <td style="width: 10%;"></td> <td style="width: 10%;"></td> <td style="width: 10%;"></td> </tr> <tr> <td></td> <td></td> <td colspan="8" style="text-align: center;"> <table border="1" style="width: 100%; border-collapse: collapse; text-align: center;"> <tr> <td style="width: 10%;"></td> <td style="width: 10%;"></td> <td style="width: 10%;"></td> <td style="width: 10%;"></td> <td style="width: 10%;"></td> <td style="width: 10%;"></td> <td style="width: 10%;"></td> <td style="width: 10%;"></td> <td style="width: 10%;"></td> <td style="width: 10%;"></td> </tr> <tr> <td></td> <td></td> <td colspan="8" style="text-align: center;"> <table border="1" style="width: 100%; border-collapse: collapse; text-align: center;"> <tr> <td style="width: 10%;"></td> <td style="width: 10%;"></td> <td style="width: 10%;"></td> <td style="width: 10%;"></td> <td style="width: 10%;"></td> <td style="width: 10%;"></td> <td style="width: 10%;"></td> <td style="width: 10%;"></td> <td style="width: 10%;"></td> <td style="width: 10%;"></td> </tr> <tr> <td></td> <td></td> <td colspan="8" style="text-align: center;"> <table border="1" style="width: 100%; border-collapse: collapse; text-align: center;"> <tr> <td style="width: 10%;"></td> <td style="width: 10%;"></td> <td style="width: 10%;"></td> <td style="width: 10%;"></td> <td style="width: 10%;"></td> <td style="width: 10%;"></td> <td style="width: 10%;"></td> <td style="width: 10%;"></td> <td style="width: 10%;"></td> <td style="width: 10%;"></td> </tr> <tr> <td></td> <td></td> <td colspan="8" style="text-align: center;"> <table border="1" style="width: 100%; border-collapse: collapse; text-align: center;"> <tr> <td style="width: 10%;"></td> <td style="width: 10%;"></td> <td style="width: 10%;"></td> <td style="width: 10%;"></td> <td style="width: 10%;"></td> <td style="width: 10%;"></td> <td style="width: 10%;"></td> <td style="width: 10%;"></td> <td style="width: 10%;"></td> <td style="width: 10%;"></td> </tr> <tr> <td></td> <td></td> <td colspan="8" style="text-align: center;"> <table border="1" style="width: 100%; border-collapse: collapse; text-align: center;"> <tr> <td style="width: 10%;"></td> <td style="width: 10%;"></td> <td style="width: 10%;"></td> <td style="width: 10%;"></td> <td style="width: 10%;"></td> <td style="width: 10%;"></td> <td style="width: 10%;"></td> <td style="width: 10%;"></td> <td style="width: 10%;"></td> <td style="width: 10%;"></td> </tr> <tr> <td></td> <td></td> <td colspan="8" style="text-align: center;"> <table border="1" style="width: 100%; border-collapse: collapse; text-align: center;"> <tr> <td style="width: 10%;"></td> <td style="width: 10%;"></td> <td style="width: 10%;"></td> <td style="width: 10%;"></td> <td style="width: 10%;"></td> <td style="width: 10%;"></td> <td style="width: 10%;"></td> <td style="width: 10%;"></td> <td style="width: 10%;"></td> <td style="width: 10%;"></td> </tr> <tr> <td></td> <td></td> <td colspan="8" style="text-align: center;"> <table border="1" style="width: 100%; border-collapse: collapse; text-align: center;"> <tr> <td style="width: 10%;"></td> <td style="width: 10%;"></td> <td style="width: 10%;"></td> <td style="width: 10%;"></td> <td style="width: 10%;"></td> <td style="width: 10%;"></td> <td style="width: 10%;"></td> <td style="width: 10%;"></td> <td style="width: 10%;"></td> <td style="width: 10%;"></td> </tr> <tr> <td></td> <td></td> <td colspan="8" style="text-align: center;"> <table border="1" style="width: 100%; border-collapse: collapse; text-align: center;"> <tr> <td style="width: 10%;"></td> <td style="width: 10%;"></td> <td style="width: 10%;"></td> <td style="width: 10%;"></td> <td style="width: 10%;"></td> <td style="width: 10%;"></td> <td style="width: 10%;"></td> <td style="width: 10%;"></td> <td style="width: 10%;"></td> <td style="width: 10%;"></td> </tr> <tr> <td></td> <td></td> <td colspan="8" style="text-align: center;"> <table border="1" style="width: 100%; border-collapse: collapse; text-align: center;"> <tr> <td style="width: 10%;"></td> <td style="width: 10%;"></td> <td style="width: 10%;"></td> <td style="width: 10%;"></td> <td style="width: 10%;"></td> <td style="width: 10%;"></td> <td style="width: 10%;"></td> <td style="width: 10%;"></td> <td style="width: 10%;"></td> <td style="width: 10%;"></td> </tr> <tr> <td></td> <td></td> <td colspan="8" style="text-align: center;"> <table border="1" style="width: 100%; border-collapse: collapse; text-align: center;"> <tr> <td style="width: 10%;"></td> <td style="width: 10%;"></td> <td style="width: 10%;"></td> <td style="width: 10%;"></td> <td style="width: 10%;"></td> <td style="width: 10%;"></td> <td style="width: 10%;"></td> <td style="width: 10%;"></td> <td style="width: 10%;"></td> <td style="width: 10%;"></td> </tr> <tr> <td></td> <td></td> <td colspan="8" style="text-align: center;"> <table border="1" style="width: 100%; border-collapse: collapse; text-align: center;"> <tr> <td style="width: 10%;"></td> <td style="width: 10%;"></td> <td style="width: 10%;"></td> <td style="width: 10%;"></td> <td style="width: 10%;"></td> <td style="width: 10%;"></td> <td style="width: 10%;"></td> <td style="width: 10%;"></td> <td style="width: 10%;"></td> <td style="width: 10%;"></td> </tr> <tr> <td></td> <td></td> <td colspan="8" style="text-align: center;"> <table border="1" style="width: 100%; border-collapse: collapse; text-align: center;"> <tr> <td style="width: 10%;"></td> <td style="width: 10%;"></td> <td style="width: 10%;"></td> <td style="width: 10%;"></td> <td style="width: 10%;"></td> <td style="width: 10%;"></td> <td style="width: 10%;"></td> <td style="width: 10%;"></td> <td style="width: 10%;"></td> <td style="width: 10%;"></td> </tr> <tr> <td></td> <td></td> <td colspan="8" style="text-align: center;"> <table border="1" style="width: 100%; border-collapse: collapse; text-align: center;"> <tr> <td style="width: 10%;"></td> <td style="width: 10%;"></td> <td style="width: 10%;"></td> <td style="width: 10%;"></td> <td style="width: 10%;"></td> <td style="width: 10%;"></td> <td style="width: 10%;"></td> <td style="width: 10%;"></td> <td style="width: 10%;"></td> <td style="width: 10%;"></td> </tr> <tr> <td></td> <td></td> <td colspan="8" style="text-align: center;"> <table border="1" style="width: 100%; border-collapse: collapse; text-align: center;"> <tr> <td style="width: 10%;"></td> <td style="width: 10%;"></td> <td style="width: 10%;"></td> <td style="width: 10%;"></td> <td style="width: 10%;"></td> <td style="width: 10%;"></td> <td style="width: 10%;"></td> <td style="width: 10%;"></td> <td style="width: 10%;"></td> <td style="width: 10%;"></td> </tr> <tr> <td></td> <td></td> <td colspan="8" style="text-align: center;"> <table border="1" style="width: 100%; border-collapse: collapse; text-align: center;"> <tr> <td style="width: 10%;"></td> <td style="width: 10%;"></td> <td style="width: 10%;"></td> <td style="width: 10%;"></td> <td style="width: 10%;"></td> <td style="width: 10%;"></td> <td style="width: 10%;"></td> <td style="width: 10%;"></td> <td style="width: 10%;"></td> <td style="width: 10%;"></td> </tr> <tr> <td></td> <td></td> <td colspan="8" style="text-align: center;"> <table border="1" style="width: 100%; border-collapse: collapse; text-align: center;"> <tr> </tr></table></td></tr></table></td></tr></table></td></tr></table></td></tr></table></td></tr></table></td></tr></table></td></tr></table></td></tr></table></td></tr></table></td></tr></table></td></tr></table></td></tr></table></td></tr></table></td></tr></table></td></tr></table></td></tr></table></td></tr></table></td></tr></table></td></tr></table></td></tr></table></td></tr></table></td></tr></table></td></tr></table></td></tr></table></td></tr></table></td></tr></table></td></tr></table></td></tr></table></td></tr></table></td></tr></table></td></tr></table></td></tr></table></td></tr></table></td></tr></table></td></tr></table></td></tr></table></td></tr></table></td></tr></table></td></tr></table></td></tr></table></td></tr></table></td></tr></table></td></tr></table></td></tr></table></td></tr></table></td></tr></table></td></tr></table></td></tr></table></td></tr></table></td></tr></table></td></tr></table></td></tr></table></td></tr></table></td></tr></table></td></tr></table></td></tr></table>
 | | | | | | | | | | | | | | | | | | | | <table border="1" style="width: 100%; border-collapse: collapse; text-align: center;"> <tr> <td style="width: 10%;"></td> <td style="width: 10%;"></td> <td style="width: 10%;"></td> <td style="width: 10%;"></td> <td style="width: 10%;"></td> <td style="width: 10%;"></td> <td style="width: 10%;"></td> <td style="width: 10%;"></td> <td style="width: 10%;"></td> <td style="width: 10%;"></td> </tr> <tr> <td></td> <td></td> <td colspan="8" style="text-align: center;"> <table border="1" style="width: 100%; border-collapse: collapse; text-align: center;"> <tr> <td style="width: 10%;"></td> <td style="width: 10%;"></td> <td style="width: 10%;"></td> <td style="width: 10%;"></td> <td style="width: 10%;"></td> <td style="width: 10%;"></td> <td style="width: 10%;"></td> <td style="width: 10%;"></td> <td style="width: 10%;"></td> <td style="width: 10%;"></td> </tr> <tr> <td></td> <td></td> <td colspan="8" style="text-align: center;"> <table border="1" style="width: 100%; border-collapse: collapse; text-align: center;"> <tr> <td style="width: 10%;"></td> <td style="width: 10%;"></td> <td style="width: 10%;"></td> <td style="width: 10%;"></td> <td style="width: 10%;"></td> <td style="width: 10%;"></td> <td style="width: 10%;"></td> <td style="width: 10%;"></td> <td style="width: 10%;"></td> <td style="width: 10%;"></td> </tr> <tr> <td></td> <td></td> <td colspan="8" style="text-align: center;"> <table border="1" style="width: 100%; border-collapse: collapse; text-align: center;"> <tr> <td style="width: 10%;"></td> <td style="width: 10%;"></td> <td style="width: 10%;"></td> <td style="width: 10%;"></td> <td style="width: 10%;"></td> <td style="width: 10%;"></td> <td style="width: 10%;"></td> <td style="width: 10%;"></td> <td style="width: 10%;"></td> <td style="width: 10%;"></td> </tr> <tr> <td></td> <td></td> <td colspan="8" style="text-align: center;"> <table border="1" style="width: 100%; border-collapse: collapse; text-align: center;"> <tr> <td style="width: 10%;"></td> <td style="width: 10%;"></td> <td style="width: 10%;"></td> <td style="width: 10%;"></td> <td style="width: 10%;"></td> <td style="width: 10%;"></td> <td style="width: 10%;"></td> <td style="width: 10%;"></td> <td style="width: 10%;"></td> <td style="width: 10%;"></td> </tr> <tr> <td></td> <td></td> <td colspan="8" style="text-align: center;"> <table border="1" style="width: 100%; border-collapse: collapse; text-align: center;"> <tr> <td style="width: 10%;"></td> <td style="width: 10%;"></td> <td style="width: 10%;"></td> <td style="width: 10%;"></td> <td style="width: 10%;"></td> <td style="width: 10%;"></td> <td style="width: 10%;"></td> <td style="width: 10%;"></td> <td style="width: 10%;"></td> <td style="width: 10%;"></td> </tr> <tr> <td></td> <td></td> <td colspan="8" style="text-align: center;"> <table border="1" style="width: 100%; border-collapse: collapse; text-align: center;"> <tr> <td style="width: 10%;"></td> <td style="width: 10%;"></td> <td style="width: 10%;"></td> <td style="width: 10%;"></td> <td style="width: 10%;"></td> <td style="width: 10%;"></td> <td style="width: 10%;"></td> <td style="width: 10%;"></td> <td style="width: 10%;"></td> <td style="width: 10%;"></td> </tr> <tr> <td></td> <td></td> <td colspan="8" style="text-align: center;"> <table border="1" style="width: 100%; border-collapse: collapse; text-align: center;"> <tr> <td style="width: 10%;"></td> <td style="width: 10%;"></td> <td style="width: 10%;"></td> <td style="width: 10%;"></td> <td style="width: 10%;"></td> <td style="width: 10%;"></td> <td style="width: 10%;"></td> <td style="width: 10%;"></td> <td style="width: 10%;"></td> <td style="width: 10%;"></td> </tr> <tr> <td></td> <td></td> <td colspan="8" style="text-align: center;"> <table border="1" style="width: 100%; border-collapse: collapse; text-align: center;"> <tr> <td style="width: 10%;"></td> <td style="width: 10%;"></td> <td style="width: 10%;"></td> <td style="width: 10%;"></td> <td style="width: 10%;"></td> <td style="width: 10%;"></td> <td style="width: 10%;"></td> <td style="width: 10%;"></td> <td style="width: 10%;"></td> <td style="width: 10%;"></td> </tr> <tr> <td></td> <td></td> <td colspan="8" style="text-align: center;"> <table border="1" style="width: 100%; border-collapse: collapse; text-align: center;"> <tr> <td style="width: 10%;"></td> <td style="width: 10%;"></td> <td style="width: 10%;"></td> <td style="width: 10%;"></td> <td style="width: 10%;"></td> <td style="width: 10%;"></td> <td style="width: 10%;"></td> <td style="width: 10%;"></td> <td style="width: 10%;"></td> <td style="width: 10%;"></td> </tr> <tr> <td></td> <td></td> <td colspan="8" style="text-align: center;"> <table border="1" style="width: 100%; border-collapse: collapse; text-align: center;"> <tr> <td style="width: 10%;"></td> <td style="width: 10%;"></td> <td style="width: 10%;"></td> <td style="width: 10%;"></td> <td style="width: 10%;"></td> <td style="width: 10%;"></td> <td style="width: 10%;"></td> <td style="width: 10%;"></td> <td style="width: 10%;"></td> <td style="width: 10%;"></td> </tr> <tr> <td></td> <td></td> <td colspan="8" style="text-align: center;"> <table border="1" style="width: 100%; border-collapse: collapse; text-align: center;"> <tr> <td style="width: 10%;"></td> <td style="width: 10%;"></td> <td style="width: 10%;"></td> <td style="width: 10%;"></td> <td style="width: 10%;"></td> <td style="width: 10%;"></td> <td style="width: 10%;"></td> <td style="width: 10%;"></td> <td style="width: 10%;"></td> <td style="width: 10%;"></td> </tr> <tr> <td></td> <td></td> <td colspan="8" style="text-align: center;"> <table border="1" style="width: 100%; border-collapse: collapse; text-align: center;"> <tr> <td style="width: 10%;"></td> <td style="width: 10%;"></td> <td style="width: 10%;"></td> <td style="width: 10%;"></td> <td style="width: 10%;"></td> <td style="width: 10%;"></td> <td style="width: 10%;"></td> <td style="width: 10%;"></td> <td style="width: 10%;"></td> <td style="width: 10%;"></td> </tr> <tr> <td></td> <td></td> <td colspan="8" style="text-align: center;"> <table border="1" style="width: 100%; border-collapse: collapse; text-align: center;"> <tr> <td style="width: 10%;"></td> <td style="width: 10%;"></td> <td style="width: 10%;"></td> <td style="width: 10%;"></td> <td style="width: 10%;"></td> <td style="width: 10%;"></td> <td style="width: 10%;"></td> <td style="width: 10%;"></td> <td style="width: 10%;"></td> <td style="width: 10%;"></td> </tr> <tr> <td></td> <td></td> <td colspan="8" style="text-align: center;"> <table border="1" style="width: 100%; border-collapse: collapse; text-align: center;"> <tr> <td style="width: 10%;"></td> <td style="width: 10%;"></td> <td style="width: 10%;"></td> <td style="width: 10%;"></td> <td style="width: 10%;"></td> <td style="width: 10%;"></td> <td style="width: 10%;"></td> <td style="width: 10%;"></td> <td style="width: 10%;"></td> <td style="width: 10%;"></td> </tr> <tr> <td></td> <td></td> <td colspan="8" style="text-align: center;"> <table border="1" style="width: 100%; border-collapse: collapse; text-align: center;"> <tr> <td style="width: 10%;"></td> <td style="width: 10%;"></td> <td style="width: 10%;"></td> <td style="width: 10%;"></td> <td style="width: 10%;"></td> <td style="width: 10%;"></td> <td style="width: 10%;"></td> <td style="width: 10%;"></td> <td style="width: 10%;"></td> <td style="width: 10%;"></td> </tr> <tr> <td></td> <td></td> <td colspan="8" style="text-align: center;"> <table border="1" style="width: 100%; border-collapse: collapse; text-align: center;"> <tr>
<td style="width: 10%;"></td> <td style="width: 10%;"></td> <td style="width: 10%;"></td> <td style="width: 10%;"></td> <td style="width: 10%;"></td> <td style="width: 10%;"></td> <td style="width: 10%;"></td> <td style="width: 10%;"></td> <td style="width: 10%;"></td> <td style="width: 10%;"></td> </tr> <tr> <td></td> <td></td> <td colspan="8" style="text-align: center;"> <table border="1" style="width: 100%; border-collapse: collapse; text-align: center;"> <tr> <td style="width: 10%;"></td> <td style="width: 10%;"></td> <td style="width: 10%;"></td> <td style="width: 10%;"></td> <td style="width: 10%;"></td> <td style="width: 10%;"></td> <td style="width: 10%;"></td> <td style="width: 10%;"></td> <td style="width: 10%;"></td> <td style="width: 10%;"></td> </tr> <tr> <td></td> <td></td> <td colspan="8" style="text-align: center;"> <table border="1" style="width: 100%; border-collapse: collapse; text-align: center;"> <tr> <td style="width: 10%;"></td> <td style="width: 10%;"></td> <td style="width: 10%;"></td> <td style="width: 10%;"></td> <td style="width: 10%;"></td> <td style="width: 10%;"></td> <td style="width: 10%;"></td> <td style="width: 10%;"></td> <td style="width: 10%;"></td> <td style="width: 10%;"></td> </tr> <tr> <td></td> <td></td> <td colspan="8" style="text-align: center;"> <table border="1" style="width: 100%; border-collapse: collapse; text-align: center;"> <tr> <td style="width: 10%;"></td> <td style="width: 10%;"></td> <td style="width: 10%;"></td> <td style="width: 10%;"></td> <td style="width: 10%;"></td> <td style="width: 10%;"></td> <td style="width: 10%;"></td> <td style="width: 10%;"></td> <td style="width: 10%;"></td> <td style="width: 10%;"></td> </tr> <tr> <td></td> <td></td> <td colspan="8" style="text-align: center;"> <table border="1" style="width: 100%; border-collapse: collapse; text-align: center;"> <tr> <td style="width: 10%;"></td> <td style="width: 10%;"></td> <td style="width: 10%;"></td> <td style="width: 10%;"></td> <td style="width: 10%;"></td> <td style="width: 10%;"></td> <td style="width: 10%;"></td> <td style="width: 10%;"></td> <td style="width: 10%;"></td> <td style="width: 10%;"></td> </tr> <tr> <td></td> <td></td> <td colspan="8" style="text-align: center;"> <table border="1" style="width: 100%; border-collapse: collapse; text-align: center;"> <tr> <td style="width: 10%;"></td> <td style="width: 10%;"></td> <td style="width: 10%;"></td> <td style="width: 10%;"></td> <td style="width: 10%;"></td> <td style="width: 10%;"></td> <td style="width: 10%;"></td> <td style="width: 10%;"></td> <td style="width: 10%;"></td> <td style="width: 10%;"></td> </tr> <tr> <td></td> <td></td> <td colspan="8" style="text-align: center;"> <table border="1" style="width: 100%; border-collapse: collapse; text-align: center;"> <tr> <td style="width: 10%;"></td> <td style="width: 10%;"></td> <td style="width: 10%;"></td> <td style="width: 10%;"></td> <td style="width: 10%;"></td> <td style="width: 10%;"></td> <td style="width: 10%;"></td> <td style="width: 10%;"></td> <td style="width: 10%;"></td> <td style="width: 10%;"></td> </tr> <tr> <td></td> <td></td> <td colspan="8" style="text-align: center;"> <table border="1" style="width: 100%; border-collapse: collapse; text-align: center;"> <tr> <td style="width: 10%;"></td> <td style="width: 10%;"></td> <td style="width: 10%;"></td> <td style="width: 10%;"></td> <td style="width: 10%;"></td> <td style="width: 10%;"></td> <td style="width: 10%;"></td> <td style="width: 10%;"></td> <td style="width: 10%;"></td> <td style="width: 10%;"></td> </tr> <tr> <td></td> <td></td> <td colspan="8" style="text-align: center;"> <table border="1" style="width: 100%; border-collapse: collapse; text-align: center;"> <tr> <td style="width: 10%;"></td> <td style="width: 10%;"></td> <td style="width: 10%;"></td> <td style="width: 10%;"></td> <td style="width: 10%;"></td> <td style="width: 10%;"></td> <td style="width: 10%;"></td> <td style="width: 10%;"></td> <td style="width: 10%;"></td> <td style="width: 10%;"></td> </tr> <tr> <td></td> <td></td> <td colspan="8" style="text-align: center;"> <table border="1" style="width: 100%; border-collapse: collapse; text-align: center;"> <tr> <td style="width: 10%;"></td> <td style="width: 10%;"></td> <td style="width: 10%;"></td> <td style="width: 10%;"></td> <td style="width: 10%;"></td> <td style="width: 10%;"></td> <td style="width: 10%;"></td> <td style="width: 10%;"></td> <td style="width: 10%;"></td> <td style="width: 10%;"></td> </tr> <tr> <td></td> <td></td> <td colspan="8" style="text-align: center;"> <table border="1" style="width: 100%; border-collapse: collapse; text-align: center;"> <tr> <td style="width: 10%;"></td> <td style="width: 10%;"></td> <td style="width: 10%;"></td> <td style="width: 10%;"></td> <td style="width: 10%;"></td> <td style="width: 10%;"></td> <td style="width: 10%;"></td> <td style="width: 10%;"></td> <td style="width: 10%;"></td> <td style="width: 10%;"></td> </tr> <tr> <td></td> <td></td> <td colspan="8" style="text-align: center;"> <table border="1" style="width: 100%; border-collapse: collapse; text-align: center;"> <tr> <td style="width: 10%;"></td> <td style="width: 10%;"></td> <td style="width: 10%;"></td> <td style="width: 10%;"></td> <td style="width: 10%;"></td> <td style="width: 10%;"></td> <td style="width: 10%;"></td> <td style="width: 10%;"></td> <td style="width: 10%;"></td> <td style="width: 10%;"></td> </tr> <tr> <td></td> <td></td> <td colspan="8" style="text-align: center;"> <table border="1" style="width: 100%; border-collapse: collapse; text-align: center;"> <tr> <td style="width: 10%;"></td> <td style="width: 10%;"></td> <td style="width: 10%;"></td> <td style="width: 10%;"></td> <td style="width: 10%;"></td> <td style="width: 10%;"></td> <td style="width: 10%;"></td> <td style="width: 10%;"></td> <td style="width: 10%;"></td> <td style="width: 10%;"></td> </tr> <tr> <td></td> <td></td> <td colspan="8" style="text-align: center;"> <table border="1" style="width: 100%; border-collapse: collapse; text-align: center;"> <tr> <td style="width: 10%;"></td> <td style="width: 10%;"></td> <td style="width: 10%;"></td> <td style="width: 10%;"></td> <td style="width: 10%;"></td> <td style="width: 10%;"></td> <td style="width: 10%;"></td> <td style="width: 10%;"></td> <td style="width: 10%;"></td> <td style="width: 10%;"></td> </tr> <tr> <td></td> <td></td> <td colspan="8" style="text-align: center;"> <table border="1" style="width: 100%; border-collapse: collapse; text-align: center;"> <tr> <td style="width: 10%;"></td> <td style="width: 10%;"></td> <td style="width: 10%;"></td> <td style="width: 10%;"></td> <td style="width: 10%;"></td> <td style="width: 10%;"></td> <td style="width: 10%;"></td> <td style="width: 10%;"></td> <td style="width: 10%;"></td> <td style="width: 10%;"></td> </tr> <tr> <td></td> <td></td> <td colspan="8" style="text-align: center;"> <table border="1" style="width: 100%; border-collapse: collapse; text-align: center;"> <tr> <td style="width: 10%;"></td> <td style="width: 10%;"></td> <td style="width: 10%;"></td> <td style="width: 10%;"></td> <td style="width: 10%;"></td> <td style="width: 10%;"></td> <td style="width: 10%;"></td> <td style="width: 10%;"></td> <td style="width: 10%;"></td> <td style="width: 10%;"></td> </tr> <tr> <td></td> <td></td> <td colspan="8" style="text-align: center;"> <table border="1" style="width: 100%; border-collapse: collapse; text-align: center;"> <tr> <td style="width: 10%;"></td> <td style="width: 10%;"></td> <td style="width: 10%;"></td> <td style="width: 10%;"></td> <td style="width: 10%;"></td> <td style="width: 10%;"></td> <td style="width: 10%;"></td> <td style="width: 10%;"></td> <td style="width: 10%;"></td> <td style="width: 10%;"></td> </tr> <tr> <td></td> <td></td> <td colspan="8" style="text-align: center;"> <table border="1" style="width: 100%; border-collapse: collapse; text-align: center;"> <tr> <td style="width: 10%;"></td> <td style="width: 10%;"></td> <td style="width: 10%;"></td> <td style="width: 10%;"></td> <td style="width: 10%;"></td> <td style="width: 10%;"></td> <td style="width: 10%;"></td> <td style="width: 10%;"></td> <td style="width: 10%;"></td> <td style="width: 10%;"></td> </tr> <tr> <td></td> <td></td> <td colspan="8" style="text-align: center;"> <table border="1" style="width: 100%; border-collapse: collapse; text-align: center;"> <tr> <td style="width: 10%;"></td> <td style="width: 10%;"></td> <td style="width: 10%;"></td> <td style="width: 10%;"></td> <td style="width: 10%;"></td> <td style="width: 10%;"></td> <td style="width: 10%;"></td> <td style="width: 10%;"></td> <td style="width: 10%;"></td> <td style="width: 10%;"></td> </tr> <tr> <td></td> <td></td> <td colspan="8" style="text-align: center;"> <table border="1" style="width: 100%; border-collapse: collapse; text-align: center;"> <tr> <td style="width: 10%;"></td> <td style="width: 10%;"></td> <td style="width: 10%;"></td> <td style="width: 10%;"></td> <td style="width: 10%;"></td> <td style="width: 10%;"></td> <td style="width: 10%;"></td> <td style="width: 10%;"></td> <td style="width: 10%;"></td> <td style="width: 10%;"></td> </tr> <tr> <td></td> <td></td> <td colspan="8" style="text-align: center;"> <table border="1" style="width: 100%; border-collapse: collapse; text-align: center;"> <tr> <td style="width: 10%;"></td> <td style="width: 10%;"></td> <td style="width: 10%;"></td> <td style="width: 10%;"></td> <td style="width: 10%;"></td> <td style="width: 10%;"></td> <td style="width: 10%;"></td> <td style="width: 10%;"></td> <td style="width: 10%;"></td> <td style="width: 10%;"></td> </tr> <tr> <td></td> <td></td> <td colspan="8" style="text-align: center;"> <table border="1" style="width: 100%; border-collapse: collapse; text-align: center;"> <tr> <td style="width: 10%;"></td> <td style="width: 10%;"></td> <td style="width: 10%;"></td> <td style="width: 10%;"></td> <td style="width: 10%;"></td> <td style="width:
10%;"></td> <td style="width: 10%;"></td> <td style="width: 10%;"></td> <td style="width: 10%;"></td> <td style="width: 10%;"></td> </tr> <tr> <td></td> <td></td> <td colspan="8" style="text-align: center;"> <table border="1" style="width: 100%; border-collapse: collapse; text-align: center;"> <tr> <td style="width: 10%;"></td> <td style="width: 10%;"></td> <td style="width: 10%;"></td> <td style="width: 10%;"></td> <td style="width: 10%;"></td> <td style="width: 10%;"></td> <td style="width: 10%;"></td> <td style="width: 10%;"></td> <td style="width: 10%;"></td> <td style="width: 10%;"></td> </tr> <tr> <td></td> <td></td> <td colspan="8" style="text-align: center;"> <table border="1" style="width: 100%; border-collapse: collapse; text-align: center;"> <tr> <td style="width: 10%;"></td> <td style="width: 10%;"></td> <td style="width: 10%;"></td> <td style="width: 10%;"></td> <td style="width: 10%;"></td> <td style="width: 10%;"></td> <td style="width: 10%;"></td> <td style="width: 10%;"></td> <td style="width: 10%;"></td> <td style="width: 10%;"></td> </tr> <tr> <td></td> <td></td> <td colspan="8" style="text-align: center;"> <table border="1" style="width: 100%; border-collapse: collapse; text-align: center;"> <tr> <td style="width: 10%;"></td> <td style="width: 10%;"></td> <td style="width: 10%;"></td> <td style="width: 10%;"></td> <td style="width: 10%;"></td> <td style="width: 10%;"></td> <td style="width: 10%;"></td> <td style="width: 10%;"></td> <td style="width: 10%;"></td> <td style="width: 10%;"></td> </tr> <tr> <td></td> <td></td> <td colspan="8" style="text-align: center;"> <table border="1" style="width: 100%; border-collapse: collapse; text-align: center;"> <tr> <td style="width: 10%;"></td> <td style="width: 10%;"></td> <td style="width: 10%;"></td> <td style="width: 10%;"></td> <td style="width: 10%;"></td> <td style="width: 10%;"></td> <td style="width: 10%;"></td> <td style="width: 10%;"></td> <td style="width: 10%;"></td> <td style="width: 10%;"></td> </tr> <tr> <td></td> <td></td> <td colspan="8" style="text-align: center;"> <table border="1" style="width: 100%; border-collapse: collapse; text-align: center;"> <tr> <td style="width: 10%;"></td> <td style="width: 10%;"></td> <td style="width: 10%;"></td> <td style="width: 10%;"></td> <td style="width: 10%;"></td> <td style="width: 10%;"></td> <td style="width: 10%;"></td> <td style="width: 10%;"></td> <td style="width: 10%;"></td> <td style="width: 10%;"></td> </tr> <tr> <td></td> <td></td> <td colspan="8" style="text-align: center;"> <table border="1" style="width: 100%; border-collapse: collapse; text-align: center;"> <tr> <td style="width: 10%;"></td> <td style="width: 10%;"></td> <td style="width: 10%;"></td> <td style="width: 10%;"></td> <td style="width: 10%;"></td> <td style="width: 10%;"></td> <td style="width: 10%;"></td> <td style="width: 10%;"></td> <td style="width: 10%;"></td> <td style="width: 10%;"></td> </tr> <tr> <td></td> <td></td> <td colspan="8" style="text-align: center;"> <table border="1" style="width: 100%; border-collapse: collapse; text-align: center;"> <tr> <td style="width: 10%;"></td> <td style="width: 10%;"></td> <td style="width: 10%;"></td> <td style="width: 10%;"></td> <td style="width: 10%;"></td> <td style="width: 10%;"></td> <td style="width: 10%;"></td> <td style="width: 10%;"></td> <td style="width: 10%;"></td> <td style="width: 10%;"></td> </tr> <tr> <td></td> <td></td> <td colspan="8" style="text-align: center;"> <table border="1" style="width: 100%; border-collapse: collapse; text-align: center;"> <tr> <td style="width: 10%;"></td> <td style="width: 10%;"></td> <td style="width: 10%;"></td> <td style="width: 10%;"></td> <td style="width: 10%;"></td> <td style="width: 10%;"></td> <td style="width: 10%;"></td> <td style="width: 10%;"></td> <td style="width: 10%;"></td> <td style="width: 10%;"></td> </tr> <tr> <td></td> <td></td> <td colspan="8" style="text-align: center;"> <table border="1" style="width: 100%; border-collapse: collapse; text-align: center;"> <tr> <td style="width: 10%;"></td> <td style="width: 10%;"></td> <td style="width: 10%;"></td> <td style="width: 10%;"></td> <td style="width: 10%;"></td> <td style="width: 10%;"></td> <td style="width: 10%;"></td> <td style="width: 10%;"></td> <td style="width: 10%;"></td> <td style="width: 10%;"></td> </tr> <tr> <td></td> <td></td> <td colspan="8" style="text-align: center;"> <table border="1" style="width: 100%; border-collapse: collapse; text-align: center;"> <tr> <td style="width: 10%;"></td> <td style="width: 10%;"></td> <td style="width: 10%;"></td> <td style="width: 10%;"></td> <td style="width: 10%;"></td> <td style="width: 10%;"></td> <td style="width: 10%;"></td> <td style="width: 10%;"></td> <td style="width: 10%;"></td> <td style="width: 10%;"></td> </tr> <tr> <td></td> <td></td> <td colspan="8" style="text-align: center;"> <table border="1" style="width: 100%; border-collapse: collapse; text-align: center;"> <tr> <td style="width: 10%;"></td> <td style="width: 10%;"></td> <td style="width: 10%;"></td> <td style="width: 10%;"></td> <td style="width: 10%;"></td> <td style="width: 10%;"></td> <td style="width: 10%;"></td> <td style="width: 10%;"></td> <td style="width: 10%;"></td> <td style="width: 10%;"></td> </tr> <tr> <td></td> <td></td> <td colspan="8" style="text-align: center;"> <table border="1" style="width: 100%; border-collapse: collapse; text-align: center;"> <tr> <td style="width: 10%;"></td> <td style="width: 10%;"></td> <td style="width: 10%;"></td> <td style="width: 10%;"></td> <td style="width: 10%;"></td> <td style="width: 10%;"></td> <td style="width: 10%;"></td> <td style="width: 10%;"></td> <td style="width: 10%;"></td> <td style="width: 10%;"></td> </tr> <tr> <td></td> <td></td> <td colspan="8" style="text-align: center;"> <table border="1" style="width: 100%; border-collapse: collapse; text-align: center;"> <tr> <td style="width: 10%;"></td> <td style="width: 10%;"></td> <td style="width: 10%;"></td> <td style="width: 10%;"></td> <td style="width: 10%;"></td> <td style="width: 10%;"></td> <td style="width: 10%;"></td> <td style="width: 10%;"></td> <td style="width: 10%;"></td> <td style="width: 10%;"></td> </tr> <tr> <td></td> <td></td> <td colspan="8" style="text-align: center;"> <table border="1" style="width: 100%; border-collapse: collapse; text-align: center;"> <tr> <td style="width: 10%;"></td> <td style="width: 10%;"></td> <td style="width: 10%;"></td> <td style="width: 10%;"></td> <td style="width: 10%;"></td> <td style="width: 10%;"></td> <td style="width: 10%;"></td> <td style="width: 10%;"></td> <td style="width: 10%;"></td> <td style="width: 10%;"></td> </tr> <tr> <td></td> <td></td> <td colspan="8" style="text-align: center;"> <table border="1" style="width: 100%; border-collapse: collapse; text-align: center;"> <tr> <td style="width: 10%;"></td> <td style="width: 10%;"></td> <td style="width: 10%;"></td> <td style="width: 10%;"></td> <td style="width: 10%;"></td> <td style="width: 10%;"></td> <td style="width: 10%;"></td> <td style="width: 10%;"></td> <td style="width: 10%;"></td> <td style="width: 10%;"></td> </tr> <tr> <td></td> <td></td> <td colspan="8" style="text-align: center;"> <table border="1" style="width: 100%; border-collapse: collapse; text-align: center;"> <tr> <td style="width: 10%;"></td> <td style="width: 10%;"></td> <td style="width: 10%;"></td> <td style="width: 10%;"></td> <td style="width: 10%;"></td> <td style="width: 10%;"></td> <td style="width: 10%;"></td> <td style="width: 10%;"></td> <td style="width: 10%;"></td> <td style="width: 10%;"></td> </tr> <tr> <td></td> <td></td> <td colspan="8" style="text-align: center;"> <table border="1" style="width: 100%; border-collapse: collapse; text-align: center;"> <tr> <td style="width: 10%;"></td> <td style="width: 10%;"></td> <td style="width: 10%;"></td> <td style="width: 10%;"></td> <td style="width: 10%;"></td> <td style="width: 10%;"></td> <td style="width: 10%;"></td> <td style="width: 10%;"></td> <td style="width: 10%;"></td> <td style="width: 10%;"></td> </tr> <tr> <td></td> <td></td> <td colspan="8" style="text-align: center;"> <table border="1" style="width: 100%; border-collapse: collapse; text-align: center;"> <tr> </tr></table></td></tr></table></td></tr></table></td></tr></table></td></tr></table></td></tr></table></td></tr></table></td></tr></table></td></tr></table></td></tr></table></td></tr></table></td></tr></table></td></tr></table></td></tr></table></td></tr></table></td></tr></table></td></tr></table></td></tr></table></td></tr></table></td></tr></table></td></tr></table></td></tr></table></td></tr></table></td></tr></table></td></tr></table></td></tr></table></td></tr></table></td></tr></table></td></tr></table></td></tr></table></td></tr></table></td></tr></table></td></tr></table></td></tr></table></td></tr></table></td></tr></table></td></tr></table></td></tr></table></td></tr></table></td></tr></table></td></tr></table></td></tr></table></td></tr></table></td></tr></table></td></tr></table></td></tr></table></td></tr></table></td></tr></table></td></tr></table></td></tr></table></td></tr></table></td></tr></table></td></tr></table></td></tr></table></td></tr></table></td></tr></table>
 | | | | | | | | | | | | | | | | | | | | <table border="1" style="width: 100%; border-collapse: collapse; text-align: center;"> <tr> <td style="width: 10%;"></td> <td style="width: 10%;"></td> <td style="width: 10%;"></td> <td style="width: 10%;"></td> <td style="width: 10%;"></td> <td style="width: 10%;"></td> <td style="width: 10%;"></td> <td style="width: 10%;"></td> <td style="width: 10%;"></td> <td style="width: 10%;"></td> </tr> <tr> <td></td> <td></td> <td colspan="8" style="text-align: center;"> <table border="1" style="width: 100%; border-collapse: collapse; text-align: center;"> <tr> <td style="width: 10%;"></td> <td style="width: 10%;"></td> <td style="width: 10%;"></td> <td style="width: 10%;"></td> <td style="width: 10%;"></td> <td style="width: 10%;"></td> <td style="width: 10%;"></td> <td style="width: 10%;"></td> <td style="width: 10%;"></td> <td style="width: 10%;"></td> </tr> <tr> <td></td> <td></td> <td colspan="8" style="text-align: center;"> <table border="1" style="width: 100%; border-collapse: collapse; text-align: center;"> <tr> <td style="width: 10%;"></td> <td style="width: 10%;"></td> <td style="width: 10%;"></td> <td style="width: 10%;"></td> <td style="width: 10%;"></td> <td style="width: 10%;"></td> <td style="width: 10%;"></td> <td style="width: 10%;"></td> <td style="width: 10%;"></td> <td style="width: 10%;"></td> </tr> <tr> <td></td> <td></td> <td colspan="8" style="text-align: center;"> <table border="1" style="width: 100%; border-collapse: collapse; text-align: center;"> <tr> <td style="width: 10%;"></td> <td style="width: 10%;"></td> <td style="width: 10%;"></td> <td style="width: 10%;"></td> <td style="width: 10%;"></td> <td style="width: 10%;"></td> <td style="width: 10%;"></td> <td style="width: 10%;"></td> <td style="width: 10%;"></td> <td style="width: 10%;"></td> </tr> <tr> <td></td> <td></td> <td colspan="8" style="text-align: center;"> <table border="1" style="width: 100%; border-collapse: collapse; text-align: center;"> <tr> <td style="width: 10%;"></td> <td style="width: 10%;"></td> <td style="width: 10%;"></td> <td style="width: 10%;"></td> <td style="width: 10%;"></td> <td style="width: 10%;"></td> <td style="width: 10%;"></td> <td style="width: 10%;"></td> <td style="width: 10%;"></td> <td style="width: 10%;"></td> </tr> <tr> <td></td> <td></td> <td colspan="8" style="text-align: center;"> <table border="1" style="width: 100%; border-collapse: collapse; text-align: center;"> <tr> <td style="width: 10%;"></td> <td style="width: 10%;"></td> <td style="width: 10%;"></td> <td style="width: 10%;"></td> <td style="width: 10%;"></td> <td style="width: 10%;"></td> <td style="width: 10%;"></td> <td style="width: 10%;"></td> <td style="width: 10%;"></td> <td style="width: 10%;"></td> </tr> <tr> <td></td> <td></td> <td colspan="8" style="text-align: center;"> <table border="1" style="width: 100%; border-collapse: collapse; text-align: center;"> <tr> <td style="width: 10%;"></td> <td style="width: 10%;"></td> <td style="width: 10%;"></td> <td style="width: 10%;"></td> <td style="width: 10%;"></td> <td style="width: 10%;"></td> <td style="width: 10%;"></td> <td style="width: 10%;"></td> <td style="width: 10%;"></td> <td style="width: 10%;"></td> </tr> <tr> <td></td> <td></td> <td colspan="8" style="text-align: center;"> <table border="1" style="width: 100%; border-collapse: collapse; text-align: center;"> <tr> <td style="width: 10%;"></td> <td style="width: 10%;"></td> <td style="width: 10%;"></td> <td style="width: 10%;"></td> <td style="width: 10%;"></td> <td style="width: 10%;"></td> <td style="width: 10%;"></td> <td style="width: 10%;"></td> <td style="width: 10%;"></td> <td style="width: 10%;"></td> </tr> <tr> <td></td> <td></td> <td colspan="8" style="text-align: center;"> <table border="1" style="width: 100%; border-collapse: collapse; text-align: center;"> <tr> <td style="width: 10%;"></td> <td style="width: 10%;"></td> <td style="width: 10%;"></td> <td style="width: 10%;"></td> <td style="width: 10%;"></td> <td style="width: 10%;"></td> <td style="width: 10%;"></td> <td style="width: 10%;"></td> <td style="width: 10%;"></td> <td style="width: 10%;"></td> </tr> <tr> <td></td> <td></td> <td colspan="8" style="text-align: center;"> <table border="1" style="width: 100%; border-collapse: collapse; text-align: center;"> <tr> <td style="width: 10%;"></td> <td style="width: 10%;"></td> <td style="width: 10%;"></td> <td style="width: 10%;"></td> <td style="width: 10%;"></td> <td style="width: 10%;"></td> <td style="width: 10%;"></td> <td style="width: 10%;"></td> <td style="width: 10%;"></td> <td style="width: 10%;"></td> </tr> <tr> <td></td> <td></td> <td colspan="8" style="text-align: center;"> <table border="1" style="width: 100%; border-collapse: collapse; text-align: center;"> <tr> <td style="width: 10%;"></td> <td style="width: 10%;"></td> <td style="width: 10%;"></td> <td style="width: 10%;"></td> <td style="width: 10%;"></td> <td style="width: 10%;"></td> <td style="width: 10%;"></td> <td style="width: 10%;"></td> <td style="width: 10%;"></td> <td style="width: 10%;"></td> </tr> <tr> <td></td> <td></td> <td colspan="8" style="text-align: center;"> <table border="1" style="width: 100%; border-collapse: collapse; text-align: center;"> <tr> <td style="width: 10%;"></td> <td style="width: 10%;"></td> <td style="width: 10%;"></td> <td style="width: 10%;"></td> <td style="width: 10%;"></td> <td style="width: 10%;"></td> <td style="width: 10%;"></td> <td style="width: 10%;"></td> <td style="width: 10%;"></td> <td style="width: 10%;"></td> </tr> <tr> <td></td> <td></td> <td colspan="8" style="text-align: center;"> <table border="1" style="width: 100%; border-collapse: collapse; text-align: center;"> <tr> <td style="width: 10%;"></td> <td style="width: 10%;"></td> <td style="width: 10%;"></td> <td style="width: 10%;"></td> <td style="width: 10%;"></td> <td style="width: 10%;"></td> <td style="width: 10%;"></td> <td style="width: 10%;"></td> <td style="width: 10%;"></td> <td style="width: 10%;"></td> </tr> <tr> <td></td> <td></td> <td colspan="8" style="text-align: center;"> <table border="1" style="width: 100%; border-collapse: collapse; text-align: center;"> <tr> <td style="width: 10%;"></td> <td style="width: 10%;"></td> <td style="width: 10%;"></td> <td style="width: 10%;"></td> <td style="width: 10%;"></td> <td style="width: 10%;"></td> <td style="width: 10%;"></td> <td style="width: 10%;"></td> <td style="width: 10%;"></td> <td style="width: 10%;"></td> </tr> <tr> <td></td> <td></td> <td colspan="8" style="text-align: center;"> <table border="1" style="width: 100%; border-collapse: collapse; text-align: center;"> <tr> <td style="width: 10%;"></td> <td style="width: 10%;"></td> <td style="width: 10%;"></td> <td style="width: 10%;"></td> <td style="width: 10%;"></td> <td style="width: 10%;"></td> <td style="width: 10%;"></td> <td style="width: 10%;"></td> <td style="width: 10%;"></td> <td style="width: 10%;"></td> </tr> <tr> <td></td> <td></td> <td colspan="8" style="text-align: center;"> <table border="1" style="width: 100%; border-collapse: collapse; text-align: center;"> <tr> <td style="width: 10%;"></td> <td style="width: 10%;"></td> <td style="width: 10%;"></td> <td style="width: 10%;"></td> <td style="width: 10%;"></td> <td style="width: 10%;"></td> <td style="width: 10%;"></td> <td style="width: 10%;"></td> <td style="width: 10%;"></td> <td style="width: 10%;"></td> </tr> <tr> <td></td> <td></td> <td colspan="8" style="text-align: center;"> <table border="1" style="width: 100%; border-collapse: collapse; text-align: center;"> <tr> <td style="width: 10%;"></td> <td style="width: 10%;"></td> <td style="width: 10%;"></td> <td style="width: 10%;"></td> <td style="width: 10%;"></td> <td style="width: 10%;"></td> <td
style="width: 10%;"></td> <td style="width: 10%;"></td> <td style="width: 10%;"></td> <td style="width: 10%;"></td> </tr> <tr> <td></td> <td></td> <td colspan="8" style="text-align: center;"> <table border="1" style="width: 100%; border-collapse: collapse; text-align: center;"> <tr> <td style="width: 10%;"></td> <td style="width: 10%;"></td> <td style="width: 10%;"></td> <td style="width: 10%;"></td> <td style="width: 10%;"></td> <td style="width: 10%;"></td> <td style="width: 10%;"></td> <td style="width: 10%;"></td> <td style="width: 10%;"></td> <td style="width: 10%;"></td> </tr> <tr> <td></td> <td></td> <td colspan="8" style="text-align: center;"> <table border="1" style="width: 100%; border-collapse: collapse; text-align: center;"> <tr> <td style="width: 10%;"></td> <td style="width: 10%;"></td> <td style="width: 10%;"></td> <td style="width: 10%;"></td> <td style="width: 10%;"></td> <td style="width: 10%;"></td> <td style="width: 10%;"></td> <td style="width: 10%;"></td> <td style="width: 10%;"></td> <td style="width: 10%;"></td> </tr> <tr> <td></td> <td></td> <td colspan="8" style="text-align: center;"> <table border="1" style="width: 100%; border-collapse: collapse; text-align: center;"> <tr> <td style="width: 10%;"></td> <td style="width: 10%;"></td> <td style="width: 10%;"></td> <td style="width: 10%;"></td> <td style="width: 10%;"></td> <td style="width: 10%;"></td> <td style="width: 10%;"></td> <td style="width: 10%;"></td> <td style="width: 10%;"></td> <td style="width: 10%;"></td> </tr> <tr> <td></td> <td></td> <td colspan="8" style="text-align: center;"> <table border="1" style="width: 100%; border-collapse: collapse; text-align: center;"> <tr> <td style="width: 10%;"></td> <td style="width: 10%;"></td> <td style="width: 10%;"></td> <td style="width: 10%;"></td> <td style="width: 10%;"></td> <td style="width: 10%;"></td> <td style="width: 10%;"></td> <td style="width: 10%;"></td> <td style="width: 10%;"></td> <td style="width: 10%;"></td> </tr> <tr> <td></td> <td></td> <td colspan="8" style="text-align: center;"> <table border="1" style="width: 100%; border-collapse: collapse; text-align: center;"> <tr> <td style="width: 10%;"></td> <td style="width: 10%;"></td> <td style="width: 10%;"></td> <td style="width: 10%;"></td> <td style="width: 10%;"></td> <td style="width: 10%;"></td> <td style="width: 10%;"></td> <td style="width: 10%;"></td> <td style="width: 10%;"></td> <td style="width: 10%;"></td> </tr> <tr> <td></td> <td></td> <td colspan="8" style="text-align: center;"> <table border="1" style="width: 100%; border-collapse: collapse; text-align: center;"> <tr> <td style="width: 10%;"></td> <td style="width: 10%;"></td> <td style="width: 10%;"></td> <td style="width: 10%;"></td> <td style="width: 10%;"></td> <td style="width: 10%;"></td> <td style="width: 10%;"></td> <td style="width: 10%;"></td> <td style="width: 10%;"></td> <td style="width: 10%;"></td> </tr> <tr> <td></td> <td></td> <td colspan="8" style="text-align: center;"> <table border="1" style="width: 100%; border-collapse: collapse; text-align: center;"> <tr> <td style="width: 10%;"></td> <td style="width: 10%;"></td> <td style="width: 10%;"></td> <td style="width: 10%;"></td> <td style="width: 10%;"></td> <td style="width: 10%;"></td> <td style="width: 10%;"></td> <td style="width: 10%;"></td> <td style="width: 10%;"></td> <td style="width: 10%;"></td> </tr> <tr> <td></td> <td></td> <td colspan="8" style="text-align: center;"> <table border="1" style="width: 100%; border-collapse: collapse; text-align: center;"> <tr> <td style="width: 10%;"></td> <td style="width: 10%;"></td> <td style="width: 10%;"></td> <td style="width: 10%;"></td> <td style="width: 10%;"></td> <td style="width: 10%;"></td> <td style="width: 10%;"></td> <td style="width: 10%;"></td> <td style="width: 10%;"></td> <td style="width: 10%;"></td> </tr> <tr> <td></td> <td></td> <td colspan="8" style="text-align: center;"> <table border="1" style="width: 100%; border-collapse: collapse; text-align: center;"> <tr> <td style="width: 10%;"></td> <td style="width: 10%;"></td> <td style="width: 10%;"></td> <td style="width: 10%;"></td> <td style="width: 10%;"></td> <td style="width: 10%;"></td> <td style="width: 10%;"></td> <td style="width: 10%;"></td> <td style="width: 10%;"></td> <td style="width: 10%;"></td> </tr> <tr> <td></td> <td></td> <td colspan="8" style="text-align: center;"> <table border="1" style="width: 100%; border-collapse: collapse; text-align: center;"> <tr> <td style="width: 10%;"></td> <td style="width: 10%;"></td> <td style="width: 10%;"></td> <td style="width: 10%;"></td> <td style="width: 10%;"></td> <td style="width: 10%;"></td> <td style="width: 10%;"></td> <td style="width: 10%;"></td> <td style="width: 10%;"></td> <td style="width: 10%;"></td> </tr> <tr> <td></td> <td></td> <td colspan="8" style="text-align: center;"> <table border="1" style="width: 100%; border-collapse: collapse; text-align: center;"> <tr> <td style="width: 10%;"></td> <td style="width: 10%;"></td> <td style="width: 10%;"></td> <td style="width: 10%;"></td> <td style="width: 10%;"></td> <td style="width: 10%;"></td> <td style="width: 10%;"></td> <td style="width: 10%;"></td> <td style="width: 10%;"></td> <td style="width: 10%;"></td> </tr> <tr> <td></td> <td></td> <td colspan="8" style="text-align: center;"> <table border="1" style="width: 100%; border-collapse: collapse; text-align: center;"> <tr> <td style="width: 10%;"></td> <td style="width: 10%;"></td> <td style="width: 10%;"></td> <td style="width: 10%;"></td> <td style="width: 10%;"></td> <td style="width: 10%;"></td> <td style="width: 10%;"></td> <td style="width: 10%;"></td> <td style="width: 10%;"></td> <td style="width: 10%;"></td> </tr> <tr> <td></td> <td></td> <td colspan="8" style="text-align: center;"> <table border="1" style="width: 100%; border-collapse: collapse; text-align: center;"> <tr> <td style="width: 10%;"></td> <td style="width: 10%;"></td> <td style="width: 10%;"></td> <td style="width: 10%;"></td> <td style="width: 10%;"></td> <td style="width: 10%;"></td> <td style="width: 10%;"></td> <td style="width: 10%;"></td> <td style="width: 10%;"></td> <td style="width: 10%;"></td> </tr> <tr> <td></td> <td></td> <td colspan="8" style="text-align: center;"> <table border="1" style="width: 100%; border-collapse: collapse; text-align: center;"> <tr> <td style="width: 10%;"></td> <td style="width: 10%;"></td> <td style="width: 10%;"></td> <td style="width: 10%;"></td> <td style="width: 10%;"></td> <td style="width: 10%;"></td> <td style="width: 10%;"></td> <td style="width: 10%;"></td> <td style="width: 10%;"></td> <td style="width: 10%;"></td> </tr> <tr> <td></td> <td></td> <td colspan="8" style="text-align: center;"> <table border="1" style="width: 100%; border-collapse: collapse; text-align: center;"> <tr> <td style="width: 10%;"></td> <td style="width: 10%;"></td> <td style="width: 10%;"></td> <td style="width: 10%;"></td> <td style="width: 10%;"></td> <td style="width: 10%;"></td> <td style="width: 10%;"></td> <td style="width: 10%;"></td> <td style="width: 10%;"></td> <td style="width: 10%;"></td> </tr> <tr> <td></td> <td></td> <td colspan="8" style="text-align: center;"> <table border="1" style="width: 100%; border-collapse: collapse; text-align: center;"> <tr> <td style="width: 10%;"></td> <td style="width: 10%;"></td> <td style="width: 10%;"></td> <td style="width: 10%;"></td> <td style="width: 10%;"></td> <td style="width: 10%;"></td> <td style="width: 10%;"></td> <td style="width: 10%;"></td> <td style="width: 10%;"></td> <td style="width: 10%;"></td> </tr> <tr> <td></td> <td></td> <td colspan="8" style="text-align: center;"> <table border="1" style="width: 100%; border-collapse: collapse; text-align: center;"> <tr> <td style="width: 10%;"></td> <td style="width: 10%;"></td> <td style="width: 10%;"></td> <td style="width: 10%;"></td> <td style="width: 10%;"></td> <td style="width: 10%;"></td> <td style="width: 10%;"></td> <td style="width: 10%;"></td> <td style="width: 10%;"></td> <td style="width: 10%;"></td> </tr> <tr> <td></td> <td></td> <td colspan="8" style="text-align: center;"> <table border="1" style="width: 100%; border-collapse: collapse; text-align: center;"> <tr> <td style="width: 10%;"></td> <td style="width: 10%;"></td> <td style="width: 10%;"></td> <td style="width: 10%;"></td> <td style="width: 10%;"></td> <td style="width: 10%;"></td> <td style="width: 10%;"></td> <td style="width: 10%;"></td> <td style="width: 10%;"></td> <td style="width: 10%;"></td> </tr> <tr> <td></td> <td></td> <td colspan="8" style="text-align: center;"> <table border="1" style="width: 100%; border-collapse: collapse; text-align: center;"> <tr> <td style="width: 10%;"></td> <td style="width: 10%;"></td> <td style="width: 10%;"></td> <td style="width: 10%;"></td> <td style="width: 10%;"></td> <td style="width: 10%;"></td> <td style="width: 10%;"></td> <td style="width: 10%;"></td> <td style="width: 10%;"></td> <td style="width: 10%;"></td> </tr> <tr> <td></td> <td></td> <td colspan="8" style="text-align: center;"> <table border="1" style="width: 100%; border-collapse: collapse; text-align: center;"> <tr> <td style="width: 10%;"></td> <td style="width: 10%;"></td> <td style="width: 10%;"></td> <td style="width: 10%;"></td> <td style="width: 10%;"></td> <td style="width: 10%;"></td> <td style="width: 10%;"></td> <td style="width: 10%;"></td> <td style="width: 10%;"></td> <td style="width: 10%;"></td> </tr> <tr> <td></td> <td></td> <td colspan="8" style="text-align: center;"> <table border="1" style="width: 100%; border-collapse: collapse; text-align: center;"> <tr> <td style="width: 10%;"></td> <td style="width: 10%;"></td> <td style="width: 10%;"></td> <td style="width: 10%;"></td> <td style="width: 10%;"></td> <td style="width: 10%;"></td> <td style="width: 10%;"></td> <td style="width: 10%;"></td> <td style="width: 10%;"></td> <td style="width: 10%;"></td> </tr> <tr> <td></td> <td></td> <td colspan="8"
style="text-align: center;"> <table border="1" style="width: 100%; border-collapse: collapse; text-align: center;"> <tr> <td style="width: 10%;"></td> <td style="width: 10%;"></td> <td style="width: 10%;"></td> <td style="width: 10%;"></td> <td style="width: 10%;"></td> <td style="width: 10%;"></td> <td style="width: 10%;"></td> <td style="width: 10%;"></td> <td style="width: 10%;"></td> <td style="width: 10%;"></td> </tr> <tr> <td></td> <td></td> <td colspan="8" style="text-align: center;"> <table border="1" style="width: 100%; border-collapse: collapse; text-align: center;"> <tr> <td style="width: 10%;"></td> <td style="width: 10%;"></td> <td style="width: 10%;"></td> <td style="width: 10%;"></td> <td style="width: 10%;"></td> <td style="width: 10%;"></td> <td style="width: 10%;"></td> <td style="width: 10%;"></td> <td style="width: 10%;"></td> <td style="width: 10%;"></td> </tr> <tr> <td></td> <td></td> <td colspan="8" style="text-align: center;"> <table border="1" style="width: 100%; border-collapse: collapse; text-align: center;"> <tr> <td style="width: 10%;"></td> <td style="width: 10%;"></td> <td style="width: 10%;"></td> <td style="width: 10%;"></td> <td style="width: 10%;"></td> <td style="width: 10%;"></td> <td style="width: 10%;"></td> <td style="width: 10%;"></td> <td style="width: 10%;"></td> <td style="width: 10%;"></td> </tr> <tr> <td></td> <td></td> <td colspan="8" style="text-align: center;"> <table border="1" style="width: 100%; border-collapse: collapse; text-align: center;"> <tr> <td style="width: 10%;"></td> <td style="width: 10%;"></td> <td style="width: 10%;"></td> <td style="width: 10%;"></td> <td style="width: 10%;"></td> <td style="width: 10%;"></td> <td style="width: 10%;"></td> <td style="width: 10%;"></td> <td style="width: 10%;"></td> <td style="width: 10%;"></td> </tr> <tr> <td></td> <td></td> <td colspan="8" style="text-align: center;"> <table border="1" style="width: 100%; border-collapse: collapse; text-align: center;"> <tr> <td style="width: 10%;"></td> <td style="width: 10%;"></td> <td style="width: 10%;"></td> <td style="width: 10%;"></td> <td style="width: 10%;"></td> <td style="width: 10%;"></td> <td style="width: 10%;"></td> <td style="width: 10%;"></td> <td style="width: 10%;"></td> <td style="width: 10%;"></td> </tr> <tr> <td></td> <td></td> <td colspan="8" style="text-align: center;"> <table border="1" style="width: 100%; border-collapse: collapse; text-align: center;"> <tr> <td style="width: 10%;"></td> <td style="width: 10%;"></td> <td style="width: 10%;"></td> <td style="width: 10%;"></td> <td style="width: 10%;"></td> <td style="width: 10%;"></td> <td style="width: 10%;"></td> <td style="width: 10%;"></td> <td style="width: 10%;"></td> <td style="width: 10%;"></td> </tr> <tr> <td></td> <td></td> <td colspan="8" style="text-align: center;"> <table border="1" style="width: 100%; border-collapse: collapse; text-align: center;"> <tr> <td style="width: 10%;"></td> <td style="width: 10%;"></td> <td style="width: 10%;"></td> <td style="width: 10%;"></td> <td style="width: 10%;"></td> <td style="width: 10%;"></td> <td style="width: 10%;"></td> <td style="width: 10%;"></td> <td style="width: 10%;"></td> <td style="width: 10%;"></td> </tr> <tr> <td></td> <td></td> <td colspan="8" style="text-align: center;"> <table border="1" style="width: 100%; border-collapse: collapse; text-align: center;"> <tr> <td style="width: 10%;"></td> <td style="width: 10%;"></td> <td style="width: 10%;"></td> <td style="width: 10%;"></td> <td style="width: 10%;"></td> <td style="width: 10%;"></td> <td style="width: 10%;"></td> <td style="width: 10%;"></td> <td style="width: 10%;"></td> <td style="width: 10%;"></td> </tr> <tr> <td></td> <td></td> <td colspan="8" style="text-align: center;"> <table border="1" style="width: 100%; border-collapse: collapse; text-align: center;"> <tr> <td style="width: 10%;"></td> <td style="width: 10%;"></td> <td style="width: 10%;"></td> <td style="width: 10%;"></td> <td style="width: 10%;"></td> <td style="width: 10%;"></td> <td style="width: 10%;"></td> <td style="width: 10%;"></td> <td style="width: 10%;"></td> <td style="width: 10%;"></td> </tr> <tr> <td></td> <td></td> <td colspan="8" style="text-align: center;"> <table border="1" style="width: 100%; border-collapse: collapse; text-align: center;"> <tr> <td style="width: 10%;"></td> <td style="width: 10%;"></td> <td style="width: 10%;"></td> <td style="width: 10%;"></td> <td style="width: 10%;"></td> <td style="width: 10%;"></td> <td style="width: 10%;"></td> <td style="width: 10%;"></td> <td style="width: 10%;"></td> <td style="width: 10%;"></td> </tr> <tr> <td></td> <td></td> <td colspan="8" style="text-align: center;"> <table border="1" style="width: 100%; border-collapse: collapse; text-align: center;"> <tr> <td style="width: 10%;"></td> <td style="width: 10%;"></td> <td style="width: 10%;"></td> <td style="width: 10%;"></td> <td style="width: 10%;"></td> <td style="width: 10%;"></td> <td style="width: 10%;"></td> <td style="width: 10%;"></td> <td style="width: 10%;"></td> <td style="width: 10%;"></td> </tr> <tr> <td></td> <td></td> <td colspan="8" style="text-align: center;"> <table border="1" style="width: 100%; border-collapse: collapse; text-align: center;"> <tr> <td style="width: 10%;"></td> <td style="width: 10%;"></td> <td style="width: 10%;"></td> <td style="width: 10%;"></td> <td style="width: 10%;"></td> <td style="width: 10%;"></td> <td style="width: 10%;"></td> <td style="width: 10%;"></td> <td style="width: 10%;"></td> <td style="width: 10%;"></td> </tr> <tr> <td></td> <td></td> <td colspan="8" style="text-align: center;"> <table border="1" style="width: 100%; border-collapse: collapse; text-align: center;"> <tr> <td style="width: 10%;"></td> <td style="width: 10%;"></td> <td style="width: 10%;"></td> <td style="width: 10%;"></td> <td style="width: 10%;"></td> <td style="width: 10%;"></td> <td style="width: 10%;"></td> <td style="width: 10%;"></td> <td style="width: 10%;"></td> <td style="width: 10%;"></td> </tr> <tr> <td></td> <td></td> <td colspan="8" style="text-align: center;"> <table border="1" style="width: 100%; border-collapse: collapse; text-align: center;"> <tr> <td style="width: 10%;"></td> <td style="width: 10%;"></td> <td style="width: 10%;"></td> <td style="width: 10%;"></td> <td style="width: 10%;"></td> <td style="width: 10%;"></td> <td style="width: 10%;"></td> <td style="width: 10%;"></td> <td style="width: 10%;"></td> <td style="width: 10%;"></td> </tr> <tr> <td></td> <td></td> <td colspan="8" style="text-align: center;"> <table border="1" style="width: 100%; border-collapse: collapse; text-align: center;"> <tr> <td style="width: 10%;"></td> <td style="width: 10%;"></td> <td style="width: 10%;"></td> <td style="width: 10%;"></td> <td style="width: 10%;"></td> <td style="width: 10%;"></td> <td style="width: 10%;"></td> <td style="width: 10%;"></td> <td style="width: 10%;"></td> <td style="width: 10%;"></td> </tr> <tr> <td></td> <td></td> <td colspan="8" style="text-align: center;"> <table border="1" style="width: 100%; border-collapse: collapse; text-align: center;"> <tr> <td style="width: 10%;"></td> <td style="width: 10%;"></td> <td style="width: 10%;"></td> <td style="width: 10%;"></td> <td style="width: 10%;"></td> <td style="width: 10%;"></td> <td style="width: 10%;"></td> <td style="width: 10%;"></td> <td style="width: 10%;"></td> <td style="width: 10%;"></td> </tr> <tr> <td></td> <td></td> <td colspan="8" style="text-align: center;"> <table border="1" style="width: 100%; border-collapse: collapse; text-align: center;"> <tr> </tr></table></td></tr></table></td></tr></table></td></tr></table></td></tr></table></td></tr></table></td></tr></table></td></tr></table></td></tr></table></td></tr></table></td></tr></table></td></tr></table></td></tr></table></td></tr></table></td></tr></table></td></tr></table></td></tr></table></td></tr></table></td></tr></table></td></tr></table></td></tr></table></td></tr></table></td></tr></table></td></tr></table></td></tr></table></td></tr></table></td></tr></table></td></tr></table></td></tr></table></td></tr></table></td></tr></table></td></tr></table></td></tr></table></td></tr></table></td></tr></table></td></tr></table></td></tr></table></td></tr></table></td></tr></table></td></tr></table></td></tr></table></td></tr></table></td></tr></table></td></tr></table></td></tr></table></td></tr></table></td></tr></table></td></tr></table></td></tr></table></td></tr></table></td></tr></table></td></tr></table></td></tr></table></td></tr></table></td></tr></table>
 | | | | | | | | | | | | | | | | | | | | <table border="1" style="width: 100%; border-collapse: collapse; text-align: center;"> <tr> <td style="width: 10%;"></td> <td style="width: 10%;"></td> <td style="width: 10%;"></td> <td style="width: 10%;"></td> <td style="width: 10%;"></td> <td style="width: 10%;"></td> <td style="width: 10%;"></td> <td style="width: 10%;"></td> <td style="width: 10%;"></td> <td style="width: 10%;"></td> </tr> <tr> <td></td> <td></td> <td colspan="8" style="text-align: center;"> <table border="1" style="width: 100%; border-collapse: collapse; text-align: center;"> <tr> <td style="width: 10%;"></td> <td style="width: 10%;"></td> <td style="width: 10%;"></td> <td style="width: 10%;"></td> <td style="width: 10%;"></td> <td style="width: 10%;"></td> <td style="width: 10%;"></td> <td style="width: 10%;"></td> <td style="width: 10%;"></td> <td style="width: 10%;"></td> </tr> <tr> <td></td> <td></td> <td colspan="8" style="text-align: center;"> <table border="1" style="width: 100%; border-collapse: collapse; text-align: center;"> <tr> <td style="width: 10%;"></td> <td style="width: 10%;"></td> <td style="width: 10%;"></td> <td style="width: 10%;"></td> <td style="width: 10%;"></td> <td style="width: 10%;"></td> <td style="width: 10%;"></td> <td style="width: 10%;"></td> <td style="width: 10%;"></td> <td style="width: 10%;"></td> </tr> <tr> <td></td> <td></td> <td colspan="8" style="text-align: center;"> <table border="1" style="width: 100%; border-collapse: collapse; text-align: center;"> <tr> <td style="width: 10%;"></td> <td style="width: 10%;"></td> <td style="width: 10%;"></td> <td style="width: 10%;"></td> <td style="width: 10%;"></td> <td style="width: 10%;"></td> <td style="width: 10%;"></td> <td style="width: 10%;"></td> <td style="width: 10%;"></td> <td style="width: 10%;"></td> </tr> <tr> <td></td> <td></td> <td colspan="8" style="text-align: center;"> <table border="1" style="width: 100%; border-collapse: collapse; text-align: center;"> <tr> <td style="width: 10%;"></td> <td style="width: 10%;"></td> <td style="width: 10%;"></td> <td style="width: 10%;"></td> <td style="width: 10%;"></td> <td style="width: 10%;"></td> <td style="width: 10%;"></td> <td style="width: 10%;"></td> <td style="width: 10%;"></td> <td style="width: 10%;"></td> </tr> <tr> <td></td> <td></td> <td colspan="8" style="text-align: center;"> <table border="1" style="width: 100%; border-collapse: collapse; text-align: center;"> <tr> <td style="width: 10%;"></td> <td style="width: 10%;"></td> <td style="width: 10%;"></td> <td style="width: 10%;"></td> <td style="width: 10%;"></td> <td style="width: 10%;"></td> <td style="width: 10%;"></td> <td style="width: 10%;"></td> <td style="width: 10%;"></td> <td style="width: 10%;"></td> </tr> <tr> <td></td> <td></td> <td colspan="8" style="text-align: center;"> <table border="1" style="width: 100%; border-collapse: collapse; text-align: center;"> <tr> <td style="width: 10%;"></td> <td style="width: 10%;"></td> <td style="width: 10%;"></td> <td style="width: 10%;"></td> <td style="width: 10%;"></td> <td style="width: 10%;"></td> <td style="width: 10%;"></td> <td style="width: 10%;"></td> <td style="width: 10%;"></td> <td style="width: 10%;"></td> </tr> <tr> <td></td> <td></td> <td colspan="8" style="text-align: center;"> <table border="1" style="width: 100%; border-collapse: collapse; text-align: center;"> <tr> <td style="width: 10%;"></td> <td style="width: 10%;"></td> <td style="width: 10%;"></td> <td style="width: 10%;"></td> <td style="width: 10%;"></td> <td style="width: 10%;"></td> <td style="width: 10%;"></td> <td style="width: 10%;"></td> <td style="width: 10%;"></td> <td style="width: 10%;"></td> </tr> <tr> <td></td> <td></td> <td colspan="8" style="text-align: center;"> <table border="1" style="width: 100%; border-collapse: collapse; text-align: center;"> <tr> <td style="width: 10%;"></td> <td style="width: 10%;"></td> <td style="width: 10%;"></td> <td style="width: 10%;"></td> <td style="width: 10%;"></td> <td style="width: 10%;"></td> <td style="width: 10%;"></td> <td style="width: 10%;"></td> <td style="width: 10%;"></td> <td style="width: 10%;"></td> </tr> <tr> <td></td> <td></td> <td colspan="8" style="text-align: center;"> <table border="1" style="width: 100%; border-collapse: collapse; text-align: center;"> <tr> <td style="width: 10%;"></td> <td style="width: 10%;"></td> <td style="width: 10%;"></td> <td style="width: 10%;"></td> <td style="width: 10%;"></td> <td style="width: 10%;"></td> <td style="width: 10%;"></td> <td style="width: 10%;"></td> <td style="width: 10%;"></td> <td style="width: 10%;"></td> </tr> <tr> <td></td> <td></td> <td colspan="8" style="text-align: center;"> <table border="1" style="width: 100%; border-collapse: collapse; text-align: center;"> <tr> <td style="width: 10%;"></td> <td style="width: 10%;"></td> <td style="width: 10%;"></td> <td style="width: 10%;"></td> <td style="width: 10%;"></td> <td style="width: 10%;"></td> <td style="width: 10%;"></td> <td style="width: 10%;"></td> <td style="width: 10%;"></td> <td style="width: 10%;"></td> </tr> <tr> <td></td> <td></td> <td colspan="8" style="text-align: center;"> <table border="1" style="width: 100%; border-collapse: collapse; text-align: center;"> <tr> <td style="width: 10%;"></td> <td style="width: 10%;"></td> <td style="width: 10%;"></td> <td style="width: 10%;"></td> <td style="width: 10%;"></td> <td style="width: 10%;"></td> <td style="width: 10%;"></td> <td style="width: 10%;"></td> <td style="width: 10%;"></td> <td style="width: 10%;"></td> </tr> <tr> <td></td> <td></td> <td colspan="8" style="text-align: center;"> <table border="1" style="width: 100%; border-collapse: collapse; text-align: center;"> <tr> <td style="width: 10%;"></td> <td style="width: 10%;"></td> <td style="width: 10%;"></td> <td style="width: 10%;"></td> <td style="width: 10%;"></td> <td style="width: 10%;"></td> <td style="width: 10%;"></td> <td style="width: 10%;"></td> <td style="width: 10%;"></td> <td style="width: 10%;"></td> </tr> <tr> <td></td> <td></td> <td colspan="8" style="text-align: center;"> <table border="1" style="width: 100%; border-collapse: collapse; text-align: center;"> <tr> <td style="width: 10%;"></td> <td style="width: 10%;"></td> <td style="width: 10%;"></td> <td style="width: 10%;"></td> <td style="width: 10%;"></td> <td style="width: 10%;"></td> <td style="width: 10%;"></td> <td style="width: 10%;"></td> <td style="width: 10%;"></td> <td style="width: 10%;"></td> </tr> <tr> <td></td> <td></td> <td colspan="8" style="text-align: center;"> <table border="1" style="width: 100%; border-collapse: collapse; text-align: center;"> <tr> <td style="width: 10%;"></td> <td style="width: 10%;"></td> <td style="width: 10%;"></td> <td style="width: 10%;"></td> <td style="width: 10%;"></td> <td style="width: 10%;"></td> <td style="width: 10%;"></td> <td style="width: 10%;"></td> <td style="width: 10%;"></td> <td style="width: 10%;"></td> </tr> <tr> <td></td> <td></td> <td colspan="8" style="text-align: center;"> <table border="1" style="width: 100%; border-collapse: collapse; text-align: center;"> <tr> <td style="width: 10%;"></td> <td style="width: 10%;"></td> <td style="width: 10%;"></td> <td style="width: 10%;"></td> <td style="width: 10%;"></td> <td style="width: 10%;"></td> <td style="width: 10%;"></td> <td style="width: 10%;"></td> <td style="width: 10%;"></td> <td style="width: 10%;"></td> </tr> <tr> <td></td> <td></td> <td colspan="8" style="text-align: center;"> <table border="1" style="width: 100%; border-collapse: collapse; text-align: center;"> <tr> <td style="width: 10%;"></td> <td style="width: 10%;"></td> <td style="width: 10%;"></td> <td style="width: 10%;"></td> <td style="width: 10%;"></td> <td style="width: 10%;"></td> <td style="width: 10%;"></td> <td style="width: 10%;"></td> <td style="width: 10%;"></td> <td style="width: 10%;"></td> </tr> <tr> <td></td> <td></td> <td colspan="8" style="text-align: center;"> <table border="1" style="width: 100%; border-collapse: collapse; text-align: center;"> <tr> <td style="width: 10%;"></td> <td style="width: 10%;"></td> <td style="width: 10%;"></td> <td style="width: 10%;"></td> <td style="width: 10%;"></td> <td style="width: 10%;"></td> <td style="width: 10%;"></td> <td style="width: 10%;"></td> <td style="width: 10%;"></td> <td style="width: 10%;"></td> </tr> <tr> <td></td> <td></td> <td colspan="8" style="text-align: center;">
<table border="1" style="width: 100%; border-collapse: collapse; text-align: center;"> <tr> <td style="width: 10%;"></td> <td style="width: 10%;"></td> <td style="width: 10%;"></td> <td style="width: 10%;"></td> <td style="width: 10%;"></td> <td style="width: 10%;"></td> <td style="width: 10%;"></td> <td style="width: 10%;"></td> <td style="width: 10%;"></td> <td style="width: 10%;"></td> </tr> <tr> <td></td> <td></td> <td colspan="8" style="text-align: center;"> <table border="1" style="width: 100%; border-collapse: collapse; text-align: center;"> <tr> <td style="width: 10%;"></td> <td style="width: 10%;"></td> <td style="width: 10%;"></td> <td style="width: 10%;"></td> <td style="width: 10%;"></td> <td style="width: 10%;"></td> <td style="width: 10%;"></td> <td style="width: 10%;"></td> <td style="width: 10%;"></td> <td style="width: 10%;"></td> </tr> <tr> <td></td> <td></td> <td colspan="8" style="text-align: center;"> <table border="1" style="width: 100%; border-collapse: collapse; text-align: center;"> <tr> <td style="width: 10%;"></td> <td style="width: 10%;"></td> <td style="width: 10%;"></td> <td style="width: 10%;"></td> <td style="width: 10%;"></td> <td style="width: 10%;"></td> <td style="width: 10%;"></td> <td style="width: 10%;"></td> <td style="width: 10%;"></td> <td style="width: 10%;"></td> </tr> <tr> <td></td> <td></td> <td colspan="8" style="text-align: center;"> <table border="1" style="width: 100%; border-collapse: collapse; text-align: center;"> <tr> <td style="width: 10%;"></td> <td style="width: 10%;"></td> <td style="width: 10%;"></td> <td style="width: 10%;"></td> <td style="width: 10%;"></td> <td style="width: 10%;"></td> <td style="width: 10%;"></td> <td style="width: 10%;"></td> <td style="width: 10%;"></td> <td style="width: 10%;"></td> </tr> <tr> <td></td> <td></td> <td colspan="8" style="text-align: center;"> <table border="1" style="width: 100%; border-collapse: collapse; text-align: center;"> <tr> <td style="width: 10%;"></td> <td style="width: 10%;"></td> <td style="width: 10%;"></td> <td style="width: 10%;"></td> <td style="width: 10%;"></td> <td style="width: 10%;"></td> <td style="width: 10%;"></td> <td style="width: 10%;"></td> <td style="width: 10%;"></td> <td style="width: 10%;"></td> </tr> <tr> <td></td> <td></td> <td colspan="8" style="text-align: center;"> <table border="1" style="width: 100%; border-collapse: collapse; text-align: center;"> <tr> <td style="width: 10%;"></td> <td style="width: 10%;"></td> <td style="width: 10%;"></td> <td style="width: 10%;"></td> <td style="width: 10%;"></td> <td style="width: 10%;"></td> <td style="width: 10%;"></td> <td style="width: 10%;"></td> <td style="width: 10%;"></td> <td style="width: 10%;"></td> </tr> <tr> <td></td> <td></td> <td colspan="8" style="text-align: center;"> <table border="1" style="width: 100%; border-collapse: collapse; text-align: center;"> <tr> <td style="width: 10%;"></td> <td style="width: 10%;"></td> <td style="width: 10%;"></td> <td style="width: 10%;"></td> <td style="width: 10%;"></td> <td style="width: 10%;"></td> <td style="width: 10%;"></td> <td style="width: 10%;"></td> <td style="width: 10%;"></td> <td style="width: 10%;"></td> </tr> <tr> <td></td> <td></td> <td colspan="8" style="text-align: center;"> <table border="1" style="width: 100%; border-collapse: collapse; text-align: center;"> <tr> <td style="width: 10%;"></td> <td style="width: 10%;"></td> <td style="width: 10%;"></td> <td style="width: 10%;"></td> <td style="width: 10%;"></td> <td style="width: 10%;"></td> <td style="width: 10%;"></td> <td style="width: 10%;"></td> <td style="width: 10%;"></td> <td style="width: 10%;"></td> </tr> <tr> <td></td> <td></td> <td colspan="8" style="text-align: center;"> <table border="1" style="width: 100%; border-collapse: collapse; text-align: center;"> <tr> <td style="width: 10%;"></td> <td style="width: 10%;"></td> <td style="width: 10%;"></td> <td style="width: 10%;"></td> <td style="width: 10%;"></td> <td style="width: 10%;"></td> <td style="width: 10%;"></td> <td style="width: 10%;"></td> <td style="width: 10%;"></td> <td style="width: 10%;"></td> </tr> <tr> <td></td> <td></td> <td colspan="8" style="text-align: center;"> <table border="1" style="width: 100%; border-collapse: collapse; text-align: center;"> <tr> <td style="width: 10%;"></td> <td style="width: 10%;"></td> <td style="width: 10%;"></td> <td style="width: 10%;"></td> <td style="width: 10%;"></td> <td style="width: 10%;"></td> <td style="width: 10%;"></td> <td style="width: 10%;"></td> <td style="width: 10%;"></td> <td style="width: 10%;"></td> </tr> <tr> <td></td> <td></td> <td colspan="8" style="text-align: center;"> <table border="1" style="width: 100%; border-collapse: collapse; text-align: center;"> <tr> <td style="width: 10%;"></td> <td style="width: 10%;"></td> <td style="width: 10%;"></td> <td style="width: 10%;"></td> <td style="width: 10%;"></td> <td style="width: 10%;"></td> <td style="width: 10%;"></td> <td style="width: 10%;"></td> <td style="width: 10%;"></td> <td style="width: 10%;"></td> </tr> <tr> <td></td> <td></td> <td colspan="8" style="text-align: center;"> <table border="1" style="width: 100%; border-collapse: collapse; text-align: center;"> <tr> <td style="width: 10%;"></td> <td style="width: 10%;"></td> <td style="width: 10%;"></td> <td style="width: 10%;"></td> <td style="width: 10%;"></td> <td style="width: 10%;"></td> <td style="width: 10%;"></td> <td style="width: 10%;"></td> <td style="width: 10%;"></td> <td style="width: 10%;"></td> </tr> <tr> <td></td> <td></td> <td colspan="8" style="text-align: center;"> <table border="1" style="width: 100%; border-collapse: collapse; text-align: center;"> <tr> <td style="width: 10%;"></td> <td style="width: 10%;"></td> <td style="width: 10%;"></td> <td style="width: 10%;"></td> <td style="width: 10%;"></td> <td style="width: 10%;"></td> <td style="width: 10%;"></td> <td style="width: 10%;"></td> <td style="width: 10%;"></td> <td style="width: 10%;"></td> </tr> <tr> <td></td> <td></td> <td colspan="8" style="text-align: center;"> <table border="1" style="width: 100%; border-collapse: collapse; text-align: center;"> <tr> <td style="width: 10%;"></td> <td style="width: 10%;"></td> <td style="width: 10%;"></td> <td style="width: 10%;"></td> <td style="width: 10%;"></td> <td style="width: 10%;"></td> <td style="width: 10%;"></td> <td style="width: 10%;"></td> <td style="width: 10%;"></td> <td style="width: 10%;"></td> </tr> <tr> <td></td> <td></td> <td colspan="8" style="text-align: center;"> <table border="1" style="width: 100%; border-collapse: collapse; text-align: center;"> <tr> <td style="width: 10%;"></td> <td style="width: 10%;"></td> <td style="width: 10%;"></td> <td style="width: 10%;"></td> <td style="width: 10%;"></td> <td style="width: 10%;"></td> <td style="width: 10%;"></td> <td style="width: 10%;"></td> <td style="width: 10%;"></td> <td style="width: 10%;"></td> </tr> <tr> <td></td> <td></td> <td colspan="8" style="text-align: center;"> <table border="1" style="width: 100%; border-collapse: collapse; text-align: center;"> <tr> <td style="width: 10%;"></td> <td style="width: 10%;"></td> <td style="width: 10%;"></td> <td style="width: 10%;"></td> <td style="width: 10%;"></td> <td style="width: 10%;"></td> <td style="width: 10%;"></td> <td style="width: 10%;"></td> <td style="width: 10%;"></td> <td style="width: 10%;"></td> </tr> <tr> <td></td> <td></td> <td colspan="8" style="text-align: center;"> <table border="1" style="width: 100%; border-collapse: collapse; text-align: center;"> <tr> <td style="width: 10%;"></td> <td style="width: 10%;"></td> <td style="width: 10%;"></td> <td style="width: 10%;"></td> <td style="width: 10%;"></td> <td style="width: 10%;"></td> <td style="width: 10%;"></td> <td style="width: 10%;"></td> <td style="width: 10%;"></td> <td style="width: 10%;"></td> </tr> <tr> <td></td> <td></td> <td colspan="8" style="text-align: center;"> <table border="1" style="width: 100%; border-collapse: collapse; text-align: center;"> <tr> <td style="width: 10%;"></td> <td style="width: 10%;"></td> <td style="width: 10%;"></td> <td style="width: 10%;"></td> <td style="width: 10%;"></td> <td style="width: 10%;"></td> <td style="width: 10%;"></td> <td style="width: 10%;"></td> <td style="width: 10%;"></td> <td style="width: 10%;"></td> </tr> <tr> <td></td> <td></td> <td colspan="8" style="text-align: center;"> <table border="1" style="width: 100%; border-collapse: collapse; text-align: center;"> <tr> <td style="width: 10%;"></td> <td style="width: 10%;"></td> <td style="width: 10%;"></td> <td style="width: 10%;"></td> <td style="width: 10%;"></td> <td style="width: 10%;"></td> <td style="width: 10%;"></td> <td style="width: 10%;"></td> <td style="width: 10%;"></td> <td style="width: 10%;"></td> </tr> <tr> <td></td> <td></td> <td colspan="8" style="text-align: center;"> <table border="1" style="width: 100%; border-collapse: collapse; text-align: center;"> <tr> <td style="width: 10%;"></td> <td style="width: 10%;"></td> <td style="width: 10%;"></td> <td style="width: 10%;"></td> <td style="width: 10%;"></td> <td style="width: 10%;"></td> <td style="width: 10%;"></td> <td style="width: 10%;"></td> <td style="width: 10%;"></td> <td style="width: 10%;"></td> </tr> <tr> <td></td> <td></td> <td colspan="8" style="text-align: center;"> <table border="1" style="width: 100%; border-collapse: collapse; text-align: center;"> <tr> <td style="width: 10%;"></td> <td style="width: 10%;"></td> <td style="width: 10%;"></td> <td style="width: 10%;"></td> <td style="width: 10%;"></td> <td style="width: 10%;"></td> <td style="width: 10%;"></td> <td style="width: 10%;"></td> <td style="width: 10%;"></td> <td style="width: 10%;"></td> </tr> <tr> <td></td> <td></td> <td colspan="8" style="text-align: center;"> <table border="1" style="width: 100%; border-collapse: collapse; text-align: center;"> <tr> <td style="width: 10%;"></td> <td style="width: 10%;"></td> <td style="width:
10%;"></td> <td style="width: 10%;"></td> <td style="width: 10%;"></td> <td style="width: 10%;"></td> <td style="width: 10%;"></td> <td style="width: 10%;"></td> <td style="width: 10%;"></td> <td style="width: 10%;"></td> </tr> <tr> <td></td> <td></td> <td colspan="8" style="text-align: center;"> <table border="1" style="width: 100%; border-collapse: collapse; text-align: center;"> <tr> <td style="width: 10%;"></td> <td style="width: 10%;"></td> <td style="width: 10%;"></td> <td style="width: 10%;"></td> <td style="width: 10%;"></td> <td style="width: 10%;"></td> <td style="width: 10%;"></td> <td style="width: 10%;"></td> <td style="width: 10%;"></td> <td style="width: 10%;"></td> </tr> <tr> <td></td> <td></td> <td colspan="8" style="text-align: center;"> <table border="1" style="width: 100%; border-collapse: collapse; text-align: center;"> <tr> <td style="width: 10%;"></td> <td style="width: 10%;"></td> <td style="width: 10%;"></td> <td style="width: 10%;"></td> <td style="width: 10%;"></td> <td style="width: 10%;"></td> <td style="width: 10%;"></td> <td style="width: 10%;"></td> <td style="width: 10%;"></td> <td style="width: 10%;"></td> </tr> <tr> <td></td> <td></td> <td colspan="8" style="text-align: center;"> <table border="1" style="width: 100%; border-collapse: collapse; text-align: center;"> <tr> <td style="width: 10%;"></td> <td style="width: 10%;"></td> <td style="width: 10%;"></td> <td style="width: 10%;"></td> <td style="width: 10%;"></td> <td style="width: 10%;"></td> <td style="width: 10%;"></td> <td style="width: 10%;"></td> <td style="width: 10%;"></td> <td style="width: 10%;"></td> </tr> <tr> <td></td> <td></td> <td colspan="8" style="text-align: center;"> <table border="1" style="width: 100%; border-collapse: collapse; text-align: center;"> <tr> <td style="width: 10%;"></td> <td style="width: 10%;"></td> <td style="width: 10%;"></td> <td style="width: 10%;"></td> <td style="width: 10%;"></td> <td style="width: 10%;"></td> <td style="width: 10%;"></td> <td style="width: 10%;"></td> <td style="width: 10%;"></td> <td style="width: 10%;"></td> </tr> <tr> <td></td> <td></td> <td colspan="8" style="text-align: center;"> <table border="1" style="width: 100%; border-collapse: collapse; text-align: center;"> <tr> <td style="width: 10%;"></td> <td style="width: 10%;"></td> <td style="width: 10%;"></td> <td style="width: 10%;"></td> <td style="width: 10%;"></td> <td style="width: 10%;"></td> <td style="width: 10%;"></td> <td style="width: 10%;"></td> <td style="width: 10%;"></td> <td style="width: 10%;"></td> </tr> <tr> <td></td> <td></td> <td colspan="8" style="text-align: center;"> <table border="1" style="width: 100%; border-collapse: collapse; text-align: center;"> <tr> <td style="width: 10%;"></td> <td style="width: 10%;"></td> <td style="width: 10%;"></td> <td style="width: 10%;"></td> <td style="width: 10%;"></td> <td style="width: 10%;"></td> <td style="width: 10%;"></td> <td style="width: 10%;"></td> <td style="width: 10%;"></td> <td style="width: 10%;"></td> </tr> <tr> <td></td> <td></td> <td colspan="8" style="text-align: center;"> <table border="1" style="width: 100%; border-collapse: collapse; text-align: center;"> <tr> <td style="width: 10%;"></td> <td style="width: 10%;"></td> <td style="width: 10%;"></td> <td style="width: 10%;"></td> <td style="width: 10%;"></td> <td style="width: 10%;"></td> <td style="width: 10%;"></td> <td style="width: 10%;"></td> <td style="width: 10%;"></td> <td style="width: 10%;"></td> </tr> <tr> <td></td> <td></td> <td colspan="8" style="text-align: center;"> <table border="1" style="width: 100%; border-collapse: collapse; text-align: center;"> <tr> <td style="width: 10%;"></td> <td style="width: 10%;"></td> <td style="width: 10%;"></td> <td style="width: 10%;"></td> <td style="width: 10%;"></td> <td style="width: 10%;"></td> <td style="width: 10%;"></td> <td style="width: 10%;"></td> <td style="width: 10%;"></td> <td style="width: 10%;"></td> </tr> <tr> <td></td> <td></td> <td colspan="8" style="text-align: center;"> <table border="1" style="width: 100%; border-collapse: collapse; text-align: center;"> <tr> <td style="width: 10%;"></td> <td style="width: 10%;"></td> <td style="width: 10%;"></td> <td style="width: 10%;"></td> <td style="width: 10%;"></td> <td style="width: 10%;"></td> <td style="width: 10%;"></td> <td style="width: 10%;"></td> <td style="width: 10%;"></td> <td style="width: 10%;"></td> </tr> <tr> <td></td> <td></td> <td colspan="8" style="text-align: center;"> <table border="1" style="width: 100%; border-collapse: collapse; text-align: center;"> <tr> <td style="width: 10%;"></td> <td style="width: 10%;"></td> <td style="width: 10%;"></td> <td style="width: 10%;"></td> <td style="width: 10%;"></td> <td style="width: 10%;"></td> <td style="width: 10%;"></td> <td style="width: 10%;"></td> <td style="width: 10%;"></td> <td style="width: 10%;"></td> </tr> <tr> <td></td> <td></td> <td colspan="8" style="text-align: center;"> <table border="1" style="width: 100%; border-collapse: collapse; text-align: center;"> <tr> <td style="width: 10%;"></td> <td style="width: 10%;"></td> <td style="width: 10%;"></td> <td style="width: 10%;"></td> <td style="width: 10%;"></td> <td style="width: 10%;"></td> <td style="width: 10%;"></td> <td style="width: 10%;"></td> <td style="width: 10%;"></td> <td style="width: 10%;"></td> </tr> <tr> <td></td> <td></td> <td colspan="8" style="text-align: center;"> <table border="1" style="width: 100%; border-collapse: collapse; text-align: center;"> <tr> <td style="width: 10%;"></td> <td style="width: 10%;"></td> <td style="width: 10%;"></td> <td style="width: 10%;"></td> <td style="width: 10%;"></td> <td style="width: 10%;"></td> <td style="width: 10%;"></td> <td style="width: 10%;"></td> <td style="width: 10%;"></td> <td style="width: 10%;"></td> </tr> <tr> <td></td> <td></td> <td colspan="8" style="text-align: center;"> <table border="1" style="width: 100%; border-collapse: collapse; text-align: center;"> <tr> <td style="width: 10%;"></td> <td style="width: 10%;"></td> <td style="width: 10%;"></td> <td style="width: 10%;"></td> <td style="width: 10%;"></td> <td style="width: 10%;"></td> <td style="width: 10%;"></td> <td style="width: 10%;"></td> <td style="width: 10%;"></td> <td style="width: 10%;"></td> </tr> <tr> <td></td> <td></td> <td colspan="8" style="text-align: center;"> <table border="1" style="width: 100%; border-collapse: collapse; text-align: center;"> <tr> </tr></table></td></tr></table></td></tr></table></td></tr></table></td></tr></table></td></tr></table></td></tr></table></td></tr></table></td></tr></table></td></tr></table></td></tr></table></td></tr></table></td></tr></table></td></tr></table></td></tr></table></td></tr></table></td></tr></table></td></tr></table></td></tr></table></td></tr></table></td></tr></table></td></tr></table></td></tr></table></td></tr></table></td></tr></table></td></tr></table></td></tr></table></td></tr></table></td></tr></table></td></tr></table></td></tr></table></td></tr></table></td></tr></table></td></tr></table></td></tr></table></td></tr></table></td></tr></table></td></tr></table></td></tr></table></td></tr></table></td></tr></table></td></tr></table></td></tr></table></td></tr></table></td></tr></table></td></tr></table></td></tr></table></td></tr></table></td></tr></table></td></tr></table></td></tr></table></td></tr></table></td></tr></table></td></tr></table>
 | | | | | | | | | | | | | | | | | | | | <table border="1" style="width: 100%; border-collapse: collapse; text-align: center;"> <tr> <td style="width: 10%;"></td> <td style="width: 10%;"></td> <td style="width: 10%;"></td> <td style="width: 10%;"></td> <td style="width: 10%;"></td> <td style="width: 10%;"></td> <td style="width: 10%;"></td> <td style="width: 10%;"></td> <td style="width: 10%;"></td> <td style="width: 10%;"></td> </tr> <tr> <td></td> <td></td> <td colspan="8" style="text-align: center;"> <table border="1" style="width: 100%; border-collapse: collapse; text-align: center;"> <tr> <td style="width: 10%;"></td> <td style="width: 10%;"></td> <td style="width: 10%;"></td> <td style="width: 10%;"></td> <td style="width: 10%;"></td> <td style="width: 10%;"></td> <td style="width: 10%;"></td> <td style="width: 10%;"></td> <td style="width: 10%;"></td> <td style="width: 10%;"></td> </tr> <tr> <td></td> <td></td> <td colspan="8" style="text-align: center;"> <table border="1" style="width: 100%; border-collapse: collapse; text-align: center;"> <tr> <td style="width: 10%;"></td> <td style="width: 10%;"></td> <td style="width: 10%;"></td> <td style="width: 10%;"></td> <td style="width: 10%;"></td> <td style="width: 10%;"></td> <td style="width: 10%;"></td> <td style="width: 10%;"></td> <td style="width: 10%;"></td> <td style="width: 10%;"></td> </tr> <tr> <td></td> <td></td> <td colspan="8" style="text-align: center;"> <table border="1" style="width: 100%; border-collapse: collapse; text-align: center;"> <tr> <td style="width: 10%;"></td> <td style="width: 10%;"></td> <td style="width: 10%;"></td> <td style="width: 10%;"></td> <td style="width: 10%;"></td> <td style="width: 10%;"></td> <td style="width: 10%;"></td> <td style="width: 10%;"></td> <td style="width: 10%;"></td> <td style="width: 10%;"></td> </tr> <tr> <td></td> <td></td> <td colspan="8" style="text-align: center;"> <table border="1" style="width: 100%; border-collapse: collapse; text-align: center;"> <tr> <td style="width: 10%;"></td> <td style="width: 10%;"></td> <td style="width: 10%;"></td> <td style="width: 10%;"></td> <td style="width: 10%;"></td> <td style="width: 10%;"></td> <td style="width: 10%;"></td> <td style="width: 10%;"></td> <td style="width: 10%;"></td> <td style="width: 10%;"></td> </tr> <tr> <td></td> <td></td> <td colspan="8" style="text-align: center;"> <table border="1" style="width: 100%; border-collapse: collapse; text-align: center;"> <tr> <td style="width: 10%;"></td> <td style="width: 10%;"></td> <td style="width: 10%;"></td> <td style="width: 10%;"></td> <td style="width: 10%;"></td> <td style="width: 10%;"></td> <td style="width: 10%;"></td> <td style="width: 10%;"></td> <td style="width: 10%;"></td> <td style="width: 10%;"></td> </tr> <tr> <td></td> <td></td> <td colspan="8" style="text-align: center;"> <table border="1" style="width: 100%; border-collapse: collapse; text-align: center;"> <tr> <td style="width: 10%;"></td> <td style="width: 10%;"></td> <td style="width: 10%;"></td> <td style="width: 10%;"></td> <td style="width: 10%;"></td> <td style="width: 10%;"></td> <td style="width: 10%;"></td> <td style="width: 10%;"></td> <td style="width: 10%;"></td> <td style="width: 10%;"></td> </tr> <tr> <td></td> <td></td> <td colspan="8" style="text-align: center;"> <table border="1" style="width: 100%; border-collapse: collapse; text-align: center;"> <tr> <td style="width: 10%;"></td> <td style="width: 10%;"></td> <td style="width: 10%;"></td> <td style="width: 10%;"></td> <td style="width: 10%;"></td> <td style="width: 10%;"></td> <td style="width: 10%;"></td> <td style="width: 10%;"></td> <td style="width: 10%;"></td> <td style="width: 10%;"></td> </tr> <tr> <td></td> <td></td> <td colspan="8" style="text-align: center;"> <table border="1" style="width: 100%; border-collapse: collapse; text-align: center;"> <tr> <td style="width: 10%;"></td> <td style="width: 10%;"></td> <td style="width: 10%;"></td> <td style="width: 10%;"></td> <td style="width: 10%;"></td> <td style="width: 10%;"></td> <td style="width: 10%;"></td> <td style="width: 10%;"></td> <td style="width: 10%;"></td> <td style="width: 10%;"></td> </tr> <tr> <td></td> <td></td> <td colspan="8" style="text-align: center;"> <table border="1" style="width: 100%; border-collapse: collapse; text-align: center;"> <tr> <td style="width: 10%;"></td> <td style="width: 10%;"></td> <td style="width: 10%;"></td> <td style="width: 10%;"></td> <td style="width: 10%;"></td> <td style="width: 10%;"></td> <td style="width: 10%;"></td> <td style="width: 10%;"></td> <td style="width: 10%;"></td> <td style="width: 10%;"></td> </tr> <tr> <td></td> <td></td> <td colspan="8" style="text-align: center;"> <table border="1" style="width: 100%; border-collapse: collapse; text-align: center;"> <tr> <td style="width: 10%;"></td> <td style="width: 10%;"></td> <td style="width: 10%;"></td> <td style="width: 10%;"></td> <td style="width: 10%;"></td> <td style="width: 10%;"></td> <td style="width: 10%;"></td> <td style="width: 10%;"></td> <td style="width: 10%;"></td> <td style="width: 10%;"></td> </tr> <tr> <td></td> <td></td> <td colspan="8" style="text-align: center;"> <table border="1" style="width: 100%; border-collapse: collapse; text-align: center;"> <tr> <td style="width: 10%;"></td> <td style="width: 10%;"></td> <td style="width: 10%;"></td> <td style="width: 10%;"></td> <td style="width: 10%;"></td> <td style="width: 10%;"></td> <td style="width: 10%;"></td> <td style="width: 10%;"></td> <td style="width: 10%;"></td> <td style="width: 10%;"></td> </tr> <tr> <td></td> <td></td> <td colspan="8" style="text-align: center;"> <table border="1" style="width: 100%; border-collapse: collapse; text-align: center;"> <tr> <td style="width: 10%;"></td> <td style="width: 10%;"></td> <td style="width: 10%;"></td> <td style="width: 10%;"></td> <td style="width: 10%;"></td> <td style="width: 10%;"></td> <td style="width: 10%;"></td> <td style="width: 10%;"></td> <td style="width: 10%;"></td> <td style="width: 10%;"></td> </tr> <tr> <td></td> <td></td> <td colspan="8" style="text-align: center;"> <table border="1" style="width: 100%; border-collapse: collapse; text-align: center;"> <tr> <td style="width: 10%;"></td> <td style="width: 10%;"></td> <td style="width: 10%;"></td> <td style="width: 10%;"></td> <td style="width: 10%;"></td> <td style="width: 10%;"></td> <td style="width: 10%;"></td> <td style="width: 10%;"></td> <td style="width: 10%;"></td> <td style="width: 10%;"></td> </tr> <tr> <td></td> <td></td> <td colspan="8" style="text-align: center;"> <table border="1" style="width: 100%; border-collapse: collapse; text-align: center;"> <tr> <td style="width: 10%;"></td> <td style="width: 10%;"></td> <td style="width: 10%;"></td> <td style="width: 10%;"></td> <td style="width: 10%;"></td> <td style="width: 10%;"></td> <td style="width: 10%;"></td> <td style="width: 10%;"></td> <td style="width: 10%;"></td> <td style="width: 10%;"></td> </tr> <tr> <td></td> <td></td> <td colspan="8" style="text-align: center;"> <table border="1" style="width: 100%; border-collapse: collapse; text-align: center;"> <tr> <td style="width: 10%;"></td> <td style="width: 10%;"></td> <td style="width: 10%;"></td> <td style="width: 10%;"></td> <td style="width: 10%;"></td> <td style="width: 10%;"></td> <td style="width: 10%;"></td> <td style="width: 10%;"></td> <td style="width: 10%;"></td> <td style="width: 10%;"></td> </tr> <tr> <td></td> <td></td> <td colspan="8" style="text-align: center;"> <table border="1" style="width: 100%; border-collapse: collapse; text-align: center;"> <tr> <td style="width: 10%;"></td> <td style="width: 10%;"></td> <td style="width: 10%;"></td> <td style="width: 10%;"></td> <td style="width: 10%;"></td> <td style="width: 10%;"></td> <td style="width: 10%;"></td> <td style="width: 10%;"></td> <td style="width: 10%;"></td> <td style="width: 10%;"></td> </tr> <tr> <td></td> <td></td> <td colspan="8" style="text-align: center;"> <table border="1" style="width: 100%; border-collapse: collapse; text-align: center;"> <tr> <td style="width: 10%;"></td> <td style="width: 10%;"></td> <td style="width: 10%;"></td> <td style="width: 10%;"></td> <td style="width: 10%;"></td> <td style="width: 10%;"></td> <td style="width: 10%;"></td> <td style="width: 10%;"></td> <td style="width: 10%;"></td> <td style="width: 10%;"></td> </tr> <tr> <td></td> <td></td> <td colspan="8" style="text-align: center;"> <table border="1" style="width: 100%; border-collapse: collapse; text-align: center;"> <tr> <td style="width: 10%;"></td> <td style="width: 10%;"></td> <td style="width: 10%;"></td> <td style="width: 10%;"></td> <td style="width: 10%;"></td> <td style="width: 10%;"></td> <td style="width: 10%;"></td> <td style="width: 10%;"></td> <td style="width: 10%;"></td> <td style="width: 10%;"></td> </tr> <tr> <td></td> <td></td> <td colspan="8" style="text-align: center;"> <table border="1" style="width: 100%; border-collapse: collapse; text-align: center;"> <tr> <td style="width: 10%;"></td> <td style="width: 10%;"></td> <td style="width: 10%;"></td> <td style="width: 10%;"></td> <td style="width: 10%;"></td> <td style="width: 10%;"></td> <td style="width: 10%;"></td> <td style="width: 10%;"></td> <td style="width: 10%;"></td> <td style="width: 10%;"></td> </tr> <tr> <td></td> <td></td> <td colspan="8" style="text-align: center;"> <table border="1" style="width: 100%; border-collapse: collapse; text-align: center;"> <tr> <td style="width: 10%;"></td> <td style="width: 10%;"></td> <td style="width: 10%;"></td> <td style="width: 10%;"></td> <td
style="width: 10%;"></td> <td style="width: 10%;"></td> <td style="width: 10%;"></td> <td style="width: 10%;"></td> <td style="width: 10%;"></td> <td style="width: 10%;"></td> </tr> <tr> <td></td> <td></td> <td colspan="8" style="text-align: center;"> <table border="1" style="width: 100%; border-collapse: collapse; text-align: center;"> <tr> <td style="width: 10%;"></td> <td style="width: 10%;"></td> <td style="width: 10%;"></td> <td style="width: 10%;"></td> <td style="width: 10%;"></td> <td style="width: 10%;"></td> <td style="width: 10%;"></td> <td style="width: 10%;"></td> <td style="width: 10%;"></td> <td style="width: 10%;"></td> </tr> <tr> <td></td> <td></td> <td colspan="8" style="text-align: center;"> <table border="1" style="width: 100%; border-collapse: collapse; text-align: center;"> <tr> <td style="width: 10%;"></td> <td style="width: 10%;"></td> <td style="width: 10%;"></td> <td style="width: 10%;"></td> <td style="width: 10%;"></td> <td style="width: 10%;"></td> <td style="width: 10%;"></td> <td style="width: 10%;"></td> <td style="width: 10%;"></td> <td style="width: 10%;"></td> </tr> <tr> <td></td> <td></td> <td colspan="8" style="text-align: center;"> <table border="1" style="width: 100%; border-collapse: collapse; text-align: center;"> <tr> <td style="width: 10%;"></td> <td style="width: 10%;"></td> <td style="width: 10%;"></td> <td style="width: 10%;"></td> <td style="width: 10%;"></td> <td style="width: 10%;"></td> <td style="width: 10%;"></td> <td style="width: 10%;"></td> <td style="width: 10%;"></td> <td style="width: 10%;"></td> </tr> <tr> <td></td> <td></td> <td colspan="8" style="text-align: center;"> <table border="1" style="width: 100%; border-collapse: collapse; text-align: center;"> <tr> <td style="width: 10%;"></td> <td style="width: 10%;"></td> <td style="width: 10%;"></td> <td style="width: 10%;"></td> <td style="width: 10%;"></td> <td style="width: 10%;"></td> <td style="width: 10%;"></td> <td style="width: 10%;"></td> <td style="width: 10%;"></td> <td style="width: 10%;"></td> </tr> <tr> <td></td> <td></td> <td colspan="8" style="text-align: center;"> <table border="1" style="width: 100%; border-collapse: collapse; text-align: center;"> <tr> <td style="width: 10%;"></td> <td style="width: 10%;"></td> <td style="width: 10%;"></td> <td style="width: 10%;"></td> <td style="width: 10%;"></td> <td style="width: 10%;"></td> <td style="width: 10%;"></td> <td style="width: 10%;"></td> <td style="width: 10%;"></td> <td style="width: 10%;"></td> </tr> <tr> <td></td> <td></td> <td colspan="8" style="text-align: center;"> <table border="1" style="width: 100%; border-collapse: collapse; text-align: center;"> <tr> <td style="width: 10%;"></td> <td style="width: 10%;"></td> <td style="width: 10%;"></td> <td style="width: 10%;"></td> <td style="width: 10%;"></td> <td style="width: 10%;"></td> <td style="width: 10%;"></td> <td style="width: 10%;"></td> <td style="width: 10%;"></td> <td style="width: 10%;"></td> </tr> <tr> <td></td> <td></td> <td colspan="8" style="text-align: center;"> <table border="1" style="width: 100%; border-collapse: collapse; text-align: center;"> <tr> <td style="width: 10%;"></td> <td style="width: 10%;"></td> <td style="width: 10%;"></td> <td style="width: 10%;"></td> <td style="width: 10%;"></td> <td style="width: 10%;"></td> <td style="width: 10%;"></td> <td style="width: 10%;"></td> <td style="width: 10%;"></td> <td style="width: 10%;"></td> </tr> <tr> <td></td> <td></td> <td colspan="8" style="text-align: center;"> <table border="1" style="width: 100%; border-collapse: collapse; text-align: center;"> <tr> <td style="width: 10%;"></td> <td style="width: 10%;"></td> <td style="width: 10%;"></td> <td style="width: 10%;"></td> <td style="width: 10%;"></td> <td style="width: 10%;"></td> <td style="width: 10%;"></td> <td style="width: 10%;"></td> <td style="width: 10%;"></td> <td style="width: 10%;"></td> </tr> <tr> <td></td> <td></td> <td colspan="8" style="text-align: center;"> <table border="1" style="width: 100%; border-collapse: collapse; text-align: center;"> <tr> <td style="width: 10%;"></td> <td style="width: 10%;"></td> <td style="width: 10%;"></td> <td style="width: 10%;"></td> <td style="width: 10%;"></td> <td style="width: 10%;"></td> <td style="width: 10%;"></td> <td style="width: 10%;"></td> <td style="width: 10%;"></td> <td style="width: 10%;"></td> </tr> <tr> <td></td> <td></td> <td colspan="8" style="text-align: center;"> <table border="1" style="width: 100%; border-collapse: collapse; text-align: center;"> <tr> <td style="width: 10%;"></td> <td style="width: 10%;"></td> <td style="width: 10%;"></td> <td style="width: 10%;"></td> <td style="width: 10%;"></td> <td style="width: 10%;"></td> <td style="width: 10%;"></td> <td style="width: 10%;"></td> <td style="width: 10%;"></td> <td style="width: 10%;"></td> </tr> <tr> <td></td> <td></td> <td colspan="8" style="text-align: center;"> <table border="1" style="width: 100%; border-collapse: collapse; text-align: center;"> <tr> <td style="width: 10%;"></td> <td style="width: 10%;"></td> <td style="width: 10%;"></td> <td style="width: 10%;"></td> <td style="width: 10%;"></td> <td style="width: 10%;"></td> <td style="width: 10%;"></td> <td style="width: 10%;"></td> <td style="width: 10%;"></td> <td style="width: 10%;"></td> </tr> <tr> <td></td> <td></td> <td colspan="8" style="text-align: center;"> <table border="1" style="width: 100%; border-collapse: collapse; text-align: center;"> <tr> <td style="width: 10%;"></td> <td style="width: 10%;"></td> <td style="width: 10%;"></td> <td style="width: 10%;"></td> <td style="width: 10%;"></td> <td style="width: 10%;"></td> <td style="width: 10%;"></td> <td style="width: 10%;"></td> <td style="width: 10%;"></td> <td style="width: 10%;"></td> </tr> <tr> <td></td> <td></td> <td colspan="8" style="text-align: center;"> <table border="1" style="width: 100%; border-collapse: collapse; text-align: center;"> <tr> <td style="width: 10%;"></td> <td style="width: 10%;"></td> <td style="width: 10%;"></td> <td style="width: 10%;"></td> <td style="width: 10%;"></td> <td style="width: 10%;"></td> <td style="width: 10%;"></td> <td style="width: 10%;"></td> <td style="width: 10%;"></td> <td style="width: 10%;"></td> </tr> <tr> <td></td> <td></td> <td colspan="8" style="text-align: center;"> <table border="1" style="width: 100%; border-collapse: collapse; text-align: center;"> <tr> <td style="width: 10%;"></td> <td style="width: 10%;"></td> <td style="width: 10%;"></td> <td style="width: 10%;"></td> <td style="width: 10%;"></td> <td style="width: 10%;"></td> <td style="width: 10%;"></td> <td style="width: 10%;"></td> <td style="width: 10%;"></td> <td style="width: 10%;"></td> </tr> <tr> <td></td> <td></td> <td colspan="8" style="text-align: center;"> <table border="1" style="width: 100%; border-collapse: collapse; text-align: center;"> <tr> <td style="width: 10%;"></td> <td style="width: 10%;"></td> <td style="width: 10%;"></td> <td style="width: 10%;"></td> <td style="width: 10%;"></td> <td style="width: 10%;"></td> <td style="width: 10%;"></td> <td style="width: 10%;"></td> <td style="width: 10%;"></td> <td style="width: 10%;"></td> </tr> <tr> <td></td> <td></td> <td colspan="8" style="text-align: center;"> <table border="1" style="width: 100%; border-collapse: collapse; text-align: center;"> <tr> <td style="width: 10%;"></td> <td style="width: 10%;"></td> <td style="width: 10%;"></td> <td style="width: 10%;"></td> <td style="width: 10%;"></td> <td style="width: 10%;"></td> <td style="width: 10%;"></td> <td style="width: 10%;"></td> <td style="width: 10%;"></td> <td style="width: 10%;"></td> </tr> <tr> <td></td> <td></td> <td colspan="8" style="text-align: center;"> <table border="1" style="width: 100%; border-collapse: collapse; text-align: center;"> <tr> <td style="width: 10%;"></td> <td style="width: 10%;"></td> <td style="width: 10%;"></td> <td style="width: 10%;"></td> <td style="width: 10%;"></td> <td style="width: 10%;"></td> <td style="width: 10%;"></td> <td style="width: 10%;"></td> <td style="width: 10%;"></td> <td style="width: 10%;"></td> </tr> <tr> <td></td> <td></td> <td colspan="8" style="text-align: center;"> <table border="1" style="width: 100%; border-collapse: collapse; text-align: center;"> <tr> <td style="width: 10%;"></td> <td style="width: 10%;"></td> <td style="width: 10%;"></td> <td style="width: 10%;"></td> <td style="width: 10%;"></td> <td style="width: 10%;"></td> <td style="width: 10%;"></td> <td style="width: 10%;"></td> <td style="width: 10%;"></td> <td style="width: 10%;"></td> </tr> <tr> <td></td> <td></td> <td colspan="8" style="text-align: center;"> <table border="1" style="width: 100%; border-collapse: collapse; text-align: center;"> <tr> <td style="width: 10%;"></td> <td style="width: 10%;"></td> <td style="width: 10%;"></td> <td style="width: 10%;"></td> <td style="width: 10%;"></td> <td style="width: 10%;"></td> <td style="width: 10%;"></td> <td style="width: 10%;"></td> <td style="width: 10%;"></td> <td style="width: 10%;"></td> </tr> <tr> <td></td> <td></td> <td colspan="8" style="text-align: center;"> <table border="1" style="width: 100%; border-collapse: collapse; text-align: center;"> <tr> <td style="width: 10%;"></td> <td style="width: 10%;"></td> <td style="width: 10%;"></td> <td style="width: 10%;"></td> <td style="width: 10%;"></td> <td style="width: 10%;"></td> <td style="width: 10%;"></td> <td style="width: 10%;"></td> <td style="width: 10%;"></td> <td style="width: 10%;"></td> </tr> <tr> <td></td> <td></td> <td colspan="8" style="text-align: center;"> <table border="1" style="width: 100%; border-collapse: collapse; text-align: center;"> <tr> <td style="width: 10%;"></td> <td style="width: 10%;"></td> <td style="width: 10%;"></td> <td style="width: 10%;"></td> <td style="width: 10%;"></td> <td style="width: 10%;"></td> <td style="width: 10%;"></td> <td style="width: 10%;"></td> <td style="width: 10%;"></td> <td style="width:
10%;"></td> </tr> <tr> <td></td> <td></td> <td colspan="8" style="text-align: center;"> <table border="1" style="width: 100%; border-collapse: collapse; text-align: center;"> <tr> <td style="width: 10%;"></td> <td style="width: 10%;"></td> <td style="width: 10%;"></td> <td style="width: 10%;"></td> <td style="width: 10%;"></td> <td style="width: 10%;"></td> <td style="width: 10%;"></td> <td style="width: 10%;"></td> <td style="width: 10%;"></td> <td style="width: 10%;"></td> </tr> <tr> <td></td> <td></td> <td colspan="8" style="text-align: center;"> <table border="1" style="width: 100%; border-collapse: collapse; text-align: center;"> <tr> <td style="width: 10%;"></td> <td style="width: 10%;"></td> <td style="width: 10%;"></td> <td style="width: 10%;"></td> <td style="width: 10%;"></td> <td style="width: 10%;"></td> <td style="width: 10%;"></td> <td style="width: 10%;"></td> <td style="width: 10%;"></td> <td style="width: 10%;"></td> </tr> <tr> <td></td> <td></td> <td colspan="8" style="text-align: center;"> <table border="1" style="width: 100%; border-collapse: collapse; text-align: center;"> <tr> <td style="width: 10%;"></td> <td style="width: 10%;"></td> <td style="width: 10%;"></td> <td style="width: 10%;"></td> <td style="width: 10%;"></td> <td style="width: 10%;"></td> <td style="width: 10%;"></td> <td style="width: 10%;"></td> <td style="width: 10%;"></td> <td style="width: 10%;"></td> </tr> <tr> <td></td> <td></td> <td colspan="8" style="text-align: center;"> <table border="1" style="width: 100%; border-collapse: collapse; text-align: center;"> <tr> <td style="width: 10%;"></td> <td style="width: 10%;"></td> <td style="width: 10%;"></td> <td style="width: 10%;"></td> <td style="width: 10%;"></td> <td style="width: 10%;"></td> <td style="width: 10%;"></td> <td style="width: 10%;"></td> <td style="width: 10%;"></td> <td style="width: 10%;"></td> </tr> <tr> <td></td> <td></td> <td colspan="8" style="text-align: center;"> <table border="1" style="width: 100%; border-collapse: collapse; text-align: center;"> <tr> <td style="width: 10%;"></td> <td style="width: 10%;"></td> <td style="width: 10%;"></td> <td style="width: 10%;"></td> <td style="width: 10%;"></td> <td style="width: 10%;"></td> <td style="width: 10%;"></td> <td style="width: 10%;"></td> <td style="width: 10%;"></td> <td style="width: 10%;"></td> </tr> <tr> <td></td> <td></td> <td colspan="8" style="text-align: center;"> <table border="1" style="width: 100%; border-collapse: collapse; text-align: center;"> <tr> <td style="width: 10%;"></td> <td style="width: 10%;"></td> <td style="width: 10%;"></td> <td style="width: 10%;"></td> <td style="width: 10%;"></td> <td style="width: 10%;"></td> <td style="width: 10%;"></td> <td style="width: 10%;"></td> <td style="width: 10%;"></td> <td style="width: 10%;"></td> </tr> <tr> <td></td> <td></td> <td colspan="8" style="text-align: center;"> <table border="1" style="width: 100%; border-collapse: collapse; text-align: center;"> <tr> <td style="width: 10%;"></td> <td style="width: 10%;"></td> <td style="width: 10%;"></td> <td style="width: 10%;"></td> <td style="width: 10%;"></td> <td style="width: 10%;"></td> <td style="width: 10%;"></td> <td style="width: 10%;"></td> <td style="width: 10%;"></td> <td style="width: 10%;"></td> </tr> <tr> <td></td> <td></td> <td colspan="8" style="text-align: center;"> <table border="1" style="width: 100%; border-collapse: collapse; text-align: center;"> <tr> <td style="width: 10%;"></td> <td style="width: 10%;"></td> <td style="width: 10%;"></td> <td style="width: 10%;"></td> <td style="width: 10%;"></td> <td style="width: 10%;"></td> <td style="width: 10%;"></td> <td style="width: 10%;"></td> <td style="width: 10%;"></td> <td style="width: 10%;"></td> </tr> <tr> <td></td> <td></td> <td colspan="8" style="text-align: center;"> <table border="1" style="width: 100%; border-collapse: collapse; text-align: center;"> <tr> <td style="width: 10%;"></td> <td style="width: 10%;"></td> <td style="width: 10%;"></td> <td style="width: 10%;"></td> <td style="width: 10%;"></td> <td style="width: 10%;"></td> <td style="width: 10%;"></td> <td style="width: 10%;"></td> <td style="width: 10%;"></td> <td style="width: 10%;"></td> </tr> <tr> <td></td> <td></td> <td colspan="8" style="text-align: center;"> <table border="1" style="width: 100%; border-collapse: collapse; text-align: center;"> <tr> <td style="width: 10%;"></td> <td style="width: 10%;"></td> <td style="width: 10%;"></td> <td style="width: 10%;"></td> <td style="width: 10%;"></td> <td style="width: 10%;"></td> <td style="width: 10%;"></td> <td style="width: 10%;"></td> <td style="width: 10%;"></td> <td style="width: 10%;"></td> </tr> <tr> <td></td> <td></td> <td colspan="8" style="text-align: center;"> <table border="1" style="width: 100%; border-collapse: collapse; text-align: center;"> <tr> </tr></table></td></tr></table></td></tr></table></td></tr></table></td></tr></table></td></tr></table></td></tr></table></td></tr></table></td></tr></table></td></tr></table></td></tr></table></td></tr></table></td></tr></table></td></tr></table></td></tr></table></td></tr></table></td></tr></table></td></tr></table></td></tr></table></td></tr></table></td></tr></table></td></tr></table></td></tr></table></td></tr></table></td></tr></table></td></tr></table></td></tr></table></td></tr></table></td></tr></table></td></tr></table></td></tr></table></td></tr></table></td></tr></table></td></tr></table></td></tr></table></td></tr></table></td></tr></table></td></tr></table></td></tr></table></td></tr></table></td></tr></table></td></tr></table></td></tr></table></td></tr></table></td></tr></table></td></tr></table></td></tr></table></td></tr></table></td></tr></table></td></tr></table></td></tr></table></td></tr></table></td></tr></table> | | | | | | | | | | | | | | | | | | | | <table border="1" style="width: 100%; border-collapse: collapse; text-align: center;"> <tr> <td style="width: 10%;"></td> <td style="width: 10%;"></td> <td style="width: 10%;"></td> <td style="width: 10%;"></td> <td style="width: 10%;"></td> <td style="width: 10%;"></td> <td style="width: 10%;"></td> <td style="width: 10%;"></td> <td style="width: 10%;"></td> <td style="width: 10%;"></td> </tr> <tr> <td></td> <td></td> <td colspan="8" style="text-align: center;"> <table border="1" style="width: 100%; border-collapse: collapse; text-align: center;"> <tr> <td style="width: 10%;"></td> <td style="width: 10%;"></td> <td style="width: 10%;"></td> <td style="width: 10%;"></td> <td style="width: 10%;"></td> <td style="width: 10%;"></td> <td style="width: 10%;"></td> <td style="width: 10%;"></td> <td style="width: 10%;"></td> <td style="width: 10%;"></td> </tr> <tr> <td></td> <td></td> <td colspan="8" style="text-align: center;"> <table border="1" style="width: 100%; border-collapse: collapse; text-align: center;"> <tr> <td style="width: 10%;"></td> <td style="width: 10%;"></td> <td style="width: 10%;"></td> <td style="width: 10%;"></td> <td style="width: 10%;"></td> <td style="width: 10%;"></td> <td
style="width: 10%;"></td> <td style="width: 10%;"></td> <td style="width: 10%;"></td> <td style="width: 10%;"></td> </tr> <tr> <td></td> <td></td> <td colspan="8" style="text-align: center;"> <table border="1" style="width: 100%; border-collapse: collapse; text-align: center;"> <tr> <td style="width: 10%;"></td> <td style="width: 10%;"></td> <td style="width: 10%;"></td> <td style="width: 10%;"></td> <td style="width: 10%;"></td> <td style="width: 10%;"></td> <td style="width: 10%;"></td> <td style="width: 10%;"></td> <td style="width: 10%;"></td> <td style="width: 10%;"></td> </tr> <tr> <td></td> <td></td> <td colspan="8" style="text-align: center;"> <table border="1" style="width: 100%; border-collapse: collapse; text-align: center;"> <tr> <td style="width: 10%;"></td> <td style="width: 10%;"></td> <td style="width: 10%;"></td> <td style="width: 10%;"></td> <td style="width: 10%;"></td> <td style="width: 10%;"></td> <td style="width: 10%;"></td> <td style="width: 10%;"></td> <td style="width: 10%;"></td> <td style="width: 10%;"></td> </tr> <tr> <td></td> <td></td> <td colspan="8" style="text-align: center;"> <table border="1" style="width: 100%; border-collapse: collapse; text-align: center;"> <tr> <td style="width: 10%;"></td> <td style="width: 10%;"></td> <td style="width: 10%;"></td> <td style="width: 10%;"></td> <td style="width: 10%;"></td> <td style="width: 10%;"></td> <td style="width: 10%;"></td> <td style="width: 10%;"></td> <td style="width: 10%;"></td> <td style="width: 10%;"></td> </tr> <tr> <td></td> <td></td> <td colspan="8" style="text-align: center;"> <table border="1" style="width: 100%; border-collapse: collapse; text-align: center;"> <tr> <td style="width: 10%;"></td> <td style="width: 10%;"></td> <td style="width: 10%;"></td> <td style="width: 10%;"></td> <td style="width: 10%;"></td> <td style="width: 10%;"></td> <td style="width: 10%;"></td> <td style="width: 10%;"></td> <td style="width: 10%;"></td> <td style="width: 10%;"></td> </tr> <tr> <td></td> <td></td> <td colspan="8" style="text-align: center;"> <table border="1" style="width: 100%; border-collapse: collapse; text-align: center;"> <tr> <td style="width: 10%;"></td> <td style="width: 10%;"></td> <td style="width: 10%;"></td> <td style="width: 10%;"></td> <td style="width: 10%;"></td> <td style="width: 10%;"></td> <td style="width: 10%;"></td> <td style="width: 10%;"></td> <td style="width: 10%;"></td> <td style="width: 10%;"></td> </tr> <tr> <td></td> <td></td> <td colspan="8" style="text-align: center;"> <table border="1" style="width: 100%; border-collapse: collapse; text-align: center;"> <tr> <td style="width: 10%;"></td> <td style="width: 10%;"></td> <td style="width: 10%;"></td> <td style="width: 10%;"></td> <td style="width: 10%;"></td> <td style="width: 10%;"></td> <td style="width: 10%;"></td> <td style="width: 10%;"></td> <td style="width: 10%;"></td> <td style="width: 10%;"></td> </tr> <tr> <td></td> <td></td> <td colspan="8" style="text-align: center;"> <table border="1" style="width: 100%; border-collapse: collapse; text-align: center;"> <tr> <td style="width: 10%;"></td> <td style="width: 10%;"></td> <td style="width: 10%;"></td> <td style="width: 10%;"></td> <td style="width: 10%;"></td> <td style="width: 10%;"></td> <td style="width: 10%;"></td> <td style="width: 10%;"></td> <td style="width: 10%;"></td> <td style="width: 10%;"></td> </tr> <tr> <td></td> <td></td> <td colspan="8" style="text-align: center;"> <table border="1" style="width: 100%; border-collapse: collapse; text-align: center;"> <tr> <td style="width: 10%;"></td> <td style="width: 10%;"></td> <td style="width: 10%;"></td> <td style="width: 10%;"></td> <td style="width: 10%;"></td> <td style="width: 10%;"></td> <td style="width: 10%;"></td> <td style="width: 10%;"></td> <td style="width: 10%;"></td> <td style="width: 10%;"></td> </tr> <tr> <td></td> <td></td> <td colspan="8" style="text-align: center;"> <table border="1" style="width: 100%; border-collapse: collapse; text-align: center;"> <tr> <td style="width: 10%;"></td> <td style="width: 10%;"></td> <td style="width: 10%;"></td> <td style="width: 10%;"></td> <td style="width: 10%;"></td> <td style="width: 10%;"></td> <td style="width: 10%;"></td> <td style="width: 10%;"></td> <td style="width: 10%;"></td> <td style="width: 10%;"></td> </tr> <tr> <td></td> <td></td> <td colspan="8" style="text-align: center;"> <table border="1" style="width: 100%; border-collapse: collapse; text-align: center;"> <tr> <td style="width: 10%;"></td> <td style="width: 10%;"></td> <td style="width: 10%;"></td> <td style="width: 10%;"></td> <td style="width: 10%;"></td> <td style="width: 10%;"></td> <td style="width: 10%;"></td> <td style="width: 10%;"></td> <td style="width: 10%;"></td> <td style="width: 10%;"></td> </tr> <tr> <td></td> <td></td> <td colspan="8" style="text-align: center;"> <table border="1" style="width: 100%; border-collapse: collapse; text-align: center;"> <tr> <td style="width: 10%;"></td> <td style="width: 10%;"></td> <td style="width: 10%;"></td> <td style="width: 10%;"></td> <td style="width: 10%;"></td> <td style="width: 10%;"></td> <td style="width: 10%;"></td> <td style="width: 10%;"></td> <td style="width: 10%;"></td> <td style="width: 10%;"></td> </tr> <tr> <td></td> <td></td> <td colspan="8" style="text-align: center;"> <table border="1" style="width: 100%; border-collapse: collapse; text-align: center;"> <tr> <td style="width: 10%;"></td> <td style="width: 10%;"></td> <td style="width: 10%;"></td> <td style="width: 10%;"></td> <td style="width: 10%;"></td> <td style="width: 10%;"></td> <td style="width: 10%;"></td> <td style="width: 10%;"></td> <td style="width: 10%;"></td> <td style="width: 10%;"></td> </tr> <tr> <td></td> <td></td> <td colspan="8" style="text-align: center;"> <table border="1" style="width: 100%; border-collapse: collapse; text-align: center;"> <tr> <td style="width: 10%;"></td> <td style="width: 10%;"></td> <td style="width: 10%;"></td> <td style="width: 10%;"></td> <td style="width: 10%;"></td> <td style="width: 10%;"></td> <td style="width: 10%;"></td> <td style="width: 10%;"></td> <td style="width: 10%;"></td> <td style="width: 10%;"></td> </tr> <tr> <td></td> <td></td> <td colspan="8" style="text-align: center;"> <table border="1" style="width: 100%; border-collapse: collapse; text-align: center;"> <tr> <td style="width: 10%;"></td> <td style="width: 10%;"></td> <td style="width: 10%;"></td> <td style="width: 10%;"></td> <td style="width: 10%;"></td> <td style="width: 10%;"></td> <td style="width: 10%;"></td> <td style="width: 10%;"></td> <td style="width: 10%;"></td> <td style="width: 10%;"></td> </tr> <tr> <td></td> <td></td> <td colspan="8" style="text-align: center;"> <table border="1" style="width: 100%; border-collapse: collapse; text-align: center;"> <tr> <td style="width: 10%;"></td> <td style="width: 10%;"></td> <td style="width: 10%;"></td> <td style="width: 10%;"></td> <td style="width: 10%;"></td> <td style="width: 10%;"></td> <td style="width: 10%;"></td> <td style="width: 10%;"></td> <td style="width: 10%;"></td> <td style="width: 10%;"></td> </tr> <tr> <td></td> <td></td> <td colspan="8" style="text-align: center;"> <table border="1" style="width: 100%; border-collapse: collapse; text-align: center;"> <tr> <td style="width: 10%;"></td> <td style="width: 10%;"></td> <td style="width: 10%;"></td> <td style="width: 10%;"></td> <td style="width: 10%;"></td> <td style="width: 10%;"></td> <td style="width: 10%;"></td> <td style="width: 10%;"></td> <td style="width: 10%;"></td> <td style="width: 10%;"></td> </tr> <tr> <td></td> <td></td> <td colspan="8" style="text-align: center;"> <table border="1" style="width: 100%; border-collapse: collapse; text-align: center;"> <tr> <td style="width: 10%;"></td> <td style="width: 10%;"></td> <td style="width: 10%;"></td> <td style="width: 10%;"></td> <td style="width: 10%;"></td> <td style="width: 10%;"></td> <td style="width: 10%;"></td> <td style="width: 10%;"></td> <td style="width: 10%;"></td> <td style="width: 10%;"></td> </tr> <tr> <td></td> <td></td> <td colspan="8" style="text-align: center;"> <table border="1" style="width: 100%; border-collapse: collapse; text-align: center;"> <tr> <td style="width: 10%;"></td> <td style="width: 10%;"></td> <td style="width: 10%;"></td> <td style="width: 10%;"></td> <td style="width: 10%;"></td> <td style="width: 10%;"></td> <td style="width: 10%;"></td> <td style="width: 10%;"></td> <td style="width: 10%;"></td> <td style="width: 10%;"></td> </tr> <tr> <td></td> <td></td> <td colspan="8" style="text-align: center;"> <table border="1" style="width: 100%; border-collapse: collapse; text-align: center;"> <tr> <td style="width: 10%;"></td> <td style="width: 10%;"></td> <td style="width: 10%;"></td> <td style="width: 10%;"></td> <td style="width: 10%;"></td> <td style="width: 10%;"></td> <td style="width: 10%;"></td> <td style="width: 10%;"></td> <td style="width: 10%;"></td> <td style="width: 10%;"></td> </tr> <tr> <td></td> <td></td> <td colspan="8" style="text-align: center;"> <table border="1" style="width: 100%; border-collapse: collapse; text-align: center;"> <tr> <td style="width: 10%;"></td> <td style="width: 10%;"></td> <td style="width: 10%;"></td> <td style="width: 10%;"></td> <td style="width: 10%;"></td> <td style="width: 10%;"></td> <td style="width: 10%;"></td> <td style="width: 10%;"></td> <td style="width: 10%;"></td> <td style="width: 10%;"></td> </tr> <tr> <td></td> <td></td> <td colspan="8" style="text-align: center;"> <table border="1" style="width: 100%; border-collapse: collapse; text-align: center;"> <tr> <td style="width: 10%;"></td> <td style="width: 10%;"></td> <td style="width: 10%;"></td> <td style="width: 10%;"></td> <td style="width: 10%;"></td> <td style="width: 10%;"></td> <td style="width: 10%;"></td> <td style="width: 10%;"></td> <td style="width: 10%;"></td> <td style="width: 10%;"></td> </tr> <tr> <td></td> <td></td> <td colspan="8"
style="text-align: center;"> <table border="1" style="width: 100%; border-collapse: collapse; text-align: center;"> <tr> <td style="width: 10%;"></td> <td style="width: 10%;"></td> <td style="width: 10%;"></td> <td style="width: 10%;"></td> <td style="width: 10%;"></td> <td style="width: 10%;"></td> <td style="width: 10%;"></td> <td style="width: 10%;"></td> <td style="width: 10%;"></td> <td style="width: 10%;"></td> </tr> <tr> <td></td> <td></td> <td colspan="8" style="text-align: center;"> <table border="1" style="width: 100%; border-collapse: collapse; text-align: center;"> <tr> <td style="width: 10%;"></td> <td style="width: 10%;"></td> <td style="width: 10%;"></td> <td style="width: 10%;"></td> <td style="width: 10%;"></td> <td style="width: 10%;"></td> <td style="width: 10%;"></td> <td style="width: 10%;"></td> <td style="width: 10%;"></td> <td style="width: 10%;"></td> </tr> <tr> <td></td> <td></td> <td colspan="8" style="text-align: center;"> <table border="1" style="width: 100%; border-collapse: collapse; text-align: center;"> <tr> <td style="width: 10%;"></td> <td style="width: 10%;"></td> <td style="width: 10%;"></td> <td style="width: 10%;"></td> <td style="width: 10%;"></td> <td style="width: 10%;"></td> <td style="width: 10%;"></td> <td style="width: 10%;"></td> <td style="width: 10%;"></td> <td style="width: 10%;"></td> </tr> <tr> <td></td> <td></td> <td colspan="8" style="text-align: center;"> <table border="1" style="width: 100%; border-collapse: collapse; text-align: center;"> <tr> <td style="width: 10%;"></td> <td style="width: 10%;"></td> <td style="width: 10%;"></td> <td style="width: 10%;"></td> <td style="width: 10%;"></td> <td style="width: 10%;"></td> <td style="width: 10%;"></td> <td style="width: 10%;"></td> <td style="width: 10%;"></td> <td style="width: 10%;"></td> </tr> <tr> <td></td> <td></td> <td colspan="8" style="text-align: center;"> <table border="1" style="width: 100%; border-collapse: collapse; text-align: center;"> <tr> <td style="width: 10%;"></td> <td style="width: 10%;"></td> <td style="width: 10%;"></td> <td style="width: 10%;"></td> <td style="width: 10%;"></td> <td style="width: 10%;"></td> <td style="width: 10%;"></td> <td style="width: 10%;"></td> <td style="width: 10%;"></td> <td style="width: 10%;"></td> </tr> <tr> <td></td> <td></td> <td colspan="8" style="text-align: center;"> <table border="1" style="width: 100%; border-collapse: collapse; text-align: center;"> <tr> <td style="width: 10%;"></td> <td style="width: 10%;"></td> <td style="width: 10%;"></td> <td style="width: 10%;"></td> <td style="width: 10%;"></td> <td style="width: 10%;"></td> <td style="width: 10%;"></td> <td style="width: 10%;"></td> <td style="width: 10%;"></td> <td style="width: 10%;"></td> </tr> <tr> <td></td> <td></td> <td colspan="8" style="text-align: center;"> <table border="1" style="width: 100%; border-collapse: collapse; text-align: center;"> <tr> <td style="width: 10%;"></td> <td style="width: 10%;"></td> <td style="width: 10%;"></td> <td style="width: 10%;"></td> <td style="width: 10%;"></td> <td style="width: 10%;"></td> <td style="width: 10%;"></td> <td style="width: 10%;"></td> <td style="width: 10%;"></td> <td style="width: 10%;"></td> </tr> <tr> <td></td> <td></td> <td colspan="8" style="text-align: center;"> <table border="1" style="width: 100%; border-collapse: collapse; text-align: center;"> <tr> <td style="width: 10%;"></td> <td style="width: 10%;"></td> <td style="width: 10%;"></td> <td style="width: 10%;"></td> <td style="width: 10%;"></td> <td style="width: 10%;"></td> <td style="width: 10%;"></td> <td style="width: 10%;"></td> <td style="width: 10%;"></td> <td style="width: 10%;"></td> </tr> <tr> <td></td> <td></td> <td colspan="8" style="text-align: center;"> <table border="1" style="width: 100%; border-collapse: collapse; text-align: center;"> <tr> <td style="width: 10%;"></td> <td style="width: 10%;"></td> <td style="width: 10%;"></td> <td style="width: 10%;"></td> <td style="width: 10%;"></td> <td style="width: 10%;"></td> <td style="width: 10%;"></td> <td style="width: 10%;"></td> <td style="width: 10%;"></td> <td style="width: 10%;"></td> </tr> <tr> <td></td> <td></td> <td colspan="8" style="text-align: center;"> <table border="1" style="width: 100%; border-collapse: collapse; text-align: center;"> <tr> <td style="width: 10%;"></td> <td style="width: 10%;"></td> <td style="width: 10%;"></td> <td style="width: 10%;"></td> <td style="width: 10%;"></td> <td style="width: 10%;"></td> <td style="width: 10%;"></td> <td style="width: 10%;"></td> <td style="width: 10%;"></td> <td style="width: 10%;"></td> </tr> <tr> <td></td> <td></td> <td colspan="8" style="text-align: center;"> <table border="1" style="width: 100%; border-collapse: collapse; text-align: center;"> <tr> <td style="width: 10%;"></td> <td style="width: 10%;"></td> <td style="width: 10%;"></td> <td style="width: 10%;"></td> <td style="width: 10%;"></td> <td style="width: 10%;"></td> <td style="width: 10%;"></td> <td style="width: 10%;"></td> <td style="width: 10%;"></td> <td style="width: 10%;"></td> </tr> <tr> <td></td> <td></td> <td colspan="8" style="text-align: center;"> <table border="1" style="width: 100%; border-collapse: collapse; text-align: center;"> <tr> <td style="width: 10%;"></td> <td style="width: 10%;"></td> <td style="width: 10%;"></td> <td style="width: 10%;"></td> <td style="width: 10%;"></td> <td style="width: 10%;"></td> <td style="width: 10%;"></td> <td style="width: 10%;"></td> <td style="width: 10%;"></td> <td style="width: 10%;"></td> </tr> <tr> <td></td> <td></td> <td colspan="8" style="text-align: center;"> <table border="1" style="width: 100%; border-collapse: collapse; text-align: center;"> <tr> <td style="width: 10%;"></td> <td style="width: 10%;"></td> <td style="width: 10%;"></td> <td style="width: 10%;"></td> <td style="width: 10%;"></td> <td style="width: 10%;"></td> <td style="width: 10%;"></td> <td style="width: 10%;"></td> <td style="width: 10%;"></td> <td style="width: 10%;"></td> </tr> <tr> <td></td> <td></td> <td colspan="8" style="text-align: center;"> <table border="1" style="width: 100%; border-collapse: collapse; text-align: center;"> <tr> <td style="width: 10%;"></td> <td style="width: 10%;"></td> <td style="width: 10%;"></td> <td style="width: 10%;"></td> <td style="width: 10%;"></td> <td style="width: 10%;"></td> <td style="width: 10%;"></td> <td style="width: 10%;"></td> <td style="width: 10%;"></td> <td style="width: 10%;"></td> </tr> <tr> <td></td> <td></td> <td colspan="8" style="text-align: center;"> <table border="1" style="width: 100%; border-collapse: collapse; text-align: center;"> <tr> <td style="width: 10%;"></td> <td style="width: 10%;"></td> <td style="width: 10%;"></td> <td style="width: 10%;"></td> <td style="width: 10%;"></td> <td style="width: 10%;"></td> <td style="width: 10%;"></td> <td style="width: 10%;"></td> <td style="width: 10%;"></td> <td style="width: 10%;"></td> </tr> <tr> <td></td> <td></td> <td colspan="8" style="text-align: center;"> <table border="1" style="width: 100%; border-collapse: collapse; text-align: center;"> <tr> <td style="width: 10%;"></td> <td style="width: 10%;"></td> <td style="width: 10%;"></td> <td style="width: 10%;"></td> <td style="width: 10%;"></td> <td style="width: 10%;"></td> <td style="width: 10%;"></td> <td style="width: 10%;"></td> <td style="width: 10%;"></td> <td style="width: 10%;"></td> </tr> <tr> <td></td> <td></td> <td colspan="8" style="text-align: center;"> <table border="1" style="width: 100%; border-collapse: collapse; text-align: center;"> <tr> <td style="width: 10%;"></td> <td style="width: 10%;"></td> <td style="width: 10%;"></td> <td style="width: 10%;"></td> <td style="width: 10%;"></td> <td style="width: 10%;"></td> <td style="width: 10%;"></td> <td style="width: 10%;"></td> <td style="width: 10%;"></td> <td style="width: 10%;"></td> </tr> <tr> <td></td> <td></td> <td colspan="8" style="text-align: center;"> <table border="1" style="width: 100%; border-collapse: collapse; text-align: center;"> <tr> <td style="width: 10%;"></td> <td style="width: 10%;"></td> <td style="width: 10%;"></td> <td style="width: 10%;"></td> <td style="width: 10%;"></td> <td style="width: 10%;"></td> <td style="width: 10%;"></td> <td style="width: 10%;"></td> <td style="width: 10%;"></td> <td style="width: 10%;"></td> </tr> <tr> <td></td> <td></td> <td colspan="8" style="text-align: center;"> <table border="1" style="width: 100%; border-collapse: collapse; text-align: center;"> <tr> <td style="width: 10%;"></td> <td style="width: 10%;"></td> <td style="width: 10%;"></td> <td style="width: 10%;"></td> <td style="width: 10%;"></td> <td style="width: 10%;"></td> <td style="width: 10%;"></td> <td style="width: 10%;"></td> <td style="width: 10%;"></td> <td style="width: 10%;"></td> </tr> <tr> <td></td> <td></td> <td colspan="8" style="text-align: center;"> <table border="1" style="width: 100%; border-collapse: collapse; text-align: center;"> <tr> <td style="width: 10%;"></td> <td style="width: 10%;"></td> <td style="width: 10%;"></td> <td style="width: 10%;"></td> <td style="width: 10%;"></td> <td style="width: 10%;"></td> <td style="width: 10%;"></td> <td style="width: 10%;"></td> <td style="width: 10%;"></td> <td style="width: 10%;"></td> </tr> <tr> <td></td> <td></td> <td colspan="8" style="text-align: center;"> <table border="1" style="width: 100%; border-collapse: collapse; text-align: center;"> <tr> <td style="width: 10%;"></td> <td style="width: 10%;"></td> <td style="width: 10%;"></td> <td style="width: 10%;"></td> <td style="width: 10%;"></td> <td style="width: 10%;"></td> <td style="width: 10%;"></td> <td style="width: 10%;"></td> <td style="width: 10%;"></td> <td style="width: 10%;"></td> </tr> <tr> <td></td> <td></td> <td colspan="8" style="text-align: center;"> <table border="1" style="width: 100%; border-collapse: collapse; text-align: center;"> <tr> <td style="width: 10%;"></td> <td style="width:
10%;"></td> <td style="width: 10%;"></td> <td style="width: 10%;"></td> <td style="width: 10%;"></td> <td style="width: 10%;"></td> <td style="width: 10%;"></td> <td style="width: 10%;"></td> <td style="width: 10%;"></td> <td style="width: 10%;"></td> </tr> <tr> <td></td> <td></td> <td colspan="8" style="text-align: center;"> <table border="1" style="width: 100%; border-collapse: collapse; text-align: center;"> <tr> <td style="width: 10%;"></td> <td style="width: 10%;"></td> <td style="width: 10%;"></td> <td style="width: 10%;"></td> <td style="width: 10%;"></td> <td style="width: 10%;"></td> <td style="width: 10%;"></td> <td style="width: 10%;"></td> <td style="width: 10%;"></td> <td style="width: 10%;"></td> </tr> <tr> <td></td> <td></td> <td colspan="8" style="text-align: center;"> <table border="1" style="width: 100%; border-collapse: collapse; text-align: center;"> <tr> <td style="width: 10%;"></td> <td style="width: 10%;"></td> <td style="width: 10%;"></td> <td style="width: 10%;"></td> <td style="width: 10%;"></td> <td style="width: 10%;"></td> <td style="width: 10%;"></td> <td style="width: 10%;"></td> <td style="width: 10%;"></td> <td style="width: 10%;"></td> </tr> <tr> <td></td> <td></td> <td colspan="8" style="text-align: center;"> <table border="1" style="width: 100%; border-collapse: collapse; text-align: center;"> <tr> <td style="width: 10%;"></td> <td style="width: 10%;"></td> <td style="width: 10%;"></td> <td style="width: 10%;"></td> <td style="width: 10%;"></td> <td style="width: 10%;"></td> <td style="width: 10%;"></td> <td style="width: 10%;"></td> <td style="width: 10%;"></td> <td style="width: 10%;"></td> </tr> <tr> <td></td> <td></td> <td colspan="8" style="text-align: center;"> <table border="1" style="width: 100%; border-collapse: collapse; text-align: center;"> <tr> <td style="width: 10%;"></td> <td style="width: 10%;"></td> <td style="width: 10%;"></td> <td style="width: 10%;"></td> <td style="width: 10%;"></td> <td style="width: 10%;"></td> <td style="width: 10%;"></td> <td style="width: 10%;"></td> <td style="width: 10%;"></td> <td style="width: 10%;"></td> </tr> <tr> <td></td> <td></td> <td colspan="8" style="text-align: center;"> <table border="1" style="width: 100%; border-collapse: collapse; text-align: center;"> <tr> <td style="width: 10%;"></td> <td style="width: 10%;"></td> <td style="width: 10%;"></td> <td style="width: 10%;"></td> <td style="width: 10%;"></td> <td style="width: 10%;"></td> <td style="width: 10%;"></td> <td style="width: 10%;"></td> <td style="width: 10%;"></td> <td style="width: 10%;"></td> </tr> <tr> <td></td> <td></td> <td colspan="8" style="text-align: center;"> <table border="1" style="width: 100%; border-collapse: collapse; text-align: center;"> <tr> </tr></table></td></tr></table></td></tr></table></td></tr></table></td></tr></table></td></tr></table></td></tr></table></td></tr></table></td></tr></table></td></tr></table></td></tr></table></td></tr></table></td></tr></table></td></tr></table></td></tr></table></td></tr></table></td></tr></table></td></tr></table></td></tr></table></td></tr></table></td></tr></table></td></tr></table></td></tr></table></td></tr></table></td></tr></table></td></tr></table></td></tr></table></td></tr></table></td></tr></table></td></tr></table></td></tr></table></td></tr></table></td></tr></table></td></tr></table></td></tr></table></td></tr></table></td></tr></table></td></tr></table></td></tr></table></td></tr></table></td></tr></table></td></tr></table></td></tr></table></td></tr></table></td></tr></table></td></tr></table></td></tr></table></td></tr></table></td></tr></table></td></tr></table></td></tr></table></td></tr></table> | | | | | | | | | | | | | | | | | | | | <table border="1" style="width: 100%; border-collapse: collapse; text-align: center;"> <tr> <td style="width: 10%;"></td> <td style="width: 10%;"></td> <td style="width: 10%;"></td> <td style="width: 10%;"></td> <td style="width: 10%;"></td> <td style="width: 10%;"></td> <td style="width: 10%;"></td> <td style="width: 10%;"></td> <td style="width: 10%;"></td> <td style="width: 10%;"></td> </tr> <tr> <td></td> <td></td> <td colspan="8" style="text-align: center;"> <table border="1" style="width: 100%; border-collapse: collapse; text-align: center;"> <tr> <td style="width: 10%;"></td> <td style="width: 10%;"></td> <td style="width: 10%;"></td> <td style="width: 10%;"></td> <td style="width: 10%;"></td> <td style="width: 10%;"></td> <td style="width: 10%;"></td> <td style="width: 10%;"></td> <td style="width: 10%;"></td> <td style="width: 10%;"></td> </tr> <tr> <td></td> <td></td> <td colspan="8" style="text-align: center;"> <table border="1" style="width: 100%; border-collapse: collapse; text-align: center;"> <tr> <td style="width: 10%;"></td> <td style="width: 10%;"></td> <td style="width: 10%;"></td> <td style="width: 10%;"></td> <td style="width: 10%;"></td> <td style="width: 10%;"></td> <td style="width: 10%;"></td> <td style="width: 10%;"></td> <td style="width: 10%;"></td> <td style="width: 10%;"></td> </tr> <tr> <td></td> <td></td> <td colspan="8" style="text-align: center;"> <table border="1" style="width: 100%; border-collapse: collapse; text-align: center;"> <tr> <td style="width: 10%;"></td> <td style="width: 10%;"></td> <td style="width: 10%;"></td> <td style="width: 10%;"></td> <td style="width: 10%;"></td> <td style="width: 10%;"></td> <td style="width: 10%;"></td> <td style="width: 10%;"></td> <td style="width: 10%;"></td> <td style="width: 10%;"></td> </tr> <tr> <td></td> <td></td> <td colspan="8" style="text-align: center;"> <table border="1" style="width: 100%; border-collapse: collapse; text-align: center;"> <tr> <td style="width: 10%;"></td> <td style="width: 10%;"></td> <td style="width: 10%;"></td> <td style="width: 10%;"></td> <td style="width: 10%;"></td> <td style="width: 10%;"></td> <td style="width: 10%;"></td> <td style="width: 10%;"></td> <td style="width: 10%;"></td> <td style="width: 10%;"></td> </tr> <tr> <td></td> <td></td> <td colspan="8" style="text-align: center;"> <table border="1" style="width: 100%; border-collapse: collapse; text-align: center;"> <tr> <td style="width: 10%;"></td> <td style="width: 10%;"></td> <td style="width: 10%;"></td> <td style="width: 10%;"></td> <td style="width: 10%;"></td> <td style="width: 10%;"></td> <td style="width: 10%;"></td> <td style="width: 10%;"></td> <td style="width: 10%;"></td> <td style="width: 10%;"></td> </tr> <tr> <td></td> <td></td> <td colspan="8" style="text-align: center;"> <table border="1" style="width: 100%; border-collapse: collapse; text-align: center;"> <tr> <td style="width: 10%;"></td> <td style="width: 10%;"></td> <td style="width: 10%;"></td> <td style="width: 10%;"></td> <td style="width: 10%;"></td> <td style="width: 10%;"></td> <td style="width: 10%;"></td> <td style="width: 10%;"></td> <td style="width: 10%;"></td> <td style="width: 10%;"></td> </tr> <tr> <td></td> <td></td> <td colspan="8" style="text-align: center;"> <table border="1" style="width: 100%; border-collapse:
collapse; text-align: center;"> <tr> <td style="width: 10%;"></td> <td style="width: 10%;"></td> <td style="width: 10%;"></td> <td style="width: 10%;"></td> <td style="width: 10%;"></td> <td style="width: 10%;"></td> <td style="width: 10%;"></td> <td style="width: 10%;"></td> <td style="width: 10%;"></td> <td style="width: 10%;"></td> </tr> <tr> <td></td> <td></td> <td colspan="8" style="text-align: center;"> <table border="1" style="width: 100%; border-collapse: collapse; text-align: center;"> <tr> <td style="width: 10%;"></td> <td style="width: 10%;"></td> <td style="width: 10%;"></td> <td style="width: 10%;"></td> <td style="width: 10%;"></td> <td style="width: 10%;"></td> <td style="width: 10%;"></td> <td style="width: 10%;"></td> <td style="width: 10%;"></td> <td style="width: 10%;"></td> </tr> <tr> <td></td> <td></td> <td colspan="8" style="text-align: center;"> <table border="1" style="width: 100%; border-collapse: collapse; text-align: center;"> <tr> <td style="width: 10%;"></td> <td style="width: 10%;"></td> <td style="width: 10%;"></td> <td style="width: 10%;"></td> <td style="width: 10%;"></td> <td style="width: 10%;"></td> <td style="width: 10%;"></td> <td style="width: 10%;"></td> <td style="width: 10%;"></td> <td style="width: 10%;"></td> </tr> <tr> <td></td> <td></td> <td colspan="8" style="text-align: center;"> <table border="1" style="width: 100%; border-collapse: collapse; text-align: center;"> <tr> <td style="width: 10%;"></td> <td style="width: 10%;"></td> <td style="width: 10%;"></td> <td style="width: 10%;"></td> <td style="width: 10%;"></td> <td style="width: 10%;"></td> <td style="width: 10%;"></td> <td style="width: 10%;"></td> <td style="width: 10%;"></td> <td style="width: 10%;"></td> </tr> <tr> <td></td> <td></td> <td colspan="8" style="text-align: center;"> <table border="1" style="width: 100%; border-collapse: collapse; text-align: center;"> <tr> <td style="width: 10%;"></td> <td style="width: 10%;"></td> <td style="width: 10%;"></td> <td style="width: 10%;"></td> <td style="width: 10%;"></td> <td style="width: 10%;"></td> <td style="width: 10%;"></td> <td style="width: 10%;"></td> <td style="width: 10%;"></td> <td style="width: 10%;"></td> </tr> <tr> <td></td> <td></td> <td colspan="8" style="text-align: center;"> <table border="1" style="width: 100%; border-collapse: collapse; text-align: center;"> <tr> <td style="width: 10%;"></td> <td style="width: 10%;"></td> <td style="width: 10%;"></td> <td style="width: 10%;"></td> <td style="width: 10%;"></td> <td style="width: 10%;"></td> <td style="width: 10%;"></td> <td style="width: 10%;"></td> <td style="width: 10%;"></td> <td style="width: 10%;"></td> </tr> <tr> <td></td> <td></td> <td colspan="8" style="text-align: center;"> <table border="1" style="width: 100%; border-collapse: collapse; text-align: center;"> <tr> <td style="width: 10%;"></td> <td style="width: 10%;"></td> <td style="width: 10%;"></td> <td style="width: 10%;"></td> <td style="width: 10%;"></td> <td style="width: 10%;"></td> <td style="width: 10%;"></td> <td style="width: 10%;"></td> <td style="width: 10%;"></td> <td style="width: 10%;"></td> </tr> <tr> <td></td> <td></td> <td colspan="8" style="text-align: center;"> <table border="1" style="width: 100%; border-collapse: collapse; text-align: center;"> <tr> <td style="width: 10%;"></td> <td style="width: 10%;"></td> <td style="width: 10%;"></td> <td style="width: 10%;"></td> <td style="width: 10%;"></td> <td style="width: 10%;"></td> <td style="width: 10%;"></td> <td style="width: 10%;"></td> <td style="width: 10%;"></td> <td style="width: 10%;"></td> </tr> <tr> <td></td> <td></td> <td colspan="8" style="text-align: center;"> <table border="1" style="width: 100%; border-collapse: collapse; text-align: center;"> <tr> <td style="width: 10%;"></td> <td style="width: 10%;"></td> <td style="width: 10%;"></td> <td style="width: 10%;"></td> <td style="width: 10%;"></td> <td style="width: 10%;"></td> <td style="width: 10%;"></td> <td style="width: 10%;"></td> <td style="width: 10%;"></td> <td style="width: 10%;"></td> </tr> <tr> <td></td> <td></td> <td colspan="8" style="text-align: center;"> <table border="1" style="width: 100%; border-collapse: collapse; text-align: center;"> <tr> <td style="width: 10%;"></td> <td style="width: 10%;"></td> <td style="width: 10%;"></td> <td style="width: 10%;"></td> <td style="width: 10%;"></td> <td style="width: 10%;"></td> <td style="width: 10%;"></td> <td style="width: 10%;"></td> <td style="width: 10%;"></td> <td style="width: 10%;"></td> </tr> <tr> <td></td> <td></td> <td colspan="8" style="text-align: center;"> <table border="1" style="width: 100%; border-collapse: collapse; text-align: center;"> <tr> <td style="width: 10%;"></td> <td style="width: 10%;"></td> <td style="width: 10%;"></td> <td style="width: 10%;"></td> <td style="width: 10%;"></td> <td style="width: 10%;"></td> <td style="width: 10%;"></td> <td style="width: 10%;"></td> <td style="width: 10%;"></td> <td style="width: 10%;"></td> </tr> <tr> <td></td> <td></td> <td colspan="8" style="text-align: center;"> <table border="1" style="width: 100%; border-collapse: collapse; text-align: center;"> <tr> <td style="width: 10%;"></td> <td style="width: 10%;"></td> <td style="width: 10%;"></td> <td style="width: 10%;"></td> <td style="width: 10%;"></td> <td style="width: 10%;"></td> <td style="width: 10%;"></td> <td style="width: 10%;"></td> <td style="width: 10%;"></td> <td style="width: 10%;"></td> </tr> <tr> <td></td> <td></td> <td colspan="8" style="text-align: center;"> <table border="1" style="width: 100%; border-collapse: collapse; text-align: center;"> <tr> <td style="width: 10%;"></td> <td style="width: 10%;"></td> <td style="width: 10%;"></td> <td style="width: 10%;"></td> <td style="width: 10%;"></td> <td style="width: 10%;"></td> <td style="width: 10%;"></td> <td style="width: 10%;"></td> <td style="width: 10%;"></td> <td style="width: 10%;"></td> </tr> <tr> <td></td> <td></td> <td colspan="8" style="text-align: center;"> <table border="1" style="width: 100%; border-collapse: collapse; text-align: center;"> <tr> <td style="width: 10%;"></td> <td style="width: 10%;"></td> <td style="width: 10%;"></td> <td style="width: 10%;"></td> <td style="width: 10%;"></td> <td style="width: 10%;"></td> <td style="width: 10%;"></td> <td style="width: 10%;"></td> <td style="width: 10%;"></td> <td style="width: 10%;"></td> </tr> <tr> <td></td> <td></td> <td colspan="8" style="text-align: center;"> <table border="1" style="width: 100%; border-collapse: collapse; text-align: center;"> <tr> <td style="width: 10%;"></td> <td style="width: 10%;"></td> <td style="width: 10%;"></td> <td style="width: 10%;"></td> <td style="width: 10%;"></td> <td style="width: 10%;"></td> <td style="width: 10%;"></td> <td style="width: 10%;"></td> <td style="width: 10%;"></td> <td style="width: 10%;"></td> </tr> <tr> <td></td> <td></td> <td colspan="8" style="text-align: center;"> <table border="1" style="width: 100%; border-collapse: collapse; text-align: center;"> <tr> <td style="width: 10%;"></td> <td style="width: 10%;"></td> <td style="width: 10%;"></td> <td style="width: 10%;"></td> <td style="width: 10%;"></td> <td style="width: 10%;"></td> <td style="width: 10%;"></td> <td style="width: 10%;"></td> <td style="width: 10%;"></td> <td style="width: 10%;"></td> </tr> <tr> <td></td> <td></td> <td colspan="8" style="text-align: center;"> <table border="1" style="width: 100%; border-collapse: collapse; text-align: center;"> <tr> <td style="width: 10%;"></td> <td style="width: 10%;"></td> <td style="width: 10%;"></td> <td style="width: 10%;"></td> <td style="width: 10%;"></td> <td style="width: 10%;"></td> <td style="width: 10%;"></td> <td style="width: 10%;"></td> <td style="width: 10%;"></td> <td style="width: 10%;"></td> </tr> <tr> <td></td> <td></td> <td colspan="8" style="text-align: center;"> <table border="1" style="width: 100%; border-collapse: collapse; text-align: center;"> <tr> <td style="width: 10%;"></td> <td style="width: 10%;"></td> <td style="width: 10%;"></td> <td style="width: 10%;"></td> <td style="width: 10%;"></td> <td style="width: 10%;"></td> <td style="width: 10%;"></td> <td style="width: 10%;"></td> <td style="width: 10%;"></td> <td style="width: 10%;"></td> </tr> <tr> <td></td> <td></td> <td colspan="8" style="text-align: center;"> <table border="1" style="width: 100%; border-collapse: collapse; text-align: center;"> <tr> <td style="width: 10%;"></td> <td style="width: 10%;"></td> <td style="width: 10%;"></td> <td style="width: 10%;"></td> <td style="width: 10%;"></td> <td style="width: 10%;"></td> <td style="width: 10%;"></td> <td style="width: 10%;"></td> <td style="width: 10%;"></td> <td style="width: 10%;"></td> </tr> <tr> <td></td> <td></td> <td colspan="8" style="text-align: center;"> <table border="1" style="width: 100%; border-collapse: collapse; text-align: center;"> <tr> <td style="width: 10%;"></td> <td style="width: 10%;"></td> <td style="width: 10%;"></td> <td style="width: 10%;"></td> <td style="width: 10%;"></td> <td style="width: 10%;"></td> <td style="width: 10%;"></td> <td style="width: 10%;"></td> <td style="width: 10%;"></td> <td style="width: 10%;"></td> </tr> <tr> <td></td> <td></td> <td colspan="8" style="text-align: center;"> <table border="1" style="width: 100%; border-collapse: collapse; text-align: center;"> <tr> <td style="width: 10%;"></td> <td style="width: 10%;"></td> <td style="width: 10%;"></td> <td style="width: 10%;"></td> <td style="width: 10%;"></td> <td style="width: 10%;"></td> <td style="width: 10%;"></td> <td style="width: 10%;"></td> <td style="width: 10%;"></td> <td style="width: 10%;"></td> </tr> <tr> <td></td> <td></td> <td colspan="8" style="text-align: center;"> <table border="1" style="width: 100%; border-collapse: collapse; text-align: center;"> <tr> <td style="width: 10%;"></td> <td style="width: 10%;"></td> <td style="width: 10%;"></td> <td style="width: 10%;"></td> <td
style="width: 10%;"></td> <td style="width: 10%;"></td> <td style="width: 10%;"></td> <td style="width: 10%;"></td> <td style="width: 10%;"></td> <td style="width: 10%;"></td> </tr> <tr> <td></td> <td></td> <td colspan="8" style="text-align: center;"> <table border="1" style="width: 100%; border-collapse: collapse; text-align: center;"> <tr> <td style="width: 10%;"></td> <td style="width: 10%;"></td> <td style="width: 10%;"></td> <td style="width: 10%;"></td> <td style="width: 10%;"></td> <td style="width: 10%;"></td> <td style="width: 10%;"></td> <td style="width: 10%;"></td> <td style="width: 10%;"></td> <td style="width: 10%;"></td> </tr> <tr> <td></td> <td></td> <td colspan="8" style="text-align: center;"> <table border="1" style="width: 100%; border-collapse: collapse; text-align: center;"> <tr> <td style="width: 10%;"></td> <td style="width: 10%;"></td> <td style="width: 10%;"></td> <td style="width: 10%;"></td> <td style="width: 10%;"></td> <td style="width: 10%;"></td> <td style="width: 10%;"></td> <td style="width: 10%;"></td> <td style="width: 10%;"></td> <td style="width: 10%;"></td> </tr> <tr> <td></td> <td></td> <td colspan="8" style="text-align: center;"> <table border="1" style="width: 100%; border-collapse: collapse; text-align: center;"> <tr> <td style="width: 10%;"></td> <td style="width: 10%;"></td> <td style="width: 10%;"></td> <td style="width: 10%;"></td> <td style="width: 10%;"></td> <td style="width: 10%;"></td> <td style="width: 10%;"></td> <td style="width: 10%;"></td> <td style="width: 10%;"></td> <td style="width: 10%;"></td> </tr> <tr> <td></td> <td></td> <td colspan="8" style="text-align: center;"> <table border="1" style="width: 100%; border-collapse: collapse; text-align: center;"> <tr> <td style="width: 10%;"></td> <td style="width: 10%;"></td> <td style="width: 10%;"></td> <td style="width: 10%;"></td> <td style="width: 10%;"></td> <td style="width: 10%;"></td> <td style="width: 10%;"></td> <td style="width: 10%;"></td> <td style="width: 10%;"></td> <td style="width: 10%;"></td> </tr> <tr> <td></td> <td></td> <td colspan="8" style="text-align: center;"> <table border="1" style="width: 100%; border-collapse: collapse; text-align: center;"> <tr> <td style="width: 10%;"></td> <td style="width: 10%;"></td> <td style="width: 10%;"></td> <td style="width: 10%;"></td> <td style="width: 10%;"></td> <td style="width: 10%;"></td> <td style="width: 10%;"></td> <td style="width: 10%;"></td> <td style="width: 10%;"></td> <td style="width: 10%;"></td> </tr> <tr> <td></td> <td></td> <td colspan="8" style="text-align: center;"> <table border="1" style="width: 100%; border-collapse: collapse; text-align: center;"> <tr> <td style="width: 10%;"></td> <td style="width: 10%;"></td> <td style="width: 10%;"></td> <td style="width: 10%;"></td> <td style="width: 10%;"></td> <td style="width: 10%;"></td> <td style="width: 10%;"></td> <td style="width: 10%;"></td> <td style="width: 10%;"></td> <td style="width: 10%;"></td> </tr> <tr> <td></td> <td></td> <td colspan="8" style="text-align: center;"> <table border="1" style="width: 100%; border-collapse: collapse; text-align: center;"> <tr> <td style="width: 10%;"></td> <td style="width: 10%;"></td> <td style="width: 10%;"></td> <td style="width: 10%;"></td> <td style="width: 10%;"></td> <td style="width: 10%;"></td> <td style="width: 10%;"></td> <td style="width: 10%;"></td> <td style="width: 10%;"></td> <td style="width: 10%;"></td> </tr> <tr> <td></td> <td></td> <td colspan="8" style="text-align: center;"> <table border="1" style="width: 100%; border-collapse: collapse; text-align: center;"> <tr> <td style="width: 10%;"></td> <td style="width: 10%;"></td> <td style="width: 10%;"></td> <td style="width: 10%;"></td> <td style="width: 10%;"></td> <td style="width: 10%;"></td> <td style="width: 10%;"></td> <td style="width: 10%;"></td> <td style="width: 10%;"></td> <td style="width: 10%;"></td> </tr> <tr> <td></td> <td></td> <td colspan="8" style="text-align: center;"> <table border="1" style="width: 100%; border-collapse: collapse; text-align: center;"> <tr> <td style="width: 10%;"></td> <td style="width: 10%;"></td> <td style="width: 10%;"></td> <td style="width: 10%;"></td> <td style="width: 10%;"></td> <td style="width: 10%;"></td> <td style="width: 10%;"></td> <td style="width: 10%;"></td> <td style="width: 10%;"></td> <td style="width: 10%;"></td> </tr> <tr> <td></td> <td></td> <td colspan="8" style="text-align: center;"> <table border="1" style="width: 100%; border-collapse: collapse; text-align: center;"> <tr> <td style="width: 10%;"></td> <td style="width: 10%;"></td> <td style="width: 10%;"></td> <td style="width: 10%;"></td> <td style="width: 10%;"></td> <td style="width: 10%;"></td> <td style="width: 10%;"></td> <td style="width: 10%;"></td> <td style="width: 10%;"></td> <td style="width: 10%;"></td> </tr> <tr> <td></td> <td></td> <td colspan="8" style="text-align: center;"> <table border="1" style="width: 100%; border-collapse: collapse; text-align: center;"> <tr> <td style="width: 10%;"></td> <td style="width: 10%;"></td> <td style="width: 10%;"></td> <td style="width: 10%;"></td> <td style="width: 10%;"></td> <td style="width: 10%;"></td> <td style="width: 10%;"></td> <td style="width: 10%;"></td> <td style="width: 10%;"></td> <td style="width: 10%;"></td> </tr> <tr> <td></td> <td></td> <td colspan="8" style="text-align: center;"> <table border="1" style="width: 100%; border-collapse: collapse; text-align: center;"> <tr> <td style="width: 10%;"></td> <td style="width: 10%;"></td> <td style="width: 10%;"></td> <td style="width: 10%;"></td> <td style="width: 10%;"></td> <td style="width: 10%;"></td> <td style="width: 10%;"></td> <td style="width: 10%;"></td> <td style="width: 10%;"></td> <td style="width: 10%;"></td> </tr> <tr> <td></td> <td></td> <td colspan="8" style="text-align: center;"> <table border="1" style="width: 100%; border-collapse: collapse; text-align: center;"> <tr> <td style="width: 10%;"></td> <td style="width: 10%;"></td> <td style="width: 10%;"></td> <td style="width: 10%;"></td> <td style="width: 10%;"></td> <td style="width: 10%;"></td> <td style="width: 10%;"></td> <td style="width: 10%;"></td> <td style="width: 10%;"></td> <td style="width: 10%;"></td> </tr> <tr> <td></td> <td></td> <td colspan="8" style="text-align: center;"> <table border="1" style="width: 100%; border-collapse: collapse; text-align: center;"> <tr> <td style="width: 10%;"></td> <td style="width: 10%;"></td> <td style="width: 10%;"></td> <td style="width: 10%;"></td> <td style="width: 10%;"></td> <td style="width: 10%;"></td> <td style="width: 10%;"></td> <td style="width: 10%;"></td> <td style="width: 10%;"></td> <td style="width: 10%;"></td> </tr> <tr> <td></td> <td></td> <td colspan="8" style="text-align: center;"> <table border="1" style="width: 100%; border-collapse: collapse; text-align: center;"> <tr> <td style="width: 10%;"></td> <td style="width: 10%;"></td> <td style="width: 10%;"></td> <td style="width: 10%;"></td> <td style="width: 10%;"></td> <td style="width: 10%;"></td> <td style="width: 10%;"></td> <td style="width: 10%;"></td> <td style="width: 10%;"></td> <td style="width: 10%;"></td> </tr> <tr> <td></td> <td></td> <td colspan="8" style="text-align: center;"> <table border="1" style="width: 100%; border-collapse: collapse; text-align: center;"> <tr> <td style="width: 10%;"></td> <td style="width: 10%;"></td> <td style="width: 10%;"></td> <td style="width: 10%;"></td> <td style="width: 10%;"></td> <td style="width: 10%;"></td> <td style="width: 10%;"></td> <td style="width: 10%;"></td> <td style="width: 10%;"></td> <td style="width: 10%;"></td> </tr> <tr> <td></td> <td></td> <td colspan="8" style="text-align: center;"> <table border="1" style="width: 100%; border-collapse: collapse; text-align: center;"> <tr> <td style="width: 10%;"></td> <td style="width: 10%;"></td> <td style="width: 10%;"></td> <td style="width: 10%;"></td> <td style="width: 10%;"></td> <td style="width: 10%;"></td> <td style="width: 10%;"></td> <td style="width: 10%;"></td> <td style="width: 10%;"></td> <td style="width: 10%;"></td> </tr> <tr> <td></td> <td></td> <td colspan="8" style="text-align: center;"> <table border="1" style="width: 100%; border-collapse: collapse; text-align: center;"> <tr> <td style="width: 10%;"></td> <td style="width: 10%;"></td> <td style="width: 10%;"></td> <td style="width: 10%;"></td> <td style="width: 10%;"></td> <td style="width: 10%;"></td> <td style="width: 10%;"></td> <td style="width: 10%;"></td> <td style="width: 10%;"></td> <td style="width: 10%;"></td> </tr> <tr> <td></td> <td></td> <td colspan="8" style="text-align: center;"> <table border="1" style="width: 100%; border-collapse: collapse; text-align: center;"> <tr> <td style="width: 10%;"></td> <td style="width: 10%;"></td> <td style="width: 10%;"></td> <td style="width: 10%;"></td> <td style="width: 10%;"></td> <td style="width: 10%;"></td> <td style="width: 10%;"></td> <td style="width: 10%;"></td> <td style="width: 10%;"></td> <td style="width: 10%;"></td> </tr> <tr> <td></td> <td></td> <td colspan="8" style="text-align: center;"> <table border="1" style="width: 100%; border-collapse: collapse; text-align: center;"> <tr> <td style="width: 10%;"></td> <td style="width: 10%;"></td> <td style="width: 10%;"></td> <td style="width: 10%;"></td> <td style="width: 10%;"></td> <td style="width: 10%;"></td> <td style="width: 10%;"></td> <td style="width: 10%;"></td> <td style="width: 10%;"></td> <td style="width: 10%;"></td> </tr> <tr> <td></td> <td></td> <td colspan="8" style="text-align: center;"> <table border="1" style="width: 100%; border-collapse: collapse; text-align: center;"> <tr> <td style="width: 10%;"></td> <td style="width: 10%;"></td> <td style="width: 10%;"></td> <td style="width: 10%;"></td> <td style="width: 10%;"></td> <td style="width: 10%;"></td> <td style="width: 10%;"></td> <td style="width: 10%;"></td> <td style="width: 10%;"></td> <td style="width:
10%;"></td> </tr> <tr> <td></td> <td></td> <td colspan="8" style="text-align: center;"> <table border="1" style="width: 100%; border-collapse: collapse; text-align: center;"> <tr> </tr></table></td></tr></table></td></tr></table></td></tr></table></td></tr></table></td></tr></table></td></tr></table></td></tr></table></td></tr></table></td></tr></table></td></tr></table></td></tr></table></td></tr></table></td></tr></table></td></tr></table></td></tr></table></td></tr></table></td></tr></table></td></tr></table></td></tr></table></td></tr></table></td></tr></table></td></tr></table></td></tr></table></td></tr></table></td></tr></table></td></tr></table></td></tr></table></td></tr></table></td></tr></table></td></tr></table></td></tr></table></td></tr></table></td></tr></table></td></tr></table></td></tr></table></td></tr></table></td></tr></table></td></tr></table></td></tr></table></td></tr></table></td></tr></table></td></tr></table></td></tr></table></td></tr></table></td></tr></table></td></tr></table></td></tr></table></td></tr></table></td></tr></table></td></tr></table> | | | | | | | | | | | | | | | | | | | | <table border="1" style="width: 100%; border-collapse: collapse; text-align: center;"> <tr> <td style="width: 10%;"></td> <td style="width: 10%;"></td> <td style="width: 10%;"></td> <td style="width: 10%;"></td> <td style="width: 10%;"></td> <td style="width: 10%;"></td> <td style="width: 10%;"></td> <td style="width: 10%;"></td> <td style="width: 10%;"></td> <td style="width: 10%;"></td> </tr> <tr> <td></td> <td></td> <td colspan="8" style="text-align: center;"> <table border="1" style="width: 100%; border-collapse: collapse; text-align: center;"> <tr> <td style="width: 10%;"></td> <td style="width: 10%;"></td> <td style="width: 10%;"></td> <td style="width: 10%;"></td> <td style="width: 10%;"></td> <td style="width: 10%;"></td> <td style="width: 10%;"></td> <td style="width: 10%;"></td> <td style="width: 10%;"></td> <td style="width: 10%;"></td> </tr> <tr> <td></td> <td></td> <td colspan="8" style="text-align: center;"> <table border="1" style="width: 100%; border-collapse: collapse; text-align: center;"> <tr> <td style="width: 10%;"></td> <td style="width: 10%;"></td> <td style="width: 10%;"></td> <td style="width: 10%;"></td> <td style="width: 10%;"></td> <td style="width: 10%;"></td> <td style="width: 10%;"></td> <td style="width: 10%;"></td> <td style="width: 10%;"></td> <td style="width: 10%;"></td> </tr> <tr> <td></td> <td></td> <td colspan="8" style="text-align: center;"> <table border="1" style="width: 100%; border-collapse: collapse; text-align: center;"> <tr> <td style="width: 10%;"></td> <td style="width: 10%;"></td> <td style="width: 10%;"></td> <td style="width: 10%;"></td> <td style="width: 10%;"></td> <td style="width: 10%;"></td> <td style="width: 10%;"></td> <td style="width: 10%;"></td> <td style="width: 10%;"></td> <td style="width: 10%;"></td> </tr> <tr> <td></td> <td></td> <td colspan="8" style="text-align: center;"> <table border="1" style="width: 100%; border-collapse: collapse; text-align: center;"> <tr> <td style="width: 10%;"></td> <td style="width: 10%;"></td> <td style="width: 10%;"></td> <td style="width: 10%;"></td> <td style="width: 10%;"></td> <td style="width: 10%;"></td> <td style="width: 10%;"></td> <td style="width: 10%;"></td> <td style="width: 10%;"></td> <td style="width: 10%;"></td> </tr> <tr> <td></td> <td></td> <td colspan="8" style="text-align: center;"> <table border="1" style="width: 100%; border-collapse: collapse; text-align: center;"> <tr> <td style="width: 10%;"></td> <td style="width: 10%;"></td> <td style="width: 10%;"></td> <td style="width: 10%;"></td> <td style="width: 10%;"></td> <td style="width: 10%;"></td> <td style="width: 10%;"></td> <td style="width: 10%;"></td> <td style="width: 10%;"></td> <td style="width: 10%;"></td> </tr> <tr> <td></td> <td></td> <td colspan="8" style="text-align: center;"> <table border="1" style="width: 100%; border-collapse: collapse; text-align: center;"> <tr> <td style="width: 10%;"></td> <td style="width: 10%;"></td> <td style="width: 10%;"></td> <td style="width: 10%;"></td> <td style="width: 10%;"></td> <td style="width: 10%;"></td> <td style="width: 10%;"></td> <td style="width: 10%;"></td> <td style="width: 10%;"></td> <td style="width: 10%;"></td> </tr> <tr> <td></td> <td></td> <td colspan="8" style="text-align: center;"> <table border="1" style="width: 100%; border-collapse: collapse; text-align: center;"> <tr> <td style="width: 10%;"></td> <td style="width: 10%;"></td> <td style="width: 10%;"></td> <td style="width: 10%;"></td> <td style="width: 10%;"></td> <td style="width: 10%;"></td> <td style="width: 10%;"></td> <td style="width: 10%;"></td> <td style="width: 10%;"></td> <td style="width: 10%;"></td> </tr> <tr> <td></td> <td></td> <td colspan="8" style="text-align: center;"> <table border="1" style="width: 100%; border-collapse: collapse; text-align: center;"> <tr> <td style="width: 10%;"></td> <td style="width: 10%;"></td> <td style="width: 10%;"></td> <td style="width: 10%;"></td> <td style="width: 10%;"></td> <td style="width: 10%;"></td> <td style="width: 10%;"></td> <td style="width: 10%;"></td> <td style="width: 10%;"></td> <td style="width: 10%;"></td> </tr> <tr> <td></td> <td></td> <td colspan="8" style="text-align: center;"> <table border="1" style="width: 100%; border-collapse: collapse; text-align: center;"> <tr> <td style="width: 10%;"></td> <td style="width: 10%;"></td> <td style="width: 10%;"></td> <td style="width: 10%;"></td> <td style="width: 10%;"></td> <td style="width: 10%;"></td> <td style="width: 10%;"></td> <td style="width: 10%;"></td> <td style="width: 10%;"></td> <td style="width: 10%;"></td> </tr> <tr> <td></td> <td></td> <td colspan="8" style="text-align: center;"> <table border="1" style="width: 100%; border-collapse: collapse; text-align: center;"> <tr> <td style="width: 10%;"></td> <td style="width: 10%;"></td> <td style="width: 10%;"></td> <td style="width: 10%;"></td> <td style="width: 10%;"></td> <td style="width: 10%;"></td> <td style="width: 10%;"></td> <td style="width: 10%;"></td> <td style="width: 10%;"></td> <td style="width: 10%;"></td> </tr> <tr> <td></td> <td></td> <td colspan="8" style="text-align: center;"> <table border="1" style="width: 100%; border-collapse: collapse; text-align: center;"> <tr> <td style="width: 10%;"></td> <td style="width: 10%;"></td> <td style="width: 10%;"></td> <td style="width: 10%;"></td> <td style="width: 10%;"></td> <td style="width: 10%;"></td> <td style="width: 10%;"></td> <td style="width: 10%;"></td> <td style="width: 10%;"></td> <td style="width: 10%;"></td> </tr> <tr> <td></td> <td></td> <td colspan="8" style="text-align: center;"> <table border="1" style="width: 100%; border-collapse: collapse; text-align: center;"> <tr> <td style="width: 10%;"></td> <td style="width: 10%;"></td> <td style="width: 10%;"></td> <td style="width: 10%;"></td> <td style="width: 10%;"></td> <td style="width: 10%;"></td> <td style="width: 10%;"></td> <td
style="width: 10%;"></td> <td style="width: 10%;"></td> <td style="width: 10%;"></td> </tr> <tr> <td></td> <td></td> <td colspan="8" style="text-align: center;"> <table border="1" style="width: 100%; border-collapse: collapse; text-align: center;"> <tr> <td style="width: 10%;"></td> <td style="width: 10%;"></td> <td style="width: 10%;"></td> <td style="width: 10%;"></td> <td style="width: 10%;"></td> <td style="width: 10%;"></td> <td style="width: 10%;"></td> <td style="width: 10%;"></td> <td style="width: 10%;"></td> <td style="width: 10%;"></td> </tr> <tr> <td></td> <td></td> <td colspan="8" style="text-align: center;"> <table border="1" style="width: 100%; border-collapse: collapse; text-align: center;"> <tr> <td style="width: 10%;"></td> <td style="width: 10%;"></td> <td style="width: 10%;"></td> <td style="width: 10%;"></td> <td style="width: 10%;"></td> <td style="width: 10%;"></td> <td style="width: 10%;"></td> <td style="width: 10%;"></td> <td style="width: 10%;"></td> <td style="width: 10%;"></td> </tr> <tr> <td></td> <td></td> <td colspan="8" style="text-align: center;"> <table border="1" style="width: 100%; border-collapse: collapse; text-align: center;"> <tr> <td style="width: 10%;"></td> <td style="width: 10%;"></td> <td style="width: 10%;"></td> <td style="width: 10%;"></td> <td style="width: 10%;"></td> <td style="width: 10%;"></td> <td style="width: 10%;"></td> <td style="width: 10%;"></td> <td style="width: 10%;"></td> <td style="width: 10%;"></td> </tr> <tr> <td></td> <td></td> <td colspan="8" style="text-align: center;"> <table border="1" style="width: 100%; border-collapse: collapse; text-align: center;"> <tr> <td style="width: 10%;"></td> <td style="width: 10%;"></td> <td style="width: 10%;"></td> <td style="width: 10%;"></td> <td style="width: 10%;"></td> <td style="width: 10%;"></td> <td style="width: 10%;"></td> <td style="width: 10%;"></td> <td style="width: 10%;"></td> <td style="width: 10%;"></td> </tr> <tr> <td></td> <td></td> <td colspan="8" style="text-align: center;"> <table border="1" style="width: 100%; border-collapse: collapse; text-align: center;"> <tr> <td style="width: 10%;"></td> <td style="width: 10%;"></td> <td style="width: 10%;"></td> <td style="width: 10%;"></td> <td style="width: 10%;"></td> <td style="width: 10%;"></td> <td style="width: 10%;"></td> <td style="width: 10%;"></td> <td style="width: 10%;"></td> <td style="width: 10%;"></td> </tr> <tr> <td></td> <td></td> <td colspan="8" style="text-align: center;"> <table border="1" style="width: 100%; border-collapse: collapse; text-align: center;"> <tr> <td style="width: 10%;"></td> <td style="width: 10%;"></td> <td style="width: 10%;"></td> <td style="width: 10%;"></td> <td style="width: 10%;"></td> <td style="width: 10%;"></td> <td style="width: 10%;"></td> <td style="width: 10%;"></td> <td style="width: 10%;"></td> <td style="width: 10%;"></td> </tr> <tr> <td></td> <td></td> <td colspan="8" style="text-align: center;"> <table border="1" style="width: 100%; border-collapse: collapse; text-align: center;"> <tr> <td style="width: 10%;"></td> <td style="width: 10%;"></td> <td style="width: 10%;"></td> <td style="width: 10%;"></td> <td style="width: 10%;"></td> <td style="width: 10%;"></td> <td style="width: 10%;"></td> <td style="width: 10%;"></td> <td style="width: 10%;"></td> <td style="width: 10%;"></td> </tr> <tr> <td></td> <td></td> <td colspan="8" style="text-align: center;"> <table border="1" style="width: 100%; border-collapse: collapse; text-align: center;"> <tr> <td style="width: 10%;"></td> <td style="width: 10%;"></td> <td style="width: 10%;"></td> <td style="width: 10%;"></td> <td style="width: 10%;"></td> <td style="width: 10%;"></td> <td style="width: 10%;"></td> <td style="width: 10%;"></td> <td style="width: 10%;"></td> <td style="width: 10%;"></td> </tr> <tr> <td></td> <td></td> <td colspan="8" style="text-align: center;"> <table border="1" style="width: 100%; border-collapse: collapse; text-align: center;"> <tr> <td style="width: 10%;"></td> <td style="width: 10%;"></td> <td style="width: 10%;"></td> <td style="width: 10%;"></td> <td style="width: 10%;"></td> <td style="width: 10%;"></td> <td style="width: 10%;"></td> <td style="width: 10%;"></td> <td style="width: 10%;"></td> <td style="width: 10%;"></td> </tr> <tr> <td></td> <td></td> <td colspan="8" style="text-align: center;"> <table border="1" style="width: 100%; border-collapse: collapse; text-align: center;"> <tr> <td style="width: 10%;"></td> <td style="width: 10%;"></td> <td style="width: 10%;"></td> <td style="width: 10%;"></td> <td style="width: 10%;"></td> <td style="width: 10%;"></td> <td style="width: 10%;"></td> <td style="width: 10%;"></td> <td style="width: 10%;"></td> <td style="width: 10%;"></td> </tr> <tr> <td></td> <td></td> <td colspan="8" style="text-align: center;"> <table border="1" style="width: 100%; border-collapse: collapse; text-align: center;"> <tr> <td style="width: 10%;"></td> <td style="width: 10%;"></td> <td style="width: 10%;"></td> <td style="width: 10%;"></td> <td style="width: 10%;"></td> <td style="width: 10%;"></td> <td style="width: 10%;"></td> <td style="width: 10%;"></td> <td style="width: 10%;"></td> <td style="width: 10%;"></td> </tr> <tr> <td></td> <td></td> <td colspan="8" style="text-align: center;"> <table border="1" style="width: 100%; border-collapse: collapse; text-align: center;"> <tr> <td style="width: 10%;"></td> <td style="width: 10%;"></td> <td style="width: 10%;"></td> <td style="width: 10%;"></td> <td style="width: 10%;"></td> <td style="width: 10%;"></td> <td style="width: 10%;"></td> <td style="width: 10%;"></td> <td style="width: 10%;"></td> <td style="width: 10%;"></td> </tr> <tr> <td></td> <td></td> <td colspan="8" style="text-align: center;"> <table border="1" style="width: 100%; border-collapse: collapse; text-align: center;"> <tr> <td style="width: 10%;"></td> <td style="width: 10%;"></td> <td style="width: 10%;"></td> <td style="width: 10%;"></td> <td style="width: 10%;"></td> <td style="width: 10%;"></td> <td style="width: 10%;"></td> <td style="width: 10%;"></td> <td style="width: 10%;"></td> <td style="width: 10%;"></td> </tr> <tr> <td></td> <td></td> <td colspan="8" style="text-align: center;"> <table border="1" style="width: 100%; border-collapse: collapse; text-align: center;"> <tr> <td style="width: 10%;"></td> <td style="width: 10%;"></td> <td style="width: 10%;"></td> <td style="width: 10%;"></td> <td style="width: 10%;"></td> <td style="width: 10%;"></td> <td style="width: 10%;"></td> <td style="width: 10%;"></td> <td style="width: 10%;"></td> <td style="width: 10%;"></td> </tr> <tr> <td></td> <td></td> <td colspan="8" style="text-align: center;"> <table border="1" style="width: 100%; border-collapse: collapse; text-align: center;"> <tr> <td style="width: 10%;"></td> <td style="width: 10%;"></td> <td style="width: 10%;"></td> <td style="width: 10%;"></td> <td style="width: 10%;"></td> <td style="width: 10%;"></td> <td style="width: 10%;"></td> <td style="width: 10%;"></td> <td style="width: 10%;"></td> <td style="width: 10%;"></td> </tr> <tr> <td></td> <td></td> <td colspan="8" style="text-align: center;"> <table border="1" style="width: 100%; border-collapse: collapse; text-align: center;"> <tr> <td style="width: 10%;"></td> <td style="width: 10%;"></td> <td style="width: 10%;"></td> <td style="width: 10%;"></td> <td style="width: 10%;"></td> <td style="width: 10%;"></td> <td style="width: 10%;"></td> <td style="width: 10%;"></td> <td style="width: 10%;"></td> <td style="width: 10%;"></td> </tr> <tr> <td></td> <td></td> <td colspan="8" style="text-align: center;"> <table border="1" style="width: 100%; border-collapse: collapse; text-align: center;"> <tr> <td style="width: 10%;"></td> <td style="width: 10%;"></td> <td style="width: 10%;"></td> <td style="width: 10%;"></td> <td style="width: 10%;"></td> <td style="width: 10%;"></td> <td style="width: 10%;"></td> <td style="width: 10%;"></td> <td style="width: 10%;"></td> <td style="width: 10%;"></td> </tr> <tr> <td></td> <td></td> <td colspan="8" style="text-align: center;"> <table border="1" style="width: 100%; border-collapse: collapse; text-align: center;"> <tr> <td style="width: 10%;"></td> <td style="width: 10%;"></td> <td style="width: 10%;"></td> <td style="width: 10%;"></td> <td style="width: 10%;"></td> <td style="width: 10%;"></td> <td style="width: 10%;"></td> <td style="width: 10%;"></td> <td style="width: 10%;"></td> <td style="width: 10%;"></td> </tr> <tr> <td></td> <td></td> <td colspan="8" style="text-align: center;"> <table border="1" style="width: 100%; border-collapse: collapse; text-align: center;"> <tr> <td style="width: 10%;"></td> <td style="width: 10%;"></td> <td style="width: 10%;"></td> <td style="width: 10%;"></td> <td style="width: 10%;"></td> <td style="width: 10%;"></td> <td style="width: 10%;"></td> <td style="width: 10%;"></td> <td style="width: 10%;"></td> <td style="width: 10%;"></td> </tr> <tr> <td></td> <td></td> <td colspan="8" style="text-align: center;"> <table border="1" style="width: 100%; border-collapse: collapse; text-align: center;"> <tr> <td style="width: 10%;"></td> <td style="width: 10%;"></td> <td style="width: 10%;"></td> <td style="width: 10%;"></td> <td style="width: 10%;"></td> <td style="width: 10%;"></td> <td style="width: 10%;"></td> <td style="width: 10%;"></td> <td style="width: 10%;"></td> <td style="width: 10%;"></td> </tr> <tr> <td></td> <td></td> <td colspan="8" style="text-align: center;"> <table border="1" style="width: 100%; border-collapse: collapse; text-align: center;"> <tr> <td style="width: 10%;"></td> <td style="width: 10%;"></td> <td style="width: 10%;"></td> <td style="width: 10%;"></td> <td style="width: 10%;"></td> <td style="width: 10%;"></td> <td style="width: 10%;"></td> <td style="width: 10%;"></td> <td style="width: 10%;"></td> <td style="width: 10%;"></td> </tr> <tr> <td></td> <td></td> <td colspan="8" style="text-align: center;"> <table
border="1" style="width: 100%; border-collapse: collapse; text-align: center;"> <tr> <td style="width: 10%;"></td> <td style="width: 10%;"></td> <td style="width: 10%;"></td> <td style="width: 10%;"></td> <td style="width: 10%;"></td> <td style="width: 10%;"></td> <td style="width: 10%;"></td> <td style="width: 10%;"></td> <td style="width: 10%;"></td> <td style="width: 10%;"></td> </tr> <tr> <td></td> <td></td> <td colspan="8" style="text-align: center;"> <table border="1" style="width: 100%; border-collapse: collapse; text-align: center;"> <tr> <td style="width: 10%;"></td> <td style="width: 10%;"></td> <td style="width: 10%;"></td> <td style="width: 10%;"></td> <td style="width: 10%;"></td> <td style="width: 10%;"></td> <td style="width: 10%;"></td> <td style="width: 10%;"></td> <td style="width: 10%;"></td> <td style="width: 10%;"></td> </tr> <tr> <td></td> <td></td> <td colspan="8" style="text-align: center;"> <table border="1" style="width: 100%; border-collapse: collapse; text-align: center;"> <tr> <td style="width: 10%;"></td> <td style="width: 10%;"></td> <td style="width: 10%;"></td> <td style="width: 10%;"></td> <td style="width: 10%;"></td> <td style="width: 10%;"></td> <td style="width: 10%;"></td> <td style="width: 10%;"></td> <td style="width: 10%;"></td> <td style="width: 10%;"></td> </tr> <tr> <td></td> <td></td> <td colspan="8" style="text-align: center;"> <table border="1" style="width: 100%; border-collapse: collapse; text-align: center;"> <tr> <td style="width: 10%;"></td> <td style="width: 10%;"></td> <td style="width: 10%;"></td> <td style="width: 10%;"></td> <td style="width: 10%;"></td> <td style="width: 10%;"></td> <td style="width: 10%;"></td> <td style="width: 10%;"></td> <td style="width: 10%;"></td> <td style="width: 10%;"></td> </tr> <tr> <td></td> <td></td> <td colspan="8" style="text-align: center;"> <table border="1" style="width: 100%; border-collapse: collapse; text-align: center;"> <tr> <td style="width: 10%;"></td> <td style="width: 10%;"></td> <td style="width: 10%;"></td> <td style="width: 10%;"></td> <td style="width: 10%;"></td> <td style="width: 10%;"></td> <td style="width: 10%;"></td> <td style="width: 10%;"></td> <td style="width: 10%;"></td> <td style="width: 10%;"></td> </tr> <tr> <td></td> <td></td> <td colspan="8" style="text-align: center;"> <table border="1" style="width: 100%; border-collapse: collapse; text-align: center;"> <tr> <td style="width: 10%;"></td> <td style="width: 10%;"></td> <td style="width: 10%;"></td> <td style="width: 10%;"></td> <td style="width: 10%;"></td> <td style="width: 10%;"></td> <td style="width: 10%;"></td> <td style="width: 10%;"></td> <td style="width: 10%;"></td> <td style="width: 10%;"></td> </tr> <tr> <td></td> <td></td> <td colspan="8" style="text-align: center;"> <table border="1" style="width: 100%; border-collapse: collapse; text-align: center;"> <tr> <td style="width: 10%;"></td> <td style="width: 10%;"></td> <td style="width: 10%;"></td> <td style="width: 10%;"></td> <td style="width: 10%;"></td> <td style="width: 10%;"></td> <td style="width: 10%;"></td> <td style="width: 10%;"></td> <td style="width: 10%;"></td> <td style="width: 10%;"></td> </tr> <tr> <td></td> <td></td> <td colspan="8" style="text-align: center;"> <table border="1" style="width: 100%; border-collapse: collapse; text-align: center;"> <tr> <td style="width: 10%;"></td> <td style="width: 10%;"></td> <td style="width: 10%;"></td> <td style="width: 10%;"></td> <td style="width: 10%;"></td> <td style="width: 10%;"></td> <td style="width: 10%;"></td> <td style="width: 10%;"></td> <td style="width: 10%;"></td> <td style="width: 10%;"></td> </tr> <tr> <td></td> <td></td> <td colspan="8" style="text-align: center;"> <table border="1" style="width: 100%; border-collapse: collapse; text-align: center;"> <tr> <td style="width: 10%;"></td> <td style="width: 10%;"></td> <td style="width: 10%;"></td> <td style="width: 10%;"></td> <td style="width: 10%;"></td> <td style="width: 10%;"></td> <td style="width: 10%;"></td> <td style="width: 10%;"></td> <td style="width: 10%;"></td> <td style="width: 10%;"></td> </tr> <tr> <td></td> <td></td> <td colspan="8" style="text-align: center;"> <table border="1" style="width: 100%; border-collapse: collapse; text-align: center;"> <tr> <td style="width: 10%;"></td> <td style="width: 10%;"></td> <td style="width: 10%;"></td> <td style="width: 10%;"></td> <td style="width: 10%;"></td> <td style="width: 10%;"></td> <td style="width: 10%;"></td> <td style="width: 10%;"></td> <td style="width: 10%;"></td> <td style="width: 10%;"></td> </tr> <tr> <td></td> <td></td> <td colspan="8" style="text-align: center;"> <table border="1" style="width: 100%; border-collapse: collapse; text-align: center;"> <tr> <td style="width: 10%;"></td> <td style="width: 10%;"></td> <td style="width: 10%;"></td> <td style="width: 10%;"></td> <td style="width: 10%;"></td> <td style="width: 10%;"></td> <td style="width: 10%;"></td> <td style="width: 10%;"></td> <td style="width: 10%;"></td> <td style="width: 10%;"></td> </tr> <tr> <td></td> <td></td> <td colspan="8" style="text-align: center;"> <table border="1" style="width: 100%; border-collapse: collapse; text-align: center;"> <tr> <td style="width: 10%;"></td> <td style="width: 10%;"></td> <td style="width: 10%;"></td> <td style="width: 10%;"></td> <td style="width: 10%;"></td> <td style="width: 10%;"></td> <td style="width: 10%;"></td> <td style="width: 10%;"></td> <td style="width: 10%;"></td> <td style="width: 10%;"></td> </tr> <tr> <td></td> <td></td> <td colspan="8" style="text-align: center;"> <table border="1" style="width: 100%; border-collapse: collapse; text-align: center;"> <tr> <td style="width: 10%;"></td> <td style="width: 10%;"></td> <td style="width: 10%;"></td> <td style="width: 10%;"></td> <td style="width: 10%;"></td> <td style="width: 10%;"></td> <td style="width: 10%;"></td> <td style="width: 10%;"></td> <td style="width: 10%;"></td> <td style="width: 10%;"></td> </tr> <tr> <td></td> <td></td> <td colspan="8" style="text-align: center;"> <table border="1" style="width: 100%; border-collapse: collapse; text-align: center;"> <tr> <td style="width: 10%;"></td> <td style="width: 10%;"></td> <td style="width: 10%;"></td> <td style="width: 10%;"></td> <td style="width: 10%;"></td> <td style="width: 10%;"></td> <td style="width: 10%;"></td> <td style="width: 10%;"></td> <td style="width: 10%;"></td> <td style="width: 10%;"></td> </tr> <tr> <td></td> <td></td> <td colspan="8" style="text-align: center;"> <table border="1" style="width: 100%; border-collapse: collapse; text-align: center;"> <tr> <td style="width: 10%;"></td> <td style="width: 10%;"></td> <td style="width: 10%;"></td> <td style="width: 10%;"></td> <td style="width: 10%;"></td> <td style="width: 10%;"></td> <td style="width: 10%;"></td> <td style="width: 10%;"></td> <td style="width: 10%;"></td> <td style="width: 10%;"></td> </tr> <tr> <td></td> <td></td> <td colspan="8" style="text-align: center;"> <table border="1" style="width: 100%; border-collapse: collapse; text-align: center;"> <tr> </tr></table></td></tr></table></td></tr></table></td></tr></table></td></tr></table></td></tr></table></td></tr></table></td></tr></table></td></tr></table></td></tr></table></td></tr></table></td></tr></table></td></tr></table></td></tr></table></td></tr></table></td></tr></table></td></tr></table></td></tr></table></td></tr></table></td></tr></table></td></tr></table></td></tr></table></td></tr></table></td></tr></table></td></tr></table></td></tr></table></td></tr></table></td></tr></table></td></tr></table></td></tr></table></td></tr></table></td></tr></table></td></tr></table></td></tr></table></td></tr></table></td></tr></table></td></tr></table></td></tr></table></td></tr></table></td></tr></table></td></tr></table></td></tr></table></td></tr></table></td></tr></table></td></tr></table></td></tr></table></td></tr></table></td></tr></table></td></tr></table></td></tr></table>
 | | | | | | | | | | | | | | | | | | | | <table border="1" style="width: 100%; border-collapse: collapse; text-align: center;"> <tr> <td style="width: 10%;"></td> <td style="width: 10%;"></td> <td style="width: 10%;"></td> <td style="width: 10%;"></td> <td style="width: 10%;"></td> <td style="width: 10%;"></td> <td style="width: 10%;"></td> <td style="width: 10%;"></td> <td style="width: 10%;"></td> <td style="width: 10%;"></td> </tr> <tr> <td></td> <td></td> <td colspan="8" style="text-align: center;"> <table border="1" style="width: 100%; border-collapse: collapse; text-align: center;"> <tr> <td style="width: 10%;"></td> <td style="width: 10%;"></td> <td style="width: 10%;"></td> <td style="width: 10%;"></td> <td style="width: 10%;"></td> <td style="width: 10%;"></td> <td style="width: 10%;"></td> <td style="width: 10%;"></td> <td style="width: 10%;"></td> <td style="width: 10%;"></td> </tr> <tr> <td></td> <td></td> <td colspan="8" style="text-align: center;"> <table border="1" style="width: 100%; border-collapse: collapse; text-align: center;"> <tr> <td style="width: 10%;"></td> <td style="width: 10%;"></td> <td style="width: 10%;"></td> <td style="width: 10%;"></td> <td style="width: 10%;"></td> <td style="width: 10%;"></td> <td style="width: 10%;"></td> <td style="width: 10%;"></td> <td style="width: 10%;"></td> <td style="width: 10%;"></td> </tr> <tr> <td></td> <td></td> <td colspan="8" style="text-align: center;"> <table border="1" style="width: 100%; border-collapse: collapse; text-align: center;"> <tr> <td style="width: 10%;"></td> <td style="width: 10%;"></td> <td style="width: 10%;"></td> <td style="width: 10%;"></td> <td style="width: 10%;"></td> <td style="width: 10%;"></td> <td style="width: 10%;"></td> <td style="width: 10%;"></td> <td style="width: 10%;"></td> <td style="width: 10%;"></td> </tr> <tr> <td></td> <td></td> <td colspan="8" style="text-align: center;"> <table border="1" style="width: 100%; border-collapse: collapse; text-align: center;"> <tr> <td style="width: 10%;"></td> <td style="width: 10%;"></td> <td style="width: 10%;"></td> <td style="width: 10%;"></td> <td style="width: 10%;"></td> <td style="width: 10%;"></td> <td style="width: 10%;"></td> <td style="width: 10%;"></td> <td style="width: 10%;"></td> <td style="width: 10%;"></td> </tr> <tr> <td></td> <td></td> <td colspan="8" style="text-align: center;"> <table border="1" style="width: 100%; border-collapse: collapse; text-align: center;"> <tr> <td style="width: 10%;"></td> <td style="width: 10%;"></td> <td style="width: 10%;"></td> <td style="width: 10%;"></td> <td style="width: 10%;"></td> <td style="width: 10%;"></td> <td style="width: 10%;"></td> <td style="width: 10%;"></td> <td style="width: 10%;"></td> <td style="width: 10%;"></td> </tr> <tr> <td></td> <td></td> <td colspan="8" style="text-align: center;"> <table border="1" style="width: 100%; border-collapse: collapse; text-align: center;"> <tr> <td style="width: 10%;"></td> <td style="width: 10%;"></td> <td style="width: 10%;"></td> <td style="width: 10%;"></td> <td style="width: 10%;"></td> <td style="width: 10%;"></td> <td style="width: 10%;"></td> <td style="width: 10%;"></td> <td style="width: 10%;"></td> <td style="width: 10%;"></td> </tr> <tr> <td></td> <td></td> <td colspan="8" style="text-align: center;"> <table border="1" style="width: 100%; border-collapse: collapse; text-align: center;"> <tr> <td style="width: 10%;"></td> <td style="width: 10%;"></td> <td style="width: 10%;"></td> <td style="width: 10%;"></td> <td style="width: 10%;"></td> <td style="width: 10%;"></td> <td style="width: 10%;"></td> <td style="width: 10%;"></td> <td style="width: 10%;"></td> <td style="width: 10%;"></td> </tr> <tr> <td></td> <td></td> <td colspan="8" style="text-align: center;"> <table border="1" style="width: 100%; border-collapse: collapse; text-align: center;"> <tr> <td style="width: 10%;"></td> <td style="width: 10%;"></td> <td style="width: 10%;"></td> <td style="width: 10%;"></td> <td style="width: 10%;"></td> <td style="width: 10%;"></td> <td style="width: 10%;"></td> <td style="width: 10%;"></td> <td style="width: 10%;"></td> <td style="width: 10%;"></td> </tr> <tr> <td></td> <td></td> <td colspan="8" style="text-align: center;"> <table border="1" style="width: 100%; border-collapse: collapse; text-align: center;"> <tr> <td style="width: 10%;"></td> <td style="width: 10%;"></td> <td style="width: 10%;"></td> <td style="width: 10%;"></td> <td style="width: 10%;"></td> <td style="width: 10%;"></td> <td style="width: 10%;"></td> <td style="width: 10%;"></td> <td style="width: 10%;"></td> <td style="width: 10%;"></td> </tr> <tr> <td></td> <td></td> <td colspan="8" style="text-align: center;"> <table border="1" style="width: 100%; border-collapse: collapse; text-align: center;"> <tr> <td style="width: 10%;"></td> <td style="width: 10%;"></td> <td style="width: 10%;"></td> <td style="width: 10%;"></td> <td style="width: 10%;"></td> <td style="width: 10%;"></td> <td style="width: 10%;"></td> <td style="width: 10%;"></td> <td style="width: 10%;"></td> <td style="width: 10%;"></td> </tr> <tr> <td></td> <td></td> <td colspan="8" style="text-align: center;"> <table border="1" style="width: 100%; border-collapse: collapse; text-align: center;"> <tr> <td style="width: 10%;"></td> <td style="width: 10%;"></td> <td style="width: 10%;"></td> <td style="width: 10%;"></td> <td style="width: 10%;"></td> <td style="width: 10%;"></td> <td style="width: 10%;"></td> <td style="width: 10%;"></td> <td style="width: 10%;"></td> <td style="width: 10%;"></td> </tr> <tr> <td></td> <td></td> <td colspan="8" style="text-align: center;"> <table border="1" style="width: 100%; border-collapse: collapse; text-align: center;"> <tr> <td style="width: 10%;"></td> <td style="width: 10%;"></td> <td style="width: 10%;"></td> <td style="width: 10%;"></td> <td style="width: 10%;"></td> <td style="width: 10%;"></td> <td style="width: 10%;"></td> <td style="width: 10%;"></td> <td style="width: 10%;"></td> <td style="width: 10%;"></td> </tr> <tr> <td></td> <td></td> <td colspan="8" style="text-align: center;"> <table border="1" style="width: 100%; border-collapse: collapse; text-align: center;"> <tr> <td style="width: 10%;"></td> <td style="width: 10%;"></td> <td style="width: 10%;"></td> <td style="width: 10%;"></td> <td style="width: 10%;"></td> <td style="width: 10%;"></td> <td style="width: 10%;"></td> <td style="width: 10%;"></td> <td style="width: 10%;"></td> <td style="width: 10%;"></td> </tr> <tr> <td></td> <td></td> <td colspan="8" style="text-align: center;"> <table border="1" style="width: 100%; border-collapse: collapse; text-align: center;"> <tr> <td style="width: 10%;"></td> <td style="width: 10%;"></td> <td style="width: 10%;"></td> <td style="width: 10%;"></td> <td style="width: 10%;"></td> <td style="width: 10%;"></td> <td style="width: 10%;"></td> <td style="width: 10%;"></td> <td style="width: 10%;"></td> <td style="width: 10%;"></td> </tr> <tr> <td></td> <td></td> <td colspan="8" style="text-align: center;"> <table border="1" style="width: 100%; border-collapse: collapse; text-align: center;"> <tr> <td style="width: 10%;"></td> <td style="width: 10%;"></td> <td style="width: 10%;"></td> <td style="width: 10%;"></td> <td style="width: 10%;"></td> <td style="width: 10%;"></td> <td style="width: 10%;"></td> <td style="width: 10%;"></td> <td style="width: 10%;"></td> <td style="width: 10%;"></td> </tr> <tr> <td></td> <td></td> <td colspan="8" style="text-align: center;"> <table border="1" style="width: 100%; border-collapse: collapse; text-align: center;"> <tr> <td style="width: 10%;"></td> <td style="width: 10%;"></td> <td style="width: 10%;"></td> <td style="width: 10%;"></td> <td style="width: 10%;"></td> <td style="width: 10%;"></td> <td style="width: 10%;"></td> <td style="width: 10%;"></td> <td style="width: 10%;"></td> <td style="width: 10%;"></td> </tr> <tr> <td></td> <td></td> <td colspan="8" style="text-align: center;"> <table border="1" style="width: 100%; border-collapse: collapse; text-align: center;"> <tr> <td style="width: 10%;"></td> <td style="width: 10%;"></td> <td style="width: 10%;"></td> <td style="width: 10%;"></td> <td style="width: 10%;"></td> <td style="width: 10%;"></td> <td style="width: 10%;"></td> <td style="width: 10%;"></td> <td style="width: 10%;"></td> <td style="width: 10%;"></td> </tr> <tr> <td></td> <td></td> <td colspan="8" style="text-align: center;"> <table border="1" style="width: 100%; border-collapse: collapse; text-align: center;"> <tr> <td style="width: 10%;"></td> <td style="width: 10%;"></td> <td style="width: 10%;"></td> <td style="width: 10%;"></td> <td style="width: 10%;"></td> <td style="width: 10%;"></td> <td style="width: 10%;"></td> <td style="width: 10%;"></td> <td style="width: 10%;"></td> <td style="width: 10%;"></td> </tr> <tr> <td></td> <td></td> <td colspan="8" style="text-align: center;"> <table border="1" style="width: 100%; border-collapse: collapse; text-align: center;"> <tr> <td style="width: 10%;"></td> <td
style="width: 10%;"></td> <td style="width: 10%;"></td> <td style="width: 10%;"></td> <td style="width: 10%;"></td> <td style="width: 10%;"></td> <td style="width: 10%;"></td> <td style="width: 10%;"></td> <td style="width: 10%;"></td> <td style="width: 10%;"></td> </tr> <tr> <td></td> <td></td> <td colspan="8" style="text-align: center;"> <table border="1" style="width: 100%; border-collapse: collapse; text-align: center;"> <tr> <td style="width: 10%;"></td> <td style="width: 10%;"></td> <td style="width: 10%;"></td> <td style="width: 10%;"></td> <td style="width: 10%;"></td> <td style="width: 10%;"></td> <td style="width: 10%;"></td> <td style="width: 10%;"></td> <td style="width: 10%;"></td> <td style="width: 10%;"></td> </tr> <tr> <td></td> <td></td> <td colspan="8" style="text-align: center;"> <table border="1" style="width: 100%; border-collapse: collapse; text-align: center;"> <tr> <td style="width: 10%;"></td> <td style="width: 10%;"></td> <td style="width: 10%;"></td> <td style="width: 10%;"></td> <td style="width: 10%;"></td> <td style="width: 10%;"></td> <td style="width: 10%;"></td> <td style="width: 10%;"></td> <td style="width: 10%;"></td> <td style="width: 10%;"></td> </tr> <tr> <td></td> <td></td> <td colspan="8" style="text-align: center;"> <table border="1" style="width: 100%; border-collapse: collapse; text-align: center;"> <tr> <td style="width: 10%;"></td> <td style="width: 10%;"></td> <td style="width: 10%;"></td> <td style="width: 10%;"></td> <td style="width: 10%;"></td> <td style="width: 10%;"></td> <td style="width: 10%;"></td> <td style="width: 10%;"></td> <td style="width: 10%;"></td> <td style="width: 10%;"></td> </tr> <tr> <td></td> <td></td> <td colspan="8" style="text-align: center;"> <table border="1" style="width: 100%; border-collapse: collapse; text-align: center;"> <tr> <td style="width: 10%;"></td> <td style="width: 10%;"></td> <td style="width: 10%;"></td> <td style="width: 10%;"></td> <td style="width: 10%;"></td> <td style="width: 10%;"></td> <td style="width: 10%;"></td> <td style="width: 10%;"></td> <td style="width: 10%;"></td> <td style="width: 10%;"></td> </tr> <tr> <td></td> <td></td> <td colspan="8" style="text-align: center;"> <table border="1" style="width: 100%; border-collapse: collapse; text-align: center;"> <tr> <td style="width: 10%;"></td> <td style="width: 10%;"></td> <td style="width: 10%;"></td> <td style="width: 10%;"></td> <td style="width: 10%;"></td> <td style="width: 10%;"></td> <td style="width: 10%;"></td> <td style="width: 10%;"></td> <td style="width: 10%;"></td> <td style="width: 10%;"></td> </tr> <tr> <td></td> <td></td> <td colspan="8" style="text-align: center;"> <table border="1" style="width: 100%; border-collapse: collapse; text-align: center;"> <tr> <td style="width: 10%;"></td> <td style="width: 10%;"></td> <td style="width: 10%;"></td> <td style="width: 10%;"></td> <td style="width: 10%;"></td> <td style="width: 10%;"></td> <td style="width: 10%;"></td> <td style="width: 10%;"></td> <td style="width: 10%;"></td> <td style="width: 10%;"></td> </tr> <tr> <td></td> <td></td> <td colspan="8" style="text-align: center;"> <table border="1" style="width: 100%; border-collapse: collapse; text-align: center;"> <tr> <td style="width: 10%;"></td> <td style="width: 10%;"></td> <td style="width: 10%;"></td> <td style="width: 10%;"></td> <td style="width: 10%;"></td> <td style="width: 10%;"></td> <td style="width: 10%;"></td> <td style="width: 10%;"></td> <td style="width: 10%;"></td> <td style="width: 10%;"></td> </tr> <tr> <td></td> <td></td> <td colspan="8" style="text-align: center;"> <table border="1" style="width: 100%; border-collapse: collapse; text-align: center;"> <tr> <td style="width: 10%;"></td> <td style="width: 10%;"></td> <td style="width: 10%;"></td> <td style="width: 10%;"></td> <td style="width: 10%;"></td> <td style="width: 10%;"></td> <td style="width: 10%;"></td> <td style="width: 10%;"></td> <td style="width: 10%;"></td> <td style="width: 10%;"></td> </tr> <tr> <td></td> <td></td> <td colspan="8" style="text-align: center;"> <table border="1" style="width: 100%; border-collapse: collapse; text-align: center;"> <tr> <td style="width: 10%;"></td> <td style="width: 10%;"></td> <td style="width: 10%;"></td> <td style="width: 10%;"></td> <td style="width: 10%;"></td> <td style="width: 10%;"></td> <td style="width: 10%;"></td> <td style="width: 10%;"></td> <td style="width: 10%;"></td> <td style="width: 10%;"></td> </tr> <tr> <td></td> <td></td> <td colspan="8" style="text-align: center;"> <table border="1" style="width: 100%; border-collapse: collapse; text-align: center;"> <tr> <td style="width: 10%;"></td> <td style="width: 10%;"></td> <td style="width: 10%;"></td> <td style="width: 10%;"></td> <td style="width: 10%;"></td> <td style="width: 10%;"></td> <td style="width: 10%;"></td> <td style="width: 10%;"></td> <td style="width: 10%;"></td> <td style="width: 10%;"></td> </tr> <tr> <td></td> <td></td> <td colspan="8" style="text-align: center;"> <table border="1" style="width: 100%; border-collapse: collapse; text-align: center;"> <tr> <td style="width: 10%;"></td> <td style="width: 10%;"></td> <td style="width: 10%;"></td> <td style="width: 10%;"></td> <td style="width: 10%;"></td> <td style="width: 10%;"></td> <td style="width: 10%;"></td> <td style="width: 10%;"></td> <td style="width: 10%;"></td> <td style="width: 10%;"></td> </tr> <tr> <td></td> <td></td> <td colspan="8" style="text-align: center;"> <table border="1" style="width: 100%; border-collapse: collapse; text-align: center;"> <tr> <td style="width: 10%;"></td> <td style="width: 10%;"></td> <td style="width: 10%;"></td> <td style="width: 10%;"></td> <td style="width: 10%;"></td> <td style="width: 10%;"></td> <td style="width: 10%;"></td> <td style="width: 10%;"></td> <td style="width: 10%;"></td> <td style="width: 10%;"></td> </tr> <tr> <td></td> <td></td> <td colspan="8" style="text-align: center;"> <table border="1" style="width: 100%; border-collapse: collapse; text-align: center;"> <tr> <td style="width: 10%;"></td> <td style="width: 10%;"></td> <td style="width: 10%;"></td> <td style="width: 10%;"></td> <td style="width: 10%;"></td> <td style="width: 10%;"></td> <td style="width: 10%;"></td> <td style="width: 10%;"></td> <td style="width: 10%;"></td> <td style="width: 10%;"></td> </tr> <tr> <td></td> <td></td> <td colspan="8" style="text-align: center;"> <table border="1" style="width: 100%; border-collapse: collapse; text-align: center;"> <tr> <td style="width: 10%;"></td> <td style="width: 10%;"></td> <td style="width: 10%;"></td> <td style="width: 10%;"></td> <td style="width: 10%;"></td> <td style="width: 10%;"></td> <td style="width: 10%;"></td> <td style="width: 10%;"></td> <td style="width: 10%;"></td> <td style="width: 10%;"></td> </tr> <tr> <td></td> <td></td> <td colspan="8" style="text-align: center;"> <table border="1" style="width: 100%; border-collapse: collapse; text-align: center;"> <tr> <td style="width: 10%;"></td> <td style="width: 10%;"></td> <td style="width: 10%;"></td> <td style="width: 10%;"></td> <td style="width: 10%;"></td> <td style="width: 10%;"></td> <td style="width: 10%;"></td> <td style="width: 10%;"></td> <td style="width: 10%;"></td> <td style="width: 10%;"></td> </tr> <tr> <td></td> <td></td> <td colspan="8" style="text-align: center;"> <table border="1" style="width: 100%; border-collapse: collapse; text-align: center;"> <tr> <td style="width: 10%;"></td> <td style="width: 10%;"></td> <td style="width: 10%;"></td> <td style="width: 10%;"></td> <td style="width: 10%;"></td> <td style="width: 10%;"></td> <td style="width: 10%;"></td> <td style="width: 10%;"></td> <td style="width: 10%;"></td> <td style="width: 10%;"></td> </tr> <tr> <td></td> <td></td> <td colspan="8" style="text-align: center;"> <table border="1" style="width: 100%; border-collapse: collapse; text-align: center;"> <tr> <td style="width: 10%;"></td> <td style="width: 10%;"></td> <td style="width: 10%;"></td> <td style="width: 10%;"></td> <td style="width: 10%;"></td> <td style="width: 10%;"></td> <td style="width: 10%;"></td> <td style="width: 10%;"></td> <td style="width: 10%;"></td> <td style="width: 10%;"></td> </tr> <tr> <td></td> <td></td> <td colspan="8" style="text-align: center;"> <table border="1" style="width: 100%; border-collapse: collapse; text-align: center;"> <tr> <td style="width: 10%;"></td> <td style="width: 10%;"></td> <td style="width: 10%;"></td> <td style="width: 10%;"></td> <td style="width: 10%;"></td> <td style="width: 10%;"></td> <td style="width: 10%;"></td> <td style="width: 10%;"></td> <td style="width: 10%;"></td> <td style="width: 10%;"></td> </tr> <tr> <td></td> <td></td> <td colspan="8" style="text-align: center;"> <table border="1" style="width: 100%; border-collapse: collapse; text-align: center;"> <tr> <td style="width: 10%;"></td> <td style="width: 10%;"></td> <td style="width: 10%;"></td> <td style="width: 10%;"></td> <td style="width: 10%;"></td> <td style="width: 10%;"></td> <td style="width: 10%;"></td> <td style="width: 10%;"></td> <td style="width: 10%;"></td> <td style="width: 10%;"></td> </tr> <tr> <td></td> <td></td> <td colspan="8" style="text-align: center;"> <table border="1" style="width: 100%; border-collapse: collapse; text-align: center;"> <tr> <td style="width: 10%;"></td> <td style="width: 10%;"></td> <td style="width: 10%;"></td> <td style="width: 10%;"></td> <td style="width: 10%;"></td> <td style="width: 10%;"></td> <td style="width: 10%;"></td> <td style="width: 10%;"></td> <td style="width: 10%;"></td> <td style="width: 10%;"></td> </tr> <tr> <td></td> <td></td> <td colspan="8" style="text-align: center;"> <table border="1" style="width: 100%; border-collapse: collapse; text-align: center;"> <tr> <td style="width: 10%;"></td> <td style="width: 10%;"></td> <td style="width: 10%;"></td> <td style="width: 10%;"></td> <td style="width: 10%;"></td> <td style="width: 10%;"></td> <td style="width:
10%;"></td> <td style="width: 10%;"></td> <td style="width: 10%;"></td> <td style="width: 10%;"></td> </tr> <tr> <td></td> <td></td> <td colspan="8" style="text-align: center;"> <table border="1" style="width: 100%; border-collapse: collapse; text-align: center;"> <tr> <td style="width: 10%;"></td> <td style="width: 10%;"></td> <td style="width: 10%;"></td> <td style="width: 10%;"></td> <td style="width: 10%;"></td> <td style="width: 10%;"></td> <td style="width: 10%;"></td> <td style="width: 10%;"></td> <td style="width: 10%;"></td> <td style="width: 10%;"></td> </tr> <tr> <td></td> <td></td> <td colspan="8" style="text-align: center;"> <table border="1" style="width: 100%; border-collapse: collapse; text-align: center;"> <tr> <td style="width: 10%;"></td> <td style="width: 10%;"></td> <td style="width: 10%;"></td> <td style="width: 10%;"></td> <td style="width: 10%;"></td> <td style="width: 10%;"></td> <td style="width: 10%;"></td> <td style="width: 10%;"></td> <td style="width: 10%;"></td> <td style="width: 10%;"></td> </tr> <tr> <td></td> <td></td> <td colspan="8" style="text-align: center;"> <table border="1" style="width: 100%; border-collapse: collapse; text-align: center;"> <tr> <td style="width: 10%;"></td> <td style="width: 10%;"></td> <td style="width: 10%;"></td> <td style="width: 10%;"></td> <td style="width: 10%;"></td> <td style="width: 10%;"></td> <td style="width: 10%;"></td> <td style="width: 10%;"></td> <td style="width: 10%;"></td> <td style="width: 10%;"></td> </tr> <tr> <td></td> <td></td> <td colspan="8" style="text-align: center;"> <table border="1" style="width: 100%; border-collapse: collapse; text-align: center;"> <tr> <td style="width: 10%;"></td> <td style="width: 10%;"></td> <td style="width: 10%;"></td> <td style="width: 10%;"></td> <td style="width: 10%;"></td> <td style="width: 10%;"></td> <td style="width: 10%;"></td> <td style="width: 10%;"></td> <td style="width: 10%;"></td> <td style="width: 10%;"></td> </tr> <tr> <td></td> <td></td> <td colspan="8" style="text-align: center;"> <table border="1" style="width: 100%; border-collapse: collapse; text-align: center;"> <tr> <td style="width: 10%;"></td> <td style="width: 10%;"></td> <td style="width: 10%;"></td> <td style="width: 10%;"></td> <td style="width: 10%;"></td> <td style="width: 10%;"></td> <td style="width: 10%;"></td> <td style="width: 10%;"></td> <td style="width: 10%;"></td> <td style="width: 10%;"></td> </tr> <tr> <td></td> <td></td> <td colspan="8" style="text-align: center;"> <table border="1" style="width: 100%; border-collapse: collapse; text-align: center;"> <tr> <td style="width: 10%;"></td> <td style="width: 10%;"></td> <td style="width: 10%;"></td> <td style="width: 10%;"></td> <td style="width: 10%;"></td> <td style="width: 10%;"></td> <td style="width: 10%;"></td> <td style="width: 10%;"></td> <td style="width: 10%;"></td> <td style="width: 10%;"></td> </tr> <tr> <td></td> <td></td> <td colspan="8" style="text-align: center;"> <table border="1" style="width: 100%; border-collapse: collapse; text-align: center;"> <tr> <td style="width: 10%;"></td> <td style="width: 10%;"></td> <td style="width: 10%;"></td> <td style="width: 10%;"></td> <td style="width: 10%;"></td> <td style="width: 10%;"></td> <td style="width: 10%;"></td> <td style="width: 10%;"></td> <td style="width: 10%;"></td> <td style="width: 10%;"></td> </tr> <tr> <td></td> <td></td> <td colspan="8" style="text-align: center;"> <table border="1" style="width: 100%; border-collapse: collapse; text-align: center;"> <tr> </tr></table></td></tr></table></td></tr></table></td></tr></table></td></tr></table></td></tr></table></td></tr></table></td></tr></table></td></tr></table></td></tr></table></td></tr></table></td></tr></table></td></tr></table></td></tr></table></td></tr></table></td></tr></table></td></tr></table></td></tr></table></td></tr></table></td></tr></table></td></tr></table></td></tr></table></td></tr></table></td></tr></table></td></tr></table></td></tr></table></td></tr></table></td></tr></table></td></tr></table></td></tr></table></td></tr></table></td></tr></table></td></tr></table></td></tr></table></td></tr></table></td></tr></table></td></tr></table></td></tr></table></td></tr></table></td></tr></table></td></tr></table></td></tr></table></td></tr></table></td></tr></table></td></tr></table></td></tr></table></td></tr></table></td></tr></table></td></tr></table> | | | | | | | | | | | | | | | | | | | | <table border="1" style="width: 100%; border-collapse: collapse; text-align: center;"> <tr> <td style="width: 10%;"></td> <td style="width: 10%;"></td> <td style="width: 10%;"></td> <td style="width: 10%;"></td> <td style="width: 10%;"></td> <td style="width: 10%;"></td> <td style="width: 10%;"></td> <td style="width: 10%;"></td> <td style="width: 10%;"></td> <td style="width: 10%;"></td> </tr> <tr> <td></td> <td></td> <td colspan="8" style="text-align: center;"> <table border="1" style="width: 100%; border-collapse: collapse; text-align: center;"> <tr> <td style="width: 10%;"></td> <td style="width: 10%;"></td> <td style="width: 10%;"></td> <td style="width: 10%;"></td> <td style="width: 10%;"></td> <td style="width: 10%;"></td> <td style="width: 10%;"></td> <td style="width: 10%;"></td> <td style="width: 10%;"></td> <td style="width: 10%;"></td> </tr> <tr> <td></td> <td></td> <td colspan="8" style="text-align: center;"> <table border="1" style="width: 100%; border-collapse: collapse; text-align: center;"> <tr> <td style="width: 10%;"></td> <td style="width: 10%;"></td> <td style="width: 10%;"></td> <td style="width: 10%;"></td> <td style="width: 10%;"></td> <td style="width: 10%;"></td> <td style="width: 10%;"></td> <td style="width: 10%;"></td> <td style="width: 10%;"></td> <td style="width: 10%;"></td> </tr> <tr> <td></td> <td></td> <td colspan="8" style="text-align: center;"> <table border="1" style="width: 100%; border-collapse: collapse; text-align: center;"> <tr> <td style="width: 10%;"></td> <td style="width: 10%;"></td> <td style="width: 10%;"></td> <td style="width: 10%;"></td> <td style="width: 10%;"></td> <td style="width: 10%;"></td> <td style="width: 10%;"></td> <td style="width: 10%;"></td> <td style="width: 10%;"></td> <td style="width: 10%;"></td> </tr> <tr> <td></td> <td></td> <td colspan="8" style="text-align: center;"> <table border="1" style="width: 100%; border-collapse: collapse; text-align: center;"> <tr> <td style="width: 10%;"></td> <td style="width: 10%;"></td> <td style="width: 10%;"></td> <td style="width: 10%;"></td> <td style="width: 10%;"></td> <td style="width: 10%;"></td> <td style="width: 10%;"></td> <td style="width: 10%;"></td> <td style="width: 10%;"></td> <td style="width: 10%;"></td> </tr> <tr> <td></td> <td></td> <td colspan="8" style="text-align: center;"> <table border="1" style="width: 100%; border-collapse: collapse; text-align: center;"> <tr> <td style="width: 10%;"></td> <td style="width: 10%;"></td> <td style="width: 10%;"></td> <td style="width: 10%;"></td> <td style="width: 10%;"></td> <td style="width:
10%;"></td> <td style="width: 10%;"></td> <td style="width: 10%;"></td> <td style="width: 10%;"></td> <td style="width: 10%;"></td> </tr> <tr> <td></td> <td></td> <td colspan="8" style="text-align: center;"> <table border="1" style="width: 100%; border-collapse: collapse; text-align: center;"> <tr> <td style="width: 10%;"></td> <td style="width: 10%;"></td> <td style="width: 10%;"></td> <td style="width: 10%;"></td> <td style="width: 10%;"></td> <td style="width: 10%;"></td> <td style="width: 10%;"></td> <td style="width: 10%;"></td> <td style="width: 10%;"></td> <td style="width: 10%;"></td> </tr> <tr> <td></td> <td></td> <td colspan="8" style="text-align: center;"> <table border="1" style="width: 100%; border-collapse: collapse; text-align: center;"> <tr> <td style="width: 10%;"></td> <td style="width: 10%;"></td> <td style="width: 10%;"></td> <td style="width: 10%;"></td> <td style="width: 10%;"></td> <td style="width: 10%;"></td> <td style="width: 10%;"></td> <td style="width: 10%;"></td> <td style="width: 10%;"></td> <td style="width: 10%;"></td> </tr> <tr> <td></td> <td></td> <td colspan="8" style="text-align: center;"> <table border="1" style="width: 100%; border-collapse: collapse; text-align: center;"> <tr> <td style="width: 10%;"></td> <td style="width: 10%;"></td> <td style="width: 10%;"></td> <td style="width: 10%;"></td> <td style="width: 10%;"></td> <td style="width: 10%;"></td> <td style="width: 10%;"></td> <td style="width: 10%;"></td> <td style="width: 10%;"></td> <td style="width: 10%;"></td> </tr> <tr> <td></td> <td></td> <td colspan="8" style="text-align: center;"> <table border="1" style="width: 100%; border-collapse: collapse; text-align: center;"> <tr> <td style="width: 10%;"></td> <td style="width: 10%;"></td> <td style="width: 10%;"></td> <td style="width: 10%;"></td> <td style="width: 10%;"></td> <td style="width: 10%;"></td> <td style="width: 10%;"></td> <td style="width: 10%;"></td> <td style="width: 10%;"></td> <td style="width: 10%;"></td> </tr> <tr> <td></td> <td></td> <td colspan="8" style="text-align: center;"> <table border="1" style="width: 100%; border-collapse: collapse; text-align: center;"> <tr> <td style="width: 10%;"></td> <td style="width: 10%;"></td> <td style="width: 10%;"></td> <td style="width: 10%;"></td> <td style="width: 10%;"></td> <td style="width: 10%;"></td> <td style="width: 10%;"></td> <td style="width: 10%;"></td> <td style="width: 10%;"></td> <td style="width: 10%;"></td> </tr> <tr> <td></td> <td></td> <td colspan="8" style="text-align: center;"> <table border="1" style="width: 100%; border-collapse: collapse; text-align: center;"> <tr> <td style="width: 10%;"></td> <td style="width: 10%;"></td> <td style="width: 10%;"></td> <td style="width: 10%;"></td> <td style="width: 10%;"></td> <td style="width: 10%;"></td> <td style="width: 10%;"></td> <td style="width: 10%;"></td> <td style="width: 10%;"></td> <td style="width: 10%;"></td> </tr> <tr> <td></td> <td></td> <td colspan="8" style="text-align: center;"> <table border="1" style="width: 100%; border-collapse: collapse; text-align: center;"> <tr> <td style="width: 10%;"></td> <td style="width: 10%;"></td> <td style="width: 10%;"></td> <td style="width: 10%;"></td> <td style="width: 10%;"></td> <td style="width: 10%;"></td> <td style="width: 10%;"></td> <td style="width: 10%;"></td> <td style="width: 10%;"></td> <td style="width: 10%;"></td> </tr> <tr> <td></td> <td></td> <td colspan="8" style="text-align: center;"> <table border="1" style="width: 100%; border-collapse: collapse; text-align: center;"> <tr> <td style="width: 10%;"></td> <td style="width: 10%;"></td> <td style="width: 10%;"></td> <td style="width: 10%;"></td> <td style="width: 10%;"></td> <td style="width: 10%;"></td> <td style="width: 10%;"></td> <td style="width: 10%;"></td> <td style="width: 10%;"></td> <td style="width: 10%;"></td> </tr> <tr> <td></td> <td></td> <td colspan="8" style="text-align: center;"> <table border="1" style="width: 100%; border-collapse: collapse; text-align: center;"> <tr> <td style="width: 10%;"></td> <td style="width: 10%;"></td> <td style="width: 10%;"></td> <td style="width: 10%;"></td> <td style="width: 10%;"></td> <td style="width: 10%;"></td> <td style="width: 10%;"></td> <td style="width: 10%;"></td> <td style="width: 10%;"></td> <td style="width: 10%;"></td> </tr> <tr> <td></td> <td></td> <td colspan="8" style="text-align: center;"> <table border="1" style="width: 100%; border-collapse: collapse; text-align: center;"> <tr> <td style="width: 10%;"></td> <td style="width: 10%;"></td> <td style="width: 10%;"></td> <td style="width: 10%;"></td> <td style="width: 10%;"></td> <td style="width: 10%;"></td> <td style="width: 10%;"></td> <td style="width: 10%;"></td> <td style="width: 10%;"></td> <td style="width: 10%;"></td> </tr> <tr> <td></td> <td></td> <td colspan="8" style="text-align: center;"> <table border="1" style="width: 100%; border-collapse: collapse; text-align: center;"> <tr> <td style="width: 10%;"></td> <td style="width: 10%;"></td> <td style="width: 10%;"></td> <td style="width: 10%;"></td> <td style="width: 10%;"></td> <td style="width: 10%;"></td> <td style="width: 10%;"></td> <td style="width: 10%;"></td> <td style="width: 10%;"></td> <td style="width: 10%;"></td> </tr> <tr> <td></td> <td></td> <td colspan="8" style="text-align: center;"> <table border="1" style="width: 100%; border-collapse: collapse; text-align: center;"> <tr> <td style="width: 10%;"></td> <td style="width: 10%;"></td> <td style="width: 10%;"></td> <td style="width: 10%;"></td> <td style="width: 10%;"></td> <td style="width: 10%;"></td> <td style="width: 10%;"></td> <td style="width: 10%;"></td> <td style="width: 10%;"></td> <td style="width: 10%;"></td> </tr> <tr> <td></td> <td></td> <td colspan="8" style="text-align: center;"> <table border="1" style="width: 100%; border-collapse: collapse; text-align: center;"> <tr> <td style="width: 10%;"></td> <td style="width: 10%;"></td> <td style="width: 10%;"></td> <td style="width: 10%;"></td> <td style="width: 10%;"></td> <td style="width: 10%;"></td> <td style="width: 10%;"></td> <td style="width: 10%;"></td> <td style="width: 10%;"></td> <td style="width: 10%;"></td> </tr> <tr> <td></td> <td></td> <td colspan="8" style="text-align: center;"> <table border="1" style="width: 100%; border-collapse: collapse; text-align: center;"> <tr> <td style="width: 10%;"></td> <td style="width: 10%;"></td> <td style="width: 10%;"></td> <td style="width: 10%;"></td> <td style="width: 10%;"></td> <td style="width: 10%;"></td> <td style="width: 10%;"></td> <td style="width: 10%;"></td> <td style="width: 10%;"></td> <td style="width: 10%;"></td> </tr> <tr> <td></td> <td></td> <td colspan="8" style="text-align: center;"> <table border="1" style="width: 100%; border-collapse: collapse; text-align: center;"> <tr> <td style="width: 10%;"></td> <td style="width: 10%;"></td> <td style="width: 10%;"></td> <td style="width: 10%;"></td> <td style="width: 10%;"></td> <td style="width: 10%;"></td> <td style="width: 10%;"></td> <td style="width: 10%;"></td> <td style="width: 10%;"></td> <td style="width: 10%;"></td> </tr> <tr> <td></td> <td></td> <td colspan="8" style="text-align: center;"> <table border="1" style="width: 100%; border-collapse: collapse; text-align: center;"> <tr> <td style="width: 10%;"></td> <td style="width: 10%;"></td> <td style="width: 10%;"></td> <td style="width: 10%;"></td> <td style="width: 10%;"></td> <td style="width: 10%;"></td> <td style="width: 10%;"></td> <td style="width: 10%;"></td> <td style="width: 10%;"></td> <td style="width: 10%;"></td> </tr> <tr> <td></td> <td></td> <td colspan="8" style="text-align: center;"> <table border="1" style="width: 100%; border-collapse: collapse; text-align: center;"> <tr> <td style="width: 10%;"></td> <td style="width: 10%;"></td> <td style="width: 10%;"></td> <td style="width: 10%;"></td> <td style="width: 10%;"></td> <td style="width: 10%;"></td> <td style="width: 10%;"></td> <td style="width: 10%;"></td> <td style="width: 10%;"></td> <td style="width: 10%;"></td> </tr> <tr> <td></td> <td></td> <td colspan="8" style="text-align: center;"> <table border="1" style="width: 100%; border-collapse: collapse; text-align: center;"> <tr> <td style="width: 10%;"></td> <td style="width: 10%;"></td> <td style="width: 10%;"></td> <td style="width: 10%;"></td> <td style="width: 10%;"></td> <td style="width: 10%;"></td> <td style="width: 10%;"></td> <td style="width: 10%;"></td> <td style="width: 10%;"></td> <td style="width: 10%;"></td> </tr> <tr> <td></td> <td></td> <td colspan="8" style="text-align: center;"> <table border="1" style="width: 100%; border-collapse: collapse; text-align: center;"> <tr> <td style="width: 10%;"></td> <td style="width: 10%;"></td> <td style="width: 10%;"></td> <td style="width: 10%;"></td> <td style="width: 10%;"></td> <td style="width: 10%;"></td> <td style="width: 10%;"></td> <td style="width: 10%;"></td> <td style="width: 10%;"></td> <td style="width: 10%;"></td> </tr> <tr> <td></td> <td></td> <td colspan="8" style="text-align: center;"> <table border="1" style="width: 100%; border-collapse: collapse; text-align: center;"> <tr> <td style="width: 10%;"></td> <td style="width: 10%;"></td> <td style="width: 10%;"></td> <td style="width: 10%;"></td> <td style="width: 10%;"></td> <td style="width: 10%;"></td> <td style="width: 10%;"></td> <td style="width: 10%;"></td> <td style="width: 10%;"></td> <td style="width: 10%;"></td> </tr> <tr> <td></td> <td></td> <td colspan="8" style="text-align: center;"> <table border="1" style="width: 100%; border-collapse: collapse; text-align: center;"> <tr> <td style="width: 10%;"></td> <td style="width: 10%;"></td> <td style="width: 10%;"></td> <td style="width: 10%;"></td> <td style="width: 10%;"></td> <td style="width: 10%;"></td> <td style="width: 10%;"></td> <td style="width: 10%;"></td> <td style="width: 10%;"></td> <td style="width: 10%;"></td> </tr> <tr> <td></td> <td></td> <td
colspan="8" style="text-align: center;"> <table border="1" style="width: 100%; border-collapse: collapse; text-align: center;"> <tr> <td style="width: 10%;"></td> <td style="width: 10%;"></td> <td style="width: 10%;"></td> <td style="width: 10%;"></td> <td style="width: 10%;"></td> <td style="width: 10%;"></td> <td style="width: 10%;"></td> <td style="width: 10%;"></td> <td style="width: 10%;"></td> <td style="width: 10%;"></td> </tr> <tr> <td></td> <td></td> <td colspan="8" style="text-align: center;"> <table border="1" style="width: 100%; border-collapse: collapse; text-align: center;"> <tr> <td style="width: 10%;"></td> <td style="width: 10%;"></td> <td style="width: 10%;"></td> <td style="width: 10%;"></td> <td style="width: 10%;"></td> <td style="width: 10%;"></td> <td style="width: 10%;"></td> <td style="width: 10%;"></td> <td style="width: 10%;"></td> <td style="width: 10%;"></td> </tr> <tr> <td></td> <td></td> <td colspan="8" style="text-align: center;"> <table border="1" style="width: 100%; border-collapse: collapse; text-align: center;"> <tr> <td style="width: 10%;"></td> <td style="width: 10%;"></td> <td style="width: 10%;"></td> <td style="width: 10%;"></td> <td style="width: 10%;"></td> <td style="width: 10%;"></td> <td style="width: 10%;"></td> <td style="width: 10%;"></td> <td style="width: 10%;"></td> <td style="width: 10%;"></td> </tr> <tr> <td></td> <td></td> <td colspan="8" style="text-align: center;"> <table border="1" style="width: 100%; border-collapse: collapse; text-align: center;"> <tr> <td style="width: 10%;"></td> <td style="width: 10%;"></td> <td style="width: 10%;"></td> <td style="width: 10%;"></td> <td style="width: 10%;"></td> <td style="width: 10%;"></td> <td style="width: 10%;"></td> <td style="width: 10%;"></td> <td style="width: 10%;"></td> <td style="width: 10%;"></td> </tr> <tr> <td></td> <td></td> <td colspan="8" style="text-align: center;"> <table border="1" style="width: 100%; border-collapse: collapse; text-align: center;"> <tr> <td style="width: 10%;"></td> <td style="width: 10%;"></td> <td style="width: 10%;"></td> <td style="width: 10%;"></td> <td style="width: 10%;"></td> <td style="width: 10%;"></td> <td style="width: 10%;"></td> <td style="width: 10%;"></td> <td style="width: 10%;"></td> <td style="width: 10%;"></td> </tr> <tr> <td></td> <td></td> <td colspan="8" style="text-align: center;"> <table border="1" style="width: 100%; border-collapse: collapse; text-align: center;"> <tr> <td style="width: 10%;"></td> <td style="width: 10%;"></td> <td style="width: 10%;"></td> <td style="width: 10%;"></td> <td style="width: 10%;"></td> <td style="width: 10%;"></td> <td style="width: 10%;"></td> <td style="width: 10%;"></td> <td style="width: 10%;"></td> <td style="width: 10%;"></td> </tr> <tr> <td></td> <td></td> <td colspan="8" style="text-align: center;"> <table border="1" style="width: 100%; border-collapse: collapse; text-align: center;"> <tr> <td style="width: 10%;"></td> <td style="width: 10%;"></td> <td style="width: 10%;"></td> <td style="width: 10%;"></td> <td style="width: 10%;"></td> <td style="width: 10%;"></td> <td style="width: 10%;"></td> <td style="width: 10%;"></td> <td style="width: 10%;"></td> <td style="width: 10%;"></td> </tr> <tr> <td></td> <td></td> <td colspan="8" style="text-align: center;"> <table border="1" style="width: 100%; border-collapse: collapse; text-align: center;"> <tr> <td style="width: 10%;"></td> <td style="width: 10%;"></td> <td style="width: 10%;"></td> <td style="width: 10%;"></td> <td style="width: 10%;"></td> <td style="width: 10%;"></td> <td style="width: 10%;"></td> <td style="width: 10%;"></td> <td style="width: 10%;"></td> <td style="width: 10%;"></td> </tr> <tr> <td></td> <td></td> <td colspan="8" style="text-align: center;"> <table border="1" style="width: 100%; border-collapse: collapse; text-align: center;"> <tr> <td style="width: 10%;"></td> <td style="width: 10%;"></td> <td style="width: 10%;"></td> <td style="width: 10%;"></td> <td style="width: 10%;"></td> <td style="width: 10%;"></td> <td style="width: 10%;"></td> <td style="width: 10%;"></td> <td style="width: 10%;"></td> <td style="width: 10%;"></td> </tr> <tr> <td></td> <td></td> <td colspan="8" style="text-align: center;"> <table border="1" style="width: 100%; border-collapse: collapse; text-align: center;"> <tr> <td style="width: 10%;"></td> <td style="width: 10%;"></td> <td style="width: 10%;"></td> <td style="width: 10%;"></td> <td style="width: 10%;"></td> <td style="width: 10%;"></td> <td style="width: 10%;"></td> <td style="width: 10%;"></td> <td style="width: 10%;"></td> <td style="width: 10%;"></td> </tr> <tr> <td></td> <td></td> <td colspan="8" style="text-align: center;"> <table border="1" style="width: 100%; border-collapse: collapse; text-align: center;"> <tr> <td style="width: 10%;"></td> <td style="width: 10%;"></td> <td style="width: 10%;"></td> <td style="width: 10%;"></td> <td style="width: 10%;"></td> <td style="width: 10%;"></td> <td style="width: 10%;"></td> <td style="width: 10%;"></td> <td style="width: 10%;"></td> <td style="width: 10%;"></td> </tr> <tr> <td></td> <td></td> <td colspan="8" style="text-align: center;"> <table border="1" style="width: 100%; border-collapse: collapse; text-align: center;"> <tr> <td style="width: 10%;"></td> <td style="width: 10%;"></td> <td style="width: 10%;"></td> <td style="width: 10%;"></td> <td style="width: 10%;"></td> <td style="width: 10%;"></td> <td style="width: 10%;"></td> <td style="width: 10%;"></td> <td style="width: 10%;"></td> <td style="width: 10%;"></td> </tr> <tr> <td></td> <td></td> <td colspan="8" style="text-align: center;"> <table border="1" style="width: 100%; border-collapse: collapse; text-align: center;"> <tr> <td style="width: 10%;"></td> <td style="width: 10%;"></td> <td style="width: 10%;"></td> <td style="width: 10%;"></td> <td style="width: 10%;"></td> <td style="width: 10%;"></td> <td style="width: 10%;"></td> <td style="width: 10%;"></td> <td style="width: 10%;"></td> <td style="width: 10%;"></td> </tr> <tr> <td></td> <td></td> <td colspan="8" style="text-align: center;"> <table border="1" style="width: 100%; border-collapse: collapse; text-align: center;"> <tr> <td style="width: 10%;"></td> <td style="width: 10%;"></td> <td style="width: 10%;"></td> <td style="width: 10%;"></td> <td style="width: 10%;"></td> <td style="width: 10%;"></td> <td style="width: 10%;"></td> <td style="width: 10%;"></td> <td style="width: 10%;"></td> <td style="width: 10%;"></td> </tr> <tr> <td></td> <td></td> <td colspan="8" style="text-align: center;"> <table border="1" style="width: 100%; border-collapse: collapse; text-align: center;"> <tr> <td style="width: 10%;"></td> <td style="width: 10%;"></td> <td style="width: 10%;"></td> <td style="width: 10%;"></td> <td style="width: 10%;"></td> <td style="width: 10%;"></td> <td style="width: 10%;"></td> <td style="width: 10%;"></td> <td style="width: 10%;"></td> <td style="width: 10%;"></td> </tr> <tr> <td></td> <td></td> <td colspan="8" style="text-align: center;"> <table border="1" style="width: 100%; border-collapse: collapse; text-align: center;"> <tr> <td style="width: 10%;"></td> <td style="width: 10%;"></td> <td style="width: 10%;"></td> <td style="width: 10%;"></td> <td style="width: 10%;"></td> <td style="width: 10%;"></td> <td style="width: 10%;"></td> <td style="width: 10%;"></td> <td style="width: 10%;"></td> <td style="width: 10%;"></td> </tr> <tr> <td></td> <td></td> <td colspan="8" style="text-align: center;"> <table border="1" style="width: 100%; border-collapse: collapse; text-align: center;"> <tr> <td style="width: 10%;"></td> <td style="width: 10%;"></td> <td style="width: 10%;"></td> <td style="width: 10%;"></td> <td style="width: 10%;"></td> <td style="width: 10%;"></td> <td style="width: 10%;"></td> <td style="width: 10%;"></td> <td style="width: 10%;"></td> <td style="width: 10%;"></td> </tr> <tr> <td></td> <td></td> <td colspan="8" style="text-align: center;"> <table border="1" style="width: 100%; border-collapse: collapse; text-align: center;"> <tr> <td style="width: 10%;"></td> <td style="width: 10%;"></td> <td style="width: 10%;"></td> <td style="width: 10%;"></td> <td style="width: 10%;"></td> <td style="width: 10%;"></td> <td style="width: 10%;"></td> <td style="width: 10%;"></td> <td style="width: 10%;"></td> <td style="width: 10%;"></td> </tr> <tr> <td></td> <td></td> <td colspan="8" style="text-align: center;"> <table border="1" style="width: 100%; border-collapse: collapse; text-align: center;"> <tr> <td style="width: 10%;"></td> <td style="width: 10%;"></td> <td style="width: 10%;"></td> <td style="width: 10%;"></td> <td style="width: 10%;"></td> <td style="width: 10%;"></td> <td style="width: 10%;"></td> <td style="width: 10%;"></td> <td style="width: 10%;"></td> <td style="width: 10%;"></td> </tr> <tr> <td></td> <td></td> <td colspan="8" style="text-align: center;"> <table border="1" style="width: 100%; border-collapse: collapse; text-align: center;"> <tr> <td style="width: 10%;"></td> <td style="width: 10%;"></td> <td style="width: 10%;"></td> <td style="width: 10%;"></td> <td style="width: 10%;"></td> <td style="width: 10%;"></td> <td style="width: 10%;"></td> <td style="width: 10%;"></td> <td style="width: 10%;"></td> <td style="width: 10%;"></td> </tr> <tr> <td></td> <td></td> <td colspan="8" style="text-align: center;"> <table border="1" style="width: 100%; border-collapse: collapse; text-align: center;"> <tr>
</tr></table></td></tr></table></td></tr></table></td></tr></table></td></tr></table></td></tr></table></td></tr></table></td></tr></table></td></tr></table></td></tr></table></td></tr></table></td></tr></table></td></tr></table></td></tr></table></td></tr></table></td></tr></table></td></tr></table></td></tr></table></td></tr></table></td></tr></table></td></tr></table></td></tr></table></td></tr></table></td></tr></table></td></tr></table></td></tr></table></td></tr></table></td></tr></table></td></tr></table></td></tr></table></td></tr></table></td></tr></table></td></tr></table></td></tr></table></td></tr></table></td></tr></table></td></tr></table></td></tr></table></td></tr></table></td></tr></table></td></tr></table></td></tr></table></td></tr></table></td></tr></table></td></tr></table></td></tr></table></td></tr></table></td></tr></table> | | | | | | | | | | | | | | | | | | | | <table border="1" style="width: 100%; border-collapse: collapse; text-align: center;"> <tr> <td style="width: 10%;"></td> <td style="width: 10%;"></td> <td style="width: 10%;"></td> <td style="width: 10%;"></td> <td style="width: 10%;"></td> <td style="width: 10%;"></td> <td style="width: 10%;"></td> <td style="width: 10%;"></td> <td style="width: 10%;"></td> <td style="width: 10%;"></td> </tr> <tr> <td></td> <td></td> <td colspan="8" style="text-align: center;"> <table border="1" style="width: 100%; border-collapse: collapse; text-align: center;"> <tr> <td style="width: 10%;"></td> <td style="width: 10%;"></td> <td style="width: 10%;"></td> <td style="width: 10%;"></td> <td style="width: 10%;"></td> <td style="width: 10%;"></td> <td style="width: 10%;"></td> <td style="width: 10%;"></td> <td style="width: 10%;"></td> <td style="width: 10%;"></td> </tr> <tr> <td></td> <td></td> <td colspan="8" style="text-align: center;"> <table border="1" style="width: 100%; border-collapse: collapse; text-align: center;"> <tr> <td style="width: 10%;"></td> <td style="width: 10%;"></td> <td style="width: 10%;"></td> <td style="width: 10%;"></td> <td style="width: 10%;"></td> <td style="width: 10%;"></td> <td style="width: 10%;"></td> <td style="width: 10%;"></td> <td style="width: 10%;"></td> <td style="width: 10%;"></td> </tr> <tr> <td></td> <td></td> <td colspan="8" style="text-align: center;"> <table border="1" style="width: 100%; border-collapse: collapse; text-align: center;"> <tr> <td style="width: 10%;"></td> <td style="width: 10%;"></td> <td style="width: 10%;"></td> <td style="width: 10%;"></td> <td style="width: 10%;"></td> <td style="width: 10%;"></td> <td style="width: 10%;"></td> <td style="width: 10%;"></td> <td style="width: 10%;"></td> <td style="width: 10%;"></td> </tr> <tr> <td></td> <td></td> <td colspan="8" style="text-align: center;"> <table border="1" style="width: 100%; border-collapse: collapse; text-align: center;"> <tr> <td style="width: 10%;"></td> <td style="width: 10%;"></td> <td style="width: 10%;"></td> <td style="width: 10%;"></td> <td style="width: 10%;"></td> <td style="width: 10%;"></td> <td style="width: 10%;"></td> <td style="width: 10%;"></td> <td style="width: 10%;"></td> <td style="width: 10%;"></td> </tr> <tr> <td></td> <td></td> <td colspan="8" style="text-align: center;"> <table border="1" style="width: 100%; border-collapse: collapse; text-align: center;"> <tr> <td style="width: 10%;"></td> <td style="width: 10%;"></td> <td style="width: 10%;"></td> <td style="width: 10%;"></td> <td style="width: 10%;"></td> <td style="width: 10%;"></td> <td style="width: 10%;"></td> <td style="width: 10%;"></td> <td style="width: 10%;"></td> <td style="width: 10%;"></td> </tr> <tr> <td></td> <td></td> <td colspan="8" style="text-align: center;"> <table border="1" style="width: 100%; border-collapse: collapse; text-align: center;"> <tr> <td style="width: 10%;"></td> <td style="width: 10%;"></td> <td style="width: 10%;"></td> <td style="width: 10%;"></td> <td style="width: 10%;"></td> <td style="width: 10%;"></td> <td style="width: 10%;"></td> <td style="width: 10%;"></td> <td style="width: 10%;"></td> <td style="width: 10%;"></td> </tr> <tr> <td></td> <td></td> <td colspan="8" style="text-align: center;"> <table border="1" style="width: 100%; border-collapse: collapse; text-align: center;"> <tr> <td style="width: 10%;"></td> <td style="width: 10%;"></td> <td style="width: 10%;"></td> <td style="width: 10%;"></td> <td style="width: 10%;"></td> <td style="width: 10%;"></td> <td style="width: 10%;"></td> <td style="width: 10%;"></td> <td style="width: 10%;"></td> <td style="width: 10%;"></td> </tr> <tr> <td></td> <td></td> <td colspan="8" style="text-align: center;"> <table border="1" style="width: 100%; border-collapse: collapse; text-align: center;"> <tr> <td style="width: 10%;"></td> <td style="width: 10%;"></td> <td style="width: 10%;"></td> <td style="width: 10%;"></td> <td style="width: 10%;"></td> <td style="width: 10%;"></td> <td style="width: 10%;"></td> <td style="width: 10%;"></td> <td style="width: 10%;"></td> <td style="width: 10%;"></td> </tr> <tr> <td></td> <td></td> <td colspan="8" style="text-align: center;"> <table border="1" style="width: 100%; border-collapse: collapse; text-align: center;"> <tr> <td style="width: 10%;"></td> <td style="width: 10%;"></td> <td style="width: 10%;"></td> <td style="width: 10%;"></td> <td style="width: 10%;"></td> <td style="width: 10%;"></td> <td style="width: 10%;"></td> <td style="width: 10%;"></td> <td style="width: 10%;"></td> <td style="width: 10%;"></td> </tr> <tr> <td></td> <td></td> <td colspan="8" style="text-align: center;"> <table border="1" style="width: 100%; border-collapse: collapse; text-align: center;"> <tr> <td style="width: 10%;"></td> <td style="width: 10%;"></td> <td style="width: 10%;"></td> <td style="width: 10%;"></td> <td style="width: 10%;"></td> <td style="width: 10%;"></td> <td style="width: 10%;"></td> <td style="width: 10%;"></td> <td style="width: 10%;"></td> <td style="width: 10%;"></td> </tr> <tr> <td></td> <td></td> <td colspan="8" style="text-align: center;"> <table border="1" style="width: 100%; border-collapse: collapse; text-align: center;"> <tr> <td style="width: 10%;"></td> <td style="width: 10%;"></td> <td style="width: 10%;"></td> <td style="width: 10%;"></td> <td style="width: 10%;"></td> <td style="width: 10%;"></td> <td style="width: 10%;"></td> <td style="width: 10%;"></td> <td style="width: 10%;"></td> <td style="width: 10%;"></td> </tr> <tr> <td></td> <td></td> <td colspan="8" style="text-align: center;"> <table border="1" style="width: 100%; border-collapse: collapse; text-align: center;"> <tr> <td style="width: 10%;"></td> <td style="width: 10%;"></td> <td style="width: 10%;"></td> <td style="width: 10%;"></td> <td style="width: 10%;"></td> <td style="width: 10%;"></td> <td style="width: 10%;"></td> <td style="width: 10%;"></td> <td style="width: 10%;"></td> <td style="width: 10%;"></td> </tr> <tr> <td></td> <td></td> <td colspan="8" style="text-align: center;"> <table border="1" style="width: 100%; border-collapse: collapse; text-align:
center;"> <tr> <td style="width: 10%;"></td> <td style="width: 10%;"></td> <td style="width: 10%;"></td> <td style="width: 10%;"></td> <td style="width: 10%;"></td> <td style="width: 10%;"></td> <td style="width: 10%;"></td> <td style="width: 10%;"></td> <td style="width: 10%;"></td> <td style="width: 10%;"></td> </tr> <tr> <td></td> <td></td> <td colspan="8" style="text-align: center;"> <table border="1" style="width: 100%; border-collapse: collapse; text-align: center;"> <tr> <td style="width: 10%;"></td> <td style="width: 10%;"></td> <td style="width: 10%;"></td> <td style="width: 10%;"></td> <td style="width: 10%;"></td> <td style="width: 10%;"></td> <td style="width: 10%;"></td> <td style="width: 10%;"></td> <td style="width: 10%;"></td> <td style="width: 10%;"></td> </tr> <tr> <td></td> <td></td> <td colspan="8" style="text-align: center;"> <table border="1" style="width: 100%; border-collapse: collapse; text-align: center;"> <tr> <td style="width: 10%;"></td> <td style="width: 10%;"></td> <td style="width: 10%;"></td> <td style="width: 10%;"></td> <td style="width: 10%;"></td> <td style="width: 10%;"></td> <td style="width: 10%;"></td> <td style="width: 10%;"></td> <td style="width: 10%;"></td> <td style="width: 10%;"></td> </tr> <tr> <td></td> <td></td> <td colspan="8" style="text-align: center;"> <table border="1" style="width: 100%; border-collapse: collapse; text-align: center;"> <tr> <td style="width: 10%;"></td> <td style="width: 10%;"></td> <td style="width: 10%;"></td> <td style="width: 10%;"></td> <td style="width: 10%;"></td> <td style="width: 10%;"></td> <td style="width: 10%;"></td> <td style="width: 10%;"></td> <td style="width: 10%;"></td> <td style="width: 10%;"></td> </tr> <tr> <td></td> <td></td> <td colspan="8" style="text-align: center;"> <table border="1" style="width: 100%; border-collapse: collapse; text-align: center;"> <tr> <td style="width: 10%;"></td> <td style="width: 10%;"></td> <td style="width: 10%;"></td> <td style="width: 10%;"></td> <td style="width: 10%;"></td> <td style="width: 10%;"></td> <td style="width: 10%;"></td> <td style="width: 10%;"></td> <td style="width: 10%;"></td> <td style="width: 10%;"></td> </tr> <tr> <td></td> <td></td> <td colspan="8" style="text-align: center;"> <table border="1" style="width: 100%; border-collapse: collapse; text-align: center;"> <tr> <td style="width: 10%;"></td> <td style="width: 10%;"></td> <td style="width: 10%;"></td> <td style="width: 10%;"></td> <td style="width: 10%;"></td> <td style="width: 10%;"></td> <td style="width: 10%;"></td> <td style="width: 10%;"></td> <td style="width: 10%;"></td> <td style="width: 10%;"></td> </tr> <tr> <td></td> <td></td> <td colspan="8" style="text-align: center;"> <table border="1" style="width: 100%; border-collapse: collapse; text-align: center;"> <tr> <td style="width: 10%;"></td> <td style="width: 10%;"></td> <td style="width: 10%;"></td> <td style="width: 10%;"></td> <td style="width: 10%;"></td> <td style="width: 10%;"></td> <td style="width: 10%;"></td> <td style="width: 10%;"></td> <td style="width: 10%;"></td> <td style="width: 10%;"></td> </tr> <tr> <td></td> <td></td> <td colspan="8" style="text-align: center;"> <table border="1" style="width: 100%; border-collapse: collapse; text-align: center;"> <tr> <td style="width: 10%;"></td> <td style="width: 10%;"></td> <td style="width: 10%;"></td> <td style="width: 10%;"></td> <td style="width: 10%;"></td> <td style="width: 10%;"></td> <td style="width: 10%;"></td> <td style="width: 10%;"></td> <td style="width: 10%;"></td> <td style="width: 10%;"></td> </tr> <tr> <td></td> <td></td> <td colspan="8" style="text-align: center;"> <table border="1" style="width: 100%; border-collapse: collapse; text-align: center;"> <tr> <td style="width: 10%;"></td> <td style="width: 10%;"></td> <td style="width: 10%;"></td> <td style="width: 10%;"></td> <td style="width: 10%;"></td> <td style="width: 10%;"></td> <td style="width: 10%;"></td> <td style="width: 10%;"></td> <td style="width: 10%;"></td> <td style="width: 10%;"></td> </tr> <tr> <td></td> <td></td> <td colspan="8" style="text-align: center;"> <table border="1" style="width: 100%; border-collapse: collapse; text-align: center;"> <tr> <td style="width: 10%;"></td> <td style="width: 10%;"></td> <td style="width: 10%;"></td> <td style="width: 10%;"></td> <td style="width: 10%;"></td> <td style="width: 10%;"></td> <td style="width: 10%;"></td> <td style="width: 10%;"></td> <td style="width: 10%;"></td> <td style="width: 10%;"></td> </tr> <tr> <td></td> <td></td> <td colspan="8" style="text-align: center;"> <table border="1" style="width: 100%; border-collapse: collapse; text-align: center;"> <tr> <td style="width: 10%;"></td> <td style="width: 10%;"></td> <td style="width: 10%;"></td> <td style="width: 10%;"></td> <td style="width: 10%;"></td> <td style="width: 10%;"></td> <td style="width: 10%;"></td> <td style="width: 10%;"></td> <td style="width: 10%;"></td> <td style="width: 10%;"></td> </tr> <tr> <td></td> <td></td> <td colspan="8" style="text-align: center;"> <table border="1" style="width: 100%; border-collapse: collapse; text-align: center;"> <tr> <td style="width: 10%;"></td> <td style="width: 10%;"></td> <td style="width: 10%;"></td> <td style="width: 10%;"></td> <td style="width: 10%;"></td> <td style="width: 10%;"></td> <td style="width: 10%;"></td> <td style="width: 10%;"></td> <td style="width: 10%;"></td> <td style="width: 10%;"></td> </tr> <tr> <td></td> <td></td> <td colspan="8" style="text-align: center;"> <table border="1" style="width: 100%; border-collapse: collapse; text-align: center;"> <tr> <td style="width: 10%;"></td> <td style="width: 10%;"></td> <td style="width: 10%;"></td> <td style="width: 10%;"></td> <td style="width: 10%;"></td> <td style="width: 10%;"></td> <td style="width: 10%;"></td> <td style="width: 10%;"></td> <td style="width: 10%;"></td> <td style="width: 10%;"></td> </tr> <tr> <td></td> <td></td> <td colspan="8" style="text-align: center;"> <table border="1" style="width: 100%; border-collapse: collapse; text-align: center;"> <tr> <td style="width: 10%;"></td> <td style="width: 10%;"></td> <td style="width: 10%;"></td> <td style="width: 10%;"></td> <td style="width: 10%;"></td> <td style="width: 10%;"></td> <td style="width: 10%;"></td> <td style="width: 10%;"></td> <td style="width: 10%;"></td> <td style="width: 10%;"></td> </tr> <tr> <td></td> <td></td> <td colspan="8" style="text-align: center;"> <table border="1" style="width: 100%; border-collapse: collapse; text-align: center;"> <tr> <td style="width: 10%;"></td> <td style="width: 10%;"></td> <td style="width: 10%;"></td> <td style="width: 10%;"></td> <td style="width: 10%;"></td> <td style="width: 10%;"></td> <td style="width: 10%;"></td> <td style="width: 10%;"></td> <td style="width: 10%;"></td> <td style="width: 10%;"></td> </tr> <tr> <td></td> <td></td> <td colspan="8" style="text-align: center;"> <table border="1" style="width: 100%; border-collapse: collapse; text-align: center;"> <tr> <td style="width: 10%;"></td> <td style="width: 10%;"></td> <td style="width: 10%;"></td> <td style="width: 10%;"></td> <td style="width: 10%;"></td> <td style="width: 10%;"></td> <td style="width: 10%;"></td> <td style="width: 10%;"></td> <td style="width: 10%;"></td> <td style="width: 10%;"></td> </tr> <tr> <td></td> <td></td> <td colspan="8" style="text-align: center;"> <table border="1" style="width: 100%; border-collapse: collapse; text-align: center;"> <tr> <td style="width: 10%;"></td> <td style="width: 10%;"></td> <td style="width: 10%;"></td> <td style="width: 10%;"></td> <td style="width: 10%;"></td> <td style="width: 10%;"></td> <td style="width: 10%;"></td> <td style="width: 10%;"></td> <td style="width: 10%;"></td> <td style="width: 10%;"></td> </tr> <tr> <td></td> <td></td> <td colspan="8" style="text-align: center;"> <table border="1" style="width: 100%; border-collapse: collapse; text-align: center;"> <tr> <td style="width: 10%;"></td> <td style="width: 10%;"></td> <td style="width: 10%;"></td> <td style="width: 10%;"></td> <td style="width: 10%;"></td> <td style="width: 10%;"></td> <td style="width: 10%;"></td> <td style="width: 10%;"></td> <td style="width: 10%;"></td> <td style="width: 10%;"></td> </tr> <tr> <td></td> <td></td> <td colspan="8" style="text-align: center;"> <table border="1" style="width: 100%; border-collapse: collapse; text-align: center;"> <tr> <td style="width: 10%;"></td> <td style="width: 10%;"></td> <td style="width: 10%;"></td> <td style="width: 10%;"></td> <td style="width: 10%;"></td> <td style="width: 10%;"></td> <td style="width: 10%;"></td> <td style="width: 10%;"></td> <td style="width: 10%;"></td> <td style="width: 10%;"></td> </tr> <tr> <td></td> <td></td> <td colspan="8" style="text-align: center;"> <table border="1" style="width: 100%; border-collapse: collapse; text-align: center;"> <tr> <td style="width: 10%;"></td> <td style="width: 10%;"></td> <td style="width: 10%;"></td> <td style="width: 10%;"></td> <td style="width: 10%;"></td> <td style="width: 10%;"></td> <td style="width: 10%;"></td> <td style="width: 10%;"></td> <td style="width: 10%;"></td> <td style="width: 10%;"></td> </tr> <tr> <td></td> <td></td> <td colspan="8" style="text-align: center;"> <table border="1" style="width: 100%; border-collapse: collapse; text-align: center;"> <tr> <td style="width: 10%;"></td> <td style="width: 10%;"></td> <td style="width: 10%;"></td> <td style="width: 10%;"></td> <td style="width: 10%;"></td> <td style="width: 10%;"></td> <td style="width: 10%;"></td> <td style="width: 10%;"></td> <td style="width: 10%;"></td> <td style="width: 10%;"></td> </tr> <tr> <td></td> <td></td> <td colspan="8" style="text-align: center;"> <table border="1" style="width: 100%; border-collapse: collapse; text-align: center;"> <tr> <td style="width: 10%;"></td> <td style="width: 10%;"></td> <td style="width: 10%;"></td> <td style="width: 10%;"></td> <td style="width: 10%;"></td> <td
style="width: 10%;"></td> <td style="width: 10%;"></td> <td style="width: 10%;"></td> <td style="width: 10%;"></td> <td style="width: 10%;"></td> </tr> <tr> <td></td> <td></td> <td colspan="8" style="text-align: center;"> <table border="1" style="width: 100%; border-collapse: collapse; text-align: center;"> <tr> <td style="width: 10%;"></td> <td style="width: 10%;"></td> <td style="width: 10%;"></td> <td style="width: 10%;"></td> <td style="width: 10%;"></td> <td style="width: 10%;"></td> <td style="width: 10%;"></td> <td style="width: 10%;"></td> <td style="width: 10%;"></td> <td style="width: 10%;"></td> </tr> <tr> <td></td> <td></td> <td colspan="8" style="text-align: center;"> <table border="1" style="width: 100%; border-collapse: collapse; text-align: center;"> <tr> <td style="width: 10%;"></td> <td style="width: 10%;"></td> <td style="width: 10%;"></td> <td style="width: 10%;"></td> <td style="width: 10%;"></td> <td style="width: 10%;"></td> <td style="width: 10%;"></td> <td style="width: 10%;"></td> <td style="width: 10%;"></td> <td style="width: 10%;"></td> </tr> <tr> <td></td> <td></td> <td colspan="8" style="text-align: center;"> <table border="1" style="width: 100%; border-collapse: collapse; text-align: center;"> <tr> <td style="width: 10%;"></td> <td style="width: 10%;"></td> <td style="width: 10%;"></td> <td style="width: 10%;"></td> <td style="width: 10%;"></td> <td style="width: 10%;"></td> <td style="width: 10%;"></td> <td style="width: 10%;"></td> <td style="width: 10%;"></td> <td style="width: 10%;"></td> </tr> <tr> <td></td> <td></td> <td colspan="8" style="text-align: center;"> <table border="1" style="width: 100%; border-collapse: collapse; text-align: center;"> <tr> <td style="width: 10%;"></td> <td style="width: 10%;"></td> <td style="width: 10%;"></td> <td style="width: 10%;"></td> <td style="width: 10%;"></td> <td style="width: 10%;"></td> <td style="width: 10%;"></td> <td style="width: 10%;"></td> <td style="width: 10%;"></td> <td style="width: 10%;"></td> </tr> <tr> <td></td> <td></td> <td colspan="8" style="text-align: center;"> <table border="1" style="width: 100%; border-collapse: collapse; text-align: center;"> <tr> <td style="width: 10%;"></td> <td style="width: 10%;"></td> <td style="width: 10%;"></td> <td style="width: 10%;"></td> <td style="width: 10%;"></td> <td style="width: 10%;"></td> <td style="width: 10%;"></td> <td style="width: 10%;"></td> <td style="width: 10%;"></td> <td style="width: 10%;"></td> </tr> <tr> <td></td> <td></td> <td colspan="8" style="text-align: center;"> <table border="1" style="width: 100%; border-collapse: collapse; text-align: center;"> <tr> <td style="width: 10%;"></td> <td style="width: 10%;"></td> <td style="width: 10%;"></td> <td style="width: 10%;"></td> <td style="width: 10%;"></td> <td style="width: 10%;"></td> <td style="width: 10%;"></td> <td style="width: 10%;"></td> <td style="width: 10%;"></td> <td style="width: 10%;"></td> </tr> <tr> <td></td> <td></td> <td colspan="8" style="text-align: center;"> <table border="1" style="width: 100%; border-collapse: collapse; text-align: center;"> <tr> <td style="width: 10%;"></td> <td style="width: 10%;"></td> <td style="width: 10%;"></td> <td style="width: 10%;"></td> <td style="width: 10%;"></td> <td style="width: 10%;"></td> <td style="width: 10%;"></td> <td style="width: 10%;"></td> <td style="width: 10%;"></td> <td style="width: 10%;"></td> </tr> <tr> <td></td> <td></td> <td colspan="8" style="text-align: center;"> <table border="1" style="width: 100%; border-collapse: collapse; text-align: center;"> <tr> <td style="width: 10%;"></td> <td style="width: 10%;"></td> <td style="width: 10%;"></td> <td style="width: 10%;"></td> <td style="width: 10%;"></td> <td style="width: 10%;"></td> <td style="width: 10%;"></td> <td style="width: 10%;"></td> <td style="width: 10%;"></td> <td style="width: 10%;"></td> </tr> <tr> <td></td> <td></td> <td colspan="8" style="text-align: center;"> <table border="1" style="width: 100%; border-collapse: collapse; text-align: center;"> <tr> <td style="width: 10%;"></td> <td style="width: 10%;"></td> <td style="width: 10%;"></td> <td style="width: 10%;"></td> <td style="width: 10%;"></td> <td style="width: 10%;"></td> <td style="width: 10%;"></td> <td style="width: 10%;"></td> <td style="width: 10%;"></td> <td style="width: 10%;"></td> </tr> <tr> <td></td> <td></td> <td colspan="8" style="text-align: center;"> <table border="1" style="width: 100%; border-collapse: collapse; text-align: center;"> <tr> <td style="width: 10%;"></td> <td style="width: 10%;"></td> <td style="width: 10%;"></td> <td style="width: 10%;"></td> <td style="width: 10%;"></td> <td style="width: 10%;"></td> <td style="width: 10%;"></td> <td style="width: 10%;"></td> <td style="width: 10%;"></td> <td style="width: 10%;"></td> </tr> <tr> <td></td> <td></td> <td colspan="8" style="text-align: center;"> <table border="1" style="width: 100%; border-collapse: collapse; text-align: center;"> <tr> <td style="width: 10%;"></td> <td style="width: 10%;"></td> <td style="width: 10%;"></td> <td style="width: 10%;"></td> <td style="width: 10%;"></td> <td style="width: 10%;"></td> <td style="width: 10%;"></td> <td style="width: 10%;"></td> <td style="width: 10%;"></td> <td style="width: 10%;"></td> </tr> <tr> <td></td> <td></td> <td colspan="8" style="text-align: center;"> <table border="1" style="width: 100%; border-collapse: collapse; text-align: center;"> <tr> </tr></table></td></tr></table></td></tr></table></td></tr></table></td></tr></table></td></tr></table></td></tr></table></td></tr></table></td></tr></table></td></tr></table></td></tr></table></td></tr></table></td></tr></table></td></tr></table></td></tr></table></td></tr></table></td></tr></table></td></tr></table></td></tr></table></td></tr></table></td></tr></table></td></tr></table></td></tr></table></td></tr></table></td></tr></table></td></tr></table></td></tr></table></td></tr></table></td></tr></table></td></tr></table></td></tr></table></td></tr></table></td></tr></table></td></tr></table></td></tr></table></td></tr></table></td></tr></table></td></tr></table></td></tr></table></td></tr></table></td></tr></table></td></tr></table></td></tr></table></td></tr></table></td></tr></table></td></tr></table></td></tr></table> | | | | | | | | | | | | | | | | | | | | <table border="1" style="width: 100%; border-collapse: collapse; text-align: center;"> <tr> <td style="width: 10%;"></td> <td style="width: 10%;"></td> <td style="width: 10%;"></td> <td style="width: 10%;"></td> <td style="width: 10%;"></td> <td style="width: 10%;"></td> <td style="width: 10%;"></td> <td style="width: 10%;"></td> <td style="width: 10%;"></td> <td style="width: 10%;"></td> </tr> <tr> <td></td> <td></td> <td colspan="8" style="text-align: center;"> <table border="1" style="width: 100%; border-collapse: collapse; text-align: center;"> <tr> <td style="width: 10%;"></td> <td style="width: 10%;"></td> <td style="width: 10%;"></td> <td style="width: 10%;"></td> <td style="width: 10%;"></td> <td
style="width: 10%;"></td> <td style="width: 10%;"></td> <td style="width: 10%;"></td> <td style="width: 10%;"></td> <td style="width: 10%;"></td> </tr> <tr> <td></td> <td></td> <td colspan="8" style="text-align: center;"> <table border="1" style="width: 100%; border-collapse: collapse; text-align: center;"> <tr> <td style="width: 10%;"></td> <td style="width: 10%;"></td> <td style="width: 10%;"></td> <td style="width: 10%;"></td> <td style="width: 10%;"></td> <td style="width: 10%;"></td> <td style="width: 10%;"></td> <td style="width: 10%;"></td> <td style="width: 10%;"></td> <td style="width: 10%;"></td> </tr> <tr> <td></td> <td></td> <td colspan="8" style="text-align: center;"> <table border="1" style="width: 100%; border-collapse: collapse; text-align: center;"> <tr> <td style="width: 10%;"></td> <td style="width: 10%;"></td> <td style="width: 10%;"></td> <td style="width: 10%;"></td> <td style="width: 10%;"></td> <td style="width: 10%;"></td> <td style="width: 10%;"></td> <td style="width: 10%;"></td> <td style="width: 10%;"></td> <td style="width: 10%;"></td> </tr> <tr> <td></td> <td></td> <td colspan="8" style="text-align: center;"> <table border="1" style="width: 100%; border-collapse: collapse; text-align: center;"> <tr> <td style="width: 10%;"></td> <td style="width: 10%;"></td> <td style="width: 10%;"></td> <td style="width: 10%;"></td> <td style="width: 10%;"></td> <td style="width: 10%;"></td> <td style="width: 10%;"></td> <td style="width: 10%;"></td> <td style="width: 10%;"></td> <td style="width: 10%;"></td> </tr> <tr> <td></td> <td></td> <td colspan="8" style="text-align: center;"> <table border="1" style="width: 100%; border-collapse: collapse; text-align: center;"> <tr> <td style="width: 10%;"></td> <td style="width: 10%;"></td> <td style="width: 10%;"></td> <td style="width: 10%;"></td> <td style="width: 10%;"></td> <td style="width: 10%;"></td> <td style="width: 10%;"></td> <td style="width: 10%;"></td> <td style="width: 10%;"></td> <td style="width: 10%;"></td> </tr> <tr> <td></td> <td></td> <td colspan="8" style="text-align: center;"> <table border="1" style="width: 100%; border-collapse: collapse; text-align: center;"> <tr> <td style="width: 10%;"></td> <td style="width: 10%;"></td> <td style="width: 10%;"></td> <td style="width: 10%;"></td> <td style="width: 10%;"></td> <td style="width: 10%;"></td> <td style="width: 10%;"></td> <td style="width: 10%;"></td> <td style="width: 10%;"></td> <td style="width: 10%;"></td> </tr> <tr> <td></td> <td></td> <td colspan="8" style="text-align: center;"> <table border="1" style="width: 100%; border-collapse: collapse; text-align: center;"> <tr> <td style="width: 10%;"></td> <td style="width: 10%;"></td> <td style="width: 10%;"></td> <td style="width: 10%;"></td> <td style="width: 10%;"></td> <td style="width: 10%;"></td> <td style="width: 10%;"></td> <td style="width: 10%;"></td> <td style="width: 10%;"></td> <td style="width: 10%;"></td> </tr> <tr> <td></td> <td></td> <td colspan="8" style="text-align: center;"> <table border="1" style="width: 100%; border-collapse: collapse; text-align: center;"> <tr> <td style="width: 10%;"></td> <td style="width: 10%;"></td> <td style="width: 10%;"></td> <td style="width: 10%;"></td> <td style="width: 10%;"></td> <td style="width: 10%;"></td> <td style="width: 10%;"></td> <td style="width: 10%;"></td> <td style="width: 10%;"></td> <td style="width: 10%;"></td> </tr> <tr> <td></td> <td></td> <td colspan="8" style="text-align: center;"> <table border="1" style="width: 100%; border-collapse: collapse; text-align: center;"> <tr> <td style="width: 10%;"></td> <td style="width: 10%;"></td> <td style="width: 10%;"></td> <td style="width: 10%;"></td> <td style="width: 10%;"></td> <td style="width: 10%;"></td> <td style="width: 10%;"></td> <td style="width: 10%;"></td> <td style="width: 10%;"></td> <td style="width: 10%;"></td> </tr> <tr> <td></td> <td></td> <td colspan="8" style="text-align: center;"> <table border="1" style="width: 100%; border-collapse: collapse; text-align: center;"> <tr> <td style="width: 10%;"></td> <td style="width: 10%;"></td> <td style="width: 10%;"></td> <td style="width: 10%;"></td> <td style="width: 10%;"></td> <td style="width: 10%;"></td> <td style="width: 10%;"></td> <td style="width: 10%;"></td> <td style="width: 10%;"></td> <td style="width: 10%;"></td> </tr> <tr> <td></td> <td></td> <td colspan="8" style="text-align: center;"> <table border="1" style="width: 100%; border-collapse: collapse; text-align: center;"> <tr> <td style="width: 10%;"></td> <td style="width: 10%;"></td> <td style="width: 10%;"></td> <td style="width: 10%;"></td> <td style="width: 10%;"></td> <td style="width: 10%;"></td> <td style="width: 10%;"></td> <td style="width: 10%;"></td> <td style="width: 10%;"></td> <td style="width: 10%;"></td> </tr> <tr> <td></td> <td></td> <td colspan="8" style="text-align: center;"> <table border="1" style="width: 100%; border-collapse: collapse; text-align: center;"> <tr> <td style="width: 10%;"></td> <td style="width: 10%;"></td> <td style="width: 10%;"></td> <td style="width: 10%;"></td> <td style="width: 10%;"></td> <td style="width: 10%;"></td> <td style="width: 10%;"></td> <td style="width: 10%;"></td> <td style="width: 10%;"></td> <td style="width: 10%;"></td> </tr> <tr> <td></td> <td></td> <td colspan="8" style="text-align: center;"> <table border="1" style="width: 100%; border-collapse: collapse; text-align: center;"> <tr> <td style="width: 10%;"></td> <td style="width: 10%;"></td> <td style="width: 10%;"></td> <td style="width: 10%;"></td> <td style="width: 10%;"></td> <td style="width: 10%;"></td> <td style="width: 10%;"></td> <td style="width: 10%;"></td> <td style="width: 10%;"></td> <td style="width: 10%;"></td> </tr> <tr> <td></td> <td></td> <td colspan="8" style="text-align: center;"> <table border="1" style="width: 100%; border-collapse: collapse; text-align: center;"> <tr> <td style="width: 10%;"></td> <td style="width: 10%;"></td> <td style="width: 10%;"></td> <td style="width: 10%;"></td> <td style="width: 10%;"></td> <td style="width: 10%;"></td> <td style="width: 10%;"></td> <td style="width: 10%;"></td> <td style="width: 10%;"></td> <td style="width: 10%;"></td> </tr> <tr> <td></td> <td></td> <td colspan="8" style="text-align: center;"> <table border="1" style="width: 100%; border-collapse: collapse; text-align: center;"> <tr> <td style="width: 10%;"></td> <td style="width: 10%;"></td> <td style="width: 10%;"></td> <td style="width: 10%;"></td> <td style="width: 10%;"></td> <td style="width: 10%;"></td> <td style="width: 10%;"></td> <td style="width: 10%;"></td> <td style="width: 10%;"></td> <td style="width: 10%;"></td> </tr> <tr> <td></td> <td></td> <td colspan="8" style="text-align: center;"> <table border="1" style="width: 100%; border-collapse: collapse; text-align: center;"> <tr> <td style="width: 10%;"></td> <td style="width: 10%;"></td> <td style="width: 10%;"></td> <td style="width: 10%;"></td> <td style="width: 10%;"></td> <td style="width: 10%;"></td> <td style="width: 10%;"></td> <td style="width: 10%;"></td> <td style="width: 10%;"></td> <td style="width: 10%;"></td> </tr> <tr> <td></td> <td></td> <td colspan="8" style="text-align: center;"> <table border="1" style="width: 100%; border-collapse: collapse; text-align: center;"> <tr> <td style="width: 10%;"></td> <td style="width: 10%;"></td> <td style="width: 10%;"></td> <td style="width: 10%;"></td> <td style="width: 10%;"></td> <td style="width: 10%;"></td> <td style="width: 10%;"></td> <td style="width: 10%;"></td> <td style="width: 10%;"></td> <td style="width: 10%;"></td> </tr> <tr> <td></td> <td></td> <td colspan="8" style="text-align: center;"> <table border="1" style="width: 100%; border-collapse: collapse; text-align: center;"> <tr> <td style="width: 10%;"></td> <td style="width: 10%;"></td> <td style="width: 10%;"></td> <td style="width: 10%;"></td> <td style="width: 10%;"></td> <td style="width: 10%;"></td> <td style="width: 10%;"></td> <td style="width: 10%;"></td> <td style="width: 10%;"></td> <td style="width: 10%;"></td> </tr> <tr> <td></td> <td></td> <td colspan="8" style="text-align: center;"> <table border="1" style="width: 100%; border-collapse: collapse; text-align: center;"> <tr> <td style="width: 10%;"></td> <td style="width: 10%;"></td> <td style="width: 10%;"></td> <td style="width: 10%;"></td> <td style="width: 10%;"></td> <td style="width: 10%;"></td> <td style="width: 10%;"></td> <td style="width: 10%;"></td> <td style="width: 10%;"></td> <td style="width: 10%;"></td> </tr> <tr> <td></td> <td></td> <td colspan="8" style="text-align: center;"> <table border="1" style="width: 100%; border-collapse: collapse; text-align: center;"> <tr> <td style="width: 10%;"></td> <td style="width: 10%;"></td> <td style="width: 10%;"></td> <td style="width: 10%;"></td> <td style="width: 10%;"></td> <td style="width: 10%;"></td> <td style="width: 10%;"></td> <td style="width: 10%;"></td> <td style="width: 10%;"></td> <td style="width: 10%;"></td> </tr> <tr> <td></td> <td></td> <td colspan="8" style="text-align: center;"> <table border="1" style="width: 100%; border-collapse: collapse; text-align: center;"> <tr> <td style="width: 10%;"></td> <td style="width: 10%;"></td> <td style="width: 10%;"></td> <td style="width: 10%;"></td> <td style="width: 10%;"></td> <td style="width: 10%;"></td> <td style="width: 10%;"></td> <td style="width: 10%;"></td> <td style="width: 10%;"></td> <td style="width: 10%;"></td> </tr> <tr> <td></td> <td></td> <td colspan="8" style="text-align: center;"> <table border="1" style="width: 100%; border-collapse: collapse; text-align: center;"> <tr> <td style="width: 10%;"></td> <td style="width: 10%;"></td> <td style="width: 10%;"></td> <td style="width: 10%;"></td> <td style="width: 10%;"></td> <td style="width: 10%;"></td> <td style="width: 10%;"></td> <td style="width: 10%;"></td> <td style="width: 10%;"></td> <td style="width: 10%;"></td> </tr> <tr> <td></td>
<td></td> <td colspan="8" style="text-align: center;"> <table border="1" style="width: 100%; border-collapse: collapse; text-align: center;"> <tr> <td style="width: 10%;"></td> <td style="width: 10%;"></td> <td style="width: 10%;"></td> <td style="width: 10%;"></td> <td style="width: 10%;"></td> <td style="width: 10%;"></td> <td style="width: 10%;"></td> <td style="width: 10%;"></td> <td style="width: 10%;"></td> <td style="width: 10%;"></td> </tr> <tr> <td></td> <td></td> <td colspan="8" style="text-align: center;"> <table border="1" style="width: 100%; border-collapse: collapse; text-align: center;"> <tr> <td style="width: 10%;"></td> <td style="width: 10%;"></td> <td style="width: 10%;"></td> <td style="width: 10%;"></td> <td style="width: 10%;"></td> <td style="width: 10%;"></td> <td style="width: 10%;"></td> <td style="width: 10%;"></td> <td style="width: 10%;"></td> <td style="width: 10%;"></td> </tr> <tr> <td></td> <td></td> <td colspan="8" style="text-align: center;"> <table border="1" style="width: 100%; border-collapse: collapse; text-align: center;"> <tr> <td style="width: 10%;"></td> <td style="width: 10%;"></td> <td style="width: 10%;"></td> <td style="width: 10%;"></td> <td style="width: 10%;"></td> <td style="width: 10%;"></td> <td style="width: 10%;"></td> <td style="width: 10%;"></td> <td style="width: 10%;"></td> <td style="width: 10%;"></td> </tr> <tr> <td></td> <td></td> <td colspan="8" style="text-align: center;"> <table border="1" style="width: 100%; border-collapse: collapse; text-align: center;"> <tr> <td style="width: 10%;"></td> <td style="width: 10%;"></td> <td style="width: 10%;"></td> <td style="width: 10%;"></td> <td style="width: 10%;"></td> <td style="width: 10%;"></td> <td style="width: 10%;"></td> <td style="width: 10%;"></td> <td style="width: 10%;"></td> <td style="width: 10%;"></td> </tr> <tr> <td></td> <td></td> <td colspan="8" style="text-align: center;"> <table border="1" style="width: 100%; border-collapse: collapse; text-align: center;"> <tr> <td style="width: 10%;"></td> <td style="width: 10%;"></td> <td style="width: 10%;"></td> <td style="width: 10%;"></td> <td style="width: 10%;"></td> <td style="width: 10%;"></td> <td style="width: 10%;"></td> <td style="width: 10%;"></td> <td style="width: 10%;"></td> <td style="width: 10%;"></td> </tr> <tr> <td></td> <td></td> <td colspan="8" style="text-align: center;"> <table border="1" style="width: 100%; border-collapse: collapse; text-align: center;"> <tr> <td style="width: 10%;"></td> <td style="width: 10%;"></td> <td style="width: 10%;"></td> <td style="width: 10%;"></td> <td style="width: 10%;"></td> <td style="width: 10%;"></td> <td style="width: 10%;"></td> <td style="width: 10%;"></td> <td style="width: 10%;"></td> <td style="width: 10%;"></td> </tr> <tr> <td></td> <td></td> <td colspan="8" style="text-align: center;"> <table border="1" style="width: 100%; border-collapse: collapse; text-align: center;"> <tr> <td style="width: 10%;"></td> <td style="width: 10%;"></td> <td style="width: 10%;"></td> <td style="width: 10%;"></td> <td style="width: 10%;"></td> <td style="width: 10%;"></td> <td style="width: 10%;"></td> <td style="width: 10%;"></td> <td style="width: 10%;"></td> <td style="width: 10%;"></td> </tr> <tr> <td></td> <td></td> <td colspan="8" style="text-align: center;"> <table border="1" style="width: 100%; border-collapse: collapse; text-align: center;"> <tr> <td style="width: 10%;"></td> <td style="width: 10%;"></td> <td style="width: 10%;"></td> <td style="width: 10%;"></td> <td style="width: 10%;"></td> <td style="width: 10%;"></td> <td style="width: 10%;"></td> <td style="width: 10%;"></td> <td style="width: 10%;"></td> <td style="width: 10%;"></td> </tr> <tr> <td></td> <td></td> <td colspan="8" style="text-align: center;"> <table border="1" style="width: 100%; border-collapse: collapse; text-align: center;"> <tr> <td style="width: 10%;"></td> <td style="width: 10%;"></td> <td style="width: 10%;"></td> <td style="width: 10%;"></td> <td style="width: 10%;"></td> <td style="width: 10%;"></td> <td style="width: 10%;"></td> <td style="width: 10%;"></td> <td style="width: 10%;"></td> <td style="width: 10%;"></td> </tr> <tr> <td></td> <td></td> <td colspan="8" style="text-align: center;"> <table border="1" style="width: 100%; border-collapse: collapse; text-align: center;"> <tr> <td style="width: 10%;"></td> <td style="width: 10%;"></td> <td style="width: 10%;"></td> <td style="width: 10%;"></td> <td style="width: 10%;"></td> <td style="width: 10%;"></td> <td style="width: 10%;"></td> <td style="width: 10%;"></td> <td style="width: 10%;"></td> <td style="width: 10%;"></td> </tr> <tr> <td></td> <td></td> <td colspan="8" style="text-align: center;"> <table border="1" style="width: 100%; border-collapse: collapse; text-align: center;"> <tr> <td style="width: 10%;"></td> <td style="width: 10%;"></td> <td style="width: 10%;"></td> <td style="width: 10%;"></td> <td style="width: 10%;"></td> <td style="width: 10%;"></td> <td style="width: 10%;"></td> <td style="width: 10%;"></td> <td style="width: 10%;"></td> <td style="width: 10%;"></td> </tr> <tr> <td></td> <td></td> <td colspan="8" style="text-align: center;"> <table border="1" style="width: 100%; border-collapse: collapse; text-align: center;"> <tr> <td style="width: 10%;"></td> <td style="width: 10%;"></td> <td style="width: 10%;"></td> <td style="width: 10%;"></td> <td style="width: 10%;"></td> <td style="width: 10%;"></td> <td style="width: 10%;"></td> <td style="width: 10%;"></td> <td style="width: 10%;"></td> <td style="width: 10%;"></td> </tr> <tr> <td></td> <td></td> <td colspan="8" style="text-align: center;"> <table border="1" style="width: 100%; border-collapse: collapse; text-align: center;"> <tr> <td style="width: 10%;"></td> <td style="width: 10%;"></td> <td style="width: 10%;"></td> <td style="width: 10%;"></td> <td style="width: 10%;"></td> <td style="width: 10%;"></td> <td style="width: 10%;"></td> <td style="width: 10%;"></td> <td style="width: 10%;"></td> <td style="width: 10%;"></td> </tr> <tr> <td></td> <td></td> <td colspan="8" style="text-align: center;"> <table border="1" style="width: 100%; border-collapse: collapse; text-align: center;"> <tr> <td style="width: 10%;"></td> <td style="width: 10%;"></td> <td style="width: 10%;"></td> <td style="width: 10%;"></td> <td style="width: 10%;"></td> <td style="width: 10%;"></td> <td style="width: 10%;"></td> <td style="width: 10%;"></td> <td style="width: 10%;"></td> <td style="width: 10%;"></td> </tr> <tr> <td></td> <td></td> <td colspan="8" style="text-align: center;"> <table border="1" style="width: 100%; border-collapse: collapse; text-align: center;"> <tr> <td style="width: 10%;"></td> <td style="width: 10%;"></td> <td style="width: 10%;"></td> <td style="width: 10%;"></td> <td style="width: 10%;"></td> <td style="width: 10%;"></td> <td style="width: 10%;"></td> <td style="width: 10%;"></td> <td style="width: 10%;"></td> <td style="width: 10%;"></td> </tr> <tr> <td></td> <td></td> <td colspan="8" style="text-align: center;"> <table border="1" style="width: 100%; border-collapse: collapse; text-align: center;"> <tr> <td style="width: 10%;"></td> <td style="width: 10%;"></td> <td style="width: 10%;"></td> <td style="width: 10%;"></td> <td style="width: 10%;"></td> <td style="width: 10%;"></td> <td style="width: 10%;"></td> <td style="width: 10%;"></td> <td style="width: 10%;"></td> <td style="width: 10%;"></td> </tr> <tr> <td></td> <td></td> <td colspan="8" style="text-align: center;"> <table border="1" style="width: 100%; border-collapse: collapse; text-align: center;"> <tr> <td style="width: 10%;"></td> <td style="width: 10%;"></td> <td style="width: 10%;"></td> <td style="width: 10%;"></td> <td style="width: 10%;"></td> <td style="width: 10%;"></td> <td style="width: 10%;"></td> <td style="width: 10%;"></td> <td style="width: 10%;"></td> <td style="width: 10%;"></td> </tr> <tr> <td></td> <td></td> <td colspan="8" style="text-align: center;"> <table border="1" style="width: 100%; border-collapse: collapse; text-align: center;"> <tr> <td style="width: 10%;"></td> <td style="width: 10%;"></td> <td style="width: 10%;"></td> <td style="width: 10%;"></td> <td style="width: 10%;"></td> <td style="width: 10%;"></td> <td style="width: 10%;"></td> <td style="width: 10%;"></td> <td style="width: 10%;"></td> <td style="width: 10%;"></td> </tr> <tr> <td></td> <td></td> <td colspan="8" style="text-align: center;"> <table border="1" style="width: 100%; border-collapse: collapse; text-align: center;"> <tr> <td style="width: 10%;"></td> <td style="width: 10%;"></td> <td style="width: 10%;"></td> <td style="width: 10%;"></td> <td style="width: 10%;"></td> <td style="width: 10%;"></td> <td style="width: 10%;"></td> <td style="width: 10%;"></td> <td style="width: 10%;"></td> <td style="width: 10%;"></td> </tr> <tr> <td></td> <td></td> <td colspan="8" style="text-align: center;"> <table border="1" style="width: 100%; border-collapse: collapse; text-align: center;"> <tr> <td style="width: 10%;"></td> <td style="width: 10%;"></td> <td style="width: 10%;"></td> <td style="width: 10%;"></td> <td style="width: 10%;"></td> <td style="width: 10%;"></td> <td style="width: 10%;"></td> <td style="width: 10%;"></td> <td style="width: 10%;"></td> <td style="width: 10%;"></td> </tr> <tr> <td></td> <td></td> <td colspan="8" style="text-align: center;"> <table border="1" style="width: 100%; border-collapse: collapse; text-align: center;"> <tr> <td style="width: 10%;"></td> <td style="width: 10%;"></td> <td style="width: 10%;"></td> <td style="width: 10%;"></td> <td style="width: 10%;"></td> <td style="width: 10%;"></td> <td style="width: 10%;"></td> <td style="width: 10%;"></td> <td style="width: 10%;"></td> <td style="width: 10%;"></td> </tr> <tr> <td></td> <td></td> <td colspan="8" style="text-align: center;"> <table border="1" style="width: 100%; border-collapse: collapse; text-align: center;"> <tr> <td style="width:
10%;"></td> <td style="width: 10%;"></td> <td style="width: 10%;"></td> <td style="width: 10%;"></td> <td style="width: 10%;"></td> <td style="width: 10%;"></td> <td style="width: 10%;"></td> <td style="width: 10%;"></td> <td style="width: 10%;"></td> <td style="width: 10%;"></td> </tr> <tr> <td></td> <td></td> <td colspan="8" style="text-align: center;"> <table border="1" style="width: 100%; border-collapse: collapse; text-align: center;"> <tr> </tr></table></td></tr></table></td></tr></table></td></tr></table></td></tr></table></td></tr></table></td></tr></table></td></tr></table></td></tr></table></td></tr></table></td></tr></table></td></tr></table></td></tr></table></td></tr></table></td></tr></table></td></tr></table></td></tr></table></td></tr></table></td></tr></table></td></tr></table></td></tr></table></td></tr></table></td></tr></table></td></tr></table></td></tr></table></td></tr></table></td></tr></table></td></tr></table></td></tr></table></td></tr></table></td></tr></table></td></tr></table></td></tr></table></td></tr></table></td></tr></table></td></tr></table></td></tr></table></td></tr></table></td></tr></table></td></tr></table></td></tr></table></td></tr></table></td></tr></table></td></tr></table></td></tr></table></td></tr></table> | | | | | | | | | | | | | | | | | | | | <table border="1" style="width: 100%; border-collapse: collapse; text-align: center;"> <tr> <td style="width: 10%;"></td> <td style="width: 10%;"></td> <td style="width: 10%;"></td> <td style="width: 10%;"></td> <td style="width: 10%;"></td> <td style="width: 10%;"></td> <td style="width: 10%;"></td> <td style="width: 10%;"></td> <td style="width: 10%;"></td> <td style="width: 10%;"></td> </tr> <tr> <td></td> <td></td> <td colspan="8" style="text-align: center;"> <table border="1" style="width: 100%; border-collapse: collapse; text-align: center;"> <tr> <td style="width: 10%;"></td> <td style="width: 10%;"></td> <td style="width: 10%;"></td> <td style="width: 10%;"></td> <td style="width: 10%;"></td> <td style="width: 10%;"></td> <td style="width: 10%;"></td> <td style="width: 10%;"></td> <td style="width: 10%;"></td> <td style="width: 10%;"></td> </tr> <tr> <td></td> <td></td> <td colspan="8" style="text-align: center;"> <table border="1" style="width: 100%; border-collapse: collapse; text-align: center;"> <tr> <td style="width: 10%;"></td> <td style="width: 10%;"></td> <td style="width: 10%;"></td> <td style="width: 10%;"></td> <td style="width: 10%;"></td> <td style="width: 10%;"></td> <td style="width: 10%;"></td> <td style="width: 10%;"></td> <td style="width: 10%;"></td> <td style="width: 10%;"></td> </tr> <tr> <td></td> <td></td> <td colspan="8" style="text-align: center;"> <table border="1" style="width: 100%; border-collapse: collapse; text-align: center;"> <tr> <td style="width: 10%;"></td> <td style="width: 10%;"></td> <td style="width: 10%;"></td> <td style="width: 10%;"></td> <td style="width: 10%;"></td> <td style="width: 10%;"></td> <td style="width: 10%;"></td> <td style="width: 10%;"></td> <td style="width: 10%;"></td> <td style="width: 10%;"></td> </tr> <tr> <td></td> <td></td> <td colspan="8" style="text-align: center;"> <table border="1" style="width: 100%; border-collapse: collapse; text-align: center;"> <tr> <td style="width: 10%;"></td> <td style="width: 10%;"></td> <td style="width: 10%;"></td> <td style="width: 10%;"></td> <td style="width: 10%;"></td> <td style="width: 10%;"></td> <td style="width: 10%;"></td> <td style="width: 10%;"></td> <td style="width: 10%;"></td> <td style="width: 10%;"></td> </tr> <tr> <td></td> <td></td> <td colspan="8" style="text-align: center;"> <table border="1" style="width: 100%; border-collapse: collapse; text-align: center;"> <tr> <td style="width: 10%;"></td> <td style="width: 10%;"></td> <td style="width: 10%;"></td> <td style="width: 10%;"></td> <td style="width: 10%;"></td> <td style="width: 10%;"></td> <td style="width: 10%;"></td> <td style="width: 10%;"></td> <td style="width: 10%;"></td> <td style="width: 10%;"></td> </tr> <tr> <td></td> <td></td> <td colspan="8" style="text-align: center;"> <table border="1" style="width: 100%; border-collapse: collapse; text-align: center;"> <tr> <td style="width: 10%;"></td> <td style="width: 10%;"></td> <td style="width: 10%;"></td> <td style="width: 10%;"></td> <td style="width: 10%;"></td> <td style="width: 10%;"></td> <td style="width: 10%;"></td> <td style="width: 10%;"></td> <td style="width: 10%;"></td> <td style="width: 10%;"></td> </tr> <tr> <td></td> <td></td> <td colspan="8" style="text-align: center;"> <table border="1" style="width: 100%; border-collapse: collapse; text-align: center;"> <tr> <td style="width: 10%;"></td> <td style="width: 10%;"></td> <td style="width: 10%;"></td> <td style="width: 10%;"></td> <td style="width: 10%;"></td> <td style="width: 10%;"></td> <td style="width: 10%;"></td> <td style="width: 10%;"></td> <td style="width: 10%;"></td> <td style="width: 10%;"></td> </tr> <tr> <td></td> <td></td> <td colspan="8" style="text-align: center;"> <table border="1" style="width: 100%; border-collapse: collapse; text-align: center;"> <tr> <td style="width: 10%;"></td> <td style="width: 10%;"></td> <td style="width: 10%;"></td> <td style="width: 10%;"></td> <td style="width: 10%;"></td> <td style="width: 10%;"></td> <td style="width: 10%;"></td> <td style="width: 10%;"></td> <td style="width: 10%;"></td> <td style="width: 10%;"></td> </tr> <tr> <td></td> <td></td> <td colspan="8" style="text-align: center;"> <table border="1" style="width: 100%; border-collapse: collapse; text-align: center;"> <tr> <td style="width: 10%;"></td> <td style="width: 10%;"></td> <td style="width: 10%;"></td> <td style="width: 10%;"></td> <td style="width: 10%;"></td> <td style="width: 10%;"></td> <td style="width: 10%;"></td> <td style="width: 10%;"></td> <td style="width: 10%;"></td> <td style="width: 10%;"></td> </tr> <tr> <td></td> <td></td> <td colspan="8" style="text-align: center;"> <table border="1" style="width: 100%; border-collapse: collapse; text-align: center;"> <tr> <td style="width: 10%;"></td> <td style="width: 10%;"></td> <td style="width: 10%;"></td> <td style="width: 10%;"></td> <td style="width: 10%;"></td> <td style="width: 10%;"></td> <td style="width: 10%;"></td> <td style="width: 10%;"></td> <td style="width: 10%;"></td> <td style="width: 10%;"></td> </tr> <tr> <td></td> <td></td> <td colspan="8" style="text-align: center;"> <table border="1" style="width: 100%; border-collapse: collapse; text-align: center;"> <tr> <td style="width: 10%;"></td> <td style="width: 10%;"></td> <td style="width: 10%;"></td> <td style="width: 10%;"></td> <td style="width: 10%;"></td> <td style="width: 10%;"></td> <td style="width: 10%;"></td> <td style="width: 10%;"></td> <td style="width: 10%;"></td> <td style="width: 10%;"></td> </tr> <tr> <td></td> <td></td> <td colspan="8" style="text-align: center;"> <table border="1" style="width: 100%; border-collapse: collapse; text-align: center;"> <tr> <td style="width: 10%;"></td> <td
style="width: 10%;"></td> <td style="width: 10%;"></td> <td style="width: 10%;"></td> <td style="width: 10%;"></td> <td style="width: 10%;"></td> <td style="width: 10%;"></td> <td style="width: 10%;"></td> <td style="width: 10%;"></td> <td style="width: 10%;"></td> </tr> <tr> <td></td> <td></td> <td colspan="8" style="text-align: center;"> <table border="1" style="width: 100%; border-collapse: collapse; text-align: center;"> <tr> <td style="width: 10%;"></td> <td style="width: 10%;"></td> <td style="width: 10%;"></td> <td style="width: 10%;"></td> <td style="width: 10%;"></td> <td style="width: 10%;"></td> <td style="width: 10%;"></td> <td style="width: 10%;"></td> <td style="width: 10%;"></td> <td style="width: 10%;"></td> </tr> <tr> <td></td> <td></td> <td colspan="8" style="text-align: center;"> <table border="1" style="width: 100%; border-collapse: collapse; text-align: center;"> <tr> <td style="width: 10%;"></td> <td style="width: 10%;"></td> <td style="width: 10%;"></td> <td style="width: 10%;"></td> <td style="width: 10%;"></td> <td style="width: 10%;"></td> <td style="width: 10%;"></td> <td style="width: 10%;"></td> <td style="width: 10%;"></td> <td style="width: 10%;"></td> </tr> <tr> <td></td> <td></td> <td colspan="8" style="text-align: center;"> <table border="1" style="width: 100%; border-collapse: collapse; text-align: center;"> <tr> <td style="width: 10%;"></td> <td style="width: 10%;"></td> <td style="width: 10%;"></td> <td style="width: 10%;"></td> <td style="width: 10%;"></td> <td style="width: 10%;"></td> <td style="width: 10%;"></td> <td style="width: 10%;"></td> <td style="width: 10%;"></td> <td style="width: 10%;"></td> </tr> <tr> <td></td> <td></td> <td colspan="8" style="text-align: center;"> <table border="1" style="width: 100%; border-collapse: collapse; text-align: center;"> <tr> <td style="width: 10%;"></td> <td style="width: 10%;"></td> <td style="width: 10%;"></td> <td style="width: 10%;"></td> <td style="width: 10%;"></td> <td style="width: 10%;"></td> <td style="width: 10%;"></td> <td style="width: 10%;"></td> <td style="width: 10%;"></td> <td style="width: 10%;"></td> </tr> <tr> <td></td> <td></td> <td colspan="8" style="text-align: center;"> <table border="1" style="width: 100%; border-collapse: collapse; text-align: center;"> <tr> <td style="width: 10%;"></td> <td style="width: 10%;"></td> <td style="width: 10%;"></td> <td style="width: 10%;"></td> <td style="width: 10%;"></td> <td style="width: 10%;"></td> <td style="width: 10%;"></td> <td style="width: 10%;"></td> <td style="width: 10%;"></td> <td style="width: 10%;"></td> </tr> <tr> <td></td> <td></td> <td colspan="8" style="text-align: center;"> <table border="1" style="width: 100%; border-collapse: collapse; text-align: center;"> <tr> <td style="width: 10%;"></td> <td style="width: 10%;"></td> <td style="width: 10%;"></td> <td style="width: 10%;"></td> <td style="width: 10%;"></td> <td style="width: 10%;"></td> <td style="width: 10%;"></td> <td style="width: 10%;"></td> <td style="width: 10%;"></td> <td style="width: 10%;"></td> </tr> <tr> <td></td> <td></td> <td colspan="8" style="text-align: center;"> <table border="1" style="width: 100%; border-collapse: collapse; text-align: center;"> <tr> <td style="width: 10%;"></td> <td style="width: 10%;"></td> <td style="width: 10%;"></td> <td style="width: 10%;"></td> <td style="width: 10%;"></td> <td style="width: 10%;"></td> <td style="width: 10%;"></td> <td style="width: 10%;"></td> <td style="width: 10%;"></td> <td style="width: 10%;"></td> </tr> <tr> <td></td> <td></td> <td colspan="8" style="text-align: center;"> <table border="1" style="width: 100%; border-collapse: collapse; text-align: center;"> <tr> <td style="width: 10%;"></td> <td style="width: 10%;"></td> <td style="width: 10%;"></td> <td style="width: 10%;"></td> <td style="width: 10%;"></td> <td style="width: 10%;"></td> <td style="width: 10%;"></td> <td style="width: 10%;"></td> <td style="width: 10%;"></td> <td style="width: 10%;"></td> </tr> <tr> <td></td> <td></td> <td colspan="8" style="text-align: center;"> <table border="1" style="width: 100%; border-collapse: collapse; text-align: center;"> <tr> <td style="width: 10%;"></td> <td style="width: 10%;"></td> <td style="width: 10%;"></td> <td style="width: 10%;"></td> <td style="width: 10%;"></td> <td style="width: 10%;"></td> <td style="width: 10%;"></td> <td style="width: 10%;"></td> <td style="width: 10%;"></td> <td style="width: 10%;"></td> </tr> <tr> <td></td> <td></td> <td colspan="8" style="text-align: center;"> <table border="1" style="width: 100%; border-collapse: collapse; text-align: center;"> <tr> <td style="width: 10%;"></td> <td style="width: 10%;"></td> <td style="width: 10%;"></td> <td style="width: 10%;"></td> <td style="width: 10%;"></td> <td style="width: 10%;"></td> <td style="width: 10%;"></td> <td style="width: 10%;"></td> <td style="width: 10%;"></td> <td style="width: 10%;"></td> </tr> <tr> <td></td> <td></td> <td colspan="8" style="text-align: center;"> <table border="1" style="width: 100%; border-collapse: collapse; text-align: center;"> <tr> <td style="width: 10%;"></td> <td style="width: 10%;"></td> <td style="width: 10%;"></td> <td style="width: 10%;"></td> <td style="width: 10%;"></td> <td style="width: 10%;"></td> <td style="width: 10%;"></td> <td style="width: 10%;"></td> <td style="width: 10%;"></td> <td style="width: 10%;"></td> </tr> <tr> <td></td> <td></td> <td colspan="8" style="text-align: center;"> <table border="1" style="width: 100%; border-collapse: collapse; text-align: center;"> <tr> <td style="width: 10%;"></td> <td style="width: 10%;"></td> <td style="width: 10%;"></td> <td style="width: 10%;"></td> <td style="width: 10%;"></td> <td style="width: 10%;"></td> <td style="width: 10%;"></td> <td style="width: 10%;"></td> <td style="width: 10%;"></td> <td style="width: 10%;"></td> </tr> <tr> <td></td> <td></td> <td colspan="8" style="text-align: center;"> <table border="1" style="width: 100%; border-collapse: collapse; text-align: center;"> <tr> <td style="width: 10%;"></td> <td style="width: 10%;"></td> <td style="width: 10%;"></td> <td style="width: 10%;"></td> <td style="width: 10%;"></td> <td style="width: 10%;"></td> <td style="width: 10%;"></td> <td style="width: 10%;"></td> <td style="width: 10%;"></td> <td style="width: 10%;"></td> </tr> <tr> <td></td> <td></td> <td colspan="8" style="text-align: center;"> <table border="1" style="width: 100%; border-collapse: collapse; text-align: center;"> <tr> <td style="width: 10%;"></td> <td style="width: 10%;"></td> <td style="width: 10%;"></td> <td style="width: 10%;"></td> <td style="width: 10%;"></td> <td style="width: 10%;"></td> <td style="width: 10%;"></td> <td style="width: 10%;"></td> <td style="width: 10%;"></td> <td style="width: 10%;"></td> </tr> <tr> <td></td> <td></td> <td colspan="8" style="text-align: center;"> <table border="1" style="width: 100%; border-collapse: collapse; text-align: center;"> <tr> <td style="width: 10%;"></td> <td style="width: 10%;"></td> <td style="width: 10%;"></td> <td style="width: 10%;"></td> <td style="width: 10%;"></td> <td style="width: 10%;"></td> <td style="width: 10%;"></td> <td style="width: 10%;"></td> <td style="width: 10%;"></td> <td style="width: 10%;"></td> </tr> <tr> <td></td> <td></td> <td colspan="8" style="text-align: center;"> <table border="1" style="width: 100%; border-collapse: collapse; text-align: center;"> <tr> <td style="width: 10%;"></td> <td style="width: 10%;"></td> <td style="width: 10%;"></td> <td style="width: 10%;"></td> <td style="width: 10%;"></td> <td style="width: 10%;"></td> <td style="width: 10%;"></td> <td style="width: 10%;"></td> <td style="width: 10%;"></td> <td style="width: 10%;"></td> </tr> <tr> <td></td> <td></td> <td colspan="8" style="text-align: center;"> <table border="1" style="width: 100%; border-collapse: collapse; text-align: center;"> <tr> <td style="width: 10%;"></td> <td style="width: 10%;"></td> <td style="width: 10%;"></td> <td style="width: 10%;"></td> <td style="width: 10%;"></td> <td style="width: 10%;"></td> <td style="width: 10%;"></td> <td style="width: 10%;"></td> <td style="width: 10%;"></td> <td style="width: 10%;"></td> </tr> <tr> <td></td> <td></td> <td colspan="8" style="text-align: center;"> <table border="1" style="width: 100%; border-collapse: collapse; text-align: center;"> <tr> <td style="width: 10%;"></td> <td style="width: 10%;"></td> <td style="width: 10%;"></td> <td style="width: 10%;"></td> <td style="width: 10%;"></td> <td style="width: 10%;"></td> <td style="width: 10%;"></td> <td style="width: 10%;"></td> <td style="width: 10%;"></td> <td style="width: 10%;"></td> </tr> <tr> <td></td> <td></td> <td colspan="8" style="text-align: center;"> <table border="1" style="width: 100%; border-collapse: collapse; text-align: center;"> <tr> <td style="width: 10%;"></td> <td style="width: 10%;"></td> <td style="width: 10%;"></td> <td style="width: 10%;"></td> <td style="width: 10%;"></td> <td style="width: 10%;"></td> <td style="width: 10%;"></td> <td style="width: 10%;"></td> <td style="width: 10%;"></td> <td style="width: 10%;"></td> </tr> <tr> <td></td> <td></td> <td colspan="8" style="text-align: center;"> <table border="1" style="width: 100%; border-collapse: collapse; text-align: center;"> <tr> <td style="width: 10%;"></td> <td style="width: 10%;"></td> <td style="width: 10%;"></td> <td style="width: 10%;"></td> <td style="width: 10%;"></td> <td style="width: 10%;"></td> <td style="width: 10%;"></td> <td style="width: 10%;"></td> <td style="width: 10%;"></td> <td style="width: 10%;"></td> </tr> <tr> <td></td> <td></td> <td colspan="8" style="text-align: center;"> <table border="1" style="width: 100%; border-collapse: collapse; text-align: center;"> <tr> <td style="width: 10%;"></td> <td style="width: 10%;"></td> <td style="width: 10%;"></td> <td style="width: 10%;"></td> <td style="width: 10%;"></td> <td style="width: 10%;"></td> <td style="width:
10%;"></td> <td style="width: 10%;"></td> <td style="width: 10%;"></td> <td style="width: 10%;"></td> </tr> <tr> <td></td> <td></td> <td colspan="8" style="text-align: center;"> <table border="1" style="width: 100%; border-collapse: collapse; text-align: center;"> <tr> <td style="width: 10%;"></td> <td style="width: 10%;"></td> <td style="width: 10%;"></td> <td style="width: 10%;"></td> <td style="width: 10%;"></td> <td style="width: 10%;"></td> <td style="width: 10%;"></td> <td style="width: 10%;"></td> <td style="width: 10%;"></td> <td style="width: 10%;"></td> </tr> <tr> <td></td> <td></td> <td colspan="8" style="text-align: center;"> <table border="1" style="width: 100%; border-collapse: collapse; text-align: center;"> <tr> <td style="width: 10%;"></td> <td style="width: 10%;"></td> <td style="width: 10%;"></td> <td style="width: 10%;"></td> <td style="width: 10%;"></td> <td style="width: 10%;"></td> <td style="width: 10%;"></td> <td style="width: 10%;"></td> <td style="width: 10%;"></td> <td style="width: 10%;"></td> </tr> <tr> <td></td> <td></td> <td colspan="8" style="text-align: center;"> <table border="1" style="width: 100%; border-collapse: collapse; text-align: center;"> <tr> <td style="width: 10%;"></td> <td style="width: 10%;"></td> <td style="width: 10%;"></td> <td style="width: 10%;"></td> <td style="width: 10%;"></td> <td style="width: 10%;"></td> <td style="width: 10%;"></td> <td style="width: 10%;"></td> <td style="width: 10%;"></td> <td style="width: 10%;"></td> </tr> <tr> <td></td> <td></td> <td colspan="8" style="text-align: center;"> <table border="1" style="width: 100%; border-collapse: collapse; text-align: center;"> <tr> <td style="width: 10%;"></td> <td style="width: 10%;"></td> <td style="width: 10%;"></td> <td style="width: 10%;"></td> <td style="width: 10%;"></td> <td style="width: 10%;"></td> <td style="width: 10%;"></td> <td style="width: 10%;"></td> <td style="width: 10%;"></td> <td style="width: 10%;"></td> </tr> <tr> <td></td> <td></td> <td colspan="8" style="text-align: center;"> <table border="1" style="width: 100%; border-collapse: collapse; text-align: center;"> <tr> <td style="width: 10%;"></td> <td style="width: 10%;"></td> <td style="width: 10%;"></td> <td style="width: 10%;"></td> <td style="width: 10%;"></td> <td style="width: 10%;"></td> <td style="width: 10%;"></td> <td style="width: 10%;"></td> <td style="width: 10%;"></td> <td style="width: 10%;"></td> </tr> <tr> <td></td> <td></td> <td colspan="8" style="text-align: center;"> <table border="1" style="width: 100%; border-collapse: collapse; text-align: center;"> <tr> <td style="width: 10%;"></td> <td style="width: 10%;"></td> <td style="width: 10%;"></td> <td style="width: 10%;"></td> <td style="width: 10%;"></td> <td style="width: 10%;"></td> <td style="width: 10%;"></td> <td style="width: 10%;"></td> <td style="width: 10%;"></td> <td style="width: 10%;"></td> </tr> <tr> <td></td> <td></td> <td colspan="8" style="text-align: center;"> <table border="1" style="width: 100%; border-collapse: collapse; text-align: center;"> <tr> <td style="width: 10%;"></td> <td style="width: 10%;"></td> <td style="width: 10%;"></td> <td style="width: 10%;"></td> <td style="width: 10%;"></td> <td style="width: 10%;"></td> <td style="width: 10%;"></td> <td style="width: 10%;"></td> <td style="width: 10%;"></td> <td style="width: 10%;"></td> </tr> <tr> <td></td> <td></td> <td colspan="8" style="text-align: center;"> <table border="1" style="width: 100%; border-collapse: collapse; text-align: center;"> <tr> <td style="width: 10%;"></td> <td style="width: 10%;"></td> <td style="width: 10%;"></td> <td style="width: 10%;"></td> <td style="width: 10%;"></td> <td style="width: 10%;"></td> <td style="width: 10%;"></td> <td style="width: 10%;"></td> <td style="width: 10%;"></td> <td style="width: 10%;"></td> </tr> <tr> <td></td> <td></td> <td colspan="8" style="text-align: center;"> <table border="1" style="width: 100%; border-collapse: collapse; text-align: center;"> <tr> <td style="width: 10%;"></td> <td style="width: 10%;"></td> <td style="width: 10%;"></td> <td style="width: 10%;"></td> <td style="width: 10%;"></td> <td style="width: 10%;"></td> <td style="width: 10%;"></td> <td style="width: 10%;"></td> <td style="width: 10%;"></td> <td style="width: 10%;"></td> </tr> <tr> <td></td> <td></td> <td colspan="8" style="text-align: center;"> <table border="1" style="width: 100%; border-collapse: collapse; text-align: center;"> <tr> <td style="width: 10%;"></td> <td style="width: 10%;"></td> <td style="width: 10%;"></td> <td style="width: 10%;"></td> <td style="width: 10%;"></td> <td style="width: 10%;"></td> <td style="width: 10%;"></td> <td style="width: 10%;"></td> <td style="width: 10%;"></td> <td style="width: 10%;"></td> </tr> <tr> <td></td> <td></td> <td colspan="8" style="text-align: center;"> <table border="1" style="width: 100%; border-collapse: collapse; text-align: center;"> <tr> </tr></table></td></tr></table></td></tr></table></td></tr></table></td></tr></table></td></tr></table></td></tr></table></td></tr></table></td></tr></table></td></tr></table></td></tr></table></td></tr></table></td></tr></table></td></tr></table></td></tr></table></td></tr></table></td></tr></table></td></tr></table></td></tr></table></td></tr></table></td></tr></table></td></tr></table></td></tr></table></td></tr></table></td></tr></table></td></tr></table></td></tr></table></td></tr></table></td></tr></table></td></tr></table></td></tr></table></td></tr></table></td></tr></table></td></tr></table></td></tr></table></td></tr></table></td></tr></table></td></tr></table></td></tr></table></td></tr></table></td></tr></table></td></tr></table></td></tr></table></td></tr></table></td></tr></table> | | | | | | | | | | | | | | | | | | | | <table border="1" style="width: 100%; border-collapse: collapse; text-align: center;"> <tr> <td style="width: 10%;"></td> <td style="width: 10%;"></td> <td style="width: 10%;"></td> <td style="width: 10%;"></td> <td style="width: 10%;"></td> <td style="width: 10%;"></td> <td style="width: 10%;"></td> <td style="width: 10%;"></td> <td style="width: 10%;"></td> <td style="width: 10%;"></td> </tr> <tr> <td></td> <td></td> <td colspan="8" style="text-align: center;"> <table border="1" style="width: 100%; border-collapse: collapse; text-align: center;"> <tr> <td style="width: 10%;"></td> <td style="width: 10%;"></td> <td style="width: 10%;"></td> <td style="width: 10%;"></td> <td style="width: 10%;"></td> <td style="width: 10%;"></td> <td style="width: 10%;"></td> <td style="width: 10%;"></td> <td style="width: 10%;"></td> <td style="width: 10%;"></td> </tr> <tr> <td></td> <td></td> <td colspan="8" style="text-align: center;"> <table border="1" style="width: 100%; border-collapse: collapse; text-align: center;"> <tr> <td style="width: 10%;"></td> <td style="width: 10%;"></td> <td style="width: 10%;"></td> <td style="width: 10%;"></td> <td style="width: 10%;"></td> <td style="width: 10%;"></td> <td style="width: 10%;"></td> <td style="width: 10%;"></td>
<td style="width: 10%;"></td> <td style="width: 10%;"></td> </tr> <tr> <td></td> <td></td> <td colspan="8" style="text-align: center;"> <table border="1" style="width: 100%; border-collapse: collapse; text-align: center;"> <tr> <td style="width: 10%;"></td> <td style="width: 10%;"></td> <td style="width: 10%;"></td> <td style="width: 10%;"></td> <td style="width: 10%;"></td> <td style="width: 10%;"></td> <td style="width: 10%;"></td> <td style="width: 10%;"></td> <td style="width: 10%;"></td> <td style="width: 10%;"></td> </tr> <tr> <td></td> <td></td> <td colspan="8" style="text-align: center;"> <table border="1" style="width: 100%; border-collapse: collapse; text-align: center;"> <tr> <td style="width: 10%;"></td> <td style="width: 10%;"></td> <td style="width: 10%;"></td> <td style="width: 10%;"></td> <td style="width: 10%;"></td> <td style="width: 10%;"></td> <td style="width: 10%;"></td> <td style="width: 10%;"></td> <td style="width: 10%;"></td> <td style="width: 10%;"></td> </tr> <tr> <td></td> <td></td> <td colspan="8" style="text-align: center;"> <table border="1" style="width: 100%; border-collapse: collapse; text-align: center;"> <tr> <td style="width: 10%;"></td> <td style="width: 10%;"></td> <td style="width: 10%;"></td> <td style="width: 10%;"></td> <td style="width: 10%;"></td> <td style="width: 10%;"></td> <td style="width: 10%;"></td> <td style="width: 10%;"></td> <td style="width: 10%;"></td> <td style="width: 10%;"></td> </tr> <tr> <td></td> <td></td> <td colspan="8" style="text-align: center;"> <table border="1" style="width: 100%; border-collapse: collapse; text-align: center;"> <tr> <td style="width: 10%;"></td> <td style="width: 10%;"></td> <td style="width: 10%;"></td> <td style="width: 10%;"></td> <td style="width: 10%;"></td> <td style="width: 10%;"></td> <td style="width: 10%;"></td> <td style="width: 10%;"></td> <td style="width: 10%;"></td> <td style="width: 10%;"></td> </tr> <tr> <td></td> <td></td> <td colspan="8" style="text-align: center;"> <table border="1" style="width: 100%; border-collapse: collapse; text-align: center;"> <tr> <td style="width: 10%;"></td> <td style="width: 10%;"></td> <td style="width: 10%;"></td> <td style="width: 10%;"></td> <td style="width: 10%;"></td> <td style="width: 10%;"></td> <td style="width: 10%;"></td> <td style="width: 10%;"></td> <td style="width: 10%;"></td> <td style="width: 10%;"></td> </tr> <tr> <td></td> <td></td> <td colspan="8" style="text-align: center;"> <table border="1" style="width: 100%; border-collapse: collapse; text-align: center;"> <tr> <td style="width: 10%;"></td> <td style="width: 10%;"></td> <td style="width: 10%;"></td> <td style="width: 10%;"></td> <td style="width: 10%;"></td> <td style="width: 10%;"></td> <td style="width: 10%;"></td> <td style="width: 10%;"></td> <td style="width: 10%;"></td> <td style="width: 10%;"></td> </tr> <tr> <td></td> <td></td> <td colspan="8" style="text-align: center;"> <table border="1" style="width: 100%; border-collapse: collapse; text-align: center;"> <tr> <td style="width: 10%;"></td> <td style="width: 10%;"></td> <td style="width: 10%;"></td> <td style="width: 10%;"></td> <td style="width: 10%;"></td> <td style="width: 10%;"></td> <td style="width: 10%;"></td> <td style="width: 10%;"></td> <td style="width: 10%;"></td> <td style="width: 10%;"></td> </tr> <tr> <td></td> <td></td> <td colspan="8" style="text-align: center;"> <table border="1" style="width: 100%; border-collapse: collapse; text-align: center;"> <tr> <td style="width: 10%;"></td> <td style="width: 10%;"></td> <td style="width: 10%;"></td> <td style="width: 10%;"></td> <td style="width: 10%;"></td> <td style="width: 10%;"></td> <td style="width: 10%;"></td> <td style="width: 10%;"></td> <td style="width: 10%;"></td> <td style="width: 10%;"></td> </tr> <tr> <td></td> <td></td> <td colspan="8" style="text-align: center;"> <table border="1" style="width: 100%; border-collapse: collapse; text-align: center;"> <tr> <td style="width: 10%;"></td> <td style="width: 10%;"></td> <td style="width: 10%;"></td> <td style="width: 10%;"></td> <td style="width: 10%;"></td> <td style="width: 10%;"></td> <td style="width: 10%;"></td> <td style="width: 10%;"></td> <td style="width: 10%;"></td> <td style="width: 10%;"></td> </tr> <tr> <td></td> <td></td> <td colspan="8" style="text-align: center;"> <table border="1" style="width: 100%; border-collapse: collapse; text-align: center;"> <tr> <td style="width: 10%;"></td> <td style="width: 10%;"></td> <td style="width: 10%;"></td> <td style="width: 10%;"></td> <td style="width: 10%;"></td> <td style="width: 10%;"></td> <td style="width: 10%;"></td> <td style="width: 10%;"></td> <td style="width: 10%;"></td> <td style="width: 10%;"></td> </tr> <tr> <td></td> <td></td> <td colspan="8" style="text-align: center;"> <table border="1" style="width: 100%; border-collapse: collapse; text-align: center;"> <tr> <td style="width: 10%;"></td> <td style="width: 10%;"></td> <td style="width: 10%;"></td> <td style="width: 10%;"></td> <td style="width: 10%;"></td> <td style="width: 10%;"></td> <td style="width: 10%;"></td> <td style="width: 10%;"></td> <td style="width: 10%;"></td> <td style="width: 10%;"></td> </tr> <tr> <td></td> <td></td> <td colspan="8" style="text-align: center;"> <table border="1" style="width: 100%; border-collapse: collapse; text-align: center;"> <tr> <td style="width: 10%;"></td> <td style="width: 10%;"></td> <td style="width: 10%;"></td> <td style="width: 10%;"></td> <td style="width: 10%;"></td> <td style="width: 10%;"></td> <td style="width: 10%;"></td> <td style="width: 10%;"></td> <td style="width: 10%;"></td> <td style="width: 10%;"></td> </tr> <tr> <td></td> <td></td> <td colspan="8" style="text-align: center;"> <table border="1" style="width: 100%; border-collapse: collapse; text-align: center;"> <tr> <td style="width: 10%;"></td> <td style="width: 10%;"></td> <td style="width: 10%;"></td> <td style="width: 10%;"></td> <td style="width: 10%;"></td> <td style="width: 10%;"></td> <td style="width: 10%;"></td> <td style="width: 10%;"></td> <td style="width: 10%;"></td> <td style="width: 10%;"></td> </tr> <tr> <td></td> <td></td> <td colspan="8" style="text-align: center;"> <table border="1" style="width: 100%; border-collapse: collapse; text-align: center;"> <tr> <td style="width: 10%;"></td> <td style="width: 10%;"></td> <td style="width: 10%;"></td> <td style="width: 10%;"></td> <td style="width: 10%;"></td> <td style="width: 10%;"></td> <td style="width: 10%;"></td> <td style="width: 10%;"></td> <td style="width: 10%;"></td> <td style="width: 10%;"></td> </tr> <tr> <td></td> <td></td> <td colspan="8" style="text-align: center;"> <table border="1" style="width: 100%; border-collapse: collapse; text-align: center;"> <tr> <td style="width: 10%;"></td> <td style="width: 10%;"></td> <td style="width: 10%;"></td> <td style="width: 10%;"></td> <td style="width: 10%;"></td> <td style="width: 10%;"></td> <td style="width: 10%;"></td> <td style="width: 10%;"></td> <td style="width: 10%;"></td> <td style="width: 10%;"></td> </tr> <tr> <td></td> <td></td> <td colspan="8" style="text-align: center;"> <table border="1" style="width: 100%; border-collapse: collapse; text-align: center;"> <tr> <td style="width: 10%;"></td> <td style="width: 10%;"></td> <td style="width: 10%;"></td> <td style="width: 10%;"></td> <td style="width: 10%;"></td> <td style="width: 10%;"></td> <td style="width: 10%;"></td> <td style="width: 10%;"></td> <td style="width: 10%;"></td> <td style="width: 10%;"></td> </tr> <tr> <td></td> <td></td> <td colspan="8" style="text-align: center;"> <table border="1" style="width: 100%; border-collapse: collapse; text-align: center;"> <tr> <td style="width: 10%;"></td> <td style="width: 10%;"></td> <td style="width: 10%;"></td> <td style="width: 10%;"></td> <td style="width: 10%;"></td> <td style="width: 10%;"></td> <td style="width: 10%;"></td> <td style="width: 10%;"></td> <td style="width: 10%;"></td> <td style="width: 10%;"></td> </tr> <tr> <td></td> <td></td> <td colspan="8" style="text-align: center;"> <table border="1" style="width: 100%; border-collapse: collapse; text-align: center;"> <tr> <td style="width: 10%;"></td> <td style="width: 10%;"></td> <td style="width: 10%;"></td> <td style="width: 10%;"></td> <td style="width: 10%;"></td> <td style="width: 10%;"></td> <td style="width: 10%;"></td> <td style="width: 10%;"></td> <td style="width: 10%;"></td> <td style="width: 10%;"></td> </tr> <tr> <td></td> <td></td> <td colspan="8" style="text-align: center;"> <table border="1" style="width: 100%; border-collapse: collapse; text-align: center;"> <tr> <td style="width: 10%;"></td> <td style="width: 10%;"></td> <td style="width: 10%;"></td> <td style="width: 10%;"></td> <td style="width: 10%;"></td> <td style="width: 10%;"></td> <td style="width: 10%;"></td> <td style="width: 10%;"></td> <td style="width: 10%;"></td> <td style="width: 10%;"></td> </tr> <tr> <td></td> <td></td> <td colspan="8" style="text-align: center;"> <table border="1" style="width: 100%; border-collapse: collapse; text-align: center;"> <tr> <td style="width: 10%;"></td> <td style="width: 10%;"></td> <td style="width: 10%;"></td> <td style="width: 10%;"></td> <td style="width: 10%;"></td> <td style="width: 10%;"></td> <td style="width: 10%;"></td> <td style="width: 10%;"></td> <td style="width: 10%;"></td> <td style="width: 10%;"></td> </tr> <tr> <td></td> <td></td> <td colspan="8" style="text-align: center;"> <table border="1" style="width: 100%; border-collapse: collapse; text-align: center;"> <tr> <td style="width: 10%;"></td> <td style="width: 10%;"></td> <td style="width: 10%;"></td> <td style="width: 10%;"></td> <td style="width: 10%;"></td> <td style="width: 10%;"></td> <td style="width: 10%;"></td> <td style="width: 10%;"></td> <td style="width: 10%;"></td> <td style="width: 10%;"></td> </tr> <tr> <td></td> <td></td> <td colspan="8" style="text-align: center;"> <table border="1" style="width:
100%; border-collapse: collapse; text-align: center;"> <tr> <td style="width: 10%;"></td> <td style="width: 10%;"></td> <td style="width: 10%;"></td> <td style="width: 10%;"></td> <td style="width: 10%;"></td> <td style="width: 10%;"></td> <td style="width: 10%;"></td> <td style="width: 10%;"></td> <td style="width: 10%;"></td> <td style="width: 10%;"></td> </tr> <tr> <td></td> <td></td> <td colspan="8" style="text-align: center;"> <table border="1" style="width: 100%; border-collapse: collapse; text-align: center;"> <tr> <td style="width: 10%;"></td> <td style="width: 10%;"></td> <td style="width: 10%;"></td> <td style="width: 10%;"></td> <td style="width: 10%;"></td> <td style="width: 10%;"></td> <td style="width: 10%;"></td> <td style="width: 10%;"></td> <td style="width: 10%;"></td> <td style="width: 10%;"></td> </tr> <tr> <td></td> <td></td> <td colspan="8" style="text-align: center;"> <table border="1" style="width: 100%; border-collapse: collapse; text-align: center;"> <tr> <td style="width: 10%;"></td> <td style="width: 10%;"></td> <td style="width: 10%;"></td> <td style="width: 10%;"></td> <td style="width: 10%;"></td> <td style="width: 10%;"></td> <td style="width: 10%;"></td> <td style="width: 10%;"></td> <td style="width: 10%;"></td> <td style="width: 10%;"></td> </tr> <tr> <td></td> <td></td> <td colspan="8" style="text-align: center;"> <table border="1" style="width: 100%; border-collapse: collapse; text-align: center;"> <tr> <td style="width: 10%;"></td> <td style="width: 10%;"></td> <td style="width: 10%;"></td> <td style="width: 10%;"></td> <td style="width: 10%;"></td> <td style="width: 10%;"></td> <td style="width: 10%;"></td> <td style="width: 10%;"></td> <td style="width: 10%;"></td> <td style="width: 10%;"></td> </tr> <tr> <td></td> <td></td> <td colspan="8" style="text-align: center;"> <table border="1" style="width: 100%; border-collapse: collapse; text-align: center;"> <tr> <td style="width: 10%;"></td> <td style="width: 10%;"></td> <td style="width: 10%;"></td> <td style="width: 10%;"></td> <td style="width: 10%;"></td> <td style="width: 10%;"></td> <td style="width: 10%;"></td> <td style="width: 10%;"></td> <td style="width: 10%;"></td> <td style="width: 10%;"></td> </tr> <tr> <td></td> <td></td> <td colspan="8" style="text-align: center;"> <table border="1" style="width: 100%; border-collapse: collapse; text-align: center;"> <tr> <td style="width: 10%;"></td> <td style="width: 10%;"></td> <td style="width: 10%;"></td> <td style="width: 10%;"></td> <td style="width: 10%;"></td> <td style="width: 10%;"></td> <td style="width: 10%;"></td> <td style="width: 10%;"></td> <td style="width: 10%;"></td> <td style="width: 10%;"></td> </tr> <tr> <td></td> <td></td> <td colspan="8" style="text-align: center;"> <table border="1" style="width: 100%; border-collapse: collapse; text-align: center;"> <tr> <td style="width: 10%;"></td> <td style="width: 10%;"></td> <td style="width: 10%;"></td> <td style="width: 10%;"></td> <td style="width: 10%;"></td> <td style="width: 10%;"></td> <td style="width: 10%;"></td> <td style="width: 10%;"></td> <td style="width: 10%;"></td> <td style="width: 10%;"></td> </tr> <tr> <td></td> <td></td> <td colspan="8" style="text-align: center;"> <table border="1" style="width: 100%; border-collapse: collapse; text-align: center;"> <tr> <td style="width: 10%;"></td> <td style="width: 10%;"></td> <td style="width: 10%;"></td> <td style="width: 10%;"></td> <td style="width: 10%;"></td> <td style="width: 10%;"></td> <td style="width: 10%;"></td> <td style="width: 10%;"></td> <td style="width: 10%;"></td> <td style="width: 10%;"></td> </tr> <tr> <td></td> <td></td> <td colspan="8" style="text-align: center;"> <table border="1" style="width: 100%; border-collapse: collapse; text-align: center;"> <tr> <td style="width: 10%;"></td> <td style="width: 10%;"></td> <td style="width: 10%;"></td> <td style="width: 10%;"></td> <td style="width: 10%;"></td> <td style="width: 10%;"></td> <td style="width: 10%;"></td> <td style="width: 10%;"></td> <td style="width: 10%;"></td> <td style="width: 10%;"></td> </tr> <tr> <td></td> <td></td> <td colspan="8" style="text-align: center;"> <table border="1" style="width: 100%; border-collapse: collapse; text-align: center;"> <tr> <td style="width: 10%;"></td> <td style="width: 10%;"></td> <td style="width: 10%;"></td> <td style="width: 10%;"></td> <td style="width: 10%;"></td> <td style="width: 10%;"></td> <td style="width: 10%;"></td> <td style="width: 10%;"></td> <td style="width: 10%;"></td> <td style="width: 10%;"></td> </tr> <tr> <td></td> <td></td> <td colspan="8" style="text-align: center;"> <table border="1" style="width: 100%; border-collapse: collapse; text-align: center;"> <tr> <td style="width: 10%;"></td> <td style="width: 10%;"></td> <td style="width: 10%;"></td> <td style="width: 10%;"></td> <td style="width: 10%;"></td> <td style="width: 10%;"></td> <td style="width: 10%;"></td> <td style="width: 10%;"></td> <td style="width: 10%;"></td> <td style="width: 10%;"></td> </tr> <tr> <td></td> <td></td> <td colspan="8" style="text-align: center;"> <table border="1" style="width: 100%; border-collapse: collapse; text-align: center;"> <tr> <td style="width: 10%;"></td> <td style="width: 10%;"></td> <td style="width: 10%;"></td> <td style="width: 10%;"></td> <td style="width: 10%;"></td> <td style="width: 10%;"></td> <td style="width: 10%;"></td> <td style="width: 10%;"></td> <td style="width: 10%;"></td> <td style="width: 10%;"></td> </tr> <tr> <td></td> <td></td> <td colspan="8" style="text-align: center;"> <table border="1" style="width: 100%; border-collapse: collapse; text-align: center;"> <tr> <td style="width: 10%;"></td> <td style="width: 10%;"></td> <td style="width: 10%;"></td> <td style="width: 10%;"></td> <td style="width: 10%;"></td> <td style="width: 10%;"></td> <td style="width: 10%;"></td> <td style="width: 10%;"></td> <td style="width: 10%;"></td> <td style="width: 10%;"></td> </tr> <tr> <td></td> <td></td> <td colspan="8" style="text-align: center;"> <table border="1" style="width: 100%; border-collapse: collapse; text-align: center;"> <tr> <td style="width: 10%;"></td> <td style="width: 10%;"></td> <td style="width: 10%;"></td> <td style="width: 10%;"></td> <td style="width: 10%;"></td> <td style="width: 10%;"></td> <td style="width: 10%;"></td> <td style="width: 10%;"></td> <td style="width: 10%;"></td> <td style="width: 10%;"></td> </tr> <tr> <td></td> <td></td> <td colspan="8" style="text-align: center;"> <table border="1" style="width: 100%; border-collapse: collapse; text-align: center;"> <tr> <td style="width: 10%;"></td> <td style="width: 10%;"></td> <td style="width: 10%;"></td> <td style="width: 10%;"></td> <td style="width: 10%;"></td> <td style="width: 10%;"></td> <td style="width: 10%;"></td> <td style="width: 10%;"></td> <td style="width: 10%;"></td> <td style="width: 10%;"></td> </tr> <tr> <td></td> <td></td> <td colspan="8" style="text-align: center;"> <table border="1" style="width: 100%; border-collapse: collapse; text-align: center;"> <tr> <td style="width: 10%;"></td> <td style="width: 10%;"></td> <td style="width: 10%;"></td> <td style="width: 10%;"></td> <td style="width: 10%;"></td> <td style="width: 10%;"></td> <td style="width: 10%;"></td> <td style="width: 10%;"></td> <td style="width: 10%;"></td> <td style="width: 10%;"></td> </tr> <tr> <td></td> <td></td> <td colspan="8" style="text-align: center;"> <table border="1" style="width: 100%; border-collapse: collapse; text-align: center;"> <tr> <td style="width: 10%;"></td> <td style="width: 10%;"></td> <td style="width: 10%;"></td> <td style="width: 10%;"></td> <td style="width: 10%;"></td> <td style="width: 10%;"></td> <td style="width: 10%;"></td> <td style="width: 10%;"></td> <td style="width: 10%;"></td> <td style="width: 10%;"></td> </tr> <tr> <td></td> <td></td> <td colspan="8" style="text-align: center;"> <table border="1" style="width: 100%; border-collapse: collapse; text-align: center;"> <tr> <td style="width: 10%;"></td> <td style="width: 10%;"></td> <td style="width: 10%;"></td> <td style="width: 10%;"></td> <td style="width: 10%;"></td> <td style="width: 10%;"></td> <td style="width: 10%;"></td> <td style="width: 10%;"></td> <td style="width: 10%;"></td> <td style="width: 10%;"></td> </tr> <tr> <td></td> <td></td> <td colspan="8" style="text-align: center;"> <table border="1" style="width: 100%; border-collapse: collapse; text-align: center;"> <tr> <td style="width: 10%;"></td> <td style="width: 10%;"></td> <td style="width: 10%;"></td> <td style="width: 10%;"></td> <td style="width: 10%;"></td> <td style="width: 10%;"></td> <td style="width: 10%;"></td> <td style="width: 10%;"></td> <td style="width: 10%;"></td> <td style="width: 10%;"></td> </tr> <tr> <td></td> <td></td> <td colspan="8" style="text-align: center;"> <table border="1" style="width: 100%; border-collapse: collapse; text-align: center;"> <tr> </tr></table></td></tr></table></td></tr></table></td></tr></table></td></tr></table></td></tr></table></td></tr></table></td></tr></table></td></tr></table></td></tr></table></td></tr></table></td></tr></table></td></tr></table></td></tr></table></td></tr></table></td></tr></table></td></tr></table></td></tr></table></td></tr></table></td></tr></table></td></tr></table></td></tr></table></td></tr></table></td></tr></table></td></tr></table></td></tr></table></td></tr></table></td></tr></table></td></tr></table></td></tr></table></td></tr></table></td></tr></table></td></tr></table></td></tr></table></td></tr></table></td></tr></table></td></tr></table></td></tr></table></td></tr></table></td></tr></table></td></tr></table></td></tr></table></td></tr></table></td></tr></table>
 | | | | | | | | | | | | | | | | | | | | <table border="1" style="width: 100%; border-collapse: collapse; text-align: center;"> <tr> <td style="width: 10%;"></td> <td style="width: 10%;"></td> <td style="width: 10%;"></td> <td style="width: 10%;"></td> <td style="width: 10%;"></td> <td style="width: 10%;"></td> <td style="width: 10%;"></td> <td style="width: 10%;"></td> <td style="width: 10%;"></td> <td style="width: 10%;"></td> </tr> <tr> <td></td> <td></td> <td colspan="8" style="text-align: center;"> <table border="1" style="width: 100%; border-collapse: collapse; text-align: center;"> <tr> <td style="width: 10%;"></td> <td style="width: 10%;"></td> <td style="width: 10%;"></td> <td style="width: 10%;"></td> <td style="width: 10%;"></td> <td style="width: 10%;"></td> <td style="width: 10%;"></td> <td style="width: 10%;"></td> <td style="width: 10%;"></td> <td style="width: 10%;"></td> </tr> <tr> <td></td> <td></td> <td colspan="8" style="text-align: center;"> <table border="1" style="width: 100%; border-collapse: collapse; text-align: center;"> <tr> <td style="width: 10%;"></td> <td style="width: 10%;"></td> <td style="width: 10%;"></td> <td style="width: 10%;"></td> <td style="width: 10%;"></td> <td style="width: 10%;"></td> <td style="width: 10%;"></td> <td style="width: 10%;"></td> <td style="width: 10%;"></td> <td style="width: 10%;"></td> </tr> <tr> <td></td> <td></td> <td colspan="8" style="text-align: center;"> <table border="1" style="width: 100%; border-collapse: collapse; text-align: center;"> <tr> <td style="width: 10%;"></td> <td style="width: 10%;"></td> <td style="width: 10%;"></td> <td style="width: 10%;"></td> <td style="width: 10%;"></td> <td style="width: 10%;"></td> <td style="width: 10%;"></td> <td style="width: 10%;"></td> <td style="width: 10%;"></td> <td style="width: 10%;"></td> </tr> <tr> <td></td> <td></td> <td colspan="8" style="text-align: center;"> <table border="1" style="width: 100%; border-collapse: collapse; text-align: center;"> <tr> <td style="width: 10%;"></td> <td style="width: 10%;"></td> <td style="width: 10%;"></td> <td style="width: 10%;"></td> <td style="width: 10%;"></td> <td style="width: 10%;"></td> <td style="width: 10%;"></td> <td style="width: 10%;"></td> <td style="width: 10%;"></td> <td style="width: 10%;"></td> </tr> <tr> <td></td> <td></td> <td colspan="8" style="text-align: center;"> <table border="1" style="width: 100%; border-collapse: collapse; text-align: center;"> <tr> <td style="width: 10%;"></td> <td style="width: 10%;"></td> <td style="width: 10%;"></td> <td style="width: 10%;"></td> <td style="width: 10%;"></td> <td style="width: 10%;"></td> <td style="width: 10%;"></td> <td style="width: 10%;"></td> <td style="width: 10%;"></td> <td style="width: 10%;"></td> </tr> <tr> <td></td> <td></td> <td colspan="8" style="text-align: center;"> <table border="1" style="width: 100%; border-collapse: collapse; text-align: center;"> <tr> <td style="width: 10%;"></td> <td style="width: 10%;"></td> <td style="width: 10%;"></td> <td style="width: 10%;"></td> <td style="width: 10%;"></td> <td style="width: 10%;"></td> <td style="width: 10%;"></td> <td style="width: 10%;"></td> <td style="width: 10%;"></td> <td style="width: 10%;"></td> </tr> <tr> <td></td> <td></td> <td colspan="8" style="text-align: center;"> <table border="1" style="width: 100%; border-collapse: collapse; text-align: center;"> <tr> <td style="width: 10%;"></td> <td style="width: 10%;"></td> <td style="width: 10%;"></td> <td style="width: 10%;"></td> <td style="width: 10%;"></td> <td style="width: 10%;"></td> <td style="width: 10%;"></td> <td style="width: 10%;"></td> <td style="width: 10%;"></td> <td style="width: 10%;"></td> </tr> <tr> <td></td> <td></td> <td colspan="8" style="text-align: center;"> <table border="1" style="width: 100%; border-collapse: collapse; text-align: center;"> <tr> <td style="width: 10%;"></td> <td style="width: 10%;"></td> <td style="width: 10%;"></td> <td style="width: 10%;"></td> <td style="width: 10%;"></td> <td style="width: 10%;"></td> <td style="width: 10%;"></td> <td style="width: 10%;"></td> <td style="width: 10%;"></td> <td style="width: 10%;"></td> </tr> <tr> <td></td> <td></td> <td colspan="8" style="text-align: center;"> <table border="1" style="width: 100%; border-collapse: collapse; text-align: center;"> <tr> <td style="width: 10%;"></td> <td style="width: 10%;"></td> <td style="width: 10%;"></td> <td style="width: 10%;"></td> <td style="width: 10%;"></td> <td style="width: 10%;"></td> <td style="width: 10%;"></td> <td style="width: 10%;"></td> <td style="width: 10%;"></td> <td style="width: 10%;"></td> </tr> <tr> <td></td> <td></td> <td colspan="8" style="text-align: center;"> <table border="1" style="width: 100%; border-collapse: collapse; text-align: center;"> <tr> <td style="width: 10%;"></td> <td style="width: 10%;"></td> <td style="width: 10%;"></td> <td style="width: 10%;"></td> <td style="width: 10%;"></td> <td style="width: 10%;"></td> <td style="width: 10%;"></td> <td style="width: 10%;"></td> <td style="width: 10%;"></td> <td style="width: 10%;"></td> </tr> <tr> <td></td> <td></td> <td colspan="8" style="text-align: center;"> <table border="1" style="width: 100%; border-collapse: collapse; text-align: center;"> <tr> <td style="width: 10%;"></td> <td style="width: 10%;"></td> <td style="width: 10%;"></td> <td style="width: 10%;"></td> <td style="width: 10%;"></td> <td style="width: 10%;"></td> <td style="width: 10%;"></td> <td style="width: 10%;"></td> <td style="width: 10%;"></td> <td style="width: 10%;"></td> </tr> <tr> <td></td> <td></td> <td colspan="8" style="text-align: center;"> <table border="1" style="width: 100%; border-collapse: collapse; text-align: center;"> <tr> <td style="width: 10%;"></td> <td style="width: 10%;"></td> <td style="width: 10%;"></td> <td style="width: 10%;"></td> <td style="width: 10%;"></td> <td style="width: 10%;"></td> <td style="width: 10%;"></td> <td style="width: 10%;"></td> <td style="width: 10%;"></td> <td style="width: 10%;"></td> </tr> <tr> <td></td> <td></td> <td colspan="8" style="text-align: center;"> <table border="1" style="width: 100%; border-collapse: collapse; text-align: center;"> <tr> <td style="width: 10%;"></td> <td style="width: 10%;"></td> <td style="width: 10%;"></td> <td style="width: 10%;"></td> <td style="width: 10%;"></td> <td style="width: 10%;"></td> <td style="width: 10%;"></td> <td style="width: 10%;"></td> <td style="width: 10%;"></td> <td style="width: 10%;"></td> </tr> <tr> <td></td> <td></td> <td colspan="8" style="text-align: center;"> <table border="1" style="width: 100%; border-collapse: collapse; text-align: center;"> <tr> <td style="width: 10%;"></td> <td style="width: 10%;"></td> <td style="width: 10%;"></td> <td style="width: 10%;"></td> <td style="width: 10%;"></td> <td style="width: 10%;"></td> <td style="width: 10%;"></td> <td style="width: 10%;"></td> <td style="width: 10%;"></td> <td style="width: 10%;"></td> </tr> <tr> <td></td> <td></td> <td colspan="8" style="text-align: center;"> <table border="1" style="width: 100%; border-collapse: collapse; text-align: center;"> <tr> <td style="width: 10%;"></td> <td style="width: 10%;"></td> <td style="width: 10%;"></td> <td style="width: 10%;"></td> <td style="width: 10%;"></td> <td style="width:
10%;"></td> <td style="width: 10%;"></td> <td style="width: 10%;"></td> <td style="width: 10%;"></td> <td style="width: 10%;"></td> </tr> <tr> <td></td> <td></td> <td colspan="8" style="text-align: center;"> <table border="1" style="width: 100%; border-collapse: collapse; text-align: center;"> <tr> <td style="width: 10%;"></td> <td style="width: 10%;"></td> <td style="width: 10%;"></td> <td style="width: 10%;"></td> <td style="width: 10%;"></td> <td style="width: 10%;"></td> <td style="width: 10%;"></td> <td style="width: 10%;"></td> <td style="width: 10%;"></td> <td style="width: 10%;"></td> </tr> <tr> <td></td> <td></td> <td colspan="8" style="text-align: center;"> <table border="1" style="width: 100%; border-collapse: collapse; text-align: center;"> <tr> <td style="width: 10%;"></td> <td style="width: 10%;"></td> <td style="width: 10%;"></td> <td style="width: 10%;"></td> <td style="width: 10%;"></td> <td style="width: 10%;"></td> <td style="width: 10%;"></td> <td style="width: 10%;"></td> <td style="width: 10%;"></td> <td style="width: 10%;"></td> </tr> <tr> <td></td> <td></td> <td colspan="8" style="text-align: center;"> <table border="1" style="width: 100%; border-collapse: collapse; text-align: center;"> <tr> <td style="width: 10%;"></td> <td style="width: 10%;"></td> <td style="width: 10%;"></td> <td style="width: 10%;"></td> <td style="width: 10%;"></td> <td style="width: 10%;"></td> <td style="width: 10%;"></td> <td style="width: 10%;"></td> <td style="width: 10%;"></td> <td style="width: 10%;"></td> </tr> <tr> <td></td> <td></td> <td colspan="8" style="text-align: center;"> <table border="1" style="width: 100%; border-collapse: collapse; text-align: center;"> <tr> <td style="width: 10%;"></td> <td style="width: 10%;"></td> <td style="width: 10%;"></td> <td style="width: 10%;"></td> <td style="width: 10%;"></td> <td style="width: 10%;"></td> <td style="width: 10%;"></td> <td style="width: 10%;"></td> <td style="width: 10%;"></td> <td style="width: 10%;"></td> </tr> <tr> <td></td> <td></td> <td colspan="8" style="text-align: center;"> <table border="1" style="width: 100%; border-collapse: collapse; text-align: center;"> <tr> <td style="width: 10%;"></td> <td style="width: 10%;"></td> <td style="width: 10%;"></td> <td style="width: 10%;"></td> <td style="width: 10%;"></td> <td style="width: 10%;"></td> <td style="width: 10%;"></td> <td style="width: 10%;"></td> <td style="width: 10%;"></td> <td style="width: 10%;"></td> </tr> <tr> <td></td> <td></td> <td colspan="8" style="text-align: center;"> <table border="1" style="width: 100%; border-collapse: collapse; text-align: center;"> <tr> <td style="width: 10%;"></td> <td style="width: 10%;"></td> <td style="width: 10%;"></td> <td style="width: 10%;"></td> <td style="width: 10%;"></td> <td style="width: 10%;"></td> <td style="width: 10%;"></td> <td style="width: 10%;"></td> <td style="width: 10%;"></td> <td style="width: 10%;"></td> </tr> <tr> <td></td> <td></td> <td colspan="8" style="text-align: center;"> <table border="1" style="width: 100%; border-collapse: collapse; text-align: center;"> <tr> <td style="width: 10%;"></td> <td style="width: 10%;"></td> <td style="width: 10%;"></td> <td style="width: 10%;"></td> <td style="width: 10%;"></td> <td style="width: 10%;"></td> <td style="width: 10%;"></td> <td style="width: 10%;"></td> <td style="width: 10%;"></td> <td style="width: 10%;"></td> </tr> <tr> <td></td> <td></td> <td colspan="8" style="text-align: center;"> <table border="1" style="width: 100%; border-collapse: collapse; text-align: center;"> <tr> <td style="width: 10%;"></td> <td style="width: 10%;"></td> <td style="width: 10%;"></td> <td style="width: 10%;"></td> <td style="width: 10%;"></td> <td style="width: 10%;"></td> <td style="width: 10%;"></td> <td style="width: 10%;"></td> <td style="width: 10%;"></td> <td style="width: 10%;"></td> </tr> <tr> <td></td> <td></td> <td colspan="8" style="text-align: center;"> <table border="1" style="width: 100%; border-collapse: collapse; text-align: center;"> <tr> <td style="width: 10%;"></td> <td style="width: 10%;"></td> <td style="width: 10%;"></td> <td style="width: 10%;"></td> <td style="width: 10%;"></td> <td style="width: 10%;"></td> <td style="width: 10%;"></td> <td style="width: 10%;"></td> <td style="width: 10%;"></td> <td style="width: 10%;"></td> </tr> <tr> <td></td> <td></td> <td colspan="8" style="text-align: center;"> <table border="1" style="width: 100%; border-collapse: collapse; text-align: center;"> <tr> <td style="width: 10%;"></td> <td style="width: 10%;"></td> <td style="width: 10%;"></td> <td style="width: 10%;"></td> <td style="width: 10%;"></td> <td style="width: 10%;"></td> <td style="width: 10%;"></td> <td style="width: 10%;"></td> <td style="width: 10%;"></td> <td style="width: 10%;"></td> </tr> <tr> <td></td> <td></td> <td colspan="8" style="text-align: center;"> <table border="1" style="width: 100%; border-collapse: collapse; text-align: center;"> <tr> <td style="width: 10%;"></td> <td style="width: 10%;"></td> <td style="width: 10%;"></td> <td style="width: 10%;"></td> <td style="width: 10%;"></td> <td style="width: 10%;"></td> <td style="width: 10%;"></td> <td style="width: 10%;"></td> <td style="width: 10%;"></td> <td style="width: 10%;"></td> </tr> <tr> <td></td> <td></td> <td colspan="8" style="text-align: center;"> <table border="1" style="width: 100%; border-collapse: collapse; text-align: center;"> <tr> <td style="width: 10%;"></td> <td style="width: 10%;"></td> <td style="width: 10%;"></td> <td style="width: 10%;"></td> <td style="width: 10%;"></td> <td style="width: 10%;"></td> <td style="width: 10%;"></td> <td style="width: 10%;"></td> <td style="width: 10%;"></td> <td style="width: 10%;"></td> </tr> <tr> <td></td> <td></td> <td colspan="8" style="text-align: center;"> <table border="1" style="width: 100%; border-collapse: collapse; text-align: center;"> <tr> <td style="width: 10%;"></td> <td style="width: 10%;"></td> <td style="width: 10%;"></td> <td style="width: 10%;"></td> <td style="width: 10%;"></td> <td style="width: 10%;"></td> <td style="width: 10%;"></td> <td style="width: 10%;"></td> <td style="width: 10%;"></td> <td style="width: 10%;"></td> </tr> <tr> <td></td> <td></td> <td colspan="8" style="text-align: center;"> <table border="1" style="width: 100%; border-collapse: collapse; text-align: center;"> <tr> <td style="width: 10%;"></td> <td style="width: 10%;"></td> <td style="width: 10%;"></td> <td style="width: 10%;"></td> <td style="width: 10%;"></td> <td style="width: 10%;"></td> <td style="width: 10%;"></td> <td style="width: 10%;"></td> <td style="width: 10%;"></td> <td style="width: 10%;"></td> </tr> <tr> <td></td> <td></td> <td colspan="8" style="text-align: center;"> <table border="1" style="width: 100%; border-collapse: collapse; text-align: center;"> <tr> <td style="width: 10%;"></td> <td style="width: 10%;"></td> <td style="width: 10%;"></td> <td style="width: 10%;"></td> <td style="width: 10%;"></td> <td style="width: 10%;"></td> <td style="width: 10%;"></td> <td style="width: 10%;"></td> <td style="width: 10%;"></td> <td style="width: 10%;"></td> </tr> <tr> <td></td> <td></td> <td colspan="8" style="text-align: center;"> <table border="1" style="width: 100%; border-collapse: collapse; text-align: center;"> <tr> <td style="width: 10%;"></td> <td style="width: 10%;"></td> <td style="width: 10%;"></td> <td style="width: 10%;"></td> <td style="width: 10%;"></td> <td style="width: 10%;"></td> <td style="width: 10%;"></td> <td style="width: 10%;"></td> <td style="width: 10%;"></td> <td style="width: 10%;"></td> </tr> <tr> <td></td> <td></td> <td colspan="8" style="text-align: center;"> <table border="1" style="width: 100%; border-collapse: collapse; text-align: center;"> <tr> <td style="width: 10%;"></td> <td style="width: 10%;"></td> <td style="width: 10%;"></td> <td style="width: 10%;"></td> <td style="width: 10%;"></td> <td style="width: 10%;"></td> <td style="width: 10%;"></td> <td style="width: 10%;"></td> <td style="width: 10%;"></td> <td style="width: 10%;"></td> </tr> <tr> <td></td> <td></td> <td colspan="8" style="text-align: center;"> <table border="1" style="width: 100%; border-collapse: collapse; text-align: center;"> <tr> <td style="width: 10%;"></td> <td style="width: 10%;"></td> <td style="width: 10%;"></td> <td style="width: 10%;"></td> <td style="width: 10%;"></td> <td style="width: 10%;"></td> <td style="width: 10%;"></td> <td style="width: 10%;"></td> <td style="width: 10%;"></td> <td style="width: 10%;"></td> </tr> <tr> <td></td> <td></td> <td colspan="8" style="text-align: center;"> <table border="1" style="width: 100%; border-collapse: collapse; text-align: center;"> <tr> <td style="width: 10%;"></td> <td style="width: 10%;"></td> <td style="width: 10%;"></td> <td style="width: 10%;"></td> <td style="width: 10%;"></td> <td style="width: 10%;"></td> <td style="width: 10%;"></td> <td style="width: 10%;"></td> <td style="width: 10%;"></td> <td style="width: 10%;"></td> </tr> <tr> <td></td> <td></td> <td colspan="8" style="text-align: center;"> <table border="1" style="width: 100%; border-collapse: collapse; text-align: center;"> <tr> <td style="width: 10%;"></td> <td style="width: 10%;"></td> <td style="width: 10%;"></td> <td style="width: 10%;"></td> <td style="width: 10%;"></td> <td style="width: 10%;"></td> <td style="width: 10%;"></td> <td style="width: 10%;"></td> <td style="width: 10%;"></td> <td style="width: 10%;"></td> </tr> <tr> <td></td> <td></td> <td colspan="8" style="text-align: center;"> <table border="1" style="width: 100%; border-collapse: collapse; text-align: center;"> <tr> <td style="width: 10%;"></td> <td style="width: 10%;"></td> <td style="width: 10%;"></td> <td style="width: 10%;"></td> <td style="width: 10%;"></td> <td style="width: 10%;"></td> <td style="width: 10%;"></td> <td style="width: 10%;"></td> <td style="width: 10%;"></td> <td style="width: 10%;"></td> </tr> <tr> <td></td> <td></td> <td
colspan="8" style="text-align: center;"> <table border="1" style="width: 100%; border-collapse: collapse; text-align: center;"> <tr> <td style="width: 10%;"></td> <td style="width: 10%;"></td> <td style="width: 10%;"></td> <td style="width: 10%;"></td> <td style="width: 10%;"></td> <td style="width: 10%;"></td> <td style="width: 10%;"></td> <td style="width: 10%;"></td> <td style="width: 10%;"></td> <td style="width: 10%;"></td> </tr> <tr> <td></td> <td></td> <td colspan="8" style="text-align: center;"> <table border="1" style="width: 100%; border-collapse: collapse; text-align: center;"> <tr> <td style="width: 10%;"></td> <td style="width: 10%;"></td> <td style="width: 10%;"></td> <td style="width: 10%;"></td> <td style="width: 10%;"></td> <td style="width: 10%;"></td> <td style="width: 10%;"></td> <td style="width: 10%;"></td> <td style="width: 10%;"></td> <td style="width: 10%;"></td> </tr> <tr> <td></td> <td></td> <td colspan="8" style="text-align: center;"> <table border="1" style="width: 100%; border-collapse: collapse; text-align: center;"> <tr> <td style="width: 10%;"></td> <td style="width: 10%;"></td> <td style="width: 10%;"></td> <td style="width: 10%;"></td> <td style="width: 10%;"></td> <td style="width: 10%;"></td> <td style="width: 10%;"></td> <td style="width: 10%;"></td> <td style="width: 10%;"></td> <td style="width: 10%;"></td> </tr> <tr> <td></td> <td></td> <td colspan="8" style="text-align: center;"> <table border="1" style="width: 100%; border-collapse: collapse; text-align: center;"> <tr> <td style="width: 10%;"></td> <td style="width: 10%;"></td> <td style="width: 10%;"></td> <td style="width: 10%;"></td> <td style="width: 10%;"></td> <td style="width: 10%;"></td> <td style="width: 10%;"></td> <td style="width: 10%;"></td> <td style="width: 10%;"></td> <td style="width: 10%;"></td> </tr> <tr> <td></td> <td></td> <td colspan="8" style="text-align: center;"> <table border="1" style="width: 100%; border-collapse: collapse; text-align: center;"> <tr> <td style="width: 10%;"></td> <td style="width: 10%;"></td> <td style="width: 10%;"></td> <td style="width: 10%;"></td> <td style="width: 10%;"></td> <td style="width: 10%;"></td> <td style="width: 10%;"></td> <td style="width: 10%;"></td> <td style="width: 10%;"></td> <td style="width: 10%;"></td> </tr> <tr> <td></td> <td></td> <td colspan="8" style="text-align: center;"> <table border="1" style="width: 100%; border-collapse: collapse; text-align: center;"> <tr> </tr></table></td></tr></table></td></tr></table></td></tr></table></td></tr></table></td></tr></table></td></tr></table></td></tr></table></td></tr></table></td></tr></table></td></tr></table></td></tr></table></td></tr></table></td></tr></table></td></tr></table></td></tr></table></td></tr></table></td></tr></table></td></tr></table></td></tr></table></td></tr></table></td></tr></table></td></tr></table></td></tr></table></td></tr></table></td></tr></table></td></tr></table></td></tr></table></td></tr></table></td></tr></table></td></tr></table></td></tr></table></td></tr></table></td></tr></table></td></tr></table></td></tr></table></td></tr></table></td></tr></table></td></tr></table></td></tr></table></td></tr></table></td></tr></table></td></tr></table> | | | | | | | | | | | | | | | | | | | | <table border="1" style="width: 100%; border-collapse: collapse; text-align: center;"> <tr> <td style="width: 10%;"></td> <td style="width: 10%;"></td> <td style="width: 10%;"></td> <td style="width: 10%;"></td> <td style="width: 10%;"></td> <td style="width: 10%;"></td> <td style="width: 10%;"></td> <td style="width: 10%;"></td> <td style="width: 10%;"></td> <td style="width: 10%;"></td> </tr> <tr> <td></td> <td></td> <td colspan="8" style="text-align: center;"> <table border="1" style="width: 100%; border-collapse: collapse; text-align: center;"> <tr> <td style="width: 10%;"></td> <td style="width: 10%;"></td> <td style="width: 10%;"></td> <td style="width: 10%;"></td> <td style="width: 10%;"></td> <td style="width: 10%;"></td> <td style="width: 10%;"></td> <td style="width: 10%;"></td> <td style="width: 10%;"></td> <td style="width: 10%;"></td> </tr> <tr> <td></td> <td></td> <td colspan="8" style="text-align: center;"> <table border="1" style="width: 100%; border-collapse: collapse; text-align: center;"> <tr> <td style="width: 10%;"></td> <td style="width: 10%;"></td> <td style="width: 10%;"></td> <td style="width: 10%;"></td> <td style="width: 10%;"></td> <td style="width: 10%;"></td> <td style="width: 10%;"></td> <td style="width: 10%;"></td> <td style="width: 10%;"></td> <td style="width: 10%;"></td> </tr> <tr> <td></td> <td></td> <td colspan="8" style="text-align: center;"> <table border="1" style="width: 100%; border-collapse: collapse; text-align: center;"> <tr> <td style="width: 10%;"></td> <td style="width: 10%;"></td> <td style="width: 10%;"></td> <td style="width: 10%;"></td> <td style="width: 10%;"></td> <td style="width: 10%;"></td> <td style="width: 10%;"></td> <td style="width: 10%;"></td> <td style="width: 10%;"></td> <td style="width: 10%;"></td> </tr> <tr> <td></td> <td></td> <td colspan="8" style="text-align: center;"> <table border="1" style="width: 100%; border-collapse: collapse; text-align: center;"> <tr> <td style="width: 10%;"></td> <td style="width: 10%;"></td> <td style="width: 10%;"></td> <td style="width: 10%;"></td> <td style="width: 10%;"></td> <td style="width: 10%;"></td> <td style="width: 10%;"></td> <td style="width: 10%;"></td> <td style="width: 10%;"></td> <td style="width: 10%;"></td> </tr> <tr> <td></td> <td></td> <td colspan="8" style="text-align: center;"> <table border="1" style="width: 100%; border-collapse: collapse; text-align: center;"> <tr> <td style="width: 10%;"></td> <td style="width: 10%;"></td> <td style="width: 10%;"></td> <td style="width: 10%;"></td> <td style="width: 10%;"></td> <td style="width: 10%;"></td> <td style="width: 10%;"></td> <td style="width: 10%;"></td> <td style="width: 10%;"></td> <td style="width: 10%;"></td> </tr> <tr> <td></td> <td></td> <td colspan="8" style="text-align: center;"> <table border="1" style="width: 100%; border-collapse: collapse; text-align: center;"> <tr> <td style="width: 10%;"></td> <td style="width: 10%;"></td> <td style="width: 10%;"></td> <td style="width: 10%;"></td> <td style="width: 10%;"></td> <td style="width: 10%;"></td> <td style="width: 10%;"></td> <td style="width: 10%;"></td> <td style="width: 10%;"></td> <td style="width: 10%;"></td> </tr> <tr> <td></td> <td></td> <td colspan="8" style="text-align: center;"> <table border="1" style="width: 100%; border-collapse: collapse; text-align: center;"> <tr> <td style="width: 10%;"></td> <td style="width: 10%;"></td> <td style="width: 10%;"></td> <td style="width: 10%;"></td> <td style="width: 10%;"></td> <td style="width: 10%;"></td> <td style="width: 10%;"></td> <td style="width: 10%;"></td> <td style="width: 10%;"></td> <td style="width: 10%;"></td> </tr> <tr> <td></td> <td></td> <td colspan="8" style="text-align: center;"> <table border="1" style="width: 100%;
border-collapse: collapse; text-align: center;"> <tr> <td style="width: 10%;"></td> <td style="width: 10%;"></td> <td style="width: 10%;"></td> <td style="width: 10%;"></td> <td style="width: 10%;"></td> <td style="width: 10%;"></td> <td style="width: 10%;"></td> <td style="width: 10%;"></td> <td style="width: 10%;"></td> <td style="width: 10%;"></td> </tr> <tr> <td></td> <td></td> <td colspan="8" style="text-align: center;"> <table border="1" style="width: 100%; border-collapse: collapse; text-align: center;"> <tr> <td style="width: 10%;"></td> <td style="width: 10%;"></td> <td style="width: 10%;"></td> <td style="width: 10%;"></td> <td style="width: 10%;"></td> <td style="width: 10%;"></td> <td style="width: 10%;"></td> <td style="width: 10%;"></td> <td style="width: 10%;"></td> <td style="width: 10%;"></td> </tr> <tr> <td></td> <td></td> <td colspan="8" style="text-align: center;"> <table border="1" style="width: 100%; border-collapse: collapse; text-align: center;"> <tr> <td style="width: 10%;"></td> <td style="width: 10%;"></td> <td style="width: 10%;"></td> <td style="width: 10%;"></td> <td style="width: 10%;"></td> <td style="width: 10%;"></td> <td style="width: 10%;"></td> <td style="width: 10%;"></td> <td style="width: 10%;"></td> <td style="width: 10%;"></td> </tr> <tr> <td></td> <td></td> <td colspan="8" style="text-align: center;"> <table border="1" style="width: 100%; border-collapse: collapse; text-align: center;"> <tr> <td style="width: 10%;"></td> <td style="width: 10%;"></td> <td style="width: 10%;"></td> <td style="width: 10%;"></td> <td style="width: 10%;"></td> <td style="width: 10%;"></td> <td style="width: 10%;"></td> <td style="width: 10%;"></td> <td style="width: 10%;"></td> <td style="width: 10%;"></td> </tr> <tr> <td></td> <td></td> <td colspan="8" style="text-align: center;"> <table border="1" style="width: 100%; border-collapse: collapse; text-align: center;"> <tr> <td style="width: 10%;"></td> <td style="width: 10%;"></td> <td style="width: 10%;"></td> <td style="width: 10%;"></td> <td style="width: 10%;"></td> <td style="width: 10%;"></td> <td style="width: 10%;"></td> <td style="width: 10%;"></td> <td style="width: 10%;"></td> <td style="width: 10%;"></td> </tr> <tr> <td></td> <td></td> <td colspan="8" style="text-align: center;"> <table border="1" style="width: 100%; border-collapse: collapse; text-align: center;"> <tr> <td style="width: 10%;"></td> <td style="width: 10%;"></td> <td style="width: 10%;"></td> <td style="width: 10%;"></td> <td style="width: 10%;"></td> <td style="width: 10%;"></td> <td style="width: 10%;"></td> <td style="width: 10%;"></td> <td style="width: 10%;"></td> <td style="width: 10%;"></td> </tr> <tr> <td></td> <td></td> <td colspan="8" style="text-align: center;"> <table border="1" style="width: 100%; border-collapse: collapse; text-align: center;"> <tr> <td style="width: 10%;"></td> <td style="width: 10%;"></td> <td style="width: 10%;"></td> <td style="width: 10%;"></td> <td style="width: 10%;"></td> <td style="width: 10%;"></td> <td style="width: 10%;"></td> <td style="width: 10%;"></td> <td style="width: 10%;"></td> <td style="width: 10%;"></td> </tr> <tr> <td></td> <td></td> <td colspan="8" style="text-align: center;"> <table border="1" style="width: 100%; border-collapse: collapse; text-align: center;"> <tr> <td style="width: 10%;"></td> <td style="width: 10%;"></td> <td style="width: 10%;"></td> <td style="width: 10%;"></td> <td style="width: 10%;"></td> <td style="width: 10%;"></td> <td style="width: 10%;"></td> <td style="width: 10%;"></td> <td style="width: 10%;"></td> <td style="width: 10%;"></td> </tr> <tr> <td></td> <td></td> <td colspan="8" style="text-align: center;"> <table border="1" style="width: 100%; border-collapse: collapse; text-align: center;"> <tr> <td style="width: 10%;"></td> <td style="width: 10%;"></td> <td style="width: 10%;"></td> <td style="width: 10%;"></td> <td style="width: 10%;"></td> <td style="width: 10%;"></td> <td style="width: 10%;"></td> <td style="width: 10%;"></td> <td style="width: 10%;"></td> <td style="width: 10%;"></td> </tr> <tr> <td></td> <td></td> <td colspan="8" style="text-align: center;"> <table border="1" style="width: 100%; border-collapse: collapse; text-align: center;"> <tr> <td style="width: 10%;"></td> <td style="width: 10%;"></td> <td style="width: 10%;"></td> <td style="width: 10%;"></td> <td style="width: 10%;"></td> <td style="width: 10%;"></td> <td style="width: 10%;"></td> <td style="width: 10%;"></td> <td style="width: 10%;"></td> <td style="width: 10%;"></td> </tr> <tr> <td></td> <td></td> <td colspan="8" style="text-align: center;"> <table border="1" style="width: 100%; border-collapse: collapse; text-align: center;"> <tr> <td style="width: 10%;"></td> <td style="width: 10%;"></td> <td style="width: 10%;"></td> <td style="width: 10%;"></td> <td style="width: 10%;"></td> <td style="width: 10%;"></td> <td style="width: 10%;"></td> <td style="width: 10%;"></td> <td style="width: 10%;"></td> <td style="width: 10%;"></td> </tr> <tr> <td></td> <td></td> <td colspan="8" style="text-align: center;"> <table border="1" style="width: 100%; border-collapse: collapse; text-align: center;"> <tr> <td style="width: 10%;"></td> <td style="width: 10%;"></td> <td style="width: 10%;"></td> <td style="width: 10%;"></td> <td style="width: 10%;"></td> <td style="width: 10%;"></td> <td style="width: 10%;"></td> <td style="width: 10%;"></td> <td style="width: 10%;"></td> <td style="width: 10%;"></td> </tr> <tr> <td></td> <td></td> <td colspan="8" style="text-align: center;"> <table border="1" style="width: 100%; border-collapse: collapse; text-align: center;"> <tr> <td style="width: 10%;"></td> <td style="width: 10%;"></td> <td style="width: 10%;"></td> <td style="width: 10%;"></td> <td style="width: 10%;"></td> <td style="width: 10%;"></td> <td style="width: 10%;"></td> <td style="width: 10%;"></td> <td style="width: 10%;"></td> <td style="width: 10%;"></td> </tr> <tr> <td></td> <td></td> <td colspan="8" style="text-align: center;"> <table border="1" style="width: 100%; border-collapse: collapse; text-align: center;"> <tr> <td style="width: 10%;"></td> <td style="width: 10%;"></td> <td style="width: 10%;"></td> <td style="width: 10%;"></td> <td style="width: 10%;"></td> <td style="width: 10%;"></td> <td style="width: 10%;"></td> <td style="width: 10%;"></td> <td style="width: 10%;"></td> <td style="width: 10%;"></td> </tr> <tr> <td></td> <td></td> <td colspan="8" style="text-align: center;"> <table border="1" style="width: 100%; border-collapse: collapse; text-align: center;"> <tr> <td style="width: 10%;"></td> <td style="width: 10%;"></td> <td style="width: 10%;"></td> <td style="width: 10%;"></td> <td style="width: 10%;"></td> <td style="width: 10%;"></td> <td style="width: 10%;"></td> <td style="width: 10%;"></td> <td style="width: 10%;"></td> <td style="width: 10%;"></td> </tr> <tr> <td></td> <td></td> <td colspan="8" style="text-align: center;"> <table border="1" style="width: 100%; border-collapse: collapse; text-align: center;"> <tr> <td style="width: 10%;"></td> <td style="width: 10%;"></td> <td style="width: 10%;"></td> <td style="width: 10%;"></td> <td style="width: 10%;"></td> <td style="width: 10%;"></td> <td style="width: 10%;"></td> <td style="width: 10%;"></td> <td style="width: 10%;"></td> <td style="width: 10%;"></td> </tr> <tr> <td></td> <td></td> <td colspan="8" style="text-align: center;"> <table border="1" style="width: 100%; border-collapse: collapse; text-align: center;"> <tr> <td style="width: 10%;"></td> <td style="width: 10%;"></td> <td style="width: 10%;"></td> <td style="width: 10%;"></td> <td style="width: 10%;"></td> <td style="width: 10%;"></td> <td style="width: 10%;"></td> <td style="width: 10%;"></td> <td style="width: 10%;"></td> <td style="width: 10%;"></td> </tr> <tr> <td></td> <td></td> <td colspan="8" style="text-align: center;"> <table border="1" style="width: 100%; border-collapse: collapse; text-align: center;"> <tr> <td style="width: 10%;"></td> <td style="width: 10%;"></td> <td style="width: 10%;"></td> <td style="width: 10%;"></td> <td style="width: 10%;"></td> <td style="width: 10%;"></td> <td style="width: 10%;"></td> <td style="width: 10%;"></td> <td style="width: 10%;"></td> <td style="width: 10%;"></td> </tr> <tr> <td></td> <td></td> <td colspan="8" style="text-align: center;"> <table border="1" style="width: 100%; border-collapse: collapse; text-align: center;"> <tr> <td style="width: 10%;"></td> <td style="width: 10%;"></td> <td style="width: 10%;"></td> <td style="width: 10%;"></td> <td style="width: 10%;"></td> <td style="width: 10%;"></td> <td style="width: 10%;"></td> <td style="width: 10%;"></td> <td style="width: 10%;"></td> <td style="width: 10%;"></td> </tr> <tr> <td></td> <td></td> <td colspan="8" style="text-align: center;"> <table border="1" style="width: 100%; border-collapse: collapse; text-align: center;"> <tr> <td style="width: 10%;"></td> <td style="width: 10%;"></td> <td style="width: 10%;"></td> <td style="width: 10%;"></td> <td style="width: 10%;"></td> <td style="width: 10%;"></td> <td style="width: 10%;"></td> <td style="width: 10%;"></td> <td style="width: 10%;"></td> <td style="width: 10%;"></td> </tr> <tr> <td></td> <td></td> <td colspan="8" style="text-align: center;"> <table border="1" style="width: 100%; border-collapse: collapse; text-align: center;"> <tr> <td style="width: 10%;"></td> <td style="width: 10%;"></td> <td style="width: 10%;"></td> <td style="width: 10%;"></td> <td style="width: 10%;"></td> <td style="width: 10%;"></td> <td style="width: 10%;"></td> <td style="width: 10%;"></td> <td style="width: 10%;"></td> <td style="width: 10%;"></td> </tr> <tr> <td></td> <td></td> <td colspan="8" style="text-align: center;"> <table border="1" style="width: 100%; border-collapse: collapse; text-align: center;"> <tr> <td style="width: 10%;"></td> <td style="width: 10%;"></td> <td style="width: 10%;"></td> <td style="width:
10%;"></td> <td style="width: 10%;"></td> <td style="width: 10%;"></td> <td style="width: 10%;"></td> <td style="width: 10%;"></td> <td style="width: 10%;"></td> <td style="width: 10%;"></td> </tr> <tr> <td></td> <td></td> <td colspan="8" style="text-align: center;"> <table border="1" style="width: 100%; border-collapse: collapse; text-align: center;"> <tr> <td style="width: 10%;"></td> <td style="width: 10%;"></td> <td style="width: 10%;"></td> <td style="width: 10%;"></td> <td style="width: 10%;"></td> <td style="width: 10%;"></td> <td style="width: 10%;"></td> <td style="width: 10%;"></td> <td style="width: 10%;"></td> <td style="width: 10%;"></td> </tr> <tr> <td></td> <td></td> <td colspan="8" style="text-align: center;"> <table border="1" style="width: 100%; border-collapse: collapse; text-align: center;"> <tr> <td style="width: 10%;"></td> <td style="width: 10%;"></td> <td style="width: 10%;"></td> <td style="width: 10%;"></td> <td style="width: 10%;"></td> <td style="width: 10%;"></td> <td style="width: 10%;"></td> <td style="width: 10%;"></td> <td style="width: 10%;"></td> <td style="width: 10%;"></td> </tr> <tr> <td></td> <td></td> <td colspan="8" style="text-align: center;"> <table border="1" style="width: 100%; border-collapse: collapse; text-align: center;"> <tr> <td style="width: 10%;"></td> <td style="width: 10%;"></td> <td style="width: 10%;"></td> <td style="width: 10%;"></td> <td style="width: 10%;"></td> <td style="width: 10%;"></td> <td style="width: 10%;"></td> <td style="width: 10%;"></td> <td style="width: 10%;"></td> <td style="width: 10%;"></td> </tr> <tr> <td></td> <td></td> <td colspan="8" style="text-align: center;"> <table border="1" style="width: 100%; border-collapse: collapse; text-align: center;"> <tr> <td style="width: 10%;"></td> <td style="width: 10%;"></td> <td style="width: 10%;"></td> <td style="width: 10%;"></td> <td style="width: 10%;"></td> <td style="width: 10%;"></td> <td style="width: 10%;"></td> <td style="width: 10%;"></td> <td style="width: 10%;"></td> <td style="width: 10%;"></td> </tr> <tr> <td></td> <td></td> <td colspan="8" style="text-align: center;"> <table border="1" style="width: 100%; border-collapse: collapse; text-align: center;"> <tr> <td style="width: 10%;"></td> <td style="width: 10%;"></td> <td style="width: 10%;"></td> <td style="width: 10%;"></td> <td style="width: 10%;"></td> <td style="width: 10%;"></td> <td style="width: 10%;"></td> <td style="width: 10%;"></td> <td style="width: 10%;"></td> <td style="width: 10%;"></td> </tr> <tr> <td></td> <td></td> <td colspan="8" style="text-align: center;"> <table border="1" style="width: 100%; border-collapse: collapse; text-align: center;"> <tr> <td style="width: 10%;"></td> <td style="width: 10%;"></td> <td style="width: 10%;"></td> <td style="width: 10%;"></td> <td style="width: 10%;"></td> <td style="width: 10%;"></td> <td style="width: 10%;"></td> <td style="width: 10%;"></td> <td style="width: 10%;"></td> <td style="width: 10%;"></td> </tr> <tr> <td></td> <td></td> <td colspan="8" style="text-align: center;"> <table border="1" style="width: 100%; border-collapse: collapse; text-align: center;"> <tr> <td style="width: 10%;"></td> <td style="width: 10%;"></td> <td style="width: 10%;"></td> <td style="width: 10%;"></td> <td style="width: 10%;"></td> <td style="width: 10%;"></td> <td style="width: 10%;"></td> <td style="width: 10%;"></td> <td style="width: 10%;"></td> <td style="width: 10%;"></td> </tr> <tr> <td></td> <td></td> <td colspan="8" style="text-align: center;"> <table border="1" style="width: 100%; border-collapse: collapse; text-align: center;"> <tr> <td style="width: 10%;"></td> <td style="width: 10%;"></td> <td style="width: 10%;"></td> <td style="width: 10%;"></td> <td style="width: 10%;"></td> <td style="width: 10%;"></td> <td style="width: 10%;"></td> <td style="width: 10%;"></td> <td style="width: 10%;"></td> <td style="width: 10%;"></td> </tr> <tr> <td></td> <td></td> <td colspan="8" style="text-align: center;"> <table border="1" style="width: 100%; border-collapse: collapse; text-align: center;"> <tr> <td style="width: 10%;"></td> <td style="width: 10%;"></td> <td style="width: 10%;"></td> <td style="width: 10%;"></td> <td style="width: 10%;"></td> <td style="width: 10%;"></td> <td style="width: 10%;"></td> <td style="width: 10%;"></td> <td style="width: 10%;"></td> <td style="width: 10%;"></td> </tr> <tr> <td></td> <td></td> <td colspan="8" style="text-align: center;"> <table border="1" style="width: 100%; border-collapse: collapse; text-align: center;"> <tr> <td style="width: 10%;"></td> <td style="width: 10%;"></td> <td style="width: 10%;"></td> <td style="width: 10%;"></td> <td style="width: 10%;"></td> <td style="width: 10%;"></td> <td style="width: 10%;"></td> <td style="width: 10%;"></td> <td style="width: 10%;"></td> <td style="width: 10%;"></td> </tr> <tr> <td></td> <td></td> <td colspan="8" style="text-align: center;"> <table border="1" style="width: 100%; border-collapse: collapse; text-align: center;"> <tr> <td style="width: 10%;"></td> <td style="width: 10%;"></td> <td style="width: 10%;"></td> <td style="width: 10%;"></td> <td style="width: 10%;"></td> <td style="width: 10%;"></td> <td style="width: 10%;"></td> <td style="width: 10%;"></td> <td style="width: 10%;"></td> <td style="width: 10%;"></td> </tr> <tr> <td></td> <td></td> <td colspan="8" style="text-align: center;"> <table border="1" style="width: 100%; border-collapse: collapse; text-align: center;"> <tr> </tr></table></td></tr></table></td></tr></table></td></tr></table></td></tr></table></td></tr></table></td></tr></table></td></tr></table></td></tr></table></td></tr></table></td></tr></table></td></tr></table></td></tr></table></td></tr></table></td></tr></table></td></tr></table></td></tr></table></td></tr></table></td></tr></table></td></tr></table></td></tr></table></td></tr></table></td></tr></table></td></tr></table></td></tr></table></td></tr></table></td></tr></table></td></tr></table></td></tr></table></td></tr></table></td></tr></table></td></tr></table></td></tr></table></td></tr></table></td></tr></table></td></tr></table></td></tr></table></td></tr></table></td></tr></table></td></tr></table></td></tr></table></td></tr></table> | | | | | | | | | | | | | | | | | | | | <table border="1" style="width: 100%; border-collapse: collapse; text-align: center;"> <tr> <td style="width: 10%;"></td> <td style="width: 10%;"></td> <td style="width: 10%;"></td> <td style="width: 10%;"></td> <td style="width: 10%;"></td> <td style="width: 10%;"></td> <td style="width: 10%;"></td> <td style="width: 10%;"></td> <td style="width: 10%;"></td> <td style="width: 10%;"></td> </tr> <tr> <td></td> <td></td> <td colspan="8" style="text-align: center;"> <table border="1" style="width: 100%; border-collapse: collapse; text-align: center;"> <tr> <td style="width: 10%;"></td> <td style="width: 10%;"></td> <td style="width: 10%;"></td> <td style="width: 10%;"></td> <td style="width: 10%;"></td> <td style="width: 10%;"></td> <td style="width:
10%;"></td> <td style="width: 10%;"></td> <td style="width: 10%;"></td> <td style="width: 10%;"></td> </tr> <tr> <td></td> <td></td> <td colspan="8" style="text-align: center;"> <table border="1" style="width: 100%; border-collapse: collapse; text-align: center;"> <tr> <td style="width: 10%;"></td> <td style="width: 10%;"></td> <td style="width: 10%;"></td> <td style="width: 10%;"></td> <td style="width: 10%;"></td> <td style="width: 10%;"></td> <td style="width: 10%;"></td> <td style="width: 10%;"></td> <td style="width: 10%;"></td> <td style="width: 10%;"></td> </tr> <tr> <td></td> <td></td> <td colspan="8" style="text-align: center;"> <table border="1" style="width: 100%; border-collapse: collapse; text-align: center;"> <tr> <td style="width: 10%;"></td> <td style="width: 10%;"></td> <td style="width: 10%;"></td> <td style="width: 10%;"></td> <td style="width: 10%;"></td> <td style="width: 10%;"></td> <td style="width: 10%;"></td> <td style="width: 10%;"></td> <td style="width: 10%;"></td> <td style="width: 10%;"></td> </tr> <tr> <td></td> <td></td> <td colspan="8" style="text-align: center;"> <table border="1" style="width: 100%; border-collapse: collapse; text-align: center;"> <tr> <td style="width: 10%;"></td> <td style="width: 10%;"></td> <td style="width: 10%;"></td> <td style="width: 10%;"></td> <td style="width: 10%;"></td> <td style="width: 10%;"></td> <td style="width: 10%;"></td> <td style="width: 10%;"></td> <td style="width: 10%;"></td> <td style="width: 10%;"></td> </tr> <tr> <td></td> <td></td> <td colspan="8" style="text-align: center;"> <table border="1" style="width: 100%; border-collapse: collapse; text-align: center;"> <tr> <td style="width: 10%;"></td> <td style="width: 10%;"></td> <td style="width: 10%;"></td> <td style="width: 10%;"></td> <td style="width: 10%;"></td> <td style="width: 10%;"></td> <td style="width: 10%;"></td> <td style="width: 10%;"></td> <td style="width: 10%;"></td> <td style="width: 10%;"></td> </tr> <tr> <td></td> <td></td> <td colspan="8" style="text-align: center;"> <table border="1" style="width: 100%; border-collapse: collapse; text-align: center;"> <tr> <td style="width: 10%;"></td> <td style="width: 10%;"></td> <td style="width: 10%;"></td> <td style="width: 10%;"></td> <td style="width: 10%;"></td> <td style="width: 10%;"></td> <td style="width: 10%;"></td> <td style="width: 10%;"></td> <td style="width: 10%;"></td> <td style="width: 10%;"></td> </tr> <tr> <td></td> <td></td> <td colspan="8" style="text-align: center;"> <table border="1" style="width: 100%; border-collapse: collapse; text-align: center;"> <tr> <td style="width: 10%;"></td> <td style="width: 10%;"></td> <td style="width: 10%;"></td> <td style="width: 10%;"></td> <td style="width: 10%;"></td> <td style="width: 10%;"></td> <td style="width: 10%;"></td> <td style="width: 10%;"></td> <td style="width: 10%;"></td> <td style="width: 10%;"></td> </tr> <tr> <td></td> <td></td> <td colspan="8" style="text-align: center;"> <table border="1" style="width: 100%; border-collapse: collapse; text-align: center;"> <tr> <td style="width: 10%;"></td> <td style="width: 10%;"></td> <td style="width: 10%;"></td> <td style="width: 10%;"></td> <td style="width: 10%;"></td> <td style="width: 10%;"></td> <td style="width: 10%;"></td> <td style="width: 10%;"></td> <td style="width: 10%;"></td> <td style="width: 10%;"></td> </tr> <tr> <td></td> <td></td> <td colspan="8" style="text-align: center;"> <table border="1" style="width: 100%; border-collapse: collapse; text-align: center;"> <tr> <td style="width: 10%;"></td> <td style="width: 10%;"></td> <td style="width: 10%;"></td> <td style="width: 10%;"></td> <td style="width: 10%;"></td> <td style="width: 10%;"></td> <td style="width: 10%;"></td> <td style="width: 10%;"></td> <td style="width: 10%;"></td> <td style="width: 10%;"></td> </tr> <tr> <td></td> <td></td> <td colspan="8" style="text-align: center;"> <table border="1" style="width: 100%; border-collapse: collapse; text-align: center;"> <tr> <td style="width: 10%;"></td> <td style="width: 10%;"></td> <td style="width: 10%;"></td> <td style="width: 10%;"></td> <td style="width: 10%;"></td> <td style="width: 10%;"></td> <td style="width: 10%;"></td> <td style="width: 10%;"></td> <td style="width: 10%;"></td> <td style="width: 10%;"></td> </tr> <tr> <td></td> <td></td> <td colspan="8" style="text-align: center;"> <table border="1" style="width: 100%; border-collapse: collapse; text-align: center;"> <tr> <td style="width: 10%;"></td> <td style="width: 10%;"></td> <td style="width: 10%;"></td> <td style="width: 10%;"></td> <td style="width: 10%;"></td> <td style="width: 10%;"></td> <td style="width: 10%;"></td> <td style="width: 10%;"></td> <td style="width: 10%;"></td> <td style="width: 10%;"></td> </tr> <tr> <td></td> <td></td> <td colspan="8" style="text-align: center;"> <table border="1" style="width: 100%; border-collapse: collapse; text-align: center;"> <tr> <td style="width: 10%;"></td> <td style="width: 10%;"></td> <td style="width: 10%;"></td> <td style="width: 10%;"></td> <td style="width: 10%;"></td> <td style="width: 10%;"></td> <td style="width: 10%;"></td> <td style="width: 10%;"></td> <td style="width: 10%;"></td> <td style="width: 10%;"></td> </tr> <tr> <td></td> <td></td> <td colspan="8" style="text-align: center;"> <table border="1" style="width: 100%; border-collapse: collapse; text-align: center;"> <tr> <td style="width: 10%;"></td> <td style="width: 10%;"></td> <td style="width: 10%;"></td> <td style="width: 10%;"></td> <td style="width: 10%;"></td> <td style="width: 10%;"></td> <td style="width: 10%;"></td> <td style="width: 10%;"></td> <td style="width: 10%;"></td> <td style="width: 10%;"></td> </tr> <tr> <td></td> <td></td> <td colspan="8" style="text-align: center;"> <table border="1" style="width: 100%; border-collapse: collapse; text-align: center;"> <tr> <td style="width: 10%;"></td> <td style="width: 10%;"></td> <td style="width: 10%;"></td> <td style="width: 10%;"></td> <td style="width: 10%;"></td> <td style="width: 10%;"></td> <td style="width: 10%;"></td> <td style="width: 10%;"></td> <td style="width: 10%;"></td> <td style="width: 10%;"></td> </tr> <tr> <td></td> <td></td> <td colspan="8" style="text-align: center;"> <table border="1" style="width: 100%; border-collapse: collapse; text-align: center;"> <tr> <td style="width: 10%;"></td> <td style="width: 10%;"></td> <td style="width: 10%;"></td> <td style="width: 10%;"></td> <td style="width: 10%;"></td> <td style="width: 10%;"></td> <td style="width: 10%;"></td> <td style="width: 10%;"></td> <td style="width: 10%;"></td> <td style="width: 10%;"></td> </tr> <tr> <td></td> <td></td> <td colspan="8" style="text-align: center;"> <table border="1" style="width: 100%; border-collapse: collapse; text-align: center;"> <tr> <td style="width: 10%;"></td> <td style="width: 10%;"></td> <td style="width: 10%;"></td> <td style="width: 10%;"></td> <td style="width: 10%;"></td> <td style="width: 10%;"></td> <td style="width: 10%;"></td> <td style="width: 10%;"></td> <td style="width: 10%;"></td> <td style="width: 10%;"></td> </tr> <tr> <td></td> <td></td> <td colspan="8" style="text-align: center;"> <table border="1" style="width: 100%; border-collapse: collapse; text-align: center;"> <tr> <td style="width: 10%;"></td> <td style="width: 10%;"></td> <td style="width: 10%;"></td> <td style="width: 10%;"></td> <td style="width: 10%;"></td> <td style="width: 10%;"></td> <td style="width: 10%;"></td> <td style="width: 10%;"></td> <td style="width: 10%;"></td> <td style="width: 10%;"></td> </tr> <tr> <td></td> <td></td> <td colspan="8" style="text-align: center;"> <table border="1" style="width: 100%; border-collapse: collapse; text-align: center;"> <tr> <td style="width: 10%;"></td> <td style="width: 10%;"></td> <td style="width: 10%;"></td> <td style="width: 10%;"></td> <td style="width: 10%;"></td> <td style="width: 10%;"></td> <td style="width: 10%;"></td> <td style="width: 10%;"></td> <td style="width: 10%;"></td> <td style="width: 10%;"></td> </tr> <tr> <td></td> <td></td> <td colspan="8" style="text-align: center;"> <table border="1" style="width: 100%; border-collapse: collapse; text-align: center;"> <tr> <td style="width: 10%;"></td> <td style="width: 10%;"></td> <td style="width: 10%;"></td> <td style="width: 10%;"></td> <td style="width: 10%;"></td> <td style="width: 10%;"></td> <td style="width: 10%;"></td> <td style="width: 10%;"></td> <td style="width: 10%;"></td> <td style="width: 10%;"></td> </tr> <tr> <td></td> <td></td> <td colspan="8" style="text-align: center;"> <table border="1" style="width: 100%; border-collapse: collapse; text-align: center;"> <tr> <td style="width: 10%;"></td> <td style="width: 10%;"></td> <td style="width: 10%;"></td> <td style="width: 10%;"></td> <td style="width: 10%;"></td> <td style="width: 10%;"></td> <td style="width: 10%;"></td> <td style="width: 10%;"></td> <td style="width: 10%;"></td> <td style="width: 10%;"></td> </tr> <tr> <td></td> <td></td> <td colspan="8" style="text-align: center;"> <table border="1" style="width: 100%; border-collapse: collapse; text-align: center;"> <tr> <td style="width: 10%;"></td> <td style="width: 10%;"></td> <td style="width: 10%;"></td> <td style="width: 10%;"></td> <td style="width: 10%;"></td> <td style="width: 10%;"></td> <td style="width: 10%;"></td> <td style="width: 10%;"></td> <td style="width: 10%;"></td> <td style="width: 10%;"></td> </tr> <tr> <td></td> <td></td> <td colspan="8" style="text-align: center;"> <table border="1" style="width: 100%; border-collapse: collapse; text-align: center;"> <tr> <td style="width: 10%;"></td> <td style="width: 10%;"></td> <td style="width: 10%;"></td> <td style="width: 10%;"></td> <td style="width: 10%;"></td> <td style="width: 10%;"></td> <td style="width: 10%;"></td> <td style="width: 10%;"></td> <td style="width: 10%;"></td> <td style="width: 10%;"></td> </tr> <tr> <td></td> <td></td> <td colspan="8" style="text-align:
center;"> <table border="1" style="width: 100%; border-collapse: collapse; text-align: center;"> <tr> <td style="width: 10%;"></td> <td style="width: 10%;"></td> <td style="width: 10%;"></td> <td style="width: 10%;"></td> <td style="width: 10%;"></td> <td style="width: 10%;"></td> <td style="width: 10%;"></td> <td style="width: 10%;"></td> <td style="width: 10%;"></td> <td style="width: 10%;"></td> </tr> <tr> <td></td> <td></td> <td colspan="8" style="text-align: center;"> <table border="1" style="width: 100%; border-collapse: collapse; text-align: center;"> <tr> <td style="width: 10%;"></td> <td style="width: 10%;"></td> <td style="width: 10%;"></td> <td style="width: 10%;"></td> <td style="width: 10%;"></td> <td style="width: 10%;"></td> <td style="width: 10%;"></td> <td style="width: 10%;"></td> <td style="width: 10%;"></td> <td style="width: 10%;"></td> </tr> <tr> <td></td> <td></td> <td colspan="8" style="text-align: center;"> <table border="1" style="width: 100%; border-collapse: collapse; text-align: center;"> <tr> <td style="width: 10%;"></td> <td style="width: 10%;"></td> <td style="width: 10%;"></td> <td style="width: 10%;"></td> <td style="width: 10%;"></td> <td style="width: 10%;"></td> <td style="width: 10%;"></td> <td style="width: 10%;"></td> <td style="width: 10%;"></td> <td style="width: 10%;"></td> </tr> <tr> <td></td> <td></td> <td colspan="8" style="text-align: center;"> <table border="1" style="width: 100%; border-collapse: collapse; text-align: center;"> <tr> <td style="width: 10%;"></td> <td style="width: 10%;"></td> <td style="width: 10%;"></td> <td style="width: 10%;"></td> <td style="width: 10%;"></td> <td style="width: 10%;"></td> <td style="width: 10%;"></td> <td style="width: 10%;"></td> <td style="width: 10%;"></td> <td style="width: 10%;"></td> </tr> <tr> <td></td> <td></td> <td colspan="8" style="text-align: center;"> <table border="1" style="width: 100%; border-collapse: collapse; text-align: center;"> <tr> <td style="width: 10%;"></td> <td style="width: 10%;"></td> <td style="width: 10%;"></td> <td style="width: 10%;"></td> <td style="width: 10%;"></td> <td style="width: 10%;"></td> <td style="width: 10%;"></td> <td style="width: 10%;"></td> <td style="width: 10%;"></td> <td style="width: 10%;"></td> </tr> <tr> <td></td> <td></td> <td colspan="8" style="text-align: center;"> <table border="1" style="width: 100%; border-collapse: collapse; text-align: center;"> <tr> <td style="width: 10%;"></td> <td style="width: 10%;"></td> <td style="width: 10%;"></td> <td style="width: 10%;"></td> <td style="width: 10%;"></td> <td style="width: 10%;"></td> <td style="width: 10%;"></td> <td style="width: 10%;"></td> <td style="width: 10%;"></td> <td style="width: 10%;"></td> </tr> <tr> <td></td> <td></td> <td colspan="8" style="text-align: center;"> <table border="1" style="width: 100%; border-collapse: collapse; text-align: center;"> <tr> <td style="width: 10%;"></td> <td style="width: 10%;"></td> <td style="width: 10%;"></td> <td style="width: 10%;"></td> <td style="width: 10%;"></td> <td style="width: 10%;"></td> <td style="width: 10%;"></td> <td style="width: 10%;"></td> <td style="width: 10%;"></td> <td style="width: 10%;"></td> </tr> <tr> <td></td> <td></td> <td colspan="8" style="text-align: center;"> <table border="1" style="width: 100%; border-collapse: collapse; text-align: center;"> <tr> <td style="width: 10%;"></td> <td style="width: 10%;"></td> <td style="width: 10%;"></td> <td style="width: 10%;"></td> <td style="width: 10%;"></td> <td style="width: 10%;"></td> <td style="width: 10%;"></td> <td style="width: 10%;"></td> <td style="width: 10%;"></td> <td style="width: 10%;"></td> </tr> <tr> <td></td> <td></td> <td colspan="8" style="text-align: center;"> <table border="1" style="width: 100%; border-collapse: collapse; text-align: center;"> <tr> <td style="width: 10%;"></td> <td style="width: 10%;"></td> <td style="width: 10%;"></td> <td style="width: 10%;"></td> <td style="width: 10%;"></td> <td style="width: 10%;"></td> <td style="width: 10%;"></td> <td style="width: 10%;"></td> <td style="width: 10%;"></td> <td style="width: 10%;"></td> </tr> <tr> <td></td> <td></td> <td colspan="8" style="text-align: center;"> <table border="1" style="width: 100%; border-collapse: collapse; text-align: center;"> <tr> <td style="width: 10%;"></td> <td style="width: 10%;"></td> <td style="width: 10%;"></td> <td style="width: 10%;"></td> <td style="width: 10%;"></td> <td style="width: 10%;"></td> <td style="width: 10%;"></td> <td style="width: 10%;"></td> <td style="width: 10%;"></td> <td style="width: 10%;"></td> </tr> <tr> <td></td> <td></td> <td colspan="8" style="text-align: center;"> <table border="1" style="width: 100%; border-collapse: collapse; text-align: center;"> <tr> <td style="width: 10%;"></td> <td style="width: 10%;"></td> <td style="width: 10%;"></td> <td style="width: 10%;"></td> <td style="width: 10%;"></td> <td style="width: 10%;"></td> <td style="width: 10%;"></td> <td style="width: 10%;"></td> <td style="width: 10%;"></td> <td style="width: 10%;"></td> </tr> <tr> <td></td> <td></td> <td colspan="8" style="text-align: center;"> <table border="1" style="width: 100%; border-collapse: collapse; text-align: center;"> <tr> <td style="width: 10%;"></td> <td style="width: 10%;"></td> <td style="width: 10%;"></td> <td style="width: 10%;"></td> <td style="width: 10%;"></td> <td style="width: 10%;"></td> <td style="width: 10%;"></td> <td style="width: 10%;"></td> <td style="width: 10%;"></td> <td style="width: 10%;"></td> </tr> <tr> <td></td> <td></td> <td colspan="8" style="text-align: center;"> <table border="1" style="width: 100%; border-collapse: collapse; text-align: center;"> <tr> <td style="width: 10%;"></td> <td style="width: 10%;"></td> <td style="width: 10%;"></td> <td style="width: 10%;"></td> <td style="width: 10%;"></td> <td style="width: 10%;"></td> <td style="width: 10%;"></td> <td style="width: 10%;"></td> <td style="width: 10%;"></td> <td style="width: 10%;"></td> </tr> <tr> <td></td> <td></td> <td colspan="8" style="text-align: center;"> <table border="1" style="width: 100%; border-collapse: collapse; text-align: center;"> <tr> <td style="width: 10%;"></td> <td style="width: 10%;"></td> <td style="width: 10%;"></td> <td style="width: 10%;"></td> <td style="width: 10%;"></td> <td style="width: 10%;"></td> <td style="width: 10%;"></td> <td style="width: 10%;"></td> <td style="width: 10%;"></td> <td style="width: 10%;"></td> </tr> <tr> <td></td> <td></td> <td colspan="8" style="text-align: center;"> <table border="1" style="width: 100%; border-collapse: collapse; text-align: center;"> <tr> <td style="width: 10%;"></td> <td style="width: 10%;"></td> <td style="width: 10%;"></td> <td style="width: 10%;"></td> <td style="width: 10%;"></td> <td style="width: 10%;"></td> <td style="width: 10%;"></td> <td style="width: 10%;"></td> <td style="width: 10%;"></td> <td style="width: 10%;"></td> </tr> <tr> <td></td> <td></td> <td colspan="8" style="text-align: center;"> <table border="1" style="width: 100%; border-collapse: collapse; text-align: center;"> <tr> <td style="width: 10%;"></td> <td style="width: 10%;"></td> <td style="width: 10%;"></td> <td style="width: 10%;"></td> <td style="width: 10%;"></td> <td style="width: 10%;"></td> <td style="width: 10%;"></td> <td style="width: 10%;"></td> <td style="width: 10%;"></td> <td style="width: 10%;"></td> </tr> <tr> <td></td> <td></td> <td colspan="8" style="text-align: center;"> <table border="1" style="width: 100%; border-collapse: collapse; text-align: center;"> <tr> <td style="width: 10%;"></td> <td style="width: 10%;"></td> <td style="width: 10%;"></td> <td style="width: 10%;"></td> <td style="width: 10%;"></td> <td style="width: 10%;"></td> <td style="width: 10%;"></td> <td style="width: 10%;"></td> <td style="width: 10%;"></td> <td style="width: 10%;"></td> </tr> <tr> <td></td> <td></td> <td colspan="8" style="text-align: center;"> <table border="1" style="width: 100%; border-collapse: collapse; text-align: center;"> <tr> </tr></table></td></tr></table></td></tr></table></td></tr></table></td></tr></table></td></tr></table></td></tr></table></td></tr></table></td></tr></table></td></tr></table></td></tr></table></td></tr></table></td></tr></table></td></tr></table></td></tr></table></td></tr></table></td></tr></table></td></tr></table></td></tr></table></td></tr></table></td></tr></table></td></tr></table></td></tr></table></td></tr></table></td></tr></table></td></tr></table></td></tr></table></td></tr></table></td></tr></table></td></tr></table></td></tr></table></td></tr></table></td></tr></table></td></tr></table></td></tr></table></td></tr></table></td></tr></table></td></tr></table></td></tr></table></td></tr></table></td></tr></table>
 | | | | | | | | | | | | | | | | | | | | <table border="1" style="width: 100%; border-collapse: collapse; text-align: center;"> <tr> <td style="width: 10%;"></td> <td style="width: 10%;"></td> <td style="width: 10%;"></td> <td style="width: 10%;"></td> <td style="width: 10%;"></td> <td style="width: 10%;"></td> <td style="width: 10%;"></td> <td style="width: 10%;"></td> <td style="width: 10%;"></td> <td style="width: 10%;"></td> </tr> <tr> <td></td> <td></td> <td colspan="8" style="text-align: center;"> <table border="1" style="width: 100%; border-collapse: collapse; text-align: center;"> <tr> <td style="width: 10%;"></td> <td style="width: 10%;"></td> <td style="width: 10%;"></td> <td style="width: 10%;"></td> <td style="width: 10%;"></td> <td style="width: 10%;"></td> <td style="width: 10%;"></td> <td style="width: 10%;"></td> <td style="width: 10%;"></td> <td style="width: 10%;"></td> </tr> <tr> <td></td> <td></td> <td colspan="8" style="text-align: center;"> <table border="1" style="width: 100%; border-collapse: collapse; text-align: center;"> <tr> <td style="width: 10%;"></td> <td style="width: 10%;"></td> <td style="width: 10%;"></td> <td style="width: 10%;"></td> <td style="width: 10%;"></td> <td style="width: 10%;"></td> <td style="width: 10%;"></td> <td style="width: 10%;"></td> <td style="width: 10%;"></td> <td style="width: 10%;"></td> </tr> <tr> <td></td> <td></td> <td colspan="8" style="text-align: center;"> <table border="1" style="width: 100%; border-collapse: collapse; text-align: center;"> <tr> <td style="width: 10%;"></td> <td style="width: 10%;"></td> <td style="width: 10%;"></td> <td style="width: 10%;"></td> <td style="width: 10%;"></td> <td style="width: 10%;"></td> <td style="width: 10%;"></td> <td style="width: 10%;"></td> <td style="width: 10%;"></td> <td style="width: 10%;"></td> </tr> <tr> <td></td> <td></td> <td colspan="8" style="text-align: center;"> <table border="1" style="width: 100%; border-collapse: collapse; text-align: center;"> <tr> <td style="width: 10%;"></td> <td style="width: 10%;"></td> <td style="width: 10%;"></td> <td style="width: 10%;"></td> <td style="width: 10%;"></td> <td style="width: 10%;"></td> <td style="width: 10%;"></td> <td style="width: 10%;"></td> <td style="width: 10%;"></td> <td style="width: 10%;"></td> </tr> <tr> <td></td> <td></td> <td colspan="8" style="text-align: center;"> <table border="1" style="width: 100%; border-collapse: collapse; text-align: center;"> <tr> <td style="width: 10%;"></td> <td style="width: 10%;"></td> <td style="width: 10%;"></td> <td style="width: 10%;"></td> <td style="width: 10%;"></td> <td style="width: 10%;"></td> <td style="width: 10%;"></td> <td style="width: 10%;"></td> <td style="width: 10%;"></td> <td style="width: 10%;"></td> </tr> <tr> <td></td> <td></td> <td colspan="8" style="text-align: center;"> <table border="1" style="width: 100%; border-collapse: collapse; text-align: center;"> <tr> <td style="width: 10%;"></td> <td style="width: 10%;"></td> <td style="width: 10%;"></td> <td style="width: 10%;"></td> <td style="width: 10%;"></td> <td style="width: 10%;"></td> <td style="width: 10%;"></td> <td style="width: 10%;"></td> <td style="width: 10%;"></td> <td style="width: 10%;"></td> </tr> <tr> <td></td> <td></td> <td colspan="8" style="text-align: center;"> <table border="1" style="width: 100%; border-collapse: collapse; text-align: center;"> <tr> <td style="width: 10%;"></td> <td style="width: 10%;"></td> <td style="width: 10%;"></td> <td style="width: 10%;"></td> <td style="width: 10%;"></td> <td style="width: 10%;"></td> <td style="width: 10%;"></td> <td style="width: 10%;"></td> <td style="width: 10%;"></td> <td style="width: 10%;"></td> </tr> <tr> <td></td> <td></td> <td colspan="8" style="text-align: center;"> <table border="1" style="width: 100%; border-collapse: collapse; text-align: center;"> <tr> <td style="width: 10%;"></td> <td style="width: 10%;"></td> <td style="width: 10%;"></td> <td style="width: 10%;"></td> <td style="width: 10%;"></td> <td style="width: 10%;"></td> <td style="width: 10%;"></td> <td style="width: 10%;"></td> <td style="width: 10%;"></td> <td style="width: 10%;"></td> </tr> <tr> <td></td> <td></td> <td colspan="8" style="text-align: center;"> <table border="1" style="width: 100%; border-collapse: collapse; text-align: center;"> <tr> <td style="width: 10%;"></td> <td style="width: 10%;"></td> <td style="width: 10%;"></td> <td style="width: 10%;"></td> <td style="width: 10%;"></td> <td style="width: 10%;"></td> <td style="width: 10%;"></td> <td style="width: 10%;"></td> <td style="width: 10%;"></td> <td style="width: 10%;"></td> </tr> <tr> <td></td> <td></td> <td colspan="8" style="text-align: center;"> <table border="1" style="width: 100%; border-collapse: collapse; text-align: center;"> <tr> <td style="width: 10%;"></td> <td style="width: 10%;"></td> <td style="width: 10%;"></td> <td style="width: 10%;"></td> <td style="width: 10%;"></td> <td style="width: 10%;"></td> <td style="width: 10%;"></td> <td style="width: 10%;"></td> <td style="width: 10%;"></td> <td style="width: 10%;"></td> </tr> <tr> <td></td> <td></td> <td colspan="8" style="text-align: center;"> <table border="1" style="width: 100%; border-collapse: collapse; text-align: center;"> <tr> <td style="width: 10%;"></td> <td style="width: 10%;"></td> <td style="width: 10%;"></td> <td style="width: 10%;"></td> <td style="width: 10%;"></td> <td style="width: 10%;"></td> <td style="width: 10%;"></td> <td style="width: 10%;"></td> <td style="width: 10%;"></td> <td style="width: 10%;"></td> </tr> <tr> <td></td> <td></td> <td colspan="8" style="text-align: center;"> <table border="1" style="width: 100%; border-collapse: collapse; text-align: center;"> <tr> <td style="width: 10%;"></td> <td style="width: 10%;"></td> <td style="width: 10%;"></td> <td style="width: 10%;"></td> <td style="width: 10%;"></td> <td style="width: 10%;"></td> <td style="width: 10%;"></td> <td style="width: 10%;"></td> <td style="width: 10%;"></td> <td style="width: 10%;"></td> </tr> <tr> <td></td> <td></td> <td colspan="8" style="text-align: center;"> <table border="1" style="width: 100%; border-collapse: collapse; text-align: center;"> <tr> <td style="width: 10%;"></td> <td style="width: 10%;"></td> <td style="width: 10%;"></td> <td style="width: 10%;"></td> <td style="width: 10%;"></td> <td style="width: 10%;"></td> <td style="width: 10%;"></td> <td style="width: 10%;"></td> <td style="width: 10%;"></td> <td style="width: 10%;"></td> </tr> <tr> <td></td> <td></td> <td colspan="8" style="text-align: center;"> <table border="1" style="width: 100%; border-collapse: collapse; text-align: center;"> <tr> <td style="width: 10%;"></td> <td style="width: 10%;"></td> <td style="width: 10%;"></td> <td style="width: 10%;"></td> <td style="width: 10%;"></td> <td style="width: 10%;"></td> <td style="width: 10%;"></td> <td style="width: 10%;"></td> <td style="width: 10%;"></td> <td style="width: 10%;"></td> </tr> <tr> <td></td> <td></td> <td colspan="8" style="text-align: center;"> <table border="1" style="width: 100%; border-collapse: collapse; text-align: center;"> <tr> <td style="width: 10%;"></td> <td style="width: 10%;"></td> <td style="width: 10%;"></td> <td style="width: 10%;"></td> <td style="width: 10%;"></td> <td style="width: 10%;"></td> <td style="width: 10%;"></td> <td style="width: 10%;"></td> <td style="width: 10%;"></td> <td style="width: 10%;"></td> </tr> <tr> <td></td> <td></td> <td colspan="8" style="text-align: center;"> <table border="1" style="width: 100%; border-collapse: collapse; text-align: center;"> <tr> <td style="width: 10%;"></td> <td style="width: 10%;"></td> <td style="width: 10%;"></td> <td style="width: 10%;"></td> <td style="width: 10%;"></td> <td style="width: 10%;"></td> <td style="width: 10%;"></td> <td style="width: 10%;"></td> <td style="width: 10%;"></td> <td style="width: 10%;"></td> </tr> <tr> <td></td> <td></td> <td colspan="8" style="text-align: center;"> <table border="1" style="width: 100%; border-collapse: collapse; text-align: center;"> <tr> <td style="width: 10%;"></td> <td style="width: 10%;"></td> <td style="width: 10%;"></td> <td style="width: 10%;"></td> <td style="width: 10%;"></td> <td style="width: 10%;"></td> <td
style="width: 10%;"></td> <td style="width: 10%;"></td> <td style="width: 10%;"></td> <td style="width: 10%;"></td> </tr> <tr> <td></td> <td></td> <td colspan="8" style="text-align: center;"> <table border="1" style="width: 100%; border-collapse: collapse; text-align: center;"> <tr> <td style="width: 10%;"></td> <td style="width: 10%;"></td> <td style="width: 10%;"></td> <td style="width: 10%;"></td> <td style="width: 10%;"></td> <td style="width: 10%;"></td> <td style="width: 10%;"></td> <td style="width: 10%;"></td> <td style="width: 10%;"></td> <td style="width: 10%;"></td> </tr> <tr> <td></td> <td></td> <td colspan="8" style="text-align: center;"> <table border="1" style="width: 100%; border-collapse: collapse; text-align: center;"> <tr> <td style="width: 10%;"></td> <td style="width: 10%;"></td> <td style="width: 10%;"></td> <td style="width: 10%;"></td> <td style="width: 10%;"></td> <td style="width: 10%;"></td> <td style="width: 10%;"></td> <td style="width: 10%;"></td> <td style="width: 10%;"></td> <td style="width: 10%;"></td> </tr> <tr> <td></td> <td></td> <td colspan="8" style="text-align: center;"> <table border="1" style="width: 100%; border-collapse: collapse; text-align: center;"> <tr> <td style="width: 10%;"></td> <td style="width: 10%;"></td> <td style="width: 10%;"></td> <td style="width: 10%;"></td> <td style="width: 10%;"></td> <td style="width: 10%;"></td> <td style="width: 10%;"></td> <td style="width: 10%;"></td> <td style="width: 10%;"></td> <td style="width: 10%;"></td> </tr> <tr> <td></td> <td></td> <td colspan="8" style="text-align: center;"> <table border="1" style="width: 100%; border-collapse: collapse; text-align: center;"> <tr> <td style="width: 10%;"></td> <td style="width: 10%;"></td> <td style="width: 10%;"></td> <td style="width: 10%;"></td> <td style="width: 10%;"></td> <td style="width: 10%;"></td> <td style="width: 10%;"></td> <td style="width: 10%;"></td> <td style="width: 10%;"></td> <td style="width: 10%;"></td> </tr> <tr> <td></td> <td></td> <td colspan="8" style="text-align: center;"> <table border="1" style="width: 100%; border-collapse: collapse; text-align: center;"> <tr> <td style="width: 10%;"></td> <td style="width: 10%;"></td> <td style="width: 10%;"></td> <td style="width: 10%;"></td> <td style="width: 10%;"></td> <td style="width: 10%;"></td> <td style="width: 10%;"></td> <td style="width: 10%;"></td> <td style="width: 10%;"></td> <td style="width: 10%;"></td> </tr> <tr> <td></td> <td></td> <td colspan="8" style="text-align: center;"> <table border="1" style="width: 100%; border-collapse: collapse; text-align: center;"> <tr> <td style="width: 10%;"></td> <td style="width: 10%;"></td> <td style="width: 10%;"></td> <td style="width: 10%;"></td> <td style="width: 10%;"></td> <td style="width: 10%;"></td> <td style="width: 10%;"></td> <td style="width: 10%;"></td> <td style="width: 10%;"></td> <td style="width: 10%;"></td> </tr> <tr> <td></td> <td></td> <td colspan="8" style="text-align: center;"> <table border="1" style="width: 100%; border-collapse: collapse; text-align: center;"> <tr> <td style="width: 10%;"></td> <td style="width: 10%;"></td> <td style="width: 10%;"></td> <td style="width: 10%;"></td> <td style="width: 10%;"></td> <td style="width: 10%;"></td> <td style="width: 10%;"></td> <td style="width: 10%;"></td> <td style="width: 10%;"></td> <td style="width: 10%;"></td> </tr> <tr> <td></td> <td></td> <td colspan="8" style="text-align: center;"> <table border="1" style="width: 100%; border-collapse: collapse; text-align: center;"> <tr> <td style="width: 10%;"></td> <td style="width: 10%;"></td> <td style="width: 10%;"></td> <td style="width: 10%;"></td> <td style="width: 10%;"></td> <td style="width: 10%;"></td> <td style="width: 10%;"></td> <td style="width: 10%;"></td> <td style="width: 10%;"></td> <td style="width: 10%;"></td> </tr> <tr> <td></td> <td></td> <td colspan="8" style="text-align: center;"> <table border="1" style="width: 100%; border-collapse: collapse; text-align: center;"> <tr> <td style="width: 10%;"></td> <td style="width: 10%;"></td> <td style="width: 10%;"></td> <td style="width: 10%;"></td> <td style="width: 10%;"></td> <td style="width: 10%;"></td> <td style="width: 10%;"></td> <td style="width: 10%;"></td> <td style="width: 10%;"></td> <td style="width: 10%;"></td> </tr> <tr> <td></td> <td></td> <td colspan="8" style="text-align: center;"> <table border="1" style="width: 100%; border-collapse: collapse; text-align: center;"> <tr> <td style="width: 10%;"></td> <td style="width: 10%;"></td> <td style="width: 10%;"></td> <td style="width: 10%;"></td> <td style="width: 10%;"></td> <td style="width: 10%;"></td> <td style="width: 10%;"></td> <td style="width: 10%;"></td> <td style="width: 10%;"></td> <td style="width: 10%;"></td> </tr> <tr> <td></td> <td></td> <td colspan="8" style="text-align: center;"> <table border="1" style="width: 100%; border-collapse: collapse; text-align: center;"> <tr> <td style="width: 10%;"></td> <td style="width: 10%;"></td> <td style="width: 10%;"></td> <td style="width: 10%;"></td> <td style="width: 10%;"></td> <td style="width: 10%;"></td> <td style="width: 10%;"></td> <td style="width: 10%;"></td> <td style="width: 10%;"></td> <td style="width: 10%;"></td> </tr> <tr> <td></td> <td></td> <td colspan="8" style="text-align: center;"> <table border="1" style="width: 100%; border-collapse: collapse; text-align: center;"> <tr> <td style="width: 10%;"></td> <td style="width: 10%;"></td> <td style="width: 10%;"></td> <td style="width: 10%;"></td> <td style="width: 10%;"></td> <td style="width: 10%;"></td> <td style="width: 10%;"></td> <td style="width: 10%;"></td> <td style="width: 10%;"></td> <td style="width: 10%;"></td> </tr> <tr> <td></td> <td></td> <td colspan="8" style="text-align: center;"> <table border="1" style="width: 100%; border-collapse: collapse; text-align: center;"> <tr> <td style="width: 10%;"></td> <td style="width: 10%;"></td> <td style="width: 10%;"></td> <td style="width: 10%;"></td> <td style="width: 10%;"></td> <td style="width: 10%;"></td> <td style="width: 10%;"></td> <td style="width: 10%;"></td> <td style="width: 10%;"></td> <td style="width: 10%;"></td> </tr> <tr> <td></td> <td></td> <td colspan="8" style="text-align: center;"> <table border="1" style="width: 100%; border-collapse: collapse; text-align: center;"> <tr> <td style="width: 10%;"></td> <td style="width: 10%;"></td> <td style="width: 10%;"></td> <td style="width: 10%;"></td> <td style="width: 10%;"></td> <td style="width: 10%;"></td> <td style="width: 10%;"></td> <td style="width: 10%;"></td> <td style="width: 10%;"></td> <td style="width: 10%;"></td> </tr> <tr> <td></td> <td></td> <td colspan="8" style="text-align: center;"> <table border="1" style="width: 100%; border-collapse: collapse; text-align: center;"> <tr> <td style="width: 10%;"></td> <td style="width: 10%;"></td> <td style="width: 10%;"></td> <td style="width: 10%;"></td> <td style="width: 10%;"></td> <td style="width: 10%;"></td> <td style="width: 10%;"></td> <td style="width: 10%;"></td> <td style="width: 10%;"></td> <td style="width: 10%;"></td> </tr> <tr> <td></td> <td></td> <td colspan="8" style="text-align: center;"> <table border="1" style="width: 100%; border-collapse: collapse; text-align: center;"> <tr> <td style="width: 10%;"></td> <td style="width: 10%;"></td> <td style="width: 10%;"></td> <td style="width: 10%;"></td> <td style="width: 10%;"></td> <td style="width: 10%;"></td> <td style="width: 10%;"></td> <td style="width: 10%;"></td> <td style="width: 10%;"></td> <td style="width: 10%;"></td> </tr> <tr> <td></td> <td></td> <td colspan="8" style="text-align: center;"> <table border="1" style="width: 100%; border-collapse: collapse; text-align: center;"> <tr> <td style="width: 10%;"></td> <td style="width: 10%;"></td> <td style="width: 10%;"></td> <td style="width: 10%;"></td> <td style="width: 10%;"></td> <td style="width: 10%;"></td> <td style="width: 10%;"></td> <td style="width: 10%;"></td> <td style="width: 10%;"></td> <td style="width: 10%;"></td> </tr> <tr> <td></td> <td></td> <td colspan="8" style="text-align: center;"> <table border="1" style="width: 100%; border-collapse: collapse; text-align: center;"> <tr> <td style="width: 10%;"></td> <td style="width: 10%;"></td> <td style="width: 10%;"></td> <td style="width: 10%;"></td> <td style="width: 10%;"></td> <td style="width: 10%;"></td> <td style="width: 10%;"></td> <td style="width: 10%;"></td> <td style="width: 10%;"></td> <td style="width: 10%;"></td> </tr> <tr> <td></td> <td></td> <td colspan="8" style="text-align: center;"> <table border="1" style="width: 100%; border-collapse: collapse; text-align: center;"> <tr> <td style="width: 10%;"></td> <td style="width: 10%;"></td> <td style="width: 10%;"></td> <td style="width: 10%;"></td> <td style="width: 10%;"></td> <td style="width: 10%;"></td> <td style="width: 10%;"></td> <td style="width: 10%;"></td> <td style="width: 10%;"></td> <td style="width: 10%;"></td> </tr> <tr> <td></td> <td></td> <td colspan="8" style="text-align: center;"> <table border="1" style="width: 100%; border-collapse: collapse; text-align: center;"> <tr> <td style="width: 10%;"></td> <td style="width: 10%;"></td> <td style="width: 10%;"></td> <td style="width: 10%;"></td> <td style="width: 10%;"></td> <td style="width: 10%;"></td> <td style="width: 10%;"></td> <td style="width: 10%;"></td> <td style="width: 10%;"></td> <td style="width: 10%;"></td> </tr> <tr> <td></td> <td></td> <td colspan="8" style="text-align: center;"> <table border="1" style="width: 100%; border-collapse: collapse; text-align: center;"> <tr> <td style="width: 10%;"></td> <td style="width: 10%;"></td> <td style="width: 10%;"></td> <td style="width: 10%;"></td> <td style="width: 10%;"></td> <td style="width: 10%;"></td> <td style="width: 10%;"></td> <td style="width: 10%;"></td> <td style="width: 10%;"></td> <td style="width: 10%;"></td> </tr> <tr> <td></td> <td></td> <td colspan="8"
style="text-align: center;"> <table border="1" style="width: 100%; border-collapse: collapse; text-align: center;"> <tr> </tr></table></td></tr></table></td></tr></table></td></tr></table></td></tr></table></td></tr></table></td></tr></table></td></tr></table></td></tr></table></td></tr></table></td></tr></table></td></tr></table></td></tr></table></td></tr></table></td></tr></table></td></tr></table></td></tr></table></td></tr></table></td></tr></table></td></tr></table></td></tr></table></td></tr></table></td></tr></table></td></tr></table></td></tr></table></td></tr></table></td></tr></table></td></tr></table></td></tr></table></td></tr></table></td></tr></table></td></tr></table></td></tr></table></td></tr></table></td></tr></table></td></tr></table></td></tr></table></td></tr></table></td></tr></table></td></tr></table> | | | | | | | | | | | | | | | | | | | | <table border="1" style="width: 100%; border-collapse: collapse; text-align: center;"> <tr> <td style="width: 10%;"></td> <td style="width: 10%;"></td> <td style="width: 10%;"></td> <td style="width: 10%;"></td> <td style="width: 10%;"></td> <td style="width: 10%;"></td> <td style="width: 10%;"></td> <td style="width: 10%;"></td> <td style="width: 10%;"></td> <td style="width: 10%;"></td> </tr> <tr> <td></td> <td></td> <td colspan="8" style="text-align: center;"> <table border="1" style="width: 100%; border-collapse: collapse; text-align: center;"> <tr> <td style="width: 10%;"></td> <td style="width: 10%;"></td> <td style="width: 10%;"></td> <td style="width: 10%;"></td> <td style="width: 10%;"></td> <td style="width: 10%;"></td> <td style="width: 10%;"></td> <td style="width: 10%;"></td> <td style="width: 10%;"></td> <td style="width: 10%;"></td> </tr> <tr> <td></td> <td></td> <td colspan="8" style="text-align: center;"> <table border="1" style="width: 100%; border-collapse: collapse; text-align: center;"> <tr> <td style="width: 10%;"></td> <td style="width: 10%;"></td> <td style="width: 10%;"></td> <td style="width: 10%;"></td> <td style="width: 10%;"></td> <td style="width: 10%;"></td> <td style="width: 10%;"></td> <td style="width: 10%;"></td> <td style="width: 10%;"></td> <td style="width: 10%;"></td> </tr> <tr> <td></td> <td></td> <td colspan="8" style="text-align: center;"> <table border="1" style="width: 100%; border-collapse: collapse; text-align: center;"> <tr> <td style="width: 10%;"></td> <td style="width: 10%;"></td> <td style="width: 10%;"></td> <td style="width: 10%;"></td> <td style="width: 10%;"></td> <td style="width: 10%;"></td> <td style="width: 10%;"></td> <td style="width: 10%;"></td> <td style="width: 10%;"></td> <td style="width: 10%;"></td> </tr> <tr> <td></td> <td></td> <td colspan="8" style="text-align: center;"> <table border="1" style="width: 100%; border-collapse: collapse; text-align: center;"> <tr> <td style="width: 10%;"></td> <td style="width: 10%;"></td> <td style="width: 10%;"></td> <td style="width: 10%;"></td> <td style="width: 10%;"></td> <td style="width: 10%;"></td> <td style="width: 10%;"></td> <td style="width: 10%;"></td> <td style="width: 10%;"></td> <td style="width: 10%;"></td> </tr> <tr> <td></td> <td></td> <td colspan="8" style="text-align: center;"> <table border="1" style="width: 100%; border-collapse: collapse; text-align: center;"> <tr> <td style="width: 10%;"></td> <td style="width: 10%;"></td> <td style="width: 10%;"></td> <td style="width: 10%;"></td> <td style="width: 10%;"></td> <td style="width: 10%;"></td> <td style="width: 10%;"></td> <td style="width: 10%;"></td> <td style="width: 10%;"></td> <td style="width: 10%;"></td> </tr> <tr> <td></td> <td></td> <td colspan="8" style="text-align: center;"> <table border="1" style="width: 100%; border-collapse: collapse; text-align: center;"> <tr> <td style="width: 10%;"></td> <td style="width: 10%;"></td> <td style="width: 10%;"></td> <td style="width: 10%;"></td> <td style="width: 10%;"></td> <td style="width: 10%;"></td> <td style="width: 10%;"></td> <td style="width: 10%;"></td> <td style="width: 10%;"></td> <td style="width: 10%;"></td> </tr> <tr> <td></td> <td></td> <td colspan="8" style="text-align: center;"> <table border="1" style="width: 100%; border-collapse: collapse; text-align: center;"> <tr> <td style="width: 10%;"></td> <td style="width: 10%;"></td> <td style="width: 10%;"></td> <td style="width: 10%;"></td> <td style="width: 10%;"></td> <td style="width: 10%;"></td> <td style="width: 10%;"></td> <td style="width: 10%;"></td> <td style="width: 10%;"></td> <td style="width: 10%;"></td> </tr> <tr> <td></td> <td></td> <td colspan="8" style="text-align: center;"> <table border="1" style="width: 100%; border-collapse: collapse; text-align: center;"> <tr> <td style="width: 10%;"></td> <td style="width: 10%;"></td> <td style="width: 10%;"></td> <td style="width: 10%;"></td> <td style="width: 10%;"></td> <td style="width: 10%;"></td> <td style="width: 10%;"></td> <td style="width: 10%;"></td> <td style="width: 10%;"></td> <td style="width: 10%;"></td> </tr> <tr> <td></td> <td></td> <td colspan="8" style="text-align: center;"> <table border="1" style="width: 100%; border-collapse: collapse; text-align: center;"> <tr> <td style="width: 10%;"></td> <td style="width: 10%;"></td> <td style="width: 10%;"></td> <td style="width: 10%;"></td> <td style="width: 10%;"></td> <td style="width: 10%;"></td> <td style="width: 10%;"></td> <td style="width: 10%;"></td> <td style="width: 10%;"></td> <td style="width: 10%;"></td> </tr> <tr> <td></td> <td></td> <td colspan="8" style="text-align: center;"> <table border="1" style="width: 100%; border-collapse: collapse; text-align: center;"> <tr> <td style="width: 10%;"></td> <td style="width: 10%;"></td> <td style="width: 10%;"></td> <td style="width: 10%;"></td> <td style="width: 10%;"></td> <td style="width: 10%;"></td> <td style="width: 10%;"></td> <td style="width: 10%;"></td> <td style="width: 10%;"></td> <td style="width: 10%;"></td> </tr> <tr> <td></td> <td></td> <td colspan="8" style="text-align: center;"> <table border="1" style="width: 100%; border-collapse: collapse; text-align: center;"> <tr> <td style="width: 10%;"></td> <td style="width: 10%;"></td> <td style="width: 10%;"></td> <td style="width: 10%;"></td> <td style="width: 10%;"></td> <td style="width: 10%;"></td> <td style="width: 10%;"></td> <td style="width: 10%;"></td> <td style="width: 10%;"></td> <td style="width: 10%;"></td> </tr> <tr> <td></td> <td></td> <td colspan="8" style="text-align: center;"> <table border="1" style="width: 100%; border-collapse: collapse; text-align: center;"> <tr> <td style="width: 10%;"></td> <td style="width: 10%;"></td> <td style="width: 10%;"></td> <td style="width: 10%;"></td> <td style="width: 10%;"></td> <td style="width: 10%;"></td> <td style="width: 10%;"></td> <td style="width: 10%;"></td> <td style="width: 10%;"></td> <td style="width: 10%;"></td> </tr> <tr> <td></td> <td></td> <td colspan="8" style="text-align: center;"> <table border="1" style="width: 100%; border-collapse: collapse; text-align: center;"> <tr> <td
style="width: 10%;"></td> <td style="width: 10%;"></td> <td style="width: 10%;"></td> <td style="width: 10%;"></td> <td style="width: 10%;"></td> <td style="width: 10%;"></td> <td style="width: 10%;"></td> <td style="width: 10%;"></td> <td style="width: 10%;"></td> <td style="width: 10%;"></td> </tr> <tr> <td></td> <td></td> <td colspan="8" style="text-align: center;"> <table border="1" style="width: 100%; border-collapse: collapse; text-align: center;"> <tr> <td style="width: 10%;"></td> <td style="width: 10%;"></td> <td style="width: 10%;"></td> <td style="width: 10%;"></td> <td style="width: 10%;"></td> <td style="width: 10%;"></td> <td style="width: 10%;"></td> <td style="width: 10%;"></td> <td style="width: 10%;"></td> <td style="width: 10%;"></td> </tr> <tr> <td></td> <td></td> <td colspan="8" style="text-align: center;"> <table border="1" style="width: 100%; border-collapse: collapse; text-align: center;"> <tr> <td style="width: 10%;"></td> <td style="width: 10%;"></td> <td style="width: 10%;"></td> <td style="width: 10%;"></td> <td style="width: 10%;"></td> <td style="width: 10%;"></td> <td style="width: 10%;"></td> <td style="width: 10%;"></td> <td style="width: 10%;"></td> <td style="width: 10%;"></td> </tr> <tr> <td></td> <td></td> <td colspan="8" style="text-align: center;"> <table border="1" style="width: 100%; border-collapse: collapse; text-align: center;"> <tr> <td style="width: 10%;"></td> <td style="width: 10%;"></td> <td style="width: 10%;"></td> <td style="width: 10%;"></td> <td style="width: 10%;"></td> <td style="width: 10%;"></td> <td style="width: 10%;"></td> <td style="width: 10%;"></td> <td style="width: 10%;"></td> <td style="width: 10%;"></td> </tr> <tr> <td></td> <td></td> <td colspan="8" style="text-align: center;"> <table border="1" style="width: 100%; border-collapse: collapse; text-align: center;"> <tr> <td style="width: 10%;"></td> <td style="width: 10%;"></td> <td style="width: 10%;"></td> <td style="width: 10%;"></td> <td style="width: 10%;"></td> <td style="width: 10%;"></td> <td style="width: 10%;"></td> <td style="width: 10%;"></td> <td style="width: 10%;"></td> <td style="width: 10%;"></td> </tr> <tr> <td></td> <td></td> <td colspan="8" style="text-align: center;"> <table border="1" style="width: 100%; border-collapse: collapse; text-align: center;"> <tr> <td style="width: 10%;"></td> <td style="width: 10%;"></td> <td style="width: 10%;"></td> <td style="width: 10%;"></td> <td style="width: 10%;"></td> <td style="width: 10%;"></td> <td style="width: 10%;"></td> <td style="width: 10%;"></td> <td style="width: 10%;"></td> <td style="width: 10%;"></td> </tr> <tr> <td></td> <td></td> <td colspan="8" style="text-align: center;"> <table border="1" style="width: 100%; border-collapse: collapse; text-align: center;"> <tr> <td style="width: 10%;"></td> <td style="width: 10%;"></td> <td style="width: 10%;"></td> <td style="width: 10%;"></td> <td style="width: 10%;"></td> <td style="width: 10%;"></td> <td style="width: 10%;"></td> <td style="width: 10%;"></td> <td style="width: 10%;"></td> <td style="width: 10%;"></td> </tr> <tr> <td></td> <td></td> <td colspan="8" style="text-align: center;"> <table border="1" style="width: 100%; border-collapse: collapse; text-align: center;"> <tr> <td style="width: 10%;"></td> <td style="width: 10%;"></td> <td style="width: 10%;"></td> <td style="width: 10%;"></td> <td style="width: 10%;"></td> <td style="width: 10%;"></td> <td style="width: 10%;"></td> <td style="width: 10%;"></td> <td style="width: 10%;"></td> <td style="width: 10%;"></td> </tr> <tr> <td></td> <td></td> <td colspan="8" style="text-align: center;"> <table border="1" style="width: 100%; border-collapse: collapse; text-align: center;"> <tr> <td style="width: 10%;"></td> <td style="width: 10%;"></td> <td style="width: 10%;"></td> <td style="width: 10%;"></td> <td style="width: 10%;"></td> <td style="width: 10%;"></td> <td style="width: 10%;"></td> <td style="width: 10%;"></td> <td style="width: 10%;"></td> <td style="width: 10%;"></td> </tr> <tr> <td></td> <td></td> <td colspan="8" style="text-align: center;"> <table border="1" style="width: 100%; border-collapse: collapse; text-align: center;"> <tr> <td style="width: 10%;"></td> <td style="width: 10%;"></td> <td style="width: 10%;"></td> <td style="width: 10%;"></td> <td style="width: 10%;"></td> <td style="width: 10%;"></td> <td style="width: 10%;"></td> <td style="width: 10%;"></td> <td style="width: 10%;"></td> <td style="width: 10%;"></td> </tr> <tr> <td></td> <td></td> <td colspan="8" style="text-align: center;"> <table border="1" style="width: 100%; border-collapse: collapse; text-align: center;"> <tr> <td style="width: 10%;"></td> <td style="width: 10%;"></td> <td style="width: 10%;"></td> <td style="width: 10%;"></td> <td style="width: 10%;"></td> <td style="width: 10%;"></td> <td style="width: 10%;"></td> <td style="width: 10%;"></td> <td style="width: 10%;"></td> <td style="width: 10%;"></td> </tr> <tr> <td></td> <td></td> <td colspan="8" style="text-align: center;"> <table border="1" style="width: 100%; border-collapse: collapse; text-align: center;"> <tr> <td style="width: 10%;"></td> <td style="width: 10%;"></td> <td style="width: 10%;"></td> <td style="width: 10%;"></td> <td style="width: 10%;"></td> <td style="width: 10%;"></td> <td style="width: 10%;"></td> <td style="width: 10%;"></td> <td style="width: 10%;"></td> <td style="width: 10%;"></td> </tr> <tr> <td></td> <td></td> <td colspan="8" style="text-align: center;"> <table border="1" style="width: 100%; border-collapse: collapse; text-align: center;"> <tr> <td style="width: 10%;"></td> <td style="width: 10%;"></td> <td style="width: 10%;"></td> <td style="width: 10%;"></td> <td style="width: 10%;"></td> <td style="width: 10%;"></td> <td style="width: 10%;"></td> <td style="width: 10%;"></td> <td style="width: 10%;"></td> <td style="width: 10%;"></td> </tr> <tr> <td></td> <td></td> <td colspan="8" style="text-align: center;"> <table border="1" style="width: 100%; border-collapse: collapse; text-align: center;"> <tr> <td style="width: 10%;"></td> <td style="width: 10%;"></td> <td style="width: 10%;"></td> <td style="width: 10%;"></td> <td style="width: 10%;"></td> <td style="width: 10%;"></td> <td style="width: 10%;"></td> <td style="width: 10%;"></td> <td style="width: 10%;"></td> <td style="width: 10%;"></td> </tr> <tr> <td></td> <td></td> <td colspan="8" style="text-align: center;"> <table border="1" style="width: 100%; border-collapse: collapse; text-align: center;"> <tr> <td style="width: 10%;"></td> <td style="width: 10%;"></td> <td style="width: 10%;"></td> <td style="width: 10%;"></td> <td style="width: 10%;"></td> <td style="width: 10%;"></td> <td style="width: 10%;"></td> <td style="width: 10%;"></td> <td style="width: 10%;"></td> <td style="width: 10%;"></td> </tr> <tr> <td></td> <td></td> <td colspan="8" style="text-align: center;"> <table border="1" style="width: 100%; border-collapse: collapse; text-align: center;"> <tr> <td style="width: 10%;"></td> <td style="width: 10%;"></td> <td style="width: 10%;"></td> <td style="width: 10%;"></td> <td style="width: 10%;"></td> <td style="width: 10%;"></td> <td style="width: 10%;"></td> <td style="width: 10%;"></td> <td style="width: 10%;"></td> <td style="width: 10%;"></td> </tr> <tr> <td></td> <td></td> <td colspan="8" style="text-align: center;"> <table border="1" style="width: 100%; border-collapse: collapse; text-align: center;"> <tr> <td style="width: 10%;"></td> <td style="width: 10%;"></td> <td style="width: 10%;"></td> <td style="width: 10%;"></td> <td style="width: 10%;"></td> <td style="width: 10%;"></td> <td style="width: 10%;"></td> <td style="width: 10%;"></td> <td style="width: 10%;"></td> <td style="width: 10%;"></td> </tr> <tr> <td></td> <td></td> <td colspan="8" style="text-align: center;"> <table border="1" style="width: 100%; border-collapse: collapse; text-align: center;"> <tr> <td style="width: 10%;"></td> <td style="width: 10%;"></td> <td style="width: 10%;"></td> <td style="width: 10%;"></td> <td style="width: 10%;"></td> <td style="width: 10%;"></td> <td style="width: 10%;"></td> <td style="width: 10%;"></td> <td style="width: 10%;"></td> <td style="width: 10%;"></td> </tr> <tr> <td></td> <td></td> <td colspan="8" style="text-align: center;"> <table border="1" style="width: 100%; border-collapse: collapse; text-align: center;"> <tr> <td style="width: 10%;"></td> <td style="width: 10%;"></td> <td style="width: 10%;"></td> <td style="width: 10%;"></td> <td style="width: 10%;"></td> <td style="width: 10%;"></td> <td style="width: 10%;"></td> <td style="width: 10%;"></td> <td style="width: 10%;"></td> <td style="width: 10%;"></td> </tr> <tr> <td></td> <td></td> <td colspan="8" style="text-align: center;"> <table border="1" style="width: 100%; border-collapse: collapse; text-align: center;"> <tr> <td style="width: 10%;"></td> <td style="width: 10%;"></td> <td style="width: 10%;"></td> <td style="width: 10%;"></td> <td style="width: 10%;"></td> <td style="width: 10%;"></td> <td style="width: 10%;"></td> <td style="width: 10%;"></td> <td style="width: 10%;"></td> <td style="width: 10%;"></td> </tr> <tr> <td></td> <td></td> <td colspan="8" style="text-align: center;"> <table border="1" style="width: 100%; border-collapse: collapse; text-align: center;"> <tr> <td style="width: 10%;"></td> <td style="width: 10%;"></td> <td style="width: 10%;"></td> <td style="width: 10%;"></td> <td style="width: 10%;"></td> <td style="width: 10%;"></td> <td style="width: 10%;"></td> <td style="width: 10%;"></td> <td style="width: 10%;"></td> <td style="width: 10%;"></td> </tr> <tr> <td></td> <td></td> <td colspan="8" style="text-align: center;"> <table border="1" style="width: 100%; border-collapse: collapse; text-align: center;"> <tr> <td style="width: 10%;"></td> <td style="width: 10%;"></td> <td style="width: 10%;"></td> <td style="width: 10%;"></td> <td style="width: 10%;"></td> <td style="width:
10%;"></td> <td style="width: 10%;"></td> <td style="width: 10%;"></td> <td style="width: 10%;"></td> <td style="width: 10%;"></td> </tr> <tr> <td></td> <td></td> <td colspan="8" style="text-align: center;"> <table border="1" style="width: 100%; border-collapse: collapse; text-align: center;"> <tr> <td style="width: 10%;"></td> <td style="width: 10%;"></td> <td style="width: 10%;"></td> <td style="width: 10%;"></td> <td style="width: 10%;"></td> <td style="width: 10%;"></td> <td style="width: 10%;"></td> <td style="width: 10%;"></td> <td style="width: 10%;"></td> <td style="width: 10%;"></td> </tr> <tr> <td></td> <td></td> <td colspan="8" style="text-align: center;"> <table border="1" style="width: 100%; border-collapse: collapse; text-align: center;"> <tr> <td style="width: 10%;"></td> <td style="width: 10%;"></td> <td style="width: 10%;"></td> <td style="width: 10%;"></td> <td style="width: 10%;"></td> <td style="width: 10%;"></td> <td style="width: 10%;"></td> <td style="width: 10%;"></td> <td style="width: 10%;"></td> <td style="width: 10%;"></td> </tr> <tr> <td></td> <td></td> <td colspan="8" style="text-align: center;"> <table border="1" style="width: 100%; border-collapse: collapse; text-align: center;"> <tr> <td style="width: 10%;"></td> <td style="width: 10%;"></td> <td style="width: 10%;"></td> <td style="width: 10%;"></td> <td style="width: 10%;"></td> <td style="width: 10%;"></td> <td style="width: 10%;"></td> <td style="width: 10%;"></td> <td style="width: 10%;"></td> <td style="width: 10%;"></td> </tr> <tr> <td></td> <td></td> <td colspan="8" style="text-align: center;"> <table border="1" style="width: 100%; border-collapse: collapse; text-align: center;"> <tr> </tr></table></td></tr></table></td></tr></table></td></tr></table></td></tr></table></td></tr></table></td></tr></table></td></tr></table></td></tr></table></td></tr></table></td></tr></table></td></tr></table></td></tr></table></td></tr></table></td></tr></table></td></tr></table></td></tr></table></td></tr></table></td></tr></table></td></tr></table></td></tr></table></td></tr></table></td></tr></table></td></tr></table></td></tr></table></td></tr></table></td></tr></table></td></tr></table></td></tr></table></td></tr></table></td></tr></table></td></tr></table></td></tr></table></td></tr></table></td></tr></table></td></tr></table></td></tr></table></td></tr></table></td></tr></table> | | | | | | | | | | | | | | | | | | | | <table border="1" style="width: 100%; border-collapse: collapse; text-align: center;"> <tr> <td style="width: 10%;"></td> <td style="width: 10%;"></td> <td style="width: 10%;"></td> <td style="width: 10%;"></td> <td style="width: 10%;"></td> <td style="width: 10%;"></td> <td style="width: 10%;"></td> <td style="width: 10%;"></td> <td style="width: 10%;"></td> <td style="width: 10%;"></td> </tr> <tr> <td></td> <td></td> <td colspan="8" style="text-align: center;"> <table border="1" style="width: 100%; border-collapse: collapse; text-align: center;"> <tr> <td style="width: 10%;"></td> <td style="width: 10%;"></td> <td style="width: 10%;"></td> <td style="width: 10%;"></td> <td style="width: 10%;"></td> <td style="width: 10%;"></td> <td style="width: 10%;"></td> <td style="width: 10%;"></td> <td style="width: 10%;"></td> <td style="width: 10%;"></td> </tr> <tr> <td></td> <td></td> <td colspan="8" style="text-align: center;"> <table border="1" style="width: 100%; border-collapse: collapse; text-align: center;"> <tr> <td style="width: 10%;"></td> <td style="width: 10%;"></td> <td style="width: 10%;"></td> <td style="width: 10%;"></td> <td style="width: 10%;"></td> <td style="width: 10%;"></td> <td style="width: 10%;"></td> <td style="width: 10%;"></td> <td style="width: 10%;"></td> <td style="width: 10%;"></td> </tr> <tr> <td></td> <td></td> <td colspan="8" style="text-align: center;"> <table border="1" style="width: 100%; border-collapse: collapse; text-align: center;"> <tr> <td style="width: 10%;"></td> <td style="width: 10%;"></td> <td style="width: 10%;"></td> <td style="width: 10%;"></td> <td style="width: 10%;"></td> <td style="width: 10%;"></td> <td style="width: 10%;"></td> <td style="width: 10%;"></td> <td style="width: 10%;"></td> <td style="width: 10%;"></td> </tr> <tr> <td></td> <td></td> <td colspan="8" style="text-align: center;"> <table border="1" style="width: 100%; border-collapse: collapse; text-align: center;"> <tr> <td style="width: 10%;"></td> <td style="width: 10%;"></td> <td style="width: 10%;"></td> <td style="width: 10%;"></td> <td style="width: 10%;"></td> <td style="width: 10%;"></td> <td style="width: 10%;"></td> <td style="width: 10%;"></td> <td style="width: 10%;"></td> <td style="width: 10%;"></td> </tr> <tr> <td></td> <td></td> <td colspan="8" style="text-align: center;"> <table border="1" style="width: 100%; border-collapse: collapse; text-align: center;"> <tr> <td style="width: 10%;"></td> <td style="width: 10%;"></td> <td style="width: 10%;"></td> <td style="width: 10%;"></td> <td style="width: 10%;"></td> <td style="width: 10%;"></td> <td style="width: 10%;"></td> <td style="width: 10%;"></td> <td style="width: 10%;"></td> <td style="width: 10%;"></td> </tr> <tr> <td></td> <td></td> <td colspan="8" style="text-align: center;"> <table border="1" style="width: 100%; border-collapse: collapse; text-align: center;"> <tr> <td style="width: 10%;"></td> <td style="width: 10%;"></td> <td style="width: 10%;"></td> <td style="width: 10%;"></td> <td style="width: 10%;"></td> <td style="width: 10%;"></td> <td style="width: 10%;"></td> <td style="width: 10%;"></td> <td style="width: 10%;"></td> <td style="width: 10%;"></td> </tr> <tr> <td></td> <td></td> <td colspan="8" style="text-align: center;"> <table border="1" style="width: 100%; border-collapse: collapse; text-align: center;"> <tr> <td style="width: 10%;"></td> <td style="width: 10%;"></td> <td style="width: 10%;"></td> <td style="width: 10%;"></td> <td style="width: 10%;"></td> <td style="width: 10%;"></td> <td style="width: 10%;"></td> <td style="width: 10%;"></td> <td style="width: 10%;"></td> <td style="width: 10%;"></td> </tr> <tr> <td></td> <td></td> <td colspan="8" style="text-align: center;"> <table border="1" style="width: 100%; border-collapse: collapse; text-align: center;"> <tr> <td style="width: 10%;"></td> <td style="width: 10%;"></td> <td style="width: 10%;"></td> <td style="width: 10%;"></td> <td style="width: 10%;"></td> <td style="width: 10%;"></td> <td style="width: 10%;"></td> <td style="width: 10%;"></td> <td style="width: 10%;"></td> <td style="width: 10%;"></td> </tr> <tr> <td></td> <td></td> <td colspan="8" style="text-align: center;"> <table border="1" style="width: 100%; border-collapse: collapse; text-align: center;"> <tr> <td style="width: 10%;"></td> <td style="width: 10%;"></td> <td style="width: 10%;"></td> <td style="width: 10%;"></td> <td style="width: 10%;"></td> <td style="width: 10%;"></td> <td style="width: 10%;"></td> <td style="width: 10%;"></td> <td style="width: 10%;"></td> <td style="width: 10%;"></td> </tr> <tr>
<td></td> <td></td> <td colspan="8" style="text-align: center;"> <table border="1" style="width: 100%; border-collapse: collapse; text-align: center;"> <tr> <td style="width: 10%;"></td> <td style="width: 10%;"></td> <td style="width: 10%;"></td> <td style="width: 10%;"></td> <td style="width: 10%;"></td> <td style="width: 10%;"></td> <td style="width: 10%;"></td> <td style="width: 10%;"></td> <td style="width: 10%;"></td> <td style="width: 10%;"></td> </tr> <tr> <td></td> <td></td> <td colspan="8" style="text-align: center;"> <table border="1" style="width: 100%; border-collapse: collapse; text-align: center;"> <tr> <td style="width: 10%;"></td> <td style="width: 10%;"></td> <td style="width: 10%;"></td> <td style="width: 10%;"></td> <td style="width: 10%;"></td> <td style="width: 10%;"></td> <td style="width: 10%;"></td> <td style="width: 10%;"></td> <td style="width: 10%;"></td> <td style="width: 10%;"></td> </tr> <tr> <td></td> <td></td> <td colspan="8" style="text-align: center;"> <table border="1" style="width: 100%; border-collapse: collapse; text-align: center;"> <tr> <td style="width: 10%;"></td> <td style="width: 10%;"></td> <td style="width: 10%;"></td> <td style="width: 10%;"></td> <td style="width: 10%;"></td> <td style="width: 10%;"></td> <td style="width: 10%;"></td> <td style="width: 10%;"></td> <td style="width: 10%;"></td> <td style="width: 10%;"></td> </tr> <tr> <td></td> <td></td> <td colspan="8" style="text-align: center;"> <table border="1" style="width: 100%; border-collapse: collapse; text-align: center;"> <tr> <td style="width: 10%;"></td> <td style="width: 10%;"></td> <td style="width: 10%;"></td> <td style="width: 10%;"></td> <td style="width: 10%;"></td> <td style="width: 10%;"></td> <td style="width: 10%;"></td> <td style="width: 10%;"></td> <td style="width: 10%;"></td> <td style="width: 10%;"></td> </tr> <tr> <td></td> <td></td> <td colspan="8" style="text-align: center;"> <table border="1" style="width: 100%; border-collapse: collapse; text-align: center;"> <tr> <td style="width: 10%;"></td> <td style="width: 10%;"></td> <td style="width: 10%;"></td> <td style="width: 10%;"></td> <td style="width: 10%;"></td> <td style="width: 10%;"></td> <td style="width: 10%;"></td> <td style="width: 10%;"></td> <td style="width: 10%;"></td> <td style="width: 10%;"></td> </tr> <tr> <td></td> <td></td> <td colspan="8" style="text-align: center;"> <table border="1" style="width: 100%; border-collapse: collapse; text-align: center;"> <tr> <td style="width: 10%;"></td> <td style="width: 10%;"></td> <td style="width: 10%;"></td> <td style="width: 10%;"></td> <td style="width: 10%;"></td> <td style="width: 10%;"></td> <td style="width: 10%;"></td> <td style="width: 10%;"></td> <td style="width: 10%;"></td> <td style="width: 10%;"></td> </tr> <tr> <td></td> <td></td> <td colspan="8" style="text-align: center;"> <table border="1" style="width: 100%; border-collapse: collapse; text-align: center;"> <tr> <td style="width: 10%;"></td> <td style="width: 10%;"></td> <td style="width: 10%;"></td> <td style="width: 10%;"></td> <td style="width: 10%;"></td> <td style="width: 10%;"></td> <td style="width: 10%;"></td> <td style="width: 10%;"></td> <td style="width: 10%;"></td> <td style="width: 10%;"></td> </tr> <tr> <td></td> <td></td> <td colspan="8" style="text-align: center;"> <table border="1" style="width: 100%; border-collapse: collapse; text-align: center;"> <tr> <td style="width: 10%;"></td> <td style="width: 10%;"></td> <td style="width: 10%;"></td> <td style="width: 10%;"></td> <td style="width: 10%;"></td> <td style="width: 10%;"></td> <td style="width: 10%;"></td> <td style="width: 10%;"></td> <td style="width: 10%;"></td> <td style="width: 10%;"></td> </tr> <tr> <td></td> <td></td> <td colspan="8" style="text-align: center;"> <table border="1" style="width: 100%; border-collapse: collapse; text-align: center;"> <tr> <td style="width: 10%;"></td> <td style="width: 10%;"></td> <td style="width: 10%;"></td> <td style="width: 10%;"></td> <td style="width: 10%;"></td> <td style="width: 10%;"></td> <td style="width: 10%;"></td> <td style="width: 10%;"></td> <td style="width: 10%;"></td> <td style="width: 10%;"></td> </tr> <tr> <td></td> <td></td> <td colspan="8" style="text-align: center;"> <table border="1" style="width: 100%; border-collapse: collapse; text-align: center;"> <tr> <td style="width: 10%;"></td> <td style="width: 10%;"></td> <td style="width: 10%;"></td> <td style="width: 10%;"></td> <td style="width: 10%;"></td> <td style="width: 10%;"></td> <td style="width: 10%;"></td> <td style="width: 10%;"></td> <td style="width: 10%;"></td> <td style="width: 10%;"></td> </tr> <tr> <td></td> <td></td> <td colspan="8" style="text-align: center;"> <table border="1" style="width: 100%; border-collapse: collapse; text-align: center;"> <tr> <td style="width: 10%;"></td> <td style="width: 10%;"></td> <td style="width: 10%;"></td> <td style="width: 10%;"></td> <td style="width: 10%;"></td> <td style="width: 10%;"></td> <td style="width: 10%;"></td> <td style="width: 10%;"></td> <td style="width: 10%;"></td> <td style="width: 10%;"></td> </tr> <tr> <td></td> <td></td> <td colspan="8" style="text-align: center;"> <table border="1" style="width: 100%; border-collapse: collapse; text-align: center;"> <tr> <td style="width: 10%;"></td> <td style="width: 10%;"></td> <td style="width: 10%;"></td> <td style="width: 10%;"></td> <td style="width: 10%;"></td> <td style="width: 10%;"></td> <td style="width: 10%;"></td> <td style="width: 10%;"></td> <td style="width: 10%;"></td> <td style="width: 10%;"></td> </tr> <tr> <td></td> <td></td> <td colspan="8" style="text-align: center;"> <table border="1" style="width: 100%; border-collapse: collapse; text-align: center;"> <tr> <td style="width: 10%;"></td> <td style="width: 10%;"></td> <td style="width: 10%;"></td> <td style="width: 10%;"></td> <td style="width: 10%;"></td> <td style="width: 10%;"></td> <td style="width: 10%;"></td> <td style="width: 10%;"></td> <td style="width: 10%;"></td> <td style="width: 10%;"></td> </tr> <tr> <td></td> <td></td> <td colspan="8" style="text-align: center;"> <table border="1" style="width: 100%; border-collapse: collapse; text-align: center;"> <tr> <td style="width: 10%;"></td> <td style="width: 10%;"></td> <td style="width: 10%;"></td> <td style="width: 10%;"></td> <td style="width: 10%;"></td> <td style="width: 10%;"></td> <td style="width: 10%;"></td> <td style="width: 10%;"></td> <td style="width: 10%;"></td> <td style="width: 10%;"></td> </tr> <tr> <td></td> <td></td> <td colspan="8" style="text-align: center;"> <table border="1" style="width: 100%; border-collapse: collapse; text-align: center;"> <tr> <td style="width: 10%;"></td> <td style="width: 10%;"></td> <td style="width: 10%;"></td> <td style="width: 10%;"></td> <td style="width: 10%;"></td> <td style="width: 10%;"></td> <td style="width: 10%;"></td> <td style="width: 10%;"></td> <td style="width: 10%;"></td> <td style="width: 10%;"></td> </tr> <tr> <td></td> <td></td> <td colspan="8" style="text-align: center;"> <table border="1" style="width: 100%; border-collapse: collapse; text-align: center;"> <tr> <td style="width: 10%;"></td> <td style="width: 10%;"></td> <td style="width: 10%;"></td> <td style="width: 10%;"></td> <td style="width: 10%;"></td> <td style="width: 10%;"></td> <td style="width: 10%;"></td> <td style="width: 10%;"></td> <td style="width: 10%;"></td> <td style="width: 10%;"></td> </tr> <tr> <td></td> <td></td> <td colspan="8" style="text-align: center;"> <table border="1" style="width: 100%; border-collapse: collapse; text-align: center;"> <tr> <td style="width: 10%;"></td> <td style="width: 10%;"></td> <td style="width: 10%;"></td> <td style="width: 10%;"></td> <td style="width: 10%;"></td> <td style="width: 10%;"></td> <td style="width: 10%;"></td> <td style="width: 10%;"></td> <td style="width: 10%;"></td> <td style="width: 10%;"></td> </tr> <tr> <td></td> <td></td> <td colspan="8" style="text-align: center;"> <table border="1" style="width: 100%; border-collapse: collapse; text-align: center;"> <tr> <td style="width: 10%;"></td> <td style="width: 10%;"></td> <td style="width: 10%;"></td> <td style="width: 10%;"></td> <td style="width: 10%;"></td> <td style="width: 10%;"></td> <td style="width: 10%;"></td> <td style="width: 10%;"></td> <td style="width: 10%;"></td> <td style="width: 10%;"></td> </tr> <tr> <td></td> <td></td> <td colspan="8" style="text-align: center;"> <table border="1" style="width: 100%; border-collapse: collapse; text-align: center;"> <tr> <td style="width: 10%;"></td> <td style="width: 10%;"></td> <td style="width: 10%;"></td> <td style="width: 10%;"></td> <td style="width: 10%;"></td> <td style="width: 10%;"></td> <td style="width: 10%;"></td> <td style="width: 10%;"></td> <td style="width: 10%;"></td> <td style="width: 10%;"></td> </tr> <tr> <td></td> <td></td> <td colspan="8" style="text-align: center;"> <table border="1" style="width: 100%; border-collapse: collapse; text-align: center;"> <tr> <td style="width: 10%;"></td> <td style="width: 10%;"></td> <td style="width: 10%;"></td> <td style="width: 10%;"></td> <td style="width: 10%;"></td> <td style="width: 10%;"></td> <td style="width: 10%;"></td> <td style="width: 10%;"></td> <td style="width: 10%;"></td> <td style="width: 10%;"></td> </tr> <tr> <td></td> <td></td> <td colspan="8" style="text-align: center;"> <table border="1" style="width: 100%; border-collapse: collapse; text-align: center;"> <tr> <td style="width: 10%;"></td> <td style="width: 10%;"></td> <td style="width: 10%;"></td> <td style="width: 10%;"></td> <td style="width: 10%;"></td> <td style="width: 10%;"></td> <td style="width: 10%;"></td> <td style="width: 10%;"></td> <td style="width: 10%;"></td> <td style="width: 10%;"></td> </tr> <tr> <td></td> <td></td> <td colspan="8" style="text-align: center;"> <table border="1" style="width: 100%; border-collapse: collapse; text-align: center;"> <tr> <td
style="width: 10%;"></td> <td style="width: 10%;"></td> <td style="width: 10%;"></td> <td style="width: 10%;"></td> <td style="width: 10%;"></td> <td style="width: 10%;"></td> <td style="width: 10%;"></td> <td style="width: 10%;"></td> <td style="width: 10%;"></td> <td style="width: 10%;"></td> </tr> <tr> <td></td> <td></td> <td colspan="8" style="text-align: center;"> <table border="1" style="width: 100%; border-collapse: collapse; text-align: center;"> <tr> <td style="width: 10%;"></td> <td style="width: 10%;"></td> <td style="width: 10%;"></td> <td style="width: 10%;"></td> <td style="width: 10%;"></td> <td style="width: 10%;"></td> <td style="width: 10%;"></td> <td style="width: 10%;"></td> <td style="width: 10%;"></td> <td style="width: 10%;"></td> </tr> <tr> <td></td> <td></td> <td colspan="8" style="text-align: center;"> <table border="1" style="width: 100%; border-collapse: collapse; text-align: center;"> <tr> <td style="width: 10%;"></td> <td style="width: 10%;"></td> <td style="width: 10%;"></td> <td style="width: 10%;"></td> <td style="width: 10%;"></td> <td style="width: 10%;"></td> <td style="width: 10%;"></td> <td style="width: 10%;"></td> <td style="width: 10%;"></td> <td style="width: 10%;"></td> </tr> <tr> <td></td> <td></td> <td colspan="8" style="text-align: center;"> <table border="1" style="width: 100%; border-collapse: collapse; text-align: center;"> <tr> <td style="width: 10%;"></td> <td style="width: 10%;"></td> <td style="width: 10%;"></td> <td style="width: 10%;"></td> <td style="width: 10%;"></td> <td style="width: 10%;"></td> <td style="width: 10%;"></td> <td style="width: 10%;"></td> <td style="width: 10%;"></td> <td style="width: 10%;"></td> </tr> <tr> <td></td> <td></td> <td colspan="8" style="text-align: center;"> <table border="1" style="width: 100%; border-collapse: collapse; text-align: center;"> <tr> <td style="width: 10%;"></td> <td style="width: 10%;"></td> <td style="width: 10%;"></td> <td style="width: 10%;"></td> <td style="width: 10%;"></td> <td style="width: 10%;"></td> <td style="width: 10%;"></td> <td style="width: 10%;"></td> <td style="width: 10%;"></td> <td style="width: 10%;"></td> </tr> <tr> <td></td> <td></td> <td colspan="8" style="text-align: center;"> <table border="1" style="width: 100%; border-collapse: collapse; text-align: center;"> <tr> <td style="width: 10%;"></td> <td style="width: 10%;"></td> <td style="width: 10%;"></td> <td style="width: 10%;"></td> <td style="width: 10%;"></td> <td style="width: 10%;"></td> <td style="width: 10%;"></td> <td style="width: 10%;"></td> <td style="width: 10%;"></td> <td style="width: 10%;"></td> </tr> <tr> <td></td> <td></td> <td colspan="8" style="text-align: center;"> <table border="1" style="width: 100%; border-collapse: collapse; text-align: center;"> <tr> </tr></table></td></tr></table></td></tr></table></td></tr></table></td></tr></table></td></tr></table></td></tr></table></td></tr></table></td></tr></table></td></tr></table></td></tr></table></td></tr></table></td></tr></table></td></tr></table></td></tr></table></td></tr></table></td></tr></table></td></tr></table></td></tr></table></td></tr></table></td></tr></table></td></tr></table></td></tr></table></td></tr></table></td></tr></table></td></tr></table></td></tr></table></td></tr></table></td></tr></table></td></tr></table></td></tr></table></td></tr></table></td></tr></table></td></tr></table></td></tr></table></td></tr></table></td></tr></table></td></tr></table> | | | | | | | | | | | | | | | | | | | | <table border="1" style="width: 100%; border-collapse: collapse; text-align: center;"> <tr> <td style="width: 10%;"></td> <td style="width: 10%;"></td> <td style="width: 10%;"></td> <td style="width: 10%;"></td> <td style="width: 10%;"></td> <td style="width: 10%;"></td> <td style="width: 10%;"></td> <td style="width: 10%;"></td> <td style="width: 10%;"></td> <td style="width: 10%;"></td> </tr> <tr> <td></td> <td></td> <td colspan="8" style="text-align: center;"> <table border="1" style="width: 100%; border-collapse: collapse; text-align: center;"> <tr> <td style="width: 10%;"></td> <td style="width: 10%;"></td> <td style="width: 10%;"></td> <td style="width: 10%;"></td> <td style="width: 10%;"></td> <td style="width: 10%;"></td> <td style="width: 10%;"></td> <td style="width: 10%;"></td> <td style="width: 10%;"></td> <td style="width: 10%;"></td> </tr> <tr> <td></td> <td></td> <td colspan="8" style="text-align: center;"> <table border="1" style="width: 100%; border-collapse: collapse; text-align: center;"> <tr> <td style="width: 10%;"></td> <td style="width: 10%;"></td> <td style="width: 10%;"></td> <td style="width: 10%;"></td> <td style="width: 10%;"></td> <td style="width: 10%;"></td> <td style="width: 10%;"></td> <td style="width: 10%;"></td> <td style="width: 10%;"></td> <td style="width: 10%;"></td> </tr> <tr> <td></td> <td></td> <td colspan="8" style="text-align: center;"> <table border="1" style="width: 100%; border-collapse: collapse; text-align: center;"> <tr> <td style="width: 10%;"></td> <td style="width: 10%;"></td> <td style="width: 10%;"></td> <td style="width: 10%;"></td> <td style="width: 10%;"></td> <td style="width: 10%;"></td> <td style="width: 10%;"></td> <td style="width: 10%;"></td> <td style="width: 10%;"></td> <td style="width: 10%;"></td> </tr> <tr> <td></td> <td></td> <td colspan="8" style="text-align: center;"> <table border="1" style="width: 100%; border-collapse: collapse; text-align: center;"> <tr> <td style="width: 10%;"></td> <td style="width: 10%;"></td> <td style="width: 10%;"></td> <td style="width: 10%;"></td> <td style="width: 10%;"></td> <td style="width: 10%;"></td> <td style="width: 10%;"></td> <td style="width: 10%;"></td> <td style="width: 10%;"></td> <td style="width: 10%;"></td> </tr> <tr> <td></td> <td></td> <td colspan="8" style="text-align: center;"> <table border="1" style="width: 100%; border-collapse: collapse; text-align: center;"> <tr> <td style="width: 10%;"></td> <td style="width: 10%;"></td> <td style="width: 10%;"></td> <td style="width: 10%;"></td> <td style="width: 10%;"></td> <td style="width: 10%;"></td> <td style="width: 10%;"></td> <td style="width: 10%;"></td> <td style="width: 10%;"></td> <td style="width: 10%;"></td> </tr> <tr> <td></td> <td></td> <td colspan="8" style="text-align: center;"> <table border="1" style="width: 100%; border-collapse: collapse; text-align: center;"> <tr> <td style="width: 10%;"></td> <td style="width: 10%;"></td> <td style="width: 10%;"></td> <td style="width: 10%;"></td> <td style="width: 10%;"></td> <td style="width: 10%;"></td> <td style="width: 10%;"></td> <td style="width: 10%;"></td> <td style="width: 10%;"></td> <td style="width: 10%;"></td> </tr> <tr> <td></td> <td></td> <td colspan="8" style="text-align: center;"> <table border="1" style="width: 100%; border-collapse: collapse; text-align: center;"> <tr> <td style="width: 10%;"></td> <td style="width: 10%;"></td> <td style="width: 10%;"></td> <td style="width: 10%;"></td> <td style="width: 10%;"></td> <td style="width:
10%;"></td> <td style="width: 10%;"></td> <td style="width: 10%;"></td> <td style="width: 10%;"></td> <td style="width: 10%;"></td> </tr> <tr> <td></td> <td></td> <td colspan="8" style="text-align: center;"> <table border="1" style="width: 100%; border-collapse: collapse; text-align: center;"> <tr> <td style="width: 10%;"></td> <td style="width: 10%;"></td> <td style="width: 10%;"></td> <td style="width: 10%;"></td> <td style="width: 10%;"></td> <td style="width: 10%;"></td> <td style="width: 10%;"></td> <td style="width: 10%;"></td> <td style="width: 10%;"></td> <td style="width: 10%;"></td> </tr> <tr> <td></td> <td></td> <td colspan="8" style="text-align: center;"> <table border="1" style="width: 100%; border-collapse: collapse; text-align: center;"> <tr> <td style="width: 10%;"></td> <td style="width: 10%;"></td> <td style="width: 10%;"></td> <td style="width: 10%;"></td> <td style="width: 10%;"></td> <td style="width: 10%;"></td> <td style="width: 10%;"></td> <td style="width: 10%;"></td> <td style="width: 10%;"></td> <td style="width: 10%;"></td> </tr> <tr> <td></td> <td></td> <td colspan="8" style="text-align: center;"> <table border="1" style="width: 100%; border-collapse: collapse; text-align: center;"> <tr> <td style="width: 10%;"></td> <td style="width: 10%;"></td> <td style="width: 10%;"></td> <td style="width: 10%;"></td> <td style="width: 10%;"></td> <td style="width: 10%;"></td> <td style="width: 10%;"></td> <td style="width: 10%;"></td> <td style="width: 10%;"></td> <td style="width: 10%;"></td> </tr> <tr> <td></td> <td></td> <td colspan="8" style="text-align: center;"> <table border="1" style="width: 100%; border-collapse: collapse; text-align: center;"> <tr> <td style="width: 10%;"></td> <td style="width: 10%;"></td> <td style="width: 10%;"></td> <td style="width: 10%;"></td> <td style="width: 10%;"></td> <td style="width: 10%;"></td> <td style="width: 10%;"></td> <td style="width: 10%;"></td> <td style="width: 10%;"></td> <td style="width: 10%;"></td> </tr> <tr> <td></td> <td></td> <td colspan="8" style="text-align: center;"> <table border="1" style="width: 100%; border-collapse: collapse; text-align: center;"> <tr> <td style="width: 10%;"></td> <td style="width: 10%;"></td> <td style="width: 10%;"></td> <td style="width: 10%;"></td> <td style="width: 10%;"></td> <td style="width: 10%;"></td> <td style="width: 10%;"></td> <td style="width: 10%;"></td> <td style="width: 10%;"></td> <td style="width: 10%;"></td> </tr> <tr> <td></td> <td></td> <td colspan="8" style="text-align: center;"> <table border="1" style="width: 100%; border-collapse: collapse; text-align: center;"> <tr> <td style="width: 10%;"></td> <td style="width: 10%;"></td> <td style="width: 10%;"></td> <td style="width: 10%;"></td> <td style="width: 10%;"></td> <td style="width: 10%;"></td> <td style="width: 10%;"></td> <td style="width: 10%;"></td> <td style="width: 10%;"></td> <td style="width: 10%;"></td> </tr> <tr> <td></td> <td></td> <td colspan="8" style="text-align: center;"> <table border="1" style="width: 100%; border-collapse: collapse; text-align: center;"> <tr> <td style="width: 10%;"></td> <td style="width: 10%;"></td> <td style="width: 10%;"></td> <td style="width: 10%;"></td> <td style="width: 10%;"></td> <td style="width: 10%;"></td> <td style="width: 10%;"></td> <td style="width: 10%;"></td> <td style="width: 10%;"></td> <td style="width: 10%;"></td> </tr> <tr> <td></td> <td></td> <td colspan="8" style="text-align: center;"> <table border="1" style="width: 100%; border-collapse: collapse; text-align: center;"> <tr> <td style="width: 10%;"></td> <td style="width: 10%;"></td> <td style="width: 10%;"></td> <td style="width: 10%;"></td> <td style="width: 10%;"></td> <td style="width: 10%;"></td> <td style="width: 10%;"></td> <td style="width: 10%;"></td> <td style="width: 10%;"></td> <td style="width: 10%;"></td> </tr> <tr> <td></td> <td></td> <td colspan="8" style="text-align: center;"> <table border="1" style="width: 100%; border-collapse: collapse; text-align: center;"> <tr> <td style="width: 10%;"></td> <td style="width: 10%;"></td> <td style="width: 10%;"></td> <td style="width: 10%;"></td> <td style="width: 10%;"></td> <td style="width: 10%;"></td> <td style="width: 10%;"></td> <td style="width: 10%;"></td> <td style="width: 10%;"></td> <td style="width: 10%;"></td> </tr> <tr> <td></td> <td></td> <td colspan="8" style="text-align: center;"> <table border="1" style="width: 100%; border-collapse: collapse; text-align: center;"> <tr> <td style="width: 10%;"></td> <td style="width: 10%;"></td> <td style="width: 10%;"></td> <td style="width: 10%;"></td> <td style="width: 10%;"></td> <td style="width: 10%;"></td> <td style="width: 10%;"></td> <td style="width: 10%;"></td> <td style="width: 10%;"></td> <td style="width: 10%;"></td> </tr> <tr> <td></td> <td></td> <td colspan="8" style="text-align: center;"> <table border="1" style="width: 100%; border-collapse: collapse; text-align: center;"> <tr> <td style="width: 10%;"></td> <td style="width: 10%;"></td> <td style="width: 10%;"></td> <td style="width: 10%;"></td> <td style="width: 10%;"></td> <td style="width: 10%;"></td> <td style="width: 10%;"></td> <td style="width: 10%;"></td> <td style="width: 10%;"></td> <td style="width: 10%;"></td> </tr> <tr> <td></td> <td></td> <td colspan="8" style="text-align: center;"> <table border="1" style="width: 100%; border-collapse: collapse; text-align: center;"> <tr> <td style="width: 10%;"></td> <td style="width: 10%;"></td> <td style="width: 10%;"></td> <td style="width: 10%;"></td> <td style="width: 10%;"></td> <td style="width: 10%;"></td> <td style="width: 10%;"></td> <td style="width: 10%;"></td> <td style="width: 10%;"></td> <td style="width: 10%;"></td> </tr> <tr> <td></td> <td></td> <td colspan="8" style="text-align: center;"> <table border="1" style="width: 100%; border-collapse: collapse; text-align: center;"> <tr> <td style="width: 10%;"></td> <td style="width: 10%;"></td> <td style="width: 10%;"></td> <td style="width: 10%;"></td> <td style="width: 10%;"></td> <td style="width: 10%;"></td> <td style="width: 10%;"></td> <td style="width: 10%;"></td> <td style="width: 10%;"></td> <td style="width: 10%;"></td> </tr> <tr> <td></td> <td></td> <td colspan="8" style="text-align: center;"> <table border="1" style="width: 100%; border-collapse: collapse; text-align: center;"> <tr> <td style="width: 10%;"></td> <td style="width: 10%;"></td> <td style="width: 10%;"></td> <td style="width: 10%;"></td> <td style="width: 10%;"></td> <td style="width: 10%;"></td> <td style="width: 10%;"></td> <td style="width: 10%;"></td> <td style="width: 10%;"></td> <td style="width: 10%;"></td> </tr> <tr> <td></td> <td></td> <td colspan="8" style="text-align: center;"> <table border="1" style="width: 100%; border-collapse: collapse; text-align: center;"> <tr> <td style="width: 10%;"></td> <td style="width: 10%;"></td> <td style="width: 10%;"></td> <td style="width: 10%;"></td> <td style="width: 10%;"></td> <td style="width: 10%;"></td> <td style="width: 10%;"></td> <td style="width: 10%;"></td> <td style="width: 10%;"></td> <td style="width: 10%;"></td> </tr> <tr> <td></td> <td></td> <td colspan="8" style="text-align: center;"> <table border="1" style="width: 100%; border-collapse: collapse; text-align: center;"> <tr> <td style="width: 10%;"></td> <td style="width: 10%;"></td> <td style="width: 10%;"></td> <td style="width: 10%;"></td> <td style="width: 10%;"></td> <td style="width: 10%;"></td> <td style="width: 10%;"></td> <td style="width: 10%;"></td> <td style="width: 10%;"></td> <td style="width: 10%;"></td> </tr> <tr> <td></td> <td></td> <td colspan="8" style="text-align: center;"> <table border="1" style="width: 100%; border-collapse: collapse; text-align: center;"> <tr> <td style="width: 10%;"></td> <td style="width: 10%;"></td> <td style="width: 10%;"></td> <td style="width: 10%;"></td> <td style="width: 10%;"></td> <td style="width: 10%;"></td> <td style="width: 10%;"></td> <td style="width: 10%;"></td> <td style="width: 10%;"></td> <td style="width: 10%;"></td> </tr> <tr> <td></td> <td></td> <td colspan="8" style="text-align: center;"> <table border="1" style="width: 100%; border-collapse: collapse; text-align: center;"> <tr> <td style="width: 10%;"></td> <td style="width: 10%;"></td> <td style="width: 10%;"></td> <td style="width: 10%;"></td> <td style="width: 10%;"></td> <td style="width: 10%;"></td> <td style="width: 10%;"></td> <td style="width: 10%;"></td> <td style="width: 10%;"></td> <td style="width: 10%;"></td> </tr> <tr> <td></td> <td></td> <td colspan="8" style="text-align: center;"> <table border="1" style="width: 100%; border-collapse: collapse; text-align: center;"> <tr> <td style="width: 10%;"></td> <td style="width: 10%;"></td> <td style="width: 10%;"></td> <td style="width: 10%;"></td> <td style="width: 10%;"></td> <td style="width: 10%;"></td> <td style="width: 10%;"></td> <td style="width: 10%;"></td> <td style="width: 10%;"></td> <td style="width: 10%;"></td> </tr> <tr> <td></td> <td></td> <td colspan="8" style="text-align: center;"> <table border="1" style="width: 100%; border-collapse: collapse; text-align: center;"> <tr> <td style="width: 10%;"></td> <td style="width: 10%;"></td> <td style="width: 10%;"></td> <td style="width: 10%;"></td> <td style="width: 10%;"></td> <td style="width: 10%;"></td> <td style="width: 10%;"></td> <td style="width: 10%;"></td> <td style="width: 10%;"></td> <td style="width: 10%;"></td> </tr> <tr> <td></td> <td></td> <td colspan="8" style="text-align: center;"> <table border="1" style="width: 100%; border-collapse: collapse; text-align: center;"> <tr> <td style="width: 10%;"></td> <td style="width: 10%;"></td> <td style="width: 10%;"></td> <td style="width: 10%;"></td> <td style="width: 10%;"></td> <td style="width: 10%;"></td> <td style="width: 10%;"></td> <td style="width: 10%;"></td> <td style="width: 10%;"></td> <td style="width: 10%;"></td> </tr> <tr> <td></td> <td></td> <td
colspan="8" style="text-align: center;"> <table border="1" style="width: 100%; border-collapse: collapse; text-align: center;"> <tr> <td style="width: 10%;"></td> <td style="width: 10%;"></td> <td style="width: 10%;"></td> <td style="width: 10%;"></td> <td style="width: 10%;"></td> <td style="width: 10%;"></td> <td style="width: 10%;"></td> <td style="width: 10%;"></td> <td style="width: 10%;"></td> <td style="width: 10%;"></td> </tr> <tr> <td></td> <td></td> <td colspan="8" style="text-align: center;"> <table border="1" style="width: 100%; border-collapse: collapse; text-align: center;"> <tr> <td style="width: 10%;"></td> <td style="width: 10%;"></td> <td style="width: 10%;"></td> <td style="width: 10%;"></td> <td style="width: 10%;"></td> <td style="width: 10%;"></td> <td style="width: 10%;"></td> <td style="width: 10%;"></td> <td style="width: 10%;"></td> <td style="width: 10%;"></td> </tr> <tr> <td></td> <td></td> <td colspan="8" style="text-align: center;"> <table border="1" style="width: 100%; border-collapse: collapse; text-align: center;"> <tr> <td style="width: 10%;"></td> <td style="width: 10%;"></td> <td style="width: 10%;"></td> <td style="width: 10%;"></td> <td style="width: 10%;"></td> <td style="width: 10%;"></td> <td style="width: 10%;"></td> <td style="width: 10%;"></td> <td style="width: 10%;"></td> <td style="width: 10%;"></td> </tr> <tr> <td></td> <td></td> <td colspan="8" style="text-align: center;"> <table border="1" style="width: 100%; border-collapse: collapse; text-align: center;"> <tr> <td style="width: 10%;"></td> <td style="width: 10%;"></td> <td style="width: 10%;"></td> <td style="width: 10%;"></td> <td style="width: 10%;"></td> <td style="width: 10%;"></td> <td style="width: 10%;"></td> <td style="width: 10%;"></td> <td style="width: 10%;"></td> <td style="width: 10%;"></td> </tr> <tr> <td></td> <td></td> <td colspan="8" style="text-align: center;"> <table border="1" style="width: 100%; border-collapse: collapse; text-align: center;"> <tr> <td style="width: 10%;"></td> <td style="width: 10%;"></td> <td style="width: 10%;"></td> <td style="width: 10%;"></td> <td style="width: 10%;"></td> <td style="width: 10%;"></td> <td style="width: 10%;"></td> <td style="width: 10%;"></td> <td style="width: 10%;"></td> <td style="width: 10%;"></td> </tr> <tr> <td></td> <td></td> <td colspan="8" style="text-align: center;"> <table border="1" style="width: 100%; border-collapse: collapse; text-align: center;"> <tr> <td style="width: 10%;"></td> <td style="width: 10%;"></td> <td style="width: 10%;"></td> <td style="width: 10%;"></td> <td style="width: 10%;"></td> <td style="width: 10%;"></td> <td style="width: 10%;"></td> <td style="width: 10%;"></td> <td style="width: 10%;"></td> <td style="width: 10%;"></td> </tr> <tr> <td></td> <td></td> <td colspan="8" style="text-align: center;"> <table border="1" style="width: 100%; border-collapse: collapse; text-align: center;"> <tr> <td style="width: 10%;"></td> <td style="width: 10%;"></td> <td style="width: 10%;"></td> <td style="width: 10%;"></td> <td style="width: 10%;"></td> <td style="width: 10%;"></td> <td style="width: 10%;"></td> <td style="width: 10%;"></td> <td style="width: 10%;"></td> <td style="width: 10%;"></td> </tr> <tr> <td></td> <td></td> <td colspan="8" style="text-align: center;"> <table border="1" style="width: 100%; border-collapse: collapse; text-align: center;"> <tr> </tr></table></td></tr></table></td></tr></table></td></tr></table></td></tr></table></td></tr></table></td></tr></table></td></tr></table></td></tr></table></td></tr></table></td></tr></table></td></tr></table></td></tr></table></td></tr></table></td></tr></table></td></tr></table></td></tr></table></td></tr></table></td></tr></table></td></tr></table></td></tr></table></td></tr></table></td></tr></table></td></tr></table></td></tr></table></td></tr></table></td></tr></table></td></tr></table></td></tr></table></td></tr></table></td></tr></table></td></tr></table></td></tr></table></td></tr></table></td></tr></table></td></tr></table></td></tr></table> | | | | | | | | | | | | | | | | | | | | <table border="1" style="width: 100%; border-collapse: collapse; text-align: center;"> <tr> <td style="width: 10%;"></td> <td style="width: 10%;"></td> <td style="width: 10%;"></td> <td style="width: 10%;"></td> <td style="width: 10%;"></td> <td style="width: 10%;"></td> <td style="width: 10%;"></td> <td style="width: 10%;"></td> <td style="width: 10%;"></td> <td style="width: 10%;"></td> </tr> <tr> <td></td> <td></td> <td colspan="8" style="text-align: center;"> <table border="1" style="width: 100%; border-collapse: collapse; text-align: center;"> <tr> <td style="width: 10%;"></td> <td style="width: 10%;"></td> <td style="width: 10%;"></td> <td style="width: 10%;"></td> <td style="width: 10%;"></td> <td style="width: 10%;"></td> <td style="width: 10%;"></td> <td style="width: 10%;"></td> <td style="width: 10%;"></td> <td style="width: 10%;"></td> </tr> <tr> <td></td> <td></td> <td colspan="8" style="text-align: center;"> <table border="1" style="width: 100%; border-collapse: collapse; text-align: center;"> <tr> <td style="width: 10%;"></td> <td style="width: 10%;"></td> <td style="width: 10%;"></td> <td style="width: 10%;"></td> <td style="width: 10%;"></td> <td style="width: 10%;"></td> <td style="width: 10%;"></td> <td style="width: 10%;"></td> <td style="width: 10%;"></td> <td style="width: 10%;"></td> </tr> <tr> <td></td> <td></td> <td colspan="8" style="text-align: center;"> <table border="1" style="width: 100%; border-collapse: collapse; text-align: center;"> <tr> <td style="width: 10%;"></td> <td style="width: 10%;"></td> <td style="width: 10%;"></td> <td style="width: 10%;"></td> <td style="width: 10%;"></td> <td style="width: 10%;"></td> <td style="width: 10%;"></td> <td style="width: 10%;"></td> <td style="width: 10%;"></td> <td style="width: 10%;"></td> </tr> <tr> <td></td> <td></td> <td colspan="8" style="text-align: center;"> <table border="1" style="width: 100%; border-collapse: collapse; text-align: center;"> <tr> <td style="width: 10%;"></td> <td style="width: 10%;"></td> <td style="width: 10%;"></td> <td style="width: 10%;"></td> <td style="width: 10%;"></td> <td style="width: 10%;"></td> <td style="width: 10%;"></td> <td style="width: 10%;"></td> <td style="width: 10%;"></td> <td style="width: 10%;"></td> </tr> <tr> <td></td> <td></td> <td colspan="8" style="text-align: center;"> <table border="1" style="width: 100%; border-collapse: collapse; text-align: center;"> <tr> <td style="width: 10%;"></td> <td style="width: 10%;"></td> <td style="width: 10%;"></td> <td style="width: 10%;"></td> <td style="width: 10%;"></td> <td style="width: 10%;"></td> <td style="width: 10%;"></td> <td style="width: 10%;"></td> <td style="width: 10%;"></td> <td style="width: 10%;"></td> </tr> <tr> <td></td> <td></td> <td colspan="8" style="text-align: center;"> <table border="1" style="width: 100%; border-collapse: collapse; text-align: center;"> <tr> <td style="width: 10%;"></td> <td style="width:
10%;"></td> <td style="width: 10%;"></td> <td style="width: 10%;"></td> <td style="width: 10%;"></td> <td style="width: 10%;"></td> <td style="width: 10%;"></td> <td style="width: 10%;"></td> <td style="width: 10%;"></td> <td style="width: 10%;"></td> </tr> <tr> <td></td> <td></td> <td colspan="8" style="text-align: center;"> <table border="1" style="width: 100%; border-collapse: collapse; text-align: center;"> <tr> <td style="width: 10%;"></td> <td style="width: 10%;"></td> <td style="width: 10%;"></td> <td style="width: 10%;"></td> <td style="width: 10%;"></td> <td style="width: 10%;"></td> <td style="width: 10%;"></td> <td style="width: 10%;"></td> <td style="width: 10%;"></td> <td style="width: 10%;"></td> </tr> <tr> <td></td> <td></td> <td colspan="8" style="text-align: center;"> <table border="1" style="width: 100%; border-collapse: collapse; text-align: center;"> <tr> <td style="width: 10%;"></td> <td style="width: 10%;"></td> <td style="width: 10%;"></td> <td style="width: 10%;"></td> <td style="width: 10%;"></td> <td style="width: 10%;"></td> <td style="width: 10%;"></td> <td style="width: 10%;"></td> <td style="width: 10%;"></td> <td style="width: 10%;"></td> </tr> <tr> <td></td> <td></td> <td colspan="8" style="text-align: center;"> <table border="1" style="width: 100%; border-collapse: collapse; text-align: center;"> <tr> <td style="width: 10%;"></td> <td style="width: 10%;"></td> <td style="width: 10%;"></td> <td style="width: 10%;"></td> <td style="width: 10%;"></td> <td style="width: 10%;"></td> <td style="width: 10%;"></td> <td style="width: 10%;"></td> <td style="width: 10%;"></td> <td style="width: 10%;"></td> </tr> <tr> <td></td> <td></td> <td colspan="8" style="text-align: center;"> <table border="1" style="width: 100%; border-collapse: collapse; text-align: center;"> <tr> <td style="width: 10%;"></td> <td style="width: 10%;"></td> <td style="width: 10%;"></td> <td style="width: 10%;"></td> <td style="width: 10%;"></td> <td style="width: 10%;"></td> <td style="width: 10%;"></td> <td style="width: 10%;"></td> <td style="width: 10%;"></td> <td style="width: 10%;"></td> </tr> <tr> <td></td> <td></td> <td colspan="8" style="text-align: center;"> <table border="1" style="width: 100%; border-collapse: collapse; text-align: center;"> <tr> <td style="width: 10%;"></td> <td style="width: 10%;"></td> <td style="width: 10%;"></td> <td style="width: 10%;"></td> <td style="width: 10%;"></td> <td style="width: 10%;"></td> <td style="width: 10%;"></td> <td style="width: 10%;"></td> <td style="width: 10%;"></td> <td style="width: 10%;"></td> </tr> <tr> <td></td> <td></td> <td colspan="8" style="text-align: center;"> <table border="1" style="width: 100%; border-collapse: collapse; text-align: center;"> <tr> <td style="width: 10%;"></td> <td style="width: 10%;"></td> <td style="width: 10%;"></td> <td style="width: 10%;"></td> <td style="width: 10%;"></td> <td style="width: 10%;"></td> <td style="width: 10%;"></td> <td style="width: 10%;"></td> <td style="width: 10%;"></td> <td style="width: 10%;"></td> </tr> <tr> <td></td> <td></td> <td colspan="8" style="text-align: center;"> <table border="1" style="width: 100%; border-collapse: collapse; text-align: center;"> <tr> <td style="width: 10%;"></td> <td style="width: 10%;"></td> <td style="width: 10%;"></td> <td style="width: 10%;"></td> <td style="width: 10%;"></td> <td style="width: 10%;"></td> <td style="width: 10%;"></td> <td style="width: 10%;"></td> <td style="width: 10%;"></td> <td style="width: 10%;"></td> </tr> <tr> <td></td> <td></td> <td colspan="8" style="text-align: center;"> <table border="1" style="width: 100%; border-collapse: collapse; text-align: center;"> <tr> <td style="width: 10%;"></td> <td style="width: 10%;"></td> <td style="width: 10%;"></td> <td style="width: 10%;"></td> <td style="width: 10%;"></td> <td style="width: 10%;"></td> <td style="width: 10%;"></td> <td style="width: 10%;"></td> <td style="width: 10%;"></td> <td style="width: 10%;"></td> </tr> <tr> <td></td> <td></td> <td colspan="8" style="text-align: center;"> <table border="1" style="width: 100%; border-collapse: collapse; text-align: center;"> <tr> <td style="width: 10%;"></td> <td style="width: 10%;"></td> <td style="width: 10%;"></td> <td style="width: 10%;"></td> <td style="width: 10%;"></td> <td style="width: 10%;"></td> <td style="width: 10%;"></td> <td style="width: 10%;"></td> <td style="width: 10%;"></td> <td style="width: 10%;"></td> </tr> <tr> <td></td> <td></td> <td colspan="8" style="text-align: center;"> <table border="1" style="width: 100%; border-collapse: collapse; text-align: center;"> <tr> <td style="width: 10%;"></td> <td style="width: 10%;"></td> <td style="width: 10%;"></td> <td style="width: 10%;"></td> <td style="width: 10%;"></td> <td style="width: 10%;"></td> <td style="width: 10%;"></td> <td style="width: 10%;"></td> <td style="width: 10%;"></td> <td style="width: 10%;"></td> </tr> <tr> <td></td> <td></td> <td colspan="8" style="text-align: center;"> <table border="1" style="width: 100%; border-collapse: collapse; text-align: center;"> <tr> <td style="width: 10%;"></td> <td style="width: 10%;"></td> <td style="width: 10%;"></td> <td style="width: 10%;"></td> <td style="width: 10%;"></td> <td style="width: 10%;"></td> <td style="width: 10%;"></td> <td style="width: 10%;"></td> <td style="width: 10%;"></td> <td style="width: 10%;"></td> </tr> <tr> <td></td> <td></td> <td colspan="8" style="text-align: center;"> <table border="1" style="width: 100%; border-collapse: collapse; text-align: center;"> <tr> <td style="width: 10%;"></td> <td style="width: 10%;"></td> <td style="width: 10%;"></td> <td style="width: 10%;"></td> <td style="width: 10%;"></td> <td style="width: 10%;"></td> <td style="width: 10%;"></td> <td style="width: 10%;"></td> <td style="width: 10%;"></td> <td style="width: 10%;"></td> </tr> <tr> <td></td> <td></td> <td colspan="8" style="text-align: center;"> <table border="1" style="width: 100%; border-collapse: collapse; text-align: center;"> <tr> <td style="width: 10%;"></td> <td style="width: 10%;"></td> <td style="width: 10%;"></td> <td style="width: 10%;"></td> <td style="width: 10%;"></td> <td style="width: 10%;"></td> <td style="width: 10%;"></td> <td style="width: 10%;"></td> <td style="width: 10%;"></td> <td style="width: 10%;"></td> </tr> <tr> <td></td> <td></td> <td colspan="8" style="text-align: center;"> <table border="1" style="width: 100%; border-collapse: collapse; text-align: center;"> <tr> <td style="width: 10%;"></td> <td style="width: 10%;"></td> <td style="width: 10%;"></td> <td style="width: 10%;"></td> <td style="width: 10%;"></td> <td style="width: 10%;"></td> <td style="width: 10%;"></td> <td style="width: 10%;"></td> <td style="width: 10%;"></td> <td style="width: 10%;"></td> </tr> <tr> <td></td> <td></td> <td colspan="8" style="text-align: center;"> <table border="1" style="width: 100%; border-collapse: collapse; text-align: center;"> <tr> <td style="width: 10%;"></td> <td style="width: 10%;"></td> <td style="width: 10%;"></td> <td style="width: 10%;"></td> <td style="width: 10%;"></td> <td style="width: 10%;"></td> <td style="width: 10%;"></td> <td style="width: 10%;"></td> <td style="width: 10%;"></td> <td style="width: 10%;"></td> </tr> <tr> <td></td> <td></td> <td colspan="8" style="text-align: center;"> <table border="1" style="width: 100%; border-collapse: collapse; text-align: center;"> <tr> <td style="width: 10%;"></td> <td style="width: 10%;"></td> <td style="width: 10%;"></td> <td style="width: 10%;"></td> <td style="width: 10%;"></td> <td style="width: 10%;"></td> <td style="width: 10%;"></td> <td style="width: 10%;"></td> <td style="width: 10%;"></td> <td style="width: 10%;"></td> </tr> <tr> <td></td> <td></td> <td colspan="8" style="text-align: center;"> <table border="1" style="width: 100%; border-collapse: collapse; text-align: center;"> <tr> <td style="width: 10%;"></td> <td style="width: 10%;"></td> <td style="width: 10%;"></td> <td style="width: 10%;"></td> <td style="width: 10%;"></td> <td style="width: 10%;"></td> <td style="width: 10%;"></td> <td style="width: 10%;"></td> <td style="width: 10%;"></td> <td style="width: 10%;"></td> </tr> <tr> <td></td> <td></td> <td colspan="8" style="text-align: center;"> <table border="1" style="width: 100%; border-collapse: collapse; text-align: center;"> <tr> <td style="width: 10%;"></td> <td style="width: 10%;"></td> <td style="width: 10%;"></td> <td style="width: 10%;"></td> <td style="width: 10%;"></td> <td style="width: 10%;"></td> <td style="width: 10%;"></td> <td style="width: 10%;"></td> <td style="width: 10%;"></td> <td style="width: 10%;"></td> </tr> <tr> <td></td> <td></td> <td colspan="8" style="text-align: center;"> <table border="1" style="width: 100%; border-collapse: collapse; text-align: center;"> <tr> <td style="width: 10%;"></td> <td style="width: 10%;"></td> <td style="width: 10%;"></td> <td style="width: 10%;"></td> <td style="width: 10%;"></td> <td style="width: 10%;"></td> <td style="width: 10%;"></td> <td style="width: 10%;"></td> <td style="width: 10%;"></td> <td style="width: 10%;"></td> </tr> <tr> <td></td> <td></td> <td colspan="8" style="text-align: center;"> <table border="1" style="width: 100%; border-collapse: collapse; text-align: center;"> <tr> <td style="width: 10%;"></td> <td style="width: 10%;"></td> <td style="width: 10%;"></td> <td style="width: 10%;"></td> <td style="width: 10%;"></td> <td style="width: 10%;"></td> <td style="width: 10%;"></td> <td style="width: 10%;"></td> <td style="width: 10%;"></td> <td style="width: 10%;"></td> </tr> <tr> <td></td> <td></td> <td colspan="8" style="text-align: center;"> <table border="1" style="width: 100%; border-collapse: collapse; text-align: center;"> <tr> <td style="width: 10%;"></td> <td style="width: 10%;"></td> <td style="width: 10%;"></td> <td style="width: 10%;"></td> <td style="width: 10%;"></td> <td style="width: 10%;"></td> <td style="width: 10%;"></td> <td
style="width: 10%;"></td> <td style="width: 10%;"></td> <td style="width: 10%;"></td> </tr> <tr> <td></td> <td></td> <td colspan="8" style="text-align: center;"> <table border="1" style="width: 100%; border-collapse: collapse; text-align: center;"> <tr> <td style="width: 10%;"></td> <td style="width: 10%;"></td> <td style="width: 10%;"></td> <td style="width: 10%;"></td> <td style="width: 10%;"></td> <td style="width: 10%;"></td> <td style="width: 10%;"></td> <td style="width: 10%;"></td> <td style="width: 10%;"></td> <td style="width: 10%;"></td> </tr> <tr> <td></td> <td></td> <td colspan="8" style="text-align: center;"> <table border="1" style="width: 100%; border-collapse: collapse; text-align: center;"> <tr> <td style="width: 10%;"></td> <td style="width: 10%;"></td> <td style="width: 10%;"></td> <td style="width: 10%;"></td> <td style="width: 10%;"></td> <td style="width: 10%;"></td> <td style="width: 10%;"></td> <td style="width: 10%;"></td> <td style="width: 10%;"></td> <td style="width: 10%;"></td> </tr> <tr> <td></td> <td></td> <td colspan="8" style="text-align: center;"> <table border="1" style="width: 100%; border-collapse: collapse; text-align: center;"> <tr> <td style="width: 10%;"></td> <td style="width: 10%;"></td> <td style="width: 10%;"></td> <td style="width: 10%;"></td> <td style="width: 10%;"></td> <td style="width: 10%;"></td> <td style="width: 10%;"></td> <td style="width: 10%;"></td> <td style="width: 10%;"></td> <td style="width: 10%;"></td> </tr> <tr> <td></td> <td></td> <td colspan="8" style="text-align: center;"> <table border="1" style="width: 100%; border-collapse: collapse; text-align: center;"> <tr> <td style="width: 10%;"></td> <td style="width: 10%;"></td> <td style="width: 10%;"></td> <td style="width: 10%;"></td> <td style="width: 10%;"></td> <td style="width: 10%;"></td> <td style="width: 10%;"></td> <td style="width: 10%;"></td> <td style="width: 10%;"></td> <td style="width: 10%;"></td> </tr> <tr> <td></td> <td></td> <td colspan="8" style="text-align: center;"> <table border="1" style="width: 100%; border-collapse: collapse; text-align: center;"> <tr> <td style="width: 10%;"></td> <td style="width: 10%;"></td> <td style="width: 10%;"></td> <td style="width: 10%;"></td> <td style="width: 10%;"></td> <td style="width: 10%;"></td> <td style="width: 10%;"></td> <td style="width: 10%;"></td> <td style="width: 10%;"></td> <td style="width: 10%;"></td> </tr> <tr> <td></td> <td></td> <td colspan="8" style="text-align: center;"> <table border="1" style="width: 100%; border-collapse: collapse; text-align: center;"> <tr> <td style="width: 10%;"></td> <td style="width: 10%;"></td> <td style="width: 10%;"></td> <td style="width: 10%;"></td> <td style="width: 10%;"></td> <td style="width: 10%;"></td> <td style="width: 10%;"></td> <td style="width: 10%;"></td> <td style="width: 10%;"></td> <td style="width: 10%;"></td> </tr> <tr> <td></td> <td></td> <td colspan="8" style="text-align: center;"> <table border="1" style="width: 100%; border-collapse: collapse; text-align: center;"> <tr> <td style="width: 10%;"></td> <td style="width: 10%;"></td> <td style="width: 10%;"></td> <td style="width: 10%;"></td> <td style="width: 10%;"></td> <td style="width: 10%;"></td> <td style="width: 10%;"></td> <td style="width: 10%;"></td> <td style="width: 10%;"></td> <td style="width: 10%;"></td> </tr> <tr> <td></td> <td></td> <td colspan="8" style="text-align: center;"> <table border="1" style="width: 100%; border-collapse: collapse; text-align: center;"> <tr> </tr></table></td></tr></table></td></tr></table></td></tr></table></td></tr></table></td></tr></table></td></tr></table></td></tr></table></td></tr></table></td></tr></table></td></tr></table></td></tr></table></td></tr></table></td></tr></table></td></tr></table></td></tr></table></td></tr></table></td></tr></table></td></tr></table></td></tr></table></td></tr></table></td></tr></table></td></tr></table></td></tr></table></td></tr></table></td></tr></table></td></tr></table></td></tr></table></td></tr></table></td></tr></table></td></tr></table></td></tr></table></td></tr></table></td></tr></table></td></tr></table></td></tr></table> | | | | | | | | | | | | | | | | | | | | <table border="1" style="width: 100%; border-collapse: collapse; text-align: center;"> <tr> <td style="width: 10%;"></td> <td style="width: 10%;"></td> <td style="width: 10%;"></td> <td style="width: 10%;"></td> <td style="width: 10%;"></td> <td style="width: 10%;"></td> <td style="width: 10%;"></td> <td style="width: 10%;"></td> <td style="width: 10%;"></td> <td style="width: 10%;"></td> </tr> <tr> <td></td> <td></td> <td colspan="8" style="text-align: center;"> <table border="1" style="width: 100%; border-collapse: collapse; text-align: center;"> <tr> <td style="width: 10%;"></td> <td style="width: 10%;"></td> <td style="width: 10%;"></td> <td style="width: 10%;"></td> <td style="width: 10%;"></td> <td style="width: 10%;"></td> <td style="width: 10%;"></td> <td style="width: 10%;"></td> <td style="width: 10%;"></td> <td style="width: 10%;"></td> </tr> <tr> <td></td> <td></td> <td colspan="8" style="text-align: center;"> <table border="1" style="width: 100%; border-collapse: collapse; text-align: center;"> <tr> <td style="width: 10%;"></td> <td style="width: 10%;"></td> <td style="width: 10%;"></td> <td style="width: 10%;"></td> <td style="width: 10%;"></td> <td style="width: 10%;"></td> <td style="width: 10%;"></td> <td style="width: 10%;"></td> <td style="width: 10%;"></td> <td style="width: 10%;"></td> </tr> <tr> <td></td> <td></td> <td colspan="8" style="text-align: center;"> <table border="1" style="width: 100%; border-collapse: collapse; text-align: center;"> <tr> <td style="width: 10%;"></td> <td style="width: 10%;"></td> <td style="width: 10%;"></td> <td style="width: 10%;"></td> <td style="width: 10%;"></td> <td style="width: 10%;"></td> <td style="width: 10%;"></td> <td style="width: 10%;"></td> <td style="width: 10%;"></td> <td style="width: 10%;"></td> </tr> <tr> <td></td> <td></td> <td colspan="8" style="text-align: center;"> <table border="1" style="width: 100%; border-collapse: collapse; text-align: center;"> <tr> <td style="width: 10%;"></td> <td style="width: 10%;"></td> <td style="width: 10%;"></td> <td style="width: 10%;"></td> <td style="width: 10%;"></td> <td style="width: 10%;"></td> <td style="width: 10%;"></td> <td style="width: 10%;"></td> <td style="width: 10%;"></td> <td style="width: 10%;"></td> </tr> <tr> <td></td> <td></td> <td colspan="8" style="text-align: center;"> <table border="1" style="width: 100%; border-collapse: collapse; text-align: center;"> <tr> <td style="width: 10%;"></td> <td style="width: 10%;"></td> <td style="width: 10%;"></td> <td style="width: 10%;"></td> <td style="width: 10%;"></td> <td style="width: 10%;"></td> <td style="width: 10%;"></td> <td style="width: 10%;"></td> <td style="width: 10%;"></td> <td style="width: 10%;"></td> </tr> <tr> <td></td> <td></td> <td colspan="8" style="text-align: center;"> <table border="1" style="width: 100%;
border-collapse: collapse; text-align: center;"> <tr> <td style="width: 10%;"></td> <td style="width: 10%;"></td> <td style="width: 10%;"></td> <td style="width: 10%;"></td> <td style="width: 10%;"></td> <td style="width: 10%;"></td> <td style="width: 10%;"></td> <td style="width: 10%;"></td> <td style="width: 10%;"></td> <td style="width: 10%;"></td> </tr> <tr> <td></td> <td></td> <td colspan="8" style="text-align: center;"> <table border="1" style="width: 100%; border-collapse: collapse; text-align: center;"> <tr> <td style="width: 10%;"></td> <td style="width: 10%;"></td> <td style="width: 10%;"></td> <td style="width: 10%;"></td> <td style="width: 10%;"></td> <td style="width: 10%;"></td> <td style="width: 10%;"></td> <td style="width: 10%;"></td> <td style="width: 10%;"></td> <td style="width: 10%;"></td> </tr> <tr> <td></td> <td></td> <td colspan="8" style="text-align: center;"> <table border="1" style="width: 100%; border-collapse: collapse; text-align: center;"> <tr> <td style="width: 10%;"></td> <td style="width: 10%;"></td> <td style="width: 10%;"></td> <td style="width: 10%;"></td> <td style="width: 10%;"></td> <td style="width: 10%;"></td> <td style="width: 10%;"></td> <td style="width: 10%;"></td> <td style="width: 10%;"></td> <td style="width: 10%;"></td> </tr> <tr> <td></td> <td></td> <td colspan="8" style="text-align: center;"> <table border="1" style="width: 100%; border-collapse: collapse; text-align: center;"> <tr> <td style="width: 10%;"></td> <td style="width: 10%;"></td> <td style="width: 10%;"></td> <td style="width: 10%;"></td> <td style="width: 10%;"></td> <td style="width: 10%;"></td> <td style="width: 10%;"></td> <td style="width: 10%;"></td> <td style="width: 10%;"></td> <td style="width: 10%;"></td> </tr> <tr> <td></td> <td></td> <td colspan="8" style="text-align: center;"> <table border="1" style="width: 100%; border-collapse: collapse; text-align: center;"> <tr> <td style="width: 10%;"></td> <td style="width: 10%;"></td> <td style="width: 10%;"></td> <td style="width: 10%;"></td> <td style="width: 10%;"></td> <td style="width: 10%;"></td> <td style="width: 10%;"></td> <td style="width: 10%;"></td> <td style="width: 10%;"></td> <td style="width: 10%;"></td> </tr> <tr> <td></td> <td></td> <td colspan="8" style="text-align: center;"> <table border="1" style="width: 100%; border-collapse: collapse; text-align: center;"> <tr> <td style="width: 10%;"></td> <td style="width: 10%;"></td> <td style="width: 10%;"></td> <td style="width: 10%;"></td> <td style="width: 10%;"></td> <td style="width: 10%;"></td> <td style="width: 10%;"></td> <td style="width: 10%;"></td> <td style="width: 10%;"></td> <td style="width: 10%;"></td> </tr> <tr> <td></td> <td></td> <td colspan="8" style="text-align: center;"> <table border="1" style="width: 100%; border-collapse: collapse; text-align: center;"> <tr> <td style="width: 10%;"></td> <td style="width: 10%;"></td> <td style="width: 10%;"></td> <td style="width: 10%;"></td> <td style="width: 10%;"></td> <td style="width: 10%;"></td> <td style="width: 10%;"></td> <td style="width: 10%;"></td> <td style="width: 10%;"></td> <td style="width: 10%;"></td> </tr> <tr> <td></td> <td></td> <td colspan="8" style="text-align: center;"> <table border="1" style="width: 100%; border-collapse: collapse; text-align: center;"> <tr> <td style="width: 10%;"></td> <td style="width: 10%;"></td> <td style="width: 10%;"></td> <td style="width: 10%;"></td> <td style="width: 10%;"></td> <td style="width: 10%;"></td> <td style="width: 10%;"></td> <td style="width: 10%;"></td> <td style="width: 10%;"></td> <td style="width: 10%;"></td> </tr> <tr> <td></td> <td></td> <td colspan="8" style="text-align: center;"> <table border="1" style="width: 100%; border-collapse: collapse; text-align: center;"> <tr> <td style="width: 10%;"></td> <td style="width: 10%;"></td> <td style="width: 10%;"></td> <td style="width: 10%;"></td> <td style="width: 10%;"></td> <td style="width: 10%;"></td> <td style="width: 10%;"></td> <td style="width: 10%;"></td> <td style="width: 10%;"></td> <td style="width: 10%;"></td> </tr> <tr> <td></td> <td></td> <td colspan="8" style="text-align: center;"> <table border="1" style="width: 100%; border-collapse: collapse; text-align: center;"> <tr> <td style="width: 10%;"></td> <td style="width: 10%;"></td> <td style="width: 10%;"></td> <td style="width: 10%;"></td> <td style="width: 10%;"></td> <td style="width: 10%;"></td> <td style="width: 10%;"></td> <td style="width: 10%;"></td> <td style="width: 10%;"></td> <td style="width: 10%;"></td> </tr> <tr> <td></td> <td></td> <td colspan="8" style="text-align: center;"> <table border="1" style="width: 100%; border-collapse: collapse; text-align: center;"> <tr> <td style="width: 10%;"></td> <td style="width: 10%;"></td> <td style="width: 10%;"></td> <td style="width: 10%;"></td> <td style="width: 10%;"></td> <td style="width: 10%;"></td> <td style="width: 10%;"></td> <td style="width: 10%;"></td> <td style="width: 10%;"></td> <td style="width: 10%;"></td> </tr> <tr> <td></td> <td></td> <td colspan="8" style="text-align: center;"> <table border="1" style="width: 100%; border-collapse: collapse; text-align: center;"> <tr> <td style="width: 10%;"></td> <td style="width: 10%;"></td> <td style="width: 10%;"></td> <td style="width: 10%;"></td> <td style="width: 10%;"></td> <td style="width: 10%;"></td> <td style="width: 10%;"></td> <td style="width: 10%;"></td> <td style="width: 10%;"></td> <td style="width: 10%;"></td> </tr> <tr> <td></td> <td></td> <td colspan="8" style="text-align: center;"> <table border="1" style="width: 100%; border-collapse: collapse; text-align: center;"> <tr> <td style="width: 10%;"></td> <td style="width: 10%;"></td> <td style="width: 10%;"></td> <td style="width: 10%;"></td> <td style="width: 10%;"></td> <td style="width: 10%;"></td> <td style="width: 10%;"></td> <td style="width: 10%;"></td> <td style="width: 10%;"></td> <td style="width: 10%;"></td> </tr> <tr> <td></td> <td></td> <td colspan="8" style="text-align: center;"> <table border="1" style="width: 100%; border-collapse: collapse; text-align: center;"> <tr> <td style="width: 10%;"></td> <td style="width: 10%;"></td> <td style="width: 10%;"></td> <td style="width: 10%;"></td> <td style="width: 10%;"></td> <td style="width: 10%;"></td> <td style="width: 10%;"></td> <td style="width: 10%;"></td> <td style="width: 10%;"></td> <td style="width: 10%;"></td> </tr> <tr> <td></td> <td></td> <td colspan="8" style="text-align: center;"> <table border="1" style="width: 100%; border-collapse: collapse; text-align: center;"> <tr> <td style="width: 10%;"></td> <td style="width: 10%;"></td> <td style="width: 10%;"></td> <td style="width: 10%;"></td> <td style="width: 10%;"></td> <td style="width: 10%;"></td> <td style="width: 10%;"></td> <td style="width: 10%;"></td> <td style="width: 10%;"></td> <td style="width: 10%;"></td> </tr> <tr> <td></td> <td></td> <td colspan="8" style="text-align: center;"> <table border="1" style="width: 100%; border-collapse: collapse; text-align: center;"> <tr> <td style="width: 10%;"></td> <td style="width: 10%;"></td> <td style="width: 10%;"></td> <td style="width: 10%;"></td> <td style="width: 10%;"></td> <td style="width: 10%;"></td> <td style="width: 10%;"></td> <td style="width: 10%;"></td> <td style="width: 10%;"></td> <td style="width: 10%;"></td> </tr> <tr> <td></td> <td></td> <td colspan="8" style="text-align: center;"> <table border="1" style="width: 100%; border-collapse: collapse; text-align: center;"> <tr> <td style="width: 10%;"></td> <td style="width: 10%;"></td> <td style="width: 10%;"></td> <td style="width: 10%;"></td> <td style="width: 10%;"></td> <td style="width: 10%;"></td> <td style="width: 10%;"></td> <td style="width: 10%;"></td> <td style="width: 10%;"></td> <td style="width: 10%;"></td> </tr> <tr> <td></td> <td></td> <td colspan="8" style="text-align: center;"> <table border="1" style="width: 100%; border-collapse: collapse; text-align: center;"> <tr> <td style="width: 10%;"></td> <td style="width: 10%;"></td> <td style="width: 10%;"></td> <td style="width: 10%;"></td> <td style="width: 10%;"></td> <td style="width: 10%;"></td> <td style="width: 10%;"></td> <td style="width: 10%;"></td> <td style="width: 10%;"></td> <td style="width: 10%;"></td> </tr> <tr> <td></td> <td></td> <td colspan="8" style="text-align: center;"> <table border="1" style="width: 100%; border-collapse: collapse; text-align: center;"> <tr> <td style="width: 10%;"></td> <td style="width: 10%;"></td> <td style="width: 10%;"></td> <td style="width: 10%;"></td> <td style="width: 10%;"></td> <td style="width: 10%;"></td> <td style="width: 10%;"></td> <td style="width: 10%;"></td> <td style="width: 10%;"></td> <td style="width: 10%;"></td> </tr> <tr> <td></td> <td></td> <td colspan="8" style="text-align: center;"> <table border="1" style="width: 100%; border-collapse: collapse; text-align: center;"> <tr> <td style="width: 10%;"></td> <td style="width: 10%;"></td> <td style="width: 10%;"></td> <td style="width: 10%;"></td> <td style="width: 10%;"></td> <td style="width: 10%;"></td> <td style="width: 10%;"></td> <td style="width: 10%;"></td> <td style="width: 10%;"></td> <td style="width: 10%;"></td> </tr> <tr> <td></td> <td></td> <td colspan="8" style="text-align: center;"> <table border="1" style="width: 100%; border-collapse: collapse; text-align: center;"> <tr> <td style="width: 10%;"></td> <td style="width: 10%;"></td> <td style="width: 10%;"></td> <td style="width: 10%;"></td> <td style="width: 10%;"></td> <td style="width: 10%;"></td> <td style="width: 10%;"></td> <td style="width: 10%;"></td> <td style="width: 10%;"></td> <td style="width: 10%;"></td> </tr> <tr> <td></td> <td></td> <td colspan="8" style="text-align: center;"> <table border="1" style="width: 100%; border-collapse: collapse; text-align: center;"> <tr> <td style="width: 10%;"></td> <td style="width: 10%;"></td> <td style="width: 10%;"></td> <td style="width:
10%;"></td> <td style="width: 10%;"></td> <td style="width: 10%;"></td> <td style="width: 10%;"></td> <td style="width: 10%;"></td> <td style="width: 10%;"></td> <td style="width: 10%;"></td> </tr> <tr> <td></td> <td></td> <td colspan="8" style="text-align: center;"> <table border="1" style="width: 100%; border-collapse: collapse; text-align: center;"> <tr> <td style="width: 10%;"></td> <td style="width: 10%;"></td> <td style="width: 10%;"></td> <td style="width: 10%;"></td> <td style="width: 10%;"></td> <td style="width: 10%;"></td> <td style="width: 10%;"></td> <td style="width: 10%;"></td> <td style="width: 10%;"></td> <td style="width: 10%;"></td> </tr> <tr> <td></td> <td></td> <td colspan="8" style="text-align: center;"> <table border="1" style="width: 100%; border-collapse: collapse; text-align: center;"> <tr> <td style="width: 10%;"></td> <td style="width: 10%;"></td> <td style="width: 10%;"></td> <td style="width: 10%;"></td> <td style="width: 10%;"></td> <td style="width: 10%;"></td> <td style="width: 10%;"></td> <td style="width: 10%;"></td> <td style="width: 10%;"></td> <td style="width: 10%;"></td> </tr> <tr> <td></td> <td></td> <td colspan="8" style="text-align: center;"> <table border="1" style="width: 100%; border-collapse: collapse; text-align: center;"> <tr> <td style="width: 10%;"></td> <td style="width: 10%;"></td> <td style="width: 10%;"></td> <td style="width: 10%;"></td> <td style="width: 10%;"></td> <td style="width: 10%;"></td> <td style="width: 10%;"></td> <td style="width: 10%;"></td> <td style="width: 10%;"></td> <td style="width: 10%;"></td> </tr> <tr> <td></td> <td></td> <td colspan="8" style="text-align: center;"> <table border="1" style="width: 100%; border-collapse: collapse; text-align: center;"> <tr> <td style="width: 10%;"></td> <td style="width: 10%;"></td> <td style="width: 10%;"></td> <td style="width: 10%;"></td> <td style="width: 10%;"></td> <td style="width: 10%;"></td> <td style="width: 10%;"></td> <td style="width: 10%;"></td> <td style="width: 10%;"></td> <td style="width: 10%;"></td> </tr> <tr> <td></td> <td></td> <td colspan="8" style="text-align: center;"> <table border="1" style="width: 100%; border-collapse: collapse; text-align: center;"> <tr> <td style="width: 10%;"></td> <td style="width: 10%;"></td> <td style="width: 10%;"></td> <td style="width: 10%;"></td> <td style="width: 10%;"></td> <td style="width: 10%;"></td> <td style="width: 10%;"></td> <td style="width: 10%;"></td> <td style="width: 10%;"></td> <td style="width: 10%;"></td> </tr> <tr> <td></td> <td></td> <td colspan="8" style="text-align: center;"> <table border="1" style="width: 100%; border-collapse: collapse; text-align: center;"> <tr> <td style="width: 10%;"></td> <td style="width: 10%;"></td> <td style="width: 10%;"></td> <td style="width: 10%;"></td> <td style="width: 10%;"></td> <td style="width: 10%;"></td> <td style="width: 10%;"></td> <td style="width: 10%;"></td> <td style="width: 10%;"></td> <td style="width: 10%;"></td> </tr> <tr> <td></td> <td></td> <td colspan="8" style="text-align: center;"> <table border="1" style="width: 100%; border-collapse: collapse; text-align: center;"> <tr> </tr></table></td></tr></table></td></tr></table></td></tr></table></td></tr></table></td></tr></table></td></tr></table></td></tr></table></td></tr></table></td></tr></table></td></tr></table></td></tr></table></td></tr></table></td></tr></table></td></tr></table></td></tr></table></td></tr></table></td></tr></table></td></tr></table></td></tr></table></td></tr></table></td></tr></table></td></tr></table></td></tr></table></td></tr></table></td></tr></table></td></tr></table></td></tr></table></td></tr></table></td></tr></table></td></tr></table></td></tr></table></td></tr></table></td></tr></table></td></tr></table> | | | | | | | | | | | | | | | | | | | | <table border="1" style="width: 100%; border-collapse: collapse; text-align: center;"> <tr> <td style="width: 10%;"></td> <td style="width: 10%;"></td> <td style="width: 10%;"></td> <td style="width: 10%;"></td> <td style="width: 10%;"></td> <td style="width: 10%;"></td> <td style="width: 10%;"></td> <td style="width: 10%;"></td> <td style="width: 10%;"></td> <td style="width: 10%;"></td> </tr> <tr> <td></td> <td></td> <td colspan="8" style="text-align: center;"> <table border="1" style="width: 100%; border-collapse: collapse; text-align: center;"> <tr> <td style="width: 10%;"></td> <td style="width: 10%;"></td> <td style="width: 10%;"></td> <td style="width: 10%;"></td> <td style="width: 10%;"></td> <td style="width: 10%;"></td> <td style="width: 10%;"></td> <td style="width: 10%;"></td> <td style="width: 10%;"></td> <td style="width: 10%;"></td> </tr> <tr> <td></td> <td></td> <td colspan="8" style="text-align: center;"> <table border="1" style="width: 100%; border-collapse: collapse; text-align: center;"> <tr> <td style="width: 10%;"></td> <td style="width: 10%;"></td> <td style="width: 10%;"></td> <td style="width: 10%;"></td> <td style="width: 10%;"></td> <td style="width: 10%;"></td> <td style="width: 10%;"></td> <td style="width: 10%;"></td> <td style="width: 10%;"></td> <td style="width: 10%;"></td> </tr> <tr> <td></td> <td></td> <td colspan="8" style="text-align: center;"> <table border="1" style="width: 100%; border-collapse: collapse; text-align: center;"> <tr> <td style="width: 10%;"></td> <td style="width: 10%;"></td> <td style="width: 10%;"></td> <td style="width: 10%;"></td> <td style="width: 10%;"></td> <td style="width: 10%;"></td> <td style="width: 10%;"></td> <td style="width: 10%;"></td> <td style="width: 10%;"></td> <td style="width: 10%;"></td> </tr> <tr> <td></td> <td></td> <td colspan="8" style="text-align: center;"> <table border="1" style="width: 100%; border-collapse: collapse; text-align: center;"> <tr> <td style="width: 10%;"></td> <td style="width: 10%;"></td> <td style="width: 10%;"></td> <td style="width: 10%;"></td> <td style="width: 10%;"></td> <td style="width: 10%;"></td> <td style="width: 10%;"></td> <td style="width: 10%;"></td> <td style="width: 10%;"></td> <td style="width: 10%;"></td> </tr> <tr> <td></td> <td></td> <td colspan="8" style="text-align: center;"> <table border="1" style="width: 100%; border-collapse: collapse; text-align: center;"> <tr> <td style="width: 10%;"></td> <td style="width: 10%;"></td> <td style="width: 10%;"></td> <td style="width: 10%;"></td> <td style="width: 10%;"></td> <td style="width: 10%;"></td> <td style="width: 10%;"></td> <td style="width: 10%;"></td> <td style="width: 10%;"></td> <td style="width: 10%;"></td> </tr> <tr> <td></td> <td></td> <td colspan="8" style="text-align: center;"> <table border="1" style="width: 100%; border-collapse: collapse; text-align: center;"> <tr> <td style="width: 10%;"></td> <td style="width: 10%;"></td> <td style="width: 10%;"></td> <td style="width: 10%;"></td> <td style="width: 10%;"></td> <td style="width: 10%;"></td> <td style="width: 10%;"></td> <td style="width: 10%;"></td> <td style="width: 10%;"></td> <td style="width: 10%;"></td> </tr> <tr> <td></td> <td></td>
<td colspan="8" style="text-align: center;"> <table border="1" style="width: 100%; border-collapse: collapse; text-align: center;"> <tr> <td style="width: 10%;"></td> <td style="width: 10%;"></td> <td style="width: 10%;"></td> <td style="width: 10%;"></td> <td style="width: 10%;"></td> <td style="width: 10%;"></td> <td style="width: 10%;"></td> <td style="width: 10%;"></td> <td style="width: 10%;"></td> <td style="width: 10%;"></td> </tr> <tr> <td></td> <td></td> <td colspan="8" style="text-align: center;"> <table border="1" style="width: 100%; border-collapse: collapse; text-align: center;"> <tr> <td style="width: 10%;"></td> <td style="width: 10%;"></td> <td style="width: 10%;"></td> <td style="width: 10%;"></td> <td style="width: 10%;"></td> <td style="width: 10%;"></td> <td style="width: 10%;"></td> <td style="width: 10%;"></td> <td style="width: 10%;"></td> <td style="width: 10%;"></td> </tr> <tr> <td></td> <td></td> <td colspan="8" style="text-align: center;"> <table border="1" style="width: 100%; border-collapse: collapse; text-align: center;"> <tr> <td style="width: 10%;"></td> <td style="width: 10%;"></td> <td style="width: 10%;"></td> <td style="width: 10%;"></td> <td style="width: 10%;"></td> <td style="width: 10%;"></td> <td style="width: 10%;"></td> <td style="width: 10%;"></td> <td style="width: 10%;"></td> <td style="width: 10%;"></td> </tr> <tr> <td></td> <td></td> <td colspan="8" style="text-align: center;"> <table border="1" style="width: 100%; border-collapse: collapse; text-align: center;"> <tr> <td style="width: 10%;"></td> <td style="width: 10%;"></td> <td style="width: 10%;"></td> <td style="width: 10%;"></td> <td style="width: 10%;"></td> <td style="width: 10%;"></td> <td style="width: 10%;"></td> <td style="width: 10%;"></td> <td style="width: 10%;"></td> <td style="width: 10%;"></td> </tr> <tr> <td></td> <td></td> <td colspan="8" style="text-align: center;"> <table border="1" style="width: 100%; border-collapse: collapse; text-align: center;"> <tr> <td style="width: 10%;"></td> <td style="width: 10%;"></td> <td style="width: 10%;"></td> <td style="width: 10%;"></td> <td style="width: 10%;"></td> <td style="width: 10%;"></td> <td style="width: 10%;"></td> <td style="width: 10%;"></td> <td style="width: 10%;"></td> <td style="width: 10%;"></td> </tr> <tr> <td></td> <td></td> <td colspan="8" style="text-align: center;"> <table border="1" style="width: 100%; border-collapse: collapse; text-align: center;"> <tr> <td style="width: 10%;"></td> <td style="width: 10%;"></td> <td style="width: 10%;"></td> <td style="width: 10%;"></td> <td style="width: 10%;"></td> <td style="width: 10%;"></td> <td style="width: 10%;"></td> <td style="width: 10%;"></td> <td style="width: 10%;"></td> <td style="width: 10%;"></td> </tr> <tr> <td></td> <td></td> <td colspan="8" style="text-align: center;"> <table border="1" style="width: 100%; border-collapse: collapse; text-align: center;"> <tr> <td style="width: 10%;"></td> <td style="width: 10%;"></td> <td style="width: 10%;"></td> <td style="width: 10%;"></td> <td style="width: 10%;"></td> <td style="width: 10%;"></td> <td style="width: 10%;"></td> <td style="width: 10%;"></td> <td style="width: 10%;"></td> <td style="width: 10%;"></td> </tr> <tr> <td></td> <td></td> <td colspan="8" style="text-align: center;"> <table border="1" style="width: 100%; border-collapse: collapse; text-align: center;"> <tr> <td style="width: 10%;"></td> <td style="width: 10%;"></td> <td style="width: 10%;"></td> <td style="width: 10%;"></td> <td style="width: 10%;"></td> <td style="width: 10%;"></td> <td style="width: 10%;"></td> <td style="width: 10%;"></td> <td style="width: 10%;"></td> <td style="width: 10%;"></td> </tr> <tr> <td></td> <td></td> <td colspan="8" style="text-align: center;"> <table border="1" style="width: 100%; border-collapse: collapse; text-align: center;"> <tr> <td style="width: 10%;"></td> <td style="width: 10%;"></td> <td style="width: 10%;"></td> <td style="width: 10%;"></td> <td style="width: 10%;"></td> <td style="width: 10%;"></td> <td style="width: 10%;"></td> <td style="width: 10%;"></td> <td style="width: 10%;"></td> <td style="width: 10%;"></td> </tr> <tr> <td></td> <td></td> <td colspan="8" style="text-align: center;"> <table border="1" style="width: 100%; border-collapse: collapse; text-align: center;"> <tr> <td style="width: 10%;"></td> <td style="width: 10%;"></td> <td style="width: 10%;"></td> <td style="width: 10%;"></td> <td style="width: 10%;"></td> <td style="width: 10%;"></td> <td style="width: 10%;"></td> <td style="width: 10%;"></td> <td style="width: 10%;"></td> <td style="width: 10%;"></td> </tr> <tr> <td></td> <td></td> <td colspan="8" style="text-align: center;"> <table border="1" style="width: 100%; border-collapse: collapse; text-align: center;"> <tr> <td style="width: 10%;"></td> <td style="width: 10%;"></td> <td style="width: 10%;"></td> <td style="width: 10%;"></td> <td style="width: 10%;"></td> <td style="width: 10%;"></td> <td style="width: 10%;"></td> <td style="width: 10%;"></td> <td style="width: 10%;"></td> <td style="width: 10%;"></td> </tr> <tr> <td></td> <td></td> <td colspan="8" style="text-align: center;"> <table border="1" style="width: 100%; border-collapse: collapse; text-align: center;"> <tr> <td style="width: 10%;"></td> <td style="width: 10%;"></td> <td style="width: 10%;"></td> <td style="width: 10%;"></td> <td style="width: 10%;"></td> <td style="width: 10%;"></td> <td style="width: 10%;"></td> <td style="width: 10%;"></td> <td style="width: 10%;"></td> <td style="width: 10%;"></td> </tr> <tr> <td></td> <td></td> <td colspan="8" style="text-align: center;"> <table border="1" style="width: 100%; border-collapse: collapse; text-align: center;"> <tr> <td style="width: 10%;"></td> <td style="width: 10%;"></td> <td style="width: 10%;"></td> <td style="width: 10%;"></td> <td style="width: 10%;"></td> <td style="width: 10%;"></td> <td style="width: 10%;"></td> <td style="width: 10%;"></td> <td style="width: 10%;"></td> <td style="width: 10%;"></td> </tr> <tr> <td></td> <td></td> <td colspan="8" style="text-align: center;"> <table border="1" style="width: 100%; border-collapse: collapse; text-align: center;"> <tr> <td style="width: 10%;"></td> <td style="width: 10%;"></td> <td style="width: 10%;"></td> <td style="width: 10%;"></td> <td style="width: 10%;"></td> <td style="width: 10%;"></td> <td style="width: 10%;"></td> <td style="width: 10%;"></td> <td style="width: 10%;"></td> <td style="width: 10%;"></td> </tr> <tr> <td></td> <td></td> <td colspan="8" style="text-align: center;"> <table border="1" style="width: 100%; border-collapse: collapse; text-align: center;"> <tr> <td style="width: 10%;"></td> <td style="width: 10%;"></td> <td style="width: 10%;"></td> <td style="width: 10%;"></td> <td style="width: 10%;"></td> <td style="width: 10%;"></td> <td style="width: 10%;"></td> <td style="width: 10%;"></td> <td style="width: 10%;"></td> <td style="width: 10%;"></td> </tr> <tr> <td></td> <td></td> <td colspan="8" style="text-align: center;"> <table border="1" style="width: 100%; border-collapse: collapse; text-align: center;"> <tr> <td style="width: 10%;"></td> <td style="width: 10%;"></td> <td style="width: 10%;"></td> <td style="width: 10%;"></td> <td style="width: 10%;"></td> <td style="width: 10%;"></td> <td style="width: 10%;"></td> <td style="width: 10%;"></td> <td style="width: 10%;"></td> <td style="width: 10%;"></td> </tr> <tr> <td></td> <td></td> <td colspan="8" style="text-align: center;"> <table border="1" style="width: 100%; border-collapse: collapse; text-align: center;"> <tr> <td style="width: 10%;"></td> <td style="width: 10%;"></td> <td style="width: 10%;"></td> <td style="width: 10%;"></td> <td style="width: 10%;"></td> <td style="width: 10%;"></td> <td style="width: 10%;"></td> <td style="width: 10%;"></td> <td style="width: 10%;"></td> <td style="width: 10%;"></td> </tr> <tr> <td></td> <td></td> <td colspan="8" style="text-align: center;"> <table border="1" style="width: 100%; border-collapse: collapse; text-align: center;"> <tr> <td style="width: 10%;"></td> <td style="width: 10%;"></td> <td style="width: 10%;"></td> <td style="width: 10%;"></td> <td style="width: 10%;"></td> <td style="width: 10%;"></td> <td style="width: 10%;"></td> <td style="width: 10%;"></td> <td style="width: 10%;"></td> <td style="width: 10%;"></td> </tr> <tr> <td></td> <td></td> <td colspan="8" style="text-align: center;"> <table border="1" style="width: 100%; border-collapse: collapse; text-align: center;"> <tr> <td style="width: 10%;"></td> <td style="width: 10%;"></td> <td style="width: 10%;"></td> <td style="width: 10%;"></td> <td style="width: 10%;"></td> <td style="width: 10%;"></td> <td style="width: 10%;"></td> <td style="width: 10%;"></td> <td style="width: 10%;"></td> <td style="width: 10%;"></td> </tr> <tr> <td></td> <td></td> <td colspan="8" style="text-align: center;"> <table border="1" style="width: 100%; border-collapse: collapse; text-align: center;"> <tr> <td style="width: 10%;"></td> <td style="width: 10%;"></td> <td style="width: 10%;"></td> <td style="width: 10%;"></td> <td style="width: 10%;"></td> <td style="width: 10%;"></td> <td style="width: 10%;"></td> <td style="width: 10%;"></td> <td style="width: 10%;"></td> <td style="width: 10%;"></td> </tr> <tr> <td></td> <td></td> <td colspan="8" style="text-align: center;"> <table border="1" style="width: 100%; border-collapse: collapse; text-align: center;"> <tr> <td style="width: 10%;"></td> <td style="width: 10%;"></td> <td style="width: 10%;"></td> <td style="width: 10%;"></td> <td style="width: 10%;"></td> <td style="width: 10%;"></td> <td style="width: 10%;"></td> <td style="width: 10%;"></td> <td style="width: 10%;"></td> <td style="width: 10%;"></td> </tr> <tr> <td></td> <td></td> <td colspan="8" style="text-align: center;"> <table border="1" style="width: 100%; border-collapse: collapse; text-align: center;"> <tr> <td style="width: 10%;"></td> <td
style="width: 10%;"></td> <td style="width: 10%;"></td> <td style="width: 10%;"></td> <td style="width: 10%;"></td> <td style="width: 10%;"></td> <td style="width: 10%;"></td> <td style="width: 10%;"></td> <td style="width: 10%;"></td> <td style="width: 10%;"></td> </tr> <tr> <td></td> <td></td> <td colspan="8" style="text-align: center;"> <table border="1" style="width: 100%; border-collapse: collapse; text-align: center;"> <tr> <td style="width: 10%;"></td> <td style="width: 10%;"></td> <td style="width: 10%;"></td> <td style="width: 10%;"></td> <td style="width: 10%;"></td> <td style="width: 10%;"></td> <td style="width: 10%;"></td> <td style="width: 10%;"></td> <td style="width: 10%;"></td> <td style="width: 10%;"></td> </tr> <tr> <td></td> <td></td> <td colspan="8" style="text-align: center;"> <table border="1" style="width: 100%; border-collapse: collapse; text-align: center;"> <tr> <td style="width: 10%;"></td> <td style="width: 10%;"></td> <td style="width: 10%;"></td> <td style="width: 10%;"></td> <td style="width: 10%;"></td> <td style="width: 10%;"></td> <td style="width: 10%;"></td> <td style="width: 10%;"></td> <td style="width: 10%;"></td> <td style="width: 10%;"></td> </tr> <tr> <td></td> <td></td> <td colspan="8" style="text-align: center;"> <table border="1" style="width: 100%; border-collapse: collapse; text-align: center;"> <tr> <td style="width: 10%;"></td> <td style="width: 10%;"></td> <td style="width: 10%;"></td> <td style="width: 10%;"></td> <td style="width: 10%;"></td> <td style="width: 10%;"></td> <td style="width: 10%;"></td> <td style="width: 10%;"></td> <td style="width: 10%;"></td> <td style="width: 10%;"></td> </tr> <tr> <td></td> <td></td> <td colspan="8" style="text-align: center;"> <table border="1" style="width: 100%; border-collapse: collapse; text-align: center;"> <tr> <td style="width: 10%;"></td> <td style="width: 10%;"></td> <td style="width: 10%;"></td> <td style="width: 10%;"></td> <td style="width: 10%;"></td> <td style="width: 10%;"></td> <td style="width: 10%;"></td> <td style="width: 10%;"></td> <td style="width: 10%;"></td> <td style="width: 10%;"></td> </tr> <tr> <td></td> <td></td> <td colspan="8" style="text-align: center;"> <table border="1" style="width: 100%; border-collapse: collapse; text-align: center;"> <tr> </tr></table></td></tr></table></td></tr></table></td></tr></table></td></tr></table></td></tr></table></td></tr></table></td></tr></table></td></tr></table></td></tr></table></td></tr></table></td></tr></table></td></tr></table></td></tr></table></td></tr></table></td></tr></table></td></tr></table></td></tr></table></td></tr></table></td></tr></table></td></tr></table></td></tr></table></td></tr></table></td></tr></table></td></tr></table></td></tr></table></td></tr></table></td></tr></table></td></tr></table></td></tr></table></td></tr></table></td></tr></table></td></tr></table></td></tr></table> | | | | | | | | | | | | | | | | | | | | <table border="1" style="width: 100%; border-collapse: collapse; text-align: center;"> <tr> <td style="width: 10%;"></td> <td style="width: 10%;"></td> <td style="width: 10%;"></td> <td style="width: 10%;"></td> <td style="width: 10%;"></td> <td style="width: 10%;"></td> <td style="width: 10%;"></td> <td style="width: 10%;"></td> <td style="width: 10%;"></td> <td style="width: 10%;"></td> </tr> <tr> <td></td> <td></td> <td colspan="8" style="text-align: center;"> <table border="1" style="width: 100%; border-collapse: collapse; text-align: center;"> <tr> <td style="width: 10%;"></td> <td style="width: 10%;"></td> <td style="width: 10%;"></td> <td style="width: 10%;"></td> <td style="width: 10%;"></td> <td style="width: 10%;"></td> <td style="width: 10%;"></td> <td style="width: 10%;"></td> <td style="width: 10%;"></td> <td style="width: 10%;"></td> </tr> <tr> <td></td> <td></td> <td colspan="8" style="text-align: center;"> <table border="1" style="width: 100%; border-collapse: collapse; text-align: center;"> <tr> <td style="width: 10%;"></td> <td style="width: 10%;"></td> <td style="width: 10%;"></td> <td style="width: 10%;"></td> <td style="width: 10%;"></td> <td style="width: 10%;"></td> <td style="width: 10%;"></td> <td style="width: 10%;"></td> <td style="width: 10%;"></td> <td style="width: 10%;"></td> </tr> <tr> <td></td> <td></td> <td colspan="8" style="text-align: center;"> <table border="1" style="width: 100%; border-collapse: collapse; text-align: center;"> <tr> <td style="width: 10%;"></td> <td style="width: 10%;"></td> <td style="width: 10%;"></td> <td style="width: 10%;"></td> <td style="width: 10%;"></td> <td style="width: 10%;"></td> <td style="width: 10%;"></td> <td style="width: 10%;"></td> <td style="width: 10%;"></td> <td style="width: 10%;"></td> </tr> <tr> <td></td> <td></td> <td colspan="8" style="text-align: center;"> <table border="1" style="width: 100%; border-collapse: collapse; text-align: center;"> <tr> <td style="width: 10%;"></td> <td style="width: 10%;"></td> <td style="width: 10%;"></td> <td style="width: 10%;"></td> <td style="width: 10%;"></td> <td style="width: 10%;"></td> <td style="width: 10%;"></td> <td style="width: 10%;"></td> <td style="width: 10%;"></td> <td style="width: 10%;"></td> </tr> <tr> <td></td> <td></td> <td colspan="8" style="text-align: center;"> <table border="1" style="width: 100%; border-collapse: collapse; text-align: center;"> <tr> <td style="width: 10%;"></td> <td style="width: 10%;"></td> <td style="width: 10%;"></td> <td style="width: 10%;"></td> <td style="width: 10%;"></td> <td style="width: 10%;"></td> <td style="width: 10%;"></td> <td style="width: 10%;"></td> <td style="width: 10%;"></td> <td style="width: 10%;"></td> </tr> <tr> <td></td> <td></td> <td colspan="8" style="text-align: center;"> <table border="1" style="width: 100%; border-collapse: collapse; text-align: center;"> <tr> <td style="width: 10%;"></td> <td style="width: 10%;"></td> <td style="width: 10%;"></td> <td style="width: 10%;"></td> <td style="width: 10%;"></td> <td style="width: 10%;"></td> <td style="width: 10%;"></td> <td style="width: 10%;"></td> <td style="width: 10%;"></td> <td style="width: 10%;"></td> </tr> <tr> <td></td> <td></td> <td colspan="8" style="text-align: center;"> <table border="1" style="width: 100%; border-collapse: collapse; text-align: center;"> <tr> <td style="width: 10%;"></td> <td style="width: 10%;"></td> <td style="width: 10%;"></td> <td style="width: 10%;"></td> <td style="width: 10%;"></td> <td style="width: 10%;"></td> <td style="width: 10%;"></td> <td style="width: 10%;"></td> <td style="width: 10%;"></td> <td style="width: 10%;"></td> </tr> <tr> <td></td> <td></td> <td colspan="8" style="text-align: center;"> <table border="1" style="width: 100%; border-collapse: collapse; text-align: center;"> <tr> <td style="width: 10%;"></td> <td style="width: 10%;"></td> <td style="width: 10%;"></td> <td style="width: 10%;"></td> <td style="width: 10%;"></td> <td style="width: 10%;"></td> <td style="width: 10%;"></td> <td style="width: 10%;"></td> <td style="width: 10%;"></td> <td
style="width: 10%;"></td> </tr> <tr> <td></td> <td></td> <td colspan="8" style="text-align: center;"> <table border="1" style="width: 100%; border-collapse: collapse; text-align: center;"> <tr> <td style="width: 10%;"></td> <td style="width: 10%;"></td> <td style="width: 10%;"></td> <td style="width: 10%;"></td> <td style="width: 10%;"></td> <td style="width: 10%;"></td> <td style="width: 10%;"></td> <td style="width: 10%;"></td> <td style="width: 10%;"></td> <td style="width: 10%;"></td> </tr> <tr> <td></td> <td></td> <td colspan="8" style="text-align: center;"> <table border="1" style="width: 100%; border-collapse: collapse; text-align: center;"> <tr> <td style="width: 10%;"></td> <td style="width: 10%;"></td> <td style="width: 10%;"></td> <td style="width: 10%;"></td> <td style="width: 10%;"></td> <td style="width: 10%;"></td> <td style="width: 10%;"></td> <td style="width: 10%;"></td> <td style="width: 10%;"></td> <td style="width: 10%;"></td> </tr> <tr> <td></td> <td></td> <td colspan="8" style="text-align: center;"> <table border="1" style="width: 100%; border-collapse: collapse; text-align: center;"> <tr> <td style="width: 10%;"></td> <td style="width: 10%;"></td> <td style="width: 10%;"></td> <td style="width: 10%;"></td> <td style="width: 10%;"></td> <td style="width: 10%;"></td> <td style="width: 10%;"></td> <td style="width: 10%;"></td> <td style="width: 10%;"></td> <td style="width: 10%;"></td> </tr> <tr> <td></td> <td></td> <td colspan="8" style="text-align: center;"> <table border="1" style="width: 100%; border-collapse: collapse; text-align: center;"> <tr> <td style="width: 10%;"></td> <td style="width: 10%;"></td> <td style="width: 10%;"></td> <td style="width: 10%;"></td> <td style="width: 10%;"></td> <td style="width: 10%;"></td> <td style="width: 10%;"></td> <td style="width: 10%;"></td> <td style="width: 10%;"></td> <td style="width: 10%;"></td> </tr> <tr> <td></td> <td></td> <td colspan="8" style="text-align: center;"> <table border="1" style="width: 100%; border-collapse: collapse; text-align: center;"> <tr> <td style="width: 10%;"></td> <td style="width: 10%;"></td> <td style="width: 10%;"></td> <td style="width: 10%;"></td> <td style="width: 10%;"></td> <td style="width: 10%;"></td> <td style="width: 10%;"></td> <td style="width: 10%;"></td> <td style="width: 10%;"></td> <td style="width: 10%;"></td> </tr> <tr> <td></td> <td></td> <td colspan="8" style="text-align: center;"> <table border="1" style="width: 100%; border-collapse: collapse; text-align: center;"> <tr> <td style="width: 10%;"></td> <td style="width: 10%;"></td> <td style="width: 10%;"></td> <td style="width: 10%;"></td> <td style="width: 10%;"></td> <td style="width: 10%;"></td> <td style="width: 10%;"></td> <td style="width: 10%;"></td> <td style="width: 10%;"></td> <td style="width: 10%;"></td> </tr> <tr> <td></td> <td></td> <td colspan="8" style="text-align: center;"> <table border="1" style="width: 100%; border-collapse: collapse; text-align: center;"> <tr> <td style="width: 10%;"></td> <td style="width: 10%;"></td> <td style="width: 10%;"></td> <td style="width: 10%;"></td> <td style="width: 10%;"></td> <td style="width: 10%;"></td> <td style="width: 10%;"></td> <td style="width: 10%;"></td> <td style="width: 10%;"></td> <td style="width: 10%;"></td> </tr> <tr> <td></td> <td></td> <td colspan="8" style="text-align: center;"> <table border="1" style="width: 100%; border-collapse: collapse; text-align: center;"> <tr> <td style="width: 10%;"></td> <td style="width: 10%;"></td> <td style="width: 10%;"></td> <td style="width: 10%;"></td> <td style="width: 10%;"></td> <td style="width: 10%;"></td> <td style="width: 10%;"></td> <td style="width: 10%;"></td> <td style="width: 10%;"></td> <td style="width: 10%;"></td> </tr> <tr> <td></td> <td></td> <td colspan="8" style="text-align: center;"> <table border="1" style="width: 100%; border-collapse: collapse; text-align: center;"> <tr> <td style="width: 10%;"></td> <td style="width: 10%;"></td> <td style="width: 10%;"></td> <td style="width: 10%;"></td> <td style="width: 10%;"></td> <td style="width: 10%;"></td> <td style="width: 10%;"></td> <td style="width: 10%;"></td> <td style="width: 10%;"></td> <td style="width: 10%;"></td> </tr> <tr> <td></td> <td></td> <td colspan="8" style="text-align: center;"> <table border="1" style="width: 100%; border-collapse: collapse; text-align: center;"> <tr> <td style="width: 10%;"></td> <td style="width: 10%;"></td> <td style="width: 10%;"></td> <td style="width: 10%;"></td> <td style="width: 10%;"></td> <td style="width: 10%;"></td> <td style="width: 10%;"></td> <td style="width: 10%;"></td> <td style="width: 10%;"></td> <td style="width: 10%;"></td> </tr> <tr> <td></td> <td></td> <td colspan="8" style="text-align: center;"> <table border="1" style="width: 100%; border-collapse: collapse; text-align: center;"> <tr> <td style="width: 10%;"></td> <td style="width: 10%;"></td> <td style="width: 10%;"></td> <td style="width: 10%;"></td> <td style="width: 10%;"></td> <td style="width: 10%;"></td> <td style="width: 10%;"></td> <td style="width: 10%;"></td> <td style="width: 10%;"></td> <td style="width: 10%;"></td> </tr> <tr> <td></td> <td></td> <td colspan="8" style="text-align: center;"> <table border="1" style="width: 100%; border-collapse: collapse; text-align: center;"> <tr> <td style="width: 10%;"></td> <td style="width: 10%;"></td> <td style="width: 10%;"></td> <td style="width: 10%;"></td> <td style="width: 10%;"></td> <td style="width: 10%;"></td> <td style="width: 10%;"></td> <td style="width: 10%;"></td> <td style="width: 10%;"></td> <td style="width: 10%;"></td> </tr> <tr> <td></td> <td></td> <td colspan="8" style="text-align: center;"> <table border="1" style="width: 100%; border-collapse: collapse; text-align: center;"> <tr> <td style="width: 10%;"></td> <td style="width: 10%;"></td> <td style="width: 10%;"></td> <td style="width: 10%;"></td> <td style="width: 10%;"></td> <td style="width: 10%;"></td> <td style="width: 10%;"></td> <td style="width: 10%;"></td> <td style="width: 10%;"></td> <td style="width: 10%;"></td> </tr> <tr> <td></td> <td></td> <td colspan="8" style="text-align: center;"> <table border="1" style="width: 100%; border-collapse: collapse; text-align: center;"> <tr> <td style="width: 10%;"></td> <td style="width: 10%;"></td> <td style="width: 10%;"></td> <td style="width: 10%;"></td> <td style="width: 10%;"></td> <td style="width: 10%;"></td> <td style="width: 10%;"></td> <td style="width: 10%;"></td> <td style="width: 10%;"></td> <td style="width: 10%;"></td> </tr> <tr> <td></td> <td></td> <td colspan="8" style="text-align: center;"> <table border="1" style="width: 100%; border-collapse: collapse; text-align: center;"> <tr> <td style="width: 10%;"></td> <td style="width: 10%;"></td> <td style="width: 10%;"></td> <td style="width: 10%;"></td> <td style="width: 10%;"></td> <td style="width: 10%;"></td> <td style="width: 10%;"></td> <td style="width: 10%;"></td> <td style="width: 10%;"></td> <td style="width: 10%;"></td> </tr> <tr> <td></td> <td></td> <td colspan="8" style="text-align: center;"> <table border="1" style="width: 100%; border-collapse: collapse; text-align: center;"> <tr> <td style="width: 10%;"></td> <td style="width: 10%;"></td> <td style="width: 10%;"></td> <td style="width: 10%;"></td> <td style="width: 10%;"></td> <td style="width: 10%;"></td> <td style="width: 10%;"></td> <td style="width: 10%;"></td> <td style="width: 10%;"></td> <td style="width: 10%;"></td> </tr> <tr> <td></td> <td></td> <td colspan="8" style="text-align: center;"> <table border="1" style="width: 100%; border-collapse: collapse; text-align: center;"> <tr> <td style="width: 10%;"></td> <td style="width: 10%;"></td> <td style="width: 10%;"></td> <td style="width: 10%;"></td> <td style="width: 10%;"></td> <td style="width: 10%;"></td> <td style="width: 10%;"></td> <td style="width: 10%;"></td> <td style="width: 10%;"></td> <td style="width: 10%;"></td> </tr> <tr> <td></td> <td></td> <td colspan="8" style="text-align: center;"> <table border="1" style="width: 100%; border-collapse: collapse; text-align: center;"> <tr> <td style="width: 10%;"></td> <td style="width: 10%;"></td> <td style="width: 10%;"></td> <td style="width: 10%;"></td> <td style="width: 10%;"></td> <td style="width: 10%;"></td> <td style="width: 10%;"></td> <td style="width: 10%;"></td> <td style="width: 10%;"></td> <td style="width: 10%;"></td> </tr> <tr> <td></td> <td></td> <td colspan="8" style="text-align: center;"> <table border="1" style="width: 100%; border-collapse: collapse; text-align: center;"> <tr> <td style="width: 10%;"></td> <td style="width: 10%;"></td> <td style="width: 10%;"></td> <td style="width: 10%;"></td> <td style="width: 10%;"></td> <td style="width: 10%;"></td> <td style="width: 10%;"></td> <td style="width: 10%;"></td> <td style="width: 10%;"></td> <td style="width: 10%;"></td> </tr> <tr> <td></td> <td></td> <td colspan="8" style="text-align: center;"> <table border="1" style="width: 100%; border-collapse: collapse; text-align: center;"> <tr> <td style="width: 10%;"></td> <td style="width: 10%;"></td> <td style="width: 10%;"></td> <td style="width: 10%;"></td> <td style="width: 10%;"></td> <td style="width: 10%;"></td> <td style="width: 10%;"></td> <td style="width: 10%;"></td> <td style="width: 10%;"></td> <td style="width: 10%;"></td> </tr> <tr> <td></td> <td></td> <td colspan="8" style="text-align: center;"> <table border="1" style="width: 100%; border-collapse: collapse; text-align: center;"> <tr> <td style="width: 10%;"></td> <td style="width: 10%;"></td> <td style="width: 10%;"></td> <td style="width: 10%;"></td> <td style="width: 10%;"></td> <td style="width: 10%;"></td> <td style="width: 10%;"></td> <td style="width: 10%;"></td> <td style="width: 10%;"></td> <td style="width: 10%;"></td> </tr> <tr> <td></td> <td></td> <td colspan="8" style="text-align: center;"> <table border="1" style="width: 100%; border-collapse: collapse;
text-align: center;"> <tr> <td style="width: 10%;"></td> <td style="width: 10%;"></td> <td style="width: 10%;"></td> <td style="width: 10%;"></td> <td style="width: 10%;"></td> <td style="width: 10%;"></td> <td style="width: 10%;"></td> <td style="width: 10%;"></td> <td style="width: 10%;"></td> <td style="width: 10%;"></td> </tr> <tr> <td></td> <td></td> <td colspan="8" style="text-align: center;"> <table border="1" style="width: 100%; border-collapse: collapse; text-align: center;"> <tr> <td style="width: 10%;"></td> <td style="width: 10%;"></td> <td style="width: 10%;"></td> <td style="width: 10%;"></td> <td style="width: 10%;"></td> <td style="width: 10%;"></td> <td style="width: 10%;"></td> <td style="width: 10%;"></td> <td style="width: 10%;"></td> <td style="width: 10%;"></td> </tr> <tr> <td></td> <td></td> <td colspan="8" style="text-align: center;"> <table border="1" style="width: 100%; border-collapse: collapse; text-align: center;"> <tr> </tr></table></td></tr></table></td></tr></table></td></tr></table></td></tr></table></td></tr></table></td></tr></table></td></tr></table></td></tr></table></td></tr></table></td></tr></table></td></tr></table></td></tr></table></td></tr></table></td></tr></table></td></tr></table></td></tr></table></td></tr></table></td></tr></table></td></tr></table></td></tr></table></td></tr></table></td></tr></table></td></tr></table></td></tr></table></td></tr></table></td></tr></table></td></tr></table></td></tr></table></td></tr></table></td></tr></table></td></tr></table></td></tr></table> | | | | | | | | | | | | | | | | | | | | <table border="1" style="width: 100%; border-collapse: collapse; text-align: center;"> <tr> <td style="width: 10%;"></td> <td style="width: 10%;"></td> <td style="width: 10%;"></td> <td style="width: 10%;"></td> <td style="width: 10%;"></td> <td style="width: 10%;"></td> <td style="width: 10%;"></td> <td style="width: 10%;"></td> <td style="width: 10%;"></td> <td style="width: 10%;"></td> </tr> <tr> <td></td> <td></td> <td colspan="8" style="text-align: center;"> <table border="1" style="width: 100%; border-collapse: collapse; text-align: center;"> <tr> <td style="width: 10%;"></td> <td style="width: 10%;"></td> <td style="width: 10%;"></td> <td style="width: 10%;"></td> <td style="width: 10%;"></td> <td style="width: 10%;"></td> <td style="width: 10%;"></td> <td style="width: 10%;"></td> <td style="width: 10%;"></td> <td style="width: 10%;"></td> </tr> <tr> <td></td> <td></td> <td colspan="8" style="text-align: center;"> <table border="1" style="width: 100%; border-collapse: collapse; text-align: center;"> <tr> <td style="width: 10%;"></td> <td style="width: 10%;"></td> <td style="width: 10%;"></td> <td style="width: 10%;"></td> <td style="width: 10%;"></td> <td style="width: 10%;"></td> <td style="width: 10%;"></td> <td style="width: 10%;"></td> <td style="width: 10%;"></td> <td style="width: 10%;"></td> </tr> <tr> <td></td> <td></td> <td colspan="8" style="text-align: center;"> <table border="1" style="width: 100%; border-collapse: collapse; text-align: center;"> <tr> <td style="width: 10%;"></td> <td style="width: 10%;"></td> <td style="width: 10%;"></td> <td style="width: 10%;"></td> <td style="width: 10%;"></td> <td style="width: 10%;"></td> <td style="width: 10%;"></td> <td style="width: 10%;"></td> <td style="width: 10%;"></td> <td style="width: 10%;"></td> </tr> <tr> <td></td> <td></td> <td colspan="8" style="text-align: center;"> <table border="1" style="width: 100%; border-collapse: collapse; text-align: center;"> <tr> <td style="width: 10%;"></td> <td style="width: 10%;"></td> <td style="width: 10%;"></td> <td style="width: 10%;"></td> <td style="width: 10%;"></td> <td style="width: 10%;"></td> <td style="width: 10%;"></td> <td style="width: 10%;"></td> <td style="width: 10%;"></td> <td style="width: 10%;"></td> </tr> <tr> <td></td> <td></td> <td colspan="8" style="text-align: center;"> <table border="1" style="width: 100%; border-collapse: collapse; text-align: center;"> <tr> <td style="width: 10%;"></td> <td style="width: 10%;"></td> <td style="width: 10%;"></td> <td style="width: 10%;"></td> <td style="width: 10%;"></td> <td style="width: 10%;"></td> <td style="width: 10%;"></td> <td style="width: 10%;"></td> <td style="width: 10%;"></td> <td style="width: 10%;"></td> </tr> <tr> <td></td> <td></td> <td colspan="8" style="text-align: center;"> <table border="1" style="width: 100%; border-collapse: collapse; text-align: center;"> <tr> <td style="width: 10%;"></td> <td style="width: 10%;"></td> <td style="width: 10%;"></td> <td style="width: 10%;"></td> <td style="width: 10%;"></td> <td style="width: 10%;"></td> <td style="width: 10%;"></td> <td style="width: 10%;"></td> <td style="width: 10%;"></td> <td style="width: 10%;"></td> </tr> <tr> <td></td> <td></td> <td colspan="8" style="text-align: center;"> <table border="1" style="width: 100%; border-collapse: collapse; text-align: center;"> <tr> <td style="width: 10%;"></td> <td style="width: 10%;"></td> <td style="width: 10%;"></td> <td style="width: 10%;"></td> <td style="width: 10%;"></td> <td style="width: 10%;"></td> <td style="width: 10%;"></td> <td style="width: 10%;"></td> <td style="width: 10%;"></td> <td style="width: 10%;"></td> </tr> <tr> <td></td> <td></td> <td colspan="8" style="text-align: center;"> <table border="1" style="width: 100%; border-collapse: collapse; text-align: center;"> <tr> <td style="width: 10%;"></td> <td style="width: 10%;"></td> <td style="width: 10%;"></td> <td style="width: 10%;"></td> <td style="width: 10%;"></td> <td style="width: 10%;"></td> <td style="width: 10%;"></td> <td style="width: 10%;"></td> <td style="width: 10%;"></td> <td style="width: 10%;"></td> </tr> <tr> <td></td> <td></td> <td colspan="8" style="text-align: center;"> <table border="1" style="width: 100%; border-collapse: collapse; text-align: center;"> <tr> <td style="width: 10%;"></td> <td style="width: 10%;"></td> <td style="width: 10%;"></td> <td style="width: 10%;"></td> <td style="width: 10%;"></td> <td style="width: 10%;"></td> <td style="width: 10%;"></td> <td style="width: 10%;"></td> <td style="width: 10%;"></td> <td style="width: 10%;"></td> </tr> <tr> <td></td> <td></td> <td colspan="8" style="text-align: center;"> <table border="1" style="width: 100%; border-collapse: collapse; text-align: center;"> <tr> <td style="width: 10%;"></td> <td style="width: 10%;"></td> <td style="width: 10%;"></td> <td style="width: 10%;"></td> <td style="width: 10%;"></td> <td style="width: 10%;"></td> <td style="width: 10%;"></td> <td style="width: 10%;"></td> <td style="width: 10%;"></td> <td style="width: 10%;"></td> </tr> <tr> <td></td> <td></td> <td colspan="8" style="text-align: center;"> <table border="1" style="width: 100%; border-collapse: collapse; text-align: center;"> <tr> <td style="width: 10%;"></td> <td style="width: 10%;"></td> <td style="width: 10%;"></td> <td style="width: 10%;"></td> <td style="width: 10%;"></td> <td style="width: 10%;"></td> <td style="width: 10%;"></td> <td style="width:
10%;"></td> <td style="width: 10%;"></td> <td style="width: 10%;"></td> </tr> <tr> <td></td> <td></td> <td colspan="8" style="text-align: center;"> <table border="1" style="width: 100%; border-collapse: collapse; text-align: center;"> <tr> <td style="width: 10%;"></td> <td style="width: 10%;"></td> <td style="width: 10%;"></td> <td style="width: 10%;"></td> <td style="width: 10%;"></td> <td style="width: 10%;"></td> <td style="width: 10%;"></td> <td style="width: 10%;"></td> <td style="width: 10%;"></td> <td style="width: 10%;"></td> </tr> <tr> <td></td> <td></td> <td colspan="8" style="text-align: center;"> <table border="1" style="width: 100%; border-collapse: collapse; text-align: center;"> <tr> <td style="width: 10%;"></td> <td style="width: 10%;"></td> <td style="width: 10%;"></td> <td style="width: 10%;"></td> <td style="width: 10%;"></td> <td style="width: 10%;"></td> <td style="width: 10%;"></td> <td style="width: 10%;"></td> <td style="width: 10%;"></td> <td style="width: 10%;"></td> </tr> <tr> <td></td> <td></td> <td colspan="8" style="text-align: center;"> <table border="1" style="width: 100%; border-collapse: collapse; text-align: center;"> <tr> <td style="width: 10%;"></td> <td style="width: 10%;"></td> <td style="width: 10%;"></td> <td style="width: 10%;"></td> <td style="width: 10%;"></td> <td style="width: 10%;"></td> <td style="width: 10%;"></td> <td style="width: 10%;"></td> <td style="width: 10%;"></td> <td style="width: 10%;"></td> </tr> <tr> <td></td> <td></td> <td colspan="8" style="text-align: center;"> <table border="1" style="width: 100%; border-collapse: collapse; text-align: center;"> <tr> <td style="width: 10%;"></td> <td style="width: 10%;"></td> <td style="width: 10%;"></td> <td style="width: 10%;"></td> <td style="width: 10%;"></td> <td style="width: 10%;"></td> <td style="width: 10%;"></td> <td style="width: 10%;"></td> <td style="width: 10%;"></td> <td style="width: 10%;"></td> </tr> <tr> <td></td> <td></td> <td colspan="8" style="text-align: center;"> <table border="1" style="width: 100%; border-collapse: collapse; text-align: center;"> <tr> <td style="width: 10%;"></td> <td style="width: 10%;"></td> <td style="width: 10%;"></td> <td style="width: 10%;"></td> <td style="width: 10%;"></td> <td style="width: 10%;"></td> <td style="width: 10%;"></td> <td style="width: 10%;"></td> <td style="width: 10%;"></td> <td style="width: 10%;"></td> </tr> <tr> <td></td> <td></td> <td colspan="8" style="text-align: center;"> <table border="1" style="width: 100%; border-collapse: collapse; text-align: center;"> <tr> <td style="width: 10%;"></td> <td style="width: 10%;"></td> <td style="width: 10%;"></td> <td style="width: 10%;"></td> <td style="width: 10%;"></td> <td style="width: 10%;"></td> <td style="width: 10%;"></td> <td style="width: 10%;"></td> <td style="width: 10%;"></td> <td style="width: 10%;"></td> </tr> <tr> <td></td> <td></td> <td colspan="8" style="text-align: center;"> <table border="1" style="width: 100%; border-collapse: collapse; text-align: center;"> <tr> <td style="width: 10%;"></td> <td style="width: 10%;"></td> <td style="width: 10%;"></td> <td style="width: 10%;"></td> <td style="width: 10%;"></td> <td style="width: 10%;"></td> <td style="width: 10%;"></td> <td style="width: 10%;"></td> <td style="width: 10%;"></td> <td style="width: 10%;"></td> </tr> <tr> <td></td> <td></td> <td colspan="8" style="text-align: center;"> <table border="1" style="width: 100%; border-collapse: collapse; text-align: center;"> <tr> <td style="width: 10%;"></td> <td style="width: 10%;"></td> <td style="width: 10%;"></td> <td style="width: 10%;"></td> <td style="width: 10%;"></td> <td style="width: 10%;"></td> <td style="width: 10%;"></td> <td style="width: 10%;"></td> <td style="width: 10%;"></td> <td style="width: 10%;"></td> </tr> <tr> <td></td> <td></td> <td colspan="8" style="text-align: center;"> <table border="1" style="width: 100%; border-collapse: collapse; text-align: center;"> <tr> <td style="width: 10%;"></td> <td style="width: 10%;"></td> <td style="width: 10%;"></td> <td style="width: 10%;"></td> <td style="width: 10%;"></td> <td style="width: 10%;"></td> <td style="width: 10%;"></td> <td style="width: 10%;"></td> <td style="width: 10%;"></td> <td style="width: 10%;"></td> </tr> <tr> <td></td> <td></td> <td colspan="8" style="text-align: center;"> <table border="1" style="width: 100%; border-collapse: collapse; text-align: center;"> <tr> <td style="width: 10%;"></td> <td style="width: 10%;"></td> <td style="width: 10%;"></td> <td style="width: 10%;"></td> <td style="width: 10%;"></td> <td style="width: 10%;"></td> <td style="width: 10%;"></td> <td style="width: 10%;"></td> <td style="width: 10%;"></td> <td style="width: 10%;"></td> </tr> <tr> <td></td> <td></td> <td colspan="8" style="text-align: center;"> <table border="1" style="width: 100%; border-collapse: collapse; text-align: center;"> <tr> <td style="width: 10%;"></td> <td style="width: 10%;"></td> <td style="width: 10%;"></td> <td style="width: 10%;"></td> <td style="width: 10%;"></td> <td style="width: 10%;"></td> <td style="width: 10%;"></td> <td style="width: 10%;"></td> <td style="width: 10%;"></td> <td style="width: 10%;"></td> </tr> <tr> <td></td> <td></td> <td colspan="8" style="text-align: center;"> <table border="1" style="width: 100%; border-collapse: collapse; text-align: center;"> <tr> <td style="width: 10%;"></td> <td style="width: 10%;"></td> <td style="width: 10%;"></td> <td style="width: 10%;"></td> <td style="width: 10%;"></td> <td style="width: 10%;"></td> <td style="width: 10%;"></td> <td style="width: 10%;"></td> <td style="width: 10%;"></td> <td style="width: 10%;"></td> </tr> <tr> <td></td> <td></td> <td colspan="8" style="text-align: center;"> <table border="1" style="width: 100%; border-collapse: collapse; text-align: center;"> <tr> <td style="width: 10%;"></td> <td style="width: 10%;"></td> <td style="width: 10%;"></td> <td style="width: 10%;"></td> <td style="width: 10%;"></td> <td style="width: 10%;"></td> <td style="width: 10%;"></td> <td style="width: 10%;"></td> <td style="width: 10%;"></td> <td style="width: 10%;"></td> </tr> <tr> <td></td> <td></td> <td colspan="8" style="text-align: center;"> <table border="1" style="width: 100%; border-collapse: collapse; text-align: center;"> <tr> <td style="width: 10%;"></td> <td style="width: 10%;"></td> <td style="width: 10%;"></td> <td style="width: 10%;"></td> <td style="width: 10%;"></td> <td style="width: 10%;"></td> <td style="width: 10%;"></td> <td style="width: 10%;"></td> <td style="width: 10%;"></td> <td style="width: 10%;"></td> </tr> <tr> <td></td> <td></td> <td colspan="8" style="text-align: center;"> <table border="1" style="width: 100%; border-collapse: collapse; text-align: center;"> <tr> <td style="width: 10%;"></td> <td style="width: 10%;"></td> <td style="width: 10%;"></td> <td style="width: 10%;"></td> <td style="width: 10%;"></td> <td style="width: 10%;"></td> <td style="width: 10%;"></td> <td style="width: 10%;"></td> <td style="width: 10%;"></td> <td style="width: 10%;"></td> </tr> <tr> <td></td> <td></td> <td colspan="8" style="text-align: center;"> <table border="1" style="width: 100%; border-collapse: collapse; text-align: center;"> <tr> <td style="width: 10%;"></td> <td style="width: 10%;"></td> <td style="width: 10%;"></td> <td style="width: 10%;"></td> <td style="width: 10%;"></td> <td style="width: 10%;"></td> <td style="width: 10%;"></td> <td style="width: 10%;"></td> <td style="width: 10%;"></td> <td style="width: 10%;"></td> </tr> <tr> <td></td> <td></td> <td colspan="8" style="text-align: center;"> <table border="1" style="width: 100%; border-collapse: collapse; text-align: center;"> <tr> <td style="width: 10%;"></td> <td style="width: 10%;"></td> <td style="width: 10%;"></td> <td style="width: 10%;"></td> <td style="width: 10%;"></td> <td style="width: 10%;"></td> <td style="width: 10%;"></td> <td style="width: 10%;"></td> <td style="width: 10%;"></td> <td style="width: 10%;"></td> </tr> <tr> <td></td> <td></td> <td colspan="8" style="text-align: center;"> <table border="1" style="width: 100%; border-collapse: collapse; text-align: center;"> <tr> <td style="width: 10%;"></td> <td style="width: 10%;"></td> <td style="width: 10%;"></td> <td style="width: 10%;"></td> <td style="width: 10%;"></td> <td style="width: 10%;"></td> <td style="width: 10%;"></td> <td style="width: 10%;"></td> <td style="width: 10%;"></td> <td style="width: 10%;"></td> </tr> <tr> <td></td> <td></td> <td colspan="8" style="text-align: center;"> <table border="1" style="width: 100%; border-collapse: collapse; text-align: center;"> <tr> <td style="width: 10%;"></td> <td style="width: 10%;"></td> <td style="width: 10%;"></td> <td style="width: 10%;"></td> <td style="width: 10%;"></td> <td style="width: 10%;"></td> <td style="width: 10%;"></td> <td style="width: 10%;"></td> <td style="width: 10%;"></td> <td style="width: 10%;"></td> </tr> <tr> <td></td> <td></td> <td colspan="8" style="text-align: center;"> <table border="1" style="width: 100%; border-collapse: collapse; text-align: center;"> <tr> </tr></table></td></tr></table></td></tr></table></td></tr></table></td></tr></table></td></tr></table></td></tr></table></td></tr></table></td></tr></table></td></tr></table></td></tr></table></td></tr></table></td></tr></table></td></tr></table></td></tr></table></td></tr></table></td></tr></table></td></tr></table></td></tr></table></td></tr></table></td></tr></table></td></tr></table></td></tr></table></td></tr></table></td></tr></table></td></tr></table></td></tr></table></td></tr></table></td></tr></table></td></tr></table></td></tr></table></td></tr></table>
 | | | | | | | | | | | | | | | | | | | | <table border="1" style="width: 100%; border-collapse: collapse; text-align: center;"> <tr> <td style="width: 10%;"></td> <td style="width: 10%;"></td> <td style="width: 10%;"></td> <td style="width: 10%;"></td> <td style="width: 10%;"></td> <td style="width: 10%;"></td> <td style="width: 10%;"></td> <td style="width: 10%;"></td> <td style="width: 10%;"></td> <td style="width: 10%;"></td> </tr> <tr> <td></td> <td></td> <td colspan="8" style="text-align: center;"> <table border="1" style="width: 100%; border-collapse: collapse; text-align: center;"> <tr> <td style="width: 10%;"></td> <td style="width: 10%;"></td> <td style="width: 10%;"></td> <td style="width: 10%;"></td> <td style="width: 10%;"></td> <td style="width: 10%;"></td> <td style="width: 10%;"></td> <td style="width: 10%;"></td> <td style="width: 10%;"></td> <td style="width: 10%;"></td> </tr> <tr> <td></td> <td></td> <td colspan="8" style="text-align: center;"> <table border="1" style="width: 100%; border-collapse: collapse; text-align: center;"> <tr> <td style="width: 10%;"></td> <td style="width: 10%;"></td> <td style="width: 10%;"></td> <td style="width: 10%;"></td> <td style="width: 10%;"></td> <td style="width: 10%;"></td> <td style="width: 10%;"></td> <td style="width: 10%;"></td> <td style="width: 10%;"></td> <td style="width: 10%;"></td> </tr> <tr> <td></td> <td></td> <td colspan="8" style="text-align: center;"> <table border="1" style="width: 100%; border-collapse: collapse; text-align: center;"> <tr> <td style="width: 10%;"></td> <td style="width: 10%;"></td> <td style="width: 10%;"></td> <td style="width: 10%;"></td> <td style="width: 10%;"></td> <td style="width: 10%;"></td> <td style="width: 10%;"></td> <td style="width: 10%;"></td> <td style="width: 10%;"></td> <td style="width: 10%;"></td> </tr> <tr> <td></td> <td></td> <td colspan="8" style="text-align: center;"> <table border="1" style="width: 100%; border-collapse: collapse; text-align: center;"> <tr> <td style="width: 10%;"></td> <td style="width: 10%;"></td> <td style="width: 10%;"></td> <td style="width: 10%;"></td> <td style="width: 10%;"></td> <td style="width: 10%;"></td> <td style="width: 10%;"></td> <td style="width: 10%;"></td> <td style="width: 10%;"></td> <td style="width: 10%;"></td> </tr> <tr> <td></td> <td></td> <td colspan="8" style="text-align: center;"> <table border="1" style="width: 100%; border-collapse: collapse; text-align: center;"> <tr> <td style="width: 10%;"></td> <td style="width: 10%;"></td> <td style="width: 10%;"></td> <td style="width: 10%;"></td> <td style="width: 10%;"></td> <td style="width: 10%;"></td> <td style="width: 10%;"></td> <td style="width: 10%;"></td> <td style="width: 10%;"></td> <td style="width: 10%;"></td> </tr> <tr> <td></td> <td></td> <td colspan="8" style="text-align: center;"> <table border="1" style="width: 100%; border-collapse: collapse; text-align: center;"> <tr> <td style="width: 10%;"></td> <td style="width: 10%;"></td> <td style="width: 10%;"></td> <td style="width: 10%;"></td> <td style="width: 10%;"></td> <td style="width: 10%;"></td> <td style="width: 10%;"></td> <td style="width: 10%;"></td> <td style="width: 10%;"></td> <td style="width: 10%;"></td> </tr> <tr> <td></td> <td></td> <td colspan="8" style="text-align: center;"> <table border="1" style="width: 100%; border-collapse: collapse; text-align: center;"> <tr> <td style="width: 10%;"></td> <td style="width: 10%;"></td> <td style="width: 10%;"></td> <td style="width: 10%;"></td> <td style="width: 10%;"></td> <td style="width: 10%;"></td> <td style="width: 10%;"></td> <td style="width: 10%;"></td> <td style="width: 10%;"></td> <td style="width: 10%;"></td> </tr> <tr> <td></td> <td></td> <td colspan="8" style="text-align: center;"> <table border="1" style="width: 100%; border-collapse: collapse; text-align: center;"> <tr> <td style="width: 10%;"></td> <td style="width: 10%;"></td> <td style="width: 10%;"></td> <td style="width: 10%;"></td> <td style="width: 10%;"></td> <td style="width: 10%;"></td> <td style="width: 10%;"></td> <td style="width: 10%;"></td> <td style="width: 10%;"></td> <td style="width: 10%;"></td> </tr> <tr> <td></td> <td></td> <td colspan="8" style="text-align: center;"> <table border="1" style="width: 100%; border-collapse: collapse; text-align: center;"> <tr> <td style="width: 10%;"></td> <td style="width: 10%;"></td> <td style="width: 10%;"></td> <td style="width: 10%;"></td> <td style="width: 10%;"></td> <td style="width: 10%;"></td> <td style="width: 10%;"></td> <td style="width: 10%;"></td> <td style="width: 10%;"></td> <td style="width: 10%;"></td> </tr> <tr> <td></td> <td></td> <td colspan="8" style="text-align: center;"> <table border="1" style="width: 100%; border-collapse: collapse; text-align: center;"> <tr> <td style="width: 10%;"></td> <td style="width: 10%;"></td> <td style="width: 10%;"></td> <td style="width: 10%;"></td> <td style="width: 10%;"></td> <td style="width: 10%;"></td> <td style="width: 10%;"></td> <td style="width: 10%;"></td> <td style="width: 10%;"></td> <td style="width: 10%;"></td> </tr> <tr> <td></td> <td></td> <td colspan="8" style="text-align: center;"> <table border="1" style="width: 100%; border-collapse: collapse; text-align: center;"> <tr> <td style="width: 10%;"></td> <td style="width: 10%;"></td> <td style="width: 10%;"></td> <td style="width: 10%;"></td> <td style="width: 10%;"></td> <td style="width: 10%;"></td> <td style="width: 10%;"></td> <td style="width: 10%;"></td> <td style="width: 10%;"></td> <td style="width: 10%;"></td> </tr> <tr> <td></td> <td></td> <td colspan="8" style="text-align: center;"> <table border="1" style="width: 100%; border-collapse: collapse; text-align: center;"> <tr> <td style="width: 10%;"></td> <td style="width: 10%;"></td> <td style="width: 10%;"></td> <td style="width: 10%;"></td> <td style="width: 10%;"></td> <td style="width: 10%;"></td> <td style="width: 10%;"></td> <td style="width: 10%;"></td> <td style="width: 10%;"></td> <td style="width: 10%;"></td> </tr> <tr> <td></td> <td></td> <td colspan="8" style="text-align: center;"> <table border="1" style="width: 100%; border-collapse: collapse; text-align: center;"> <tr> <td style="width: 10%;"></td> <td style="width: 10%;"></td> <td style="width: 10%;"></td> <td style="width: 10%;"></td> <td style="width: 10%;"></td> <td style="width: 10%;"></td> <td style="width: 10%;"></td> <td style="width: 10%;"></td> <td style="width: 10%;"></td> <td style="width: 10%;"></td> </tr> <tr> <td></td> <td></td> <td colspan="8" style="text-align: center;"> <table border="1" style="width: 100%; border-collapse: collapse; text-align: center;"> <tr> <td style="width: 10%;"></td> <td style="width: 10%;"></td> <td style="width: 10%;"></td> <td style="width: 10%;"></td> <td style="width: 10%;"></td> <td style="width: 10%;"></td> <td style="width: 10%;"></td> <td style="width: 10%;"></td> <td style="width: 10%;"></td> <td style="width: 10%;"></td> </tr> <tr> <td></td> <td></td> <td colspan="8" style="text-align: center;"> <table border="1" style="width: 100%; border-collapse: collapse; text-align: center;"> <tr> <td style="width: 10%;"></td> <td style="width: 10%;"></td> <td style="width: 10%;"></td> <td style="width: 10%;"></td> <td style="width: 10%;"></td> <td style="width: 10%;"></td> <td style="width:
10%;"></td> <td style="width: 10%;"></td> <td style="width: 10%;"></td> <td style="width: 10%;"></td> </tr> <tr> <td></td> <td></td> <td colspan="8" style="text-align: center;"> <table border="1" style="width: 100%; border-collapse: collapse; text-align: center;"> <tr> <td style="width: 10%;"></td> <td style="width: 10%;"></td> <td style="width: 10%;"></td> <td style="width: 10%;"></td> <td style="width: 10%;"></td> <td style="width: 10%;"></td> <td style="width: 10%;"></td> <td style="width: 10%;"></td> <td style="width: 10%;"></td> <td style="width: 10%;"></td> </tr> <tr> <td></td> <td></td> <td colspan="8" style="text-align: center;"> <table border="1" style="width: 100%; border-collapse: collapse; text-align: center;"> <tr> <td style="width: 10%;"></td> <td style="width: 10%;"></td> <td style="width: 10%;"></td> <td style="width: 10%;"></td> <td style="width: 10%;"></td> <td style="width: 10%;"></td> <td style="width: 10%;"></td> <td style="width: 10%;"></td> <td style="width: 10%;"></td> <td style="width: 10%;"></td> </tr> <tr> <td></td> <td></td> <td colspan="8" style="text-align: center;"> <table border="1" style="width: 100%; border-collapse: collapse; text-align: center;"> <tr> <td style="width: 10%;"></td> <td style="width: 10%;"></td> <td style="width: 10%;"></td> <td style="width: 10%;"></td> <td style="width: 10%;"></td> <td style="width: 10%;"></td> <td style="width: 10%;"></td> <td style="width: 10%;"></td> <td style="width: 10%;"></td> <td style="width: 10%;"></td> </tr> <tr> <td></td> <td></td> <td colspan="8" style="text-align: center;"> <table border="1" style="width: 100%; border-collapse: collapse; text-align: center;"> <tr> <td style="width: 10%;"></td> <td style="width: 10%;"></td> <td style="width: 10%;"></td> <td style="width: 10%;"></td> <td style="width: 10%;"></td> <td style="width: 10%;"></td> <td style="width: 10%;"></td> <td style="width: 10%;"></td> <td style="width: 10%;"></td> <td style="width: 10%;"></td> </tr> <tr> <td></td> <td></td> <td colspan="8" style="text-align: center;"> <table border="1" style="width: 100%; border-collapse: collapse; text-align: center;"> <tr> <td style="width: 10%;"></td> <td style="width: 10%;"></td> <td style="width: 10%;"></td> <td style="width: 10%;"></td> <td style="width: 10%;"></td> <td style="width: 10%;"></td> <td style="width: 10%;"></td> <td style="width: 10%;"></td> <td style="width: 10%;"></td> <td style="width: 10%;"></td> </tr> <tr> <td></td> <td></td> <td colspan="8" style="text-align: center;"> <table border="1" style="width: 100%; border-collapse: collapse; text-align: center;"> <tr> <td style="width: 10%;"></td> <td style="width: 10%;"></td> <td style="width: 10%;"></td> <td style="width: 10%;"></td> <td style="width: 10%;"></td> <td style="width: 10%;"></td> <td style="width: 10%;"></td> <td style="width: 10%;"></td> <td style="width: 10%;"></td> <td style="width: 10%;"></td> </tr> <tr> <td></td> <td></td> <td colspan="8" style="text-align: center;"> <table border="1" style="width: 100%; border-collapse: collapse; text-align: center;"> <tr> <td style="width: 10%;"></td> <td style="width: 10%;"></td> <td style="width: 10%;"></td> <td style="width: 10%;"></td> <td style="width: 10%;"></td> <td style="width: 10%;"></td> <td style="width: 10%;"></td> <td style="width: 10%;"></td> <td style="width: 10%;"></td> <td style="width: 10%;"></td> </tr> <tr> <td></td> <td></td> <td colspan="8" style="text-align: center;"> <table border="1" style="width: 100%; border-collapse: collapse; text-align: center;"> <tr> <td style="width: 10%;"></td> <td style="width: 10%;"></td> <td style="width: 10%;"></td> <td style="width: 10%;"></td> <td style="width: 10%;"></td> <td style="width: 10%;"></td> <td style="width: 10%;"></td> <td style="width: 10%;"></td> <td style="width: 10%;"></td> <td style="width: 10%;"></td> </tr> <tr> <td></td> <td></td> <td colspan="8" style="text-align: center;"> <table border="1" style="width: 100%; border-collapse: collapse; text-align: center;"> <tr> <td style="width: 10%;"></td> <td style="width: 10%;"></td> <td style="width: 10%;"></td> <td style="width: 10%;"></td> <td style="width: 10%;"></td> <td style="width: 10%;"></td> <td style="width: 10%;"></td> <td style="width: 10%;"></td> <td style="width: 10%;"></td> <td style="width: 10%;"></td> </tr> <tr> <td></td> <td></td> <td colspan="8" style="text-align: center;"> <table border="1" style="width: 100%; border-collapse: collapse; text-align: center;"> <tr> <td style="width: 10%;"></td> <td style="width: 10%;"></td> <td style="width: 10%;"></td> <td style="width: 10%;"></td> <td style="width: 10%;"></td> <td style="width: 10%;"></td> <td style="width: 10%;"></td> <td style="width: 10%;"></td> <td style="width: 10%;"></td> <td style="width: 10%;"></td> </tr> <tr> <td></td> <td></td> <td colspan="8" style="text-align: center;"> <table border="1" style="width: 100%; border-collapse: collapse; text-align: center;"> <tr> <td style="width: 10%;"></td> <td style="width: 10%;"></td> <td style="width: 10%;"></td> <td style="width: 10%;"></td> <td style="width: 10%;"></td> <td style="width: 10%;"></td> <td style="width: 10%;"></td> <td style="width: 10%;"></td> <td style="width: 10%;"></td> <td style="width: 10%;"></td> </tr> <tr> <td></td> <td></td> <td colspan="8" style="text-align: center;"> <table border="1" style="width: 100%; border-collapse: collapse; text-align: center;"> <tr> <td style="width: 10%;"></td> <td style="width: 10%;"></td> <td style="width: 10%;"></td> <td style="width: 10%;"></td> <td style="width: 10%;"></td> <td style="width: 10%;"></td> <td style="width: 10%;"></td> <td style="width: 10%;"></td> <td style="width: 10%;"></td> <td style="width: 10%;"></td> </tr> <tr> <td></td> <td></td> <td colspan="8" style="text-align: center;"> <table border="1" style="width: 100%; border-collapse: collapse; text-align: center;"> <tr> <td style="width: 10%;"></td> <td style="width: 10%;"></td> <td style="width: 10%;"></td> <td style="width: 10%;"></td> <td style="width: 10%;"></td> <td style="width: 10%;"></td> <td style="width: 10%;"></td> <td style="width: 10%;"></td> <td style="width: 10%;"></td> <td style="width: 10%;"></td> </tr> <tr> <td></td> <td></td> <td colspan="8" style="text-align: center;"> <table border="1" style="width: 100%; border-collapse: collapse; text-align: center;"> <tr> <td style="width: 10%;"></td> <td style="width: 10%;"></td> <td style="width: 10%;"></td> <td style="width: 10%;"></td> <td style="width: 10%;"></td> <td style="width: 10%;"></td> <td style="width: 10%;"></td> <td style="width: 10%;"></td> <td style="width: 10%;"></td> <td style="width: 10%;"></td> </tr> <tr> <td></td> <td></td> <td colspan="8" style="text-align: center;"> <table border="1" style="width: 100%; border-collapse: collapse; text-align: center;"> <tr> </tr></table></td></tr></table></td></tr></table></td></tr></table></td></tr></table></td></tr></table></td></tr></table></td></tr></table></td></tr></table></td></tr></table></td></tr></table></td></tr></table></td></tr></table></td></tr></table></td></tr></table></td></tr></table></td></tr></table></td></tr></table></td></tr></table></td></tr></table></td></tr></table></td></tr></table></td></tr></table></td></tr></table></td></tr></table></td></tr></table></td></tr></table></td></tr></table></td></tr></table></td></tr></table></td></tr></table>
 | | | | | | | | | | | | | | | | | | | | <table border="1" style="width: 100%; border-collapse: collapse; text-align: center;"> <tr> <td style="width: 10%;"></td> <td style="width: 10%;"></td> <td style="width: 10%;"></td> <td style="width: 10%;"></td> <td style="width: 10%;"></td> <td style="width: 10%;"></td> <td style="width: 10%;"></td> <td style="width: 10%;"></td> <td style="width: 10%;"></td> <td style="width: 10%;"></td> </tr> <tr> <td></td> <td></td> <td colspan="8" style="text-align: center;"> <table border="1" style="width: 100%; border-collapse: collapse; text-align: center;"> <tr> <td style="width: 10%;"></td> <td style="width: 10%;"></td> <td style="width: 10%;"></td> <td style="width: 10%;"></td> <td style="width: 10%;"></td> <td style="width: 10%;"></td> <td style="width: 10%;"></td> <td style="width: 10%;"></td> <td style="width: 10%;"></td> <td style="width: 10%;"></td> </tr> <tr> <td></td> <td></td> <td colspan="8" style="text-align: center;"> <table border="1" style="width: 100%; border-collapse: collapse; text-align: center;"> <tr> <td style="width: 10%;"></td> <td style="width: 10%;"></td> <td style="width: 10%;"></td> <td style="width: 10%;"></td> <td style="width: 10%;"></td> <td style="width: 10%;"></td> <td style="width: 10%;"></td> <td style="width: 10%;"></td> <td style="width: 10%;"></td> <td style="width: 10%;"></td> </tr> <tr> <td></td> <td></td> <td colspan="8" style="text-align: center;"> <table border="1" style="width: 100%; border-collapse: collapse; text-align: center;"> <tr> <td style="width: 10%;"></td> <td style="width: 10%;"></td> <td style="width: 10%;"></td> <td style="width: 10%;"></td> <td style="width: 10%;"></td> <td style="width: 10%;"></td> <td style="width: 10%;"></td> <td style="width: 10%;"></td> <td style="width: 10%;"></td> <td style="width: 10%;"></td> </tr> <tr> <td></td> <td></td> <td colspan="8" style="text-align: center;"> <table border="1" style="width: 100%; border-collapse: collapse; text-align: center;"> <tr> <td style="width: 10%;"></td> <td style="width: 10%;"></td> <td style="width: 10%;"></td> <td style="width: 10%;"></td> <td style="width: 10%;"></td> <td style="width: 10%;"></td> <td style="width: 10%;"></td> <td style="width: 10%;"></td> <td style="width: 10%;"></td> <td style="width: 10%;"></td> </tr> <tr> <td></td> <td></td> <td colspan="8" style="text-align: center;"> <table border="1" style="width: 100%; border-collapse: collapse; text-align: center;"> <tr> <td style="width: 10%;"></td> <td style="width: 10%;"></td> <td style="width: 10%;"></td> <td style="width: 10%;"></td> <td style="width: 10%;"></td> <td style="width: 10%;"></td> <td style="width: 10%;"></td> <td style="width: 10%;"></td> <td style="width: 10%;"></td> <td style="width: 10%;"></td> </tr> <tr> <td></td> <td></td> <td colspan="8" style="text-align: center;"> <table border="1" style="width: 100%; border-collapse: collapse; text-align: center;"> <tr> <td style="width: 10%;"></td> <td style="width: 10%;"></td> <td style="width: 10%;"></td> <td style="width: 10%;"></td> <td style="width: 10%;"></td> <td style="width: 10%;"></td> <td style="width: 10%;"></td> <td style="width: 10%;"></td> <td style="width: 10%;"></td> <td style="width: 10%;"></td> </tr> <tr> <td></td> <td></td> <td colspan="8" style="text-align: center;"> <table border="1" style="width: 100%; border-collapse: collapse; text-align: center;"> <tr> <td style="width: 10%;"></td> <td style="width: 10%;"></td> <td style="width: 10%;"></td> <td style="width: 10%;"></td> <td style="width: 10%;"></td> <td style="width: 10%;"></td> <td style="width: 10%;"></td> <td style="width: 10%;"></td> <td style="width: 10%;"></td> <td style="width: 10%;"></td> </tr> <tr> <td></td> <td></td> <td colspan="8" style="text-align: center;"> <table border="1" style="width: 100%; border-collapse: collapse; text-align: center;"> <tr> <td style="width: 10%;"></td> <td style="width: 10%;"></td> <td style="width: 10%;"></td> <td style="width: 10%;"></td> <td style="width: 10%;"></td> <td style="width: 10%;"></td> <td style="width: 10%;"></td> <td style="width: 10%;"></td> <td style="width: 10%;"></td> <td style="width: 10%;"></td> </tr> <tr> <td></td> <td></td> <td colspan="8" style="text-align: center;"> <table border="1" style="width: 100%; border-collapse: collapse; text-align: center;"> <tr> <td style="width: 10%;"></td> <td style="width: 10%;"></td> <td style="width: 10%;"></td> <td style="width: 10%;"></td> <td style="width: 10%;"></td> <td style="width: 10%;"></td> <td style="width: 10%;"></td> <td style="width: 10%;"></td> <td style="width: 10%;"></td> <td style="width: 10%;"></td> </tr> <tr> <td></td> <td></td> <td colspan="8" style="text-align: center;"> <table border="1" style="width: 100%; border-collapse: collapse; text-align: center;"> <tr> <td style="width: 10%;"></td> <td style="width: 10%;"></td> <td style="width: 10%;"></td> <td style="width: 10%;"></td> <td style="width: 10%;"></td> <td style="width: 10%;"></td> <td style="width: 10%;"></td> <td style="width: 10%;"></td> <td style="width: 10%;"></td> <td style="width: 10%;"></td> </tr> <tr> <td></td> <td></td> <td colspan="8" style="text-align: center;"> <table border="1" style="width: 100%; border-collapse: collapse; text-align: center;"> <tr> <td style="width: 10%;"></td> <td style="width: 10%;"></td> <td style="width: 10%;"></td> <td style="width: 10%;"></td> <td style="width: 10%;"></td> <td style="width: 10%;"></td> <td style="width: 10%;"></td> <td style="width: 10%;"></td> <td style="width: 10%;"></td> <td style="width: 10%;"></td> </tr> <tr> <td></td> <td></td> <td colspan="8" style="text-align: center;"> <table border="1" style="width: 100%; border-collapse: collapse; text-align: center;"> <tr> <td style="width: 10%;"></td> <td style="width: 10%;"></td> <td style="width: 10%;"></td> <td style="width: 10%;"></td> <td style="width: 10%;"></td> <td style="width: 10%;"></td> <td style="width: 10%;"></td> <td style="width: 10%;"></td> <td style="width: 10%;"></td> <td style="width: 10%;"></td> </tr> <tr> <td></td> <td></td> <td colspan="8" style="text-align: center;"> <table border="1" style="width: 100%; border-collapse: collapse; text-align: center;"> <tr> <td style="width: 10%;"></td> <td style="width: 10%;"></td> <td style="width: 10%;"></td> <td style="width: 10%;"></td> <td style="width: 10%;"></td> <td style="width: 10%;"></td> <td style="width: 10%;"></td> <td style="width: 10%;"></td> <td style="width: 10%;"></td> <td style="width: 10%;"></td> </tr> <tr> <td></td> <td></td> <td colspan="8" style="text-align: center;"> <table border="1" style="width: 100%; border-collapse: collapse; text-align: center;"> <tr> <td style="width: 10%;"></td> <td style="width: 10%;"></td> <td style="width: 10%;"></td> <td style="width: 10%;"></td> <td style="width: 10%;"></td> <td style="width: 10%;"></td> <td style="width: 10%;"></td> <td style="width: 10%;"></td> <td style="width: 10%;"></td> <td style="width: 10%;"></td> </tr> <tr> <td></td> <td></td> <td colspan="8" style="text-align: center;"> <table border="1" style="width: 100%; border-collapse: collapse; text-align: center;"> <tr> <td style="width: 10%;"></td> <td style="width: 10%;"></td> <td style="width: 10%;"></td> <td style="width: 10%;"></td> <td style="width: 10%;"></td> <td style="width: 10%;"></td> <td style="width: 10%;"></td> <td style="width: 10%;"></td> <td style="width: 10%;"></td> <td style="width: 10%;"></td> </tr> <tr> <td></td> <td></td> <td colspan="8" style="text-align: center;"> <table border="1" style="width: 100%; border-collapse: collapse; text-align: center;"> <tr> <td style="width: 10%;"></td> <td style="width: 10%;"></td> <td style="width: 10%;"></td> <td style="width: 10%;"></td> <td style="width: 10%;"></td> <td style="width: 10%;"></td> <td style="width: 10%;"></td> <td style="width: 10%;"></td> <td style="width: 10%;"></td> <td style="width: 10%;"></td> </tr> <tr> <td></td> <td></td> <td colspan="8" style="text-align: center;"> <table border="1" style="width: 100%; border-collapse: collapse; text-align: center;"> <tr> <td style="width: 10%;"></td> <td style="width: 10%;"></td> <td style="width: 10%;"></td> <td style="width: 10%;"></td> <td style="width: 10%;"></td> <td style="width: 10%;"></td> <td style="width: 10%;"></td> <td style="width: 10%;"></td> <td style="width: 10%;"></td> <td style="width: 10%;"></td> </tr> <tr> <td></td> <td></td> <td colspan="8" style="text-align: center;"> <table border="1" style="width: 100%; border-collapse: collapse; text-align: center;"> <tr> <td style="width: 10%;"></td> <td style="width: 10%;"></td> <td style="width: 10%;"></td> <td style="width: 10%;"></td> <td style="width: 10%;"></td> <td style="width: 10%;"></td> <td style="width: 10%;"></td> <td style="width: 10%;"></td> <td style="width: 10%;"></td> <td style="width: 10%;"></td> </tr> <tr> <td></td> <td></td> <td colspan="8" style="text-align: center;"> <table border="1" style="width: 100%; border-collapse: collapse; text-align: center;"> <tr> <td style="width: 10%;"></td> <td style="width: 10%;"></td> <td style="width: 10%;"></td> <td style="width: 10%;"></td> <td style="width: 10%;"></td> <td style="width: 10%;"></td> <td style="width: 10%;"></td> <td style="width: 10%;"></td> <td style="width: 10%;"></td> <td style="width: 10%;"></td> </tr> <tr> <td></td> <td></td> <td colspan="8" style="text-align: center;"> <table border="1" style="width: 100%; border-collapse: collapse; text-align: center;"> <tr> <td style="width: 10%;"></td> <td style="width: 10%;"></td> <td style="width: 10%;"></td> <td style="width: 10%;"></td> <td style="width: 10%;"></td> <td style="width: 10%;"></td> <td
style="width: 10%;"></td> <td style="width: 10%;"></td> <td style="width: 10%;"></td> <td style="width: 10%;"></td> </tr> <tr> <td></td> <td></td> <td colspan="8" style="text-align: center;"> <table border="1" style="width: 100%; border-collapse: collapse; text-align: center;"> <tr> <td style="width: 10%;"></td> <td style="width: 10%;"></td> <td style="width: 10%;"></td> <td style="width: 10%;"></td> <td style="width: 10%;"></td> <td style="width: 10%;"></td> <td style="width: 10%;"></td> <td style="width: 10%;"></td> <td style="width: 10%;"></td> <td style="width: 10%;"></td> </tr> <tr> <td></td> <td></td> <td colspan="8" style="text-align: center;"> <table border="1" style="width: 100%; border-collapse: collapse; text-align: center;"> <tr> <td style="width: 10%;"></td> <td style="width: 10%;"></td> <td style="width: 10%;"></td> <td style="width: 10%;"></td> <td style="width: 10%;"></td> <td style="width: 10%;"></td> <td style="width: 10%;"></td> <td style="width: 10%;"></td> <td style="width: 10%;"></td> <td style="width: 10%;"></td> </tr> <tr> <td></td> <td></td> <td colspan="8" style="text-align: center;"> <table border="1" style="width: 100%; border-collapse: collapse; text-align: center;"> <tr> <td style="width: 10%;"></td> <td style="width: 10%;"></td> <td style="width: 10%;"></td> <td style="width: 10%;"></td> <td style="width: 10%;"></td> <td style="width: 10%;"></td> <td style="width: 10%;"></td> <td style="width: 10%;"></td> <td style="width: 10%;"></td> <td style="width: 10%;"></td> </tr> <tr> <td></td> <td></td> <td colspan="8" style="text-align: center;"> <table border="1" style="width: 100%; border-collapse: collapse; text-align: center;"> <tr> <td style="width: 10%;"></td> <td style="width: 10%;"></td> <td style="width: 10%;"></td> <td style="width: 10%;"></td> <td style="width: 10%;"></td> <td style="width: 10%;"></td> <td style="width: 10%;"></td> <td style="width: 10%;"></td> <td style="width: 10%;"></td> <td style="width: 10%;"></td> </tr> <tr> <td></td> <td></td> <td colspan="8" style="text-align: center;"> <table border="1" style="width: 100%; border-collapse: collapse; text-align: center;"> <tr> <td style="width: 10%;"></td> <td style="width: 10%;"></td> <td style="width: 10%;"></td> <td style="width: 10%;"></td> <td style="width: 10%;"></td> <td style="width: 10%;"></td> <td style="width: 10%;"></td> <td style="width: 10%;"></td> <td style="width: 10%;"></td> <td style="width: 10%;"></td> </tr> <tr> <td></td> <td></td> <td colspan="8" style="text-align: center;"> <table border="1" style="width: 100%; border-collapse: collapse; text-align: center;"> <tr> <td style="width: 10%;"></td> <td style="width: 10%;"></td> <td style="width: 10%;"></td> <td style="width: 10%;"></td> <td style="width: 10%;"></td> <td style="width: 10%;"></td> <td style="width: 10%;"></td> <td style="width: 10%;"></td> <td style="width: 10%;"></td> <td style="width: 10%;"></td> </tr> <tr> <td></td> <td></td> <td colspan="8" style="text-align: center;"> <table border="1" style="width: 100%; border-collapse: collapse; text-align: center;"> <tr> <td style="width: 10%;"></td> <td style="width: 10%;"></td> <td style="width: 10%;"></td> <td style="width: 10%;"></td> <td style="width: 10%;"></td> <td style="width: 10%;"></td> <td style="width: 10%;"></td> <td style="width: 10%;"></td> <td style="width: 10%;"></td> <td style="width: 10%;"></td> </tr> <tr> <td></td> <td></td> <td colspan="8" style="text-align: center;"> <table border="1" style="width: 100%; border-collapse: collapse; text-align: center;"> <tr> <td style="width: 10%;"></td> <td style="width: 10%;"></td> <td style="width: 10%;"></td> <td style="width: 10%;"></td> <td style="width: 10%;"></td> <td style="width: 10%;"></td> <td style="width: 10%;"></td> <td style="width: 10%;"></td> <td style="width: 10%;"></td> <td style="width: 10%;"></td> </tr> <tr> <td></td> <td></td> <td colspan="8" style="text-align: center;"> <table border="1" style="width: 100%; border-collapse: collapse; text-align: center;"> <tr> </tr></table></td></tr></table></td></tr></table></td></tr></table></td></tr></table></td></tr></table></td></tr></table></td></tr></table></td></tr></table></td></tr></table></td></tr></table></td></tr></table></td></tr></table></td></tr></table></td></tr></table></td></tr></table></td></tr></table></td></tr></table></td></tr></table></td></tr></table></td></tr></table></td></tr></table></td></tr></table></td></tr></table></td></tr></table></td></tr></table></td></tr></table></td></tr></table></td></tr></table></td></tr></table> | | | | | | | | | | | | | | | | | | | | <table border="1" style="width: 100%; border-collapse: collapse; text-align: center;"> <tr> <td style="width: 10%;"></td> <td style="width: 10%;"></td> <td style="width: 10%;"></td> <td style="width: 10%;"></td> <td style="width: 10%;"></td> <td style="width: 10%;"></td> <td style="width: 10%;"></td> <td style="width: 10%;"></td> <td style="width: 10%;"></td> <td style="width: 10%;"></td> </tr> <tr> <td></td> <td></td> <td colspan="8" style="text-align: center;"> <table border="1" style="width: 100%; border-collapse: collapse; text-align: center;"> <tr> <td style="width: 10%;"></td> <td style="width: 10%;"></td> <td style="width: 10%;"></td> <td style="width: 10%;"></td> <td style="width: 10%;"></td> <td style="width: 10%;"></td> <td style="width: 10%;"></td> <td style="width: 10%;"></td> <td style="width: 10%;"></td> <td style="width: 10%;"></td> </tr> <tr> <td></td> <td></td> <td colspan="8" style="text-align: center;"> <table border="1" style="width: 100%; border-collapse: collapse; text-align: center;"> <tr> <td style="width: 10%;"></td> <td style="width: 10%;"></td> <td style="width: 10%;"></td> <td style="width: 10%;"></td> <td style="width: 10%;"></td> <td style="width: 10%;"></td> <td style="width: 10%;"></td> <td style="width: 10%;"></td> <td style="width: 10%;"></td> <td style="width: 10%;"></td> </tr> <tr> <td></td> <td></td> <td colspan="8" style="text-align: center;"> <table border="1" style="width: 100%; border-collapse: collapse; text-align: center;"> <tr> <td style="width: 10%;"></td> <td style="width: 10%;"></td> <td style="width: 10%;"></td> <td style="width: 10%;"></td> <td style="width: 10%;"></td> <td style="width: 10%;"></td> <td style="width: 10%;"></td> <td style="width: 10%;"></td> <td style="width: 10%;"></td> <td style="width: 10%;"></td> </tr> <tr> <td></td> <td></td> <td colspan="8" style="text-align: center;"> <table border="1" style="width: 100%; border-collapse: collapse; text-align: center;"> <tr> <td style="width: 10%;"></td> <td style="width: 10%;"></td> <td style="width: 10%;"></td> <td style="width: 10%;"></td> <td style="width: 10%;"></td> <td style="width: 10%;"></td> <td style="width: 10%;"></td> <td style="width: 10%;"></td> <td style="width: 10%;"></td> <td style="width: 10%;"></td> </tr> <tr> <td></td> <td></td> <td colspan="8" style="text-align: center;"> <table border="1" style="width: 100%; border-collapse: collapse; text-align: center;"> <tr> <td style="width:
10%;"></td> <td style="width: 10%;"></td> <td style="width: 10%;"></td> <td style="width: 10%;"></td> <td style="width: 10%;"></td> <td style="width: 10%;"></td> <td style="width: 10%;"></td> <td style="width: 10%;"></td> <td style="width: 10%;"></td> <td style="width: 10%;"></td> </tr> <tr> <td></td> <td></td> <td colspan="8" style="text-align: center;"> <table border="1" style="width: 100%; border-collapse: collapse; text-align: center;"> <tr> <td style="width: 10%;"></td> <td style="width: 10%;"></td> <td style="width: 10%;"></td> <td style="width: 10%;"></td> <td style="width: 10%;"></td> <td style="width: 10%;"></td> <td style="width: 10%;"></td> <td style="width: 10%;"></td> <td style="width: 10%;"></td> <td style="width: 10%;"></td> </tr> <tr> <td></td> <td></td> <td colspan="8" style="text-align: center;"> <table border="1" style="width: 100%; border-collapse: collapse; text-align: center;"> <tr> <td style="width: 10%;"></td> <td style="width: 10%;"></td> <td style="width: 10%;"></td> <td style="width: 10%;"></td> <td style="width: 10%;"></td> <td style="width: 10%;"></td> <td style="width: 10%;"></td> <td style="width: 10%;"></td> <td style="width: 10%;"></td> <td style="width: 10%;"></td> </tr> <tr> <td></td> <td></td> <td colspan="8" style="text-align: center;"> <table border="1" style="width: 100%; border-collapse: collapse; text-align: center;"> <tr> <td style="width: 10%;"></td> <td style="width: 10%;"></td> <td style="width: 10%;"></td> <td style="width: 10%;"></td> <td style="width: 10%;"></td> <td style="width: 10%;"></td> <td style="width: 10%;"></td> <td style="width: 10%;"></td> <td style="width: 10%;"></td> <td style="width: 10%;"></td> </tr> <tr> <td></td> <td></td> <td colspan="8" style="text-align: center;"> <table border="1" style="width: 100%; border-collapse: collapse; text-align: center;"> <tr> <td style="width: 10%;"></td> <td style="width: 10%;"></td> <td style="width: 10%;"></td> <td style="width: 10%;"></td> <td style="width: 10%;"></td> <td style="width: 10%;"></td> <td style="width: 10%;"></td> <td style="width: 10%;"></td> <td style="width: 10%;"></td> <td style="width: 10%;"></td> </tr> <tr> <td></td> <td></td> <td colspan="8" style="text-align: center;"> <table border="1" style="width: 100%; border-collapse: collapse; text-align: center;"> <tr> <td style="width: 10%;"></td> <td style="width: 10%;"></td> <td style="width: 10%;"></td> <td style="width: 10%;"></td> <td style="width: 10%;"></td> <td style="width: 10%;"></td> <td style="width: 10%;"></td> <td style="width: 10%;"></td> <td style="width: 10%;"></td> <td style="width: 10%;"></td> </tr> <tr> <td></td> <td></td> <td colspan="8" style="text-align: center;"> <table border="1" style="width: 100%; border-collapse: collapse; text-align: center;"> <tr> <td style="width: 10%;"></td> <td style="width: 10%;"></td> <td style="width: 10%;"></td> <td style="width: 10%;"></td> <td style="width: 10%;"></td> <td style="width: 10%;"></td> <td style="width: 10%;"></td> <td style="width: 10%;"></td> <td style="width: 10%;"></td> <td style="width: 10%;"></td> </tr> <tr> <td></td> <td></td> <td colspan="8" style="text-align: center;"> <table border="1" style="width: 100%; border-collapse: collapse; text-align: center;"> <tr> <td style="width: 10%;"></td> <td style="width: 10%;"></td> <td style="width: 10%;"></td> <td style="width: 10%;"></td> <td style="width: 10%;"></td> <td style="width: 10%;"></td> <td style="width: 10%;"></td> <td style="width: 10%;"></td> <td style="width: 10%;"></td> <td style="width: 10%;"></td> </tr> <tr> <td></td> <td></td> <td colspan="8" style="text-align: center;"> <table border="1" style="width: 100%; border-collapse: collapse; text-align: center;"> <tr> <td style="width: 10%;"></td> <td style="width: 10%;"></td> <td style="width: 10%;"></td> <td style="width: 10%;"></td> <td style="width: 10%;"></td> <td style="width: 10%;"></td> <td style="width: 10%;"></td> <td style="width: 10%;"></td> <td style="width: 10%;"></td> <td style="width: 10%;"></td> </tr> <tr> <td></td> <td></td> <td colspan="8" style="text-align: center;"> <table border="1" style="width: 100%; border-collapse: collapse; text-align: center;"> <tr> <td style="width: 10%;"></td> <td style="width: 10%;"></td> <td style="width: 10%;"></td> <td style="width: 10%;"></td> <td style="width: 10%;"></td> <td style="width: 10%;"></td> <td style="width: 10%;"></td> <td style="width: 10%;"></td> <td style="width: 10%;"></td> <td style="width: 10%;"></td> </tr> <tr> <td></td> <td></td> <td colspan="8" style="text-align: center;"> <table border="1" style="width: 100%; border-collapse: collapse; text-align: center;"> <tr> <td style="width: 10%;"></td> <td style="width: 10%;"></td> <td style="width: 10%;"></td> <td style="width: 10%;"></td> <td style="width: 10%;"></td> <td style="width: 10%;"></td> <td style="width: 10%;"></td> <td style="width: 10%;"></td> <td style="width: 10%;"></td> <td style="width: 10%;"></td> </tr> <tr> <td></td> <td></td> <td colspan="8" style="text-align: center;"> <table border="1" style="width: 100%; border-collapse: collapse; text-align: center;"> <tr> <td style="width: 10%;"></td> <td style="width: 10%;"></td> <td style="width: 10%;"></td> <td style="width: 10%;"></td> <td style="width: 10%;"></td> <td style="width: 10%;"></td> <td style="width: 10%;"></td> <td style="width: 10%;"></td> <td style="width: 10%;"></td> <td style="width: 10%;"></td> </tr> <tr> <td></td> <td></td> <td colspan="8" style="text-align: center;"> <table border="1" style="width: 100%; border-collapse: collapse; text-align: center;"> <tr> <td style="width: 10%;"></td> <td style="width: 10%;"></td> <td style="width: 10%;"></td> <td style="width: 10%;"></td> <td style="width: 10%;"></td> <td style="width: 10%;"></td> <td style="width: 10%;"></td> <td style="width: 10%;"></td> <td style="width: 10%;"></td> <td style="width: 10%;"></td> </tr> <tr> <td></td> <td></td> <td colspan="8" style="text-align: center;"> <table border="1" style="width: 100%; border-collapse: collapse; text-align: center;"> <tr> <td style="width: 10%;"></td> <td style="width: 10%;"></td> <td style="width: 10%;"></td> <td style="width: 10%;"></td> <td style="width: 10%;"></td> <td style="width: 10%;"></td> <td style="width: 10%;"></td> <td style="width: 10%;"></td> <td style="width: 10%;"></td> <td style="width: 10%;"></td> </tr> <tr> <td></td> <td></td> <td colspan="8" style="text-align: center;"> <table border="1" style="width: 100%; border-collapse: collapse; text-align: center;"> <tr> <td style="width: 10%;"></td> <td style="width: 10%;"></td> <td style="width: 10%;"></td> <td style="width: 10%;"></td> <td style="width: 10%;"></td> <td style="width: 10%;"></td> <td style="width: 10%;"></td> <td style="width: 10%;"></td> <td style="width: 10%;"></td> <td style="width: 10%;"></td> </tr> <tr> <td></td> <td></td> <td colspan="8" style="text-align: center;"> <table border="1" style="width: 100%; border-collapse: collapse; text-align: center;"> <tr> <td style="width: 10%;"></td> <td style="width: 10%;"></td> <td style="width: 10%;"></td> <td style="width: 10%;"></td> <td style="width: 10%;"></td> <td style="width: 10%;"></td> <td style="width: 10%;"></td> <td style="width: 10%;"></td> <td style="width: 10%;"></td> <td style="width: 10%;"></td> </tr> <tr> <td></td> <td></td> <td colspan="8" style="text-align: center;"> <table border="1" style="width: 100%; border-collapse: collapse; text-align: center;"> <tr> <td style="width: 10%;"></td> <td style="width: 10%;"></td> <td style="width: 10%;"></td> <td style="width: 10%;"></td> <td style="width: 10%;"></td> <td style="width: 10%;"></td> <td style="width: 10%;"></td> <td style="width: 10%;"></td> <td style="width: 10%;"></td> <td style="width: 10%;"></td> </tr> <tr> <td></td> <td></td> <td colspan="8" style="text-align: center;"> <table border="1" style="width: 100%; border-collapse: collapse; text-align: center;"> <tr> <td style="width: 10%;"></td> <td style="width: 10%;"></td> <td style="width: 10%;"></td> <td style="width: 10%;"></td> <td style="width: 10%;"></td> <td style="width: 10%;"></td> <td style="width: 10%;"></td> <td style="width: 10%;"></td> <td style="width: 10%;"></td> <td style="width: 10%;"></td> </tr> <tr> <td></td> <td></td> <td colspan="8" style="text-align: center;"> <table border="1" style="width: 100%; border-collapse: collapse; text-align: center;"> <tr> <td style="width: 10%;"></td> <td style="width: 10%;"></td> <td style="width: 10%;"></td> <td style="width: 10%;"></td> <td style="width: 10%;"></td> <td style="width: 10%;"></td> <td style="width: 10%;"></td> <td style="width: 10%;"></td> <td style="width: 10%;"></td> <td style="width: 10%;"></td> </tr> <tr> <td></td> <td></td> <td colspan="8" style="text-align: center;"> <table border="1" style="width: 100%; border-collapse: collapse; text-align: center;"> <tr> <td style="width: 10%;"></td> <td style="width: 10%;"></td> <td style="width: 10%;"></td> <td style="width: 10%;"></td> <td style="width: 10%;"></td> <td style="width: 10%;"></td> <td style="width: 10%;"></td> <td style="width: 10%;"></td> <td style="width: 10%;"></td> <td style="width: 10%;"></td> </tr> <tr> <td></td> <td></td> <td colspan="8" style="text-align: center;"> <table border="1" style="width: 100%; border-collapse: collapse; text-align: center;"> <tr> <td style="width: 10%;"></td> <td style="width: 10%;"></td> <td style="width: 10%;"></td> <td style="width: 10%;"></td> <td style="width: 10%;"></td> <td style="width: 10%;"></td> <td style="width: 10%;"></td> <td style="width: 10%;"></td> <td style="width: 10%;"></td> <td style="width: 10%;"></td> </tr> <tr> <td></td> <td></td> <td colspan="8" style="text-align: center;"> <table border="1" style="width: 100%; border-collapse: collapse; text-align: center;"> <tr> <td style="width: 10%;"></td> <td style="width: 10%;"></td> <td style="width: 10%;"></td> <td style="width: 10%;"></td> <td style="width: 10%;"></td> <td style="width: 10%;"></td> <td
style="width: 10%;"></td> <td style="width: 10%;"></td> <td style="width: 10%;"></td> <td style="width: 10%;"></td> </tr> <tr> <td></td> <td></td> <td colspan="8" style="text-align: center;"> <table border="1" style="width: 100%; border-collapse: collapse; text-align: center;"> <tr> <td style="width: 10%;"></td> <td style="width: 10%;"></td> <td style="width: 10%;"></td> <td style="width: 10%;"></td> <td style="width: 10%;"></td> <td style="width: 10%;"></td> <td style="width: 10%;"></td> <td style="width: 10%;"></td> <td style="width: 10%;"></td> <td style="width: 10%;"></td> </tr> <tr> <td></td> <td></td> <td colspan="8" style="text-align: center;"> <table border="1" style="width: 100%; border-collapse: collapse; text-align: center;"> <tr> </tr></table></td></tr></table></td></tr></table></td></tr></table></td></tr></table></td></tr></table></td></tr></table></td></tr></table></td></tr></table></td></tr></table></td></tr></table></td></tr></table></td></tr></table></td></tr></table></td></tr></table></td></tr></table></td></tr></table></td></tr></table></td></tr></table></td></tr></table></td></tr></table></td></tr></table></td></tr></table></td></tr></table></td></tr></table></td></tr></table></td></tr></table></td></tr></table></td></tr></table> | | | | | | | | | | | | | | | | | | | | <table border="1" style="width: 100%; border-collapse: collapse; text-align: center;"> <tr> <td style="width: 10%;"></td> <td style="width: 10%;"></td> <td style="width: 10%;"></td> <td style="width: 10%;"></td> <td style="width: 10%;"></td> <td style="width: 10%;"></td> <td style="width: 10%;"></td> <td style="width: 10%;"></td> <td style="width: 10%;"></td> <td style="width: 10%;"></td> </tr> <tr> <td></td> <td></td> <td colspan="8" style="text-align: center;"> <table border="1" style="width: 100%; border-collapse: collapse; text-align: center;"> <tr> <td style="width: 10%;"></td> <td style="width: 10%;"></td> <td style="width: 10%;"></td> <td style="width: 10%;"></td> <td style="width: 10%;"></td> <td style="width: 10%;"></td> <td style="width: 10%;"></td> <td style="width: 10%;"></td> <td style="width: 10%;"></td> <td style="width: 10%;"></td> </tr> <tr> <td></td> <td></td> <td colspan="8" style="text-align: center;"> <table border="1" style="width: 100%; border-collapse: collapse; text-align: center;"> <tr> <td style="width: 10%;"></td> <td style="width: 10%;"></td> <td style="width: 10%;"></td> <td style="width: 10%;"></td> <td style="width: 10%;"></td> <td style="width: 10%;"></td> <td style="width: 10%;"></td> <td style="width: 10%;"></td> <td style="width: 10%;"></td> <td style="width: 10%;"></td> </tr> <tr> <td></td> <td></td> <td colspan="8" style="text-align: center;"> <table border="1" style="width: 100%; border-collapse: collapse; text-align: center;"> <tr> <td style="width: 10%;"></td> <td style="width: 10%;"></td> <td style="width: 10%;"></td> <td style="width: 10%;"></td> <td style="width: 10%;"></td> <td style="width: 10%;"></td> <td style="width: 10%;"></td> <td style="width: 10%;"></td> <td style="width: 10%;"></td> <td style="width: 10%;"></td> </tr> <tr> <td></td> <td></td> <td colspan="8" style="text-align: center;"> <table border="1" style="width: 100%; border-collapse: collapse; text-align: center;"> <tr> <td style="width: 10%;"></td> <td style="width: 10%;"></td> <td style="width: 10%;"></td> <td style="width: 10%;"></td> <td style="width: 10%;"></td> <td style="width: 10%;"></td> <td style="width: 10%;"></td> <td style="width: 10%;"></td> <td style="width: 10%;"></td> <td style="width: 10%;"></td> </tr> <tr> <td></td> <td></td> <td colspan="8" style="text-align: center;"> <table border="1" style="width: 100%; border-collapse: collapse; text-align: center;"> <tr> <td style="width: 10%;"></td> <td style="width: 10%;"></td> <td style="width: 10%;"></td> <td style="width: 10%;"></td> <td style="width: 10%;"></td> <td style="width: 10%;"></td> <td style="width: 10%;"></td> <td style="width: 10%;"></td> <td style="width: 10%;"></td> <td style="width: 10%;"></td> </tr> <tr> <td></td> <td></td> <td colspan="8" style="text-align: center;"> <table border="1" style="width: 100%; border-collapse: collapse; text-align: center;"> <tr> <td style="width: 10%;"></td> <td style="width: 10%;"></td> <td style="width: 10%;"></td> <td style="width: 10%;"></td> <td style="width: 10%;"></td> <td style="width: 10%;"></td> <td style="width: 10%;"></td> <td style="width: 10%;"></td> <td style="width: 10%;"></td> <td style="width: 10%;"></td> </tr> <tr> <td></td> <td></td> <td colspan="8" style="text-align: center;"> <table border="1" style="width: 100%; border-collapse: collapse; text-align: center;"> <tr> <td style="width: 10%;"></td> <td style="width: 10%;"></td> <td style="width: 10%;"></td> <td style="width: 10%;"></td> <td style="width: 10%;"></td> <td style="width: 10%;"></td> <td style="width: 10%;"></td> <td style="width: 10%;"></td> <td style="width: 10%;"></td> <td style="width: 10%;"></td> </tr> <tr> <td></td> <td></td> <td colspan="8" style="text-align: center;"> <table border="1" style="width: 100%; border-collapse: collapse; text-align: center;"> <tr> <td style="width: 10%;"></td> <td style="width: 10%;"></td> <td style="width: 10%;"></td> <td style="width: 10%;"></td> <td style="width: 10%;"></td> <td style="width: 10%;"></td> <td style="width: 10%;"></td> <td style="width: 10%;"></td> <td style="width: 10%;"></td> <td style="width: 10%;"></td> </tr> <tr> <td></td> <td></td> <td colspan="8" style="text-align: center;"> <table border="1" style="width: 100%; border-collapse: collapse; text-align: center;"> <tr> <td style="width: 10%;"></td> <td style="width: 10%;"></td> <td style="width: 10%;"></td> <td style="width: 10%;"></td> <td style="width: 10%;"></td> <td style="width: 10%;"></td> <td style="width: 10%;"></td> <td style="width: 10%;"></td> <td style="width: 10%;"></td> <td style="width: 10%;"></td> </tr> <tr> <td></td> <td></td> <td colspan="8" style="text-align: center;"> <table border="1" style="width: 100%; border-collapse: collapse; text-align: center;"> <tr> <td style="width: 10%;"></td> <td style="width: 10%;"></td> <td style="width: 10%;"></td> <td style="width: 10%;"></td> <td style="width: 10%;"></td> <td style="width: 10%;"></td> <td style="width: 10%;"></td> <td style="width: 10%;"></td> <td style="width: 10%;"></td> <td style="width: 10%;"></td> </tr> <tr> <td></td> <td></td> <td colspan="8" style="text-align: center;"> <table border="1" style="width: 100%; border-collapse: collapse; text-align: center;"> <tr> <td style="width: 10%;"></td> <td style="width: 10%;"></td> <td style="width: 10%;"></td> <td style="width: 10%;"></td> <td style="width: 10%;"></td> <td style="width: 10%;"></td> <td style="width: 10%;"></td> <td style="width: 10%;"></td> <td style="width: 10%;"></td> <td style="width: 10%;"></td> </tr> <tr> <td></td> <td></td> <td colspan="8" style="text-align: center;"> <table border="1" style="width: 100%; border-collapse: collapse; text-align: center;"> <tr> <td style="width: 10%;"></td> <td
style="width: 10%;"></td> <td style="width: 10%;"></td> <td style="width: 10%;"></td> <td style="width: 10%;"></td> <td style="width: 10%;"></td> <td style="width: 10%;"></td> <td style="width: 10%;"></td> <td style="width: 10%;"></td> <td style="width: 10%;"></td> </tr> <tr> <td></td> <td></td> <td colspan="8" style="text-align: center;"> <table border="1" style="width: 100%; border-collapse: collapse; text-align: center;"> <tr> <td style="width: 10%;"></td> <td style="width: 10%;"></td> <td style="width: 10%;"></td> <td style="width: 10%;"></td> <td style="width: 10%;"></td> <td style="width: 10%;"></td> <td style="width: 10%;"></td> <td style="width: 10%;"></td> <td style="width: 10%;"></td> <td style="width: 10%;"></td> </tr> <tr> <td></td> <td></td> <td colspan="8" style="text-align: center;"> <table border="1" style="width: 100%; border-collapse: collapse; text-align: center;"> <tr> <td style="width: 10%;"></td> <td style="width: 10%;"></td> <td style="width: 10%;"></td> <td style="width: 10%;"></td> <td style="width: 10%;"></td> <td style="width: 10%;"></td> <td style="width: 10%;"></td> <td style="width: 10%;"></td> <td style="width: 10%;"></td> <td style="width: 10%;"></td> </tr> <tr> <td></td> <td></td> <td colspan="8" style="text-align: center;"> <table border="1" style="width: 100%; border-collapse: collapse; text-align: center;"> <tr> <td style="width: 10%;"></td> <td style="width: 10%;"></td> <td style="width: 10%;"></td> <td style="width: 10%;"></td> <td style="width: 10%;"></td> <td style="width: 10%;"></td> <td style="width: 10%;"></td> <td style="width: 10%;"></td> <td style="width: 10%;"></td> <td style="width: 10%;"></td> </tr> <tr> <td></td> <td></td> <td colspan="8" style="text-align: center;"> <table border="1" style="width: 100%; border-collapse: collapse; text-align: center;"> <tr> <td style="width: 10%;"></td> <td style="width: 10%;"></td> <td style="width: 10%;"></td> <td style="width: 10%;"></td> <td style="width: 10%;"></td> <td style="width: 10%;"></td> <td style="width: 10%;"></td> <td style="width: 10%;"></td> <td style="width: 10%;"></td> <td style="width: 10%;"></td> </tr> <tr> <td></td> <td></td> <td colspan="8" style="text-align: center;"> <table border="1" style="width: 100%; border-collapse: collapse; text-align: center;"> <tr> <td style="width: 10%;"></td> <td style="width: 10%;"></td> <td style="width: 10%;"></td> <td style="width: 10%;"></td> <td style="width: 10%;"></td> <td style="width: 10%;"></td> <td style="width: 10%;"></td> <td style="width: 10%;"></td> <td style="width: 10%;"></td> <td style="width: 10%;"></td> </tr> <tr> <td></td> <td></td> <td colspan="8" style="text-align: center;"> <table border="1" style="width: 100%; border-collapse: collapse; text-align: center;"> <tr> <td style="width: 10%;"></td> <td style="width: 10%;"></td> <td style="width: 10%;"></td> <td style="width: 10%;"></td> <td style="width: 10%;"></td> <td style="width: 10%;"></td> <td style="width: 10%;"></td> <td style="width: 10%;"></td> <td style="width: 10%;"></td> <td style="width: 10%;"></td> </tr> <tr> <td></td> <td></td> <td colspan="8" style="text-align: center;"> <table border="1" style="width: 100%; border-collapse: collapse; text-align: center;"> <tr> <td style="width: 10%;"></td> <td style="width: 10%;"></td> <td style="width: 10%;"></td> <td style="width: 10%;"></td> <td style="width: 10%;"></td> <td style="width: 10%;"></td> <td style="width: 10%;"></td> <td style="width: 10%;"></td> <td style="width: 10%;"></td> <td style="width: 10%;"></td> </tr> <tr> <td></td> <td></td> <td colspan="8" style="text-align: center;"> <table border="1" style="width: 100%; border-collapse: collapse; text-align: center;"> <tr> <td style="width: 10%;"></td> <td style="width: 10%;"></td> <td style="width: 10%;"></td> <td style="width: 10%;"></td> <td style="width: 10%;"></td> <td style="width: 10%;"></td> <td style="width: 10%;"></td> <td style="width: 10%;"></td> <td style="width: 10%;"></td> <td style="width: 10%;"></td> </tr> <tr> <td></td> <td></td> <td colspan="8" style="text-align: center;"> <table border="1" style="width: 100%; border-collapse: collapse; text-align: center;"> <tr> <td style="width: 10%;"></td> <td style="width: 10%;"></td> <td style="width: 10%;"></td> <td style="width: 10%;"></td> <td style="width: 10%;"></td> <td style="width: 10%;"></td> <td style="width: 10%;"></td> <td style="width: 10%;"></td> <td style="width: 10%;"></td> <td style="width: 10%;"></td> </tr> <tr> <td></td> <td></td> <td colspan="8" style="text-align: center;"> <table border="1" style="width: 100%; border-collapse: collapse; text-align: center;"> <tr> <td style="width: 10%;"></td> <td style="width: 10%;"></td> <td style="width: 10%;"></td> <td style="width: 10%;"></td> <td style="width: 10%;"></td> <td style="width: 10%;"></td> <td style="width: 10%;"></td> <td style="width: 10%;"></td> <td style="width: 10%;"></td> <td style="width: 10%;"></td> </tr> <tr> <td></td> <td></td> <td colspan="8" style="text-align: center;"> <table border="1" style="width: 100%; border-collapse: collapse; text-align: center;"> <tr> <td style="width: 10%;"></td> <td style="width: 10%;"></td> <td style="width: 10%;"></td> <td style="width: 10%;"></td> <td style="width: 10%;"></td> <td style="width: 10%;"></td> <td style="width: 10%;"></td> <td style="width: 10%;"></td> <td style="width: 10%;"></td> <td style="width: 10%;"></td> </tr> <tr> <td></td> <td></td> <td colspan="8" style="text-align: center;"> <table border="1" style="width: 100%; border-collapse: collapse; text-align: center;"> <tr> <td style="width: 10%;"></td> <td style="width: 10%;"></td> <td style="width: 10%;"></td> <td style="width: 10%;"></td> <td style="width: 10%;"></td> <td style="width: 10%;"></td> <td style="width: 10%;"></td> <td style="width: 10%;"></td> <td style="width: 10%;"></td> <td style="width: 10%;"></td> </tr> <tr> <td></td> <td></td> <td colspan="8" style="text-align: center;"> <table border="1" style="width: 100%; border-collapse: collapse; text-align: center;"> <tr> <td style="width: 10%;"></td> <td style="width: 10%;"></td> <td style="width: 10%;"></td> <td style="width: 10%;"></td> <td style="width: 10%;"></td> <td style="width: 10%;"></td> <td style="width: 10%;"></td> <td style="width: 10%;"></td> <td style="width: 10%;"></td> <td style="width: 10%;"></td> </tr> <tr> <td></td> <td></td> <td colspan="8" style="text-align: center;"> <table border="1" style="width: 100%; border-collapse: collapse; text-align: center;"> <tr> <td style="width: 10%;"></td> <td style="width: 10%;"></td> <td style="width: 10%;"></td> <td style="width: 10%;"></td> <td style="width: 10%;"></td> <td style="width: 10%;"></td> <td style="width: 10%;"></td> <td style="width: 10%;"></td> <td style="width: 10%;"></td> <td style="width: 10%;"></td> </tr> <tr> <td></td> <td></td> <td colspan="8" style="text-align: center;"> <table border="1" style="width: 100%; border-collapse: collapse; text-align: center;"> <tr> </tr></table></td></tr></table></td></tr></table></td></tr></table></td></tr></table></td></tr></table></td></tr></table></td></tr></table></td></tr></table></td></tr></table></td></tr></table></td></tr></table></td></tr></table></td></tr></table></td></tr></table></td></tr></table></td></tr></table></td></tr></table></td></tr></table></td></tr></table></td></tr></table></td></tr></table></td></tr></table></td></tr></table></td></tr></table></td></tr></table></td></tr></table></td></tr></table>
 | | | | | | | | | | | | | | | | | | | | <table border="1" style="width: 100%; border-collapse: collapse; text-align: center;"> <tr> <td style="width: 10%;"></td> <td style="width: 10%;"></td> <td style="width: 10%;"></td> <td style="width: 10%;"></td> <td style="width: 10%;"></td> <td style="width: 10%;"></td> <td style="width: 10%;"></td> <td style="width: 10%;"></td> <td style="width: 10%;"></td> <td style="width: 10%;"></td> </tr> <tr> <td></td> <td></td> <td colspan="8" style="text-align: center;"> <table border="1" style="width: 100%; border-collapse: collapse; text-align: center;"> <tr> <td style="width: 10%;"></td> <td style="width: 10%;"></td> <td style="width: 10%;"></td> <td style="width: 10%;"></td> <td style="width: 10%;"></td> <td style="width: 10%;"></td> <td style="width: 10%;"></td> <td style="width: 10%;"></td> <td style="width: 10%;"></td> <td style="width: 10%;"></td> </tr> <tr> <td></td> <td></td> <td colspan="8" style="text-align: center;"> <table border="1" style="width: 100%; border-collapse: collapse; text-align: center;"> <tr> <td style="width: 10%;"></td> <td style="width: 10%;"></td> <td style="width: 10%;"></td> <td style="width: 10%;"></td> <td style="width: 10%;"></td> <td style="width: 10%;"></td> <td style="width: 10%;"></td> <td style="width: 10%;"></td> <td style="width: 10%;"></td> <td style="width: 10%;"></td> </tr> <tr> <td></td> <td></td> <td colspan="8" style="text-align: center;"> <table border="1" style="width: 100%; border-collapse: collapse; text-align: center;"> <tr> <td style="width: 10%;"></td> <td style="width: 10%;"></td> <td style="width: 10%;"></td> <td style="width: 10%;"></td> <td style="width: 10%;"></td> <td style="width: 10%;"></td> <td style="width: 10%;"></td> <td style="width: 10%;"></td> <td style="width: 10%;"></td> <td style="width: 10%;"></td> </tr> <tr> <td></td> <td></td> <td colspan="8" style="text-align: center;"> <table border="1" style="width: 100%; border-collapse: collapse; text-align: center;"> <tr> <td style="width: 10%;"></td> <td style="width: 10%;"></td> <td style="width: 10%;"></td> <td style="width: 10%;"></td> <td style="width: 10%;"></td> <td style="width: 10%;"></td> <td style="width: 10%;"></td> <td style="width: 10%;"></td> <td style="width: 10%;"></td> <td style="width: 10%;"></td> </tr> <tr> <td></td> <td></td> <td colspan="8" style="text-align: center;"> <table border="1" style="width: 100%; border-collapse: collapse; text-align: center;"> <tr> <td style="width: 10%;"></td> <td style="width: 10%;"></td> <td style="width: 10%;"></td> <td style="width: 10%;"></td> <td style="width: 10%;"></td> <td style="width: 10%;"></td> <td style="width: 10%;"></td> <td style="width: 10%;"></td> <td style="width: 10%;"></td> <td style="width: 10%;"></td> </tr> <tr> <td></td> <td></td> <td colspan="8" style="text-align: center;"> <table border="1" style="width: 100%; border-collapse: collapse; text-align: center;"> <tr> <td style="width: 10%;"></td> <td style="width: 10%;"></td> <td style="width: 10%;"></td> <td style="width: 10%;"></td> <td style="width: 10%;"></td> <td style="width: 10%;"></td> <td style="width: 10%;"></td> <td style="width: 10%;"></td> <td style="width: 10%;"></td> <td style="width: 10%;"></td> </tr> <tr> <td></td> <td></td> <td colspan="8" style="text-align: center;"> <table border="1" style="width: 100%; border-collapse: collapse; text-align: center;"> <tr> <td style="width: 10%;"></td> <td style="width: 10%;"></td> <td style="width: 10%;"></td> <td style="width: 10%;"></td> <td style="width: 10%;"></td> <td style="width: 10%;"></td> <td style="width: 10%;"></td> <td style="width: 10%;"></td> <td style="width: 10%;"></td> <td style="width: 10%;"></td> </tr> <tr> <td></td> <td></td> <td colspan="8" style="text-align: center;"> <table border="1" style="width: 100%; border-collapse: collapse; text-align: center;"> <tr> <td style="width: 10%;"></td> <td style="width: 10%;"></td> <td style="width: 10%;"></td> <td style="width: 10%;"></td> <td style="width: 10%;"></td> <td style="width: 10%;"></td> <td style="width: 10%;"></td> <td style="width: 10%;"></td> <td style="width: 10%;"></td> <td style="width: 10%;"></td> </tr> <tr> <td></td> <td></td> <td colspan="8" style="text-align: center;"> <table border="1" style="width: 100%; border-collapse: collapse; text-align: center;"> <tr> <td style="width: 10%;"></td> <td style="width: 10%;"></td> <td style="width: 10%;"></td> <td style="width: 10%;"></td> <td style="width: 10%;"></td> <td style="width: 10%;"></td> <td style="width: 10%;"></td> <td style="width: 10%;"></td> <td style="width: 10%;"></td> <td style="width: 10%;"></td> </tr> <tr> <td></td> <td></td> <td colspan="8" style="text-align: center;"> <table border="1" style="width: 100%; border-collapse: collapse; text-align: center;"> <tr> <td style="width: 10%;"></td> <td style="width: 10%;"></td> <td style="width: 10%;"></td> <td style="width: 10%;"></td> <td style="width: 10%;"></td> <td style="width: 10%;"></td> <td style="width: 10%;"></td> <td style="width: 10%;"></td> <td style="width: 10%;"></td> <td style="width: 10%;"></td> </tr> <tr> <td></td> <td></td> <td colspan="8" style="text-align: center;"> <table border="1" style="width: 100%; border-collapse: collapse; text-align: center;"> <tr> <td style="width: 10%;"></td> <td style="width: 10%;"></td> <td style="width: 10%;"></td> <td style="width: 10%;"></td> <td style="width: 10%;"></td> <td style="width: 10%;"></td> <td style="width: 10%;"></td> <td style="width: 10%;"></td> <td style="width: 10%;"></td> <td style="width: 10%;"></td> </tr> <tr> <td></td> <td></td> <td colspan="8" style="text-align: center;"> <table border="1" style="width: 100%; border-collapse: collapse; text-align: center;"> <tr> <td style="width: 10%;"></td> <td style="width: 10%;"></td> <td style="width: 10%;"></td> <td style="width: 10%;"></td> <td style="width: 10%;"></td> <td style="width: 10%;"></td> <td style="width: 10%;"></td> <td style="width: 10%;"></td> <td style="width: 10%;"></td> <td style="width: 10%;"></td> </tr> <tr> <td></td> <td></td> <td colspan="8" style="text-align: center;"> <table border="1" style="width: 100%; border-collapse: collapse; text-align: center;"> <tr> <td style="width: 10%;"></td> <td style="width: 10%;"></td> <td style="width: 10%;"></td> <td style="width: 10%;"></td> <td style="width: 10%;"></td> <td style="width: 10%;"></td> <td style="width: 10%;"></td> <td style="width: 10%;"></td> <td style="width: 10%;"></td> <td style="width: 10%;"></td> </tr> <tr> <td></td> <td></td> <td colspan="8" style="text-align: center;"> <table border="1" style="width: 100%; border-collapse: collapse; text-align: center;"> <tr> <td style="width: 10%;"></td> <td style="width: 10%;"></td> <td style="width: 10%;"></td> <td style="width: 10%;"></td> <td style="width: 10%;"></td> <td style="width: 10%;"></td> <td style="width: 10%;"></td> <td style="width: 10%;"></td> <td style="width: 10%;"></td> <td style="width: 10%;"></td> </tr> <tr> <td></td> <td></td> <td colspan="8" style="text-align: center;"> <table border="1" style="width: 100%; border-collapse: collapse; text-align: center;"> <tr> <td style="width: 10%;"></td> <td style="width: 10%;"></td> <td style="width: 10%;"></td> <td style="width: 10%;"></td> <td style="width: 10%;"></td> <td style="width: 10%;"></td> <td style="width: 10%;"></td> <td style="width: 10%;"></td> <td style="width: 10%;"></td> <td style="width: 10%;"></td> </tr> <tr> <td></td> <td></td> <td colspan="8" style="text-align: center;"> <table border="1" style="width: 100%; border-collapse: collapse; text-align: center;"> <tr> <td style="width: 10%;"></td> <td style="width: 10%;"></td> <td style="width: 10%;"></td> <td style="width: 10%;"></td> <td style="width: 10%;"></td> <td style="width: 10%;"></td> <td style="width: 10%;"></td> <td style="width: 10%;"></td> <td style="width: 10%;"></td> <td style="width: 10%;"></td> </tr> <tr> <td></td> <td></td> <td colspan="8" style="text-align: center;"> <table border="1" style="width: 100%; border-collapse: collapse; text-align: center;"> <tr> <td style="width: 10%;"></td> <td style="width: 10%;"></td> <td style="width: 10%;"></td> <td style="width: 10%;"></td> <td style="width: 10%;"></td> <td style="width: 10%;"></td> <td style="width: 10%;"></td> <td style="width: 10%;"></td> <td style="width: 10%;"></td> <td style="width: 10%;"></td> </tr> <tr> <td></td> <td></td> <td colspan="8" style="text-align: center;"> <table border="1" style="width: 100%; border-collapse: collapse; text-align: center;"> <tr> <td style="width: 10%;"></td> <td style="width: 10%;"></td> <td style="width: 10%;"></td> <td style="width: 10%;"></td> <td style="width: 10%;"></td> <td style="width: 10%;"></td> <td style="width: 10%;"></td> <td style="width: 10%;"></td> <td style="width: 10%;"></td> <td style="width: 10%;"></td> </tr> <tr> <td></td> <td></td> <td colspan="8" style="text-align: center;"> <table border="1" style="width: 100%; border-collapse: collapse; text-align: center;"> <tr> <td style="width: 10%;"></td> <td style="width: 10%;"></td> <td style="width: 10%;"></td> <td style="width: 10%;"></td> <td style="width: 10%;"></td> <td style="width: 10%;"></td> <td style="width: 10%;"></td> <td style="width: 10%;"></td> <td style="width: 10%;"></td> <td style="width: 10%;"></td> </tr> <tr> <td></td> <td></td> <td colspan="8" style="text-align: center;"> <table border="1" style="width: 100%; border-collapse: collapse; text-align: center;"> <tr> <td style="width: 10%;"></td> <td style="width: 10%;"></td> <td style="width:
10%;"></td> <td style="width: 10%;"></td> <td style="width: 10%;"></td> <td style="width: 10%;"></td> <td style="width: 10%;"></td> <td style="width: 10%;"></td> <td style="width: 10%;"></td> <td style="width: 10%;"></td> </tr> <tr> <td></td> <td></td> <td colspan="8" style="text-align: center;"> <table border="1" style="width: 100%; border-collapse: collapse; text-align: center;"> <tr> <td style="width: 10%;"></td> <td style="width: 10%;"></td> <td style="width: 10%;"></td> <td style="width: 10%;"></td> <td style="width: 10%;"></td> <td style="width: 10%;"></td> <td style="width: 10%;"></td> <td style="width: 10%;"></td> <td style="width: 10%;"></td> <td style="width: 10%;"></td> </tr> <tr> <td></td> <td></td> <td colspan="8" style="text-align: center;"> <table border="1" style="width: 100%; border-collapse: collapse; text-align: center;"> <tr> <td style="width: 10%;"></td> <td style="width: 10%;"></td> <td style="width: 10%;"></td> <td style="width: 10%;"></td> <td style="width: 10%;"></td> <td style="width: 10%;"></td> <td style="width: 10%;"></td> <td style="width: 10%;"></td> <td style="width: 10%;"></td> <td style="width: 10%;"></td> </tr> <tr> <td></td> <td></td> <td colspan="8" style="text-align: center;"> <table border="1" style="width: 100%; border-collapse: collapse; text-align: center;"> <tr> <td style="width: 10%;"></td> <td style="width: 10%;"></td> <td style="width: 10%;"></td> <td style="width: 10%;"></td> <td style="width: 10%;"></td> <td style="width: 10%;"></td> <td style="width: 10%;"></td> <td style="width: 10%;"></td> <td style="width: 10%;"></td> <td style="width: 10%;"></td> </tr> <tr> <td></td> <td></td> <td colspan="8" style="text-align: center;"> <table border="1" style="width: 100%; border-collapse: collapse; text-align: center;"> <tr> <td style="width: 10%;"></td> <td style="width: 10%;"></td> <td style="width: 10%;"></td> <td style="width: 10%;"></td> <td style="width: 10%;"></td> <td style="width: 10%;"></td> <td style="width: 10%;"></td> <td style="width: 10%;"></td> <td style="width: 10%;"></td> <td style="width: 10%;"></td> </tr> <tr> <td></td> <td></td> <td colspan="8" style="text-align: center;"> <table border="1" style="width: 100%; border-collapse: collapse; text-align: center;"> <tr> <td style="width: 10%;"></td> <td style="width: 10%;"></td> <td style="width: 10%;"></td> <td style="width: 10%;"></td> <td style="width: 10%;"></td> <td style="width: 10%;"></td> <td style="width: 10%;"></td> <td style="width: 10%;"></td> <td style="width: 10%;"></td> <td style="width: 10%;"></td> </tr> <tr> <td></td> <td></td> <td colspan="8" style="text-align: center;"> <table border="1" style="width: 100%; border-collapse: collapse; text-align: center;"> <tr> </tr></table></td></tr></table></td></tr></table></td></tr></table></td></tr></table></td></tr></table></td></tr></table></td></tr></table></td></tr></table></td></tr></table></td></tr></table></td></tr></table></td></tr></table></td></tr></table></td></tr></table></td></tr></table></td></tr></table></td></tr></table></td></tr></table></td></tr></table></td></tr></table></td></tr></table></td></tr></table></td></tr></table></td></tr></table></td></tr></table></td></tr></table> | | | | | | | | | | | | | | | | | | | | <table border="1" style="width: 100%; border-collapse: collapse; text-align: center;"> <tr> <td style="width: 10%;"></td> <td style="width: 10%;"></td> <td style="width: 10%;"></td> <td style="width: 10%;"></td> <td style="width: 10%;"></td> <td style="width: 10%;"></td> <td style="width: 10%;"></td> <td style="width: 10%;"></td> <td style="width: 10%;"></td> <td style="width: 10%;"></td> </tr> <tr> <td></td> <td></td> <td colspan="8" style="text-align: center;"> <table border="1" style="width: 100%; border-collapse: collapse; text-align: center;"> <tr> <td style="width: 10%;"></td> <td style="width: 10%;"></td> <td style="width: 10%;"></td> <td style="width: 10%;"></td> <td style="width: 10%;"></td> <td style="width: 10%;"></td> <td style="width: 10%;"></td> <td style="width: 10%;"></td> <td style="width: 10%;"></td> <td style="width: 10%;"></td> </tr> <tr> <td></td> <td></td> <td colspan="8" style="text-align: center;"> <table border="1" style="width: 100%; border-collapse: collapse; text-align: center;"> <tr> <td style="width: 10%;"></td> <td style="width: 10%;"></td> <td style="width: 10%;"></td> <td style="width: 10%;"></td> <td style="width: 10%;"></td> <td style="width: 10%;"></td> <td style="width: 10%;"></td> <td style="width: 10%;"></td> <td style="width: 10%;"></td> <td style="width: 10%;"></td> </tr> <tr> <td></td> <td></td> <td colspan="8" style="text-align: center;"> <table border="1" style="width: 100%; border-collapse: collapse; text-align: center;"> <tr> <td style="width: 10%;"></td> <td style="width: 10%;"></td> <td style="width: 10%;"></td> <td style="width: 10%;"></td> <td style="width: 10%;"></td> <td style="width: 10%;"></td> <td style="width: 10%;"></td> <td style="width: 10%;"></td> <td style="width: 10%;"></td> <td style="width: 10%;"></td> </tr> <tr> <td></td> <td></td> <td colspan="8" style="text-align: center;"> <table border="1" style="width: 100%; border-collapse: collapse; text-align: center;"> <tr> <td style="width: 10%;"></td> <td style="width: 10%;"></td> <td style="width: 10%;"></td> <td style="width: 10%;"></td> <td style="width: 10%;"></td> <td style="width: 10%;"></td> <td style="width: 10%;"></td> <td style="width: 10%;"></td> <td style="width: 10%;"></td> <td style="width: 10%;"></td> </tr> <tr> <td></td> <td></td> <td colspan="8" style="text-align: center;"> <table border="1" style="width: 100%; border-collapse: collapse; text-align: center;"> <tr> <td style="width: 10%;"></td> <td style="width: 10%;"></td> <td style="width: 10%;"></td> <td style="width: 10%;"></td> <td style="width: 10%;"></td> <td style="width: 10%;"></td> <td style="width: 10%;"></td> <td style="width: 10%;"></td> <td style="width: 10%;"></td> <td style="width: 10%;"></td> </tr> <tr> <td></td> <td></td> <td colspan="8" style="text-align: center;"> <table border="1" style="width: 100%; border-collapse: collapse; text-align: center;"> <tr> <td style="width: 10%;"></td> <td style="width: 10%;"></td> <td style="width: 10%;"></td> <td style="width: 10%;"></td> <td style="width: 10%;"></td> <td style="width: 10%;"></td> <td style="width: 10%;"></td> <td style="width: 10%;"></td> <td style="width: 10%;"></td> <td style="width: 10%;"></td> </tr> <tr> <td></td> <td></td> <td colspan="8" style="text-align: center;"> <table border="1" style="width: 100%; border-collapse: collapse; text-align: center;"> <tr> <td style="width: 10%;"></td> <td style="width: 10%;"></td> <td style="width: 10%;"></td> <td style="width: 10%;"></td> <td style="width: 10%;"></td> <td style="width: 10%;"></td> <td style="width: 10%;"></td> <td style="width: 10%;"></td> <td style="width: 10%;"></td> <td style="width: 10%;"></td> </tr> <tr> <td></td> <td></td> <td colspan="8" style="text-align: center;"> <table border="1" style="width: 100%; border-collapse: collapse;
text-align: center;"> <tr> <td style="width: 10%;"></td> <td style="width: 10%;"></td> <td style="width: 10%;"></td> <td style="width: 10%;"></td> <td style="width: 10%;"></td> <td style="width: 10%;"></td> <td style="width: 10%;"></td> <td style="width: 10%;"></td> <td style="width: 10%;"></td> <td style="width: 10%;"></td> </tr> <tr> <td></td> <td></td> <td colspan="8" style="text-align: center;"> <table border="1" style="width: 100%; border-collapse: collapse; text-align: center;"> <tr> <td style="width: 10%;"></td> <td style="width: 10%;"></td> <td style="width: 10%;"></td> <td style="width: 10%;"></td> <td style="width: 10%;"></td> <td style="width: 10%;"></td> <td style="width: 10%;"></td> <td style="width: 10%;"></td> <td style="width: 10%;"></td> <td style="width: 10%;"></td> </tr> <tr> <td></td> <td></td> <td colspan="8" style="text-align: center;"> <table border="1" style="width: 100%; border-collapse: collapse; text-align: center;"> <tr> <td style="width: 10%;"></td> <td style="width: 10%;"></td> <td style="width: 10%;"></td> <td style="width: 10%;"></td> <td style="width: 10%;"></td> <td style="width: 10%;"></td> <td style="width: 10%;"></td> <td style="width: 10%;"></td> <td style="width: 10%;"></td> <td style="width: 10%;"></td> </tr> <tr> <td></td> <td></td> <td colspan="8" style="text-align: center;"> <table border="1" style="width: 100%; border-collapse: collapse; text-align: center;"> <tr> <td style="width: 10%;"></td> <td style="width: 10%;"></td> <td style="width: 10%;"></td> <td style="width: 10%;"></td> <td style="width: 10%;"></td> <td style="width: 10%;"></td> <td style="width: 10%;"></td> <td style="width: 10%;"></td> <td style="width: 10%;"></td> <td style="width: 10%;"></td> </tr> <tr> <td></td> <td></td> <td colspan="8" style="text-align: center;"> <table border="1" style="width: 100%; border-collapse: collapse; text-align: center;"> <tr> <td style="width: 10%;"></td> <td style="width: 10%;"></td> <td style="width: 10%;"></td> <td style="width: 10%;"></td> <td style="width: 10%;"></td> <td style="width: 10%;"></td> <td style="width: 10%;"></td> <td style="width: 10%;"></td> <td style="width: 10%;"></td> <td style="width: 10%;"></td> </tr> <tr> <td></td> <td></td> <td colspan="8" style="text-align: center;"> <table border="1" style="width: 100%; border-collapse: collapse; text-align: center;"> <tr> <td style="width: 10%;"></td> <td style="width: 10%;"></td> <td style="width: 10%;"></td> <td style="width: 10%;"></td> <td style="width: 10%;"></td> <td style="width: 10%;"></td> <td style="width: 10%;"></td> <td style="width: 10%;"></td> <td style="width: 10%;"></td> <td style="width: 10%;"></td> </tr> <tr> <td></td> <td></td> <td colspan="8" style="text-align: center;"> <table border="1" style="width: 100%; border-collapse: collapse; text-align: center;"> <tr> <td style="width: 10%;"></td> <td style="width: 10%;"></td> <td style="width: 10%;"></td> <td style="width: 10%;"></td> <td style="width: 10%;"></td> <td style="width: 10%;"></td> <td style="width: 10%;"></td> <td style="width: 10%;"></td> <td style="width: 10%;"></td> <td style="width: 10%;"></td> </tr> <tr> <td></td> <td></td> <td colspan="8" style="text-align: center;"> <table border="1" style="width: 100%; border-collapse: collapse; text-align: center;"> <tr> <td style="width: 10%;"></td> <td style="width: 10%;"></td> <td style="width: 10%;"></td> <td style="width: 10%;"></td> <td style="width: 10%;"></td> <td style="width: 10%;"></td> <td style="width: 10%;"></td> <td style="width: 10%;"></td> <td style="width: 10%;"></td> <td style="width: 10%;"></td> </tr> <tr> <td></td> <td></td> <td colspan="8" style="text-align: center;"> <table border="1" style="width: 100%; border-collapse: collapse; text-align: center;"> <tr> <td style="width: 10%;"></td> <td style="width: 10%;"></td> <td style="width: 10%;"></td> <td style="width: 10%;"></td> <td style="width: 10%;"></td> <td style="width: 10%;"></td> <td style="width: 10%;"></td> <td style="width: 10%;"></td> <td style="width: 10%;"></td> <td style="width: 10%;"></td> </tr> <tr> <td></td> <td></td> <td colspan="8" style="text-align: center;"> <table border="1" style="width: 100%; border-collapse: collapse; text-align: center;"> <tr> <td style="width: 10%;"></td> <td style="width: 10%;"></td> <td style="width: 10%;"></td> <td style="width: 10%;"></td> <td style="width: 10%;"></td> <td style="width: 10%;"></td> <td style="width: 10%;"></td> <td style="width: 10%;"></td> <td style="width: 10%;"></td> <td style="width: 10%;"></td> </tr> <tr> <td></td> <td></td> <td colspan="8" style="text-align: center;"> <table border="1" style="width: 100%; border-collapse: collapse; text-align: center;"> <tr> <td style="width: 10%;"></td> <td style="width: 10%;"></td> <td style="width: 10%;"></td> <td style="width: 10%;"></td> <td style="width: 10%;"></td> <td style="width: 10%;"></td> <td style="width: 10%;"></td> <td style="width: 10%;"></td> <td style="width: 10%;"></td> <td style="width: 10%;"></td> </tr> <tr> <td></td> <td></td> <td colspan="8" style="text-align: center;"> <table border="1" style="width: 100%; border-collapse: collapse; text-align: center;"> <tr> <td style="width: 10%;"></td> <td style="width: 10%;"></td> <td style="width: 10%;"></td> <td style="width: 10%;"></td> <td style="width: 10%;"></td> <td style="width: 10%;"></td> <td style="width: 10%;"></td> <td style="width: 10%;"></td> <td style="width: 10%;"></td> <td style="width: 10%;"></td> </tr> <tr> <td></td> <td></td> <td colspan="8" style="text-align: center;"> <table border="1" style="width: 100%; border-collapse: collapse; text-align: center;"> <tr> <td style="width: 10%;"></td> <td style="width: 10%;"></td> <td style="width: 10%;"></td> <td style="width: 10%;"></td> <td style="width: 10%;"></td> <td style="width: 10%;"></td> <td style="width: 10%;"></td> <td style="width: 10%;"></td> <td style="width: 10%;"></td> <td style="width: 10%;"></td> </tr> <tr> <td></td> <td></td> <td colspan="8" style="text-align: center;"> <table border="1" style="width: 100%; border-collapse: collapse; text-align: center;"> <tr> <td style="width: 10%;"></td> <td style="width: 10%;"></td> <td style="width: 10%;"></td> <td style="width: 10%;"></td> <td style="width: 10%;"></td> <td style="width: 10%;"></td> <td style="width: 10%;"></td> <td style="width: 10%;"></td> <td style="width: 10%;"></td> <td style="width: 10%;"></td> </tr> <tr> <td></td> <td></td> <td colspan="8" style="text-align: center;"> <table border="1" style="width: 100%; border-collapse: collapse; text-align: center;"> <tr> <td style="width: 10%;"></td> <td style="width: 10%;"></td> <td style="width: 10%;"></td> <td style="width: 10%;"></td> <td style="width: 10%;"></td> <td style="width: 10%;"></td> <td style="width: 10%;"></td> <td style="width: 10%;"></td> <td style="width: 10%;"></td> <td style="width: 10%;"></td> </tr> <tr> <td></td> <td></td> <td colspan="8" style="text-align: center;"> <table border="1" style="width: 100%; border-collapse: collapse; text-align: center;"> <tr> <td style="width: 10%;"></td> <td style="width: 10%;"></td> <td style="width: 10%;"></td> <td style="width: 10%;"></td> <td style="width: 10%;"></td> <td style="width: 10%;"></td> <td style="width: 10%;"></td> <td style="width: 10%;"></td> <td style="width: 10%;"></td> <td style="width: 10%;"></td> </tr> <tr> <td></td> <td></td> <td colspan="8" style="text-align: center;"> <table border="1" style="width: 100%; border-collapse: collapse; text-align: center;"> <tr> <td style="width: 10%;"></td> <td style="width: 10%;"></td> <td style="width: 10%;"></td> <td style="width: 10%;"></td> <td style="width: 10%;"></td> <td style="width: 10%;"></td> <td style="width: 10%;"></td> <td style="width: 10%;"></td> <td style="width: 10%;"></td> <td style="width: 10%;"></td> </tr> <tr> <td></td> <td></td> <td colspan="8" style="text-align: center;"> <table border="1" style="width: 100%; border-collapse: collapse; text-align: center;"> <tr> </tr></table></td></tr></table></td></tr></table></td></tr></table></td></tr></table></td></tr></table></td></tr></table></td></tr></table></td></tr></table></td></tr></table></td></tr></table></td></tr></table></td></tr></table></td></tr></table></td></tr></table></td></tr></table></td></tr></table></td></tr></table></td></tr></table></td></tr></table></td></tr></table></td></tr></table></td></tr></table></td></tr></table></td></tr></table></td></tr></table>
 | | | | | | | | | | | | | | | | | | | | <table border="1" style="width: 100%; border-collapse: collapse; text-align: center;"> <tr> <td style="width: 10%;"></td> <td style="width: 10%;"></td> <td style="width: 10%;"></td> <td style="width: 10%;"></td> <td style="width: 10%;"></td> <td style="width: 10%;"></td> <td style="width: 10%;"></td> <td style="width: 10%;"></td> <td style="width: 10%;"></td> <td style="width: 10%;"></td> </tr> <tr> <td></td> <td></td> <td colspan="8" style="text-align: center;"> <table border="1" style="width: 100%; border-collapse: collapse; text-align: center;"> <tr> <td style="width: 10%;"></td> <td style="width: 10%;"></td> <td style="width: 10%;"></td> <td style="width: 10%;"></td> <td style="width: 10%;"></td> <td style="width: 10%;"></td> <td style="width: 10%;"></td> <td style="width: 10%;"></td> <td style="width: 10%;"></td> <td style="width: 10%;"></td> </tr> <tr> <td></td> <td></td> <td colspan="8" style="text-align: center;"> <table border="1" style="width: 100%; border-collapse: collapse; text-align: center;"> <tr> <td style="width: 10%;"></td> <td style="width: 10%;"></td> <td style="width: 10%;"></td> <td style="width: 10%;"></td> <td style="width: 10%;"></td> <td style="width: 10%;"></td> <td style="width: 10%;"></td> <td style="width: 10%;"></td> <td style="width: 10%;"></td> <td style="width: 10%;"></td> </tr> <tr> <td></td> <td></td> <td colspan="8" style="text-align: center;"> <table border="1" style="width: 100%; border-collapse: collapse; text-align: center;"> <tr> <td style="width: 10%;"></td> <td style="width: 10%;"></td> <td style="width: 10%;"></td> <td style="width: 10%;"></td> <td style="width: 10%;"></td> <td style="width: 10%;"></td> <td style="width: 10%;"></td> <td style="width: 10%;"></td> <td style="width: 10%;"></td> <td style="width: 10%;"></td> </tr> <tr> <td></td> <td></td> <td colspan="8" style="text-align: center;"> <table border="1" style="width: 100%; border-collapse: collapse; text-align: center;"> <tr> <td style="width: 10%;"></td> <td style="width: 10%;"></td> <td style="width: 10%;"></td> <td style="width: 10%;"></td> <td style="width: 10%;"></td> <td style="width: 10%;"></td> <td style="width: 10%;"></td> <td style="width: 10%;"></td> <td style="width: 10%;"></td> <td style="width: 10%;"></td> </tr> <tr> <td></td> <td></td> <td colspan="8" style="text-align: center;"> <table border="1" style="width: 100%; border-collapse: collapse; text-align: center;"> <tr> <td style="width: 10%;"></td> <td style="width: 10%;"></td> <td style="width: 10%;"></td> <td style="width: 10%;"></td> <td style="width: 10%;"></td> <td style="width: 10%;"></td> <td style="width: 10%;"></td> <td style="width: 10%;"></td> <td style="width: 10%;"></td> <td style="width: 10%;"></td> </tr> <tr> <td></td> <td></td> <td colspan="8" style="text-align: center;"> <table border="1" style="width: 100%; border-collapse: collapse; text-align: center;"> <tr> <td style="width: 10%;"></td> <td style="width: 10%;"></td> <td style="width: 10%;"></td> <td style="width: 10%;"></td> <td style="width: 10%;"></td> <td style="width: 10%;"></td> <td style="width: 10%;"></td> <td style="width: 10%;"></td> <td style="width: 10%;"></td> <td style="width: 10%;"></td> </tr> <tr> <td></td> <td></td> <td colspan="8" style="text-align: center;"> <table border="1" style="width: 100%; border-collapse: collapse; text-align: center;"> <tr> <td style="width: 10%;"></td> <td style="width: 10%;"></td> <td style="width: 10%;"></td> <td style="width: 10%;"></td> <td style="width: 10%;"></td> <td style="width: 10%;"></td> <td style="width: 10%;"></td> <td style="width: 10%;"></td> <td style="width: 10%;"></td> <td style="width: 10%;"></td> </tr> <tr> <td></td> <td></td> <td colspan="8" style="text-align: center;"> <table border="1" style="width: 100%; border-collapse: collapse; text-align: center;"> <tr> <td style="width: 10%;"></td> <td style="width: 10%;"></td> <td style="width: 10%;"></td> <td style="width: 10%;"></td> <td style="width: 10%;"></td> <td style="width: 10%;"></td> <td style="width: 10%;"></td> <td style="width: 10%;"></td> <td style="width: 10%;"></td> <td style="width: 10%;"></td> </tr> <tr> <td></td> <td></td> <td colspan="8" style="text-align: center;"> <table border="1" style="width: 100%; border-collapse: collapse; text-align: center;"> <tr> <td style="width: 10%;"></td> <td style="width: 10%;"></td> <td style="width: 10%;"></td> <td style="width: 10%;"></td> <td style="width: 10%;"></td> <td style="width: 10%;"></td> <td style="width: 10%;"></td> <td style="width: 10%;"></td> <td style="width: 10%;"></td> <td style="width: 10%;"></td> </tr> <tr> <td></td> <td></td> <td colspan="8" style="text-align: center;"> <table border="1" style="width: 100%; border-collapse: collapse; text-align: center;"> <tr> <td style="width: 10%;"></td> <td style="width: 10%;"></td> <td style="width: 10%;"></td> <td style="width: 10%;"></td> <td style="width: 10%;"></td> <td style="width: 10%;"></td> <td style="width: 10%;"></td> <td style="width: 10%;"></td> <td style="width: 10%;"></td> <td style="width: 10%;"></td> </tr> <tr> <td></td> <td></td> <td colspan="8" style="text-align: center;"> <table border="1" style="width: 100%; border-collapse: collapse; text-align: center;"> <tr> <td style="width: 10%;"></td> <td style="width: 10%;"></td> <td style="width: 10%;"></td> <td style="width: 10%;"></td> <td style="width: 10%;"></td> <td style="width: 10%;"></td> <td style="width: 10%;"></td> <td style="width: 10%;"></td> <td style="width: 10%;"></td> <td style="width: 10%;"></td> </tr> <tr> <td></td> <td></td> <td colspan="8" style="text-align: center;"> <table border="1" style="width: 100%; border-collapse: collapse; text-align: center;"> <tr> <td style="width: 10%;"></td> <td style="width: 10%;"></td> <td style="width: 10%;"></td> <td style="width: 10%;"></td> <td style="width: 10%;"></td> <td style="width: 10%;"></td> <td style="width: 10%;"></td> <td style="width: 10%;"></td> <td style="width: 10%;"></td> <td style="width: 10%;"></td> </tr> <tr> <td></td> <td></td> <td colspan="8" style="text-align: center;"> <table border="1" style="width: 100%; border-collapse: collapse; text-align: center;"> <tr> <td style="width: 10%;"></td> <td style="width: 10%;"></td> <td style="width: 10%;"></td> <td style="width: 10%;"></td> <td style="width: 10%;"></td> <td style="width: 10%;"></td> <td style="width: 10%;"></td> <td style="width: 10%;"></td> <td style="width: 10%;"></td> <td style="width: 10%;"></td> </tr> <tr> <td></td> <td></td> <td colspan="8" style="text-align: center;"> <table border="1" style="width: 100%; border-collapse: collapse; text-align: center;"> <tr> <td style="width: 10%;"></td> <td style="width: 10%;"></td> <td style="width: 10%;"></td> <td style="width: 10%;"></td> <td style="width: 10%;"></td> <td style="width: 10%;"></td> <td style="width: 10%;"></td> <td style="width: 10%;"></td> <td style="width: 10%;"></td> <td style="width: 10%;"></td> </tr> <tr> <td></td> <td></td> <td colspan="8" style="text-align: center;"> <table border="1" style="width: 100%; border-collapse: collapse; text-align: center;"> <tr> <td style="width: 10%;"></td> <td style="width: 10%;"></td> <td style="width: 10%;"></td> <td style="width: 10%;"></td> <td style="width: 10%;"></td> <td style="width: 10%;"></td> <td style="width: 10%;"></td> <td style="width: 10%;"></td> <td style="width: 10%;"></td> <td style="width: 10%;"></td> </tr> <tr> <td></td> <td></td> <td colspan="8" style="text-align: center;"> <table border="1" style="width: 100%; border-collapse: collapse; text-align: center;"> <tr> <td style="width: 10%;"></td> <td style="width: 10%;"></td> <td style="width: 10%;"></td> <td style="width: 10%;"></td> <td style="width: 10%;"></td> <td style="width: 10%;"></td> <td style="width: 10%;"></td> <td style="width: 10%;"></td> <td style="width: 10%;"></td> <td style="width: 10%;"></td> </tr> <tr> <td></td> <td></td> <td colspan="8" style="text-align: center;"> <table border="1" style="width: 100%; border-collapse: collapse; text-align: center;"> <tr> <td style="width: 10%;"></td> <td style="width: 10%;"></td> <td style="width: 10%;"></td> <td style="width: 10%;"></td> <td style="width: 10%;"></td> <td style="width: 10%;"></td> <td style="width: 10%;"></td> <td style="width: 10%;"></td> <td style="width: 10%;"></td> <td style="width: 10%;"></td> </tr> <tr> <td></td> <td></td> <td colspan="8" style="text-align: center;"> <table border="1" style="width: 100%; border-collapse: collapse; text-align: center;"> <tr> <td style="width: 10%;"></td> <td style="width: 10%;"></td>
<td style="width: 10%;"></td> <td style="width: 10%;"></td> <td style="width: 10%;"></td> <td style="width: 10%;"></td> <td style="width: 10%;"></td> <td style="width: 10%;"></td> <td style="width: 10%;"></td> <td style="width: 10%;"></td> </tr> <tr> <td></td> <td></td> <td colspan="8" style="text-align: center;"> <table border="1" style="width: 100%; border-collapse: collapse; text-align: center;"> <tr> <td style="width: 10%;"></td> <td style="width: 10%;"></td> <td style="width: 10%;"></td> <td style="width: 10%;"></td> <td style="width: 10%;"></td> <td style="width: 10%;"></td> <td style="width: 10%;"></td> <td style="width: 10%;"></td> <td style="width: 10%;"></td> <td style="width: 10%;"></td> </tr> <tr> <td></td> <td></td> <td colspan="8" style="text-align: center;"> <table border="1" style="width: 100%; border-collapse: collapse; text-align: center;"> <tr> <td style="width: 10%;"></td> <td style="width: 10%;"></td> <td style="width: 10%;"></td> <td style="width: 10%;"></td> <td style="width: 10%;"></td> <td style="width: 10%;"></td> <td style="width: 10%;"></td> <td style="width: 10%;"></td> <td style="width: 10%;"></td> <td style="width: 10%;"></td> </tr> <tr> <td></td> <td></td> <td colspan="8" style="text-align: center;"> <table border="1" style="width: 100%; border-collapse: collapse; text-align: center;"> <tr> <td style="width: 10%;"></td> <td style="width: 10%;"></td> <td style="width: 10%;"></td> <td style="width: 10%;"></td> <td style="width: 10%;"></td> <td style="width: 10%;"></td> <td style="width: 10%;"></td> <td style="width: 10%;"></td> <td style="width: 10%;"></td> <td style="width: 10%;"></td> </tr> <tr> <td></td> <td></td> <td colspan="8" style="text-align: center;"> <table border="1" style="width: 100%; border-collapse: collapse; text-align: center;"> <tr> <td style="width: 10%;"></td> <td style="width: 10%;"></td> <td style="width: 10%;"></td> <td style="width: 10%;"></td> <td style="width: 10%;"></td> <td style="width: 10%;"></td> <td style="width: 10%;"></td> <td style="width: 10%;"></td> <td style="width: 10%;"></td> <td style="width: 10%;"></td> </tr> <tr> <td></td> <td></td> <td colspan="8" style="text-align: center;"> <table border="1" style="width: 100%; border-collapse: collapse; text-align: center;"> <tr> <td style="width: 10%;"></td> <td style="width: 10%;"></td> <td style="width: 10%;"></td> <td style="width: 10%;"></td> <td style="width: 10%;"></td> <td style="width: 10%;"></td> <td style="width: 10%;"></td> <td style="width: 10%;"></td> <td style="width: 10%;"></td> <td style="width: 10%;"></td> </tr> <tr> <td></td> <td></td> <td colspan="8" style="text-align: center;"> <table border="1" style="width: 100%; border-collapse: collapse; text-align: center;"> <tr> </tr></table></td></tr></table></td></tr></table></td></tr></table></td></tr></table></td></tr></table></td></tr></table></td></tr></table></td></tr></table></td></tr></table></td></tr></table></td></tr></table></td></tr></table></td></tr></table></td></tr></table></td></tr></table></td></tr></table></td></tr></table></td></tr></table></td></tr></table></td></tr></table></td></tr></table></td></tr></table></td></tr></table></td></tr></table> | | | | | | | | | | | | | | | | | | | | <table border="1" style="width: 100%; border-collapse: collapse; text-align: center;"> <tr> <td style="width: 10%;"></td> <td style="width: 10%;"></td> <td style="width: 10%;"></td> <td style="width: 10%;"></td> <td style="width: 10%;"></td> <td style="width: 10%;"></td> <td style="width: 10%;"></td> <td style="width: 10%;"></td> <td style="width: 10%;"></td> <td style="width: 10%;"></td> </tr> <tr> <td></td> <td></td> <td colspan="8" style="text-align: center;"> <table border="1" style="width: 100%; border-collapse: collapse; text-align: center;"> <tr> <td style="width: 10%;"></td> <td style="width: 10%;"></td> <td style="width: 10%;"></td> <td style="width: 10%;"></td> <td style="width: 10%;"></td> <td style="width: 10%;"></td> <td style="width: 10%;"></td> <td style="width: 10%;"></td> <td style="width: 10%;"></td> <td style="width: 10%;"></td> </tr> <tr> <td></td> <td></td> <td colspan="8" style="text-align: center;"> <table border="1" style="width: 100%; border-collapse: collapse; text-align: center;"> <tr> <td style="width: 10%;"></td> <td style="width: 10%;"></td> <td style="width: 10%;"></td> <td style="width: 10%;"></td> <td style="width: 10%;"></td> <td style="width: 10%;"></td> <td style="width: 10%;"></td> <td style="width: 10%;"></td> <td style="width: 10%;"></td> <td style="width: 10%;"></td> </tr> <tr> <td></td> <td></td> <td colspan="8" style="text-align: center;"> <table border="1" style="width: 100%; border-collapse: collapse; text-align: center;"> <tr> <td style="width: 10%;"></td> <td style="width: 10%;"></td> <td style="width: 10%;"></td> <td style="width: 10%;"></td> <td style="width: 10%;"></td> <td style="width: 10%;"></td> <td style="width: 10%;"></td> <td style="width: 10%;"></td> <td style="width: 10%;"></td> <td style="width: 10%;"></td> </tr> <tr> <td></td> <td></td> <td colspan="8" style="text-align: center;"> <table border="1" style="width: 100%; border-collapse: collapse; text-align: center;"> <tr> <td style="width: 10%;"></td> <td style="width: 10%;"></td> <td style="width: 10%;"></td> <td style="width: 10%;"></td> <td style="width: 10%;"></td> <td style="width: 10%;"></td> <td style="width: 10%;"></td> <td style="width: 10%;"></td> <td style="width: 10%;"></td> <td style="width: 10%;"></td> </tr> <tr> <td></td> <td></td> <td colspan="8" style="text-align: center;"> <table border="1" style="width: 100%; border-collapse: collapse; text-align: center;"> <tr> <td style="width: 10%;"></td> <td style="width: 10%;"></td> <td style="width: 10%;"></td> <td style="width: 10%;"></td> <td style="width: 10%;"></td> <td style="width: 10%;"></td> <td style="width: 10%;"></td> <td style="width: 10%;"></td> <td style="width: 10%;"></td> <td style="width: 10%;"></td> </tr> <tr> <td></td> <td></td> <td colspan="8" style="text-align: center;"> <table border="1" style="width: 100%; border-collapse: collapse; text-align: center;"> <tr> <td style="width: 10%;"></td> <td style="width: 10%;"></td> <td style="width: 10%;"></td> <td style="width: 10%;"></td> <td style="width: 10%;"></td> <td style="width: 10%;"></td> <td style="width: 10%;"></td> <td style="width: 10%;"></td> <td style="width: 10%;"></td> <td style="width: 10%;"></td> </tr> <tr> <td></td> <td></td> <td colspan="8" style="text-align: center;"> <table border="1" style="width: 100%; border-collapse: collapse; text-align: center;"> <tr> <td style="width: 10%;"></td> <td style="width: 10%;"></td> <td style="width: 10%;"></td> <td style="width: 10%;"></td> <td style="width: 10%;"></td> <td style="width: 10%;"></td> <td style="width: 10%;"></td> <td style="width: 10%;"></td> <td style="width: 10%;"></td> <td style="width: 10%;"></td> </tr> <tr> <td></td> <td></td> <td colspan="8" style="text-align: center;"> <table border="1" style="width: 100%; border-collapse: collapse; text-align: center;">
<tr> <td style="width: 10%;"></td> <td style="width: 10%;"></td> <td style="width: 10%;"></td> <td style="width: 10%;"></td> <td style="width: 10%;"></td> <td style="width: 10%;"></td> <td style="width: 10%;"></td> <td style="width: 10%;"></td> <td style="width: 10%;"></td> <td style="width: 10%;"></td> </tr> <tr> <td></td> <td></td> <td colspan="8" style="text-align: center;"> <table border="1" style="width: 100%; border-collapse: collapse; text-align: center;"> <tr> <td style="width: 10%;"></td> <td style="width: 10%;"></td> <td style="width: 10%;"></td> <td style="width: 10%;"></td> <td style="width: 10%;"></td> <td style="width: 10%;"></td> <td style="width: 10%;"></td> <td style="width: 10%;"></td> <td style="width: 10%;"></td> <td style="width: 10%;"></td> </tr> <tr> <td></td> <td></td> <td colspan="8" style="text-align: center;"> <table border="1" style="width: 100%; border-collapse: collapse; text-align: center;"> <tr> <td style="width: 10%;"></td> <td style="width: 10%;"></td> <td style="width: 10%;"></td> <td style="width: 10%;"></td> <td style="width: 10%;"></td> <td style="width: 10%;"></td> <td style="width: 10%;"></td> <td style="width: 10%;"></td> <td style="width: 10%;"></td> <td style="width: 10%;"></td> </tr> <tr> <td></td> <td></td> <td colspan="8" style="text-align: center;"> <table border="1" style="width: 100%; border-collapse: collapse; text-align: center;"> <tr> <td style="width: 10%;"></td> <td style="width: 10%;"></td> <td style="width: 10%;"></td> <td style="width: 10%;"></td> <td style="width: 10%;"></td> <td style="width: 10%;"></td> <td style="width: 10%;"></td> <td style="width: 10%;"></td> <td style="width: 10%;"></td> <td style="width: 10%;"></td> </tr> <tr> <td></td> <td></td> <td colspan="8" style="text-align: center;"> <table border="1" style="width: 100%; border-collapse: collapse; text-align: center;"> <tr> <td style="width: 10%;"></td> <td style="width: 10%;"></td> <td style="width: 10%;"></td> <td style="width: 10%;"></td> <td style="width: 10%;"></td> <td style="width: 10%;"></td> <td style="width: 10%;"></td> <td style="width: 10%;"></td> <td style="width: 10%;"></td> <td style="width: 10%;"></td> </tr> <tr> <td></td> <td></td> <td colspan="8" style="text-align: center;"> <table border="1" style="width: 100%; border-collapse: collapse; text-align: center;"> <tr> <td style="width: 10%;"></td> <td style="width: 10%;"></td> <td style="width: 10%;"></td> <td style="width: 10%;"></td> <td style="width: 10%;"></td> <td style="width: 10%;"></td> <td style="width: 10%;"></td> <td style="width: 10%;"></td> <td style="width: 10%;"></td> <td style="width: 10%;"></td> </tr> <tr> <td></td> <td></td> <td colspan="8" style="text-align: center;"> <table border="1" style="width: 100%; border-collapse: collapse; text-align: center;"> <tr> <td style="width: 10%;"></td> <td style="width: 10%;"></td> <td style="width: 10%;"></td> <td style="width: 10%;"></td> <td style="width: 10%;"></td> <td style="width: 10%;"></td> <td style="width: 10%;"></td> <td style="width: 10%;"></td> <td style="width: 10%;"></td> <td style="width: 10%;"></td> </tr> <tr> <td></td> <td></td> <td colspan="8" style="text-align: center;"> <table border="1" style="width: 100%; border-collapse: collapse; text-align: center;"> <tr> <td style="width: 10%;"></td> <td style="width: 10%;"></td> <td style="width: 10%;"></td> <td style="width: 10%;"></td> <td style="width: 10%;"></td> <td style="width: 10%;"></td> <td style="width: 10%;"></td> <td style="width: 10%;"></td> <td style="width: 10%;"></td> <td style="width: 10%;"></td> </tr> <tr> <td></td> <td></td> <td colspan="8" style="text-align: center;"> <table border="1" style="width: 100%; border-collapse: collapse; text-align: center;"> <tr> <td style="width: 10%;"></td> <td style="width: 10%;"></td> <td style="width: 10%;"></td> <td style="width: 10%;"></td> <td style="width: 10%;"></td> <td style="width: 10%;"></td> <td style="width: 10%;"></td> <td style="width: 10%;"></td> <td style="width: 10%;"></td> <td style="width: 10%;"></td> </tr> <tr> <td></td> <td></td> <td colspan="8" style="text-align: center;"> <table border="1" style="width: 100%; border-collapse: collapse; text-align: center;"> <tr> <td style="width: 10%;"></td> <td style="width: 10%;"></td> <td style="width: 10%;"></td> <td style="width: 10%;"></td> <td style="width: 10%;"></td> <td style="width: 10%;"></td> <td style="width: 10%;"></td> <td style="width: 10%;"></td> <td style="width: 10%;"></td> <td style="width: 10%;"></td> </tr> <tr> <td></td> <td></td> <td colspan="8" style="text-align: center;"> <table border="1" style="width: 100%; border-collapse: collapse; text-align: center;"> <tr> <td style="width: 10%;"></td> <td style="width: 10%;"></td> <td style="width: 10%;"></td> <td style="width: 10%;"></td> <td style="width: 10%;"></td> <td style="width: 10%;"></td> <td style="width: 10%;"></td> <td style="width: 10%;"></td> <td style="width: 10%;"></td> <td style="width: 10%;"></td> </tr> <tr> <td></td> <td></td> <td colspan="8" style="text-align: center;"> <table border="1" style="width: 100%; border-collapse: collapse; text-align: center;"> <tr> <td style="width: 10%;"></td> <td style="width: 10%;"></td> <td style="width: 10%;"></td> <td style="width: 10%;"></td> <td style="width: 10%;"></td> <td style="width: 10%;"></td> <td style="width: 10%;"></td> <td style="width: 10%;"></td> <td style="width: 10%;"></td> <td style="width: 10%;"></td> </tr> <tr> <td></td> <td></td> <td colspan="8" style="text-align: center;"> <table border="1" style="width: 100%; border-collapse: collapse; text-align: center;"> <tr> <td style="width: 10%;"></td> <td style="width: 10%;"></td> <td style="width: 10%;"></td> <td style="width: 10%;"></td> <td style="width: 10%;"></td> <td style="width: 10%;"></td> <td style="width: 10%;"></td> <td style="width: 10%;"></td> <td style="width: 10%;"></td> <td style="width: 10%;"></td> </tr> <tr> <td></td> <td></td> <td colspan="8" style="text-align: center;"> <table border="1" style="width: 100%; border-collapse: collapse; text-align: center;"> <tr> <td style="width: 10%;"></td> <td style="width: 10%;"></td> <td style="width: 10%;"></td> <td style="width: 10%;"></td> <td style="width: 10%;"></td> <td style="width: 10%;"></td> <td style="width: 10%;"></td> <td style="width: 10%;"></td> <td style="width: 10%;"></td> <td style="width: 10%;"></td> </tr> <tr> <td></td> <td></td> <td colspan="8" style="text-align: center;"> <table border="1" style="width: 100%; border-collapse: collapse; text-align: center;"> <tr> <td style="width: 10%;"></td> <td style="width: 10%;"></td> <td style="width: 10%;"></td> <td style="width: 10%;"></td> <td style="width: 10%;"></td> <td style="width: 10%;"></td> <td style="width: 10%;"></td> <td style="width: 10%;"></td> <td style="width: 10%;"></td> <td style="width: 10%;"></td> </tr> <tr> <td></td> <td></td> <td colspan="8" style="text-align: center;"> <table border="1" style="width: 100%; border-collapse: collapse; text-align: center;"> <tr> </tr></table></td></tr></table></td></tr></table></td></tr></table></td></tr></table></td></tr></table></td></tr></table></td></tr></table></td></tr></table></td></tr></table></td></tr></table></td></tr></table></td></tr></table></td></tr></table></td></tr></table></td></tr></table></td></tr></table></td></tr></table></td></tr></table></td></tr></table></td></tr></table></td></tr></table></td></tr></table></td></tr></table>
 | | | | | | | | | | | | | | | | | | | | <table border="1" style="width: 100%; border-collapse: collapse; text-align: center;"> <tr> <td style="width: 10%;"></td> <td style="width: 10%;"></td> <td style="width: 10%;"></td> <td style="width: 10%;"></td> <td style="width: 10%;"></td> <td style="width: 10%;"></td> <td style="width: 10%;"></td> <td style="width: 10%;"></td> <td style="width: 10%;"></td> <td style="width: 10%;"></td> </tr> <tr> <td></td> <td></td> <td colspan="8" style="text-align: center;"> <table border="1" style="width: 100%; border-collapse: collapse; text-align: center;"> <tr> <td style="width: 10%;"></td> <td style="width: 10%;"></td> <td style="width: 10%;"></td> <td style="width: 10%;"></td> <td style="width: 10%;"></td> <td style="width: 10%;"></td> <td style="width: 10%;"></td> <td style="width: 10%;"></td> <td style="width: 10%;"></td> <td style="width: 10%;"></td> </tr> <tr> <td></td> <td></td> <td colspan="8" style="text-align: center;"> <table border="1" style="width: 100%; border-collapse: collapse; text-align: center;"> <tr> <td style="width: 10%;"></td> <td style="width: 10%;"></td> <td style="width: 10%;"></td> <td style="width: 10%;"></td> <td style="width: 10%;"></td> <td style="width: 10%;"></td> <td style="width: 10%;"></td> <td style="width: 10%;"></td> <td style="width: 10%;"></td> <td style="width: 10%;"></td> </tr> <tr> <td></td> <td></td> <td colspan="8" style="text-align: center;"> <table border="1" style="width: 100%; border-collapse: collapse; text-align: center;"> <tr> <td style="width: 10%;"></td> <td style="width: 10%;"></td> <td style="width: 10%;"></td> <td style="width: 10%;"></td> <td style="width: 10%;"></td> <td style="width: 10%;"></td> <td style="width: 10%;"></td> <td style="width: 10%;"></td> <td style="width: 10%;"></td> <td style="width: 10%;"></td> </tr> <tr> <td></td> <td></td> <td colspan="8" style="text-align: center;"> <table border="1" style="width: 100%; border-collapse: collapse; text-align: center;"> <tr> <td style="width: 10%;"></td> <td style="width: 10%;"></td> <td style="width: 10%;"></td> <td style="width: 10%;"></td> <td style="width: 10%;"></td> <td style="width: 10%;"></td> <td style="width: 10%;"></td> <td style="width: 10%;"></td> <td style="width: 10%;"></td> <td style="width: 10%;"></td> </tr> <tr> <td></td> <td></td> <td colspan="8" style="text-align: center;"> <table border="1" style="width: 100%; border-collapse: collapse; text-align: center;"> <tr> <td style="width: 10%;"></td> <td style="width: 10%;"></td> <td style="width: 10%;"></td> <td style="width: 10%;"></td> <td style="width: 10%;"></td> <td style="width: 10%;"></td> <td style="width: 10%;"></td> <td style="width: 10%;"></td> <td style="width: 10%;"></td> <td style="width: 10%;"></td> </tr> <tr> <td></td> <td></td> <td colspan="8" style="text-align: center;"> <table border="1" style="width: 100%; border-collapse: collapse; text-align: center;"> <tr> <td style="width: 10%;"></td> <td style="width: 10%;"></td> <td style="width: 10%;"></td> <td style="width: 10%;"></td> <td style="width: 10%;"></td> <td style="width: 10%;"></td> <td style="width: 10%;"></td> <td style="width: 10%;"></td> <td style="width: 10%;"></td> <td style="width: 10%;"></td> </tr> <tr> <td></td> <td></td> <td colspan="8" style="text-align: center;"> <table border="1" style="width: 100%; border-collapse: collapse; text-align: center;"> <tr> <td style="width: 10%;"></td> <td style="width: 10%;"></td> <td style="width: 10%;"></td> <td style="width: 10%;"></td> <td style="width: 10%;"></td> <td style="width: 10%;"></td> <td style="width: 10%;"></td> <td style="width: 10%;"></td> <td style="width: 10%;"></td> <td style="width: 10%;"></td> </tr> <tr> <td></td> <td></td> <td colspan="8" style="text-align: center;"> <table border="1" style="width: 100%; border-collapse: collapse; text-align: center;"> <tr> <td style="width: 10%;"></td> <td style="width: 10%;"></td> <td style="width: 10%;"></td> <td style="width: 10%;"></td> <td style="width: 10%;"></td> <td style="width: 10%;"></td> <td style="width: 10%;"></td> <td style="width: 10%;"></td> <td style="width: 10%;"></td> <td style="width: 10%;"></td> </tr> <tr> <td></td> <td></td> <td colspan="8" style="text-align: center;"> <table border="1" style="width: 100%; border-collapse: collapse; text-align: center;"> <tr> <td style="width: 10%;"></td> <td style="width: 10%;"></td> <td style="width: 10%;"></td> <td style="width: 10%;"></td> <td style="width: 10%;"></td> <td style="width: 10%;"></td> <td style="width: 10%;"></td> <td style="width: 10%;"></td> <td style="width: 10%;"></td> <td style="width: 10%;"></td> </tr> <tr> <td></td> <td></td> <td colspan="8" style="text-align: center;"> <table border="1" style="width: 100%; border-collapse: collapse; text-align: center;"> <tr> <td style="width: 10%;"></td> <td style="width: 10%;"></td> <td style="width: 10%;"></td> <td style="width: 10%;"></td> <td style="width: 10%;"></td> <td style="width: 10%;"></td> <td style="width: 10%;"></td> <td style="width: 10%;"></td> <td style="width: 10%;"></td> <td style="width: 10%;"></td> </tr> <tr> <td></td> <td></td> <td colspan="8" style="text-align: center;"> <table border="1" style="width: 100%; border-collapse: collapse; text-align: center;"> <tr> <td style="width: 10%;"></td> <td style="width: 10%;"></td> <td style="width: 10%;"></td> <td style="width: 10%;"></td> <td style="width: 10%;"></td> <td style="width: 10%;"></td> <td style="width: 10%;"></td> <td style="width: 10%;"></td> <td style="width: 10%;"></td> <td style="width: 10%;"></td> </tr> <tr> <td></td> <td></td> <td colspan="8" style="text-align: center;"> <table border="1" style="width: 100%; border-collapse: collapse; text-align: center;"> <tr> <td style="width: 10%;"></td> <td style="width: 10%;"></td> <td style="width: 10%;"></td> <td style="width: 10%;"></td> <td style="width: 10%;"></td> <td style="width: 10%;"></td> <td style="width: 10%;"></td> <td style="width: 10%;"></td> <td style="width: 10%;"></td> <td style="width: 10%;"></td> </tr> <tr> <td></td> <td></td> <td colspan="8" style="text-align: center;"> <table border="1" style="width: 100%; border-collapse: collapse; text-align: center;"> <tr> <td style="width: 10%;"></td> <td style="width: 10%;"></td> <td style="width: 10%;"></td> <td style="width: 10%;"></td> <td style="width: 10%;"></td> <td style="width: 10%;"></td> <td style="width: 10%;"></td> <td style="width: 10%;"></td> <td style="width: 10%;"></td> <td style="width: 10%;"></td> </tr> <tr> <td></td> <td></td> <td colspan="8" style="text-align: center;"> <table border="1" style="width: 100%; border-collapse: collapse; text-align: center;"> <tr> <td style="width: 10%;"></td> <td style="width: 10%;"></td> <td style="width: 10%;"></td> <td style="width: 10%;"></td> <td style="width: 10%;"></td> <td style="width: 10%;"></td> <td style="width: 10%;"></td> <td style="width: 10%;"></td> <td style="width: 10%;"></td> <td style="width: 10%;"></td> </tr> <tr> <td></td> <td></td> <td colspan="8" style="text-align: center;"> <table border="1" style="width: 100%; border-collapse: collapse; text-align: center;"> <tr> <td style="width: 10%;"></td> <td style="width: 10%;"></td> <td style="width: 10%;"></td> <td style="width: 10%;"></td> <td style="width: 10%;"></td> <td style="width: 10%;"></td> <td style="width: 10%;"></td> <td style="width: 10%;"></td> <td style="width: 10%;"></td> <td style="width: 10%;"></td> </tr> <tr> <td></td> <td></td> <td colspan="8" style="text-align: center;"> <table border="1" style="width: 100%; border-collapse: collapse; text-align: center;"> <tr> <td style="width: 10%;"></td> <td style="width: 10%;"></td> <td style="width: 10%;"></td> <td style="width: 10%;"></td> <td style="width: 10%;"></td> <td style="width: 10%;"></td> <td style="width: 10%;"></td> <td style="width: 10%;"></td> <td style="width: 10%;"></td> <td style="width: 10%;"></td> </tr> <tr> <td></td> <td></td> <td colspan="8" style="text-align: center;"> <table border="1" style="width: 100%; border-collapse: collapse; text-align: center;"> <tr> <td style="width: 10%;"></td> <td style="width: 10%;"></td> <td style="width: 10%;"></td> <td style="width: 10%;"></td> <td style="width: 10%;"></td> <td style="width: 10%;"></td> <td style="width: 10%;"></td> <td style="width: 10%;"></td> <td style="width: 10%;"></td> <td style="width: 10%;"></td> </tr> <tr> <td></td> <td></td> <td colspan="8" style="text-align: center;"> <table border="1" style="width: 100%; border-collapse: collapse; text-align: center;"> <tr> <td style="width: 10%;"></td> <td style="width: 10%;"></td> <td style="width: 10%;"></td> <td style="width: 10%;"></td> <td style="width: 10%;"></td> <td style="width: 10%;"></td> <td style="width: 10%;"></td> <td style="width: 10%;"></td> <td style="width: 10%;"></td> <td style="width: 10%;"></td> </tr> <tr> <td></td> <td></td> <td colspan="8" style="text-align: center;"> <table border="1" style="width: 100%; border-collapse: collapse; text-align: center;"> <tr> <td style="width: 10%;"></td> <td style="width: 10%;"></td> <td style="width: 10%;"></td> <td style="width: 10%;"></td> <td style="width: 10%;"></td> <td style="width: 10%;"></td> <td style="width: 10%;"></td> <td style="width: 10%;"></td> <td style="width: 10%;"></td> <td style="width: 10%;"></td> </tr> <tr> <td></td> <td></td> <td colspan="8" style="text-align: center;"> <table border="1" style="width: 100%; border-collapse: collapse; text-align: center;"> <tr> <td style="width: 10%;"></td> <td style="width: 10%;"></td> <td style="width: 10%;"></td> <td style="width: 10%;"></td>
<td style="width: 10%;"></td> <td style="width: 10%;"></td> <td style="width: 10%;"></td> <td style="width: 10%;"></td> <td style="width: 10%;"></td> <td style="width: 10%;"></td> </tr> <tr> <td></td> <td></td> <td colspan="8" style="text-align: center;"> <table border="1" style="width: 100%; border-collapse: collapse; text-align: center;"> <tr> <td style="width: 10%;"></td> <td style="width: 10%;"></td> <td style="width: 10%;"></td> <td style="width: 10%;"></td> <td style="width: 10%;"></td> <td style="width: 10%;"></td> <td style="width: 10%;"></td> <td style="width: 10%;"></td> <td style="width: 10%;"></td> <td style="width: 10%;"></td> </tr> <tr> <td></td> <td></td> <td colspan="8" style="text-align: center;"> <table border="1" style="width: 100%; border-collapse: collapse; text-align: center;"> <tr> </tr></table></td></tr></table></td></tr></table></td></tr></table></td></tr></table></td></tr></table></td></tr></table></td></tr></table></td></tr></table></td></tr></table></td></tr></table></td></tr></table></td></tr></table></td></tr></table></td></tr></table></td></tr></table></td></tr></table></td></tr></table></td></tr></table></td></tr></table></td></tr></table></td></tr></table></td></tr></table> | | | | | | | | | | | | | | | | | | | | <table border="1" style="width: 100%; border-collapse: collapse; text-align: center;"> <tr> <td style="width: 10%;"></td> <td style="width: 10%;"></td> <td style="width: 10%;"></td> <td style="width: 10%;"></td> <td style="width: 10%;"></td> <td style="width: 10%;"></td> <td style="width: 10%;"></td> <td style="width: 10%;"></td> <td style="width: 10%;"></td> <td style="width: 10%;"></td> </tr> <tr> <td></td> <td></td> <td colspan="8" style="text-align: center;"> <table border="1" style="width: 100%; border-collapse: collapse; text-align: center;"> <tr> <td style="width: 10%;"></td> <td style="width: 10%;"></td> <td style="width: 10%;"></td> <td style="width: 10%;"></td> <td style="width: 10%;"></td> <td style="width: 10%;"></td> <td style="width: 10%;"></td> <td style="width: 10%;"></td> <td style="width: 10%;"></td> <td style="width: 10%;"></td> </tr> <tr> <td></td> <td></td> <td colspan="8" style="text-align: center;"> <table border="1" style="width: 100%; border-collapse: collapse; text-align: center;"> <tr> <td style="width: 10%;"></td> <td style="width: 10%;"></td> <td style="width: 10%;"></td> <td style="width: 10%;"></td> <td style="width: 10%;"></td> <td style="width: 10%;"></td> <td style="width: 10%;"></td> <td style="width: 10%;"></td> <td style="width: 10%;"></td> <td style="width: 10%;"></td> </tr> <tr> <td></td> <td></td> <td colspan="8" style="text-align: center;"> <table border="1" style="width: 100%; border-collapse: collapse; text-align: center;"> <tr> <td style="width: 10%;"></td> <td style="width: 10%;"></td> <td style="width: 10%;"></td> <td style="width: 10%;"></td> <td style="width: 10%;"></td> <td style="width: 10%;"></td> <td style="width: 10%;"></td> <td style="width: 10%;"></td> <td style="width: 10%;"></td> <td style="width: 10%;"></td> </tr> <tr> <td></td> <td></td> <td colspan="8" style="text-align: center;"> <table border="1" style="width: 100%; border-collapse: collapse; text-align: center;"> <tr> <td style="width: 10%;"></td> <td style="width: 10%;"></td> <td style="width: 10%;"></td> <td style="width: 10%;"></td> <td style="width: 10%;"></td> <td style="width: 10%;"></td> <td style="width: 10%;"></td> <td style="width: 10%;"></td> <td style="width: 10%;"></td> <td style="width: 10%;"></td> </tr> <tr> <td></td> <td></td> <td colspan="8" style="text-align: center;"> <table border="1" style="width: 100%; border-collapse: collapse; text-align: center;"> <tr> <td style="width: 10%;"></td> <td style="width: 10%;"></td> <td style="width: 10%;"></td> <td style="width: 10%;"></td> <td style="width: 10%;"></td> <td style="width: 10%;"></td> <td style="width: 10%;"></td> <td style="width: 10%;"></td> <td style="width: 10%;"></td> <td style="width: 10%;"></td> </tr> <tr> <td></td> <td></td> <td colspan="8" style="text-align: center;"> <table border="1" style="width: 100%; border-collapse: collapse; text-align: center;"> <tr> <td style="width: 10%;"></td> <td style="width: 10%;"></td> <td style="width: 10%;"></td> <td style="width: 10%;"></td> <td style="width: 10%;"></td> <td style="width: 10%;"></td> <td style="width: 10%;"></td> <td style="width: 10%;"></td> <td style="width: 10%;"></td> <td style="width: 10%;"></td> </tr> <tr> <td></td> <td></td> <td colspan="8" style="text-align: center;"> <table border="1" style="width: 100%; border-collapse: collapse; text-align: center;"> <tr> <td style="width: 10%;"></td> <td style="width: 10%;"></td> <td style="width: 10%;"></td> <td style="width: 10%;"></td> <td style="width: 10%;"></td> <td style="width: 10%;"></td> <td style="width: 10%;"></td> <td style="width: 10%;"></td> <td style="width: 10%;"></td> <td style="width: 10%;"></td> </tr> <tr> <td></td> <td></td> <td colspan="8" style="text-align: center;"> <table border="1" style="width: 100%; border-collapse: collapse; text-align: center;"> <tr> <td style="width: 10%;"></td> <td style="width: 10%;"></td> <td style="width: 10%;"></td> <td style="width: 10%;"></td> <td style="width: 10%;"></td> <td style="width: 10%;"></td> <td style="width: 10%;"></td> <td style="width: 10%;"></td> <td style="width: 10%;"></td> <td style="width: 10%;"></td> </tr> <tr> <td></td> <td></td> <td colspan="8" style="text-align: center;"> <table border="1" style="width: 100%; border-collapse: collapse; text-align: center;"> <tr> <td style="width: 10%;"></td> <td style="width: 10%;"></td> <td style="width: 10%;"></td> <td style="width: 10%;"></td> <td style="width: 10%;"></td> <td style="width: 10%;"></td> <td style="width: 10%;"></td> <td style="width: 10%;"></td> <td style="width: 10%;"></td> <td style="width: 10%;"></td> </tr> <tr> <td></td> <td></td> <td colspan="8" style="text-align: center;"> <table border="1" style="width: 100%; border-collapse: collapse; text-align: center;"> <tr> <td style="width: 10%;"></td> <td style="width: 10%;"></td> <td style="width: 10%;"></td> <td style="width: 10%;"></td> <td style="width: 10%;"></td> <td style="width: 10%;"></td> <td style="width: 10%;"></td> <td style="width: 10%;"></td> <td style="width: 10%;"></td> <td style="width: 10%;"></td> </tr> <tr> <td></td> <td></td> <td colspan="8" style="text-align: center;"> <table border="1" style="width: 100%; border-collapse: collapse; text-align: center;"> <tr> <td style="width: 10%;"></td> <td style="width: 10%;"></td> <td style="width: 10%;"></td> <td style="width: 10%;"></td> <td style="width: 10%;"></td> <td style="width: 10%;"></td> <td style="width: 10%;"></td> <td style="width: 10%;"></td> <td style="width: 10%;"></td> <td style="width: 10%;"></td> </tr> <tr> <td></td> <td></td> <td colspan="8" style="text-align: center;"> <table border="1" style="width: 100%; border-collapse: collapse; text-align: center;"> <tr> <td style="width: 10%;"></td> <td style="width: 10%;"></td> <td style="width: 10%;"></td>
<td style="width: 10%;"></td> <td style="width: 10%;"></td> <td style="width: 10%;"></td> <td style="width: 10%;"></td> <td style="width: 10%;"></td> <td style="width: 10%;"></td> <td style="width: 10%;"></td> </tr> <tr> <td></td> <td></td> <td colspan="8" style="text-align: center;"> <table border="1" style="width: 100%; border-collapse: collapse; text-align: center;"> <tr> <td style="width: 10%;"></td> <td style="width: 10%;"></td> <td style="width: 10%;"></td> <td style="width: 10%;"></td> <td style="width: 10%;"></td> <td style="width: 10%;"></td> <td style="width: 10%;"></td> <td style="width: 10%;"></td> <td style="width: 10%;"></td> <td style="width: 10%;"></td> </tr> <tr> <td></td> <td></td> <td colspan="8" style="text-align: center;"> <table border="1" style="width: 100%; border-collapse: collapse; text-align: center;"> <tr> <td style="width: 10%;"></td> <td style="width: 10%;"></td> <td style="width: 10%;"></td> <td style="width: 10%;"></td> <td style="width: 10%;"></td> <td style="width: 10%;"></td> <td style="width: 10%;"></td> <td style="width: 10%;"></td> <td style="width: 10%;"></td> <td style="width: 10%;"></td> </tr> <tr> <td></td> <td></td> <td colspan="8" style="text-align: center;"> <table border="1" style="width: 100%; border-collapse: collapse; text-align: center;"> <tr> <td style="width: 10%;"></td> <td style="width: 10%;"></td> <td style="width: 10%;"></td> <td style="width: 10%;"></td> <td style="width: 10%;"></td> <td style="width: 10%;"></td> <td style="width: 10%;"></td> <td style="width: 10%;"></td> <td style="width: 10%;"></td> <td style="width: 10%;"></td> </tr> <tr> <td></td> <td></td> <td colspan="8" style="text-align: center;"> <table border="1" style="width: 100%; border-collapse: collapse; text-align: center;"> <tr> <td style="width: 10%;"></td> <td style="width: 10%;"></td> <td style="width: 10%;"></td> <td style="width: 10%;"></td> <td style="width: 10%;"></td> <td style="width: 10%;"></td> <td style="width: 10%;"></td> <td style="width: 10%;"></td> <td style="width: 10%;"></td> <td style="width: 10%;"></td> </tr> <tr> <td></td> <td></td> <td colspan="8" style="text-align: center;"> <table border="1" style="width: 100%; border-collapse: collapse; text-align: center;"> <tr> <td style="width: 10%;"></td> <td style="width: 10%;"></td> <td style="width: 10%;"></td> <td style="width: 10%;"></td> <td style="width: 10%;"></td> <td style="width: 10%;"></td> <td style="width: 10%;"></td> <td style="width: 10%;"></td> <td style="width: 10%;"></td> <td style="width: 10%;"></td> </tr> <tr> <td></td> <td></td> <td colspan="8" style="text-align: center;"> <table border="1" style="width: 100%; border-collapse: collapse; text-align: center;"> <tr> <td style="width: 10%;"></td> <td style="width: 10%;"></td> <td style="width: 10%;"></td> <td style="width: 10%;"></td> <td style="width: 10%;"></td> <td style="width: 10%;"></td> <td style="width: 10%;"></td> <td style="width: 10%;"></td> <td style="width: 10%;"></td> <td style="width: 10%;"></td> </tr> <tr> <td></td> <td></td> <td colspan="8" style="text-align: center;"> <table border="1" style="width: 100%; border-collapse: collapse; text-align: center;"> <tr> <td style="width: 10%;"></td> <td style="width: 10%;"></td> <td style="width: 10%;"></td> <td style="width: 10%;"></td> <td style="width: 10%;"></td> <td style="width: 10%;"></td> <td style="width: 10%;"></td> <td style="width: 10%;"></td> <td style="width: 10%;"></td> <td style="width: 10%;"></td> </tr> <tr> <td></td> <td></td> <td colspan="8" style="text-align: center;"> <table border="1" style="width: 100%; border-collapse: collapse; text-align: center;"> <tr> <td style="width: 10%;"></td> <td style="width: 10%;"></td> <td style="width: 10%;"></td> <td style="width: 10%;"></td> <td style="width: 10%;"></td> <td style="width: 10%;"></td> <td style="width: 10%;"></td> <td style="width: 10%;"></td> <td style="width: 10%;"></td> <td style="width: 10%;"></td> </tr> <tr> <td></td> <td></td> <td colspan="8" style="text-align: center;"> <table border="1" style="width: 100%; border-collapse: collapse; text-align: center;"> <tr> </tr></table></td></tr></table></td></tr></table></td></tr></table></td></tr></table></td></tr></table></td></tr></table></td></tr></table></td></tr></table></td></tr></table></td></tr></table></td></tr></table></td></tr></table></td></tr></table></td></tr></table></td></tr></table></td></tr></table></td></tr></table></td></tr></table></td></tr></table></td></tr></table></td></tr></table> | | | | | | | | | | | | | | | | | | | | <table border="1" style="width: 100%; border-collapse: collapse; text-align: center;"> <tr> <td style="width: 10%;"></td> <td style="width: 10%;"></td> <td style="width: 10%;"></td> <td style="width: 10%;"></td> <td style="width: 10%;"></td> <td style="width: 10%;"></td> <td style="width: 10%;"></td> <td style="width: 10%;"></td> <td style="width: 10%;"></td> <td style="width: 10%;"></td> </tr> <tr> <td></td> <td></td> <td colspan="8" style="text-align: center;"> <table border="1" style="width: 100%; border-collapse: collapse; text-align: center;"> <tr> <td style="width: 10%;"></td> <td style="width: 10%;"></td> <td style="width: 10%;"></td> <td style="width: 10%;"></td> <td style="width: 10%;"></td> <td style="width: 10%;"></td> <td style="width: 10%;"></td> <td style="width: 10%;"></td> <td style="width: 10%;"></td> <td style="width: 10%;"></td> </tr> <tr> <td></td> <td></td> <td colspan="8" style="text-align: center;"> <table border="1" style="width: 100%; border-collapse: collapse; text-align: center;"> <tr> <td style="width: 10%;"></td> <td style="width: 10%;"></td> <td style="width: 10%;"></td> <td style="width: 10%;"></td> <td style="width: 10%;"></td> <td style="width: 10%;"></td> <td style="width: 10%;"></td> <td style="width: 10%;"></td> <td style="width: 10%;"></td> <td style="width: 10%;"></td> </tr> <tr> <td></td> <td></td> <td colspan="8" style="text-align: center;"> <table border="1" style="width: 100%; border-collapse: collapse; text-align: center;"> <tr> <td style="width: 10%;"></td> <td style="width: 10%;"></td> <td style="width: 10%;"></td> <td style="width: 10%;"></td> <td style="width: 10%;"></td> <td style="width: 10%;"></td> <td style="width: 10%;"></td> <td style="width: 10%;"></td> <td style="width: 10%;"></td> <td style="width: 10%;"></td> </tr> <tr> <td></td> <td></td> <td colspan="8" style="text-align: center;"> <table border="1" style="width: 100%; border-collapse: collapse; text-align: center;"> <tr> <td style="width: 10%;"></td> <td style="width: 10%;"></td> <td style="width: 10%;"></td> <td style="width: 10%;"></td> <td style="width: 10%;"></td> <td style="width: 10%;"></td> <td style="width: 10%;"></td> <td style="width: 10%;"></td> <td style="width: 10%;"></td> <td style="width: 10%;"></td> </tr> <tr> <td></td> <td></td> <td colspan="8" style="text-align: center;"> <table border="1" style="width: 100%; border-collapse: collapse; text-align: center;"> <tr> <td style="width: 10%;"></td> <td style="width: 10%;"></td> <td style="width:
10%;"></td> <td style="width: 10%;"></td> <td style="width: 10%;"></td> <td style="width: 10%;"></td> <td style="width: 10%;"></td> <td style="width: 10%;"></td> <td style="width: 10%;"></td> <td style="width: 10%;"></td> </tr> <tr> <td></td> <td></td> <td colspan="8" style="text-align: center;"> <table border="1" style="width: 100%; border-collapse: collapse; text-align: center;"> <tr> <td style="width: 10%;"></td> <td style="width: 10%;"></td> <td style="width: 10%;"></td> <td style="width: 10%;"></td> <td style="width: 10%;"></td> <td style="width: 10%;"></td> <td style="width: 10%;"></td> <td style="width: 10%;"></td> <td style="width: 10%;"></td> <td style="width: 10%;"></td> </tr> <tr> <td></td> <td></td> <td colspan="8" style="text-align: center;"> <table border="1" style="width: 100%; border-collapse: collapse; text-align: center;"> <tr> <td style="width: 10%;"></td> <td style="width: 10%;"></td> <td style="width: 10%;"></td> <td style="width: 10%;"></td> <td style="width: 10%;"></td> <td style="width: 10%;"></td> <td style="width: 10%;"></td> <td style="width: 10%;"></td> <td style="width: 10%;"></td> <td style="width: 10%;"></td> </tr> <tr> <td></td> <td></td> <td colspan="8" style="text-align: center;"> <table border="1" style="width: 100%; border-collapse: collapse; text-align: center;"> <tr> <td style="width: 10%;"></td> <td style="width: 10%;"></td> <td style="width: 10%;"></td> <td style="width: 10%;"></td> <td style="width: 10%;"></td> <td style="width: 10%;"></td> <td style="width: 10%;"></td> <td style="width: 10%;"></td> <td style="width: 10%;"></td> <td style="width: 10%;"></td> </tr> <tr> <td></td> <td></td> <td colspan="8" style="text-align: center;"> <table border="1" style="width: 100%; border-collapse: collapse; text-align: center;"> <tr> <td style="width: 10%;"></td> <td style="width: 10%;"></td> <td style="width: 10%;"></td> <td style="width: 10%;"></td> <td style="width: 10%;"></td> <td style="width: 10%;"></td> <td style="width: 10%;"></td> <td style="width: 10%;"></td> <td style="width: 10%;"></td> <td style="width: 10%;"></td> </tr> <tr> <td></td> <td></td> <td colspan="8" style="text-align: center;"> <table border="1" style="width: 100%; border-collapse: collapse; text-align: center;"> <tr> <td style="width: 10%;"></td> <td style="width: 10%;"></td> <td style="width: 10%;"></td> <td style="width: 10%;"></td> <td style="width: 10%;"></td> <td style="width: 10%;"></td> <td style="width: 10%;"></td> <td style="width: 10%;"></td> <td style="width: 10%;"></td> <td style="width: 10%;"></td> </tr> <tr> <td></td> <td></td> <td colspan="8" style="text-align: center;"> <table border="1" style="width: 100%; border-collapse: collapse; text-align: center;"> <tr> <td style="width: 10%;"></td> <td style="width: 10%;"></td> <td style="width: 10%;"></td> <td style="width: 10%;"></td> <td style="width: 10%;"></td> <td style="width: 10%;"></td> <td style="width: 10%;"></td> <td style="width: 10%;"></td> <td style="width: 10%;"></td> <td style="width: 10%;"></td> </tr> <tr> <td></td> <td></td> <td colspan="8" style="text-align: center;"> <table border="1" style="width: 100%; border-collapse: collapse; text-align: center;"> <tr> <td style="width: 10%;"></td> <td style="width: 10%;"></td> <td style="width: 10%;"></td> <td style="width: 10%;"></td> <td style="width: 10%;"></td> <td style="width: 10%;"></td> <td style="width: 10%;"></td> <td style="width: 10%;"></td> <td style="width: 10%;"></td> <td style="width: 10%;"></td> </tr> <tr> <td></td> <td></td> <td colspan="8" style="text-align: center;"> <table border="1" style="width: 100%; border-collapse: collapse; text-align: center;"> <tr> <td style="width: 10%;"></td> <td style="width: 10%;"></td> <td style="width: 10%;"></td> <td style="width: 10%;"></td> <td style="width: 10%;"></td> <td style="width: 10%;"></td> <td style="width: 10%;"></td> <td style="width: 10%;"></td> <td style="width: 10%;"></td> <td style="width: 10%;"></td> </tr> <tr> <td></td> <td></td> <td colspan="8" style="text-align: center;"> <table border="1" style="width: 100%; border-collapse: collapse; text-align: center;"> <tr> <td style="width: 10%;"></td> <td style="width: 10%;"></td> <td style="width: 10%;"></td> <td style="width: 10%;"></td> <td style="width: 10%;"></td> <td style="width: 10%;"></td> <td style="width: 10%;"></td> <td style="width: 10%;"></td> <td style="width: 10%;"></td> <td style="width: 10%;"></td> </tr> <tr> <td></td> <td></td> <td colspan="8" style="text-align: center;"> <table border="1" style="width: 100%; border-collapse: collapse; text-align: center;"> <tr> <td style="width: 10%;"></td> <td style="width: 10%;"></td> <td style="width: 10%;"></td> <td style="width: 10%;"></td> <td style="width: 10%;"></td> <td style="width: 10%;"></td> <td style="width: 10%;"></td> <td style="width: 10%;"></td> <td style="width: 10%;"></td> <td style="width: 10%;"></td> </tr> <tr> <td></td> <td></td> <td colspan="8" style="text-align: center;"> <table border="1" style="width: 100%; border-collapse: collapse; text-align: center;"> <tr> <td style="width: 10%;"></td> <td style="width: 10%;"></td> <td style="width: 10%;"></td> <td style="width: 10%;"></td> <td style="width: 10%;"></td> <td style="width: 10%;"></td> <td style="width: 10%;"></td> <td style="width: 10%;"></td> <td style="width: 10%;"></td> <td style="width: 10%;"></td> </tr> <tr> <td></td> <td></td> <td colspan="8" style="text-align: center;"> <table border="1" style="width: 100%; border-collapse: collapse; text-align: center;"> <tr> <td style="width: 10%;"></td> <td style="width: 10%;"></td> <td style="width: 10%;"></td> <td style="width: 10%;"></td> <td style="width: 10%;"></td> <td style="width: 10%;"></td> <td style="width: 10%;"></td> <td style="width: 10%;"></td> <td style="width: 10%;"></td> <td style="width: 10%;"></td> </tr> <tr> <td></td> <td></td> <td colspan="8" style="text-align: center;"> <table border="1" style="width: 100%; border-collapse: collapse; text-align: center;"> <tr> <td style="width: 10%;"></td> <td style="width: 10%;"></td> <td style="width: 10%;"></td> <td style="width: 10%;"></td> <td style="width: 10%;"></td> <td style="width: 10%;"></td> <td style="width: 10%;"></td> <td style="width: 10%;"></td> <td style="width: 10%;"></td> <td style="width: 10%;"></td> </tr> <tr> <td></td> <td></td> <td colspan="8" style="text-align: center;"> <table border="1" style="width: 100%; border-collapse: collapse; text-align: center;"> <tr> <td style="width: 10%;"></td> <td style="width: 10%;"></td> <td style="width: 10%;"></td> <td style="width: 10%;"></td> <td style="width: 10%;"></td> <td style="width: 10%;"></td> <td style="width: 10%;"></td> <td style="width: 10%;"></td> <td style="width: 10%;"></td> <td style="width: 10%;"></td> </tr> <tr> <td></td> <td></td> <td colspan="8" style="text-align: center;"> <table border="1" style="width: 100%; border-collapse: collapse; text-align: center;"> <tr> </tr></table></td></tr></table></td></tr></table></td></tr></table></td></tr></table></td></tr></table></td></tr></table></td></tr></table></td></tr></table></td></tr></table></td></tr></table></td></tr></table></td></tr></table></td></tr></table></td></tr></table></td></tr></table></td></tr></table></td></tr></table></td></tr></table></td></tr></table></td></tr></table>
 | | | | | | | | | | | | | | | | | | | | <table border="1" style="width: 100%; border-collapse: collapse; text-align: center;"> <tr> <td style="width: 10%;"></td> <td style="width: 10%;"></td> <td style="width: 10%;"></td> <td style="width: 10%;"></td> <td style="width: 10%;"></td> <td style="width: 10%;"></td> <td style="width: 10%;"></td> <td style="width: 10%;"></td> <td style="width: 10%;"></td> <td style="width: 10%;"></td> </tr> <tr> <td></td> <td></td> <td colspan="8" style="text-align: center;"> <table border="1" style="width: 100%; border-collapse: collapse; text-align: center;"> <tr> <td style="width: 10%;"></td> <td style="width: 10%;"></td> <td style="width: 10%;"></td> <td style="width: 10%;"></td> <td style="width: 10%;"></td> <td style="width: 10%;"></td> <td style="width: 10%;"></td> <td style="width: 10%;"></td> <td style="width: 10%;"></td> <td style="width: 10%;"></td> </tr> <tr> <td></td> <td></td> <td colspan="8" style="text-align: center;"> <table border="1" style="width: 100%; border-collapse: collapse; text-align: center;"> <tr> <td style="width: 10%;"></td> <td style="width: 10%;"></td> <td style="width: 10%;"></td> <td style="width: 10%;"></td> <td style="width: 10%;"></td> <td style="width: 10%;"></td> <td style="width: 10%;"></td> <td style="width: 10%;"></td> <td style="width: 10%;"></td> <td style="width: 10%;"></td> </tr> <tr> <td></td> <td></td> <td colspan="8" style="text-align: center;"> <table border="1" style="width: 100%; border-collapse: collapse; text-align: center;"> <tr> <td style="width: 10%;"></td> <td style="width: 10%;"></td> <td style="width: 10%;"></td> <td style="width: 10%;"></td> <td style="width: 10%;"></td> <td style="width: 10%;"></td> <td style="width: 10%;"></td> <td style="width: 10%;"></td> <td style="width: 10%;"></td> <td style="width: 10%;"></td> </tr> <tr> <td></td> <td></td> <td colspan="8" style="text-align: center;"> <table border="1" style="width: 100%; border-collapse: collapse; text-align: center;"> <tr> <td style="width: 10%;"></td> <td style="width: 10%;"></td> <td style="width: 10%;"></td> <td style="width: 10%;"></td> <td style="width: 10%;"></td> <td style="width: 10%;"></td> <td style="width: 10%;"></td> <td style="width: 10%;"></td> <td style="width: 10%;"></td> <td style="width: 10%;"></td> </tr> <tr> <td></td> <td></td> <td colspan="8" style="text-align: center;"> <table border="1" style="width: 100%; border-collapse: collapse; text-align: center;"> <tr> <td style="width: 10%;"></td> <td style="width: 10%;"></td> <td style="width: 10%;"></td> <td style="width: 10%;"></td> <td style="width: 10%;"></td> <td style="width: 10%;"></td> <td style="width: 10%;"></td> <td style="width: 10%;"></td> <td style="width: 10%;"></td> <td style="width: 10%;"></td> </tr> <tr> <td></td> <td></td> <td colspan="8" style="text-align: center;"> <table border="1" style="width: 100%; border-collapse: collapse; text-align: center;"> <tr> <td style="width: 10%;"></td> <td style="width: 10%;"></td> <td style="width: 10%;"></td> <td style="width: 10%;"></td> <td style="width: 10%;"></td> <td style="width: 10%;"></td> <td style="width: 10%;"></td> <td style="width: 10%;"></td> <td style="width: 10%;"></td> <td style="width: 10%;"></td> </tr> <tr> <td></td> <td></td> <td colspan="8" style="text-align: center;"> <table border="1" style="width: 100%; border-collapse: collapse; text-align: center;"> <tr> <td style="width: 10%;"></td> <td style="width: 10%;"></td> <td style="width: 10%;"></td> <td style="width: 10%;"></td> <td style="width: 10%;"></td> <td style="width: 10%;"></td> <td style="width: 10%;"></td> <td style="width: 10%;"></td> <td style="width: 10%;"></td> <td style="width: 10%;"></td> </tr> <tr> <td></td> <td></td> <td colspan="8" style="text-align: center;"> <table border="1" style="width: 100%; border-collapse: collapse; text-align: center;"> <tr> <td style="width: 10%;"></td> <td style="width: 10%;"></td> <td style="width: 10%;"></td> <td style="width: 10%;"></td> <td style="width: 10%;"></td> <td style="width: 10%;"></td> <td style="width: 10%;"></td> <td style="width: 10%;"></td> <td style="width: 10%;"></td> <td style="width: 10%;"></td> </tr> <tr> <td></td> <td></td> <td colspan="8" style="text-align: center;"> <table border="1" style="width: 100%; border-collapse: collapse; text-align: center;"> <tr> <td style="width: 10%;"></td> <td style="width: 10%;"></td> <td style="width: 10%;"></td> <td style="width: 10%;"></td> <td style="width: 10%;"></td> <td style="width: 10%;"></td> <td style="width: 10%;"></td> <td style="width: 10%;"></td> <td style="width: 10%;"></td> <td style="width: 10%;"></td> </tr> <tr> <td></td> <td></td> <td colspan="8" style="text-align: center;"> <table border="1" style="width: 100%; border-collapse: collapse; text-align: center;"> <tr> <td style="width: 10%;"></td> <td style="width: 10%;"></td> <td style="width: 10%;"></td> <td style="width: 10%;"></td> <td style="width: 10%;"></td> <td style="width: 10%;"></td> <td style="width: 10%;"></td> <td style="width: 10%;"></td> <td style="width: 10%;"></td> <td style="width: 10%;"></td> </tr> <tr> <td></td> <td></td> <td colspan="8" style="text-align: center;"> <table border="1" style="width: 100%; border-collapse: collapse; text-align: center;"> <tr> <td style="width: 10%;"></td> <td style="width: 10%;"></td> <td style="width: 10%;"></td> <td style="width: 10%;"></td> <td style="width: 10%;"></td> <td style="width: 10%;"></td> <td style="width: 10%;"></td> <td style="width: 10%;"></td> <td style="width: 10%;"></td> <td style="width: 10%;"></td> </tr> <tr> <td></td> <td></td> <td colspan="8" style="text-align: center;"> <table border="1" style="width: 100%; border-collapse: collapse; text-align: center;"> <tr> <td style="width: 10%;"></td> <td style="width: 10%;"></td> <td style="width: 10%;"></td> <td style="width: 10%;"></td> <td style="width: 10%;"></td> <td style="width: 10%;"></td> <td style="width: 10%;"></td> <td style="width: 10%;"></td> <td style="width: 10%;"></td> <td style="width: 10%;"></td> </tr> <tr> <td></td> <td></td> <td colspan="8" style="text-align: center;"> <table border="1" style="width: 100%; border-collapse: collapse; text-align: center;"> <tr> <td style="width: 10%;"></td> <td style="width: 10%;"></td> <td style="width: 10%;"></td> <td style="width: 10%;"></td> <td style="width: 10%;"></td> <td style="width: 10%;"></td> <td style="width: 10%;"></td> <td style="width: 10%;"></td> <td style="width: 10%;"></td> <td style="width: 10%;"></td> </tr> <tr> <td></td> <td></td> <td colspan="8" style="text-align: center;"> <table border="1" style="width: 100%; border-collapse: collapse; text-align: center;"> <tr> <td style="width: 10%;"></td> <td style="width: 10%;"></td> <td style="width: 10%;"></td> <td style="width: 10%;"></td> <td style="width: 10%;"></td> <td style="width: 10%;"></td> <td style="width: 10%;"></td> <td style="width: 10%;"></td> <td style="width: 10%;"></td> <td style="width: 10%;"></td> </tr> <tr> <td></td> <td></td> <td colspan="8" style="text-align: center;"> <table border="1" style="width: 100%; border-collapse: collapse; text-align: center;"> <tr> <td style="width: 10%;"></td> <td style="width: 10%;"></td> <td style="width: 10%;"></td> <td style="width: 10%;"></td> <td style="width: 10%;"></td> <td style="width: 10%;"></td> <td style="width: 10%;"></td> <td style="width: 10%;"></td> <td style="width: 10%;"></td> <td style="width: 10%;"></td> </tr> <tr> <td></td> <td></td> <td colspan="8" style="text-align: center;"> <table border="1" style="width: 100%; border-collapse: collapse; text-align: center;"> <tr> <td style="width: 10%;"></td> <td style="width: 10%;"></td> <td style="width: 10%;"></td> <td style="width: 10%;"></td> <td style="width: 10%;"></td> <td style="width: 10%;"></td> <td style="width: 10%;"></td> <td style="width: 10%;"></td> <td style="width: 10%;"></td> <td style="width: 10%;"></td> </tr> <tr> <td></td> <td></td> <td colspan="8" style="text-align: center;"> <table border="1" style="width: 100%; border-collapse: collapse; text-align: center;"> <tr> <td style="width: 10%;"></td> <td style="width: 10%;"></td> <td style="width: 10%;"></td> <td style="width: 10%;"></td> <td style="width: 10%;"></td> <td style="width: 10%;"></td> <td style="width: 10%;"></td> <td style="width: 10%;"></td> <td style="width: 10%;"></td> <td style="width: 10%;"></td> </tr> <tr> <td></td> <td></td> <td colspan="8" style="text-align: center;"> <table border="1" style="width: 100%; border-collapse: collapse; text-align: center;"> <tr> <td style="width: 10%;"></td> <td style="width: 10%;"></td> <td style="width: 10%;"></td> <td style="width: 10%;"></td> <td style="width: 10%;"></td> <td style="width: 10%;"></td> <td style="width: 10%;"></td> <td style="width: 10%;"></td> <td style="width: 10%;"></td> <td style="width: 10%;"></td> </tr> <tr> <td></td> <td></td> <td colspan="8" style="text-align: center;"> <table border="1" style="width: 100%; border-collapse: collapse; text-align: center;"> <tr> </tr></table></td></tr></table></td></tr></table></td></tr></table></td></tr></table></td></tr></table></td></tr></table></td></tr></table></td></tr></table></td></tr></table></td></tr></table></td></tr></table></td></tr></table></td></tr></table></td></tr></table></td></tr></table></td></tr></table></td></tr></table></td></tr></table></td></tr></table>
 | | | | | | | | | | | | | | | | | | | | <table border="1" style="width: 100%; border-collapse: collapse; text-align: center;"> <tr> <td style="width: 10%;"></td> <td style="width: 10%;"></td> <td style="width: 10%;"></td> <td style="width: 10%;"></td> <td style="width: 10%;"></td> <td style="width: 10%;"></td> <td style="width: 10%;"></td> <td style="width: 10%;"></td> <td style="width: 10%;"></td> <td style="width: 10%;"></td> </tr> <tr> <td></td> <td></td> <td colspan="8" style="text-align: center;"> <table border="1" style="width: 100%; border-collapse: collapse; text-align: center;"> <tr> <td style="width: 10%;"></td> <td style="width: 10%;"></td> <td style="width: 10%;"></td> <td style="width: 10%;"></td> <td style="width: 10%;"></td> <td style="width: 10%;"></td> <td style="width: 10%;"></td> <td style="width: 10%;"></td> <td style="width: 10%;"></td> <td style="width: 10%;"></td> </tr> <tr> <td></td> <td></td> <td colspan="8" style="text-align: center;"> <table border="1" style="width: 100%; border-collapse: collapse; text-align: center;"> <tr> <td style="width: 10%;"></td> <td style="width: 10%;"></td> <td style="width: 10%;"></td> <td style="width: 10%;"></td> <td style="width: 10%;"></td> <td style="width: 10%;"></td> <td style="width: 10%;"></td> <td style="width: 10%;"></td> <td style="width: 10%;"></td> <td style="width: 10%;"></td> </tr> <tr> <td></td> <td></td> <td colspan="8" style="text-align: center;"> <table border="1" style="width: 100%; border-collapse: collapse; text-align: center;"> <tr> <td style="width: 10%;"></td> <td style="width: 10%;"></td> <td style="width: 10%;"></td> <td style="width: 10%;"></td> <td style="width: 10%;"></td> <td style="width: 10%;"></td> <td style="width: 10%;"></td> <td style="width: 10%;"></td> <td style="width: 10%;"></td> <td style="width: 10%;"></td> </tr> <tr> <td></td> <td></td> <td colspan="8" style="text-align: center;"> <table border="1" style="width: 100%; border-collapse: collapse; text-align: center;"> <tr> <td style="width: 10%;"></td> <td style="width: 10%;"></td> <td style="width: 10%;"></td> <td style="width: 10%;"></td> <td style="width: 10%;"></td> <td style="width: 10%;"></td> <td style="width: 10%;"></td> <td style="width: 10%;"></td> <td style="width: 10%;"></td> <td style="width: 10%;"></td> </tr> <tr> <td></td> <td></td> <td colspan="8" style="text-align: center;"> <table border="1" style="width: 100%; border-collapse: collapse; text-align: center;"> <tr> <td style="width: 10%;"></td> <td style="width: 10%;"></td> <td style="width: 10%;"></td> <td style="width: 10%;"></td> <td style="width: 10%;"></td> <td style="width: 10%;"></td> <td style="width: 10%;"></td> <td style="width: 10%;"></td> <td style="width: 10%;"></td> <td style="width: 10%;"></td> </tr> <tr> <td></td> <td></td> <td colspan="8" style="text-align: center;"> <table border="1" style="width: 100%; border-collapse: collapse; text-align: center;"> <tr> <td style="width: 10%;"></td> <td style="width: 10%;"></td> <td style="width: 10%;"></td> <td style="width: 10%;"></td> <td style="width: 10%;"></td> <td style="width: 10%;"></td> <td style="width: 10%;"></td> <td style="width: 10%;"></td> <td style="width: 10%;"></td> <td style="width: 10%;"></td> </tr> <tr> <td></td> <td></td> <td colspan="8" style="text-align: center;"> <table border="1" style="width: 100%; border-collapse: collapse; text-align: center;"> <tr> <td style="width: 10%;"></td> <td style="width: 10%;"></td> <td style="width: 10%;"></td> <td style="width: 10%;"></td> <td style="width: 10%;"></td> <td style="width: 10%;"></td> <td style="width: 10%;"></td> <td style="width: 10%;"></td> <td style="width: 10%;"></td> <td style="width: 10%;"></td> </tr> <tr> <td></td> <td></td> <td colspan="8" style="text-align: center;"> <table border="1" style="width: 100%; border-collapse: collapse; text-align: center;"> <tr> <td style="width: 10%;"></td> <td style="width: 10%;"></td> <td style="width: 10%;"></td> <td style="width: 10%;"></td> <td style="width: 10%;"></td> <td style="width: 10%;"></td> <td style="width: 10%;"></td> <td style="width: 10%;"></td> <td style="width: 10%;"></td> <td style="width: 10%;"></td> </tr> <tr> <td></td> <td></td> <td colspan="8" style="text-align: center;"> <table border="1" style="width: 100%; border-collapse: collapse; text-align: center;"> <tr> <td style="width: 10%;"></td> <td style="width: 10%;"></td> <td style="width: 10%;"></td> <td style="width: 10%;"></td> <td style="width: 10%;"></td> <td style="width: 10%;"></td> <td style="width: 10%;"></td> <td style="width: 10%;"></td> <td style="width: 10%;"></td> <td style="width: 10%;"></td> </tr> <tr> <td></td> <td></td> <td colspan="8" style="text-align: center;"> <table border="1" style="width: 100%; border-collapse: collapse; text-align: center;"> <tr> <td style="width: 10%;"></td> <td style="width: 10%;"></td> <td style="width: 10%;"></td> <td style="width: 10%;"></td> <td style="width: 10%;"></td> <td style="width: 10%;"></td> <td style="width: 10%;"></td> <td style="width: 10%;"></td> <td style="width: 10%;"></td> <td style="width: 10%;"></td> </tr> <tr> <td></td> <td></td> <td colspan="8" style="text-align: center;"> <table border="1" style="width: 100%; border-collapse: collapse; text-align: center;"> <tr> <td style="width: 10%;"></td> <td style="width: 10%;"></td> <td style="width: 10%;"></td> <td style="width: 10%;"></td> <td style="width: 10%;"></td> <td style="width: 10%;"></td> <td style="width: 10%;"></td> <td style="width: 10%;"></td> <td style="width: 10%;"></td> <td style="width: 10%;"></td> </tr> <tr> <td></td> <td></td> <td colspan="8" style="text-align: center;"> <table border="1" style="width: 100%; border-collapse: collapse; text-align: center;"> <tr> <td style="width: 10%;"></td> <td style="width: 10%;"></td> <td style="width: 10%;"></td> <td style="width: 10%;"></td> <td style="width: 10%;"></td> <td style="width: 10%;"></td> <td style="width: 10%;"></td> <td style="width: 10%;"></td> <td style="width: 10%;"></td> <td style="width: 10%;"></td> </tr> <tr> <td></td> <td></td> <td colspan="8" style="text-align: center;"> <table border="1" style="width: 100%; border-collapse: collapse; text-align: center;"> <tr> <td style="width: 10%;"></td> <td style="width: 10%;"></td> <td style="width: 10%;"></td> <td style="width: 10%;"></td> <td style="width: 10%;"></td> <td style="width: 10%;"></td> <td style="width: 10%;"></td> <td style="width: 10%;"></td> <td style="width: 10%;"></td> <td style="width: 10%;"></td> </tr> <tr> <td></td> <td></td> <td colspan="8" style="text-align: center;"> <table border="1" style="width: 100%; border-collapse: collapse; text-align: center;"> <tr> <td style="width: 10%;"></td> <td style="width: 10%;"></td> <td style="width: 10%;"></td> <td style="width: 10%;"></td> <td style="width: 10%;"></td> <td style="width: 10%;"></td> <td style="width: 10%;"></td> <td style="width: 10%;"></td> <td style="width: 10%;"></td> <td style="width: 10%;"></td> </tr> <tr> <td></td> <td></td> <td colspan="8" style="text-align: center;"> <table border="1" style="width: 100%; border-collapse: collapse; text-align: center;"> <tr> <td style="width: 10%;"></td> <td style="width: 10%;"></td> <td style="width: 10%;"></td> <td style="width: 10%;"></td> <td style="width: 10%;"></td> <td style="width: 10%;"></td> <td style="width: 10%;"></td> <td style="width: 10%;"></td> <td style="width: 10%;"></td> <td
style="width: 10%;"></td> </tr> <tr> <td></td> <td></td> <td colspan="8" style="text-align: center;"> <table border="1" style="width: 100%; border-collapse: collapse; text-align: center;"> <tr> <td style="width: 10%;"></td> <td style="width: 10%;"></td> <td style="width: 10%;"></td> <td style="width: 10%;"></td> <td style="width: 10%;"></td> <td style="width: 10%;"></td> <td style="width: 10%;"></td> <td style="width: 10%;"></td> <td style="width: 10%;"></td> <td style="width: 10%;"></td> </tr> <tr> <td></td> <td></td> <td colspan="8" style="text-align: center;"> <table border="1" style="width: 100%; border-collapse: collapse; text-align: center;"> <tr> <td style="width: 10%;"></td> <td style="width: 10%;"></td> <td style="width: 10%;"></td> <td style="width: 10%;"></td> <td style="width: 10%;"></td> <td style="width: 10%;"></td> <td style="width: 10%;"></td> <td style="width: 10%;"></td> <td style="width: 10%;"></td> <td style="width: 10%;"></td> </tr> <tr> <td></td> <td></td> <td colspan="8" style="text-align: center;"> <table border="1" style="width: 100%; border-collapse: collapse; text-align: center;"> <tr> </tr></table></td></tr></table></td></tr></table></td></tr></table></td></tr></table></td></tr></table></td></tr></table></td></tr></table></td></tr></table></td></tr></table></td></tr></table></td></tr></table></td></tr></table></td></tr></table></td></tr></table></td></tr></table></td></tr></table></td></tr></table></td></tr></table> | | | | | | | | | | | | | | | | | | | | <table border="1" style="width: 100%; border-collapse: collapse; text-align: center;"> <tr> <td style="width: 10%;"></td> <td style="width: 10%;"></td> <td style="width: 10%;"></td> <td style="width: 10%;"></td> <td style="width: 10%;"></td> <td style="width: 10%;"></td> <td style="width: 10%;"></td> <td style="width: 10%;"></td> <td style="width: 10%;"></td> <td style="width: 10%;"></td> </tr> <tr> <td></td> <td></td> <td colspan="8" style="text-align: center;"> <table border="1" style="width: 100%; border-collapse: collapse; text-align: center;"> <tr> <td style="width: 10%;"></td> <td style="width: 10%;"></td> <td style="width: 10%;"></td> <td style="width: 10%;"></td> <td style="width: 10%;"></td> <td style="width: 10%;"></td> <td style="width: 10%;"></td> <td style="width: 10%;"></td> <td style="width: 10%;"></td> <td style="width: 10%;"></td> </tr> <tr> <td></td> <td></td> <td colspan="8" style="text-align: center;"> <table border="1" style="width: 100%; border-collapse: collapse; text-align: center;"> <tr> <td style="width: 10%;"></td> <td style="width: 10%;"></td> <td style="width: 10%;"></td> <td style="width: 10%;"></td> <td style="width: 10%;"></td> <td style="width: 10%;"></td> <td style="width: 10%;"></td> <td style="width: 10%;"></td> <td style="width: 10%;"></td> <td style="width: 10%;"></td> </tr> <tr> <td></td> <td></td> <td colspan="8" style="text-align: center;"> <table border="1" style="width: 100%; border-collapse: collapse; text-align: center;"> <tr> <td style="width: 10%;"></td> <td style="width: 10%;"></td> <td style="width: 10%;"></td> <td style="width: 10%;"></td> <td style="width: 10%;"></td> <td style="width: 10%;"></td> <td style="width: 10%;"></td> <td style="width: 10%;"></td> <td style="width: 10%;"></td> <td style="width: 10%;"></td> </tr> <tr> <td></td> <td></td> <td colspan="8" style="text-align: center;"> <table border="1" style="width: 100%; border-collapse: collapse; text-align: center;"> <tr> <td style="width: 10%;"></td> <td style="width: 10%;"></td> <td style="width: 10%;"></td> <td style="width: 10%;"></td> <td style="width: 10%;"></td> <td style="width: 10%;"></td> <td style="width: 10%;"></td> <td style="width: 10%;"></td> <td style="width: 10%;"></td> <td style="width: 10%;"></td> </tr> <tr> <td></td> <td></td> <td colspan="8" style="text-align: center;"> <table border="1" style="width: 100%; border-collapse: collapse; text-align: center;"> <tr> <td style="width: 10%;"></td> <td style="width: 10%;"></td> <td style="width: 10%;"></td> <td style="width: 10%;"></td> <td style="width: 10%;"></td> <td style="width: 10%;"></td> <td style="width: 10%;"></td> <td style="width: 10%;"></td> <td style="width: 10%;"></td> <td style="width: 10%;"></td> </tr> <tr> <td></td> <td></td> <td colspan="8" style="text-align: center;"> <table border="1" style="width: 100%; border-collapse: collapse; text-align: center;"> <tr> <td style="width: 10%;"></td> <td style="width: 10%;"></td> <td style="width: 10%;"></td> <td style="width: 10%;"></td> <td style="width: 10%;"></td> <td style="width: 10%;"></td> <td style="width: 10%;"></td> <td style="width: 10%;"></td> <td style="width: 10%;"></td> <td style="width: 10%;"></td> </tr> <tr> <td></td> <td></td> <td colspan="8" style="text-align: center;"> <table border="1" style="width: 100%; border-collapse: collapse; text-align: center;"> <tr> <td style="width: 10%;"></td> <td style="width: 10%;"></td> <td style="width: 10%;"></td> <td style="width: 10%;"></td> <td style="width: 10%;"></td> <td style="width: 10%;"></td> <td style="width: 10%;"></td> <td style="width: 10%;"></td> <td style="width: 10%;"></td> <td style="width: 10%;"></td> </tr> <tr> <td></td> <td></td> <td colspan="8" style="text-align: center;"> <table border="1" style="width: 100%; border-collapse: collapse; text-align: center;"> <tr> <td style="width: 10%;"></td> <td style="width: 10%;"></td> <td style="width: 10%;"></td> <td style="width: 10%;"></td> <td style="width: 10%;"></td> <td style="width: 10%;"></td> <td style="width: 10%;"></td> <td style="width: 10%;"></td> <td style="width: 10%;"></td> <td style="width: 10%;"></td> </tr> <tr> <td></td> <td></td> <td colspan="8" style="text-align: center;"> <table border="1" style="width: 100%; border-collapse: collapse; text-align: center;"> <tr> <td style="width: 10%;"></td> <td style="width: 10%;"></td> <td style="width: 10%;"></td> <td style="width: 10%;"></td> <td style="width: 10%;"></td> <td style="width: 10%;"></td> <td style="width: 10%;"></td> <td style="width: 10%;"></td> <td style="width: 10%;"></td> <td style="width: 10%;"></td> </tr> <tr> <td></td> <td></td> <td colspan="8" style="text-align: center;"> <table border="1" style="width: 100%; border-collapse: collapse; text-align: center;"> <tr> <td style="width: 10%;"></td> <td style="width: 10%;"></td> <td style="width: 10%;"></td> <td style="width: 10%;"></td> <td style="width: 10%;"></td> <td style="width: 10%;"></td> <td style="width: 10%;"></td> <td style="width: 10%;"></td> <td style="width: 10%;"></td> <td style="width: 10%;"></td> </tr> <tr> <td></td> <td></td> <td colspan="8" style="text-align: center;"> <table border="1" style="width: 100%; border-collapse: collapse; text-align: center;"> <tr> <td style="width: 10%;"></td> <td style="width: 10%;"></td> <td style="width: 10%;"></td> <td style="width: 10%;"></td> <td style="width: 10%;"></td> <td style="width: 10%;"></td> <td style="width: 10%;"></td> <td style="width: 10%;"></td> <td style="width: 10%;"></td> <td style="width: 10%;"></td> </tr> <tr>
<td></td> <td></td> <td colspan="8" style="text-align: center;"> <table border="1" style="width: 100%; border-collapse: collapse; text-align: center;"> <tr> <td style="width: 10%;"></td> <td style="width: 10%;"></td> <td style="width: 10%;"></td> <td style="width: 10%;"></td> <td style="width: 10%;"></td> <td style="width: 10%;"></td> <td style="width: 10%;"></td> <td style="width: 10%;"></td> <td style="width: 10%;"></td> <td style="width: 10%;"></td> </tr> <tr> <td></td> <td></td> <td colspan="8" style="text-align: center;"> <table border="1" style="width: 100%; border-collapse: collapse; text-align: center;"> <tr> <td style="width: 10%;"></td> <td style="width: 10%;"></td> <td style="width: 10%;"></td> <td style="width: 10%;"></td> <td style="width: 10%;"></td> <td style="width: 10%;"></td> <td style="width: 10%;"></td> <td style="width: 10%;"></td> <td style="width: 10%;"></td> <td style="width: 10%;"></td> </tr> <tr> <td></td> <td></td> <td colspan="8" style="text-align: center;"> <table border="1" style="width: 100%; border-collapse: collapse; text-align: center;"> <tr> <td style="width: 10%;"></td> <td style="width: 10%;"></td> <td style="width: 10%;"></td> <td style="width: 10%;"></td> <td style="width: 10%;"></td> <td style="width: 10%;"></td> <td style="width: 10%;"></td> <td style="width: 10%;"></td> <td style="width: 10%;"></td> <td style="width: 10%;"></td> </tr> <tr> <td></td> <td></td> <td colspan="8" style="text-align: center;"> <table border="1" style="width: 100%; border-collapse: collapse; text-align: center;"> <tr> <td style="width: 10%;"></td> <td style="width: 10%;"></td> <td style="width: 10%;"></td> <td style="width: 10%;"></td> <td style="width: 10%;"></td> <td style="width: 10%;"></td> <td style="width: 10%;"></td> <td style="width: 10%;"></td> <td style="width: 10%;"></td> <td style="width: 10%;"></td> </tr> <tr> <td></td> <td></td> <td colspan="8" style="text-align: center;"> <table border="1" style="width: 100%; border-collapse: collapse; text-align: center;"> <tr> <td style="width: 10%;"></td> <td style="width: 10%;"></td> <td style="width: 10%;"></td> <td style="width: 10%;"></td> <td style="width: 10%;"></td> <td style="width: 10%;"></td> <td style="width: 10%;"></td> <td style="width: 10%;"></td> <td style="width: 10%;"></td> <td style="width: 10%;"></td> </tr> <tr> <td></td> <td></td> <td colspan="8" style="text-align: center;"> <table border="1" style="width: 100%; border-collapse: collapse; text-align: center;"> <tr> </tr></table></td></tr></table></td></tr></table></td></tr></table></td></tr></table></td></tr></table></td></tr></table></td></tr></table></td></tr></table></td></tr></table></td></tr></table></td></tr></table></td></tr></table></td></tr></table></td></tr></table></td></tr></table></td></tr></table></td></tr></table> | | | | | | | | | | | | | | | | | | | | <table border="1" style="width: 100%; border-collapse: collapse; text-align: center;"> <tr> <td style="width: 10%;"></td> <td style="width: 10%;"></td> <td style="width: 10%;"></td> <td style="width: 10%;"></td> <td style="width: 10%;"></td> <td style="width: 10%;"></td> <td style="width: 10%;"></td> <td style="width: 10%;"></td> <td style="width: 10%;"></td> <td style="width: 10%;"></td> </tr> <tr> <td></td> <td></td> <td colspan="8" style="text-align: center;"> <table border="1" style="width: 100%; border-collapse: collapse; text-align: center;"> <tr> <td style="width: 10%;"></td> <td style="width: 10%;"></td> <td style="width: 10%;"></td> <td style="width: 10%;"></td> <td style="width: 10%;"></td> <td style="width: 10%;"></td> <td style="width: 10%;"></td> <td style="width: 10%;"></td> <td style="width: 10%;"></td> <td style="width: 10%;"></td> </tr> <tr> <td></td> <td></td> <td colspan="8" style="text-align: center;"> <table border="1" style="width: 100%; border-collapse: collapse; text-align: center;"> <tr> <td style="width: 10%;"></td> <td style="width: 10%;"></td> <td style="width: 10%;"></td> <td style="width: 10%;"></td> <td style="width: 10%;"></td> <td style="width: 10%;"></td> <td style="width: 10%;"></td> <td style="width: 10%;"></td> <td style="width: 10%;"></td> <td style="width: 10%;"></td> </tr> <tr> <td></td> <td></td> <td colspan="8" style="text-align: center;"> <table border="1" style="width: 100%; border-collapse: collapse; text-align: center;"> <tr> <td style="width: 10%;"></td> <td style="width: 10%;"></td> <td style="width: 10%;"></td> <td style="width: 10%;"></td> <td style="width: 10%;"></td> <td style="width: 10%;"></td> <td style="width: 10%;"></td> <td style="width: 10%;"></td> <td style="width: 10%;"></td> <td style="width: 10%;"></td> </tr> <tr> <td></td> <td></td> <td colspan="8" style="text-align: center;"> <table border="1" style="width: 100%; border-collapse: collapse; text-align: center;"> <tr> <td style="width: 10%;"></td> <td style="width: 10%;"></td> <td style="width: 10%;"></td> <td style="width: 10%;"></td> <td style="width: 10%;"></td> <td style="width: 10%;"></td> <td style="width: 10%;"></td> <td style="width: 10%;"></td> <td style="width: 10%;"></td> <td style="width: 10%;"></td> </tr> <tr> <td></td> <td></td> <td colspan="8" style="text-align: center;"> <table border="1" style="width: 100%; border-collapse: collapse; text-align: center;"> <tr> <td style="width: 10%;"></td> <td style="width: 10%;"></td> <td style="width: 10%;"></td> <td style="width: 10%;"></td> <td style="width: 10%;"></td> <td style="width: 10%;"></td> <td style="width: 10%;"></td> <td style="width: 10%;"></td> <td style="width: 10%;"></td> <td style="width: 10%;"></td> </tr> <tr> <td></td> <td></td> <td colspan="8" style="text-align: center;"> <table border="1" style="width: 100%; border-collapse: collapse; text-align: center;"> <tr> <td style="width: 10%;"></td> <td style="width: 10%;"></td> <td style="width: 10%;"></td> <td style="width: 10%;"></td> <td style="width: 10%;"></td> <td style="width: 10%;"></td> <td style="width: 10%;"></td> <td style="width: 10%;"></td> <td style="width: 10%;"></td> <td style="width: 10%;"></td> </tr> <tr> <td></td> <td></td> <td colspan="8" style="text-align: center;"> <table border="1" style="width: 100%; border-collapse: collapse; text-align: center;"> <tr> <td style="width: 10%;"></td> <td style="width: 10%;"></td> <td style="width: 10%;"></td> <td style="width: 10%;"></td> <td style="width: 10%;"></td> <td style="width: 10%;"></td> <td style="width: 10%;"></td> <td style="width: 10%;"></td> <td style="width: 10%;"></td> <td style="width: 10%;"></td> </tr> <tr> <td></td> <td></td> <td colspan="8" style="text-align: center;"> <table border="1" style="width: 100%; border-collapse: collapse; text-align: center;"> <tr> <td style="width: 10%;"></td> <td style="width: 10%;"></td> <td style="width: 10%;"></td> <td style="width: 10%;"></td> <td style="width: 10%;"></td> <td style="width: 10%;"></td> <td style="width: 10%;"></td> <td style="width: 10%;"></td> <td style="width: 10%;"></td> <td style="width: 10%;"></td> </tr> <tr> <td></td> <td></td> <td colspan="8" style="text-align:
center;"> <table border="1" style="width: 100%; border-collapse: collapse; text-align: center;"> <tr> <td style="width: 10%;"></td> <td style="width: 10%;"></td> <td style="width: 10%;"></td> <td style="width: 10%;"></td> <td style="width: 10%;"></td> <td style="width: 10%;"></td> <td style="width: 10%;"></td> <td style="width: 10%;"></td> <td style="width: 10%;"></td> <td style="width: 10%;"></td> </tr> <tr> <td></td> <td></td> <td colspan="8" style="text-align: center;"> <table border="1" style="width: 100%; border-collapse: collapse; text-align: center;"> <tr> <td style="width: 10%;"></td> <td style="width: 10%;"></td> <td style="width: 10%;"></td> <td style="width: 10%;"></td> <td style="width: 10%;"></td> <td style="width: 10%;"></td> <td style="width: 10%;"></td> <td style="width: 10%;"></td> <td style="width: 10%;"></td> <td style="width: 10%;"></td> </tr> <tr> <td></td> <td></td> <td colspan="8" style="text-align: center;"> <table border="1" style="width: 100%; border-collapse: collapse; text-align: center;"> <tr> <td style="width: 10%;"></td> <td style="width: 10%;"></td> <td style="width: 10%;"></td> <td style="width: 10%;"></td> <td style="width: 10%;"></td> <td style="width: 10%;"></td> <td style="width: 10%;"></td> <td style="width: 10%;"></td> <td style="width: 10%;"></td> <td style="width: 10%;"></td> </tr> <tr> <td></td> <td></td> <td colspan="8" style="text-align: center;"> <table border="1" style="width: 100%; border-collapse: collapse; text-align: center;"> <tr> <td style="width: 10%;"></td> <td style="width: 10%;"></td> <td style="width: 10%;"></td> <td style="width: 10%;"></td> <td style="width: 10%;"></td> <td style="width: 10%;"></td> <td style="width: 10%;"></td> <td style="width: 10%;"></td> <td style="width: 10%;"></td> <td style="width: 10%;"></td> </tr> <tr> <td></td> <td></td> <td colspan="8" style="text-align: center;"> <table border="1" style="width: 100%; border-collapse: collapse; text-align: center;"> <tr> <td style="width: 10%;"></td> <td style="width: 10%;"></td> <td style="width: 10%;"></td> <td style="width: 10%;"></td> <td style="width: 10%;"></td> <td style="width: 10%;"></td> <td style="width: 10%;"></td> <td style="width: 10%;"></td> <td style="width: 10%;"></td> <td style="width: 10%;"></td> </tr> <tr> <td></td> <td></td> <td colspan="8" style="text-align: center;"> <table border="1" style="width: 100%; border-collapse: collapse; text-align: center;"> <tr> <td style="width: 10%;"></td> <td style="width: 10%;"></td> <td style="width: 10%;"></td> <td style="width: 10%;"></td> <td style="width: 10%;"></td> <td style="width: 10%;"></td> <td style="width: 10%;"></td> <td style="width: 10%;"></td> <td style="width: 10%;"></td> <td style="width: 10%;"></td> </tr> <tr> <td></td> <td></td> <td colspan="8" style="text-align: center;"> <table border="1" style="width: 100%; border-collapse: collapse; text-align: center;"> <tr> <td style="width: 10%;"></td> <td style="width: 10%;"></td> <td style="width: 10%;"></td> <td style="width: 10%;"></td> <td style="width: 10%;"></td> <td style="width: 10%;"></td> <td style="width: 10%;"></td> <td style="width: 10%;"></td> <td style="width: 10%;"></td> <td style="width: 10%;"></td> </tr> <tr> <td></td> <td></td> <td colspan="8" style="text-align: center;"> <table border="1" style="width: 100%; border-collapse: collapse; text-align: center;"> <tr> </tr></table></td></tr></table></td></tr></table></td></tr></table></td></tr></table></td></tr></table></td></tr></table></td></tr></table></td></tr></table></td></tr></table></td></tr></table></td></tr></table></td></tr></table></td></tr></table></td></tr></table></td></tr></table></td></tr></table> | | | | | | | | | | | | | | | | | | | | <table border="1" style="width: 100%; border-collapse: collapse; text-align: center;"> <tr> <td style="width: 10%;"></td> <td style="width: 10%;"></td> <td style="width: 10%;"></td> <td style="width: 10%;"></td> <td style="width: 10%;"></td> <td style="width: 10%;"></td> <td style="width: 10%;"></td> <td style="width: 10%;"></td> <td style="width: 10%;"></td> <td style="width: 10%;"></td> </tr> <tr> <td></td> <td></td> <td colspan="8" style="text-align: center;"> <table border="1" style="width: 100%; border-collapse: collapse; text-align: center;"> <tr> <td style="width: 10%;"></td> <td style="width: 10%;"></td> <td style="width: 10%;"></td> <td style="width: 10%;"></td> <td style="width: 10%;"></td> <td style="width: 10%;"></td> <td style="width: 10%;"></td> <td style="width: 10%;"></td> <td style="width: 10%;"></td> <td style="width: 10%;"></td> </tr> <tr> <td></td> <td></td> <td colspan="8" style="text-align: center;"> <table border="1" style="width: 100%; border-collapse: collapse; text-align: center;"> <tr> <td style="width: 10%;"></td> <td style="width: 10%;"></td> <td style="width: 10%;"></td> <td style="width: 10%;"></td> <td style="width: 10%;"></td> <td style="width: 10%;"></td> <td style="width: 10%;"></td> <td style="width: 10%;"></td> <td style="width: 10%;"></td> <td style="width: 10%;"></td> </tr> <tr> <td></td> <td></td> <td colspan="8" style="text-align: center;"> <table border="1" style="width: 100%; border-collapse: collapse; text-align: center;"> <tr> <td style="width: 10%;"></td> <td style="width: 10%;"></td> <td style="width: 10%;"></td> <td style="width: 10%;"></td> <td style="width: 10%;"></td> <td style="width: 10%;"></td> <td style="width: 10%;"></td> <td style="width: 10%;"></td> <td style="width: 10%;"></td> <td style="width: 10%;"></td> </tr> <tr> <td></td> <td></td> <td colspan="8" style="text-align: center;"> <table border="1" style="width: 100%; border-collapse: collapse; text-align: center;"> <tr> <td style="width: 10%;"></td> <td style="width: 10%;"></td> <td style="width: 10%;"></td> <td style="width: 10%;"></td> <td style="width: 10%;"></td> <td style="width: 10%;"></td> <td style="width: 10%;"></td> <td style="width: 10%;"></td> <td style="width: 10%;"></td> <td style="width: 10%;"></td> </tr> <tr> <td></td> <td></td> <td colspan="8" style="text-align: center;"> <table border="1" style="width: 100%; border-collapse: collapse; text-align: center;"> <tr> <td style="width: 10%;"></td> <td style="width: 10%;"></td> <td style="width: 10%;"></td> <td style="width: 10%;"></td> <td style="width: 10%;"></td> <td style="width: 10%;"></td> <td style="width: 10%;"></td> <td style="width: 10%;"></td> <td style="width: 10%;"></td> <td style="width: 10%;"></td> </tr> <tr> <td></td> <td></td> <td colspan="8" style="text-align: center;"> <table border="1" style="width: 100%; border-collapse: collapse; text-align: center;"> <tr> <td style="width: 10%;"></td> <td style="width: 10%;"></td> <td style="width: 10%;"></td> <td style="width: 10%;"></td> <td style="width: 10%;"></td> <td style="width: 10%;"></td> <td style="width: 10%;"></td> <td style="width: 10%;"></td> <td style="width: 10%;"></td> <td style="width: 10%;"></td> </tr> <tr> <td></td> <td></td> <td colspan="8" style="text-align: center;"> <table border="1" style="width: 100%; border-collapse: collapse;
text-align: center;"> <tr> <td style="width: 10%;"></td> <td style="width: 10%;"></td> <td style="width: 10%;"></td> <td style="width: 10%;"></td> <td style="width: 10%;"></td> <td style="width: 10%;"></td> <td style="width: 10%;"></td> <td style="width: 10%;"></td> <td style="width: 10%;"></td> <td style="width: 10%;"></td> </tr> <tr> <td></td> <td></td> <td colspan="8" style="text-align: center;"> <table border="1" style="width: 100%; border-collapse: collapse; text-align: center;"> <tr> <td style="width: 10%;"></td> <td style="width: 10%;"></td> <td style="width: 10%;"></td> <td style="width: 10%;"></td> <td style="width: 10%;"></td> <td style="width: 10%;"></td> <td style="width: 10%;"></td> <td style="width: 10%;"></td> <td style="width: 10%;"></td> <td style="width: 10%;"></td> </tr> <tr> <td></td> <td></td> <td colspan="8" style="text-align: center;"> <table border="1" style="width: 100%; border-collapse: collapse; text-align: center;"> <tr> <td style="width: 10%;"></td> <td style="width: 10%;"></td> <td style="width: 10%;"></td> <td style="width: 10%;"></td> <td style="width: 10%;"></td> <td style="width: 10%;"></td> <td style="width: 10%;"></td> <td style="width: 10%;"></td> <td style="width: 10%;"></td> <td style="width: 10%;"></td> </tr> <tr> <td></td> <td></td> <td colspan="8" style="text-align: center;"> <table border="1" style="width: 100%; border-collapse: collapse; text-align: center;"> <tr> <td style="width: 10%;"></td> <td style="width: 10%;"></td> <td style="width: 10%;"></td> <td style="width: 10%;"></td> <td style="width: 10%;"></td> <td style="width: 10%;"></td> <td style="width: 10%;"></td> <td style="width: 10%;"></td> <td style="width: 10%;"></td> <td style="width: 10%;"></td> </tr> <tr> <td></td> <td></td> <td colspan="8" style="text-align: center;"> <table border="1" style="width: 100%; border-collapse: collapse; text-align: center;"> <tr> <td style="width: 10%;"></td> <td style="width: 10%;"></td> <td style="width: 10%;"></td> <td style="width: 10%;"></td> <td style="width: 10%;"></td> <td style="width: 10%;"></td> <td style="width: 10%;"></td> <td style="width: 10%;"></td> <td style="width: 10%;"></td> <td style="width: 10%;"></td> </tr> <tr> <td></td> <td></td> <td colspan="8" style="text-align: center;"> <table border="1" style="width: 100%; border-collapse: collapse; text-align: center;"> <tr> <td style="width: 10%;"></td> <td style="width: 10%;"></td> <td style="width: 10%;"></td> <td style="width: 10%;"></td> <td style="width: 10%;"></td> <td style="width: 10%;"></td> <td style="width: 10%;"></td> <td style="width: 10%;"></td> <td style="width: 10%;"></td> <td style="width: 10%;"></td> </tr> <tr> <td></td> <td></td> <td colspan="8" style="text-align: center;"> <table border="1" style="width: 100%; border-collapse: collapse; text-align: center;"> <tr> <td style="width: 10%;"></td> <td style="width: 10%;"></td> <td style="width: 10%;"></td> <td style="width: 10%;"></td> <td style="width: 10%;"></td> <td style="width: 10%;"></td> <td style="width: 10%;"></td> <td style="width: 10%;"></td> <td style="width: 10%;"></td> <td style="width: 10%;"></td> </tr> <tr> <td></td> <td></td> <td colspan="8" style="text-align: center;"> <table border="1" style="width: 100%; border-collapse: collapse; text-align: center;"> <tr> <td style="width: 10%;"></td> <td style="width: 10%;"></td> <td style="width: 10%;"></td> <td style="width: 10%;"></td> <td style="width: 10%;"></td> <td style="width: 10%;"></td> <td style="width: 10%;"></td> <td style="width: 10%;"></td> <td style="width: 10%;"></td> <td style="width: 10%;"></td> </tr> <tr> <td></td> <td></td> <td colspan="8" style="text-align: center;"> <table border="1" style="width: 100%; border-collapse: collapse; text-align: center;"> <tr> </tr></table></td></tr></table></td></tr></table></td></tr></table></td></tr></table></td></tr></table></td></tr></table></td></tr></table></td></tr></table></td></tr></table></td></tr></table></td></tr></table></td></tr></table></td></tr></table></td></tr></table></td></tr></table> | | | | | | | | | | | | | | | | | | | | <table border="1" style="width: 100%; border-collapse: collapse; text-align: center;"> <tr> <td style="width: 10%;"></td> <td style="width: 10%;"></td> <td style="width: 10%;"></td> <td style="width: 10%;"></td> <td style="width: 10%;"></td> <td style="width: 10%;"></td> <td style="width: 10%;"></td> <td style="width: 10%;"></td> <td style="width: 10%;"></td> <td style="width: 10%;"></td> </tr> <tr> <td></td> <td></td> <td colspan="8" style="text-align: center;"> <table border="1" style="width: 100%; border-collapse: collapse; text-align: center;"> <tr> <td style="width: 10%;"></td> <td style="width: 10%;"></td> <td style="width: 10%;"></td> <td style="width: 10%;"></td> <td style="width: 10%;"></td> <td style="width: 10%;"></td> <td style="width: 10%;"></td> <td style="width: 10%;"></td> <td style="width: 10%;"></td> <td style="width: 10%;"></td> </tr> <tr> <td></td> <td></td> <td colspan="8" style="text-align: center;"> <table border="1" style="width: 100%; border-collapse: collapse; text-align: center;"> <tr> <td style="width: 10%;"></td> <td style="width: 10%;"></td> <td style="width: 10%;"></td> <td style="width: 10%;"></td> <td style="width: 10%;"></td> <td style="width: 10%;"></td> <td style="width: 10%;"></td> <td style="width: 10%;"></td> <td style="width: 10%;"></td> <td style="width: 10%;"></td> </tr> <tr> <td></td> <td></td> <td colspan="8" style="text-align: center;"> <table border="1" style="width: 100%; border-collapse: collapse; text-align: center;"> <tr> <td style="width: 10%;"></td> <td style="width: 10%;"></td> <td style="width: 10%;"></td> <td style="width: 10%;"></td> <td style="width: 10%;"></td> <td style="width: 10%;"></td> <td style="width: 10%;"></td> <td style="width: 10%;"></td> <td style="width: 10%;"></td> <td style="width: 10%;"></td> </tr> <tr> <td></td> <td></td> <td colspan="8" style="text-align: center;"> <table border="1" style="width: 100%; border-collapse: collapse; text-align: center;"> <tr> <td style="width: 10%;"></td> <td style="width: 10%;"></td> <td style="width: 10%;"></td> <td style="width: 10%;"></td> <td style="width: 10%;"></td> <td style="width: 10%;"></td> <td style="width: 10%;"></td> <td style="width: 10%;"></td> <td style="width: 10%;"></td> <td style="width: 10%;"></td> </tr> <tr> <td></td> <td></td> <td colspan="8" style="text-align: center;"> <table border="1" style="width: 100%; border-collapse: collapse; text-align: center;"> <tr> <td style="width: 10%;"></td> <td style="width: 10%;"></td> <td style="width: 10%;"></td> <td style="width: 10%;"></td> <td style="width: 10%;"></td> <td style="width: 10%;"></td> <td style="width: 10%;"></td> <td style="width: 10%;"></td> <td style="width: 10%;"></td> <td style="width: 10%;"></td> </tr> <tr> <td></td> <td></td> <td colspan="8" style="text-align: center;"> <table border="1" style="width: 100%; border-collapse: collapse; text-align: center;"> <tr> <td style="width: 10%;"></td> <td style="width: 10%;"></td> <td
style="width: 10%;"></td> <td style="width: 10%;"></td> <td style="width: 10%;"></td> <td style="width: 10%;"></td> <td style="width: 10%;"></td> <td style="width: 10%;"></td> <td style="width: 10%;"></td> <td style="width: 10%;"></td> </tr> <tr> <td></td> <td></td> <td colspan="8" style="text-align: center;"> <table border="1" style="width: 100%; border-collapse: collapse; text-align: center;"> <tr> <td style="width: 10%;"></td> <td style="width: 10%;"></td> <td style="width: 10%;"></td> <td style="width: 10%;"></td> <td style="width: 10%;"></td> <td style="width: 10%;"></td> <td style="width: 10%;"></td> <td style="width: 10%;"></td> <td style="width: 10%;"></td> <td style="width: 10%;"></td> </tr> <tr> <td></td> <td></td> <td colspan="8" style="text-align: center;"> <table border="1" style="width: 100%; border-collapse: collapse; text-align: center;"> <tr> <td style="width: 10%;"></td> <td style="width: 10%;"></td> <td style="width: 10%;"></td> <td style="width: 10%;"></td> <td style="width: 10%;"></td> <td style="width: 10%;"></td> <td style="width: 10%;"></td> <td style="width: 10%;"></td> <td style="width: 10%;"></td> <td style="width: 10%;"></td> </tr> <tr> <td></td> <td></td> <td colspan="8" style="text-align: center;"> <table border="1" style="width: 100%; border-collapse: collapse; text-align: center;"> <tr> <td style="width: 10%;"></td> <td style="width: 10%;"></td> <td style="width: 10%;"></td> <td style="width: 10%;"></td> <td style="width: 10%;"></td> <td style="width: 10%;"></td> <td style="width: 10%;"></td> <td style="width: 10%;"></td> <td style="width: 10%;"></td> <td style="width: 10%;"></td> </tr> <tr> <td></td> <td></td> <td colspan="8" style="text-align: center;"> <table border="1" style="width: 100%; border-collapse: collapse; text-align: center;"> <tr> <td style="width: 10%;"></td> <td style="width: 10%;"></td> <td style="width: 10%;"></td> <td style="width: 10%;"></td> <td style="width: 10%;"></td> <td style="width: 10%;"></td> <td style="width: 10%;"></td> <td style="width: 10%;"></td> <td style="width: 10%;"></td> <td style="width: 10%;"></td> </tr> <tr> <td></td> <td></td> <td colspan="8" style="text-align: center;"> <table border="1" style="width: 100%; border-collapse: collapse; text-align: center;"> <tr> <td style="width: 10%;"></td> <td style="width: 10%;"></td> <td style="width: 10%;"></td> <td style="width: 10%;"></td> <td style="width: 10%;"></td> <td style="width: 10%;"></td> <td style="width: 10%;"></td> <td style="width: 10%;"></td> <td style="width: 10%;"></td> <td style="width: 10%;"></td> </tr> <tr> <td></td> <td></td> <td colspan="8" style="text-align: center;"> <table border="1" style="width: 100%; border-collapse: collapse; text-align: center;"> <tr> <td style="width: 10%;"></td> <td style="width: 10%;"></td> <td style="width: 10%;"></td> <td style="width: 10%;"></td> <td style="width: 10%;"></td> <td style="width: 10%;"></td> <td style="width: 10%;"></td> <td style="width: 10%;"></td> <td style="width: 10%;"></td> <td style="width: 10%;"></td> </tr> <tr> <td></td> <td></td> <td colspan="8" style="text-align: center;"> <table border="1" style="width: 100%; border-collapse: collapse; text-align: center;"> <tr> <td style="width: 10%;"></td> <td style="width: 10%;"></td> <td style="width: 10%;"></td> <td style="width: 10%;"></td> <td style="width: 10%;"></td> <td style="width: 10%;"></td> <td style="width: 10%;"></td> <td style="width: 10%;"></td> <td style="width: 10%;"></td> <td style="width: 10%;"></td> </tr> <tr> <td></td> <td></td> <td colspan="8" style="text-align: center;"> <table border="1" style="width: 100%; border-collapse: collapse; text-align: center;"> <tr> </tr></table></td></tr></table></td></tr></table></td></tr></table></td></tr></table></td></tr></table></td></tr></table></td></tr></table></td></tr></table></td></tr></table></td></tr></table></td></tr></table></td></tr></table></td></tr></table></td></tr></table> | | | | | | | | | | | | | | | | | | | | <table border="1" style="width: 100%; border-collapse: collapse; text-align: center;"> <tr> <td style="width: 10%;"></td> <td style="width: 10%;"></td> <td style="width: 10%;"></td> <td style="width: 10%;"></td> <td style="width: 10%;"></td> <td style="width: 10%;"></td> <td style="width: 10%;"></td> <td style="width: 10%;"></td> <td style="width: 10%;"></td> <td style="width: 10%;"></td> </tr> <tr> <td></td> <td></td> <td colspan="8" style="text-align: center;"> <table border="1" style="width: 100%; border-collapse: collapse; text-align: center;"> <tr> <td style="width: 10%;"></td> <td style="width: 10%;"></td> <td style="width: 10%;"></td> <td style="width: 10%;"></td> <td style="width: 10%;"></td> <td style="width: 10%;"></td> <td style="width: 10%;"></td> <td style="width: 10%;"></td> <td style="width: 10%;"></td> <td style="width: 10%;"></td> </tr> <tr> <td></td> <td></td> <td colspan="8" style="text-align: center;"> <table border="1" style="width: 100%; border-collapse: collapse; text-align: center;"> <tr> <td style="width: 10%;"></td> <td style="width: 10%;"></td> <td style="width: 10%;"></td> <td style="width: 10%;"></td> <td style="width: 10%;"></td> <td style="width: 10%;"></td> <td style="width: 10%;"></td> <td style="width: 10%;"></td> <td style="width: 10%;"></td> <td style="width: 10%;"></td> </tr> <tr> <td></td> <td></td> <td colspan="8" style="text-align: center;"> <table border="1" style="width: 100%; border-collapse: collapse; text-align: center;"> <tr> <td style="width: 10%;"></td> <td style="width: 10%;"></td> <td style="width: 10%;"></td> <td style="width: 10%;"></td> <td style="width: 10%;"></td> <td style="width: 10%;"></td> <td style="width: 10%;"></td> <td style="width: 10%;"></td> <td style="width: 10%;"></td> <td style="width: 10%;"></td> </tr> <tr> <td></td> <td></td> <td colspan="8" style="text-align: center;"> <table border="1" style="width: 100%; border-collapse: collapse; text-align: center;"> <tr> <td style="width: 10%;"></td> <td style="width: 10%;"></td> <td style="width: 10%;"></td> <td style="width: 10%;"></td> <td style="width: 10%;"></td> <td style="width: 10%;"></td> <td style="width: 10%;"></td> <td style="width: 10%;"></td> <td style="width: 10%;"></td> <td style="width: 10%;"></td> </tr> <tr> <td></td> <td></td> <td colspan="8" style="text-align: center;"> <table border="1" style="width: 100%; border-collapse: collapse; text-align: center;"> <tr> <td style="width: 10%;"></td> <td style="width: 10%;"></td> <td style="width: 10%;"></td> <td style="width: 10%;"></td> <td style="width: 10%;"></td> <td style="width: 10%;"></td> <td style="width: 10%;"></td> <td style="width: 10%;"></td> <td style="width: 10%;"></td> <td style="width: 10%;"></td> </tr> <tr> <td></td> <td></td> <td colspan="8" style="text-align: center;"> <table border="1" style="width: 100%; border-collapse: collapse; text-align: center;"> <tr> <td style="width: 10%;"></td> <td style="width: 10%;"></td> <td style="width: 10%;"></td> <td style="width: 10%;"></td> <td style="width: 10%;"></td> <td style="width:
10%;"></td> <td style="width: 10%;"></td> <td style="width: 10%;"></td> <td style="width: 10%;"></td> <td style="width: 10%;"></td> </tr> <tr> <td></td> <td></td> <td colspan="8" style="text-align: center;"> <table border="1" style="width: 100%; border-collapse: collapse; text-align: center;"> <tr> <td style="width: 10%;"></td> <td style="width: 10%;"></td> <td style="width: 10%;"></td> <td style="width: 10%;"></td> <td style="width: 10%;"></td> <td style="width: 10%;"></td> <td style="width: 10%;"></td> <td style="width: 10%;"></td> <td style="width: 10%;"></td> <td style="width: 10%;"></td> </tr> <tr> <td></td> <td></td> <td colspan="8" style="text-align: center;"> <table border="1" style="width: 100%; border-collapse: collapse; text-align: center;"> <tr> <td style="width: 10%;"></td> <td style="width: 10%;"></td> <td style="width: 10%;"></td> <td style="width: 10%;"></td> <td style="width: 10%;"></td> <td style="width: 10%;"></td> <td style="width: 10%;"></td> <td style="width: 10%;"></td> <td style="width: 10%;"></td> <td style="width: 10%;"></td> </tr> <tr> <td></td> <td></td> <td colspan="8" style="text-align: center;"> <table border="1" style="width: 100%; border-collapse: collapse; text-align: center;"> <tr> <td style="width: 10%;"></td> <td style="width: 10%;"></td> <td style="width: 10%;"></td> <td style="width: 10%;"></td> <td style="width: 10%;"></td> <td style="width: 10%;"></td> <td style="width: 10%;"></td> <td style="width: 10%;"></td> <td style="width: 10%;"></td> <td style="width: 10%;"></td> </tr> <tr> <td></td> <td></td> <td colspan="8" style="text-align: center;"> <table border="1" style="width: 100%; border-collapse: collapse; text-align: center;"> <tr> <td style="width: 10%;"></td> <td style="width: 10%;"></td> <td style="width: 10%;"></td> <td style="width: 10%;"></td> <td style="width: 10%;"></td> <td style="width: 10%;"></td> <td style="width: 10%;"></td> <td style="width: 10%;"></td> <td style="width: 10%;"></td> <td style="width: 10%;"></td> </tr> <tr> <td></td> <td></td> <td colspan="8" style="text-align: center;"> <table border="1" style="width: 100%; border-collapse: collapse; text-align: center;"> <tr> <td style="width: 10%;"></td> <td style="width: 10%;"></td> <td style="width: 10%;"></td> <td style="width: 10%;"></td> <td style="width: 10%;"></td> <td style="width: 10%;"></td> <td style="width: 10%;"></td> <td style="width: 10%;"></td> <td style="width: 10%;"></td> <td style="width: 10%;"></td> </tr> <tr> <td></td> <td></td> <td colspan="8" style="text-align: center;"> <table border="1" style="width: 100%; border-collapse: collapse; text-align: center;"> <tr> <td style="width: 10%;"></td> <td style="width: 10%;"></td> <td style="width: 10%;"></td> <td style="width: 10%;"></td> <td style="width: 10%;"></td> <td style="width: 10%;"></td> <td style="width: 10%;"></td> <td style="width: 10%;"></td> <td style="width: 10%;"></td> <td style="width: 10%;"></td> </tr> <tr> <td></td> <td></td> <td colspan="8" style="text-align: center;"> <table border="1" style="width: 100%; border-collapse: collapse; text-align: center;"> <tr> </tr></table></td></tr></table></td></tr></table></td></tr></table></td></tr></table></td></tr></table></td></tr></table></td></tr></table></td></tr></table></td></tr></table></td></tr></table></td></tr></table></td></tr></table></td></tr></table> | | | | | | | | | | | | | | | | | | | | <table border="1" style="width: 100%; border-collapse: collapse; text-align: center;"> <tr> <td style="width: 10%;"></td> <td style="width: 10%;"></td> <td style="width: 10%;"></td> <td style="width: 10%;"></td> <td style="width: 10%;"></td> <td style="width: 10%;"></td> <td style="width: 10%;"></td> <td style="width: 10%;"></td> <td style="width: 10%;"></td> <td style="width: 10%;"></td> </tr> <tr> <td></td> <td></td> <td colspan="8" style="text-align: center;"> <table border="1" style="width: 100%; border-collapse: collapse; text-align: center;"> <tr> <td style="width: 10%;"></td> <td style="width: 10%;"></td> <td style="width: 10%;"></td> <td style="width: 10%;"></td> <td style="width: 10%;"></td> <td style="width: 10%;"></td> <td style="width: 10%;"></td> <td style="width: 10%;"></td> <td style="width: 10%;"></td> <td style="width: 10%;"></td> </tr> <tr> <td></td> <td></td> <td colspan="8" style="text-align: center;"> <table border="1" style="width: 100%; border-collapse: collapse; text-align: center;"> <tr> <td style="width: 10%;"></td> <td style="width: 10%;"></td> <td style="width: 10%;"></td> <td style="width: 10%;"></td> <td style="width: 10%;"></td> <td style="width: 10%;"></td> <td style="width: 10%;"></td> <td style="width: 10%;"></td> <td style="width: 10%;"></td> <td style="width: 10%;"></td> </tr> <tr> <td></td> <td></td> <td colspan="8" style="text-align: center;"> <table border="1" style="width: 100%; border-collapse: collapse; text-align: center;"> <tr> <td style="width: 10%;"></td> <td style="width: 10%;"></td> <td style="width: 10%;"></td> <td style="width: 10%;"></td> <td style="width: 10%;"></td> <td style="width: 10%;"></td> <td style="width: 10%;"></td> <td style="width: 10%;"></td> <td style="width: 10%;"></td> <td style="width: 10%;"></td> </tr> <tr> <td></td> <td></td> <td colspan="8" style="text-align: center;"> <table border="1" style="width: 100%; border-collapse: collapse; text-align: center;"> <tr> <td style="width: 10%;"></td> <td style="width: 10%;"></td> <td style="width: 10%;"></td> <td style="width: 10%;"></td> <td style="width: 10%;"></td> <td style="width: 10%;"></td> <td style="width: 10%;"></td> <td style="width: 10%;"></td> <td style="width: 10%;"></td> <td style="width: 10%;"></td> </tr> <tr> <td></td> <td></td> <td colspan="8" style="text-align: center;"> <table border="1" style="width: 100%; border-collapse: collapse; text-align: center;"> <tr> <td style="width: 10%;"></td> <td style="width: 10%;"></td> <td style="width: 10%;"></td> <td style="width: 10%;"></td> <td style="width: 10%;"></td> <td style="width: 10%;"></td> <td style="width: 10%;"></td> <td style="width: 10%;"></td> <td style="width: 10%;"></td> <td style="width: 10%;"></td> </tr> <tr> <td></td> <td></td> <td colspan="8" style="text-align: center;"> <table border="1" style="width: 100%; border-collapse: collapse; text-align: center;"> <tr> <td style="width: 10%;"></td> <td style="width: 10%;"></td> <td style="width: 10%;"></td> <td style="width: 10%;"></td> <td style="width: 10%;"></td> <td style="width: 10%;"></td> <td style="width: 10%;"></td> <td style="width: 10%;"></td> <td style="width: 10%;"></td> <td style="width: 10%;"></td> </tr> <tr> <td></td> <td></td> <td colspan="8" style="text-align: center;"> <table border="1" style="width: 100%; border-collapse: collapse; text-align: center;"> <tr> <td style="width: 10%;"></td> <td style="width: 10%;"></td> <td style="width: 10%;"></td> <td style="width: 10%;"></td> <td style="width: 10%;"></td> <td style="width: 10%;"></td> <td style="width: 10%;"></td> <td style="width: 10%;"></td> <td style="width: 10%;"></td> <td style="width: 10%;"></td>
</tr> <tr> <td></td> <td></td> <td colspan="8" style="text-align: center;"> <table border="1" style="width: 100%; border-collapse: collapse; text-align: center;"> <tr> <td style="width: 10%;"></td> <td style="width: 10%;"></td> <td style="width: 10%;"></td> <td style="width: 10%;"></td> <td style="width: 10%;"></td> <td style="width: 10%;"></td> <td style="width: 10%;"></td> <td style="width: 10%;"></td> <td style="width: 10%;"></td> <td style="width: 10%;"></td> </tr> <tr> <td></td> <td></td> <td colspan="8" style="text-align: center;"> <table border="1" style="width: 100%; border-collapse: collapse; text-align: center;"> <tr> <td style="width: 10%;"></td> <td style="width: 10%;"></td> <td style="width: 10%;"></td> <td style="width: 10%;"></td> <td style="width: 10%;"></td> <td style="width: 10%;"></td> <td style="width: 10%;"></td> <td style="width: 10%;"></td> <td style="width: 10%;"></td> <td style="width: 10%;"></td> </tr> <tr> <td></td> <td></td> <td colspan="8" style="text-align: center;"> <table border="1" style="width: 100%; border-collapse: collapse; text-align: center;"> <tr> <td style="width: 10%;"></td> <td style="width: 10%;"></td> <td style="width: 10%;"></td> <td style="width: 10%;"></td> <td style="width: 10%;"></td> <td style="width: 10%;"></td> <td style="width: 10%;"></td> <td style="width: 10%;"></td> <td style="width: 10%;"></td> <td style="width: 10%;"></td> </tr> <tr> <td></td> <td></td> <td colspan="8" style="text-align: center;"> <table border="1" style="width: 100%; border-collapse: collapse; text-align: center;"> <tr> <td style="width: 10%;"></td> <td style="width: 10%;"></td> <td style="width: 10%;"></td> <td style="width: 10%;"></td> <td style="width: 10%;"></td> <td style="width: 10%;"></td> <td style="width: 10%;"></td> <td style="width: 10%;"></td> <td style="width: 10%;"></td> <td style="width: 10%;"></td> </tr> <tr> <td></td> <td></td> <td colspan="8" style="text-align: center;"> <table border="1" style="width: 100%; border-collapse: collapse; text-align: center;"> <tr> </tr></table></td></tr></table></td></tr></table></td></tr></table></td></tr></table></td></tr></table></td></tr></table></td></tr></table></td></tr></table></td></tr></table></td></tr></table></td></tr></table></td></tr></table> | | | | | | | | | | | | | | | | | | | | <table border="1" style="width: 100%; border-collapse: collapse; text-align: center;"> <tr> <td style="width: 10%;"></td> <td style="width: 10%;"></td> <td style="width: 10%;"></td> <td style="width: 10%;"></td> <td style="width: 10%;"></td> <td style="width: 10%;"></td> <td style="width: 10%;"></td> <td style="width: 10%;"></td> <td style="width: 10%;"></td> <td style="width: 10%;"></td> </tr> <tr> <td></td> <td></td> <td colspan="8" style="text-align: center;"> <table border="1" style="width: 100%; border-collapse: collapse; text-align: center;"> <tr> <td style="width: 10%;"></td> <td style="width: 10%;"></td> <td style="width: 10%;"></td> <td style="width: 10%;"></td> <td style="width: 10%;"></td> <td style="width: 10%;"></td> <td style="width: 10%;"></td> <td style="width: 10%;"></td> <td style="width: 10%;"></td> <td style="width: 10%;"></td> </tr> <tr> <td></td> <td></td> <td colspan="8" style="text-align: center;"> <table border="1" style="width: 100%; border-collapse: collapse; text-align: center;"> <tr> <td style="width: 10%;"></td> <td style="width: 10%;"></td> <td style="width: 10%;"></td> <td style="width: 10%;"></td> <td style="width: 10%;"></td> <td style="width: 10%;"></td> <td style="width: 10%;"></td> <td style="width: 10%;"></td> <td style="width: 10%;"></td> <td style="width: 10%;"></td> </tr> <tr> <td></td> <td></td> <td colspan="8" style="text-align: center;"> <table border="1" style="width: 100%; border-collapse: collapse; text-align: center;"> <tr> <td style="width: 10%;"></td> <td style="width: 10%;"></td> <td style="width: 10%;"></td> <td style="width: 10%;"></td> <td style="width: 10%;"></td> <td style="width: 10%;"></td> <td style="width: 10%;"></td> <td style="width: 10%;"></td> <td style="width: 10%;"></td> <td style="width: 10%;"></td> </tr> <tr> <td></td> <td></td> <td colspan="8" style="text-align: center;"> <table border="1" style="width: 100%; border-collapse: collapse; text-align: center;"> <tr> <td style="width: 10%;"></td> <td style="width: 10%;"></td> <td style="width: 10%;"></td> <td style="width: 10%;"></td> <td style="width: 10%;"></td> <td style="width: 10%;"></td> <td style="width: 10%;"></td> <td style="width: 10%;"></td> <td style="width: 10%;"></td> <td style="width: 10%;"></td> </tr> <tr> <td></td> <td></td> <td colspan="8" style="text-align: center;"> <table border="1" style="width: 100%; border-collapse: collapse; text-align: center;"> <tr> <td style="width: 10%;"></td> <td style="width: 10%;"></td> <td style="width: 10%;"></td> <td style="width: 10%;"></td> <td style="width: 10%;"></td> <td style="width: 10%;"></td> <td style="width: 10%;"></td> <td style="width: 10%;"></td> <td style="width: 10%;"></td> <td style="width: 10%;"></td> </tr> <tr> <td></td> <td></td> <td colspan="8" style="text-align: center;"> <table border="1" style="width: 100%; border-collapse: collapse; text-align: center;"> <tr> <td style="width: 10%;"></td> <td style="width: 10%;"></td> <td style="width: 10%;"></td> <td style="width: 10%;"></td> <td style="width: 10%;"></td> <td style="width: 10%;"></td> <td style="width: 10%;"></td> <td style="width: 10%;"></td> <td style="width: 10%;"></td> <td style="width: 10%;"></td> </tr> <tr> <td></td> <td></td> <td colspan="8" style="text-align: center;"> <table border="1" style="width: 100%; border-collapse: collapse; text-align: center;"> <tr> <td style="width: 10%;"></td> <td style="width: 10%;"></td> <td style="width: 10%;"></td> <td style="width: 10%;"></td> <td style="width: 10%;"></td> <td style="width: 10%;"></td> <td style="width: 10%;"></td> <td style="width: 10%;"></td> <td style="width: 10%;"></td> <td style="width: 10%;"></td> </tr> <tr> <td></td> <td></td> <td colspan="8" style="text-align: center;"> <table border="1" style="width: 100%; border-collapse: collapse; text-align: center;"> <tr> <td style="width: 10%;"></td> <td style="width: 10%;"></td> <td style="width: 10%;"></td> <td style="width: 10%;"></td> <td style="width: 10%;"></td> <td style="width: 10%;"></td> <td style="width: 10%;"></td> <td style="width: 10%;"></td> <td style="width: 10%;"></td> <td style="width: 10%;"></td> </tr> <tr> <td></td> <td></td> <td colspan="8" style="text-align: center;"> <table border="1" style="width: 100%; border-collapse: collapse; text-align: center;"> <tr> <td style="width: 10%;"></td> <td style="width: 10%;"></td> <td style="width: 10%;"></td> <td style="width: 10%;"></td> <td style="width: 10%;"></td> <td style="width: 10%;"></td> <td style="width: 10%;"></td> <td style="width: 10%;"></td> <td style="width: 10%;"></td> <td style="width: 10%;"></td> </tr> <tr> <td></td> <td></td> <td colspan="8" style="text-align: center;"> <table border="1" style="width: 100%; border-collapse: collapse;
text-align: center;"> <tr> <td style="width: 10%;"></td> <td style="width: 10%;"></td> <td style="width: 10%;"></td> <td style="width: 10%;"></td> <td style="width: 10%;"></td> <td style="width: 10%;"></td> <td style="width: 10%;"></td> <td style="width: 10%;"></td> <td style="width: 10%;"></td> <td style="width: 10%;"></td> </tr> <tr> <td></td> <td></td> <td colspan="8" style="text-align: center;"> <table border="1" style="width: 100%; border-collapse: collapse; text-align: center;"> <tr> </tr></table></td></tr></table></td></tr></table></td></tr></table></td></tr></table></td></tr></table></td></tr></table></td></tr></table></td></tr></table></td></tr></table></td></tr></table></td></tr></table> | | | | | | | | | | | | | | | | | | | | <table border="1" style="width: 100%; border-collapse: collapse; text-align: center;"> <tr> <td style="width: 10%;"></td> <td style="width: 10%;"></td> <td style="width: 10%;"></td> <td style="width: 10%;"></td> <td style="width: 10%;"></td> <td style="width: 10%;"></td> <td style="width: 10%;"></td> <td style="width: 10%;"></td> <td style="width: 10%;"></td> <td style="width: 10%;"></td> </tr> <tr> <td></td> <td></td> <td colspan="8" style="text-align: center;"> <table border="1" style="width: 100%; border-collapse: collapse; text-align: center;"> <tr> <td style="width: 10%;"></td> <td style="width: 10%;"></td> <td style="width: 10%;"></td> <td style="width: 10%;"></td> <td style="width: 10%;"></td> <td style="width: 10%;"></td> <td style="width: 10%;"></td> <td style="width: 10%;"></td> <td style="width: 10%;"></td> <td style="width: 10%;"></td> </tr> <tr> <td></td> <td></td> <td colspan="8" style="text-align: center;"> <table border="1" style="width: 100%; border-collapse: collapse; text-align: center;"> <tr> <td style="width: 10%;"></td> <td style="width: 10%;"></td> <td style="width: 10%;"></td> <td style="width: 10%;"></td> <td style="width: 10%;"></td> <td style="width: 10%;"></td> <td style="width: 10%;"></td> <td style="width: 10%;"></td> <td style="width: 10%;"></td> <td style="width: 10%;"></td> </tr> <tr> <td></td> <td></td> <td colspan="8" style="text-align: center;"> <table border="1" style="width: 100%; border-collapse: collapse; text-align: center;"> <tr> <td style="width: 10%;"></td> <td style="width: 10%;"></td> <td style="width: 10%;"></td> <td style="width: 10%;"></td> <td style="width: 10%;"></td> <td style="width: 10%;"></td> <td style="width: 10%;"></td> <td style="width: 10%;"></td> <td style="width: 10%;"></td> <td style="width: 10%;"></td> </tr> <tr> <td></td> <td></td> <td colspan="8" style="text-align: center;"> <table border="1" style="width: 100%; border-collapse: collapse; text-align: center;"> <tr> <td style="width: 10%;"></td> <td style="width: 10%;"></td> <td style="width: 10%;"></td> <td style="width: 10%;"></td> <td style="width: 10%;"></td> <td style="width: 10%;"></td> <td style="width: 10%;"></td> <td style="width: 10%;"></td> <td style="width: 10%;"></td> <td style="width: 10%;"></td> </tr> <tr> <td></td> <td></td> <td colspan="8" style="text-align: center;"> <table border="1" style="width: 100%; border-collapse: collapse; text-align: center;"> <tr> <td style="width: 10%;"></td> <td style="width: 10%;"></td> <td style="width: 10%;"></td> <td style="width: 10%;"></td> <td style="width: 10%;"></td> <td style="width: 10%;"></td> <td style="width: 10%;"></td> <td style="width: 10%;"></td> <td style="width: 10%;"></td> <td style="width: 10%;"></td> </tr> <tr> <td></td> <td></td> <td colspan="8" style="text-align: center;"> <table border="1" style="width: 100%; border-collapse: collapse; text-align: center;"> <tr> <td style="width: 10%;"></td> <td style="width: 10%;"></td> <td style="width: 10%;"></td> <td style="width: 10%;"></td> <td style="width: 10%;"></td> <td style="width: 10%;"></td> <td style="width: 10%;"></td> <td style="width: 10%;"></td> <td style="width: 10%;"></td> <td style="width: 10%;"></td> </tr> <tr> <td></td> <td></td> <td colspan="8" style="text-align: center;"> <table border="1" style="width: 100%; border-collapse: collapse; text-align: center;"> <tr> <td style="width: 10%;"></td> <td style="width: 10%;"></td> <td style="width: 10%;"></td> <td style="width: 10%;"></td> <td style="width: 10%;"></td> <td style="width: 10%;"></td> <td style="width: 10%;"></td> <td style="width: 10%;"></td> <td style="width: 10%;"></td> <td style="width: 10%;"></td> </tr> <tr> <td></td> <td></td> <td colspan="8" style="text-align: center;"> <table border="1" style="width: 100%; border-collapse: collapse; text-align: center;"> <tr> <td style="width: 10%;"></td> <td style="width: 10%;"></td> <td style="width: 10%;"></td> <td style="width: 10%;"></td> <td style="width: 10%;"></td> <td style="width: 10%;"></td> <td style="width: 10%;"></td> <td style="width: 10%;"></td> <td style="width: 10%;"></td> <td style="width: 10%;"></td> </tr> <tr> <td></td> <td></td> <td colspan="8" style="text-align: center;"> <table border="1" style="width: 100%; border-collapse: collapse; text-align: center;"> <tr> <td style="width: 10%;"></td> <td style="width: 10%;"></td> <td style="width: 10%;"></td> <td style="width: 10%;"></td> <td style="width: 10%;"></td> <td style="width: 10%;"></td> <td style="width: 10%;"></td> <td style="width: 10%;"></td> <td style="width: 10%;"></td> <td style="width: 10%;"></td> </tr> <tr> <td></td> <td></td> <td colspan="8" style="text-align: center;"> <table border="1" style="width: 100%; border-collapse: collapse; text-align: center;"> <tr> </tr></table></td></tr></table></td></tr></table></td></tr></table></td></tr></table></td></tr></table></td></tr></table></td></tr></table></td></tr></table></td></tr></table></td></tr></table>
 | | | | | | | | | | | | | | | | | | | | <table border="1" style="width: 100%; border-collapse: collapse; text-align: center;"> <tr> <td style="width: 10%;"></td> <td style="width: 10%;"></td> <td style="width: 10%;"></td> <td style="width: 10%;"></td> <td style="width: 10%;"></td> <td style="width: 10%;"></td> <td style="width: 10%;"></td> <td style="width: 10%;"></td> <td style="width: 10%;"></td> <td style="width: 10%;"></td> </tr> <tr> <td></td> <td></td> <td colspan="8" style="text-align: center;"> <table border="1" style="width: 100%; border-collapse: collapse; text-align: center;"> <tr> <td style="width: 10%;"></td> <td style="width: 10%;"></td> <td style="width: 10%;"></td> <td style="width: 10%;"></td> <td style="width: 10%;"></td> <td style="width: 10%;"></td> <td style="width: 10%;"></td> <td style="width: 10%;"></td> <td style="width: 10%;"></td> <td style="width: 10%;"></td> </tr> <tr> <td></td> <td></td> <td colspan="8" style="text-align: center;"> <table border="1" style="width: 100%; border-collapse: collapse; text-align: center;"> <tr> <td style="width: 10%;"></td> <td style="width: 10%;"></td> <td style="width: 10%;"></td> <td style="width: 10%;"></td> <td style="width: 10%;"></td> <td style="width: 10%;"></td> <td style="width: 10%;"></td> <td style="width: 10%;"></td> <td style="width: 10%;"></td> <td style="width: 10%;"></td> </tr> <tr> <td></td> <td></td> <td colspan="8" style="text-align: center;"> <table border="1" style="width: 100%; border-collapse: collapse; text-align: center;"> <tr> <td style="width: 10%;"></td> <td style="width: 10%;"></td> <td style="width: 10%;"></td> <td style="width: 10%;"></td> <td style="width: 10%;"></td> <td style="width: 10%;"></td> <td style="width: 10%;"></td> <td style="width: 10%;"></td> <td style="width: 10%;"></td> <td style="width: 10%;"></td> </tr> <tr> <td></td> <td></td> <td colspan="8" style="text-align: center;"> <table border="1" style="width: 100%; border-collapse: collapse; text-align: center;"> <tr> <td style="width: 10%;"></td> <td style="width: 10%;"></td> <td style="width: 10%;"></td> <td style="width: 10%;"></td> <td style="width: 10%;"></td> <td style="width: 10%;"></td> <td style="width: 10%;"></td> <td style="width: 10%;"></td> <td style="width: 10%;"></td> <td style="width: 10%;"></td> </tr> <tr> <td></td> <td></td> <td colspan="8" style="text-align: center;"> <table border="1" style="width: 100%; border-collapse: collapse; text-align: center;"> <tr> <td style="width: 10%;"></td> <td style="width: 10%;"></td> <td style="width: 10%;"></td> <td style="width: 10%;"></td> <td style="width: 10%;"></td> <td style="width: 10%;"></td> <td style="width: 10%;"></td> <td style="width: 10%;"></td> <td style="width: 10%;"></td> <td style="width: 10%;"></td> </tr> <tr> <td></td> <td></td> <td colspan="8" style="text-align: center;"> <table border="1" style="width: 100%; border-collapse: collapse; text-align: center;"> <tr> <td style="width: 10%;"></td> <td style="width: 10%;"></td> <td style="width: 10%;"></td> <td style="width: 10%;"></td> <td style="width: 10%;"></td> <td style="width: 10%;"></td> <td style="width: 10%;"></td> <td style="width: 10%;"></td> <td style="width: 10%;"></td> <td style="width: 10%;"></td> </tr> <tr> <td></td> <td></td> <td colspan="8" style="text-align: center;"> <table border="1" style="width: 100%; border-collapse: collapse; text-align: center;"> <tr> <td style="width: 10%;"></td> <td style="width: 10%;"></td> <td style="width: 10%;"></td> <td style="width: 10%;"></td> <td style="width: 10%;"></td> <td style="width: 10%;"></td> <td style="width: 10%;"></td> <td style="width: 10%;"></td> <td style="width: 10%;"></td> <td style="width: 10%;"></td> </tr> <tr> <td></td> <td></td> <td colspan="8" style="text-align: center;"> <table border="1" style="width: 100%; border-collapse: collapse; text-align: center;"> <tr> <td style="width: 10%;"></td> <td style="width: 10%;"></td> <td style="width: 10%;"></td> <td style="width: 10%;"></td> <td style="width: 10%;"></td> <td style="width: 10%;"></td> <td style="width: 10%;"></td> <td style="width: 10%;"></td> <td style="width: 10%;"></td> <td style="width: 10%;"></td> </tr> <tr> <td></td> <td></td> <td colspan="8" style="text-align: center;"> <table border="1" style="width: 100%; border-collapse: collapse; text-align: center;"> <tr> </tr></table></td></tr></table></td></tr></table></td></tr></table></td></tr></table></td></tr></table></td></tr></table></td></tr></table></td></tr></table></td></tr></table> | | | | | | | | | | | | | | | | | | | | <table border="1" style="width: 100%; border-collapse: collapse; text-align: center;"> <tr> <td style="width: 10%;"></td> <td style="width: 10%;"></td> <td style="width: 10%;"></td> <td style="width: 10%;"></td> <td style="width: 10%;"></td> <td style="width: 10%;"></td> <td style="width: 10%;"></td> <td style="width: 10%;"></td> <td style="width: 10%;"></td> <td style="width: 10%;"></td> </tr> <tr> <td></td> <td></td> <td colspan="8" style="text-align: center;"> <table border="1" style="width: 100%; border-collapse: collapse; text-align: center;"> <tr> <td style="width: 10%;"></td> <td style="width: 10%;"></td> <td style="width: 10%;"></td> <td style="width: 10%;"></td> <td style="width: 10%;"></td> <td style="width: 10%;"></td> <td style="width: 10%;"></td> <td style="width: 10%;"></td> <td style="width: 10%;"></td> <td style="width: 10%;"></td> </tr> <tr> <td></td> <td></td> <td colspan="8"
style="text-align: center;"> <table border="1" style="width: 100%; border-collapse: collapse; text-align: center;"> <tr> <td style="width: 10%;"></td> <td style="width: 10%;"></td> <td style="width: 10%;"></td> <td style="width: 10%;"></td> <td style="width: 10%;"></td> <td style="width: 10%;"></td> <td style="width: 10%;"></td> <td style="width: 10%;"></td> <td style="width: 10%;"></td> <td style="width: 10%;"></td> </tr> <tr> <td></td> <td></td> <td colspan="8" style="text-align: center;"> <table border="1" style="width: 100%; border-collapse: collapse; text-align: center;"> <tr> <td style="width: 10%;"></td> <td style="width: 10%;"></td> <td style="width: 10%;"></td> <td style="width: 10%;"></td> <td style="width: 10%;"></td> <td style="width: 10%;"></td> <td style="width: 10%;"></td> <td style="width: 10%;"></td> <td style="width: 10%;"></td> <td style="width: 10%;"></td> </tr> <tr> <td></td> <td></td> <td colspan="8" style="text-align: center;"> <table border="1" style="width: 100%; border-collapse: collapse; text-align: center;"> <tr> <td style="width: 10%;"></td> <td style="width: 10%;"></td> <td style="width: 10%;"></td> <td style="width: 10%;"></td> <td style="width: 10%;"></td> <td style="width: 10%;"></td> <td style="width: 10%;"></td> <td style="width: 10%;"></td> <td style="width: 10%;"></td> <td style="width: 10%;"></td> </tr> <tr> <td></td> <td></td> <td colspan="8" style="text-align: center;"> <table border="1" style="width: 100%; border-collapse: collapse; text-align: center;"> <tr> <td style="width: 10%;"></td> <td style="width: 10%;"></td> <td style="width: 10%;"></td> <td style="width: 10%;"></td> <td style="width: 10%;"></td> <td style="width: 10%;"></td> <td style="width: 10%;"></td> <td style="width: 10%;"></td> <td style="width: 10%;"></td> <td style="width: 10%;"></td> </tr> <tr> <td></td> <td></td> <td colspan="8" style="text-align: center;"> <table border="1" style="width: 100%; border-collapse: collapse; text-align: center;"> <tr> <td style="width: 10%;"></td> <td style="width: 10%;"></td> <td style="width: 10%;"></td> <td style="width: 10%;"></td> <td style="width: 10%;"></td> <td style="width: 10%;"></td> <td style="width: 10%;"></td> <td style="width: 10%;"></td> <td style="width: 10%;"></td> <td style="width: 10%;"></td> </tr> <tr> <td></td> <td></td> <td colspan="8" style="text-align: center;"> <table border="1" style="width: 100%; border-collapse: collapse; text-align: center;"> <tr> <td style="width: 10%;"></td> <td style="width: 10%;"></td> <td style="width: 10%;"></td> <td style="width: 10%;"></td> <td style="width: 10%;"></td> <td style="width: 10%;"></td> <td style="width: 10%;"></td> <td style="width: 10%;"></td> <td style="width: 10%;"></td> <td style="width: 10%;"></td> </tr> <tr> <td></td> <td></td> <td colspan="8" style="text-align: center;"> <table border="1" style="width: 100%; border-collapse: collapse; text-align: center;"> <tr> </tr></table></td></tr></table></td></tr></table></td></tr></table></td></tr></table></td></tr></table></td></tr></table></td></tr></table></td></tr></table> | | | | | | | | | | | | | | | | | | | | <table border="1" style="width: 100%; border-collapse: collapse; text-align: center;"> <tr> <td style="width: 10%;"></td> <td style="width: 10%;"></td> <td style="width: 10%;"></td> <td style="width: 10%;"></td> <td style="width: 10%;"></td> <td style="width: 10%;"></td> <td style="width: 10%;"></td> <td style="width: 10%;"></td> <td style="width: 10%;"></td> <td style="width: 10%;"></td> </tr> <tr> <td></td> <td></td> <td colspan="8" style="text-align: center;"> <table border="1" style="width: 100%; border-collapse: collapse; text-align: center;"> <tr> <td style="width: 10%;"></td> <td style="width: 10%;"></td> <td style="width: 10%;"></td> <td style="width: 10%;"></td> <td style="width: 10%;"></td> <td style="width: 10%;"></td> <td style="width: 10%;"></td> <td style="width: 10%;"></td> <td style="width: 10%;"></td> <td style="width: 10%;"></td> </tr> <tr> <td></td> <td></td> <td colspan="8" style="text-align: center;"> <table border="1" style="width: 100%; border-collapse: collapse; text-align: center;"> <tr> <td style="width: 10%;"></td> <td style="width: 10%;"></td> <td style="width: 10%;"></td> <td style="width: 10%;"></td> <td style="width: 10%;"></td> <td style="width: 10%;"></td> <td style="width: 10%;"></td> <td style="width: 10%;"></td> <td style="width: 10%;"></td> <td style="width: 10%;"></td> </tr> <tr> <td></td> <td></td> <td colspan="8" style="text-align: center;"> <table border="1" style="width: 100%; border-collapse: collapse; text-align: center;"> <tr> <td style="width: 10%;"></td> <td style="width: 10%;"></td> <td style="width: 10%;"></td> <td style="width: 10%;"></td> <td style="width: 10%;"></td> <td style="width: 10%;"></td> <td style="width: 10%;"></td> <td style="width: 10%;"></td> <td style="width: 10%;"></td> <td style="width: 10%;"></td> </tr> <tr> <td></td> <td></td> <td colspan="8" style="text-align: center;"> <table border="1" style="width: 100%; border-collapse: collapse; text-align: center;"> <tr> <td style="width: 10%;"></td> <td style="width: 10%;"></td> <td style="width: 10%;"></td> <td style="width: 10%;"></td> <td style="width: 10%;"></td> <td style="width: 10%;"></td> <td style="width: 10%;"></td> <td style="width: 10%;"></td> <td style="width: 10%;"></td> <td style="width: 10%;"></td> </tr> <tr> <td></td> <td></td> <td colspan="8" style="text-align: center;"> <table border="1" style="width: 100%; border-collapse: collapse; text-align: center;"> <tr> <td style="width: 10%;"></td> <td style="width: 10%;"></td> <td style="width: 10%;"></td> <td style="width: 10%;"></td> <td style="width: 10%;"></td> <td style="width: 10%;"></td> <td style="width: 10%;"></td> <td style="width: 10%;"></td> <td style="width: 10%;"></td> <td style="width: 10%;"></td> </tr> <tr> <td></td> <td></td> <td colspan="8" style="text-align: center;"> <table border="1" style="width: 100%; border-collapse: collapse; text-align: center;"> <tr> <td style="width: 10%;"></td> <td style="width: 10%;"></td> <td style="width: 10%;"></td> <td style="width: 10%;"></td> <td style="width: 10%;"></td> <td style="width: 10%;"></td> <td style="width: 10%;"></td> <td style="width: 10%;"></td> <td style="width: 10%;"></td> <td style="width: 10%;"></td> </tr> <tr> <td></td> <td></td> <td colspan="8" style="text-align: center;"> <table border="1" style="width: 100%; border-collapse: collapse; text-align: center;"> <tr> </tr></table></td></tr></table></td></tr></table></td></tr></table></td></tr></table></td></tr></table></td></tr></table></td></tr></table>
 | | | | | | | | | | | | | | | | | | | | <table border="1" style="width: 100%; border-collapse: collapse; text-align: center;"> <tr> <td style="width: 10%;"></td> <td style="width: 10%;"></td> <td style="width: 10%;"></td> <td style="width: 10%;"></td> <td style="width: 10%;"></td> <td style="width: 10%;"></td> <td style="width: 10%;"></td> <td style="width: 10%;"></td> <td style="width: 10%;"></td> <td style="width: 10%;"></td> </tr> <tr> <td></td> <td></td> <td colspan="8" style="text-align: center;"> <table border="1" style="width: 100%; border-collapse: collapse; text-align: center;"> <tr> <td style="width: 10%;"></td> <td style="width: 10%;"></td> <td style="width: 10%;"></td> <td style="width: 10%;"></td> <td style="width: 10%;"></td> <td style="width: 10%;"></td> <td style="width: 10%;"></td> <td style="width: 10%;"></td> <td style="width: 10%;"></td> <td style="width: 10%;"></td> </tr> <tr> <td></td> <td></td> <td colspan="8" style="text-align: center;"> <table border="1" style="width: 100%; border-collapse: collapse; text-align: center;"> <tr> <td style="width: 10%;"></td> <td style="width: 10%;"></td> <td style="width: 10%;"></td> <td style="width: 10%;"></td> <td style="width: 10%;"></td> <td style="width: 10%;"></td> <td style="width: 10%;"></td> <td style="width: 10%;"></td> <td style="width: 10%;"></td> <td style="width: 10%;"></td> </tr> <tr> <td></td> <td></td> <td colspan="8" style="text-align: center;"> <table border="1" style="width: 100%; border-collapse: collapse; text-align: center;"> <tr> <td style="width: 10%;"></td> <td style="width: 10%;"></td> <td style="width: 10%;"></td> <td style="width: 10%;"></td> <td style="width: 10%;"></td> <td style="width: 10%;"></td> <td style="width: 10%;"></td> <td style="width: 10%;"></td> <td style="width: 10%;"></td> <td style="width: 10%;"></td> </tr> <tr> <td></td> <td></td> <td colspan="8" style="text-align: center;"> <table border="1" style="width: 100%; border-collapse: collapse; text-align: center;"> <tr> <td style="width: 10%;"></td> <td style="width: 10%;"></td> <td style="width: 10%;"></td> <td style="width: 10%;"></td> <td style="width: 10%;"></td> <td style="width: 10%;"></td> <td style="width: 10%;"></td> <td style="width: 10%;"></td> <td style="width: 10%;"></td> <td style="width: 10%;"></td> </tr> <tr> <td></td> <td></td> <td colspan="8" style="text-align: center;"> <table border="1" style="width: 100%; border-collapse: collapse; text-align: center;"> <tr> <td style="width: 10%;"></td> <td style="width: 10%;"></td> <td style="width: 10%;"></td> <td style="width: 10%;"></td> <td style="width: 10%;"></td> <td style="width: 10%;"></td> <td style="width: 10%;"></td> <td style="width: 10%;"></td> <td style="width: 10%;"></td> <td style="width: 10%;"></td> </tr> <tr> <td></td> <td></td> <td colspan="8" style="text-align: center;"> <table border="1" style="width: 100%; border-collapse: collapse; text-align: center;"> <tr> </tr></table></td></tr></table></td></tr></table></td></tr></table></td></tr></table></td></tr></table></td></tr></table> | | | | | | | | | | | | | | | | | | | | <table border="1" style="width: 100%; border-collapse: collapse; text-align: center;"> <tr> <td style="width: 10%;"></td> <td style="width: 10%;"></td> <td style="width: 10%;"></td> <td style="width: 10%;"></td> <td style="width: 10%;"></td> <td style="width: 10%;"></td> <td style="width: 10%;"></td> <td style="width: 10%;"></td> <td style="width: 10%;"></td> <td style="width: 10%;"></td> </tr> <tr> <td></td> <td></td> <td colspan="8" style="text-align: center;"> <table border="1" style="width: 100%; border-collapse: collapse; text-align: center;"> <tr> <td style="width: 10%;"></td> <td style="width: 10%;"></td> <td style="width: 10%;"></td> <td style="width: 10%;"></td> <td style="width: 10%;"></td> <td style="width: 10%;"></td> <td style="width: 10%;"></td> <td style="width: 10%;"></td> <td style="width: 10%;"></td> <td style="width: 10%;"></td> </tr> <tr> <td></td> <td></td> <td colspan="8" style="text-align: center;"> <table border="1" style="width: 100%; border-collapse: collapse; text-align: center;"> <tr> <td style="width: 10%;"></td> <td style="width: 10%;"></td> <td style="width: 10%;"></td> <td style="width: 10%;"></td> <td style="width: 10%;"></td> <td style="width: 10%;"></td> <td style="width: 10%;"></td> <td style="width: 10%;"></td> <td style="width: 10%;"></td> <td style="width: 10%;"></td> </tr> <tr> <td></td> <td></td> <td colspan="8" style="text-align: center;"> <table border="1" style="width: 100%;
border-collapse: collapse; text-align: center;"> <tr> <td style="width: 10%;"></td> <td style="width: 10%;"></td> <td style="width: 10%;"></td> <td style="width: 10%;"></td> <td style="width: 10%;"></td> <td style="width: 10%;"></td> <td style="width: 10%;"></td> <td style="width: 10%;"></td> <td style="width: 10%;"></td> <td style="width: 10%;"></td> </tr> <tr> <td></td> <td></td> <td colspan="8" style="text-align: center;"> <table border="1" style="width: 100%; border-collapse: collapse; text-align: center;"> <tr> <td style="width: 10%;"></td> <td style="width: 10%;"></td> <td style="width: 10%;"></td> <td style="width: 10%;"></td> <td style="width: 10%;"></td> <td style="width: 10%;"></td> <td style="width: 10%;"></td> <td style="width: 10%;"></td> <td style="width: 10%;"></td> <td style="width: 10%;"></td> </tr> <tr> <td></td> <td></td> <td colspan="8" style="text-align: center;"> <table border="1" style="width: 100%; border-collapse: collapse; text-align: center;"> <tr> </tr></table></td></tr></table></td></tr></table></td></tr></table></td></tr></table></td></tr></table> | | | | | | | | | | | | | | | | | | | | <table border="1" style="width: 100%; border-collapse: collapse; text-align: center;"> <tr> <td style="width: 10%;"></td> <td style="width: 10%;"></td> <td style="width: 10%;"></td> <td style="width: 10%;"></td> <td style="width: 10%;"></td> <td style="width: 10%;"></td> <td style="width: 10%;"></td> <td style="width: 10%;"></td> <td style="width: 10%;"></td> <td style="width: 10%;"></td> </tr> <tr> <td></td> <td></td> <td colspan="8" style="text-align: center;"> <table border="1" style="width: 100%; border-collapse: collapse; text-align: center;"> <tr> <td style="width: 10%;"></td> <td style="width: 10%;"></td> <td style="width: 10%;"></td> <td style="width: 10%;"></td> <td style="width: 10%;"></td> <td style="width: 10%;"></td> <td style="width: 10%;"></td> <td style="width: 10%;"></td> <td style="width: 10%;"></td> <td style="width: 10%;"></td> </tr> <tr> <td></td> <td></td> <td colspan="8" style="text-align: center;"> <table border="1" style="width: 100%; border-collapse: collapse; text-align: center;"> <tr> <td style="width: 10%;"></td> <td style="width: 10%;"></td> <td style="width: 10%;"></td> <td style="width: 10%;"></td> <td style="width: 10%;"></td> <td style="width: 10%;"></td> <td style="width: 10%;"></td> <td style="width: 10%;"></td> <td style="width: 10%;"></td> <td style="width: 10%;"></td> </tr> <tr> <td></td> <td></td> <td colspan="8" style="text-align: center;"> <table border="1" style="width: 100%; border-collapse: collapse; text-align: center;"> <tr> <td style="width: 10%;"></td> <td style="width: 10%;"></td> <td style="width: 10%;"></td> <td style="width: 10%;"></td> <td style="width: 10%;"></td> <td style="width: 10%;"></td> <td style="width: 10%;"></td> <td style="width: 10%;"></td> <td style="width: 10%;"></td> <td style="width: 10%;"></td> </tr> <tr> <td></td> <td></td> <td colspan="8" style="text-align: center;"> <table border="1" style="width: 100%; border-collapse: collapse; text-align: center;"> <tr> </tr></table></td></tr></table></td></tr></table></td></tr></table></td></tr></table> | | | | | | | | | | | | | | | | | | | | <table border="1" style="width: 100%; border-collapse: collapse; text-align: center;"> <tr> <td style="width: 10%;"></td> <td style="width: 10%;"></td> <td style="width: 10%;"></td> <td style="width: 10%;"></td> <td style="width: 10%;"></td> <td style="width: 10%;"></td> <td style="width: 10%;"></td> <td style="width: 10%;"></td> <td style="width: 10%;"></td> <td style="width: 10%;"></td> </tr> <tr> <td></td> <td></td> <td colspan="8" style="text-align: center;"> <table border="1" style="width: 100%; border-collapse: collapse; text-align: center;"> <tr> <td style="width: 10%;"></td> <td style="width: 10%;"></td> <td style="width: 10%;"></td> <td style="width: 10%;"></td> <td style="width: 10%;"></td> <td style="width: 10%;"></td> <td style="width: 10%;"></td> <td style="width: 10%;"></td> <td style="width: 10%;"></td> <td style="width: 10%;"></td> </tr> <tr> <td></td> <td></td> <td
colspan="8" style="text-align: center;"> <table border="1" style="width: 100%; border-collapse: collapse; text-align: center;"> <tr> <td style="width: 10%;"></td> <td style="width: 10%;"></td> <td style="width: 10%;"></td> <td style="width: 10%;"></td> <td style="width: 10%;"></td> <td style="width: 10%;"></td> <td style="width: 10%;"></td> <td style="width: 10%;"></td> <td style="width: 10%;"></td> <td style="width: 10%;"></td> </tr> <tr> <td></td> <td></td> <td colspan="8" style="text-align: center;"> <table border="1" style="width: 100%; border-collapse: collapse; text-align: center;"> <tr> </tr></table></td></tr></table></td></tr></table></td></tr></table> | | | | | | | | | | | | | | | | | | | | <table border="1" style="width: 100%; border-collapse: collapse; text-align: center;"> <tr> <td style="width: 10%;"></td> <td style="width: 10%;"></td> <td style="width: 10%;"></td> <td style="width: 10%;"></td> <td style="width: 10%;"></td> <td style="width: 10%;"></td> <td style="width: 10%;"></td> <td style="width: 10%;"></td> <td style="width: 10%;"></td> <td style="width: 10%;"></td> </tr> <tr> <td></td> <td></td> <td colspan="8" style="text-align: center;"> <table border="1" style="width: 100%; border-collapse: collapse; text-align: center;"> <tr> <td style="width: 10%;"></td> <td style="width: 10%;"></td> <td style="width: 10%;"></td> <td style="width: 10%;"></td> <td style="width: 10%;"></td> <td style="width: 10%;"></td> <td style="width: 10%;"></td> <td style="width: 10%;"></td> <td style="width: 10%;"></td> <td style="width: 10%;"></td> </tr> <tr> <td></td> <td></td> <td colspan="8" style="text-align: center;"> <table border="1" style="width: 100%; border-collapse: collapse; text-align: center;"> <tr> </tr></table></td></tr></table></td></tr></table> | | | | | | | | | | | | | | | | | | | | <table border="1" style="width: 100%; border-collapse: collapse; text-align: center;"> <tr> <td style="width: 10%;"></td> <td style="width: 10%;"></td> <td style="width: 10%;"></td> <td style="width: 10%;"></td> <td style="width: 10%;"></td> <td style="width: 10%;"></td> <td style="width: 10%;"></td> <td style="width: 10%;"></td> <td style="width: 10%;"></td> <td style="width: 10%;"></td> </tr> <tr> <td></td> <td></td> <td colspan="8" style="text-align: center;"> <table border="1" style="width: 100%; border-collapse: collapse; text-align: center;"> <tr> </tr></table></td></tr></table>
 | | | | | | | | | | | | | | | | | | | | <table border="1" style="width: 100%; border-collapse: collapse; text-align: center;"> <tr> </tr></table> | | | | | | | | | | | | | | | | | | | | | | | | | | | | | | | | | | | | | | | | | | | | | | | | | | | | | | | | | | | |
 | | | | | | | | | | | | | | | | | | | | | | | | | | | | | | | | | | | | | | | | | | | | | | | | | | | | | | | | | | | | | | | | | | | |
| | |

 | | | | | | | | | | | | | | | | | | | |

 | | | | | | | | | | | | | | | | | | | |

 | | | | | | | | | | | | | | | | | | | |

 | | | | | | | | | | | | | | | | | | | |

 | | | | | | | | | | | | | | | | | | | |

 | | | | | | | | | | | | | | | | | | | |

 | | | | | | | | | | | | | | | | | | | |

 | | | | | | | | | | | | | | | | | | | |

 | | | | | | | | | | | | | | | | | | | |

 | | | | | | | | | | | | | | | | | | | |

 | | | | | | | | | | | | | | | | | | | |

 | | | | | | | | | | | | | | | | | | | |

 | | | | | | | | | | | | | | | | | | | |

 | | | | | | | | | | | | | | | | | | | |

 | | | | | | | | | | | | | | | | | | | |

 | | | | | | | | | | | | | | | | | | | |

 | | | | | | | | | | | | | | | | | | | |

 | | | | | | | | | | | | | | | | | | | |

 | | | | | | | | | | | | | | | | | | | |

 | | | | | | | | | | | | | | | | | | | |

 | | | | | | | | | | | | | | | | | | | |

 | | | | | | | | | | | | | | | | | | | |

 | | | | | | | | | | | | | | | | | | | |

 | | | | | | | | | | | | | | | | | | | |

 | | | | | | | | | | | | | | | | | | | |

 | | | | | | | | | | | | | | | | | | | |

 | | | | | | | | | | | | | | | | | | | |

 | | | | | | | | | | | | | | | | | | | |
 | | | | | | | | | | | | | | | | | | | |

 | | | | | | | | | | | | | | | | | | | |

 | | | | | | | | | | | | | | | | | | | |
 | | | | | | | | | | | | | | | | | | | |

 | | | | | | | | | | | | | | | | | | | |

 | | | | | | | | | | | | | | | | | | | |
 | | | | | | | | | | | | | | | | | | | |
 | | | | | | | | | | | | | | | | | | | |

 | | | | | | | | | | | | | | | | | | | |
 | | | | | | | | | | | | | | | | | | | |
 | | | | | | | | | | | | | | | | | | | |

 | | | | | | | | | | | | | | | | | | | | | | | | | | | | | | | | | | | | | | | | | | | | | | | | | | | | | | | | | | | | | | | | | | | | | | | | | | | | | | | | | | | | | | | | | | | | | | | | | | | |
 | | | | | | | | | | | | | | | | | | | |
 | | | | | | | | | | | | | | | | | | | |
 | | | | | | | | | | | | | | | | | | | |
 | | | | | | | | | | | | | | | | | | | |
 | | | | | | | | | | | | | | | | | | | |
 | | | | | | | | | | | | | | | | | | | |
 | | | | | | | | | | | | | | | | | | | |
 | | | | | | | | | | | | | | | | | | | |
 | | | | | | | | | | | | | | | | | | | | | | | | | | | | | | | | | | | | | | | |
 | | | | | | | | | | | | | | | | | | | |
 | | | | | | | | | | | | | | | | | | | | | | | | | | | | | | | | | | | | | | | |
 | | | | | | | | | | | | | | | | | | | | | | | | | | | | | | | | | | | | | | | |
 | | | | | | | | | | | | | | | | | | | | | | | | | | | | | | | | | | | | | | | |
 | | | | | | | | | | | | | | | | | | | | | | | | | | | | | | | | | | | | | | | | | | | | | | | | | | | | | | | | | | | | | | | | | | | | | | | | | | | | | | | | | | | | | | | | | | | | | | | | | | | |
 | | | | | | | | | | | | | | | | | | | | | | | | | | | | | | | | | | | | | | | | | | | | | | | |
| | | <table border="1" style="width: 100%; border-collapse: collapse; text-align: center;"> <tr> <td style="width: 10%;"></td> <td style="width: 10%;"></td> <td style="width: 10%;"></td> <td style="width: 10%;"></td> <td style="width: 10%;"></td> <td style="width: 10%;"></td> <td style="width: 10%;"></td> <td style="width: 10%;"></td> <td style="width: 10%;"></td> <td style="width: 10%;"></td> </tr> <tr> <td></td> <td></td> <td colspan="8" style="text-align: center;"> <table border="1" style="width: 100%; border-collapse: collapse; text-align: center;"> <tr> <td style="width: 10%;"></td> <td style="width: 10%;"></td> <td style="width: 10%;"></td> <td style="width: 10%;"></td> <td style="width: 10%;"></td> <td style="width: 10%;"></td> <td style="width: 10%;"></td> <td style="width: 10%;"></td> <td style="width: 10%;"></td> <td style="width: 10%;"></td> </tr> <tr> <td></td> <td></td> <td colspan="8" style="text-align: center;"> <table border="1" style="width: 100%; border-collapse: collapse; text-align: center;"> <tr> <td style="width: 10%;"></td> <td style="width: 10%;"></td> <td style="width: 10%;"></td> <td style="width: 10%;"></td> <td style="width: 10%;"></td> <td style="width: 10%;"></td> <td style="width: 10%;"></td> <td style="width: 10%;"></td> <td style="width: 10%;"></td> <td style="width: 10%;"></td> </tr> <tr> <td></td> <td></td> <td colspan="8" style="text-align: center;"> <table border="1" style="width: 100%; border-collapse: collapse; text-align: center;"> <tr> <td style="width: 10%;"></td> <td style="width: 10%;"></td> <td style="width: 10%;"></td> <td style="width: 10%;"></td> <td style="width: 10%;"></td> <td style="width: 10%;"></td> <td style="width: 10%;"></td> <td style="width: 10%;"></td> <td style="width: 10%;"></td> <td style="width: 10%;"></td> </tr> <tr> <td></td> <td></td> <td colspan="8" style="text-align: center;"> <table border="1" style="width: 100%; border-collapse: collapse; text-align: center;"> <tr> <td style="width: 10%;"></td> <td style="width: 10%;"></td> <td style="width: 10%;"></td> <td style="width: 10%;"></td> <td style="width: 10%;"></td> <td style="width: 10%;"></td> <td style="width: 10%;"></td> <td style="width: 10%;"></td> <td style="width: 10%;"></td> <td style="width: 10%;"></td> </tr> <tr> <td></td> <td></td> <td colspan="8" style="text-align: center;"> <table border="1" style="width: 100%; border-collapse: collapse; text-align: center;"> <tr> <td style="width: 10%;"></td> <td style="width: 10%;"></td> <td style="width: 10%;"></td> <td style="width: 10%;"></td> <td style="width: 10%;"></td> <td style="width: 10%;"></td> <td style="width: 10%;"></td> <td style="width: 10%;"></td> <td style="width: 10%;"></td> <td style="width: 10%;"></td> </tr> <tr> <td></td> <td></td> <td colspan="8" style="text-align: center;"> <table border="1" style="width: 100%; border-collapse: collapse; text-align: center;"> <tr> <td style="width: 10%;"></td> <td style="width: 10%;"></td> <td style="width: 10%;"></td> <td style="width: 10%;"></td> <td style="width: 10%;"></td> <td style="width: 10%;"></td> <td style="width: 10%;"></td> <td style="width: 10%;"></td> <td style="width: 10%;"></td> <td style="width: 10%;"></td> </tr> <tr> <td></td> <td></td> <td colspan="8" style="text-align: center;"> <table border="1" style="width: 100%; border-collapse: collapse; text-align: center;"> <tr> <td style="width: 10%;"></td> <td style="width: 10%;"></td> <td style="width: 10%;"></td> <td style="width: 10%;"></td> <td style="width: 10%;"></td> <td style="width: 10%;"></td> <td style="width: 10%;"></td> <td style="width: 10%;"></td> <td style="width: 10%;"></td> <td style="width: 10%;"></td> </tr> <tr> <td></td> <td></td> <td colspan="8" style="text-align: center;"> <table border="1" style="width: 100%; border-collapse: collapse; text-align: center;"> <tr> <td style="width: 10%;"></td> <td style="width: 10%;"></td> <td style="width: 10%;"></td> <td style="width: 10%;"></td> <td style="width: 10%;"></td> <td style="width: 10%;"></td> <td style="width: 10%;"></td> <td style="width: 10%;"></td> <td style="width: 10%;"></td> <td style="width: 10%;"></td> </tr> <tr> <td></td> <td></td> <td colspan="8" style="text-align: center;"> <table border="1" style="width: 100%; border-collapse: collapse; text-align: center;"> <tr> <td style="width: 10%;"></td> <td style="width: 10%;"></td> <td style="width: 10%;"></td> <td style="width: 10%;"></td> <td style="width: 10%;"></td> <td style="width: 10%;"></td> <td style="width: 10%;"></td> <td style="width: 10%;"></td> <td style="width: 10%;"></td> <td style="width: 10%;"></td> </tr> <tr> <td></td> <td></td> <td colspan="8" style="text-align: center;"> <table border="1" style="width: 100%; border-collapse: collapse; text-align: center;"> <tr> <td style="width: 10%;"></td> <td style="width: 10%;"></td> <td style="width: 10%;"></td> <td style="width: 10%;"></td> <td style="width: 10%;"></td> <td style="width: 10%;"></td> <td style="width: 10%;"></td> <td style="width: 10%;"></td> <td style="width: 10%;"></td> <td style="width: 10%;"></td> </tr> <tr> <td></td> <td></td> <td colspan="8" style="text-align: center;"> <table border="1" style="width: 100%; border-collapse: collapse; text-align: center;"> <tr> <td style="width: 10%;"></td> <td style="width: 10%;"></td> <td style="width: 10%;"></td> <td style="width: 10%;"></td> <td style="width: 10%;"></td> <td style="width: 10%;"></td> <td style="width: 10%;"></td> <td style="width: 10%;"></td> <td style="width: 10%;"></td> <td style="width: 10%;"></td> </tr> <tr> <td></td> <td></td> <td colspan="8" style="text-align: center;"> <table border="1" style="width: 100%; border-collapse: collapse; text-align: center;"> <tr> <td style="width: 10%;"></td> <td style="width: 10%;"></td> <td style="width: 10%;"></td> <td style="width: 10%;"></td> <td style="width: 10%;"></td> <td style="width: 10%;"></td> <td style="width: 10%;"></td> <td style="width: 10%;"></td> <td style="width: 10%;"></td> <td style="width: 10%;"></td> </tr> <tr> <td></td> <td></td> <td colspan="8" style="text-align: center;"> <table border="1" style="width: 100%; border-collapse: collapse; text-align: center;"> <tr> <td style="width: 10%;"></td> <td style="width: 10%;"></td> <td style="width: 10%;"></td> <td style="width: 10%;"></td> <td style="width: 10%;"></td> <td style="width: 10%;"></td> <td style="width: 10%;"></td> <td style="width: 10%;"></td> <td style="width: 10%;"></td> <td style="width: 10%;"></td> </tr> <tr> <td></td> <td></td> <td colspan="8" style="text-align: center;"> <table border="1" style="width: 100%; border-collapse: collapse; text-align: center;"> <tr> <td style="width: 10%;"></td> <td style="width: 10%;"></td> <td style="width: 10%;"></td> <td style="width: 10%;"></td> <td style="width: 10%;"></td> <td style="width: 10%;"></td> <td style="width: 10%;"></td> <td style="width: 10%;"></td> <td style="width: 10%;"></td> <td style="width: 10%;"></td> </tr> <tr> <td></td> <td></td> <td colspan="8" style="text-align: center;"> <table border="1" style="width: 100%; border-collapse: collapse; text-align: center;"> <tr> <td style="width: 10%;"></td> <td style="width: 10%;"></td> <td style="width: 10%;"></td> <td style="width: 10%;"></td> <td style="width: 10%;"></td> <td style="width: 10%;"></td> <td style="width: 10%;"></td> <td style="width: 10%;"></td> <td style="width: 10%;"></td> <td style="width: 10%;"></td> </tr> <tr> <td></td> <td></td> <td colspan="8" style="text-align: center;"> <table border="1" style="width: 100%; border-collapse: collapse; text-align: center;"> <tr> <td style="width: 10%;"></td> <td style="width: 10%;"></td> <td style="width: 10%;"></td> <td style="width: 10%;"></td> <td style="width: 10%;"></td> <td style="width: 10%;"></td> <td style="width: 10%;"></td> <td style="width: 10%;"></td> <td style="width: 10%;"></td> <td style="width: 10%;"></td> </tr> <tr> <td></td> <td></td> <td colspan="8" style="text-align: center;"> <table border="1" style="width: 100%; border-collapse: collapse; text-align: center;"> <tr> <td style="width: 10%;"></td> <td style="width: 10%;"></td> <td style="width: 10%;"></td> <td style="width: 10%;"></td> <td style="width: 10%;"></td> <td style="width: 10%;"></td> <td style="width: 10%;"></td> <td style="width: 10%;"></td> <td style="width: 10%;"></td> <td style="width: 10%;"></td> </tr> <tr> <td></td> <td></td> <td colspan="8" style="text-align: center;"> <table border="1" style="width: 100%; border-collapse: collapse; text-align: center;"> <tr> <td style="width: 10%;"></td> <td style="width: 10%;"></td> <td style="width: 10%;"></td> <td style="width: 10%;"></td> <td style="width: 10%;"></td> <td style="width: 10%;"></td> <td style="width: 10%;"></td> <td style="width: 10%;"></td> <td style="width: 10%;"></td> <td style="width: 10%;"></td> </tr> <tr> <td></td> <td></td> <td colspan="8" style="text-align: center;"> <table border="1" style="width: 100%; border-collapse: collapse; text-align: center;"> <tr> <td style="width: 10%;"></td> <td style="width: 10%;"></td> <td style="width: 10%;"></td> <td style="width: 10%;"></td> <td style="width: 10%;"></td> <td style="width: 10%;"></td> <td style="width: 10%;"></td> <td style="width: 10%;"></td> <td style="width: 10%;"></td> <td style="width: 10%;"></td> </tr> <tr> <td></td> <td></td> <td colspan="8" style="text-align: center;"> <table border="1" style="width: 100%; border-collapse: collapse; text-align: center;"> <tr> <td style="width: 10%;"></td> <td style="width: 10%;"></td> <td style="width: 10%;"></td> <td style="width: 10%;"></td> <td style="width: 10%;"></td> <td style="width: 10%;"></td> <td style="width: 10%;"></td> <td style="width: 10%;"></td> <td style="width: 10%;"></td> <td style="width: 10%;"></td> </tr> <tr> <td></td> <td></td> <td colspan="8" style="text-align: center;"> <table border="1" style="width: 100%; border-collapse: collapse; text-align: center;"> <tr> <td style="width: 10%;"></td> <td style="width: 10%;"></td> <td
style="width: 10%;"></td> <td style="width: 10%;"></td> <td style="width: 10%;"></td> <td style="width: 10%;"></td> <td style="width: 10%;"></td> <td style="width: 10%;"></td> <td style="width: 10%;"></td> <td style="width: 10%;"></td> </tr> <tr> <td></td> <td></td> <td colspan="8" style="text-align: center;"> <table border="1" style="width: 100%; border-collapse: collapse; text-align: center;"> <tr> <td style="width: 10%;"></td> <td style="width: 10%;"></td> <td style="width: 10%;"></td> <td style="width: 10%;"></td> <td style="width: 10%;"></td> <td style="width: 10%;"></td> <td style="width: 10%;"></td> <td style="width: 10%;"></td> <td style="width: 10%;"></td> <td style="width: 10%;"></td> </tr> <tr> <td></td> <td></td> <td colspan="8" style="text-align: center;"> <table border="1" style="width: 100%; border-collapse: collapse; text-align: center;"> <tr> <td style="width: 10%;"></td> <td style="width: 10%;"></td> <td style="width: 10%;"></td> <td style="width: 10%;"></td> <td style="width: 10%;"></td> <td style="width: 10%;"></td> <td style="width: 10%;"></td> <td style="width: 10%;"></td> <td style="width: 10%;"></td> <td style="width: 10%;"></td> </tr> <tr> <td></td> <td></td> <td colspan="8" style="text-align: center;"> <table border="1" style="width: 100%; border-collapse: collapse; text-align: center;"> <tr> <td style="width: 10%;"></td> <td style="width: 10%;"></td> <td style="width: 10%;"></td> <td style="width: 10%;"></td> <td style="width: 10%;"></td> <td style="width: 10%;"></td> <td style="width: 10%;"></td> <td style="width: 10%;"></td> <td style="width: 10%;"></td> <td style="width: 10%;"></td> </tr> <tr> <td></td> <td></td> <td colspan="8" style="text-align: center;"> <table border="1" style="width: 100%; border-collapse: collapse; text-align: center;"> <tr> <td style="width: 10%;"></td> <td style="width: 10%;"></td> <td style="width: 10%;"></td> <td style="width: 10%;"></td> <td style="width: 10%;"></td> <td style="width: 10%;"></td> <td style="width: 10%;"></td> <td style="width: 10%;"></td> <td style="width: 10%;"></td> <td style="width: 10%;"></td> </tr> <tr> <td></td> <td></td> <td colspan="8" style="text-align: center;"> <table border="1" style="width: 100%; border-collapse: collapse; text-align: center;"> <tr> <td style="width: 10%;"></td> <td style="width: 10%;"></td> <td style="width: 10%;"></td> <td style="width: 10%;"></td> <td style="width: 10%;"></td> <td style="width: 10%;"></td> <td style="width: 10%;"></td> <td style="width: 10%;"></td> <td style="width: 10%;"></td> <td style="width: 10%;"></td> </tr> <tr> <td></td> <td></td> <td colspan="8" style="text-align: center;"> <table border="1" style="width: 100%; border-collapse: collapse; text-align: center;"> <tr> <td style="width: 10%;"></td> <td style="width: 10%;"></td> <td style="width: 10%;"></td> <td style="width: 10%;"></td> <td style="width: 10%;"></td> <td style="width: 10%;"></td> <td style="width: 10%;"></td> <td style="width: 10%;"></td> <td style="width: 10%;"></td> <td style="width: 10%;"></td> </tr> <tr> <td></td> <td></td> <td colspan="8" style="text-align: center;"> <table border="1" style="width: 100%; border-collapse: collapse; text-align: center;"> <tr> <td style="width: 10%;"></td> <td style="width: 10%;"></td> <td style="width: 10%;"></td> <td style="width: 10%;"></td> <td style="width: 10%;"></td> <td style="width: 10%;"></td> <td style="width: 10%;"></td> <td style="width: 10%;"></td> <td style="width: 10%;"></td> <td style="width: 10%;"></td> </tr> <tr> <td></td> <td></td> <td colspan="8" style="text-align: center;"> <table border="1" style="width: 100%; border-collapse: collapse; text-align: center;"> <tr> <td style="width: 10%;"></td> <td style="width: 10%;"></td> <td style="width: 10%;"></td> <td style="width: 10%;"></td> <td style="width: 10%;"></td> <td style="width: 10%;"></td> <td style="width: 10%;"></td> <td style="width: 10%;"></td> <td style="width: 10%;"></td> <td style="width: 10%;"></td> </tr> <tr> <td></td> <td></td> <td colspan="8" style="text-align: center;"> <table border="1" style="width: 100%; border-collapse: collapse; text-align: center;"> <tr> <td style="width: 10%;"></td> <td style="width: 10%;"></td> <td style="width: 10%;"></td> <td style="width: 10%;"></td> <td style="width: 10%;"></td> <td style="width: 10%;"></td> <td style="width: 10%;"></td> <td style="width: 10%;"></td> <td style="width: 10%;"></td> <td style="width: 10%;"></td> </tr> <tr> <td></td> <td></td> <td colspan="8" style="text-align: center;"> <table border="1" style="width: 100%; border-collapse: collapse; text-align: center;"> <tr> <td style="width: 10%;"></td> <td style="width: 10%;"></td> <td style="width: 10%;"></td> <td style="width: 10%;"></td> <td style="width: 10%;"></td> <td style="width: 10%;"></td> <td style="width: 10%;"></td> <td style="width: 10%;"></td> <td style="width: 10%;"></td> <td style="width: 10%;"></td> </tr> <tr> <td></td> <td></td> <td colspan="8" style="text-align: center;"> <table border="1" style="width: 100%; border-collapse: collapse; text-align: center;"> <tr> <td style="width: 10%;"></td> <td style="width: 10%;"></td> <td style="width: 10%;"></td> <td style="width: 10%;"></td> <td style="width: 10%;"></td> <td style="width: 10%;"></td> <td style="width: 10%;"></td> <td style="width: 10%;"></td> <td style="width: 10%;"></td> <td style="width: 10%;"></td> </tr> <tr> <td></td> <td></td> <td colspan="8" style="text-align: center;"> <table border="1" style="width: 100%; border-collapse: collapse; text-align: center;"> <tr> <td style="width: 10%;"></td> <td style="width: 10%;"></td> <td style="width: 10%;"></td> <td style="width: 10%;"></td> <td style="width: 10%;"></td> <td style="width: 10%;"></td> <td style="width: 10%;"></td> <td style="width: 10%;"></td> <td style="width: 10%;"></td> <td style="width: 10%;"></td> </tr> <tr> <td></td> <td></td> <td colspan="8" style="text-align: center;"> <table border="1" style="width: 100%; border-collapse: collapse; text-align: center;"> <tr> <td style="width: 10%;"></td> <td style="width: 10%;"></td> <td style="width: 10%;"></td> <td style="width: 10%;"></td> <td style="width: 10%;"></td> <td style="width: 10%;"></td> <td style="width: 10%;"></td> <td style="width: 10%;"></td> <td style="width: 10%;"></td> <td style="width: 10%;"></td> </tr> <tr> <td></td> <td></td> <td colspan="8" style="text-align: center;"> <table border="1" style="width: 100%; border-collapse: collapse; text-align: center;"> <tr> <td style="width: 10%;"></td> <td style="width: 10%;"></td> <td style="width: 10%;"></td> <td style="width: 10%;"></td> <td style="width: 10%;"></td> <td style="width: 10%;"></td> <td style="width: 10%;"></td> <td style="width: 10%;"></td> <td style="width: 10%;"></td> <td style="width: 10%;"></td> </tr> <tr> <td></td> <td></td> <td colspan="8" style="text-align: center;"> <table border="1" style="width: 100%; border-collapse: collapse; text-align: center;"> <tr> <td style="width: 10%;"></td> <td style="width: 10%;"></td> <td style="width: 10%;"></td> <td style="width: 10%;"></td> <td style="width: 10%;"></td> <td style="width: 10%;"></td> <td style="width: 10%;"></td> <td style="width: 10%;"></td> <td style="width: 10%;"></td> <td style="width: 10%;"></td> </tr> <tr> <td></td> <td></td> <td colspan="8" style="text-align: center;"> <table border="1" style="width: 100%; border-collapse: collapse; text-align: center;"> <tr> <td style="width: 10%;"></td> <td style="width: 10%;"></td> <td style="width: 10%;"></td> <td style="width: 10%;"></td> <td style="width: 10%;"></td> <td style="width: 10%;"></td> <td style="width: 10%;"></td> <td style="width: 10%;"></td> <td style="width: 10%;"></td> <td style="width: 10%;"></td> </tr> <tr> <td></td> <td></td> <td colspan="8" style="text-align: center;"> <table border="1" style="width: 100%; border-collapse: collapse; text-align: center;"> <tr> <td style="width: 10%;"></td> <td style="width: 10%;"></td> <td style="width: 10%;"></td> <td style="width: 10%;"></td> <td style="width: 10%;"></td> <td style="width: 10%;"></td> <td style="width: 10%;"></td> <td style="width: 10%;"></td> <td style="width: 10%;"></td> <td style="width: 10%;"></td> </tr> <tr> <td></td> <td></td> <td colspan="8" style="text-align: center;"> <table border="1" style="width: 100%; border-collapse: collapse; text-align: center;"> <tr> <td style="width: 10%;"></td> <td style="width: 10%;"></td> <td style="width: 10%;"></td> <td style="width: 10%;"></td> <td style="width: 10%;"></td> <td style="width: 10%;"></td> <td style="width: 10%;"></td> <td style="width: 10%;"></td> <td style="width: 10%;"></td> <td style="width: 10%;"></td> </tr> <tr> <td></td> <td></td> <td colspan="8" style="text-align: center;"> <table border="1" style="width: 100%; border-collapse: collapse; text-align: center;"> <tr> <td style="width: 10%;"></td> <td style="width: 10%;"></td> <td style="width: 10%;"></td> <td style="width: 10%;"></td> <td style="width: 10%;"></td> <td style="width: 10%;"></td> <td style="width: 10%;"></td> <td style="width: 10%;"></td> <td style="width: 10%;"></td> <td style="width: 10%;"></td> </tr> <tr> <td></td> <td></td> <td colspan="8" style="text-align: center;"> <table border="1" style="width: 100%; border-collapse: collapse; text-align: center;"> <tr> <td style="width: 10%;"></td> <td style="width: 10%;"></td> <td style="width: 10%;"></td> <td style="width: 10%;"></td> <td style="width: 10%;"></td> <td style="width: 10%;"></td> <td style="width: 10%;"></td> <td style="width: 10%;"></td> <td style="width: 10%;"></td> <td style="width: 10%;"></td> </tr> <tr> <td></td> <td></td> <td colspan="8" style="text-align: center;"> <table border="1" style="width: 100%; border-collapse: collapse; text-align: center;"> <tr> <td style="width: 10%;"></td> <td style="width: 10%;"></td> <td style="width: 10%;"></td> <td style="width: 10%;"></td> <td style="width: 10%;"></td> <td style="width: 10%;"></td> <td style="width: 10%;"></td> <td style="width:
10%;"></td> <td style="width: 10%;"></td> <td style="width: 10%;"></td> </tr> <tr> <td></td> <td></td> <td colspan="8" style="text-align: center;"> <table border="1" style="width: 100%; border-collapse: collapse; text-align: center;"> <tr> <td style="width: 10%;"></td> <td style="width: 10%;"></td> <td style="width: 10%;"></td> <td style="width: 10%;"></td> <td style="width: 10%;"></td> <td style="width: 10%;"></td> <td style="width: 10%;"></td> <td style="width: 10%;"></td> <td style="width: 10%;"></td> <td style="width: 10%;"></td> </tr> <tr> <td></td> <td></td> <td colspan="8" style="text-align: center;"> <table border="1" style="width: 100%; border-collapse: collapse; text-align: center;"> <tr> <td style="width: 10%;"></td> <td style="width: 10%;"></td> <td style="width: 10%;"></td> <td style="width: 10%;"></td> <td style="width: 10%;"></td> <td style="width: 10%;"></td> <td style="width: 10%;"></td> <td style="width: 10%;"></td> <td style="width: 10%;"></td> <td style="width: 10%;"></td> </tr> <tr> <td></td> <td></td> <td colspan="8" style="text-align: center;"> <table border="1" style="width: 100%; border-collapse: collapse; text-align: center;"> <tr> <td style="width: 10%;"></td> <td style="width: 10%;"></td> <td style="width: 10%;"></td> <td style="width: 10%;"></td> <td style="width: 10%;"></td> <td style="width: 10%;"></td> <td style="width: 10%;"></td> <td style="width: 10%;"></td> <td style="width: 10%;"></td> <td style="width: 10%;"></td> </tr> <tr> <td></td> <td></td> <td colspan="8" style="text-align: center;"> <table border="1" style="width: 100%; border-collapse: collapse; text-align: center;"> <tr> <td style="width: 10%;"></td> <td style="width: 10%;"></td> <td style="width: 10%;"></td> <td style="width: 10%;"></td> <td style="width: 10%;"></td> <td style="width: 10%;"></td> <td style="width: 10%;"></td> <td style="width: 10%;"></td> <td style="width: 10%;"></td> <td style="width: 10%;"></td> </tr> <tr> <td></td> <td></td> <td colspan="8" style="text-align: center;"> <table border="1" style="width: 100%; border-collapse: collapse; text-align: center;"> <tr> <td style="width: 10%;"></td> <td style="width: 10%;"></td> <td style="width: 10%;"></td> <td style="width: 10%;"></td> <td style="width: 10%;"></td> <td style="width: 10%;"></td> <td style="width: 10%;"></td> <td style="width: 10%;"></td> <td style="width: 10%;"></td> <td style="width: 10%;"></td> </tr> <tr> <td></td> <td></td> <td colspan="8" style="text-align: center;"> <table border="1" style="width: 100%; border-collapse: collapse; text-align: center;"> <tr> <td style="width: 10%;"></td> <td style="width: 10%;"></td> <td style="width: 10%;"></td> <td style="width: 10%;"></td> <td style="width: 10%;"></td> <td style="width: 10%;"></td> <td style="width: 10%;"></td> <td style="width: 10%;"></td> <td style="width: 10%;"></td> <td style="width: 10%;"></td> </tr> <tr> <td></td> <td></td> <td colspan="8" style="text-align: center;"> <table border="1" style="width: 100%; border-collapse: collapse; text-align: center;"> <tr> <td style="width: 10%;"></td> <td style="width: 10%;"></td> <td style="width: 10%;"></td> <td style="width: 10%;"></td> <td style="width: 10%;"></td> <td style="width: 10%;"></td> <td style="width: 10%;"></td> <td style="width: 10%;"></td> <td style="width: 10%;"></td> <td style="width: 10%;"></td> </tr> <tr> <td></td> <td></td> <td colspan="8" style="text-align: center;"> <table border="1" style="width: 100%; border-collapse: collapse; text-align: center;"> <tr> <td style="width: 10%;"></td> <td style="width: 10%;"></td> <td style="width: 10%;"></td> <td style="width: 10%;"></td> <td style="width: 10%;"></td> <td style="width: 10%;"></td> <td style="width: 10%;"></td> <td style="width: 10%;"></td> <td style="width: 10%;"></td> <td style="width: 10%;"></td> </tr> <tr> <td></td> <td></td> <td colspan="8" style="text-align: center;"> <table border="1" style="width: 100%; border-collapse: collapse; text-align: center;"> <tr> <td style="width: 10%;"></td> <td style="width: 10%;"></td> <td style="width: 10%;"></td> <td style="width: 10%;"></td> <td style="width: 10%;"></td> <td style="width: 10%;"></td> <td style="width: 10%;"></td> <td style="width: 10%;"></td> <td style="width: 10%;"></td> <td style="width: 10%;"></td> </tr> <tr> <td></td> <td></td> <td colspan="8" style="text-align: center;"> <table border="1" style="width: 100%; border-collapse: collapse; text-align: center;"> <tr> <td style="width: 10%;"></td> <td style="width: 10%;"></td> <td style="width: 10%;"></td> <td style="width: 10%;"></td> <td style="width: 10%;"></td> <td style="width: 10%;"></td> <td style="width: 10%;"></td> <td style="width: 10%;"></td> <td style="width: 10%;"></td> <td style="width: 10%;"></td> </tr> <tr> <td></td> <td></td> <td colspan="8" style="text-align: center;"> <table border="1" style="width: 100%; border-collapse: collapse; text-align: center;"> <tr> <td style="width: 10%;"></td> <td style="width: 10%;"></td> <td style="width: 10%;"></td> <td style="width: 10%;"></td> <td style="width: 10%;"></td> <td style="width: 10%;"></td> <td style="width: 10%;"></td> <td style="width: 10%;"></td> <td style="width: 10%;"></td> <td style="width: 10%;"></td> </tr> <tr> <td></td> <td></td> <td colspan="8" style="text-align: center;"> <table border="1" style="width: 100%; border-collapse: collapse; text-align: center;"> <tr> <td style="width: 10%;"></td> <td style="width: 10%;"></td> <td style="width: 10%;"></td> <td style="width: 10%;"></td> <td style="width: 10%;"></td> <td style="width: 10%;"></td> <td style="width: 10%;"></td> <td style="width: 10%;"></td> <td style="width: 10%;"></td> <td style="width: 10%;"></td> </tr> <tr> <td></td> <td></td> <td colspan="8" style="text-align: center;"> <table border="1" style="width: 100%; border-collapse: collapse; text-align: center;"> <tr> <td style="width: 10%;"></td> <td style="width: 10%;"></td> <td style="width: 10%;"></td> <td style="width: 10%;"></td> <td style="width: 10%;"></td> <td style="width: 10%;"></td> <td style="width: 10%;"></td> <td style="width: 10%;"></td> <td style="width: 10%;"></td> <td style="width: 10%;"></td> </tr> <tr> <td></td> <td></td> <td colspan="8" style="text-align: center;"> <table border="1" style="width: 100%; border-collapse: collapse; text-align: center;"> <tr> <td style="width: 10%;"></td> <td style="width: 10%;"></td> <td style="width: 10%;"></td> <td style="width: 10%;"></td> <td style="width: 10%;"></td> <td style="width: 10%;"></td> <td style="width: 10%;"></td> <td style="width: 10%;"></td> <td style="width: 10%;"></td> <td style="width: 10%;"></td> </tr> <tr> <td></td> <td></td> <td colspan="8" style="text-align: center;"> <table border="1" style="width: 100%; border-collapse: collapse; text-align: center;"> <tr> </tr></table></td></tr></table></td></tr></table></td></tr></table></td></tr></table></td></tr></table></td></tr></table></td></tr></table></td></tr></table></td></tr></table></td></tr></table></td></tr></table></td></tr></table></td></tr></table></td></tr></table></td></tr></table></td></tr></table></td></tr></table></td></tr></table></td></tr></table></td></tr></table></td></tr></table></td></tr></table></td></tr></table></td></tr></table></td></tr></table></td></tr></table></td></tr></table></td></tr></table></td></tr></table></td></tr></table></td></tr></table></td></tr></table></td></tr></table></td></tr></table></td></tr></table></td></tr></table></td></tr></table></td></tr></table></td></tr></table></td></tr></table></td></tr></table></td></tr></table></td></tr></table></td></tr></table></td></tr></table></td></tr></table></td></tr></table></td></tr></table></td></tr></table></td></tr></table></td></tr></table></td></tr></table></td></tr></table></td></tr></table></td></tr></table></td></tr></table></td></tr></table>
 | | | | | | | | | | | | | | | | | | | | <table border="1" style="width: 100%; border-collapse: collapse; text-align: center;"> <tr> <td style="width: 10%;"></td> <td style="width: 10%;"></td> <td style="width: 10%;"></td> <td style="width: 10%;"></td> <td style="width: 10%;"></td> <td style="width: 10%;"></td> <td style="width: 10%;"></td> <td style="width: 10%;"></td> <td style="width: 10%;"></td> <td style="width: 10%;"></td> </tr> <tr> <td></td> <td></td> <td colspan="8" style="text-align: center;"> <table border="1" style="width: 100%; border-collapse: collapse; text-align: center;"> <tr> <td style="width: 10%;"></td> <td style="width: 10%;"></td> <td style="width: 10%;"></td> <td style="width: 10%;"></td> <td style="width: 10%;"></td> <td style="width: 10%;"></td> <td style="width: 10%;"></td> <td style="width: 10%;"></td> <td style="width: 10%;"></td> <td style="width: 10%;"></td> </tr> <tr> <td></td> <td></td> <td colspan="8" style="text-align: center;"> <table border="1" style="width: 100%; border-collapse: collapse; text-align: center;"> <tr> <td style="width: 10%;"></td> <td style="width: 10%;"></td> <td style="width: 10%;"></td> <td style="width: 10%;"></td> <td style="width: 10%;"></td> <td style="width: 10%;"></td> <td style="width: 10%;"></td> <td style="width: 10%;"></td> <td style="width: 10%;"></td> <td style="width: 10%;"></td> </tr> <tr> <td></td> <td></td> <td colspan="8" style="text-align: center;"> <table border="1" style="width: 100%; border-collapse: collapse; text-align: center;"> <tr> <td style="width: 10%;"></td> <td style="width: 10%;"></td> <td style="width: 10%;"></td> <td style="width: 10%;"></td> <td style="width: 10%;"></td> <td style="width: 10%;"></td> <td style="width: 10%;"></td> <td style="width: 10%;"></td> <td style="width: 10%;"></td> <td style="width: 10%;"></td> </tr> <tr> <td></td> <td></td> <td colspan="8" style="text-align: center;"> <table border="1" style="width: 100%; border-collapse: collapse; text-align: center;"> <tr> <td style="width: 10%;"></td> <td style="width: 10%;"></td> <td style="width: 10%;"></td> <td style="width: 10%;"></td> <td style="width: 10%;"></td> <td style="width: 10%;"></td> <td style="width: 10%;"></td> <td style="width: 10%;"></td> <td style="width: 10%;"></td> <td style="width: 10%;"></td> </tr> <tr> <td></td> <td></td> <td colspan="8" style="text-align: center;"> <table border="1" style="width: 100%; border-collapse: collapse; text-align: center;"> <tr> <td style="width: 10%;"></td> <td style="width: 10%;"></td> <td style="width: 10%;"></td> <td style="width: 10%;"></td> <td style="width: 10%;"></td> <td style="width: 10%;"></td> <td style="width: 10%;"></td> <td style="width: 10%;"></td> <td style="width: 10%;"></td> <td style="width: 10%;"></td> </tr> <tr> <td></td> <td></td> <td colspan="8" style="text-align: center;"> <table border="1" style="width: 100%; border-collapse: collapse; text-align: center;"> <tr> <td style="width: 10%;"></td> <td style="width: 10%;"></td> <td style="width: 10%;"></td> <td style="width: 10%;"></td> <td style="width: 10%;"></td> <td style="width: 10%;"></td> <td style="width: 10%;"></td> <td style="width: 10%;"></td> <td style="width: 10%;"></td> <td style="width: 10%;"></td> </tr> <tr> <td></td> <td></td> <td colspan="8" style="text-align: center;"> <table border="1" style="width: 100%; border-collapse: collapse; text-align: center;"> <tr> <td style="width: 10%;"></td> <td style="width: 10%;"></td> <td style="width: 10%;"></td> <td style="width: 10%;"></td> <td style="width: 10%;"></td> <td style="width: 10%;"></td> <td style="width: 10%;"></td> <td style="width: 10%;"></td> <td style="width: 10%;"></td> <td style="width: 10%;"></td> </tr> <tr> <td></td> <td></td> <td colspan="8" style="text-align: center;"> <table border="1" style="width: 100%; border-collapse: collapse; text-align: center;"> <tr> <td style="width: 10%;"></td> <td style="width: 10%;"></td> <td style="width: 10%;"></td> <td style="width: 10%;"></td> <td style="width: 10%;"></td> <td style="width: 10%;"></td> <td style="width: 10%;"></td> <td style="width: 10%;"></td> <td style="width: 10%;"></td> <td style="width: 10%;"></td> </tr> <tr> <td></td> <td></td> <td colspan="8" style="text-align: center;"> <table border="1" style="width: 100%; border-collapse: collapse; text-align: center;"> <tr> <td style="width: 10%;"></td> <td style="width: 10%;"></td> <td style="width: 10%;"></td> <td style="width: 10%;"></td> <td style="width: 10%;"></td> <td style="width: 10%;"></td> <td style="width: 10%;"></td> <td style="width: 10%;"></td> <td style="width: 10%;"></td> <td style="width: 10%;"></td> </tr> <tr> <td></td> <td></td> <td colspan="8" style="text-align: center;"> <table border="1" style="width: 100%; border-collapse: collapse; text-align: center;"> <tr> <td style="width: 10%;"></td> <td style="width: 10%;"></td> <td style="width: 10%;"></td> <td style="width: 10%;"></td> <td style="width: 10%;"></td> <td style="width: 10%;"></td> <td style="width: 10%;"></td> <td style="width: 10%;"></td> <td style="width: 10%;"></td> <td style="width: 10%;"></td> </tr> <tr> <td></td> <td></td> <td colspan="8" style="text-align: center;"> <table border="1" style="width: 100%; border-collapse: collapse; text-align: center;"> <tr> <td style="width: 10%;"></td> <td style="width: 10%;"></td> <td style="width: 10%;"></td> <td style="width: 10%;"></td> <td style="width: 10%;"></td> <td style="width: 10%;"></td> <td style="width: 10%;"></td> <td style="width: 10%;"></td> <td style="width: 10%;"></td> <td style="width: 10%;"></td> </tr> <tr> <td></td> <td></td> <td colspan="8" style="text-align: center;"> <table border="1" style="width: 100%; border-collapse: collapse; text-align: center;"> <tr> <td style="width: 10%;"></td> <td style="width: 10%;"></td> <td style="width: 10%;"></td> <td style="width: 10%;"></td> <td style="width: 10%;"></td> <td style="width: 10%;"></td> <td style="width: 10%;"></td> <td style="width: 10%;"></td> <td style="width: 10%;"></td> <td style="width: 10%;"></td> </tr> <tr> <td></td> <td></td> <td colspan="8" style="text-align: center;"> <table border="1" style="width: 100%; border-collapse: collapse; text-align: center;"> <tr> <td style="width: 10%;"></td> <td style="width: 10%;"></td> <td style="width: 10%;"></td> <td style="width: 10%;"></td> <td style="width: 10%;"></td> <td style="width: 10%;"></td> <td style="width: 10%;"></td> <td style="width: 10%;"></td> <td style="width: 10%;"></td> <td style="width: 10%;"></td> </tr> <tr> <td></td> <td></td> <td colspan="8" style="text-align: center;"> <table border="1" style="width: 100%; border-collapse: collapse; text-align: center;"> <tr> <td style="width: 10%;"></td> <td style="width: 10%;"></td> <td style="width: 10%;"></td> <td style="width: 10%;"></td> <td style="width: 10%;"></td> <td style="width: 10%;"></td> <td style="width: 10%;"></td> <td style="width: 10%;"></td> <td style="width: 10%;"></td> <td style="width: 10%;"></td> </tr> <tr> <td></td> <td></td> <td colspan="8" style="text-align: center;"> <table border="1" style="width: 100%; border-collapse: collapse; text-align: center;"> <tr> <td style="width: 10%;"></td> <td style="width: 10%;"></td> <td style="width: 10%;"></td> <td style="width: 10%;"></td> <td style="width: 10%;"></td> <td style="width: 10%;"></td> <td style="width: 10%;"></td> <td style="width: 10%;"></td> <td style="width: 10%;"></td> <td style="width: 10%;"></td> </tr> <tr> <td></td> <td></td> <td colspan="8" style="text-align: center;"> <table border="1" style="width: 100%; border-collapse: collapse; text-align: center;"> <tr> <td style="width: 10%;"></td> <td style="width: 10%;"></td> <td style="width: 10%;"></td> <td style="width: 10%;"></td> <td style="width: 10%;"></td> <td style="width: 10%;"></td> <td style="width: 10%;"></td> <td style="width: 10%;"></td> <td style="width: 10%;"></td> <td style="width: 10%;"></td> </tr> <tr> <td></td> <td></td> <td colspan="8" style="text-align: center;"> <table border="1" style="width: 100%; border-collapse: collapse; text-align: center;"> <tr> <td style="width: 10%;"></td> <td style="width: 10%;"></td> <td style="width: 10%;"></td> <td style="width: 10%;"></td> <td style="width: 10%;"></td> <td style="width: 10%;"></td> <td style="width: 10%;"></td> <td style="width: 10%;"></td> <td style="width: 10%;"></td> <td style="width: 10%;"></td> </tr> <tr> <td></td> <td></td> <td colspan="8" style="text-align: center;"> <table border="1" style="width: 100%; border-collapse: collapse; text-align: center;"> <tr> <td style="width: 10%;"></td> <td style="width: 10%;"></td> <td style="width: 10%;"></td> <td style="width: 10%;"></td> <td style="width: 10%;"></td> <td style="width:
10%;"></td> <td style="width: 10%;"></td> <td style="width: 10%;"></td> <td style="width: 10%;"></td> <td style="width: 10%;"></td> </tr> <tr> <td></td> <td></td> <td colspan="8" style="text-align: center;"> <table border="1" style="width: 100%; border-collapse: collapse; text-align: center;"> <tr> <td style="width: 10%;"></td> <td style="width: 10%;"></td> <td style="width: 10%;"></td> <td style="width: 10%;"></td> <td style="width: 10%;"></td> <td style="width: 10%;"></td> <td style="width: 10%;"></td> <td style="width: 10%;"></td> <td style="width: 10%;"></td> <td style="width: 10%;"></td> </tr> <tr> <td></td> <td></td> <td colspan="8" style="text-align: center;"> <table border="1" style="width: 100%; border-collapse: collapse; text-align: center;"> <tr> <td style="width: 10%;"></td> <td style="width: 10%;"></td> <td style="width: 10%;"></td> <td style="width: 10%;"></td> <td style="width: 10%;"></td> <td style="width: 10%;"></td> <td style="width: 10%;"></td> <td style="width: 10%;"></td> <td style="width: 10%;"></td> <td style="width: 10%;"></td> </tr> <tr> <td></td> <td></td> <td colspan="8" style="text-align: center;"> <table border="1" style="width: 100%; border-collapse: collapse; text-align: center;"> <tr> <td style="width: 10%;"></td> <td style="width: 10%;"></td> <td style="width: 10%;"></td> <td style="width: 10%;"></td> <td style="width: 10%;"></td> <td style="width: 10%;"></td> <td style="width: 10%;"></td> <td style="width: 10%;"></td> <td style="width: 10%;"></td> <td style="width: 10%;"></td> </tr> <tr> <td></td> <td></td> <td colspan="8" style="text-align: center;"> <table border="1" style="width: 100%; border-collapse: collapse; text-align: center;"> <tr> <td style="width: 10%;"></td> <td style="width: 10%;"></td> <td style="width: 10%;"></td> <td style="width: 10%;"></td> <td style="width: 10%;"></td> <td style="width: 10%;"></td> <td style="width: 10%;"></td> <td style="width: 10%;"></td> <td style="width: 10%;"></td> <td style="width: 10%;"></td> </tr> <tr> <td></td> <td></td> <td colspan="8" style="text-align: center;"> <table border="1" style="width: 100%; border-collapse: collapse; text-align: center;"> <tr> <td style="width: 10%;"></td> <td style="width: 10%;"></td> <td style="width: 10%;"></td> <td style="width: 10%;"></td> <td style="width: 10%;"></td> <td style="width: 10%;"></td> <td style="width: 10%;"></td> <td style="width: 10%;"></td> <td style="width: 10%;"></td> <td style="width: 10%;"></td> </tr> <tr> <td></td> <td></td> <td colspan="8" style="text-align: center;"> <table border="1" style="width: 100%; border-collapse: collapse; text-align: center;"> <tr> <td style="width: 10%;"></td> <td style="width: 10%;"></td> <td style="width: 10%;"></td> <td style="width: 10%;"></td> <td style="width: 10%;"></td> <td style="width: 10%;"></td> <td style="width: 10%;"></td> <td style="width: 10%;"></td> <td style="width: 10%;"></td> <td style="width: 10%;"></td> </tr> <tr> <td></td> <td></td> <td colspan="8" style="text-align: center;"> <table border="1" style="width: 100%; border-collapse: collapse; text-align: center;"> <tr> <td style="width: 10%;"></td> <td style="width: 10%;"></td> <td style="width: 10%;"></td> <td style="width: 10%;"></td> <td style="width: 10%;"></td> <td style="width: 10%;"></td> <td style="width: 10%;"></td> <td style="width: 10%;"></td> <td style="width: 10%;"></td> <td style="width: 10%;"></td> </tr> <tr> <td></td> <td></td> <td colspan="8" style="text-align: center;"> <table border="1" style="width: 100%; border-collapse: collapse; text-align: center;"> <tr> <td style="width: 10%;"></td> <td style="width: 10%;"></td> <td style="width: 10%;"></td> <td style="width: 10%;"></td> <td style="width: 10%;"></td> <td style="width: 10%;"></td> <td style="width: 10%;"></td> <td style="width: 10%;"></td> <td style="width: 10%;"></td> <td style="width: 10%;"></td> </tr> <tr> <td></td> <td></td> <td colspan="8" style="text-align: center;"> <table border="1" style="width: 100%; border-collapse: collapse; text-align: center;"> <tr> <td style="width: 10%;"></td> <td style="width: 10%;"></td> <td style="width: 10%;"></td> <td style="width: 10%;"></td> <td style="width: 10%;"></td> <td style="width: 10%;"></td> <td style="width: 10%;"></td> <td style="width: 10%;"></td> <td style="width: 10%;"></td> <td style="width: 10%;"></td> </tr> <tr> <td></td> <td></td> <td colspan="8" style="text-align: center;"> <table border="1" style="width: 100%; border-collapse: collapse; text-align: center;"> <tr> <td style="width: 10%;"></td> <td style="width: 10%;"></td> <td style="width: 10%;"></td> <td style="width: 10%;"></td> <td style="width: 10%;"></td> <td style="width: 10%;"></td> <td style="width: 10%;"></td> <td style="width: 10%;"></td> <td style="width: 10%;"></td> <td style="width: 10%;"></td> </tr> <tr> <td></td> <td></td> <td colspan="8" style="text-align: center;"> <table border="1" style="width: 100%; border-collapse: collapse; text-align: center;"> <tr> <td style="width: 10%;"></td> <td style="width: 10%;"></td> <td style="width: 10%;"></td> <td style="width: 10%;"></td> <td style="width: 10%;"></td> <td style="width: 10%;"></td> <td style="width: 10%;"></td> <td style="width: 10%;"></td> <td style="width: 10%;"></td> <td style="width: 10%;"></td> </tr> <tr> <td></td> <td></td> <td colspan="8" style="text-align: center;"> <table border="1" style="width: 100%; border-collapse: collapse; text-align: center;"> <tr> <td style="width: 10%;"></td> <td style="width: 10%;"></td> <td style="width: 10%;"></td> <td style="width: 10%;"></td> <td style="width: 10%;"></td> <td style="width: 10%;"></td> <td style="width: 10%;"></td> <td style="width: 10%;"></td> <td style="width: 10%;"></td> <td style="width: 10%;"></td> </tr> <tr> <td></td> <td></td> <td colspan="8" style="text-align: center;"> <table border="1" style="width: 100%; border-collapse: collapse; text-align: center;"> <tr> <td style="width: 10%;"></td> <td style="width: 10%;"></td> <td style="width: 10%;"></td> <td style="width: 10%;"></td> <td style="width: 10%;"></td> <td style="width: 10%;"></td> <td style="width: 10%;"></td> <td style="width: 10%;"></td> <td style="width: 10%;"></td> <td style="width: 10%;"></td> </tr> <tr> <td></td> <td></td> <td colspan="8" style="text-align: center;"> <table border="1" style="width: 100%; border-collapse: collapse; text-align: center;"> <tr> <td style="width: 10%;"></td> <td style="width: 10%;"></td> <td style="width: 10%;"></td> <td style="width: 10%;"></td> <td style="width: 10%;"></td> <td style="width: 10%;"></td> <td style="width: 10%;"></td> <td style="width: 10%;"></td> <td style="width: 10%;"></td> <td style="width: 10%;"></td> </tr> <tr> <td></td> <td></td> <td colspan="8" style="text-align: center;"> <table border="1" style="width: 100%; border-collapse: collapse; text-align: center;"> <tr> <td style="width: 10%;"></td> <td style="width: 10%;"></td> <td style="width: 10%;"></td> <td style="width: 10%;"></td> <td style="width: 10%;"></td> <td style="width: 10%;"></td> <td style="width: 10%;"></td> <td style="width: 10%;"></td> <td style="width: 10%;"></td> <td style="width: 10%;"></td> </tr> <tr> <td></td> <td></td> <td colspan="8" style="text-align: center;"> <table border="1" style="width: 100%; border-collapse: collapse; text-align: center;"> <tr> <td style="width: 10%;"></td> <td style="width: 10%;"></td> <td style="width: 10%;"></td> <td style="width: 10%;"></td> <td style="width: 10%;"></td> <td style="width: 10%;"></td> <td style="width: 10%;"></td> <td style="width: 10%;"></td> <td style="width: 10%;"></td> <td style="width: 10%;"></td> </tr> <tr> <td></td> <td></td> <td colspan="8" style="text-align: center;"> <table border="1" style="width: 100%; border-collapse: collapse; text-align: center;"> <tr> <td style="width: 10%;"></td> <td style="width: 10%;"></td> <td style="width: 10%;"></td> <td style="width: 10%;"></td> <td style="width: 10%;"></td> <td style="width: 10%;"></td> <td style="width: 10%;"></td> <td style="width: 10%;"></td> <td style="width: 10%;"></td> <td style="width: 10%;"></td> </tr> <tr> <td></td> <td></td> <td colspan="8" style="text-align: center;"> <table border="1" style="width: 100%; border-collapse: collapse; text-align: center;"> <tr> <td style="width: 10%;"></td> <td style="width: 10%;"></td> <td style="width: 10%;"></td> <td style="width: 10%;"></td> <td style="width: 10%;"></td> <td style="width: 10%;"></td> <td style="width: 10%;"></td> <td style="width: 10%;"></td> <td style="width: 10%;"></td> <td style="width: 10%;"></td> </tr> <tr> <td></td> <td></td> <td colspan="8" style="text-align: center;"> <table border="1" style="width: 100%; border-collapse: collapse; text-align: center;"> <tr> <td style="width: 10%;"></td> <td style="width: 10%;"></td> <td style="width: 10%;"></td> <td style="width: 10%;"></td> <td style="width: 10%;"></td> <td style="width: 10%;"></td> <td style="width: 10%;"></td> <td style="width: 10%;"></td> <td style="width: 10%;"></td> <td style="width: 10%;"></td> </tr> <tr> <td></td> <td></td> <td colspan="8" style="text-align: center;"> <table border="1" style="width: 100%; border-collapse: collapse; text-align: center;"> <tr> <td style="width: 10%;"></td> <td style="width: 10%;"></td> <td style="width: 10%;"></td> <td style="width: 10%;"></td> <td style="width: 10%;"></td> <td style="width: 10%;"></td> <td style="width: 10%;"></td> <td style="width: 10%;"></td> <td style="width: 10%;"></td> <td style="width: 10%;"></td> </tr> <tr> <td></td> <td></td> <td colspan="8" style="text-align: center;"> <table border="1" style="width: 100%; border-collapse: collapse; text-align: center;"> <tr> <td style="width: 10%;"></td> <td style="width: 10%;"></td> <td style="width: 10%;"></td> <td style="width: 10%;"></td> <td style="width: 10%;"></td> <td style="width: 10%;"></td> <td style="width: 10%;"></td> <td style="width: 10%;"></td> <td style="width: 10%;"></td> <td style="width: 10%;"></td> </tr> <tr> <td></td> <td></td> <td
colspan="8" style="text-align: center;"> <table border="1" style="width: 100%; border-collapse: collapse; text-align: center;"> <tr> <td style="width: 10%;"></td> <td style="width: 10%;"></td> <td style="width: 10%;"></td> <td style="width: 10%;"></td> <td style="width: 10%;"></td> <td style="width: 10%;"></td> <td style="width: 10%;"></td> <td style="width: 10%;"></td> <td style="width: 10%;"></td> <td style="width: 10%;"></td> </tr> <tr> <td></td> <td></td> <td colspan="8" style="text-align: center;"> <table border="1" style="width: 100%; border-collapse: collapse; text-align: center;"> <tr> <td style="width: 10%;"></td> <td style="width: 10%;"></td> <td style="width: 10%;"></td> <td style="width: 10%;"></td> <td style="width: 10%;"></td> <td style="width: 10%;"></td> <td style="width: 10%;"></td> <td style="width: 10%;"></td> <td style="width: 10%;"></td> <td style="width: 10%;"></td> </tr> <tr> <td></td> <td></td> <td colspan="8" style="text-align: center;"> <table border="1" style="width: 100%; border-collapse: collapse; text-align: center;"> <tr> <td style="width: 10%;"></td> <td style="width: 10%;"></td> <td style="width: 10%;"></td> <td style="width: 10%;"></td> <td style="width: 10%;"></td> <td style="width: 10%;"></td> <td style="width: 10%;"></td> <td style="width: 10%;"></td> <td style="width: 10%;"></td> <td style="width: 10%;"></td> </tr> <tr> <td></td> <td></td> <td colspan="8" style="text-align: center;"> <table border="1" style="width: 100%; border-collapse: collapse; text-align: center;"> <tr> <td style="width: 10%;"></td> <td style="width: 10%;"></td> <td style="width: 10%;"></td> <td style="width: 10%;"></td> <td style="width: 10%;"></td> <td style="width: 10%;"></td> <td style="width: 10%;"></td> <td style="width: 10%;"></td> <td style="width: 10%;"></td> <td style="width: 10%;"></td> </tr> <tr> <td></td> <td></td> <td colspan="8" style="text-align: center;"> <table border="1" style="width: 100%; border-collapse: collapse; text-align: center;"> <tr> <td style="width: 10%;"></td> <td style="width: 10%;"></td> <td style="width: 10%;"></td> <td style="width: 10%;"></td> <td style="width: 10%;"></td> <td style="width: 10%;"></td> <td style="width: 10%;"></td> <td style="width: 10%;"></td> <td style="width: 10%;"></td> <td style="width: 10%;"></td> </tr> <tr> <td></td> <td></td> <td colspan="8" style="text-align: center;"> <table border="1" style="width: 100%; border-collapse: collapse; text-align: center;"> <tr> <td style="width: 10%;"></td> <td style="width: 10%;"></td> <td style="width: 10%;"></td> <td style="width: 10%;"></td> <td style="width: 10%;"></td> <td style="width: 10%;"></td> <td style="width: 10%;"></td> <td style="width: 10%;"></td> <td style="width: 10%;"></td> <td style="width: 10%;"></td> </tr> <tr> <td></td> <td></td> <td colspan="8" style="text-align: center;"> <table border="1" style="width: 100%; border-collapse: collapse; text-align: center;"> <tr> <td style="width: 10%;"></td> <td style="width: 10%;"></td> <td style="width: 10%;"></td> <td style="width: 10%;"></td> <td style="width: 10%;"></td> <td style="width: 10%;"></td> <td style="width: 10%;"></td> <td style="width: 10%;"></td> <td style="width: 10%;"></td> <td style="width: 10%;"></td> </tr> <tr> <td></td> <td></td> <td colspan="8" style="text-align: center;"> <table border="1" style="width: 100%; border-collapse: collapse; text-align: center;"> <tr> <td style="width: 10%;"></td> <td style="width: 10%;"></td> <td style="width: 10%;"></td> <td style="width: 10%;"></td> <td style="width: 10%;"></td> <td style="width: 10%;"></td> <td style="width: 10%;"></td> <td style="width: 10%;"></td> <td style="width: 10%;"></td> <td style="width: 10%;"></td> </tr> <tr> <td></td> <td></td> <td colspan="8" style="text-align: center;"> <table border="1" style="width: 100%; border-collapse: collapse; text-align: center;"> <tr> <td style="width: 10%;"></td> <td style="width: 10%;"></td> <td style="width: 10%;"></td> <td style="width: 10%;"></td> <td style="width: 10%;"></td> <td style="width: 10%;"></td> <td style="width: 10%;"></td> <td style="width: 10%;"></td> <td style="width: 10%;"></td> <td style="width: 10%;"></td> </tr> <tr> <td></td> <td></td> <td colspan="8" style="text-align: center;"> <table border="1" style="width: 100%; border-collapse: collapse; text-align: center;"> <tr> <td style="width: 10%;"></td> <td style="width: 10%;"></td> <td style="width: 10%;"></td> <td style="width: 10%;"></td> <td style="width: 10%;"></td> <td style="width: 10%;"></td> <td style="width: 10%;"></td> <td style="width: 10%;"></td> <td style="width: 10%;"></td> <td style="width: 10%;"></td> </tr> <tr> <td></td> <td></td> <td colspan="8" style="text-align: center;"> <table border="1" style="width: 100%; border-collapse: collapse; text-align: center;"> <tr> <td style="width: 10%;"></td> <td style="width: 10%;"></td> <td style="width: 10%;"></td> <td style="width: 10%;"></td> <td style="width: 10%;"></td> <td style="width: 10%;"></td> <td style="width: 10%;"></td> <td style="width: 10%;"></td> <td style="width: 10%;"></td> <td style="width: 10%;"></td> </tr> <tr> <td></td> <td></td> <td colspan="8" style="text-align: center;"> <table border="1" style="width: 100%; border-collapse: collapse; text-align: center;"> <tr> <td style="width: 10%;"></td> <td style="width: 10%;"></td> <td style="width: 10%;"></td> <td style="width: 10%;"></td> <td style="width: 10%;"></td> <td style="width: 10%;"></td> <td style="width: 10%;"></td> <td style="width: 10%;"></td> <td style="width: 10%;"></td> <td style="width: 10%;"></td> </tr> <tr> <td></td> <td></td> <td colspan="8" style="text-align: center;"> <table border="1" style="width: 100%; border-collapse: collapse; text-align: center;"> <tr> <td style="width: 10%;"></td> <td style="width: 10%;"></td> <td style="width: 10%;"></td> <td style="width: 10%;"></td> <td style="width: 10%;"></td> <td style="width: 10%;"></td> <td style="width: 10%;"></td> <td style="width: 10%;"></td> <td style="width: 10%;"></td> <td style="width: 10%;"></td> </tr> <tr> <td></td> <td></td> <td colspan="8" style="text-align: center;"> <table border="1" style="width: 100%; border-collapse: collapse; text-align: center;"> <tr> <td style="width: 10%;"></td> <td style="width: 10%;"></td> <td style="width: 10%;"></td> <td style="width: 10%;"></td> <td style="width: 10%;"></td> <td style="width: 10%;"></td> <td style="width: 10%;"></td> <td style="width: 10%;"></td> <td style="width: 10%;"></td> <td style="width: 10%;"></td> </tr> <tr> <td></td> <td></td> <td colspan="8" style="text-align: center;"> <table border="1" style="width: 100%; border-collapse: collapse; text-align: center;"> <tr> <td style="width: 10%;"></td> <td style="width: 10%;"></td> <td style="width: 10%;"></td> <td style="width: 10%;"></td> <td style="width: 10%;"></td> <td style="width: 10%;"></td> <td style="width: 10%;"></td> <td style="width: 10%;"></td> <td style="width: 10%;"></td> <td style="width: 10%;"></td> </tr> <tr> <td></td> <td></td> <td colspan="8" style="text-align: center;"> <table border="1" style="width: 100%; border-collapse: collapse; text-align: center;"> <tr> <td style="width: 10%;"></td> <td style="width: 10%;"></td> <td style="width: 10%;"></td> <td style="width: 10%;"></td> <td style="width: 10%;"></td> <td style="width: 10%;"></td> <td style="width: 10%;"></td> <td style="width: 10%;"></td> <td style="width: 10%;"></td> <td style="width: 10%;"></td> </tr> <tr> <td></td> <td></td> <td colspan="8" style="text-align: center;"> <table border="1" style="width: 100%; border-collapse: collapse; text-align: center;"> <tr> </tr></table></td></tr></table></td></tr></table></td></tr></table></td></tr></table></td></tr></table></td></tr></table></td></tr></table></td></tr></table></td></tr></table></td></tr></table></td></tr></table></td></tr></table></td></tr></table></td></tr></table></td></tr></table></td></tr></table></td></tr></table></td></tr></table></td></tr></table></td></tr></table></td></tr></table></td></tr></table></td></tr></table></td></tr></table></td></tr></table></td></tr></table></td></tr></table></td></tr></table></td></tr></table></td></tr></table></td></tr></table></td></tr></table></td></tr></table></td></tr></table></td></tr></table></td></tr></table></td></tr></table></td></tr></table></td></tr></table></td></tr></table></td></tr></table></td></tr></table></td></tr></table></td></tr></table></td></tr></table></td></tr></table></td></tr></table></td></tr></table></td></tr></table></td></tr></table></td></tr></table></td></tr></table></td></tr></table></td></tr></table></td></tr></table></td></tr></table>
 | | | | | | | | | | | | | | | | | | | | <table border="1" style="width: 100%; border-collapse: collapse; text-align: center;"> <tr> <td style="width: 10%;"></td> <td style="width: 10%;"></td> <td style="width: 10%;"></td> <td style="width: 10%;"></td> <td style="width: 10%;"></td> <td style="width: 10%;"></td> <td style="width: 10%;"></td> <td style="width: 10%;"></td> <td style="width: 10%;"></td> <td style="width: 10%;"></td> </tr> <tr> <td></td> <td></td> <td colspan="8" style="text-align: center;"> <table border="1" style="width: 100%; border-collapse: collapse; text-align: center;"> <tr> <td style="width: 10%;"></td> <td style="width: 10%;"></td> <td style="width: 10%;"></td> <td style="width: 10%;"></td> <td style="width: 10%;"></td> <td style="width: 10%;"></td> <td style="width: 10%;"></td> <td style="width: 10%;"></td> <td style="width: 10%;"></td> <td style="width: 10%;"></td> </tr> <tr> <td></td> <td></td> <td colspan="8" style="text-align: center;"> <table border="1" style="width: 100%; border-collapse: collapse; text-align: center;"> <tr> <td style="width: 10%;"></td> <td style="width: 10%;"></td> <td style="width: 10%;"></td> <td style="width: 10%;"></td> <td style="width: 10%;"></td> <td style="width: 10%;"></td> <td style="width: 10%;"></td> <td style="width: 10%;"></td> <td style="width: 10%;"></td> <td style="width: 10%;"></td> </tr> <tr> <td></td> <td></td> <td colspan="8" style="text-align: center;"> <table border="1" style="width: 100%; border-collapse: collapse; text-align: center;"> <tr> <td style="width: 10%;"></td> <td style="width: 10%;"></td> <td style="width: 10%;"></td> <td style="width: 10%;"></td> <td style="width: 10%;"></td> <td style="width: 10%;"></td> <td style="width: 10%;"></td> <td style="width: 10%;"></td> <td style="width: 10%;"></td> <td style="width: 10%;"></td> </tr> <tr> <td></td> <td></td> <td colspan="8" style="text-align: center;"> <table border="1" style="width: 100%; border-collapse: collapse; text-align: center;"> <tr> <td style="width: 10%;"></td> <td style="width: 10%;"></td> <td style="width: 10%;"></td> <td style="width: 10%;"></td> <td style="width: 10%;"></td> <td style="width: 10%;"></td> <td style="width: 10%;"></td> <td style="width: 10%;"></td> <td style="width: 10%;"></td> <td style="width: 10%;"></td> </tr> <tr> <td></td> <td></td> <td colspan="8" style="text-align: center;"> <table border="1" style="width: 100%; border-collapse: collapse; text-align: center;"> <tr> <td style="width: 10%;"></td> <td style="width: 10%;"></td> <td style="width: 10%;"></td> <td style="width: 10%;"></td> <td style="width: 10%;"></td> <td style="width: 10%;"></td> <td style="width: 10%;"></td> <td style="width: 10%;"></td> <td style="width: 10%;"></td> <td style="width: 10%;"></td> </tr> <tr> <td></td> <td></td> <td colspan="8" style="text-align: center;"> <table border="1" style="width: 100%; border-collapse: collapse; text-align: center;"> <tr> <td style="width: 10%;"></td> <td style="width: 10%;"></td> <td style="width: 10%;"></td> <td style="width: 10%;"></td> <td style="width: 10%;"></td> <td style="width: 10%;"></td> <td style="width: 10%;"></td> <td style="width: 10%;"></td> <td style="width: 10%;"></td> <td style="width: 10%;"></td> </tr> <tr> <td></td> <td></td> <td colspan="8" style="text-align: center;"> <table border="1" style="width: 100%; border-collapse: collapse; text-align: center;"> <tr> <td style="width: 10%;"></td> <td style="width: 10%;"></td> <td style="width: 10%;"></td> <td style="width: 10%;"></td> <td style="width: 10%;"></td> <td style="width: 10%;"></td> <td style="width: 10%;"></td> <td style="width: 10%;"></td> <td style="width: 10%;"></td> <td style="width: 10%;"></td> </tr> <tr> <td></td> <td></td> <td colspan="8" style="text-align: center;"> <table border="1" style="width: 100%; border-collapse: collapse; text-align: center;"> <tr> <td style="width: 10%;"></td> <td style="width: 10%;"></td> <td style="width: 10%;"></td> <td style="width: 10%;"></td> <td style="width: 10%;"></td> <td style="width: 10%;"></td> <td style="width: 10%;"></td> <td style="width: 10%;"></td> <td style="width: 10%;"></td> <td style="width: 10%;"></td> </tr> <tr> <td></td> <td></td> <td colspan="8" style="text-align: center;"> <table border="1" style="width: 100%; border-collapse: collapse; text-align: center;"> <tr> <td style="width: 10%;"></td> <td style="width: 10%;"></td> <td style="width: 10%;"></td> <td style="width: 10%;"></td> <td style="width: 10%;"></td> <td style="width: 10%;"></td> <td style="width: 10%;"></td> <td style="width: 10%;"></td> <td style="width: 10%;"></td> <td style="width: 10%;"></td> </tr> <tr> <td></td> <td></td> <td colspan="8" style="text-align: center;"> <table border="1" style="width: 100%; border-collapse: collapse; text-align: center;"> <tr> <td style="width: 10%;"></td> <td style="width: 10%;"></td> <td style="width: 10%;"></td> <td style="width: 10%;"></td> <td style="width: 10%;"></td> <td style="width: 10%;"></td> <td style="width: 10%;"></td> <td style="width: 10%;"></td> <td style="width: 10%;"></td> <td style="width: 10%;"></td> </tr> <tr> <td></td> <td></td> <td colspan="8" style="text-align: center;"> <table border="1" style="width: 100%; border-collapse: collapse; text-align: center;"> <tr> <td style="width: 10%;"></td> <td style="width: 10%;"></td> <td style="width: 10%;"></td> <td style="width: 10%;"></td> <td style="width: 10%;"></td> <td style="width: 10%;"></td> <td style="width: 10%;"></td> <td style="width: 10%;"></td> <td style="width: 10%;"></td> <td style="width: 10%;"></td> </tr> <tr> <td></td> <td></td> <td colspan="8" style="text-align: center;"> <table border="1" style="width: 100%; border-collapse: collapse; text-align: center;"> <tr> <td style="width: 10%;"></td> <td style="width: 10%;"></td> <td style="width: 10%;"></td> <td style="width: 10%;"></td> <td style="width: 10%;"></td> <td style="width: 10%;"></td> <td style="width: 10%;"></td> <td style="width: 10%;"></td> <td style="width: 10%;"></td> <td style="width: 10%;"></td> </tr> <tr> <td></td> <td></td> <td colspan="8" style="text-align: center;"> <table border="1" style="width: 100%; border-collapse: collapse; text-align: center;"> <tr> <td style="width: 10%;"></td> <td style="width: 10%;"></td> <td style="width: 10%;"></td> <td style="width: 10%;"></td> <td style="width: 10%;"></td> <td style="width: 10%;"></td> <td style="width: 10%;"></td> <td style="width: 10%;"></td> <td style="width: 10%;"></td> <td style="width: 10%;"></td> </tr> <tr> <td></td> <td></td> <td colspan="8" style="text-align: center;"> <table border="1" style="width: 100%; border-collapse: collapse; text-align: center;"> <tr> <td style="width: 10%;"></td> <td style="width: 10%;"></td> <td style="width: 10%;"></td> <td style="width: 10%;"></td> <td style="width: 10%;"></td> <td style="width: 10%;"></td> <td style="width: 10%;"></td> <td style="width: 10%;"></td> <td style="width: 10%;"></td> <td style="width: 10%;"></td> </tr> <tr> <td></td> <td></td> <td colspan="8" style="text-align: center;"> <table border="1" style="width: 100%; border-collapse: collapse; text-align: center;"> <tr> <td style="width: 10%;"></td> <td style="width: 10%;"></td> <td style="width: 10%;"></td> <td style="width: 10%;"></td> <td style="width: 10%;"></td> <td style="width: 10%;"></td> <td style="width: 10%;"></td> <td style="width: 10%;"></td> <td style="width: 10%;"></td> <td style="width: 10%;"></td> </tr> <tr> <td></td> <td></td> <td colspan="8" style="text-align: center;"> <table border="1" style="width: 100%; border-collapse: collapse; text-align: center;"> <tr> <td style="width: 10%;"></td> <td style="width: 10%;"></td> <td style="width: 10%;"></td> <td style="width: 10%;"></td> <td style="width: 10%;"></td> <td style="width: 10%;"></td> <td style="width: 10%;"></td> <td style="width: 10%;"></td> <td style="width: 10%;"></td> <td style="width: 10%;"></td> </tr> <tr>
<td></td> <td></td> <td colspan="8" style="text-align: center;"> <table border="1" style="width: 100%; border-collapse: collapse; text-align: center;"> <tr> <td style="width: 10%;"></td> <td style="width: 10%;"></td> <td style="width: 10%;"></td> <td style="width: 10%;"></td> <td style="width: 10%;"></td> <td style="width: 10%;"></td> <td style="width: 10%;"></td> <td style="width: 10%;"></td> <td style="width: 10%;"></td> <td style="width: 10%;"></td> </tr> <tr> <td></td> <td></td> <td colspan="8" style="text-align: center;"> <table border="1" style="width: 100%; border-collapse: collapse; text-align: center;"> <tr> <td style="width: 10%;"></td> <td style="width: 10%;"></td> <td style="width: 10%;"></td> <td style="width: 10%;"></td> <td style="width: 10%;"></td> <td style="width: 10%;"></td> <td style="width: 10%;"></td> <td style="width: 10%;"></td> <td style="width: 10%;"></td> <td style="width: 10%;"></td> </tr> <tr> <td></td> <td></td> <td colspan="8" style="text-align: center;"> <table border="1" style="width: 100%; border-collapse: collapse; text-align: center;"> <tr> <td style="width: 10%;"></td> <td style="width: 10%;"></td> <td style="width: 10%;"></td> <td style="width: 10%;"></td> <td style="width: 10%;"></td> <td style="width: 10%;"></td> <td style="width: 10%;"></td> <td style="width: 10%;"></td> <td style="width: 10%;"></td> <td style="width: 10%;"></td> </tr> <tr> <td></td> <td></td> <td colspan="8" style="text-align: center;"> <table border="1" style="width: 100%; border-collapse: collapse; text-align: center;"> <tr> <td style="width: 10%;"></td> <td style="width: 10%;"></td> <td style="width: 10%;"></td> <td style="width: 10%;"></td> <td style="width: 10%;"></td> <td style="width: 10%;"></td> <td style="width: 10%;"></td> <td style="width: 10%;"></td> <td style="width: 10%;"></td> <td style="width: 10%;"></td> </tr> <tr> <td></td> <td></td> <td colspan="8" style="text-align: center;"> <table border="1" style="width: 100%; border-collapse: collapse; text-align: center;"> <tr> <td style="width: 10%;"></td> <td style="width: 10%;"></td> <td style="width: 10%;"></td> <td style="width: 10%;"></td> <td style="width: 10%;"></td> <td style="width: 10%;"></td> <td style="width: 10%;"></td> <td style="width: 10%;"></td> <td style="width: 10%;"></td> <td style="width: 10%;"></td> </tr> <tr> <td></td> <td></td> <td colspan="8" style="text-align: center;"> <table border="1" style="width: 100%; border-collapse: collapse; text-align: center;"> <tr> <td style="width: 10%;"></td> <td style="width: 10%;"></td> <td style="width: 10%;"></td> <td style="width: 10%;"></td> <td style="width: 10%;"></td> <td style="width: 10%;"></td> <td style="width: 10%;"></td> <td style="width: 10%;"></td> <td style="width: 10%;"></td> <td style="width: 10%;"></td> </tr> <tr> <td></td> <td></td> <td colspan="8" style="text-align: center;"> <table border="1" style="width: 100%; border-collapse: collapse; text-align: center;"> <tr> <td style="width: 10%;"></td> <td style="width: 10%;"></td> <td style="width: 10%;"></td> <td style="width: 10%;"></td> <td style="width: 10%;"></td> <td style="width: 10%;"></td> <td style="width: 10%;"></td> <td style="width: 10%;"></td> <td style="width: 10%;"></td> <td style="width: 10%;"></td> </tr> <tr> <td></td> <td></td> <td colspan="8" style="text-align: center;"> <table border="1" style="width: 100%; border-collapse: collapse; text-align: center;"> <tr> <td style="width: 10%;"></td> <td style="width: 10%;"></td> <td style="width: 10%;"></td> <td style="width: 10%;"></td> <td style="width: 10%;"></td> <td style="width: 10%;"></td> <td style="width: 10%;"></td> <td style="width: 10%;"></td> <td style="width: 10%;"></td> <td style="width: 10%;"></td> </tr> <tr> <td></td> <td></td> <td colspan="8" style="text-align: center;"> <table border="1" style="width: 100%; border-collapse: collapse; text-align: center;"> <tr> <td style="width: 10%;"></td> <td style="width: 10%;"></td> <td style="width: 10%;"></td> <td style="width: 10%;"></td> <td style="width: 10%;"></td> <td style="width: 10%;"></td> <td style="width: 10%;"></td> <td style="width: 10%;"></td> <td style="width: 10%;"></td> <td style="width: 10%;"></td> </tr> <tr> <td></td> <td></td> <td colspan="8" style="text-align: center;"> <table border="1" style="width: 100%; border-collapse: collapse; text-align: center;"> <tr> <td style="width: 10%;"></td> <td style="width: 10%;"></td> <td style="width: 10%;"></td> <td style="width: 10%;"></td> <td style="width: 10%;"></td> <td style="width: 10%;"></td> <td style="width: 10%;"></td> <td style="width: 10%;"></td> <td style="width: 10%;"></td> <td style="width: 10%;"></td> </tr> <tr> <td></td> <td></td> <td colspan="8" style="text-align: center;"> <table border="1" style="width: 100%; border-collapse: collapse; text-align: center;"> <tr> <td style="width: 10%;"></td> <td style="width: 10%;"></td> <td style="width: 10%;"></td> <td style="width: 10%;"></td> <td style="width: 10%;"></td> <td style="width: 10%;"></td> <td style="width: 10%;"></td> <td style="width: 10%;"></td> <td style="width: 10%;"></td> <td style="width: 10%;"></td> </tr> <tr> <td></td> <td></td> <td colspan="8" style="text-align: center;"> <table border="1" style="width: 100%; border-collapse: collapse; text-align: center;"> <tr> <td style="width: 10%;"></td> <td style="width: 10%;"></td> <td style="width: 10%;"></td> <td style="width: 10%;"></td> <td style="width: 10%;"></td> <td style="width: 10%;"></td> <td style="width: 10%;"></td> <td style="width: 10%;"></td> <td style="width: 10%;"></td> <td style="width: 10%;"></td> </tr> <tr> <td></td> <td></td> <td colspan="8" style="text-align: center;"> <table border="1" style="width: 100%; border-collapse: collapse; text-align: center;"> <tr> <td style="width: 10%;"></td> <td style="width: 10%;"></td> <td style="width: 10%;"></td> <td style="width: 10%;"></td> <td style="width: 10%;"></td> <td style="width: 10%;"></td> <td style="width: 10%;"></td> <td style="width: 10%;"></td> <td style="width: 10%;"></td> <td style="width: 10%;"></td> </tr> <tr> <td></td> <td></td> <td colspan="8" style="text-align: center;"> <table border="1" style="width: 100%; border-collapse: collapse; text-align: center;"> <tr> <td style="width: 10%;"></td> <td style="width: 10%;"></td> <td style="width: 10%;"></td> <td style="width: 10%;"></td> <td style="width: 10%;"></td> <td style="width: 10%;"></td> <td style="width: 10%;"></td> <td style="width: 10%;"></td> <td style="width: 10%;"></td> <td style="width: 10%;"></td> </tr> <tr> <td></td> <td></td> <td colspan="8" style="text-align: center;"> <table border="1" style="width: 100%; border-collapse: collapse; text-align: center;"> <tr> <td style="width: 10%;"></td> <td style="width: 10%;"></td> <td style="width: 10%;"></td> <td style="width: 10%;"></td> <td style="width: 10%;"></td> <td style="width: 10%;"></td> <td style="width: 10%;"></td> <td style="width: 10%;"></td> <td style="width: 10%;"></td> <td style="width: 10%;"></td> </tr> <tr> <td></td> <td></td> <td colspan="8" style="text-align: center;"> <table border="1" style="width: 100%; border-collapse: collapse; text-align: center;"> <tr> <td style="width: 10%;"></td> <td style="width: 10%;"></td> <td style="width: 10%;"></td> <td style="width: 10%;"></td> <td style="width: 10%;"></td> <td style="width: 10%;"></td> <td style="width: 10%;"></td> <td style="width: 10%;"></td> <td style="width: 10%;"></td> <td style="width: 10%;"></td> </tr> <tr> <td></td> <td></td> <td colspan="8" style="text-align: center;"> <table border="1" style="width: 100%; border-collapse: collapse; text-align: center;"> <tr> <td style="width: 10%;"></td> <td style="width: 10%;"></td> <td style="width: 10%;"></td> <td style="width: 10%;"></td> <td style="width: 10%;"></td> <td style="width: 10%;"></td> <td style="width: 10%;"></td> <td style="width: 10%;"></td> <td style="width: 10%;"></td> <td style="width: 10%;"></td> </tr> <tr> <td></td> <td></td> <td colspan="8" style="text-align: center;"> <table border="1" style="width: 100%; border-collapse: collapse; text-align: center;"> <tr> <td style="width: 10%;"></td> <td style="width: 10%;"></td> <td style="width: 10%;"></td> <td style="width: 10%;"></td> <td style="width: 10%;"></td> <td style="width: 10%;"></td> <td style="width: 10%;"></td> <td style="width: 10%;"></td> <td style="width: 10%;"></td> <td style="width: 10%;"></td> </tr> <tr> <td></td> <td></td> <td colspan="8" style="text-align: center;"> <table border="1" style="width: 100%; border-collapse: collapse; text-align: center;"> <tr> <td style="width: 10%;"></td> <td style="width: 10%;"></td> <td style="width: 10%;"></td> <td style="width: 10%;"></td> <td style="width: 10%;"></td> <td style="width: 10%;"></td> <td style="width: 10%;"></td> <td style="width: 10%;"></td> <td style="width: 10%;"></td> <td style="width: 10%;"></td> </tr> <tr> <td></td> <td></td> <td colspan="8" style="text-align: center;"> <table border="1" style="width: 100%; border-collapse: collapse; text-align: center;"> <tr> <td style="width: 10%;"></td> <td style="width: 10%;"></td> <td style="width: 10%;"></td> <td style="width: 10%;"></td> <td style="width: 10%;"></td> <td style="width: 10%;"></td> <td style="width: 10%;"></td> <td style="width: 10%;"></td> <td style="width: 10%;"></td> <td style="width: 10%;"></td> </tr> <tr> <td></td> <td></td> <td colspan="8" style="text-align: center;"> <table border="1" style="width: 100%; border-collapse: collapse; text-align: center;"> <tr> <td style="width: 10%;"></td> <td style="width: 10%;"></td> <td style="width: 10%;"></td> <td style="width: 10%;"></td> <td style="width: 10%;"></td> <td style="width: 10%;"></td> <td style="width: 10%;"></td> <td style="width: 10%;"></td> <td style="width: 10%;"></td> <td style="width: 10%;"></td> </tr> <tr> <td></td> <td></td> <td colspan="8" style="text-align: center;"> <table border="1" style="width: 100%; border-collapse: collapse; text-align: center;"> <tr> <td
style="width: 10%;"></td> <td style="width: 10%;"></td> <td style="width: 10%;"></td> <td style="width: 10%;"></td> <td style="width: 10%;"></td> <td style="width: 10%;"></td> <td style="width: 10%;"></td> <td style="width: 10%;"></td> <td style="width: 10%;"></td> <td style="width: 10%;"></td> </tr> <tr> <td></td> <td></td> <td colspan="8" style="text-align: center;"> <table border="1" style="width: 100%; border-collapse: collapse; text-align: center;"> <tr> <td style="width: 10%;"></td> <td style="width: 10%;"></td> <td style="width: 10%;"></td> <td style="width: 10%;"></td> <td style="width: 10%;"></td> <td style="width: 10%;"></td> <td style="width: 10%;"></td> <td style="width: 10%;"></td> <td style="width: 10%;"></td> <td style="width: 10%;"></td> </tr> <tr> <td></td> <td></td> <td colspan="8" style="text-align: center;"> <table border="1" style="width: 100%; border-collapse: collapse; text-align: center;"> <tr> <td style="width: 10%;"></td> <td style="width: 10%;"></td> <td style="width: 10%;"></td> <td style="width: 10%;"></td> <td style="width: 10%;"></td> <td style="width: 10%;"></td> <td style="width: 10%;"></td> <td style="width: 10%;"></td> <td style="width: 10%;"></td> <td style="width: 10%;"></td> </tr> <tr> <td></td> <td></td> <td colspan="8" style="text-align: center;"> <table border="1" style="width: 100%; border-collapse: collapse; text-align: center;"> <tr> <td style="width: 10%;"></td> <td style="width: 10%;"></td> <td style="width: 10%;"></td> <td style="width: 10%;"></td> <td style="width: 10%;"></td> <td style="width: 10%;"></td> <td style="width: 10%;"></td> <td style="width: 10%;"></td> <td style="width: 10%;"></td> <td style="width: 10%;"></td> </tr> <tr> <td></td> <td></td> <td colspan="8" style="text-align: center;"> <table border="1" style="width: 100%; border-collapse: collapse; text-align: center;"> <tr> <td style="width: 10%;"></td> <td style="width: 10%;"></td> <td style="width: 10%;"></td> <td style="width: 10%;"></td> <td style="width: 10%;"></td> <td style="width: 10%;"></td> <td style="width: 10%;"></td> <td style="width: 10%;"></td> <td style="width: 10%;"></td> <td style="width: 10%;"></td> </tr> <tr> <td></td> <td></td> <td colspan="8" style="text-align: center;"> <table border="1" style="width: 100%; border-collapse: collapse; text-align: center;"> <tr> <td style="width: 10%;"></td> <td style="width: 10%;"></td> <td style="width: 10%;"></td> <td style="width: 10%;"></td> <td style="width: 10%;"></td> <td style="width: 10%;"></td> <td style="width: 10%;"></td> <td style="width: 10%;"></td> <td style="width: 10%;"></td> <td style="width: 10%;"></td> </tr> <tr> <td></td> <td></td> <td colspan="8" style="text-align: center;"> <table border="1" style="width: 100%; border-collapse: collapse; text-align: center;"> <tr> <td style="width: 10%;"></td> <td style="width: 10%;"></td> <td style="width: 10%;"></td> <td style="width: 10%;"></td> <td style="width: 10%;"></td> <td style="width: 10%;"></td> <td style="width: 10%;"></td> <td style="width: 10%;"></td> <td style="width: 10%;"></td> <td style="width: 10%;"></td> </tr> <tr> <td></td> <td></td> <td colspan="8" style="text-align: center;"> <table border="1" style="width: 100%; border-collapse: collapse; text-align: center;"> <tr> <td style="width: 10%;"></td> <td style="width: 10%;"></td> <td style="width: 10%;"></td> <td style="width: 10%;"></td> <td style="width: 10%;"></td> <td style="width: 10%;"></td> <td style="width: 10%;"></td> <td style="width: 10%;"></td> <td style="width: 10%;"></td> <td style="width: 10%;"></td> </tr> <tr> <td></td> <td></td> <td colspan="8" style="text-align: center;"> <table border="1" style="width: 100%; border-collapse: collapse; text-align: center;"> <tr> <td style="width: 10%;"></td> <td style="width: 10%;"></td> <td style="width: 10%;"></td> <td style="width: 10%;"></td> <td style="width: 10%;"></td> <td style="width: 10%;"></td> <td style="width: 10%;"></td> <td style="width: 10%;"></td> <td style="width: 10%;"></td> <td style="width: 10%;"></td> </tr> <tr> <td></td> <td></td> <td colspan="8" style="text-align: center;"> <table border="1" style="width: 100%; border-collapse: collapse; text-align: center;"> <tr> <td style="width: 10%;"></td> <td style="width: 10%;"></td> <td style="width: 10%;"></td> <td style="width: 10%;"></td> <td style="width: 10%;"></td> <td style="width: 10%;"></td> <td style="width: 10%;"></td> <td style="width: 10%;"></td> <td style="width: 10%;"></td> <td style="width: 10%;"></td> </tr> <tr> <td></td> <td></td> <td colspan="8" style="text-align: center;"> <table border="1" style="width: 100%; border-collapse: collapse; text-align: center;"> <tr> <td style="width: 10%;"></td> <td style="width: 10%;"></td> <td style="width: 10%;"></td> <td style="width: 10%;"></td> <td style="width: 10%;"></td> <td style="width: 10%;"></td> <td style="width: 10%;"></td> <td style="width: 10%;"></td> <td style="width: 10%;"></td> <td style="width: 10%;"></td> </tr> <tr> <td></td> <td></td> <td colspan="8" style="text-align: center;"> <table border="1" style="width: 100%; border-collapse: collapse; text-align: center;"> <tr> <td style="width: 10%;"></td> <td style="width: 10%;"></td> <td style="width: 10%;"></td> <td style="width: 10%;"></td> <td style="width: 10%;"></td> <td style="width: 10%;"></td> <td style="width: 10%;"></td> <td style="width: 10%;"></td> <td style="width: 10%;"></td> <td style="width: 10%;"></td> </tr> <tr> <td></td> <td></td> <td colspan="8" style="text-align: center;"> <table border="1" style="width: 100%; border-collapse: collapse; text-align: center;"> <tr> <td style="width: 10%;"></td> <td style="width: 10%;"></td> <td style="width: 10%;"></td> <td style="width: 10%;"></td> <td style="width: 10%;"></td> <td style="width: 10%;"></td> <td style="width: 10%;"></td> <td style="width: 10%;"></td> <td style="width: 10%;"></td> <td style="width: 10%;"></td> </tr> <tr> <td></td> <td></td> <td colspan="8" style="text-align: center;"> <table border="1" style="width: 100%; border-collapse: collapse; text-align: center;"> <tr> <td style="width: 10%;"></td> <td style="width: 10%;"></td> <td style="width: 10%;"></td> <td style="width: 10%;"></td> <td style="width: 10%;"></td> <td style="width: 10%;"></td> <td style="width: 10%;"></td> <td style="width: 10%;"></td> <td style="width: 10%;"></td> <td style="width: 10%;"></td> </tr> <tr> <td></td> <td></td> <td colspan="8" style="text-align: center;"> <table border="1" style="width: 100%; border-collapse: collapse; text-align: center;"> <tr> <td style="width: 10%;"></td> <td style="width: 10%;"></td> <td style="width: 10%;"></td> <td style="width: 10%;"></td> <td style="width: 10%;"></td> <td style="width: 10%;"></td> <td style="width: 10%;"></td> <td style="width: 10%;"></td> <td style="width: 10%;"></td> <td style="width: 10%;"></td> </tr> <tr> <td></td> <td></td> <td colspan="8" style="text-align: center;"> <table border="1" style="width: 100%; border-collapse: collapse; text-align: center;"> <tr> <td style="width: 10%;"></td> <td style="width: 10%;"></td> <td style="width: 10%;"></td> <td style="width: 10%;"></td> <td style="width: 10%;"></td> <td style="width: 10%;"></td> <td style="width: 10%;"></td> <td style="width: 10%;"></td> <td style="width: 10%;"></td> <td style="width: 10%;"></td> </tr> <tr> <td></td> <td></td> <td colspan="8" style="text-align: center;"> <table border="1" style="width: 100%; border-collapse: collapse; text-align: center;"> <tr> <td style="width: 10%;"></td> <td style="width: 10%;"></td> <td style="width: 10%;"></td> <td style="width: 10%;"></td> <td style="width: 10%;"></td> <td style="width: 10%;"></td> <td style="width: 10%;"></td> <td style="width: 10%;"></td> <td style="width: 10%;"></td> <td style="width: 10%;"></td> </tr> <tr> <td></td> <td></td> <td colspan="8" style="text-align: center;"> <table border="1" style="width: 100%; border-collapse: collapse; text-align: center;"> <tr> </tr></table></td></tr></table></td></tr></table></td></tr></table></td></tr></table></td></tr></table></td></tr></table></td></tr></table></td></tr></table></td></tr></table></td></tr></table></td></tr></table></td></tr></table></td></tr></table></td></tr></table></td></tr></table></td></tr></table></td></tr></table></td></tr></table></td></tr></table></td></tr></table></td></tr></table></td></tr></table></td></tr></table></td></tr></table></td></tr></table></td></tr></table></td></tr></table></td></tr></table></td></tr></table></td></tr></table></td></tr></table></td></tr></table></td></tr></table></td></tr></table></td></tr></table></td></tr></table></td></tr></table></td></tr></table></td></tr></table></td></tr></table></td></tr></table></td></tr></table></td></tr></table></td></tr></table></td></tr></table></td></tr></table></td></tr></table></td></tr></table></td></tr></table></td></tr></table></td></tr></table></td></tr></table></td></tr></table></td></tr></table></td></tr></table>
 | | | | | | | | | | | | | | | | | | | | <table border="1" style="width: 100%; border-collapse: collapse; text-align: center;"> <tr> <td style="width: 10%;"></td> <td style="width: 10%;"></td> <td style="width: 10%;"></td> <td style="width: 10%;"></td> <td style="width: 10%;"></td> <td style="width: 10%;"></td> <td style="width: 10%;"></td> <td style="width: 10%;"></td> <td style="width: 10%;"></td> <td style="width: 10%;"></td> </tr> <tr> <td></td> <td></td> <td colspan="8" style="text-align: center;"> <table border="1" style="width: 100%; border-collapse: collapse; text-align: center;"> <tr> <td style="width: 10%;"></td> <td style="width: 10%;"></td> <td style="width: 10%;"></td> <td style="width: 10%;"></td> <td style="width: 10%;"></td> <td style="width: 10%;"></td> <td style="width: 10%;"></td> <td style="width: 10%;"></td> <td style="width: 10%;"></td> <td style="width: 10%;"></td> </tr> <tr> <td></td> <td></td> <td colspan="8" style="text-align: center;"> <table border="1" style="width: 100%; border-collapse: collapse; text-align: center;"> <tr> <td style="width: 10%;"></td> <td style="width: 10%;"></td> <td style="width: 10%;"></td> <td style="width: 10%;"></td> <td style="width: 10%;"></td> <td style="width: 10%;"></td> <td style="width: 10%;"></td> <td style="width: 10%;"></td> <td style="width: 10%;"></td> <td style="width: 10%;"></td> </tr> <tr> <td></td> <td></td> <td colspan="8" style="text-align: center;"> <table border="1" style="width: 100%; border-collapse: collapse; text-align: center;"> <tr> <td style="width: 10%;"></td> <td style="width: 10%;"></td> <td style="width: 10%;"></td> <td style="width: 10%;"></td> <td style="width: 10%;"></td> <td style="width: 10%;"></td> <td style="width: 10%;"></td> <td style="width: 10%;"></td> <td style="width: 10%;"></td> <td style="width: 10%;"></td> </tr> <tr> <td></td> <td></td> <td colspan="8" style="text-align: center;"> <table border="1" style="width: 100%; border-collapse: collapse; text-align: center;"> <tr> <td style="width: 10%;"></td> <td style="width: 10%;"></td> <td style="width: 10%;"></td> <td style="width: 10%;"></td> <td style="width: 10%;"></td> <td style="width: 10%;"></td> <td style="width: 10%;"></td> <td style="width: 10%;"></td> <td style="width: 10%;"></td> <td style="width: 10%;"></td> </tr> <tr> <td></td> <td></td> <td colspan="8" style="text-align: center;"> <table border="1" style="width: 100%; border-collapse: collapse; text-align: center;"> <tr> <td style="width: 10%;"></td> <td style="width: 10%;"></td> <td style="width: 10%;"></td> <td style="width: 10%;"></td> <td style="width: 10%;"></td> <td style="width: 10%;"></td> <td style="width: 10%;"></td> <td style="width: 10%;"></td> <td style="width: 10%;"></td> <td style="width: 10%;"></td> </tr> <tr> <td></td> <td></td> <td colspan="8" style="text-align: center;"> <table border="1" style="width: 100%; border-collapse: collapse; text-align: center;"> <tr> <td style="width: 10%;"></td> <td style="width: 10%;"></td> <td style="width: 10%;"></td> <td style="width: 10%;"></td> <td style="width: 10%;"></td> <td style="width: 10%;"></td> <td style="width: 10%;"></td> <td style="width: 10%;"></td> <td style="width: 10%;"></td> <td style="width: 10%;"></td> </tr> <tr> <td></td> <td></td> <td colspan="8" style="text-align: center;"> <table border="1" style="width: 100%; border-collapse: collapse; text-align: center;"> <tr> <td style="width: 10%;"></td> <td style="width: 10%;"></td> <td style="width: 10%;"></td> <td style="width: 10%;"></td> <td style="width: 10%;"></td> <td style="width: 10%;"></td> <td style="width: 10%;"></td> <td style="width: 10%;"></td> <td style="width: 10%;"></td> <td style="width: 10%;"></td> </tr> <tr> <td></td> <td></td> <td colspan="8" style="text-align: center;"> <table border="1" style="width: 100%; border-collapse: collapse; text-align: center;"> <tr> <td style="width: 10%;"></td> <td style="width: 10%;"></td> <td style="width: 10%;"></td> <td style="width: 10%;"></td> <td style="width: 10%;"></td> <td style="width: 10%;"></td> <td style="width: 10%;"></td> <td style="width: 10%;"></td> <td style="width: 10%;"></td> <td style="width: 10%;"></td> </tr> <tr> <td></td> <td></td> <td colspan="8" style="text-align: center;"> <table border="1" style="width: 100%; border-collapse: collapse; text-align: center;"> <tr> <td style="width: 10%;"></td> <td style="width: 10%;"></td> <td style="width: 10%;"></td> <td style="width: 10%;"></td> <td style="width: 10%;"></td> <td style="width: 10%;"></td> <td style="width: 10%;"></td> <td style="width: 10%;"></td> <td style="width: 10%;"></td> <td style="width: 10%;"></td> </tr> <tr> <td></td> <td></td> <td colspan="8" style="text-align: center;"> <table border="1" style="width: 100%; border-collapse: collapse; text-align: center;"> <tr> <td style="width: 10%;"></td> <td style="width: 10%;"></td> <td style="width: 10%;"></td> <td style="width: 10%;"></td> <td style="width: 10%;"></td> <td style="width: 10%;"></td> <td style="width: 10%;"></td> <td style="width: 10%;"></td> <td style="width: 10%;"></td> <td style="width: 10%;"></td> </tr> <tr> <td></td> <td></td> <td colspan="8" style="text-align: center;"> <table border="1" style="width: 100%; border-collapse: collapse; text-align: center;"> <tr> <td style="width: 10%;"></td> <td style="width: 10%;"></td> <td style="width: 10%;"></td> <td style="width: 10%;"></td> <td style="width: 10%;"></td> <td style="width: 10%;"></td> <td style="width: 10%;"></td> <td style="width: 10%;"></td> <td style="width: 10%;"></td> <td style="width: 10%;"></td> </tr> <tr> <td></td> <td></td> <td colspan="8" style="text-align: center;"> <table border="1" style="width: 100%; border-collapse: collapse; text-align: center;"> <tr> <td style="width: 10%;"></td> <td style="width: 10%;"></td> <td style="width: 10%;"></td> <td style="width: 10%;"></td> <td style="width: 10%;"></td> <td style="width: 10%;"></td> <td style="width: 10%;"></td> <td style="width: 10%;"></td> <td style="width: 10%;"></td> <td style="width: 10%;"></td> </tr> <tr> <td></td> <td></td> <td colspan="8" style="text-align: center;"> <table border="1" style="width: 100%; border-collapse: collapse; text-align: center;"> <tr> <td style="width: 10%;"></td> <td style="width: 10%;"></td> <td style="width: 10%;"></td> <td style="width: 10%;"></td> <td style="width: 10%;"></td> <td style="width: 10%;"></td> <td style="width: 10%;"></td> <td style="width: 10%;"></td> <td style="width: 10%;"></td> <td style="width: 10%;"></td> </tr> <tr> <td></td> <td></td> <td colspan="8" style="text-align: center;"> <table border="1" style="width: 100%; border-collapse: collapse; text-align: center;"> <tr> <td style="width: 10%;"></td> <td style="width: 10%;"></td> <td style="width: 10%;"></td> <td style="width: 10%;"></td> <td style="width: 10%;"></td> <td style="width: 10%;"></td> <td style="width: 10%;"></td> <td style="width: 10%;"></td> <td style="width: 10%;"></td> <td style="width: 10%;"></td> </tr> <tr> <td></td> <td></td> <td colspan="8" style="text-align: center;"> <table border="1" style="width: 100%; border-collapse: collapse; text-align: center;"> <tr> <td style="width: 10%;"></td> <td style="width: 10%;"></td> <td style="width: 10%;"></td> <td style="width: 10%;"></td> <td style="width: 10%;"></td> <td style="width: 10%;"></td> <td style="width: 10%;"></td> <td style="width: 10%;"></td> <td style="width: 10%;"></td> <td style="width: 10%;"></td> </tr> <tr> <td></td> <td></td> <td colspan="8" style="text-align: center;"> <table border="1" style="width: 100%; border-collapse: collapse; text-align: center;"> <tr>
<td style="width: 10%;"></td> <td style="width: 10%;"></td> <td style="width: 10%;"></td> <td style="width: 10%;"></td> <td style="width: 10%;"></td> <td style="width: 10%;"></td> <td style="width: 10%;"></td> <td style="width: 10%;"></td> <td style="width: 10%;"></td> <td style="width: 10%;"></td> </tr> <tr> <td></td> <td></td> <td colspan="8" style="text-align: center;"> <table border="1" style="width: 100%; border-collapse: collapse; text-align: center;"> <tr> <td style="width: 10%;"></td> <td style="width: 10%;"></td> <td style="width: 10%;"></td> <td style="width: 10%;"></td> <td style="width: 10%;"></td> <td style="width: 10%;"></td> <td style="width: 10%;"></td> <td style="width: 10%;"></td> <td style="width: 10%;"></td> <td style="width: 10%;"></td> </tr> <tr> <td></td> <td></td> <td colspan="8" style="text-align: center;"> <table border="1" style="width: 100%; border-collapse: collapse; text-align: center;"> <tr> <td style="width: 10%;"></td> <td style="width: 10%;"></td> <td style="width: 10%;"></td> <td style="width: 10%;"></td> <td style="width: 10%;"></td> <td style="width: 10%;"></td> <td style="width: 10%;"></td> <td style="width: 10%;"></td> <td style="width: 10%;"></td> <td style="width: 10%;"></td> </tr> <tr> <td></td> <td></td> <td colspan="8" style="text-align: center;"> <table border="1" style="width: 100%; border-collapse: collapse; text-align: center;"> <tr> <td style="width: 10%;"></td> <td style="width: 10%;"></td> <td style="width: 10%;"></td> <td style="width: 10%;"></td> <td style="width: 10%;"></td> <td style="width: 10%;"></td> <td style="width: 10%;"></td> <td style="width: 10%;"></td> <td style="width: 10%;"></td> <td style="width: 10%;"></td> </tr> <tr> <td></td> <td></td> <td colspan="8" style="text-align: center;"> <table border="1" style="width: 100%; border-collapse: collapse; text-align: center;"> <tr> <td style="width: 10%;"></td> <td style="width: 10%;"></td> <td style="width: 10%;"></td> <td style="width: 10%;"></td> <td style="width: 10%;"></td> <td style="width: 10%;"></td> <td style="width: 10%;"></td> <td style="width: 10%;"></td> <td style="width: 10%;"></td> <td style="width: 10%;"></td> </tr> <tr> <td></td> <td></td> <td colspan="8" style="text-align: center;"> <table border="1" style="width: 100%; border-collapse: collapse; text-align: center;"> <tr> <td style="width: 10%;"></td> <td style="width: 10%;"></td> <td style="width: 10%;"></td> <td style="width: 10%;"></td> <td style="width: 10%;"></td> <td style="width: 10%;"></td> <td style="width: 10%;"></td> <td style="width: 10%;"></td> <td style="width: 10%;"></td> <td style="width: 10%;"></td> </tr> <tr> <td></td> <td></td> <td colspan="8" style="text-align: center;"> <table border="1" style="width: 100%; border-collapse: collapse; text-align: center;"> <tr> <td style="width: 10%;"></td> <td style="width: 10%;"></td> <td style="width: 10%;"></td> <td style="width: 10%;"></td> <td style="width: 10%;"></td> <td style="width: 10%;"></td> <td style="width: 10%;"></td> <td style="width: 10%;"></td> <td style="width: 10%;"></td> <td style="width: 10%;"></td> </tr> <tr> <td></td> <td></td> <td colspan="8" style="text-align: center;"> <table border="1" style="width: 100%; border-collapse: collapse; text-align: center;"> <tr> <td style="width: 10%;"></td> <td style="width: 10%;"></td> <td style="width: 10%;"></td> <td style="width: 10%;"></td> <td style="width: 10%;"></td> <td style="width: 10%;"></td> <td style="width: 10%;"></td> <td style="width: 10%;"></td> <td style="width: 10%;"></td> <td style="width: 10%;"></td> </tr> <tr> <td></td> <td></td> <td colspan="8" style="text-align: center;"> <table border="1" style="width: 100%; border-collapse: collapse; text-align: center;"> <tr> <td style="width: 10%;"></td> <td style="width: 10%;"></td> <td style="width: 10%;"></td> <td style="width: 10%;"></td> <td style="width: 10%;"></td> <td style="width: 10%;"></td> <td style="width: 10%;"></td> <td style="width: 10%;"></td> <td style="width: 10%;"></td> <td style="width: 10%;"></td> </tr> <tr> <td></td> <td></td> <td colspan="8" style="text-align: center;"> <table border="1" style="width: 100%; border-collapse: collapse; text-align: center;"> <tr> <td style="width: 10%;"></td> <td style="width: 10%;"></td> <td style="width: 10%;"></td> <td style="width: 10%;"></td> <td style="width: 10%;"></td> <td style="width: 10%;"></td> <td style="width: 10%;"></td> <td style="width: 10%;"></td> <td style="width: 10%;"></td> <td style="width: 10%;"></td> </tr> <tr> <td></td> <td></td> <td colspan="8" style="text-align: center;"> <table border="1" style="width: 100%; border-collapse: collapse; text-align: center;"> <tr> <td style="width: 10%;"></td> <td style="width: 10%;"></td> <td style="width: 10%;"></td> <td style="width: 10%;"></td> <td style="width: 10%;"></td> <td style="width: 10%;"></td> <td style="width: 10%;"></td> <td style="width: 10%;"></td> <td style="width: 10%;"></td> <td style="width: 10%;"></td> </tr> <tr> <td></td> <td></td> <td colspan="8" style="text-align: center;"> <table border="1" style="width: 100%; border-collapse: collapse; text-align: center;"> <tr> <td style="width: 10%;"></td> <td style="width: 10%;"></td> <td style="width: 10%;"></td> <td style="width: 10%;"></td> <td style="width: 10%;"></td> <td style="width: 10%;"></td> <td style="width: 10%;"></td> <td style="width: 10%;"></td> <td style="width: 10%;"></td> <td style="width: 10%;"></td> </tr> <tr> <td></td> <td></td> <td colspan="8" style="text-align: center;"> <table border="1" style="width: 100%; border-collapse: collapse; text-align: center;"> <tr> <td style="width: 10%;"></td> <td style="width: 10%;"></td> <td style="width: 10%;"></td> <td style="width: 10%;"></td> <td style="width: 10%;"></td> <td style="width: 10%;"></td> <td style="width: 10%;"></td> <td style="width: 10%;"></td> <td style="width: 10%;"></td> <td style="width: 10%;"></td> </tr> <tr> <td></td> <td></td> <td colspan="8" style="text-align: center;"> <table border="1" style="width: 100%; border-collapse: collapse; text-align: center;"> <tr> <td style="width: 10%;"></td> <td style="width: 10%;"></td> <td style="width: 10%;"></td> <td style="width: 10%;"></td> <td style="width: 10%;"></td> <td style="width: 10%;"></td> <td style="width: 10%;"></td> <td style="width: 10%;"></td> <td style="width: 10%;"></td> <td style="width: 10%;"></td> </tr> <tr> <td></td> <td></td> <td colspan="8" style="text-align: center;"> <table border="1" style="width: 100%; border-collapse: collapse; text-align: center;"> <tr> <td style="width: 10%;"></td> <td style="width: 10%;"></td> <td style="width: 10%;"></td> <td style="width: 10%;"></td> <td style="width: 10%;"></td> <td style="width: 10%;"></td> <td style="width: 10%;"></td> <td style="width: 10%;"></td> <td style="width: 10%;"></td> <td style="width: 10%;"></td> </tr> <tr> <td></td> <td></td> <td colspan="8" style="text-align: center;"> <table border="1" style="width: 100%; border-collapse: collapse; text-align: center;"> <tr> <td style="width: 10%;"></td> <td style="width: 10%;"></td> <td style="width: 10%;"></td> <td style="width: 10%;"></td> <td style="width: 10%;"></td> <td style="width: 10%;"></td> <td style="width: 10%;"></td> <td style="width: 10%;"></td> <td style="width: 10%;"></td> <td style="width: 10%;"></td> </tr> <tr> <td></td> <td></td> <td colspan="8" style="text-align: center;"> <table border="1" style="width: 100%; border-collapse: collapse; text-align: center;"> <tr> <td style="width: 10%;"></td> <td style="width: 10%;"></td> <td style="width: 10%;"></td> <td style="width: 10%;"></td> <td style="width: 10%;"></td> <td style="width: 10%;"></td> <td style="width: 10%;"></td> <td style="width: 10%;"></td> <td style="width: 10%;"></td> <td style="width: 10%;"></td> </tr> <tr> <td></td> <td></td> <td colspan="8" style="text-align: center;"> <table border="1" style="width: 100%; border-collapse: collapse; text-align: center;"> <tr> <td style="width: 10%;"></td> <td style="width: 10%;"></td> <td style="width: 10%;"></td> <td style="width: 10%;"></td> <td style="width: 10%;"></td> <td style="width: 10%;"></td> <td style="width: 10%;"></td> <td style="width: 10%;"></td> <td style="width: 10%;"></td> <td style="width: 10%;"></td> </tr> <tr> <td></td> <td></td> <td colspan="8" style="text-align: center;"> <table border="1" style="width: 100%; border-collapse: collapse; text-align: center;"> <tr> <td style="width: 10%;"></td> <td style="width: 10%;"></td> <td style="width: 10%;"></td> <td style="width: 10%;"></td> <td style="width: 10%;"></td> <td style="width: 10%;"></td> <td style="width: 10%;"></td> <td style="width: 10%;"></td> <td style="width: 10%;"></td> <td style="width: 10%;"></td> </tr> <tr> <td></td> <td></td> <td colspan="8" style="text-align: center;"> <table border="1" style="width: 100%; border-collapse: collapse; text-align: center;"> <tr> <td style="width: 10%;"></td> <td style="width: 10%;"></td> <td style="width: 10%;"></td> <td style="width: 10%;"></td> <td style="width: 10%;"></td> <td style="width: 10%;"></td> <td style="width: 10%;"></td> <td style="width: 10%;"></td> <td style="width: 10%;"></td> <td style="width: 10%;"></td> </tr> <tr> <td></td> <td></td> <td colspan="8" style="text-align: center;"> <table border="1" style="width: 100%; border-collapse: collapse; text-align: center;"> <tr> <td style="width: 10%;"></td> <td style="width: 10%;"></td> <td style="width: 10%;"></td> <td style="width: 10%;"></td> <td style="width: 10%;"></td> <td style="width: 10%;"></td> <td style="width: 10%;"></td> <td style="width: 10%;"></td> <td style="width: 10%;"></td> <td style="width: 10%;"></td> </tr> <tr> <td></td> <td></td> <td colspan="8" style="text-align: center;"> <table border="1" style="width: 100%; border-collapse: collapse; text-align: center;"> <tr> <td style="width: 10%;"></td> <td style="width: 10%;"></td> <td style="width: 10%;"></td> <td style="width: 10%;"></td> <td style="width: 10%;"></td> <td style="width:
10%;"></td> <td style="width: 10%;"></td> <td style="width: 10%;"></td> <td style="width: 10%;"></td> <td style="width: 10%;"></td> </tr> <tr> <td></td> <td></td> <td colspan="8" style="text-align: center;"> <table border="1" style="width: 100%; border-collapse: collapse; text-align: center;"> <tr> <td style="width: 10%;"></td> <td style="width: 10%;"></td> <td style="width: 10%;"></td> <td style="width: 10%;"></td> <td style="width: 10%;"></td> <td style="width: 10%;"></td> <td style="width: 10%;"></td> <td style="width: 10%;"></td> <td style="width: 10%;"></td> <td style="width: 10%;"></td> </tr> <tr> <td></td> <td></td> <td colspan="8" style="text-align: center;"> <table border="1" style="width: 100%; border-collapse: collapse; text-align: center;"> <tr> <td style="width: 10%;"></td> <td style="width: 10%;"></td> <td style="width: 10%;"></td> <td style="width: 10%;"></td> <td style="width: 10%;"></td> <td style="width: 10%;"></td> <td style="width: 10%;"></td> <td style="width: 10%;"></td> <td style="width: 10%;"></td> <td style="width: 10%;"></td> </tr> <tr> <td></td> <td></td> <td colspan="8" style="text-align: center;"> <table border="1" style="width: 100%; border-collapse: collapse; text-align: center;"> <tr> <td style="width: 10%;"></td> <td style="width: 10%;"></td> <td style="width: 10%;"></td> <td style="width: 10%;"></td> <td style="width: 10%;"></td> <td style="width: 10%;"></td> <td style="width: 10%;"></td> <td style="width: 10%;"></td> <td style="width: 10%;"></td> <td style="width: 10%;"></td> </tr> <tr> <td></td> <td></td> <td colspan="8" style="text-align: center;"> <table border="1" style="width: 100%; border-collapse: collapse; text-align: center;"> <tr> <td style="width: 10%;"></td> <td style="width: 10%;"></td> <td style="width: 10%;"></td> <td style="width: 10%;"></td> <td style="width: 10%;"></td> <td style="width: 10%;"></td> <td style="width: 10%;"></td> <td style="width: 10%;"></td> <td style="width: 10%;"></td> <td style="width: 10%;"></td> </tr> <tr> <td></td> <td></td> <td colspan="8" style="text-align: center;"> <table border="1" style="width: 100%; border-collapse: collapse; text-align: center;"> <tr> <td style="width: 10%;"></td> <td style="width: 10%;"></td> <td style="width: 10%;"></td> <td style="width: 10%;"></td> <td style="width: 10%;"></td> <td style="width: 10%;"></td> <td style="width: 10%;"></td> <td style="width: 10%;"></td> <td style="width: 10%;"></td> <td style="width: 10%;"></td> </tr> <tr> <td></td> <td></td> <td colspan="8" style="text-align: center;"> <table border="1" style="width: 100%; border-collapse: collapse; text-align: center;"> <tr> <td style="width: 10%;"></td> <td style="width: 10%;"></td> <td style="width: 10%;"></td> <td style="width: 10%;"></td> <td style="width: 10%;"></td> <td style="width: 10%;"></td> <td style="width: 10%;"></td> <td style="width: 10%;"></td> <td style="width: 10%;"></td> <td style="width: 10%;"></td> </tr> <tr> <td></td> <td></td> <td colspan="8" style="text-align: center;"> <table border="1" style="width: 100%; border-collapse: collapse; text-align: center;"> <tr> <td style="width: 10%;"></td> <td style="width: 10%;"></td> <td style="width: 10%;"></td> <td style="width: 10%;"></td> <td style="width: 10%;"></td> <td style="width: 10%;"></td> <td style="width: 10%;"></td> <td style="width: 10%;"></td> <td style="width: 10%;"></td> <td style="width: 10%;"></td> </tr> <tr> <td></td> <td></td> <td colspan="8" style="text-align: center;"> <table border="1" style="width: 100%; border-collapse: collapse; text-align: center;"> <tr> <td style="width: 10%;"></td> <td style="width: 10%;"></td> <td style="width: 10%;"></td> <td style="width: 10%;"></td> <td style="width: 10%;"></td> <td style="width: 10%;"></td> <td style="width: 10%;"></td> <td style="width: 10%;"></td> <td style="width: 10%;"></td> <td style="width: 10%;"></td> </tr> <tr> <td></td> <td></td> <td colspan="8" style="text-align: center;"> <table border="1" style="width: 100%; border-collapse: collapse; text-align: center;"> <tr> <td style="width: 10%;"></td> <td style="width: 10%;"></td> <td style="width: 10%;"></td> <td style="width: 10%;"></td> <td style="width: 10%;"></td> <td style="width: 10%;"></td> <td style="width: 10%;"></td> <td style="width: 10%;"></td> <td style="width: 10%;"></td> <td style="width: 10%;"></td> </tr> <tr> <td></td> <td></td> <td colspan="8" style="text-align: center;"> <table border="1" style="width: 100%; border-collapse: collapse; text-align: center;"> <tr> <td style="width: 10%;"></td> <td style="width: 10%;"></td> <td style="width: 10%;"></td> <td style="width: 10%;"></td> <td style="width: 10%;"></td> <td style="width: 10%;"></td> <td style="width: 10%;"></td> <td style="width: 10%;"></td> <td style="width: 10%;"></td> <td style="width: 10%;"></td> </tr> <tr> <td></td> <td></td> <td colspan="8" style="text-align: center;"> <table border="1" style="width: 100%; border-collapse: collapse; text-align: center;"> <tr> <td style="width: 10%;"></td> <td style="width: 10%;"></td> <td style="width: 10%;"></td> <td style="width: 10%;"></td> <td style="width: 10%;"></td> <td style="width: 10%;"></td> <td style="width: 10%;"></td> <td style="width: 10%;"></td> <td style="width: 10%;"></td> <td style="width: 10%;"></td> </tr> <tr> <td></td> <td></td> <td colspan="8" style="text-align: center;"> <table border="1" style="width: 100%; border-collapse: collapse; text-align: center;"> <tr> <td style="width: 10%;"></td> <td style="width: 10%;"></td> <td style="width: 10%;"></td> <td style="width: 10%;"></td> <td style="width: 10%;"></td> <td style="width: 10%;"></td> <td style="width: 10%;"></td> <td style="width: 10%;"></td> <td style="width: 10%;"></td> <td style="width: 10%;"></td> </tr> <tr> <td></td> <td></td> <td colspan="8" style="text-align: center;"> <table border="1" style="width: 100%; border-collapse: collapse; text-align: center;"> <tr> <td style="width: 10%;"></td> <td style="width: 10%;"></td> <td style="width: 10%;"></td> <td style="width: 10%;"></td> <td style="width: 10%;"></td> <td style="width: 10%;"></td> <td style="width: 10%;"></td> <td style="width: 10%;"></td> <td style="width: 10%;"></td> <td style="width: 10%;"></td> </tr> <tr> <td></td> <td></td> <td colspan="8" style="text-align: center;"> <table border="1" style="width: 100%; border-collapse: collapse; text-align: center;"> <tr> <td style="width: 10%;"></td> <td style="width: 10%;"></td> <td style="width: 10%;"></td> <td style="width: 10%;"></td> <td style="width: 10%;"></td> <td style="width: 10%;"></td> <td style="width: 10%;"></td> <td style="width: 10%;"></td> <td style="width: 10%;"></td> <td style="width: 10%;"></td> </tr> <tr> <td></td> <td></td> <td colspan="8" style="text-align: center;"> <table border="1" style="width: 100%; border-collapse: collapse; text-align: center;"> <tr> <td style="width: 10%;"></td> <td style="width: 10%;"></td> <td style="width: 10%;"></td> <td style="width: 10%;"></td> <td style="width: 10%;"></td> <td style="width: 10%;"></td> <td style="width: 10%;"></td> <td style="width: 10%;"></td> <td style="width: 10%;"></td> <td style="width: 10%;"></td> </tr> <tr> <td></td> <td></td> <td colspan="8" style="text-align: center;"> <table border="1" style="width: 100%; border-collapse: collapse; text-align: center;"> <tr> <td style="width: 10%;"></td> <td style="width: 10%;"></td> <td style="width: 10%;"></td> <td style="width: 10%;"></td> <td style="width: 10%;"></td> <td style="width: 10%;"></td> <td style="width: 10%;"></td> <td style="width: 10%;"></td> <td style="width: 10%;"></td> <td style="width: 10%;"></td> </tr> <tr> <td></td> <td></td> <td colspan="8" style="text-align: center;"> <table border="1" style="width: 100%; border-collapse: collapse; text-align: center;"> <tr> </tr></table></td></tr></table></td></tr></table></td></tr></table></td></tr></table></td></tr></table></td></tr></table></td></tr></table></td></tr></table></td></tr></table></td></tr></table></td></tr></table></td></tr></table></td></tr></table></td></tr></table></td></tr></table></td></tr></table></td></tr></table></td></tr></table></td></tr></table></td></tr></table></td></tr></table></td></tr></table></td></tr></table></td></tr></table></td></tr></table></td></tr></table></td></tr></table></td></tr></table></td></tr></table></td></tr></table></td></tr></table></td></tr></table></td></tr></table></td></tr></table></td></tr></table></td></tr></table></td></tr></table></td></tr></table></td></tr></table></td></tr></table></td></tr></table></td></tr></table></td></tr></table></td></tr></table></td></tr></table></td></tr></table></td></tr></table></td></tr></table></td></tr></table></td></tr></table></td></tr></table></td></tr></table></td></tr></table></td></tr></table>
 | | | | | | | | | | | | | | | | | | | | <table border="1" style="width: 100%; border-collapse: collapse; text-align: center;"> <tr> <td style="width: 10%;"></td> <td style="width: 10%;"></td> <td style="width: 10%;"></td> <td style="width: 10%;"></td> <td style="width: 10%;"></td> <td style="width: 10%;"></td> <td style="width: 10%;"></td> <td style="width: 10%;"></td> <td style="width: 10%;"></td> <td style="width: 10%;"></td> </tr> <tr> <td></td> <td></td> <td colspan="8" style="text-align: center;"> <table border="1" style="width: 100%; border-collapse: collapse; text-align: center;"> <tr> <td style="width: 10%;"></td> <td style="width: 10%;"></td> <td style="width: 10%;"></td> <td style="width: 10%;"></td> <td style="width: 10%;"></td> <td style="width: 10%;"></td> <td style="width: 10%;"></td> <td style="width: 10%;"></td> <td style="width: 10%;"></td> <td style="width: 10%;"></td> </tr> <tr> <td></td> <td></td> <td colspan="8" style="text-align: center;"> <table border="1" style="width: 100%; border-collapse: collapse; text-align: center;"> <tr> <td style="width: 10%;"></td> <td style="width: 10%;"></td> <td style="width: 10%;"></td> <td style="width: 10%;"></td> <td style="width: 10%;"></td> <td style="width: 10%;"></td> <td style="width: 10%;"></td> <td style="width: 10%;"></td> <td style="width: 10%;"></td> <td style="width: 10%;"></td> </tr> <tr> <td></td> <td></td> <td colspan="8" style="text-align: center;"> <table border="1" style="width: 100%; border-collapse: collapse; text-align: center;"> <tr> <td style="width: 10%;"></td> <td style="width: 10%;"></td> <td style="width: 10%;"></td> <td style="width: 10%;"></td> <td style="width: 10%;"></td> <td style="width: 10%;"></td> <td style="width: 10%;"></td> <td style="width: 10%;"></td> <td style="width: 10%;"></td> <td style="width: 10%;"></td> </tr> <tr> <td></td> <td></td> <td colspan="8" style="text-align: center;"> <table border="1" style="width: 100%; border-collapse: collapse; text-align: center;"> <tr> <td style="width: 10%;"></td> <td style="width: 10%;"></td> <td style="width: 10%;"></td> <td style="width: 10%;"></td> <td style="width: 10%;"></td> <td style="width: 10%;"></td> <td style="width: 10%;"></td> <td style="width: 10%;"></td> <td style="width: 10%;"></td> <td style="width: 10%;"></td> </tr> <tr> <td></td> <td></td> <td colspan="8" style="text-align: center;"> <table border="1" style="width: 100%; border-collapse: collapse; text-align: center;"> <tr> <td style="width: 10%;"></td> <td style="width: 10%;"></td> <td style="width: 10%;"></td> <td style="width: 10%;"></td> <td style="width: 10%;"></td> <td style="width: 10%;"></td> <td style="width: 10%;"></td> <td style="width: 10%;"></td> <td style="width: 10%;"></td> <td style="width: 10%;"></td> </tr> <tr> <td></td> <td></td> <td colspan="8" style="text-align: center;"> <table border="1" style="width: 100%; border-collapse: collapse; text-align: center;"> <tr> <td style="width: 10%;"></td> <td style="width: 10%;"></td> <td style="width: 10%;"></td> <td style="width: 10%;"></td> <td style="width: 10%;"></td> <td style="width: 10%;"></td> <td style="width: 10%;"></td> <td style="width: 10%;"></td> <td style="width: 10%;"></td> <td style="width: 10%;"></td> </tr> <tr> <td></td> <td></td> <td colspan="8" style="text-align: center;"> <table border="1" style="width: 100%; border-collapse: collapse; text-align: center;"> <tr> <td style="width: 10%;"></td> <td style="width: 10%;"></td> <td style="width: 10%;"></td> <td style="width: 10%;"></td> <td style="width: 10%;"></td> <td style="width: 10%;"></td> <td style="width: 10%;"></td> <td style="width: 10%;"></td> <td style="width: 10%;"></td> <td style="width: 10%;"></td> </tr> <tr> <td></td> <td></td> <td colspan="8" style="text-align: center;"> <table border="1" style="width: 100%; border-collapse: collapse; text-align: center;"> <tr> <td style="width: 10%;"></td> <td style="width: 10%;"></td> <td style="width: 10%;"></td> <td style="width: 10%;"></td> <td style="width: 10%;"></td> <td style="width: 10%;"></td> <td style="width: 10%;"></td> <td style="width: 10%;"></td> <td style="width: 10%;"></td> <td style="width: 10%;"></td> </tr> <tr> <td></td> <td></td> <td colspan="8" style="text-align: center;"> <table border="1" style="width: 100%; border-collapse: collapse; text-align: center;"> <tr> <td style="width: 10%;"></td> <td style="width: 10%;"></td> <td style="width: 10%;"></td> <td style="width: 10%;"></td> <td style="width: 10%;"></td> <td style="width: 10%;"></td> <td style="width: 10%;"></td> <td style="width: 10%;"></td> <td style="width: 10%;"></td> <td style="width: 10%;"></td> </tr> <tr> <td></td> <td></td> <td colspan="8" style="text-align: center;"> <table border="1" style="width: 100%; border-collapse: collapse; text-align: center;"> <tr> <td style="width: 10%;"></td> <td style="width: 10%;"></td> <td style="width: 10%;"></td> <td style="width: 10%;"></td> <td style="width: 10%;"></td> <td style="width: 10%;"></td> <td style="width: 10%;"></td> <td style="width: 10%;"></td> <td style="width: 10%;"></td> <td style="width: 10%;"></td> </tr> <tr> <td></td> <td></td> <td colspan="8" style="text-align: center;"> <table border="1" style="width: 100%; border-collapse: collapse; text-align: center;"> <tr> <td style="width: 10%;"></td> <td style="width: 10%;"></td> <td style="width: 10%;"></td> <td style="width: 10%;"></td> <td style="width: 10%;"></td> <td style="width: 10%;"></td> <td style="width: 10%;"></td> <td style="width: 10%;"></td> <td style="width: 10%;"></td> <td style="width: 10%;"></td> </tr> <tr> <td></td> <td></td> <td colspan="8" style="text-align: center;"> <table border="1" style="width: 100%; border-collapse: collapse; text-align: center;"> <tr> <td style="width: 10%;"></td> <td style="width: 10%;"></td> <td style="width: 10%;"></td> <td style="width: 10%;"></td> <td style="width: 10%;"></td> <td style="width: 10%;"></td> <td style="width: 10%;"></td> <td style="width: 10%;"></td> <td style="width: 10%;"></td> <td style="width: 10%;"></td> </tr> <tr> <td></td> <td></td> <td colspan="8" style="text-align: center;"> <table border="1" style="width: 100%; border-collapse: collapse; text-align: center;"> <tr> <td style="width: 10%;"></td> <td style="width: 10%;"></td> <td style="width: 10%;"></td> <td style="width: 10%;"></td> <td style="width: 10%;"></td> <td style="width: 10%;"></td> <td style="width: 10%;"></td> <td style="width: 10%;"></td> <td style="width: 10%;"></td> <td style="width: 10%;"></td> </tr> <tr> <td></td> <td></td> <td colspan="8" style="text-align: center;"> <table border="1" style="width: 100%; border-collapse: collapse; text-align: center;"> <tr> <td style="width: 10%;"></td> <td style="width: 10%;"></td> <td style="width: 10%;"></td> <td style="width: 10%;"></td> <td style="width: 10%;"></td> <td style="width: 10%;"></td> <td style="width: 10%;"></td> <td style="width: 10%;"></td> <td style="width: 10%;"></td> <td style="width: 10%;"></td> </tr> <tr> <td></td> <td></td> <td colspan="8" style="text-align: center;"> <table border="1" style="width: 100%; border-collapse: collapse; text-align: center;"> <tr> <td style="width: 10%;"></td> <td style="width: 10%;"></td> <td style="width: 10%;"></td> <td style="width: 10%;"></td> <td style="width: 10%;"></td> <td style="width: 10%;"></td> <td style="width: 10%;"></td> <td style="width: 10%;"></td> <td style="width: 10%;"></td> <td style="width: 10%;"></td> </tr> <tr> <td></td> <td></td> <td colspan="8" style="text-align: center;"> <table border="1" style="width: 100%; border-collapse: collapse; text-align: center;"> <tr> <td style="width: 10%;"></td> <td style="width: 10%;"></td> <td style="width: 10%;"></td> <td style="width: 10%;"></td> <td style="width: 10%;"></td> <td style="width: 10%;"></td> <td
style="width: 10%;"></td> <td style="width: 10%;"></td> <td style="width: 10%;"></td> <td style="width: 10%;"></td> </tr> <tr> <td></td> <td></td> <td colspan="8" style="text-align: center;"> <table border="1" style="width: 100%; border-collapse: collapse; text-align: center;"> <tr> <td style="width: 10%;"></td> <td style="width: 10%;"></td> <td style="width: 10%;"></td> <td style="width: 10%;"></td> <td style="width: 10%;"></td> <td style="width: 10%;"></td> <td style="width: 10%;"></td> <td style="width: 10%;"></td> <td style="width: 10%;"></td> <td style="width: 10%;"></td> </tr> <tr> <td></td> <td></td> <td colspan="8" style="text-align: center;"> <table border="1" style="width: 100%; border-collapse: collapse; text-align: center;"> <tr> <td style="width: 10%;"></td> <td style="width: 10%;"></td> <td style="width: 10%;"></td> <td style="width: 10%;"></td> <td style="width: 10%;"></td> <td style="width: 10%;"></td> <td style="width: 10%;"></td> <td style="width: 10%;"></td> <td style="width: 10%;"></td> <td style="width: 10%;"></td> </tr> <tr> <td></td> <td></td> <td colspan="8" style="text-align: center;"> <table border="1" style="width: 100%; border-collapse: collapse; text-align: center;"> <tr> <td style="width: 10%;"></td> <td style="width: 10%;"></td> <td style="width: 10%;"></td> <td style="width: 10%;"></td> <td style="width: 10%;"></td> <td style="width: 10%;"></td> <td style="width: 10%;"></td> <td style="width: 10%;"></td> <td style="width: 10%;"></td> <td style="width: 10%;"></td> </tr> <tr> <td></td> <td></td> <td colspan="8" style="text-align: center;"> <table border="1" style="width: 100%; border-collapse: collapse; text-align: center;"> <tr> <td style="width: 10%;"></td> <td style="width: 10%;"></td> <td style="width: 10%;"></td> <td style="width: 10%;"></td> <td style="width: 10%;"></td> <td style="width: 10%;"></td> <td style="width: 10%;"></td> <td style="width: 10%;"></td> <td style="width: 10%;"></td> <td style="width: 10%;"></td> </tr> <tr> <td></td> <td></td> <td colspan="8" style="text-align: center;"> <table border="1" style="width: 100%; border-collapse: collapse; text-align: center;"> <tr> <td style="width: 10%;"></td> <td style="width: 10%;"></td> <td style="width: 10%;"></td> <td style="width: 10%;"></td> <td style="width: 10%;"></td> <td style="width: 10%;"></td> <td style="width: 10%;"></td> <td style="width: 10%;"></td> <td style="width: 10%;"></td> <td style="width: 10%;"></td> </tr> <tr> <td></td> <td></td> <td colspan="8" style="text-align: center;"> <table border="1" style="width: 100%; border-collapse: collapse; text-align: center;"> <tr> <td style="width: 10%;"></td> <td style="width: 10%;"></td> <td style="width: 10%;"></td> <td style="width: 10%;"></td> <td style="width: 10%;"></td> <td style="width: 10%;"></td> <td style="width: 10%;"></td> <td style="width: 10%;"></td> <td style="width: 10%;"></td> <td style="width: 10%;"></td> </tr> <tr> <td></td> <td></td> <td colspan="8" style="text-align: center;"> <table border="1" style="width: 100%; border-collapse: collapse; text-align: center;"> <tr> <td style="width: 10%;"></td> <td style="width: 10%;"></td> <td style="width: 10%;"></td> <td style="width: 10%;"></td> <td style="width: 10%;"></td> <td style="width: 10%;"></td> <td style="width: 10%;"></td> <td style="width: 10%;"></td> <td style="width: 10%;"></td> <td style="width: 10%;"></td> </tr> <tr> <td></td> <td></td> <td colspan="8" style="text-align: center;"> <table border="1" style="width: 100%; border-collapse: collapse; text-align: center;"> <tr> <td style="width: 10%;"></td> <td style="width: 10%;"></td> <td style="width: 10%;"></td> <td style="width: 10%;"></td> <td style="width: 10%;"></td> <td style="width: 10%;"></td> <td style="width: 10%;"></td> <td style="width: 10%;"></td> <td style="width: 10%;"></td> <td style="width: 10%;"></td> </tr> <tr> <td></td> <td></td> <td colspan="8" style="text-align: center;"> <table border="1" style="width: 100%; border-collapse: collapse; text-align: center;"> <tr> <td style="width: 10%;"></td> <td style="width: 10%;"></td> <td style="width: 10%;"></td> <td style="width: 10%;"></td> <td style="width: 10%;"></td> <td style="width: 10%;"></td> <td style="width: 10%;"></td> <td style="width: 10%;"></td> <td style="width: 10%;"></td> <td style="width: 10%;"></td> </tr> <tr> <td></td> <td></td> <td colspan="8" style="text-align: center;"> <table border="1" style="width: 100%; border-collapse: collapse; text-align: center;"> <tr> <td style="width: 10%;"></td> <td style="width: 10%;"></td> <td style="width: 10%;"></td> <td style="width: 10%;"></td> <td style="width: 10%;"></td> <td style="width: 10%;"></td> <td style="width: 10%;"></td> <td style="width: 10%;"></td> <td style="width: 10%;"></td> <td style="width: 10%;"></td> </tr> <tr> <td></td> <td></td> <td colspan="8" style="text-align: center;"> <table border="1" style="width: 100%; border-collapse: collapse; text-align: center;"> <tr> <td style="width: 10%;"></td> <td style="width: 10%;"></td> <td style="width: 10%;"></td> <td style="width: 10%;"></td> <td style="width: 10%;"></td> <td style="width: 10%;"></td> <td style="width: 10%;"></td> <td style="width: 10%;"></td> <td style="width: 10%;"></td> <td style="width: 10%;"></td> </tr> <tr> <td></td> <td></td> <td colspan="8" style="text-align: center;"> <table border="1" style="width: 100%; border-collapse: collapse; text-align: center;"> <tr> <td style="width: 10%;"></td> <td style="width: 10%;"></td> <td style="width: 10%;"></td> <td style="width: 10%;"></td> <td style="width: 10%;"></td> <td style="width: 10%;"></td> <td style="width: 10%;"></td> <td style="width: 10%;"></td> <td style="width: 10%;"></td> <td style="width: 10%;"></td> </tr> <tr> <td></td> <td></td> <td colspan="8" style="text-align: center;"> <table border="1" style="width: 100%; border-collapse: collapse; text-align: center;"> <tr> <td style="width: 10%;"></td> <td style="width: 10%;"></td> <td style="width: 10%;"></td> <td style="width: 10%;"></td> <td style="width: 10%;"></td> <td style="width: 10%;"></td> <td style="width: 10%;"></td> <td style="width: 10%;"></td> <td style="width: 10%;"></td> <td style="width: 10%;"></td> </tr> <tr> <td></td> <td></td> <td colspan="8" style="text-align: center;"> <table border="1" style="width: 100%; border-collapse: collapse; text-align: center;"> <tr> <td style="width: 10%;"></td> <td style="width: 10%;"></td> <td style="width: 10%;"></td> <td style="width: 10%;"></td> <td style="width: 10%;"></td> <td style="width: 10%;"></td> <td style="width: 10%;"></td> <td style="width: 10%;"></td> <td style="width: 10%;"></td> <td style="width: 10%;"></td> </tr> <tr> <td></td> <td></td> <td colspan="8" style="text-align: center;"> <table border="1" style="width: 100%; border-collapse: collapse; text-align: center;"> <tr> <td style="width: 10%;"></td> <td style="width: 10%;"></td> <td style="width: 10%;"></td> <td style="width: 10%;"></td> <td style="width: 10%;"></td> <td style="width: 10%;"></td> <td style="width: 10%;"></td> <td style="width: 10%;"></td> <td style="width: 10%;"></td> <td style="width: 10%;"></td> </tr> <tr> <td></td> <td></td> <td colspan="8" style="text-align: center;"> <table border="1" style="width: 100%; border-collapse: collapse; text-align: center;"> <tr> <td style="width: 10%;"></td> <td style="width: 10%;"></td> <td style="width: 10%;"></td> <td style="width: 10%;"></td> <td style="width: 10%;"></td> <td style="width: 10%;"></td> <td style="width: 10%;"></td> <td style="width: 10%;"></td> <td style="width: 10%;"></td> <td style="width: 10%;"></td> </tr> <tr> <td></td> <td></td> <td colspan="8" style="text-align: center;"> <table border="1" style="width: 100%; border-collapse: collapse; text-align: center;"> <tr> <td style="width: 10%;"></td> <td style="width: 10%;"></td> <td style="width: 10%;"></td> <td style="width: 10%;"></td> <td style="width: 10%;"></td> <td style="width: 10%;"></td> <td style="width: 10%;"></td> <td style="width: 10%;"></td> <td style="width: 10%;"></td> <td style="width: 10%;"></td> </tr> <tr> <td></td> <td></td> <td colspan="8" style="text-align: center;"> <table border="1" style="width: 100%; border-collapse: collapse; text-align: center;"> <tr> <td style="width: 10%;"></td> <td style="width: 10%;"></td> <td style="width: 10%;"></td> <td style="width: 10%;"></td> <td style="width: 10%;"></td> <td style="width: 10%;"></td> <td style="width: 10%;"></td> <td style="width: 10%;"></td> <td style="width: 10%;"></td> <td style="width: 10%;"></td> </tr> <tr> <td></td> <td></td> <td colspan="8" style="text-align: center;"> <table border="1" style="width: 100%; border-collapse: collapse; text-align: center;"> <tr> <td style="width: 10%;"></td> <td style="width: 10%;"></td> <td style="width: 10%;"></td> <td style="width: 10%;"></td> <td style="width: 10%;"></td> <td style="width: 10%;"></td> <td style="width: 10%;"></td> <td style="width: 10%;"></td> <td style="width: 10%;"></td> <td style="width: 10%;"></td> </tr> <tr> <td></td> <td></td> <td colspan="8" style="text-align: center;"> <table border="1" style="width: 100%; border-collapse: collapse; text-align: center;"> <tr> <td style="width: 10%;"></td> <td style="width: 10%;"></td> <td style="width: 10%;"></td> <td style="width: 10%;"></td> <td style="width: 10%;"></td> <td style="width: 10%;"></td> <td style="width: 10%;"></td> <td style="width: 10%;"></td> <td style="width: 10%;"></td> <td style="width: 10%;"></td> </tr> <tr> <td></td> <td></td> <td colspan="8" style="text-align: center;"> <table border="1" style="width: 100%; border-collapse: collapse; text-align: center;"> <tr> <td style="width: 10%;"></td> <td style="width: 10%;"></td> <td style="width: 10%;"></td> <td style="width: 10%;"></td> <td style="width: 10%;"></td> <td style="width: 10%;"></td> <td style="width: 10%;"></td> <td style="width: 10%;"></td> <td style="width: 10%;"></td> <td style="width: 10%;"></td> </tr> <tr> <td></td> <td></td> <td colspan="8"
style="text-align: center;"> <table border="1" style="width: 100%; border-collapse: collapse; text-align: center;"> <tr> <td style="width: 10%;"></td> <td style="width: 10%;"></td> <td style="width: 10%;"></td> <td style="width: 10%;"></td> <td style="width: 10%;"></td> <td style="width: 10%;"></td> <td style="width: 10%;"></td> <td style="width: 10%;"></td> <td style="width: 10%;"></td> <td style="width: 10%;"></td> </tr> <tr> <td></td> <td></td> <td colspan="8" style="text-align: center;"> <table border="1" style="width: 100%; border-collapse: collapse; text-align: center;"> <tr> <td style="width: 10%;"></td> <td style="width: 10%;"></td> <td style="width: 10%;"></td> <td style="width: 10%;"></td> <td style="width: 10%;"></td> <td style="width: 10%;"></td> <td style="width: 10%;"></td> <td style="width: 10%;"></td> <td style="width: 10%;"></td> <td style="width: 10%;"></td> </tr> <tr> <td></td> <td></td> <td colspan="8" style="text-align: center;"> <table border="1" style="width: 100%; border-collapse: collapse; text-align: center;"> <tr> <td style="width: 10%;"></td> <td style="width: 10%;"></td> <td style="width: 10%;"></td> <td style="width: 10%;"></td> <td style="width: 10%;"></td> <td style="width: 10%;"></td> <td style="width: 10%;"></td> <td style="width: 10%;"></td> <td style="width: 10%;"></td> <td style="width: 10%;"></td> </tr> <tr> <td></td> <td></td> <td colspan="8" style="text-align: center;"> <table border="1" style="width: 100%; border-collapse: collapse; text-align: center;"> <tr> <td style="width: 10%;"></td> <td style="width: 10%;"></td> <td style="width: 10%;"></td> <td style="width: 10%;"></td> <td style="width: 10%;"></td> <td style="width: 10%;"></td> <td style="width: 10%;"></td> <td style="width: 10%;"></td> <td style="width: 10%;"></td> <td style="width: 10%;"></td> </tr> <tr> <td></td> <td></td> <td colspan="8" style="text-align: center;"> <table border="1" style="width: 100%; border-collapse: collapse; text-align: center;"> <tr> <td style="width: 10%;"></td> <td style="width: 10%;"></td> <td style="width: 10%;"></td> <td style="width: 10%;"></td> <td style="width: 10%;"></td> <td style="width: 10%;"></td> <td style="width: 10%;"></td> <td style="width: 10%;"></td> <td style="width: 10%;"></td> <td style="width: 10%;"></td> </tr> <tr> <td></td> <td></td> <td colspan="8" style="text-align: center;"> <table border="1" style="width: 100%; border-collapse: collapse; text-align: center;"> <tr> <td style="width: 10%;"></td> <td style="width: 10%;"></td> <td style="width: 10%;"></td> <td style="width: 10%;"></td> <td style="width: 10%;"></td> <td style="width: 10%;"></td> <td style="width: 10%;"></td> <td style="width: 10%;"></td> <td style="width: 10%;"></td> <td style="width: 10%;"></td> </tr> <tr> <td></td> <td></td> <td colspan="8" style="text-align: center;"> <table border="1" style="width: 100%; border-collapse: collapse; text-align: center;"> <tr> <td style="width: 10%;"></td> <td style="width: 10%;"></td> <td style="width: 10%;"></td> <td style="width: 10%;"></td> <td style="width: 10%;"></td> <td style="width: 10%;"></td> <td style="width: 10%;"></td> <td style="width: 10%;"></td> <td style="width: 10%;"></td> <td style="width: 10%;"></td> </tr> <tr> <td></td> <td></td> <td colspan="8" style="text-align: center;"> <table border="1" style="width: 100%; border-collapse: collapse; text-align: center;"> <tr> <td style="width: 10%;"></td> <td style="width: 10%;"></td> <td style="width: 10%;"></td> <td style="width: 10%;"></td> <td style="width: 10%;"></td> <td style="width: 10%;"></td> <td style="width: 10%;"></td> <td style="width: 10%;"></td> <td style="width: 10%;"></td> <td style="width: 10%;"></td> </tr> <tr> <td></td> <td></td> <td colspan="8" style="text-align: center;"> <table border="1" style="width: 100%; border-collapse: collapse; text-align: center;"> <tr> <td style="width: 10%;"></td> <td style="width: 10%;"></td> <td style="width: 10%;"></td> <td style="width: 10%;"></td> <td style="width: 10%;"></td> <td style="width: 10%;"></td> <td style="width: 10%;"></td> <td style="width: 10%;"></td> <td style="width: 10%;"></td> <td style="width: 10%;"></td> </tr> <tr> <td></td> <td></td> <td colspan="8" style="text-align: center;"> <table border="1" style="width: 100%; border-collapse: collapse; text-align: center;"> <tr> <td style="width: 10%;"></td> <td style="width: 10%;"></td> <td style="width: 10%;"></td> <td style="width: 10%;"></td> <td style="width: 10%;"></td> <td style="width: 10%;"></td> <td style="width: 10%;"></td> <td style="width: 10%;"></td> <td style="width: 10%;"></td> <td style="width: 10%;"></td> </tr> <tr> <td></td> <td></td> <td colspan="8" style="text-align: center;"> <table border="1" style="width: 100%; border-collapse: collapse; text-align: center;"> <tr> <td style="width: 10%;"></td> <td style="width: 10%;"></td> <td style="width: 10%;"></td> <td style="width: 10%;"></td> <td style="width: 10%;"></td> <td style="width: 10%;"></td> <td style="width: 10%;"></td> <td style="width: 10%;"></td> <td style="width: 10%;"></td> <td style="width: 10%;"></td> </tr> <tr> <td></td> <td></td> <td colspan="8" style="text-align: center;"> <table border="1" style="width: 100%; border-collapse: collapse; text-align: center;"> <tr> <td style="width: 10%;"></td> <td style="width: 10%;"></td> <td style="width: 10%;"></td> <td style="width: 10%;"></td> <td style="width: 10%;"></td> <td style="width: 10%;"></td> <td style="width: 10%;"></td> <td style="width: 10%;"></td> <td style="width: 10%;"></td> <td style="width: 10%;"></td> </tr> <tr> <td></td> <td></td> <td colspan="8" style="text-align: center;"> <table border="1" style="width: 100%; border-collapse: collapse; text-align: center;"> <tr> <td style="width: 10%;"></td> <td style="width: 10%;"></td> <td style="width: 10%;"></td> <td style="width: 10%;"></td> <td style="width: 10%;"></td> <td style="width: 10%;"></td> <td style="width: 10%;"></td> <td style="width: 10%;"></td> <td style="width: 10%;"></td> <td style="width: 10%;"></td> </tr> <tr> <td></td> <td></td> <td colspan="8" style="text-align: center;"> <table border="1" style="width: 100%; border-collapse: collapse; text-align: center;"> <tr> <td style="width: 10%;"></td> <td style="width: 10%;"></td> <td style="width: 10%;"></td> <td style="width: 10%;"></td> <td style="width: 10%;"></td> <td style="width: 10%;"></td> <td style="width: 10%;"></td> <td style="width: 10%;"></td> <td style="width: 10%;"></td> <td style="width: 10%;"></td> </tr> <tr> <td></td> <td></td> <td colspan="8" style="text-align: center;"> <table border="1" style="width: 100%; border-collapse: collapse; text-align: center;"> <tr> <td style="width: 10%;"></td> <td style="width: 10%;"></td> <td style="width: 10%;"></td> <td style="width: 10%;"></td> <td style="width: 10%;"></td> <td style="width: 10%;"></td> <td style="width: 10%;"></td> <td style="width: 10%;"></td> <td style="width: 10%;"></td> <td style="width: 10%;"></td> </tr> <tr> <td></td> <td></td> <td colspan="8" style="text-align: center;"> <table border="1" style="width: 100%; border-collapse: collapse; text-align: center;"> <tr> </tr></table></td></tr></table></td></tr></table></td></tr></table></td></tr></table></td></tr></table></td></tr></table></td></tr></table></td></tr></table></td></tr></table></td></tr></table></td></tr></table></td></tr></table></td></tr></table></td></tr></table></td></tr></table></td></tr></table></td></tr></table></td></tr></table></td></tr></table></td></tr></table></td></tr></table></td></tr></table></td></tr></table></td></tr></table></td></tr></table></td></tr></table></td></tr></table></td></tr></table></td></tr></table></td></tr></table></td></tr></table></td></tr></table></td></tr></table></td></tr></table></td></tr></table></td></tr></table></td></tr></table></td></tr></table></td></tr></table></td></tr></table></td></tr></table></td></tr></table></td></tr></table></td></tr></table></td></tr></table></td></tr></table></td></tr></table></td></tr></table></td></tr></table></td></tr></table></td></tr></table></td></tr></table></td></tr></table>
 | | | | | | | | | | | | | | | | | | | | <table border="1" style="width: 100%; border-collapse: collapse; text-align: center;"> <tr> <td style="width: 10%;"></td> <td style="width: 10%;"></td> <td style="width: 10%;"></td> <td style="width: 10%;"></td> <td style="width: 10%;"></td> <td style="width: 10%;"></td> <td style="width: 10%;"></td> <td style="width: 10%;"></td> <td style="width: 10%;"></td> <td style="width: 10%;"></td> </tr> <tr> <td></td> <td></td> <td colspan="8" style="text-align: center;"> <table border="1" style="width: 100%; border-collapse: collapse; text-align: center;"> <tr> <td style="width: 10%;"></td> <td style="width: 10%;"></td> <td style="width: 10%;"></td> <td style="width: 10%;"></td> <td style="width: 10%;"></td> <td style="width: 10%;"></td> <td style="width: 10%;"></td> <td style="width: 10%;"></td> <td style="width: 10%;"></td> <td style="width: 10%;"></td> </tr> <tr> <td></td> <td></td> <td colspan="8" style="text-align: center;"> <table border="1" style="width: 100%; border-collapse: collapse; text-align: center;"> <tr> <td style="width: 10%;"></td> <td style="width: 10%;"></td> <td style="width: 10%;"></td> <td style="width: 10%;"></td> <td style="width: 10%;"></td> <td style="width: 10%;"></td> <td style="width: 10%;"></td> <td style="width: 10%;"></td> <td style="width: 10%;"></td> <td style="width: 10%;"></td> </tr> <tr> <td></td> <td></td> <td colspan="8" style="text-align: center;"> <table border="1" style="width: 100%; border-collapse: collapse; text-align: center;"> <tr> <td style="width: 10%;"></td> <td style="width: 10%;"></td> <td style="width: 10%;"></td> <td style="width: 10%;"></td> <td style="width: 10%;"></td> <td style="width: 10%;"></td> <td style="width: 10%;"></td> <td style="width: 10%;"></td> <td style="width: 10%;"></td> <td style="width: 10%;"></td> </tr> <tr> <td></td> <td></td> <td colspan="8" style="text-align: center;"> <table border="1" style="width: 100%; border-collapse: collapse; text-align: center;"> <tr> <td style="width: 10%;"></td> <td style="width: 10%;"></td> <td style="width: 10%;"></td> <td style="width: 10%;"></td> <td style="width: 10%;"></td> <td style="width: 10%;"></td> <td style="width: 10%;"></td> <td style="width: 10%;"></td> <td style="width: 10%;"></td> <td style="width: 10%;"></td> </tr> <tr> <td></td> <td></td> <td colspan="8" style="text-align: center;"> <table border="1" style="width: 100%; border-collapse: collapse; text-align: center;"> <tr> <td style="width: 10%;"></td> <td style="width: 10%;"></td> <td style="width: 10%;"></td> <td style="width: 10%;"></td> <td style="width: 10%;"></td> <td style="width: 10%;"></td> <td style="width: 10%;"></td> <td style="width: 10%;"></td> <td style="width: 10%;"></td> <td style="width: 10%;"></td> </tr> <tr> <td></td> <td></td> <td colspan="8" style="text-align: center;"> <table border="1" style="width: 100%; border-collapse: collapse; text-align: center;"> <tr> <td style="width: 10%;"></td> <td style="width: 10%;"></td> <td style="width: 10%;"></td> <td style="width: 10%;"></td> <td style="width: 10%;"></td> <td style="width: 10%;"></td> <td style="width: 10%;"></td> <td style="width: 10%;"></td> <td style="width: 10%;"></td> <td style="width: 10%;"></td> </tr> <tr> <td></td> <td></td> <td colspan="8" style="text-align: center;"> <table border="1" style="width: 100%; border-collapse: collapse; text-align: center;"> <tr> <td style="width: 10%;"></td> <td style="width: 10%;"></td> <td style="width: 10%;"></td> <td style="width: 10%;"></td> <td style="width: 10%;"></td> <td style="width: 10%;"></td> <td style="width: 10%;"></td> <td style="width: 10%;"></td> <td style="width: 10%;"></td> <td style="width: 10%;"></td> </tr> <tr> <td></td> <td></td> <td colspan="8" style="text-align: center;"> <table border="1" style="width: 100%; border-collapse: collapse; text-align: center;"> <tr> <td style="width: 10%;"></td> <td style="width: 10%;"></td> <td style="width: 10%;"></td> <td style="width: 10%;"></td> <td style="width: 10%;"></td> <td style="width: 10%;"></td> <td style="width: 10%;"></td> <td style="width: 10%;"></td> <td style="width: 10%;"></td> <td style="width: 10%;"></td> </tr> <tr> <td></td> <td></td> <td colspan="8" style="text-align: center;"> <table border="1" style="width: 100%; border-collapse: collapse; text-align: center;"> <tr> <td style="width: 10%;"></td> <td style="width: 10%;"></td> <td style="width: 10%;"></td> <td style="width: 10%;"></td> <td style="width: 10%;"></td> <td style="width: 10%;"></td> <td style="width: 10%;"></td> <td style="width: 10%;"></td> <td style="width: 10%;"></td> <td style="width: 10%;"></td> </tr> <tr> <td></td> <td></td> <td colspan="8" style="text-align: center;"> <table border="1" style="width: 100%; border-collapse: collapse; text-align: center;"> <tr> <td style="width: 10%;"></td> <td style="width: 10%;"></td> <td style="width: 10%;"></td> <td style="width: 10%;"></td> <td style="width: 10%;"></td> <td style="width: 10%;"></td> <td style="width: 10%;"></td> <td style="width: 10%;"></td> <td style="width: 10%;"></td> <td style="width: 10%;"></td> </tr> <tr> <td></td> <td></td> <td colspan="8" style="text-align: center;"> <table border="1" style="width: 100%; border-collapse: collapse; text-align: center;"> <tr> <td style="width: 10%;"></td> <td style="width: 10%;"></td> <td style="width: 10%;"></td> <td style="width: 10%;"></td> <td style="width: 10%;"></td> <td style="width: 10%;"></td> <td style="width: 10%;"></td> <td style="width: 10%;"></td> <td style="width: 10%;"></td> <td style="width: 10%;"></td> </tr> <tr> <td></td> <td></td> <td colspan="8" style="text-align: center;"> <table border="1" style="width: 100%; border-collapse: collapse; text-align: center;"> <tr> <td style="width: 10%;"></td> <td style="width: 10%;"></td> <td style="width: 10%;"></td> <td style="width: 10%;"></td> <td style="width: 10%;"></td> <td style="width: 10%;"></td> <td style="width: 10%;"></td> <td style="width: 10%;"></td> <td style="width: 10%;"></td> <td style="width: 10%;"></td> </tr> <tr> <td></td> <td></td> <td colspan="8" style="text-align: center;"> <table border="1" style="width: 100%; border-collapse: collapse; text-align: center;"> <tr> <td style="width: 10%;"></td> <td style="width: 10%;"></td> <td style="width: 10%;"></td> <td style="width: 10%;"></td> <td style="width: 10%;"></td> <td style="width: 10%;"></td> <td style="width: 10%;"></td> <td style="width: 10%;"></td> <td style="width: 10%;"></td> <td style="width: 10%;"></td> </tr> <tr> <td></td> <td></td> <td colspan="8" style="text-align: center;"> <table border="1" style="width: 100%; border-collapse: collapse; text-align: center;"> <tr> <td style="width: 10%;"></td> <td style="width: 10%;"></td> <td style="width: 10%;"></td> <td style="width: 10%;"></td> <td style="width: 10%;"></td> <td style="width: 10%;"></td> <td style="width: 10%;"></td> <td style="width: 10%;"></td> <td style="width: 10%;"></td> <td style="width: 10%;"></td> </tr> <tr> <td></td> <td></td> <td colspan="8" style="text-align: center;"> <table border="1" style="width: 100%; border-collapse: collapse; text-align: center;"> <tr> <td style="width: 10%;"></td> <td style="width: 10%;"></td> <td style="width: 10%;"></td> <td style="width: 10%;"></td> <td style="width: 10%;"></td> <td style="width: 10%;"></td> <td style="width: 10%;"></td> <td style="width: 10%;"></td> <td style="width: 10%;"></td> <td style="width: 10%;"></td> </tr> <tr> <td></td> <td></td> <td colspan="8" style="text-align: center;"> <table border="1" style="width: 100%; border-collapse: collapse; text-align: center;"> <tr> <td style="width: 10%;"></td> <td style="width: 10%;"></td> <td style="width: 10%;"></td> <td style="width: 10%;"></td> <td style="width: 10%;"></td> <td style="width: 10%;"></td> <td style="width: 10%;"></td> <td style="width: 10%;"></td> <td style="width: 10%;"></td> <td style="width: 10%;"></td> </tr> <tr> <td></td> <td></td> <td colspan="8" style="text-align: center;"> <table border="1" style="width: 100%; border-collapse: collapse; text-align: center;"> <tr> <td style="width: 10%;"></td> <td style="width: 10%;"></td> <td style="width: 10%;"></td> <td style="width: 10%;"></td> <td style="width: 10%;"></td> <td style="width: 10%;"></td> <td style="width: 10%;"></td> <td style="width: 10%;"></td> <td style="width: 10%;"></td> <td style="width: 10%;"></td> </tr> <tr> <td></td> <td></td> <td colspan="8" style="text-align: center;">
<table border="1" style="width: 100%; border-collapse: collapse; text-align: center;"> <tr> <td style="width: 10%;"></td> <td style="width: 10%;"></td> <td style="width: 10%;"></td> <td style="width: 10%;"></td> <td style="width: 10%;"></td> <td style="width: 10%;"></td> <td style="width: 10%;"></td> <td style="width: 10%;"></td> <td style="width: 10%;"></td> <td style="width: 10%;"></td> </tr> <tr> <td></td> <td></td> <td colspan="8" style="text-align: center;"> <table border="1" style="width: 100%; border-collapse: collapse; text-align: center;"> <tr> <td style="width: 10%;"></td> <td style="width: 10%;"></td> <td style="width: 10%;"></td> <td style="width: 10%;"></td> <td style="width: 10%;"></td> <td style="width: 10%;"></td> <td style="width: 10%;"></td> <td style="width: 10%;"></td> <td style="width: 10%;"></td> <td style="width: 10%;"></td> </tr> <tr> <td></td> <td></td> <td colspan="8" style="text-align: center;"> <table border="1" style="width: 100%; border-collapse: collapse; text-align: center;"> <tr> <td style="width: 10%;"></td> <td style="width: 10%;"></td> <td style="width: 10%;"></td> <td style="width: 10%;"></td> <td style="width: 10%;"></td> <td style="width: 10%;"></td> <td style="width: 10%;"></td> <td style="width: 10%;"></td> <td style="width: 10%;"></td> <td style="width: 10%;"></td> </tr> <tr> <td></td> <td></td> <td colspan="8" style="text-align: center;"> <table border="1" style="width: 100%; border-collapse: collapse; text-align: center;"> <tr> <td style="width: 10%;"></td> <td style="width: 10%;"></td> <td style="width: 10%;"></td> <td style="width: 10%;"></td> <td style="width: 10%;"></td> <td style="width: 10%;"></td> <td style="width: 10%;"></td> <td style="width: 10%;"></td> <td style="width: 10%;"></td> <td style="width: 10%;"></td> </tr> <tr> <td></td> <td></td> <td colspan="8" style="text-align: center;"> <table border="1" style="width: 100%; border-collapse: collapse; text-align: center;"> <tr> <td style="width: 10%;"></td> <td style="width: 10%;"></td> <td style="width: 10%;"></td> <td style="width: 10%;"></td> <td style="width: 10%;"></td> <td style="width: 10%;"></td> <td style="width: 10%;"></td> <td style="width: 10%;"></td> <td style="width: 10%;"></td> <td style="width: 10%;"></td> </tr> <tr> <td></td> <td></td> <td colspan="8" style="text-align: center;"> <table border="1" style="width: 100%; border-collapse: collapse; text-align: center;"> <tr> <td style="width: 10%;"></td> <td style="width: 10%;"></td> <td style="width: 10%;"></td> <td style="width: 10%;"></td> <td style="width: 10%;"></td> <td style="width: 10%;"></td> <td style="width: 10%;"></td> <td style="width: 10%;"></td> <td style="width: 10%;"></td> <td style="width: 10%;"></td> </tr> <tr> <td></td> <td></td> <td colspan="8" style="text-align: center;"> <table border="1" style="width: 100%; border-collapse: collapse; text-align: center;"> <tr> <td style="width: 10%;"></td> <td style="width: 10%;"></td> <td style="width: 10%;"></td> <td style="width: 10%;"></td> <td style="width: 10%;"></td> <td style="width: 10%;"></td> <td style="width: 10%;"></td> <td style="width: 10%;"></td> <td style="width: 10%;"></td> <td style="width: 10%;"></td> </tr> <tr> <td></td> <td></td> <td colspan="8" style="text-align: center;"> <table border="1" style="width: 100%; border-collapse: collapse; text-align: center;"> <tr> <td style="width: 10%;"></td> <td style="width: 10%;"></td> <td style="width: 10%;"></td> <td style="width: 10%;"></td> <td style="width: 10%;"></td> <td style="width: 10%;"></td> <td style="width: 10%;"></td> <td style="width: 10%;"></td> <td style="width: 10%;"></td> <td style="width: 10%;"></td> </tr> <tr> <td></td> <td></td> <td colspan="8" style="text-align: center;"> <table border="1" style="width: 100%; border-collapse: collapse; text-align: center;"> <tr> <td style="width: 10%;"></td> <td style="width: 10%;"></td> <td style="width: 10%;"></td> <td style="width: 10%;"></td> <td style="width: 10%;"></td> <td style="width: 10%;"></td> <td style="width: 10%;"></td> <td style="width: 10%;"></td> <td style="width: 10%;"></td> <td style="width: 10%;"></td> </tr> <tr> <td></td> <td></td> <td colspan="8" style="text-align: center;"> <table border="1" style="width: 100%; border-collapse: collapse; text-align: center;"> <tr> <td style="width: 10%;"></td> <td style="width: 10%;"></td> <td style="width: 10%;"></td> <td style="width: 10%;"></td> <td style="width: 10%;"></td> <td style="width: 10%;"></td> <td style="width: 10%;"></td> <td style="width: 10%;"></td> <td style="width: 10%;"></td> <td style="width: 10%;"></td> </tr> <tr> <td></td> <td></td> <td colspan="8" style="text-align: center;"> <table border="1" style="width: 100%; border-collapse: collapse; text-align: center;"> <tr> <td style="width: 10%;"></td> <td style="width: 10%;"></td> <td style="width: 10%;"></td> <td style="width: 10%;"></td> <td style="width: 10%;"></td> <td style="width: 10%;"></td> <td style="width: 10%;"></td> <td style="width: 10%;"></td> <td style="width: 10%;"></td> <td style="width: 10%;"></td> </tr> <tr> <td></td> <td></td> <td colspan="8" style="text-align: center;"> <table border="1" style="width: 100%; border-collapse: collapse; text-align: center;"> <tr> <td style="width: 10%;"></td> <td style="width: 10%;"></td> <td style="width: 10%;"></td> <td style="width: 10%;"></td> <td style="width: 10%;"></td> <td style="width: 10%;"></td> <td style="width: 10%;"></td> <td style="width: 10%;"></td> <td style="width: 10%;"></td> <td style="width: 10%;"></td> </tr> <tr> <td></td> <td></td> <td colspan="8" style="text-align: center;"> <table border="1" style="width: 100%; border-collapse: collapse; text-align: center;"> <tr> <td style="width: 10%;"></td> <td style="width: 10%;"></td> <td style="width: 10%;"></td> <td style="width: 10%;"></td> <td style="width: 10%;"></td> <td style="width: 10%;"></td> <td style="width: 10%;"></td> <td style="width: 10%;"></td> <td style="width: 10%;"></td> <td style="width: 10%;"></td> </tr> <tr> <td></td> <td></td> <td colspan="8" style="text-align: center;"> <table border="1" style="width: 100%; border-collapse: collapse; text-align: center;"> <tr> <td style="width: 10%;"></td> <td style="width: 10%;"></td> <td style="width: 10%;"></td> <td style="width: 10%;"></td> <td style="width: 10%;"></td> <td style="width: 10%;"></td> <td style="width: 10%;"></td> <td style="width: 10%;"></td> <td style="width: 10%;"></td> <td style="width: 10%;"></td> </tr> <tr> <td></td> <td></td> <td colspan="8" style="text-align: center;"> <table border="1" style="width: 100%; border-collapse: collapse; text-align: center;"> <tr> <td style="width: 10%;"></td> <td style="width: 10%;"></td> <td style="width: 10%;"></td> <td style="width: 10%;"></td> <td style="width: 10%;"></td> <td style="width: 10%;"></td> <td style="width: 10%;"></td> <td style="width: 10%;"></td> <td style="width: 10%;"></td> <td style="width: 10%;"></td> </tr> <tr> <td></td> <td></td> <td colspan="8" style="text-align: center;"> <table border="1" style="width: 100%; border-collapse: collapse; text-align: center;"> <tr> <td style="width: 10%;"></td> <td style="width: 10%;"></td> <td style="width: 10%;"></td> <td style="width: 10%;"></td> <td style="width: 10%;"></td> <td style="width: 10%;"></td> <td style="width: 10%;"></td> <td style="width: 10%;"></td> <td style="width: 10%;"></td> <td style="width: 10%;"></td> </tr> <tr> <td></td> <td></td> <td colspan="8" style="text-align: center;"> <table border="1" style="width: 100%; border-collapse: collapse; text-align: center;"> <tr> <td style="width: 10%;"></td> <td style="width: 10%;"></td> <td style="width: 10%;"></td> <td style="width: 10%;"></td> <td style="width: 10%;"></td> <td style="width: 10%;"></td> <td style="width: 10%;"></td> <td style="width: 10%;"></td> <td style="width: 10%;"></td> <td style="width: 10%;"></td> </tr> <tr> <td></td> <td></td> <td colspan="8" style="text-align: center;"> <table border="1" style="width: 100%; border-collapse: collapse; text-align: center;"> <tr> <td style="width: 10%;"></td> <td style="width: 10%;"></td> <td style="width: 10%;"></td> <td style="width: 10%;"></td> <td style="width: 10%;"></td> <td style="width: 10%;"></td> <td style="width: 10%;"></td> <td style="width: 10%;"></td> <td style="width: 10%;"></td> <td style="width: 10%;"></td> </tr> <tr> <td></td> <td></td> <td colspan="8" style="text-align: center;"> <table border="1" style="width: 100%; border-collapse: collapse; text-align: center;"> <tr> <td style="width: 10%;"></td> <td style="width: 10%;"></td> <td style="width: 10%;"></td> <td style="width: 10%;"></td> <td style="width: 10%;"></td> <td style="width: 10%;"></td> <td style="width: 10%;"></td> <td style="width: 10%;"></td> <td style="width: 10%;"></td> <td style="width: 10%;"></td> </tr> <tr> <td></td> <td></td> <td colspan="8" style="text-align: center;"> <table border="1" style="width: 100%; border-collapse: collapse; text-align: center;"> <tr> <td style="width: 10%;"></td> <td style="width: 10%;"></td> <td style="width: 10%;"></td> <td style="width: 10%;"></td> <td style="width: 10%;"></td> <td style="width: 10%;"></td> <td style="width: 10%;"></td> <td style="width: 10%;"></td> <td style="width: 10%;"></td> <td style="width: 10%;"></td> </tr> <tr> <td></td> <td></td> <td colspan="8" style="text-align: center;"> <table border="1" style="width: 100%; border-collapse: collapse; text-align: center;"> <tr> <td style="width: 10%;"></td> <td style="width: 10%;"></td> <td style="width: 10%;"></td> <td style="width: 10%;"></td> <td style="width: 10%;"></td> <td style="width: 10%;"></td> <td style="width: 10%;"></td> <td style="width: 10%;"></td> <td style="width: 10%;"></td> <td style="width: 10%;"></td> </tr> <tr> <td></td> <td></td> <td colspan="8" style="text-align: center;"> <table border="1" style="width: 100%; border-collapse: collapse; text-align: center;"> <tr> <td style="width: 10%;"></td> <td style="width: 10%;"></td> <td style="width:
10%;"></td> <td style="width: 10%;"></td> <td style="width: 10%;"></td> <td style="width: 10%;"></td> <td style="width: 10%;"></td> <td style="width: 10%;"></td> <td style="width: 10%;"></td> <td style="width: 10%;"></td> </tr> <tr> <td></td> <td></td> <td colspan="8" style="text-align: center;"> <table border="1" style="width: 100%; border-collapse: collapse; text-align: center;"> <tr> <td style="width: 10%;"></td> <td style="width: 10%;"></td> <td style="width: 10%;"></td> <td style="width: 10%;"></td> <td style="width: 10%;"></td> <td style="width: 10%;"></td> <td style="width: 10%;"></td> <td style="width: 10%;"></td> <td style="width: 10%;"></td> <td style="width: 10%;"></td> </tr> <tr> <td></td> <td></td> <td colspan="8" style="text-align: center;"> <table border="1" style="width: 100%; border-collapse: collapse; text-align: center;"> <tr> <td style="width: 10%;"></td> <td style="width: 10%;"></td> <td style="width: 10%;"></td> <td style="width: 10%;"></td> <td style="width: 10%;"></td> <td style="width: 10%;"></td> <td style="width: 10%;"></td> <td style="width: 10%;"></td> <td style="width: 10%;"></td> <td style="width: 10%;"></td> </tr> <tr> <td></td> <td></td> <td colspan="8" style="text-align: center;"> <table border="1" style="width: 100%; border-collapse: collapse; text-align: center;"> <tr> <td style="width: 10%;"></td> <td style="width: 10%;"></td> <td style="width: 10%;"></td> <td style="width: 10%;"></td> <td style="width: 10%;"></td> <td style="width: 10%;"></td> <td style="width: 10%;"></td> <td style="width: 10%;"></td> <td style="width: 10%;"></td> <td style="width: 10%;"></td> </tr> <tr> <td></td> <td></td> <td colspan="8" style="text-align: center;"> <table border="1" style="width: 100%; border-collapse: collapse; text-align: center;"> <tr> <td style="width: 10%;"></td> <td style="width: 10%;"></td> <td style="width: 10%;"></td> <td style="width: 10%;"></td> <td style="width: 10%;"></td> <td style="width: 10%;"></td> <td style="width: 10%;"></td> <td style="width: 10%;"></td> <td style="width: 10%;"></td> <td style="width: 10%;"></td> </tr> <tr> <td></td> <td></td> <td colspan="8" style="text-align: center;"> <table border="1" style="width: 100%; border-collapse: collapse; text-align: center;"> <tr> <td style="width: 10%;"></td> <td style="width: 10%;"></td> <td style="width: 10%;"></td> <td style="width: 10%;"></td> <td style="width: 10%;"></td> <td style="width: 10%;"></td> <td style="width: 10%;"></td> <td style="width: 10%;"></td> <td style="width: 10%;"></td> <td style="width: 10%;"></td> </tr> <tr> <td></td> <td></td> <td colspan="8" style="text-align: center;"> <table border="1" style="width: 100%; border-collapse: collapse; text-align: center;"> <tr> <td style="width: 10%;"></td> <td style="width: 10%;"></td> <td style="width: 10%;"></td> <td style="width: 10%;"></td> <td style="width: 10%;"></td> <td style="width: 10%;"></td> <td style="width: 10%;"></td> <td style="width: 10%;"></td> <td style="width: 10%;"></td> <td style="width: 10%;"></td> </tr> <tr> <td></td> <td></td> <td colspan="8" style="text-align: center;"> <table border="1" style="width: 100%; border-collapse: collapse; text-align: center;"> <tr> <td style="width: 10%;"></td> <td style="width: 10%;"></td> <td style="width: 10%;"></td> <td style="width: 10%;"></td> <td style="width: 10%;"></td> <td style="width: 10%;"></td> <td style="width: 10%;"></td> <td style="width: 10%;"></td> <td style="width: 10%;"></td> <td style="width: 10%;"></td> </tr> <tr> <td></td> <td></td> <td colspan="8" style="text-align: center;"> <table border="1" style="width: 100%; border-collapse: collapse; text-align: center;"> <tr> <td style="width: 10%;"></td> <td style="width: 10%;"></td> <td style="width: 10%;"></td> <td style="width: 10%;"></td> <td style="width: 10%;"></td> <td style="width: 10%;"></td> <td style="width: 10%;"></td> <td style="width: 10%;"></td> <td style="width: 10%;"></td> <td style="width: 10%;"></td> </tr> <tr> <td></td> <td></td> <td colspan="8" style="text-align: center;"> <table border="1" style="width: 100%; border-collapse: collapse; text-align: center;"> <tr> <td style="width: 10%;"></td> <td style="width: 10%;"></td> <td style="width: 10%;"></td> <td style="width: 10%;"></td> <td style="width: 10%;"></td> <td style="width: 10%;"></td> <td style="width: 10%;"></td> <td style="width: 10%;"></td> <td style="width: 10%;"></td> <td style="width: 10%;"></td> </tr> <tr> <td></td> <td></td> <td colspan="8" style="text-align: center;"> <table border="1" style="width: 100%; border-collapse: collapse; text-align: center;"> <tr> <td style="width: 10%;"></td> <td style="width: 10%;"></td> <td style="width: 10%;"></td> <td style="width: 10%;"></td> <td style="width: 10%;"></td> <td style="width: 10%;"></td> <td style="width: 10%;"></td> <td style="width: 10%;"></td> <td style="width: 10%;"></td> <td style="width: 10%;"></td> </tr> <tr> <td></td> <td></td> <td colspan="8" style="text-align: center;"> <table border="1" style="width: 100%; border-collapse: collapse; text-align: center;"> <tr> <td style="width: 10%;"></td> <td style="width: 10%;"></td> <td style="width: 10%;"></td> <td style="width: 10%;"></td> <td style="width: 10%;"></td> <td style="width: 10%;"></td> <td style="width: 10%;"></td> <td style="width: 10%;"></td> <td style="width: 10%;"></td> <td style="width: 10%;"></td> </tr> <tr> <td></td> <td></td> <td colspan="8" style="text-align: center;"> <table border="1" style="width: 100%; border-collapse: collapse; text-align: center;"> <tr> <td style="width: 10%;"></td> <td style="width: 10%;"></td> <td style="width: 10%;"></td> <td style="width: 10%;"></td> <td style="width: 10%;"></td> <td style="width: 10%;"></td> <td style="width: 10%;"></td> <td style="width: 10%;"></td> <td style="width: 10%;"></td> <td style="width: 10%;"></td> </tr> <tr> <td></td> <td></td> <td colspan="8" style="text-align: center;"> <table border="1" style="width: 100%; border-collapse: collapse; text-align: center;"> <tr> </tr></table></td></tr></table></td></tr></table></td></tr></table></td></tr></table></td></tr></table></td></tr></table></td></tr></table></td></tr></table></td></tr></table></td></tr></table></td></tr></table></td></tr></table></td></tr></table></td></tr></table></td></tr></table></td></tr></table></td></tr></table></td></tr></table></td></tr></table></td></tr></table></td></tr></table></td></tr></table></td></tr></table></td></tr></table></td></tr></table></td></tr></table></td></tr></table></td></tr></table></td></tr></table></td></tr></table></td></tr></table></td></tr></table></td></tr></table></td></tr></table></td></tr></table></td></tr></table></td></tr></table></td></tr></table></td></tr></table></td></tr></table></td></tr></table></td></tr></table></td></tr></table></td></tr></table></td></tr></table></td></tr></table></td></tr></table></td></tr></table></td></tr></table></td></tr></table></td></tr></table></td></tr></table>
 | | | | | | | | | | | | | | | | | | | | <table border="1" style="width: 100%; border-collapse: collapse; text-align: center;"> <tr> <td style="width: 10%;"></td> <td style="width: 10%;"></td> <td style="width: 10%;"></td> <td style="width: 10%;"></td> <td style="width: 10%;"></td> <td style="width: 10%;"></td> <td style="width: 10%;"></td> <td style="width: 10%;"></td> <td style="width: 10%;"></td> <td style="width: 10%;"></td> </tr> <tr> <td></td> <td></td> <td colspan="8" style="text-align: center;"> <table border="1" style="width: 100%; border-collapse: collapse; text-align: center;"> <tr> <td style="width: 10%;"></td> <td style="width: 10%;"></td> <td style="width: 10%;"></td> <td style="width: 10%;"></td> <td style="width: 10%;"></td> <td style="width: 10%;"></td> <td style="width: 10%;"></td> <td style="width: 10%;"></td> <td style="width: 10%;"></td> <td style="width: 10%;"></td> </tr> <tr> <td></td> <td></td> <td colspan="8" style="text-align: center;"> <table border="1" style="width: 100%; border-collapse: collapse; text-align: center;"> <tr> <td style="width: 10%;"></td> <td style="width: 10%;"></td> <td style="width: 10%;"></td> <td style="width: 10%;"></td> <td style="width: 10%;"></td> <td style="width: 10%;"></td> <td style="width: 10%;"></td> <td style="width: 10%;"></td> <td style="width: 10%;"></td> <td style="width: 10%;"></td> </tr> <tr> <td></td> <td></td> <td colspan="8" style="text-align: center;"> <table border="1" style="width: 100%; border-collapse: collapse; text-align: center;"> <tr> <td style="width: 10%;"></td> <td style="width: 10%;"></td> <td style="width: 10%;"></td> <td style="width: 10%;"></td> <td style="width: 10%;"></td> <td style="width: 10%;"></td> <td style="width: 10%;"></td> <td style="width: 10%;"></td> <td style="width: 10%;"></td> <td style="width: 10%;"></td> </tr> <tr> <td></td> <td></td> <td colspan="8" style="text-align: center;"> <table border="1" style="width: 100%; border-collapse: collapse; text-align: center;"> <tr> <td style="width: 10%;"></td> <td style="width: 10%;"></td> <td style="width: 10%;"></td> <td style="width: 10%;"></td> <td style="width: 10%;"></td> <td style="width: 10%;"></td> <td style="width: 10%;"></td> <td style="width: 10%;"></td> <td style="width: 10%;"></td> <td style="width: 10%;"></td> </tr> <tr> <td></td> <td></td> <td colspan="8" style="text-align: center;"> <table border="1" style="width: 100%; border-collapse: collapse; text-align: center;"> <tr> <td style="width: 10%;"></td> <td style="width: 10%;"></td> <td style="width: 10%;"></td> <td style="width: 10%;"></td> <td style="width: 10%;"></td> <td style="width: 10%;"></td> <td style="width: 10%;"></td> <td style="width: 10%;"></td> <td style="width: 10%;"></td> <td style="width: 10%;"></td> </tr> <tr> <td></td> <td></td> <td colspan="8" style="text-align: center;"> <table border="1" style="width: 100%; border-collapse: collapse; text-align: center;"> <tr> <td style="width: 10%;"></td> <td style="width: 10%;"></td> <td style="width: 10%;"></td> <td style="width: 10%;"></td> <td style="width: 10%;"></td> <td style="width: 10%;"></td> <td style="width: 10%;"></td> <td style="width: 10%;"></td> <td style="width: 10%;"></td> <td style="width: 10%;"></td> </tr> <tr> <td></td> <td></td> <td colspan="8" style="text-align: center;"> <table border="1" style="width: 100%; border-collapse: collapse; text-align: center;"> <tr> <td style="width: 10%;"></td> <td style="width: 10%;"></td> <td style="width: 10%;"></td> <td style="width: 10%;"></td> <td style="width: 10%;"></td> <td style="width: 10%;"></td> <td style="width: 10%;"></td> <td style="width: 10%;"></td> <td style="width: 10%;"></td> <td style="width: 10%;"></td> </tr> <tr> <td></td> <td></td> <td colspan="8" style="text-align: center;"> <table border="1" style="width: 100%; border-collapse: collapse; text-align: center;"> <tr> <td style="width: 10%;"></td> <td style="width: 10%;"></td> <td style="width: 10%;"></td> <td style="width: 10%;"></td> <td style="width: 10%;"></td> <td style="width: 10%;"></td> <td style="width: 10%;"></td> <td style="width: 10%;"></td> <td style="width: 10%;"></td> <td style="width: 10%;"></td> </tr> <tr> <td></td> <td></td> <td colspan="8" style="text-align: center;"> <table border="1" style="width: 100%; border-collapse: collapse; text-align: center;"> <tr> <td style="width: 10%;"></td> <td style="width: 10%;"></td> <td style="width: 10%;"></td> <td style="width: 10%;"></td> <td style="width: 10%;"></td> <td style="width: 10%;"></td> <td style="width: 10%;"></td> <td style="width: 10%;"></td> <td style="width: 10%;"></td> <td style="width: 10%;"></td> </tr> <tr> <td></td> <td></td> <td colspan="8" style="text-align: center;"> <table border="1" style="width: 100%; border-collapse: collapse; text-align: center;"> <tr> <td style="width: 10%;"></td> <td style="width: 10%;"></td> <td style="width: 10%;"></td> <td style="width: 10%;"></td> <td style="width: 10%;"></td> <td style="width: 10%;"></td> <td style="width: 10%;"></td> <td style="width: 10%;"></td> <td style="width: 10%;"></td> <td style="width: 10%;"></td> </tr> <tr> <td></td> <td></td> <td colspan="8" style="text-align: center;"> <table border="1" style="width: 100%; border-collapse: collapse; text-align: center;"> <tr> <td style="width: 10%;"></td> <td style="width: 10%;"></td> <td style="width: 10%;"></td> <td style="width: 10%;"></td> <td style="width: 10%;"></td> <td style="width: 10%;"></td> <td style="width: 10%;"></td> <td style="width: 10%;"></td> <td style="width: 10%;"></td> <td style="width: 10%;"></td> </tr> <tr> <td></td> <td></td> <td colspan="8" style="text-align: center;"> <table border="1" style="width: 100%; border-collapse: collapse; text-align: center;"> <tr> <td style="width: 10%;"></td> <td style="width: 10%;"></td> <td style="width: 10%;"></td> <td style="width: 10%;"></td> <td style="width: 10%;"></td> <td style="width: 10%;"></td> <td style="width: 10%;"></td> <td style="width: 10%;"></td> <td style="width: 10%;"></td> <td style="width: 10%;"></td> </tr> <tr> <td></td> <td></td> <td colspan="8" style="text-align: center;"> <table border="1" style="width: 100%; border-collapse: collapse; text-align: center;"> <tr> <td style="width: 10%;"></td> <td style="width: 10%;"></td> <td style="width: 10%;"></td> <td style="width: 10%;"></td> <td style="width: 10%;"></td> <td style="width: 10%;"></td> <td style="width: 10%;"></td> <td style="width: 10%;"></td> <td style="width: 10%;"></td> <td style="width: 10%;"></td> </tr> <tr> <td></td> <td></td> <td colspan="8" style="text-align: center;"> <table border="1" style="width: 100%; border-collapse: collapse; text-align: center;"> <tr> <td style="width: 10%;"></td> <td style="width: 10%;"></td> <td style="width: 10%;"></td> <td style="width: 10%;"></td> <td style="width: 10%;"></td> <td style="width: 10%;"></td> <td style="width: 10%;"></td> <td style="width: 10%;"></td> <td style="width: 10%;"></td> <td style="width: 10%;"></td> </tr> <tr> <td></td> <td></td> <td colspan="8" style="text-align: center;"> <table border="1" style="width: 100%; border-collapse: collapse; text-align: center;"> <tr> <td style="width: 10%;"></td> <td style="width: 10%;"></td> <td style="width: 10%;"></td> <td style="width: 10%;"></td> <td style="width: 10%;"></td> <td style="width: 10%;"></td> <td style="width: 10%;"></td> <td style="width: 10%;"></td> <td style="width: 10%;"></td> <td style="width: 10%;"></td> </tr> <tr> <td></td> <td></td> <td colspan="8" style="text-align: center;"> <table border="1" style="width: 100%; border-collapse: collapse; text-align: center;"> <tr> <td style="width: 10%;"></td> <td style="width: 10%;"></td> <td style="width: 10%;"></td> <td style="width: 10%;"></td> <td style="width: 10%;"></td> <td style="width: 10%;"></td> <td style="width: 10%;"></td> <td style="width: 10%;"></td> <td style="width: 10%;"></td> <td style="width: 10%;"></td> </tr> <tr> <td></td> <td></td> <td colspan="8" style="text-align: center;"> <table border="1" style="width: 100%; border-collapse: collapse; text-align: center;"> <tr> <td style="width: 10%;"></td> <td style="width: 10%;"></td> <td style="width: 10%;"></td> <td style="width: 10%;"></td> <td style="width: 10%;"></td> <td style="width: 10%;"></td> <td style="width: 10%;"></td> <td style="width: 10%;"></td> <td style="width: 10%;"></td> <td style="width: 10%;"></td> </tr> <tr> <td></td> <td></td> <td colspan="8" style="text-align: center;"> <table border="1" style="width: 100%; border-collapse: collapse; text-align: center;"> <tr> <td style="width: 10%;"></td> <td style="width: 10%;"></td> <td style="width: 10%;"></td> <td style="width: 10%;"></td> <td style="width: 10%;"></td> <td style="width: 10%;"></td> <td style="width: 10%;"></td> <td style="width: 10%;"></td> <td style="width: 10%;"></td> <td style="width: 10%;"></td> </tr> <tr> <td></td> <td></td> <td colspan="8" style="text-align: center;"> <table border="1" style="width: 100%; border-collapse: collapse; text-align: center;"> <tr> <td style="width: 10%;"></td> <td style="width: 10%;"></td> <td style="width: 10%;"></td> <td style="width: 10%;"></td> <td style="width: 10%;"></td> <td style="width: 10%;"></td> <td style="width: 10%;"></td> <td style="width: 10%;"></td> <td style="width: 10%;"></td> <td style="width: 10%;"></td> </tr> <tr> <td></td> <td></td> <td colspan="8" style="text-align: center;"> <table border="1" style="width: 100%; border-collapse: collapse; text-align: center;"> <tr> <td style="width: 10%;"></td> <td style="width: 10%;"></td> <td style="width: 10%;"></td> <td style="width: 10%;"></td> <td
style="width: 10%;"></td> <td style="width: 10%;"></td> <td style="width: 10%;"></td> <td style="width: 10%;"></td> <td style="width: 10%;"></td> <td style="width: 10%;"></td> </tr> <tr> <td></td> <td></td> <td colspan="8" style="text-align: center;"> <table border="1" style="width: 100%; border-collapse: collapse; text-align: center;"> <tr> <td style="width: 10%;"></td> <td style="width: 10%;"></td> <td style="width: 10%;"></td> <td style="width: 10%;"></td> <td style="width: 10%;"></td> <td style="width: 10%;"></td> <td style="width: 10%;"></td> <td style="width: 10%;"></td> <td style="width: 10%;"></td> <td style="width: 10%;"></td> </tr> <tr> <td></td> <td></td> <td colspan="8" style="text-align: center;"> <table border="1" style="width: 100%; border-collapse: collapse; text-align: center;"> <tr> <td style="width: 10%;"></td> <td style="width: 10%;"></td> <td style="width: 10%;"></td> <td style="width: 10%;"></td> <td style="width: 10%;"></td> <td style="width: 10%;"></td> <td style="width: 10%;"></td> <td style="width: 10%;"></td> <td style="width: 10%;"></td> <td style="width: 10%;"></td> </tr> <tr> <td></td> <td></td> <td colspan="8" style="text-align: center;"> <table border="1" style="width: 100%; border-collapse: collapse; text-align: center;"> <tr> <td style="width: 10%;"></td> <td style="width: 10%;"></td> <td style="width: 10%;"></td> <td style="width: 10%;"></td> <td style="width: 10%;"></td> <td style="width: 10%;"></td> <td style="width: 10%;"></td> <td style="width: 10%;"></td> <td style="width: 10%;"></td> <td style="width: 10%;"></td> </tr> <tr> <td></td> <td></td> <td colspan="8" style="text-align: center;"> <table border="1" style="width: 100%; border-collapse: collapse; text-align: center;"> <tr> <td style="width: 10%;"></td> <td style="width: 10%;"></td> <td style="width: 10%;"></td> <td style="width: 10%;"></td> <td style="width: 10%;"></td> <td style="width: 10%;"></td> <td style="width: 10%;"></td> <td style="width: 10%;"></td> <td style="width: 10%;"></td> <td style="width: 10%;"></td> </tr> <tr> <td></td> <td></td> <td colspan="8" style="text-align: center;"> <table border="1" style="width: 100%; border-collapse: collapse; text-align: center;"> <tr> <td style="width: 10%;"></td> <td style="width: 10%;"></td> <td style="width: 10%;"></td> <td style="width: 10%;"></td> <td style="width: 10%;"></td> <td style="width: 10%;"></td> <td style="width: 10%;"></td> <td style="width: 10%;"></td> <td style="width: 10%;"></td> <td style="width: 10%;"></td> </tr> <tr> <td></td> <td></td> <td colspan="8" style="text-align: center;"> <table border="1" style="width: 100%; border-collapse: collapse; text-align: center;"> <tr> <td style="width: 10%;"></td> <td style="width: 10%;"></td> <td style="width: 10%;"></td> <td style="width: 10%;"></td> <td style="width: 10%;"></td> <td style="width: 10%;"></td> <td style="width: 10%;"></td> <td style="width: 10%;"></td> <td style="width: 10%;"></td> <td style="width: 10%;"></td> </tr> <tr> <td></td> <td></td> <td colspan="8" style="text-align: center;"> <table border="1" style="width: 100%; border-collapse: collapse; text-align: center;"> <tr> <td style="width: 10%;"></td> <td style="width: 10%;"></td> <td style="width: 10%;"></td> <td style="width: 10%;"></td> <td style="width: 10%;"></td> <td style="width: 10%;"></td> <td style="width: 10%;"></td> <td style="width: 10%;"></td> <td style="width: 10%;"></td> <td style="width: 10%;"></td> </tr> <tr> <td></td> <td></td> <td colspan="8" style="text-align: center;"> <table border="1" style="width: 100%; border-collapse: collapse; text-align: center;"> <tr> <td style="width: 10%;"></td> <td style="width: 10%;"></td> <td style="width: 10%;"></td> <td style="width: 10%;"></td> <td style="width: 10%;"></td> <td style="width: 10%;"></td> <td style="width: 10%;"></td> <td style="width: 10%;"></td> <td style="width: 10%;"></td> <td style="width: 10%;"></td> </tr> <tr> <td></td> <td></td> <td colspan="8" style="text-align: center;"> <table border="1" style="width: 100%; border-collapse: collapse; text-align: center;"> <tr> <td style="width: 10%;"></td> <td style="width: 10%;"></td> <td style="width: 10%;"></td> <td style="width: 10%;"></td> <td style="width: 10%;"></td> <td style="width: 10%;"></td> <td style="width: 10%;"></td> <td style="width: 10%;"></td> <td style="width: 10%;"></td> <td style="width: 10%;"></td> </tr> <tr> <td></td> <td></td> <td colspan="8" style="text-align: center;"> <table border="1" style="width: 100%; border-collapse: collapse; text-align: center;"> <tr> <td style="width: 10%;"></td> <td style="width: 10%;"></td> <td style="width: 10%;"></td> <td style="width: 10%;"></td> <td style="width: 10%;"></td> <td style="width: 10%;"></td> <td style="width: 10%;"></td> <td style="width: 10%;"></td> <td style="width: 10%;"></td> <td style="width: 10%;"></td> </tr> <tr> <td></td> <td></td> <td colspan="8" style="text-align: center;"> <table border="1" style="width: 100%; border-collapse: collapse; text-align: center;"> <tr> <td style="width: 10%;"></td> <td style="width: 10%;"></td> <td style="width: 10%;"></td> <td style="width: 10%;"></td> <td style="width: 10%;"></td> <td style="width: 10%;"></td> <td style="width: 10%;"></td> <td style="width: 10%;"></td> <td style="width: 10%;"></td> <td style="width: 10%;"></td> </tr> <tr> <td></td> <td></td> <td colspan="8" style="text-align: center;"> <table border="1" style="width: 100%; border-collapse: collapse; text-align: center;"> <tr> <td style="width: 10%;"></td> <td style="width: 10%;"></td> <td style="width: 10%;"></td> <td style="width: 10%;"></td> <td style="width: 10%;"></td> <td style="width: 10%;"></td> <td style="width: 10%;"></td> <td style="width: 10%;"></td> <td style="width: 10%;"></td> <td style="width: 10%;"></td> </tr> <tr> <td></td> <td></td> <td colspan="8" style="text-align: center;"> <table border="1" style="width: 100%; border-collapse: collapse; text-align: center;"> <tr> <td style="width: 10%;"></td> <td style="width: 10%;"></td> <td style="width: 10%;"></td> <td style="width: 10%;"></td> <td style="width: 10%;"></td> <td style="width: 10%;"></td> <td style="width: 10%;"></td> <td style="width: 10%;"></td> <td style="width: 10%;"></td> <td style="width: 10%;"></td> </tr> <tr> <td></td> <td></td> <td colspan="8" style="text-align: center;"> <table border="1" style="width: 100%; border-collapse: collapse; text-align: center;"> <tr> <td style="width: 10%;"></td> <td style="width: 10%;"></td> <td style="width: 10%;"></td> <td style="width: 10%;"></td> <td style="width: 10%;"></td> <td style="width: 10%;"></td> <td style="width: 10%;"></td> <td style="width: 10%;"></td> <td style="width: 10%;"></td> <td style="width: 10%;"></td> </tr> <tr> <td></td> <td></td> <td colspan="8" style="text-align: center;"> <table border="1" style="width: 100%; border-collapse: collapse; text-align: center;"> <tr> <td style="width: 10%;"></td> <td style="width: 10%;"></td> <td style="width: 10%;"></td> <td style="width: 10%;"></td> <td style="width: 10%;"></td> <td style="width: 10%;"></td> <td style="width: 10%;"></td> <td style="width: 10%;"></td> <td style="width: 10%;"></td> <td style="width: 10%;"></td> </tr> <tr> <td></td> <td></td> <td colspan="8" style="text-align: center;"> <table border="1" style="width: 100%; border-collapse: collapse; text-align: center;"> <tr> <td style="width: 10%;"></td> <td style="width: 10%;"></td> <td style="width: 10%;"></td> <td style="width: 10%;"></td> <td style="width: 10%;"></td> <td style="width: 10%;"></td> <td style="width: 10%;"></td> <td style="width: 10%;"></td> <td style="width: 10%;"></td> <td style="width: 10%;"></td> </tr> <tr> <td></td> <td></td> <td colspan="8" style="text-align: center;"> <table border="1" style="width: 100%; border-collapse: collapse; text-align: center;"> <tr> <td style="width: 10%;"></td> <td style="width: 10%;"></td> <td style="width: 10%;"></td> <td style="width: 10%;"></td> <td style="width: 10%;"></td> <td style="width: 10%;"></td> <td style="width: 10%;"></td> <td style="width: 10%;"></td> <td style="width: 10%;"></td> <td style="width: 10%;"></td> </tr> <tr> <td></td> <td></td> <td colspan="8" style="text-align: center;"> <table border="1" style="width: 100%; border-collapse: collapse; text-align: center;"> <tr> <td style="width: 10%;"></td> <td style="width: 10%;"></td> <td style="width: 10%;"></td> <td style="width: 10%;"></td> <td style="width: 10%;"></td> <td style="width: 10%;"></td> <td style="width: 10%;"></td> <td style="width: 10%;"></td> <td style="width: 10%;"></td> <td style="width: 10%;"></td> </tr> <tr> <td></td> <td></td> <td colspan="8" style="text-align: center;"> <table border="1" style="width: 100%; border-collapse: collapse; text-align: center;"> <tr> <td style="width: 10%;"></td> <td style="width: 10%;"></td> <td style="width: 10%;"></td> <td style="width: 10%;"></td> <td style="width: 10%;"></td> <td style="width: 10%;"></td> <td style="width: 10%;"></td> <td style="width: 10%;"></td> <td style="width: 10%;"></td> <td style="width: 10%;"></td> </tr> <tr> <td></td> <td></td> <td colspan="8" style="text-align: center;"> <table border="1" style="width: 100%; border-collapse: collapse; text-align: center;"> <tr> <td style="width: 10%;"></td> <td style="width: 10%;"></td> <td style="width: 10%;"></td> <td style="width: 10%;"></td> <td style="width: 10%;"></td> <td style="width: 10%;"></td> <td style="width: 10%;"></td> <td style="width: 10%;"></td> <td style="width: 10%;"></td> <td style="width: 10%;"></td> </tr> <tr> <td></td> <td></td> <td colspan="8" style="text-align: center;"> <table border="1" style="width: 100%; border-collapse: collapse; text-align: center;"> <tr> <td style="width: 10%;"></td> <td style="width: 10%;"></td> <td style="width: 10%;"></td> <td style="width: 10%;"></td> <td style="width: 10%;"></td> <td style="width: 10%;"></td> <td style="width: 10%;"></td> <td style="width: 10%;"></td> <td style="width: 10%;"></td> <td style="width:
10%;"></td> </tr> <tr> <td></td> <td></td> <td colspan="8" style="text-align: center;"> <table border="1" style="width: 100%; border-collapse: collapse; text-align: center;"> <tr> <td style="width: 10%;"></td> <td style="width: 10%;"></td> <td style="width: 10%;"></td> <td style="width: 10%;"></td> <td style="width: 10%;"></td> <td style="width: 10%;"></td> <td style="width: 10%;"></td> <td style="width: 10%;"></td> <td style="width: 10%;"></td> <td style="width: 10%;"></td> </tr> <tr> <td></td> <td></td> <td colspan="8" style="text-align: center;"> <table border="1" style="width: 100%; border-collapse: collapse; text-align: center;"> <tr> <td style="width: 10%;"></td> <td style="width: 10%;"></td> <td style="width: 10%;"></td> <td style="width: 10%;"></td> <td style="width: 10%;"></td> <td style="width: 10%;"></td> <td style="width: 10%;"></td> <td style="width: 10%;"></td> <td style="width: 10%;"></td> <td style="width: 10%;"></td> </tr> <tr> <td></td> <td></td> <td colspan="8" style="text-align: center;"> <table border="1" style="width: 100%; border-collapse: collapse; text-align: center;"> <tr> <td style="width: 10%;"></td> <td style="width: 10%;"></td> <td style="width: 10%;"></td> <td style="width: 10%;"></td> <td style="width: 10%;"></td> <td style="width: 10%;"></td> <td style="width: 10%;"></td> <td style="width: 10%;"></td> <td style="width: 10%;"></td> <td style="width: 10%;"></td> </tr> <tr> <td></td> <td></td> <td colspan="8" style="text-align: center;"> <table border="1" style="width: 100%; border-collapse: collapse; text-align: center;"> <tr> <td style="width: 10%;"></td> <td style="width: 10%;"></td> <td style="width: 10%;"></td> <td style="width: 10%;"></td> <td style="width: 10%;"></td> <td style="width: 10%;"></td> <td style="width: 10%;"></td> <td style="width: 10%;"></td> <td style="width: 10%;"></td> <td style="width: 10%;"></td> </tr> <tr> <td></td> <td></td> <td colspan="8" style="text-align: center;"> <table border="1" style="width: 100%; border-collapse: collapse; text-align: center;"> <tr> <td style="width: 10%;"></td> <td style="width: 10%;"></td> <td style="width: 10%;"></td> <td style="width: 10%;"></td> <td style="width: 10%;"></td> <td style="width: 10%;"></td> <td style="width: 10%;"></td> <td style="width: 10%;"></td> <td style="width: 10%;"></td> <td style="width: 10%;"></td> </tr> <tr> <td></td> <td></td> <td colspan="8" style="text-align: center;"> <table border="1" style="width: 100%; border-collapse: collapse; text-align: center;"> <tr> <td style="width: 10%;"></td> <td style="width: 10%;"></td> <td style="width: 10%;"></td> <td style="width: 10%;"></td> <td style="width: 10%;"></td> <td style="width: 10%;"></td> <td style="width: 10%;"></td> <td style="width: 10%;"></td> <td style="width: 10%;"></td> <td style="width: 10%;"></td> </tr> <tr> <td></td> <td></td> <td colspan="8" style="text-align: center;"> <table border="1" style="width: 100%; border-collapse: collapse; text-align: center;"> <tr> <td style="width: 10%;"></td> <td style="width: 10%;"></td> <td style="width: 10%;"></td> <td style="width: 10%;"></td> <td style="width: 10%;"></td> <td style="width: 10%;"></td> <td style="width: 10%;"></td> <td style="width: 10%;"></td> <td style="width: 10%;"></td> <td style="width: 10%;"></td> </tr> <tr> <td></td> <td></td> <td colspan="8" style="text-align: center;"> <table border="1" style="width: 100%; border-collapse: collapse; text-align: center;"> <tr> <td style="width: 10%;"></td> <td style="width: 10%;"></td> <td style="width: 10%;"></td> <td style="width: 10%;"></td> <td style="width: 10%;"></td> <td style="width: 10%;"></td> <td style="width: 10%;"></td> <td style="width: 10%;"></td> <td style="width: 10%;"></td> <td style="width: 10%;"></td> </tr> <tr> <td></td> <td></td> <td colspan="8" style="text-align: center;"> <table border="1" style="width: 100%; border-collapse: collapse; text-align: center;"> <tr> <td style="width: 10%;"></td> <td style="width: 10%;"></td> <td style="width: 10%;"></td> <td style="width: 10%;"></td> <td style="width: 10%;"></td> <td style="width: 10%;"></td> <td style="width: 10%;"></td> <td style="width: 10%;"></td> <td style="width: 10%;"></td> <td style="width: 10%;"></td> </tr> <tr> <td></td> <td></td> <td colspan="8" style="text-align: center;"> <table border="1" style="width: 100%; border-collapse: collapse; text-align: center;"> <tr> </tr></table></td></tr></table></td></tr></table></td></tr></table></td></tr></table></td></tr></table></td></tr></table></td></tr></table></td></tr></table></td></tr></table></td></tr></table></td></tr></table></td></tr></table></td></tr></table></td></tr></table></td></tr></table></td></tr></table></td></tr></table></td></tr></table></td></tr></table></td></tr></table></td></tr></table></td></tr></table></td></tr></table></td></tr></table></td></tr></table></td></tr></table></td></tr></table></td></tr></table></td></tr></table></td></tr></table></td></tr></table></td></tr></table></td></tr></table></td></tr></table></td></tr></table></td></tr></table></td></tr></table></td></tr></table></td></tr></table></td></tr></table></td></tr></table></td></tr></table></td></tr></table></td></tr></table></td></tr></table></td></tr></table></td></tr></table></td></tr></table></td></tr></table></td></tr></table></td></tr></table> | | | | | | | | | | | | | | | | | | | | <table border="1" style="width: 100%; border-collapse: collapse; text-align: center;"> <tr> <td style="width: 10%;"></td> <td style="width: 10%;"></td> <td style="width: 10%;"></td> <td style="width: 10%;"></td> <td style="width: 10%;"></td> <td style="width: 10%;"></td> <td style="width: 10%;"></td> <td style="width: 10%;"></td> <td style="width: 10%;"></td> <td style="width: 10%;"></td> </tr> <tr> <td></td> <td></td> <td colspan="8" style="text-align: center;"> <table border="1" style="width: 100%; border-collapse: collapse; text-align: center;"> <tr> <td style="width: 10%;"></td> <td style="width: 10%;"></td> <td style="width: 10%;"></td> <td style="width: 10%;"></td> <td style="width: 10%;"></td> <td style="width: 10%;"></td> <td style="width: 10%;"></td> <td style="width: 10%;"></td> <td style="width: 10%;"></td> <td style="width: 10%;"></td> </tr> <tr> <td></td> <td></td> <td colspan="8" style="text-align: center;"> <table border="1" style="width: 100%; border-collapse: collapse; text-align: center;"> <tr> <td style="width: 10%;"></td> <td style="width: 10%;"></td> <td style="width: 10%;"></td> <td style="width: 10%;"></td> <td style="width: 10%;"></td> <td style="width: 10%;"></td> <td
style="width: 10%;"></td> <td style="width: 10%;"></td> <td style="width: 10%;"></td> <td style="width: 10%;"></td> </tr> <tr> <td></td> <td></td> <td colspan="8" style="text-align: center;"> <table border="1" style="width: 100%; border-collapse: collapse; text-align: center;"> <tr> <td style="width: 10%;"></td> <td style="width: 10%;"></td> <td style="width: 10%;"></td> <td style="width: 10%;"></td> <td style="width: 10%;"></td> <td style="width: 10%;"></td> <td style="width: 10%;"></td> <td style="width: 10%;"></td> <td style="width: 10%;"></td> <td style="width: 10%;"></td> </tr> <tr> <td></td> <td></td> <td colspan="8" style="text-align: center;"> <table border="1" style="width: 100%; border-collapse: collapse; text-align: center;"> <tr> <td style="width: 10%;"></td> <td style="width: 10%;"></td> <td style="width: 10%;"></td> <td style="width: 10%;"></td> <td style="width: 10%;"></td> <td style="width: 10%;"></td> <td style="width: 10%;"></td> <td style="width: 10%;"></td> <td style="width: 10%;"></td> <td style="width: 10%;"></td> </tr> <tr> <td></td> <td></td> <td colspan="8" style="text-align: center;"> <table border="1" style="width: 100%; border-collapse: collapse; text-align: center;"> <tr> <td style="width: 10%;"></td> <td style="width: 10%;"></td> <td style="width: 10%;"></td> <td style="width: 10%;"></td> <td style="width: 10%;"></td> <td style="width: 10%;"></td> <td style="width: 10%;"></td> <td style="width: 10%;"></td> <td style="width: 10%;"></td> <td style="width: 10%;"></td> </tr> <tr> <td></td> <td></td> <td colspan="8" style="text-align: center;"> <table border="1" style="width: 100%; border-collapse: collapse; text-align: center;"> <tr> <td style="width: 10%;"></td> <td style="width: 10%;"></td> <td style="width: 10%;"></td> <td style="width: 10%;"></td> <td style="width: 10%;"></td> <td style="width: 10%;"></td> <td style="width: 10%;"></td> <td style="width: 10%;"></td> <td style="width: 10%;"></td> <td style="width: 10%;"></td> </tr> <tr> <td></td> <td></td> <td colspan="8" style="text-align: center;"> <table border="1" style="width: 100%; border-collapse: collapse; text-align: center;"> <tr> <td style="width: 10%;"></td> <td style="width: 10%;"></td> <td style="width: 10%;"></td> <td style="width: 10%;"></td> <td style="width: 10%;"></td> <td style="width: 10%;"></td> <td style="width: 10%;"></td> <td style="width: 10%;"></td> <td style="width: 10%;"></td> <td style="width: 10%;"></td> </tr> <tr> <td></td> <td></td> <td colspan="8" style="text-align: center;"> <table border="1" style="width: 100%; border-collapse: collapse; text-align: center;"> <tr> <td style="width: 10%;"></td> <td style="width: 10%;"></td> <td style="width: 10%;"></td> <td style="width: 10%;"></td> <td style="width: 10%;"></td> <td style="width: 10%;"></td> <td style="width: 10%;"></td> <td style="width: 10%;"></td> <td style="width: 10%;"></td> <td style="width: 10%;"></td> </tr> <tr> <td></td> <td></td> <td colspan="8" style="text-align: center;"> <table border="1" style="width: 100%; border-collapse: collapse; text-align: center;"> <tr> <td style="width: 10%;"></td> <td style="width: 10%;"></td> <td style="width: 10%;"></td> <td style="width: 10%;"></td> <td style="width: 10%;"></td> <td style="width: 10%;"></td> <td style="width: 10%;"></td> <td style="width: 10%;"></td> <td style="width: 10%;"></td> <td style="width: 10%;"></td> </tr> <tr> <td></td> <td></td> <td colspan="8" style="text-align: center;"> <table border="1" style="width: 100%; border-collapse: collapse; text-align: center;"> <tr> <td style="width: 10%;"></td> <td style="width: 10%;"></td> <td style="width: 10%;"></td> <td style="width: 10%;"></td> <td style="width: 10%;"></td> <td style="width: 10%;"></td> <td style="width: 10%;"></td> <td style="width: 10%;"></td> <td style="width: 10%;"></td> <td style="width: 10%;"></td> </tr> <tr> <td></td> <td></td> <td colspan="8" style="text-align: center;"> <table border="1" style="width: 100%; border-collapse: collapse; text-align: center;"> <tr> <td style="width: 10%;"></td> <td style="width: 10%;"></td> <td style="width: 10%;"></td> <td style="width: 10%;"></td> <td style="width: 10%;"></td> <td style="width: 10%;"></td> <td style="width: 10%;"></td> <td style="width: 10%;"></td> <td style="width: 10%;"></td> <td style="width: 10%;"></td> </tr> <tr> <td></td> <td></td> <td colspan="8" style="text-align: center;"> <table border="1" style="width: 100%; border-collapse: collapse; text-align: center;"> <tr> <td style="width: 10%;"></td> <td style="width: 10%;"></td> <td style="width: 10%;"></td> <td style="width: 10%;"></td> <td style="width: 10%;"></td> <td style="width: 10%;"></td> <td style="width: 10%;"></td> <td style="width: 10%;"></td> <td style="width: 10%;"></td> <td style="width: 10%;"></td> </tr> <tr> <td></td> <td></td> <td colspan="8" style="text-align: center;"> <table border="1" style="width: 100%; border-collapse: collapse; text-align: center;"> <tr> <td style="width: 10%;"></td> <td style="width: 10%;"></td> <td style="width: 10%;"></td> <td style="width: 10%;"></td> <td style="width: 10%;"></td> <td style="width: 10%;"></td> <td style="width: 10%;"></td> <td style="width: 10%;"></td> <td style="width: 10%;"></td> <td style="width: 10%;"></td> </tr> <tr> <td></td> <td></td> <td colspan="8" style="text-align: center;"> <table border="1" style="width: 100%; border-collapse: collapse; text-align: center;"> <tr> <td style="width: 10%;"></td> <td style="width: 10%;"></td> <td style="width: 10%;"></td> <td style="width: 10%;"></td> <td style="width: 10%;"></td> <td style="width: 10%;"></td> <td style="width: 10%;"></td> <td style="width: 10%;"></td> <td style="width: 10%;"></td> <td style="width: 10%;"></td> </tr> <tr> <td></td> <td></td> <td colspan="8" style="text-align: center;"> <table border="1" style="width: 100%; border-collapse: collapse; text-align: center;"> <tr> <td style="width: 10%;"></td> <td style="width: 10%;"></td> <td style="width: 10%;"></td> <td style="width: 10%;"></td> <td style="width: 10%;"></td> <td style="width: 10%;"></td> <td style="width: 10%;"></td> <td style="width: 10%;"></td> <td style="width: 10%;"></td> <td style="width: 10%;"></td> </tr> <tr> <td></td> <td></td> <td colspan="8" style="text-align: center;"> <table border="1" style="width: 100%; border-collapse: collapse; text-align: center;"> <tr> <td style="width: 10%;"></td> <td style="width: 10%;"></td> <td style="width: 10%;"></td> <td style="width: 10%;"></td> <td style="width: 10%;"></td> <td style="width: 10%;"></td> <td style="width: 10%;"></td> <td style="width: 10%;"></td> <td style="width: 10%;"></td> <td style="width: 10%;"></td> </tr> <tr> <td></td> <td></td> <td colspan="8" style="text-align: center;"> <table border="1" style="width: 100%; border-collapse: collapse; text-align: center;"> <tr> <td style="width: 10%;"></td> <td style="width: 10%;"></td> <td style="width: 10%;"></td> <td style="width: 10%;"></td> <td style="width: 10%;"></td> <td style="width: 10%;"></td> <td style="width: 10%;"></td> <td style="width: 10%;"></td> <td style="width: 10%;"></td> <td style="width: 10%;"></td> </tr> <tr> <td></td> <td></td> <td colspan="8" style="text-align: center;"> <table border="1" style="width: 100%; border-collapse: collapse; text-align: center;"> <tr> <td style="width: 10%;"></td> <td style="width: 10%;"></td> <td style="width: 10%;"></td> <td style="width: 10%;"></td> <td style="width: 10%;"></td> <td style="width: 10%;"></td> <td style="width: 10%;"></td> <td style="width: 10%;"></td> <td style="width: 10%;"></td> <td style="width: 10%;"></td> </tr> <tr> <td></td> <td></td> <td colspan="8" style="text-align: center;"> <table border="1" style="width: 100%; border-collapse: collapse; text-align: center;"> <tr> <td style="width: 10%;"></td> <td style="width: 10%;"></td> <td style="width: 10%;"></td> <td style="width: 10%;"></td> <td style="width: 10%;"></td> <td style="width: 10%;"></td> <td style="width: 10%;"></td> <td style="width: 10%;"></td> <td style="width: 10%;"></td> <td style="width: 10%;"></td> </tr> <tr> <td></td> <td></td> <td colspan="8" style="text-align: center;"> <table border="1" style="width: 100%; border-collapse: collapse; text-align: center;"> <tr> <td style="width: 10%;"></td> <td style="width: 10%;"></td> <td style="width: 10%;"></td> <td style="width: 10%;"></td> <td style="width: 10%;"></td> <td style="width: 10%;"></td> <td style="width: 10%;"></td> <td style="width: 10%;"></td> <td style="width: 10%;"></td> <td style="width: 10%;"></td> </tr> <tr> <td></td> <td></td> <td colspan="8" style="text-align: center;"> <table border="1" style="width: 100%; border-collapse: collapse; text-align: center;"> <tr> <td style="width: 10%;"></td> <td style="width: 10%;"></td> <td style="width: 10%;"></td> <td style="width: 10%;"></td> <td style="width: 10%;"></td> <td style="width: 10%;"></td> <td style="width: 10%;"></td> <td style="width: 10%;"></td> <td style="width: 10%;"></td> <td style="width: 10%;"></td> </tr> <tr> <td></td> <td></td> <td colspan="8" style="text-align: center;"> <table border="1" style="width: 100%; border-collapse: collapse; text-align: center;"> <tr> <td style="width: 10%;"></td> <td style="width: 10%;"></td> <td style="width: 10%;"></td> <td style="width: 10%;"></td> <td style="width: 10%;"></td> <td style="width: 10%;"></td> <td style="width: 10%;"></td> <td style="width: 10%;"></td> <td style="width: 10%;"></td> <td style="width: 10%;"></td> </tr> <tr> <td></td> <td></td> <td colspan="8" style="text-align: center;"> <table border="1" style="width: 100%; border-collapse: collapse; text-align: center;"> <tr> <td style="width: 10%;"></td> <td style="width: 10%;"></td> <td style="width: 10%;"></td> <td style="width: 10%;"></td> <td style="width: 10%;"></td> <td style="width: 10%;"></td> <td style="width: 10%;"></td> <td style="width: 10%;"></td> <td style="width: 10%;"></td> <td style="width: 10%;"></td> </tr> <tr> <td></td> <td></td> <td colspan="8"
style="text-align: center;"> <table border="1" style="width: 100%; border-collapse: collapse; text-align: center;"> <tr> <td style="width: 10%;"></td> <td style="width: 10%;"></td> <td style="width: 10%;"></td> <td style="width: 10%;"></td> <td style="width: 10%;"></td> <td style="width: 10%;"></td> <td style="width: 10%;"></td> <td style="width: 10%;"></td> <td style="width: 10%;"></td> <td style="width: 10%;"></td> </tr> <tr> <td></td> <td></td> <td colspan="8" style="text-align: center;"> <table border="1" style="width: 100%; border-collapse: collapse; text-align: center;"> <tr> <td style="width: 10%;"></td> <td style="width: 10%;"></td> <td style="width: 10%;"></td> <td style="width: 10%;"></td> <td style="width: 10%;"></td> <td style="width: 10%;"></td> <td style="width: 10%;"></td> <td style="width: 10%;"></td> <td style="width: 10%;"></td> <td style="width: 10%;"></td> </tr> <tr> <td></td> <td></td> <td colspan="8" style="text-align: center;"> <table border="1" style="width: 100%; border-collapse: collapse; text-align: center;"> <tr> <td style="width: 10%;"></td> <td style="width: 10%;"></td> <td style="width: 10%;"></td> <td style="width: 10%;"></td> <td style="width: 10%;"></td> <td style="width: 10%;"></td> <td style="width: 10%;"></td> <td style="width: 10%;"></td> <td style="width: 10%;"></td> <td style="width: 10%;"></td> </tr> <tr> <td></td> <td></td> <td colspan="8" style="text-align: center;"> <table border="1" style="width: 100%; border-collapse: collapse; text-align: center;"> <tr> <td style="width: 10%;"></td> <td style="width: 10%;"></td> <td style="width: 10%;"></td> <td style="width: 10%;"></td> <td style="width: 10%;"></td> <td style="width: 10%;"></td> <td style="width: 10%;"></td> <td style="width: 10%;"></td> <td style="width: 10%;"></td> <td style="width: 10%;"></td> </tr> <tr> <td></td> <td></td> <td colspan="8" style="text-align: center;"> <table border="1" style="width: 100%; border-collapse: collapse; text-align: center;"> <tr> <td style="width: 10%;"></td> <td style="width: 10%;"></td> <td style="width: 10%;"></td> <td style="width: 10%;"></td> <td style="width: 10%;"></td> <td style="width: 10%;"></td> <td style="width: 10%;"></td> <td style="width: 10%;"></td> <td style="width: 10%;"></td> <td style="width: 10%;"></td> </tr> <tr> <td></td> <td></td> <td colspan="8" style="text-align: center;"> <table border="1" style="width: 100%; border-collapse: collapse; text-align: center;"> <tr> <td style="width: 10%;"></td> <td style="width: 10%;"></td> <td style="width: 10%;"></td> <td style="width: 10%;"></td> <td style="width: 10%;"></td> <td style="width: 10%;"></td> <td style="width: 10%;"></td> <td style="width: 10%;"></td> <td style="width: 10%;"></td> <td style="width: 10%;"></td> </tr> <tr> <td></td> <td></td> <td colspan="8" style="text-align: center;"> <table border="1" style="width: 100%; border-collapse: collapse; text-align: center;"> <tr> <td style="width: 10%;"></td> <td style="width: 10%;"></td> <td style="width: 10%;"></td> <td style="width: 10%;"></td> <td style="width: 10%;"></td> <td style="width: 10%;"></td> <td style="width: 10%;"></td> <td style="width: 10%;"></td> <td style="width: 10%;"></td> <td style="width: 10%;"></td> </tr> <tr> <td></td> <td></td> <td colspan="8" style="text-align: center;"> <table border="1" style="width: 100%; border-collapse: collapse; text-align: center;"> <tr> <td style="width: 10%;"></td> <td style="width: 10%;"></td> <td style="width: 10%;"></td> <td style="width: 10%;"></td> <td style="width: 10%;"></td> <td style="width: 10%;"></td> <td style="width: 10%;"></td> <td style="width: 10%;"></td> <td style="width: 10%;"></td> <td style="width: 10%;"></td> </tr> <tr> <td></td> <td></td> <td colspan="8" style="text-align: center;"> <table border="1" style="width: 100%; border-collapse: collapse; text-align: center;"> <tr> <td style="width: 10%;"></td> <td style="width: 10%;"></td> <td style="width: 10%;"></td> <td style="width: 10%;"></td> <td style="width: 10%;"></td> <td style="width: 10%;"></td> <td style="width: 10%;"></td> <td style="width: 10%;"></td> <td style="width: 10%;"></td> <td style="width: 10%;"></td> </tr> <tr> <td></td> <td></td> <td colspan="8" style="text-align: center;"> <table border="1" style="width: 100%; border-collapse: collapse; text-align: center;"> <tr> <td style="width: 10%;"></td> <td style="width: 10%;"></td> <td style="width: 10%;"></td> <td style="width: 10%;"></td> <td style="width: 10%;"></td> <td style="width: 10%;"></td> <td style="width: 10%;"></td> <td style="width: 10%;"></td> <td style="width: 10%;"></td> <td style="width: 10%;"></td> </tr> <tr> <td></td> <td></td> <td colspan="8" style="text-align: center;"> <table border="1" style="width: 100%; border-collapse: collapse; text-align: center;"> <tr> <td style="width: 10%;"></td> <td style="width: 10%;"></td> <td style="width: 10%;"></td> <td style="width: 10%;"></td> <td style="width: 10%;"></td> <td style="width: 10%;"></td> <td style="width: 10%;"></td> <td style="width: 10%;"></td> <td style="width: 10%;"></td> <td style="width: 10%;"></td> </tr> <tr> <td></td> <td></td> <td colspan="8" style="text-align: center;"> <table border="1" style="width: 100%; border-collapse: collapse; text-align: center;"> <tr> <td style="width: 10%;"></td> <td style="width: 10%;"></td> <td style="width: 10%;"></td> <td style="width: 10%;"></td> <td style="width: 10%;"></td> <td style="width: 10%;"></td> <td style="width: 10%;"></td> <td style="width: 10%;"></td> <td style="width: 10%;"></td> <td style="width: 10%;"></td> </tr> <tr> <td></td> <td></td> <td colspan="8" style="text-align: center;"> <table border="1" style="width: 100%; border-collapse: collapse; text-align: center;"> <tr> <td style="width: 10%;"></td> <td style="width: 10%;"></td> <td style="width: 10%;"></td> <td style="width: 10%;"></td> <td style="width: 10%;"></td> <td style="width: 10%;"></td> <td style="width: 10%;"></td> <td style="width: 10%;"></td> <td style="width: 10%;"></td> <td style="width: 10%;"></td> </tr> <tr> <td></td> <td></td> <td colspan="8" style="text-align: center;"> <table border="1" style="width: 100%; border-collapse: collapse; text-align: center;"> <tr> <td style="width: 10%;"></td> <td style="width: 10%;"></td> <td style="width: 10%;"></td> <td style="width: 10%;"></td> <td style="width: 10%;"></td> <td style="width: 10%;"></td> <td style="width: 10%;"></td> <td style="width: 10%;"></td> <td style="width: 10%;"></td> <td style="width: 10%;"></td> </tr> <tr> <td></td> <td></td> <td colspan="8" style="text-align: center;"> <table border="1" style="width: 100%; border-collapse: collapse; text-align: center;"> <tr> <td style="width: 10%;"></td> <td style="width: 10%;"></td> <td style="width: 10%;"></td> <td style="width: 10%;"></td> <td style="width: 10%;"></td> <td style="width: 10%;"></td> <td style="width: 10%;"></td> <td style="width: 10%;"></td> <td style="width: 10%;"></td> <td style="width: 10%;"></td> </tr> <tr> <td></td> <td></td> <td colspan="8" style="text-align: center;"> <table border="1" style="width: 100%; border-collapse: collapse; text-align: center;"> <tr> <td style="width: 10%;"></td> <td style="width: 10%;"></td> <td style="width: 10%;"></td> <td style="width: 10%;"></td> <td style="width: 10%;"></td> <td style="width: 10%;"></td> <td style="width: 10%;"></td> <td style="width: 10%;"></td> <td style="width: 10%;"></td> <td style="width: 10%;"></td> </tr> <tr> <td></td> <td></td> <td colspan="8" style="text-align: center;"> <table border="1" style="width: 100%; border-collapse: collapse; text-align: center;"> <tr> <td style="width: 10%;"></td> <td style="width: 10%;"></td> <td style="width: 10%;"></td> <td style="width: 10%;"></td> <td style="width: 10%;"></td> <td style="width: 10%;"></td> <td style="width: 10%;"></td> <td style="width: 10%;"></td> <td style="width: 10%;"></td> <td style="width: 10%;"></td> </tr> <tr> <td></td> <td></td> <td colspan="8" style="text-align: center;"> <table border="1" style="width: 100%; border-collapse: collapse; text-align: center;"> <tr> <td style="width: 10%;"></td> <td style="width: 10%;"></td> <td style="width: 10%;"></td> <td style="width: 10%;"></td> <td style="width: 10%;"></td> <td style="width: 10%;"></td> <td style="width: 10%;"></td> <td style="width: 10%;"></td> <td style="width: 10%;"></td> <td style="width: 10%;"></td> </tr> <tr> <td></td> <td></td> <td colspan="8" style="text-align: center;"> <table border="1" style="width: 100%; border-collapse: collapse; text-align: center;"> <tr> <td style="width: 10%;"></td> <td style="width: 10%;"></td> <td style="width: 10%;"></td> <td style="width: 10%;"></td> <td style="width: 10%;"></td> <td style="width: 10%;"></td> <td style="width: 10%;"></td> <td style="width: 10%;"></td> <td style="width: 10%;"></td> <td style="width: 10%;"></td> </tr> <tr> <td></td> <td></td> <td colspan="8" style="text-align: center;"> <table border="1" style="width: 100%; border-collapse: collapse; text-align: center;"> <tr> <td style="width: 10%;"></td> <td style="width: 10%;"></td> <td style="width: 10%;"></td> <td style="width: 10%;"></td> <td style="width: 10%;"></td> <td style="width: 10%;"></td> <td style="width: 10%;"></td> <td style="width: 10%;"></td> <td style="width: 10%;"></td> <td style="width: 10%;"></td> </tr> <tr> <td></td> <td></td> <td colspan="8" style="text-align: center;"> <table border="1" style="width: 100%; border-collapse: collapse; text-align: center;"> <tr> <td style="width: 10%;"></td> <td style="width: 10%;"></td> <td style="width: 10%;"></td> <td style="width: 10%;"></td> <td style="width: 10%;"></td> <td style="width: 10%;"></td> <td style="width: 10%;"></td> <td style="width: 10%;"></td> <td style="width: 10%;"></td> <td style="width: 10%;"></td> </tr> <tr> <td></td> <td></td> <td colspan="8" style="text-align: center;"> <table border="1" style="width: 100%; border-collapse: collapse; text-align: center;"> <tr> <td style="width: 10%;"></td> <td style="width:
10%;"></td> <td style="width: 10%;"></td> <td style="width: 10%;"></td> <td style="width: 10%;"></td> <td style="width: 10%;"></td> <td style="width: 10%;"></td> <td style="width: 10%;"></td> <td style="width: 10%;"></td> <td style="width: 10%;"></td> </tr> <tr> <td></td> <td></td> <td colspan="8" style="text-align: center;"> <table border="1" style="width: 100%; border-collapse: collapse; text-align: center;"> <tr> <td style="width: 10%;"></td> <td style="width: 10%;"></td> <td style="width: 10%;"></td> <td style="width: 10%;"></td> <td style="width: 10%;"></td> <td style="width: 10%;"></td> <td style="width: 10%;"></td> <td style="width: 10%;"></td> <td style="width: 10%;"></td> <td style="width: 10%;"></td> </tr> <tr> <td></td> <td></td> <td colspan="8" style="text-align: center;"> <table border="1" style="width: 100%; border-collapse: collapse; text-align: center;"> <tr> <td style="width: 10%;"></td> <td style="width: 10%;"></td> <td style="width: 10%;"></td> <td style="width: 10%;"></td> <td style="width: 10%;"></td> <td style="width: 10%;"></td> <td style="width: 10%;"></td> <td style="width: 10%;"></td> <td style="width: 10%;"></td> <td style="width: 10%;"></td> </tr> <tr> <td></td> <td></td> <td colspan="8" style="text-align: center;"> <table border="1" style="width: 100%; border-collapse: collapse; text-align: center;"> <tr> <td style="width: 10%;"></td> <td style="width: 10%;"></td> <td style="width: 10%;"></td> <td style="width: 10%;"></td> <td style="width: 10%;"></td> <td style="width: 10%;"></td> <td style="width: 10%;"></td> <td style="width: 10%;"></td> <td style="width: 10%;"></td> <td style="width: 10%;"></td> </tr> <tr> <td></td> <td></td> <td colspan="8" style="text-align: center;"> <table border="1" style="width: 100%; border-collapse: collapse; text-align: center;"> <tr> <td style="width: 10%;"></td> <td style="width: 10%;"></td> <td style="width: 10%;"></td> <td style="width: 10%;"></td> <td style="width: 10%;"></td> <td style="width: 10%;"></td> <td style="width: 10%;"></td> <td style="width: 10%;"></td> <td style="width: 10%;"></td> <td style="width: 10%;"></td> </tr> <tr> <td></td> <td></td> <td colspan="8" style="text-align: center;"> <table border="1" style="width: 100%; border-collapse: collapse; text-align: center;"> <tr> </tr></table></td></tr></table></td></tr></table></td></tr></table></td></tr></table></td></tr></table></td></tr></table></td></tr></table></td></tr></table></td></tr></table></td></tr></table></td></tr></table></td></tr></table></td></tr></table></td></tr></table></td></tr></table></td></tr></table></td></tr></table></td></tr></table></td></tr></table></td></tr></table></td></tr></table></td></tr></table></td></tr></table></td></tr></table></td></tr></table></td></tr></table></td></tr></table></td></tr></table></td></tr></table></td></tr></table></td></tr></table></td></tr></table></td></tr></table></td></tr></table></td></tr></table></td></tr></table></td></tr></table></td></tr></table></td></tr></table></td></tr></table></td></tr></table></td></tr></table></td></tr></table></td></tr></table></td></tr></table></td></tr></table></td></tr></table></td></tr></table></td></tr></table></td></tr></table> | | | | | | | | | | | | | | | | | | | | <table border="1" style="width: 100%; border-collapse: collapse; text-align: center;"> <tr> <td style="width: 10%;"></td> <td style="width: 10%;"></td> <td style="width: 10%;"></td> <td style="width: 10%;"></td> <td style="width: 10%;"></td> <td style="width: 10%;"></td> <td style="width: 10%;"></td> <td style="width: 10%;"></td> <td style="width: 10%;"></td> <td style="width: 10%;"></td> </tr> <tr> <td></td> <td></td> <td colspan="8" style="text-align: center;"> <table border="1" style="width: 100%; border-collapse: collapse; text-align: center;"> <tr> <td style="width: 10%;"></td> <td style="width: 10%;"></td> <td style="width: 10%;"></td> <td style="width: 10%;"></td> <td style="width: 10%;"></td> <td style="width: 10%;"></td> <td style="width: 10%;"></td> <td style="width: 10%;"></td> <td style="width: 10%;"></td> <td style="width: 10%;"></td> </tr> <tr> <td></td> <td></td> <td colspan="8" style="text-align: center;"> <table border="1" style="width: 100%; border-collapse: collapse; text-align: center;"> <tr> <td style="width: 10%;"></td> <td style="width: 10%;"></td> <td style="width: 10%;"></td> <td style="width: 10%;"></td> <td style="width: 10%;"></td> <td style="width: 10%;"></td> <td style="width: 10%;"></td> <td style="width: 10%;"></td> <td style="width: 10%;"></td> <td style="width: 10%;"></td> </tr> <tr> <td></td> <td></td> <td colspan="8" style="text-align: center;"> <table border="1" style="width: 100%; border-collapse: collapse; text-align: center;"> <tr> <td style="width: 10%;"></td> <td style="width: 10%;"></td> <td style="width: 10%;"></td> <td style="width: 10%;"></td> <td style="width: 10%;"></td> <td style="width: 10%;"></td> <td style="width: 10%;"></td> <td style="width: 10%;"></td> <td style="width: 10%;"></td> <td style="width: 10%;"></td> </tr> <tr> <td></td> <td></td> <td colspan="8" style="text-align: center;"> <table border="1" style="width: 100%; border-collapse: collapse; text-align: center;"> <tr> <td style="width: 10%;"></td> <td style="width: 10%;"></td> <td style="width: 10%;"></td> <td style="width: 10%;"></td> <td style="width: 10%;"></td> <td style="width: 10%;"></td> <td style="width: 10%;"></td> <td style="width: 10%;"></td> <td style="width: 10%;"></td> <td style="width: 10%;"></td> </tr> <tr> <td></td> <td></td> <td colspan="8" style="text-align: center;"> <table border="1" style="width: 100%; border-collapse: collapse; text-align: center;"> <tr> <td style="width: 10%;"></td> <td style="width: 10%;"></td> <td style="width: 10%;"></td> <td style="width: 10%;"></td> <td style="width: 10%;"></td> <td style="width: 10%;"></td> <td style="width: 10%;"></td> <td style="width: 10%;"></td> <td style="width: 10%;"></td> <td style="width: 10%;"></td> </tr> <tr> <td></td> <td></td> <td colspan="8" style="text-align: center;"> <table border="1" style="width: 100%; border-collapse: collapse; text-align: center;"> <tr> <td style="width: 10%;"></td> <td style="width: 10%;"></td> <td style="width: 10%;"></td> <td style="width: 10%;"></td> <td style="width: 10%;"></td> <td style="width: 10%;"></td> <td style="width: 10%;"></td> <td style="width: 10%;"></td> <td style="width: 10%;"></td> <td style="width: 10%;"></td> </tr> <tr> <td></td> <td></td> <td colspan="8" style="text-align: center;"> <table border="1" style="width: 100%; border-collapse:
collapse; text-align: center;"> <tr> <td style="width: 10%;"></td> <td style="width: 10%;"></td> <td style="width: 10%;"></td> <td style="width: 10%;"></td> <td style="width: 10%;"></td> <td style="width: 10%;"></td> <td style="width: 10%;"></td> <td style="width: 10%;"></td> <td style="width: 10%;"></td> <td style="width: 10%;"></td> </tr> <tr> <td></td> <td></td> <td colspan="8" style="text-align: center;"> <table border="1" style="width: 100%; border-collapse: collapse; text-align: center;"> <tr> <td style="width: 10%;"></td> <td style="width: 10%;"></td> <td style="width: 10%;"></td> <td style="width: 10%;"></td> <td style="width: 10%;"></td> <td style="width: 10%;"></td> <td style="width: 10%;"></td> <td style="width: 10%;"></td> <td style="width: 10%;"></td> <td style="width: 10%;"></td> </tr> <tr> <td></td> <td></td> <td colspan="8" style="text-align: center;"> <table border="1" style="width: 100%; border-collapse: collapse; text-align: center;"> <tr> <td style="width: 10%;"></td> <td style="width: 10%;"></td> <td style="width: 10%;"></td> <td style="width: 10%;"></td> <td style="width: 10%;"></td> <td style="width: 10%;"></td> <td style="width: 10%;"></td> <td style="width: 10%;"></td> <td style="width: 10%;"></td> <td style="width: 10%;"></td> </tr> <tr> <td></td> <td></td> <td colspan="8" style="text-align: center;"> <table border="1" style="width: 100%; border-collapse: collapse; text-align: center;"> <tr> <td style="width: 10%;"></td> <td style="width: 10%;"></td> <td style="width: 10%;"></td> <td style="width: 10%;"></td> <td style="width: 10%;"></td> <td style="width: 10%;"></td> <td style="width: 10%;"></td> <td style="width: 10%;"></td> <td style="width: 10%;"></td> <td style="width: 10%;"></td> </tr> <tr> <td></td> <td></td> <td colspan="8" style="text-align: center;"> <table border="1" style="width: 100%; border-collapse: collapse; text-align: center;"> <tr> <td style="width: 10%;"></td> <td style="width: 10%;"></td> <td style="width: 10%;"></td> <td style="width: 10%;"></td> <td style="width: 10%;"></td> <td style="width: 10%;"></td> <td style="width: 10%;"></td> <td style="width: 10%;"></td> <td style="width: 10%;"></td> <td style="width: 10%;"></td> </tr> <tr> <td></td> <td></td> <td colspan="8" style="text-align: center;"> <table border="1" style="width: 100%; border-collapse: collapse; text-align: center;"> <tr> <td style="width: 10%;"></td> <td style="width: 10%;"></td> <td style="width: 10%;"></td> <td style="width: 10%;"></td> <td style="width: 10%;"></td> <td style="width: 10%;"></td> <td style="width: 10%;"></td> <td style="width: 10%;"></td> <td style="width: 10%;"></td> <td style="width: 10%;"></td> </tr> <tr> <td></td> <td></td> <td colspan="8" style="text-align: center;"> <table border="1" style="width: 100%; border-collapse: collapse; text-align: center;"> <tr> <td style="width: 10%;"></td> <td style="width: 10%;"></td> <td style="width: 10%;"></td> <td style="width: 10%;"></td> <td style="width: 10%;"></td> <td style="width: 10%;"></td> <td style="width: 10%;"></td> <td style="width: 10%;"></td> <td style="width: 10%;"></td> <td style="width: 10%;"></td> </tr> <tr> <td></td> <td></td> <td colspan="8" style="text-align: center;"> <table border="1" style="width: 100%; border-collapse: collapse; text-align: center;"> <tr> <td style="width: 10%;"></td> <td style="width: 10%;"></td> <td style="width: 10%;"></td> <td style="width: 10%;"></td> <td style="width: 10%;"></td> <td style="width: 10%;"></td> <td style="width: 10%;"></td> <td style="width: 10%;"></td> <td style="width: 10%;"></td> <td style="width: 10%;"></td> </tr> <tr> <td></td> <td></td> <td colspan="8" style="text-align: center;"> <table border="1" style="width: 100%; border-collapse: collapse; text-align: center;"> <tr> <td style="width: 10%;"></td> <td style="width: 10%;"></td> <td style="width: 10%;"></td> <td style="width: 10%;"></td> <td style="width: 10%;"></td> <td style="width: 10%;"></td> <td style="width: 10%;"></td> <td style="width: 10%;"></td> <td style="width: 10%;"></td> <td style="width: 10%;"></td> </tr> <tr> <td></td> <td></td> <td colspan="8" style="text-align: center;"> <table border="1" style="width: 100%; border-collapse: collapse; text-align: center;"> <tr> <td style="width: 10%;"></td> <td style="width: 10%;"></td> <td style="width: 10%;"></td> <td style="width: 10%;"></td> <td style="width: 10%;"></td> <td style="width: 10%;"></td> <td style="width: 10%;"></td> <td style="width: 10%;"></td> <td style="width: 10%;"></td> <td style="width: 10%;"></td> </tr> <tr> <td></td> <td></td> <td colspan="8" style="text-align: center;"> <table border="1" style="width: 100%; border-collapse: collapse; text-align: center;"> <tr> <td style="width: 10%;"></td> <td style="width: 10%;"></td> <td style="width: 10%;"></td> <td style="width: 10%;"></td> <td style="width: 10%;"></td> <td style="width: 10%;"></td> <td style="width: 10%;"></td> <td style="width: 10%;"></td> <td style="width: 10%;"></td> <td style="width: 10%;"></td> </tr> <tr> <td></td> <td></td> <td colspan="8" style="text-align: center;"> <table border="1" style="width: 100%; border-collapse: collapse; text-align: center;"> <tr> <td style="width: 10%;"></td> <td style="width: 10%;"></td> <td style="width: 10%;"></td> <td style="width: 10%;"></td> <td style="width: 10%;"></td> <td style="width: 10%;"></td> <td style="width: 10%;"></td> <td style="width: 10%;"></td> <td style="width: 10%;"></td> <td style="width: 10%;"></td> </tr> <tr> <td></td> <td></td> <td colspan="8" style="text-align: center;"> <table border="1" style="width: 100%; border-collapse: collapse; text-align: center;"> <tr> <td style="width: 10%;"></td> <td style="width: 10%;"></td> <td style="width: 10%;"></td> <td style="width: 10%;"></td> <td style="width: 10%;"></td> <td style="width: 10%;"></td> <td style="width: 10%;"></td> <td style="width: 10%;"></td> <td style="width: 10%;"></td> <td style="width: 10%;"></td> </tr> <tr> <td></td> <td></td> <td colspan="8" style="text-align: center;"> <table border="1" style="width: 100%; border-collapse: collapse; text-align: center;"> <tr> <td style="width: 10%;"></td> <td style="width: 10%;"></td> <td style="width: 10%;"></td> <td style="width: 10%;"></td> <td style="width: 10%;"></td> <td style="width: 10%;"></td> <td style="width: 10%;"></td> <td style="width: 10%;"></td> <td style="width: 10%;"></td> <td style="width: 10%;"></td> </tr> <tr> <td></td> <td></td> <td colspan="8" style="text-align: center;"> <table border="1" style="width: 100%; border-collapse: collapse; text-align: center;"> <tr> <td style="width: 10%;"></td> <td style="width: 10%;"></td> <td style="width: 10%;"></td> <td style="width: 10%;"></td> <td style="width: 10%;"></td> <td style="width: 10%;"></td> <td style="width: 10%;"></td> <td style="width: 10%;"></td> <td style="width: 10%;"></td> <td style="width: 10%;"></td> </tr> <tr> <td></td> <td></td> <td colspan="8" style="text-align: center;"> <table border="1" style="width: 100%; border-collapse: collapse; text-align: center;"> <tr> <td style="width: 10%;"></td> <td style="width: 10%;"></td> <td style="width: 10%;"></td> <td style="width: 10%;"></td> <td style="width: 10%;"></td> <td style="width: 10%;"></td> <td style="width: 10%;"></td> <td style="width: 10%;"></td> <td style="width: 10%;"></td> <td style="width: 10%;"></td> </tr> <tr> <td></td> <td></td> <td colspan="8" style="text-align: center;"> <table border="1" style="width: 100%; border-collapse: collapse; text-align: center;"> <tr> <td style="width: 10%;"></td> <td style="width: 10%;"></td> <td style="width: 10%;"></td> <td style="width: 10%;"></td> <td style="width: 10%;"></td> <td style="width: 10%;"></td> <td style="width: 10%;"></td> <td style="width: 10%;"></td> <td style="width: 10%;"></td> <td style="width: 10%;"></td> </tr> <tr> <td></td> <td></td> <td colspan="8" style="text-align: center;"> <table border="1" style="width: 100%; border-collapse: collapse; text-align: center;"> <tr> <td style="width: 10%;"></td> <td style="width: 10%;"></td> <td style="width: 10%;"></td> <td style="width: 10%;"></td> <td style="width: 10%;"></td> <td style="width: 10%;"></td> <td style="width: 10%;"></td> <td style="width: 10%;"></td> <td style="width: 10%;"></td> <td style="width: 10%;"></td> </tr> <tr> <td></td> <td></td> <td colspan="8" style="text-align: center;"> <table border="1" style="width: 100%; border-collapse: collapse; text-align: center;"> <tr> <td style="width: 10%;"></td> <td style="width: 10%;"></td> <td style="width: 10%;"></td> <td style="width: 10%;"></td> <td style="width: 10%;"></td> <td style="width: 10%;"></td> <td style="width: 10%;"></td> <td style="width: 10%;"></td> <td style="width: 10%;"></td> <td style="width: 10%;"></td> </tr> <tr> <td></td> <td></td> <td colspan="8" style="text-align: center;"> <table border="1" style="width: 100%; border-collapse: collapse; text-align: center;"> <tr> <td style="width: 10%;"></td> <td style="width: 10%;"></td> <td style="width: 10%;"></td> <td style="width: 10%;"></td> <td style="width: 10%;"></td> <td style="width: 10%;"></td> <td style="width: 10%;"></td> <td style="width: 10%;"></td> <td style="width: 10%;"></td> <td style="width: 10%;"></td> </tr> <tr> <td></td> <td></td> <td colspan="8" style="text-align: center;"> <table border="1" style="width: 100%; border-collapse: collapse; text-align: center;"> <tr> <td style="width: 10%;"></td> <td style="width: 10%;"></td> <td style="width: 10%;"></td> <td style="width: 10%;"></td> <td style="width: 10%;"></td> <td style="width: 10%;"></td> <td style="width: 10%;"></td> <td style="width: 10%;"></td> <td style="width: 10%;"></td> <td style="width: 10%;"></td> </tr> <tr> <td></td> <td></td> <td colspan="8" style="text-align: center;"> <table border="1" style="width: 100%; border-collapse: collapse; text-align: center;"> <tr> <td style="width: 10%;"></td> <td style="width: 10%;"></td> <td style="width: 10%;"></td> <td style="width: 10%;"></td> <td
style="width: 10%;"></td> <td style="width: 10%;"></td> <td style="width: 10%;"></td> <td style="width: 10%;"></td> <td style="width: 10%;"></td> <td style="width: 10%;"></td> </tr> <tr> <td></td> <td></td> <td colspan="8" style="text-align: center;"> <table border="1" style="width: 100%; border-collapse: collapse; text-align: center;"> <tr> <td style="width: 10%;"></td> <td style="width: 10%;"></td> <td style="width: 10%;"></td> <td style="width: 10%;"></td> <td style="width: 10%;"></td> <td style="width: 10%;"></td> <td style="width: 10%;"></td> <td style="width: 10%;"></td> <td style="width: 10%;"></td> <td style="width: 10%;"></td> </tr> <tr> <td></td> <td></td> <td colspan="8" style="text-align: center;"> <table border="1" style="width: 100%; border-collapse: collapse; text-align: center;"> <tr> <td style="width: 10%;"></td> <td style="width: 10%;"></td> <td style="width: 10%;"></td> <td style="width: 10%;"></td> <td style="width: 10%;"></td> <td style="width: 10%;"></td> <td style="width: 10%;"></td> <td style="width: 10%;"></td> <td style="width: 10%;"></td> <td style="width: 10%;"></td> </tr> <tr> <td></td> <td></td> <td colspan="8" style="text-align: center;"> <table border="1" style="width: 100%; border-collapse: collapse; text-align: center;"> <tr> <td style="width: 10%;"></td> <td style="width: 10%;"></td> <td style="width: 10%;"></td> <td style="width: 10%;"></td> <td style="width: 10%;"></td> <td style="width: 10%;"></td> <td style="width: 10%;"></td> <td style="width: 10%;"></td> <td style="width: 10%;"></td> <td style="width: 10%;"></td> </tr> <tr> <td></td> <td></td> <td colspan="8" style="text-align: center;"> <table border="1" style="width: 100%; border-collapse: collapse; text-align: center;"> <tr> <td style="width: 10%;"></td> <td style="width: 10%;"></td> <td style="width: 10%;"></td> <td style="width: 10%;"></td> <td style="width: 10%;"></td> <td style="width: 10%;"></td> <td style="width: 10%;"></td> <td style="width: 10%;"></td> <td style="width: 10%;"></td> <td style="width: 10%;"></td> </tr> <tr> <td></td> <td></td> <td colspan="8" style="text-align: center;"> <table border="1" style="width: 100%; border-collapse: collapse; text-align: center;"> <tr> <td style="width: 10%;"></td> <td style="width: 10%;"></td> <td style="width: 10%;"></td> <td style="width: 10%;"></td> <td style="width: 10%;"></td> <td style="width: 10%;"></td> <td style="width: 10%;"></td> <td style="width: 10%;"></td> <td style="width: 10%;"></td> <td style="width: 10%;"></td> </tr> <tr> <td></td> <td></td> <td colspan="8" style="text-align: center;"> <table border="1" style="width: 100%; border-collapse: collapse; text-align: center;"> <tr> <td style="width: 10%;"></td> <td style="width: 10%;"></td> <td style="width: 10%;"></td> <td style="width: 10%;"></td> <td style="width: 10%;"></td> <td style="width: 10%;"></td> <td style="width: 10%;"></td> <td style="width: 10%;"></td> <td style="width: 10%;"></td> <td style="width: 10%;"></td> </tr> <tr> <td></td> <td></td> <td colspan="8" style="text-align: center;"> <table border="1" style="width: 100%; border-collapse: collapse; text-align: center;"> <tr> <td style="width: 10%;"></td> <td style="width: 10%;"></td> <td style="width: 10%;"></td> <td style="width: 10%;"></td> <td style="width: 10%;"></td> <td style="width: 10%;"></td> <td style="width: 10%;"></td> <td style="width: 10%;"></td> <td style="width: 10%;"></td> <td style="width: 10%;"></td> </tr> <tr> <td></td> <td></td> <td colspan="8" style="text-align: center;"> <table border="1" style="width: 100%; border-collapse: collapse; text-align: center;"> <tr> <td style="width: 10%;"></td> <td style="width: 10%;"></td> <td style="width: 10%;"></td> <td style="width: 10%;"></td> <td style="width: 10%;"></td> <td style="width: 10%;"></td> <td style="width: 10%;"></td> <td style="width: 10%;"></td> <td style="width: 10%;"></td> <td style="width: 10%;"></td> </tr> <tr> <td></td> <td></td> <td colspan="8" style="text-align: center;"> <table border="1" style="width: 100%; border-collapse: collapse; text-align: center;"> <tr> <td style="width: 10%;"></td> <td style="width: 10%;"></td> <td style="width: 10%;"></td> <td style="width: 10%;"></td> <td style="width: 10%;"></td> <td style="width: 10%;"></td> <td style="width: 10%;"></td> <td style="width: 10%;"></td> <td style="width: 10%;"></td> <td style="width: 10%;"></td> </tr> <tr> <td></td> <td></td> <td colspan="8" style="text-align: center;"> <table border="1" style="width: 100%; border-collapse: collapse; text-align: center;"> <tr> <td style="width: 10%;"></td> <td style="width: 10%;"></td> <td style="width: 10%;"></td> <td style="width: 10%;"></td> <td style="width: 10%;"></td> <td style="width: 10%;"></td> <td style="width: 10%;"></td> <td style="width: 10%;"></td> <td style="width: 10%;"></td> <td style="width: 10%;"></td> </tr> <tr> <td></td> <td></td> <td colspan="8" style="text-align: center;"> <table border="1" style="width: 100%; border-collapse: collapse; text-align: center;"> <tr> <td style="width: 10%;"></td> <td style="width: 10%;"></td> <td style="width: 10%;"></td> <td style="width: 10%;"></td> <td style="width: 10%;"></td> <td style="width: 10%;"></td> <td style="width: 10%;"></td> <td style="width: 10%;"></td> <td style="width: 10%;"></td> <td style="width: 10%;"></td> </tr> <tr> <td></td> <td></td> <td colspan="8" style="text-align: center;"> <table border="1" style="width: 100%; border-collapse: collapse; text-align: center;"> <tr> <td style="width: 10%;"></td> <td style="width: 10%;"></td> <td style="width: 10%;"></td> <td style="width: 10%;"></td> <td style="width: 10%;"></td> <td style="width: 10%;"></td> <td style="width: 10%;"></td> <td style="width: 10%;"></td> <td style="width: 10%;"></td> <td style="width: 10%;"></td> </tr> <tr> <td></td> <td></td> <td colspan="8" style="text-align: center;"> <table border="1" style="width: 100%; border-collapse: collapse; text-align: center;"> <tr> <td style="width: 10%;"></td> <td style="width: 10%;"></td> <td style="width: 10%;"></td> <td style="width: 10%;"></td> <td style="width: 10%;"></td> <td style="width: 10%;"></td> <td style="width: 10%;"></td> <td style="width: 10%;"></td> <td style="width: 10%;"></td> <td style="width: 10%;"></td> </tr> <tr> <td></td> <td></td> <td colspan="8" style="text-align: center;"> <table border="1" style="width: 100%; border-collapse: collapse; text-align: center;"> <tr> <td style="width: 10%;"></td> <td style="width: 10%;"></td> <td style="width: 10%;"></td> <td style="width: 10%;"></td> <td style="width: 10%;"></td> <td style="width: 10%;"></td> <td style="width: 10%;"></td> <td style="width: 10%;"></td> <td style="width: 10%;"></td> <td style="width: 10%;"></td> </tr> <tr> <td></td> <td></td> <td colspan="8" style="text-align: center;"> <table border="1" style="width: 100%; border-collapse: collapse; text-align: center;"> <tr> <td style="width: 10%;"></td> <td style="width: 10%;"></td> <td style="width: 10%;"></td> <td style="width: 10%;"></td> <td style="width: 10%;"></td> <td style="width: 10%;"></td> <td style="width: 10%;"></td> <td style="width: 10%;"></td> <td style="width: 10%;"></td> <td style="width: 10%;"></td> </tr> <tr> <td></td> <td></td> <td colspan="8" style="text-align: center;"> <table border="1" style="width: 100%; border-collapse: collapse; text-align: center;"> <tr> <td style="width: 10%;"></td> <td style="width: 10%;"></td> <td style="width: 10%;"></td> <td style="width: 10%;"></td> <td style="width: 10%;"></td> <td style="width: 10%;"></td> <td style="width: 10%;"></td> <td style="width: 10%;"></td> <td style="width: 10%;"></td> <td style="width: 10%;"></td> </tr> <tr> <td></td> <td></td> <td colspan="8" style="text-align: center;"> <table border="1" style="width: 100%; border-collapse: collapse; text-align: center;"> <tr> <td style="width: 10%;"></td> <td style="width: 10%;"></td> <td style="width: 10%;"></td> <td style="width: 10%;"></td> <td style="width: 10%;"></td> <td style="width: 10%;"></td> <td style="width: 10%;"></td> <td style="width: 10%;"></td> <td style="width: 10%;"></td> <td style="width: 10%;"></td> </tr> <tr> <td></td> <td></td> <td colspan="8" style="text-align: center;"> <table border="1" style="width: 100%; border-collapse: collapse; text-align: center;"> <tr> <td style="width: 10%;"></td> <td style="width: 10%;"></td> <td style="width: 10%;"></td> <td style="width: 10%;"></td> <td style="width: 10%;"></td> <td style="width: 10%;"></td> <td style="width: 10%;"></td> <td style="width: 10%;"></td> <td style="width: 10%;"></td> <td style="width: 10%;"></td> </tr> <tr> <td></td> <td></td> <td colspan="8" style="text-align: center;"> <table border="1" style="width: 100%; border-collapse: collapse; text-align: center;"> <tr> <td style="width: 10%;"></td> <td style="width: 10%;"></td> <td style="width: 10%;"></td> <td style="width: 10%;"></td> <td style="width: 10%;"></td> <td style="width: 10%;"></td> <td style="width: 10%;"></td> <td style="width: 10%;"></td> <td style="width: 10%;"></td> <td style="width: 10%;"></td> </tr> <tr> <td></td> <td></td> <td colspan="8" style="text-align: center;"> <table border="1" style="width: 100%; border-collapse: collapse; text-align: center;"> <tr> <td style="width: 10%;"></td> <td style="width: 10%;"></td> <td style="width: 10%;"></td> <td style="width: 10%;"></td> <td style="width: 10%;"></td> <td style="width: 10%;"></td> <td style="width: 10%;"></td> <td style="width: 10%;"></td> <td style="width: 10%;"></td> <td style="width: 10%;"></td> </tr> <tr> <td></td> <td></td> <td colspan="8" style="text-align: center;"> <table border="1" style="width: 100%; border-collapse: collapse; text-align: center;"> <tr>
</tr></table></td></tr></table></td></tr></table></td></tr></table></td></tr></table></td></tr></table></td></tr></table></td></tr></table></td></tr></table></td></tr></table></td></tr></table></td></tr></table></td></tr></table></td></tr></table></td></tr></table></td></tr></table></td></tr></table></td></tr></table></td></tr></table></td></tr></table></td></tr></table></td></tr></table></td></tr></table></td></tr></table></td></tr></table></td></tr></table></td></tr></table></td></tr></table></td></tr></table></td></tr></table></td></tr></table></td></tr></table></td></tr></table></td></tr></table></td></tr></table></td></tr></table></td></tr></table></td></tr></table></td></tr></table></td></tr></table></td></tr></table></td></tr></table></td></tr></table></td></tr></table></td></tr></table></td></tr></table></td></tr></table></td></tr></table></td></tr></table></td></tr></table> | | | | | | | | | | | | | | | | | | | | <table border="1" style="width: 100%; border-collapse: collapse; text-align: center;"> <tr> <td style="width: 10%;"></td> <td style="width: 10%;"></td> <td style="width: 10%;"></td> <td style="width: 10%;"></td> <td style="width: 10%;"></td> <td style="width: 10%;"></td> <td style="width: 10%;"></td> <td style="width: 10%;"></td> <td style="width: 10%;"></td> <td style="width: 10%;"></td> </tr> <tr> <td></td> <td></td> <td colspan="8" style="text-align: center;"> <table border="1" style="width: 100%; border-collapse: collapse; text-align: center;"> <tr> <td style="width: 10%;"></td> <td style="width: 10%;"></td> <td style="width: 10%;"></td> <td style="width: 10%;"></td> <td style="width: 10%;"></td> <td style="width: 10%;"></td> <td style="width: 10%;"></td> <td style="width: 10%;"></td> <td style="width: 10%;"></td> <td style="width: 10%;"></td> </tr> <tr> <td></td> <td></td> <td colspan="8" style="text-align: center;"> <table border="1" style="width: 100%; border-collapse: collapse; text-align: center;"> <tr> <td style="width: 10%;"></td> <td style="width: 10%;"></td> <td style="width: 10%;"></td> <td style="width: 10%;"></td> <td style="width: 10%;"></td> <td style="width: 10%;"></td> <td style="width: 10%;"></td> <td style="width: 10%;"></td> <td style="width: 10%;"></td> <td style="width: 10%;"></td> </tr> <tr> <td></td> <td></td> <td colspan="8" style="text-align: center;"> <table border="1" style="width: 100%; border-collapse: collapse; text-align: center;"> <tr> <td style="width: 10%;"></td> <td style="width: 10%;"></td> <td style="width: 10%;"></td> <td style="width: 10%;"></td> <td style="width: 10%;"></td> <td style="width: 10%;"></td> <td style="width: 10%;"></td> <td style="width: 10%;"></td> <td style="width: 10%;"></td> <td style="width: 10%;"></td> </tr> <tr> <td></td> <td></td> <td colspan="8" style="text-align: center;"> <table border="1" style="width: 100%; border-collapse: collapse; text-align: center;"> <tr> <td style="width: 10%;"></td> <td style="width: 10%;"></td> <td style="width: 10%;"></td> <td style="width: 10%;"></td> <td style="width: 10%;"></td> <td style="width: 10%;"></td> <td style="width: 10%;"></td> <td style="width: 10%;"></td> <td style="width: 10%;"></td> <td style="width: 10%;"></td> </tr> <tr> <td></td> <td></td> <td colspan="8" style="text-align: center;"> <table border="1" style="width: 100%; border-collapse: collapse; text-align: center;"> <tr> <td style="width: 10%;"></td> <td style="width: 10%;"></td> <td style="width: 10%;"></td> <td style="width: 10%;"></td> <td style="width: 10%;"></td> <td style="width: 10%;"></td> <td style="width: 10%;"></td> <td style="width: 10%;"></td> <td style="width: 10%;"></td> <td style="width: 10%;"></td> </tr> <tr> <td></td> <td></td> <td colspan="8" style="text-align: center;"> <table border="1" style="width: 100%; border-collapse: collapse; text-align: center;"> <tr> <td style="width: 10%;"></td> <td style="width: 10%;"></td> <td style="width: 10%;"></td> <td style="width: 10%;"></td> <td style="width: 10%;"></td> <td style="width: 10%;"></td> <td style="width: 10%;"></td> <td style="width: 10%;"></td> <td style="width: 10%;"></td> <td style="width: 10%;"></td> </tr> <tr> <td></td> <td></td> <td colspan="8" style="text-align: center;"> <table border="1" style="width: 100%; border-collapse: collapse; text-align: center;"> <tr> <td style="width: 10%;"></td> <td style="width: 10%;"></td> <td style="width: 10%;"></td> <td style="width: 10%;"></td> <td style="width: 10%;"></td> <td style="width: 10%;"></td> <td style="width: 10%;"></td> <td style="width: 10%;"></td> <td style="width: 10%;"></td> <td style="width: 10%;"></td> </tr> <tr> <td></td> <td></td> <td colspan="8" style="text-align: center;"> <table border="1" style="width: 100%; border-collapse: collapse; text-align: center;"> <tr> <td style="width: 10%;"></td> <td style="width: 10%;"></td> <td style="width: 10%;"></td> <td style="width: 10%;"></td> <td style="width: 10%;"></td> <td style="width: 10%;"></td> <td style="width: 10%;"></td> <td style="width: 10%;"></td> <td style="width: 10%;"></td> <td style="width: 10%;"></td> </tr> <tr> <td></td> <td></td> <td colspan="8" style="text-align: center;"> <table border="1" style="width: 100%; border-collapse: collapse; text-align: center;"> <tr> <td style="width: 10%;"></td> <td style="width: 10%;"></td> <td style="width: 10%;"></td> <td style="width: 10%;"></td> <td style="width: 10%;"></td> <td style="width: 10%;"></td> <td style="width: 10%;"></td> <td style="width: 10%;"></td> <td style="width: 10%;"></td> <td style="width: 10%;"></td> </tr> <tr> <td></td> <td></td> <td colspan="8" style="text-align: center;"> <table border="1" style="width: 100%; border-collapse: collapse; text-align: center;"> <tr> <td style="width: 10%;"></td> <td style="width: 10%;"></td> <td style="width: 10%;"></td> <td style="width: 10%;"></td> <td style="width: 10%;"></td> <td style="width: 10%;"></td> <td style="width: 10%;"></td> <td style="width: 10%;"></td> <td style="width: 10%;"></td> <td style="width: 10%;"></td> </tr> <tr> <td></td> <td></td> <td colspan="8" style="text-align: center;"> <table border="1" style="width: 100%; border-collapse: collapse; text-align: center;"> <tr> <td style="width: 10%;"></td> <td style="width: 10%;"></td> <td style="width: 10%;"></td> <td style="width: 10%;"></td> <td style="width: 10%;"></td> <td style="width: 10%;"></td> <td style="width: 10%;"></td> <td style="width: 10%;"></td> <td style="width: 10%;"></td> <td style="width: 10%;"></td> </tr> <tr> <td></td> <td></td> <td colspan="8" style="text-align: center;"> <table border="1"
style="width: 100%; border-collapse: collapse; text-align: center;"> <tr> <td style="width: 10%;"></td> <td style="width: 10%;"></td> <td style="width: 10%;"></td> <td style="width: 10%;"></td> <td style="width: 10%;"></td> <td style="width: 10%;"></td> <td style="width: 10%;"></td> <td style="width: 10%;"></td> <td style="width: 10%;"></td> <td style="width: 10%;"></td> </tr> <tr> <td></td> <td></td> <td colspan="8" style="text-align: center;"> <table border="1" style="width: 100%; border-collapse: collapse; text-align: center;"> <tr> <td style="width: 10%;"></td> <td style="width: 10%;"></td> <td style="width: 10%;"></td> <td style="width: 10%;"></td> <td style="width: 10%;"></td> <td style="width: 10%;"></td> <td style="width: 10%;"></td> <td style="width: 10%;"></td> <td style="width: 10%;"></td> <td style="width: 10%;"></td> </tr> <tr> <td></td> <td></td> <td colspan="8" style="text-align: center;"> <table border="1" style="width: 100%; border-collapse: collapse; text-align: center;"> <tr> <td style="width: 10%;"></td> <td style="width: 10%;"></td> <td style="width: 10%;"></td> <td style="width: 10%;"></td> <td style="width: 10%;"></td> <td style="width: 10%;"></td> <td style="width: 10%;"></td> <td style="width: 10%;"></td> <td style="width: 10%;"></td> <td style="width: 10%;"></td> </tr> <tr> <td></td> <td></td> <td colspan="8" style="text-align: center;"> <table border="1" style="width: 100%; border-collapse: collapse; text-align: center;"> <tr> <td style="width: 10%;"></td> <td style="width: 10%;"></td> <td style="width: 10%;"></td> <td style="width: 10%;"></td> <td style="width: 10%;"></td> <td style="width: 10%;"></td> <td style="width: 10%;"></td> <td style="width: 10%;"></td> <td style="width: 10%;"></td> <td style="width: 10%;"></td> </tr> <tr> <td></td> <td></td> <td colspan="8" style="text-align: center;"> <table border="1" style="width: 100%; border-collapse: collapse; text-align: center;"> <tr> <td style="width: 10%;"></td> <td style="width: 10%;"></td> <td style="width: 10%;"></td> <td style="width: 10%;"></td> <td style="width: 10%;"></td> <td style="width: 10%;"></td> <td style="width: 10%;"></td> <td style="width: 10%;"></td> <td style="width: 10%;"></td> <td style="width: 10%;"></td> </tr> <tr> <td></td> <td></td> <td colspan="8" style="text-align: center;"> <table border="1" style="width: 100%; border-collapse: collapse; text-align: center;"> <tr> <td style="width: 10%;"></td> <td style="width: 10%;"></td> <td style="width: 10%;"></td> <td style="width: 10%;"></td> <td style="width: 10%;"></td> <td style="width: 10%;"></td> <td style="width: 10%;"></td> <td style="width: 10%;"></td> <td style="width: 10%;"></td> <td style="width: 10%;"></td> </tr> <tr> <td></td> <td></td> <td colspan="8" style="text-align: center;"> <table border="1" style="width: 100%; border-collapse: collapse; text-align: center;"> <tr> <td style="width: 10%;"></td> <td style="width: 10%;"></td> <td style="width: 10%;"></td> <td style="width: 10%;"></td> <td style="width: 10%;"></td> <td style="width: 10%;"></td> <td style="width: 10%;"></td> <td style="width: 10%;"></td> <td style="width: 10%;"></td> <td style="width: 10%;"></td> </tr> <tr> <td></td> <td></td> <td colspan="8" style="text-align: center;"> <table border="1" style="width: 100%; border-collapse: collapse; text-align: center;"> <tr> <td style="width: 10%;"></td> <td style="width: 10%;"></td> <td style="width: 10%;"></td> <td style="width: 10%;"></td> <td style="width: 10%;"></td> <td style="width: 10%;"></td> <td style="width: 10%;"></td> <td style="width: 10%;"></td> <td style="width: 10%;"></td> <td style="width: 10%;"></td> </tr> <tr> <td></td> <td></td> <td colspan="8" style="text-align: center;"> <table border="1" style="width: 100%; border-collapse: collapse; text-align: center;"> <tr> <td style="width: 10%;"></td> <td style="width: 10%;"></td> <td style="width: 10%;"></td> <td style="width: 10%;"></td> <td style="width: 10%;"></td> <td style="width: 10%;"></td> <td style="width: 10%;"></td> <td style="width: 10%;"></td> <td style="width: 10%;"></td> <td style="width: 10%;"></td> </tr> <tr> <td></td> <td></td> <td colspan="8" style="text-align: center;"> <table border="1" style="width: 100%; border-collapse: collapse; text-align: center;"> <tr> <td style="width: 10%;"></td> <td style="width: 10%;"></td> <td style="width: 10%;"></td> <td style="width: 10%;"></td> <td style="width: 10%;"></td> <td style="width: 10%;"></td> <td style="width: 10%;"></td> <td style="width: 10%;"></td> <td style="width: 10%;"></td> <td style="width: 10%;"></td> </tr> <tr> <td></td> <td></td> <td colspan="8" style="text-align: center;"> <table border="1" style="width: 100%; border-collapse: collapse; text-align: center;"> <tr> <td style="width: 10%;"></td> <td style="width: 10%;"></td> <td style="width: 10%;"></td> <td style="width: 10%;"></td> <td style="width: 10%;"></td> <td style="width: 10%;"></td> <td style="width: 10%;"></td> <td style="width: 10%;"></td> <td style="width: 10%;"></td> <td style="width: 10%;"></td> </tr> <tr> <td></td> <td></td> <td colspan="8" style="text-align: center;"> <table border="1" style="width: 100%; border-collapse: collapse; text-align: center;"> <tr> <td style="width: 10%;"></td> <td style="width: 10%;"></td> <td style="width: 10%;"></td> <td style="width: 10%;"></td> <td style="width: 10%;"></td> <td style="width: 10%;"></td> <td style="width: 10%;"></td> <td style="width: 10%;"></td> <td style="width: 10%;"></td> <td style="width: 10%;"></td> </tr> <tr> <td></td> <td></td> <td colspan="8" style="text-align: center;"> <table border="1" style="width: 100%; border-collapse: collapse; text-align: center;"> <tr> <td style="width: 10%;"></td> <td style="width: 10%;"></td> <td style="width: 10%;"></td> <td style="width: 10%;"></td> <td style="width: 10%;"></td> <td style="width: 10%;"></td> <td style="width: 10%;"></td> <td style="width: 10%;"></td> <td style="width: 10%;"></td> <td style="width: 10%;"></td> </tr> <tr> <td></td> <td></td> <td colspan="8" style="text-align: center;"> <table border="1" style="width: 100%; border-collapse: collapse; text-align: center;"> <tr> <td style="width: 10%;"></td> <td style="width: 10%;"></td> <td style="width: 10%;"></td> <td style="width: 10%;"></td> <td style="width: 10%;"></td> <td style="width: 10%;"></td> <td style="width: 10%;"></td> <td style="width: 10%;"></td> <td style="width: 10%;"></td> <td style="width: 10%;"></td> </tr> <tr> <td></td> <td></td> <td colspan="8" style="text-align: center;"> <table border="1" style="width: 100%; border-collapse: collapse; text-align: center;"> <tr> <td style="width: 10%;"></td> <td style="width: 10%;"></td> <td style="width: 10%;"></td> <td style="width: 10%;"></td> <td style="width: 10%;"></td> <td style="width: 10%;"></td> <td style="width: 10%;"></td> <td style="width: 10%;"></td> <td style="width: 10%;"></td> <td style="width: 10%;"></td> </tr> <tr> <td></td> <td></td> <td colspan="8" style="text-align: center;"> <table border="1" style="width: 100%; border-collapse: collapse; text-align: center;"> <tr> <td style="width: 10%;"></td> <td style="width: 10%;"></td> <td style="width: 10%;"></td> <td style="width: 10%;"></td> <td style="width: 10%;"></td> <td style="width: 10%;"></td> <td style="width: 10%;"></td> <td style="width: 10%;"></td> <td style="width: 10%;"></td> <td style="width: 10%;"></td> </tr> <tr> <td></td> <td></td> <td colspan="8" style="text-align: center;"> <table border="1" style="width: 100%; border-collapse: collapse; text-align: center;"> <tr> <td style="width: 10%;"></td> <td style="width: 10%;"></td> <td style="width: 10%;"></td> <td style="width: 10%;"></td> <td style="width: 10%;"></td> <td style="width: 10%;"></td> <td style="width: 10%;"></td> <td style="width: 10%;"></td> <td style="width: 10%;"></td> <td style="width: 10%;"></td> </tr> <tr> <td></td> <td></td> <td colspan="8" style="text-align: center;"> <table border="1" style="width: 100%; border-collapse: collapse; text-align: center;"> <tr> <td style="width: 10%;"></td> <td style="width: 10%;"></td> <td style="width: 10%;"></td> <td style="width: 10%;"></td> <td style="width: 10%;"></td> <td style="width: 10%;"></td> <td style="width: 10%;"></td> <td style="width: 10%;"></td> <td style="width: 10%;"></td> <td style="width: 10%;"></td> </tr> <tr> <td></td> <td></td> <td colspan="8" style="text-align: center;"> <table border="1" style="width: 100%; border-collapse: collapse; text-align: center;"> <tr> <td style="width: 10%;"></td> <td style="width: 10%;"></td> <td style="width: 10%;"></td> <td style="width: 10%;"></td> <td style="width: 10%;"></td> <td style="width: 10%;"></td> <td style="width: 10%;"></td> <td style="width: 10%;"></td> <td style="width: 10%;"></td> <td style="width: 10%;"></td> </tr> <tr> <td></td> <td></td> <td colspan="8" style="text-align: center;"> <table border="1" style="width: 100%; border-collapse: collapse; text-align: center;"> <tr> <td style="width: 10%;"></td> <td style="width: 10%;"></td> <td style="width: 10%;"></td> <td style="width: 10%;"></td> <td style="width: 10%;"></td> <td style="width: 10%;"></td> <td style="width: 10%;"></td> <td style="width: 10%;"></td> <td style="width: 10%;"></td> <td style="width: 10%;"></td> </tr> <tr> <td></td> <td></td> <td colspan="8" style="text-align: center;"> <table border="1" style="width: 100%; border-collapse: collapse; text-align: center;"> <tr> <td style="width: 10%;"></td> <td style="width: 10%;"></td> <td style="width: 10%;"></td> <td style="width: 10%;"></td> <td style="width: 10%;"></td> <td style="width: 10%;"></td> <td style="width: 10%;"></td> <td style="width: 10%;"></td> <td style="width: 10%;"></td> <td style="width: 10%;"></td> </tr> <tr> <td></td> <td></td> <td colspan="8" style="text-align: center;"> <table border="1" style="width: 100%; border-collapse: collapse; text-align: center;"> <tr> <td style="width: 10%;"></td> <td style="width: 10%;"></td> <td style="width: 10%;"></td> <td
style="width: 10%;"></td> <td style="width: 10%;"></td> <td style="width: 10%;"></td> <td style="width: 10%;"></td> <td style="width: 10%;"></td> <td style="width: 10%;"></td> <td style="width: 10%;"></td> </tr> <tr> <td></td> <td></td> <td colspan="8" style="text-align: center;"> <table border="1" style="width: 100%; border-collapse: collapse; text-align: center;"> <tr> <td style="width: 10%;"></td> <td style="width: 10%;"></td> <td style="width: 10%;"></td> <td style="width: 10%;"></td> <td style="width: 10%;"></td> <td style="width: 10%;"></td> <td style="width: 10%;"></td> <td style="width: 10%;"></td> <td style="width: 10%;"></td> <td style="width: 10%;"></td> </tr> <tr> <td></td> <td></td> <td colspan="8" style="text-align: center;"> <table border="1" style="width: 100%; border-collapse: collapse; text-align: center;"> <tr> <td style="width: 10%;"></td> <td style="width: 10%;"></td> <td style="width: 10%;"></td> <td style="width: 10%;"></td> <td style="width: 10%;"></td> <td style="width: 10%;"></td> <td style="width: 10%;"></td> <td style="width: 10%;"></td> <td style="width: 10%;"></td> <td style="width: 10%;"></td> </tr> <tr> <td></td> <td></td> <td colspan="8" style="text-align: center;"> <table border="1" style="width: 100%; border-collapse: collapse; text-align: center;"> <tr> <td style="width: 10%;"></td> <td style="width: 10%;"></td> <td style="width: 10%;"></td> <td style="width: 10%;"></td> <td style="width: 10%;"></td> <td style="width: 10%;"></td> <td style="width: 10%;"></td> <td style="width: 10%;"></td> <td style="width: 10%;"></td> <td style="width: 10%;"></td> </tr> <tr> <td></td> <td></td> <td colspan="8" style="text-align: center;"> <table border="1" style="width: 100%; border-collapse: collapse; text-align: center;"> <tr> <td style="width: 10%;"></td> <td style="width: 10%;"></td> <td style="width: 10%;"></td> <td style="width: 10%;"></td> <td style="width: 10%;"></td> <td style="width: 10%;"></td> <td style="width: 10%;"></td> <td style="width: 10%;"></td> <td style="width: 10%;"></td> <td style="width: 10%;"></td> </tr> <tr> <td></td> <td></td> <td colspan="8" style="text-align: center;"> <table border="1" style="width: 100%; border-collapse: collapse; text-align: center;"> <tr> <td style="width: 10%;"></td> <td style="width: 10%;"></td> <td style="width: 10%;"></td> <td style="width: 10%;"></td> <td style="width: 10%;"></td> <td style="width: 10%;"></td> <td style="width: 10%;"></td> <td style="width: 10%;"></td> <td style="width: 10%;"></td> <td style="width: 10%;"></td> </tr> <tr> <td></td> <td></td> <td colspan="8" style="text-align: center;"> <table border="1" style="width: 100%; border-collapse: collapse; text-align: center;"> <tr> <td style="width: 10%;"></td> <td style="width: 10%;"></td> <td style="width: 10%;"></td> <td style="width: 10%;"></td> <td style="width: 10%;"></td> <td style="width: 10%;"></td> <td style="width: 10%;"></td> <td style="width: 10%;"></td> <td style="width: 10%;"></td> <td style="width: 10%;"></td> </tr> <tr> <td></td> <td></td> <td colspan="8" style="text-align: center;"> <table border="1" style="width: 100%; border-collapse: collapse; text-align: center;"> <tr> <td style="width: 10%;"></td> <td style="width: 10%;"></td> <td style="width: 10%;"></td> <td style="width: 10%;"></td> <td style="width: 10%;"></td> <td style="width: 10%;"></td> <td style="width: 10%;"></td> <td style="width: 10%;"></td> <td style="width: 10%;"></td> <td style="width: 10%;"></td> </tr> <tr> <td></td> <td></td> <td colspan="8" style="text-align: center;"> <table border="1" style="width: 100%; border-collapse: collapse; text-align: center;"> <tr> <td style="width: 10%;"></td> <td style="width: 10%;"></td> <td style="width: 10%;"></td> <td style="width: 10%;"></td> <td style="width: 10%;"></td> <td style="width: 10%;"></td> <td style="width: 10%;"></td> <td style="width: 10%;"></td> <td style="width: 10%;"></td> <td style="width: 10%;"></td> </tr> <tr> <td></td> <td></td> <td colspan="8" style="text-align: center;"> <table border="1" style="width: 100%; border-collapse: collapse; text-align: center;"> <tr> <td style="width: 10%;"></td> <td style="width: 10%;"></td> <td style="width: 10%;"></td> <td style="width: 10%;"></td> <td style="width: 10%;"></td> <td style="width: 10%;"></td> <td style="width: 10%;"></td> <td style="width: 10%;"></td> <td style="width: 10%;"></td> <td style="width: 10%;"></td> </tr> <tr> <td></td> <td></td> <td colspan="8" style="text-align: center;"> <table border="1" style="width: 100%; border-collapse: collapse; text-align: center;"> <tr> <td style="width: 10%;"></td> <td style="width: 10%;"></td> <td style="width: 10%;"></td> <td style="width: 10%;"></td> <td style="width: 10%;"></td> <td style="width: 10%;"></td> <td style="width: 10%;"></td> <td style="width: 10%;"></td> <td style="width: 10%;"></td> <td style="width: 10%;"></td> </tr> <tr> <td></td> <td></td> <td colspan="8" style="text-align: center;"> <table border="1" style="width: 100%; border-collapse: collapse; text-align: center;"> <tr> <td style="width: 10%;"></td> <td style="width: 10%;"></td> <td style="width: 10%;"></td> <td style="width: 10%;"></td> <td style="width: 10%;"></td> <td style="width: 10%;"></td> <td style="width: 10%;"></td> <td style="width: 10%;"></td> <td style="width: 10%;"></td> <td style="width: 10%;"></td> </tr> <tr> <td></td> <td></td> <td colspan="8" style="text-align: center;"> <table border="1" style="width: 100%; border-collapse: collapse; text-align: center;"> <tr> <td style="width: 10%;"></td> <td style="width: 10%;"></td> <td style="width: 10%;"></td> <td style="width: 10%;"></td> <td style="width: 10%;"></td> <td style="width: 10%;"></td> <td style="width: 10%;"></td> <td style="width: 10%;"></td> <td style="width: 10%;"></td> <td style="width: 10%;"></td> </tr> <tr> <td></td> <td></td> <td colspan="8" style="text-align: center;"> <table border="1" style="width: 100%; border-collapse: collapse; text-align: center;"> <tr> <td style="width: 10%;"></td> <td style="width: 10%;"></td> <td style="width: 10%;"></td> <td style="width: 10%;"></td> <td style="width: 10%;"></td> <td style="width: 10%;"></td> <td style="width: 10%;"></td> <td style="width: 10%;"></td> <td style="width: 10%;"></td> <td style="width: 10%;"></td> </tr> <tr> <td></td> <td></td> <td colspan="8" style="text-align: center;"> <table border="1" style="width: 100%; border-collapse: collapse; text-align: center;"> <tr> <td style="width: 10%;"></td> <td style="width: 10%;"></td> <td style="width: 10%;"></td> <td style="width: 10%;"></td> <td style="width: 10%;"></td> <td style="width: 10%;"></td> <td style="width: 10%;"></td> <td style="width: 10%;"></td> <td style="width: 10%;"></td> <td style="width: 10%;"></td> </tr> <tr> <td></td> <td></td> <td colspan="8" style="text-align: center;"> <table border="1" style="width: 100%; border-collapse: collapse; text-align: center;"> <tr> </tr></table></td></tr></table></td></tr></table></td></tr></table></td></tr></table></td></tr></table></td></tr></table></td></tr></table></td></tr></table></td></tr></table></td></tr></table></td></tr></table></td></tr></table></td></tr></table></td></tr></table></td></tr></table></td></tr></table></td></tr></table></td></tr></table></td></tr></table></td></tr></table></td></tr></table></td></tr></table></td></tr></table></td></tr></table></td></tr></table></td></tr></table></td></tr></table></td></tr></table></td></tr></table></td></tr></table></td></tr></table></td></tr></table></td></tr></table></td></tr></table></td></tr></table></td></tr></table></td></tr></table></td></tr></table></td></tr></table></td></tr></table></td></tr></table></td></tr></table></td></tr></table></td></tr></table></td></tr></table></td></tr></table></td></tr></table></td></tr></table>
 | | | | | | | | | | | | | | | | | | | | <table border="1" style="width: 100%; border-collapse: collapse; text-align: center;"> <tr> <td style="width: 10%;"></td> <td style="width: 10%;"></td> <td style="width: 10%;"></td> <td style="width: 10%;"></td> <td style="width: 10%;"></td> <td style="width: 10%;"></td> <td style="width: 10%;"></td> <td style="width: 10%;"></td> <td style="width: 10%;"></td> <td style="width: 10%;"></td> </tr> <tr> <td></td> <td></td> <td colspan="8" style="text-align: center;"> <table border="1" style="width: 100%; border-collapse: collapse; text-align: center;"> <tr> <td style="width: 10%;"></td> <td style="width: 10%;"></td> <td style="width: 10%;"></td> <td style="width: 10%;"></td> <td style="width: 10%;"></td> <td style="width: 10%;"></td> <td style="width: 10%;"></td> <td style="width: 10%;"></td> <td style="width: 10%;"></td> <td style="width: 10%;"></td> </tr> <tr> <td></td> <td></td> <td colspan="8" style="text-align: center;"> <table border="1" style="width: 100%; border-collapse: collapse; text-align: center;"> <tr> <td style="width: 10%;"></td> <td style="width: 10%;"></td> <td style="width: 10%;"></td> <td style="width: 10%;"></td> <td style="width: 10%;"></td> <td style="width: 10%;"></td> <td style="width: 10%;"></td> <td style="width: 10%;"></td> <td style="width: 10%;"></td> <td style="width: 10%;"></td> </tr> <tr> <td></td> <td></td> <td colspan="8" style="text-align: center;"> <table border="1" style="width: 100%; border-collapse: collapse; text-align: center;"> <tr> <td style="width: 10%;"></td> <td style="width: 10%;"></td> <td style="width: 10%;"></td> <td style="width: 10%;"></td> <td style="width: 10%;"></td> <td style="width: 10%;"></td> <td style="width: 10%;"></td> <td style="width: 10%;"></td> <td style="width: 10%;"></td> <td style="width: 10%;"></td> </tr> <tr> <td></td> <td></td> <td colspan="8" style="text-align: center;"> <table border="1" style="width: 100%; border-collapse: collapse; text-align: center;"> <tr> <td style="width: 10%;"></td> <td style="width: 10%;"></td> <td style="width: 10%;"></td> <td style="width: 10%;"></td> <td style="width: 10%;"></td> <td style="width: 10%;"></td> <td style="width: 10%;"></td> <td style="width: 10%;"></td> <td style="width: 10%;"></td> <td style="width: 10%;"></td> </tr> <tr> <td></td> <td></td> <td colspan="8" style="text-align: center;"> <table border="1" style="width: 100%; border-collapse: collapse; text-align: center;"> <tr> <td style="width: 10%;"></td> <td style="width: 10%;"></td> <td style="width: 10%;"></td> <td style="width: 10%;"></td> <td style="width: 10%;"></td> <td style="width: 10%;"></td> <td style="width: 10%;"></td> <td style="width: 10%;"></td> <td style="width: 10%;"></td> <td style="width: 10%;"></td> </tr> <tr> <td></td> <td></td> <td colspan="8" style="text-align: center;"> <table border="1" style="width: 100%; border-collapse: collapse; text-align: center;"> <tr> <td style="width: 10%;"></td> <td style="width: 10%;"></td> <td style="width: 10%;"></td> <td style="width: 10%;"></td> <td style="width: 10%;"></td> <td style="width: 10%;"></td> <td style="width: 10%;"></td> <td style="width: 10%;"></td> <td style="width: 10%;"></td> <td style="width: 10%;"></td> </tr> <tr> <td></td> <td></td> <td colspan="8" style="text-align: center;"> <table border="1" style="width: 100%; border-collapse: collapse; text-align: center;"> <tr> <td style="width: 10%;"></td> <td style="width: 10%;"></td> <td style="width: 10%;"></td> <td style="width: 10%;"></td> <td style="width: 10%;"></td> <td style="width: 10%;"></td> <td style="width: 10%;"></td> <td style="width: 10%;"></td> <td style="width: 10%;"></td> <td style="width: 10%;"></td> </tr> <tr> <td></td> <td></td> <td colspan="8" style="text-align: center;"> <table border="1" style="width: 100%; border-collapse: collapse; text-align: center;"> <tr> <td style="width: 10%;"></td> <td style="width: 10%;"></td> <td style="width: 10%;"></td> <td style="width: 10%;"></td> <td style="width: 10%;"></td> <td style="width: 10%;"></td> <td style="width: 10%;"></td> <td style="width: 10%;"></td> <td style="width: 10%;"></td> <td style="width: 10%;"></td> </tr> <tr> <td></td> <td></td> <td colspan="8" style="text-align: center;"> <table border="1" style="width: 100%; border-collapse: collapse; text-align: center;"> <tr> <td style="width: 10%;"></td> <td style="width: 10%;"></td> <td style="width: 10%;"></td> <td style="width: 10%;"></td> <td style="width: 10%;"></td> <td style="width: 10%;"></td> <td style="width: 10%;"></td> <td style="width: 10%;"></td> <td style="width: 10%;"></td> <td style="width: 10%;"></td> </tr> <tr> <td></td> <td></td> <td colspan="8" style="text-align: center;"> <table border="1" style="width: 100%; border-collapse: collapse; text-align: center;"> <tr> <td style="width: 10%;"></td> <td style="width: 10%;"></td> <td style="width: 10%;"></td> <td style="width: 10%;"></td> <td style="width: 10%;"></td> <td style="width: 10%;"></td> <td style="width: 10%;"></td> <td style="width: 10%;"></td> <td style="width: 10%;"></td> <td style="width: 10%;"></td> </tr> <tr> <td></td> <td></td> <td colspan="8" style="text-align: center;"> <table border="1" style="width: 100%; border-collapse: collapse; text-align: center;"> <tr> <td style="width: 10%;"></td> <td style="width: 10%;"></td> <td style="width: 10%;"></td> <td style="width: 10%;"></td> <td style="width: 10%;"></td> <td style="width: 10%;"></td> <td style="width: 10%;"></td> <td style="width: 10%;"></td> <td style="width: 10%;"></td> <td style="width: 10%;"></td> </tr> <tr> <td></td> <td></td> <td colspan="8" style="text-align: center;"> <table border="1" style="width: 100%; border-collapse: collapse; text-align: center;"> <tr> <td style="width: 10%;"></td> <td style="width: 10%;"></td> <td style="width: 10%;"></td> <td style="width: 10%;"></td> <td style="width: 10%;"></td> <td style="width: 10%;"></td> <td style="width: 10%;"></td> <td style="width: 10%;"></td> <td style="width: 10%;"></td> <td style="width: 10%;"></td> </tr> <tr> <td></td> <td></td> <td colspan="8" style="text-align: center;"> <table border="1" style="width: 100%; border-collapse: collapse; text-align: center;"> <tr> <td style="width: 10%;"></td> <td style="width: 10%;"></td> <td style="width: 10%;"></td> <td style="width: 10%;"></td> <td style="width: 10%;"></td> <td style="width: 10%;"></td> <td style="width: 10%;"></td> <td style="width: 10%;"></td> <td style="width: 10%;"></td> <td style="width: 10%;"></td> </tr> <tr> <td></td> <td></td> <td colspan="8" style="text-align: center;"> <table border="1" style="width: 100%; border-collapse: collapse; text-align: center;"> <tr> <td style="width: 10%;"></td> <td style="width: 10%;"></td> <td style="width: 10%;"></td> <td style="width: 10%;"></td> <td style="width: 10%;"></td> <td style="width: 10%;"></td> <td style="width: 10%;"></td> <td style="width: 10%;"></td> <td style="width: 10%;"></td> <td style="width: 10%;"></td> </tr> <tr> <td></td> <td></td> <td colspan="8" style="text-align: center;"> <table border="1" style="width: 100%; border-collapse: collapse; text-align: center;"> <tr> <td style="width: 10%;"></td> <td style="width: 10%;"></td> <td style="width: 10%;"></td> <td style="width: 10%;"></td> <td style="width: 10%;"></td> <td style="width: 10%;"></td> <td style="width: 10%;"></td> <td style="width: 10%;"></td> <td style="width: 10%;"></td> <td style="width: 10%;"></td> </tr> <tr> <td></td> <td></td> <td colspan="8" style="text-align: center;"> <table border="1" style="width: 100%; border-collapse: collapse; text-align: center;"> <tr> <td style="width: 10%;"></td> <td style="width: 10%;"></td> <td style="width: 10%;"></td> <td style="width: 10%;"></td> <td style="width: 10%;"></td> <td style="width: 10%;"></td> <td style="width: 10%;"></td> <td style="width: 10%;"></td> <td style="width: 10%;"></td> <td style="width: 10%;"></td> </tr> <tr> <td></td> <td></td> <td colspan="8" style="text-align: center;"> <table border="1" style="width: 100%; border-collapse: collapse; text-align: center;"> <tr> <td style="width: 10%;"></td> <td style="width: 10%;"></td> <td style="width: 10%;"></td> <td style="width: 10%;"></td> <td style="width: 10%;"></td> <td style="width: 10%;"></td> <td style="width: 10%;"></td> <td style="width: 10%;"></td> <td style="width: 10%;"></td> <td style="width: 10%;"></td> </tr> <tr> <td></td> <td></td> <td colspan="8" style="text-align: center;"> <table border="1" style="width: 100%; border-collapse: collapse; text-align: center;"> <tr> <td style="width: 10%;"></td> <td style="width: 10%;"></td> <td style="width: 10%;"></td> <td style="width: 10%;"></td> <td style="width: 10%;"></td> <td style="width: 10%;"></td> <td style="width: 10%;"></td> <td
style="width: 10%;"></td> <td style="width: 10%;"></td> <td style="width: 10%;"></td> </tr> <tr> <td></td> <td></td> <td colspan="8" style="text-align: center;"> <table border="1" style="width: 100%; border-collapse: collapse; text-align: center;"> <tr> <td style="width: 10%;"></td> <td style="width: 10%;"></td> <td style="width: 10%;"></td> <td style="width: 10%;"></td> <td style="width: 10%;"></td> <td style="width: 10%;"></td> <td style="width: 10%;"></td> <td style="width: 10%;"></td> <td style="width: 10%;"></td> <td style="width: 10%;"></td> </tr> <tr> <td></td> <td></td> <td colspan="8" style="text-align: center;"> <table border="1" style="width: 100%; border-collapse: collapse; text-align: center;"> <tr> <td style="width: 10%;"></td> <td style="width: 10%;"></td> <td style="width: 10%;"></td> <td style="width: 10%;"></td> <td style="width: 10%;"></td> <td style="width: 10%;"></td> <td style="width: 10%;"></td> <td style="width: 10%;"></td> <td style="width: 10%;"></td> <td style="width: 10%;"></td> </tr> <tr> <td></td> <td></td> <td colspan="8" style="text-align: center;"> <table border="1" style="width: 100%; border-collapse: collapse; text-align: center;"> <tr> <td style="width: 10%;"></td> <td style="width: 10%;"></td> <td style="width: 10%;"></td> <td style="width: 10%;"></td> <td style="width: 10%;"></td> <td style="width: 10%;"></td> <td style="width: 10%;"></td> <td style="width: 10%;"></td> <td style="width: 10%;"></td> <td style="width: 10%;"></td> </tr> <tr> <td></td> <td></td> <td colspan="8" style="text-align: center;"> <table border="1" style="width: 100%; border-collapse: collapse; text-align: center;"> <tr> <td style="width: 10%;"></td> <td style="width: 10%;"></td> <td style="width: 10%;"></td> <td style="width: 10%;"></td> <td style="width: 10%;"></td> <td style="width: 10%;"></td> <td style="width: 10%;"></td> <td style="width: 10%;"></td> <td style="width: 10%;"></td> <td style="width: 10%;"></td> </tr> <tr> <td></td> <td></td> <td colspan="8" style="text-align: center;"> <table border="1" style="width: 100%; border-collapse: collapse; text-align: center;"> <tr> <td style="width: 10%;"></td> <td style="width: 10%;"></td> <td style="width: 10%;"></td> <td style="width: 10%;"></td> <td style="width: 10%;"></td> <td style="width: 10%;"></td> <td style="width: 10%;"></td> <td style="width: 10%;"></td> <td style="width: 10%;"></td> <td style="width: 10%;"></td> </tr> <tr> <td></td> <td></td> <td colspan="8" style="text-align: center;"> <table border="1" style="width: 100%; border-collapse: collapse; text-align: center;"> <tr> <td style="width: 10%;"></td> <td style="width: 10%;"></td> <td style="width: 10%;"></td> <td style="width: 10%;"></td> <td style="width: 10%;"></td> <td style="width: 10%;"></td> <td style="width: 10%;"></td> <td style="width: 10%;"></td> <td style="width: 10%;"></td> <td style="width: 10%;"></td> </tr> <tr> <td></td> <td></td> <td colspan="8" style="text-align: center;"> <table border="1" style="width: 100%; border-collapse: collapse; text-align: center;"> <tr> <td style="width: 10%;"></td> <td style="width: 10%;"></td> <td style="width: 10%;"></td> <td style="width: 10%;"></td> <td style="width: 10%;"></td> <td style="width: 10%;"></td> <td style="width: 10%;"></td> <td style="width: 10%;"></td> <td style="width: 10%;"></td> <td style="width: 10%;"></td> </tr> <tr> <td></td> <td></td> <td colspan="8" style="text-align: center;"> <table border="1" style="width: 100%; border-collapse: collapse; text-align: center;"> <tr> <td style="width: 10%;"></td> <td style="width: 10%;"></td> <td style="width: 10%;"></td> <td style="width: 10%;"></td> <td style="width: 10%;"></td> <td style="width: 10%;"></td> <td style="width: 10%;"></td> <td style="width: 10%;"></td> <td style="width: 10%;"></td> <td style="width: 10%;"></td> </tr> <tr> <td></td> <td></td> <td colspan="8" style="text-align: center;"> <table border="1" style="width: 100%; border-collapse: collapse; text-align: center;"> <tr> <td style="width: 10%;"></td> <td style="width: 10%;"></td> <td style="width: 10%;"></td> <td style="width: 10%;"></td> <td style="width: 10%;"></td> <td style="width: 10%;"></td> <td style="width: 10%;"></td> <td style="width: 10%;"></td> <td style="width: 10%;"></td> <td style="width: 10%;"></td> </tr> <tr> <td></td> <td></td> <td colspan="8" style="text-align: center;"> <table border="1" style="width: 100%; border-collapse: collapse; text-align: center;"> <tr> <td style="width: 10%;"></td> <td style="width: 10%;"></td> <td style="width: 10%;"></td> <td style="width: 10%;"></td> <td style="width: 10%;"></td> <td style="width: 10%;"></td> <td style="width: 10%;"></td> <td style="width: 10%;"></td> <td style="width: 10%;"></td> <td style="width: 10%;"></td> </tr> <tr> <td></td> <td></td> <td colspan="8" style="text-align: center;"> <table border="1" style="width: 100%; border-collapse: collapse; text-align: center;"> <tr> <td style="width: 10%;"></td> <td style="width: 10%;"></td> <td style="width: 10%;"></td> <td style="width: 10%;"></td> <td style="width: 10%;"></td> <td style="width: 10%;"></td> <td style="width: 10%;"></td> <td style="width: 10%;"></td> <td style="width: 10%;"></td> <td style="width: 10%;"></td> </tr> <tr> <td></td> <td></td> <td colspan="8" style="text-align: center;"> <table border="1" style="width: 100%; border-collapse: collapse; text-align: center;"> <tr> <td style="width: 10%;"></td> <td style="width: 10%;"></td> <td style="width: 10%;"></td> <td style="width: 10%;"></td> <td style="width: 10%;"></td> <td style="width: 10%;"></td> <td style="width: 10%;"></td> <td style="width: 10%;"></td> <td style="width: 10%;"></td> <td style="width: 10%;"></td> </tr> <tr> <td></td> <td></td> <td colspan="8" style="text-align: center;"> <table border="1" style="width: 100%; border-collapse: collapse; text-align: center;"> <tr> <td style="width: 10%;"></td> <td style="width: 10%;"></td> <td style="width: 10%;"></td> <td style="width: 10%;"></td> <td style="width: 10%;"></td> <td style="width: 10%;"></td> <td style="width: 10%;"></td> <td style="width: 10%;"></td> <td style="width: 10%;"></td> <td style="width: 10%;"></td> </tr> <tr> <td></td> <td></td> <td colspan="8" style="text-align: center;"> <table border="1" style="width: 100%; border-collapse: collapse; text-align: center;"> <tr> <td style="width: 10%;"></td> <td style="width: 10%;"></td> <td style="width: 10%;"></td> <td style="width: 10%;"></td> <td style="width: 10%;"></td> <td style="width: 10%;"></td> <td style="width: 10%;"></td> <td style="width: 10%;"></td> <td style="width: 10%;"></td> <td style="width: 10%;"></td> </tr> <tr> <td></td> <td></td> <td colspan="8" style="text-align: center;"> <table border="1" style="width: 100%; border-collapse: collapse; text-align: center;"> <tr> <td style="width: 10%;"></td> <td style="width: 10%;"></td> <td style="width: 10%;"></td> <td style="width: 10%;"></td> <td style="width: 10%;"></td> <td style="width: 10%;"></td> <td style="width: 10%;"></td> <td style="width: 10%;"></td> <td style="width: 10%;"></td> <td style="width: 10%;"></td> </tr> <tr> <td></td> <td></td> <td colspan="8" style="text-align: center;"> <table border="1" style="width: 100%; border-collapse: collapse; text-align: center;"> <tr> <td style="width: 10%;"></td> <td style="width: 10%;"></td> <td style="width: 10%;"></td> <td style="width: 10%;"></td> <td style="width: 10%;"></td> <td style="width: 10%;"></td> <td style="width: 10%;"></td> <td style="width: 10%;"></td> <td style="width: 10%;"></td> <td style="width: 10%;"></td> </tr> <tr> <td></td> <td></td> <td colspan="8" style="text-align: center;"> <table border="1" style="width: 100%; border-collapse: collapse; text-align: center;"> <tr> <td style="width: 10%;"></td> <td style="width: 10%;"></td> <td style="width: 10%;"></td> <td style="width: 10%;"></td> <td style="width: 10%;"></td> <td style="width: 10%;"></td> <td style="width: 10%;"></td> <td style="width: 10%;"></td> <td style="width: 10%;"></td> <td style="width: 10%;"></td> </tr> <tr> <td></td> <td></td> <td colspan="8" style="text-align: center;"> <table border="1" style="width: 100%; border-collapse: collapse; text-align: center;"> <tr> <td style="width: 10%;"></td> <td style="width: 10%;"></td> <td style="width: 10%;"></td> <td style="width: 10%;"></td> <td style="width: 10%;"></td> <td style="width: 10%;"></td> <td style="width: 10%;"></td> <td style="width: 10%;"></td> <td style="width: 10%;"></td> <td style="width: 10%;"></td> </tr> <tr> <td></td> <td></td> <td colspan="8" style="text-align: center;"> <table border="1" style="width: 100%; border-collapse: collapse; text-align: center;"> <tr> <td style="width: 10%;"></td> <td style="width: 10%;"></td> <td style="width: 10%;"></td> <td style="width: 10%;"></td> <td style="width: 10%;"></td> <td style="width: 10%;"></td> <td style="width: 10%;"></td> <td style="width: 10%;"></td> <td style="width: 10%;"></td> <td style="width: 10%;"></td> </tr> <tr> <td></td> <td></td> <td colspan="8" style="text-align: center;"> <table border="1" style="width: 100%; border-collapse: collapse; text-align: center;"> <tr> <td style="width: 10%;"></td> <td style="width: 10%;"></td> <td style="width: 10%;"></td> <td style="width: 10%;"></td> <td style="width: 10%;"></td> <td style="width: 10%;"></td> <td style="width: 10%;"></td> <td style="width: 10%;"></td> <td style="width: 10%;"></td> <td style="width: 10%;"></td> </tr> <tr> <td></td> <td></td> <td colspan="8" style="text-align: center;"> <table border="1" style="width: 100%; border-collapse: collapse; text-align: center;"> <tr> <td style="width: 10%;"></td> <td style="width: 10%;"></td> <td style="width: 10%;"></td> <td style="width: 10%;"></td> <td style="width: 10%;"></td> <td style="width: 10%;"></td> <td style="width: 10%;"></td> <td style="width: 10%;"></td> <td style="width: 10%;"></td> <td style="width: 10%;"></td> </tr> <tr> <td></td> <td></td> <td colspan="8" style="text-align: center;"> <table
border="1" style="width: 100%; border-collapse: collapse; text-align: center;"> <tr> <td style="width: 10%;"></td> <td style="width: 10%;"></td> <td style="width: 10%;"></td> <td style="width: 10%;"></td> <td style="width: 10%;"></td> <td style="width: 10%;"></td> <td style="width: 10%;"></td> <td style="width: 10%;"></td> <td style="width: 10%;"></td> <td style="width: 10%;"></td> </tr> <tr> <td></td> <td></td> <td colspan="8" style="text-align: center;"> <table border="1" style="width: 100%; border-collapse: collapse; text-align: center;"> <tr> <td style="width: 10%;"></td> <td style="width: 10%;"></td> <td style="width: 10%;"></td> <td style="width: 10%;"></td> <td style="width: 10%;"></td> <td style="width: 10%;"></td> <td style="width: 10%;"></td> <td style="width: 10%;"></td> <td style="width: 10%;"></td> <td style="width: 10%;"></td> </tr> <tr> <td></td> <td></td> <td colspan="8" style="text-align: center;"> <table border="1" style="width: 100%; border-collapse: collapse; text-align: center;"> <tr> <td style="width: 10%;"></td> <td style="width: 10%;"></td> <td style="width: 10%;"></td> <td style="width: 10%;"></td> <td style="width: 10%;"></td> <td style="width: 10%;"></td> <td style="width: 10%;"></td> <td style="width: 10%;"></td> <td style="width: 10%;"></td> <td style="width: 10%;"></td> </tr> <tr> <td></td> <td></td> <td colspan="8" style="text-align: center;"> <table border="1" style="width: 100%; border-collapse: collapse; text-align: center;"> <tr> <td style="width: 10%;"></td> <td style="width: 10%;"></td> <td style="width: 10%;"></td> <td style="width: 10%;"></td> <td style="width: 10%;"></td> <td style="width: 10%;"></td> <td style="width: 10%;"></td> <td style="width: 10%;"></td> <td style="width: 10%;"></td> <td style="width: 10%;"></td> </tr> <tr> <td></td> <td></td> <td colspan="8" style="text-align: center;"> <table border="1" style="width: 100%; border-collapse: collapse; text-align: center;"> <tr> <td style="width: 10%;"></td> <td style="width: 10%;"></td> <td style="width: 10%;"></td> <td style="width: 10%;"></td> <td style="width: 10%;"></td> <td style="width: 10%;"></td> <td style="width: 10%;"></td> <td style="width: 10%;"></td> <td style="width: 10%;"></td> <td style="width: 10%;"></td> </tr> <tr> <td></td> <td></td> <td colspan="8" style="text-align: center;"> <table border="1" style="width: 100%; border-collapse: collapse; text-align: center;"> <tr> <td style="width: 10%;"></td> <td style="width: 10%;"></td> <td style="width: 10%;"></td> <td style="width: 10%;"></td> <td style="width: 10%;"></td> <td style="width: 10%;"></td> <td style="width: 10%;"></td> <td style="width: 10%;"></td> <td style="width: 10%;"></td> <td style="width: 10%;"></td> </tr> <tr> <td></td> <td></td> <td colspan="8" style="text-align: center;"> <table border="1" style="width: 100%; border-collapse: collapse; text-align: center;"> <tr> <td style="width: 10%;"></td> <td style="width: 10%;"></td> <td style="width: 10%;"></td> <td style="width: 10%;"></td> <td style="width: 10%;"></td> <td style="width: 10%;"></td> <td style="width: 10%;"></td> <td style="width: 10%;"></td> <td style="width: 10%;"></td> <td style="width: 10%;"></td> </tr> <tr> <td></td> <td></td> <td colspan="8" style="text-align: center;"> <table border="1" style="width: 100%; border-collapse: collapse; text-align: center;"> <tr> </tr></table></td></tr></table></td></tr></table></td></tr></table></td></tr></table></td></tr></table></td></tr></table></td></tr></table></td></tr></table></td></tr></table></td></tr></table></td></tr></table></td></tr></table></td></tr></table></td></tr></table></td></tr></table></td></tr></table></td></tr></table></td></tr></table></td></tr></table></td></tr></table></td></tr></table></td></tr></table></td></tr></table></td></tr></table></td></tr></table></td></tr></table></td></tr></table></td></tr></table></td></tr></table></td></tr></table></td></tr></table></td></tr></table></td></tr></table></td></tr></table></td></tr></table></td></tr></table></td></tr></table></td></tr></table></td></tr></table></td></tr></table></td></tr></table></td></tr></table></td></tr></table></td></tr></table></td></tr></table></td></tr></table></td></tr></table> | | | | | | | | | | | | | | | | | | | | <table border="1" style="width: 100%; border-collapse: collapse; text-align: center;"> <tr> <td style="width: 10%;"></td> <td style="width: 10%;"></td> <td style="width: 10%;"></td> <td style="width: 10%;"></td> <td style="width: 10%;"></td> <td style="width: 10%;"></td> <td style="width: 10%;"></td> <td style="width: 10%;"></td> <td style="width: 10%;"></td> <td style="width: 10%;"></td> </tr> <tr> <td></td> <td></td> <td colspan="8" style="text-align: center;"> <table border="1" style="width: 100%; border-collapse: collapse; text-align: center;"> <tr> <td style="width: 10%;"></td> <td style="width: 10%;"></td> <td style="width: 10%;"></td> <td style="width: 10%;"></td> <td style="width: 10%;"></td> <td style="width: 10%;"></td> <td style="width: 10%;"></td> <td style="width: 10%;"></td> <td style="width: 10%;"></td> <td style="width: 10%;"></td> </tr> <tr> <td></td> <td></td> <td colspan="8" style="text-align: center;"> <table border="1" style="width: 100%; border-collapse: collapse; text-align: center;"> <tr> <td style="width: 10%;"></td> <td style="width: 10%;"></td> <td style="width: 10%;"></td> <td style="width: 10%;"></td> <td style="width: 10%;"></td> <td style="width: 10%;"></td> <td style="width: 10%;"></td> <td style="width: 10%;"></td> <td style="width: 10%;"></td> <td style="width: 10%;"></td> </tr> <tr> <td></td> <td></td> <td colspan="8" style="text-align: center;"> <table border="1" style="width: 100%; border-collapse: collapse; text-align: center;"> <tr> <td style="width: 10%;"></td> <td style="width: 10%;"></td> <td style="width: 10%;"></td> <td style="width: 10%;"></td> <td style="width: 10%;"></td> <td style="width: 10%;"></td> <td style="width: 10%;"></td> <td style="width: 10%;"></td> <td style="width: 10%;"></td> <td style="width: 10%;"></td> </tr> <tr> <td></td> <td></td> <td colspan="8" style="text-align: center;"> <table border="1" style="width: 100%; border-collapse: collapse; text-align: center;"> <tr> <td style="width: 10%;"></td> <td style="width: 10%;"></td> <td style="width: 10%;"></td> <td style="width: 10%;"></td> <td style="width: 10%;"></td> <td style="width: 10%;"></td> <td style="width: 10%;"></td> <td style="width: 10%;"></td> <td style="width: 10%;"></td> <td style="width: 10%;"></td> </tr> <tr> <td></td> <td></td> <td colspan="8"
style="text-align: center;"> <table border="1" style="width: 100%; border-collapse: collapse; text-align: center;"> <tr> <td style="width: 10%;"></td> <td style="width: 10%;"></td> <td style="width: 10%;"></td> <td style="width: 10%;"></td> <td style="width: 10%;"></td> <td style="width: 10%;"></td> <td style="width: 10%;"></td> <td style="width: 10%;"></td> <td style="width: 10%;"></td> <td style="width: 10%;"></td> </tr> <tr> <td></td> <td></td> <td colspan="8" style="text-align: center;"> <table border="1" style="width: 100%; border-collapse: collapse; text-align: center;"> <tr> <td style="width: 10%;"></td> <td style="width: 10%;"></td> <td style="width: 10%;"></td> <td style="width: 10%;"></td> <td style="width: 10%;"></td> <td style="width: 10%;"></td> <td style="width: 10%;"></td> <td style="width: 10%;"></td> <td style="width: 10%;"></td> <td style="width: 10%;"></td> </tr> <tr> <td></td> <td></td> <td colspan="8" style="text-align: center;"> <table border="1" style="width: 100%; border-collapse: collapse; text-align: center;"> <tr> <td style="width: 10%;"></td> <td style="width: 10%;"></td> <td style="width: 10%;"></td> <td style="width: 10%;"></td> <td style="width: 10%;"></td> <td style="width: 10%;"></td> <td style="width: 10%;"></td> <td style="width: 10%;"></td> <td style="width: 10%;"></td> <td style="width: 10%;"></td> </tr> <tr> <td></td> <td></td> <td colspan="8" style="text-align: center;"> <table border="1" style="width: 100%; border-collapse: collapse; text-align: center;"> <tr> <td style="width: 10%;"></td> <td style="width: 10%;"></td> <td style="width: 10%;"></td> <td style="width: 10%;"></td> <td style="width: 10%;"></td> <td style="width: 10%;"></td> <td style="width: 10%;"></td> <td style="width: 10%;"></td> <td style="width: 10%;"></td> <td style="width: 10%;"></td> </tr> <tr> <td></td> <td></td> <td colspan="8" style="text-align: center;"> <table border="1" style="width: 100%; border-collapse: collapse; text-align: center;"> <tr> <td style="width: 10%;"></td> <td style="width: 10%;"></td> <td style="width: 10%;"></td> <td style="width: 10%;"></td> <td style="width: 10%;"></td> <td style="width: 10%;"></td> <td style="width: 10%;"></td> <td style="width: 10%;"></td> <td style="width: 10%;"></td> <td style="width: 10%;"></td> </tr> <tr> <td></td> <td></td> <td colspan="8" style="text-align: center;"> <table border="1" style="width: 100%; border-collapse: collapse; text-align: center;"> <tr> <td style="width: 10%;"></td> <td style="width: 10%;"></td> <td style="width: 10%;"></td> <td style="width: 10%;"></td> <td style="width: 10%;"></td> <td style="width: 10%;"></td> <td style="width: 10%;"></td> <td style="width: 10%;"></td> <td style="width: 10%;"></td> <td style="width: 10%;"></td> </tr> <tr> <td></td> <td></td> <td colspan="8" style="text-align: center;"> <table border="1" style="width: 100%; border-collapse: collapse; text-align: center;"> <tr> <td style="width: 10%;"></td> <td style="width: 10%;"></td> <td style="width: 10%;"></td> <td style="width: 10%;"></td> <td style="width: 10%;"></td> <td style="width: 10%;"></td> <td style="width: 10%;"></td> <td style="width: 10%;"></td> <td style="width: 10%;"></td> <td style="width: 10%;"></td> </tr> <tr> <td></td> <td></td> <td colspan="8" style="text-align: center;"> <table border="1" style="width: 100%; border-collapse: collapse; text-align: center;"> <tr> <td style="width: 10%;"></td> <td style="width: 10%;"></td> <td style="width: 10%;"></td> <td style="width: 10%;"></td> <td style="width: 10%;"></td> <td style="width: 10%;"></td> <td style="width: 10%;"></td> <td style="width: 10%;"></td> <td style="width: 10%;"></td> <td style="width: 10%;"></td> </tr> <tr> <td></td> <td></td> <td colspan="8" style="text-align: center;"> <table border="1" style="width: 100%; border-collapse: collapse; text-align: center;"> <tr> <td style="width: 10%;"></td> <td style="width: 10%;"></td> <td style="width: 10%;"></td> <td style="width: 10%;"></td> <td style="width: 10%;"></td> <td style="width: 10%;"></td> <td style="width: 10%;"></td> <td style="width: 10%;"></td> <td style="width: 10%;"></td> <td style="width: 10%;"></td> </tr> <tr> <td></td> <td></td> <td colspan="8" style="text-align: center;"> <table border="1" style="width: 100%; border-collapse: collapse; text-align: center;"> <tr> <td style="width: 10%;"></td> <td style="width: 10%;"></td> <td style="width: 10%;"></td> <td style="width: 10%;"></td> <td style="width: 10%;"></td> <td style="width: 10%;"></td> <td style="width: 10%;"></td> <td style="width: 10%;"></td> <td style="width: 10%;"></td> <td style="width: 10%;"></td> </tr> <tr> <td></td> <td></td> <td colspan="8" style="text-align: center;"> <table border="1" style="width: 100%; border-collapse: collapse; text-align: center;"> <tr> <td style="width: 10%;"></td> <td style="width: 10%;"></td> <td style="width: 10%;"></td> <td style="width: 10%;"></td> <td style="width: 10%;"></td> <td style="width: 10%;"></td> <td style="width: 10%;"></td> <td style="width: 10%;"></td> <td style="width: 10%;"></td> <td style="width: 10%;"></td> </tr> <tr> <td></td> <td></td> <td colspan="8" style="text-align: center;"> <table border="1" style="width: 100%; border-collapse: collapse; text-align: center;"> <tr> <td style="width: 10%;"></td> <td style="width: 10%;"></td> <td style="width: 10%;"></td> <td style="width: 10%;"></td> <td style="width: 10%;"></td> <td style="width: 10%;"></td> <td style="width: 10%;"></td> <td style="width: 10%;"></td> <td style="width: 10%;"></td> <td style="width: 10%;"></td> </tr> <tr> <td></td> <td></td> <td colspan="8" style="text-align: center;"> <table border="1" style="width: 100%; border-collapse: collapse; text-align: center;"> <tr> <td style="width: 10%;"></td> <td style="width: 10%;"></td> <td style="width: 10%;"></td> <td style="width: 10%;"></td> <td style="width: 10%;"></td> <td style="width: 10%;"></td> <td style="width: 10%;"></td> <td style="width: 10%;"></td> <td style="width: 10%;"></td> <td style="width: 10%;"></td> </tr> <tr> <td></td> <td></td> <td colspan="8" style="text-align: center;"> <table border="1" style="width: 100%; border-collapse: collapse; text-align: center;"> <tr> <td style="width: 10%;"></td> <td style="width: 10%;"></td> <td style="width: 10%;"></td> <td style="width: 10%;"></td> <td style="width: 10%;"></td> <td style="width: 10%;"></td> <td style="width: 10%;"></td> <td style="width: 10%;"></td> <td style="width: 10%;"></td> <td style="width: 10%;"></td> </tr> <tr> <td></td> <td></td> <td colspan="8" style="text-align: center;"> <table border="1" style="width: 100%; border-collapse: collapse; text-align: center;"> <tr> <td style="width: 10%;"></td> <td style="width: 10%;"></td> <td style="width: 10%;"></td> <td style="width: 10%;"></td> <td style="width: 10%;"></td> <td style="width: 10%;"></td> <td style="width: 10%;"></td> <td style="width: 10%;"></td> <td style="width: 10%;"></td> <td style="width: 10%;"></td> </tr> <tr> <td></td> <td></td> <td colspan="8" style="text-align: center;"> <table border="1" style="width: 100%; border-collapse: collapse; text-align: center;"> <tr> <td style="width: 10%;"></td> <td style="width: 10%;"></td> <td style="width: 10%;"></td> <td style="width: 10%;"></td> <td style="width: 10%;"></td> <td style="width: 10%;"></td> <td style="width: 10%;"></td> <td style="width: 10%;"></td> <td style="width: 10%;"></td> <td style="width: 10%;"></td> </tr> <tr> <td></td> <td></td> <td colspan="8" style="text-align: center;"> <table border="1" style="width: 100%; border-collapse: collapse; text-align: center;"> <tr> <td style="width: 10%;"></td> <td style="width: 10%;"></td> <td style="width: 10%;"></td> <td style="width: 10%;"></td> <td style="width: 10%;"></td> <td style="width: 10%;"></td> <td style="width: 10%;"></td> <td style="width: 10%;"></td> <td style="width: 10%;"></td> <td style="width: 10%;"></td> </tr> <tr> <td></td> <td></td> <td colspan="8" style="text-align: center;"> <table border="1" style="width: 100%; border-collapse: collapse; text-align: center;"> <tr> <td style="width: 10%;"></td> <td style="width: 10%;"></td> <td style="width: 10%;"></td> <td style="width: 10%;"></td> <td style="width: 10%;"></td> <td style="width: 10%;"></td> <td style="width: 10%;"></td> <td style="width: 10%;"></td> <td style="width: 10%;"></td> <td style="width: 10%;"></td> </tr> <tr> <td></td> <td></td> <td colspan="8" style="text-align: center;"> <table border="1" style="width: 100%; border-collapse: collapse; text-align: center;"> <tr> <td style="width: 10%;"></td> <td style="width: 10%;"></td> <td style="width: 10%;"></td> <td style="width: 10%;"></td> <td style="width: 10%;"></td> <td style="width: 10%;"></td> <td style="width: 10%;"></td> <td style="width: 10%;"></td> <td style="width: 10%;"></td> <td style="width: 10%;"></td> </tr> <tr> <td></td> <td></td> <td colspan="8" style="text-align: center;"> <table border="1" style="width: 100%; border-collapse: collapse; text-align: center;"> <tr> <td style="width: 10%;"></td> <td style="width: 10%;"></td> <td style="width: 10%;"></td> <td style="width: 10%;"></td> <td style="width: 10%;"></td> <td style="width: 10%;"></td> <td style="width: 10%;"></td> <td style="width: 10%;"></td> <td style="width: 10%;"></td> <td style="width: 10%;"></td> </tr> <tr> <td></td> <td></td> <td colspan="8" style="text-align: center;"> <table border="1" style="width: 100%; border-collapse: collapse; text-align: center;"> <tr> <td style="width: 10%;"></td> <td style="width: 10%;"></td> <td style="width: 10%;"></td> <td style="width: 10%;"></td> <td style="width: 10%;"></td> <td style="width: 10%;"></td> <td style="width: 10%;"></td> <td style="width: 10%;"></td> <td style="width: 10%;"></td> <td style="width: 10%;"></td> </tr> <tr> <td></td> <td></td> <td colspan="8" style="text-align: center;"> <table border="1" style="width: 100%; border-collapse: collapse; text-align: center;"> <tr> <td style="width: 10%;"></td> <td style="width:
10%;"></td> <td style="width: 10%;"></td> <td style="width: 10%;"></td> <td style="width: 10%;"></td> <td style="width: 10%;"></td> <td style="width: 10%;"></td> <td style="width: 10%;"></td> <td style="width: 10%;"></td> <td style="width: 10%;"></td> </tr> <tr> <td></td> <td></td> <td colspan="8" style="text-align: center;"> <table border="1" style="width: 100%; border-collapse: collapse; text-align: center;"> <tr> <td style="width: 10%;"></td> <td style="width: 10%;"></td> <td style="width: 10%;"></td> <td style="width: 10%;"></td> <td style="width: 10%;"></td> <td style="width: 10%;"></td> <td style="width: 10%;"></td> <td style="width: 10%;"></td> <td style="width: 10%;"></td> <td style="width: 10%;"></td> </tr> <tr> <td></td> <td></td> <td colspan="8" style="text-align: center;"> <table border="1" style="width: 100%; border-collapse: collapse; text-align: center;"> <tr> <td style="width: 10%;"></td> <td style="width: 10%;"></td> <td style="width: 10%;"></td> <td style="width: 10%;"></td> <td style="width: 10%;"></td> <td style="width: 10%;"></td> <td style="width: 10%;"></td> <td style="width: 10%;"></td> <td style="width: 10%;"></td> <td style="width: 10%;"></td> </tr> <tr> <td></td> <td></td> <td colspan="8" style="text-align: center;"> <table border="1" style="width: 100%; border-collapse: collapse; text-align: center;"> <tr> <td style="width: 10%;"></td> <td style="width: 10%;"></td> <td style="width: 10%;"></td> <td style="width: 10%;"></td> <td style="width: 10%;"></td> <td style="width: 10%;"></td> <td style="width: 10%;"></td> <td style="width: 10%;"></td> <td style="width: 10%;"></td> <td style="width: 10%;"></td> </tr> <tr> <td></td> <td></td> <td colspan="8" style="text-align: center;"> <table border="1" style="width: 100%; border-collapse: collapse; text-align: center;"> <tr> <td style="width: 10%;"></td> <td style="width: 10%;"></td> <td style="width: 10%;"></td> <td style="width: 10%;"></td> <td style="width: 10%;"></td> <td style="width: 10%;"></td> <td style="width: 10%;"></td> <td style="width: 10%;"></td> <td style="width: 10%;"></td> <td style="width: 10%;"></td> </tr> <tr> <td></td> <td></td> <td colspan="8" style="text-align: center;"> <table border="1" style="width: 100%; border-collapse: collapse; text-align: center;"> <tr> <td style="width: 10%;"></td> <td style="width: 10%;"></td> <td style="width: 10%;"></td> <td style="width: 10%;"></td> <td style="width: 10%;"></td> <td style="width: 10%;"></td> <td style="width: 10%;"></td> <td style="width: 10%;"></td> <td style="width: 10%;"></td> <td style="width: 10%;"></td> </tr> <tr> <td></td> <td></td> <td colspan="8" style="text-align: center;"> <table border="1" style="width: 100%; border-collapse: collapse; text-align: center;"> <tr> <td style="width: 10%;"></td> <td style="width: 10%;"></td> <td style="width: 10%;"></td> <td style="width: 10%;"></td> <td style="width: 10%;"></td> <td style="width: 10%;"></td> <td style="width: 10%;"></td> <td style="width: 10%;"></td> <td style="width: 10%;"></td> <td style="width: 10%;"></td> </tr> <tr> <td></td> <td></td> <td colspan="8" style="text-align: center;"> <table border="1" style="width: 100%; border-collapse: collapse; text-align: center;"> <tr> <td style="width: 10%;"></td> <td style="width: 10%;"></td> <td style="width: 10%;"></td> <td style="width: 10%;"></td> <td style="width: 10%;"></td> <td style="width: 10%;"></td> <td style="width: 10%;"></td> <td style="width: 10%;"></td> <td style="width: 10%;"></td> <td style="width: 10%;"></td> </tr> <tr> <td></td> <td></td> <td colspan="8" style="text-align: center;"> <table border="1" style="width: 100%; border-collapse: collapse; text-align: center;"> <tr> <td style="width: 10%;"></td> <td style="width: 10%;"></td> <td style="width: 10%;"></td> <td style="width: 10%;"></td> <td style="width: 10%;"></td> <td style="width: 10%;"></td> <td style="width: 10%;"></td> <td style="width: 10%;"></td> <td style="width: 10%;"></td> <td style="width: 10%;"></td> </tr> <tr> <td></td> <td></td> <td colspan="8" style="text-align: center;"> <table border="1" style="width: 100%; border-collapse: collapse; text-align: center;"> <tr> <td style="width: 10%;"></td> <td style="width: 10%;"></td> <td style="width: 10%;"></td> <td style="width: 10%;"></td> <td style="width: 10%;"></td> <td style="width: 10%;"></td> <td style="width: 10%;"></td> <td style="width: 10%;"></td> <td style="width: 10%;"></td> <td style="width: 10%;"></td> </tr> <tr> <td></td> <td></td> <td colspan="8" style="text-align: center;"> <table border="1" style="width: 100%; border-collapse: collapse; text-align: center;"> <tr> <td style="width: 10%;"></td> <td style="width: 10%;"></td> <td style="width: 10%;"></td> <td style="width: 10%;"></td> <td style="width: 10%;"></td> <td style="width: 10%;"></td> <td style="width: 10%;"></td> <td style="width: 10%;"></td> <td style="width: 10%;"></td> <td style="width: 10%;"></td> </tr> <tr> <td></td> <td></td> <td colspan="8" style="text-align: center;"> <table border="1" style="width: 100%; border-collapse: collapse; text-align: center;"> <tr> <td style="width: 10%;"></td> <td style="width: 10%;"></td> <td style="width: 10%;"></td> <td style="width: 10%;"></td> <td style="width: 10%;"></td> <td style="width: 10%;"></td> <td style="width: 10%;"></td> <td style="width: 10%;"></td> <td style="width: 10%;"></td> <td style="width: 10%;"></td> </tr> <tr> <td></td> <td></td> <td colspan="8" style="text-align: center;"> <table border="1" style="width: 100%; border-collapse: collapse; text-align: center;"> <tr> <td style="width: 10%;"></td> <td style="width: 10%;"></td> <td style="width: 10%;"></td> <td style="width: 10%;"></td> <td style="width: 10%;"></td> <td style="width: 10%;"></td> <td style="width: 10%;"></td> <td style="width: 10%;"></td> <td style="width: 10%;"></td> <td style="width: 10%;"></td> </tr> <tr> <td></td> <td></td> <td colspan="8" style="text-align: center;"> <table border="1" style="width: 100%; border-collapse: collapse; text-align: center;"> <tr> <td style="width: 10%;"></td> <td style="width: 10%;"></td> <td style="width: 10%;"></td> <td style="width: 10%;"></td> <td style="width: 10%;"></td> <td style="width: 10%;"></td> <td style="width: 10%;"></td> <td style="width: 10%;"></td> <td style="width: 10%;"></td> <td style="width: 10%;"></td> </tr> <tr> <td></td> <td></td> <td colspan="8" style="text-align: center;"> <table border="1" style="width: 100%; border-collapse: collapse; text-align: center;"> <tr> <td style="width: 10%;"></td> <td style="width: 10%;"></td> <td style="width: 10%;"></td> <td style="width: 10%;"></td> <td style="width: 10%;"></td> <td style="width: 10%;"></td> <td style="width: 10%;"></td> <td style="width: 10%;"></td> <td style="width: 10%;"></td> <td style="width: 10%;"></td> </tr> <tr> <td></td> <td></td> <td colspan="8" style="text-align: center;"> <table border="1" style="width: 100%; border-collapse: collapse; text-align: center;"> <tr> <td style="width: 10%;"></td> <td style="width: 10%;"></td> <td style="width: 10%;"></td> <td style="width: 10%;"></td> <td style="width: 10%;"></td> <td style="width: 10%;"></td> <td style="width: 10%;"></td> <td style="width: 10%;"></td> <td style="width: 10%;"></td> <td style="width: 10%;"></td> </tr> <tr> <td></td> <td></td> <td colspan="8" style="text-align: center;"> <table border="1" style="width: 100%; border-collapse: collapse; text-align: center;"> <tr> <td style="width: 10%;"></td> <td style="width: 10%;"></td> <td style="width: 10%;"></td> <td style="width: 10%;"></td> <td style="width: 10%;"></td> <td style="width: 10%;"></td> <td style="width: 10%;"></td> <td style="width: 10%;"></td> <td style="width: 10%;"></td> <td style="width: 10%;"></td> </tr> <tr> <td></td> <td></td> <td colspan="8" style="text-align: center;"> <table border="1" style="width: 100%; border-collapse: collapse; text-align: center;"> <tr> <td style="width: 10%;"></td> <td style="width: 10%;"></td> <td style="width: 10%;"></td> <td style="width: 10%;"></td> <td style="width: 10%;"></td> <td style="width: 10%;"></td> <td style="width: 10%;"></td> <td style="width: 10%;"></td> <td style="width: 10%;"></td> <td style="width: 10%;"></td> </tr> <tr> <td></td> <td></td> <td colspan="8" style="text-align: center;"> <table border="1" style="width: 100%; border-collapse: collapse; text-align: center;"> <tr> <td style="width: 10%;"></td> <td style="width: 10%;"></td> <td style="width: 10%;"></td> <td style="width: 10%;"></td> <td style="width: 10%;"></td> <td style="width: 10%;"></td> <td style="width: 10%;"></td> <td style="width: 10%;"></td> <td style="width: 10%;"></td> <td style="width: 10%;"></td> </tr> <tr> <td></td> <td></td> <td colspan="8" style="text-align: center;"> <table border="1" style="width: 100%; border-collapse: collapse; text-align: center;"> <tr> <td style="width: 10%;"></td> <td style="width: 10%;"></td> <td style="width: 10%;"></td> <td style="width: 10%;"></td> <td style="width: 10%;"></td> <td style="width: 10%;"></td> <td style="width: 10%;"></td> <td style="width: 10%;"></td> <td style="width: 10%;"></td> <td style="width: 10%;"></td> </tr> <tr> <td></td> <td></td> <td colspan="8" style="text-align: center;"> <table border="1" style="width: 100%; border-collapse: collapse; text-align: center;"> <tr>
</tr></table></td></tr></table></td></tr></table></td></tr></table></td></tr></table></td></tr></table></td></tr></table></td></tr></table></td></tr></table></td></tr></table></td></tr></table></td></tr></table></td></tr></table></td></tr></table></td></tr></table></td></tr></table></td></tr></table></td></tr></table></td></tr></table></td></tr></table></td></tr></table></td></tr></table></td></tr></table></td></tr></table></td></tr></table></td></tr></table></td></tr></table></td></tr></table></td></tr></table></td></tr></table></td></tr></table></td></tr></table></td></tr></table></td></tr></table></td></tr></table></td></tr></table></td></tr></table></td></tr></table></td></tr></table></td></tr></table></td></tr></table></td></tr></table></td></tr></table></td></tr></table></td></tr></table></td></tr></table></td></tr></table> | | | | | | | | | | | | | | | | | | | | <table border="1" style="width: 100%; border-collapse: collapse; text-align: center;"> <tr> <td style="width: 10%;"></td> <td style="width: 10%;"></td> <td style="width: 10%;"></td> <td style="width: 10%;"></td> <td style="width: 10%;"></td> <td style="width: 10%;"></td> <td style="width: 10%;"></td> <td style="width: 10%;"></td> <td style="width: 10%;"></td> <td style="width: 10%;"></td> </tr> <tr> <td></td> <td></td> <td colspan="8" style="text-align: center;"> <table border="1" style="width: 100%; border-collapse: collapse; text-align: center;"> <tr> <td style="width: 10%;"></td> <td style="width: 10%;"></td> <td style="width: 10%;"></td> <td style="width: 10%;"></td> <td style="width: 10%;"></td> <td style="width: 10%;"></td> <td style="width: 10%;"></td> <td style="width: 10%;"></td> <td style="width: 10%;"></td> <td style="width: 10%;"></td> </tr> <tr> <td></td> <td></td> <td colspan="8" style="text-align: center;"> <table border="1" style="width: 100%; border-collapse: collapse; text-align: center;"> <tr> <td style="width: 10%;"></td> <td style="width: 10%;"></td> <td style="width: 10%;"></td> <td style="width: 10%;"></td> <td style="width: 10%;"></td> <td style="width: 10%;"></td> <td style="width: 10%;"></td> <td style="width: 10%;"></td> <td style="width: 10%;"></td> <td style="width: 10%;"></td> </tr> <tr> <td></td> <td></td> <td colspan="8" style="text-align: center;"> <table border="1" style="width: 100%; border-collapse: collapse; text-align: center;"> <tr> <td style="width: 10%;"></td> <td style="width: 10%;"></td> <td style="width: 10%;"></td> <td style="width: 10%;"></td> <td style="width: 10%;"></td> <td style="width: 10%;"></td> <td style="width: 10%;"></td> <td style="width: 10%;"></td> <td style="width: 10%;"></td> <td style="width: 10%;"></td> </tr> <tr> <td></td> <td></td> <td colspan="8" style="text-align: center;"> <table border="1" style="width: 100%; border-collapse: collapse; text-align: center;"> <tr> <td style="width: 10%;"></td> <td style="width: 10%;"></td> <td style="width: 10%;"></td> <td style="width: 10%;"></td> <td style="width: 10%;"></td> <td style="width: 10%;"></td> <td style="width: 10%;"></td> <td style="width: 10%;"></td> <td style="width: 10%;"></td> <td style="width: 10%;"></td> </tr> <tr> <td></td> <td></td> <td colspan="8" style="text-align: center;"> <table border="1" style="width: 100%; border-collapse: collapse; text-align: center;"> <tr> <td style="width: 10%;"></td> <td style="width: 10%;"></td> <td style="width: 10%;"></td> <td style="width: 10%;"></td> <td style="width: 10%;"></td> <td style="width: 10%;"></td> <td style="width: 10%;"></td> <td style="width: 10%;"></td> <td style="width: 10%;"></td> <td style="width: 10%;"></td> </tr> <tr> <td></td> <td></td> <td colspan="8" style="text-align: center;"> <table border="1" style="width: 100%; border-collapse: collapse; text-align: center;"> <tr> <td style="width: 10%;"></td> <td style="width: 10%;"></td> <td style="width: 10%;"></td> <td style="width: 10%;"></td> <td style="width: 10%;"></td> <td style="width: 10%;"></td> <td style="width: 10%;"></td> <td style="width: 10%;"></td> <td style="width: 10%;"></td> <td style="width: 10%;"></td> </tr> <tr> <td></td> <td></td> <td colspan="8" style="text-align: center;"> <table border="1" style="width: 100%; border-collapse: collapse; text-align: center;"> <tr> <td style="width: 10%;"></td> <td style="width: 10%;"></td> <td style="width: 10%;"></td> <td style="width: 10%;"></td> <td style="width: 10%;"></td> <td style="width: 10%;"></td> <td style="width: 10%;"></td> <td style="width: 10%;"></td> <td style="width: 10%;"></td> <td style="width: 10%;"></td> </tr> <tr> <td></td> <td></td> <td colspan="8" style="text-align: center;"> <table border="1" style="width: 100%; border-collapse: collapse; text-align: center;"> <tr> <td style="width: 10%;"></td> <td style="width: 10%;"></td> <td style="width: 10%;"></td> <td style="width: 10%;"></td> <td style="width: 10%;"></td> <td style="width: 10%;"></td> <td style="width: 10%;"></td> <td style="width: 10%;"></td> <td style="width: 10%;"></td> <td style="width: 10%;"></td> </tr> <tr> <td></td> <td></td> <td colspan="8" style="text-align: center;"> <table border="1" style="width: 100%; border-collapse: collapse; text-align: center;"> <tr> <td style="width: 10%;"></td> <td style="width: 10%;"></td> <td style="width: 10%;"></td> <td style="width: 10%;"></td> <td style="width: 10%;"></td> <td style="width: 10%;"></td> <td style="width: 10%;"></td> <td style="width: 10%;"></td> <td style="width: 10%;"></td> <td style="width: 10%;"></td> </tr> <tr> <td></td> <td></td> <td colspan="8" style="text-align: center;"> <table border="1" style="width: 100%; border-collapse: collapse; text-align: center;"> <tr> <td style="width: 10%;"></td> <td style="width: 10%;"></td> <td style="width: 10%;"></td> <td style="width: 10%;"></td> <td style="width: 10%;"></td> <td style="width: 10%;"></td> <td style="width: 10%;"></td> <td style="width: 10%;"></td> <td style="width: 10%;"></td> <td style="width: 10%;"></td> </tr> <tr> <td></td> <td></td> <td colspan="8" style="text-align: center;"> <table border="1" style="width: 100%; border-collapse: collapse; text-align: center;"> <tr> <td style="width: 10%;"></td> <td style="width: 10%;"></td> <td style="width: 10%;"></td> <td style="width: 10%;"></td> <td style="width: 10%;"></td> <td style="width: 10%;"></td> <td style="width: 10%;"></td> <td style="width: 10%;"></td> <td style="width: 10%;"></td> <td style="width: 10%;"></td> </tr> <tr> <td></td> <td></td> <td colspan="8" style="text-align: center;"> <table border="1" style="width: 100%; border-collapse: collapse; text-align:
center;"> <tr> <td style="width: 10%;"></td> <td style="width: 10%;"></td> <td style="width: 10%;"></td> <td style="width: 10%;"></td> <td style="width: 10%;"></td> <td style="width: 10%;"></td> <td style="width: 10%;"></td> <td style="width: 10%;"></td> <td style="width: 10%;"></td> <td style="width: 10%;"></td> </tr> <tr> <td></td> <td></td> <td colspan="8" style="text-align: center;"> <table border="1" style="width: 100%; border-collapse: collapse; text-align: center;"> <tr> <td style="width: 10%;"></td> <td style="width: 10%;"></td> <td style="width: 10%;"></td> <td style="width: 10%;"></td> <td style="width: 10%;"></td> <td style="width: 10%;"></td> <td style="width: 10%;"></td> <td style="width: 10%;"></td> <td style="width: 10%;"></td> <td style="width: 10%;"></td> </tr> <tr> <td></td> <td></td> <td colspan="8" style="text-align: center;"> <table border="1" style="width: 100%; border-collapse: collapse; text-align: center;"> <tr> <td style="width: 10%;"></td> <td style="width: 10%;"></td> <td style="width: 10%;"></td> <td style="width: 10%;"></td> <td style="width: 10%;"></td> <td style="width: 10%;"></td> <td style="width: 10%;"></td> <td style="width: 10%;"></td> <td style="width: 10%;"></td> <td style="width: 10%;"></td> </tr> <tr> <td></td> <td></td> <td colspan="8" style="text-align: center;"> <table border="1" style="width: 100%; border-collapse: collapse; text-align: center;"> <tr> <td style="width: 10%;"></td> <td style="width: 10%;"></td> <td style="width: 10%;"></td> <td style="width: 10%;"></td> <td style="width: 10%;"></td> <td style="width: 10%;"></td> <td style="width: 10%;"></td> <td style="width: 10%;"></td> <td style="width: 10%;"></td> <td style="width: 10%;"></td> </tr> <tr> <td></td> <td></td> <td colspan="8" style="text-align: center;"> <table border="1" style="width: 100%; border-collapse: collapse; text-align: center;"> <tr> <td style="width: 10%;"></td> <td style="width: 10%;"></td> <td style="width: 10%;"></td> <td style="width: 10%;"></td> <td style="width: 10%;"></td> <td style="width: 10%;"></td> <td style="width: 10%;"></td> <td style="width: 10%;"></td> <td style="width: 10%;"></td> <td style="width: 10%;"></td> </tr> <tr> <td></td> <td></td> <td colspan="8" style="text-align: center;"> <table border="1" style="width: 100%; border-collapse: collapse; text-align: center;"> <tr> <td style="width: 10%;"></td> <td style="width: 10%;"></td> <td style="width: 10%;"></td> <td style="width: 10%;"></td> <td style="width: 10%;"></td> <td style="width: 10%;"></td> <td style="width: 10%;"></td> <td style="width: 10%;"></td> <td style="width: 10%;"></td> <td style="width: 10%;"></td> </tr> <tr> <td></td> <td></td> <td colspan="8" style="text-align: center;"> <table border="1" style="width: 100%; border-collapse: collapse; text-align: center;"> <tr> <td style="width: 10%;"></td> <td style="width: 10%;"></td> <td style="width: 10%;"></td> <td style="width: 10%;"></td> <td style="width: 10%;"></td> <td style="width: 10%;"></td> <td style="width: 10%;"></td> <td style="width: 10%;"></td> <td style="width: 10%;"></td> <td style="width: 10%;"></td> </tr> <tr> <td></td> <td></td> <td colspan="8" style="text-align: center;"> <table border="1" style="width: 100%; border-collapse: collapse; text-align: center;"> <tr> <td style="width: 10%;"></td> <td style="width: 10%;"></td> <td style="width: 10%;"></td> <td style="width: 10%;"></td> <td style="width: 10%;"></td> <td style="width: 10%;"></td> <td style="width: 10%;"></td> <td style="width: 10%;"></td> <td style="width: 10%;"></td> <td style="width: 10%;"></td> </tr> <tr> <td></td> <td></td> <td colspan="8" style="text-align: center;"> <table border="1" style="width: 100%; border-collapse: collapse; text-align: center;"> <tr> <td style="width: 10%;"></td> <td style="width: 10%;"></td> <td style="width: 10%;"></td> <td style="width: 10%;"></td> <td style="width: 10%;"></td> <td style="width: 10%;"></td> <td style="width: 10%;"></td> <td style="width: 10%;"></td> <td style="width: 10%;"></td> <td style="width: 10%;"></td> </tr> <tr> <td></td> <td></td> <td colspan="8" style="text-align: center;"> <table border="1" style="width: 100%; border-collapse: collapse; text-align: center;"> <tr> <td style="width: 10%;"></td> <td style="width: 10%;"></td> <td style="width: 10%;"></td> <td style="width: 10%;"></td> <td style="width: 10%;"></td> <td style="width: 10%;"></td> <td style="width: 10%;"></td> <td style="width: 10%;"></td> <td style="width: 10%;"></td> <td style="width: 10%;"></td> </tr> <tr> <td></td> <td></td> <td colspan="8" style="text-align: center;"> <table border="1" style="width: 100%; border-collapse: collapse; text-align: center;"> <tr> <td style="width: 10%;"></td> <td style="width: 10%;"></td> <td style="width: 10%;"></td> <td style="width: 10%;"></td> <td style="width: 10%;"></td> <td style="width: 10%;"></td> <td style="width: 10%;"></td> <td style="width: 10%;"></td> <td style="width: 10%;"></td> <td style="width: 10%;"></td> </tr> <tr> <td></td> <td></td> <td colspan="8" style="text-align: center;"> <table border="1" style="width: 100%; border-collapse: collapse; text-align: center;"> <tr> <td style="width: 10%;"></td> <td style="width: 10%;"></td> <td style="width: 10%;"></td> <td style="width: 10%;"></td> <td style="width: 10%;"></td> <td style="width: 10%;"></td> <td style="width: 10%;"></td> <td style="width: 10%;"></td> <td style="width: 10%;"></td> <td style="width: 10%;"></td> </tr> <tr> <td></td> <td></td> <td colspan="8" style="text-align: center;"> <table border="1" style="width: 100%; border-collapse: collapse; text-align: center;"> <tr> <td style="width: 10%;"></td> <td style="width: 10%;"></td> <td style="width: 10%;"></td> <td style="width: 10%;"></td> <td style="width: 10%;"></td> <td style="width: 10%;"></td> <td style="width: 10%;"></td> <td style="width: 10%;"></td> <td style="width: 10%;"></td> <td style="width: 10%;"></td> </tr> <tr> <td></td> <td></td> <td colspan="8" style="text-align: center;"> <table border="1" style="width: 100%; border-collapse: collapse; text-align: center;"> <tr> <td style="width: 10%;"></td> <td style="width: 10%;"></td> <td style="width: 10%;"></td> <td style="width: 10%;"></td> <td style="width: 10%;"></td> <td style="width: 10%;"></td> <td style="width: 10%;"></td> <td style="width: 10%;"></td> <td style="width: 10%;"></td> <td style="width: 10%;"></td> </tr> <tr> <td></td> <td></td> <td colspan="8" style="text-align: center;"> <table border="1" style="width: 100%; border-collapse: collapse; text-align: center;"> <tr> <td style="width: 10%;"></td> <td style="width: 10%;"></td> <td style="width: 10%;"></td> <td style="width: 10%;"></td> <td style="width: 10%;"></td> <td style="width: 10%;"></td> <td style="width: 10%;"></td> <td style="width: 10%;"></td> <td style="width: 10%;"></td> <td style="width: 10%;"></td> </tr> <tr> <td></td> <td></td> <td colspan="8" style="text-align: center;"> <table border="1" style="width: 100%; border-collapse: collapse; text-align: center;"> <tr> <td style="width: 10%;"></td> <td style="width: 10%;"></td> <td style="width: 10%;"></td> <td style="width: 10%;"></td> <td style="width: 10%;"></td> <td style="width: 10%;"></td> <td style="width: 10%;"></td> <td style="width: 10%;"></td> <td style="width: 10%;"></td> <td style="width: 10%;"></td> </tr> <tr> <td></td> <td></td> <td colspan="8" style="text-align: center;"> <table border="1" style="width: 100%; border-collapse: collapse; text-align: center;"> <tr> <td style="width: 10%;"></td> <td style="width: 10%;"></td> <td style="width: 10%;"></td> <td style="width: 10%;"></td> <td style="width: 10%;"></td> <td style="width: 10%;"></td> <td style="width: 10%;"></td> <td style="width: 10%;"></td> <td style="width: 10%;"></td> <td style="width: 10%;"></td> </tr> <tr> <td></td> <td></td> <td colspan="8" style="text-align: center;"> <table border="1" style="width: 100%; border-collapse: collapse; text-align: center;"> <tr> <td style="width: 10%;"></td> <td style="width: 10%;"></td> <td style="width: 10%;"></td> <td style="width: 10%;"></td> <td style="width: 10%;"></td> <td style="width: 10%;"></td> <td style="width: 10%;"></td> <td style="width: 10%;"></td> <td style="width: 10%;"></td> <td style="width: 10%;"></td> </tr> <tr> <td></td> <td></td> <td colspan="8" style="text-align: center;"> <table border="1" style="width: 100%; border-collapse: collapse; text-align: center;"> <tr> <td style="width: 10%;"></td> <td style="width: 10%;"></td> <td style="width: 10%;"></td> <td style="width: 10%;"></td> <td style="width: 10%;"></td> <td style="width: 10%;"></td> <td style="width: 10%;"></td> <td style="width: 10%;"></td> <td style="width: 10%;"></td> <td style="width: 10%;"></td> </tr> <tr> <td></td> <td></td> <td colspan="8" style="text-align: center;"> <table border="1" style="width: 100%; border-collapse: collapse; text-align: center;"> <tr> <td style="width: 10%;"></td> <td style="width: 10%;"></td> <td style="width: 10%;"></td> <td style="width: 10%;"></td> <td style="width: 10%;"></td> <td style="width: 10%;"></td> <td style="width: 10%;"></td> <td style="width: 10%;"></td> <td style="width: 10%;"></td> <td style="width: 10%;"></td> </tr> <tr> <td></td> <td></td> <td colspan="8" style="text-align: center;"> <table border="1" style="width: 100%; border-collapse: collapse; text-align: center;"> <tr> <td style="width: 10%;"></td> <td style="width: 10%;"></td> <td style="width: 10%;"></td> <td style="width: 10%;"></td> <td style="width: 10%;"></td> <td style="width: 10%;"></td> <td style="width: 10%;"></td> <td style="width: 10%;"></td> <td style="width: 10%;"></td> <td style="width: 10%;"></td> </tr> <tr> <td></td> <td></td> <td colspan="8" style="text-align: center;"> <table border="1" style="width: 100%; border-collapse: collapse; text-align: center;"> <tr> <td style="width: 10%;"></td> <td style="width: 10%;"></td> <td style="width: 10%;"></td> <td style="width: 10%;"></td> <td style="width: 10%;"></td> <td
style="width: 10%;"></td> <td style="width: 10%;"></td> <td style="width: 10%;"></td> <td style="width: 10%;"></td> <td style="width: 10%;"></td> </tr> <tr> <td></td> <td></td> <td colspan="8" style="text-align: center;"> <table border="1" style="width: 100%; border-collapse: collapse; text-align: center;"> <tr> <td style="width: 10%;"></td> <td style="width: 10%;"></td> <td style="width: 10%;"></td> <td style="width: 10%;"></td> <td style="width: 10%;"></td> <td style="width: 10%;"></td> <td style="width: 10%;"></td> <td style="width: 10%;"></td> <td style="width: 10%;"></td> <td style="width: 10%;"></td> </tr> <tr> <td></td> <td></td> <td colspan="8" style="text-align: center;"> <table border="1" style="width: 100%; border-collapse: collapse; text-align: center;"> <tr> <td style="width: 10%;"></td> <td style="width: 10%;"></td> <td style="width: 10%;"></td> <td style="width: 10%;"></td> <td style="width: 10%;"></td> <td style="width: 10%;"></td> <td style="width: 10%;"></td> <td style="width: 10%;"></td> <td style="width: 10%;"></td> <td style="width: 10%;"></td> </tr> <tr> <td></td> <td></td> <td colspan="8" style="text-align: center;"> <table border="1" style="width: 100%; border-collapse: collapse; text-align: center;"> <tr> <td style="width: 10%;"></td> <td style="width: 10%;"></td> <td style="width: 10%;"></td> <td style="width: 10%;"></td> <td style="width: 10%;"></td> <td style="width: 10%;"></td> <td style="width: 10%;"></td> <td style="width: 10%;"></td> <td style="width: 10%;"></td> <td style="width: 10%;"></td> </tr> <tr> <td></td> <td></td> <td colspan="8" style="text-align: center;"> <table border="1" style="width: 100%; border-collapse: collapse; text-align: center;"> <tr> <td style="width: 10%;"></td> <td style="width: 10%;"></td> <td style="width: 10%;"></td> <td style="width: 10%;"></td> <td style="width: 10%;"></td> <td style="width: 10%;"></td> <td style="width: 10%;"></td> <td style="width: 10%;"></td> <td style="width: 10%;"></td> <td style="width: 10%;"></td> </tr> <tr> <td></td> <td></td> <td colspan="8" style="text-align: center;"> <table border="1" style="width: 100%; border-collapse: collapse; text-align: center;"> <tr> <td style="width: 10%;"></td> <td style="width: 10%;"></td> <td style="width: 10%;"></td> <td style="width: 10%;"></td> <td style="width: 10%;"></td> <td style="width: 10%;"></td> <td style="width: 10%;"></td> <td style="width: 10%;"></td> <td style="width: 10%;"></td> <td style="width: 10%;"></td> </tr> <tr> <td></td> <td></td> <td colspan="8" style="text-align: center;"> <table border="1" style="width: 100%; border-collapse: collapse; text-align: center;"> <tr> <td style="width: 10%;"></td> <td style="width: 10%;"></td> <td style="width: 10%;"></td> <td style="width: 10%;"></td> <td style="width: 10%;"></td> <td style="width: 10%;"></td> <td style="width: 10%;"></td> <td style="width: 10%;"></td> <td style="width: 10%;"></td> <td style="width: 10%;"></td> </tr> <tr> <td></td> <td></td> <td colspan="8" style="text-align: center;"> <table border="1" style="width: 100%; border-collapse: collapse; text-align: center;"> <tr> <td style="width: 10%;"></td> <td style="width: 10%;"></td> <td style="width: 10%;"></td> <td style="width: 10%;"></td> <td style="width: 10%;"></td> <td style="width: 10%;"></td> <td style="width: 10%;"></td> <td style="width: 10%;"></td> <td style="width: 10%;"></td> <td style="width: 10%;"></td> </tr> <tr> <td></td> <td></td> <td colspan="8" style="text-align: center;"> <table border="1" style="width: 100%; border-collapse: collapse; text-align: center;"> <tr> <td style="width: 10%;"></td> <td style="width: 10%;"></td> <td style="width: 10%;"></td> <td style="width: 10%;"></td> <td style="width: 10%;"></td> <td style="width: 10%;"></td> <td style="width: 10%;"></td> <td style="width: 10%;"></td> <td style="width: 10%;"></td> <td style="width: 10%;"></td> </tr> <tr> <td></td> <td></td> <td colspan="8" style="text-align: center;"> <table border="1" style="width: 100%; border-collapse: collapse; text-align: center;"> <tr> <td style="width: 10%;"></td> <td style="width: 10%;"></td> <td style="width: 10%;"></td> <td style="width: 10%;"></td> <td style="width: 10%;"></td> <td style="width: 10%;"></td> <td style="width: 10%;"></td> <td style="width: 10%;"></td> <td style="width: 10%;"></td> <td style="width: 10%;"></td> </tr> <tr> <td></td> <td></td> <td colspan="8" style="text-align: center;"> <table border="1" style="width: 100%; border-collapse: collapse; text-align: center;"> <tr> <td style="width: 10%;"></td> <td style="width: 10%;"></td> <td style="width: 10%;"></td> <td style="width: 10%;"></td> <td style="width: 10%;"></td> <td style="width: 10%;"></td> <td style="width: 10%;"></td> <td style="width: 10%;"></td> <td style="width: 10%;"></td> <td style="width: 10%;"></td> </tr> <tr> <td></td> <td></td> <td colspan="8" style="text-align: center;"> <table border="1" style="width: 100%; border-collapse: collapse; text-align: center;"> <tr> <td style="width: 10%;"></td> <td style="width: 10%;"></td> <td style="width: 10%;"></td> <td style="width: 10%;"></td> <td style="width: 10%;"></td> <td style="width: 10%;"></td> <td style="width: 10%;"></td> <td style="width: 10%;"></td> <td style="width: 10%;"></td> <td style="width: 10%;"></td> </tr> <tr> <td></td> <td></td> <td colspan="8" style="text-align: center;"> <table border="1" style="width: 100%; border-collapse: collapse; text-align: center;"> <tr> </tr></table></td></tr></table></td></tr></table></td></tr></table></td></tr></table></td></tr></table></td></tr></table></td></tr></table></td></tr></table></td></tr></table></td></tr></table></td></tr></table></td></tr></table></td></tr></table></td></tr></table></td></tr></table></td></tr></table></td></tr></table></td></tr></table></td></tr></table></td></tr></table></td></tr></table></td></tr></table></td></tr></table></td></tr></table></td></tr></table></td></tr></table></td></tr></table></td></tr></table></td></tr></table></td></tr></table></td></tr></table></td></tr></table></td></tr></table></td></tr></table></td></tr></table></td></tr></table></td></tr></table></td></tr></table></td></tr></table></td></tr></table></td></tr></table></td></tr></table></td></tr></table></td></tr></table></td></tr></table> | | | | | | | | | | | | | | | | | | | | <table border="1" style="width: 100%; border-collapse: collapse; text-align: center;"> <tr> <td style="width: 10%;"></td> <td style="width: 10%;"></td> <td style="width: 10%;"></td> <td style="width: 10%;"></td> <td style="width: 10%;"></td> <td
style="width: 10%;"></td> <td style="width: 10%;"></td> <td style="width: 10%;"></td> <td style="width: 10%;"></td> <td style="width: 10%;"></td> </tr> <tr> <td></td> <td></td> <td colspan="8" style="text-align: center;"> <table border="1" style="width: 100%; border-collapse: collapse; text-align: center;"> <tr> <td style="width: 10%;"></td> <td style="width: 10%;"></td> <td style="width: 10%;"></td> <td style="width: 10%;"></td> <td style="width: 10%;"></td> <td style="width: 10%;"></td> <td style="width: 10%;"></td> <td style="width: 10%;"></td> <td style="width: 10%;"></td> <td style="width: 10%;"></td> </tr> <tr> <td></td> <td></td> <td colspan="8" style="text-align: center;"> <table border="1" style="width: 100%; border-collapse: collapse; text-align: center;"> <tr> <td style="width: 10%;"></td> <td style="width: 10%;"></td> <td style="width: 10%;"></td> <td style="width: 10%;"></td> <td style="width: 10%;"></td> <td style="width: 10%;"></td> <td style="width: 10%;"></td> <td style="width: 10%;"></td> <td style="width: 10%;"></td> <td style="width: 10%;"></td> </tr> <tr> <td></td> <td></td> <td colspan="8" style="text-align: center;"> <table border="1" style="width: 100%; border-collapse: collapse; text-align: center;"> <tr> <td style="width: 10%;"></td> <td style="width: 10%;"></td> <td style="width: 10%;"></td> <td style="width: 10%;"></td> <td style="width: 10%;"></td> <td style="width: 10%;"></td> <td style="width: 10%;"></td> <td style="width: 10%;"></td> <td style="width: 10%;"></td> <td style="width: 10%;"></td> </tr> <tr> <td></td> <td></td> <td colspan="8" style="text-align: center;"> <table border="1" style="width: 100%; border-collapse: collapse; text-align: center;"> <tr> <td style="width: 10%;"></td> <td style="width: 10%;"></td> <td style="width: 10%;"></td> <td style="width: 10%;"></td> <td style="width: 10%;"></td> <td style="width: 10%;"></td> <td style="width: 10%;"></td> <td style="width: 10%;"></td> <td style="width: 10%;"></td> <td style="width: 10%;"></td> </tr> <tr> <td></td> <td></td> <td colspan="8" style="text-align: center;"> <table border="1" style="width: 100%; border-collapse: collapse; text-align: center;"> <tr> <td style="width: 10%;"></td> <td style="width: 10%;"></td> <td style="width: 10%;"></td> <td style="width: 10%;"></td> <td style="width: 10%;"></td> <td style="width: 10%;"></td> <td style="width: 10%;"></td> <td style="width: 10%;"></td> <td style="width: 10%;"></td> <td style="width: 10%;"></td> </tr> <tr> <td></td> <td></td> <td colspan="8" style="text-align: center;"> <table border="1" style="width: 100%; border-collapse: collapse; text-align: center;"> <tr> <td style="width: 10%;"></td> <td style="width: 10%;"></td> <td style="width: 10%;"></td> <td style="width: 10%;"></td> <td style="width: 10%;"></td> <td style="width: 10%;"></td> <td style="width: 10%;"></td> <td style="width: 10%;"></td> <td style="width: 10%;"></td> <td style="width: 10%;"></td> </tr> <tr> <td></td> <td></td> <td colspan="8" style="text-align: center;"> <table border="1" style="width: 100%; border-collapse: collapse; text-align: center;"> <tr> <td style="width: 10%;"></td> <td style="width: 10%;"></td> <td style="width: 10%;"></td> <td style="width: 10%;"></td> <td style="width: 10%;"></td> <td style="width: 10%;"></td> <td style="width: 10%;"></td> <td style="width: 10%;"></td> <td style="width: 10%;"></td> <td style="width: 10%;"></td> </tr> <tr> <td></td> <td></td> <td colspan="8" style="text-align: center;"> <table border="1" style="width: 100%; border-collapse: collapse; text-align: center;"> <tr> <td style="width: 10%;"></td> <td style="width: 10%;"></td> <td style="width: 10%;"></td> <td style="width: 10%;"></td> <td style="width: 10%;"></td> <td style="width: 10%;"></td> <td style="width: 10%;"></td> <td style="width: 10%;"></td> <td style="width: 10%;"></td> <td style="width: 10%;"></td> </tr> <tr> <td></td> <td></td> <td colspan="8" style="text-align: center;"> <table border="1" style="width: 100%; border-collapse: collapse; text-align: center;"> <tr> <td style="width: 10%;"></td> <td style="width: 10%;"></td> <td style="width: 10%;"></td> <td style="width: 10%;"></td> <td style="width: 10%;"></td> <td style="width: 10%;"></td> <td style="width: 10%;"></td> <td style="width: 10%;"></td> <td style="width: 10%;"></td> <td style="width: 10%;"></td> </tr> <tr> <td></td> <td></td> <td colspan="8" style="text-align: center;"> <table border="1" style="width: 100%; border-collapse: collapse; text-align: center;"> <tr> <td style="width: 10%;"></td> <td style="width: 10%;"></td> <td style="width: 10%;"></td> <td style="width: 10%;"></td> <td style="width: 10%;"></td> <td style="width: 10%;"></td> <td style="width: 10%;"></td> <td style="width: 10%;"></td> <td style="width: 10%;"></td> <td style="width: 10%;"></td> </tr> <tr> <td></td> <td></td> <td colspan="8" style="text-align: center;"> <table border="1" style="width: 100%; border-collapse: collapse; text-align: center;"> <tr> <td style="width: 10%;"></td> <td style="width: 10%;"></td> <td style="width: 10%;"></td> <td style="width: 10%;"></td> <td style="width: 10%;"></td> <td style="width: 10%;"></td> <td style="width: 10%;"></td> <td style="width: 10%;"></td> <td style="width: 10%;"></td> <td style="width: 10%;"></td> </tr> <tr> <td></td> <td></td> <td colspan="8" style="text-align: center;"> <table border="1" style="width: 100%; border-collapse: collapse; text-align: center;"> <tr> <td style="width: 10%;"></td> <td style="width: 10%;"></td> <td style="width: 10%;"></td> <td style="width: 10%;"></td> <td style="width: 10%;"></td> <td style="width: 10%;"></td> <td style="width: 10%;"></td> <td style="width: 10%;"></td> <td style="width: 10%;"></td> <td style="width: 10%;"></td> </tr> <tr> <td></td> <td></td> <td colspan="8" style="text-align: center;"> <table border="1" style="width: 100%; border-collapse: collapse; text-align: center;"> <tr> <td style="width: 10%;"></td> <td style="width: 10%;"></td> <td style="width: 10%;"></td> <td style="width: 10%;"></td> <td style="width: 10%;"></td> <td style="width: 10%;"></td> <td style="width: 10%;"></td> <td style="width: 10%;"></td> <td style="width: 10%;"></td> <td style="width: 10%;"></td> </tr> <tr> <td></td> <td></td> <td colspan="8" style="text-align: center;"> <table border="1" style="width: 100%; border-collapse: collapse; text-align: center;"> <tr> <td style="width: 10%;"></td> <td style="width: 10%;"></td> <td style="width: 10%;"></td> <td style="width: 10%;"></td> <td style="width: 10%;"></td> <td style="width: 10%;"></td> <td style="width: 10%;"></td> <td style="width: 10%;"></td> <td style="width: 10%;"></td> <td style="width: 10%;"></td> </tr> <tr> <td></td> <td></td> <td colspan="8" style="text-align: center;"> <table border="1" style="width: 100%; border-collapse: collapse; text-align: center;"> <tr> <td style="width: 10%;"></td> <td style="width: 10%;"></td> <td style="width: 10%;"></td> <td style="width: 10%;"></td> <td style="width: 10%;"></td> <td style="width: 10%;"></td> <td style="width: 10%;"></td> <td style="width: 10%;"></td> <td style="width: 10%;"></td> <td style="width: 10%;"></td> </tr> <tr> <td></td> <td></td> <td colspan="8" style="text-align: center;"> <table border="1" style="width: 100%; border-collapse: collapse; text-align: center;"> <tr> <td style="width: 10%;"></td> <td style="width: 10%;"></td> <td style="width: 10%;"></td> <td style="width: 10%;"></td> <td style="width: 10%;"></td> <td style="width: 10%;"></td> <td style="width: 10%;"></td> <td style="width: 10%;"></td> <td style="width: 10%;"></td> <td style="width: 10%;"></td> </tr> <tr> <td></td> <td></td> <td colspan="8" style="text-align: center;"> <table border="1" style="width: 100%; border-collapse: collapse; text-align: center;"> <tr> <td style="width: 10%;"></td> <td style="width: 10%;"></td> <td style="width: 10%;"></td> <td style="width: 10%;"></td> <td style="width: 10%;"></td> <td style="width: 10%;"></td> <td style="width: 10%;"></td> <td style="width: 10%;"></td> <td style="width: 10%;"></td> <td style="width: 10%;"></td> </tr> <tr> <td></td> <td></td> <td colspan="8" style="text-align: center;"> <table border="1" style="width: 100%; border-collapse: collapse; text-align: center;"> <tr> <td style="width: 10%;"></td> <td style="width: 10%;"></td> <td style="width: 10%;"></td> <td style="width: 10%;"></td> <td style="width: 10%;"></td> <td style="width: 10%;"></td> <td style="width: 10%;"></td> <td style="width: 10%;"></td> <td style="width: 10%;"></td> <td style="width: 10%;"></td> </tr> <tr> <td></td> <td></td> <td colspan="8" style="text-align: center;"> <table border="1" style="width: 100%; border-collapse: collapse; text-align: center;"> <tr> <td style="width: 10%;"></td> <td style="width: 10%;"></td> <td style="width: 10%;"></td> <td style="width: 10%;"></td> <td style="width: 10%;"></td> <td style="width: 10%;"></td> <td style="width: 10%;"></td> <td style="width: 10%;"></td> <td style="width: 10%;"></td> <td style="width: 10%;"></td> </tr> <tr> <td></td> <td></td> <td colspan="8" style="text-align: center;"> <table border="1" style="width: 100%; border-collapse: collapse; text-align: center;"> <tr> <td style="width: 10%;"></td> <td style="width: 10%;"></td> <td style="width: 10%;"></td> <td style="width: 10%;"></td> <td style="width: 10%;"></td> <td style="width: 10%;"></td> <td style="width: 10%;"></td> <td style="width: 10%;"></td> <td style="width: 10%;"></td> <td style="width: 10%;"></td> </tr> <tr> <td></td> <td></td> <td colspan="8" style="text-align: center;"> <table border="1" style="width: 100%; border-collapse: collapse; text-align: center;"> <tr> <td style="width: 10%;"></td> <td style="width: 10%;"></td> <td style="width: 10%;"></td> <td style="width: 10%;"></td> <td style="width: 10%;"></td> <td style="width: 10%;"></td> <td style="width: 10%;"></td> <td style="width: 10%;"></td> <td style="width: 10%;"></td> <td style="width: 10%;"></td> </tr> <tr> <td></td>
<td></td> <td colspan="8" style="text-align: center;"> <table border="1" style="width: 100%; border-collapse: collapse; text-align: center;"> <tr> <td style="width: 10%;"></td> <td style="width: 10%;"></td> <td style="width: 10%;"></td> <td style="width: 10%;"></td> <td style="width: 10%;"></td> <td style="width: 10%;"></td> <td style="width: 10%;"></td> <td style="width: 10%;"></td> <td style="width: 10%;"></td> <td style="width: 10%;"></td> </tr> <tr> <td></td> <td></td> <td colspan="8" style="text-align: center;"> <table border="1" style="width: 100%; border-collapse: collapse; text-align: center;"> <tr> <td style="width: 10%;"></td> <td style="width: 10%;"></td> <td style="width: 10%;"></td> <td style="width: 10%;"></td> <td style="width: 10%;"></td> <td style="width: 10%;"></td> <td style="width: 10%;"></td> <td style="width: 10%;"></td> <td style="width: 10%;"></td> <td style="width: 10%;"></td> </tr> <tr> <td></td> <td></td> <td colspan="8" style="text-align: center;"> <table border="1" style="width: 100%; border-collapse: collapse; text-align: center;"> <tr> <td style="width: 10%;"></td> <td style="width: 10%;"></td> <td style="width: 10%;"></td> <td style="width: 10%;"></td> <td style="width: 10%;"></td> <td style="width: 10%;"></td> <td style="width: 10%;"></td> <td style="width: 10%;"></td> <td style="width: 10%;"></td> <td style="width: 10%;"></td> </tr> <tr> <td></td> <td></td> <td colspan="8" style="text-align: center;"> <table border="1" style="width: 100%; border-collapse: collapse; text-align: center;"> <tr> <td style="width: 10%;"></td> <td style="width: 10%;"></td> <td style="width: 10%;"></td> <td style="width: 10%;"></td> <td style="width: 10%;"></td> <td style="width: 10%;"></td> <td style="width: 10%;"></td> <td style="width: 10%;"></td> <td style="width: 10%;"></td> <td style="width: 10%;"></td> </tr> <tr> <td></td> <td></td> <td colspan="8" style="text-align: center;"> <table border="1" style="width: 100%; border-collapse: collapse; text-align: center;"> <tr> <td style="width: 10%;"></td> <td style="width: 10%;"></td> <td style="width: 10%;"></td> <td style="width: 10%;"></td> <td style="width: 10%;"></td> <td style="width: 10%;"></td> <td style="width: 10%;"></td> <td style="width: 10%;"></td> <td style="width: 10%;"></td> <td style="width: 10%;"></td> </tr> <tr> <td></td> <td></td> <td colspan="8" style="text-align: center;"> <table border="1" style="width: 100%; border-collapse: collapse; text-align: center;"> <tr> <td style="width: 10%;"></td> <td style="width: 10%;"></td> <td style="width: 10%;"></td> <td style="width: 10%;"></td> <td style="width: 10%;"></td> <td style="width: 10%;"></td> <td style="width: 10%;"></td> <td style="width: 10%;"></td> <td style="width: 10%;"></td> <td style="width: 10%;"></td> </tr> <tr> <td></td> <td></td> <td colspan="8" style="text-align: center;"> <table border="1" style="width: 100%; border-collapse: collapse; text-align: center;"> <tr> <td style="width: 10%;"></td> <td style="width: 10%;"></td> <td style="width: 10%;"></td> <td style="width: 10%;"></td> <td style="width: 10%;"></td> <td style="width: 10%;"></td> <td style="width: 10%;"></td> <td style="width: 10%;"></td> <td style="width: 10%;"></td> <td style="width: 10%;"></td> </tr> <tr> <td></td> <td></td> <td colspan="8" style="text-align: center;"> <table border="1" style="width: 100%; border-collapse: collapse; text-align: center;"> <tr> <td style="width: 10%;"></td> <td style="width: 10%;"></td> <td style="width: 10%;"></td> <td style="width: 10%;"></td> <td style="width: 10%;"></td> <td style="width: 10%;"></td> <td style="width: 10%;"></td> <td style="width: 10%;"></td> <td style="width: 10%;"></td> <td style="width: 10%;"></td> </tr> <tr> <td></td> <td></td> <td colspan="8" style="text-align: center;"> <table border="1" style="width: 100%; border-collapse: collapse; text-align: center;"> <tr> <td style="width: 10%;"></td> <td style="width: 10%;"></td> <td style="width: 10%;"></td> <td style="width: 10%;"></td> <td style="width: 10%;"></td> <td style="width: 10%;"></td> <td style="width: 10%;"></td> <td style="width: 10%;"></td> <td style="width: 10%;"></td> <td style="width: 10%;"></td> </tr> <tr> <td></td> <td></td> <td colspan="8" style="text-align: center;"> <table border="1" style="width: 100%; border-collapse: collapse; text-align: center;"> <tr> <td style="width: 10%;"></td> <td style="width: 10%;"></td> <td style="width: 10%;"></td> <td style="width: 10%;"></td> <td style="width: 10%;"></td> <td style="width: 10%;"></td> <td style="width: 10%;"></td> <td style="width: 10%;"></td> <td style="width: 10%;"></td> <td style="width: 10%;"></td> </tr> <tr> <td></td> <td></td> <td colspan="8" style="text-align: center;"> <table border="1" style="width: 100%; border-collapse: collapse; text-align: center;"> <tr> <td style="width: 10%;"></td> <td style="width: 10%;"></td> <td style="width: 10%;"></td> <td style="width: 10%;"></td> <td style="width: 10%;"></td> <td style="width: 10%;"></td> <td style="width: 10%;"></td> <td style="width: 10%;"></td> <td style="width: 10%;"></td> <td style="width: 10%;"></td> </tr> <tr> <td></td> <td></td> <td colspan="8" style="text-align: center;"> <table border="1" style="width: 100%; border-collapse: collapse; text-align: center;"> <tr> <td style="width: 10%;"></td> <td style="width: 10%;"></td> <td style="width: 10%;"></td> <td style="width: 10%;"></td> <td style="width: 10%;"></td> <td style="width: 10%;"></td> <td style="width: 10%;"></td> <td style="width: 10%;"></td> <td style="width: 10%;"></td> <td style="width: 10%;"></td> </tr> <tr> <td></td> <td></td> <td colspan="8" style="text-align: center;"> <table border="1" style="width: 100%; border-collapse: collapse; text-align: center;"> <tr> <td style="width: 10%;"></td> <td style="width: 10%;"></td> <td style="width: 10%;"></td> <td style="width: 10%;"></td> <td style="width: 10%;"></td> <td style="width: 10%;"></td> <td style="width: 10%;"></td> <td style="width: 10%;"></td> <td style="width: 10%;"></td> <td style="width: 10%;"></td> </tr> <tr> <td></td> <td></td> <td colspan="8" style="text-align: center;"> <table border="1" style="width: 100%; border-collapse: collapse; text-align: center;"> <tr> <td style="width: 10%;"></td> <td style="width: 10%;"></td> <td style="width: 10%;"></td> <td style="width: 10%;"></td> <td style="width: 10%;"></td> <td style="width: 10%;"></td> <td style="width: 10%;"></td> <td style="width: 10%;"></td> <td style="width: 10%;"></td> <td style="width: 10%;"></td> </tr> <tr> <td></td> <td></td> <td colspan="8" style="text-align: center;"> <table border="1" style="width: 100%; border-collapse: collapse; text-align: center;"> <tr> <td style="width: 10%;"></td> <td style="width: 10%;"></td> <td style="width: 10%;"></td> <td style="width: 10%;"></td> <td style="width: 10%;"></td> <td style="width: 10%;"></td> <td style="width: 10%;"></td> <td style="width: 10%;"></td> <td style="width: 10%;"></td> <td style="width: 10%;"></td> </tr> <tr> <td></td> <td></td> <td colspan="8" style="text-align: center;"> <table border="1" style="width: 100%; border-collapse: collapse; text-align: center;"> <tr> <td style="width: 10%;"></td> <td style="width: 10%;"></td> <td style="width: 10%;"></td> <td style="width: 10%;"></td> <td style="width: 10%;"></td> <td style="width: 10%;"></td> <td style="width: 10%;"></td> <td style="width: 10%;"></td> <td style="width: 10%;"></td> <td style="width: 10%;"></td> </tr> <tr> <td></td> <td></td> <td colspan="8" style="text-align: center;"> <table border="1" style="width: 100%; border-collapse: collapse; text-align: center;"> <tr> <td style="width: 10%;"></td> <td style="width: 10%;"></td> <td style="width: 10%;"></td> <td style="width: 10%;"></td> <td style="width: 10%;"></td> <td style="width: 10%;"></td> <td style="width: 10%;"></td> <td style="width: 10%;"></td> <td style="width: 10%;"></td> <td style="width: 10%;"></td> </tr> <tr> <td></td> <td></td> <td colspan="8" style="text-align: center;"> <table border="1" style="width: 100%; border-collapse: collapse; text-align: center;"> <tr> <td style="width: 10%;"></td> <td style="width: 10%;"></td> <td style="width: 10%;"></td> <td style="width: 10%;"></td> <td style="width: 10%;"></td> <td style="width: 10%;"></td> <td style="width: 10%;"></td> <td style="width: 10%;"></td> <td style="width: 10%;"></td> <td style="width: 10%;"></td> </tr> <tr> <td></td> <td></td> <td colspan="8" style="text-align: center;"> <table border="1" style="width: 100%; border-collapse: collapse; text-align: center;"> <tr> <td style="width: 10%;"></td> <td style="width: 10%;"></td> <td style="width: 10%;"></td> <td style="width: 10%;"></td> <td style="width: 10%;"></td> <td style="width: 10%;"></td> <td style="width: 10%;"></td> <td style="width: 10%;"></td> <td style="width: 10%;"></td> <td style="width: 10%;"></td> </tr> <tr> <td></td> <td></td> <td colspan="8" style="text-align: center;"> <table border="1" style="width: 100%; border-collapse: collapse; text-align: center;"> <tr> <td style="width: 10%;"></td> <td style="width: 10%;"></td> <td style="width: 10%;"></td> <td style="width: 10%;"></td> <td style="width: 10%;"></td> <td style="width: 10%;"></td> <td style="width: 10%;"></td> <td style="width: 10%;"></td> <td style="width: 10%;"></td> <td style="width: 10%;"></td> </tr> <tr> <td></td> <td></td> <td colspan="8" style="text-align: center;"> <table border="1" style="width: 100%; border-collapse: collapse; text-align: center;"> <tr> <td style="width: 10%;"></td> <td style="width: 10%;"></td> <td style="width: 10%;"></td> <td style="width: 10%;"></td> <td style="width: 10%;"></td> <td style="width: 10%;"></td> <td style="width: 10%;"></td> <td style="width: 10%;"></td> <td style="width: 10%;"></td> <td style="width: 10%;"></td> </tr> <tr> <td></td> <td></td> <td colspan="8" style="text-align: center;"> <table border="1" style="width: 100%; border-collapse: collapse; text-align: center;"> <tr> <td style="width:
10%;"></td> <td style="width: 10%;"></td> <td style="width: 10%;"></td> <td style="width: 10%;"></td> <td style="width: 10%;"></td> <td style="width: 10%;"></td> <td style="width: 10%;"></td> <td style="width: 10%;"></td> <td style="width: 10%;"></td> <td style="width: 10%;"></td> </tr> <tr> <td></td> <td></td> <td colspan="8" style="text-align: center;"> <table border="1" style="width: 100%; border-collapse: collapse; text-align: center;"> <tr> </tr></table></td></tr></table></td></tr></table></td></tr></table></td></tr></table></td></tr></table></td></tr></table></td></tr></table></td></tr></table></td></tr></table></td></tr></table></td></tr></table></td></tr></table></td></tr></table></td></tr></table></td></tr></table></td></tr></table></td></tr></table></td></tr></table></td></tr></table></td></tr></table></td></tr></table></td></tr></table></td></tr></table></td></tr></table></td></tr></table></td></tr></table></td></tr></table></td></tr></table></td></tr></table></td></tr></table></td></tr></table></td></tr></table></td></tr></table></td></tr></table></td></tr></table></td></tr></table></td></tr></table></td></tr></table></td></tr></table></td></tr></table></td></tr></table></td></tr></table></td></tr></table></td></tr></table> | | | | | | | | | | | | | | | | | | | | <table border="1" style="width: 100%; border-collapse: collapse; text-align: center;"> <tr> <td style="width: 10%;"></td> <td style="width: 10%;"></td> <td style="width: 10%;"></td> <td style="width: 10%;"></td> <td style="width: 10%;"></td> <td style="width: 10%;"></td> <td style="width: 10%;"></td> <td style="width: 10%;"></td> <td style="width: 10%;"></td> <td style="width: 10%;"></td> </tr> <tr> <td></td> <td></td> <td colspan="8" style="text-align: center;"> <table border="1" style="width: 100%; border-collapse: collapse; text-align: center;"> <tr> <td style="width: 10%;"></td> <td style="width: 10%;"></td> <td style="width: 10%;"></td> <td style="width: 10%;"></td> <td style="width: 10%;"></td> <td style="width: 10%;"></td> <td style="width: 10%;"></td> <td style="width: 10%;"></td> <td style="width: 10%;"></td> <td style="width: 10%;"></td> </tr> <tr> <td></td> <td></td> <td colspan="8" style="text-align: center;"> <table border="1" style="width: 100%; border-collapse: collapse; text-align: center;"> <tr> <td style="width: 10%;"></td> <td style="width: 10%;"></td> <td style="width: 10%;"></td> <td style="width: 10%;"></td> <td style="width: 10%;"></td> <td style="width: 10%;"></td> <td style="width: 10%;"></td> <td style="width: 10%;"></td> <td style="width: 10%;"></td> <td style="width: 10%;"></td> </tr> <tr> <td></td> <td></td> <td colspan="8" style="text-align: center;"> <table border="1" style="width: 100%; border-collapse: collapse; text-align: center;"> <tr> <td style="width: 10%;"></td> <td style="width: 10%;"></td> <td style="width: 10%;"></td> <td style="width: 10%;"></td> <td style="width: 10%;"></td> <td style="width: 10%;"></td> <td style="width: 10%;"></td> <td style="width: 10%;"></td> <td style="width: 10%;"></td> <td style="width: 10%;"></td> </tr> <tr> <td></td> <td></td> <td colspan="8" style="text-align: center;"> <table border="1" style="width: 100%; border-collapse: collapse; text-align: center;"> <tr> <td style="width: 10%;"></td> <td style="width: 10%;"></td> <td style="width: 10%;"></td> <td style="width: 10%;"></td> <td style="width: 10%;"></td> <td style="width: 10%;"></td> <td style="width: 10%;"></td> <td style="width: 10%;"></td> <td style="width: 10%;"></td> <td style="width: 10%;"></td> </tr> <tr> <td></td> <td></td> <td colspan="8" style="text-align: center;"> <table border="1" style="width: 100%; border-collapse: collapse; text-align: center;"> <tr> <td style="width: 10%;"></td> <td style="width: 10%;"></td> <td style="width: 10%;"></td> <td style="width: 10%;"></td> <td style="width: 10%;"></td> <td style="width: 10%;"></td> <td style="width: 10%;"></td> <td style="width: 10%;"></td> <td style="width: 10%;"></td> <td style="width: 10%;"></td> </tr> <tr> <td></td> <td></td> <td colspan="8" style="text-align: center;"> <table border="1" style="width: 100%; border-collapse: collapse; text-align: center;"> <tr> <td style="width: 10%;"></td> <td style="width: 10%;"></td> <td style="width: 10%;"></td> <td style="width: 10%;"></td> <td style="width: 10%;"></td> <td style="width: 10%;"></td> <td style="width: 10%;"></td> <td style="width: 10%;"></td> <td style="width: 10%;"></td> <td style="width: 10%;"></td> </tr> <tr> <td></td> <td></td> <td colspan="8" style="text-align: center;"> <table border="1" style="width: 100%; border-collapse: collapse; text-align: center;"> <tr> <td style="width: 10%;"></td> <td style="width: 10%;"></td> <td style="width: 10%;"></td> <td style="width: 10%;"></td> <td style="width: 10%;"></td> <td style="width: 10%;"></td> <td style="width: 10%;"></td> <td style="width: 10%;"></td> <td style="width: 10%;"></td> <td style="width: 10%;"></td> </tr> <tr> <td></td> <td></td> <td colspan="8" style="text-align: center;"> <table border="1" style="width: 100%; border-collapse: collapse; text-align: center;"> <tr> <td style="width: 10%;"></td> <td style="width: 10%;"></td> <td style="width: 10%;"></td> <td style="width: 10%;"></td> <td style="width: 10%;"></td> <td style="width: 10%;"></td> <td style="width: 10%;"></td> <td style="width: 10%;"></td> <td style="width: 10%;"></td> <td style="width: 10%;"></td> </tr> <tr> <td></td> <td></td> <td colspan="8" style="text-align: center;"> <table border="1" style="width: 100%; border-collapse: collapse; text-align: center;"> <tr> <td style="width: 10%;"></td> <td style="width: 10%;"></td> <td style="width: 10%;"></td> <td style="width: 10%;"></td> <td style="width: 10%;"></td> <td style="width: 10%;"></td> <td style="width: 10%;"></td> <td style="width: 10%;"></td> <td style="width: 10%;"></td> <td style="width: 10%;"></td> </tr> <tr> <td></td> <td></td> <td colspan="8" style="text-align: center;"> <table border="1" style="width: 100%; border-collapse: collapse; text-align: center;"> <tr> <td style="width: 10%;"></td> <td style="width: 10%;"></td> <td style="width: 10%;"></td> <td style="width: 10%;"></td> <td style="width: 10%;"></td> <td style="width: 10%;"></td> <td style="width: 10%;"></td> <td style="width: 10%;"></td> <td style="width: 10%;"></td> <td style="width: 10%;"></td> </tr> <tr> <td></td> <td></td> <td colspan="8" style="text-align: center;"> <table border="1" style="width: 100%; border-collapse: collapse; text-align: center;"> <tr> <td style="width: 10%;"></td> <td
style="width: 10%;"></td> <td style="width: 10%;"></td> <td style="width: 10%;"></td> <td style="width: 10%;"></td> <td style="width: 10%;"></td> <td style="width: 10%;"></td> <td style="width: 10%;"></td> <td style="width: 10%;"></td> <td style="width: 10%;"></td> </tr> <tr> <td></td> <td></td> <td colspan="8" style="text-align: center;"> <table border="1" style="width: 100%; border-collapse: collapse; text-align: center;"> <tr> <td style="width: 10%;"></td> <td style="width: 10%;"></td> <td style="width: 10%;"></td> <td style="width: 10%;"></td> <td style="width: 10%;"></td> <td style="width: 10%;"></td> <td style="width: 10%;"></td> <td style="width: 10%;"></td> <td style="width: 10%;"></td> <td style="width: 10%;"></td> </tr> <tr> <td></td> <td></td> <td colspan="8" style="text-align: center;"> <table border="1" style="width: 100%; border-collapse: collapse; text-align: center;"> <tr> <td style="width: 10%;"></td> <td style="width: 10%;"></td> <td style="width: 10%;"></td> <td style="width: 10%;"></td> <td style="width: 10%;"></td> <td style="width: 10%;"></td> <td style="width: 10%;"></td> <td style="width: 10%;"></td> <td style="width: 10%;"></td> <td style="width: 10%;"></td> </tr> <tr> <td></td> <td></td> <td colspan="8" style="text-align: center;"> <table border="1" style="width: 100%; border-collapse: collapse; text-align: center;"> <tr> <td style="width: 10%;"></td> <td style="width: 10%;"></td> <td style="width: 10%;"></td> <td style="width: 10%;"></td> <td style="width: 10%;"></td> <td style="width: 10%;"></td> <td style="width: 10%;"></td> <td style="width: 10%;"></td> <td style="width: 10%;"></td> <td style="width: 10%;"></td> </tr> <tr> <td></td> <td></td> <td colspan="8" style="text-align: center;"> <table border="1" style="width: 100%; border-collapse: collapse; text-align: center;"> <tr> <td style="width: 10%;"></td> <td style="width: 10%;"></td> <td style="width: 10%;"></td> <td style="width: 10%;"></td> <td style="width: 10%;"></td> <td style="width: 10%;"></td> <td style="width: 10%;"></td> <td style="width: 10%;"></td> <td style="width: 10%;"></td> <td style="width: 10%;"></td> </tr> <tr> <td></td> <td></td> <td colspan="8" style="text-align: center;"> <table border="1" style="width: 100%; border-collapse: collapse; text-align: center;"> <tr> <td style="width: 10%;"></td> <td style="width: 10%;"></td> <td style="width: 10%;"></td> <td style="width: 10%;"></td> <td style="width: 10%;"></td> <td style="width: 10%;"></td> <td style="width: 10%;"></td> <td style="width: 10%;"></td> <td style="width: 10%;"></td> <td style="width: 10%;"></td> </tr> <tr> <td></td> <td></td> <td colspan="8" style="text-align: center;"> <table border="1" style="width: 100%; border-collapse: collapse; text-align: center;"> <tr> <td style="width: 10%;"></td> <td style="width: 10%;"></td> <td style="width: 10%;"></td> <td style="width: 10%;"></td> <td style="width: 10%;"></td> <td style="width: 10%;"></td> <td style="width: 10%;"></td> <td style="width: 10%;"></td> <td style="width: 10%;"></td> <td style="width: 10%;"></td> </tr> <tr> <td></td> <td></td> <td colspan="8" style="text-align: center;"> <table border="1" style="width: 100%; border-collapse: collapse; text-align: center;"> <tr> <td style="width: 10%;"></td> <td style="width: 10%;"></td> <td style="width: 10%;"></td> <td style="width: 10%;"></td> <td style="width: 10%;"></td> <td style="width: 10%;"></td> <td style="width: 10%;"></td> <td style="width: 10%;"></td> <td style="width: 10%;"></td> <td style="width: 10%;"></td> </tr> <tr> <td></td> <td></td> <td colspan="8" style="text-align: center;"> <table border="1" style="width: 100%; border-collapse: collapse; text-align: center;"> <tr> <td style="width: 10%;"></td> <td style="width: 10%;"></td> <td style="width: 10%;"></td> <td style="width: 10%;"></td> <td style="width: 10%;"></td> <td style="width: 10%;"></td> <td style="width: 10%;"></td> <td style="width: 10%;"></td> <td style="width: 10%;"></td> <td style="width: 10%;"></td> </tr> <tr> <td></td> <td></td> <td colspan="8" style="text-align: center;"> <table border="1" style="width: 100%; border-collapse: collapse; text-align: center;"> <tr> <td style="width: 10%;"></td> <td style="width: 10%;"></td> <td style="width: 10%;"></td> <td style="width: 10%;"></td> <td style="width: 10%;"></td> <td style="width: 10%;"></td> <td style="width: 10%;"></td> <td style="width: 10%;"></td> <td style="width: 10%;"></td> <td style="width: 10%;"></td> </tr> <tr> <td></td> <td></td> <td colspan="8" style="text-align: center;"> <table border="1" style="width: 100%; border-collapse: collapse; text-align: center;"> <tr> <td style="width: 10%;"></td> <td style="width: 10%;"></td> <td style="width: 10%;"></td> <td style="width: 10%;"></td> <td style="width: 10%;"></td> <td style="width: 10%;"></td> <td style="width: 10%;"></td> <td style="width: 10%;"></td> <td style="width: 10%;"></td> <td style="width: 10%;"></td> </tr> <tr> <td></td> <td></td> <td colspan="8" style="text-align: center;"> <table border="1" style="width: 100%; border-collapse: collapse; text-align: center;"> <tr> <td style="width: 10%;"></td> <td style="width: 10%;"></td> <td style="width: 10%;"></td> <td style="width: 10%;"></td> <td style="width: 10%;"></td> <td style="width: 10%;"></td> <td style="width: 10%;"></td> <td style="width: 10%;"></td> <td style="width: 10%;"></td> <td style="width: 10%;"></td> </tr> <tr> <td></td> <td></td> <td colspan="8" style="text-align: center;"> <table border="1" style="width: 100%; border-collapse: collapse; text-align: center;"> <tr> <td style="width: 10%;"></td> <td style="width: 10%;"></td> <td style="width: 10%;"></td> <td style="width: 10%;"></td> <td style="width: 10%;"></td> <td style="width: 10%;"></td> <td style="width: 10%;"></td> <td style="width: 10%;"></td> <td style="width: 10%;"></td> <td style="width: 10%;"></td> </tr> <tr> <td></td> <td></td> <td colspan="8" style="text-align: center;"> <table border="1" style="width: 100%; border-collapse: collapse; text-align: center;"> <tr> <td style="width: 10%;"></td> <td style="width: 10%;"></td> <td style="width: 10%;"></td> <td style="width: 10%;"></td> <td style="width: 10%;"></td> <td style="width: 10%;"></td> <td style="width: 10%;"></td> <td style="width: 10%;"></td> <td style="width: 10%;"></td> <td style="width: 10%;"></td> </tr> <tr> <td></td> <td></td> <td colspan="8" style="text-align: center;"> <table border="1" style="width: 100%; border-collapse: collapse; text-align: center;"> <tr> <td style="width: 10%;"></td> <td style="width: 10%;"></td> <td style="width: 10%;"></td> <td style="width: 10%;"></td> <td style="width: 10%;"></td> <td style="width: 10%;"></td> <td style="width: 10%;"></td> <td style="width: 10%;"></td> <td style="width: 10%;"></td> <td style="width: 10%;"></td> </tr> <tr> <td></td> <td></td> <td colspan="8" style="text-align: center;"> <table border="1" style="width: 100%; border-collapse: collapse; text-align: center;"> <tr> <td style="width: 10%;"></td> <td style="width: 10%;"></td> <td style="width: 10%;"></td> <td style="width: 10%;"></td> <td style="width: 10%;"></td> <td style="width: 10%;"></td> <td style="width: 10%;"></td> <td style="width: 10%;"></td> <td style="width: 10%;"></td> <td style="width: 10%;"></td> </tr> <tr> <td></td> <td></td> <td colspan="8" style="text-align: center;"> <table border="1" style="width: 100%; border-collapse: collapse; text-align: center;"> <tr> <td style="width: 10%;"></td> <td style="width: 10%;"></td> <td style="width: 10%;"></td> <td style="width: 10%;"></td> <td style="width: 10%;"></td> <td style="width: 10%;"></td> <td style="width: 10%;"></td> <td style="width: 10%;"></td> <td style="width: 10%;"></td> <td style="width: 10%;"></td> </tr> <tr> <td></td> <td></td> <td colspan="8" style="text-align: center;"> <table border="1" style="width: 100%; border-collapse: collapse; text-align: center;"> <tr> <td style="width: 10%;"></td> <td style="width: 10%;"></td> <td style="width: 10%;"></td> <td style="width: 10%;"></td> <td style="width: 10%;"></td> <td style="width: 10%;"></td> <td style="width: 10%;"></td> <td style="width: 10%;"></td> <td style="width: 10%;"></td> <td style="width: 10%;"></td> </tr> <tr> <td></td> <td></td> <td colspan="8" style="text-align: center;"> <table border="1" style="width: 100%; border-collapse: collapse; text-align: center;"> <tr> <td style="width: 10%;"></td> <td style="width: 10%;"></td> <td style="width: 10%;"></td> <td style="width: 10%;"></td> <td style="width: 10%;"></td> <td style="width: 10%;"></td> <td style="width: 10%;"></td> <td style="width: 10%;"></td> <td style="width: 10%;"></td> <td style="width: 10%;"></td> </tr> <tr> <td></td> <td></td> <td colspan="8" style="text-align: center;"> <table border="1" style="width: 100%; border-collapse: collapse; text-align: center;"> <tr> <td style="width: 10%;"></td> <td style="width: 10%;"></td> <td style="width: 10%;"></td> <td style="width: 10%;"></td> <td style="width: 10%;"></td> <td style="width: 10%;"></td> <td style="width: 10%;"></td> <td style="width: 10%;"></td> <td style="width: 10%;"></td> <td style="width: 10%;"></td> </tr> <tr> <td></td> <td></td> <td colspan="8" style="text-align: center;"> <table border="1" style="width: 100%; border-collapse: collapse; text-align: center;"> <tr> <td style="width: 10%;"></td> <td style="width: 10%;"></td> <td style="width: 10%;"></td> <td style="width: 10%;"></td> <td style="width: 10%;"></td> <td style="width: 10%;"></td> <td style="width: 10%;"></td> <td style="width: 10%;"></td> <td style="width: 10%;"></td> <td style="width: 10%;"></td> </tr> <tr> <td></td> <td></td> <td colspan="8" style="text-align: center;"> <table border="1" style="width: 100%; border-collapse: collapse; text-align: center;"> <tr> <td style="width: 10%;"></td> <td style="width: 10%;"></td> <td style="width: 10%;"></td> <td style="width: 10%;"></td> <td style="width: 10%;"></td> <td style="width: 10%;"></td> <td style="width:
10%;"></td> <td style="width: 10%;"></td> <td style="width: 10%;"></td> <td style="width: 10%;"></td> </tr> <tr> <td></td> <td></td> <td colspan="8" style="text-align: center;"> <table border="1" style="width: 100%; border-collapse: collapse; text-align: center;"> <tr> <td style="width: 10%;"></td> <td style="width: 10%;"></td> <td style="width: 10%;"></td> <td style="width: 10%;"></td> <td style="width: 10%;"></td> <td style="width: 10%;"></td> <td style="width: 10%;"></td> <td style="width: 10%;"></td> <td style="width: 10%;"></td> <td style="width: 10%;"></td> </tr> <tr> <td></td> <td></td> <td colspan="8" style="text-align: center;"> <table border="1" style="width: 100%; border-collapse: collapse; text-align: center;"> <tr> <td style="width: 10%;"></td> <td style="width: 10%;"></td> <td style="width: 10%;"></td> <td style="width: 10%;"></td> <td style="width: 10%;"></td> <td style="width: 10%;"></td> <td style="width: 10%;"></td> <td style="width: 10%;"></td> <td style="width: 10%;"></td> <td style="width: 10%;"></td> </tr> <tr> <td></td> <td></td> <td colspan="8" style="text-align: center;"> <table border="1" style="width: 100%; border-collapse: collapse; text-align: center;"> <tr> <td style="width: 10%;"></td> <td style="width: 10%;"></td> <td style="width: 10%;"></td> <td style="width: 10%;"></td> <td style="width: 10%;"></td> <td style="width: 10%;"></td> <td style="width: 10%;"></td> <td style="width: 10%;"></td> <td style="width: 10%;"></td> <td style="width: 10%;"></td> </tr> <tr> <td></td> <td></td> <td colspan="8" style="text-align: center;"> <table border="1" style="width: 100%; border-collapse: collapse; text-align: center;"> <tr> <td style="width: 10%;"></td> <td style="width: 10%;"></td> <td style="width: 10%;"></td> <td style="width: 10%;"></td> <td style="width: 10%;"></td> <td style="width: 10%;"></td> <td style="width: 10%;"></td> <td style="width: 10%;"></td> <td style="width: 10%;"></td> <td style="width: 10%;"></td> </tr> <tr> <td></td> <td></td> <td colspan="8" style="text-align: center;"> <table border="1" style="width: 100%; border-collapse: collapse; text-align: center;"> <tr> <td style="width: 10%;"></td> <td style="width: 10%;"></td> <td style="width: 10%;"></td> <td style="width: 10%;"></td> <td style="width: 10%;"></td> <td style="width: 10%;"></td> <td style="width: 10%;"></td> <td style="width: 10%;"></td> <td style="width: 10%;"></td> <td style="width: 10%;"></td> </tr> <tr> <td></td> <td></td> <td colspan="8" style="text-align: center;"> <table border="1" style="width: 100%; border-collapse: collapse; text-align: center;"> <tr> <td style="width: 10%;"></td> <td style="width: 10%;"></td> <td style="width: 10%;"></td> <td style="width: 10%;"></td> <td style="width: 10%;"></td> <td style="width: 10%;"></td> <td style="width: 10%;"></td> <td style="width: 10%;"></td> <td style="width: 10%;"></td> <td style="width: 10%;"></td> </tr> <tr> <td></td> <td></td> <td colspan="8" style="text-align: center;"> <table border="1" style="width: 100%; border-collapse: collapse; text-align: center;"> <tr> <td style="width: 10%;"></td> <td style="width: 10%;"></td> <td style="width: 10%;"></td> <td style="width: 10%;"></td> <td style="width: 10%;"></td> <td style="width: 10%;"></td> <td style="width: 10%;"></td> <td style="width: 10%;"></td> <td style="width: 10%;"></td> <td style="width: 10%;"></td> </tr> <tr> <td></td> <td></td> <td colspan="8" style="text-align: center;"> <table border="1" style="width: 100%; border-collapse: collapse; text-align: center;"> <tr> <td style="width: 10%;"></td> <td style="width: 10%;"></td> <td style="width: 10%;"></td> <td style="width: 10%;"></td> <td style="width: 10%;"></td> <td style="width: 10%;"></td> <td style="width: 10%;"></td> <td style="width: 10%;"></td> <td style="width: 10%;"></td> <td style="width: 10%;"></td> </tr> <tr> <td></td> <td></td> <td colspan="8" style="text-align: center;"> <table border="1" style="width: 100%; border-collapse: collapse; text-align: center;"> <tr> <td style="width: 10%;"></td> <td style="width: 10%;"></td> <td style="width: 10%;"></td> <td style="width: 10%;"></td> <td style="width: 10%;"></td> <td style="width: 10%;"></td> <td style="width: 10%;"></td> <td style="width: 10%;"></td> <td style="width: 10%;"></td> <td style="width: 10%;"></td> </tr> <tr> <td></td> <td></td> <td colspan="8" style="text-align: center;"> <table border="1" style="width: 100%; border-collapse: collapse; text-align: center;"> <tr> <td style="width: 10%;"></td> <td style="width: 10%;"></td> <td style="width: 10%;"></td> <td style="width: 10%;"></td> <td style="width: 10%;"></td> <td style="width: 10%;"></td> <td style="width: 10%;"></td> <td style="width: 10%;"></td> <td style="width: 10%;"></td> <td style="width: 10%;"></td> </tr> <tr> <td></td> <td></td> <td colspan="8" style="text-align: center;"> <table border="1" style="width: 100%; border-collapse: collapse; text-align: center;"> <tr> </tr></table></td></tr></table></td></tr></table></td></tr></table></td></tr></table></td></tr></table></td></tr></table></td></tr></table></td></tr></table></td></tr></table></td></tr></table></td></tr></table></td></tr></table></td></tr></table></td></tr></table></td></tr></table></td></tr></table></td></tr></table></td></tr></table></td></tr></table></td></tr></table></td></tr></table></td></tr></table></td></tr></table></td></tr></table></td></tr></table></td></tr></table></td></tr></table></td></tr></table></td></tr></table></td></tr></table></td></tr></table></td></tr></table></td></tr></table></td></tr></table></td></tr></table></td></tr></table></td></tr></table></td></tr></table></td></tr></table></td></tr></table></td></tr></table></td></tr></table></td></tr></table> | | | | | | | | | | | | | | | | | | | | <table border="1" style="width: 100%; border-collapse: collapse; text-align: center;"> <tr> <td style="width: 10%;"></td> <td style="width: 10%;"></td> <td style="width: 10%;"></td> <td style="width: 10%;"></td> <td style="width: 10%;"></td> <td style="width: 10%;"></td> <td style="width: 10%;"></td> <td style="width: 10%;"></td> <td style="width: 10%;"></td> <td style="width: 10%;"></td> </tr> <tr> <td></td> <td></td> <td colspan="8" style="text-align: center;"> <table border="1" style="width: 100%; border-collapse: collapse; text-align: center;"> <tr> <td style="width: 10%;"></td> <td style="width: 10%;"></td> <td style="width: 10%;"></td> <td style="width: 10%;"></td> <td style="width: 10%;"></td> <td style="width: 10%;"></td> <td style="width: 10%;"></td> <td style="width: 10%;"></td>
<td style="width: 10%;"></td> <td style="width: 10%;"></td> </tr> <tr> <td></td> <td></td> <td colspan="8" style="text-align: center;"> <table border="1" style="width: 100%; border-collapse: collapse; text-align: center;"> <tr> <td style="width: 10%;"></td> <td style="width: 10%;"></td> <td style="width: 10%;"></td> <td style="width: 10%;"></td> <td style="width: 10%;"></td> <td style="width: 10%;"></td> <td style="width: 10%;"></td> <td style="width: 10%;"></td> <td style="width: 10%;"></td> <td style="width: 10%;"></td> </tr> <tr> <td></td> <td></td> <td colspan="8" style="text-align: center;"> <table border="1" style="width: 100%; border-collapse: collapse; text-align: center;"> <tr> <td style="width: 10%;"></td> <td style="width: 10%;"></td> <td style="width: 10%;"></td> <td style="width: 10%;"></td> <td style="width: 10%;"></td> <td style="width: 10%;"></td> <td style="width: 10%;"></td> <td style="width: 10%;"></td> <td style="width: 10%;"></td> <td style="width: 10%;"></td> </tr> <tr> <td></td> <td></td> <td colspan="8" style="text-align: center;"> <table border="1" style="width: 100%; border-collapse: collapse; text-align: center;"> <tr> <td style="width: 10%;"></td> <td style="width: 10%;"></td> <td style="width: 10%;"></td> <td style="width: 10%;"></td> <td style="width: 10%;"></td> <td style="width: 10%;"></td> <td style="width: 10%;"></td> <td style="width: 10%;"></td> <td style="width: 10%;"></td> <td style="width: 10%;"></td> </tr> <tr> <td></td> <td></td> <td colspan="8" style="text-align: center;"> <table border="1" style="width: 100%; border-collapse: collapse; text-align: center;"> <tr> <td style="width: 10%;"></td> <td style="width: 10%;"></td> <td style="width: 10%;"></td> <td style="width: 10%;"></td> <td style="width: 10%;"></td> <td style="width: 10%;"></td> <td style="width: 10%;"></td> <td style="width: 10%;"></td> <td style="width: 10%;"></td> <td style="width: 10%;"></td> </tr> <tr> <td></td> <td></td> <td colspan="8" style="text-align: center;"> <table border="1" style="width: 100%; border-collapse: collapse; text-align: center;"> <tr> <td style="width: 10%;"></td> <td style="width: 10%;"></td> <td style="width: 10%;"></td> <td style="width: 10%;"></td> <td style="width: 10%;"></td> <td style="width: 10%;"></td> <td style="width: 10%;"></td> <td style="width: 10%;"></td> <td style="width: 10%;"></td> <td style="width: 10%;"></td> </tr> <tr> <td></td> <td></td> <td colspan="8" style="text-align: center;"> <table border="1" style="width: 100%; border-collapse: collapse; text-align: center;"> <tr> <td style="width: 10%;"></td> <td style="width: 10%;"></td> <td style="width: 10%;"></td> <td style="width: 10%;"></td> <td style="width: 10%;"></td> <td style="width: 10%;"></td> <td style="width: 10%;"></td> <td style="width: 10%;"></td> <td style="width: 10%;"></td> <td style="width: 10%;"></td> </tr> <tr> <td></td> <td></td> <td colspan="8" style="text-align: center;"> <table border="1" style="width: 100%; border-collapse: collapse; text-align: center;"> <tr> <td style="width: 10%;"></td> <td style="width: 10%;"></td> <td style="width: 10%;"></td> <td style="width: 10%;"></td> <td style="width: 10%;"></td> <td style="width: 10%;"></td> <td style="width: 10%;"></td> <td style="width: 10%;"></td> <td style="width: 10%;"></td> <td style="width: 10%;"></td> </tr> <tr> <td></td> <td></td> <td colspan="8" style="text-align: center;"> <table border="1" style="width: 100%; border-collapse: collapse; text-align: center;"> <tr> <td style="width: 10%;"></td> <td style="width: 10%;"></td> <td style="width: 10%;"></td> <td style="width: 10%;"></td> <td style="width: 10%;"></td> <td style="width: 10%;"></td> <td style="width: 10%;"></td> <td style="width: 10%;"></td> <td style="width: 10%;"></td> <td style="width: 10%;"></td> </tr> <tr> <td></td> <td></td> <td colspan="8" style="text-align: center;"> <table border="1" style="width: 100%; border-collapse: collapse; text-align: center;"> <tr> <td style="width: 10%;"></td> <td style="width: 10%;"></td> <td style="width: 10%;"></td> <td style="width: 10%;"></td> <td style="width: 10%;"></td> <td style="width: 10%;"></td> <td style="width: 10%;"></td> <td style="width: 10%;"></td> <td style="width: 10%;"></td> <td style="width: 10%;"></td> </tr> <tr> <td></td> <td></td> <td colspan="8" style="text-align: center;"> <table border="1" style="width: 100%; border-collapse: collapse; text-align: center;"> <tr> <td style="width: 10%;"></td> <td style="width: 10%;"></td> <td style="width: 10%;"></td> <td style="width: 10%;"></td> <td style="width: 10%;"></td> <td style="width: 10%;"></td> <td style="width: 10%;"></td> <td style="width: 10%;"></td> <td style="width: 10%;"></td> <td style="width: 10%;"></td> </tr> <tr> <td></td> <td></td> <td colspan="8" style="text-align: center;"> <table border="1" style="width: 100%; border-collapse: collapse; text-align: center;"> <tr> <td style="width: 10%;"></td> <td style="width: 10%;"></td> <td style="width: 10%;"></td> <td style="width: 10%;"></td> <td style="width: 10%;"></td> <td style="width: 10%;"></td> <td style="width: 10%;"></td> <td style="width: 10%;"></td> <td style="width: 10%;"></td> <td style="width: 10%;"></td> </tr> <tr> <td></td> <td></td> <td colspan="8" style="text-align: center;"> <table border="1" style="width: 100%; border-collapse: collapse; text-align: center;"> <tr> <td style="width: 10%;"></td> <td style="width: 10%;"></td> <td style="width: 10%;"></td> <td style="width: 10%;"></td> <td style="width: 10%;"></td> <td style="width: 10%;"></td> <td style="width: 10%;"></td> <td style="width: 10%;"></td> <td style="width: 10%;"></td> <td style="width: 10%;"></td> </tr> <tr> <td></td> <td></td> <td colspan="8" style="text-align: center;"> <table border="1" style="width: 100%; border-collapse: collapse; text-align: center;"> <tr> <td style="width: 10%;"></td> <td style="width: 10%;"></td> <td style="width: 10%;"></td> <td style="width: 10%;"></td> <td style="width: 10%;"></td> <td style="width: 10%;"></td> <td style="width: 10%;"></td> <td style="width: 10%;"></td> <td style="width: 10%;"></td> <td style="width: 10%;"></td> </tr> <tr> <td></td> <td></td> <td colspan="8" style="text-align: center;"> <table border="1" style="width: 100%; border-collapse: collapse; text-align: center;"> <tr> <td style="width: 10%;"></td> <td style="width: 10%;"></td> <td style="width: 10%;"></td> <td style="width: 10%;"></td> <td style="width: 10%;"></td> <td style="width: 10%;"></td> <td style="width: 10%;"></td> <td style="width: 10%;"></td> <td style="width: 10%;"></td> <td style="width: 10%;"></td> </tr> <tr> <td></td> <td></td> <td colspan="8" style="text-align: center;"> <table border="1" style="width: 100%; border-collapse: collapse; text-align: center;"> <tr> <td style="width: 10%;"></td> <td style="width: 10%;"></td> <td style="width: 10%;"></td> <td style="width: 10%;"></td> <td style="width: 10%;"></td> <td style="width: 10%;"></td> <td style="width: 10%;"></td> <td style="width: 10%;"></td> <td style="width: 10%;"></td> <td style="width: 10%;"></td> </tr> <tr> <td></td> <td></td> <td colspan="8" style="text-align: center;"> <table border="1" style="width: 100%; border-collapse: collapse; text-align: center;"> <tr> <td style="width: 10%;"></td> <td style="width: 10%;"></td> <td style="width: 10%;"></td> <td style="width: 10%;"></td> <td style="width: 10%;"></td> <td style="width: 10%;"></td> <td style="width: 10%;"></td> <td style="width: 10%;"></td> <td style="width: 10%;"></td> <td style="width: 10%;"></td> </tr> <tr> <td></td> <td></td> <td colspan="8" style="text-align: center;"> <table border="1" style="width: 100%; border-collapse: collapse; text-align: center;"> <tr> <td style="width: 10%;"></td> <td style="width: 10%;"></td> <td style="width: 10%;"></td> <td style="width: 10%;"></td> <td style="width: 10%;"></td> <td style="width: 10%;"></td> <td style="width: 10%;"></td> <td style="width: 10%;"></td> <td style="width: 10%;"></td> <td style="width: 10%;"></td> </tr> <tr> <td></td> <td></td> <td colspan="8" style="text-align: center;"> <table border="1" style="width: 100%; border-collapse: collapse; text-align: center;"> <tr> <td style="width: 10%;"></td> <td style="width: 10%;"></td> <td style="width: 10%;"></td> <td style="width: 10%;"></td> <td style="width: 10%;"></td> <td style="width: 10%;"></td> <td style="width: 10%;"></td> <td style="width: 10%;"></td> <td style="width: 10%;"></td> <td style="width: 10%;"></td> </tr> <tr> <td></td> <td></td> <td colspan="8" style="text-align: center;"> <table border="1" style="width: 100%; border-collapse: collapse; text-align: center;"> <tr> <td style="width: 10%;"></td> <td style="width: 10%;"></td> <td style="width: 10%;"></td> <td style="width: 10%;"></td> <td style="width: 10%;"></td> <td style="width: 10%;"></td> <td style="width: 10%;"></td> <td style="width: 10%;"></td> <td style="width: 10%;"></td> <td style="width: 10%;"></td> </tr> <tr> <td></td> <td></td> <td colspan="8" style="text-align: center;"> <table border="1" style="width: 100%; border-collapse: collapse; text-align: center;"> <tr> <td style="width: 10%;"></td> <td style="width: 10%;"></td> <td style="width: 10%;"></td> <td style="width: 10%;"></td> <td style="width: 10%;"></td> <td style="width: 10%;"></td> <td style="width: 10%;"></td> <td style="width: 10%;"></td> <td style="width: 10%;"></td> <td style="width: 10%;"></td> </tr> <tr> <td></td> <td></td> <td colspan="8" style="text-align: center;"> <table border="1" style="width: 100%; border-collapse: collapse; text-align: center;"> <tr> <td style="width: 10%;"></td> <td style="width: 10%;"></td> <td style="width: 10%;"></td> <td style="width: 10%;"></td> <td style="width: 10%;"></td> <td style="width: 10%;"></td> <td style="width: 10%;"></td> <td style="width: 10%;"></td> <td style="width: 10%;"></td> <td style="width: 10%;"></td> </tr> <tr> <td></td> <td></td> <td colspan="8" style="text-align: center;"> <table border="1" style="width:
100%; border-collapse: collapse; text-align: center;"> <tr> <td style="width: 10%;"></td> <td style="width: 10%;"></td> <td style="width: 10%;"></td> <td style="width: 10%;"></td> <td style="width: 10%;"></td> <td style="width: 10%;"></td> <td style="width: 10%;"></td> <td style="width: 10%;"></td> <td style="width: 10%;"></td> <td style="width: 10%;"></td> </tr> <tr> <td></td> <td></td> <td colspan="8" style="text-align: center;"> <table border="1" style="width: 100%; border-collapse: collapse; text-align: center;"> <tr> <td style="width: 10%;"></td> <td style="width: 10%;"></td> <td style="width: 10%;"></td> <td style="width: 10%;"></td> <td style="width: 10%;"></td> <td style="width: 10%;"></td> <td style="width: 10%;"></td> <td style="width: 10%;"></td> <td style="width: 10%;"></td> <td style="width: 10%;"></td> </tr> <tr> <td></td> <td></td> <td colspan="8" style="text-align: center;"> <table border="1" style="width: 100%; border-collapse: collapse; text-align: center;"> <tr> <td style="width: 10%;"></td> <td style="width: 10%;"></td> <td style="width: 10%;"></td> <td style="width: 10%;"></td> <td style="width: 10%;"></td> <td style="width: 10%;"></td> <td style="width: 10%;"></td> <td style="width: 10%;"></td> <td style="width: 10%;"></td> <td style="width: 10%;"></td> </tr> <tr> <td></td> <td></td> <td colspan="8" style="text-align: center;"> <table border="1" style="width: 100%; border-collapse: collapse; text-align: center;"> <tr> <td style="width: 10%;"></td> <td style="width: 10%;"></td> <td style="width: 10%;"></td> <td style="width: 10%;"></td> <td style="width: 10%;"></td> <td style="width: 10%;"></td> <td style="width: 10%;"></td> <td style="width: 10%;"></td> <td style="width: 10%;"></td> <td style="width: 10%;"></td> </tr> <tr> <td></td> <td></td> <td colspan="8" style="text-align: center;"> <table border="1" style="width: 100%; border-collapse: collapse; text-align: center;"> <tr> <td style="width: 10%;"></td> <td style="width: 10%;"></td> <td style="width: 10%;"></td> <td style="width: 10%;"></td> <td style="width: 10%;"></td> <td style="width: 10%;"></td> <td style="width: 10%;"></td> <td style="width: 10%;"></td> <td style="width: 10%;"></td> <td style="width: 10%;"></td> </tr> <tr> <td></td> <td></td> <td colspan="8" style="text-align: center;"> <table border="1" style="width: 100%; border-collapse: collapse; text-align: center;"> <tr> <td style="width: 10%;"></td> <td style="width: 10%;"></td> <td style="width: 10%;"></td> <td style="width: 10%;"></td> <td style="width: 10%;"></td> <td style="width: 10%;"></td> <td style="width: 10%;"></td> <td style="width: 10%;"></td> <td style="width: 10%;"></td> <td style="width: 10%;"></td> </tr> <tr> <td></td> <td></td> <td colspan="8" style="text-align: center;"> <table border="1" style="width: 100%; border-collapse: collapse; text-align: center;"> <tr> <td style="width: 10%;"></td> <td style="width: 10%;"></td> <td style="width: 10%;"></td> <td style="width: 10%;"></td> <td style="width: 10%;"></td> <td style="width: 10%;"></td> <td style="width: 10%;"></td> <td style="width: 10%;"></td> <td style="width: 10%;"></td> <td style="width: 10%;"></td> </tr> <tr> <td></td> <td></td> <td colspan="8" style="text-align: center;"> <table border="1" style="width: 100%; border-collapse: collapse; text-align: center;"> <tr> <td style="width: 10%;"></td> <td style="width: 10%;"></td> <td style="width: 10%;"></td> <td style="width: 10%;"></td> <td style="width: 10%;"></td> <td style="width: 10%;"></td> <td style="width: 10%;"></td> <td style="width: 10%;"></td> <td style="width: 10%;"></td> <td style="width: 10%;"></td> </tr> <tr> <td></td> <td></td> <td colspan="8" style="text-align: center;"> <table border="1" style="width: 100%; border-collapse: collapse; text-align: center;"> <tr> <td style="width: 10%;"></td> <td style="width: 10%;"></td> <td style="width: 10%;"></td> <td style="width: 10%;"></td> <td style="width: 10%;"></td> <td style="width: 10%;"></td> <td style="width: 10%;"></td> <td style="width: 10%;"></td> <td style="width: 10%;"></td> <td style="width: 10%;"></td> </tr> <tr> <td></td> <td></td> <td colspan="8" style="text-align: center;"> <table border="1" style="width: 100%; border-collapse: collapse; text-align: center;"> <tr> <td style="width: 10%;"></td> <td style="width: 10%;"></td> <td style="width: 10%;"></td> <td style="width: 10%;"></td> <td style="width: 10%;"></td> <td style="width: 10%;"></td> <td style="width: 10%;"></td> <td style="width: 10%;"></td> <td style="width: 10%;"></td> <td style="width: 10%;"></td> </tr> <tr> <td></td> <td></td> <td colspan="8" style="text-align: center;"> <table border="1" style="width: 100%; border-collapse: collapse; text-align: center;"> <tr> <td style="width: 10%;"></td> <td style="width: 10%;"></td> <td style="width: 10%;"></td> <td style="width: 10%;"></td> <td style="width: 10%;"></td> <td style="width: 10%;"></td> <td style="width: 10%;"></td> <td style="width: 10%;"></td> <td style="width: 10%;"></td> <td style="width: 10%;"></td> </tr> <tr> <td></td> <td></td> <td colspan="8" style="text-align: center;"> <table border="1" style="width: 100%; border-collapse: collapse; text-align: center;"> <tr> <td style="width: 10%;"></td> <td style="width: 10%;"></td> <td style="width: 10%;"></td> <td style="width: 10%;"></td> <td style="width: 10%;"></td> <td style="width: 10%;"></td> <td style="width: 10%;"></td> <td style="width: 10%;"></td> <td style="width: 10%;"></td> <td style="width: 10%;"></td> </tr> <tr> <td></td> <td></td> <td colspan="8" style="text-align: center;"> <table border="1" style="width: 100%; border-collapse: collapse; text-align: center;"> <tr> <td style="width: 10%;"></td> <td style="width: 10%;"></td> <td style="width: 10%;"></td> <td style="width: 10%;"></td> <td style="width: 10%;"></td> <td style="width: 10%;"></td> <td style="width: 10%;"></td> <td style="width: 10%;"></td> <td style="width: 10%;"></td> <td style="width: 10%;"></td> </tr> <tr> <td></td> <td></td> <td colspan="8" style="text-align: center;"> <table border="1" style="width: 100%; border-collapse: collapse; text-align: center;"> <tr> <td style="width: 10%;"></td> <td style="width: 10%;"></td> <td style="width: 10%;"></td> <td style="width: 10%;"></td> <td style="width: 10%;"></td> <td style="width: 10%;"></td> <td style="width: 10%;"></td> <td style="width: 10%;"></td> <td style="width: 10%;"></td> <td style="width: 10%;"></td> </tr> <tr> <td></td> <td></td> <td colspan="8" style="text-align: center;"> <table border="1" style="width: 100%; border-collapse: collapse; text-align: center;"> <tr> <td style="width: 10%;"></td> <td style="width: 10%;"></td> <td style="width: 10%;"></td> <td style="width: 10%;"></td> <td style="width: 10%;"></td> <td style="width: 10%;"></td> <td style="width: 10%;"></td> <td style="width: 10%;"></td> <td style="width: 10%;"></td> <td style="width: 10%;"></td> </tr> <tr> <td></td> <td></td> <td colspan="8" style="text-align: center;"> <table border="1" style="width: 100%; border-collapse: collapse; text-align: center;"> <tr> <td style="width: 10%;"></td> <td style="width: 10%;"></td> <td style="width: 10%;"></td> <td style="width: 10%;"></td> <td style="width: 10%;"></td> <td style="width: 10%;"></td> <td style="width: 10%;"></td> <td style="width: 10%;"></td> <td style="width: 10%;"></td> <td style="width: 10%;"></td> </tr> <tr> <td></td> <td></td> <td colspan="8" style="text-align: center;"> <table border="1" style="width: 100%; border-collapse: collapse; text-align: center;"> <tr> <td style="width: 10%;"></td> <td style="width: 10%;"></td> <td style="width: 10%;"></td> <td style="width: 10%;"></td> <td style="width: 10%;"></td> <td style="width: 10%;"></td> <td style="width: 10%;"></td> <td style="width: 10%;"></td> <td style="width: 10%;"></td> <td style="width: 10%;"></td> </tr> <tr> <td></td> <td></td> <td colspan="8" style="text-align: center;"> <table border="1" style="width: 100%; border-collapse: collapse; text-align: center;"> <tr> <td style="width: 10%;"></td> <td style="width: 10%;"></td> <td style="width: 10%;"></td> <td style="width: 10%;"></td> <td style="width: 10%;"></td> <td style="width: 10%;"></td> <td style="width: 10%;"></td> <td style="width: 10%;"></td> <td style="width: 10%;"></td> <td style="width: 10%;"></td> </tr> <tr> <td></td> <td></td> <td colspan="8" style="text-align: center;"> <table border="1" style="width: 100%; border-collapse: collapse; text-align: center;"> <tr> <td style="width: 10%;"></td> <td style="width: 10%;"></td> <td style="width: 10%;"></td> <td style="width: 10%;"></td> <td style="width: 10%;"></td> <td style="width: 10%;"></td> <td style="width: 10%;"></td> <td style="width: 10%;"></td> <td style="width: 10%;"></td> <td style="width: 10%;"></td> </tr> <tr> <td></td> <td></td> <td colspan="8" style="text-align: center;"> <table border="1" style="width: 100%; border-collapse: collapse; text-align: center;"> <tr> </tr></table></td></tr></table></td></tr></table></td></tr></table></td></tr></table></td></tr></table></td></tr></table></td></tr></table></td></tr></table></td></tr></table></td></tr></table></td></tr></table></td></tr></table></td></tr></table></td></tr></table></td></tr></table></td></tr></table></td></tr></table></td></tr></table></td></tr></table></td></tr></table></td></tr></table></td></tr></table></td></tr></table></td></tr></table></td></tr></table></td></tr></table></td></tr></table></td></tr></table></td></tr></table></td></tr></table></td></tr></table></td></tr></table></td></tr></table></td></tr></table></td></tr></table></td></tr></table></td></tr></table></td></tr></table></td></tr></table></td></tr></table></td></tr></table></td></tr></table>
 | | | | | | | | | | | | | | | | | | | | <table border="1" style="width: 100%; border-collapse: collapse; text-align: center;"> <tr> <td style="width: 10%;"></td> <td style="width: 10%;"></td> <td style="width: 10%;"></td> <td style="width: 10%;"></td> <td style="width: 10%;"></td> <td style="width: 10%;"></td> <td style="width: 10%;"></td> <td style="width: 10%;"></td> <td style="width: 10%;"></td> <td style="width: 10%;"></td> </tr> <tr> <td></td> <td></td> <td colspan="8" style="text-align: center;"> <table border="1" style="width: 100%; border-collapse: collapse; text-align: center;"> <tr> <td style="width: 10%;"></td> <td style="width: 10%;"></td> <td style="width: 10%;"></td> <td style="width: 10%;"></td> <td style="width: 10%;"></td> <td style="width: 10%;"></td> <td style="width: 10%;"></td> <td style="width: 10%;"></td> <td style="width: 10%;"></td> <td style="width: 10%;"></td> </tr> <tr> <td></td> <td></td> <td colspan="8" style="text-align: center;"> <table border="1" style="width: 100%; border-collapse: collapse; text-align: center;"> <tr> <td style="width: 10%;"></td> <td style="width: 10%;"></td> <td style="width: 10%;"></td> <td style="width: 10%;"></td> <td style="width: 10%;"></td> <td style="width: 10%;"></td> <td style="width: 10%;"></td> <td style="width: 10%;"></td> <td style="width: 10%;"></td> <td style="width: 10%;"></td> </tr> <tr> <td></td> <td></td> <td colspan="8" style="text-align: center;"> <table border="1" style="width: 100%; border-collapse: collapse; text-align: center;"> <tr> <td style="width: 10%;"></td> <td style="width: 10%;"></td> <td style="width: 10%;"></td> <td style="width: 10%;"></td> <td style="width: 10%;"></td> <td style="width: 10%;"></td> <td style="width: 10%;"></td> <td style="width: 10%;"></td> <td style="width: 10%;"></td> <td style="width: 10%;"></td> </tr> <tr> <td></td> <td></td> <td colspan="8" style="text-align: center;"> <table border="1" style="width: 100%; border-collapse: collapse; text-align: center;"> <tr> <td style="width: 10%;"></td> <td style="width: 10%;"></td> <td style="width: 10%;"></td> <td style="width: 10%;"></td> <td style="width: 10%;"></td> <td style="width: 10%;"></td> <td style="width: 10%;"></td> <td style="width: 10%;"></td> <td style="width: 10%;"></td> <td style="width: 10%;"></td> </tr> <tr> <td></td> <td></td> <td colspan="8" style="text-align: center;"> <table border="1" style="width: 100%; border-collapse: collapse; text-align: center;"> <tr> <td style="width: 10%;"></td> <td style="width: 10%;"></td> <td style="width: 10%;"></td> <td style="width: 10%;"></td> <td style="width: 10%;"></td> <td style="width: 10%;"></td> <td style="width: 10%;"></td> <td style="width: 10%;"></td> <td style="width: 10%;"></td> <td style="width: 10%;"></td> </tr> <tr> <td></td> <td></td> <td colspan="8" style="text-align: center;"> <table border="1" style="width: 100%; border-collapse: collapse; text-align: center;"> <tr> <td style="width: 10%;"></td> <td style="width: 10%;"></td> <td style="width: 10%;"></td> <td style="width: 10%;"></td> <td style="width: 10%;"></td> <td style="width: 10%;"></td> <td style="width: 10%;"></td> <td style="width: 10%;"></td> <td style="width: 10%;"></td> <td style="width: 10%;"></td> </tr> <tr> <td></td> <td></td> <td colspan="8" style="text-align: center;"> <table border="1" style="width: 100%; border-collapse: collapse; text-align: center;"> <tr> <td style="width: 10%;"></td> <td style="width: 10%;"></td> <td style="width: 10%;"></td> <td style="width: 10%;"></td> <td style="width: 10%;"></td> <td style="width: 10%;"></td> <td style="width: 10%;"></td> <td style="width: 10%;"></td> <td style="width: 10%;"></td> <td style="width: 10%;"></td> </tr> <tr> <td></td> <td></td> <td colspan="8" style="text-align: center;"> <table border="1" style="width: 100%; border-collapse: collapse; text-align: center;"> <tr> <td style="width: 10%;"></td> <td style="width: 10%;"></td> <td style="width: 10%;"></td> <td style="width: 10%;"></td> <td style="width: 10%;"></td> <td style="width: 10%;"></td> <td style="width: 10%;"></td> <td style="width: 10%;"></td> <td style="width: 10%;"></td> <td style="width: 10%;"></td> </tr> <tr> <td></td> <td></td> <td colspan="8" style="text-align: center;"> <table border="1" style="width: 100%; border-collapse: collapse; text-align: center;"> <tr> <td style="width: 10%;"></td> <td style="width: 10%;"></td> <td style="width: 10%;"></td> <td style="width: 10%;"></td> <td style="width: 10%;"></td> <td style="width: 10%;"></td> <td style="width: 10%;"></td> <td style="width: 10%;"></td> <td style="width: 10%;"></td> <td style="width: 10%;"></td> </tr> <tr> <td></td> <td></td> <td colspan="8" style="text-align: center;"> <table border="1" style="width: 100%; border-collapse: collapse; text-align: center;"> <tr> <td style="width: 10%;"></td> <td style="width: 10%;"></td> <td style="width: 10%;"></td> <td style="width: 10%;"></td> <td style="width: 10%;"></td> <td style="width: 10%;"></td> <td style="width: 10%;"></td> <td style="width: 10%;"></td> <td style="width: 10%;"></td> <td style="width: 10%;"></td> </tr> <tr> <td></td> <td></td> <td colspan="8" style="text-align: center;"> <table border="1" style="width: 100%; border-collapse: collapse; text-align: center;"> <tr> <td style="width: 10%;"></td> <td style="width: 10%;"></td> <td style="width: 10%;"></td> <td style="width: 10%;"></td> <td style="width: 10%;"></td> <td style="width: 10%;"></td> <td style="width: 10%;"></td> <td style="width: 10%;"></td> <td style="width: 10%;"></td> <td style="width: 10%;"></td> </tr> <tr> <td></td> <td></td> <td colspan="8" style="text-align: center;"> <table border="1" style="width: 100%; border-collapse: collapse; text-align: center;"> <tr> <td style="width: 10%;"></td> <td style="width: 10%;"></td> <td style="width: 10%;"></td> <td style="width: 10%;"></td> <td style="width: 10%;"></td> <td style="width: 10%;"></td> <td style="width: 10%;"></td> <td style="width: 10%;"></td> <td style="width: 10%;"></td> <td style="width: 10%;"></td> </tr> <tr> <td></td> <td></td> <td colspan="8" style="text-align: center;"> <table border="1" style="width: 100%; border-collapse: collapse; text-align: center;"> <tr> <td style="width: 10%;"></td> <td style="width: 10%;"></td> <td style="width: 10%;"></td> <td style="width: 10%;"></td> <td style="width: 10%;"></td> <td style="width: 10%;"></td> <td style="width: 10%;"></td> <td style="width: 10%;"></td> <td style="width: 10%;"></td> <td style="width: 10%;"></td> </tr> <tr> <td></td> <td></td> <td colspan="8" style="text-align: center;"> <table border="1" style="width: 100%; border-collapse: collapse; text-align: center;"> <tr> <td style="width: 10%;"></td> <td style="width: 10%;"></td> <td style="width: 10%;"></td> <td style="width: 10%;"></td> <td style="width: 10%;"></td> <td style="width:
10%;"></td> <td style="width: 10%;"></td> <td style="width: 10%;"></td> <td style="width: 10%;"></td> <td style="width: 10%;"></td> </tr> <tr> <td></td> <td></td> <td colspan="8" style="text-align: center;"> <table border="1" style="width: 100%; border-collapse: collapse; text-align: center;"> <tr> <td style="width: 10%;"></td> <td style="width: 10%;"></td> <td style="width: 10%;"></td> <td style="width: 10%;"></td> <td style="width: 10%;"></td> <td style="width: 10%;"></td> <td style="width: 10%;"></td> <td style="width: 10%;"></td> <td style="width: 10%;"></td> <td style="width: 10%;"></td> </tr> <tr> <td></td> <td></td> <td colspan="8" style="text-align: center;"> <table border="1" style="width: 100%; border-collapse: collapse; text-align: center;"> <tr> <td style="width: 10%;"></td> <td style="width: 10%;"></td> <td style="width: 10%;"></td> <td style="width: 10%;"></td> <td style="width: 10%;"></td> <td style="width: 10%;"></td> <td style="width: 10%;"></td> <td style="width: 10%;"></td> <td style="width: 10%;"></td> <td style="width: 10%;"></td> </tr> <tr> <td></td> <td></td> <td colspan="8" style="text-align: center;"> <table border="1" style="width: 100%; border-collapse: collapse; text-align: center;"> <tr> <td style="width: 10%;"></td> <td style="width: 10%;"></td> <td style="width: 10%;"></td> <td style="width: 10%;"></td> <td style="width: 10%;"></td> <td style="width: 10%;"></td> <td style="width: 10%;"></td> <td style="width: 10%;"></td> <td style="width: 10%;"></td> <td style="width: 10%;"></td> </tr> <tr> <td></td> <td></td> <td colspan="8" style="text-align: center;"> <table border="1" style="width: 100%; border-collapse: collapse; text-align: center;"> <tr> <td style="width: 10%;"></td> <td style="width: 10%;"></td> <td style="width: 10%;"></td> <td style="width: 10%;"></td> <td style="width: 10%;"></td> <td style="width: 10%;"></td> <td style="width: 10%;"></td> <td style="width: 10%;"></td> <td style="width: 10%;"></td> <td style="width: 10%;"></td> </tr> <tr> <td></td> <td></td> <td colspan="8" style="text-align: center;"> <table border="1" style="width: 100%; border-collapse: collapse; text-align: center;"> <tr> <td style="width: 10%;"></td> <td style="width: 10%;"></td> <td style="width: 10%;"></td> <td style="width: 10%;"></td> <td style="width: 10%;"></td> <td style="width: 10%;"></td> <td style="width: 10%;"></td> <td style="width: 10%;"></td> <td style="width: 10%;"></td> <td style="width: 10%;"></td> </tr> <tr> <td></td> <td></td> <td colspan="8" style="text-align: center;"> <table border="1" style="width: 100%; border-collapse: collapse; text-align: center;"> <tr> <td style="width: 10%;"></td> <td style="width: 10%;"></td> <td style="width: 10%;"></td> <td style="width: 10%;"></td> <td style="width: 10%;"></td> <td style="width: 10%;"></td> <td style="width: 10%;"></td> <td style="width: 10%;"></td> <td style="width: 10%;"></td> <td style="width: 10%;"></td> </tr> <tr> <td></td> <td></td> <td colspan="8" style="text-align: center;"> <table border="1" style="width: 100%; border-collapse: collapse; text-align: center;"> <tr> <td style="width: 10%;"></td> <td style="width: 10%;"></td> <td style="width: 10%;"></td> <td style="width: 10%;"></td> <td style="width: 10%;"></td> <td style="width: 10%;"></td> <td style="width: 10%;"></td> <td style="width: 10%;"></td> <td style="width: 10%;"></td> <td style="width: 10%;"></td> </tr> <tr> <td></td> <td></td> <td colspan="8" style="text-align: center;"> <table border="1" style="width: 100%; border-collapse: collapse; text-align: center;"> <tr> <td style="width: 10%;"></td> <td style="width: 10%;"></td> <td style="width: 10%;"></td> <td style="width: 10%;"></td> <td style="width: 10%;"></td> <td style="width: 10%;"></td> <td style="width: 10%;"></td> <td style="width: 10%;"></td> <td style="width: 10%;"></td> <td style="width: 10%;"></td> </tr> <tr> <td></td> <td></td> <td colspan="8" style="text-align: center;"> <table border="1" style="width: 100%; border-collapse: collapse; text-align: center;"> <tr> <td style="width: 10%;"></td> <td style="width: 10%;"></td> <td style="width: 10%;"></td> <td style="width: 10%;"></td> <td style="width: 10%;"></td> <td style="width: 10%;"></td> <td style="width: 10%;"></td> <td style="width: 10%;"></td> <td style="width: 10%;"></td> <td style="width: 10%;"></td> </tr> <tr> <td></td> <td></td> <td colspan="8" style="text-align: center;"> <table border="1" style="width: 100%; border-collapse: collapse; text-align: center;"> <tr> <td style="width: 10%;"></td> <td style="width: 10%;"></td> <td style="width: 10%;"></td> <td style="width: 10%;"></td> <td style="width: 10%;"></td> <td style="width: 10%;"></td> <td style="width: 10%;"></td> <td style="width: 10%;"></td> <td style="width: 10%;"></td> <td style="width: 10%;"></td> </tr> <tr> <td></td> <td></td> <td colspan="8" style="text-align: center;"> <table border="1" style="width: 100%; border-collapse: collapse; text-align: center;"> <tr> <td style="width: 10%;"></td> <td style="width: 10%;"></td> <td style="width: 10%;"></td> <td style="width: 10%;"></td> <td style="width: 10%;"></td> <td style="width: 10%;"></td> <td style="width: 10%;"></td> <td style="width: 10%;"></td> <td style="width: 10%;"></td> <td style="width: 10%;"></td> </tr> <tr> <td></td> <td></td> <td colspan="8" style="text-align: center;"> <table border="1" style="width: 100%; border-collapse: collapse; text-align: center;"> <tr> <td style="width: 10%;"></td> <td style="width: 10%;"></td> <td style="width: 10%;"></td> <td style="width: 10%;"></td> <td style="width: 10%;"></td> <td style="width: 10%;"></td> <td style="width: 10%;"></td> <td style="width: 10%;"></td> <td style="width: 10%;"></td> <td style="width: 10%;"></td> </tr> <tr> <td></td> <td></td> <td colspan="8" style="text-align: center;"> <table border="1" style="width: 100%; border-collapse: collapse; text-align: center;"> <tr> <td style="width: 10%;"></td> <td style="width: 10%;"></td> <td style="width: 10%;"></td> <td style="width: 10%;"></td> <td style="width: 10%;"></td> <td style="width: 10%;"></td> <td style="width: 10%;"></td> <td style="width: 10%;"></td> <td style="width: 10%;"></td> <td style="width: 10%;"></td> </tr> <tr> <td></td> <td></td> <td colspan="8" style="text-align: center;"> <table border="1" style="width: 100%; border-collapse: collapse; text-align: center;"> <tr> <td style="width: 10%;"></td> <td style="width: 10%;"></td> <td style="width: 10%;"></td> <td style="width: 10%;"></td> <td style="width: 10%;"></td> <td style="width: 10%;"></td> <td style="width: 10%;"></td> <td style="width: 10%;"></td> <td style="width: 10%;"></td> <td style="width: 10%;"></td> </tr> <tr> <td></td> <td></td> <td colspan="8" style="text-align: center;"> <table border="1" style="width: 100%; border-collapse: collapse; text-align: center;"> <tr> <td style="width: 10%;"></td> <td style="width: 10%;"></td> <td style="width: 10%;"></td> <td style="width: 10%;"></td> <td style="width: 10%;"></td> <td style="width: 10%;"></td> <td style="width: 10%;"></td> <td style="width: 10%;"></td> <td style="width: 10%;"></td> <td style="width: 10%;"></td> </tr> <tr> <td></td> <td></td> <td colspan="8" style="text-align: center;"> <table border="1" style="width: 100%; border-collapse: collapse; text-align: center;"> <tr> <td style="width: 10%;"></td> <td style="width: 10%;"></td> <td style="width: 10%;"></td> <td style="width: 10%;"></td> <td style="width: 10%;"></td> <td style="width: 10%;"></td> <td style="width: 10%;"></td> <td style="width: 10%;"></td> <td style="width: 10%;"></td> <td style="width: 10%;"></td> </tr> <tr> <td></td> <td></td> <td colspan="8" style="text-align: center;"> <table border="1" style="width: 100%; border-collapse: collapse; text-align: center;"> <tr> <td style="width: 10%;"></td> <td style="width: 10%;"></td> <td style="width: 10%;"></td> <td style="width: 10%;"></td> <td style="width: 10%;"></td> <td style="width: 10%;"></td> <td style="width: 10%;"></td> <td style="width: 10%;"></td> <td style="width: 10%;"></td> <td style="width: 10%;"></td> </tr> <tr> <td></td> <td></td> <td colspan="8" style="text-align: center;"> <table border="1" style="width: 100%; border-collapse: collapse; text-align: center;"> <tr> <td style="width: 10%;"></td> <td style="width: 10%;"></td> <td style="width: 10%;"></td> <td style="width: 10%;"></td> <td style="width: 10%;"></td> <td style="width: 10%;"></td> <td style="width: 10%;"></td> <td style="width: 10%;"></td> <td style="width: 10%;"></td> <td style="width: 10%;"></td> </tr> <tr> <td></td> <td></td> <td colspan="8" style="text-align: center;"> <table border="1" style="width: 100%; border-collapse: collapse; text-align: center;"> <tr> <td style="width: 10%;"></td> <td style="width: 10%;"></td> <td style="width: 10%;"></td> <td style="width: 10%;"></td> <td style="width: 10%;"></td> <td style="width: 10%;"></td> <td style="width: 10%;"></td> <td style="width: 10%;"></td> <td style="width: 10%;"></td> <td style="width: 10%;"></td> </tr> <tr> <td></td> <td></td> <td colspan="8" style="text-align: center;"> <table border="1" style="width: 100%; border-collapse: collapse; text-align: center;"> <tr> <td style="width: 10%;"></td> <td style="width: 10%;"></td> <td style="width: 10%;"></td> <td style="width: 10%;"></td> <td style="width: 10%;"></td> <td style="width: 10%;"></td> <td style="width: 10%;"></td> <td style="width: 10%;"></td> <td style="width: 10%;"></td> <td style="width: 10%;"></td> </tr> <tr> <td></td> <td></td> <td colspan="8" style="text-align: center;"> <table border="1" style="width: 100%; border-collapse: collapse; text-align: center;"> <tr> <td style="width: 10%;"></td> <td style="width: 10%;"></td> <td style="width: 10%;"></td> <td style="width: 10%;"></td> <td style="width: 10%;"></td> <td style="width: 10%;"></td> <td style="width: 10%;"></td> <td style="width: 10%;"></td> <td style="width: 10%;"></td> <td style="width: 10%;"></td> </tr> <tr> <td></td> <td></td> <td
colspan="8" style="text-align: center;"> <table border="1" style="width: 100%; border-collapse: collapse; text-align: center;"> <tr> <td style="width: 10%;"></td> <td style="width: 10%;"></td> <td style="width: 10%;"></td> <td style="width: 10%;"></td> <td style="width: 10%;"></td> <td style="width: 10%;"></td> <td style="width: 10%;"></td> <td style="width: 10%;"></td> <td style="width: 10%;"></td> <td style="width: 10%;"></td> </tr> <tr> <td></td> <td></td> <td colspan="8" style="text-align: center;"> <table border="1" style="width: 100%; border-collapse: collapse; text-align: center;"> <tr> <td style="width: 10%;"></td> <td style="width: 10%;"></td> <td style="width: 10%;"></td> <td style="width: 10%;"></td> <td style="width: 10%;"></td> <td style="width: 10%;"></td> <td style="width: 10%;"></td> <td style="width: 10%;"></td> <td style="width: 10%;"></td> <td style="width: 10%;"></td> </tr> <tr> <td></td> <td></td> <td colspan="8" style="text-align: center;"> <table border="1" style="width: 100%; border-collapse: collapse; text-align: center;"> <tr> <td style="width: 10%;"></td> <td style="width: 10%;"></td> <td style="width: 10%;"></td> <td style="width: 10%;"></td> <td style="width: 10%;"></td> <td style="width: 10%;"></td> <td style="width: 10%;"></td> <td style="width: 10%;"></td> <td style="width: 10%;"></td> <td style="width: 10%;"></td> </tr> <tr> <td></td> <td></td> <td colspan="8" style="text-align: center;"> <table border="1" style="width: 100%; border-collapse: collapse; text-align: center;"> <tr> <td style="width: 10%;"></td> <td style="width: 10%;"></td> <td style="width: 10%;"></td> <td style="width: 10%;"></td> <td style="width: 10%;"></td> <td style="width: 10%;"></td> <td style="width: 10%;"></td> <td style="width: 10%;"></td> <td style="width: 10%;"></td> <td style="width: 10%;"></td> </tr> <tr> <td></td> <td></td> <td colspan="8" style="text-align: center;"> <table border="1" style="width: 100%; border-collapse: collapse; text-align: center;"> <tr> <td style="width: 10%;"></td> <td style="width: 10%;"></td> <td style="width: 10%;"></td> <td style="width: 10%;"></td> <td style="width: 10%;"></td> <td style="width: 10%;"></td> <td style="width: 10%;"></td> <td style="width: 10%;"></td> <td style="width: 10%;"></td> <td style="width: 10%;"></td> </tr> <tr> <td></td> <td></td> <td colspan="8" style="text-align: center;"> <table border="1" style="width: 100%; border-collapse: collapse; text-align: center;"> <tr> </tr></table></td></tr></table></td></tr></table></td></tr></table></td></tr></table></td></tr></table></td></tr></table></td></tr></table></td></tr></table></td></tr></table></td></tr></table></td></tr></table></td></tr></table></td></tr></table></td></tr></table></td></tr></table></td></tr></table></td></tr></table></td></tr></table></td></tr></table></td></tr></table></td></tr></table></td></tr></table></td></tr></table></td></tr></table></td></tr></table></td></tr></table></td></tr></table></td></tr></table></td></tr></table></td></tr></table></td></tr></table></td></tr></table></td></tr></table></td></tr></table></td></tr></table></td></tr></table></td></tr></table></td></tr></table></td></tr></table></td></tr></table></td></tr></table> | | | | | | | | | | | | | | | | | | | | <table border="1" style="width: 100%; border-collapse: collapse; text-align: center;"> <tr> <td style="width: 10%;"></td> <td style="width: 10%;"></td> <td style="width: 10%;"></td> <td style="width: 10%;"></td> <td style="width: 10%;"></td> <td style="width: 10%;"></td> <td style="width: 10%;"></td> <td style="width: 10%;"></td> <td style="width: 10%;"></td> <td style="width: 10%;"></td> </tr> <tr> <td></td> <td></td> <td colspan="8" style="text-align: center;"> <table border="1" style="width: 100%; border-collapse: collapse; text-align: center;"> <tr> <td style="width: 10%;"></td> <td style="width: 10%;"></td> <td style="width: 10%;"></td> <td style="width: 10%;"></td> <td style="width: 10%;"></td> <td style="width: 10%;"></td> <td style="width: 10%;"></td> <td style="width: 10%;"></td> <td style="width: 10%;"></td> <td style="width: 10%;"></td> </tr> <tr> <td></td> <td></td> <td colspan="8" style="text-align: center;"> <table border="1" style="width: 100%; border-collapse: collapse; text-align: center;"> <tr> <td style="width: 10%;"></td> <td style="width: 10%;"></td> <td style="width: 10%;"></td> <td style="width: 10%;"></td> <td style="width: 10%;"></td> <td style="width: 10%;"></td> <td style="width: 10%;"></td> <td style="width: 10%;"></td> <td style="width: 10%;"></td> <td style="width: 10%;"></td> </tr> <tr> <td></td> <td></td> <td colspan="8" style="text-align: center;"> <table border="1" style="width: 100%; border-collapse: collapse; text-align: center;"> <tr> <td style="width: 10%;"></td> <td style="width: 10%;"></td> <td style="width: 10%;"></td> <td style="width: 10%;"></td> <td style="width: 10%;"></td> <td style="width: 10%;"></td> <td style="width: 10%;"></td> <td style="width: 10%;"></td> <td style="width: 10%;"></td> <td style="width: 10%;"></td> </tr> <tr> <td></td> <td></td> <td colspan="8" style="text-align: center;"> <table border="1" style="width: 100%; border-collapse: collapse; text-align: center;"> <tr> <td style="width: 10%;"></td> <td style="width: 10%;"></td> <td style="width: 10%;"></td> <td style="width: 10%;"></td> <td style="width: 10%;"></td> <td style="width: 10%;"></td> <td style="width: 10%;"></td> <td style="width: 10%;"></td> <td style="width: 10%;"></td> <td style="width: 10%;"></td> </tr> <tr> <td></td> <td></td> <td colspan="8" style="text-align: center;"> <table border="1" style="width: 100%; border-collapse: collapse; text-align: center;"> <tr> <td style="width: 10%;"></td> <td style="width: 10%;"></td> <td style="width: 10%;"></td> <td style="width: 10%;"></td> <td style="width: 10%;"></td> <td style="width: 10%;"></td> <td style="width: 10%;"></td> <td style="width: 10%;"></td> <td style="width: 10%;"></td> <td style="width: 10%;"></td> </tr> <tr> <td></td> <td></td> <td colspan="8" style="text-align: center;"> <table border="1" style="width: 100%; border-collapse: collapse; text-align: center;"> <tr> <td style="width: 10%;"></td> <td style="width: 10%;"></td> <td style="width: 10%;"></td> <td style="width: 10%;"></td> <td style="width: 10%;"></td> <td style="width: 10%;"></td> <td style="width: 10%;"></td> <td style="width: 10%;"></td> <td style="width: 10%;"></td> <td style="width: 10%;"></td> </tr> <tr> <td></td> <td></td> <td colspan="8" style="text-align: center;"> <table border="1" style="width: 100%;
border-collapse: collapse; text-align: center;"> <tr> <td style="width: 10%;"></td> <td style="width: 10%;"></td> <td style="width: 10%;"></td> <td style="width: 10%;"></td> <td style="width: 10%;"></td> <td style="width: 10%;"></td> <td style="width: 10%;"></td> <td style="width: 10%;"></td> <td style="width: 10%;"></td> <td style="width: 10%;"></td> </tr> <tr> <td></td> <td></td> <td colspan="8" style="text-align: center;"> <table border="1" style="width: 100%; border-collapse: collapse; text-align: center;"> <tr> <td style="width: 10%;"></td> <td style="width: 10%;"></td> <td style="width: 10%;"></td> <td style="width: 10%;"></td> <td style="width: 10%;"></td> <td style="width: 10%;"></td> <td style="width: 10%;"></td> <td style="width: 10%;"></td> <td style="width: 10%;"></td> <td style="width: 10%;"></td> </tr> <tr> <td></td> <td></td> <td colspan="8" style="text-align: center;"> <table border="1" style="width: 100%; border-collapse: collapse; text-align: center;"> <tr> <td style="width: 10%;"></td> <td style="width: 10%;"></td> <td style="width: 10%;"></td> <td style="width: 10%;"></td> <td style="width: 10%;"></td> <td style="width: 10%;"></td> <td style="width: 10%;"></td> <td style="width: 10%;"></td> <td style="width: 10%;"></td> <td style="width: 10%;"></td> </tr> <tr> <td></td> <td></td> <td colspan="8" style="text-align: center;"> <table border="1" style="width: 100%; border-collapse: collapse; text-align: center;"> <tr> <td style="width: 10%;"></td> <td style="width: 10%;"></td> <td style="width: 10%;"></td> <td style="width: 10%;"></td> <td style="width: 10%;"></td> <td style="width: 10%;"></td> <td style="width: 10%;"></td> <td style="width: 10%;"></td> <td style="width: 10%;"></td> <td style="width: 10%;"></td> </tr> <tr> <td></td> <td></td> <td colspan="8" style="text-align: center;"> <table border="1" style="width: 100%; border-collapse: collapse; text-align: center;"> <tr> <td style="width: 10%;"></td> <td style="width: 10%;"></td> <td style="width: 10%;"></td> <td style="width: 10%;"></td> <td style="width: 10%;"></td> <td style="width: 10%;"></td> <td style="width: 10%;"></td> <td style="width: 10%;"></td> <td style="width: 10%;"></td> <td style="width: 10%;"></td> </tr> <tr> <td></td> <td></td> <td colspan="8" style="text-align: center;"> <table border="1" style="width: 100%; border-collapse: collapse; text-align: center;"> <tr> <td style="width: 10%;"></td> <td style="width: 10%;"></td> <td style="width: 10%;"></td> <td style="width: 10%;"></td> <td style="width: 10%;"></td> <td style="width: 10%;"></td> <td style="width: 10%;"></td> <td style="width: 10%;"></td> <td style="width: 10%;"></td> <td style="width: 10%;"></td> </tr> <tr> <td></td> <td></td> <td colspan="8" style="text-align: center;"> <table border="1" style="width: 100%; border-collapse: collapse; text-align: center;"> <tr> <td style="width: 10%;"></td> <td style="width: 10%;"></td> <td style="width: 10%;"></td> <td style="width: 10%;"></td> <td style="width: 10%;"></td> <td style="width: 10%;"></td> <td style="width: 10%;"></td> <td style="width: 10%;"></td> <td style="width: 10%;"></td> <td style="width: 10%;"></td> </tr> <tr> <td></td> <td></td> <td colspan="8" style="text-align: center;"> <table border="1" style="width: 100%; border-collapse: collapse; text-align: center;"> <tr> <td style="width: 10%;"></td> <td style="width: 10%;"></td> <td style="width: 10%;"></td> <td style="width: 10%;"></td> <td style="width: 10%;"></td> <td style="width: 10%;"></td> <td style="width: 10%;"></td> <td style="width: 10%;"></td> <td style="width: 10%;"></td> <td style="width: 10%;"></td> </tr> <tr> <td></td> <td></td> <td colspan="8" style="text-align: center;"> <table border="1" style="width: 100%; border-collapse: collapse; text-align: center;"> <tr> <td style="width: 10%;"></td> <td style="width: 10%;"></td> <td style="width: 10%;"></td> <td style="width: 10%;"></td> <td style="width: 10%;"></td> <td style="width: 10%;"></td> <td style="width: 10%;"></td> <td style="width: 10%;"></td> <td style="width: 10%;"></td> <td style="width: 10%;"></td> </tr> <tr> <td></td> <td></td> <td colspan="8" style="text-align: center;"> <table border="1" style="width: 100%; border-collapse: collapse; text-align: center;"> <tr> <td style="width: 10%;"></td> <td style="width: 10%;"></td> <td style="width: 10%;"></td> <td style="width: 10%;"></td> <td style="width: 10%;"></td> <td style="width: 10%;"></td> <td style="width: 10%;"></td> <td style="width: 10%;"></td> <td style="width: 10%;"></td> <td style="width: 10%;"></td> </tr> <tr> <td></td> <td></td> <td colspan="8" style="text-align: center;"> <table border="1" style="width: 100%; border-collapse: collapse; text-align: center;"> <tr> <td style="width: 10%;"></td> <td style="width: 10%;"></td> <td style="width: 10%;"></td> <td style="width: 10%;"></td> <td style="width: 10%;"></td> <td style="width: 10%;"></td> <td style="width: 10%;"></td> <td style="width: 10%;"></td> <td style="width: 10%;"></td> <td style="width: 10%;"></td> </tr> <tr> <td></td> <td></td> <td colspan="8" style="text-align: center;"> <table border="1" style="width: 100%; border-collapse: collapse; text-align: center;"> <tr> <td style="width: 10%;"></td> <td style="width: 10%;"></td> <td style="width: 10%;"></td> <td style="width: 10%;"></td> <td style="width: 10%;"></td> <td style="width: 10%;"></td> <td style="width: 10%;"></td> <td style="width: 10%;"></td> <td style="width: 10%;"></td> <td style="width: 10%;"></td> </tr> <tr> <td></td> <td></td> <td colspan="8" style="text-align: center;"> <table border="1" style="width: 100%; border-collapse: collapse; text-align: center;"> <tr> <td style="width: 10%;"></td> <td style="width: 10%;"></td> <td style="width: 10%;"></td> <td style="width: 10%;"></td> <td style="width: 10%;"></td> <td style="width: 10%;"></td> <td style="width: 10%;"></td> <td style="width: 10%;"></td> <td style="width: 10%;"></td> <td style="width: 10%;"></td> </tr> <tr> <td></td> <td></td> <td colspan="8" style="text-align: center;"> <table border="1" style="width: 100%; border-collapse: collapse; text-align: center;"> <tr> <td style="width: 10%;"></td> <td style="width: 10%;"></td> <td style="width: 10%;"></td> <td style="width: 10%;"></td> <td style="width: 10%;"></td> <td style="width: 10%;"></td> <td style="width: 10%;"></td> <td style="width: 10%;"></td> <td style="width: 10%;"></td> <td style="width: 10%;"></td> </tr> <tr> <td></td> <td></td> <td colspan="8" style="text-align: center;"> <table border="1" style="width: 100%; border-collapse: collapse; text-align: center;"> <tr> <td style="width: 10%;"></td> <td style="width: 10%;"></td> <td style="width: 10%;"></td> <td style="width: 10%;"></td> <td style="width: 10%;"></td> <td style="width: 10%;"></td> <td style="width: 10%;"></td> <td style="width: 10%;"></td> <td style="width: 10%;"></td> <td style="width: 10%;"></td> </tr> <tr> <td></td> <td></td> <td colspan="8" style="text-align: center;"> <table border="1" style="width: 100%; border-collapse: collapse; text-align: center;"> <tr> <td style="width: 10%;"></td> <td style="width: 10%;"></td> <td style="width: 10%;"></td> <td style="width: 10%;"></td> <td style="width: 10%;"></td> <td style="width: 10%;"></td> <td style="width: 10%;"></td> <td style="width: 10%;"></td> <td style="width: 10%;"></td> <td style="width: 10%;"></td> </tr> <tr> <td></td> <td></td> <td colspan="8" style="text-align: center;"> <table border="1" style="width: 100%; border-collapse: collapse; text-align: center;"> <tr> <td style="width: 10%;"></td> <td style="width: 10%;"></td> <td style="width: 10%;"></td> <td style="width: 10%;"></td> <td style="width: 10%;"></td> <td style="width: 10%;"></td> <td style="width: 10%;"></td> <td style="width: 10%;"></td> <td style="width: 10%;"></td> <td style="width: 10%;"></td> </tr> <tr> <td></td> <td></td> <td colspan="8" style="text-align: center;"> <table border="1" style="width: 100%; border-collapse: collapse; text-align: center;"> <tr> <td style="width: 10%;"></td> <td style="width: 10%;"></td> <td style="width: 10%;"></td> <td style="width: 10%;"></td> <td style="width: 10%;"></td> <td style="width: 10%;"></td> <td style="width: 10%;"></td> <td style="width: 10%;"></td> <td style="width: 10%;"></td> <td style="width: 10%;"></td> </tr> <tr> <td></td> <td></td> <td colspan="8" style="text-align: center;"> <table border="1" style="width: 100%; border-collapse: collapse; text-align: center;"> <tr> <td style="width: 10%;"></td> <td style="width: 10%;"></td> <td style="width: 10%;"></td> <td style="width: 10%;"></td> <td style="width: 10%;"></td> <td style="width: 10%;"></td> <td style="width: 10%;"></td> <td style="width: 10%;"></td> <td style="width: 10%;"></td> <td style="width: 10%;"></td> </tr> <tr> <td></td> <td></td> <td colspan="8" style="text-align: center;"> <table border="1" style="width: 100%; border-collapse: collapse; text-align: center;"> <tr> <td style="width: 10%;"></td> <td style="width: 10%;"></td> <td style="width: 10%;"></td> <td style="width: 10%;"></td> <td style="width: 10%;"></td> <td style="width: 10%;"></td> <td style="width: 10%;"></td> <td style="width: 10%;"></td> <td style="width: 10%;"></td> <td style="width: 10%;"></td> </tr> <tr> <td></td> <td></td> <td colspan="8" style="text-align: center;"> <table border="1" style="width: 100%; border-collapse: collapse; text-align: center;"> <tr> <td style="width: 10%;"></td> <td style="width: 10%;"></td> <td style="width: 10%;"></td> <td style="width: 10%;"></td> <td style="width: 10%;"></td> <td style="width: 10%;"></td> <td style="width: 10%;"></td> <td style="width: 10%;"></td> <td style="width: 10%;"></td> <td style="width: 10%;"></td> </tr> <tr> <td></td> <td></td> <td colspan="8" style="text-align: center;"> <table border="1" style="width: 100%; border-collapse: collapse; text-align: center;"> <tr> <td style="width: 10%;"></td> <td style="width: 10%;"></td> <td style="width: 10%;"></td> <td style="width:
10%;"></td> <td style="width: 10%;"></td> <td style="width: 10%;"></td> <td style="width: 10%;"></td> <td style="width: 10%;"></td> <td style="width: 10%;"></td> <td style="width: 10%;"></td> </tr> <tr> <td></td> <td></td> <td colspan="8" style="text-align: center;"> <table border="1" style="width: 100%; border-collapse: collapse; text-align: center;"> <tr> <td style="width: 10%;"></td> <td style="width: 10%;"></td> <td style="width: 10%;"></td> <td style="width: 10%;"></td> <td style="width: 10%;"></td> <td style="width: 10%;"></td> <td style="width: 10%;"></td> <td style="width: 10%;"></td> <td style="width: 10%;"></td> <td style="width: 10%;"></td> </tr> <tr> <td></td> <td></td> <td colspan="8" style="text-align: center;"> <table border="1" style="width: 100%; border-collapse: collapse; text-align: center;"> <tr> <td style="width: 10%;"></td> <td style="width: 10%;"></td> <td style="width: 10%;"></td> <td style="width: 10%;"></td> <td style="width: 10%;"></td> <td style="width: 10%;"></td> <td style="width: 10%;"></td> <td style="width: 10%;"></td> <td style="width: 10%;"></td> <td style="width: 10%;"></td> </tr> <tr> <td></td> <td></td> <td colspan="8" style="text-align: center;"> <table border="1" style="width: 100%; border-collapse: collapse; text-align: center;"> <tr> <td style="width: 10%;"></td> <td style="width: 10%;"></td> <td style="width: 10%;"></td> <td style="width: 10%;"></td> <td style="width: 10%;"></td> <td style="width: 10%;"></td> <td style="width: 10%;"></td> <td style="width: 10%;"></td> <td style="width: 10%;"></td> <td style="width: 10%;"></td> </tr> <tr> <td></td> <td></td> <td colspan="8" style="text-align: center;"> <table border="1" style="width: 100%; border-collapse: collapse; text-align: center;"> <tr> <td style="width: 10%;"></td> <td style="width: 10%;"></td> <td style="width: 10%;"></td> <td style="width: 10%;"></td> <td style="width: 10%;"></td> <td style="width: 10%;"></td> <td style="width: 10%;"></td> <td style="width: 10%;"></td> <td style="width: 10%;"></td> <td style="width: 10%;"></td> </tr> <tr> <td></td> <td></td> <td colspan="8" style="text-align: center;"> <table border="1" style="width: 100%; border-collapse: collapse; text-align: center;"> <tr> <td style="width: 10%;"></td> <td style="width: 10%;"></td> <td style="width: 10%;"></td> <td style="width: 10%;"></td> <td style="width: 10%;"></td> <td style="width: 10%;"></td> <td style="width: 10%;"></td> <td style="width: 10%;"></td> <td style="width: 10%;"></td> <td style="width: 10%;"></td> </tr> <tr> <td></td> <td></td> <td colspan="8" style="text-align: center;"> <table border="1" style="width: 100%; border-collapse: collapse; text-align: center;"> <tr> <td style="width: 10%;"></td> <td style="width: 10%;"></td> <td style="width: 10%;"></td> <td style="width: 10%;"></td> <td style="width: 10%;"></td> <td style="width: 10%;"></td> <td style="width: 10%;"></td> <td style="width: 10%;"></td> <td style="width: 10%;"></td> <td style="width: 10%;"></td> </tr> <tr> <td></td> <td></td> <td colspan="8" style="text-align: center;"> <table border="1" style="width: 100%; border-collapse: collapse; text-align: center;"> <tr> <td style="width: 10%;"></td> <td style="width: 10%;"></td> <td style="width: 10%;"></td> <td style="width: 10%;"></td> <td style="width: 10%;"></td> <td style="width: 10%;"></td> <td style="width: 10%;"></td> <td style="width: 10%;"></td> <td style="width: 10%;"></td> <td style="width: 10%;"></td> </tr> <tr> <td></td> <td></td> <td colspan="8" style="text-align: center;"> <table border="1" style="width: 100%; border-collapse: collapse; text-align: center;"> <tr> <td style="width: 10%;"></td> <td style="width: 10%;"></td> <td style="width: 10%;"></td> <td style="width: 10%;"></td> <td style="width: 10%;"></td> <td style="width: 10%;"></td> <td style="width: 10%;"></td> <td style="width: 10%;"></td> <td style="width: 10%;"></td> <td style="width: 10%;"></td> </tr> <tr> <td></td> <td></td> <td colspan="8" style="text-align: center;"> <table border="1" style="width: 100%; border-collapse: collapse; text-align: center;"> <tr> <td style="width: 10%;"></td> <td style="width: 10%;"></td> <td style="width: 10%;"></td> <td style="width: 10%;"></td> <td style="width: 10%;"></td> <td style="width: 10%;"></td> <td style="width: 10%;"></td> <td style="width: 10%;"></td> <td style="width: 10%;"></td> <td style="width: 10%;"></td> </tr> <tr> <td></td> <td></td> <td colspan="8" style="text-align: center;"> <table border="1" style="width: 100%; border-collapse: collapse; text-align: center;"> <tr> <td style="width: 10%;"></td> <td style="width: 10%;"></td> <td style="width: 10%;"></td> <td style="width: 10%;"></td> <td style="width: 10%;"></td> <td style="width: 10%;"></td> <td style="width: 10%;"></td> <td style="width: 10%;"></td> <td style="width: 10%;"></td> <td style="width: 10%;"></td> </tr> <tr> <td></td> <td></td> <td colspan="8" style="text-align: center;"> <table border="1" style="width: 100%; border-collapse: collapse; text-align: center;"> <tr> <td style="width: 10%;"></td> <td style="width: 10%;"></td> <td style="width: 10%;"></td> <td style="width: 10%;"></td> <td style="width: 10%;"></td> <td style="width: 10%;"></td> <td style="width: 10%;"></td> <td style="width: 10%;"></td> <td style="width: 10%;"></td> <td style="width: 10%;"></td> </tr> <tr> <td></td> <td></td> <td colspan="8" style="text-align: center;"> <table border="1" style="width: 100%; border-collapse: collapse; text-align: center;"> <tr> </tr></table></td></tr></table></td></tr></table></td></tr></table></td></tr></table></td></tr></table></td></tr></table></td></tr></table></td></tr></table></td></tr></table></td></tr></table></td></tr></table></td></tr></table></td></tr></table></td></tr></table></td></tr></table></td></tr></table></td></tr></table></td></tr></table></td></tr></table></td></tr></table></td></tr></table></td></tr></table></td></tr></table></td></tr></table></td></tr></table></td></tr></table></td></tr></table></td></tr></table></td></tr></table></td></tr></table></td></tr></table></td></tr></table></td></tr></table></td></tr></table></td></tr></table></td></tr></table></td></tr></table></td></tr></table></td></tr></table></td></tr></table> | | | | | | | | | | | | | | | | | | | | <table border="1" style="width: 100%; border-collapse: collapse; text-align: center;"> <tr> <td style="width: 10%;"></td> <td style="width: 10%;"></td> <td style="width: 10%;"></td> <td style="width: 10%;"></td> <td style="width: 10%;"></td> <td style="width: 10%;"></td> <td style="width:
10%;"></td> <td style="width: 10%;"></td> <td style="width: 10%;"></td> <td style="width: 10%;"></td> </tr> <tr> <td></td> <td></td> <td colspan="8" style="text-align: center;"> <table border="1" style="width: 100%; border-collapse: collapse; text-align: center;"> <tr> <td style="width: 10%;"></td> <td style="width: 10%;"></td> <td style="width: 10%;"></td> <td style="width: 10%;"></td> <td style="width: 10%;"></td> <td style="width: 10%;"></td> <td style="width: 10%;"></td> <td style="width: 10%;"></td> <td style="width: 10%;"></td> <td style="width: 10%;"></td> </tr> <tr> <td></td> <td></td> <td colspan="8" style="text-align: center;"> <table border="1" style="width: 100%; border-collapse: collapse; text-align: center;"> <tr> <td style="width: 10%;"></td> <td style="width: 10%;"></td> <td style="width: 10%;"></td> <td style="width: 10%;"></td> <td style="width: 10%;"></td> <td style="width: 10%;"></td> <td style="width: 10%;"></td> <td style="width: 10%;"></td> <td style="width: 10%;"></td> <td style="width: 10%;"></td> </tr> <tr> <td></td> <td></td> <td colspan="8" style="text-align: center;"> <table border="1" style="width: 100%; border-collapse: collapse; text-align: center;"> <tr> <td style="width: 10%;"></td> <td style="width: 10%;"></td> <td style="width: 10%;"></td> <td style="width: 10%;"></td> <td style="width: 10%;"></td> <td style="width: 10%;"></td> <td style="width: 10%;"></td> <td style="width: 10%;"></td> <td style="width: 10%;"></td> <td style="width: 10%;"></td> </tr> <tr> <td></td> <td></td> <td colspan="8" style="text-align: center;"> <table border="1" style="width: 100%; border-collapse: collapse; text-align: center;"> <tr> <td style="width: 10%;"></td> <td style="width: 10%;"></td> <td style="width: 10%;"></td> <td style="width: 10%;"></td> <td style="width: 10%;"></td> <td style="width: 10%;"></td> <td style="width: 10%;"></td> <td style="width: 10%;"></td> <td style="width: 10%;"></td> <td style="width: 10%;"></td> </tr> <tr> <td></td> <td></td> <td colspan="8" style="text-align: center;"> <table border="1" style="width: 100%; border-collapse: collapse; text-align: center;"> <tr> <td style="width: 10%;"></td> <td style="width: 10%;"></td> <td style="width: 10%;"></td> <td style="width: 10%;"></td> <td style="width: 10%;"></td> <td style="width: 10%;"></td> <td style="width: 10%;"></td> <td style="width: 10%;"></td> <td style="width: 10%;"></td> <td style="width: 10%;"></td> </tr> <tr> <td></td> <td></td> <td colspan="8" style="text-align: center;"> <table border="1" style="width: 100%; border-collapse: collapse; text-align: center;"> <tr> <td style="width: 10%;"></td> <td style="width: 10%;"></td> <td style="width: 10%;"></td> <td style="width: 10%;"></td> <td style="width: 10%;"></td> <td style="width: 10%;"></td> <td style="width: 10%;"></td> <td style="width: 10%;"></td> <td style="width: 10%;"></td> <td style="width: 10%;"></td> </tr> <tr> <td></td> <td></td> <td colspan="8" style="text-align: center;"> <table border="1" style="width: 100%; border-collapse: collapse; text-align: center;"> <tr> <td style="width: 10%;"></td> <td style="width: 10%;"></td> <td style="width: 10%;"></td> <td style="width: 10%;"></td> <td style="width: 10%;"></td> <td style="width: 10%;"></td> <td style="width: 10%;"></td> <td style="width: 10%;"></td> <td style="width: 10%;"></td> <td style="width: 10%;"></td> </tr> <tr> <td></td> <td></td> <td colspan="8" style="text-align: center;"> <table border="1" style="width: 100%; border-collapse: collapse; text-align: center;"> <tr> <td style="width: 10%;"></td> <td style="width: 10%;"></td> <td style="width: 10%;"></td> <td style="width: 10%;"></td> <td style="width: 10%;"></td> <td style="width: 10%;"></td> <td style="width: 10%;"></td> <td style="width: 10%;"></td> <td style="width: 10%;"></td> <td style="width: 10%;"></td> </tr> <tr> <td></td> <td></td> <td colspan="8" style="text-align: center;"> <table border="1" style="width: 100%; border-collapse: collapse; text-align: center;"> <tr> <td style="width: 10%;"></td> <td style="width: 10%;"></td> <td style="width: 10%;"></td> <td style="width: 10%;"></td> <td style="width: 10%;"></td> <td style="width: 10%;"></td> <td style="width: 10%;"></td> <td style="width: 10%;"></td> <td style="width: 10%;"></td> <td style="width: 10%;"></td> </tr> <tr> <td></td> <td></td> <td colspan="8" style="text-align: center;"> <table border="1" style="width: 100%; border-collapse: collapse; text-align: center;"> <tr> <td style="width: 10%;"></td> <td style="width: 10%;"></td> <td style="width: 10%;"></td> <td style="width: 10%;"></td> <td style="width: 10%;"></td> <td style="width: 10%;"></td> <td style="width: 10%;"></td> <td style="width: 10%;"></td> <td style="width: 10%;"></td> <td style="width: 10%;"></td> </tr> <tr> <td></td> <td></td> <td colspan="8" style="text-align: center;"> <table border="1" style="width: 100%; border-collapse: collapse; text-align: center;"> <tr> <td style="width: 10%;"></td> <td style="width: 10%;"></td> <td style="width: 10%;"></td> <td style="width: 10%;"></td> <td style="width: 10%;"></td> <td style="width: 10%;"></td> <td style="width: 10%;"></td> <td style="width: 10%;"></td> <td style="width: 10%;"></td> <td style="width: 10%;"></td> </tr> <tr> <td></td> <td></td> <td colspan="8" style="text-align: center;"> <table border="1" style="width: 100%; border-collapse: collapse; text-align: center;"> <tr> <td style="width: 10%;"></td> <td style="width: 10%;"></td> <td style="width: 10%;"></td> <td style="width: 10%;"></td> <td style="width: 10%;"></td> <td style="width: 10%;"></td> <td style="width: 10%;"></td> <td style="width: 10%;"></td> <td style="width: 10%;"></td> <td style="width: 10%;"></td> </tr> <tr> <td></td> <td></td> <td colspan="8" style="text-align: center;"> <table border="1" style="width: 100%; border-collapse: collapse; text-align: center;"> <tr> <td style="width: 10%;"></td> <td style="width: 10%;"></td> <td style="width: 10%;"></td> <td style="width: 10%;"></td> <td style="width: 10%;"></td> <td style="width: 10%;"></td> <td style="width: 10%;"></td> <td style="width: 10%;"></td> <td style="width: 10%;"></td> <td style="width: 10%;"></td> </tr> <tr> <td></td> <td></td> <td colspan="8" style="text-align: center;"> <table border="1" style="width: 100%; border-collapse: collapse; text-align: center;"> <tr> <td style="width: 10%;"></td> <td style="width: 10%;"></td> <td style="width: 10%;"></td> <td style="width: 10%;"></td> <td style="width: 10%;"></td> <td style="width: 10%;"></td> <td style="width: 10%;"></td> <td style="width: 10%;"></td> <td style="width: 10%;"></td> <td style="width: 10%;"></td> </tr> <tr> <td></td> <td></td> <td colspan="8" style="text-align: center;"> <table border="1" style="width: 100%; border-collapse: collapse; text-align: center;"> <tr> <td style="width: 10%;"></td> <td style="width: 10%;"></td> <td style="width: 10%;"></td> <td style="width: 10%;"></td> <td style="width: 10%;"></td> <td style="width: 10%;"></td> <td style="width: 10%;"></td> <td style="width: 10%;"></td> <td style="width: 10%;"></td> <td style="width: 10%;"></td> </tr> <tr> <td></td> <td></td> <td colspan="8" style="text-align: center;"> <table border="1" style="width: 100%; border-collapse: collapse; text-align: center;"> <tr> <td style="width: 10%;"></td> <td style="width: 10%;"></td> <td style="width: 10%;"></td> <td style="width: 10%;"></td> <td style="width: 10%;"></td> <td style="width: 10%;"></td> <td style="width: 10%;"></td> <td style="width: 10%;"></td> <td style="width: 10%;"></td> <td style="width: 10%;"></td> </tr> <tr> <td></td> <td></td> <td colspan="8" style="text-align: center;"> <table border="1" style="width: 100%; border-collapse: collapse; text-align: center;"> <tr> <td style="width: 10%;"></td> <td style="width: 10%;"></td> <td style="width: 10%;"></td> <td style="width: 10%;"></td> <td style="width: 10%;"></td> <td style="width: 10%;"></td> <td style="width: 10%;"></td> <td style="width: 10%;"></td> <td style="width: 10%;"></td> <td style="width: 10%;"></td> </tr> <tr> <td></td> <td></td> <td colspan="8" style="text-align: center;"> <table border="1" style="width: 100%; border-collapse: collapse; text-align: center;"> <tr> <td style="width: 10%;"></td> <td style="width: 10%;"></td> <td style="width: 10%;"></td> <td style="width: 10%;"></td> <td style="width: 10%;"></td> <td style="width: 10%;"></td> <td style="width: 10%;"></td> <td style="width: 10%;"></td> <td style="width: 10%;"></td> <td style="width: 10%;"></td> </tr> <tr> <td></td> <td></td> <td colspan="8" style="text-align: center;"> <table border="1" style="width: 100%; border-collapse: collapse; text-align: center;"> <tr> <td style="width: 10%;"></td> <td style="width: 10%;"></td> <td style="width: 10%;"></td> <td style="width: 10%;"></td> <td style="width: 10%;"></td> <td style="width: 10%;"></td> <td style="width: 10%;"></td> <td style="width: 10%;"></td> <td style="width: 10%;"></td> <td style="width: 10%;"></td> </tr> <tr> <td></td> <td></td> <td colspan="8" style="text-align: center;"> <table border="1" style="width: 100%; border-collapse: collapse; text-align: center;"> <tr> <td style="width: 10%;"></td> <td style="width: 10%;"></td> <td style="width: 10%;"></td> <td style="width: 10%;"></td> <td style="width: 10%;"></td> <td style="width: 10%;"></td> <td style="width: 10%;"></td> <td style="width: 10%;"></td> <td style="width: 10%;"></td> <td style="width: 10%;"></td> </tr> <tr> <td></td> <td></td> <td colspan="8" style="text-align: center;"> <table border="1" style="width: 100%; border-collapse: collapse; text-align: center;"> <tr> <td style="width: 10%;"></td> <td style="width: 10%;"></td> <td style="width: 10%;"></td> <td style="width: 10%;"></td> <td style="width: 10%;"></td> <td style="width: 10%;"></td> <td style="width: 10%;"></td> <td style="width: 10%;"></td> <td style="width: 10%;"></td> <td style="width: 10%;"></td> </tr> <tr> <td></td> <td></td> <td colspan="8" style="text-align:
center;"> <table border="1" style="width: 100%; border-collapse: collapse; text-align: center;"> <tr> <td style="width: 10%;"></td> <td style="width: 10%;"></td> <td style="width: 10%;"></td> <td style="width: 10%;"></td> <td style="width: 10%;"></td> <td style="width: 10%;"></td> <td style="width: 10%;"></td> <td style="width: 10%;"></td> <td style="width: 10%;"></td> <td style="width: 10%;"></td> </tr> <tr> <td></td> <td></td> <td colspan="8" style="text-align: center;"> <table border="1" style="width: 100%; border-collapse: collapse; text-align: center;"> <tr> <td style="width: 10%;"></td> <td style="width: 10%;"></td> <td style="width: 10%;"></td> <td style="width: 10%;"></td> <td style="width: 10%;"></td> <td style="width: 10%;"></td> <td style="width: 10%;"></td> <td style="width: 10%;"></td> <td style="width: 10%;"></td> <td style="width: 10%;"></td> </tr> <tr> <td></td> <td></td> <td colspan="8" style="text-align: center;"> <table border="1" style="width: 100%; border-collapse: collapse; text-align: center;"> <tr> <td style="width: 10%;"></td> <td style="width: 10%;"></td> <td style="width: 10%;"></td> <td style="width: 10%;"></td> <td style="width: 10%;"></td> <td style="width: 10%;"></td> <td style="width: 10%;"></td> <td style="width: 10%;"></td> <td style="width: 10%;"></td> <td style="width: 10%;"></td> </tr> <tr> <td></td> <td></td> <td colspan="8" style="text-align: center;"> <table border="1" style="width: 100%; border-collapse: collapse; text-align: center;"> <tr> <td style="width: 10%;"></td> <td style="width: 10%;"></td> <td style="width: 10%;"></td> <td style="width: 10%;"></td> <td style="width: 10%;"></td> <td style="width: 10%;"></td> <td style="width: 10%;"></td> <td style="width: 10%;"></td> <td style="width: 10%;"></td> <td style="width: 10%;"></td> </tr> <tr> <td></td> <td></td> <td colspan="8" style="text-align: center;"> <table border="1" style="width: 100%; border-collapse: collapse; text-align: center;"> <tr> <td style="width: 10%;"></td> <td style="width: 10%;"></td> <td style="width: 10%;"></td> <td style="width: 10%;"></td> <td style="width: 10%;"></td> <td style="width: 10%;"></td> <td style="width: 10%;"></td> <td style="width: 10%;"></td> <td style="width: 10%;"></td> <td style="width: 10%;"></td> </tr> <tr> <td></td> <td></td> <td colspan="8" style="text-align: center;"> <table border="1" style="width: 100%; border-collapse: collapse; text-align: center;"> <tr> <td style="width: 10%;"></td> <td style="width: 10%;"></td> <td style="width: 10%;"></td> <td style="width: 10%;"></td> <td style="width: 10%;"></td> <td style="width: 10%;"></td> <td style="width: 10%;"></td> <td style="width: 10%;"></td> <td style="width: 10%;"></td> <td style="width: 10%;"></td> </tr> <tr> <td></td> <td></td> <td colspan="8" style="text-align: center;"> <table border="1" style="width: 100%; border-collapse: collapse; text-align: center;"> <tr> <td style="width: 10%;"></td> <td style="width: 10%;"></td> <td style="width: 10%;"></td> <td style="width: 10%;"></td> <td style="width: 10%;"></td> <td style="width: 10%;"></td> <td style="width: 10%;"></td> <td style="width: 10%;"></td> <td style="width: 10%;"></td> <td style="width: 10%;"></td> </tr> <tr> <td></td> <td></td> <td colspan="8" style="text-align: center;"> <table border="1" style="width: 100%; border-collapse: collapse; text-align: center;"> <tr> <td style="width: 10%;"></td> <td style="width: 10%;"></td> <td style="width: 10%;"></td> <td style="width: 10%;"></td> <td style="width: 10%;"></td> <td style="width: 10%;"></td> <td style="width: 10%;"></td> <td style="width: 10%;"></td> <td style="width: 10%;"></td> <td style="width: 10%;"></td> </tr> <tr> <td></td> <td></td> <td colspan="8" style="text-align: center;"> <table border="1" style="width: 100%; border-collapse: collapse; text-align: center;"> <tr> <td style="width: 10%;"></td> <td style="width: 10%;"></td> <td style="width: 10%;"></td> <td style="width: 10%;"></td> <td style="width: 10%;"></td> <td style="width: 10%;"></td> <td style="width: 10%;"></td> <td style="width: 10%;"></td> <td style="width: 10%;"></td> <td style="width: 10%;"></td> </tr> <tr> <td></td> <td></td> <td colspan="8" style="text-align: center;"> <table border="1" style="width: 100%; border-collapse: collapse; text-align: center;"> <tr> <td style="width: 10%;"></td> <td style="width: 10%;"></td> <td style="width: 10%;"></td> <td style="width: 10%;"></td> <td style="width: 10%;"></td> <td style="width: 10%;"></td> <td style="width: 10%;"></td> <td style="width: 10%;"></td> <td style="width: 10%;"></td> <td style="width: 10%;"></td> </tr> <tr> <td></td> <td></td> <td colspan="8" style="text-align: center;"> <table border="1" style="width: 100%; border-collapse: collapse; text-align: center;"> <tr> <td style="width: 10%;"></td> <td style="width: 10%;"></td> <td style="width: 10%;"></td> <td style="width: 10%;"></td> <td style="width: 10%;"></td> <td style="width: 10%;"></td> <td style="width: 10%;"></td> <td style="width: 10%;"></td> <td style="width: 10%;"></td> <td style="width: 10%;"></td> </tr> <tr> <td></td> <td></td> <td colspan="8" style="text-align: center;"> <table border="1" style="width: 100%; border-collapse: collapse; text-align: center;"> <tr> <td style="width: 10%;"></td> <td style="width: 10%;"></td> <td style="width: 10%;"></td> <td style="width: 10%;"></td> <td style="width: 10%;"></td> <td style="width: 10%;"></td> <td style="width: 10%;"></td> <td style="width: 10%;"></td> <td style="width: 10%;"></td> <td style="width: 10%;"></td> </tr> <tr> <td></td> <td></td> <td colspan="8" style="text-align: center;"> <table border="1" style="width: 100%; border-collapse: collapse; text-align: center;"> <tr> <td style="width: 10%;"></td> <td style="width: 10%;"></td> <td style="width: 10%;"></td> <td style="width: 10%;"></td> <td style="width: 10%;"></td> <td style="width: 10%;"></td> <td style="width: 10%;"></td> <td style="width: 10%;"></td> <td style="width: 10%;"></td> <td style="width: 10%;"></td> </tr> <tr> <td></td> <td></td> <td colspan="8" style="text-align: center;"> <table border="1" style="width: 100%; border-collapse: collapse; text-align: center;"> <tr> <td style="width: 10%;"></td> <td style="width: 10%;"></td> <td style="width: 10%;"></td> <td style="width: 10%;"></td> <td style="width: 10%;"></td> <td style="width: 10%;"></td> <td style="width: 10%;"></td> <td style="width: 10%;"></td> <td style="width: 10%;"></td> <td style="width: 10%;"></td> </tr> <tr> <td></td> <td></td> <td colspan="8" style="text-align: center;"> <table border="1" style="width: 100%; border-collapse: collapse; text-align: center;"> <tr> <td style="width: 10%;"></td> <td style="width: 10%;"></td> <td style="width: 10%;"></td> <td style="width: 10%;"></td> <td style="width: 10%;"></td> <td style="width: 10%;"></td> <td style="width: 10%;"></td> <td style="width: 10%;"></td> <td style="width: 10%;"></td> <td style="width: 10%;"></td> </tr> <tr> <td></td> <td></td> <td colspan="8" style="text-align: center;"> <table border="1" style="width: 100%; border-collapse: collapse; text-align: center;"> <tr> <td style="width: 10%;"></td> <td style="width: 10%;"></td> <td style="width: 10%;"></td> <td style="width: 10%;"></td> <td style="width: 10%;"></td> <td style="width: 10%;"></td> <td style="width: 10%;"></td> <td style="width: 10%;"></td> <td style="width: 10%;"></td> <td style="width: 10%;"></td> </tr> <tr> <td></td> <td></td> <td colspan="8" style="text-align: center;"> <table border="1" style="width: 100%; border-collapse: collapse; text-align: center;"> <tr> <td style="width: 10%;"></td> <td style="width: 10%;"></td> <td style="width: 10%;"></td> <td style="width: 10%;"></td> <td style="width: 10%;"></td> <td style="width: 10%;"></td> <td style="width: 10%;"></td> <td style="width: 10%;"></td> <td style="width: 10%;"></td> <td style="width: 10%;"></td> </tr> <tr> <td></td> <td></td> <td colspan="8" style="text-align: center;"> <table border="1" style="width: 100%; border-collapse: collapse; text-align: center;"> <tr> </tr></table></td></tr></table></td></tr></table></td></tr></table></td></tr></table></td></tr></table></td></tr></table></td></tr></table></td></tr></table></td></tr></table></td></tr></table></td></tr></table></td></tr></table></td></tr></table></td></tr></table></td></tr></table></td></tr></table></td></tr></table></td></tr></table></td></tr></table></td></tr></table></td></tr></table></td></tr></table></td></tr></table></td></tr></table></td></tr></table></td></tr></table></td></tr></table></td></tr></table></td></tr></table></td></tr></table></td></tr></table></td></tr></table></td></tr></table></td></tr></table></td></tr></table></td></tr></table></td></tr></table></td></tr></table></td></tr></table>
 | | | | | | | | | | | | | | | | | | | | <table border="1" style="width: 100%; border-collapse: collapse; text-align: center;"> <tr> <td style="width: 10%;"></td> <td style="width: 10%;"></td> <td style="width: 10%;"></td> <td style="width: 10%;"></td> <td style="width: 10%;"></td> <td style="width: 10%;"></td> <td style="width: 10%;"></td> <td style="width: 10%;"></td> <td style="width: 10%;"></td> <td style="width: 10%;"></td> </tr> <tr> <td></td> <td></td> <td colspan="8" style="text-align: center;"> <table border="1" style="width: 100%; border-collapse: collapse; text-align: center;"> <tr> <td style="width: 10%;"></td> <td style="width: 10%;"></td> <td style="width: 10%;"></td> <td style="width: 10%;"></td> <td style="width: 10%;"></td> <td style="width: 10%;"></td> <td style="width: 10%;"></td> <td style="width: 10%;"></td> <td style="width: 10%;"></td> <td style="width: 10%;"></td> </tr> <tr> <td></td> <td></td> <td colspan="8" style="text-align: center;"> <table border="1" style="width: 100%; border-collapse: collapse; text-align: center;"> <tr> <td style="width: 10%;"></td> <td style="width: 10%;"></td> <td style="width: 10%;"></td> <td style="width: 10%;"></td> <td style="width: 10%;"></td> <td style="width: 10%;"></td> <td style="width: 10%;"></td> <td style="width: 10%;"></td> <td style="width: 10%;"></td> <td style="width: 10%;"></td> </tr> <tr> <td></td> <td></td> <td colspan="8" style="text-align: center;"> <table border="1" style="width: 100%; border-collapse: collapse; text-align: center;"> <tr> <td style="width: 10%;"></td> <td style="width: 10%;"></td> <td style="width: 10%;"></td> <td style="width: 10%;"></td> <td style="width: 10%;"></td> <td style="width: 10%;"></td> <td style="width: 10%;"></td> <td style="width: 10%;"></td> <td style="width: 10%;"></td> <td style="width: 10%;"></td> </tr> <tr> <td></td> <td></td> <td colspan="8" style="text-align: center;"> <table border="1" style="width: 100%; border-collapse: collapse; text-align: center;"> <tr> <td style="width: 10%;"></td> <td style="width: 10%;"></td> <td style="width: 10%;"></td> <td style="width: 10%;"></td> <td style="width: 10%;"></td> <td style="width: 10%;"></td> <td style="width: 10%;"></td> <td style="width: 10%;"></td> <td style="width: 10%;"></td> <td style="width: 10%;"></td> </tr> <tr> <td></td> <td></td> <td colspan="8" style="text-align: center;"> <table border="1" style="width: 100%; border-collapse: collapse; text-align: center;"> <tr> <td style="width: 10%;"></td> <td style="width: 10%;"></td> <td style="width: 10%;"></td> <td style="width: 10%;"></td> <td style="width: 10%;"></td> <td style="width: 10%;"></td> <td style="width: 10%;"></td> <td style="width: 10%;"></td> <td style="width: 10%;"></td> <td style="width: 10%;"></td> </tr> <tr> <td></td> <td></td> <td colspan="8" style="text-align: center;"> <table border="1" style="width: 100%; border-collapse: collapse; text-align: center;"> <tr> <td style="width: 10%;"></td> <td style="width: 10%;"></td> <td style="width: 10%;"></td> <td style="width: 10%;"></td> <td style="width: 10%;"></td> <td style="width: 10%;"></td> <td style="width: 10%;"></td> <td style="width: 10%;"></td> <td style="width: 10%;"></td> <td style="width: 10%;"></td> </tr> <tr> <td></td> <td></td> <td colspan="8" style="text-align: center;"> <table border="1" style="width: 100%; border-collapse: collapse; text-align: center;"> <tr> <td style="width: 10%;"></td> <td style="width: 10%;"></td> <td style="width: 10%;"></td> <td style="width: 10%;"></td> <td style="width: 10%;"></td> <td style="width: 10%;"></td> <td style="width: 10%;"></td> <td style="width: 10%;"></td> <td style="width: 10%;"></td> <td style="width: 10%;"></td> </tr> <tr> <td></td> <td></td> <td colspan="8" style="text-align: center;"> <table border="1" style="width: 100%; border-collapse: collapse; text-align: center;"> <tr> <td style="width: 10%;"></td> <td style="width: 10%;"></td> <td style="width: 10%;"></td> <td style="width: 10%;"></td> <td style="width: 10%;"></td> <td style="width: 10%;"></td> <td style="width: 10%;"></td> <td style="width: 10%;"></td> <td style="width: 10%;"></td> <td style="width: 10%;"></td> </tr> <tr> <td></td> <td></td> <td colspan="8" style="text-align: center;"> <table border="1" style="width: 100%; border-collapse: collapse; text-align: center;"> <tr> <td style="width: 10%;"></td> <td style="width: 10%;"></td> <td style="width: 10%;"></td> <td style="width: 10%;"></td> <td style="width: 10%;"></td> <td style="width: 10%;"></td> <td style="width: 10%;"></td> <td style="width: 10%;"></td> <td style="width: 10%;"></td> <td style="width: 10%;"></td> </tr> <tr> <td></td> <td></td> <td colspan="8" style="text-align: center;"> <table border="1" style="width: 100%; border-collapse: collapse; text-align: center;"> <tr> <td style="width: 10%;"></td> <td style="width: 10%;"></td> <td style="width: 10%;"></td> <td style="width: 10%;"></td> <td style="width: 10%;"></td> <td style="width: 10%;"></td> <td style="width: 10%;"></td> <td style="width: 10%;"></td> <td style="width: 10%;"></td> <td style="width: 10%;"></td> </tr> <tr> <td></td> <td></td> <td colspan="8" style="text-align: center;"> <table border="1" style="width: 100%; border-collapse: collapse; text-align: center;"> <tr> <td style="width: 10%;"></td> <td style="width: 10%;"></td> <td style="width: 10%;"></td> <td style="width: 10%;"></td> <td style="width: 10%;"></td> <td style="width: 10%;"></td> <td style="width: 10%;"></td> <td style="width: 10%;"></td> <td style="width: 10%;"></td> <td style="width: 10%;"></td> </tr> <tr> <td></td> <td></td> <td colspan="8" style="text-align: center;"> <table border="1" style="width: 100%; border-collapse: collapse; text-align: center;"> <tr> <td style="width: 10%;"></td> <td style="width: 10%;"></td> <td style="width: 10%;"></td> <td style="width: 10%;"></td> <td style="width: 10%;"></td> <td style="width: 10%;"></td> <td style="width: 10%;"></td> <td style="width: 10%;"></td> <td style="width: 10%;"></td> <td style="width: 10%;"></td> </tr> <tr> <td></td> <td></td> <td colspan="8" style="text-align: center;"> <table border="1" style="width: 100%; border-collapse: collapse; text-align: center;"> <tr> <td style="width: 10%;"></td> <td style="width: 10%;"></td> <td style="width: 10%;"></td> <td style="width: 10%;"></td> <td style="width: 10%;"></td> <td style="width: 10%;"></td> <td style="width: 10%;"></td> <td style="width: 10%;"></td> <td style="width: 10%;"></td> <td style="width: 10%;"></td> </tr> <tr> <td></td> <td></td> <td colspan="8" style="text-align: center;"> <table border="1" style="width: 100%; border-collapse: collapse; text-align: center;"> <tr> <td style="width: 10%;"></td> <td style="width: 10%;"></td> <td style="width: 10%;"></td> <td style="width: 10%;"></td> <td style="width: 10%;"></td> <td style="width: 10%;"></td> <td style="width: 10%;"></td> <td style="width: 10%;"></td> <td style="width: 10%;"></td> <td style="width: 10%;"></td> </tr> <tr> <td></td> <td></td> <td colspan="8" style="text-align: center;"> <table border="1" style="width: 100%; border-collapse: collapse; text-align: center;"> <tr> <td style="width: 10%;"></td> <td style="width: 10%;"></td> <td style="width: 10%;"></td> <td style="width: 10%;"></td> <td style="width: 10%;"></td> <td style="width: 10%;"></td> <td style="width: 10%;"></td> <td style="width: 10%;"></td> <td style="width: 10%;"></td> <td style="width: 10%;"></td> </tr> <tr> <td></td> <td></td> <td colspan="8" style="text-align: center;"> <table border="1" style="width: 100%; border-collapse: collapse; text-align: center;"> <tr> <td style="width: 10%;"></td> <td style="width: 10%;"></td> <td style="width: 10%;"></td> <td style="width: 10%;"></td> <td style="width: 10%;"></td> <td style="width: 10%;"></td> <td
style="width: 10%;"></td> <td style="width: 10%;"></td> <td style="width: 10%;"></td> <td style="width: 10%;"></td> </tr> <tr> <td></td> <td></td> <td colspan="8" style="text-align: center;"> <table border="1" style="width: 100%; border-collapse: collapse; text-align: center;"> <tr> <td style="width: 10%;"></td> <td style="width: 10%;"></td> <td style="width: 10%;"></td> <td style="width: 10%;"></td> <td style="width: 10%;"></td> <td style="width: 10%;"></td> <td style="width: 10%;"></td> <td style="width: 10%;"></td> <td style="width: 10%;"></td> <td style="width: 10%;"></td> </tr> <tr> <td></td> <td></td> <td colspan="8" style="text-align: center;"> <table border="1" style="width: 100%; border-collapse: collapse; text-align: center;"> <tr> <td style="width: 10%;"></td> <td style="width: 10%;"></td> <td style="width: 10%;"></td> <td style="width: 10%;"></td> <td style="width: 10%;"></td> <td style="width: 10%;"></td> <td style="width: 10%;"></td> <td style="width: 10%;"></td> <td style="width: 10%;"></td> <td style="width: 10%;"></td> </tr> <tr> <td></td> <td></td> <td colspan="8" style="text-align: center;"> <table border="1" style="width: 100%; border-collapse: collapse; text-align: center;"> <tr> <td style="width: 10%;"></td> <td style="width: 10%;"></td> <td style="width: 10%;"></td> <td style="width: 10%;"></td> <td style="width: 10%;"></td> <td style="width: 10%;"></td> <td style="width: 10%;"></td> <td style="width: 10%;"></td> <td style="width: 10%;"></td> <td style="width: 10%;"></td> </tr> <tr> <td></td> <td></td> <td colspan="8" style="text-align: center;"> <table border="1" style="width: 100%; border-collapse: collapse; text-align: center;"> <tr> <td style="width: 10%;"></td> <td style="width: 10%;"></td> <td style="width: 10%;"></td> <td style="width: 10%;"></td> <td style="width: 10%;"></td> <td style="width: 10%;"></td> <td style="width: 10%;"></td> <td style="width: 10%;"></td> <td style="width: 10%;"></td> <td style="width: 10%;"></td> </tr> <tr> <td></td> <td></td> <td colspan="8" style="text-align: center;"> <table border="1" style="width: 100%; border-collapse: collapse; text-align: center;"> <tr> <td style="width: 10%;"></td> <td style="width: 10%;"></td> <td style="width: 10%;"></td> <td style="width: 10%;"></td> <td style="width: 10%;"></td> <td style="width: 10%;"></td> <td style="width: 10%;"></td> <td style="width: 10%;"></td> <td style="width: 10%;"></td> <td style="width: 10%;"></td> </tr> <tr> <td></td> <td></td> <td colspan="8" style="text-align: center;"> <table border="1" style="width: 100%; border-collapse: collapse; text-align: center;"> <tr> <td style="width: 10%;"></td> <td style="width: 10%;"></td> <td style="width: 10%;"></td> <td style="width: 10%;"></td> <td style="width: 10%;"></td> <td style="width: 10%;"></td> <td style="width: 10%;"></td> <td style="width: 10%;"></td> <td style="width: 10%;"></td> <td style="width: 10%;"></td> </tr> <tr> <td></td> <td></td> <td colspan="8" style="text-align: center;"> <table border="1" style="width: 100%; border-collapse: collapse; text-align: center;"> <tr> <td style="width: 10%;"></td> <td style="width: 10%;"></td> <td style="width: 10%;"></td> <td style="width: 10%;"></td> <td style="width: 10%;"></td> <td style="width: 10%;"></td> <td style="width: 10%;"></td> <td style="width: 10%;"></td> <td style="width: 10%;"></td> <td style="width: 10%;"></td> </tr> <tr> <td></td> <td></td> <td colspan="8" style="text-align: center;"> <table border="1" style="width: 100%; border-collapse: collapse; text-align: center;"> <tr> <td style="width: 10%;"></td> <td style="width: 10%;"></td> <td style="width: 10%;"></td> <td style="width: 10%;"></td> <td style="width: 10%;"></td> <td style="width: 10%;"></td> <td style="width: 10%;"></td> <td style="width: 10%;"></td> <td style="width: 10%;"></td> <td style="width: 10%;"></td> </tr> <tr> <td></td> <td></td> <td colspan="8" style="text-align: center;"> <table border="1" style="width: 100%; border-collapse: collapse; text-align: center;"> <tr> <td style="width: 10%;"></td> <td style="width: 10%;"></td> <td style="width: 10%;"></td> <td style="width: 10%;"></td> <td style="width: 10%;"></td> <td style="width: 10%;"></td> <td style="width: 10%;"></td> <td style="width: 10%;"></td> <td style="width: 10%;"></td> <td style="width: 10%;"></td> </tr> <tr> <td></td> <td></td> <td colspan="8" style="text-align: center;"> <table border="1" style="width: 100%; border-collapse: collapse; text-align: center;"> <tr> <td style="width: 10%;"></td> <td style="width: 10%;"></td> <td style="width: 10%;"></td> <td style="width: 10%;"></td> <td style="width: 10%;"></td> <td style="width: 10%;"></td> <td style="width: 10%;"></td> <td style="width: 10%;"></td> <td style="width: 10%;"></td> <td style="width: 10%;"></td> </tr> <tr> <td></td> <td></td> <td colspan="8" style="text-align: center;"> <table border="1" style="width: 100%; border-collapse: collapse; text-align: center;"> <tr> <td style="width: 10%;"></td> <td style="width: 10%;"></td> <td style="width: 10%;"></td> <td style="width: 10%;"></td> <td style="width: 10%;"></td> <td style="width: 10%;"></td> <td style="width: 10%;"></td> <td style="width: 10%;"></td> <td style="width: 10%;"></td> <td style="width: 10%;"></td> </tr> <tr> <td></td> <td></td> <td colspan="8" style="text-align: center;"> <table border="1" style="width: 100%; border-collapse: collapse; text-align: center;"> <tr> <td style="width: 10%;"></td> <td style="width: 10%;"></td> <td style="width: 10%;"></td> <td style="width: 10%;"></td> <td style="width: 10%;"></td> <td style="width: 10%;"></td> <td style="width: 10%;"></td> <td style="width: 10%;"></td> <td style="width: 10%;"></td> <td style="width: 10%;"></td> </tr> <tr> <td></td> <td></td> <td colspan="8" style="text-align: center;"> <table border="1" style="width: 100%; border-collapse: collapse; text-align: center;"> <tr> <td style="width: 10%;"></td> <td style="width: 10%;"></td> <td style="width: 10%;"></td> <td style="width: 10%;"></td> <td style="width: 10%;"></td> <td style="width: 10%;"></td> <td style="width: 10%;"></td> <td style="width: 10%;"></td> <td style="width: 10%;"></td> <td style="width: 10%;"></td> </tr> <tr> <td></td> <td></td> <td colspan="8" style="text-align: center;"> <table border="1" style="width: 100%; border-collapse: collapse; text-align: center;"> <tr> <td style="width: 10%;"></td> <td style="width: 10%;"></td> <td style="width: 10%;"></td> <td style="width: 10%;"></td> <td style="width: 10%;"></td> <td style="width: 10%;"></td> <td style="width: 10%;"></td> <td style="width: 10%;"></td> <td style="width: 10%;"></td> <td style="width: 10%;"></td> </tr> <tr> <td></td> <td></td> <td colspan="8" style="text-align: center;"> <table border="1" style="width: 100%; border-collapse: collapse; text-align: center;"> <tr> <td style="width: 10%;"></td> <td style="width: 10%;"></td> <td style="width: 10%;"></td> <td style="width: 10%;"></td> <td style="width: 10%;"></td> <td style="width: 10%;"></td> <td style="width: 10%;"></td> <td style="width: 10%;"></td> <td style="width: 10%;"></td> <td style="width: 10%;"></td> </tr> <tr> <td></td> <td></td> <td colspan="8" style="text-align: center;"> <table border="1" style="width: 100%; border-collapse: collapse; text-align: center;"> <tr> <td style="width: 10%;"></td> <td style="width: 10%;"></td> <td style="width: 10%;"></td> <td style="width: 10%;"></td> <td style="width: 10%;"></td> <td style="width: 10%;"></td> <td style="width: 10%;"></td> <td style="width: 10%;"></td> <td style="width: 10%;"></td> <td style="width: 10%;"></td> </tr> <tr> <td></td> <td></td> <td colspan="8" style="text-align: center;"> <table border="1" style="width: 100%; border-collapse: collapse; text-align: center;"> <tr> <td style="width: 10%;"></td> <td style="width: 10%;"></td> <td style="width: 10%;"></td> <td style="width: 10%;"></td> <td style="width: 10%;"></td> <td style="width: 10%;"></td> <td style="width: 10%;"></td> <td style="width: 10%;"></td> <td style="width: 10%;"></td> <td style="width: 10%;"></td> </tr> <tr> <td></td> <td></td> <td colspan="8" style="text-align: center;"> <table border="1" style="width: 100%; border-collapse: collapse; text-align: center;"> <tr> <td style="width: 10%;"></td> <td style="width: 10%;"></td> <td style="width: 10%;"></td> <td style="width: 10%;"></td> <td style="width: 10%;"></td> <td style="width: 10%;"></td> <td style="width: 10%;"></td> <td style="width: 10%;"></td> <td style="width: 10%;"></td> <td style="width: 10%;"></td> </tr> <tr> <td></td> <td></td> <td colspan="8" style="text-align: center;"> <table border="1" style="width: 100%; border-collapse: collapse; text-align: center;"> <tr> <td style="width: 10%;"></td> <td style="width: 10%;"></td> <td style="width: 10%;"></td> <td style="width: 10%;"></td> <td style="width: 10%;"></td> <td style="width: 10%;"></td> <td style="width: 10%;"></td> <td style="width: 10%;"></td> <td style="width: 10%;"></td> <td style="width: 10%;"></td> </tr> <tr> <td></td> <td></td> <td colspan="8" style="text-align: center;"> <table border="1" style="width: 100%; border-collapse: collapse; text-align: center;"> <tr> <td style="width: 10%;"></td> <td style="width: 10%;"></td> <td style="width: 10%;"></td> <td style="width: 10%;"></td> <td style="width: 10%;"></td> <td style="width: 10%;"></td> <td style="width: 10%;"></td> <td style="width: 10%;"></td> <td style="width: 10%;"></td> <td style="width: 10%;"></td> </tr> <tr> <td></td> <td></td> <td colspan="8" style="text-align: center;"> <table border="1" style="width: 100%; border-collapse: collapse; text-align: center;"> <tr> <td style="width: 10%;"></td> <td style="width: 10%;"></td> <td style="width: 10%;"></td> <td style="width: 10%;"></td> <td style="width: 10%;"></td> <td style="width: 10%;"></td> <td style="width: 10%;"></td> <td style="width: 10%;"></td> <td style="width: 10%;"></td> <td style="width: 10%;"></td> </tr> <tr> <td></td> <td></td> <td colspan="8"
style="text-align: center;"> <table border="1" style="width: 100%; border-collapse: collapse; text-align: center;"> <tr> </tr></table></td></tr></table></td></tr></table></td></tr></table></td></tr></table></td></tr></table></td></tr></table></td></tr></table></td></tr></table></td></tr></table></td></tr></table></td></tr></table></td></tr></table></td></tr></table></td></tr></table></td></tr></table></td></tr></table></td></tr></table></td></tr></table></td></tr></table></td></tr></table></td></tr></table></td></tr></table></td></tr></table></td></tr></table></td></tr></table></td></tr></table></td></tr></table></td></tr></table></td></tr></table></td></tr></table></td></tr></table></td></tr></table></td></tr></table></td></tr></table></td></tr></table></td></tr></table></td></tr></table></td></tr></table> | | | | | | | | | | | | | | | | | | | | <table border="1" style="width: 100%; border-collapse: collapse; text-align: center;"> <tr> <td style="width: 10%;"></td> <td style="width: 10%;"></td> <td style="width: 10%;"></td> <td style="width: 10%;"></td> <td style="width: 10%;"></td> <td style="width: 10%;"></td> <td style="width: 10%;"></td> <td style="width: 10%;"></td> <td style="width: 10%;"></td> <td style="width: 10%;"></td> </tr> <tr> <td></td> <td></td> <td colspan="8" style="text-align: center;"> <table border="1" style="width: 100%; border-collapse: collapse; text-align: center;"> <tr> <td style="width: 10%;"></td> <td style="width: 10%;"></td> <td style="width: 10%;"></td> <td style="width: 10%;"></td> <td style="width: 10%;"></td> <td style="width: 10%;"></td> <td style="width: 10%;"></td> <td style="width: 10%;"></td> <td style="width: 10%;"></td> <td style="width: 10%;"></td> </tr> <tr> <td></td> <td></td> <td colspan="8" style="text-align: center;"> <table border="1" style="width: 100%; border-collapse: collapse; text-align: center;"> <tr> <td style="width: 10%;"></td> <td style="width: 10%;"></td> <td style="width: 10%;"></td> <td style="width: 10%;"></td> <td style="width: 10%;"></td> <td style="width: 10%;"></td> <td style="width: 10%;"></td> <td style="width: 10%;"></td> <td style="width: 10%;"></td> <td style="width: 10%;"></td> </tr> <tr> <td></td> <td></td> <td colspan="8" style="text-align: center;"> <table border="1" style="width: 100%; border-collapse: collapse; text-align: center;"> <tr> <td style="width: 10%;"></td> <td style="width: 10%;"></td> <td style="width: 10%;"></td> <td style="width: 10%;"></td> <td style="width: 10%;"></td> <td style="width: 10%;"></td> <td style="width: 10%;"></td> <td style="width: 10%;"></td> <td style="width: 10%;"></td> <td style="width: 10%;"></td> </tr> <tr> <td></td> <td></td> <td colspan="8" style="text-align: center;"> <table border="1" style="width: 100%; border-collapse: collapse; text-align: center;"> <tr> <td style="width: 10%;"></td> <td style="width: 10%;"></td> <td style="width: 10%;"></td> <td style="width: 10%;"></td> <td style="width: 10%;"></td> <td style="width: 10%;"></td> <td style="width: 10%;"></td> <td style="width: 10%;"></td> <td style="width: 10%;"></td> <td style="width: 10%;"></td> </tr> <tr> <td></td> <td></td> <td colspan="8" style="text-align: center;"> <table border="1" style="width: 100%; border-collapse: collapse; text-align: center;"> <tr> <td style="width: 10%;"></td> <td style="width: 10%;"></td> <td style="width: 10%;"></td> <td style="width: 10%;"></td> <td style="width: 10%;"></td> <td style="width: 10%;"></td> <td style="width: 10%;"></td> <td style="width: 10%;"></td> <td style="width: 10%;"></td> <td style="width: 10%;"></td> </tr> <tr> <td></td> <td></td> <td colspan="8" style="text-align: center;"> <table border="1" style="width: 100%; border-collapse: collapse; text-align: center;"> <tr> <td style="width: 10%;"></td> <td style="width: 10%;"></td> <td style="width: 10%;"></td> <td style="width: 10%;"></td> <td style="width: 10%;"></td> <td style="width: 10%;"></td> <td style="width: 10%;"></td> <td style="width: 10%;"></td> <td style="width: 10%;"></td> <td style="width: 10%;"></td> </tr> <tr> <td></td> <td></td> <td colspan="8" style="text-align: center;"> <table border="1" style="width: 100%; border-collapse: collapse; text-align: center;"> <tr> <td style="width: 10%;"></td> <td style="width: 10%;"></td> <td style="width: 10%;"></td> <td style="width: 10%;"></td> <td style="width: 10%;"></td> <td style="width: 10%;"></td> <td style="width: 10%;"></td> <td style="width: 10%;"></td> <td style="width: 10%;"></td> <td style="width: 10%;"></td> </tr> <tr> <td></td> <td></td> <td colspan="8" style="text-align: center;"> <table border="1" style="width: 100%; border-collapse: collapse; text-align: center;"> <tr> <td style="width: 10%;"></td> <td style="width: 10%;"></td> <td style="width: 10%;"></td> <td style="width: 10%;"></td> <td style="width: 10%;"></td> <td style="width: 10%;"></td> <td style="width: 10%;"></td> <td style="width: 10%;"></td> <td style="width: 10%;"></td> <td style="width: 10%;"></td> </tr> <tr> <td></td> <td></td> <td colspan="8" style="text-align: center;"> <table border="1" style="width: 100%; border-collapse: collapse; text-align: center;"> <tr> <td style="width: 10%;"></td> <td style="width: 10%;"></td> <td style="width: 10%;"></td> <td style="width: 10%;"></td> <td style="width: 10%;"></td> <td style="width: 10%;"></td> <td style="width: 10%;"></td> <td style="width: 10%;"></td> <td style="width: 10%;"></td> <td style="width: 10%;"></td> </tr> <tr> <td></td> <td></td> <td colspan="8" style="text-align: center;"> <table border="1" style="width: 100%; border-collapse: collapse; text-align: center;"> <tr> <td style="width: 10%;"></td> <td style="width: 10%;"></td> <td style="width: 10%;"></td> <td style="width: 10%;"></td> <td style="width: 10%;"></td> <td style="width: 10%;"></td> <td style="width: 10%;"></td> <td style="width: 10%;"></td> <td style="width: 10%;"></td> <td style="width: 10%;"></td> </tr> <tr> <td></td> <td></td> <td colspan="8" style="text-align: center;"> <table border="1" style="width: 100%; border-collapse: collapse; text-align: center;"> <tr> <td style="width: 10%;"></td> <td style="width: 10%;"></td> <td style="width: 10%;"></td> <td style="width: 10%;"></td> <td style="width: 10%;"></td> <td style="width: 10%;"></td> <td style="width: 10%;"></td> <td style="width: 10%;"></td> <td style="width: 10%;"></td> <td style="width: 10%;"></td> </tr> <tr> <td></td> <td></td> <td colspan="8" style="text-align: center;"> <table border="1" style="width: 100%; border-collapse: collapse; text-align: center;"> <tr> <td
style="width: 10%;"></td> <td style="width: 10%;"></td> <td style="width: 10%;"></td> <td style="width: 10%;"></td> <td style="width: 10%;"></td> <td style="width: 10%;"></td> <td style="width: 10%;"></td> <td style="width: 10%;"></td> <td style="width: 10%;"></td> <td style="width: 10%;"></td> </tr> <tr> <td></td> <td></td> <td colspan="8" style="text-align: center;"> <table border="1" style="width: 100%; border-collapse: collapse; text-align: center;"> <tr> <td style="width: 10%;"></td> <td style="width: 10%;"></td> <td style="width: 10%;"></td> <td style="width: 10%;"></td> <td style="width: 10%;"></td> <td style="width: 10%;"></td> <td style="width: 10%;"></td> <td style="width: 10%;"></td> <td style="width: 10%;"></td> <td style="width: 10%;"></td> </tr> <tr> <td></td> <td></td> <td colspan="8" style="text-align: center;"> <table border="1" style="width: 100%; border-collapse: collapse; text-align: center;"> <tr> <td style="width: 10%;"></td> <td style="width: 10%;"></td> <td style="width: 10%;"></td> <td style="width: 10%;"></td> <td style="width: 10%;"></td> <td style="width: 10%;"></td> <td style="width: 10%;"></td> <td style="width: 10%;"></td> <td style="width: 10%;"></td> <td style="width: 10%;"></td> </tr> <tr> <td></td> <td></td> <td colspan="8" style="text-align: center;"> <table border="1" style="width: 100%; border-collapse: collapse; text-align: center;"> <tr> <td style="width: 10%;"></td> <td style="width: 10%;"></td> <td style="width: 10%;"></td> <td style="width: 10%;"></td> <td style="width: 10%;"></td> <td style="width: 10%;"></td> <td style="width: 10%;"></td> <td style="width: 10%;"></td> <td style="width: 10%;"></td> <td style="width: 10%;"></td> </tr> <tr> <td></td> <td></td> <td colspan="8" style="text-align: center;"> <table border="1" style="width: 100%; border-collapse: collapse; text-align: center;"> <tr> <td style="width: 10%;"></td> <td style="width: 10%;"></td> <td style="width: 10%;"></td> <td style="width: 10%;"></td> <td style="width: 10%;"></td> <td style="width: 10%;"></td> <td style="width: 10%;"></td> <td style="width: 10%;"></td> <td style="width: 10%;"></td> <td style="width: 10%;"></td> </tr> <tr> <td></td> <td></td> <td colspan="8" style="text-align: center;"> <table border="1" style="width: 100%; border-collapse: collapse; text-align: center;"> <tr> <td style="width: 10%;"></td> <td style="width: 10%;"></td> <td style="width: 10%;"></td> <td style="width: 10%;"></td> <td style="width: 10%;"></td> <td style="width: 10%;"></td> <td style="width: 10%;"></td> <td style="width: 10%;"></td> <td style="width: 10%;"></td> <td style="width: 10%;"></td> </tr> <tr> <td></td> <td></td> <td colspan="8" style="text-align: center;"> <table border="1" style="width: 100%; border-collapse: collapse; text-align: center;"> <tr> <td style="width: 10%;"></td> <td style="width: 10%;"></td> <td style="width: 10%;"></td> <td style="width: 10%;"></td> <td style="width: 10%;"></td> <td style="width: 10%;"></td> <td style="width: 10%;"></td> <td style="width: 10%;"></td> <td style="width: 10%;"></td> <td style="width: 10%;"></td> </tr> <tr> <td></td> <td></td> <td colspan="8" style="text-align: center;"> <table border="1" style="width: 100%; border-collapse: collapse; text-align: center;"> <tr> <td style="width: 10%;"></td> <td style="width: 10%;"></td> <td style="width: 10%;"></td> <td style="width: 10%;"></td> <td style="width: 10%;"></td> <td style="width: 10%;"></td> <td style="width: 10%;"></td> <td style="width: 10%;"></td> <td style="width: 10%;"></td> <td style="width: 10%;"></td> </tr> <tr> <td></td> <td></td> <td colspan="8" style="text-align: center;"> <table border="1" style="width: 100%; border-collapse: collapse; text-align: center;"> <tr> <td style="width: 10%;"></td> <td style="width: 10%;"></td> <td style="width: 10%;"></td> <td style="width: 10%;"></td> <td style="width: 10%;"></td> <td style="width: 10%;"></td> <td style="width: 10%;"></td> <td style="width: 10%;"></td> <td style="width: 10%;"></td> <td style="width: 10%;"></td> </tr> <tr> <td></td> <td></td> <td colspan="8" style="text-align: center;"> <table border="1" style="width: 100%; border-collapse: collapse; text-align: center;"> <tr> <td style="width: 10%;"></td> <td style="width: 10%;"></td> <td style="width: 10%;"></td> <td style="width: 10%;"></td> <td style="width: 10%;"></td> <td style="width: 10%;"></td> <td style="width: 10%;"></td> <td style="width: 10%;"></td> <td style="width: 10%;"></td> <td style="width: 10%;"></td> </tr> <tr> <td></td> <td></td> <td colspan="8" style="text-align: center;"> <table border="1" style="width: 100%; border-collapse: collapse; text-align: center;"> <tr> <td style="width: 10%;"></td> <td style="width: 10%;"></td> <td style="width: 10%;"></td> <td style="width: 10%;"></td> <td style="width: 10%;"></td> <td style="width: 10%;"></td> <td style="width: 10%;"></td> <td style="width: 10%;"></td> <td style="width: 10%;"></td> <td style="width: 10%;"></td> </tr> <tr> <td></td> <td></td> <td colspan="8" style="text-align: center;"> <table border="1" style="width: 100%; border-collapse: collapse; text-align: center;"> <tr> <td style="width: 10%;"></td> <td style="width: 10%;"></td> <td style="width: 10%;"></td> <td style="width: 10%;"></td> <td style="width: 10%;"></td> <td style="width: 10%;"></td> <td style="width: 10%;"></td> <td style="width: 10%;"></td> <td style="width: 10%;"></td> <td style="width: 10%;"></td> </tr> <tr> <td></td> <td></td> <td colspan="8" style="text-align: center;"> <table border="1" style="width: 100%; border-collapse: collapse; text-align: center;"> <tr> <td style="width: 10%;"></td> <td style="width: 10%;"></td> <td style="width: 10%;"></td> <td style="width: 10%;"></td> <td style="width: 10%;"></td> <td style="width: 10%;"></td> <td style="width: 10%;"></td> <td style="width: 10%;"></td> <td style="width: 10%;"></td> <td style="width: 10%;"></td> </tr> <tr> <td></td> <td></td> <td colspan="8" style="text-align: center;"> <table border="1" style="width: 100%; border-collapse: collapse; text-align: center;"> <tr> <td style="width: 10%;"></td> <td style="width: 10%;"></td> <td style="width: 10%;"></td> <td style="width: 10%;"></td> <td style="width: 10%;"></td> <td style="width: 10%;"></td> <td style="width: 10%;"></td> <td style="width: 10%;"></td> <td style="width: 10%;"></td> <td style="width: 10%;"></td> </tr> <tr> <td></td> <td></td> <td colspan="8" style="text-align: center;"> <table border="1" style="width: 100%; border-collapse: collapse; text-align: center;"> <tr> <td style="width: 10%;"></td> <td style="width: 10%;"></td> <td style="width: 10%;"></td> <td style="width: 10%;"></td> <td style="width: 10%;"></td> <td style="width: 10%;"></td> <td style="width: 10%;"></td> <td style="width: 10%;"></td> <td style="width: 10%;"></td> <td style="width: 10%;"></td> </tr> <tr> <td></td> <td></td> <td colspan="8" style="text-align: center;"> <table border="1" style="width: 100%; border-collapse: collapse; text-align: center;"> <tr> <td style="width: 10%;"></td> <td style="width: 10%;"></td> <td style="width: 10%;"></td> <td style="width: 10%;"></td> <td style="width: 10%;"></td> <td style="width: 10%;"></td> <td style="width: 10%;"></td> <td style="width: 10%;"></td> <td style="width: 10%;"></td> <td style="width: 10%;"></td> </tr> <tr> <td></td> <td></td> <td colspan="8" style="text-align: center;"> <table border="1" style="width: 100%; border-collapse: collapse; text-align: center;"> <tr> <td style="width: 10%;"></td> <td style="width: 10%;"></td> <td style="width: 10%;"></td> <td style="width: 10%;"></td> <td style="width: 10%;"></td> <td style="width: 10%;"></td> <td style="width: 10%;"></td> <td style="width: 10%;"></td> <td style="width: 10%;"></td> <td style="width: 10%;"></td> </tr> <tr> <td></td> <td></td> <td colspan="8" style="text-align: center;"> <table border="1" style="width: 100%; border-collapse: collapse; text-align: center;"> <tr> <td style="width: 10%;"></td> <td style="width: 10%;"></td> <td style="width: 10%;"></td> <td style="width: 10%;"></td> <td style="width: 10%;"></td> <td style="width: 10%;"></td> <td style="width: 10%;"></td> <td style="width: 10%;"></td> <td style="width: 10%;"></td> <td style="width: 10%;"></td> </tr> <tr> <td></td> <td></td> <td colspan="8" style="text-align: center;"> <table border="1" style="width: 100%; border-collapse: collapse; text-align: center;"> <tr> <td style="width: 10%;"></td> <td style="width: 10%;"></td> <td style="width: 10%;"></td> <td style="width: 10%;"></td> <td style="width: 10%;"></td> <td style="width: 10%;"></td> <td style="width: 10%;"></td> <td style="width: 10%;"></td> <td style="width: 10%;"></td> <td style="width: 10%;"></td> </tr> <tr> <td></td> <td></td> <td colspan="8" style="text-align: center;"> <table border="1" style="width: 100%; border-collapse: collapse; text-align: center;"> <tr> <td style="width: 10%;"></td> <td style="width: 10%;"></td> <td style="width: 10%;"></td> <td style="width: 10%;"></td> <td style="width: 10%;"></td> <td style="width: 10%;"></td> <td style="width: 10%;"></td> <td style="width: 10%;"></td> <td style="width: 10%;"></td> <td style="width: 10%;"></td> </tr> <tr> <td></td> <td></td> <td colspan="8" style="text-align: center;"> <table border="1" style="width: 100%; border-collapse: collapse; text-align: center;"> <tr> <td style="width: 10%;"></td> <td style="width: 10%;"></td> <td style="width: 10%;"></td> <td style="width: 10%;"></td> <td style="width: 10%;"></td> <td style="width: 10%;"></td> <td style="width: 10%;"></td> <td style="width: 10%;"></td> <td style="width: 10%;"></td> <td style="width: 10%;"></td> </tr> <tr> <td></td> <td></td> <td colspan="8" style="text-align: center;"> <table border="1" style="width: 100%; border-collapse: collapse; text-align: center;"> <tr> <td style="width: 10%;"></td> <td style="width: 10%;"></td> <td style="width: 10%;"></td> <td style="width: 10%;"></td> <td style="width: 10%;"></td> <td style="width:
10%;"></td> <td style="width: 10%;"></td> <td style="width: 10%;"></td> <td style="width: 10%;"></td> <td style="width: 10%;"></td> </tr> <tr> <td></td> <td></td> <td colspan="8" style="text-align: center;"> <table border="1" style="width: 100%; border-collapse: collapse; text-align: center;"> <tr> <td style="width: 10%;"></td> <td style="width: 10%;"></td> <td style="width: 10%;"></td> <td style="width: 10%;"></td> <td style="width: 10%;"></td> <td style="width: 10%;"></td> <td style="width: 10%;"></td> <td style="width: 10%;"></td> <td style="width: 10%;"></td> <td style="width: 10%;"></td> </tr> <tr> <td></td> <td></td> <td colspan="8" style="text-align: center;"> <table border="1" style="width: 100%; border-collapse: collapse; text-align: center;"> <tr> <td style="width: 10%;"></td> <td style="width: 10%;"></td> <td style="width: 10%;"></td> <td style="width: 10%;"></td> <td style="width: 10%;"></td> <td style="width: 10%;"></td> <td style="width: 10%;"></td> <td style="width: 10%;"></td> <td style="width: 10%;"></td> <td style="width: 10%;"></td> </tr> <tr> <td></td> <td></td> <td colspan="8" style="text-align: center;"> <table border="1" style="width: 100%; border-collapse: collapse; text-align: center;"> <tr> <td style="width: 10%;"></td> <td style="width: 10%;"></td> <td style="width: 10%;"></td> <td style="width: 10%;"></td> <td style="width: 10%;"></td> <td style="width: 10%;"></td> <td style="width: 10%;"></td> <td style="width: 10%;"></td> <td style="width: 10%;"></td> <td style="width: 10%;"></td> </tr> <tr> <td></td> <td></td> <td colspan="8" style="text-align: center;"> <table border="1" style="width: 100%; border-collapse: collapse; text-align: center;"> <tr> </tr></table></td></tr></table></td></tr></table></td></tr></table></td></tr></table></td></tr></table></td></tr></table></td></tr></table></td></tr></table></td></tr></table></td></tr></table></td></tr></table></td></tr></table></td></tr></table></td></tr></table></td></tr></table></td></tr></table></td></tr></table></td></tr></table></td></tr></table></td></tr></table></td></tr></table></td></tr></table></td></tr></table></td></tr></table></td></tr></table></td></tr></table></td></tr></table></td></tr></table></td></tr></table></td></tr></table></td></tr></table></td></tr></table></td></tr></table></td></tr></table></td></tr></table></td></tr></table></td></tr></table> | | | | | | | | | | | | | | | | | | | | <table border="1" style="width: 100%; border-collapse: collapse; text-align: center;"> <tr> <td style="width: 10%;"></td> <td style="width: 10%;"></td> <td style="width: 10%;"></td> <td style="width: 10%;"></td> <td style="width: 10%;"></td> <td style="width: 10%;"></td> <td style="width: 10%;"></td> <td style="width: 10%;"></td> <td style="width: 10%;"></td> <td style="width: 10%;"></td> </tr> <tr> <td></td> <td></td> <td colspan="8" style="text-align: center;"> <table border="1" style="width: 100%; border-collapse: collapse; text-align: center;"> <tr> <td style="width: 10%;"></td> <td style="width: 10%;"></td> <td style="width: 10%;"></td> <td style="width: 10%;"></td> <td style="width: 10%;"></td> <td style="width: 10%;"></td> <td style="width: 10%;"></td> <td style="width: 10%;"></td> <td style="width: 10%;"></td> <td style="width: 10%;"></td> </tr> <tr> <td></td> <td></td> <td colspan="8" style="text-align: center;"> <table border="1" style="width: 100%; border-collapse: collapse; text-align: center;"> <tr> <td style="width: 10%;"></td> <td style="width: 10%;"></td> <td style="width: 10%;"></td> <td style="width: 10%;"></td> <td style="width: 10%;"></td> <td style="width: 10%;"></td> <td style="width: 10%;"></td> <td style="width: 10%;"></td> <td style="width: 10%;"></td> <td style="width: 10%;"></td> </tr> <tr> <td></td> <td></td> <td colspan="8" style="text-align: center;"> <table border="1" style="width: 100%; border-collapse: collapse; text-align: center;"> <tr> <td style="width: 10%;"></td> <td style="width: 10%;"></td> <td style="width: 10%;"></td> <td style="width: 10%;"></td> <td style="width: 10%;"></td> <td style="width: 10%;"></td> <td style="width: 10%;"></td> <td style="width: 10%;"></td> <td style="width: 10%;"></td> <td style="width: 10%;"></td> </tr> <tr> <td></td> <td></td> <td colspan="8" style="text-align: center;"> <table border="1" style="width: 100%; border-collapse: collapse; text-align: center;"> <tr> <td style="width: 10%;"></td> <td style="width: 10%;"></td> <td style="width: 10%;"></td> <td style="width: 10%;"></td> <td style="width: 10%;"></td> <td style="width: 10%;"></td> <td style="width: 10%;"></td> <td style="width: 10%;"></td> <td style="width: 10%;"></td> <td style="width: 10%;"></td> </tr> <tr> <td></td> <td></td> <td colspan="8" style="text-align: center;"> <table border="1" style="width: 100%; border-collapse: collapse; text-align: center;"> <tr> <td style="width: 10%;"></td> <td style="width: 10%;"></td> <td style="width: 10%;"></td> <td style="width: 10%;"></td> <td style="width: 10%;"></td> <td style="width: 10%;"></td> <td style="width: 10%;"></td> <td style="width: 10%;"></td> <td style="width: 10%;"></td> <td style="width: 10%;"></td> </tr> <tr> <td></td> <td></td> <td colspan="8" style="text-align: center;"> <table border="1" style="width: 100%; border-collapse: collapse; text-align: center;"> <tr> <td style="width: 10%;"></td> <td style="width: 10%;"></td> <td style="width: 10%;"></td> <td style="width: 10%;"></td> <td style="width: 10%;"></td> <td style="width: 10%;"></td> <td style="width: 10%;"></td> <td style="width: 10%;"></td> <td style="width: 10%;"></td> <td style="width: 10%;"></td> </tr> <tr> <td></td> <td></td> <td colspan="8" style="text-align: center;"> <table border="1" style="width: 100%; border-collapse: collapse; text-align: center;"> <tr> <td style="width: 10%;"></td> <td style="width: 10%;"></td> <td style="width: 10%;"></td> <td style="width: 10%;"></td> <td style="width: 10%;"></td> <td style="width: 10%;"></td> <td style="width: 10%;"></td> <td style="width: 10%;"></td> <td style="width: 10%;"></td> <td style="width: 10%;"></td> </tr> <tr> <td></td> <td></td> <td colspan="8" style="text-align: center;"> <table border="1" style="width: 100%; border-collapse: collapse; text-align: center;"> <tr> <td style="width: 10%;"></td> <td style="width: 10%;"></td> <td style="width: 10%;"></td> <td style="width: 10%;"></td> <td style="width: 10%;"></td> <td style="width: 10%;"></td> <td style="width: 10%;"></td> <td style="width: 10%;"></td> <td style="width: 10%;"></td> <td style="width: 10%;"></td> </tr> <tr>
<td></td> <td></td> <td colspan="8" style="text-align: center;"> <table border="1" style="width: 100%; border-collapse: collapse; text-align: center;"> <tr> <td style="width: 10%;"></td> <td style="width: 10%;"></td> <td style="width: 10%;"></td> <td style="width: 10%;"></td> <td style="width: 10%;"></td> <td style="width: 10%;"></td> <td style="width: 10%;"></td> <td style="width: 10%;"></td> <td style="width: 10%;"></td> <td style="width: 10%;"></td> </tr> <tr> <td></td> <td></td> <td colspan="8" style="text-align: center;"> <table border="1" style="width: 100%; border-collapse: collapse; text-align: center;"> <tr> <td style="width: 10%;"></td> <td style="width: 10%;"></td> <td style="width: 10%;"></td> <td style="width: 10%;"></td> <td style="width: 10%;"></td> <td style="width: 10%;"></td> <td style="width: 10%;"></td> <td style="width: 10%;"></td> <td style="width: 10%;"></td> <td style="width: 10%;"></td> </tr> <tr> <td></td> <td></td> <td colspan="8" style="text-align: center;"> <table border="1" style="width: 100%; border-collapse: collapse; text-align: center;"> <tr> <td style="width: 10%;"></td> <td style="width: 10%;"></td> <td style="width: 10%;"></td> <td style="width: 10%;"></td> <td style="width: 10%;"></td> <td style="width: 10%;"></td> <td style="width: 10%;"></td> <td style="width: 10%;"></td> <td style="width: 10%;"></td> <td style="width: 10%;"></td> </tr> <tr> <td></td> <td></td> <td colspan="8" style="text-align: center;"> <table border="1" style="width: 100%; border-collapse: collapse; text-align: center;"> <tr> <td style="width: 10%;"></td> <td style="width: 10%;"></td> <td style="width: 10%;"></td> <td style="width: 10%;"></td> <td style="width: 10%;"></td> <td style="width: 10%;"></td> <td style="width: 10%;"></td> <td style="width: 10%;"></td> <td style="width: 10%;"></td> <td style="width: 10%;"></td> </tr> <tr> <td></td> <td></td> <td colspan="8" style="text-align: center;"> <table border="1" style="width: 100%; border-collapse: collapse; text-align: center;"> <tr> <td style="width: 10%;"></td> <td style="width: 10%;"></td> <td style="width: 10%;"></td> <td style="width: 10%;"></td> <td style="width: 10%;"></td> <td style="width: 10%;"></td> <td style="width: 10%;"></td> <td style="width: 10%;"></td> <td style="width: 10%;"></td> <td style="width: 10%;"></td> </tr> <tr> <td></td> <td></td> <td colspan="8" style="text-align: center;"> <table border="1" style="width: 100%; border-collapse: collapse; text-align: center;"> <tr> <td style="width: 10%;"></td> <td style="width: 10%;"></td> <td style="width: 10%;"></td> <td style="width: 10%;"></td> <td style="width: 10%;"></td> <td style="width: 10%;"></td> <td style="width: 10%;"></td> <td style="width: 10%;"></td> <td style="width: 10%;"></td> <td style="width: 10%;"></td> </tr> <tr> <td></td> <td></td> <td colspan="8" style="text-align: center;"> <table border="1" style="width: 100%; border-collapse: collapse; text-align: center;"> <tr> <td style="width: 10%;"></td> <td style="width: 10%;"></td> <td style="width: 10%;"></td> <td style="width: 10%;"></td> <td style="width: 10%;"></td> <td style="width: 10%;"></td> <td style="width: 10%;"></td> <td style="width: 10%;"></td> <td style="width: 10%;"></td> <td style="width: 10%;"></td> </tr> <tr> <td></td> <td></td> <td colspan="8" style="text-align: center;"> <table border="1" style="width: 100%; border-collapse: collapse; text-align: center;"> <tr> <td style="width: 10%;"></td> <td style="width: 10%;"></td> <td style="width: 10%;"></td> <td style="width: 10%;"></td> <td style="width: 10%;"></td> <td style="width: 10%;"></td> <td style="width: 10%;"></td> <td style="width: 10%;"></td> <td style="width: 10%;"></td> <td style="width: 10%;"></td> </tr> <tr> <td></td> <td></td> <td colspan="8" style="text-align: center;"> <table border="1" style="width: 100%; border-collapse: collapse; text-align: center;"> <tr> <td style="width: 10%;"></td> <td style="width: 10%;"></td> <td style="width: 10%;"></td> <td style="width: 10%;"></td> <td style="width: 10%;"></td> <td style="width: 10%;"></td> <td style="width: 10%;"></td> <td style="width: 10%;"></td> <td style="width: 10%;"></td> <td style="width: 10%;"></td> </tr> <tr> <td></td> <td></td> <td colspan="8" style="text-align: center;"> <table border="1" style="width: 100%; border-collapse: collapse; text-align: center;"> <tr> <td style="width: 10%;"></td> <td style="width: 10%;"></td> <td style="width: 10%;"></td> <td style="width: 10%;"></td> <td style="width: 10%;"></td> <td style="width: 10%;"></td> <td style="width: 10%;"></td> <td style="width: 10%;"></td> <td style="width: 10%;"></td> <td style="width: 10%;"></td> </tr> <tr> <td></td> <td></td> <td colspan="8" style="text-align: center;"> <table border="1" style="width: 100%; border-collapse: collapse; text-align: center;"> <tr> <td style="width: 10%;"></td> <td style="width: 10%;"></td> <td style="width: 10%;"></td> <td style="width: 10%;"></td> <td style="width: 10%;"></td> <td style="width: 10%;"></td> <td style="width: 10%;"></td> <td style="width: 10%;"></td> <td style="width: 10%;"></td> <td style="width: 10%;"></td> </tr> <tr> <td></td> <td></td> <td colspan="8" style="text-align: center;"> <table border="1" style="width: 100%; border-collapse: collapse; text-align: center;"> <tr> <td style="width: 10%;"></td> <td style="width: 10%;"></td> <td style="width: 10%;"></td> <td style="width: 10%;"></td> <td style="width: 10%;"></td> <td style="width: 10%;"></td> <td style="width: 10%;"></td> <td style="width: 10%;"></td> <td style="width: 10%;"></td> <td style="width: 10%;"></td> </tr> <tr> <td></td> <td></td> <td colspan="8" style="text-align: center;"> <table border="1" style="width: 100%; border-collapse: collapse; text-align: center;"> <tr> <td style="width: 10%;"></td> <td style="width: 10%;"></td> <td style="width: 10%;"></td> <td style="width: 10%;"></td> <td style="width: 10%;"></td> <td style="width: 10%;"></td> <td style="width: 10%;"></td> <td style="width: 10%;"></td> <td style="width: 10%;"></td> <td style="width: 10%;"></td> </tr> <tr> <td></td> <td></td> <td colspan="8" style="text-align: center;"> <table border="1" style="width: 100%; border-collapse: collapse; text-align: center;"> <tr> <td style="width: 10%;"></td> <td style="width: 10%;"></td> <td style="width: 10%;"></td> <td style="width: 10%;"></td> <td style="width: 10%;"></td> <td style="width: 10%;"></td> <td style="width: 10%;"></td> <td style="width: 10%;"></td> <td style="width: 10%;"></td> <td style="width: 10%;"></td> </tr> <tr> <td></td> <td></td> <td colspan="8" style="text-align: center;"> <table border="1" style="width: 100%; border-collapse: collapse; text-align: center;"> <tr> <td style="width: 10%;"></td> <td style="width: 10%;"></td> <td style="width: 10%;"></td> <td style="width: 10%;"></td> <td style="width: 10%;"></td> <td style="width: 10%;"></td> <td style="width: 10%;"></td> <td style="width: 10%;"></td> <td style="width: 10%;"></td> <td style="width: 10%;"></td> </tr> <tr> <td></td> <td></td> <td colspan="8" style="text-align: center;"> <table border="1" style="width: 100%; border-collapse: collapse; text-align: center;"> <tr> <td style="width: 10%;"></td> <td style="width: 10%;"></td> <td style="width: 10%;"></td> <td style="width: 10%;"></td> <td style="width: 10%;"></td> <td style="width: 10%;"></td> <td style="width: 10%;"></td> <td style="width: 10%;"></td> <td style="width: 10%;"></td> <td style="width: 10%;"></td> </tr> <tr> <td></td> <td></td> <td colspan="8" style="text-align: center;"> <table border="1" style="width: 100%; border-collapse: collapse; text-align: center;"> <tr> <td style="width: 10%;"></td> <td style="width: 10%;"></td> <td style="width: 10%;"></td> <td style="width: 10%;"></td> <td style="width: 10%;"></td> <td style="width: 10%;"></td> <td style="width: 10%;"></td> <td style="width: 10%;"></td> <td style="width: 10%;"></td> <td style="width: 10%;"></td> </tr> <tr> <td></td> <td></td> <td colspan="8" style="text-align: center;"> <table border="1" style="width: 100%; border-collapse: collapse; text-align: center;"> <tr> <td style="width: 10%;"></td> <td style="width: 10%;"></td> <td style="width: 10%;"></td> <td style="width: 10%;"></td> <td style="width: 10%;"></td> <td style="width: 10%;"></td> <td style="width: 10%;"></td> <td style="width: 10%;"></td> <td style="width: 10%;"></td> <td style="width: 10%;"></td> </tr> <tr> <td></td> <td></td> <td colspan="8" style="text-align: center;"> <table border="1" style="width: 100%; border-collapse: collapse; text-align: center;"> <tr> <td style="width: 10%;"></td> <td style="width: 10%;"></td> <td style="width: 10%;"></td> <td style="width: 10%;"></td> <td style="width: 10%;"></td> <td style="width: 10%;"></td> <td style="width: 10%;"></td> <td style="width: 10%;"></td> <td style="width: 10%;"></td> <td style="width: 10%;"></td> </tr> <tr> <td></td> <td></td> <td colspan="8" style="text-align: center;"> <table border="1" style="width: 100%; border-collapse: collapse; text-align: center;"> <tr> <td style="width: 10%;"></td> <td style="width: 10%;"></td> <td style="width: 10%;"></td> <td style="width: 10%;"></td> <td style="width: 10%;"></td> <td style="width: 10%;"></td> <td style="width: 10%;"></td> <td style="width: 10%;"></td> <td style="width: 10%;"></td> <td style="width: 10%;"></td> </tr> <tr> <td></td> <td></td> <td colspan="8" style="text-align: center;"> <table border="1" style="width: 100%; border-collapse: collapse; text-align: center;"> <tr> <td style="width: 10%;"></td> <td style="width: 10%;"></td> <td style="width: 10%;"></td> <td style="width: 10%;"></td> <td style="width: 10%;"></td> <td style="width: 10%;"></td> <td style="width: 10%;"></td> <td style="width: 10%;"></td> <td style="width: 10%;"></td> <td style="width: 10%;"></td> </tr> <tr> <td></td> <td></td> <td colspan="8" style="text-align: center;"> <table border="1" style="width: 100%; border-collapse: collapse; text-align: center;"> <tr> <td
style="width: 10%;"></td> <td style="width: 10%;"></td> <td style="width: 10%;"></td> <td style="width: 10%;"></td> <td style="width: 10%;"></td> <td style="width: 10%;"></td> <td style="width: 10%;"></td> <td style="width: 10%;"></td> <td style="width: 10%;"></td> <td style="width: 10%;"></td> </tr> <tr> <td></td> <td></td> <td colspan="8" style="text-align: center;"> <table border="1" style="width: 100%; border-collapse: collapse; text-align: center;"> <tr> <td style="width: 10%;"></td> <td style="width: 10%;"></td> <td style="width: 10%;"></td> <td style="width: 10%;"></td> <td style="width: 10%;"></td> <td style="width: 10%;"></td> <td style="width: 10%;"></td> <td style="width: 10%;"></td> <td style="width: 10%;"></td> <td style="width: 10%;"></td> </tr> <tr> <td></td> <td></td> <td colspan="8" style="text-align: center;"> <table border="1" style="width: 100%; border-collapse: collapse; text-align: center;"> <tr> <td style="width: 10%;"></td> <td style="width: 10%;"></td> <td style="width: 10%;"></td> <td style="width: 10%;"></td> <td style="width: 10%;"></td> <td style="width: 10%;"></td> <td style="width: 10%;"></td> <td style="width: 10%;"></td> <td style="width: 10%;"></td> <td style="width: 10%;"></td> </tr> <tr> <td></td> <td></td> <td colspan="8" style="text-align: center;"> <table border="1" style="width: 100%; border-collapse: collapse; text-align: center;"> <tr> <td style="width: 10%;"></td> <td style="width: 10%;"></td> <td style="width: 10%;"></td> <td style="width: 10%;"></td> <td style="width: 10%;"></td> <td style="width: 10%;"></td> <td style="width: 10%;"></td> <td style="width: 10%;"></td> <td style="width: 10%;"></td> <td style="width: 10%;"></td> </tr> <tr> <td></td> <td></td> <td colspan="8" style="text-align: center;"> <table border="1" style="width: 100%; border-collapse: collapse; text-align: center;"> <tr> <td style="width: 10%;"></td> <td style="width: 10%;"></td> <td style="width: 10%;"></td> <td style="width: 10%;"></td> <td style="width: 10%;"></td> <td style="width: 10%;"></td> <td style="width: 10%;"></td> <td style="width: 10%;"></td> <td style="width: 10%;"></td> <td style="width: 10%;"></td> </tr> <tr> <td></td> <td></td> <td colspan="8" style="text-align: center;"> <table border="1" style="width: 100%; border-collapse: collapse; text-align: center;"> <tr> <td style="width: 10%;"></td> <td style="width: 10%;"></td> <td style="width: 10%;"></td> <td style="width: 10%;"></td> <td style="width: 10%;"></td> <td style="width: 10%;"></td> <td style="width: 10%;"></td> <td style="width: 10%;"></td> <td style="width: 10%;"></td> <td style="width: 10%;"></td> </tr> <tr> <td></td> <td></td> <td colspan="8" style="text-align: center;"> <table border="1" style="width: 100%; border-collapse: collapse; text-align: center;"> <tr> </tr></table></td></tr></table></td></tr></table></td></tr></table></td></tr></table></td></tr></table></td></tr></table></td></tr></table></td></tr></table></td></tr></table></td></tr></table></td></tr></table></td></tr></table></td></tr></table></td></tr></table></td></tr></table></td></tr></table></td></tr></table></td></tr></table></td></tr></table></td></tr></table></td></tr></table></td></tr></table></td></tr></table></td></tr></table></td></tr></table></td></tr></table></td></tr></table></td></tr></table></td></tr></table></td></tr></table></td></tr></table></td></tr></table></td></tr></table></td></tr></table></td></tr></table></td></tr></table> | | | | | | | | | | | | | | | | | | | | <table border="1" style="width: 100%; border-collapse: collapse; text-align: center;"> <tr> <td style="width: 10%;"></td> <td style="width: 10%;"></td> <td style="width: 10%;"></td> <td style="width: 10%;"></td> <td style="width: 10%;"></td> <td style="width: 10%;"></td> <td style="width: 10%;"></td> <td style="width: 10%;"></td> <td style="width: 10%;"></td> <td style="width: 10%;"></td> </tr> <tr> <td></td> <td></td> <td colspan="8" style="text-align: center;"> <table border="1" style="width: 100%; border-collapse: collapse; text-align: center;"> <tr> <td style="width: 10%;"></td> <td style="width: 10%;"></td> <td style="width: 10%;"></td> <td style="width: 10%;"></td> <td style="width: 10%;"></td> <td style="width: 10%;"></td> <td style="width: 10%;"></td> <td style="width: 10%;"></td> <td style="width: 10%;"></td> <td style="width: 10%;"></td> </tr> <tr> <td></td> <td></td> <td colspan="8" style="text-align: center;"> <table border="1" style="width: 100%; border-collapse: collapse; text-align: center;"> <tr> <td style="width: 10%;"></td> <td style="width: 10%;"></td> <td style="width: 10%;"></td> <td style="width: 10%;"></td> <td style="width: 10%;"></td> <td style="width: 10%;"></td> <td style="width: 10%;"></td> <td style="width: 10%;"></td> <td style="width: 10%;"></td> <td style="width: 10%;"></td> </tr> <tr> <td></td> <td></td> <td colspan="8" style="text-align: center;"> <table border="1" style="width: 100%; border-collapse: collapse; text-align: center;"> <tr> <td style="width: 10%;"></td> <td style="width: 10%;"></td> <td style="width: 10%;"></td> <td style="width: 10%;"></td> <td style="width: 10%;"></td> <td style="width: 10%;"></td> <td style="width: 10%;"></td> <td style="width: 10%;"></td> <td style="width: 10%;"></td> <td style="width: 10%;"></td> </tr> <tr> <td></td> <td></td> <td colspan="8" style="text-align: center;"> <table border="1" style="width: 100%; border-collapse: collapse; text-align: center;"> <tr> <td style="width: 10%;"></td> <td style="width: 10%;"></td> <td style="width: 10%;"></td> <td style="width: 10%;"></td> <td style="width: 10%;"></td> <td style="width: 10%;"></td> <td style="width: 10%;"></td> <td style="width: 10%;"></td> <td style="width: 10%;"></td> <td style="width: 10%;"></td> </tr> <tr> <td></td> <td></td> <td colspan="8" style="text-align: center;"> <table border="1" style="width: 100%; border-collapse: collapse; text-align: center;"> <tr> <td style="width: 10%;"></td> <td style="width: 10%;"></td> <td style="width: 10%;"></td> <td style="width: 10%;"></td> <td style="width: 10%;"></td> <td style="width: 10%;"></td> <td style="width: 10%;"></td> <td style="width: 10%;"></td> <td style="width: 10%;"></td> <td style="width: 10%;"></td> </tr> <tr> <td></td> <td></td> <td colspan="8" style="text-align: center;"> <table border="1" style="width: 100%; border-collapse: collapse; text-align: center;"> <tr> <td style="width: 10%;"></td> <td style="width: 10%;"></td> <td style="width: 10%;"></td> <td style="width: 10%;"></td> <td style="width: 10%;"></td> <td style="width:
10%;"></td> <td style="width: 10%;"></td> <td style="width: 10%;"></td> <td style="width: 10%;"></td> <td style="width: 10%;"></td> </tr> <tr> <td></td> <td></td> <td colspan="8" style="text-align: center;"> <table border="1" style="width: 100%; border-collapse: collapse; text-align: center;"> <tr> <td style="width: 10%;"></td> <td style="width: 10%;"></td> <td style="width: 10%;"></td> <td style="width: 10%;"></td> <td style="width: 10%;"></td> <td style="width: 10%;"></td> <td style="width: 10%;"></td> <td style="width: 10%;"></td> <td style="width: 10%;"></td> <td style="width: 10%;"></td> </tr> <tr> <td></td> <td></td> <td colspan="8" style="text-align: center;"> <table border="1" style="width: 100%; border-collapse: collapse; text-align: center;"> <tr> <td style="width: 10%;"></td> <td style="width: 10%;"></td> <td style="width: 10%;"></td> <td style="width: 10%;"></td> <td style="width: 10%;"></td> <td style="width: 10%;"></td> <td style="width: 10%;"></td> <td style="width: 10%;"></td> <td style="width: 10%;"></td> <td style="width: 10%;"></td> </tr> <tr> <td></td> <td></td> <td colspan="8" style="text-align: center;"> <table border="1" style="width: 100%; border-collapse: collapse; text-align: center;"> <tr> <td style="width: 10%;"></td> <td style="width: 10%;"></td> <td style="width: 10%;"></td> <td style="width: 10%;"></td> <td style="width: 10%;"></td> <td style="width: 10%;"></td> <td style="width: 10%;"></td> <td style="width: 10%;"></td> <td style="width: 10%;"></td> <td style="width: 10%;"></td> </tr> <tr> <td></td> <td></td> <td colspan="8" style="text-align: center;"> <table border="1" style="width: 100%; border-collapse: collapse; text-align: center;"> <tr> <td style="width: 10%;"></td> <td style="width: 10%;"></td> <td style="width: 10%;"></td> <td style="width: 10%;"></td> <td style="width: 10%;"></td> <td style="width: 10%;"></td> <td style="width: 10%;"></td> <td style="width: 10%;"></td> <td style="width: 10%;"></td> <td style="width: 10%;"></td> </tr> <tr> <td></td> <td></td> <td colspan="8" style="text-align: center;"> <table border="1" style="width: 100%; border-collapse: collapse; text-align: center;"> <tr> <td style="width: 10%;"></td> <td style="width: 10%;"></td> <td style="width: 10%;"></td> <td style="width: 10%;"></td> <td style="width: 10%;"></td> <td style="width: 10%;"></td> <td style="width: 10%;"></td> <td style="width: 10%;"></td> <td style="width: 10%;"></td> <td style="width: 10%;"></td> </tr> <tr> <td></td> <td></td> <td colspan="8" style="text-align: center;"> <table border="1" style="width: 100%; border-collapse: collapse; text-align: center;"> <tr> <td style="width: 10%;"></td> <td style="width: 10%;"></td> <td style="width: 10%;"></td> <td style="width: 10%;"></td> <td style="width: 10%;"></td> <td style="width: 10%;"></td> <td style="width: 10%;"></td> <td style="width: 10%;"></td> <td style="width: 10%;"></td> <td style="width: 10%;"></td> </tr> <tr> <td></td> <td></td> <td colspan="8" style="text-align: center;"> <table border="1" style="width: 100%; border-collapse: collapse; text-align: center;"> <tr> <td style="width: 10%;"></td> <td style="width: 10%;"></td> <td style="width: 10%;"></td> <td style="width: 10%;"></td> <td style="width: 10%;"></td> <td style="width: 10%;"></td> <td style="width: 10%;"></td> <td style="width: 10%;"></td> <td style="width: 10%;"></td> <td style="width: 10%;"></td> </tr> <tr> <td></td> <td></td> <td colspan="8" style="text-align: center;"> <table border="1" style="width: 100%; border-collapse: collapse; text-align: center;"> <tr> <td style="width: 10%;"></td> <td style="width: 10%;"></td> <td style="width: 10%;"></td> <td style="width: 10%;"></td> <td style="width: 10%;"></td> <td style="width: 10%;"></td> <td style="width: 10%;"></td> <td style="width: 10%;"></td> <td style="width: 10%;"></td> <td style="width: 10%;"></td> </tr> <tr> <td></td> <td></td> <td colspan="8" style="text-align: center;"> <table border="1" style="width: 100%; border-collapse: collapse; text-align: center;"> <tr> <td style="width: 10%;"></td> <td style="width: 10%;"></td> <td style="width: 10%;"></td> <td style="width: 10%;"></td> <td style="width: 10%;"></td> <td style="width: 10%;"></td> <td style="width: 10%;"></td> <td style="width: 10%;"></td> <td style="width: 10%;"></td> <td style="width: 10%;"></td> </tr> <tr> <td></td> <td></td> <td colspan="8" style="text-align: center;"> <table border="1" style="width: 100%; border-collapse: collapse; text-align: center;"> <tr> <td style="width: 10%;"></td> <td style="width: 10%;"></td> <td style="width: 10%;"></td> <td style="width: 10%;"></td> <td style="width: 10%;"></td> <td style="width: 10%;"></td> <td style="width: 10%;"></td> <td style="width: 10%;"></td> <td style="width: 10%;"></td> <td style="width: 10%;"></td> </tr> <tr> <td></td> <td></td> <td colspan="8" style="text-align: center;"> <table border="1" style="width: 100%; border-collapse: collapse; text-align: center;"> <tr> <td style="width: 10%;"></td> <td style="width: 10%;"></td> <td style="width: 10%;"></td> <td style="width: 10%;"></td> <td style="width: 10%;"></td> <td style="width: 10%;"></td> <td style="width: 10%;"></td> <td style="width: 10%;"></td> <td style="width: 10%;"></td> <td style="width: 10%;"></td> </tr> <tr> <td></td> <td></td> <td colspan="8" style="text-align: center;"> <table border="1" style="width: 100%; border-collapse: collapse; text-align: center;"> <tr> <td style="width: 10%;"></td> <td style="width: 10%;"></td> <td style="width: 10%;"></td> <td style="width: 10%;"></td> <td style="width: 10%;"></td> <td style="width: 10%;"></td> <td style="width: 10%;"></td> <td style="width: 10%;"></td> <td style="width: 10%;"></td> <td style="width: 10%;"></td> </tr> <tr> <td></td> <td></td> <td colspan="8" style="text-align: center;"> <table border="1" style="width: 100%; border-collapse: collapse; text-align: center;"> <tr> <td style="width: 10%;"></td> <td style="width: 10%;"></td> <td style="width: 10%;"></td> <td style="width: 10%;"></td> <td style="width: 10%;"></td> <td style="width: 10%;"></td> <td style="width: 10%;"></td> <td style="width: 10%;"></td> <td style="width: 10%;"></td> <td style="width: 10%;"></td> </tr> <tr> <td></td> <td></td> <td colspan="8" style="text-align: center;"> <table border="1" style="width: 100%; border-collapse: collapse; text-align: center;"> <tr> <td style="width: 10%;"></td> <td style="width: 10%;"></td> <td style="width: 10%;"></td> <td style="width: 10%;"></td> <td style="width: 10%;"></td> <td style="width: 10%;"></td> <td style="width: 10%;"></td> <td style="width: 10%;"></td> <td style="width: 10%;"></td> <td style="width: 10%;"></td> </tr> <tr> <td></td> <td></td> <td colspan="8" style="text-align: center;"> <table border="1" style="width: 100%; border-collapse: collapse; text-align: center;"> <tr> <td style="width: 10%;"></td> <td style="width: 10%;"></td> <td style="width: 10%;"></td> <td style="width: 10%;"></td> <td style="width: 10%;"></td> <td style="width: 10%;"></td> <td style="width: 10%;"></td> <td style="width: 10%;"></td> <td style="width: 10%;"></td> <td style="width: 10%;"></td> </tr> <tr> <td></td> <td></td> <td colspan="8" style="text-align: center;"> <table border="1" style="width: 100%; border-collapse: collapse; text-align: center;"> <tr> <td style="width: 10%;"></td> <td style="width: 10%;"></td> <td style="width: 10%;"></td> <td style="width: 10%;"></td> <td style="width: 10%;"></td> <td style="width: 10%;"></td> <td style="width: 10%;"></td> <td style="width: 10%;"></td> <td style="width: 10%;"></td> <td style="width: 10%;"></td> </tr> <tr> <td></td> <td></td> <td colspan="8" style="text-align: center;"> <table border="1" style="width: 100%; border-collapse: collapse; text-align: center;"> <tr> <td style="width: 10%;"></td> <td style="width: 10%;"></td> <td style="width: 10%;"></td> <td style="width: 10%;"></td> <td style="width: 10%;"></td> <td style="width: 10%;"></td> <td style="width: 10%;"></td> <td style="width: 10%;"></td> <td style="width: 10%;"></td> <td style="width: 10%;"></td> </tr> <tr> <td></td> <td></td> <td colspan="8" style="text-align: center;"> <table border="1" style="width: 100%; border-collapse: collapse; text-align: center;"> <tr> <td style="width: 10%;"></td> <td style="width: 10%;"></td> <td style="width: 10%;"></td> <td style="width: 10%;"></td> <td style="width: 10%;"></td> <td style="width: 10%;"></td> <td style="width: 10%;"></td> <td style="width: 10%;"></td> <td style="width: 10%;"></td> <td style="width: 10%;"></td> </tr> <tr> <td></td> <td></td> <td colspan="8" style="text-align: center;"> <table border="1" style="width: 100%; border-collapse: collapse; text-align: center;"> <tr> <td style="width: 10%;"></td> <td style="width: 10%;"></td> <td style="width: 10%;"></td> <td style="width: 10%;"></td> <td style="width: 10%;"></td> <td style="width: 10%;"></td> <td style="width: 10%;"></td> <td style="width: 10%;"></td> <td style="width: 10%;"></td> <td style="width: 10%;"></td> </tr> <tr> <td></td> <td></td> <td colspan="8" style="text-align: center;"> <table border="1" style="width: 100%; border-collapse: collapse; text-align: center;"> <tr> <td style="width: 10%;"></td> <td style="width: 10%;"></td> <td style="width: 10%;"></td> <td style="width: 10%;"></td> <td style="width: 10%;"></td> <td style="width: 10%;"></td> <td style="width: 10%;"></td> <td style="width: 10%;"></td> <td style="width: 10%;"></td> <td style="width: 10%;"></td> </tr> <tr> <td></td> <td></td> <td colspan="8" style="text-align: center;"> <table border="1" style="width: 100%; border-collapse: collapse; text-align: center;"> <tr> <td style="width: 10%;"></td> <td style="width: 10%;"></td> <td style="width: 10%;"></td> <td style="width: 10%;"></td> <td style="width: 10%;"></td> <td style="width: 10%;"></td> <td style="width: 10%;"></td> <td style="width: 10%;"></td> <td style="width: 10%;"></td> <td style="width: 10%;"></td> </tr> <tr> <td></td> <td></td> <td
colspan="8" style="text-align: center;"> <table border="1" style="width: 100%; border-collapse: collapse; text-align: center;"> <tr> <td style="width: 10%;"></td> <td style="width: 10%;"></td> <td style="width: 10%;"></td> <td style="width: 10%;"></td> <td style="width: 10%;"></td> <td style="width: 10%;"></td> <td style="width: 10%;"></td> <td style="width: 10%;"></td> <td style="width: 10%;"></td> <td style="width: 10%;"></td> </tr> <tr> <td></td> <td></td> <td colspan="8" style="text-align: center;"> <table border="1" style="width: 100%; border-collapse: collapse; text-align: center;"> <tr> <td style="width: 10%;"></td> <td style="width: 10%;"></td> <td style="width: 10%;"></td> <td style="width: 10%;"></td> <td style="width: 10%;"></td> <td style="width: 10%;"></td> <td style="width: 10%;"></td> <td style="width: 10%;"></td> <td style="width: 10%;"></td> <td style="width: 10%;"></td> </tr> <tr> <td></td> <td></td> <td colspan="8" style="text-align: center;"> <table border="1" style="width: 100%; border-collapse: collapse; text-align: center;"> <tr> <td style="width: 10%;"></td> <td style="width: 10%;"></td> <td style="width: 10%;"></td> <td style="width: 10%;"></td> <td style="width: 10%;"></td> <td style="width: 10%;"></td> <td style="width: 10%;"></td> <td style="width: 10%;"></td> <td style="width: 10%;"></td> <td style="width: 10%;"></td> </tr> <tr> <td></td> <td></td> <td colspan="8" style="text-align: center;"> <table border="1" style="width: 100%; border-collapse: collapse; text-align: center;"> <tr> <td style="width: 10%;"></td> <td style="width: 10%;"></td> <td style="width: 10%;"></td> <td style="width: 10%;"></td> <td style="width: 10%;"></td> <td style="width: 10%;"></td> <td style="width: 10%;"></td> <td style="width: 10%;"></td> <td style="width: 10%;"></td> <td style="width: 10%;"></td> </tr> <tr> <td></td> <td></td> <td colspan="8" style="text-align: center;"> <table border="1" style="width: 100%; border-collapse: collapse; text-align: center;"> <tr> <td style="width: 10%;"></td> <td style="width: 10%;"></td> <td style="width: 10%;"></td> <td style="width: 10%;"></td> <td style="width: 10%;"></td> <td style="width: 10%;"></td> <td style="width: 10%;"></td> <td style="width: 10%;"></td> <td style="width: 10%;"></td> <td style="width: 10%;"></td> </tr> <tr> <td></td> <td></td> <td colspan="8" style="text-align: center;"> <table border="1" style="width: 100%; border-collapse: collapse; text-align: center;"> <tr> <td style="width: 10%;"></td> <td style="width: 10%;"></td> <td style="width: 10%;"></td> <td style="width: 10%;"></td> <td style="width: 10%;"></td> <td style="width: 10%;"></td> <td style="width: 10%;"></td> <td style="width: 10%;"></td> <td style="width: 10%;"></td> <td style="width: 10%;"></td> </tr> <tr> <td></td> <td></td> <td colspan="8" style="text-align: center;"> <table border="1" style="width: 100%; border-collapse: collapse; text-align: center;"> <tr> <td style="width: 10%;"></td> <td style="width: 10%;"></td> <td style="width: 10%;"></td> <td style="width: 10%;"></td> <td style="width: 10%;"></td> <td style="width: 10%;"></td> <td style="width: 10%;"></td> <td style="width: 10%;"></td> <td style="width: 10%;"></td> <td style="width: 10%;"></td> </tr> <tr> <td></td> <td></td> <td colspan="8" style="text-align: center;"> <table border="1" style="width: 100%; border-collapse: collapse; text-align: center;"> <tr> </tr></table></td></tr></table></td></tr></table></td></tr></table></td></tr></table></td></tr></table></td></tr></table></td></tr></table></td></tr></table></td></tr></table></td></tr></table></td></tr></table></td></tr></table></td></tr></table></td></tr></table></td></tr></table></td></tr></table></td></tr></table></td></tr></table></td></tr></table></td></tr></table></td></tr></table></td></tr></table></td></tr></table></td></tr></table></td></tr></table></td></tr></table></td></tr></table></td></tr></table></td></tr></table></td></tr></table></td></tr></table></td></tr></table></td></tr></table></td></tr></table></td></tr></table> | | | | | | | | | | | | | | | | | | | | <table border="1" style="width: 100%; border-collapse: collapse; text-align: center;"> <tr> <td style="width: 10%;"></td> <td style="width: 10%;"></td> <td style="width: 10%;"></td> <td style="width: 10%;"></td> <td style="width: 10%;"></td> <td style="width: 10%;"></td> <td style="width: 10%;"></td> <td style="width: 10%;"></td> <td style="width: 10%;"></td> <td style="width: 10%;"></td> </tr> <tr> <td></td> <td></td> <td colspan="8" style="text-align: center;"> <table border="1" style="width: 100%; border-collapse: collapse; text-align: center;"> <tr> <td style="width: 10%;"></td> <td style="width: 10%;"></td> <td style="width: 10%;"></td> <td style="width: 10%;"></td> <td style="width: 10%;"></td> <td style="width: 10%;"></td> <td style="width: 10%;"></td> <td style="width: 10%;"></td> <td style="width: 10%;"></td> <td style="width: 10%;"></td> </tr> <tr> <td></td> <td></td> <td colspan="8" style="text-align: center;"> <table border="1" style="width: 100%; border-collapse: collapse; text-align: center;"> <tr> <td style="width: 10%;"></td> <td style="width: 10%;"></td> <td style="width: 10%;"></td> <td style="width: 10%;"></td> <td style="width: 10%;"></td> <td style="width: 10%;"></td> <td style="width: 10%;"></td> <td style="width: 10%;"></td> <td style="width: 10%;"></td> <td style="width: 10%;"></td> </tr> <tr> <td></td> <td></td> <td colspan="8" style="text-align: center;"> <table border="1" style="width: 100%; border-collapse: collapse; text-align: center;"> <tr> <td style="width: 10%;"></td> <td style="width: 10%;"></td> <td style="width: 10%;"></td> <td style="width: 10%;"></td> <td style="width: 10%;"></td> <td style="width: 10%;"></td> <td style="width: 10%;"></td> <td style="width: 10%;"></td> <td style="width: 10%;"></td> <td style="width: 10%;"></td> </tr> <tr> <td></td> <td></td> <td colspan="8" style="text-align: center;"> <table border="1" style="width: 100%; border-collapse: collapse; text-align: center;"> <tr> <td style="width: 10%;"></td> <td style="width: 10%;"></td> <td style="width: 10%;"></td> <td style="width: 10%;"></td> <td style="width: 10%;"></td> <td style="width: 10%;"></td> <td style="width: 10%;"></td> <td style="width: 10%;"></td> <td style="width: 10%;"></td> <td style="width: 10%;"></td> </tr> <tr> <td></td> <td></td> <td colspan="8" style="text-align: center;"> <table border="1" style="width: 100%; border-collapse: collapse; text-align: center;"> <tr> <td style="width: 10%;"></td> <td style="width:
10%;"></td> <td style="width: 10%;"></td> <td style="width: 10%;"></td> <td style="width: 10%;"></td> <td style="width: 10%;"></td> <td style="width: 10%;"></td> <td style="width: 10%;"></td> <td style="width: 10%;"></td> <td style="width: 10%;"></td> </tr> <tr> <td></td> <td></td> <td colspan="8" style="text-align: center;"> <table border="1" style="width: 100%; border-collapse: collapse; text-align: center;"> <tr> <td style="width: 10%;"></td> <td style="width: 10%;"></td> <td style="width: 10%;"></td> <td style="width: 10%;"></td> <td style="width: 10%;"></td> <td style="width: 10%;"></td> <td style="width: 10%;"></td> <td style="width: 10%;"></td> <td style="width: 10%;"></td> <td style="width: 10%;"></td> </tr> <tr> <td></td> <td></td> <td colspan="8" style="text-align: center;"> <table border="1" style="width: 100%; border-collapse: collapse; text-align: center;"> <tr> <td style="width: 10%;"></td> <td style="width: 10%;"></td> <td style="width: 10%;"></td> <td style="width: 10%;"></td> <td style="width: 10%;"></td> <td style="width: 10%;"></td> <td style="width: 10%;"></td> <td style="width: 10%;"></td> <td style="width: 10%;"></td> <td style="width: 10%;"></td> </tr> <tr> <td></td> <td></td> <td colspan="8" style="text-align: center;"> <table border="1" style="width: 100%; border-collapse: collapse; text-align: center;"> <tr> <td style="width: 10%;"></td> <td style="width: 10%;"></td> <td style="width: 10%;"></td> <td style="width: 10%;"></td> <td style="width: 10%;"></td> <td style="width: 10%;"></td> <td style="width: 10%;"></td> <td style="width: 10%;"></td> <td style="width: 10%;"></td> <td style="width: 10%;"></td> </tr> <tr> <td></td> <td></td> <td colspan="8" style="text-align: center;"> <table border="1" style="width: 100%; border-collapse: collapse; text-align: center;"> <tr> <td style="width: 10%;"></td> <td style="width: 10%;"></td> <td style="width: 10%;"></td> <td style="width: 10%;"></td> <td style="width: 10%;"></td> <td style="width: 10%;"></td> <td style="width: 10%;"></td> <td style="width: 10%;"></td> <td style="width: 10%;"></td> <td style="width: 10%;"></td> </tr> <tr> <td></td> <td></td> <td colspan="8" style="text-align: center;"> <table border="1" style="width: 100%; border-collapse: collapse; text-align: center;"> <tr> <td style="width: 10%;"></td> <td style="width: 10%;"></td> <td style="width: 10%;"></td> <td style="width: 10%;"></td> <td style="width: 10%;"></td> <td style="width: 10%;"></td> <td style="width: 10%;"></td> <td style="width: 10%;"></td> <td style="width: 10%;"></td> <td style="width: 10%;"></td> </tr> <tr> <td></td> <td></td> <td colspan="8" style="text-align: center;"> <table border="1" style="width: 100%; border-collapse: collapse; text-align: center;"> <tr> <td style="width: 10%;"></td> <td style="width: 10%;"></td> <td style="width: 10%;"></td> <td style="width: 10%;"></td> <td style="width: 10%;"></td> <td style="width: 10%;"></td> <td style="width: 10%;"></td> <td style="width: 10%;"></td> <td style="width: 10%;"></td> <td style="width: 10%;"></td> </tr> <tr> <td></td> <td></td> <td colspan="8" style="text-align: center;"> <table border="1" style="width: 100%; border-collapse: collapse; text-align: center;"> <tr> <td style="width: 10%;"></td> <td style="width: 10%;"></td> <td style="width: 10%;"></td> <td style="width: 10%;"></td> <td style="width: 10%;"></td> <td style="width: 10%;"></td> <td style="width: 10%;"></td> <td style="width: 10%;"></td> <td style="width: 10%;"></td> <td style="width: 10%;"></td> </tr> <tr> <td></td> <td></td> <td colspan="8" style="text-align: center;"> <table border="1" style="width: 100%; border-collapse: collapse; text-align: center;"> <tr> <td style="width: 10%;"></td> <td style="width: 10%;"></td> <td style="width: 10%;"></td> <td style="width: 10%;"></td> <td style="width: 10%;"></td> <td style="width: 10%;"></td> <td style="width: 10%;"></td> <td style="width: 10%;"></td> <td style="width: 10%;"></td> <td style="width: 10%;"></td> </tr> <tr> <td></td> <td></td> <td colspan="8" style="text-align: center;"> <table border="1" style="width: 100%; border-collapse: collapse; text-align: center;"> <tr> <td style="width: 10%;"></td> <td style="width: 10%;"></td> <td style="width: 10%;"></td> <td style="width: 10%;"></td> <td style="width: 10%;"></td> <td style="width: 10%;"></td> <td style="width: 10%;"></td> <td style="width: 10%;"></td> <td style="width: 10%;"></td> <td style="width: 10%;"></td> </tr> <tr> <td></td> <td></td> <td colspan="8" style="text-align: center;"> <table border="1" style="width: 100%; border-collapse: collapse; text-align: center;"> <tr> <td style="width: 10%;"></td> <td style="width: 10%;"></td> <td style="width: 10%;"></td> <td style="width: 10%;"></td> <td style="width: 10%;"></td> <td style="width: 10%;"></td> <td style="width: 10%;"></td> <td style="width: 10%;"></td> <td style="width: 10%;"></td> <td style="width: 10%;"></td> </tr> <tr> <td></td> <td></td> <td colspan="8" style="text-align: center;"> <table border="1" style="width: 100%; border-collapse: collapse; text-align: center;"> <tr> <td style="width: 10%;"></td> <td style="width: 10%;"></td> <td style="width: 10%;"></td> <td style="width: 10%;"></td> <td style="width: 10%;"></td> <td style="width: 10%;"></td> <td style="width: 10%;"></td> <td style="width: 10%;"></td> <td style="width: 10%;"></td> <td style="width: 10%;"></td> </tr> <tr> <td></td> <td></td> <td colspan="8" style="text-align: center;"> <table border="1" style="width: 100%; border-collapse: collapse; text-align: center;"> <tr> <td style="width: 10%;"></td> <td style="width: 10%;"></td> <td style="width: 10%;"></td> <td style="width: 10%;"></td> <td style="width: 10%;"></td> <td style="width: 10%;"></td> <td style="width: 10%;"></td> <td style="width: 10%;"></td> <td style="width: 10%;"></td> <td style="width: 10%;"></td> </tr> <tr> <td></td> <td></td> <td colspan="8" style="text-align: center;"> <table border="1" style="width: 100%; border-collapse: collapse; text-align: center;"> <tr> <td style="width: 10%;"></td> <td style="width: 10%;"></td> <td style="width: 10%;"></td> <td style="width: 10%;"></td> <td style="width: 10%;"></td> <td style="width: 10%;"></td> <td style="width: 10%;"></td> <td style="width: 10%;"></td> <td style="width: 10%;"></td> <td style="width: 10%;"></td> </tr> <tr> <td></td> <td></td> <td colspan="8" style="text-align: center;"> <table border="1" style="width: 100%; border-collapse: collapse; text-align: center;"> <tr> <td style="width: 10%;"></td> <td style="width: 10%;"></td> <td style="width: 10%;"></td> <td style="width: 10%;"></td> <td style="width: 10%;"></td> <td style="width: 10%;"></td> <td style="width: 10%;"></td> <td style="width: 10%;"></td> <td style="width: 10%;"></td> <td style="width: 10%;"></td> </tr> <tr> <td></td> <td></td> <td colspan="8" style="text-align: center;"> <table border="1" style="width: 100%; border-collapse: collapse; text-align: center;"> <tr> <td style="width: 10%;"></td> <td style="width: 10%;"></td> <td style="width: 10%;"></td> <td style="width: 10%;"></td> <td style="width: 10%;"></td> <td style="width: 10%;"></td> <td style="width: 10%;"></td> <td style="width: 10%;"></td> <td style="width: 10%;"></td> <td style="width: 10%;"></td> </tr> <tr> <td></td> <td></td> <td colspan="8" style="text-align: center;"> <table border="1" style="width: 100%; border-collapse: collapse; text-align: center;"> <tr> <td style="width: 10%;"></td> <td style="width: 10%;"></td> <td style="width: 10%;"></td> <td style="width: 10%;"></td> <td style="width: 10%;"></td> <td style="width: 10%;"></td> <td style="width: 10%;"></td> <td style="width: 10%;"></td> <td style="width: 10%;"></td> <td style="width: 10%;"></td> </tr> <tr> <td></td> <td></td> <td colspan="8" style="text-align: center;"> <table border="1" style="width: 100%; border-collapse: collapse; text-align: center;"> <tr> <td style="width: 10%;"></td> <td style="width: 10%;"></td> <td style="width: 10%;"></td> <td style="width: 10%;"></td> <td style="width: 10%;"></td> <td style="width: 10%;"></td> <td style="width: 10%;"></td> <td style="width: 10%;"></td> <td style="width: 10%;"></td> <td style="width: 10%;"></td> </tr> <tr> <td></td> <td></td> <td colspan="8" style="text-align: center;"> <table border="1" style="width: 100%; border-collapse: collapse; text-align: center;"> <tr> <td style="width: 10%;"></td> <td style="width: 10%;"></td> <td style="width: 10%;"></td> <td style="width: 10%;"></td> <td style="width: 10%;"></td> <td style="width: 10%;"></td> <td style="width: 10%;"></td> <td style="width: 10%;"></td> <td style="width: 10%;"></td> <td style="width: 10%;"></td> </tr> <tr> <td></td> <td></td> <td colspan="8" style="text-align: center;"> <table border="1" style="width: 100%; border-collapse: collapse; text-align: center;"> <tr> <td style="width: 10%;"></td> <td style="width: 10%;"></td> <td style="width: 10%;"></td> <td style="width: 10%;"></td> <td style="width: 10%;"></td> <td style="width: 10%;"></td> <td style="width: 10%;"></td> <td style="width: 10%;"></td> <td style="width: 10%;"></td> <td style="width: 10%;"></td> </tr> <tr> <td></td> <td></td> <td colspan="8" style="text-align: center;"> <table border="1" style="width: 100%; border-collapse: collapse; text-align: center;"> <tr> <td style="width: 10%;"></td> <td style="width: 10%;"></td> <td style="width: 10%;"></td> <td style="width: 10%;"></td> <td style="width: 10%;"></td> <td style="width: 10%;"></td> <td style="width: 10%;"></td> <td style="width: 10%;"></td> <td style="width: 10%;"></td> <td style="width: 10%;"></td> </tr> <tr> <td></td> <td></td> <td colspan="8" style="text-align: center;"> <table border="1" style="width: 100%; border-collapse: collapse; text-align: center;"> <tr> <td style="width: 10%;"></td> <td style="width: 10%;"></td> <td style="width: 10%;"></td> <td style="width: 10%;"></td> <td style="width: 10%;"></td> <td style="width: 10%;"></td> <td style="width: 10%;"></td> <td
style="width: 10%;"></td> <td style="width: 10%;"></td> <td style="width: 10%;"></td> </tr> <tr> <td></td> <td></td> <td colspan="8" style="text-align: center;"> <table border="1" style="width: 100%; border-collapse: collapse; text-align: center;"> <tr> <td style="width: 10%;"></td> <td style="width: 10%;"></td> <td style="width: 10%;"></td> <td style="width: 10%;"></td> <td style="width: 10%;"></td> <td style="width: 10%;"></td> <td style="width: 10%;"></td> <td style="width: 10%;"></td> <td style="width: 10%;"></td> <td style="width: 10%;"></td> </tr> <tr> <td></td> <td></td> <td colspan="8" style="text-align: center;"> <table border="1" style="width: 100%; border-collapse: collapse; text-align: center;"> <tr> <td style="width: 10%;"></td> <td style="width: 10%;"></td> <td style="width: 10%;"></td> <td style="width: 10%;"></td> <td style="width: 10%;"></td> <td style="width: 10%;"></td> <td style="width: 10%;"></td> <td style="width: 10%;"></td> <td style="width: 10%;"></td> <td style="width: 10%;"></td> </tr> <tr> <td></td> <td></td> <td colspan="8" style="text-align: center;"> <table border="1" style="width: 100%; border-collapse: collapse; text-align: center;"> <tr> <td style="width: 10%;"></td> <td style="width: 10%;"></td> <td style="width: 10%;"></td> <td style="width: 10%;"></td> <td style="width: 10%;"></td> <td style="width: 10%;"></td> <td style="width: 10%;"></td> <td style="width: 10%;"></td> <td style="width: 10%;"></td> <td style="width: 10%;"></td> </tr> <tr> <td></td> <td></td> <td colspan="8" style="text-align: center;"> <table border="1" style="width: 100%; border-collapse: collapse; text-align: center;"> <tr> <td style="width: 10%;"></td> <td style="width: 10%;"></td> <td style="width: 10%;"></td> <td style="width: 10%;"></td> <td style="width: 10%;"></td> <td style="width: 10%;"></td> <td style="width: 10%;"></td> <td style="width: 10%;"></td> <td style="width: 10%;"></td> <td style="width: 10%;"></td> </tr> <tr> <td></td> <td></td> <td colspan="8" style="text-align: center;"> <table border="1" style="width: 100%; border-collapse: collapse; text-align: center;"> <tr> <td style="width: 10%;"></td> <td style="width: 10%;"></td> <td style="width: 10%;"></td> <td style="width: 10%;"></td> <td style="width: 10%;"></td> <td style="width: 10%;"></td> <td style="width: 10%;"></td> <td style="width: 10%;"></td> <td style="width: 10%;"></td> <td style="width: 10%;"></td> </tr> <tr> <td></td> <td></td> <td colspan="8" style="text-align: center;"> <table border="1" style="width: 100%; border-collapse: collapse; text-align: center;"> <tr> <td style="width: 10%;"></td> <td style="width: 10%;"></td> <td style="width: 10%;"></td> <td style="width: 10%;"></td> <td style="width: 10%;"></td> <td style="width: 10%;"></td> <td style="width: 10%;"></td> <td style="width: 10%;"></td> <td style="width: 10%;"></td> <td style="width: 10%;"></td> </tr> <tr> <td></td> <td></td> <td colspan="8" style="text-align: center;"> <table border="1" style="width: 100%; border-collapse: collapse; text-align: center;"> <tr> <td style="width: 10%;"></td> <td style="width: 10%;"></td> <td style="width: 10%;"></td> <td style="width: 10%;"></td> <td style="width: 10%;"></td> <td style="width: 10%;"></td> <td style="width: 10%;"></td> <td style="width: 10%;"></td> <td style="width: 10%;"></td> <td style="width: 10%;"></td> </tr> <tr> <td></td> <td></td> <td colspan="8" style="text-align: center;"> <table border="1" style="width: 100%; border-collapse: collapse; text-align: center;"> <tr> </tr></table></td></tr></table></td></tr></table></td></tr></table></td></tr></table></td></tr></table></td></tr></table></td></tr></table></td></tr></table></td></tr></table></td></tr></table></td></tr></table></td></tr></table></td></tr></table></td></tr></table></td></tr></table></td></tr></table></td></tr></table></td></tr></table></td></tr></table></td></tr></table></td></tr></table></td></tr></table></td></tr></table></td></tr></table></td></tr></table></td></tr></table></td></tr></table></td></tr></table></td></tr></table></td></tr></table></td></tr></table></td></tr></table></td></tr></table></td></tr></table> | | | | | | | | | | | | | | | | | | | | <table border="1" style="width: 100%; border-collapse: collapse; text-align: center;"> <tr> <td style="width: 10%;"></td> <td style="width: 10%;"></td> <td style="width: 10%;"></td> <td style="width: 10%;"></td> <td style="width: 10%;"></td> <td style="width: 10%;"></td> <td style="width: 10%;"></td> <td style="width: 10%;"></td> <td style="width: 10%;"></td> <td style="width: 10%;"></td> </tr> <tr> <td></td> <td></td> <td colspan="8" style="text-align: center;"> <table border="1" style="width: 100%; border-collapse: collapse; text-align: center;"> <tr> <td style="width: 10%;"></td> <td style="width: 10%;"></td> <td style="width: 10%;"></td> <td style="width: 10%;"></td> <td style="width: 10%;"></td> <td style="width: 10%;"></td> <td style="width: 10%;"></td> <td style="width: 10%;"></td> <td style="width: 10%;"></td> <td style="width: 10%;"></td> </tr> <tr> <td></td> <td></td> <td colspan="8" style="text-align: center;"> <table border="1" style="width: 100%; border-collapse: collapse; text-align: center;"> <tr> <td style="width: 10%;"></td> <td style="width: 10%;"></td> <td style="width: 10%;"></td> <td style="width: 10%;"></td> <td style="width: 10%;"></td> <td style="width: 10%;"></td> <td style="width: 10%;"></td> <td style="width: 10%;"></td> <td style="width: 10%;"></td> <td style="width: 10%;"></td> </tr> <tr> <td></td> <td></td> <td colspan="8" style="text-align: center;"> <table border="1" style="width: 100%; border-collapse: collapse; text-align: center;"> <tr> <td style="width: 10%;"></td> <td style="width: 10%;"></td> <td style="width: 10%;"></td> <td style="width: 10%;"></td> <td style="width: 10%;"></td> <td style="width: 10%;"></td> <td style="width: 10%;"></td> <td style="width: 10%;"></td> <td style="width: 10%;"></td> <td style="width: 10%;"></td> </tr> <tr> <td></td> <td></td> <td colspan="8" style="text-align: center;"> <table border="1" style="width: 100%; border-collapse: collapse; text-align: center;"> <tr> <td style="width: 10%;"></td> <td style="width: 10%;"></td> <td style="width: 10%;"></td> <td style="width: 10%;"></td> <td style="width: 10%;"></td> <td style="width: 10%;"></td> <td style="width: 10%;"></td> <td style="width: 10%;"></td> <td style="width: 10%;"></td> <td style="width: 10%;"></td> </tr> <tr> <td></td> <td></td> <td colspan="8" style="text-align: center;"> <table border="1" style="width: 100%;
border-collapse: collapse; text-align: center;"> <tr> <td style="width: 10%;"></td> <td style="width: 10%;"></td> <td style="width: 10%;"></td> <td style="width: 10%;"></td> <td style="width: 10%;"></td> <td style="width: 10%;"></td> <td style="width: 10%;"></td> <td style="width: 10%;"></td> <td style="width: 10%;"></td> <td style="width: 10%;"></td> </tr> <tr> <td></td> <td></td> <td colspan="8" style="text-align: center;"> <table border="1" style="width: 100%; border-collapse: collapse; text-align: center;"> <tr> <td style="width: 10%;"></td> <td style="width: 10%;"></td> <td style="width: 10%;"></td> <td style="width: 10%;"></td> <td style="width: 10%;"></td> <td style="width: 10%;"></td> <td style="width: 10%;"></td> <td style="width: 10%;"></td> <td style="width: 10%;"></td> <td style="width: 10%;"></td> </tr> <tr> <td></td> <td></td> <td colspan="8" style="text-align: center;"> <table border="1" style="width: 100%; border-collapse: collapse; text-align: center;"> <tr> <td style="width: 10%;"></td> <td style="width: 10%;"></td> <td style="width: 10%;"></td> <td style="width: 10%;"></td> <td style="width: 10%;"></td> <td style="width: 10%;"></td> <td style="width: 10%;"></td> <td style="width: 10%;"></td> <td style="width: 10%;"></td> <td style="width: 10%;"></td> </tr> <tr> <td></td> <td></td> <td colspan="8" style="text-align: center;"> <table border="1" style="width: 100%; border-collapse: collapse; text-align: center;"> <tr> <td style="width: 10%;"></td> <td style="width: 10%;"></td> <td style="width: 10%;"></td> <td style="width: 10%;"></td> <td style="width: 10%;"></td> <td style="width: 10%;"></td> <td style="width: 10%;"></td> <td style="width: 10%;"></td> <td style="width: 10%;"></td> <td style="width: 10%;"></td> </tr> <tr> <td></td> <td></td> <td colspan="8" style="text-align: center;"> <table border="1" style="width: 100%; border-collapse: collapse; text-align: center;"> <tr> <td style="width: 10%;"></td> <td style="width: 10%;"></td> <td style="width: 10%;"></td> <td style="width: 10%;"></td> <td style="width: 10%;"></td> <td style="width: 10%;"></td> <td style="width: 10%;"></td> <td style="width: 10%;"></td> <td style="width: 10%;"></td> <td style="width: 10%;"></td> </tr> <tr> <td></td> <td></td> <td colspan="8" style="text-align: center;"> <table border="1" style="width: 100%; border-collapse: collapse; text-align: center;"> <tr> <td style="width: 10%;"></td> <td style="width: 10%;"></td> <td style="width: 10%;"></td> <td style="width: 10%;"></td> <td style="width: 10%;"></td> <td style="width: 10%;"></td> <td style="width: 10%;"></td> <td style="width: 10%;"></td> <td style="width: 10%;"></td> <td style="width: 10%;"></td> </tr> <tr> <td></td> <td></td> <td colspan="8" style="text-align: center;"> <table border="1" style="width: 100%; border-collapse: collapse; text-align: center;"> <tr> <td style="width: 10%;"></td> <td style="width: 10%;"></td> <td style="width: 10%;"></td> <td style="width: 10%;"></td> <td style="width: 10%;"></td> <td style="width: 10%;"></td> <td style="width: 10%;"></td> <td style="width: 10%;"></td> <td style="width: 10%;"></td> <td style="width: 10%;"></td> </tr> <tr> <td></td> <td></td> <td colspan="8" style="text-align: center;"> <table border="1" style="width: 100%; border-collapse: collapse; text-align: center;"> <tr> <td style="width: 10%;"></td> <td style="width: 10%;"></td> <td style="width: 10%;"></td> <td style="width: 10%;"></td> <td style="width: 10%;"></td> <td style="width: 10%;"></td> <td style="width: 10%;"></td> <td style="width: 10%;"></td> <td style="width: 10%;"></td> <td style="width: 10%;"></td> </tr> <tr> <td></td> <td></td> <td colspan="8" style="text-align: center;"> <table border="1" style="width: 100%; border-collapse: collapse; text-align: center;"> <tr> <td style="width: 10%;"></td> <td style="width: 10%;"></td> <td style="width: 10%;"></td> <td style="width: 10%;"></td> <td style="width: 10%;"></td> <td style="width: 10%;"></td> <td style="width: 10%;"></td> <td style="width: 10%;"></td> <td style="width: 10%;"></td> <td style="width: 10%;"></td> </tr> <tr> <td></td> <td></td> <td colspan="8" style="text-align: center;"> <table border="1" style="width: 100%; border-collapse: collapse; text-align: center;"> <tr> <td style="width: 10%;"></td> <td style="width: 10%;"></td> <td style="width: 10%;"></td> <td style="width: 10%;"></td> <td style="width: 10%;"></td> <td style="width: 10%;"></td> <td style="width: 10%;"></td> <td style="width: 10%;"></td> <td style="width: 10%;"></td> <td style="width: 10%;"></td> </tr> <tr> <td></td> <td></td> <td colspan="8" style="text-align: center;"> <table border="1" style="width: 100%; border-collapse: collapse; text-align: center;"> <tr> <td style="width: 10%;"></td> <td style="width: 10%;"></td> <td style="width: 10%;"></td> <td style="width: 10%;"></td> <td style="width: 10%;"></td> <td style="width: 10%;"></td> <td style="width: 10%;"></td> <td style="width: 10%;"></td> <td style="width: 10%;"></td> <td style="width: 10%;"></td> </tr> <tr> <td></td> <td></td> <td colspan="8" style="text-align: center;"> <table border="1" style="width: 100%; border-collapse: collapse; text-align: center;"> <tr> <td style="width: 10%;"></td> <td style="width: 10%;"></td> <td style="width: 10%;"></td> <td style="width: 10%;"></td> <td style="width: 10%;"></td> <td style="width: 10%;"></td> <td style="width: 10%;"></td> <td style="width: 10%;"></td> <td style="width: 10%;"></td> <td style="width: 10%;"></td> </tr> <tr> <td></td> <td></td> <td colspan="8" style="text-align: center;"> <table border="1" style="width: 100%; border-collapse: collapse; text-align: center;"> <tr> <td style="width: 10%;"></td> <td style="width: 10%;"></td> <td style="width: 10%;"></td> <td style="width: 10%;"></td> <td style="width: 10%;"></td> <td style="width: 10%;"></td> <td style="width: 10%;"></td> <td style="width: 10%;"></td> <td style="width: 10%;"></td> <td style="width: 10%;"></td> </tr> <tr> <td></td> <td></td> <td colspan="8" style="text-align: center;"> <table border="1" style="width: 100%; border-collapse: collapse; text-align: center;"> <tr> <td style="width: 10%;"></td> <td style="width: 10%;"></td> <td style="width: 10%;"></td> <td style="width: 10%;"></td> <td style="width: 10%;"></td> <td style="width: 10%;"></td> <td style="width: 10%;"></td> <td style="width: 10%;"></td> <td style="width: 10%;"></td> <td style="width: 10%;"></td> </tr> <tr> <td></td> <td></td> <td colspan="8" style="text-align: center;"> <table border="1" style="width: 100%; border-collapse: collapse; text-align: center;"> <tr> <td style="width: 10%;"></td> <td style="width: 10%;"></td> <td style="width: 10%;"></td> <td style="width: 10%;"></td> <td style="width: 10%;"></td> <td style="width: 10%;"></td> <td style="width: 10%;"></td> <td style="width: 10%;"></td> <td style="width: 10%;"></td> <td style="width: 10%;"></td> </tr> <tr> <td></td> <td></td> <td colspan="8" style="text-align: center;"> <table border="1" style="width: 100%; border-collapse: collapse; text-align: center;"> <tr> <td style="width: 10%;"></td> <td style="width: 10%;"></td> <td style="width: 10%;"></td> <td style="width: 10%;"></td> <td style="width: 10%;"></td> <td style="width: 10%;"></td> <td style="width: 10%;"></td> <td style="width: 10%;"></td> <td style="width: 10%;"></td> <td style="width: 10%;"></td> </tr> <tr> <td></td> <td></td> <td colspan="8" style="text-align: center;"> <table border="1" style="width: 100%; border-collapse: collapse; text-align: center;"> <tr> <td style="width: 10%;"></td> <td style="width: 10%;"></td> <td style="width: 10%;"></td> <td style="width: 10%;"></td> <td style="width: 10%;"></td> <td style="width: 10%;"></td> <td style="width: 10%;"></td> <td style="width: 10%;"></td> <td style="width: 10%;"></td> <td style="width: 10%;"></td> </tr> <tr> <td></td> <td></td> <td colspan="8" style="text-align: center;"> <table border="1" style="width: 100%; border-collapse: collapse; text-align: center;"> <tr> <td style="width: 10%;"></td> <td style="width: 10%;"></td> <td style="width: 10%;"></td> <td style="width: 10%;"></td> <td style="width: 10%;"></td> <td style="width: 10%;"></td> <td style="width: 10%;"></td> <td style="width: 10%;"></td> <td style="width: 10%;"></td> <td style="width: 10%;"></td> </tr> <tr> <td></td> <td></td> <td colspan="8" style="text-align: center;"> <table border="1" style="width: 100%; border-collapse: collapse; text-align: center;"> <tr> <td style="width: 10%;"></td> <td style="width: 10%;"></td> <td style="width: 10%;"></td> <td style="width: 10%;"></td> <td style="width: 10%;"></td> <td style="width: 10%;"></td> <td style="width: 10%;"></td> <td style="width: 10%;"></td> <td style="width: 10%;"></td> <td style="width: 10%;"></td> </tr> <tr> <td></td> <td></td> <td colspan="8" style="text-align: center;"> <table border="1" style="width: 100%; border-collapse: collapse; text-align: center;"> <tr> <td style="width: 10%;"></td> <td style="width: 10%;"></td> <td style="width: 10%;"></td> <td style="width: 10%;"></td> <td style="width: 10%;"></td> <td style="width: 10%;"></td> <td style="width: 10%;"></td> <td style="width: 10%;"></td> <td style="width: 10%;"></td> <td style="width: 10%;"></td> </tr> <tr> <td></td> <td></td> <td colspan="8" style="text-align: center;"> <table border="1" style="width: 100%; border-collapse: collapse; text-align: center;"> <tr> <td style="width: 10%;"></td> <td style="width: 10%;"></td> <td style="width: 10%;"></td> <td style="width: 10%;"></td> <td style="width: 10%;"></td> <td style="width: 10%;"></td> <td style="width: 10%;"></td> <td style="width: 10%;"></td> <td style="width: 10%;"></td> <td style="width: 10%;"></td> </tr> <tr> <td></td> <td></td> <td colspan="8" style="text-align: center;"> <table border="1" style="width: 100%; border-collapse: collapse; text-align: center;"> <tr> <td style="width: 10%;"></td> <td style="width: 10%;"></td> <td style="width: 10%;"></td> <td style="width:
10%;"></td> <td style="width: 10%;"></td> <td style="width: 10%;"></td> <td style="width: 10%;"></td> <td style="width: 10%;"></td> <td style="width: 10%;"></td> <td style="width: 10%;"></td> </tr> <tr> <td></td> <td></td> <td colspan="8" style="text-align: center;"> <table border="1" style="width: 100%; border-collapse: collapse; text-align: center;"> <tr> <td style="width: 10%;"></td> <td style="width: 10%;"></td> <td style="width: 10%;"></td> <td style="width: 10%;"></td> <td style="width: 10%;"></td> <td style="width: 10%;"></td> <td style="width: 10%;"></td> <td style="width: 10%;"></td> <td style="width: 10%;"></td> <td style="width: 10%;"></td> </tr> <tr> <td></td> <td></td> <td colspan="8" style="text-align: center;"> <table border="1" style="width: 100%; border-collapse: collapse; text-align: center;"> <tr> <td style="width: 10%;"></td> <td style="width: 10%;"></td> <td style="width: 10%;"></td> <td style="width: 10%;"></td> <td style="width: 10%;"></td> <td style="width: 10%;"></td> <td style="width: 10%;"></td> <td style="width: 10%;"></td> <td style="width: 10%;"></td> <td style="width: 10%;"></td> </tr> <tr> <td></td> <td></td> <td colspan="8" style="text-align: center;"> <table border="1" style="width: 100%; border-collapse: collapse; text-align: center;"> <tr> <td style="width: 10%;"></td> <td style="width: 10%;"></td> <td style="width: 10%;"></td> <td style="width: 10%;"></td> <td style="width: 10%;"></td> <td style="width: 10%;"></td> <td style="width: 10%;"></td> <td style="width: 10%;"></td> <td style="width: 10%;"></td> <td style="width: 10%;"></td> </tr> <tr> <td></td> <td></td> <td colspan="8" style="text-align: center;"> <table border="1" style="width: 100%; border-collapse: collapse; text-align: center;"> <tr> <td style="width: 10%;"></td> <td style="width: 10%;"></td> <td style="width: 10%;"></td> <td style="width: 10%;"></td> <td style="width: 10%;"></td> <td style="width: 10%;"></td> <td style="width: 10%;"></td> <td style="width: 10%;"></td> <td style="width: 10%;"></td> <td style="width: 10%;"></td> </tr> <tr> <td></td> <td></td> <td colspan="8" style="text-align: center;"> <table border="1" style="width: 100%; border-collapse: collapse; text-align: center;"> <tr> <td style="width: 10%;"></td> <td style="width: 10%;"></td> <td style="width: 10%;"></td> <td style="width: 10%;"></td> <td style="width: 10%;"></td> <td style="width: 10%;"></td> <td style="width: 10%;"></td> <td style="width: 10%;"></td> <td style="width: 10%;"></td> <td style="width: 10%;"></td> </tr> <tr> <td></td> <td></td> <td colspan="8" style="text-align: center;"> <table border="1" style="width: 100%; border-collapse: collapse; text-align: center;"> <tr> <td style="width: 10%;"></td> <td style="width: 10%;"></td> <td style="width: 10%;"></td> <td style="width: 10%;"></td> <td style="width: 10%;"></td> <td style="width: 10%;"></td> <td style="width: 10%;"></td> <td style="width: 10%;"></td> <td style="width: 10%;"></td> <td style="width: 10%;"></td> </tr> <tr> <td></td> <td></td> <td colspan="8" style="text-align: center;"> <table border="1" style="width: 100%; border-collapse: collapse; text-align: center;"> <tr> </tr></table></td></tr></table></td></tr></table></td></tr></table></td></tr></table></td></tr></table></td></tr></table></td></tr></table></td></tr></table></td></tr></table></td></tr></table></td></tr></table></td></tr></table></td></tr></table></td></tr></table></td></tr></table></td></tr></table></td></tr></table></td></tr></table></td></tr></table></td></tr></table></td></tr></table></td></tr></table></td></tr></table></td></tr></table></td></tr></table></td></tr></table></td></tr></table></td></tr></table></td></tr></table></td></tr></table></td></tr></table></td></tr></table></td></tr></table> | | | | | | | | | | | | | | | | | | | | <table border="1" style="width: 100%; border-collapse: collapse; text-align: center;"> <tr> <td style="width: 10%;"></td> <td style="width: 10%;"></td> <td style="width: 10%;"></td> <td style="width: 10%;"></td> <td style="width: 10%;"></td> <td style="width: 10%;"></td> <td style="width: 10%;"></td> <td style="width: 10%;"></td> <td style="width: 10%;"></td> <td style="width: 10%;"></td> </tr> <tr> <td></td> <td></td> <td colspan="8" style="text-align: center;"> <table border="1" style="width: 100%; border-collapse: collapse; text-align: center;"> <tr> <td style="width: 10%;"></td> <td style="width: 10%;"></td> <td style="width: 10%;"></td> <td style="width: 10%;"></td> <td style="width: 10%;"></td> <td style="width: 10%;"></td> <td style="width: 10%;"></td> <td style="width: 10%;"></td> <td style="width: 10%;"></td> <td style="width: 10%;"></td> </tr> <tr> <td></td> <td></td> <td colspan="8" style="text-align: center;"> <table border="1" style="width: 100%; border-collapse: collapse; text-align: center;"> <tr> <td style="width: 10%;"></td> <td style="width: 10%;"></td> <td style="width: 10%;"></td> <td style="width: 10%;"></td> <td style="width: 10%;"></td> <td style="width: 10%;"></td> <td style="width: 10%;"></td> <td style="width: 10%;"></td> <td style="width: 10%;"></td> <td style="width: 10%;"></td> </tr> <tr> <td></td> <td></td> <td colspan="8" style="text-align: center;"> <table border="1" style="width: 100%; border-collapse: collapse; text-align: center;"> <tr> <td style="width: 10%;"></td> <td style="width: 10%;"></td> <td style="width: 10%;"></td> <td style="width: 10%;"></td> <td style="width: 10%;"></td> <td style="width: 10%;"></td> <td style="width: 10%;"></td> <td style="width: 10%;"></td> <td style="width: 10%;"></td> <td style="width: 10%;"></td> </tr> <tr> <td></td> <td></td> <td colspan="8" style="text-align: center;"> <table border="1" style="width: 100%; border-collapse: collapse; text-align: center;"> <tr> <td style="width: 10%;"></td> <td style="width: 10%;"></td> <td style="width: 10%;"></td> <td style="width: 10%;"></td> <td style="width: 10%;"></td> <td style="width: 10%;"></td> <td style="width: 10%;"></td> <td style="width: 10%;"></td> <td style="width: 10%;"></td> <td style="width: 10%;"></td> </tr> <tr> <td></td> <td></td> <td colspan="8" style="text-align: center;"> <table border="1" style="width: 100%; border-collapse: collapse; text-align: center;"> <tr> <td style="width: 10%;"></td> <td style="width: 10%;"></td> <td style="width: 10%;"></td> <td style="width: 10%;"></td> <td style="width: 10%;"></td> <td style="width: 10%;"></td> <td style="width: 10%;"></td> <td style="width: 10%;"></td> <td style="width: 10%;"></td> <td style="width: 10%;"></td> </tr> <tr> <td></td> <td></td>
<td colspan="8" style="text-align: center;"> <table border="1" style="width: 100%; border-collapse: collapse; text-align: center;"> <tr> <td style="width: 10%;"></td> <td style="width: 10%;"></td> <td style="width: 10%;"></td> <td style="width: 10%;"></td> <td style="width: 10%;"></td> <td style="width: 10%;"></td> <td style="width: 10%;"></td> <td style="width: 10%;"></td> <td style="width: 10%;"></td> <td style="width: 10%;"></td> </tr> <tr> <td></td> <td></td> <td colspan="8" style="text-align: center;"> <table border="1" style="width: 100%; border-collapse: collapse; text-align: center;"> <tr> <td style="width: 10%;"></td> <td style="width: 10%;"></td> <td style="width: 10%;"></td> <td style="width: 10%;"></td> <td style="width: 10%;"></td> <td style="width: 10%;"></td> <td style="width: 10%;"></td> <td style="width: 10%;"></td> <td style="width: 10%;"></td> <td style="width: 10%;"></td> </tr> <tr> <td></td> <td></td> <td colspan="8" style="text-align: center;"> <table border="1" style="width: 100%; border-collapse: collapse; text-align: center;"> <tr> <td style="width: 10%;"></td> <td style="width: 10%;"></td> <td style="width: 10%;"></td> <td style="width: 10%;"></td> <td style="width: 10%;"></td> <td style="width: 10%;"></td> <td style="width: 10%;"></td> <td style="width: 10%;"></td> <td style="width: 10%;"></td> <td style="width: 10%;"></td> </tr> <tr> <td></td> <td></td> <td colspan="8" style="text-align: center;"> <table border="1" style="width: 100%; border-collapse: collapse; text-align: center;"> <tr> <td style="width: 10%;"></td> <td style="width: 10%;"></td> <td style="width: 10%;"></td> <td style="width: 10%;"></td> <td style="width: 10%;"></td> <td style="width: 10%;"></td> <td style="width: 10%;"></td> <td style="width: 10%;"></td> <td style="width: 10%;"></td> <td style="width: 10%;"></td> </tr> <tr> <td></td> <td></td> <td colspan="8" style="text-align: center;"> <table border="1" style="width: 100%; border-collapse: collapse; text-align: center;"> <tr> <td style="width: 10%;"></td> <td style="width: 10%;"></td> <td style="width: 10%;"></td> <td style="width: 10%;"></td> <td style="width: 10%;"></td> <td style="width: 10%;"></td> <td style="width: 10%;"></td> <td style="width: 10%;"></td> <td style="width: 10%;"></td> <td style="width: 10%;"></td> </tr> <tr> <td></td> <td></td> <td colspan="8" style="text-align: center;"> <table border="1" style="width: 100%; border-collapse: collapse; text-align: center;"> <tr> <td style="width: 10%;"></td> <td style="width: 10%;"></td> <td style="width: 10%;"></td> <td style="width: 10%;"></td> <td style="width: 10%;"></td> <td style="width: 10%;"></td> <td style="width: 10%;"></td> <td style="width: 10%;"></td> <td style="width: 10%;"></td> <td style="width: 10%;"></td> </tr> <tr> <td></td> <td></td> <td colspan="8" style="text-align: center;"> <table border="1" style="width: 100%; border-collapse: collapse; text-align: center;"> <tr> <td style="width: 10%;"></td> <td style="width: 10%;"></td> <td style="width: 10%;"></td> <td style="width: 10%;"></td> <td style="width: 10%;"></td> <td style="width: 10%;"></td> <td style="width: 10%;"></td> <td style="width: 10%;"></td> <td style="width: 10%;"></td> <td style="width: 10%;"></td> </tr> <tr> <td></td> <td></td> <td colspan="8" style="text-align: center;"> <table border="1" style="width: 100%; border-collapse: collapse; text-align: center;"> <tr> <td style="width: 10%;"></td> <td style="width: 10%;"></td> <td style="width: 10%;"></td> <td style="width: 10%;"></td> <td style="width: 10%;"></td> <td style="width: 10%;"></td> <td style="width: 10%;"></td> <td style="width: 10%;"></td> <td style="width: 10%;"></td> <td style="width: 10%;"></td> </tr> <tr> <td></td> <td></td> <td colspan="8" style="text-align: center;"> <table border="1" style="width: 100%; border-collapse: collapse; text-align: center;"> <tr> <td style="width: 10%;"></td> <td style="width: 10%;"></td> <td style="width: 10%;"></td> <td style="width: 10%;"></td> <td style="width: 10%;"></td> <td style="width: 10%;"></td> <td style="width: 10%;"></td> <td style="width: 10%;"></td> <td style="width: 10%;"></td> <td style="width: 10%;"></td> </tr> <tr> <td></td> <td></td> <td colspan="8" style="text-align: center;"> <table border="1" style="width: 100%; border-collapse: collapse; text-align: center;"> <tr> <td style="width: 10%;"></td> <td style="width: 10%;"></td> <td style="width: 10%;"></td> <td style="width: 10%;"></td> <td style="width: 10%;"></td> <td style="width: 10%;"></td> <td style="width: 10%;"></td> <td style="width: 10%;"></td> <td style="width: 10%;"></td> <td style="width: 10%;"></td> </tr> <tr> <td></td> <td></td> <td colspan="8" style="text-align: center;"> <table border="1" style="width: 100%; border-collapse: collapse; text-align: center;"> <tr> <td style="width: 10%;"></td> <td style="width: 10%;"></td> <td style="width: 10%;"></td> <td style="width: 10%;"></td> <td style="width: 10%;"></td> <td style="width: 10%;"></td> <td style="width: 10%;"></td> <td style="width: 10%;"></td> <td style="width: 10%;"></td> <td style="width: 10%;"></td> </tr> <tr> <td></td> <td></td> <td colspan="8" style="text-align: center;"> <table border="1" style="width: 100%; border-collapse: collapse; text-align: center;"> <tr> <td style="width: 10%;"></td> <td style="width: 10%;"></td> <td style="width: 10%;"></td> <td style="width: 10%;"></td> <td style="width: 10%;"></td> <td style="width: 10%;"></td> <td style="width: 10%;"></td> <td style="width: 10%;"></td> <td style="width: 10%;"></td> <td style="width: 10%;"></td> </tr> <tr> <td></td> <td></td> <td colspan="8" style="text-align: center;"> <table border="1" style="width: 100%; border-collapse: collapse; text-align: center;"> <tr> <td style="width: 10%;"></td> <td style="width: 10%;"></td> <td style="width: 10%;"></td> <td style="width: 10%;"></td> <td style="width: 10%;"></td> <td style="width: 10%;"></td> <td style="width: 10%;"></td> <td style="width: 10%;"></td> <td style="width: 10%;"></td> <td style="width: 10%;"></td> </tr> <tr> <td></td> <td></td> <td colspan="8" style="text-align: center;"> <table border="1" style="width: 100%; border-collapse: collapse; text-align: center;"> <tr> <td style="width: 10%;"></td> <td style="width: 10%;"></td> <td style="width: 10%;"></td> <td style="width: 10%;"></td> <td style="width: 10%;"></td> <td style="width: 10%;"></td> <td style="width: 10%;"></td> <td style="width: 10%;"></td> <td style="width: 10%;"></td> <td style="width: 10%;"></td> </tr> <tr> <td></td> <td></td> <td colspan="8" style="text-align: center;"> <table border="1" style="width: 100%; border-collapse: collapse; text-align: center;"> <tr> <td style="width: 10%;"></td> <td style="width: 10%;"></td> <td style="width: 10%;"></td> <td style="width: 10%;"></td> <td style="width: 10%;"></td> <td style="width: 10%;"></td> <td style="width: 10%;"></td> <td style="width: 10%;"></td> <td style="width: 10%;"></td> <td style="width: 10%;"></td> </tr> <tr> <td></td> <td></td> <td colspan="8" style="text-align: center;"> <table border="1" style="width: 100%; border-collapse: collapse; text-align: center;"> <tr> <td style="width: 10%;"></td> <td style="width: 10%;"></td> <td style="width: 10%;"></td> <td style="width: 10%;"></td> <td style="width: 10%;"></td> <td style="width: 10%;"></td> <td style="width: 10%;"></td> <td style="width: 10%;"></td> <td style="width: 10%;"></td> <td style="width: 10%;"></td> </tr> <tr> <td></td> <td></td> <td colspan="8" style="text-align: center;"> <table border="1" style="width: 100%; border-collapse: collapse; text-align: center;"> <tr> <td style="width: 10%;"></td> <td style="width: 10%;"></td> <td style="width: 10%;"></td> <td style="width: 10%;"></td> <td style="width: 10%;"></td> <td style="width: 10%;"></td> <td style="width: 10%;"></td> <td style="width: 10%;"></td> <td style="width: 10%;"></td> <td style="width: 10%;"></td> </tr> <tr> <td></td> <td></td> <td colspan="8" style="text-align: center;"> <table border="1" style="width: 100%; border-collapse: collapse; text-align: center;"> <tr> <td style="width: 10%;"></td> <td style="width: 10%;"></td> <td style="width: 10%;"></td> <td style="width: 10%;"></td> <td style="width: 10%;"></td> <td style="width: 10%;"></td> <td style="width: 10%;"></td> <td style="width: 10%;"></td> <td style="width: 10%;"></td> <td style="width: 10%;"></td> </tr> <tr> <td></td> <td></td> <td colspan="8" style="text-align: center;"> <table border="1" style="width: 100%; border-collapse: collapse; text-align: center;"> <tr> <td style="width: 10%;"></td> <td style="width: 10%;"></td> <td style="width: 10%;"></td> <td style="width: 10%;"></td> <td style="width: 10%;"></td> <td style="width: 10%;"></td> <td style="width: 10%;"></td> <td style="width: 10%;"></td> <td style="width: 10%;"></td> <td style="width: 10%;"></td> </tr> <tr> <td></td> <td></td> <td colspan="8" style="text-align: center;"> <table border="1" style="width: 100%; border-collapse: collapse; text-align: center;"> <tr> <td style="width: 10%;"></td> <td style="width: 10%;"></td> <td style="width: 10%;"></td> <td style="width: 10%;"></td> <td style="width: 10%;"></td> <td style="width: 10%;"></td> <td style="width: 10%;"></td> <td style="width: 10%;"></td> <td style="width: 10%;"></td> <td style="width: 10%;"></td> </tr> <tr> <td></td> <td></td> <td colspan="8" style="text-align: center;"> <table border="1" style="width: 100%; border-collapse: collapse; text-align: center;"> <tr> <td style="width: 10%;"></td> <td style="width: 10%;"></td> <td style="width: 10%;"></td> <td style="width: 10%;"></td> <td style="width: 10%;"></td> <td style="width: 10%;"></td> <td style="width: 10%;"></td> <td style="width: 10%;"></td> <td style="width: 10%;"></td> <td style="width: 10%;"></td> </tr> <tr> <td></td> <td></td> <td colspan="8" style="text-align: center;"> <table border="1" style="width: 100%; border-collapse: collapse; text-align: center;"> <tr> <td style="width: 10%;"></td> <td
style="width: 10%;"></td> <td style="width: 10%;"></td> <td style="width: 10%;"></td> <td style="width: 10%;"></td> <td style="width: 10%;"></td> <td style="width: 10%;"></td> <td style="width: 10%;"></td> <td style="width: 10%;"></td> <td style="width: 10%;"></td> </tr> <tr> <td></td> <td></td> <td colspan="8" style="text-align: center;"> <table border="1" style="width: 100%; border-collapse: collapse; text-align: center;"> <tr> <td style="width: 10%;"></td> <td style="width: 10%;"></td> <td style="width: 10%;"></td> <td style="width: 10%;"></td> <td style="width: 10%;"></td> <td style="width: 10%;"></td> <td style="width: 10%;"></td> <td style="width: 10%;"></td> <td style="width: 10%;"></td> <td style="width: 10%;"></td> </tr> <tr> <td></td> <td></td> <td colspan="8" style="text-align: center;"> <table border="1" style="width: 100%; border-collapse: collapse; text-align: center;"> <tr> <td style="width: 10%;"></td> <td style="width: 10%;"></td> <td style="width: 10%;"></td> <td style="width: 10%;"></td> <td style="width: 10%;"></td> <td style="width: 10%;"></td> <td style="width: 10%;"></td> <td style="width: 10%;"></td> <td style="width: 10%;"></td> <td style="width: 10%;"></td> </tr> <tr> <td></td> <td></td> <td colspan="8" style="text-align: center;"> <table border="1" style="width: 100%; border-collapse: collapse; text-align: center;"> <tr> <td style="width: 10%;"></td> <td style="width: 10%;"></td> <td style="width: 10%;"></td> <td style="width: 10%;"></td> <td style="width: 10%;"></td> <td style="width: 10%;"></td> <td style="width: 10%;"></td> <td style="width: 10%;"></td> <td style="width: 10%;"></td> <td style="width: 10%;"></td> </tr> <tr> <td></td> <td></td> <td colspan="8" style="text-align: center;"> <table border="1" style="width: 100%; border-collapse: collapse; text-align: center;"> <tr> <td style="width: 10%;"></td> <td style="width: 10%;"></td> <td style="width: 10%;"></td> <td style="width: 10%;"></td> <td style="width: 10%;"></td> <td style="width: 10%;"></td> <td style="width: 10%;"></td> <td style="width: 10%;"></td> <td style="width: 10%;"></td> <td style="width: 10%;"></td> </tr> <tr> <td></td> <td></td> <td colspan="8" style="text-align: center;"> <table border="1" style="width: 100%; border-collapse: collapse; text-align: center;"> <tr> </tr></table></td></tr></table></td></tr></table></td></tr></table></td></tr></table></td></tr></table></td></tr></table></td></tr></table></td></tr></table></td></tr></table></td></tr></table></td></tr></table></td></tr></table></td></tr></table></td></tr></table></td></tr></table></td></tr></table></td></tr></table></td></tr></table></td></tr></table></td></tr></table></td></tr></table></td></tr></table></td></tr></table></td></tr></table></td></tr></table></td></tr></table></td></tr></table></td></tr></table></td></tr></table></td></tr></table></td></tr></table></td></tr></table> | | | | | | | | | | | | | | | | | | | | <table border="1" style="width: 100%; border-collapse: collapse; text-align: center;"> <tr> <td style="width: 10%;"></td> <td style="width: 10%;"></td> <td style="width: 10%;"></td> <td style="width: 10%;"></td> <td style="width: 10%;"></td> <td style="width: 10%;"></td> <td style="width: 10%;"></td> <td style="width: 10%;"></td> <td style="width: 10%;"></td> <td style="width: 10%;"></td> </tr> <tr> <td></td> <td></td> <td colspan="8" style="text-align: center;"> <table border="1" style="width: 100%; border-collapse: collapse; text-align: center;"> <tr> <td style="width: 10%;"></td> <td style="width: 10%;"></td> <td style="width: 10%;"></td> <td style="width: 10%;"></td> <td style="width: 10%;"></td> <td style="width: 10%;"></td> <td style="width: 10%;"></td> <td style="width: 10%;"></td> <td style="width: 10%;"></td> <td style="width: 10%;"></td> </tr> <tr> <td></td> <td></td> <td colspan="8" style="text-align: center;"> <table border="1" style="width: 100%; border-collapse: collapse; text-align: center;"> <tr> <td style="width: 10%;"></td> <td style="width: 10%;"></td> <td style="width: 10%;"></td> <td style="width: 10%;"></td> <td style="width: 10%;"></td> <td style="width: 10%;"></td> <td style="width: 10%;"></td> <td style="width: 10%;"></td> <td style="width: 10%;"></td> <td style="width: 10%;"></td> </tr> <tr> <td></td> <td></td> <td colspan="8" style="text-align: center;"> <table border="1" style="width: 100%; border-collapse: collapse; text-align: center;"> <tr> <td style="width: 10%;"></td> <td style="width: 10%;"></td> <td style="width: 10%;"></td> <td style="width: 10%;"></td> <td style="width: 10%;"></td> <td style="width: 10%;"></td> <td style="width: 10%;"></td> <td style="width: 10%;"></td> <td style="width: 10%;"></td> <td style="width: 10%;"></td> </tr> <tr> <td></td> <td></td> <td colspan="8" style="text-align: center;"> <table border="1" style="width: 100%; border-collapse: collapse; text-align: center;"> <tr> <td style="width: 10%;"></td> <td style="width: 10%;"></td> <td style="width: 10%;"></td> <td style="width: 10%;"></td> <td style="width: 10%;"></td> <td style="width: 10%;"></td> <td style="width: 10%;"></td> <td style="width: 10%;"></td> <td style="width: 10%;"></td> <td style="width: 10%;"></td> </tr> <tr> <td></td> <td></td> <td colspan="8" style="text-align: center;"> <table border="1" style="width: 100%; border-collapse: collapse; text-align: center;"> <tr> <td style="width: 10%;"></td> <td style="width: 10%;"></td> <td style="width: 10%;"></td> <td style="width: 10%;"></td> <td style="width: 10%;"></td> <td style="width: 10%;"></td> <td style="width: 10%;"></td> <td style="width: 10%;"></td> <td style="width: 10%;"></td> <td style="width: 10%;"></td> </tr> <tr> <td></td> <td></td> <td colspan="8" style="text-align: center;"> <table border="1" style="width: 100%; border-collapse: collapse; text-align: center;"> <tr> <td style="width: 10%;"></td> <td style="width: 10%;"></td> <td style="width: 10%;"></td> <td style="width: 10%;"></td> <td style="width: 10%;"></td> <td style="width: 10%;"></td> <td style="width: 10%;"></td> <td style="width: 10%;"></td> <td style="width: 10%;"></td> <td style="width: 10%;"></td> </tr> <tr> <td></td> <td></td> <td colspan="8" style="text-align: center;"> <table border="1" style="width: 100%; border-collapse: collapse; text-align: center;"> <tr> <td style="width: 10%;"></td> <td style="width: 10%;"></td> <td style="width: 10%;"></td> <td style="width: 10%;"></td> <td style="width: 10%;"></td> <td style="width: 10%;"></td> <td style="width: 10%;"></td> <td style="width: 10%;"></td> <td style="width: 10%;"></td> <td
style="width: 10%;"></td> </tr> <tr> <td></td> <td></td> <td colspan="8" style="text-align: center;"> <table border="1" style="width: 100%; border-collapse: collapse; text-align: center;"> <tr> <td style="width: 10%;"></td> <td style="width: 10%;"></td> <td style="width: 10%;"></td> <td style="width: 10%;"></td> <td style="width: 10%;"></td> <td style="width: 10%;"></td> <td style="width: 10%;"></td> <td style="width: 10%;"></td> <td style="width: 10%;"></td> <td style="width: 10%;"></td> </tr> <tr> <td></td> <td></td> <td colspan="8" style="text-align: center;"> <table border="1" style="width: 100%; border-collapse: collapse; text-align: center;"> <tr> <td style="width: 10%;"></td> <td style="width: 10%;"></td> <td style="width: 10%;"></td> <td style="width: 10%;"></td> <td style="width: 10%;"></td> <td style="width: 10%;"></td> <td style="width: 10%;"></td> <td style="width: 10%;"></td> <td style="width: 10%;"></td> <td style="width: 10%;"></td> </tr> <tr> <td></td> <td></td> <td colspan="8" style="text-align: center;"> <table border="1" style="width: 100%; border-collapse: collapse; text-align: center;"> <tr> <td style="width: 10%;"></td> <td style="width: 10%;"></td> <td style="width: 10%;"></td> <td style="width: 10%;"></td> <td style="width: 10%;"></td> <td style="width: 10%;"></td> <td style="width: 10%;"></td> <td style="width: 10%;"></td> <td style="width: 10%;"></td> <td style="width: 10%;"></td> </tr> <tr> <td></td> <td></td> <td colspan="8" style="text-align: center;"> <table border="1" style="width: 100%; border-collapse: collapse; text-align: center;"> <tr> <td style="width: 10%;"></td> <td style="width: 10%;"></td> <td style="width: 10%;"></td> <td style="width: 10%;"></td> <td style="width: 10%;"></td> <td style="width: 10%;"></td> <td style="width: 10%;"></td> <td style="width: 10%;"></td> <td style="width: 10%;"></td> <td style="width: 10%;"></td> </tr> <tr> <td></td> <td></td> <td colspan="8" style="text-align: center;"> <table border="1" style="width: 100%; border-collapse: collapse; text-align: center;"> <tr> <td style="width: 10%;"></td> <td style="width: 10%;"></td> <td style="width: 10%;"></td> <td style="width: 10%;"></td> <td style="width: 10%;"></td> <td style="width: 10%;"></td> <td style="width: 10%;"></td> <td style="width: 10%;"></td> <td style="width: 10%;"></td> <td style="width: 10%;"></td> </tr> <tr> <td></td> <td></td> <td colspan="8" style="text-align: center;"> <table border="1" style="width: 100%; border-collapse: collapse; text-align: center;"> <tr> <td style="width: 10%;"></td> <td style="width: 10%;"></td> <td style="width: 10%;"></td> <td style="width: 10%;"></td> <td style="width: 10%;"></td> <td style="width: 10%;"></td> <td style="width: 10%;"></td> <td style="width: 10%;"></td> <td style="width: 10%;"></td> <td style="width: 10%;"></td> </tr> <tr> <td></td> <td></td> <td colspan="8" style="text-align: center;"> <table border="1" style="width: 100%; border-collapse: collapse; text-align: center;"> <tr> <td style="width: 10%;"></td> <td style="width: 10%;"></td> <td style="width: 10%;"></td> <td style="width: 10%;"></td> <td style="width: 10%;"></td> <td style="width: 10%;"></td> <td style="width: 10%;"></td> <td style="width: 10%;"></td> <td style="width: 10%;"></td> <td style="width: 10%;"></td> </tr> <tr> <td></td> <td></td> <td colspan="8" style="text-align: center;"> <table border="1" style="width: 100%; border-collapse: collapse; text-align: center;"> <tr> <td style="width: 10%;"></td> <td style="width: 10%;"></td> <td style="width: 10%;"></td> <td style="width: 10%;"></td> <td style="width: 10%;"></td> <td style="width: 10%;"></td> <td style="width: 10%;"></td> <td style="width: 10%;"></td> <td style="width: 10%;"></td> <td style="width: 10%;"></td> </tr> <tr> <td></td> <td></td> <td colspan="8" style="text-align: center;"> <table border="1" style="width: 100%; border-collapse: collapse; text-align: center;"> <tr> <td style="width: 10%;"></td> <td style="width: 10%;"></td> <td style="width: 10%;"></td> <td style="width: 10%;"></td> <td style="width: 10%;"></td> <td style="width: 10%;"></td> <td style="width: 10%;"></td> <td style="width: 10%;"></td> <td style="width: 10%;"></td> <td style="width: 10%;"></td> </tr> <tr> <td></td> <td></td> <td colspan="8" style="text-align: center;"> <table border="1" style="width: 100%; border-collapse: collapse; text-align: center;"> <tr> <td style="width: 10%;"></td> <td style="width: 10%;"></td> <td style="width: 10%;"></td> <td style="width: 10%;"></td> <td style="width: 10%;"></td> <td style="width: 10%;"></td> <td style="width: 10%;"></td> <td style="width: 10%;"></td> <td style="width: 10%;"></td> <td style="width: 10%;"></td> </tr> <tr> <td></td> <td></td> <td colspan="8" style="text-align: center;"> <table border="1" style="width: 100%; border-collapse: collapse; text-align: center;"> <tr> <td style="width: 10%;"></td> <td style="width: 10%;"></td> <td style="width: 10%;"></td> <td style="width: 10%;"></td> <td style="width: 10%;"></td> <td style="width: 10%;"></td> <td style="width: 10%;"></td> <td style="width: 10%;"></td> <td style="width: 10%;"></td> <td style="width: 10%;"></td> </tr> <tr> <td></td> <td></td> <td colspan="8" style="text-align: center;"> <table border="1" style="width: 100%; border-collapse: collapse; text-align: center;"> <tr> <td style="width: 10%;"></td> <td style="width: 10%;"></td> <td style="width: 10%;"></td> <td style="width: 10%;"></td> <td style="width: 10%;"></td> <td style="width: 10%;"></td> <td style="width: 10%;"></td> <td style="width: 10%;"></td> <td style="width: 10%;"></td> <td style="width: 10%;"></td> </tr> <tr> <td></td> <td></td> <td colspan="8" style="text-align: center;"> <table border="1" style="width: 100%; border-collapse: collapse; text-align: center;"> <tr> <td style="width: 10%;"></td> <td style="width: 10%;"></td> <td style="width: 10%;"></td> <td style="width: 10%;"></td> <td style="width: 10%;"></td> <td style="width: 10%;"></td> <td style="width: 10%;"></td> <td style="width: 10%;"></td> <td style="width: 10%;"></td> <td style="width: 10%;"></td> </tr> <tr> <td></td> <td></td> <td colspan="8" style="text-align: center;"> <table border="1" style="width: 100%; border-collapse: collapse; text-align: center;"> <tr> <td style="width: 10%;"></td> <td style="width: 10%;"></td> <td style="width: 10%;"></td> <td style="width: 10%;"></td> <td style="width: 10%;"></td> <td style="width: 10%;"></td> <td style="width: 10%;"></td> <td style="width: 10%;"></td> <td style="width: 10%;"></td> <td style="width: 10%;"></td> </tr> <tr> <td></td> <td></td> <td colspan="8" style="text-align: center;"> <table border="1" style="width: 100%; border-collapse: collapse; text-align: center;"> <tr> <td style="width: 10%;"></td> <td style="width: 10%;"></td> <td style="width: 10%;"></td> <td style="width: 10%;"></td> <td style="width: 10%;"></td> <td style="width: 10%;"></td> <td style="width: 10%;"></td> <td style="width: 10%;"></td> <td style="width: 10%;"></td> <td style="width: 10%;"></td> </tr> <tr> <td></td> <td></td> <td colspan="8" style="text-align: center;"> <table border="1" style="width: 100%; border-collapse: collapse; text-align: center;"> <tr> <td style="width: 10%;"></td> <td style="width: 10%;"></td> <td style="width: 10%;"></td> <td style="width: 10%;"></td> <td style="width: 10%;"></td> <td style="width: 10%;"></td> <td style="width: 10%;"></td> <td style="width: 10%;"></td> <td style="width: 10%;"></td> <td style="width: 10%;"></td> </tr> <tr> <td></td> <td></td> <td colspan="8" style="text-align: center;"> <table border="1" style="width: 100%; border-collapse: collapse; text-align: center;"> <tr> <td style="width: 10%;"></td> <td style="width: 10%;"></td> <td style="width: 10%;"></td> <td style="width: 10%;"></td> <td style="width: 10%;"></td> <td style="width: 10%;"></td> <td style="width: 10%;"></td> <td style="width: 10%;"></td> <td style="width: 10%;"></td> <td style="width: 10%;"></td> </tr> <tr> <td></td> <td></td> <td colspan="8" style="text-align: center;"> <table border="1" style="width: 100%; border-collapse: collapse; text-align: center;"> <tr> <td style="width: 10%;"></td> <td style="width: 10%;"></td> <td style="width: 10%;"></td> <td style="width: 10%;"></td> <td style="width: 10%;"></td> <td style="width: 10%;"></td> <td style="width: 10%;"></td> <td style="width: 10%;"></td> <td style="width: 10%;"></td> <td style="width: 10%;"></td> </tr> <tr> <td></td> <td></td> <td colspan="8" style="text-align: center;"> <table border="1" style="width: 100%; border-collapse: collapse; text-align: center;"> <tr> <td style="width: 10%;"></td> <td style="width: 10%;"></td> <td style="width: 10%;"></td> <td style="width: 10%;"></td> <td style="width: 10%;"></td> <td style="width: 10%;"></td> <td style="width: 10%;"></td> <td style="width: 10%;"></td> <td style="width: 10%;"></td> <td style="width: 10%;"></td> </tr> <tr> <td></td> <td></td> <td colspan="8" style="text-align: center;"> <table border="1" style="width: 100%; border-collapse: collapse; text-align: center;"> <tr> <td style="width: 10%;"></td> <td style="width: 10%;"></td> <td style="width: 10%;"></td> <td style="width: 10%;"></td> <td style="width: 10%;"></td> <td style="width: 10%;"></td> <td style="width: 10%;"></td> <td style="width: 10%;"></td> <td style="width: 10%;"></td> <td style="width: 10%;"></td> </tr> <tr> <td></td> <td></td> <td colspan="8" style="text-align: center;"> <table border="1" style="width: 100%; border-collapse: collapse; text-align: center;"> <tr> <td style="width: 10%;"></td> <td style="width: 10%;"></td> <td style="width: 10%;"></td> <td style="width: 10%;"></td> <td style="width: 10%;"></td> <td style="width: 10%;"></td> <td style="width: 10%;"></td> <td style="width: 10%;"></td> <td style="width: 10%;"></td> <td style="width: 10%;"></td> </tr> <tr> <td></td> <td></td> <td colspan="8" style="text-align: center;"> <table border="1" style="width: 100%; border-collapse: collapse;
text-align: center;"> <tr> <td style="width: 10%;"></td> <td style="width: 10%;"></td> <td style="width: 10%;"></td> <td style="width: 10%;"></td> <td style="width: 10%;"></td> <td style="width: 10%;"></td> <td style="width: 10%;"></td> <td style="width: 10%;"></td> <td style="width: 10%;"></td> <td style="width: 10%;"></td> </tr> <tr> <td></td> <td></td> <td colspan="8" style="text-align: center;"> <table border="1" style="width: 100%; border-collapse: collapse; text-align: center;"> <tr> <td style="width: 10%;"></td> <td style="width: 10%;"></td> <td style="width: 10%;"></td> <td style="width: 10%;"></td> <td style="width: 10%;"></td> <td style="width: 10%;"></td> <td style="width: 10%;"></td> <td style="width: 10%;"></td> <td style="width: 10%;"></td> <td style="width: 10%;"></td> </tr> <tr> <td></td> <td></td> <td colspan="8" style="text-align: center;"> <table border="1" style="width: 100%; border-collapse: collapse; text-align: center;"> <tr> </tr></table></td></tr></table></td></tr></table></td></tr></table></td></tr></table></td></tr></table></td></tr></table></td></tr></table></td></tr></table></td></tr></table></td></tr></table></td></tr></table></td></tr></table></td></tr></table></td></tr></table></td></tr></table></td></tr></table></td></tr></table></td></tr></table></td></tr></table></td></tr></table></td></tr></table></td></tr></table></td></tr></table></td></tr></table></td></tr></table></td></tr></table></td></tr></table></td></tr></table></td></tr></table></td></tr></table></td></tr></table> | | | | | | | | | | | | | | | | | | | | <table border="1" style="width: 100%; border-collapse: collapse; text-align: center;"> <tr> <td style="width: 10%;"></td> <td style="width: 10%;"></td> <td style="width: 10%;"></td> <td style="width: 10%;"></td> <td style="width: 10%;"></td> <td style="width: 10%;"></td> <td style="width: 10%;"></td> <td style="width: 10%;"></td> <td style="width: 10%;"></td> <td style="width: 10%;"></td> </tr> <tr> <td></td> <td></td> <td colspan="8" style="text-align: center;"> <table border="1" style="width: 100%; border-collapse: collapse; text-align: center;"> <tr> <td style="width: 10%;"></td> <td style="width: 10%;"></td> <td style="width: 10%;"></td> <td style="width: 10%;"></td> <td style="width: 10%;"></td> <td style="width: 10%;"></td> <td style="width: 10%;"></td> <td style="width: 10%;"></td> <td style="width: 10%;"></td> <td style="width: 10%;"></td> </tr> <tr> <td></td> <td></td> <td colspan="8" style="text-align: center;"> <table border="1" style="width: 100%; border-collapse: collapse; text-align: center;"> <tr> <td style="width: 10%;"></td> <td style="width: 10%;"></td> <td style="width: 10%;"></td> <td style="width: 10%;"></td> <td style="width: 10%;"></td> <td style="width: 10%;"></td> <td style="width: 10%;"></td> <td style="width: 10%;"></td> <td style="width: 10%;"></td> <td style="width: 10%;"></td> </tr> <tr> <td></td> <td></td> <td colspan="8" style="text-align: center;"> <table border="1" style="width: 100%; border-collapse: collapse; text-align: center;"> <tr> <td style="width: 10%;"></td> <td style="width: 10%;"></td> <td style="width: 10%;"></td> <td style="width: 10%;"></td> <td style="width: 10%;"></td> <td style="width: 10%;"></td> <td style="width: 10%;"></td> <td style="width: 10%;"></td> <td style="width: 10%;"></td> <td style="width: 10%;"></td> </tr> <tr> <td></td> <td></td> <td colspan="8" style="text-align: center;"> <table border="1" style="width: 100%; border-collapse: collapse; text-align: center;"> <tr> <td style="width: 10%;"></td> <td style="width: 10%;"></td> <td style="width: 10%;"></td> <td style="width: 10%;"></td> <td style="width: 10%;"></td> <td style="width: 10%;"></td> <td style="width: 10%;"></td> <td style="width: 10%;"></td> <td style="width: 10%;"></td> <td style="width: 10%;"></td> </tr> <tr> <td></td> <td></td> <td colspan="8" style="text-align: center;"> <table border="1" style="width: 100%; border-collapse: collapse; text-align: center;"> <tr> <td style="width: 10%;"></td> <td style="width: 10%;"></td> <td style="width: 10%;"></td> <td style="width: 10%;"></td> <td style="width: 10%;"></td> <td style="width: 10%;"></td> <td style="width: 10%;"></td> <td style="width: 10%;"></td> <td style="width: 10%;"></td> <td style="width: 10%;"></td> </tr> <tr> <td></td> <td></td> <td colspan="8" style="text-align: center;"> <table border="1" style="width: 100%; border-collapse: collapse; text-align: center;"> <tr> <td style="width: 10%;"></td> <td style="width: 10%;"></td> <td style="width: 10%;"></td> <td style="width: 10%;"></td> <td style="width: 10%;"></td> <td style="width: 10%;"></td> <td style="width: 10%;"></td> <td style="width: 10%;"></td> <td style="width: 10%;"></td> <td style="width: 10%;"></td> </tr> <tr> <td></td> <td></td> <td colspan="8" style="text-align: center;"> <table border="1" style="width: 100%; border-collapse: collapse; text-align: center;"> <tr> <td style="width: 10%;"></td> <td style="width: 10%;"></td> <td style="width: 10%;"></td> <td style="width: 10%;"></td> <td style="width: 10%;"></td> <td style="width: 10%;"></td> <td style="width: 10%;"></td> <td style="width: 10%;"></td> <td style="width: 10%;"></td> <td style="width: 10%;"></td> </tr> <tr> <td></td> <td></td> <td colspan="8" style="text-align: center;"> <table border="1" style="width: 100%; border-collapse: collapse; text-align: center;"> <tr> <td style="width: 10%;"></td> <td style="width: 10%;"></td> <td style="width: 10%;"></td> <td style="width: 10%;"></td> <td style="width: 10%;"></td> <td style="width: 10%;"></td> <td style="width: 10%;"></td> <td style="width: 10%;"></td> <td style="width: 10%;"></td> <td style="width: 10%;"></td> </tr> <tr> <td></td> <td></td> <td colspan="8" style="text-align: center;"> <table border="1" style="width: 100%; border-collapse: collapse; text-align: center;"> <tr> <td style="width: 10%;"></td> <td style="width: 10%;"></td> <td style="width: 10%;"></td> <td style="width: 10%;"></td> <td style="width: 10%;"></td> <td style="width: 10%;"></td> <td style="width: 10%;"></td> <td style="width: 10%;"></td> <td style="width: 10%;"></td> <td style="width: 10%;"></td> </tr> <tr> <td></td> <td></td> <td colspan="8" style="text-align: center;"> <table border="1" style="width: 100%; border-collapse: collapse; text-align: center;"> <tr> <td style="width: 10%;"></td> <td style="width: 10%;"></td> <td style="width: 10%;"></td> <td style="width: 10%;"></td> <td style="width: 10%;"></td> <td style="width: 10%;"></td> <td style="width: 10%;"></td> <td style="width:
10%;"></td> <td style="width: 10%;"></td> <td style="width: 10%;"></td> </tr> <tr> <td></td> <td></td> <td colspan="8" style="text-align: center;"> <table border="1" style="width: 100%; border-collapse: collapse; text-align: center;"> <tr> <td style="width: 10%;"></td> <td style="width: 10%;"></td> <td style="width: 10%;"></td> <td style="width: 10%;"></td> <td style="width: 10%;"></td> <td style="width: 10%;"></td> <td style="width: 10%;"></td> <td style="width: 10%;"></td> <td style="width: 10%;"></td> <td style="width: 10%;"></td> </tr> <tr> <td></td> <td></td> <td colspan="8" style="text-align: center;"> <table border="1" style="width: 100%; border-collapse: collapse; text-align: center;"> <tr> <td style="width: 10%;"></td> <td style="width: 10%;"></td> <td style="width: 10%;"></td> <td style="width: 10%;"></td> <td style="width: 10%;"></td> <td style="width: 10%;"></td> <td style="width: 10%;"></td> <td style="width: 10%;"></td> <td style="width: 10%;"></td> <td style="width: 10%;"></td> </tr> <tr> <td></td> <td></td> <td colspan="8" style="text-align: center;"> <table border="1" style="width: 100%; border-collapse: collapse; text-align: center;"> <tr> <td style="width: 10%;"></td> <td style="width: 10%;"></td> <td style="width: 10%;"></td> <td style="width: 10%;"></td> <td style="width: 10%;"></td> <td style="width: 10%;"></td> <td style="width: 10%;"></td> <td style="width: 10%;"></td> <td style="width: 10%;"></td> <td style="width: 10%;"></td> </tr> <tr> <td></td> <td></td> <td colspan="8" style="text-align: center;"> <table border="1" style="width: 100%; border-collapse: collapse; text-align: center;"> <tr> <td style="width: 10%;"></td> <td style="width: 10%;"></td> <td style="width: 10%;"></td> <td style="width: 10%;"></td> <td style="width: 10%;"></td> <td style="width: 10%;"></td> <td style="width: 10%;"></td> <td style="width: 10%;"></td> <td style="width: 10%;"></td> <td style="width: 10%;"></td> </tr> <tr> <td></td> <td></td> <td colspan="8" style="text-align: center;"> <table border="1" style="width: 100%; border-collapse: collapse; text-align: center;"> <tr> <td style="width: 10%;"></td> <td style="width: 10%;"></td> <td style="width: 10%;"></td> <td style="width: 10%;"></td> <td style="width: 10%;"></td> <td style="width: 10%;"></td> <td style="width: 10%;"></td> <td style="width: 10%;"></td> <td style="width: 10%;"></td> <td style="width: 10%;"></td> </tr> <tr> <td></td> <td></td> <td colspan="8" style="text-align: center;"> <table border="1" style="width: 100%; border-collapse: collapse; text-align: center;"> <tr> <td style="width: 10%;"></td> <td style="width: 10%;"></td> <td style="width: 10%;"></td> <td style="width: 10%;"></td> <td style="width: 10%;"></td> <td style="width: 10%;"></td> <td style="width: 10%;"></td> <td style="width: 10%;"></td> <td style="width: 10%;"></td> <td style="width: 10%;"></td> </tr> <tr> <td></td> <td></td> <td colspan="8" style="text-align: center;"> <table border="1" style="width: 100%; border-collapse: collapse; text-align: center;"> <tr> <td style="width: 10%;"></td> <td style="width: 10%;"></td> <td style="width: 10%;"></td> <td style="width: 10%;"></td> <td style="width: 10%;"></td> <td style="width: 10%;"></td> <td style="width: 10%;"></td> <td style="width: 10%;"></td> <td style="width: 10%;"></td> <td style="width: 10%;"></td> </tr> <tr> <td></td> <td></td> <td colspan="8" style="text-align: center;"> <table border="1" style="width: 100%; border-collapse: collapse; text-align: center;"> <tr> <td style="width: 10%;"></td> <td style="width: 10%;"></td> <td style="width: 10%;"></td> <td style="width: 10%;"></td> <td style="width: 10%;"></td> <td style="width: 10%;"></td> <td style="width: 10%;"></td> <td style="width: 10%;"></td> <td style="width: 10%;"></td> <td style="width: 10%;"></td> </tr> <tr> <td></td> <td></td> <td colspan="8" style="text-align: center;"> <table border="1" style="width: 100%; border-collapse: collapse; text-align: center;"> <tr> <td style="width: 10%;"></td> <td style="width: 10%;"></td> <td style="width: 10%;"></td> <td style="width: 10%;"></td> <td style="width: 10%;"></td> <td style="width: 10%;"></td> <td style="width: 10%;"></td> <td style="width: 10%;"></td> <td style="width: 10%;"></td> <td style="width: 10%;"></td> </tr> <tr> <td></td> <td></td> <td colspan="8" style="text-align: center;"> <table border="1" style="width: 100%; border-collapse: collapse; text-align: center;"> <tr> <td style="width: 10%;"></td> <td style="width: 10%;"></td> <td style="width: 10%;"></td> <td style="width: 10%;"></td> <td style="width: 10%;"></td> <td style="width: 10%;"></td> <td style="width: 10%;"></td> <td style="width: 10%;"></td> <td style="width: 10%;"></td> <td style="width: 10%;"></td> </tr> <tr> <td></td> <td></td> <td colspan="8" style="text-align: center;"> <table border="1" style="width: 100%; border-collapse: collapse; text-align: center;"> <tr> <td style="width: 10%;"></td> <td style="width: 10%;"></td> <td style="width: 10%;"></td> <td style="width: 10%;"></td> <td style="width: 10%;"></td> <td style="width: 10%;"></td> <td style="width: 10%;"></td> <td style="width: 10%;"></td> <td style="width: 10%;"></td> <td style="width: 10%;"></td> </tr> <tr> <td></td> <td></td> <td colspan="8" style="text-align: center;"> <table border="1" style="width: 100%; border-collapse: collapse; text-align: center;"> <tr> <td style="width: 10%;"></td> <td style="width: 10%;"></td> <td style="width: 10%;"></td> <td style="width: 10%;"></td> <td style="width: 10%;"></td> <td style="width: 10%;"></td> <td style="width: 10%;"></td> <td style="width: 10%;"></td> <td style="width: 10%;"></td> <td style="width: 10%;"></td> </tr> <tr> <td></td> <td></td> <td colspan="8" style="text-align: center;"> <table border="1" style="width: 100%; border-collapse: collapse; text-align: center;"> <tr> <td style="width: 10%;"></td> <td style="width: 10%;"></td> <td style="width: 10%;"></td> <td style="width: 10%;"></td> <td style="width: 10%;"></td> <td style="width: 10%;"></td> <td style="width: 10%;"></td> <td style="width: 10%;"></td> <td style="width: 10%;"></td> <td style="width: 10%;"></td> </tr> <tr> <td></td> <td></td> <td colspan="8" style="text-align: center;"> <table border="1" style="width: 100%; border-collapse: collapse; text-align: center;"> <tr> <td style="width: 10%;"></td> <td style="width: 10%;"></td> <td style="width: 10%;"></td> <td style="width: 10%;"></td> <td style="width: 10%;"></td> <td style="width: 10%;"></td> <td style="width: 10%;"></td> <td style="width: 10%;"></td> <td style="width: 10%;"></td> <td style="width: 10%;"></td> </tr> <tr> <td></td> <td></td> <td colspan="8" style="text-align: center;"> <table border="1" style="width: 100%; border-collapse: collapse; text-align: center;"> <tr> <td style="width: 10%;"></td> <td style="width: 10%;"></td> <td style="width: 10%;"></td> <td style="width: 10%;"></td> <td style="width: 10%;"></td> <td style="width: 10%;"></td> <td style="width: 10%;"></td> <td style="width: 10%;"></td> <td style="width: 10%;"></td> <td style="width: 10%;"></td> </tr> <tr> <td></td> <td></td> <td colspan="8" style="text-align: center;"> <table border="1" style="width: 100%; border-collapse: collapse; text-align: center;"> <tr> <td style="width: 10%;"></td> <td style="width: 10%;"></td> <td style="width: 10%;"></td> <td style="width: 10%;"></td> <td style="width: 10%;"></td> <td style="width: 10%;"></td> <td style="width: 10%;"></td> <td style="width: 10%;"></td> <td style="width: 10%;"></td> <td style="width: 10%;"></td> </tr> <tr> <td></td> <td></td> <td colspan="8" style="text-align: center;"> <table border="1" style="width: 100%; border-collapse: collapse; text-align: center;"> <tr> <td style="width: 10%;"></td> <td style="width: 10%;"></td> <td style="width: 10%;"></td> <td style="width: 10%;"></td> <td style="width: 10%;"></td> <td style="width: 10%;"></td> <td style="width: 10%;"></td> <td style="width: 10%;"></td> <td style="width: 10%;"></td> <td style="width: 10%;"></td> </tr> <tr> <td></td> <td></td> <td colspan="8" style="text-align: center;"> <table border="1" style="width: 100%; border-collapse: collapse; text-align: center;"> <tr> <td style="width: 10%;"></td> <td style="width: 10%;"></td> <td style="width: 10%;"></td> <td style="width: 10%;"></td> <td style="width: 10%;"></td> <td style="width: 10%;"></td> <td style="width: 10%;"></td> <td style="width: 10%;"></td> <td style="width: 10%;"></td> <td style="width: 10%;"></td> </tr> <tr> <td></td> <td></td> <td colspan="8" style="text-align: center;"> <table border="1" style="width: 100%; border-collapse: collapse; text-align: center;"> <tr> <td style="width: 10%;"></td> <td style="width: 10%;"></td> <td style="width: 10%;"></td> <td style="width: 10%;"></td> <td style="width: 10%;"></td> <td style="width: 10%;"></td> <td style="width: 10%;"></td> <td style="width: 10%;"></td> <td style="width: 10%;"></td> <td style="width: 10%;"></td> </tr> <tr> <td></td> <td></td> <td colspan="8" style="text-align: center;"> <table border="1" style="width: 100%; border-collapse: collapse; text-align: center;"> <tr> </tr></table></td></tr></table></td></tr></table></td></tr></table></td></tr></table></td></tr></table></td></tr></table></td></tr></table></td></tr></table></td></tr></table></td></tr></table></td></tr></table></td></tr></table></td></tr></table></td></tr></table></td></tr></table></td></tr></table></td></tr></table></td></tr></table></td></tr></table></td></tr></table></td></tr></table></td></tr></table></td></tr></table></td></tr></table></td></tr></table></td></tr></table></td></tr></table></td></tr></table></td></tr></table></td></tr></table>
 | | | | | | | | | | | | | | | | | | | | <table border="1" style="width: 100%; border-collapse: collapse; text-align: center;"> <tr> <td style="width: 10%;"></td> <td style="width: 10%;"></td> <td style="width: 10%;"></td> <td style="width: 10%;"></td> <td style="width: 10%;"></td> <td style="width: 10%;"></td> <td style="width: 10%;"></td> <td style="width: 10%;"></td> <td style="width: 10%;"></td> <td style="width: 10%;"></td> </tr> <tr> <td></td> <td></td> <td colspan="8" style="text-align: center;"> <table border="1" style="width: 100%; border-collapse: collapse; text-align: center;"> <tr> <td style="width: 10%;"></td> <td style="width: 10%;"></td> <td style="width: 10%;"></td> <td style="width: 10%;"></td> <td style="width: 10%;"></td> <td style="width: 10%;"></td> <td style="width: 10%;"></td> <td style="width: 10%;"></td> <td style="width: 10%;"></td> <td style="width: 10%;"></td> </tr> <tr> <td></td> <td></td> <td colspan="8" style="text-align: center;"> <table border="1" style="width: 100%; border-collapse: collapse; text-align: center;"> <tr> <td style="width: 10%;"></td> <td style="width: 10%;"></td> <td style="width: 10%;"></td> <td style="width: 10%;"></td> <td style="width: 10%;"></td> <td style="width: 10%;"></td> <td style="width: 10%;"></td> <td style="width: 10%;"></td> <td style="width: 10%;"></td> <td style="width: 10%;"></td> </tr> <tr> <td></td> <td></td> <td colspan="8" style="text-align: center;"> <table border="1" style="width: 100%; border-collapse: collapse; text-align: center;"> <tr> <td style="width: 10%;"></td> <td style="width: 10%;"></td> <td style="width: 10%;"></td> <td style="width: 10%;"></td> <td style="width: 10%;"></td> <td style="width: 10%;"></td> <td style="width: 10%;"></td> <td style="width: 10%;"></td> <td style="width: 10%;"></td> <td style="width: 10%;"></td> </tr> <tr> <td></td> <td></td> <td colspan="8" style="text-align: center;"> <table border="1" style="width: 100%; border-collapse: collapse; text-align: center;"> <tr> <td style="width: 10%;"></td> <td style="width: 10%;"></td> <td style="width: 10%;"></td> <td style="width: 10%;"></td> <td style="width: 10%;"></td> <td style="width: 10%;"></td> <td style="width: 10%;"></td> <td style="width: 10%;"></td> <td style="width: 10%;"></td> <td style="width: 10%;"></td> </tr> <tr> <td></td> <td></td> <td colspan="8" style="text-align: center;"> <table border="1" style="width: 100%; border-collapse: collapse; text-align: center;"> <tr> <td style="width: 10%;"></td> <td style="width: 10%;"></td> <td style="width: 10%;"></td> <td style="width: 10%;"></td> <td style="width: 10%;"></td> <td style="width: 10%;"></td> <td style="width: 10%;"></td> <td style="width: 10%;"></td> <td style="width: 10%;"></td> <td style="width: 10%;"></td> </tr> <tr> <td></td> <td></td> <td colspan="8" style="text-align: center;"> <table border="1" style="width: 100%; border-collapse: collapse; text-align: center;"> <tr> <td style="width: 10%;"></td> <td style="width: 10%;"></td> <td style="width: 10%;"></td> <td style="width: 10%;"></td> <td style="width: 10%;"></td> <td style="width: 10%;"></td> <td style="width: 10%;"></td> <td style="width: 10%;"></td> <td style="width: 10%;"></td> <td style="width: 10%;"></td> </tr> <tr> <td></td> <td></td> <td colspan="8" style="text-align: center;"> <table border="1" style="width: 100%; border-collapse: collapse; text-align: center;"> <tr> <td style="width: 10%;"></td> <td style="width: 10%;"></td> <td style="width: 10%;"></td> <td style="width: 10%;"></td> <td style="width: 10%;"></td> <td style="width: 10%;"></td> <td style="width: 10%;"></td> <td style="width: 10%;"></td> <td style="width: 10%;"></td> <td style="width: 10%;"></td> </tr> <tr> <td></td> <td></td> <td colspan="8" style="text-align: center;"> <table border="1" style="width: 100%; border-collapse: collapse; text-align: center;"> <tr> <td style="width: 10%;"></td> <td style="width: 10%;"></td> <td style="width: 10%;"></td> <td style="width: 10%;"></td> <td style="width: 10%;"></td> <td style="width: 10%;"></td> <td style="width: 10%;"></td> <td style="width: 10%;"></td> <td style="width: 10%;"></td> <td style="width: 10%;"></td> </tr> <tr> <td></td> <td></td> <td colspan="8" style="text-align: center;"> <table border="1" style="width: 100%; border-collapse: collapse; text-align: center;"> <tr> <td style="width: 10%;"></td> <td style="width: 10%;"></td> <td style="width: 10%;"></td> <td style="width: 10%;"></td> <td style="width: 10%;"></td> <td style="width: 10%;"></td> <td style="width: 10%;"></td> <td style="width: 10%;"></td> <td style="width: 10%;"></td> <td style="width: 10%;"></td> </tr> <tr> <td></td> <td></td> <td colspan="8" style="text-align: center;"> <table border="1" style="width: 100%; border-collapse: collapse; text-align: center;"> <tr> <td style="width: 10%;"></td> <td style="width: 10%;"></td> <td style="width: 10%;"></td> <td style="width: 10%;"></td> <td style="width: 10%;"></td> <td style="width: 10%;"></td> <td style="width: 10%;"></td> <td style="width: 10%;"></td> <td style="width: 10%;"></td> <td style="width: 10%;"></td> </tr> <tr> <td></td> <td></td> <td colspan="8" style="text-align: center;"> <table border="1" style="width: 100%; border-collapse: collapse; text-align: center;"> <tr> <td style="width: 10%;"></td> <td style="width: 10%;"></td> <td style="width: 10%;"></td> <td style="width: 10%;"></td> <td style="width: 10%;"></td> <td style="width: 10%;"></td> <td style="width: 10%;"></td> <td style="width: 10%;"></td> <td style="width: 10%;"></td> <td style="width: 10%;"></td> </tr> <tr> <td></td> <td></td> <td colspan="8" style="text-align: center;"> <table border="1" style="width: 100%; border-collapse: collapse; text-align: center;"> <tr> <td style="width: 10%;"></td> <td style="width: 10%;"></td> <td style="width: 10%;"></td> <td style="width: 10%;"></td> <td style="width: 10%;"></td> <td style="width: 10%;"></td> <td style="width: 10%;"></td> <td style="width: 10%;"></td> <td style="width: 10%;"></td> <td style="width: 10%;"></td> </tr> <tr> <td></td> <td></td> <td colspan="8" style="text-align: center;"> <table border="1" style="width: 100%; border-collapse: collapse; text-align: center;"> <tr> <td style="width: 10%;"></td> <td style="width: 10%;"></td> <td style="width: 10%;"></td> <td style="width: 10%;"></td> <td style="width: 10%;"></td> <td style="width: 10%;"></td> <td style="width: 10%;"></td> <td style="width: 10%;"></td> <td style="width: 10%;"></td> <td style="width: 10%;"></td> </tr> <tr> <td></td> <td></td> <td colspan="8" style="text-align: center;"> <table border="1" style="width: 100%; border-collapse: collapse; text-align: center;"> <tr> <td style="width: 10%;"></td> <td style="width: 10%;"></td> <td style="width: 10%;"></td> <td style="width: 10%;"></td> <td style="width: 10%;"></td> <td style="width: 10%;"></td> <td style="width:
10%;"></td> <td style="width: 10%;"></td> <td style="width: 10%;"></td> <td style="width: 10%;"></td> </tr> <tr> <td></td> <td></td> <td colspan="8" style="text-align: center;"> <table border="1" style="width: 100%; border-collapse: collapse; text-align: center;"> <tr> <td style="width: 10%;"></td> <td style="width: 10%;"></td> <td style="width: 10%;"></td> <td style="width: 10%;"></td> <td style="width: 10%;"></td> <td style="width: 10%;"></td> <td style="width: 10%;"></td> <td style="width: 10%;"></td> <td style="width: 10%;"></td> <td style="width: 10%;"></td> </tr> <tr> <td></td> <td></td> <td colspan="8" style="text-align: center;"> <table border="1" style="width: 100%; border-collapse: collapse; text-align: center;"> <tr> <td style="width: 10%;"></td> <td style="width: 10%;"></td> <td style="width: 10%;"></td> <td style="width: 10%;"></td> <td style="width: 10%;"></td> <td style="width: 10%;"></td> <td style="width: 10%;"></td> <td style="width: 10%;"></td> <td style="width: 10%;"></td> <td style="width: 10%;"></td> </tr> <tr> <td></td> <td></td> <td colspan="8" style="text-align: center;"> <table border="1" style="width: 100%; border-collapse: collapse; text-align: center;"> <tr> <td style="width: 10%;"></td> <td style="width: 10%;"></td> <td style="width: 10%;"></td> <td style="width: 10%;"></td> <td style="width: 10%;"></td> <td style="width: 10%;"></td> <td style="width: 10%;"></td> <td style="width: 10%;"></td> <td style="width: 10%;"></td> <td style="width: 10%;"></td> </tr> <tr> <td></td> <td></td> <td colspan="8" style="text-align: center;"> <table border="1" style="width: 100%; border-collapse: collapse; text-align: center;"> <tr> <td style="width: 10%;"></td> <td style="width: 10%;"></td> <td style="width: 10%;"></td> <td style="width: 10%;"></td> <td style="width: 10%;"></td> <td style="width: 10%;"></td> <td style="width: 10%;"></td> <td style="width: 10%;"></td> <td style="width: 10%;"></td> <td style="width: 10%;"></td> </tr> <tr> <td></td> <td></td> <td colspan="8" style="text-align: center;"> <table border="1" style="width: 100%; border-collapse: collapse; text-align: center;"> <tr> <td style="width: 10%;"></td> <td style="width: 10%;"></td> <td style="width: 10%;"></td> <td style="width: 10%;"></td> <td style="width: 10%;"></td> <td style="width: 10%;"></td> <td style="width: 10%;"></td> <td style="width: 10%;"></td> <td style="width: 10%;"></td> <td style="width: 10%;"></td> </tr> <tr> <td></td> <td></td> <td colspan="8" style="text-align: center;"> <table border="1" style="width: 100%; border-collapse: collapse; text-align: center;"> <tr> <td style="width: 10%;"></td> <td style="width: 10%;"></td> <td style="width: 10%;"></td> <td style="width: 10%;"></td> <td style="width: 10%;"></td> <td style="width: 10%;"></td> <td style="width: 10%;"></td> <td style="width: 10%;"></td> <td style="width: 10%;"></td> <td style="width: 10%;"></td> </tr> <tr> <td></td> <td></td> <td colspan="8" style="text-align: center;"> <table border="1" style="width: 100%; border-collapse: collapse; text-align: center;"> <tr> <td style="width: 10%;"></td> <td style="width: 10%;"></td> <td style="width: 10%;"></td> <td style="width: 10%;"></td> <td style="width: 10%;"></td> <td style="width: 10%;"></td> <td style="width: 10%;"></td> <td style="width: 10%;"></td> <td style="width: 10%;"></td> <td style="width: 10%;"></td> </tr> <tr> <td></td> <td></td> <td colspan="8" style="text-align: center;"> <table border="1" style="width: 100%; border-collapse: collapse; text-align: center;"> <tr> <td style="width: 10%;"></td> <td style="width: 10%;"></td> <td style="width: 10%;"></td> <td style="width: 10%;"></td> <td style="width: 10%;"></td> <td style="width: 10%;"></td> <td style="width: 10%;"></td> <td style="width: 10%;"></td> <td style="width: 10%;"></td> <td style="width: 10%;"></td> </tr> <tr> <td></td> <td></td> <td colspan="8" style="text-align: center;"> <table border="1" style="width: 100%; border-collapse: collapse; text-align: center;"> <tr> <td style="width: 10%;"></td> <td style="width: 10%;"></td> <td style="width: 10%;"></td> <td style="width: 10%;"></td> <td style="width: 10%;"></td> <td style="width: 10%;"></td> <td style="width: 10%;"></td> <td style="width: 10%;"></td> <td style="width: 10%;"></td> <td style="width: 10%;"></td> </tr> <tr> <td></td> <td></td> <td colspan="8" style="text-align: center;"> <table border="1" style="width: 100%; border-collapse: collapse; text-align: center;"> <tr> <td style="width: 10%;"></td> <td style="width: 10%;"></td> <td style="width: 10%;"></td> <td style="width: 10%;"></td> <td style="width: 10%;"></td> <td style="width: 10%;"></td> <td style="width: 10%;"></td> <td style="width: 10%;"></td> <td style="width: 10%;"></td> <td style="width: 10%;"></td> </tr> <tr> <td></td> <td></td> <td colspan="8" style="text-align: center;"> <table border="1" style="width: 100%; border-collapse: collapse; text-align: center;"> <tr> <td style="width: 10%;"></td> <td style="width: 10%;"></td> <td style="width: 10%;"></td> <td style="width: 10%;"></td> <td style="width: 10%;"></td> <td style="width: 10%;"></td> <td style="width: 10%;"></td> <td style="width: 10%;"></td> <td style="width: 10%;"></td> <td style="width: 10%;"></td> </tr> <tr> <td></td> <td></td> <td colspan="8" style="text-align: center;"> <table border="1" style="width: 100%; border-collapse: collapse; text-align: center;"> <tr> <td style="width: 10%;"></td> <td style="width: 10%;"></td> <td style="width: 10%;"></td> <td style="width: 10%;"></td> <td style="width: 10%;"></td> <td style="width: 10%;"></td> <td style="width: 10%;"></td> <td style="width: 10%;"></td> <td style="width: 10%;"></td> <td style="width: 10%;"></td> </tr> <tr> <td></td> <td></td> <td colspan="8" style="text-align: center;"> <table border="1" style="width: 100%; border-collapse: collapse; text-align: center;"> <tr> <td style="width: 10%;"></td> <td style="width: 10%;"></td> <td style="width: 10%;"></td> <td style="width: 10%;"></td> <td style="width: 10%;"></td> <td style="width: 10%;"></td> <td style="width: 10%;"></td> <td style="width: 10%;"></td> <td style="width: 10%;"></td> <td style="width: 10%;"></td> </tr> <tr> <td></td> <td></td> <td colspan="8" style="text-align: center;"> <table border="1" style="width: 100%; border-collapse: collapse; text-align: center;"> <tr> <td style="width: 10%;"></td> <td style="width: 10%;"></td> <td style="width: 10%;"></td> <td style="width: 10%;"></td> <td style="width: 10%;"></td> <td style="width: 10%;"></td> <td style="width: 10%;"></td> <td style="width: 10%;"></td> <td style="width: 10%;"></td> <td style="width: 10%;"></td> </tr> <tr> <td></td> <td></td> <td colspan="8" style="text-align: center;"> <table border="1" style="width: 100%; border-collapse: collapse; text-align: center;"> <tr> </tr></table></td></tr></table></td></tr></table></td></tr></table></td></tr></table></td></tr></table></td></tr></table></td></tr></table></td></tr></table></td></tr></table></td></tr></table></td></tr></table></td></tr></table></td></tr></table></td></tr></table></td></tr></table></td></tr></table></td></tr></table></td></tr></table></td></tr></table></td></tr></table></td></tr></table></td></tr></table></td></tr></table></td></tr></table></td></tr></table></td></tr></table></td></tr></table></td></tr></table></td></tr></table>
 | | | | | | | | | | | | | | | | | | | | <table border="1" style="width: 100%; border-collapse: collapse; text-align: center;"> <tr> <td style="width: 10%;"></td> <td style="width: 10%;"></td> <td style="width: 10%;"></td> <td style="width: 10%;"></td> <td style="width: 10%;"></td> <td style="width: 10%;"></td> <td style="width: 10%;"></td> <td style="width: 10%;"></td> <td style="width: 10%;"></td> <td style="width: 10%;"></td> </tr> <tr> <td></td> <td></td> <td colspan="8" style="text-align: center;"> <table border="1" style="width: 100%; border-collapse: collapse; text-align: center;"> <tr> <td style="width: 10%;"></td> <td style="width: 10%;"></td> <td style="width: 10%;"></td> <td style="width: 10%;"></td> <td style="width: 10%;"></td> <td style="width: 10%;"></td> <td style="width: 10%;"></td> <td style="width: 10%;"></td> <td style="width: 10%;"></td> <td style="width: 10%;"></td> </tr> <tr> <td></td> <td></td> <td colspan="8" style="text-align: center;"> <table border="1" style="width: 100%; border-collapse: collapse; text-align: center;"> <tr> <td style="width: 10%;"></td> <td style="width: 10%;"></td> <td style="width: 10%;"></td> <td style="width: 10%;"></td> <td style="width: 10%;"></td> <td style="width: 10%;"></td> <td style="width: 10%;"></td> <td style="width: 10%;"></td> <td style="width: 10%;"></td> <td style="width: 10%;"></td> </tr> <tr> <td></td> <td></td> <td colspan="8" style="text-align: center;"> <table border="1" style="width: 100%; border-collapse: collapse; text-align: center;"> <tr> <td style="width: 10%;"></td> <td style="width: 10%;"></td> <td style="width: 10%;"></td> <td style="width: 10%;"></td> <td style="width: 10%;"></td> <td style="width: 10%;"></td> <td style="width: 10%;"></td> <td style="width: 10%;"></td> <td style="width: 10%;"></td> <td style="width: 10%;"></td> </tr> <tr> <td></td> <td></td> <td colspan="8" style="text-align: center;"> <table border="1" style="width: 100%; border-collapse: collapse; text-align: center;"> <tr> <td style="width: 10%;"></td> <td style="width: 10%;"></td> <td style="width: 10%;"></td> <td style="width: 10%;"></td> <td style="width: 10%;"></td> <td style="width: 10%;"></td> <td style="width: 10%;"></td> <td style="width: 10%;"></td> <td style="width: 10%;"></td> <td style="width: 10%;"></td> </tr> <tr> <td></td> <td></td> <td colspan="8" style="text-align: center;"> <table border="1" style="width: 100%; border-collapse: collapse; text-align: center;"> <tr> <td style="width: 10%;"></td> <td style="width: 10%;"></td> <td style="width: 10%;"></td> <td style="width: 10%;"></td> <td style="width: 10%;"></td> <td style="width: 10%;"></td> <td style="width: 10%;"></td> <td style="width: 10%;"></td> <td style="width: 10%;"></td> <td style="width: 10%;"></td> </tr> <tr> <td></td> <td></td> <td colspan="8" style="text-align: center;"> <table border="1" style="width: 100%; border-collapse: collapse; text-align: center;"> <tr> <td style="width: 10%;"></td> <td style="width: 10%;"></td> <td style="width: 10%;"></td> <td style="width: 10%;"></td> <td style="width: 10%;"></td> <td style="width: 10%;"></td> <td style="width: 10%;"></td> <td style="width: 10%;"></td> <td style="width: 10%;"></td> <td style="width: 10%;"></td> </tr> <tr> <td></td> <td></td> <td colspan="8" style="text-align: center;"> <table border="1" style="width: 100%; border-collapse: collapse; text-align: center;"> <tr> <td style="width: 10%;"></td> <td style="width: 10%;"></td> <td style="width: 10%;"></td> <td style="width: 10%;"></td> <td style="width: 10%;"></td> <td style="width: 10%;"></td> <td style="width: 10%;"></td> <td style="width: 10%;"></td> <td style="width: 10%;"></td> <td style="width: 10%;"></td> </tr> <tr> <td></td> <td></td> <td colspan="8" style="text-align: center;"> <table border="1" style="width: 100%; border-collapse: collapse; text-align: center;"> <tr> <td style="width: 10%;"></td> <td style="width: 10%;"></td> <td style="width: 10%;"></td> <td style="width: 10%;"></td> <td style="width: 10%;"></td> <td style="width: 10%;"></td> <td style="width: 10%;"></td> <td style="width: 10%;"></td> <td style="width: 10%;"></td> <td style="width: 10%;"></td> </tr> <tr> <td></td> <td></td> <td colspan="8" style="text-align: center;"> <table border="1" style="width: 100%; border-collapse: collapse; text-align: center;"> <tr> <td style="width: 10%;"></td> <td style="width: 10%;"></td> <td style="width: 10%;"></td> <td style="width: 10%;"></td> <td style="width: 10%;"></td> <td style="width: 10%;"></td> <td style="width: 10%;"></td> <td style="width: 10%;"></td> <td style="width: 10%;"></td> <td style="width: 10%;"></td> </tr> <tr> <td></td> <td></td> <td colspan="8" style="text-align: center;"> <table border="1" style="width: 100%; border-collapse: collapse; text-align: center;"> <tr> <td style="width: 10%;"></td> <td style="width: 10%;"></td> <td style="width: 10%;"></td> <td style="width: 10%;"></td> <td style="width: 10%;"></td> <td style="width: 10%;"></td> <td style="width: 10%;"></td> <td style="width: 10%;"></td> <td style="width: 10%;"></td> <td style="width: 10%;"></td> </tr> <tr> <td></td> <td></td> <td colspan="8" style="text-align: center;"> <table border="1" style="width: 100%; border-collapse: collapse; text-align: center;"> <tr> <td style="width: 10%;"></td> <td style="width: 10%;"></td> <td style="width: 10%;"></td> <td style="width: 10%;"></td> <td style="width: 10%;"></td> <td style="width: 10%;"></td> <td style="width: 10%;"></td> <td style="width: 10%;"></td> <td style="width: 10%;"></td> <td style="width: 10%;"></td> </tr> <tr> <td></td> <td></td> <td colspan="8" style="text-align: center;"> <table border="1" style="width: 100%; border-collapse: collapse; text-align: center;"> <tr> <td style="width: 10%;"></td> <td style="width: 10%;"></td> <td style="width: 10%;"></td> <td style="width: 10%;"></td> <td style="width: 10%;"></td> <td style="width: 10%;"></td> <td style="width: 10%;"></td> <td style="width: 10%;"></td> <td style="width: 10%;"></td> <td style="width: 10%;"></td> </tr> <tr> <td></td> <td></td> <td colspan="8" style="text-align: center;"> <table border="1" style="width: 100%; border-collapse: collapse; text-align: center;"> <tr> <td style="width: 10%;"></td> <td style="width: 10%;"></td> <td style="width: 10%;"></td> <td style="width: 10%;"></td> <td style="width: 10%;"></td> <td style="width: 10%;"></td> <td style="width: 10%;"></td> <td style="width: 10%;"></td> <td style="width: 10%;"></td> <td style="width: 10%;"></td> </tr> <tr> <td></td> <td></td> <td colspan="8" style="text-align: center;"> <table border="1" style="width: 100%; border-collapse: collapse; text-align: center;"> <tr> <td style="width: 10%;"></td> <td style="width: 10%;"></td> <td style="width: 10%;"></td> <td style="width: 10%;"></td> <td style="width: 10%;"></td> <td style="width: 10%;"></td> <td style="width: 10%;"></td> <td style="width: 10%;"></td> <td style="width: 10%;"></td> <td style="width: 10%;"></td> </tr> <tr> <td></td> <td></td> <td colspan="8" style="text-align: center;"> <table border="1" style="width: 100%; border-collapse: collapse; text-align: center;"> <tr> <td style="width: 10%;"></td> <td style="width: 10%;"></td> <td style="width: 10%;"></td> <td style="width: 10%;"></td> <td style="width: 10%;"></td> <td style="width: 10%;"></td> <td style="width: 10%;"></td> <td style="width: 10%;"></td> <td style="width: 10%;"></td> <td style="width: 10%;"></td> </tr> <tr> <td></td> <td></td> <td colspan="8" style="text-align: center;"> <table border="1" style="width: 100%; border-collapse: collapse; text-align: center;"> <tr> <td style="width: 10%;"></td> <td style="width: 10%;"></td> <td style="width: 10%;"></td> <td style="width: 10%;"></td> <td style="width: 10%;"></td> <td style="width: 10%;"></td> <td style="width: 10%;"></td> <td style="width: 10%;"></td> <td style="width: 10%;"></td> <td style="width: 10%;"></td> </tr> <tr> <td></td> <td></td> <td colspan="8" style="text-align: center;"> <table border="1" style="width: 100%; border-collapse: collapse; text-align: center;"> <tr> <td style="width: 10%;"></td> <td style="width: 10%;"></td> <td style="width: 10%;"></td> <td style="width: 10%;"></td> <td style="width: 10%;"></td> <td style="width: 10%;"></td> <td style="width: 10%;"></td> <td style="width: 10%;"></td> <td style="width: 10%;"></td> <td style="width: 10%;"></td> </tr> <tr> <td></td> <td></td> <td colspan="8" style="text-align: center;"> <table border="1" style="width: 100%; border-collapse: collapse; text-align: center;"> <tr> <td style="width: 10%;"></td> <td style="width: 10%;"></td> <td style="width: 10%;"></td> <td style="width: 10%;"></td> <td style="width: 10%;"></td> <td style="width: 10%;"></td> <td style="width: 10%;"></td> <td style="width: 10%;"></td> <td style="width: 10%;"></td> <td style="width: 10%;"></td> </tr> <tr> <td></td> <td></td> <td colspan="8" style="text-align: center;"> <table border="1" style="width: 100%; border-collapse: collapse; text-align: center;"> <tr> <td style="width: 10%;"></td> <td style="width: 10%;"></td> <td style="width: 10%;"></td> <td style="width: 10%;"></td> <td style="width: 10%;"></td> <td style="width: 10%;"></td> <td
style="width: 10%;"></td> <td style="width: 10%;"></td> <td style="width: 10%;"></td> <td style="width: 10%;"></td> </tr> <tr> <td></td> <td></td> <td colspan="8" style="text-align: center;"> <table border="1" style="width: 100%; border-collapse: collapse; text-align: center;"> <tr> <td style="width: 10%;"></td> <td style="width: 10%;"></td> <td style="width: 10%;"></td> <td style="width: 10%;"></td> <td style="width: 10%;"></td> <td style="width: 10%;"></td> <td style="width: 10%;"></td> <td style="width: 10%;"></td> <td style="width: 10%;"></td> <td style="width: 10%;"></td> </tr> <tr> <td></td> <td></td> <td colspan="8" style="text-align: center;"> <table border="1" style="width: 100%; border-collapse: collapse; text-align: center;"> <tr> <td style="width: 10%;"></td> <td style="width: 10%;"></td> <td style="width: 10%;"></td> <td style="width: 10%;"></td> <td style="width: 10%;"></td> <td style="width: 10%;"></td> <td style="width: 10%;"></td> <td style="width: 10%;"></td> <td style="width: 10%;"></td> <td style="width: 10%;"></td> </tr> <tr> <td></td> <td></td> <td colspan="8" style="text-align: center;"> <table border="1" style="width: 100%; border-collapse: collapse; text-align: center;"> <tr> <td style="width: 10%;"></td> <td style="width: 10%;"></td> <td style="width: 10%;"></td> <td style="width: 10%;"></td> <td style="width: 10%;"></td> <td style="width: 10%;"></td> <td style="width: 10%;"></td> <td style="width: 10%;"></td> <td style="width: 10%;"></td> <td style="width: 10%;"></td> </tr> <tr> <td></td> <td></td> <td colspan="8" style="text-align: center;"> <table border="1" style="width: 100%; border-collapse: collapse; text-align: center;"> <tr> <td style="width: 10%;"></td> <td style="width: 10%;"></td> <td style="width: 10%;"></td> <td style="width: 10%;"></td> <td style="width: 10%;"></td> <td style="width: 10%;"></td> <td style="width: 10%;"></td> <td style="width: 10%;"></td> <td style="width: 10%;"></td> <td style="width: 10%;"></td> </tr> <tr> <td></td> <td></td> <td colspan="8" style="text-align: center;"> <table border="1" style="width: 100%; border-collapse: collapse; text-align: center;"> <tr> <td style="width: 10%;"></td> <td style="width: 10%;"></td> <td style="width: 10%;"></td> <td style="width: 10%;"></td> <td style="width: 10%;"></td> <td style="width: 10%;"></td> <td style="width: 10%;"></td> <td style="width: 10%;"></td> <td style="width: 10%;"></td> <td style="width: 10%;"></td> </tr> <tr> <td></td> <td></td> <td colspan="8" style="text-align: center;"> <table border="1" style="width: 100%; border-collapse: collapse; text-align: center;"> <tr> <td style="width: 10%;"></td> <td style="width: 10%;"></td> <td style="width: 10%;"></td> <td style="width: 10%;"></td> <td style="width: 10%;"></td> <td style="width: 10%;"></td> <td style="width: 10%;"></td> <td style="width: 10%;"></td> <td style="width: 10%;"></td> <td style="width: 10%;"></td> </tr> <tr> <td></td> <td></td> <td colspan="8" style="text-align: center;"> <table border="1" style="width: 100%; border-collapse: collapse; text-align: center;"> <tr> <td style="width: 10%;"></td> <td style="width: 10%;"></td> <td style="width: 10%;"></td> <td style="width: 10%;"></td> <td style="width: 10%;"></td> <td style="width: 10%;"></td> <td style="width: 10%;"></td> <td style="width: 10%;"></td> <td style="width: 10%;"></td> <td style="width: 10%;"></td> </tr> <tr> <td></td> <td></td> <td colspan="8" style="text-align: center;"> <table border="1" style="width: 100%; border-collapse: collapse; text-align: center;"> <tr> <td style="width: 10%;"></td> <td style="width: 10%;"></td> <td style="width: 10%;"></td> <td style="width: 10%;"></td> <td style="width: 10%;"></td> <td style="width: 10%;"></td> <td style="width: 10%;"></td> <td style="width: 10%;"></td> <td style="width: 10%;"></td> <td style="width: 10%;"></td> </tr> <tr> <td></td> <td></td> <td colspan="8" style="text-align: center;"> <table border="1" style="width: 100%; border-collapse: collapse; text-align: center;"> <tr> </tr></table></td></tr></table></td></tr></table></td></tr></table></td></tr></table></td></tr></table></td></tr></table></td></tr></table></td></tr></table></td></tr></table></td></tr></table></td></tr></table></td></tr></table></td></tr></table></td></tr></table></td></tr></table></td></tr></table></td></tr></table></td></tr></table></td></tr></table></td></tr></table></td></tr></table></td></tr></table></td></tr></table></td></tr></table></td></tr></table></td></tr></table></td></tr></table></td></tr></table> | | | | | | | | | | | | | | | | | | | | <table border="1" style="width: 100%; border-collapse: collapse; text-align: center;"> <tr> <td style="width: 10%;"></td> <td style="width: 10%;"></td> <td style="width: 10%;"></td> <td style="width: 10%;"></td> <td style="width: 10%;"></td> <td style="width: 10%;"></td> <td style="width: 10%;"></td> <td style="width: 10%;"></td> <td style="width: 10%;"></td> <td style="width: 10%;"></td> </tr> <tr> <td></td> <td></td> <td colspan="8" style="text-align: center;"> <table border="1" style="width: 100%; border-collapse: collapse; text-align: center;"> <tr> <td style="width: 10%;"></td> <td style="width: 10%;"></td> <td style="width: 10%;"></td> <td style="width: 10%;"></td> <td style="width: 10%;"></td> <td style="width: 10%;"></td> <td style="width: 10%;"></td> <td style="width: 10%;"></td> <td style="width: 10%;"></td> <td style="width: 10%;"></td> </tr> <tr> <td></td> <td></td> <td colspan="8" style="text-align: center;"> <table border="1" style="width: 100%; border-collapse: collapse; text-align: center;"> <tr> <td style="width: 10%;"></td> <td style="width: 10%;"></td> <td style="width: 10%;"></td> <td style="width: 10%;"></td> <td style="width: 10%;"></td> <td style="width: 10%;"></td> <td style="width: 10%;"></td> <td style="width: 10%;"></td> <td style="width: 10%;"></td> <td style="width: 10%;"></td> </tr> <tr> <td></td> <td></td> <td colspan="8" style="text-align: center;"> <table border="1" style="width: 100%; border-collapse: collapse; text-align: center;"> <tr> <td style="width: 10%;"></td> <td style="width: 10%;"></td> <td style="width: 10%;"></td> <td style="width: 10%;"></td> <td style="width: 10%;"></td> <td style="width: 10%;"></td> <td style="width: 10%;"></td> <td style="width: 10%;"></td> <td style="width: 10%;"></td> <td style="width: 10%;"></td> </tr> <tr> <td></td> <td></td> <td colspan="8" style="text-align: center;"> <table border="1" style="width: 100%; border-collapse: collapse; text-align: center;"> <tr> <td style="width:
10%;"></td> <td style="width: 10%;"></td> <td style="width: 10%;"></td> <td style="width: 10%;"></td> <td style="width: 10%;"></td> <td style="width: 10%;"></td> <td style="width: 10%;"></td> <td style="width: 10%;"></td> <td style="width: 10%;"></td> <td style="width: 10%;"></td> </tr> <tr> <td></td> <td></td> <td colspan="8" style="text-align: center;"> <table border="1" style="width: 100%; border-collapse: collapse; text-align: center;"> <tr> <td style="width: 10%;"></td> <td style="width: 10%;"></td> <td style="width: 10%;"></td> <td style="width: 10%;"></td> <td style="width: 10%;"></td> <td style="width: 10%;"></td> <td style="width: 10%;"></td> <td style="width: 10%;"></td> <td style="width: 10%;"></td> <td style="width: 10%;"></td> </tr> <tr> <td></td> <td></td> <td colspan="8" style="text-align: center;"> <table border="1" style="width: 100%; border-collapse: collapse; text-align: center;"> <tr> <td style="width: 10%;"></td> <td style="width: 10%;"></td> <td style="width: 10%;"></td> <td style="width: 10%;"></td> <td style="width: 10%;"></td> <td style="width: 10%;"></td> <td style="width: 10%;"></td> <td style="width: 10%;"></td> <td style="width: 10%;"></td> <td style="width: 10%;"></td> </tr> <tr> <td></td> <td></td> <td colspan="8" style="text-align: center;"> <table border="1" style="width: 100%; border-collapse: collapse; text-align: center;"> <tr> <td style="width: 10%;"></td> <td style="width: 10%;"></td> <td style="width: 10%;"></td> <td style="width: 10%;"></td> <td style="width: 10%;"></td> <td style="width: 10%;"></td> <td style="width: 10%;"></td> <td style="width: 10%;"></td> <td style="width: 10%;"></td> <td style="width: 10%;"></td> </tr> <tr> <td></td> <td></td> <td colspan="8" style="text-align: center;"> <table border="1" style="width: 100%; border-collapse: collapse; text-align: center;"> <tr> <td style="width: 10%;"></td> <td style="width: 10%;"></td> <td style="width: 10%;"></td> <td style="width: 10%;"></td> <td style="width: 10%;"></td> <td style="width: 10%;"></td> <td style="width: 10%;"></td> <td style="width: 10%;"></td> <td style="width: 10%;"></td> <td style="width: 10%;"></td> </tr> <tr> <td></td> <td></td> <td colspan="8" style="text-align: center;"> <table border="1" style="width: 100%; border-collapse: collapse; text-align: center;"> <tr> <td style="width: 10%;"></td> <td style="width: 10%;"></td> <td style="width: 10%;"></td> <td style="width: 10%;"></td> <td style="width: 10%;"></td> <td style="width: 10%;"></td> <td style="width: 10%;"></td> <td style="width: 10%;"></td> <td style="width: 10%;"></td> <td style="width: 10%;"></td> </tr> <tr> <td></td> <td></td> <td colspan="8" style="text-align: center;"> <table border="1" style="width: 100%; border-collapse: collapse; text-align: center;"> <tr> <td style="width: 10%;"></td> <td style="width: 10%;"></td> <td style="width: 10%;"></td> <td style="width: 10%;"></td> <td style="width: 10%;"></td> <td style="width: 10%;"></td> <td style="width: 10%;"></td> <td style="width: 10%;"></td> <td style="width: 10%;"></td> <td style="width: 10%;"></td> </tr> <tr> <td></td> <td></td> <td colspan="8" style="text-align: center;"> <table border="1" style="width: 100%; border-collapse: collapse; text-align: center;"> <tr> <td style="width: 10%;"></td> <td style="width: 10%;"></td> <td style="width: 10%;"></td> <td style="width: 10%;"></td> <td style="width: 10%;"></td> <td style="width: 10%;"></td> <td style="width: 10%;"></td> <td style="width: 10%;"></td> <td style="width: 10%;"></td> <td style="width: 10%;"></td> </tr> <tr> <td></td> <td></td> <td colspan="8" style="text-align: center;"> <table border="1" style="width: 100%; border-collapse: collapse; text-align: center;"> <tr> <td style="width: 10%;"></td> <td style="width: 10%;"></td> <td style="width: 10%;"></td> <td style="width: 10%;"></td> <td style="width: 10%;"></td> <td style="width: 10%;"></td> <td style="width: 10%;"></td> <td style="width: 10%;"></td> <td style="width: 10%;"></td> <td style="width: 10%;"></td> </tr> <tr> <td></td> <td></td> <td colspan="8" style="text-align: center;"> <table border="1" style="width: 100%; border-collapse: collapse; text-align: center;"> <tr> <td style="width: 10%;"></td> <td style="width: 10%;"></td> <td style="width: 10%;"></td> <td style="width: 10%;"></td> <td style="width: 10%;"></td> <td style="width: 10%;"></td> <td style="width: 10%;"></td> <td style="width: 10%;"></td> <td style="width: 10%;"></td> <td style="width: 10%;"></td> </tr> <tr> <td></td> <td></td> <td colspan="8" style="text-align: center;"> <table border="1" style="width: 100%; border-collapse: collapse; text-align: center;"> <tr> <td style="width: 10%;"></td> <td style="width: 10%;"></td> <td style="width: 10%;"></td> <td style="width: 10%;"></td> <td style="width: 10%;"></td> <td style="width: 10%;"></td> <td style="width: 10%;"></td> <td style="width: 10%;"></td> <td style="width: 10%;"></td> <td style="width: 10%;"></td> </tr> <tr> <td></td> <td></td> <td colspan="8" style="text-align: center;"> <table border="1" style="width: 100%; border-collapse: collapse; text-align: center;"> <tr> <td style="width: 10%;"></td> <td style="width: 10%;"></td> <td style="width: 10%;"></td> <td style="width: 10%;"></td> <td style="width: 10%;"></td> <td style="width: 10%;"></td> <td style="width: 10%;"></td> <td style="width: 10%;"></td> <td style="width: 10%;"></td> <td style="width: 10%;"></td> </tr> <tr> <td></td> <td></td> <td colspan="8" style="text-align: center;"> <table border="1" style="width: 100%; border-collapse: collapse; text-align: center;"> <tr> <td style="width: 10%;"></td> <td style="width: 10%;"></td> <td style="width: 10%;"></td> <td style="width: 10%;"></td> <td style="width: 10%;"></td> <td style="width: 10%;"></td> <td style="width: 10%;"></td> <td style="width: 10%;"></td> <td style="width: 10%;"></td> <td style="width: 10%;"></td> </tr> <tr> <td></td> <td></td> <td colspan="8" style="text-align: center;"> <table border="1" style="width: 100%; border-collapse: collapse; text-align: center;"> <tr> <td style="width: 10%;"></td> <td style="width: 10%;"></td> <td style="width: 10%;"></td> <td style="width: 10%;"></td> <td style="width: 10%;"></td> <td style="width: 10%;"></td> <td style="width: 10%;"></td> <td style="width: 10%;"></td> <td style="width: 10%;"></td> <td style="width: 10%;"></td> </tr> <tr> <td></td> <td></td> <td colspan="8" style="text-align: center;"> <table border="1" style="width: 100%; border-collapse: collapse; text-align: center;"> <tr> <td style="width: 10%;"></td> <td style="width: 10%;"></td> <td style="width: 10%;"></td> <td style="width: 10%;"></td> <td style="width: 10%;"></td> <td style="width: 10%;"></td> <td style="width: 10%;"></td> <td style="width: 10%;"></td> <td style="width: 10%;"></td> <td style="width: 10%;"></td> </tr> <tr> <td></td> <td></td> <td colspan="8" style="text-align: center;"> <table border="1" style="width: 100%; border-collapse: collapse; text-align: center;"> <tr> <td style="width: 10%;"></td> <td style="width: 10%;"></td> <td style="width: 10%;"></td> <td style="width: 10%;"></td> <td style="width: 10%;"></td> <td style="width: 10%;"></td> <td style="width: 10%;"></td> <td style="width: 10%;"></td> <td style="width: 10%;"></td> <td style="width: 10%;"></td> </tr> <tr> <td></td> <td></td> <td colspan="8" style="text-align: center;"> <table border="1" style="width: 100%; border-collapse: collapse; text-align: center;"> <tr> <td style="width: 10%;"></td> <td style="width: 10%;"></td> <td style="width: 10%;"></td> <td style="width: 10%;"></td> <td style="width: 10%;"></td> <td style="width: 10%;"></td> <td style="width: 10%;"></td> <td style="width: 10%;"></td> <td style="width: 10%;"></td> <td style="width: 10%;"></td> </tr> <tr> <td></td> <td></td> <td colspan="8" style="text-align: center;"> <table border="1" style="width: 100%; border-collapse: collapse; text-align: center;"> <tr> <td style="width: 10%;"></td> <td style="width: 10%;"></td> <td style="width: 10%;"></td> <td style="width: 10%;"></td> <td style="width: 10%;"></td> <td style="width: 10%;"></td> <td style="width: 10%;"></td> <td style="width: 10%;"></td> <td style="width: 10%;"></td> <td style="width: 10%;"></td> </tr> <tr> <td></td> <td></td> <td colspan="8" style="text-align: center;"> <table border="1" style="width: 100%; border-collapse: collapse; text-align: center;"> <tr> <td style="width: 10%;"></td> <td style="width: 10%;"></td> <td style="width: 10%;"></td> <td style="width: 10%;"></td> <td style="width: 10%;"></td> <td style="width: 10%;"></td> <td style="width: 10%;"></td> <td style="width: 10%;"></td> <td style="width: 10%;"></td> <td style="width: 10%;"></td> </tr> <tr> <td></td> <td></td> <td colspan="8" style="text-align: center;"> <table border="1" style="width: 100%; border-collapse: collapse; text-align: center;"> <tr> <td style="width: 10%;"></td> <td style="width: 10%;"></td> <td style="width: 10%;"></td> <td style="width: 10%;"></td> <td style="width: 10%;"></td> <td style="width: 10%;"></td> <td style="width: 10%;"></td> <td style="width: 10%;"></td> <td style="width: 10%;"></td> <td style="width: 10%;"></td> </tr> <tr> <td></td> <td></td> <td colspan="8" style="text-align: center;"> <table border="1" style="width: 100%; border-collapse: collapse; text-align: center;"> <tr> <td style="width: 10%;"></td> <td style="width: 10%;"></td> <td style="width: 10%;"></td> <td style="width: 10%;"></td> <td style="width: 10%;"></td> <td style="width: 10%;"></td> <td style="width: 10%;"></td> <td style="width: 10%;"></td> <td style="width: 10%;"></td> <td style="width: 10%;"></td> </tr> <tr> <td></td> <td></td> <td colspan="8" style="text-align: center;"> <table border="1" style="width: 100%; border-collapse: collapse; text-align: center;"> <tr> <td style="width: 10%;"></td> <td style="width: 10%;"></td> <td style="width: 10%;"></td> <td style="width: 10%;"></td> <td style="width: 10%;"></td> <td style="width: 10%;"></td> <td
style="width: 10%;"></td> <td style="width: 10%;"></td> <td style="width: 10%;"></td> <td style="width: 10%;"></td> </tr> <tr> <td></td> <td></td> <td colspan="8" style="text-align: center;"> <table border="1" style="width: 100%; border-collapse: collapse; text-align: center;"> <tr> <td style="width: 10%;"></td> <td style="width: 10%;"></td> <td style="width: 10%;"></td> <td style="width: 10%;"></td> <td style="width: 10%;"></td> <td style="width: 10%;"></td> <td style="width: 10%;"></td> <td style="width: 10%;"></td> <td style="width: 10%;"></td> <td style="width: 10%;"></td> </tr> <tr> <td></td> <td></td> <td colspan="8" style="text-align: center;"> <table border="1" style="width: 100%; border-collapse: collapse; text-align: center;"> <tr> </tr></table></td></tr></table></td></tr></table></td></tr></table></td></tr></table></td></tr></table></td></tr></table></td></tr></table></td></tr></table></td></tr></table></td></tr></table></td></tr></table></td></tr></table></td></tr></table></td></tr></table></td></tr></table></td></tr></table></td></tr></table></td></tr></table></td></tr></table></td></tr></table></td></tr></table></td></tr></table></td></tr></table></td></tr></table></td></tr></table></td></tr></table></td></tr></table> | | | | | | | | | | | | | | | | | | | | <table border="1" style="width: 100%; border-collapse: collapse; text-align: center;"> <tr> <td style="width: 10%;"></td> <td style="width: 10%;"></td> <td style="width: 10%;"></td> <td style="width: 10%;"></td> <td style="width: 10%;"></td> <td style="width: 10%;"></td> <td style="width: 10%;"></td> <td style="width: 10%;"></td> <td style="width: 10%;"></td> <td style="width: 10%;"></td> </tr> <tr> <td></td> <td></td> <td colspan="8" style="text-align: center;"> <table border="1" style="width: 100%; border-collapse: collapse; text-align: center;"> <tr> <td style="width: 10%;"></td> <td style="width: 10%;"></td> <td style="width: 10%;"></td> <td style="width: 10%;"></td> <td style="width: 10%;"></td> <td style="width: 10%;"></td> <td style="width: 10%;"></td> <td style="width: 10%;"></td> <td style="width: 10%;"></td> <td style="width: 10%;"></td> </tr> <tr> <td></td> <td></td> <td colspan="8" style="text-align: center;"> <table border="1" style="width: 100%; border-collapse: collapse; text-align: center;"> <tr> <td style="width: 10%;"></td> <td style="width: 10%;"></td> <td style="width: 10%;"></td> <td style="width: 10%;"></td> <td style="width: 10%;"></td> <td style="width: 10%;"></td> <td style="width: 10%;"></td> <td style="width: 10%;"></td> <td style="width: 10%;"></td> <td style="width: 10%;"></td> </tr> <tr> <td></td> <td></td> <td colspan="8" style="text-align: center;"> <table border="1" style="width: 100%; border-collapse: collapse; text-align: center;"> <tr> <td style="width: 10%;"></td> <td style="width: 10%;"></td> <td style="width: 10%;"></td> <td style="width: 10%;"></td> <td style="width: 10%;"></td> <td style="width: 10%;"></td> <td style="width: 10%;"></td> <td style="width: 10%;"></td> <td style="width: 10%;"></td> <td style="width: 10%;"></td> </tr> <tr> <td></td> <td></td> <td colspan="8" style="text-align: center;"> <table border="1" style="width: 100%; border-collapse: collapse; text-align: center;"> <tr> <td style="width: 10%;"></td> <td style="width: 10%;"></td> <td style="width: 10%;"></td> <td style="width: 10%;"></td> <td style="width: 10%;"></td> <td style="width: 10%;"></td> <td style="width: 10%;"></td> <td style="width: 10%;"></td> <td style="width: 10%;"></td> <td style="width: 10%;"></td> </tr> <tr> <td></td> <td></td> <td colspan="8" style="text-align: center;"> <table border="1" style="width: 100%; border-collapse: collapse; text-align: center;"> <tr> <td style="width: 10%;"></td> <td style="width: 10%;"></td> <td style="width: 10%;"></td> <td style="width: 10%;"></td> <td style="width: 10%;"></td> <td style="width: 10%;"></td> <td style="width: 10%;"></td> <td style="width: 10%;"></td> <td style="width: 10%;"></td> <td style="width: 10%;"></td> </tr> <tr> <td></td> <td></td> <td colspan="8" style="text-align: center;"> <table border="1" style="width: 100%; border-collapse: collapse; text-align: center;"> <tr> <td style="width: 10%;"></td> <td style="width: 10%;"></td> <td style="width: 10%;"></td> <td style="width: 10%;"></td> <td style="width: 10%;"></td> <td style="width: 10%;"></td> <td style="width: 10%;"></td> <td style="width: 10%;"></td> <td style="width: 10%;"></td> <td style="width: 10%;"></td> </tr> <tr> <td></td> <td></td> <td colspan="8" style="text-align: center;"> <table border="1" style="width: 100%; border-collapse: collapse; text-align: center;"> <tr> <td style="width: 10%;"></td> <td style="width: 10%;"></td> <td style="width: 10%;"></td> <td style="width: 10%;"></td> <td style="width: 10%;"></td> <td style="width: 10%;"></td> <td style="width: 10%;"></td> <td style="width: 10%;"></td> <td style="width: 10%;"></td> <td style="width: 10%;"></td> </tr> <tr> <td></td> <td></td> <td colspan="8" style="text-align: center;"> <table border="1" style="width: 100%; border-collapse: collapse; text-align: center;"> <tr> <td style="width: 10%;"></td> <td style="width: 10%;"></td> <td style="width: 10%;"></td> <td style="width: 10%;"></td> <td style="width: 10%;"></td> <td style="width: 10%;"></td> <td style="width: 10%;"></td> <td style="width: 10%;"></td> <td style="width: 10%;"></td> <td style="width: 10%;"></td> </tr> <tr> <td></td> <td></td> <td colspan="8" style="text-align: center;"> <table border="1" style="width: 100%; border-collapse: collapse; text-align: center;"> <tr> <td style="width: 10%;"></td> <td style="width: 10%;"></td> <td style="width: 10%;"></td> <td style="width: 10%;"></td> <td style="width: 10%;"></td> <td style="width: 10%;"></td> <td style="width: 10%;"></td> <td style="width: 10%;"></td> <td style="width: 10%;"></td> <td style="width: 10%;"></td> </tr> <tr> <td></td> <td></td> <td colspan="8" style="text-align: center;"> <table border="1" style="width: 100%; border-collapse: collapse; text-align: center;"> <tr> <td style="width: 10%;"></td> <td style="width: 10%;"></td> <td style="width: 10%;"></td> <td style="width: 10%;"></td> <td style="width: 10%;"></td> <td style="width: 10%;"></td> <td style="width: 10%;"></td> <td style="width: 10%;"></td> <td style="width: 10%;"></td> <td style="width: 10%;"></td> </tr> <tr> <td></td> <td></td> <td colspan="8" style="text-align: center;"> <table border="1" style="width: 100%; border-collapse: collapse; text-align: center;"> <tr> <td style="width: 10%;"></td> <td
style="width: 10%;"></td> <td style="width: 10%;"></td> <td style="width: 10%;"></td> <td style="width: 10%;"></td> <td style="width: 10%;"></td> <td style="width: 10%;"></td> <td style="width: 10%;"></td> <td style="width: 10%;"></td> <td style="width: 10%;"></td> </tr> <tr> <td></td> <td></td> <td colspan="8" style="text-align: center;"> <table border="1" style="width: 100%; border-collapse: collapse; text-align: center;"> <tr> <td style="width: 10%;"></td> <td style="width: 10%;"></td> <td style="width: 10%;"></td> <td style="width: 10%;"></td> <td style="width: 10%;"></td> <td style="width: 10%;"></td> <td style="width: 10%;"></td> <td style="width: 10%;"></td> <td style="width: 10%;"></td> <td style="width: 10%;"></td> </tr> <tr> <td></td> <td></td> <td colspan="8" style="text-align: center;"> <table border="1" style="width: 100%; border-collapse: collapse; text-align: center;"> <tr> <td style="width: 10%;"></td> <td style="width: 10%;"></td> <td style="width: 10%;"></td> <td style="width: 10%;"></td> <td style="width: 10%;"></td> <td style="width: 10%;"></td> <td style="width: 10%;"></td> <td style="width: 10%;"></td> <td style="width: 10%;"></td> <td style="width: 10%;"></td> </tr> <tr> <td></td> <td></td> <td colspan="8" style="text-align: center;"> <table border="1" style="width: 100%; border-collapse: collapse; text-align: center;"> <tr> <td style="width: 10%;"></td> <td style="width: 10%;"></td> <td style="width: 10%;"></td> <td style="width: 10%;"></td> <td style="width: 10%;"></td> <td style="width: 10%;"></td> <td style="width: 10%;"></td> <td style="width: 10%;"></td> <td style="width: 10%;"></td> <td style="width: 10%;"></td> </tr> <tr> <td></td> <td></td> <td colspan="8" style="text-align: center;"> <table border="1" style="width: 100%; border-collapse: collapse; text-align: center;"> <tr> <td style="width: 10%;"></td> <td style="width: 10%;"></td> <td style="width: 10%;"></td> <td style="width: 10%;"></td> <td style="width: 10%;"></td> <td style="width: 10%;"></td> <td style="width: 10%;"></td> <td style="width: 10%;"></td> <td style="width: 10%;"></td> <td style="width: 10%;"></td> </tr> <tr> <td></td> <td></td> <td colspan="8" style="text-align: center;"> <table border="1" style="width: 100%; border-collapse: collapse; text-align: center;"> <tr> <td style="width: 10%;"></td> <td style="width: 10%;"></td> <td style="width: 10%;"></td> <td style="width: 10%;"></td> <td style="width: 10%;"></td> <td style="width: 10%;"></td> <td style="width: 10%;"></td> <td style="width: 10%;"></td> <td style="width: 10%;"></td> <td style="width: 10%;"></td> </tr> <tr> <td></td> <td></td> <td colspan="8" style="text-align: center;"> <table border="1" style="width: 100%; border-collapse: collapse; text-align: center;"> <tr> <td style="width: 10%;"></td> <td style="width: 10%;"></td> <td style="width: 10%;"></td> <td style="width: 10%;"></td> <td style="width: 10%;"></td> <td style="width: 10%;"></td> <td style="width: 10%;"></td> <td style="width: 10%;"></td> <td style="width: 10%;"></td> <td style="width: 10%;"></td> </tr> <tr> <td></td> <td></td> <td colspan="8" style="text-align: center;"> <table border="1" style="width: 100%; border-collapse: collapse; text-align: center;"> <tr> <td style="width: 10%;"></td> <td style="width: 10%;"></td> <td style="width: 10%;"></td> <td style="width: 10%;"></td> <td style="width: 10%;"></td> <td style="width: 10%;"></td> <td style="width: 10%;"></td> <td style="width: 10%;"></td> <td style="width: 10%;"></td> <td style="width: 10%;"></td> </tr> <tr> <td></td> <td></td> <td colspan="8" style="text-align: center;"> <table border="1" style="width: 100%; border-collapse: collapse; text-align: center;"> <tr> <td style="width: 10%;"></td> <td style="width: 10%;"></td> <td style="width: 10%;"></td> <td style="width: 10%;"></td> <td style="width: 10%;"></td> <td style="width: 10%;"></td> <td style="width: 10%;"></td> <td style="width: 10%;"></td> <td style="width: 10%;"></td> <td style="width: 10%;"></td> </tr> <tr> <td></td> <td></td> <td colspan="8" style="text-align: center;"> <table border="1" style="width: 100%; border-collapse: collapse; text-align: center;"> <tr> <td style="width: 10%;"></td> <td style="width: 10%;"></td> <td style="width: 10%;"></td> <td style="width: 10%;"></td> <td style="width: 10%;"></td> <td style="width: 10%;"></td> <td style="width: 10%;"></td> <td style="width: 10%;"></td> <td style="width: 10%;"></td> <td style="width: 10%;"></td> </tr> <tr> <td></td> <td></td> <td colspan="8" style="text-align: center;"> <table border="1" style="width: 100%; border-collapse: collapse; text-align: center;"> <tr> <td style="width: 10%;"></td> <td style="width: 10%;"></td> <td style="width: 10%;"></td> <td style="width: 10%;"></td> <td style="width: 10%;"></td> <td style="width: 10%;"></td> <td style="width: 10%;"></td> <td style="width: 10%;"></td> <td style="width: 10%;"></td> <td style="width: 10%;"></td> </tr> <tr> <td></td> <td></td> <td colspan="8" style="text-align: center;"> <table border="1" style="width: 100%; border-collapse: collapse; text-align: center;"> <tr> <td style="width: 10%;"></td> <td style="width: 10%;"></td> <td style="width: 10%;"></td> <td style="width: 10%;"></td> <td style="width: 10%;"></td> <td style="width: 10%;"></td> <td style="width: 10%;"></td> <td style="width: 10%;"></td> <td style="width: 10%;"></td> <td style="width: 10%;"></td> </tr> <tr> <td></td> <td></td> <td colspan="8" style="text-align: center;"> <table border="1" style="width: 100%; border-collapse: collapse; text-align: center;"> <tr> <td style="width: 10%;"></td> <td style="width: 10%;"></td> <td style="width: 10%;"></td> <td style="width: 10%;"></td> <td style="width: 10%;"></td> <td style="width: 10%;"></td> <td style="width: 10%;"></td> <td style="width: 10%;"></td> <td style="width: 10%;"></td> <td style="width: 10%;"></td> </tr> <tr> <td></td> <td></td> <td colspan="8" style="text-align: center;"> <table border="1" style="width: 100%; border-collapse: collapse; text-align: center;"> <tr> <td style="width: 10%;"></td> <td style="width: 10%;"></td> <td style="width: 10%;"></td> <td style="width: 10%;"></td> <td style="width: 10%;"></td> <td style="width: 10%;"></td> <td style="width: 10%;"></td> <td style="width: 10%;"></td> <td style="width: 10%;"></td> <td style="width: 10%;"></td> </tr> <tr> <td></td> <td></td> <td colspan="8" style="text-align: center;"> <table border="1" style="width: 100%; border-collapse: collapse; text-align: center;"> <tr> <td style="width: 10%;"></td> <td style="width: 10%;"></td> <td style="width: 10%;"></td> <td style="width: 10%;"></td> <td style="width: 10%;"></td> <td style="width: 10%;"></td> <td style="width: 10%;"></td> <td style="width: 10%;"></td> <td style="width: 10%;"></td> <td style="width: 10%;"></td> </tr> <tr> <td></td> <td></td> <td colspan="8" style="text-align: center;"> <table border="1" style="width: 100%; border-collapse: collapse; text-align: center;"> <tr> </tr></table></td></tr></table></td></tr></table></td></tr></table></td></tr></table></td></tr></table></td></tr></table></td></tr></table></td></tr></table></td></tr></table></td></tr></table></td></tr></table></td></tr></table></td></tr></table></td></tr></table></td></tr></table></td></tr></table></td></tr></table></td></tr></table></td></tr></table></td></tr></table></td></tr></table></td></tr></table></td></tr></table></td></tr></table></td></tr></table></td></tr></table>
 | | | | | | | | | | | | | | | | | | | | <table border="1" style="width: 100%; border-collapse: collapse; text-align: center;"> <tr> <td style="width: 10%;"></td> <td style="width: 10%;"></td> <td style="width: 10%;"></td> <td style="width: 10%;"></td> <td style="width: 10%;"></td> <td style="width: 10%;"></td> <td style="width: 10%;"></td> <td style="width: 10%;"></td> <td style="width: 10%;"></td> <td style="width: 10%;"></td> </tr> <tr> <td></td> <td></td> <td colspan="8" style="text-align: center;"> <table border="1" style="width: 100%; border-collapse: collapse; text-align: center;"> <tr> <td style="width: 10%;"></td> <td style="width: 10%;"></td> <td style="width: 10%;"></td> <td style="width: 10%;"></td> <td style="width: 10%;"></td> <td style="width: 10%;"></td> <td style="width: 10%;"></td> <td style="width: 10%;"></td> <td style="width: 10%;"></td> <td style="width: 10%;"></td> </tr> <tr> <td></td> <td></td> <td colspan="8" style="text-align: center;"> <table border="1" style="width: 100%; border-collapse: collapse; text-align: center;"> <tr> <td style="width: 10%;"></td> <td style="width: 10%;"></td> <td style="width: 10%;"></td> <td style="width: 10%;"></td> <td style="width: 10%;"></td> <td style="width: 10%;"></td> <td style="width: 10%;"></td> <td style="width: 10%;"></td> <td style="width: 10%;"></td> <td style="width: 10%;"></td> </tr> <tr> <td></td> <td></td> <td colspan="8" style="text-align: center;"> <table border="1" style="width: 100%; border-collapse: collapse; text-align: center;"> <tr> <td style="width: 10%;"></td> <td style="width: 10%;"></td> <td style="width: 10%;"></td> <td style="width: 10%;"></td> <td style="width: 10%;"></td> <td style="width: 10%;"></td> <td style="width: 10%;"></td> <td style="width: 10%;"></td> <td style="width: 10%;"></td> <td style="width: 10%;"></td> </tr> <tr> <td></td> <td></td> <td colspan="8" style="text-align: center;"> <table border="1" style="width: 100%; border-collapse: collapse; text-align: center;"> <tr> <td style="width: 10%;"></td> <td style="width: 10%;"></td> <td style="width: 10%;"></td> <td style="width: 10%;"></td> <td style="width: 10%;"></td> <td style="width: 10%;"></td> <td style="width: 10%;"></td> <td style="width: 10%;"></td> <td style="width: 10%;"></td> <td style="width: 10%;"></td> </tr> <tr> <td></td> <td></td> <td colspan="8" style="text-align: center;"> <table border="1" style="width: 100%; border-collapse: collapse; text-align: center;"> <tr> <td style="width: 10%;"></td> <td style="width: 10%;"></td> <td style="width: 10%;"></td> <td style="width: 10%;"></td> <td style="width: 10%;"></td> <td style="width: 10%;"></td> <td style="width: 10%;"></td> <td style="width: 10%;"></td> <td style="width: 10%;"></td> <td style="width: 10%;"></td> </tr> <tr> <td></td> <td></td> <td colspan="8" style="text-align: center;"> <table border="1" style="width: 100%; border-collapse: collapse; text-align: center;"> <tr> <td style="width: 10%;"></td> <td style="width: 10%;"></td> <td style="width: 10%;"></td> <td style="width: 10%;"></td> <td style="width: 10%;"></td> <td style="width: 10%;"></td> <td style="width: 10%;"></td> <td style="width: 10%;"></td> <td style="width: 10%;"></td> <td style="width: 10%;"></td> </tr> <tr> <td></td> <td></td> <td colspan="8" style="text-align: center;"> <table border="1" style="width: 100%; border-collapse: collapse; text-align: center;"> <tr> <td style="width: 10%;"></td> <td style="width: 10%;"></td> <td style="width: 10%;"></td> <td style="width: 10%;"></td> <td style="width: 10%;"></td> <td style="width: 10%;"></td> <td style="width: 10%;"></td> <td style="width: 10%;"></td> <td style="width: 10%;"></td> <td style="width: 10%;"></td> </tr> <tr> <td></td> <td></td> <td colspan="8" style="text-align: center;"> <table border="1" style="width: 100%; border-collapse: collapse; text-align: center;"> <tr> <td style="width: 10%;"></td> <td style="width: 10%;"></td> <td style="width: 10%;"></td> <td style="width: 10%;"></td> <td style="width: 10%;"></td> <td style="width: 10%;"></td> <td style="width: 10%;"></td> <td style="width: 10%;"></td> <td style="width: 10%;"></td> <td style="width: 10%;"></td> </tr> <tr> <td></td> <td></td> <td colspan="8" style="text-align: center;"> <table border="1" style="width: 100%; border-collapse: collapse; text-align: center;"> <tr> <td style="width: 10%;"></td> <td style="width: 10%;"></td> <td style="width: 10%;"></td> <td style="width: 10%;"></td> <td style="width: 10%;"></td> <td style="width: 10%;"></td> <td style="width: 10%;"></td> <td style="width: 10%;"></td> <td style="width: 10%;"></td> <td style="width: 10%;"></td> </tr> <tr> <td></td> <td></td> <td colspan="8" style="text-align: center;"> <table border="1" style="width: 100%; border-collapse: collapse; text-align: center;"> <tr> <td style="width: 10%;"></td> <td style="width: 10%;"></td> <td style="width: 10%;"></td> <td style="width: 10%;"></td> <td style="width: 10%;"></td> <td style="width: 10%;"></td> <td style="width: 10%;"></td> <td style="width: 10%;"></td> <td style="width: 10%;"></td> <td style="width: 10%;"></td> </tr> <tr> <td></td> <td></td> <td colspan="8" style="text-align: center;"> <table border="1" style="width: 100%; border-collapse: collapse; text-align: center;"> <tr> <td style="width: 10%;"></td> <td style="width: 10%;"></td> <td style="width: 10%;"></td> <td style="width: 10%;"></td> <td style="width: 10%;"></td> <td style="width: 10%;"></td> <td style="width: 10%;"></td> <td style="width: 10%;"></td> <td style="width: 10%;"></td> <td style="width: 10%;"></td> </tr> <tr> <td></td> <td></td> <td colspan="8" style="text-align: center;"> <table border="1" style="width: 100%; border-collapse: collapse; text-align: center;"> <tr> <td style="width: 10%;"></td> <td style="width: 10%;"></td> <td style="width: 10%;"></td> <td style="width: 10%;"></td> <td style="width: 10%;"></td> <td style="width: 10%;"></td> <td style="width: 10%;"></td> <td style="width: 10%;"></td> <td style="width: 10%;"></td> <td style="width: 10%;"></td> </tr> <tr> <td></td> <td></td> <td colspan="8" style="text-align: center;"> <table border="1" style="width: 100%; border-collapse: collapse; text-align: center;"> <tr> <td style="width: 10%;"></td> <td style="width: 10%;"></td> <td style="width: 10%;"></td> <td style="width: 10%;"></td> <td style="width: 10%;"></td> <td style="width: 10%;"></td> <td style="width: 10%;"></td> <td style="width: 10%;"></td> <td style="width: 10%;"></td> <td style="width: 10%;"></td> </tr> <tr> <td></td> <td></td> <td colspan="8" style="text-align: center;"> <table border="1" style="width: 100%; border-collapse: collapse; text-align: center;"> <tr> <td style="width: 10%;"></td> <td style="width: 10%;"></td> <td style="width: 10%;"></td> <td style="width: 10%;"></td> <td style="width: 10%;"></td> <td style="width: 10%;"></td> <td style="width: 10%;"></td> <td style="width: 10%;"></td> <td style="width: 10%;"></td> <td style="width: 10%;"></td> </tr> <tr> <td></td> <td></td> <td colspan="8" style="text-align: center;"> <table border="1" style="width: 100%; border-collapse: collapse; text-align: center;"> <tr> <td style="width: 10%;"></td> <td style="width: 10%;"></td> <td style="width: 10%;"></td> <td style="width: 10%;"></td> <td style="width: 10%;"></td> <td style="width: 10%;"></td> <td style="width: 10%;"></td> <td style="width: 10%;"></td> <td style="width: 10%;"></td> <td style="width: 10%;"></td> </tr> <tr> <td></td> <td></td> <td colspan="8" style="text-align: center;"> <table border="1" style="width: 100%; border-collapse: collapse; text-align: center;"> <tr> <td style="width: 10%;"></td> <td style="width: 10%;"></td> <td style="width: 10%;"></td> <td style="width: 10%;"></td> <td style="width: 10%;"></td> <td style="width: 10%;"></td> <td style="width: 10%;"></td> <td style="width: 10%;"></td> <td style="width: 10%;"></td> <td style="width: 10%;"></td> </tr> <tr> <td></td> <td></td> <td colspan="8" style="text-align: center;"> <table border="1" style="width: 100%; border-collapse: collapse; text-align: center;"> <tr> <td style="width: 10%;"></td> <td style="width: 10%;"></td> <td style="width: 10%;"></td> <td style="width: 10%;"></td> <td style="width: 10%;"></td> <td style="width: 10%;"></td> <td style="width: 10%;"></td> <td style="width: 10%;"></td> <td style="width: 10%;"></td> <td style="width: 10%;"></td> </tr> <tr> <td></td> <td></td> <td colspan="8" style="text-align: center;"> <table border="1" style="width: 100%; border-collapse: collapse; text-align: center;"> <tr> <td style="width: 10%;"></td> <td style="width: 10%;"></td> <td style="width: 10%;"></td> <td style="width: 10%;"></td> <td style="width: 10%;"></td> <td style="width: 10%;"></td> <td style="width: 10%;"></td> <td style="width: 10%;"></td> <td style="width: 10%;"></td> <td style="width: 10%;"></td> </tr> <tr> <td></td> <td></td> <td colspan="8" style="text-align: center;"> <table border="1" style="width: 100%; border-collapse: collapse; text-align: center;"> <tr> <td style="width: 10%;"></td> <td style="width: 10%;"></td> <td style="width:
10%;"></td> <td style="width: 10%;"></td> <td style="width: 10%;"></td> <td style="width: 10%;"></td> <td style="width: 10%;"></td> <td style="width: 10%;"></td> <td style="width: 10%;"></td> <td style="width: 10%;"></td> </tr> <tr> <td></td> <td></td> <td colspan="8" style="text-align: center;"> <table border="1" style="width: 100%; border-collapse: collapse; text-align: center;"> <tr> <td style="width: 10%;"></td> <td style="width: 10%;"></td> <td style="width: 10%;"></td> <td style="width: 10%;"></td> <td style="width: 10%;"></td> <td style="width: 10%;"></td> <td style="width: 10%;"></td> <td style="width: 10%;"></td> <td style="width: 10%;"></td> <td style="width: 10%;"></td> </tr> <tr> <td></td> <td></td> <td colspan="8" style="text-align: center;"> <table border="1" style="width: 100%; border-collapse: collapse; text-align: center;"> <tr> <td style="width: 10%;"></td> <td style="width: 10%;"></td> <td style="width: 10%;"></td> <td style="width: 10%;"></td> <td style="width: 10%;"></td> <td style="width: 10%;"></td> <td style="width: 10%;"></td> <td style="width: 10%;"></td> <td style="width: 10%;"></td> <td style="width: 10%;"></td> </tr> <tr> <td></td> <td></td> <td colspan="8" style="text-align: center;"> <table border="1" style="width: 100%; border-collapse: collapse; text-align: center;"> <tr> <td style="width: 10%;"></td> <td style="width: 10%;"></td> <td style="width: 10%;"></td> <td style="width: 10%;"></td> <td style="width: 10%;"></td> <td style="width: 10%;"></td> <td style="width: 10%;"></td> <td style="width: 10%;"></td> <td style="width: 10%;"></td> <td style="width: 10%;"></td> </tr> <tr> <td></td> <td></td> <td colspan="8" style="text-align: center;"> <table border="1" style="width: 100%; border-collapse: collapse; text-align: center;"> <tr> <td style="width: 10%;"></td> <td style="width: 10%;"></td> <td style="width: 10%;"></td> <td style="width: 10%;"></td> <td style="width: 10%;"></td> <td style="width: 10%;"></td> <td style="width: 10%;"></td> <td style="width: 10%;"></td> <td style="width: 10%;"></td> <td style="width: 10%;"></td> </tr> <tr> <td></td> <td></td> <td colspan="8" style="text-align: center;"> <table border="1" style="width: 100%; border-collapse: collapse; text-align: center;"> <tr> <td style="width: 10%;"></td> <td style="width: 10%;"></td> <td style="width: 10%;"></td> <td style="width: 10%;"></td> <td style="width: 10%;"></td> <td style="width: 10%;"></td> <td style="width: 10%;"></td> <td style="width: 10%;"></td> <td style="width: 10%;"></td> <td style="width: 10%;"></td> </tr> <tr> <td></td> <td></td> <td colspan="8" style="text-align: center;"> <table border="1" style="width: 100%; border-collapse: collapse; text-align: center;"> <tr> </tr></table></td></tr></table></td></tr></table></td></tr></table></td></tr></table></td></tr></table></td></tr></table></td></tr></table></td></tr></table></td></tr></table></td></tr></table></td></tr></table></td></tr></table></td></tr></table></td></tr></table></td></tr></table></td></tr></table></td></tr></table></td></tr></table></td></tr></table></td></tr></table></td></tr></table></td></tr></table></td></tr></table></td></tr></table></td></tr></table> | | | | | | | | | | | | | | | | | | | | <table border="1" style="width: 100%; border-collapse: collapse; text-align: center;"> <tr> <td style="width: 10%;"></td> <td style="width: 10%;"></td> <td style="width: 10%;"></td> <td style="width: 10%;"></td> <td style="width: 10%;"></td> <td style="width: 10%;"></td> <td style="width: 10%;"></td> <td style="width: 10%;"></td> <td style="width: 10%;"></td> <td style="width: 10%;"></td> </tr> <tr> <td></td> <td></td> <td colspan="8" style="text-align: center;"> <table border="1" style="width: 100%; border-collapse: collapse; text-align: center;"> <tr> <td style="width: 10%;"></td> <td style="width: 10%;"></td> <td style="width: 10%;"></td> <td style="width: 10%;"></td> <td style="width: 10%;"></td> <td style="width: 10%;"></td> <td style="width: 10%;"></td> <td style="width: 10%;"></td> <td style="width: 10%;"></td> <td style="width: 10%;"></td> </tr> <tr> <td></td> <td></td> <td colspan="8" style="text-align: center;"> <table border="1" style="width: 100%; border-collapse: collapse; text-align: center;"> <tr> <td style="width: 10%;"></td> <td style="width: 10%;"></td> <td style="width: 10%;"></td> <td style="width: 10%;"></td> <td style="width: 10%;"></td> <td style="width: 10%;"></td> <td style="width: 10%;"></td> <td style="width: 10%;"></td> <td style="width: 10%;"></td> <td style="width: 10%;"></td> </tr> <tr> <td></td> <td></td> <td colspan="8" style="text-align: center;"> <table border="1" style="width: 100%; border-collapse: collapse; text-align: center;"> <tr> <td style="width: 10%;"></td> <td style="width: 10%;"></td> <td style="width: 10%;"></td> <td style="width: 10%;"></td> <td style="width: 10%;"></td> <td style="width: 10%;"></td> <td style="width: 10%;"></td> <td style="width: 10%;"></td> <td style="width: 10%;"></td> <td style="width: 10%;"></td> </tr> <tr> <td></td> <td></td> <td colspan="8" style="text-align: center;"> <table border="1" style="width: 100%; border-collapse: collapse; text-align: center;"> <tr> <td style="width: 10%;"></td> <td style="width: 10%;"></td> <td style="width: 10%;"></td> <td style="width: 10%;"></td> <td style="width: 10%;"></td> <td style="width: 10%;"></td> <td style="width: 10%;"></td> <td style="width: 10%;"></td> <td style="width: 10%;"></td> <td style="width: 10%;"></td> </tr> <tr> <td></td> <td></td> <td colspan="8" style="text-align: center;"> <table border="1" style="width: 100%; border-collapse: collapse; text-align: center;"> <tr> <td style="width: 10%;"></td> <td style="width: 10%;"></td> <td style="width: 10%;"></td> <td style="width: 10%;"></td> <td style="width: 10%;"></td> <td style="width: 10%;"></td> <td style="width: 10%;"></td> <td style="width: 10%;"></td> <td style="width: 10%;"></td> <td style="width: 10%;"></td> </tr> <tr> <td></td> <td></td> <td colspan="8" style="text-align: center;"> <table border="1" style="width: 100%; border-collapse: collapse; text-align: center;"> <tr> <td style="width: 10%;"></td> <td style="width: 10%;"></td> <td style="width: 10%;"></td> <td style="width: 10%;"></td> <td style="width: 10%;"></td> <td style="width: 10%;"></td> <td style="width: 10%;"></td> <td style="width: 10%;"></td> <td style="width: 10%;"></td> <td style="width: 10%;"></td> </tr> <tr> <td></td> <td></td> <td colspan="8" style="text-align: center;"> <table border="1" style="width: 100%; border-collapse: collapse;
text-align: center;"> <tr> <td style="width: 10%;"></td> <td style="width: 10%;"></td> <td style="width: 10%;"></td> <td style="width: 10%;"></td> <td style="width: 10%;"></td> <td style="width: 10%;"></td> <td style="width: 10%;"></td> <td style="width: 10%;"></td> <td style="width: 10%;"></td> <td style="width: 10%;"></td> </tr> <tr> <td></td> <td></td> <td colspan="8" style="text-align: center;"> <table border="1" style="width: 100%; border-collapse: collapse; text-align: center;"> <tr> <td style="width: 10%;"></td> <td style="width: 10%;"></td> <td style="width: 10%;"></td> <td style="width: 10%;"></td> <td style="width: 10%;"></td> <td style="width: 10%;"></td> <td style="width: 10%;"></td> <td style="width: 10%;"></td> <td style="width: 10%;"></td> <td style="width: 10%;"></td> </tr> <tr> <td></td> <td></td> <td colspan="8" style="text-align: center;"> <table border="1" style="width: 100%; border-collapse: collapse; text-align: center;"> <tr> <td style="width: 10%;"></td> <td style="width: 10%;"></td> <td style="width: 10%;"></td> <td style="width: 10%;"></td> <td style="width: 10%;"></td> <td style="width: 10%;"></td> <td style="width: 10%;"></td> <td style="width: 10%;"></td> <td style="width: 10%;"></td> <td style="width: 10%;"></td> </tr> <tr> <td></td> <td></td> <td colspan="8" style="text-align: center;"> <table border="1" style="width: 100%; border-collapse: collapse; text-align: center;"> <tr> <td style="width: 10%;"></td> <td style="width: 10%;"></td> <td style="width: 10%;"></td> <td style="width: 10%;"></td> <td style="width: 10%;"></td> <td style="width: 10%;"></td> <td style="width: 10%;"></td> <td style="width: 10%;"></td> <td style="width: 10%;"></td> <td style="width: 10%;"></td> </tr> <tr> <td></td> <td></td> <td colspan="8" style="text-align: center;"> <table border="1" style="width: 100%; border-collapse: collapse; text-align: center;"> <tr> <td style="width: 10%;"></td> <td style="width: 10%;"></td> <td style="width: 10%;"></td> <td style="width: 10%;"></td> <td style="width: 10%;"></td> <td style="width: 10%;"></td> <td style="width: 10%;"></td> <td style="width: 10%;"></td> <td style="width: 10%;"></td> <td style="width: 10%;"></td> </tr> <tr> <td></td> <td></td> <td colspan="8" style="text-align: center;"> <table border="1" style="width: 100%; border-collapse: collapse; text-align: center;"> <tr> <td style="width: 10%;"></td> <td style="width: 10%;"></td> <td style="width: 10%;"></td> <td style="width: 10%;"></td> <td style="width: 10%;"></td> <td style="width: 10%;"></td> <td style="width: 10%;"></td> <td style="width: 10%;"></td> <td style="width: 10%;"></td> <td style="width: 10%;"></td> </tr> <tr> <td></td> <td></td> <td colspan="8" style="text-align: center;"> <table border="1" style="width: 100%; border-collapse: collapse; text-align: center;"> <tr> <td style="width: 10%;"></td> <td style="width: 10%;"></td> <td style="width: 10%;"></td> <td style="width: 10%;"></td> <td style="width: 10%;"></td> <td style="width: 10%;"></td> <td style="width: 10%;"></td> <td style="width: 10%;"></td> <td style="width: 10%;"></td> <td style="width: 10%;"></td> </tr> <tr> <td></td> <td></td> <td colspan="8" style="text-align: center;"> <table border="1" style="width: 100%; border-collapse: collapse; text-align: center;"> <tr> <td style="width: 10%;"></td> <td style="width: 10%;"></td> <td style="width: 10%;"></td> <td style="width: 10%;"></td> <td style="width: 10%;"></td> <td style="width: 10%;"></td> <td style="width: 10%;"></td> <td style="width: 10%;"></td> <td style="width: 10%;"></td> <td style="width: 10%;"></td> </tr> <tr> <td></td> <td></td> <td colspan="8" style="text-align: center;"> <table border="1" style="width: 100%; border-collapse: collapse; text-align: center;"> <tr> <td style="width: 10%;"></td> <td style="width: 10%;"></td> <td style="width: 10%;"></td> <td style="width: 10%;"></td> <td style="width: 10%;"></td> <td style="width: 10%;"></td> <td style="width: 10%;"></td> <td style="width: 10%;"></td> <td style="width: 10%;"></td> <td style="width: 10%;"></td> </tr> <tr> <td></td> <td></td> <td colspan="8" style="text-align: center;"> <table border="1" style="width: 100%; border-collapse: collapse; text-align: center;"> <tr> <td style="width: 10%;"></td> <td style="width: 10%;"></td> <td style="width: 10%;"></td> <td style="width: 10%;"></td> <td style="width: 10%;"></td> <td style="width: 10%;"></td> <td style="width: 10%;"></td> <td style="width: 10%;"></td> <td style="width: 10%;"></td> <td style="width: 10%;"></td> </tr> <tr> <td></td> <td></td> <td colspan="8" style="text-align: center;"> <table border="1" style="width: 100%; border-collapse: collapse; text-align: center;"> <tr> <td style="width: 10%;"></td> <td style="width: 10%;"></td> <td style="width: 10%;"></td> <td style="width: 10%;"></td> <td style="width: 10%;"></td> <td style="width: 10%;"></td> <td style="width: 10%;"></td> <td style="width: 10%;"></td> <td style="width: 10%;"></td> <td style="width: 10%;"></td> </tr> <tr> <td></td> <td></td> <td colspan="8" style="text-align: center;"> <table border="1" style="width: 100%; border-collapse: collapse; text-align: center;"> <tr> <td style="width: 10%;"></td> <td style="width: 10%;"></td> <td style="width: 10%;"></td> <td style="width: 10%;"></td> <td style="width: 10%;"></td> <td style="width: 10%;"></td> <td style="width: 10%;"></td> <td style="width: 10%;"></td> <td style="width: 10%;"></td> <td style="width: 10%;"></td> </tr> <tr> <td></td> <td></td> <td colspan="8" style="text-align: center;"> <table border="1" style="width: 100%; border-collapse: collapse; text-align: center;"> <tr> <td style="width: 10%;"></td> <td style="width: 10%;"></td> <td style="width: 10%;"></td> <td style="width: 10%;"></td> <td style="width: 10%;"></td> <td style="width: 10%;"></td> <td style="width: 10%;"></td> <td style="width: 10%;"></td> <td style="width: 10%;"></td> <td style="width: 10%;"></td> </tr> <tr> <td></td> <td></td> <td colspan="8" style="text-align: center;"> <table border="1" style="width: 100%; border-collapse: collapse; text-align: center;"> <tr> <td style="width: 10%;"></td> <td style="width: 10%;"></td> <td style="width: 10%;"></td> <td style="width: 10%;"></td> <td style="width: 10%;"></td> <td style="width: 10%;"></td> <td style="width: 10%;"></td> <td style="width: 10%;"></td> <td style="width: 10%;"></td> <td style="width: 10%;"></td> </tr> <tr> <td></td> <td></td> <td colspan="8" style="text-align: center;"> <table border="1" style="width: 100%; border-collapse: collapse; text-align: center;"> <tr> <td style="width: 10%;"></td> <td style="width: 10%;"></td> <td style="width: 10%;"></td> <td style="width: 10%;"></td> <td style="width: 10%;"></td> <td style="width: 10%;"></td> <td style="width: 10%;"></td> <td style="width: 10%;"></td> <td style="width: 10%;"></td> <td style="width: 10%;"></td> </tr> <tr> <td></td> <td></td> <td colspan="8" style="text-align: center;"> <table border="1" style="width: 100%; border-collapse: collapse; text-align: center;"> <tr> <td style="width: 10%;"></td> <td style="width: 10%;"></td> <td style="width: 10%;"></td> <td style="width: 10%;"></td> <td style="width: 10%;"></td> <td style="width: 10%;"></td> <td style="width: 10%;"></td> <td style="width: 10%;"></td> <td style="width: 10%;"></td> <td style="width: 10%;"></td> </tr> <tr> <td></td> <td></td> <td colspan="8" style="text-align: center;"> <table border="1" style="width: 100%; border-collapse: collapse; text-align: center;"> <tr> <td style="width: 10%;"></td> <td style="width: 10%;"></td> <td style="width: 10%;"></td> <td style="width: 10%;"></td> <td style="width: 10%;"></td> <td style="width: 10%;"></td> <td style="width: 10%;"></td> <td style="width: 10%;"></td> <td style="width: 10%;"></td> <td style="width: 10%;"></td> </tr> <tr> <td></td> <td></td> <td colspan="8" style="text-align: center;"> <table border="1" style="width: 100%; border-collapse: collapse; text-align: center;"> <tr> </tr></table></td></tr></table></td></tr></table></td></tr></table></td></tr></table></td></tr></table></td></tr></table></td></tr></table></td></tr></table></td></tr></table></td></tr></table></td></tr></table></td></tr></table></td></tr></table></td></tr></table></td></tr></table></td></tr></table></td></tr></table></td></tr></table></td></tr></table></td></tr></table></td></tr></table></td></tr></table></td></tr></table></td></tr></table>
 | | | | | | | | | | | | | | | | | | | | <table border="1" style="width: 100%; border-collapse: collapse; text-align: center;"> <tr> <td style="width: 10%;"></td> <td style="width: 10%;"></td> <td style="width: 10%;"></td> <td style="width: 10%;"></td> <td style="width: 10%;"></td> <td style="width: 10%;"></td> <td style="width: 10%;"></td> <td style="width: 10%;"></td> <td style="width: 10%;"></td> <td style="width: 10%;"></td> </tr> <tr> <td></td> <td></td> <td colspan="8" style="text-align: center;"> <table border="1" style="width: 100%; border-collapse: collapse; text-align: center;"> <tr> <td style="width: 10%;"></td> <td style="width: 10%;"></td> <td style="width: 10%;"></td> <td style="width: 10%;"></td> <td style="width: 10%;"></td> <td style="width: 10%;"></td> <td style="width: 10%;"></td> <td style="width: 10%;"></td> <td style="width: 10%;"></td> <td style="width: 10%;"></td> </tr> <tr> <td></td> <td></td> <td colspan="8" style="text-align: center;"> <table border="1" style="width: 100%; border-collapse: collapse; text-align: center;"> <tr> <td style="width: 10%;"></td> <td style="width: 10%;"></td> <td style="width: 10%;"></td> <td style="width: 10%;"></td> <td style="width: 10%;"></td> <td style="width: 10%;"></td> <td style="width: 10%;"></td> <td style="width: 10%;"></td> <td style="width: 10%;"></td> <td style="width: 10%;"></td> </tr> <tr> <td></td> <td></td> <td colspan="8" style="text-align: center;"> <table border="1" style="width: 100%; border-collapse: collapse; text-align: center;"> <tr> <td style="width: 10%;"></td> <td style="width: 10%;"></td> <td style="width: 10%;"></td> <td style="width: 10%;"></td> <td style="width: 10%;"></td> <td style="width: 10%;"></td> <td style="width: 10%;"></td> <td style="width: 10%;"></td> <td style="width: 10%;"></td> <td style="width: 10%;"></td> </tr> <tr> <td></td> <td></td> <td colspan="8" style="text-align: center;"> <table border="1" style="width: 100%; border-collapse: collapse; text-align: center;"> <tr> <td style="width: 10%;"></td> <td style="width: 10%;"></td> <td style="width: 10%;"></td> <td style="width: 10%;"></td> <td style="width: 10%;"></td> <td style="width: 10%;"></td> <td style="width: 10%;"></td> <td style="width: 10%;"></td> <td style="width: 10%;"></td> <td style="width: 10%;"></td> </tr> <tr> <td></td> <td></td> <td colspan="8" style="text-align: center;"> <table border="1" style="width: 100%; border-collapse: collapse; text-align: center;"> <tr> <td style="width: 10%;"></td> <td style="width: 10%;"></td> <td style="width: 10%;"></td> <td style="width: 10%;"></td> <td style="width: 10%;"></td> <td style="width: 10%;"></td> <td style="width: 10%;"></td> <td style="width: 10%;"></td> <td style="width: 10%;"></td> <td style="width: 10%;"></td> </tr> <tr> <td></td> <td></td> <td colspan="8" style="text-align: center;"> <table border="1" style="width: 100%; border-collapse: collapse; text-align: center;"> <tr> <td style="width: 10%;"></td> <td style="width: 10%;"></td> <td style="width: 10%;"></td> <td style="width: 10%;"></td> <td style="width: 10%;"></td> <td style="width: 10%;"></td> <td style="width: 10%;"></td> <td style="width: 10%;"></td> <td style="width: 10%;"></td> <td style="width: 10%;"></td> </tr> <tr> <td></td> <td></td> <td colspan="8" style="text-align: center;"> <table border="1" style="width: 100%; border-collapse: collapse; text-align: center;"> <tr> <td style="width: 10%;"></td> <td style="width: 10%;"></td> <td style="width: 10%;"></td> <td style="width: 10%;"></td> <td style="width: 10%;"></td> <td style="width: 10%;"></td> <td style="width: 10%;"></td> <td style="width: 10%;"></td> <td style="width: 10%;"></td> <td style="width: 10%;"></td> </tr> <tr> <td></td> <td></td> <td colspan="8" style="text-align: center;"> <table border="1" style="width: 100%; border-collapse: collapse; text-align: center;"> <tr> <td style="width: 10%;"></td> <td style="width: 10%;"></td> <td style="width: 10%;"></td> <td style="width: 10%;"></td> <td style="width: 10%;"></td> <td style="width: 10%;"></td> <td style="width: 10%;"></td> <td style="width: 10%;"></td> <td style="width: 10%;"></td> <td style="width: 10%;"></td> </tr> <tr> <td></td> <td></td> <td colspan="8" style="text-align: center;"> <table border="1" style="width: 100%; border-collapse: collapse; text-align: center;"> <tr> <td style="width: 10%;"></td> <td style="width: 10%;"></td> <td style="width: 10%;"></td> <td style="width: 10%;"></td> <td style="width: 10%;"></td> <td style="width: 10%;"></td> <td style="width: 10%;"></td> <td style="width: 10%;"></td> <td style="width: 10%;"></td> <td style="width: 10%;"></td> </tr> <tr> <td></td> <td></td> <td colspan="8" style="text-align: center;"> <table border="1" style="width: 100%; border-collapse: collapse; text-align: center;"> <tr> <td style="width: 10%;"></td> <td style="width: 10%;"></td> <td style="width: 10%;"></td> <td style="width: 10%;"></td> <td style="width: 10%;"></td> <td style="width: 10%;"></td> <td style="width: 10%;"></td> <td style="width: 10%;"></td> <td style="width: 10%;"></td> <td style="width: 10%;"></td> </tr> <tr> <td></td> <td></td> <td colspan="8" style="text-align: center;"> <table border="1" style="width: 100%; border-collapse: collapse; text-align: center;"> <tr> <td style="width: 10%;"></td> <td style="width: 10%;"></td> <td style="width: 10%;"></td> <td style="width: 10%;"></td> <td style="width: 10%;"></td> <td style="width: 10%;"></td> <td style="width: 10%;"></td> <td style="width: 10%;"></td> <td style="width: 10%;"></td> <td style="width: 10%;"></td> </tr> <tr> <td></td> <td></td> <td colspan="8" style="text-align: center;"> <table border="1" style="width: 100%; border-collapse: collapse; text-align: center;"> <tr> <td style="width: 10%;"></td> <td style="width: 10%;"></td> <td style="width: 10%;"></td> <td style="width: 10%;"></td> <td style="width: 10%;"></td> <td style="width: 10%;"></td> <td style="width: 10%;"></td> <td style="width: 10%;"></td> <td style="width: 10%;"></td> <td style="width: 10%;"></td> </tr> <tr> <td></td> <td></td> <td colspan="8" style="text-align: center;"> <table border="1" style="width: 100%; border-collapse: collapse; text-align: center;"> <tr> <td style="width: 10%;"></td> <td style="width: 10%;"></td> <td style="width: 10%;"></td> <td style="width: 10%;"></td> <td style="width: 10%;"></td> <td style="width: 10%;"></td> <td style="width: 10%;"></td> <td style="width: 10%;"></td> <td style="width: 10%;"></td> <td style="width: 10%;"></td> </tr> <tr> <td></td> <td></td> <td colspan="8" style="text-align: center;"> <table border="1" style="width: 100%; border-collapse: collapse; text-align: center;"> <tr> <td style="width: 10%;"></td> <td style="width: 10%;"></td> <td style="width: 10%;"></td> <td style="width: 10%;"></td> <td style="width: 10%;"></td> <td style="width: 10%;"></td> <td style="width: 10%;"></td> <td style="width: 10%;"></td> <td style="width: 10%;"></td> <td style="width: 10%;"></td> </tr> <tr> <td></td> <td></td> <td colspan="8" style="text-align: center;"> <table border="1" style="width: 100%; border-collapse: collapse; text-align: center;"> <tr> <td style="width: 10%;"></td> <td style="width: 10%;"></td> <td style="width: 10%;"></td> <td style="width: 10%;"></td> <td style="width: 10%;"></td> <td style="width: 10%;"></td> <td style="width: 10%;"></td> <td style="width: 10%;"></td> <td style="width: 10%;"></td> <td style="width: 10%;"></td> </tr> <tr> <td></td> <td></td> <td colspan="8" style="text-align: center;"> <table border="1" style="width: 100%; border-collapse: collapse; text-align: center;"> <tr> <td style="width: 10%;"></td> <td style="width: 10%;"></td> <td style="width: 10%;"></td> <td style="width: 10%;"></td> <td style="width: 10%;"></td> <td style="width: 10%;"></td> <td style="width: 10%;"></td> <td style="width: 10%;"></td> <td style="width: 10%;"></td> <td style="width: 10%;"></td> </tr> <tr> <td></td> <td></td> <td colspan="8" style="text-align: center;"> <table border="1" style="width: 100%; border-collapse: collapse; text-align: center;"> <tr> <td style="width: 10%;"></td> <td style="width: 10%;"></td>
<td style="width: 10%;"></td> <td style="width: 10%;"></td> <td style="width: 10%;"></td> <td style="width: 10%;"></td> <td style="width: 10%;"></td> <td style="width: 10%;"></td> <td style="width: 10%;"></td> <td style="width: 10%;"></td> </tr> <tr> <td></td> <td></td> <td colspan="8" style="text-align: center;"> <table border="1" style="width: 100%; border-collapse: collapse; text-align: center;"> <tr> <td style="width: 10%;"></td> <td style="width: 10%;"></td> <td style="width: 10%;"></td> <td style="width: 10%;"></td> <td style="width: 10%;"></td> <td style="width: 10%;"></td> <td style="width: 10%;"></td> <td style="width: 10%;"></td> <td style="width: 10%;"></td> <td style="width: 10%;"></td> </tr> <tr> <td></td> <td></td> <td colspan="8" style="text-align: center;"> <table border="1" style="width: 100%; border-collapse: collapse; text-align: center;"> <tr> <td style="width: 10%;"></td> <td style="width: 10%;"></td> <td style="width: 10%;"></td> <td style="width: 10%;"></td> <td style="width: 10%;"></td> <td style="width: 10%;"></td> <td style="width: 10%;"></td> <td style="width: 10%;"></td> <td style="width: 10%;"></td> <td style="width: 10%;"></td> </tr> <tr> <td></td> <td></td> <td colspan="8" style="text-align: center;"> <table border="1" style="width: 100%; border-collapse: collapse; text-align: center;"> <tr> <td style="width: 10%;"></td> <td style="width: 10%;"></td> <td style="width: 10%;"></td> <td style="width: 10%;"></td> <td style="width: 10%;"></td> <td style="width: 10%;"></td> <td style="width: 10%;"></td> <td style="width: 10%;"></td> <td style="width: 10%;"></td> <td style="width: 10%;"></td> </tr> <tr> <td></td> <td></td> <td colspan="8" style="text-align: center;"> <table border="1" style="width: 100%; border-collapse: collapse; text-align: center;"> <tr> <td style="width: 10%;"></td> <td style="width: 10%;"></td> <td style="width: 10%;"></td> <td style="width: 10%;"></td> <td style="width: 10%;"></td> <td style="width: 10%;"></td> <td style="width: 10%;"></td> <td style="width: 10%;"></td> <td style="width: 10%;"></td> <td style="width: 10%;"></td> </tr> <tr> <td></td> <td></td> <td colspan="8" style="text-align: center;"> <table border="1" style="width: 100%; border-collapse: collapse; text-align: center;"> <tr> <td style="width: 10%;"></td> <td style="width: 10%;"></td> <td style="width: 10%;"></td> <td style="width: 10%;"></td> <td style="width: 10%;"></td> <td style="width: 10%;"></td> <td style="width: 10%;"></td> <td style="width: 10%;"></td> <td style="width: 10%;"></td> <td style="width: 10%;"></td> </tr> <tr> <td></td> <td></td> <td colspan="8" style="text-align: center;"> <table border="1" style="width: 100%; border-collapse: collapse; text-align: center;"> <tr> </tr></table></td></tr></table></td></tr></table></td></tr></table></td></tr></table></td></tr></table></td></tr></table></td></tr></table></td></tr></table></td></tr></table></td></tr></table></td></tr></table></td></tr></table></td></tr></table></td></tr></table></td></tr></table></td></tr></table></td></tr></table></td></tr></table></td></tr></table></td></tr></table></td></tr></table></td></tr></table></td></tr></table> | | | | | | | | | | | | | | | | | | | | <table border="1" style="width: 100%; border-collapse: collapse; text-align: center;"> <tr> <td style="width: 10%;"></td> <td style="width: 10%;"></td> <td style="width: 10%;"></td> <td style="width: 10%;"></td> <td style="width: 10%;"></td> <td style="width: 10%;"></td> <td style="width: 10%;"></td> <td style="width: 10%;"></td> <td style="width: 10%;"></td> <td style="width: 10%;"></td> </tr> <tr> <td></td> <td></td> <td colspan="8" style="text-align: center;"> <table border="1" style="width: 100%; border-collapse: collapse; text-align: center;"> <tr> <td style="width: 10%;"></td> <td style="width: 10%;"></td> <td style="width: 10%;"></td> <td style="width: 10%;"></td> <td style="width: 10%;"></td> <td style="width: 10%;"></td> <td style="width: 10%;"></td> <td style="width: 10%;"></td> <td style="width: 10%;"></td> <td style="width: 10%;"></td> </tr> <tr> <td></td> <td></td> <td colspan="8" style="text-align: center;"> <table border="1" style="width: 100%; border-collapse: collapse; text-align: center;"> <tr> <td style="width: 10%;"></td> <td style="width: 10%;"></td> <td style="width: 10%;"></td> <td style="width: 10%;"></td> <td style="width: 10%;"></td> <td style="width: 10%;"></td> <td style="width: 10%;"></td> <td style="width: 10%;"></td> <td style="width: 10%;"></td> <td style="width: 10%;"></td> </tr> <tr> <td></td> <td></td> <td colspan="8" style="text-align: center;"> <table border="1" style="width: 100%; border-collapse: collapse; text-align: center;"> <tr> <td style="width: 10%;"></td> <td style="width: 10%;"></td> <td style="width: 10%;"></td> <td style="width: 10%;"></td> <td style="width: 10%;"></td> <td style="width: 10%;"></td> <td style="width: 10%;"></td> <td style="width: 10%;"></td> <td style="width: 10%;"></td> <td style="width: 10%;"></td> </tr> <tr> <td></td> <td></td> <td colspan="8" style="text-align: center;"> <table border="1" style="width: 100%; border-collapse: collapse; text-align: center;"> <tr> <td style="width: 10%;"></td> <td style="width: 10%;"></td> <td style="width: 10%;"></td> <td style="width: 10%;"></td> <td style="width: 10%;"></td> <td style="width: 10%;"></td> <td style="width: 10%;"></td> <td style="width: 10%;"></td> <td style="width: 10%;"></td> <td style="width: 10%;"></td> </tr> <tr> <td></td> <td></td> <td colspan="8" style="text-align: center;"> <table border="1" style="width: 100%; border-collapse: collapse; text-align: center;"> <tr> <td style="width: 10%;"></td> <td style="width: 10%;"></td> <td style="width: 10%;"></td> <td style="width: 10%;"></td> <td style="width: 10%;"></td> <td style="width: 10%;"></td> <td style="width: 10%;"></td> <td style="width: 10%;"></td> <td style="width: 10%;"></td> <td style="width: 10%;"></td> </tr> <tr> <td></td> <td></td> <td colspan="8" style="text-align: center;"> <table border="1" style="width: 100%; border-collapse: collapse; text-align: center;"> <tr> <td style="width: 10%;"></td> <td style="width: 10%;"></td> <td style="width: 10%;"></td> <td style="width: 10%;"></td> <td style="width: 10%;"></td> <td style="width: 10%;"></td> <td style="width: 10%;"></td> <td style="width: 10%;"></td> <td style="width: 10%;"></td> <td style="width: 10%;"></td> </tr> <tr> <td></td> <td></td> <td colspan="8" style="text-align: center;"> <table border="1" style="width: 100%; border-collapse: collapse; text-align: center;">
<tr> <td style="width: 10%;"></td> <td style="width: 10%;"></td> <td style="width: 10%;"></td> <td style="width: 10%;"></td> <td style="width: 10%;"></td> <td style="width: 10%;"></td> <td style="width: 10%;"></td> <td style="width: 10%;"></td> <td style="width: 10%;"></td> <td style="width: 10%;"></td> </tr> <tr> <td></td> <td></td> <td colspan="8" style="text-align: center;"> <table border="1" style="width: 100%; border-collapse: collapse; text-align: center;"> <tr> <td style="width: 10%;"></td> <td style="width: 10%;"></td> <td style="width: 10%;"></td> <td style="width: 10%;"></td> <td style="width: 10%;"></td> <td style="width: 10%;"></td> <td style="width: 10%;"></td> <td style="width: 10%;"></td> <td style="width: 10%;"></td> <td style="width: 10%;"></td> </tr> <tr> <td></td> <td></td> <td colspan="8" style="text-align: center;"> <table border="1" style="width: 100%; border-collapse: collapse; text-align: center;"> <tr> <td style="width: 10%;"></td> <td style="width: 10%;"></td> <td style="width: 10%;"></td> <td style="width: 10%;"></td> <td style="width: 10%;"></td> <td style="width: 10%;"></td> <td style="width: 10%;"></td> <td style="width: 10%;"></td> <td style="width: 10%;"></td> <td style="width: 10%;"></td> </tr> <tr> <td></td> <td></td> <td colspan="8" style="text-align: center;"> <table border="1" style="width: 100%; border-collapse: collapse; text-align: center;"> <tr> <td style="width: 10%;"></td> <td style="width: 10%;"></td> <td style="width: 10%;"></td> <td style="width: 10%;"></td> <td style="width: 10%;"></td> <td style="width: 10%;"></td> <td style="width: 10%;"></td> <td style="width: 10%;"></td> <td style="width: 10%;"></td> <td style="width: 10%;"></td> </tr> <tr> <td></td> <td></td> <td colspan="8" style="text-align: center;"> <table border="1" style="width: 100%; border-collapse: collapse; text-align: center;"> <tr> <td style="width: 10%;"></td> <td style="width: 10%;"></td> <td style="width: 10%;"></td> <td style="width: 10%;"></td> <td style="width: 10%;"></td> <td style="width: 10%;"></td> <td style="width: 10%;"></td> <td style="width: 10%;"></td> <td style="width: 10%;"></td> <td style="width: 10%;"></td> </tr> <tr> <td></td> <td></td> <td colspan="8" style="text-align: center;"> <table border="1" style="width: 100%; border-collapse: collapse; text-align: center;"> <tr> <td style="width: 10%;"></td> <td style="width: 10%;"></td> <td style="width: 10%;"></td> <td style="width: 10%;"></td> <td style="width: 10%;"></td> <td style="width: 10%;"></td> <td style="width: 10%;"></td> <td style="width: 10%;"></td> <td style="width: 10%;"></td> <td style="width: 10%;"></td> </tr> <tr> <td></td> <td></td> <td colspan="8" style="text-align: center;"> <table border="1" style="width: 100%; border-collapse: collapse; text-align: center;"> <tr> <td style="width: 10%;"></td> <td style="width: 10%;"></td> <td style="width: 10%;"></td> <td style="width: 10%;"></td> <td style="width: 10%;"></td> <td style="width: 10%;"></td> <td style="width: 10%;"></td> <td style="width: 10%;"></td> <td style="width: 10%;"></td> <td style="width: 10%;"></td> </tr> <tr> <td></td> <td></td> <td colspan="8" style="text-align: center;"> <table border="1" style="width: 100%; border-collapse: collapse; text-align: center;"> <tr> <td style="width: 10%;"></td> <td style="width: 10%;"></td> <td style="width: 10%;"></td> <td style="width: 10%;"></td> <td style="width: 10%;"></td> <td style="width: 10%;"></td> <td style="width: 10%;"></td> <td style="width: 10%;"></td> <td style="width: 10%;"></td> <td style="width: 10%;"></td> </tr> <tr> <td></td> <td></td> <td colspan="8" style="text-align: center;"> <table border="1" style="width: 100%; border-collapse: collapse; text-align: center;"> <tr> <td style="width: 10%;"></td> <td style="width: 10%;"></td> <td style="width: 10%;"></td> <td style="width: 10%;"></td> <td style="width: 10%;"></td> <td style="width: 10%;"></td> <td style="width: 10%;"></td> <td style="width: 10%;"></td> <td style="width: 10%;"></td> <td style="width: 10%;"></td> </tr> <tr> <td></td> <td></td> <td colspan="8" style="text-align: center;"> <table border="1" style="width: 100%; border-collapse: collapse; text-align: center;"> <tr> <td style="width: 10%;"></td> <td style="width: 10%;"></td> <td style="width: 10%;"></td> <td style="width: 10%;"></td> <td style="width: 10%;"></td> <td style="width: 10%;"></td> <td style="width: 10%;"></td> <td style="width: 10%;"></td> <td style="width: 10%;"></td> <td style="width: 10%;"></td> </tr> <tr> <td></td> <td></td> <td colspan="8" style="text-align: center;"> <table border="1" style="width: 100%; border-collapse: collapse; text-align: center;"> <tr> <td style="width: 10%;"></td> <td style="width: 10%;"></td> <td style="width: 10%;"></td> <td style="width: 10%;"></td> <td style="width: 10%;"></td> <td style="width: 10%;"></td> <td style="width: 10%;"></td> <td style="width: 10%;"></td> <td style="width: 10%;"></td> <td style="width: 10%;"></td> </tr> <tr> <td></td> <td></td> <td colspan="8" style="text-align: center;"> <table border="1" style="width: 100%; border-collapse: collapse; text-align: center;"> <tr> <td style="width: 10%;"></td> <td style="width: 10%;"></td> <td style="width: 10%;"></td> <td style="width: 10%;"></td> <td style="width: 10%;"></td> <td style="width: 10%;"></td> <td style="width: 10%;"></td> <td style="width: 10%;"></td> <td style="width: 10%;"></td> <td style="width: 10%;"></td> </tr> <tr> <td></td> <td></td> <td colspan="8" style="text-align: center;"> <table border="1" style="width: 100%; border-collapse: collapse; text-align: center;"> <tr> <td style="width: 10%;"></td> <td style="width: 10%;"></td> <td style="width: 10%;"></td> <td style="width: 10%;"></td> <td style="width: 10%;"></td> <td style="width: 10%;"></td> <td style="width: 10%;"></td> <td style="width: 10%;"></td> <td style="width: 10%;"></td> <td style="width: 10%;"></td> </tr> <tr> <td></td> <td></td> <td colspan="8" style="text-align: center;"> <table border="1" style="width: 100%; border-collapse: collapse; text-align: center;"> <tr> <td style="width: 10%;"></td> <td style="width: 10%;"></td> <td style="width: 10%;"></td> <td style="width: 10%;"></td> <td style="width: 10%;"></td> <td style="width: 10%;"></td> <td style="width: 10%;"></td> <td style="width: 10%;"></td> <td style="width: 10%;"></td> <td style="width: 10%;"></td> </tr> <tr> <td></td> <td></td> <td colspan="8" style="text-align: center;"> <table border="1" style="width: 100%; border-collapse: collapse; text-align: center;"> <tr> <td style="width: 10%;"></td> <td style="width: 10%;"></td> <td style="width: 10%;"></td> <td style="width: 10%;"></td> <td style="width: 10%;"></td> <td style="width: 10%;"></td> <td style="width: 10%;"></td> <td style="width: 10%;"></td> <td style="width: 10%;"></td> <td style="width: 10%;"></td> </tr> <tr> <td></td> <td></td> <td colspan="8" style="text-align: center;"> <table border="1" style="width: 100%; border-collapse: collapse; text-align: center;"> <tr> </tr></table></td></tr></table></td></tr></table></td></tr></table></td></tr></table></td></tr></table></td></tr></table></td></tr></table></td></tr></table></td></tr></table></td></tr></table></td></tr></table></td></tr></table></td></tr></table></td></tr></table></td></tr></table></td></tr></table></td></tr></table></td></tr></table></td></tr></table></td></tr></table></td></tr></table></td></tr></table>
 | | | | | | | | | | | | | | | | | | | | <table border="1" style="width: 100%; border-collapse: collapse; text-align: center;"> <tr> <td style="width: 10%;"></td> <td style="width: 10%;"></td> <td style="width: 10%;"></td> <td style="width: 10%;"></td> <td style="width: 10%;"></td> <td style="width: 10%;"></td> <td style="width: 10%;"></td> <td style="width: 10%;"></td> <td style="width: 10%;"></td> <td style="width: 10%;"></td> </tr> <tr> <td></td> <td></td> <td colspan="8" style="text-align: center;"> <table border="1" style="width: 100%; border-collapse: collapse; text-align: center;"> <tr> <td style="width: 10%;"></td> <td style="width: 10%;"></td> <td style="width: 10%;"></td> <td style="width: 10%;"></td> <td style="width: 10%;"></td> <td style="width: 10%;"></td> <td style="width: 10%;"></td> <td style="width: 10%;"></td> <td style="width: 10%;"></td> <td style="width: 10%;"></td> </tr> <tr> <td></td> <td></td> <td colspan="8" style="text-align: center;"> <table border="1" style="width: 100%; border-collapse: collapse; text-align: center;"> <tr> <td style="width: 10%;"></td> <td style="width: 10%;"></td> <td style="width: 10%;"></td> <td style="width: 10%;"></td> <td style="width: 10%;"></td> <td style="width: 10%;"></td> <td style="width: 10%;"></td> <td style="width: 10%;"></td> <td style="width: 10%;"></td> <td style="width: 10%;"></td> </tr> <tr> <td></td> <td></td> <td colspan="8" style="text-align: center;"> <table border="1" style="width: 100%; border-collapse: collapse; text-align: center;"> <tr> <td style="width: 10%;"></td> <td style="width: 10%;"></td> <td style="width: 10%;"></td> <td style="width: 10%;"></td> <td style="width: 10%;"></td> <td style="width: 10%;"></td> <td style="width: 10%;"></td> <td style="width: 10%;"></td> <td style="width: 10%;"></td> <td style="width: 10%;"></td> </tr> <tr> <td></td> <td></td> <td colspan="8" style="text-align: center;"> <table border="1" style="width: 100%; border-collapse: collapse; text-align: center;"> <tr> <td style="width: 10%;"></td> <td style="width: 10%;"></td> <td style="width: 10%;"></td> <td style="width: 10%;"></td> <td style="width: 10%;"></td> <td style="width: 10%;"></td> <td style="width: 10%;"></td> <td style="width: 10%;"></td> <td style="width: 10%;"></td> <td style="width: 10%;"></td> </tr> <tr> <td></td> <td></td> <td colspan="8" style="text-align: center;"> <table border="1" style="width: 100%; border-collapse: collapse; text-align: center;"> <tr> <td style="width: 10%;"></td> <td style="width: 10%;"></td> <td style="width: 10%;"></td> <td style="width: 10%;"></td> <td style="width: 10%;"></td> <td style="width: 10%;"></td> <td style="width: 10%;"></td> <td style="width: 10%;"></td> <td style="width: 10%;"></td> <td style="width: 10%;"></td> </tr> <tr> <td></td> <td></td> <td colspan="8" style="text-align: center;"> <table border="1" style="width: 100%; border-collapse: collapse; text-align: center;"> <tr> <td style="width: 10%;"></td> <td style="width: 10%;"></td> <td style="width: 10%;"></td> <td style="width: 10%;"></td> <td style="width: 10%;"></td> <td style="width: 10%;"></td> <td style="width: 10%;"></td> <td style="width: 10%;"></td> <td style="width: 10%;"></td> <td style="width: 10%;"></td> </tr> <tr> <td></td> <td></td> <td colspan="8" style="text-align: center;"> <table border="1" style="width: 100%; border-collapse: collapse; text-align: center;"> <tr> <td style="width: 10%;"></td> <td style="width: 10%;"></td> <td style="width: 10%;"></td> <td style="width: 10%;"></td> <td style="width: 10%;"></td> <td style="width: 10%;"></td> <td style="width: 10%;"></td> <td style="width: 10%;"></td> <td style="width: 10%;"></td> <td style="width: 10%;"></td> </tr> <tr> <td></td> <td></td> <td colspan="8" style="text-align: center;"> <table border="1" style="width: 100%; border-collapse: collapse; text-align: center;"> <tr> <td style="width: 10%;"></td> <td style="width: 10%;"></td> <td style="width: 10%;"></td> <td style="width: 10%;"></td> <td style="width: 10%;"></td> <td style="width: 10%;"></td> <td style="width: 10%;"></td> <td style="width: 10%;"></td> <td style="width: 10%;"></td> <td style="width: 10%;"></td> </tr> <tr> <td></td> <td></td> <td colspan="8" style="text-align: center;"> <table border="1" style="width: 100%; border-collapse: collapse; text-align: center;"> <tr> <td style="width: 10%;"></td> <td style="width: 10%;"></td> <td style="width: 10%;"></td> <td style="width: 10%;"></td> <td style="width: 10%;"></td> <td style="width: 10%;"></td> <td style="width: 10%;"></td> <td style="width: 10%;"></td> <td style="width: 10%;"></td> <td style="width: 10%;"></td> </tr> <tr> <td></td> <td></td> <td colspan="8" style="text-align: center;"> <table border="1" style="width: 100%; border-collapse: collapse; text-align: center;"> <tr> <td style="width: 10%;"></td> <td style="width: 10%;"></td> <td style="width: 10%;"></td> <td style="width: 10%;"></td> <td style="width: 10%;"></td> <td style="width: 10%;"></td> <td style="width: 10%;"></td> <td style="width: 10%;"></td> <td style="width: 10%;"></td> <td style="width: 10%;"></td> </tr> <tr> <td></td> <td></td> <td colspan="8" style="text-align: center;"> <table border="1" style="width: 100%; border-collapse: collapse; text-align: center;"> <tr> <td style="width: 10%;"></td> <td style="width: 10%;"></td> <td style="width: 10%;"></td> <td style="width: 10%;"></td> <td style="width: 10%;"></td> <td style="width: 10%;"></td> <td style="width: 10%;"></td> <td style="width: 10%;"></td> <td style="width: 10%;"></td> <td style="width: 10%;"></td> </tr> <tr> <td></td> <td></td> <td colspan="8" style="text-align: center;"> <table border="1" style="width: 100%; border-collapse: collapse; text-align: center;"> <tr> <td style="width: 10%;"></td> <td style="width: 10%;"></td> <td style="width: 10%;"></td> <td style="width: 10%;"></td> <td style="width: 10%;"></td> <td style="width: 10%;"></td> <td style="width: 10%;"></td> <td style="width: 10%;"></td> <td style="width: 10%;"></td> <td style="width: 10%;"></td> </tr> <tr> <td></td> <td></td> <td colspan="8" style="text-align: center;"> <table border="1" style="width: 100%; border-collapse: collapse; text-align: center;"> <tr> <td style="width: 10%;"></td> <td style="width: 10%;"></td> <td style="width: 10%;"></td> <td style="width: 10%;"></td> <td style="width: 10%;"></td> <td style="width: 10%;"></td> <td style="width: 10%;"></td> <td style="width: 10%;"></td> <td style="width: 10%;"></td> <td style="width: 10%;"></td> </tr> <tr> <td></td> <td></td> <td colspan="8" style="text-align: center;"> <table border="1" style="width: 100%; border-collapse: collapse; text-align: center;"> <tr> <td style="width: 10%;"></td> <td style="width: 10%;"></td> <td style="width: 10%;"></td> <td style="width: 10%;"></td> <td style="width: 10%;"></td> <td style="width: 10%;"></td> <td style="width: 10%;"></td> <td style="width: 10%;"></td> <td style="width: 10%;"></td> <td style="width: 10%;"></td> </tr> <tr> <td></td> <td></td> <td colspan="8" style="text-align: center;"> <table border="1" style="width: 100%; border-collapse: collapse; text-align: center;"> <tr> <td style="width: 10%;"></td> <td style="width: 10%;"></td> <td style="width: 10%;"></td> <td style="width: 10%;"></td> <td style="width: 10%;"></td> <td style="width: 10%;"></td> <td style="width: 10%;"></td> <td style="width: 10%;"></td> <td style="width: 10%;"></td> <td style="width: 10%;"></td> </tr> <tr> <td></td> <td></td> <td colspan="8" style="text-align: center;"> <table border="1" style="width: 100%; border-collapse: collapse; text-align: center;"> <tr> <td style="width: 10%;"></td> <td style="width: 10%;"></td> <td style="width: 10%;"></td> <td style="width: 10%;"></td> <td style="width: 10%;"></td> <td style="width: 10%;"></td> <td style="width: 10%;"></td> <td style="width: 10%;"></td> <td style="width: 10%;"></td> <td style="width: 10%;"></td> </tr> <tr> <td></td> <td></td> <td colspan="8" style="text-align: center;"> <table border="1" style="width: 100%; border-collapse: collapse; text-align: center;"> <tr> <td style="width: 10%;"></td> <td style="width: 10%;"></td> <td style="width: 10%;"></td> <td style="width: 10%;"></td> <td style="width: 10%;"></td> <td style="width: 10%;"></td> <td style="width: 10%;"></td> <td style="width: 10%;"></td> <td style="width: 10%;"></td> <td style="width: 10%;"></td> </tr> <tr> <td></td> <td></td> <td colspan="8" style="text-align: center;"> <table border="1" style="width: 100%; border-collapse: collapse; text-align: center;"> <tr> <td style="width: 10%;"></td> <td style="width: 10%;"></td> <td style="width: 10%;"></td> <td style="width: 10%;"></td> <td style="width: 10%;"></td> <td style="width: 10%;"></td> <td style="width: 10%;"></td> <td style="width: 10%;"></td> <td style="width: 10%;"></td> <td style="width: 10%;"></td> </tr> <tr> <td></td> <td></td> <td colspan="8" style="text-align: center;"> <table border="1" style="width: 100%; border-collapse: collapse; text-align: center;"> <tr> <td style="width: 10%;"></td> <td style="width: 10%;"></td> <td style="width: 10%;"></td> <td style="width: 10%;"></td>
<td style="width: 10%;"></td> <td style="width: 10%;"></td> <td style="width: 10%;"></td> <td style="width: 10%;"></td> <td style="width: 10%;"></td> <td style="width: 10%;"></td> </tr> <tr> <td></td> <td></td> <td colspan="8" style="text-align: center;"> <table border="1" style="width: 100%; border-collapse: collapse; text-align: center;"> <tr> <td style="width: 10%;"></td> <td style="width: 10%;"></td> <td style="width: 10%;"></td> <td style="width: 10%;"></td> <td style="width: 10%;"></td> <td style="width: 10%;"></td> <td style="width: 10%;"></td> <td style="width: 10%;"></td> <td style="width: 10%;"></td> <td style="width: 10%;"></td> </tr> <tr> <td></td> <td></td> <td colspan="8" style="text-align: center;"> <table border="1" style="width: 100%; border-collapse: collapse; text-align: center;"> <tr> </tr></table></td></tr></table></td></tr></table></td></tr></table></td></tr></table></td></tr></table></td></tr></table></td></tr></table></td></tr></table></td></tr></table></td></tr></table></td></tr></table></td></tr></table></td></tr></table></td></tr></table></td></tr></table></td></tr></table></td></tr></table></td></tr></table></td></tr></table></td></tr></table></td></tr></table> | | | | | | | | | | | | | | | | | | | | <table border="1" style="width: 100%; border-collapse: collapse; text-align: center;"> <tr> <td style="width: 10%;"></td> <td style="width: 10%;"></td> <td style="width: 10%;"></td> <td style="width: 10%;"></td> <td style="width: 10%;"></td> <td style="width: 10%;"></td> <td style="width: 10%;"></td> <td style="width: 10%;"></td> <td style="width: 10%;"></td> <td style="width: 10%;"></td> </tr> <tr> <td></td> <td></td> <td colspan="8" style="text-align: center;"> <table border="1" style="width: 100%; border-collapse: collapse; text-align: center;"> <tr> <td style="width: 10%;"></td> <td style="width: 10%;"></td> <td style="width: 10%;"></td> <td style="width: 10%;"></td> <td style="width: 10%;"></td> <td style="width: 10%;"></td> <td style="width: 10%;"></td> <td style="width: 10%;"></td> <td style="width: 10%;"></td> <td style="width: 10%;"></td> </tr> <tr> <td></td> <td></td> <td colspan="8" style="text-align: center;"> <table border="1" style="width: 100%; border-collapse: collapse; text-align: center;"> <tr> <td style="width: 10%;"></td> <td style="width: 10%;"></td> <td style="width: 10%;"></td> <td style="width: 10%;"></td> <td style="width: 10%;"></td> <td style="width: 10%;"></td> <td style="width: 10%;"></td> <td style="width: 10%;"></td> <td style="width: 10%;"></td> <td style="width: 10%;"></td> </tr> <tr> <td></td> <td></td> <td colspan="8" style="text-align: center;"> <table border="1" style="width: 100%; border-collapse: collapse; text-align: center;"> <tr> <td style="width: 10%;"></td> <td style="width: 10%;"></td> <td style="width: 10%;"></td> <td style="width: 10%;"></td> <td style="width: 10%;"></td> <td style="width: 10%;"></td> <td style="width: 10%;"></td> <td style="width: 10%;"></td> <td style="width: 10%;"></td> <td style="width: 10%;"></td> </tr> <tr> <td></td> <td></td> <td colspan="8" style="text-align: center;"> <table border="1" style="width: 100%; border-collapse: collapse; text-align: center;"> <tr> <td style="width: 10%;"></td> <td style="width: 10%;"></td> <td style="width: 10%;"></td> <td style="width: 10%;"></td> <td style="width: 10%;"></td> <td style="width: 10%;"></td> <td style="width: 10%;"></td> <td style="width: 10%;"></td> <td style="width: 10%;"></td> <td style="width: 10%;"></td> </tr> <tr> <td></td> <td></td> <td colspan="8" style="text-align: center;"> <table border="1" style="width: 100%; border-collapse: collapse; text-align: center;"> <tr> <td style="width: 10%;"></td> <td style="width: 10%;"></td> <td style="width: 10%;"></td> <td style="width: 10%;"></td> <td style="width: 10%;"></td> <td style="width: 10%;"></td> <td style="width: 10%;"></td> <td style="width: 10%;"></td> <td style="width: 10%;"></td> <td style="width: 10%;"></td> </tr> <tr> <td></td> <td></td> <td colspan="8" style="text-align: center;"> <table border="1" style="width: 100%; border-collapse: collapse; text-align: center;"> <tr> <td style="width: 10%;"></td> <td style="width: 10%;"></td> <td style="width: 10%;"></td> <td style="width: 10%;"></td> <td style="width: 10%;"></td> <td style="width: 10%;"></td> <td style="width: 10%;"></td> <td style="width: 10%;"></td> <td style="width: 10%;"></td> <td style="width: 10%;"></td> </tr> <tr> <td></td> <td></td> <td colspan="8" style="text-align: center;"> <table border="1" style="width: 100%; border-collapse: collapse; text-align: center;"> <tr> <td style="width: 10%;"></td> <td style="width: 10%;"></td> <td style="width: 10%;"></td> <td style="width: 10%;"></td> <td style="width: 10%;"></td> <td style="width: 10%;"></td> <td style="width: 10%;"></td> <td style="width: 10%;"></td> <td style="width: 10%;"></td> <td style="width: 10%;"></td> </tr> <tr> <td></td> <td></td> <td colspan="8" style="text-align: center;"> <table border="1" style="width: 100%; border-collapse: collapse; text-align: center;"> <tr> <td style="width: 10%;"></td> <td style="width: 10%;"></td> <td style="width: 10%;"></td> <td style="width: 10%;"></td> <td style="width: 10%;"></td> <td style="width: 10%;"></td> <td style="width: 10%;"></td> <td style="width: 10%;"></td> <td style="width: 10%;"></td> <td style="width: 10%;"></td> </tr> <tr> <td></td> <td></td> <td colspan="8" style="text-align: center;"> <table border="1" style="width: 100%; border-collapse: collapse; text-align: center;"> <tr> <td style="width: 10%;"></td> <td style="width: 10%;"></td> <td style="width: 10%;"></td> <td style="width: 10%;"></td> <td style="width: 10%;"></td> <td style="width: 10%;"></td> <td style="width: 10%;"></td> <td style="width: 10%;"></td> <td style="width: 10%;"></td> <td style="width: 10%;"></td> </tr> <tr> <td></td> <td></td> <td colspan="8" style="text-align: center;"> <table border="1" style="width: 100%; border-collapse: collapse; text-align: center;"> <tr> <td style="width: 10%;"></td> <td style="width: 10%;"></td> <td style="width: 10%;"></td> <td style="width: 10%;"></td> <td style="width: 10%;"></td> <td style="width: 10%;"></td> <td style="width: 10%;"></td> <td style="width: 10%;"></td> <td style="width: 10%;"></td> <td style="width: 10%;"></td> </tr> <tr> <td></td> <td></td> <td colspan="8" style="text-align: center;"> <table border="1" style="width: 100%; border-collapse: collapse; text-align: center;"> <tr> <td style="width: 10%;"></td> <td style="width: 10%;"></td> <td style="width: 10%;"></td>
<td style="width: 10%;"></td> <td style="width: 10%;"></td> <td style="width: 10%;"></td> <td style="width: 10%;"></td> <td style="width: 10%;"></td> <td style="width: 10%;"></td> <td style="width: 10%;"></td> </tr> <tr> <td></td> <td></td> <td colspan="8" style="text-align: center;"> <table border="1" style="width: 100%; border-collapse: collapse; text-align: center;"> <tr> <td style="width: 10%;"></td> <td style="width: 10%;"></td> <td style="width: 10%;"></td> <td style="width: 10%;"></td> <td style="width: 10%;"></td> <td style="width: 10%;"></td> <td style="width: 10%;"></td> <td style="width: 10%;"></td> <td style="width: 10%;"></td> <td style="width: 10%;"></td> </tr> <tr> <td></td> <td></td> <td colspan="8" style="text-align: center;"> <table border="1" style="width: 100%; border-collapse: collapse; text-align: center;"> <tr> <td style="width: 10%;"></td> <td style="width: 10%;"></td> <td style="width: 10%;"></td> <td style="width: 10%;"></td> <td style="width: 10%;"></td> <td style="width: 10%;"></td> <td style="width: 10%;"></td> <td style="width: 10%;"></td> <td style="width: 10%;"></td> <td style="width: 10%;"></td> </tr> <tr> <td></td> <td></td> <td colspan="8" style="text-align: center;"> <table border="1" style="width: 100%; border-collapse: collapse; text-align: center;"> <tr> <td style="width: 10%;"></td> <td style="width: 10%;"></td> <td style="width: 10%;"></td> <td style="width: 10%;"></td> <td style="width: 10%;"></td> <td style="width: 10%;"></td> <td style="width: 10%;"></td> <td style="width: 10%;"></td> <td style="width: 10%;"></td> <td style="width: 10%;"></td> </tr> <tr> <td></td> <td></td> <td colspan="8" style="text-align: center;"> <table border="1" style="width: 100%; border-collapse: collapse; text-align: center;"> <tr> <td style="width: 10%;"></td> <td style="width: 10%;"></td> <td style="width: 10%;"></td> <td style="width: 10%;"></td> <td style="width: 10%;"></td> <td style="width: 10%;"></td> <td style="width: 10%;"></td> <td style="width: 10%;"></td> <td style="width: 10%;"></td> <td style="width: 10%;"></td> </tr> <tr> <td></td> <td></td> <td colspan="8" style="text-align: center;"> <table border="1" style="width: 100%; border-collapse: collapse; text-align: center;"> <tr> <td style="width: 10%;"></td> <td style="width: 10%;"></td> <td style="width: 10%;"></td> <td style="width: 10%;"></td> <td style="width: 10%;"></td> <td style="width: 10%;"></td> <td style="width: 10%;"></td> <td style="width: 10%;"></td> <td style="width: 10%;"></td> <td style="width: 10%;"></td> </tr> <tr> <td></td> <td></td> <td colspan="8" style="text-align: center;"> <table border="1" style="width: 100%; border-collapse: collapse; text-align: center;"> <tr> <td style="width: 10%;"></td> <td style="width: 10%;"></td> <td style="width: 10%;"></td> <td style="width: 10%;"></td> <td style="width: 10%;"></td> <td style="width: 10%;"></td> <td style="width: 10%;"></td> <td style="width: 10%;"></td> <td style="width: 10%;"></td> <td style="width: 10%;"></td> </tr> <tr> <td></td> <td></td> <td colspan="8" style="text-align: center;"> <table border="1" style="width: 100%; border-collapse: collapse; text-align: center;"> <tr> <td style="width: 10%;"></td> <td style="width: 10%;"></td> <td style="width: 10%;"></td> <td style="width: 10%;"></td> <td style="width: 10%;"></td> <td style="width: 10%;"></td> <td style="width: 10%;"></td> <td style="width: 10%;"></td> <td style="width: 10%;"></td> <td style="width: 10%;"></td> </tr> <tr> <td></td> <td></td> <td colspan="8" style="text-align: center;"> <table border="1" style="width: 100%; border-collapse: collapse; text-align: center;"> <tr> <td style="width: 10%;"></td> <td style="width: 10%;"></td> <td style="width: 10%;"></td> <td style="width: 10%;"></td> <td style="width: 10%;"></td> <td style="width: 10%;"></td> <td style="width: 10%;"></td> <td style="width: 10%;"></td> <td style="width: 10%;"></td> <td style="width: 10%;"></td> </tr> <tr> <td></td> <td></td> <td colspan="8" style="text-align: center;"> <table border="1" style="width: 100%; border-collapse: collapse; text-align: center;"> <tr> </tr></table></td></tr></table></td></tr></table></td></tr></table></td></tr></table></td></tr></table></td></tr></table></td></tr></table></td></tr></table></td></tr></table></td></tr></table></td></tr></table></td></tr></table></td></tr></table></td></tr></table></td></tr></table></td></tr></table></td></tr></table></td></tr></table></td></tr></table></td></tr></table> | | | | | | | | | | | | | | | | | | | | <table border="1" style="width: 100%; border-collapse: collapse; text-align: center;"> <tr> <td style="width: 10%;"></td> <td style="width: 10%;"></td> <td style="width: 10%;"></td> <td style="width: 10%;"></td> <td style="width: 10%;"></td> <td style="width: 10%;"></td> <td style="width: 10%;"></td> <td style="width: 10%;"></td> <td style="width: 10%;"></td> <td style="width: 10%;"></td> </tr> <tr> <td></td> <td></td> <td colspan="8" style="text-align: center;"> <table border="1" style="width: 100%; border-collapse: collapse; text-align: center;"> <tr> <td style="width: 10%;"></td> <td style="width: 10%;"></td> <td style="width: 10%;"></td> <td style="width: 10%;"></td> <td style="width: 10%;"></td> <td style="width: 10%;"></td> <td style="width: 10%;"></td> <td style="width: 10%;"></td> <td style="width: 10%;"></td> <td style="width: 10%;"></td> </tr> <tr> <td></td> <td></td> <td colspan="8" style="text-align: center;"> <table border="1" style="width: 100%; border-collapse: collapse; text-align: center;"> <tr> <td style="width: 10%;"></td> <td style="width: 10%;"></td> <td style="width: 10%;"></td> <td style="width: 10%;"></td> <td style="width: 10%;"></td> <td style="width: 10%;"></td> <td style="width: 10%;"></td> <td style="width: 10%;"></td> <td style="width: 10%;"></td> <td style="width: 10%;"></td> </tr> <tr> <td></td> <td></td> <td colspan="8" style="text-align: center;"> <table border="1" style="width: 100%; border-collapse: collapse; text-align: center;"> <tr> <td style="width: 10%;"></td> <td style="width: 10%;"></td> <td style="width: 10%;"></td> <td style="width: 10%;"></td> <td style="width: 10%;"></td> <td style="width: 10%;"></td> <td style="width: 10%;"></td> <td style="width: 10%;"></td> <td style="width: 10%;"></td> <td style="width: 10%;"></td> </tr> <tr> <td></td> <td></td> <td colspan="8" style="text-align: center;"> <table border="1" style="width: 100%; border-collapse: collapse; text-align: center;"> <tr> <td style="width: 10%;"></td> <td style="width: 10%;"></td> <td style="width:
10%;"></td> <td style="width: 10%;"></td> <td style="width: 10%;"></td> <td style="width: 10%;"></td> <td style="width: 10%;"></td> <td style="width: 10%;"></td> <td style="width: 10%;"></td> <td style="width: 10%;"></td> </tr> <tr> <td></td> <td></td> <td colspan="8" style="text-align: center;"> <table border="1" style="width: 100%; border-collapse: collapse; text-align: center;"> <tr> <td style="width: 10%;"></td> <td style="width: 10%;"></td> <td style="width: 10%;"></td> <td style="width: 10%;"></td> <td style="width: 10%;"></td> <td style="width: 10%;"></td> <td style="width: 10%;"></td> <td style="width: 10%;"></td> <td style="width: 10%;"></td> <td style="width: 10%;"></td> </tr> <tr> <td></td> <td></td> <td colspan="8" style="text-align: center;"> <table border="1" style="width: 100%; border-collapse: collapse; text-align: center;"> <tr> <td style="width: 10%;"></td> <td style="width: 10%;"></td> <td style="width: 10%;"></td> <td style="width: 10%;"></td> <td style="width: 10%;"></td> <td style="width: 10%;"></td> <td style="width: 10%;"></td> <td style="width: 10%;"></td> <td style="width: 10%;"></td> <td style="width: 10%;"></td> </tr> <tr> <td></td> <td></td> <td colspan="8" style="text-align: center;"> <table border="1" style="width: 100%; border-collapse: collapse; text-align: center;"> <tr> <td style="width: 10%;"></td> <td style="width: 10%;"></td> <td style="width: 10%;"></td> <td style="width: 10%;"></td> <td style="width: 10%;"></td> <td style="width: 10%;"></td> <td style="width: 10%;"></td> <td style="width: 10%;"></td> <td style="width: 10%;"></td> <td style="width: 10%;"></td> </tr> <tr> <td></td> <td></td> <td colspan="8" style="text-align: center;"> <table border="1" style="width: 100%; border-collapse: collapse; text-align: center;"> <tr> <td style="width: 10%;"></td> <td style="width: 10%;"></td> <td style="width: 10%;"></td> <td style="width: 10%;"></td> <td style="width: 10%;"></td> <td style="width: 10%;"></td> <td style="width: 10%;"></td> <td style="width: 10%;"></td> <td style="width: 10%;"></td> <td style="width: 10%;"></td> </tr> <tr> <td></td> <td></td> <td colspan="8" style="text-align: center;"> <table border="1" style="width: 100%; border-collapse: collapse; text-align: center;"> <tr> <td style="width: 10%;"></td> <td style="width: 10%;"></td> <td style="width: 10%;"></td> <td style="width: 10%;"></td> <td style="width: 10%;"></td> <td style="width: 10%;"></td> <td style="width: 10%;"></td> <td style="width: 10%;"></td> <td style="width: 10%;"></td> <td style="width: 10%;"></td> </tr> <tr> <td></td> <td></td> <td colspan="8" style="text-align: center;"> <table border="1" style="width: 100%; border-collapse: collapse; text-align: center;"> <tr> <td style="width: 10%;"></td> <td style="width: 10%;"></td> <td style="width: 10%;"></td> <td style="width: 10%;"></td> <td style="width: 10%;"></td> <td style="width: 10%;"></td> <td style="width: 10%;"></td> <td style="width: 10%;"></td> <td style="width: 10%;"></td> <td style="width: 10%;"></td> </tr> <tr> <td></td> <td></td> <td colspan="8" style="text-align: center;"> <table border="1" style="width: 100%; border-collapse: collapse; text-align: center;"> <tr> <td style="width: 10%;"></td> <td style="width: 10%;"></td> <td style="width: 10%;"></td> <td style="width: 10%;"></td> <td style="width: 10%;"></td> <td style="width: 10%;"></td> <td style="width: 10%;"></td> <td style="width: 10%;"></td> <td style="width: 10%;"></td> <td style="width: 10%;"></td> </tr> <tr> <td></td> <td></td> <td colspan="8" style="text-align: center;"> <table border="1" style="width: 100%; border-collapse: collapse; text-align: center;"> <tr> <td style="width: 10%;"></td> <td style="width: 10%;"></td> <td style="width: 10%;"></td> <td style="width: 10%;"></td> <td style="width: 10%;"></td> <td style="width: 10%;"></td> <td style="width: 10%;"></td> <td style="width: 10%;"></td> <td style="width: 10%;"></td> <td style="width: 10%;"></td> </tr> <tr> <td></td> <td></td> <td colspan="8" style="text-align: center;"> <table border="1" style="width: 100%; border-collapse: collapse; text-align: center;"> <tr> <td style="width: 10%;"></td> <td style="width: 10%;"></td> <td style="width: 10%;"></td> <td style="width: 10%;"></td> <td style="width: 10%;"></td> <td style="width: 10%;"></td> <td style="width: 10%;"></td> <td style="width: 10%;"></td> <td style="width: 10%;"></td> <td style="width: 10%;"></td> </tr> <tr> <td></td> <td></td> <td colspan="8" style="text-align: center;"> <table border="1" style="width: 100%; border-collapse: collapse; text-align: center;"> <tr> <td style="width: 10%;"></td> <td style="width: 10%;"></td> <td style="width: 10%;"></td> <td style="width: 10%;"></td> <td style="width: 10%;"></td> <td style="width: 10%;"></td> <td style="width: 10%;"></td> <td style="width: 10%;"></td> <td style="width: 10%;"></td> <td style="width: 10%;"></td> </tr> <tr> <td></td> <td></td> <td colspan="8" style="text-align: center;"> <table border="1" style="width: 100%; border-collapse: collapse; text-align: center;"> <tr> <td style="width: 10%;"></td> <td style="width: 10%;"></td> <td style="width: 10%;"></td> <td style="width: 10%;"></td> <td style="width: 10%;"></td> <td style="width: 10%;"></td> <td style="width: 10%;"></td> <td style="width: 10%;"></td> <td style="width: 10%;"></td> <td style="width: 10%;"></td> </tr> <tr> <td></td> <td></td> <td colspan="8" style="text-align: center;"> <table border="1" style="width: 100%; border-collapse: collapse; text-align: center;"> <tr> <td style="width: 10%;"></td> <td style="width: 10%;"></td> <td style="width: 10%;"></td> <td style="width: 10%;"></td> <td style="width: 10%;"></td> <td style="width: 10%;"></td> <td style="width: 10%;"></td> <td style="width: 10%;"></td> <td style="width: 10%;"></td> <td style="width: 10%;"></td> </tr> <tr> <td></td> <td></td> <td colspan="8" style="text-align: center;"> <table border="1" style="width: 100%; border-collapse: collapse; text-align: center;"> <tr> <td style="width: 10%;"></td> <td style="width: 10%;"></td> <td style="width: 10%;"></td> <td style="width: 10%;"></td> <td style="width: 10%;"></td> <td style="width: 10%;"></td> <td style="width: 10%;"></td> <td style="width: 10%;"></td> <td style="width: 10%;"></td> <td style="width: 10%;"></td> </tr> <tr> <td></td> <td></td> <td colspan="8" style="text-align: center;"> <table border="1" style="width: 100%; border-collapse: collapse; text-align: center;"> <tr> <td style="width: 10%;"></td> <td style="width: 10%;"></td> <td style="width: 10%;"></td> <td style="width: 10%;"></td> <td style="width: 10%;"></td> <td style="width: 10%;"></td> <td style="width: 10%;"></td> <td style="width: 10%;"></td> <td style="width: 10%;"></td> <td style="width: 10%;"></td> </tr> <tr> <td></td> <td></td> <td colspan="8" style="text-align: center;"> <table border="1" style="width: 100%; border-collapse: collapse; text-align: center;"> <tr> </tr></table></td></tr></table></td></tr></table></td></tr></table></td></tr></table></td></tr></table></td></tr></table></td></tr></table></td></tr></table></td></tr></table></td></tr></table></td></tr></table></td></tr></table></td></tr></table></td></tr></table></td></tr></table></td></tr></table></td></tr></table></td></tr></table></td></tr></table>
 | | | | | | | | | | | | | | | | | | | | <table border="1" style="width: 100%; border-collapse: collapse; text-align: center;"> <tr> <td style="width: 10%;"></td> <td style="width: 10%;"></td> <td style="width: 10%;"></td> <td style="width: 10%;"></td> <td style="width: 10%;"></td> <td style="width: 10%;"></td> <td style="width: 10%;"></td> <td style="width: 10%;"></td> <td style="width: 10%;"></td> <td style="width: 10%;"></td> </tr> <tr> <td></td> <td></td> <td colspan="8" style="text-align: center;"> <table border="1" style="width: 100%; border-collapse: collapse; text-align: center;"> <tr> <td style="width: 10%;"></td> <td style="width: 10%;"></td> <td style="width: 10%;"></td> <td style="width: 10%;"></td> <td style="width: 10%;"></td> <td style="width: 10%;"></td> <td style="width: 10%;"></td> <td style="width: 10%;"></td> <td style="width: 10%;"></td> <td style="width: 10%;"></td> </tr> <tr> <td></td> <td></td> <td colspan="8" style="text-align: center;"> <table border="1" style="width: 100%; border-collapse: collapse; text-align: center;"> <tr> <td style="width: 10%;"></td> <td style="width: 10%;"></td> <td style="width: 10%;"></td> <td style="width: 10%;"></td> <td style="width: 10%;"></td> <td style="width: 10%;"></td> <td style="width: 10%;"></td> <td style="width: 10%;"></td> <td style="width: 10%;"></td> <td style="width: 10%;"></td> </tr> <tr> <td></td> <td></td> <td colspan="8" style="text-align: center;"> <table border="1" style="width: 100%; border-collapse: collapse; text-align: center;"> <tr> <td style="width: 10%;"></td> <td style="width: 10%;"></td> <td style="width: 10%;"></td> <td style="width: 10%;"></td> <td style="width: 10%;"></td> <td style="width: 10%;"></td> <td style="width: 10%;"></td> <td style="width: 10%;"></td> <td style="width: 10%;"></td> <td style="width: 10%;"></td> </tr> <tr> <td></td> <td></td> <td colspan="8" style="text-align: center;"> <table border="1" style="width: 100%; border-collapse: collapse; text-align: center;"> <tr> <td style="width: 10%;"></td> <td style="width: 10%;"></td> <td style="width: 10%;"></td> <td style="width: 10%;"></td> <td style="width: 10%;"></td> <td style="width: 10%;"></td> <td style="width: 10%;"></td> <td style="width: 10%;"></td> <td style="width: 10%;"></td> <td style="width: 10%;"></td> </tr> <tr> <td></td> <td></td> <td colspan="8" style="text-align: center;"> <table border="1" style="width: 100%; border-collapse: collapse; text-align: center;"> <tr> <td style="width: 10%;"></td> <td style="width: 10%;"></td> <td style="width: 10%;"></td> <td style="width: 10%;"></td> <td style="width: 10%;"></td> <td style="width: 10%;"></td> <td style="width: 10%;"></td> <td style="width: 10%;"></td> <td style="width: 10%;"></td> <td style="width: 10%;"></td> </tr> <tr> <td></td> <td></td> <td colspan="8" style="text-align: center;"> <table border="1" style="width: 100%; border-collapse: collapse; text-align: center;"> <tr> <td style="width: 10%;"></td> <td style="width: 10%;"></td> <td style="width: 10%;"></td> <td style="width: 10%;"></td> <td style="width: 10%;"></td> <td style="width: 10%;"></td> <td style="width: 10%;"></td> <td style="width: 10%;"></td> <td style="width: 10%;"></td> <td style="width: 10%;"></td> </tr> <tr> <td></td> <td></td> <td colspan="8" style="text-align: center;"> <table border="1" style="width: 100%; border-collapse: collapse; text-align: center;"> <tr> <td style="width: 10%;"></td> <td style="width: 10%;"></td> <td style="width: 10%;"></td> <td style="width: 10%;"></td> <td style="width: 10%;"></td> <td style="width: 10%;"></td> <td style="width: 10%;"></td> <td style="width: 10%;"></td> <td style="width: 10%;"></td> <td style="width: 10%;"></td> </tr> <tr> <td></td> <td></td> <td colspan="8" style="text-align: center;"> <table border="1" style="width: 100%; border-collapse: collapse; text-align: center;"> <tr> <td style="width: 10%;"></td> <td style="width: 10%;"></td> <td style="width: 10%;"></td> <td style="width: 10%;"></td> <td style="width: 10%;"></td> <td style="width: 10%;"></td> <td style="width: 10%;"></td> <td style="width: 10%;"></td> <td style="width: 10%;"></td> <td style="width: 10%;"></td> </tr> <tr> <td></td> <td></td> <td colspan="8" style="text-align: center;"> <table border="1" style="width: 100%; border-collapse: collapse; text-align: center;"> <tr> <td style="width: 10%;"></td> <td style="width: 10%;"></td> <td style="width: 10%;"></td> <td style="width: 10%;"></td> <td style="width: 10%;"></td> <td style="width: 10%;"></td> <td style="width: 10%;"></td> <td style="width: 10%;"></td> <td style="width: 10%;"></td> <td style="width: 10%;"></td> </tr> <tr> <td></td> <td></td> <td colspan="8" style="text-align: center;"> <table border="1" style="width: 100%; border-collapse: collapse; text-align: center;"> <tr> <td style="width: 10%;"></td> <td style="width: 10%;"></td> <td style="width: 10%;"></td> <td style="width: 10%;"></td> <td style="width: 10%;"></td> <td style="width: 10%;"></td> <td style="width: 10%;"></td> <td style="width: 10%;"></td> <td style="width: 10%;"></td> <td style="width: 10%;"></td> </tr> <tr> <td></td> <td></td> <td colspan="8" style="text-align: center;"> <table border="1" style="width: 100%; border-collapse: collapse; text-align: center;"> <tr> <td style="width: 10%;"></td> <td style="width: 10%;"></td> <td style="width: 10%;"></td> <td style="width: 10%;"></td> <td style="width: 10%;"></td> <td style="width: 10%;"></td> <td style="width: 10%;"></td> <td style="width: 10%;"></td> <td style="width: 10%;"></td> <td style="width: 10%;"></td> </tr> <tr> <td></td> <td></td> <td colspan="8" style="text-align: center;"> <table border="1" style="width: 100%; border-collapse: collapse; text-align: center;"> <tr> <td style="width: 10%;"></td> <td style="width: 10%;"></td> <td style="width: 10%;"></td> <td style="width: 10%;"></td> <td style="width: 10%;"></td> <td style="width: 10%;"></td> <td style="width: 10%;"></td> <td style="width: 10%;"></td> <td style="width: 10%;"></td> <td style="width: 10%;"></td> </tr> <tr> <td></td> <td></td> <td colspan="8" style="text-align: center;"> <table border="1" style="width: 100%; border-collapse: collapse; text-align: center;"> <tr> <td style="width: 10%;"></td> <td style="width: 10%;"></td> <td style="width: 10%;"></td> <td style="width: 10%;"></td> <td style="width: 10%;"></td> <td style="width: 10%;"></td> <td style="width: 10%;"></td> <td style="width: 10%;"></td> <td style="width: 10%;"></td> <td style="width: 10%;"></td> </tr> <tr> <td></td> <td></td> <td colspan="8" style="text-align: center;"> <table border="1" style="width: 100%; border-collapse: collapse; text-align: center;"> <tr> <td style="width: 10%;"></td> <td style="width: 10%;"></td> <td style="width: 10%;"></td> <td style="width: 10%;"></td> <td style="width: 10%;"></td> <td style="width: 10%;"></td> <td style="width: 10%;"></td> <td style="width: 10%;"></td> <td style="width: 10%;"></td> <td style="width: 10%;"></td> </tr> <tr> <td></td> <td></td> <td colspan="8" style="text-align: center;"> <table border="1" style="width: 100%; border-collapse: collapse; text-align: center;"> <tr> <td style="width: 10%;"></td> <td style="width: 10%;"></td> <td style="width: 10%;"></td> <td style="width: 10%;"></td> <td style="width: 10%;"></td> <td style="width: 10%;"></td> <td style="width: 10%;"></td> <td style="width: 10%;"></td> <td style="width: 10%;"></td> <td style="width: 10%;"></td> </tr> <tr> <td></td> <td></td> <td colspan="8" style="text-align: center;"> <table border="1" style="width: 100%; border-collapse: collapse; text-align: center;"> <tr> <td style="width: 10%;"></td> <td style="width: 10%;"></td> <td style="width: 10%;"></td> <td style="width: 10%;"></td> <td style="width: 10%;"></td> <td style="width: 10%;"></td> <td style="width: 10%;"></td> <td style="width: 10%;"></td> <td style="width: 10%;"></td> <td style="width: 10%;"></td> </tr> <tr> <td></td> <td></td> <td colspan="8" style="text-align: center;"> <table border="1" style="width: 100%; border-collapse: collapse; text-align: center;"> <tr> <td style="width: 10%;"></td> <td style="width: 10%;"></td> <td style="width: 10%;"></td> <td style="width: 10%;"></td> <td style="width: 10%;"></td> <td style="width: 10%;"></td> <td style="width: 10%;"></td> <td style="width: 10%;"></td> <td style="width: 10%;"></td> <td style="width: 10%;"></td> </tr> <tr> <td></td> <td></td> <td colspan="8" style="text-align: center;"> <table border="1" style="width: 100%; border-collapse: collapse; text-align: center;"> <tr> </tr></table></td></tr></table></td></tr></table></td></tr></table></td></tr></table></td></tr></table></td></tr></table></td></tr></table></td></tr></table></td></tr></table></td></tr></table></td></tr></table></td></tr></table></td></tr></table></td></tr></table></td></tr></table></td></tr></table></td></tr></table></td></tr></table>
 | | | | | | | | | | | | | | | | | | | | <table border="1" style="width: 100%; border-collapse: collapse; text-align: center;"> <tr> <td style="width: 10%;"></td> <td style="width: 10%;"></td> <td style="width: 10%;"></td> <td style="width: 10%;"></td> <td style="width: 10%;"></td> <td style="width: 10%;"></td> <td style="width: 10%;"></td> <td style="width: 10%;"></td> <td style="width: 10%;"></td> <td style="width: 10%;"></td> </tr> <tr> <td></td> <td></td> <td colspan="8" style="text-align: center;"> <table border="1" style="width: 100%; border-collapse: collapse; text-align: center;"> <tr> <td style="width: 10%;"></td> <td style="width: 10%;"></td> <td style="width: 10%;"></td> <td style="width: 10%;"></td> <td style="width: 10%;"></td> <td style="width: 10%;"></td> <td style="width: 10%;"></td> <td style="width: 10%;"></td> <td style="width: 10%;"></td> <td style="width: 10%;"></td> </tr> <tr> <td></td> <td></td> <td colspan="8" style="text-align: center;"> <table border="1" style="width: 100%; border-collapse: collapse; text-align: center;"> <tr> <td style="width: 10%;"></td> <td style="width: 10%;"></td> <td style="width: 10%;"></td> <td style="width: 10%;"></td> <td style="width: 10%;"></td> <td style="width: 10%;"></td> <td style="width: 10%;"></td> <td style="width: 10%;"></td> <td style="width: 10%;"></td> <td style="width: 10%;"></td> </tr> <tr> <td></td> <td></td> <td colspan="8" style="text-align: center;"> <table border="1" style="width: 100%; border-collapse: collapse; text-align: center;"> <tr> <td style="width: 10%;"></td> <td style="width: 10%;"></td> <td style="width: 10%;"></td> <td style="width: 10%;"></td> <td style="width: 10%;"></td> <td style="width: 10%;"></td> <td style="width: 10%;"></td> <td style="width: 10%;"></td> <td style="width: 10%;"></td> <td style="width: 10%;"></td> </tr> <tr> <td></td> <td></td> <td colspan="8" style="text-align: center;"> <table border="1" style="width: 100%; border-collapse: collapse; text-align: center;"> <tr> <td style="width: 10%;"></td> <td style="width: 10%;"></td> <td style="width: 10%;"></td> <td style="width: 10%;"></td> <td style="width: 10%;"></td> <td style="width: 10%;"></td> <td style="width: 10%;"></td> <td style="width: 10%;"></td> <td style="width: 10%;"></td> <td style="width: 10%;"></td> </tr> <tr> <td></td> <td></td> <td colspan="8" style="text-align: center;"> <table border="1" style="width: 100%; border-collapse: collapse; text-align: center;"> <tr> <td style="width: 10%;"></td> <td style="width: 10%;"></td> <td style="width: 10%;"></td> <td style="width: 10%;"></td> <td style="width: 10%;"></td> <td style="width: 10%;"></td> <td style="width: 10%;"></td> <td style="width: 10%;"></td> <td style="width: 10%;"></td> <td style="width: 10%;"></td> </tr> <tr> <td></td> <td></td> <td colspan="8" style="text-align: center;"> <table border="1" style="width: 100%; border-collapse: collapse; text-align: center;"> <tr> <td style="width: 10%;"></td> <td style="width: 10%;"></td> <td style="width: 10%;"></td> <td style="width: 10%;"></td> <td style="width: 10%;"></td> <td style="width: 10%;"></td> <td style="width: 10%;"></td> <td style="width: 10%;"></td> <td style="width: 10%;"></td> <td style="width: 10%;"></td> </tr> <tr> <td></td> <td></td> <td colspan="8" style="text-align: center;"> <table border="1" style="width: 100%; border-collapse: collapse; text-align: center;"> <tr> <td style="width: 10%;"></td> <td style="width: 10%;"></td> <td style="width: 10%;"></td> <td style="width: 10%;"></td> <td style="width: 10%;"></td> <td style="width: 10%;"></td> <td style="width: 10%;"></td> <td style="width: 10%;"></td> <td style="width: 10%;"></td> <td style="width: 10%;"></td> </tr> <tr> <td></td> <td></td> <td colspan="8" style="text-align: center;"> <table border="1" style="width: 100%; border-collapse: collapse; text-align: center;"> <tr> <td style="width: 10%;"></td> <td style="width: 10%;"></td> <td style="width: 10%;"></td> <td style="width: 10%;"></td> <td style="width: 10%;"></td> <td style="width: 10%;"></td> <td style="width: 10%;"></td> <td style="width: 10%;"></td> <td style="width: 10%;"></td> <td style="width: 10%;"></td> </tr> <tr> <td></td> <td></td> <td colspan="8" style="text-align: center;"> <table border="1" style="width: 100%; border-collapse: collapse; text-align: center;"> <tr> <td style="width: 10%;"></td> <td style="width: 10%;"></td> <td style="width: 10%;"></td> <td style="width: 10%;"></td> <td style="width: 10%;"></td> <td style="width: 10%;"></td> <td style="width: 10%;"></td> <td style="width: 10%;"></td> <td style="width: 10%;"></td> <td style="width: 10%;"></td> </tr> <tr> <td></td> <td></td> <td colspan="8" style="text-align: center;"> <table border="1" style="width: 100%; border-collapse: collapse; text-align: center;"> <tr> <td style="width: 10%;"></td> <td style="width: 10%;"></td> <td style="width: 10%;"></td> <td style="width: 10%;"></td> <td style="width: 10%;"></td> <td style="width: 10%;"></td> <td style="width: 10%;"></td> <td style="width: 10%;"></td> <td style="width: 10%;"></td> <td style="width: 10%;"></td> </tr> <tr> <td></td> <td></td> <td colspan="8" style="text-align: center;"> <table border="1" style="width: 100%; border-collapse: collapse; text-align: center;"> <tr> <td style="width: 10%;"></td> <td style="width: 10%;"></td> <td style="width: 10%;"></td> <td style="width: 10%;"></td> <td style="width: 10%;"></td> <td style="width: 10%;"></td> <td style="width: 10%;"></td> <td style="width: 10%;"></td> <td style="width: 10%;"></td> <td style="width: 10%;"></td> </tr> <tr> <td></td> <td></td> <td colspan="8" style="text-align: center;"> <table border="1" style="width: 100%; border-collapse: collapse; text-align: center;"> <tr> <td style="width: 10%;"></td> <td style="width: 10%;"></td> <td style="width: 10%;"></td> <td style="width: 10%;"></td> <td style="width: 10%;"></td> <td style="width: 10%;"></td> <td style="width: 10%;"></td> <td style="width: 10%;"></td> <td style="width: 10%;"></td> <td style="width: 10%;"></td> </tr> <tr> <td></td> <td></td> <td colspan="8" style="text-align: center;"> <table border="1" style="width: 100%; border-collapse: collapse; text-align: center;"> <tr> <td style="width: 10%;"></td> <td style="width: 10%;"></td> <td style="width: 10%;"></td> <td style="width: 10%;"></td> <td style="width: 10%;"></td> <td style="width: 10%;"></td> <td style="width: 10%;"></td> <td style="width: 10%;"></td> <td style="width: 10%;"></td> <td style="width: 10%;"></td> </tr> <tr> <td></td> <td></td> <td colspan="8" style="text-align: center;"> <table border="1" style="width: 100%; border-collapse: collapse; text-align: center;"> <tr> <td style="width: 10%;"></td> <td style="width: 10%;"></td> <td style="width: 10%;"></td> <td style="width: 10%;"></td> <td style="width: 10%;"></td> <td style="width: 10%;"></td> <td style="width: 10%;"></td> <td style="width: 10%;"></td> <td style="width: 10%;"></td> <td
style="width: 10%;"></td> </tr> <tr> <td></td> <td></td> <td colspan="8" style="text-align: center;"> <table border="1" style="width: 100%; border-collapse: collapse; text-align: center;"> <tr> <td style="width: 10%;"></td> <td style="width: 10%;"></td> <td style="width: 10%;"></td> <td style="width: 10%;"></td> <td style="width: 10%;"></td> <td style="width: 10%;"></td> <td style="width: 10%;"></td> <td style="width: 10%;"></td> <td style="width: 10%;"></td> <td style="width: 10%;"></td> </tr> <tr> <td></td> <td></td> <td colspan="8" style="text-align: center;"> <table border="1" style="width: 100%; border-collapse: collapse; text-align: center;"> <tr> <td style="width: 10%;"></td> <td style="width: 10%;"></td> <td style="width: 10%;"></td> <td style="width: 10%;"></td> <td style="width: 10%;"></td> <td style="width: 10%;"></td> <td style="width: 10%;"></td> <td style="width: 10%;"></td> <td style="width: 10%;"></td> <td style="width: 10%;"></td> </tr> <tr> <td></td> <td></td> <td colspan="8" style="text-align: center;"> <table border="1" style="width: 100%; border-collapse: collapse; text-align: center;"> <tr> </tr></table></td></tr></table></td></tr></table></td></tr></table></td></tr></table></td></tr></table></td></tr></table></td></tr></table></td></tr></table></td></tr></table></td></tr></table></td></tr></table></td></tr></table></td></tr></table></td></tr></table></td></tr></table></td></tr></table></td></tr></table> | | | | | | | | | | | | | | | | | | | | <table border="1" style="width: 100%; border-collapse: collapse; text-align: center;"> <tr> <td style="width: 10%;"></td> <td style="width: 10%;"></td> <td style="width: 10%;"></td> <td style="width: 10%;"></td> <td style="width: 10%;"></td> <td style="width: 10%;"></td> <td style="width: 10%;"></td> <td style="width: 10%;"></td> <td style="width: 10%;"></td> <td style="width: 10%;"></td> </tr> <tr> <td></td> <td></td> <td colspan="8" style="text-align: center;"> <table border="1" style="width: 100%; border-collapse: collapse; text-align: center;"> <tr> <td style="width: 10%;"></td> <td style="width: 10%;"></td> <td style="width: 10%;"></td> <td style="width: 10%;"></td> <td style="width: 10%;"></td> <td style="width: 10%;"></td> <td style="width: 10%;"></td> <td style="width: 10%;"></td> <td style="width: 10%;"></td> <td style="width: 10%;"></td> </tr> <tr> <td></td> <td></td> <td colspan="8" style="text-align: center;"> <table border="1" style="width: 100%; border-collapse: collapse; text-align: center;"> <tr> <td style="width: 10%;"></td> <td style="width: 10%;"></td> <td style="width: 10%;"></td> <td style="width: 10%;"></td> <td style="width: 10%;"></td> <td style="width: 10%;"></td> <td style="width: 10%;"></td> <td style="width: 10%;"></td> <td style="width: 10%;"></td> <td style="width: 10%;"></td> </tr> <tr> <td></td> <td></td> <td colspan="8" style="text-align: center;"> <table border="1" style="width: 100%; border-collapse: collapse; text-align: center;"> <tr> <td style="width: 10%;"></td> <td style="width: 10%;"></td> <td style="width: 10%;"></td> <td style="width: 10%;"></td> <td style="width: 10%;"></td> <td style="width: 10%;"></td> <td style="width: 10%;"></td> <td style="width: 10%;"></td> <td style="width: 10%;"></td> <td style="width: 10%;"></td> </tr> <tr> <td></td> <td></td> <td colspan="8" style="text-align: center;"> <table border="1" style="width: 100%; border-collapse: collapse; text-align: center;"> <tr> <td style="width: 10%;"></td> <td style="width: 10%;"></td> <td style="width: 10%;"></td> <td style="width: 10%;"></td> <td style="width: 10%;"></td> <td style="width: 10%;"></td> <td style="width: 10%;"></td> <td style="width: 10%;"></td> <td style="width: 10%;"></td> <td style="width: 10%;"></td> </tr> <tr> <td></td> <td></td> <td colspan="8" style="text-align: center;"> <table border="1" style="width: 100%; border-collapse: collapse; text-align: center;"> <tr> <td style="width: 10%;"></td> <td style="width: 10%;"></td> <td style="width: 10%;"></td> <td style="width: 10%;"></td> <td style="width: 10%;"></td> <td style="width: 10%;"></td> <td style="width: 10%;"></td> <td style="width: 10%;"></td> <td style="width: 10%;"></td> <td style="width: 10%;"></td> </tr> <tr> <td></td> <td></td> <td colspan="8" style="text-align: center;"> <table border="1" style="width: 100%; border-collapse: collapse; text-align: center;"> <tr> <td style="width: 10%;"></td> <td style="width: 10%;"></td> <td style="width: 10%;"></td> <td style="width: 10%;"></td> <td style="width: 10%;"></td> <td style="width: 10%;"></td> <td style="width: 10%;"></td> <td style="width: 10%;"></td> <td style="width: 10%;"></td> <td style="width: 10%;"></td> </tr> <tr> <td></td> <td></td> <td colspan="8" style="text-align: center;"> <table border="1" style="width: 100%; border-collapse: collapse; text-align: center;"> <tr> <td style="width: 10%;"></td> <td style="width: 10%;"></td> <td style="width: 10%;"></td> <td style="width: 10%;"></td> <td style="width: 10%;"></td> <td style="width: 10%;"></td> <td style="width: 10%;"></td> <td style="width: 10%;"></td> <td style="width: 10%;"></td> <td style="width: 10%;"></td> </tr> <tr> <td></td> <td></td> <td colspan="8" style="text-align: center;"> <table border="1" style="width: 100%; border-collapse: collapse; text-align: center;"> <tr> <td style="width: 10%;"></td> <td style="width: 10%;"></td> <td style="width: 10%;"></td> <td style="width: 10%;"></td> <td style="width: 10%;"></td> <td style="width: 10%;"></td> <td style="width: 10%;"></td> <td style="width: 10%;"></td> <td style="width: 10%;"></td> <td style="width: 10%;"></td> </tr> <tr> <td></td> <td></td> <td colspan="8" style="text-align: center;"> <table border="1" style="width: 100%; border-collapse: collapse; text-align: center;"> <tr> <td style="width: 10%;"></td> <td style="width: 10%;"></td> <td style="width: 10%;"></td> <td style="width: 10%;"></td> <td style="width: 10%;"></td> <td style="width: 10%;"></td> <td style="width: 10%;"></td> <td style="width: 10%;"></td> <td style="width: 10%;"></td> <td style="width: 10%;"></td> </tr> <tr> <td></td> <td></td> <td colspan="8" style="text-align: center;"> <table border="1" style="width: 100%; border-collapse: collapse; text-align: center;"> <tr> <td style="width: 10%;"></td> <td style="width: 10%;"></td> <td style="width: 10%;"></td> <td style="width: 10%;"></td> <td style="width: 10%;"></td> <td style="width: 10%;"></td> <td style="width: 10%;"></td> <td style="width: 10%;"></td> <td style="width: 10%;"></td> <td style="width: 10%;"></td> </tr> <tr>
<td></td> <td></td> <td colspan="8" style="text-align: center;"> <table border="1" style="width: 100%; border-collapse: collapse; text-align: center;"> <tr> <td style="width: 10%;"></td> <td style="width: 10%;"></td> <td style="width: 10%;"></td> <td style="width: 10%;"></td> <td style="width: 10%;"></td> <td style="width: 10%;"></td> <td style="width: 10%;"></td> <td style="width: 10%;"></td> <td style="width: 10%;"></td> <td style="width: 10%;"></td> </tr> <tr> <td></td> <td></td> <td colspan="8" style="text-align: center;"> <table border="1" style="width: 100%; border-collapse: collapse; text-align: center;"> <tr> <td style="width: 10%;"></td> <td style="width: 10%;"></td> <td style="width: 10%;"></td> <td style="width: 10%;"></td> <td style="width: 10%;"></td> <td style="width: 10%;"></td> <td style="width: 10%;"></td> <td style="width: 10%;"></td> <td style="width: 10%;"></td> <td style="width: 10%;"></td> </tr> <tr> <td></td> <td></td> <td colspan="8" style="text-align: center;"> <table border="1" style="width: 100%; border-collapse: collapse; text-align: center;"> <tr> <td style="width: 10%;"></td> <td style="width: 10%;"></td> <td style="width: 10%;"></td> <td style="width: 10%;"></td> <td style="width: 10%;"></td> <td style="width: 10%;"></td> <td style="width: 10%;"></td> <td style="width: 10%;"></td> <td style="width: 10%;"></td> <td style="width: 10%;"></td> </tr> <tr> <td></td> <td></td> <td colspan="8" style="text-align: center;"> <table border="1" style="width: 100%; border-collapse: collapse; text-align: center;"> <tr> <td style="width: 10%;"></td> <td style="width: 10%;"></td> <td style="width: 10%;"></td> <td style="width: 10%;"></td> <td style="width: 10%;"></td> <td style="width: 10%;"></td> <td style="width: 10%;"></td> <td style="width: 10%;"></td> <td style="width: 10%;"></td> <td style="width: 10%;"></td> </tr> <tr> <td></td> <td></td> <td colspan="8" style="text-align: center;"> <table border="1" style="width: 100%; border-collapse: collapse; text-align: center;"> <tr> <td style="width: 10%;"></td> <td style="width: 10%;"></td> <td style="width: 10%;"></td> <td style="width: 10%;"></td> <td style="width: 10%;"></td> <td style="width: 10%;"></td> <td style="width: 10%;"></td> <td style="width: 10%;"></td> <td style="width: 10%;"></td> <td style="width: 10%;"></td> </tr> <tr> <td></td> <td></td> <td colspan="8" style="text-align: center;"> <table border="1" style="width: 100%; border-collapse: collapse; text-align: center;"> <tr> </tr></table></td></tr></table></td></tr></table></td></tr></table></td></tr></table></td></tr></table></td></tr></table></td></tr></table></td></tr></table></td></tr></table></td></tr></table></td></tr></table></td></tr></table></td></tr></table></td></tr></table></td></tr></table></td></tr></table> | | | | | | | | | | | | | | | | | | | | <table border="1" style="width: 100%; border-collapse: collapse; text-align: center;"> <tr> <td style="width: 10%;"></td> <td style="width: 10%;"></td> <td style="width: 10%;"></td> <td style="width: 10%;"></td> <td style="width: 10%;"></td> <td style="width: 10%;"></td> <td style="width: 10%;"></td> <td style="width: 10%;"></td> <td style="width: 10%;"></td> <td style="width: 10%;"></td> </tr> <tr> <td></td> <td></td> <td colspan="8" style="text-align: center;"> <table border="1" style="width: 100%; border-collapse: collapse; text-align: center;"> <tr> <td style="width: 10%;"></td> <td style="width: 10%;"></td> <td style="width: 10%;"></td> <td style="width: 10%;"></td> <td style="width: 10%;"></td> <td style="width: 10%;"></td> <td style="width: 10%;"></td> <td style="width: 10%;"></td> <td style="width: 10%;"></td> <td style="width: 10%;"></td> </tr> <tr> <td></td> <td></td> <td colspan="8" style="text-align: center;"> <table border="1" style="width: 100%; border-collapse: collapse; text-align: center;"> <tr> <td style="width: 10%;"></td> <td style="width: 10%;"></td> <td style="width: 10%;"></td> <td style="width: 10%;"></td> <td style="width: 10%;"></td> <td style="width: 10%;"></td> <td style="width: 10%;"></td> <td style="width: 10%;"></td> <td style="width: 10%;"></td> <td style="width: 10%;"></td> </tr> <tr> <td></td> <td></td> <td colspan="8" style="text-align: center;"> <table border="1" style="width: 100%; border-collapse: collapse; text-align: center;"> <tr> <td style="width: 10%;"></td> <td style="width: 10%;"></td> <td style="width: 10%;"></td> <td style="width: 10%;"></td> <td style="width: 10%;"></td> <td style="width: 10%;"></td> <td style="width: 10%;"></td> <td style="width: 10%;"></td> <td style="width: 10%;"></td> <td style="width: 10%;"></td> </tr> <tr> <td></td> <td></td> <td colspan="8" style="text-align: center;"> <table border="1" style="width: 100%; border-collapse: collapse; text-align: center;"> <tr> <td style="width: 10%;"></td> <td style="width: 10%;"></td> <td style="width: 10%;"></td> <td style="width: 10%;"></td> <td style="width: 10%;"></td> <td style="width: 10%;"></td> <td style="width: 10%;"></td> <td style="width: 10%;"></td> <td style="width: 10%;"></td> <td style="width: 10%;"></td> </tr> <tr> <td></td> <td></td> <td colspan="8" style="text-align: center;"> <table border="1" style="width: 100%; border-collapse: collapse; text-align: center;"> <tr> <td style="width: 10%;"></td> <td style="width: 10%;"></td> <td style="width: 10%;"></td> <td style="width: 10%;"></td> <td style="width: 10%;"></td> <td style="width: 10%;"></td> <td style="width: 10%;"></td> <td style="width: 10%;"></td> <td style="width: 10%;"></td> <td style="width: 10%;"></td> </tr> <tr> <td></td> <td></td> <td colspan="8" style="text-align: center;"> <table border="1" style="width: 100%; border-collapse: collapse; text-align: center;"> <tr> <td style="width: 10%;"></td> <td style="width: 10%;"></td> <td style="width: 10%;"></td> <td style="width: 10%;"></td> <td style="width: 10%;"></td> <td style="width: 10%;"></td> <td style="width: 10%;"></td> <td style="width: 10%;"></td> <td style="width: 10%;"></td> <td style="width: 10%;"></td> </tr> <tr> <td></td> <td></td> <td colspan="8" style="text-align: center;"> <table border="1" style="width: 100%; border-collapse: collapse; text-align: center;"> <tr> <td style="width: 10%;"></td> <td style="width: 10%;"></td> <td style="width: 10%;"></td> <td style="width: 10%;"></td> <td style="width: 10%;"></td> <td style="width: 10%;"></td> <td style="width: 10%;"></td> <td style="width: 10%;"></td> <td style="width: 10%;"></td> <td style="width: 10%;"></td> </tr> <tr> <td></td> <td></td> <td colspan="8" style="text-align:
center;"> <table border="1" style="width: 100%; border-collapse: collapse; text-align: center;"> <tr> <td style="width: 10%;"></td> <td style="width: 10%;"></td> <td style="width: 10%;"></td> <td style="width: 10%;"></td> <td style="width: 10%;"></td> <td style="width: 10%;"></td> <td style="width: 10%;"></td> <td style="width: 10%;"></td> <td style="width: 10%;"></td> <td style="width: 10%;"></td> </tr> <tr> <td></td> <td></td> <td colspan="8" style="text-align: center;"> <table border="1" style="width: 100%; border-collapse: collapse; text-align: center;"> <tr> <td style="width: 10%;"></td> <td style="width: 10%;"></td> <td style="width: 10%;"></td> <td style="width: 10%;"></td> <td style="width: 10%;"></td> <td style="width: 10%;"></td> <td style="width: 10%;"></td> <td style="width: 10%;"></td> <td style="width: 10%;"></td> <td style="width: 10%;"></td> </tr> <tr> <td></td> <td></td> <td colspan="8" style="text-align: center;"> <table border="1" style="width: 100%; border-collapse: collapse; text-align: center;"> <tr> <td style="width: 10%;"></td> <td style="width: 10%;"></td> <td style="width: 10%;"></td> <td style="width: 10%;"></td> <td style="width: 10%;"></td> <td style="width: 10%;"></td> <td style="width: 10%;"></td> <td style="width: 10%;"></td> <td style="width: 10%;"></td> <td style="width: 10%;"></td> </tr> <tr> <td></td> <td></td> <td colspan="8" style="text-align: center;"> <table border="1" style="width: 100%; border-collapse: collapse; text-align: center;"> <tr> <td style="width: 10%;"></td> <td style="width: 10%;"></td> <td style="width: 10%;"></td> <td style="width: 10%;"></td> <td style="width: 10%;"></td> <td style="width: 10%;"></td> <td style="width: 10%;"></td> <td style="width: 10%;"></td> <td style="width: 10%;"></td> <td style="width: 10%;"></td> </tr> <tr> <td></td> <td></td> <td colspan="8" style="text-align: center;"> <table border="1" style="width: 100%; border-collapse: collapse; text-align: center;"> <tr> <td style="width: 10%;"></td> <td style="width: 10%;"></td> <td style="width: 10%;"></td> <td style="width: 10%;"></td> <td style="width: 10%;"></td> <td style="width: 10%;"></td> <td style="width: 10%;"></td> <td style="width: 10%;"></td> <td style="width: 10%;"></td> <td style="width: 10%;"></td> </tr> <tr> <td></td> <td></td> <td colspan="8" style="text-align: center;"> <table border="1" style="width: 100%; border-collapse: collapse; text-align: center;"> <tr> <td style="width: 10%;"></td> <td style="width: 10%;"></td> <td style="width: 10%;"></td> <td style="width: 10%;"></td> <td style="width: 10%;"></td> <td style="width: 10%;"></td> <td style="width: 10%;"></td> <td style="width: 10%;"></td> <td style="width: 10%;"></td> <td style="width: 10%;"></td> </tr> <tr> <td></td> <td></td> <td colspan="8" style="text-align: center;"> <table border="1" style="width: 100%; border-collapse: collapse; text-align: center;"> <tr> <td style="width: 10%;"></td> <td style="width: 10%;"></td> <td style="width: 10%;"></td> <td style="width: 10%;"></td> <td style="width: 10%;"></td> <td style="width: 10%;"></td> <td style="width: 10%;"></td> <td style="width: 10%;"></td> <td style="width: 10%;"></td> <td style="width: 10%;"></td> </tr> <tr> <td></td> <td></td> <td colspan="8" style="text-align: center;"> <table border="1" style="width: 100%; border-collapse: collapse; text-align: center;"> <tr> </tr></table></td></tr></table></td></tr></table></td></tr></table></td></tr></table></td></tr></table></td></tr></table></td></tr></table></td></tr></table></td></tr></table></td></tr></table></td></tr></table></td></tr></table></td></tr></table></td></tr></table></td></tr></table> | | | | | | | | | | | | | | | | | | | | <table border="1" style="width: 100%; border-collapse: collapse; text-align: center;"> <tr> <td style="width: 10%;"></td> <td style="width: 10%;"></td> <td style="width: 10%;"></td> <td style="width: 10%;"></td> <td style="width: 10%;"></td> <td style="width: 10%;"></td> <td style="width: 10%;"></td> <td style="width: 10%;"></td> <td style="width: 10%;"></td> <td style="width: 10%;"></td> </tr> <tr> <td></td> <td></td> <td colspan="8" style="text-align: center;"> <table border="1" style="width: 100%; border-collapse: collapse; text-align: center;"> <tr> <td style="width: 10%;"></td> <td style="width: 10%;"></td> <td style="width: 10%;"></td> <td style="width: 10%;"></td> <td style="width: 10%;"></td> <td style="width: 10%;"></td> <td style="width: 10%;"></td> <td style="width: 10%;"></td> <td style="width: 10%;"></td> <td style="width: 10%;"></td> </tr> <tr> <td></td> <td></td> <td colspan="8" style="text-align: center;"> <table border="1" style="width: 100%; border-collapse: collapse; text-align: center;"> <tr> <td style="width: 10%;"></td> <td style="width: 10%;"></td> <td style="width: 10%;"></td> <td style="width: 10%;"></td> <td style="width: 10%;"></td> <td style="width: 10%;"></td> <td style="width: 10%;"></td> <td style="width: 10%;"></td> <td style="width: 10%;"></td> <td style="width: 10%;"></td> </tr> <tr> <td></td> <td></td> <td colspan="8" style="text-align: center;"> <table border="1" style="width: 100%; border-collapse: collapse; text-align: center;"> <tr> <td style="width: 10%;"></td> <td style="width: 10%;"></td> <td style="width: 10%;"></td> <td style="width: 10%;"></td> <td style="width: 10%;"></td> <td style="width: 10%;"></td> <td style="width: 10%;"></td> <td style="width: 10%;"></td> <td style="width: 10%;"></td> <td style="width: 10%;"></td> </tr> <tr> <td></td> <td></td> <td colspan="8" style="text-align: center;"> <table border="1" style="width: 100%; border-collapse: collapse; text-align: center;"> <tr> <td style="width: 10%;"></td> <td style="width: 10%;"></td> <td style="width: 10%;"></td> <td style="width: 10%;"></td> <td style="width: 10%;"></td> <td style="width: 10%;"></td> <td style="width: 10%;"></td> <td style="width: 10%;"></td> <td style="width: 10%;"></td> <td style="width: 10%;"></td> </tr> <tr> <td></td> <td></td> <td colspan="8" style="text-align: center;"> <table border="1" style="width: 100%; border-collapse: collapse; text-align: center;"> <tr> <td style="width: 10%;"></td> <td style="width: 10%;"></td> <td style="width: 10%;"></td> <td style="width: 10%;"></td> <td style="width: 10%;"></td> <td style="width: 10%;"></td> <td style="width: 10%;"></td> <td style="width: 10%;"></td> <td style="width: 10%;"></td> <td style="width: 10%;"></td> </tr> <tr> <td></td> <td></td> <td colspan="8" style="text-align: center;"> <table border="1" style="width: 100%; border-collapse: collapse;
text-align: center;"> <tr> <td style="width: 10%;"></td> <td style="width: 10%;"></td> <td style="width: 10%;"></td> <td style="width: 10%;"></td> <td style="width: 10%;"></td> <td style="width: 10%;"></td> <td style="width: 10%;"></td> <td style="width: 10%;"></td> <td style="width: 10%;"></td> <td style="width: 10%;"></td> </tr> <tr> <td></td> <td></td> <td colspan="8" style="text-align: center;"> <table border="1" style="width: 100%; border-collapse: collapse; text-align: center;"> <tr> <td style="width: 10%;"></td> <td style="width: 10%;"></td> <td style="width: 10%;"></td> <td style="width: 10%;"></td> <td style="width: 10%;"></td> <td style="width: 10%;"></td> <td style="width: 10%;"></td> <td style="width: 10%;"></td> <td style="width: 10%;"></td> <td style="width: 10%;"></td> </tr> <tr> <td></td> <td></td> <td colspan="8" style="text-align: center;"> <table border="1" style="width: 100%; border-collapse: collapse; text-align: center;"> <tr> <td style="width: 10%;"></td> <td style="width: 10%;"></td> <td style="width: 10%;"></td> <td style="width: 10%;"></td> <td style="width: 10%;"></td> <td style="width: 10%;"></td> <td style="width: 10%;"></td> <td style="width: 10%;"></td> <td style="width: 10%;"></td> <td style="width: 10%;"></td> </tr> <tr> <td></td> <td></td> <td colspan="8" style="text-align: center;"> <table border="1" style="width: 100%; border-collapse: collapse; text-align: center;"> <tr> <td style="width: 10%;"></td> <td style="width: 10%;"></td> <td style="width: 10%;"></td> <td style="width: 10%;"></td> <td style="width: 10%;"></td> <td style="width: 10%;"></td> <td style="width: 10%;"></td> <td style="width: 10%;"></td> <td style="width: 10%;"></td> <td style="width: 10%;"></td> </tr> <tr> <td></td> <td></td> <td colspan="8" style="text-align: center;"> <table border="1" style="width: 100%; border-collapse: collapse; text-align: center;"> <tr> <td style="width: 10%;"></td> <td style="width: 10%;"></td> <td style="width: 10%;"></td> <td style="width: 10%;"></td> <td style="width: 10%;"></td> <td style="width: 10%;"></td> <td style="width: 10%;"></td> <td style="width: 10%;"></td> <td style="width: 10%;"></td> <td style="width: 10%;"></td> </tr> <tr> <td></td> <td></td> <td colspan="8" style="text-align: center;"> <table border="1" style="width: 100%; border-collapse: collapse; text-align: center;"> <tr> <td style="width: 10%;"></td> <td style="width: 10%;"></td> <td style="width: 10%;"></td> <td style="width: 10%;"></td> <td style="width: 10%;"></td> <td style="width: 10%;"></td> <td style="width: 10%;"></td> <td style="width: 10%;"></td> <td style="width: 10%;"></td> <td style="width: 10%;"></td> </tr> <tr> <td></td> <td></td> <td colspan="8" style="text-align: center;"> <table border="1" style="width: 100%; border-collapse: collapse; text-align: center;"> <tr> <td style="width: 10%;"></td> <td style="width: 10%;"></td> <td style="width: 10%;"></td> <td style="width: 10%;"></td> <td style="width: 10%;"></td> <td style="width: 10%;"></td> <td style="width: 10%;"></td> <td style="width: 10%;"></td> <td style="width: 10%;"></td> <td style="width: 10%;"></td> </tr> <tr> <td></td> <td></td> <td colspan="8" style="text-align: center;"> <table border="1" style="width: 100%; border-collapse: collapse; text-align: center;"> <tr> <td style="width: 10%;"></td> <td style="width: 10%;"></td> <td style="width: 10%;"></td> <td style="width: 10%;"></td> <td style="width: 10%;"></td> <td style="width: 10%;"></td> <td style="width: 10%;"></td> <td style="width: 10%;"></td> <td style="width: 10%;"></td> <td style="width: 10%;"></td> </tr> <tr> <td></td> <td></td> <td colspan="8" style="text-align: center;"> <table border="1" style="width: 100%; border-collapse: collapse; text-align: center;"> <tr> </tr></table></td></tr></table></td></tr></table></td></tr></table></td></tr></table></td></tr></table></td></tr></table></td></tr></table></td></tr></table></td></tr></table></td></tr></table></td></tr></table></td></tr></table></td></tr></table></td></tr></table> | | | | | | | | | | | | | | | | | | | | <table border="1" style="width: 100%; border-collapse: collapse; text-align: center;"> <tr> <td style="width: 10%;"></td> <td style="width: 10%;"></td> <td style="width: 10%;"></td> <td style="width: 10%;"></td> <td style="width: 10%;"></td> <td style="width: 10%;"></td> <td style="width: 10%;"></td> <td style="width: 10%;"></td> <td style="width: 10%;"></td> <td style="width: 10%;"></td> </tr> <tr> <td></td> <td></td> <td colspan="8" style="text-align: center;"> <table border="1" style="width: 100%; border-collapse: collapse; text-align: center;"> <tr> <td style="width: 10%;"></td> <td style="width: 10%;"></td> <td style="width: 10%;"></td> <td style="width: 10%;"></td> <td style="width: 10%;"></td> <td style="width: 10%;"></td> <td style="width: 10%;"></td> <td style="width: 10%;"></td> <td style="width: 10%;"></td> <td style="width: 10%;"></td> </tr> <tr> <td></td> <td></td> <td colspan="8" style="text-align: center;"> <table border="1" style="width: 100%; border-collapse: collapse; text-align: center;"> <tr> <td style="width: 10%;"></td> <td style="width: 10%;"></td> <td style="width: 10%;"></td> <td style="width: 10%;"></td> <td style="width: 10%;"></td> <td style="width: 10%;"></td> <td style="width: 10%;"></td> <td style="width: 10%;"></td> <td style="width: 10%;"></td> <td style="width: 10%;"></td> </tr> <tr> <td></td> <td></td> <td colspan="8" style="text-align: center;"> <table border="1" style="width: 100%; border-collapse: collapse; text-align: center;"> <tr> <td style="width: 10%;"></td> <td style="width: 10%;"></td> <td style="width: 10%;"></td> <td style="width: 10%;"></td> <td style="width: 10%;"></td> <td style="width: 10%;"></td> <td style="width: 10%;"></td> <td style="width: 10%;"></td> <td style="width: 10%;"></td> <td style="width: 10%;"></td> </tr> <tr> <td></td> <td></td> <td colspan="8" style="text-align: center;"> <table border="1" style="width: 100%; border-collapse: collapse; text-align: center;"> <tr> <td style="width: 10%;"></td> <td style="width: 10%;"></td> <td style="width: 10%;"></td> <td style="width: 10%;"></td> <td style="width: 10%;"></td> <td style="width: 10%;"></td> <td style="width: 10%;"></td> <td style="width: 10%;"></td> <td style="width: 10%;"></td> <td style="width: 10%;"></td> </tr> <tr> <td></td> <td></td> <td colspan="8" style="text-align: center;"> <table border="1" style="width: 100%; border-collapse: collapse; text-align: center;"> <tr> <td style="width: 10%;"></td> <td style="width: 10%;"></td> <td
style="width: 10%;"></td> <td style="width: 10%;"></td> <td style="width: 10%;"></td> <td style="width: 10%;"></td> <td style="width: 10%;"></td> <td style="width: 10%;"></td> <td style="width: 10%;"></td> <td style="width: 10%;"></td> </tr> <tr> <td></td> <td></td> <td colspan="8" style="text-align: center;"> <table border="1" style="width: 100%; border-collapse: collapse; text-align: center;"> <tr> <td style="width: 10%;"></td> <td style="width: 10%;"></td> <td style="width: 10%;"></td> <td style="width: 10%;"></td> <td style="width: 10%;"></td> <td style="width: 10%;"></td> <td style="width: 10%;"></td> <td style="width: 10%;"></td> <td style="width: 10%;"></td> <td style="width: 10%;"></td> </tr> <tr> <td></td> <td></td> <td colspan="8" style="text-align: center;"> <table border="1" style="width: 100%; border-collapse: collapse; text-align: center;"> <tr> <td style="width: 10%;"></td> <td style="width: 10%;"></td> <td style="width: 10%;"></td> <td style="width: 10%;"></td> <td style="width: 10%;"></td> <td style="width: 10%;"></td> <td style="width: 10%;"></td> <td style="width: 10%;"></td> <td style="width: 10%;"></td> <td style="width: 10%;"></td> </tr> <tr> <td></td> <td></td> <td colspan="8" style="text-align: center;"> <table border="1" style="width: 100%; border-collapse: collapse; text-align: center;"> <tr> <td style="width: 10%;"></td> <td style="width: 10%;"></td> <td style="width: 10%;"></td> <td style="width: 10%;"></td> <td style="width: 10%;"></td> <td style="width: 10%;"></td> <td style="width: 10%;"></td> <td style="width: 10%;"></td> <td style="width: 10%;"></td> <td style="width: 10%;"></td> </tr> <tr> <td></td> <td></td> <td colspan="8" style="text-align: center;"> <table border="1" style="width: 100%; border-collapse: collapse; text-align: center;"> <tr> <td style="width: 10%;"></td> <td style="width: 10%;"></td> <td style="width: 10%;"></td> <td style="width: 10%;"></td> <td style="width: 10%;"></td> <td style="width: 10%;"></td> <td style="width: 10%;"></td> <td style="width: 10%;"></td> <td style="width: 10%;"></td> <td style="width: 10%;"></td> </tr> <tr> <td></td> <td></td> <td colspan="8" style="text-align: center;"> <table border="1" style="width: 100%; border-collapse: collapse; text-align: center;"> <tr> <td style="width: 10%;"></td> <td style="width: 10%;"></td> <td style="width: 10%;"></td> <td style="width: 10%;"></td> <td style="width: 10%;"></td> <td style="width: 10%;"></td> <td style="width: 10%;"></td> <td style="width: 10%;"></td> <td style="width: 10%;"></td> <td style="width: 10%;"></td> </tr> <tr> <td></td> <td></td> <td colspan="8" style="text-align: center;"> <table border="1" style="width: 100%; border-collapse: collapse; text-align: center;"> <tr> <td style="width: 10%;"></td> <td style="width: 10%;"></td> <td style="width: 10%;"></td> <td style="width: 10%;"></td> <td style="width: 10%;"></td> <td style="width: 10%;"></td> <td style="width: 10%;"></td> <td style="width: 10%;"></td> <td style="width: 10%;"></td> <td style="width: 10%;"></td> </tr> <tr> <td></td> <td></td> <td colspan="8" style="text-align: center;"> <table border="1" style="width: 100%; border-collapse: collapse; text-align: center;"> <tr> <td style="width: 10%;"></td> <td style="width: 10%;"></td> <td style="width: 10%;"></td> <td style="width: 10%;"></td> <td style="width: 10%;"></td> <td style="width: 10%;"></td> <td style="width: 10%;"></td> <td style="width: 10%;"></td> <td style="width: 10%;"></td> <td style="width: 10%;"></td> </tr> <tr> <td></td> <td></td> <td colspan="8" style="text-align: center;"> <table border="1" style="width: 100%; border-collapse: collapse; text-align: center;"> <tr> </tr></table></td></tr></table></td></tr></table></td></tr></table></td></tr></table></td></tr></table></td></tr></table></td></tr></table></td></tr></table></td></tr></table></td></tr></table></td></tr></table></td></tr></table></td></tr></table> | | | | | | | | | | | | | | | | | | | | <table border="1" style="width: 100%; border-collapse: collapse; text-align: center;"> <tr> <td style="width: 10%;"></td> <td style="width: 10%;"></td> <td style="width: 10%;"></td> <td style="width: 10%;"></td> <td style="width: 10%;"></td> <td style="width: 10%;"></td> <td style="width: 10%;"></td> <td style="width: 10%;"></td> <td style="width: 10%;"></td> <td style="width: 10%;"></td> </tr> <tr> <td></td> <td></td> <td colspan="8" style="text-align: center;"> <table border="1" style="width: 100%; border-collapse: collapse; text-align: center;"> <tr> <td style="width: 10%;"></td> <td style="width: 10%;"></td> <td style="width: 10%;"></td> <td style="width: 10%;"></td> <td style="width: 10%;"></td> <td style="width: 10%;"></td> <td style="width: 10%;"></td> <td style="width: 10%;"></td> <td style="width: 10%;"></td> <td style="width: 10%;"></td> </tr> <tr> <td></td> <td></td> <td colspan="8" style="text-align: center;"> <table border="1" style="width: 100%; border-collapse: collapse; text-align: center;"> <tr> <td style="width: 10%;"></td> <td style="width: 10%;"></td> <td style="width: 10%;"></td> <td style="width: 10%;"></td> <td style="width: 10%;"></td> <td style="width: 10%;"></td> <td style="width: 10%;"></td> <td style="width: 10%;"></td> <td style="width: 10%;"></td> <td style="width: 10%;"></td> </tr> <tr> <td></td> <td></td> <td colspan="8" style="text-align: center;"> <table border="1" style="width: 100%; border-collapse: collapse; text-align: center;"> <tr> <td style="width: 10%;"></td> <td style="width: 10%;"></td> <td style="width: 10%;"></td> <td style="width: 10%;"></td> <td style="width: 10%;"></td> <td style="width: 10%;"></td> <td style="width: 10%;"></td> <td style="width: 10%;"></td> <td style="width: 10%;"></td> <td style="width: 10%;"></td> </tr> <tr> <td></td> <td></td> <td colspan="8" style="text-align: center;"> <table border="1" style="width: 100%; border-collapse: collapse; text-align: center;"> <tr> <td style="width: 10%;"></td> <td style="width: 10%;"></td> <td style="width: 10%;"></td> <td style="width: 10%;"></td> <td style="width: 10%;"></td> <td style="width: 10%;"></td> <td style="width: 10%;"></td> <td style="width: 10%;"></td> <td style="width: 10%;"></td> <td style="width: 10%;"></td> </tr> <tr> <td></td> <td></td> <td colspan="8" style="text-align: center;"> <table border="1" style="width: 100%; border-collapse: collapse; text-align: center;"> <tr> <td style="width: 10%;"></td> <td style="width: 10%;"></td> <td style="width: 10%;"></td> <td style="width: 10%;"></td> <td style="width: 10%;"></td> <td style="width:
10%;"></td> <td style="width: 10%;"></td> <td style="width: 10%;"></td> <td style="width: 10%;"></td> <td style="width: 10%;"></td> </tr> <tr> <td></td> <td></td> <td colspan="8" style="text-align: center;"> <table border="1" style="width: 100%; border-collapse: collapse; text-align: center;"> <tr> <td style="width: 10%;"></td> <td style="width: 10%;"></td> <td style="width: 10%;"></td> <td style="width: 10%;"></td> <td style="width: 10%;"></td> <td style="width: 10%;"></td> <td style="width: 10%;"></td> <td style="width: 10%;"></td> <td style="width: 10%;"></td> <td style="width: 10%;"></td> </tr> <tr> <td></td> <td></td> <td colspan="8" style="text-align: center;"> <table border="1" style="width: 100%; border-collapse: collapse; text-align: center;"> <tr> <td style="width: 10%;"></td> <td style="width: 10%;"></td> <td style="width: 10%;"></td> <td style="width: 10%;"></td> <td style="width: 10%;"></td> <td style="width: 10%;"></td> <td style="width: 10%;"></td> <td style="width: 10%;"></td> <td style="width: 10%;"></td> <td style="width: 10%;"></td> </tr> <tr> <td></td> <td></td> <td colspan="8" style="text-align: center;"> <table border="1" style="width: 100%; border-collapse: collapse; text-align: center;"> <tr> <td style="width: 10%;"></td> <td style="width: 10%;"></td> <td style="width: 10%;"></td> <td style="width: 10%;"></td> <td style="width: 10%;"></td> <td style="width: 10%;"></td> <td style="width: 10%;"></td> <td style="width: 10%;"></td> <td style="width: 10%;"></td> <td style="width: 10%;"></td> </tr> <tr> <td></td> <td></td> <td colspan="8" style="text-align: center;"> <table border="1" style="width: 100%; border-collapse: collapse; text-align: center;"> <tr> <td style="width: 10%;"></td> <td style="width: 10%;"></td> <td style="width: 10%;"></td> <td style="width: 10%;"></td> <td style="width: 10%;"></td> <td style="width: 10%;"></td> <td style="width: 10%;"></td> <td style="width: 10%;"></td> <td style="width: 10%;"></td> <td style="width: 10%;"></td> </tr> <tr> <td></td> <td></td> <td colspan="8" style="text-align: center;"> <table border="1" style="width: 100%; border-collapse: collapse; text-align: center;"> <tr> <td style="width: 10%;"></td> <td style="width: 10%;"></td> <td style="width: 10%;"></td> <td style="width: 10%;"></td> <td style="width: 10%;"></td> <td style="width: 10%;"></td> <td style="width: 10%;"></td> <td style="width: 10%;"></td> <td style="width: 10%;"></td> <td style="width: 10%;"></td> </tr> <tr> <td></td> <td></td> <td colspan="8" style="text-align: center;"> <table border="1" style="width: 100%; border-collapse: collapse; text-align: center;"> <tr> <td style="width: 10%;"></td> <td style="width: 10%;"></td> <td style="width: 10%;"></td> <td style="width: 10%;"></td> <td style="width: 10%;"></td> <td style="width: 10%;"></td> <td style="width: 10%;"></td> <td style="width: 10%;"></td> <td style="width: 10%;"></td> <td style="width: 10%;"></td> </tr> <tr> <td></td> <td></td> <td colspan="8" style="text-align: center;"> <table border="1" style="width: 100%; border-collapse: collapse; text-align: center;"> <tr> </tr></table></td></tr></table></td></tr></table></td></tr></table></td></tr></table></td></tr></table></td></tr></table></td></tr></table></td></tr></table></td></tr></table></td></tr></table></td></tr></table></td></tr></table> | | | | | | | | | | | | | | | | | | | | <table border="1" style="width: 100%; border-collapse: collapse; text-align: center;"> <tr> <td style="width: 10%;"></td> <td style="width: 10%;"></td> <td style="width: 10%;"></td> <td style="width: 10%;"></td> <td style="width: 10%;"></td> <td style="width: 10%;"></td> <td style="width: 10%;"></td> <td style="width: 10%;"></td> <td style="width: 10%;"></td> <td style="width: 10%;"></td> </tr> <tr> <td></td> <td></td> <td colspan="8" style="text-align: center;"> <table border="1" style="width: 100%; border-collapse: collapse; text-align: center;"> <tr> <td style="width: 10%;"></td> <td style="width: 10%;"></td> <td style="width: 10%;"></td> <td style="width: 10%;"></td> <td style="width: 10%;"></td> <td style="width: 10%;"></td> <td style="width: 10%;"></td> <td style="width: 10%;"></td> <td style="width: 10%;"></td> <td style="width: 10%;"></td> </tr> <tr> <td></td> <td></td> <td colspan="8" style="text-align: center;"> <table border="1" style="width: 100%; border-collapse: collapse; text-align: center;"> <tr> <td style="width: 10%;"></td> <td style="width: 10%;"></td> <td style="width: 10%;"></td> <td style="width: 10%;"></td> <td style="width: 10%;"></td> <td style="width: 10%;"></td> <td style="width: 10%;"></td> <td style="width: 10%;"></td> <td style="width: 10%;"></td> <td style="width: 10%;"></td> </tr> <tr> <td></td> <td></td> <td colspan="8" style="text-align: center;"> <table border="1" style="width: 100%; border-collapse: collapse; text-align: center;"> <tr> <td style="width: 10%;"></td> <td style="width: 10%;"></td> <td style="width: 10%;"></td> <td style="width: 10%;"></td> <td style="width: 10%;"></td> <td style="width: 10%;"></td> <td style="width: 10%;"></td> <td style="width: 10%;"></td> <td style="width: 10%;"></td> <td style="width: 10%;"></td> </tr> <tr> <td></td> <td></td> <td colspan="8" style="text-align: center;"> <table border="1" style="width: 100%; border-collapse: collapse; text-align: center;"> <tr> <td style="width: 10%;"></td> <td style="width: 10%;"></td> <td style="width: 10%;"></td> <td style="width: 10%;"></td> <td style="width: 10%;"></td> <td style="width: 10%;"></td> <td style="width: 10%;"></td> <td style="width: 10%;"></td> <td style="width: 10%;"></td> <td style="width: 10%;"></td> </tr> <tr> <td></td> <td></td> <td colspan="8" style="text-align: center;"> <table border="1" style="width: 100%; border-collapse: collapse; text-align: center;"> <tr> <td style="width: 10%;"></td> <td style="width: 10%;"></td> <td style="width: 10%;"></td> <td style="width: 10%;"></td> <td style="width: 10%;"></td> <td style="width: 10%;"></td> <td style="width: 10%;"></td> <td style="width: 10%;"></td> <td style="width: 10%;"></td> <td style="width: 10%;"></td> </tr> <tr> <td></td> <td></td> <td colspan="8" style="text-align: center;"> <table border="1" style="width: 100%; border-collapse: collapse; text-align: center;"> <tr> <td style="width: 10%;"></td> <td style="width: 10%;"></td> <td style="width: 10%;"></td> <td style="width: 10%;"></td> <td style="width: 10%;"></td> <td style="width: 10%;"></td> <td style="width: 10%;"></td> <td style="width: 10%;"></td> <td style="width: 10%;"></td> <td style="width: 10%;"></td>
</tr> <tr> <td></td> <td></td> <td colspan="8" style="text-align: center;"> <table border="1" style="width: 100%; border-collapse: collapse; text-align: center;"> <tr> <td style="width: 10%;"></td> <td style="width: 10%;"></td> <td style="width: 10%;"></td> <td style="width: 10%;"></td> <td style="width: 10%;"></td> <td style="width: 10%;"></td> <td style="width: 10%;"></td> <td style="width: 10%;"></td> <td style="width: 10%;"></td> <td style="width: 10%;"></td> </tr> <tr> <td></td> <td></td> <td colspan="8" style="text-align: center;"> <table border="1" style="width: 100%; border-collapse: collapse; text-align: center;"> <tr> <td style="width: 10%;"></td> <td style="width: 10%;"></td> <td style="width: 10%;"></td> <td style="width: 10%;"></td> <td style="width: 10%;"></td> <td style="width: 10%;"></td> <td style="width: 10%;"></td> <td style="width: 10%;"></td> <td style="width: 10%;"></td> <td style="width: 10%;"></td> </tr> <tr> <td></td> <td></td> <td colspan="8" style="text-align: center;"> <table border="1" style="width: 100%; border-collapse: collapse; text-align: center;"> <tr> <td style="width: 10%;"></td> <td style="width: 10%;"></td> <td style="width: 10%;"></td> <td style="width: 10%;"></td> <td style="width: 10%;"></td> <td style="width: 10%;"></td> <td style="width: 10%;"></td> <td style="width: 10%;"></td> <td style="width: 10%;"></td> <td style="width: 10%;"></td> </tr> <tr> <td></td> <td></td> <td colspan="8" style="text-align: center;"> <table border="1" style="width: 100%; border-collapse: collapse; text-align: center;"> <tr> <td style="width: 10%;"></td> <td style="width: 10%;"></td> <td style="width: 10%;"></td> <td style="width: 10%;"></td> <td style="width: 10%;"></td> <td style="width: 10%;"></td> <td style="width: 10%;"></td> <td style="width: 10%;"></td> <td style="width: 10%;"></td> <td style="width: 10%;"></td> </tr> <tr> <td></td> <td></td> <td colspan="8" style="text-align: center;"> <table border="1" style="width: 100%; border-collapse: collapse; text-align: center;"> <tr> </tr></table></td></tr></table></td></tr></table></td></tr></table></td></tr></table></td></tr></table></td></tr></table></td></tr></table></td></tr></table></td></tr></table></td></tr></table></td></tr></table> | | | | | | | | | | | | | | | | | | | | <table border="1" style="width: 100%; border-collapse: collapse; text-align: center;"> <tr> <td style="width: 10%;"></td> <td style="width: 10%;"></td> <td style="width: 10%;"></td> <td style="width: 10%;"></td> <td style="width: 10%;"></td> <td style="width: 10%;"></td> <td style="width: 10%;"></td> <td style="width: 10%;"></td> <td style="width: 10%;"></td> <td style="width: 10%;"></td> </tr> <tr> <td></td> <td></td> <td colspan="8" style="text-align: center;"> <table border="1" style="width: 100%; border-collapse: collapse; text-align: center;"> <tr> <td style="width: 10%;"></td> <td style="width: 10%;"></td> <td style="width: 10%;"></td> <td style="width: 10%;"></td> <td style="width: 10%;"></td> <td style="width: 10%;"></td> <td style="width: 10%;"></td> <td style="width: 10%;"></td> <td style="width: 10%;"></td> <td style="width: 10%;"></td> </tr> <tr> <td></td> <td></td> <td colspan="8" style="text-align: center;"> <table border="1" style="width: 100%; border-collapse: collapse; text-align: center;"> <tr> <td style="width: 10%;"></td> <td style="width: 10%;"></td> <td style="width: 10%;"></td> <td style="width: 10%;"></td> <td style="width: 10%;"></td> <td style="width: 10%;"></td> <td style="width: 10%;"></td> <td style="width: 10%;"></td> <td style="width: 10%;"></td> <td style="width: 10%;"></td> </tr> <tr> <td></td> <td></td> <td colspan="8" style="text-align: center;"> <table border="1" style="width: 100%; border-collapse: collapse; text-align: center;"> <tr> <td style="width: 10%;"></td> <td style="width: 10%;"></td> <td style="width: 10%;"></td> <td style="width: 10%;"></td> <td style="width: 10%;"></td> <td style="width: 10%;"></td> <td style="width: 10%;"></td> <td style="width: 10%;"></td> <td style="width: 10%;"></td> <td style="width: 10%;"></td> </tr> <tr> <td></td> <td></td> <td colspan="8" style="text-align: center;"> <table border="1" style="width: 100%; border-collapse: collapse; text-align: center;"> <tr> <td style="width: 10%;"></td> <td style="width: 10%;"></td> <td style="width: 10%;"></td> <td style="width: 10%;"></td> <td style="width: 10%;"></td> <td style="width: 10%;"></td> <td style="width: 10%;"></td> <td style="width: 10%;"></td> <td style="width: 10%;"></td> <td style="width: 10%;"></td> </tr> <tr> <td></td> <td></td> <td colspan="8" style="text-align: center;"> <table border="1" style="width: 100%; border-collapse: collapse; text-align: center;"> <tr> <td style="width: 10%;"></td> <td style="width: 10%;"></td> <td style="width: 10%;"></td> <td style="width: 10%;"></td> <td style="width: 10%;"></td> <td style="width: 10%;"></td> <td style="width: 10%;"></td> <td style="width: 10%;"></td> <td style="width: 10%;"></td> <td style="width: 10%;"></td> </tr> <tr> <td></td> <td></td> <td colspan="8" style="text-align: center;"> <table border="1" style="width: 100%; border-collapse: collapse; text-align: center;"> <tr> <td style="width: 10%;"></td> <td style="width: 10%;"></td> <td style="width: 10%;"></td> <td style="width: 10%;"></td> <td style="width: 10%;"></td> <td style="width: 10%;"></td> <td style="width: 10%;"></td> <td style="width: 10%;"></td> <td style="width: 10%;"></td> <td style="width: 10%;"></td> </tr> <tr> <td></td> <td></td> <td colspan="8" style="text-align: center;"> <table border="1" style="width: 100%; border-collapse: collapse; text-align: center;"> <tr> <td style="width: 10%;"></td> <td style="width: 10%;"></td> <td style="width: 10%;"></td> <td style="width: 10%;"></td> <td style="width: 10%;"></td> <td style="width: 10%;"></td> <td style="width: 10%;"></td> <td style="width: 10%;"></td> <td style="width: 10%;"></td> <td style="width: 10%;"></td> </tr> <tr> <td></td> <td></td> <td colspan="8" style="text-align: center;"> <table border="1" style="width: 100%; border-collapse: collapse; text-align: center;"> <tr> <td style="width: 10%;"></td> <td style="width: 10%;"></td> <td style="width: 10%;"></td> <td style="width: 10%;"></td> <td style="width: 10%;"></td> <td style="width: 10%;"></td> <td style="width: 10%;"></td> <td style="width: 10%;"></td> <td style="width: 10%;"></td> <td style="width: 10%;"></td> </tr> <tr> <td></td> <td></td> <td colspan="8" style="text-align: center;"> <table border="1" style="width: 100%; border-collapse: collapse;
text-align: center;"> <tr> <td style="width: 10%;"></td> <td style="width: 10%;"></td> <td style="width: 10%;"></td> <td style="width: 10%;"></td> <td style="width: 10%;"></td> <td style="width: 10%;"></td> <td style="width: 10%;"></td> <td style="width: 10%;"></td> <td style="width: 10%;"></td> <td style="width: 10%;"></td> </tr> <tr> <td></td> <td></td> <td colspan="8" style="text-align: center;"> <table border="1" style="width: 100%; border-collapse: collapse; text-align: center;"> <tr> </tr></table></td></tr></table></td></tr></table></td></tr></table></td></tr></table></td></tr></table></td></tr></table></td></tr></table></td></tr></table></td></tr></table></td></tr></table> | | | | | | | | | | | | | | | | | | | | <table border="1" style="width: 100%; border-collapse: collapse; text-align: center;"> <tr> <td style="width: 10%;"></td> <td style="width: 10%;"></td> <td style="width: 10%;"></td> <td style="width: 10%;"></td> <td style="width: 10%;"></td> <td style="width: 10%;"></td> <td style="width: 10%;"></td> <td style="width: 10%;"></td> <td style="width: 10%;"></td> <td style="width: 10%;"></td> </tr> <tr> <td></td> <td></td> <td colspan="8" style="text-align: center;"> <table border="1" style="width: 100%; border-collapse: collapse; text-align: center;"> <tr> <td style="width: 10%;"></td> <td style="width: 10%;"></td> <td style="width: 10%;"></td> <td style="width: 10%;"></td> <td style="width: 10%;"></td> <td style="width: 10%;"></td> <td style="width: 10%;"></td> <td style="width: 10%;"></td> <td style="width: 10%;"></td> <td style="width: 10%;"></td> </tr> <tr> <td></td> <td></td> <td colspan="8" style="text-align: center;"> <table border="1" style="width: 100%; border-collapse: collapse; text-align: center;"> <tr> <td style="width: 10%;"></td> <td style="width: 10%;"></td> <td style="width: 10%;"></td> <td style="width: 10%;"></td> <td style="width: 10%;"></td> <td style="width: 10%;"></td> <td style="width: 10%;"></td> <td style="width: 10%;"></td> <td style="width: 10%;"></td> <td style="width: 10%;"></td> </tr> <tr> <td></td> <td></td> <td colspan="8" style="text-align: center;"> <table border="1" style="width: 100%; border-collapse: collapse; text-align: center;"> <tr> <td style="width: 10%;"></td> <td style="width: 10%;"></td> <td style="width: 10%;"></td> <td style="width: 10%;"></td> <td style="width: 10%;"></td> <td style="width: 10%;"></td> <td style="width: 10%;"></td> <td style="width: 10%;"></td> <td style="width: 10%;"></td> <td style="width: 10%;"></td> </tr> <tr> <td></td> <td></td> <td colspan="8" style="text-align: center;"> <table border="1" style="width: 100%; border-collapse: collapse; text-align: center;"> <tr> <td style="width: 10%;"></td> <td style="width: 10%;"></td> <td style="width: 10%;"></td> <td style="width: 10%;"></td> <td style="width: 10%;"></td> <td style="width: 10%;"></td> <td style="width: 10%;"></td> <td style="width: 10%;"></td> <td style="width: 10%;"></td> <td style="width: 10%;"></td> </tr> <tr> <td></td> <td></td> <td colspan="8" style="text-align: center;"> <table border="1" style="width: 100%; border-collapse: collapse; text-align: center;"> <tr> <td style="width: 10%;"></td> <td style="width: 10%;"></td> <td style="width: 10%;"></td> <td style="width: 10%;"></td> <td style="width: 10%;"></td> <td style="width: 10%;"></td> <td style="width: 10%;"></td> <td style="width: 10%;"></td> <td style="width: 10%;"></td> <td style="width: 10%;"></td> </tr> <tr> <td></td> <td></td> <td colspan="8" style="text-align: center;"> <table border="1" style="width: 100%; border-collapse: collapse; text-align: center;"> <tr> <td style="width: 10%;"></td> <td style="width: 10%;"></td> <td style="width: 10%;"></td> <td style="width: 10%;"></td> <td style="width: 10%;"></td> <td style="width: 10%;"></td> <td style="width: 10%;"></td> <td style="width: 10%;"></td> <td style="width: 10%;"></td> <td style="width: 10%;"></td> </tr> <tr> <td></td> <td></td> <td colspan="8" style="text-align: center;"> <table border="1" style="width: 100%; border-collapse: collapse; text-align: center;"> <tr> <td style="width: 10%;"></td> <td style="width: 10%;"></td> <td style="width: 10%;"></td> <td style="width: 10%;"></td> <td style="width: 10%;"></td> <td style="width: 10%;"></td> <td style="width: 10%;"></td> <td style="width: 10%;"></td> <td style="width: 10%;"></td> <td style="width: 10%;"></td> </tr> <tr> <td></td> <td></td> <td colspan="8" style="text-align: center;"> <table border="1" style="width: 100%; border-collapse: collapse; text-align: center;"> <tr> <td style="width: 10%;"></td> <td style="width: 10%;"></td> <td style="width: 10%;"></td> <td style="width: 10%;"></td> <td style="width: 10%;"></td> <td style="width: 10%;"></td> <td style="width: 10%;"></td> <td style="width: 10%;"></td> <td style="width: 10%;"></td> <td style="width: 10%;"></td> </tr> <tr> <td></td> <td></td> <td colspan="8" style="text-align: center;"> <table border="1" style="width: 100%; border-collapse: collapse; text-align: center;"> <tr> </tr></table></td></tr></table></td></tr></table></td></tr></table></td></tr></table></td></tr></table></td></tr></table></td></tr></table></td></tr></table></td></tr></table>
 | | | | | | | | | | | | | | | | | | | | <table border="1" style="width: 100%; border-collapse: collapse; text-align: center;"> <tr> <td style="width: 10%;"></td> <td style="width: 10%;"></td> <td style="width: 10%;"></td> <td style="width: 10%;"></td> <td style="width: 10%;"></td> <td style="width: 10%;"></td> <td style="width: 10%;"></td> <td style="width: 10%;"></td> <td style="width: 10%;"></td> <td style="width: 10%;"></td> </tr> <tr> <td></td> <td></td> <td colspan="8" style="text-align: center;"> <table border="1" style="width: 100%; border-collapse: collapse; text-align: center;"> <tr> <td style="width: 10%;"></td> <td style="width: 10%;"></td> <td style="width: 10%;"></td> <td style="width: 10%;"></td> <td style="width: 10%;"></td> <td style="width: 10%;"></td> <td style="width: 10%;"></td> <td style="width: 10%;"></td> <td style="width: 10%;"></td> <td style="width: 10%;"></td> </tr> <tr> <td></td> <td></td> <td colspan="8" style="text-align: center;"> <table border="1" style="width: 100%; border-collapse: collapse; text-align: center;"> <tr> <td style="width: 10%;"></td> <td style="width: 10%;"></td> <td style="width: 10%;"></td> <td style="width: 10%;"></td> <td style="width: 10%;"></td> <td style="width: 10%;"></td> <td style="width: 10%;"></td> <td style="width: 10%;"></td> <td style="width: 10%;"></td> <td style="width: 10%;"></td> </tr> <tr> <td></td> <td></td> <td colspan="8" style="text-align: center;"> <table border="1" style="width: 100%; border-collapse: collapse; text-align: center;"> <tr> <td style="width: 10%;"></td> <td style="width: 10%;"></td> <td style="width: 10%;"></td> <td style="width: 10%;"></td> <td style="width: 10%;"></td> <td style="width: 10%;"></td> <td style="width: 10%;"></td> <td style="width: 10%;"></td> <td style="width: 10%;"></td> <td style="width: 10%;"></td> </tr> <tr> <td></td> <td></td> <td colspan="8" style="text-align: center;"> <table border="1" style="width: 100%; border-collapse: collapse; text-align: center;"> <tr> <td style="width: 10%;"></td> <td style="width: 10%;"></td> <td style="width: 10%;"></td> <td style="width: 10%;"></td> <td style="width: 10%;"></td> <td style="width: 10%;"></td> <td style="width: 10%;"></td> <td style="width: 10%;"></td> <td style="width: 10%;"></td> <td style="width: 10%;"></td> </tr> <tr> <td></td> <td></td> <td colspan="8" style="text-align: center;"> <table border="1" style="width: 100%; border-collapse: collapse; text-align: center;"> <tr> <td style="width: 10%;"></td> <td style="width: 10%;"></td> <td style="width: 10%;"></td> <td style="width: 10%;"></td> <td style="width: 10%;"></td> <td style="width: 10%;"></td> <td style="width: 10%;"></td> <td style="width: 10%;"></td> <td style="width: 10%;"></td> <td style="width: 10%;"></td> </tr> <tr> <td></td> <td></td> <td colspan="8" style="text-align: center;"> <table border="1" style="width: 100%; border-collapse: collapse; text-align: center;"> <tr> <td style="width: 10%;"></td> <td style="width: 10%;"></td> <td style="width: 10%;"></td> <td style="width: 10%;"></td> <td style="width: 10%;"></td> <td style="width: 10%;"></td> <td style="width: 10%;"></td> <td style="width: 10%;"></td> <td style="width: 10%;"></td> <td style="width: 10%;"></td> </tr> <tr> <td></td> <td></td> <td colspan="8" style="text-align: center;"> <table border="1" style="width: 100%; border-collapse: collapse; text-align: center;"> <tr> <td style="width: 10%;"></td> <td style="width: 10%;"></td> <td style="width: 10%;"></td> <td style="width: 10%;"></td> <td style="width: 10%;"></td> <td style="width: 10%;"></td> <td style="width: 10%;"></td> <td style="width: 10%;"></td> <td style="width: 10%;"></td> <td style="width: 10%;"></td> </tr> <tr> <td></td> <td></td> <td colspan="8" style="text-align: center;"> <table border="1" style="width: 100%; border-collapse: collapse; text-align: center;"> <tr> </tr></table></td></tr></table></td></tr></table></td></tr></table></td></tr></table></td></tr></table></td></tr></table></td></tr></table></td></tr></table> | | | | | | | | | | | | | | | | | | | | <table border="1" style="width: 100%; border-collapse: collapse; text-align: center;"> <tr> <td style="width: 10%;"></td> <td style="width: 10%;"></td> <td style="width: 10%;"></td> <td style="width: 10%;"></td> <td style="width: 10%;"></td> <td style="width: 10%;"></td> <td style="width: 10%;"></td> <td style="width: 10%;"></td> <td style="width: 10%;"></td> <td style="width: 10%;"></td> </tr> <tr> <td></td> <td></td> <td colspan="8"
style="text-align: center;"> <table border="1" style="width: 100%; border-collapse: collapse; text-align: center;"> <tr> <td style="width: 10%;"></td> <td style="width: 10%;"></td> <td style="width: 10%;"></td> <td style="width: 10%;"></td> <td style="width: 10%;"></td> <td style="width: 10%;"></td> <td style="width: 10%;"></td> <td style="width: 10%;"></td> <td style="width: 10%;"></td> <td style="width: 10%;"></td> </tr> <tr> <td></td> <td></td> <td colspan="8" style="text-align: center;"> <table border="1" style="width: 100%; border-collapse: collapse; text-align: center;"> <tr> <td style="width: 10%;"></td> <td style="width: 10%;"></td> <td style="width: 10%;"></td> <td style="width: 10%;"></td> <td style="width: 10%;"></td> <td style="width: 10%;"></td> <td style="width: 10%;"></td> <td style="width: 10%;"></td> <td style="width: 10%;"></td> <td style="width: 10%;"></td> </tr> <tr> <td></td> <td></td> <td colspan="8" style="text-align: center;"> <table border="1" style="width: 100%; border-collapse: collapse; text-align: center;"> <tr> <td style="width: 10%;"></td> <td style="width: 10%;"></td> <td style="width: 10%;"></td> <td style="width: 10%;"></td> <td style="width: 10%;"></td> <td style="width: 10%;"></td> <td style="width: 10%;"></td> <td style="width: 10%;"></td> <td style="width: 10%;"></td> <td style="width: 10%;"></td> </tr> <tr> <td></td> <td></td> <td colspan="8" style="text-align: center;"> <table border="1" style="width: 100%; border-collapse: collapse; text-align: center;"> <tr> <td style="width: 10%;"></td> <td style="width: 10%;"></td> <td style="width: 10%;"></td> <td style="width: 10%;"></td> <td style="width: 10%;"></td> <td style="width: 10%;"></td> <td style="width: 10%;"></td> <td style="width: 10%;"></td> <td style="width: 10%;"></td> <td style="width: 10%;"></td> </tr> <tr> <td></td> <td></td> <td colspan="8" style="text-align: center;"> <table border="1" style="width: 100%; border-collapse: collapse; text-align: center;"> <tr> <td style="width: 10%;"></td> <td style="width: 10%;"></td> <td style="width: 10%;"></td> <td style="width: 10%;"></td> <td style="width: 10%;"></td> <td style="width: 10%;"></td> <td style="width: 10%;"></td> <td style="width: 10%;"></td> <td style="width: 10%;"></td> <td style="width: 10%;"></td> </tr> <tr> <td></td> <td></td> <td colspan="8" style="text-align: center;"> <table border="1" style="width: 100%; border-collapse: collapse; text-align: center;"> <tr> <td style="width: 10%;"></td> <td style="width: 10%;"></td> <td style="width: 10%;"></td> <td style="width: 10%;"></td> <td style="width: 10%;"></td> <td style="width: 10%;"></td> <td style="width: 10%;"></td> <td style="width: 10%;"></td> <td style="width: 10%;"></td> <td style="width: 10%;"></td> </tr> <tr> <td></td> <td></td> <td colspan="8" style="text-align: center;"> <table border="1" style="width: 100%; border-collapse: collapse; text-align: center;"> <tr> </tr></table></td></tr></table></td></tr></table></td></tr></table></td></tr></table></td></tr></table></td></tr></table></td></tr></table> | | | | | | | | | | | | | | | | | | | | <table border="1" style="width: 100%; border-collapse: collapse; text-align: center;"> <tr> <td style="width: 10%;"></td> <td style="width: 10%;"></td> <td style="width: 10%;"></td> <td style="width: 10%;"></td> <td style="width: 10%;"></td> <td style="width: 10%;"></td> <td style="width: 10%;"></td> <td style="width: 10%;"></td> <td style="width: 10%;"></td> <td style="width: 10%;"></td> </tr> <tr> <td></td> <td></td> <td colspan="8" style="text-align: center;"> <table border="1" style="width: 100%; border-collapse: collapse; text-align: center;"> <tr> <td style="width: 10%;"></td> <td style="width: 10%;"></td> <td style="width: 10%;"></td> <td style="width: 10%;"></td> <td style="width: 10%;"></td> <td style="width: 10%;"></td> <td style="width: 10%;"></td> <td style="width: 10%;"></td> <td style="width: 10%;"></td> <td style="width: 10%;"></td> </tr> <tr> <td></td> <td></td> <td colspan="8" style="text-align: center;"> <table border="1" style="width: 100%; border-collapse: collapse; text-align: center;"> <tr> <td style="width: 10%;"></td> <td style="width: 10%;"></td> <td style="width: 10%;"></td> <td style="width: 10%;"></td> <td style="width: 10%;"></td> <td style="width: 10%;"></td> <td style="width: 10%;"></td> <td style="width: 10%;"></td> <td style="width: 10%;"></td> <td style="width: 10%;"></td> </tr> <tr> <td></td> <td></td> <td colspan="8" style="text-align: center;"> <table border="1" style="width: 100%; border-collapse: collapse; text-align: center;"> <tr> <td style="width: 10%;"></td> <td style="width: 10%;"></td> <td style="width: 10%;"></td> <td style="width: 10%;"></td> <td style="width: 10%;"></td> <td style="width: 10%;"></td> <td style="width: 10%;"></td> <td style="width: 10%;"></td> <td style="width: 10%;"></td> <td style="width: 10%;"></td> </tr> <tr> <td></td> <td></td> <td colspan="8" style="text-align: center;"> <table border="1" style="width: 100%; border-collapse: collapse; text-align: center;"> <tr> <td style="width: 10%;"></td> <td style="width: 10%;"></td> <td style="width: 10%;"></td> <td style="width: 10%;"></td> <td style="width: 10%;"></td> <td style="width: 10%;"></td> <td style="width: 10%;"></td> <td style="width: 10%;"></td> <td style="width: 10%;"></td> <td style="width: 10%;"></td> </tr> <tr> <td></td> <td></td> <td colspan="8" style="text-align: center;"> <table border="1" style="width: 100%; border-collapse: collapse; text-align: center;"> <tr> <td style="width: 10%;"></td> <td style="width: 10%;"></td> <td style="width: 10%;"></td> <td style="width: 10%;"></td> <td style="width: 10%;"></td> <td style="width: 10%;"></td> <td style="width: 10%;"></td> <td style="width: 10%;"></td> <td style="width: 10%;"></td> <td style="width: 10%;"></td> </tr> <tr> <td></td> <td></td> <td colspan="8" style="text-align: center;"> <table border="1" style="width: 100%; border-collapse: collapse; text-align: center;"> <tr> </tr></table></td></tr></table></td></tr></table></td></tr></table></td></tr></table></td></tr></table></td></tr></table>
 | | | | | | | | | | | | | | | | | | | | <table border="1" style="width: 100%; border-collapse: collapse; text-align: center;"> <tr> <td style="width: 10%;"></td> <td style="width: 10%;"></td> <td style="width: 10%;"></td> <td style="width: 10%;"></td> <td style="width: 10%;"></td> <td style="width: 10%;"></td> <td style="width: 10%;"></td> <td style="width: 10%;"></td> <td style="width: 10%;"></td> <td style="width: 10%;"></td> </tr> <tr> <td></td> <td></td> <td colspan="8" style="text-align: center;"> <table border="1" style="width: 100%; border-collapse: collapse; text-align: center;"> <tr> <td style="width: 10%;"></td> <td style="width: 10%;"></td> <td style="width: 10%;"></td> <td style="width: 10%;"></td> <td style="width: 10%;"></td> <td style="width: 10%;"></td> <td style="width: 10%;"></td> <td style="width: 10%;"></td> <td style="width: 10%;"></td> <td style="width: 10%;"></td> </tr> <tr> <td></td> <td></td> <td colspan="8" style="text-align: center;"> <table border="1" style="width: 100%; border-collapse: collapse; text-align: center;"> <tr> <td style="width: 10%;"></td> <td style="width: 10%;"></td> <td style="width: 10%;"></td> <td style="width: 10%;"></td> <td style="width: 10%;"></td> <td style="width: 10%;"></td> <td style="width: 10%;"></td> <td style="width: 10%;"></td> <td style="width: 10%;"></td> <td style="width: 10%;"></td> </tr> <tr> <td></td> <td></td> <td colspan="8" style="text-align: center;"> <table border="1" style="width: 100%; border-collapse: collapse; text-align: center;"> <tr> <td style="width: 10%;"></td> <td style="width: 10%;"></td> <td style="width: 10%;"></td> <td style="width: 10%;"></td> <td style="width: 10%;"></td> <td style="width: 10%;"></td> <td style="width: 10%;"></td> <td style="width: 10%;"></td> <td style="width: 10%;"></td> <td style="width: 10%;"></td> </tr> <tr> <td></td> <td></td> <td colspan="8" style="text-align: center;"> <table border="1" style="width: 100%; border-collapse: collapse; text-align: center;"> <tr> <td style="width: 10%;"></td> <td style="width: 10%;"></td> <td style="width: 10%;"></td> <td style="width: 10%;"></td> <td style="width: 10%;"></td> <td style="width: 10%;"></td> <td style="width: 10%;"></td> <td style="width: 10%;"></td> <td style="width: 10%;"></td> <td style="width: 10%;"></td> </tr> <tr> <td></td> <td></td> <td colspan="8" style="text-align: center;"> <table border="1" style="width: 100%; border-collapse: collapse; text-align: center;"> <tr> </tr></table></td></tr></table></td></tr></table></td></tr></table></td></tr></table></td></tr></table> | | | | | | | | | | | | | | | | | | | | <table border="1" style="width: 100%; border-collapse: collapse; text-align: center;"> <tr> <td style="width: 10%;"></td> <td style="width: 10%;"></td> <td style="width: 10%;"></td> <td style="width: 10%;"></td> <td style="width: 10%;"></td> <td style="width: 10%;"></td> <td style="width: 10%;"></td> <td style="width: 10%;"></td> <td style="width: 10%;"></td> <td style="width: 10%;"></td> </tr> <tr> <td></td> <td></td> <td colspan="8" style="text-align: center;"> <table border="1" style="width: 100%; border-collapse: collapse; text-align: center;"> <tr> <td style="width: 10%;"></td> <td style="width: 10%;"></td> <td style="width: 10%;"></td> <td style="width: 10%;"></td> <td style="width: 10%;"></td> <td style="width: 10%;"></td> <td style="width: 10%;"></td> <td style="width: 10%;"></td> <td style="width: 10%;"></td> <td style="width: 10%;"></td> </tr> <tr> <td></td> <td></td> <td colspan="8" style="text-align: center;"> <table border="1" style="width: 100%;
border-collapse: collapse; text-align: center;"> <tr> <td style="width: 10%;"></td> <td style="width: 10%;"></td> <td style="width: 10%;"></td> <td style="width: 10%;"></td> <td style="width: 10%;"></td> <td style="width: 10%;"></td> <td style="width: 10%;"></td> <td style="width: 10%;"></td> <td style="width: 10%;"></td> <td style="width: 10%;"></td> </tr> <tr> <td></td> <td></td> <td colspan="8" style="text-align: center;"> <table border="1" style="width: 100%; border-collapse: collapse; text-align: center;"> <tr> <td style="width: 10%;"></td> <td style="width: 10%;"></td> <td style="width: 10%;"></td> <td style="width: 10%;"></td> <td style="width: 10%;"></td> <td style="width: 10%;"></td> <td style="width: 10%;"></td> <td style="width: 10%;"></td> <td style="width: 10%;"></td> <td style="width: 10%;"></td> </tr> <tr> <td></td> <td></td> <td colspan="8" style="text-align: center;"> <table border="1" style="width: 100%; border-collapse: collapse; text-align: center;"> <tr> </tr></table></td></tr></table></td></tr></table></td></tr></table></td></tr></table> | | | | | | | | | | | | | | | | | | | | <table border="1" style="width: 100%; border-collapse: collapse; text-align: center;"> <tr> <td style="width: 10%;"></td> <td style="width: 10%;"></td> <td style="width: 10%;"></td> <td style="width: 10%;"></td> <td style="width: 10%;"></td> <td style="width: 10%;"></td> <td style="width: 10%;"></td> <td style="width: 10%;"></td> <td style="width: 10%;"></td> <td style="width: 10%;"></td> </tr> <tr> <td></td> <td></td> <td colspan="8" style="text-align: center;"> <table border="1" style="width: 100%; border-collapse: collapse; text-align: center;"> <tr> <td style="width: 10%;"></td> <td style="width: 10%;"></td> <td style="width: 10%;"></td> <td style="width: 10%;"></td> <td style="width: 10%;"></td> <td style="width: 10%;"></td> <td style="width: 10%;"></td> <td style="width: 10%;"></td> <td style="width: 10%;"></td> <td style="width: 10%;"></td> </tr> <tr> <td></td> <td></td> <td colspan="8" style="text-align: center;"> <table border="1" style="width: 100%; border-collapse: collapse; text-align: center;"> <tr> <td style="width: 10%;"></td> <td style="width: 10%;"></td> <td style="width: 10%;"></td> <td style="width: 10%;"></td> <td style="width: 10%;"></td> <td style="width: 10%;"></td> <td style="width: 10%;"></td> <td style="width: 10%;"></td> <td style="width: 10%;"></td> <td style="width: 10%;"></td> </tr> <tr> <td></td> <td></td> <td colspan="8" style="text-align: center;"> <table border="1" style="width: 100%; border-collapse: collapse; text-align: center;"> <tr> </tr></table></td></tr></table></td></tr></table></td></tr></table> | | | | | | | | | | | | | | | | | | | | <table border="1" style="width: 100%; border-collapse: collapse; text-align: center;"> <tr> <td style="width: 10%;"></td> <td style="width: 10%;"></td> <td style="width: 10%;"></td> <td style="width: 10%;"></td> <td style="width: 10%;"></td> <td style="width: 10%;"></td> <td style="width: 10%;"></td> <td style="width: 10%;"></td> <td style="width: 10%;"></td> <td style="width: 10%;"></td> </tr> <tr> <td></td> <td></td> <td
colspan="8" style="text-align: center;"> <table border="1" style="width: 100%; border-collapse: collapse; text-align: center;"> <tr> <td style="width: 10%;"></td> <td style="width: 10%;"></td> <td style="width: 10%;"></td> <td style="width: 10%;"></td> <td style="width: 10%;"></td> <td style="width: 10%;"></td> <td style="width: 10%;"></td> <td style="width: 10%;"></td> <td style="width: 10%;"></td> <td style="width: 10%;"></td> </tr> <tr> <td></td> <td></td> <td colspan="8" style="text-align: center;"> <table border="1" style="width: 100%; border-collapse: collapse; text-align: center;"> <tr> </tr></table></td></tr></table></td></tr></table> | | | | | | | | | | | | | | | | | | | | <table border="1" style="width: 100%; border-collapse: collapse; text-align: center;"> <tr> <td style="width: 10%;"></td> <td style="width: 10%;"></td> <td style="width: 10%;"></td> <td style="width: 10%;"></td> <td style="width: 10%;"></td> <td style="width: 10%;"></td> <td style="width: 10%;"></td> <td style="width: 10%;"></td> <td style="width: 10%;"></td> <td style="width: 10%;"></td> </tr> <tr> <td></td> <td></td> <td colspan="8" style="text-align: center;"> <table border="1" style="width: 100%; border-collapse: collapse; text-align: center;"> <tr> </tr></table></td></tr></table> | | | | | | | | | | | | | | | | | | | | <table border="1" style="width: 100%; border-collapse: collapse; text-align: center;"> <tr> </tr></table>
 | | | | | | | | | | | | | | | | | | | | | | | | | | | | | | | | | | | | | | | | | | | | | | | | | | | | | | | | | | | | | | | | | | | | | | | | | | | | | | | |
 | | | | | | | | | | | | | | | | | | | | | | | | | | | | | | | | | | | | | | | | | | | | | | | | | | | | | | | | | | | | | | | | | | | |
| | |

 | | | | | | | | | | | | | | | | | | | |

 | | | | | | | | | | | | | | | | | | | |

 | | | | | | | | | | | | | | | | | | | |

 | | | | | | | | | | | | | | | | | | | |

 | | | | | | | | | | | | | | | | | | | |

 | | | | | | | | | | | | | | | | | | | |

 | | | | | | | | | | | | | | | | | | | |

 | | | | | | | | | | | | | | | | | | | |

 | | | | | | | | | | | | | | | | | | | |

 | | | | | | | | | | | | | | | | | | | |

 | | | | | | | | | | | | | | | | | | | |

 | | | | | | | | | | | | | | | | | | | |

 | | | | | | | | | | | | | | | | | | | |

 | | | | | | | | | | | | | | | | | | | |

 | | | | | | | | | | | | | | | | | | | |

 | | | | | | | | | | | | | | | | | | | |

 | | | | | | | | | | | | | | | | | | | |

 | | | | | | | | | | | | | | | | | | | |

 | | | | | | | | | | | | | | | | | | | |

 | | | | | | | | | | | | | | | | | | | |

 | | | | | | | | | | | | | | | | | | | |

 | | | | | | | | | | | | | | | | | | | |

 | | | | | | | | | | | | | | | | | | | |

 | | | | | | | | | | | | | | | | | | | |

 | | | | | | | | | | | | | | | | | | | |

 | | | | | | | | | | | | | | | | | | | |

 | | | | | | | | | | | | | | | | | | | |

 | | | | | | | | | | | | | | | | | | | |
 | | | | | | | | | | | | | | | | | | | |

 | | | | | | | | | | | | | | | | | | | |

 | | | | | | | | | | | | | | | | | | | |
 | | | | | | | | | | | | | | | | | | | |

 | | | | | | | | | | | | | | | | | | | |

 | | | | | | | | | | | | | | | | | | | |
 | | | | | | | | | | | | | | | | | | | |
 | | | | | | | | | | | | | | | | | | | |

 | | | | | | | | | | | | | | | | | | | |
 | | | | | | | | | | | | | | | | | | | |
 | | | | | | | | | | | | | | | | | | | |

 | | | | | | | | | | | | | | | | | | | | | | | | | | | | | | | | | | | | | | | | | | | | | | | | | | | | | | | | | | | | | | | | | | | | | | | | | | | | | | | | | | | | | | | | | | | | | | | | | | | |
 | | | | | | | | | | | | | | | | | | | |
 | | | | | | | | | | | | | | | | | | | |
 | | | | | | | | | | | | | | | | | | | |
 | | | | | | | | | | | | | | | | | | | |
 | | | | | | | | | | | | | | | | | | | |
 | | | | | | | | | | | | | | | | | | | |
 | | | | | | | | | | | | | | | | | | | |
 | | | | | | | | | | | | | | | | | | | |
 | | | | | | | | | | | | | | | | | | | | | | | | | | | | | | | | | | | | | | | |
 | | | | | | | | | | | | | | | | | | | |
 | | | | | | | | | | | | | | | | | | | | | | | | | | | | | | | | | | | | | | | |
 | | | | | | | | | | | | | | | | | | | | | | | | | | | | | | | | | | | | | | | |
 | | | | | | | | | | | | | | | | | | | | | | | | | | | | | | | | | | | | | | | |
 | | | | | | | | | | | | | | | | | | | | | | | | | | | | | | | | | | | | | | | | | | | | | | | | | | | | | | | | | | | | | | | | | | | | | | | | | | | | | | | | | | | | | | | | | | | | | | | | | | | |
 | | | | | | | | | | | | | | | | | | | | | | | | | | | | | | | | | | | | | | | | | | | | | | | |
| | | <table border="1" style="width: 100%; border-collapse: collapse; text-align: center;"> <tr> <td style="width: 10%;"></td> <td style="width: 10%;"></td> <td style="width: 10%;"></td> <td style="width: 10%;"></td> <td style="width: 10%;"></td> <td style="width: 10%;"></td> <td style="width: 10%;"></td> <td style="width: 10%;"></td> <td style="width: 10%;"></td> <td style="width: 10%;"></td> </tr> <tr> <td></td> <td></td> <td colspan="8" style="text-align: center;"> <table border="1" style="width: 100%; border-collapse: collapse; text-align: center;"> <tr> <td style="width: 10%;"></td> <td style="width: 10%;"></td> <td style="width: 10%;"></td> <td style="width: 10%;"></td> <td style="width: 10%;"></td> <td style="width: 10%;"></td> <td style="width: 10%;"></td> <td style="width: 10%;"></td> <td style="width: 10%;"></td> <td style="width: 10%;"></td> </tr> <tr> <td></td> <td></td> <td colspan="8" style="text-align: center;"> <table border="1" style="width: 100%; border-collapse: collapse; text-align: center;"> <tr> <td style="width: 10%;"></td> <td style="width: 10%;"></td> <td style="width: 10%;"></td> <td style="width: 10%;"></td> <td style="width: 10%;"></td> <td style="width: 10%;"></td> <td style="width: 10%;"></td> <td style="width: 10%;"></td> <td style="width: 10%;"></td> <td style="width: 10%;"></td> </tr> <tr> <td></td> <td></td> <td colspan="8" style="text-align: center;"> <table border="1" style="width: 100%; border-collapse: collapse; text-align: center;"> <tr> <td style="width: 10%;"></td> <td style="width: 10%;"></td> <td style="width: 10%;"></td> <td style="width: 10%;"></td> <td style="width: 10%;"></td> <td style="width: 10%;"></td> <td style="width: 10%;"></td> <td style="width: 10%;"></td> <td style="width: 10%;"></td> <td style="width: 10%;"></td> </tr> <tr> <td></td> <td></td> <td colspan="8" style="text-align: center;"> <table border="1" style="width: 100%; border-collapse: collapse; text-align: center;"> <tr> <td style="width: 10%;"></td> <td style="width: 10%;"></td> <td style="width: 10%;"></td> <td style="width: 10%;"></td> <td style="width: 10%;"></td> <td style="width: 10%;"></td> <td style="width: 10%;"></td> <td style="width: 10%;"></td> <td style="width: 10%;"></td> <td style="width: 10%;"></td> </tr> <tr> <td></td> <td></td> <td colspan="8" style="text-align: center;"> <table border="1" style="width: 100%; border-collapse: collapse; text-align: center;"> <tr> <td style="width: 10%;"></td> <td style="width: 10%;"></td> <td style="width: 10%;"></td> <td style="width: 10%;"></td> <td style="width: 10%;"></td> <td style="width: 10%;"></td> <td style="width: 10%;"></td> <td style="width: 10%;"></td> <td style="width: 10%;"></td> <td style="width: 10%;"></td> </tr> <tr> <td></td> <td></td> <td colspan="8" style="text-align: center;"> <table border="1" style="width: 100%; border-collapse: collapse; text-align: center;"> <tr> <td style="width: 10%;"></td> <td style="width: 10%;"></td> <td style="width: 10%;"></td> <td style="width: 10%;"></td> <td style="width: 10%;"></td> <td style="width: 10%;"></td> <td style="width: 10%;"></td> <td style="width: 10%;"></td> <td style="width: 10%;"></td> <td style="width: 10%;"></td> </tr> <tr> <td></td> <td></td> <td colspan="8" style="text-align: center;"> <table border="1" style="width: 100%; border-collapse: collapse; text-align: center;"> <tr> <td style="width: 10%;"></td> <td style="width: 10%;"></td> <td style="width: 10%;"></td> <td style="width: 10%;"></td> <td style="width: 10%;"></td> <td style="width: 10%;"></td> <td style="width: 10%;"></td> <td style="width: 10%;"></td> <td style="width: 10%;"></td> <td style="width: 10%;"></td> </tr> <tr> <td></td> <td></td> <td colspan="8" style="text-align: center;"> <table border="1" style="width: 100%; border-collapse: collapse; text-align: center;"> <tr> <td style="width: 10%;"></td> <td style="width: 10%;"></td> <td style="width: 10%;"></td> <td style="width: 10%;"></td> <td style="width: 10%;"></td> <td style="width: 10%;"></td> <td style="width: 10%;"></td> <td style="width: 10%;"></td> <td style="width: 10%;"></td> <td style="width: 10%;"></td> </tr> <tr> <td></td> <td></td> <td colspan="8" style="text-align: center;"> <table border="1" style="width: 100%; border-collapse: collapse; text-align: center;"> <tr> <td style="width: 10%;"></td> <td style="width: 10%;"></td> <td style="width: 10%;"></td> <td style="width: 10%;"></td> <td style="width: 10%;"></td> <td style="width: 10%;"></td> <td style="width: 10%;"></td> <td style="width: 10%;"></td> <td style="width: 10%;"></td> <td style="width: 10%;"></td> </tr> <tr> <td></td> <td></td> <td colspan="8" style="text-align: center;"> <table border="1" style="width: 100%; border-collapse: collapse; text-align: center;"> <tr> <td style="width: 10%;"></td> <td style="width: 10%;"></td> <td style="width: 10%;"></td> <td style="width: 10%;"></td> <td style="width: 10%;"></td> <td style="width: 10%;"></td> <td style="width: 10%;"></td> <td style="width: 10%;"></td> <td style="width: 10%;"></td> <td style="width: 10%;"></td> </tr> <tr> <td></td> <td></td> <td colspan="8" style="text-align: center;"> <table border="1" style="width: 100%; border-collapse: collapse; text-align: center;"> <tr> <td style="width: 10%;"></td> <td style="width: 10%;"></td> <td style="width: 10%;"></td> <td style="width: 10%;"></td> <td style="width: 10%;"></td> <td style="width: 10%;"></td> <td style="width: 10%;"></td> <td style="width: 10%;"></td> <td style="width: 10%;"></td> <td style="width: 10%;"></td> </tr> <tr> <td></td> <td></td> <td colspan="8" style="text-align: center;"> <table border="1" style="width: 100%; border-collapse: collapse; text-align: center;"> <tr> <td style="width: 10%;"></td> <td style="width: 10%;"></td> <td style="width: 10%;"></td> <td style="width: 10%;"></td> <td style="width: 10%;"></td> <td style="width: 10%;"></td> <td style="width: 10%;"></td> <td style="width: 10%;"></td> <td style="width: 10%;"></td> <td style="width: 10%;"></td> </tr> <tr> <td></td> <td></td> <td colspan="8" style="text-align: center;"> <table border="1" style="width: 100%; border-collapse: collapse; text-align: center;"> <tr> <td style="width: 10%;"></td> <td style="width: 10%;"></td> <td style="width: 10%;"></td> <td style="width: 10%;"></td> <td style="width: 10%;"></td> <td style="width: 10%;"></td> <td style="width: 10%;"></td> <td style="width: 10%;"></td> <td style="width: 10%;"></td> <td style="width: 10%;"></td> </tr> <tr> <td></td> <td></td> <td colspan="8" style="text-align: center;"> <table border="1" style="width: 100%; border-collapse: collapse; text-align: center;"> <tr> <td style="width: 10%;"></td> <td style="width: 10%;"></td> <td style="width: 10%;"></td> <td style="width: 10%;"></td> <td style="width: 10%;"></td> <td style="width: 10%;"></td> <td style="width: 10%;"></td> <td style="width: 10%;"></td> <td style="width: 10%;"></td> <td style="width: 10%;"></td> </tr> <tr> <td></td> <td></td> <td colspan="8" style="text-align: center;"> <table border="1" style="width: 100%; border-collapse: collapse; text-align: center;"> <tr> <td style="width: 10%;"></td> <td style="width: 10%;"></td> <td style="width: 10%;"></td> <td style="width: 10%;"></td> <td style="width: 10%;"></td> <td style="width: 10%;"></td> <td style="width: 10%;"></td> <td style="width: 10%;"></td> <td style="width: 10%;"></td> <td style="width: 10%;"></td> </tr> <tr> <td></td> <td></td> <td colspan="8" style="text-align: center;"> <table border="1" style="width: 100%; border-collapse: collapse; text-align: center;"> <tr> <td style="width: 10%;"></td> <td style="width: 10%;"></td> <td style="width: 10%;"></td> <td style="width: 10%;"></td> <td style="width: 10%;"></td> <td style="width: 10%;"></td> <td style="width: 10%;"></td> <td style="width: 10%;"></td> <td style="width: 10%;"></td> <td style="width: 10%;"></td> </tr> <tr> <td></td> <td></td> <td colspan="8" style="text-align: center;"> <table border="1" style="width: 100%; border-collapse: collapse; text-align: center;"> <tr> <td style="width: 10%;"></td> <td style="width: 10%;"></td> <td style="width: 10%;"></td> <td style="width: 10%;"></td> <td style="width: 10%;"></td> <td style="width: 10%;"></td> <td style="width: 10%;"></td> <td style="width: 10%;"></td> <td style="width: 10%;"></td> <td style="width: 10%;"></td> </tr> <tr> <td></td> <td></td> <td colspan="8" style="text-align: center;"> <table border="1" style="width: 100%; border-collapse: collapse; text-align: center;"> <tr> <td style="width: 10%;"></td> <td style="width: 10%;"></td> <td style="width: 10%;"></td> <td style="width: 10%;"></td> <td style="width: 10%;"></td> <td style="width: 10%;"></td> <td style="width: 10%;"></td> <td style="width: 10%;"></td> <td style="width: 10%;"></td> <td style="width: 10%;"></td> </tr> <tr> <td></td> <td></td> <td colspan="8" style="text-align: center;"> <table border="1" style="width: 100%; border-collapse: collapse; text-align: center;"> <tr> <td style="width: 10%;"></td> <td style="width: 10%;"></td> <td style="width: 10%;"></td> <td style="width: 10%;"></td> <td style="width: 10%;"></td> <td style="width: 10%;"></td> <td style="width: 10%;"></td> <td style="width: 10%;"></td> <td style="width: 10%;"></td> <td style="width: 10%;"></td> </tr> <tr> <td></td> <td></td> <td colspan="8" style="text-align: center;"> <table border="1" style="width: 100%; border-collapse: collapse; text-align: center;"> <tr> <td style="width: 10%;"></td> <td style="width: 10%;"></td> <td style="width: 10%;"></td> <td style="width: 10%;"></td> <td style="width: 10%;"></td> <td style="width: 10%;"></td> <td style="width: 10%;"></td> <td style="width: 10%;"></td> <td style="width: 10%;"></td> <td style="width: 10%;"></td> </tr> <tr> <td></td> <td></td> <td colspan="8" style="text-align: center;"> <table border="1" style="width: 100%; border-collapse: collapse; text-align: center;"> <tr> <td style="width: 10%;"></td> <td style="width: 10%;"></td> <td
style="width: 10%;"></td> <td style="width: 10%;"></td> <td style="width: 10%;"></td> <td style="width: 10%;"></td> <td style="width: 10%;"></td> <td style="width: 10%;"></td> <td style="width: 10%;"></td> <td style="width: 10%;"></td> </tr> <tr> <td></td> <td></td> <td colspan="8" style="text-align: center;"> <table border="1" style="width: 100%; border-collapse: collapse; text-align: center;"> <tr> <td style="width: 10%;"></td> <td style="width: 10%;"></td> <td style="width: 10%;"></td> <td style="width: 10%;"></td> <td style="width: 10%;"></td> <td style="width: 10%;"></td> <td style="width: 10%;"></td> <td style="width: 10%;"></td> <td style="width: 10%;"></td> <td style="width: 10%;"></td> </tr> <tr> <td></td> <td></td> <td colspan="8" style="text-align: center;"> <table border="1" style="width: 100%; border-collapse: collapse; text-align: center;"> <tr> <td style="width: 10%;"></td> <td style="width: 10%;"></td> <td style="width: 10%;"></td> <td style="width: 10%;"></td> <td style="width: 10%;"></td> <td style="width: 10%;"></td> <td style="width: 10%;"></td> <td style="width: 10%;"></td> <td style="width: 10%;"></td> <td style="width: 10%;"></td> </tr> <tr> <td></td> <td></td> <td colspan="8" style="text-align: center;"> <table border="1" style="width: 100%; border-collapse: collapse; text-align: center;"> <tr> <td style="width: 10%;"></td> <td style="width: 10%;"></td> <td style="width: 10%;"></td> <td style="width: 10%;"></td> <td style="width: 10%;"></td> <td style="width: 10%;"></td> <td style="width: 10%;"></td> <td style="width: 10%;"></td> <td style="width: 10%;"></td> <td style="width: 10%;"></td> </tr> <tr> <td></td> <td></td> <td colspan="8" style="text-align: center;"> <table border="1" style="width: 100%; border-collapse: collapse; text-align: center;"> <tr> <td style="width: 10%;"></td> <td style="width: 10%;"></td> <td style="width: 10%;"></td> <td style="width: 10%;"></td> <td style="width: 10%;"></td> <td style="width: 10%;"></td> <td style="width: 10%;"></td> <td style="width: 10%;"></td> <td style="width: 10%;"></td> <td style="width: 10%;"></td> </tr> <tr> <td></td> <td></td> <td colspan="8" style="text-align: center;"> <table border="1" style="width: 100%; border-collapse: collapse; text-align: center;"> <tr> <td style="width: 10%;"></td> <td style="width: 10%;"></td> <td style="width: 10%;"></td> <td style="width: 10%;"></td> <td style="width: 10%;"></td> <td style="width: 10%;"></td> <td style="width: 10%;"></td> <td style="width: 10%;"></td> <td style="width: 10%;"></td> <td style="width: 10%;"></td> </tr> <tr> <td></td> <td></td> <td colspan="8" style="text-align: center;"> <table border="1" style="width: 100%; border-collapse: collapse; text-align: center;"> <tr> <td style="width: 10%;"></td> <td style="width: 10%;"></td> <td style="width: 10%;"></td> <td style="width: 10%;"></td> <td style="width: 10%;"></td> <td style="width: 10%;"></td> <td style="width: 10%;"></td> <td style="width: 10%;"></td> <td style="width: 10%;"></td> <td style="width: 10%;"></td> </tr> <tr> <td></td> <td></td> <td colspan="8" style="text-align: center;"> <table border="1" style="width: 100%; border-collapse: collapse; text-align: center;"> <tr> <td style="width: 10%;"></td> <td style="width: 10%;"></td> <td style="width: 10%;"></td> <td style="width: 10%;"></td> <td style="width: 10%;"></td> <td style="width: 10%;"></td> <td style="width: 10%;"></td> <td style="width: 10%;"></td> <td style="width: 10%;"></td> <td style="width: 10%;"></td> </tr> <tr> <td></td> <td></td> <td colspan="8" style="text-align: center;"> <table border="1" style="width: 100%; border-collapse: collapse; text-align: center;"> <tr> <td style="width: 10%;"></td> <td style="width: 10%;"></td> <td style="width: 10%;"></td> <td style="width: 10%;"></td> <td style="width: 10%;"></td> <td style="width: 10%;"></td> <td style="width: 10%;"></td> <td style="width: 10%;"></td> <td style="width: 10%;"></td> <td style="width: 10%;"></td> </tr> <tr> <td></td> <td></td> <td colspan="8" style="text-align: center;"> <table border="1" style="width: 100%; border-collapse: collapse; text-align: center;"> <tr> <td style="width: 10%;"></td> <td style="width: 10%;"></td> <td style="width: 10%;"></td> <td style="width: 10%;"></td> <td style="width: 10%;"></td> <td style="width: 10%;"></td> <td style="width: 10%;"></td> <td style="width: 10%;"></td> <td style="width: 10%;"></td> <td style="width: 10%;"></td> </tr> <tr> <td></td> <td></td> <td colspan="8" style="text-align: center;"> <table border="1" style="width: 100%; border-collapse: collapse; text-align: center;"> <tr> <td style="width: 10%;"></td> <td style="width: 10%;"></td> <td style="width: 10%;"></td> <td style="width: 10%;"></td> <td style="width: 10%;"></td> <td style="width: 10%;"></td> <td style="width: 10%;"></td> <td style="width: 10%;"></td> <td style="width: 10%;"></td> <td style="width: 10%;"></td> </tr> <tr> <td></td> <td></td> <td colspan="8" style="text-align: center;"> <table border="1" style="width: 100%; border-collapse: collapse; text-align: center;"> <tr> <td style="width: 10%;"></td> <td style="width: 10%;"></td> <td style="width: 10%;"></td> <td style="width: 10%;"></td> <td style="width: 10%;"></td> <td style="width: 10%;"></td> <td style="width: 10%;"></td> <td style="width: 10%;"></td> <td style="width: 10%;"></td> <td style="width: 10%;"></td> </tr> <tr> <td></td> <td></td> <td colspan="8" style="text-align: center;"> <table border="1" style="width: 100%; border-collapse: collapse; text-align: center;"> <tr> <td style="width: 10%;"></td> <td style="width: 10%;"></td> <td style="width: 10%;"></td> <td style="width: 10%;"></td> <td style="width: 10%;"></td> <td style="width: 10%;"></td> <td style="width: 10%;"></td> <td style="width: 10%;"></td> <td style="width: 10%;"></td> <td style="width: 10%;"></td> </tr> <tr> <td></td> <td></td> <td colspan="8" style="text-align: center;"> <table border="1" style="width: 100%; border-collapse: collapse; text-align: center;"> <tr> <td style="width: 10%;"></td> <td style="width: 10%;"></td> <td style="width: 10%;"></td> <td style="width: 10%;"></td> <td style="width: 10%;"></td> <td style="width: 10%;"></td> <td style="width: 10%;"></td> <td style="width: 10%;"></td> <td style="width: 10%;"></td> <td style="width: 10%;"></td> </tr> <tr> <td></td> <td></td> <td colspan="8" style="text-align: center;"> <table border="1" style="width: 100%; border-collapse: collapse; text-align: center;"> <tr> <td style="width: 10%;"></td> <td style="width: 10%;"></td> <td style="width: 10%;"></td> <td style="width: 10%;"></td> <td style="width: 10%;"></td> <td style="width: 10%;"></td> <td style="width: 10%;"></td> <td style="width: 10%;"></td> <td style="width: 10%;"></td> <td style="width: 10%;"></td> </tr> <tr> <td></td> <td></td> <td colspan="8" style="text-align: center;"> <table border="1" style="width: 100%; border-collapse: collapse; text-align: center;"> <tr> <td style="width: 10%;"></td> <td style="width: 10%;"></td> <td style="width: 10%;"></td> <td style="width: 10%;"></td> <td style="width: 10%;"></td> <td style="width: 10%;"></td> <td style="width: 10%;"></td> <td style="width: 10%;"></td> <td style="width: 10%;"></td> <td style="width: 10%;"></td> </tr> <tr> <td></td> <td></td> <td colspan="8" style="text-align: center;"> <table border="1" style="width: 100%; border-collapse: collapse; text-align: center;"> <tr> <td style="width: 10%;"></td> <td style="width: 10%;"></td> <td style="width: 10%;"></td> <td style="width: 10%;"></td> <td style="width: 10%;"></td> <td style="width: 10%;"></td> <td style="width: 10%;"></td> <td style="width: 10%;"></td> <td style="width: 10%;"></td> <td style="width: 10%;"></td> </tr> <tr> <td></td> <td></td> <td colspan="8" style="text-align: center;"> <table border="1" style="width: 100%; border-collapse: collapse; text-align: center;"> <tr> <td style="width: 10%;"></td> <td style="width: 10%;"></td> <td style="width: 10%;"></td> <td style="width: 10%;"></td> <td style="width: 10%;"></td> <td style="width: 10%;"></td> <td style="width: 10%;"></td> <td style="width: 10%;"></td> <td style="width: 10%;"></td> <td style="width: 10%;"></td> </tr> <tr> <td></td> <td></td> <td colspan="8" style="text-align: center;"> <table border="1" style="width: 100%; border-collapse: collapse; text-align: center;"> <tr> <td style="width: 10%;"></td> <td style="width: 10%;"></td> <td style="width: 10%;"></td> <td style="width: 10%;"></td> <td style="width: 10%;"></td> <td style="width: 10%;"></td> <td style="width: 10%;"></td> <td style="width: 10%;"></td> <td style="width: 10%;"></td> <td style="width: 10%;"></td> </tr> <tr> <td></td> <td></td> <td colspan="8" style="text-align: center;"> <table border="1" style="width: 100%; border-collapse: collapse; text-align: center;"> <tr> <td style="width: 10%;"></td> <td style="width: 10%;"></td> <td style="width: 10%;"></td> <td style="width: 10%;"></td> <td style="width: 10%;"></td> <td style="width: 10%;"></td> <td style="width: 10%;"></td> <td style="width: 10%;"></td> <td style="width: 10%;"></td> <td style="width: 10%;"></td> </tr> <tr> <td></td> <td></td> <td colspan="8" style="text-align: center;"> <table border="1" style="width: 100%; border-collapse: collapse; text-align: center;"> <tr> <td style="width: 10%;"></td> <td style="width: 10%;"></td> <td style="width: 10%;"></td> <td style="width: 10%;"></td> <td style="width: 10%;"></td> <td style="width: 10%;"></td> <td style="width: 10%;"></td> <td style="width: 10%;"></td> <td style="width: 10%;"></td> <td style="width: 10%;"></td> </tr> <tr> <td></td> <td></td> <td colspan="8" style="text-align: center;"> <table border="1" style="width: 100%; border-collapse: collapse; text-align: center;"> <tr> <td style="width: 10%;"></td> <td style="width: 10%;"></td> <td style="width: 10%;"></td> <td style="width: 10%;"></td> <td style="width: 10%;"></td> <td style="width: 10%;"></td> <td style="width: 10%;"></td> <td style="width:
10%;"></td> <td style="width: 10%;"></td> <td style="width: 10%;"></td> </tr> <tr> <td></td> <td></td> <td colspan="8" style="text-align: center;"> <table border="1" style="width: 100%; border-collapse: collapse; text-align: center;"> <tr> <td style="width: 10%;"></td> <td style="width: 10%;"></td> <td style="width: 10%;"></td> <td style="width: 10%;"></td> <td style="width: 10%;"></td> <td style="width: 10%;"></td> <td style="width: 10%;"></td> <td style="width: 10%;"></td> <td style="width: 10%;"></td> <td style="width: 10%;"></td> </tr> <tr> <td></td> <td></td> <td colspan="8" style="text-align: center;"> <table border="1" style="width: 100%; border-collapse: collapse; text-align: center;"> <tr> <td style="width: 10%;"></td> <td style="width: 10%;"></td> <td style="width: 10%;"></td> <td style="width: 10%;"></td> <td style="width: 10%;"></td> <td style="width: 10%;"></td> <td style="width: 10%;"></td> <td style="width: 10%;"></td> <td style="width: 10%;"></td> <td style="width: 10%;"></td> </tr> <tr> <td></td> <td></td> <td colspan="8" style="text-align: center;"> <table border="1" style="width: 100%; border-collapse: collapse; text-align: center;"> <tr> <td style="width: 10%;"></td> <td style="width: 10%;"></td> <td style="width: 10%;"></td> <td style="width: 10%;"></td> <td style="width: 10%;"></td> <td style="width: 10%;"></td> <td style="width: 10%;"></td> <td style="width: 10%;"></td> <td style="width: 10%;"></td> <td style="width: 10%;"></td> </tr> <tr> <td></td> <td></td> <td colspan="8" style="text-align: center;"> <table border="1" style="width: 100%; border-collapse: collapse; text-align: center;"> <tr> <td style="width: 10%;"></td> <td style="width: 10%;"></td> <td style="width: 10%;"></td> <td style="width: 10%;"></td> <td style="width: 10%;"></td> <td style="width: 10%;"></td> <td style="width: 10%;"></td> <td style="width: 10%;"></td> <td style="width: 10%;"></td> <td style="width: 10%;"></td> </tr> <tr> <td></td> <td></td> <td colspan="8" style="text-align: center;"> <table border="1" style="width: 100%; border-collapse: collapse; text-align: center;"> <tr> <td style="width: 10%;"></td> <td style="width: 10%;"></td> <td style="width: 10%;"></td> <td style="width: 10%;"></td> <td style="width: 10%;"></td> <td style="width: 10%;"></td> <td style="width: 10%;"></td> <td style="width: 10%;"></td> <td style="width: 10%;"></td> <td style="width: 10%;"></td> </tr> <tr> <td></td> <td></td> <td colspan="8" style="text-align: center;"> <table border="1" style="width: 100%; border-collapse: collapse; text-align: center;"> <tr> <td style="width: 10%;"></td> <td style="width: 10%;"></td> <td style="width: 10%;"></td> <td style="width: 10%;"></td> <td style="width: 10%;"></td> <td style="width: 10%;"></td> <td style="width: 10%;"></td> <td style="width: 10%;"></td> <td style="width: 10%;"></td> <td style="width: 10%;"></td> </tr> <tr> <td></td> <td></td> <td colspan="8" style="text-align: center;"> <table border="1" style="width: 100%; border-collapse: collapse; text-align: center;"> <tr> <td style="width: 10%;"></td> <td style="width: 10%;"></td> <td style="width: 10%;"></td> <td style="width: 10%;"></td> <td style="width: 10%;"></td> <td style="width: 10%;"></td> <td style="width: 10%;"></td> <td style="width: 10%;"></td> <td style="width: 10%;"></td> <td style="width: 10%;"></td> </tr> <tr> <td></td> <td></td> <td colspan="8" style="text-align: center;"> <table border="1" style="width: 100%; border-collapse: collapse; text-align: center;"> <tr> <td style="width: 10%;"></td> <td style="width: 10%;"></td> <td style="width: 10%;"></td> <td style="width: 10%;"></td> <td style="width: 10%;"></td> <td style="width: 10%;"></td> <td style="width: 10%;"></td> <td style="width: 10%;"></td> <td style="width: 10%;"></td> <td style="width: 10%;"></td> </tr> <tr> <td></td> <td></td> <td colspan="8" style="text-align: center;"> <table border="1" style="width: 100%; border-collapse: collapse; text-align: center;"> <tr> <td style="width: 10%;"></td> <td style="width: 10%;"></td> <td style="width: 10%;"></td> <td style="width: 10%;"></td> <td style="width: 10%;"></td> <td style="width: 10%;"></td> <td style="width: 10%;"></td> <td style="width: 10%;"></td> <td style="width: 10%;"></td> <td style="width: 10%;"></td> </tr> <tr> <td></td> <td></td> <td colspan="8" style="text-align: center;"> <table border="1" style="width: 100%; border-collapse: collapse; text-align: center;"> <tr> <td style="width: 10%;"></td> <td style="width: 10%;"></td> <td style="width: 10%;"></td> <td style="width: 10%;"></td> <td style="width: 10%;"></td> <td style="width: 10%;"></td> <td style="width: 10%;"></td> <td style="width: 10%;"></td> <td style="width: 10%;"></td> <td style="width: 10%;"></td> </tr> <tr> <td></td> <td></td> <td colspan="8" style="text-align: center;"> <table border="1" style="width: 100%; border-collapse: collapse; text-align: center;"> <tr> <td style="width: 10%;"></td> <td style="width: 10%;"></td> <td style="width: 10%;"></td> <td style="width: 10%;"></td> <td style="width: 10%;"></td> <td style="width: 10%;"></td> <td style="width: 10%;"></td> <td style="width: 10%;"></td> <td style="width: 10%;"></td> <td style="width: 10%;"></td> </tr> <tr> <td></td> <td></td> <td colspan="8" style="text-align: center;"> <table border="1" style="width: 100%; border-collapse: collapse; text-align: center;"> <tr> <td style="width: 10%;"></td> <td style="width: 10%;"></td> <td style="width: 10%;"></td> <td style="width: 10%;"></td> <td style="width: 10%;"></td> <td style="width: 10%;"></td> <td style="width: 10%;"></td> <td style="width: 10%;"></td> <td style="width: 10%;"></td> <td style="width: 10%;"></td> </tr> <tr> <td></td> <td></td> <td colspan="8" style="text-align: center;"> <table border="1" style="width: 100%; border-collapse: collapse; text-align: center;"> <tr> <td style="width: 10%;"></td> <td style="width: 10%;"></td> <td style="width: 10%;"></td> <td style="width: 10%;"></td> <td style="width: 10%;"></td> <td style="width: 10%;"></td> <td style="width: 10%;"></td> <td style="width: 10%;"></td> <td style="width: 10%;"></td> <td style="width: 10%;"></td> </tr> <tr> <td></td> <td></td> <td colspan="8" style="text-align: center;"> <table border="1" style="width: 100%; border-collapse: collapse; text-align: center;"> <tr> </tr></table></td></tr></table></td></tr></table></td></tr></table></td></tr></table></td></tr></table></td></tr></table></td></tr></table></td></tr></table></td></tr></table></td></tr></table></td></tr></table></td></tr></table></td></tr></table></td></tr></table></td></tr></table></td></tr></table></td></tr></table></td></tr></table></td></tr></table></td></tr></table></td></tr></table></td></tr></table></td></tr></table></td></tr></table></td></tr></table></td></tr></table></td></tr></table></td></tr></table></td></tr></table></td></tr></table></td></tr></table></td></tr></table></td></tr></table></td></tr></table></td></tr></table></td></tr></table></td></tr></table></td></tr></table></td></tr></table></td></tr></table></td></tr></table></td></tr></table></td></tr></table></td></tr></table></td></tr></table></td></tr></table></td></tr></table></td></tr></table></td></tr></table></td></tr></table></td></tr></table></td></tr></table></td></tr></table></td></tr></table></td></tr></table></td></tr></table>
 | | | | | | | | | | | | | | | | | | | | <table border="1" style="width: 100%; border-collapse: collapse; text-align: center;"> <tr> <td style="width: 10%;"></td> <td style="width: 10%;"></td> <td style="width: 10%;"></td> <td style="width: 10%;"></td> <td style="width: 10%;"></td> <td style="width: 10%;"></td> <td style="width: 10%;"></td> <td style="width: 10%;"></td> <td style="width: 10%;"></td> <td style="width: 10%;"></td> </tr> <tr> <td></td> <td></td> <td colspan="8" style="text-align: center;"> <table border="1" style="width: 100%; border-collapse: collapse; text-align: center;"> <tr> <td style="width: 10%;"></td> <td style="width: 10%;"></td> <td style="width: 10%;"></td> <td style="width: 10%;"></td> <td style="width: 10%;"></td> <td style="width: 10%;"></td> <td style="width: 10%;"></td> <td style="width: 10%;"></td> <td style="width: 10%;"></td> <td style="width: 10%;"></td> </tr> <tr> <td></td> <td></td> <td colspan="8" style="text-align: center;"> <table border="1" style="width: 100%; border-collapse: collapse; text-align: center;"> <tr> <td style="width: 10%;"></td> <td style="width: 10%;"></td> <td style="width: 10%;"></td> <td style="width: 10%;"></td> <td style="width: 10%;"></td> <td style="width: 10%;"></td> <td style="width: 10%;"></td> <td style="width: 10%;"></td> <td style="width: 10%;"></td> <td style="width: 10%;"></td> </tr> <tr> <td></td> <td></td> <td colspan="8" style="text-align: center;"> <table border="1" style="width: 100%; border-collapse: collapse; text-align: center;"> <tr> <td style="width: 10%;"></td> <td style="width: 10%;"></td> <td style="width: 10%;"></td> <td style="width: 10%;"></td> <td style="width: 10%;"></td> <td style="width: 10%;"></td> <td style="width: 10%;"></td> <td style="width: 10%;"></td> <td style="width: 10%;"></td> <td style="width: 10%;"></td> </tr> <tr> <td></td> <td></td> <td colspan="8" style="text-align: center;"> <table border="1" style="width: 100%; border-collapse: collapse; text-align: center;"> <tr> <td style="width: 10%;"></td> <td style="width: 10%;"></td> <td style="width: 10%;"></td> <td style="width: 10%;"></td> <td style="width: 10%;"></td> <td style="width: 10%;"></td> <td style="width: 10%;"></td> <td style="width: 10%;"></td> <td style="width: 10%;"></td> <td style="width: 10%;"></td> </tr> <tr> <td></td> <td></td> <td colspan="8" style="text-align: center;"> <table border="1" style="width: 100%; border-collapse: collapse; text-align: center;"> <tr> <td style="width: 10%;"></td> <td style="width: 10%;"></td> <td style="width: 10%;"></td> <td style="width: 10%;"></td> <td style="width: 10%;"></td> <td style="width: 10%;"></td> <td style="width: 10%;"></td> <td style="width: 10%;"></td> <td style="width: 10%;"></td> <td style="width: 10%;"></td> </tr> <tr> <td></td> <td></td> <td colspan="8" style="text-align: center;"> <table border="1" style="width: 100%; border-collapse: collapse; text-align: center;"> <tr> <td style="width: 10%;"></td> <td style="width: 10%;"></td> <td style="width: 10%;"></td> <td style="width: 10%;"></td> <td style="width: 10%;"></td> <td style="width: 10%;"></td> <td style="width: 10%;"></td> <td style="width: 10%;"></td> <td style="width: 10%;"></td> <td style="width: 10%;"></td> </tr> <tr> <td></td> <td></td> <td colspan="8" style="text-align: center;"> <table border="1" style="width: 100%; border-collapse: collapse; text-align: center;"> <tr> <td style="width: 10%;"></td> <td style="width: 10%;"></td> <td style="width: 10%;"></td> <td style="width: 10%;"></td> <td style="width: 10%;"></td> <td style="width: 10%;"></td> <td style="width: 10%;"></td> <td style="width: 10%;"></td> <td style="width: 10%;"></td> <td style="width: 10%;"></td> </tr> <tr> <td></td> <td></td> <td colspan="8" style="text-align: center;"> <table border="1" style="width: 100%; border-collapse: collapse; text-align: center;"> <tr> <td style="width: 10%;"></td> <td style="width: 10%;"></td> <td style="width: 10%;"></td> <td style="width: 10%;"></td> <td style="width: 10%;"></td> <td style="width: 10%;"></td> <td style="width: 10%;"></td> <td style="width: 10%;"></td> <td style="width: 10%;"></td> <td style="width: 10%;"></td> </tr> <tr> <td></td> <td></td> <td colspan="8" style="text-align: center;"> <table border="1" style="width: 100%; border-collapse: collapse; text-align: center;"> <tr> <td style="width: 10%;"></td> <td style="width: 10%;"></td> <td style="width: 10%;"></td> <td style="width: 10%;"></td> <td style="width: 10%;"></td> <td style="width: 10%;"></td> <td style="width: 10%;"></td> <td style="width: 10%;"></td> <td style="width: 10%;"></td> <td style="width: 10%;"></td> </tr> <tr> <td></td> <td></td> <td colspan="8" style="text-align: center;"> <table border="1" style="width: 100%; border-collapse: collapse; text-align: center;"> <tr> <td style="width: 10%;"></td> <td style="width: 10%;"></td> <td style="width: 10%;"></td> <td style="width: 10%;"></td> <td style="width: 10%;"></td> <td style="width: 10%;"></td> <td style="width: 10%;"></td> <td style="width: 10%;"></td> <td style="width: 10%;"></td> <td style="width: 10%;"></td> </tr> <tr> <td></td> <td></td> <td colspan="8" style="text-align: center;"> <table border="1" style="width: 100%; border-collapse: collapse; text-align: center;"> <tr> <td style="width: 10%;"></td> <td style="width: 10%;"></td> <td style="width: 10%;"></td> <td style="width: 10%;"></td> <td style="width: 10%;"></td> <td style="width: 10%;"></td> <td style="width: 10%;"></td> <td style="width: 10%;"></td> <td style="width: 10%;"></td> <td style="width: 10%;"></td> </tr> <tr> <td></td> <td></td> <td colspan="8" style="text-align: center;"> <table border="1" style="width: 100%; border-collapse: collapse; text-align: center;"> <tr> <td style="width: 10%;"></td> <td style="width: 10%;"></td> <td style="width: 10%;"></td> <td style="width: 10%;"></td> <td style="width: 10%;"></td> <td style="width: 10%;"></td> <td style="width: 10%;"></td> <td style="width: 10%;"></td> <td style="width: 10%;"></td> <td style="width: 10%;"></td> </tr> <tr> <td></td> <td></td> <td colspan="8" style="text-align: center;"> <table border="1" style="width: 100%; border-collapse: collapse; text-align: center;"> <tr> <td style="width: 10%;"></td> <td style="width: 10%;"></td> <td style="width: 10%;"></td> <td style="width: 10%;"></td> <td style="width: 10%;"></td> <td style="width: 10%;"></td> <td style="width: 10%;"></td> <td style="width: 10%;"></td> <td style="width: 10%;"></td> <td style="width: 10%;"></td> </tr> <tr> <td></td> <td></td> <td colspan="8" style="text-align: center;"> <table border="1" style="width: 100%; border-collapse: collapse; text-align: center;"> <tr> <td style="width: 10%;"></td> <td style="width: 10%;"></td> <td style="width: 10%;"></td> <td style="width: 10%;"></td> <td style="width: 10%;"></td> <td style="width: 10%;"></td> <td style="width: 10%;"></td> <td style="width: 10%;"></td> <td style="width: 10%;"></td> <td style="width: 10%;"></td> </tr> <tr> <td></td> <td></td> <td colspan="8" style="text-align: center;"> <table border="1" style="width: 100%; border-collapse: collapse; text-align: center;"> <tr> <td style="width: 10%;"></td> <td style="width: 10%;"></td> <td style="width: 10%;"></td> <td style="width: 10%;"></td> <td style="width: 10%;"></td> <td style="width: 10%;"></td> <td style="width: 10%;"></td> <td style="width: 10%;"></td> <td style="width: 10%;"></td> <td style="width: 10%;"></td> </tr> <tr> <td></td> <td></td> <td colspan="8" style="text-align: center;"> <table border="1" style="width: 100%; border-collapse: collapse; text-align: center;"> <tr> <td style="width: 10%;"></td> <td style="width: 10%;"></td> <td style="width: 10%;"></td> <td style="width: 10%;"></td> <td style="width: 10%;"></td> <td style="width: 10%;"></td> <td style="width: 10%;"></td> <td style="width: 10%;"></td> <td style="width: 10%;"></td> <td style="width: 10%;"></td> </tr> <tr> <td></td> <td></td> <td colspan="8" style="text-align: center;"> <table border="1" style="width: 100%; border-collapse: collapse; text-align: center;"> <tr> <td style="width: 10%;"></td> <td style="width: 10%;"></td> <td style="width: 10%;"></td> <td style="width: 10%;"></td> <td style="width: 10%;"></td> <td style="width: 10%;"></td> <td style="width: 10%;"></td> <td style="width: 10%;"></td> <td style="width: 10%;"></td> <td style="width: 10%;"></td> </tr> <tr> <td></td> <td></td> <td colspan="8" style="text-align: center;"> <table border="1" style="width: 100%; border-collapse: collapse; text-align: center;"> <tr> <td style="width: 10%;"></td> <td style="width: 10%;"></td> <td style="width: 10%;"></td> <td style="width: 10%;"></td> <td style="width: 10%;"></td> <td style="width:
10%;"></td> <td style="width: 10%;"></td> <td style="width: 10%;"></td> <td style="width: 10%;"></td> <td style="width: 10%;"></td> </tr> <tr> <td></td> <td></td> <td colspan="8" style="text-align: center;"> <table border="1" style="width: 100%; border-collapse: collapse; text-align: center;"> <tr> <td style="width: 10%;"></td> <td style="width: 10%;"></td> <td style="width: 10%;"></td> <td style="width: 10%;"></td> <td style="width: 10%;"></td> <td style="width: 10%;"></td> <td style="width: 10%;"></td> <td style="width: 10%;"></td> <td style="width: 10%;"></td> <td style="width: 10%;"></td> </tr> <tr> <td></td> <td></td> <td colspan="8" style="text-align: center;"> <table border="1" style="width: 100%; border-collapse: collapse; text-align: center;"> <tr> <td style="width: 10%;"></td> <td style="width: 10%;"></td> <td style="width: 10%;"></td> <td style="width: 10%;"></td> <td style="width: 10%;"></td> <td style="width: 10%;"></td> <td style="width: 10%;"></td> <td style="width: 10%;"></td> <td style="width: 10%;"></td> <td style="width: 10%;"></td> </tr> <tr> <td></td> <td></td> <td colspan="8" style="text-align: center;"> <table border="1" style="width: 100%; border-collapse: collapse; text-align: center;"> <tr> <td style="width: 10%;"></td> <td style="width: 10%;"></td> <td style="width: 10%;"></td> <td style="width: 10%;"></td> <td style="width: 10%;"></td> <td style="width: 10%;"></td> <td style="width: 10%;"></td> <td style="width: 10%;"></td> <td style="width: 10%;"></td> <td style="width: 10%;"></td> </tr> <tr> <td></td> <td></td> <td colspan="8" style="text-align: center;"> <table border="1" style="width: 100%; border-collapse: collapse; text-align: center;"> <tr> <td style="width: 10%;"></td> <td style="width: 10%;"></td> <td style="width: 10%;"></td> <td style="width: 10%;"></td> <td style="width: 10%;"></td> <td style="width: 10%;"></td> <td style="width: 10%;"></td> <td style="width: 10%;"></td> <td style="width: 10%;"></td> <td style="width: 10%;"></td> </tr> <tr> <td></td> <td></td> <td colspan="8" style="text-align: center;"> <table border="1" style="width: 100%; border-collapse: collapse; text-align: center;"> <tr> <td style="width: 10%;"></td> <td style="width: 10%;"></td> <td style="width: 10%;"></td> <td style="width: 10%;"></td> <td style="width: 10%;"></td> <td style="width: 10%;"></td> <td style="width: 10%;"></td> <td style="width: 10%;"></td> <td style="width: 10%;"></td> <td style="width: 10%;"></td> </tr> <tr> <td></td> <td></td> <td colspan="8" style="text-align: center;"> <table border="1" style="width: 100%; border-collapse: collapse; text-align: center;"> <tr> <td style="width: 10%;"></td> <td style="width: 10%;"></td> <td style="width: 10%;"></td> <td style="width: 10%;"></td> <td style="width: 10%;"></td> <td style="width: 10%;"></td> <td style="width: 10%;"></td> <td style="width: 10%;"></td> <td style="width: 10%;"></td> <td style="width: 10%;"></td> </tr> <tr> <td></td> <td></td> <td colspan="8" style="text-align: center;"> <table border="1" style="width: 100%; border-collapse: collapse; text-align: center;"> <tr> <td style="width: 10%;"></td> <td style="width: 10%;"></td> <td style="width: 10%;"></td> <td style="width: 10%;"></td> <td style="width: 10%;"></td> <td style="width: 10%;"></td> <td style="width: 10%;"></td> <td style="width: 10%;"></td> <td style="width: 10%;"></td> <td style="width: 10%;"></td> </tr> <tr> <td></td> <td></td> <td colspan="8" style="text-align: center;"> <table border="1" style="width: 100%; border-collapse: collapse; text-align: center;"> <tr> <td style="width: 10%;"></td> <td style="width: 10%;"></td> <td style="width: 10%;"></td> <td style="width: 10%;"></td> <td style="width: 10%;"></td> <td style="width: 10%;"></td> <td style="width: 10%;"></td> <td style="width: 10%;"></td> <td style="width: 10%;"></td> <td style="width: 10%;"></td> </tr> <tr> <td></td> <td></td> <td colspan="8" style="text-align: center;"> <table border="1" style="width: 100%; border-collapse: collapse; text-align: center;"> <tr> <td style="width: 10%;"></td> <td style="width: 10%;"></td> <td style="width: 10%;"></td> <td style="width: 10%;"></td> <td style="width: 10%;"></td> <td style="width: 10%;"></td> <td style="width: 10%;"></td> <td style="width: 10%;"></td> <td style="width: 10%;"></td> <td style="width: 10%;"></td> </tr> <tr> <td></td> <td></td> <td colspan="8" style="text-align: center;"> <table border="1" style="width: 100%; border-collapse: collapse; text-align: center;"> <tr> <td style="width: 10%;"></td> <td style="width: 10%;"></td> <td style="width: 10%;"></td> <td style="width: 10%;"></td> <td style="width: 10%;"></td> <td style="width: 10%;"></td> <td style="width: 10%;"></td> <td style="width: 10%;"></td> <td style="width: 10%;"></td> <td style="width: 10%;"></td> </tr> <tr> <td></td> <td></td> <td colspan="8" style="text-align: center;"> <table border="1" style="width: 100%; border-collapse: collapse; text-align: center;"> <tr> <td style="width: 10%;"></td> <td style="width: 10%;"></td> <td style="width: 10%;"></td> <td style="width: 10%;"></td> <td style="width: 10%;"></td> <td style="width: 10%;"></td> <td style="width: 10%;"></td> <td style="width: 10%;"></td> <td style="width: 10%;"></td> <td style="width: 10%;"></td> </tr> <tr> <td></td> <td></td> <td colspan="8" style="text-align: center;"> <table border="1" style="width: 100%; border-collapse: collapse; text-align: center;"> <tr> <td style="width: 10%;"></td> <td style="width: 10%;"></td> <td style="width: 10%;"></td> <td style="width: 10%;"></td> <td style="width: 10%;"></td> <td style="width: 10%;"></td> <td style="width: 10%;"></td> <td style="width: 10%;"></td> <td style="width: 10%;"></td> <td style="width: 10%;"></td> </tr> <tr> <td></td> <td></td> <td colspan="8" style="text-align: center;"> <table border="1" style="width: 100%; border-collapse: collapse; text-align: center;"> <tr> <td style="width: 10%;"></td> <td style="width: 10%;"></td> <td style="width: 10%;"></td> <td style="width: 10%;"></td> <td style="width: 10%;"></td> <td style="width: 10%;"></td> <td style="width: 10%;"></td> <td style="width: 10%;"></td> <td style="width: 10%;"></td> <td style="width: 10%;"></td> </tr> <tr> <td></td> <td></td> <td colspan="8" style="text-align: center;"> <table border="1" style="width: 100%; border-collapse: collapse; text-align: center;"> <tr> <td style="width: 10%;"></td> <td style="width: 10%;"></td> <td style="width: 10%;"></td> <td style="width: 10%;"></td> <td style="width: 10%;"></td> <td style="width: 10%;"></td> <td style="width: 10%;"></td> <td style="width: 10%;"></td> <td style="width: 10%;"></td> <td style="width: 10%;"></td> </tr> <tr> <td></td> <td></td> <td colspan="8" style="text-align: center;"> <table border="1" style="width: 100%; border-collapse: collapse; text-align: center;"> <tr> <td style="width: 10%;"></td> <td style="width: 10%;"></td> <td style="width: 10%;"></td> <td style="width: 10%;"></td> <td style="width: 10%;"></td> <td style="width: 10%;"></td> <td style="width: 10%;"></td> <td style="width: 10%;"></td> <td style="width: 10%;"></td> <td style="width: 10%;"></td> </tr> <tr> <td></td> <td></td> <td colspan="8" style="text-align: center;"> <table border="1" style="width: 100%; border-collapse: collapse; text-align: center;"> <tr> <td style="width: 10%;"></td> <td style="width: 10%;"></td> <td style="width: 10%;"></td> <td style="width: 10%;"></td> <td style="width: 10%;"></td> <td style="width: 10%;"></td> <td style="width: 10%;"></td> <td style="width: 10%;"></td> <td style="width: 10%;"></td> <td style="width: 10%;"></td> </tr> <tr> <td></td> <td></td> <td colspan="8" style="text-align: center;"> <table border="1" style="width: 100%; border-collapse: collapse; text-align: center;"> <tr> <td style="width: 10%;"></td> <td style="width: 10%;"></td> <td style="width: 10%;"></td> <td style="width: 10%;"></td> <td style="width: 10%;"></td> <td style="width: 10%;"></td> <td style="width: 10%;"></td> <td style="width: 10%;"></td> <td style="width: 10%;"></td> <td style="width: 10%;"></td> </tr> <tr> <td></td> <td></td> <td colspan="8" style="text-align: center;"> <table border="1" style="width: 100%; border-collapse: collapse; text-align: center;"> <tr> <td style="width: 10%;"></td> <td style="width: 10%;"></td> <td style="width: 10%;"></td> <td style="width: 10%;"></td> <td style="width: 10%;"></td> <td style="width: 10%;"></td> <td style="width: 10%;"></td> <td style="width: 10%;"></td> <td style="width: 10%;"></td> <td style="width: 10%;"></td> </tr> <tr> <td></td> <td></td> <td colspan="8" style="text-align: center;"> <table border="1" style="width: 100%; border-collapse: collapse; text-align: center;"> <tr> <td style="width: 10%;"></td> <td style="width: 10%;"></td> <td style="width: 10%;"></td> <td style="width: 10%;"></td> <td style="width: 10%;"></td> <td style="width: 10%;"></td> <td style="width: 10%;"></td> <td style="width: 10%;"></td> <td style="width: 10%;"></td> <td style="width: 10%;"></td> </tr> <tr> <td></td> <td></td> <td colspan="8" style="text-align: center;"> <table border="1" style="width: 100%; border-collapse: collapse; text-align: center;"> <tr> <td style="width: 10%;"></td> <td style="width: 10%;"></td> <td style="width: 10%;"></td> <td style="width: 10%;"></td> <td style="width: 10%;"></td> <td style="width: 10%;"></td> <td style="width: 10%;"></td> <td style="width: 10%;"></td> <td style="width: 10%;"></td> <td style="width: 10%;"></td> </tr> <tr> <td></td> <td></td> <td colspan="8" style="text-align: center;"> <table border="1" style="width: 100%; border-collapse: collapse; text-align: center;"> <tr> <td style="width: 10%;"></td> <td style="width: 10%;"></td> <td style="width: 10%;"></td> <td style="width: 10%;"></td> <td style="width: 10%;"></td> <td style="width: 10%;"></td> <td style="width: 10%;"></td> <td style="width: 10%;"></td> <td style="width: 10%;"></td> <td style="width: 10%;"></td> </tr> <tr> <td></td> <td></td> <td
colspan="8" style="text-align: center;"> <table border="1" style="width: 100%; border-collapse: collapse; text-align: center;"> <tr> <td style="width: 10%;"></td> <td style="width: 10%;"></td> <td style="width: 10%;"></td> <td style="width: 10%;"></td> <td style="width: 10%;"></td> <td style="width: 10%;"></td> <td style="width: 10%;"></td> <td style="width: 10%;"></td> <td style="width: 10%;"></td> <td style="width: 10%;"></td> </tr> <tr> <td></td> <td></td> <td colspan="8" style="text-align: center;"> <table border="1" style="width: 100%; border-collapse: collapse; text-align: center;"> <tr> <td style="width: 10%;"></td> <td style="width: 10%;"></td> <td style="width: 10%;"></td> <td style="width: 10%;"></td> <td style="width: 10%;"></td> <td style="width: 10%;"></td> <td style="width: 10%;"></td> <td style="width: 10%;"></td> <td style="width: 10%;"></td> <td style="width: 10%;"></td> </tr> <tr> <td></td> <td></td> <td colspan="8" style="text-align: center;"> <table border="1" style="width: 100%; border-collapse: collapse; text-align: center;"> <tr> <td style="width: 10%;"></td> <td style="width: 10%;"></td> <td style="width: 10%;"></td> <td style="width: 10%;"></td> <td style="width: 10%;"></td> <td style="width: 10%;"></td> <td style="width: 10%;"></td> <td style="width: 10%;"></td> <td style="width: 10%;"></td> <td style="width: 10%;"></td> </tr> <tr> <td></td> <td></td> <td colspan="8" style="text-align: center;"> <table border="1" style="width: 100%; border-collapse: collapse; text-align: center;"> <tr> <td style="width: 10%;"></td> <td style="width: 10%;"></td> <td style="width: 10%;"></td> <td style="width: 10%;"></td> <td style="width: 10%;"></td> <td style="width: 10%;"></td> <td style="width: 10%;"></td> <td style="width: 10%;"></td> <td style="width: 10%;"></td> <td style="width: 10%;"></td> </tr> <tr> <td></td> <td></td> <td colspan="8" style="text-align: center;"> <table border="1" style="width: 100%; border-collapse: collapse; text-align: center;"> <tr> <td style="width: 10%;"></td> <td style="width: 10%;"></td> <td style="width: 10%;"></td> <td style="width: 10%;"></td> <td style="width: 10%;"></td> <td style="width: 10%;"></td> <td style="width: 10%;"></td> <td style="width: 10%;"></td> <td style="width: 10%;"></td> <td style="width: 10%;"></td> </tr> <tr> <td></td> <td></td> <td colspan="8" style="text-align: center;"> <table border="1" style="width: 100%; border-collapse: collapse; text-align: center;"> <tr> <td style="width: 10%;"></td> <td style="width: 10%;"></td> <td style="width: 10%;"></td> <td style="width: 10%;"></td> <td style="width: 10%;"></td> <td style="width: 10%;"></td> <td style="width: 10%;"></td> <td style="width: 10%;"></td> <td style="width: 10%;"></td> <td style="width: 10%;"></td> </tr> <tr> <td></td> <td></td> <td colspan="8" style="text-align: center;"> <table border="1" style="width: 100%; border-collapse: collapse; text-align: center;"> <tr> <td style="width: 10%;"></td> <td style="width: 10%;"></td> <td style="width: 10%;"></td> <td style="width: 10%;"></td> <td style="width: 10%;"></td> <td style="width: 10%;"></td> <td style="width: 10%;"></td> <td style="width: 10%;"></td> <td style="width: 10%;"></td> <td style="width: 10%;"></td> </tr> <tr> <td></td> <td></td> <td colspan="8" style="text-align: center;"> <table border="1" style="width: 100%; border-collapse: collapse; text-align: center;"> <tr> <td style="width: 10%;"></td> <td style="width: 10%;"></td> <td style="width: 10%;"></td> <td style="width: 10%;"></td> <td style="width: 10%;"></td> <td style="width: 10%;"></td> <td style="width: 10%;"></td> <td style="width: 10%;"></td> <td style="width: 10%;"></td> <td style="width: 10%;"></td> </tr> <tr> <td></td> <td></td> <td colspan="8" style="text-align: center;"> <table border="1" style="width: 100%; border-collapse: collapse; text-align: center;"> <tr> <td style="width: 10%;"></td> <td style="width: 10%;"></td> <td style="width: 10%;"></td> <td style="width: 10%;"></td> <td style="width: 10%;"></td> <td style="width: 10%;"></td> <td style="width: 10%;"></td> <td style="width: 10%;"></td> <td style="width: 10%;"></td> <td style="width: 10%;"></td> </tr> <tr> <td></td> <td></td> <td colspan="8" style="text-align: center;"> <table border="1" style="width: 100%; border-collapse: collapse; text-align: center;"> <tr> <td style="width: 10%;"></td> <td style="width: 10%;"></td> <td style="width: 10%;"></td> <td style="width: 10%;"></td> <td style="width: 10%;"></td> <td style="width: 10%;"></td> <td style="width: 10%;"></td> <td style="width: 10%;"></td> <td style="width: 10%;"></td> <td style="width: 10%;"></td> </tr> <tr> <td></td> <td></td> <td colspan="8" style="text-align: center;"> <table border="1" style="width: 100%; border-collapse: collapse; text-align: center;"> <tr> <td style="width: 10%;"></td> <td style="width: 10%;"></td> <td style="width: 10%;"></td> <td style="width: 10%;"></td> <td style="width: 10%;"></td> <td style="width: 10%;"></td> <td style="width: 10%;"></td> <td style="width: 10%;"></td> <td style="width: 10%;"></td> <td style="width: 10%;"></td> </tr> <tr> <td></td> <td></td> <td colspan="8" style="text-align: center;"> <table border="1" style="width: 100%; border-collapse: collapse; text-align: center;"> <tr> <td style="width: 10%;"></td> <td style="width: 10%;"></td> <td style="width: 10%;"></td> <td style="width: 10%;"></td> <td style="width: 10%;"></td> <td style="width: 10%;"></td> <td style="width: 10%;"></td> <td style="width: 10%;"></td> <td style="width: 10%;"></td> <td style="width: 10%;"></td> </tr> <tr> <td></td> <td></td> <td colspan="8" style="text-align: center;"> <table border="1" style="width: 100%; border-collapse: collapse; text-align: center;"> <tr> <td style="width: 10%;"></td> <td style="width: 10%;"></td> <td style="width: 10%;"></td> <td style="width: 10%;"></td> <td style="width: 10%;"></td> <td style="width: 10%;"></td> <td style="width: 10%;"></td> <td style="width: 10%;"></td> <td style="width: 10%;"></td> <td style="width: 10%;"></td> </tr> <tr> <td></td> <td></td> <td colspan="8" style="text-align: center;"> <table border="1" style="width: 100%; border-collapse: collapse; text-align: center;"> <tr> <td style="width: 10%;"></td> <td style="width: 10%;"></td> <td style="width: 10%;"></td> <td style="width: 10%;"></td> <td style="width: 10%;"></td> <td style="width: 10%;"></td> <td style="width: 10%;"></td> <td style="width: 10%;"></td> <td style="width: 10%;"></td> <td style="width: 10%;"></td> </tr> <tr> <td></td> <td></td> <td colspan="8" style="text-align: center;"> <table border="1" style="width: 100%; border-collapse: collapse; text-align: center;"> <tr> <td style="width: 10%;"></td> <td style="width: 10%;"></td> <td style="width: 10%;"></td> <td style="width: 10%;"></td> <td style="width: 10%;"></td> <td style="width: 10%;"></td> <td style="width: 10%;"></td> <td style="width: 10%;"></td> <td style="width: 10%;"></td> <td style="width: 10%;"></td> </tr> <tr> <td></td> <td></td> <td colspan="8" style="text-align: center;"> <table border="1" style="width: 100%; border-collapse: collapse; text-align: center;"> <tr> </tr></table></td></tr></table></td></tr></table></td></tr></table></td></tr></table></td></tr></table></td></tr></table></td></tr></table></td></tr></table></td></tr></table></td></tr></table></td></tr></table></td></tr></table></td></tr></table></td></tr></table></td></tr></table></td></tr></table></td></tr></table></td></tr></table></td></tr></table></td></tr></table></td></tr></table></td></tr></table></td></tr></table></td></tr></table></td></tr></table></td></tr></table></td></tr></table></td></tr></table></td></tr></table></td></tr></table></td></tr></table></td></tr></table></td></tr></table></td></tr></table></td></tr></table></td></tr></table></td></tr></table></td></tr></table></td></tr></table></td></tr></table></td></tr></table></td></tr></table></td></tr></table></td></tr></table></td></tr></table></td></tr></table></td></tr></table></td></tr></table></td></tr></table></td></tr></table></td></tr></table></td></tr></table></td></tr></table></td></tr></table></td></tr></table>
 | | | | | | | | | | | | | | | | | | | | <table border="1" style="width: 100%; border-collapse: collapse; text-align: center;"> <tr> <td style="width: 10%;"></td> <td style="width: 10%;"></td> <td style="width: 10%;"></td> <td style="width: 10%;"></td> <td style="width: 10%;"></td> <td style="width: 10%;"></td> <td style="width: 10%;"></td> <td style="width: 10%;"></td> <td style="width: 10%;"></td> <td style="width: 10%;"></td> </tr> <tr> <td></td> <td></td> <td colspan="8" style="text-align: center;"> <table border="1" style="width: 100%; border-collapse: collapse; text-align: center;"> <tr> <td style="width: 10%;"></td> <td style="width: 10%;"></td> <td style="width: 10%;"></td> <td style="width: 10%;"></td> <td style="width: 10%;"></td> <td style="width: 10%;"></td> <td style="width: 10%;"></td> <td style="width: 10%;"></td> <td style="width: 10%;"></td> <td style="width: 10%;"></td> </tr> <tr> <td></td> <td></td> <td colspan="8" style="text-align: center;"> <table border="1" style="width: 100%; border-collapse: collapse; text-align: center;"> <tr> <td style="width: 10%;"></td> <td style="width: 10%;"></td> <td style="width: 10%;"></td> <td style="width: 10%;"></td> <td style="width: 10%;"></td> <td style="width: 10%;"></td> <td style="width: 10%;"></td> <td style="width: 10%;"></td> <td style="width: 10%;"></td> <td style="width: 10%;"></td> </tr> <tr> <td></td> <td></td> <td colspan="8" style="text-align: center;"> <table border="1" style="width: 100%; border-collapse: collapse; text-align: center;"> <tr> <td style="width: 10%;"></td> <td style="width: 10%;"></td> <td style="width: 10%;"></td> <td style="width: 10%;"></td> <td style="width: 10%;"></td> <td style="width: 10%;"></td> <td style="width: 10%;"></td> <td style="width: 10%;"></td> <td style="width: 10%;"></td> <td style="width: 10%;"></td> </tr> <tr> <td></td> <td></td> <td colspan="8" style="text-align: center;"> <table border="1" style="width: 100%; border-collapse: collapse; text-align: center;"> <tr> <td style="width: 10%;"></td> <td style="width: 10%;"></td> <td style="width: 10%;"></td> <td style="width: 10%;"></td> <td style="width: 10%;"></td> <td style="width: 10%;"></td> <td style="width: 10%;"></td> <td style="width: 10%;"></td> <td style="width: 10%;"></td> <td style="width: 10%;"></td> </tr> <tr> <td></td> <td></td> <td colspan="8" style="text-align: center;"> <table border="1" style="width: 100%; border-collapse: collapse; text-align: center;"> <tr> <td style="width: 10%;"></td> <td style="width: 10%;"></td> <td style="width: 10%;"></td> <td style="width: 10%;"></td> <td style="width: 10%;"></td> <td style="width: 10%;"></td> <td style="width: 10%;"></td> <td style="width: 10%;"></td> <td style="width: 10%;"></td> <td style="width: 10%;"></td> </tr> <tr> <td></td> <td></td> <td colspan="8" style="text-align: center;"> <table border="1" style="width: 100%; border-collapse: collapse; text-align: center;"> <tr> <td style="width: 10%;"></td> <td style="width: 10%;"></td> <td style="width: 10%;"></td> <td style="width: 10%;"></td> <td style="width: 10%;"></td> <td style="width: 10%;"></td> <td style="width: 10%;"></td> <td style="width: 10%;"></td> <td style="width: 10%;"></td> <td style="width: 10%;"></td> </tr> <tr> <td></td> <td></td> <td colspan="8" style="text-align: center;"> <table border="1" style="width: 100%; border-collapse: collapse; text-align: center;"> <tr> <td style="width: 10%;"></td> <td style="width: 10%;"></td> <td style="width: 10%;"></td> <td style="width: 10%;"></td> <td style="width: 10%;"></td> <td style="width: 10%;"></td> <td style="width: 10%;"></td> <td style="width: 10%;"></td> <td style="width: 10%;"></td> <td style="width: 10%;"></td> </tr> <tr> <td></td> <td></td> <td colspan="8" style="text-align: center;"> <table border="1" style="width: 100%; border-collapse: collapse; text-align: center;"> <tr> <td style="width: 10%;"></td> <td style="width: 10%;"></td> <td style="width: 10%;"></td> <td style="width: 10%;"></td> <td style="width: 10%;"></td> <td style="width: 10%;"></td> <td style="width: 10%;"></td> <td style="width: 10%;"></td> <td style="width: 10%;"></td> <td style="width: 10%;"></td> </tr> <tr> <td></td> <td></td> <td colspan="8" style="text-align: center;"> <table border="1" style="width: 100%; border-collapse: collapse; text-align: center;"> <tr> <td style="width: 10%;"></td> <td style="width: 10%;"></td> <td style="width: 10%;"></td> <td style="width: 10%;"></td> <td style="width: 10%;"></td> <td style="width: 10%;"></td> <td style="width: 10%;"></td> <td style="width: 10%;"></td> <td style="width: 10%;"></td> <td style="width: 10%;"></td> </tr> <tr> <td></td> <td></td> <td colspan="8" style="text-align: center;"> <table border="1" style="width: 100%; border-collapse: collapse; text-align: center;"> <tr> <td style="width: 10%;"></td> <td style="width: 10%;"></td> <td style="width: 10%;"></td> <td style="width: 10%;"></td> <td style="width: 10%;"></td> <td style="width: 10%;"></td> <td style="width: 10%;"></td> <td style="width: 10%;"></td> <td style="width: 10%;"></td> <td style="width: 10%;"></td> </tr> <tr> <td></td> <td></td> <td colspan="8" style="text-align: center;"> <table border="1" style="width: 100%; border-collapse: collapse; text-align: center;"> <tr> <td style="width: 10%;"></td> <td style="width: 10%;"></td> <td style="width: 10%;"></td> <td style="width: 10%;"></td> <td style="width: 10%;"></td> <td style="width: 10%;"></td> <td style="width: 10%;"></td> <td style="width: 10%;"></td> <td style="width: 10%;"></td> <td style="width: 10%;"></td> </tr> <tr> <td></td> <td></td> <td colspan="8" style="text-align: center;"> <table border="1" style="width: 100%; border-collapse: collapse; text-align: center;"> <tr> <td style="width: 10%;"></td> <td style="width: 10%;"></td> <td style="width: 10%;"></td> <td style="width: 10%;"></td> <td style="width: 10%;"></td> <td style="width: 10%;"></td> <td style="width: 10%;"></td> <td style="width: 10%;"></td> <td style="width: 10%;"></td> <td style="width: 10%;"></td> </tr> <tr> <td></td> <td></td> <td colspan="8" style="text-align: center;"> <table border="1" style="width: 100%; border-collapse: collapse; text-align: center;"> <tr> <td style="width: 10%;"></td> <td style="width: 10%;"></td> <td style="width: 10%;"></td> <td style="width: 10%;"></td> <td style="width: 10%;"></td> <td style="width: 10%;"></td> <td style="width: 10%;"></td> <td style="width: 10%;"></td> <td style="width: 10%;"></td> <td style="width: 10%;"></td> </tr> <tr> <td></td> <td></td> <td colspan="8" style="text-align: center;"> <table border="1" style="width: 100%; border-collapse: collapse; text-align: center;"> <tr> <td style="width: 10%;"></td> <td style="width: 10%;"></td> <td style="width: 10%;"></td> <td style="width: 10%;"></td> <td style="width: 10%;"></td> <td style="width: 10%;"></td> <td style="width: 10%;"></td> <td style="width: 10%;"></td> <td style="width: 10%;"></td> <td style="width: 10%;"></td> </tr> <tr> <td></td> <td></td> <td colspan="8" style="text-align: center;"> <table border="1" style="width: 100%; border-collapse: collapse; text-align: center;"> <tr> <td style="width: 10%;"></td> <td style="width: 10%;"></td> <td style="width: 10%;"></td> <td style="width: 10%;"></td> <td style="width: 10%;"></td> <td style="width: 10%;"></td> <td style="width: 10%;"></td> <td style="width: 10%;"></td> <td style="width: 10%;"></td> <td style="width: 10%;"></td> </tr> <tr> <td></td> <td></td> <td colspan="8" style="text-align: center;"> <table border="1" style="width: 100%; border-collapse: collapse; text-align: center;"> <tr> <td style="width: 10%;"></td> <td style="width: 10%;"></td> <td style="width: 10%;"></td> <td style="width: 10%;"></td> <td style="width: 10%;"></td> <td style="width: 10%;"></td> <td style="width: 10%;"></td> <td style="width: 10%;"></td> <td style="width: 10%;"></td> <td style="width: 10%;"></td> </tr> <tr>
<td></td> <td></td> <td colspan="8" style="text-align: center;"> <table border="1" style="width: 100%; border-collapse: collapse; text-align: center;"> <tr> <td style="width: 10%;"></td> <td style="width: 10%;"></td> <td style="width: 10%;"></td> <td style="width: 10%;"></td> <td style="width: 10%;"></td> <td style="width: 10%;"></td> <td style="width: 10%;"></td> <td style="width: 10%;"></td> <td style="width: 10%;"></td> <td style="width: 10%;"></td> </tr> <tr> <td></td> <td></td> <td colspan="8" style="text-align: center;"> <table border="1" style="width: 100%; border-collapse: collapse; text-align: center;"> <tr> <td style="width: 10%;"></td> <td style="width: 10%;"></td> <td style="width: 10%;"></td> <td style="width: 10%;"></td> <td style="width: 10%;"></td> <td style="width: 10%;"></td> <td style="width: 10%;"></td> <td style="width: 10%;"></td> <td style="width: 10%;"></td> <td style="width: 10%;"></td> </tr> <tr> <td></td> <td></td> <td colspan="8" style="text-align: center;"> <table border="1" style="width: 100%; border-collapse: collapse; text-align: center;"> <tr> <td style="width: 10%;"></td> <td style="width: 10%;"></td> <td style="width: 10%;"></td> <td style="width: 10%;"></td> <td style="width: 10%;"></td> <td style="width: 10%;"></td> <td style="width: 10%;"></td> <td style="width: 10%;"></td> <td style="width: 10%;"></td> <td style="width: 10%;"></td> </tr> <tr> <td></td> <td></td> <td colspan="8" style="text-align: center;"> <table border="1" style="width: 100%; border-collapse: collapse; text-align: center;"> <tr> <td style="width: 10%;"></td> <td style="width: 10%;"></td> <td style="width: 10%;"></td> <td style="width: 10%;"></td> <td style="width: 10%;"></td> <td style="width: 10%;"></td> <td style="width: 10%;"></td> <td style="width: 10%;"></td> <td style="width: 10%;"></td> <td style="width: 10%;"></td> </tr> <tr> <td></td> <td></td> <td colspan="8" style="text-align: center;"> <table border="1" style="width: 100%; border-collapse: collapse; text-align: center;"> <tr> <td style="width: 10%;"></td> <td style="width: 10%;"></td> <td style="width: 10%;"></td> <td style="width: 10%;"></td> <td style="width: 10%;"></td> <td style="width: 10%;"></td> <td style="width: 10%;"></td> <td style="width: 10%;"></td> <td style="width: 10%;"></td> <td style="width: 10%;"></td> </tr> <tr> <td></td> <td></td> <td colspan="8" style="text-align: center;"> <table border="1" style="width: 100%; border-collapse: collapse; text-align: center;"> <tr> <td style="width: 10%;"></td> <td style="width: 10%;"></td> <td style="width: 10%;"></td> <td style="width: 10%;"></td> <td style="width: 10%;"></td> <td style="width: 10%;"></td> <td style="width: 10%;"></td> <td style="width: 10%;"></td> <td style="width: 10%;"></td> <td style="width: 10%;"></td> </tr> <tr> <td></td> <td></td> <td colspan="8" style="text-align: center;"> <table border="1" style="width: 100%; border-collapse: collapse; text-align: center;"> <tr> <td style="width: 10%;"></td> <td style="width: 10%;"></td> <td style="width: 10%;"></td> <td style="width: 10%;"></td> <td style="width: 10%;"></td> <td style="width: 10%;"></td> <td style="width: 10%;"></td> <td style="width: 10%;"></td> <td style="width: 10%;"></td> <td style="width: 10%;"></td> </tr> <tr> <td></td> <td></td> <td colspan="8" style="text-align: center;"> <table border="1" style="width: 100%; border-collapse: collapse; text-align: center;"> <tr> <td style="width: 10%;"></td> <td style="width: 10%;"></td> <td style="width: 10%;"></td> <td style="width: 10%;"></td> <td style="width: 10%;"></td> <td style="width: 10%;"></td> <td style="width: 10%;"></td> <td style="width: 10%;"></td> <td style="width: 10%;"></td> <td style="width: 10%;"></td> </tr> <tr> <td></td> <td></td> <td colspan="8" style="text-align: center;"> <table border="1" style="width: 100%; border-collapse: collapse; text-align: center;"> <tr> <td style="width: 10%;"></td> <td style="width: 10%;"></td> <td style="width: 10%;"></td> <td style="width: 10%;"></td> <td style="width: 10%;"></td> <td style="width: 10%;"></td> <td style="width: 10%;"></td> <td style="width: 10%;"></td> <td style="width: 10%;"></td> <td style="width: 10%;"></td> </tr> <tr> <td></td> <td></td> <td colspan="8" style="text-align: center;"> <table border="1" style="width: 100%; border-collapse: collapse; text-align: center;"> <tr> <td style="width: 10%;"></td> <td style="width: 10%;"></td> <td style="width: 10%;"></td> <td style="width: 10%;"></td> <td style="width: 10%;"></td> <td style="width: 10%;"></td> <td style="width: 10%;"></td> <td style="width: 10%;"></td> <td style="width: 10%;"></td> <td style="width: 10%;"></td> </tr> <tr> <td></td> <td></td> <td colspan="8" style="text-align: center;"> <table border="1" style="width: 100%; border-collapse: collapse; text-align: center;"> <tr> <td style="width: 10%;"></td> <td style="width: 10%;"></td> <td style="width: 10%;"></td> <td style="width: 10%;"></td> <td style="width: 10%;"></td> <td style="width: 10%;"></td> <td style="width: 10%;"></td> <td style="width: 10%;"></td> <td style="width: 10%;"></td> <td style="width: 10%;"></td> </tr> <tr> <td></td> <td></td> <td colspan="8" style="text-align: center;"> <table border="1" style="width: 100%; border-collapse: collapse; text-align: center;"> <tr> <td style="width: 10%;"></td> <td style="width: 10%;"></td> <td style="width: 10%;"></td> <td style="width: 10%;"></td> <td style="width: 10%;"></td> <td style="width: 10%;"></td> <td style="width: 10%;"></td> <td style="width: 10%;"></td> <td style="width: 10%;"></td> <td style="width: 10%;"></td> </tr> <tr> <td></td> <td></td> <td colspan="8" style="text-align: center;"> <table border="1" style="width: 100%; border-collapse: collapse; text-align: center;"> <tr> <td style="width: 10%;"></td> <td style="width: 10%;"></td> <td style="width: 10%;"></td> <td style="width: 10%;"></td> <td style="width: 10%;"></td> <td style="width: 10%;"></td> <td style="width: 10%;"></td> <td style="width: 10%;"></td> <td style="width: 10%;"></td> <td style="width: 10%;"></td> </tr> <tr> <td></td> <td></td> <td colspan="8" style="text-align: center;"> <table border="1" style="width: 100%; border-collapse: collapse; text-align: center;"> <tr> <td style="width: 10%;"></td> <td style="width: 10%;"></td> <td style="width: 10%;"></td> <td style="width: 10%;"></td> <td style="width: 10%;"></td> <td style="width: 10%;"></td> <td style="width: 10%;"></td> <td style="width: 10%;"></td> <td style="width: 10%;"></td> <td style="width: 10%;"></td> </tr> <tr> <td></td> <td></td> <td colspan="8" style="text-align: center;"> <table border="1" style="width: 100%; border-collapse: collapse; text-align: center;"> <tr> <td style="width: 10%;"></td> <td style="width: 10%;"></td> <td style="width: 10%;"></td> <td style="width: 10%;"></td> <td style="width: 10%;"></td> <td style="width: 10%;"></td> <td style="width: 10%;"></td> <td style="width: 10%;"></td> <td style="width: 10%;"></td> <td style="width: 10%;"></td> </tr> <tr> <td></td> <td></td> <td colspan="8" style="text-align: center;"> <table border="1" style="width: 100%; border-collapse: collapse; text-align: center;"> <tr> <td style="width: 10%;"></td> <td style="width: 10%;"></td> <td style="width: 10%;"></td> <td style="width: 10%;"></td> <td style="width: 10%;"></td> <td style="width: 10%;"></td> <td style="width: 10%;"></td> <td style="width: 10%;"></td> <td style="width: 10%;"></td> <td style="width: 10%;"></td> </tr> <tr> <td></td> <td></td> <td colspan="8" style="text-align: center;"> <table border="1" style="width: 100%; border-collapse: collapse; text-align: center;"> <tr> <td style="width: 10%;"></td> <td style="width: 10%;"></td> <td style="width: 10%;"></td> <td style="width: 10%;"></td> <td style="width: 10%;"></td> <td style="width: 10%;"></td> <td style="width: 10%;"></td> <td style="width: 10%;"></td> <td style="width: 10%;"></td> <td style="width: 10%;"></td> </tr> <tr> <td></td> <td></td> <td colspan="8" style="text-align: center;"> <table border="1" style="width: 100%; border-collapse: collapse; text-align: center;"> <tr> <td style="width: 10%;"></td> <td style="width: 10%;"></td> <td style="width: 10%;"></td> <td style="width: 10%;"></td> <td style="width: 10%;"></td> <td style="width: 10%;"></td> <td style="width: 10%;"></td> <td style="width: 10%;"></td> <td style="width: 10%;"></td> <td style="width: 10%;"></td> </tr> <tr> <td></td> <td></td> <td colspan="8" style="text-align: center;"> <table border="1" style="width: 100%; border-collapse: collapse; text-align: center;"> <tr> <td style="width: 10%;"></td> <td style="width: 10%;"></td> <td style="width: 10%;"></td> <td style="width: 10%;"></td> <td style="width: 10%;"></td> <td style="width: 10%;"></td> <td style="width: 10%;"></td> <td style="width: 10%;"></td> <td style="width: 10%;"></td> <td style="width: 10%;"></td> </tr> <tr> <td></td> <td></td> <td colspan="8" style="text-align: center;"> <table border="1" style="width: 100%; border-collapse: collapse; text-align: center;"> <tr> <td style="width: 10%;"></td> <td style="width: 10%;"></td> <td style="width: 10%;"></td> <td style="width: 10%;"></td> <td style="width: 10%;"></td> <td style="width: 10%;"></td> <td style="width: 10%;"></td> <td style="width: 10%;"></td> <td style="width: 10%;"></td> <td style="width: 10%;"></td> </tr> <tr> <td></td> <td></td> <td colspan="8" style="text-align: center;"> <table border="1" style="width: 100%; border-collapse: collapse; text-align: center;"> <tr> <td style="width: 10%;"></td> <td style="width: 10%;"></td> <td style="width: 10%;"></td> <td style="width: 10%;"></td> <td style="width: 10%;"></td> <td style="width: 10%;"></td> <td style="width: 10%;"></td> <td style="width: 10%;"></td> <td style="width: 10%;"></td> <td style="width: 10%;"></td> </tr> <tr> <td></td> <td></td> <td colspan="8" style="text-align: center;"> <table border="1" style="width: 100%; border-collapse: collapse; text-align: center;"> <tr> <td
style="width: 10%;"></td> <td style="width: 10%;"></td> <td style="width: 10%;"></td> <td style="width: 10%;"></td> <td style="width: 10%;"></td> <td style="width: 10%;"></td> <td style="width: 10%;"></td> <td style="width: 10%;"></td> <td style="width: 10%;"></td> <td style="width: 10%;"></td> </tr> <tr> <td></td> <td></td> <td colspan="8" style="text-align: center;"> <table border="1" style="width: 100%; border-collapse: collapse; text-align: center;"> <tr> <td style="width: 10%;"></td> <td style="width: 10%;"></td> <td style="width: 10%;"></td> <td style="width: 10%;"></td> <td style="width: 10%;"></td> <td style="width: 10%;"></td> <td style="width: 10%;"></td> <td style="width: 10%;"></td> <td style="width: 10%;"></td> <td style="width: 10%;"></td> </tr> <tr> <td></td> <td></td> <td colspan="8" style="text-align: center;"> <table border="1" style="width: 100%; border-collapse: collapse; text-align: center;"> <tr> <td style="width: 10%;"></td> <td style="width: 10%;"></td> <td style="width: 10%;"></td> <td style="width: 10%;"></td> <td style="width: 10%;"></td> <td style="width: 10%;"></td> <td style="width: 10%;"></td> <td style="width: 10%;"></td> <td style="width: 10%;"></td> <td style="width: 10%;"></td> </tr> <tr> <td></td> <td></td> <td colspan="8" style="text-align: center;"> <table border="1" style="width: 100%; border-collapse: collapse; text-align: center;"> <tr> <td style="width: 10%;"></td> <td style="width: 10%;"></td> <td style="width: 10%;"></td> <td style="width: 10%;"></td> <td style="width: 10%;"></td> <td style="width: 10%;"></td> <td style="width: 10%;"></td> <td style="width: 10%;"></td> <td style="width: 10%;"></td> <td style="width: 10%;"></td> </tr> <tr> <td></td> <td></td> <td colspan="8" style="text-align: center;"> <table border="1" style="width: 100%; border-collapse: collapse; text-align: center;"> <tr> <td style="width: 10%;"></td> <td style="width: 10%;"></td> <td style="width: 10%;"></td> <td style="width: 10%;"></td> <td style="width: 10%;"></td> <td style="width: 10%;"></td> <td style="width: 10%;"></td> <td style="width: 10%;"></td> <td style="width: 10%;"></td> <td style="width: 10%;"></td> </tr> <tr> <td></td> <td></td> <td colspan="8" style="text-align: center;"> <table border="1" style="width: 100%; border-collapse: collapse; text-align: center;"> <tr> <td style="width: 10%;"></td> <td style="width: 10%;"></td> <td style="width: 10%;"></td> <td style="width: 10%;"></td> <td style="width: 10%;"></td> <td style="width: 10%;"></td> <td style="width: 10%;"></td> <td style="width: 10%;"></td> <td style="width: 10%;"></td> <td style="width: 10%;"></td> </tr> <tr> <td></td> <td></td> <td colspan="8" style="text-align: center;"> <table border="1" style="width: 100%; border-collapse: collapse; text-align: center;"> <tr> <td style="width: 10%;"></td> <td style="width: 10%;"></td> <td style="width: 10%;"></td> <td style="width: 10%;"></td> <td style="width: 10%;"></td> <td style="width: 10%;"></td> <td style="width: 10%;"></td> <td style="width: 10%;"></td> <td style="width: 10%;"></td> <td style="width: 10%;"></td> </tr> <tr> <td></td> <td></td> <td colspan="8" style="text-align: center;"> <table border="1" style="width: 100%; border-collapse: collapse; text-align: center;"> <tr> <td style="width: 10%;"></td> <td style="width: 10%;"></td> <td style="width: 10%;"></td> <td style="width: 10%;"></td> <td style="width: 10%;"></td> <td style="width: 10%;"></td> <td style="width: 10%;"></td> <td style="width: 10%;"></td> <td style="width: 10%;"></td> <td style="width: 10%;"></td> </tr> <tr> <td></td> <td></td> <td colspan="8" style="text-align: center;"> <table border="1" style="width: 100%; border-collapse: collapse; text-align: center;"> <tr> <td style="width: 10%;"></td> <td style="width: 10%;"></td> <td style="width: 10%;"></td> <td style="width: 10%;"></td> <td style="width: 10%;"></td> <td style="width: 10%;"></td> <td style="width: 10%;"></td> <td style="width: 10%;"></td> <td style="width: 10%;"></td> <td style="width: 10%;"></td> </tr> <tr> <td></td> <td></td> <td colspan="8" style="text-align: center;"> <table border="1" style="width: 100%; border-collapse: collapse; text-align: center;"> <tr> <td style="width: 10%;"></td> <td style="width: 10%;"></td> <td style="width: 10%;"></td> <td style="width: 10%;"></td> <td style="width: 10%;"></td> <td style="width: 10%;"></td> <td style="width: 10%;"></td> <td style="width: 10%;"></td> <td style="width: 10%;"></td> <td style="width: 10%;"></td> </tr> <tr> <td></td> <td></td> <td colspan="8" style="text-align: center;"> <table border="1" style="width: 100%; border-collapse: collapse; text-align: center;"> <tr> <td style="width: 10%;"></td> <td style="width: 10%;"></td> <td style="width: 10%;"></td> <td style="width: 10%;"></td> <td style="width: 10%;"></td> <td style="width: 10%;"></td> <td style="width: 10%;"></td> <td style="width: 10%;"></td> <td style="width: 10%;"></td> <td style="width: 10%;"></td> </tr> <tr> <td></td> <td></td> <td colspan="8" style="text-align: center;"> <table border="1" style="width: 100%; border-collapse: collapse; text-align: center;"> <tr> <td style="width: 10%;"></td> <td style="width: 10%;"></td> <td style="width: 10%;"></td> <td style="width: 10%;"></td> <td style="width: 10%;"></td> <td style="width: 10%;"></td> <td style="width: 10%;"></td> <td style="width: 10%;"></td> <td style="width: 10%;"></td> <td style="width: 10%;"></td> </tr> <tr> <td></td> <td></td> <td colspan="8" style="text-align: center;"> <table border="1" style="width: 100%; border-collapse: collapse; text-align: center;"> <tr> <td style="width: 10%;"></td> <td style="width: 10%;"></td> <td style="width: 10%;"></td> <td style="width: 10%;"></td> <td style="width: 10%;"></td> <td style="width: 10%;"></td> <td style="width: 10%;"></td> <td style="width: 10%;"></td> <td style="width: 10%;"></td> <td style="width: 10%;"></td> </tr> <tr> <td></td> <td></td> <td colspan="8" style="text-align: center;"> <table border="1" style="width: 100%; border-collapse: collapse; text-align: center;"> <tr> <td style="width: 10%;"></td> <td style="width: 10%;"></td> <td style="width: 10%;"></td> <td style="width: 10%;"></td> <td style="width: 10%;"></td> <td style="width: 10%;"></td> <td style="width: 10%;"></td> <td style="width: 10%;"></td> <td style="width: 10%;"></td> <td style="width: 10%;"></td> </tr> <tr> <td></td> <td></td> <td colspan="8" style="text-align: center;"> <table border="1" style="width: 100%; border-collapse: collapse; text-align: center;"> <tr> <td style="width: 10%;"></td> <td style="width: 10%;"></td> <td style="width: 10%;"></td> <td style="width: 10%;"></td> <td style="width: 10%;"></td> <td style="width: 10%;"></td> <td style="width: 10%;"></td> <td style="width: 10%;"></td> <td style="width: 10%;"></td> <td style="width: 10%;"></td> </tr> <tr> <td></td> <td></td> <td colspan="8" style="text-align: center;"> <table border="1" style="width: 100%; border-collapse: collapse; text-align: center;"> <tr> <td style="width: 10%;"></td> <td style="width: 10%;"></td> <td style="width: 10%;"></td> <td style="width: 10%;"></td> <td style="width: 10%;"></td> <td style="width: 10%;"></td> <td style="width: 10%;"></td> <td style="width: 10%;"></td> <td style="width: 10%;"></td> <td style="width: 10%;"></td> </tr> <tr> <td></td> <td></td> <td colspan="8" style="text-align: center;"> <table border="1" style="width: 100%; border-collapse: collapse; text-align: center;"> <tr> </tr></table></td></tr></table></td></tr></table></td></tr></table></td></tr></table></td></tr></table></td></tr></table></td></tr></table></td></tr></table></td></tr></table></td></tr></table></td></tr></table></td></tr></table></td></tr></table></td></tr></table></td></tr></table></td></tr></table></td></tr></table></td></tr></table></td></tr></table></td></tr></table></td></tr></table></td></tr></table></td></tr></table></td></tr></table></td></tr></table></td></tr></table></td></tr></table></td></tr></table></td></tr></table></td></tr></table></td></tr></table></td></tr></table></td></tr></table></td></tr></table></td></tr></table></td></tr></table></td></tr></table></td></tr></table></td></tr></table></td></tr></table></td></tr></table></td></tr></table></td></tr></table></td></tr></table></td></tr></table></td></tr></table></td></tr></table></td></tr></table></td></tr></table></td></tr></table></td></tr></table></td></tr></table></td></tr></table></td></tr></table>
 | | | | | | | | | | | | | | | | | | | | <table border="1" style="width: 100%; border-collapse: collapse; text-align: center;"> <tr> <td style="width: 10%;"></td> <td style="width: 10%;"></td> <td style="width: 10%;"></td> <td style="width: 10%;"></td> <td style="width: 10%;"></td> <td style="width: 10%;"></td> <td style="width: 10%;"></td> <td style="width: 10%;"></td> <td style="width: 10%;"></td> <td style="width: 10%;"></td> </tr> <tr> <td></td> <td></td> <td colspan="8" style="text-align: center;"> <table border="1" style="width: 100%; border-collapse: collapse; text-align: center;"> <tr> <td style="width: 10%;"></td> <td style="width: 10%;"></td> <td style="width: 10%;"></td> <td style="width: 10%;"></td> <td style="width: 10%;"></td> <td style="width: 10%;"></td> <td style="width: 10%;"></td> <td style="width: 10%;"></td> <td style="width: 10%;"></td> <td style="width: 10%;"></td> </tr> <tr> <td></td> <td></td> <td colspan="8" style="text-align: center;"> <table border="1" style="width: 100%; border-collapse: collapse; text-align: center;"> <tr> <td style="width: 10%;"></td> <td style="width: 10%;"></td> <td style="width: 10%;"></td> <td style="width: 10%;"></td> <td style="width: 10%;"></td> <td style="width: 10%;"></td> <td style="width: 10%;"></td> <td style="width: 10%;"></td> <td style="width: 10%;"></td> <td style="width: 10%;"></td> </tr> <tr> <td></td> <td></td> <td colspan="8" style="text-align: center;"> <table border="1" style="width: 100%; border-collapse: collapse; text-align: center;"> <tr> <td style="width: 10%;"></td> <td style="width: 10%;"></td> <td style="width: 10%;"></td> <td style="width: 10%;"></td> <td style="width: 10%;"></td> <td style="width: 10%;"></td> <td style="width: 10%;"></td> <td style="width: 10%;"></td> <td style="width: 10%;"></td> <td style="width: 10%;"></td> </tr> <tr> <td></td> <td></td> <td colspan="8" style="text-align: center;"> <table border="1" style="width: 100%; border-collapse: collapse; text-align: center;"> <tr> <td style="width: 10%;"></td> <td style="width: 10%;"></td> <td style="width: 10%;"></td> <td style="width: 10%;"></td> <td style="width: 10%;"></td> <td style="width: 10%;"></td> <td style="width: 10%;"></td> <td style="width: 10%;"></td> <td style="width: 10%;"></td> <td style="width: 10%;"></td> </tr> <tr> <td></td> <td></td> <td colspan="8" style="text-align: center;"> <table border="1" style="width: 100%; border-collapse: collapse; text-align: center;"> <tr> <td style="width: 10%;"></td> <td style="width: 10%;"></td> <td style="width: 10%;"></td> <td style="width: 10%;"></td> <td style="width: 10%;"></td> <td style="width: 10%;"></td> <td style="width: 10%;"></td> <td style="width: 10%;"></td> <td style="width: 10%;"></td> <td style="width: 10%;"></td> </tr> <tr> <td></td> <td></td> <td colspan="8" style="text-align: center;"> <table border="1" style="width: 100%; border-collapse: collapse; text-align: center;"> <tr> <td style="width: 10%;"></td> <td style="width: 10%;"></td> <td style="width: 10%;"></td> <td style="width: 10%;"></td> <td style="width: 10%;"></td> <td style="width: 10%;"></td> <td style="width: 10%;"></td> <td style="width: 10%;"></td> <td style="width: 10%;"></td> <td style="width: 10%;"></td> </tr> <tr> <td></td> <td></td> <td colspan="8" style="text-align: center;"> <table border="1" style="width: 100%; border-collapse: collapse; text-align: center;"> <tr> <td style="width: 10%;"></td> <td style="width: 10%;"></td> <td style="width: 10%;"></td> <td style="width: 10%;"></td> <td style="width: 10%;"></td> <td style="width: 10%;"></td> <td style="width: 10%;"></td> <td style="width: 10%;"></td> <td style="width: 10%;"></td> <td style="width: 10%;"></td> </tr> <tr> <td></td> <td></td> <td colspan="8" style="text-align: center;"> <table border="1" style="width: 100%; border-collapse: collapse; text-align: center;"> <tr> <td style="width: 10%;"></td> <td style="width: 10%;"></td> <td style="width: 10%;"></td> <td style="width: 10%;"></td> <td style="width: 10%;"></td> <td style="width: 10%;"></td> <td style="width: 10%;"></td> <td style="width: 10%;"></td> <td style="width: 10%;"></td> <td style="width: 10%;"></td> </tr> <tr> <td></td> <td></td> <td colspan="8" style="text-align: center;"> <table border="1" style="width: 100%; border-collapse: collapse; text-align: center;"> <tr> <td style="width: 10%;"></td> <td style="width: 10%;"></td> <td style="width: 10%;"></td> <td style="width: 10%;"></td> <td style="width: 10%;"></td> <td style="width: 10%;"></td> <td style="width: 10%;"></td> <td style="width: 10%;"></td> <td style="width: 10%;"></td> <td style="width: 10%;"></td> </tr> <tr> <td></td> <td></td> <td colspan="8" style="text-align: center;"> <table border="1" style="width: 100%; border-collapse: collapse; text-align: center;"> <tr> <td style="width: 10%;"></td> <td style="width: 10%;"></td> <td style="width: 10%;"></td> <td style="width: 10%;"></td> <td style="width: 10%;"></td> <td style="width: 10%;"></td> <td style="width: 10%;"></td> <td style="width: 10%;"></td> <td style="width: 10%;"></td> <td style="width: 10%;"></td> </tr> <tr> <td></td> <td></td> <td colspan="8" style="text-align: center;"> <table border="1" style="width: 100%; border-collapse: collapse; text-align: center;"> <tr> <td style="width: 10%;"></td> <td style="width: 10%;"></td> <td style="width: 10%;"></td> <td style="width: 10%;"></td> <td style="width: 10%;"></td> <td style="width: 10%;"></td> <td style="width: 10%;"></td> <td style="width: 10%;"></td> <td style="width: 10%;"></td> <td style="width: 10%;"></td> </tr> <tr> <td></td> <td></td> <td colspan="8" style="text-align: center;"> <table border="1" style="width: 100%; border-collapse: collapse; text-align: center;"> <tr> <td style="width: 10%;"></td> <td style="width: 10%;"></td> <td style="width: 10%;"></td> <td style="width: 10%;"></td> <td style="width: 10%;"></td> <td style="width: 10%;"></td> <td style="width: 10%;"></td> <td style="width: 10%;"></td> <td style="width: 10%;"></td> <td style="width: 10%;"></td> </tr> <tr> <td></td> <td></td> <td colspan="8" style="text-align: center;"> <table border="1" style="width: 100%; border-collapse: collapse; text-align: center;"> <tr> <td style="width: 10%;"></td> <td style="width: 10%;"></td> <td style="width: 10%;"></td> <td style="width: 10%;"></td> <td style="width: 10%;"></td> <td style="width: 10%;"></td> <td style="width: 10%;"></td> <td style="width: 10%;"></td> <td style="width: 10%;"></td> <td style="width: 10%;"></td> </tr> <tr> <td></td> <td></td> <td colspan="8" style="text-align: center;"> <table border="1" style="width: 100%; border-collapse: collapse; text-align: center;"> <tr> <td style="width: 10%;"></td> <td style="width: 10%;"></td> <td style="width: 10%;"></td> <td style="width: 10%;"></td> <td style="width: 10%;"></td> <td style="width: 10%;"></td> <td style="width: 10%;"></td> <td style="width: 10%;"></td> <td style="width: 10%;"></td> <td style="width: 10%;"></td> </tr> <tr> <td></td> <td></td> <td colspan="8" style="text-align: center;"> <table border="1" style="width: 100%; border-collapse: collapse; text-align: center;"> <tr> <td style="width: 10%;"></td> <td style="width: 10%;"></td> <td style="width: 10%;"></td> <td style="width: 10%;"></td> <td style="width: 10%;"></td> <td style="width: 10%;"></td> <td style="width: 10%;"></td> <td style="width: 10%;"></td> <td style="width: 10%;"></td> <td style="width: 10%;"></td> </tr> <tr> <td></td> <td></td> <td colspan="8" style="text-align: center;"> <table border="1" style="width: 100%; border-collapse: collapse; text-align: center;"> <tr>
<td style="width: 10%;"></td> <td style="width: 10%;"></td> <td style="width: 10%;"></td> <td style="width: 10%;"></td> <td style="width: 10%;"></td> <td style="width: 10%;"></td> <td style="width: 10%;"></td> <td style="width: 10%;"></td> <td style="width: 10%;"></td> <td style="width: 10%;"></td> </tr> <tr> <td></td> <td></td> <td colspan="8" style="text-align: center;"> <table border="1" style="width: 100%; border-collapse: collapse; text-align: center;"> <tr> <td style="width: 10%;"></td> <td style="width: 10%;"></td> <td style="width: 10%;"></td> <td style="width: 10%;"></td> <td style="width: 10%;"></td> <td style="width: 10%;"></td> <td style="width: 10%;"></td> <td style="width: 10%;"></td> <td style="width: 10%;"></td> <td style="width: 10%;"></td> </tr> <tr> <td></td> <td></td> <td colspan="8" style="text-align: center;"> <table border="1" style="width: 100%; border-collapse: collapse; text-align: center;"> <tr> <td style="width: 10%;"></td> <td style="width: 10%;"></td> <td style="width: 10%;"></td> <td style="width: 10%;"></td> <td style="width: 10%;"></td> <td style="width: 10%;"></td> <td style="width: 10%;"></td> <td style="width: 10%;"></td> <td style="width: 10%;"></td> <td style="width: 10%;"></td> </tr> <tr> <td></td> <td></td> <td colspan="8" style="text-align: center;"> <table border="1" style="width: 100%; border-collapse: collapse; text-align: center;"> <tr> <td style="width: 10%;"></td> <td style="width: 10%;"></td> <td style="width: 10%;"></td> <td style="width: 10%;"></td> <td style="width: 10%;"></td> <td style="width: 10%;"></td> <td style="width: 10%;"></td> <td style="width: 10%;"></td> <td style="width: 10%;"></td> <td style="width: 10%;"></td> </tr> <tr> <td></td> <td></td> <td colspan="8" style="text-align: center;"> <table border="1" style="width: 100%; border-collapse: collapse; text-align: center;"> <tr> <td style="width: 10%;"></td> <td style="width: 10%;"></td> <td style="width: 10%;"></td> <td style="width: 10%;"></td> <td style="width: 10%;"></td> <td style="width: 10%;"></td> <td style="width: 10%;"></td> <td style="width: 10%;"></td> <td style="width: 10%;"></td> <td style="width: 10%;"></td> </tr> <tr> <td></td> <td></td> <td colspan="8" style="text-align: center;"> <table border="1" style="width: 100%; border-collapse: collapse; text-align: center;"> <tr> <td style="width: 10%;"></td> <td style="width: 10%;"></td> <td style="width: 10%;"></td> <td style="width: 10%;"></td> <td style="width: 10%;"></td> <td style="width: 10%;"></td> <td style="width: 10%;"></td> <td style="width: 10%;"></td> <td style="width: 10%;"></td> <td style="width: 10%;"></td> </tr> <tr> <td></td> <td></td> <td colspan="8" style="text-align: center;"> <table border="1" style="width: 100%; border-collapse: collapse; text-align: center;"> <tr> <td style="width: 10%;"></td> <td style="width: 10%;"></td> <td style="width: 10%;"></td> <td style="width: 10%;"></td> <td style="width: 10%;"></td> <td style="width: 10%;"></td> <td style="width: 10%;"></td> <td style="width: 10%;"></td> <td style="width: 10%;"></td> <td style="width: 10%;"></td> </tr> <tr> <td></td> <td></td> <td colspan="8" style="text-align: center;"> <table border="1" style="width: 100%; border-collapse: collapse; text-align: center;"> <tr> <td style="width: 10%;"></td> <td style="width: 10%;"></td> <td style="width: 10%;"></td> <td style="width: 10%;"></td> <td style="width: 10%;"></td> <td style="width: 10%;"></td> <td style="width: 10%;"></td> <td style="width: 10%;"></td> <td style="width: 10%;"></td> <td style="width: 10%;"></td> </tr> <tr> <td></td> <td></td> <td colspan="8" style="text-align: center;"> <table border="1" style="width: 100%; border-collapse: collapse; text-align: center;"> <tr> <td style="width: 10%;"></td> <td style="width: 10%;"></td> <td style="width: 10%;"></td> <td style="width: 10%;"></td> <td style="width: 10%;"></td> <td style="width: 10%;"></td> <td style="width: 10%;"></td> <td style="width: 10%;"></td> <td style="width: 10%;"></td> <td style="width: 10%;"></td> </tr> <tr> <td></td> <td></td> <td colspan="8" style="text-align: center;"> <table border="1" style="width: 100%; border-collapse: collapse; text-align: center;"> <tr> <td style="width: 10%;"></td> <td style="width: 10%;"></td> <td style="width: 10%;"></td> <td style="width: 10%;"></td> <td style="width: 10%;"></td> <td style="width: 10%;"></td> <td style="width: 10%;"></td> <td style="width: 10%;"></td> <td style="width: 10%;"></td> <td style="width: 10%;"></td> </tr> <tr> <td></td> <td></td> <td colspan="8" style="text-align: center;"> <table border="1" style="width: 100%; border-collapse: collapse; text-align: center;"> <tr> <td style="width: 10%;"></td> <td style="width: 10%;"></td> <td style="width: 10%;"></td> <td style="width: 10%;"></td> <td style="width: 10%;"></td> <td style="width: 10%;"></td> <td style="width: 10%;"></td> <td style="width: 10%;"></td> <td style="width: 10%;"></td> <td style="width: 10%;"></td> </tr> <tr> <td></td> <td></td> <td colspan="8" style="text-align: center;"> <table border="1" style="width: 100%; border-collapse: collapse; text-align: center;"> <tr> <td style="width: 10%;"></td> <td style="width: 10%;"></td> <td style="width: 10%;"></td> <td style="width: 10%;"></td> <td style="width: 10%;"></td> <td style="width: 10%;"></td> <td style="width: 10%;"></td> <td style="width: 10%;"></td> <td style="width: 10%;"></td> <td style="width: 10%;"></td> </tr> <tr> <td></td> <td></td> <td colspan="8" style="text-align: center;"> <table border="1" style="width: 100%; border-collapse: collapse; text-align: center;"> <tr> <td style="width: 10%;"></td> <td style="width: 10%;"></td> <td style="width: 10%;"></td> <td style="width: 10%;"></td> <td style="width: 10%;"></td> <td style="width: 10%;"></td> <td style="width: 10%;"></td> <td style="width: 10%;"></td> <td style="width: 10%;"></td> <td style="width: 10%;"></td> </tr> <tr> <td></td> <td></td> <td colspan="8" style="text-align: center;"> <table border="1" style="width: 100%; border-collapse: collapse; text-align: center;"> <tr> <td style="width: 10%;"></td> <td style="width: 10%;"></td> <td style="width: 10%;"></td> <td style="width: 10%;"></td> <td style="width: 10%;"></td> <td style="width: 10%;"></td> <td style="width: 10%;"></td> <td style="width: 10%;"></td> <td style="width: 10%;"></td> <td style="width: 10%;"></td> </tr> <tr> <td></td> <td></td> <td colspan="8" style="text-align: center;"> <table border="1" style="width: 100%; border-collapse: collapse; text-align: center;"> <tr> <td style="width: 10%;"></td> <td style="width: 10%;"></td> <td style="width: 10%;"></td> <td style="width: 10%;"></td> <td style="width: 10%;"></td> <td style="width: 10%;"></td> <td style="width: 10%;"></td> <td style="width: 10%;"></td> <td style="width: 10%;"></td> <td style="width: 10%;"></td> </tr> <tr> <td></td> <td></td> <td colspan="8" style="text-align: center;"> <table border="1" style="width: 100%; border-collapse: collapse; text-align: center;"> <tr> <td style="width: 10%;"></td> <td style="width: 10%;"></td> <td style="width: 10%;"></td> <td style="width: 10%;"></td> <td style="width: 10%;"></td> <td style="width: 10%;"></td> <td style="width: 10%;"></td> <td style="width: 10%;"></td> <td style="width: 10%;"></td> <td style="width: 10%;"></td> </tr> <tr> <td></td> <td></td> <td colspan="8" style="text-align: center;"> <table border="1" style="width: 100%; border-collapse: collapse; text-align: center;"> <tr> <td style="width: 10%;"></td> <td style="width: 10%;"></td> <td style="width: 10%;"></td> <td style="width: 10%;"></td> <td style="width: 10%;"></td> <td style="width: 10%;"></td> <td style="width: 10%;"></td> <td style="width: 10%;"></td> <td style="width: 10%;"></td> <td style="width: 10%;"></td> </tr> <tr> <td></td> <td></td> <td colspan="8" style="text-align: center;"> <table border="1" style="width: 100%; border-collapse: collapse; text-align: center;"> <tr> <td style="width: 10%;"></td> <td style="width: 10%;"></td> <td style="width: 10%;"></td> <td style="width: 10%;"></td> <td style="width: 10%;"></td> <td style="width: 10%;"></td> <td style="width: 10%;"></td> <td style="width: 10%;"></td> <td style="width: 10%;"></td> <td style="width: 10%;"></td> </tr> <tr> <td></td> <td></td> <td colspan="8" style="text-align: center;"> <table border="1" style="width: 100%; border-collapse: collapse; text-align: center;"> <tr> <td style="width: 10%;"></td> <td style="width: 10%;"></td> <td style="width: 10%;"></td> <td style="width: 10%;"></td> <td style="width: 10%;"></td> <td style="width: 10%;"></td> <td style="width: 10%;"></td> <td style="width: 10%;"></td> <td style="width: 10%;"></td> <td style="width: 10%;"></td> </tr> <tr> <td></td> <td></td> <td colspan="8" style="text-align: center;"> <table border="1" style="width: 100%; border-collapse: collapse; text-align: center;"> <tr> <td style="width: 10%;"></td> <td style="width: 10%;"></td> <td style="width: 10%;"></td> <td style="width: 10%;"></td> <td style="width: 10%;"></td> <td style="width: 10%;"></td> <td style="width: 10%;"></td> <td style="width: 10%;"></td> <td style="width: 10%;"></td> <td style="width: 10%;"></td> </tr> <tr> <td></td> <td></td> <td colspan="8" style="text-align: center;"> <table border="1" style="width: 100%; border-collapse: collapse; text-align: center;"> <tr> <td style="width: 10%;"></td> <td style="width: 10%;"></td> <td style="width: 10%;"></td> <td style="width: 10%;"></td> <td style="width: 10%;"></td> <td style="width: 10%;"></td> <td style="width: 10%;"></td> <td style="width: 10%;"></td> <td style="width: 10%;"></td> <td style="width: 10%;"></td> </tr> <tr> <td></td> <td></td> <td colspan="8" style="text-align: center;"> <table border="1" style="width: 100%; border-collapse: collapse; text-align: center;"> <tr> <td style="width: 10%;"></td> <td style="width: 10%;"></td> <td style="width: 10%;"></td> <td style="width: 10%;"></td> <td style="width: 10%;"></td> <td style="width:
10%;"></td> <td style="width: 10%;"></td> <td style="width: 10%;"></td> <td style="width: 10%;"></td> <td style="width: 10%;"></td> </tr> <tr> <td></td> <td></td> <td colspan="8" style="text-align: center;"> <table border="1" style="width: 100%; border-collapse: collapse; text-align: center;"> <tr> <td style="width: 10%;"></td> <td style="width: 10%;"></td> <td style="width: 10%;"></td> <td style="width: 10%;"></td> <td style="width: 10%;"></td> <td style="width: 10%;"></td> <td style="width: 10%;"></td> <td style="width: 10%;"></td> <td style="width: 10%;"></td> <td style="width: 10%;"></td> </tr> <tr> <td></td> <td></td> <td colspan="8" style="text-align: center;"> <table border="1" style="width: 100%; border-collapse: collapse; text-align: center;"> <tr> <td style="width: 10%;"></td> <td style="width: 10%;"></td> <td style="width: 10%;"></td> <td style="width: 10%;"></td> <td style="width: 10%;"></td> <td style="width: 10%;"></td> <td style="width: 10%;"></td> <td style="width: 10%;"></td> <td style="width: 10%;"></td> <td style="width: 10%;"></td> </tr> <tr> <td></td> <td></td> <td colspan="8" style="text-align: center;"> <table border="1" style="width: 100%; border-collapse: collapse; text-align: center;"> <tr> <td style="width: 10%;"></td> <td style="width: 10%;"></td> <td style="width: 10%;"></td> <td style="width: 10%;"></td> <td style="width: 10%;"></td> <td style="width: 10%;"></td> <td style="width: 10%;"></td> <td style="width: 10%;"></td> <td style="width: 10%;"></td> <td style="width: 10%;"></td> </tr> <tr> <td></td> <td></td> <td colspan="8" style="text-align: center;"> <table border="1" style="width: 100%; border-collapse: collapse; text-align: center;"> <tr> <td style="width: 10%;"></td> <td style="width: 10%;"></td> <td style="width: 10%;"></td> <td style="width: 10%;"></td> <td style="width: 10%;"></td> <td style="width: 10%;"></td> <td style="width: 10%;"></td> <td style="width: 10%;"></td> <td style="width: 10%;"></td> <td style="width: 10%;"></td> </tr> <tr> <td></td> <td></td> <td colspan="8" style="text-align: center;"> <table border="1" style="width: 100%; border-collapse: collapse; text-align: center;"> <tr> <td style="width: 10%;"></td> <td style="width: 10%;"></td> <td style="width: 10%;"></td> <td style="width: 10%;"></td> <td style="width: 10%;"></td> <td style="width: 10%;"></td> <td style="width: 10%;"></td> <td style="width: 10%;"></td> <td style="width: 10%;"></td> <td style="width: 10%;"></td> </tr> <tr> <td></td> <td></td> <td colspan="8" style="text-align: center;"> <table border="1" style="width: 100%; border-collapse: collapse; text-align: center;"> <tr> <td style="width: 10%;"></td> <td style="width: 10%;"></td> <td style="width: 10%;"></td> <td style="width: 10%;"></td> <td style="width: 10%;"></td> <td style="width: 10%;"></td> <td style="width: 10%;"></td> <td style="width: 10%;"></td> <td style="width: 10%;"></td> <td style="width: 10%;"></td> </tr> <tr> <td></td> <td></td> <td colspan="8" style="text-align: center;"> <table border="1" style="width: 100%; border-collapse: collapse; text-align: center;"> <tr> <td style="width: 10%;"></td> <td style="width: 10%;"></td> <td style="width: 10%;"></td> <td style="width: 10%;"></td> <td style="width: 10%;"></td> <td style="width: 10%;"></td> <td style="width: 10%;"></td> <td style="width: 10%;"></td> <td style="width: 10%;"></td> <td style="width: 10%;"></td> </tr> <tr> <td></td> <td></td> <td colspan="8" style="text-align: center;"> <table border="1" style="width: 100%; border-collapse: collapse; text-align: center;"> <tr> <td style="width: 10%;"></td> <td style="width: 10%;"></td> <td style="width: 10%;"></td> <td style="width: 10%;"></td> <td style="width: 10%;"></td> <td style="width: 10%;"></td> <td style="width: 10%;"></td> <td style="width: 10%;"></td> <td style="width: 10%;"></td> <td style="width: 10%;"></td> </tr> <tr> <td></td> <td></td> <td colspan="8" style="text-align: center;"> <table border="1" style="width: 100%; border-collapse: collapse; text-align: center;"> <tr> <td style="width: 10%;"></td> <td style="width: 10%;"></td> <td style="width: 10%;"></td> <td style="width: 10%;"></td> <td style="width: 10%;"></td> <td style="width: 10%;"></td> <td style="width: 10%;"></td> <td style="width: 10%;"></td> <td style="width: 10%;"></td> <td style="width: 10%;"></td> </tr> <tr> <td></td> <td></td> <td colspan="8" style="text-align: center;"> <table border="1" style="width: 100%; border-collapse: collapse; text-align: center;"> <tr> <td style="width: 10%;"></td> <td style="width: 10%;"></td> <td style="width: 10%;"></td> <td style="width: 10%;"></td> <td style="width: 10%;"></td> <td style="width: 10%;"></td> <td style="width: 10%;"></td> <td style="width: 10%;"></td> <td style="width: 10%;"></td> <td style="width: 10%;"></td> </tr> <tr> <td></td> <td></td> <td colspan="8" style="text-align: center;"> <table border="1" style="width: 100%; border-collapse: collapse; text-align: center;"> <tr> <td style="width: 10%;"></td> <td style="width: 10%;"></td> <td style="width: 10%;"></td> <td style="width: 10%;"></td> <td style="width: 10%;"></td> <td style="width: 10%;"></td> <td style="width: 10%;"></td> <td style="width: 10%;"></td> <td style="width: 10%;"></td> <td style="width: 10%;"></td> </tr> <tr> <td></td> <td></td> <td colspan="8" style="text-align: center;"> <table border="1" style="width: 100%; border-collapse: collapse; text-align: center;"> <tr> <td style="width: 10%;"></td> <td style="width: 10%;"></td> <td style="width: 10%;"></td> <td style="width: 10%;"></td> <td style="width: 10%;"></td> <td style="width: 10%;"></td> <td style="width: 10%;"></td> <td style="width: 10%;"></td> <td style="width: 10%;"></td> <td style="width: 10%;"></td> </tr> <tr> <td></td> <td></td> <td colspan="8" style="text-align: center;"> <table border="1" style="width: 100%; border-collapse: collapse; text-align: center;"> <tr> <td style="width: 10%;"></td> <td style="width: 10%;"></td> <td style="width: 10%;"></td> <td style="width: 10%;"></td> <td style="width: 10%;"></td> <td style="width: 10%;"></td> <td style="width: 10%;"></td> <td style="width: 10%;"></td> <td style="width: 10%;"></td> <td style="width: 10%;"></td> </tr> <tr> <td></td> <td></td> <td colspan="8" style="text-align: center;"> <table border="1" style="width: 100%; border-collapse: collapse; text-align: center;"> <tr> <td style="width: 10%;"></td> <td style="width: 10%;"></td> <td style="width: 10%;"></td> <td style="width: 10%;"></td> <td style="width: 10%;"></td> <td style="width: 10%;"></td> <td style="width: 10%;"></td> <td style="width: 10%;"></td> <td style="width: 10%;"></td> <td style="width: 10%;"></td> </tr> <tr> <td></td> <td></td> <td colspan="8" style="text-align: center;"> <table border="1" style="width: 100%; border-collapse: collapse; text-align: center;"> <tr> <td style="width: 10%;"></td> <td style="width: 10%;"></td> <td style="width: 10%;"></td> <td style="width: 10%;"></td> <td style="width: 10%;"></td> <td style="width: 10%;"></td> <td style="width: 10%;"></td> <td style="width: 10%;"></td> <td style="width: 10%;"></td> <td style="width: 10%;"></td> </tr> <tr> <td></td> <td></td> <td colspan="8" style="text-align: center;"> <table border="1" style="width: 100%; border-collapse: collapse; text-align: center;"> <tr> </tr></table></td></tr></table></td></tr></table></td></tr></table></td></tr></table></td></tr></table></td></tr></table></td></tr></table></td></tr></table></td></tr></table></td></tr></table></td></tr></table></td></tr></table></td></tr></table></td></tr></table></td></tr></table></td></tr></table></td></tr></table></td></tr></table></td></tr></table></td></tr></table></td></tr></table></td></tr></table></td></tr></table></td></tr></table></td></tr></table></td></tr></table></td></tr></table></td></tr></table></td></tr></table></td></tr></table></td></tr></table></td></tr></table></td></tr></table></td></tr></table></td></tr></table></td></tr></table></td></tr></table></td></tr></table></td></tr></table></td></tr></table></td></tr></table></td></tr></table></td></tr></table></td></tr></table></td></tr></table></td></tr></table></td></tr></table></td></tr></table></td></tr></table></td></tr></table></td></tr></table></td></tr></table></td></tr></table>
 | | | | | | | | | | | | | | | | | | | | <table border="1" style="width: 100%; border-collapse: collapse; text-align: center;"> <tr> <td style="width: 10%;"></td> <td style="width: 10%;"></td> <td style="width: 10%;"></td> <td style="width: 10%;"></td> <td style="width: 10%;"></td> <td style="width: 10%;"></td> <td style="width: 10%;"></td> <td style="width: 10%;"></td> <td style="width: 10%;"></td> <td style="width: 10%;"></td> </tr> <tr> <td></td> <td></td> <td colspan="8" style="text-align: center;"> <table border="1" style="width: 100%; border-collapse: collapse; text-align: center;"> <tr> <td style="width: 10%;"></td> <td style="width: 10%;"></td> <td style="width: 10%;"></td> <td style="width: 10%;"></td> <td style="width: 10%;"></td> <td style="width: 10%;"></td> <td style="width: 10%;"></td> <td style="width: 10%;"></td> <td style="width: 10%;"></td> <td style="width: 10%;"></td> </tr> <tr> <td></td> <td></td> <td colspan="8" style="text-align: center;"> <table border="1" style="width: 100%; border-collapse: collapse; text-align: center;"> <tr> <td style="width: 10%;"></td> <td style="width: 10%;"></td> <td style="width: 10%;"></td> <td style="width: 10%;"></td> <td style="width: 10%;"></td> <td style="width: 10%;"></td> <td style="width: 10%;"></td> <td style="width: 10%;"></td> <td style="width: 10%;"></td> <td style="width: 10%;"></td> </tr> <tr> <td></td> <td></td> <td colspan="8" style="text-align: center;"> <table border="1" style="width: 100%; border-collapse: collapse; text-align: center;"> <tr> <td style="width: 10%;"></td> <td style="width: 10%;"></td> <td style="width: 10%;"></td> <td style="width: 10%;"></td> <td style="width: 10%;"></td> <td style="width: 10%;"></td> <td style="width: 10%;"></td> <td style="width: 10%;"></td> <td style="width: 10%;"></td> <td style="width: 10%;"></td> </tr> <tr> <td></td> <td></td> <td colspan="8" style="text-align: center;"> <table border="1" style="width: 100%; border-collapse: collapse; text-align: center;"> <tr> <td style="width: 10%;"></td> <td style="width: 10%;"></td> <td style="width: 10%;"></td> <td style="width: 10%;"></td> <td style="width: 10%;"></td> <td style="width: 10%;"></td> <td style="width: 10%;"></td> <td style="width: 10%;"></td> <td style="width: 10%;"></td> <td style="width: 10%;"></td> </tr> <tr> <td></td> <td></td> <td colspan="8" style="text-align: center;"> <table border="1" style="width: 100%; border-collapse: collapse; text-align: center;"> <tr> <td style="width: 10%;"></td> <td style="width: 10%;"></td> <td style="width: 10%;"></td> <td style="width: 10%;"></td> <td style="width: 10%;"></td> <td style="width: 10%;"></td> <td style="width: 10%;"></td> <td style="width: 10%;"></td> <td style="width: 10%;"></td> <td style="width: 10%;"></td> </tr> <tr> <td></td> <td></td> <td colspan="8" style="text-align: center;"> <table border="1" style="width: 100%; border-collapse: collapse; text-align: center;"> <tr> <td style="width: 10%;"></td> <td style="width: 10%;"></td> <td style="width: 10%;"></td> <td style="width: 10%;"></td> <td style="width: 10%;"></td> <td style="width: 10%;"></td> <td style="width: 10%;"></td> <td style="width: 10%;"></td> <td style="width: 10%;"></td> <td style="width: 10%;"></td> </tr> <tr> <td></td> <td></td> <td colspan="8" style="text-align: center;"> <table border="1" style="width: 100%; border-collapse: collapse; text-align: center;"> <tr> <td style="width: 10%;"></td> <td style="width: 10%;"></td> <td style="width: 10%;"></td> <td style="width: 10%;"></td> <td style="width: 10%;"></td> <td style="width: 10%;"></td> <td style="width: 10%;"></td> <td style="width: 10%;"></td> <td style="width: 10%;"></td> <td style="width: 10%;"></td> </tr> <tr> <td></td> <td></td> <td colspan="8" style="text-align: center;"> <table border="1" style="width: 100%; border-collapse: collapse; text-align: center;"> <tr> <td style="width: 10%;"></td> <td style="width: 10%;"></td> <td style="width: 10%;"></td> <td style="width: 10%;"></td> <td style="width: 10%;"></td> <td style="width: 10%;"></td> <td style="width: 10%;"></td> <td style="width: 10%;"></td> <td style="width: 10%;"></td> <td style="width: 10%;"></td> </tr> <tr> <td></td> <td></td> <td colspan="8" style="text-align: center;"> <table border="1" style="width: 100%; border-collapse: collapse; text-align: center;"> <tr> <td style="width: 10%;"></td> <td style="width: 10%;"></td> <td style="width: 10%;"></td> <td style="width: 10%;"></td> <td style="width: 10%;"></td> <td style="width: 10%;"></td> <td style="width: 10%;"></td> <td style="width: 10%;"></td> <td style="width: 10%;"></td> <td style="width: 10%;"></td> </tr> <tr> <td></td> <td></td> <td colspan="8" style="text-align: center;"> <table border="1" style="width: 100%; border-collapse: collapse; text-align: center;"> <tr> <td style="width: 10%;"></td> <td style="width: 10%;"></td> <td style="width: 10%;"></td> <td style="width: 10%;"></td> <td style="width: 10%;"></td> <td style="width: 10%;"></td> <td style="width: 10%;"></td> <td style="width: 10%;"></td> <td style="width: 10%;"></td> <td style="width: 10%;"></td> </tr> <tr> <td></td> <td></td> <td colspan="8" style="text-align: center;"> <table border="1" style="width: 100%; border-collapse: collapse; text-align: center;"> <tr> <td style="width: 10%;"></td> <td style="width: 10%;"></td> <td style="width: 10%;"></td> <td style="width: 10%;"></td> <td style="width: 10%;"></td> <td style="width: 10%;"></td> <td style="width: 10%;"></td> <td style="width: 10%;"></td> <td style="width: 10%;"></td> <td style="width: 10%;"></td> </tr> <tr> <td></td> <td></td> <td colspan="8" style="text-align: center;"> <table border="1" style="width: 100%; border-collapse: collapse; text-align: center;"> <tr> <td style="width: 10%;"></td> <td style="width: 10%;"></td> <td style="width: 10%;"></td> <td style="width: 10%;"></td> <td style="width: 10%;"></td> <td style="width: 10%;"></td> <td style="width: 10%;"></td> <td style="width: 10%;"></td> <td style="width: 10%;"></td> <td style="width: 10%;"></td> </tr> <tr> <td></td> <td></td> <td colspan="8" style="text-align: center;"> <table border="1" style="width: 100%; border-collapse: collapse; text-align: center;"> <tr> <td style="width: 10%;"></td> <td style="width: 10%;"></td> <td style="width: 10%;"></td> <td style="width: 10%;"></td> <td style="width: 10%;"></td> <td style="width: 10%;"></td> <td style="width: 10%;"></td> <td style="width: 10%;"></td> <td style="width: 10%;"></td> <td style="width: 10%;"></td> </tr> <tr> <td></td> <td></td> <td colspan="8" style="text-align: center;"> <table border="1" style="width: 100%; border-collapse: collapse; text-align: center;"> <tr> <td style="width: 10%;"></td> <td style="width: 10%;"></td> <td style="width: 10%;"></td> <td style="width: 10%;"></td> <td style="width: 10%;"></td> <td style="width: 10%;"></td> <td style="width: 10%;"></td> <td style="width: 10%;"></td> <td style="width: 10%;"></td> <td style="width: 10%;"></td> </tr> <tr> <td></td> <td></td> <td colspan="8" style="text-align: center;"> <table border="1" style="width: 100%; border-collapse: collapse; text-align: center;"> <tr> <td style="width: 10%;"></td> <td style="width: 10%;"></td> <td style="width: 10%;"></td> <td style="width: 10%;"></td> <td style="width: 10%;"></td> <td style="width: 10%;"></td> <td style="width: 10%;"></td> <td style="width: 10%;"></td> <td style="width: 10%;"></td> <td style="width: 10%;"></td> </tr> <tr> <td></td> <td></td> <td colspan="8" style="text-align: center;"> <table border="1" style="width: 100%; border-collapse: collapse; text-align: center;"> <tr> <td style="width: 10%;"></td> <td style="width: 10%;"></td> <td style="width: 10%;"></td> <td style="width: 10%;"></td> <td style="width: 10%;"></td> <td style="width: 10%;"></td> <td
style="width: 10%;"></td> <td style="width: 10%;"></td> <td style="width: 10%;"></td> <td style="width: 10%;"></td> </tr> <tr> <td></td> <td></td> <td colspan="8" style="text-align: center;"> <table border="1" style="width: 100%; border-collapse: collapse; text-align: center;"> <tr> <td style="width: 10%;"></td> <td style="width: 10%;"></td> <td style="width: 10%;"></td> <td style="width: 10%;"></td> <td style="width: 10%;"></td> <td style="width: 10%;"></td> <td style="width: 10%;"></td> <td style="width: 10%;"></td> <td style="width: 10%;"></td> <td style="width: 10%;"></td> </tr> <tr> <td></td> <td></td> <td colspan="8" style="text-align: center;"> <table border="1" style="width: 100%; border-collapse: collapse; text-align: center;"> <tr> <td style="width: 10%;"></td> <td style="width: 10%;"></td> <td style="width: 10%;"></td> <td style="width: 10%;"></td> <td style="width: 10%;"></td> <td style="width: 10%;"></td> <td style="width: 10%;"></td> <td style="width: 10%;"></td> <td style="width: 10%;"></td> <td style="width: 10%;"></td> </tr> <tr> <td></td> <td></td> <td colspan="8" style="text-align: center;"> <table border="1" style="width: 100%; border-collapse: collapse; text-align: center;"> <tr> <td style="width: 10%;"></td> <td style="width: 10%;"></td> <td style="width: 10%;"></td> <td style="width: 10%;"></td> <td style="width: 10%;"></td> <td style="width: 10%;"></td> <td style="width: 10%;"></td> <td style="width: 10%;"></td> <td style="width: 10%;"></td> <td style="width: 10%;"></td> </tr> <tr> <td></td> <td></td> <td colspan="8" style="text-align: center;"> <table border="1" style="width: 100%; border-collapse: collapse; text-align: center;"> <tr> <td style="width: 10%;"></td> <td style="width: 10%;"></td> <td style="width: 10%;"></td> <td style="width: 10%;"></td> <td style="width: 10%;"></td> <td style="width: 10%;"></td> <td style="width: 10%;"></td> <td style="width: 10%;"></td> <td style="width: 10%;"></td> <td style="width: 10%;"></td> </tr> <tr> <td></td> <td></td> <td colspan="8" style="text-align: center;"> <table border="1" style="width: 100%; border-collapse: collapse; text-align: center;"> <tr> <td style="width: 10%;"></td> <td style="width: 10%;"></td> <td style="width: 10%;"></td> <td style="width: 10%;"></td> <td style="width: 10%;"></td> <td style="width: 10%;"></td> <td style="width: 10%;"></td> <td style="width: 10%;"></td> <td style="width: 10%;"></td> <td style="width: 10%;"></td> </tr> <tr> <td></td> <td></td> <td colspan="8" style="text-align: center;"> <table border="1" style="width: 100%; border-collapse: collapse; text-align: center;"> <tr> <td style="width: 10%;"></td> <td style="width: 10%;"></td> <td style="width: 10%;"></td> <td style="width: 10%;"></td> <td style="width: 10%;"></td> <td style="width: 10%;"></td> <td style="width: 10%;"></td> <td style="width: 10%;"></td> <td style="width: 10%;"></td> <td style="width: 10%;"></td> </tr> <tr> <td></td> <td></td> <td colspan="8" style="text-align: center;"> <table border="1" style="width: 100%; border-collapse: collapse; text-align: center;"> <tr> <td style="width: 10%;"></td> <td style="width: 10%;"></td> <td style="width: 10%;"></td> <td style="width: 10%;"></td> <td style="width: 10%;"></td> <td style="width: 10%;"></td> <td style="width: 10%;"></td> <td style="width: 10%;"></td> <td style="width: 10%;"></td> <td style="width: 10%;"></td> </tr> <tr> <td></td> <td></td> <td colspan="8" style="text-align: center;"> <table border="1" style="width: 100%; border-collapse: collapse; text-align: center;"> <tr> <td style="width: 10%;"></td> <td style="width: 10%;"></td> <td style="width: 10%;"></td> <td style="width: 10%;"></td> <td style="width: 10%;"></td> <td style="width: 10%;"></td> <td style="width: 10%;"></td> <td style="width: 10%;"></td> <td style="width: 10%;"></td> <td style="width: 10%;"></td> </tr> <tr> <td></td> <td></td> <td colspan="8" style="text-align: center;"> <table border="1" style="width: 100%; border-collapse: collapse; text-align: center;"> <tr> <td style="width: 10%;"></td> <td style="width: 10%;"></td> <td style="width: 10%;"></td> <td style="width: 10%;"></td> <td style="width: 10%;"></td> <td style="width: 10%;"></td> <td style="width: 10%;"></td> <td style="width: 10%;"></td> <td style="width: 10%;"></td> <td style="width: 10%;"></td> </tr> <tr> <td></td> <td></td> <td colspan="8" style="text-align: center;"> <table border="1" style="width: 100%; border-collapse: collapse; text-align: center;"> <tr> <td style="width: 10%;"></td> <td style="width: 10%;"></td> <td style="width: 10%;"></td> <td style="width: 10%;"></td> <td style="width: 10%;"></td> <td style="width: 10%;"></td> <td style="width: 10%;"></td> <td style="width: 10%;"></td> <td style="width: 10%;"></td> <td style="width: 10%;"></td> </tr> <tr> <td></td> <td></td> <td colspan="8" style="text-align: center;"> <table border="1" style="width: 100%; border-collapse: collapse; text-align: center;"> <tr> <td style="width: 10%;"></td> <td style="width: 10%;"></td> <td style="width: 10%;"></td> <td style="width: 10%;"></td> <td style="width: 10%;"></td> <td style="width: 10%;"></td> <td style="width: 10%;"></td> <td style="width: 10%;"></td> <td style="width: 10%;"></td> <td style="width: 10%;"></td> </tr> <tr> <td></td> <td></td> <td colspan="8" style="text-align: center;"> <table border="1" style="width: 100%; border-collapse: collapse; text-align: center;"> <tr> <td style="width: 10%;"></td> <td style="width: 10%;"></td> <td style="width: 10%;"></td> <td style="width: 10%;"></td> <td style="width: 10%;"></td> <td style="width: 10%;"></td> <td style="width: 10%;"></td> <td style="width: 10%;"></td> <td style="width: 10%;"></td> <td style="width: 10%;"></td> </tr> <tr> <td></td> <td></td> <td colspan="8" style="text-align: center;"> <table border="1" style="width: 100%; border-collapse: collapse; text-align: center;"> <tr> <td style="width: 10%;"></td> <td style="width: 10%;"></td> <td style="width: 10%;"></td> <td style="width: 10%;"></td> <td style="width: 10%;"></td> <td style="width: 10%;"></td> <td style="width: 10%;"></td> <td style="width: 10%;"></td> <td style="width: 10%;"></td> <td style="width: 10%;"></td> </tr> <tr> <td></td> <td></td> <td colspan="8" style="text-align: center;"> <table border="1" style="width: 100%; border-collapse: collapse; text-align: center;"> <tr> <td style="width: 10%;"></td> <td style="width: 10%;"></td> <td style="width: 10%;"></td> <td style="width: 10%;"></td> <td style="width: 10%;"></td> <td style="width: 10%;"></td> <td style="width: 10%;"></td> <td style="width: 10%;"></td> <td style="width: 10%;"></td> <td style="width: 10%;"></td> </tr> <tr> <td></td> <td></td> <td colspan="8" style="text-align: center;"> <table border="1" style="width: 100%; border-collapse: collapse; text-align: center;"> <tr> <td style="width: 10%;"></td> <td style="width: 10%;"></td> <td style="width: 10%;"></td> <td style="width: 10%;"></td> <td style="width: 10%;"></td> <td style="width: 10%;"></td> <td style="width: 10%;"></td> <td style="width: 10%;"></td> <td style="width: 10%;"></td> <td style="width: 10%;"></td> </tr> <tr> <td></td> <td></td> <td colspan="8" style="text-align: center;"> <table border="1" style="width: 100%; border-collapse: collapse; text-align: center;"> <tr> <td style="width: 10%;"></td> <td style="width: 10%;"></td> <td style="width: 10%;"></td> <td style="width: 10%;"></td> <td style="width: 10%;"></td> <td style="width: 10%;"></td> <td style="width: 10%;"></td> <td style="width: 10%;"></td> <td style="width: 10%;"></td> <td style="width: 10%;"></td> </tr> <tr> <td></td> <td></td> <td colspan="8" style="text-align: center;"> <table border="1" style="width: 100%; border-collapse: collapse; text-align: center;"> <tr> <td style="width: 10%;"></td> <td style="width: 10%;"></td> <td style="width: 10%;"></td> <td style="width: 10%;"></td> <td style="width: 10%;"></td> <td style="width: 10%;"></td> <td style="width: 10%;"></td> <td style="width: 10%;"></td> <td style="width: 10%;"></td> <td style="width: 10%;"></td> </tr> <tr> <td></td> <td></td> <td colspan="8" style="text-align: center;"> <table border="1" style="width: 100%; border-collapse: collapse; text-align: center;"> <tr> <td style="width: 10%;"></td> <td style="width: 10%;"></td> <td style="width: 10%;"></td> <td style="width: 10%;"></td> <td style="width: 10%;"></td> <td style="width: 10%;"></td> <td style="width: 10%;"></td> <td style="width: 10%;"></td> <td style="width: 10%;"></td> <td style="width: 10%;"></td> </tr> <tr> <td></td> <td></td> <td colspan="8" style="text-align: center;"> <table border="1" style="width: 100%; border-collapse: collapse; text-align: center;"> <tr> <td style="width: 10%;"></td> <td style="width: 10%;"></td> <td style="width: 10%;"></td> <td style="width: 10%;"></td> <td style="width: 10%;"></td> <td style="width: 10%;"></td> <td style="width: 10%;"></td> <td style="width: 10%;"></td> <td style="width: 10%;"></td> <td style="width: 10%;"></td> </tr> <tr> <td></td> <td></td> <td colspan="8" style="text-align: center;"> <table border="1" style="width: 100%; border-collapse: collapse; text-align: center;"> <tr> <td style="width: 10%;"></td> <td style="width: 10%;"></td> <td style="width: 10%;"></td> <td style="width: 10%;"></td> <td style="width: 10%;"></td> <td style="width: 10%;"></td> <td style="width: 10%;"></td> <td style="width: 10%;"></td> <td style="width: 10%;"></td> <td style="width: 10%;"></td> </tr> <tr> <td></td> <td></td> <td colspan="8" style="text-align: center;"> <table border="1" style="width: 100%; border-collapse: collapse; text-align: center;"> <tr> <td style="width: 10%;"></td> <td style="width: 10%;"></td> <td style="width: 10%;"></td> <td style="width: 10%;"></td> <td style="width: 10%;"></td> <td style="width: 10%;"></td> <td style="width: 10%;"></td> <td style="width: 10%;"></td> <td style="width: 10%;"></td> <td style="width: 10%;"></td> </tr> <tr> <td></td> <td></td> <td colspan="8"
style="text-align: center;"> <table border="1" style="width: 100%; border-collapse: collapse; text-align: center;"> <tr> <td style="width: 10%;"></td> <td style="width: 10%;"></td> <td style="width: 10%;"></td> <td style="width: 10%;"></td> <td style="width: 10%;"></td> <td style="width: 10%;"></td> <td style="width: 10%;"></td> <td style="width: 10%;"></td> <td style="width: 10%;"></td> <td style="width: 10%;"></td> </tr> <tr> <td></td> <td></td> <td colspan="8" style="text-align: center;"> <table border="1" style="width: 100%; border-collapse: collapse; text-align: center;"> <tr> <td style="width: 10%;"></td> <td style="width: 10%;"></td> <td style="width: 10%;"></td> <td style="width: 10%;"></td> <td style="width: 10%;"></td> <td style="width: 10%;"></td> <td style="width: 10%;"></td> <td style="width: 10%;"></td> <td style="width: 10%;"></td> <td style="width: 10%;"></td> </tr> <tr> <td></td> <td></td> <td colspan="8" style="text-align: center;"> <table border="1" style="width: 100%; border-collapse: collapse; text-align: center;"> <tr> <td style="width: 10%;"></td> <td style="width: 10%;"></td> <td style="width: 10%;"></td> <td style="width: 10%;"></td> <td style="width: 10%;"></td> <td style="width: 10%;"></td> <td style="width: 10%;"></td> <td style="width: 10%;"></td> <td style="width: 10%;"></td> <td style="width: 10%;"></td> </tr> <tr> <td></td> <td></td> <td colspan="8" style="text-align: center;"> <table border="1" style="width: 100%; border-collapse: collapse; text-align: center;"> <tr> <td style="width: 10%;"></td> <td style="width: 10%;"></td> <td style="width: 10%;"></td> <td style="width: 10%;"></td> <td style="width: 10%;"></td> <td style="width: 10%;"></td> <td style="width: 10%;"></td> <td style="width: 10%;"></td> <td style="width: 10%;"></td> <td style="width: 10%;"></td> </tr> <tr> <td></td> <td></td> <td colspan="8" style="text-align: center;"> <table border="1" style="width: 100%; border-collapse: collapse; text-align: center;"> <tr> <td style="width: 10%;"></td> <td style="width: 10%;"></td> <td style="width: 10%;"></td> <td style="width: 10%;"></td> <td style="width: 10%;"></td> <td style="width: 10%;"></td> <td style="width: 10%;"></td> <td style="width: 10%;"></td> <td style="width: 10%;"></td> <td style="width: 10%;"></td> </tr> <tr> <td></td> <td></td> <td colspan="8" style="text-align: center;"> <table border="1" style="width: 100%; border-collapse: collapse; text-align: center;"> <tr> <td style="width: 10%;"></td> <td style="width: 10%;"></td> <td style="width: 10%;"></td> <td style="width: 10%;"></td> <td style="width: 10%;"></td> <td style="width: 10%;"></td> <td style="width: 10%;"></td> <td style="width: 10%;"></td> <td style="width: 10%;"></td> <td style="width: 10%;"></td> </tr> <tr> <td></td> <td></td> <td colspan="8" style="text-align: center;"> <table border="1" style="width: 100%; border-collapse: collapse; text-align: center;"> <tr> <td style="width: 10%;"></td> <td style="width: 10%;"></td> <td style="width: 10%;"></td> <td style="width: 10%;"></td> <td style="width: 10%;"></td> <td style="width: 10%;"></td> <td style="width: 10%;"></td> <td style="width: 10%;"></td> <td style="width: 10%;"></td> <td style="width: 10%;"></td> </tr> <tr> <td></td> <td></td> <td colspan="8" style="text-align: center;"> <table border="1" style="width: 100%; border-collapse: collapse; text-align: center;"> <tr> <td style="width: 10%;"></td> <td style="width: 10%;"></td> <td style="width: 10%;"></td> <td style="width: 10%;"></td> <td style="width: 10%;"></td> <td style="width: 10%;"></td> <td style="width: 10%;"></td> <td style="width: 10%;"></td> <td style="width: 10%;"></td> <td style="width: 10%;"></td> </tr> <tr> <td></td> <td></td> <td colspan="8" style="text-align: center;"> <table border="1" style="width: 100%; border-collapse: collapse; text-align: center;"> <tr> <td style="width: 10%;"></td> <td style="width: 10%;"></td> <td style="width: 10%;"></td> <td style="width: 10%;"></td> <td style="width: 10%;"></td> <td style="width: 10%;"></td> <td style="width: 10%;"></td> <td style="width: 10%;"></td> <td style="width: 10%;"></td> <td style="width: 10%;"></td> </tr> <tr> <td></td> <td></td> <td colspan="8" style="text-align: center;"> <table border="1" style="width: 100%; border-collapse: collapse; text-align: center;"> <tr> <td style="width: 10%;"></td> <td style="width: 10%;"></td> <td style="width: 10%;"></td> <td style="width: 10%;"></td> <td style="width: 10%;"></td> <td style="width: 10%;"></td> <td style="width: 10%;"></td> <td style="width: 10%;"></td> <td style="width: 10%;"></td> <td style="width: 10%;"></td> </tr> <tr> <td></td> <td></td> <td colspan="8" style="text-align: center;"> <table border="1" style="width: 100%; border-collapse: collapse; text-align: center;"> <tr> <td style="width: 10%;"></td> <td style="width: 10%;"></td> <td style="width: 10%;"></td> <td style="width: 10%;"></td> <td style="width: 10%;"></td> <td style="width: 10%;"></td> <td style="width: 10%;"></td> <td style="width: 10%;"></td> <td style="width: 10%;"></td> <td style="width: 10%;"></td> </tr> <tr> <td></td> <td></td> <td colspan="8" style="text-align: center;"> <table border="1" style="width: 100%; border-collapse: collapse; text-align: center;"> <tr> <td style="width: 10%;"></td> <td style="width: 10%;"></td> <td style="width: 10%;"></td> <td style="width: 10%;"></td> <td style="width: 10%;"></td> <td style="width: 10%;"></td> <td style="width: 10%;"></td> <td style="width: 10%;"></td> <td style="width: 10%;"></td> <td style="width: 10%;"></td> </tr> <tr> <td></td> <td></td> <td colspan="8" style="text-align: center;"> <table border="1" style="width: 100%; border-collapse: collapse; text-align: center;"> <tr> <td style="width: 10%;"></td> <td style="width: 10%;"></td> <td style="width: 10%;"></td> <td style="width: 10%;"></td> <td style="width: 10%;"></td> <td style="width: 10%;"></td> <td style="width: 10%;"></td> <td style="width: 10%;"></td> <td style="width: 10%;"></td> <td style="width: 10%;"></td> </tr> <tr> <td></td> <td></td> <td colspan="8" style="text-align: center;"> <table border="1" style="width: 100%; border-collapse: collapse; text-align: center;"> <tr> <td style="width: 10%;"></td> <td style="width: 10%;"></td> <td style="width: 10%;"></td> <td style="width: 10%;"></td> <td style="width: 10%;"></td> <td style="width: 10%;"></td> <td style="width: 10%;"></td> <td style="width: 10%;"></td> <td style="width: 10%;"></td> <td style="width: 10%;"></td> </tr> <tr> <td></td> <td></td> <td colspan="8" style="text-align: center;"> <table border="1" style="width: 100%; border-collapse: collapse; text-align: center;"> <tr> </tr></table></td></tr></table></td></tr></table></td></tr></table></td></tr></table></td></tr></table></td></tr></table></td></tr></table></td></tr></table></td></tr></table></td></tr></table></td></tr></table></td></tr></table></td></tr></table></td></tr></table></td></tr></table></td></tr></table></td></tr></table></td></tr></table></td></tr></table></td></tr></table></td></tr></table></td></tr></table></td></tr></table></td></tr></table></td></tr></table></td></tr></table></td></tr></table></td></tr></table></td></tr></table></td></tr></table></td></tr></table></td></tr></table></td></tr></table></td></tr></table></td></tr></table></td></tr></table></td></tr></table></td></tr></table></td></tr></table></td></tr></table></td></tr></table></td></tr></table></td></tr></table></td></tr></table></td></tr></table></td></tr></table></td></tr></table></td></tr></table></td></tr></table></td></tr></table></td></tr></table></td></tr></table>
 | | | | | | | | | | | | | | | | | | | | <table border="1" style="width: 100%; border-collapse: collapse; text-align: center;"> <tr> <td style="width: 10%;"></td> <td style="width: 10%;"></td> <td style="width: 10%;"></td> <td style="width: 10%;"></td> <td style="width: 10%;"></td> <td style="width: 10%;"></td> <td style="width: 10%;"></td> <td style="width: 10%;"></td> <td style="width: 10%;"></td> <td style="width: 10%;"></td> </tr> <tr> <td></td> <td></td> <td colspan="8" style="text-align: center;"> <table border="1" style="width: 100%; border-collapse: collapse; text-align: center;"> <tr> <td style="width: 10%;"></td> <td style="width: 10%;"></td> <td style="width: 10%;"></td> <td style="width: 10%;"></td> <td style="width: 10%;"></td> <td style="width: 10%;"></td> <td style="width: 10%;"></td> <td style="width: 10%;"></td> <td style="width: 10%;"></td> <td style="width: 10%;"></td> </tr> <tr> <td></td> <td></td> <td colspan="8" style="text-align: center;"> <table border="1" style="width: 100%; border-collapse: collapse; text-align: center;"> <tr> <td style="width: 10%;"></td> <td style="width: 10%;"></td> <td style="width: 10%;"></td> <td style="width: 10%;"></td> <td style="width: 10%;"></td> <td style="width: 10%;"></td> <td style="width: 10%;"></td> <td style="width: 10%;"></td> <td style="width: 10%;"></td> <td style="width: 10%;"></td> </tr> <tr> <td></td> <td></td> <td colspan="8" style="text-align: center;"> <table border="1" style="width: 100%; border-collapse: collapse; text-align: center;"> <tr> <td style="width: 10%;"></td> <td style="width: 10%;"></td> <td style="width: 10%;"></td> <td style="width: 10%;"></td> <td style="width: 10%;"></td> <td style="width: 10%;"></td> <td style="width: 10%;"></td> <td style="width: 10%;"></td> <td style="width: 10%;"></td> <td style="width: 10%;"></td> </tr> <tr> <td></td> <td></td> <td colspan="8" style="text-align: center;"> <table border="1" style="width: 100%; border-collapse: collapse; text-align: center;"> <tr> <td style="width: 10%;"></td> <td style="width: 10%;"></td> <td style="width: 10%;"></td> <td style="width: 10%;"></td> <td style="width: 10%;"></td> <td style="width: 10%;"></td> <td style="width: 10%;"></td> <td style="width: 10%;"></td> <td style="width: 10%;"></td> <td style="width: 10%;"></td> </tr> <tr> <td></td> <td></td> <td colspan="8" style="text-align: center;"> <table border="1" style="width: 100%; border-collapse: collapse; text-align: center;"> <tr> <td style="width: 10%;"></td> <td style="width: 10%;"></td> <td style="width: 10%;"></td> <td style="width: 10%;"></td> <td style="width: 10%;"></td> <td style="width: 10%;"></td> <td style="width: 10%;"></td> <td style="width: 10%;"></td> <td style="width: 10%;"></td> <td style="width: 10%;"></td> </tr> <tr> <td></td> <td></td> <td colspan="8" style="text-align: center;"> <table border="1" style="width: 100%; border-collapse: collapse; text-align: center;"> <tr> <td style="width: 10%;"></td> <td style="width: 10%;"></td> <td style="width: 10%;"></td> <td style="width: 10%;"></td> <td style="width: 10%;"></td> <td style="width: 10%;"></td> <td style="width: 10%;"></td> <td style="width: 10%;"></td> <td style="width: 10%;"></td> <td style="width: 10%;"></td> </tr> <tr> <td></td> <td></td> <td colspan="8" style="text-align: center;"> <table border="1" style="width: 100%; border-collapse: collapse; text-align: center;"> <tr> <td style="width: 10%;"></td> <td style="width: 10%;"></td> <td style="width: 10%;"></td> <td style="width: 10%;"></td> <td style="width: 10%;"></td> <td style="width: 10%;"></td> <td style="width: 10%;"></td> <td style="width: 10%;"></td> <td style="width: 10%;"></td> <td style="width: 10%;"></td> </tr> <tr> <td></td> <td></td> <td colspan="8" style="text-align: center;"> <table border="1" style="width: 100%; border-collapse: collapse; text-align: center;"> <tr> <td style="width: 10%;"></td> <td style="width: 10%;"></td> <td style="width: 10%;"></td> <td style="width: 10%;"></td> <td style="width: 10%;"></td> <td style="width: 10%;"></td> <td style="width: 10%;"></td> <td style="width: 10%;"></td> <td style="width: 10%;"></td> <td style="width: 10%;"></td> </tr> <tr> <td></td> <td></td> <td colspan="8" style="text-align: center;"> <table border="1" style="width: 100%; border-collapse: collapse; text-align: center;"> <tr> <td style="width: 10%;"></td> <td style="width: 10%;"></td> <td style="width: 10%;"></td> <td style="width: 10%;"></td> <td style="width: 10%;"></td> <td style="width: 10%;"></td> <td style="width: 10%;"></td> <td style="width: 10%;"></td> <td style="width: 10%;"></td> <td style="width: 10%;"></td> </tr> <tr> <td></td> <td></td> <td colspan="8" style="text-align: center;"> <table border="1" style="width: 100%; border-collapse: collapse; text-align: center;"> <tr> <td style="width: 10%;"></td> <td style="width: 10%;"></td> <td style="width: 10%;"></td> <td style="width: 10%;"></td> <td style="width: 10%;"></td> <td style="width: 10%;"></td> <td style="width: 10%;"></td> <td style="width: 10%;"></td> <td style="width: 10%;"></td> <td style="width: 10%;"></td> </tr> <tr> <td></td> <td></td> <td colspan="8" style="text-align: center;"> <table border="1" style="width: 100%; border-collapse: collapse; text-align: center;"> <tr> <td style="width: 10%;"></td> <td style="width: 10%;"></td> <td style="width: 10%;"></td> <td style="width: 10%;"></td> <td style="width: 10%;"></td> <td style="width: 10%;"></td> <td style="width: 10%;"></td> <td style="width: 10%;"></td> <td style="width: 10%;"></td> <td style="width: 10%;"></td> </tr> <tr> <td></td> <td></td> <td colspan="8" style="text-align: center;"> <table border="1" style="width: 100%; border-collapse: collapse; text-align: center;"> <tr> <td style="width: 10%;"></td> <td style="width: 10%;"></td> <td style="width: 10%;"></td> <td style="width: 10%;"></td> <td style="width: 10%;"></td> <td style="width: 10%;"></td> <td style="width: 10%;"></td> <td style="width: 10%;"></td> <td style="width: 10%;"></td> <td style="width: 10%;"></td> </tr> <tr> <td></td> <td></td> <td colspan="8" style="text-align: center;"> <table border="1" style="width: 100%; border-collapse: collapse; text-align: center;"> <tr> <td style="width: 10%;"></td> <td style="width: 10%;"></td> <td style="width: 10%;"></td> <td style="width: 10%;"></td> <td style="width: 10%;"></td> <td style="width: 10%;"></td> <td style="width: 10%;"></td> <td style="width: 10%;"></td> <td style="width: 10%;"></td> <td style="width: 10%;"></td> </tr> <tr> <td></td> <td></td> <td colspan="8" style="text-align: center;"> <table border="1" style="width: 100%; border-collapse: collapse; text-align: center;"> <tr> <td style="width: 10%;"></td> <td style="width: 10%;"></td> <td style="width: 10%;"></td> <td style="width: 10%;"></td> <td style="width: 10%;"></td> <td style="width: 10%;"></td> <td style="width: 10%;"></td> <td style="width: 10%;"></td> <td style="width: 10%;"></td> <td style="width: 10%;"></td> </tr> <tr> <td></td> <td></td> <td colspan="8" style="text-align: center;"> <table border="1" style="width: 100%; border-collapse: collapse; text-align: center;"> <tr> <td style="width: 10%;"></td> <td style="width: 10%;"></td> <td style="width: 10%;"></td> <td style="width: 10%;"></td> <td style="width: 10%;"></td> <td style="width: 10%;"></td> <td style="width: 10%;"></td> <td style="width: 10%;"></td> <td style="width: 10%;"></td> <td style="width: 10%;"></td> </tr> <tr> <td></td> <td></td> <td colspan="8" style="text-align: center;"> <table border="1" style="width: 100%; border-collapse: collapse; text-align: center;"> <tr> <td style="width: 10%;"></td> <td style="width: 10%;"></td> <td style="width: 10%;"></td> <td style="width: 10%;"></td> <td style="width: 10%;"></td> <td style="width: 10%;"></td> <td style="width: 10%;"></td> <td style="width: 10%;"></td> <td style="width: 10%;"></td> <td style="width: 10%;"></td> </tr> <tr> <td></td> <td></td> <td colspan="8" style="text-align: center;"> <table border="1" style="width: 100%; border-collapse: collapse; text-align: center;"> <tr> <td style="width: 10%;"></td> <td style="width: 10%;"></td> <td style="width: 10%;"></td> <td style="width: 10%;"></td> <td style="width: 10%;"></td> <td style="width: 10%;"></td> <td style="width: 10%;"></td> <td style="width: 10%;"></td> <td style="width: 10%;"></td> <td style="width: 10%;"></td> </tr> <tr> <td></td> <td></td> <td colspan="8" style="text-align: center;">
<table border="1" style="width: 100%; border-collapse: collapse; text-align: center;"> <tr> <td style="width: 10%;"></td> <td style="width: 10%;"></td> <td style="width: 10%;"></td> <td style="width: 10%;"></td> <td style="width: 10%;"></td> <td style="width: 10%;"></td> <td style="width: 10%;"></td> <td style="width: 10%;"></td> <td style="width: 10%;"></td> <td style="width: 10%;"></td> </tr> <tr> <td></td> <td></td> <td colspan="8" style="text-align: center;"> <table border="1" style="width: 100%; border-collapse: collapse; text-align: center;"> <tr> <td style="width: 10%;"></td> <td style="width: 10%;"></td> <td style="width: 10%;"></td> <td style="width: 10%;"></td> <td style="width: 10%;"></td> <td style="width: 10%;"></td> <td style="width: 10%;"></td> <td style="width: 10%;"></td> <td style="width: 10%;"></td> <td style="width: 10%;"></td> </tr> <tr> <td></td> <td></td> <td colspan="8" style="text-align: center;"> <table border="1" style="width: 100%; border-collapse: collapse; text-align: center;"> <tr> <td style="width: 10%;"></td> <td style="width: 10%;"></td> <td style="width: 10%;"></td> <td style="width: 10%;"></td> <td style="width: 10%;"></td> <td style="width: 10%;"></td> <td style="width: 10%;"></td> <td style="width: 10%;"></td> <td style="width: 10%;"></td> <td style="width: 10%;"></td> </tr> <tr> <td></td> <td></td> <td colspan="8" style="text-align: center;"> <table border="1" style="width: 100%; border-collapse: collapse; text-align: center;"> <tr> <td style="width: 10%;"></td> <td style="width: 10%;"></td> <td style="width: 10%;"></td> <td style="width: 10%;"></td> <td style="width: 10%;"></td> <td style="width: 10%;"></td> <td style="width: 10%;"></td> <td style="width: 10%;"></td> <td style="width: 10%;"></td> <td style="width: 10%;"></td> </tr> <tr> <td></td> <td></td> <td colspan="8" style="text-align: center;"> <table border="1" style="width: 100%; border-collapse: collapse; text-align: center;"> <tr> <td style="width: 10%;"></td> <td style="width: 10%;"></td> <td style="width: 10%;"></td> <td style="width: 10%;"></td> <td style="width: 10%;"></td> <td style="width: 10%;"></td> <td style="width: 10%;"></td> <td style="width: 10%;"></td> <td style="width: 10%;"></td> <td style="width: 10%;"></td> </tr> <tr> <td></td> <td></td> <td colspan="8" style="text-align: center;"> <table border="1" style="width: 100%; border-collapse: collapse; text-align: center;"> <tr> <td style="width: 10%;"></td> <td style="width: 10%;"></td> <td style="width: 10%;"></td> <td style="width: 10%;"></td> <td style="width: 10%;"></td> <td style="width: 10%;"></td> <td style="width: 10%;"></td> <td style="width: 10%;"></td> <td style="width: 10%;"></td> <td style="width: 10%;"></td> </tr> <tr> <td></td> <td></td> <td colspan="8" style="text-align: center;"> <table border="1" style="width: 100%; border-collapse: collapse; text-align: center;"> <tr> <td style="width: 10%;"></td> <td style="width: 10%;"></td> <td style="width: 10%;"></td> <td style="width: 10%;"></td> <td style="width: 10%;"></td> <td style="width: 10%;"></td> <td style="width: 10%;"></td> <td style="width: 10%;"></td> <td style="width: 10%;"></td> <td style="width: 10%;"></td> </tr> <tr> <td></td> <td></td> <td colspan="8" style="text-align: center;"> <table border="1" style="width: 100%; border-collapse: collapse; text-align: center;"> <tr> <td style="width: 10%;"></td> <td style="width: 10%;"></td> <td style="width: 10%;"></td> <td style="width: 10%;"></td> <td style="width: 10%;"></td> <td style="width: 10%;"></td> <td style="width: 10%;"></td> <td style="width: 10%;"></td> <td style="width: 10%;"></td> <td style="width: 10%;"></td> </tr> <tr> <td></td> <td></td> <td colspan="8" style="text-align: center;"> <table border="1" style="width: 100%; border-collapse: collapse; text-align: center;"> <tr> <td style="width: 10%;"></td> <td style="width: 10%;"></td> <td style="width: 10%;"></td> <td style="width: 10%;"></td> <td style="width: 10%;"></td> <td style="width: 10%;"></td> <td style="width: 10%;"></td> <td style="width: 10%;"></td> <td style="width: 10%;"></td> <td style="width: 10%;"></td> </tr> <tr> <td></td> <td></td> <td colspan="8" style="text-align: center;"> <table border="1" style="width: 100%; border-collapse: collapse; text-align: center;"> <tr> <td style="width: 10%;"></td> <td style="width: 10%;"></td> <td style="width: 10%;"></td> <td style="width: 10%;"></td> <td style="width: 10%;"></td> <td style="width: 10%;"></td> <td style="width: 10%;"></td> <td style="width: 10%;"></td> <td style="width: 10%;"></td> <td style="width: 10%;"></td> </tr> <tr> <td></td> <td></td> <td colspan="8" style="text-align: center;"> <table border="1" style="width: 100%; border-collapse: collapse; text-align: center;"> <tr> <td style="width: 10%;"></td> <td style="width: 10%;"></td> <td style="width: 10%;"></td> <td style="width: 10%;"></td> <td style="width: 10%;"></td> <td style="width: 10%;"></td> <td style="width: 10%;"></td> <td style="width: 10%;"></td> <td style="width: 10%;"></td> <td style="width: 10%;"></td> </tr> <tr> <td></td> <td></td> <td colspan="8" style="text-align: center;"> <table border="1" style="width: 100%; border-collapse: collapse; text-align: center;"> <tr> <td style="width: 10%;"></td> <td style="width: 10%;"></td> <td style="width: 10%;"></td> <td style="width: 10%;"></td> <td style="width: 10%;"></td> <td style="width: 10%;"></td> <td style="width: 10%;"></td> <td style="width: 10%;"></td> <td style="width: 10%;"></td> <td style="width: 10%;"></td> </tr> <tr> <td></td> <td></td> <td colspan="8" style="text-align: center;"> <table border="1" style="width: 100%; border-collapse: collapse; text-align: center;"> <tr> <td style="width: 10%;"></td> <td style="width: 10%;"></td> <td style="width: 10%;"></td> <td style="width: 10%;"></td> <td style="width: 10%;"></td> <td style="width: 10%;"></td> <td style="width: 10%;"></td> <td style="width: 10%;"></td> <td style="width: 10%;"></td> <td style="width: 10%;"></td> </tr> <tr> <td></td> <td></td> <td colspan="8" style="text-align: center;"> <table border="1" style="width: 100%; border-collapse: collapse; text-align: center;"> <tr> <td style="width: 10%;"></td> <td style="width: 10%;"></td> <td style="width: 10%;"></td> <td style="width: 10%;"></td> <td style="width: 10%;"></td> <td style="width: 10%;"></td> <td style="width: 10%;"></td> <td style="width: 10%;"></td> <td style="width: 10%;"></td> <td style="width: 10%;"></td> </tr> <tr> <td></td> <td></td> <td colspan="8" style="text-align: center;"> <table border="1" style="width: 100%; border-collapse: collapse; text-align: center;"> <tr> <td style="width: 10%;"></td> <td style="width: 10%;"></td> <td style="width: 10%;"></td> <td style="width: 10%;"></td> <td style="width: 10%;"></td> <td style="width: 10%;"></td> <td style="width: 10%;"></td> <td style="width: 10%;"></td> <td style="width: 10%;"></td> <td style="width: 10%;"></td> </tr> <tr> <td></td> <td></td> <td colspan="8" style="text-align: center;"> <table border="1" style="width: 100%; border-collapse: collapse; text-align: center;"> <tr> <td style="width: 10%;"></td> <td style="width: 10%;"></td> <td style="width: 10%;"></td> <td style="width: 10%;"></td> <td style="width: 10%;"></td> <td style="width: 10%;"></td> <td style="width: 10%;"></td> <td style="width: 10%;"></td> <td style="width: 10%;"></td> <td style="width: 10%;"></td> </tr> <tr> <td></td> <td></td> <td colspan="8" style="text-align: center;"> <table border="1" style="width: 100%; border-collapse: collapse; text-align: center;"> <tr> <td style="width: 10%;"></td> <td style="width: 10%;"></td> <td style="width: 10%;"></td> <td style="width: 10%;"></td> <td style="width: 10%;"></td> <td style="width: 10%;"></td> <td style="width: 10%;"></td> <td style="width: 10%;"></td> <td style="width: 10%;"></td> <td style="width: 10%;"></td> </tr> <tr> <td></td> <td></td> <td colspan="8" style="text-align: center;"> <table border="1" style="width: 100%; border-collapse: collapse; text-align: center;"> <tr> <td style="width: 10%;"></td> <td style="width: 10%;"></td> <td style="width: 10%;"></td> <td style="width: 10%;"></td> <td style="width: 10%;"></td> <td style="width: 10%;"></td> <td style="width: 10%;"></td> <td style="width: 10%;"></td> <td style="width: 10%;"></td> <td style="width: 10%;"></td> </tr> <tr> <td></td> <td></td> <td colspan="8" style="text-align: center;"> <table border="1" style="width: 100%; border-collapse: collapse; text-align: center;"> <tr> <td style="width: 10%;"></td> <td style="width: 10%;"></td> <td style="width: 10%;"></td> <td style="width: 10%;"></td> <td style="width: 10%;"></td> <td style="width: 10%;"></td> <td style="width: 10%;"></td> <td style="width: 10%;"></td> <td style="width: 10%;"></td> <td style="width: 10%;"></td> </tr> <tr> <td></td> <td></td> <td colspan="8" style="text-align: center;"> <table border="1" style="width: 100%; border-collapse: collapse; text-align: center;"> <tr> <td style="width: 10%;"></td> <td style="width: 10%;"></td> <td style="width: 10%;"></td> <td style="width: 10%;"></td> <td style="width: 10%;"></td> <td style="width: 10%;"></td> <td style="width: 10%;"></td> <td style="width: 10%;"></td> <td style="width: 10%;"></td> <td style="width: 10%;"></td> </tr> <tr> <td></td> <td></td> <td colspan="8" style="text-align: center;"> <table border="1" style="width: 100%; border-collapse: collapse; text-align: center;"> <tr> <td style="width: 10%;"></td> <td style="width: 10%;"></td> <td style="width: 10%;"></td> <td style="width: 10%;"></td> <td style="width: 10%;"></td> <td style="width: 10%;"></td> <td style="width: 10%;"></td> <td style="width: 10%;"></td> <td style="width: 10%;"></td> <td style="width: 10%;"></td> </tr> <tr> <td></td> <td></td> <td colspan="8" style="text-align: center;"> <table border="1" style="width: 100%; border-collapse: collapse; text-align: center;"> <tr> <td style="width: 10%;"></td> <td style="width: 10%;"></td> <td style="width:
10%;"></td> <td style="width: 10%;"></td> <td style="width: 10%;"></td> <td style="width: 10%;"></td> <td style="width: 10%;"></td> <td style="width: 10%;"></td> <td style="width: 10%;"></td> <td style="width: 10%;"></td> </tr> <tr> <td></td> <td></td> <td colspan="8" style="text-align: center;"> <table border="1" style="width: 100%; border-collapse: collapse; text-align: center;"> <tr> <td style="width: 10%;"></td> <td style="width: 10%;"></td> <td style="width: 10%;"></td> <td style="width: 10%;"></td> <td style="width: 10%;"></td> <td style="width: 10%;"></td> <td style="width: 10%;"></td> <td style="width: 10%;"></td> <td style="width: 10%;"></td> <td style="width: 10%;"></td> </tr> <tr> <td></td> <td></td> <td colspan="8" style="text-align: center;"> <table border="1" style="width: 100%; border-collapse: collapse; text-align: center;"> <tr> <td style="width: 10%;"></td> <td style="width: 10%;"></td> <td style="width: 10%;"></td> <td style="width: 10%;"></td> <td style="width: 10%;"></td> <td style="width: 10%;"></td> <td style="width: 10%;"></td> <td style="width: 10%;"></td> <td style="width: 10%;"></td> <td style="width: 10%;"></td> </tr> <tr> <td></td> <td></td> <td colspan="8" style="text-align: center;"> <table border="1" style="width: 100%; border-collapse: collapse; text-align: center;"> <tr> <td style="width: 10%;"></td> <td style="width: 10%;"></td> <td style="width: 10%;"></td> <td style="width: 10%;"></td> <td style="width: 10%;"></td> <td style="width: 10%;"></td> <td style="width: 10%;"></td> <td style="width: 10%;"></td> <td style="width: 10%;"></td> <td style="width: 10%;"></td> </tr> <tr> <td></td> <td></td> <td colspan="8" style="text-align: center;"> <table border="1" style="width: 100%; border-collapse: collapse; text-align: center;"> <tr> <td style="width: 10%;"></td> <td style="width: 10%;"></td> <td style="width: 10%;"></td> <td style="width: 10%;"></td> <td style="width: 10%;"></td> <td style="width: 10%;"></td> <td style="width: 10%;"></td> <td style="width: 10%;"></td> <td style="width: 10%;"></td> <td style="width: 10%;"></td> </tr> <tr> <td></td> <td></td> <td colspan="8" style="text-align: center;"> <table border="1" style="width: 100%; border-collapse: collapse; text-align: center;"> <tr> <td style="width: 10%;"></td> <td style="width: 10%;"></td> <td style="width: 10%;"></td> <td style="width: 10%;"></td> <td style="width: 10%;"></td> <td style="width: 10%;"></td> <td style="width: 10%;"></td> <td style="width: 10%;"></td> <td style="width: 10%;"></td> <td style="width: 10%;"></td> </tr> <tr> <td></td> <td></td> <td colspan="8" style="text-align: center;"> <table border="1" style="width: 100%; border-collapse: collapse; text-align: center;"> <tr> <td style="width: 10%;"></td> <td style="width: 10%;"></td> <td style="width: 10%;"></td> <td style="width: 10%;"></td> <td style="width: 10%;"></td> <td style="width: 10%;"></td> <td style="width: 10%;"></td> <td style="width: 10%;"></td> <td style="width: 10%;"></td> <td style="width: 10%;"></td> </tr> <tr> <td></td> <td></td> <td colspan="8" style="text-align: center;"> <table border="1" style="width: 100%; border-collapse: collapse; text-align: center;"> <tr> <td style="width: 10%;"></td> <td style="width: 10%;"></td> <td style="width: 10%;"></td> <td style="width: 10%;"></td> <td style="width: 10%;"></td> <td style="width: 10%;"></td> <td style="width: 10%;"></td> <td style="width: 10%;"></td> <td style="width: 10%;"></td> <td style="width: 10%;"></td> </tr> <tr> <td></td> <td></td> <td colspan="8" style="text-align: center;"> <table border="1" style="width: 100%; border-collapse: collapse; text-align: center;"> <tr> <td style="width: 10%;"></td> <td style="width: 10%;"></td> <td style="width: 10%;"></td> <td style="width: 10%;"></td> <td style="width: 10%;"></td> <td style="width: 10%;"></td> <td style="width: 10%;"></td> <td style="width: 10%;"></td> <td style="width: 10%;"></td> <td style="width: 10%;"></td> </tr> <tr> <td></td> <td></td> <td colspan="8" style="text-align: center;"> <table border="1" style="width: 100%; border-collapse: collapse; text-align: center;"> <tr> <td style="width: 10%;"></td> <td style="width: 10%;"></td> <td style="width: 10%;"></td> <td style="width: 10%;"></td> <td style="width: 10%;"></td> <td style="width: 10%;"></td> <td style="width: 10%;"></td> <td style="width: 10%;"></td> <td style="width: 10%;"></td> <td style="width: 10%;"></td> </tr> <tr> <td></td> <td></td> <td colspan="8" style="text-align: center;"> <table border="1" style="width: 100%; border-collapse: collapse; text-align: center;"> <tr> <td style="width: 10%;"></td> <td style="width: 10%;"></td> <td style="width: 10%;"></td> <td style="width: 10%;"></td> <td style="width: 10%;"></td> <td style="width: 10%;"></td> <td style="width: 10%;"></td> <td style="width: 10%;"></td> <td style="width: 10%;"></td> <td style="width: 10%;"></td> </tr> <tr> <td></td> <td></td> <td colspan="8" style="text-align: center;"> <table border="1" style="width: 100%; border-collapse: collapse; text-align: center;"> <tr> <td style="width: 10%;"></td> <td style="width: 10%;"></td> <td style="width: 10%;"></td> <td style="width: 10%;"></td> <td style="width: 10%;"></td> <td style="width: 10%;"></td> <td style="width: 10%;"></td> <td style="width: 10%;"></td> <td style="width: 10%;"></td> <td style="width: 10%;"></td> </tr> <tr> <td></td> <td></td> <td colspan="8" style="text-align: center;"> <table border="1" style="width: 100%; border-collapse: collapse; text-align: center;"> <tr> </tr></table></td></tr></table></td></tr></table></td></tr></table></td></tr></table></td></tr></table></td></tr></table></td></tr></table></td></tr></table></td></tr></table></td></tr></table></td></tr></table></td></tr></table></td></tr></table></td></tr></table></td></tr></table></td></tr></table></td></tr></table></td></tr></table></td></tr></table></td></tr></table></td></tr></table></td></tr></table></td></tr></table></td></tr></table></td></tr></table></td></tr></table></td></tr></table></td></tr></table></td></tr></table></td></tr></table></td></tr></table></td></tr></table></td></tr></table></td></tr></table></td></tr></table></td></tr></table></td></tr></table></td></tr></table></td></tr></table></td></tr></table></td></tr></table></td></tr></table></td></tr></table></td></tr></table></td></tr></table></td></tr></table></td></tr></table></td></tr></table></td></tr></table></td></tr></table></td></tr></table>
 | | | | | | | | | | | | | | | | | | | | <table border="1" style="width: 100%; border-collapse: collapse; text-align: center;"> <tr> <td style="width: 10%;"></td> <td style="width: 10%;"></td> <td style="width: 10%;"></td> <td style="width: 10%;"></td> <td style="width: 10%;"></td> <td style="width: 10%;"></td> <td style="width: 10%;"></td> <td style="width: 10%;"></td> <td style="width: 10%;"></td> <td style="width: 10%;"></td> </tr> <tr> <td></td> <td></td> <td colspan="8" style="text-align: center;"> <table border="1" style="width: 100%; border-collapse: collapse; text-align: center;"> <tr> <td style="width: 10%;"></td> <td style="width: 10%;"></td> <td style="width: 10%;"></td> <td style="width: 10%;"></td> <td style="width: 10%;"></td> <td style="width: 10%;"></td> <td style="width: 10%;"></td> <td style="width: 10%;"></td> <td style="width: 10%;"></td> <td style="width: 10%;"></td> </tr> <tr> <td></td> <td></td> <td colspan="8" style="text-align: center;"> <table border="1" style="width: 100%; border-collapse: collapse; text-align: center;"> <tr> <td style="width: 10%;"></td> <td style="width: 10%;"></td> <td style="width: 10%;"></td> <td style="width: 10%;"></td> <td style="width: 10%;"></td> <td style="width: 10%;"></td> <td style="width: 10%;"></td> <td style="width: 10%;"></td> <td style="width: 10%;"></td> <td style="width: 10%;"></td> </tr> <tr> <td></td> <td></td> <td colspan="8" style="text-align: center;"> <table border="1" style="width: 100%; border-collapse: collapse; text-align: center;"> <tr> <td style="width: 10%;"></td> <td style="width: 10%;"></td> <td style="width: 10%;"></td> <td style="width: 10%;"></td> <td style="width: 10%;"></td> <td style="width: 10%;"></td> <td style="width: 10%;"></td> <td style="width: 10%;"></td> <td style="width: 10%;"></td> <td style="width: 10%;"></td> </tr> <tr> <td></td> <td></td> <td colspan="8" style="text-align: center;"> <table border="1" style="width: 100%; border-collapse: collapse; text-align: center;"> <tr> <td style="width: 10%;"></td> <td style="width: 10%;"></td> <td style="width: 10%;"></td> <td style="width: 10%;"></td> <td style="width: 10%;"></td> <td style="width: 10%;"></td> <td style="width: 10%;"></td> <td style="width: 10%;"></td> <td style="width: 10%;"></td> <td style="width: 10%;"></td> </tr> <tr> <td></td> <td></td> <td colspan="8" style="text-align: center;"> <table border="1" style="width: 100%; border-collapse: collapse; text-align: center;"> <tr> <td style="width: 10%;"></td> <td style="width: 10%;"></td> <td style="width: 10%;"></td> <td style="width: 10%;"></td> <td style="width: 10%;"></td> <td style="width: 10%;"></td> <td style="width: 10%;"></td> <td style="width: 10%;"></td> <td style="width: 10%;"></td> <td style="width: 10%;"></td> </tr> <tr> <td></td> <td></td> <td colspan="8" style="text-align: center;"> <table border="1" style="width: 100%; border-collapse: collapse; text-align: center;"> <tr> <td style="width: 10%;"></td> <td style="width: 10%;"></td> <td style="width: 10%;"></td> <td style="width: 10%;"></td> <td style="width: 10%;"></td> <td style="width: 10%;"></td> <td style="width: 10%;"></td> <td style="width: 10%;"></td> <td style="width: 10%;"></td> <td style="width: 10%;"></td> </tr> <tr> <td></td> <td></td> <td colspan="8" style="text-align: center;"> <table border="1" style="width: 100%; border-collapse: collapse; text-align: center;"> <tr> <td style="width: 10%;"></td> <td style="width: 10%;"></td> <td style="width: 10%;"></td> <td style="width: 10%;"></td> <td style="width: 10%;"></td> <td style="width: 10%;"></td> <td style="width: 10%;"></td> <td style="width: 10%;"></td> <td style="width: 10%;"></td> <td style="width: 10%;"></td> </tr> <tr> <td></td> <td></td> <td colspan="8" style="text-align: center;"> <table border="1" style="width: 100%; border-collapse: collapse; text-align: center;"> <tr> <td style="width: 10%;"></td> <td style="width: 10%;"></td> <td style="width: 10%;"></td> <td style="width: 10%;"></td> <td style="width: 10%;"></td> <td style="width: 10%;"></td> <td style="width: 10%;"></td> <td style="width: 10%;"></td> <td style="width: 10%;"></td> <td style="width: 10%;"></td> </tr> <tr> <td></td> <td></td> <td colspan="8" style="text-align: center;"> <table border="1" style="width: 100%; border-collapse: collapse; text-align: center;"> <tr> <td style="width: 10%;"></td> <td style="width: 10%;"></td> <td style="width: 10%;"></td> <td style="width: 10%;"></td> <td style="width: 10%;"></td> <td style="width: 10%;"></td> <td style="width: 10%;"></td> <td style="width: 10%;"></td> <td style="width: 10%;"></td> <td style="width: 10%;"></td> </tr> <tr> <td></td> <td></td> <td colspan="8" style="text-align: center;"> <table border="1" style="width: 100%; border-collapse: collapse; text-align: center;"> <tr> <td style="width: 10%;"></td> <td style="width: 10%;"></td> <td style="width: 10%;"></td> <td style="width: 10%;"></td> <td style="width: 10%;"></td> <td style="width: 10%;"></td> <td style="width: 10%;"></td> <td style="width: 10%;"></td> <td style="width: 10%;"></td> <td style="width: 10%;"></td> </tr> <tr> <td></td> <td></td> <td colspan="8" style="text-align: center;"> <table border="1" style="width: 100%; border-collapse: collapse; text-align: center;"> <tr> <td style="width: 10%;"></td> <td style="width: 10%;"></td> <td style="width: 10%;"></td> <td style="width: 10%;"></td> <td style="width: 10%;"></td> <td style="width: 10%;"></td> <td style="width: 10%;"></td> <td style="width: 10%;"></td> <td style="width: 10%;"></td> <td style="width: 10%;"></td> </tr> <tr> <td></td> <td></td> <td colspan="8" style="text-align: center;"> <table border="1" style="width: 100%; border-collapse: collapse; text-align: center;"> <tr> <td style="width: 10%;"></td> <td style="width: 10%;"></td> <td style="width: 10%;"></td> <td style="width: 10%;"></td> <td style="width: 10%;"></td> <td style="width: 10%;"></td> <td style="width: 10%;"></td> <td style="width: 10%;"></td> <td style="width: 10%;"></td> <td style="width: 10%;"></td> </tr> <tr> <td></td> <td></td> <td colspan="8" style="text-align: center;"> <table border="1" style="width: 100%; border-collapse: collapse; text-align: center;"> <tr> <td style="width: 10%;"></td> <td style="width: 10%;"></td> <td style="width: 10%;"></td> <td style="width: 10%;"></td> <td style="width: 10%;"></td> <td style="width: 10%;"></td> <td style="width: 10%;"></td> <td style="width: 10%;"></td> <td style="width: 10%;"></td> <td style="width: 10%;"></td> </tr> <tr> <td></td> <td></td> <td colspan="8" style="text-align: center;"> <table border="1" style="width: 100%; border-collapse: collapse; text-align: center;"> <tr> <td style="width: 10%;"></td> <td style="width: 10%;"></td> <td style="width: 10%;"></td> <td style="width: 10%;"></td> <td style="width: 10%;"></td> <td style="width: 10%;"></td> <td style="width: 10%;"></td> <td style="width: 10%;"></td> <td style="width: 10%;"></td> <td style="width: 10%;"></td> </tr> <tr> <td></td> <td></td> <td colspan="8" style="text-align: center;"> <table border="1" style="width: 100%; border-collapse: collapse; text-align: center;"> <tr> <td style="width: 10%;"></td> <td style="width: 10%;"></td> <td style="width: 10%;"></td> <td style="width: 10%;"></td> <td style="width: 10%;"></td> <td style="width: 10%;"></td> <td style="width: 10%;"></td> <td style="width: 10%;"></td> <td style="width: 10%;"></td> <td style="width: 10%;"></td> </tr> <tr> <td></td> <td></td> <td colspan="8" style="text-align: center;"> <table border="1" style="width: 100%; border-collapse: collapse; text-align: center;"> <tr> <td style="width: 10%;"></td> <td style="width: 10%;"></td> <td style="width: 10%;"></td> <td style="width: 10%;"></td> <td style="width: 10%;"></td> <td style="width: 10%;"></td> <td style="width: 10%;"></td> <td style="width: 10%;"></td> <td style="width: 10%;"></td> <td style="width: 10%;"></td> </tr> <tr> <td></td> <td></td> <td colspan="8" style="text-align: center;"> <table border="1" style="width: 100%; border-collapse: collapse; text-align: center;"> <tr> <td style="width: 10%;"></td> <td style="width: 10%;"></td> <td style="width: 10%;"></td> <td style="width: 10%;"></td> <td style="width: 10%;"></td> <td style="width: 10%;"></td> <td style="width: 10%;"></td> <td style="width: 10%;"></td> <td style="width: 10%;"></td> <td style="width: 10%;"></td> </tr> <tr> <td></td> <td></td> <td colspan="8" style="text-align: center;"> <table border="1" style="width: 100%; border-collapse: collapse; text-align: center;"> <tr> <td style="width: 10%;"></td> <td style="width: 10%;"></td> <td style="width: 10%;"></td> <td style="width: 10%;"></td> <td style="width: 10%;"></td> <td style="width: 10%;"></td> <td style="width: 10%;"></td> <td style="width: 10%;"></td> <td style="width: 10%;"></td> <td style="width: 10%;"></td> </tr> <tr> <td></td> <td></td> <td colspan="8" style="text-align: center;"> <table border="1" style="width: 100%; border-collapse: collapse; text-align: center;"> <tr> <td style="width: 10%;"></td> <td style="width: 10%;"></td> <td style="width: 10%;"></td> <td style="width: 10%;"></td> <td style="width: 10%;"></td> <td style="width: 10%;"></td> <td style="width: 10%;"></td> <td style="width: 10%;"></td> <td style="width: 10%;"></td> <td style="width: 10%;"></td> </tr> <tr> <td></td> <td></td> <td colspan="8" style="text-align: center;"> <table border="1" style="width: 100%; border-collapse: collapse; text-align: center;"> <tr> <td style="width: 10%;"></td> <td style="width: 10%;"></td> <td style="width: 10%;"></td> <td style="width: 10%;"></td> <td
style="width: 10%;"></td> <td style="width: 10%;"></td> <td style="width: 10%;"></td> <td style="width: 10%;"></td> <td style="width: 10%;"></td> <td style="width: 10%;"></td> </tr> <tr> <td></td> <td></td> <td colspan="8" style="text-align: center;"> <table border="1" style="width: 100%; border-collapse: collapse; text-align: center;"> <tr> <td style="width: 10%;"></td> <td style="width: 10%;"></td> <td style="width: 10%;"></td> <td style="width: 10%;"></td> <td style="width: 10%;"></td> <td style="width: 10%;"></td> <td style="width: 10%;"></td> <td style="width: 10%;"></td> <td style="width: 10%;"></td> <td style="width: 10%;"></td> </tr> <tr> <td></td> <td></td> <td colspan="8" style="text-align: center;"> <table border="1" style="width: 100%; border-collapse: collapse; text-align: center;"> <tr> <td style="width: 10%;"></td> <td style="width: 10%;"></td> <td style="width: 10%;"></td> <td style="width: 10%;"></td> <td style="width: 10%;"></td> <td style="width: 10%;"></td> <td style="width: 10%;"></td> <td style="width: 10%;"></td> <td style="width: 10%;"></td> <td style="width: 10%;"></td> </tr> <tr> <td></td> <td></td> <td colspan="8" style="text-align: center;"> <table border="1" style="width: 100%; border-collapse: collapse; text-align: center;"> <tr> <td style="width: 10%;"></td> <td style="width: 10%;"></td> <td style="width: 10%;"></td> <td style="width: 10%;"></td> <td style="width: 10%;"></td> <td style="width: 10%;"></td> <td style="width: 10%;"></td> <td style="width: 10%;"></td> <td style="width: 10%;"></td> <td style="width: 10%;"></td> </tr> <tr> <td></td> <td></td> <td colspan="8" style="text-align: center;"> <table border="1" style="width: 100%; border-collapse: collapse; text-align: center;"> <tr> <td style="width: 10%;"></td> <td style="width: 10%;"></td> <td style="width: 10%;"></td> <td style="width: 10%;"></td> <td style="width: 10%;"></td> <td style="width: 10%;"></td> <td style="width: 10%;"></td> <td style="width: 10%;"></td> <td style="width: 10%;"></td> <td style="width: 10%;"></td> </tr> <tr> <td></td> <td></td> <td colspan="8" style="text-align: center;"> <table border="1" style="width: 100%; border-collapse: collapse; text-align: center;"> <tr> <td style="width: 10%;"></td> <td style="width: 10%;"></td> <td style="width: 10%;"></td> <td style="width: 10%;"></td> <td style="width: 10%;"></td> <td style="width: 10%;"></td> <td style="width: 10%;"></td> <td style="width: 10%;"></td> <td style="width: 10%;"></td> <td style="width: 10%;"></td> </tr> <tr> <td></td> <td></td> <td colspan="8" style="text-align: center;"> <table border="1" style="width: 100%; border-collapse: collapse; text-align: center;"> <tr> <td style="width: 10%;"></td> <td style="width: 10%;"></td> <td style="width: 10%;"></td> <td style="width: 10%;"></td> <td style="width: 10%;"></td> <td style="width: 10%;"></td> <td style="width: 10%;"></td> <td style="width: 10%;"></td> <td style="width: 10%;"></td> <td style="width: 10%;"></td> </tr> <tr> <td></td> <td></td> <td colspan="8" style="text-align: center;"> <table border="1" style="width: 100%; border-collapse: collapse; text-align: center;"> <tr> <td style="width: 10%;"></td> <td style="width: 10%;"></td> <td style="width: 10%;"></td> <td style="width: 10%;"></td> <td style="width: 10%;"></td> <td style="width: 10%;"></td> <td style="width: 10%;"></td> <td style="width: 10%;"></td> <td style="width: 10%;"></td> <td style="width: 10%;"></td> </tr> <tr> <td></td> <td></td> <td colspan="8" style="text-align: center;"> <table border="1" style="width: 100%; border-collapse: collapse; text-align: center;"> <tr> <td style="width: 10%;"></td> <td style="width: 10%;"></td> <td style="width: 10%;"></td> <td style="width: 10%;"></td> <td style="width: 10%;"></td> <td style="width: 10%;"></td> <td style="width: 10%;"></td> <td style="width: 10%;"></td> <td style="width: 10%;"></td> <td style="width: 10%;"></td> </tr> <tr> <td></td> <td></td> <td colspan="8" style="text-align: center;"> <table border="1" style="width: 100%; border-collapse: collapse; text-align: center;"> <tr> <td style="width: 10%;"></td> <td style="width: 10%;"></td> <td style="width: 10%;"></td> <td style="width: 10%;"></td> <td style="width: 10%;"></td> <td style="width: 10%;"></td> <td style="width: 10%;"></td> <td style="width: 10%;"></td> <td style="width: 10%;"></td> <td style="width: 10%;"></td> </tr> <tr> <td></td> <td></td> <td colspan="8" style="text-align: center;"> <table border="1" style="width: 100%; border-collapse: collapse; text-align: center;"> <tr> <td style="width: 10%;"></td> <td style="width: 10%;"></td> <td style="width: 10%;"></td> <td style="width: 10%;"></td> <td style="width: 10%;"></td> <td style="width: 10%;"></td> <td style="width: 10%;"></td> <td style="width: 10%;"></td> <td style="width: 10%;"></td> <td style="width: 10%;"></td> </tr> <tr> <td></td> <td></td> <td colspan="8" style="text-align: center;"> <table border="1" style="width: 100%; border-collapse: collapse; text-align: center;"> <tr> <td style="width: 10%;"></td> <td style="width: 10%;"></td> <td style="width: 10%;"></td> <td style="width: 10%;"></td> <td style="width: 10%;"></td> <td style="width: 10%;"></td> <td style="width: 10%;"></td> <td style="width: 10%;"></td> <td style="width: 10%;"></td> <td style="width: 10%;"></td> </tr> <tr> <td></td> <td></td> <td colspan="8" style="text-align: center;"> <table border="1" style="width: 100%; border-collapse: collapse; text-align: center;"> <tr> <td style="width: 10%;"></td> <td style="width: 10%;"></td> <td style="width: 10%;"></td> <td style="width: 10%;"></td> <td style="width: 10%;"></td> <td style="width: 10%;"></td> <td style="width: 10%;"></td> <td style="width: 10%;"></td> <td style="width: 10%;"></td> <td style="width: 10%;"></td> </tr> <tr> <td></td> <td></td> <td colspan="8" style="text-align: center;"> <table border="1" style="width: 100%; border-collapse: collapse; text-align: center;"> <tr> <td style="width: 10%;"></td> <td style="width: 10%;"></td> <td style="width: 10%;"></td> <td style="width: 10%;"></td> <td style="width: 10%;"></td> <td style="width: 10%;"></td> <td style="width: 10%;"></td> <td style="width: 10%;"></td> <td style="width: 10%;"></td> <td style="width: 10%;"></td> </tr> <tr> <td></td> <td></td> <td colspan="8" style="text-align: center;"> <table border="1" style="width: 100%; border-collapse: collapse; text-align: center;"> <tr> <td style="width: 10%;"></td> <td style="width: 10%;"></td> <td style="width: 10%;"></td> <td style="width: 10%;"></td> <td style="width: 10%;"></td> <td style="width: 10%;"></td> <td style="width: 10%;"></td> <td style="width: 10%;"></td> <td style="width: 10%;"></td> <td style="width: 10%;"></td> </tr> <tr> <td></td> <td></td> <td colspan="8" style="text-align: center;"> <table border="1" style="width: 100%; border-collapse: collapse; text-align: center;"> <tr> <td style="width: 10%;"></td> <td style="width: 10%;"></td> <td style="width: 10%;"></td> <td style="width: 10%;"></td> <td style="width: 10%;"></td> <td style="width: 10%;"></td> <td style="width: 10%;"></td> <td style="width: 10%;"></td> <td style="width: 10%;"></td> <td style="width: 10%;"></td> </tr> <tr> <td></td> <td></td> <td colspan="8" style="text-align: center;"> <table border="1" style="width: 100%; border-collapse: collapse; text-align: center;"> <tr> <td style="width: 10%;"></td> <td style="width: 10%;"></td> <td style="width: 10%;"></td> <td style="width: 10%;"></td> <td style="width: 10%;"></td> <td style="width: 10%;"></td> <td style="width: 10%;"></td> <td style="width: 10%;"></td> <td style="width: 10%;"></td> <td style="width: 10%;"></td> </tr> <tr> <td></td> <td></td> <td colspan="8" style="text-align: center;"> <table border="1" style="width: 100%; border-collapse: collapse; text-align: center;"> <tr> <td style="width: 10%;"></td> <td style="width: 10%;"></td> <td style="width: 10%;"></td> <td style="width: 10%;"></td> <td style="width: 10%;"></td> <td style="width: 10%;"></td> <td style="width: 10%;"></td> <td style="width: 10%;"></td> <td style="width: 10%;"></td> <td style="width: 10%;"></td> </tr> <tr> <td></td> <td></td> <td colspan="8" style="text-align: center;"> <table border="1" style="width: 100%; border-collapse: collapse; text-align: center;"> <tr> <td style="width: 10%;"></td> <td style="width: 10%;"></td> <td style="width: 10%;"></td> <td style="width: 10%;"></td> <td style="width: 10%;"></td> <td style="width: 10%;"></td> <td style="width: 10%;"></td> <td style="width: 10%;"></td> <td style="width: 10%;"></td> <td style="width: 10%;"></td> </tr> <tr> <td></td> <td></td> <td colspan="8" style="text-align: center;"> <table border="1" style="width: 100%; border-collapse: collapse; text-align: center;"> <tr> <td style="width: 10%;"></td> <td style="width: 10%;"></td> <td style="width: 10%;"></td> <td style="width: 10%;"></td> <td style="width: 10%;"></td> <td style="width: 10%;"></td> <td style="width: 10%;"></td> <td style="width: 10%;"></td> <td style="width: 10%;"></td> <td style="width: 10%;"></td> </tr> <tr> <td></td> <td></td> <td colspan="8" style="text-align: center;"> <table border="1" style="width: 100%; border-collapse: collapse; text-align: center;"> <tr> <td style="width: 10%;"></td> <td style="width: 10%;"></td> <td style="width: 10%;"></td> <td style="width: 10%;"></td> <td style="width: 10%;"></td> <td style="width: 10%;"></td> <td style="width: 10%;"></td> <td style="width: 10%;"></td> <td style="width: 10%;"></td> <td style="width: 10%;"></td> </tr> <tr> <td></td> <td></td> <td colspan="8" style="text-align: center;"> <table border="1" style="width: 100%; border-collapse: collapse; text-align: center;"> <tr> <td style="width: 10%;"></td> <td style="width: 10%;"></td> <td style="width: 10%;"></td> <td style="width: 10%;"></td> <td style="width: 10%;"></td> <td style="width: 10%;"></td> <td style="width: 10%;"></td> <td style="width: 10%;"></td> <td style="width: 10%;"></td> <td style="width:
10%;"></td> </tr> <tr> <td></td> <td></td> <td colspan="8" style="text-align: center;"> <table border="1" style="width: 100%; border-collapse: collapse; text-align: center;"> <tr> <td style="width: 10%;"></td> <td style="width: 10%;"></td> <td style="width: 10%;"></td> <td style="width: 10%;"></td> <td style="width: 10%;"></td> <td style="width: 10%;"></td> <td style="width: 10%;"></td> <td style="width: 10%;"></td> <td style="width: 10%;"></td> <td style="width: 10%;"></td> </tr> <tr> <td></td> <td></td> <td colspan="8" style="text-align: center;"> <table border="1" style="width: 100%; border-collapse: collapse; text-align: center;"> <tr> <td style="width: 10%;"></td> <td style="width: 10%;"></td> <td style="width: 10%;"></td> <td style="width: 10%;"></td> <td style="width: 10%;"></td> <td style="width: 10%;"></td> <td style="width: 10%;"></td> <td style="width: 10%;"></td> <td style="width: 10%;"></td> <td style="width: 10%;"></td> </tr> <tr> <td></td> <td></td> <td colspan="8" style="text-align: center;"> <table border="1" style="width: 100%; border-collapse: collapse; text-align: center;"> <tr> <td style="width: 10%;"></td> <td style="width: 10%;"></td> <td style="width: 10%;"></td> <td style="width: 10%;"></td> <td style="width: 10%;"></td> <td style="width: 10%;"></td> <td style="width: 10%;"></td> <td style="width: 10%;"></td> <td style="width: 10%;"></td> <td style="width: 10%;"></td> </tr> <tr> <td></td> <td></td> <td colspan="8" style="text-align: center;"> <table border="1" style="width: 100%; border-collapse: collapse; text-align: center;"> <tr> <td style="width: 10%;"></td> <td style="width: 10%;"></td> <td style="width: 10%;"></td> <td style="width: 10%;"></td> <td style="width: 10%;"></td> <td style="width: 10%;"></td> <td style="width: 10%;"></td> <td style="width: 10%;"></td> <td style="width: 10%;"></td> <td style="width: 10%;"></td> </tr> <tr> <td></td> <td></td> <td colspan="8" style="text-align: center;"> <table border="1" style="width: 100%; border-collapse: collapse; text-align: center;"> <tr> <td style="width: 10%;"></td> <td style="width: 10%;"></td> <td style="width: 10%;"></td> <td style="width: 10%;"></td> <td style="width: 10%;"></td> <td style="width: 10%;"></td> <td style="width: 10%;"></td> <td style="width: 10%;"></td> <td style="width: 10%;"></td> <td style="width: 10%;"></td> </tr> <tr> <td></td> <td></td> <td colspan="8" style="text-align: center;"> <table border="1" style="width: 100%; border-collapse: collapse; text-align: center;"> <tr> <td style="width: 10%;"></td> <td style="width: 10%;"></td> <td style="width: 10%;"></td> <td style="width: 10%;"></td> <td style="width: 10%;"></td> <td style="width: 10%;"></td> <td style="width: 10%;"></td> <td style="width: 10%;"></td> <td style="width: 10%;"></td> <td style="width: 10%;"></td> </tr> <tr> <td></td> <td></td> <td colspan="8" style="text-align: center;"> <table border="1" style="width: 100%; border-collapse: collapse; text-align: center;"> <tr> <td style="width: 10%;"></td> <td style="width: 10%;"></td> <td style="width: 10%;"></td> <td style="width: 10%;"></td> <td style="width: 10%;"></td> <td style="width: 10%;"></td> <td style="width: 10%;"></td> <td style="width: 10%;"></td> <td style="width: 10%;"></td> <td style="width: 10%;"></td> </tr> <tr> <td></td> <td></td> <td colspan="8" style="text-align: center;"> <table border="1" style="width: 100%; border-collapse: collapse; text-align: center;"> <tr> <td style="width: 10%;"></td> <td style="width: 10%;"></td> <td style="width: 10%;"></td> <td style="width: 10%;"></td> <td style="width: 10%;"></td> <td style="width: 10%;"></td> <td style="width: 10%;"></td> <td style="width: 10%;"></td> <td style="width: 10%;"></td> <td style="width: 10%;"></td> </tr> <tr> <td></td> <td></td> <td colspan="8" style="text-align: center;"> <table border="1" style="width: 100%; border-collapse: collapse; text-align: center;"> <tr> </tr></table></td></tr></table></td></tr></table></td></tr></table></td></tr></table></td></tr></table></td></tr></table></td></tr></table></td></tr></table></td></tr></table></td></tr></table></td></tr></table></td></tr></table></td></tr></table></td></tr></table></td></tr></table></td></tr></table></td></tr></table></td></tr></table></td></tr></table></td></tr></table></td></tr></table></td></tr></table></td></tr></table></td></tr></table></td></tr></table></td></tr></table></td></tr></table></td></tr></table></td></tr></table></td></tr></table></td></tr></table></td></tr></table></td></tr></table></td></tr></table></td></tr></table></td></tr></table></td></tr></table></td></tr></table></td></tr></table></td></tr></table></td></tr></table></td></tr></table></td></tr></table></td></tr></table></td></tr></table></td></tr></table></td></tr></table></td></tr></table></td></tr></table></td></tr></table> | | | | | | | | | | | | | | | | | | | | <table border="1" style="width: 100%; border-collapse: collapse; text-align: center;"> <tr> <td style="width: 10%;"></td> <td style="width: 10%;"></td> <td style="width: 10%;"></td> <td style="width: 10%;"></td> <td style="width: 10%;"></td> <td style="width: 10%;"></td> <td style="width: 10%;"></td> <td style="width: 10%;"></td> <td style="width: 10%;"></td> <td style="width: 10%;"></td> </tr> <tr> <td></td> <td></td> <td colspan="8" style="text-align: center;"> <table border="1" style="width: 100%; border-collapse: collapse; text-align: center;"> <tr> <td style="width: 10%;"></td> <td style="width: 10%;"></td> <td style="width: 10%;"></td> <td style="width: 10%;"></td> <td style="width: 10%;"></td> <td style="width: 10%;"></td> <td style="width: 10%;"></td> <td style="width: 10%;"></td> <td style="width: 10%;"></td> <td style="width: 10%;"></td> </tr> <tr> <td></td> <td></td> <td colspan="8" style="text-align: center;"> <table border="1" style="width: 100%; border-collapse: collapse; text-align: center;"> <tr> <td style="width: 10%;"></td> <td style="width: 10%;"></td> <td style="width: 10%;"></td> <td style="width: 10%;"></td> <td style="width: 10%;"></td> <td style="width: 10%;"></td> <td
style="width: 10%;"></td> <td style="width: 10%;"></td> <td style="width: 10%;"></td> <td style="width: 10%;"></td> </tr> <tr> <td></td> <td></td> <td colspan="8" style="text-align: center;"> <table border="1" style="width: 100%; border-collapse: collapse; text-align: center;"> <tr> <td style="width: 10%;"></td> <td style="width: 10%;"></td> <td style="width: 10%;"></td> <td style="width: 10%;"></td> <td style="width: 10%;"></td> <td style="width: 10%;"></td> <td style="width: 10%;"></td> <td style="width: 10%;"></td> <td style="width: 10%;"></td> <td style="width: 10%;"></td> </tr> <tr> <td></td> <td></td> <td colspan="8" style="text-align: center;"> <table border="1" style="width: 100%; border-collapse: collapse; text-align: center;"> <tr> <td style="width: 10%;"></td> <td style="width: 10%;"></td> <td style="width: 10%;"></td> <td style="width: 10%;"></td> <td style="width: 10%;"></td> <td style="width: 10%;"></td> <td style="width: 10%;"></td> <td style="width: 10%;"></td> <td style="width: 10%;"></td> <td style="width: 10%;"></td> </tr> <tr> <td></td> <td></td> <td colspan="8" style="text-align: center;"> <table border="1" style="width: 100%; border-collapse: collapse; text-align: center;"> <tr> <td style="width: 10%;"></td> <td style="width: 10%;"></td> <td style="width: 10%;"></td> <td style="width: 10%;"></td> <td style="width: 10%;"></td> <td style="width: 10%;"></td> <td style="width: 10%;"></td> <td style="width: 10%;"></td> <td style="width: 10%;"></td> <td style="width: 10%;"></td> </tr> <tr> <td></td> <td></td> <td colspan="8" style="text-align: center;"> <table border="1" style="width: 100%; border-collapse: collapse; text-align: center;"> <tr> <td style="width: 10%;"></td> <td style="width: 10%;"></td> <td style="width: 10%;"></td> <td style="width: 10%;"></td> <td style="width: 10%;"></td> <td style="width: 10%;"></td> <td style="width: 10%;"></td> <td style="width: 10%;"></td> <td style="width: 10%;"></td> <td style="width: 10%;"></td> </tr> <tr> <td></td> <td></td> <td colspan="8" style="text-align: center;"> <table border="1" style="width: 100%; border-collapse: collapse; text-align: center;"> <tr> <td style="width: 10%;"></td> <td style="width: 10%;"></td> <td style="width: 10%;"></td> <td style="width: 10%;"></td> <td style="width: 10%;"></td> <td style="width: 10%;"></td> <td style="width: 10%;"></td> <td style="width: 10%;"></td> <td style="width: 10%;"></td> <td style="width: 10%;"></td> </tr> <tr> <td></td> <td></td> <td colspan="8" style="text-align: center;"> <table border="1" style="width: 100%; border-collapse: collapse; text-align: center;"> <tr> <td style="width: 10%;"></td> <td style="width: 10%;"></td> <td style="width: 10%;"></td> <td style="width: 10%;"></td> <td style="width: 10%;"></td> <td style="width: 10%;"></td> <td style="width: 10%;"></td> <td style="width: 10%;"></td> <td style="width: 10%;"></td> <td style="width: 10%;"></td> </tr> <tr> <td></td> <td></td> <td colspan="8" style="text-align: center;"> <table border="1" style="width: 100%; border-collapse: collapse; text-align: center;"> <tr> <td style="width: 10%;"></td> <td style="width: 10%;"></td> <td style="width: 10%;"></td> <td style="width: 10%;"></td> <td style="width: 10%;"></td> <td style="width: 10%;"></td> <td style="width: 10%;"></td> <td style="width: 10%;"></td> <td style="width: 10%;"></td> <td style="width: 10%;"></td> </tr> <tr> <td></td> <td></td> <td colspan="8" style="text-align: center;"> <table border="1" style="width: 100%; border-collapse: collapse; text-align: center;"> <tr> <td style="width: 10%;"></td> <td style="width: 10%;"></td> <td style="width: 10%;"></td> <td style="width: 10%;"></td> <td style="width: 10%;"></td> <td style="width: 10%;"></td> <td style="width: 10%;"></td> <td style="width: 10%;"></td> <td style="width: 10%;"></td> <td style="width: 10%;"></td> </tr> <tr> <td></td> <td></td> <td colspan="8" style="text-align: center;"> <table border="1" style="width: 100%; border-collapse: collapse; text-align: center;"> <tr> <td style="width: 10%;"></td> <td style="width: 10%;"></td> <td style="width: 10%;"></td> <td style="width: 10%;"></td> <td style="width: 10%;"></td> <td style="width: 10%;"></td> <td style="width: 10%;"></td> <td style="width: 10%;"></td> <td style="width: 10%;"></td> <td style="width: 10%;"></td> </tr> <tr> <td></td> <td></td> <td colspan="8" style="text-align: center;"> <table border="1" style="width: 100%; border-collapse: collapse; text-align: center;"> <tr> <td style="width: 10%;"></td> <td style="width: 10%;"></td> <td style="width: 10%;"></td> <td style="width: 10%;"></td> <td style="width: 10%;"></td> <td style="width: 10%;"></td> <td style="width: 10%;"></td> <td style="width: 10%;"></td> <td style="width: 10%;"></td> <td style="width: 10%;"></td> </tr> <tr> <td></td> <td></td> <td colspan="8" style="text-align: center;"> <table border="1" style="width: 100%; border-collapse: collapse; text-align: center;"> <tr> <td style="width: 10%;"></td> <td style="width: 10%;"></td> <td style="width: 10%;"></td> <td style="width: 10%;"></td> <td style="width: 10%;"></td> <td style="width: 10%;"></td> <td style="width: 10%;"></td> <td style="width: 10%;"></td> <td style="width: 10%;"></td> <td style="width: 10%;"></td> </tr> <tr> <td></td> <td></td> <td colspan="8" style="text-align: center;"> <table border="1" style="width: 100%; border-collapse: collapse; text-align: center;"> <tr> <td style="width: 10%;"></td> <td style="width: 10%;"></td> <td style="width: 10%;"></td> <td style="width: 10%;"></td> <td style="width: 10%;"></td> <td style="width: 10%;"></td> <td style="width: 10%;"></td> <td style="width: 10%;"></td> <td style="width: 10%;"></td> <td style="width: 10%;"></td> </tr> <tr> <td></td> <td></td> <td colspan="8" style="text-align: center;"> <table border="1" style="width: 100%; border-collapse: collapse; text-align: center;"> <tr> <td style="width: 10%;"></td> <td style="width: 10%;"></td> <td style="width: 10%;"></td> <td style="width: 10%;"></td> <td style="width: 10%;"></td> <td style="width: 10%;"></td> <td style="width: 10%;"></td> <td style="width: 10%;"></td> <td style="width: 10%;"></td> <td style="width: 10%;"></td> </tr> <tr> <td></td> <td></td> <td colspan="8" style="text-align: center;"> <table border="1" style="width: 100%; border-collapse: collapse; text-align: center;"> <tr> <td style="width: 10%;"></td> <td style="width: 10%;"></td> <td style="width: 10%;"></td> <td style="width: 10%;"></td> <td style="width: 10%;"></td> <td style="width: 10%;"></td> <td style="width: 10%;"></td> <td style="width: 10%;"></td> <td style="width: 10%;"></td> <td style="width: 10%;"></td> </tr> <tr> <td></td> <td></td> <td colspan="8" style="text-align: center;"> <table border="1" style="width: 100%; border-collapse: collapse; text-align: center;"> <tr> <td style="width: 10%;"></td> <td style="width: 10%;"></td> <td style="width: 10%;"></td> <td style="width: 10%;"></td> <td style="width: 10%;"></td> <td style="width: 10%;"></td> <td style="width: 10%;"></td> <td style="width: 10%;"></td> <td style="width: 10%;"></td> <td style="width: 10%;"></td> </tr> <tr> <td></td> <td></td> <td colspan="8" style="text-align: center;"> <table border="1" style="width: 100%; border-collapse: collapse; text-align: center;"> <tr> <td style="width: 10%;"></td> <td style="width: 10%;"></td> <td style="width: 10%;"></td> <td style="width: 10%;"></td> <td style="width: 10%;"></td> <td style="width: 10%;"></td> <td style="width: 10%;"></td> <td style="width: 10%;"></td> <td style="width: 10%;"></td> <td style="width: 10%;"></td> </tr> <tr> <td></td> <td></td> <td colspan="8" style="text-align: center;"> <table border="1" style="width: 100%; border-collapse: collapse; text-align: center;"> <tr> <td style="width: 10%;"></td> <td style="width: 10%;"></td> <td style="width: 10%;"></td> <td style="width: 10%;"></td> <td style="width: 10%;"></td> <td style="width: 10%;"></td> <td style="width: 10%;"></td> <td style="width: 10%;"></td> <td style="width: 10%;"></td> <td style="width: 10%;"></td> </tr> <tr> <td></td> <td></td> <td colspan="8" style="text-align: center;"> <table border="1" style="width: 100%; border-collapse: collapse; text-align: center;"> <tr> <td style="width: 10%;"></td> <td style="width: 10%;"></td> <td style="width: 10%;"></td> <td style="width: 10%;"></td> <td style="width: 10%;"></td> <td style="width: 10%;"></td> <td style="width: 10%;"></td> <td style="width: 10%;"></td> <td style="width: 10%;"></td> <td style="width: 10%;"></td> </tr> <tr> <td></td> <td></td> <td colspan="8" style="text-align: center;"> <table border="1" style="width: 100%; border-collapse: collapse; text-align: center;"> <tr> <td style="width: 10%;"></td> <td style="width: 10%;"></td> <td style="width: 10%;"></td> <td style="width: 10%;"></td> <td style="width: 10%;"></td> <td style="width: 10%;"></td> <td style="width: 10%;"></td> <td style="width: 10%;"></td> <td style="width: 10%;"></td> <td style="width: 10%;"></td> </tr> <tr> <td></td> <td></td> <td colspan="8" style="text-align: center;"> <table border="1" style="width: 100%; border-collapse: collapse; text-align: center;"> <tr> <td style="width: 10%;"></td> <td style="width: 10%;"></td> <td style="width: 10%;"></td> <td style="width: 10%;"></td> <td style="width: 10%;"></td> <td style="width: 10%;"></td> <td style="width: 10%;"></td> <td style="width: 10%;"></td> <td style="width: 10%;"></td> <td style="width: 10%;"></td> </tr> <tr> <td></td> <td></td> <td colspan="8" style="text-align: center;"> <table border="1" style="width: 100%; border-collapse: collapse; text-align: center;"> <tr> <td style="width: 10%;"></td> <td style="width: 10%;"></td> <td style="width: 10%;"></td> <td style="width: 10%;"></td> <td style="width: 10%;"></td> <td style="width: 10%;"></td> <td style="width: 10%;"></td> <td style="width: 10%;"></td> <td style="width: 10%;"></td> <td style="width: 10%;"></td> </tr> <tr> <td></td> <td></td> <td colspan="8"
style="text-align: center;"> <table border="1" style="width: 100%; border-collapse: collapse; text-align: center;"> <tr> <td style="width: 10%;"></td> <td style="width: 10%;"></td> <td style="width: 10%;"></td> <td style="width: 10%;"></td> <td style="width: 10%;"></td> <td style="width: 10%;"></td> <td style="width: 10%;"></td> <td style="width: 10%;"></td> <td style="width: 10%;"></td> <td style="width: 10%;"></td> </tr> <tr> <td></td> <td></td> <td colspan="8" style="text-align: center;"> <table border="1" style="width: 100%; border-collapse: collapse; text-align: center;"> <tr> <td style="width: 10%;"></td> <td style="width: 10%;"></td> <td style="width: 10%;"></td> <td style="width: 10%;"></td> <td style="width: 10%;"></td> <td style="width: 10%;"></td> <td style="width: 10%;"></td> <td style="width: 10%;"></td> <td style="width: 10%;"></td> <td style="width: 10%;"></td> </tr> <tr> <td></td> <td></td> <td colspan="8" style="text-align: center;"> <table border="1" style="width: 100%; border-collapse: collapse; text-align: center;"> <tr> <td style="width: 10%;"></td> <td style="width: 10%;"></td> <td style="width: 10%;"></td> <td style="width: 10%;"></td> <td style="width: 10%;"></td> <td style="width: 10%;"></td> <td style="width: 10%;"></td> <td style="width: 10%;"></td> <td style="width: 10%;"></td> <td style="width: 10%;"></td> </tr> <tr> <td></td> <td></td> <td colspan="8" style="text-align: center;"> <table border="1" style="width: 100%; border-collapse: collapse; text-align: center;"> <tr> <td style="width: 10%;"></td> <td style="width: 10%;"></td> <td style="width: 10%;"></td> <td style="width: 10%;"></td> <td style="width: 10%;"></td> <td style="width: 10%;"></td> <td style="width: 10%;"></td> <td style="width: 10%;"></td> <td style="width: 10%;"></td> <td style="width: 10%;"></td> </tr> <tr> <td></td> <td></td> <td colspan="8" style="text-align: center;"> <table border="1" style="width: 100%; border-collapse: collapse; text-align: center;"> <tr> <td style="width: 10%;"></td> <td style="width: 10%;"></td> <td style="width: 10%;"></td> <td style="width: 10%;"></td> <td style="width: 10%;"></td> <td style="width: 10%;"></td> <td style="width: 10%;"></td> <td style="width: 10%;"></td> <td style="width: 10%;"></td> <td style="width: 10%;"></td> </tr> <tr> <td></td> <td></td> <td colspan="8" style="text-align: center;"> <table border="1" style="width: 100%; border-collapse: collapse; text-align: center;"> <tr> <td style="width: 10%;"></td> <td style="width: 10%;"></td> <td style="width: 10%;"></td> <td style="width: 10%;"></td> <td style="width: 10%;"></td> <td style="width: 10%;"></td> <td style="width: 10%;"></td> <td style="width: 10%;"></td> <td style="width: 10%;"></td> <td style="width: 10%;"></td> </tr> <tr> <td></td> <td></td> <td colspan="8" style="text-align: center;"> <table border="1" style="width: 100%; border-collapse: collapse; text-align: center;"> <tr> <td style="width: 10%;"></td> <td style="width: 10%;"></td> <td style="width: 10%;"></td> <td style="width: 10%;"></td> <td style="width: 10%;"></td> <td style="width: 10%;"></td> <td style="width: 10%;"></td> <td style="width: 10%;"></td> <td style="width: 10%;"></td> <td style="width: 10%;"></td> </tr> <tr> <td></td> <td></td> <td colspan="8" style="text-align: center;"> <table border="1" style="width: 100%; border-collapse: collapse; text-align: center;"> <tr> <td style="width: 10%;"></td> <td style="width: 10%;"></td> <td style="width: 10%;"></td> <td style="width: 10%;"></td> <td style="width: 10%;"></td> <td style="width: 10%;"></td> <td style="width: 10%;"></td> <td style="width: 10%;"></td> <td style="width: 10%;"></td> <td style="width: 10%;"></td> </tr> <tr> <td></td> <td></td> <td colspan="8" style="text-align: center;"> <table border="1" style="width: 100%; border-collapse: collapse; text-align: center;"> <tr> <td style="width: 10%;"></td> <td style="width: 10%;"></td> <td style="width: 10%;"></td> <td style="width: 10%;"></td> <td style="width: 10%;"></td> <td style="width: 10%;"></td> <td style="width: 10%;"></td> <td style="width: 10%;"></td> <td style="width: 10%;"></td> <td style="width: 10%;"></td> </tr> <tr> <td></td> <td></td> <td colspan="8" style="text-align: center;"> <table border="1" style="width: 100%; border-collapse: collapse; text-align: center;"> <tr> <td style="width: 10%;"></td> <td style="width: 10%;"></td> <td style="width: 10%;"></td> <td style="width: 10%;"></td> <td style="width: 10%;"></td> <td style="width: 10%;"></td> <td style="width: 10%;"></td> <td style="width: 10%;"></td> <td style="width: 10%;"></td> <td style="width: 10%;"></td> </tr> <tr> <td></td> <td></td> <td colspan="8" style="text-align: center;"> <table border="1" style="width: 100%; border-collapse: collapse; text-align: center;"> <tr> <td style="width: 10%;"></td> <td style="width: 10%;"></td> <td style="width: 10%;"></td> <td style="width: 10%;"></td> <td style="width: 10%;"></td> <td style="width: 10%;"></td> <td style="width: 10%;"></td> <td style="width: 10%;"></td> <td style="width: 10%;"></td> <td style="width: 10%;"></td> </tr> <tr> <td></td> <td></td> <td colspan="8" style="text-align: center;"> <table border="1" style="width: 100%; border-collapse: collapse; text-align: center;"> <tr> <td style="width: 10%;"></td> <td style="width: 10%;"></td> <td style="width: 10%;"></td> <td style="width: 10%;"></td> <td style="width: 10%;"></td> <td style="width: 10%;"></td> <td style="width: 10%;"></td> <td style="width: 10%;"></td> <td style="width: 10%;"></td> <td style="width: 10%;"></td> </tr> <tr> <td></td> <td></td> <td colspan="8" style="text-align: center;"> <table border="1" style="width: 100%; border-collapse: collapse; text-align: center;"> <tr> <td style="width: 10%;"></td> <td style="width: 10%;"></td> <td style="width: 10%;"></td> <td style="width: 10%;"></td> <td style="width: 10%;"></td> <td style="width: 10%;"></td> <td style="width: 10%;"></td> <td style="width: 10%;"></td> <td style="width: 10%;"></td> <td style="width: 10%;"></td> </tr> <tr> <td></td> <td></td> <td colspan="8" style="text-align: center;"> <table border="1" style="width: 100%; border-collapse: collapse; text-align: center;"> <tr> <td style="width: 10%;"></td> <td style="width: 10%;"></td> <td style="width: 10%;"></td> <td style="width: 10%;"></td> <td style="width: 10%;"></td> <td style="width: 10%;"></td> <td style="width: 10%;"></td> <td style="width: 10%;"></td> <td style="width: 10%;"></td> <td style="width: 10%;"></td> </tr> <tr> <td></td> <td></td> <td colspan="8" style="text-align: center;"> <table border="1" style="width: 100%; border-collapse: collapse; text-align: center;"> <tr> <td style="width: 10%;"></td> <td style="width: 10%;"></td> <td style="width: 10%;"></td> <td style="width: 10%;"></td> <td style="width: 10%;"></td> <td style="width: 10%;"></td> <td style="width: 10%;"></td> <td style="width: 10%;"></td> <td style="width: 10%;"></td> <td style="width: 10%;"></td> </tr> <tr> <td></td> <td></td> <td colspan="8" style="text-align: center;"> <table border="1" style="width: 100%; border-collapse: collapse; text-align: center;"> <tr> <td style="width: 10%;"></td> <td style="width: 10%;"></td> <td style="width: 10%;"></td> <td style="width: 10%;"></td> <td style="width: 10%;"></td> <td style="width: 10%;"></td> <td style="width: 10%;"></td> <td style="width: 10%;"></td> <td style="width: 10%;"></td> <td style="width: 10%;"></td> </tr> <tr> <td></td> <td></td> <td colspan="8" style="text-align: center;"> <table border="1" style="width: 100%; border-collapse: collapse; text-align: center;"> <tr> <td style="width: 10%;"></td> <td style="width: 10%;"></td> <td style="width: 10%;"></td> <td style="width: 10%;"></td> <td style="width: 10%;"></td> <td style="width: 10%;"></td> <td style="width: 10%;"></td> <td style="width: 10%;"></td> <td style="width: 10%;"></td> <td style="width: 10%;"></td> </tr> <tr> <td></td> <td></td> <td colspan="8" style="text-align: center;"> <table border="1" style="width: 100%; border-collapse: collapse; text-align: center;"> <tr> <td style="width: 10%;"></td> <td style="width: 10%;"></td> <td style="width: 10%;"></td> <td style="width: 10%;"></td> <td style="width: 10%;"></td> <td style="width: 10%;"></td> <td style="width: 10%;"></td> <td style="width: 10%;"></td> <td style="width: 10%;"></td> <td style="width: 10%;"></td> </tr> <tr> <td></td> <td></td> <td colspan="8" style="text-align: center;"> <table border="1" style="width: 100%; border-collapse: collapse; text-align: center;"> <tr> <td style="width: 10%;"></td> <td style="width: 10%;"></td> <td style="width: 10%;"></td> <td style="width: 10%;"></td> <td style="width: 10%;"></td> <td style="width: 10%;"></td> <td style="width: 10%;"></td> <td style="width: 10%;"></td> <td style="width: 10%;"></td> <td style="width: 10%;"></td> </tr> <tr> <td></td> <td></td> <td colspan="8" style="text-align: center;"> <table border="1" style="width: 100%; border-collapse: collapse; text-align: center;"> <tr> <td style="width: 10%;"></td> <td style="width: 10%;"></td> <td style="width: 10%;"></td> <td style="width: 10%;"></td> <td style="width: 10%;"></td> <td style="width: 10%;"></td> <td style="width: 10%;"></td> <td style="width: 10%;"></td> <td style="width: 10%;"></td> <td style="width: 10%;"></td> </tr> <tr> <td></td> <td></td> <td colspan="8" style="text-align: center;"> <table border="1" style="width: 100%; border-collapse: collapse; text-align: center;"> <tr> <td style="width: 10%;"></td> <td style="width: 10%;"></td> <td style="width: 10%;"></td> <td style="width: 10%;"></td> <td style="width: 10%;"></td> <td style="width: 10%;"></td> <td style="width: 10%;"></td> <td style="width: 10%;"></td> <td style="width: 10%;"></td> <td style="width: 10%;"></td> </tr> <tr> <td></td> <td></td> <td colspan="8" style="text-align: center;"> <table border="1" style="width: 100%; border-collapse: collapse; text-align: center;"> <tr> <td style="width: 10%;"></td> <td style="width:
10%;"></td> <td style="width: 10%;"></td> <td style="width: 10%;"></td> <td style="width: 10%;"></td> <td style="width: 10%;"></td> <td style="width: 10%;"></td> <td style="width: 10%;"></td> <td style="width: 10%;"></td> <td style="width: 10%;"></td> </tr> <tr> <td></td> <td></td> <td colspan="8" style="text-align: center;"> <table border="1" style="width: 100%; border-collapse: collapse; text-align: center;"> <tr> <td style="width: 10%;"></td> <td style="width: 10%;"></td> <td style="width: 10%;"></td> <td style="width: 10%;"></td> <td style="width: 10%;"></td> <td style="width: 10%;"></td> <td style="width: 10%;"></td> <td style="width: 10%;"></td> <td style="width: 10%;"></td> <td style="width: 10%;"></td> </tr> <tr> <td></td> <td></td> <td colspan="8" style="text-align: center;"> <table border="1" style="width: 100%; border-collapse: collapse; text-align: center;"> <tr> <td style="width: 10%;"></td> <td style="width: 10%;"></td> <td style="width: 10%;"></td> <td style="width: 10%;"></td> <td style="width: 10%;"></td> <td style="width: 10%;"></td> <td style="width: 10%;"></td> <td style="width: 10%;"></td> <td style="width: 10%;"></td> <td style="width: 10%;"></td> </tr> <tr> <td></td> <td></td> <td colspan="8" style="text-align: center;"> <table border="1" style="width: 100%; border-collapse: collapse; text-align: center;"> <tr> <td style="width: 10%;"></td> <td style="width: 10%;"></td> <td style="width: 10%;"></td> <td style="width: 10%;"></td> <td style="width: 10%;"></td> <td style="width: 10%;"></td> <td style="width: 10%;"></td> <td style="width: 10%;"></td> <td style="width: 10%;"></td> <td style="width: 10%;"></td> </tr> <tr> <td></td> <td></td> <td colspan="8" style="text-align: center;"> <table border="1" style="width: 100%; border-collapse: collapse; text-align: center;"> <tr> </tr></table></td></tr></table></td></tr></table></td></tr></table></td></tr></table></td></tr></table></td></tr></table></td></tr></table></td></tr></table></td></tr></table></td></tr></table></td></tr></table></td></tr></table></td></tr></table></td></tr></table></td></tr></table></td></tr></table></td></tr></table></td></tr></table></td></tr></table></td></tr></table></td></tr></table></td></tr></table></td></tr></table></td></tr></table></td></tr></table></td></tr></table></td></tr></table></td></tr></table></td></tr></table></td></tr></table></td></tr></table></td></tr></table></td></tr></table></td></tr></table></td></tr></table></td></tr></table></td></tr></table></td></tr></table></td></tr></table></td></tr></table></td></tr></table></td></tr></table></td></tr></table></td></tr></table></td></tr></table></td></tr></table></td></tr></table></td></tr></table></td></tr></table> | | | | | | | | | | | | | | | | | | | | <table border="1" style="width: 100%; border-collapse: collapse; text-align: center;"> <tr> <td style="width: 10%;"></td> <td style="width: 10%;"></td> <td style="width: 10%;"></td> <td style="width: 10%;"></td> <td style="width: 10%;"></td> <td style="width: 10%;"></td> <td style="width: 10%;"></td> <td style="width: 10%;"></td> <td style="width: 10%;"></td> <td style="width: 10%;"></td> </tr> <tr> <td></td> <td></td> <td colspan="8" style="text-align: center;"> <table border="1" style="width: 100%; border-collapse: collapse; text-align: center;"> <tr> <td style="width: 10%;"></td> <td style="width: 10%;"></td> <td style="width: 10%;"></td> <td style="width: 10%;"></td> <td style="width: 10%;"></td> <td style="width: 10%;"></td> <td style="width: 10%;"></td> <td style="width: 10%;"></td> <td style="width: 10%;"></td> <td style="width: 10%;"></td> </tr> <tr> <td></td> <td></td> <td colspan="8" style="text-align: center;"> <table border="1" style="width: 100%; border-collapse: collapse; text-align: center;"> <tr> <td style="width: 10%;"></td> <td style="width: 10%;"></td> <td style="width: 10%;"></td> <td style="width: 10%;"></td> <td style="width: 10%;"></td> <td style="width: 10%;"></td> <td style="width: 10%;"></td> <td style="width: 10%;"></td> <td style="width: 10%;"></td> <td style="width: 10%;"></td> </tr> <tr> <td></td> <td></td> <td colspan="8" style="text-align: center;"> <table border="1" style="width: 100%; border-collapse: collapse; text-align: center;"> <tr> <td style="width: 10%;"></td> <td style="width: 10%;"></td> <td style="width: 10%;"></td> <td style="width: 10%;"></td> <td style="width: 10%;"></td> <td style="width: 10%;"></td> <td style="width: 10%;"></td> <td style="width: 10%;"></td> <td style="width: 10%;"></td> <td style="width: 10%;"></td> </tr> <tr> <td></td> <td></td> <td colspan="8" style="text-align: center;"> <table border="1" style="width: 100%; border-collapse: collapse; text-align: center;"> <tr> <td style="width: 10%;"></td> <td style="width: 10%;"></td> <td style="width: 10%;"></td> <td style="width: 10%;"></td> <td style="width: 10%;"></td> <td style="width: 10%;"></td> <td style="width: 10%;"></td> <td style="width: 10%;"></td> <td style="width: 10%;"></td> <td style="width: 10%;"></td> </tr> <tr> <td></td> <td></td> <td colspan="8" style="text-align: center;"> <table border="1" style="width: 100%; border-collapse: collapse; text-align: center;"> <tr> <td style="width: 10%;"></td> <td style="width: 10%;"></td> <td style="width: 10%;"></td> <td style="width: 10%;"></td> <td style="width: 10%;"></td> <td style="width: 10%;"></td> <td style="width: 10%;"></td> <td style="width: 10%;"></td> <td style="width: 10%;"></td> <td style="width: 10%;"></td> </tr> <tr> <td></td> <td></td> <td colspan="8" style="text-align: center;"> <table border="1" style="width: 100%; border-collapse: collapse; text-align: center;"> <tr> <td style="width: 10%;"></td> <td style="width: 10%;"></td> <td style="width: 10%;"></td> <td style="width: 10%;"></td> <td style="width: 10%;"></td> <td style="width: 10%;"></td> <td style="width: 10%;"></td> <td style="width: 10%;"></td> <td style="width: 10%;"></td> <td style="width: 10%;"></td> </tr> <tr> <td></td> <td></td> <td colspan="8" style="text-align: center;"> <table border="1" style="width: 100%; border-collapse:
collapse; text-align: center;"> <tr> <td style="width: 10%;"></td> <td style="width: 10%;"></td> <td style="width: 10%;"></td> <td style="width: 10%;"></td> <td style="width: 10%;"></td> <td style="width: 10%;"></td> <td style="width: 10%;"></td> <td style="width: 10%;"></td> <td style="width: 10%;"></td> <td style="width: 10%;"></td> </tr> <tr> <td></td> <td></td> <td colspan="8" style="text-align: center;"> <table border="1" style="width: 100%; border-collapse: collapse; text-align: center;"> <tr> <td style="width: 10%;"></td> <td style="width: 10%;"></td> <td style="width: 10%;"></td> <td style="width: 10%;"></td> <td style="width: 10%;"></td> <td style="width: 10%;"></td> <td style="width: 10%;"></td> <td style="width: 10%;"></td> <td style="width: 10%;"></td> <td style="width: 10%;"></td> </tr> <tr> <td></td> <td></td> <td colspan="8" style="text-align: center;"> <table border="1" style="width: 100%; border-collapse: collapse; text-align: center;"> <tr> <td style="width: 10%;"></td> <td style="width: 10%;"></td> <td style="width: 10%;"></td> <td style="width: 10%;"></td> <td style="width: 10%;"></td> <td style="width: 10%;"></td> <td style="width: 10%;"></td> <td style="width: 10%;"></td> <td style="width: 10%;"></td> <td style="width: 10%;"></td> </tr> <tr> <td></td> <td></td> <td colspan="8" style="text-align: center;"> <table border="1" style="width: 100%; border-collapse: collapse; text-align: center;"> <tr> <td style="width: 10%;"></td> <td style="width: 10%;"></td> <td style="width: 10%;"></td> <td style="width: 10%;"></td> <td style="width: 10%;"></td> <td style="width: 10%;"></td> <td style="width: 10%;"></td> <td style="width: 10%;"></td> <td style="width: 10%;"></td> <td style="width: 10%;"></td> </tr> <tr> <td></td> <td></td> <td colspan="8" style="text-align: center;"> <table border="1" style="width: 100%; border-collapse: collapse; text-align: center;"> <tr> <td style="width: 10%;"></td> <td style="width: 10%;"></td> <td style="width: 10%;"></td> <td style="width: 10%;"></td> <td style="width: 10%;"></td> <td style="width: 10%;"></td> <td style="width: 10%;"></td> <td style="width: 10%;"></td> <td style="width: 10%;"></td> <td style="width: 10%;"></td> </tr> <tr> <td></td> <td></td> <td colspan="8" style="text-align: center;"> <table border="1" style="width: 100%; border-collapse: collapse; text-align: center;"> <tr> <td style="width: 10%;"></td> <td style="width: 10%;"></td> <td style="width: 10%;"></td> <td style="width: 10%;"></td> <td style="width: 10%;"></td> <td style="width: 10%;"></td> <td style="width: 10%;"></td> <td style="width: 10%;"></td> <td style="width: 10%;"></td> <td style="width: 10%;"></td> </tr> <tr> <td></td> <td></td> <td colspan="8" style="text-align: center;"> <table border="1" style="width: 100%; border-collapse: collapse; text-align: center;"> <tr> <td style="width: 10%;"></td> <td style="width: 10%;"></td> <td style="width: 10%;"></td> <td style="width: 10%;"></td> <td style="width: 10%;"></td> <td style="width: 10%;"></td> <td style="width: 10%;"></td> <td style="width: 10%;"></td> <td style="width: 10%;"></td> <td style="width: 10%;"></td> </tr> <tr> <td></td> <td></td> <td colspan="8" style="text-align: center;"> <table border="1" style="width: 100%; border-collapse: collapse; text-align: center;"> <tr> <td style="width: 10%;"></td> <td style="width: 10%;"></td> <td style="width: 10%;"></td> <td style="width: 10%;"></td> <td style="width: 10%;"></td> <td style="width: 10%;"></td> <td style="width: 10%;"></td> <td style="width: 10%;"></td> <td style="width: 10%;"></td> <td style="width: 10%;"></td> </tr> <tr> <td></td> <td></td> <td colspan="8" style="text-align: center;"> <table border="1" style="width: 100%; border-collapse: collapse; text-align: center;"> <tr> <td style="width: 10%;"></td> <td style="width: 10%;"></td> <td style="width: 10%;"></td> <td style="width: 10%;"></td> <td style="width: 10%;"></td> <td style="width: 10%;"></td> <td style="width: 10%;"></td> <td style="width: 10%;"></td> <td style="width: 10%;"></td> <td style="width: 10%;"></td> </tr> <tr> <td></td> <td></td> <td colspan="8" style="text-align: center;"> <table border="1" style="width: 100%; border-collapse: collapse; text-align: center;"> <tr> <td style="width: 10%;"></td> <td style="width: 10%;"></td> <td style="width: 10%;"></td> <td style="width: 10%;"></td> <td style="width: 10%;"></td> <td style="width: 10%;"></td> <td style="width: 10%;"></td> <td style="width: 10%;"></td> <td style="width: 10%;"></td> <td style="width: 10%;"></td> </tr> <tr> <td></td> <td></td> <td colspan="8" style="text-align: center;"> <table border="1" style="width: 100%; border-collapse: collapse; text-align: center;"> <tr> <td style="width: 10%;"></td> <td style="width: 10%;"></td> <td style="width: 10%;"></td> <td style="width: 10%;"></td> <td style="width: 10%;"></td> <td style="width: 10%;"></td> <td style="width: 10%;"></td> <td style="width: 10%;"></td> <td style="width: 10%;"></td> <td style="width: 10%;"></td> </tr> <tr> <td></td> <td></td> <td colspan="8" style="text-align: center;"> <table border="1" style="width: 100%; border-collapse: collapse; text-align: center;"> <tr> <td style="width: 10%;"></td> <td style="width: 10%;"></td> <td style="width: 10%;"></td> <td style="width: 10%;"></td> <td style="width: 10%;"></td> <td style="width: 10%;"></td> <td style="width: 10%;"></td> <td style="width: 10%;"></td> <td style="width: 10%;"></td> <td style="width: 10%;"></td> </tr> <tr> <td></td> <td></td> <td colspan="8" style="text-align: center;"> <table border="1" style="width: 100%; border-collapse: collapse; text-align: center;"> <tr> <td style="width: 10%;"></td> <td style="width: 10%;"></td> <td style="width: 10%;"></td> <td style="width: 10%;"></td> <td style="width: 10%;"></td> <td style="width: 10%;"></td> <td style="width: 10%;"></td> <td style="width: 10%;"></td> <td style="width: 10%;"></td> <td style="width: 10%;"></td> </tr> <tr> <td></td> <td></td> <td colspan="8" style="text-align: center;"> <table border="1" style="width: 100%; border-collapse: collapse; text-align: center;"> <tr> <td style="width: 10%;"></td> <td style="width: 10%;"></td> <td style="width: 10%;"></td> <td style="width: 10%;"></td> <td style="width: 10%;"></td> <td style="width: 10%;"></td> <td style="width: 10%;"></td> <td style="width: 10%;"></td> <td style="width: 10%;"></td> <td style="width: 10%;"></td> </tr> <tr> <td></td> <td></td> <td colspan="8" style="text-align: center;"> <table border="1" style="width: 100%; border-collapse: collapse; text-align: center;"> <tr> <td style="width: 10%;"></td> <td style="width: 10%;"></td> <td style="width: 10%;"></td> <td style="width: 10%;"></td> <td style="width: 10%;"></td> <td style="width: 10%;"></td> <td style="width: 10%;"></td> <td style="width: 10%;"></td> <td style="width: 10%;"></td> <td style="width: 10%;"></td> </tr> <tr> <td></td> <td></td> <td colspan="8" style="text-align: center;"> <table border="1" style="width: 100%; border-collapse: collapse; text-align: center;"> <tr> <td style="width: 10%;"></td> <td style="width: 10%;"></td> <td style="width: 10%;"></td> <td style="width: 10%;"></td> <td style="width: 10%;"></td> <td style="width: 10%;"></td> <td style="width: 10%;"></td> <td style="width: 10%;"></td> <td style="width: 10%;"></td> <td style="width: 10%;"></td> </tr> <tr> <td></td> <td></td> <td colspan="8" style="text-align: center;"> <table border="1" style="width: 100%; border-collapse: collapse; text-align: center;"> <tr> <td style="width: 10%;"></td> <td style="width: 10%;"></td> <td style="width: 10%;"></td> <td style="width: 10%;"></td> <td style="width: 10%;"></td> <td style="width: 10%;"></td> <td style="width: 10%;"></td> <td style="width: 10%;"></td> <td style="width: 10%;"></td> <td style="width: 10%;"></td> </tr> <tr> <td></td> <td></td> <td colspan="8" style="text-align: center;"> <table border="1" style="width: 100%; border-collapse: collapse; text-align: center;"> <tr> <td style="width: 10%;"></td> <td style="width: 10%;"></td> <td style="width: 10%;"></td> <td style="width: 10%;"></td> <td style="width: 10%;"></td> <td style="width: 10%;"></td> <td style="width: 10%;"></td> <td style="width: 10%;"></td> <td style="width: 10%;"></td> <td style="width: 10%;"></td> </tr> <tr> <td></td> <td></td> <td colspan="8" style="text-align: center;"> <table border="1" style="width: 100%; border-collapse: collapse; text-align: center;"> <tr> <td style="width: 10%;"></td> <td style="width: 10%;"></td> <td style="width: 10%;"></td> <td style="width: 10%;"></td> <td style="width: 10%;"></td> <td style="width: 10%;"></td> <td style="width: 10%;"></td> <td style="width: 10%;"></td> <td style="width: 10%;"></td> <td style="width: 10%;"></td> </tr> <tr> <td></td> <td></td> <td colspan="8" style="text-align: center;"> <table border="1" style="width: 100%; border-collapse: collapse; text-align: center;"> <tr> <td style="width: 10%;"></td> <td style="width: 10%;"></td> <td style="width: 10%;"></td> <td style="width: 10%;"></td> <td style="width: 10%;"></td> <td style="width: 10%;"></td> <td style="width: 10%;"></td> <td style="width: 10%;"></td> <td style="width: 10%;"></td> <td style="width: 10%;"></td> </tr> <tr> <td></td> <td></td> <td colspan="8" style="text-align: center;"> <table border="1" style="width: 100%; border-collapse: collapse; text-align: center;"> <tr> <td style="width: 10%;"></td> <td style="width: 10%;"></td> <td style="width: 10%;"></td> <td style="width: 10%;"></td> <td style="width: 10%;"></td> <td style="width: 10%;"></td> <td style="width: 10%;"></td> <td style="width: 10%;"></td> <td style="width: 10%;"></td> <td style="width: 10%;"></td> </tr> <tr> <td></td> <td></td> <td colspan="8" style="text-align: center;"> <table border="1" style="width: 100%; border-collapse: collapse; text-align: center;"> <tr> <td style="width: 10%;"></td> <td style="width: 10%;"></td> <td style="width: 10%;"></td> <td style="width: 10%;"></td> <td
style="width: 10%;"></td> <td style="width: 10%;"></td> <td style="width: 10%;"></td> <td style="width: 10%;"></td> <td style="width: 10%;"></td> <td style="width: 10%;"></td> </tr> <tr> <td></td> <td></td> <td colspan="8" style="text-align: center;"> <table border="1" style="width: 100%; border-collapse: collapse; text-align: center;"> <tr> <td style="width: 10%;"></td> <td style="width: 10%;"></td> <td style="width: 10%;"></td> <td style="width: 10%;"></td> <td style="width: 10%;"></td> <td style="width: 10%;"></td> <td style="width: 10%;"></td> <td style="width: 10%;"></td> <td style="width: 10%;"></td> <td style="width: 10%;"></td> </tr> <tr> <td></td> <td></td> <td colspan="8" style="text-align: center;"> <table border="1" style="width: 100%; border-collapse: collapse; text-align: center;"> <tr> <td style="width: 10%;"></td> <td style="width: 10%;"></td> <td style="width: 10%;"></td> <td style="width: 10%;"></td> <td style="width: 10%;"></td> <td style="width: 10%;"></td> <td style="width: 10%;"></td> <td style="width: 10%;"></td> <td style="width: 10%;"></td> <td style="width: 10%;"></td> </tr> <tr> <td></td> <td></td> <td colspan="8" style="text-align: center;"> <table border="1" style="width: 100%; border-collapse: collapse; text-align: center;"> <tr> <td style="width: 10%;"></td> <td style="width: 10%;"></td> <td style="width: 10%;"></td> <td style="width: 10%;"></td> <td style="width: 10%;"></td> <td style="width: 10%;"></td> <td style="width: 10%;"></td> <td style="width: 10%;"></td> <td style="width: 10%;"></td> <td style="width: 10%;"></td> </tr> <tr> <td></td> <td></td> <td colspan="8" style="text-align: center;"> <table border="1" style="width: 100%; border-collapse: collapse; text-align: center;"> <tr> <td style="width: 10%;"></td> <td style="width: 10%;"></td> <td style="width: 10%;"></td> <td style="width: 10%;"></td> <td style="width: 10%;"></td> <td style="width: 10%;"></td> <td style="width: 10%;"></td> <td style="width: 10%;"></td> <td style="width: 10%;"></td> <td style="width: 10%;"></td> </tr> <tr> <td></td> <td></td> <td colspan="8" style="text-align: center;"> <table border="1" style="width: 100%; border-collapse: collapse; text-align: center;"> <tr> <td style="width: 10%;"></td> <td style="width: 10%;"></td> <td style="width: 10%;"></td> <td style="width: 10%;"></td> <td style="width: 10%;"></td> <td style="width: 10%;"></td> <td style="width: 10%;"></td> <td style="width: 10%;"></td> <td style="width: 10%;"></td> <td style="width: 10%;"></td> </tr> <tr> <td></td> <td></td> <td colspan="8" style="text-align: center;"> <table border="1" style="width: 100%; border-collapse: collapse; text-align: center;"> <tr> <td style="width: 10%;"></td> <td style="width: 10%;"></td> <td style="width: 10%;"></td> <td style="width: 10%;"></td> <td style="width: 10%;"></td> <td style="width: 10%;"></td> <td style="width: 10%;"></td> <td style="width: 10%;"></td> <td style="width: 10%;"></td> <td style="width: 10%;"></td> </tr> <tr> <td></td> <td></td> <td colspan="8" style="text-align: center;"> <table border="1" style="width: 100%; border-collapse: collapse; text-align: center;"> <tr> <td style="width: 10%;"></td> <td style="width: 10%;"></td> <td style="width: 10%;"></td> <td style="width: 10%;"></td> <td style="width: 10%;"></td> <td style="width: 10%;"></td> <td style="width: 10%;"></td> <td style="width: 10%;"></td> <td style="width: 10%;"></td> <td style="width: 10%;"></td> </tr> <tr> <td></td> <td></td> <td colspan="8" style="text-align: center;"> <table border="1" style="width: 100%; border-collapse: collapse; text-align: center;"> <tr> <td style="width: 10%;"></td> <td style="width: 10%;"></td> <td style="width: 10%;"></td> <td style="width: 10%;"></td> <td style="width: 10%;"></td> <td style="width: 10%;"></td> <td style="width: 10%;"></td> <td style="width: 10%;"></td> <td style="width: 10%;"></td> <td style="width: 10%;"></td> </tr> <tr> <td></td> <td></td> <td colspan="8" style="text-align: center;"> <table border="1" style="width: 100%; border-collapse: collapse; text-align: center;"> <tr> <td style="width: 10%;"></td> <td style="width: 10%;"></td> <td style="width: 10%;"></td> <td style="width: 10%;"></td> <td style="width: 10%;"></td> <td style="width: 10%;"></td> <td style="width: 10%;"></td> <td style="width: 10%;"></td> <td style="width: 10%;"></td> <td style="width: 10%;"></td> </tr> <tr> <td></td> <td></td> <td colspan="8" style="text-align: center;"> <table border="1" style="width: 100%; border-collapse: collapse; text-align: center;"> <tr> <td style="width: 10%;"></td> <td style="width: 10%;"></td> <td style="width: 10%;"></td> <td style="width: 10%;"></td> <td style="width: 10%;"></td> <td style="width: 10%;"></td> <td style="width: 10%;"></td> <td style="width: 10%;"></td> <td style="width: 10%;"></td> <td style="width: 10%;"></td> </tr> <tr> <td></td> <td></td> <td colspan="8" style="text-align: center;"> <table border="1" style="width: 100%; border-collapse: collapse; text-align: center;"> <tr> <td style="width: 10%;"></td> <td style="width: 10%;"></td> <td style="width: 10%;"></td> <td style="width: 10%;"></td> <td style="width: 10%;"></td> <td style="width: 10%;"></td> <td style="width: 10%;"></td> <td style="width: 10%;"></td> <td style="width: 10%;"></td> <td style="width: 10%;"></td> </tr> <tr> <td></td> <td></td> <td colspan="8" style="text-align: center;"> <table border="1" style="width: 100%; border-collapse: collapse; text-align: center;"> <tr> <td style="width: 10%;"></td> <td style="width: 10%;"></td> <td style="width: 10%;"></td> <td style="width: 10%;"></td> <td style="width: 10%;"></td> <td style="width: 10%;"></td> <td style="width: 10%;"></td> <td style="width: 10%;"></td> <td style="width: 10%;"></td> <td style="width: 10%;"></td> </tr> <tr> <td></td> <td></td> <td colspan="8" style="text-align: center;"> <table border="1" style="width: 100%; border-collapse: collapse; text-align: center;"> <tr> <td style="width: 10%;"></td> <td style="width: 10%;"></td> <td style="width: 10%;"></td> <td style="width: 10%;"></td> <td style="width: 10%;"></td> <td style="width: 10%;"></td> <td style="width: 10%;"></td> <td style="width: 10%;"></td> <td style="width: 10%;"></td> <td style="width: 10%;"></td> </tr> <tr> <td></td> <td></td> <td colspan="8" style="text-align: center;"> <table border="1" style="width: 100%; border-collapse: collapse; text-align: center;"> <tr> <td style="width: 10%;"></td> <td style="width: 10%;"></td> <td style="width: 10%;"></td> <td style="width: 10%;"></td> <td style="width: 10%;"></td> <td style="width: 10%;"></td> <td style="width: 10%;"></td> <td style="width: 10%;"></td> <td style="width: 10%;"></td> <td style="width: 10%;"></td> </tr> <tr> <td></td> <td></td> <td colspan="8" style="text-align: center;"> <table border="1" style="width: 100%; border-collapse: collapse; text-align: center;"> <tr> <td style="width: 10%;"></td> <td style="width: 10%;"></td> <td style="width: 10%;"></td> <td style="width: 10%;"></td> <td style="width: 10%;"></td> <td style="width: 10%;"></td> <td style="width: 10%;"></td> <td style="width: 10%;"></td> <td style="width: 10%;"></td> <td style="width: 10%;"></td> </tr> <tr> <td></td> <td></td> <td colspan="8" style="text-align: center;"> <table border="1" style="width: 100%; border-collapse: collapse; text-align: center;"> <tr> <td style="width: 10%;"></td> <td style="width: 10%;"></td> <td style="width: 10%;"></td> <td style="width: 10%;"></td> <td style="width: 10%;"></td> <td style="width: 10%;"></td> <td style="width: 10%;"></td> <td style="width: 10%;"></td> <td style="width: 10%;"></td> <td style="width: 10%;"></td> </tr> <tr> <td></td> <td></td> <td colspan="8" style="text-align: center;"> <table border="1" style="width: 100%; border-collapse: collapse; text-align: center;"> <tr> <td style="width: 10%;"></td> <td style="width: 10%;"></td> <td style="width: 10%;"></td> <td style="width: 10%;"></td> <td style="width: 10%;"></td> <td style="width: 10%;"></td> <td style="width: 10%;"></td> <td style="width: 10%;"></td> <td style="width: 10%;"></td> <td style="width: 10%;"></td> </tr> <tr> <td></td> <td></td> <td colspan="8" style="text-align: center;"> <table border="1" style="width: 100%; border-collapse: collapse; text-align: center;"> <tr> <td style="width: 10%;"></td> <td style="width: 10%;"></td> <td style="width: 10%;"></td> <td style="width: 10%;"></td> <td style="width: 10%;"></td> <td style="width: 10%;"></td> <td style="width: 10%;"></td> <td style="width: 10%;"></td> <td style="width: 10%;"></td> <td style="width: 10%;"></td> </tr> <tr> <td></td> <td></td> <td colspan="8" style="text-align: center;"> <table border="1" style="width: 100%; border-collapse: collapse; text-align: center;"> <tr> <td style="width: 10%;"></td> <td style="width: 10%;"></td> <td style="width: 10%;"></td> <td style="width: 10%;"></td> <td style="width: 10%;"></td> <td style="width: 10%;"></td> <td style="width: 10%;"></td> <td style="width: 10%;"></td> <td style="width: 10%;"></td> <td style="width: 10%;"></td> </tr> <tr> <td></td> <td></td> <td colspan="8" style="text-align: center;"> <table border="1" style="width: 100%; border-collapse: collapse; text-align: center;"> <tr>
</tr></table></td></tr></table></td></tr></table></td></tr></table></td></tr></table></td></tr></table></td></tr></table></td></tr></table></td></tr></table></td></tr></table></td></tr></table></td></tr></table></td></tr></table></td></tr></table></td></tr></table></td></tr></table></td></tr></table></td></tr></table></td></tr></table></td></tr></table></td></tr></table></td></tr></table></td></tr></table></td></tr></table></td></tr></table></td></tr></table></td></tr></table></td></tr></table></td></tr></table></td></tr></table></td></tr></table></td></tr></table></td></tr></table></td></tr></table></td></tr></table></td></tr></table></td></tr></table></td></tr></table></td></tr></table></td></tr></table></td></tr></table></td></tr></table></td></tr></table></td></tr></table></td></tr></table></td></tr></table></td></tr></table></td></tr></table></td></tr></table> | | | | | | | | | | | | | | | | | | | | <table border="1" style="width: 100%; border-collapse: collapse; text-align: center;"> <tr> <td style="width: 10%;"></td> <td style="width: 10%;"></td> <td style="width: 10%;"></td> <td style="width: 10%;"></td> <td style="width: 10%;"></td> <td style="width: 10%;"></td> <td style="width: 10%;"></td> <td style="width: 10%;"></td> <td style="width: 10%;"></td> <td style="width: 10%;"></td> </tr> <tr> <td></td> <td></td> <td colspan="8" style="text-align: center;"> <table border="1" style="width: 100%; border-collapse: collapse; text-align: center;"> <tr> <td style="width: 10%;"></td> <td style="width: 10%;"></td> <td style="width: 10%;"></td> <td style="width: 10%;"></td> <td style="width: 10%;"></td> <td style="width: 10%;"></td> <td style="width: 10%;"></td> <td style="width: 10%;"></td> <td style="width: 10%;"></td> <td style="width: 10%;"></td> </tr> <tr> <td></td> <td></td> <td colspan="8" style="text-align: center;"> <table border="1" style="width: 100%; border-collapse: collapse; text-align: center;"> <tr> <td style="width: 10%;"></td> <td style="width: 10%;"></td> <td style="width: 10%;"></td> <td style="width: 10%;"></td> <td style="width: 10%;"></td> <td style="width: 10%;"></td> <td style="width: 10%;"></td> <td style="width: 10%;"></td> <td style="width: 10%;"></td> <td style="width: 10%;"></td> </tr> <tr> <td></td> <td></td> <td colspan="8" style="text-align: center;"> <table border="1" style="width: 100%; border-collapse: collapse; text-align: center;"> <tr> <td style="width: 10%;"></td> <td style="width: 10%;"></td> <td style="width: 10%;"></td> <td style="width: 10%;"></td> <td style="width: 10%;"></td> <td style="width: 10%;"></td> <td style="width: 10%;"></td> <td style="width: 10%;"></td> <td style="width: 10%;"></td> <td style="width: 10%;"></td> </tr> <tr> <td></td> <td></td> <td colspan="8" style="text-align: center;"> <table border="1" style="width: 100%; border-collapse: collapse; text-align: center;"> <tr> <td style="width: 10%;"></td> <td style="width: 10%;"></td> <td style="width: 10%;"></td> <td style="width: 10%;"></td> <td style="width: 10%;"></td> <td style="width: 10%;"></td> <td style="width: 10%;"></td> <td style="width: 10%;"></td> <td style="width: 10%;"></td> <td style="width: 10%;"></td> </tr> <tr> <td></td> <td></td> <td colspan="8" style="text-align: center;"> <table border="1" style="width: 100%; border-collapse: collapse; text-align: center;"> <tr> <td style="width: 10%;"></td> <td style="width: 10%;"></td> <td style="width: 10%;"></td> <td style="width: 10%;"></td> <td style="width: 10%;"></td> <td style="width: 10%;"></td> <td style="width: 10%;"></td> <td style="width: 10%;"></td> <td style="width: 10%;"></td> <td style="width: 10%;"></td> </tr> <tr> <td></td> <td></td> <td colspan="8" style="text-align: center;"> <table border="1" style="width: 100%; border-collapse: collapse; text-align: center;"> <tr> <td style="width: 10%;"></td> <td style="width: 10%;"></td> <td style="width: 10%;"></td> <td style="width: 10%;"></td> <td style="width: 10%;"></td> <td style="width: 10%;"></td> <td style="width: 10%;"></td> <td style="width: 10%;"></td> <td style="width: 10%;"></td> <td style="width: 10%;"></td> </tr> <tr> <td></td> <td></td> <td colspan="8" style="text-align: center;"> <table border="1" style="width: 100%; border-collapse: collapse; text-align: center;"> <tr> <td style="width: 10%;"></td> <td style="width: 10%;"></td> <td style="width: 10%;"></td> <td style="width: 10%;"></td> <td style="width: 10%;"></td> <td style="width: 10%;"></td> <td style="width: 10%;"></td> <td style="width: 10%;"></td> <td style="width: 10%;"></td> <td style="width: 10%;"></td> </tr> <tr> <td></td> <td></td> <td colspan="8" style="text-align: center;"> <table border="1" style="width: 100%; border-collapse: collapse; text-align: center;"> <tr> <td style="width: 10%;"></td> <td style="width: 10%;"></td> <td style="width: 10%;"></td> <td style="width: 10%;"></td> <td style="width: 10%;"></td> <td style="width: 10%;"></td> <td style="width: 10%;"></td> <td style="width: 10%;"></td> <td style="width: 10%;"></td> <td style="width: 10%;"></td> </tr> <tr> <td></td> <td></td> <td colspan="8" style="text-align: center;"> <table border="1" style="width: 100%; border-collapse: collapse; text-align: center;"> <tr> <td style="width: 10%;"></td> <td style="width: 10%;"></td> <td style="width: 10%;"></td> <td style="width: 10%;"></td> <td style="width: 10%;"></td> <td style="width: 10%;"></td> <td style="width: 10%;"></td> <td style="width: 10%;"></td> <td style="width: 10%;"></td> <td style="width: 10%;"></td> </tr> <tr> <td></td> <td></td> <td colspan="8" style="text-align: center;"> <table border="1" style="width: 100%; border-collapse: collapse; text-align: center;"> <tr> <td style="width: 10%;"></td> <td style="width: 10%;"></td> <td style="width: 10%;"></td> <td style="width: 10%;"></td> <td style="width: 10%;"></td> <td style="width: 10%;"></td> <td style="width: 10%;"></td> <td style="width: 10%;"></td> <td style="width: 10%;"></td> <td style="width: 10%;"></td> </tr> <tr> <td></td> <td></td> <td colspan="8" style="text-align: center;"> <table border="1"
style="width: 100%; border-collapse: collapse; text-align: center;"> <tr> <td style="width: 10%;"></td> <td style="width: 10%;"></td> <td style="width: 10%;"></td> <td style="width: 10%;"></td> <td style="width: 10%;"></td> <td style="width: 10%;"></td> <td style="width: 10%;"></td> <td style="width: 10%;"></td> <td style="width: 10%;"></td> <td style="width: 10%;"></td> </tr> <tr> <td></td> <td></td> <td colspan="8" style="text-align: center;"> <table border="1" style="width: 100%; border-collapse: collapse; text-align: center;"> <tr> <td style="width: 10%;"></td> <td style="width: 10%;"></td> <td style="width: 10%;"></td> <td style="width: 10%;"></td> <td style="width: 10%;"></td> <td style="width: 10%;"></td> <td style="width: 10%;"></td> <td style="width: 10%;"></td> <td style="width: 10%;"></td> <td style="width: 10%;"></td> </tr> <tr> <td></td> <td></td> <td colspan="8" style="text-align: center;"> <table border="1" style="width: 100%; border-collapse: collapse; text-align: center;"> <tr> <td style="width: 10%;"></td> <td style="width: 10%;"></td> <td style="width: 10%;"></td> <td style="width: 10%;"></td> <td style="width: 10%;"></td> <td style="width: 10%;"></td> <td style="width: 10%;"></td> <td style="width: 10%;"></td> <td style="width: 10%;"></td> <td style="width: 10%;"></td> </tr> <tr> <td></td> <td></td> <td colspan="8" style="text-align: center;"> <table border="1" style="width: 100%; border-collapse: collapse; text-align: center;"> <tr> <td style="width: 10%;"></td> <td style="width: 10%;"></td> <td style="width: 10%;"></td> <td style="width: 10%;"></td> <td style="width: 10%;"></td> <td style="width: 10%;"></td> <td style="width: 10%;"></td> <td style="width: 10%;"></td> <td style="width: 10%;"></td> <td style="width: 10%;"></td> </tr> <tr> <td></td> <td></td> <td colspan="8" style="text-align: center;"> <table border="1" style="width: 100%; border-collapse: collapse; text-align: center;"> <tr> <td style="width: 10%;"></td> <td style="width: 10%;"></td> <td style="width: 10%;"></td> <td style="width: 10%;"></td> <td style="width: 10%;"></td> <td style="width: 10%;"></td> <td style="width: 10%;"></td> <td style="width: 10%;"></td> <td style="width: 10%;"></td> <td style="width: 10%;"></td> </tr> <tr> <td></td> <td></td> <td colspan="8" style="text-align: center;"> <table border="1" style="width: 100%; border-collapse: collapse; text-align: center;"> <tr> <td style="width: 10%;"></td> <td style="width: 10%;"></td> <td style="width: 10%;"></td> <td style="width: 10%;"></td> <td style="width: 10%;"></td> <td style="width: 10%;"></td> <td style="width: 10%;"></td> <td style="width: 10%;"></td> <td style="width: 10%;"></td> <td style="width: 10%;"></td> </tr> <tr> <td></td> <td></td> <td colspan="8" style="text-align: center;"> <table border="1" style="width: 100%; border-collapse: collapse; text-align: center;"> <tr> <td style="width: 10%;"></td> <td style="width: 10%;"></td> <td style="width: 10%;"></td> <td style="width: 10%;"></td> <td style="width: 10%;"></td> <td style="width: 10%;"></td> <td style="width: 10%;"></td> <td style="width: 10%;"></td> <td style="width: 10%;"></td> <td style="width: 10%;"></td> </tr> <tr> <td></td> <td></td> <td colspan="8" style="text-align: center;"> <table border="1" style="width: 100%; border-collapse: collapse; text-align: center;"> <tr> <td style="width: 10%;"></td> <td style="width: 10%;"></td> <td style="width: 10%;"></td> <td style="width: 10%;"></td> <td style="width: 10%;"></td> <td style="width: 10%;"></td> <td style="width: 10%;"></td> <td style="width: 10%;"></td> <td style="width: 10%;"></td> <td style="width: 10%;"></td> </tr> <tr> <td></td> <td></td> <td colspan="8" style="text-align: center;"> <table border="1" style="width: 100%; border-collapse: collapse; text-align: center;"> <tr> <td style="width: 10%;"></td> <td style="width: 10%;"></td> <td style="width: 10%;"></td> <td style="width: 10%;"></td> <td style="width: 10%;"></td> <td style="width: 10%;"></td> <td style="width: 10%;"></td> <td style="width: 10%;"></td> <td style="width: 10%;"></td> <td style="width: 10%;"></td> </tr> <tr> <td></td> <td></td> <td colspan="8" style="text-align: center;"> <table border="1" style="width: 100%; border-collapse: collapse; text-align: center;"> <tr> <td style="width: 10%;"></td> <td style="width: 10%;"></td> <td style="width: 10%;"></td> <td style="width: 10%;"></td> <td style="width: 10%;"></td> <td style="width: 10%;"></td> <td style="width: 10%;"></td> <td style="width: 10%;"></td> <td style="width: 10%;"></td> <td style="width: 10%;"></td> </tr> <tr> <td></td> <td></td> <td colspan="8" style="text-align: center;"> <table border="1" style="width: 100%; border-collapse: collapse; text-align: center;"> <tr> <td style="width: 10%;"></td> <td style="width: 10%;"></td> <td style="width: 10%;"></td> <td style="width: 10%;"></td> <td style="width: 10%;"></td> <td style="width: 10%;"></td> <td style="width: 10%;"></td> <td style="width: 10%;"></td> <td style="width: 10%;"></td> <td style="width: 10%;"></td> </tr> <tr> <td></td> <td></td> <td colspan="8" style="text-align: center;"> <table border="1" style="width: 100%; border-collapse: collapse; text-align: center;"> <tr> <td style="width: 10%;"></td> <td style="width: 10%;"></td> <td style="width: 10%;"></td> <td style="width: 10%;"></td> <td style="width: 10%;"></td> <td style="width: 10%;"></td> <td style="width: 10%;"></td> <td style="width: 10%;"></td> <td style="width: 10%;"></td> <td style="width: 10%;"></td> </tr> <tr> <td></td> <td></td> <td colspan="8" style="text-align: center;"> <table border="1" style="width: 100%; border-collapse: collapse; text-align: center;"> <tr> <td style="width: 10%;"></td> <td style="width: 10%;"></td> <td style="width: 10%;"></td> <td style="width: 10%;"></td> <td style="width: 10%;"></td> <td style="width: 10%;"></td> <td style="width: 10%;"></td> <td style="width: 10%;"></td> <td style="width: 10%;"></td> <td style="width: 10%;"></td> </tr> <tr> <td></td> <td></td> <td colspan="8" style="text-align: center;"> <table border="1" style="width: 100%; border-collapse: collapse; text-align: center;"> <tr> <td style="width: 10%;"></td> <td style="width: 10%;"></td> <td style="width: 10%;"></td> <td style="width: 10%;"></td> <td style="width: 10%;"></td> <td style="width: 10%;"></td> <td style="width: 10%;"></td> <td style="width: 10%;"></td> <td style="width: 10%;"></td> <td style="width: 10%;"></td> </tr> <tr> <td></td> <td></td> <td colspan="8" style="text-align: center;"> <table border="1" style="width: 100%; border-collapse: collapse; text-align: center;"> <tr> <td style="width: 10%;"></td> <td style="width: 10%;"></td> <td style="width: 10%;"></td> <td style="width: 10%;"></td> <td style="width: 10%;"></td> <td style="width: 10%;"></td> <td style="width: 10%;"></td> <td style="width: 10%;"></td> <td style="width: 10%;"></td> <td style="width: 10%;"></td> </tr> <tr> <td></td> <td></td> <td colspan="8" style="text-align: center;"> <table border="1" style="width: 100%; border-collapse: collapse; text-align: center;"> <tr> <td style="width: 10%;"></td> <td style="width: 10%;"></td> <td style="width: 10%;"></td> <td style="width: 10%;"></td> <td style="width: 10%;"></td> <td style="width: 10%;"></td> <td style="width: 10%;"></td> <td style="width: 10%;"></td> <td style="width: 10%;"></td> <td style="width: 10%;"></td> </tr> <tr> <td></td> <td></td> <td colspan="8" style="text-align: center;"> <table border="1" style="width: 100%; border-collapse: collapse; text-align: center;"> <tr> <td style="width: 10%;"></td> <td style="width: 10%;"></td> <td style="width: 10%;"></td> <td style="width: 10%;"></td> <td style="width: 10%;"></td> <td style="width: 10%;"></td> <td style="width: 10%;"></td> <td style="width: 10%;"></td> <td style="width: 10%;"></td> <td style="width: 10%;"></td> </tr> <tr> <td></td> <td></td> <td colspan="8" style="text-align: center;"> <table border="1" style="width: 100%; border-collapse: collapse; text-align: center;"> <tr> <td style="width: 10%;"></td> <td style="width: 10%;"></td> <td style="width: 10%;"></td> <td style="width: 10%;"></td> <td style="width: 10%;"></td> <td style="width: 10%;"></td> <td style="width: 10%;"></td> <td style="width: 10%;"></td> <td style="width: 10%;"></td> <td style="width: 10%;"></td> </tr> <tr> <td></td> <td></td> <td colspan="8" style="text-align: center;"> <table border="1" style="width: 100%; border-collapse: collapse; text-align: center;"> <tr> <td style="width: 10%;"></td> <td style="width: 10%;"></td> <td style="width: 10%;"></td> <td style="width: 10%;"></td> <td style="width: 10%;"></td> <td style="width: 10%;"></td> <td style="width: 10%;"></td> <td style="width: 10%;"></td> <td style="width: 10%;"></td> <td style="width: 10%;"></td> </tr> <tr> <td></td> <td></td> <td colspan="8" style="text-align: center;"> <table border="1" style="width: 100%; border-collapse: collapse; text-align: center;"> <tr> <td style="width: 10%;"></td> <td style="width: 10%;"></td> <td style="width: 10%;"></td> <td style="width: 10%;"></td> <td style="width: 10%;"></td> <td style="width: 10%;"></td> <td style="width: 10%;"></td> <td style="width: 10%;"></td> <td style="width: 10%;"></td> <td style="width: 10%;"></td> </tr> <tr> <td></td> <td></td> <td colspan="8" style="text-align: center;"> <table border="1" style="width: 100%; border-collapse: collapse; text-align: center;"> <tr> <td style="width: 10%;"></td> <td style="width: 10%;"></td> <td style="width: 10%;"></td> <td style="width: 10%;"></td> <td style="width: 10%;"></td> <td style="width: 10%;"></td> <td style="width: 10%;"></td> <td style="width: 10%;"></td> <td style="width: 10%;"></td> <td style="width: 10%;"></td> </tr> <tr> <td></td> <td></td> <td colspan="8" style="text-align: center;"> <table border="1" style="width: 100%; border-collapse: collapse; text-align: center;"> <tr> <td style="width: 10%;"></td> <td style="width: 10%;"></td> <td style="width: 10%;"></td> <td
style="width: 10%;"></td> <td style="width: 10%;"></td> <td style="width: 10%;"></td> <td style="width: 10%;"></td> <td style="width: 10%;"></td> <td style="width: 10%;"></td> <td style="width: 10%;"></td> </tr> <tr> <td></td> <td></td> <td colspan="8" style="text-align: center;"> <table border="1" style="width: 100%; border-collapse: collapse; text-align: center;"> <tr> <td style="width: 10%;"></td> <td style="width: 10%;"></td> <td style="width: 10%;"></td> <td style="width: 10%;"></td> <td style="width: 10%;"></td> <td style="width: 10%;"></td> <td style="width: 10%;"></td> <td style="width: 10%;"></td> <td style="width: 10%;"></td> <td style="width: 10%;"></td> </tr> <tr> <td></td> <td></td> <td colspan="8" style="text-align: center;"> <table border="1" style="width: 100%; border-collapse: collapse; text-align: center;"> <tr> <td style="width: 10%;"></td> <td style="width: 10%;"></td> <td style="width: 10%;"></td> <td style="width: 10%;"></td> <td style="width: 10%;"></td> <td style="width: 10%;"></td> <td style="width: 10%;"></td> <td style="width: 10%;"></td> <td style="width: 10%;"></td> <td style="width: 10%;"></td> </tr> <tr> <td></td> <td></td> <td colspan="8" style="text-align: center;"> <table border="1" style="width: 100%; border-collapse: collapse; text-align: center;"> <tr> <td style="width: 10%;"></td> <td style="width: 10%;"></td> <td style="width: 10%;"></td> <td style="width: 10%;"></td> <td style="width: 10%;"></td> <td style="width: 10%;"></td> <td style="width: 10%;"></td> <td style="width: 10%;"></td> <td style="width: 10%;"></td> <td style="width: 10%;"></td> </tr> <tr> <td></td> <td></td> <td colspan="8" style="text-align: center;"> <table border="1" style="width: 100%; border-collapse: collapse; text-align: center;"> <tr> <td style="width: 10%;"></td> <td style="width: 10%;"></td> <td style="width: 10%;"></td> <td style="width: 10%;"></td> <td style="width: 10%;"></td> <td style="width: 10%;"></td> <td style="width: 10%;"></td> <td style="width: 10%;"></td> <td style="width: 10%;"></td> <td style="width: 10%;"></td> </tr> <tr> <td></td> <td></td> <td colspan="8" style="text-align: center;"> <table border="1" style="width: 100%; border-collapse: collapse; text-align: center;"> <tr> <td style="width: 10%;"></td> <td style="width: 10%;"></td> <td style="width: 10%;"></td> <td style="width: 10%;"></td> <td style="width: 10%;"></td> <td style="width: 10%;"></td> <td style="width: 10%;"></td> <td style="width: 10%;"></td> <td style="width: 10%;"></td> <td style="width: 10%;"></td> </tr> <tr> <td></td> <td></td> <td colspan="8" style="text-align: center;"> <table border="1" style="width: 100%; border-collapse: collapse; text-align: center;"> <tr> <td style="width: 10%;"></td> <td style="width: 10%;"></td> <td style="width: 10%;"></td> <td style="width: 10%;"></td> <td style="width: 10%;"></td> <td style="width: 10%;"></td> <td style="width: 10%;"></td> <td style="width: 10%;"></td> <td style="width: 10%;"></td> <td style="width: 10%;"></td> </tr> <tr> <td></td> <td></td> <td colspan="8" style="text-align: center;"> <table border="1" style="width: 100%; border-collapse: collapse; text-align: center;"> <tr> <td style="width: 10%;"></td> <td style="width: 10%;"></td> <td style="width: 10%;"></td> <td style="width: 10%;"></td> <td style="width: 10%;"></td> <td style="width: 10%;"></td> <td style="width: 10%;"></td> <td style="width: 10%;"></td> <td style="width: 10%;"></td> <td style="width: 10%;"></td> </tr> <tr> <td></td> <td></td> <td colspan="8" style="text-align: center;"> <table border="1" style="width: 100%; border-collapse: collapse; text-align: center;"> <tr> <td style="width: 10%;"></td> <td style="width: 10%;"></td> <td style="width: 10%;"></td> <td style="width: 10%;"></td> <td style="width: 10%;"></td> <td style="width: 10%;"></td> <td style="width: 10%;"></td> <td style="width: 10%;"></td> <td style="width: 10%;"></td> <td style="width: 10%;"></td> </tr> <tr> <td></td> <td></td> <td colspan="8" style="text-align: center;"> <table border="1" style="width: 100%; border-collapse: collapse; text-align: center;"> <tr> <td style="width: 10%;"></td> <td style="width: 10%;"></td> <td style="width: 10%;"></td> <td style="width: 10%;"></td> <td style="width: 10%;"></td> <td style="width: 10%;"></td> <td style="width: 10%;"></td> <td style="width: 10%;"></td> <td style="width: 10%;"></td> <td style="width: 10%;"></td> </tr> <tr> <td></td> <td></td> <td colspan="8" style="text-align: center;"> <table border="1" style="width: 100%; border-collapse: collapse; text-align: center;"> <tr> <td style="width: 10%;"></td> <td style="width: 10%;"></td> <td style="width: 10%;"></td> <td style="width: 10%;"></td> <td style="width: 10%;"></td> <td style="width: 10%;"></td> <td style="width: 10%;"></td> <td style="width: 10%;"></td> <td style="width: 10%;"></td> <td style="width: 10%;"></td> </tr> <tr> <td></td> <td></td> <td colspan="8" style="text-align: center;"> <table border="1" style="width: 100%; border-collapse: collapse; text-align: center;"> <tr> <td style="width: 10%;"></td> <td style="width: 10%;"></td> <td style="width: 10%;"></td> <td style="width: 10%;"></td> <td style="width: 10%;"></td> <td style="width: 10%;"></td> <td style="width: 10%;"></td> <td style="width: 10%;"></td> <td style="width: 10%;"></td> <td style="width: 10%;"></td> </tr> <tr> <td></td> <td></td> <td colspan="8" style="text-align: center;"> <table border="1" style="width: 100%; border-collapse: collapse; text-align: center;"> <tr> <td style="width: 10%;"></td> <td style="width: 10%;"></td> <td style="width: 10%;"></td> <td style="width: 10%;"></td> <td style="width: 10%;"></td> <td style="width: 10%;"></td> <td style="width: 10%;"></td> <td style="width: 10%;"></td> <td style="width: 10%;"></td> <td style="width: 10%;"></td> </tr> <tr> <td></td> <td></td> <td colspan="8" style="text-align: center;"> <table border="1" style="width: 100%; border-collapse: collapse; text-align: center;"> <tr> <td style="width: 10%;"></td> <td style="width: 10%;"></td> <td style="width: 10%;"></td> <td style="width: 10%;"></td> <td style="width: 10%;"></td> <td style="width: 10%;"></td> <td style="width: 10%;"></td> <td style="width: 10%;"></td> <td style="width: 10%;"></td> <td style="width: 10%;"></td> </tr> <tr> <td></td> <td></td> <td colspan="8" style="text-align: center;"> <table border="1" style="width: 100%; border-collapse: collapse; text-align: center;"> <tr> <td style="width: 10%;"></td> <td style="width: 10%;"></td> <td style="width: 10%;"></td> <td style="width: 10%;"></td> <td style="width: 10%;"></td> <td style="width: 10%;"></td> <td style="width: 10%;"></td> <td style="width: 10%;"></td> <td style="width: 10%;"></td> <td style="width: 10%;"></td> </tr> <tr> <td></td> <td></td> <td colspan="8" style="text-align: center;"> <table border="1" style="width: 100%; border-collapse: collapse; text-align: center;"> <tr> </tr></table></td></tr></table></td></tr></table></td></tr></table></td></tr></table></td></tr></table></td></tr></table></td></tr></table></td></tr></table></td></tr></table></td></tr></table></td></tr></table></td></tr></table></td></tr></table></td></tr></table></td></tr></table></td></tr></table></td></tr></table></td></tr></table></td></tr></table></td></tr></table></td></tr></table></td></tr></table></td></tr></table></td></tr></table></td></tr></table></td></tr></table></td></tr></table></td></tr></table></td></tr></table></td></tr></table></td></tr></table></td></tr></table></td></tr></table></td></tr></table></td></tr></table></td></tr></table></td></tr></table></td></tr></table></td></tr></table></td></tr></table></td></tr></table></td></tr></table></td></tr></table></td></tr></table></td></tr></table></td></tr></table></td></tr></table>
 | | | | | | | | | | | | | | | | | | | | <table border="1" style="width: 100%; border-collapse: collapse; text-align: center;"> <tr> <td style="width: 10%;"></td> <td style="width: 10%;"></td> <td style="width: 10%;"></td> <td style="width: 10%;"></td> <td style="width: 10%;"></td> <td style="width: 10%;"></td> <td style="width: 10%;"></td> <td style="width: 10%;"></td> <td style="width: 10%;"></td> <td style="width: 10%;"></td> </tr> <tr> <td></td> <td></td> <td colspan="8" style="text-align: center;"> <table border="1" style="width: 100%; border-collapse: collapse; text-align: center;"> <tr> <td style="width: 10%;"></td> <td style="width: 10%;"></td> <td style="width: 10%;"></td> <td style="width: 10%;"></td> <td style="width: 10%;"></td> <td style="width: 10%;"></td> <td style="width: 10%;"></td> <td style="width: 10%;"></td> <td style="width: 10%;"></td> <td style="width: 10%;"></td> </tr> <tr> <td></td> <td></td> <td colspan="8" style="text-align: center;"> <table border="1" style="width: 100%; border-collapse: collapse; text-align: center;"> <tr> <td style="width: 10%;"></td> <td style="width: 10%;"></td> <td style="width: 10%;"></td> <td style="width: 10%;"></td> <td style="width: 10%;"></td> <td style="width: 10%;"></td> <td style="width: 10%;"></td> <td style="width: 10%;"></td> <td style="width: 10%;"></td> <td style="width: 10%;"></td> </tr> <tr> <td></td> <td></td> <td colspan="8" style="text-align: center;"> <table border="1" style="width: 100%; border-collapse: collapse; text-align: center;"> <tr> <td style="width: 10%;"></td> <td style="width: 10%;"></td> <td style="width: 10%;"></td> <td style="width: 10%;"></td> <td style="width: 10%;"></td> <td style="width: 10%;"></td> <td style="width: 10%;"></td> <td style="width: 10%;"></td> <td style="width: 10%;"></td> <td style="width: 10%;"></td> </tr> <tr> <td></td> <td></td> <td colspan="8" style="text-align: center;"> <table border="1" style="width: 100%; border-collapse: collapse; text-align: center;"> <tr> <td style="width: 10%;"></td> <td style="width: 10%;"></td> <td style="width: 10%;"></td> <td style="width: 10%;"></td> <td style="width: 10%;"></td> <td style="width: 10%;"></td> <td style="width: 10%;"></td> <td style="width: 10%;"></td> <td style="width: 10%;"></td> <td style="width: 10%;"></td> </tr> <tr> <td></td> <td></td> <td colspan="8" style="text-align: center;"> <table border="1" style="width: 100%; border-collapse: collapse; text-align: center;"> <tr> <td style="width: 10%;"></td> <td style="width: 10%;"></td> <td style="width: 10%;"></td> <td style="width: 10%;"></td> <td style="width: 10%;"></td> <td style="width: 10%;"></td> <td style="width: 10%;"></td> <td style="width: 10%;"></td> <td style="width: 10%;"></td> <td style="width: 10%;"></td> </tr> <tr> <td></td> <td></td> <td colspan="8" style="text-align: center;"> <table border="1" style="width: 100%; border-collapse: collapse; text-align: center;"> <tr> <td style="width: 10%;"></td> <td style="width: 10%;"></td> <td style="width: 10%;"></td> <td style="width: 10%;"></td> <td style="width: 10%;"></td> <td style="width: 10%;"></td> <td style="width: 10%;"></td> <td style="width: 10%;"></td> <td style="width: 10%;"></td> <td style="width: 10%;"></td> </tr> <tr> <td></td> <td></td> <td colspan="8" style="text-align: center;"> <table border="1" style="width: 100%; border-collapse: collapse; text-align: center;"> <tr> <td style="width: 10%;"></td> <td style="width: 10%;"></td> <td style="width: 10%;"></td> <td style="width: 10%;"></td> <td style="width: 10%;"></td> <td style="width: 10%;"></td> <td style="width: 10%;"></td> <td style="width: 10%;"></td> <td style="width: 10%;"></td> <td style="width: 10%;"></td> </tr> <tr> <td></td> <td></td> <td colspan="8" style="text-align: center;"> <table border="1" style="width: 100%; border-collapse: collapse; text-align: center;"> <tr> <td style="width: 10%;"></td> <td style="width: 10%;"></td> <td style="width: 10%;"></td> <td style="width: 10%;"></td> <td style="width: 10%;"></td> <td style="width: 10%;"></td> <td style="width: 10%;"></td> <td style="width: 10%;"></td> <td style="width: 10%;"></td> <td style="width: 10%;"></td> </tr> <tr> <td></td> <td></td> <td colspan="8" style="text-align: center;"> <table border="1" style="width: 100%; border-collapse: collapse; text-align: center;"> <tr> <td style="width: 10%;"></td> <td style="width: 10%;"></td> <td style="width: 10%;"></td> <td style="width: 10%;"></td> <td style="width: 10%;"></td> <td style="width: 10%;"></td> <td style="width: 10%;"></td> <td style="width: 10%;"></td> <td style="width: 10%;"></td> <td style="width: 10%;"></td> </tr> <tr> <td></td> <td></td> <td colspan="8" style="text-align: center;"> <table border="1" style="width: 100%; border-collapse: collapse; text-align: center;"> <tr> <td style="width: 10%;"></td> <td style="width: 10%;"></td> <td style="width: 10%;"></td> <td style="width: 10%;"></td> <td style="width: 10%;"></td> <td style="width: 10%;"></td> <td style="width: 10%;"></td> <td style="width: 10%;"></td> <td style="width: 10%;"></td> <td style="width: 10%;"></td> </tr> <tr> <td></td> <td></td> <td colspan="8" style="text-align: center;"> <table border="1" style="width: 100%; border-collapse: collapse; text-align: center;"> <tr> <td style="width: 10%;"></td> <td style="width: 10%;"></td> <td style="width: 10%;"></td> <td style="width: 10%;"></td> <td style="width: 10%;"></td> <td style="width: 10%;"></td> <td style="width: 10%;"></td> <td style="width: 10%;"></td> <td style="width: 10%;"></td> <td style="width: 10%;"></td> </tr> <tr> <td></td> <td></td> <td colspan="8" style="text-align: center;"> <table border="1" style="width: 100%; border-collapse: collapse; text-align: center;"> <tr> <td style="width: 10%;"></td> <td style="width: 10%;"></td> <td style="width: 10%;"></td> <td style="width: 10%;"></td> <td style="width: 10%;"></td> <td style="width: 10%;"></td> <td style="width: 10%;"></td> <td style="width: 10%;"></td> <td style="width: 10%;"></td> <td style="width: 10%;"></td> </tr> <tr> <td></td> <td></td> <td colspan="8" style="text-align: center;"> <table border="1" style="width: 100%; border-collapse: collapse; text-align: center;"> <tr> <td style="width: 10%;"></td> <td style="width: 10%;"></td> <td style="width: 10%;"></td> <td style="width: 10%;"></td> <td style="width: 10%;"></td> <td style="width: 10%;"></td> <td style="width: 10%;"></td> <td style="width: 10%;"></td> <td style="width: 10%;"></td> <td style="width: 10%;"></td> </tr> <tr> <td></td> <td></td> <td colspan="8" style="text-align: center;"> <table border="1" style="width: 100%; border-collapse: collapse; text-align: center;"> <tr> <td style="width: 10%;"></td> <td style="width: 10%;"></td> <td style="width: 10%;"></td> <td style="width: 10%;"></td> <td style="width: 10%;"></td> <td style="width: 10%;"></td> <td style="width: 10%;"></td> <td style="width: 10%;"></td> <td style="width: 10%;"></td> <td style="width: 10%;"></td> </tr> <tr> <td></td> <td></td> <td colspan="8" style="text-align: center;"> <table border="1" style="width: 100%; border-collapse: collapse; text-align: center;"> <tr> <td style="width: 10%;"></td> <td style="width: 10%;"></td> <td style="width: 10%;"></td> <td style="width: 10%;"></td> <td style="width: 10%;"></td> <td style="width: 10%;"></td> <td style="width: 10%;"></td> <td style="width: 10%;"></td> <td style="width: 10%;"></td> <td style="width: 10%;"></td> </tr> <tr> <td></td> <td></td> <td colspan="8" style="text-align: center;"> <table border="1" style="width: 100%; border-collapse: collapse; text-align: center;"> <tr> <td style="width: 10%;"></td> <td style="width: 10%;"></td> <td style="width: 10%;"></td> <td style="width: 10%;"></td> <td style="width: 10%;"></td> <td style="width: 10%;"></td> <td style="width: 10%;"></td> <td style="width: 10%;"></td> <td style="width: 10%;"></td> <td style="width: 10%;"></td> </tr> <tr> <td></td> <td></td> <td colspan="8" style="text-align: center;"> <table border="1" style="width: 100%; border-collapse: collapse; text-align: center;"> <tr> <td style="width: 10%;"></td> <td style="width: 10%;"></td> <td style="width: 10%;"></td> <td style="width: 10%;"></td> <td style="width: 10%;"></td> <td style="width: 10%;"></td> <td style="width: 10%;"></td> <td
style="width: 10%;"></td> <td style="width: 10%;"></td> <td style="width: 10%;"></td> </tr> <tr> <td></td> <td></td> <td colspan="8" style="text-align: center;"> <table border="1" style="width: 100%; border-collapse: collapse; text-align: center;"> <tr> <td style="width: 10%;"></td> <td style="width: 10%;"></td> <td style="width: 10%;"></td> <td style="width: 10%;"></td> <td style="width: 10%;"></td> <td style="width: 10%;"></td> <td style="width: 10%;"></td> <td style="width: 10%;"></td> <td style="width: 10%;"></td> <td style="width: 10%;"></td> </tr> <tr> <td></td> <td></td> <td colspan="8" style="text-align: center;"> <table border="1" style="width: 100%; border-collapse: collapse; text-align: center;"> <tr> <td style="width: 10%;"></td> <td style="width: 10%;"></td> <td style="width: 10%;"></td> <td style="width: 10%;"></td> <td style="width: 10%;"></td> <td style="width: 10%;"></td> <td style="width: 10%;"></td> <td style="width: 10%;"></td> <td style="width: 10%;"></td> <td style="width: 10%;"></td> </tr> <tr> <td></td> <td></td> <td colspan="8" style="text-align: center;"> <table border="1" style="width: 100%; border-collapse: collapse; text-align: center;"> <tr> <td style="width: 10%;"></td> <td style="width: 10%;"></td> <td style="width: 10%;"></td> <td style="width: 10%;"></td> <td style="width: 10%;"></td> <td style="width: 10%;"></td> <td style="width: 10%;"></td> <td style="width: 10%;"></td> <td style="width: 10%;"></td> <td style="width: 10%;"></td> </tr> <tr> <td></td> <td></td> <td colspan="8" style="text-align: center;"> <table border="1" style="width: 100%; border-collapse: collapse; text-align: center;"> <tr> <td style="width: 10%;"></td> <td style="width: 10%;"></td> <td style="width: 10%;"></td> <td style="width: 10%;"></td> <td style="width: 10%;"></td> <td style="width: 10%;"></td> <td style="width: 10%;"></td> <td style="width: 10%;"></td> <td style="width: 10%;"></td> <td style="width: 10%;"></td> </tr> <tr> <td></td> <td></td> <td colspan="8" style="text-align: center;"> <table border="1" style="width: 100%; border-collapse: collapse; text-align: center;"> <tr> <td style="width: 10%;"></td> <td style="width: 10%;"></td> <td style="width: 10%;"></td> <td style="width: 10%;"></td> <td style="width: 10%;"></td> <td style="width: 10%;"></td> <td style="width: 10%;"></td> <td style="width: 10%;"></td> <td style="width: 10%;"></td> <td style="width: 10%;"></td> </tr> <tr> <td></td> <td></td> <td colspan="8" style="text-align: center;"> <table border="1" style="width: 100%; border-collapse: collapse; text-align: center;"> <tr> <td style="width: 10%;"></td> <td style="width: 10%;"></td> <td style="width: 10%;"></td> <td style="width: 10%;"></td> <td style="width: 10%;"></td> <td style="width: 10%;"></td> <td style="width: 10%;"></td> <td style="width: 10%;"></td> <td style="width: 10%;"></td> <td style="width: 10%;"></td> </tr> <tr> <td></td> <td></td> <td colspan="8" style="text-align: center;"> <table border="1" style="width: 100%; border-collapse: collapse; text-align: center;"> <tr> <td style="width: 10%;"></td> <td style="width: 10%;"></td> <td style="width: 10%;"></td> <td style="width: 10%;"></td> <td style="width: 10%;"></td> <td style="width: 10%;"></td> <td style="width: 10%;"></td> <td style="width: 10%;"></td> <td style="width: 10%;"></td> <td style="width: 10%;"></td> </tr> <tr> <td></td> <td></td> <td colspan="8" style="text-align: center;"> <table border="1" style="width: 100%; border-collapse: collapse; text-align: center;"> <tr> <td style="width: 10%;"></td> <td style="width: 10%;"></td> <td style="width: 10%;"></td> <td style="width: 10%;"></td> <td style="width: 10%;"></td> <td style="width: 10%;"></td> <td style="width: 10%;"></td> <td style="width: 10%;"></td> <td style="width: 10%;"></td> <td style="width: 10%;"></td> </tr> <tr> <td></td> <td></td> <td colspan="8" style="text-align: center;"> <table border="1" style="width: 100%; border-collapse: collapse; text-align: center;"> <tr> <td style="width: 10%;"></td> <td style="width: 10%;"></td> <td style="width: 10%;"></td> <td style="width: 10%;"></td> <td style="width: 10%;"></td> <td style="width: 10%;"></td> <td style="width: 10%;"></td> <td style="width: 10%;"></td> <td style="width: 10%;"></td> <td style="width: 10%;"></td> </tr> <tr> <td></td> <td></td> <td colspan="8" style="text-align: center;"> <table border="1" style="width: 100%; border-collapse: collapse; text-align: center;"> <tr> <td style="width: 10%;"></td> <td style="width: 10%;"></td> <td style="width: 10%;"></td> <td style="width: 10%;"></td> <td style="width: 10%;"></td> <td style="width: 10%;"></td> <td style="width: 10%;"></td> <td style="width: 10%;"></td> <td style="width: 10%;"></td> <td style="width: 10%;"></td> </tr> <tr> <td></td> <td></td> <td colspan="8" style="text-align: center;"> <table border="1" style="width: 100%; border-collapse: collapse; text-align: center;"> <tr> <td style="width: 10%;"></td> <td style="width: 10%;"></td> <td style="width: 10%;"></td> <td style="width: 10%;"></td> <td style="width: 10%;"></td> <td style="width: 10%;"></td> <td style="width: 10%;"></td> <td style="width: 10%;"></td> <td style="width: 10%;"></td> <td style="width: 10%;"></td> </tr> <tr> <td></td> <td></td> <td colspan="8" style="text-align: center;"> <table border="1" style="width: 100%; border-collapse: collapse; text-align: center;"> <tr> <td style="width: 10%;"></td> <td style="width: 10%;"></td> <td style="width: 10%;"></td> <td style="width: 10%;"></td> <td style="width: 10%;"></td> <td style="width: 10%;"></td> <td style="width: 10%;"></td> <td style="width: 10%;"></td> <td style="width: 10%;"></td> <td style="width: 10%;"></td> </tr> <tr> <td></td> <td></td> <td colspan="8" style="text-align: center;"> <table border="1" style="width: 100%; border-collapse: collapse; text-align: center;"> <tr> <td style="width: 10%;"></td> <td style="width: 10%;"></td> <td style="width: 10%;"></td> <td style="width: 10%;"></td> <td style="width: 10%;"></td> <td style="width: 10%;"></td> <td style="width: 10%;"></td> <td style="width: 10%;"></td> <td style="width: 10%;"></td> <td style="width: 10%;"></td> </tr> <tr> <td></td> <td></td> <td colspan="8" style="text-align: center;"> <table border="1" style="width: 100%; border-collapse: collapse; text-align: center;"> <tr> <td style="width: 10%;"></td> <td style="width: 10%;"></td> <td style="width: 10%;"></td> <td style="width: 10%;"></td> <td style="width: 10%;"></td> <td style="width: 10%;"></td> <td style="width: 10%;"></td> <td style="width: 10%;"></td> <td style="width: 10%;"></td> <td style="width: 10%;"></td> </tr> <tr> <td></td> <td></td> <td colspan="8" style="text-align: center;"> <table border="1" style="width: 100%; border-collapse: collapse; text-align: center;"> <tr> <td style="width: 10%;"></td> <td style="width: 10%;"></td> <td style="width: 10%;"></td> <td style="width: 10%;"></td> <td style="width: 10%;"></td> <td style="width: 10%;"></td> <td style="width: 10%;"></td> <td style="width: 10%;"></td> <td style="width: 10%;"></td> <td style="width: 10%;"></td> </tr> <tr> <td></td> <td></td> <td colspan="8" style="text-align: center;"> <table border="1" style="width: 100%; border-collapse: collapse; text-align: center;"> <tr> <td style="width: 10%;"></td> <td style="width: 10%;"></td> <td style="width: 10%;"></td> <td style="width: 10%;"></td> <td style="width: 10%;"></td> <td style="width: 10%;"></td> <td style="width: 10%;"></td> <td style="width: 10%;"></td> <td style="width: 10%;"></td> <td style="width: 10%;"></td> </tr> <tr> <td></td> <td></td> <td colspan="8" style="text-align: center;"> <table border="1" style="width: 100%; border-collapse: collapse; text-align: center;"> <tr> <td style="width: 10%;"></td> <td style="width: 10%;"></td> <td style="width: 10%;"></td> <td style="width: 10%;"></td> <td style="width: 10%;"></td> <td style="width: 10%;"></td> <td style="width: 10%;"></td> <td style="width: 10%;"></td> <td style="width: 10%;"></td> <td style="width: 10%;"></td> </tr> <tr> <td></td> <td></td> <td colspan="8" style="text-align: center;"> <table border="1" style="width: 100%; border-collapse: collapse; text-align: center;"> <tr> <td style="width: 10%;"></td> <td style="width: 10%;"></td> <td style="width: 10%;"></td> <td style="width: 10%;"></td> <td style="width: 10%;"></td> <td style="width: 10%;"></td> <td style="width: 10%;"></td> <td style="width: 10%;"></td> <td style="width: 10%;"></td> <td style="width: 10%;"></td> </tr> <tr> <td></td> <td></td> <td colspan="8" style="text-align: center;"> <table border="1" style="width: 100%; border-collapse: collapse; text-align: center;"> <tr> <td style="width: 10%;"></td> <td style="width: 10%;"></td> <td style="width: 10%;"></td> <td style="width: 10%;"></td> <td style="width: 10%;"></td> <td style="width: 10%;"></td> <td style="width: 10%;"></td> <td style="width: 10%;"></td> <td style="width: 10%;"></td> <td style="width: 10%;"></td> </tr> <tr> <td></td> <td></td> <td colspan="8" style="text-align: center;"> <table border="1" style="width: 100%; border-collapse: collapse; text-align: center;"> <tr> <td style="width: 10%;"></td> <td style="width: 10%;"></td> <td style="width: 10%;"></td> <td style="width: 10%;"></td> <td style="width: 10%;"></td> <td style="width: 10%;"></td> <td style="width: 10%;"></td> <td style="width: 10%;"></td> <td style="width: 10%;"></td> <td style="width: 10%;"></td> </tr> <tr> <td></td> <td></td> <td colspan="8" style="text-align: center;"> <table border="1" style="width: 100%; border-collapse: collapse; text-align: center;"> <tr> <td style="width: 10%;"></td> <td style="width: 10%;"></td> <td style="width: 10%;"></td> <td style="width: 10%;"></td> <td style="width: 10%;"></td> <td style="width: 10%;"></td> <td style="width: 10%;"></td> <td style="width: 10%;"></td> <td style="width: 10%;"></td> <td style="width: 10%;"></td> </tr> <tr> <td></td> <td></td> <td colspan="8" style="text-align: center;"> <table
border="1" style="width: 100%; border-collapse: collapse; text-align: center;"> <tr> <td style="width: 10%;"></td> <td style="width: 10%;"></td> <td style="width: 10%;"></td> <td style="width: 10%;"></td> <td style="width: 10%;"></td> <td style="width: 10%;"></td> <td style="width: 10%;"></td> <td style="width: 10%;"></td> <td style="width: 10%;"></td> <td style="width: 10%;"></td> </tr> <tr> <td></td> <td></td> <td colspan="8" style="text-align: center;"> <table border="1" style="width: 100%; border-collapse: collapse; text-align: center;"> <tr> <td style="width: 10%;"></td> <td style="width: 10%;"></td> <td style="width: 10%;"></td> <td style="width: 10%;"></td> <td style="width: 10%;"></td> <td style="width: 10%;"></td> <td style="width: 10%;"></td> <td style="width: 10%;"></td> <td style="width: 10%;"></td> <td style="width: 10%;"></td> </tr> <tr> <td></td> <td></td> <td colspan="8" style="text-align: center;"> <table border="1" style="width: 100%; border-collapse: collapse; text-align: center;"> <tr> <td style="width: 10%;"></td> <td style="width: 10%;"></td> <td style="width: 10%;"></td> <td style="width: 10%;"></td> <td style="width: 10%;"></td> <td style="width: 10%;"></td> <td style="width: 10%;"></td> <td style="width: 10%;"></td> <td style="width: 10%;"></td> <td style="width: 10%;"></td> </tr> <tr> <td></td> <td></td> <td colspan="8" style="text-align: center;"> <table border="1" style="width: 100%; border-collapse: collapse; text-align: center;"> <tr> <td style="width: 10%;"></td> <td style="width: 10%;"></td> <td style="width: 10%;"></td> <td style="width: 10%;"></td> <td style="width: 10%;"></td> <td style="width: 10%;"></td> <td style="width: 10%;"></td> <td style="width: 10%;"></td> <td style="width: 10%;"></td> <td style="width: 10%;"></td> </tr> <tr> <td></td> <td></td> <td colspan="8" style="text-align: center;"> <table border="1" style="width: 100%; border-collapse: collapse; text-align: center;"> <tr> <td style="width: 10%;"></td> <td style="width: 10%;"></td> <td style="width: 10%;"></td> <td style="width: 10%;"></td> <td style="width: 10%;"></td> <td style="width: 10%;"></td> <td style="width: 10%;"></td> <td style="width: 10%;"></td> <td style="width: 10%;"></td> <td style="width: 10%;"></td> </tr> <tr> <td></td> <td></td> <td colspan="8" style="text-align: center;"> <table border="1" style="width: 100%; border-collapse: collapse; text-align: center;"> <tr> <td style="width: 10%;"></td> <td style="width: 10%;"></td> <td style="width: 10%;"></td> <td style="width: 10%;"></td> <td style="width: 10%;"></td> <td style="width: 10%;"></td> <td style="width: 10%;"></td> <td style="width: 10%;"></td> <td style="width: 10%;"></td> <td style="width: 10%;"></td> </tr> <tr> <td></td> <td></td> <td colspan="8" style="text-align: center;"> <table border="1" style="width: 100%; border-collapse: collapse; text-align: center;"> <tr> <td style="width: 10%;"></td> <td style="width: 10%;"></td> <td style="width: 10%;"></td> <td style="width: 10%;"></td> <td style="width: 10%;"></td> <td style="width: 10%;"></td> <td style="width: 10%;"></td> <td style="width: 10%;"></td> <td style="width: 10%;"></td> <td style="width: 10%;"></td> </tr> <tr> <td></td> <td></td> <td colspan="8" style="text-align: center;"> <table border="1" style="width: 100%; border-collapse: collapse; text-align: center;"> <tr> </tr></table></td></tr></table></td></tr></table></td></tr></table></td></tr></table></td></tr></table></td></tr></table></td></tr></table></td></tr></table></td></tr></table></td></tr></table></td></tr></table></td></tr></table></td></tr></table></td></tr></table></td></tr></table></td></tr></table></td></tr></table></td></tr></table></td></tr></table></td></tr></table></td></tr></table></td></tr></table></td></tr></table></td></tr></table></td></tr></table></td></tr></table></td></tr></table></td></tr></table></td></tr></table></td></tr></table></td></tr></table></td></tr></table></td></tr></table></td></tr></table></td></tr></table></td></tr></table></td></tr></table></td></tr></table></td></tr></table></td></tr></table></td></tr></table></td></tr></table></td></tr></table></td></tr></table></td></tr></table></td></tr></table> | | | | | | | | | | | | | | | | | | | | <table border="1" style="width: 100%; border-collapse: collapse; text-align: center;"> <tr> <td style="width: 10%;"></td> <td style="width: 10%;"></td> <td style="width: 10%;"></td> <td style="width: 10%;"></td> <td style="width: 10%;"></td> <td style="width: 10%;"></td> <td style="width: 10%;"></td> <td style="width: 10%;"></td> <td style="width: 10%;"></td> <td style="width: 10%;"></td> </tr> <tr> <td></td> <td></td> <td colspan="8" style="text-align: center;"> <table border="1" style="width: 100%; border-collapse: collapse; text-align: center;"> <tr> <td style="width: 10%;"></td> <td style="width: 10%;"></td> <td style="width: 10%;"></td> <td style="width: 10%;"></td> <td style="width: 10%;"></td> <td style="width: 10%;"></td> <td style="width: 10%;"></td> <td style="width: 10%;"></td> <td style="width: 10%;"></td> <td style="width: 10%;"></td> </tr> <tr> <td></td> <td></td> <td colspan="8" style="text-align: center;"> <table border="1" style="width: 100%; border-collapse: collapse; text-align: center;"> <tr> <td style="width: 10%;"></td> <td style="width: 10%;"></td> <td style="width: 10%;"></td> <td style="width: 10%;"></td> <td style="width: 10%;"></td> <td style="width: 10%;"></td> <td style="width: 10%;"></td> <td style="width: 10%;"></td> <td style="width: 10%;"></td> <td style="width: 10%;"></td> </tr> <tr> <td></td> <td></td> <td colspan="8" style="text-align: center;"> <table border="1" style="width: 100%; border-collapse: collapse; text-align: center;"> <tr> <td style="width: 10%;"></td> <td style="width: 10%;"></td> <td style="width: 10%;"></td> <td style="width: 10%;"></td> <td style="width: 10%;"></td> <td style="width: 10%;"></td> <td style="width: 10%;"></td> <td style="width: 10%;"></td> <td style="width: 10%;"></td> <td style="width: 10%;"></td> </tr> <tr> <td></td> <td></td> <td colspan="8"
style="text-align: center;"> <table border="1" style="width: 100%; border-collapse: collapse; text-align: center;"> <tr> <td style="width: 10%;"></td> <td style="width: 10%;"></td> <td style="width: 10%;"></td> <td style="width: 10%;"></td> <td style="width: 10%;"></td> <td style="width: 10%;"></td> <td style="width: 10%;"></td> <td style="width: 10%;"></td> <td style="width: 10%;"></td> <td style="width: 10%;"></td> </tr> <tr> <td></td> <td></td> <td colspan="8" style="text-align: center;"> <table border="1" style="width: 100%; border-collapse: collapse; text-align: center;"> <tr> <td style="width: 10%;"></td> <td style="width: 10%;"></td> <td style="width: 10%;"></td> <td style="width: 10%;"></td> <td style="width: 10%;"></td> <td style="width: 10%;"></td> <td style="width: 10%;"></td> <td style="width: 10%;"></td> <td style="width: 10%;"></td> <td style="width: 10%;"></td> </tr> <tr> <td></td> <td></td> <td colspan="8" style="text-align: center;"> <table border="1" style="width: 100%; border-collapse: collapse; text-align: center;"> <tr> <td style="width: 10%;"></td> <td style="width: 10%;"></td> <td style="width: 10%;"></td> <td style="width: 10%;"></td> <td style="width: 10%;"></td> <td style="width: 10%;"></td> <td style="width: 10%;"></td> <td style="width: 10%;"></td> <td style="width: 10%;"></td> <td style="width: 10%;"></td> </tr> <tr> <td></td> <td></td> <td colspan="8" style="text-align: center;"> <table border="1" style="width: 100%; border-collapse: collapse; text-align: center;"> <tr> <td style="width: 10%;"></td> <td style="width: 10%;"></td> <td style="width: 10%;"></td> <td style="width: 10%;"></td> <td style="width: 10%;"></td> <td style="width: 10%;"></td> <td style="width: 10%;"></td> <td style="width: 10%;"></td> <td style="width: 10%;"></td> <td style="width: 10%;"></td> </tr> <tr> <td></td> <td></td> <td colspan="8" style="text-align: center;"> <table border="1" style="width: 100%; border-collapse: collapse; text-align: center;"> <tr> <td style="width: 10%;"></td> <td style="width: 10%;"></td> <td style="width: 10%;"></td> <td style="width: 10%;"></td> <td style="width: 10%;"></td> <td style="width: 10%;"></td> <td style="width: 10%;"></td> <td style="width: 10%;"></td> <td style="width: 10%;"></td> <td style="width: 10%;"></td> </tr> <tr> <td></td> <td></td> <td colspan="8" style="text-align: center;"> <table border="1" style="width: 100%; border-collapse: collapse; text-align: center;"> <tr> <td style="width: 10%;"></td> <td style="width: 10%;"></td> <td style="width: 10%;"></td> <td style="width: 10%;"></td> <td style="width: 10%;"></td> <td style="width: 10%;"></td> <td style="width: 10%;"></td> <td style="width: 10%;"></td> <td style="width: 10%;"></td> <td style="width: 10%;"></td> </tr> <tr> <td></td> <td></td> <td colspan="8" style="text-align: center;"> <table border="1" style="width: 100%; border-collapse: collapse; text-align: center;"> <tr> <td style="width: 10%;"></td> <td style="width: 10%;"></td> <td style="width: 10%;"></td> <td style="width: 10%;"></td> <td style="width: 10%;"></td> <td style="width: 10%;"></td> <td style="width: 10%;"></td> <td style="width: 10%;"></td> <td style="width: 10%;"></td> <td style="width: 10%;"></td> </tr> <tr> <td></td> <td></td> <td colspan="8" style="text-align: center;"> <table border="1" style="width: 100%; border-collapse: collapse; text-align: center;"> <tr> <td style="width: 10%;"></td> <td style="width: 10%;"></td> <td style="width: 10%;"></td> <td style="width: 10%;"></td> <td style="width: 10%;"></td> <td style="width: 10%;"></td> <td style="width: 10%;"></td> <td style="width: 10%;"></td> <td style="width: 10%;"></td> <td style="width: 10%;"></td> </tr> <tr> <td></td> <td></td> <td colspan="8" style="text-align: center;"> <table border="1" style="width: 100%; border-collapse: collapse; text-align: center;"> <tr> <td style="width: 10%;"></td> <td style="width: 10%;"></td> <td style="width: 10%;"></td> <td style="width: 10%;"></td> <td style="width: 10%;"></td> <td style="width: 10%;"></td> <td style="width: 10%;"></td> <td style="width: 10%;"></td> <td style="width: 10%;"></td> <td style="width: 10%;"></td> </tr> <tr> <td></td> <td></td> <td colspan="8" style="text-align: center;"> <table border="1" style="width: 100%; border-collapse: collapse; text-align: center;"> <tr> <td style="width: 10%;"></td> <td style="width: 10%;"></td> <td style="width: 10%;"></td> <td style="width: 10%;"></td> <td style="width: 10%;"></td> <td style="width: 10%;"></td> <td style="width: 10%;"></td> <td style="width: 10%;"></td> <td style="width: 10%;"></td> <td style="width: 10%;"></td> </tr> <tr> <td></td> <td></td> <td colspan="8" style="text-align: center;"> <table border="1" style="width: 100%; border-collapse: collapse; text-align: center;"> <tr> <td style="width: 10%;"></td> <td style="width: 10%;"></td> <td style="width: 10%;"></td> <td style="width: 10%;"></td> <td style="width: 10%;"></td> <td style="width: 10%;"></td> <td style="width: 10%;"></td> <td style="width: 10%;"></td> <td style="width: 10%;"></td> <td style="width: 10%;"></td> </tr> <tr> <td></td> <td></td> <td colspan="8" style="text-align: center;"> <table border="1" style="width: 100%; border-collapse: collapse; text-align: center;"> <tr> <td style="width: 10%;"></td> <td style="width: 10%;"></td> <td style="width: 10%;"></td> <td style="width: 10%;"></td> <td style="width: 10%;"></td> <td style="width: 10%;"></td> <td style="width: 10%;"></td> <td style="width: 10%;"></td> <td style="width: 10%;"></td> <td style="width: 10%;"></td> </tr> <tr> <td></td> <td></td> <td colspan="8" style="text-align: center;"> <table border="1" style="width: 100%; border-collapse: collapse; text-align: center;"> <tr> <td style="width: 10%;"></td> <td style="width: 10%;"></td> <td style="width: 10%;"></td> <td style="width: 10%;"></td> <td style="width: 10%;"></td> <td style="width: 10%;"></td> <td style="width: 10%;"></td> <td style="width: 10%;"></td> <td style="width: 10%;"></td> <td style="width: 10%;"></td> </tr> <tr> <td></td> <td></td> <td colspan="8" style="text-align: center;"> <table border="1" style="width: 100%; border-collapse: collapse; text-align: center;"> <tr> <td style="width: 10%;"></td> <td style="width: 10%;"></td> <td style="width: 10%;"></td> <td style="width: 10%;"></td> <td style="width: 10%;"></td> <td style="width: 10%;"></td> <td style="width: 10%;"></td> <td style="width: 10%;"></td> <td style="width: 10%;"></td> <td style="width: 10%;"></td> </tr> <tr> <td></td> <td></td> <td colspan="8" style="text-align: center;"> <table border="1" style="width: 100%; border-collapse: collapse; text-align: center;"> <tr> <td style="width: 10%;"></td> <td style="width: 10%;"></td> <td style="width: 10%;"></td> <td style="width: 10%;"></td> <td style="width: 10%;"></td> <td style="width: 10%;"></td> <td style="width: 10%;"></td> <td style="width: 10%;"></td> <td style="width: 10%;"></td> <td style="width: 10%;"></td> </tr> <tr> <td></td> <td></td> <td colspan="8" style="text-align: center;"> <table border="1" style="width: 100%; border-collapse: collapse; text-align: center;"> <tr> <td style="width: 10%;"></td> <td style="width: 10%;"></td> <td style="width: 10%;"></td> <td style="width: 10%;"></td> <td style="width: 10%;"></td> <td style="width: 10%;"></td> <td style="width: 10%;"></td> <td style="width: 10%;"></td> <td style="width: 10%;"></td> <td style="width: 10%;"></td> </tr> <tr> <td></td> <td></td> <td colspan="8" style="text-align: center;"> <table border="1" style="width: 100%; border-collapse: collapse; text-align: center;"> <tr> <td style="width: 10%;"></td> <td style="width: 10%;"></td> <td style="width: 10%;"></td> <td style="width: 10%;"></td> <td style="width: 10%;"></td> <td style="width: 10%;"></td> <td style="width: 10%;"></td> <td style="width: 10%;"></td> <td style="width: 10%;"></td> <td style="width: 10%;"></td> </tr> <tr> <td></td> <td></td> <td colspan="8" style="text-align: center;"> <table border="1" style="width: 100%; border-collapse: collapse; text-align: center;"> <tr> <td style="width: 10%;"></td> <td style="width: 10%;"></td> <td style="width: 10%;"></td> <td style="width: 10%;"></td> <td style="width: 10%;"></td> <td style="width: 10%;"></td> <td style="width: 10%;"></td> <td style="width: 10%;"></td> <td style="width: 10%;"></td> <td style="width: 10%;"></td> </tr> <tr> <td></td> <td></td> <td colspan="8" style="text-align: center;"> <table border="1" style="width: 100%; border-collapse: collapse; text-align: center;"> <tr> <td style="width: 10%;"></td> <td style="width: 10%;"></td> <td style="width: 10%;"></td> <td style="width: 10%;"></td> <td style="width: 10%;"></td> <td style="width: 10%;"></td> <td style="width: 10%;"></td> <td style="width: 10%;"></td> <td style="width: 10%;"></td> <td style="width: 10%;"></td> </tr> <tr> <td></td> <td></td> <td colspan="8" style="text-align: center;"> <table border="1" style="width: 100%; border-collapse: collapse; text-align: center;"> <tr> <td style="width: 10%;"></td> <td style="width: 10%;"></td> <td style="width: 10%;"></td> <td style="width: 10%;"></td> <td style="width: 10%;"></td> <td style="width: 10%;"></td> <td style="width: 10%;"></td> <td style="width: 10%;"></td> <td style="width: 10%;"></td> <td style="width: 10%;"></td> </tr> <tr> <td></td> <td></td> <td colspan="8" style="text-align: center;"> <table border="1" style="width: 100%; border-collapse: collapse; text-align: center;"> <tr> <td style="width: 10%;"></td> <td style="width: 10%;"></td> <td style="width: 10%;"></td> <td style="width: 10%;"></td> <td style="width: 10%;"></td> <td style="width: 10%;"></td> <td style="width: 10%;"></td> <td style="width: 10%;"></td> <td style="width: 10%;"></td> <td style="width: 10%;"></td> </tr> <tr> <td></td> <td></td> <td colspan="8" style="text-align: center;"> <table border="1" style="width: 100%; border-collapse: collapse; text-align: center;"> <tr> <td style="width: 10%;"></td> <td style="width:
10%;"></td> <td style="width: 10%;"></td> <td style="width: 10%;"></td> <td style="width: 10%;"></td> <td style="width: 10%;"></td> <td style="width: 10%;"></td> <td style="width: 10%;"></td> <td style="width: 10%;"></td> <td style="width: 10%;"></td> </tr> <tr> <td></td> <td></td> <td colspan="8" style="text-align: center;"> <table border="1" style="width: 100%; border-collapse: collapse; text-align: center;"> <tr> <td style="width: 10%;"></td> <td style="width: 10%;"></td> <td style="width: 10%;"></td> <td style="width: 10%;"></td> <td style="width: 10%;"></td> <td style="width: 10%;"></td> <td style="width: 10%;"></td> <td style="width: 10%;"></td> <td style="width: 10%;"></td> <td style="width: 10%;"></td> </tr> <tr> <td></td> <td></td> <td colspan="8" style="text-align: center;"> <table border="1" style="width: 100%; border-collapse: collapse; text-align: center;"> <tr> <td style="width: 10%;"></td> <td style="width: 10%;"></td> <td style="width: 10%;"></td> <td style="width: 10%;"></td> <td style="width: 10%;"></td> <td style="width: 10%;"></td> <td style="width: 10%;"></td> <td style="width: 10%;"></td> <td style="width: 10%;"></td> <td style="width: 10%;"></td> </tr> <tr> <td></td> <td></td> <td colspan="8" style="text-align: center;"> <table border="1" style="width: 100%; border-collapse: collapse; text-align: center;"> <tr> <td style="width: 10%;"></td> <td style="width: 10%;"></td> <td style="width: 10%;"></td> <td style="width: 10%;"></td> <td style="width: 10%;"></td> <td style="width: 10%;"></td> <td style="width: 10%;"></td> <td style="width: 10%;"></td> <td style="width: 10%;"></td> <td style="width: 10%;"></td> </tr> <tr> <td></td> <td></td> <td colspan="8" style="text-align: center;"> <table border="1" style="width: 100%; border-collapse: collapse; text-align: center;"> <tr> <td style="width: 10%;"></td> <td style="width: 10%;"></td> <td style="width: 10%;"></td> <td style="width: 10%;"></td> <td style="width: 10%;"></td> <td style="width: 10%;"></td> <td style="width: 10%;"></td> <td style="width: 10%;"></td> <td style="width: 10%;"></td> <td style="width: 10%;"></td> </tr> <tr> <td></td> <td></td> <td colspan="8" style="text-align: center;"> <table border="1" style="width: 100%; border-collapse: collapse; text-align: center;"> <tr> <td style="width: 10%;"></td> <td style="width: 10%;"></td> <td style="width: 10%;"></td> <td style="width: 10%;"></td> <td style="width: 10%;"></td> <td style="width: 10%;"></td> <td style="width: 10%;"></td> <td style="width: 10%;"></td> <td style="width: 10%;"></td> <td style="width: 10%;"></td> </tr> <tr> <td></td> <td></td> <td colspan="8" style="text-align: center;"> <table border="1" style="width: 100%; border-collapse: collapse; text-align: center;"> <tr> <td style="width: 10%;"></td> <td style="width: 10%;"></td> <td style="width: 10%;"></td> <td style="width: 10%;"></td> <td style="width: 10%;"></td> <td style="width: 10%;"></td> <td style="width: 10%;"></td> <td style="width: 10%;"></td> <td style="width: 10%;"></td> <td style="width: 10%;"></td> </tr> <tr> <td></td> <td></td> <td colspan="8" style="text-align: center;"> <table border="1" style="width: 100%; border-collapse: collapse; text-align: center;"> <tr> <td style="width: 10%;"></td> <td style="width: 10%;"></td> <td style="width: 10%;"></td> <td style="width: 10%;"></td> <td style="width: 10%;"></td> <td style="width: 10%;"></td> <td style="width: 10%;"></td> <td style="width: 10%;"></td> <td style="width: 10%;"></td> <td style="width: 10%;"></td> </tr> <tr> <td></td> <td></td> <td colspan="8" style="text-align: center;"> <table border="1" style="width: 100%; border-collapse: collapse; text-align: center;"> <tr> <td style="width: 10%;"></td> <td style="width: 10%;"></td> <td style="width: 10%;"></td> <td style="width: 10%;"></td> <td style="width: 10%;"></td> <td style="width: 10%;"></td> <td style="width: 10%;"></td> <td style="width: 10%;"></td> <td style="width: 10%;"></td> <td style="width: 10%;"></td> </tr> <tr> <td></td> <td></td> <td colspan="8" style="text-align: center;"> <table border="1" style="width: 100%; border-collapse: collapse; text-align: center;"> <tr> <td style="width: 10%;"></td> <td style="width: 10%;"></td> <td style="width: 10%;"></td> <td style="width: 10%;"></td> <td style="width: 10%;"></td> <td style="width: 10%;"></td> <td style="width: 10%;"></td> <td style="width: 10%;"></td> <td style="width: 10%;"></td> <td style="width: 10%;"></td> </tr> <tr> <td></td> <td></td> <td colspan="8" style="text-align: center;"> <table border="1" style="width: 100%; border-collapse: collapse; text-align: center;"> <tr> <td style="width: 10%;"></td> <td style="width: 10%;"></td> <td style="width: 10%;"></td> <td style="width: 10%;"></td> <td style="width: 10%;"></td> <td style="width: 10%;"></td> <td style="width: 10%;"></td> <td style="width: 10%;"></td> <td style="width: 10%;"></td> <td style="width: 10%;"></td> </tr> <tr> <td></td> <td></td> <td colspan="8" style="text-align: center;"> <table border="1" style="width: 100%; border-collapse: collapse; text-align: center;"> <tr> <td style="width: 10%;"></td> <td style="width: 10%;"></td> <td style="width: 10%;"></td> <td style="width: 10%;"></td> <td style="width: 10%;"></td> <td style="width: 10%;"></td> <td style="width: 10%;"></td> <td style="width: 10%;"></td> <td style="width: 10%;"></td> <td style="width: 10%;"></td> </tr> <tr> <td></td> <td></td> <td colspan="8" style="text-align: center;"> <table border="1" style="width: 100%; border-collapse: collapse; text-align: center;"> <tr> <td style="width: 10%;"></td> <td style="width: 10%;"></td> <td style="width: 10%;"></td> <td style="width: 10%;"></td> <td style="width: 10%;"></td> <td style="width: 10%;"></td> <td style="width: 10%;"></td> <td style="width: 10%;"></td> <td style="width: 10%;"></td> <td style="width: 10%;"></td> </tr> <tr> <td></td> <td></td> <td colspan="8" style="text-align: center;"> <table border="1" style="width: 100%; border-collapse: collapse; text-align: center;"> <tr> <td style="width: 10%;"></td> <td style="width: 10%;"></td> <td style="width: 10%;"></td> <td style="width: 10%;"></td> <td style="width: 10%;"></td> <td style="width: 10%;"></td> <td style="width: 10%;"></td> <td style="width: 10%;"></td> <td style="width: 10%;"></td> <td style="width: 10%;"></td> </tr> <tr> <td></td> <td></td> <td colspan="8" style="text-align: center;"> <table border="1" style="width: 100%; border-collapse: collapse; text-align: center;"> <tr> <td style="width: 10%;"></td> <td style="width: 10%;"></td> <td style="width: 10%;"></td> <td style="width: 10%;"></td> <td style="width: 10%;"></td> <td style="width: 10%;"></td> <td style="width: 10%;"></td> <td style="width: 10%;"></td> <td style="width: 10%;"></td> <td style="width: 10%;"></td> </tr> <tr> <td></td> <td></td> <td colspan="8" style="text-align: center;"> <table border="1" style="width: 100%; border-collapse: collapse; text-align: center;"> <tr> <td style="width: 10%;"></td> <td style="width: 10%;"></td> <td style="width: 10%;"></td> <td style="width: 10%;"></td> <td style="width: 10%;"></td> <td style="width: 10%;"></td> <td style="width: 10%;"></td> <td style="width: 10%;"></td> <td style="width: 10%;"></td> <td style="width: 10%;"></td> </tr> <tr> <td></td> <td></td> <td colspan="8" style="text-align: center;"> <table border="1" style="width: 100%; border-collapse: collapse; text-align: center;"> <tr> <td style="width: 10%;"></td> <td style="width: 10%;"></td> <td style="width: 10%;"></td> <td style="width: 10%;"></td> <td style="width: 10%;"></td> <td style="width: 10%;"></td> <td style="width: 10%;"></td> <td style="width: 10%;"></td> <td style="width: 10%;"></td> <td style="width: 10%;"></td> </tr> <tr> <td></td> <td></td> <td colspan="8" style="text-align: center;"> <table border="1" style="width: 100%; border-collapse: collapse; text-align: center;"> <tr> <td style="width: 10%;"></td> <td style="width: 10%;"></td> <td style="width: 10%;"></td> <td style="width: 10%;"></td> <td style="width: 10%;"></td> <td style="width: 10%;"></td> <td style="width: 10%;"></td> <td style="width: 10%;"></td> <td style="width: 10%;"></td> <td style="width: 10%;"></td> </tr> <tr> <td></td> <td></td> <td colspan="8" style="text-align: center;"> <table border="1" style="width: 100%; border-collapse: collapse; text-align: center;"> <tr> <td style="width: 10%;"></td> <td style="width: 10%;"></td> <td style="width: 10%;"></td> <td style="width: 10%;"></td> <td style="width: 10%;"></td> <td style="width: 10%;"></td> <td style="width: 10%;"></td> <td style="width: 10%;"></td> <td style="width: 10%;"></td> <td style="width: 10%;"></td> </tr> <tr> <td></td> <td></td> <td colspan="8" style="text-align: center;"> <table border="1" style="width: 100%; border-collapse: collapse; text-align: center;"> <tr> <td style="width: 10%;"></td> <td style="width: 10%;"></td> <td style="width: 10%;"></td> <td style="width: 10%;"></td> <td style="width: 10%;"></td> <td style="width: 10%;"></td> <td style="width: 10%;"></td> <td style="width: 10%;"></td> <td style="width: 10%;"></td> <td style="width: 10%;"></td> </tr> <tr> <td></td> <td></td> <td colspan="8" style="text-align: center;"> <table border="1" style="width: 100%; border-collapse: collapse; text-align: center;"> <tr>
</tr></table></td></tr></table></td></tr></table></td></tr></table></td></tr></table></td></tr></table></td></tr></table></td></tr></table></td></tr></table></td></tr></table></td></tr></table></td></tr></table></td></tr></table></td></tr></table></td></tr></table></td></tr></table></td></tr></table></td></tr></table></td></tr></table></td></tr></table></td></tr></table></td></tr></table></td></tr></table></td></tr></table></td></tr></table></td></tr></table></td></tr></table></td></tr></table></td></tr></table></td></tr></table></td></tr></table></td></tr></table></td></tr></table></td></tr></table></td></tr></table></td></tr></table></td></tr></table></td></tr></table></td></tr></table></td></tr></table></td></tr></table></td></tr></table></td></tr></table></td></tr></table></td></tr></table></td></tr></table> | | | | | | | | | | | | | | | | | | | | <table border="1" style="width: 100%; border-collapse: collapse; text-align: center;"> <tr> <td style="width: 10%;"></td> <td style="width: 10%;"></td> <td style="width: 10%;"></td> <td style="width: 10%;"></td> <td style="width: 10%;"></td> <td style="width: 10%;"></td> <td style="width: 10%;"></td> <td style="width: 10%;"></td> <td style="width: 10%;"></td> <td style="width: 10%;"></td> </tr> <tr> <td></td> <td></td> <td colspan="8" style="text-align: center;"> <table border="1" style="width: 100%; border-collapse: collapse; text-align: center;"> <tr> <td style="width: 10%;"></td> <td style="width: 10%;"></td> <td style="width: 10%;"></td> <td style="width: 10%;"></td> <td style="width: 10%;"></td> <td style="width: 10%;"></td> <td style="width: 10%;"></td> <td style="width: 10%;"></td> <td style="width: 10%;"></td> <td style="width: 10%;"></td> </tr> <tr> <td></td> <td></td> <td colspan="8" style="text-align: center;"> <table border="1" style="width: 100%; border-collapse: collapse; text-align: center;"> <tr> <td style="width: 10%;"></td> <td style="width: 10%;"></td> <td style="width: 10%;"></td> <td style="width: 10%;"></td> <td style="width: 10%;"></td> <td style="width: 10%;"></td> <td style="width: 10%;"></td> <td style="width: 10%;"></td> <td style="width: 10%;"></td> <td style="width: 10%;"></td> </tr> <tr> <td></td> <td></td> <td colspan="8" style="text-align: center;"> <table border="1" style="width: 100%; border-collapse: collapse; text-align: center;"> <tr> <td style="width: 10%;"></td> <td style="width: 10%;"></td> <td style="width: 10%;"></td> <td style="width: 10%;"></td> <td style="width: 10%;"></td> <td style="width: 10%;"></td> <td style="width: 10%;"></td> <td style="width: 10%;"></td> <td style="width: 10%;"></td> <td style="width: 10%;"></td> </tr> <tr> <td></td> <td></td> <td colspan="8" style="text-align: center;"> <table border="1" style="width: 100%; border-collapse: collapse; text-align: center;"> <tr> <td style="width: 10%;"></td> <td style="width: 10%;"></td> <td style="width: 10%;"></td> <td style="width: 10%;"></td> <td style="width: 10%;"></td> <td style="width: 10%;"></td> <td style="width: 10%;"></td> <td style="width: 10%;"></td> <td style="width: 10%;"></td> <td style="width: 10%;"></td> </tr> <tr> <td></td> <td></td> <td colspan="8" style="text-align: center;"> <table border="1" style="width: 100%; border-collapse: collapse; text-align: center;"> <tr> <td style="width: 10%;"></td> <td style="width: 10%;"></td> <td style="width: 10%;"></td> <td style="width: 10%;"></td> <td style="width: 10%;"></td> <td style="width: 10%;"></td> <td style="width: 10%;"></td> <td style="width: 10%;"></td> <td style="width: 10%;"></td> <td style="width: 10%;"></td> </tr> <tr> <td></td> <td></td> <td colspan="8" style="text-align: center;"> <table border="1" style="width: 100%; border-collapse: collapse; text-align: center;"> <tr> <td style="width: 10%;"></td> <td style="width: 10%;"></td> <td style="width: 10%;"></td> <td style="width: 10%;"></td> <td style="width: 10%;"></td> <td style="width: 10%;"></td> <td style="width: 10%;"></td> <td style="width: 10%;"></td> <td style="width: 10%;"></td> <td style="width: 10%;"></td> </tr> <tr> <td></td> <td></td> <td colspan="8" style="text-align: center;"> <table border="1" style="width: 100%; border-collapse: collapse; text-align: center;"> <tr> <td style="width: 10%;"></td> <td style="width: 10%;"></td> <td style="width: 10%;"></td> <td style="width: 10%;"></td> <td style="width: 10%;"></td> <td style="width: 10%;"></td> <td style="width: 10%;"></td> <td style="width: 10%;"></td> <td style="width: 10%;"></td> <td style="width: 10%;"></td> </tr> <tr> <td></td> <td></td> <td colspan="8" style="text-align: center;"> <table border="1" style="width: 100%; border-collapse: collapse; text-align: center;"> <tr> <td style="width: 10%;"></td> <td style="width: 10%;"></td> <td style="width: 10%;"></td> <td style="width: 10%;"></td> <td style="width: 10%;"></td> <td style="width: 10%;"></td> <td style="width: 10%;"></td> <td style="width: 10%;"></td> <td style="width: 10%;"></td> <td style="width: 10%;"></td> </tr> <tr> <td></td> <td></td> <td colspan="8" style="text-align: center;"> <table border="1" style="width: 100%; border-collapse: collapse; text-align: center;"> <tr> <td style="width: 10%;"></td> <td style="width: 10%;"></td> <td style="width: 10%;"></td> <td style="width: 10%;"></td> <td style="width: 10%;"></td> <td style="width: 10%;"></td> <td style="width: 10%;"></td> <td style="width: 10%;"></td> <td style="width: 10%;"></td> <td style="width: 10%;"></td> </tr> <tr> <td></td> <td></td> <td colspan="8" style="text-align: center;"> <table border="1" style="width: 100%; border-collapse: collapse; text-align: center;"> <tr> <td style="width: 10%;"></td> <td style="width: 10%;"></td> <td style="width: 10%;"></td> <td style="width: 10%;"></td> <td style="width: 10%;"></td> <td style="width: 10%;"></td> <td style="width: 10%;"></td> <td style="width: 10%;"></td> <td style="width: 10%;"></td> <td style="width: 10%;"></td> </tr> <tr> <td></td> <td></td> <td colspan="8" style="text-align: center;"> <table border="1" style="width: 100%; border-collapse: collapse; text-align:
center;"> <tr> <td style="width: 10%;"></td> <td style="width: 10%;"></td> <td style="width: 10%;"></td> <td style="width: 10%;"></td> <td style="width: 10%;"></td> <td style="width: 10%;"></td> <td style="width: 10%;"></td> <td style="width: 10%;"></td> <td style="width: 10%;"></td> <td style="width: 10%;"></td> </tr> <tr> <td></td> <td></td> <td colspan="8" style="text-align: center;"> <table border="1" style="width: 100%; border-collapse: collapse; text-align: center;"> <tr> <td style="width: 10%;"></td> <td style="width: 10%;"></td> <td style="width: 10%;"></td> <td style="width: 10%;"></td> <td style="width: 10%;"></td> <td style="width: 10%;"></td> <td style="width: 10%;"></td> <td style="width: 10%;"></td> <td style="width: 10%;"></td> <td style="width: 10%;"></td> </tr> <tr> <td></td> <td></td> <td colspan="8" style="text-align: center;"> <table border="1" style="width: 100%; border-collapse: collapse; text-align: center;"> <tr> <td style="width: 10%;"></td> <td style="width: 10%;"></td> <td style="width: 10%;"></td> <td style="width: 10%;"></td> <td style="width: 10%;"></td> <td style="width: 10%;"></td> <td style="width: 10%;"></td> <td style="width: 10%;"></td> <td style="width: 10%;"></td> <td style="width: 10%;"></td> </tr> <tr> <td></td> <td></td> <td colspan="8" style="text-align: center;"> <table border="1" style="width: 100%; border-collapse: collapse; text-align: center;"> <tr> <td style="width: 10%;"></td> <td style="width: 10%;"></td> <td style="width: 10%;"></td> <td style="width: 10%;"></td> <td style="width: 10%;"></td> <td style="width: 10%;"></td> <td style="width: 10%;"></td> <td style="width: 10%;"></td> <td style="width: 10%;"></td> <td style="width: 10%;"></td> </tr> <tr> <td></td> <td></td> <td colspan="8" style="text-align: center;"> <table border="1" style="width: 100%; border-collapse: collapse; text-align: center;"> <tr> <td style="width: 10%;"></td> <td style="width: 10%;"></td> <td style="width: 10%;"></td> <td style="width: 10%;"></td> <td style="width: 10%;"></td> <td style="width: 10%;"></td> <td style="width: 10%;"></td> <td style="width: 10%;"></td> <td style="width: 10%;"></td> <td style="width: 10%;"></td> </tr> <tr> <td></td> <td></td> <td colspan="8" style="text-align: center;"> <table border="1" style="width: 100%; border-collapse: collapse; text-align: center;"> <tr> <td style="width: 10%;"></td> <td style="width: 10%;"></td> <td style="width: 10%;"></td> <td style="width: 10%;"></td> <td style="width: 10%;"></td> <td style="width: 10%;"></td> <td style="width: 10%;"></td> <td style="width: 10%;"></td> <td style="width: 10%;"></td> <td style="width: 10%;"></td> </tr> <tr> <td></td> <td></td> <td colspan="8" style="text-align: center;"> <table border="1" style="width: 100%; border-collapse: collapse; text-align: center;"> <tr> <td style="width: 10%;"></td> <td style="width: 10%;"></td> <td style="width: 10%;"></td> <td style="width: 10%;"></td> <td style="width: 10%;"></td> <td style="width: 10%;"></td> <td style="width: 10%;"></td> <td style="width: 10%;"></td> <td style="width: 10%;"></td> <td style="width: 10%;"></td> </tr> <tr> <td></td> <td></td> <td colspan="8" style="text-align: center;"> <table border="1" style="width: 100%; border-collapse: collapse; text-align: center;"> <tr> <td style="width: 10%;"></td> <td style="width: 10%;"></td> <td style="width: 10%;"></td> <td style="width: 10%;"></td> <td style="width: 10%;"></td> <td style="width: 10%;"></td> <td style="width: 10%;"></td> <td style="width: 10%;"></td> <td style="width: 10%;"></td> <td style="width: 10%;"></td> </tr> <tr> <td></td> <td></td> <td colspan="8" style="text-align: center;"> <table border="1" style="width: 100%; border-collapse: collapse; text-align: center;"> <tr> <td style="width: 10%;"></td> <td style="width: 10%;"></td> <td style="width: 10%;"></td> <td style="width: 10%;"></td> <td style="width: 10%;"></td> <td style="width: 10%;"></td> <td style="width: 10%;"></td> <td style="width: 10%;"></td> <td style="width: 10%;"></td> <td style="width: 10%;"></td> </tr> <tr> <td></td> <td></td> <td colspan="8" style="text-align: center;"> <table border="1" style="width: 100%; border-collapse: collapse; text-align: center;"> <tr> <td style="width: 10%;"></td> <td style="width: 10%;"></td> <td style="width: 10%;"></td> <td style="width: 10%;"></td> <td style="width: 10%;"></td> <td style="width: 10%;"></td> <td style="width: 10%;"></td> <td style="width: 10%;"></td> <td style="width: 10%;"></td> <td style="width: 10%;"></td> </tr> <tr> <td></td> <td></td> <td colspan="8" style="text-align: center;"> <table border="1" style="width: 100%; border-collapse: collapse; text-align: center;"> <tr> <td style="width: 10%;"></td> <td style="width: 10%;"></td> <td style="width: 10%;"></td> <td style="width: 10%;"></td> <td style="width: 10%;"></td> <td style="width: 10%;"></td> <td style="width: 10%;"></td> <td style="width: 10%;"></td> <td style="width: 10%;"></td> <td style="width: 10%;"></td> </tr> <tr> <td></td> <td></td> <td colspan="8" style="text-align: center;"> <table border="1" style="width: 100%; border-collapse: collapse; text-align: center;"> <tr> <td style="width: 10%;"></td> <td style="width: 10%;"></td> <td style="width: 10%;"></td> <td style="width: 10%;"></td> <td style="width: 10%;"></td> <td style="width: 10%;"></td> <td style="width: 10%;"></td> <td style="width: 10%;"></td> <td style="width: 10%;"></td> <td style="width: 10%;"></td> </tr> <tr> <td></td> <td></td> <td colspan="8" style="text-align: center;"> <table border="1" style="width: 100%; border-collapse: collapse; text-align: center;"> <tr> <td style="width: 10%;"></td> <td style="width: 10%;"></td> <td style="width: 10%;"></td> <td style="width: 10%;"></td> <td style="width: 10%;"></td> <td style="width: 10%;"></td> <td style="width: 10%;"></td> <td style="width: 10%;"></td> <td style="width: 10%;"></td> <td style="width: 10%;"></td> </tr> <tr> <td></td> <td></td> <td colspan="8" style="text-align: center;"> <table border="1" style="width: 100%; border-collapse: collapse; text-align: center;"> <tr> <td style="width: 10%;"></td> <td style="width: 10%;"></td> <td style="width: 10%;"></td> <td style="width: 10%;"></td> <td style="width: 10%;"></td> <td style="width: 10%;"></td> <td style="width: 10%;"></td> <td style="width: 10%;"></td> <td style="width: 10%;"></td> <td style="width: 10%;"></td> </tr> <tr> <td></td> <td></td> <td colspan="8" style="text-align: center;"> <table border="1" style="width: 100%; border-collapse: collapse; text-align: center;"> <tr> <td style="width: 10%;"></td> <td style="width: 10%;"></td> <td style="width: 10%;"></td> <td style="width: 10%;"></td> <td style="width: 10%;"></td> <td style="width: 10%;"></td> <td style="width: 10%;"></td> <td style="width: 10%;"></td> <td style="width: 10%;"></td> <td style="width: 10%;"></td> </tr> <tr> <td></td> <td></td> <td colspan="8" style="text-align: center;"> <table border="1" style="width: 100%; border-collapse: collapse; text-align: center;"> <tr> <td style="width: 10%;"></td> <td style="width: 10%;"></td> <td style="width: 10%;"></td> <td style="width: 10%;"></td> <td style="width: 10%;"></td> <td style="width: 10%;"></td> <td style="width: 10%;"></td> <td style="width: 10%;"></td> <td style="width: 10%;"></td> <td style="width: 10%;"></td> </tr> <tr> <td></td> <td></td> <td colspan="8" style="text-align: center;"> <table border="1" style="width: 100%; border-collapse: collapse; text-align: center;"> <tr> <td style="width: 10%;"></td> <td style="width: 10%;"></td> <td style="width: 10%;"></td> <td style="width: 10%;"></td> <td style="width: 10%;"></td> <td style="width: 10%;"></td> <td style="width: 10%;"></td> <td style="width: 10%;"></td> <td style="width: 10%;"></td> <td style="width: 10%;"></td> </tr> <tr> <td></td> <td></td> <td colspan="8" style="text-align: center;"> <table border="1" style="width: 100%; border-collapse: collapse; text-align: center;"> <tr> <td style="width: 10%;"></td> <td style="width: 10%;"></td> <td style="width: 10%;"></td> <td style="width: 10%;"></td> <td style="width: 10%;"></td> <td style="width: 10%;"></td> <td style="width: 10%;"></td> <td style="width: 10%;"></td> <td style="width: 10%;"></td> <td style="width: 10%;"></td> </tr> <tr> <td></td> <td></td> <td colspan="8" style="text-align: center;"> <table border="1" style="width: 100%; border-collapse: collapse; text-align: center;"> <tr> <td style="width: 10%;"></td> <td style="width: 10%;"></td> <td style="width: 10%;"></td> <td style="width: 10%;"></td> <td style="width: 10%;"></td> <td style="width: 10%;"></td> <td style="width: 10%;"></td> <td style="width: 10%;"></td> <td style="width: 10%;"></td> <td style="width: 10%;"></td> </tr> <tr> <td></td> <td></td> <td colspan="8" style="text-align: center;"> <table border="1" style="width: 100%; border-collapse: collapse; text-align: center;"> <tr> <td style="width: 10%;"></td> <td style="width: 10%;"></td> <td style="width: 10%;"></td> <td style="width: 10%;"></td> <td style="width: 10%;"></td> <td style="width: 10%;"></td> <td style="width: 10%;"></td> <td style="width: 10%;"></td> <td style="width: 10%;"></td> <td style="width: 10%;"></td> </tr> <tr> <td></td> <td></td> <td colspan="8" style="text-align: center;"> <table border="1" style="width: 100%; border-collapse: collapse; text-align: center;"> <tr> <td style="width: 10%;"></td> <td style="width: 10%;"></td> <td style="width: 10%;"></td> <td style="width: 10%;"></td> <td style="width: 10%;"></td> <td style="width: 10%;"></td> <td style="width: 10%;"></td> <td style="width: 10%;"></td> <td style="width: 10%;"></td> <td style="width: 10%;"></td> </tr> <tr> <td></td> <td></td> <td colspan="8" style="text-align: center;"> <table border="1" style="width: 100%; border-collapse: collapse; text-align: center;"> <tr> <td style="width: 10%;"></td> <td style="width: 10%;"></td> <td style="width: 10%;"></td> <td style="width: 10%;"></td> <td style="width: 10%;"></td> <td
style="width: 10%;"></td> <td style="width: 10%;"></td> <td style="width: 10%;"></td> <td style="width: 10%;"></td> <td style="width: 10%;"></td> </tr> <tr> <td></td> <td></td> <td colspan="8" style="text-align: center;"> <table border="1" style="width: 100%; border-collapse: collapse; text-align: center;"> <tr> <td style="width: 10%;"></td> <td style="width: 10%;"></td> <td style="width: 10%;"></td> <td style="width: 10%;"></td> <td style="width: 10%;"></td> <td style="width: 10%;"></td> <td style="width: 10%;"></td> <td style="width: 10%;"></td> <td style="width: 10%;"></td> <td style="width: 10%;"></td> </tr> <tr> <td></td> <td></td> <td colspan="8" style="text-align: center;"> <table border="1" style="width: 100%; border-collapse: collapse; text-align: center;"> <tr> <td style="width: 10%;"></td> <td style="width: 10%;"></td> <td style="width: 10%;"></td> <td style="width: 10%;"></td> <td style="width: 10%;"></td> <td style="width: 10%;"></td> <td style="width: 10%;"></td> <td style="width: 10%;"></td> <td style="width: 10%;"></td> <td style="width: 10%;"></td> </tr> <tr> <td></td> <td></td> <td colspan="8" style="text-align: center;"> <table border="1" style="width: 100%; border-collapse: collapse; text-align: center;"> <tr> <td style="width: 10%;"></td> <td style="width: 10%;"></td> <td style="width: 10%;"></td> <td style="width: 10%;"></td> <td style="width: 10%;"></td> <td style="width: 10%;"></td> <td style="width: 10%;"></td> <td style="width: 10%;"></td> <td style="width: 10%;"></td> <td style="width: 10%;"></td> </tr> <tr> <td></td> <td></td> <td colspan="8" style="text-align: center;"> <table border="1" style="width: 100%; border-collapse: collapse; text-align: center;"> <tr> <td style="width: 10%;"></td> <td style="width: 10%;"></td> <td style="width: 10%;"></td> <td style="width: 10%;"></td> <td style="width: 10%;"></td> <td style="width: 10%;"></td> <td style="width: 10%;"></td> <td style="width: 10%;"></td> <td style="width: 10%;"></td> <td style="width: 10%;"></td> </tr> <tr> <td></td> <td></td> <td colspan="8" style="text-align: center;"> <table border="1" style="width: 100%; border-collapse: collapse; text-align: center;"> <tr> <td style="width: 10%;"></td> <td style="width: 10%;"></td> <td style="width: 10%;"></td> <td style="width: 10%;"></td> <td style="width: 10%;"></td> <td style="width: 10%;"></td> <td style="width: 10%;"></td> <td style="width: 10%;"></td> <td style="width: 10%;"></td> <td style="width: 10%;"></td> </tr> <tr> <td></td> <td></td> <td colspan="8" style="text-align: center;"> <table border="1" style="width: 100%; border-collapse: collapse; text-align: center;"> <tr> <td style="width: 10%;"></td> <td style="width: 10%;"></td> <td style="width: 10%;"></td> <td style="width: 10%;"></td> <td style="width: 10%;"></td> <td style="width: 10%;"></td> <td style="width: 10%;"></td> <td style="width: 10%;"></td> <td style="width: 10%;"></td> <td style="width: 10%;"></td> </tr> <tr> <td></td> <td></td> <td colspan="8" style="text-align: center;"> <table border="1" style="width: 100%; border-collapse: collapse; text-align: center;"> <tr> <td style="width: 10%;"></td> <td style="width: 10%;"></td> <td style="width: 10%;"></td> <td style="width: 10%;"></td> <td style="width: 10%;"></td> <td style="width: 10%;"></td> <td style="width: 10%;"></td> <td style="width: 10%;"></td> <td style="width: 10%;"></td> <td style="width: 10%;"></td> </tr> <tr> <td></td> <td></td> <td colspan="8" style="text-align: center;"> <table border="1" style="width: 100%; border-collapse: collapse; text-align: center;"> <tr> <td style="width: 10%;"></td> <td style="width: 10%;"></td> <td style="width: 10%;"></td> <td style="width: 10%;"></td> <td style="width: 10%;"></td> <td style="width: 10%;"></td> <td style="width: 10%;"></td> <td style="width: 10%;"></td> <td style="width: 10%;"></td> <td style="width: 10%;"></td> </tr> <tr> <td></td> <td></td> <td colspan="8" style="text-align: center;"> <table border="1" style="width: 100%; border-collapse: collapse; text-align: center;"> <tr> <td style="width: 10%;"></td> <td style="width: 10%;"></td> <td style="width: 10%;"></td> <td style="width: 10%;"></td> <td style="width: 10%;"></td> <td style="width: 10%;"></td> <td style="width: 10%;"></td> <td style="width: 10%;"></td> <td style="width: 10%;"></td> <td style="width: 10%;"></td> </tr> <tr> <td></td> <td></td> <td colspan="8" style="text-align: center;"> <table border="1" style="width: 100%; border-collapse: collapse; text-align: center;"> <tr> <td style="width: 10%;"></td> <td style="width: 10%;"></td> <td style="width: 10%;"></td> <td style="width: 10%;"></td> <td style="width: 10%;"></td> <td style="width: 10%;"></td> <td style="width: 10%;"></td> <td style="width: 10%;"></td> <td style="width: 10%;"></td> <td style="width: 10%;"></td> </tr> <tr> <td></td> <td></td> <td colspan="8" style="text-align: center;"> <table border="1" style="width: 100%; border-collapse: collapse; text-align: center;"> <tr> <td style="width: 10%;"></td> <td style="width: 10%;"></td> <td style="width: 10%;"></td> <td style="width: 10%;"></td> <td style="width: 10%;"></td> <td style="width: 10%;"></td> <td style="width: 10%;"></td> <td style="width: 10%;"></td> <td style="width: 10%;"></td> <td style="width: 10%;"></td> </tr> <tr> <td></td> <td></td> <td colspan="8" style="text-align: center;"> <table border="1" style="width: 100%; border-collapse: collapse; text-align: center;"> <tr> </tr></table></td></tr></table></td></tr></table></td></tr></table></td></tr></table></td></tr></table></td></tr></table></td></tr></table></td></tr></table></td></tr></table></td></tr></table></td></tr></table></td></tr></table></td></tr></table></td></tr></table></td></tr></table></td></tr></table></td></tr></table></td></tr></table></td></tr></table></td></tr></table></td></tr></table></td></tr></table></td></tr></table></td></tr></table></td></tr></table></td></tr></table></td></tr></table></td></tr></table></td></tr></table></td></tr></table></td></tr></table></td></tr></table></td></tr></table></td></tr></table></td></tr></table></td></tr></table></td></tr></table></td></tr></table></td></tr></table></td></tr></table></td></tr></table></td></tr></table></td></tr></table></td></tr></table>
 | | | | | | | | | | | | | | | | | | | | <table border="1" style="width: 100%; border-collapse: collapse; text-align: center;"> <tr> <td style="width: 10%;"></td> <td style="width: 10%;"></td> <td style="width: 10%;"></td> <td style="width: 10%;"></td> <td style="width: 10%;"></td> <td style="width: 10%;"></td> <td style="width: 10%;"></td> <td style="width: 10%;"></td> <td style="width: 10%;"></td> <td style="width: 10%;"></td> </tr> <tr> <td></td> <td></td> <td colspan="8" style="text-align: center;"> <table border="1" style="width: 100%; border-collapse: collapse; text-align: center;"> <tr> <td style="width: 10%;"></td> <td style="width: 10%;"></td> <td style="width: 10%;"></td> <td style="width: 10%;"></td> <td style="width: 10%;"></td> <td style="width: 10%;"></td> <td style="width: 10%;"></td> <td style="width: 10%;"></td> <td style="width: 10%;"></td> <td style="width: 10%;"></td> </tr> <tr> <td></td> <td></td> <td colspan="8" style="text-align: center;"> <table border="1" style="width: 100%; border-collapse: collapse; text-align: center;"> <tr> <td style="width: 10%;"></td> <td style="width: 10%;"></td> <td style="width: 10%;"></td> <td style="width: 10%;"></td> <td style="width: 10%;"></td> <td style="width: 10%;"></td> <td style="width: 10%;"></td> <td style="width: 10%;"></td> <td style="width: 10%;"></td> <td style="width: 10%;"></td> </tr> <tr> <td></td> <td></td> <td colspan="8" style="text-align: center;"> <table border="1" style="width: 100%; border-collapse: collapse; text-align: center;"> <tr> <td style="width: 10%;"></td> <td style="width: 10%;"></td> <td style="width: 10%;"></td> <td style="width: 10%;"></td> <td style="width: 10%;"></td> <td style="width: 10%;"></td> <td style="width: 10%;"></td> <td style="width: 10%;"></td> <td style="width: 10%;"></td> <td style="width: 10%;"></td> </tr> <tr> <td></td> <td></td> <td colspan="8" style="text-align: center;"> <table border="1" style="width: 100%; border-collapse: collapse; text-align: center;"> <tr> <td style="width: 10%;"></td> <td style="width: 10%;"></td> <td style="width: 10%;"></td> <td style="width: 10%;"></td> <td style="width: 10%;"></td> <td style="width: 10%;"></td> <td style="width: 10%;"></td> <td style="width: 10%;"></td> <td style="width: 10%;"></td> <td style="width: 10%;"></td> </tr> <tr> <td></td> <td></td> <td colspan="8" style="text-align: center;"> <table border="1" style="width: 100%; border-collapse: collapse; text-align: center;"> <tr> <td style="width: 10%;"></td> <td style="width: 10%;"></td> <td style="width: 10%;"></td> <td style="width: 10%;"></td> <td style="width: 10%;"></td> <td style="width: 10%;"></td> <td style="width: 10%;"></td> <td style="width: 10%;"></td> <td style="width: 10%;"></td> <td style="width: 10%;"></td> </tr> <tr> <td></td> <td></td> <td colspan="8" style="text-align: center;"> <table border="1" style="width: 100%; border-collapse: collapse; text-align: center;"> <tr> <td style="width: 10%;"></td> <td style="width: 10%;"></td> <td style="width: 10%;"></td> <td style="width: 10%;"></td> <td style="width: 10%;"></td> <td style="width: 10%;"></td> <td style="width: 10%;"></td> <td style="width: 10%;"></td> <td style="width: 10%;"></td> <td style="width: 10%;"></td> </tr> <tr> <td></td> <td></td> <td colspan="8" style="text-align: center;"> <table border="1" style="width: 100%; border-collapse: collapse; text-align: center;"> <tr> <td style="width: 10%;"></td> <td style="width: 10%;"></td> <td style="width: 10%;"></td> <td style="width: 10%;"></td> <td style="width: 10%;"></td> <td style="width: 10%;"></td> <td style="width: 10%;"></td> <td style="width: 10%;"></td> <td style="width: 10%;"></td> <td style="width: 10%;"></td> </tr> <tr> <td></td> <td></td> <td colspan="8" style="text-align: center;"> <table border="1" style="width: 100%; border-collapse: collapse; text-align: center;"> <tr> <td style="width: 10%;"></td> <td style="width: 10%;"></td> <td style="width: 10%;"></td> <td style="width: 10%;"></td> <td style="width: 10%;"></td> <td style="width: 10%;"></td> <td style="width: 10%;"></td> <td style="width: 10%;"></td> <td style="width: 10%;"></td> <td style="width: 10%;"></td> </tr> <tr> <td></td> <td></td> <td colspan="8" style="text-align: center;"> <table border="1" style="width: 100%; border-collapse: collapse; text-align: center;"> <tr> <td style="width: 10%;"></td> <td style="width: 10%;"></td> <td style="width: 10%;"></td> <td style="width: 10%;"></td> <td style="width: 10%;"></td> <td style="width: 10%;"></td> <td style="width: 10%;"></td> <td style="width: 10%;"></td> <td style="width: 10%;"></td> <td style="width: 10%;"></td> </tr> <tr> <td></td> <td></td> <td colspan="8" style="text-align: center;"> <table border="1" style="width: 100%; border-collapse: collapse; text-align: center;"> <tr> <td style="width: 10%;"></td> <td style="width: 10%;"></td> <td style="width: 10%;"></td> <td style="width: 10%;"></td> <td style="width: 10%;"></td> <td style="width: 10%;"></td> <td style="width: 10%;"></td> <td style="width: 10%;"></td> <td style="width: 10%;"></td> <td style="width: 10%;"></td> </tr> <tr> <td></td> <td></td> <td colspan="8" style="text-align: center;"> <table border="1" style="width: 100%; border-collapse: collapse; text-align: center;"> <tr> <td style="width: 10%;"></td> <td style="width: 10%;"></td> <td style="width: 10%;"></td> <td style="width: 10%;"></td> <td style="width: 10%;"></td> <td style="width: 10%;"></td> <td style="width: 10%;"></td> <td style="width: 10%;"></td> <td style="width: 10%;"></td> <td style="width: 10%;"></td> </tr> <tr> <td></td> <td></td> <td colspan="8" style="text-align: center;"> <table border="1" style="width: 100%; border-collapse: collapse; text-align: center;"> <tr> <td style="width: 10%;"></td> <td style="width: 10%;"></td> <td style="width: 10%;"></td> <td style="width: 10%;"></td> <td style="width: 10%;"></td> <td style="width: 10%;"></td> <td style="width: 10%;"></td> <td style="width: 10%;"></td> <td style="width: 10%;"></td> <td style="width: 10%;"></td> </tr> <tr> <td></td> <td></td> <td colspan="8" style="text-align: center;"> <table border="1" style="width: 100%; border-collapse: collapse; text-align: center;"> <tr> <td style="width: 10%;"></td> <td style="width: 10%;"></td> <td style="width: 10%;"></td> <td style="width: 10%;"></td> <td style="width: 10%;"></td> <td style="width: 10%;"></td> <td style="width: 10%;"></td> <td style="width: 10%;"></td> <td style="width: 10%;"></td> <td style="width: 10%;"></td> </tr> <tr> <td></td> <td></td> <td colspan="8" style="text-align: center;"> <table border="1" style="width: 100%; border-collapse: collapse; text-align: center;"> <tr> <td style="width: 10%;"></td> <td style="width: 10%;"></td> <td style="width: 10%;"></td> <td style="width: 10%;"></td> <td style="width: 10%;"></td> <td style="width: 10%;"></td> <td style="width: 10%;"></td> <td style="width: 10%;"></td> <td style="width: 10%;"></td> <td style="width: 10%;"></td> </tr> <tr> <td></td> <td></td> <td colspan="8" style="text-align: center;"> <table border="1" style="width: 100%; border-collapse: collapse; text-align: center;"> <tr> <td style="width: 10%;"></td> <td style="width: 10%;"></td> <td style="width: 10%;"></td> <td style="width: 10%;"></td> <td style="width: 10%;"></td> <td style="width: 10%;"></td> <td style="width: 10%;"></td> <td style="width: 10%;"></td> <td style="width: 10%;"></td> <td style="width: 10%;"></td> </tr> <tr> <td></td> <td></td> <td colspan="8" style="text-align: center;"> <table border="1" style="width: 100%; border-collapse: collapse; text-align: center;"> <tr> <td style="width: 10%;"></td> <td style="width: 10%;"></td> <td style="width: 10%;"></td> <td style="width: 10%;"></td> <td style="width: 10%;"></td> <td style="width: 10%;"></td> <td style="width: 10%;"></td> <td style="width: 10%;"></td> <td style="width: 10%;"></td> <td style="width: 10%;"></td> </tr> <tr> <td></td> <td></td> <td colspan="8" style="text-align: center;"> <table border="1" style="width: 100%; border-collapse: collapse; text-align: center;"> <tr> <td style="width: 10%;"></td> <td style="width: 10%;"></td> <td style="width: 10%;"></td> <td style="width: 10%;"></td> <td style="width: 10%;"></td> <td style="width: 10%;"></td> <td style="width: 10%;"></td> <td style="width: 10%;"></td> <td style="width: 10%;"></td> <td style="width: 10%;"></td> </tr> <tr> <td></td> <td></td> <td colspan="8" style="text-align: center;"> <table border="1" style="width: 100%; border-collapse: collapse; text-align: center;"> <tr> <td style="width: 10%;"></td> <td style="width: 10%;"></td> <td style="width: 10%;"></td> <td style="width: 10%;"></td> <td style="width: 10%;"></td> <td style="width: 10%;"></td> <td style="width: 10%;"></td> <td style="width: 10%;"></td> <td style="width: 10%;"></td> <td style="width: 10%;"></td> </tr> <tr> <td></td> <td></td> <td colspan="8" style="text-align: center;"> <table border="1" style="width: 100%; border-collapse: collapse; text-align: center;"> <tr> <td style="width: 10%;"></td> <td style="width: 10%;"></td> <td style="width: 10%;"></td> <td style="width: 10%;"></td> <td style="width: 10%;"></td> <td style="width: 10%;"></td> <td style="width: 10%;"></td> <td style="width: 10%;"></td> <td style="width: 10%;"></td> <td style="width: 10%;"></td> </tr> <tr> <td></td> <td></td> <td colspan="8" style="text-align: center;"> <table border="1" style="width: 100%; border-collapse: collapse; text-align: center;"> <tr> <td style="width: 10%;"></td> <td style="width: 10%;"></td> <td style="width: 10%;"></td> <td style="width: 10%;"></td> <td style="width: 10%;"></td> <td style="width: 10%;"></td> <td style="width: 10%;"></td> <td style="width: 10%;"></td> <td style="width: 10%;"></td> <td style="width: 10%;"></td> </tr> <tr> <td></td> <td></td>
<td colspan="8" style="text-align: center;"> <table border="1" style="width: 100%; border-collapse: collapse; text-align: center;"> <tr> <td style="width: 10%;"></td> <td style="width: 10%;"></td> <td style="width: 10%;"></td> <td style="width: 10%;"></td> <td style="width: 10%;"></td> <td style="width: 10%;"></td> <td style="width: 10%;"></td> <td style="width: 10%;"></td> <td style="width: 10%;"></td> <td style="width: 10%;"></td> </tr> <tr> <td></td> <td></td> <td colspan="8" style="text-align: center;"> <table border="1" style="width: 100%; border-collapse: collapse; text-align: center;"> <tr> <td style="width: 10%;"></td> <td style="width: 10%;"></td> <td style="width: 10%;"></td> <td style="width: 10%;"></td> <td style="width: 10%;"></td> <td style="width: 10%;"></td> <td style="width: 10%;"></td> <td style="width: 10%;"></td> <td style="width: 10%;"></td> <td style="width: 10%;"></td> </tr> <tr> <td></td> <td></td> <td colspan="8" style="text-align: center;"> <table border="1" style="width: 100%; border-collapse: collapse; text-align: center;"> <tr> <td style="width: 10%;"></td> <td style="width: 10%;"></td> <td style="width: 10%;"></td> <td style="width: 10%;"></td> <td style="width: 10%;"></td> <td style="width: 10%;"></td> <td style="width: 10%;"></td> <td style="width: 10%;"></td> <td style="width: 10%;"></td> <td style="width: 10%;"></td> </tr> <tr> <td></td> <td></td> <td colspan="8" style="text-align: center;"> <table border="1" style="width: 100%; border-collapse: collapse; text-align: center;"> <tr> <td style="width: 10%;"></td> <td style="width: 10%;"></td> <td style="width: 10%;"></td> <td style="width: 10%;"></td> <td style="width: 10%;"></td> <td style="width: 10%;"></td> <td style="width: 10%;"></td> <td style="width: 10%;"></td> <td style="width: 10%;"></td> <td style="width: 10%;"></td> </tr> <tr> <td></td> <td></td> <td colspan="8" style="text-align: center;"> <table border="1" style="width: 100%; border-collapse: collapse; text-align: center;"> <tr> <td style="width: 10%;"></td> <td style="width: 10%;"></td> <td style="width: 10%;"></td> <td style="width: 10%;"></td> <td style="width: 10%;"></td> <td style="width: 10%;"></td> <td style="width: 10%;"></td> <td style="width: 10%;"></td> <td style="width: 10%;"></td> <td style="width: 10%;"></td> </tr> <tr> <td></td> <td></td> <td colspan="8" style="text-align: center;"> <table border="1" style="width: 100%; border-collapse: collapse; text-align: center;"> <tr> <td style="width: 10%;"></td> <td style="width: 10%;"></td> <td style="width: 10%;"></td> <td style="width: 10%;"></td> <td style="width: 10%;"></td> <td style="width: 10%;"></td> <td style="width: 10%;"></td> <td style="width: 10%;"></td> <td style="width: 10%;"></td> <td style="width: 10%;"></td> </tr> <tr> <td></td> <td></td> <td colspan="8" style="text-align: center;"> <table border="1" style="width: 100%; border-collapse: collapse; text-align: center;"> <tr> <td style="width: 10%;"></td> <td style="width: 10%;"></td> <td style="width: 10%;"></td> <td style="width: 10%;"></td> <td style="width: 10%;"></td> <td style="width: 10%;"></td> <td style="width: 10%;"></td> <td style="width: 10%;"></td> <td style="width: 10%;"></td> <td style="width: 10%;"></td> </tr> <tr> <td></td> <td></td> <td colspan="8" style="text-align: center;"> <table border="1" style="width: 100%; border-collapse: collapse; text-align: center;"> <tr> <td style="width: 10%;"></td> <td style="width: 10%;"></td> <td style="width: 10%;"></td> <td style="width: 10%;"></td> <td style="width: 10%;"></td> <td style="width: 10%;"></td> <td style="width: 10%;"></td> <td style="width: 10%;"></td> <td style="width: 10%;"></td> <td style="width: 10%;"></td> </tr> <tr> <td></td> <td></td> <td colspan="8" style="text-align: center;"> <table border="1" style="width: 100%; border-collapse: collapse; text-align: center;"> <tr> <td style="width: 10%;"></td> <td style="width: 10%;"></td> <td style="width: 10%;"></td> <td style="width: 10%;"></td> <td style="width: 10%;"></td> <td style="width: 10%;"></td> <td style="width: 10%;"></td> <td style="width: 10%;"></td> <td style="width: 10%;"></td> <td style="width: 10%;"></td> </tr> <tr> <td></td> <td></td> <td colspan="8" style="text-align: center;"> <table border="1" style="width: 100%; border-collapse: collapse; text-align: center;"> <tr> <td style="width: 10%;"></td> <td style="width: 10%;"></td> <td style="width: 10%;"></td> <td style="width: 10%;"></td> <td style="width: 10%;"></td> <td style="width: 10%;"></td> <td style="width: 10%;"></td> <td style="width: 10%;"></td> <td style="width: 10%;"></td> <td style="width: 10%;"></td> </tr> <tr> <td></td> <td></td> <td colspan="8" style="text-align: center;"> <table border="1" style="width: 100%; border-collapse: collapse; text-align: center;"> <tr> <td style="width: 10%;"></td> <td style="width: 10%;"></td> <td style="width: 10%;"></td> <td style="width: 10%;"></td> <td style="width: 10%;"></td> <td style="width: 10%;"></td> <td style="width: 10%;"></td> <td style="width: 10%;"></td> <td style="width: 10%;"></td> <td style="width: 10%;"></td> </tr> <tr> <td></td> <td></td> <td colspan="8" style="text-align: center;"> <table border="1" style="width: 100%; border-collapse: collapse; text-align: center;"> <tr> <td style="width: 10%;"></td> <td style="width: 10%;"></td> <td style="width: 10%;"></td> <td style="width: 10%;"></td> <td style="width: 10%;"></td> <td style="width: 10%;"></td> <td style="width: 10%;"></td> <td style="width: 10%;"></td> <td style="width: 10%;"></td> <td style="width: 10%;"></td> </tr> <tr> <td></td> <td></td> <td colspan="8" style="text-align: center;"> <table border="1" style="width: 100%; border-collapse: collapse; text-align: center;"> <tr> <td style="width: 10%;"></td> <td style="width: 10%;"></td> <td style="width: 10%;"></td> <td style="width: 10%;"></td> <td style="width: 10%;"></td> <td style="width: 10%;"></td> <td style="width: 10%;"></td> <td style="width: 10%;"></td> <td style="width: 10%;"></td> <td style="width: 10%;"></td> </tr> <tr> <td></td> <td></td> <td colspan="8" style="text-align: center;"> <table border="1" style="width: 100%; border-collapse: collapse; text-align: center;"> <tr> <td style="width: 10%;"></td> <td style="width: 10%;"></td> <td style="width: 10%;"></td> <td style="width: 10%;"></td> <td style="width: 10%;"></td> <td style="width: 10%;"></td> <td style="width: 10%;"></td> <td style="width: 10%;"></td> <td style="width: 10%;"></td> <td style="width: 10%;"></td> </tr> <tr> <td></td> <td></td> <td colspan="8" style="text-align: center;"> <table border="1" style="width: 100%; border-collapse: collapse; text-align: center;"> <tr> <td style="width: 10%;"></td> <td style="width: 10%;"></td> <td style="width: 10%;"></td> <td style="width: 10%;"></td> <td style="width: 10%;"></td> <td style="width: 10%;"></td> <td style="width: 10%;"></td> <td style="width: 10%;"></td> <td style="width: 10%;"></td> <td style="width: 10%;"></td> </tr> <tr> <td></td> <td></td> <td colspan="8" style="text-align: center;"> <table border="1" style="width: 100%; border-collapse: collapse; text-align: center;"> <tr> <td style="width: 10%;"></td> <td style="width: 10%;"></td> <td style="width: 10%;"></td> <td style="width: 10%;"></td> <td style="width: 10%;"></td> <td style="width: 10%;"></td> <td style="width: 10%;"></td> <td style="width: 10%;"></td> <td style="width: 10%;"></td> <td style="width: 10%;"></td> </tr> <tr> <td></td> <td></td> <td colspan="8" style="text-align: center;"> <table border="1" style="width: 100%; border-collapse: collapse; text-align: center;"> <tr> <td style="width: 10%;"></td> <td style="width: 10%;"></td> <td style="width: 10%;"></td> <td style="width: 10%;"></td> <td style="width: 10%;"></td> <td style="width: 10%;"></td> <td style="width: 10%;"></td> <td style="width: 10%;"></td> <td style="width: 10%;"></td> <td style="width: 10%;"></td> </tr> <tr> <td></td> <td></td> <td colspan="8" style="text-align: center;"> <table border="1" style="width: 100%; border-collapse: collapse; text-align: center;"> <tr> <td style="width: 10%;"></td> <td style="width: 10%;"></td> <td style="width: 10%;"></td> <td style="width: 10%;"></td> <td style="width: 10%;"></td> <td style="width: 10%;"></td> <td style="width: 10%;"></td> <td style="width: 10%;"></td> <td style="width: 10%;"></td> <td style="width: 10%;"></td> </tr> <tr> <td></td> <td></td> <td colspan="8" style="text-align: center;"> <table border="1" style="width: 100%; border-collapse: collapse; text-align: center;"> <tr> <td style="width: 10%;"></td> <td style="width: 10%;"></td> <td style="width: 10%;"></td> <td style="width: 10%;"></td> <td style="width: 10%;"></td> <td style="width: 10%;"></td> <td style="width: 10%;"></td> <td style="width: 10%;"></td> <td style="width: 10%;"></td> <td style="width: 10%;"></td> </tr> <tr> <td></td> <td></td> <td colspan="8" style="text-align: center;"> <table border="1" style="width: 100%; border-collapse: collapse; text-align: center;"> <tr> <td style="width: 10%;"></td> <td style="width: 10%;"></td> <td style="width: 10%;"></td> <td style="width: 10%;"></td> <td style="width: 10%;"></td> <td style="width: 10%;"></td> <td style="width: 10%;"></td> <td style="width: 10%;"></td> <td style="width: 10%;"></td> <td style="width: 10%;"></td> </tr> <tr> <td></td> <td></td> <td colspan="8" style="text-align: center;"> <table border="1" style="width: 100%; border-collapse: collapse; text-align: center;"> <tr> <td style="width: 10%;"></td> <td style="width: 10%;"></td> <td style="width: 10%;"></td> <td style="width: 10%;"></td> <td style="width: 10%;"></td> <td style="width: 10%;"></td> <td style="width: 10%;"></td> <td style="width: 10%;"></td> <td style="width: 10%;"></td> <td style="width: 10%;"></td> </tr> <tr> <td></td> <td></td> <td colspan="8" style="text-align: center;"> <table border="1" style="width: 100%; border-collapse: collapse; text-align: center;"> <tr> <td style="width: 10%;"></td> <td
style="width: 10%;"></td> <td style="width: 10%;"></td> <td style="width: 10%;"></td> <td style="width: 10%;"></td> <td style="width: 10%;"></td> <td style="width: 10%;"></td> <td style="width: 10%;"></td> <td style="width: 10%;"></td> <td style="width: 10%;"></td> </tr> <tr> <td></td> <td></td> <td colspan="8" style="text-align: center;"> <table border="1" style="width: 100%; border-collapse: collapse; text-align: center;"> <tr> </tr></table></td></tr></table></td></tr></table></td></tr></table></td></tr></table></td></tr></table></td></tr></table></td></tr></table></td></tr></table></td></tr></table></td></tr></table></td></tr></table></td></tr></table></td></tr></table></td></tr></table></td></tr></table></td></tr></table></td></tr></table></td></tr></table></td></tr></table></td></tr></table></td></tr></table></td></tr></table></td></tr></table></td></tr></table></td></tr></table></td></tr></table></td></tr></table></td></tr></table></td></tr></table></td></tr></table></td></tr></table></td></tr></table></td></tr></table></td></tr></table></td></tr></table></td></tr></table></td></tr></table></td></tr></table></td></tr></table></td></tr></table></td></tr></table></td></tr></table></td></tr></table> | | | | | | | | | | | | | | | | | | | | <table border="1" style="width: 100%; border-collapse: collapse; text-align: center;"> <tr> <td style="width: 10%;"></td> <td style="width: 10%;"></td> <td style="width: 10%;"></td> <td style="width: 10%;"></td> <td style="width: 10%;"></td> <td style="width: 10%;"></td> <td style="width: 10%;"></td> <td style="width: 10%;"></td> <td style="width: 10%;"></td> <td style="width: 10%;"></td> </tr> <tr> <td></td> <td></td> <td colspan="8" style="text-align: center;"> <table border="1" style="width: 100%; border-collapse: collapse; text-align: center;"> <tr> <td style="width: 10%;"></td> <td style="width: 10%;"></td> <td style="width: 10%;"></td> <td style="width: 10%;"></td> <td style="width: 10%;"></td> <td style="width: 10%;"></td> <td style="width: 10%;"></td> <td style="width: 10%;"></td> <td style="width: 10%;"></td> <td style="width: 10%;"></td> </tr> <tr> <td></td> <td></td> <td colspan="8" style="text-align: center;"> <table border="1" style="width: 100%; border-collapse: collapse; text-align: center;"> <tr> <td style="width: 10%;"></td> <td style="width: 10%;"></td> <td style="width: 10%;"></td> <td style="width: 10%;"></td> <td style="width: 10%;"></td> <td style="width: 10%;"></td> <td style="width: 10%;"></td> <td style="width: 10%;"></td> <td style="width: 10%;"></td> <td style="width: 10%;"></td> </tr> <tr> <td></td> <td></td> <td colspan="8" style="text-align: center;"> <table border="1" style="width: 100%; border-collapse: collapse; text-align: center;"> <tr> <td style="width: 10%;"></td> <td style="width: 10%;"></td> <td style="width: 10%;"></td> <td style="width: 10%;"></td> <td style="width: 10%;"></td> <td style="width: 10%;"></td> <td style="width: 10%;"></td> <td style="width: 10%;"></td> <td style="width: 10%;"></td> <td style="width: 10%;"></td> </tr> <tr> <td></td> <td></td> <td colspan="8" style="text-align: center;"> <table border="1" style="width: 100%; border-collapse: collapse; text-align: center;"> <tr> <td style="width: 10%;"></td> <td style="width: 10%;"></td> <td style="width: 10%;"></td> <td style="width: 10%;"></td> <td style="width: 10%;"></td> <td style="width: 10%;"></td> <td style="width: 10%;"></td> <td style="width: 10%;"></td> <td style="width: 10%;"></td> <td style="width: 10%;"></td> </tr> <tr> <td></td> <td></td> <td colspan="8" style="text-align: center;"> <table border="1" style="width: 100%; border-collapse: collapse; text-align: center;"> <tr> <td style="width: 10%;"></td> <td style="width: 10%;"></td> <td style="width: 10%;"></td> <td style="width: 10%;"></td> <td style="width: 10%;"></td> <td style="width: 10%;"></td> <td style="width: 10%;"></td> <td style="width: 10%;"></td> <td style="width: 10%;"></td> <td style="width: 10%;"></td> </tr> <tr> <td></td> <td></td> <td colspan="8" style="text-align: center;"> <table border="1" style="width: 100%; border-collapse: collapse; text-align: center;"> <tr> <td style="width: 10%;"></td> <td style="width: 10%;"></td> <td style="width: 10%;"></td> <td style="width: 10%;"></td> <td style="width: 10%;"></td> <td style="width: 10%;"></td> <td style="width: 10%;"></td> <td style="width: 10%;"></td> <td style="width: 10%;"></td> <td style="width: 10%;"></td> </tr> <tr> <td></td> <td></td> <td colspan="8" style="text-align: center;"> <table border="1" style="width: 100%; border-collapse: collapse; text-align: center;"> <tr> <td style="width: 10%;"></td> <td style="width: 10%;"></td> <td style="width: 10%;"></td> <td style="width: 10%;"></td> <td style="width: 10%;"></td> <td style="width: 10%;"></td> <td style="width: 10%;"></td> <td style="width: 10%;"></td> <td style="width: 10%;"></td> <td style="width: 10%;"></td> </tr> <tr> <td></td> <td></td> <td colspan="8" style="text-align: center;"> <table border="1" style="width: 100%; border-collapse: collapse; text-align: center;"> <tr> <td style="width: 10%;"></td> <td style="width: 10%;"></td> <td style="width: 10%;"></td> <td style="width: 10%;"></td> <td style="width: 10%;"></td> <td style="width: 10%;"></td> <td style="width: 10%;"></td> <td style="width: 10%;"></td> <td style="width: 10%;"></td> <td style="width: 10%;"></td> </tr> <tr> <td></td> <td></td> <td colspan="8" style="text-align: center;"> <table border="1" style="width: 100%; border-collapse: collapse; text-align: center;"> <tr> <td style="width: 10%;"></td> <td style="width: 10%;"></td> <td style="width: 10%;"></td> <td style="width: 10%;"></td> <td style="width: 10%;"></td> <td style="width: 10%;"></td> <td style="width: 10%;"></td> <td style="width: 10%;"></td> <td style="width: 10%;"></td> <td style="width: 10%;"></td> </tr> <tr> <td></td> <td></td> <td colspan="8" style="text-align: center;"> <table border="1" style="width: 100%; border-collapse: collapse; text-align: center;"> <tr> <td style="width: 10%;"></td> <td style="width:
10%;"></td> <td style="width: 10%;"></td> <td style="width: 10%;"></td> <td style="width: 10%;"></td> <td style="width: 10%;"></td> <td style="width: 10%;"></td> <td style="width: 10%;"></td> <td style="width: 10%;"></td> <td style="width: 10%;"></td> </tr> <tr> <td></td> <td></td> <td colspan="8" style="text-align: center;"> <table border="1" style="width: 100%; border-collapse: collapse; text-align: center;"> <tr> <td style="width: 10%;"></td> <td style="width: 10%;"></td> <td style="width: 10%;"></td> <td style="width: 10%;"></td> <td style="width: 10%;"></td> <td style="width: 10%;"></td> <td style="width: 10%;"></td> <td style="width: 10%;"></td> <td style="width: 10%;"></td> <td style="width: 10%;"></td> </tr> <tr> <td></td> <td></td> <td colspan="8" style="text-align: center;"> <table border="1" style="width: 100%; border-collapse: collapse; text-align: center;"> <tr> <td style="width: 10%;"></td> <td style="width: 10%;"></td> <td style="width: 10%;"></td> <td style="width: 10%;"></td> <td style="width: 10%;"></td> <td style="width: 10%;"></td> <td style="width: 10%;"></td> <td style="width: 10%;"></td> <td style="width: 10%;"></td> <td style="width: 10%;"></td> </tr> <tr> <td></td> <td></td> <td colspan="8" style="text-align: center;"> <table border="1" style="width: 100%; border-collapse: collapse; text-align: center;"> <tr> <td style="width: 10%;"></td> <td style="width: 10%;"></td> <td style="width: 10%;"></td> <td style="width: 10%;"></td> <td style="width: 10%;"></td> <td style="width: 10%;"></td> <td style="width: 10%;"></td> <td style="width: 10%;"></td> <td style="width: 10%;"></td> <td style="width: 10%;"></td> </tr> <tr> <td></td> <td></td> <td colspan="8" style="text-align: center;"> <table border="1" style="width: 100%; border-collapse: collapse; text-align: center;"> <tr> <td style="width: 10%;"></td> <td style="width: 10%;"></td> <td style="width: 10%;"></td> <td style="width: 10%;"></td> <td style="width: 10%;"></td> <td style="width: 10%;"></td> <td style="width: 10%;"></td> <td style="width: 10%;"></td> <td style="width: 10%;"></td> <td style="width: 10%;"></td> </tr> <tr> <td></td> <td></td> <td colspan="8" style="text-align: center;"> <table border="1" style="width: 100%; border-collapse: collapse; text-align: center;"> <tr> <td style="width: 10%;"></td> <td style="width: 10%;"></td> <td style="width: 10%;"></td> <td style="width: 10%;"></td> <td style="width: 10%;"></td> <td style="width: 10%;"></td> <td style="width: 10%;"></td> <td style="width: 10%;"></td> <td style="width: 10%;"></td> <td style="width: 10%;"></td> </tr> <tr> <td></td> <td></td> <td colspan="8" style="text-align: center;"> <table border="1" style="width: 100%; border-collapse: collapse; text-align: center;"> <tr> <td style="width: 10%;"></td> <td style="width: 10%;"></td> <td style="width: 10%;"></td> <td style="width: 10%;"></td> <td style="width: 10%;"></td> <td style="width: 10%;"></td> <td style="width: 10%;"></td> <td style="width: 10%;"></td> <td style="width: 10%;"></td> <td style="width: 10%;"></td> </tr> <tr> <td></td> <td></td> <td colspan="8" style="text-align: center;"> <table border="1" style="width: 100%; border-collapse: collapse; text-align: center;"> <tr> <td style="width: 10%;"></td> <td style="width: 10%;"></td> <td style="width: 10%;"></td> <td style="width: 10%;"></td> <td style="width: 10%;"></td> <td style="width: 10%;"></td> <td style="width: 10%;"></td> <td style="width: 10%;"></td> <td style="width: 10%;"></td> <td style="width: 10%;"></td> </tr> <tr> <td></td> <td></td> <td colspan="8" style="text-align: center;"> <table border="1" style="width: 100%; border-collapse: collapse; text-align: center;"> <tr> <td style="width: 10%;"></td> <td style="width: 10%;"></td> <td style="width: 10%;"></td> <td style="width: 10%;"></td> <td style="width: 10%;"></td> <td style="width: 10%;"></td> <td style="width: 10%;"></td> <td style="width: 10%;"></td> <td style="width: 10%;"></td> <td style="width: 10%;"></td> </tr> <tr> <td></td> <td></td> <td colspan="8" style="text-align: center;"> <table border="1" style="width: 100%; border-collapse: collapse; text-align: center;"> <tr> <td style="width: 10%;"></td> <td style="width: 10%;"></td> <td style="width: 10%;"></td> <td style="width: 10%;"></td> <td style="width: 10%;"></td> <td style="width: 10%;"></td> <td style="width: 10%;"></td> <td style="width: 10%;"></td> <td style="width: 10%;"></td> <td style="width: 10%;"></td> </tr> <tr> <td></td> <td></td> <td colspan="8" style="text-align: center;"> <table border="1" style="width: 100%; border-collapse: collapse; text-align: center;"> <tr> <td style="width: 10%;"></td> <td style="width: 10%;"></td> <td style="width: 10%;"></td> <td style="width: 10%;"></td> <td style="width: 10%;"></td> <td style="width: 10%;"></td> <td style="width: 10%;"></td> <td style="width: 10%;"></td> <td style="width: 10%;"></td> <td style="width: 10%;"></td> </tr> <tr> <td></td> <td></td> <td colspan="8" style="text-align: center;"> <table border="1" style="width: 100%; border-collapse: collapse; text-align: center;"> <tr> <td style="width: 10%;"></td> <td style="width: 10%;"></td> <td style="width: 10%;"></td> <td style="width: 10%;"></td> <td style="width: 10%;"></td> <td style="width: 10%;"></td> <td style="width: 10%;"></td> <td style="width: 10%;"></td> <td style="width: 10%;"></td> <td style="width: 10%;"></td> </tr> <tr> <td></td> <td></td> <td colspan="8" style="text-align: center;"> <table border="1" style="width: 100%; border-collapse: collapse; text-align: center;"> <tr> <td style="width: 10%;"></td> <td style="width: 10%;"></td> <td style="width: 10%;"></td> <td style="width: 10%;"></td> <td style="width: 10%;"></td> <td style="width: 10%;"></td> <td style="width: 10%;"></td> <td style="width: 10%;"></td> <td style="width: 10%;"></td> <td style="width: 10%;"></td> </tr> <tr> <td></td> <td></td> <td colspan="8" style="text-align: center;"> <table border="1" style="width: 100%; border-collapse: collapse; text-align: center;"> <tr> <td style="width: 10%;"></td> <td style="width: 10%;"></td> <td style="width: 10%;"></td> <td style="width: 10%;"></td> <td style="width: 10%;"></td> <td style="width: 10%;"></td> <td style="width: 10%;"></td> <td style="width: 10%;"></td> <td style="width: 10%;"></td> <td style="width: 10%;"></td> </tr> <tr> <td></td> <td></td> <td colspan="8" style="text-align: center;"> <table border="1" style="width: 100%; border-collapse: collapse; text-align: center;"> <tr> <td style="width: 10%;"></td> <td style="width: 10%;"></td> <td style="width: 10%;"></td> <td style="width: 10%;"></td> <td style="width: 10%;"></td> <td style="width: 10%;"></td> <td style="width: 10%;"></td> <td style="width: 10%;"></td> <td style="width: 10%;"></td> <td style="width: 10%;"></td> </tr> <tr> <td></td> <td></td> <td colspan="8" style="text-align: center;"> <table border="1" style="width: 100%; border-collapse: collapse; text-align: center;"> <tr> <td style="width: 10%;"></td> <td style="width: 10%;"></td> <td style="width: 10%;"></td> <td style="width: 10%;"></td> <td style="width: 10%;"></td> <td style="width: 10%;"></td> <td style="width: 10%;"></td> <td style="width: 10%;"></td> <td style="width: 10%;"></td> <td style="width: 10%;"></td> </tr> <tr> <td></td> <td></td> <td colspan="8" style="text-align: center;"> <table border="1" style="width: 100%; border-collapse: collapse; text-align: center;"> <tr> <td style="width: 10%;"></td> <td style="width: 10%;"></td> <td style="width: 10%;"></td> <td style="width: 10%;"></td> <td style="width: 10%;"></td> <td style="width: 10%;"></td> <td style="width: 10%;"></td> <td style="width: 10%;"></td> <td style="width: 10%;"></td> <td style="width: 10%;"></td> </tr> <tr> <td></td> <td></td> <td colspan="8" style="text-align: center;"> <table border="1" style="width: 100%; border-collapse: collapse; text-align: center;"> <tr> <td style="width: 10%;"></td> <td style="width: 10%;"></td> <td style="width: 10%;"></td> <td style="width: 10%;"></td> <td style="width: 10%;"></td> <td style="width: 10%;"></td> <td style="width: 10%;"></td> <td style="width: 10%;"></td> <td style="width: 10%;"></td> <td style="width: 10%;"></td> </tr> <tr> <td></td> <td></td> <td colspan="8" style="text-align: center;"> <table border="1" style="width: 100%; border-collapse: collapse; text-align: center;"> <tr> <td style="width: 10%;"></td> <td style="width: 10%;"></td> <td style="width: 10%;"></td> <td style="width: 10%;"></td> <td style="width: 10%;"></td> <td style="width: 10%;"></td> <td style="width: 10%;"></td> <td style="width: 10%;"></td> <td style="width: 10%;"></td> <td style="width: 10%;"></td> </tr> <tr> <td></td> <td></td> <td colspan="8" style="text-align: center;"> <table border="1" style="width: 100%; border-collapse: collapse; text-align: center;"> <tr> <td style="width: 10%;"></td> <td style="width: 10%;"></td> <td style="width: 10%;"></td> <td style="width: 10%;"></td> <td style="width: 10%;"></td> <td style="width: 10%;"></td> <td style="width: 10%;"></td> <td style="width: 10%;"></td> <td style="width: 10%;"></td> <td style="width: 10%;"></td> </tr> <tr> <td></td> <td></td> <td colspan="8" style="text-align: center;"> <table border="1" style="width: 100%; border-collapse: collapse; text-align: center;"> <tr> <td style="width: 10%;"></td> <td style="width: 10%;"></td> <td style="width: 10%;"></td> <td style="width: 10%;"></td> <td style="width: 10%;"></td> <td style="width: 10%;"></td> <td style="width: 10%;"></td> <td style="width: 10%;"></td> <td style="width: 10%;"></td> <td style="width: 10%;"></td> </tr> <tr> <td></td> <td></td> <td colspan="8" style="text-align: center;"> <table border="1" style="width: 100%; border-collapse: collapse; text-align: center;"> <tr> <td style="width: 10%;"></td> <td style="width: 10%;"></td> <td style="width: 10%;"></td> <td style="width: 10%;"></td> <td style="width: 10%;"></td> <td style="width: 10%;"></td> <td style="width: 10%;"></td> <td
style="width: 10%;"></td> <td style="width: 10%;"></td> <td style="width: 10%;"></td> </tr> <tr> <td></td> <td></td> <td colspan="8" style="text-align: center;"> <table border="1" style="width: 100%; border-collapse: collapse; text-align: center;"> <tr> <td style="width: 10%;"></td> <td style="width: 10%;"></td> <td style="width: 10%;"></td> <td style="width: 10%;"></td> <td style="width: 10%;"></td> <td style="width: 10%;"></td> <td style="width: 10%;"></td> <td style="width: 10%;"></td> <td style="width: 10%;"></td> <td style="width: 10%;"></td> </tr> <tr> <td></td> <td></td> <td colspan="8" style="text-align: center;"> <table border="1" style="width: 100%; border-collapse: collapse; text-align: center;"> <tr> <td style="width: 10%;"></td> <td style="width: 10%;"></td> <td style="width: 10%;"></td> <td style="width: 10%;"></td> <td style="width: 10%;"></td> <td style="width: 10%;"></td> <td style="width: 10%;"></td> <td style="width: 10%;"></td> <td style="width: 10%;"></td> <td style="width: 10%;"></td> </tr> <tr> <td></td> <td></td> <td colspan="8" style="text-align: center;"> <table border="1" style="width: 100%; border-collapse: collapse; text-align: center;"> <tr> <td style="width: 10%;"></td> <td style="width: 10%;"></td> <td style="width: 10%;"></td> <td style="width: 10%;"></td> <td style="width: 10%;"></td> <td style="width: 10%;"></td> <td style="width: 10%;"></td> <td style="width: 10%;"></td> <td style="width: 10%;"></td> <td style="width: 10%;"></td> </tr> <tr> <td></td> <td></td> <td colspan="8" style="text-align: center;"> <table border="1" style="width: 100%; border-collapse: collapse; text-align: center;"> <tr> <td style="width: 10%;"></td> <td style="width: 10%;"></td> <td style="width: 10%;"></td> <td style="width: 10%;"></td> <td style="width: 10%;"></td> <td style="width: 10%;"></td> <td style="width: 10%;"></td> <td style="width: 10%;"></td> <td style="width: 10%;"></td> <td style="width: 10%;"></td> </tr> <tr> <td></td> <td></td> <td colspan="8" style="text-align: center;"> <table border="1" style="width: 100%; border-collapse: collapse; text-align: center;"> <tr> <td style="width: 10%;"></td> <td style="width: 10%;"></td> <td style="width: 10%;"></td> <td style="width: 10%;"></td> <td style="width: 10%;"></td> <td style="width: 10%;"></td> <td style="width: 10%;"></td> <td style="width: 10%;"></td> <td style="width: 10%;"></td> <td style="width: 10%;"></td> </tr> <tr> <td></td> <td></td> <td colspan="8" style="text-align: center;"> <table border="1" style="width: 100%; border-collapse: collapse; text-align: center;"> <tr> <td style="width: 10%;"></td> <td style="width: 10%;"></td> <td style="width: 10%;"></td> <td style="width: 10%;"></td> <td style="width: 10%;"></td> <td style="width: 10%;"></td> <td style="width: 10%;"></td> <td style="width: 10%;"></td> <td style="width: 10%;"></td> <td style="width: 10%;"></td> </tr> <tr> <td></td> <td></td> <td colspan="8" style="text-align: center;"> <table border="1" style="width: 100%; border-collapse: collapse; text-align: center;"> <tr> <td style="width: 10%;"></td> <td style="width: 10%;"></td> <td style="width: 10%;"></td> <td style="width: 10%;"></td> <td style="width: 10%;"></td> <td style="width: 10%;"></td> <td style="width: 10%;"></td> <td style="width: 10%;"></td> <td style="width: 10%;"></td> <td style="width: 10%;"></td> </tr> <tr> <td></td> <td></td> <td colspan="8" style="text-align: center;"> <table border="1" style="width: 100%; border-collapse: collapse; text-align: center;"> <tr> <td style="width: 10%;"></td> <td style="width: 10%;"></td> <td style="width: 10%;"></td> <td style="width: 10%;"></td> <td style="width: 10%;"></td> <td style="width: 10%;"></td> <td style="width: 10%;"></td> <td style="width: 10%;"></td> <td style="width: 10%;"></td> <td style="width: 10%;"></td> </tr> <tr> <td></td> <td></td> <td colspan="8" style="text-align: center;"> <table border="1" style="width: 100%; border-collapse: collapse; text-align: center;"> <tr> <td style="width: 10%;"></td> <td style="width: 10%;"></td> <td style="width: 10%;"></td> <td style="width: 10%;"></td> <td style="width: 10%;"></td> <td style="width: 10%;"></td> <td style="width: 10%;"></td> <td style="width: 10%;"></td> <td style="width: 10%;"></td> <td style="width: 10%;"></td> </tr> <tr> <td></td> <td></td> <td colspan="8" style="text-align: center;"> <table border="1" style="width: 100%; border-collapse: collapse; text-align: center;"> <tr> <td style="width: 10%;"></td> <td style="width: 10%;"></td> <td style="width: 10%;"></td> <td style="width: 10%;"></td> <td style="width: 10%;"></td> <td style="width: 10%;"></td> <td style="width: 10%;"></td> <td style="width: 10%;"></td> <td style="width: 10%;"></td> <td style="width: 10%;"></td> </tr> <tr> <td></td> <td></td> <td colspan="8" style="text-align: center;"> <table border="1" style="width: 100%; border-collapse: collapse; text-align: center;"> <tr> </tr></table></td></tr></table></td></tr></table></td></tr></table></td></tr></table></td></tr></table></td></tr></table></td></tr></table></td></tr></table></td></tr></table></td></tr></table></td></tr></table></td></tr></table></td></tr></table></td></tr></table></td></tr></table></td></tr></table></td></tr></table></td></tr></table></td></tr></table></td></tr></table></td></tr></table></td></tr></table></td></tr></table></td></tr></table></td></tr></table></td></tr></table></td></tr></table></td></tr></table></td></tr></table></td></tr></table></td></tr></table></td></tr></table></td></tr></table></td></tr></table></td></tr></table></td></tr></table></td></tr></table></td></tr></table></td></tr></table></td></tr></table></td></tr></table></td></tr></table> | | | | | | | | | | | | | | | | | | | | <table border="1" style="width: 100%; border-collapse: collapse; text-align: center;"> <tr> <td style="width: 10%;"></td> <td style="width: 10%;"></td> <td style="width: 10%;"></td> <td style="width: 10%;"></td> <td style="width: 10%;"></td> <td style="width: 10%;"></td> <td style="width: 10%;"></td> <td style="width: 10%;"></td> <td
style="width: 10%;"></td> <td style="width: 10%;"></td> </tr> <tr> <td></td> <td></td> <td colspan="8" style="text-align: center;"> <table border="1" style="width: 100%; border-collapse: collapse; text-align: center;"> <tr> <td style="width: 10%;"></td> <td style="width: 10%;"></td> <td style="width: 10%;"></td> <td style="width: 10%;"></td> <td style="width: 10%;"></td> <td style="width: 10%;"></td> <td style="width: 10%;"></td> <td style="width: 10%;"></td> <td style="width: 10%;"></td> <td style="width: 10%;"></td> </tr> <tr> <td></td> <td></td> <td colspan="8" style="text-align: center;"> <table border="1" style="width: 100%; border-collapse: collapse; text-align: center;"> <tr> <td style="width: 10%;"></td> <td style="width: 10%;"></td> <td style="width: 10%;"></td> <td style="width: 10%;"></td> <td style="width: 10%;"></td> <td style="width: 10%;"></td> <td style="width: 10%;"></td> <td style="width: 10%;"></td> <td style="width: 10%;"></td> <td style="width: 10%;"></td> </tr> <tr> <td></td> <td></td> <td colspan="8" style="text-align: center;"> <table border="1" style="width: 100%; border-collapse: collapse; text-align: center;"> <tr> <td style="width: 10%;"></td> <td style="width: 10%;"></td> <td style="width: 10%;"></td> <td style="width: 10%;"></td> <td style="width: 10%;"></td> <td style="width: 10%;"></td> <td style="width: 10%;"></td> <td style="width: 10%;"></td> <td style="width: 10%;"></td> <td style="width: 10%;"></td> </tr> <tr> <td></td> <td></td> <td colspan="8" style="text-align: center;"> <table border="1" style="width: 100%; border-collapse: collapse; text-align: center;"> <tr> <td style="width: 10%;"></td> <td style="width: 10%;"></td> <td style="width: 10%;"></td> <td style="width: 10%;"></td> <td style="width: 10%;"></td> <td style="width: 10%;"></td> <td style="width: 10%;"></td> <td style="width: 10%;"></td> <td style="width: 10%;"></td> <td style="width: 10%;"></td> </tr> <tr> <td></td> <td></td> <td colspan="8" style="text-align: center;"> <table border="1" style="width: 100%; border-collapse: collapse; text-align: center;"> <tr> <td style="width: 10%;"></td> <td style="width: 10%;"></td> <td style="width: 10%;"></td> <td style="width: 10%;"></td> <td style="width: 10%;"></td> <td style="width: 10%;"></td> <td style="width: 10%;"></td> <td style="width: 10%;"></td> <td style="width: 10%;"></td> <td style="width: 10%;"></td> </tr> <tr> <td></td> <td></td> <td colspan="8" style="text-align: center;"> <table border="1" style="width: 100%; border-collapse: collapse; text-align: center;"> <tr> <td style="width: 10%;"></td> <td style="width: 10%;"></td> <td style="width: 10%;"></td> <td style="width: 10%;"></td> <td style="width: 10%;"></td> <td style="width: 10%;"></td> <td style="width: 10%;"></td> <td style="width: 10%;"></td> <td style="width: 10%;"></td> <td style="width: 10%;"></td> </tr> <tr> <td></td> <td></td> <td colspan="8" style="text-align: center;"> <table border="1" style="width: 100%; border-collapse: collapse; text-align: center;"> <tr> <td style="width: 10%;"></td> <td style="width: 10%;"></td> <td style="width: 10%;"></td> <td style="width: 10%;"></td> <td style="width: 10%;"></td> <td style="width: 10%;"></td> <td style="width: 10%;"></td> <td style="width: 10%;"></td> <td style="width: 10%;"></td> <td style="width: 10%;"></td> </tr> <tr> <td></td> <td></td> <td colspan="8" style="text-align: center;"> <table border="1" style="width: 100%; border-collapse: collapse; text-align: center;"> <tr> <td style="width: 10%;"></td> <td style="width: 10%;"></td> <td style="width: 10%;"></td> <td style="width: 10%;"></td> <td style="width: 10%;"></td> <td style="width: 10%;"></td> <td style="width: 10%;"></td> <td style="width: 10%;"></td> <td style="width: 10%;"></td> <td style="width: 10%;"></td> </tr> <tr> <td></td> <td></td> <td colspan="8" style="text-align: center;"> <table border="1" style="width: 100%; border-collapse: collapse; text-align: center;"> <tr> <td style="width: 10%;"></td> <td style="width: 10%;"></td> <td style="width: 10%;"></td> <td style="width: 10%;"></td> <td style="width: 10%;"></td> <td style="width: 10%;"></td> <td style="width: 10%;"></td> <td style="width: 10%;"></td> <td style="width: 10%;"></td> <td style="width: 10%;"></td> </tr> <tr> <td></td> <td></td> <td colspan="8" style="text-align: center;"> <table border="1" style="width: 100%; border-collapse: collapse; text-align: center;"> <tr> <td style="width: 10%;"></td> <td style="width: 10%;"></td> <td style="width: 10%;"></td> <td style="width: 10%;"></td> <td style="width: 10%;"></td> <td style="width: 10%;"></td> <td style="width: 10%;"></td> <td style="width: 10%;"></td> <td style="width: 10%;"></td> <td style="width: 10%;"></td> </tr> <tr> <td></td> <td></td> <td colspan="8" style="text-align: center;"> <table border="1" style="width: 100%; border-collapse: collapse; text-align: center;"> <tr> <td style="width: 10%;"></td> <td style="width: 10%;"></td> <td style="width: 10%;"></td> <td style="width: 10%;"></td> <td style="width: 10%;"></td> <td style="width: 10%;"></td> <td style="width: 10%;"></td> <td style="width: 10%;"></td> <td style="width: 10%;"></td> <td style="width: 10%;"></td> </tr> <tr> <td></td> <td></td> <td colspan="8" style="text-align: center;"> <table border="1" style="width: 100%; border-collapse: collapse; text-align: center;"> <tr> <td style="width: 10%;"></td> <td style="width: 10%;"></td> <td style="width: 10%;"></td> <td style="width: 10%;"></td> <td style="width: 10%;"></td> <td style="width: 10%;"></td> <td style="width: 10%;"></td> <td style="width: 10%;"></td> <td style="width: 10%;"></td> <td style="width: 10%;"></td> </tr> <tr> <td></td> <td></td> <td colspan="8" style="text-align: center;"> <table border="1" style="width: 100%; border-collapse: collapse; text-align: center;"> <tr> <td style="width: 10%;"></td> <td style="width: 10%;"></td> <td style="width: 10%;"></td> <td style="width: 10%;"></td> <td style="width: 10%;"></td> <td style="width: 10%;"></td> <td style="width: 10%;"></td> <td style="width: 10%;"></td> <td style="width: 10%;"></td> <td style="width: 10%;"></td> </tr> <tr> <td></td> <td></td> <td colspan="8" style="text-align: center;"> <table border="1" style="width: 100%; border-collapse: collapse; text-align: center;"> <tr> <td style="width: 10%;"></td> <td style="width: 10%;"></td> <td style="width: 10%;"></td> <td style="width: 10%;"></td> <td style="width: 10%;"></td> <td style="width: 10%;"></td> <td style="width: 10%;"></td> <td style="width: 10%;"></td> <td style="width: 10%;"></td> <td style="width: 10%;"></td> </tr> <tr> <td></td> <td></td> <td colspan="8" style="text-align: center;"> <table border="1" style="width: 100%; border-collapse: collapse; text-align: center;"> <tr> <td style="width: 10%;"></td> <td style="width: 10%;"></td> <td style="width: 10%;"></td> <td style="width: 10%;"></td> <td style="width: 10%;"></td> <td style="width: 10%;"></td> <td style="width: 10%;"></td> <td style="width: 10%;"></td> <td style="width: 10%;"></td> <td style="width: 10%;"></td> </tr> <tr> <td></td> <td></td> <td colspan="8" style="text-align: center;"> <table border="1" style="width: 100%; border-collapse: collapse; text-align: center;"> <tr> <td style="width: 10%;"></td> <td style="width: 10%;"></td> <td style="width: 10%;"></td> <td style="width: 10%;"></td> <td style="width: 10%;"></td> <td style="width: 10%;"></td> <td style="width: 10%;"></td> <td style="width: 10%;"></td> <td style="width: 10%;"></td> <td style="width: 10%;"></td> </tr> <tr> <td></td> <td></td> <td colspan="8" style="text-align: center;"> <table border="1" style="width: 100%; border-collapse: collapse; text-align: center;"> <tr> <td style="width: 10%;"></td> <td style="width: 10%;"></td> <td style="width: 10%;"></td> <td style="width: 10%;"></td> <td style="width: 10%;"></td> <td style="width: 10%;"></td> <td style="width: 10%;"></td> <td style="width: 10%;"></td> <td style="width: 10%;"></td> <td style="width: 10%;"></td> </tr> <tr> <td></td> <td></td> <td colspan="8" style="text-align: center;"> <table border="1" style="width: 100%; border-collapse: collapse; text-align: center;"> <tr> <td style="width: 10%;"></td> <td style="width: 10%;"></td> <td style="width: 10%;"></td> <td style="width: 10%;"></td> <td style="width: 10%;"></td> <td style="width: 10%;"></td> <td style="width: 10%;"></td> <td style="width: 10%;"></td> <td style="width: 10%;"></td> <td style="width: 10%;"></td> </tr> <tr> <td></td> <td></td> <td colspan="8" style="text-align: center;"> <table border="1" style="width: 100%; border-collapse: collapse; text-align: center;"> <tr> <td style="width: 10%;"></td> <td style="width: 10%;"></td> <td style="width: 10%;"></td> <td style="width: 10%;"></td> <td style="width: 10%;"></td> <td style="width: 10%;"></td> <td style="width: 10%;"></td> <td style="width: 10%;"></td> <td style="width: 10%;"></td> <td style="width: 10%;"></td> </tr> <tr> <td></td> <td></td> <td colspan="8" style="text-align: center;"> <table border="1" style="width: 100%; border-collapse: collapse; text-align: center;"> <tr> <td style="width: 10%;"></td> <td style="width: 10%;"></td> <td style="width: 10%;"></td> <td style="width: 10%;"></td> <td style="width: 10%;"></td> <td style="width: 10%;"></td> <td style="width: 10%;"></td> <td style="width: 10%;"></td> <td style="width: 10%;"></td> <td style="width: 10%;"></td> </tr> <tr> <td></td> <td></td> <td colspan="8" style="text-align: center;"> <table border="1" style="width: 100%; border-collapse: collapse; text-align: center;"> <tr> <td style="width: 10%;"></td> <td style="width: 10%;"></td> <td style="width: 10%;"></td> <td style="width: 10%;"></td> <td style="width: 10%;"></td> <td style="width: 10%;"></td> <td style="width: 10%;"></td> <td style="width: 10%;"></td> <td style="width: 10%;"></td> <td style="width: 10%;"></td> </tr> <tr> <td></td> <td></td> <td colspan="8" style="text-align: center;"> <table border="1" style="width: 100%;
border-collapse: collapse; text-align: center;"> <tr> <td style="width: 10%;"></td> <td style="width: 10%;"></td> <td style="width: 10%;"></td> <td style="width: 10%;"></td> <td style="width: 10%;"></td> <td style="width: 10%;"></td> <td style="width: 10%;"></td> <td style="width: 10%;"></td> <td style="width: 10%;"></td> <td style="width: 10%;"></td> </tr> <tr> <td></td> <td></td> <td colspan="8" style="text-align: center;"> <table border="1" style="width: 100%; border-collapse: collapse; text-align: center;"> <tr> <td style="width: 10%;"></td> <td style="width: 10%;"></td> <td style="width: 10%;"></td> <td style="width: 10%;"></td> <td style="width: 10%;"></td> <td style="width: 10%;"></td> <td style="width: 10%;"></td> <td style="width: 10%;"></td> <td style="width: 10%;"></td> <td style="width: 10%;"></td> </tr> <tr> <td></td> <td></td> <td colspan="8" style="text-align: center;"> <table border="1" style="width: 100%; border-collapse: collapse; text-align: center;"> <tr> <td style="width: 10%;"></td> <td style="width: 10%;"></td> <td style="width: 10%;"></td> <td style="width: 10%;"></td> <td style="width: 10%;"></td> <td style="width: 10%;"></td> <td style="width: 10%;"></td> <td style="width: 10%;"></td> <td style="width: 10%;"></td> <td style="width: 10%;"></td> </tr> <tr> <td></td> <td></td> <td colspan="8" style="text-align: center;"> <table border="1" style="width: 100%; border-collapse: collapse; text-align: center;"> <tr> <td style="width: 10%;"></td> <td style="width: 10%;"></td> <td style="width: 10%;"></td> <td style="width: 10%;"></td> <td style="width: 10%;"></td> <td style="width: 10%;"></td> <td style="width: 10%;"></td> <td style="width: 10%;"></td> <td style="width: 10%;"></td> <td style="width: 10%;"></td> </tr> <tr> <td></td> <td></td> <td colspan="8" style="text-align: center;"> <table border="1" style="width: 100%; border-collapse: collapse; text-align: center;"> <tr> <td style="width: 10%;"></td> <td style="width: 10%;"></td> <td style="width: 10%;"></td> <td style="width: 10%;"></td> <td style="width: 10%;"></td> <td style="width: 10%;"></td> <td style="width: 10%;"></td> <td style="width: 10%;"></td> <td style="width: 10%;"></td> <td style="width: 10%;"></td> </tr> <tr> <td></td> <td></td> <td colspan="8" style="text-align: center;"> <table border="1" style="width: 100%; border-collapse: collapse; text-align: center;"> <tr> <td style="width: 10%;"></td> <td style="width: 10%;"></td> <td style="width: 10%;"></td> <td style="width: 10%;"></td> <td style="width: 10%;"></td> <td style="width: 10%;"></td> <td style="width: 10%;"></td> <td style="width: 10%;"></td> <td style="width: 10%;"></td> <td style="width: 10%;"></td> </tr> <tr> <td></td> <td></td> <td colspan="8" style="text-align: center;"> <table border="1" style="width: 100%; border-collapse: collapse; text-align: center;"> <tr> <td style="width: 10%;"></td> <td style="width: 10%;"></td> <td style="width: 10%;"></td> <td style="width: 10%;"></td> <td style="width: 10%;"></td> <td style="width: 10%;"></td> <td style="width: 10%;"></td> <td style="width: 10%;"></td> <td style="width: 10%;"></td> <td style="width: 10%;"></td> </tr> <tr> <td></td> <td></td> <td colspan="8" style="text-align: center;"> <table border="1" style="width: 100%; border-collapse: collapse; text-align: center;"> <tr> <td style="width: 10%;"></td> <td style="width: 10%;"></td> <td style="width: 10%;"></td> <td style="width: 10%;"></td> <td style="width: 10%;"></td> <td style="width: 10%;"></td> <td style="width: 10%;"></td> <td style="width: 10%;"></td> <td style="width: 10%;"></td> <td style="width: 10%;"></td> </tr> <tr> <td></td> <td></td> <td colspan="8" style="text-align: center;"> <table border="1" style="width: 100%; border-collapse: collapse; text-align: center;"> <tr> <td style="width: 10%;"></td> <td style="width: 10%;"></td> <td style="width: 10%;"></td> <td style="width: 10%;"></td> <td style="width: 10%;"></td> <td style="width: 10%;"></td> <td style="width: 10%;"></td> <td style="width: 10%;"></td> <td style="width: 10%;"></td> <td style="width: 10%;"></td> </tr> <tr> <td></td> <td></td> <td colspan="8" style="text-align: center;"> <table border="1" style="width: 100%; border-collapse: collapse; text-align: center;"> <tr> <td style="width: 10%;"></td> <td style="width: 10%;"></td> <td style="width: 10%;"></td> <td style="width: 10%;"></td> <td style="width: 10%;"></td> <td style="width: 10%;"></td> <td style="width: 10%;"></td> <td style="width: 10%;"></td> <td style="width: 10%;"></td> <td style="width: 10%;"></td> </tr> <tr> <td></td> <td></td> <td colspan="8" style="text-align: center;"> <table border="1" style="width: 100%; border-collapse: collapse; text-align: center;"> <tr> <td style="width: 10%;"></td> <td style="width: 10%;"></td> <td style="width: 10%;"></td> <td style="width: 10%;"></td> <td style="width: 10%;"></td> <td style="width: 10%;"></td> <td style="width: 10%;"></td> <td style="width: 10%;"></td> <td style="width: 10%;"></td> <td style="width: 10%;"></td> </tr> <tr> <td></td> <td></td> <td colspan="8" style="text-align: center;"> <table border="1" style="width: 100%; border-collapse: collapse; text-align: center;"> <tr> <td style="width: 10%;"></td> <td style="width: 10%;"></td> <td style="width: 10%;"></td> <td style="width: 10%;"></td> <td style="width: 10%;"></td> <td style="width: 10%;"></td> <td style="width: 10%;"></td> <td style="width: 10%;"></td> <td style="width: 10%;"></td> <td style="width: 10%;"></td> </tr> <tr> <td></td> <td></td> <td colspan="8" style="text-align: center;"> <table border="1" style="width: 100%; border-collapse: collapse; text-align: center;"> <tr> <td style="width: 10%;"></td> <td style="width: 10%;"></td> <td style="width: 10%;"></td> <td style="width: 10%;"></td> <td style="width: 10%;"></td> <td style="width: 10%;"></td> <td style="width: 10%;"></td> <td style="width: 10%;"></td> <td style="width: 10%;"></td> <td style="width: 10%;"></td> </tr> <tr> <td></td> <td></td> <td colspan="8" style="text-align: center;"> <table border="1" style="width: 100%; border-collapse: collapse; text-align: center;"> <tr> <td style="width: 10%;"></td> <td style="width: 10%;"></td> <td style="width: 10%;"></td> <td style="width: 10%;"></td> <td style="width: 10%;"></td> <td style="width: 10%;"></td> <td style="width: 10%;"></td> <td style="width: 10%;"></td> <td style="width: 10%;"></td> <td style="width: 10%;"></td> </tr> <tr> <td></td> <td></td> <td colspan="8" style="text-align: center;"> <table border="1" style="width: 100%; border-collapse: collapse; text-align: center;"> <tr> <td style="width: 10%;"></td> <td style="width: 10%;"></td> <td style="width: 10%;"></td> <td style="width: 10%;"></td> <td style="width: 10%;"></td> <td style="width: 10%;"></td> <td style="width: 10%;"></td> <td style="width: 10%;"></td> <td style="width: 10%;"></td> <td style="width: 10%;"></td> </tr> <tr> <td></td> <td></td> <td colspan="8" style="text-align: center;"> <table border="1" style="width: 100%; border-collapse: collapse; text-align: center;"> <tr> <td style="width: 10%;"></td> <td style="width: 10%;"></td> <td style="width: 10%;"></td> <td style="width: 10%;"></td> <td style="width: 10%;"></td> <td style="width: 10%;"></td> <td style="width: 10%;"></td> <td style="width: 10%;"></td> <td style="width: 10%;"></td> <td style="width: 10%;"></td> </tr> <tr> <td></td> <td></td> <td colspan="8" style="text-align: center;"> <table border="1" style="width: 100%; border-collapse: collapse; text-align: center;"> <tr> <td style="width: 10%;"></td> <td style="width: 10%;"></td> <td style="width: 10%;"></td> <td style="width: 10%;"></td> <td style="width: 10%;"></td> <td style="width: 10%;"></td> <td style="width: 10%;"></td> <td style="width: 10%;"></td> <td style="width: 10%;"></td> <td style="width: 10%;"></td> </tr> <tr> <td></td> <td></td> <td colspan="8" style="text-align: center;"> <table border="1" style="width: 100%; border-collapse: collapse; text-align: center;"> <tr> <td style="width: 10%;"></td> <td style="width: 10%;"></td> <td style="width: 10%;"></td> <td style="width: 10%;"></td> <td style="width: 10%;"></td> <td style="width: 10%;"></td> <td style="width: 10%;"></td> <td style="width: 10%;"></td> <td style="width: 10%;"></td> <td style="width: 10%;"></td> </tr> <tr> <td></td> <td></td> <td colspan="8" style="text-align: center;"> <table border="1" style="width: 100%; border-collapse: collapse; text-align: center;"> <tr> <td style="width: 10%;"></td> <td style="width: 10%;"></td> <td style="width: 10%;"></td> <td style="width: 10%;"></td> <td style="width: 10%;"></td> <td style="width: 10%;"></td> <td style="width: 10%;"></td> <td style="width: 10%;"></td> <td style="width: 10%;"></td> <td style="width: 10%;"></td> </tr> <tr> <td></td> <td></td> <td colspan="8" style="text-align: center;"> <table border="1" style="width: 100%; border-collapse: collapse; text-align: center;"> <tr> </tr></table></td></tr></table></td></tr></table></td></tr></table></td></tr></table></td></tr></table></td></tr></table></td></tr></table></td></tr></table></td></tr></table></td></tr></table></td></tr></table></td></tr></table></td></tr></table></td></tr></table></td></tr></table></td></tr></table></td></tr></table></td></tr></table></td></tr></table></td></tr></table></td></tr></table></td></tr></table></td></tr></table></td></tr></table></td></tr></table></td></tr></table></td></tr></table></td></tr></table></td></tr></table></td></tr></table></td></tr></table></td></tr></table></td></tr></table></td></tr></table></td></tr></table></td></tr></table></td></tr></table></td></tr></table></td></tr></table></td></tr></table></td></tr></table>
 | | | | | | | | | | | | | | | | | | | | <table border="1" style="width: 100%; border-collapse: collapse; text-align: center;"> <tr> <td style="width: 10%;"></td> <td style="width: 10%;"></td> <td style="width: 10%;"></td> <td style="width: 10%;"></td> <td style="width: 10%;"></td> <td style="width: 10%;"></td> <td style="width: 10%;"></td> <td style="width: 10%;"></td> <td style="width: 10%;"></td> <td style="width: 10%;"></td> </tr> <tr> <td></td> <td></td> <td colspan="8" style="text-align: center;"> <table border="1" style="width: 100%; border-collapse: collapse; text-align: center;"> <tr> <td style="width: 10%;"></td> <td style="width: 10%;"></td> <td style="width: 10%;"></td> <td style="width: 10%;"></td> <td style="width: 10%;"></td> <td style="width: 10%;"></td> <td style="width: 10%;"></td> <td style="width: 10%;"></td> <td style="width: 10%;"></td> <td style="width: 10%;"></td> </tr> <tr> <td></td> <td></td> <td colspan="8" style="text-align: center;"> <table border="1" style="width: 100%; border-collapse: collapse; text-align: center;"> <tr> <td style="width: 10%;"></td> <td style="width: 10%;"></td> <td style="width: 10%;"></td> <td style="width: 10%;"></td> <td style="width: 10%;"></td> <td style="width: 10%;"></td> <td style="width: 10%;"></td> <td style="width: 10%;"></td> <td style="width: 10%;"></td> <td style="width: 10%;"></td> </tr> <tr> <td></td> <td></td> <td colspan="8" style="text-align: center;"> <table border="1" style="width: 100%; border-collapse: collapse; text-align: center;"> <tr> <td style="width: 10%;"></td> <td style="width: 10%;"></td> <td style="width: 10%;"></td> <td style="width: 10%;"></td> <td style="width: 10%;"></td> <td style="width: 10%;"></td> <td style="width: 10%;"></td> <td style="width: 10%;"></td> <td style="width: 10%;"></td> <td style="width: 10%;"></td> </tr> <tr> <td></td> <td></td> <td colspan="8" style="text-align: center;"> <table border="1" style="width: 100%; border-collapse: collapse; text-align: center;"> <tr> <td style="width: 10%;"></td> <td style="width: 10%;"></td> <td style="width: 10%;"></td> <td style="width: 10%;"></td> <td style="width: 10%;"></td> <td style="width: 10%;"></td> <td style="width: 10%;"></td> <td style="width: 10%;"></td> <td style="width: 10%;"></td> <td style="width: 10%;"></td> </tr> <tr> <td></td> <td></td> <td colspan="8" style="text-align: center;"> <table border="1" style="width: 100%; border-collapse: collapse; text-align: center;"> <tr> <td style="width: 10%;"></td> <td style="width: 10%;"></td> <td style="width: 10%;"></td> <td style="width: 10%;"></td> <td style="width: 10%;"></td> <td style="width: 10%;"></td> <td style="width: 10%;"></td> <td style="width: 10%;"></td> <td style="width: 10%;"></td> <td style="width: 10%;"></td> </tr> <tr> <td></td> <td></td> <td colspan="8" style="text-align: center;"> <table border="1" style="width: 100%; border-collapse: collapse; text-align: center;"> <tr> <td style="width: 10%;"></td> <td style="width: 10%;"></td> <td style="width: 10%;"></td> <td style="width: 10%;"></td> <td style="width: 10%;"></td> <td style="width: 10%;"></td> <td style="width: 10%;"></td> <td style="width: 10%;"></td> <td style="width: 10%;"></td> <td style="width: 10%;"></td> </tr> <tr> <td></td> <td></td> <td colspan="8" style="text-align: center;"> <table border="1" style="width: 100%; border-collapse: collapse; text-align: center;"> <tr> <td style="width: 10%;"></td> <td style="width: 10%;"></td> <td style="width: 10%;"></td> <td style="width: 10%;"></td> <td style="width: 10%;"></td> <td style="width: 10%;"></td> <td style="width: 10%;"></td> <td style="width: 10%;"></td> <td style="width: 10%;"></td> <td style="width: 10%;"></td> </tr> <tr> <td></td> <td></td> <td colspan="8" style="text-align: center;"> <table border="1" style="width: 100%; border-collapse: collapse; text-align: center;"> <tr> <td style="width: 10%;"></td> <td style="width: 10%;"></td> <td style="width: 10%;"></td> <td style="width: 10%;"></td> <td style="width: 10%;"></td> <td style="width: 10%;"></td> <td style="width: 10%;"></td> <td style="width: 10%;"></td> <td style="width: 10%;"></td> <td style="width: 10%;"></td> </tr> <tr> <td></td> <td></td> <td colspan="8" style="text-align: center;"> <table border="1" style="width: 100%; border-collapse: collapse; text-align: center;"> <tr> <td style="width: 10%;"></td> <td style="width: 10%;"></td> <td style="width: 10%;"></td> <td style="width: 10%;"></td> <td style="width: 10%;"></td> <td style="width: 10%;"></td> <td style="width: 10%;"></td> <td style="width: 10%;"></td> <td style="width: 10%;"></td> <td style="width: 10%;"></td> </tr> <tr> <td></td> <td></td> <td colspan="8" style="text-align: center;"> <table border="1" style="width: 100%; border-collapse: collapse; text-align: center;"> <tr> <td style="width: 10%;"></td> <td style="width: 10%;"></td> <td style="width: 10%;"></td> <td style="width: 10%;"></td> <td style="width: 10%;"></td> <td style="width: 10%;"></td> <td style="width: 10%;"></td> <td style="width: 10%;"></td> <td style="width: 10%;"></td> <td style="width: 10%;"></td> </tr> <tr> <td></td> <td></td> <td colspan="8" style="text-align: center;"> <table border="1" style="width: 100%; border-collapse: collapse; text-align: center;"> <tr> <td style="width: 10%;"></td> <td style="width: 10%;"></td> <td style="width: 10%;"></td> <td style="width: 10%;"></td> <td style="width: 10%;"></td> <td style="width: 10%;"></td> <td style="width: 10%;"></td> <td style="width: 10%;"></td> <td style="width: 10%;"></td> <td style="width: 10%;"></td> </tr> <tr> <td></td> <td></td> <td colspan="8" style="text-align: center;"> <table border="1" style="width: 100%; border-collapse: collapse; text-align: center;"> <tr> <td style="width: 10%;"></td> <td style="width: 10%;"></td> <td style="width: 10%;"></td> <td style="width: 10%;"></td> <td style="width: 10%;"></td> <td style="width: 10%;"></td> <td style="width: 10%;"></td> <td style="width: 10%;"></td> <td style="width: 10%;"></td> <td style="width: 10%;"></td> </tr> <tr> <td></td> <td></td> <td colspan="8" style="text-align: center;"> <table border="1" style="width: 100%; border-collapse: collapse; text-align: center;"> <tr> <td style="width: 10%;"></td> <td style="width: 10%;"></td> <td style="width: 10%;"></td> <td style="width: 10%;"></td> <td style="width: 10%;"></td> <td style="width:
10%;"></td> <td style="width: 10%;"></td> <td style="width: 10%;"></td> <td style="width: 10%;"></td> <td style="width: 10%;"></td> </tr> <tr> <td></td> <td></td> <td colspan="8" style="text-align: center;"> <table border="1" style="width: 100%; border-collapse: collapse; text-align: center;"> <tr> <td style="width: 10%;"></td> <td style="width: 10%;"></td> <td style="width: 10%;"></td> <td style="width: 10%;"></td> <td style="width: 10%;"></td> <td style="width: 10%;"></td> <td style="width: 10%;"></td> <td style="width: 10%;"></td> <td style="width: 10%;"></td> <td style="width: 10%;"></td> </tr> <tr> <td></td> <td></td> <td colspan="8" style="text-align: center;"> <table border="1" style="width: 100%; border-collapse: collapse; text-align: center;"> <tr> <td style="width: 10%;"></td> <td style="width: 10%;"></td> <td style="width: 10%;"></td> <td style="width: 10%;"></td> <td style="width: 10%;"></td> <td style="width: 10%;"></td> <td style="width: 10%;"></td> <td style="width: 10%;"></td> <td style="width: 10%;"></td> <td style="width: 10%;"></td> </tr> <tr> <td></td> <td></td> <td colspan="8" style="text-align: center;"> <table border="1" style="width: 100%; border-collapse: collapse; text-align: center;"> <tr> <td style="width: 10%;"></td> <td style="width: 10%;"></td> <td style="width: 10%;"></td> <td style="width: 10%;"></td> <td style="width: 10%;"></td> <td style="width: 10%;"></td> <td style="width: 10%;"></td> <td style="width: 10%;"></td> <td style="width: 10%;"></td> <td style="width: 10%;"></td> </tr> <tr> <td></td> <td></td> <td colspan="8" style="text-align: center;"> <table border="1" style="width: 100%; border-collapse: collapse; text-align: center;"> <tr> <td style="width: 10%;"></td> <td style="width: 10%;"></td> <td style="width: 10%;"></td> <td style="width: 10%;"></td> <td style="width: 10%;"></td> <td style="width: 10%;"></td> <td style="width: 10%;"></td> <td style="width: 10%;"></td> <td style="width: 10%;"></td> <td style="width: 10%;"></td> </tr> <tr> <td></td> <td></td> <td colspan="8" style="text-align: center;"> <table border="1" style="width: 100%; border-collapse: collapse; text-align: center;"> <tr> <td style="width: 10%;"></td> <td style="width: 10%;"></td> <td style="width: 10%;"></td> <td style="width: 10%;"></td> <td style="width: 10%;"></td> <td style="width: 10%;"></td> <td style="width: 10%;"></td> <td style="width: 10%;"></td> <td style="width: 10%;"></td> <td style="width: 10%;"></td> </tr> <tr> <td></td> <td></td> <td colspan="8" style="text-align: center;"> <table border="1" style="width: 100%; border-collapse: collapse; text-align: center;"> <tr> <td style="width: 10%;"></td> <td style="width: 10%;"></td> <td style="width: 10%;"></td> <td style="width: 10%;"></td> <td style="width: 10%;"></td> <td style="width: 10%;"></td> <td style="width: 10%;"></td> <td style="width: 10%;"></td> <td style="width: 10%;"></td> <td style="width: 10%;"></td> </tr> <tr> <td></td> <td></td> <td colspan="8" style="text-align: center;"> <table border="1" style="width: 100%; border-collapse: collapse; text-align: center;"> <tr> <td style="width: 10%;"></td> <td style="width: 10%;"></td> <td style="width: 10%;"></td> <td style="width: 10%;"></td> <td style="width: 10%;"></td> <td style="width: 10%;"></td> <td style="width: 10%;"></td> <td style="width: 10%;"></td> <td style="width: 10%;"></td> <td style="width: 10%;"></td> </tr> <tr> <td></td> <td></td> <td colspan="8" style="text-align: center;"> <table border="1" style="width: 100%; border-collapse: collapse; text-align: center;"> <tr> <td style="width: 10%;"></td> <td style="width: 10%;"></td> <td style="width: 10%;"></td> <td style="width: 10%;"></td> <td style="width: 10%;"></td> <td style="width: 10%;"></td> <td style="width: 10%;"></td> <td style="width: 10%;"></td> <td style="width: 10%;"></td> <td style="width: 10%;"></td> </tr> <tr> <td></td> <td></td> <td colspan="8" style="text-align: center;"> <table border="1" style="width: 100%; border-collapse: collapse; text-align: center;"> <tr> <td style="width: 10%;"></td> <td style="width: 10%;"></td> <td style="width: 10%;"></td> <td style="width: 10%;"></td> <td style="width: 10%;"></td> <td style="width: 10%;"></td> <td style="width: 10%;"></td> <td style="width: 10%;"></td> <td style="width: 10%;"></td> <td style="width: 10%;"></td> </tr> <tr> <td></td> <td></td> <td colspan="8" style="text-align: center;"> <table border="1" style="width: 100%; border-collapse: collapse; text-align: center;"> <tr> <td style="width: 10%;"></td> <td style="width: 10%;"></td> <td style="width: 10%;"></td> <td style="width: 10%;"></td> <td style="width: 10%;"></td> <td style="width: 10%;"></td> <td style="width: 10%;"></td> <td style="width: 10%;"></td> <td style="width: 10%;"></td> <td style="width: 10%;"></td> </tr> <tr> <td></td> <td></td> <td colspan="8" style="text-align: center;"> <table border="1" style="width: 100%; border-collapse: collapse; text-align: center;"> <tr> <td style="width: 10%;"></td> <td style="width: 10%;"></td> <td style="width: 10%;"></td> <td style="width: 10%;"></td> <td style="width: 10%;"></td> <td style="width: 10%;"></td> <td style="width: 10%;"></td> <td style="width: 10%;"></td> <td style="width: 10%;"></td> <td style="width: 10%;"></td> </tr> <tr> <td></td> <td></td> <td colspan="8" style="text-align: center;"> <table border="1" style="width: 100%; border-collapse: collapse; text-align: center;"> <tr> <td style="width: 10%;"></td> <td style="width: 10%;"></td> <td style="width: 10%;"></td> <td style="width: 10%;"></td> <td style="width: 10%;"></td> <td style="width: 10%;"></td> <td style="width: 10%;"></td> <td style="width: 10%;"></td> <td style="width: 10%;"></td> <td style="width: 10%;"></td> </tr> <tr> <td></td> <td></td> <td colspan="8" style="text-align: center;"> <table border="1" style="width: 100%; border-collapse: collapse; text-align: center;"> <tr> <td style="width: 10%;"></td> <td style="width: 10%;"></td> <td style="width: 10%;"></td> <td style="width: 10%;"></td> <td style="width: 10%;"></td> <td style="width: 10%;"></td> <td style="width: 10%;"></td> <td style="width: 10%;"></td> <td style="width: 10%;"></td> <td style="width: 10%;"></td> </tr> <tr> <td></td> <td></td> <td colspan="8" style="text-align: center;"> <table border="1" style="width: 100%; border-collapse: collapse; text-align: center;"> <tr> <td style="width: 10%;"></td> <td style="width: 10%;"></td> <td style="width: 10%;"></td> <td style="width: 10%;"></td> <td style="width: 10%;"></td> <td style="width: 10%;"></td> <td style="width: 10%;"></td> <td style="width: 10%;"></td> <td style="width: 10%;"></td> <td style="width: 10%;"></td> </tr> <tr> <td></td> <td></td> <td colspan="8" style="text-align: center;"> <table border="1" style="width: 100%; border-collapse: collapse; text-align: center;"> <tr> <td style="width: 10%;"></td> <td style="width: 10%;"></td> <td style="width: 10%;"></td> <td style="width: 10%;"></td> <td style="width: 10%;"></td> <td style="width: 10%;"></td> <td style="width: 10%;"></td> <td style="width: 10%;"></td> <td style="width: 10%;"></td> <td style="width: 10%;"></td> </tr> <tr> <td></td> <td></td> <td colspan="8" style="text-align: center;"> <table border="1" style="width: 100%; border-collapse: collapse; text-align: center;"> <tr> <td style="width: 10%;"></td> <td style="width: 10%;"></td> <td style="width: 10%;"></td> <td style="width: 10%;"></td> <td style="width: 10%;"></td> <td style="width: 10%;"></td> <td style="width: 10%;"></td> <td style="width: 10%;"></td> <td style="width: 10%;"></td> <td style="width: 10%;"></td> </tr> <tr> <td></td> <td></td> <td colspan="8" style="text-align: center;"> <table border="1" style="width: 100%; border-collapse: collapse; text-align: center;"> <tr> <td style="width: 10%;"></td> <td style="width: 10%;"></td> <td style="width: 10%;"></td> <td style="width: 10%;"></td> <td style="width: 10%;"></td> <td style="width: 10%;"></td> <td style="width: 10%;"></td> <td style="width: 10%;"></td> <td style="width: 10%;"></td> <td style="width: 10%;"></td> </tr> <tr> <td></td> <td></td> <td colspan="8" style="text-align: center;"> <table border="1" style="width: 100%; border-collapse: collapse; text-align: center;"> <tr> <td style="width: 10%;"></td> <td style="width: 10%;"></td> <td style="width: 10%;"></td> <td style="width: 10%;"></td> <td style="width: 10%;"></td> <td style="width: 10%;"></td> <td style="width: 10%;"></td> <td style="width: 10%;"></td> <td style="width: 10%;"></td> <td style="width: 10%;"></td> </tr> <tr> <td></td> <td></td> <td colspan="8" style="text-align: center;"> <table border="1" style="width: 100%; border-collapse: collapse; text-align: center;"> <tr> <td style="width: 10%;"></td> <td style="width: 10%;"></td> <td style="width: 10%;"></td> <td style="width: 10%;"></td> <td style="width: 10%;"></td> <td style="width: 10%;"></td> <td style="width: 10%;"></td> <td style="width: 10%;"></td> <td style="width: 10%;"></td> <td style="width: 10%;"></td> </tr> <tr> <td></td> <td></td> <td colspan="8" style="text-align: center;"> <table border="1" style="width: 100%; border-collapse: collapse; text-align: center;"> <tr> <td style="width: 10%;"></td> <td style="width: 10%;"></td> <td style="width: 10%;"></td> <td style="width: 10%;"></td> <td style="width: 10%;"></td> <td style="width: 10%;"></td> <td style="width: 10%;"></td> <td style="width: 10%;"></td> <td style="width: 10%;"></td> <td style="width: 10%;"></td> </tr> <tr> <td></td> <td></td> <td colspan="8" style="text-align: center;"> <table border="1" style="width: 100%; border-collapse: collapse; text-align: center;"> <tr> <td style="width: 10%;"></td> <td style="width: 10%;"></td> <td style="width: 10%;"></td> <td style="width: 10%;"></td> <td style="width: 10%;"></td> <td style="width: 10%;"></td> <td style="width: 10%;"></td> <td style="width: 10%;"></td> <td style="width: 10%;"></td> <td style="width: 10%;"></td> </tr> <tr> <td></td> <td></td> <td
colspan="8" style="text-align: center;"> <table border="1" style="width: 100%; border-collapse: collapse; text-align: center;"> <tr> <td style="width: 10%;"></td> <td style="width: 10%;"></td> <td style="width: 10%;"></td> <td style="width: 10%;"></td> <td style="width: 10%;"></td> <td style="width: 10%;"></td> <td style="width: 10%;"></td> <td style="width: 10%;"></td> <td style="width: 10%;"></td> <td style="width: 10%;"></td> </tr> <tr> <td></td> <td></td> <td colspan="8" style="text-align: center;"> <table border="1" style="width: 100%; border-collapse: collapse; text-align: center;"> <tr> <td style="width: 10%;"></td> <td style="width: 10%;"></td> <td style="width: 10%;"></td> <td style="width: 10%;"></td> <td style="width: 10%;"></td> <td style="width: 10%;"></td> <td style="width: 10%;"></td> <td style="width: 10%;"></td> <td style="width: 10%;"></td> <td style="width: 10%;"></td> </tr> <tr> <td></td> <td></td> <td colspan="8" style="text-align: center;"> <table border="1" style="width: 100%; border-collapse: collapse; text-align: center;"> <tr> <td style="width: 10%;"></td> <td style="width: 10%;"></td> <td style="width: 10%;"></td> <td style="width: 10%;"></td> <td style="width: 10%;"></td> <td style="width: 10%;"></td> <td style="width: 10%;"></td> <td style="width: 10%;"></td> <td style="width: 10%;"></td> <td style="width: 10%;"></td> </tr> <tr> <td></td> <td></td> <td colspan="8" style="text-align: center;"> <table border="1" style="width: 100%; border-collapse: collapse; text-align: center;"> <tr> <td style="width: 10%;"></td> <td style="width: 10%;"></td> <td style="width: 10%;"></td> <td style="width: 10%;"></td> <td style="width: 10%;"></td> <td style="width: 10%;"></td> <td style="width: 10%;"></td> <td style="width: 10%;"></td> <td style="width: 10%;"></td> <td style="width: 10%;"></td> </tr> <tr> <td></td> <td></td> <td colspan="8" style="text-align: center;"> <table border="1" style="width: 100%; border-collapse: collapse; text-align: center;"> <tr> <td style="width: 10%;"></td> <td style="width: 10%;"></td> <td style="width: 10%;"></td> <td style="width: 10%;"></td> <td style="width: 10%;"></td> <td style="width: 10%;"></td> <td style="width: 10%;"></td> <td style="width: 10%;"></td> <td style="width: 10%;"></td> <td style="width: 10%;"></td> </tr> <tr> <td></td> <td></td> <td colspan="8" style="text-align: center;"> <table border="1" style="width: 100%; border-collapse: collapse; text-align: center;"> <tr> </tr></table></td></tr></table></td></tr></table></td></tr></table></td></tr></table></td></tr></table></td></tr></table></td></tr></table></td></tr></table></td></tr></table></td></tr></table></td></tr></table></td></tr></table></td></tr></table></td></tr></table></td></tr></table></td></tr></table></td></tr></table></td></tr></table></td></tr></table></td></tr></table></td></tr></table></td></tr></table></td></tr></table></td></tr></table></td></tr></table></td></tr></table></td></tr></table></td></tr></table></td></tr></table></td></tr></table></td></tr></table></td></tr></table></td></tr></table></td></tr></table></td></tr></table></td></tr></table></td></tr></table></td></tr></table></td></tr></table></td></tr></table> | | | | | | | | | | | | | | | | | | | | <table border="1" style="width: 100%; border-collapse: collapse; text-align: center;"> <tr> <td style="width: 10%;"></td> <td style="width: 10%;"></td> <td style="width: 10%;"></td> <td style="width: 10%;"></td> <td style="width: 10%;"></td> <td style="width: 10%;"></td> <td style="width: 10%;"></td> <td style="width: 10%;"></td> <td style="width: 10%;"></td> <td style="width: 10%;"></td> </tr> <tr> <td></td> <td></td> <td colspan="8" style="text-align: center;"> <table border="1" style="width: 100%; border-collapse: collapse; text-align: center;"> <tr> <td style="width: 10%;"></td> <td style="width: 10%;"></td> <td style="width: 10%;"></td> <td style="width: 10%;"></td> <td style="width: 10%;"></td> <td style="width: 10%;"></td> <td style="width: 10%;"></td> <td style="width: 10%;"></td> <td style="width: 10%;"></td> <td style="width: 10%;"></td> </tr> <tr> <td></td> <td></td> <td colspan="8" style="text-align: center;"> <table border="1" style="width: 100%; border-collapse: collapse; text-align: center;"> <tr> <td style="width: 10%;"></td> <td style="width: 10%;"></td> <td style="width: 10%;"></td> <td style="width: 10%;"></td> <td style="width: 10%;"></td> <td style="width: 10%;"></td> <td style="width: 10%;"></td> <td style="width: 10%;"></td> <td style="width: 10%;"></td> <td style="width: 10%;"></td> </tr> <tr> <td></td> <td></td> <td colspan="8" style="text-align: center;"> <table border="1" style="width: 100%; border-collapse: collapse; text-align: center;"> <tr> <td style="width: 10%;"></td> <td style="width: 10%;"></td> <td style="width: 10%;"></td> <td style="width: 10%;"></td> <td style="width: 10%;"></td> <td style="width: 10%;"></td> <td style="width: 10%;"></td> <td style="width: 10%;"></td> <td style="width: 10%;"></td> <td style="width: 10%;"></td> </tr> <tr> <td></td> <td></td> <td colspan="8" style="text-align: center;"> <table border="1" style="width: 100%; border-collapse: collapse; text-align: center;"> <tr> <td style="width: 10%;"></td> <td style="width: 10%;"></td> <td style="width: 10%;"></td> <td style="width: 10%;"></td> <td style="width: 10%;"></td> <td style="width: 10%;"></td> <td style="width: 10%;"></td> <td style="width: 10%;"></td> <td style="width: 10%;"></td> <td style="width: 10%;"></td> </tr> <tr> <td></td> <td></td> <td colspan="8" style="text-align: center;"> <table border="1" style="width: 100%; border-collapse: collapse; text-align: center;"> <tr> <td style="width: 10%;"></td> <td style="width: 10%;"></td> <td style="width: 10%;"></td> <td style="width: 10%;"></td> <td style="width: 10%;"></td> <td style="width: 10%;"></td> <td style="width: 10%;"></td> <td style="width: 10%;"></td> <td style="width: 10%;"></td> <td style="width: 10%;"></td> </tr> <tr> <td></td> <td></td> <td colspan="8" style="text-align: center;"> <table border="1" style="width: 100%;
border-collapse: collapse; text-align: center;"> <tr> <td style="width: 10%;"></td> <td style="width: 10%;"></td> <td style="width: 10%;"></td> <td style="width: 10%;"></td> <td style="width: 10%;"></td> <td style="width: 10%;"></td> <td style="width: 10%;"></td> <td style="width: 10%;"></td> <td style="width: 10%;"></td> <td style="width: 10%;"></td> </tr> <tr> <td></td> <td></td> <td colspan="8" style="text-align: center;"> <table border="1" style="width: 100%; border-collapse: collapse; text-align: center;"> <tr> <td style="width: 10%;"></td> <td style="width: 10%;"></td> <td style="width: 10%;"></td> <td style="width: 10%;"></td> <td style="width: 10%;"></td> <td style="width: 10%;"></td> <td style="width: 10%;"></td> <td style="width: 10%;"></td> <td style="width: 10%;"></td> <td style="width: 10%;"></td> </tr> <tr> <td></td> <td></td> <td colspan="8" style="text-align: center;"> <table border="1" style="width: 100%; border-collapse: collapse; text-align: center;"> <tr> <td style="width: 10%;"></td> <td style="width: 10%;"></td> <td style="width: 10%;"></td> <td style="width: 10%;"></td> <td style="width: 10%;"></td> <td style="width: 10%;"></td> <td style="width: 10%;"></td> <td style="width: 10%;"></td> <td style="width: 10%;"></td> <td style="width: 10%;"></td> </tr> <tr> <td></td> <td></td> <td colspan="8" style="text-align: center;"> <table border="1" style="width: 100%; border-collapse: collapse; text-align: center;"> <tr> <td style="width: 10%;"></td> <td style="width: 10%;"></td> <td style="width: 10%;"></td> <td style="width: 10%;"></td> <td style="width: 10%;"></td> <td style="width: 10%;"></td> <td style="width: 10%;"></td> <td style="width: 10%;"></td> <td style="width: 10%;"></td> <td style="width: 10%;"></td> </tr> <tr> <td></td> <td></td> <td colspan="8" style="text-align: center;"> <table border="1" style="width: 100%; border-collapse: collapse; text-align: center;"> <tr> <td style="width: 10%;"></td> <td style="width: 10%;"></td> <td style="width: 10%;"></td> <td style="width: 10%;"></td> <td style="width: 10%;"></td> <td style="width: 10%;"></td> <td style="width: 10%;"></td> <td style="width: 10%;"></td> <td style="width: 10%;"></td> <td style="width: 10%;"></td> </tr> <tr> <td></td> <td></td> <td colspan="8" style="text-align: center;"> <table border="1" style="width: 100%; border-collapse: collapse; text-align: center;"> <tr> <td style="width: 10%;"></td> <td style="width: 10%;"></td> <td style="width: 10%;"></td> <td style="width: 10%;"></td> <td style="width: 10%;"></td> <td style="width: 10%;"></td> <td style="width: 10%;"></td> <td style="width: 10%;"></td> <td style="width: 10%;"></td> <td style="width: 10%;"></td> </tr> <tr> <td></td> <td></td> <td colspan="8" style="text-align: center;"> <table border="1" style="width: 100%; border-collapse: collapse; text-align: center;"> <tr> <td style="width: 10%;"></td> <td style="width: 10%;"></td> <td style="width: 10%;"></td> <td style="width: 10%;"></td> <td style="width: 10%;"></td> <td style="width: 10%;"></td> <td style="width: 10%;"></td> <td style="width: 10%;"></td> <td style="width: 10%;"></td> <td style="width: 10%;"></td> </tr> <tr> <td></td> <td></td> <td colspan="8" style="text-align: center;"> <table border="1" style="width: 100%; border-collapse: collapse; text-align: center;"> <tr> <td style="width: 10%;"></td> <td style="width: 10%;"></td> <td style="width: 10%;"></td> <td style="width: 10%;"></td> <td style="width: 10%;"></td> <td style="width: 10%;"></td> <td style="width: 10%;"></td> <td style="width: 10%;"></td> <td style="width: 10%;"></td> <td style="width: 10%;"></td> </tr> <tr> <td></td> <td></td> <td colspan="8" style="text-align: center;"> <table border="1" style="width: 100%; border-collapse: collapse; text-align: center;"> <tr> <td style="width: 10%;"></td> <td style="width: 10%;"></td> <td style="width: 10%;"></td> <td style="width: 10%;"></td> <td style="width: 10%;"></td> <td style="width: 10%;"></td> <td style="width: 10%;"></td> <td style="width: 10%;"></td> <td style="width: 10%;"></td> <td style="width: 10%;"></td> </tr> <tr> <td></td> <td></td> <td colspan="8" style="text-align: center;"> <table border="1" style="width: 100%; border-collapse: collapse; text-align: center;"> <tr> <td style="width: 10%;"></td> <td style="width: 10%;"></td> <td style="width: 10%;"></td> <td style="width: 10%;"></td> <td style="width: 10%;"></td> <td style="width: 10%;"></td> <td style="width: 10%;"></td> <td style="width: 10%;"></td> <td style="width: 10%;"></td> <td style="width: 10%;"></td> </tr> <tr> <td></td> <td></td> <td colspan="8" style="text-align: center;"> <table border="1" style="width: 100%; border-collapse: collapse; text-align: center;"> <tr> <td style="width: 10%;"></td> <td style="width: 10%;"></td> <td style="width: 10%;"></td> <td style="width: 10%;"></td> <td style="width: 10%;"></td> <td style="width: 10%;"></td> <td style="width: 10%;"></td> <td style="width: 10%;"></td> <td style="width: 10%;"></td> <td style="width: 10%;"></td> </tr> <tr> <td></td> <td></td> <td colspan="8" style="text-align: center;"> <table border="1" style="width: 100%; border-collapse: collapse; text-align: center;"> <tr> <td style="width: 10%;"></td> <td style="width: 10%;"></td> <td style="width: 10%;"></td> <td style="width: 10%;"></td> <td style="width: 10%;"></td> <td style="width: 10%;"></td> <td style="width: 10%;"></td> <td style="width: 10%;"></td> <td style="width: 10%;"></td> <td style="width: 10%;"></td> </tr> <tr> <td></td> <td></td> <td colspan="8" style="text-align: center;"> <table border="1" style="width: 100%; border-collapse: collapse; text-align: center;"> <tr> <td style="width: 10%;"></td> <td style="width: 10%;"></td> <td style="width: 10%;"></td> <td style="width: 10%;"></td> <td style="width: 10%;"></td> <td style="width: 10%;"></td> <td style="width: 10%;"></td> <td style="width: 10%;"></td> <td style="width: 10%;"></td> <td style="width: 10%;"></td> </tr> <tr> <td></td> <td></td> <td colspan="8" style="text-align: center;"> <table border="1" style="width: 100%; border-collapse: collapse; text-align: center;"> <tr> <td style="width: 10%;"></td> <td style="width: 10%;"></td> <td style="width: 10%;"></td> <td style="width: 10%;"></td> <td style="width: 10%;"></td> <td style="width: 10%;"></td> <td style="width: 10%;"></td> <td style="width: 10%;"></td> <td style="width: 10%;"></td> <td style="width: 10%;"></td> </tr> <tr> <td></td> <td></td> <td colspan="8" style="text-align: center;"> <table border="1" style="width: 100%; border-collapse: collapse; text-align: center;"> <tr> <td style="width: 10%;"></td> <td style="width: 10%;"></td> <td style="width: 10%;"></td> <td style="width: 10%;"></td> <td style="width: 10%;"></td> <td style="width: 10%;"></td> <td style="width: 10%;"></td> <td style="width: 10%;"></td> <td style="width: 10%;"></td> <td style="width: 10%;"></td> </tr> <tr> <td></td> <td></td> <td colspan="8" style="text-align: center;"> <table border="1" style="width: 100%; border-collapse: collapse; text-align: center;"> <tr> <td style="width: 10%;"></td> <td style="width: 10%;"></td> <td style="width: 10%;"></td> <td style="width: 10%;"></td> <td style="width: 10%;"></td> <td style="width: 10%;"></td> <td style="width: 10%;"></td> <td style="width: 10%;"></td> <td style="width: 10%;"></td> <td style="width: 10%;"></td> </tr> <tr> <td></td> <td></td> <td colspan="8" style="text-align: center;"> <table border="1" style="width: 100%; border-collapse: collapse; text-align: center;"> <tr> <td style="width: 10%;"></td> <td style="width: 10%;"></td> <td style="width: 10%;"></td> <td style="width: 10%;"></td> <td style="width: 10%;"></td> <td style="width: 10%;"></td> <td style="width: 10%;"></td> <td style="width: 10%;"></td> <td style="width: 10%;"></td> <td style="width: 10%;"></td> </tr> <tr> <td></td> <td></td> <td colspan="8" style="text-align: center;"> <table border="1" style="width: 100%; border-collapse: collapse; text-align: center;"> <tr> <td style="width: 10%;"></td> <td style="width: 10%;"></td> <td style="width: 10%;"></td> <td style="width: 10%;"></td> <td style="width: 10%;"></td> <td style="width: 10%;"></td> <td style="width: 10%;"></td> <td style="width: 10%;"></td> <td style="width: 10%;"></td> <td style="width: 10%;"></td> </tr> <tr> <td></td> <td></td> <td colspan="8" style="text-align: center;"> <table border="1" style="width: 100%; border-collapse: collapse; text-align: center;"> <tr> <td style="width: 10%;"></td> <td style="width: 10%;"></td> <td style="width: 10%;"></td> <td style="width: 10%;"></td> <td style="width: 10%;"></td> <td style="width: 10%;"></td> <td style="width: 10%;"></td> <td style="width: 10%;"></td> <td style="width: 10%;"></td> <td style="width: 10%;"></td> </tr> <tr> <td></td> <td></td> <td colspan="8" style="text-align: center;"> <table border="1" style="width: 100%; border-collapse: collapse; text-align: center;"> <tr> <td style="width: 10%;"></td> <td style="width: 10%;"></td> <td style="width: 10%;"></td> <td style="width: 10%;"></td> <td style="width: 10%;"></td> <td style="width: 10%;"></td> <td style="width: 10%;"></td> <td style="width: 10%;"></td> <td style="width: 10%;"></td> <td style="width: 10%;"></td> </tr> <tr> <td></td> <td></td> <td colspan="8" style="text-align: center;"> <table border="1" style="width: 100%; border-collapse: collapse; text-align: center;"> <tr> <td style="width: 10%;"></td> <td style="width: 10%;"></td> <td style="width: 10%;"></td> <td style="width: 10%;"></td> <td style="width: 10%;"></td> <td style="width: 10%;"></td> <td style="width: 10%;"></td> <td style="width: 10%;"></td> <td style="width: 10%;"></td> <td style="width: 10%;"></td> </tr> <tr> <td></td> <td></td> <td colspan="8" style="text-align: center;"> <table border="1" style="width: 100%; border-collapse: collapse; text-align: center;"> <tr> <td style="width: 10%;"></td> <td style="width: 10%;"></td> <td style="width: 10%;"></td> <td style="width:
10%;"></td> <td style="width: 10%;"></td> <td style="width: 10%;"></td> <td style="width: 10%;"></td> <td style="width: 10%;"></td> <td style="width: 10%;"></td> <td style="width: 10%;"></td> </tr> <tr> <td></td> <td></td> <td colspan="8" style="text-align: center;"> <table border="1" style="width: 100%; border-collapse: collapse; text-align: center;"> <tr> <td style="width: 10%;"></td> <td style="width: 10%;"></td> <td style="width: 10%;"></td> <td style="width: 10%;"></td> <td style="width: 10%;"></td> <td style="width: 10%;"></td> <td style="width: 10%;"></td> <td style="width: 10%;"></td> <td style="width: 10%;"></td> <td style="width: 10%;"></td> </tr> <tr> <td></td> <td></td> <td colspan="8" style="text-align: center;"> <table border="1" style="width: 100%; border-collapse: collapse; text-align: center;"> <tr> <td style="width: 10%;"></td> <td style="width: 10%;"></td> <td style="width: 10%;"></td> <td style="width: 10%;"></td> <td style="width: 10%;"></td> <td style="width: 10%;"></td> <td style="width: 10%;"></td> <td style="width: 10%;"></td> <td style="width: 10%;"></td> <td style="width: 10%;"></td> </tr> <tr> <td></td> <td></td> <td colspan="8" style="text-align: center;"> <table border="1" style="width: 100%; border-collapse: collapse; text-align: center;"> <tr> <td style="width: 10%;"></td> <td style="width: 10%;"></td> <td style="width: 10%;"></td> <td style="width: 10%;"></td> <td style="width: 10%;"></td> <td style="width: 10%;"></td> <td style="width: 10%;"></td> <td style="width: 10%;"></td> <td style="width: 10%;"></td> <td style="width: 10%;"></td> </tr> <tr> <td></td> <td></td> <td colspan="8" style="text-align: center;"> <table border="1" style="width: 100%; border-collapse: collapse; text-align: center;"> <tr> <td style="width: 10%;"></td> <td style="width: 10%;"></td> <td style="width: 10%;"></td> <td style="width: 10%;"></td> <td style="width: 10%;"></td> <td style="width: 10%;"></td> <td style="width: 10%;"></td> <td style="width: 10%;"></td> <td style="width: 10%;"></td> <td style="width: 10%;"></td> </tr> <tr> <td></td> <td></td> <td colspan="8" style="text-align: center;"> <table border="1" style="width: 100%; border-collapse: collapse; text-align: center;"> <tr> <td style="width: 10%;"></td> <td style="width: 10%;"></td> <td style="width: 10%;"></td> <td style="width: 10%;"></td> <td style="width: 10%;"></td> <td style="width: 10%;"></td> <td style="width: 10%;"></td> <td style="width: 10%;"></td> <td style="width: 10%;"></td> <td style="width: 10%;"></td> </tr> <tr> <td></td> <td></td> <td colspan="8" style="text-align: center;"> <table border="1" style="width: 100%; border-collapse: collapse; text-align: center;"> <tr> <td style="width: 10%;"></td> <td style="width: 10%;"></td> <td style="width: 10%;"></td> <td style="width: 10%;"></td> <td style="width: 10%;"></td> <td style="width: 10%;"></td> <td style="width: 10%;"></td> <td style="width: 10%;"></td> <td style="width: 10%;"></td> <td style="width: 10%;"></td> </tr> <tr> <td></td> <td></td> <td colspan="8" style="text-align: center;"> <table border="1" style="width: 100%; border-collapse: collapse; text-align: center;"> <tr> <td style="width: 10%;"></td> <td style="width: 10%;"></td> <td style="width: 10%;"></td> <td style="width: 10%;"></td> <td style="width: 10%;"></td> <td style="width: 10%;"></td> <td style="width: 10%;"></td> <td style="width: 10%;"></td> <td style="width: 10%;"></td> <td style="width: 10%;"></td> </tr> <tr> <td></td> <td></td> <td colspan="8" style="text-align: center;"> <table border="1" style="width: 100%; border-collapse: collapse; text-align: center;"> <tr> <td style="width: 10%;"></td> <td style="width: 10%;"></td> <td style="width: 10%;"></td> <td style="width: 10%;"></td> <td style="width: 10%;"></td> <td style="width: 10%;"></td> <td style="width: 10%;"></td> <td style="width: 10%;"></td> <td style="width: 10%;"></td> <td style="width: 10%;"></td> </tr> <tr> <td></td> <td></td> <td colspan="8" style="text-align: center;"> <table border="1" style="width: 100%; border-collapse: collapse; text-align: center;"> <tr> <td style="width: 10%;"></td> <td style="width: 10%;"></td> <td style="width: 10%;"></td> <td style="width: 10%;"></td> <td style="width: 10%;"></td> <td style="width: 10%;"></td> <td style="width: 10%;"></td> <td style="width: 10%;"></td> <td style="width: 10%;"></td> <td style="width: 10%;"></td> </tr> <tr> <td></td> <td></td> <td colspan="8" style="text-align: center;"> <table border="1" style="width: 100%; border-collapse: collapse; text-align: center;"> <tr> <td style="width: 10%;"></td> <td style="width: 10%;"></td> <td style="width: 10%;"></td> <td style="width: 10%;"></td> <td style="width: 10%;"></td> <td style="width: 10%;"></td> <td style="width: 10%;"></td> <td style="width: 10%;"></td> <td style="width: 10%;"></td> <td style="width: 10%;"></td> </tr> <tr> <td></td> <td></td> <td colspan="8" style="text-align: center;"> <table border="1" style="width: 100%; border-collapse: collapse; text-align: center;"> <tr> <td style="width: 10%;"></td> <td style="width: 10%;"></td> <td style="width: 10%;"></td> <td style="width: 10%;"></td> <td style="width: 10%;"></td> <td style="width: 10%;"></td> <td style="width: 10%;"></td> <td style="width: 10%;"></td> <td style="width: 10%;"></td> <td style="width: 10%;"></td> </tr> <tr> <td></td> <td></td> <td colspan="8" style="text-align: center;"> <table border="1" style="width: 100%; border-collapse: collapse; text-align: center;"> <tr> </tr></table></td></tr></table></td></tr></table></td></tr></table></td></tr></table></td></tr></table></td></tr></table></td></tr></table></td></tr></table></td></tr></table></td></tr></table></td></tr></table></td></tr></table></td></tr></table></td></tr></table></td></tr></table></td></tr></table></td></tr></table></td></tr></table></td></tr></table></td></tr></table></td></tr></table></td></tr></table></td></tr></table></td></tr></table></td></tr></table></td></tr></table></td></tr></table></td></tr></table></td></tr></table></td></tr></table></td></tr></table></td></tr></table></td></tr></table></td></tr></table></td></tr></table></td></tr></table></td></tr></table></td></tr></table></td></tr></table>
 | | | | | | | | | | | | | | | | | | | | <table border="1" style="width: 100%; border-collapse: collapse; text-align: center;"> <tr> <td style="width: 10%;"></td> <td style="width: 10%;"></td> <td style="width: 10%;"></td> <td style="width: 10%;"></td> <td style="width: 10%;"></td> <td style="width: 10%;"></td> <td style="width: 10%;"></td> <td style="width: 10%;"></td> <td style="width: 10%;"></td> <td style="width: 10%;"></td> </tr> <tr> <td></td> <td></td> <td colspan="8" style="text-align: center;"> <table border="1" style="width: 100%; border-collapse: collapse; text-align: center;"> <tr> <td style="width: 10%;"></td> <td style="width: 10%;"></td> <td style="width: 10%;"></td> <td style="width: 10%;"></td> <td style="width: 10%;"></td> <td style="width: 10%;"></td> <td style="width: 10%;"></td> <td style="width: 10%;"></td> <td style="width: 10%;"></td> <td style="width: 10%;"></td> </tr> <tr> <td></td> <td></td> <td colspan="8" style="text-align: center;"> <table border="1" style="width: 100%; border-collapse: collapse; text-align: center;"> <tr> <td style="width: 10%;"></td> <td style="width: 10%;"></td> <td style="width: 10%;"></td> <td style="width: 10%;"></td> <td style="width: 10%;"></td> <td style="width: 10%;"></td> <td style="width: 10%;"></td> <td style="width: 10%;"></td> <td style="width: 10%;"></td> <td style="width: 10%;"></td> </tr> <tr> <td></td> <td></td> <td colspan="8" style="text-align: center;"> <table border="1" style="width: 100%; border-collapse: collapse; text-align: center;"> <tr> <td style="width: 10%;"></td> <td style="width: 10%;"></td> <td style="width: 10%;"></td> <td style="width: 10%;"></td> <td style="width: 10%;"></td> <td style="width: 10%;"></td> <td style="width: 10%;"></td> <td style="width: 10%;"></td> <td style="width: 10%;"></td> <td style="width: 10%;"></td> </tr> <tr> <td></td> <td></td> <td colspan="8" style="text-align: center;"> <table border="1" style="width: 100%; border-collapse: collapse; text-align: center;"> <tr> <td style="width: 10%;"></td> <td style="width: 10%;"></td> <td style="width: 10%;"></td> <td style="width: 10%;"></td> <td style="width: 10%;"></td> <td style="width: 10%;"></td> <td style="width: 10%;"></td> <td style="width: 10%;"></td> <td style="width: 10%;"></td> <td style="width: 10%;"></td> </tr> <tr> <td></td> <td></td> <td colspan="8" style="text-align: center;"> <table border="1" style="width: 100%; border-collapse: collapse; text-align: center;"> <tr> <td style="width: 10%;"></td> <td style="width: 10%;"></td> <td style="width: 10%;"></td> <td style="width: 10%;"></td> <td style="width: 10%;"></td> <td style="width: 10%;"></td> <td style="width: 10%;"></td> <td style="width: 10%;"></td> <td style="width: 10%;"></td> <td style="width: 10%;"></td> </tr> <tr> <td></td> <td></td> <td colspan="8" style="text-align: center;"> <table border="1" style="width: 100%; border-collapse: collapse; text-align: center;"> <tr> <td style="width: 10%;"></td> <td style="width: 10%;"></td> <td style="width: 10%;"></td> <td style="width: 10%;"></td> <td style="width: 10%;"></td> <td style="width: 10%;"></td> <td style="width: 10%;"></td> <td style="width: 10%;"></td> <td style="width: 10%;"></td> <td style="width: 10%;"></td> </tr> <tr> <td></td> <td></td> <td colspan="8" style="text-align: center;"> <table border="1" style="width: 100%; border-collapse: collapse; text-align: center;"> <tr> <td style="width: 10%;"></td> <td style="width: 10%;"></td> <td style="width: 10%;"></td> <td style="width: 10%;"></td> <td style="width: 10%;"></td> <td style="width: 10%;"></td> <td style="width: 10%;"></td> <td style="width: 10%;"></td> <td style="width: 10%;"></td> <td style="width: 10%;"></td> </tr> <tr> <td></td> <td></td> <td colspan="8" style="text-align: center;"> <table border="1" style="width: 100%; border-collapse: collapse; text-align: center;"> <tr> <td style="width: 10%;"></td> <td style="width: 10%;"></td> <td style="width: 10%;"></td> <td style="width: 10%;"></td> <td style="width: 10%;"></td> <td style="width: 10%;"></td> <td style="width: 10%;"></td> <td style="width: 10%;"></td> <td style="width: 10%;"></td> <td style="width: 10%;"></td> </tr> <tr> <td></td> <td></td> <td colspan="8" style="text-align: center;"> <table border="1" style="width: 100%; border-collapse: collapse; text-align: center;"> <tr> <td style="width: 10%;"></td> <td style="width: 10%;"></td> <td style="width: 10%;"></td> <td style="width: 10%;"></td> <td style="width: 10%;"></td> <td style="width: 10%;"></td> <td style="width: 10%;"></td> <td style="width: 10%;"></td> <td style="width: 10%;"></td> <td style="width: 10%;"></td> </tr> <tr> <td></td> <td></td> <td colspan="8" style="text-align: center;"> <table border="1" style="width: 100%; border-collapse: collapse; text-align: center;"> <tr> <td style="width: 10%;"></td> <td style="width: 10%;"></td> <td style="width: 10%;"></td> <td style="width: 10%;"></td> <td style="width: 10%;"></td> <td style="width: 10%;"></td> <td style="width: 10%;"></td> <td style="width: 10%;"></td> <td style="width: 10%;"></td> <td style="width: 10%;"></td> </tr> <tr> <td></td> <td></td> <td colspan="8" style="text-align: center;"> <table border="1" style="width: 100%; border-collapse: collapse; text-align: center;"> <tr> <td style="width: 10%;"></td> <td style="width: 10%;"></td> <td style="width: 10%;"></td> <td style="width: 10%;"></td> <td style="width: 10%;"></td> <td style="width: 10%;"></td> <td style="width: 10%;"></td> <td style="width: 10%;"></td> <td style="width: 10%;"></td> <td style="width: 10%;"></td> </tr> <tr> <td></td> <td></td> <td colspan="8" style="text-align: center;"> <table border="1" style="width: 100%; border-collapse: collapse; text-align: center;"> <tr> <td style="width: 10%;"></td> <td style="width: 10%;"></td> <td style="width: 10%;"></td> <td style="width: 10%;"></td> <td style="width: 10%;"></td> <td style="width: 10%;"></td> <td style="width: 10%;"></td> <td style="width: 10%;"></td> <td style="width: 10%;"></td> <td style="width: 10%;"></td> </tr> <tr> <td></td> <td></td> <td colspan="8" style="text-align: center;"> <table border="1" style="width: 100%; border-collapse: collapse; text-align: center;"> <tr> <td style="width: 10%;"></td> <td style="width: 10%;"></td> <td style="width: 10%;"></td> <td style="width: 10%;"></td> <td style="width: 10%;"></td> <td style="width: 10%;"></td> <td style="width: 10%;"></td> <td style="width: 10%;"></td> <td style="width: 10%;"></td> <td style="width: 10%;"></td> </tr> <tr> <td></td> <td></td> <td colspan="8" style="text-align: center;"> <table border="1" style="width: 100%; border-collapse: collapse; text-align: center;"> <tr> <td style="width: 10%;"></td> <td style="width: 10%;"></td> <td style="width: 10%;"></td> <td style="width: 10%;"></td> <td style="width: 10%;"></td> <td style="width: 10%;"></td> <td style="width: 10%;"></td> <td style="width: 10%;"></td> <td style="width: 10%;"></td> <td style="width: 10%;"></td> </tr> <tr> <td></td> <td></td> <td colspan="8" style="text-align: center;"> <table border="1" style="width: 100%; border-collapse: collapse; text-align: center;"> <tr> <td style="width: 10%;"></td> <td style="width: 10%;"></td> <td style="width: 10%;"></td> <td style="width: 10%;"></td> <td style="width: 10%;"></td> <td style="width: 10%;"></td> <td style="width: 10%;"></td> <td style="width: 10%;"></td> <td style="width: 10%;"></td> <td style="width: 10%;"></td> </tr> <tr> <td></td> <td></td> <td colspan="8" style="text-align: center;"> <table border="1" style="width: 100%; border-collapse: collapse; text-align: center;"> <tr> <td style="width: 10%;"></td> <td style="width: 10%;"></td> <td style="width: 10%;"></td> <td style="width: 10%;"></td> <td style="width: 10%;"></td> <td style="width: 10%;"></td> <td style="width: 10%;"></td> <td style="width: 10%;"></td> <td style="width: 10%;"></td> <td style="width: 10%;"></td> </tr> <tr> <td></td> <td></td> <td colspan="8" style="text-align: center;"> <table border="1" style="width: 100%; border-collapse: collapse; text-align: center;"> <tr> <td style="width: 10%;"></td> <td style="width: 10%;"></td> <td style="width: 10%;"></td> <td style="width: 10%;"></td> <td style="width: 10%;"></td> <td style="width: 10%;"></td> <td style="width: 10%;"></td> <td style="width: 10%;"></td> <td style="width: 10%;"></td> <td style="width: 10%;"></td> </tr> <tr> <td></td> <td></td> <td colspan="8" style="text-align: center;"> <table border="1" style="width: 100%; border-collapse: collapse; text-align: center;"> <tr> <td style="width: 10%;"></td> <td style="width: 10%;"></td> <td style="width: 10%;"></td> <td style="width: 10%;"></td> <td style="width: 10%;"></td> <td style="width: 10%;"></td> <td style="width: 10%;"></td> <td style="width: 10%;"></td> <td style="width: 10%;"></td> <td style="width: 10%;"></td> </tr> <tr> <td></td> <td></td> <td colspan="8" style="text-align: center;"> <table border="1" style="width: 100%; border-collapse: collapse; text-align: center;"> <tr> <td style="width: 10%;"></td> <td style="width: 10%;"></td> <td style="width: 10%;"></td> <td style="width: 10%;"></td> <td style="width: 10%;"></td> <td style="width: 10%;"></td> <td style="width: 10%;"></td> <td style="width: 10%;"></td> <td style="width: 10%;"></td> <td style="width: 10%;"></td> </tr> <tr> <td></td> <td></td> <td colspan="8" style="text-align: center;"> <table border="1" style="width: 100%; border-collapse: collapse; text-align: center;"> <tr> <td style="width: 10%;"></td> <td style="width: 10%;"></td> <td style="width: 10%;"></td> <td style="width: 10%;"></td> <td style="width: 10%;"></td> <td style="width: 10%;"></td> <td style="width: 10%;"></td> <td style="width: 10%;"></td> <td style="width: 10%;"></td> <td style="width: 10%;"></td> </tr> <tr> <td></td> <td></td> <td colspan="8" style="text-align: center;">
<table border="1" style="width: 100%; border-collapse: collapse; text-align: center;"> <tr> <td style="width: 10%;"></td> <td style="width: 10%;"></td> <td style="width: 10%;"></td> <td style="width: 10%;"></td> <td style="width: 10%;"></td> <td style="width: 10%;"></td> <td style="width: 10%;"></td> <td style="width: 10%;"></td> <td style="width: 10%;"></td> <td style="width: 10%;"></td> </tr> <tr> <td></td> <td></td> <td colspan="8" style="text-align: center;"> <table border="1" style="width: 100%; border-collapse: collapse; text-align: center;"> <tr> <td style="width: 10%;"></td> <td style="width: 10%;"></td> <td style="width: 10%;"></td> <td style="width: 10%;"></td> <td style="width: 10%;"></td> <td style="width: 10%;"></td> <td style="width: 10%;"></td> <td style="width: 10%;"></td> <td style="width: 10%;"></td> <td style="width: 10%;"></td> </tr> <tr> <td></td> <td></td> <td colspan="8" style="text-align: center;"> <table border="1" style="width: 100%; border-collapse: collapse; text-align: center;"> <tr> <td style="width: 10%;"></td> <td style="width: 10%;"></td> <td style="width: 10%;"></td> <td style="width: 10%;"></td> <td style="width: 10%;"></td> <td style="width: 10%;"></td> <td style="width: 10%;"></td> <td style="width: 10%;"></td> <td style="width: 10%;"></td> <td style="width: 10%;"></td> </tr> <tr> <td></td> <td></td> <td colspan="8" style="text-align: center;"> <table border="1" style="width: 100%; border-collapse: collapse; text-align: center;"> <tr> <td style="width: 10%;"></td> <td style="width: 10%;"></td> <td style="width: 10%;"></td> <td style="width: 10%;"></td> <td style="width: 10%;"></td> <td style="width: 10%;"></td> <td style="width: 10%;"></td> <td style="width: 10%;"></td> <td style="width: 10%;"></td> <td style="width: 10%;"></td> </tr> <tr> <td></td> <td></td> <td colspan="8" style="text-align: center;"> <table border="1" style="width: 100%; border-collapse: collapse; text-align: center;"> <tr> <td style="width: 10%;"></td> <td style="width: 10%;"></td> <td style="width: 10%;"></td> <td style="width: 10%;"></td> <td style="width: 10%;"></td> <td style="width: 10%;"></td> <td style="width: 10%;"></td> <td style="width: 10%;"></td> <td style="width: 10%;"></td> <td style="width: 10%;"></td> </tr> <tr> <td></td> <td></td> <td colspan="8" style="text-align: center;"> <table border="1" style="width: 100%; border-collapse: collapse; text-align: center;"> <tr> <td style="width: 10%;"></td> <td style="width: 10%;"></td> <td style="width: 10%;"></td> <td style="width: 10%;"></td> <td style="width: 10%;"></td> <td style="width: 10%;"></td> <td style="width: 10%;"></td> <td style="width: 10%;"></td> <td style="width: 10%;"></td> <td style="width: 10%;"></td> </tr> <tr> <td></td> <td></td> <td colspan="8" style="text-align: center;"> <table border="1" style="width: 100%; border-collapse: collapse; text-align: center;"> <tr> <td style="width: 10%;"></td> <td style="width: 10%;"></td> <td style="width: 10%;"></td> <td style="width: 10%;"></td> <td style="width: 10%;"></td> <td style="width: 10%;"></td> <td style="width: 10%;"></td> <td style="width: 10%;"></td> <td style="width: 10%;"></td> <td style="width: 10%;"></td> </tr> <tr> <td></td> <td></td> <td colspan="8" style="text-align: center;"> <table border="1" style="width: 100%; border-collapse: collapse; text-align: center;"> <tr> <td style="width: 10%;"></td> <td style="width: 10%;"></td> <td style="width: 10%;"></td> <td style="width: 10%;"></td> <td style="width: 10%;"></td> <td style="width: 10%;"></td> <td style="width: 10%;"></td> <td style="width: 10%;"></td> <td style="width: 10%;"></td> <td style="width: 10%;"></td> </tr> <tr> <td></td> <td></td> <td colspan="8" style="text-align: center;"> <table border="1" style="width: 100%; border-collapse: collapse; text-align: center;"> <tr> <td style="width: 10%;"></td> <td style="width: 10%;"></td> <td style="width: 10%;"></td> <td style="width: 10%;"></td> <td style="width: 10%;"></td> <td style="width: 10%;"></td> <td style="width: 10%;"></td> <td style="width: 10%;"></td> <td style="width: 10%;"></td> <td style="width: 10%;"></td> </tr> <tr> <td></td> <td></td> <td colspan="8" style="text-align: center;"> <table border="1" style="width: 100%; border-collapse: collapse; text-align: center;"> <tr> <td style="width: 10%;"></td> <td style="width: 10%;"></td> <td style="width: 10%;"></td> <td style="width: 10%;"></td> <td style="width: 10%;"></td> <td style="width: 10%;"></td> <td style="width: 10%;"></td> <td style="width: 10%;"></td> <td style="width: 10%;"></td> <td style="width: 10%;"></td> </tr> <tr> <td></td> <td></td> <td colspan="8" style="text-align: center;"> <table border="1" style="width: 100%; border-collapse: collapse; text-align: center;"> <tr> <td style="width: 10%;"></td> <td style="width: 10%;"></td> <td style="width: 10%;"></td> <td style="width: 10%;"></td> <td style="width: 10%;"></td> <td style="width: 10%;"></td> <td style="width: 10%;"></td> <td style="width: 10%;"></td> <td style="width: 10%;"></td> <td style="width: 10%;"></td> </tr> <tr> <td></td> <td></td> <td colspan="8" style="text-align: center;"> <table border="1" style="width: 100%; border-collapse: collapse; text-align: center;"> <tr> <td style="width: 10%;"></td> <td style="width: 10%;"></td> <td style="width: 10%;"></td> <td style="width: 10%;"></td> <td style="width: 10%;"></td> <td style="width: 10%;"></td> <td style="width: 10%;"></td> <td style="width: 10%;"></td> <td style="width: 10%;"></td> <td style="width: 10%;"></td> </tr> <tr> <td></td> <td></td> <td colspan="8" style="text-align: center;"> <table border="1" style="width: 100%; border-collapse: collapse; text-align: center;"> <tr> <td style="width: 10%;"></td> <td style="width: 10%;"></td> <td style="width: 10%;"></td> <td style="width: 10%;"></td> <td style="width: 10%;"></td> <td style="width: 10%;"></td> <td style="width: 10%;"></td> <td style="width: 10%;"></td> <td style="width: 10%;"></td> <td style="width: 10%;"></td> </tr> <tr> <td></td> <td></td> <td colspan="8" style="text-align: center;"> <table border="1" style="width: 100%; border-collapse: collapse; text-align: center;"> <tr> <td style="width: 10%;"></td> <td style="width: 10%;"></td> <td style="width: 10%;"></td> <td style="width: 10%;"></td> <td style="width: 10%;"></td> <td style="width: 10%;"></td> <td style="width: 10%;"></td> <td style="width: 10%;"></td> <td style="width: 10%;"></td> <td style="width: 10%;"></td> </tr> <tr> <td></td> <td></td> <td colspan="8" style="text-align: center;"> <table border="1" style="width: 100%; border-collapse: collapse; text-align: center;"> <tr> <td style="width: 10%;"></td> <td style="width: 10%;"></td> <td style="width: 10%;"></td> <td style="width: 10%;"></td> <td style="width: 10%;"></td> <td style="width: 10%;"></td> <td style="width: 10%;"></td> <td style="width: 10%;"></td> <td style="width: 10%;"></td> <td style="width: 10%;"></td> </tr> <tr> <td></td> <td></td> <td colspan="8" style="text-align: center;"> <table border="1" style="width: 100%; border-collapse: collapse; text-align: center;"> <tr> <td style="width: 10%;"></td> <td style="width: 10%;"></td> <td style="width: 10%;"></td> <td style="width: 10%;"></td> <td style="width: 10%;"></td> <td style="width: 10%;"></td> <td style="width: 10%;"></td> <td style="width: 10%;"></td> <td style="width: 10%;"></td> <td style="width: 10%;"></td> </tr> <tr> <td></td> <td></td> <td colspan="8" style="text-align: center;"> <table border="1" style="width: 100%; border-collapse: collapse; text-align: center;"> <tr> <td style="width: 10%;"></td> <td style="width: 10%;"></td> <td style="width: 10%;"></td> <td style="width: 10%;"></td> <td style="width: 10%;"></td> <td style="width: 10%;"></td> <td style="width: 10%;"></td> <td style="width: 10%;"></td> <td style="width: 10%;"></td> <td style="width: 10%;"></td> </tr> <tr> <td></td> <td></td> <td colspan="8" style="text-align: center;"> <table border="1" style="width: 100%; border-collapse: collapse; text-align: center;"> <tr> </tr></table></td></tr></table></td></tr></table></td></tr></table></td></tr></table></td></tr></table></td></tr></table></td></tr></table></td></tr></table></td></tr></table></td></tr></table></td></tr></table></td></tr></table></td></tr></table></td></tr></table></td></tr></table></td></tr></table></td></tr></table></td></tr></table></td></tr></table></td></tr></table></td></tr></table></td></tr></table></td></tr></table></td></tr></table></td></tr></table></td></tr></table></td></tr></table></td></tr></table></td></tr></table></td></tr></table></td></tr></table></td></tr></table></td></tr></table></td></tr></table></td></tr></table></td></tr></table></td></tr></table></td></tr></table>
 | | | | | | | | | | | | | | | | | | | | <table border="1" style="width: 100%; border-collapse: collapse; text-align: center;"> <tr> <td style="width: 10%;"></td> <td style="width: 10%;"></td> <td style="width: 10%;"></td> <td style="width: 10%;"></td> <td style="width: 10%;"></td> <td style="width: 10%;"></td> <td style="width: 10%;"></td> <td style="width: 10%;"></td> <td style="width: 10%;"></td> <td style="width: 10%;"></td> </tr> <tr> <td></td> <td></td> <td colspan="8" style="text-align: center;"> <table border="1" style="width: 100%; border-collapse: collapse; text-align: center;"> <tr> <td style="width: 10%;"></td> <td style="width: 10%;"></td> <td style="width: 10%;"></td> <td style="width: 10%;"></td> <td style="width: 10%;"></td> <td style="width: 10%;"></td> <td style="width: 10%;"></td> <td style="width: 10%;"></td> <td style="width: 10%;"></td> <td style="width: 10%;"></td> </tr> <tr> <td></td> <td></td> <td colspan="8" style="text-align: center;"> <table border="1" style="width: 100%; border-collapse: collapse; text-align: center;"> <tr> <td style="width: 10%;"></td> <td style="width: 10%;"></td> <td style="width: 10%;"></td> <td style="width: 10%;"></td> <td style="width: 10%;"></td> <td style="width: 10%;"></td> <td style="width: 10%;"></td> <td style="width: 10%;"></td> <td style="width: 10%;"></td> <td style="width: 10%;"></td> </tr> <tr> <td></td> <td></td> <td colspan="8" style="text-align: center;"> <table border="1" style="width: 100%; border-collapse: collapse; text-align: center;"> <tr> <td style="width: 10%;"></td> <td style="width: 10%;"></td> <td style="width: 10%;"></td> <td style="width: 10%;"></td> <td style="width: 10%;"></td> <td style="width: 10%;"></td> <td style="width: 10%;"></td> <td style="width: 10%;"></td> <td style="width: 10%;"></td> <td style="width: 10%;"></td> </tr> <tr> <td></td> <td></td> <td colspan="8" style="text-align: center;"> <table border="1" style="width: 100%; border-collapse: collapse; text-align: center;"> <tr> <td style="width: 10%;"></td> <td style="width: 10%;"></td> <td style="width: 10%;"></td> <td style="width: 10%;"></td> <td style="width: 10%;"></td> <td style="width: 10%;"></td> <td style="width: 10%;"></td> <td style="width: 10%;"></td> <td style="width: 10%;"></td> <td style="width: 10%;"></td> </tr> <tr> <td></td> <td></td> <td colspan="8" style="text-align: center;"> <table border="1" style="width: 100%; border-collapse: collapse; text-align: center;"> <tr> <td style="width: 10%;"></td> <td style="width: 10%;"></td> <td style="width: 10%;"></td> <td style="width: 10%;"></td> <td style="width: 10%;"></td> <td style="width: 10%;"></td> <td style="width: 10%;"></td> <td style="width: 10%;"></td> <td style="width: 10%;"></td> <td style="width: 10%;"></td> </tr> <tr> <td></td> <td></td> <td colspan="8" style="text-align: center;"> <table border="1" style="width: 100%; border-collapse: collapse; text-align: center;"> <tr> <td style="width: 10%;"></td> <td style="width: 10%;"></td> <td style="width: 10%;"></td> <td style="width: 10%;"></td> <td style="width: 10%;"></td> <td style="width: 10%;"></td> <td style="width: 10%;"></td> <td style="width: 10%;"></td> <td style="width: 10%;"></td> <td style="width: 10%;"></td> </tr> <tr> <td></td> <td></td> <td colspan="8" style="text-align: center;"> <table border="1" style="width: 100%; border-collapse: collapse; text-align: center;"> <tr> <td style="width: 10%;"></td> <td style="width: 10%;"></td> <td style="width: 10%;"></td> <td style="width: 10%;"></td> <td style="width: 10%;"></td> <td style="width: 10%;"></td> <td style="width: 10%;"></td> <td style="width: 10%;"></td> <td style="width: 10%;"></td> <td style="width: 10%;"></td> </tr> <tr> <td></td> <td></td> <td colspan="8" style="text-align: center;"> <table border="1" style="width: 100%; border-collapse: collapse; text-align: center;"> <tr> <td style="width: 10%;"></td> <td style="width: 10%;"></td> <td style="width: 10%;"></td> <td style="width: 10%;"></td> <td style="width: 10%;"></td> <td style="width: 10%;"></td> <td style="width: 10%;"></td> <td style="width: 10%;"></td> <td style="width: 10%;"></td> <td style="width: 10%;"></td> </tr> <tr> <td></td> <td></td> <td colspan="8" style="text-align: center;"> <table border="1" style="width: 100%; border-collapse: collapse; text-align: center;"> <tr> <td style="width: 10%;"></td> <td style="width: 10%;"></td> <td style="width: 10%;"></td> <td style="width: 10%;"></td> <td style="width: 10%;"></td> <td style="width: 10%;"></td> <td style="width: 10%;"></td> <td style="width: 10%;"></td> <td style="width: 10%;"></td> <td style="width: 10%;"></td> </tr> <tr> <td></td> <td></td> <td colspan="8" style="text-align: center;"> <table border="1" style="width: 100%; border-collapse: collapse; text-align: center;"> <tr> <td style="width: 10%;"></td> <td style="width: 10%;"></td> <td style="width: 10%;"></td> <td style="width: 10%;"></td> <td style="width: 10%;"></td> <td style="width: 10%;"></td> <td style="width: 10%;"></td> <td style="width: 10%;"></td> <td style="width: 10%;"></td> <td style="width: 10%;"></td> </tr> <tr> <td></td> <td></td> <td colspan="8" style="text-align: center;"> <table border="1" style="width: 100%; border-collapse: collapse; text-align: center;"> <tr> <td style="width: 10%;"></td> <td style="width: 10%;"></td> <td style="width: 10%;"></td> <td style="width: 10%;"></td> <td style="width: 10%;"></td> <td style="width: 10%;"></td> <td style="width: 10%;"></td> <td style="width: 10%;"></td> <td style="width: 10%;"></td> <td style="width: 10%;"></td> </tr> <tr> <td></td> <td></td> <td colspan="8" style="text-align: center;"> <table border="1" style="width: 100%; border-collapse: collapse; text-align: center;"> <tr> <td style="width: 10%;"></td> <td style="width: 10%;"></td> <td style="width: 10%;"></td> <td style="width: 10%;"></td> <td style="width: 10%;"></td> <td style="width: 10%;"></td> <td style="width: 10%;"></td> <td style="width: 10%;"></td> <td style="width: 10%;"></td> <td style="width: 10%;"></td> </tr> <tr> <td></td> <td></td> <td colspan="8" style="text-align: center;"> <table border="1" style="width: 100%; border-collapse: collapse; text-align: center;"> <tr> <td style="width: 10%;"></td> <td style="width: 10%;"></td> <td style="width: 10%;"></td> <td style="width: 10%;"></td> <td style="width: 10%;"></td> <td style="width: 10%;"></td> <td style="width: 10%;"></td> <td style="width: 10%;"></td> <td style="width: 10%;"></td> <td style="width: 10%;"></td> </tr> <tr> <td></td> <td></td> <td colspan="8" style="text-align: center;"> <table border="1" style="width: 100%; border-collapse: collapse; text-align: center;"> <tr> <td style="width: 10%;"></td> <td style="width: 10%;"></td> <td style="width: 10%;"></td> <td style="width: 10%;"></td> <td style="width: 10%;"></td> <td style="width: 10%;"></td> <td style="width: 10%;"></td> <td style="width: 10%;"></td> <td style="width: 10%;"></td> <td style="width: 10%;"></td> </tr> <tr> <td></td> <td></td> <td colspan="8" style="text-align: center;"> <table border="1" style="width: 100%; border-collapse: collapse; text-align: center;"> <tr> <td style="width: 10%;"></td> <td style="width: 10%;"></td> <td style="width: 10%;"></td> <td style="width: 10%;"></td> <td style="width: 10%;"></td> <td style="width: 10%;"></td> <td
style="width: 10%;"></td> <td style="width: 10%;"></td> <td style="width: 10%;"></td> <td style="width: 10%;"></td> </tr> <tr> <td></td> <td></td> <td colspan="8" style="text-align: center;"> <table border="1" style="width: 100%; border-collapse: collapse; text-align: center;"> <tr> <td style="width: 10%;"></td> <td style="width: 10%;"></td> <td style="width: 10%;"></td> <td style="width: 10%;"></td> <td style="width: 10%;"></td> <td style="width: 10%;"></td> <td style="width: 10%;"></td> <td style="width: 10%;"></td> <td style="width: 10%;"></td> <td style="width: 10%;"></td> </tr> <tr> <td></td> <td></td> <td colspan="8" style="text-align: center;"> <table border="1" style="width: 100%; border-collapse: collapse; text-align: center;"> <tr> <td style="width: 10%;"></td> <td style="width: 10%;"></td> <td style="width: 10%;"></td> <td style="width: 10%;"></td> <td style="width: 10%;"></td> <td style="width: 10%;"></td> <td style="width: 10%;"></td> <td style="width: 10%;"></td> <td style="width: 10%;"></td> <td style="width: 10%;"></td> </tr> <tr> <td></td> <td></td> <td colspan="8" style="text-align: center;"> <table border="1" style="width: 100%; border-collapse: collapse; text-align: center;"> <tr> <td style="width: 10%;"></td> <td style="width: 10%;"></td> <td style="width: 10%;"></td> <td style="width: 10%;"></td> <td style="width: 10%;"></td> <td style="width: 10%;"></td> <td style="width: 10%;"></td> <td style="width: 10%;"></td> <td style="width: 10%;"></td> <td style="width: 10%;"></td> </tr> <tr> <td></td> <td></td> <td colspan="8" style="text-align: center;"> <table border="1" style="width: 100%; border-collapse: collapse; text-align: center;"> <tr> <td style="width: 10%;"></td> <td style="width: 10%;"></td> <td style="width: 10%;"></td> <td style="width: 10%;"></td> <td style="width: 10%;"></td> <td style="width: 10%;"></td> <td style="width: 10%;"></td> <td style="width: 10%;"></td> <td style="width: 10%;"></td> <td style="width: 10%;"></td> </tr> <tr> <td></td> <td></td> <td colspan="8" style="text-align: center;"> <table border="1" style="width: 100%; border-collapse: collapse; text-align: center;"> <tr> <td style="width: 10%;"></td> <td style="width: 10%;"></td> <td style="width: 10%;"></td> <td style="width: 10%;"></td> <td style="width: 10%;"></td> <td style="width: 10%;"></td> <td style="width: 10%;"></td> <td style="width: 10%;"></td> <td style="width: 10%;"></td> <td style="width: 10%;"></td> </tr> <tr> <td></td> <td></td> <td colspan="8" style="text-align: center;"> <table border="1" style="width: 100%; border-collapse: collapse; text-align: center;"> <tr> <td style="width: 10%;"></td> <td style="width: 10%;"></td> <td style="width: 10%;"></td> <td style="width: 10%;"></td> <td style="width: 10%;"></td> <td style="width: 10%;"></td> <td style="width: 10%;"></td> <td style="width: 10%;"></td> <td style="width: 10%;"></td> <td style="width: 10%;"></td> </tr> <tr> <td></td> <td></td> <td colspan="8" style="text-align: center;"> <table border="1" style="width: 100%; border-collapse: collapse; text-align: center;"> <tr> <td style="width: 10%;"></td> <td style="width: 10%;"></td> <td style="width: 10%;"></td> <td style="width: 10%;"></td> <td style="width: 10%;"></td> <td style="width: 10%;"></td> <td style="width: 10%;"></td> <td style="width: 10%;"></td> <td style="width: 10%;"></td> <td style="width: 10%;"></td> </tr> <tr> <td></td> <td></td> <td colspan="8" style="text-align: center;"> <table border="1" style="width: 100%; border-collapse: collapse; text-align: center;"> <tr> <td style="width: 10%;"></td> <td style="width: 10%;"></td> <td style="width: 10%;"></td> <td style="width: 10%;"></td> <td style="width: 10%;"></td> <td style="width: 10%;"></td> <td style="width: 10%;"></td> <td style="width: 10%;"></td> <td style="width: 10%;"></td> <td style="width: 10%;"></td> </tr> <tr> <td></td> <td></td> <td colspan="8" style="text-align: center;"> <table border="1" style="width: 100%; border-collapse: collapse; text-align: center;"> <tr> <td style="width: 10%;"></td> <td style="width: 10%;"></td> <td style="width: 10%;"></td> <td style="width: 10%;"></td> <td style="width: 10%;"></td> <td style="width: 10%;"></td> <td style="width: 10%;"></td> <td style="width: 10%;"></td> <td style="width: 10%;"></td> <td style="width: 10%;"></td> </tr> <tr> <td></td> <td></td> <td colspan="8" style="text-align: center;"> <table border="1" style="width: 100%; border-collapse: collapse; text-align: center;"> <tr> <td style="width: 10%;"></td> <td style="width: 10%;"></td> <td style="width: 10%;"></td> <td style="width: 10%;"></td> <td style="width: 10%;"></td> <td style="width: 10%;"></td> <td style="width: 10%;"></td> <td style="width: 10%;"></td> <td style="width: 10%;"></td> <td style="width: 10%;"></td> </tr> <tr> <td></td> <td></td> <td colspan="8" style="text-align: center;"> <table border="1" style="width: 100%; border-collapse: collapse; text-align: center;"> <tr> <td style="width: 10%;"></td> <td style="width: 10%;"></td> <td style="width: 10%;"></td> <td style="width: 10%;"></td> <td style="width: 10%;"></td> <td style="width: 10%;"></td> <td style="width: 10%;"></td> <td style="width: 10%;"></td> <td style="width: 10%;"></td> <td style="width: 10%;"></td> </tr> <tr> <td></td> <td></td> <td colspan="8" style="text-align: center;"> <table border="1" style="width: 100%; border-collapse: collapse; text-align: center;"> <tr> <td style="width: 10%;"></td> <td style="width: 10%;"></td> <td style="width: 10%;"></td> <td style="width: 10%;"></td> <td style="width: 10%;"></td> <td style="width: 10%;"></td> <td style="width: 10%;"></td> <td style="width: 10%;"></td> <td style="width: 10%;"></td> <td style="width: 10%;"></td> </tr> <tr> <td></td> <td></td> <td colspan="8" style="text-align: center;"> <table border="1" style="width: 100%; border-collapse: collapse; text-align: center;"> <tr> <td style="width: 10%;"></td> <td style="width: 10%;"></td> <td style="width: 10%;"></td> <td style="width: 10%;"></td> <td style="width: 10%;"></td> <td style="width: 10%;"></td> <td style="width: 10%;"></td> <td style="width: 10%;"></td> <td style="width: 10%;"></td> <td style="width: 10%;"></td> </tr> <tr> <td></td> <td></td> <td colspan="8" style="text-align: center;"> <table border="1" style="width: 100%; border-collapse: collapse; text-align: center;"> <tr> <td style="width: 10%;"></td> <td style="width: 10%;"></td> <td style="width: 10%;"></td> <td style="width: 10%;"></td> <td style="width: 10%;"></td> <td style="width: 10%;"></td> <td style="width: 10%;"></td> <td style="width: 10%;"></td> <td style="width: 10%;"></td> <td style="width: 10%;"></td> </tr> <tr> <td></td> <td></td> <td colspan="8" style="text-align: center;"> <table border="1" style="width: 100%; border-collapse: collapse; text-align: center;"> <tr> <td style="width: 10%;"></td> <td style="width: 10%;"></td> <td style="width: 10%;"></td> <td style="width: 10%;"></td> <td style="width: 10%;"></td> <td style="width: 10%;"></td> <td style="width: 10%;"></td> <td style="width: 10%;"></td> <td style="width: 10%;"></td> <td style="width: 10%;"></td> </tr> <tr> <td></td> <td></td> <td colspan="8" style="text-align: center;"> <table border="1" style="width: 100%; border-collapse: collapse; text-align: center;"> <tr> <td style="width: 10%;"></td> <td style="width: 10%;"></td> <td style="width: 10%;"></td> <td style="width: 10%;"></td> <td style="width: 10%;"></td> <td style="width: 10%;"></td> <td style="width: 10%;"></td> <td style="width: 10%;"></td> <td style="width: 10%;"></td> <td style="width: 10%;"></td> </tr> <tr> <td></td> <td></td> <td colspan="8" style="text-align: center;"> <table border="1" style="width: 100%; border-collapse: collapse; text-align: center;"> <tr> <td style="width: 10%;"></td> <td style="width: 10%;"></td> <td style="width: 10%;"></td> <td style="width: 10%;"></td> <td style="width: 10%;"></td> <td style="width: 10%;"></td> <td style="width: 10%;"></td> <td style="width: 10%;"></td> <td style="width: 10%;"></td> <td style="width: 10%;"></td> </tr> <tr> <td></td> <td></td> <td colspan="8" style="text-align: center;"> <table border="1" style="width: 100%; border-collapse: collapse; text-align: center;"> <tr> <td style="width: 10%;"></td> <td style="width: 10%;"></td> <td style="width: 10%;"></td> <td style="width: 10%;"></td> <td style="width: 10%;"></td> <td style="width: 10%;"></td> <td style="width: 10%;"></td> <td style="width: 10%;"></td> <td style="width: 10%;"></td> <td style="width: 10%;"></td> </tr> <tr> <td></td> <td></td> <td colspan="8" style="text-align: center;"> <table border="1" style="width: 100%; border-collapse: collapse; text-align: center;"> <tr> <td style="width: 10%;"></td> <td style="width: 10%;"></td> <td style="width: 10%;"></td> <td style="width: 10%;"></td> <td style="width: 10%;"></td> <td style="width: 10%;"></td> <td style="width: 10%;"></td> <td style="width: 10%;"></td> <td style="width: 10%;"></td> <td style="width: 10%;"></td> </tr> <tr> <td></td> <td></td> <td colspan="8" style="text-align: center;"> <table border="1" style="width: 100%; border-collapse: collapse; text-align: center;"> <tr> <td style="width: 10%;"></td> <td style="width: 10%;"></td> <td style="width: 10%;"></td> <td style="width: 10%;"></td> <td style="width: 10%;"></td> <td style="width: 10%;"></td> <td style="width: 10%;"></td> <td style="width: 10%;"></td> <td style="width: 10%;"></td> <td style="width: 10%;"></td> </tr> <tr> <td></td> <td></td> <td colspan="8" style="text-align: center;"> <table border="1" style="width: 100%; border-collapse: collapse; text-align: center;"> <tr> <td style="width: 10%;"></td> <td style="width: 10%;"></td> <td style="width: 10%;"></td> <td style="width: 10%;"></td> <td style="width: 10%;"></td> <td style="width: 10%;"></td> <td style="width: 10%;"></td> <td style="width: 10%;"></td> <td style="width: 10%;"></td> <td style="width: 10%;"></td> </tr> <tr> <td></td> <td></td> <td colspan="8"
style="text-align: center;"> <table border="1" style="width: 100%; border-collapse: collapse; text-align: center;"> <tr> </tr></table></td></tr></table></td></tr></table></td></tr></table></td></tr></table></td></tr></table></td></tr></table></td></tr></table></td></tr></table></td></tr></table></td></tr></table></td></tr></table></td></tr></table></td></tr></table></td></tr></table></td></tr></table></td></tr></table></td></tr></table></td></tr></table></td></tr></table></td></tr></table></td></tr></table></td></tr></table></td></tr></table></td></tr></table></td></tr></table></td></tr></table></td></tr></table></td></tr></table></td></tr></table></td></tr></table></td></tr></table></td></tr></table></td></tr></table></td></tr></table></td></tr></table></td></tr></table></td></tr></table> | | | | | | | | | | | | | | | | | | | | <table border="1" style="width: 100%; border-collapse: collapse; text-align: center;"> <tr> <td style="width: 10%;"></td> <td style="width: 10%;"></td> <td style="width: 10%;"></td> <td style="width: 10%;"></td> <td style="width: 10%;"></td> <td style="width: 10%;"></td> <td style="width: 10%;"></td> <td style="width: 10%;"></td> <td style="width: 10%;"></td> <td style="width: 10%;"></td> </tr> <tr> <td></td> <td></td> <td colspan="8" style="text-align: center;"> <table border="1" style="width: 100%; border-collapse: collapse; text-align: center;"> <tr> <td style="width: 10%;"></td> <td style="width: 10%;"></td> <td style="width: 10%;"></td> <td style="width: 10%;"></td> <td style="width: 10%;"></td> <td style="width: 10%;"></td> <td style="width: 10%;"></td> <td style="width: 10%;"></td> <td style="width: 10%;"></td> <td style="width: 10%;"></td> </tr> <tr> <td></td> <td></td> <td colspan="8" style="text-align: center;"> <table border="1" style="width: 100%; border-collapse: collapse; text-align: center;"> <tr> <td style="width: 10%;"></td> <td style="width: 10%;"></td> <td style="width: 10%;"></td> <td style="width: 10%;"></td> <td style="width: 10%;"></td> <td style="width: 10%;"></td> <td style="width: 10%;"></td> <td style="width: 10%;"></td> <td style="width: 10%;"></td> <td style="width: 10%;"></td> </tr> <tr> <td></td> <td></td> <td colspan="8" style="text-align: center;"> <table border="1" style="width: 100%; border-collapse: collapse; text-align: center;"> <tr> <td style="width: 10%;"></td> <td style="width: 10%;"></td> <td style="width: 10%;"></td> <td style="width: 10%;"></td> <td style="width: 10%;"></td> <td style="width: 10%;"></td> <td style="width: 10%;"></td> <td style="width: 10%;"></td> <td style="width: 10%;"></td> <td style="width: 10%;"></td> </tr> <tr> <td></td> <td></td> <td colspan="8" style="text-align: center;"> <table border="1" style="width: 100%; border-collapse: collapse; text-align: center;"> <tr> <td style="width: 10%;"></td> <td style="width: 10%;"></td> <td style="width: 10%;"></td> <td style="width: 10%;"></td> <td style="width: 10%;"></td> <td style="width: 10%;"></td> <td style="width: 10%;"></td> <td style="width: 10%;"></td> <td style="width: 10%;"></td> <td style="width: 10%;"></td> </tr> <tr> <td></td> <td></td> <td colspan="8" style="text-align: center;"> <table border="1" style="width: 100%; border-collapse: collapse; text-align: center;"> <tr> <td style="width: 10%;"></td> <td style="width: 10%;"></td> <td style="width: 10%;"></td> <td style="width: 10%;"></td> <td style="width: 10%;"></td> <td style="width: 10%;"></td> <td style="width: 10%;"></td> <td style="width: 10%;"></td> <td style="width: 10%;"></td> <td style="width: 10%;"></td> </tr> <tr> <td></td> <td></td> <td colspan="8" style="text-align: center;"> <table border="1" style="width: 100%; border-collapse: collapse; text-align: center;"> <tr> <td style="width: 10%;"></td> <td style="width: 10%;"></td> <td style="width: 10%;"></td> <td style="width: 10%;"></td> <td style="width: 10%;"></td> <td style="width: 10%;"></td> <td style="width: 10%;"></td> <td style="width: 10%;"></td> <td style="width: 10%;"></td> <td style="width: 10%;"></td> </tr> <tr> <td></td> <td></td> <td colspan="8" style="text-align: center;"> <table border="1" style="width: 100%; border-collapse: collapse; text-align: center;"> <tr> <td style="width: 10%;"></td> <td style="width: 10%;"></td> <td style="width: 10%;"></td> <td style="width: 10%;"></td> <td style="width: 10%;"></td> <td style="width: 10%;"></td> <td style="width: 10%;"></td> <td style="width: 10%;"></td> <td style="width: 10%;"></td> <td style="width: 10%;"></td> </tr> <tr> <td></td> <td></td> <td colspan="8" style="text-align: center;"> <table border="1" style="width: 100%; border-collapse: collapse; text-align: center;"> <tr> <td style="width: 10%;"></td> <td style="width: 10%;"></td> <td style="width: 10%;"></td> <td style="width: 10%;"></td> <td style="width: 10%;"></td> <td style="width: 10%;"></td> <td style="width: 10%;"></td> <td style="width: 10%;"></td> <td style="width: 10%;"></td> <td style="width: 10%;"></td> </tr> <tr> <td></td> <td></td> <td colspan="8" style="text-align: center;"> <table border="1" style="width: 100%; border-collapse: collapse; text-align: center;"> <tr> <td style="width: 10%;"></td> <td style="width: 10%;"></td> <td style="width: 10%;"></td> <td style="width: 10%;"></td> <td style="width: 10%;"></td> <td style="width: 10%;"></td> <td style="width: 10%;"></td> <td style="width: 10%;"></td> <td style="width: 10%;"></td> <td style="width: 10%;"></td> </tr> <tr> <td></td> <td></td> <td colspan="8" style="text-align: center;"> <table border="1" style="width: 100%; border-collapse: collapse; text-align: center;"> <tr> <td style="width: 10%;"></td> <td style="width: 10%;"></td> <td style="width: 10%;"></td> <td style="width: 10%;"></td> <td style="width: 10%;"></td> <td style="width: 10%;"></td> <td style="width: 10%;"></td> <td style="width: 10%;"></td> <td style="width: 10%;"></td> <td style="width: 10%;"></td> </tr> <tr> <td></td> <td></td> <td colspan="8" style="text-align: center;"> <table border="1" style="width: 100%; border-collapse: collapse; text-align: center;"> <tr> <td
style="width: 10%;"></td> <td style="width: 10%;"></td> <td style="width: 10%;"></td> <td style="width: 10%;"></td> <td style="width: 10%;"></td> <td style="width: 10%;"></td> <td style="width: 10%;"></td> <td style="width: 10%;"></td> <td style="width: 10%;"></td> <td style="width: 10%;"></td> </tr> <tr> <td></td> <td></td> <td colspan="8" style="text-align: center;"> <table border="1" style="width: 100%; border-collapse: collapse; text-align: center;"> <tr> <td style="width: 10%;"></td> <td style="width: 10%;"></td> <td style="width: 10%;"></td> <td style="width: 10%;"></td> <td style="width: 10%;"></td> <td style="width: 10%;"></td> <td style="width: 10%;"></td> <td style="width: 10%;"></td> <td style="width: 10%;"></td> <td style="width: 10%;"></td> </tr> <tr> <td></td> <td></td> <td colspan="8" style="text-align: center;"> <table border="1" style="width: 100%; border-collapse: collapse; text-align: center;"> <tr> <td style="width: 10%;"></td> <td style="width: 10%;"></td> <td style="width: 10%;"></td> <td style="width: 10%;"></td> <td style="width: 10%;"></td> <td style="width: 10%;"></td> <td style="width: 10%;"></td> <td style="width: 10%;"></td> <td style="width: 10%;"></td> <td style="width: 10%;"></td> </tr> <tr> <td></td> <td></td> <td colspan="8" style="text-align: center;"> <table border="1" style="width: 100%; border-collapse: collapse; text-align: center;"> <tr> <td style="width: 10%;"></td> <td style="width: 10%;"></td> <td style="width: 10%;"></td> <td style="width: 10%;"></td> <td style="width: 10%;"></td> <td style="width: 10%;"></td> <td style="width: 10%;"></td> <td style="width: 10%;"></td> <td style="width: 10%;"></td> <td style="width: 10%;"></td> </tr> <tr> <td></td> <td></td> <td colspan="8" style="text-align: center;"> <table border="1" style="width: 100%; border-collapse: collapse; text-align: center;"> <tr> <td style="width: 10%;"></td> <td style="width: 10%;"></td> <td style="width: 10%;"></td> <td style="width: 10%;"></td> <td style="width: 10%;"></td> <td style="width: 10%;"></td> <td style="width: 10%;"></td> <td style="width: 10%;"></td> <td style="width: 10%;"></td> <td style="width: 10%;"></td> </tr> <tr> <td></td> <td></td> <td colspan="8" style="text-align: center;"> <table border="1" style="width: 100%; border-collapse: collapse; text-align: center;"> <tr> <td style="width: 10%;"></td> <td style="width: 10%;"></td> <td style="width: 10%;"></td> <td style="width: 10%;"></td> <td style="width: 10%;"></td> <td style="width: 10%;"></td> <td style="width: 10%;"></td> <td style="width: 10%;"></td> <td style="width: 10%;"></td> <td style="width: 10%;"></td> </tr> <tr> <td></td> <td></td> <td colspan="8" style="text-align: center;"> <table border="1" style="width: 100%; border-collapse: collapse; text-align: center;"> <tr> <td style="width: 10%;"></td> <td style="width: 10%;"></td> <td style="width: 10%;"></td> <td style="width: 10%;"></td> <td style="width: 10%;"></td> <td style="width: 10%;"></td> <td style="width: 10%;"></td> <td style="width: 10%;"></td> <td style="width: 10%;"></td> <td style="width: 10%;"></td> </tr> <tr> <td></td> <td></td> <td colspan="8" style="text-align: center;"> <table border="1" style="width: 100%; border-collapse: collapse; text-align: center;"> <tr> <td style="width: 10%;"></td> <td style="width: 10%;"></td> <td style="width: 10%;"></td> <td style="width: 10%;"></td> <td style="width: 10%;"></td> <td style="width: 10%;"></td> <td style="width: 10%;"></td> <td style="width: 10%;"></td> <td style="width: 10%;"></td> <td style="width: 10%;"></td> </tr> <tr> <td></td> <td></td> <td colspan="8" style="text-align: center;"> <table border="1" style="width: 100%; border-collapse: collapse; text-align: center;"> <tr> <td style="width: 10%;"></td> <td style="width: 10%;"></td> <td style="width: 10%;"></td> <td style="width: 10%;"></td> <td style="width: 10%;"></td> <td style="width: 10%;"></td> <td style="width: 10%;"></td> <td style="width: 10%;"></td> <td style="width: 10%;"></td> <td style="width: 10%;"></td> </tr> <tr> <td></td> <td></td> <td colspan="8" style="text-align: center;"> <table border="1" style="width: 100%; border-collapse: collapse; text-align: center;"> <tr> <td style="width: 10%;"></td> <td style="width: 10%;"></td> <td style="width: 10%;"></td> <td style="width: 10%;"></td> <td style="width: 10%;"></td> <td style="width: 10%;"></td> <td style="width: 10%;"></td> <td style="width: 10%;"></td> <td style="width: 10%;"></td> <td style="width: 10%;"></td> </tr> <tr> <td></td> <td></td> <td colspan="8" style="text-align: center;"> <table border="1" style="width: 100%; border-collapse: collapse; text-align: center;"> <tr> <td style="width: 10%;"></td> <td style="width: 10%;"></td> <td style="width: 10%;"></td> <td style="width: 10%;"></td> <td style="width: 10%;"></td> <td style="width: 10%;"></td> <td style="width: 10%;"></td> <td style="width: 10%;"></td> <td style="width: 10%;"></td> <td style="width: 10%;"></td> </tr> <tr> <td></td> <td></td> <td colspan="8" style="text-align: center;"> <table border="1" style="width: 100%; border-collapse: collapse; text-align: center;"> <tr> <td style="width: 10%;"></td> <td style="width: 10%;"></td> <td style="width: 10%;"></td> <td style="width: 10%;"></td> <td style="width: 10%;"></td> <td style="width: 10%;"></td> <td style="width: 10%;"></td> <td style="width: 10%;"></td> <td style="width: 10%;"></td> <td style="width: 10%;"></td> </tr> <tr> <td></td> <td></td> <td colspan="8" style="text-align: center;"> <table border="1" style="width: 100%; border-collapse: collapse; text-align: center;"> <tr> <td style="width: 10%;"></td> <td style="width: 10%;"></td> <td style="width: 10%;"></td> <td style="width: 10%;"></td> <td style="width: 10%;"></td> <td style="width: 10%;"></td> <td style="width: 10%;"></td> <td style="width: 10%;"></td> <td style="width: 10%;"></td> <td style="width: 10%;"></td> </tr> <tr> <td></td> <td></td> <td colspan="8" style="text-align: center;"> <table border="1" style="width: 100%; border-collapse: collapse; text-align: center;"> <tr> <td style="width: 10%;"></td> <td style="width: 10%;"></td> <td style="width: 10%;"></td> <td style="width: 10%;"></td> <td style="width: 10%;"></td> <td style="width: 10%;"></td> <td style="width: 10%;"></td> <td style="width: 10%;"></td> <td style="width: 10%;"></td> <td style="width: 10%;"></td> </tr> <tr> <td></td> <td></td> <td colspan="8" style="text-align: center;"> <table border="1" style="width: 100%; border-collapse: collapse; text-align: center;"> <tr> <td style="width: 10%;"></td> <td style="width: 10%;"></td> <td style="width: 10%;"></td> <td style="width: 10%;"></td> <td style="width: 10%;"></td> <td style="width: 10%;"></td> <td style="width: 10%;"></td> <td style="width: 10%;"></td> <td style="width: 10%;"></td> <td style="width: 10%;"></td> </tr> <tr> <td></td> <td></td> <td colspan="8" style="text-align: center;"> <table border="1" style="width: 100%; border-collapse: collapse; text-align: center;"> <tr> <td style="width: 10%;"></td> <td style="width: 10%;"></td> <td style="width: 10%;"></td> <td style="width: 10%;"></td> <td style="width: 10%;"></td> <td style="width: 10%;"></td> <td style="width: 10%;"></td> <td style="width: 10%;"></td> <td style="width: 10%;"></td> <td style="width: 10%;"></td> </tr> <tr> <td></td> <td></td> <td colspan="8" style="text-align: center;"> <table border="1" style="width: 100%; border-collapse: collapse; text-align: center;"> <tr> <td style="width: 10%;"></td> <td style="width: 10%;"></td> <td style="width: 10%;"></td> <td style="width: 10%;"></td> <td style="width: 10%;"></td> <td style="width: 10%;"></td> <td style="width: 10%;"></td> <td style="width: 10%;"></td> <td style="width: 10%;"></td> <td style="width: 10%;"></td> </tr> <tr> <td></td> <td></td> <td colspan="8" style="text-align: center;"> <table border="1" style="width: 100%; border-collapse: collapse; text-align: center;"> <tr> <td style="width: 10%;"></td> <td style="width: 10%;"></td> <td style="width: 10%;"></td> <td style="width: 10%;"></td> <td style="width: 10%;"></td> <td style="width: 10%;"></td> <td style="width: 10%;"></td> <td style="width: 10%;"></td> <td style="width: 10%;"></td> <td style="width: 10%;"></td> </tr> <tr> <td></td> <td></td> <td colspan="8" style="text-align: center;"> <table border="1" style="width: 100%; border-collapse: collapse; text-align: center;"> <tr> <td style="width: 10%;"></td> <td style="width: 10%;"></td> <td style="width: 10%;"></td> <td style="width: 10%;"></td> <td style="width: 10%;"></td> <td style="width: 10%;"></td> <td style="width: 10%;"></td> <td style="width: 10%;"></td> <td style="width: 10%;"></td> <td style="width: 10%;"></td> </tr> <tr> <td></td> <td></td> <td colspan="8" style="text-align: center;"> <table border="1" style="width: 100%; border-collapse: collapse; text-align: center;"> <tr> <td style="width: 10%;"></td> <td style="width: 10%;"></td> <td style="width: 10%;"></td> <td style="width: 10%;"></td> <td style="width: 10%;"></td> <td style="width: 10%;"></td> <td style="width: 10%;"></td> <td style="width: 10%;"></td> <td style="width: 10%;"></td> <td style="width: 10%;"></td> </tr> <tr> <td></td> <td></td> <td colspan="8" style="text-align: center;"> <table border="1" style="width: 100%; border-collapse: collapse; text-align: center;"> <tr> <td style="width: 10%;"></td> <td style="width: 10%;"></td> <td style="width: 10%;"></td> <td style="width: 10%;"></td> <td style="width: 10%;"></td> <td style="width: 10%;"></td> <td style="width: 10%;"></td> <td style="width: 10%;"></td> <td style="width: 10%;"></td> <td style="width: 10%;"></td> </tr> <tr> <td></td> <td></td> <td colspan="8" style="text-align: center;"> <table border="1" style="width: 100%; border-collapse: collapse; text-align: center;"> <tr> <td style="width: 10%;"></td> <td style="width: 10%;"></td> <td style="width: 10%;"></td> <td style="width: 10%;"></td> <td style="width: 10%;"></td> <td style="width:
10%;"></td> <td style="width: 10%;"></td> <td style="width: 10%;"></td> <td style="width: 10%;"></td> <td style="width: 10%;"></td> </tr> <tr> <td></td> <td></td> <td colspan="8" style="text-align: center;"> <table border="1" style="width: 100%; border-collapse: collapse; text-align: center;"> <tr> <td style="width: 10%;"></td> <td style="width: 10%;"></td> <td style="width: 10%;"></td> <td style="width: 10%;"></td> <td style="width: 10%;"></td> <td style="width: 10%;"></td> <td style="width: 10%;"></td> <td style="width: 10%;"></td> <td style="width: 10%;"></td> <td style="width: 10%;"></td> </tr> <tr> <td></td> <td></td> <td colspan="8" style="text-align: center;"> <table border="1" style="width: 100%; border-collapse: collapse; text-align: center;"> <tr> <td style="width: 10%;"></td> <td style="width: 10%;"></td> <td style="width: 10%;"></td> <td style="width: 10%;"></td> <td style="width: 10%;"></td> <td style="width: 10%;"></td> <td style="width: 10%;"></td> <td style="width: 10%;"></td> <td style="width: 10%;"></td> <td style="width: 10%;"></td> </tr> <tr> <td></td> <td></td> <td colspan="8" style="text-align: center;"> <table border="1" style="width: 100%; border-collapse: collapse; text-align: center;"> <tr> <td style="width: 10%;"></td> <td style="width: 10%;"></td> <td style="width: 10%;"></td> <td style="width: 10%;"></td> <td style="width: 10%;"></td> <td style="width: 10%;"></td> <td style="width: 10%;"></td> <td style="width: 10%;"></td> <td style="width: 10%;"></td> <td style="width: 10%;"></td> </tr> <tr> <td></td> <td></td> <td colspan="8" style="text-align: center;"> <table border="1" style="width: 100%; border-collapse: collapse; text-align: center;"> <tr> </tr></table></td></tr></table></td></tr></table></td></tr></table></td></tr></table></td></tr></table></td></tr></table></td></tr></table></td></tr></table></td></tr></table></td></tr></table></td></tr></table></td></tr></table></td></tr></table></td></tr></table></td></tr></table></td></tr></table></td></tr></table></td></tr></table></td></tr></table></td></tr></table></td></tr></table></td></tr></table></td></tr></table></td></tr></table></td></tr></table></td></tr></table></td></tr></table></td></tr></table></td></tr></table></td></tr></table></td></tr></table></td></tr></table></td></tr></table></td></tr></table></td></tr></table></td></tr></table> | | | | | | | | | | | | | | | | | | | | <table border="1" style="width: 100%; border-collapse: collapse; text-align: center;"> <tr> <td style="width: 10%;"></td> <td style="width: 10%;"></td> <td style="width: 10%;"></td> <td style="width: 10%;"></td> <td style="width: 10%;"></td> <td style="width: 10%;"></td> <td style="width: 10%;"></td> <td style="width: 10%;"></td> <td style="width: 10%;"></td> <td style="width: 10%;"></td> </tr> <tr> <td></td> <td></td> <td colspan="8" style="text-align: center;"> <table border="1" style="width: 100%; border-collapse: collapse; text-align: center;"> <tr> <td style="width: 10%;"></td> <td style="width: 10%;"></td> <td style="width: 10%;"></td> <td style="width: 10%;"></td> <td style="width: 10%;"></td> <td style="width: 10%;"></td> <td style="width: 10%;"></td> <td style="width: 10%;"></td> <td style="width: 10%;"></td> <td style="width: 10%;"></td> </tr> <tr> <td></td> <td></td> <td colspan="8" style="text-align: center;"> <table border="1" style="width: 100%; border-collapse: collapse; text-align: center;"> <tr> <td style="width: 10%;"></td> <td style="width: 10%;"></td> <td style="width: 10%;"></td> <td style="width: 10%;"></td> <td style="width: 10%;"></td> <td style="width: 10%;"></td> <td style="width: 10%;"></td> <td style="width: 10%;"></td> <td style="width: 10%;"></td> <td style="width: 10%;"></td> </tr> <tr> <td></td> <td></td> <td colspan="8" style="text-align: center;"> <table border="1" style="width: 100%; border-collapse: collapse; text-align: center;"> <tr> <td style="width: 10%;"></td> <td style="width: 10%;"></td> <td style="width: 10%;"></td> <td style="width: 10%;"></td> <td style="width: 10%;"></td> <td style="width: 10%;"></td> <td style="width: 10%;"></td> <td style="width: 10%;"></td> <td style="width: 10%;"></td> <td style="width: 10%;"></td> </tr> <tr> <td></td> <td></td> <td colspan="8" style="text-align: center;"> <table border="1" style="width: 100%; border-collapse: collapse; text-align: center;"> <tr> <td style="width: 10%;"></td> <td style="width: 10%;"></td> <td style="width: 10%;"></td> <td style="width: 10%;"></td> <td style="width: 10%;"></td> <td style="width: 10%;"></td> <td style="width: 10%;"></td> <td style="width: 10%;"></td> <td style="width: 10%;"></td> <td style="width: 10%;"></td> </tr> <tr> <td></td> <td></td> <td colspan="8" style="text-align: center;"> <table border="1" style="width: 100%; border-collapse: collapse; text-align: center;"> <tr> <td style="width: 10%;"></td> <td style="width: 10%;"></td> <td style="width: 10%;"></td> <td style="width: 10%;"></td> <td style="width: 10%;"></td> <td style="width: 10%;"></td> <td style="width: 10%;"></td> <td style="width: 10%;"></td> <td style="width: 10%;"></td> <td style="width: 10%;"></td> </tr> <tr> <td></td> <td></td> <td colspan="8" style="text-align: center;"> <table border="1" style="width: 100%; border-collapse: collapse; text-align: center;"> <tr> <td style="width: 10%;"></td> <td style="width: 10%;"></td> <td style="width: 10%;"></td> <td style="width: 10%;"></td> <td style="width: 10%;"></td> <td style="width: 10%;"></td> <td style="width: 10%;"></td> <td style="width: 10%;"></td> <td style="width: 10%;"></td> <td style="width: 10%;"></td> </tr> <tr> <td></td> <td></td> <td colspan="8" style="text-align: center;"> <table border="1" style="width: 100%; border-collapse: collapse; text-align: center;"> <tr> <td style="width: 10%;"></td> <td style="width: 10%;"></td> <td style="width: 10%;"></td> <td style="width: 10%;"></td> <td style="width: 10%;"></td> <td style="width: 10%;"></td> <td style="width: 10%;"></td> <td style="width: 10%;"></td> <td style="width: 10%;"></td> <td style="width: 10%;"></td> </tr> <tr>
<td></td> <td></td> <td colspan="8" style="text-align: center;"> <table border="1" style="width: 100%; border-collapse: collapse; text-align: center;"> <tr> <td style="width: 10%;"></td> <td style="width: 10%;"></td> <td style="width: 10%;"></td> <td style="width: 10%;"></td> <td style="width: 10%;"></td> <td style="width: 10%;"></td> <td style="width: 10%;"></td> <td style="width: 10%;"></td> <td style="width: 10%;"></td> <td style="width: 10%;"></td> </tr> <tr> <td></td> <td></td> <td colspan="8" style="text-align: center;"> <table border="1" style="width: 100%; border-collapse: collapse; text-align: center;"> <tr> <td style="width: 10%;"></td> <td style="width: 10%;"></td> <td style="width: 10%;"></td> <td style="width: 10%;"></td> <td style="width: 10%;"></td> <td style="width: 10%;"></td> <td style="width: 10%;"></td> <td style="width: 10%;"></td> <td style="width: 10%;"></td> <td style="width: 10%;"></td> </tr> <tr> <td></td> <td></td> <td colspan="8" style="text-align: center;"> <table border="1" style="width: 100%; border-collapse: collapse; text-align: center;"> <tr> <td style="width: 10%;"></td> <td style="width: 10%;"></td> <td style="width: 10%;"></td> <td style="width: 10%;"></td> <td style="width: 10%;"></td> <td style="width: 10%;"></td> <td style="width: 10%;"></td> <td style="width: 10%;"></td> <td style="width: 10%;"></td> <td style="width: 10%;"></td> </tr> <tr> <td></td> <td></td> <td colspan="8" style="text-align: center;"> <table border="1" style="width: 100%; border-collapse: collapse; text-align: center;"> <tr> <td style="width: 10%;"></td> <td style="width: 10%;"></td> <td style="width: 10%;"></td> <td style="width: 10%;"></td> <td style="width: 10%;"></td> <td style="width: 10%;"></td> <td style="width: 10%;"></td> <td style="width: 10%;"></td> <td style="width: 10%;"></td> <td style="width: 10%;"></td> </tr> <tr> <td></td> <td></td> <td colspan="8" style="text-align: center;"> <table border="1" style="width: 100%; border-collapse: collapse; text-align: center;"> <tr> <td style="width: 10%;"></td> <td style="width: 10%;"></td> <td style="width: 10%;"></td> <td style="width: 10%;"></td> <td style="width: 10%;"></td> <td style="width: 10%;"></td> <td style="width: 10%;"></td> <td style="width: 10%;"></td> <td style="width: 10%;"></td> <td style="width: 10%;"></td> </tr> <tr> <td></td> <td></td> <td colspan="8" style="text-align: center;"> <table border="1" style="width: 100%; border-collapse: collapse; text-align: center;"> <tr> <td style="width: 10%;"></td> <td style="width: 10%;"></td> <td style="width: 10%;"></td> <td style="width: 10%;"></td> <td style="width: 10%;"></td> <td style="width: 10%;"></td> <td style="width: 10%;"></td> <td style="width: 10%;"></td> <td style="width: 10%;"></td> <td style="width: 10%;"></td> </tr> <tr> <td></td> <td></td> <td colspan="8" style="text-align: center;"> <table border="1" style="width: 100%; border-collapse: collapse; text-align: center;"> <tr> <td style="width: 10%;"></td> <td style="width: 10%;"></td> <td style="width: 10%;"></td> <td style="width: 10%;"></td> <td style="width: 10%;"></td> <td style="width: 10%;"></td> <td style="width: 10%;"></td> <td style="width: 10%;"></td> <td style="width: 10%;"></td> <td style="width: 10%;"></td> </tr> <tr> <td></td> <td></td> <td colspan="8" style="text-align: center;"> <table border="1" style="width: 100%; border-collapse: collapse; text-align: center;"> <tr> <td style="width: 10%;"></td> <td style="width: 10%;"></td> <td style="width: 10%;"></td> <td style="width: 10%;"></td> <td style="width: 10%;"></td> <td style="width: 10%;"></td> <td style="width: 10%;"></td> <td style="width: 10%;"></td> <td style="width: 10%;"></td> <td style="width: 10%;"></td> </tr> <tr> <td></td> <td></td> <td colspan="8" style="text-align: center;"> <table border="1" style="width: 100%; border-collapse: collapse; text-align: center;"> <tr> <td style="width: 10%;"></td> <td style="width: 10%;"></td> <td style="width: 10%;"></td> <td style="width: 10%;"></td> <td style="width: 10%;"></td> <td style="width: 10%;"></td> <td style="width: 10%;"></td> <td style="width: 10%;"></td> <td style="width: 10%;"></td> <td style="width: 10%;"></td> </tr> <tr> <td></td> <td></td> <td colspan="8" style="text-align: center;"> <table border="1" style="width: 100%; border-collapse: collapse; text-align: center;"> <tr> <td style="width: 10%;"></td> <td style="width: 10%;"></td> <td style="width: 10%;"></td> <td style="width: 10%;"></td> <td style="width: 10%;"></td> <td style="width: 10%;"></td> <td style="width: 10%;"></td> <td style="width: 10%;"></td> <td style="width: 10%;"></td> <td style="width: 10%;"></td> </tr> <tr> <td></td> <td></td> <td colspan="8" style="text-align: center;"> <table border="1" style="width: 100%; border-collapse: collapse; text-align: center;"> <tr> <td style="width: 10%;"></td> <td style="width: 10%;"></td> <td style="width: 10%;"></td> <td style="width: 10%;"></td> <td style="width: 10%;"></td> <td style="width: 10%;"></td> <td style="width: 10%;"></td> <td style="width: 10%;"></td> <td style="width: 10%;"></td> <td style="width: 10%;"></td> </tr> <tr> <td></td> <td></td> <td colspan="8" style="text-align: center;"> <table border="1" style="width: 100%; border-collapse: collapse; text-align: center;"> <tr> <td style="width: 10%;"></td> <td style="width: 10%;"></td> <td style="width: 10%;"></td> <td style="width: 10%;"></td> <td style="width: 10%;"></td> <td style="width: 10%;"></td> <td style="width: 10%;"></td> <td style="width: 10%;"></td> <td style="width: 10%;"></td> <td style="width: 10%;"></td> </tr> <tr> <td></td> <td></td> <td colspan="8" style="text-align: center;"> <table border="1" style="width: 100%; border-collapse: collapse; text-align: center;"> <tr> <td style="width: 10%;"></td> <td style="width: 10%;"></td> <td style="width: 10%;"></td> <td style="width: 10%;"></td> <td style="width: 10%;"></td> <td style="width: 10%;"></td> <td style="width: 10%;"></td> <td style="width: 10%;"></td> <td style="width: 10%;"></td> <td style="width: 10%;"></td> </tr> <tr> <td></td> <td></td> <td colspan="8" style="text-align: center;"> <table border="1" style="width: 100%; border-collapse: collapse; text-align: center;"> <tr> <td style="width: 10%;"></td> <td style="width: 10%;"></td> <td style="width: 10%;"></td> <td style="width: 10%;"></td> <td style="width: 10%;"></td> <td style="width: 10%;"></td> <td style="width: 10%;"></td> <td style="width: 10%;"></td> <td style="width: 10%;"></td> <td style="width: 10%;"></td> </tr> <tr> <td></td> <td></td> <td colspan="8" style="text-align: center;"> <table border="1" style="width: 100%; border-collapse: collapse; text-align: center;"> <tr> <td style="width: 10%;"></td> <td style="width: 10%;"></td> <td style="width: 10%;"></td> <td style="width: 10%;"></td> <td style="width: 10%;"></td> <td style="width: 10%;"></td> <td style="width: 10%;"></td> <td style="width: 10%;"></td> <td style="width: 10%;"></td> <td style="width: 10%;"></td> </tr> <tr> <td></td> <td></td> <td colspan="8" style="text-align: center;"> <table border="1" style="width: 100%; border-collapse: collapse; text-align: center;"> <tr> <td style="width: 10%;"></td> <td style="width: 10%;"></td> <td style="width: 10%;"></td> <td style="width: 10%;"></td> <td style="width: 10%;"></td> <td style="width: 10%;"></td> <td style="width: 10%;"></td> <td style="width: 10%;"></td> <td style="width: 10%;"></td> <td style="width: 10%;"></td> </tr> <tr> <td></td> <td></td> <td colspan="8" style="text-align: center;"> <table border="1" style="width: 100%; border-collapse: collapse; text-align: center;"> <tr> <td style="width: 10%;"></td> <td style="width: 10%;"></td> <td style="width: 10%;"></td> <td style="width: 10%;"></td> <td style="width: 10%;"></td> <td style="width: 10%;"></td> <td style="width: 10%;"></td> <td style="width: 10%;"></td> <td style="width: 10%;"></td> <td style="width: 10%;"></td> </tr> <tr> <td></td> <td></td> <td colspan="8" style="text-align: center;"> <table border="1" style="width: 100%; border-collapse: collapse; text-align: center;"> <tr> <td style="width: 10%;"></td> <td style="width: 10%;"></td> <td style="width: 10%;"></td> <td style="width: 10%;"></td> <td style="width: 10%;"></td> <td style="width: 10%;"></td> <td style="width: 10%;"></td> <td style="width: 10%;"></td> <td style="width: 10%;"></td> <td style="width: 10%;"></td> </tr> <tr> <td></td> <td></td> <td colspan="8" style="text-align: center;"> <table border="1" style="width: 100%; border-collapse: collapse; text-align: center;"> <tr> <td style="width: 10%;"></td> <td style="width: 10%;"></td> <td style="width: 10%;"></td> <td style="width: 10%;"></td> <td style="width: 10%;"></td> <td style="width: 10%;"></td> <td style="width: 10%;"></td> <td style="width: 10%;"></td> <td style="width: 10%;"></td> <td style="width: 10%;"></td> </tr> <tr> <td></td> <td></td> <td colspan="8" style="text-align: center;"> <table border="1" style="width: 100%; border-collapse: collapse; text-align: center;"> <tr> <td style="width: 10%;"></td> <td style="width: 10%;"></td> <td style="width: 10%;"></td> <td style="width: 10%;"></td> <td style="width: 10%;"></td> <td style="width: 10%;"></td> <td style="width: 10%;"></td> <td style="width: 10%;"></td> <td style="width: 10%;"></td> <td style="width: 10%;"></td> </tr> <tr> <td></td> <td></td> <td colspan="8" style="text-align: center;"> <table border="1" style="width: 100%; border-collapse: collapse; text-align: center;"> <tr> <td style="width: 10%;"></td> <td style="width: 10%;"></td> <td style="width: 10%;"></td> <td style="width: 10%;"></td> <td style="width: 10%;"></td> <td style="width: 10%;"></td> <td style="width: 10%;"></td> <td style="width: 10%;"></td> <td style="width: 10%;"></td> <td style="width: 10%;"></td> </tr> <tr> <td></td> <td></td> <td colspan="8" style="text-align: center;"> <table border="1" style="width: 100%; border-collapse: collapse; text-align: center;"> <tr> <td
style="width: 10%;"></td> <td style="width: 10%;"></td> <td style="width: 10%;"></td> <td style="width: 10%;"></td> <td style="width: 10%;"></td> <td style="width: 10%;"></td> <td style="width: 10%;"></td> <td style="width: 10%;"></td> <td style="width: 10%;"></td> <td style="width: 10%;"></td> </tr> <tr> <td></td> <td></td> <td colspan="8" style="text-align: center;"> <table border="1" style="width: 100%; border-collapse: collapse; text-align: center;"> <tr> <td style="width: 10%;"></td> <td style="width: 10%;"></td> <td style="width: 10%;"></td> <td style="width: 10%;"></td> <td style="width: 10%;"></td> <td style="width: 10%;"></td> <td style="width: 10%;"></td> <td style="width: 10%;"></td> <td style="width: 10%;"></td> <td style="width: 10%;"></td> </tr> <tr> <td></td> <td></td> <td colspan="8" style="text-align: center;"> <table border="1" style="width: 100%; border-collapse: collapse; text-align: center;"> <tr> <td style="width: 10%;"></td> <td style="width: 10%;"></td> <td style="width: 10%;"></td> <td style="width: 10%;"></td> <td style="width: 10%;"></td> <td style="width: 10%;"></td> <td style="width: 10%;"></td> <td style="width: 10%;"></td> <td style="width: 10%;"></td> <td style="width: 10%;"></td> </tr> <tr> <td></td> <td></td> <td colspan="8" style="text-align: center;"> <table border="1" style="width: 100%; border-collapse: collapse; text-align: center;"> <tr> <td style="width: 10%;"></td> <td style="width: 10%;"></td> <td style="width: 10%;"></td> <td style="width: 10%;"></td> <td style="width: 10%;"></td> <td style="width: 10%;"></td> <td style="width: 10%;"></td> <td style="width: 10%;"></td> <td style="width: 10%;"></td> <td style="width: 10%;"></td> </tr> <tr> <td></td> <td></td> <td colspan="8" style="text-align: center;"> <table border="1" style="width: 100%; border-collapse: collapse; text-align: center;"> <tr> <td style="width: 10%;"></td> <td style="width: 10%;"></td> <td style="width: 10%;"></td> <td style="width: 10%;"></td> <td style="width: 10%;"></td> <td style="width: 10%;"></td> <td style="width: 10%;"></td> <td style="width: 10%;"></td> <td style="width: 10%;"></td> <td style="width: 10%;"></td> </tr> <tr> <td></td> <td></td> <td colspan="8" style="text-align: center;"> <table border="1" style="width: 100%; border-collapse: collapse; text-align: center;"> <tr> <td style="width: 10%;"></td> <td style="width: 10%;"></td> <td style="width: 10%;"></td> <td style="width: 10%;"></td> <td style="width: 10%;"></td> <td style="width: 10%;"></td> <td style="width: 10%;"></td> <td style="width: 10%;"></td> <td style="width: 10%;"></td> <td style="width: 10%;"></td> </tr> <tr> <td></td> <td></td> <td colspan="8" style="text-align: center;"> <table border="1" style="width: 100%; border-collapse: collapse; text-align: center;"> <tr> </tr></table></td></tr></table></td></tr></table></td></tr></table></td></tr></table></td></tr></table></td></tr></table></td></tr></table></td></tr></table></td></tr></table></td></tr></table></td></tr></table></td></tr></table></td></tr></table></td></tr></table></td></tr></table></td></tr></table></td></tr></table></td></tr></table></td></tr></table></td></tr></table></td></tr></table></td></tr></table></td></tr></table></td></tr></table></td></tr></table></td></tr></table></td></tr></table></td></tr></table></td></tr></table></td></tr></table></td></tr></table></td></tr></table></td></tr></table></td></tr></table></td></tr></table> | | | | | | | | | | | | | | | | | | | | <table border="1" style="width: 100%; border-collapse: collapse; text-align: center;"> <tr> <td style="width: 10%;"></td> <td style="width: 10%;"></td> <td style="width: 10%;"></td> <td style="width: 10%;"></td> <td style="width: 10%;"></td> <td style="width: 10%;"></td> <td style="width: 10%;"></td> <td style="width: 10%;"></td> <td style="width: 10%;"></td> <td style="width: 10%;"></td> </tr> <tr> <td></td> <td></td> <td colspan="8" style="text-align: center;"> <table border="1" style="width: 100%; border-collapse: collapse; text-align: center;"> <tr> <td style="width: 10%;"></td> <td style="width: 10%;"></td> <td style="width: 10%;"></td> <td style="width: 10%;"></td> <td style="width: 10%;"></td> <td style="width: 10%;"></td> <td style="width: 10%;"></td> <td style="width: 10%;"></td> <td style="width: 10%;"></td> <td style="width: 10%;"></td> </tr> <tr> <td></td> <td></td> <td colspan="8" style="text-align: center;"> <table border="1" style="width: 100%; border-collapse: collapse; text-align: center;"> <tr> <td style="width: 10%;"></td> <td style="width: 10%;"></td> <td style="width: 10%;"></td> <td style="width: 10%;"></td> <td style="width: 10%;"></td> <td style="width: 10%;"></td> <td style="width: 10%;"></td> <td style="width: 10%;"></td> <td style="width: 10%;"></td> <td style="width: 10%;"></td> </tr> <tr> <td></td> <td></td> <td colspan="8" style="text-align: center;"> <table border="1" style="width: 100%; border-collapse: collapse; text-align: center;"> <tr> <td style="width: 10%;"></td> <td style="width: 10%;"></td> <td style="width: 10%;"></td> <td style="width: 10%;"></td> <td style="width: 10%;"></td> <td style="width: 10%;"></td> <td style="width: 10%;"></td> <td style="width: 10%;"></td> <td style="width: 10%;"></td> <td style="width: 10%;"></td> </tr> <tr> <td></td> <td></td> <td colspan="8" style="text-align: center;"> <table border="1" style="width: 100%; border-collapse: collapse; text-align: center;"> <tr> <td style="width: 10%;"></td> <td style="width: 10%;"></td> <td style="width: 10%;"></td> <td style="width: 10%;"></td> <td style="width: 10%;"></td> <td style="width: 10%;"></td> <td style="width: 10%;"></td> <td style="width: 10%;"></td> <td style="width: 10%;"></td> <td style="width: 10%;"></td> </tr> <tr> <td></td> <td></td> <td colspan="8" style="text-align: center;"> <table border="1" style="width: 100%; border-collapse: collapse; text-align: center;"> <tr> <td style="width: 10%;"></td> <td style="width: 10%;"></td> <td style="width: 10%;"></td> <td style="width: 10%;"></td> <td style="width: 10%;"></td> <td style="width:
10%;"></td> <td style="width: 10%;"></td> <td style="width: 10%;"></td> <td style="width: 10%;"></td> <td style="width: 10%;"></td> </tr> <tr> <td></td> <td></td> <td colspan="8" style="text-align: center;"> <table border="1" style="width: 100%; border-collapse: collapse; text-align: center;"> <tr> <td style="width: 10%;"></td> <td style="width: 10%;"></td> <td style="width: 10%;"></td> <td style="width: 10%;"></td> <td style="width: 10%;"></td> <td style="width: 10%;"></td> <td style="width: 10%;"></td> <td style="width: 10%;"></td> <td style="width: 10%;"></td> <td style="width: 10%;"></td> </tr> <tr> <td></td> <td></td> <td colspan="8" style="text-align: center;"> <table border="1" style="width: 100%; border-collapse: collapse; text-align: center;"> <tr> <td style="width: 10%;"></td> <td style="width: 10%;"></td> <td style="width: 10%;"></td> <td style="width: 10%;"></td> <td style="width: 10%;"></td> <td style="width: 10%;"></td> <td style="width: 10%;"></td> <td style="width: 10%;"></td> <td style="width: 10%;"></td> <td style="width: 10%;"></td> </tr> <tr> <td></td> <td></td> <td colspan="8" style="text-align: center;"> <table border="1" style="width: 100%; border-collapse: collapse; text-align: center;"> <tr> <td style="width: 10%;"></td> <td style="width: 10%;"></td> <td style="width: 10%;"></td> <td style="width: 10%;"></td> <td style="width: 10%;"></td> <td style="width: 10%;"></td> <td style="width: 10%;"></td> <td style="width: 10%;"></td> <td style="width: 10%;"></td> <td style="width: 10%;"></td> </tr> <tr> <td></td> <td></td> <td colspan="8" style="text-align: center;"> <table border="1" style="width: 100%; border-collapse: collapse; text-align: center;"> <tr> <td style="width: 10%;"></td> <td style="width: 10%;"></td> <td style="width: 10%;"></td> <td style="width: 10%;"></td> <td style="width: 10%;"></td> <td style="width: 10%;"></td> <td style="width: 10%;"></td> <td style="width: 10%;"></td> <td style="width: 10%;"></td> <td style="width: 10%;"></td> </tr> <tr> <td></td> <td></td> <td colspan="8" style="text-align: center;"> <table border="1" style="width: 100%; border-collapse: collapse; text-align: center;"> <tr> <td style="width: 10%;"></td> <td style="width: 10%;"></td> <td style="width: 10%;"></td> <td style="width: 10%;"></td> <td style="width: 10%;"></td> <td style="width: 10%;"></td> <td style="width: 10%;"></td> <td style="width: 10%;"></td> <td style="width: 10%;"></td> <td style="width: 10%;"></td> </tr> <tr> <td></td> <td></td> <td colspan="8" style="text-align: center;"> <table border="1" style="width: 100%; border-collapse: collapse; text-align: center;"> <tr> <td style="width: 10%;"></td> <td style="width: 10%;"></td> <td style="width: 10%;"></td> <td style="width: 10%;"></td> <td style="width: 10%;"></td> <td style="width: 10%;"></td> <td style="width: 10%;"></td> <td style="width: 10%;"></td> <td style="width: 10%;"></td> <td style="width: 10%;"></td> </tr> <tr> <td></td> <td></td> <td colspan="8" style="text-align: center;"> <table border="1" style="width: 100%; border-collapse: collapse; text-align: center;"> <tr> <td style="width: 10%;"></td> <td style="width: 10%;"></td> <td style="width: 10%;"></td> <td style="width: 10%;"></td> <td style="width: 10%;"></td> <td style="width: 10%;"></td> <td style="width: 10%;"></td> <td style="width: 10%;"></td> <td style="width: 10%;"></td> <td style="width: 10%;"></td> </tr> <tr> <td></td> <td></td> <td colspan="8" style="text-align: center;"> <table border="1" style="width: 100%; border-collapse: collapse; text-align: center;"> <tr> <td style="width: 10%;"></td> <td style="width: 10%;"></td> <td style="width: 10%;"></td> <td style="width: 10%;"></td> <td style="width: 10%;"></td> <td style="width: 10%;"></td> <td style="width: 10%;"></td> <td style="width: 10%;"></td> <td style="width: 10%;"></td> <td style="width: 10%;"></td> </tr> <tr> <td></td> <td></td> <td colspan="8" style="text-align: center;"> <table border="1" style="width: 100%; border-collapse: collapse; text-align: center;"> <tr> <td style="width: 10%;"></td> <td style="width: 10%;"></td> <td style="width: 10%;"></td> <td style="width: 10%;"></td> <td style="width: 10%;"></td> <td style="width: 10%;"></td> <td style="width: 10%;"></td> <td style="width: 10%;"></td> <td style="width: 10%;"></td> <td style="width: 10%;"></td> </tr> <tr> <td></td> <td></td> <td colspan="8" style="text-align: center;"> <table border="1" style="width: 100%; border-collapse: collapse; text-align: center;"> <tr> <td style="width: 10%;"></td> <td style="width: 10%;"></td> <td style="width: 10%;"></td> <td style="width: 10%;"></td> <td style="width: 10%;"></td> <td style="width: 10%;"></td> <td style="width: 10%;"></td> <td style="width: 10%;"></td> <td style="width: 10%;"></td> <td style="width: 10%;"></td> </tr> <tr> <td></td> <td></td> <td colspan="8" style="text-align: center;"> <table border="1" style="width: 100%; border-collapse: collapse; text-align: center;"> <tr> <td style="width: 10%;"></td> <td style="width: 10%;"></td> <td style="width: 10%;"></td> <td style="width: 10%;"></td> <td style="width: 10%;"></td> <td style="width: 10%;"></td> <td style="width: 10%;"></td> <td style="width: 10%;"></td> <td style="width: 10%;"></td> <td style="width: 10%;"></td> </tr> <tr> <td></td> <td></td> <td colspan="8" style="text-align: center;"> <table border="1" style="width: 100%; border-collapse: collapse; text-align: center;"> <tr> <td style="width: 10%;"></td> <td style="width: 10%;"></td> <td style="width: 10%;"></td> <td style="width: 10%;"></td> <td style="width: 10%;"></td> <td style="width: 10%;"></td> <td style="width: 10%;"></td> <td style="width: 10%;"></td> <td style="width: 10%;"></td> <td style="width: 10%;"></td> </tr> <tr> <td></td> <td></td> <td colspan="8" style="text-align: center;"> <table border="1" style="width: 100%; border-collapse: collapse; text-align: center;"> <tr> <td style="width: 10%;"></td> <td style="width: 10%;"></td> <td style="width: 10%;"></td> <td style="width: 10%;"></td> <td style="width: 10%;"></td> <td style="width: 10%;"></td> <td style="width: 10%;"></td> <td style="width: 10%;"></td> <td style="width: 10%;"></td> <td style="width: 10%;"></td> </tr> <tr> <td></td> <td></td> <td colspan="8" style="text-align: center;"> <table border="1" style="width: 100%; border-collapse: collapse; text-align: center;"> <tr> <td style="width: 10%;"></td> <td style="width: 10%;"></td> <td style="width: 10%;"></td> <td style="width: 10%;"></td> <td style="width: 10%;"></td> <td style="width: 10%;"></td> <td style="width: 10%;"></td> <td style="width: 10%;"></td> <td style="width: 10%;"></td> <td style="width: 10%;"></td> </tr> <tr> <td></td> <td></td> <td colspan="8" style="text-align: center;"> <table border="1" style="width: 100%; border-collapse: collapse; text-align: center;"> <tr> <td style="width: 10%;"></td> <td style="width: 10%;"></td> <td style="width: 10%;"></td> <td style="width: 10%;"></td> <td style="width: 10%;"></td> <td style="width: 10%;"></td> <td style="width: 10%;"></td> <td style="width: 10%;"></td> <td style="width: 10%;"></td> <td style="width: 10%;"></td> </tr> <tr> <td></td> <td></td> <td colspan="8" style="text-align: center;"> <table border="1" style="width: 100%; border-collapse: collapse; text-align: center;"> <tr> <td style="width: 10%;"></td> <td style="width: 10%;"></td> <td style="width: 10%;"></td> <td style="width: 10%;"></td> <td style="width: 10%;"></td> <td style="width: 10%;"></td> <td style="width: 10%;"></td> <td style="width: 10%;"></td> <td style="width: 10%;"></td> <td style="width: 10%;"></td> </tr> <tr> <td></td> <td></td> <td colspan="8" style="text-align: center;"> <table border="1" style="width: 100%; border-collapse: collapse; text-align: center;"> <tr> <td style="width: 10%;"></td> <td style="width: 10%;"></td> <td style="width: 10%;"></td> <td style="width: 10%;"></td> <td style="width: 10%;"></td> <td style="width: 10%;"></td> <td style="width: 10%;"></td> <td style="width: 10%;"></td> <td style="width: 10%;"></td> <td style="width: 10%;"></td> </tr> <tr> <td></td> <td></td> <td colspan="8" style="text-align: center;"> <table border="1" style="width: 100%; border-collapse: collapse; text-align: center;"> <tr> <td style="width: 10%;"></td> <td style="width: 10%;"></td> <td style="width: 10%;"></td> <td style="width: 10%;"></td> <td style="width: 10%;"></td> <td style="width: 10%;"></td> <td style="width: 10%;"></td> <td style="width: 10%;"></td> <td style="width: 10%;"></td> <td style="width: 10%;"></td> </tr> <tr> <td></td> <td></td> <td colspan="8" style="text-align: center;"> <table border="1" style="width: 100%; border-collapse: collapse; text-align: center;"> <tr> <td style="width: 10%;"></td> <td style="width: 10%;"></td> <td style="width: 10%;"></td> <td style="width: 10%;"></td> <td style="width: 10%;"></td> <td style="width: 10%;"></td> <td style="width: 10%;"></td> <td style="width: 10%;"></td> <td style="width: 10%;"></td> <td style="width: 10%;"></td> </tr> <tr> <td></td> <td></td> <td colspan="8" style="text-align: center;"> <table border="1" style="width: 100%; border-collapse: collapse; text-align: center;"> <tr> <td style="width: 10%;"></td> <td style="width: 10%;"></td> <td style="width: 10%;"></td> <td style="width: 10%;"></td> <td style="width: 10%;"></td> <td style="width: 10%;"></td> <td style="width: 10%;"></td> <td style="width: 10%;"></td> <td style="width: 10%;"></td> <td style="width: 10%;"></td> </tr> <tr> <td></td> <td></td> <td colspan="8" style="text-align: center;"> <table border="1" style="width: 100%; border-collapse: collapse; text-align: center;"> <tr> <td style="width: 10%;"></td> <td style="width: 10%;"></td> <td style="width: 10%;"></td> <td style="width: 10%;"></td> <td style="width: 10%;"></td> <td style="width: 10%;"></td> <td style="width: 10%;"></td> <td style="width: 10%;"></td> <td style="width: 10%;"></td> <td style="width: 10%;"></td> </tr> <tr> <td></td> <td></td> <td
colspan="8" style="text-align: center;"> <table border="1" style="width: 100%; border-collapse: collapse; text-align: center;"> <tr> <td style="width: 10%;"></td> <td style="width: 10%;"></td> <td style="width: 10%;"></td> <td style="width: 10%;"></td> <td style="width: 10%;"></td> <td style="width: 10%;"></td> <td style="width: 10%;"></td> <td style="width: 10%;"></td> <td style="width: 10%;"></td> <td style="width: 10%;"></td> </tr> <tr> <td></td> <td></td> <td colspan="8" style="text-align: center;"> <table border="1" style="width: 100%; border-collapse: collapse; text-align: center;"> <tr> <td style="width: 10%;"></td> <td style="width: 10%;"></td> <td style="width: 10%;"></td> <td style="width: 10%;"></td> <td style="width: 10%;"></td> <td style="width: 10%;"></td> <td style="width: 10%;"></td> <td style="width: 10%;"></td> <td style="width: 10%;"></td> <td style="width: 10%;"></td> </tr> <tr> <td></td> <td></td> <td colspan="8" style="text-align: center;"> <table border="1" style="width: 100%; border-collapse: collapse; text-align: center;"> <tr> <td style="width: 10%;"></td> <td style="width: 10%;"></td> <td style="width: 10%;"></td> <td style="width: 10%;"></td> <td style="width: 10%;"></td> <td style="width: 10%;"></td> <td style="width: 10%;"></td> <td style="width: 10%;"></td> <td style="width: 10%;"></td> <td style="width: 10%;"></td> </tr> <tr> <td></td> <td></td> <td colspan="8" style="text-align: center;"> <table border="1" style="width: 100%; border-collapse: collapse; text-align: center;"> <tr> <td style="width: 10%;"></td> <td style="width: 10%;"></td> <td style="width: 10%;"></td> <td style="width: 10%;"></td> <td style="width: 10%;"></td> <td style="width: 10%;"></td> <td style="width: 10%;"></td> <td style="width: 10%;"></td> <td style="width: 10%;"></td> <td style="width: 10%;"></td> </tr> <tr> <td></td> <td></td> <td colspan="8" style="text-align: center;"> <table border="1" style="width: 100%; border-collapse: collapse; text-align: center;"> <tr> <td style="width: 10%;"></td> <td style="width: 10%;"></td> <td style="width: 10%;"></td> <td style="width: 10%;"></td> <td style="width: 10%;"></td> <td style="width: 10%;"></td> <td style="width: 10%;"></td> <td style="width: 10%;"></td> <td style="width: 10%;"></td> <td style="width: 10%;"></td> </tr> <tr> <td></td> <td></td> <td colspan="8" style="text-align: center;"> <table border="1" style="width: 100%; border-collapse: collapse; text-align: center;"> <tr> <td style="width: 10%;"></td> <td style="width: 10%;"></td> <td style="width: 10%;"></td> <td style="width: 10%;"></td> <td style="width: 10%;"></td> <td style="width: 10%;"></td> <td style="width: 10%;"></td> <td style="width: 10%;"></td> <td style="width: 10%;"></td> <td style="width: 10%;"></td> </tr> <tr> <td></td> <td></td> <td colspan="8" style="text-align: center;"> <table border="1" style="width: 100%; border-collapse: collapse; text-align: center;"> <tr> <td style="width: 10%;"></td> <td style="width: 10%;"></td> <td style="width: 10%;"></td> <td style="width: 10%;"></td> <td style="width: 10%;"></td> <td style="width: 10%;"></td> <td style="width: 10%;"></td> <td style="width: 10%;"></td> <td style="width: 10%;"></td> <td style="width: 10%;"></td> </tr> <tr> <td></td> <td></td> <td colspan="8" style="text-align: center;"> <table border="1" style="width: 100%; border-collapse: collapse; text-align: center;"> <tr> </tr></table></td></tr></table></td></tr></table></td></tr></table></td></tr></table></td></tr></table></td></tr></table></td></tr></table></td></tr></table></td></tr></table></td></tr></table></td></tr></table></td></tr></table></td></tr></table></td></tr></table></td></tr></table></td></tr></table></td></tr></table></td></tr></table></td></tr></table></td></tr></table></td></tr></table></td></tr></table></td></tr></table></td></tr></table></td></tr></table></td></tr></table></td></tr></table></td></tr></table></td></tr></table></td></tr></table></td></tr></table></td></tr></table></td></tr></table></td></tr></table> | | | | | | | | | | | | | | | | | | | | <table border="1" style="width: 100%; border-collapse: collapse; text-align: center;"> <tr> <td style="width: 10%;"></td> <td style="width: 10%;"></td> <td style="width: 10%;"></td> <td style="width: 10%;"></td> <td style="width: 10%;"></td> <td style="width: 10%;"></td> <td style="width: 10%;"></td> <td style="width: 10%;"></td> <td style="width: 10%;"></td> <td style="width: 10%;"></td> </tr> <tr> <td></td> <td></td> <td colspan="8" style="text-align: center;"> <table border="1" style="width: 100%; border-collapse: collapse; text-align: center;"> <tr> <td style="width: 10%;"></td> <td style="width: 10%;"></td> <td style="width: 10%;"></td> <td style="width: 10%;"></td> <td style="width: 10%;"></td> <td style="width: 10%;"></td> <td style="width: 10%;"></td> <td style="width: 10%;"></td> <td style="width: 10%;"></td> <td style="width: 10%;"></td> </tr> <tr> <td></td> <td></td> <td colspan="8" style="text-align: center;"> <table border="1" style="width: 100%; border-collapse: collapse; text-align: center;"> <tr> <td style="width: 10%;"></td> <td style="width: 10%;"></td> <td style="width: 10%;"></td> <td style="width: 10%;"></td> <td style="width: 10%;"></td> <td style="width: 10%;"></td> <td style="width: 10%;"></td> <td style="width: 10%;"></td> <td style="width: 10%;"></td> <td style="width: 10%;"></td> </tr> <tr> <td></td> <td></td> <td colspan="8" style="text-align: center;"> <table border="1" style="width: 100%; border-collapse: collapse; text-align: center;"> <tr> <td style="width: 10%;"></td> <td style="width: 10%;"></td> <td style="width: 10%;"></td> <td style="width: 10%;"></td> <td style="width: 10%;"></td> <td style="width: 10%;"></td> <td style="width: 10%;"></td> <td style="width: 10%;"></td> <td style="width: 10%;"></td> <td style="width: 10%;"></td> </tr> <tr> <td></td> <td></td> <td colspan="8" style="text-align: center;"> <table border="1" style="width: 100%; border-collapse: collapse; text-align: center;"> <tr> <td style="width: 10%;"></td> <td style="width:
10%;"></td> <td style="width: 10%;"></td> <td style="width: 10%;"></td> <td style="width: 10%;"></td> <td style="width: 10%;"></td> <td style="width: 10%;"></td> <td style="width: 10%;"></td> <td style="width: 10%;"></td> <td style="width: 10%;"></td> </tr> <tr> <td></td> <td></td> <td colspan="8" style="text-align: center;"> <table border="1" style="width: 100%; border-collapse: collapse; text-align: center;"> <tr> <td style="width: 10%;"></td> <td style="width: 10%;"></td> <td style="width: 10%;"></td> <td style="width: 10%;"></td> <td style="width: 10%;"></td> <td style="width: 10%;"></td> <td style="width: 10%;"></td> <td style="width: 10%;"></td> <td style="width: 10%;"></td> <td style="width: 10%;"></td> </tr> <tr> <td></td> <td></td> <td colspan="8" style="text-align: center;"> <table border="1" style="width: 100%; border-collapse: collapse; text-align: center;"> <tr> <td style="width: 10%;"></td> <td style="width: 10%;"></td> <td style="width: 10%;"></td> <td style="width: 10%;"></td> <td style="width: 10%;"></td> <td style="width: 10%;"></td> <td style="width: 10%;"></td> <td style="width: 10%;"></td> <td style="width: 10%;"></td> <td style="width: 10%;"></td> </tr> <tr> <td></td> <td></td> <td colspan="8" style="text-align: center;"> <table border="1" style="width: 100%; border-collapse: collapse; text-align: center;"> <tr> <td style="width: 10%;"></td> <td style="width: 10%;"></td> <td style="width: 10%;"></td> <td style="width: 10%;"></td> <td style="width: 10%;"></td> <td style="width: 10%;"></td> <td style="width: 10%;"></td> <td style="width: 10%;"></td> <td style="width: 10%;"></td> <td style="width: 10%;"></td> </tr> <tr> <td></td> <td></td> <td colspan="8" style="text-align: center;"> <table border="1" style="width: 100%; border-collapse: collapse; text-align: center;"> <tr> <td style="width: 10%;"></td> <td style="width: 10%;"></td> <td style="width: 10%;"></td> <td style="width: 10%;"></td> <td style="width: 10%;"></td> <td style="width: 10%;"></td> <td style="width: 10%;"></td> <td style="width: 10%;"></td> <td style="width: 10%;"></td> <td style="width: 10%;"></td> </tr> <tr> <td></td> <td></td> <td colspan="8" style="text-align: center;"> <table border="1" style="width: 100%; border-collapse: collapse; text-align: center;"> <tr> <td style="width: 10%;"></td> <td style="width: 10%;"></td> <td style="width: 10%;"></td> <td style="width: 10%;"></td> <td style="width: 10%;"></td> <td style="width: 10%;"></td> <td style="width: 10%;"></td> <td style="width: 10%;"></td> <td style="width: 10%;"></td> <td style="width: 10%;"></td> </tr> <tr> <td></td> <td></td> <td colspan="8" style="text-align: center;"> <table border="1" style="width: 100%; border-collapse: collapse; text-align: center;"> <tr> <td style="width: 10%;"></td> <td style="width: 10%;"></td> <td style="width: 10%;"></td> <td style="width: 10%;"></td> <td style="width: 10%;"></td> <td style="width: 10%;"></td> <td style="width: 10%;"></td> <td style="width: 10%;"></td> <td style="width: 10%;"></td> <td style="width: 10%;"></td> </tr> <tr> <td></td> <td></td> <td colspan="8" style="text-align: center;"> <table border="1" style="width: 100%; border-collapse: collapse; text-align: center;"> <tr> <td style="width: 10%;"></td> <td style="width: 10%;"></td> <td style="width: 10%;"></td> <td style="width: 10%;"></td> <td style="width: 10%;"></td> <td style="width: 10%;"></td> <td style="width: 10%;"></td> <td style="width: 10%;"></td> <td style="width: 10%;"></td> <td style="width: 10%;"></td> </tr> <tr> <td></td> <td></td> <td colspan="8" style="text-align: center;"> <table border="1" style="width: 100%; border-collapse: collapse; text-align: center;"> <tr> <td style="width: 10%;"></td> <td style="width: 10%;"></td> <td style="width: 10%;"></td> <td style="width: 10%;"></td> <td style="width: 10%;"></td> <td style="width: 10%;"></td> <td style="width: 10%;"></td> <td style="width: 10%;"></td> <td style="width: 10%;"></td> <td style="width: 10%;"></td> </tr> <tr> <td></td> <td></td> <td colspan="8" style="text-align: center;"> <table border="1" style="width: 100%; border-collapse: collapse; text-align: center;"> <tr> <td style="width: 10%;"></td> <td style="width: 10%;"></td> <td style="width: 10%;"></td> <td style="width: 10%;"></td> <td style="width: 10%;"></td> <td style="width: 10%;"></td> <td style="width: 10%;"></td> <td style="width: 10%;"></td> <td style="width: 10%;"></td> <td style="width: 10%;"></td> </tr> <tr> <td></td> <td></td> <td colspan="8" style="text-align: center;"> <table border="1" style="width: 100%; border-collapse: collapse; text-align: center;"> <tr> <td style="width: 10%;"></td> <td style="width: 10%;"></td> <td style="width: 10%;"></td> <td style="width: 10%;"></td> <td style="width: 10%;"></td> <td style="width: 10%;"></td> <td style="width: 10%;"></td> <td style="width: 10%;"></td> <td style="width: 10%;"></td> <td style="width: 10%;"></td> </tr> <tr> <td></td> <td></td> <td colspan="8" style="text-align: center;"> <table border="1" style="width: 100%; border-collapse: collapse; text-align: center;"> <tr> <td style="width: 10%;"></td> <td style="width: 10%;"></td> <td style="width: 10%;"></td> <td style="width: 10%;"></td> <td style="width: 10%;"></td> <td style="width: 10%;"></td> <td style="width: 10%;"></td> <td style="width: 10%;"></td> <td style="width: 10%;"></td> <td style="width: 10%;"></td> </tr> <tr> <td></td> <td></td> <td colspan="8" style="text-align: center;"> <table border="1" style="width: 100%; border-collapse: collapse; text-align: center;"> <tr> <td style="width: 10%;"></td> <td style="width: 10%;"></td> <td style="width: 10%;"></td> <td style="width: 10%;"></td> <td style="width: 10%;"></td> <td style="width: 10%;"></td> <td style="width: 10%;"></td> <td style="width: 10%;"></td> <td style="width: 10%;"></td> <td style="width: 10%;"></td> </tr> <tr> <td></td> <td></td> <td colspan="8" style="text-align: center;"> <table border="1" style="width: 100%; border-collapse: collapse; text-align: center;"> <tr> <td style="width: 10%;"></td> <td style="width: 10%;"></td> <td style="width: 10%;"></td> <td style="width: 10%;"></td> <td style="width: 10%;"></td> <td style="width: 10%;"></td> <td style="width: 10%;"></td> <td style="width: 10%;"></td> <td style="width: 10%;"></td> <td style="width: 10%;"></td> </tr> <tr> <td></td> <td></td> <td colspan="8" style="text-align: center;"> <table border="1" style="width: 100%; border-collapse: collapse; text-align: center;"> <tr> <td style="width: 10%;"></td> <td style="width: 10%;"></td> <td style="width: 10%;"></td> <td style="width: 10%;"></td> <td style="width: 10%;"></td> <td style="width: 10%;"></td> <td style="width: 10%;"></td> <td style="width: 10%;"></td> <td style="width: 10%;"></td> <td style="width: 10%;"></td> </tr> <tr> <td></td> <td></td> <td colspan="8" style="text-align: center;"> <table border="1" style="width: 100%; border-collapse: collapse; text-align: center;"> <tr> <td style="width: 10%;"></td> <td style="width: 10%;"></td> <td style="width: 10%;"></td> <td style="width: 10%;"></td> <td style="width: 10%;"></td> <td style="width: 10%;"></td> <td style="width: 10%;"></td> <td style="width: 10%;"></td> <td style="width: 10%;"></td> <td style="width: 10%;"></td> </tr> <tr> <td></td> <td></td> <td colspan="8" style="text-align: center;"> <table border="1" style="width: 100%; border-collapse: collapse; text-align: center;"> <tr> <td style="width: 10%;"></td> <td style="width: 10%;"></td> <td style="width: 10%;"></td> <td style="width: 10%;"></td> <td style="width: 10%;"></td> <td style="width: 10%;"></td> <td style="width: 10%;"></td> <td style="width: 10%;"></td> <td style="width: 10%;"></td> <td style="width: 10%;"></td> </tr> <tr> <td></td> <td></td> <td colspan="8" style="text-align: center;"> <table border="1" style="width: 100%; border-collapse: collapse; text-align: center;"> <tr> <td style="width: 10%;"></td> <td style="width: 10%;"></td> <td style="width: 10%;"></td> <td style="width: 10%;"></td> <td style="width: 10%;"></td> <td style="width: 10%;"></td> <td style="width: 10%;"></td> <td style="width: 10%;"></td> <td style="width: 10%;"></td> <td style="width: 10%;"></td> </tr> <tr> <td></td> <td></td> <td colspan="8" style="text-align: center;"> <table border="1" style="width: 100%; border-collapse: collapse; text-align: center;"> <tr> <td style="width: 10%;"></td> <td style="width: 10%;"></td> <td style="width: 10%;"></td> <td style="width: 10%;"></td> <td style="width: 10%;"></td> <td style="width: 10%;"></td> <td style="width: 10%;"></td> <td style="width: 10%;"></td> <td style="width: 10%;"></td> <td style="width: 10%;"></td> </tr> <tr> <td></td> <td></td> <td colspan="8" style="text-align: center;"> <table border="1" style="width: 100%; border-collapse: collapse; text-align: center;"> <tr> <td style="width: 10%;"></td> <td style="width: 10%;"></td> <td style="width: 10%;"></td> <td style="width: 10%;"></td> <td style="width: 10%;"></td> <td style="width: 10%;"></td> <td style="width: 10%;"></td> <td style="width: 10%;"></td> <td style="width: 10%;"></td> <td style="width: 10%;"></td> </tr> <tr> <td></td> <td></td> <td colspan="8" style="text-align: center;"> <table border="1" style="width: 100%; border-collapse: collapse; text-align: center;"> <tr> <td style="width: 10%;"></td> <td style="width: 10%;"></td> <td style="width: 10%;"></td> <td style="width: 10%;"></td> <td style="width: 10%;"></td> <td style="width: 10%;"></td> <td style="width: 10%;"></td> <td style="width: 10%;"></td> <td style="width: 10%;"></td> <td style="width: 10%;"></td> </tr> <tr> <td></td> <td></td> <td colspan="8" style="text-align: center;"> <table border="1" style="width: 100%; border-collapse: collapse; text-align: center;"> <tr> <td style="width: 10%;"></td> <td style="width: 10%;"></td> <td style="width: 10%;"></td> <td style="width: 10%;"></td> <td style="width: 10%;"></td> <td style="width: 10%;"></td> <td style="width: 10%;"></td> <td
style="width: 10%;"></td> <td style="width: 10%;"></td> <td style="width: 10%;"></td> </tr> <tr> <td></td> <td></td> <td colspan="8" style="text-align: center;"> <table border="1" style="width: 100%; border-collapse: collapse; text-align: center;"> <tr> <td style="width: 10%;"></td> <td style="width: 10%;"></td> <td style="width: 10%;"></td> <td style="width: 10%;"></td> <td style="width: 10%;"></td> <td style="width: 10%;"></td> <td style="width: 10%;"></td> <td style="width: 10%;"></td> <td style="width: 10%;"></td> <td style="width: 10%;"></td> </tr> <tr> <td></td> <td></td> <td colspan="8" style="text-align: center;"> <table border="1" style="width: 100%; border-collapse: collapse; text-align: center;"> <tr> <td style="width: 10%;"></td> <td style="width: 10%;"></td> <td style="width: 10%;"></td> <td style="width: 10%;"></td> <td style="width: 10%;"></td> <td style="width: 10%;"></td> <td style="width: 10%;"></td> <td style="width: 10%;"></td> <td style="width: 10%;"></td> <td style="width: 10%;"></td> </tr> <tr> <td></td> <td></td> <td colspan="8" style="text-align: center;"> <table border="1" style="width: 100%; border-collapse: collapse; text-align: center;"> <tr> <td style="width: 10%;"></td> <td style="width: 10%;"></td> <td style="width: 10%;"></td> <td style="width: 10%;"></td> <td style="width: 10%;"></td> <td style="width: 10%;"></td> <td style="width: 10%;"></td> <td style="width: 10%;"></td> <td style="width: 10%;"></td> <td style="width: 10%;"></td> </tr> <tr> <td></td> <td></td> <td colspan="8" style="text-align: center;"> <table border="1" style="width: 100%; border-collapse: collapse; text-align: center;"> <tr> <td style="width: 10%;"></td> <td style="width: 10%;"></td> <td style="width: 10%;"></td> <td style="width: 10%;"></td> <td style="width: 10%;"></td> <td style="width: 10%;"></td> <td style="width: 10%;"></td> <td style="width: 10%;"></td> <td style="width: 10%;"></td> <td style="width: 10%;"></td> </tr> <tr> <td></td> <td></td> <td colspan="8" style="text-align: center;"> <table border="1" style="width: 100%; border-collapse: collapse; text-align: center;"> <tr> <td style="width: 10%;"></td> <td style="width: 10%;"></td> <td style="width: 10%;"></td> <td style="width: 10%;"></td> <td style="width: 10%;"></td> <td style="width: 10%;"></td> <td style="width: 10%;"></td> <td style="width: 10%;"></td> <td style="width: 10%;"></td> <td style="width: 10%;"></td> </tr> <tr> <td></td> <td></td> <td colspan="8" style="text-align: center;"> <table border="1" style="width: 100%; border-collapse: collapse; text-align: center;"> <tr> <td style="width: 10%;"></td> <td style="width: 10%;"></td> <td style="width: 10%;"></td> <td style="width: 10%;"></td> <td style="width: 10%;"></td> <td style="width: 10%;"></td> <td style="width: 10%;"></td> <td style="width: 10%;"></td> <td style="width: 10%;"></td> <td style="width: 10%;"></td> </tr> <tr> <td></td> <td></td> <td colspan="8" style="text-align: center;"> <table border="1" style="width: 100%; border-collapse: collapse; text-align: center;"> <tr> <td style="width: 10%;"></td> <td style="width: 10%;"></td> <td style="width: 10%;"></td> <td style="width: 10%;"></td> <td style="width: 10%;"></td> <td style="width: 10%;"></td> <td style="width: 10%;"></td> <td style="width: 10%;"></td> <td style="width: 10%;"></td> <td style="width: 10%;"></td> </tr> <tr> <td></td> <td></td> <td colspan="8" style="text-align: center;"> <table border="1" style="width: 100%; border-collapse: collapse; text-align: center;"> <tr> </tr></table></td></tr></table></td></tr></table></td></tr></table></td></tr></table></td></tr></table></td></tr></table></td></tr></table></td></tr></table></td></tr></table></td></tr></table></td></tr></table></td></tr></table></td></tr></table></td></tr></table></td></tr></table></td></tr></table></td></tr></table></td></tr></table></td></tr></table></td></tr></table></td></tr></table></td></tr></table></td></tr></table></td></tr></table></td></tr></table></td></tr></table></td></tr></table></td></tr></table></td></tr></table></td></tr></table></td></tr></table></td></tr></table></td></tr></table> | | | | | | | | | | | | | | | | | | | | <table border="1" style="width: 100%; border-collapse: collapse; text-align: center;"> <tr> <td style="width: 10%;"></td> <td style="width: 10%;"></td> <td style="width: 10%;"></td> <td style="width: 10%;"></td> <td style="width: 10%;"></td> <td style="width: 10%;"></td> <td style="width: 10%;"></td> <td style="width: 10%;"></td> <td style="width: 10%;"></td> <td style="width: 10%;"></td> </tr> <tr> <td></td> <td></td> <td colspan="8" style="text-align: center;"> <table border="1" style="width: 100%; border-collapse: collapse; text-align: center;"> <tr> <td style="width: 10%;"></td> <td style="width: 10%;"></td> <td style="width: 10%;"></td> <td style="width: 10%;"></td> <td style="width: 10%;"></td> <td style="width: 10%;"></td> <td style="width: 10%;"></td> <td style="width: 10%;"></td> <td style="width: 10%;"></td> <td style="width: 10%;"></td> </tr> <tr> <td></td> <td></td> <td colspan="8" style="text-align: center;"> <table border="1" style="width: 100%; border-collapse: collapse; text-align: center;"> <tr> <td style="width: 10%;"></td> <td style="width: 10%;"></td> <td style="width: 10%;"></td> <td style="width: 10%;"></td> <td style="width: 10%;"></td> <td style="width: 10%;"></td> <td style="width: 10%;"></td> <td style="width: 10%;"></td> <td style="width: 10%;"></td> <td style="width: 10%;"></td> </tr> <tr> <td></td> <td></td> <td colspan="8" style="text-align: center;"> <table border="1" style="width: 100%; border-collapse: collapse; text-align: center;"> <tr> <td style="width: 10%;"></td> <td style="width: 10%;"></td> <td style="width: 10%;"></td> <td style="width: 10%;"></td> <td style="width: 10%;"></td> <td style="width: 10%;"></td> <td style="width: 10%;"></td> <td style="width: 10%;"></td> <td style="width: 10%;"></td> <td style="width: 10%;"></td> </tr> <tr> <td></td> <td></td> <td colspan="8" style="text-align: center;"> <table border="1" style="width: 100%;
border-collapse: collapse; text-align: center;"> <tr> <td style="width: 10%;"></td> <td style="width: 10%;"></td> <td style="width: 10%;"></td> <td style="width: 10%;"></td> <td style="width: 10%;"></td> <td style="width: 10%;"></td> <td style="width: 10%;"></td> <td style="width: 10%;"></td> <td style="width: 10%;"></td> <td style="width: 10%;"></td> </tr> <tr> <td></td> <td></td> <td colspan="8" style="text-align: center;"> <table border="1" style="width: 100%; border-collapse: collapse; text-align: center;"> <tr> <td style="width: 10%;"></td> <td style="width: 10%;"></td> <td style="width: 10%;"></td> <td style="width: 10%;"></td> <td style="width: 10%;"></td> <td style="width: 10%;"></td> <td style="width: 10%;"></td> <td style="width: 10%;"></td> <td style="width: 10%;"></td> <td style="width: 10%;"></td> </tr> <tr> <td></td> <td></td> <td colspan="8" style="text-align: center;"> <table border="1" style="width: 100%; border-collapse: collapse; text-align: center;"> <tr> <td style="width: 10%;"></td> <td style="width: 10%;"></td> <td style="width: 10%;"></td> <td style="width: 10%;"></td> <td style="width: 10%;"></td> <td style="width: 10%;"></td> <td style="width: 10%;"></td> <td style="width: 10%;"></td> <td style="width: 10%;"></td> <td style="width: 10%;"></td> </tr> <tr> <td></td> <td></td> <td colspan="8" style="text-align: center;"> <table border="1" style="width: 100%; border-collapse: collapse; text-align: center;"> <tr> <td style="width: 10%;"></td> <td style="width: 10%;"></td> <td style="width: 10%;"></td> <td style="width: 10%;"></td> <td style="width: 10%;"></td> <td style="width: 10%;"></td> <td style="width: 10%;"></td> <td style="width: 10%;"></td> <td style="width: 10%;"></td> <td style="width: 10%;"></td> </tr> <tr> <td></td> <td></td> <td colspan="8" style="text-align: center;"> <table border="1" style="width: 100%; border-collapse: collapse; text-align: center;"> <tr> <td style="width: 10%;"></td> <td style="width: 10%;"></td> <td style="width: 10%;"></td> <td style="width: 10%;"></td> <td style="width: 10%;"></td> <td style="width: 10%;"></td> <td style="width: 10%;"></td> <td style="width: 10%;"></td> <td style="width: 10%;"></td> <td style="width: 10%;"></td> </tr> <tr> <td></td> <td></td> <td colspan="8" style="text-align: center;"> <table border="1" style="width: 100%; border-collapse: collapse; text-align: center;"> <tr> <td style="width: 10%;"></td> <td style="width: 10%;"></td> <td style="width: 10%;"></td> <td style="width: 10%;"></td> <td style="width: 10%;"></td> <td style="width: 10%;"></td> <td style="width: 10%;"></td> <td style="width: 10%;"></td> <td style="width: 10%;"></td> <td style="width: 10%;"></td> </tr> <tr> <td></td> <td></td> <td colspan="8" style="text-align: center;"> <table border="1" style="width: 100%; border-collapse: collapse; text-align: center;"> <tr> <td style="width: 10%;"></td> <td style="width: 10%;"></td> <td style="width: 10%;"></td> <td style="width: 10%;"></td> <td style="width: 10%;"></td> <td style="width: 10%;"></td> <td style="width: 10%;"></td> <td style="width: 10%;"></td> <td style="width: 10%;"></td> <td style="width: 10%;"></td> </tr> <tr> <td></td> <td></td> <td colspan="8" style="text-align: center;"> <table border="1" style="width: 100%; border-collapse: collapse; text-align: center;"> <tr> <td style="width: 10%;"></td> <td style="width: 10%;"></td> <td style="width: 10%;"></td> <td style="width: 10%;"></td> <td style="width: 10%;"></td> <td style="width: 10%;"></td> <td style="width: 10%;"></td> <td style="width: 10%;"></td> <td style="width: 10%;"></td> <td style="width: 10%;"></td> </tr> <tr> <td></td> <td></td> <td colspan="8" style="text-align: center;"> <table border="1" style="width: 100%; border-collapse: collapse; text-align: center;"> <tr> <td style="width: 10%;"></td> <td style="width: 10%;"></td> <td style="width: 10%;"></td> <td style="width: 10%;"></td> <td style="width: 10%;"></td> <td style="width: 10%;"></td> <td style="width: 10%;"></td> <td style="width: 10%;"></td> <td style="width: 10%;"></td> <td style="width: 10%;"></td> </tr> <tr> <td></td> <td></td> <td colspan="8" style="text-align: center;"> <table border="1" style="width: 100%; border-collapse: collapse; text-align: center;"> <tr> <td style="width: 10%;"></td> <td style="width: 10%;"></td> <td style="width: 10%;"></td> <td style="width: 10%;"></td> <td style="width: 10%;"></td> <td style="width: 10%;"></td> <td style="width: 10%;"></td> <td style="width: 10%;"></td> <td style="width: 10%;"></td> <td style="width: 10%;"></td> </tr> <tr> <td></td> <td></td> <td colspan="8" style="text-align: center;"> <table border="1" style="width: 100%; border-collapse: collapse; text-align: center;"> <tr> <td style="width: 10%;"></td> <td style="width: 10%;"></td> <td style="width: 10%;"></td> <td style="width: 10%;"></td> <td style="width: 10%;"></td> <td style="width: 10%;"></td> <td style="width: 10%;"></td> <td style="width: 10%;"></td> <td style="width: 10%;"></td> <td style="width: 10%;"></td> </tr> <tr> <td></td> <td></td> <td colspan="8" style="text-align: center;"> <table border="1" style="width: 100%; border-collapse: collapse; text-align: center;"> <tr> <td style="width: 10%;"></td> <td style="width: 10%;"></td> <td style="width: 10%;"></td> <td style="width: 10%;"></td> <td style="width: 10%;"></td> <td style="width: 10%;"></td> <td style="width: 10%;"></td> <td style="width: 10%;"></td> <td style="width: 10%;"></td> <td style="width: 10%;"></td> </tr> <tr> <td></td> <td></td> <td colspan="8" style="text-align: center;"> <table border="1" style="width: 100%; border-collapse: collapse; text-align: center;"> <tr> <td style="width: 10%;"></td> <td style="width: 10%;"></td> <td style="width: 10%;"></td> <td style="width: 10%;"></td> <td style="width: 10%;"></td> <td style="width: 10%;"></td> <td style="width: 10%;"></td> <td style="width: 10%;"></td> <td style="width: 10%;"></td> <td style="width: 10%;"></td> </tr> <tr> <td></td> <td></td> <td colspan="8" style="text-align: center;"> <table border="1" style="width: 100%; border-collapse: collapse; text-align: center;"> <tr> <td style="width: 10%;"></td> <td style="width: 10%;"></td> <td style="width: 10%;"></td> <td style="width: 10%;"></td> <td style="width: 10%;"></td> <td style="width: 10%;"></td> <td style="width: 10%;"></td> <td style="width: 10%;"></td> <td style="width: 10%;"></td> <td style="width: 10%;"></td> </tr> <tr> <td></td> <td></td> <td colspan="8" style="text-align: center;"> <table border="1" style="width: 100%; border-collapse: collapse; text-align: center;"> <tr> <td style="width: 10%;"></td> <td style="width: 10%;"></td> <td style="width: 10%;"></td> <td style="width: 10%;"></td> <td style="width: 10%;"></td> <td style="width: 10%;"></td> <td style="width: 10%;"></td> <td style="width: 10%;"></td> <td style="width: 10%;"></td> <td style="width: 10%;"></td> </tr> <tr> <td></td> <td></td> <td colspan="8" style="text-align: center;"> <table border="1" style="width: 100%; border-collapse: collapse; text-align: center;"> <tr> <td style="width: 10%;"></td> <td style="width: 10%;"></td> <td style="width: 10%;"></td> <td style="width: 10%;"></td> <td style="width: 10%;"></td> <td style="width: 10%;"></td> <td style="width: 10%;"></td> <td style="width: 10%;"></td> <td style="width: 10%;"></td> <td style="width: 10%;"></td> </tr> <tr> <td></td> <td></td> <td colspan="8" style="text-align: center;"> <table border="1" style="width: 100%; border-collapse: collapse; text-align: center;"> <tr> <td style="width: 10%;"></td> <td style="width: 10%;"></td> <td style="width: 10%;"></td> <td style="width: 10%;"></td> <td style="width: 10%;"></td> <td style="width: 10%;"></td> <td style="width: 10%;"></td> <td style="width: 10%;"></td> <td style="width: 10%;"></td> <td style="width: 10%;"></td> </tr> <tr> <td></td> <td></td> <td colspan="8" style="text-align: center;"> <table border="1" style="width: 100%; border-collapse: collapse; text-align: center;"> <tr> <td style="width: 10%;"></td> <td style="width: 10%;"></td> <td style="width: 10%;"></td> <td style="width: 10%;"></td> <td style="width: 10%;"></td> <td style="width: 10%;"></td> <td style="width: 10%;"></td> <td style="width: 10%;"></td> <td style="width: 10%;"></td> <td style="width: 10%;"></td> </tr> <tr> <td></td> <td></td> <td colspan="8" style="text-align: center;"> <table border="1" style="width: 100%; border-collapse: collapse; text-align: center;"> <tr> <td style="width: 10%;"></td> <td style="width: 10%;"></td> <td style="width: 10%;"></td> <td style="width: 10%;"></td> <td style="width: 10%;"></td> <td style="width: 10%;"></td> <td style="width: 10%;"></td> <td style="width: 10%;"></td> <td style="width: 10%;"></td> <td style="width: 10%;"></td> </tr> <tr> <td></td> <td></td> <td colspan="8" style="text-align: center;"> <table border="1" style="width: 100%; border-collapse: collapse; text-align: center;"> <tr> <td style="width: 10%;"></td> <td style="width: 10%;"></td> <td style="width: 10%;"></td> <td style="width: 10%;"></td> <td style="width: 10%;"></td> <td style="width: 10%;"></td> <td style="width: 10%;"></td> <td style="width: 10%;"></td> <td style="width: 10%;"></td> <td style="width: 10%;"></td> </tr> <tr> <td></td> <td></td> <td colspan="8" style="text-align: center;"> <table border="1" style="width: 100%; border-collapse: collapse; text-align: center;"> <tr> <td style="width: 10%;"></td> <td style="width: 10%;"></td> <td style="width: 10%;"></td> <td style="width: 10%;"></td> <td style="width: 10%;"></td> <td style="width: 10%;"></td> <td style="width: 10%;"></td> <td style="width: 10%;"></td> <td style="width: 10%;"></td> <td style="width: 10%;"></td> </tr> <tr> <td></td> <td></td> <td colspan="8" style="text-align: center;"> <table border="1" style="width: 100%; border-collapse: collapse; text-align: center;"> <tr> <td style="width: 10%;"></td> <td style="width: 10%;"></td> <td style="width: 10%;"></td> <td style="width:
10%;"></td> <td style="width: 10%;"></td> <td style="width: 10%;"></td> <td style="width: 10%;"></td> <td style="width: 10%;"></td> <td style="width: 10%;"></td> <td style="width: 10%;"></td> </tr> <tr> <td></td> <td></td> <td colspan="8" style="text-align: center;"> <table border="1" style="width: 100%; border-collapse: collapse; text-align: center;"> <tr> <td style="width: 10%;"></td> <td style="width: 10%;"></td> <td style="width: 10%;"></td> <td style="width: 10%;"></td> <td style="width: 10%;"></td> <td style="width: 10%;"></td> <td style="width: 10%;"></td> <td style="width: 10%;"></td> <td style="width: 10%;"></td> <td style="width: 10%;"></td> </tr> <tr> <td></td> <td></td> <td colspan="8" style="text-align: center;"> <table border="1" style="width: 100%; border-collapse: collapse; text-align: center;"> <tr> <td style="width: 10%;"></td> <td style="width: 10%;"></td> <td style="width: 10%;"></td> <td style="width: 10%;"></td> <td style="width: 10%;"></td> <td style="width: 10%;"></td> <td style="width: 10%;"></td> <td style="width: 10%;"></td> <td style="width: 10%;"></td> <td style="width: 10%;"></td> </tr> <tr> <td></td> <td></td> <td colspan="8" style="text-align: center;"> <table border="1" style="width: 100%; border-collapse: collapse; text-align: center;"> <tr> <td style="width: 10%;"></td> <td style="width: 10%;"></td> <td style="width: 10%;"></td> <td style="width: 10%;"></td> <td style="width: 10%;"></td> <td style="width: 10%;"></td> <td style="width: 10%;"></td> <td style="width: 10%;"></td> <td style="width: 10%;"></td> <td style="width: 10%;"></td> </tr> <tr> <td></td> <td></td> <td colspan="8" style="text-align: center;"> <table border="1" style="width: 100%; border-collapse: collapse; text-align: center;"> <tr> <td style="width: 10%;"></td> <td style="width: 10%;"></td> <td style="width: 10%;"></td> <td style="width: 10%;"></td> <td style="width: 10%;"></td> <td style="width: 10%;"></td> <td style="width: 10%;"></td> <td style="width: 10%;"></td> <td style="width: 10%;"></td> <td style="width: 10%;"></td> </tr> <tr> <td></td> <td></td> <td colspan="8" style="text-align: center;"> <table border="1" style="width: 100%; border-collapse: collapse; text-align: center;"> <tr> <td style="width: 10%;"></td> <td style="width: 10%;"></td> <td style="width: 10%;"></td> <td style="width: 10%;"></td> <td style="width: 10%;"></td> <td style="width: 10%;"></td> <td style="width: 10%;"></td> <td style="width: 10%;"></td> <td style="width: 10%;"></td> <td style="width: 10%;"></td> </tr> <tr> <td></td> <td></td> <td colspan="8" style="text-align: center;"> <table border="1" style="width: 100%; border-collapse: collapse; text-align: center;"> <tr> <td style="width: 10%;"></td> <td style="width: 10%;"></td> <td style="width: 10%;"></td> <td style="width: 10%;"></td> <td style="width: 10%;"></td> <td style="width: 10%;"></td> <td style="width: 10%;"></td> <td style="width: 10%;"></td> <td style="width: 10%;"></td> <td style="width: 10%;"></td> </tr> <tr> <td></td> <td></td> <td colspan="8" style="text-align: center;"> <table border="1" style="width: 100%; border-collapse: collapse; text-align: center;"> <tr> </tr></table></td></tr></table></td></tr></table></td></tr></table></td></tr></table></td></tr></table></td></tr></table></td></tr></table></td></tr></table></td></tr></table></td></tr></table></td></tr></table></td></tr></table></td></tr></table></td></tr></table></td></tr></table></td></tr></table></td></tr></table></td></tr></table></td></tr></table></td></tr></table></td></tr></table></td></tr></table></td></tr></table></td></tr></table></td></tr></table></td></tr></table></td></tr></table></td></tr></table></td></tr></table></td></tr></table></td></tr></table></td></tr></table> | | | | | | | | | | | | | | | | | | | | <table border="1" style="width: 100%; border-collapse: collapse; text-align: center;"> <tr> <td style="width: 10%;"></td> <td style="width: 10%;"></td> <td style="width: 10%;"></td> <td style="width: 10%;"></td> <td style="width: 10%;"></td> <td style="width: 10%;"></td> <td style="width: 10%;"></td> <td style="width: 10%;"></td> <td style="width: 10%;"></td> <td style="width: 10%;"></td> </tr> <tr> <td></td> <td></td> <td colspan="8" style="text-align: center;"> <table border="1" style="width: 100%; border-collapse: collapse; text-align: center;"> <tr> <td style="width: 10%;"></td> <td style="width: 10%;"></td> <td style="width: 10%;"></td> <td style="width: 10%;"></td> <td style="width: 10%;"></td> <td style="width: 10%;"></td> <td style="width: 10%;"></td> <td style="width: 10%;"></td> <td style="width: 10%;"></td> <td style="width: 10%;"></td> </tr> <tr> <td></td> <td></td> <td colspan="8" style="text-align: center;"> <table border="1" style="width: 100%; border-collapse: collapse; text-align: center;"> <tr> <td style="width: 10%;"></td> <td style="width: 10%;"></td> <td style="width: 10%;"></td> <td style="width: 10%;"></td> <td style="width: 10%;"></td> <td style="width: 10%;"></td> <td style="width: 10%;"></td> <td style="width: 10%;"></td> <td style="width: 10%;"></td> <td style="width: 10%;"></td> </tr> <tr> <td></td> <td></td> <td colspan="8" style="text-align: center;"> <table border="1" style="width: 100%; border-collapse: collapse; text-align: center;"> <tr> <td style="width: 10%;"></td> <td style="width: 10%;"></td> <td style="width: 10%;"></td> <td style="width: 10%;"></td> <td style="width: 10%;"></td> <td style="width: 10%;"></td> <td style="width: 10%;"></td> <td style="width: 10%;"></td> <td style="width: 10%;"></td> <td style="width: 10%;"></td> </tr> <tr> <td></td> <td></td> <td colspan="8" style="text-align: center;"> <table border="1" style="width: 100%; border-collapse: collapse; text-align: center;"> <tr> <td style="width: 10%;"></td> <td style="width: 10%;"></td> <td style="width: 10%;"></td> <td style="width: 10%;"></td> <td style="width: 10%;"></td> <td style="width: 10%;"></td> <td style="width: 10%;"></td> <td style="width: 10%;"></td> <td style="width: 10%;"></td> <td style="width: 10%;"></td> </tr> <tr> <td></td> <td></td>
<td colspan="8" style="text-align: center;"> <table border="1" style="width: 100%; border-collapse: collapse; text-align: center;"> <tr> <td style="width: 10%;"></td> <td style="width: 10%;"></td> <td style="width: 10%;"></td> <td style="width: 10%;"></td> <td style="width: 10%;"></td> <td style="width: 10%;"></td> <td style="width: 10%;"></td> <td style="width: 10%;"></td> <td style="width: 10%;"></td> <td style="width: 10%;"></td> </tr> <tr> <td></td> <td></td> <td colspan="8" style="text-align: center;"> <table border="1" style="width: 100%; border-collapse: collapse; text-align: center;"> <tr> <td style="width: 10%;"></td> <td style="width: 10%;"></td> <td style="width: 10%;"></td> <td style="width: 10%;"></td> <td style="width: 10%;"></td> <td style="width: 10%;"></td> <td style="width: 10%;"></td> <td style="width: 10%;"></td> <td style="width: 10%;"></td> <td style="width: 10%;"></td> </tr> <tr> <td></td> <td></td> <td colspan="8" style="text-align: center;"> <table border="1" style="width: 100%; border-collapse: collapse; text-align: center;"> <tr> <td style="width: 10%;"></td> <td style="width: 10%;"></td> <td style="width: 10%;"></td> <td style="width: 10%;"></td> <td style="width: 10%;"></td> <td style="width: 10%;"></td> <td style="width: 10%;"></td> <td style="width: 10%;"></td> <td style="width: 10%;"></td> <td style="width: 10%;"></td> </tr> <tr> <td></td> <td></td> <td colspan="8" style="text-align: center;"> <table border="1" style="width: 100%; border-collapse: collapse; text-align: center;"> <tr> <td style="width: 10%;"></td> <td style="width: 10%;"></td> <td style="width: 10%;"></td> <td style="width: 10%;"></td> <td style="width: 10%;"></td> <td style="width: 10%;"></td> <td style="width: 10%;"></td> <td style="width: 10%;"></td> <td style="width: 10%;"></td> <td style="width: 10%;"></td> </tr> <tr> <td></td> <td></td> <td colspan="8" style="text-align: center;"> <table border="1" style="width: 100%; border-collapse: collapse; text-align: center;"> <tr> <td style="width: 10%;"></td> <td style="width: 10%;"></td> <td style="width: 10%;"></td> <td style="width: 10%;"></td> <td style="width: 10%;"></td> <td style="width: 10%;"></td> <td style="width: 10%;"></td> <td style="width: 10%;"></td> <td style="width: 10%;"></td> <td style="width: 10%;"></td> </tr> <tr> <td></td> <td></td> <td colspan="8" style="text-align: center;"> <table border="1" style="width: 100%; border-collapse: collapse; text-align: center;"> <tr> <td style="width: 10%;"></td> <td style="width: 10%;"></td> <td style="width: 10%;"></td> <td style="width: 10%;"></td> <td style="width: 10%;"></td> <td style="width: 10%;"></td> <td style="width: 10%;"></td> <td style="width: 10%;"></td> <td style="width: 10%;"></td> <td style="width: 10%;"></td> </tr> <tr> <td></td> <td></td> <td colspan="8" style="text-align: center;"> <table border="1" style="width: 100%; border-collapse: collapse; text-align: center;"> <tr> <td style="width: 10%;"></td> <td style="width: 10%;"></td> <td style="width: 10%;"></td> <td style="width: 10%;"></td> <td style="width: 10%;"></td> <td style="width: 10%;"></td> <td style="width: 10%;"></td> <td style="width: 10%;"></td> <td style="width: 10%;"></td> <td style="width: 10%;"></td> </tr> <tr> <td></td> <td></td> <td colspan="8" style="text-align: center;"> <table border="1" style="width: 100%; border-collapse: collapse; text-align: center;"> <tr> <td style="width: 10%;"></td> <td style="width: 10%;"></td> <td style="width: 10%;"></td> <td style="width: 10%;"></td> <td style="width: 10%;"></td> <td style="width: 10%;"></td> <td style="width: 10%;"></td> <td style="width: 10%;"></td> <td style="width: 10%;"></td> <td style="width: 10%;"></td> </tr> <tr> <td></td> <td></td> <td colspan="8" style="text-align: center;"> <table border="1" style="width: 100%; border-collapse: collapse; text-align: center;"> <tr> <td style="width: 10%;"></td> <td style="width: 10%;"></td> <td style="width: 10%;"></td> <td style="width: 10%;"></td> <td style="width: 10%;"></td> <td style="width: 10%;"></td> <td style="width: 10%;"></td> <td style="width: 10%;"></td> <td style="width: 10%;"></td> <td style="width: 10%;"></td> </tr> <tr> <td></td> <td></td> <td colspan="8" style="text-align: center;"> <table border="1" style="width: 100%; border-collapse: collapse; text-align: center;"> <tr> <td style="width: 10%;"></td> <td style="width: 10%;"></td> <td style="width: 10%;"></td> <td style="width: 10%;"></td> <td style="width: 10%;"></td> <td style="width: 10%;"></td> <td style="width: 10%;"></td> <td style="width: 10%;"></td> <td style="width: 10%;"></td> <td style="width: 10%;"></td> </tr> <tr> <td></td> <td></td> <td colspan="8" style="text-align: center;"> <table border="1" style="width: 100%; border-collapse: collapse; text-align: center;"> <tr> <td style="width: 10%;"></td> <td style="width: 10%;"></td> <td style="width: 10%;"></td> <td style="width: 10%;"></td> <td style="width: 10%;"></td> <td style="width: 10%;"></td> <td style="width: 10%;"></td> <td style="width: 10%;"></td> <td style="width: 10%;"></td> <td style="width: 10%;"></td> </tr> <tr> <td></td> <td></td> <td colspan="8" style="text-align: center;"> <table border="1" style="width: 100%; border-collapse: collapse; text-align: center;"> <tr> <td style="width: 10%;"></td> <td style="width: 10%;"></td> <td style="width: 10%;"></td> <td style="width: 10%;"></td> <td style="width: 10%;"></td> <td style="width: 10%;"></td> <td style="width: 10%;"></td> <td style="width: 10%;"></td> <td style="width: 10%;"></td> <td style="width: 10%;"></td> </tr> <tr> <td></td> <td></td> <td colspan="8" style="text-align: center;"> <table border="1" style="width: 100%; border-collapse: collapse; text-align: center;"> <tr> <td style="width: 10%;"></td> <td style="width: 10%;"></td> <td style="width: 10%;"></td> <td style="width: 10%;"></td> <td style="width: 10%;"></td> <td style="width: 10%;"></td> <td style="width: 10%;"></td> <td style="width: 10%;"></td> <td style="width: 10%;"></td> <td style="width: 10%;"></td> </tr> <tr> <td></td> <td></td> <td colspan="8" style="text-align: center;"> <table border="1" style="width: 100%; border-collapse: collapse; text-align: center;"> <tr> <td style="width: 10%;"></td> <td style="width: 10%;"></td> <td style="width: 10%;"></td> <td style="width: 10%;"></td> <td style="width: 10%;"></td> <td style="width: 10%;"></td> <td style="width: 10%;"></td> <td style="width: 10%;"></td> <td style="width: 10%;"></td> <td style="width: 10%;"></td> </tr> <tr> <td></td> <td></td> <td colspan="8" style="text-align: center;"> <table border="1" style="width: 100%; border-collapse: collapse; text-align: center;"> <tr> <td style="width: 10%;"></td> <td style="width: 10%;"></td> <td style="width: 10%;"></td> <td style="width: 10%;"></td> <td style="width: 10%;"></td> <td style="width: 10%;"></td> <td style="width: 10%;"></td> <td style="width: 10%;"></td> <td style="width: 10%;"></td> <td style="width: 10%;"></td> </tr> <tr> <td></td> <td></td> <td colspan="8" style="text-align: center;"> <table border="1" style="width: 100%; border-collapse: collapse; text-align: center;"> <tr> <td style="width: 10%;"></td> <td style="width: 10%;"></td> <td style="width: 10%;"></td> <td style="width: 10%;"></td> <td style="width: 10%;"></td> <td style="width: 10%;"></td> <td style="width: 10%;"></td> <td style="width: 10%;"></td> <td style="width: 10%;"></td> <td style="width: 10%;"></td> </tr> <tr> <td></td> <td></td> <td colspan="8" style="text-align: center;"> <table border="1" style="width: 100%; border-collapse: collapse; text-align: center;"> <tr> <td style="width: 10%;"></td> <td style="width: 10%;"></td> <td style="width: 10%;"></td> <td style="width: 10%;"></td> <td style="width: 10%;"></td> <td style="width: 10%;"></td> <td style="width: 10%;"></td> <td style="width: 10%;"></td> <td style="width: 10%;"></td> <td style="width: 10%;"></td> </tr> <tr> <td></td> <td></td> <td colspan="8" style="text-align: center;"> <table border="1" style="width: 100%; border-collapse: collapse; text-align: center;"> <tr> <td style="width: 10%;"></td> <td style="width: 10%;"></td> <td style="width: 10%;"></td> <td style="width: 10%;"></td> <td style="width: 10%;"></td> <td style="width: 10%;"></td> <td style="width: 10%;"></td> <td style="width: 10%;"></td> <td style="width: 10%;"></td> <td style="width: 10%;"></td> </tr> <tr> <td></td> <td></td> <td colspan="8" style="text-align: center;"> <table border="1" style="width: 100%; border-collapse: collapse; text-align: center;"> <tr> <td style="width: 10%;"></td> <td style="width: 10%;"></td> <td style="width: 10%;"></td> <td style="width: 10%;"></td> <td style="width: 10%;"></td> <td style="width: 10%;"></td> <td style="width: 10%;"></td> <td style="width: 10%;"></td> <td style="width: 10%;"></td> <td style="width: 10%;"></td> </tr> <tr> <td></td> <td></td> <td colspan="8" style="text-align: center;"> <table border="1" style="width: 100%; border-collapse: collapse; text-align: center;"> <tr> <td style="width: 10%;"></td> <td style="width: 10%;"></td> <td style="width: 10%;"></td> <td style="width: 10%;"></td> <td style="width: 10%;"></td> <td style="width: 10%;"></td> <td style="width: 10%;"></td> <td style="width: 10%;"></td> <td style="width: 10%;"></td> <td style="width: 10%;"></td> </tr> <tr> <td></td> <td></td> <td colspan="8" style="text-align: center;"> <table border="1" style="width: 100%; border-collapse: collapse; text-align: center;"> <tr> <td style="width: 10%;"></td> <td style="width: 10%;"></td> <td style="width: 10%;"></td> <td style="width: 10%;"></td> <td style="width: 10%;"></td> <td style="width: 10%;"></td> <td style="width: 10%;"></td> <td style="width: 10%;"></td> <td style="width: 10%;"></td> <td style="width: 10%;"></td> </tr> <tr> <td></td> <td></td> <td colspan="8" style="text-align: center;"> <table border="1" style="width: 100%; border-collapse: collapse; text-align: center;"> <tr> <td style="width: 10%;"></td> <td
style="width: 10%;"></td> <td style="width: 10%;"></td> <td style="width: 10%;"></td> <td style="width: 10%;"></td> <td style="width: 10%;"></td> <td style="width: 10%;"></td> <td style="width: 10%;"></td> <td style="width: 10%;"></td> <td style="width: 10%;"></td> </tr> <tr> <td></td> <td></td> <td colspan="8" style="text-align: center;"> <table border="1" style="width: 100%; border-collapse: collapse; text-align: center;"> <tr> <td style="width: 10%;"></td> <td style="width: 10%;"></td> <td style="width: 10%;"></td> <td style="width: 10%;"></td> <td style="width: 10%;"></td> <td style="width: 10%;"></td> <td style="width: 10%;"></td> <td style="width: 10%;"></td> <td style="width: 10%;"></td> <td style="width: 10%;"></td> </tr> <tr> <td></td> <td></td> <td colspan="8" style="text-align: center;"> <table border="1" style="width: 100%; border-collapse: collapse; text-align: center;"> <tr> <td style="width: 10%;"></td> <td style="width: 10%;"></td> <td style="width: 10%;"></td> <td style="width: 10%;"></td> <td style="width: 10%;"></td> <td style="width: 10%;"></td> <td style="width: 10%;"></td> <td style="width: 10%;"></td> <td style="width: 10%;"></td> <td style="width: 10%;"></td> </tr> <tr> <td></td> <td></td> <td colspan="8" style="text-align: center;"> <table border="1" style="width: 100%; border-collapse: collapse; text-align: center;"> <tr> <td style="width: 10%;"></td> <td style="width: 10%;"></td> <td style="width: 10%;"></td> <td style="width: 10%;"></td> <td style="width: 10%;"></td> <td style="width: 10%;"></td> <td style="width: 10%;"></td> <td style="width: 10%;"></td> <td style="width: 10%;"></td> <td style="width: 10%;"></td> </tr> <tr> <td></td> <td></td> <td colspan="8" style="text-align: center;"> <table border="1" style="width: 100%; border-collapse: collapse; text-align: center;"> <tr> <td style="width: 10%;"></td> <td style="width: 10%;"></td> <td style="width: 10%;"></td> <td style="width: 10%;"></td> <td style="width: 10%;"></td> <td style="width: 10%;"></td> <td style="width: 10%;"></td> <td style="width: 10%;"></td> <td style="width: 10%;"></td> <td style="width: 10%;"></td> </tr> <tr> <td></td> <td></td> <td colspan="8" style="text-align: center;"> <table border="1" style="width: 100%; border-collapse: collapse; text-align: center;"> <tr> </tr></table></td></tr></table></td></tr></table></td></tr></table></td></tr></table></td></tr></table></td></tr></table></td></tr></table></td></tr></table></td></tr></table></td></tr></table></td></tr></table></td></tr></table></td></tr></table></td></tr></table></td></tr></table></td></tr></table></td></tr></table></td></tr></table></td></tr></table></td></tr></table></td></tr></table></td></tr></table></td></tr></table></td></tr></table></td></tr></table></td></tr></table></td></tr></table></td></tr></table></td></tr></table></td></tr></table></td></tr></table> | | | | | | | | | | | | | | | | | | | | <table border="1" style="width: 100%; border-collapse: collapse; text-align: center;"> <tr> <td style="width: 10%;"></td> <td style="width: 10%;"></td> <td style="width: 10%;"></td> <td style="width: 10%;"></td> <td style="width: 10%;"></td> <td style="width: 10%;"></td> <td style="width: 10%;"></td> <td style="width: 10%;"></td> <td style="width: 10%;"></td> <td style="width: 10%;"></td> </tr> <tr> <td></td> <td></td> <td colspan="8" style="text-align: center;"> <table border="1" style="width: 100%; border-collapse: collapse; text-align: center;"> <tr> <td style="width: 10%;"></td> <td style="width: 10%;"></td> <td style="width: 10%;"></td> <td style="width: 10%;"></td> <td style="width: 10%;"></td> <td style="width: 10%;"></td> <td style="width: 10%;"></td> <td style="width: 10%;"></td> <td style="width: 10%;"></td> <td style="width: 10%;"></td> </tr> <tr> <td></td> <td></td> <td colspan="8" style="text-align: center;"> <table border="1" style="width: 100%; border-collapse: collapse; text-align: center;"> <tr> <td style="width: 10%;"></td> <td style="width: 10%;"></td> <td style="width: 10%;"></td> <td style="width: 10%;"></td> <td style="width: 10%;"></td> <td style="width: 10%;"></td> <td style="width: 10%;"></td> <td style="width: 10%;"></td> <td style="width: 10%;"></td> <td style="width: 10%;"></td> </tr> <tr> <td></td> <td></td> <td colspan="8" style="text-align: center;"> <table border="1" style="width: 100%; border-collapse: collapse; text-align: center;"> <tr> <td style="width: 10%;"></td> <td style="width: 10%;"></td> <td style="width: 10%;"></td> <td style="width: 10%;"></td> <td style="width: 10%;"></td> <td style="width: 10%;"></td> <td style="width: 10%;"></td> <td style="width: 10%;"></td> <td style="width: 10%;"></td> <td style="width: 10%;"></td> </tr> <tr> <td></td> <td></td> <td colspan="8" style="text-align: center;"> <table border="1" style="width: 100%; border-collapse: collapse; text-align: center;"> <tr> <td style="width: 10%;"></td> <td style="width: 10%;"></td> <td style="width: 10%;"></td> <td style="width: 10%;"></td> <td style="width: 10%;"></td> <td style="width: 10%;"></td> <td style="width: 10%;"></td> <td style="width: 10%;"></td> <td style="width: 10%;"></td> <td style="width: 10%;"></td> </tr> <tr> <td></td> <td></td> <td colspan="8" style="text-align: center;"> <table border="1" style="width: 100%; border-collapse: collapse; text-align: center;"> <tr> <td style="width: 10%;"></td> <td style="width: 10%;"></td> <td style="width: 10%;"></td> <td style="width: 10%;"></td> <td style="width: 10%;"></td> <td style="width: 10%;"></td> <td style="width: 10%;"></td> <td style="width: 10%;"></td> <td style="width: 10%;"></td> <td style="width: 10%;"></td> </tr> <tr> <td></td> <td></td> <td colspan="8" style="text-align: center;"> <table border="1" style="width: 100%; border-collapse: collapse; text-align: center;"> <tr> <td style="width: 10%;"></td> <td style="width: 10%;"></td> <td style="width: 10%;"></td> <td style="width: 10%;"></td> <td style="width: 10%;"></td> <td style="width: 10%;"></td> <td style="width: 10%;"></td> <td style="width: 10%;"></td> <td style="width: 10%;"></td> <td
style="width: 10%;"></td> </tr> <tr> <td></td> <td></td> <td colspan="8" style="text-align: center;"> <table border="1" style="width: 100%; border-collapse: collapse; text-align: center;"> <tr> <td style="width: 10%;"></td> <td style="width: 10%;"></td> <td style="width: 10%;"></td> <td style="width: 10%;"></td> <td style="width: 10%;"></td> <td style="width: 10%;"></td> <td style="width: 10%;"></td> <td style="width: 10%;"></td> <td style="width: 10%;"></td> <td style="width: 10%;"></td> </tr> <tr> <td></td> <td></td> <td colspan="8" style="text-align: center;"> <table border="1" style="width: 100%; border-collapse: collapse; text-align: center;"> <tr> <td style="width: 10%;"></td> <td style="width: 10%;"></td> <td style="width: 10%;"></td> <td style="width: 10%;"></td> <td style="width: 10%;"></td> <td style="width: 10%;"></td> <td style="width: 10%;"></td> <td style="width: 10%;"></td> <td style="width: 10%;"></td> <td style="width: 10%;"></td> </tr> <tr> <td></td> <td></td> <td colspan="8" style="text-align: center;"> <table border="1" style="width: 100%; border-collapse: collapse; text-align: center;"> <tr> <td style="width: 10%;"></td> <td style="width: 10%;"></td> <td style="width: 10%;"></td> <td style="width: 10%;"></td> <td style="width: 10%;"></td> <td style="width: 10%;"></td> <td style="width: 10%;"></td> <td style="width: 10%;"></td> <td style="width: 10%;"></td> <td style="width: 10%;"></td> </tr> <tr> <td></td> <td></td> <td colspan="8" style="text-align: center;"> <table border="1" style="width: 100%; border-collapse: collapse; text-align: center;"> <tr> <td style="width: 10%;"></td> <td style="width: 10%;"></td> <td style="width: 10%;"></td> <td style="width: 10%;"></td> <td style="width: 10%;"></td> <td style="width: 10%;"></td> <td style="width: 10%;"></td> <td style="width: 10%;"></td> <td style="width: 10%;"></td> <td style="width: 10%;"></td> </tr> <tr> <td></td> <td></td> <td colspan="8" style="text-align: center;"> <table border="1" style="width: 100%; border-collapse: collapse; text-align: center;"> <tr> <td style="width: 10%;"></td> <td style="width: 10%;"></td> <td style="width: 10%;"></td> <td style="width: 10%;"></td> <td style="width: 10%;"></td> <td style="width: 10%;"></td> <td style="width: 10%;"></td> <td style="width: 10%;"></td> <td style="width: 10%;"></td> <td style="width: 10%;"></td> </tr> <tr> <td></td> <td></td> <td colspan="8" style="text-align: center;"> <table border="1" style="width: 100%; border-collapse: collapse; text-align: center;"> <tr> <td style="width: 10%;"></td> <td style="width: 10%;"></td> <td style="width: 10%;"></td> <td style="width: 10%;"></td> <td style="width: 10%;"></td> <td style="width: 10%;"></td> <td style="width: 10%;"></td> <td style="width: 10%;"></td> <td style="width: 10%;"></td> <td style="width: 10%;"></td> </tr> <tr> <td></td> <td></td> <td colspan="8" style="text-align: center;"> <table border="1" style="width: 100%; border-collapse: collapse; text-align: center;"> <tr> <td style="width: 10%;"></td> <td style="width: 10%;"></td> <td style="width: 10%;"></td> <td style="width: 10%;"></td> <td style="width: 10%;"></td> <td style="width: 10%;"></td> <td style="width: 10%;"></td> <td style="width: 10%;"></td> <td style="width: 10%;"></td> <td style="width: 10%;"></td> </tr> <tr> <td></td> <td></td> <td colspan="8" style="text-align: center;"> <table border="1" style="width: 100%; border-collapse: collapse; text-align: center;"> <tr> <td style="width: 10%;"></td> <td style="width: 10%;"></td> <td style="width: 10%;"></td> <td style="width: 10%;"></td> <td style="width: 10%;"></td> <td style="width: 10%;"></td> <td style="width: 10%;"></td> <td style="width: 10%;"></td> <td style="width: 10%;"></td> <td style="width: 10%;"></td> </tr> <tr> <td></td> <td></td> <td colspan="8" style="text-align: center;"> <table border="1" style="width: 100%; border-collapse: collapse; text-align: center;"> <tr> <td style="width: 10%;"></td> <td style="width: 10%;"></td> <td style="width: 10%;"></td> <td style="width: 10%;"></td> <td style="width: 10%;"></td> <td style="width: 10%;"></td> <td style="width: 10%;"></td> <td style="width: 10%;"></td> <td style="width: 10%;"></td> <td style="width: 10%;"></td> </tr> <tr> <td></td> <td></td> <td colspan="8" style="text-align: center;"> <table border="1" style="width: 100%; border-collapse: collapse; text-align: center;"> <tr> <td style="width: 10%;"></td> <td style="width: 10%;"></td> <td style="width: 10%;"></td> <td style="width: 10%;"></td> <td style="width: 10%;"></td> <td style="width: 10%;"></td> <td style="width: 10%;"></td> <td style="width: 10%;"></td> <td style="width: 10%;"></td> <td style="width: 10%;"></td> </tr> <tr> <td></td> <td></td> <td colspan="8" style="text-align: center;"> <table border="1" style="width: 100%; border-collapse: collapse; text-align: center;"> <tr> <td style="width: 10%;"></td> <td style="width: 10%;"></td> <td style="width: 10%;"></td> <td style="width: 10%;"></td> <td style="width: 10%;"></td> <td style="width: 10%;"></td> <td style="width: 10%;"></td> <td style="width: 10%;"></td> <td style="width: 10%;"></td> <td style="width: 10%;"></td> </tr> <tr> <td></td> <td></td> <td colspan="8" style="text-align: center;"> <table border="1" style="width: 100%; border-collapse: collapse; text-align: center;"> <tr> <td style="width: 10%;"></td> <td style="width: 10%;"></td> <td style="width: 10%;"></td> <td style="width: 10%;"></td> <td style="width: 10%;"></td> <td style="width: 10%;"></td> <td style="width: 10%;"></td> <td style="width: 10%;"></td> <td style="width: 10%;"></td> <td style="width: 10%;"></td> </tr> <tr> <td></td> <td></td> <td colspan="8" style="text-align: center;"> <table border="1" style="width: 100%; border-collapse: collapse; text-align: center;"> <tr> <td style="width: 10%;"></td> <td style="width: 10%;"></td> <td style="width: 10%;"></td> <td style="width: 10%;"></td> <td style="width: 10%;"></td> <td style="width: 10%;"></td> <td style="width: 10%;"></td> <td style="width: 10%;"></td> <td style="width: 10%;"></td> <td style="width: 10%;"></td> </tr> <tr> <td></td> <td></td> <td colspan="8" style="text-align: center;"> <table border="1" style="width: 100%; border-collapse: collapse; text-align: center;"> <tr> <td style="width: 10%;"></td> <td style="width: 10%;"></td> <td style="width: 10%;"></td> <td style="width: 10%;"></td> <td style="width: 10%;"></td> <td style="width: 10%;"></td> <td style="width: 10%;"></td> <td style="width: 10%;"></td> <td style="width: 10%;"></td> <td style="width: 10%;"></td> </tr> <tr> <td></td> <td></td> <td colspan="8" style="text-align: center;"> <table border="1" style="width: 100%; border-collapse: collapse; text-align: center;"> <tr> <td style="width: 10%;"></td> <td style="width: 10%;"></td> <td style="width: 10%;"></td> <td style="width: 10%;"></td> <td style="width: 10%;"></td> <td style="width: 10%;"></td> <td style="width: 10%;"></td> <td style="width: 10%;"></td> <td style="width: 10%;"></td> <td style="width: 10%;"></td> </tr> <tr> <td></td> <td></td> <td colspan="8" style="text-align: center;"> <table border="1" style="width: 100%; border-collapse: collapse; text-align: center;"> <tr> <td style="width: 10%;"></td> <td style="width: 10%;"></td> <td style="width: 10%;"></td> <td style="width: 10%;"></td> <td style="width: 10%;"></td> <td style="width: 10%;"></td> <td style="width: 10%;"></td> <td style="width: 10%;"></td> <td style="width: 10%;"></td> <td style="width: 10%;"></td> </tr> <tr> <td></td> <td></td> <td colspan="8" style="text-align: center;"> <table border="1" style="width: 100%; border-collapse: collapse; text-align: center;"> <tr> <td style="width: 10%;"></td> <td style="width: 10%;"></td> <td style="width: 10%;"></td> <td style="width: 10%;"></td> <td style="width: 10%;"></td> <td style="width: 10%;"></td> <td style="width: 10%;"></td> <td style="width: 10%;"></td> <td style="width: 10%;"></td> <td style="width: 10%;"></td> </tr> <tr> <td></td> <td></td> <td colspan="8" style="text-align: center;"> <table border="1" style="width: 100%; border-collapse: collapse; text-align: center;"> <tr> <td style="width: 10%;"></td> <td style="width: 10%;"></td> <td style="width: 10%;"></td> <td style="width: 10%;"></td> <td style="width: 10%;"></td> <td style="width: 10%;"></td> <td style="width: 10%;"></td> <td style="width: 10%;"></td> <td style="width: 10%;"></td> <td style="width: 10%;"></td> </tr> <tr> <td></td> <td></td> <td colspan="8" style="text-align: center;"> <table border="1" style="width: 100%; border-collapse: collapse; text-align: center;"> <tr> <td style="width: 10%;"></td> <td style="width: 10%;"></td> <td style="width: 10%;"></td> <td style="width: 10%;"></td> <td style="width: 10%;"></td> <td style="width: 10%;"></td> <td style="width: 10%;"></td> <td style="width: 10%;"></td> <td style="width: 10%;"></td> <td style="width: 10%;"></td> </tr> <tr> <td></td> <td></td> <td colspan="8" style="text-align: center;"> <table border="1" style="width: 100%; border-collapse: collapse; text-align: center;"> <tr> <td style="width: 10%;"></td> <td style="width: 10%;"></td> <td style="width: 10%;"></td> <td style="width: 10%;"></td> <td style="width: 10%;"></td> <td style="width: 10%;"></td> <td style="width: 10%;"></td> <td style="width: 10%;"></td> <td style="width: 10%;"></td> <td style="width: 10%;"></td> </tr> <tr> <td></td> <td></td> <td colspan="8" style="text-align: center;"> <table border="1" style="width: 100%; border-collapse: collapse; text-align: center;"> <tr> <td style="width: 10%;"></td> <td style="width: 10%;"></td> <td style="width: 10%;"></td> <td style="width: 10%;"></td> <td style="width: 10%;"></td> <td style="width: 10%;"></td> <td style="width: 10%;"></td> <td style="width: 10%;"></td> <td style="width: 10%;"></td> <td style="width: 10%;"></td> </tr> <tr> <td></td> <td></td> <td colspan="8" style="text-align: center;"> <table border="1" style="width: 100%; border-collapse: collapse;
text-align: center;"> <tr> <td style="width: 10%;"></td> <td style="width: 10%;"></td> <td style="width: 10%;"></td> <td style="width: 10%;"></td> <td style="width: 10%;"></td> <td style="width: 10%;"></td> <td style="width: 10%;"></td> <td style="width: 10%;"></td> <td style="width: 10%;"></td> <td style="width: 10%;"></td> </tr> <tr> <td></td> <td></td> <td colspan="8" style="text-align: center;"> <table border="1" style="width: 100%; border-collapse: collapse; text-align: center;"> <tr> <td style="width: 10%;"></td> <td style="width: 10%;"></td> <td style="width: 10%;"></td> <td style="width: 10%;"></td> <td style="width: 10%;"></td> <td style="width: 10%;"></td> <td style="width: 10%;"></td> <td style="width: 10%;"></td> <td style="width: 10%;"></td> <td style="width: 10%;"></td> </tr> <tr> <td></td> <td></td> <td colspan="8" style="text-align: center;"> <table border="1" style="width: 100%; border-collapse: collapse; text-align: center;"> <tr> </tr></table></td></tr></table></td></tr></table></td></tr></table></td></tr></table></td></tr></table></td></tr></table></td></tr></table></td></tr></table></td></tr></table></td></tr></table></td></tr></table></td></tr></table></td></tr></table></td></tr></table></td></tr></table></td></tr></table></td></tr></table></td></tr></table></td></tr></table></td></tr></table></td></tr></table></td></tr></table></td></tr></table></td></tr></table></td></tr></table></td></tr></table></td></tr></table></td></tr></table></td></tr></table></td></tr></table> | | | | | | | | | | | | | | | | | | | | <table border="1" style="width: 100%; border-collapse: collapse; text-align: center;"> <tr> <td style="width: 10%;"></td> <td style="width: 10%;"></td> <td style="width: 10%;"></td> <td style="width: 10%;"></td> <td style="width: 10%;"></td> <td style="width: 10%;"></td> <td style="width: 10%;"></td> <td style="width: 10%;"></td> <td style="width: 10%;"></td> <td style="width: 10%;"></td> </tr> <tr> <td></td> <td></td> <td colspan="8" style="text-align: center;"> <table border="1" style="width: 100%; border-collapse: collapse; text-align: center;"> <tr> <td style="width: 10%;"></td> <td style="width: 10%;"></td> <td style="width: 10%;"></td> <td style="width: 10%;"></td> <td style="width: 10%;"></td> <td style="width: 10%;"></td> <td style="width: 10%;"></td> <td style="width: 10%;"></td> <td style="width: 10%;"></td> <td style="width: 10%;"></td> </tr> <tr> <td></td> <td></td> <td colspan="8" style="text-align: center;"> <table border="1" style="width: 100%; border-collapse: collapse; text-align: center;"> <tr> <td style="width: 10%;"></td> <td style="width: 10%;"></td> <td style="width: 10%;"></td> <td style="width: 10%;"></td> <td style="width: 10%;"></td> <td style="width: 10%;"></td> <td style="width: 10%;"></td> <td style="width: 10%;"></td> <td style="width: 10%;"></td> <td style="width: 10%;"></td> </tr> <tr> <td></td> <td></td> <td colspan="8" style="text-align: center;"> <table border="1" style="width: 100%; border-collapse: collapse; text-align: center;"> <tr> <td style="width: 10%;"></td> <td style="width: 10%;"></td> <td style="width: 10%;"></td> <td style="width: 10%;"></td> <td style="width: 10%;"></td> <td style="width: 10%;"></td> <td style="width: 10%;"></td> <td style="width: 10%;"></td> <td style="width: 10%;"></td> <td style="width: 10%;"></td> </tr> <tr> <td></td> <td></td> <td colspan="8" style="text-align: center;"> <table border="1" style="width: 100%; border-collapse: collapse; text-align: center;"> <tr> <td style="width: 10%;"></td> <td style="width: 10%;"></td> <td style="width: 10%;"></td> <td style="width: 10%;"></td> <td style="width: 10%;"></td> <td style="width: 10%;"></td> <td style="width: 10%;"></td> <td style="width: 10%;"></td> <td style="width: 10%;"></td> <td style="width: 10%;"></td> </tr> <tr> <td></td> <td></td> <td colspan="8" style="text-align: center;"> <table border="1" style="width: 100%; border-collapse: collapse; text-align: center;"> <tr> <td style="width: 10%;"></td> <td style="width: 10%;"></td> <td style="width: 10%;"></td> <td style="width: 10%;"></td> <td style="width: 10%;"></td> <td style="width: 10%;"></td> <td style="width: 10%;"></td> <td style="width: 10%;"></td> <td style="width: 10%;"></td> <td style="width: 10%;"></td> </tr> <tr> <td></td> <td></td> <td colspan="8" style="text-align: center;"> <table border="1" style="width: 100%; border-collapse: collapse; text-align: center;"> <tr> <td style="width: 10%;"></td> <td style="width: 10%;"></td> <td style="width: 10%;"></td> <td style="width: 10%;"></td> <td style="width: 10%;"></td> <td style="width: 10%;"></td> <td style="width: 10%;"></td> <td style="width: 10%;"></td> <td style="width: 10%;"></td> <td style="width: 10%;"></td> </tr> <tr> <td></td> <td></td> <td colspan="8" style="text-align: center;"> <table border="1" style="width: 100%; border-collapse: collapse; text-align: center;"> <tr> <td style="width: 10%;"></td> <td style="width: 10%;"></td> <td style="width: 10%;"></td> <td style="width: 10%;"></td> <td style="width: 10%;"></td> <td style="width: 10%;"></td> <td style="width: 10%;"></td> <td style="width: 10%;"></td> <td style="width: 10%;"></td> <td style="width: 10%;"></td> </tr> <tr> <td></td> <td></td> <td colspan="8" style="text-align: center;"> <table border="1" style="width: 100%; border-collapse: collapse; text-align: center;"> <tr> <td style="width: 10%;"></td> <td style="width: 10%;"></td> <td style="width: 10%;"></td> <td style="width: 10%;"></td> <td style="width: 10%;"></td> <td style="width: 10%;"></td> <td style="width: 10%;"></td> <td style="width: 10%;"></td> <td style="width: 10%;"></td> <td style="width: 10%;"></td> </tr> <tr> <td></td> <td></td> <td colspan="8" style="text-align: center;"> <table border="1" style="width: 100%; border-collapse: collapse; text-align: center;"> <tr> <td style="width: 10%;"></td> <td style="width: 10%;"></td> <td style="width: 10%;"></td> <td style="width: 10%;"></td> <td style="width: 10%;"></td> <td style="width: 10%;"></td> <td style="width: 10%;"></td> <td style="width:
10%;"></td> <td style="width: 10%;"></td> <td style="width: 10%;"></td> </tr> <tr> <td></td> <td></td> <td colspan="8" style="text-align: center;"> <table border="1" style="width: 100%; border-collapse: collapse; text-align: center;"> <tr> <td style="width: 10%;"></td> <td style="width: 10%;"></td> <td style="width: 10%;"></td> <td style="width: 10%;"></td> <td style="width: 10%;"></td> <td style="width: 10%;"></td> <td style="width: 10%;"></td> <td style="width: 10%;"></td> <td style="width: 10%;"></td> <td style="width: 10%;"></td> </tr> <tr> <td></td> <td></td> <td colspan="8" style="text-align: center;"> <table border="1" style="width: 100%; border-collapse: collapse; text-align: center;"> <tr> <td style="width: 10%;"></td> <td style="width: 10%;"></td> <td style="width: 10%;"></td> <td style="width: 10%;"></td> <td style="width: 10%;"></td> <td style="width: 10%;"></td> <td style="width: 10%;"></td> <td style="width: 10%;"></td> <td style="width: 10%;"></td> <td style="width: 10%;"></td> </tr> <tr> <td></td> <td></td> <td colspan="8" style="text-align: center;"> <table border="1" style="width: 100%; border-collapse: collapse; text-align: center;"> <tr> <td style="width: 10%;"></td> <td style="width: 10%;"></td> <td style="width: 10%;"></td> <td style="width: 10%;"></td> <td style="width: 10%;"></td> <td style="width: 10%;"></td> <td style="width: 10%;"></td> <td style="width: 10%;"></td> <td style="width: 10%;"></td> <td style="width: 10%;"></td> </tr> <tr> <td></td> <td></td> <td colspan="8" style="text-align: center;"> <table border="1" style="width: 100%; border-collapse: collapse; text-align: center;"> <tr> <td style="width: 10%;"></td> <td style="width: 10%;"></td> <td style="width: 10%;"></td> <td style="width: 10%;"></td> <td style="width: 10%;"></td> <td style="width: 10%;"></td> <td style="width: 10%;"></td> <td style="width: 10%;"></td> <td style="width: 10%;"></td> <td style="width: 10%;"></td> </tr> <tr> <td></td> <td></td> <td colspan="8" style="text-align: center;"> <table border="1" style="width: 100%; border-collapse: collapse; text-align: center;"> <tr> <td style="width: 10%;"></td> <td style="width: 10%;"></td> <td style="width: 10%;"></td> <td style="width: 10%;"></td> <td style="width: 10%;"></td> <td style="width: 10%;"></td> <td style="width: 10%;"></td> <td style="width: 10%;"></td> <td style="width: 10%;"></td> <td style="width: 10%;"></td> </tr> <tr> <td></td> <td></td> <td colspan="8" style="text-align: center;"> <table border="1" style="width: 100%; border-collapse: collapse; text-align: center;"> <tr> <td style="width: 10%;"></td> <td style="width: 10%;"></td> <td style="width: 10%;"></td> <td style="width: 10%;"></td> <td style="width: 10%;"></td> <td style="width: 10%;"></td> <td style="width: 10%;"></td> <td style="width: 10%;"></td> <td style="width: 10%;"></td> <td style="width: 10%;"></td> </tr> <tr> <td></td> <td></td> <td colspan="8" style="text-align: center;"> <table border="1" style="width: 100%; border-collapse: collapse; text-align: center;"> <tr> <td style="width: 10%;"></td> <td style="width: 10%;"></td> <td style="width: 10%;"></td> <td style="width: 10%;"></td> <td style="width: 10%;"></td> <td style="width: 10%;"></td> <td style="width: 10%;"></td> <td style="width: 10%;"></td> <td style="width: 10%;"></td> <td style="width: 10%;"></td> </tr> <tr> <td></td> <td></td> <td colspan="8" style="text-align: center;"> <table border="1" style="width: 100%; border-collapse: collapse; text-align: center;"> <tr> <td style="width: 10%;"></td> <td style="width: 10%;"></td> <td style="width: 10%;"></td> <td style="width: 10%;"></td> <td style="width: 10%;"></td> <td style="width: 10%;"></td> <td style="width: 10%;"></td> <td style="width: 10%;"></td> <td style="width: 10%;"></td> <td style="width: 10%;"></td> </tr> <tr> <td></td> <td></td> <td colspan="8" style="text-align: center;"> <table border="1" style="width: 100%; border-collapse: collapse; text-align: center;"> <tr> <td style="width: 10%;"></td> <td style="width: 10%;"></td> <td style="width: 10%;"></td> <td style="width: 10%;"></td> <td style="width: 10%;"></td> <td style="width: 10%;"></td> <td style="width: 10%;"></td> <td style="width: 10%;"></td> <td style="width: 10%;"></td> <td style="width: 10%;"></td> </tr> <tr> <td></td> <td></td> <td colspan="8" style="text-align: center;"> <table border="1" style="width: 100%; border-collapse: collapse; text-align: center;"> <tr> <td style="width: 10%;"></td> <td style="width: 10%;"></td> <td style="width: 10%;"></td> <td style="width: 10%;"></td> <td style="width: 10%;"></td> <td style="width: 10%;"></td> <td style="width: 10%;"></td> <td style="width: 10%;"></td> <td style="width: 10%;"></td> <td style="width: 10%;"></td> </tr> <tr> <td></td> <td></td> <td colspan="8" style="text-align: center;"> <table border="1" style="width: 100%; border-collapse: collapse; text-align: center;"> <tr> <td style="width: 10%;"></td> <td style="width: 10%;"></td> <td style="width: 10%;"></td> <td style="width: 10%;"></td> <td style="width: 10%;"></td> <td style="width: 10%;"></td> <td style="width: 10%;"></td> <td style="width: 10%;"></td> <td style="width: 10%;"></td> <td style="width: 10%;"></td> </tr> <tr> <td></td> <td></td> <td colspan="8" style="text-align: center;"> <table border="1" style="width: 100%; border-collapse: collapse; text-align: center;"> <tr> <td style="width: 10%;"></td> <td style="width: 10%;"></td> <td style="width: 10%;"></td> <td style="width: 10%;"></td> <td style="width: 10%;"></td> <td style="width: 10%;"></td> <td style="width: 10%;"></td> <td style="width: 10%;"></td> <td style="width: 10%;"></td> <td style="width: 10%;"></td> </tr> <tr> <td></td> <td></td> <td colspan="8" style="text-align: center;"> <table border="1" style="width: 100%; border-collapse: collapse; text-align: center;"> <tr> <td style="width: 10%;"></td> <td style="width: 10%;"></td> <td style="width: 10%;"></td> <td style="width: 10%;"></td> <td style="width: 10%;"></td> <td style="width: 10%;"></td> <td style="width: 10%;"></td> <td style="width: 10%;"></td> <td style="width: 10%;"></td> <td style="width: 10%;"></td> </tr> <tr> <td></td> <td></td> <td colspan="8" style="text-align: center;"> <table border="1" style="width: 100%; border-collapse: collapse; text-align: center;"> <tr> <td style="width: 10%;"></td> <td style="width: 10%;"></td> <td style="width: 10%;"></td> <td style="width: 10%;"></td> <td style="width: 10%;"></td> <td style="width: 10%;"></td> <td style="width: 10%;"></td> <td style="width: 10%;"></td> <td style="width: 10%;"></td> <td style="width: 10%;"></td> </tr> <tr> <td></td> <td></td> <td colspan="8" style="text-align: center;"> <table border="1" style="width: 100%; border-collapse: collapse; text-align: center;"> <tr> <td style="width: 10%;"></td> <td style="width: 10%;"></td> <td style="width: 10%;"></td> <td style="width: 10%;"></td> <td style="width: 10%;"></td> <td style="width: 10%;"></td> <td style="width: 10%;"></td> <td style="width: 10%;"></td> <td style="width: 10%;"></td> <td style="width: 10%;"></td> </tr> <tr> <td></td> <td></td> <td colspan="8" style="text-align: center;"> <table border="1" style="width: 100%; border-collapse: collapse; text-align: center;"> <tr> <td style="width: 10%;"></td> <td style="width: 10%;"></td> <td style="width: 10%;"></td> <td style="width: 10%;"></td> <td style="width: 10%;"></td> <td style="width: 10%;"></td> <td style="width: 10%;"></td> <td style="width: 10%;"></td> <td style="width: 10%;"></td> <td style="width: 10%;"></td> </tr> <tr> <td></td> <td></td> <td colspan="8" style="text-align: center;"> <table border="1" style="width: 100%; border-collapse: collapse; text-align: center;"> <tr> <td style="width: 10%;"></td> <td style="width: 10%;"></td> <td style="width: 10%;"></td> <td style="width: 10%;"></td> <td style="width: 10%;"></td> <td style="width: 10%;"></td> <td style="width: 10%;"></td> <td style="width: 10%;"></td> <td style="width: 10%;"></td> <td style="width: 10%;"></td> </tr> <tr> <td></td> <td></td> <td colspan="8" style="text-align: center;"> <table border="1" style="width: 100%; border-collapse: collapse; text-align: center;"> <tr> <td style="width: 10%;"></td> <td style="width: 10%;"></td> <td style="width: 10%;"></td> <td style="width: 10%;"></td> <td style="width: 10%;"></td> <td style="width: 10%;"></td> <td style="width: 10%;"></td> <td style="width: 10%;"></td> <td style="width: 10%;"></td> <td style="width: 10%;"></td> </tr> <tr> <td></td> <td></td> <td colspan="8" style="text-align: center;"> <table border="1" style="width: 100%; border-collapse: collapse; text-align: center;"> <tr> <td style="width: 10%;"></td> <td style="width: 10%;"></td> <td style="width: 10%;"></td> <td style="width: 10%;"></td> <td style="width: 10%;"></td> <td style="width: 10%;"></td> <td style="width: 10%;"></td> <td style="width: 10%;"></td> <td style="width: 10%;"></td> <td style="width: 10%;"></td> </tr> <tr> <td></td> <td></td> <td colspan="8" style="text-align: center;"> <table border="1" style="width: 100%; border-collapse: collapse; text-align: center;"> <tr> </tr></table></td></tr></table></td></tr></table></td></tr></table></td></tr></table></td></tr></table></td></tr></table></td></tr></table></td></tr></table></td></tr></table></td></tr></table></td></tr></table></td></tr></table></td></tr></table></td></tr></table></td></tr></table></td></tr></table></td></tr></table></td></tr></table></td></tr></table></td></tr></table></td></tr></table></td></tr></table></td></tr></table></td></tr></table></td></tr></table></td></tr></table></td></tr></table></td></tr></table></td></tr></table>
 | | | | | | | | | | | | | | | | | | | | <table border="1" style="width: 100%; border-collapse: collapse; text-align: center;"> <tr> <td style="width: 10%;"></td> <td style="width: 10%;"></td> <td style="width: 10%;"></td> <td style="width: 10%;"></td> <td style="width: 10%;"></td> <td style="width: 10%;"></td> <td style="width: 10%;"></td> <td style="width: 10%;"></td> <td style="width: 10%;"></td> <td style="width: 10%;"></td> </tr> <tr> <td></td> <td></td> <td colspan="8" style="text-align: center;"> <table border="1" style="width: 100%; border-collapse: collapse; text-align: center;"> <tr> <td style="width: 10%;"></td> <td style="width: 10%;"></td> <td style="width: 10%;"></td> <td style="width: 10%;"></td> <td style="width: 10%;"></td> <td style="width: 10%;"></td> <td style="width: 10%;"></td> <td style="width: 10%;"></td> <td style="width: 10%;"></td> <td style="width: 10%;"></td> </tr> <tr> <td></td> <td></td> <td colspan="8" style="text-align: center;"> <table border="1" style="width: 100%; border-collapse: collapse; text-align: center;"> <tr> <td style="width: 10%;"></td> <td style="width: 10%;"></td> <td style="width: 10%;"></td> <td style="width: 10%;"></td> <td style="width: 10%;"></td> <td style="width: 10%;"></td> <td style="width: 10%;"></td> <td style="width: 10%;"></td> <td style="width: 10%;"></td> <td style="width: 10%;"></td> </tr> <tr> <td></td> <td></td> <td colspan="8" style="text-align: center;"> <table border="1" style="width: 100%; border-collapse: collapse; text-align: center;"> <tr> <td style="width: 10%;"></td> <td style="width: 10%;"></td> <td style="width: 10%;"></td> <td style="width: 10%;"></td> <td style="width: 10%;"></td> <td style="width: 10%;"></td> <td style="width: 10%;"></td> <td style="width: 10%;"></td> <td style="width: 10%;"></td> <td style="width: 10%;"></td> </tr> <tr> <td></td> <td></td> <td colspan="8" style="text-align: center;"> <table border="1" style="width: 100%; border-collapse: collapse; text-align: center;"> <tr> <td style="width: 10%;"></td> <td style="width: 10%;"></td> <td style="width: 10%;"></td> <td style="width: 10%;"></td> <td style="width: 10%;"></td> <td style="width: 10%;"></td> <td style="width: 10%;"></td> <td style="width: 10%;"></td> <td style="width: 10%;"></td> <td style="width: 10%;"></td> </tr> <tr> <td></td> <td></td> <td colspan="8" style="text-align: center;"> <table border="1" style="width: 100%; border-collapse: collapse; text-align: center;"> <tr> <td style="width: 10%;"></td> <td style="width: 10%;"></td> <td style="width: 10%;"></td> <td style="width: 10%;"></td> <td style="width: 10%;"></td> <td style="width: 10%;"></td> <td style="width: 10%;"></td> <td style="width: 10%;"></td> <td style="width: 10%;"></td> <td style="width: 10%;"></td> </tr> <tr> <td></td> <td></td> <td colspan="8" style="text-align: center;"> <table border="1" style="width: 100%; border-collapse: collapse; text-align: center;"> <tr> <td style="width: 10%;"></td> <td style="width: 10%;"></td> <td style="width: 10%;"></td> <td style="width: 10%;"></td> <td style="width: 10%;"></td> <td style="width: 10%;"></td> <td style="width: 10%;"></td> <td style="width: 10%;"></td> <td style="width: 10%;"></td> <td style="width: 10%;"></td> </tr> <tr> <td></td> <td></td> <td colspan="8" style="text-align: center;"> <table border="1" style="width: 100%; border-collapse: collapse; text-align: center;"> <tr> <td style="width: 10%;"></td> <td style="width: 10%;"></td> <td style="width: 10%;"></td> <td style="width: 10%;"></td> <td style="width: 10%;"></td> <td style="width: 10%;"></td> <td style="width: 10%;"></td> <td style="width: 10%;"></td> <td style="width: 10%;"></td> <td style="width: 10%;"></td> </tr> <tr> <td></td> <td></td> <td colspan="8" style="text-align: center;"> <table border="1" style="width: 100%; border-collapse: collapse; text-align: center;"> <tr> <td style="width: 10%;"></td> <td style="width: 10%;"></td> <td style="width: 10%;"></td> <td style="width: 10%;"></td> <td style="width: 10%;"></td> <td style="width: 10%;"></td> <td style="width: 10%;"></td> <td style="width: 10%;"></td> <td style="width: 10%;"></td> <td style="width: 10%;"></td> </tr> <tr> <td></td> <td></td> <td colspan="8" style="text-align: center;"> <table border="1" style="width: 100%; border-collapse: collapse; text-align: center;"> <tr> <td style="width: 10%;"></td> <td style="width: 10%;"></td> <td style="width: 10%;"></td> <td style="width: 10%;"></td> <td style="width: 10%;"></td> <td style="width: 10%;"></td> <td style="width: 10%;"></td> <td style="width: 10%;"></td> <td style="width: 10%;"></td> <td style="width: 10%;"></td> </tr> <tr> <td></td> <td></td> <td colspan="8" style="text-align: center;"> <table border="1" style="width: 100%; border-collapse: collapse; text-align: center;"> <tr> <td style="width: 10%;"></td> <td style="width: 10%;"></td> <td style="width: 10%;"></td> <td style="width: 10%;"></td> <td style="width: 10%;"></td> <td style="width: 10%;"></td> <td style="width: 10%;"></td> <td style="width: 10%;"></td> <td style="width: 10%;"></td> <td style="width: 10%;"></td> </tr> <tr> <td></td> <td></td> <td colspan="8" style="text-align: center;"> <table border="1" style="width: 100%; border-collapse: collapse; text-align: center;"> <tr> <td style="width: 10%;"></td> <td style="width: 10%;"></td> <td style="width: 10%;"></td> <td style="width: 10%;"></td> <td style="width: 10%;"></td> <td style="width: 10%;"></td> <td style="width: 10%;"></td> <td style="width: 10%;"></td> <td style="width: 10%;"></td> <td style="width: 10%;"></td> </tr> <tr> <td></td> <td></td> <td colspan="8" style="text-align: center;"> <table border="1" style="width: 100%; border-collapse: collapse; text-align: center;"> <tr> <td style="width: 10%;"></td> <td style="width: 10%;"></td> <td style="width: 10%;"></td> <td style="width: 10%;"></td> <td style="width: 10%;"></td> <td style="width: 10%;"></td> <td style="width: 10%;"></td> <td style="width: 10%;"></td> <td style="width: 10%;"></td> <td style="width: 10%;"></td> </tr> <tr> <td></td> <td></td> <td colspan="8" style="text-align: center;"> <table border="1" style="width: 100%; border-collapse: collapse; text-align: center;"> <tr> <td style="width: 10%;"></td> <td style="width: 10%;"></td> <td style="width: 10%;"></td> <td style="width: 10%;"></td> <td style="width: 10%;"></td> <td style="width: 10%;"></td> <td style="width:
10%;"></td> <td style="width: 10%;"></td> <td style="width: 10%;"></td> <td style="width: 10%;"></td> </tr> <tr> <td></td> <td></td> <td colspan="8" style="text-align: center;"> <table border="1" style="width: 100%; border-collapse: collapse; text-align: center;"> <tr> <td style="width: 10%;"></td> <td style="width: 10%;"></td> <td style="width: 10%;"></td> <td style="width: 10%;"></td> <td style="width: 10%;"></td> <td style="width: 10%;"></td> <td style="width: 10%;"></td> <td style="width: 10%;"></td> <td style="width: 10%;"></td> <td style="width: 10%;"></td> </tr> <tr> <td></td> <td></td> <td colspan="8" style="text-align: center;"> <table border="1" style="width: 100%; border-collapse: collapse; text-align: center;"> <tr> <td style="width: 10%;"></td> <td style="width: 10%;"></td> <td style="width: 10%;"></td> <td style="width: 10%;"></td> <td style="width: 10%;"></td> <td style="width: 10%;"></td> <td style="width: 10%;"></td> <td style="width: 10%;"></td> <td style="width: 10%;"></td> <td style="width: 10%;"></td> </tr> <tr> <td></td> <td></td> <td colspan="8" style="text-align: center;"> <table border="1" style="width: 100%; border-collapse: collapse; text-align: center;"> <tr> <td style="width: 10%;"></td> <td style="width: 10%;"></td> <td style="width: 10%;"></td> <td style="width: 10%;"></td> <td style="width: 10%;"></td> <td style="width: 10%;"></td> <td style="width: 10%;"></td> <td style="width: 10%;"></td> <td style="width: 10%;"></td> <td style="width: 10%;"></td> </tr> <tr> <td></td> <td></td> <td colspan="8" style="text-align: center;"> <table border="1" style="width: 100%; border-collapse: collapse; text-align: center;"> <tr> <td style="width: 10%;"></td> <td style="width: 10%;"></td> <td style="width: 10%;"></td> <td style="width: 10%;"></td> <td style="width: 10%;"></td> <td style="width: 10%;"></td> <td style="width: 10%;"></td> <td style="width: 10%;"></td> <td style="width: 10%;"></td> <td style="width: 10%;"></td> </tr> <tr> <td></td> <td></td> <td colspan="8" style="text-align: center;"> <table border="1" style="width: 100%; border-collapse: collapse; text-align: center;"> <tr> <td style="width: 10%;"></td> <td style="width: 10%;"></td> <td style="width: 10%;"></td> <td style="width: 10%;"></td> <td style="width: 10%;"></td> <td style="width: 10%;"></td> <td style="width: 10%;"></td> <td style="width: 10%;"></td> <td style="width: 10%;"></td> <td style="width: 10%;"></td> </tr> <tr> <td></td> <td></td> <td colspan="8" style="text-align: center;"> <table border="1" style="width: 100%; border-collapse: collapse; text-align: center;"> <tr> <td style="width: 10%;"></td> <td style="width: 10%;"></td> <td style="width: 10%;"></td> <td style="width: 10%;"></td> <td style="width: 10%;"></td> <td style="width: 10%;"></td> <td style="width: 10%;"></td> <td style="width: 10%;"></td> <td style="width: 10%;"></td> <td style="width: 10%;"></td> </tr> <tr> <td></td> <td></td> <td colspan="8" style="text-align: center;"> <table border="1" style="width: 100%; border-collapse: collapse; text-align: center;"> <tr> <td style="width: 10%;"></td> <td style="width: 10%;"></td> <td style="width: 10%;"></td> <td style="width: 10%;"></td> <td style="width: 10%;"></td> <td style="width: 10%;"></td> <td style="width: 10%;"></td> <td style="width: 10%;"></td> <td style="width: 10%;"></td> <td style="width: 10%;"></td> </tr> <tr> <td></td> <td></td> <td colspan="8" style="text-align: center;"> <table border="1" style="width: 100%; border-collapse: collapse; text-align: center;"> <tr> <td style="width: 10%;"></td> <td style="width: 10%;"></td> <td style="width: 10%;"></td> <td style="width: 10%;"></td> <td style="width: 10%;"></td> <td style="width: 10%;"></td> <td style="width: 10%;"></td> <td style="width: 10%;"></td> <td style="width: 10%;"></td> <td style="width: 10%;"></td> </tr> <tr> <td></td> <td></td> <td colspan="8" style="text-align: center;"> <table border="1" style="width: 100%; border-collapse: collapse; text-align: center;"> <tr> <td style="width: 10%;"></td> <td style="width: 10%;"></td> <td style="width: 10%;"></td> <td style="width: 10%;"></td> <td style="width: 10%;"></td> <td style="width: 10%;"></td> <td style="width: 10%;"></td> <td style="width: 10%;"></td> <td style="width: 10%;"></td> <td style="width: 10%;"></td> </tr> <tr> <td></td> <td></td> <td colspan="8" style="text-align: center;"> <table border="1" style="width: 100%; border-collapse: collapse; text-align: center;"> <tr> <td style="width: 10%;"></td> <td style="width: 10%;"></td> <td style="width: 10%;"></td> <td style="width: 10%;"></td> <td style="width: 10%;"></td> <td style="width: 10%;"></td> <td style="width: 10%;"></td> <td style="width: 10%;"></td> <td style="width: 10%;"></td> <td style="width: 10%;"></td> </tr> <tr> <td></td> <td></td> <td colspan="8" style="text-align: center;"> <table border="1" style="width: 100%; border-collapse: collapse; text-align: center;"> <tr> <td style="width: 10%;"></td> <td style="width: 10%;"></td> <td style="width: 10%;"></td> <td style="width: 10%;"></td> <td style="width: 10%;"></td> <td style="width: 10%;"></td> <td style="width: 10%;"></td> <td style="width: 10%;"></td> <td style="width: 10%;"></td> <td style="width: 10%;"></td> </tr> <tr> <td></td> <td></td> <td colspan="8" style="text-align: center;"> <table border="1" style="width: 100%; border-collapse: collapse; text-align: center;"> <tr> <td style="width: 10%;"></td> <td style="width: 10%;"></td> <td style="width: 10%;"></td> <td style="width: 10%;"></td> <td style="width: 10%;"></td> <td style="width: 10%;"></td> <td style="width: 10%;"></td> <td style="width: 10%;"></td> <td style="width: 10%;"></td> <td style="width: 10%;"></td> </tr> <tr> <td></td> <td></td> <td colspan="8" style="text-align: center;"> <table border="1" style="width: 100%; border-collapse: collapse; text-align: center;"> <tr> <td style="width: 10%;"></td> <td style="width: 10%;"></td> <td style="width: 10%;"></td> <td style="width: 10%;"></td> <td style="width: 10%;"></td> <td style="width: 10%;"></td> <td style="width: 10%;"></td> <td style="width: 10%;"></td> <td style="width: 10%;"></td> <td style="width: 10%;"></td> </tr> <tr> <td></td> <td></td> <td colspan="8" style="text-align: center;"> <table border="1" style="width: 100%; border-collapse: collapse; text-align: center;"> <tr> <td style="width: 10%;"></td> <td style="width: 10%;"></td> <td style="width: 10%;"></td> <td style="width: 10%;"></td> <td style="width: 10%;"></td> <td style="width: 10%;"></td> <td style="width: 10%;"></td> <td style="width: 10%;"></td> <td style="width: 10%;"></td> <td style="width: 10%;"></td> </tr> <tr> <td></td> <td></td> <td colspan="8" style="text-align: center;"> <table border="1" style="width: 100%; border-collapse: collapse; text-align: center;"> <tr> </tr></table></td></tr></table></td></tr></table></td></tr></table></td></tr></table></td></tr></table></td></tr></table></td></tr></table></td></tr></table></td></tr></table></td></tr></table></td></tr></table></td></tr></table></td></tr></table></td></tr></table></td></tr></table></td></tr></table></td></tr></table></td></tr></table></td></tr></table></td></tr></table></td></tr></table></td></tr></table></td></tr></table></td></tr></table></td></tr></table></td></tr></table></td></tr></table></td></tr></table>
 | | | | | | | | | | | | | | | | | | | | <table border="1" style="width: 100%; border-collapse: collapse; text-align: center;"> <tr> <td style="width: 10%;"></td> <td style="width: 10%;"></td> <td style="width: 10%;"></td> <td style="width: 10%;"></td> <td style="width: 10%;"></td> <td style="width: 10%;"></td> <td style="width: 10%;"></td> <td style="width: 10%;"></td> <td style="width: 10%;"></td> <td style="width: 10%;"></td> </tr> <tr> <td></td> <td></td> <td colspan="8" style="text-align: center;"> <table border="1" style="width: 100%; border-collapse: collapse; text-align: center;"> <tr> <td style="width: 10%;"></td> <td style="width: 10%;"></td> <td style="width: 10%;"></td> <td style="width: 10%;"></td> <td style="width: 10%;"></td> <td style="width: 10%;"></td> <td style="width: 10%;"></td> <td style="width: 10%;"></td> <td style="width: 10%;"></td> <td style="width: 10%;"></td> </tr> <tr> <td></td> <td></td> <td colspan="8" style="text-align: center;"> <table border="1" style="width: 100%; border-collapse: collapse; text-align: center;"> <tr> <td style="width: 10%;"></td> <td style="width: 10%;"></td> <td style="width: 10%;"></td> <td style="width: 10%;"></td> <td style="width: 10%;"></td> <td style="width: 10%;"></td> <td style="width: 10%;"></td> <td style="width: 10%;"></td> <td style="width: 10%;"></td> <td style="width: 10%;"></td> </tr> <tr> <td></td> <td></td> <td colspan="8" style="text-align: center;"> <table border="1" style="width: 100%; border-collapse: collapse; text-align: center;"> <tr> <td style="width: 10%;"></td> <td style="width: 10%;"></td> <td style="width: 10%;"></td> <td style="width: 10%;"></td> <td style="width: 10%;"></td> <td style="width: 10%;"></td> <td style="width: 10%;"></td> <td style="width: 10%;"></td> <td style="width: 10%;"></td> <td style="width: 10%;"></td> </tr> <tr> <td></td> <td></td> <td colspan="8" style="text-align: center;"> <table border="1" style="width: 100%; border-collapse: collapse; text-align: center;"> <tr> <td style="width: 10%;"></td> <td style="width: 10%;"></td> <td style="width: 10%;"></td> <td style="width: 10%;"></td> <td style="width: 10%;"></td> <td style="width: 10%;"></td> <td style="width: 10%;"></td> <td style="width: 10%;"></td> <td style="width: 10%;"></td> <td style="width: 10%;"></td> </tr> <tr> <td></td> <td></td> <td colspan="8" style="text-align: center;"> <table border="1" style="width: 100%; border-collapse: collapse; text-align: center;"> <tr> <td style="width: 10%;"></td> <td style="width: 10%;"></td> <td style="width: 10%;"></td> <td style="width: 10%;"></td> <td style="width: 10%;"></td> <td style="width: 10%;"></td> <td style="width: 10%;"></td> <td style="width: 10%;"></td> <td style="width: 10%;"></td> <td style="width: 10%;"></td> </tr> <tr> <td></td> <td></td> <td colspan="8" style="text-align: center;"> <table border="1" style="width: 100%; border-collapse: collapse; text-align: center;"> <tr> <td style="width: 10%;"></td> <td style="width: 10%;"></td> <td style="width: 10%;"></td> <td style="width: 10%;"></td> <td style="width: 10%;"></td> <td style="width: 10%;"></td> <td style="width: 10%;"></td> <td style="width: 10%;"></td> <td style="width: 10%;"></td> <td style="width: 10%;"></td> </tr> <tr> <td></td> <td></td> <td colspan="8" style="text-align: center;"> <table border="1" style="width: 100%; border-collapse: collapse; text-align: center;"> <tr> <td style="width: 10%;"></td> <td style="width: 10%;"></td> <td style="width: 10%;"></td> <td style="width: 10%;"></td> <td style="width: 10%;"></td> <td style="width: 10%;"></td> <td style="width: 10%;"></td> <td style="width: 10%;"></td> <td style="width: 10%;"></td> <td style="width: 10%;"></td> </tr> <tr> <td></td> <td></td> <td colspan="8" style="text-align: center;"> <table border="1" style="width: 100%; border-collapse: collapse; text-align: center;"> <tr> <td style="width: 10%;"></td> <td style="width: 10%;"></td> <td style="width: 10%;"></td> <td style="width: 10%;"></td> <td style="width: 10%;"></td> <td style="width: 10%;"></td> <td style="width: 10%;"></td> <td style="width: 10%;"></td> <td style="width: 10%;"></td> <td style="width: 10%;"></td> </tr> <tr> <td></td> <td></td> <td colspan="8" style="text-align: center;"> <table border="1" style="width: 100%; border-collapse: collapse; text-align: center;"> <tr> <td style="width: 10%;"></td> <td style="width: 10%;"></td> <td style="width: 10%;"></td> <td style="width: 10%;"></td> <td style="width: 10%;"></td> <td style="width: 10%;"></td> <td style="width: 10%;"></td> <td style="width: 10%;"></td> <td style="width: 10%;"></td> <td style="width: 10%;"></td> </tr> <tr> <td></td> <td></td> <td colspan="8" style="text-align: center;"> <table border="1" style="width: 100%; border-collapse: collapse; text-align: center;"> <tr> <td style="width: 10%;"></td> <td style="width: 10%;"></td> <td style="width: 10%;"></td> <td style="width: 10%;"></td> <td style="width: 10%;"></td> <td style="width: 10%;"></td> <td style="width: 10%;"></td> <td style="width: 10%;"></td> <td style="width: 10%;"></td> <td style="width: 10%;"></td> </tr> <tr> <td></td> <td></td> <td colspan="8" style="text-align: center;"> <table border="1" style="width: 100%; border-collapse: collapse; text-align: center;"> <tr> <td style="width: 10%;"></td> <td style="width: 10%;"></td> <td style="width: 10%;"></td> <td style="width: 10%;"></td> <td style="width: 10%;"></td> <td style="width: 10%;"></td> <td style="width: 10%;"></td> <td style="width: 10%;"></td> <td style="width: 10%;"></td> <td style="width: 10%;"></td> </tr> <tr> <td></td> <td></td> <td colspan="8" style="text-align: center;"> <table border="1" style="width: 100%; border-collapse: collapse; text-align: center;"> <tr> <td style="width: 10%;"></td> <td style="width: 10%;"></td> <td style="width: 10%;"></td> <td style="width: 10%;"></td> <td style="width: 10%;"></td> <td style="width: 10%;"></td> <td style="width: 10%;"></td> <td style="width: 10%;"></td> <td style="width: 10%;"></td> <td style="width: 10%;"></td> </tr> <tr> <td></td> <td></td> <td colspan="8" style="text-align: center;"> <table border="1" style="width: 100%; border-collapse: collapse; text-align: center;"> <tr> <td style="width: 10%;"></td> <td style="width: 10%;"></td> <td style="width: 10%;"></td> <td style="width: 10%;"></td> <td style="width: 10%;"></td> <td style="width: 10%;"></td> <td style="width: 10%;"></td> <td style="width: 10%;"></td> <td style="width: 10%;"></td> <td style="width: 10%;"></td> </tr> <tr> <td></td> <td></td> <td colspan="8" style="text-align: center;"> <table border="1" style="width: 100%; border-collapse: collapse; text-align: center;"> <tr> <td style="width: 10%;"></td> <td style="width: 10%;"></td> <td style="width: 10%;"></td> <td style="width: 10%;"></td> <td style="width: 10%;"></td> <td style="width: 10%;"></td> <td style="width: 10%;"></td> <td style="width: 10%;"></td> <td style="width: 10%;"></td> <td style="width: 10%;"></td> </tr> <tr> <td></td> <td></td> <td colspan="8" style="text-align: center;"> <table border="1" style="width: 100%; border-collapse: collapse; text-align: center;"> <tr> <td style="width: 10%;"></td> <td style="width: 10%;"></td> <td style="width: 10%;"></td> <td style="width: 10%;"></td> <td style="width: 10%;"></td> <td style="width: 10%;"></td> <td style="width: 10%;"></td> <td style="width: 10%;"></td> <td style="width: 10%;"></td> <td style="width: 10%;"></td> </tr> <tr> <td></td> <td></td> <td colspan="8" style="text-align: center;"> <table border="1" style="width: 100%; border-collapse: collapse; text-align: center;"> <tr> <td style="width: 10%;"></td> <td style="width: 10%;"></td> <td style="width: 10%;"></td> <td style="width: 10%;"></td> <td style="width: 10%;"></td> <td style="width: 10%;"></td> <td style="width: 10%;"></td> <td style="width: 10%;"></td> <td style="width: 10%;"></td> <td style="width: 10%;"></td> </tr> <tr> <td></td> <td></td> <td colspan="8" style="text-align: center;"> <table border="1" style="width: 100%; border-collapse: collapse; text-align: center;"> <tr> <td style="width: 10%;"></td> <td style="width: 10%;"></td> <td style="width: 10%;"></td> <td style="width: 10%;"></td> <td style="width: 10%;"></td> <td style="width: 10%;"></td> <td style="width: 10%;"></td> <td style="width: 10%;"></td> <td style="width: 10%;"></td> <td style="width: 10%;"></td> </tr> <tr> <td></td> <td></td> <td colspan="8" style="text-align: center;"> <table border="1" style="width: 100%; border-collapse: collapse; text-align: center;"> <tr> <td style="width: 10%;"></td> <td style="width: 10%;"></td> <td style="width: 10%;"></td> <td style="width: 10%;"></td> <td style="width: 10%;"></td> <td style="width: 10%;"></td> <td
style="width: 10%;"></td> <td style="width: 10%;"></td> <td style="width: 10%;"></td> <td style="width: 10%;"></td> </tr> <tr> <td></td> <td></td> <td colspan="8" style="text-align: center;"> <table border="1" style="width: 100%; border-collapse: collapse; text-align: center;"> <tr> <td style="width: 10%;"></td> <td style="width: 10%;"></td> <td style="width: 10%;"></td> <td style="width: 10%;"></td> <td style="width: 10%;"></td> <td style="width: 10%;"></td> <td style="width: 10%;"></td> <td style="width: 10%;"></td> <td style="width: 10%;"></td> <td style="width: 10%;"></td> </tr> <tr> <td></td> <td></td> <td colspan="8" style="text-align: center;"> <table border="1" style="width: 100%; border-collapse: collapse; text-align: center;"> <tr> <td style="width: 10%;"></td> <td style="width: 10%;"></td> <td style="width: 10%;"></td> <td style="width: 10%;"></td> <td style="width: 10%;"></td> <td style="width: 10%;"></td> <td style="width: 10%;"></td> <td style="width: 10%;"></td> <td style="width: 10%;"></td> <td style="width: 10%;"></td> </tr> <tr> <td></td> <td></td> <td colspan="8" style="text-align: center;"> <table border="1" style="width: 100%; border-collapse: collapse; text-align: center;"> <tr> <td style="width: 10%;"></td> <td style="width: 10%;"></td> <td style="width: 10%;"></td> <td style="width: 10%;"></td> <td style="width: 10%;"></td> <td style="width: 10%;"></td> <td style="width: 10%;"></td> <td style="width: 10%;"></td> <td style="width: 10%;"></td> <td style="width: 10%;"></td> </tr> <tr> <td></td> <td></td> <td colspan="8" style="text-align: center;"> <table border="1" style="width: 100%; border-collapse: collapse; text-align: center;"> <tr> <td style="width: 10%;"></td> <td style="width: 10%;"></td> <td style="width: 10%;"></td> <td style="width: 10%;"></td> <td style="width: 10%;"></td> <td style="width: 10%;"></td> <td style="width: 10%;"></td> <td style="width: 10%;"></td> <td style="width: 10%;"></td> <td style="width: 10%;"></td> </tr> <tr> <td></td> <td></td> <td colspan="8" style="text-align: center;"> <table border="1" style="width: 100%; border-collapse: collapse; text-align: center;"> <tr> <td style="width: 10%;"></td> <td style="width: 10%;"></td> <td style="width: 10%;"></td> <td style="width: 10%;"></td> <td style="width: 10%;"></td> <td style="width: 10%;"></td> <td style="width: 10%;"></td> <td style="width: 10%;"></td> <td style="width: 10%;"></td> <td style="width: 10%;"></td> </tr> <tr> <td></td> <td></td> <td colspan="8" style="text-align: center;"> <table border="1" style="width: 100%; border-collapse: collapse; text-align: center;"> <tr> <td style="width: 10%;"></td> <td style="width: 10%;"></td> <td style="width: 10%;"></td> <td style="width: 10%;"></td> <td style="width: 10%;"></td> <td style="width: 10%;"></td> <td style="width: 10%;"></td> <td style="width: 10%;"></td> <td style="width: 10%;"></td> <td style="width: 10%;"></td> </tr> <tr> <td></td> <td></td> <td colspan="8" style="text-align: center;"> <table border="1" style="width: 100%; border-collapse: collapse; text-align: center;"> <tr> <td style="width: 10%;"></td> <td style="width: 10%;"></td> <td style="width: 10%;"></td> <td style="width: 10%;"></td> <td style="width: 10%;"></td> <td style="width: 10%;"></td> <td style="width: 10%;"></td> <td style="width: 10%;"></td> <td style="width: 10%;"></td> <td style="width: 10%;"></td> </tr> <tr> <td></td> <td></td> <td colspan="8" style="text-align: center;"> <table border="1" style="width: 100%; border-collapse: collapse; text-align: center;"> <tr> <td style="width: 10%;"></td> <td style="width: 10%;"></td> <td style="width: 10%;"></td> <td style="width: 10%;"></td> <td style="width: 10%;"></td> <td style="width: 10%;"></td> <td style="width: 10%;"></td> <td style="width: 10%;"></td> <td style="width: 10%;"></td> <td style="width: 10%;"></td> </tr> <tr> <td></td> <td></td> <td colspan="8" style="text-align: center;"> <table border="1" style="width: 100%; border-collapse: collapse; text-align: center;"> <tr> </tr></table></td></tr></table></td></tr></table></td></tr></table></td></tr></table></td></tr></table></td></tr></table></td></tr></table></td></tr></table></td></tr></table></td></tr></table></td></tr></table></td></tr></table></td></tr></table></td></tr></table></td></tr></table></td></tr></table></td></tr></table></td></tr></table></td></tr></table></td></tr></table></td></tr></table></td></tr></table></td></tr></table></td></tr></table></td></tr></table></td></tr></table></td></tr></table> | | | | | | | | | | | | | | | | | | | | <table border="1" style="width: 100%; border-collapse: collapse; text-align: center;"> <tr> <td style="width: 10%;"></td> <td style="width: 10%;"></td> <td style="width: 10%;"></td> <td style="width: 10%;"></td> <td style="width: 10%;"></td> <td style="width: 10%;"></td> <td style="width: 10%;"></td> <td style="width: 10%;"></td> <td style="width: 10%;"></td> <td style="width: 10%;"></td> </tr> <tr> <td></td> <td></td> <td colspan="8" style="text-align: center;"> <table border="1" style="width: 100%; border-collapse: collapse; text-align: center;"> <tr> <td style="width: 10%;"></td> <td style="width: 10%;"></td> <td style="width: 10%;"></td> <td style="width: 10%;"></td> <td style="width: 10%;"></td> <td style="width: 10%;"></td> <td style="width: 10%;"></td> <td style="width: 10%;"></td> <td style="width: 10%;"></td> <td style="width: 10%;"></td> </tr> <tr> <td></td> <td></td> <td colspan="8" style="text-align: center;"> <table border="1" style="width: 100%; border-collapse: collapse; text-align: center;"> <tr> <td style="width: 10%;"></td> <td style="width: 10%;"></td> <td style="width: 10%;"></td> <td style="width: 10%;"></td> <td style="width: 10%;"></td> <td style="width: 10%;"></td> <td style="width: 10%;"></td> <td style="width: 10%;"></td> <td style="width: 10%;"></td> <td style="width: 10%;"></td> </tr> <tr> <td></td> <td></td> <td colspan="8" style="text-align: center;"> <table border="1" style="width: 100%; border-collapse: collapse; text-align: center;"> <tr> <td style="width:
10%;"></td> <td style="width: 10%;"></td> <td style="width: 10%;"></td> <td style="width: 10%;"></td> <td style="width: 10%;"></td> <td style="width: 10%;"></td> <td style="width: 10%;"></td> <td style="width: 10%;"></td> <td style="width: 10%;"></td> <td style="width: 10%;"></td> </tr> <tr> <td></td> <td></td> <td colspan="8" style="text-align: center;"> <table border="1" style="width: 100%; border-collapse: collapse; text-align: center;"> <tr> <td style="width: 10%;"></td> <td style="width: 10%;"></td> <td style="width: 10%;"></td> <td style="width: 10%;"></td> <td style="width: 10%;"></td> <td style="width: 10%;"></td> <td style="width: 10%;"></td> <td style="width: 10%;"></td> <td style="width: 10%;"></td> <td style="width: 10%;"></td> </tr> <tr> <td></td> <td></td> <td colspan="8" style="text-align: center;"> <table border="1" style="width: 100%; border-collapse: collapse; text-align: center;"> <tr> <td style="width: 10%;"></td> <td style="width: 10%;"></td> <td style="width: 10%;"></td> <td style="width: 10%;"></td> <td style="width: 10%;"></td> <td style="width: 10%;"></td> <td style="width: 10%;"></td> <td style="width: 10%;"></td> <td style="width: 10%;"></td> <td style="width: 10%;"></td> </tr> <tr> <td></td> <td></td> <td colspan="8" style="text-align: center;"> <table border="1" style="width: 100%; border-collapse: collapse; text-align: center;"> <tr> <td style="width: 10%;"></td> <td style="width: 10%;"></td> <td style="width: 10%;"></td> <td style="width: 10%;"></td> <td style="width: 10%;"></td> <td style="width: 10%;"></td> <td style="width: 10%;"></td> <td style="width: 10%;"></td> <td style="width: 10%;"></td> <td style="width: 10%;"></td> </tr> <tr> <td></td> <td></td> <td colspan="8" style="text-align: center;"> <table border="1" style="width: 100%; border-collapse: collapse; text-align: center;"> <tr> <td style="width: 10%;"></td> <td style="width: 10%;"></td> <td style="width: 10%;"></td> <td style="width: 10%;"></td> <td style="width: 10%;"></td> <td style="width: 10%;"></td> <td style="width: 10%;"></td> <td style="width: 10%;"></td> <td style="width: 10%;"></td> <td style="width: 10%;"></td> </tr> <tr> <td></td> <td></td> <td colspan="8" style="text-align: center;"> <table border="1" style="width: 100%; border-collapse: collapse; text-align: center;"> <tr> <td style="width: 10%;"></td> <td style="width: 10%;"></td> <td style="width: 10%;"></td> <td style="width: 10%;"></td> <td style="width: 10%;"></td> <td style="width: 10%;"></td> <td style="width: 10%;"></td> <td style="width: 10%;"></td> <td style="width: 10%;"></td> <td style="width: 10%;"></td> </tr> <tr> <td></td> <td></td> <td colspan="8" style="text-align: center;"> <table border="1" style="width: 100%; border-collapse: collapse; text-align: center;"> <tr> <td style="width: 10%;"></td> <td style="width: 10%;"></td> <td style="width: 10%;"></td> <td style="width: 10%;"></td> <td style="width: 10%;"></td> <td style="width: 10%;"></td> <td style="width: 10%;"></td> <td style="width: 10%;"></td> <td style="width: 10%;"></td> <td style="width: 10%;"></td> </tr> <tr> <td></td> <td></td> <td colspan="8" style="text-align: center;"> <table border="1" style="width: 100%; border-collapse: collapse; text-align: center;"> <tr> <td style="width: 10%;"></td> <td style="width: 10%;"></td> <td style="width: 10%;"></td> <td style="width: 10%;"></td> <td style="width: 10%;"></td> <td style="width: 10%;"></td> <td style="width: 10%;"></td> <td style="width: 10%;"></td> <td style="width: 10%;"></td> <td style="width: 10%;"></td> </tr> <tr> <td></td> <td></td> <td colspan="8" style="text-align: center;"> <table border="1" style="width: 100%; border-collapse: collapse; text-align: center;"> <tr> <td style="width: 10%;"></td> <td style="width: 10%;"></td> <td style="width: 10%;"></td> <td style="width: 10%;"></td> <td style="width: 10%;"></td> <td style="width: 10%;"></td> <td style="width: 10%;"></td> <td style="width: 10%;"></td> <td style="width: 10%;"></td> <td style="width: 10%;"></td> </tr> <tr> <td></td> <td></td> <td colspan="8" style="text-align: center;"> <table border="1" style="width: 100%; border-collapse: collapse; text-align: center;"> <tr> <td style="width: 10%;"></td> <td style="width: 10%;"></td> <td style="width: 10%;"></td> <td style="width: 10%;"></td> <td style="width: 10%;"></td> <td style="width: 10%;"></td> <td style="width: 10%;"></td> <td style="width: 10%;"></td> <td style="width: 10%;"></td> <td style="width: 10%;"></td> </tr> <tr> <td></td> <td></td> <td colspan="8" style="text-align: center;"> <table border="1" style="width: 100%; border-collapse: collapse; text-align: center;"> <tr> <td style="width: 10%;"></td> <td style="width: 10%;"></td> <td style="width: 10%;"></td> <td style="width: 10%;"></td> <td style="width: 10%;"></td> <td style="width: 10%;"></td> <td style="width: 10%;"></td> <td style="width: 10%;"></td> <td style="width: 10%;"></td> <td style="width: 10%;"></td> </tr> <tr> <td></td> <td></td> <td colspan="8" style="text-align: center;"> <table border="1" style="width: 100%; border-collapse: collapse; text-align: center;"> <tr> <td style="width: 10%;"></td> <td style="width: 10%;"></td> <td style="width: 10%;"></td> <td style="width: 10%;"></td> <td style="width: 10%;"></td> <td style="width: 10%;"></td> <td style="width: 10%;"></td> <td style="width: 10%;"></td> <td style="width: 10%;"></td> <td style="width: 10%;"></td> </tr> <tr> <td></td> <td></td> <td colspan="8" style="text-align: center;"> <table border="1" style="width: 100%; border-collapse: collapse; text-align: center;"> <tr> <td style="width: 10%;"></td> <td style="width: 10%;"></td> <td style="width: 10%;"></td> <td style="width: 10%;"></td> <td style="width: 10%;"></td> <td style="width: 10%;"></td> <td style="width: 10%;"></td> <td style="width: 10%;"></td> <td style="width: 10%;"></td> <td style="width: 10%;"></td> </tr> <tr> <td></td> <td></td> <td colspan="8" style="text-align: center;"> <table border="1" style="width: 100%; border-collapse: collapse; text-align: center;"> <tr> <td style="width: 10%;"></td> <td style="width: 10%;"></td> <td style="width: 10%;"></td> <td style="width: 10%;"></td> <td style="width: 10%;"></td> <td style="width: 10%;"></td> <td style="width: 10%;"></td> <td style="width: 10%;"></td> <td style="width: 10%;"></td> <td style="width: 10%;"></td> </tr> <tr> <td></td> <td></td> <td colspan="8" style="text-align: center;"> <table border="1" style="width: 100%; border-collapse: collapse; text-align: center;"> <tr> <td style="width: 10%;"></td> <td style="width: 10%;"></td> <td style="width: 10%;"></td> <td style="width: 10%;"></td> <td style="width: 10%;"></td> <td style="width: 10%;"></td> <td style="width: 10%;"></td> <td style="width: 10%;"></td> <td style="width: 10%;"></td> <td style="width: 10%;"></td> </tr> <tr> <td></td> <td></td> <td colspan="8" style="text-align: center;"> <table border="1" style="width: 100%; border-collapse: collapse; text-align: center;"> <tr> <td style="width: 10%;"></td> <td style="width: 10%;"></td> <td style="width: 10%;"></td> <td style="width: 10%;"></td> <td style="width: 10%;"></td> <td style="width: 10%;"></td> <td style="width: 10%;"></td> <td style="width: 10%;"></td> <td style="width: 10%;"></td> <td style="width: 10%;"></td> </tr> <tr> <td></td> <td></td> <td colspan="8" style="text-align: center;"> <table border="1" style="width: 100%; border-collapse: collapse; text-align: center;"> <tr> <td style="width: 10%;"></td> <td style="width: 10%;"></td> <td style="width: 10%;"></td> <td style="width: 10%;"></td> <td style="width: 10%;"></td> <td style="width: 10%;"></td> <td style="width: 10%;"></td> <td style="width: 10%;"></td> <td style="width: 10%;"></td> <td style="width: 10%;"></td> </tr> <tr> <td></td> <td></td> <td colspan="8" style="text-align: center;"> <table border="1" style="width: 100%; border-collapse: collapse; text-align: center;"> <tr> <td style="width: 10%;"></td> <td style="width: 10%;"></td> <td style="width: 10%;"></td> <td style="width: 10%;"></td> <td style="width: 10%;"></td> <td style="width: 10%;"></td> <td style="width: 10%;"></td> <td style="width: 10%;"></td> <td style="width: 10%;"></td> <td style="width: 10%;"></td> </tr> <tr> <td></td> <td></td> <td colspan="8" style="text-align: center;"> <table border="1" style="width: 100%; border-collapse: collapse; text-align: center;"> <tr> <td style="width: 10%;"></td> <td style="width: 10%;"></td> <td style="width: 10%;"></td> <td style="width: 10%;"></td> <td style="width: 10%;"></td> <td style="width: 10%;"></td> <td style="width: 10%;"></td> <td style="width: 10%;"></td> <td style="width: 10%;"></td> <td style="width: 10%;"></td> </tr> <tr> <td></td> <td></td> <td colspan="8" style="text-align: center;"> <table border="1" style="width: 100%; border-collapse: collapse; text-align: center;"> <tr> <td style="width: 10%;"></td> <td style="width: 10%;"></td> <td style="width: 10%;"></td> <td style="width: 10%;"></td> <td style="width: 10%;"></td> <td style="width: 10%;"></td> <td style="width: 10%;"></td> <td style="width: 10%;"></td> <td style="width: 10%;"></td> <td style="width: 10%;"></td> </tr> <tr> <td></td> <td></td> <td colspan="8" style="text-align: center;"> <table border="1" style="width: 100%; border-collapse: collapse; text-align: center;"> <tr> <td style="width: 10%;"></td> <td style="width: 10%;"></td> <td style="width: 10%;"></td> <td style="width: 10%;"></td> <td style="width: 10%;"></td> <td style="width: 10%;"></td> <td style="width: 10%;"></td> <td style="width: 10%;"></td> <td style="width: 10%;"></td> <td style="width: 10%;"></td> </tr> <tr> <td></td> <td></td> <td colspan="8" style="text-align: center;"> <table border="1" style="width: 100%; border-collapse: collapse; text-align: center;"> <tr> <td style="width: 10%;"></td> <td style="width: 10%;"></td> <td style="width: 10%;"></td> <td style="width: 10%;"></td> <td style="width: 10%;"></td> <td style="width: 10%;"></td> <td
style="width: 10%;"></td> <td style="width: 10%;"></td> <td style="width: 10%;"></td> <td style="width: 10%;"></td> </tr> <tr> <td></td> <td></td> <td colspan="8" style="text-align: center;"> <table border="1" style="width: 100%; border-collapse: collapse; text-align: center;"> <tr> <td style="width: 10%;"></td> <td style="width: 10%;"></td> <td style="width: 10%;"></td> <td style="width: 10%;"></td> <td style="width: 10%;"></td> <td style="width: 10%;"></td> <td style="width: 10%;"></td> <td style="width: 10%;"></td> <td style="width: 10%;"></td> <td style="width: 10%;"></td> </tr> <tr> <td></td> <td></td> <td colspan="8" style="text-align: center;"> <table border="1" style="width: 100%; border-collapse: collapse; text-align: center;"> <tr> </tr></table></td></tr></table></td></tr></table></td></tr></table></td></tr></table></td></tr></table></td></tr></table></td></tr></table></td></tr></table></td></tr></table></td></tr></table></td></tr></table></td></tr></table></td></tr></table></td></tr></table></td></tr></table></td></tr></table></td></tr></table></td></tr></table></td></tr></table></td></tr></table></td></tr></table></td></tr></table></td></tr></table></td></tr></table></td></tr></table></td></tr></table> | | | | | | | | | | | | | | | | | | | | <table border="1" style="width: 100%; border-collapse: collapse; text-align: center;"> <tr> <td style="width: 10%;"></td> <td style="width: 10%;"></td> <td style="width: 10%;"></td> <td style="width: 10%;"></td> <td style="width: 10%;"></td> <td style="width: 10%;"></td> <td style="width: 10%;"></td> <td style="width: 10%;"></td> <td style="width: 10%;"></td> <td style="width: 10%;"></td> </tr> <tr> <td></td> <td></td> <td colspan="8" style="text-align: center;"> <table border="1" style="width: 100%; border-collapse: collapse; text-align: center;"> <tr> <td style="width: 10%;"></td> <td style="width: 10%;"></td> <td style="width: 10%;"></td> <td style="width: 10%;"></td> <td style="width: 10%;"></td> <td style="width: 10%;"></td> <td style="width: 10%;"></td> <td style="width: 10%;"></td> <td style="width: 10%;"></td> <td style="width: 10%;"></td> </tr> <tr> <td></td> <td></td> <td colspan="8" style="text-align: center;"> <table border="1" style="width: 100%; border-collapse: collapse; text-align: center;"> <tr> <td style="width: 10%;"></td> <td style="width: 10%;"></td> <td style="width: 10%;"></td> <td style="width: 10%;"></td> <td style="width: 10%;"></td> <td style="width: 10%;"></td> <td style="width: 10%;"></td> <td style="width: 10%;"></td> <td style="width: 10%;"></td> <td style="width: 10%;"></td> </tr> <tr> <td></td> <td></td> <td colspan="8" style="text-align: center;"> <table border="1" style="width: 100%; border-collapse: collapse; text-align: center;"> <tr> <td style="width: 10%;"></td> <td style="width: 10%;"></td> <td style="width: 10%;"></td> <td style="width: 10%;"></td> <td style="width: 10%;"></td> <td style="width: 10%;"></td> <td style="width: 10%;"></td> <td style="width: 10%;"></td> <td style="width: 10%;"></td> <td style="width: 10%;"></td> </tr> <tr> <td></td> <td></td> <td colspan="8" style="text-align: center;"> <table border="1" style="width: 100%; border-collapse: collapse; text-align: center;"> <tr> <td style="width: 10%;"></td> <td style="width: 10%;"></td> <td style="width: 10%;"></td> <td style="width: 10%;"></td> <td style="width: 10%;"></td> <td style="width: 10%;"></td> <td style="width: 10%;"></td> <td style="width: 10%;"></td> <td style="width: 10%;"></td> <td style="width: 10%;"></td> </tr> <tr> <td></td> <td></td> <td colspan="8" style="text-align: center;"> <table border="1" style="width: 100%; border-collapse: collapse; text-align: center;"> <tr> <td style="width: 10%;"></td> <td style="width: 10%;"></td> <td style="width: 10%;"></td> <td style="width: 10%;"></td> <td style="width: 10%;"></td> <td style="width: 10%;"></td> <td style="width: 10%;"></td> <td style="width: 10%;"></td> <td style="width: 10%;"></td> <td style="width: 10%;"></td> </tr> <tr> <td></td> <td></td> <td colspan="8" style="text-align: center;"> <table border="1" style="width: 100%; border-collapse: collapse; text-align: center;"> <tr> <td style="width: 10%;"></td> <td style="width: 10%;"></td> <td style="width: 10%;"></td> <td style="width: 10%;"></td> <td style="width: 10%;"></td> <td style="width: 10%;"></td> <td style="width: 10%;"></td> <td style="width: 10%;"></td> <td style="width: 10%;"></td> <td style="width: 10%;"></td> </tr> <tr> <td></td> <td></td> <td colspan="8" style="text-align: center;"> <table border="1" style="width: 100%; border-collapse: collapse; text-align: center;"> <tr> <td style="width: 10%;"></td> <td style="width: 10%;"></td> <td style="width: 10%;"></td> <td style="width: 10%;"></td> <td style="width: 10%;"></td> <td style="width: 10%;"></td> <td style="width: 10%;"></td> <td style="width: 10%;"></td> <td style="width: 10%;"></td> <td style="width: 10%;"></td> </tr> <tr> <td></td> <td></td> <td colspan="8" style="text-align: center;"> <table border="1" style="width: 100%; border-collapse: collapse; text-align: center;"> <tr> <td style="width: 10%;"></td> <td style="width: 10%;"></td> <td style="width: 10%;"></td> <td style="width: 10%;"></td> <td style="width: 10%;"></td> <td style="width: 10%;"></td> <td style="width: 10%;"></td> <td style="width: 10%;"></td> <td style="width: 10%;"></td> <td style="width: 10%;"></td> </tr> <tr> <td></td> <td></td> <td colspan="8" style="text-align: center;"> <table border="1" style="width: 100%; border-collapse: collapse; text-align: center;"> <tr> <td style="width: 10%;"></td> <td style="width: 10%;"></td> <td style="width: 10%;"></td> <td style="width: 10%;"></td> <td style="width: 10%;"></td> <td style="width: 10%;"></td> <td style="width: 10%;"></td> <td style="width: 10%;"></td> <td style="width: 10%;"></td> <td style="width: 10%;"></td> </tr> <tr> <td></td> <td></td> <td colspan="8" style="text-align: center;"> <table border="1" style="width: 100%; border-collapse: collapse; text-align: center;"> <tr> <td style="width: 10%;"></td> <td
style="width: 10%;"></td> <td style="width: 10%;"></td> <td style="width: 10%;"></td> <td style="width: 10%;"></td> <td style="width: 10%;"></td> <td style="width: 10%;"></td> <td style="width: 10%;"></td> <td style="width: 10%;"></td> <td style="width: 10%;"></td> </tr> <tr> <td></td> <td></td> <td colspan="8" style="text-align: center;"> <table border="1" style="width: 100%; border-collapse: collapse; text-align: center;"> <tr> <td style="width: 10%;"></td> <td style="width: 10%;"></td> <td style="width: 10%;"></td> <td style="width: 10%;"></td> <td style="width: 10%;"></td> <td style="width: 10%;"></td> <td style="width: 10%;"></td> <td style="width: 10%;"></td> <td style="width: 10%;"></td> <td style="width: 10%;"></td> </tr> <tr> <td></td> <td></td> <td colspan="8" style="text-align: center;"> <table border="1" style="width: 100%; border-collapse: collapse; text-align: center;"> <tr> <td style="width: 10%;"></td> <td style="width: 10%;"></td> <td style="width: 10%;"></td> <td style="width: 10%;"></td> <td style="width: 10%;"></td> <td style="width: 10%;"></td> <td style="width: 10%;"></td> <td style="width: 10%;"></td> <td style="width: 10%;"></td> <td style="width: 10%;"></td> </tr> <tr> <td></td> <td></td> <td colspan="8" style="text-align: center;"> <table border="1" style="width: 100%; border-collapse: collapse; text-align: center;"> <tr> <td style="width: 10%;"></td> <td style="width: 10%;"></td> <td style="width: 10%;"></td> <td style="width: 10%;"></td> <td style="width: 10%;"></td> <td style="width: 10%;"></td> <td style="width: 10%;"></td> <td style="width: 10%;"></td> <td style="width: 10%;"></td> <td style="width: 10%;"></td> </tr> <tr> <td></td> <td></td> <td colspan="8" style="text-align: center;"> <table border="1" style="width: 100%; border-collapse: collapse; text-align: center;"> <tr> <td style="width: 10%;"></td> <td style="width: 10%;"></td> <td style="width: 10%;"></td> <td style="width: 10%;"></td> <td style="width: 10%;"></td> <td style="width: 10%;"></td> <td style="width: 10%;"></td> <td style="width: 10%;"></td> <td style="width: 10%;"></td> <td style="width: 10%;"></td> </tr> <tr> <td></td> <td></td> <td colspan="8" style="text-align: center;"> <table border="1" style="width: 100%; border-collapse: collapse; text-align: center;"> <tr> <td style="width: 10%;"></td> <td style="width: 10%;"></td> <td style="width: 10%;"></td> <td style="width: 10%;"></td> <td style="width: 10%;"></td> <td style="width: 10%;"></td> <td style="width: 10%;"></td> <td style="width: 10%;"></td> <td style="width: 10%;"></td> <td style="width: 10%;"></td> </tr> <tr> <td></td> <td></td> <td colspan="8" style="text-align: center;"> <table border="1" style="width: 100%; border-collapse: collapse; text-align: center;"> <tr> <td style="width: 10%;"></td> <td style="width: 10%;"></td> <td style="width: 10%;"></td> <td style="width: 10%;"></td> <td style="width: 10%;"></td> <td style="width: 10%;"></td> <td style="width: 10%;"></td> <td style="width: 10%;"></td> <td style="width: 10%;"></td> <td style="width: 10%;"></td> </tr> <tr> <td></td> <td></td> <td colspan="8" style="text-align: center;"> <table border="1" style="width: 100%; border-collapse: collapse; text-align: center;"> <tr> <td style="width: 10%;"></td> <td style="width: 10%;"></td> <td style="width: 10%;"></td> <td style="width: 10%;"></td> <td style="width: 10%;"></td> <td style="width: 10%;"></td> <td style="width: 10%;"></td> <td style="width: 10%;"></td> <td style="width: 10%;"></td> <td style="width: 10%;"></td> </tr> <tr> <td></td> <td></td> <td colspan="8" style="text-align: center;"> <table border="1" style="width: 100%; border-collapse: collapse; text-align: center;"> <tr> <td style="width: 10%;"></td> <td style="width: 10%;"></td> <td style="width: 10%;"></td> <td style="width: 10%;"></td> <td style="width: 10%;"></td> <td style="width: 10%;"></td> <td style="width: 10%;"></td> <td style="width: 10%;"></td> <td style="width: 10%;"></td> <td style="width: 10%;"></td> </tr> <tr> <td></td> <td></td> <td colspan="8" style="text-align: center;"> <table border="1" style="width: 100%; border-collapse: collapse; text-align: center;"> <tr> <td style="width: 10%;"></td> <td style="width: 10%;"></td> <td style="width: 10%;"></td> <td style="width: 10%;"></td> <td style="width: 10%;"></td> <td style="width: 10%;"></td> <td style="width: 10%;"></td> <td style="width: 10%;"></td> <td style="width: 10%;"></td> <td style="width: 10%;"></td> </tr> <tr> <td></td> <td></td> <td colspan="8" style="text-align: center;"> <table border="1" style="width: 100%; border-collapse: collapse; text-align: center;"> <tr> <td style="width: 10%;"></td> <td style="width: 10%;"></td> <td style="width: 10%;"></td> <td style="width: 10%;"></td> <td style="width: 10%;"></td> <td style="width: 10%;"></td> <td style="width: 10%;"></td> <td style="width: 10%;"></td> <td style="width: 10%;"></td> <td style="width: 10%;"></td> </tr> <tr> <td></td> <td></td> <td colspan="8" style="text-align: center;"> <table border="1" style="width: 100%; border-collapse: collapse; text-align: center;"> <tr> <td style="width: 10%;"></td> <td style="width: 10%;"></td> <td style="width: 10%;"></td> <td style="width: 10%;"></td> <td style="width: 10%;"></td> <td style="width: 10%;"></td> <td style="width: 10%;"></td> <td style="width: 10%;"></td> <td style="width: 10%;"></td> <td style="width: 10%;"></td> </tr> <tr> <td></td> <td></td> <td colspan="8" style="text-align: center;"> <table border="1" style="width: 100%; border-collapse: collapse; text-align: center;"> <tr> <td style="width: 10%;"></td> <td style="width: 10%;"></td> <td style="width: 10%;"></td> <td style="width: 10%;"></td> <td style="width: 10%;"></td> <td style="width: 10%;"></td> <td style="width: 10%;"></td> <td style="width: 10%;"></td> <td style="width: 10%;"></td> <td style="width: 10%;"></td> </tr> <tr> <td></td> <td></td> <td colspan="8" style="text-align: center;"> <table border="1" style="width: 100%; border-collapse: collapse; text-align: center;"> <tr> <td style="width: 10%;"></td> <td style="width: 10%;"></td> <td style="width: 10%;"></td> <td style="width: 10%;"></td> <td style="width: 10%;"></td> <td style="width: 10%;"></td> <td style="width: 10%;"></td> <td style="width: 10%;"></td> <td style="width: 10%;"></td> <td style="width: 10%;"></td> </tr> <tr> <td></td> <td></td> <td colspan="8" style="text-align: center;"> <table border="1" style="width: 100%; border-collapse: collapse; text-align: center;"> <tr> <td style="width: 10%;"></td> <td style="width: 10%;"></td> <td style="width: 10%;"></td> <td style="width: 10%;"></td> <td style="width: 10%;"></td> <td style="width: 10%;"></td> <td style="width: 10%;"></td> <td style="width: 10%;"></td> <td style="width: 10%;"></td> <td style="width: 10%;"></td> </tr> <tr> <td></td> <td></td> <td colspan="8" style="text-align: center;"> <table border="1" style="width: 100%; border-collapse: collapse; text-align: center;"> <tr> </tr></table></td></tr></table></td></tr></table></td></tr></table></td></tr></table></td></tr></table></td></tr></table></td></tr></table></td></tr></table></td></tr></table></td></tr></table></td></tr></table></td></tr></table></td></tr></table></td></tr></table></td></tr></table></td></tr></table></td></tr></table></td></tr></table></td></tr></table></td></tr></table></td></tr></table></td></tr></table></td></tr></table></td></tr></table></td></tr></table>
 | | | | | | | | | | | | | | | | | | | | <table border="1" style="width: 100%; border-collapse: collapse; text-align: center;"> <tr> <td style="width: 10%;"></td> <td style="width: 10%;"></td> <td style="width: 10%;"></td> <td style="width: 10%;"></td> <td style="width: 10%;"></td> <td style="width: 10%;"></td> <td style="width: 10%;"></td> <td style="width: 10%;"></td> <td style="width: 10%;"></td> <td style="width: 10%;"></td> </tr> <tr> <td></td> <td></td> <td colspan="8" style="text-align: center;"> <table border="1" style="width: 100%; border-collapse: collapse; text-align: center;"> <tr> <td style="width: 10%;"></td> <td style="width: 10%;"></td> <td style="width: 10%;"></td> <td style="width: 10%;"></td> <td style="width: 10%;"></td> <td style="width: 10%;"></td> <td style="width: 10%;"></td> <td style="width: 10%;"></td> <td style="width: 10%;"></td> <td style="width: 10%;"></td> </tr> <tr> <td></td> <td></td> <td colspan="8" style="text-align: center;"> <table border="1" style="width: 100%; border-collapse: collapse; text-align: center;"> <tr> <td style="width: 10%;"></td> <td style="width: 10%;"></td> <td style="width: 10%;"></td> <td style="width: 10%;"></td> <td style="width: 10%;"></td> <td style="width: 10%;"></td> <td style="width: 10%;"></td> <td style="width: 10%;"></td> <td style="width: 10%;"></td> <td style="width: 10%;"></td> </tr> <tr> <td></td> <td></td> <td colspan="8" style="text-align: center;"> <table border="1" style="width: 100%; border-collapse: collapse; text-align: center;"> <tr> <td style="width: 10%;"></td> <td style="width: 10%;"></td> <td style="width: 10%;"></td> <td style="width: 10%;"></td> <td style="width: 10%;"></td> <td style="width: 10%;"></td> <td style="width: 10%;"></td> <td style="width: 10%;"></td> <td style="width: 10%;"></td> <td style="width: 10%;"></td> </tr> <tr> <td></td> <td></td> <td colspan="8" style="text-align: center;"> <table border="1" style="width: 100%; border-collapse: collapse; text-align: center;"> <tr> <td style="width: 10%;"></td> <td style="width: 10%;"></td> <td style="width: 10%;"></td> <td style="width: 10%;"></td> <td style="width: 10%;"></td> <td style="width: 10%;"></td> <td style="width: 10%;"></td> <td style="width: 10%;"></td> <td style="width: 10%;"></td> <td style="width: 10%;"></td> </tr> <tr> <td></td> <td></td> <td colspan="8" style="text-align: center;"> <table border="1" style="width: 100%; border-collapse: collapse; text-align: center;"> <tr> <td style="width: 10%;"></td> <td style="width: 10%;"></td> <td style="width: 10%;"></td> <td style="width: 10%;"></td> <td style="width: 10%;"></td> <td style="width: 10%;"></td> <td style="width: 10%;"></td> <td style="width: 10%;"></td> <td style="width: 10%;"></td> <td style="width: 10%;"></td> </tr> <tr> <td></td> <td></td> <td colspan="8" style="text-align: center;"> <table border="1" style="width: 100%; border-collapse: collapse; text-align: center;"> <tr> <td style="width: 10%;"></td> <td style="width: 10%;"></td> <td style="width: 10%;"></td> <td style="width: 10%;"></td> <td style="width: 10%;"></td> <td style="width: 10%;"></td> <td style="width: 10%;"></td> <td style="width: 10%;"></td> <td style="width: 10%;"></td> <td style="width: 10%;"></td> </tr> <tr> <td></td> <td></td> <td colspan="8" style="text-align: center;"> <table border="1" style="width: 100%; border-collapse: collapse; text-align: center;"> <tr> <td style="width: 10%;"></td> <td style="width: 10%;"></td> <td style="width: 10%;"></td> <td style="width: 10%;"></td> <td style="width: 10%;"></td> <td style="width: 10%;"></td> <td style="width: 10%;"></td> <td style="width: 10%;"></td> <td style="width: 10%;"></td> <td style="width: 10%;"></td> </tr> <tr> <td></td> <td></td> <td colspan="8" style="text-align: center;"> <table border="1" style="width: 100%; border-collapse: collapse; text-align: center;"> <tr> <td style="width: 10%;"></td> <td style="width: 10%;"></td> <td style="width: 10%;"></td> <td style="width: 10%;"></td> <td style="width: 10%;"></td> <td style="width: 10%;"></td> <td style="width: 10%;"></td> <td style="width: 10%;"></td> <td style="width: 10%;"></td> <td style="width: 10%;"></td> </tr> <tr> <td></td> <td></td> <td colspan="8" style="text-align: center;"> <table border="1" style="width: 100%; border-collapse: collapse; text-align: center;"> <tr> <td style="width: 10%;"></td> <td style="width: 10%;"></td> <td style="width: 10%;"></td> <td style="width: 10%;"></td> <td style="width: 10%;"></td> <td style="width: 10%;"></td> <td style="width: 10%;"></td> <td style="width: 10%;"></td> <td style="width: 10%;"></td> <td style="width: 10%;"></td> </tr> <tr> <td></td> <td></td> <td colspan="8" style="text-align: center;"> <table border="1" style="width: 100%; border-collapse: collapse; text-align: center;"> <tr> <td style="width: 10%;"></td> <td style="width: 10%;"></td> <td style="width: 10%;"></td> <td style="width: 10%;"></td> <td style="width: 10%;"></td> <td style="width: 10%;"></td> <td style="width: 10%;"></td> <td style="width: 10%;"></td> <td style="width: 10%;"></td> <td style="width: 10%;"></td> </tr> <tr> <td></td> <td></td> <td colspan="8" style="text-align: center;"> <table border="1" style="width: 100%; border-collapse: collapse; text-align: center;"> <tr> <td style="width: 10%;"></td> <td style="width: 10%;"></td> <td style="width: 10%;"></td> <td style="width: 10%;"></td> <td style="width: 10%;"></td> <td style="width: 10%;"></td> <td style="width: 10%;"></td> <td style="width: 10%;"></td> <td style="width: 10%;"></td> <td style="width: 10%;"></td> </tr> <tr> <td></td> <td></td> <td colspan="8" style="text-align: center;"> <table border="1" style="width: 100%; border-collapse: collapse; text-align: center;"> <tr> <td style="width: 10%;"></td> <td style="width: 10%;"></td> <td style="width: 10%;"></td> <td style="width: 10%;"></td> <td style="width: 10%;"></td> <td style="width: 10%;"></td> <td style="width: 10%;"></td> <td style="width: 10%;"></td> <td style="width: 10%;"></td> <td style="width: 10%;"></td> </tr> <tr> <td></td> <td></td> <td colspan="8" style="text-align: center;"> <table border="1" style="width: 100%; border-collapse: collapse; text-align: center;"> <tr> <td style="width: 10%;"></td> <td style="width: 10%;"></td> <td style="width: 10%;"></td> <td style="width: 10%;"></td> <td style="width: 10%;"></td> <td style="width: 10%;"></td> <td style="width: 10%;"></td> <td style="width: 10%;"></td> <td style="width: 10%;"></td> <td style="width: 10%;"></td> </tr> <tr> <td></td> <td></td> <td colspan="8" style="text-align: center;"> <table border="1" style="width: 100%; border-collapse: collapse; text-align: center;"> <tr> <td style="width: 10%;"></td> <td style="width: 10%;"></td> <td style="width: 10%;"></td> <td style="width: 10%;"></td> <td style="width: 10%;"></td> <td style="width: 10%;"></td> <td style="width: 10%;"></td> <td style="width: 10%;"></td> <td style="width: 10%;"></td> <td style="width: 10%;"></td> </tr> <tr> <td></td> <td></td> <td colspan="8" style="text-align: center;"> <table border="1" style="width: 100%; border-collapse: collapse; text-align: center;"> <tr> <td style="width: 10%;"></td> <td style="width: 10%;"></td> <td style="width: 10%;"></td> <td style="width: 10%;"></td> <td style="width: 10%;"></td> <td style="width: 10%;"></td> <td style="width: 10%;"></td> <td style="width: 10%;"></td> <td style="width: 10%;"></td> <td style="width: 10%;"></td> </tr> <tr> <td></td> <td></td> <td colspan="8" style="text-align: center;"> <table border="1" style="width: 100%; border-collapse: collapse; text-align: center;"> <tr> <td style="width: 10%;"></td> <td style="width: 10%;"></td> <td style="width: 10%;"></td> <td style="width: 10%;"></td> <td style="width: 10%;"></td> <td style="width: 10%;"></td> <td style="width: 10%;"></td> <td style="width: 10%;"></td> <td style="width: 10%;"></td> <td style="width: 10%;"></td> </tr> <tr> <td></td> <td></td> <td colspan="8" style="text-align: center;"> <table border="1" style="width: 100%; border-collapse: collapse; text-align: center;"> <tr> <td style="width: 10%;"></td> <td style="width: 10%;"></td> <td style="width: 10%;"></td> <td style="width: 10%;"></td> <td style="width: 10%;"></td> <td style="width: 10%;"></td> <td style="width: 10%;"></td> <td style="width: 10%;"></td> <td style="width: 10%;"></td> <td style="width: 10%;"></td> </tr> <tr> <td></td> <td></td> <td colspan="8" style="text-align: center;"> <table border="1" style="width: 100%; border-collapse: collapse; text-align: center;"> <tr> <td style="width: 10%;"></td> <td style="width: 10%;"></td> <td style="width:
10%;"></td> <td style="width: 10%;"></td> <td style="width: 10%;"></td> <td style="width: 10%;"></td> <td style="width: 10%;"></td> <td style="width: 10%;"></td> <td style="width: 10%;"></td> <td style="width: 10%;"></td> </tr> <tr> <td></td> <td></td> <td colspan="8" style="text-align: center;"> <table border="1" style="width: 100%; border-collapse: collapse; text-align: center;"> <tr> <td style="width: 10%;"></td> <td style="width: 10%;"></td> <td style="width: 10%;"></td> <td style="width: 10%;"></td> <td style="width: 10%;"></td> <td style="width: 10%;"></td> <td style="width: 10%;"></td> <td style="width: 10%;"></td> <td style="width: 10%;"></td> <td style="width: 10%;"></td> </tr> <tr> <td></td> <td></td> <td colspan="8" style="text-align: center;"> <table border="1" style="width: 100%; border-collapse: collapse; text-align: center;"> <tr> <td style="width: 10%;"></td> <td style="width: 10%;"></td> <td style="width: 10%;"></td> <td style="width: 10%;"></td> <td style="width: 10%;"></td> <td style="width: 10%;"></td> <td style="width: 10%;"></td> <td style="width: 10%;"></td> <td style="width: 10%;"></td> <td style="width: 10%;"></td> </tr> <tr> <td></td> <td></td> <td colspan="8" style="text-align: center;"> <table border="1" style="width: 100%; border-collapse: collapse; text-align: center;"> <tr> <td style="width: 10%;"></td> <td style="width: 10%;"></td> <td style="width: 10%;"></td> <td style="width: 10%;"></td> <td style="width: 10%;"></td> <td style="width: 10%;"></td> <td style="width: 10%;"></td> <td style="width: 10%;"></td> <td style="width: 10%;"></td> <td style="width: 10%;"></td> </tr> <tr> <td></td> <td></td> <td colspan="8" style="text-align: center;"> <table border="1" style="width: 100%; border-collapse: collapse; text-align: center;"> <tr> <td style="width: 10%;"></td> <td style="width: 10%;"></td> <td style="width: 10%;"></td> <td style="width: 10%;"></td> <td style="width: 10%;"></td> <td style="width: 10%;"></td> <td style="width: 10%;"></td> <td style="width: 10%;"></td> <td style="width: 10%;"></td> <td style="width: 10%;"></td> </tr> <tr> <td></td> <td></td> <td colspan="8" style="text-align: center;"> <table border="1" style="width: 100%; border-collapse: collapse; text-align: center;"> <tr> <td style="width: 10%;"></td> <td style="width: 10%;"></td> <td style="width: 10%;"></td> <td style="width: 10%;"></td> <td style="width: 10%;"></td> <td style="width: 10%;"></td> <td style="width: 10%;"></td> <td style="width: 10%;"></td> <td style="width: 10%;"></td> <td style="width: 10%;"></td> </tr> <tr> <td></td> <td></td> <td colspan="8" style="text-align: center;"> <table border="1" style="width: 100%; border-collapse: collapse; text-align: center;"> <tr> </tr></table></td></tr></table></td></tr></table></td></tr></table></td></tr></table></td></tr></table></td></tr></table></td></tr></table></td></tr></table></td></tr></table></td></tr></table></td></tr></table></td></tr></table></td></tr></table></td></tr></table></td></tr></table></td></tr></table></td></tr></table></td></tr></table></td></tr></table></td></tr></table></td></tr></table></td></tr></table></td></tr></table></td></tr></table> | | | | | | | | | | | | | | | | | | | | <table border="1" style="width: 100%; border-collapse: collapse; text-align: center;"> <tr> <td style="width: 10%;"></td> <td style="width: 10%;"></td> <td style="width: 10%;"></td> <td style="width: 10%;"></td> <td style="width: 10%;"></td> <td style="width: 10%;"></td> <td style="width: 10%;"></td> <td style="width: 10%;"></td> <td style="width: 10%;"></td> <td style="width: 10%;"></td> </tr> <tr> <td></td> <td></td> <td colspan="8" style="text-align: center;"> <table border="1" style="width: 100%; border-collapse: collapse; text-align: center;"> <tr> <td style="width: 10%;"></td> <td style="width: 10%;"></td> <td style="width: 10%;"></td> <td style="width: 10%;"></td> <td style="width: 10%;"></td> <td style="width: 10%;"></td> <td style="width: 10%;"></td> <td style="width: 10%;"></td> <td style="width: 10%;"></td> <td style="width: 10%;"></td> </tr> <tr> <td></td> <td></td> <td colspan="8" style="text-align: center;"> <table border="1" style="width: 100%; border-collapse: collapse; text-align: center;"> <tr> <td style="width: 10%;"></td> <td style="width: 10%;"></td> <td style="width: 10%;"></td> <td style="width: 10%;"></td> <td style="width: 10%;"></td> <td style="width: 10%;"></td> <td style="width: 10%;"></td> <td style="width: 10%;"></td> <td style="width: 10%;"></td> <td style="width: 10%;"></td> </tr> <tr> <td></td> <td></td> <td colspan="8" style="text-align: center;"> <table border="1" style="width: 100%; border-collapse: collapse; text-align: center;"> <tr> <td style="width: 10%;"></td> <td style="width: 10%;"></td> <td style="width: 10%;"></td> <td style="width: 10%;"></td> <td style="width: 10%;"></td> <td style="width: 10%;"></td> <td style="width: 10%;"></td> <td style="width: 10%;"></td> <td style="width: 10%;"></td> <td style="width: 10%;"></td> </tr> <tr> <td></td> <td></td> <td colspan="8" style="text-align: center;"> <table border="1" style="width: 100%; border-collapse: collapse; text-align: center;"> <tr> <td style="width: 10%;"></td> <td style="width: 10%;"></td> <td style="width: 10%;"></td> <td style="width: 10%;"></td> <td style="width: 10%;"></td> <td style="width: 10%;"></td> <td style="width: 10%;"></td> <td style="width: 10%;"></td> <td style="width: 10%;"></td> <td style="width: 10%;"></td> </tr> <tr> <td></td> <td></td> <td colspan="8" style="text-align: center;"> <table border="1" style="width: 100%; border-collapse: collapse; text-align: center;"> <tr> <td style="width: 10%;"></td> <td style="width: 10%;"></td> <td style="width: 10%;"></td> <td style="width: 10%;"></td> <td style="width: 10%;"></td> <td style="width: 10%;"></td> <td style="width: 10%;"></td> <td style="width: 10%;"></td> <td style="width: 10%;"></td> <td style="width: 10%;"></td> </tr> <tr> <td></td> <td></td> <td colspan="8" style="text-align: center;"> <table border="1" style="width: 100%; border-collapse: collapse;
text-align: center;"> <tr> <td style="width: 10%;"></td> <td style="width: 10%;"></td> <td style="width: 10%;"></td> <td style="width: 10%;"></td> <td style="width: 10%;"></td> <td style="width: 10%;"></td> <td style="width: 10%;"></td> <td style="width: 10%;"></td> <td style="width: 10%;"></td> <td style="width: 10%;"></td> </tr> <tr> <td></td> <td></td> <td colspan="8" style="text-align: center;"> <table border="1" style="width: 100%; border-collapse: collapse; text-align: center;"> <tr> <td style="width: 10%;"></td> <td style="width: 10%;"></td> <td style="width: 10%;"></td> <td style="width: 10%;"></td> <td style="width: 10%;"></td> <td style="width: 10%;"></td> <td style="width: 10%;"></td> <td style="width: 10%;"></td> <td style="width: 10%;"></td> <td style="width: 10%;"></td> </tr> <tr> <td></td> <td></td> <td colspan="8" style="text-align: center;"> <table border="1" style="width: 100%; border-collapse: collapse; text-align: center;"> <tr> <td style="width: 10%;"></td> <td style="width: 10%;"></td> <td style="width: 10%;"></td> <td style="width: 10%;"></td> <td style="width: 10%;"></td> <td style="width: 10%;"></td> <td style="width: 10%;"></td> <td style="width: 10%;"></td> <td style="width: 10%;"></td> <td style="width: 10%;"></td> </tr> <tr> <td></td> <td></td> <td colspan="8" style="text-align: center;"> <table border="1" style="width: 100%; border-collapse: collapse; text-align: center;"> <tr> <td style="width: 10%;"></td> <td style="width: 10%;"></td> <td style="width: 10%;"></td> <td style="width: 10%;"></td> <td style="width: 10%;"></td> <td style="width: 10%;"></td> <td style="width: 10%;"></td> <td style="width: 10%;"></td> <td style="width: 10%;"></td> <td style="width: 10%;"></td> </tr> <tr> <td></td> <td></td> <td colspan="8" style="text-align: center;"> <table border="1" style="width: 100%; border-collapse: collapse; text-align: center;"> <tr> <td style="width: 10%;"></td> <td style="width: 10%;"></td> <td style="width: 10%;"></td> <td style="width: 10%;"></td> <td style="width: 10%;"></td> <td style="width: 10%;"></td> <td style="width: 10%;"></td> <td style="width: 10%;"></td> <td style="width: 10%;"></td> <td style="width: 10%;"></td> </tr> <tr> <td></td> <td></td> <td colspan="8" style="text-align: center;"> <table border="1" style="width: 100%; border-collapse: collapse; text-align: center;"> <tr> <td style="width: 10%;"></td> <td style="width: 10%;"></td> <td style="width: 10%;"></td> <td style="width: 10%;"></td> <td style="width: 10%;"></td> <td style="width: 10%;"></td> <td style="width: 10%;"></td> <td style="width: 10%;"></td> <td style="width: 10%;"></td> <td style="width: 10%;"></td> </tr> <tr> <td></td> <td></td> <td colspan="8" style="text-align: center;"> <table border="1" style="width: 100%; border-collapse: collapse; text-align: center;"> <tr> <td style="width: 10%;"></td> <td style="width: 10%;"></td> <td style="width: 10%;"></td> <td style="width: 10%;"></td> <td style="width: 10%;"></td> <td style="width: 10%;"></td> <td style="width: 10%;"></td> <td style="width: 10%;"></td> <td style="width: 10%;"></td> <td style="width: 10%;"></td> </tr> <tr> <td></td> <td></td> <td colspan="8" style="text-align: center;"> <table border="1" style="width: 100%; border-collapse: collapse; text-align: center;"> <tr> <td style="width: 10%;"></td> <td style="width: 10%;"></td> <td style="width: 10%;"></td> <td style="width: 10%;"></td> <td style="width: 10%;"></td> <td style="width: 10%;"></td> <td style="width: 10%;"></td> <td style="width: 10%;"></td> <td style="width: 10%;"></td> <td style="width: 10%;"></td> </tr> <tr> <td></td> <td></td> <td colspan="8" style="text-align: center;"> <table border="1" style="width: 100%; border-collapse: collapse; text-align: center;"> <tr> <td style="width: 10%;"></td> <td style="width: 10%;"></td> <td style="width: 10%;"></td> <td style="width: 10%;"></td> <td style="width: 10%;"></td> <td style="width: 10%;"></td> <td style="width: 10%;"></td> <td style="width: 10%;"></td> <td style="width: 10%;"></td> <td style="width: 10%;"></td> </tr> <tr> <td></td> <td></td> <td colspan="8" style="text-align: center;"> <table border="1" style="width: 100%; border-collapse: collapse; text-align: center;"> <tr> <td style="width: 10%;"></td> <td style="width: 10%;"></td> <td style="width: 10%;"></td> <td style="width: 10%;"></td> <td style="width: 10%;"></td> <td style="width: 10%;"></td> <td style="width: 10%;"></td> <td style="width: 10%;"></td> <td style="width: 10%;"></td> <td style="width: 10%;"></td> </tr> <tr> <td></td> <td></td> <td colspan="8" style="text-align: center;"> <table border="1" style="width: 100%; border-collapse: collapse; text-align: center;"> <tr> <td style="width: 10%;"></td> <td style="width: 10%;"></td> <td style="width: 10%;"></td> <td style="width: 10%;"></td> <td style="width: 10%;"></td> <td style="width: 10%;"></td> <td style="width: 10%;"></td> <td style="width: 10%;"></td> <td style="width: 10%;"></td> <td style="width: 10%;"></td> </tr> <tr> <td></td> <td></td> <td colspan="8" style="text-align: center;"> <table border="1" style="width: 100%; border-collapse: collapse; text-align: center;"> <tr> <td style="width: 10%;"></td> <td style="width: 10%;"></td> <td style="width: 10%;"></td> <td style="width: 10%;"></td> <td style="width: 10%;"></td> <td style="width: 10%;"></td> <td style="width: 10%;"></td> <td style="width: 10%;"></td> <td style="width: 10%;"></td> <td style="width: 10%;"></td> </tr> <tr> <td></td> <td></td> <td colspan="8" style="text-align: center;"> <table border="1" style="width: 100%; border-collapse: collapse; text-align: center;"> <tr> <td style="width: 10%;"></td> <td style="width: 10%;"></td> <td style="width: 10%;"></td> <td style="width: 10%;"></td> <td style="width: 10%;"></td> <td style="width: 10%;"></td> <td style="width: 10%;"></td> <td style="width: 10%;"></td> <td style="width: 10%;"></td> <td style="width: 10%;"></td> </tr> <tr> <td></td> <td></td> <td colspan="8" style="text-align: center;"> <table border="1" style="width: 100%; border-collapse: collapse; text-align: center;"> <tr> <td style="width: 10%;"></td> <td style="width: 10%;"></td> <td style="width: 10%;"></td> <td style="width: 10%;"></td> <td style="width: 10%;"></td> <td style="width: 10%;"></td> <td style="width: 10%;"></td> <td style="width: 10%;"></td> <td style="width: 10%;"></td> <td style="width: 10%;"></td> </tr> <tr> <td></td> <td></td> <td colspan="8" style="text-align: center;"> <table border="1" style="width: 100%; border-collapse: collapse; text-align: center;"> <tr> <td style="width: 10%;"></td> <td style="width: 10%;"></td> <td style="width: 10%;"></td> <td style="width: 10%;"></td> <td style="width: 10%;"></td> <td style="width: 10%;"></td> <td style="width: 10%;"></td> <td style="width: 10%;"></td> <td style="width: 10%;"></td> <td style="width: 10%;"></td> </tr> <tr> <td></td> <td></td> <td colspan="8" style="text-align: center;"> <table border="1" style="width: 100%; border-collapse: collapse; text-align: center;"> <tr> <td style="width: 10%;"></td> <td style="width: 10%;"></td> <td style="width: 10%;"></td> <td style="width: 10%;"></td> <td style="width: 10%;"></td> <td style="width: 10%;"></td> <td style="width: 10%;"></td> <td style="width: 10%;"></td> <td style="width: 10%;"></td> <td style="width: 10%;"></td> </tr> <tr> <td></td> <td></td> <td colspan="8" style="text-align: center;"> <table border="1" style="width: 100%; border-collapse: collapse; text-align: center;"> <tr> <td style="width: 10%;"></td> <td style="width: 10%;"></td> <td style="width: 10%;"></td> <td style="width: 10%;"></td> <td style="width: 10%;"></td> <td style="width: 10%;"></td> <td style="width: 10%;"></td> <td style="width: 10%;"></td> <td style="width: 10%;"></td> <td style="width: 10%;"></td> </tr> <tr> <td></td> <td></td> <td colspan="8" style="text-align: center;"> <table border="1" style="width: 100%; border-collapse: collapse; text-align: center;"> <tr> </tr></table></td></tr></table></td></tr></table></td></tr></table></td></tr></table></td></tr></table></td></tr></table></td></tr></table></td></tr></table></td></tr></table></td></tr></table></td></tr></table></td></tr></table></td></tr></table></td></tr></table></td></tr></table></td></tr></table></td></tr></table></td></tr></table></td></tr></table></td></tr></table></td></tr></table></td></tr></table></td></tr></table>
 | | | | | | | | | | | | | | | | | | | | <table border="1" style="width: 100%; border-collapse: collapse; text-align: center;"> <tr> <td style="width: 10%;"></td> <td style="width: 10%;"></td> <td style="width: 10%;"></td> <td style="width: 10%;"></td> <td style="width: 10%;"></td> <td style="width: 10%;"></td> <td style="width: 10%;"></td> <td style="width: 10%;"></td> <td style="width: 10%;"></td> <td style="width: 10%;"></td> </tr> <tr> <td></td> <td></td> <td colspan="8" style="text-align: center;"> <table border="1" style="width: 100%; border-collapse: collapse; text-align: center;"> <tr> <td style="width: 10%;"></td> <td style="width: 10%;"></td> <td style="width: 10%;"></td> <td style="width: 10%;"></td> <td style="width: 10%;"></td> <td style="width: 10%;"></td> <td style="width: 10%;"></td> <td style="width: 10%;"></td> <td style="width: 10%;"></td> <td style="width: 10%;"></td> </tr> <tr> <td></td> <td></td> <td colspan="8" style="text-align: center;"> <table border="1" style="width: 100%; border-collapse: collapse; text-align: center;"> <tr> <td style="width: 10%;"></td> <td style="width: 10%;"></td> <td style="width: 10%;"></td> <td style="width: 10%;"></td> <td style="width: 10%;"></td> <td style="width: 10%;"></td> <td style="width: 10%;"></td> <td style="width: 10%;"></td> <td style="width: 10%;"></td> <td style="width: 10%;"></td> </tr> <tr> <td></td> <td></td> <td colspan="8" style="text-align: center;"> <table border="1" style="width: 100%; border-collapse: collapse; text-align: center;"> <tr> <td style="width: 10%;"></td> <td style="width: 10%;"></td> <td style="width: 10%;"></td> <td style="width: 10%;"></td> <td style="width: 10%;"></td> <td style="width: 10%;"></td> <td style="width: 10%;"></td> <td style="width: 10%;"></td> <td style="width: 10%;"></td> <td style="width: 10%;"></td> </tr> <tr> <td></td> <td></td> <td colspan="8" style="text-align: center;"> <table border="1" style="width: 100%; border-collapse: collapse; text-align: center;"> <tr> <td style="width: 10%;"></td> <td style="width: 10%;"></td> <td style="width: 10%;"></td> <td style="width: 10%;"></td> <td style="width: 10%;"></td> <td style="width: 10%;"></td> <td style="width: 10%;"></td> <td style="width: 10%;"></td> <td style="width: 10%;"></td> <td style="width: 10%;"></td> </tr> <tr> <td></td> <td></td> <td colspan="8" style="text-align: center;"> <table border="1" style="width: 100%; border-collapse: collapse; text-align: center;"> <tr> <td style="width: 10%;"></td> <td style="width: 10%;"></td> <td style="width: 10%;"></td> <td style="width: 10%;"></td> <td style="width: 10%;"></td> <td style="width: 10%;"></td> <td style="width: 10%;"></td> <td style="width: 10%;"></td> <td style="width: 10%;"></td> <td style="width: 10%;"></td> </tr> <tr> <td></td> <td></td> <td colspan="8" style="text-align: center;"> <table border="1" style="width: 100%; border-collapse: collapse; text-align: center;"> <tr> <td style="width: 10%;"></td> <td style="width: 10%;"></td> <td style="width: 10%;"></td> <td style="width: 10%;"></td> <td style="width: 10%;"></td> <td style="width: 10%;"></td> <td style="width: 10%;"></td> <td style="width: 10%;"></td> <td style="width: 10%;"></td> <td style="width: 10%;"></td> </tr> <tr> <td></td> <td></td> <td colspan="8" style="text-align: center;"> <table border="1" style="width: 100%; border-collapse: collapse; text-align: center;"> <tr> <td style="width: 10%;"></td> <td style="width: 10%;"></td> <td style="width: 10%;"></td> <td style="width: 10%;"></td> <td style="width: 10%;"></td> <td style="width: 10%;"></td> <td style="width: 10%;"></td> <td style="width: 10%;"></td> <td style="width: 10%;"></td> <td style="width: 10%;"></td> </tr> <tr> <td></td> <td></td> <td colspan="8" style="text-align: center;"> <table border="1" style="width: 100%; border-collapse: collapse; text-align: center;"> <tr> <td style="width: 10%;"></td> <td style="width: 10%;"></td> <td style="width: 10%;"></td> <td style="width: 10%;"></td> <td style="width: 10%;"></td> <td style="width: 10%;"></td> <td style="width: 10%;"></td> <td style="width: 10%;"></td> <td style="width: 10%;"></td> <td style="width: 10%;"></td> </tr> <tr> <td></td> <td></td> <td colspan="8" style="text-align: center;"> <table border="1" style="width: 100%; border-collapse: collapse; text-align: center;"> <tr> <td style="width: 10%;"></td> <td style="width: 10%;"></td> <td style="width: 10%;"></td> <td style="width: 10%;"></td> <td style="width: 10%;"></td> <td style="width: 10%;"></td> <td style="width: 10%;"></td> <td style="width: 10%;"></td> <td style="width: 10%;"></td> <td style="width: 10%;"></td> </tr> <tr> <td></td> <td></td> <td colspan="8" style="text-align: center;"> <table border="1" style="width: 100%; border-collapse: collapse; text-align: center;"> <tr> <td style="width: 10%;"></td> <td style="width: 10%;"></td> <td style="width: 10%;"></td> <td style="width: 10%;"></td> <td style="width: 10%;"></td> <td style="width: 10%;"></td> <td style="width: 10%;"></td> <td style="width: 10%;"></td> <td style="width: 10%;"></td> <td style="width: 10%;"></td> </tr> <tr> <td></td> <td></td> <td colspan="8" style="text-align: center;"> <table border="1" style="width: 100%; border-collapse: collapse; text-align: center;"> <tr> <td style="width: 10%;"></td> <td style="width: 10%;"></td> <td style="width: 10%;"></td> <td style="width: 10%;"></td> <td style="width: 10%;"></td> <td style="width: 10%;"></td> <td style="width: 10%;"></td> <td style="width: 10%;"></td> <td style="width: 10%;"></td> <td style="width: 10%;"></td> </tr> <tr> <td></td> <td></td> <td colspan="8" style="text-align: center;"> <table border="1" style="width: 100%; border-collapse: collapse; text-align: center;"> <tr> <td style="width: 10%;"></td> <td style="width: 10%;"></td> <td style="width: 10%;"></td> <td style="width: 10%;"></td> <td style="width: 10%;"></td> <td style="width: 10%;"></td> <td style="width: 10%;"></td> <td style="width: 10%;"></td> <td style="width: 10%;"></td> <td style="width: 10%;"></td> </tr> <tr> <td></td> <td></td> <td colspan="8" style="text-align: center;"> <table border="1" style="width: 100%; border-collapse: collapse; text-align: center;"> <tr> <td style="width: 10%;"></td> <td style="width: 10%;"></td> <td style="width: 10%;"></td> <td style="width: 10%;"></td> <td style="width: 10%;"></td> <td style="width: 10%;"></td> <td style="width: 10%;"></td> <td style="width: 10%;"></td> <td style="width: 10%;"></td> <td style="width: 10%;"></td> </tr> <tr> <td></td> <td></td> <td colspan="8" style="text-align: center;"> <table border="1" style="width: 100%; border-collapse: collapse; text-align: center;"> <tr> <td style="width: 10%;"></td> <td style="width: 10%;"></td> <td style="width: 10%;"></td> <td style="width: 10%;"></td> <td style="width: 10%;"></td> <td style="width: 10%;"></td> <td style="width: 10%;"></td> <td style="width: 10%;"></td> <td style="width: 10%;"></td> <td style="width: 10%;"></td> </tr> <tr> <td></td> <td></td> <td colspan="8" style="text-align: center;"> <table border="1" style="width: 100%; border-collapse: collapse; text-align: center;"> <tr> <td style="width: 10%;"></td> <td style="width: 10%;"></td> <td style="width: 10%;"></td> <td style="width: 10%;"></td> <td style="width: 10%;"></td> <td style="width: 10%;"></td> <td style="width: 10%;"></td> <td style="width: 10%;"></td> <td style="width: 10%;"></td> <td style="width: 10%;"></td> </tr> <tr> <td></td> <td></td> <td colspan="8" style="text-align: center;"> <table border="1" style="width: 100%; border-collapse: collapse; text-align: center;"> <tr> <td style="width: 10%;"></td> <td style="width: 10%;"></td>
<td style="width: 10%;"></td> <td style="width: 10%;"></td> <td style="width: 10%;"></td> <td style="width: 10%;"></td> <td style="width: 10%;"></td> <td style="width: 10%;"></td> <td style="width: 10%;"></td> <td style="width: 10%;"></td> </tr> <tr> <td></td> <td></td> <td colspan="8" style="text-align: center;"> <table border="1" style="width: 100%; border-collapse: collapse; text-align: center;"> <tr> <td style="width: 10%;"></td> <td style="width: 10%;"></td> <td style="width: 10%;"></td> <td style="width: 10%;"></td> <td style="width: 10%;"></td> <td style="width: 10%;"></td> <td style="width: 10%;"></td> <td style="width: 10%;"></td> <td style="width: 10%;"></td> <td style="width: 10%;"></td> </tr> <tr> <td></td> <td></td> <td colspan="8" style="text-align: center;"> <table border="1" style="width: 100%; border-collapse: collapse; text-align: center;"> <tr> <td style="width: 10%;"></td> <td style="width: 10%;"></td> <td style="width: 10%;"></td> <td style="width: 10%;"></td> <td style="width: 10%;"></td> <td style="width: 10%;"></td> <td style="width: 10%;"></td> <td style="width: 10%;"></td> <td style="width: 10%;"></td> <td style="width: 10%;"></td> </tr> <tr> <td></td> <td></td> <td colspan="8" style="text-align: center;"> <table border="1" style="width: 100%; border-collapse: collapse; text-align: center;"> <tr> <td style="width: 10%;"></td> <td style="width: 10%;"></td> <td style="width: 10%;"></td> <td style="width: 10%;"></td> <td style="width: 10%;"></td> <td style="width: 10%;"></td> <td style="width: 10%;"></td> <td style="width: 10%;"></td> <td style="width: 10%;"></td> <td style="width: 10%;"></td> </tr> <tr> <td></td> <td></td> <td colspan="8" style="text-align: center;"> <table border="1" style="width: 100%; border-collapse: collapse; text-align: center;"> <tr> <td style="width: 10%;"></td> <td style="width: 10%;"></td> <td style="width: 10%;"></td> <td style="width: 10%;"></td> <td style="width: 10%;"></td> <td style="width: 10%;"></td> <td style="width: 10%;"></td> <td style="width: 10%;"></td> <td style="width: 10%;"></td> <td style="width: 10%;"></td> </tr> <tr> <td></td> <td></td> <td colspan="8" style="text-align: center;"> <table border="1" style="width: 100%; border-collapse: collapse; text-align: center;"> <tr> <td style="width: 10%;"></td> <td style="width: 10%;"></td> <td style="width: 10%;"></td> <td style="width: 10%;"></td> <td style="width: 10%;"></td> <td style="width: 10%;"></td> <td style="width: 10%;"></td> <td style="width: 10%;"></td> <td style="width: 10%;"></td> <td style="width: 10%;"></td> </tr> <tr> <td></td> <td></td> <td colspan="8" style="text-align: center;"> <table border="1" style="width: 100%; border-collapse: collapse; text-align: center;"> <tr> </tr></table></td></tr></table></td></tr></table></td></tr></table></td></tr></table></td></tr></table></td></tr></table></td></tr></table></td></tr></table></td></tr></table></td></tr></table></td></tr></table></td></tr></table></td></tr></table></td></tr></table></td></tr></table></td></tr></table></td></tr></table></td></tr></table></td></tr></table></td></tr></table></td></tr></table></td></tr></table> | | | | | | | | | | | | | | | | | | | | <table border="1" style="width: 100%; border-collapse: collapse; text-align: center;"> <tr> <td style="width: 10%;"></td> <td style="width: 10%;"></td> <td style="width: 10%;"></td> <td style="width: 10%;"></td> <td style="width: 10%;"></td> <td style="width: 10%;"></td> <td style="width: 10%;"></td> <td style="width: 10%;"></td> <td style="width: 10%;"></td> <td style="width: 10%;"></td> </tr> <tr> <td></td> <td></td> <td colspan="8" style="text-align: center;"> <table border="1" style="width: 100%; border-collapse: collapse; text-align: center;"> <tr> <td style="width: 10%;"></td> <td style="width: 10%;"></td> <td style="width: 10%;"></td> <td style="width: 10%;"></td> <td style="width: 10%;"></td> <td style="width: 10%;"></td> <td style="width: 10%;"></td> <td style="width: 10%;"></td> <td style="width: 10%;"></td> <td style="width: 10%;"></td> </tr> <tr> <td></td> <td></td> <td colspan="8" style="text-align: center;"> <table border="1" style="width: 100%; border-collapse: collapse; text-align: center;"> <tr> <td style="width: 10%;"></td> <td style="width: 10%;"></td> <td style="width: 10%;"></td> <td style="width: 10%;"></td> <td style="width: 10%;"></td> <td style="width: 10%;"></td> <td style="width: 10%;"></td> <td style="width: 10%;"></td> <td style="width: 10%;"></td> <td style="width: 10%;"></td> </tr> <tr> <td></td> <td></td> <td colspan="8" style="text-align: center;"> <table border="1" style="width: 100%; border-collapse: collapse; text-align: center;"> <tr> <td style="width: 10%;"></td> <td style="width: 10%;"></td> <td style="width: 10%;"></td> <td style="width: 10%;"></td> <td style="width: 10%;"></td> <td style="width: 10%;"></td> <td style="width: 10%;"></td> <td style="width: 10%;"></td> <td style="width: 10%;"></td> <td style="width: 10%;"></td> </tr> <tr> <td></td> <td></td> <td colspan="8" style="text-align: center;"> <table border="1" style="width: 100%; border-collapse: collapse; text-align: center;"> <tr> <td style="width: 10%;"></td> <td style="width: 10%;"></td> <td style="width: 10%;"></td> <td style="width: 10%;"></td> <td style="width: 10%;"></td> <td style="width: 10%;"></td> <td style="width: 10%;"></td> <td style="width: 10%;"></td> <td style="width: 10%;"></td> <td style="width: 10%;"></td> </tr> <tr> <td></td> <td></td> <td colspan="8" style="text-align: center;"> <table border="1" style="width: 100%; border-collapse: collapse; text-align: center;"> <tr> <td style="width: 10%;"></td> <td style="width: 10%;"></td> <td style="width: 10%;"></td> <td style="width: 10%;"></td> <td style="width: 10%;"></td> <td style="width: 10%;"></td> <td style="width: 10%;"></td> <td style="width: 10%;"></td> <td style="width: 10%;"></td> <td style="width: 10%;"></td> </tr> <tr> <td></td> <td></td> <td colspan="8" style="text-align: center;"> <table border="1" style="width: 100%; border-collapse: collapse; text-align: center;">
<tr> <td style="width: 10%;"></td> <td style="width: 10%;"></td> <td style="width: 10%;"></td> <td style="width: 10%;"></td> <td style="width: 10%;"></td> <td style="width: 10%;"></td> <td style="width: 10%;"></td> <td style="width: 10%;"></td> <td style="width: 10%;"></td> <td style="width: 10%;"></td> </tr> <tr> <td></td> <td></td> <td colspan="8" style="text-align: center;"> <table border="1" style="width: 100%; border-collapse: collapse; text-align: center;"> <tr> <td style="width: 10%;"></td> <td style="width: 10%;"></td> <td style="width: 10%;"></td> <td style="width: 10%;"></td> <td style="width: 10%;"></td> <td style="width: 10%;"></td> <td style="width: 10%;"></td> <td style="width: 10%;"></td> <td style="width: 10%;"></td> <td style="width: 10%;"></td> </tr> <tr> <td></td> <td></td> <td colspan="8" style="text-align: center;"> <table border="1" style="width: 100%; border-collapse: collapse; text-align: center;"> <tr> <td style="width: 10%;"></td> <td style="width: 10%;"></td> <td style="width: 10%;"></td> <td style="width: 10%;"></td> <td style="width: 10%;"></td> <td style="width: 10%;"></td> <td style="width: 10%;"></td> <td style="width: 10%;"></td> <td style="width: 10%;"></td> <td style="width: 10%;"></td> </tr> <tr> <td></td> <td></td> <td colspan="8" style="text-align: center;"> <table border="1" style="width: 100%; border-collapse: collapse; text-align: center;"> <tr> <td style="width: 10%;"></td> <td style="width: 10%;"></td> <td style="width: 10%;"></td> <td style="width: 10%;"></td> <td style="width: 10%;"></td> <td style="width: 10%;"></td> <td style="width: 10%;"></td> <td style="width: 10%;"></td> <td style="width: 10%;"></td> <td style="width: 10%;"></td> </tr> <tr> <td></td> <td></td> <td colspan="8" style="text-align: center;"> <table border="1" style="width: 100%; border-collapse: collapse; text-align: center;"> <tr> <td style="width: 10%;"></td> <td style="width: 10%;"></td> <td style="width: 10%;"></td> <td style="width: 10%;"></td> <td style="width: 10%;"></td> <td style="width: 10%;"></td> <td style="width: 10%;"></td> <td style="width: 10%;"></td> <td style="width: 10%;"></td> <td style="width: 10%;"></td> </tr> <tr> <td></td> <td></td> <td colspan="8" style="text-align: center;"> <table border="1" style="width: 100%; border-collapse: collapse; text-align: center;"> <tr> <td style="width: 10%;"></td> <td style="width: 10%;"></td> <td style="width: 10%;"></td> <td style="width: 10%;"></td> <td style="width: 10%;"></td> <td style="width: 10%;"></td> <td style="width: 10%;"></td> <td style="width: 10%;"></td> <td style="width: 10%;"></td> <td style="width: 10%;"></td> </tr> <tr> <td></td> <td></td> <td colspan="8" style="text-align: center;"> <table border="1" style="width: 100%; border-collapse: collapse; text-align: center;"> <tr> <td style="width: 10%;"></td> <td style="width: 10%;"></td> <td style="width: 10%;"></td> <td style="width: 10%;"></td> <td style="width: 10%;"></td> <td style="width: 10%;"></td> <td style="width: 10%;"></td> <td style="width: 10%;"></td> <td style="width: 10%;"></td> <td style="width: 10%;"></td> </tr> <tr> <td></td> <td></td> <td colspan="8" style="text-align: center;"> <table border="1" style="width: 100%; border-collapse: collapse; text-align: center;"> <tr> <td style="width: 10%;"></td> <td style="width: 10%;"></td> <td style="width: 10%;"></td> <td style="width: 10%;"></td> <td style="width: 10%;"></td> <td style="width: 10%;"></td> <td style="width: 10%;"></td> <td style="width: 10%;"></td> <td style="width: 10%;"></td> <td style="width: 10%;"></td> </tr> <tr> <td></td> <td></td> <td colspan="8" style="text-align: center;"> <table border="1" style="width: 100%; border-collapse: collapse; text-align: center;"> <tr> <td style="width: 10%;"></td> <td style="width: 10%;"></td> <td style="width: 10%;"></td> <td style="width: 10%;"></td> <td style="width: 10%;"></td> <td style="width: 10%;"></td> <td style="width: 10%;"></td> <td style="width: 10%;"></td> <td style="width: 10%;"></td> <td style="width: 10%;"></td> </tr> <tr> <td></td> <td></td> <td colspan="8" style="text-align: center;"> <table border="1" style="width: 100%; border-collapse: collapse; text-align: center;"> <tr> <td style="width: 10%;"></td> <td style="width: 10%;"></td> <td style="width: 10%;"></td> <td style="width: 10%;"></td> <td style="width: 10%;"></td> <td style="width: 10%;"></td> <td style="width: 10%;"></td> <td style="width: 10%;"></td> <td style="width: 10%;"></td> <td style="width: 10%;"></td> </tr> <tr> <td></td> <td></td> <td colspan="8" style="text-align: center;"> <table border="1" style="width: 100%; border-collapse: collapse; text-align: center;"> <tr> <td style="width: 10%;"></td> <td style="width: 10%;"></td> <td style="width: 10%;"></td> <td style="width: 10%;"></td> <td style="width: 10%;"></td> <td style="width: 10%;"></td> <td style="width: 10%;"></td> <td style="width: 10%;"></td> <td style="width: 10%;"></td> <td style="width: 10%;"></td> </tr> <tr> <td></td> <td></td> <td colspan="8" style="text-align: center;"> <table border="1" style="width: 100%; border-collapse: collapse; text-align: center;"> <tr> <td style="width: 10%;"></td> <td style="width: 10%;"></td> <td style="width: 10%;"></td> <td style="width: 10%;"></td> <td style="width: 10%;"></td> <td style="width: 10%;"></td> <td style="width: 10%;"></td> <td style="width: 10%;"></td> <td style="width: 10%;"></td> <td style="width: 10%;"></td> </tr> <tr> <td></td> <td></td> <td colspan="8" style="text-align: center;"> <table border="1" style="width: 100%; border-collapse: collapse; text-align: center;"> <tr> <td style="width: 10%;"></td> <td style="width: 10%;"></td> <td style="width: 10%;"></td> <td style="width: 10%;"></td> <td style="width: 10%;"></td> <td style="width: 10%;"></td> <td style="width: 10%;"></td> <td style="width: 10%;"></td> <td style="width: 10%;"></td> <td style="width: 10%;"></td> </tr> <tr> <td></td> <td></td> <td colspan="8" style="text-align: center;"> <table border="1" style="width: 100%; border-collapse: collapse; text-align: center;"> <tr> <td style="width: 10%;"></td> <td style="width: 10%;"></td> <td style="width: 10%;"></td> <td style="width: 10%;"></td> <td style="width: 10%;"></td> <td style="width: 10%;"></td> <td style="width: 10%;"></td> <td style="width: 10%;"></td> <td style="width: 10%;"></td> <td style="width: 10%;"></td> </tr> <tr> <td></td> <td></td> <td colspan="8" style="text-align: center;"> <table border="1" style="width: 100%; border-collapse: collapse; text-align: center;"> <tr> <td style="width: 10%;"></td> <td style="width: 10%;"></td> <td style="width: 10%;"></td> <td style="width: 10%;"></td> <td style="width: 10%;"></td> <td style="width: 10%;"></td> <td style="width: 10%;"></td> <td style="width: 10%;"></td> <td style="width: 10%;"></td> <td style="width: 10%;"></td> </tr> <tr> <td></td> <td></td> <td colspan="8" style="text-align: center;"> <table border="1" style="width: 100%; border-collapse: collapse; text-align: center;"> <tr> </tr></table></td></tr></table></td></tr></table></td></tr></table></td></tr></table></td></tr></table></td></tr></table></td></tr></table></td></tr></table></td></tr></table></td></tr></table></td></tr></table></td></tr></table></td></tr></table></td></tr></table></td></tr></table></td></tr></table></td></tr></table></td></tr></table></td></tr></table></td></tr></table></td></tr></table>
 | | | | | | | | | | | | | | | | | | | | <table border="1" style="width: 100%; border-collapse: collapse; text-align: center;"> <tr> <td style="width: 10%;"></td> <td style="width: 10%;"></td> <td style="width: 10%;"></td> <td style="width: 10%;"></td> <td style="width: 10%;"></td> <td style="width: 10%;"></td> <td style="width: 10%;"></td> <td style="width: 10%;"></td> <td style="width: 10%;"></td> <td style="width: 10%;"></td> </tr> <tr> <td></td> <td></td> <td colspan="8" style="text-align: center;"> <table border="1" style="width: 100%; border-collapse: collapse; text-align: center;"> <tr> <td style="width: 10%;"></td> <td style="width: 10%;"></td> <td style="width: 10%;"></td> <td style="width: 10%;"></td> <td style="width: 10%;"></td> <td style="width: 10%;"></td> <td style="width: 10%;"></td> <td style="width: 10%;"></td> <td style="width: 10%;"></td> <td style="width: 10%;"></td> </tr> <tr> <td></td> <td></td> <td colspan="8" style="text-align: center;"> <table border="1" style="width: 100%; border-collapse: collapse; text-align: center;"> <tr> <td style="width: 10%;"></td> <td style="width: 10%;"></td> <td style="width: 10%;"></td> <td style="width: 10%;"></td> <td style="width: 10%;"></td> <td style="width: 10%;"></td> <td style="width: 10%;"></td> <td style="width: 10%;"></td> <td style="width: 10%;"></td> <td style="width: 10%;"></td> </tr> <tr> <td></td> <td></td> <td colspan="8" style="text-align: center;"> <table border="1" style="width: 100%; border-collapse: collapse; text-align: center;"> <tr> <td style="width: 10%;"></td> <td style="width: 10%;"></td> <td style="width: 10%;"></td> <td style="width: 10%;"></td> <td style="width: 10%;"></td> <td style="width: 10%;"></td> <td style="width: 10%;"></td> <td style="width: 10%;"></td> <td style="width: 10%;"></td> <td style="width: 10%;"></td> </tr> <tr> <td></td> <td></td> <td colspan="8" style="text-align: center;"> <table border="1" style="width: 100%; border-collapse: collapse; text-align: center;"> <tr> <td style="width: 10%;"></td> <td style="width: 10%;"></td> <td style="width: 10%;"></td> <td style="width: 10%;"></td> <td style="width: 10%;"></td> <td style="width: 10%;"></td> <td style="width: 10%;"></td> <td style="width: 10%;"></td> <td style="width: 10%;"></td> <td style="width: 10%;"></td> </tr> <tr> <td></td> <td></td> <td colspan="8" style="text-align: center;"> <table border="1" style="width: 100%; border-collapse: collapse; text-align: center;"> <tr> <td style="width: 10%;"></td> <td style="width: 10%;"></td> <td style="width: 10%;"></td> <td style="width: 10%;"></td> <td style="width: 10%;"></td> <td style="width: 10%;"></td> <td style="width: 10%;"></td> <td style="width: 10%;"></td> <td style="width: 10%;"></td> <td style="width: 10%;"></td> </tr> <tr> <td></td> <td></td> <td colspan="8" style="text-align: center;"> <table border="1" style="width: 100%; border-collapse: collapse; text-align: center;"> <tr> <td style="width: 10%;"></td> <td style="width: 10%;"></td> <td style="width: 10%;"></td> <td style="width: 10%;"></td> <td style="width: 10%;"></td> <td style="width: 10%;"></td> <td style="width: 10%;"></td> <td style="width: 10%;"></td> <td style="width: 10%;"></td> <td style="width: 10%;"></td> </tr> <tr> <td></td> <td></td> <td colspan="8" style="text-align: center;"> <table border="1" style="width: 100%; border-collapse: collapse; text-align: center;"> <tr> <td style="width: 10%;"></td> <td style="width: 10%;"></td> <td style="width: 10%;"></td> <td style="width: 10%;"></td> <td style="width: 10%;"></td> <td style="width: 10%;"></td> <td style="width: 10%;"></td> <td style="width: 10%;"></td> <td style="width: 10%;"></td> <td style="width: 10%;"></td> </tr> <tr> <td></td> <td></td> <td colspan="8" style="text-align: center;"> <table border="1" style="width: 100%; border-collapse: collapse; text-align: center;"> <tr> <td style="width: 10%;"></td> <td style="width: 10%;"></td> <td style="width: 10%;"></td> <td style="width: 10%;"></td> <td style="width: 10%;"></td> <td style="width: 10%;"></td> <td style="width: 10%;"></td> <td style="width: 10%;"></td> <td style="width: 10%;"></td> <td style="width: 10%;"></td> </tr> <tr> <td></td> <td></td> <td colspan="8" style="text-align: center;"> <table border="1" style="width: 100%; border-collapse: collapse; text-align: center;"> <tr> <td style="width: 10%;"></td> <td style="width: 10%;"></td> <td style="width: 10%;"></td> <td style="width: 10%;"></td> <td style="width: 10%;"></td> <td style="width: 10%;"></td> <td style="width: 10%;"></td> <td style="width: 10%;"></td> <td style="width: 10%;"></td> <td style="width: 10%;"></td> </tr> <tr> <td></td> <td></td> <td colspan="8" style="text-align: center;"> <table border="1" style="width: 100%; border-collapse: collapse; text-align: center;"> <tr> <td style="width: 10%;"></td> <td style="width: 10%;"></td> <td style="width: 10%;"></td> <td style="width: 10%;"></td> <td style="width: 10%;"></td> <td style="width: 10%;"></td> <td style="width: 10%;"></td> <td style="width: 10%;"></td> <td style="width: 10%;"></td> <td style="width: 10%;"></td> </tr> <tr> <td></td> <td></td> <td colspan="8" style="text-align: center;"> <table border="1" style="width: 100%; border-collapse: collapse; text-align: center;"> <tr> <td style="width: 10%;"></td> <td style="width: 10%;"></td> <td style="width: 10%;"></td> <td style="width: 10%;"></td> <td style="width: 10%;"></td> <td style="width: 10%;"></td> <td style="width: 10%;"></td> <td style="width: 10%;"></td> <td style="width: 10%;"></td> <td style="width: 10%;"></td> </tr> <tr> <td></td> <td></td> <td colspan="8" style="text-align: center;"> <table border="1" style="width: 100%; border-collapse: collapse; text-align: center;"> <tr> <td style="width: 10%;"></td> <td style="width: 10%;"></td> <td style="width: 10%;"></td> <td style="width: 10%;"></td> <td style="width: 10%;"></td> <td style="width: 10%;"></td> <td style="width: 10%;"></td> <td style="width: 10%;"></td> <td style="width: 10%;"></td> <td style="width: 10%;"></td> </tr> <tr> <td></td> <td></td> <td colspan="8" style="text-align: center;"> <table border="1" style="width: 100%; border-collapse: collapse; text-align: center;"> <tr> <td style="width: 10%;"></td> <td style="width: 10%;"></td> <td style="width: 10%;"></td> <td style="width: 10%;"></td> <td style="width: 10%;"></td> <td style="width: 10%;"></td> <td style="width: 10%;"></td> <td style="width: 10%;"></td> <td style="width: 10%;"></td> <td style="width: 10%;"></td> </tr> <tr> <td></td> <td></td> <td colspan="8" style="text-align: center;"> <table border="1" style="width: 100%; border-collapse: collapse; text-align: center;"> <tr> <td style="width: 10%;"></td> <td style="width: 10%;"></td> <td style="width: 10%;"></td> <td style="width: 10%;"></td> <td style="width: 10%;"></td> <td style="width: 10%;"></td> <td style="width: 10%;"></td> <td style="width: 10%;"></td> <td style="width: 10%;"></td> <td style="width: 10%;"></td> </tr> <tr> <td></td> <td></td> <td colspan="8" style="text-align: center;"> <table border="1" style="width: 100%; border-collapse: collapse; text-align: center;"> <tr> <td style="width: 10%;"></td> <td style="width: 10%;"></td> <td style="width: 10%;"></td> <td style="width: 10%;"></td> <td style="width: 10%;"></td> <td style="width: 10%;"></td> <td style="width: 10%;"></td> <td style="width: 10%;"></td> <td style="width: 10%;"></td> <td style="width: 10%;"></td> </tr> <tr> <td></td> <td></td> <td colspan="8" style="text-align: center;"> <table border="1" style="width: 100%; border-collapse: collapse; text-align: center;"> <tr> <td style="width: 10%;"></td> <td style="width: 10%;"></td> <td style="width: 10%;"></td> <td style="width: 10%;"></td> <td style="width: 10%;"></td> <td style="width: 10%;"></td> <td style="width: 10%;"></td> <td style="width: 10%;"></td> <td style="width: 10%;"></td> <td style="width: 10%;"></td> </tr> <tr> <td></td> <td></td> <td colspan="8" style="text-align: center;"> <table border="1" style="width: 100%; border-collapse: collapse; text-align: center;"> <tr> <td style="width: 10%;"></td> <td style="width: 10%;"></td> <td style="width: 10%;"></td> <td style="width: 10%;"></td> <td style="width: 10%;"></td> <td style="width: 10%;"></td> <td style="width: 10%;"></td> <td style="width: 10%;"></td> <td style="width: 10%;"></td> <td style="width: 10%;"></td> </tr> <tr> <td></td> <td></td> <td colspan="8" style="text-align: center;"> <table border="1" style="width: 100%; border-collapse: collapse; text-align: center;"> <tr> <td style="width: 10%;"></td> <td style="width: 10%;"></td> <td style="width: 10%;"></td> <td style="width: 10%;"></td>
<td style="width: 10%;"></td> <td style="width: 10%;"></td> <td style="width: 10%;"></td> <td style="width: 10%;"></td> <td style="width: 10%;"></td> <td style="width: 10%;"></td> </tr> <tr> <td></td> <td></td> <td colspan="8" style="text-align: center;"> <table border="1" style="width: 100%; border-collapse: collapse; text-align: center;"> <tr> <td style="width: 10%;"></td> <td style="width: 10%;"></td> <td style="width: 10%;"></td> <td style="width: 10%;"></td> <td style="width: 10%;"></td> <td style="width: 10%;"></td> <td style="width: 10%;"></td> <td style="width: 10%;"></td> <td style="width: 10%;"></td> <td style="width: 10%;"></td> </tr> <tr> <td></td> <td></td> <td colspan="8" style="text-align: center;"> <table border="1" style="width: 100%; border-collapse: collapse; text-align: center;"> <tr> </tr></table></td></tr></table></td></tr></table></td></tr></table></td></tr></table></td></tr></table></td></tr></table></td></tr></table></td></tr></table></td></tr></table></td></tr></table></td></tr></table></td></tr></table></td></tr></table></td></tr></table></td></tr></table></td></tr></table></td></tr></table></td></tr></table></td></tr></table></td></tr></table> | | | | | | | | | | | | | | | | | | | | <table border="1" style="width: 100%; border-collapse: collapse; text-align: center;"> <tr> <td style="width: 10%;"></td> <td style="width: 10%;"></td> <td style="width: 10%;"></td> <td style="width: 10%;"></td> <td style="width: 10%;"></td> <td style="width: 10%;"></td> <td style="width: 10%;"></td> <td style="width: 10%;"></td> <td style="width: 10%;"></td> <td style="width: 10%;"></td> </tr> <tr> <td></td> <td></td> <td colspan="8" style="text-align: center;"> <table border="1" style="width: 100%; border-collapse: collapse; text-align: center;"> <tr> <td style="width: 10%;"></td> <td style="width: 10%;"></td> <td style="width: 10%;"></td> <td style="width: 10%;"></td> <td style="width: 10%;"></td> <td style="width: 10%;"></td> <td style="width: 10%;"></td> <td style="width: 10%;"></td> <td style="width: 10%;"></td> <td style="width: 10%;"></td> </tr> <tr> <td></td> <td></td> <td colspan="8" style="text-align: center;"> <table border="1" style="width: 100%; border-collapse: collapse; text-align: center;"> <tr> <td style="width: 10%;"></td> <td style="width: 10%;"></td> <td style="width: 10%;"></td> <td style="width: 10%;"></td> <td style="width: 10%;"></td> <td style="width: 10%;"></td> <td style="width: 10%;"></td> <td style="width: 10%;"></td> <td style="width: 10%;"></td> <td style="width: 10%;"></td> </tr> <tr> <td></td> <td></td> <td colspan="8" style="text-align: center;"> <table border="1" style="width: 100%; border-collapse: collapse; text-align: center;"> <tr> <td style="width: 10%;"></td> <td style="width: 10%;"></td> <td style="width: 10%;"></td> <td style="width: 10%;"></td> <td style="width: 10%;"></td> <td style="width: 10%;"></td> <td style="width: 10%;"></td> <td style="width: 10%;"></td> <td style="width: 10%;"></td> <td style="width: 10%;"></td> </tr> <tr> <td></td> <td></td> <td colspan="8" style="text-align: center;"> <table border="1" style="width: 100%; border-collapse: collapse; text-align: center;"> <tr> <td style="width: 10%;"></td> <td style="width: 10%;"></td> <td style="width: 10%;"></td> <td style="width: 10%;"></td> <td style="width: 10%;"></td> <td style="width: 10%;"></td> <td style="width: 10%;"></td> <td style="width: 10%;"></td> <td style="width: 10%;"></td> <td style="width: 10%;"></td> </tr> <tr> <td></td> <td></td> <td colspan="8" style="text-align: center;"> <table border="1" style="width: 100%; border-collapse: collapse; text-align: center;"> <tr> <td style="width: 10%;"></td> <td style="width: 10%;"></td> <td style="width: 10%;"></td> <td style="width: 10%;"></td> <td style="width: 10%;"></td> <td style="width: 10%;"></td> <td style="width: 10%;"></td> <td style="width: 10%;"></td> <td style="width: 10%;"></td> <td style="width: 10%;"></td> </tr> <tr> <td></td> <td></td> <td colspan="8" style="text-align: center;"> <table border="1" style="width: 100%; border-collapse: collapse; text-align: center;"> <tr> <td style="width: 10%;"></td> <td style="width: 10%;"></td> <td style="width: 10%;"></td> <td style="width: 10%;"></td> <td style="width: 10%;"></td> <td style="width: 10%;"></td> <td style="width: 10%;"></td> <td style="width: 10%;"></td> <td style="width: 10%;"></td> <td style="width: 10%;"></td> </tr> <tr> <td></td> <td></td> <td colspan="8" style="text-align: center;"> <table border="1" style="width: 100%; border-collapse: collapse; text-align: center;"> <tr> <td style="width: 10%;"></td> <td style="width: 10%;"></td> <td style="width: 10%;"></td> <td style="width: 10%;"></td> <td style="width: 10%;"></td> <td style="width: 10%;"></td> <td style="width: 10%;"></td> <td style="width: 10%;"></td> <td style="width: 10%;"></td> <td style="width: 10%;"></td> </tr> <tr> <td></td> <td></td> <td colspan="8" style="text-align: center;"> <table border="1" style="width: 100%; border-collapse: collapse; text-align: center;"> <tr> <td style="width: 10%;"></td> <td style="width: 10%;"></td> <td style="width: 10%;"></td> <td style="width: 10%;"></td> <td style="width: 10%;"></td> <td style="width: 10%;"></td> <td style="width: 10%;"></td> <td style="width: 10%;"></td> <td style="width: 10%;"></td> <td style="width: 10%;"></td> </tr> <tr> <td></td> <td></td> <td colspan="8" style="text-align: center;"> <table border="1" style="width: 100%; border-collapse: collapse; text-align: center;"> <tr> <td style="width: 10%;"></td> <td style="width: 10%;"></td> <td style="width: 10%;"></td> <td style="width: 10%;"></td> <td style="width: 10%;"></td> <td style="width: 10%;"></td> <td style="width: 10%;"></td> <td style="width: 10%;"></td> <td style="width: 10%;"></td> <td style="width: 10%;"></td> </tr> <tr> <td></td> <td></td> <td colspan="8" style="text-align: center;"> <table border="1" style="width: 100%; border-collapse: collapse; text-align: center;"> <tr> <td style="width: 10%;"></td> <td style="width: 10%;"></td> <td style="width: 10%;"></td>
<td style="width: 10%;"></td> <td style="width: 10%;"></td> <td style="width: 10%;"></td> <td style="width: 10%;"></td> <td style="width: 10%;"></td> <td style="width: 10%;"></td> <td style="width: 10%;"></td> </tr> <tr> <td></td> <td></td> <td colspan="8" style="text-align: center;"> <table border="1" style="width: 100%; border-collapse: collapse; text-align: center;"> <tr> <td style="width: 10%;"></td> <td style="width: 10%;"></td> <td style="width: 10%;"></td> <td style="width: 10%;"></td> <td style="width: 10%;"></td> <td style="width: 10%;"></td> <td style="width: 10%;"></td> <td style="width: 10%;"></td> <td style="width: 10%;"></td> <td style="width: 10%;"></td> </tr> <tr> <td></td> <td></td> <td colspan="8" style="text-align: center;"> <table border="1" style="width: 100%; border-collapse: collapse; text-align: center;"> <tr> <td style="width: 10%;"></td> <td style="width: 10%;"></td> <td style="width: 10%;"></td> <td style="width: 10%;"></td> <td style="width: 10%;"></td> <td style="width: 10%;"></td> <td style="width: 10%;"></td> <td style="width: 10%;"></td> <td style="width: 10%;"></td> <td style="width: 10%;"></td> </tr> <tr> <td></td> <td></td> <td colspan="8" style="text-align: center;"> <table border="1" style="width: 100%; border-collapse: collapse; text-align: center;"> <tr> <td style="width: 10%;"></td> <td style="width: 10%;"></td> <td style="width: 10%;"></td> <td style="width: 10%;"></td> <td style="width: 10%;"></td> <td style="width: 10%;"></td> <td style="width: 10%;"></td> <td style="width: 10%;"></td> <td style="width: 10%;"></td> <td style="width: 10%;"></td> </tr> <tr> <td></td> <td></td> <td colspan="8" style="text-align: center;"> <table border="1" style="width: 100%; border-collapse: collapse; text-align: center;"> <tr> <td style="width: 10%;"></td> <td style="width: 10%;"></td> <td style="width: 10%;"></td> <td style="width: 10%;"></td> <td style="width: 10%;"></td> <td style="width: 10%;"></td> <td style="width: 10%;"></td> <td style="width: 10%;"></td> <td style="width: 10%;"></td> <td style="width: 10%;"></td> </tr> <tr> <td></td> <td></td> <td colspan="8" style="text-align: center;"> <table border="1" style="width: 100%; border-collapse: collapse; text-align: center;"> <tr> <td style="width: 10%;"></td> <td style="width: 10%;"></td> <td style="width: 10%;"></td> <td style="width: 10%;"></td> <td style="width: 10%;"></td> <td style="width: 10%;"></td> <td style="width: 10%;"></td> <td style="width: 10%;"></td> <td style="width: 10%;"></td> <td style="width: 10%;"></td> </tr> <tr> <td></td> <td></td> <td colspan="8" style="text-align: center;"> <table border="1" style="width: 100%; border-collapse: collapse; text-align: center;"> <tr> <td style="width: 10%;"></td> <td style="width: 10%;"></td> <td style="width: 10%;"></td> <td style="width: 10%;"></td> <td style="width: 10%;"></td> <td style="width: 10%;"></td> <td style="width: 10%;"></td> <td style="width: 10%;"></td> <td style="width: 10%;"></td> <td style="width: 10%;"></td> </tr> <tr> <td></td> <td></td> <td colspan="8" style="text-align: center;"> <table border="1" style="width: 100%; border-collapse: collapse; text-align: center;"> <tr> <td style="width: 10%;"></td> <td style="width: 10%;"></td> <td style="width: 10%;"></td> <td style="width: 10%;"></td> <td style="width: 10%;"></td> <td style="width: 10%;"></td> <td style="width: 10%;"></td> <td style="width: 10%;"></td> <td style="width: 10%;"></td> <td style="width: 10%;"></td> </tr> <tr> <td></td> <td></td> <td colspan="8" style="text-align: center;"> <table border="1" style="width: 100%; border-collapse: collapse; text-align: center;"> <tr> <td style="width: 10%;"></td> <td style="width: 10%;"></td> <td style="width: 10%;"></td> <td style="width: 10%;"></td> <td style="width: 10%;"></td> <td style="width: 10%;"></td> <td style="width: 10%;"></td> <td style="width: 10%;"></td> <td style="width: 10%;"></td> <td style="width: 10%;"></td> </tr> <tr> <td></td> <td></td> <td colspan="8" style="text-align: center;"> <table border="1" style="width: 100%; border-collapse: collapse; text-align: center;"> <tr> </tr></table></td></tr></table></td></tr></table></td></tr></table></td></tr></table></td></tr></table></td></tr></table></td></tr></table></td></tr></table></td></tr></table></td></tr></table></td></tr></table></td></tr></table></td></tr></table></td></tr></table></td></tr></table></td></tr></table></td></tr></table></td></tr></table></td></tr></table> | | | | | | | | | | | | | | | | | | | | <table border="1" style="width: 100%; border-collapse: collapse; text-align: center;"> <tr> <td style="width: 10%;"></td> <td style="width: 10%;"></td> <td style="width: 10%;"></td> <td style="width: 10%;"></td> <td style="width: 10%;"></td> <td style="width: 10%;"></td> <td style="width: 10%;"></td> <td style="width: 10%;"></td> <td style="width: 10%;"></td> <td style="width: 10%;"></td> </tr> <tr> <td></td> <td></td> <td colspan="8" style="text-align: center;"> <table border="1" style="width: 100%; border-collapse: collapse; text-align: center;"> <tr> <td style="width: 10%;"></td> <td style="width: 10%;"></td> <td style="width: 10%;"></td> <td style="width: 10%;"></td> <td style="width: 10%;"></td> <td style="width: 10%;"></td> <td style="width: 10%;"></td> <td style="width: 10%;"></td> <td style="width: 10%;"></td> <td style="width: 10%;"></td> </tr> <tr> <td></td> <td></td> <td colspan="8" style="text-align: center;"> <table border="1" style="width: 100%; border-collapse: collapse; text-align: center;"> <tr> <td style="width: 10%;"></td> <td style="width: 10%;"></td> <td style="width: 10%;"></td> <td style="width: 10%;"></td> <td style="width: 10%;"></td> <td style="width: 10%;"></td> <td style="width: 10%;"></td> <td style="width: 10%;"></td> <td style="width: 10%;"></td> <td style="width: 10%;"></td> </tr> <tr> <td></td> <td></td> <td colspan="8" style="text-align: center;"> <table border="1" style="width: 100%; border-collapse: collapse; text-align: center;"> <tr> <td style="width: 10%;"></td> <td style="width: 10%;"></td> <td style="width:
10%;"></td> <td style="width: 10%;"></td> <td style="width: 10%;"></td> <td style="width: 10%;"></td> <td style="width: 10%;"></td> <td style="width: 10%;"></td> <td style="width: 10%;"></td> <td style="width: 10%;"></td> </tr> <tr> <td></td> <td></td> <td colspan="8" style="text-align: center;"> <table border="1" style="width: 100%; border-collapse: collapse; text-align: center;"> <tr> <td style="width: 10%;"></td> <td style="width: 10%;"></td> <td style="width: 10%;"></td> <td style="width: 10%;"></td> <td style="width: 10%;"></td> <td style="width: 10%;"></td> <td style="width: 10%;"></td> <td style="width: 10%;"></td> <td style="width: 10%;"></td> <td style="width: 10%;"></td> </tr> <tr> <td></td> <td></td> <td colspan="8" style="text-align: center;"> <table border="1" style="width: 100%; border-collapse: collapse; text-align: center;"> <tr> <td style="width: 10%;"></td> <td style="width: 10%;"></td> <td style="width: 10%;"></td> <td style="width: 10%;"></td> <td style="width: 10%;"></td> <td style="width: 10%;"></td> <td style="width: 10%;"></td> <td style="width: 10%;"></td> <td style="width: 10%;"></td> <td style="width: 10%;"></td> </tr> <tr> <td></td> <td></td> <td colspan="8" style="text-align: center;"> <table border="1" style="width: 100%; border-collapse: collapse; text-align: center;"> <tr> <td style="width: 10%;"></td> <td style="width: 10%;"></td> <td style="width: 10%;"></td> <td style="width: 10%;"></td> <td style="width: 10%;"></td> <td style="width: 10%;"></td> <td style="width: 10%;"></td> <td style="width: 10%;"></td> <td style="width: 10%;"></td> <td style="width: 10%;"></td> </tr> <tr> <td></td> <td></td> <td colspan="8" style="text-align: center;"> <table border="1" style="width: 100%; border-collapse: collapse; text-align: center;"> <tr> <td style="width: 10%;"></td> <td style="width: 10%;"></td> <td style="width: 10%;"></td> <td style="width: 10%;"></td> <td style="width: 10%;"></td> <td style="width: 10%;"></td> <td style="width: 10%;"></td> <td style="width: 10%;"></td> <td style="width: 10%;"></td> <td style="width: 10%;"></td> </tr> <tr> <td></td> <td></td> <td colspan="8" style="text-align: center;"> <table border="1" style="width: 100%; border-collapse: collapse; text-align: center;"> <tr> <td style="width: 10%;"></td> <td style="width: 10%;"></td> <td style="width: 10%;"></td> <td style="width: 10%;"></td> <td style="width: 10%;"></td> <td style="width: 10%;"></td> <td style="width: 10%;"></td> <td style="width: 10%;"></td> <td style="width: 10%;"></td> <td style="width: 10%;"></td> </tr> <tr> <td></td> <td></td> <td colspan="8" style="text-align: center;"> <table border="1" style="width: 100%; border-collapse: collapse; text-align: center;"> <tr> <td style="width: 10%;"></td> <td style="width: 10%;"></td> <td style="width: 10%;"></td> <td style="width: 10%;"></td> <td style="width: 10%;"></td> <td style="width: 10%;"></td> <td style="width: 10%;"></td> <td style="width: 10%;"></td> <td style="width: 10%;"></td> <td style="width: 10%;"></td> </tr> <tr> <td></td> <td></td> <td colspan="8" style="text-align: center;"> <table border="1" style="width: 100%; border-collapse: collapse; text-align: center;"> <tr> <td style="width: 10%;"></td> <td style="width: 10%;"></td> <td style="width: 10%;"></td> <td style="width: 10%;"></td> <td style="width: 10%;"></td> <td style="width: 10%;"></td> <td style="width: 10%;"></td> <td style="width: 10%;"></td> <td style="width: 10%;"></td> <td style="width: 10%;"></td> </tr> <tr> <td></td> <td></td> <td colspan="8" style="text-align: center;"> <table border="1" style="width: 100%; border-collapse: collapse; text-align: center;"> <tr> <td style="width: 10%;"></td> <td style="width: 10%;"></td> <td style="width: 10%;"></td> <td style="width: 10%;"></td> <td style="width: 10%;"></td> <td style="width: 10%;"></td> <td style="width: 10%;"></td> <td style="width: 10%;"></td> <td style="width: 10%;"></td> <td style="width: 10%;"></td> </tr> <tr> <td></td> <td></td> <td colspan="8" style="text-align: center;"> <table border="1" style="width: 100%; border-collapse: collapse; text-align: center;"> <tr> <td style="width: 10%;"></td> <td style="width: 10%;"></td> <td style="width: 10%;"></td> <td style="width: 10%;"></td> <td style="width: 10%;"></td> <td style="width: 10%;"></td> <td style="width: 10%;"></td> <td style="width: 10%;"></td> <td style="width: 10%;"></td> <td style="width: 10%;"></td> </tr> <tr> <td></td> <td></td> <td colspan="8" style="text-align: center;"> <table border="1" style="width: 100%; border-collapse: collapse; text-align: center;"> <tr> <td style="width: 10%;"></td> <td style="width: 10%;"></td> <td style="width: 10%;"></td> <td style="width: 10%;"></td> <td style="width: 10%;"></td> <td style="width: 10%;"></td> <td style="width: 10%;"></td> <td style="width: 10%;"></td> <td style="width: 10%;"></td> <td style="width: 10%;"></td> </tr> <tr> <td></td> <td></td> <td colspan="8" style="text-align: center;"> <table border="1" style="width: 100%; border-collapse: collapse; text-align: center;"> <tr> <td style="width: 10%;"></td> <td style="width: 10%;"></td> <td style="width: 10%;"></td> <td style="width: 10%;"></td> <td style="width: 10%;"></td> <td style="width: 10%;"></td> <td style="width: 10%;"></td> <td style="width: 10%;"></td> <td style="width: 10%;"></td> <td style="width: 10%;"></td> </tr> <tr> <td></td> <td></td> <td colspan="8" style="text-align: center;"> <table border="1" style="width: 100%; border-collapse: collapse; text-align: center;"> <tr> <td style="width: 10%;"></td> <td style="width: 10%;"></td> <td style="width: 10%;"></td> <td style="width: 10%;"></td> <td style="width: 10%;"></td> <td style="width: 10%;"></td> <td style="width: 10%;"></td> <td style="width: 10%;"></td> <td style="width: 10%;"></td> <td style="width: 10%;"></td> </tr> <tr> <td></td> <td></td> <td colspan="8" style="text-align: center;"> <table border="1" style="width: 100%; border-collapse: collapse; text-align: center;"> <tr> <td style="width: 10%;"></td> <td style="width: 10%;"></td> <td style="width: 10%;"></td> <td style="width: 10%;"></td> <td style="width: 10%;"></td> <td style="width: 10%;"></td> <td style="width: 10%;"></td> <td style="width: 10%;"></td> <td style="width: 10%;"></td> <td style="width: 10%;"></td> </tr> <tr> <td></td> <td></td> <td colspan="8" style="text-align: center;"> <table border="1" style="width: 100%; border-collapse: collapse; text-align: center;"> <tr> <td style="width: 10%;"></td> <td style="width: 10%;"></td> <td style="width: 10%;"></td> <td style="width: 10%;"></td> <td style="width: 10%;"></td> <td style="width: 10%;"></td> <td style="width: 10%;"></td> <td style="width: 10%;"></td> <td style="width: 10%;"></td> <td style="width: 10%;"></td> </tr> <tr> <td></td> <td></td> <td colspan="8" style="text-align: center;"> <table border="1" style="width: 100%; border-collapse: collapse; text-align: center;"> <tr> </tr></table></td></tr></table></td></tr></table></td></tr></table></td></tr></table></td></tr></table></td></tr></table></td></tr></table></td></tr></table></td></tr></table></td></tr></table></td></tr></table></td></tr></table></td></tr></table></td></tr></table></td></tr></table></td></tr></table></td></tr></table></td></tr></table>
 | | | | | | | | | | | | | | | | | | | | <table border="1" style="width: 100%; border-collapse: collapse; text-align: center;"> <tr> <td style="width: 10%;"></td> <td style="width: 10%;"></td> <td style="width: 10%;"></td> <td style="width: 10%;"></td> <td style="width: 10%;"></td> <td style="width: 10%;"></td> <td style="width: 10%;"></td> <td style="width: 10%;"></td> <td style="width: 10%;"></td> <td style="width: 10%;"></td> </tr> <tr> <td></td> <td></td> <td colspan="8" style="text-align: center;"> <table border="1" style="width: 100%; border-collapse: collapse; text-align: center;"> <tr> <td style="width: 10%;"></td> <td style="width: 10%;"></td> <td style="width: 10%;"></td> <td style="width: 10%;"></td> <td style="width: 10%;"></td> <td style="width: 10%;"></td> <td style="width: 10%;"></td> <td style="width: 10%;"></td> <td style="width: 10%;"></td> <td style="width: 10%;"></td> </tr> <tr> <td></td> <td></td> <td colspan="8" style="text-align: center;"> <table border="1" style="width: 100%; border-collapse: collapse; text-align: center;"> <tr> <td style="width: 10%;"></td> <td style="width: 10%;"></td> <td style="width: 10%;"></td> <td style="width: 10%;"></td> <td style="width: 10%;"></td> <td style="width: 10%;"></td> <td style="width: 10%;"></td> <td style="width: 10%;"></td> <td style="width: 10%;"></td> <td style="width: 10%;"></td> </tr> <tr> <td></td> <td></td> <td colspan="8" style="text-align: center;"> <table border="1" style="width: 100%; border-collapse: collapse; text-align: center;"> <tr> <td style="width: 10%;"></td> <td style="width: 10%;"></td> <td style="width: 10%;"></td> <td style="width: 10%;"></td> <td style="width: 10%;"></td> <td style="width: 10%;"></td> <td style="width: 10%;"></td> <td style="width: 10%;"></td> <td style="width: 10%;"></td> <td style="width: 10%;"></td> </tr> <tr> <td></td> <td></td> <td colspan="8" style="text-align: center;"> <table border="1" style="width: 100%; border-collapse: collapse; text-align: center;"> <tr> <td style="width: 10%;"></td> <td style="width: 10%;"></td> <td style="width: 10%;"></td> <td style="width: 10%;"></td> <td style="width: 10%;"></td> <td style="width: 10%;"></td> <td style="width: 10%;"></td> <td style="width: 10%;"></td> <td style="width: 10%;"></td> <td style="width: 10%;"></td> </tr> <tr> <td></td> <td></td> <td colspan="8" style="text-align: center;"> <table border="1" style="width: 100%; border-collapse: collapse; text-align: center;"> <tr> <td style="width: 10%;"></td> <td style="width: 10%;"></td> <td style="width: 10%;"></td> <td style="width: 10%;"></td> <td style="width: 10%;"></td> <td style="width: 10%;"></td> <td style="width: 10%;"></td> <td style="width: 10%;"></td> <td style="width: 10%;"></td> <td style="width: 10%;"></td> </tr> <tr> <td></td> <td></td> <td colspan="8" style="text-align: center;"> <table border="1" style="width: 100%; border-collapse: collapse; text-align: center;"> <tr> <td style="width: 10%;"></td> <td style="width: 10%;"></td> <td style="width: 10%;"></td> <td style="width: 10%;"></td> <td style="width: 10%;"></td> <td style="width: 10%;"></td> <td style="width: 10%;"></td> <td style="width: 10%;"></td> <td style="width: 10%;"></td> <td style="width: 10%;"></td> </tr> <tr> <td></td> <td></td> <td colspan="8" style="text-align: center;"> <table border="1" style="width: 100%; border-collapse: collapse; text-align: center;"> <tr> <td style="width: 10%;"></td> <td style="width: 10%;"></td> <td style="width: 10%;"></td> <td style="width: 10%;"></td> <td style="width: 10%;"></td> <td style="width: 10%;"></td> <td style="width: 10%;"></td> <td style="width: 10%;"></td> <td style="width: 10%;"></td> <td style="width: 10%;"></td> </tr> <tr> <td></td> <td></td> <td colspan="8" style="text-align: center;"> <table border="1" style="width: 100%; border-collapse: collapse; text-align: center;"> <tr> <td style="width: 10%;"></td> <td style="width: 10%;"></td> <td style="width: 10%;"></td> <td style="width: 10%;"></td> <td style="width: 10%;"></td> <td style="width: 10%;"></td> <td style="width: 10%;"></td> <td style="width: 10%;"></td> <td style="width: 10%;"></td> <td style="width: 10%;"></td> </tr> <tr> <td></td> <td></td> <td colspan="8" style="text-align: center;"> <table border="1" style="width: 100%; border-collapse: collapse; text-align: center;"> <tr> <td style="width: 10%;"></td> <td style="width: 10%;"></td> <td style="width: 10%;"></td> <td style="width: 10%;"></td> <td style="width: 10%;"></td> <td style="width: 10%;"></td> <td style="width: 10%;"></td> <td style="width: 10%;"></td> <td style="width: 10%;"></td> <td style="width: 10%;"></td> </tr> <tr> <td></td> <td></td> <td colspan="8" style="text-align: center;"> <table border="1" style="width: 100%; border-collapse: collapse; text-align: center;"> <tr> <td style="width: 10%;"></td> <td style="width: 10%;"></td> <td style="width: 10%;"></td> <td style="width: 10%;"></td> <td style="width: 10%;"></td> <td style="width: 10%;"></td> <td style="width: 10%;"></td> <td style="width: 10%;"></td> <td style="width: 10%;"></td> <td style="width: 10%;"></td> </tr> <tr> <td></td> <td></td> <td colspan="8" style="text-align: center;"> <table border="1" style="width: 100%; border-collapse: collapse; text-align: center;"> <tr> <td style="width: 10%;"></td> <td style="width: 10%;"></td> <td style="width: 10%;"></td> <td style="width: 10%;"></td> <td style="width: 10%;"></td> <td style="width: 10%;"></td> <td style="width: 10%;"></td> <td style="width: 10%;"></td> <td style="width: 10%;"></td> <td style="width: 10%;"></td> </tr> <tr> <td></td> <td></td> <td colspan="8" style="text-align: center;"> <table border="1" style="width: 100%; border-collapse: collapse; text-align: center;"> <tr> <td style="width: 10%;"></td> <td style="width: 10%;"></td> <td style="width: 10%;"></td> <td style="width: 10%;"></td> <td style="width: 10%;"></td> <td style="width: 10%;"></td> <td style="width: 10%;"></td> <td style="width: 10%;"></td> <td style="width: 10%;"></td> <td style="width: 10%;"></td> </tr> <tr> <td></td> <td></td> <td colspan="8" style="text-align: center;"> <table border="1" style="width: 100%; border-collapse: collapse; text-align: center;"> <tr> <td style="width: 10%;"></td> <td style="width: 10%;"></td> <td style="width: 10%;"></td> <td style="width: 10%;"></td> <td style="width: 10%;"></td> <td style="width: 10%;"></td> <td style="width: 10%;"></td> <td style="width: 10%;"></td> <td style="width: 10%;"></td> <td style="width: 10%;"></td> </tr> <tr> <td></td> <td></td> <td colspan="8" style="text-align: center;"> <table border="1" style="width: 100%; border-collapse: collapse; text-align: center;"> <tr> <td style="width: 10%;"></td> <td style="width: 10%;"></td> <td style="width: 10%;"></td> <td style="width: 10%;"></td> <td style="width: 10%;"></td> <td style="width: 10%;"></td> <td style="width: 10%;"></td> <td style="width: 10%;"></td> <td style="width: 10%;"></td> <td style="width: 10%;"></td> </tr> <tr> <td></td> <td></td> <td colspan="8" style="text-align: center;"> <table border="1" style="width: 100%; border-collapse: collapse; text-align: center;"> <tr> <td style="width: 10%;"></td> <td style="width: 10%;"></td> <td style="width: 10%;"></td> <td style="width: 10%;"></td> <td style="width: 10%;"></td> <td style="width: 10%;"></td> <td style="width: 10%;"></td> <td style="width: 10%;"></td> <td style="width: 10%;"></td> <td style="width: 10%;"></td> </tr> <tr> <td></td> <td></td> <td colspan="8" style="text-align: center;"> <table border="1" style="width: 100%; border-collapse: collapse; text-align: center;"> <tr> <td style="width: 10%;"></td> <td style="width: 10%;"></td> <td style="width: 10%;"></td> <td style="width: 10%;"></td> <td style="width: 10%;"></td> <td style="width: 10%;"></td> <td style="width: 10%;"></td> <td style="width: 10%;"></td> <td style="width: 10%;"></td> <td style="width: 10%;"></td> </tr> <tr> <td></td> <td></td> <td colspan="8" style="text-align: center;"> <table border="1" style="width: 100%; border-collapse: collapse; text-align: center;"> <tr> </tr></table></td></tr></table></td></tr></table></td></tr></table></td></tr></table></td></tr></table></td></tr></table></td></tr></table></td></tr></table></td></tr></table></td></tr></table></td></tr></table></td></tr></table></td></tr></table></td></tr></table></td></tr></table></td></tr></table></td></tr></table>
 | | | | | | | | | | | | | | | | | | | | <table border="1" style="width: 100%; border-collapse: collapse; text-align: center;"> <tr> <td style="width: 10%;"></td> <td style="width: 10%;"></td> <td style="width: 10%;"></td> <td style="width: 10%;"></td> <td style="width: 10%;"></td> <td style="width: 10%;"></td> <td style="width: 10%;"></td> <td style="width: 10%;"></td> <td style="width: 10%;"></td> <td style="width: 10%;"></td> </tr> <tr> <td></td> <td></td> <td colspan="8" style="text-align: center;"> <table border="1" style="width: 100%; border-collapse: collapse; text-align: center;"> <tr> <td style="width: 10%;"></td> <td style="width: 10%;"></td> <td style="width: 10%;"></td> <td style="width: 10%;"></td> <td style="width: 10%;"></td> <td style="width: 10%;"></td> <td style="width: 10%;"></td> <td style="width: 10%;"></td> <td style="width: 10%;"></td> <td style="width: 10%;"></td> </tr> <tr> <td></td> <td></td> <td colspan="8" style="text-align: center;"> <table border="1" style="width: 100%; border-collapse: collapse; text-align: center;"> <tr> <td style="width: 10%;"></td> <td style="width: 10%;"></td> <td style="width: 10%;"></td> <td style="width: 10%;"></td> <td style="width: 10%;"></td> <td style="width: 10%;"></td> <td style="width: 10%;"></td> <td style="width: 10%;"></td> <td style="width: 10%;"></td> <td style="width: 10%;"></td> </tr> <tr> <td></td> <td></td> <td colspan="8" style="text-align: center;"> <table border="1" style="width: 100%; border-collapse: collapse; text-align: center;"> <tr> <td style="width: 10%;"></td> <td style="width: 10%;"></td> <td style="width: 10%;"></td> <td style="width: 10%;"></td> <td style="width: 10%;"></td> <td style="width: 10%;"></td> <td style="width: 10%;"></td> <td style="width: 10%;"></td> <td style="width: 10%;"></td> <td style="width: 10%;"></td> </tr> <tr> <td></td> <td></td> <td colspan="8" style="text-align: center;"> <table border="1" style="width: 100%; border-collapse: collapse; text-align: center;"> <tr> <td style="width: 10%;"></td> <td style="width: 10%;"></td> <td style="width: 10%;"></td> <td style="width: 10%;"></td> <td style="width: 10%;"></td> <td style="width: 10%;"></td> <td style="width: 10%;"></td> <td style="width: 10%;"></td> <td style="width: 10%;"></td> <td style="width: 10%;"></td> </tr> <tr> <td></td> <td></td> <td colspan="8" style="text-align: center;"> <table border="1" style="width: 100%; border-collapse: collapse; text-align: center;"> <tr> <td style="width: 10%;"></td> <td style="width: 10%;"></td> <td style="width: 10%;"></td> <td style="width: 10%;"></td> <td style="width: 10%;"></td> <td style="width: 10%;"></td> <td style="width: 10%;"></td> <td style="width: 10%;"></td> <td style="width: 10%;"></td> <td style="width: 10%;"></td> </tr> <tr> <td></td> <td></td> <td colspan="8" style="text-align: center;"> <table border="1" style="width: 100%; border-collapse: collapse; text-align: center;"> <tr> <td style="width: 10%;"></td> <td style="width: 10%;"></td> <td style="width: 10%;"></td> <td style="width: 10%;"></td> <td style="width: 10%;"></td> <td style="width: 10%;"></td> <td style="width: 10%;"></td> <td style="width: 10%;"></td> <td style="width: 10%;"></td> <td style="width: 10%;"></td> </tr> <tr> <td></td> <td></td> <td colspan="8" style="text-align: center;"> <table border="1" style="width: 100%; border-collapse: collapse; text-align: center;"> <tr> <td style="width: 10%;"></td> <td style="width: 10%;"></td> <td style="width: 10%;"></td> <td style="width: 10%;"></td> <td style="width: 10%;"></td> <td style="width: 10%;"></td> <td style="width: 10%;"></td> <td style="width: 10%;"></td> <td style="width: 10%;"></td> <td style="width: 10%;"></td> </tr> <tr> <td></td> <td></td> <td colspan="8" style="text-align: center;"> <table border="1" style="width: 100%; border-collapse: collapse; text-align: center;"> <tr> <td style="width: 10%;"></td> <td style="width: 10%;"></td> <td style="width: 10%;"></td> <td style="width: 10%;"></td> <td style="width: 10%;"></td> <td style="width: 10%;"></td> <td style="width: 10%;"></td> <td style="width: 10%;"></td> <td style="width: 10%;"></td> <td style="width: 10%;"></td> </tr> <tr> <td></td> <td></td> <td colspan="8" style="text-align: center;"> <table border="1" style="width: 100%; border-collapse: collapse; text-align: center;"> <tr> <td style="width: 10%;"></td> <td style="width: 10%;"></td> <td style="width: 10%;"></td> <td style="width: 10%;"></td> <td style="width: 10%;"></td> <td style="width: 10%;"></td> <td style="width: 10%;"></td> <td style="width: 10%;"></td> <td style="width: 10%;"></td> <td style="width: 10%;"></td> </tr> <tr> <td></td> <td></td> <td colspan="8" style="text-align: center;"> <table border="1" style="width: 100%; border-collapse: collapse; text-align: center;"> <tr> <td style="width: 10%;"></td> <td style="width: 10%;"></td> <td style="width: 10%;"></td> <td style="width: 10%;"></td> <td style="width: 10%;"></td> <td style="width: 10%;"></td> <td style="width: 10%;"></td> <td style="width: 10%;"></td> <td style="width: 10%;"></td> <td style="width: 10%;"></td> </tr> <tr> <td></td> <td></td> <td colspan="8" style="text-align: center;"> <table border="1" style="width: 100%; border-collapse: collapse; text-align: center;"> <tr> <td style="width: 10%;"></td> <td style="width: 10%;"></td> <td style="width: 10%;"></td> <td style="width: 10%;"></td> <td style="width: 10%;"></td> <td style="width: 10%;"></td> <td style="width: 10%;"></td> <td style="width: 10%;"></td> <td style="width: 10%;"></td> <td style="width: 10%;"></td> </tr> <tr> <td></td> <td></td> <td colspan="8" style="text-align: center;"> <table border="1" style="width: 100%; border-collapse: collapse; text-align: center;"> <tr> <td style="width: 10%;"></td> <td style="width: 10%;"></td> <td style="width: 10%;"></td> <td style="width: 10%;"></td> <td style="width: 10%;"></td> <td style="width: 10%;"></td> <td style="width: 10%;"></td> <td style="width: 10%;"></td> <td style="width: 10%;"></td> <td style="width: 10%;"></td> </tr> <tr> <td></td> <td></td> <td colspan="8" style="text-align: center;"> <table border="1" style="width: 100%; border-collapse: collapse; text-align: center;"> <tr> <td style="width: 10%;"></td> <td style="width: 10%;"></td> <td style="width: 10%;"></td> <td style="width: 10%;"></td> <td style="width: 10%;"></td> <td style="width: 10%;"></td> <td style="width: 10%;"></td> <td style="width: 10%;"></td> <td style="width: 10%;"></td> <td
style="width: 10%;"></td> </tr> <tr> <td></td> <td></td> <td colspan="8" style="text-align: center;"> <table border="1" style="width: 100%; border-collapse: collapse; text-align: center;"> <tr> <td style="width: 10%;"></td> <td style="width: 10%;"></td> <td style="width: 10%;"></td> <td style="width: 10%;"></td> <td style="width: 10%;"></td> <td style="width: 10%;"></td> <td style="width: 10%;"></td> <td style="width: 10%;"></td> <td style="width: 10%;"></td> <td style="width: 10%;"></td> </tr> <tr> <td></td> <td></td> <td colspan="8" style="text-align: center;"> <table border="1" style="width: 100%; border-collapse: collapse; text-align: center;"> <tr> <td style="width: 10%;"></td> <td style="width: 10%;"></td> <td style="width: 10%;"></td> <td style="width: 10%;"></td> <td style="width: 10%;"></td> <td style="width: 10%;"></td> <td style="width: 10%;"></td> <td style="width: 10%;"></td> <td style="width: 10%;"></td> <td style="width: 10%;"></td> </tr> <tr> <td></td> <td></td> <td colspan="8" style="text-align: center;"> <table border="1" style="width: 100%; border-collapse: collapse; text-align: center;"> <tr> </tr></table></td></tr></table></td></tr></table></td></tr></table></td></tr></table></td></tr></table></td></tr></table></td></tr></table></td></tr></table></td></tr></table></td></tr></table></td></tr></table></td></tr></table></td></tr></table></td></tr></table></td></tr></table></td></tr></table> | | | | | | | | | | | | | | | | | | | | <table border="1" style="width: 100%; border-collapse: collapse; text-align: center;"> <tr> <td style="width: 10%;"></td> <td style="width: 10%;"></td> <td style="width: 10%;"></td> <td style="width: 10%;"></td> <td style="width: 10%;"></td> <td style="width: 10%;"></td> <td style="width: 10%;"></td> <td style="width: 10%;"></td> <td style="width: 10%;"></td> <td style="width: 10%;"></td> </tr> <tr> <td></td> <td></td> <td colspan="8" style="text-align: center;"> <table border="1" style="width: 100%; border-collapse: collapse; text-align: center;"> <tr> <td style="width: 10%;"></td> <td style="width: 10%;"></td> <td style="width: 10%;"></td> <td style="width: 10%;"></td> <td style="width: 10%;"></td> <td style="width: 10%;"></td> <td style="width: 10%;"></td> <td style="width: 10%;"></td> <td style="width: 10%;"></td> <td style="width: 10%;"></td> </tr> <tr> <td></td> <td></td> <td colspan="8" style="text-align: center;"> <table border="1" style="width: 100%; border-collapse: collapse; text-align: center;"> <tr> <td style="width: 10%;"></td> <td style="width: 10%;"></td> <td style="width: 10%;"></td> <td style="width: 10%;"></td> <td style="width: 10%;"></td> <td style="width: 10%;"></td> <td style="width: 10%;"></td> <td style="width: 10%;"></td> <td style="width: 10%;"></td> <td style="width: 10%;"></td> </tr> <tr> <td></td> <td></td> <td colspan="8" style="text-align: center;"> <table border="1" style="width: 100%; border-collapse: collapse; text-align: center;"> <tr> <td style="width: 10%;"></td> <td style="width: 10%;"></td> <td style="width: 10%;"></td> <td style="width: 10%;"></td> <td style="width: 10%;"></td> <td style="width: 10%;"></td> <td style="width: 10%;"></td> <td style="width: 10%;"></td> <td style="width: 10%;"></td> <td style="width: 10%;"></td> </tr> <tr> <td></td> <td></td> <td colspan="8" style="text-align: center;"> <table border="1" style="width: 100%; border-collapse: collapse; text-align: center;"> <tr> <td style="width: 10%;"></td> <td style="width: 10%;"></td> <td style="width: 10%;"></td> <td style="width: 10%;"></td> <td style="width: 10%;"></td> <td style="width: 10%;"></td> <td style="width: 10%;"></td> <td style="width: 10%;"></td> <td style="width: 10%;"></td> <td style="width: 10%;"></td> </tr> <tr> <td></td> <td></td> <td colspan="8" style="text-align: center;"> <table border="1" style="width: 100%; border-collapse: collapse; text-align: center;"> <tr> <td style="width: 10%;"></td> <td style="width: 10%;"></td> <td style="width: 10%;"></td> <td style="width: 10%;"></td> <td style="width: 10%;"></td> <td style="width: 10%;"></td> <td style="width: 10%;"></td> <td style="width: 10%;"></td> <td style="width: 10%;"></td> <td style="width: 10%;"></td> </tr> <tr> <td></td> <td></td> <td colspan="8" style="text-align: center;"> <table border="1" style="width: 100%; border-collapse: collapse; text-align: center;"> <tr> <td style="width: 10%;"></td> <td style="width: 10%;"></td> <td style="width: 10%;"></td> <td style="width: 10%;"></td> <td style="width: 10%;"></td> <td style="width: 10%;"></td> <td style="width: 10%;"></td> <td style="width: 10%;"></td> <td style="width: 10%;"></td> <td style="width: 10%;"></td> </tr> <tr> <td></td> <td></td> <td colspan="8" style="text-align: center;"> <table border="1" style="width: 100%; border-collapse: collapse; text-align: center;"> <tr> <td style="width: 10%;"></td> <td style="width: 10%;"></td> <td style="width: 10%;"></td> <td style="width: 10%;"></td> <td style="width: 10%;"></td> <td style="width: 10%;"></td> <td style="width: 10%;"></td> <td style="width: 10%;"></td> <td style="width: 10%;"></td> <td style="width: 10%;"></td> </tr> <tr> <td></td> <td></td> <td colspan="8" style="text-align: center;"> <table border="1" style="width: 100%; border-collapse: collapse; text-align: center;"> <tr> <td style="width: 10%;"></td> <td style="width: 10%;"></td> <td style="width: 10%;"></td> <td style="width: 10%;"></td> <td style="width: 10%;"></td> <td style="width: 10%;"></td> <td style="width: 10%;"></td> <td style="width: 10%;"></td> <td style="width: 10%;"></td> <td style="width: 10%;"></td> </tr> <tr> <td></td> <td></td> <td colspan="8" style="text-align: center;"> <table border="1" style="width: 100%; border-collapse: collapse; text-align: center;"> <tr> <td style="width: 10%;"></td> <td style="width: 10%;"></td> <td style="width: 10%;"></td> <td style="width: 10%;"></td> <td style="width: 10%;"></td> <td style="width: 10%;"></td> <td style="width: 10%;"></td> <td style="width: 10%;"></td> <td style="width: 10%;"></td> <td style="width: 10%;"></td> </tr> <tr>
<td></td> <td></td> <td colspan="8" style="text-align: center;"> <table border="1" style="width: 100%; border-collapse: collapse; text-align: center;"> <tr> <td style="width: 10%;"></td> <td style="width: 10%;"></td> <td style="width: 10%;"></td> <td style="width: 10%;"></td> <td style="width: 10%;"></td> <td style="width: 10%;"></td> <td style="width: 10%;"></td> <td style="width: 10%;"></td> <td style="width: 10%;"></td> <td style="width: 10%;"></td> </tr> <tr> <td></td> <td></td> <td colspan="8" style="text-align: center;"> <table border="1" style="width: 100%; border-collapse: collapse; text-align: center;"> <tr> <td style="width: 10%;"></td> <td style="width: 10%;"></td> <td style="width: 10%;"></td> <td style="width: 10%;"></td> <td style="width: 10%;"></td> <td style="width: 10%;"></td> <td style="width: 10%;"></td> <td style="width: 10%;"></td> <td style="width: 10%;"></td> <td style="width: 10%;"></td> </tr> <tr> <td></td> <td></td> <td colspan="8" style="text-align: center;"> <table border="1" style="width: 100%; border-collapse: collapse; text-align: center;"> <tr> <td style="width: 10%;"></td> <td style="width: 10%;"></td> <td style="width: 10%;"></td> <td style="width: 10%;"></td> <td style="width: 10%;"></td> <td style="width: 10%;"></td> <td style="width: 10%;"></td> <td style="width: 10%;"></td> <td style="width: 10%;"></td> <td style="width: 10%;"></td> </tr> <tr> <td></td> <td></td> <td colspan="8" style="text-align: center;"> <table border="1" style="width: 100%; border-collapse: collapse; text-align: center;"> <tr> <td style="width: 10%;"></td> <td style="width: 10%;"></td> <td style="width: 10%;"></td> <td style="width: 10%;"></td> <td style="width: 10%;"></td> <td style="width: 10%;"></td> <td style="width: 10%;"></td> <td style="width: 10%;"></td> <td style="width: 10%;"></td> <td style="width: 10%;"></td> </tr> <tr> <td></td> <td></td> <td colspan="8" style="text-align: center;"> <table border="1" style="width: 100%; border-collapse: collapse; text-align: center;"> <tr> <td style="width: 10%;"></td> <td style="width: 10%;"></td> <td style="width: 10%;"></td> <td style="width: 10%;"></td> <td style="width: 10%;"></td> <td style="width: 10%;"></td> <td style="width: 10%;"></td> <td style="width: 10%;"></td> <td style="width: 10%;"></td> <td style="width: 10%;"></td> </tr> <tr> <td></td> <td></td> <td colspan="8" style="text-align: center;"> <table border="1" style="width: 100%; border-collapse: collapse; text-align: center;"> <tr> </tr></table></td></tr></table></td></tr></table></td></tr></table></td></tr></table></td></tr></table></td></tr></table></td></tr></table></td></tr></table></td></tr></table></td></tr></table></td></tr></table></td></tr></table></td></tr></table></td></tr></table></td></tr></table> | | | | | | | | | | | | | | | | | | | | <table border="1" style="width: 100%; border-collapse: collapse; text-align: center;"> <tr> <td style="width: 10%;"></td> <td style="width: 10%;"></td> <td style="width: 10%;"></td> <td style="width: 10%;"></td> <td style="width: 10%;"></td> <td style="width: 10%;"></td> <td style="width: 10%;"></td> <td style="width: 10%;"></td> <td style="width: 10%;"></td> <td style="width: 10%;"></td> </tr> <tr> <td></td> <td></td> <td colspan="8" style="text-align: center;"> <table border="1" style="width: 100%; border-collapse: collapse; text-align: center;"> <tr> <td style="width: 10%;"></td> <td style="width: 10%;"></td> <td style="width: 10%;"></td> <td style="width: 10%;"></td> <td style="width: 10%;"></td> <td style="width: 10%;"></td> <td style="width: 10%;"></td> <td style="width: 10%;"></td> <td style="width: 10%;"></td> <td style="width: 10%;"></td> </tr> <tr> <td></td> <td></td> <td colspan="8" style="text-align: center;"> <table border="1" style="width: 100%; border-collapse: collapse; text-align: center;"> <tr> <td style="width: 10%;"></td> <td style="width: 10%;"></td> <td style="width: 10%;"></td> <td style="width: 10%;"></td> <td style="width: 10%;"></td> <td style="width: 10%;"></td> <td style="width: 10%;"></td> <td style="width: 10%;"></td> <td style="width: 10%;"></td> <td style="width: 10%;"></td> </tr> <tr> <td></td> <td></td> <td colspan="8" style="text-align: center;"> <table border="1" style="width: 100%; border-collapse: collapse; text-align: center;"> <tr> <td style="width: 10%;"></td> <td style="width: 10%;"></td> <td style="width: 10%;"></td> <td style="width: 10%;"></td> <td style="width: 10%;"></td> <td style="width: 10%;"></td> <td style="width: 10%;"></td> <td style="width: 10%;"></td> <td style="width: 10%;"></td> <td style="width: 10%;"></td> </tr> <tr> <td></td> <td></td> <td colspan="8" style="text-align: center;"> <table border="1" style="width: 100%; border-collapse: collapse; text-align: center;"> <tr> <td style="width: 10%;"></td> <td style="width: 10%;"></td> <td style="width: 10%;"></td> <td style="width: 10%;"></td> <td style="width: 10%;"></td> <td style="width: 10%;"></td> <td style="width: 10%;"></td> <td style="width: 10%;"></td> <td style="width: 10%;"></td> <td style="width: 10%;"></td> </tr> <tr> <td></td> <td></td> <td colspan="8" style="text-align: center;"> <table border="1" style="width: 100%; border-collapse: collapse; text-align: center;"> <tr> <td style="width: 10%;"></td> <td style="width: 10%;"></td> <td style="width: 10%;"></td> <td style="width: 10%;"></td> <td style="width: 10%;"></td> <td style="width: 10%;"></td> <td style="width: 10%;"></td> <td style="width: 10%;"></td> <td style="width: 10%;"></td> <td style="width: 10%;"></td> </tr> <tr> <td></td> <td></td> <td colspan="8" style="text-align: center;"> <table border="1" style="width: 100%; border-collapse: collapse; text-align: center;"> <tr> <td style="width: 10%;"></td> <td style="width: 10%;"></td> <td style="width: 10%;"></td> <td style="width: 10%;"></td> <td style="width: 10%;"></td> <td style="width: 10%;"></td> <td style="width: 10%;"></td> <td style="width: 10%;"></td> <td style="width: 10%;"></td> <td style="width: 10%;"></td> </tr> <tr> <td></td> <td></td> <td colspan="8" style="text-align:
center;"> <table border="1" style="width: 100%; border-collapse: collapse; text-align: center;"> <tr> <td style="width: 10%;"></td> <td style="width: 10%;"></td> <td style="width: 10%;"></td> <td style="width: 10%;"></td> <td style="width: 10%;"></td> <td style="width: 10%;"></td> <td style="width: 10%;"></td> <td style="width: 10%;"></td> <td style="width: 10%;"></td> <td style="width: 10%;"></td> </tr> <tr> <td></td> <td></td> <td colspan="8" style="text-align: center;"> <table border="1" style="width: 100%; border-collapse: collapse; text-align: center;"> <tr> <td style="width: 10%;"></td> <td style="width: 10%;"></td> <td style="width: 10%;"></td> <td style="width: 10%;"></td> <td style="width: 10%;"></td> <td style="width: 10%;"></td> <td style="width: 10%;"></td> <td style="width: 10%;"></td> <td style="width: 10%;"></td> <td style="width: 10%;"></td> </tr> <tr> <td></td> <td></td> <td colspan="8" style="text-align: center;"> <table border="1" style="width: 100%; border-collapse: collapse; text-align: center;"> <tr> <td style="width: 10%;"></td> <td style="width: 10%;"></td> <td style="width: 10%;"></td> <td style="width: 10%;"></td> <td style="width: 10%;"></td> <td style="width: 10%;"></td> <td style="width: 10%;"></td> <td style="width: 10%;"></td> <td style="width: 10%;"></td> <td style="width: 10%;"></td> </tr> <tr> <td></td> <td></td> <td colspan="8" style="text-align: center;"> <table border="1" style="width: 100%; border-collapse: collapse; text-align: center;"> <tr> <td style="width: 10%;"></td> <td style="width: 10%;"></td> <td style="width: 10%;"></td> <td style="width: 10%;"></td> <td style="width: 10%;"></td> <td style="width: 10%;"></td> <td style="width: 10%;"></td> <td style="width: 10%;"></td> <td style="width: 10%;"></td> <td style="width: 10%;"></td> </tr> <tr> <td></td> <td></td> <td colspan="8" style="text-align: center;"> <table border="1" style="width: 100%; border-collapse: collapse; text-align: center;"> <tr> <td style="width: 10%;"></td> <td style="width: 10%;"></td> <td style="width: 10%;"></td> <td style="width: 10%;"></td> <td style="width: 10%;"></td> <td style="width: 10%;"></td> <td style="width: 10%;"></td> <td style="width: 10%;"></td> <td style="width: 10%;"></td> <td style="width: 10%;"></td> </tr> <tr> <td></td> <td></td> <td colspan="8" style="text-align: center;"> <table border="1" style="width: 100%; border-collapse: collapse; text-align: center;"> <tr> <td style="width: 10%;"></td> <td style="width: 10%;"></td> <td style="width: 10%;"></td> <td style="width: 10%;"></td> <td style="width: 10%;"></td> <td style="width: 10%;"></td> <td style="width: 10%;"></td> <td style="width: 10%;"></td> <td style="width: 10%;"></td> <td style="width: 10%;"></td> </tr> <tr> <td></td> <td></td> <td colspan="8" style="text-align: center;"> <table border="1" style="width: 100%; border-collapse: collapse; text-align: center;"> <tr> <td style="width: 10%;"></td> <td style="width: 10%;"></td> <td style="width: 10%;"></td> <td style="width: 10%;"></td> <td style="width: 10%;"></td> <td style="width: 10%;"></td> <td style="width: 10%;"></td> <td style="width: 10%;"></td> <td style="width: 10%;"></td> <td style="width: 10%;"></td> </tr> <tr> <td></td> <td></td> <td colspan="8" style="text-align: center;"> <table border="1" style="width: 100%; border-collapse: collapse; text-align: center;"> <tr> </tr></table></td></tr></table></td></tr></table></td></tr></table></td></tr></table></td></tr></table></td></tr></table></td></tr></table></td></tr></table></td></tr></table></td></tr></table></td></tr></table></td></tr></table></td></tr></table></td></tr></table> | | | | | | | | | | | | | | | | | | | | <table border="1" style="width: 100%; border-collapse: collapse; text-align: center;"> <tr> <td style="width: 10%;"></td> <td style="width: 10%;"></td> <td style="width: 10%;"></td> <td style="width: 10%;"></td> <td style="width: 10%;"></td> <td style="width: 10%;"></td> <td style="width: 10%;"></td> <td style="width: 10%;"></td> <td style="width: 10%;"></td> <td style="width: 10%;"></td> </tr> <tr> <td></td> <td></td> <td colspan="8" style="text-align: center;"> <table border="1" style="width: 100%; border-collapse: collapse; text-align: center;"> <tr> <td style="width: 10%;"></td> <td style="width: 10%;"></td> <td style="width: 10%;"></td> <td style="width: 10%;"></td> <td style="width: 10%;"></td> <td style="width: 10%;"></td> <td style="width: 10%;"></td> <td style="width: 10%;"></td> <td style="width: 10%;"></td> <td style="width: 10%;"></td> </tr> <tr> <td></td> <td></td> <td colspan="8" style="text-align: center;"> <table border="1" style="width: 100%; border-collapse: collapse; text-align: center;"> <tr> <td style="width: 10%;"></td> <td style="width: 10%;"></td> <td style="width: 10%;"></td> <td style="width: 10%;"></td> <td style="width: 10%;"></td> <td style="width: 10%;"></td> <td style="width: 10%;"></td> <td style="width: 10%;"></td> <td style="width: 10%;"></td> <td style="width: 10%;"></td> </tr> <tr> <td></td> <td></td> <td colspan="8" style="text-align: center;"> <table border="1" style="width: 100%; border-collapse: collapse; text-align: center;"> <tr> <td style="width: 10%;"></td> <td style="width: 10%;"></td> <td style="width: 10%;"></td> <td style="width: 10%;"></td> <td style="width: 10%;"></td> <td style="width: 10%;"></td> <td style="width: 10%;"></td> <td style="width: 10%;"></td> <td style="width: 10%;"></td> <td style="width: 10%;"></td> </tr> <tr> <td></td> <td></td> <td colspan="8" style="text-align: center;"> <table border="1" style="width: 100%; border-collapse: collapse; text-align: center;"> <tr> <td style="width: 10%;"></td> <td style="width: 10%;"></td> <td style="width: 10%;"></td> <td style="width: 10%;"></td> <td style="width: 10%;"></td> <td style="width: 10%;"></td> <td style="width: 10%;"></td> <td style="width: 10%;"></td> <td style="width: 10%;"></td> <td style="width: 10%;"></td> </tr> <tr> <td></td> <td></td> <td colspan="8" style="text-align: center;"> <table border="1" style="width: 100%; border-collapse: collapse;
text-align: center;"> <tr> <td style="width: 10%;"></td> <td style="width: 10%;"></td> <td style="width: 10%;"></td> <td style="width: 10%;"></td> <td style="width: 10%;"></td> <td style="width: 10%;"></td> <td style="width: 10%;"></td> <td style="width: 10%;"></td> <td style="width: 10%;"></td> <td style="width: 10%;"></td> </tr> <tr> <td></td> <td></td> <td colspan="8" style="text-align: center;"> <table border="1" style="width: 100%; border-collapse: collapse; text-align: center;"> <tr> <td style="width: 10%;"></td> <td style="width: 10%;"></td> <td style="width: 10%;"></td> <td style="width: 10%;"></td> <td style="width: 10%;"></td> <td style="width: 10%;"></td> <td style="width: 10%;"></td> <td style="width: 10%;"></td> <td style="width: 10%;"></td> <td style="width: 10%;"></td> </tr> <tr> <td></td> <td></td> <td colspan="8" style="text-align: center;"> <table border="1" style="width: 100%; border-collapse: collapse; text-align: center;"> <tr> <td style="width: 10%;"></td> <td style="width: 10%;"></td> <td style="width: 10%;"></td> <td style="width: 10%;"></td> <td style="width: 10%;"></td> <td style="width: 10%;"></td> <td style="width: 10%;"></td> <td style="width: 10%;"></td> <td style="width: 10%;"></td> <td style="width: 10%;"></td> </tr> <tr> <td></td> <td></td> <td colspan="8" style="text-align: center;"> <table border="1" style="width: 100%; border-collapse: collapse; text-align: center;"> <tr> <td style="width: 10%;"></td> <td style="width: 10%;"></td> <td style="width: 10%;"></td> <td style="width: 10%;"></td> <td style="width: 10%;"></td> <td style="width: 10%;"></td> <td style="width: 10%;"></td> <td style="width: 10%;"></td> <td style="width: 10%;"></td> <td style="width: 10%;"></td> </tr> <tr> <td></td> <td></td> <td colspan="8" style="text-align: center;"> <table border="1" style="width: 100%; border-collapse: collapse; text-align: center;"> <tr> <td style="width: 10%;"></td> <td style="width: 10%;"></td> <td style="width: 10%;"></td> <td style="width: 10%;"></td> <td style="width: 10%;"></td> <td style="width: 10%;"></td> <td style="width: 10%;"></td> <td style="width: 10%;"></td> <td style="width: 10%;"></td> <td style="width: 10%;"></td> </tr> <tr> <td></td> <td></td> <td colspan="8" style="text-align: center;"> <table border="1" style="width: 100%; border-collapse: collapse; text-align: center;"> <tr> <td style="width: 10%;"></td> <td style="width: 10%;"></td> <td style="width: 10%;"></td> <td style="width: 10%;"></td> <td style="width: 10%;"></td> <td style="width: 10%;"></td> <td style="width: 10%;"></td> <td style="width: 10%;"></td> <td style="width: 10%;"></td> <td style="width: 10%;"></td> </tr> <tr> <td></td> <td></td> <td colspan="8" style="text-align: center;"> <table border="1" style="width: 100%; border-collapse: collapse; text-align: center;"> <tr> <td style="width: 10%;"></td> <td style="width: 10%;"></td> <td style="width: 10%;"></td> <td style="width: 10%;"></td> <td style="width: 10%;"></td> <td style="width: 10%;"></td> <td style="width: 10%;"></td> <td style="width: 10%;"></td> <td style="width: 10%;"></td> <td style="width: 10%;"></td> </tr> <tr> <td></td> <td></td> <td colspan="8" style="text-align: center;"> <table border="1" style="width: 100%; border-collapse: collapse; text-align: center;"> <tr> <td style="width: 10%;"></td> <td style="width: 10%;"></td> <td style="width: 10%;"></td> <td style="width: 10%;"></td> <td style="width: 10%;"></td> <td style="width: 10%;"></td> <td style="width: 10%;"></td> <td style="width: 10%;"></td> <td style="width: 10%;"></td> <td style="width: 10%;"></td> </tr> <tr> <td></td> <td></td> <td colspan="8" style="text-align: center;"> <table border="1" style="width: 100%; border-collapse: collapse; text-align: center;"> <tr> </tr></table></td></tr></table></td></tr></table></td></tr></table></td></tr></table></td></tr></table></td></tr></table></td></tr></table></td></tr></table></td></tr></table></td></tr></table></td></tr></table></td></tr></table></td></tr></table> | | | | | | | | | | | | | | | | | | | | <table border="1" style="width: 100%; border-collapse: collapse; text-align: center;"> <tr> <td style="width: 10%;"></td> <td style="width: 10%;"></td> <td style="width: 10%;"></td> <td style="width: 10%;"></td> <td style="width: 10%;"></td> <td style="width: 10%;"></td> <td style="width: 10%;"></td> <td style="width: 10%;"></td> <td style="width: 10%;"></td> <td style="width: 10%;"></td> </tr> <tr> <td></td> <td></td> <td colspan="8" style="text-align: center;"> <table border="1" style="width: 100%; border-collapse: collapse; text-align: center;"> <tr> <td style="width: 10%;"></td> <td style="width: 10%;"></td> <td style="width: 10%;"></td> <td style="width: 10%;"></td> <td style="width: 10%;"></td> <td style="width: 10%;"></td> <td style="width: 10%;"></td> <td style="width: 10%;"></td> <td style="width: 10%;"></td> <td style="width: 10%;"></td> </tr> <tr> <td></td> <td></td> <td colspan="8" style="text-align: center;"> <table border="1" style="width: 100%; border-collapse: collapse; text-align: center;"> <tr> <td style="width: 10%;"></td> <td style="width: 10%;"></td> <td style="width: 10%;"></td> <td style="width: 10%;"></td> <td style="width: 10%;"></td> <td style="width: 10%;"></td> <td style="width: 10%;"></td> <td style="width: 10%;"></td> <td style="width: 10%;"></td> <td style="width: 10%;"></td> </tr> <tr> <td></td> <td></td> <td colspan="8" style="text-align: center;"> <table border="1" style="width: 100%; border-collapse: collapse; text-align: center;"> <tr> <td style="width: 10%;"></td> <td style="width: 10%;"></td> <td style="width: 10%;"></td> <td style="width: 10%;"></td> <td style="width: 10%;"></td> <td style="width: 10%;"></td> <td style="width: 10%;"></td> <td style="width: 10%;"></td> <td style="width: 10%;"></td> <td style="width: 10%;"></td> </tr> <tr> <td></td> <td></td> <td colspan="8" style="text-align: center;"> <table border="1" style="width: 100%; border-collapse: collapse; text-align: center;"> <tr> <td style="width: 10%;"></td> <td style="width: 10%;"></td> <td
style="width: 10%;"></td> <td style="width: 10%;"></td> <td style="width: 10%;"></td> <td style="width: 10%;"></td> <td style="width: 10%;"></td> <td style="width: 10%;"></td> <td style="width: 10%;"></td> <td style="width: 10%;"></td> </tr> <tr> <td></td> <td></td> <td colspan="8" style="text-align: center;"> <table border="1" style="width: 100%; border-collapse: collapse; text-align: center;"> <tr> <td style="width: 10%;"></td> <td style="width: 10%;"></td> <td style="width: 10%;"></td> <td style="width: 10%;"></td> <td style="width: 10%;"></td> <td style="width: 10%;"></td> <td style="width: 10%;"></td> <td style="width: 10%;"></td> <td style="width: 10%;"></td> <td style="width: 10%;"></td> </tr> <tr> <td></td> <td></td> <td colspan="8" style="text-align: center;"> <table border="1" style="width: 100%; border-collapse: collapse; text-align: center;"> <tr> <td style="width: 10%;"></td> <td style="width: 10%;"></td> <td style="width: 10%;"></td> <td style="width: 10%;"></td> <td style="width: 10%;"></td> <td style="width: 10%;"></td> <td style="width: 10%;"></td> <td style="width: 10%;"></td> <td style="width: 10%;"></td> <td style="width: 10%;"></td> </tr> <tr> <td></td> <td></td> <td colspan="8" style="text-align: center;"> <table border="1" style="width: 100%; border-collapse: collapse; text-align: center;"> <tr> <td style="width: 10%;"></td> <td style="width: 10%;"></td> <td style="width: 10%;"></td> <td style="width: 10%;"></td> <td style="width: 10%;"></td> <td style="width: 10%;"></td> <td style="width: 10%;"></td> <td style="width: 10%;"></td> <td style="width: 10%;"></td> <td style="width: 10%;"></td> </tr> <tr> <td></td> <td></td> <td colspan="8" style="text-align: center;"> <table border="1" style="width: 100%; border-collapse: collapse; text-align: center;"> <tr> <td style="width: 10%;"></td> <td style="width: 10%;"></td> <td style="width: 10%;"></td> <td style="width: 10%;"></td> <td style="width: 10%;"></td> <td style="width: 10%;"></td> <td style="width: 10%;"></td> <td style="width: 10%;"></td> <td style="width: 10%;"></td> <td style="width: 10%;"></td> </tr> <tr> <td></td> <td></td> <td colspan="8" style="text-align: center;"> <table border="1" style="width: 100%; border-collapse: collapse; text-align: center;"> <tr> <td style="width: 10%;"></td> <td style="width: 10%;"></td> <td style="width: 10%;"></td> <td style="width: 10%;"></td> <td style="width: 10%;"></td> <td style="width: 10%;"></td> <td style="width: 10%;"></td> <td style="width: 10%;"></td> <td style="width: 10%;"></td> <td style="width: 10%;"></td> </tr> <tr> <td></td> <td></td> <td colspan="8" style="text-align: center;"> <table border="1" style="width: 100%; border-collapse: collapse; text-align: center;"> <tr> <td style="width: 10%;"></td> <td style="width: 10%;"></td> <td style="width: 10%;"></td> <td style="width: 10%;"></td> <td style="width: 10%;"></td> <td style="width: 10%;"></td> <td style="width: 10%;"></td> <td style="width: 10%;"></td> <td style="width: 10%;"></td> <td style="width: 10%;"></td> </tr> <tr> <td></td> <td></td> <td colspan="8" style="text-align: center;"> <table border="1" style="width: 100%; border-collapse: collapse; text-align: center;"> <tr> <td style="width: 10%;"></td> <td style="width: 10%;"></td> <td style="width: 10%;"></td> <td style="width: 10%;"></td> <td style="width: 10%;"></td> <td style="width: 10%;"></td> <td style="width: 10%;"></td> <td style="width: 10%;"></td> <td style="width: 10%;"></td> <td style="width: 10%;"></td> </tr> <tr> <td></td> <td></td> <td colspan="8" style="text-align: center;"> <table border="1" style="width: 100%; border-collapse: collapse; text-align: center;"> <tr> </tr></table></td></tr></table></td></tr></table></td></tr></table></td></tr></table></td></tr></table></td></tr></table></td></tr></table></td></tr></table></td></tr></table></td></tr></table></td></tr></table></td></tr></table> | | | | | | | | | | | | | | | | | | | | <table border="1" style="width: 100%; border-collapse: collapse; text-align: center;"> <tr> <td style="width: 10%;"></td> <td style="width: 10%;"></td> <td style="width: 10%;"></td> <td style="width: 10%;"></td> <td style="width: 10%;"></td> <td style="width: 10%;"></td> <td style="width: 10%;"></td> <td style="width: 10%;"></td> <td style="width: 10%;"></td> <td style="width: 10%;"></td> </tr> <tr> <td></td> <td></td> <td colspan="8" style="text-align: center;"> <table border="1" style="width: 100%; border-collapse: collapse; text-align: center;"> <tr> <td style="width: 10%;"></td> <td style="width: 10%;"></td> <td style="width: 10%;"></td> <td style="width: 10%;"></td> <td style="width: 10%;"></td> <td style="width: 10%;"></td> <td style="width: 10%;"></td> <td style="width: 10%;"></td> <td style="width: 10%;"></td> <td style="width: 10%;"></td> </tr> <tr> <td></td> <td></td> <td colspan="8" style="text-align: center;"> <table border="1" style="width: 100%; border-collapse: collapse; text-align: center;"> <tr> <td style="width: 10%;"></td> <td style="width: 10%;"></td> <td style="width: 10%;"></td> <td style="width: 10%;"></td> <td style="width: 10%;"></td> <td style="width: 10%;"></td> <td style="width: 10%;"></td> <td style="width: 10%;"></td> <td style="width: 10%;"></td> <td style="width: 10%;"></td> </tr> <tr> <td></td> <td></td> <td colspan="8" style="text-align: center;"> <table border="1" style="width: 100%; border-collapse: collapse; text-align: center;"> <tr> <td style="width: 10%;"></td> <td style="width: 10%;"></td> <td style="width: 10%;"></td> <td style="width: 10%;"></td> <td style="width: 10%;"></td> <td style="width: 10%;"></td> <td style="width: 10%;"></td> <td style="width: 10%;"></td> <td style="width: 10%;"></td> <td style="width: 10%;"></td> </tr> <tr> <td></td> <td></td> <td colspan="8" style="text-align: center;"> <table border="1" style="width: 100%; border-collapse: collapse; text-align: center;"> <tr> <td style="width: 10%;"></td> <td style="width: 10%;"></td> <td style="width: 10%;"></td> <td style="width: 10%;"></td> <td style="width: 10%;"></td> <td style="width:
10%;"></td> <td style="width: 10%;"></td> <td style="width: 10%;"></td> <td style="width: 10%;"></td> <td style="width: 10%;"></td> </tr> <tr> <td></td> <td></td> <td colspan="8" style="text-align: center;"> <table border="1" style="width: 100%; border-collapse: collapse; text-align: center;"> <tr> <td style="width: 10%;"></td> <td style="width: 10%;"></td> <td style="width: 10%;"></td> <td style="width: 10%;"></td> <td style="width: 10%;"></td> <td style="width: 10%;"></td> <td style="width: 10%;"></td> <td style="width: 10%;"></td> <td style="width: 10%;"></td> <td style="width: 10%;"></td> </tr> <tr> <td></td> <td></td> <td colspan="8" style="text-align: center;"> <table border="1" style="width: 100%; border-collapse: collapse; text-align: center;"> <tr> <td style="width: 10%;"></td> <td style="width: 10%;"></td> <td style="width: 10%;"></td> <td style="width: 10%;"></td> <td style="width: 10%;"></td> <td style="width: 10%;"></td> <td style="width: 10%;"></td> <td style="width: 10%;"></td> <td style="width: 10%;"></td> <td style="width: 10%;"></td> </tr> <tr> <td></td> <td></td> <td colspan="8" style="text-align: center;"> <table border="1" style="width: 100%; border-collapse: collapse; text-align: center;"> <tr> <td style="width: 10%;"></td> <td style="width: 10%;"></td> <td style="width: 10%;"></td> <td style="width: 10%;"></td> <td style="width: 10%;"></td> <td style="width: 10%;"></td> <td style="width: 10%;"></td> <td style="width: 10%;"></td> <td style="width: 10%;"></td> <td style="width: 10%;"></td> </tr> <tr> <td></td> <td></td> <td colspan="8" style="text-align: center;"> <table border="1" style="width: 100%; border-collapse: collapse; text-align: center;"> <tr> <td style="width: 10%;"></td> <td style="width: 10%;"></td> <td style="width: 10%;"></td> <td style="width: 10%;"></td> <td style="width: 10%;"></td> <td style="width: 10%;"></td> <td style="width: 10%;"></td> <td style="width: 10%;"></td> <td style="width: 10%;"></td> <td style="width: 10%;"></td> </tr> <tr> <td></td> <td></td> <td colspan="8" style="text-align: center;"> <table border="1" style="width: 100%; border-collapse: collapse; text-align: center;"> <tr> <td style="width: 10%;"></td> <td style="width: 10%;"></td> <td style="width: 10%;"></td> <td style="width: 10%;"></td> <td style="width: 10%;"></td> <td style="width: 10%;"></td> <td style="width: 10%;"></td> <td style="width: 10%;"></td> <td style="width: 10%;"></td> <td style="width: 10%;"></td> </tr> <tr> <td></td> <td></td> <td colspan="8" style="text-align: center;"> <table border="1" style="width: 100%; border-collapse: collapse; text-align: center;"> <tr> <td style="width: 10%;"></td> <td style="width: 10%;"></td> <td style="width: 10%;"></td> <td style="width: 10%;"></td> <td style="width: 10%;"></td> <td style="width: 10%;"></td> <td style="width: 10%;"></td> <td style="width: 10%;"></td> <td style="width: 10%;"></td> <td style="width: 10%;"></td> </tr> <tr> <td></td> <td></td> <td colspan="8" style="text-align: center;"> <table border="1" style="width: 100%; border-collapse: collapse; text-align: center;"> <tr> </tr></table></td></tr></table></td></tr></table></td></tr></table></td></tr></table></td></tr></table></td></tr></table></td></tr></table></td></tr></table></td></tr></table></td></tr></table></td></tr></table> | | | | | | | | | | | | | | | | | | | | <table border="1" style="width: 100%; border-collapse: collapse; text-align: center;"> <tr> <td style="width: 10%;"></td> <td style="width: 10%;"></td> <td style="width: 10%;"></td> <td style="width: 10%;"></td> <td style="width: 10%;"></td> <td style="width: 10%;"></td> <td style="width: 10%;"></td> <td style="width: 10%;"></td> <td style="width: 10%;"></td> <td style="width: 10%;"></td> </tr> <tr> <td></td> <td></td> <td colspan="8" style="text-align: center;"> <table border="1" style="width: 100%; border-collapse: collapse; text-align: center;"> <tr> <td style="width: 10%;"></td> <td style="width: 10%;"></td> <td style="width: 10%;"></td> <td style="width: 10%;"></td> <td style="width: 10%;"></td> <td style="width: 10%;"></td> <td style="width: 10%;"></td> <td style="width: 10%;"></td> <td style="width: 10%;"></td> <td style="width: 10%;"></td> </tr> <tr> <td></td> <td></td> <td colspan="8" style="text-align: center;"> <table border="1" style="width: 100%; border-collapse: collapse; text-align: center;"> <tr> <td style="width: 10%;"></td> <td style="width: 10%;"></td> <td style="width: 10%;"></td> <td style="width: 10%;"></td> <td style="width: 10%;"></td> <td style="width: 10%;"></td> <td style="width: 10%;"></td> <td style="width: 10%;"></td> <td style="width: 10%;"></td> <td style="width: 10%;"></td> </tr> <tr> <td></td> <td></td> <td colspan="8" style="text-align: center;"> <table border="1" style="width: 100%; border-collapse: collapse; text-align: center;"> <tr> <td style="width: 10%;"></td> <td style="width: 10%;"></td> <td style="width: 10%;"></td> <td style="width: 10%;"></td> <td style="width: 10%;"></td> <td style="width: 10%;"></td> <td style="width: 10%;"></td> <td style="width: 10%;"></td> <td style="width: 10%;"></td> <td style="width: 10%;"></td> </tr> <tr> <td></td> <td></td> <td colspan="8" style="text-align: center;"> <table border="1" style="width: 100%; border-collapse: collapse; text-align: center;"> <tr> <td style="width: 10%;"></td> <td style="width: 10%;"></td> <td style="width: 10%;"></td> <td style="width: 10%;"></td> <td style="width: 10%;"></td> <td style="width: 10%;"></td> <td style="width: 10%;"></td> <td style="width: 10%;"></td> <td style="width: 10%;"></td> <td style="width: 10%;"></td> </tr> <tr> <td></td> <td></td> <td colspan="8" style="text-align: center;"> <table border="1" style="width: 100%; border-collapse: collapse; text-align: center;"> <tr> <td style="width: 10%;"></td> <td style="width: 10%;"></td> <td style="width: 10%;"></td> <td style="width: 10%;"></td> <td style="width: 10%;"></td> <td style="width: 10%;"></td> <td style="width: 10%;"></td> <td style="width: 10%;"></td> <td style="width: 10%;"></td> <td style="width: 10%;"></td>
</tr> <tr> <td></td> <td></td> <td colspan="8" style="text-align: center;"> <table border="1" style="width: 100%; border-collapse: collapse; text-align: center;"> <tr> <td style="width: 10%;"></td> <td style="width: 10%;"></td> <td style="width: 10%;"></td> <td style="width: 10%;"></td> <td style="width: 10%;"></td> <td style="width: 10%;"></td> <td style="width: 10%;"></td> <td style="width: 10%;"></td> <td style="width: 10%;"></td> <td style="width: 10%;"></td> </tr> <tr> <td></td> <td></td> <td colspan="8" style="text-align: center;"> <table border="1" style="width: 100%; border-collapse: collapse; text-align: center;"> <tr> <td style="width: 10%;"></td> <td style="width: 10%;"></td> <td style="width: 10%;"></td> <td style="width: 10%;"></td> <td style="width: 10%;"></td> <td style="width: 10%;"></td> <td style="width: 10%;"></td> <td style="width: 10%;"></td> <td style="width: 10%;"></td> <td style="width: 10%;"></td> </tr> <tr> <td></td> <td></td> <td colspan="8" style="text-align: center;"> <table border="1" style="width: 100%; border-collapse: collapse; text-align: center;"> <tr> <td style="width: 10%;"></td> <td style="width: 10%;"></td> <td style="width: 10%;"></td> <td style="width: 10%;"></td> <td style="width: 10%;"></td> <td style="width: 10%;"></td> <td style="width: 10%;"></td> <td style="width: 10%;"></td> <td style="width: 10%;"></td> <td style="width: 10%;"></td> </tr> <tr> <td></td> <td></td> <td colspan="8" style="text-align: center;"> <table border="1" style="width: 100%; border-collapse: collapse; text-align: center;"> <tr> <td style="width: 10%;"></td> <td style="width: 10%;"></td> <td style="width: 10%;"></td> <td style="width: 10%;"></td> <td style="width: 10%;"></td> <td style="width: 10%;"></td> <td style="width: 10%;"></td> <td style="width: 10%;"></td> <td style="width: 10%;"></td> <td style="width: 10%;"></td> </tr> <tr> <td></td> <td></td> <td colspan="8" style="text-align: center;"> <table border="1" style="width: 100%; border-collapse: collapse; text-align: center;"> <tr> </tr></table></td></tr></table></td></tr></table></td></tr></table></td></tr></table></td></tr></table></td></tr></table></td></tr></table></td></tr></table></td></tr></table></td></tr></table> | | | | | | | | | | | | | | | | | | | | <table border="1" style="width: 100%; border-collapse: collapse; text-align: center;"> <tr> <td style="width: 10%;"></td> <td style="width: 10%;"></td> <td style="width: 10%;"></td> <td style="width: 10%;"></td> <td style="width: 10%;"></td> <td style="width: 10%;"></td> <td style="width: 10%;"></td> <td style="width: 10%;"></td> <td style="width: 10%;"></td> <td style="width: 10%;"></td> </tr> <tr> <td></td> <td></td> <td colspan="8" style="text-align: center;"> <table border="1" style="width: 100%; border-collapse: collapse; text-align: center;"> <tr> <td style="width: 10%;"></td> <td style="width: 10%;"></td> <td style="width: 10%;"></td> <td style="width: 10%;"></td> <td style="width: 10%;"></td> <td style="width: 10%;"></td> <td style="width: 10%;"></td> <td style="width: 10%;"></td> <td style="width: 10%;"></td> <td style="width: 10%;"></td> </tr> <tr> <td></td> <td></td> <td colspan="8" style="text-align: center;"> <table border="1" style="width: 100%; border-collapse: collapse; text-align: center;"> <tr> <td style="width: 10%;"></td> <td style="width: 10%;"></td> <td style="width: 10%;"></td> <td style="width: 10%;"></td> <td style="width: 10%;"></td> <td style="width: 10%;"></td> <td style="width: 10%;"></td> <td style="width: 10%;"></td> <td style="width: 10%;"></td> <td style="width: 10%;"></td> </tr> <tr> <td></td> <td></td> <td colspan="8" style="text-align: center;"> <table border="1" style="width: 100%; border-collapse: collapse; text-align: center;"> <tr> <td style="width: 10%;"></td> <td style="width: 10%;"></td> <td style="width: 10%;"></td> <td style="width: 10%;"></td> <td style="width: 10%;"></td> <td style="width: 10%;"></td> <td style="width: 10%;"></td> <td style="width: 10%;"></td> <td style="width: 10%;"></td> <td style="width: 10%;"></td> </tr> <tr> <td></td> <td></td> <td colspan="8" style="text-align: center;"> <table border="1" style="width: 100%; border-collapse: collapse; text-align: center;"> <tr> <td style="width: 10%;"></td> <td style="width: 10%;"></td> <td style="width: 10%;"></td> <td style="width: 10%;"></td> <td style="width: 10%;"></td> <td style="width: 10%;"></td> <td style="width: 10%;"></td> <td style="width: 10%;"></td> <td style="width: 10%;"></td> <td style="width: 10%;"></td> </tr> <tr> <td></td> <td></td> <td colspan="8" style="text-align: center;"> <table border="1" style="width: 100%; border-collapse: collapse; text-align: center;"> <tr> <td style="width: 10%;"></td> <td style="width: 10%;"></td> <td style="width: 10%;"></td> <td style="width: 10%;"></td> <td style="width: 10%;"></td> <td style="width: 10%;"></td> <td style="width: 10%;"></td> <td style="width: 10%;"></td> <td style="width: 10%;"></td> <td style="width: 10%;"></td> </tr> <tr> <td></td> <td></td> <td colspan="8" style="text-align: center;"> <table border="1" style="width: 100%; border-collapse: collapse; text-align: center;"> <tr> <td style="width: 10%;"></td> <td style="width: 10%;"></td> <td style="width: 10%;"></td> <td style="width: 10%;"></td> <td style="width: 10%;"></td> <td style="width: 10%;"></td> <td style="width: 10%;"></td> <td style="width: 10%;"></td> <td style="width: 10%;"></td> <td style="width: 10%;"></td> </tr> <tr> <td></td> <td></td> <td colspan="8" style="text-align: center;"> <table border="1" style="width: 100%; border-collapse: collapse; text-align: center;"> <tr> <td style="width: 10%;"></td> <td style="width: 10%;"></td> <td style="width: 10%;"></td> <td style="width: 10%;"></td> <td style="width: 10%;"></td> <td style="width: 10%;"></td> <td style="width: 10%;"></td> <td style="width: 10%;"></td> <td style="width: 10%;"></td> <td style="width: 10%;"></td> </tr> <tr> <td></td> <td></td> <td colspan="8" style="text-align: center;"> <table border="1" style="width: 100%; border-collapse: collapse;
text-align: center;"> <tr> <td style="width: 10%;"></td> <td style="width: 10%;"></td> <td style="width: 10%;"></td> <td style="width: 10%;"></td> <td style="width: 10%;"></td> <td style="width: 10%;"></td> <td style="width: 10%;"></td> <td style="width: 10%;"></td> <td style="width: 10%;"></td> <td style="width: 10%;"></td> </tr> <tr> <td></td> <td></td> <td colspan="8" style="text-align: center;"> <table border="1" style="width: 100%; border-collapse: collapse; text-align: center;"> <tr> </tr></table></td></tr></table></td></tr></table></td></tr></table></td></tr></table></td></tr></table></td></tr></table></td></tr></table></td></tr></table></td></tr></table> | | | | | | | | | | | | | | | | | | | | <table border="1" style="width: 100%; border-collapse: collapse; text-align: center;"> <tr> <td style="width: 10%;"></td> <td style="width: 10%;"></td> <td style="width: 10%;"></td> <td style="width: 10%;"></td> <td style="width: 10%;"></td> <td style="width: 10%;"></td> <td style="width: 10%;"></td> <td style="width: 10%;"></td> <td style="width: 10%;"></td> <td style="width: 10%;"></td> </tr> <tr> <td></td> <td></td> <td colspan="8" style="text-align: center;"> <table border="1" style="width: 100%; border-collapse: collapse; text-align: center;"> <tr> <td style="width: 10%;"></td> <td style="width: 10%;"></td> <td style="width: 10%;"></td> <td style="width: 10%;"></td> <td style="width: 10%;"></td> <td style="width: 10%;"></td> <td style="width: 10%;"></td> <td style="width: 10%;"></td> <td style="width: 10%;"></td> <td style="width: 10%;"></td> </tr> <tr> <td></td> <td></td> <td colspan="8" style="text-align: center;"> <table border="1" style="width: 100%; border-collapse: collapse; text-align: center;"> <tr> <td style="width: 10%;"></td> <td style="width: 10%;"></td> <td style="width: 10%;"></td> <td style="width: 10%;"></td> <td style="width: 10%;"></td> <td style="width: 10%;"></td> <td style="width: 10%;"></td> <td style="width: 10%;"></td> <td style="width: 10%;"></td> <td style="width: 10%;"></td> </tr> <tr> <td></td> <td></td> <td colspan="8" style="text-align: center;"> <table border="1" style="width: 100%; border-collapse: collapse; text-align: center;"> <tr> <td style="width: 10%;"></td> <td style="width: 10%;"></td> <td style="width: 10%;"></td> <td style="width: 10%;"></td> <td style="width: 10%;"></td> <td style="width: 10%;"></td> <td style="width: 10%;"></td> <td style="width: 10%;"></td> <td style="width: 10%;"></td> <td style="width: 10%;"></td> </tr> <tr> <td></td> <td></td> <td colspan="8" style="text-align: center;"> <table border="1" style="width: 100%; border-collapse: collapse; text-align: center;"> <tr> <td style="width: 10%;"></td> <td style="width: 10%;"></td> <td style="width: 10%;"></td> <td style="width: 10%;"></td> <td style="width: 10%;"></td> <td style="width: 10%;"></td> <td style="width: 10%;"></td> <td style="width: 10%;"></td> <td style="width: 10%;"></td> <td style="width: 10%;"></td> </tr> <tr> <td></td> <td></td> <td colspan="8" style="text-align: center;"> <table border="1" style="width: 100%; border-collapse: collapse; text-align: center;"> <tr> <td style="width: 10%;"></td> <td style="width: 10%;"></td> <td style="width: 10%;"></td> <td style="width: 10%;"></td> <td style="width: 10%;"></td> <td style="width: 10%;"></td> <td style="width: 10%;"></td> <td style="width: 10%;"></td> <td style="width: 10%;"></td> <td style="width: 10%;"></td> </tr> <tr> <td></td> <td></td> <td colspan="8" style="text-align: center;"> <table border="1" style="width: 100%; border-collapse: collapse; text-align: center;"> <tr> <td style="width: 10%;"></td> <td style="width: 10%;"></td> <td style="width: 10%;"></td> <td style="width: 10%;"></td> <td style="width: 10%;"></td> <td style="width: 10%;"></td> <td style="width: 10%;"></td> <td style="width: 10%;"></td> <td style="width: 10%;"></td> <td style="width: 10%;"></td> </tr> <tr> <td></td> <td></td> <td colspan="8" style="text-align: center;"> <table border="1" style="width: 100%; border-collapse: collapse; text-align: center;"> <tr> <td style="width: 10%;"></td> <td style="width: 10%;"></td> <td style="width: 10%;"></td> <td style="width: 10%;"></td> <td style="width: 10%;"></td> <td style="width: 10%;"></td> <td style="width: 10%;"></td> <td style="width: 10%;"></td> <td style="width: 10%;"></td> <td style="width: 10%;"></td> </tr> <tr> <td></td> <td></td> <td colspan="8" style="text-align: center;"> <table border="1" style="width: 100%; border-collapse: collapse; text-align: center;"> <tr> </tr></table></td></tr></table></td></tr></table></td></tr></table></td></tr></table></td></tr></table></td></tr></table></td></tr></table></td></tr></table>
 | | | | | | | | | | | | | | | | | | | | <table border="1" style="width: 100%; border-collapse: collapse; text-align: center;"> <tr> <td style="width: 10%;"></td> <td style="width: 10%;"></td> <td style="width: 10%;"></td> <td style="width: 10%;"></td> <td style="width: 10%;"></td> <td style="width: 10%;"></td> <td style="width: 10%;"></td> <td style="width: 10%;"></td> <td style="width: 10%;"></td> <td style="width: 10%;"></td> </tr> <tr> <td></td> <td></td> <td colspan="8" style="text-align: center;"> <table border="1" style="width: 100%; border-collapse: collapse; text-align: center;"> <tr> <td style="width: 10%;"></td> <td style="width: 10%;"></td> <td style="width: 10%;"></td> <td style="width: 10%;"></td> <td style="width: 10%;"></td> <td style="width: 10%;"></td> <td style="width: 10%;"></td> <td style="width: 10%;"></td> <td style="width: 10%;"></td> <td style="width: 10%;"></td> </tr> <tr> <td></td> <td></td> <td colspan="8" style="text-align: center;"> <table border="1" style="width: 100%; border-collapse: collapse; text-align: center;"> <tr> <td style="width: 10%;"></td> <td style="width: 10%;"></td> <td style="width: 10%;"></td> <td style="width: 10%;"></td> <td style="width: 10%;"></td> <td style="width: 10%;"></td> <td style="width: 10%;"></td> <td style="width: 10%;"></td> <td style="width: 10%;"></td> <td style="width: 10%;"></td> </tr> <tr> <td></td> <td></td> <td colspan="8" style="text-align: center;"> <table border="1" style="width: 100%; border-collapse: collapse; text-align: center;"> <tr> <td style="width: 10%;"></td> <td style="width: 10%;"></td> <td style="width: 10%;"></td> <td style="width: 10%;"></td> <td style="width: 10%;"></td> <td style="width: 10%;"></td> <td style="width: 10%;"></td> <td style="width: 10%;"></td> <td style="width: 10%;"></td> <td style="width: 10%;"></td> </tr> <tr> <td></td> <td></td> <td colspan="8" style="text-align: center;"> <table border="1" style="width: 100%; border-collapse: collapse; text-align: center;"> <tr> <td style="width: 10%;"></td> <td style="width: 10%;"></td> <td style="width: 10%;"></td> <td style="width: 10%;"></td> <td style="width: 10%;"></td> <td style="width: 10%;"></td> <td style="width: 10%;"></td> <td style="width: 10%;"></td> <td style="width: 10%;"></td> <td style="width: 10%;"></td> </tr> <tr> <td></td> <td></td> <td colspan="8" style="text-align: center;"> <table border="1" style="width: 100%; border-collapse: collapse; text-align: center;"> <tr> <td style="width: 10%;"></td> <td style="width: 10%;"></td> <td style="width: 10%;"></td> <td style="width: 10%;"></td> <td style="width: 10%;"></td> <td style="width: 10%;"></td> <td style="width: 10%;"></td> <td style="width: 10%;"></td> <td style="width: 10%;"></td> <td style="width: 10%;"></td> </tr> <tr> <td></td> <td></td> <td colspan="8" style="text-align: center;"> <table border="1" style="width: 100%; border-collapse: collapse; text-align: center;"> <tr> <td style="width: 10%;"></td> <td style="width: 10%;"></td> <td style="width: 10%;"></td> <td style="width: 10%;"></td> <td style="width: 10%;"></td> <td style="width: 10%;"></td> <td style="width: 10%;"></td> <td style="width: 10%;"></td> <td style="width: 10%;"></td> <td style="width: 10%;"></td> </tr> <tr> <td></td> <td></td> <td colspan="8" style="text-align: center;"> <table border="1" style="width: 100%; border-collapse: collapse; text-align: center;"> <tr> </tr></table></td></tr></table></td></tr></table></td></tr></table></td></tr></table></td></tr></table></td></tr></table></td></tr></table> | | | | | | | | | | | | | | |
| | | | | <table border="1" style="width: 100%; border-collapse: collapse; text-align: center;"> <tr> <td style="width: 10%;"></td> <td style="width: 10%;"></td> <td style="width: 10%;"></td> <td style="width: 10%;"></td> <td style="width: 10%;"></td> <td style="width: 10%;"></td> <td style="width: 10%;"></td> <td style="width: 10%;"></td> <td style="width: 10%;"></td> <td style="width: 10%;"></td> </tr> <tr> <td></td> <td></td> <td colspan="8" style="text-align: center;"> <table border="1" style="width: 100%; border-collapse: collapse; text-align: center;"> <tr> <td style="width: 10%;"></td> <td style="width: 10%;"></td> <td style="width: 10%;"></td> <td style="width: 10%;"></td> <td style="width: 10%;"></td> <td style="width: 10%;"></td> <td style="width: 10%;"></td> <td style="width: 10%;"></td> <td style="width: 10%;"></td> <td style="width: 10%;"></td> </tr> <tr> <td></td> <td></td> <td colspan="8" style="text-align: center;"> <table border="1" style="width: 100%; border-collapse: collapse; text-align: center;"> <tr> <td style="width: 10%;"></td> <td style="width: 10%;"></td> <td style="width: 10%;"></td> <td style="width: 10%;"></td> <td style="width: 10%;"></td> <td style="width: 10%;"></td> <td style="width: 10%;"></td> <td style="width: 10%;"></td> <td style="width: 10%;"></td> <td style="width: 10%;"></td> </tr> <tr> <td></td> <td></td> <td colspan="8" style="text-align: center;"> <table border="1" style="width: 100%; border-collapse: collapse; text-align: center;"> <tr> <td style="width: 10%;"></td> <td style="width: 10%;"></td> <td style="width: 10%;"></td> <td style="width: 10%;"></td> <td style="width: 10%;"></td> <td style="width: 10%;"></td> <td style="width: 10%;"></td> <td style="width: 10%;"></td> <td style="width: 10%;"></td> <td style="width: 10%;"></td> </tr> <tr> <td></td> <td></td> <td colspan="8" style="text-align: center;"> <table border="1" style="width: 100%; border-collapse: collapse; text-align: center;"> <tr> <td style="width: 10%;"></td> <td style="width: 10%;"></td> <td style="width: 10%;"></td> <td style="width: 10%;"></td> <td style="width: 10%;"></td> <td style="width: 10%;"></td> <td style="width: 10%;"></td> <td style="width: 10%;"></td> <td style="width: 10%;"></td> <td style="width: 10%;"></td> </tr> <tr> <td></td> <td></td> <td colspan="8" style="text-align: center;"> <table border="1" style="width: 100%; border-collapse: collapse; text-align: center;"> <tr> <td style="width: 10%;"></td> <td style="width: 10%;"></td> <td style="width: 10%;"></td> <td style="width: 10%;"></td> <td style="width: 10%;"></td> <td style="width: 10%;"></td> <td style="width: 10%;"></td> <td style="width: 10%;"></td> <td style="width: 10%;"></td> <td style="width: 10%;"></td> </tr> <tr> <td></td> <td></td> <td colspan="8" style="text-align: center;"> <table border="1" style="width: 100%; border-collapse: collapse; text-align: center;"> <tr> </tr></table></td></tr></table></td></tr></table></td></tr></table></td></tr></table></td></tr></table></td></tr></table> | | | | | | | | | | | | | | | | | | | | <table border="1" style="width: 100%; border-collapse: collapse; text-align: center;"> <tr> <td style="width: 10%;"></td> <td style="width: 10%;"></td> <td style="width: 10%;"></td> <td style="width: 10%;"></td> <td style="width: 10%;"></td> <td style="width: 10%;"></td> <td style="width: 10%;"></td> <td style="width: 10%;"></td> <td style="width: 10%;"></td> <td style="width: 10%;"></td> </tr> <tr> <td></td> <td></td> <td colspan="8" style="text-align: center;"> <table border="1" style="width: 100%; border-collapse: collapse; text-align: center;"> <tr> <td style="width: 10%;"></td> <td style="width: 10%;"></td> <td style="width: 10%;"></td> <td style="width: 10%;"></td> <td style="width: 10%;"></td> <td style="width: 10%;"></td> <td style="width: 10%;"></td> <td style="width: 10%;"></td> <td style="width: 10%;"></td> <td style="width: 10%;"></td> </tr> <tr> <td></td> <td></td> <td colspan="8" style="text-align: center;"> <table border="1" style="width: 100%; border-collapse: collapse; text-align: center;"> <tr> <td style="width: 10%;"></td> <td style="width: 10%;"></td> <td style="width: 10%;"></td> <td style="width: 10%;"></td> <td style="width: 10%;"></td> <td style="width: 10%;"></td> <td style="width: 10%;"></td> <td style="width: 10%;"></td> <td style="width: 10%;"></td> <td style="width: 10%;"></td> </tr> <tr> <td></td> <td></td> <td colspan="8" style="text-align: center;"> <table border="1" style="width: 100%; border-collapse: collapse; text-align: center;"> <tr> <td style="width: 10%;"></td> <td style="width: 10%;"></td> <td style="width: 10%;"></td> <td style="width: 10%;"></td> <td style="width: 10%;"></td> <td style="width: 10%;"></td> <td style="width: 10%;"></td> <td style="width: 10%;"></td> <td style="width: 10%;"></td> <td style="width: 10%;"></td> </tr> <tr> <td></td> <td></td> <td colspan="8" style="text-align: center;"> <table border="1" style="width: 100%; border-collapse: collapse; text-align: center;"> <tr> <td style="width: 10%;"></td> <td style="width: 10%;"></td> <td style="width: 10%;"></td> <td style="width: 10%;"></td> <td style="width: 10%;"></td> <td style="width: 10%;"></td> <td style="width: 10%;"></td> <td style="width: 10%;"></td> <td style="width: 10%;"></td> <td style="width: 10%;"></td> </tr> <tr> <td></td> <td></td> <td colspan="8" style="text-align: center;"> <table border="1" style="width: 100%; border-collapse: collapse; text-align: center;"> <tr> </tr></table></td></tr></table></td></tr></table></td></tr></table></td></tr></table></td></tr></table>
 | | | | | | | | | | | | | | | | | | | | <table border="1" style="width: 100%; border-collapse: collapse; text-align: center;"> <tr> <td style="width: 10%;"></td> <td style="width: 10%;"></td> <td style="width: 10%;"></td> <td style="width: 10%;"></td> <td style="width: 10%;"></td> <td style="width: 10%;"></td> <td style="width: 10%;"></td> <td style="width: 10%;"></td> <td style="width: 10%;"></td> <td style="width: 10%;"></td> </tr> <tr> <td></td> <td></td> <td colspan="8" style="text-align: center;"> <table border="1" style="width: 100%; border-collapse: collapse; text-align: center;"> <tr> <td style="width: 10%;"></td> <td style="width: 10%;"></td> <td style="width: 10%;"></td> <td style="width: 10%;"></td> <td style="width: 10%;"></td> <td style="width: 10%;"></td> <td style="width: 10%;"></td> <td style="width: 10%;"></td> <td style="width: 10%;"></td> <td style="width: 10%;"></td> </tr> <tr> <td></td> <td></td> <td colspan="8" style="text-align: center;"> <table border="1" style="width: 100%; border-collapse: collapse; text-align: center;"> <tr> <td style="width: 10%;"></td> <td style="width: 10%;"></td> <td style="width: 10%;"></td> <td style="width: 10%;"></td> <td style="width: 10%;"></td> <td style="width: 10%;"></td> <td style="width: 10%;"></td> <td style="width: 10%;"></td> <td style="width: 10%;"></td> <td style="width: 10%;"></td> </tr> <tr> <td></td> <td></td> <td colspan="8" style="text-align: center;"> <table border="1" style="width: 100%; border-collapse: collapse; text-align: center;"> <tr> <td style="width: 10%;"></td> <td style="width: 10%;"></td> <td style="width: 10%;"></td> <td style="width: 10%;"></td> <td style="width: 10%;"></td> <td style="width: 10%;"></td> <td style="width: 10%;"></td> <td style="width: 10%;"></td> <td style="width: 10%;"></td> <td style="width: 10%;"></td> </tr> <tr> <td></td> <td></td> <td colspan="8" style="text-align: center;"> <table border="1" style="width: 100%; border-collapse: collapse; text-align: center;"> <tr> </tr></table></td></tr></table></td></tr></table></td></tr></table></td></tr></table> | | | | | | | | | | | | | | | | | | | | <table border="1" style="width: 100%; border-collapse: collapse; text-align: center;"> <tr> <td style="width: 10%;"></td> <td style="width: 10%;"></td> <td style="width: 10%;"></td> <td style="width: 10%;"></td> <td style="width: 10%;"></td> <td style="width: 10%;"></td> <td style="width: 10%;"></td> <td style="width: 10%;"></td> <td style="width: 10%;"></td> <td style="width: 10%;"></td> </tr> <tr> <td></td> <td></td> <td colspan="8" style="text-align: center;"> <table border="1" style="width: 100%; border-collapse: collapse;
text-align: center;"> <tr> <td style="width: 10%;"></td> <td style="width: 10%;"></td> <td style="width: 10%;"></td> <td style="width: 10%;"></td> <td style="width: 10%;"></td> <td style="width: 10%;"></td> <td style="width: 10%;"></td> <td style="width: 10%;"></td> <td style="width: 10%;"></td> <td style="width: 10%;"></td> </tr> <tr> <td></td> <td></td> <td colspan="8" style="text-align: center;"> <table border="1" style="width: 100%; border-collapse: collapse; text-align: center;"> <tr> <td style="width: 10%;"></td> <td style="width: 10%;"></td> <td style="width: 10%;"></td> <td style="width: 10%;"></td> <td style="width: 10%;"></td> <td style="width: 10%;"></td> <td style="width: 10%;"></td> <td style="width: 10%;"></td> <td style="width: 10%;"></td> <td style="width: 10%;"></td> </tr> <tr> <td></td> <td></td> <td colspan="8" style="text-align: center;"> <table border="1" style="width: 100%; border-collapse: collapse; text-align: center;"> <tr> </tr></table></td></tr></table></td></tr></table></td></tr></table> | | | | | | | | | | | | | | | | | | | | <table border="1" style="width: 100%; border-collapse: collapse; text-align: center;"> <tr> <td style="width: 10%;"></td> <td style="width: 10%;"></td> <td style="width: 10%;"></td> <td style="width: 10%;"></td> <td style="width: 10%;"></td> <td style="width: 10%;"></td> <td style="width: 10%;"></td> <td style="width: 10%;"></td> <td style="width: 10%;"></td> <td style="width: 10%;"></td> </tr> <tr> <td></td> <td></td> <td colspan="8" style="text-align: center;"> <table border="1" style="width: 100%; border-collapse: collapse; text-align: center;"> <tr> <td style="width: 10%;"></td> <td style="width: 10%;"></td> <td style="width: 10%;"></td> <td style="width: 10%;"></td> <td style="width: 10%;"></td> <td style="width: 10%;"></td> <td style="width: 10%;"></td> <td style="width: 10%;"></td> <td style="width: 10%;"></td> <td style="width: 10%;"></td> </tr> <tr> <td></td> <td></td> <td colspan="8" style="text-align: center;"> <table border="1" style="width: 100%; border-collapse: collapse; text-align: center;"> <tr> </tr></table></td></tr></table></td></tr></table> | | | | | | | | | | | | | | | | | | |
 | <table border="1" style="width: 100%; border-collapse: collapse; text-align: center;"> <tr> <td style="width: 10%;"></td> <td style="width: 10%;"></td> <td style="width: 10%;"></td> <td style="width: 10%;"></td> <td style="width: 10%;"></td> <td style="width: 10%;"></td> <td style="width: 10%;"></td> <td style="width: 10%;"></td> <td style="width: 10%;"></td> <td style="width: 10%;"></td> </tr> <tr> <td></td> <td></td> <td colspan="8" style="text-align: center;"> <table border="1" style="width: 100%; border-collapse: collapse; text-align: center;"> <tr> </tr></table></td></tr></table> | | | | | | | | | | | | | | | | | | | | <table border="1" style="width: 100%; border-collapse: collapse; text-align: center;"> <tr> </tr></table> | | | | | | | | | | | | | | | | | | | | | | | | | | | | | | | | | | | | | | | | | | | | | | | | | | | | | | | | | | |
 | | | | | | | | | | | | | | | | | | | | | | | | | | | | | | | | | | | | | | | | | | | | | | | | | | | | | | | | | | | | | | | | | | | | | | | | | | | | | | | |
 | | | | | | | | | | | | | | | | | | | | | | | | | | | | | | | | | | | | | | | | | | | | | | | | | | | | | | | | | | | | | | | | | | | |
| | |

 | | | | | | | | | | | | | | | | | | | |

 | | | | | | | | | | | | | | | | | | | |

 | | | | | | | | | | | | | | | | | | | |

 | | | | | | | | | | | | | | | | | | | |

 | | | | | | | | | | | | | | | | | | | |

 | | | | | | | | | | | | | | | | | | | |

 | | | | | | | | | | | | | | | | | | | |

 | | | | | | | | | | | | | | | | | | | |

 | | | | | | | | | | | | | | | | | | | |

 | | | | | | | | | | | | | | | | | | | |

 | | | | | | | | | | | | | | | | | | | |

 | | | | | | | | | | | | | | | | | | | |

 | | | | | | | | | | | | | | | | | | | |

 | | | | | | | | | | | | | | | | | | | |

 | | | | | | | | | | | | | | | | | | | |

 | | | | | | | | | | | | | | | | | | | |

 | | | | | | | | | | | | | | | | | | | |

 | | | | | | | | | | | | | | | | | | | |

 | | | | | | | | | | | | | | | | | | | |

 | | | | | | | | | | | | | | | | | | | |

 | | | | | | | | | | | | | | | | | | | |

 | | | | | | | | | | | | | | | | | | | |

 | | | | | | | | | | | | | | | | | | | |

 | | | | | | | | | | | | | | | | | | | |

 | | | | | | | | | | | | | | | | | | | |

 | | | | | | | | | | | | | | | | | | | |

 | | | | | | | | | | | | | | | | | | | |

 | | | | | | | | | | | | | | | | | | | |
 | | | | | | | | | | | | | | | | | | | |

 | | | | | | | | | | | | | | | | | | | |

 | | | | | | | | | | | | | | | | | | | |
 | | | | | | | | | | | | | | | | | | | |

 | | | | | | | | | | | | | | | | | | | |

 | | | | | | | | | | | | | | | | | | | |
 | | | | | | | | | | | | | | | | | | | |
 | | | | | | | | | | | | | | | | | | | |

 | | | | | | | | | | | | | | | | | | | |
 | | | | | | | | | | | | | | | | | | | |
 | | | | | | | | | | | | | | | | | | | |

 | | | | | | | | | | | | | | | | | | | | | | | | | | | | | | | | | | | | | | | | | | | | | | | | | | | | | | | | | | | | | | | | | | | | | | | | | | | | | | | | | | | | | | | | | | | | | | | | | | | |
 | | | | | | | | | | | | | | | | | | | |
 | | | | | | | | | | | | | | | | | | | |
 | | | | | | | | | | | | | | | | | | | |
 | | | | | | | | | | | | | | | | | | | |
 | | | | | | | | | | | | | | | | | | | |
 | | | | | | | | | | | | | | | | | | | |
 | | | | | | | | | | | | | | | | | | | |
 | | | | | | | | | | | | | | | | | | | |
 | | | | | | | | | | | | | | | | | | | | | | | | | | | | | | | | | | | | | | | |
 | | | | | | | | | | | | | | | | | | | |
 | | | | | | | | | | | | | | | | | | | | | | | | | | | | | | | | | | | | | | | |
 | | | | | | | | | | | | | | | | | | | | | | | | | | | | | | | | | | | | | | | |
 | | | | | | | | | | | | | | | | | | | | | | | | | | | | | | | | | | | | | | | |
 | | | | | | | | | | | | | | | | | | | | | | | | | | | | | | | | | | | | | | | | | | | | | | | | | | | | | | | | | | | | | | | | | | | | | | | | | | | | | | | | | | | | | | | | | | | | | | | | | | | |
 | | | | | | | | | | | | | | | | | | | | | | | | | | | | | | | | | | | | | | | | | | | | | | | |
| | | <table border="1" style="width: 100%; border-collapse: collapse; text-align: center;"> <tr> <td style="width: 10%;"></td> <td style="width: 10%;"></td> <td style="width: 10%;"></td> <td style="width: 10%;"></td> <td style="width: 10%;"></td> <td style="width: 10%;"></td> <td style="width: 10%;"></td> <td style="width: 10%;"></td> <td style="width: 10%;"></td> <td style="width: 10%;"></td> </tr> <tr> <td></td> <td></td> <td colspan="8" style="text-align: center;"> <table border="1" style="width: 100%; border-collapse: collapse; text-align: center;"> <tr> <td style="width: 10%;"></td> <td style="width: 10%;"></td> <td style="width: 10%;"></td> <td style="width: 10%;"></td> <td style="width: 10%;"></td> <td style="width: 10%;"></td> <td style="width: 10%;"></td> <td style="width: 10%;"></td> <td style="width: 10%;"></td> <td style="width: 10%;"></td> </tr> <tr> <td></td> <td></td> <td colspan="8" style="text-align: center;"> <table border="1" style="width: 100%; border-collapse: collapse; text-align: center;"> <tr> <td style="width: 10%;"></td> <td style="width: 10%;"></td> <td style="width: 10%;"></td> <td style="width: 10%;"></td> <td style="width: 10%;"></td> <td style="width: 10%;"></td> <td style="width: 10%;"></td> <td style="width: 10%;"></td> <td style="width: 10%;"></td> <td style="width: 10%;"></td> </tr> <tr> <td></td> <td></td> <td colspan="8" style="text-align: center;"> <table border="1" style="width: 100%; border-collapse: collapse; text-align: center;"> <tr> <td style="width: 10%;"></td> <td style="width: 10%;"></td> <td style="width: 10%;"></td> <td style="width: 10%;"></td> <td style="width: 10%;"></td> <td style="width: 10%;"></td> <td style="width: 10%;"></td> <td style="width: 10%;"></td> <td style="width: 10%;"></td> <td style="width: 10%;"></td> </tr> <tr> <td></td> <td></td> <td colspan="8" style="text-align: center;"> <table border="1" style="width: 100%; border-collapse: collapse; text-align: center;"> <tr> <td style="width: 10%;"></td> <td style="width: 10%;"></td> <td style="width: 10%;"></td> <td style="width: 10%;"></td> <td style="width: 10%;"></td> <td style="width: 10%;"></td> <td style="width: 10%;"></td> <td style="width: 10%;"></td> <td style="width: 10%;"></td> <td style="width: 10%;"></td> </tr> <tr> <td></td> <td></td> <td colspan="8" style="text-align: center;"> <table border="1" style="width: 100%; border-collapse: collapse; text-align: center;"> <tr> <td style="width: 10%;"></td> <td style="width: 10%;"></td> <td style="width: 10%;"></td> <td style="width: 10%;"></td> <td style="width: 10%;"></td> <td style="width: 10%;"></td> <td style="width: 10%;"></td> <td style="width: 10%;"></td> <td style="width: 10%;"></td> <td style="width: 10%;"></td> </tr> <tr> <td></td> <td></td> <td colspan="8" style="text-align: center;"> <table border="1" style="width: 100%; border-collapse: collapse; text-align: center;"> <tr> <td style="width: 10%;"></td> <td style="width: 10%;"></td> <td style="width: 10%;"></td> <td style="width: 10%;"></td> <td style="width: 10%;"></td> <td style="width: 10%;"></td> <td style="width: 10%;"></td> <td style="width: 10%;"></td> <td style="width: 10%;"></td> <td style="width: 10%;"></td> </tr> <tr> <td></td> <td></td> <td colspan="8" style="text-align: center;"> <table border="1" style="width: 100%; border-collapse: collapse; text-align: center;"> <tr> <td style="width: 10%;"></td> <td style="width: 10%;"></td> <td style="width: 10%;"></td> <td style="width: 10%;"></td> <td style="width: 10%;"></td> <td style="width: 10%;"></td> <td style="width: 10%;"></td> <td style="width: 10%;"></td> <td style="width: 10%;"></td> <td style="width: 10%;"></td> </tr> <tr> <td></td> <td></td> <td colspan="8" style="text-align: center;"> <table border="1" style="width: 100%; border-collapse: collapse; text-align: center;"> <tr> <td style="width: 10%;"></td> <td style="width: 10%;"></td> <td style="width: 10%;"></td> <td style="width: 10%;"></td> <td style="width: 10%;"></td> <td style="width: 10%;"></td> <td style="width: 10%;"></td> <td style="width: 10%;"></td> <td style="width: 10%;"></td> <td style="width: 10%;"></td> </tr> <tr> <td></td> <td></td> <td colspan="8" style="text-align: center;"> <table border="1" style="width: 100%; border-collapse: collapse; text-align: center;"> <tr> <td style="width: 10%;"></td> <td style="width: 10%;"></td> <td style="width: 10%;"></td> <td style="width: 10%;"></td> <td style="width: 10%;"></td> <td style="width: 10%;"></td> <td style="width: 10%;"></td> <td style="width: 10%;"></td> <td style="width: 10%;"></td> <td style="width: 10%;"></td> </tr> <tr> <td></td> <td></td> <td colspan="8" style="text-align: center;"> <table border="1" style="width: 100%; border-collapse: collapse; text-align: center;"> <tr> <td style="width: 10%;"></td> <td style="width: 10%;"></td> <td style="width: 10%;"></td> <td style="width: 10%;"></td> <td style="width: 10%;"></td> <td style="width: 10%;"></td> <td style="width: 10%;"></td> <td style="width: 10%;"></td> <td style="width: 10%;"></td> <td style="width: 10%;"></td> </tr> <tr> <td></td> <td></td> <td colspan="8" style="text-align: center;"> <table border="1" style="width: 100%; border-collapse: collapse; text-align: center;"> <tr> <td style="width: 10%;"></td> <td style="width: 10%;"></td> <td style="width: 10%;"></td> <td style="width: 10%;"></td> <td style="width: 10%;"></td> <td style="width: 10%;"></td> <td style="width: 10%;"></td> <td style="width: 10%;"></td> <td style="width: 10%;"></td> <td style="width: 10%;"></td> </tr> <tr> <td></td> <td></td> <td colspan="8" style="text-align: center;"> <table border="1" style="width: 100%; border-collapse: collapse; text-align: center;"> <tr> <td style="width: 10%;"></td> <td style="width: 10%;"></td> <td style="width: 10%;"></td> <td style="width: 10%;"></td> <td style="width: 10%;"></td> <td style="width: 10%;"></td> <td style="width: 10%;"></td> <td style="width: 10%;"></td> <td style="width: 10%;"></td> <td style="width: 10%;"></td> </tr> <tr> <td></td> <td></td> <td colspan="8" style="text-align: center;"> <table border="1" style="width: 100%; border-collapse: collapse; text-align: center;"> <tr> <td style="width: 10%;"></td> <td style="width: 10%;"></td> <td style="width: 10%;"></td> <td style="width: 10%;"></td> <td style="width: 10%;"></td> <td style="width: 10%;"></td> <td style="width: 10%;"></td> <td style="width: 10%;"></td> <td style="width: 10%;"></td> <td style="width: 10%;"></td> </tr> <tr> <td></td> <td></td> <td colspan="8" style="text-align: center;"> <table border="1" style="width: 100%; border-collapse: collapse; text-align: center;"> <tr> <td style="width: 10%;"></td> <td style="width: 10%;"></td> <td style="width: 10%;"></td> <td style="width: 10%;"></td> <td style="width: 10%;"></td> <td style="width: 10%;"></td> <td style="width: 10%;"></td> <td style="width: 10%;"></td> <td style="width: 10%;"></td> <td style="width: 10%;"></td> </tr> <tr> <td></td> <td></td> <td colspan="8" style="text-align: center;"> <table border="1" style="width: 100%; border-collapse: collapse; text-align: center;"> <tr> <td style="width: 10%;"></td> <td style="width: 10%;"></td> <td style="width: 10%;"></td> <td style="width: 10%;"></td> <td style="width: 10%;"></td> <td style="width: 10%;"></td> <td style="width: 10%;"></td> <td style="width: 10%;"></td> <td style="width: 10%;"></td> <td style="width: 10%;"></td> </tr> <tr> <td></td> <td></td> <td colspan="8" style="text-align: center;"> <table border="1" style="width: 100%; border-collapse: collapse; text-align: center;"> <tr> <td style="width: 10%;"></td> <td style="width: 10%;"></td> <td style="width: 10%;"></td> <td style="width: 10%;"></td> <td style="width: 10%;"></td> <td style="width: 10%;"></td> <td style="width: 10%;"></td> <td style="width: 10%;"></td> <td style="width: 10%;"></td> <td style="width: 10%;"></td> </tr> <tr> <td></td> <td></td> <td colspan="8" style="text-align: center;"> <table border="1" style="width: 100%; border-collapse: collapse; text-align: center;"> <tr> <td style="width: 10%;"></td> <td style="width: 10%;"></td> <td style="width: 10%;"></td> <td style="width: 10%;"></td> <td style="width: 10%;"></td> <td style="width: 10%;"></td> <td style="width: 10%;"></td> <td style="width: 10%;"></td> <td style="width: 10%;"></td> <td style="width: 10%;"></td> </tr> <tr> <td></td> <td></td> <td colspan="8" style="text-align: center;"> <table border="1" style="width: 100%; border-collapse: collapse; text-align: center;"> <tr> <td style="width: 10%;"></td> <td style="width: 10%;"></td> <td style="width: 10%;"></td> <td style="width: 10%;"></td> <td style="width: 10%;"></td> <td style="width: 10%;"></td> <td style="width: 10%;"></td> <td style="width: 10%;"></td> <td style="width: 10%;"></td> <td style="width: 10%;"></td> </tr> <tr> <td></td> <td></td> <td colspan="8" style="text-align: center;"> <table border="1" style="width: 100%; border-collapse: collapse; text-align: center;"> <tr> <td style="width: 10%;"></td> <td style="width: 10%;"></td> <td style="width: 10%;"></td> <td style="width: 10%;"></td> <td style="width: 10%;"></td> <td style="width: 10%;"></td> <td style="width: 10%;"></td> <td style="width: 10%;"></td> <td style="width: 10%;"></td> <td style="width: 10%;"></td> </tr> <tr> <td></td> <td></td> <td colspan="8" style="text-align: center;"> <table border="1" style="width: 100%; border-collapse: collapse; text-align: center;"> <tr> <td style="width: 10%;"></td> <td style="width: 10%;"></td> <td style="width: 10%;"></td> <td style="width: 10%;"></td> <td style="width: 10%;"></td> <td style="width: 10%;"></td> <td style="width: 10%;"></td> <td style="width: 10%;"></td> <td style="width: 10%;"></td> <td style="width: 10%;"></td> </tr> <tr> <td></td> <td></td> <td colspan="8" style="text-align: center;"> <table border="1" style="width: 100%; border-collapse: collapse; text-align: center;"> <tr> <td style="width: 10%;"></td> <td style="width: 10%;"></td> <td
style="width: 10%;"></td> <td style="width: 10%;"></td> <td style="width: 10%;"></td> <td style="width: 10%;"></td> <td style="width: 10%;"></td> <td style="width: 10%;"></td> <td style="width: 10%;"></td> <td style="width: 10%;"></td> </tr> <tr> <td></td> <td></td> <td colspan="8" style="text-align: center;"> <table border="1" style="width: 100%; border-collapse: collapse; text-align: center;"> <tr> <td style="width: 10%;"></td> <td style="width: 10%;"></td> <td style="width: 10%;"></td> <td style="width: 10%;"></td> <td style="width: 10%;"></td> <td style="width: 10%;"></td> <td style="width: 10%;"></td> <td style="width: 10%;"></td> <td style="width: 10%;"></td> <td style="width: 10%;"></td> </tr> <tr> <td></td> <td></td> <td colspan="8" style="text-align: center;"> <table border="1" style="width: 100%; border-collapse: collapse; text-align: center;"> <tr> <td style="width: 10%;"></td> <td style="width: 10%;"></td> <td style="width: 10%;"></td> <td style="width: 10%;"></td> <td style="width: 10%;"></td> <td style="width: 10%;"></td> <td style="width: 10%;"></td> <td style="width: 10%;"></td> <td style="width: 10%;"></td> <td style="width: 10%;"></td> </tr> <tr> <td></td> <td></td> <td colspan="8" style="text-align: center;"> <table border="1" style="width: 100%; border-collapse: collapse; text-align: center;"> <tr> <td style="width: 10%;"></td> <td style="width: 10%;"></td> <td style="width: 10%;"></td> <td style="width: 10%;"></td> <td style="width: 10%;"></td> <td style="width: 10%;"></td> <td style="width: 10%;"></td> <td style="width: 10%;"></td> <td style="width: 10%;"></td> <td style="width: 10%;"></td> </tr> <tr> <td></td> <td></td> <td colspan="8" style="text-align: center;"> <table border="1" style="width: 100%; border-collapse: collapse; text-align: center;"> <tr> <td style="width: 10%;"></td> <td style="width: 10%;"></td> <td style="width: 10%;"></td> <td style="width: 10%;"></td> <td style="width: 10%;"></td> <td style="width: 10%;"></td> <td style="width: 10%;"></td> <td style="width: 10%;"></td> <td style="width: 10%;"></td> <td style="width: 10%;"></td> </tr> <tr> <td></td> <td></td> <td colspan="8" style="text-align: center;"> <table border="1" style="width: 100%; border-collapse: collapse; text-align: center;"> <tr> <td style="width: 10%;"></td> <td style="width: 10%;"></td> <td style="width: 10%;"></td> <td style="width: 10%;"></td> <td style="width: 10%;"></td> <td style="width: 10%;"></td> <td style="width: 10%;"></td> <td style="width: 10%;"></td> <td style="width: 10%;"></td> <td style="width: 10%;"></td> </tr> <tr> <td></td> <td></td> <td colspan="8" style="text-align: center;"> <table border="1" style="width: 100%; border-collapse: collapse; text-align: center;"> <tr> <td style="width: 10%;"></td> <td style="width: 10%;"></td> <td style="width: 10%;"></td> <td style="width: 10%;"></td> <td style="width: 10%;"></td> <td style="width: 10%;"></td> <td style="width: 10%;"></td> <td style="width: 10%;"></td> <td style="width: 10%;"></td> <td style="width: 10%;"></td> </tr> <tr> <td></td> <td></td> <td colspan="8" style="text-align: center;"> <table border="1" style="width: 100%; border-collapse: collapse; text-align: center;"> <tr> <td style="width: 10%;"></td> <td style="width: 10%;"></td> <td style="width: 10%;"></td> <td style="width: 10%;"></td> <td style="width: 10%;"></td> <td style="width: 10%;"></td> <td style="width: 10%;"></td> <td style="width: 10%;"></td> <td style="width: 10%;"></td> <td style="width: 10%;"></td> </tr> <tr> <td></td> <td></td> <td colspan="8" style="text-align: center;"> <table border="1" style="width: 100%; border-collapse: collapse; text-align: center;"> <tr> <td style="width: 10%;"></td> <td style="width: 10%;"></td> <td style="width: 10%;"></td> <td style="width: 10%;"></td> <td style="width: 10%;"></td> <td style="width: 10%;"></td> <td style="width: 10%;"></td> <td style="width: 10%;"></td> <td style="width: 10%;"></td> <td style="width: 10%;"></td> </tr> <tr> <td></td> <td></td> <td colspan="8" style="text-align: center;"> <table border="1" style="width: 100%; border-collapse: collapse; text-align: center;"> <tr> <td style="width: 10%;"></td> <td style="width: 10%;"></td> <td style="width: 10%;"></td> <td style="width: 10%;"></td> <td style="width: 10%;"></td> <td style="width: 10%;"></td> <td style="width: 10%;"></td> <td style="width: 10%;"></td> <td style="width: 10%;"></td> <td style="width: 10%;"></td> </tr> <tr> <td></td> <td></td> <td colspan="8" style="text-align: center;"> <table border="1" style="width: 100%; border-collapse: collapse; text-align: center;"> <tr> <td style="width: 10%;"></td> <td style="width: 10%;"></td> <td style="width: 10%;"></td> <td style="width: 10%;"></td> <td style="width: 10%;"></td> <td style="width: 10%;"></td> <td style="width: 10%;"></td> <td style="width: 10%;"></td> <td style="width: 10%;"></td> <td style="width: 10%;"></td> </tr> <tr> <td></td> <td></td> <td colspan="8" style="text-align: center;"> <table border="1" style="width: 100%; border-collapse: collapse; text-align: center;"> <tr> <td style="width: 10%;"></td> <td style="width: 10%;"></td> <td style="width: 10%;"></td> <td style="width: 10%;"></td> <td style="width: 10%;"></td> <td style="width: 10%;"></td> <td style="width: 10%;"></td> <td style="width: 10%;"></td> <td style="width: 10%;"></td> <td style="width: 10%;"></td> </tr> <tr> <td></td> <td></td> <td colspan="8" style="text-align: center;"> <table border="1" style="width: 100%; border-collapse: collapse; text-align: center;"> <tr> <td style="width: 10%;"></td> <td style="width: 10%;"></td> <td style="width: 10%;"></td> <td style="width: 10%;"></td> <td style="width: 10%;"></td> <td style="width: 10%;"></td> <td style="width: 10%;"></td> <td style="width: 10%;"></td> <td style="width: 10%;"></td> <td style="width: 10%;"></td> </tr> <tr> <td></td> <td></td> <td colspan="8" style="text-align: center;"> <table border="1" style="width: 100%; border-collapse: collapse; text-align: center;"> <tr> <td style="width: 10%;"></td> <td style="width: 10%;"></td> <td style="width: 10%;"></td> <td style="width: 10%;"></td> <td style="width: 10%;"></td> <td style="width: 10%;"></td> <td style="width: 10%;"></td> <td style="width: 10%;"></td> <td style="width: 10%;"></td> <td style="width: 10%;"></td> </tr> <tr> <td></td> <td></td> <td colspan="8" style="text-align: center;"> <table border="1" style="width: 100%; border-collapse: collapse; text-align: center;"> <tr> <td style="width: 10%;"></td> <td style="width: 10%;"></td> <td style="width: 10%;"></td> <td style="width: 10%;"></td> <td style="width: 10%;"></td> <td style="width: 10%;"></td> <td style="width: 10%;"></td> <td style="width: 10%;"></td> <td style="width: 10%;"></td> <td style="width: 10%;"></td> </tr> <tr> <td></td> <td></td> <td colspan="8" style="text-align: center;"> <table border="1" style="width: 100%; border-collapse: collapse; text-align: center;"> <tr> <td style="width: 10%;"></td> <td style="width: 10%;"></td> <td style="width: 10%;"></td> <td style="width: 10%;"></td> <td style="width: 10%;"></td> <td style="width: 10%;"></td> <td style="width: 10%;"></td> <td style="width: 10%;"></td> <td style="width: 10%;"></td> <td style="width: 10%;"></td> </tr> <tr> <td></td> <td></td> <td colspan="8" style="text-align: center;"> <table border="1" style="width: 100%; border-collapse: collapse; text-align: center;"> <tr> <td style="width: 10%;"></td> <td style="width: 10%;"></td> <td style="width: 10%;"></td> <td style="width: 10%;"></td> <td style="width: 10%;"></td> <td style="width: 10%;"></td> <td style="width: 10%;"></td> <td style="width: 10%;"></td> <td style="width: 10%;"></td> <td style="width: 10%;"></td> </tr> <tr> <td></td> <td></td> <td colspan="8" style="text-align: center;"> <table border="1" style="width: 100%; border-collapse: collapse; text-align: center;"> <tr> <td style="width: 10%;"></td> <td style="width: 10%;"></td> <td style="width: 10%;"></td> <td style="width: 10%;"></td> <td style="width: 10%;"></td> <td style="width: 10%;"></td> <td style="width: 10%;"></td> <td style="width: 10%;"></td> <td style="width: 10%;"></td> <td style="width: 10%;"></td> </tr> <tr> <td></td> <td></td> <td colspan="8" style="text-align: center;"> <table border="1" style="width: 100%; border-collapse: collapse; text-align: center;"> <tr> <td style="width: 10%;"></td> <td style="width: 10%;"></td> <td style="width: 10%;"></td> <td style="width: 10%;"></td> <td style="width: 10%;"></td> <td style="width: 10%;"></td> <td style="width: 10%;"></td> <td style="width: 10%;"></td> <td style="width: 10%;"></td> <td style="width: 10%;"></td> </tr> <tr> <td></td> <td></td> <td colspan="8" style="text-align: center;"> <table border="1" style="width: 100%; border-collapse: collapse; text-align: center;"> <tr> <td style="width: 10%;"></td> <td style="width: 10%;"></td> <td style="width: 10%;"></td> <td style="width: 10%;"></td> <td style="width: 10%;"></td> <td style="width: 10%;"></td> <td style="width: 10%;"></td> <td style="width: 10%;"></td> <td style="width: 10%;"></td> <td style="width: 10%;"></td> </tr> <tr> <td></td> <td></td> <td colspan="8" style="text-align: center;"> <table border="1" style="width: 100%; border-collapse: collapse; text-align: center;"> <tr> <td style="width: 10%;"></td> <td style="width: 10%;"></td> <td style="width: 10%;"></td> <td style="width: 10%;"></td> <td style="width: 10%;"></td> <td style="width: 10%;"></td> <td style="width: 10%;"></td> <td style="width: 10%;"></td> <td style="width: 10%;"></td> <td style="width: 10%;"></td> </tr> <tr> <td></td> <td></td> <td colspan="8" style="text-align: center;"> <table border="1" style="width: 100%; border-collapse: collapse; text-align: center;"> <tr> <td style="width: 10%;"></td> <td style="width: 10%;"></td> <td style="width: 10%;"></td> <td style="width: 10%;"></td> <td style="width: 10%;"></td> <td style="width: 10%;"></td> <td style="width: 10%;"></td> <td style="width:
10%;"></td> <td style="width: 10%;"></td> <td style="width: 10%;"></td> </tr> <tr> <td></td> <td></td> <td colspan="8" style="text-align: center;"> <table border="1" style="width: 100%; border-collapse: collapse; text-align: center;"> <tr> <td style="width: 10%;"></td> <td style="width: 10%;"></td> <td style="width: 10%;"></td> <td style="width: 10%;"></td> <td style="width: 10%;"></td> <td style="width: 10%;"></td> <td style="width: 10%;"></td> <td style="width: 10%;"></td> <td style="width: 10%;"></td> <td style="width: 10%;"></td> </tr> <tr> <td></td> <td></td> <td colspan="8" style="text-align: center;"> <table border="1" style="width: 100%; border-collapse: collapse; text-align: center;"> <tr> <td style="width: 10%;"></td> <td style="width: 10%;"></td> <td style="width: 10%;"></td> <td style="width: 10%;"></td> <td style="width: 10%;"></td> <td style="width: 10%;"></td> <td style="width: 10%;"></td> <td style="width: 10%;"></td> <td style="width: 10%;"></td> <td style="width: 10%;"></td> </tr> <tr> <td></td> <td></td> <td colspan="8" style="text-align: center;"> <table border="1" style="width: 100%; border-collapse: collapse; text-align: center;"> <tr> <td style="width: 10%;"></td> <td style="width: 10%;"></td> <td style="width: 10%;"></td> <td style="width: 10%;"></td> <td style="width: 10%;"></td> <td style="width: 10%;"></td> <td style="width: 10%;"></td> <td style="width: 10%;"></td> <td style="width: 10%;"></td> <td style="width: 10%;"></td> </tr> <tr> <td></td> <td></td> <td colspan="8" style="text-align: center;"> <table border="1" style="width: 100%; border-collapse: collapse; text-align: center;"> <tr> <td style="width: 10%;"></td> <td style="width: 10%;"></td> <td style="width: 10%;"></td> <td style="width: 10%;"></td> <td style="width: 10%;"></td> <td style="width: 10%;"></td> <td style="width: 10%;"></td> <td style="width: 10%;"></td> <td style="width: 10%;"></td> <td style="width: 10%;"></td> </tr> <tr> <td></td> <td></td> <td colspan="8" style="text-align: center;"> <table border="1" style="width: 100%; border-collapse: collapse; text-align: center;"> <tr> <td style="width: 10%;"></td> <td style="width: 10%;"></td> <td style="width: 10%;"></td> <td style="width: 10%;"></td> <td style="width: 10%;"></td> <td style="width: 10%;"></td> <td style="width: 10%;"></td> <td style="width: 10%;"></td> <td style="width: 10%;"></td> <td style="width: 10%;"></td> </tr> <tr> <td></td> <td></td> <td colspan="8" style="text-align: center;"> <table border="1" style="width: 100%; border-collapse: collapse; text-align: center;"> <tr> <td style="width: 10%;"></td> <td style="width: 10%;"></td> <td style="width: 10%;"></td> <td style="width: 10%;"></td> <td style="width: 10%;"></td> <td style="width: 10%;"></td> <td style="width: 10%;"></td> <td style="width: 10%;"></td> <td style="width: 10%;"></td> <td style="width: 10%;"></td> </tr> <tr> <td></td> <td></td> <td colspan="8" style="text-align: center;"> <table border="1" style="width: 100%; border-collapse: collapse; text-align: center;"> <tr> <td style="width: 10%;"></td> <td style="width: 10%;"></td> <td style="width: 10%;"></td> <td style="width: 10%;"></td> <td style="width: 10%;"></td> <td style="width: 10%;"></td> <td style="width: 10%;"></td> <td style="width: 10%;"></td> <td style="width: 10%;"></td> <td style="width: 10%;"></td> </tr> <tr> <td></td> <td></td> <td colspan="8" style="text-align: center;"> <table border="1" style="width: 100%; border-collapse: collapse; text-align: center;"> <tr> <td style="width: 10%;"></td> <td style="width: 10%;"></td> <td style="width: 10%;"></td> <td style="width: 10%;"></td> <td style="width: 10%;"></td> <td style="width: 10%;"></td> <td style="width: 10%;"></td> <td style="width: 10%;"></td> <td style="width: 10%;"></td> <td style="width: 10%;"></td> </tr> <tr> <td></td> <td></td> <td colspan="8" style="text-align: center;"> <table border="1" style="width: 100%; border-collapse: collapse; text-align: center;"> <tr> <td style="width: 10%;"></td> <td style="width: 10%;"></td> <td style="width: 10%;"></td> <td style="width: 10%;"></td> <td style="width: 10%;"></td> <td style="width: 10%;"></td> <td style="width: 10%;"></td> <td style="width: 10%;"></td> <td style="width: 10%;"></td> <td style="width: 10%;"></td> </tr> <tr> <td></td> <td></td> <td colspan="8" style="text-align: center;"> <table border="1" style="width: 100%; border-collapse: collapse; text-align: center;"> <tr> <td style="width: 10%;"></td> <td style="width: 10%;"></td> <td style="width: 10%;"></td> <td style="width: 10%;"></td> <td style="width: 10%;"></td> <td style="width: 10%;"></td> <td style="width: 10%;"></td> <td style="width: 10%;"></td> <td style="width: 10%;"></td> <td style="width: 10%;"></td> </tr> <tr> <td></td> <td></td> <td colspan="8" style="text-align: center;"> <table border="1" style="width: 100%; border-collapse: collapse; text-align: center;"> <tr> <td style="width: 10%;"></td> <td style="width: 10%;"></td> <td style="width: 10%;"></td> <td style="width: 10%;"></td> <td style="width: 10%;"></td> <td style="width: 10%;"></td> <td style="width: 10%;"></td> <td style="width: 10%;"></td> <td style="width: 10%;"></td> <td style="width: 10%;"></td> </tr> <tr> <td></td> <td></td> <td colspan="8" style="text-align: center;"> <table border="1" style="width: 100%; border-collapse: collapse; text-align: center;"> <tr> <td style="width: 10%;"></td> <td style="width: 10%;"></td> <td style="width: 10%;"></td> <td style="width: 10%;"></td> <td style="width: 10%;"></td> <td style="width: 10%;"></td> <td style="width: 10%;"></td> <td style="width: 10%;"></td> <td style="width: 10%;"></td> <td style="width: 10%;"></td> </tr> <tr> <td></td> <td></td> <td colspan="8" style="text-align: center;"> <table border="1" style="width: 100%; border-collapse: collapse; text-align: center;"> <tr> </tr></table></td></tr></table></td></tr></table></td></tr></table></td></tr></table></td></tr></table></td></tr></table></td></tr></table></td></tr></table></td></tr></table></td></tr></table></td></tr></table></td></tr></table></td></tr></table></td></tr></table></td></tr></table></td></tr></table></td></tr></table></td></tr></table></td></tr></table></td></tr></table></td></tr></table></td></tr></table></td></tr></table></td></tr></table></td></tr></table></td></tr></table></td></tr></table></td></tr></table></td></tr></table></td></tr></table></td></tr></table></td></tr></table></td></tr></table></td></tr></table></td></tr></table></td></tr></table></td></tr></table></td></tr></table></td></tr></table></td></tr></table></td></tr></table></td></tr></table></td></tr></table></td></tr></table></td></tr></table></td></tr></table></td></tr></table></td></tr></table></td></tr></table></td></tr></table></td></tr></table></td></tr></table></td></tr></table></td></tr></table></td></tr></table>
 | | | | | | | | | | | | | | | | | | | | <table border="1" style="width: 100%; border-collapse: collapse; text-align: center;"> <tr> <td style="width: 10%;"></td> <td style="width: 10%;"></td> <td style="width: 10%;"></td> <td style="width: 10%;"></td> <td style="width: 10%;"></td> <td style="width: 10%;"></td> <td style="width: 10%;"></td> <td style="width: 10%;"></td> <td style="width: 10%;"></td> <td style="width: 10%;"></td> </tr> <tr> <td></td> <td></td> <td colspan="8" style="text-align: center;"> <table border="1" style="width: 100%; border-collapse: collapse; text-align: center;"> <tr> <td style="width: 10%;"></td> <td style="width: 10%;"></td> <td style="width: 10%;"></td> <td style="width: 10%;"></td> <td style="width: 10%;"></td> <td style="width: 10%;"></td> <td style="width: 10%;"></td> <td style="width: 10%;"></td> <td style="width: 10%;"></td> <td style="width: 10%;"></td> </tr> <tr> <td></td> <td></td> <td colspan="8" style="text-align: center;"> <table border="1" style="width: 100%; border-collapse: collapse; text-align: center;"> <tr> <td style="width: 10%;"></td> <td style="width: 10%;"></td> <td style="width: 10%;"></td> <td style="width: 10%;"></td> <td style="width: 10%;"></td> <td style="width: 10%;"></td> <td style="width: 10%;"></td> <td style="width: 10%;"></td> <td style="width: 10%;"></td> <td style="width: 10%;"></td> </tr> <tr> <td></td> <td></td> <td colspan="8" style="text-align: center;"> <table border="1" style="width: 100%; border-collapse: collapse; text-align: center;"> <tr> <td style="width: 10%;"></td> <td style="width: 10%;"></td> <td style="width: 10%;"></td> <td style="width: 10%;"></td> <td style="width: 10%;"></td> <td style="width: 10%;"></td> <td style="width: 10%;"></td> <td style="width: 10%;"></td> <td style="width: 10%;"></td> <td style="width: 10%;"></td> </tr> <tr> <td></td> <td></td> <td colspan="8" style="text-align: center;"> <table border="1" style="width: 100%; border-collapse: collapse; text-align: center;"> <tr> <td style="width: 10%;"></td> <td style="width: 10%;"></td> <td style="width: 10%;"></td> <td style="width: 10%;"></td> <td style="width: 10%;"></td> <td style="width: 10%;"></td> <td style="width: 10%;"></td> <td style="width: 10%;"></td> <td style="width: 10%;"></td> <td style="width: 10%;"></td> </tr> <tr> <td></td> <td></td> <td colspan="8" style="text-align: center;"> <table border="1" style="width: 100%; border-collapse: collapse; text-align: center;"> <tr> <td style="width: 10%;"></td> <td style="width: 10%;"></td> <td style="width: 10%;"></td> <td style="width: 10%;"></td> <td style="width: 10%;"></td> <td style="width: 10%;"></td> <td style="width: 10%;"></td> <td style="width: 10%;"></td> <td style="width: 10%;"></td> <td style="width: 10%;"></td> </tr> <tr> <td></td> <td></td> <td colspan="8" style="text-align: center;"> <table border="1" style="width: 100%; border-collapse: collapse; text-align: center;"> <tr> <td style="width: 10%;"></td> <td style="width: 10%;"></td> <td style="width: 10%;"></td> <td style="width: 10%;"></td> <td style="width: 10%;"></td> <td style="width: 10%;"></td> <td style="width: 10%;"></td> <td style="width: 10%;"></td> <td style="width: 10%;"></td> <td style="width: 10%;"></td> </tr> <tr> <td></td> <td></td> <td colspan="8" style="text-align: center;"> <table border="1" style="width: 100%; border-collapse: collapse; text-align: center;"> <tr> <td style="width: 10%;"></td> <td style="width: 10%;"></td> <td style="width: 10%;"></td> <td style="width: 10%;"></td> <td style="width: 10%;"></td> <td style="width: 10%;"></td> <td style="width: 10%;"></td> <td style="width: 10%;"></td> <td style="width: 10%;"></td> <td style="width: 10%;"></td> </tr> <tr> <td></td> <td></td> <td colspan="8" style="text-align: center;"> <table border="1" style="width: 100%; border-collapse: collapse; text-align: center;"> <tr> <td style="width: 10%;"></td> <td style="width: 10%;"></td> <td style="width: 10%;"></td> <td style="width: 10%;"></td> <td style="width: 10%;"></td> <td style="width: 10%;"></td> <td style="width: 10%;"></td> <td style="width: 10%;"></td> <td style="width: 10%;"></td> <td style="width: 10%;"></td> </tr> <tr> <td></td> <td></td> <td colspan="8" style="text-align: center;"> <table border="1" style="width: 100%; border-collapse: collapse; text-align: center;"> <tr> <td style="width: 10%;"></td> <td style="width: 10%;"></td> <td style="width: 10%;"></td> <td style="width: 10%;"></td> <td style="width: 10%;"></td> <td style="width: 10%;"></td> <td style="width: 10%;"></td> <td style="width: 10%;"></td> <td style="width: 10%;"></td> <td style="width: 10%;"></td> </tr> <tr> <td></td> <td></td> <td colspan="8" style="text-align: center;"> <table border="1" style="width: 100%; border-collapse: collapse; text-align: center;"> <tr> <td style="width: 10%;"></td> <td style="width: 10%;"></td> <td style="width: 10%;"></td> <td style="width: 10%;"></td> <td style="width: 10%;"></td> <td style="width: 10%;"></td> <td style="width: 10%;"></td> <td style="width: 10%;"></td> <td style="width: 10%;"></td> <td style="width: 10%;"></td> </tr> <tr> <td></td> <td></td> <td colspan="8" style="text-align: center;"> <table border="1" style="width: 100%; border-collapse: collapse; text-align: center;"> <tr> <td style="width: 10%;"></td> <td style="width: 10%;"></td> <td style="width: 10%;"></td> <td style="width: 10%;"></td> <td style="width: 10%;"></td> <td style="width: 10%;"></td> <td style="width: 10%;"></td> <td style="width: 10%;"></td> <td style="width: 10%;"></td> <td style="width: 10%;"></td> </tr> <tr> <td></td> <td></td> <td colspan="8" style="text-align: center;"> <table border="1" style="width: 100%; border-collapse: collapse; text-align: center;"> <tr> <td style="width: 10%;"></td> <td style="width: 10%;"></td> <td style="width: 10%;"></td> <td style="width: 10%;"></td> <td style="width: 10%;"></td> <td style="width: 10%;"></td> <td style="width: 10%;"></td> <td style="width: 10%;"></td> <td style="width: 10%;"></td> <td style="width: 10%;"></td> </tr> <tr> <td></td> <td></td> <td colspan="8" style="text-align: center;"> <table border="1" style="width: 100%; border-collapse: collapse; text-align: center;"> <tr> <td style="width: 10%;"></td> <td style="width: 10%;"></td> <td style="width: 10%;"></td> <td style="width: 10%;"></td> <td style="width: 10%;"></td> <td style="width: 10%;"></td> <td style="width: 10%;"></td> <td style="width: 10%;"></td> <td style="width: 10%;"></td> <td style="width: 10%;"></td> </tr> <tr> <td></td> <td></td> <td colspan="8" style="text-align: center;"> <table border="1" style="width: 100%; border-collapse: collapse; text-align: center;"> <tr> <td style="width: 10%;"></td> <td style="width: 10%;"></td> <td style="width: 10%;"></td> <td style="width: 10%;"></td> <td style="width: 10%;"></td> <td style="width: 10%;"></td> <td style="width: 10%;"></td> <td style="width: 10%;"></td> <td style="width: 10%;"></td> <td style="width: 10%;"></td> </tr> <tr> <td></td> <td></td> <td colspan="8" style="text-align: center;"> <table border="1" style="width: 100%; border-collapse: collapse; text-align: center;"> <tr> <td style="width: 10%;"></td> <td style="width: 10%;"></td> <td style="width: 10%;"></td> <td style="width: 10%;"></td> <td style="width: 10%;"></td> <td style="width: 10%;"></td> <td style="width: 10%;"></td> <td style="width: 10%;"></td> <td style="width: 10%;"></td> <td style="width: 10%;"></td> </tr> <tr> <td></td> <td></td> <td colspan="8" style="text-align: center;"> <table border="1" style="width: 100%; border-collapse: collapse; text-align: center;"> <tr> <td style="width: 10%;"></td> <td style="width: 10%;"></td> <td style="width: 10%;"></td> <td style="width: 10%;"></td> <td style="width: 10%;"></td> <td style="width: 10%;"></td> <td style="width: 10%;"></td> <td style="width: 10%;"></td> <td style="width: 10%;"></td> <td style="width: 10%;"></td> </tr> <tr> <td></td> <td></td> <td colspan="8" style="text-align: center;"> <table border="1" style="width: 100%; border-collapse: collapse; text-align: center;"> <tr> <td style="width: 10%;"></td> <td style="width: 10%;"></td> <td style="width: 10%;"></td> <td style="width: 10%;"></td> <td style="width: 10%;"></td> <td style="width: 10%;"></td> <td style="width: 10%;"></td> <td style="width: 10%;"></td> <td style="width: 10%;"></td> <td style="width: 10%;"></td> </tr> <tr> <td></td> <td></td> <td colspan="8" style="text-align: center;"> <table border="1" style="width: 100%; border-collapse: collapse; text-align: center;"> <tr> <td style="width: 10%;"></td> <td style="width: 10%;"></td> <td style="width: 10%;"></td> <td style="width: 10%;"></td> <td style="width: 10%;"></td> <td style="width:
10%;"></td> <td style="width: 10%;"></td> <td style="width: 10%;"></td> <td style="width: 10%;"></td> <td style="width: 10%;"></td> </tr> <tr> <td></td> <td></td> <td colspan="8" style="text-align: center;"> <table border="1" style="width: 100%; border-collapse: collapse; text-align: center;"> <tr> <td style="width: 10%;"></td> <td style="width: 10%;"></td> <td style="width: 10%;"></td> <td style="width: 10%;"></td> <td style="width: 10%;"></td> <td style="width: 10%;"></td> <td style="width: 10%;"></td> <td style="width: 10%;"></td> <td style="width: 10%;"></td> <td style="width: 10%;"></td> </tr> <tr> <td></td> <td></td> <td colspan="8" style="text-align: center;"> <table border="1" style="width: 100%; border-collapse: collapse; text-align: center;"> <tr> <td style="width: 10%;"></td> <td style="width: 10%;"></td> <td style="width: 10%;"></td> <td style="width: 10%;"></td> <td style="width: 10%;"></td> <td style="width: 10%;"></td> <td style="width: 10%;"></td> <td style="width: 10%;"></td> <td style="width: 10%;"></td> <td style="width: 10%;"></td> </tr> <tr> <td></td> <td></td> <td colspan="8" style="text-align: center;"> <table border="1" style="width: 100%; border-collapse: collapse; text-align: center;"> <tr> <td style="width: 10%;"></td> <td style="width: 10%;"></td> <td style="width: 10%;"></td> <td style="width: 10%;"></td> <td style="width: 10%;"></td> <td style="width: 10%;"></td> <td style="width: 10%;"></td> <td style="width: 10%;"></td> <td style="width: 10%;"></td> <td style="width: 10%;"></td> </tr> <tr> <td></td> <td></td> <td colspan="8" style="text-align: center;"> <table border="1" style="width: 100%; border-collapse: collapse; text-align: center;"> <tr> <td style="width: 10%;"></td> <td style="width: 10%;"></td> <td style="width: 10%;"></td> <td style="width: 10%;"></td> <td style="width: 10%;"></td> <td style="width: 10%;"></td> <td style="width: 10%;"></td> <td style="width: 10%;"></td> <td style="width: 10%;"></td> <td style="width: 10%;"></td> </tr> <tr> <td></td> <td></td> <td colspan="8" style="text-align: center;"> <table border="1" style="width: 100%; border-collapse: collapse; text-align: center;"> <tr> <td style="width: 10%;"></td> <td style="width: 10%;"></td> <td style="width: 10%;"></td> <td style="width: 10%;"></td> <td style="width: 10%;"></td> <td style="width: 10%;"></td> <td style="width: 10%;"></td> <td style="width: 10%;"></td> <td style="width: 10%;"></td> <td style="width: 10%;"></td> </tr> <tr> <td></td> <td></td> <td colspan="8" style="text-align: center;"> <table border="1" style="width: 100%; border-collapse: collapse; text-align: center;"> <tr> <td style="width: 10%;"></td> <td style="width: 10%;"></td> <td style="width: 10%;"></td> <td style="width: 10%;"></td> <td style="width: 10%;"></td> <td style="width: 10%;"></td> <td style="width: 10%;"></td> <td style="width: 10%;"></td> <td style="width: 10%;"></td> <td style="width: 10%;"></td> </tr> <tr> <td></td> <td></td> <td colspan="8" style="text-align: center;"> <table border="1" style="width: 100%; border-collapse: collapse; text-align: center;"> <tr> <td style="width: 10%;"></td> <td style="width: 10%;"></td> <td style="width: 10%;"></td> <td style="width: 10%;"></td> <td style="width: 10%;"></td> <td style="width: 10%;"></td> <td style="width: 10%;"></td> <td style="width: 10%;"></td> <td style="width: 10%;"></td> <td style="width: 10%;"></td> </tr> <tr> <td></td> <td></td> <td colspan="8" style="text-align: center;"> <table border="1" style="width: 100%; border-collapse: collapse; text-align: center;"> <tr> <td style="width: 10%;"></td> <td style="width: 10%;"></td> <td style="width: 10%;"></td> <td style="width: 10%;"></td> <td style="width: 10%;"></td> <td style="width: 10%;"></td> <td style="width: 10%;"></td> <td style="width: 10%;"></td> <td style="width: 10%;"></td> <td style="width: 10%;"></td> </tr> <tr> <td></td> <td></td> <td colspan="8" style="text-align: center;"> <table border="1" style="width: 100%; border-collapse: collapse; text-align: center;"> <tr> <td style="width: 10%;"></td> <td style="width: 10%;"></td> <td style="width: 10%;"></td> <td style="width: 10%;"></td> <td style="width: 10%;"></td> <td style="width: 10%;"></td> <td style="width: 10%;"></td> <td style="width: 10%;"></td> <td style="width: 10%;"></td> <td style="width: 10%;"></td> </tr> <tr> <td></td> <td></td> <td colspan="8" style="text-align: center;"> <table border="1" style="width: 100%; border-collapse: collapse; text-align: center;"> <tr> <td style="width: 10%;"></td> <td style="width: 10%;"></td> <td style="width: 10%;"></td> <td style="width: 10%;"></td> <td style="width: 10%;"></td> <td style="width: 10%;"></td> <td style="width: 10%;"></td> <td style="width: 10%;"></td> <td style="width: 10%;"></td> <td style="width: 10%;"></td> </tr> <tr> <td></td> <td></td> <td colspan="8" style="text-align: center;"> <table border="1" style="width: 100%; border-collapse: collapse; text-align: center;"> <tr> <td style="width: 10%;"></td> <td style="width: 10%;"></td> <td style="width: 10%;"></td> <td style="width: 10%;"></td> <td style="width: 10%;"></td> <td style="width: 10%;"></td> <td style="width: 10%;"></td> <td style="width: 10%;"></td> <td style="width: 10%;"></td> <td style="width: 10%;"></td> </tr> <tr> <td></td> <td></td> <td colspan="8" style="text-align: center;"> <table border="1" style="width: 100%; border-collapse: collapse; text-align: center;"> <tr> <td style="width: 10%;"></td> <td style="width: 10%;"></td> <td style="width: 10%;"></td> <td style="width: 10%;"></td> <td style="width: 10%;"></td> <td style="width: 10%;"></td> <td style="width: 10%;"></td> <td style="width: 10%;"></td> <td style="width: 10%;"></td> <td style="width: 10%;"></td> </tr> <tr> <td></td> <td></td> <td colspan="8" style="text-align: center;"> <table border="1" style="width: 100%; border-collapse: collapse; text-align: center;"> <tr> <td style="width: 10%;"></td> <td style="width: 10%;"></td> <td style="width: 10%;"></td> <td style="width: 10%;"></td> <td style="width: 10%;"></td> <td style="width: 10%;"></td> <td style="width: 10%;"></td> <td style="width: 10%;"></td> <td style="width: 10%;"></td> <td style="width: 10%;"></td> </tr> <tr> <td></td> <td></td> <td colspan="8" style="text-align: center;"> <table border="1" style="width: 100%; border-collapse: collapse; text-align: center;"> <tr> <td style="width: 10%;"></td> <td style="width: 10%;"></td> <td style="width: 10%;"></td> <td style="width: 10%;"></td> <td style="width: 10%;"></td> <td style="width: 10%;"></td> <td style="width: 10%;"></td> <td style="width: 10%;"></td> <td style="width: 10%;"></td> <td style="width: 10%;"></td> </tr> <tr> <td></td> <td></td> <td colspan="8" style="text-align: center;"> <table border="1" style="width: 100%; border-collapse: collapse; text-align: center;"> <tr> <td style="width: 10%;"></td> <td style="width: 10%;"></td> <td style="width: 10%;"></td> <td style="width: 10%;"></td> <td style="width: 10%;"></td> <td style="width: 10%;"></td> <td style="width: 10%;"></td> <td style="width: 10%;"></td> <td style="width: 10%;"></td> <td style="width: 10%;"></td> </tr> <tr> <td></td> <td></td> <td colspan="8" style="text-align: center;"> <table border="1" style="width: 100%; border-collapse: collapse; text-align: center;"> <tr> <td style="width: 10%;"></td> <td style="width: 10%;"></td> <td style="width: 10%;"></td> <td style="width: 10%;"></td> <td style="width: 10%;"></td> <td style="width: 10%;"></td> <td style="width: 10%;"></td> <td style="width: 10%;"></td> <td style="width: 10%;"></td> <td style="width: 10%;"></td> </tr> <tr> <td></td> <td></td> <td colspan="8" style="text-align: center;"> <table border="1" style="width: 100%; border-collapse: collapse; text-align: center;"> <tr> <td style="width: 10%;"></td> <td style="width: 10%;"></td> <td style="width: 10%;"></td> <td style="width: 10%;"></td> <td style="width: 10%;"></td> <td style="width: 10%;"></td> <td style="width: 10%;"></td> <td style="width: 10%;"></td> <td style="width: 10%;"></td> <td style="width: 10%;"></td> </tr> <tr> <td></td> <td></td> <td colspan="8" style="text-align: center;"> <table border="1" style="width: 100%; border-collapse: collapse; text-align: center;"> <tr> <td style="width: 10%;"></td> <td style="width: 10%;"></td> <td style="width: 10%;"></td> <td style="width: 10%;"></td> <td style="width: 10%;"></td> <td style="width: 10%;"></td> <td style="width: 10%;"></td> <td style="width: 10%;"></td> <td style="width: 10%;"></td> <td style="width: 10%;"></td> </tr> <tr> <td></td> <td></td> <td colspan="8" style="text-align: center;"> <table border="1" style="width: 100%; border-collapse: collapse; text-align: center;"> <tr> <td style="width: 10%;"></td> <td style="width: 10%;"></td> <td style="width: 10%;"></td> <td style="width: 10%;"></td> <td style="width: 10%;"></td> <td style="width: 10%;"></td> <td style="width: 10%;"></td> <td style="width: 10%;"></td> <td style="width: 10%;"></td> <td style="width: 10%;"></td> </tr> <tr> <td></td> <td></td> <td colspan="8" style="text-align: center;"> <table border="1" style="width: 100%; border-collapse: collapse; text-align: center;"> <tr> <td style="width: 10%;"></td> <td style="width: 10%;"></td> <td style="width: 10%;"></td> <td style="width: 10%;"></td> <td style="width: 10%;"></td> <td style="width: 10%;"></td> <td style="width: 10%;"></td> <td style="width: 10%;"></td> <td style="width: 10%;"></td> <td style="width: 10%;"></td> </tr> <tr> <td></td> <td></td> <td colspan="8" style="text-align: center;"> <table border="1" style="width: 100%; border-collapse: collapse; text-align: center;"> <tr> <td style="width: 10%;"></td> <td style="width: 10%;"></td> <td style="width: 10%;"></td> <td style="width: 10%;"></td> <td style="width: 10%;"></td> <td style="width: 10%;"></td> <td style="width: 10%;"></td> <td style="width: 10%;"></td> <td style="width: 10%;"></td> <td style="width: 10%;"></td> </tr> <tr> <td></td> <td></td> <td
colspan="8" style="text-align: center;"> <table border="1" style="width: 100%; border-collapse: collapse; text-align: center;"> <tr> <td style="width: 10%;"></td> <td style="width: 10%;"></td> <td style="width: 10%;"></td> <td style="width: 10%;"></td> <td style="width: 10%;"></td> <td style="width: 10%;"></td> <td style="width: 10%;"></td> <td style="width: 10%;"></td> <td style="width: 10%;"></td> <td style="width: 10%;"></td> </tr> <tr> <td></td> <td></td> <td colspan="8" style="text-align: center;"> <table border="1" style="width: 100%; border-collapse: collapse; text-align: center;"> <tr> <td style="width: 10%;"></td> <td style="width: 10%;"></td> <td style="width: 10%;"></td> <td style="width: 10%;"></td> <td style="width: 10%;"></td> <td style="width: 10%;"></td> <td style="width: 10%;"></td> <td style="width: 10%;"></td> <td style="width: 10%;"></td> <td style="width: 10%;"></td> </tr> <tr> <td></td> <td></td> <td colspan="8" style="text-align: center;"> <table border="1" style="width: 100%; border-collapse: collapse; text-align: center;"> <tr> <td style="width: 10%;"></td> <td style="width: 10%;"></td> <td style="width: 10%;"></td> <td style="width: 10%;"></td> <td style="width: 10%;"></td> <td style="width: 10%;"></td> <td style="width: 10%;"></td> <td style="width: 10%;"></td> <td style="width: 10%;"></td> <td style="width: 10%;"></td> </tr> <tr> <td></td> <td></td> <td colspan="8" style="text-align: center;"> <table border="1" style="width: 100%; border-collapse: collapse; text-align: center;"> <tr> <td style="width: 10%;"></td> <td style="width: 10%;"></td> <td style="width: 10%;"></td> <td style="width: 10%;"></td> <td style="width: 10%;"></td> <td style="width: 10%;"></td> <td style="width: 10%;"></td> <td style="width: 10%;"></td> <td style="width: 10%;"></td> <td style="width: 10%;"></td> </tr> <tr> <td></td> <td></td> <td colspan="8" style="text-align: center;"> <table border="1" style="width: 100%; border-collapse: collapse; text-align: center;"> <tr> <td style="width: 10%;"></td> <td style="width: 10%;"></td> <td style="width: 10%;"></td> <td style="width: 10%;"></td> <td style="width: 10%;"></td> <td style="width: 10%;"></td> <td style="width: 10%;"></td> <td style="width: 10%;"></td> <td style="width: 10%;"></td> <td style="width: 10%;"></td> </tr> <tr> <td></td> <td></td> <td colspan="8" style="text-align: center;"> <table border="1" style="width: 100%; border-collapse: collapse; text-align: center;"> <tr> <td style="width: 10%;"></td> <td style="width: 10%;"></td> <td style="width: 10%;"></td> <td style="width: 10%;"></td> <td style="width: 10%;"></td> <td style="width: 10%;"></td> <td style="width: 10%;"></td> <td style="width: 10%;"></td> <td style="width: 10%;"></td> <td style="width: 10%;"></td> </tr> <tr> <td></td> <td></td> <td colspan="8" style="text-align: center;"> <table border="1" style="width: 100%; border-collapse: collapse; text-align: center;"> <tr> <td style="width: 10%;"></td> <td style="width: 10%;"></td> <td style="width: 10%;"></td> <td style="width: 10%;"></td> <td style="width: 10%;"></td> <td style="width: 10%;"></td> <td style="width: 10%;"></td> <td style="width: 10%;"></td> <td style="width: 10%;"></td> <td style="width: 10%;"></td> </tr> <tr> <td></td> <td></td> <td colspan="8" style="text-align: center;"> <table border="1" style="width: 100%; border-collapse: collapse; text-align: center;"> <tr> <td style="width: 10%;"></td> <td style="width: 10%;"></td> <td style="width: 10%;"></td> <td style="width: 10%;"></td> <td style="width: 10%;"></td> <td style="width: 10%;"></td> <td style="width: 10%;"></td> <td style="width: 10%;"></td> <td style="width: 10%;"></td> <td style="width: 10%;"></td> </tr> <tr> <td></td> <td></td> <td colspan="8" style="text-align: center;"> <table border="1" style="width: 100%; border-collapse: collapse; text-align: center;"> <tr> <td style="width: 10%;"></td> <td style="width: 10%;"></td> <td style="width: 10%;"></td> <td style="width: 10%;"></td> <td style="width: 10%;"></td> <td style="width: 10%;"></td> <td style="width: 10%;"></td> <td style="width: 10%;"></td> <td style="width: 10%;"></td> <td style="width: 10%;"></td> </tr> <tr> <td></td> <td></td> <td colspan="8" style="text-align: center;"> <table border="1" style="width: 100%; border-collapse: collapse; text-align: center;"> <tr> <td style="width: 10%;"></td> <td style="width: 10%;"></td> <td style="width: 10%;"></td> <td style="width: 10%;"></td> <td style="width: 10%;"></td> <td style="width: 10%;"></td> <td style="width: 10%;"></td> <td style="width: 10%;"></td> <td style="width: 10%;"></td> <td style="width: 10%;"></td> </tr> <tr> <td></td> <td></td> <td colspan="8" style="text-align: center;"> <table border="1" style="width: 100%; border-collapse: collapse; text-align: center;"> <tr> <td style="width: 10%;"></td> <td style="width: 10%;"></td> <td style="width: 10%;"></td> <td style="width: 10%;"></td> <td style="width: 10%;"></td> <td style="width: 10%;"></td> <td style="width: 10%;"></td> <td style="width: 10%;"></td> <td style="width: 10%;"></td> <td style="width: 10%;"></td> </tr> <tr> <td></td> <td></td> <td colspan="8" style="text-align: center;"> <table border="1" style="width: 100%; border-collapse: collapse; text-align: center;"> <tr> <td style="width: 10%;"></td> <td style="width: 10%;"></td> <td style="width: 10%;"></td> <td style="width: 10%;"></td> <td style="width: 10%;"></td> <td style="width: 10%;"></td> <td style="width: 10%;"></td> <td style="width: 10%;"></td> <td style="width: 10%;"></td> <td style="width: 10%;"></td> </tr> <tr> <td></td> <td></td> <td colspan="8" style="text-align: center;"> <table border="1" style="width: 100%; border-collapse: collapse; text-align: center;"> <tr> <td style="width: 10%;"></td> <td style="width: 10%;"></td> <td style="width: 10%;"></td> <td style="width: 10%;"></td> <td style="width: 10%;"></td> <td style="width: 10%;"></td> <td style="width: 10%;"></td> <td style="width: 10%;"></td> <td style="width: 10%;"></td> <td style="width: 10%;"></td> </tr> <tr> <td></td> <td></td> <td colspan="8" style="text-align: center;"> <table border="1" style="width: 100%; border-collapse: collapse; text-align: center;"> <tr> <td style="width: 10%;"></td> <td style="width: 10%;"></td> <td style="width: 10%;"></td> <td style="width: 10%;"></td> <td style="width: 10%;"></td> <td style="width: 10%;"></td> <td style="width: 10%;"></td> <td style="width: 10%;"></td> <td style="width: 10%;"></td> <td style="width: 10%;"></td> </tr> <tr> <td></td> <td></td> <td colspan="8" style="text-align: center;"> <table border="1" style="width: 100%; border-collapse: collapse; text-align: center;"> <tr> </tr></table></td></tr></table></td></tr></table></td></tr></table></td></tr></table></td></tr></table></td></tr></table></td></tr></table></td></tr></table></td></tr></table></td></tr></table></td></tr></table></td></tr></table></td></tr></table></td></tr></table></td></tr></table></td></tr></table></td></tr></table></td></tr></table></td></tr></table></td></tr></table></td></tr></table></td></tr></table></td></tr></table></td></tr></table></td></tr></table></td></tr></table></td></tr></table></td></tr></table></td></tr></table></td></tr></table></td></tr></table></td></tr></table></td></tr></table></td></tr></table></td></tr></table></td></tr></table></td></tr></table></td></tr></table></td></tr></table></td></tr></table></td></tr></table></td></tr></table></td></tr></table></td></tr></table></td></tr></table></td></tr></table></td></tr></table></td></tr></table></td></tr></table></td></tr></table></td></tr></table></td></tr></table></td></tr></table></td></tr></table>
 | | | | | | | | | | | | | | | | | | | | <table border="1" style="width: 100%; border-collapse: collapse; text-align: center;"> <tr> <td style="width: 10%;"></td> <td style="width: 10%;"></td> <td style="width: 10%;"></td> <td style="width: 10%;"></td> <td style="width: 10%;"></td> <td style="width: 10%;"></td> <td style="width: 10%;"></td> <td style="width: 10%;"></td> <td style="width: 10%;"></td> <td style="width: 10%;"></td> </tr> <tr> <td></td> <td></td> <td colspan="8" style="text-align: center;"> <table border="1" style="width: 100%; border-collapse: collapse; text-align: center;"> <tr> <td style="width: 10%;"></td> <td style="width: 10%;"></td> <td style="width: 10%;"></td> <td style="width: 10%;"></td> <td style="width: 10%;"></td> <td style="width: 10%;"></td> <td style="width: 10%;"></td> <td style="width: 10%;"></td> <td style="width: 10%;"></td> <td style="width: 10%;"></td> </tr> <tr> <td></td> <td></td> <td colspan="8" style="text-align: center;"> <table border="1" style="width: 100%; border-collapse: collapse; text-align: center;"> <tr> <td style="width: 10%;"></td> <td style="width: 10%;"></td> <td style="width: 10%;"></td> <td style="width: 10%;"></td> <td style="width: 10%;"></td> <td style="width: 10%;"></td> <td style="width: 10%;"></td> <td style="width: 10%;"></td> <td style="width: 10%;"></td> <td style="width: 10%;"></td> </tr> <tr> <td></td> <td></td> <td colspan="8" style="text-align: center;"> <table border="1" style="width: 100%; border-collapse: collapse; text-align: center;"> <tr> <td style="width: 10%;"></td> <td style="width: 10%;"></td> <td style="width: 10%;"></td> <td style="width: 10%;"></td> <td style="width: 10%;"></td> <td style="width: 10%;"></td> <td style="width: 10%;"></td> <td style="width: 10%;"></td> <td style="width: 10%;"></td> <td style="width: 10%;"></td> </tr> <tr> <td></td> <td></td> <td colspan="8" style="text-align: center;"> <table border="1" style="width: 100%; border-collapse: collapse; text-align: center;"> <tr> <td style="width: 10%;"></td> <td style="width: 10%;"></td> <td style="width: 10%;"></td> <td style="width: 10%;"></td> <td style="width: 10%;"></td> <td style="width: 10%;"></td> <td style="width: 10%;"></td> <td style="width: 10%;"></td> <td style="width: 10%;"></td> <td style="width: 10%;"></td> </tr> <tr> <td></td> <td></td> <td colspan="8" style="text-align: center;"> <table border="1" style="width: 100%; border-collapse: collapse; text-align: center;"> <tr> <td style="width: 10%;"></td> <td style="width: 10%;"></td> <td style="width: 10%;"></td> <td style="width: 10%;"></td> <td style="width: 10%;"></td> <td style="width: 10%;"></td> <td style="width: 10%;"></td> <td style="width: 10%;"></td> <td style="width: 10%;"></td> <td style="width: 10%;"></td> </tr> <tr> <td></td> <td></td> <td colspan="8" style="text-align: center;"> <table border="1" style="width: 100%; border-collapse: collapse; text-align: center;"> <tr> <td style="width: 10%;"></td> <td style="width: 10%;"></td> <td style="width: 10%;"></td> <td style="width: 10%;"></td> <td style="width: 10%;"></td> <td style="width: 10%;"></td> <td style="width: 10%;"></td> <td style="width: 10%;"></td> <td style="width: 10%;"></td> <td style="width: 10%;"></td> </tr> <tr> <td></td> <td></td> <td colspan="8" style="text-align: center;"> <table border="1" style="width: 100%; border-collapse: collapse; text-align: center;"> <tr> <td style="width: 10%;"></td> <td style="width: 10%;"></td> <td style="width: 10%;"></td> <td style="width: 10%;"></td> <td style="width: 10%;"></td> <td style="width: 10%;"></td> <td style="width: 10%;"></td> <td style="width: 10%;"></td> <td style="width: 10%;"></td> <td style="width: 10%;"></td> </tr> <tr> <td></td> <td></td> <td colspan="8" style="text-align: center;"> <table border="1" style="width: 100%; border-collapse: collapse; text-align: center;"> <tr> <td style="width: 10%;"></td> <td style="width: 10%;"></td> <td style="width: 10%;"></td> <td style="width: 10%;"></td> <td style="width: 10%;"></td> <td style="width: 10%;"></td> <td style="width: 10%;"></td> <td style="width: 10%;"></td> <td style="width: 10%;"></td> <td style="width: 10%;"></td> </tr> <tr> <td></td> <td></td> <td colspan="8" style="text-align: center;"> <table border="1" style="width: 100%; border-collapse: collapse; text-align: center;"> <tr> <td style="width: 10%;"></td> <td style="width: 10%;"></td> <td style="width: 10%;"></td> <td style="width: 10%;"></td> <td style="width: 10%;"></td> <td style="width: 10%;"></td> <td style="width: 10%;"></td> <td style="width: 10%;"></td> <td style="width: 10%;"></td> <td style="width: 10%;"></td> </tr> <tr> <td></td> <td></td> <td colspan="8" style="text-align: center;"> <table border="1" style="width: 100%; border-collapse: collapse; text-align: center;"> <tr> <td style="width: 10%;"></td> <td style="width: 10%;"></td> <td style="width: 10%;"></td> <td style="width: 10%;"></td> <td style="width: 10%;"></td> <td style="width: 10%;"></td> <td style="width: 10%;"></td> <td style="width: 10%;"></td> <td style="width: 10%;"></td> <td style="width: 10%;"></td> </tr> <tr> <td></td> <td></td> <td colspan="8" style="text-align: center;"> <table border="1" style="width: 100%; border-collapse: collapse; text-align: center;"> <tr> <td style="width: 10%;"></td> <td style="width: 10%;"></td> <td style="width: 10%;"></td> <td style="width: 10%;"></td> <td style="width: 10%;"></td> <td style="width: 10%;"></td> <td style="width: 10%;"></td> <td style="width: 10%;"></td> <td style="width: 10%;"></td> <td style="width: 10%;"></td> </tr> <tr> <td></td> <td></td> <td colspan="8" style="text-align: center;"> <table border="1" style="width: 100%; border-collapse: collapse; text-align: center;"> <tr> <td style="width: 10%;"></td> <td style="width: 10%;"></td> <td style="width: 10%;"></td> <td style="width: 10%;"></td> <td style="width: 10%;"></td> <td style="width: 10%;"></td> <td style="width: 10%;"></td> <td style="width: 10%;"></td> <td style="width: 10%;"></td> <td style="width: 10%;"></td> </tr> <tr> <td></td> <td></td> <td colspan="8" style="text-align: center;"> <table border="1" style="width: 100%; border-collapse: collapse; text-align: center;"> <tr> <td style="width: 10%;"></td> <td style="width: 10%;"></td> <td style="width: 10%;"></td> <td style="width: 10%;"></td> <td style="width: 10%;"></td> <td style="width: 10%;"></td> <td style="width: 10%;"></td> <td style="width: 10%;"></td> <td style="width: 10%;"></td> <td style="width: 10%;"></td> </tr> <tr> <td></td> <td></td> <td colspan="8" style="text-align: center;"> <table border="1" style="width: 100%; border-collapse: collapse; text-align: center;"> <tr> <td style="width: 10%;"></td> <td style="width: 10%;"></td> <td style="width: 10%;"></td> <td style="width: 10%;"></td> <td style="width: 10%;"></td> <td style="width: 10%;"></td> <td style="width: 10%;"></td> <td style="width: 10%;"></td> <td style="width: 10%;"></td> <td style="width: 10%;"></td> </tr> <tr> <td></td> <td></td> <td colspan="8" style="text-align: center;"> <table border="1" style="width: 100%; border-collapse: collapse; text-align: center;"> <tr> <td style="width: 10%;"></td> <td style="width: 10%;"></td> <td style="width: 10%;"></td> <td style="width: 10%;"></td> <td style="width: 10%;"></td> <td style="width: 10%;"></td> <td style="width: 10%;"></td> <td style="width: 10%;"></td> <td style="width: 10%;"></td> <td style="width: 10%;"></td> </tr> <tr> <td></td> <td></td> <td colspan="8" style="text-align: center;"> <table border="1" style="width: 100%; border-collapse: collapse; text-align: center;"> <tr> <td style="width: 10%;"></td> <td style="width: 10%;"></td> <td style="width: 10%;"></td> <td style="width: 10%;"></td> <td style="width: 10%;"></td> <td style="width: 10%;"></td> <td style="width: 10%;"></td> <td style="width: 10%;"></td> <td style="width: 10%;"></td> <td style="width: 10%;"></td> </tr> <tr>
<td></td> <td></td> <td colspan="8" style="text-align: center;"> <table border="1" style="width: 100%; border-collapse: collapse; text-align: center;"> <tr> <td style="width: 10%;"></td> <td style="width: 10%;"></td> <td style="width: 10%;"></td> <td style="width: 10%;"></td> <td style="width: 10%;"></td> <td style="width: 10%;"></td> <td style="width: 10%;"></td> <td style="width: 10%;"></td> <td style="width: 10%;"></td> <td style="width: 10%;"></td> </tr> <tr> <td></td> <td></td> <td colspan="8" style="text-align: center;"> <table border="1" style="width: 100%; border-collapse: collapse; text-align: center;"> <tr> <td style="width: 10%;"></td> <td style="width: 10%;"></td> <td style="width: 10%;"></td> <td style="width: 10%;"></td> <td style="width: 10%;"></td> <td style="width: 10%;"></td> <td style="width: 10%;"></td> <td style="width: 10%;"></td> <td style="width: 10%;"></td> <td style="width: 10%;"></td> </tr> <tr> <td></td> <td></td> <td colspan="8" style="text-align: center;"> <table border="1" style="width: 100%; border-collapse: collapse; text-align: center;"> <tr> <td style="width: 10%;"></td> <td style="width: 10%;"></td> <td style="width: 10%;"></td> <td style="width: 10%;"></td> <td style="width: 10%;"></td> <td style="width: 10%;"></td> <td style="width: 10%;"></td> <td style="width: 10%;"></td> <td style="width: 10%;"></td> <td style="width: 10%;"></td> </tr> <tr> <td></td> <td></td> <td colspan="8" style="text-align: center;"> <table border="1" style="width: 100%; border-collapse: collapse; text-align: center;"> <tr> <td style="width: 10%;"></td> <td style="width: 10%;"></td> <td style="width: 10%;"></td> <td style="width: 10%;"></td> <td style="width: 10%;"></td> <td style="width: 10%;"></td> <td style="width: 10%;"></td> <td style="width: 10%;"></td> <td style="width: 10%;"></td> <td style="width: 10%;"></td> </tr> <tr> <td></td> <td></td> <td colspan="8" style="text-align: center;"> <table border="1" style="width: 100%; border-collapse: collapse; text-align: center;"> <tr> <td style="width: 10%;"></td> <td style="width: 10%;"></td> <td style="width: 10%;"></td> <td style="width: 10%;"></td> <td style="width: 10%;"></td> <td style="width: 10%;"></td> <td style="width: 10%;"></td> <td style="width: 10%;"></td> <td style="width: 10%;"></td> <td style="width: 10%;"></td> </tr> <tr> <td></td> <td></td> <td colspan="8" style="text-align: center;"> <table border="1" style="width: 100%; border-collapse: collapse; text-align: center;"> <tr> <td style="width: 10%;"></td> <td style="width: 10%;"></td> <td style="width: 10%;"></td> <td style="width: 10%;"></td> <td style="width: 10%;"></td> <td style="width: 10%;"></td> <td style="width: 10%;"></td> <td style="width: 10%;"></td> <td style="width: 10%;"></td> <td style="width: 10%;"></td> </tr> <tr> <td></td> <td></td> <td colspan="8" style="text-align: center;"> <table border="1" style="width: 100%; border-collapse: collapse; text-align: center;"> <tr> <td style="width: 10%;"></td> <td style="width: 10%;"></td> <td style="width: 10%;"></td> <td style="width: 10%;"></td> <td style="width: 10%;"></td> <td style="width: 10%;"></td> <td style="width: 10%;"></td> <td style="width: 10%;"></td> <td style="width: 10%;"></td> <td style="width: 10%;"></td> </tr> <tr> <td></td> <td></td> <td colspan="8" style="text-align: center;"> <table border="1" style="width: 100%; border-collapse: collapse; text-align: center;"> <tr> <td style="width: 10%;"></td> <td style="width: 10%;"></td> <td style="width: 10%;"></td> <td style="width: 10%;"></td> <td style="width: 10%;"></td> <td style="width: 10%;"></td> <td style="width: 10%;"></td> <td style="width: 10%;"></td> <td style="width: 10%;"></td> <td style="width: 10%;"></td> </tr> <tr> <td></td> <td></td> <td colspan="8" style="text-align: center;"> <table border="1" style="width: 100%; border-collapse: collapse; text-align: center;"> <tr> <td style="width: 10%;"></td> <td style="width: 10%;"></td> <td style="width: 10%;"></td> <td style="width: 10%;"></td> <td style="width: 10%;"></td> <td style="width: 10%;"></td> <td style="width: 10%;"></td> <td style="width: 10%;"></td> <td style="width: 10%;"></td> <td style="width: 10%;"></td> </tr> <tr> <td></td> <td></td> <td colspan="8" style="text-align: center;"> <table border="1" style="width: 100%; border-collapse: collapse; text-align: center;"> <tr> <td style="width: 10%;"></td> <td style="width: 10%;"></td> <td style="width: 10%;"></td> <td style="width: 10%;"></td> <td style="width: 10%;"></td> <td style="width: 10%;"></td> <td style="width: 10%;"></td> <td style="width: 10%;"></td> <td style="width: 10%;"></td> <td style="width: 10%;"></td> </tr> <tr> <td></td> <td></td> <td colspan="8" style="text-align: center;"> <table border="1" style="width: 100%; border-collapse: collapse; text-align: center;"> <tr> <td style="width: 10%;"></td> <td style="width: 10%;"></td> <td style="width: 10%;"></td> <td style="width: 10%;"></td> <td style="width: 10%;"></td> <td style="width: 10%;"></td> <td style="width: 10%;"></td> <td style="width: 10%;"></td> <td style="width: 10%;"></td> <td style="width: 10%;"></td> </tr> <tr> <td></td> <td></td> <td colspan="8" style="text-align: center;"> <table border="1" style="width: 100%; border-collapse: collapse; text-align: center;"> <tr> <td style="width: 10%;"></td> <td style="width: 10%;"></td> <td style="width: 10%;"></td> <td style="width: 10%;"></td> <td style="width: 10%;"></td> <td style="width: 10%;"></td> <td style="width: 10%;"></td> <td style="width: 10%;"></td> <td style="width: 10%;"></td> <td style="width: 10%;"></td> </tr> <tr> <td></td> <td></td> <td colspan="8" style="text-align: center;"> <table border="1" style="width: 100%; border-collapse: collapse; text-align: center;"> <tr> <td style="width: 10%;"></td> <td style="width: 10%;"></td> <td style="width: 10%;"></td> <td style="width: 10%;"></td> <td style="width: 10%;"></td> <td style="width: 10%;"></td> <td style="width: 10%;"></td> <td style="width: 10%;"></td> <td style="width: 10%;"></td> <td style="width: 10%;"></td> </tr> <tr> <td></td> <td></td> <td colspan="8" style="text-align: center;"> <table border="1" style="width: 100%; border-collapse: collapse; text-align: center;"> <tr> <td style="width: 10%;"></td> <td style="width: 10%;"></td> <td style="width: 10%;"></td> <td style="width: 10%;"></td> <td style="width: 10%;"></td> <td style="width: 10%;"></td> <td style="width: 10%;"></td> <td style="width: 10%;"></td> <td style="width: 10%;"></td> <td style="width: 10%;"></td> </tr> <tr> <td></td> <td></td> <td colspan="8" style="text-align: center;"> <table border="1" style="width: 100%; border-collapse: collapse; text-align: center;"> <tr> <td style="width: 10%;"></td> <td style="width: 10%;"></td> <td style="width: 10%;"></td> <td style="width: 10%;"></td> <td style="width: 10%;"></td> <td style="width: 10%;"></td> <td style="width: 10%;"></td> <td style="width: 10%;"></td> <td style="width: 10%;"></td> <td style="width: 10%;"></td> </tr> <tr> <td></td> <td></td> <td colspan="8" style="text-align: center;"> <table border="1" style="width: 100%; border-collapse: collapse; text-align: center;"> <tr> <td style="width: 10%;"></td> <td style="width: 10%;"></td> <td style="width: 10%;"></td> <td style="width: 10%;"></td> <td style="width: 10%;"></td> <td style="width: 10%;"></td> <td style="width: 10%;"></td> <td style="width: 10%;"></td> <td style="width: 10%;"></td> <td style="width: 10%;"></td> </tr> <tr> <td></td> <td></td> <td colspan="8" style="text-align: center;"> <table border="1" style="width: 100%; border-collapse: collapse; text-align: center;"> <tr> <td style="width: 10%;"></td> <td style="width: 10%;"></td> <td style="width: 10%;"></td> <td style="width: 10%;"></td> <td style="width: 10%;"></td> <td style="width: 10%;"></td> <td style="width: 10%;"></td> <td style="width: 10%;"></td> <td style="width: 10%;"></td> <td style="width: 10%;"></td> </tr> <tr> <td></td> <td></td> <td colspan="8" style="text-align: center;"> <table border="1" style="width: 100%; border-collapse: collapse; text-align: center;"> <tr> <td style="width: 10%;"></td> <td style="width: 10%;"></td> <td style="width: 10%;"></td> <td style="width: 10%;"></td> <td style="width: 10%;"></td> <td style="width: 10%;"></td> <td style="width: 10%;"></td> <td style="width: 10%;"></td> <td style="width: 10%;"></td> <td style="width: 10%;"></td> </tr> <tr> <td></td> <td></td> <td colspan="8" style="text-align: center;"> <table border="1" style="width: 100%; border-collapse: collapse; text-align: center;"> <tr> <td style="width: 10%;"></td> <td style="width: 10%;"></td> <td style="width: 10%;"></td> <td style="width: 10%;"></td> <td style="width: 10%;"></td> <td style="width: 10%;"></td> <td style="width: 10%;"></td> <td style="width: 10%;"></td> <td style="width: 10%;"></td> <td style="width: 10%;"></td> </tr> <tr> <td></td> <td></td> <td colspan="8" style="text-align: center;"> <table border="1" style="width: 100%; border-collapse: collapse; text-align: center;"> <tr> <td style="width: 10%;"></td> <td style="width: 10%;"></td> <td style="width: 10%;"></td> <td style="width: 10%;"></td> <td style="width: 10%;"></td> <td style="width: 10%;"></td> <td style="width: 10%;"></td> <td style="width: 10%;"></td> <td style="width: 10%;"></td> <td style="width: 10%;"></td> </tr> <tr> <td></td> <td></td> <td colspan="8" style="text-align: center;"> <table border="1" style="width: 100%; border-collapse: collapse; text-align: center;"> <tr> <td style="width: 10%;"></td> <td style="width: 10%;"></td> <td style="width: 10%;"></td> <td style="width: 10%;"></td> <td style="width: 10%;"></td> <td style="width: 10%;"></td> <td style="width: 10%;"></td> <td style="width: 10%;"></td> <td style="width: 10%;"></td> <td style="width: 10%;"></td> </tr> <tr> <td></td> <td></td> <td colspan="8" style="text-align: center;"> <table border="1" style="width: 100%; border-collapse: collapse; text-align: center;"> <tr> <td
style="width: 10%;"></td> <td style="width: 10%;"></td> <td style="width: 10%;"></td> <td style="width: 10%;"></td> <td style="width: 10%;"></td> <td style="width: 10%;"></td> <td style="width: 10%;"></td> <td style="width: 10%;"></td> <td style="width: 10%;"></td> <td style="width: 10%;"></td> </tr> <tr> <td></td> <td></td> <td colspan="8" style="text-align: center;"> <table border="1" style="width: 100%; border-collapse: collapse; text-align: center;"> <tr> <td style="width: 10%;"></td> <td style="width: 10%;"></td> <td style="width: 10%;"></td> <td style="width: 10%;"></td> <td style="width: 10%;"></td> <td style="width: 10%;"></td> <td style="width: 10%;"></td> <td style="width: 10%;"></td> <td style="width: 10%;"></td> <td style="width: 10%;"></td> </tr> <tr> <td></td> <td></td> <td colspan="8" style="text-align: center;"> <table border="1" style="width: 100%; border-collapse: collapse; text-align: center;"> <tr> <td style="width: 10%;"></td> <td style="width: 10%;"></td> <td style="width: 10%;"></td> <td style="width: 10%;"></td> <td style="width: 10%;"></td> <td style="width: 10%;"></td> <td style="width: 10%;"></td> <td style="width: 10%;"></td> <td style="width: 10%;"></td> <td style="width: 10%;"></td> </tr> <tr> <td></td> <td></td> <td colspan="8" style="text-align: center;"> <table border="1" style="width: 100%; border-collapse: collapse; text-align: center;"> <tr> <td style="width: 10%;"></td> <td style="width: 10%;"></td> <td style="width: 10%;"></td> <td style="width: 10%;"></td> <td style="width: 10%;"></td> <td style="width: 10%;"></td> <td style="width: 10%;"></td> <td style="width: 10%;"></td> <td style="width: 10%;"></td> <td style="width: 10%;"></td> </tr> <tr> <td></td> <td></td> <td colspan="8" style="text-align: center;"> <table border="1" style="width: 100%; border-collapse: collapse; text-align: center;"> <tr> <td style="width: 10%;"></td> <td style="width: 10%;"></td> <td style="width: 10%;"></td> <td style="width: 10%;"></td> <td style="width: 10%;"></td> <td style="width: 10%;"></td> <td style="width: 10%;"></td> <td style="width: 10%;"></td> <td style="width: 10%;"></td> <td style="width: 10%;"></td> </tr> <tr> <td></td> <td></td> <td colspan="8" style="text-align: center;"> <table border="1" style="width: 100%; border-collapse: collapse; text-align: center;"> <tr> <td style="width: 10%;"></td> <td style="width: 10%;"></td> <td style="width: 10%;"></td> <td style="width: 10%;"></td> <td style="width: 10%;"></td> <td style="width: 10%;"></td> <td style="width: 10%;"></td> <td style="width: 10%;"></td> <td style="width: 10%;"></td> <td style="width: 10%;"></td> </tr> <tr> <td></td> <td></td> <td colspan="8" style="text-align: center;"> <table border="1" style="width: 100%; border-collapse: collapse; text-align: center;"> <tr> <td style="width: 10%;"></td> <td style="width: 10%;"></td> <td style="width: 10%;"></td> <td style="width: 10%;"></td> <td style="width: 10%;"></td> <td style="width: 10%;"></td> <td style="width: 10%;"></td> <td style="width: 10%;"></td> <td style="width: 10%;"></td> <td style="width: 10%;"></td> </tr> <tr> <td></td> <td></td> <td colspan="8" style="text-align: center;"> <table border="1" style="width: 100%; border-collapse: collapse; text-align: center;"> <tr> <td style="width: 10%;"></td> <td style="width: 10%;"></td> <td style="width: 10%;"></td> <td style="width: 10%;"></td> <td style="width: 10%;"></td> <td style="width: 10%;"></td> <td style="width: 10%;"></td> <td style="width: 10%;"></td> <td style="width: 10%;"></td> <td style="width: 10%;"></td> </tr> <tr> <td></td> <td></td> <td colspan="8" style="text-align: center;"> <table border="1" style="width: 100%; border-collapse: collapse; text-align: center;"> <tr> <td style="width: 10%;"></td> <td style="width: 10%;"></td> <td style="width: 10%;"></td> <td style="width: 10%;"></td> <td style="width: 10%;"></td> <td style="width: 10%;"></td> <td style="width: 10%;"></td> <td style="width: 10%;"></td> <td style="width: 10%;"></td> <td style="width: 10%;"></td> </tr> <tr> <td></td> <td></td> <td colspan="8" style="text-align: center;"> <table border="1" style="width: 100%; border-collapse: collapse; text-align: center;"> <tr> <td style="width: 10%;"></td> <td style="width: 10%;"></td> <td style="width: 10%;"></td> <td style="width: 10%;"></td> <td style="width: 10%;"></td> <td style="width: 10%;"></td> <td style="width: 10%;"></td> <td style="width: 10%;"></td> <td style="width: 10%;"></td> <td style="width: 10%;"></td> </tr> <tr> <td></td> <td></td> <td colspan="8" style="text-align: center;"> <table border="1" style="width: 100%; border-collapse: collapse; text-align: center;"> <tr> <td style="width: 10%;"></td> <td style="width: 10%;"></td> <td style="width: 10%;"></td> <td style="width: 10%;"></td> <td style="width: 10%;"></td> <td style="width: 10%;"></td> <td style="width: 10%;"></td> <td style="width: 10%;"></td> <td style="width: 10%;"></td> <td style="width: 10%;"></td> </tr> <tr> <td></td> <td></td> <td colspan="8" style="text-align: center;"> <table border="1" style="width: 100%; border-collapse: collapse; text-align: center;"> <tr> <td style="width: 10%;"></td> <td style="width: 10%;"></td> <td style="width: 10%;"></td> <td style="width: 10%;"></td> <td style="width: 10%;"></td> <td style="width: 10%;"></td> <td style="width: 10%;"></td> <td style="width: 10%;"></td> <td style="width: 10%;"></td> <td style="width: 10%;"></td> </tr> <tr> <td></td> <td></td> <td colspan="8" style="text-align: center;"> <table border="1" style="width: 100%; border-collapse: collapse; text-align: center;"> <tr> <td style="width: 10%;"></td> <td style="width: 10%;"></td> <td style="width: 10%;"></td> <td style="width: 10%;"></td> <td style="width: 10%;"></td> <td style="width: 10%;"></td> <td style="width: 10%;"></td> <td style="width: 10%;"></td> <td style="width: 10%;"></td> <td style="width: 10%;"></td> </tr> <tr> <td></td> <td></td> <td colspan="8" style="text-align: center;"> <table border="1" style="width: 100%; border-collapse: collapse; text-align: center;"> <tr> <td style="width: 10%;"></td> <td style="width: 10%;"></td> <td style="width: 10%;"></td> <td style="width: 10%;"></td> <td style="width: 10%;"></td> <td style="width: 10%;"></td> <td style="width: 10%;"></td> <td style="width: 10%;"></td> <td style="width: 10%;"></td> <td style="width: 10%;"></td> </tr> <tr> <td></td> <td></td> <td colspan="8" style="text-align: center;"> <table border="1" style="width: 100%; border-collapse: collapse; text-align: center;"> <tr> <td style="width: 10%;"></td> <td style="width: 10%;"></td> <td style="width: 10%;"></td> <td style="width: 10%;"></td> <td style="width: 10%;"></td> <td style="width: 10%;"></td> <td style="width: 10%;"></td> <td style="width: 10%;"></td> <td style="width: 10%;"></td> <td style="width: 10%;"></td> </tr> <tr> <td></td> <td></td> <td colspan="8" style="text-align: center;"> <table border="1" style="width: 100%; border-collapse: collapse; text-align: center;"> <tr> </tr></table></td></tr></table></td></tr></table></td></tr></table></td></tr></table></td></tr></table></td></tr></table></td></tr></table></td></tr></table></td></tr></table></td></tr></table></td></tr></table></td></tr></table></td></tr></table></td></tr></table></td></tr></table></td></tr></table></td></tr></table></td></tr></table></td></tr></table></td></tr></table></td></tr></table></td></tr></table></td></tr></table></td></tr></table></td></tr></table></td></tr></table></td></tr></table></td></tr></table></td></tr></table></td></tr></table></td></tr></table></td></tr></table></td></tr></table></td></tr></table></td></tr></table></td></tr></table></td></tr></table></td></tr></table></td></tr></table></td></tr></table></td></tr></table></td></tr></table></td></tr></table></td></tr></table></td></tr></table></td></tr></table></td></tr></table></td></tr></table></td></tr></table></td></tr></table></td></tr></table></td></tr></table></td></tr></table>
 | | | | | | | | | | | | | | | | | | | | <table border="1" style="width: 100%; border-collapse: collapse; text-align: center;"> <tr> <td style="width: 10%;"></td> <td style="width: 10%;"></td> <td style="width: 10%;"></td> <td style="width: 10%;"></td> <td style="width: 10%;"></td> <td style="width: 10%;"></td> <td style="width: 10%;"></td> <td style="width: 10%;"></td> <td style="width: 10%;"></td> <td style="width: 10%;"></td> </tr> <tr> <td></td> <td></td> <td colspan="8" style="text-align: center;"> <table border="1" style="width: 100%; border-collapse: collapse; text-align: center;"> <tr> <td style="width: 10%;"></td> <td style="width: 10%;"></td> <td style="width: 10%;"></td> <td style="width: 10%;"></td> <td style="width: 10%;"></td> <td style="width: 10%;"></td> <td style="width: 10%;"></td> <td style="width: 10%;"></td> <td style="width: 10%;"></td> <td style="width: 10%;"></td> </tr> <tr> <td></td> <td></td> <td colspan="8" style="text-align: center;"> <table border="1" style="width: 100%; border-collapse: collapse; text-align: center;"> <tr> <td style="width: 10%;"></td> <td style="width: 10%;"></td> <td style="width: 10%;"></td> <td style="width: 10%;"></td> <td style="width: 10%;"></td> <td style="width: 10%;"></td> <td style="width: 10%;"></td> <td style="width: 10%;"></td> <td style="width: 10%;"></td> <td style="width: 10%;"></td> </tr> <tr> <td></td> <td></td> <td colspan="8" style="text-align: center;"> <table border="1" style="width: 100%; border-collapse: collapse; text-align: center;"> <tr> <td style="width: 10%;"></td> <td style="width: 10%;"></td> <td style="width: 10%;"></td> <td style="width: 10%;"></td> <td style="width: 10%;"></td> <td style="width: 10%;"></td> <td style="width: 10%;"></td> <td style="width: 10%;"></td> <td style="width: 10%;"></td> <td style="width: 10%;"></td> </tr> <tr> <td></td> <td></td> <td colspan="8" style="text-align: center;"> <table border="1" style="width: 100%; border-collapse: collapse; text-align: center;"> <tr> <td style="width: 10%;"></td> <td style="width: 10%;"></td> <td style="width: 10%;"></td> <td style="width: 10%;"></td> <td style="width: 10%;"></td> <td style="width: 10%;"></td> <td style="width: 10%;"></td> <td style="width: 10%;"></td> <td style="width: 10%;"></td> <td style="width: 10%;"></td> </tr> <tr> <td></td> <td></td> <td colspan="8" style="text-align: center;"> <table border="1" style="width: 100%; border-collapse: collapse; text-align: center;"> <tr> <td style="width: 10%;"></td> <td style="width: 10%;"></td> <td style="width: 10%;"></td> <td style="width: 10%;"></td> <td style="width: 10%;"></td> <td style="width: 10%;"></td> <td style="width: 10%;"></td> <td style="width: 10%;"></td> <td style="width: 10%;"></td> <td style="width: 10%;"></td> </tr> <tr> <td></td> <td></td> <td colspan="8" style="text-align: center;"> <table border="1" style="width: 100%; border-collapse: collapse; text-align: center;"> <tr> <td style="width: 10%;"></td> <td style="width: 10%;"></td> <td style="width: 10%;"></td> <td style="width: 10%;"></td> <td style="width: 10%;"></td> <td style="width: 10%;"></td> <td style="width: 10%;"></td> <td style="width: 10%;"></td> <td style="width: 10%;"></td> <td style="width: 10%;"></td> </tr> <tr> <td></td> <td></td> <td colspan="8" style="text-align: center;"> <table border="1" style="width: 100%; border-collapse: collapse; text-align: center;"> <tr> <td style="width: 10%;"></td> <td style="width: 10%;"></td> <td style="width: 10%;"></td> <td style="width: 10%;"></td> <td style="width: 10%;"></td> <td style="width: 10%;"></td> <td style="width: 10%;"></td> <td style="width: 10%;"></td> <td style="width: 10%;"></td> <td style="width: 10%;"></td> </tr> <tr> <td></td> <td></td> <td colspan="8" style="text-align: center;"> <table border="1" style="width: 100%; border-collapse: collapse; text-align: center;"> <tr> <td style="width: 10%;"></td> <td style="width: 10%;"></td> <td style="width: 10%;"></td> <td style="width: 10%;"></td> <td style="width: 10%;"></td> <td style="width: 10%;"></td> <td style="width: 10%;"></td> <td style="width: 10%;"></td> <td style="width: 10%;"></td> <td style="width: 10%;"></td> </tr> <tr> <td></td> <td></td> <td colspan="8" style="text-align: center;"> <table border="1" style="width: 100%; border-collapse: collapse; text-align: center;"> <tr> <td style="width: 10%;"></td> <td style="width: 10%;"></td> <td style="width: 10%;"></td> <td style="width: 10%;"></td> <td style="width: 10%;"></td> <td style="width: 10%;"></td> <td style="width: 10%;"></td> <td style="width: 10%;"></td> <td style="width: 10%;"></td> <td style="width: 10%;"></td> </tr> <tr> <td></td> <td></td> <td colspan="8" style="text-align: center;"> <table border="1" style="width: 100%; border-collapse: collapse; text-align: center;"> <tr> <td style="width: 10%;"></td> <td style="width: 10%;"></td> <td style="width: 10%;"></td> <td style="width: 10%;"></td> <td style="width: 10%;"></td> <td style="width: 10%;"></td> <td style="width: 10%;"></td> <td style="width: 10%;"></td> <td style="width: 10%;"></td> <td style="width: 10%;"></td> </tr> <tr> <td></td> <td></td> <td colspan="8" style="text-align: center;"> <table border="1" style="width: 100%; border-collapse: collapse; text-align: center;"> <tr> <td style="width: 10%;"></td> <td style="width: 10%;"></td> <td style="width: 10%;"></td> <td style="width: 10%;"></td> <td style="width: 10%;"></td> <td style="width: 10%;"></td> <td style="width: 10%;"></td> <td style="width: 10%;"></td> <td style="width: 10%;"></td> <td style="width: 10%;"></td> </tr> <tr> <td></td> <td></td> <td colspan="8" style="text-align: center;"> <table border="1" style="width: 100%; border-collapse: collapse; text-align: center;"> <tr> <td style="width: 10%;"></td> <td style="width: 10%;"></td> <td style="width: 10%;"></td> <td style="width: 10%;"></td> <td style="width: 10%;"></td> <td style="width: 10%;"></td> <td style="width: 10%;"></td> <td style="width: 10%;"></td> <td style="width: 10%;"></td> <td style="width: 10%;"></td> </tr> <tr> <td></td> <td></td> <td colspan="8" style="text-align: center;"> <table border="1" style="width: 100%; border-collapse: collapse; text-align: center;"> <tr> <td style="width: 10%;"></td> <td style="width: 10%;"></td> <td style="width: 10%;"></td> <td style="width: 10%;"></td> <td style="width: 10%;"></td> <td style="width: 10%;"></td> <td style="width: 10%;"></td> <td style="width: 10%;"></td> <td style="width: 10%;"></td> <td style="width: 10%;"></td> </tr> <tr> <td></td> <td></td> <td colspan="8" style="text-align: center;"> <table border="1" style="width: 100%; border-collapse: collapse; text-align: center;"> <tr> <td style="width: 10%;"></td> <td style="width: 10%;"></td> <td style="width: 10%;"></td> <td style="width: 10%;"></td> <td style="width: 10%;"></td> <td style="width: 10%;"></td> <td style="width: 10%;"></td> <td style="width: 10%;"></td> <td style="width: 10%;"></td> <td style="width: 10%;"></td> </tr> <tr> <td></td> <td></td> <td colspan="8" style="text-align: center;"> <table border="1" style="width: 100%; border-collapse: collapse; text-align: center;"> <tr> <td style="width: 10%;"></td> <td style="width: 10%;"></td> <td style="width: 10%;"></td> <td style="width: 10%;"></td> <td style="width: 10%;"></td> <td style="width: 10%;"></td> <td style="width: 10%;"></td> <td style="width: 10%;"></td> <td style="width: 10%;"></td> <td style="width: 10%;"></td> </tr> <tr> <td></td> <td></td> <td colspan="8" style="text-align: center;"> <table border="1" style="width: 100%; border-collapse: collapse; text-align: center;"> <tr>
<td style="width: 10%;"></td> <td style="width: 10%;"></td> <td style="width: 10%;"></td> <td style="width: 10%;"></td> <td style="width: 10%;"></td> <td style="width: 10%;"></td> <td style="width: 10%;"></td> <td style="width: 10%;"></td> <td style="width: 10%;"></td> <td style="width: 10%;"></td> </tr> <tr> <td></td> <td></td> <td colspan="8" style="text-align: center;"> <table border="1" style="width: 100%; border-collapse: collapse; text-align: center;"> <tr> <td style="width: 10%;"></td> <td style="width: 10%;"></td> <td style="width: 10%;"></td> <td style="width: 10%;"></td> <td style="width: 10%;"></td> <td style="width: 10%;"></td> <td style="width: 10%;"></td> <td style="width: 10%;"></td> <td style="width: 10%;"></td> <td style="width: 10%;"></td> </tr> <tr> <td></td> <td></td> <td colspan="8" style="text-align: center;"> <table border="1" style="width: 100%; border-collapse: collapse; text-align: center;"> <tr> <td style="width: 10%;"></td> <td style="width: 10%;"></td> <td style="width: 10%;"></td> <td style="width: 10%;"></td> <td style="width: 10%;"></td> <td style="width: 10%;"></td> <td style="width: 10%;"></td> <td style="width: 10%;"></td> <td style="width: 10%;"></td> <td style="width: 10%;"></td> </tr> <tr> <td></td> <td></td> <td colspan="8" style="text-align: center;"> <table border="1" style="width: 100%; border-collapse: collapse; text-align: center;"> <tr> <td style="width: 10%;"></td> <td style="width: 10%;"></td> <td style="width: 10%;"></td> <td style="width: 10%;"></td> <td style="width: 10%;"></td> <td style="width: 10%;"></td> <td style="width: 10%;"></td> <td style="width: 10%;"></td> <td style="width: 10%;"></td> <td style="width: 10%;"></td> </tr> <tr> <td></td> <td></td> <td colspan="8" style="text-align: center;"> <table border="1" style="width: 100%; border-collapse: collapse; text-align: center;"> <tr> <td style="width: 10%;"></td> <td style="width: 10%;"></td> <td style="width: 10%;"></td> <td style="width: 10%;"></td> <td style="width: 10%;"></td> <td style="width: 10%;"></td> <td style="width: 10%;"></td> <td style="width: 10%;"></td> <td style="width: 10%;"></td> <td style="width: 10%;"></td> </tr> <tr> <td></td> <td></td> <td colspan="8" style="text-align: center;"> <table border="1" style="width: 100%; border-collapse: collapse; text-align: center;"> <tr> <td style="width: 10%;"></td> <td style="width: 10%;"></td> <td style="width: 10%;"></td> <td style="width: 10%;"></td> <td style="width: 10%;"></td> <td style="width: 10%;"></td> <td style="width: 10%;"></td> <td style="width: 10%;"></td> <td style="width: 10%;"></td> <td style="width: 10%;"></td> </tr> <tr> <td></td> <td></td> <td colspan="8" style="text-align: center;"> <table border="1" style="width: 100%; border-collapse: collapse; text-align: center;"> <tr> <td style="width: 10%;"></td> <td style="width: 10%;"></td> <td style="width: 10%;"></td> <td style="width: 10%;"></td> <td style="width: 10%;"></td> <td style="width: 10%;"></td> <td style="width: 10%;"></td> <td style="width: 10%;"></td> <td style="width: 10%;"></td> <td style="width: 10%;"></td> </tr> <tr> <td></td> <td></td> <td colspan="8" style="text-align: center;"> <table border="1" style="width: 100%; border-collapse: collapse; text-align: center;"> <tr> <td style="width: 10%;"></td> <td style="width: 10%;"></td> <td style="width: 10%;"></td> <td style="width: 10%;"></td> <td style="width: 10%;"></td> <td style="width: 10%;"></td> <td style="width: 10%;"></td> <td style="width: 10%;"></td> <td style="width: 10%;"></td> <td style="width: 10%;"></td> </tr> <tr> <td></td> <td></td> <td colspan="8" style="text-align: center;"> <table border="1" style="width: 100%; border-collapse: collapse; text-align: center;"> <tr> <td style="width: 10%;"></td> <td style="width: 10%;"></td> <td style="width: 10%;"></td> <td style="width: 10%;"></td> <td style="width: 10%;"></td> <td style="width: 10%;"></td> <td style="width: 10%;"></td> <td style="width: 10%;"></td> <td style="width: 10%;"></td> <td style="width: 10%;"></td> </tr> <tr> <td></td> <td></td> <td colspan="8" style="text-align: center;"> <table border="1" style="width: 100%; border-collapse: collapse; text-align: center;"> <tr> <td style="width: 10%;"></td> <td style="width: 10%;"></td> <td style="width: 10%;"></td> <td style="width: 10%;"></td> <td style="width: 10%;"></td> <td style="width: 10%;"></td> <td style="width: 10%;"></td> <td style="width: 10%;"></td> <td style="width: 10%;"></td> <td style="width: 10%;"></td> </tr> <tr> <td></td> <td></td> <td colspan="8" style="text-align: center;"> <table border="1" style="width: 100%; border-collapse: collapse; text-align: center;"> <tr> <td style="width: 10%;"></td> <td style="width: 10%;"></td> <td style="width: 10%;"></td> <td style="width: 10%;"></td> <td style="width: 10%;"></td> <td style="width: 10%;"></td> <td style="width: 10%;"></td> <td style="width: 10%;"></td> <td style="width: 10%;"></td> <td style="width: 10%;"></td> </tr> <tr> <td></td> <td></td> <td colspan="8" style="text-align: center;"> <table border="1" style="width: 100%; border-collapse: collapse; text-align: center;"> <tr> <td style="width: 10%;"></td> <td style="width: 10%;"></td> <td style="width: 10%;"></td> <td style="width: 10%;"></td> <td style="width: 10%;"></td> <td style="width: 10%;"></td> <td style="width: 10%;"></td> <td style="width: 10%;"></td> <td style="width: 10%;"></td> <td style="width: 10%;"></td> </tr> <tr> <td></td> <td></td> <td colspan="8" style="text-align: center;"> <table border="1" style="width: 100%; border-collapse: collapse; text-align: center;"> <tr> <td style="width: 10%;"></td> <td style="width: 10%;"></td> <td style="width: 10%;"></td> <td style="width: 10%;"></td> <td style="width: 10%;"></td> <td style="width: 10%;"></td> <td style="width: 10%;"></td> <td style="width: 10%;"></td> <td style="width: 10%;"></td> <td style="width: 10%;"></td> </tr> <tr> <td></td> <td></td> <td colspan="8" style="text-align: center;"> <table border="1" style="width: 100%; border-collapse: collapse; text-align: center;"> <tr> <td style="width: 10%;"></td> <td style="width: 10%;"></td> <td style="width: 10%;"></td> <td style="width: 10%;"></td> <td style="width: 10%;"></td> <td style="width: 10%;"></td> <td style="width: 10%;"></td> <td style="width: 10%;"></td> <td style="width: 10%;"></td> <td style="width: 10%;"></td> </tr> <tr> <td></td> <td></td> <td colspan="8" style="text-align: center;"> <table border="1" style="width: 100%; border-collapse: collapse; text-align: center;"> <tr> <td style="width: 10%;"></td> <td style="width: 10%;"></td> <td style="width: 10%;"></td> <td style="width: 10%;"></td> <td style="width: 10%;"></td> <td style="width: 10%;"></td> <td style="width: 10%;"></td> <td style="width: 10%;"></td> <td style="width: 10%;"></td> <td style="width: 10%;"></td> </tr> <tr> <td></td> <td></td> <td colspan="8" style="text-align: center;"> <table border="1" style="width: 100%; border-collapse: collapse; text-align: center;"> <tr> <td style="width: 10%;"></td> <td style="width: 10%;"></td> <td style="width: 10%;"></td> <td style="width: 10%;"></td> <td style="width: 10%;"></td> <td style="width: 10%;"></td> <td style="width: 10%;"></td> <td style="width: 10%;"></td> <td style="width: 10%;"></td> <td style="width: 10%;"></td> </tr> <tr> <td></td> <td></td> <td colspan="8" style="text-align: center;"> <table border="1" style="width: 100%; border-collapse: collapse; text-align: center;"> <tr> <td style="width: 10%;"></td> <td style="width: 10%;"></td> <td style="width: 10%;"></td> <td style="width: 10%;"></td> <td style="width: 10%;"></td> <td style="width: 10%;"></td> <td style="width: 10%;"></td> <td style="width: 10%;"></td> <td style="width: 10%;"></td> <td style="width: 10%;"></td> </tr> <tr> <td></td> <td></td> <td colspan="8" style="text-align: center;"> <table border="1" style="width: 100%; border-collapse: collapse; text-align: center;"> <tr> <td style="width: 10%;"></td> <td style="width: 10%;"></td> <td style="width: 10%;"></td> <td style="width: 10%;"></td> <td style="width: 10%;"></td> <td style="width: 10%;"></td> <td style="width: 10%;"></td> <td style="width: 10%;"></td> <td style="width: 10%;"></td> <td style="width: 10%;"></td> </tr> <tr> <td></td> <td></td> <td colspan="8" style="text-align: center;"> <table border="1" style="width: 100%; border-collapse: collapse; text-align: center;"> <tr> <td style="width: 10%;"></td> <td style="width: 10%;"></td> <td style="width: 10%;"></td> <td style="width: 10%;"></td> <td style="width: 10%;"></td> <td style="width: 10%;"></td> <td style="width: 10%;"></td> <td style="width: 10%;"></td> <td style="width: 10%;"></td> <td style="width: 10%;"></td> </tr> <tr> <td></td> <td></td> <td colspan="8" style="text-align: center;"> <table border="1" style="width: 100%; border-collapse: collapse; text-align: center;"> <tr> <td style="width: 10%;"></td> <td style="width: 10%;"></td> <td style="width: 10%;"></td> <td style="width: 10%;"></td> <td style="width: 10%;"></td> <td style="width: 10%;"></td> <td style="width: 10%;"></td> <td style="width: 10%;"></td> <td style="width: 10%;"></td> <td style="width: 10%;"></td> </tr> <tr> <td></td> <td></td> <td colspan="8" style="text-align: center;"> <table border="1" style="width: 100%; border-collapse: collapse; text-align: center;"> <tr> <td style="width: 10%;"></td> <td style="width: 10%;"></td> <td style="width: 10%;"></td> <td style="width: 10%;"></td> <td style="width: 10%;"></td> <td style="width: 10%;"></td> <td style="width: 10%;"></td> <td style="width: 10%;"></td> <td style="width: 10%;"></td> <td style="width: 10%;"></td> </tr> <tr> <td></td> <td></td> <td colspan="8" style="text-align: center;"> <table border="1" style="width: 100%; border-collapse: collapse; text-align: center;"> <tr> <td style="width: 10%;"></td> <td style="width: 10%;"></td> <td style="width: 10%;"></td> <td style="width: 10%;"></td> <td style="width: 10%;"></td> <td style="width:
10%;"></td> <td style="width: 10%;"></td> <td style="width: 10%;"></td> <td style="width: 10%;"></td> <td style="width: 10%;"></td> </tr> <tr> <td></td> <td></td> <td colspan="8" style="text-align: center;"> <table border="1" style="width: 100%; border-collapse: collapse; text-align: center;"> <tr> <td style="width: 10%;"></td> <td style="width: 10%;"></td> <td style="width: 10%;"></td> <td style="width: 10%;"></td> <td style="width: 10%;"></td> <td style="width: 10%;"></td> <td style="width: 10%;"></td> <td style="width: 10%;"></td> <td style="width: 10%;"></td> <td style="width: 10%;"></td> </tr> <tr> <td></td> <td></td> <td colspan="8" style="text-align: center;"> <table border="1" style="width: 100%; border-collapse: collapse; text-align: center;"> <tr> <td style="width: 10%;"></td> <td style="width: 10%;"></td> <td style="width: 10%;"></td> <td style="width: 10%;"></td> <td style="width: 10%;"></td> <td style="width: 10%;"></td> <td style="width: 10%;"></td> <td style="width: 10%;"></td> <td style="width: 10%;"></td> <td style="width: 10%;"></td> </tr> <tr> <td></td> <td></td> <td colspan="8" style="text-align: center;"> <table border="1" style="width: 100%; border-collapse: collapse; text-align: center;"> <tr> <td style="width: 10%;"></td> <td style="width: 10%;"></td> <td style="width: 10%;"></td> <td style="width: 10%;"></td> <td style="width: 10%;"></td> <td style="width: 10%;"></td> <td style="width: 10%;"></td> <td style="width: 10%;"></td> <td style="width: 10%;"></td> <td style="width: 10%;"></td> </tr> <tr> <td></td> <td></td> <td colspan="8" style="text-align: center;"> <table border="1" style="width: 100%; border-collapse: collapse; text-align: center;"> <tr> <td style="width: 10%;"></td> <td style="width: 10%;"></td> <td style="width: 10%;"></td> <td style="width: 10%;"></td> <td style="width: 10%;"></td> <td style="width: 10%;"></td> <td style="width: 10%;"></td> <td style="width: 10%;"></td> <td style="width: 10%;"></td> <td style="width: 10%;"></td> </tr> <tr> <td></td> <td></td> <td colspan="8" style="text-align: center;"> <table border="1" style="width: 100%; border-collapse: collapse; text-align: center;"> <tr> <td style="width: 10%;"></td> <td style="width: 10%;"></td> <td style="width: 10%;"></td> <td style="width: 10%;"></td> <td style="width: 10%;"></td> <td style="width: 10%;"></td> <td style="width: 10%;"></td> <td style="width: 10%;"></td> <td style="width: 10%;"></td> <td style="width: 10%;"></td> </tr> <tr> <td></td> <td></td> <td colspan="8" style="text-align: center;"> <table border="1" style="width: 100%; border-collapse: collapse; text-align: center;"> <tr> <td style="width: 10%;"></td> <td style="width: 10%;"></td> <td style="width: 10%;"></td> <td style="width: 10%;"></td> <td style="width: 10%;"></td> <td style="width: 10%;"></td> <td style="width: 10%;"></td> <td style="width: 10%;"></td> <td style="width: 10%;"></td> <td style="width: 10%;"></td> </tr> <tr> <td></td> <td></td> <td colspan="8" style="text-align: center;"> <table border="1" style="width: 100%; border-collapse: collapse; text-align: center;"> <tr> <td style="width: 10%;"></td> <td style="width: 10%;"></td> <td style="width: 10%;"></td> <td style="width: 10%;"></td> <td style="width: 10%;"></td> <td style="width: 10%;"></td> <td style="width: 10%;"></td> <td style="width: 10%;"></td> <td style="width: 10%;"></td> <td style="width: 10%;"></td> </tr> <tr> <td></td> <td></td> <td colspan="8" style="text-align: center;"> <table border="1" style="width: 100%; border-collapse: collapse; text-align: center;"> <tr> <td style="width: 10%;"></td> <td style="width: 10%;"></td> <td style="width: 10%;"></td> <td style="width: 10%;"></td> <td style="width: 10%;"></td> <td style="width: 10%;"></td> <td style="width: 10%;"></td> <td style="width: 10%;"></td> <td style="width: 10%;"></td> <td style="width: 10%;"></td> </tr> <tr> <td></td> <td></td> <td colspan="8" style="text-align: center;"> <table border="1" style="width: 100%; border-collapse: collapse; text-align: center;"> <tr> <td style="width: 10%;"></td> <td style="width: 10%;"></td> <td style="width: 10%;"></td> <td style="width: 10%;"></td> <td style="width: 10%;"></td> <td style="width: 10%;"></td> <td style="width: 10%;"></td> <td style="width: 10%;"></td> <td style="width: 10%;"></td> <td style="width: 10%;"></td> </tr> <tr> <td></td> <td></td> <td colspan="8" style="text-align: center;"> <table border="1" style="width: 100%; border-collapse: collapse; text-align: center;"> <tr> <td style="width: 10%;"></td> <td style="width: 10%;"></td> <td style="width: 10%;"></td> <td style="width: 10%;"></td> <td style="width: 10%;"></td> <td style="width: 10%;"></td> <td style="width: 10%;"></td> <td style="width: 10%;"></td> <td style="width: 10%;"></td> <td style="width: 10%;"></td> </tr> <tr> <td></td> <td></td> <td colspan="8" style="text-align: center;"> <table border="1" style="width: 100%; border-collapse: collapse; text-align: center;"> <tr> <td style="width: 10%;"></td> <td style="width: 10%;"></td> <td style="width: 10%;"></td> <td style="width: 10%;"></td> <td style="width: 10%;"></td> <td style="width: 10%;"></td> <td style="width: 10%;"></td> <td style="width: 10%;"></td> <td style="width: 10%;"></td> <td style="width: 10%;"></td> </tr> <tr> <td></td> <td></td> <td colspan="8" style="text-align: center;"> <table border="1" style="width: 100%; border-collapse: collapse; text-align: center;"> <tr> <td style="width: 10%;"></td> <td style="width: 10%;"></td> <td style="width: 10%;"></td> <td style="width: 10%;"></td> <td style="width: 10%;"></td> <td style="width: 10%;"></td> <td style="width: 10%;"></td> <td style="width: 10%;"></td> <td style="width: 10%;"></td> <td style="width: 10%;"></td> </tr> <tr> <td></td> <td></td> <td colspan="8" style="text-align: center;"> <table border="1" style="width: 100%; border-collapse: collapse; text-align: center;"> <tr> <td style="width: 10%;"></td> <td style="width: 10%;"></td> <td style="width: 10%;"></td> <td style="width: 10%;"></td> <td style="width: 10%;"></td> <td style="width: 10%;"></td> <td style="width: 10%;"></td> <td style="width: 10%;"></td> <td style="width: 10%;"></td> <td style="width: 10%;"></td> </tr> <tr> <td></td> <td></td> <td colspan="8" style="text-align: center;"> <table border="1" style="width: 100%; border-collapse: collapse; text-align: center;"> <tr> <td style="width: 10%;"></td> <td style="width: 10%;"></td> <td style="width: 10%;"></td> <td style="width: 10%;"></td> <td style="width: 10%;"></td> <td style="width: 10%;"></td> <td style="width: 10%;"></td> <td style="width: 10%;"></td> <td style="width: 10%;"></td> <td style="width: 10%;"></td> </tr> <tr> <td></td> <td></td> <td colspan="8" style="text-align: center;"> <table border="1" style="width: 100%; border-collapse: collapse; text-align: center;"> <tr> </tr></table></td></tr></table></td></tr></table></td></tr></table></td></tr></table></td></tr></table></td></tr></table></td></tr></table></td></tr></table></td></tr></table></td></tr></table></td></tr></table></td></tr></table></td></tr></table></td></tr></table></td></tr></table></td></tr></table></td></tr></table></td></tr></table></td></tr></table></td></tr></table></td></tr></table></td></tr></table></td></tr></table></td></tr></table></td></tr></table></td></tr></table></td></tr></table></td></tr></table></td></tr></table></td></tr></table></td></tr></table></td></tr></table></td></tr></table></td></tr></table></td></tr></table></td></tr></table></td></tr></table></td></tr></table></td></tr></table></td></tr></table></td></tr></table></td></tr></table></td></tr></table></td></tr></table></td></tr></table></td></tr></table></td></tr></table></td></tr></table></td></tr></table></td></tr></table></td></tr></table></td></tr></table>
 | | | | | | | | | | | | | | | | | | | | <table border="1" style="width: 100%; border-collapse: collapse; text-align: center;"> <tr> <td style="width: 10%;"></td> <td style="width: 10%;"></td> <td style="width: 10%;"></td> <td style="width: 10%;"></td> <td style="width: 10%;"></td> <td style="width: 10%;"></td> <td style="width: 10%;"></td> <td style="width: 10%;"></td> <td style="width: 10%;"></td> <td style="width: 10%;"></td> </tr> <tr> <td></td> <td></td> <td colspan="8" style="text-align: center;"> <table border="1" style="width: 100%; border-collapse: collapse; text-align: center;"> <tr> <td style="width: 10%;"></td> <td style="width: 10%;"></td> <td style="width: 10%;"></td> <td style="width: 10%;"></td> <td style="width: 10%;"></td> <td style="width: 10%;"></td> <td style="width: 10%;"></td> <td style="width: 10%;"></td> <td style="width: 10%;"></td> <td style="width: 10%;"></td> </tr> <tr> <td></td> <td></td> <td colspan="8" style="text-align: center;"> <table border="1" style="width: 100%; border-collapse: collapse; text-align: center;"> <tr> <td style="width: 10%;"></td> <td style="width: 10%;"></td> <td style="width: 10%;"></td> <td style="width: 10%;"></td> <td style="width: 10%;"></td> <td style="width: 10%;"></td> <td style="width: 10%;"></td> <td style="width: 10%;"></td> <td style="width: 10%;"></td> <td style="width: 10%;"></td> </tr> <tr> <td></td> <td></td> <td colspan="8" style="text-align: center;"> <table border="1" style="width: 100%; border-collapse: collapse; text-align: center;"> <tr> <td style="width: 10%;"></td> <td style="width: 10%;"></td> <td style="width: 10%;"></td> <td style="width: 10%;"></td> <td style="width: 10%;"></td> <td style="width: 10%;"></td> <td style="width: 10%;"></td> <td style="width: 10%;"></td> <td style="width: 10%;"></td> <td style="width: 10%;"></td> </tr> <tr> <td></td> <td></td> <td colspan="8" style="text-align: center;"> <table border="1" style="width: 100%; border-collapse: collapse; text-align: center;"> <tr> <td style="width: 10%;"></td> <td style="width: 10%;"></td> <td style="width: 10%;"></td> <td style="width: 10%;"></td> <td style="width: 10%;"></td> <td style="width: 10%;"></td> <td style="width: 10%;"></td> <td style="width: 10%;"></td> <td style="width: 10%;"></td> <td style="width: 10%;"></td> </tr> <tr> <td></td> <td></td> <td colspan="8" style="text-align: center;"> <table border="1" style="width: 100%; border-collapse: collapse; text-align: center;"> <tr> <td style="width: 10%;"></td> <td style="width: 10%;"></td> <td style="width: 10%;"></td> <td style="width: 10%;"></td> <td style="width: 10%;"></td> <td style="width: 10%;"></td> <td style="width: 10%;"></td> <td style="width: 10%;"></td> <td style="width: 10%;"></td> <td style="width: 10%;"></td> </tr> <tr> <td></td> <td></td> <td colspan="8" style="text-align: center;"> <table border="1" style="width: 100%; border-collapse: collapse; text-align: center;"> <tr> <td style="width: 10%;"></td> <td style="width: 10%;"></td> <td style="width: 10%;"></td> <td style="width: 10%;"></td> <td style="width: 10%;"></td> <td style="width: 10%;"></td> <td style="width: 10%;"></td> <td style="width: 10%;"></td> <td style="width: 10%;"></td> <td style="width: 10%;"></td> </tr> <tr> <td></td> <td></td> <td colspan="8" style="text-align: center;"> <table border="1" style="width: 100%; border-collapse: collapse; text-align: center;"> <tr> <td style="width: 10%;"></td> <td style="width: 10%;"></td> <td style="width: 10%;"></td> <td style="width: 10%;"></td> <td style="width: 10%;"></td> <td style="width: 10%;"></td> <td style="width: 10%;"></td> <td style="width: 10%;"></td> <td style="width: 10%;"></td> <td style="width: 10%;"></td> </tr> <tr> <td></td> <td></td> <td colspan="8" style="text-align: center;"> <table border="1" style="width: 100%; border-collapse: collapse; text-align: center;"> <tr> <td style="width: 10%;"></td> <td style="width: 10%;"></td> <td style="width: 10%;"></td> <td style="width: 10%;"></td> <td style="width: 10%;"></td> <td style="width: 10%;"></td> <td style="width: 10%;"></td> <td style="width: 10%;"></td> <td style="width: 10%;"></td> <td style="width: 10%;"></td> </tr> <tr> <td></td> <td></td> <td colspan="8" style="text-align: center;"> <table border="1" style="width: 100%; border-collapse: collapse; text-align: center;"> <tr> <td style="width: 10%;"></td> <td style="width: 10%;"></td> <td style="width: 10%;"></td> <td style="width: 10%;"></td> <td style="width: 10%;"></td> <td style="width: 10%;"></td> <td style="width: 10%;"></td> <td style="width: 10%;"></td> <td style="width: 10%;"></td> <td style="width: 10%;"></td> </tr> <tr> <td></td> <td></td> <td colspan="8" style="text-align: center;"> <table border="1" style="width: 100%; border-collapse: collapse; text-align: center;"> <tr> <td style="width: 10%;"></td> <td style="width: 10%;"></td> <td style="width: 10%;"></td> <td style="width: 10%;"></td> <td style="width: 10%;"></td> <td style="width: 10%;"></td> <td style="width: 10%;"></td> <td style="width: 10%;"></td> <td style="width: 10%;"></td> <td style="width: 10%;"></td> </tr> <tr> <td></td> <td></td> <td colspan="8" style="text-align: center;"> <table border="1" style="width: 100%; border-collapse: collapse; text-align: center;"> <tr> <td style="width: 10%;"></td> <td style="width: 10%;"></td> <td style="width: 10%;"></td> <td style="width: 10%;"></td> <td style="width: 10%;"></td> <td style="width: 10%;"></td> <td style="width: 10%;"></td> <td style="width: 10%;"></td> <td style="width: 10%;"></td> <td style="width: 10%;"></td> </tr> <tr> <td></td> <td></td> <td colspan="8" style="text-align: center;"> <table border="1" style="width: 100%; border-collapse: collapse; text-align: center;"> <tr> <td style="width: 10%;"></td> <td style="width: 10%;"></td> <td style="width: 10%;"></td> <td style="width: 10%;"></td> <td style="width: 10%;"></td> <td style="width: 10%;"></td> <td style="width: 10%;"></td> <td style="width: 10%;"></td> <td style="width: 10%;"></td> <td style="width: 10%;"></td> </tr> <tr> <td></td> <td></td> <td colspan="8" style="text-align: center;"> <table border="1" style="width: 100%; border-collapse: collapse; text-align: center;"> <tr> <td style="width: 10%;"></td> <td style="width: 10%;"></td> <td style="width: 10%;"></td> <td style="width: 10%;"></td> <td style="width: 10%;"></td> <td style="width: 10%;"></td> <td style="width: 10%;"></td> <td style="width: 10%;"></td> <td style="width: 10%;"></td> <td style="width: 10%;"></td> </tr> <tr> <td></td> <td></td> <td colspan="8" style="text-align: center;"> <table border="1" style="width: 100%; border-collapse: collapse; text-align: center;"> <tr> <td style="width: 10%;"></td> <td style="width: 10%;"></td> <td style="width: 10%;"></td> <td style="width: 10%;"></td> <td style="width: 10%;"></td> <td style="width: 10%;"></td> <td style="width: 10%;"></td> <td style="width: 10%;"></td> <td style="width: 10%;"></td> <td style="width: 10%;"></td> </tr> <tr> <td></td> <td></td> <td colspan="8" style="text-align: center;"> <table border="1" style="width: 100%; border-collapse: collapse; text-align: center;"> <tr> <td style="width: 10%;"></td> <td style="width: 10%;"></td> <td style="width: 10%;"></td> <td style="width: 10%;"></td> <td style="width: 10%;"></td> <td style="width: 10%;"></td> <td style="width: 10%;"></td> <td style="width: 10%;"></td> <td style="width: 10%;"></td> <td style="width: 10%;"></td> </tr> <tr> <td></td> <td></td> <td colspan="8" style="text-align: center;"> <table border="1" style="width: 100%; border-collapse: collapse; text-align: center;"> <tr> <td style="width: 10%;"></td> <td style="width: 10%;"></td> <td style="width: 10%;"></td> <td style="width: 10%;"></td> <td style="width: 10%;"></td> <td style="width: 10%;"></td> <td
style="width: 10%;"></td> <td style="width: 10%;"></td> <td style="width: 10%;"></td> <td style="width: 10%;"></td> </tr> <tr> <td></td> <td></td> <td colspan="8" style="text-align: center;"> <table border="1" style="width: 100%; border-collapse: collapse; text-align: center;"> <tr> <td style="width: 10%;"></td> <td style="width: 10%;"></td> <td style="width: 10%;"></td> <td style="width: 10%;"></td> <td style="width: 10%;"></td> <td style="width: 10%;"></td> <td style="width: 10%;"></td> <td style="width: 10%;"></td> <td style="width: 10%;"></td> <td style="width: 10%;"></td> </tr> <tr> <td></td> <td></td> <td colspan="8" style="text-align: center;"> <table border="1" style="width: 100%; border-collapse: collapse; text-align: center;"> <tr> <td style="width: 10%;"></td> <td style="width: 10%;"></td> <td style="width: 10%;"></td> <td style="width: 10%;"></td> <td style="width: 10%;"></td> <td style="width: 10%;"></td> <td style="width: 10%;"></td> <td style="width: 10%;"></td> <td style="width: 10%;"></td> <td style="width: 10%;"></td> </tr> <tr> <td></td> <td></td> <td colspan="8" style="text-align: center;"> <table border="1" style="width: 100%; border-collapse: collapse; text-align: center;"> <tr> <td style="width: 10%;"></td> <td style="width: 10%;"></td> <td style="width: 10%;"></td> <td style="width: 10%;"></td> <td style="width: 10%;"></td> <td style="width: 10%;"></td> <td style="width: 10%;"></td> <td style="width: 10%;"></td> <td style="width: 10%;"></td> <td style="width: 10%;"></td> </tr> <tr> <td></td> <td></td> <td colspan="8" style="text-align: center;"> <table border="1" style="width: 100%; border-collapse: collapse; text-align: center;"> <tr> <td style="width: 10%;"></td> <td style="width: 10%;"></td> <td style="width: 10%;"></td> <td style="width: 10%;"></td> <td style="width: 10%;"></td> <td style="width: 10%;"></td> <td style="width: 10%;"></td> <td style="width: 10%;"></td> <td style="width: 10%;"></td> <td style="width: 10%;"></td> </tr> <tr> <td></td> <td></td> <td colspan="8" style="text-align: center;"> <table border="1" style="width: 100%; border-collapse: collapse; text-align: center;"> <tr> <td style="width: 10%;"></td> <td style="width: 10%;"></td> <td style="width: 10%;"></td> <td style="width: 10%;"></td> <td style="width: 10%;"></td> <td style="width: 10%;"></td> <td style="width: 10%;"></td> <td style="width: 10%;"></td> <td style="width: 10%;"></td> <td style="width: 10%;"></td> </tr> <tr> <td></td> <td></td> <td colspan="8" style="text-align: center;"> <table border="1" style="width: 100%; border-collapse: collapse; text-align: center;"> <tr> <td style="width: 10%;"></td> <td style="width: 10%;"></td> <td style="width: 10%;"></td> <td style="width: 10%;"></td> <td style="width: 10%;"></td> <td style="width: 10%;"></td> <td style="width: 10%;"></td> <td style="width: 10%;"></td> <td style="width: 10%;"></td> <td style="width: 10%;"></td> </tr> <tr> <td></td> <td></td> <td colspan="8" style="text-align: center;"> <table border="1" style="width: 100%; border-collapse: collapse; text-align: center;"> <tr> <td style="width: 10%;"></td> <td style="width: 10%;"></td> <td style="width: 10%;"></td> <td style="width: 10%;"></td> <td style="width: 10%;"></td> <td style="width: 10%;"></td> <td style="width: 10%;"></td> <td style="width: 10%;"></td> <td style="width: 10%;"></td> <td style="width: 10%;"></td> </tr> <tr> <td></td> <td></td> <td colspan="8" style="text-align: center;"> <table border="1" style="width: 100%; border-collapse: collapse; text-align: center;"> <tr> <td style="width: 10%;"></td> <td style="width: 10%;"></td> <td style="width: 10%;"></td> <td style="width: 10%;"></td> <td style="width: 10%;"></td> <td style="width: 10%;"></td> <td style="width: 10%;"></td> <td style="width: 10%;"></td> <td style="width: 10%;"></td> <td style="width: 10%;"></td> </tr> <tr> <td></td> <td></td> <td colspan="8" style="text-align: center;"> <table border="1" style="width: 100%; border-collapse: collapse; text-align: center;"> <tr> <td style="width: 10%;"></td> <td style="width: 10%;"></td> <td style="width: 10%;"></td> <td style="width: 10%;"></td> <td style="width: 10%;"></td> <td style="width: 10%;"></td> <td style="width: 10%;"></td> <td style="width: 10%;"></td> <td style="width: 10%;"></td> <td style="width: 10%;"></td> </tr> <tr> <td></td> <td></td> <td colspan="8" style="text-align: center;"> <table border="1" style="width: 100%; border-collapse: collapse; text-align: center;"> <tr> <td style="width: 10%;"></td> <td style="width: 10%;"></td> <td style="width: 10%;"></td> <td style="width: 10%;"></td> <td style="width: 10%;"></td> <td style="width: 10%;"></td> <td style="width: 10%;"></td> <td style="width: 10%;"></td> <td style="width: 10%;"></td> <td style="width: 10%;"></td> </tr> <tr> <td></td> <td></td> <td colspan="8" style="text-align: center;"> <table border="1" style="width: 100%; border-collapse: collapse; text-align: center;"> <tr> <td style="width: 10%;"></td> <td style="width: 10%;"></td> <td style="width: 10%;"></td> <td style="width: 10%;"></td> <td style="width: 10%;"></td> <td style="width: 10%;"></td> <td style="width: 10%;"></td> <td style="width: 10%;"></td> <td style="width: 10%;"></td> <td style="width: 10%;"></td> </tr> <tr> <td></td> <td></td> <td colspan="8" style="text-align: center;"> <table border="1" style="width: 100%; border-collapse: collapse; text-align: center;"> <tr> <td style="width: 10%;"></td> <td style="width: 10%;"></td> <td style="width: 10%;"></td> <td style="width: 10%;"></td> <td style="width: 10%;"></td> <td style="width: 10%;"></td> <td style="width: 10%;"></td> <td style="width: 10%;"></td> <td style="width: 10%;"></td> <td style="width: 10%;"></td> </tr> <tr> <td></td> <td></td> <td colspan="8" style="text-align: center;"> <table border="1" style="width: 100%; border-collapse: collapse; text-align: center;"> <tr> <td style="width: 10%;"></td> <td style="width: 10%;"></td> <td style="width: 10%;"></td> <td style="width: 10%;"></td> <td style="width: 10%;"></td> <td style="width: 10%;"></td> <td style="width: 10%;"></td> <td style="width: 10%;"></td> <td style="width: 10%;"></td> <td style="width: 10%;"></td> </tr> <tr> <td></td> <td></td> <td colspan="8" style="text-align: center;"> <table border="1" style="width: 100%; border-collapse: collapse; text-align: center;"> <tr> <td style="width: 10%;"></td> <td style="width: 10%;"></td> <td style="width: 10%;"></td> <td style="width: 10%;"></td> <td style="width: 10%;"></td> <td style="width: 10%;"></td> <td style="width: 10%;"></td> <td style="width: 10%;"></td> <td style="width: 10%;"></td> <td style="width: 10%;"></td> </tr> <tr> <td></td> <td></td> <td colspan="8" style="text-align: center;"> <table border="1" style="width: 100%; border-collapse: collapse; text-align: center;"> <tr> <td style="width: 10%;"></td> <td style="width: 10%;"></td> <td style="width: 10%;"></td> <td style="width: 10%;"></td> <td style="width: 10%;"></td> <td style="width: 10%;"></td> <td style="width: 10%;"></td> <td style="width: 10%;"></td> <td style="width: 10%;"></td> <td style="width: 10%;"></td> </tr> <tr> <td></td> <td></td> <td colspan="8" style="text-align: center;"> <table border="1" style="width: 100%; border-collapse: collapse; text-align: center;"> <tr> <td style="width: 10%;"></td> <td style="width: 10%;"></td> <td style="width: 10%;"></td> <td style="width: 10%;"></td> <td style="width: 10%;"></td> <td style="width: 10%;"></td> <td style="width: 10%;"></td> <td style="width: 10%;"></td> <td style="width: 10%;"></td> <td style="width: 10%;"></td> </tr> <tr> <td></td> <td></td> <td colspan="8" style="text-align: center;"> <table border="1" style="width: 100%; border-collapse: collapse; text-align: center;"> <tr> <td style="width: 10%;"></td> <td style="width: 10%;"></td> <td style="width: 10%;"></td> <td style="width: 10%;"></td> <td style="width: 10%;"></td> <td style="width: 10%;"></td> <td style="width: 10%;"></td> <td style="width: 10%;"></td> <td style="width: 10%;"></td> <td style="width: 10%;"></td> </tr> <tr> <td></td> <td></td> <td colspan="8" style="text-align: center;"> <table border="1" style="width: 100%; border-collapse: collapse; text-align: center;"> <tr> <td style="width: 10%;"></td> <td style="width: 10%;"></td> <td style="width: 10%;"></td> <td style="width: 10%;"></td> <td style="width: 10%;"></td> <td style="width: 10%;"></td> <td style="width: 10%;"></td> <td style="width: 10%;"></td> <td style="width: 10%;"></td> <td style="width: 10%;"></td> </tr> <tr> <td></td> <td></td> <td colspan="8" style="text-align: center;"> <table border="1" style="width: 100%; border-collapse: collapse; text-align: center;"> <tr> <td style="width: 10%;"></td> <td style="width: 10%;"></td> <td style="width: 10%;"></td> <td style="width: 10%;"></td> <td style="width: 10%;"></td> <td style="width: 10%;"></td> <td style="width: 10%;"></td> <td style="width: 10%;"></td> <td style="width: 10%;"></td> <td style="width: 10%;"></td> </tr> <tr> <td></td> <td></td> <td colspan="8" style="text-align: center;"> <table border="1" style="width: 100%; border-collapse: collapse; text-align: center;"> <tr> <td style="width: 10%;"></td> <td style="width: 10%;"></td> <td style="width: 10%;"></td> <td style="width: 10%;"></td> <td style="width: 10%;"></td> <td style="width: 10%;"></td> <td style="width: 10%;"></td> <td style="width: 10%;"></td> <td style="width: 10%;"></td> <td style="width: 10%;"></td> </tr> <tr> <td></td> <td></td> <td colspan="8" style="text-align: center;"> <table border="1" style="width: 100%; border-collapse: collapse; text-align: center;"> <tr> <td style="width: 10%;"></td> <td style="width: 10%;"></td> <td style="width: 10%;"></td> <td style="width: 10%;"></td> <td style="width: 10%;"></td> <td style="width: 10%;"></td> <td style="width: 10%;"></td> <td style="width: 10%;"></td> <td style="width: 10%;"></td> <td style="width: 10%;"></td> </tr> <tr> <td></td> <td></td> <td colspan="8"
style="text-align: center;"> <table border="1" style="width: 100%; border-collapse: collapse; text-align: center;"> <tr> <td style="width: 10%;"></td> <td style="width: 10%;"></td> <td style="width: 10%;"></td> <td style="width: 10%;"></td> <td style="width: 10%;"></td> <td style="width: 10%;"></td> <td style="width: 10%;"></td> <td style="width: 10%;"></td> <td style="width: 10%;"></td> <td style="width: 10%;"></td> </tr> <tr> <td></td> <td></td> <td colspan="8" style="text-align: center;"> <table border="1" style="width: 100%; border-collapse: collapse; text-align: center;"> <tr> <td style="width: 10%;"></td> <td style="width: 10%;"></td> <td style="width: 10%;"></td> <td style="width: 10%;"></td> <td style="width: 10%;"></td> <td style="width: 10%;"></td> <td style="width: 10%;"></td> <td style="width: 10%;"></td> <td style="width: 10%;"></td> <td style="width: 10%;"></td> </tr> <tr> <td></td> <td></td> <td colspan="8" style="text-align: center;"> <table border="1" style="width: 100%; border-collapse: collapse; text-align: center;"> <tr> <td style="width: 10%;"></td> <td style="width: 10%;"></td> <td style="width: 10%;"></td> <td style="width: 10%;"></td> <td style="width: 10%;"></td> <td style="width: 10%;"></td> <td style="width: 10%;"></td> <td style="width: 10%;"></td> <td style="width: 10%;"></td> <td style="width: 10%;"></td> </tr> <tr> <td></td> <td></td> <td colspan="8" style="text-align: center;"> <table border="1" style="width: 100%; border-collapse: collapse; text-align: center;"> <tr> <td style="width: 10%;"></td> <td style="width: 10%;"></td> <td style="width: 10%;"></td> <td style="width: 10%;"></td> <td style="width: 10%;"></td> <td style="width: 10%;"></td> <td style="width: 10%;"></td> <td style="width: 10%;"></td> <td style="width: 10%;"></td> <td style="width: 10%;"></td> </tr> <tr> <td></td> <td></td> <td colspan="8" style="text-align: center;"> <table border="1" style="width: 100%; border-collapse: collapse; text-align: center;"> <tr> <td style="width: 10%;"></td> <td style="width: 10%;"></td> <td style="width: 10%;"></td> <td style="width: 10%;"></td> <td style="width: 10%;"></td> <td style="width: 10%;"></td> <td style="width: 10%;"></td> <td style="width: 10%;"></td> <td style="width: 10%;"></td> <td style="width: 10%;"></td> </tr> <tr> <td></td> <td></td> <td colspan="8" style="text-align: center;"> <table border="1" style="width: 100%; border-collapse: collapse; text-align: center;"> <tr> <td style="width: 10%;"></td> <td style="width: 10%;"></td> <td style="width: 10%;"></td> <td style="width: 10%;"></td> <td style="width: 10%;"></td> <td style="width: 10%;"></td> <td style="width: 10%;"></td> <td style="width: 10%;"></td> <td style="width: 10%;"></td> <td style="width: 10%;"></td> </tr> <tr> <td></td> <td></td> <td colspan="8" style="text-align: center;"> <table border="1" style="width: 100%; border-collapse: collapse; text-align: center;"> <tr> <td style="width: 10%;"></td> <td style="width: 10%;"></td> <td style="width: 10%;"></td> <td style="width: 10%;"></td> <td style="width: 10%;"></td> <td style="width: 10%;"></td> <td style="width: 10%;"></td> <td style="width: 10%;"></td> <td style="width: 10%;"></td> <td style="width: 10%;"></td> </tr> <tr> <td></td> <td></td> <td colspan="8" style="text-align: center;"> <table border="1" style="width: 100%; border-collapse: collapse; text-align: center;"> <tr> <td style="width: 10%;"></td> <td style="width: 10%;"></td> <td style="width: 10%;"></td> <td style="width: 10%;"></td> <td style="width: 10%;"></td> <td style="width: 10%;"></td> <td style="width: 10%;"></td> <td style="width: 10%;"></td> <td style="width: 10%;"></td> <td style="width: 10%;"></td> </tr> <tr> <td></td> <td></td> <td colspan="8" style="text-align: center;"> <table border="1" style="width: 100%; border-collapse: collapse; text-align: center;"> <tr> <td style="width: 10%;"></td> <td style="width: 10%;"></td> <td style="width: 10%;"></td> <td style="width: 10%;"></td> <td style="width: 10%;"></td> <td style="width: 10%;"></td> <td style="width: 10%;"></td> <td style="width: 10%;"></td> <td style="width: 10%;"></td> <td style="width: 10%;"></td> </tr> <tr> <td></td> <td></td> <td colspan="8" style="text-align: center;"> <table border="1" style="width: 100%; border-collapse: collapse; text-align: center;"> <tr> <td style="width: 10%;"></td> <td style="width: 10%;"></td> <td style="width: 10%;"></td> <td style="width: 10%;"></td> <td style="width: 10%;"></td> <td style="width: 10%;"></td> <td style="width: 10%;"></td> <td style="width: 10%;"></td> <td style="width: 10%;"></td> <td style="width: 10%;"></td> </tr> <tr> <td></td> <td></td> <td colspan="8" style="text-align: center;"> <table border="1" style="width: 100%; border-collapse: collapse; text-align: center;"> <tr> <td style="width: 10%;"></td> <td style="width: 10%;"></td> <td style="width: 10%;"></td> <td style="width: 10%;"></td> <td style="width: 10%;"></td> <td style="width: 10%;"></td> <td style="width: 10%;"></td> <td style="width: 10%;"></td> <td style="width: 10%;"></td> <td style="width: 10%;"></td> </tr> <tr> <td></td> <td></td> <td colspan="8" style="text-align: center;"> <table border="1" style="width: 100%; border-collapse: collapse; text-align: center;"> <tr> <td style="width: 10%;"></td> <td style="width: 10%;"></td> <td style="width: 10%;"></td> <td style="width: 10%;"></td> <td style="width: 10%;"></td> <td style="width: 10%;"></td> <td style="width: 10%;"></td> <td style="width: 10%;"></td> <td style="width: 10%;"></td> <td style="width: 10%;"></td> </tr> <tr> <td></td> <td></td> <td colspan="8" style="text-align: center;"> <table border="1" style="width: 100%; border-collapse: collapse; text-align: center;"> <tr> <td style="width: 10%;"></td> <td style="width: 10%;"></td> <td style="width: 10%;"></td> <td style="width: 10%;"></td> <td style="width: 10%;"></td> <td style="width: 10%;"></td> <td style="width: 10%;"></td> <td style="width: 10%;"></td> <td style="width: 10%;"></td> <td style="width: 10%;"></td> </tr> <tr> <td></td> <td></td> <td colspan="8" style="text-align: center;"> <table border="1" style="width: 100%; border-collapse: collapse; text-align: center;"> <tr> </tr></table></td></tr></table></td></tr></table></td></tr></table></td></tr></table></td></tr></table></td></tr></table></td></tr></table></td></tr></table></td></tr></table></td></tr></table></td></tr></table></td></tr></table></td></tr></table></td></tr></table></td></tr></table></td></tr></table></td></tr></table></td></tr></table></td></tr></table></td></tr></table></td></tr></table></td></tr></table></td></tr></table></td></tr></table></td></tr></table></td></tr></table></td></tr></table></td></tr></table></td></tr></table></td></tr></table></td></tr></table></td></tr></table></td></tr></table></td></tr></table></td></tr></table></td></tr></table></td></tr></table></td></tr></table></td></tr></table></td></tr></table></td></tr></table></td></tr></table></td></tr></table></td></tr></table></td></tr></table></td></tr></table></td></tr></table></td></tr></table></td></tr></table></td></tr></table></td></tr></table>
 | | | | | | | | | | | | | | | | | | | | <table border="1" style="width: 100%; border-collapse: collapse; text-align: center;"> <tr> <td style="width: 10%;"></td> <td style="width: 10%;"></td> <td style="width: 10%;"></td> <td style="width: 10%;"></td> <td style="width: 10%;"></td> <td style="width: 10%;"></td> <td style="width: 10%;"></td> <td style="width: 10%;"></td> <td style="width: 10%;"></td> <td style="width: 10%;"></td> </tr> <tr> <td></td> <td></td> <td colspan="8" style="text-align: center;"> <table border="1" style="width: 100%; border-collapse: collapse; text-align: center;"> <tr> <td style="width: 10%;"></td> <td style="width: 10%;"></td> <td style="width: 10%;"></td> <td style="width: 10%;"></td> <td style="width: 10%;"></td> <td style="width: 10%;"></td> <td style="width: 10%;"></td> <td style="width: 10%;"></td> <td style="width: 10%;"></td> <td style="width: 10%;"></td> </tr> <tr> <td></td> <td></td> <td colspan="8" style="text-align: center;"> <table border="1" style="width: 100%; border-collapse: collapse; text-align: center;"> <tr> <td style="width: 10%;"></td> <td style="width: 10%;"></td> <td style="width: 10%;"></td> <td style="width: 10%;"></td> <td style="width: 10%;"></td> <td style="width: 10%;"></td> <td style="width: 10%;"></td> <td style="width: 10%;"></td> <td style="width: 10%;"></td> <td style="width: 10%;"></td> </tr> <tr> <td></td> <td></td> <td colspan="8" style="text-align: center;"> <table border="1" style="width: 100%; border-collapse: collapse; text-align: center;"> <tr> <td style="width: 10%;"></td> <td style="width: 10%;"></td> <td style="width: 10%;"></td> <td style="width: 10%;"></td> <td style="width: 10%;"></td> <td style="width: 10%;"></td> <td style="width: 10%;"></td> <td style="width: 10%;"></td> <td style="width: 10%;"></td> <td style="width: 10%;"></td> </tr> <tr> <td></td> <td></td> <td colspan="8" style="text-align: center;"> <table border="1" style="width: 100%; border-collapse: collapse; text-align: center;"> <tr> <td style="width: 10%;"></td> <td style="width: 10%;"></td> <td style="width: 10%;"></td> <td style="width: 10%;"></td> <td style="width: 10%;"></td> <td style="width: 10%;"></td> <td style="width: 10%;"></td> <td style="width: 10%;"></td> <td style="width: 10%;"></td> <td style="width: 10%;"></td> </tr> <tr> <td></td> <td></td> <td colspan="8" style="text-align: center;"> <table border="1" style="width: 100%; border-collapse: collapse; text-align: center;"> <tr> <td style="width: 10%;"></td> <td style="width: 10%;"></td> <td style="width: 10%;"></td> <td style="width: 10%;"></td> <td style="width: 10%;"></td> <td style="width: 10%;"></td> <td style="width: 10%;"></td> <td style="width: 10%;"></td> <td style="width: 10%;"></td> <td style="width: 10%;"></td> </tr> <tr> <td></td> <td></td> <td colspan="8" style="text-align: center;"> <table border="1" style="width: 100%; border-collapse: collapse; text-align: center;"> <tr> <td style="width: 10%;"></td> <td style="width: 10%;"></td> <td style="width: 10%;"></td> <td style="width: 10%;"></td> <td style="width: 10%;"></td> <td style="width: 10%;"></td> <td style="width: 10%;"></td> <td style="width: 10%;"></td> <td style="width: 10%;"></td> <td style="width: 10%;"></td> </tr> <tr> <td></td> <td></td> <td colspan="8" style="text-align: center;"> <table border="1" style="width: 100%; border-collapse: collapse; text-align: center;"> <tr> <td style="width: 10%;"></td> <td style="width: 10%;"></td> <td style="width: 10%;"></td> <td style="width: 10%;"></td> <td style="width: 10%;"></td> <td style="width: 10%;"></td> <td style="width: 10%;"></td> <td style="width: 10%;"></td> <td style="width: 10%;"></td> <td style="width: 10%;"></td> </tr> <tr> <td></td> <td></td> <td colspan="8" style="text-align: center;"> <table border="1" style="width: 100%; border-collapse: collapse; text-align: center;"> <tr> <td style="width: 10%;"></td> <td style="width: 10%;"></td> <td style="width: 10%;"></td> <td style="width: 10%;"></td> <td style="width: 10%;"></td> <td style="width: 10%;"></td> <td style="width: 10%;"></td> <td style="width: 10%;"></td> <td style="width: 10%;"></td> <td style="width: 10%;"></td> </tr> <tr> <td></td> <td></td> <td colspan="8" style="text-align: center;"> <table border="1" style="width: 100%; border-collapse: collapse; text-align: center;"> <tr> <td style="width: 10%;"></td> <td style="width: 10%;"></td> <td style="width: 10%;"></td> <td style="width: 10%;"></td> <td style="width: 10%;"></td> <td style="width: 10%;"></td> <td style="width: 10%;"></td> <td style="width: 10%;"></td> <td style="width: 10%;"></td> <td style="width: 10%;"></td> </tr> <tr> <td></td> <td></td> <td colspan="8" style="text-align: center;"> <table border="1" style="width: 100%; border-collapse: collapse; text-align: center;"> <tr> <td style="width: 10%;"></td> <td style="width: 10%;"></td> <td style="width: 10%;"></td> <td style="width: 10%;"></td> <td style="width: 10%;"></td> <td style="width: 10%;"></td> <td style="width: 10%;"></td> <td style="width: 10%;"></td> <td style="width: 10%;"></td> <td style="width: 10%;"></td> </tr> <tr> <td></td> <td></td> <td colspan="8" style="text-align: center;"> <table border="1" style="width: 100%; border-collapse: collapse; text-align: center;"> <tr> <td style="width: 10%;"></td> <td style="width: 10%;"></td> <td style="width: 10%;"></td> <td style="width: 10%;"></td> <td style="width: 10%;"></td> <td style="width: 10%;"></td> <td style="width: 10%;"></td> <td style="width: 10%;"></td> <td style="width: 10%;"></td> <td style="width: 10%;"></td> </tr> <tr> <td></td> <td></td> <td colspan="8" style="text-align: center;"> <table border="1" style="width: 100%; border-collapse: collapse; text-align: center;"> <tr> <td style="width: 10%;"></td> <td style="width: 10%;"></td> <td style="width: 10%;"></td> <td style="width: 10%;"></td> <td style="width: 10%;"></td> <td style="width: 10%;"></td> <td style="width: 10%;"></td> <td style="width: 10%;"></td> <td style="width: 10%;"></td> <td style="width: 10%;"></td> </tr> <tr> <td></td> <td></td> <td colspan="8" style="text-align: center;"> <table border="1" style="width: 100%; border-collapse: collapse; text-align: center;"> <tr> <td style="width: 10%;"></td> <td style="width: 10%;"></td> <td style="width: 10%;"></td> <td style="width: 10%;"></td> <td style="width: 10%;"></td> <td style="width: 10%;"></td> <td style="width: 10%;"></td> <td style="width: 10%;"></td> <td style="width: 10%;"></td> <td style="width: 10%;"></td> </tr> <tr> <td></td> <td></td> <td colspan="8" style="text-align: center;"> <table border="1" style="width: 100%; border-collapse: collapse; text-align: center;"> <tr> <td style="width: 10%;"></td> <td style="width: 10%;"></td> <td style="width: 10%;"></td> <td style="width: 10%;"></td> <td style="width: 10%;"></td> <td style="width: 10%;"></td> <td style="width: 10%;"></td> <td style="width: 10%;"></td> <td style="width: 10%;"></td> <td style="width: 10%;"></td> </tr> <tr> <td></td> <td></td> <td colspan="8" style="text-align: center;"> <table border="1" style="width: 100%; border-collapse: collapse; text-align: center;"> <tr> <td style="width: 10%;"></td> <td style="width: 10%;"></td> <td style="width: 10%;"></td> <td style="width: 10%;"></td> <td style="width: 10%;"></td> <td style="width: 10%;"></td> <td style="width: 10%;"></td> <td style="width: 10%;"></td> <td style="width: 10%;"></td> <td style="width: 10%;"></td> </tr> <tr> <td></td> <td></td> <td colspan="8" style="text-align: center;"> <table border="1" style="width: 100%; border-collapse: collapse; text-align: center;"> <tr> <td style="width: 10%;"></td> <td style="width: 10%;"></td> <td style="width: 10%;"></td> <td style="width: 10%;"></td> <td style="width: 10%;"></td> <td style="width: 10%;"></td> <td style="width: 10%;"></td> <td style="width: 10%;"></td> <td style="width: 10%;"></td> <td style="width: 10%;"></td> </tr> <tr> <td></td> <td></td> <td colspan="8" style="text-align: center;"> <table border="1" style="width: 100%; border-collapse: collapse; text-align: center;"> <tr> <td style="width: 10%;"></td> <td style="width: 10%;"></td> <td style="width: 10%;"></td> <td style="width: 10%;"></td> <td style="width: 10%;"></td> <td style="width: 10%;"></td> <td style="width: 10%;"></td> <td style="width: 10%;"></td> <td style="width: 10%;"></td> <td style="width: 10%;"></td> </tr> <tr> <td></td> <td></td> <td colspan="8" style="text-align: center;">
<table border="1" style="width: 100%; border-collapse: collapse; text-align: center;"> <tr> <td style="width: 10%;"></td> <td style="width: 10%;"></td> <td style="width: 10%;"></td> <td style="width: 10%;"></td> <td style="width: 10%;"></td> <td style="width: 10%;"></td> <td style="width: 10%;"></td> <td style="width: 10%;"></td> <td style="width: 10%;"></td> <td style="width: 10%;"></td> </tr> <tr> <td></td> <td></td> <td colspan="8" style="text-align: center;"> <table border="1" style="width: 100%; border-collapse: collapse; text-align: center;"> <tr> <td style="width: 10%;"></td> <td style="width: 10%;"></td> <td style="width: 10%;"></td> <td style="width: 10%;"></td> <td style="width: 10%;"></td> <td style="width: 10%;"></td> <td style="width: 10%;"></td> <td style="width: 10%;"></td> <td style="width: 10%;"></td> <td style="width: 10%;"></td> </tr> <tr> <td></td> <td></td> <td colspan="8" style="text-align: center;"> <table border="1" style="width: 100%; border-collapse: collapse; text-align: center;"> <tr> <td style="width: 10%;"></td> <td style="width: 10%;"></td> <td style="width: 10%;"></td> <td style="width: 10%;"></td> <td style="width: 10%;"></td> <td style="width: 10%;"></td> <td style="width: 10%;"></td> <td style="width: 10%;"></td> <td style="width: 10%;"></td> <td style="width: 10%;"></td> </tr> <tr> <td></td> <td></td> <td colspan="8" style="text-align: center;"> <table border="1" style="width: 100%; border-collapse: collapse; text-align: center;"> <tr> <td style="width: 10%;"></td> <td style="width: 10%;"></td> <td style="width: 10%;"></td> <td style="width: 10%;"></td> <td style="width: 10%;"></td> <td style="width: 10%;"></td> <td style="width: 10%;"></td> <td style="width: 10%;"></td> <td style="width: 10%;"></td> <td style="width: 10%;"></td> </tr> <tr> <td></td> <td></td> <td colspan="8" style="text-align: center;"> <table border="1" style="width: 100%; border-collapse: collapse; text-align: center;"> <tr> <td style="width: 10%;"></td> <td style="width: 10%;"></td> <td style="width: 10%;"></td> <td style="width: 10%;"></td> <td style="width: 10%;"></td> <td style="width: 10%;"></td> <td style="width: 10%;"></td> <td style="width: 10%;"></td> <td style="width: 10%;"></td> <td style="width: 10%;"></td> </tr> <tr> <td></td> <td></td> <td colspan="8" style="text-align: center;"> <table border="1" style="width: 100%; border-collapse: collapse; text-align: center;"> <tr> <td style="width: 10%;"></td> <td style="width: 10%;"></td> <td style="width: 10%;"></td> <td style="width: 10%;"></td> <td style="width: 10%;"></td> <td style="width: 10%;"></td> <td style="width: 10%;"></td> <td style="width: 10%;"></td> <td style="width: 10%;"></td> <td style="width: 10%;"></td> </tr> <tr> <td></td> <td></td> <td colspan="8" style="text-align: center;"> <table border="1" style="width: 100%; border-collapse: collapse; text-align: center;"> <tr> <td style="width: 10%;"></td> <td style="width: 10%;"></td> <td style="width: 10%;"></td> <td style="width: 10%;"></td> <td style="width: 10%;"></td> <td style="width: 10%;"></td> <td style="width: 10%;"></td> <td style="width: 10%;"></td> <td style="width: 10%;"></td> <td style="width: 10%;"></td> </tr> <tr> <td></td> <td></td> <td colspan="8" style="text-align: center;"> <table border="1" style="width: 100%; border-collapse: collapse; text-align: center;"> <tr> <td style="width: 10%;"></td> <td style="width: 10%;"></td> <td style="width: 10%;"></td> <td style="width: 10%;"></td> <td style="width: 10%;"></td> <td style="width: 10%;"></td> <td style="width: 10%;"></td> <td style="width: 10%;"></td> <td style="width: 10%;"></td> <td style="width: 10%;"></td> </tr> <tr> <td></td> <td></td> <td colspan="8" style="text-align: center;"> <table border="1" style="width: 100%; border-collapse: collapse; text-align: center;"> <tr> <td style="width: 10%;"></td> <td style="width: 10%;"></td> <td style="width: 10%;"></td> <td style="width: 10%;"></td> <td style="width: 10%;"></td> <td style="width: 10%;"></td> <td style="width: 10%;"></td> <td style="width: 10%;"></td> <td style="width: 10%;"></td> <td style="width: 10%;"></td> </tr> <tr> <td></td> <td></td> <td colspan="8" style="text-align: center;"> <table border="1" style="width: 100%; border-collapse: collapse; text-align: center;"> <tr> <td style="width: 10%;"></td> <td style="width: 10%;"></td> <td style="width: 10%;"></td> <td style="width: 10%;"></td> <td style="width: 10%;"></td> <td style="width: 10%;"></td> <td style="width: 10%;"></td> <td style="width: 10%;"></td> <td style="width: 10%;"></td> <td style="width: 10%;"></td> </tr> <tr> <td></td> <td></td> <td colspan="8" style="text-align: center;"> <table border="1" style="width: 100%; border-collapse: collapse; text-align: center;"> <tr> <td style="width: 10%;"></td> <td style="width: 10%;"></td> <td style="width: 10%;"></td> <td style="width: 10%;"></td> <td style="width: 10%;"></td> <td style="width: 10%;"></td> <td style="width: 10%;"></td> <td style="width: 10%;"></td> <td style="width: 10%;"></td> <td style="width: 10%;"></td> </tr> <tr> <td></td> <td></td> <td colspan="8" style="text-align: center;"> <table border="1" style="width: 100%; border-collapse: collapse; text-align: center;"> <tr> <td style="width: 10%;"></td> <td style="width: 10%;"></td> <td style="width: 10%;"></td> <td style="width: 10%;"></td> <td style="width: 10%;"></td> <td style="width: 10%;"></td> <td style="width: 10%;"></td> <td style="width: 10%;"></td> <td style="width: 10%;"></td> <td style="width: 10%;"></td> </tr> <tr> <td></td> <td></td> <td colspan="8" style="text-align: center;"> <table border="1" style="width: 100%; border-collapse: collapse; text-align: center;"> <tr> <td style="width: 10%;"></td> <td style="width: 10%;"></td> <td style="width: 10%;"></td> <td style="width: 10%;"></td> <td style="width: 10%;"></td> <td style="width: 10%;"></td> <td style="width: 10%;"></td> <td style="width: 10%;"></td> <td style="width: 10%;"></td> <td style="width: 10%;"></td> </tr> <tr> <td></td> <td></td> <td colspan="8" style="text-align: center;"> <table border="1" style="width: 100%; border-collapse: collapse; text-align: center;"> <tr> <td style="width: 10%;"></td> <td style="width: 10%;"></td> <td style="width: 10%;"></td> <td style="width: 10%;"></td> <td style="width: 10%;"></td> <td style="width: 10%;"></td> <td style="width: 10%;"></td> <td style="width: 10%;"></td> <td style="width: 10%;"></td> <td style="width: 10%;"></td> </tr> <tr> <td></td> <td></td> <td colspan="8" style="text-align: center;"> <table border="1" style="width: 100%; border-collapse: collapse; text-align: center;"> <tr> <td style="width: 10%;"></td> <td style="width: 10%;"></td> <td style="width: 10%;"></td> <td style="width: 10%;"></td> <td style="width: 10%;"></td> <td style="width: 10%;"></td> <td style="width: 10%;"></td> <td style="width: 10%;"></td> <td style="width: 10%;"></td> <td style="width: 10%;"></td> </tr> <tr> <td></td> <td></td> <td colspan="8" style="text-align: center;"> <table border="1" style="width: 100%; border-collapse: collapse; text-align: center;"> <tr> <td style="width: 10%;"></td> <td style="width: 10%;"></td> <td style="width: 10%;"></td> <td style="width: 10%;"></td> <td style="width: 10%;"></td> <td style="width: 10%;"></td> <td style="width: 10%;"></td> <td style="width: 10%;"></td> <td style="width: 10%;"></td> <td style="width: 10%;"></td> </tr> <tr> <td></td> <td></td> <td colspan="8" style="text-align: center;"> <table border="1" style="width: 100%; border-collapse: collapse; text-align: center;"> <tr> <td style="width: 10%;"></td> <td style="width: 10%;"></td> <td style="width: 10%;"></td> <td style="width: 10%;"></td> <td style="width: 10%;"></td> <td style="width: 10%;"></td> <td style="width: 10%;"></td> <td style="width: 10%;"></td> <td style="width: 10%;"></td> <td style="width: 10%;"></td> </tr> <tr> <td></td> <td></td> <td colspan="8" style="text-align: center;"> <table border="1" style="width: 100%; border-collapse: collapse; text-align: center;"> <tr> <td style="width: 10%;"></td> <td style="width: 10%;"></td> <td style="width: 10%;"></td> <td style="width: 10%;"></td> <td style="width: 10%;"></td> <td style="width: 10%;"></td> <td style="width: 10%;"></td> <td style="width: 10%;"></td> <td style="width: 10%;"></td> <td style="width: 10%;"></td> </tr> <tr> <td></td> <td></td> <td colspan="8" style="text-align: center;"> <table border="1" style="width: 100%; border-collapse: collapse; text-align: center;"> <tr> <td style="width: 10%;"></td> <td style="width: 10%;"></td> <td style="width: 10%;"></td> <td style="width: 10%;"></td> <td style="width: 10%;"></td> <td style="width: 10%;"></td> <td style="width: 10%;"></td> <td style="width: 10%;"></td> <td style="width: 10%;"></td> <td style="width: 10%;"></td> </tr> <tr> <td></td> <td></td> <td colspan="8" style="text-align: center;"> <table border="1" style="width: 100%; border-collapse: collapse; text-align: center;"> <tr> <td style="width: 10%;"></td> <td style="width: 10%;"></td> <td style="width: 10%;"></td> <td style="width: 10%;"></td> <td style="width: 10%;"></td> <td style="width: 10%;"></td> <td style="width: 10%;"></td> <td style="width: 10%;"></td> <td style="width: 10%;"></td> <td style="width: 10%;"></td> </tr> <tr> <td></td> <td></td> <td colspan="8" style="text-align: center;"> <table border="1" style="width: 100%; border-collapse: collapse; text-align: center;"> <tr> <td style="width: 10%;"></td> <td style="width: 10%;"></td> <td style="width: 10%;"></td> <td style="width: 10%;"></td> <td style="width: 10%;"></td> <td style="width: 10%;"></td> <td style="width: 10%;"></td> <td style="width: 10%;"></td> <td style="width: 10%;"></td> <td style="width: 10%;"></td> </tr> <tr> <td></td> <td></td> <td colspan="8" style="text-align: center;"> <table border="1" style="width: 100%; border-collapse: collapse; text-align: center;"> <tr> <td style="width: 10%;"></td> <td style="width: 10%;"></td> <td style="width:
10%;"></td> <td style="width: 10%;"></td> <td style="width: 10%;"></td> <td style="width: 10%;"></td> <td style="width: 10%;"></td> <td style="width: 10%;"></td> <td style="width: 10%;"></td> <td style="width: 10%;"></td> </tr> <tr> <td></td> <td></td> <td colspan="8" style="text-align: center;"> <table border="1" style="width: 100%; border-collapse: collapse; text-align: center;"> <tr> <td style="width: 10%;"></td> <td style="width: 10%;"></td> <td style="width: 10%;"></td> <td style="width: 10%;"></td> <td style="width: 10%;"></td> <td style="width: 10%;"></td> <td style="width: 10%;"></td> <td style="width: 10%;"></td> <td style="width: 10%;"></td> <td style="width: 10%;"></td> </tr> <tr> <td></td> <td></td> <td colspan="8" style="text-align: center;"> <table border="1" style="width: 100%; border-collapse: collapse; text-align: center;"> <tr> <td style="width: 10%;"></td> <td style="width: 10%;"></td> <td style="width: 10%;"></td> <td style="width: 10%;"></td> <td style="width: 10%;"></td> <td style="width: 10%;"></td> <td style="width: 10%;"></td> <td style="width: 10%;"></td> <td style="width: 10%;"></td> <td style="width: 10%;"></td> </tr> <tr> <td></td> <td></td> <td colspan="8" style="text-align: center;"> <table border="1" style="width: 100%; border-collapse: collapse; text-align: center;"> <tr> <td style="width: 10%;"></td> <td style="width: 10%;"></td> <td style="width: 10%;"></td> <td style="width: 10%;"></td> <td style="width: 10%;"></td> <td style="width: 10%;"></td> <td style="width: 10%;"></td> <td style="width: 10%;"></td> <td style="width: 10%;"></td> <td style="width: 10%;"></td> </tr> <tr> <td></td> <td></td> <td colspan="8" style="text-align: center;"> <table border="1" style="width: 100%; border-collapse: collapse; text-align: center;"> <tr> <td style="width: 10%;"></td> <td style="width: 10%;"></td> <td style="width: 10%;"></td> <td style="width: 10%;"></td> <td style="width: 10%;"></td> <td style="width: 10%;"></td> <td style="width: 10%;"></td> <td style="width: 10%;"></td> <td style="width: 10%;"></td> <td style="width: 10%;"></td> </tr> <tr> <td></td> <td></td> <td colspan="8" style="text-align: center;"> <table border="1" style="width: 100%; border-collapse: collapse; text-align: center;"> <tr> <td style="width: 10%;"></td> <td style="width: 10%;"></td> <td style="width: 10%;"></td> <td style="width: 10%;"></td> <td style="width: 10%;"></td> <td style="width: 10%;"></td> <td style="width: 10%;"></td> <td style="width: 10%;"></td> <td style="width: 10%;"></td> <td style="width: 10%;"></td> </tr> <tr> <td></td> <td></td> <td colspan="8" style="text-align: center;"> <table border="1" style="width: 100%; border-collapse: collapse; text-align: center;"> <tr> <td style="width: 10%;"></td> <td style="width: 10%;"></td> <td style="width: 10%;"></td> <td style="width: 10%;"></td> <td style="width: 10%;"></td> <td style="width: 10%;"></td> <td style="width: 10%;"></td> <td style="width: 10%;"></td> <td style="width: 10%;"></td> <td style="width: 10%;"></td> </tr> <tr> <td></td> <td></td> <td colspan="8" style="text-align: center;"> <table border="1" style="width: 100%; border-collapse: collapse; text-align: center;"> <tr> <td style="width: 10%;"></td> <td style="width: 10%;"></td> <td style="width: 10%;"></td> <td style="width: 10%;"></td> <td style="width: 10%;"></td> <td style="width: 10%;"></td> <td style="width: 10%;"></td> <td style="width: 10%;"></td> <td style="width: 10%;"></td> <td style="width: 10%;"></td> </tr> <tr> <td></td> <td></td> <td colspan="8" style="text-align: center;"> <table border="1" style="width: 100%; border-collapse: collapse; text-align: center;"> <tr> <td style="width: 10%;"></td> <td style="width: 10%;"></td> <td style="width: 10%;"></td> <td style="width: 10%;"></td> <td style="width: 10%;"></td> <td style="width: 10%;"></td> <td style="width: 10%;"></td> <td style="width: 10%;"></td> <td style="width: 10%;"></td> <td style="width: 10%;"></td> </tr> <tr> <td></td> <td></td> <td colspan="8" style="text-align: center;"> <table border="1" style="width: 100%; border-collapse: collapse; text-align: center;"> <tr> <td style="width: 10%;"></td> <td style="width: 10%;"></td> <td style="width: 10%;"></td> <td style="width: 10%;"></td> <td style="width: 10%;"></td> <td style="width: 10%;"></td> <td style="width: 10%;"></td> <td style="width: 10%;"></td> <td style="width: 10%;"></td> <td style="width: 10%;"></td> </tr> <tr> <td></td> <td></td> <td colspan="8" style="text-align: center;"> <table border="1" style="width: 100%; border-collapse: collapse; text-align: center;"> <tr> <td style="width: 10%;"></td> <td style="width: 10%;"></td> <td style="width: 10%;"></td> <td style="width: 10%;"></td> <td style="width: 10%;"></td> <td style="width: 10%;"></td> <td style="width: 10%;"></td> <td style="width: 10%;"></td> <td style="width: 10%;"></td> <td style="width: 10%;"></td> </tr> <tr> <td></td> <td></td> <td colspan="8" style="text-align: center;"> <table border="1" style="width: 100%; border-collapse: collapse; text-align: center;"> <tr> </tr></table></td></tr></table></td></tr></table></td></tr></table></td></tr></table></td></tr></table></td></tr></table></td></tr></table></td></tr></table></td></tr></table></td></tr></table></td></tr></table></td></tr></table></td></tr></table></td></tr></table></td></tr></table></td></tr></table></td></tr></table></td></tr></table></td></tr></table></td></tr></table></td></tr></table></td></tr></table></td></tr></table></td></tr></table></td></tr></table></td></tr></table></td></tr></table></td></tr></table></td></tr></table></td></tr></table></td></tr></table></td></tr></table></td></tr></table></td></tr></table></td></tr></table></td></tr></table></td></tr></table></td></tr></table></td></tr></table></td></tr></table></td></tr></table></td></tr></table></td></tr></table></td></tr></table></td></tr></table></td></tr></table></td></tr></table></td></tr></table></td></tr></table></td></tr></table>
 | | | | | | | | | | | | | | | | | | | | <table border="1" style="width: 100%; border-collapse: collapse; text-align: center;"> <tr> <td style="width: 10%;"></td> <td style="width: 10%;"></td> <td style="width: 10%;"></td> <td style="width: 10%;"></td> <td style="width: 10%;"></td> <td style="width: 10%;"></td> <td style="width: 10%;"></td> <td style="width: 10%;"></td> <td style="width: 10%;"></td> <td style="width: 10%;"></td> </tr> <tr> <td></td> <td></td> <td colspan="8" style="text-align: center;"> <table border="1" style="width: 100%; border-collapse: collapse; text-align: center;"> <tr> <td style="width: 10%;"></td> <td style="width: 10%;"></td> <td style="width: 10%;"></td> <td style="width: 10%;"></td> <td style="width: 10%;"></td> <td style="width: 10%;"></td> <td style="width: 10%;"></td> <td style="width: 10%;"></td> <td style="width: 10%;"></td> <td style="width: 10%;"></td> </tr> <tr> <td></td> <td></td> <td colspan="8" style="text-align: center;"> <table border="1" style="width: 100%; border-collapse: collapse; text-align: center;"> <tr> <td style="width: 10%;"></td> <td style="width: 10%;"></td> <td style="width: 10%;"></td> <td style="width: 10%;"></td> <td style="width: 10%;"></td> <td style="width: 10%;"></td> <td style="width: 10%;"></td> <td style="width: 10%;"></td> <td style="width: 10%;"></td> <td style="width: 10%;"></td> </tr> <tr> <td></td> <td></td> <td colspan="8" style="text-align: center;"> <table border="1" style="width: 100%; border-collapse: collapse; text-align: center;"> <tr> <td style="width: 10%;"></td> <td style="width: 10%;"></td> <td style="width: 10%;"></td> <td style="width: 10%;"></td> <td style="width: 10%;"></td> <td style="width: 10%;"></td> <td style="width: 10%;"></td> <td style="width: 10%;"></td> <td style="width: 10%;"></td> <td style="width: 10%;"></td> </tr> <tr> <td></td> <td></td> <td colspan="8" style="text-align: center;"> <table border="1" style="width: 100%; border-collapse: collapse; text-align: center;"> <tr> <td style="width: 10%;"></td> <td style="width: 10%;"></td> <td style="width: 10%;"></td> <td style="width: 10%;"></td> <td style="width: 10%;"></td> <td style="width: 10%;"></td> <td style="width: 10%;"></td> <td style="width: 10%;"></td> <td style="width: 10%;"></td> <td style="width: 10%;"></td> </tr> <tr> <td></td> <td></td> <td colspan="8" style="text-align: center;"> <table border="1" style="width: 100%; border-collapse: collapse; text-align: center;"> <tr> <td style="width: 10%;"></td> <td style="width: 10%;"></td> <td style="width: 10%;"></td> <td style="width: 10%;"></td> <td style="width: 10%;"></td> <td style="width: 10%;"></td> <td style="width: 10%;"></td> <td style="width: 10%;"></td> <td style="width: 10%;"></td> <td style="width: 10%;"></td> </tr> <tr> <td></td> <td></td> <td colspan="8" style="text-align: center;"> <table border="1" style="width: 100%; border-collapse: collapse; text-align: center;"> <tr> <td style="width: 10%;"></td> <td style="width: 10%;"></td> <td style="width: 10%;"></td> <td style="width: 10%;"></td> <td style="width: 10%;"></td> <td style="width: 10%;"></td> <td style="width: 10%;"></td> <td style="width: 10%;"></td> <td style="width: 10%;"></td> <td style="width: 10%;"></td> </tr> <tr> <td></td> <td></td> <td colspan="8" style="text-align: center;"> <table border="1" style="width: 100%; border-collapse: collapse; text-align: center;"> <tr> <td style="width: 10%;"></td> <td style="width: 10%;"></td> <td style="width: 10%;"></td> <td style="width: 10%;"></td> <td style="width: 10%;"></td> <td style="width: 10%;"></td> <td style="width: 10%;"></td> <td style="width: 10%;"></td> <td style="width: 10%;"></td> <td style="width: 10%;"></td> </tr> <tr> <td></td> <td></td> <td colspan="8" style="text-align: center;"> <table border="1" style="width: 100%; border-collapse: collapse; text-align: center;"> <tr> <td style="width: 10%;"></td> <td style="width: 10%;"></td> <td style="width: 10%;"></td> <td style="width: 10%;"></td> <td style="width: 10%;"></td> <td style="width: 10%;"></td> <td style="width: 10%;"></td> <td style="width: 10%;"></td> <td style="width: 10%;"></td> <td style="width: 10%;"></td> </tr> <tr> <td></td> <td></td> <td colspan="8" style="text-align: center;"> <table border="1" style="width: 100%; border-collapse: collapse; text-align: center;"> <tr> <td style="width: 10%;"></td> <td style="width: 10%;"></td> <td style="width: 10%;"></td> <td style="width: 10%;"></td> <td style="width: 10%;"></td> <td style="width: 10%;"></td> <td style="width: 10%;"></td> <td style="width: 10%;"></td> <td style="width: 10%;"></td> <td style="width: 10%;"></td> </tr> <tr> <td></td> <td></td> <td colspan="8" style="text-align: center;"> <table border="1" style="width: 100%; border-collapse: collapse; text-align: center;"> <tr> <td style="width: 10%;"></td> <td style="width: 10%;"></td> <td style="width: 10%;"></td> <td style="width: 10%;"></td> <td style="width: 10%;"></td> <td style="width: 10%;"></td> <td style="width: 10%;"></td> <td style="width: 10%;"></td> <td style="width: 10%;"></td> <td style="width: 10%;"></td> </tr> <tr> <td></td> <td></td> <td colspan="8" style="text-align: center;"> <table border="1" style="width: 100%; border-collapse: collapse; text-align: center;"> <tr> <td style="width: 10%;"></td> <td style="width: 10%;"></td> <td style="width: 10%;"></td> <td style="width: 10%;"></td> <td style="width: 10%;"></td> <td style="width: 10%;"></td> <td style="width: 10%;"></td> <td style="width: 10%;"></td> <td style="width: 10%;"></td> <td style="width: 10%;"></td> </tr> <tr> <td></td> <td></td> <td colspan="8" style="text-align: center;"> <table border="1" style="width: 100%; border-collapse: collapse; text-align: center;"> <tr> <td style="width: 10%;"></td> <td style="width: 10%;"></td> <td style="width: 10%;"></td> <td style="width: 10%;"></td> <td style="width: 10%;"></td> <td style="width: 10%;"></td> <td style="width: 10%;"></td> <td style="width: 10%;"></td> <td style="width: 10%;"></td> <td style="width: 10%;"></td> </tr> <tr> <td></td> <td></td> <td colspan="8" style="text-align: center;"> <table border="1" style="width: 100%; border-collapse: collapse; text-align: center;"> <tr> <td style="width: 10%;"></td> <td style="width: 10%;"></td> <td style="width: 10%;"></td> <td style="width: 10%;"></td> <td style="width: 10%;"></td> <td style="width: 10%;"></td> <td style="width: 10%;"></td> <td style="width: 10%;"></td> <td style="width: 10%;"></td> <td style="width: 10%;"></td> </tr> <tr> <td></td> <td></td> <td colspan="8" style="text-align: center;"> <table border="1" style="width: 100%; border-collapse: collapse; text-align: center;"> <tr> <td style="width: 10%;"></td> <td style="width: 10%;"></td> <td style="width: 10%;"></td> <td style="width: 10%;"></td> <td style="width: 10%;"></td> <td style="width: 10%;"></td> <td style="width: 10%;"></td> <td style="width: 10%;"></td> <td style="width: 10%;"></td> <td style="width: 10%;"></td> </tr> <tr> <td></td> <td></td> <td colspan="8" style="text-align: center;"> <table border="1" style="width: 100%; border-collapse: collapse; text-align: center;"> <tr> <td style="width: 10%;"></td> <td style="width: 10%;"></td> <td style="width: 10%;"></td> <td style="width: 10%;"></td> <td style="width: 10%;"></td> <td style="width: 10%;"></td> <td style="width: 10%;"></td> <td style="width: 10%;"></td> <td style="width: 10%;"></td> <td style="width: 10%;"></td> </tr> <tr> <td></td> <td></td> <td colspan="8" style="text-align: center;"> <table border="1" style="width: 100%; border-collapse: collapse; text-align: center;"> <tr> <td style="width: 10%;"></td> <td style="width: 10%;"></td> <td style="width: 10%;"></td> <td style="width: 10%;"></td> <td style="width: 10%;"></td> <td style="width: 10%;"></td> <td style="width: 10%;"></td> <td style="width: 10%;"></td> <td style="width: 10%;"></td> <td style="width: 10%;"></td> </tr> <tr> <td></td> <td></td> <td colspan="8" style="text-align: center;"> <table border="1" style="width: 100%; border-collapse: collapse; text-align: center;"> <tr> <td style="width: 10%;"></td> <td style="width: 10%;"></td> <td style="width: 10%;"></td> <td style="width: 10%;"></td> <td style="width: 10%;"></td> <td style="width: 10%;"></td> <td style="width: 10%;"></td> <td style="width: 10%;"></td> <td style="width: 10%;"></td> <td style="width: 10%;"></td> </tr> <tr> <td></td> <td></td> <td colspan="8" style="text-align: center;"> <table border="1" style="width: 100%; border-collapse: collapse; text-align: center;"> <tr> <td style="width: 10%;"></td> <td style="width: 10%;"></td> <td style="width: 10%;"></td> <td style="width: 10%;"></td> <td style="width: 10%;"></td> <td style="width: 10%;"></td> <td style="width: 10%;"></td> <td style="width: 10%;"></td> <td style="width: 10%;"></td> <td style="width: 10%;"></td> </tr> <tr> <td></td> <td></td> <td colspan="8" style="text-align: center;"> <table border="1" style="width: 100%; border-collapse: collapse; text-align: center;"> <tr> <td style="width: 10%;"></td> <td style="width: 10%;"></td> <td style="width: 10%;"></td> <td style="width: 10%;"></td> <td style="width: 10%;"></td> <td style="width: 10%;"></td> <td style="width: 10%;"></td> <td style="width: 10%;"></td> <td style="width: 10%;"></td> <td style="width: 10%;"></td> </tr> <tr> <td></td> <td></td> <td colspan="8" style="text-align: center;"> <table border="1" style="width: 100%; border-collapse: collapse; text-align: center;"> <tr> <td style="width: 10%;"></td> <td style="width: 10%;"></td> <td style="width: 10%;"></td> <td style="width: 10%;"></td> <td
style="width: 10%;"></td> <td style="width: 10%;"></td> <td style="width: 10%;"></td> <td style="width: 10%;"></td> <td style="width: 10%;"></td> <td style="width: 10%;"></td> </tr> <tr> <td></td> <td></td> <td colspan="8" style="text-align: center;"> <table border="1" style="width: 100%; border-collapse: collapse; text-align: center;"> <tr> <td style="width: 10%;"></td> <td style="width: 10%;"></td> <td style="width: 10%;"></td> <td style="width: 10%;"></td> <td style="width: 10%;"></td> <td style="width: 10%;"></td> <td style="width: 10%;"></td> <td style="width: 10%;"></td> <td style="width: 10%;"></td> <td style="width: 10%;"></td> </tr> <tr> <td></td> <td></td> <td colspan="8" style="text-align: center;"> <table border="1" style="width: 100%; border-collapse: collapse; text-align: center;"> <tr> <td style="width: 10%;"></td> <td style="width: 10%;"></td> <td style="width: 10%;"></td> <td style="width: 10%;"></td> <td style="width: 10%;"></td> <td style="width: 10%;"></td> <td style="width: 10%;"></td> <td style="width: 10%;"></td> <td style="width: 10%;"></td> <td style="width: 10%;"></td> </tr> <tr> <td></td> <td></td> <td colspan="8" style="text-align: center;"> <table border="1" style="width: 100%; border-collapse: collapse; text-align: center;"> <tr> <td style="width: 10%;"></td> <td style="width: 10%;"></td> <td style="width: 10%;"></td> <td style="width: 10%;"></td> <td style="width: 10%;"></td> <td style="width: 10%;"></td> <td style="width: 10%;"></td> <td style="width: 10%;"></td> <td style="width: 10%;"></td> <td style="width: 10%;"></td> </tr> <tr> <td></td> <td></td> <td colspan="8" style="text-align: center;"> <table border="1" style="width: 100%; border-collapse: collapse; text-align: center;"> <tr> <td style="width: 10%;"></td> <td style="width: 10%;"></td> <td style="width: 10%;"></td> <td style="width: 10%;"></td> <td style="width: 10%;"></td> <td style="width: 10%;"></td> <td style="width: 10%;"></td> <td style="width: 10%;"></td> <td style="width: 10%;"></td> <td style="width: 10%;"></td> </tr> <tr> <td></td> <td></td> <td colspan="8" style="text-align: center;"> <table border="1" style="width: 100%; border-collapse: collapse; text-align: center;"> <tr> <td style="width: 10%;"></td> <td style="width: 10%;"></td> <td style="width: 10%;"></td> <td style="width: 10%;"></td> <td style="width: 10%;"></td> <td style="width: 10%;"></td> <td style="width: 10%;"></td> <td style="width: 10%;"></td> <td style="width: 10%;"></td> <td style="width: 10%;"></td> </tr> <tr> <td></td> <td></td> <td colspan="8" style="text-align: center;"> <table border="1" style="width: 100%; border-collapse: collapse; text-align: center;"> <tr> <td style="width: 10%;"></td> <td style="width: 10%;"></td> <td style="width: 10%;"></td> <td style="width: 10%;"></td> <td style="width: 10%;"></td> <td style="width: 10%;"></td> <td style="width: 10%;"></td> <td style="width: 10%;"></td> <td style="width: 10%;"></td> <td style="width: 10%;"></td> </tr> <tr> <td></td> <td></td> <td colspan="8" style="text-align: center;"> <table border="1" style="width: 100%; border-collapse: collapse; text-align: center;"> <tr> <td style="width: 10%;"></td> <td style="width: 10%;"></td> <td style="width: 10%;"></td> <td style="width: 10%;"></td> <td style="width: 10%;"></td> <td style="width: 10%;"></td> <td style="width: 10%;"></td> <td style="width: 10%;"></td> <td style="width: 10%;"></td> <td style="width: 10%;"></td> </tr> <tr> <td></td> <td></td> <td colspan="8" style="text-align: center;"> <table border="1" style="width: 100%; border-collapse: collapse; text-align: center;"> <tr> <td style="width: 10%;"></td> <td style="width: 10%;"></td> <td style="width: 10%;"></td> <td style="width: 10%;"></td> <td style="width: 10%;"></td> <td style="width: 10%;"></td> <td style="width: 10%;"></td> <td style="width: 10%;"></td> <td style="width: 10%;"></td> <td style="width: 10%;"></td> </tr> <tr> <td></td> <td></td> <td colspan="8" style="text-align: center;"> <table border="1" style="width: 100%; border-collapse: collapse; text-align: center;"> <tr> <td style="width: 10%;"></td> <td style="width: 10%;"></td> <td style="width: 10%;"></td> <td style="width: 10%;"></td> <td style="width: 10%;"></td> <td style="width: 10%;"></td> <td style="width: 10%;"></td> <td style="width: 10%;"></td> <td style="width: 10%;"></td> <td style="width: 10%;"></td> </tr> <tr> <td></td> <td></td> <td colspan="8" style="text-align: center;"> <table border="1" style="width: 100%; border-collapse: collapse; text-align: center;"> <tr> <td style="width: 10%;"></td> <td style="width: 10%;"></td> <td style="width: 10%;"></td> <td style="width: 10%;"></td> <td style="width: 10%;"></td> <td style="width: 10%;"></td> <td style="width: 10%;"></td> <td style="width: 10%;"></td> <td style="width: 10%;"></td> <td style="width: 10%;"></td> </tr> <tr> <td></td> <td></td> <td colspan="8" style="text-align: center;"> <table border="1" style="width: 100%; border-collapse: collapse; text-align: center;"> <tr> <td style="width: 10%;"></td> <td style="width: 10%;"></td> <td style="width: 10%;"></td> <td style="width: 10%;"></td> <td style="width: 10%;"></td> <td style="width: 10%;"></td> <td style="width: 10%;"></td> <td style="width: 10%;"></td> <td style="width: 10%;"></td> <td style="width: 10%;"></td> </tr> <tr> <td></td> <td></td> <td colspan="8" style="text-align: center;"> <table border="1" style="width: 100%; border-collapse: collapse; text-align: center;"> <tr> <td style="width: 10%;"></td> <td style="width: 10%;"></td> <td style="width: 10%;"></td> <td style="width: 10%;"></td> <td style="width: 10%;"></td> <td style="width: 10%;"></td> <td style="width: 10%;"></td> <td style="width: 10%;"></td> <td style="width: 10%;"></td> <td style="width: 10%;"></td> </tr> <tr> <td></td> <td></td> <td colspan="8" style="text-align: center;"> <table border="1" style="width: 100%; border-collapse: collapse; text-align: center;"> <tr> <td style="width: 10%;"></td> <td style="width: 10%;"></td> <td style="width: 10%;"></td> <td style="width: 10%;"></td> <td style="width: 10%;"></td> <td style="width: 10%;"></td> <td style="width: 10%;"></td> <td style="width: 10%;"></td> <td style="width: 10%;"></td> <td style="width: 10%;"></td> </tr> <tr> <td></td> <td></td> <td colspan="8" style="text-align: center;"> <table border="1" style="width: 100%; border-collapse: collapse; text-align: center;"> <tr> <td style="width: 10%;"></td> <td style="width: 10%;"></td> <td style="width: 10%;"></td> <td style="width: 10%;"></td> <td style="width: 10%;"></td> <td style="width: 10%;"></td> <td style="width: 10%;"></td> <td style="width: 10%;"></td> <td style="width: 10%;"></td> <td style="width: 10%;"></td> </tr> <tr> <td></td> <td></td> <td colspan="8" style="text-align: center;"> <table border="1" style="width: 100%; border-collapse: collapse; text-align: center;"> <tr> <td style="width: 10%;"></td> <td style="width: 10%;"></td> <td style="width: 10%;"></td> <td style="width: 10%;"></td> <td style="width: 10%;"></td> <td style="width: 10%;"></td> <td style="width: 10%;"></td> <td style="width: 10%;"></td> <td style="width: 10%;"></td> <td style="width: 10%;"></td> </tr> <tr> <td></td> <td></td> <td colspan="8" style="text-align: center;"> <table border="1" style="width: 100%; border-collapse: collapse; text-align: center;"> <tr> <td style="width: 10%;"></td> <td style="width: 10%;"></td> <td style="width: 10%;"></td> <td style="width: 10%;"></td> <td style="width: 10%;"></td> <td style="width: 10%;"></td> <td style="width: 10%;"></td> <td style="width: 10%;"></td> <td style="width: 10%;"></td> <td style="width: 10%;"></td> </tr> <tr> <td></td> <td></td> <td colspan="8" style="text-align: center;"> <table border="1" style="width: 100%; border-collapse: collapse; text-align: center;"> <tr> <td style="width: 10%;"></td> <td style="width: 10%;"></td> <td style="width: 10%;"></td> <td style="width: 10%;"></td> <td style="width: 10%;"></td> <td style="width: 10%;"></td> <td style="width: 10%;"></td> <td style="width: 10%;"></td> <td style="width: 10%;"></td> <td style="width: 10%;"></td> </tr> <tr> <td></td> <td></td> <td colspan="8" style="text-align: center;"> <table border="1" style="width: 100%; border-collapse: collapse; text-align: center;"> <tr> <td style="width: 10%;"></td> <td style="width: 10%;"></td> <td style="width: 10%;"></td> <td style="width: 10%;"></td> <td style="width: 10%;"></td> <td style="width: 10%;"></td> <td style="width: 10%;"></td> <td style="width: 10%;"></td> <td style="width: 10%;"></td> <td style="width: 10%;"></td> </tr> <tr> <td></td> <td></td> <td colspan="8" style="text-align: center;"> <table border="1" style="width: 100%; border-collapse: collapse; text-align: center;"> <tr> <td style="width: 10%;"></td> <td style="width: 10%;"></td> <td style="width: 10%;"></td> <td style="width: 10%;"></td> <td style="width: 10%;"></td> <td style="width: 10%;"></td> <td style="width: 10%;"></td> <td style="width: 10%;"></td> <td style="width: 10%;"></td> <td style="width: 10%;"></td> </tr> <tr> <td></td> <td></td> <td colspan="8" style="text-align: center;"> <table border="1" style="width: 100%; border-collapse: collapse; text-align: center;"> <tr> <td style="width: 10%;"></td> <td style="width: 10%;"></td> <td style="width: 10%;"></td> <td style="width: 10%;"></td> <td style="width: 10%;"></td> <td style="width: 10%;"></td> <td style="width: 10%;"></td> <td style="width: 10%;"></td> <td style="width: 10%;"></td> <td style="width: 10%;"></td> </tr> <tr> <td></td> <td></td> <td colspan="8" style="text-align: center;"> <table border="1" style="width: 100%; border-collapse: collapse; text-align: center;"> <tr> <td style="width: 10%;"></td> <td style="width: 10%;"></td> <td style="width: 10%;"></td> <td style="width: 10%;"></td> <td style="width: 10%;"></td> <td style="width: 10%;"></td> <td style="width: 10%;"></td> <td style="width: 10%;"></td> <td style="width: 10%;"></td> <td style="width:
10%;"></td> </tr> <tr> <td></td> <td></td> <td colspan="8" style="text-align: center;"> <table border="1" style="width: 100%; border-collapse: collapse; text-align: center;"> <tr> <td style="width: 10%;"></td> <td style="width: 10%;"></td> <td style="width: 10%;"></td> <td style="width: 10%;"></td> <td style="width: 10%;"></td> <td style="width: 10%;"></td> <td style="width: 10%;"></td> <td style="width: 10%;"></td> <td style="width: 10%;"></td> <td style="width: 10%;"></td> </tr> <tr> <td></td> <td></td> <td colspan="8" style="text-align: center;"> <table border="1" style="width: 100%; border-collapse: collapse; text-align: center;"> <tr> <td style="width: 10%;"></td> <td style="width: 10%;"></td> <td style="width: 10%;"></td> <td style="width: 10%;"></td> <td style="width: 10%;"></td> <td style="width: 10%;"></td> <td style="width: 10%;"></td> <td style="width: 10%;"></td> <td style="width: 10%;"></td> <td style="width: 10%;"></td> </tr> <tr> <td></td> <td></td> <td colspan="8" style="text-align: center;"> <table border="1" style="width: 100%; border-collapse: collapse; text-align: center;"> <tr> <td style="width: 10%;"></td> <td style="width: 10%;"></td> <td style="width: 10%;"></td> <td style="width: 10%;"></td> <td style="width: 10%;"></td> <td style="width: 10%;"></td> <td style="width: 10%;"></td> <td style="width: 10%;"></td> <td style="width: 10%;"></td> <td style="width: 10%;"></td> </tr> <tr> <td></td> <td></td> <td colspan="8" style="text-align: center;"> <table border="1" style="width: 100%; border-collapse: collapse; text-align: center;"> <tr> <td style="width: 10%;"></td> <td style="width: 10%;"></td> <td style="width: 10%;"></td> <td style="width: 10%;"></td> <td style="width: 10%;"></td> <td style="width: 10%;"></td> <td style="width: 10%;"></td> <td style="width: 10%;"></td> <td style="width: 10%;"></td> <td style="width: 10%;"></td> </tr> <tr> <td></td> <td></td> <td colspan="8" style="text-align: center;"> <table border="1" style="width: 100%; border-collapse: collapse; text-align: center;"> <tr> <td style="width: 10%;"></td> <td style="width: 10%;"></td> <td style="width: 10%;"></td> <td style="width: 10%;"></td> <td style="width: 10%;"></td> <td style="width: 10%;"></td> <td style="width: 10%;"></td> <td style="width: 10%;"></td> <td style="width: 10%;"></td> <td style="width: 10%;"></td> </tr> <tr> <td></td> <td></td> <td colspan="8" style="text-align: center;"> <table border="1" style="width: 100%; border-collapse: collapse; text-align: center;"> <tr> <td style="width: 10%;"></td> <td style="width: 10%;"></td> <td style="width: 10%;"></td> <td style="width: 10%;"></td> <td style="width: 10%;"></td> <td style="width: 10%;"></td> <td style="width: 10%;"></td> <td style="width: 10%;"></td> <td style="width: 10%;"></td> <td style="width: 10%;"></td> </tr> <tr> <td></td> <td></td> <td colspan="8" style="text-align: center;"> <table border="1" style="width: 100%; border-collapse: collapse; text-align: center;"> <tr> <td style="width: 10%;"></td> <td style="width: 10%;"></td> <td style="width: 10%;"></td> <td style="width: 10%;"></td> <td style="width: 10%;"></td> <td style="width: 10%;"></td> <td style="width: 10%;"></td> <td style="width: 10%;"></td> <td style="width: 10%;"></td> <td style="width: 10%;"></td> </tr> <tr> <td></td> <td></td> <td colspan="8" style="text-align: center;"> <table border="1" style="width: 100%; border-collapse: collapse; text-align: center;"> <tr> </tr></table></td></tr></table></td></tr></table></td></tr></table></td></tr></table></td></tr></table></td></tr></table></td></tr></table></td></tr></table></td></tr></table></td></tr></table></td></tr></table></td></tr></table></td></tr></table></td></tr></table></td></tr></table></td></tr></table></td></tr></table></td></tr></table></td></tr></table></td></tr></table></td></tr></table></td></tr></table></td></tr></table></td></tr></table></td></tr></table></td></tr></table></td></tr></table></td></tr></table></td></tr></table></td></tr></table></td></tr></table></td></tr></table></td></tr></table></td></tr></table></td></tr></table></td></tr></table></td></tr></table></td></tr></table></td></tr></table></td></tr></table></td></tr></table></td></tr></table></td></tr></table></td></tr></table></td></tr></table></td></tr></table></td></tr></table></td></tr></table></td></tr></table> | | | | | | | | | | | | | | | | | | | | <table border="1" style="width: 100%; border-collapse: collapse; text-align: center;"> <tr> <td style="width: 10%;"></td> <td style="width: 10%;"></td> <td style="width: 10%;"></td> <td style="width: 10%;"></td> <td style="width: 10%;"></td> <td style="width: 10%;"></td> <td style="width: 10%;"></td> <td style="width: 10%;"></td> <td style="width: 10%;"></td> <td style="width: 10%;"></td> </tr> <tr> <td></td> <td></td> <td colspan="8" style="text-align: center;"> <table border="1" style="width: 100%; border-collapse: collapse; text-align: center;"> <tr> <td style="width: 10%;"></td> <td style="width: 10%;"></td> <td style="width: 10%;"></td> <td style="width: 10%;"></td> <td style="width: 10%;"></td> <td style="width: 10%;"></td> <td style="width: 10%;"></td> <td style="width: 10%;"></td> <td style="width: 10%;"></td> <td style="width: 10%;"></td> </tr> <tr> <td></td> <td></td> <td colspan="8" style="text-align: center;"> <table border="1" style="width: 100%; border-collapse: collapse; text-align: center;"> <tr> <td style="width: 10%;"></td> <td style="width: 10%;"></td> <td style="width: 10%;"></td> <td style="width: 10%;"></td> <td style="width: 10%;"></td> <td style="width: 10%;"></td> <td
style="width: 10%;"></td> <td style="width: 10%;"></td> <td style="width: 10%;"></td> <td style="width: 10%;"></td> </tr> <tr> <td></td> <td></td> <td colspan="8" style="text-align: center;"> <table border="1" style="width: 100%; border-collapse: collapse; text-align: center;"> <tr> <td style="width: 10%;"></td> <td style="width: 10%;"></td> <td style="width: 10%;"></td> <td style="width: 10%;"></td> <td style="width: 10%;"></td> <td style="width: 10%;"></td> <td style="width: 10%;"></td> <td style="width: 10%;"></td> <td style="width: 10%;"></td> <td style="width: 10%;"></td> </tr> <tr> <td></td> <td></td> <td colspan="8" style="text-align: center;"> <table border="1" style="width: 100%; border-collapse: collapse; text-align: center;"> <tr> <td style="width: 10%;"></td> <td style="width: 10%;"></td> <td style="width: 10%;"></td> <td style="width: 10%;"></td> <td style="width: 10%;"></td> <td style="width: 10%;"></td> <td style="width: 10%;"></td> <td style="width: 10%;"></td> <td style="width: 10%;"></td> <td style="width: 10%;"></td> </tr> <tr> <td></td> <td></td> <td colspan="8" style="text-align: center;"> <table border="1" style="width: 100%; border-collapse: collapse; text-align: center;"> <tr> <td style="width: 10%;"></td> <td style="width: 10%;"></td> <td style="width: 10%;"></td> <td style="width: 10%;"></td> <td style="width: 10%;"></td> <td style="width: 10%;"></td> <td style="width: 10%;"></td> <td style="width: 10%;"></td> <td style="width: 10%;"></td> <td style="width: 10%;"></td> </tr> <tr> <td></td> <td></td> <td colspan="8" style="text-align: center;"> <table border="1" style="width: 100%; border-collapse: collapse; text-align: center;"> <tr> <td style="width: 10%;"></td> <td style="width: 10%;"></td> <td style="width: 10%;"></td> <td style="width: 10%;"></td> <td style="width: 10%;"></td> <td style="width: 10%;"></td> <td style="width: 10%;"></td> <td style="width: 10%;"></td> <td style="width: 10%;"></td> <td style="width: 10%;"></td> </tr> <tr> <td></td> <td></td> <td colspan="8" style="text-align: center;"> <table border="1" style="width: 100%; border-collapse: collapse; text-align: center;"> <tr> <td style="width: 10%;"></td> <td style="width: 10%;"></td> <td style="width: 10%;"></td> <td style="width: 10%;"></td> <td style="width: 10%;"></td> <td style="width: 10%;"></td> <td style="width: 10%;"></td> <td style="width: 10%;"></td> <td style="width: 10%;"></td> <td style="width: 10%;"></td> </tr> <tr> <td></td> <td></td> <td colspan="8" style="text-align: center;"> <table border="1" style="width: 100%; border-collapse: collapse; text-align: center;"> <tr> <td style="width: 10%;"></td> <td style="width: 10%;"></td> <td style="width: 10%;"></td> <td style="width: 10%;"></td> <td style="width: 10%;"></td> <td style="width: 10%;"></td> <td style="width: 10%;"></td> <td style="width: 10%;"></td> <td style="width: 10%;"></td> <td style="width: 10%;"></td> </tr> <tr> <td></td> <td></td> <td colspan="8" style="text-align: center;"> <table border="1" style="width: 100%; border-collapse: collapse; text-align: center;"> <tr> <td style="width: 10%;"></td> <td style="width: 10%;"></td> <td style="width: 10%;"></td> <td style="width: 10%;"></td> <td style="width: 10%;"></td> <td style="width: 10%;"></td> <td style="width: 10%;"></td> <td style="width: 10%;"></td> <td style="width: 10%;"></td> <td style="width: 10%;"></td> </tr> <tr> <td></td> <td></td> <td colspan="8" style="text-align: center;"> <table border="1" style="width: 100%; border-collapse: collapse; text-align: center;"> <tr> <td style="width: 10%;"></td> <td style="width: 10%;"></td> <td style="width: 10%;"></td> <td style="width: 10%;"></td> <td style="width: 10%;"></td> <td style="width: 10%;"></td> <td style="width: 10%;"></td> <td style="width: 10%;"></td> <td style="width: 10%;"></td> <td style="width: 10%;"></td> </tr> <tr> <td></td> <td></td> <td colspan="8" style="text-align: center;"> <table border="1" style="width: 100%; border-collapse: collapse; text-align: center;"> <tr> <td style="width: 10%;"></td> <td style="width: 10%;"></td> <td style="width: 10%;"></td> <td style="width: 10%;"></td> <td style="width: 10%;"></td> <td style="width: 10%;"></td> <td style="width: 10%;"></td> <td style="width: 10%;"></td> <td style="width: 10%;"></td> <td style="width: 10%;"></td> </tr> <tr> <td></td> <td></td> <td colspan="8" style="text-align: center;"> <table border="1" style="width: 100%; border-collapse: collapse; text-align: center;"> <tr> <td style="width: 10%;"></td> <td style="width: 10%;"></td> <td style="width: 10%;"></td> <td style="width: 10%;"></td> <td style="width: 10%;"></td> <td style="width: 10%;"></td> <td style="width: 10%;"></td> <td style="width: 10%;"></td> <td style="width: 10%;"></td> <td style="width: 10%;"></td> </tr> <tr> <td></td> <td></td> <td colspan="8" style="text-align: center;"> <table border="1" style="width: 100%; border-collapse: collapse; text-align: center;"> <tr> <td style="width: 10%;"></td> <td style="width: 10%;"></td> <td style="width: 10%;"></td> <td style="width: 10%;"></td> <td style="width: 10%;"></td> <td style="width: 10%;"></td> <td style="width: 10%;"></td> <td style="width: 10%;"></td> <td style="width: 10%;"></td> <td style="width: 10%;"></td> </tr> <tr> <td></td> <td></td> <td colspan="8" style="text-align: center;"> <table border="1" style="width: 100%; border-collapse: collapse; text-align: center;"> <tr> <td style="width: 10%;"></td> <td style="width: 10%;"></td> <td style="width: 10%;"></td> <td style="width: 10%;"></td> <td style="width: 10%;"></td> <td style="width: 10%;"></td> <td style="width: 10%;"></td> <td style="width: 10%;"></td> <td style="width: 10%;"></td> <td style="width: 10%;"></td> </tr> <tr> <td></td> <td></td> <td colspan="8" style="text-align: center;"> <table border="1" style="width: 100%; border-collapse: collapse; text-align: center;"> <tr> <td style="width: 10%;"></td> <td style="width: 10%;"></td> <td style="width: 10%;"></td> <td style="width: 10%;"></td> <td style="width: 10%;"></td> <td style="width: 10%;"></td> <td style="width: 10%;"></td> <td style="width: 10%;"></td> <td style="width: 10%;"></td> <td style="width: 10%;"></td> </tr> <tr> <td></td> <td></td> <td colspan="8" style="text-align: center;"> <table border="1" style="width: 100%; border-collapse: collapse; text-align: center;"> <tr> <td style="width: 10%;"></td> <td style="width: 10%;"></td> <td style="width: 10%;"></td> <td style="width: 10%;"></td> <td style="width: 10%;"></td> <td style="width: 10%;"></td> <td style="width: 10%;"></td> <td style="width: 10%;"></td> <td style="width: 10%;"></td> <td style="width: 10%;"></td> </tr> <tr> <td></td> <td></td> <td colspan="8" style="text-align: center;"> <table border="1" style="width: 100%; border-collapse: collapse; text-align: center;"> <tr> <td style="width: 10%;"></td> <td style="width: 10%;"></td> <td style="width: 10%;"></td> <td style="width: 10%;"></td> <td style="width: 10%;"></td> <td style="width: 10%;"></td> <td style="width: 10%;"></td> <td style="width: 10%;"></td> <td style="width: 10%;"></td> <td style="width: 10%;"></td> </tr> <tr> <td></td> <td></td> <td colspan="8" style="text-align: center;"> <table border="1" style="width: 100%; border-collapse: collapse; text-align: center;"> <tr> <td style="width: 10%;"></td> <td style="width: 10%;"></td> <td style="width: 10%;"></td> <td style="width: 10%;"></td> <td style="width: 10%;"></td> <td style="width: 10%;"></td> <td style="width: 10%;"></td> <td style="width: 10%;"></td> <td style="width: 10%;"></td> <td style="width: 10%;"></td> </tr> <tr> <td></td> <td></td> <td colspan="8" style="text-align: center;"> <table border="1" style="width: 100%; border-collapse: collapse; text-align: center;"> <tr> <td style="width: 10%;"></td> <td style="width: 10%;"></td> <td style="width: 10%;"></td> <td style="width: 10%;"></td> <td style="width: 10%;"></td> <td style="width: 10%;"></td> <td style="width: 10%;"></td> <td style="width: 10%;"></td> <td style="width: 10%;"></td> <td style="width: 10%;"></td> </tr> <tr> <td></td> <td></td> <td colspan="8" style="text-align: center;"> <table border="1" style="width: 100%; border-collapse: collapse; text-align: center;"> <tr> <td style="width: 10%;"></td> <td style="width: 10%;"></td> <td style="width: 10%;"></td> <td style="width: 10%;"></td> <td style="width: 10%;"></td> <td style="width: 10%;"></td> <td style="width: 10%;"></td> <td style="width: 10%;"></td> <td style="width: 10%;"></td> <td style="width: 10%;"></td> </tr> <tr> <td></td> <td></td> <td colspan="8" style="text-align: center;"> <table border="1" style="width: 100%; border-collapse: collapse; text-align: center;"> <tr> <td style="width: 10%;"></td> <td style="width: 10%;"></td> <td style="width: 10%;"></td> <td style="width: 10%;"></td> <td style="width: 10%;"></td> <td style="width: 10%;"></td> <td style="width: 10%;"></td> <td style="width: 10%;"></td> <td style="width: 10%;"></td> <td style="width: 10%;"></td> </tr> <tr> <td></td> <td></td> <td colspan="8" style="text-align: center;"> <table border="1" style="width: 100%; border-collapse: collapse; text-align: center;"> <tr> <td style="width: 10%;"></td> <td style="width: 10%;"></td> <td style="width: 10%;"></td> <td style="width: 10%;"></td> <td style="width: 10%;"></td> <td style="width: 10%;"></td> <td style="width: 10%;"></td> <td style="width: 10%;"></td> <td style="width: 10%;"></td> <td style="width: 10%;"></td> </tr> <tr> <td></td> <td></td> <td colspan="8" style="text-align: center;"> <table border="1" style="width: 100%; border-collapse: collapse; text-align: center;"> <tr> <td style="width: 10%;"></td> <td style="width: 10%;"></td> <td style="width: 10%;"></td> <td style="width: 10%;"></td> <td style="width: 10%;"></td> <td style="width: 10%;"></td> <td style="width: 10%;"></td> <td style="width: 10%;"></td> <td style="width: 10%;"></td> <td style="width: 10%;"></td> </tr> <tr> <td></td> <td></td> <td colspan="8"
style="text-align: center;"> <table border="1" style="width: 100%; border-collapse: collapse; text-align: center;"> <tr> <td style="width: 10%;"></td> <td style="width: 10%;"></td> <td style="width: 10%;"></td> <td style="width: 10%;"></td> <td style="width: 10%;"></td> <td style="width: 10%;"></td> <td style="width: 10%;"></td> <td style="width: 10%;"></td> <td style="width: 10%;"></td> <td style="width: 10%;"></td> </tr> <tr> <td></td> <td></td> <td colspan="8" style="text-align: center;"> <table border="1" style="width: 100%; border-collapse: collapse; text-align: center;"> <tr> <td style="width: 10%;"></td> <td style="width: 10%;"></td> <td style="width: 10%;"></td> <td style="width: 10%;"></td> <td style="width: 10%;"></td> <td style="width: 10%;"></td> <td style="width: 10%;"></td> <td style="width: 10%;"></td> <td style="width: 10%;"></td> <td style="width: 10%;"></td> </tr> <tr> <td></td> <td></td> <td colspan="8" style="text-align: center;"> <table border="1" style="width: 100%; border-collapse: collapse; text-align: center;"> <tr> <td style="width: 10%;"></td> <td style="width: 10%;"></td> <td style="width: 10%;"></td> <td style="width: 10%;"></td> <td style="width: 10%;"></td> <td style="width: 10%;"></td> <td style="width: 10%;"></td> <td style="width: 10%;"></td> <td style="width: 10%;"></td> <td style="width: 10%;"></td> </tr> <tr> <td></td> <td></td> <td colspan="8" style="text-align: center;"> <table border="1" style="width: 100%; border-collapse: collapse; text-align: center;"> <tr> <td style="width: 10%;"></td> <td style="width: 10%;"></td> <td style="width: 10%;"></td> <td style="width: 10%;"></td> <td style="width: 10%;"></td> <td style="width: 10%;"></td> <td style="width: 10%;"></td> <td style="width: 10%;"></td> <td style="width: 10%;"></td> <td style="width: 10%;"></td> </tr> <tr> <td></td> <td></td> <td colspan="8" style="text-align: center;"> <table border="1" style="width: 100%; border-collapse: collapse; text-align: center;"> <tr> <td style="width: 10%;"></td> <td style="width: 10%;"></td> <td style="width: 10%;"></td> <td style="width: 10%;"></td> <td style="width: 10%;"></td> <td style="width: 10%;"></td> <td style="width: 10%;"></td> <td style="width: 10%;"></td> <td style="width: 10%;"></td> <td style="width: 10%;"></td> </tr> <tr> <td></td> <td></td> <td colspan="8" style="text-align: center;"> <table border="1" style="width: 100%; border-collapse: collapse; text-align: center;"> <tr> <td style="width: 10%;"></td> <td style="width: 10%;"></td> <td style="width: 10%;"></td> <td style="width: 10%;"></td> <td style="width: 10%;"></td> <td style="width: 10%;"></td> <td style="width: 10%;"></td> <td style="width: 10%;"></td> <td style="width: 10%;"></td> <td style="width: 10%;"></td> </tr> <tr> <td></td> <td></td> <td colspan="8" style="text-align: center;"> <table border="1" style="width: 100%; border-collapse: collapse; text-align: center;"> <tr> <td style="width: 10%;"></td> <td style="width: 10%;"></td> <td style="width: 10%;"></td> <td style="width: 10%;"></td> <td style="width: 10%;"></td> <td style="width: 10%;"></td> <td style="width: 10%;"></td> <td style="width: 10%;"></td> <td style="width: 10%;"></td> <td style="width: 10%;"></td> </tr> <tr> <td></td> <td></td> <td colspan="8" style="text-align: center;"> <table border="1" style="width: 100%; border-collapse: collapse; text-align: center;"> <tr> <td style="width: 10%;"></td> <td style="width: 10%;"></td> <td style="width: 10%;"></td> <td style="width: 10%;"></td> <td style="width: 10%;"></td> <td style="width: 10%;"></td> <td style="width: 10%;"></td> <td style="width: 10%;"></td> <td style="width: 10%;"></td> <td style="width: 10%;"></td> </tr> <tr> <td></td> <td></td> <td colspan="8" style="text-align: center;"> <table border="1" style="width: 100%; border-collapse: collapse; text-align: center;"> <tr> <td style="width: 10%;"></td> <td style="width: 10%;"></td> <td style="width: 10%;"></td> <td style="width: 10%;"></td> <td style="width: 10%;"></td> <td style="width: 10%;"></td> <td style="width: 10%;"></td> <td style="width: 10%;"></td> <td style="width: 10%;"></td> <td style="width: 10%;"></td> </tr> <tr> <td></td> <td></td> <td colspan="8" style="text-align: center;"> <table border="1" style="width: 100%; border-collapse: collapse; text-align: center;"> <tr> <td style="width: 10%;"></td> <td style="width: 10%;"></td> <td style="width: 10%;"></td> <td style="width: 10%;"></td> <td style="width: 10%;"></td> <td style="width: 10%;"></td> <td style="width: 10%;"></td> <td style="width: 10%;"></td> <td style="width: 10%;"></td> <td style="width: 10%;"></td> </tr> <tr> <td></td> <td></td> <td colspan="8" style="text-align: center;"> <table border="1" style="width: 100%; border-collapse: collapse; text-align: center;"> <tr> <td style="width: 10%;"></td> <td style="width: 10%;"></td> <td style="width: 10%;"></td> <td style="width: 10%;"></td> <td style="width: 10%;"></td> <td style="width: 10%;"></td> <td style="width: 10%;"></td> <td style="width: 10%;"></td> <td style="width: 10%;"></td> <td style="width: 10%;"></td> </tr> <tr> <td></td> <td></td> <td colspan="8" style="text-align: center;"> <table border="1" style="width: 100%; border-collapse: collapse; text-align: center;"> <tr> <td style="width: 10%;"></td> <td style="width: 10%;"></td> <td style="width: 10%;"></td> <td style="width: 10%;"></td> <td style="width: 10%;"></td> <td style="width: 10%;"></td> <td style="width: 10%;"></td> <td style="width: 10%;"></td> <td style="width: 10%;"></td> <td style="width: 10%;"></td> </tr> <tr> <td></td> <td></td> <td colspan="8" style="text-align: center;"> <table border="1" style="width: 100%; border-collapse: collapse; text-align: center;"> <tr> <td style="width: 10%;"></td> <td style="width: 10%;"></td> <td style="width: 10%;"></td> <td style="width: 10%;"></td> <td style="width: 10%;"></td> <td style="width: 10%;"></td> <td style="width: 10%;"></td> <td style="width: 10%;"></td> <td style="width: 10%;"></td> <td style="width: 10%;"></td> </tr> <tr> <td></td> <td></td> <td colspan="8" style="text-align: center;"> <table border="1" style="width: 100%; border-collapse: collapse; text-align: center;"> <tr> <td style="width: 10%;"></td> <td style="width: 10%;"></td> <td style="width: 10%;"></td> <td style="width: 10%;"></td> <td style="width: 10%;"></td> <td style="width: 10%;"></td> <td style="width: 10%;"></td> <td style="width: 10%;"></td> <td style="width: 10%;"></td> <td style="width: 10%;"></td> </tr> <tr> <td></td> <td></td> <td colspan="8" style="text-align: center;"> <table border="1" style="width: 100%; border-collapse: collapse; text-align: center;"> <tr> <td style="width: 10%;"></td> <td style="width: 10%;"></td> <td style="width: 10%;"></td> <td style="width: 10%;"></td> <td style="width: 10%;"></td> <td style="width: 10%;"></td> <td style="width: 10%;"></td> <td style="width: 10%;"></td> <td style="width: 10%;"></td> <td style="width: 10%;"></td> </tr> <tr> <td></td> <td></td> <td colspan="8" style="text-align: center;"> <table border="1" style="width: 100%; border-collapse: collapse; text-align: center;"> <tr> <td style="width: 10%;"></td> <td style="width: 10%;"></td> <td style="width: 10%;"></td> <td style="width: 10%;"></td> <td style="width: 10%;"></td> <td style="width: 10%;"></td> <td style="width: 10%;"></td> <td style="width: 10%;"></td> <td style="width: 10%;"></td> <td style="width: 10%;"></td> </tr> <tr> <td></td> <td></td> <td colspan="8" style="text-align: center;"> <table border="1" style="width: 100%; border-collapse: collapse; text-align: center;"> <tr> <td style="width: 10%;"></td> <td style="width: 10%;"></td> <td style="width: 10%;"></td> <td style="width: 10%;"></td> <td style="width: 10%;"></td> <td style="width: 10%;"></td> <td style="width: 10%;"></td> <td style="width: 10%;"></td> <td style="width: 10%;"></td> <td style="width: 10%;"></td> </tr> <tr> <td></td> <td></td> <td colspan="8" style="text-align: center;"> <table border="1" style="width: 100%; border-collapse: collapse; text-align: center;"> <tr> <td style="width: 10%;"></td> <td style="width: 10%;"></td> <td style="width: 10%;"></td> <td style="width: 10%;"></td> <td style="width: 10%;"></td> <td style="width: 10%;"></td> <td style="width: 10%;"></td> <td style="width: 10%;"></td> <td style="width: 10%;"></td> <td style="width: 10%;"></td> </tr> <tr> <td></td> <td></td> <td colspan="8" style="text-align: center;"> <table border="1" style="width: 100%; border-collapse: collapse; text-align: center;"> <tr> <td style="width: 10%;"></td> <td style="width: 10%;"></td> <td style="width: 10%;"></td> <td style="width: 10%;"></td> <td style="width: 10%;"></td> <td style="width: 10%;"></td> <td style="width: 10%;"></td> <td style="width: 10%;"></td> <td style="width: 10%;"></td> <td style="width: 10%;"></td> </tr> <tr> <td></td> <td></td> <td colspan="8" style="text-align: center;"> <table border="1" style="width: 100%; border-collapse: collapse; text-align: center;"> <tr> <td style="width: 10%;"></td> <td style="width: 10%;"></td> <td style="width: 10%;"></td> <td style="width: 10%;"></td> <td style="width: 10%;"></td> <td style="width: 10%;"></td> <td style="width: 10%;"></td> <td style="width: 10%;"></td> <td style="width: 10%;"></td> <td style="width: 10%;"></td> </tr> <tr> <td></td> <td></td> <td colspan="8" style="text-align: center;"> <table border="1" style="width: 100%; border-collapse: collapse; text-align: center;"> <tr> <td style="width: 10%;"></td> <td style="width: 10%;"></td> <td style="width: 10%;"></td> <td style="width: 10%;"></td> <td style="width: 10%;"></td> <td style="width: 10%;"></td> <td style="width: 10%;"></td> <td style="width: 10%;"></td> <td style="width: 10%;"></td> <td style="width: 10%;"></td> </tr> <tr> <td></td> <td></td> <td colspan="8" style="text-align: center;"> <table border="1" style="width: 100%; border-collapse: collapse; text-align: center;"> <tr> <td style="width: 10%;"></td> <td style="width:
10%;"></td> <td style="width: 10%;"></td> <td style="width: 10%;"></td> <td style="width: 10%;"></td> <td style="width: 10%;"></td> <td style="width: 10%;"></td> <td style="width: 10%;"></td> <td style="width: 10%;"></td> <td style="width: 10%;"></td> </tr> <tr> <td></td> <td></td> <td colspan="8" style="text-align: center;"> <table border="1" style="width: 100%; border-collapse: collapse; text-align: center;"> <tr> <td style="width: 10%;"></td> <td style="width: 10%;"></td> <td style="width: 10%;"></td> <td style="width: 10%;"></td> <td style="width: 10%;"></td> <td style="width: 10%;"></td> <td style="width: 10%;"></td> <td style="width: 10%;"></td> <td style="width: 10%;"></td> <td style="width: 10%;"></td> </tr> <tr> <td></td> <td></td> <td colspan="8" style="text-align: center;"> <table border="1" style="width: 100%; border-collapse: collapse; text-align: center;"> <tr> <td style="width: 10%;"></td> <td style="width: 10%;"></td> <td style="width: 10%;"></td> <td style="width: 10%;"></td> <td style="width: 10%;"></td> <td style="width: 10%;"></td> <td style="width: 10%;"></td> <td style="width: 10%;"></td> <td style="width: 10%;"></td> <td style="width: 10%;"></td> </tr> <tr> <td></td> <td></td> <td colspan="8" style="text-align: center;"> <table border="1" style="width: 100%; border-collapse: collapse; text-align: center;"> <tr> </tr></table></td></tr></table></td></tr></table></td></tr></table></td></tr></table></td></tr></table></td></tr></table></td></tr></table></td></tr></table></td></tr></table></td></tr></table></td></tr></table></td></tr></table></td></tr></table></td></tr></table></td></tr></table></td></tr></table></td></tr></table></td></tr></table></td></tr></table></td></tr></table></td></tr></table></td></tr></table></td></tr></table></td></tr></table></td></tr></table></td></tr></table></td></tr></table></td></tr></table></td></tr></table></td></tr></table></td></tr></table></td></tr></table></td></tr></table></td></tr></table></td></tr></table></td></tr></table></td></tr></table></td></tr></table></td></tr></table></td></tr></table></td></tr></table></td></tr></table></td></tr></table></td></tr></table></td></tr></table></td></tr></table></td></tr></table></td></tr></table> | | | | | | | | | | | | | | | | | | | | <table border="1" style="width: 100%; border-collapse: collapse; text-align: center;"> <tr> <td style="width: 10%;"></td> <td style="width: 10%;"></td> <td style="width: 10%;"></td> <td style="width: 10%;"></td> <td style="width: 10%;"></td> <td style="width: 10%;"></td> <td style="width: 10%;"></td> <td style="width: 10%;"></td> <td style="width: 10%;"></td> <td style="width: 10%;"></td> </tr> <tr> <td></td> <td></td> <td colspan="8" style="text-align: center;"> <table border="1" style="width: 100%; border-collapse: collapse; text-align: center;"> <tr> <td style="width: 10%;"></td> <td style="width: 10%;"></td> <td style="width: 10%;"></td> <td style="width: 10%;"></td> <td style="width: 10%;"></td> <td style="width: 10%;"></td> <td style="width: 10%;"></td> <td style="width: 10%;"></td> <td style="width: 10%;"></td> <td style="width: 10%;"></td> </tr> <tr> <td></td> <td></td> <td colspan="8" style="text-align: center;"> <table border="1" style="width: 100%; border-collapse: collapse; text-align: center;"> <tr> <td style="width: 10%;"></td> <td style="width: 10%;"></td> <td style="width: 10%;"></td> <td style="width: 10%;"></td> <td style="width: 10%;"></td> <td style="width: 10%;"></td> <td style="width: 10%;"></td> <td style="width: 10%;"></td> <td style="width: 10%;"></td> <td style="width: 10%;"></td> </tr> <tr> <td></td> <td></td> <td colspan="8" style="text-align: center;"> <table border="1" style="width: 100%; border-collapse: collapse; text-align: center;"> <tr> <td style="width: 10%;"></td> <td style="width: 10%;"></td> <td style="width: 10%;"></td> <td style="width: 10%;"></td> <td style="width: 10%;"></td> <td style="width: 10%;"></td> <td style="width: 10%;"></td> <td style="width: 10%;"></td> <td style="width: 10%;"></td> <td style="width: 10%;"></td> </tr> <tr> <td></td> <td></td> <td colspan="8" style="text-align: center;"> <table border="1" style="width: 100%; border-collapse: collapse; text-align: center;"> <tr> <td style="width: 10%;"></td> <td style="width: 10%;"></td> <td style="width: 10%;"></td> <td style="width: 10%;"></td> <td style="width: 10%;"></td> <td style="width: 10%;"></td> <td style="width: 10%;"></td> <td style="width: 10%;"></td> <td style="width: 10%;"></td> <td style="width: 10%;"></td> </tr> <tr> <td></td> <td></td> <td colspan="8" style="text-align: center;"> <table border="1" style="width: 100%; border-collapse: collapse; text-align: center;"> <tr> <td style="width: 10%;"></td> <td style="width: 10%;"></td> <td style="width: 10%;"></td> <td style="width: 10%;"></td> <td style="width: 10%;"></td> <td style="width: 10%;"></td> <td style="width: 10%;"></td> <td style="width: 10%;"></td> <td style="width: 10%;"></td> <td style="width: 10%;"></td> </tr> <tr> <td></td> <td></td> <td colspan="8" style="text-align: center;"> <table border="1" style="width: 100%; border-collapse: collapse; text-align: center;"> <tr> <td style="width: 10%;"></td> <td style="width: 10%;"></td> <td style="width: 10%;"></td> <td style="width: 10%;"></td> <td style="width: 10%;"></td> <td style="width: 10%;"></td> <td style="width: 10%;"></td> <td style="width: 10%;"></td> <td style="width: 10%;"></td> <td style="width: 10%;"></td> </tr> <tr> <td></td> <td></td> <td colspan="8" style="text-align: center;"> <table border="1" style="width: 100%; border-collapse:
collapse; text-align: center;"> <tr> <td style="width: 10%;"></td> <td style="width: 10%;"></td> <td style="width: 10%;"></td> <td style="width: 10%;"></td> <td style="width: 10%;"></td> <td style="width: 10%;"></td> <td style="width: 10%;"></td> <td style="width: 10%;"></td> <td style="width: 10%;"></td> <td style="width: 10%;"></td> </tr> <tr> <td></td> <td></td> <td colspan="8" style="text-align: center;"> <table border="1" style="width: 100%; border-collapse: collapse; text-align: center;"> <tr> <td style="width: 10%;"></td> <td style="width: 10%;"></td> <td style="width: 10%;"></td> <td style="width: 10%;"></td> <td style="width: 10%;"></td> <td style="width: 10%;"></td> <td style="width: 10%;"></td> <td style="width: 10%;"></td> <td style="width: 10%;"></td> <td style="width: 10%;"></td> </tr> <tr> <td></td> <td></td> <td colspan="8" style="text-align: center;"> <table border="1" style="width: 100%; border-collapse: collapse; text-align: center;"> <tr> <td style="width: 10%;"></td> <td style="width: 10%;"></td> <td style="width: 10%;"></td> <td style="width: 10%;"></td> <td style="width: 10%;"></td> <td style="width: 10%;"></td> <td style="width: 10%;"></td> <td style="width: 10%;"></td> <td style="width: 10%;"></td> <td style="width: 10%;"></td> </tr> <tr> <td></td> <td></td> <td colspan="8" style="text-align: center;"> <table border="1" style="width: 100%; border-collapse: collapse; text-align: center;"> <tr> <td style="width: 10%;"></td> <td style="width: 10%;"></td> <td style="width: 10%;"></td> <td style="width: 10%;"></td> <td style="width: 10%;"></td> <td style="width: 10%;"></td> <td style="width: 10%;"></td> <td style="width: 10%;"></td> <td style="width: 10%;"></td> <td style="width: 10%;"></td> </tr> <tr> <td></td> <td></td> <td colspan="8" style="text-align: center;"> <table border="1" style="width: 100%; border-collapse: collapse; text-align: center;"> <tr> <td style="width: 10%;"></td> <td style="width: 10%;"></td> <td style="width: 10%;"></td> <td style="width: 10%;"></td> <td style="width: 10%;"></td> <td style="width: 10%;"></td> <td style="width: 10%;"></td> <td style="width: 10%;"></td> <td style="width: 10%;"></td> <td style="width: 10%;"></td> </tr> <tr> <td></td> <td></td> <td colspan="8" style="text-align: center;"> <table border="1" style="width: 100%; border-collapse: collapse; text-align: center;"> <tr> <td style="width: 10%;"></td> <td style="width: 10%;"></td> <td style="width: 10%;"></td> <td style="width: 10%;"></td> <td style="width: 10%;"></td> <td style="width: 10%;"></td> <td style="width: 10%;"></td> <td style="width: 10%;"></td> <td style="width: 10%;"></td> <td style="width: 10%;"></td> </tr> <tr> <td></td> <td></td> <td colspan="8" style="text-align: center;"> <table border="1" style="width: 100%; border-collapse: collapse; text-align: center;"> <tr> <td style="width: 10%;"></td> <td style="width: 10%;"></td> <td style="width: 10%;"></td> <td style="width: 10%;"></td> <td style="width: 10%;"></td> <td style="width: 10%;"></td> <td style="width: 10%;"></td> <td style="width: 10%;"></td> <td style="width: 10%;"></td> <td style="width: 10%;"></td> </tr> <tr> <td></td> <td></td> <td colspan="8" style="text-align: center;"> <table border="1" style="width: 100%; border-collapse: collapse; text-align: center;"> <tr> <td style="width: 10%;"></td> <td style="width: 10%;"></td> <td style="width: 10%;"></td> <td style="width: 10%;"></td> <td style="width: 10%;"></td> <td style="width: 10%;"></td> <td style="width: 10%;"></td> <td style="width: 10%;"></td> <td style="width: 10%;"></td> <td style="width: 10%;"></td> </tr> <tr> <td></td> <td></td> <td colspan="8" style="text-align: center;"> <table border="1" style="width: 100%; border-collapse: collapse; text-align: center;"> <tr> <td style="width: 10%;"></td> <td style="width: 10%;"></td> <td style="width: 10%;"></td> <td style="width: 10%;"></td> <td style="width: 10%;"></td> <td style="width: 10%;"></td> <td style="width: 10%;"></td> <td style="width: 10%;"></td> <td style="width: 10%;"></td> <td style="width: 10%;"></td> </tr> <tr> <td></td> <td></td> <td colspan="8" style="text-align: center;"> <table border="1" style="width: 100%; border-collapse: collapse; text-align: center;"> <tr> <td style="width: 10%;"></td> <td style="width: 10%;"></td> <td style="width: 10%;"></td> <td style="width: 10%;"></td> <td style="width: 10%;"></td> <td style="width: 10%;"></td> <td style="width: 10%;"></td> <td style="width: 10%;"></td> <td style="width: 10%;"></td> <td style="width: 10%;"></td> </tr> <tr> <td></td> <td></td> <td colspan="8" style="text-align: center;"> <table border="1" style="width: 100%; border-collapse: collapse; text-align: center;"> <tr> <td style="width: 10%;"></td> <td style="width: 10%;"></td> <td style="width: 10%;"></td> <td style="width: 10%;"></td> <td style="width: 10%;"></td> <td style="width: 10%;"></td> <td style="width: 10%;"></td> <td style="width: 10%;"></td> <td style="width: 10%;"></td> <td style="width: 10%;"></td> </tr> <tr> <td></td> <td></td> <td colspan="8" style="text-align: center;"> <table border="1" style="width: 100%; border-collapse: collapse; text-align: center;"> <tr> <td style="width: 10%;"></td> <td style="width: 10%;"></td> <td style="width: 10%;"></td> <td style="width: 10%;"></td> <td style="width: 10%;"></td> <td style="width: 10%;"></td> <td style="width: 10%;"></td> <td style="width: 10%;"></td> <td style="width: 10%;"></td> <td style="width: 10%;"></td> </tr> <tr> <td></td> <td></td> <td colspan="8" style="text-align: center;"> <table border="1" style="width: 100%; border-collapse: collapse; text-align: center;"> <tr> <td style="width: 10%;"></td> <td style="width: 10%;"></td> <td style="width: 10%;"></td> <td style="width: 10%;"></td> <td style="width: 10%;"></td> <td style="width: 10%;"></td> <td style="width: 10%;"></td> <td style="width: 10%;"></td> <td style="width: 10%;"></td> <td style="width: 10%;"></td> </tr> <tr> <td></td> <td></td> <td colspan="8" style="text-align: center;"> <table border="1" style="width: 100%; border-collapse: collapse; text-align: center;"> <tr> <td style="width: 10%;"></td> <td style="width: 10%;"></td> <td style="width: 10%;"></td> <td style="width: 10%;"></td> <td style="width: 10%;"></td> <td style="width: 10%;"></td> <td style="width: 10%;"></td> <td style="width: 10%;"></td> <td style="width: 10%;"></td> <td style="width: 10%;"></td> </tr> <tr> <td></td> <td></td> <td colspan="8" style="text-align: center;"> <table border="1" style="width: 100%; border-collapse: collapse; text-align: center;"> <tr> <td style="width: 10%;"></td> <td style="width: 10%;"></td> <td style="width: 10%;"></td> <td style="width: 10%;"></td> <td style="width: 10%;"></td> <td style="width: 10%;"></td> <td style="width: 10%;"></td> <td style="width: 10%;"></td> <td style="width: 10%;"></td> <td style="width: 10%;"></td> </tr> <tr> <td></td> <td></td> <td colspan="8" style="text-align: center;"> <table border="1" style="width: 100%; border-collapse: collapse; text-align: center;"> <tr> <td style="width: 10%;"></td> <td style="width: 10%;"></td> <td style="width: 10%;"></td> <td style="width: 10%;"></td> <td style="width: 10%;"></td> <td style="width: 10%;"></td> <td style="width: 10%;"></td> <td style="width: 10%;"></td> <td style="width: 10%;"></td> <td style="width: 10%;"></td> </tr> <tr> <td></td> <td></td> <td colspan="8" style="text-align: center;"> <table border="1" style="width: 100%; border-collapse: collapse; text-align: center;"> <tr> <td style="width: 10%;"></td> <td style="width: 10%;"></td> <td style="width: 10%;"></td> <td style="width: 10%;"></td> <td style="width: 10%;"></td> <td style="width: 10%;"></td> <td style="width: 10%;"></td> <td style="width: 10%;"></td> <td style="width: 10%;"></td> <td style="width: 10%;"></td> </tr> <tr> <td></td> <td></td> <td colspan="8" style="text-align: center;"> <table border="1" style="width: 100%; border-collapse: collapse; text-align: center;"> <tr> <td style="width: 10%;"></td> <td style="width: 10%;"></td> <td style="width: 10%;"></td> <td style="width: 10%;"></td> <td style="width: 10%;"></td> <td style="width: 10%;"></td> <td style="width: 10%;"></td> <td style="width: 10%;"></td> <td style="width: 10%;"></td> <td style="width: 10%;"></td> </tr> <tr> <td></td> <td></td> <td colspan="8" style="text-align: center;"> <table border="1" style="width: 100%; border-collapse: collapse; text-align: center;"> <tr> <td style="width: 10%;"></td> <td style="width: 10%;"></td> <td style="width: 10%;"></td> <td style="width: 10%;"></td> <td style="width: 10%;"></td> <td style="width: 10%;"></td> <td style="width: 10%;"></td> <td style="width: 10%;"></td> <td style="width: 10%;"></td> <td style="width: 10%;"></td> </tr> <tr> <td></td> <td></td> <td colspan="8" style="text-align: center;"> <table border="1" style="width: 100%; border-collapse: collapse; text-align: center;"> <tr> <td style="width: 10%;"></td> <td style="width: 10%;"></td> <td style="width: 10%;"></td> <td style="width: 10%;"></td> <td style="width: 10%;"></td> <td style="width: 10%;"></td> <td style="width: 10%;"></td> <td style="width: 10%;"></td> <td style="width: 10%;"></td> <td style="width: 10%;"></td> </tr> <tr> <td></td> <td></td> <td colspan="8" style="text-align: center;"> <table border="1" style="width: 100%; border-collapse: collapse; text-align: center;"> <tr> <td style="width: 10%;"></td> <td style="width: 10%;"></td> <td style="width: 10%;"></td> <td style="width: 10%;"></td> <td style="width: 10%;"></td> <td style="width: 10%;"></td> <td style="width: 10%;"></td> <td style="width: 10%;"></td> <td style="width: 10%;"></td> <td style="width: 10%;"></td> </tr> <tr> <td></td> <td></td> <td colspan="8" style="text-align: center;"> <table border="1" style="width: 100%; border-collapse: collapse; text-align: center;"> <tr> <td style="width: 10%;"></td> <td style="width: 10%;"></td> <td style="width: 10%;"></td> <td style="width: 10%;"></td> <td
style="width: 10%;"></td> <td style="width: 10%;"></td> <td style="width: 10%;"></td> <td style="width: 10%;"></td> <td style="width: 10%;"></td> <td style="width: 10%;"></td> </tr> <tr> <td></td> <td></td> <td colspan="8" style="text-align: center;"> <table border="1" style="width: 100%; border-collapse: collapse; text-align: center;"> <tr> <td style="width: 10%;"></td> <td style="width: 10%;"></td> <td style="width: 10%;"></td> <td style="width: 10%;"></td> <td style="width: 10%;"></td> <td style="width: 10%;"></td> <td style="width: 10%;"></td> <td style="width: 10%;"></td> <td style="width: 10%;"></td> <td style="width: 10%;"></td> </tr> <tr> <td></td> <td></td> <td colspan="8" style="text-align: center;"> <table border="1" style="width: 100%; border-collapse: collapse; text-align: center;"> <tr> <td style="width: 10%;"></td> <td style="width: 10%;"></td> <td style="width: 10%;"></td> <td style="width: 10%;"></td> <td style="width: 10%;"></td> <td style="width: 10%;"></td> <td style="width: 10%;"></td> <td style="width: 10%;"></td> <td style="width: 10%;"></td> <td style="width: 10%;"></td> </tr> <tr> <td></td> <td></td> <td colspan="8" style="text-align: center;"> <table border="1" style="width: 100%; border-collapse: collapse; text-align: center;"> <tr> <td style="width: 10%;"></td> <td style="width: 10%;"></td> <td style="width: 10%;"></td> <td style="width: 10%;"></td> <td style="width: 10%;"></td> <td style="width: 10%;"></td> <td style="width: 10%;"></td> <td style="width: 10%;"></td> <td style="width: 10%;"></td> <td style="width: 10%;"></td> </tr> <tr> <td></td> <td></td> <td colspan="8" style="text-align: center;"> <table border="1" style="width: 100%; border-collapse: collapse; text-align: center;"> <tr> <td style="width: 10%;"></td> <td style="width: 10%;"></td> <td style="width: 10%;"></td> <td style="width: 10%;"></td> <td style="width: 10%;"></td> <td style="width: 10%;"></td> <td style="width: 10%;"></td> <td style="width: 10%;"></td> <td style="width: 10%;"></td> <td style="width: 10%;"></td> </tr> <tr> <td></td> <td></td> <td colspan="8" style="text-align: center;"> <table border="1" style="width: 100%; border-collapse: collapse; text-align: center;"> <tr> <td style="width: 10%;"></td> <td style="width: 10%;"></td> <td style="width: 10%;"></td> <td style="width: 10%;"></td> <td style="width: 10%;"></td> <td style="width: 10%;"></td> <td style="width: 10%;"></td> <td style="width: 10%;"></td> <td style="width: 10%;"></td> <td style="width: 10%;"></td> </tr> <tr> <td></td> <td></td> <td colspan="8" style="text-align: center;"> <table border="1" style="width: 100%; border-collapse: collapse; text-align: center;"> <tr> <td style="width: 10%;"></td> <td style="width: 10%;"></td> <td style="width: 10%;"></td> <td style="width: 10%;"></td> <td style="width: 10%;"></td> <td style="width: 10%;"></td> <td style="width: 10%;"></td> <td style="width: 10%;"></td> <td style="width: 10%;"></td> <td style="width: 10%;"></td> </tr> <tr> <td></td> <td></td> <td colspan="8" style="text-align: center;"> <table border="1" style="width: 100%; border-collapse: collapse; text-align: center;"> <tr> <td style="width: 10%;"></td> <td style="width: 10%;"></td> <td style="width: 10%;"></td> <td style="width: 10%;"></td> <td style="width: 10%;"></td> <td style="width: 10%;"></td> <td style="width: 10%;"></td> <td style="width: 10%;"></td> <td style="width: 10%;"></td> <td style="width: 10%;"></td> </tr> <tr> <td></td> <td></td> <td colspan="8" style="text-align: center;"> <table border="1" style="width: 100%; border-collapse: collapse; text-align: center;"> <tr> <td style="width: 10%;"></td> <td style="width: 10%;"></td> <td style="width: 10%;"></td> <td style="width: 10%;"></td> <td style="width: 10%;"></td> <td style="width: 10%;"></td> <td style="width: 10%;"></td> <td style="width: 10%;"></td> <td style="width: 10%;"></td> <td style="width: 10%;"></td> </tr> <tr> <td></td> <td></td> <td colspan="8" style="text-align: center;"> <table border="1" style="width: 100%; border-collapse: collapse; text-align: center;"> <tr> <td style="width: 10%;"></td> <td style="width: 10%;"></td> <td style="width: 10%;"></td> <td style="width: 10%;"></td> <td style="width: 10%;"></td> <td style="width: 10%;"></td> <td style="width: 10%;"></td> <td style="width: 10%;"></td> <td style="width: 10%;"></td> <td style="width: 10%;"></td> </tr> <tr> <td></td> <td></td> <td colspan="8" style="text-align: center;"> <table border="1" style="width: 100%; border-collapse: collapse; text-align: center;"> <tr> <td style="width: 10%;"></td> <td style="width: 10%;"></td> <td style="width: 10%;"></td> <td style="width: 10%;"></td> <td style="width: 10%;"></td> <td style="width: 10%;"></td> <td style="width: 10%;"></td> <td style="width: 10%;"></td> <td style="width: 10%;"></td> <td style="width: 10%;"></td> </tr> <tr> <td></td> <td></td> <td colspan="8" style="text-align: center;"> <table border="1" style="width: 100%; border-collapse: collapse; text-align: center;"> <tr> <td style="width: 10%;"></td> <td style="width: 10%;"></td> <td style="width: 10%;"></td> <td style="width: 10%;"></td> <td style="width: 10%;"></td> <td style="width: 10%;"></td> <td style="width: 10%;"></td> <td style="width: 10%;"></td> <td style="width: 10%;"></td> <td style="width: 10%;"></td> </tr> <tr> <td></td> <td></td> <td colspan="8" style="text-align: center;"> <table border="1" style="width: 100%; border-collapse: collapse; text-align: center;"> <tr> <td style="width: 10%;"></td> <td style="width: 10%;"></td> <td style="width: 10%;"></td> <td style="width: 10%;"></td> <td style="width: 10%;"></td> <td style="width: 10%;"></td> <td style="width: 10%;"></td> <td style="width: 10%;"></td> <td style="width: 10%;"></td> <td style="width: 10%;"></td> </tr> <tr> <td></td> <td></td> <td colspan="8" style="text-align: center;"> <table border="1" style="width: 100%; border-collapse: collapse; text-align: center;"> <tr> <td style="width: 10%;"></td> <td style="width: 10%;"></td> <td style="width: 10%;"></td> <td style="width: 10%;"></td> <td style="width: 10%;"></td> <td style="width: 10%;"></td> <td style="width: 10%;"></td> <td style="width: 10%;"></td> <td style="width: 10%;"></td> <td style="width: 10%;"></td> </tr> <tr> <td></td> <td></td> <td colspan="8" style="text-align: center;"> <table border="1" style="width: 100%; border-collapse: collapse; text-align: center;"> <tr> <td style="width: 10%;"></td> <td style="width: 10%;"></td> <td style="width: 10%;"></td> <td style="width: 10%;"></td> <td style="width: 10%;"></td> <td style="width: 10%;"></td> <td style="width: 10%;"></td> <td style="width: 10%;"></td> <td style="width: 10%;"></td> <td style="width: 10%;"></td> </tr> <tr> <td></td> <td></td> <td colspan="8" style="text-align: center;"> <table border="1" style="width: 100%; border-collapse: collapse; text-align: center;"> <tr> <td style="width: 10%;"></td> <td style="width: 10%;"></td> <td style="width: 10%;"></td> <td style="width: 10%;"></td> <td style="width: 10%;"></td> <td style="width: 10%;"></td> <td style="width: 10%;"></td> <td style="width: 10%;"></td> <td style="width: 10%;"></td> <td style="width: 10%;"></td> </tr> <tr> <td></td> <td></td> <td colspan="8" style="text-align: center;"> <table border="1" style="width: 100%; border-collapse: collapse; text-align: center;"> <tr> <td style="width: 10%;"></td> <td style="width: 10%;"></td> <td style="width: 10%;"></td> <td style="width: 10%;"></td> <td style="width: 10%;"></td> <td style="width: 10%;"></td> <td style="width: 10%;"></td> <td style="width: 10%;"></td> <td style="width: 10%;"></td> <td style="width: 10%;"></td> </tr> <tr> <td></td> <td></td> <td colspan="8" style="text-align: center;"> <table border="1" style="width: 100%; border-collapse: collapse; text-align: center;"> <tr> <td style="width: 10%;"></td> <td style="width: 10%;"></td> <td style="width: 10%;"></td> <td style="width: 10%;"></td> <td style="width: 10%;"></td> <td style="width: 10%;"></td> <td style="width: 10%;"></td> <td style="width: 10%;"></td> <td style="width: 10%;"></td> <td style="width: 10%;"></td> </tr> <tr> <td></td> <td></td> <td colspan="8" style="text-align: center;"> <table border="1" style="width: 100%; border-collapse: collapse; text-align: center;"> <tr> <td style="width: 10%;"></td> <td style="width: 10%;"></td> <td style="width: 10%;"></td> <td style="width: 10%;"></td> <td style="width: 10%;"></td> <td style="width: 10%;"></td> <td style="width: 10%;"></td> <td style="width: 10%;"></td> <td style="width: 10%;"></td> <td style="width: 10%;"></td> </tr> <tr> <td></td> <td></td> <td colspan="8" style="text-align: center;"> <table border="1" style="width: 100%; border-collapse: collapse; text-align: center;"> <tr> </tr></table></td></tr></table></td></tr></table></td></tr></table></td></tr></table></td></tr></table></td></tr></table></td></tr></table></td></tr></table></td></tr></table></td></tr></table></td></tr></table></td></tr></table></td></tr></table></td></tr></table></td></tr></table></td></tr></table></td></tr></table></td></tr></table></td></tr></table></td></tr></table></td></tr></table></td></tr></table></td></tr></table></td></tr></table></td></tr></table></td></tr></table></td></tr></table></td></tr></table></td></tr></table></td></tr></table></td></tr></table></td></tr></table></td></tr></table></td></tr></table></td></tr></table></td></tr></table></td></tr></table></td></tr></table></td></tr></table></td></tr></table></td></tr></table></td></tr></table></td></tr></table></td></tr></table></td></tr></table></td></tr></table></td></tr></table>
 | | | | | | | | | | | | | | | | | | | | <table border="1" style="width: 100%; border-collapse: collapse; text-align: center;"> <tr> <td style="width: 10%;"></td> <td style="width: 10%;"></td> <td style="width: 10%;"></td> <td style="width: 10%;"></td> <td style="width: 10%;"></td> <td style="width: 10%;"></td> <td style="width: 10%;"></td> <td style="width: 10%;"></td> <td style="width: 10%;"></td> <td style="width: 10%;"></td> </tr> <tr> <td></td> <td></td> <td colspan="8" style="text-align: center;"> <table border="1" style="width: 100%; border-collapse: collapse; text-align: center;"> <tr> <td style="width: 10%;"></td> <td style="width: 10%;"></td> <td style="width: 10%;"></td> <td style="width: 10%;"></td> <td style="width: 10%;"></td> <td style="width: 10%;"></td> <td style="width: 10%;"></td> <td style="width: 10%;"></td> <td style="width: 10%;"></td> <td style="width: 10%;"></td> </tr> <tr> <td></td> <td></td> <td colspan="8" style="text-align: center;"> <table border="1" style="width: 100%; border-collapse: collapse; text-align: center;"> <tr> <td style="width: 10%;"></td> <td style="width: 10%;"></td> <td style="width: 10%;"></td> <td style="width: 10%;"></td> <td style="width: 10%;"></td> <td style="width: 10%;"></td> <td style="width: 10%;"></td> <td style="width: 10%;"></td> <td style="width: 10%;"></td> <td style="width: 10%;"></td> </tr> <tr> <td></td> <td></td> <td colspan="8" style="text-align: center;"> <table border="1" style="width: 100%; border-collapse: collapse; text-align: center;"> <tr> <td style="width: 10%;"></td> <td style="width: 10%;"></td> <td style="width: 10%;"></td> <td style="width: 10%;"></td> <td style="width: 10%;"></td> <td style="width: 10%;"></td> <td style="width: 10%;"></td> <td style="width: 10%;"></td> <td style="width: 10%;"></td> <td style="width: 10%;"></td> </tr> <tr> <td></td> <td></td> <td colspan="8" style="text-align: center;"> <table border="1" style="width: 100%; border-collapse: collapse; text-align: center;"> <tr> <td style="width: 10%;"></td> <td style="width: 10%;"></td> <td style="width: 10%;"></td> <td style="width: 10%;"></td> <td style="width: 10%;"></td> <td style="width: 10%;"></td> <td style="width: 10%;"></td> <td style="width: 10%;"></td> <td style="width: 10%;"></td> <td style="width: 10%;"></td> </tr> <tr> <td></td> <td></td> <td colspan="8" style="text-align: center;"> <table border="1" style="width: 100%; border-collapse: collapse; text-align: center;"> <tr> <td style="width: 10%;"></td> <td style="width: 10%;"></td> <td style="width: 10%;"></td> <td style="width: 10%;"></td> <td style="width: 10%;"></td> <td style="width: 10%;"></td> <td style="width: 10%;"></td> <td style="width: 10%;"></td> <td style="width: 10%;"></td> <td style="width: 10%;"></td> </tr> <tr> <td></td> <td></td> <td colspan="8" style="text-align: center;"> <table border="1" style="width: 100%; border-collapse: collapse; text-align: center;"> <tr> <td style="width: 10%;"></td> <td style="width: 10%;"></td> <td style="width: 10%;"></td> <td style="width: 10%;"></td> <td style="width: 10%;"></td> <td style="width: 10%;"></td> <td style="width: 10%;"></td> <td style="width: 10%;"></td> <td style="width: 10%;"></td> <td style="width: 10%;"></td> </tr> <tr> <td></td> <td></td> <td colspan="8" style="text-align: center;"> <table border="1" style="width: 100%; border-collapse: collapse; text-align: center;"> <tr> <td style="width: 10%;"></td> <td style="width: 10%;"></td> <td style="width: 10%;"></td> <td style="width: 10%;"></td> <td style="width: 10%;"></td> <td style="width: 10%;"></td> <td style="width: 10%;"></td> <td style="width: 10%;"></td> <td style="width: 10%;"></td> <td style="width: 10%;"></td> </tr> <tr> <td></td> <td></td> <td colspan="8" style="text-align: center;"> <table border="1" style="width: 100%; border-collapse: collapse; text-align: center;"> <tr> <td style="width: 10%;"></td> <td style="width: 10%;"></td> <td style="width: 10%;"></td> <td style="width: 10%;"></td> <td style="width: 10%;"></td> <td style="width: 10%;"></td> <td style="width: 10%;"></td> <td style="width: 10%;"></td> <td style="width: 10%;"></td> <td style="width: 10%;"></td> </tr> <tr> <td></td> <td></td> <td colspan="8" style="text-align: center;"> <table border="1" style="width: 100%; border-collapse: collapse; text-align: center;"> <tr> <td style="width: 10%;"></td> <td style="width: 10%;"></td> <td style="width: 10%;"></td> <td style="width: 10%;"></td> <td style="width: 10%;"></td> <td style="width: 10%;"></td> <td style="width: 10%;"></td> <td style="width: 10%;"></td> <td style="width: 10%;"></td> <td style="width: 10%;"></td> </tr> <tr> <td></td> <td></td> <td colspan="8" style="text-align: center;"> <table border="1" style="width: 100%; border-collapse: collapse; text-align: center;"> <tr> <td style="width: 10%;"></td> <td style="width: 10%;"></td> <td style="width: 10%;"></td> <td style="width: 10%;"></td> <td style="width: 10%;"></td> <td style="width: 10%;"></td> <td style="width: 10%;"></td> <td style="width: 10%;"></td> <td style="width: 10%;"></td> <td style="width: 10%;"></td> </tr> <tr> <td></td> <td></td> <td colspan="8" style="text-align: center;"> <table border="1" style="width: 100%; border-collapse: collapse; text-align: center;"> <tr> <td style="width: 10%;"></td> <td style="width: 10%;"></td> <td style="width: 10%;"></td> <td style="width: 10%;"></td> <td style="width: 10%;"></td> <td style="width: 10%;"></td> <td style="width: 10%;"></td> <td style="width: 10%;"></td> <td style="width: 10%;"></td> <td style="width: 10%;"></td> </tr> <tr> <td></td> <td></td> <td colspan="8" style="text-align: center;"> <table border="1" style="width: 100%; border-collapse: collapse; text-align: center;"> <tr> <td style="width: 10%;"></td> <td style="width: 10%;"></td> <td style="width: 10%;"></td> <td style="width: 10%;"></td> <td style="width: 10%;"></td> <td style="width: 10%;"></td> <td style="width: 10%;"></td> <td style="width:
10%;"></td> <td style="width: 10%;"></td> <td style="width: 10%;"></td> </tr> <tr> <td></td> <td></td> <td colspan="8" style="text-align: center;"> <table border="1" style="width: 100%; border-collapse: collapse; text-align: center;"> <tr> <td style="width: 10%;"></td> <td style="width: 10%;"></td> <td style="width: 10%;"></td> <td style="width: 10%;"></td> <td style="width: 10%;"></td> <td style="width: 10%;"></td> <td style="width: 10%;"></td> <td style="width: 10%;"></td> <td style="width: 10%;"></td> <td style="width: 10%;"></td> </tr> <tr> <td></td> <td></td> <td colspan="8" style="text-align: center;"> <table border="1" style="width: 100%; border-collapse: collapse; text-align: center;"> <tr> <td style="width: 10%;"></td> <td style="width: 10%;"></td> <td style="width: 10%;"></td> <td style="width: 10%;"></td> <td style="width: 10%;"></td> <td style="width: 10%;"></td> <td style="width: 10%;"></td> <td style="width: 10%;"></td> <td style="width: 10%;"></td> <td style="width: 10%;"></td> </tr> <tr> <td></td> <td></td> <td colspan="8" style="text-align: center;"> <table border="1" style="width: 100%; border-collapse: collapse; text-align: center;"> <tr> <td style="width: 10%;"></td> <td style="width: 10%;"></td> <td style="width: 10%;"></td> <td style="width: 10%;"></td> <td style="width: 10%;"></td> <td style="width: 10%;"></td> <td style="width: 10%;"></td> <td style="width: 10%;"></td> <td style="width: 10%;"></td> <td style="width: 10%;"></td> </tr> <tr> <td></td> <td></td> <td colspan="8" style="text-align: center;"> <table border="1" style="width: 100%; border-collapse: collapse; text-align: center;"> <tr> <td style="width: 10%;"></td> <td style="width: 10%;"></td> <td style="width: 10%;"></td> <td style="width: 10%;"></td> <td style="width: 10%;"></td> <td style="width: 10%;"></td> <td style="width: 10%;"></td> <td style="width: 10%;"></td> <td style="width: 10%;"></td> <td style="width: 10%;"></td> </tr> <tr> <td></td> <td></td> <td colspan="8" style="text-align: center;"> <table border="1" style="width: 100%; border-collapse: collapse; text-align: center;"> <tr> <td style="width: 10%;"></td> <td style="width: 10%;"></td> <td style="width: 10%;"></td> <td style="width: 10%;"></td> <td style="width: 10%;"></td> <td style="width: 10%;"></td> <td style="width: 10%;"></td> <td style="width: 10%;"></td> <td style="width: 10%;"></td> <td style="width: 10%;"></td> </tr> <tr> <td></td> <td></td> <td colspan="8" style="text-align: center;"> <table border="1" style="width: 100%; border-collapse: collapse; text-align: center;"> <tr> <td style="width: 10%;"></td> <td style="width: 10%;"></td> <td style="width: 10%;"></td> <td style="width: 10%;"></td> <td style="width: 10%;"></td> <td style="width: 10%;"></td> <td style="width: 10%;"></td> <td style="width: 10%;"></td> <td style="width: 10%;"></td> <td style="width: 10%;"></td> </tr> <tr> <td></td> <td></td> <td colspan="8" style="text-align: center;"> <table border="1" style="width: 100%; border-collapse: collapse; text-align: center;"> <tr> <td style="width: 10%;"></td> <td style="width: 10%;"></td> <td style="width: 10%;"></td> <td style="width: 10%;"></td> <td style="width: 10%;"></td> <td style="width: 10%;"></td> <td style="width: 10%;"></td> <td style="width: 10%;"></td> <td style="width: 10%;"></td> <td style="width: 10%;"></td> </tr> <tr> <td></td> <td></td> <td colspan="8" style="text-align: center;"> <table border="1" style="width: 100%; border-collapse: collapse; text-align: center;"> <tr> <td style="width: 10%;"></td> <td style="width: 10%;"></td> <td style="width: 10%;"></td> <td style="width: 10%;"></td> <td style="width: 10%;"></td> <td style="width: 10%;"></td> <td style="width: 10%;"></td> <td style="width: 10%;"></td> <td style="width: 10%;"></td> <td style="width: 10%;"></td> </tr> <tr> <td></td> <td></td> <td colspan="8" style="text-align: center;"> <table border="1" style="width: 100%; border-collapse: collapse; text-align: center;"> <tr> <td style="width: 10%;"></td> <td style="width: 10%;"></td> <td style="width: 10%;"></td> <td style="width: 10%;"></td> <td style="width: 10%;"></td> <td style="width: 10%;"></td> <td style="width: 10%;"></td> <td style="width: 10%;"></td> <td style="width: 10%;"></td> <td style="width: 10%;"></td> </tr> <tr> <td></td> <td></td> <td colspan="8" style="text-align: center;"> <table border="1" style="width: 100%; border-collapse: collapse; text-align: center;"> <tr> <td style="width: 10%;"></td> <td style="width: 10%;"></td> <td style="width: 10%;"></td> <td style="width: 10%;"></td> <td style="width: 10%;"></td> <td style="width: 10%;"></td> <td style="width: 10%;"></td> <td style="width: 10%;"></td> <td style="width: 10%;"></td> <td style="width: 10%;"></td> </tr> <tr> <td></td> <td></td> <td colspan="8" style="text-align: center;"> <table border="1" style="width: 100%; border-collapse: collapse; text-align: center;"> <tr> <td style="width: 10%;"></td> <td style="width: 10%;"></td> <td style="width: 10%;"></td> <td style="width: 10%;"></td> <td style="width: 10%;"></td> <td style="width: 10%;"></td> <td style="width: 10%;"></td> <td style="width: 10%;"></td> <td style="width: 10%;"></td> <td style="width: 10%;"></td> </tr> <tr> <td></td> <td></td> <td colspan="8" style="text-align: center;"> <table border="1" style="width: 100%; border-collapse: collapse; text-align: center;"> <tr> <td style="width: 10%;"></td> <td style="width: 10%;"></td> <td style="width: 10%;"></td> <td style="width: 10%;"></td> <td style="width: 10%;"></td> <td style="width: 10%;"></td> <td style="width: 10%;"></td> <td style="width: 10%;"></td> <td style="width: 10%;"></td> <td style="width: 10%;"></td> </tr> <tr> <td></td> <td></td> <td colspan="8" style="text-align: center;"> <table border="1" style="width: 100%; border-collapse: collapse; text-align: center;"> <tr> <td style="width: 10%;"></td> <td style="width: 10%;"></td> <td style="width: 10%;"></td> <td style="width: 10%;"></td> <td style="width: 10%;"></td> <td style="width: 10%;"></td> <td style="width: 10%;"></td> <td style="width: 10%;"></td> <td style="width: 10%;"></td> <td style="width: 10%;"></td> </tr> <tr> <td></td> <td></td> <td colspan="8" style="text-align: center;"> <table border="1" style="width: 100%; border-collapse: collapse; text-align: center;"> <tr> <td style="width: 10%;"></td> <td style="width: 10%;"></td> <td style="width: 10%;"></td> <td style="width: 10%;"></td> <td style="width: 10%;"></td> <td style="width: 10%;"></td> <td style="width: 10%;"></td> <td style="width: 10%;"></td> <td style="width: 10%;"></td> <td style="width: 10%;"></td> </tr> <tr> <td></td> <td></td> <td colspan="8" style="text-align: center;"> <table border="1" style="width: 100%; border-collapse: collapse; text-align: center;"> <tr> <td style="width: 10%;"></td> <td style="width: 10%;"></td> <td style="width: 10%;"></td> <td style="width: 10%;"></td> <td style="width: 10%;"></td> <td style="width: 10%;"></td> <td style="width: 10%;"></td> <td style="width: 10%;"></td> <td style="width: 10%;"></td> <td style="width: 10%;"></td> </tr> <tr> <td></td> <td></td> <td colspan="8" style="text-align: center;"> <table border="1" style="width: 100%; border-collapse: collapse; text-align: center;"> <tr> <td style="width: 10%;"></td> <td style="width: 10%;"></td> <td style="width: 10%;"></td> <td style="width: 10%;"></td> <td style="width: 10%;"></td> <td style="width: 10%;"></td> <td style="width: 10%;"></td> <td style="width: 10%;"></td> <td style="width: 10%;"></td> <td style="width: 10%;"></td> </tr> <tr> <td></td> <td></td> <td colspan="8" style="text-align: center;"> <table border="1" style="width: 100%; border-collapse: collapse; text-align: center;"> <tr> <td style="width: 10%;"></td> <td style="width: 10%;"></td> <td style="width: 10%;"></td> <td style="width: 10%;"></td> <td style="width: 10%;"></td> <td style="width: 10%;"></td> <td style="width: 10%;"></td> <td style="width: 10%;"></td> <td style="width: 10%;"></td> <td style="width: 10%;"></td> </tr> <tr> <td></td> <td></td> <td colspan="8" style="text-align: center;"> <table border="1" style="width: 100%; border-collapse: collapse; text-align: center;"> <tr> <td style="width: 10%;"></td> <td style="width: 10%;"></td> <td style="width: 10%;"></td> <td style="width: 10%;"></td> <td style="width: 10%;"></td> <td style="width: 10%;"></td> <td style="width: 10%;"></td> <td style="width: 10%;"></td> <td style="width: 10%;"></td> <td style="width: 10%;"></td> </tr> <tr> <td></td> <td></td> <td colspan="8" style="text-align: center;"> <table border="1" style="width: 100%; border-collapse: collapse; text-align: center;"> <tr> <td style="width: 10%;"></td> <td style="width: 10%;"></td> <td style="width: 10%;"></td> <td style="width: 10%;"></td> <td style="width: 10%;"></td> <td style="width: 10%;"></td> <td style="width: 10%;"></td> <td style="width: 10%;"></td> <td style="width: 10%;"></td> <td style="width: 10%;"></td> </tr> <tr> <td></td> <td></td> <td colspan="8" style="text-align: center;"> <table border="1" style="width: 100%; border-collapse: collapse; text-align: center;"> <tr> <td style="width: 10%;"></td> <td style="width: 10%;"></td> <td style="width: 10%;"></td> <td style="width: 10%;"></td> <td style="width: 10%;"></td> <td style="width: 10%;"></td> <td style="width: 10%;"></td> <td style="width: 10%;"></td> <td style="width: 10%;"></td> <td style="width: 10%;"></td> </tr> <tr> <td></td> <td></td> <td colspan="8" style="text-align: center;"> <table border="1" style="width: 100%; border-collapse: collapse; text-align: center;"> <tr> <td style="width: 10%;"></td> <td style="width: 10%;"></td> <td style="width: 10%;"></td> <td style="width: 10%;"></td> <td style="width: 10%;"></td> <td style="width: 10%;"></td> <td style="width: 10%;"></td> <td style="width: 10%;"></td> <td style="width: 10%;"></td> <td style="width: 10%;"></td> </tr> <tr> <td></td> <td></td> <td colspan="8" style="text-align: center;"> <table border="1"
style="width: 100%; border-collapse: collapse; text-align: center;"> <tr> <td style="width: 10%;"></td> <td style="width: 10%;"></td> <td style="width: 10%;"></td> <td style="width: 10%;"></td> <td style="width: 10%;"></td> <td style="width: 10%;"></td> <td style="width: 10%;"></td> <td style="width: 10%;"></td> <td style="width: 10%;"></td> <td style="width: 10%;"></td> </tr> <tr> <td></td> <td></td> <td colspan="8" style="text-align: center;"> <table border="1" style="width: 100%; border-collapse: collapse; text-align: center;"> <tr> <td style="width: 10%;"></td> <td style="width: 10%;"></td> <td style="width: 10%;"></td> <td style="width: 10%;"></td> <td style="width: 10%;"></td> <td style="width: 10%;"></td> <td style="width: 10%;"></td> <td style="width: 10%;"></td> <td style="width: 10%;"></td> <td style="width: 10%;"></td> </tr> <tr> <td></td> <td></td> <td colspan="8" style="text-align: center;"> <table border="1" style="width: 100%; border-collapse: collapse; text-align: center;"> <tr> <td style="width: 10%;"></td> <td style="width: 10%;"></td> <td style="width: 10%;"></td> <td style="width: 10%;"></td> <td style="width: 10%;"></td> <td style="width: 10%;"></td> <td style="width: 10%;"></td> <td style="width: 10%;"></td> <td style="width: 10%;"></td> <td style="width: 10%;"></td> </tr> <tr> <td></td> <td></td> <td colspan="8" style="text-align: center;"> <table border="1" style="width: 100%; border-collapse: collapse; text-align: center;"> <tr> <td style="width: 10%;"></td> <td style="width: 10%;"></td> <td style="width: 10%;"></td> <td style="width: 10%;"></td> <td style="width: 10%;"></td> <td style="width: 10%;"></td> <td style="width: 10%;"></td> <td style="width: 10%;"></td> <td style="width: 10%;"></td> <td style="width: 10%;"></td> </tr> <tr> <td></td> <td></td> <td colspan="8" style="text-align: center;"> <table border="1" style="width: 100%; border-collapse: collapse; text-align: center;"> <tr> <td style="width: 10%;"></td> <td style="width: 10%;"></td> <td style="width: 10%;"></td> <td style="width: 10%;"></td> <td style="width: 10%;"></td> <td style="width: 10%;"></td> <td style="width: 10%;"></td> <td style="width: 10%;"></td> <td style="width: 10%;"></td> <td style="width: 10%;"></td> </tr> <tr> <td></td> <td></td> <td colspan="8" style="text-align: center;"> <table border="1" style="width: 100%; border-collapse: collapse; text-align: center;"> <tr> <td style="width: 10%;"></td> <td style="width: 10%;"></td> <td style="width: 10%;"></td> <td style="width: 10%;"></td> <td style="width: 10%;"></td> <td style="width: 10%;"></td> <td style="width: 10%;"></td> <td style="width: 10%;"></td> <td style="width: 10%;"></td> <td style="width: 10%;"></td> </tr> <tr> <td></td> <td></td> <td colspan="8" style="text-align: center;"> <table border="1" style="width: 100%; border-collapse: collapse; text-align: center;"> <tr> <td style="width: 10%;"></td> <td style="width: 10%;"></td> <td style="width: 10%;"></td> <td style="width: 10%;"></td> <td style="width: 10%;"></td> <td style="width: 10%;"></td> <td style="width: 10%;"></td> <td style="width: 10%;"></td> <td style="width: 10%;"></td> <td style="width: 10%;"></td> </tr> <tr> <td></td> <td></td> <td colspan="8" style="text-align: center;"> <table border="1" style="width: 100%; border-collapse: collapse; text-align: center;"> <tr> <td style="width: 10%;"></td> <td style="width: 10%;"></td> <td style="width: 10%;"></td> <td style="width: 10%;"></td> <td style="width: 10%;"></td> <td style="width: 10%;"></td> <td style="width: 10%;"></td> <td style="width: 10%;"></td> <td style="width: 10%;"></td> <td style="width: 10%;"></td> </tr> <tr> <td></td> <td></td> <td colspan="8" style="text-align: center;"> <table border="1" style="width: 100%; border-collapse: collapse; text-align: center;"> <tr> <td style="width: 10%;"></td> <td style="width: 10%;"></td> <td style="width: 10%;"></td> <td style="width: 10%;"></td> <td style="width: 10%;"></td> <td style="width: 10%;"></td> <td style="width: 10%;"></td> <td style="width: 10%;"></td> <td style="width: 10%;"></td> <td style="width: 10%;"></td> </tr> <tr> <td></td> <td></td> <td colspan="8" style="text-align: center;"> <table border="1" style="width: 100%; border-collapse: collapse; text-align: center;"> <tr> <td style="width: 10%;"></td> <td style="width: 10%;"></td> <td style="width: 10%;"></td> <td style="width: 10%;"></td> <td style="width: 10%;"></td> <td style="width: 10%;"></td> <td style="width: 10%;"></td> <td style="width: 10%;"></td> <td style="width: 10%;"></td> <td style="width: 10%;"></td> </tr> <tr> <td></td> <td></td> <td colspan="8" style="text-align: center;"> <table border="1" style="width: 100%; border-collapse: collapse; text-align: center;"> <tr> <td style="width: 10%;"></td> <td style="width: 10%;"></td> <td style="width: 10%;"></td> <td style="width: 10%;"></td> <td style="width: 10%;"></td> <td style="width: 10%;"></td> <td style="width: 10%;"></td> <td style="width: 10%;"></td> <td style="width: 10%;"></td> <td style="width: 10%;"></td> </tr> <tr> <td></td> <td></td> <td colspan="8" style="text-align: center;"> <table border="1" style="width: 100%; border-collapse: collapse; text-align: center;"> <tr> <td style="width: 10%;"></td> <td style="width: 10%;"></td> <td style="width: 10%;"></td> <td style="width: 10%;"></td> <td style="width: 10%;"></td> <td style="width: 10%;"></td> <td style="width: 10%;"></td> <td style="width: 10%;"></td> <td style="width: 10%;"></td> <td style="width: 10%;"></td> </tr> <tr> <td></td> <td></td> <td colspan="8" style="text-align: center;"> <table border="1" style="width: 100%; border-collapse: collapse; text-align: center;"> <tr> </tr></table></td></tr></table></td></tr></table></td></tr></table></td></tr></table></td></tr></table></td></tr></table></td></tr></table></td></tr></table></td></tr></table></td></tr></table></td></tr></table></td></tr></table></td></tr></table></td></tr></table></td></tr></table></td></tr></table></td></tr></table></td></tr></table></td></tr></table></td></tr></table></td></tr></table></td></tr></table></td></tr></table></td></tr></table></td></tr></table></td></tr></table></td></tr></table></td></tr></table></td></tr></table></td></tr></table></td></tr></table></td></tr></table></td></tr></table></td></tr></table></td></tr></table></td></tr></table></td></tr></table></td></tr></table></td></tr></table></td></tr></table></td></tr></table></td></tr></table></td></tr></table></td></tr></table></td></tr></table></td></tr></table>
 | | | | | | | | | | | | | | | | | | | | <table border="1" style="width: 100%; border-collapse: collapse; text-align: center;"> <tr> <td style="width: 10%;"></td> <td style="width: 10%;"></td> <td style="width: 10%;"></td> <td style="width: 10%;"></td> <td style="width: 10%;"></td> <td style="width: 10%;"></td> <td style="width: 10%;"></td> <td style="width: 10%;"></td> <td style="width: 10%;"></td> <td style="width: 10%;"></td> </tr> <tr> <td></td> <td></td> <td colspan="8" style="text-align: center;"> <table border="1" style="width: 100%; border-collapse: collapse; text-align: center;"> <tr> <td style="width: 10%;"></td> <td style="width: 10%;"></td> <td style="width: 10%;"></td> <td style="width: 10%;"></td> <td style="width: 10%;"></td> <td style="width: 10%;"></td> <td style="width: 10%;"></td> <td style="width: 10%;"></td> <td style="width: 10%;"></td> <td style="width: 10%;"></td> </tr> <tr> <td></td> <td></td> <td colspan="8" style="text-align: center;"> <table border="1" style="width: 100%; border-collapse: collapse; text-align: center;"> <tr> <td style="width: 10%;"></td> <td style="width: 10%;"></td> <td style="width: 10%;"></td> <td style="width: 10%;"></td> <td style="width: 10%;"></td> <td style="width: 10%;"></td> <td style="width: 10%;"></td> <td style="width: 10%;"></td> <td style="width: 10%;"></td> <td style="width: 10%;"></td> </tr> <tr> <td></td> <td></td> <td colspan="8" style="text-align: center;"> <table border="1" style="width: 100%; border-collapse: collapse; text-align: center;"> <tr> <td style="width: 10%;"></td> <td style="width: 10%;"></td> <td style="width: 10%;"></td> <td style="width: 10%;"></td> <td style="width: 10%;"></td> <td style="width: 10%;"></td> <td style="width: 10%;"></td> <td style="width: 10%;"></td> <td style="width: 10%;"></td> <td style="width: 10%;"></td> </tr> <tr> <td></td> <td></td> <td colspan="8" style="text-align: center;"> <table border="1" style="width: 100%; border-collapse: collapse; text-align: center;"> <tr> <td style="width: 10%;"></td> <td style="width: 10%;"></td> <td style="width: 10%;"></td> <td style="width: 10%;"></td> <td style="width: 10%;"></td> <td style="width: 10%;"></td> <td style="width: 10%;"></td> <td style="width: 10%;"></td> <td style="width: 10%;"></td> <td style="width: 10%;"></td> </tr> <tr> <td></td> <td></td> <td colspan="8" style="text-align: center;"> <table border="1" style="width: 100%; border-collapse: collapse; text-align: center;"> <tr> <td style="width: 10%;"></td> <td style="width: 10%;"></td> <td style="width: 10%;"></td> <td style="width: 10%;"></td> <td style="width: 10%;"></td> <td style="width: 10%;"></td> <td style="width: 10%;"></td> <td style="width: 10%;"></td> <td style="width: 10%;"></td> <td style="width: 10%;"></td> </tr> <tr> <td></td> <td></td> <td colspan="8" style="text-align: center;"> <table border="1" style="width: 100%; border-collapse: collapse; text-align: center;"> <tr> <td style="width: 10%;"></td> <td style="width: 10%;"></td> <td style="width: 10%;"></td> <td style="width: 10%;"></td> <td style="width: 10%;"></td> <td style="width: 10%;"></td> <td style="width: 10%;"></td> <td style="width: 10%;"></td> <td style="width: 10%;"></td> <td style="width: 10%;"></td> </tr> <tr> <td></td> <td></td> <td colspan="8" style="text-align: center;"> <table border="1" style="width: 100%; border-collapse: collapse; text-align: center;"> <tr> <td style="width: 10%;"></td> <td style="width: 10%;"></td> <td style="width: 10%;"></td> <td style="width: 10%;"></td> <td style="width: 10%;"></td> <td style="width: 10%;"></td> <td style="width: 10%;"></td> <td style="width: 10%;"></td> <td style="width: 10%;"></td> <td style="width: 10%;"></td> </tr> <tr> <td></td> <td></td> <td colspan="8" style="text-align: center;"> <table border="1" style="width: 100%; border-collapse: collapse; text-align: center;"> <tr> <td style="width: 10%;"></td> <td style="width: 10%;"></td> <td style="width: 10%;"></td> <td style="width: 10%;"></td> <td style="width: 10%;"></td> <td style="width: 10%;"></td> <td style="width: 10%;"></td> <td style="width: 10%;"></td> <td style="width: 10%;"></td> <td style="width: 10%;"></td> </tr> <tr> <td></td> <td></td> <td colspan="8" style="text-align: center;"> <table border="1" style="width: 100%; border-collapse: collapse; text-align: center;"> <tr> <td style="width: 10%;"></td> <td style="width: 10%;"></td> <td style="width: 10%;"></td> <td style="width: 10%;"></td> <td style="width: 10%;"></td> <td style="width: 10%;"></td> <td style="width: 10%;"></td> <td style="width: 10%;"></td> <td style="width: 10%;"></td> <td style="width: 10%;"></td> </tr> <tr> <td></td> <td></td> <td colspan="8" style="text-align: center;"> <table border="1" style="width: 100%; border-collapse: collapse; text-align: center;"> <tr> <td style="width: 10%;"></td> <td style="width: 10%;"></td> <td style="width: 10%;"></td> <td style="width: 10%;"></td> <td style="width: 10%;"></td> <td style="width: 10%;"></td> <td style="width: 10%;"></td> <td style="width: 10%;"></td> <td style="width: 10%;"></td> <td style="width: 10%;"></td> </tr> <tr> <td></td> <td></td> <td colspan="8" style="text-align: center;"> <table border="1" style="width: 100%; border-collapse: collapse; text-align: center;"> <tr> <td style="width: 10%;"></td> <td style="width: 10%;"></td> <td style="width: 10%;"></td> <td style="width: 10%;"></td> <td style="width: 10%;"></td> <td style="width: 10%;"></td> <td style="width: 10%;"></td> <td style="width: 10%;"></td> <td style="width: 10%;"></td> <td style="width: 10%;"></td> </tr> <tr> <td></td> <td></td> <td colspan="8" style="text-align: center;"> <table border="1" style="width: 100%; border-collapse: collapse; text-align: center;"> <tr> <td style="width: 10%;"></td> <td style="width: 10%;"></td> <td style="width: 10%;"></td> <td style="width: 10%;"></td> <td style="width: 10%;"></td> <td style="width: 10%;"></td> <td style="width: 10%;"></td> <td style="width: 10%;"></td> <td style="width: 10%;"></td> <td style="width: 10%;"></td> </tr> <tr> <td></td> <td></td> <td colspan="8" style="text-align: center;"> <table border="1" style="width: 100%; border-collapse: collapse; text-align: center;"> <tr> <td style="width: 10%;"></td> <td style="width: 10%;"></td> <td style="width: 10%;"></td> <td style="width: 10%;"></td> <td style="width: 10%;"></td> <td style="width: 10%;"></td> <td style="width: 10%;"></td> <td style="width: 10%;"></td> <td style="width: 10%;"></td> <td style="width: 10%;"></td> </tr> <tr> <td></td> <td></td> <td colspan="8" style="text-align: center;"> <table border="1" style="width: 100%; border-collapse: collapse; text-align: center;"> <tr> <td style="width: 10%;"></td> <td style="width: 10%;"></td> <td style="width: 10%;"></td> <td style="width: 10%;"></td> <td style="width: 10%;"></td> <td style="width: 10%;"></td> <td style="width: 10%;"></td> <td style="width: 10%;"></td> <td style="width: 10%;"></td> <td style="width: 10%;"></td> </tr> <tr> <td></td> <td></td> <td colspan="8" style="text-align: center;"> <table border="1" style="width: 100%; border-collapse: collapse; text-align: center;"> <tr> <td style="width: 10%;"></td> <td style="width: 10%;"></td> <td style="width: 10%;"></td> <td style="width: 10%;"></td> <td style="width: 10%;"></td> <td style="width: 10%;"></td> <td style="width: 10%;"></td> <td style="width: 10%;"></td> <td style="width: 10%;"></td> <td style="width: 10%;"></td> </tr> <tr> <td></td> <td></td> <td colspan="8" style="text-align: center;"> <table border="1" style="width: 100%; border-collapse: collapse; text-align: center;"> <tr> <td style="width: 10%;"></td> <td style="width: 10%;"></td> <td style="width: 10%;"></td> <td style="width: 10%;"></td> <td style="width: 10%;"></td> <td style="width: 10%;"></td> <td style="width: 10%;"></td> <td style="width: 10%;"></td> <td style="width: 10%;"></td> <td style="width: 10%;"></td> </tr> <tr> <td></td> <td></td> <td colspan="8" style="text-align: center;"> <table border="1" style="width: 100%; border-collapse: collapse; text-align: center;"> <tr> <td style="width: 10%;"></td> <td style="width: 10%;"></td> <td style="width: 10%;"></td> <td style="width: 10%;"></td> <td style="width: 10%;"></td> <td style="width: 10%;"></td> <td style="width: 10%;"></td> <td style="width: 10%;"></td> <td style="width: 10%;"></td> <td style="width: 10%;"></td> </tr> <tr> <td></td> <td></td> <td colspan="8" style="text-align: center;"> <table border="1" style="width: 100%; border-collapse: collapse; text-align: center;"> <tr> <td style="width: 10%;"></td> <td style="width: 10%;"></td> <td style="width: 10%;"></td> <td style="width: 10%;"></td> <td style="width: 10%;"></td> <td style="width: 10%;"></td> <td style="width: 10%;"></td> <td style="width: 10%;"></td> <td style="width: 10%;"></td> <td style="width: 10%;"></td> </tr> <tr> <td></td> <td></td> <td colspan="8" style="text-align: center;"> <table border="1" style="width: 100%; border-collapse: collapse; text-align: center;"> <tr> <td style="width: 10%;"></td> <td style="width:
10%;"></td> <td style="width: 10%;"></td> <td style="width: 10%;"></td> <td style="width: 10%;"></td> <td style="width: 10%;"></td> <td style="width: 10%;"></td> <td style="width: 10%;"></td> <td style="width: 10%;"></td> <td style="width: 10%;"></td> </tr> <tr> <td></td> <td></td> <td colspan="8" style="text-align: center;"> <table border="1" style="width: 100%; border-collapse: collapse; text-align: center;"> <tr> <td style="width: 10%;"></td> <td style="width: 10%;"></td> <td style="width: 10%;"></td> <td style="width: 10%;"></td> <td style="width: 10%;"></td> <td style="width: 10%;"></td> <td style="width: 10%;"></td> <td style="width: 10%;"></td> <td style="width: 10%;"></td> <td style="width: 10%;"></td> </tr> <tr> <td></td> <td></td> <td colspan="8" style="text-align: center;"> <table border="1" style="width: 100%; border-collapse: collapse; text-align: center;"> <tr> <td style="width: 10%;"></td> <td style="width: 10%;"></td> <td style="width: 10%;"></td> <td style="width: 10%;"></td> <td style="width: 10%;"></td> <td style="width: 10%;"></td> <td style="width: 10%;"></td> <td style="width: 10%;"></td> <td style="width: 10%;"></td> <td style="width: 10%;"></td> </tr> <tr> <td></td> <td></td> <td colspan="8" style="text-align: center;"> <table border="1" style="width: 100%; border-collapse: collapse; text-align: center;"> <tr> <td style="width: 10%;"></td> <td style="width: 10%;"></td> <td style="width: 10%;"></td> <td style="width: 10%;"></td> <td style="width: 10%;"></td> <td style="width: 10%;"></td> <td style="width: 10%;"></td> <td style="width: 10%;"></td> <td style="width: 10%;"></td> <td style="width: 10%;"></td> </tr> <tr> <td></td> <td></td> <td colspan="8" style="text-align: center;"> <table border="1" style="width: 100%; border-collapse: collapse; text-align: center;"> <tr> <td style="width: 10%;"></td> <td style="width: 10%;"></td> <td style="width: 10%;"></td> <td style="width: 10%;"></td> <td style="width: 10%;"></td> <td style="width: 10%;"></td> <td style="width: 10%;"></td> <td style="width: 10%;"></td> <td style="width: 10%;"></td> <td style="width: 10%;"></td> </tr> <tr> <td></td> <td></td> <td colspan="8" style="text-align: center;"> <table border="1" style="width: 100%; border-collapse: collapse; text-align: center;"> <tr> <td style="width: 10%;"></td> <td style="width: 10%;"></td> <td style="width: 10%;"></td> <td style="width: 10%;"></td> <td style="width: 10%;"></td> <td style="width: 10%;"></td> <td style="width: 10%;"></td> <td style="width: 10%;"></td> <td style="width: 10%;"></td> <td style="width: 10%;"></td> </tr> <tr> <td></td> <td></td> <td colspan="8" style="text-align: center;"> <table border="1" style="width: 100%; border-collapse: collapse; text-align: center;"> <tr> <td style="width: 10%;"></td> <td style="width: 10%;"></td> <td style="width: 10%;"></td> <td style="width: 10%;"></td> <td style="width: 10%;"></td> <td style="width: 10%;"></td> <td style="width: 10%;"></td> <td style="width: 10%;"></td> <td style="width: 10%;"></td> <td style="width: 10%;"></td> </tr> <tr> <td></td> <td></td> <td colspan="8" style="text-align: center;"> <table border="1" style="width: 100%; border-collapse: collapse; text-align: center;"> <tr> <td style="width: 10%;"></td> <td style="width: 10%;"></td> <td style="width: 10%;"></td> <td style="width: 10%;"></td> <td style="width: 10%;"></td> <td style="width: 10%;"></td> <td style="width: 10%;"></td> <td style="width: 10%;"></td> <td style="width: 10%;"></td> <td style="width: 10%;"></td> </tr> <tr> <td></td> <td></td> <td colspan="8" style="text-align: center;"> <table border="1" style="width: 100%; border-collapse: collapse; text-align: center;"> <tr> <td style="width: 10%;"></td> <td style="width: 10%;"></td> <td style="width: 10%;"></td> <td style="width: 10%;"></td> <td style="width: 10%;"></td> <td style="width: 10%;"></td> <td style="width: 10%;"></td> <td style="width: 10%;"></td> <td style="width: 10%;"></td> <td style="width: 10%;"></td> </tr> <tr> <td></td> <td></td> <td colspan="8" style="text-align: center;"> <table border="1" style="width: 100%; border-collapse: collapse; text-align: center;"> <tr> <td style="width: 10%;"></td> <td style="width: 10%;"></td> <td style="width: 10%;"></td> <td style="width: 10%;"></td> <td style="width: 10%;"></td> <td style="width: 10%;"></td> <td style="width: 10%;"></td> <td style="width: 10%;"></td> <td style="width: 10%;"></td> <td style="width: 10%;"></td> </tr> <tr> <td></td> <td></td> <td colspan="8" style="text-align: center;"> <table border="1" style="width: 100%; border-collapse: collapse; text-align: center;"> <tr> <td style="width: 10%;"></td> <td style="width: 10%;"></td> <td style="width: 10%;"></td> <td style="width: 10%;"></td> <td style="width: 10%;"></td> <td style="width: 10%;"></td> <td style="width: 10%;"></td> <td style="width: 10%;"></td> <td style="width: 10%;"></td> <td style="width: 10%;"></td> </tr> <tr> <td></td> <td></td> <td colspan="8" style="text-align: center;"> <table border="1" style="width: 100%; border-collapse: collapse; text-align: center;"> <tr> <td style="width: 10%;"></td> <td style="width: 10%;"></td> <td style="width: 10%;"></td> <td style="width: 10%;"></td> <td style="width: 10%;"></td> <td style="width: 10%;"></td> <td style="width: 10%;"></td> <td style="width: 10%;"></td> <td style="width: 10%;"></td> <td style="width: 10%;"></td> </tr> <tr> <td></td> <td></td> <td colspan="8" style="text-align: center;"> <table border="1" style="width: 100%; border-collapse: collapse; text-align: center;"> <tr> <td style="width: 10%;"></td> <td style="width: 10%;"></td> <td style="width: 10%;"></td> <td style="width: 10%;"></td> <td style="width: 10%;"></td> <td style="width: 10%;"></td> <td style="width: 10%;"></td> <td style="width: 10%;"></td> <td style="width: 10%;"></td> <td style="width: 10%;"></td> </tr> <tr> <td></td> <td></td> <td colspan="8" style="text-align: center;"> <table border="1" style="width: 100%; border-collapse: collapse; text-align: center;"> <tr> <td style="width: 10%;"></td> <td style="width: 10%;"></td> <td style="width: 10%;"></td> <td style="width: 10%;"></td> <td style="width: 10%;"></td> <td style="width: 10%;"></td> <td style="width: 10%;"></td> <td style="width: 10%;"></td> <td style="width: 10%;"></td> <td style="width: 10%;"></td> </tr> <tr> <td></td> <td></td> <td colspan="8" style="text-align: center;"> <table border="1" style="width: 100%; border-collapse: collapse; text-align: center;"> <tr> <td style="width: 10%;"></td> <td style="width: 10%;"></td> <td style="width: 10%;"></td> <td style="width: 10%;"></td> <td style="width: 10%;"></td> <td style="width: 10%;"></td> <td style="width: 10%;"></td> <td style="width: 10%;"></td> <td style="width: 10%;"></td> <td style="width: 10%;"></td> </tr> <tr> <td></td> <td></td> <td colspan="8" style="text-align: center;"> <table border="1" style="width: 100%; border-collapse: collapse; text-align: center;"> <tr> <td style="width: 10%;"></td> <td style="width: 10%;"></td> <td style="width: 10%;"></td> <td style="width: 10%;"></td> <td style="width: 10%;"></td> <td style="width: 10%;"></td> <td style="width: 10%;"></td> <td style="width: 10%;"></td> <td style="width: 10%;"></td> <td style="width: 10%;"></td> </tr> <tr> <td></td> <td></td> <td colspan="8" style="text-align: center;"> <table border="1" style="width: 100%; border-collapse: collapse; text-align: center;"> <tr> <td style="width: 10%;"></td> <td style="width: 10%;"></td> <td style="width: 10%;"></td> <td style="width: 10%;"></td> <td style="width: 10%;"></td> <td style="width: 10%;"></td> <td style="width: 10%;"></td> <td style="width: 10%;"></td> <td style="width: 10%;"></td> <td style="width: 10%;"></td> </tr> <tr> <td></td> <td></td> <td colspan="8" style="text-align: center;"> <table border="1" style="width: 100%; border-collapse: collapse; text-align: center;"> <tr> <td style="width: 10%;"></td> <td style="width: 10%;"></td> <td style="width: 10%;"></td> <td style="width: 10%;"></td> <td style="width: 10%;"></td> <td style="width: 10%;"></td> <td style="width: 10%;"></td> <td style="width: 10%;"></td> <td style="width: 10%;"></td> <td style="width: 10%;"></td> </tr> <tr> <td></td> <td></td> <td colspan="8" style="text-align: center;"> <table border="1" style="width: 100%; border-collapse: collapse; text-align: center;"> <tr> <td style="width: 10%;"></td> <td style="width: 10%;"></td> <td style="width: 10%;"></td> <td style="width: 10%;"></td> <td style="width: 10%;"></td> <td style="width: 10%;"></td> <td style="width: 10%;"></td> <td style="width: 10%;"></td> <td style="width: 10%;"></td> <td style="width: 10%;"></td> </tr> <tr> <td></td> <td></td> <td colspan="8" style="text-align: center;"> <table border="1" style="width: 100%; border-collapse: collapse; text-align: center;"> <tr> <td style="width: 10%;"></td> <td style="width: 10%;"></td> <td style="width: 10%;"></td> <td style="width: 10%;"></td> <td style="width: 10%;"></td> <td style="width: 10%;"></td> <td style="width: 10%;"></td> <td style="width: 10%;"></td> <td style="width: 10%;"></td> <td style="width: 10%;"></td> </tr> <tr> <td></td> <td></td> <td colspan="8" style="text-align: center;"> <table border="1" style="width: 100%; border-collapse: collapse; text-align: center;"> <tr> <td style="width: 10%;"></td> <td style="width: 10%;"></td> <td style="width: 10%;"></td> <td style="width: 10%;"></td> <td style="width: 10%;"></td> <td style="width: 10%;"></td> <td style="width: 10%;"></td> <td style="width: 10%;"></td> <td style="width: 10%;"></td> <td style="width: 10%;"></td> </tr> <tr> <td></td> <td></td> <td colspan="8" style="text-align: center;"> <table border="1" style="width: 100%; border-collapse: collapse; text-align: center;"> <tr> <td style="width: 10%;"></td> <td style="width: 10%;"></td> <td style="width: 10%;"></td> <td style="width: 10%;"></td> <td style="width: 10%;"></td> <td style="width: 10%;"></td> <td style="width: 10%;"></td> <td
style="width: 10%;"></td> <td style="width: 10%;"></td> <td style="width: 10%;"></td> </tr> <tr> <td></td> <td></td> <td colspan="8" style="text-align: center;"> <table border="1" style="width: 100%; border-collapse: collapse; text-align: center;"> <tr> <td style="width: 10%;"></td> <td style="width: 10%;"></td> <td style="width: 10%;"></td> <td style="width: 10%;"></td> <td style="width: 10%;"></td> <td style="width: 10%;"></td> <td style="width: 10%;"></td> <td style="width: 10%;"></td> <td style="width: 10%;"></td> <td style="width: 10%;"></td> </tr> <tr> <td></td> <td></td> <td colspan="8" style="text-align: center;"> <table border="1" style="width: 100%; border-collapse: collapse; text-align: center;"> <tr> <td style="width: 10%;"></td> <td style="width: 10%;"></td> <td style="width: 10%;"></td> <td style="width: 10%;"></td> <td style="width: 10%;"></td> <td style="width: 10%;"></td> <td style="width: 10%;"></td> <td style="width: 10%;"></td> <td style="width: 10%;"></td> <td style="width: 10%;"></td> </tr> <tr> <td></td> <td></td> <td colspan="8" style="text-align: center;"> <table border="1" style="width: 100%; border-collapse: collapse; text-align: center;"> <tr> <td style="width: 10%;"></td> <td style="width: 10%;"></td> <td style="width: 10%;"></td> <td style="width: 10%;"></td> <td style="width: 10%;"></td> <td style="width: 10%;"></td> <td style="width: 10%;"></td> <td style="width: 10%;"></td> <td style="width: 10%;"></td> <td style="width: 10%;"></td> </tr> <tr> <td></td> <td></td> <td colspan="8" style="text-align: center;"> <table border="1" style="width: 100%; border-collapse: collapse; text-align: center;"> <tr> <td style="width: 10%;"></td> <td style="width: 10%;"></td> <td style="width: 10%;"></td> <td style="width: 10%;"></td> <td style="width: 10%;"></td> <td style="width: 10%;"></td> <td style="width: 10%;"></td> <td style="width: 10%;"></td> <td style="width: 10%;"></td> <td style="width: 10%;"></td> </tr> <tr> <td></td> <td></td> <td colspan="8" style="text-align: center;"> <table border="1" style="width: 100%; border-collapse: collapse; text-align: center;"> <tr> </tr></table></td></tr></table></td></tr></table></td></tr></table></td></tr></table></td></tr></table></td></tr></table></td></tr></table></td></tr></table></td></tr></table></td></tr></table></td></tr></table></td></tr></table></td></tr></table></td></tr></table></td></tr></table></td></tr></table></td></tr></table></td></tr></table></td></tr></table></td></tr></table></td></tr></table></td></tr></table></td></tr></table></td></tr></table></td></tr></table></td></tr></table></td></tr></table></td></tr></table></td></tr></table></td></tr></table></td></tr></table></td></tr></table></td></tr></table></td></tr></table></td></tr></table></td></tr></table></td></tr></table></td></tr></table></td></tr></table></td></tr></table></td></tr></table></td></tr></table></td></tr></table></td></tr></table></td></tr></table> | | | | | | | | | | | | | | | | | | | | <table border="1" style="width: 100%; border-collapse: collapse; text-align: center;"> <tr> <td style="width: 10%;"></td> <td style="width: 10%;"></td> <td style="width: 10%;"></td> <td style="width: 10%;"></td> <td style="width: 10%;"></td> <td style="width: 10%;"></td> <td style="width: 10%;"></td> <td style="width: 10%;"></td> <td style="width: 10%;"></td> <td style="width: 10%;"></td> </tr> <tr> <td></td> <td></td> <td colspan="8" style="text-align: center;"> <table border="1" style="width: 100%; border-collapse: collapse; text-align: center;"> <tr> <td style="width: 10%;"></td> <td style="width: 10%;"></td> <td style="width: 10%;"></td> <td style="width: 10%;"></td> <td style="width: 10%;"></td> <td style="width: 10%;"></td> <td style="width: 10%;"></td> <td style="width: 10%;"></td> <td style="width: 10%;"></td> <td style="width: 10%;"></td> </tr> <tr> <td></td> <td></td> <td colspan="8" style="text-align: center;"> <table border="1" style="width: 100%; border-collapse: collapse; text-align: center;"> <tr> <td style="width: 10%;"></td> <td style="width: 10%;"></td> <td style="width: 10%;"></td> <td style="width: 10%;"></td> <td style="width: 10%;"></td> <td style="width: 10%;"></td> <td style="width: 10%;"></td> <td style="width: 10%;"></td> <td style="width: 10%;"></td> <td style="width: 10%;"></td> </tr> <tr> <td></td> <td></td> <td colspan="8" style="text-align: center;"> <table border="1" style="width: 100%; border-collapse: collapse; text-align: center;"> <tr> <td style="width: 10%;"></td> <td style="width: 10%;"></td> <td style="width: 10%;"></td> <td style="width: 10%;"></td> <td style="width: 10%;"></td> <td style="width: 10%;"></td> <td style="width: 10%;"></td> <td style="width: 10%;"></td> <td style="width: 10%;"></td> <td style="width: 10%;"></td> </tr> <tr> <td></td> <td></td> <td colspan="8" style="text-align: center;"> <table border="1" style="width: 100%; border-collapse: collapse; text-align: center;"> <tr> <td style="width: 10%;"></td> <td style="width: 10%;"></td> <td style="width: 10%;"></td> <td style="width: 10%;"></td> <td style="width: 10%;"></td> <td style="width: 10%;"></td> <td style="width: 10%;"></td> <td style="width: 10%;"></td> <td style="width: 10%;"></td> <td style="width: 10%;"></td> </tr> <tr> <td></td> <td></td> <td colspan="8" style="text-align: center;"> <table border="1" style="width: 100%; border-collapse: collapse; text-align: center;"> <tr> <td style="width: 10%;"></td> <td style="width: 10%;"></td> <td style="width: 10%;"></td> <td style="width: 10%;"></td> <td style="width: 10%;"></td> <td style="width: 10%;"></td> <td
style="width: 10%;"></td> <td style="width: 10%;"></td> <td style="width: 10%;"></td> <td style="width: 10%;"></td> </tr> <tr> <td></td> <td></td> <td colspan="8" style="text-align: center;"> <table border="1" style="width: 100%; border-collapse: collapse; text-align: center;"> <tr> <td style="width: 10%;"></td> <td style="width: 10%;"></td> <td style="width: 10%;"></td> <td style="width: 10%;"></td> <td style="width: 10%;"></td> <td style="width: 10%;"></td> <td style="width: 10%;"></td> <td style="width: 10%;"></td> <td style="width: 10%;"></td> <td style="width: 10%;"></td> </tr> <tr> <td></td> <td></td> <td colspan="8" style="text-align: center;"> <table border="1" style="width: 100%; border-collapse: collapse; text-align: center;"> <tr> <td style="width: 10%;"></td> <td style="width: 10%;"></td> <td style="width: 10%;"></td> <td style="width: 10%;"></td> <td style="width: 10%;"></td> <td style="width: 10%;"></td> <td style="width: 10%;"></td> <td style="width: 10%;"></td> <td style="width: 10%;"></td> <td style="width: 10%;"></td> </tr> <tr> <td></td> <td></td> <td colspan="8" style="text-align: center;"> <table border="1" style="width: 100%; border-collapse: collapse; text-align: center;"> <tr> <td style="width: 10%;"></td> <td style="width: 10%;"></td> <td style="width: 10%;"></td> <td style="width: 10%;"></td> <td style="width: 10%;"></td> <td style="width: 10%;"></td> <td style="width: 10%;"></td> <td style="width: 10%;"></td> <td style="width: 10%;"></td> <td style="width: 10%;"></td> </tr> <tr> <td></td> <td></td> <td colspan="8" style="text-align: center;"> <table border="1" style="width: 100%; border-collapse: collapse; text-align: center;"> <tr> <td style="width: 10%;"></td> <td style="width: 10%;"></td> <td style="width: 10%;"></td> <td style="width: 10%;"></td> <td style="width: 10%;"></td> <td style="width: 10%;"></td> <td style="width: 10%;"></td> <td style="width: 10%;"></td> <td style="width: 10%;"></td> <td style="width: 10%;"></td> </tr> <tr> <td></td> <td></td> <td colspan="8" style="text-align: center;"> <table border="1" style="width: 100%; border-collapse: collapse; text-align: center;"> <tr> <td style="width: 10%;"></td> <td style="width: 10%;"></td> <td style="width: 10%;"></td> <td style="width: 10%;"></td> <td style="width: 10%;"></td> <td style="width: 10%;"></td> <td style="width: 10%;"></td> <td style="width: 10%;"></td> <td style="width: 10%;"></td> <td style="width: 10%;"></td> </tr> <tr> <td></td> <td></td> <td colspan="8" style="text-align: center;"> <table border="1" style="width: 100%; border-collapse: collapse; text-align: center;"> <tr> <td style="width: 10%;"></td> <td style="width: 10%;"></td> <td style="width: 10%;"></td> <td style="width: 10%;"></td> <td style="width: 10%;"></td> <td style="width: 10%;"></td> <td style="width: 10%;"></td> <td style="width: 10%;"></td> <td style="width: 10%;"></td> <td style="width: 10%;"></td> </tr> <tr> <td></td> <td></td> <td colspan="8" style="text-align: center;"> <table border="1" style="width: 100%; border-collapse: collapse; text-align: center;"> <tr> <td style="width: 10%;"></td> <td style="width: 10%;"></td> <td style="width: 10%;"></td> <td style="width: 10%;"></td> <td style="width: 10%;"></td> <td style="width: 10%;"></td> <td style="width: 10%;"></td> <td style="width: 10%;"></td> <td style="width: 10%;"></td> <td style="width: 10%;"></td> </tr> <tr> <td></td> <td></td> <td colspan="8" style="text-align: center;"> <table border="1" style="width: 100%; border-collapse: collapse; text-align: center;"> <tr> <td style="width: 10%;"></td> <td style="width: 10%;"></td> <td style="width: 10%;"></td> <td style="width: 10%;"></td> <td style="width: 10%;"></td> <td style="width: 10%;"></td> <td style="width: 10%;"></td> <td style="width: 10%;"></td> <td style="width: 10%;"></td> <td style="width: 10%;"></td> </tr> <tr> <td></td> <td></td> <td colspan="8" style="text-align: center;"> <table border="1" style="width: 100%; border-collapse: collapse; text-align: center;"> <tr> <td style="width: 10%;"></td> <td style="width: 10%;"></td> <td style="width: 10%;"></td> <td style="width: 10%;"></td> <td style="width: 10%;"></td> <td style="width: 10%;"></td> <td style="width: 10%;"></td> <td style="width: 10%;"></td> <td style="width: 10%;"></td> <td style="width: 10%;"></td> </tr> <tr> <td></td> <td></td> <td colspan="8" style="text-align: center;"> <table border="1" style="width: 100%; border-collapse: collapse; text-align: center;"> <tr> <td style="width: 10%;"></td> <td style="width: 10%;"></td> <td style="width: 10%;"></td> <td style="width: 10%;"></td> <td style="width: 10%;"></td> <td style="width: 10%;"></td> <td style="width: 10%;"></td> <td style="width: 10%;"></td> <td style="width: 10%;"></td> <td style="width: 10%;"></td> </tr> <tr> <td></td> <td></td> <td colspan="8" style="text-align: center;"> <table border="1" style="width: 100%; border-collapse: collapse; text-align: center;"> <tr> <td style="width: 10%;"></td> <td style="width: 10%;"></td> <td style="width: 10%;"></td> <td style="width: 10%;"></td> <td style="width: 10%;"></td> <td style="width: 10%;"></td> <td style="width: 10%;"></td> <td style="width: 10%;"></td> <td style="width: 10%;"></td> <td style="width: 10%;"></td> </tr> <tr> <td></td> <td></td> <td colspan="8" style="text-align: center;"> <table border="1" style="width: 100%; border-collapse: collapse; text-align: center;"> <tr> <td style="width: 10%;"></td> <td style="width: 10%;"></td> <td style="width: 10%;"></td> <td style="width: 10%;"></td> <td style="width: 10%;"></td> <td style="width: 10%;"></td> <td style="width: 10%;"></td> <td style="width: 10%;"></td> <td style="width: 10%;"></td> <td style="width: 10%;"></td> </tr> <tr> <td></td> <td></td> <td colspan="8" style="text-align: center;"> <table border="1" style="width: 100%; border-collapse: collapse; text-align: center;"> <tr> <td style="width: 10%;"></td> <td style="width: 10%;"></td> <td style="width: 10%;"></td> <td style="width: 10%;"></td> <td style="width: 10%;"></td> <td style="width: 10%;"></td> <td style="width: 10%;"></td> <td style="width: 10%;"></td> <td style="width: 10%;"></td> <td style="width: 10%;"></td> </tr> <tr> <td></td> <td></td> <td colspan="8" style="text-align: center;"> <table border="1" style="width: 100%; border-collapse: collapse; text-align: center;"> <tr> <td style="width: 10%;"></td> <td style="width: 10%;"></td> <td style="width: 10%;"></td> <td style="width: 10%;"></td> <td style="width: 10%;"></td> <td style="width: 10%;"></td> <td style="width: 10%;"></td> <td style="width: 10%;"></td> <td style="width: 10%;"></td> <td style="width: 10%;"></td> </tr> <tr> <td></td> <td></td> <td colspan="8" style="text-align: center;"> <table border="1" style="width: 100%; border-collapse: collapse; text-align: center;"> <tr> <td style="width: 10%;"></td> <td style="width: 10%;"></td> <td style="width: 10%;"></td> <td style="width: 10%;"></td> <td style="width: 10%;"></td> <td style="width: 10%;"></td> <td style="width: 10%;"></td> <td style="width: 10%;"></td> <td style="width: 10%;"></td> <td style="width: 10%;"></td> </tr> <tr> <td></td> <td></td> <td colspan="8" style="text-align: center;"> <table border="1" style="width: 100%; border-collapse: collapse; text-align: center;"> <tr> <td style="width: 10%;"></td> <td style="width: 10%;"></td> <td style="width: 10%;"></td> <td style="width: 10%;"></td> <td style="width: 10%;"></td> <td style="width: 10%;"></td> <td style="width: 10%;"></td> <td style="width: 10%;"></td> <td style="width: 10%;"></td> <td style="width: 10%;"></td> </tr> <tr> <td></td> <td></td> <td colspan="8" style="text-align: center;"> <table border="1" style="width: 100%; border-collapse: collapse; text-align: center;"> <tr> <td style="width: 10%;"></td> <td style="width: 10%;"></td> <td style="width: 10%;"></td> <td style="width: 10%;"></td> <td style="width: 10%;"></td> <td style="width: 10%;"></td> <td style="width: 10%;"></td> <td style="width: 10%;"></td> <td style="width: 10%;"></td> <td style="width: 10%;"></td> </tr> <tr> <td></td> <td></td> <td colspan="8" style="text-align: center;"> <table border="1" style="width: 100%; border-collapse: collapse; text-align: center;"> <tr> <td style="width: 10%;"></td> <td style="width: 10%;"></td> <td style="width: 10%;"></td> <td style="width: 10%;"></td> <td style="width: 10%;"></td> <td style="width: 10%;"></td> <td style="width: 10%;"></td> <td style="width: 10%;"></td> <td style="width: 10%;"></td> <td style="width: 10%;"></td> </tr> <tr> <td></td> <td></td> <td colspan="8" style="text-align: center;"> <table border="1" style="width: 100%; border-collapse: collapse; text-align: center;"> <tr> <td style="width: 10%;"></td> <td style="width: 10%;"></td> <td style="width: 10%;"></td> <td style="width: 10%;"></td> <td style="width: 10%;"></td> <td style="width: 10%;"></td> <td style="width: 10%;"></td> <td style="width: 10%;"></td> <td style="width: 10%;"></td> <td style="width: 10%;"></td> </tr> <tr> <td></td> <td></td> <td colspan="8" style="text-align: center;"> <table border="1" style="width: 100%; border-collapse: collapse; text-align: center;"> <tr> <td style="width: 10%;"></td> <td style="width: 10%;"></td> <td style="width: 10%;"></td> <td style="width: 10%;"></td> <td style="width: 10%;"></td> <td style="width: 10%;"></td> <td style="width: 10%;"></td> <td style="width: 10%;"></td> <td style="width: 10%;"></td> <td style="width: 10%;"></td> </tr> <tr> <td></td> <td></td> <td colspan="8" style="text-align: center;"> <table border="1" style="width: 100%; border-collapse: collapse; text-align: center;"> <tr> <td style="width: 10%;"></td> <td style="width: 10%;"></td> <td style="width: 10%;"></td> <td style="width: 10%;"></td> <td style="width: 10%;"></td> <td style="width: 10%;"></td> <td style="width: 10%;"></td> <td style="width: 10%;"></td> <td style="width: 10%;"></td> <td style="width: 10%;"></td> </tr> <tr> <td></td> <td></td> <td colspan="8"
style="text-align: center;"> <table border="1" style="width: 100%; border-collapse: collapse; text-align: center;"> <tr> <td style="width: 10%;"></td> <td style="width: 10%;"></td> <td style="width: 10%;"></td> <td style="width: 10%;"></td> <td style="width: 10%;"></td> <td style="width: 10%;"></td> <td style="width: 10%;"></td> <td style="width: 10%;"></td> <td style="width: 10%;"></td> <td style="width: 10%;"></td> </tr> <tr> <td></td> <td></td> <td colspan="8" style="text-align: center;"> <table border="1" style="width: 100%; border-collapse: collapse; text-align: center;"> <tr> <td style="width: 10%;"></td> <td style="width: 10%;"></td> <td style="width: 10%;"></td> <td style="width: 10%;"></td> <td style="width: 10%;"></td> <td style="width: 10%;"></td> <td style="width: 10%;"></td> <td style="width: 10%;"></td> <td style="width: 10%;"></td> <td style="width: 10%;"></td> </tr> <tr> <td></td> <td></td> <td colspan="8" style="text-align: center;"> <table border="1" style="width: 100%; border-collapse: collapse; text-align: center;"> <tr> <td style="width: 10%;"></td> <td style="width: 10%;"></td> <td style="width: 10%;"></td> <td style="width: 10%;"></td> <td style="width: 10%;"></td> <td style="width: 10%;"></td> <td style="width: 10%;"></td> <td style="width: 10%;"></td> <td style="width: 10%;"></td> <td style="width: 10%;"></td> </tr> <tr> <td></td> <td></td> <td colspan="8" style="text-align: center;"> <table border="1" style="width: 100%; border-collapse: collapse; text-align: center;"> <tr> <td style="width: 10%;"></td> <td style="width: 10%;"></td> <td style="width: 10%;"></td> <td style="width: 10%;"></td> <td style="width: 10%;"></td> <td style="width: 10%;"></td> <td style="width: 10%;"></td> <td style="width: 10%;"></td> <td style="width: 10%;"></td> <td style="width: 10%;"></td> </tr> <tr> <td></td> <td></td> <td colspan="8" style="text-align: center;"> <table border="1" style="width: 100%; border-collapse: collapse; text-align: center;"> <tr> <td style="width: 10%;"></td> <td style="width: 10%;"></td> <td style="width: 10%;"></td> <td style="width: 10%;"></td> <td style="width: 10%;"></td> <td style="width: 10%;"></td> <td style="width: 10%;"></td> <td style="width: 10%;"></td> <td style="width: 10%;"></td> <td style="width: 10%;"></td> </tr> <tr> <td></td> <td></td> <td colspan="8" style="text-align: center;"> <table border="1" style="width: 100%; border-collapse: collapse; text-align: center;"> <tr> <td style="width: 10%;"></td> <td style="width: 10%;"></td> <td style="width: 10%;"></td> <td style="width: 10%;"></td> <td style="width: 10%;"></td> <td style="width: 10%;"></td> <td style="width: 10%;"></td> <td style="width: 10%;"></td> <td style="width: 10%;"></td> <td style="width: 10%;"></td> </tr> <tr> <td></td> <td></td> <td colspan="8" style="text-align: center;"> <table border="1" style="width: 100%; border-collapse: collapse; text-align: center;"> <tr> <td style="width: 10%;"></td> <td style="width: 10%;"></td> <td style="width: 10%;"></td> <td style="width: 10%;"></td> <td style="width: 10%;"></td> <td style="width: 10%;"></td> <td style="width: 10%;"></td> <td style="width: 10%;"></td> <td style="width: 10%;"></td> <td style="width: 10%;"></td> </tr> <tr> <td></td> <td></td> <td colspan="8" style="text-align: center;"> <table border="1" style="width: 100%; border-collapse: collapse; text-align: center;"> <tr> <td style="width: 10%;"></td> <td style="width: 10%;"></td> <td style="width: 10%;"></td> <td style="width: 10%;"></td> <td style="width: 10%;"></td> <td style="width: 10%;"></td> <td style="width: 10%;"></td> <td style="width: 10%;"></td> <td style="width: 10%;"></td> <td style="width: 10%;"></td> </tr> <tr> <td></td> <td></td> <td colspan="8" style="text-align: center;"> <table border="1" style="width: 100%; border-collapse: collapse; text-align: center;"> <tr> <td style="width: 10%;"></td> <td style="width: 10%;"></td> <td style="width: 10%;"></td> <td style="width: 10%;"></td> <td style="width: 10%;"></td> <td style="width: 10%;"></td> <td style="width: 10%;"></td> <td style="width: 10%;"></td> <td style="width: 10%;"></td> <td style="width: 10%;"></td> </tr> <tr> <td></td> <td></td> <td colspan="8" style="text-align: center;"> <table border="1" style="width: 100%; border-collapse: collapse; text-align: center;"> <tr> <td style="width: 10%;"></td> <td style="width: 10%;"></td> <td style="width: 10%;"></td> <td style="width: 10%;"></td> <td style="width: 10%;"></td> <td style="width: 10%;"></td> <td style="width: 10%;"></td> <td style="width: 10%;"></td> <td style="width: 10%;"></td> <td style="width: 10%;"></td> </tr> <tr> <td></td> <td></td> <td colspan="8" style="text-align: center;"> <table border="1" style="width: 100%; border-collapse: collapse; text-align: center;"> <tr> <td style="width: 10%;"></td> <td style="width: 10%;"></td> <td style="width: 10%;"></td> <td style="width: 10%;"></td> <td style="width: 10%;"></td> <td style="width: 10%;"></td> <td style="width: 10%;"></td> <td style="width: 10%;"></td> <td style="width: 10%;"></td> <td style="width: 10%;"></td> </tr> <tr> <td></td> <td></td> <td colspan="8" style="text-align: center;"> <table border="1" style="width: 100%; border-collapse: collapse; text-align: center;"> <tr> <td style="width: 10%;"></td> <td style="width: 10%;"></td> <td style="width: 10%;"></td> <td style="width: 10%;"></td> <td style="width: 10%;"></td> <td style="width: 10%;"></td> <td style="width: 10%;"></td> <td style="width: 10%;"></td> <td style="width: 10%;"></td> <td style="width: 10%;"></td> </tr> <tr> <td></td> <td></td> <td colspan="8" style="text-align: center;"> <table border="1" style="width: 100%; border-collapse: collapse; text-align: center;"> <tr> <td style="width: 10%;"></td> <td style="width: 10%;"></td> <td style="width: 10%;"></td> <td style="width: 10%;"></td> <td style="width: 10%;"></td> <td style="width: 10%;"></td> <td style="width: 10%;"></td> <td style="width: 10%;"></td> <td style="width: 10%;"></td> <td style="width: 10%;"></td> </tr> <tr> <td></td> <td></td> <td colspan="8" style="text-align: center;"> <table border="1" style="width: 100%; border-collapse: collapse; text-align: center;"> <tr> <td style="width: 10%;"></td> <td style="width: 10%;"></td> <td style="width: 10%;"></td> <td style="width: 10%;"></td> <td style="width: 10%;"></td> <td style="width: 10%;"></td> <td style="width: 10%;"></td> <td style="width: 10%;"></td> <td style="width: 10%;"></td> <td style="width: 10%;"></td> </tr> <tr> <td></td> <td></td> <td colspan="8" style="text-align: center;"> <table border="1" style="width: 100%; border-collapse: collapse; text-align: center;"> <tr> <td style="width: 10%;"></td> <td style="width: 10%;"></td> <td style="width: 10%;"></td> <td style="width: 10%;"></td> <td style="width: 10%;"></td> <td style="width: 10%;"></td> <td style="width: 10%;"></td> <td style="width: 10%;"></td> <td style="width: 10%;"></td> <td style="width: 10%;"></td> </tr> <tr> <td></td> <td></td> <td colspan="8" style="text-align: center;"> <table border="1" style="width: 100%; border-collapse: collapse; text-align: center;"> <tr> <td style="width: 10%;"></td> <td style="width: 10%;"></td> <td style="width: 10%;"></td> <td style="width: 10%;"></td> <td style="width: 10%;"></td> <td style="width: 10%;"></td> <td style="width: 10%;"></td> <td style="width: 10%;"></td> <td style="width: 10%;"></td> <td style="width: 10%;"></td> </tr> <tr> <td></td> <td></td> <td colspan="8" style="text-align: center;"> <table border="1" style="width: 100%; border-collapse: collapse; text-align: center;"> <tr> <td style="width: 10%;"></td> <td style="width: 10%;"></td> <td style="width: 10%;"></td> <td style="width: 10%;"></td> <td style="width: 10%;"></td> <td style="width: 10%;"></td> <td style="width: 10%;"></td> <td style="width: 10%;"></td> <td style="width: 10%;"></td> <td style="width: 10%;"></td> </tr> <tr> <td></td> <td></td> <td colspan="8" style="text-align: center;"> <table border="1" style="width: 100%; border-collapse: collapse; text-align: center;"> <tr> </tr></table></td></tr></table></td></tr></table></td></tr></table></td></tr></table></td></tr></table></td></tr></table></td></tr></table></td></tr></table></td></tr></table></td></tr></table></td></tr></table></td></tr></table></td></tr></table></td></tr></table></td></tr></table></td></tr></table></td></tr></table></td></tr></table></td></tr></table></td></tr></table></td></tr></table></td></tr></table></td></tr></table></td></tr></table></td></tr></table></td></tr></table></td></tr></table></td></tr></table></td></tr></table></td></tr></table></td></tr></table></td></tr></table></td></tr></table></td></tr></table></td></tr></table></td></tr></table></td></tr></table></td></tr></table></td></tr></table></td></tr></table></td></tr></table></td></tr></table></td></tr></table></td></tr></table>
 | | | | | | | | | | | | | | | | | | | | <table border="1" style="width: 100%; border-collapse: collapse; text-align: center;"> <tr> <td style="width: 10%;"></td> <td style="width: 10%;"></td> <td style="width: 10%;"></td> <td style="width: 10%;"></td> <td style="width: 10%;"></td> <td style="width: 10%;"></td> <td style="width: 10%;"></td> <td style="width: 10%;"></td> <td style="width: 10%;"></td> <td style="width: 10%;"></td> </tr> <tr> <td></td> <td></td> <td colspan="8" style="text-align: center;"> <table border="1" style="width: 100%; border-collapse: collapse; text-align: center;"> <tr> <td style="width: 10%;"></td> <td style="width: 10%;"></td> <td style="width: 10%;"></td> <td style="width: 10%;"></td> <td style="width: 10%;"></td> <td style="width: 10%;"></td> <td style="width: 10%;"></td> <td style="width: 10%;"></td> <td style="width: 10%;"></td> <td style="width: 10%;"></td> </tr> <tr> <td></td> <td></td> <td colspan="8" style="text-align: center;"> <table border="1" style="width: 100%; border-collapse: collapse; text-align: center;"> <tr> <td style="width: 10%;"></td> <td style="width: 10%;"></td> <td style="width: 10%;"></td> <td style="width: 10%;"></td> <td style="width: 10%;"></td> <td style="width: 10%;"></td> <td style="width: 10%;"></td> <td style="width: 10%;"></td> <td style="width: 10%;"></td> <td style="width: 10%;"></td> </tr> <tr> <td></td> <td></td> <td colspan="8" style="text-align: center;"> <table border="1" style="width: 100%; border-collapse: collapse; text-align: center;"> <tr> <td style="width: 10%;"></td> <td style="width: 10%;"></td> <td style="width: 10%;"></td> <td style="width: 10%;"></td> <td style="width: 10%;"></td> <td style="width: 10%;"></td> <td style="width: 10%;"></td> <td style="width: 10%;"></td> <td style="width: 10%;"></td> <td style="width: 10%;"></td> </tr> <tr> <td></td> <td></td> <td colspan="8" style="text-align: center;"> <table border="1" style="width: 100%; border-collapse: collapse; text-align: center;"> <tr> <td style="width: 10%;"></td> <td style="width: 10%;"></td> <td style="width: 10%;"></td> <td style="width: 10%;"></td> <td style="width: 10%;"></td> <td style="width: 10%;"></td> <td style="width: 10%;"></td> <td style="width: 10%;"></td> <td style="width: 10%;"></td> <td style="width: 10%;"></td> </tr> <tr> <td></td> <td></td> <td colspan="8" style="text-align: center;"> <table border="1" style="width: 100%; border-collapse: collapse; text-align: center;"> <tr> <td style="width: 10%;"></td> <td style="width: 10%;"></td> <td style="width: 10%;"></td> <td style="width: 10%;"></td> <td style="width: 10%;"></td> <td style="width: 10%;"></td> <td style="width: 10%;"></td> <td style="width: 10%;"></td> <td style="width: 10%;"></td> <td style="width: 10%;"></td> </tr> <tr> <td></td> <td></td> <td colspan="8" style="text-align: center;"> <table border="1" style="width: 100%; border-collapse: collapse; text-align: center;"> <tr> <td style="width: 10%;"></td> <td style="width: 10%;"></td> <td style="width: 10%;"></td> <td style="width: 10%;"></td> <td style="width: 10%;"></td> <td style="width: 10%;"></td> <td style="width: 10%;"></td> <td style="width: 10%;"></td> <td style="width: 10%;"></td> <td style="width: 10%;"></td> </tr> <tr> <td></td> <td></td> <td colspan="8" style="text-align: center;"> <table border="1" style="width: 100%; border-collapse: collapse; text-align: center;"> <tr> <td style="width: 10%;"></td> <td style="width: 10%;"></td> <td style="width: 10%;"></td> <td style="width: 10%;"></td> <td style="width: 10%;"></td> <td style="width: 10%;"></td> <td style="width: 10%;"></td> <td style="width: 10%;"></td> <td style="width: 10%;"></td> <td style="width: 10%;"></td> </tr> <tr> <td></td> <td></td> <td colspan="8" style="text-align: center;"> <table border="1" style="width: 100%; border-collapse: collapse; text-align: center;"> <tr> <td style="width: 10%;"></td> <td style="width: 10%;"></td> <td style="width: 10%;"></td> <td style="width: 10%;"></td> <td style="width: 10%;"></td> <td style="width: 10%;"></td> <td style="width: 10%;"></td> <td style="width: 10%;"></td> <td style="width: 10%;"></td> <td style="width: 10%;"></td> </tr> <tr> <td></td> <td></td> <td colspan="8" style="text-align: center;"> <table border="1" style="width: 100%; border-collapse: collapse; text-align: center;"> <tr> <td style="width: 10%;"></td> <td style="width: 10%;"></td> <td style="width: 10%;"></td> <td style="width: 10%;"></td> <td style="width: 10%;"></td> <td style="width: 10%;"></td> <td style="width: 10%;"></td> <td style="width: 10%;"></td> <td style="width: 10%;"></td> <td style="width: 10%;"></td> </tr> <tr> <td></td> <td></td> <td colspan="8" style="text-align: center;"> <table border="1" style="width: 100%; border-collapse: collapse; text-align: center;"> <tr> <td style="width: 10%;"></td> <td style="width: 10%;"></td> <td style="width: 10%;"></td> <td style="width: 10%;"></td> <td style="width: 10%;"></td> <td style="width: 10%;"></td> <td style="width: 10%;"></td> <td style="width: 10%;"></td> <td style="width: 10%;"></td> <td style="width: 10%;"></td> </tr> <tr> <td></td> <td></td> <td colspan="8" style="text-align: center;"> <table border="1" style="width: 100%; border-collapse: collapse; text-align: center;"> <tr> <td style="width: 10%;"></td> <td style="width: 10%;"></td> <td style="width: 10%;"></td> <td style="width: 10%;"></td> <td style="width: 10%;"></td> <td style="width: 10%;"></td> <td style="width: 10%;"></td> <td style="width: 10%;"></td> <td style="width: 10%;"></td> <td style="width: 10%;"></td> </tr> <tr> <td></td> <td></td> <td colspan="8" style="text-align: center;"> <table border="1" style="width: 100%; border-collapse: collapse; text-align: center;"> <tr> <td style="width: 10%;"></td> <td style="width: 10%;"></td> <td style="width: 10%;"></td> <td style="width: 10%;"></td> <td style="width: 10%;"></td> <td style="width: 10%;"></td> <td style="width: 10%;"></td> <td style="width: 10%;"></td> <td style="width: 10%;"></td> <td style="width: 10%;"></td> </tr> <tr> <td></td> <td></td> <td colspan="8" style="text-align: center;"> <table border="1" style="width: 100%; border-collapse: collapse; text-align: center;"> <tr> <td style="width: 10%;"></td> <td style="width: 10%;"></td> <td style="width: 10%;"></td> <td style="width: 10%;"></td> <td style="width: 10%;"></td> <td style="width: 10%;"></td> <td style="width: 10%;"></td> <td style="width: 10%;"></td> <td style="width: 10%;"></td> <td style="width: 10%;"></td> </tr> <tr> <td></td> <td></td> <td colspan="8" style="text-align: center;"> <table border="1" style="width: 100%; border-collapse: collapse; text-align: center;"> <tr> <td style="width: 10%;"></td> <td
style="width: 10%;"></td> <td style="width: 10%;"></td> <td style="width: 10%;"></td> <td style="width: 10%;"></td> <td style="width: 10%;"></td> <td style="width: 10%;"></td> <td style="width: 10%;"></td> <td style="width: 10%;"></td> <td style="width: 10%;"></td> </tr> <tr> <td></td> <td></td> <td colspan="8" style="text-align: center;"> <table border="1" style="width: 100%; border-collapse: collapse; text-align: center;"> <tr> <td style="width: 10%;"></td> <td style="width: 10%;"></td> <td style="width: 10%;"></td> <td style="width: 10%;"></td> <td style="width: 10%;"></td> <td style="width: 10%;"></td> <td style="width: 10%;"></td> <td style="width: 10%;"></td> <td style="width: 10%;"></td> <td style="width: 10%;"></td> </tr> <tr> <td></td> <td></td> <td colspan="8" style="text-align: center;"> <table border="1" style="width: 100%; border-collapse: collapse; text-align: center;"> <tr> <td style="width: 10%;"></td> <td style="width: 10%;"></td> <td style="width: 10%;"></td> <td style="width: 10%;"></td> <td style="width: 10%;"></td> <td style="width: 10%;"></td> <td style="width: 10%;"></td> <td style="width: 10%;"></td> <td style="width: 10%;"></td> <td style="width: 10%;"></td> </tr> <tr> <td></td> <td></td> <td colspan="8" style="text-align: center;"> <table border="1" style="width: 100%; border-collapse: collapse; text-align: center;"> <tr> <td style="width: 10%;"></td> <td style="width: 10%;"></td> <td style="width: 10%;"></td> <td style="width: 10%;"></td> <td style="width: 10%;"></td> <td style="width: 10%;"></td> <td style="width: 10%;"></td> <td style="width: 10%;"></td> <td style="width: 10%;"></td> <td style="width: 10%;"></td> </tr> <tr> <td></td> <td></td> <td colspan="8" style="text-align: center;"> <table border="1" style="width: 100%; border-collapse: collapse; text-align: center;"> <tr> <td style="width: 10%;"></td> <td style="width: 10%;"></td> <td style="width: 10%;"></td> <td style="width: 10%;"></td> <td style="width: 10%;"></td> <td style="width: 10%;"></td> <td style="width: 10%;"></td> <td style="width: 10%;"></td> <td style="width: 10%;"></td> <td style="width: 10%;"></td> </tr> <tr> <td></td> <td></td> <td colspan="8" style="text-align: center;"> <table border="1" style="width: 100%; border-collapse: collapse; text-align: center;"> <tr> <td style="width: 10%;"></td> <td style="width: 10%;"></td> <td style="width: 10%;"></td> <td style="width: 10%;"></td> <td style="width: 10%;"></td> <td style="width: 10%;"></td> <td style="width: 10%;"></td> <td style="width: 10%;"></td> <td style="width: 10%;"></td> <td style="width: 10%;"></td> </tr> <tr> <td></td> <td></td> <td colspan="8" style="text-align: center;"> <table border="1" style="width: 100%; border-collapse: collapse; text-align: center;"> <tr> <td style="width: 10%;"></td> <td style="width: 10%;"></td> <td style="width: 10%;"></td> <td style="width: 10%;"></td> <td style="width: 10%;"></td> <td style="width: 10%;"></td> <td style="width: 10%;"></td> <td style="width: 10%;"></td> <td style="width: 10%;"></td> <td style="width: 10%;"></td> </tr> <tr> <td></td> <td></td> <td colspan="8" style="text-align: center;"> <table border="1" style="width: 100%; border-collapse: collapse; text-align: center;"> <tr> <td style="width: 10%;"></td> <td style="width: 10%;"></td> <td style="width: 10%;"></td> <td style="width: 10%;"></td> <td style="width: 10%;"></td> <td style="width: 10%;"></td> <td style="width: 10%;"></td> <td style="width: 10%;"></td> <td style="width: 10%;"></td> <td style="width: 10%;"></td> </tr> <tr> <td></td> <td></td> <td colspan="8" style="text-align: center;"> <table border="1" style="width: 100%; border-collapse: collapse; text-align: center;"> <tr> <td style="width: 10%;"></td> <td style="width: 10%;"></td> <td style="width: 10%;"></td> <td style="width: 10%;"></td> <td style="width: 10%;"></td> <td style="width: 10%;"></td> <td style="width: 10%;"></td> <td style="width: 10%;"></td> <td style="width: 10%;"></td> <td style="width: 10%;"></td> </tr> <tr> <td></td> <td></td> <td colspan="8" style="text-align: center;"> <table border="1" style="width: 100%; border-collapse: collapse; text-align: center;"> <tr> <td style="width: 10%;"></td> <td style="width: 10%;"></td> <td style="width: 10%;"></td> <td style="width: 10%;"></td> <td style="width: 10%;"></td> <td style="width: 10%;"></td> <td style="width: 10%;"></td> <td style="width: 10%;"></td> <td style="width: 10%;"></td> <td style="width: 10%;"></td> </tr> <tr> <td></td> <td></td> <td colspan="8" style="text-align: center;"> <table border="1" style="width: 100%; border-collapse: collapse; text-align: center;"> <tr> <td style="width: 10%;"></td> <td style="width: 10%;"></td> <td style="width: 10%;"></td> <td style="width: 10%;"></td> <td style="width: 10%;"></td> <td style="width: 10%;"></td> <td style="width: 10%;"></td> <td style="width: 10%;"></td> <td style="width: 10%;"></td> <td style="width: 10%;"></td> </tr> <tr> <td></td> <td></td> <td colspan="8" style="text-align: center;"> <table border="1" style="width: 100%; border-collapse: collapse; text-align: center;"> <tr> <td style="width: 10%;"></td> <td style="width: 10%;"></td> <td style="width: 10%;"></td> <td style="width: 10%;"></td> <td style="width: 10%;"></td> <td style="width: 10%;"></td> <td style="width: 10%;"></td> <td style="width: 10%;"></td> <td style="width: 10%;"></td> <td style="width: 10%;"></td> </tr> <tr> <td></td> <td></td> <td colspan="8" style="text-align: center;"> <table border="1" style="width: 100%; border-collapse: collapse; text-align: center;"> <tr> <td style="width: 10%;"></td> <td style="width: 10%;"></td> <td style="width: 10%;"></td> <td style="width: 10%;"></td> <td style="width: 10%;"></td> <td style="width: 10%;"></td> <td style="width: 10%;"></td> <td style="width: 10%;"></td> <td style="width: 10%;"></td> <td style="width: 10%;"></td> </tr> <tr> <td></td> <td></td> <td colspan="8" style="text-align: center;"> <table border="1" style="width: 100%; border-collapse: collapse; text-align: center;"> <tr> <td style="width: 10%;"></td> <td style="width: 10%;"></td> <td style="width: 10%;"></td> <td style="width: 10%;"></td> <td style="width: 10%;"></td> <td style="width: 10%;"></td> <td style="width: 10%;"></td> <td style="width: 10%;"></td> <td style="width: 10%;"></td> <td style="width: 10%;"></td> </tr> <tr> <td></td> <td></td> <td colspan="8" style="text-align: center;"> <table border="1" style="width: 100%; border-collapse: collapse; text-align: center;"> <tr> <td style="width: 10%;"></td> <td style="width: 10%;"></td> <td style="width: 10%;"></td> <td style="width: 10%;"></td> <td style="width: 10%;"></td> <td style="width: 10%;"></td> <td style="width: 10%;"></td> <td style="width: 10%;"></td> <td style="width: 10%;"></td> <td style="width: 10%;"></td> </tr> <tr> <td></td> <td></td> <td colspan="8" style="text-align: center;"> <table border="1" style="width: 100%; border-collapse: collapse; text-align: center;"> <tr> <td style="width: 10%;"></td> <td style="width: 10%;"></td> <td style="width: 10%;"></td> <td style="width: 10%;"></td> <td style="width: 10%;"></td> <td style="width: 10%;"></td> <td style="width: 10%;"></td> <td style="width: 10%;"></td> <td style="width: 10%;"></td> <td style="width: 10%;"></td> </tr> <tr> <td></td> <td></td> <td colspan="8" style="text-align: center;"> <table border="1" style="width: 100%; border-collapse: collapse; text-align: center;"> <tr> <td style="width: 10%;"></td> <td style="width: 10%;"></td> <td style="width: 10%;"></td> <td style="width: 10%;"></td> <td style="width: 10%;"></td> <td style="width: 10%;"></td> <td style="width: 10%;"></td> <td style="width: 10%;"></td> <td style="width: 10%;"></td> <td style="width: 10%;"></td> </tr> <tr> <td></td> <td></td> <td colspan="8" style="text-align: center;"> <table border="1" style="width: 100%; border-collapse: collapse; text-align: center;"> <tr> <td style="width: 10%;"></td> <td style="width: 10%;"></td> <td style="width: 10%;"></td> <td style="width: 10%;"></td> <td style="width: 10%;"></td> <td style="width: 10%;"></td> <td style="width: 10%;"></td> <td style="width: 10%;"></td> <td style="width: 10%;"></td> <td style="width: 10%;"></td> </tr> <tr> <td></td> <td></td> <td colspan="8" style="text-align: center;"> <table border="1" style="width: 100%; border-collapse: collapse; text-align: center;"> <tr> <td style="width: 10%;"></td> <td style="width: 10%;"></td> <td style="width: 10%;"></td> <td style="width: 10%;"></td> <td style="width: 10%;"></td> <td style="width: 10%;"></td> <td style="width: 10%;"></td> <td style="width: 10%;"></td> <td style="width: 10%;"></td> <td style="width: 10%;"></td> </tr> <tr> <td></td> <td></td> <td colspan="8" style="text-align: center;"> <table border="1" style="width: 100%; border-collapse: collapse; text-align: center;"> <tr> <td style="width: 10%;"></td> <td style="width: 10%;"></td> <td style="width: 10%;"></td> <td style="width: 10%;"></td> <td style="width: 10%;"></td> <td style="width: 10%;"></td> <td style="width: 10%;"></td> <td style="width: 10%;"></td> <td style="width: 10%;"></td> <td style="width: 10%;"></td> </tr> <tr> <td></td> <td></td> <td colspan="8" style="text-align: center;"> <table border="1" style="width: 100%; border-collapse: collapse; text-align: center;"> <tr> <td style="width: 10%;"></td> <td style="width: 10%;"></td> <td style="width: 10%;"></td> <td style="width: 10%;"></td> <td style="width: 10%;"></td> <td style="width: 10%;"></td> <td style="width: 10%;"></td> <td style="width: 10%;"></td> <td style="width: 10%;"></td> <td style="width: 10%;"></td> </tr> <tr> <td></td> <td></td> <td colspan="8" style="text-align: center;"> <table border="1" style="width: 100%; border-collapse: collapse; text-align: center;"> <tr> <td style="width: 10%;"></td> <td style="width: 10%;"></td> <td style="width: 10%;"></td> <td style="width: 10%;"></td> <td style="width: 10%;"></td> <td style="width: 10%;"></td> <td style="width:
10%;"></td> <td style="width: 10%;"></td> <td style="width: 10%;"></td> <td style="width: 10%;"></td> </tr> <tr> <td></td> <td></td> <td colspan="8" style="text-align: center;"> <table border="1" style="width: 100%; border-collapse: collapse; text-align: center;"> <tr> <td style="width: 10%;"></td> <td style="width: 10%;"></td> <td style="width: 10%;"></td> <td style="width: 10%;"></td> <td style="width: 10%;"></td> <td style="width: 10%;"></td> <td style="width: 10%;"></td> <td style="width: 10%;"></td> <td style="width: 10%;"></td> <td style="width: 10%;"></td> </tr> <tr> <td></td> <td></td> <td colspan="8" style="text-align: center;"> <table border="1" style="width: 100%; border-collapse: collapse; text-align: center;"> <tr> <td style="width: 10%;"></td> <td style="width: 10%;"></td> <td style="width: 10%;"></td> <td style="width: 10%;"></td> <td style="width: 10%;"></td> <td style="width: 10%;"></td> <td style="width: 10%;"></td> <td style="width: 10%;"></td> <td style="width: 10%;"></td> <td style="width: 10%;"></td> </tr> <tr> <td></td> <td></td> <td colspan="8" style="text-align: center;"> <table border="1" style="width: 100%; border-collapse: collapse; text-align: center;"> <tr> <td style="width: 10%;"></td> <td style="width: 10%;"></td> <td style="width: 10%;"></td> <td style="width: 10%;"></td> <td style="width: 10%;"></td> <td style="width: 10%;"></td> <td style="width: 10%;"></td> <td style="width: 10%;"></td> <td style="width: 10%;"></td> <td style="width: 10%;"></td> </tr> <tr> <td></td> <td></td> <td colspan="8" style="text-align: center;"> <table border="1" style="width: 100%; border-collapse: collapse; text-align: center;"> <tr> <td style="width: 10%;"></td> <td style="width: 10%;"></td> <td style="width: 10%;"></td> <td style="width: 10%;"></td> <td style="width: 10%;"></td> <td style="width: 10%;"></td> <td style="width: 10%;"></td> <td style="width: 10%;"></td> <td style="width: 10%;"></td> <td style="width: 10%;"></td> </tr> <tr> <td></td> <td></td> <td colspan="8" style="text-align: center;"> <table border="1" style="width: 100%; border-collapse: collapse; text-align: center;"> <tr> <td style="width: 10%;"></td> <td style="width: 10%;"></td> <td style="width: 10%;"></td> <td style="width: 10%;"></td> <td style="width: 10%;"></td> <td style="width: 10%;"></td> <td style="width: 10%;"></td> <td style="width: 10%;"></td> <td style="width: 10%;"></td> <td style="width: 10%;"></td> </tr> <tr> <td></td> <td></td> <td colspan="8" style="text-align: center;"> <table border="1" style="width: 100%; border-collapse: collapse; text-align: center;"> <tr> <td style="width: 10%;"></td> <td style="width: 10%;"></td> <td style="width: 10%;"></td> <td style="width: 10%;"></td> <td style="width: 10%;"></td> <td style="width: 10%;"></td> <td style="width: 10%;"></td> <td style="width: 10%;"></td> <td style="width: 10%;"></td> <td style="width: 10%;"></td> </tr> <tr> <td></td> <td></td> <td colspan="8" style="text-align: center;"> <table border="1" style="width: 100%; border-collapse: collapse; text-align: center;"> <tr> <td style="width: 10%;"></td> <td style="width: 10%;"></td> <td style="width: 10%;"></td> <td style="width: 10%;"></td> <td style="width: 10%;"></td> <td style="width: 10%;"></td> <td style="width: 10%;"></td> <td style="width: 10%;"></td> <td style="width: 10%;"></td> <td style="width: 10%;"></td> </tr> <tr> <td></td> <td></td> <td colspan="8" style="text-align: center;"> <table border="1" style="width: 100%; border-collapse: collapse; text-align: center;"> <tr> </tr></table></td></tr></table></td></tr></table></td></tr></table></td></tr></table></td></tr></table></td></tr></table></td></tr></table></td></tr></table></td></tr></table></td></tr></table></td></tr></table></td></tr></table></td></tr></table></td></tr></table></td></tr></table></td></tr></table></td></tr></table></td></tr></table></td></tr></table></td></tr></table></td></tr></table></td></tr></table></td></tr></table></td></tr></table></td></tr></table></td></tr></table></td></tr></table></td></tr></table></td></tr></table></td></tr></table></td></tr></table></td></tr></table></td></tr></table></td></tr></table></td></tr></table></td></tr></table></td></tr></table></td></tr></table></td></tr></table></td></tr></table></td></tr></table></td></tr></table></td></tr></table> | | | | | | | | | | | | | | | | | | | | <table border="1" style="width: 100%; border-collapse: collapse; text-align: center;"> <tr> <td style="width: 10%;"></td> <td style="width: 10%;"></td> <td style="width: 10%;"></td> <td style="width: 10%;"></td> <td style="width: 10%;"></td> <td style="width: 10%;"></td> <td style="width: 10%;"></td> <td style="width: 10%;"></td> <td style="width: 10%;"></td> <td style="width: 10%;"></td> </tr> <tr> <td></td> <td></td> <td colspan="8" style="text-align: center;"> <table border="1" style="width: 100%; border-collapse: collapse; text-align: center;"> <tr> <td style="width: 10%;"></td> <td style="width: 10%;"></td> <td style="width: 10%;"></td> <td style="width: 10%;"></td> <td style="width: 10%;"></td> <td style="width: 10%;"></td> <td style="width: 10%;"></td> <td style="width: 10%;"></td> <td style="width: 10%;"></td> <td style="width: 10%;"></td> </tr> <tr> <td></td> <td></td> <td colspan="8" style="text-align: center;"> <table border="1" style="width: 100%; border-collapse: collapse; text-align: center;"> <tr> <td style="width: 10%;"></td> <td style="width: 10%;"></td> <td style="width: 10%;"></td> <td style="width: 10%;"></td> <td style="width: 10%;"></td> <td style="width: 10%;"></td> <td style="width:
10%;"></td> <td style="width: 10%;"></td> <td style="width: 10%;"></td> <td style="width: 10%;"></td> </tr> <tr> <td></td> <td></td> <td colspan="8" style="text-align: center;"> <table border="1" style="width: 100%; border-collapse: collapse; text-align: center;"> <tr> <td style="width: 10%;"></td> <td style="width: 10%;"></td> <td style="width: 10%;"></td> <td style="width: 10%;"></td> <td style="width: 10%;"></td> <td style="width: 10%;"></td> <td style="width: 10%;"></td> <td style="width: 10%;"></td> <td style="width: 10%;"></td> <td style="width: 10%;"></td> </tr> <tr> <td></td> <td></td> <td colspan="8" style="text-align: center;"> <table border="1" style="width: 100%; border-collapse: collapse; text-align: center;"> <tr> <td style="width: 10%;"></td> <td style="width: 10%;"></td> <td style="width: 10%;"></td> <td style="width: 10%;"></td> <td style="width: 10%;"></td> <td style="width: 10%;"></td> <td style="width: 10%;"></td> <td style="width: 10%;"></td> <td style="width: 10%;"></td> <td style="width: 10%;"></td> </tr> <tr> <td></td> <td></td> <td colspan="8" style="text-align: center;"> <table border="1" style="width: 100%; border-collapse: collapse; text-align: center;"> <tr> <td style="width: 10%;"></td> <td style="width: 10%;"></td> <td style="width: 10%;"></td> <td style="width: 10%;"></td> <td style="width: 10%;"></td> <td style="width: 10%;"></td> <td style="width: 10%;"></td> <td style="width: 10%;"></td> <td style="width: 10%;"></td> <td style="width: 10%;"></td> </tr> <tr> <td></td> <td></td> <td colspan="8" style="text-align: center;"> <table border="1" style="width: 100%; border-collapse: collapse; text-align: center;"> <tr> <td style="width: 10%;"></td> <td style="width: 10%;"></td> <td style="width: 10%;"></td> <td style="width: 10%;"></td> <td style="width: 10%;"></td> <td style="width: 10%;"></td> <td style="width: 10%;"></td> <td style="width: 10%;"></td> <td style="width: 10%;"></td> <td style="width: 10%;"></td> </tr> <tr> <td></td> <td></td> <td colspan="8" style="text-align: center;"> <table border="1" style="width: 100%; border-collapse: collapse; text-align: center;"> <tr> <td style="width: 10%;"></td> <td style="width: 10%;"></td> <td style="width: 10%;"></td> <td style="width: 10%;"></td> <td style="width: 10%;"></td> <td style="width: 10%;"></td> <td style="width: 10%;"></td> <td style="width: 10%;"></td> <td style="width: 10%;"></td> <td style="width: 10%;"></td> </tr> <tr> <td></td> <td></td> <td colspan="8" style="text-align: center;"> <table border="1" style="width: 100%; border-collapse: collapse; text-align: center;"> <tr> <td style="width: 10%;"></td> <td style="width: 10%;"></td> <td style="width: 10%;"></td> <td style="width: 10%;"></td> <td style="width: 10%;"></td> <td style="width: 10%;"></td> <td style="width: 10%;"></td> <td style="width: 10%;"></td> <td style="width: 10%;"></td> <td style="width: 10%;"></td> </tr> <tr> <td></td> <td></td> <td colspan="8" style="text-align: center;"> <table border="1" style="width: 100%; border-collapse: collapse; text-align: center;"> <tr> <td style="width: 10%;"></td> <td style="width: 10%;"></td> <td style="width: 10%;"></td> <td style="width: 10%;"></td> <td style="width: 10%;"></td> <td style="width: 10%;"></td> <td style="width: 10%;"></td> <td style="width: 10%;"></td> <td style="width: 10%;"></td> <td style="width: 10%;"></td> </tr> <tr> <td></td> <td></td> <td colspan="8" style="text-align: center;"> <table border="1" style="width: 100%; border-collapse: collapse; text-align: center;"> <tr> <td style="width: 10%;"></td> <td style="width: 10%;"></td> <td style="width: 10%;"></td> <td style="width: 10%;"></td> <td style="width: 10%;"></td> <td style="width: 10%;"></td> <td style="width: 10%;"></td> <td style="width: 10%;"></td> <td style="width: 10%;"></td> <td style="width: 10%;"></td> </tr> <tr> <td></td> <td></td> <td colspan="8" style="text-align: center;"> <table border="1" style="width: 100%; border-collapse: collapse; text-align: center;"> <tr> <td style="width: 10%;"></td> <td style="width: 10%;"></td> <td style="width: 10%;"></td> <td style="width: 10%;"></td> <td style="width: 10%;"></td> <td style="width: 10%;"></td> <td style="width: 10%;"></td> <td style="width: 10%;"></td> <td style="width: 10%;"></td> <td style="width: 10%;"></td> </tr> <tr> <td></td> <td></td> <td colspan="8" style="text-align: center;"> <table border="1" style="width: 100%; border-collapse: collapse; text-align: center;"> <tr> <td style="width: 10%;"></td> <td style="width: 10%;"></td> <td style="width: 10%;"></td> <td style="width: 10%;"></td> <td style="width: 10%;"></td> <td style="width: 10%;"></td> <td style="width: 10%;"></td> <td style="width: 10%;"></td> <td style="width: 10%;"></td> <td style="width: 10%;"></td> </tr> <tr> <td></td> <td></td> <td colspan="8" style="text-align: center;"> <table border="1" style="width: 100%; border-collapse: collapse; text-align: center;"> <tr> <td style="width: 10%;"></td> <td style="width: 10%;"></td> <td style="width: 10%;"></td> <td style="width: 10%;"></td> <td style="width: 10%;"></td> <td style="width: 10%;"></td> <td style="width: 10%;"></td> <td style="width: 10%;"></td> <td style="width: 10%;"></td> <td style="width: 10%;"></td> </tr> <tr> <td></td> <td></td> <td colspan="8" style="text-align: center;"> <table border="1" style="width: 100%; border-collapse: collapse; text-align: center;"> <tr> <td style="width: 10%;"></td> <td style="width: 10%;"></td> <td style="width: 10%;"></td> <td style="width: 10%;"></td> <td style="width: 10%;"></td> <td style="width: 10%;"></td> <td style="width: 10%;"></td> <td style="width: 10%;"></td> <td style="width: 10%;"></td> <td style="width: 10%;"></td> </tr> <tr> <td></td> <td></td> <td colspan="8" style="text-align: center;"> <table border="1" style="width: 100%; border-collapse: collapse; text-align: center;"> <tr> <td style="width: 10%;"></td> <td style="width: 10%;"></td> <td style="width: 10%;"></td> <td style="width: 10%;"></td> <td style="width: 10%;"></td> <td style="width: 10%;"></td> <td style="width: 10%;"></td> <td style="width: 10%;"></td> <td style="width: 10%;"></td> <td style="width: 10%;"></td> </tr> <tr> <td></td> <td></td> <td colspan="8" style="text-align: center;"> <table border="1" style="width: 100%; border-collapse: collapse; text-align: center;"> <tr> <td style="width: 10%;"></td> <td style="width: 10%;"></td> <td style="width: 10%;"></td> <td style="width: 10%;"></td> <td style="width: 10%;"></td> <td style="width: 10%;"></td> <td style="width: 10%;"></td> <td style="width: 10%;"></td> <td style="width: 10%;"></td> <td style="width: 10%;"></td> </tr> <tr> <td></td> <td></td> <td colspan="8" style="text-align: center;"> <table border="1" style="width: 100%; border-collapse: collapse; text-align: center;"> <tr> <td style="width: 10%;"></td> <td style="width: 10%;"></td> <td style="width: 10%;"></td> <td style="width: 10%;"></td> <td style="width: 10%;"></td> <td style="width: 10%;"></td> <td style="width: 10%;"></td> <td style="width: 10%;"></td> <td style="width: 10%;"></td> <td style="width: 10%;"></td> </tr> <tr> <td></td> <td></td> <td colspan="8" style="text-align: center;"> <table border="1" style="width: 100%; border-collapse: collapse; text-align: center;"> <tr> <td style="width: 10%;"></td> <td style="width: 10%;"></td> <td style="width: 10%;"></td> <td style="width: 10%;"></td> <td style="width: 10%;"></td> <td style="width: 10%;"></td> <td style="width: 10%;"></td> <td style="width: 10%;"></td> <td style="width: 10%;"></td> <td style="width: 10%;"></td> </tr> <tr> <td></td> <td></td> <td colspan="8" style="text-align: center;"> <table border="1" style="width: 100%; border-collapse: collapse; text-align: center;"> <tr> <td style="width: 10%;"></td> <td style="width: 10%;"></td> <td style="width: 10%;"></td> <td style="width: 10%;"></td> <td style="width: 10%;"></td> <td style="width: 10%;"></td> <td style="width: 10%;"></td> <td style="width: 10%;"></td> <td style="width: 10%;"></td> <td style="width: 10%;"></td> </tr> <tr> <td></td> <td></td> <td colspan="8" style="text-align: center;"> <table border="1" style="width: 100%; border-collapse: collapse; text-align: center;"> <tr> <td style="width: 10%;"></td> <td style="width: 10%;"></td> <td style="width: 10%;"></td> <td style="width: 10%;"></td> <td style="width: 10%;"></td> <td style="width: 10%;"></td> <td style="width: 10%;"></td> <td style="width: 10%;"></td> <td style="width: 10%;"></td> <td style="width: 10%;"></td> </tr> <tr> <td></td> <td></td> <td colspan="8" style="text-align: center;"> <table border="1" style="width: 100%; border-collapse: collapse; text-align: center;"> <tr> <td style="width: 10%;"></td> <td style="width: 10%;"></td> <td style="width: 10%;"></td> <td style="width: 10%;"></td> <td style="width: 10%;"></td> <td style="width: 10%;"></td> <td style="width: 10%;"></td> <td style="width: 10%;"></td> <td style="width: 10%;"></td> <td style="width: 10%;"></td> </tr> <tr> <td></td> <td></td> <td colspan="8" style="text-align: center;"> <table border="1" style="width: 100%; border-collapse: collapse; text-align: center;"> <tr> <td style="width: 10%;"></td> <td style="width: 10%;"></td> <td style="width: 10%;"></td> <td style="width: 10%;"></td> <td style="width: 10%;"></td> <td style="width: 10%;"></td> <td style="width: 10%;"></td> <td style="width: 10%;"></td> <td style="width: 10%;"></td> <td style="width: 10%;"></td> </tr> <tr> <td></td> <td></td> <td colspan="8" style="text-align: center;"> <table border="1" style="width: 100%; border-collapse: collapse; text-align: center;"> <tr> <td style="width: 10%;"></td> <td style="width: 10%;"></td> <td style="width: 10%;"></td> <td style="width: 10%;"></td> <td style="width: 10%;"></td> <td style="width: 10%;"></td> <td style="width: 10%;"></td> <td style="width: 10%;"></td> <td style="width: 10%;"></td> <td style="width: 10%;"></td> </tr> <tr> <td></td> <td></td> <td colspan="8" style="text-align:
center;"> <table border="1" style="width: 100%; border-collapse: collapse; text-align: center;"> <tr> <td style="width: 10%;"></td> <td style="width: 10%;"></td> <td style="width: 10%;"></td> <td style="width: 10%;"></td> <td style="width: 10%;"></td> <td style="width: 10%;"></td> <td style="width: 10%;"></td> <td style="width: 10%;"></td> <td style="width: 10%;"></td> <td style="width: 10%;"></td> </tr> <tr> <td></td> <td></td> <td colspan="8" style="text-align: center;"> <table border="1" style="width: 100%; border-collapse: collapse; text-align: center;"> <tr> <td style="width: 10%;"></td> <td style="width: 10%;"></td> <td style="width: 10%;"></td> <td style="width: 10%;"></td> <td style="width: 10%;"></td> <td style="width: 10%;"></td> <td style="width: 10%;"></td> <td style="width: 10%;"></td> <td style="width: 10%;"></td> <td style="width: 10%;"></td> </tr> <tr> <td></td> <td></td> <td colspan="8" style="text-align: center;"> <table border="1" style="width: 100%; border-collapse: collapse; text-align: center;"> <tr> <td style="width: 10%;"></td> <td style="width: 10%;"></td> <td style="width: 10%;"></td> <td style="width: 10%;"></td> <td style="width: 10%;"></td> <td style="width: 10%;"></td> <td style="width: 10%;"></td> <td style="width: 10%;"></td> <td style="width: 10%;"></td> <td style="width: 10%;"></td> </tr> <tr> <td></td> <td></td> <td colspan="8" style="text-align: center;"> <table border="1" style="width: 100%; border-collapse: collapse; text-align: center;"> <tr> <td style="width: 10%;"></td> <td style="width: 10%;"></td> <td style="width: 10%;"></td> <td style="width: 10%;"></td> <td style="width: 10%;"></td> <td style="width: 10%;"></td> <td style="width: 10%;"></td> <td style="width: 10%;"></td> <td style="width: 10%;"></td> <td style="width: 10%;"></td> </tr> <tr> <td></td> <td></td> <td colspan="8" style="text-align: center;"> <table border="1" style="width: 100%; border-collapse: collapse; text-align: center;"> <tr> <td style="width: 10%;"></td> <td style="width: 10%;"></td> <td style="width: 10%;"></td> <td style="width: 10%;"></td> <td style="width: 10%;"></td> <td style="width: 10%;"></td> <td style="width: 10%;"></td> <td style="width: 10%;"></td> <td style="width: 10%;"></td> <td style="width: 10%;"></td> </tr> <tr> <td></td> <td></td> <td colspan="8" style="text-align: center;"> <table border="1" style="width: 100%; border-collapse: collapse; text-align: center;"> <tr> <td style="width: 10%;"></td> <td style="width: 10%;"></td> <td style="width: 10%;"></td> <td style="width: 10%;"></td> <td style="width: 10%;"></td> <td style="width: 10%;"></td> <td style="width: 10%;"></td> <td style="width: 10%;"></td> <td style="width: 10%;"></td> <td style="width: 10%;"></td> </tr> <tr> <td></td> <td></td> <td colspan="8" style="text-align: center;"> <table border="1" style="width: 100%; border-collapse: collapse; text-align: center;"> <tr> <td style="width: 10%;"></td> <td style="width: 10%;"></td> <td style="width: 10%;"></td> <td style="width: 10%;"></td> <td style="width: 10%;"></td> <td style="width: 10%;"></td> <td style="width: 10%;"></td> <td style="width: 10%;"></td> <td style="width: 10%;"></td> <td style="width: 10%;"></td> </tr> <tr> <td></td> <td></td> <td colspan="8" style="text-align: center;"> <table border="1" style="width: 100%; border-collapse: collapse; text-align: center;"> <tr> <td style="width: 10%;"></td> <td style="width: 10%;"></td> <td style="width: 10%;"></td> <td style="width: 10%;"></td> <td style="width: 10%;"></td> <td style="width: 10%;"></td> <td style="width: 10%;"></td> <td style="width: 10%;"></td> <td style="width: 10%;"></td> <td style="width: 10%;"></td> </tr> <tr> <td></td> <td></td> <td colspan="8" style="text-align: center;"> <table border="1" style="width: 100%; border-collapse: collapse; text-align: center;"> <tr> <td style="width: 10%;"></td> <td style="width: 10%;"></td> <td style="width: 10%;"></td> <td style="width: 10%;"></td> <td style="width: 10%;"></td> <td style="width: 10%;"></td> <td style="width: 10%;"></td> <td style="width: 10%;"></td> <td style="width: 10%;"></td> <td style="width: 10%;"></td> </tr> <tr> <td></td> <td></td> <td colspan="8" style="text-align: center;"> <table border="1" style="width: 100%; border-collapse: collapse; text-align: center;"> <tr> <td style="width: 10%;"></td> <td style="width: 10%;"></td> <td style="width: 10%;"></td> <td style="width: 10%;"></td> <td style="width: 10%;"></td> <td style="width: 10%;"></td> <td style="width: 10%;"></td> <td style="width: 10%;"></td> <td style="width: 10%;"></td> <td style="width: 10%;"></td> </tr> <tr> <td></td> <td></td> <td colspan="8" style="text-align: center;"> <table border="1" style="width: 100%; border-collapse: collapse; text-align: center;"> <tr> <td style="width: 10%;"></td> <td style="width: 10%;"></td> <td style="width: 10%;"></td> <td style="width: 10%;"></td> <td style="width: 10%;"></td> <td style="width: 10%;"></td> <td style="width: 10%;"></td> <td style="width: 10%;"></td> <td style="width: 10%;"></td> <td style="width: 10%;"></td> </tr> <tr> <td></td> <td></td> <td colspan="8" style="text-align: center;"> <table border="1" style="width: 100%; border-collapse: collapse; text-align: center;"> <tr> <td style="width: 10%;"></td> <td style="width: 10%;"></td> <td style="width: 10%;"></td> <td style="width: 10%;"></td> <td style="width: 10%;"></td> <td style="width: 10%;"></td> <td style="width: 10%;"></td> <td style="width: 10%;"></td> <td style="width: 10%;"></td> <td style="width: 10%;"></td> </tr> <tr> <td></td> <td></td> <td colspan="8" style="text-align: center;"> <table border="1" style="width: 100%; border-collapse: collapse; text-align: center;"> <tr> <td style="width: 10%;"></td> <td style="width: 10%;"></td> <td style="width: 10%;"></td> <td style="width: 10%;"></td> <td style="width: 10%;"></td> <td style="width: 10%;"></td> <td style="width: 10%;"></td> <td style="width: 10%;"></td> <td style="width: 10%;"></td> <td style="width: 10%;"></td> </tr> <tr> <td></td> <td></td> <td colspan="8" style="text-align: center;"> <table border="1" style="width: 100%; border-collapse: collapse; text-align: center;"> <tr> <td style="width: 10%;"></td> <td style="width: 10%;"></td> <td style="width: 10%;"></td> <td style="width: 10%;"></td> <td style="width: 10%;"></td> <td style="width: 10%;"></td> <td style="width: 10%;"></td> <td style="width: 10%;"></td> <td style="width: 10%;"></td> <td style="width: 10%;"></td> </tr> <tr> <td></td> <td></td> <td colspan="8" style="text-align: center;"> <table border="1" style="width: 100%; border-collapse: collapse; text-align: center;"> <tr> <td style="width: 10%;"></td> <td style="width: 10%;"></td> <td style="width: 10%;"></td> <td style="width: 10%;"></td> <td style="width: 10%;"></td> <td style="width: 10%;"></td> <td style="width: 10%;"></td> <td style="width: 10%;"></td> <td style="width: 10%;"></td> <td style="width: 10%;"></td> </tr> <tr> <td></td> <td></td> <td colspan="8" style="text-align: center;"> <table border="1" style="width: 100%; border-collapse: collapse; text-align: center;"> <tr> <td style="width: 10%;"></td> <td style="width: 10%;"></td> <td style="width: 10%;"></td> <td style="width: 10%;"></td> <td style="width: 10%;"></td> <td style="width: 10%;"></td> <td style="width: 10%;"></td> <td style="width: 10%;"></td> <td style="width: 10%;"></td> <td style="width: 10%;"></td> </tr> <tr> <td></td> <td></td> <td colspan="8" style="text-align: center;"> <table border="1" style="width: 100%; border-collapse: collapse; text-align: center;"> <tr> <td style="width: 10%;"></td> <td style="width: 10%;"></td> <td style="width: 10%;"></td> <td style="width: 10%;"></td> <td style="width: 10%;"></td> <td style="width: 10%;"></td> <td style="width: 10%;"></td> <td style="width: 10%;"></td> <td style="width: 10%;"></td> <td style="width: 10%;"></td> </tr> <tr> <td></td> <td></td> <td colspan="8" style="text-align: center;"> <table border="1" style="width: 100%; border-collapse: collapse; text-align: center;"> <tr> <td style="width: 10%;"></td> <td style="width: 10%;"></td> <td style="width: 10%;"></td> <td style="width: 10%;"></td> <td style="width: 10%;"></td> <td style="width: 10%;"></td> <td style="width: 10%;"></td> <td style="width: 10%;"></td> <td style="width: 10%;"></td> <td style="width: 10%;"></td> </tr> <tr> <td></td> <td></td> <td colspan="8" style="text-align: center;"> <table border="1" style="width: 100%; border-collapse: collapse; text-align: center;"> <tr> </tr></table></td></tr></table></td></tr></table></td></tr></table></td></tr></table></td></tr></table></td></tr></table></td></tr></table></td></tr></table></td></tr></table></td></tr></table></td></tr></table></td></tr></table></td></tr></table></td></tr></table></td></tr></table></td></tr></table></td></tr></table></td></tr></table></td></tr></table></td></tr></table></td></tr></table></td></tr></table></td></tr></table></td></tr></table></td></tr></table></td></tr></table></td></tr></table></td></tr></table></td></tr></table></td></tr></table></td></tr></table></td></tr></table></td></tr></table></td></tr></table></td></tr></table></td></tr></table></td></tr></table></td></tr></table></td></tr></table></td></tr></table></td></tr></table></td></tr></table>
 | | | | | | | | | | | | | | | | | | | | <table border="1" style="width: 100%; border-collapse: collapse; text-align: center;"> <tr> <td style="width: 10%;"></td> <td style="width: 10%;"></td> <td style="width: 10%;"></td> <td style="width: 10%;"></td> <td style="width: 10%;"></td> <td style="width: 10%;"></td> <td style="width: 10%;"></td> <td style="width: 10%;"></td> <td style="width: 10%;"></td> <td style="width: 10%;"></td> </tr> <tr> <td></td> <td></td> <td colspan="8" style="text-align: center;"> <table border="1" style="width: 100%; border-collapse: collapse; text-align: center;"> <tr> <td style="width: 10%;"></td> <td style="width: 10%;"></td> <td style="width: 10%;"></td> <td style="width: 10%;"></td> <td style="width: 10%;"></td> <td style="width: 10%;"></td> <td style="width: 10%;"></td> <td style="width: 10%;"></td> <td style="width: 10%;"></td> <td style="width: 10%;"></td> </tr> <tr> <td></td> <td></td> <td colspan="8" style="text-align: center;"> <table border="1" style="width: 100%; border-collapse: collapse; text-align: center;"> <tr> <td style="width: 10%;"></td> <td style="width: 10%;"></td> <td style="width: 10%;"></td> <td style="width: 10%;"></td> <td style="width: 10%;"></td> <td style="width: 10%;"></td> <td style="width: 10%;"></td> <td style="width: 10%;"></td> <td style="width: 10%;"></td> <td style="width: 10%;"></td> </tr> <tr> <td></td> <td></td> <td colspan="8" style="text-align: center;"> <table border="1" style="width: 100%; border-collapse: collapse; text-align: center;"> <tr> <td style="width: 10%;"></td> <td style="width: 10%;"></td> <td style="width: 10%;"></td> <td style="width: 10%;"></td> <td style="width: 10%;"></td> <td style="width: 10%;"></td> <td style="width: 10%;"></td> <td style="width: 10%;"></td> <td style="width: 10%;"></td> <td style="width: 10%;"></td> </tr> <tr> <td></td> <td></td> <td colspan="8" style="text-align: center;"> <table border="1" style="width: 100%; border-collapse: collapse; text-align: center;"> <tr> <td style="width: 10%;"></td> <td style="width: 10%;"></td> <td style="width: 10%;"></td> <td style="width: 10%;"></td> <td style="width: 10%;"></td> <td style="width: 10%;"></td> <td style="width: 10%;"></td> <td style="width: 10%;"></td> <td style="width: 10%;"></td> <td style="width: 10%;"></td> </tr> <tr> <td></td> <td></td> <td colspan="8" style="text-align: center;"> <table border="1" style="width: 100%; border-collapse: collapse; text-align: center;"> <tr> <td style="width: 10%;"></td> <td style="width: 10%;"></td> <td style="width: 10%;"></td> <td style="width: 10%;"></td> <td style="width: 10%;"></td> <td style="width: 10%;"></td> <td style="width: 10%;"></td> <td style="width: 10%;"></td> <td style="width: 10%;"></td> <td style="width: 10%;"></td> </tr> <tr> <td></td> <td></td> <td colspan="8" style="text-align: center;"> <table border="1" style="width: 100%; border-collapse: collapse; text-align: center;"> <tr> <td style="width: 10%;"></td> <td style="width: 10%;"></td> <td style="width: 10%;"></td> <td style="width: 10%;"></td> <td style="width: 10%;"></td> <td style="width: 10%;"></td> <td style="width: 10%;"></td> <td style="width: 10%;"></td> <td style="width: 10%;"></td> <td style="width: 10%;"></td> </tr> <tr> <td></td> <td></td> <td colspan="8" style="text-align: center;"> <table border="1" style="width: 100%; border-collapse: collapse; text-align: center;"> <tr> <td style="width: 10%;"></td> <td style="width: 10%;"></td> <td style="width: 10%;"></td> <td style="width: 10%;"></td> <td style="width: 10%;"></td> <td style="width: 10%;"></td> <td style="width: 10%;"></td> <td style="width: 10%;"></td> <td style="width: 10%;"></td> <td style="width: 10%;"></td> </tr> <tr> <td></td> <td></td> <td colspan="8" style="text-align: center;"> <table border="1" style="width: 100%; border-collapse: collapse; text-align: center;"> <tr> <td style="width: 10%;"></td> <td style="width: 10%;"></td> <td style="width: 10%;"></td> <td style="width: 10%;"></td> <td style="width: 10%;"></td> <td style="width: 10%;"></td> <td style="width: 10%;"></td> <td style="width: 10%;"></td> <td style="width: 10%;"></td> <td style="width: 10%;"></td> </tr> <tr> <td></td> <td></td> <td colspan="8" style="text-align: center;"> <table border="1" style="width: 100%; border-collapse: collapse; text-align: center;"> <tr> <td style="width: 10%;"></td> <td style="width: 10%;"></td> <td style="width: 10%;"></td> <td style="width: 10%;"></td> <td style="width: 10%;"></td> <td style="width: 10%;"></td> <td style="width: 10%;"></td> <td style="width: 10%;"></td> <td style="width: 10%;"></td> <td style="width: 10%;"></td> </tr> <tr> <td></td> <td></td> <td colspan="8" style="text-align: center;"> <table border="1" style="width: 100%; border-collapse: collapse; text-align: center;"> <tr> <td style="width: 10%;"></td> <td style="width: 10%;"></td> <td style="width: 10%;"></td> <td style="width: 10%;"></td> <td style="width: 10%;"></td> <td style="width: 10%;"></td> <td style="width: 10%;"></td> <td style="width: 10%;"></td> <td style="width: 10%;"></td> <td style="width: 10%;"></td> </tr> <tr> <td></td> <td></td> <td colspan="8" style="text-align: center;"> <table border="1" style="width: 100%; border-collapse: collapse; text-align: center;"> <tr> <td style="width: 10%;"></td> <td style="width: 10%;"></td> <td style="width: 10%;"></td> <td style="width: 10%;"></td> <td style="width: 10%;"></td> <td style="width: 10%;"></td> <td style="width: 10%;"></td> <td style="width: 10%;"></td> <td style="width: 10%;"></td> <td style="width: 10%;"></td> </tr> <tr> <td></td> <td></td> <td colspan="8" style="text-align: center;"> <table border="1" style="width: 100%; border-collapse: collapse; text-align: center;"> <tr> <td style="width: 10%;"></td> <td style="width: 10%;"></td> <td style="width: 10%;"></td> <td style="width: 10%;"></td> <td style="width: 10%;"></td> <td style="width: 10%;"></td> <td style="width: 10%;"></td> <td style="width: 10%;"></td> <td style="width: 10%;"></td> <td style="width: 10%;"></td> </tr> <tr> <td></td> <td></td> <td colspan="8" style="text-align: center;"> <table border="1" style="width: 100%; border-collapse: collapse; text-align: center;"> <tr> <td style="width: 10%;"></td> <td style="width: 10%;"></td> <td style="width: 10%;"></td> <td
style="width: 10%;"></td> <td style="width: 10%;"></td> <td style="width: 10%;"></td> <td style="width: 10%;"></td> <td style="width: 10%;"></td> <td style="width: 10%;"></td> <td style="width: 10%;"></td> </tr> <tr> <td></td> <td></td> <td colspan="8" style="text-align: center;"> <table border="1" style="width: 100%; border-collapse: collapse; text-align: center;"> <tr> <td style="width: 10%;"></td> <td style="width: 10%;"></td> <td style="width: 10%;"></td> <td style="width: 10%;"></td> <td style="width: 10%;"></td> <td style="width: 10%;"></td> <td style="width: 10%;"></td> <td style="width: 10%;"></td> <td style="width: 10%;"></td> <td style="width: 10%;"></td> </tr> <tr> <td></td> <td></td> <td colspan="8" style="text-align: center;"> <table border="1" style="width: 100%; border-collapse: collapse; text-align: center;"> <tr> <td style="width: 10%;"></td> <td style="width: 10%;"></td> <td style="width: 10%;"></td> <td style="width: 10%;"></td> <td style="width: 10%;"></td> <td style="width: 10%;"></td> <td style="width: 10%;"></td> <td style="width: 10%;"></td> <td style="width: 10%;"></td> <td style="width: 10%;"></td> </tr> <tr> <td></td> <td></td> <td colspan="8" style="text-align: center;"> <table border="1" style="width: 100%; border-collapse: collapse; text-align: center;"> <tr> <td style="width: 10%;"></td> <td style="width: 10%;"></td> <td style="width: 10%;"></td> <td style="width: 10%;"></td> <td style="width: 10%;"></td> <td style="width: 10%;"></td> <td style="width: 10%;"></td> <td style="width: 10%;"></td> <td style="width: 10%;"></td> <td style="width: 10%;"></td> </tr> <tr> <td></td> <td></td> <td colspan="8" style="text-align: center;"> <table border="1" style="width: 100%; border-collapse: collapse; text-align: center;"> <tr> <td style="width: 10%;"></td> <td style="width: 10%;"></td> <td style="width: 10%;"></td> <td style="width: 10%;"></td> <td style="width: 10%;"></td> <td style="width: 10%;"></td> <td style="width: 10%;"></td> <td style="width: 10%;"></td> <td style="width: 10%;"></td> <td style="width: 10%;"></td> </tr> <tr> <td></td> <td></td> <td colspan="8" style="text-align: center;"> <table border="1" style="width: 100%; border-collapse: collapse; text-align: center;"> <tr> <td style="width: 10%;"></td> <td style="width: 10%;"></td> <td style="width: 10%;"></td> <td style="width: 10%;"></td> <td style="width: 10%;"></td> <td style="width: 10%;"></td> <td style="width: 10%;"></td> <td style="width: 10%;"></td> <td style="width: 10%;"></td> <td style="width: 10%;"></td> </tr> <tr> <td></td> <td></td> <td colspan="8" style="text-align: center;"> <table border="1" style="width: 100%; border-collapse: collapse; text-align: center;"> <tr> <td style="width: 10%;"></td> <td style="width: 10%;"></td> <td style="width: 10%;"></td> <td style="width: 10%;"></td> <td style="width: 10%;"></td> <td style="width: 10%;"></td> <td style="width: 10%;"></td> <td style="width: 10%;"></td> <td style="width: 10%;"></td> <td style="width: 10%;"></td> </tr> <tr> <td></td> <td></td> <td colspan="8" style="text-align: center;"> <table border="1" style="width: 100%; border-collapse: collapse; text-align: center;"> <tr> <td style="width: 10%;"></td> <td style="width: 10%;"></td> <td style="width: 10%;"></td> <td style="width: 10%;"></td> <td style="width: 10%;"></td> <td style="width: 10%;"></td> <td style="width: 10%;"></td> <td style="width: 10%;"></td> <td style="width: 10%;"></td> <td style="width: 10%;"></td> </tr> <tr> <td></td> <td></td> <td colspan="8" style="text-align: center;"> <table border="1" style="width: 100%; border-collapse: collapse; text-align: center;"> <tr> <td style="width: 10%;"></td> <td style="width: 10%;"></td> <td style="width: 10%;"></td> <td style="width: 10%;"></td> <td style="width: 10%;"></td> <td style="width: 10%;"></td> <td style="width: 10%;"></td> <td style="width: 10%;"></td> <td style="width: 10%;"></td> <td style="width: 10%;"></td> </tr> <tr> <td></td> <td></td> <td colspan="8" style="text-align: center;"> <table border="1" style="width: 100%; border-collapse: collapse; text-align: center;"> <tr> <td style="width: 10%;"></td> <td style="width: 10%;"></td> <td style="width: 10%;"></td> <td style="width: 10%;"></td> <td style="width: 10%;"></td> <td style="width: 10%;"></td> <td style="width: 10%;"></td> <td style="width: 10%;"></td> <td style="width: 10%;"></td> <td style="width: 10%;"></td> </tr> <tr> <td></td> <td></td> <td colspan="8" style="text-align: center;"> <table border="1" style="width: 100%; border-collapse: collapse; text-align: center;"> <tr> <td style="width: 10%;"></td> <td style="width: 10%;"></td> <td style="width: 10%;"></td> <td style="width: 10%;"></td> <td style="width: 10%;"></td> <td style="width: 10%;"></td> <td style="width: 10%;"></td> <td style="width: 10%;"></td> <td style="width: 10%;"></td> <td style="width: 10%;"></td> </tr> <tr> <td></td> <td></td> <td colspan="8" style="text-align: center;"> <table border="1" style="width: 100%; border-collapse: collapse; text-align: center;"> <tr> <td style="width: 10%;"></td> <td style="width: 10%;"></td> <td style="width: 10%;"></td> <td style="width: 10%;"></td> <td style="width: 10%;"></td> <td style="width: 10%;"></td> <td style="width: 10%;"></td> <td style="width: 10%;"></td> <td style="width: 10%;"></td> <td style="width: 10%;"></td> </tr> <tr> <td></td> <td></td> <td colspan="8" style="text-align: center;"> <table border="1" style="width: 100%; border-collapse: collapse; text-align: center;"> <tr> <td style="width: 10%;"></td> <td style="width: 10%;"></td> <td style="width: 10%;"></td> <td style="width: 10%;"></td> <td style="width: 10%;"></td> <td style="width: 10%;"></td> <td style="width: 10%;"></td> <td style="width: 10%;"></td> <td style="width: 10%;"></td> <td style="width: 10%;"></td> </tr> <tr> <td></td> <td></td> <td colspan="8" style="text-align: center;"> <table border="1" style="width: 100%; border-collapse: collapse; text-align: center;"> <tr> <td style="width: 10%;"></td> <td style="width: 10%;"></td> <td style="width: 10%;"></td> <td style="width: 10%;"></td> <td style="width: 10%;"></td> <td style="width: 10%;"></td> <td style="width: 10%;"></td> <td style="width: 10%;"></td> <td style="width: 10%;"></td> <td style="width: 10%;"></td> </tr> <tr> <td></td> <td></td> <td colspan="8" style="text-align: center;"> <table border="1" style="width: 100%; border-collapse: collapse; text-align: center;"> <tr> <td style="width: 10%;"></td> <td style="width: 10%;"></td> <td style="width: 10%;"></td> <td style="width: 10%;"></td> <td style="width: 10%;"></td> <td style="width: 10%;"></td> <td style="width: 10%;"></td> <td style="width: 10%;"></td> <td style="width: 10%;"></td> <td style="width: 10%;"></td> </tr> <tr> <td></td> <td></td> <td colspan="8" style="text-align: center;"> <table border="1" style="width: 100%; border-collapse: collapse; text-align: center;"> <tr> <td style="width: 10%;"></td> <td style="width: 10%;"></td> <td style="width: 10%;"></td> <td style="width: 10%;"></td> <td style="width: 10%;"></td> <td style="width: 10%;"></td> <td style="width: 10%;"></td> <td style="width: 10%;"></td> <td style="width: 10%;"></td> <td style="width: 10%;"></td> </tr> <tr> <td></td> <td></td> <td colspan="8" style="text-align: center;"> <table border="1" style="width: 100%; border-collapse: collapse; text-align: center;"> <tr> <td style="width: 10%;"></td> <td style="width: 10%;"></td> <td style="width: 10%;"></td> <td style="width: 10%;"></td> <td style="width: 10%;"></td> <td style="width: 10%;"></td> <td style="width: 10%;"></td> <td style="width: 10%;"></td> <td style="width: 10%;"></td> <td style="width: 10%;"></td> </tr> <tr> <td></td> <td></td> <td colspan="8" style="text-align: center;"> <table border="1" style="width: 100%; border-collapse: collapse; text-align: center;"> <tr> <td style="width: 10%;"></td> <td style="width: 10%;"></td> <td style="width: 10%;"></td> <td style="width: 10%;"></td> <td style="width: 10%;"></td> <td style="width: 10%;"></td> <td style="width: 10%;"></td> <td style="width: 10%;"></td> <td style="width: 10%;"></td> <td style="width: 10%;"></td> </tr> <tr> <td></td> <td></td> <td colspan="8" style="text-align: center;"> <table border="1" style="width: 100%; border-collapse: collapse; text-align: center;"> <tr> <td style="width: 10%;"></td> <td style="width: 10%;"></td> <td style="width: 10%;"></td> <td style="width: 10%;"></td> <td style="width: 10%;"></td> <td style="width: 10%;"></td> <td style="width: 10%;"></td> <td style="width: 10%;"></td> <td style="width: 10%;"></td> <td style="width: 10%;"></td> </tr> <tr> <td></td> <td></td> <td colspan="8" style="text-align: center;"> <table border="1" style="width: 100%; border-collapse: collapse; text-align: center;"> <tr> <td style="width: 10%;"></td> <td style="width: 10%;"></td> <td style="width: 10%;"></td> <td style="width: 10%;"></td> <td style="width: 10%;"></td> <td style="width: 10%;"></td> <td style="width: 10%;"></td> <td style="width: 10%;"></td> <td style="width: 10%;"></td> <td style="width: 10%;"></td> </tr> <tr> <td></td> <td></td> <td colspan="8" style="text-align: center;"> <table border="1" style="width: 100%; border-collapse: collapse; text-align: center;"> <tr> <td style="width: 10%;"></td> <td style="width: 10%;"></td> <td style="width: 10%;"></td> <td style="width: 10%;"></td> <td style="width: 10%;"></td> <td style="width: 10%;"></td> <td style="width: 10%;"></td> <td style="width: 10%;"></td> <td style="width: 10%;"></td> <td style="width: 10%;"></td> </tr> <tr> <td></td> <td></td> <td colspan="8" style="text-align: center;"> <table border="1" style="width: 100%; border-collapse: collapse; text-align: center;"> <tr> <td style="width: 10%;"></td> <td style="width: 10%;"></td> <td style="width: 10%;"></td> <td style="width: 10%;"></td> <td style="width: 10%;"></td> <td style="width: 10%;"></td> <td style="width: 10%;"></td> <td style="width: 10%;"></td> <td style="width:
10%;"></td> <td style="width: 10%;"></td> </tr> <tr> <td></td> <td></td> <td colspan="8" style="text-align: center;"> <table border="1" style="width: 100%; border-collapse: collapse; text-align: center;"> <tr> <td style="width: 10%;"></td> <td style="width: 10%;"></td> <td style="width: 10%;"></td> <td style="width: 10%;"></td> <td style="width: 10%;"></td> <td style="width: 10%;"></td> <td style="width: 10%;"></td> <td style="width: 10%;"></td> <td style="width: 10%;"></td> <td style="width: 10%;"></td> </tr> <tr> <td></td> <td></td> <td colspan="8" style="text-align: center;"> <table border="1" style="width: 100%; border-collapse: collapse; text-align: center;"> <tr> <td style="width: 10%;"></td> <td style="width: 10%;"></td> <td style="width: 10%;"></td> <td style="width: 10%;"></td> <td style="width: 10%;"></td> <td style="width: 10%;"></td> <td style="width: 10%;"></td> <td style="width: 10%;"></td> <td style="width: 10%;"></td> <td style="width: 10%;"></td> </tr> <tr> <td></td> <td></td> <td colspan="8" style="text-align: center;"> <table border="1" style="width: 100%; border-collapse: collapse; text-align: center;"> <tr> <td style="width: 10%;"></td> <td style="width: 10%;"></td> <td style="width: 10%;"></td> <td style="width: 10%;"></td> <td style="width: 10%;"></td> <td style="width: 10%;"></td> <td style="width: 10%;"></td> <td style="width: 10%;"></td> <td style="width: 10%;"></td> <td style="width: 10%;"></td> </tr> <tr> <td></td> <td></td> <td colspan="8" style="text-align: center;"> <table border="1" style="width: 100%; border-collapse: collapse; text-align: center;"> <tr> <td style="width: 10%;"></td> <td style="width: 10%;"></td> <td style="width: 10%;"></td> <td style="width: 10%;"></td> <td style="width: 10%;"></td> <td style="width: 10%;"></td> <td style="width: 10%;"></td> <td style="width: 10%;"></td> <td style="width: 10%;"></td> <td style="width: 10%;"></td> </tr> <tr> <td></td> <td></td> <td colspan="8" style="text-align: center;"> <table border="1" style="width: 100%; border-collapse: collapse; text-align: center;"> <tr> <td style="width: 10%;"></td> <td style="width: 10%;"></td> <td style="width: 10%;"></td> <td style="width: 10%;"></td> <td style="width: 10%;"></td> <td style="width: 10%;"></td> <td style="width: 10%;"></td> <td style="width: 10%;"></td> <td style="width: 10%;"></td> <td style="width: 10%;"></td> </tr> <tr> <td></td> <td></td> <td colspan="8" style="text-align: center;"> <table border="1" style="width: 100%; border-collapse: collapse; text-align: center;"> <tr> <td style="width: 10%;"></td> <td style="width: 10%;"></td> <td style="width: 10%;"></td> <td style="width: 10%;"></td> <td style="width: 10%;"></td> <td style="width: 10%;"></td> <td style="width: 10%;"></td> <td style="width: 10%;"></td> <td style="width: 10%;"></td> <td style="width: 10%;"></td> </tr> <tr> <td></td> <td></td> <td colspan="8" style="text-align: center;"> <table border="1" style="width: 100%; border-collapse: collapse; text-align: center;"> <tr> </tr></table></td></tr></table></td></tr></table></td></tr></table></td></tr></table></td></tr></table></td></tr></table></td></tr></table></td></tr></table></td></tr></table></td></tr></table></td></tr></table></td></tr></table></td></tr></table></td></tr></table></td></tr></table></td></tr></table></td></tr></table></td></tr></table></td></tr></table></td></tr></table></td></tr></table></td></tr></table></td></tr></table></td></tr></table></td></tr></table></td></tr></table></td></tr></table></td></tr></table></td></tr></table></td></tr></table></td></tr></table></td></tr></table></td></tr></table></td></tr></table></td></tr></table></td></tr></table></td></tr></table></td></tr></table></td></tr></table></td></tr></table></td></tr></table> | | | | | | | | | | | | | | | | | | | | <table border="1" style="width: 100%; border-collapse: collapse; text-align: center;"> <tr> <td style="width: 10%;"></td> <td style="width: 10%;"></td> <td style="width: 10%;"></td> <td style="width: 10%;"></td> <td style="width: 10%;"></td> <td style="width: 10%;"></td> <td style="width: 10%;"></td> <td style="width: 10%;"></td> <td style="width: 10%;"></td> <td style="width: 10%;"></td> </tr> <tr> <td></td> <td></td> <td colspan="8" style="text-align: center;"> <table border="1" style="width: 100%; border-collapse: collapse; text-align: center;"> <tr> <td style="width: 10%;"></td> <td style="width: 10%;"></td> <td style="width: 10%;"></td> <td style="width: 10%;"></td> <td style="width: 10%;"></td> <td style="width: 10%;"></td> <td style="width: 10%;"></td> <td style="width: 10%;"></td> <td style="width: 10%;"></td> <td style="width: 10%;"></td> </tr> <tr> <td></td> <td></td> <td colspan="8" style="text-align: center;"> <table border="1" style="width: 100%; border-collapse: collapse; text-align: center;"> <tr> <td style="width: 10%;"></td> <td style="width: 10%;"></td> <td style="width: 10%;"></td> <td style="width: 10%;"></td> <td style="width: 10%;"></td> <td style="width: 10%;"></td> <td style="width: 10%;"></td> <td style="width: 10%;"></td> <td style="width: 10%;"></td> <td style="width: 10%;"></td> </tr> <tr> <td></td> <td></td> <td colspan="8" style="text-align: center;"> <table border="1" style="width: 100%; border-collapse: collapse; text-align: center;"> <tr> <td style="width: 10%;"></td> <td style="width: 10%;"></td> <td style="width: 10%;"></td> <td style="width: 10%;"></td> <td style="width: 10%;"></td> <td style="width: 10%;"></td> <td style="width: 10%;"></td> <td style="width: 10%;"></td> <td style="width: 10%;"></td> <td style="width: 10%;"></td>
</tr> <tr> <td></td> <td></td> <td colspan="8" style="text-align: center;"> <table border="1" style="width: 100%; border-collapse: collapse; text-align: center;"> <tr> <td style="width: 10%;"></td> <td style="width: 10%;"></td> <td style="width: 10%;"></td> <td style="width: 10%;"></td> <td style="width: 10%;"></td> <td style="width: 10%;"></td> <td style="width: 10%;"></td> <td style="width: 10%;"></td> <td style="width: 10%;"></td> <td style="width: 10%;"></td> </tr> <tr> <td></td> <td></td> <td colspan="8" style="text-align: center;"> <table border="1" style="width: 100%; border-collapse: collapse; text-align: center;"> <tr> <td style="width: 10%;"></td> <td style="width: 10%;"></td> <td style="width: 10%;"></td> <td style="width: 10%;"></td> <td style="width: 10%;"></td> <td style="width: 10%;"></td> <td style="width: 10%;"></td> <td style="width: 10%;"></td> <td style="width: 10%;"></td> <td style="width: 10%;"></td> </tr> <tr> <td></td> <td></td> <td colspan="8" style="text-align: center;"> <table border="1" style="width: 100%; border-collapse: collapse; text-align: center;"> <tr> <td style="width: 10%;"></td> <td style="width: 10%;"></td> <td style="width: 10%;"></td> <td style="width: 10%;"></td> <td style="width: 10%;"></td> <td style="width: 10%;"></td> <td style="width: 10%;"></td> <td style="width: 10%;"></td> <td style="width: 10%;"></td> <td style="width: 10%;"></td> </tr> <tr> <td></td> <td></td> <td colspan="8" style="text-align: center;"> <table border="1" style="width: 100%; border-collapse: collapse; text-align: center;"> <tr> <td style="width: 10%;"></td> <td style="width: 10%;"></td> <td style="width: 10%;"></td> <td style="width: 10%;"></td> <td style="width: 10%;"></td> <td style="width: 10%;"></td> <td style="width: 10%;"></td> <td style="width: 10%;"></td> <td style="width: 10%;"></td> <td style="width: 10%;"></td> </tr> <tr> <td></td> <td></td> <td colspan="8" style="text-align: center;"> <table border="1" style="width: 100%; border-collapse: collapse; text-align: center;"> <tr> <td style="width: 10%;"></td> <td style="width: 10%;"></td> <td style="width: 10%;"></td> <td style="width: 10%;"></td> <td style="width: 10%;"></td> <td style="width: 10%;"></td> <td style="width: 10%;"></td> <td style="width: 10%;"></td> <td style="width: 10%;"></td> <td style="width: 10%;"></td> </tr> <tr> <td></td> <td></td> <td colspan="8" style="text-align: center;"> <table border="1" style="width: 100%; border-collapse: collapse; text-align: center;"> <tr> <td style="width: 10%;"></td> <td style="width: 10%;"></td> <td style="width: 10%;"></td> <td style="width: 10%;"></td> <td style="width: 10%;"></td> <td style="width: 10%;"></td> <td style="width: 10%;"></td> <td style="width: 10%;"></td> <td style="width: 10%;"></td> <td style="width: 10%;"></td> </tr> <tr> <td></td> <td></td> <td colspan="8" style="text-align: center;"> <table border="1" style="width: 100%; border-collapse: collapse; text-align: center;"> <tr> <td style="width: 10%;"></td> <td style="width: 10%;"></td> <td style="width: 10%;"></td> <td style="width: 10%;"></td> <td style="width: 10%;"></td> <td style="width: 10%;"></td> <td style="width: 10%;"></td> <td style="width: 10%;"></td> <td style="width: 10%;"></td> <td style="width: 10%;"></td> </tr> <tr> <td></td> <td></td> <td colspan="8" style="text-align: center;"> <table border="1" style="width: 100%; border-collapse: collapse; text-align: center;"> <tr> <td style="width: 10%;"></td> <td style="width: 10%;"></td> <td style="width: 10%;"></td> <td style="width: 10%;"></td> <td style="width: 10%;"></td> <td style="width: 10%;"></td> <td style="width: 10%;"></td> <td style="width: 10%;"></td> <td style="width: 10%;"></td> <td style="width: 10%;"></td> </tr> <tr> <td></td> <td></td> <td colspan="8" style="text-align: center;"> <table border="1" style="width: 100%; border-collapse: collapse; text-align: center;"> <tr> <td style="width: 10%;"></td> <td style="width: 10%;"></td> <td style="width: 10%;"></td> <td style="width: 10%;"></td> <td style="width: 10%;"></td> <td style="width: 10%;"></td> <td style="width: 10%;"></td> <td style="width: 10%;"></td> <td style="width: 10%;"></td> <td style="width: 10%;"></td> </tr> <tr> <td></td> <td></td> <td colspan="8" style="text-align: center;"> <table border="1" style="width: 100%; border-collapse: collapse; text-align: center;"> <tr> <td style="width: 10%;"></td> <td style="width: 10%;"></td> <td style="width: 10%;"></td> <td style="width: 10%;"></td> <td style="width: 10%;"></td> <td style="width: 10%;"></td> <td style="width: 10%;"></td> <td style="width: 10%;"></td> <td style="width: 10%;"></td> <td style="width: 10%;"></td> </tr> <tr> <td></td> <td></td> <td colspan="8" style="text-align: center;"> <table border="1" style="width: 100%; border-collapse: collapse; text-align: center;"> <tr> <td style="width: 10%;"></td> <td style="width: 10%;"></td> <td style="width: 10%;"></td> <td style="width: 10%;"></td> <td style="width: 10%;"></td> <td style="width: 10%;"></td> <td style="width: 10%;"></td> <td style="width: 10%;"></td> <td style="width: 10%;"></td> <td style="width: 10%;"></td> </tr> <tr> <td></td> <td></td> <td colspan="8" style="text-align: center;"> <table border="1" style="width: 100%; border-collapse: collapse; text-align: center;"> <tr> <td style="width: 10%;"></td> <td style="width: 10%;"></td> <td style="width: 10%;"></td> <td style="width: 10%;"></td> <td style="width: 10%;"></td> <td style="width: 10%;"></td> <td style="width: 10%;"></td> <td style="width: 10%;"></td> <td style="width: 10%;"></td> <td style="width: 10%;"></td> </tr> <tr> <td></td> <td></td> <td colspan="8" style="text-align: center;"> <table border="1" style="width: 100%; border-collapse: collapse; text-align: center;"> <tr> <td style="width: 10%;"></td> <td style="width: 10%;"></td> <td style="width: 10%;"></td> <td style="width: 10%;"></td> <td style="width: 10%;"></td> <td style="width: 10%;"></td> <td style="width: 10%;"></td> <td style="width: 10%;"></td> <td style="width: 10%;"></td> <td style="width: 10%;"></td> </tr> <tr> <td></td> <td></td> <td colspan="8" style="text-align: center;"> <table border="1" style="width: 100%; border-collapse: collapse; text-align: center;"> <tr> <td style="width: 10%;"></td> <td style="width: 10%;"></td> <td style="width: 10%;"></td> <td style="width: 10%;"></td> <td style="width: 10%;"></td> <td style="width: 10%;"></td> <td style="width: 10%;"></td> <td style="width: 10%;"></td> <td style="width: 10%;"></td> <td style="width: 10%;"></td> </tr> <tr> <td></td> <td></td> <td colspan="8" style="text-align: center;"> <table border="1" style="width: 100%; border-collapse: collapse; text-align: center;"> <tr> <td style="width: 10%;"></td> <td style="width: 10%;"></td> <td style="width: 10%;"></td> <td style="width: 10%;"></td> <td style="width: 10%;"></td> <td style="width: 10%;"></td> <td style="width: 10%;"></td> <td style="width: 10%;"></td> <td style="width: 10%;"></td> <td style="width: 10%;"></td> </tr> <tr> <td></td> <td></td> <td colspan="8" style="text-align: center;"> <table border="1" style="width: 100%; border-collapse: collapse; text-align: center;"> <tr> <td style="width: 10%;"></td> <td style="width: 10%;"></td> <td style="width: 10%;"></td> <td style="width: 10%;"></td> <td style="width: 10%;"></td> <td style="width: 10%;"></td> <td style="width: 10%;"></td> <td style="width: 10%;"></td> <td style="width: 10%;"></td> <td style="width: 10%;"></td> </tr> <tr> <td></td> <td></td> <td colspan="8" style="text-align: center;"> <table border="1" style="width: 100%; border-collapse: collapse; text-align: center;"> <tr> <td style="width: 10%;"></td> <td style="width: 10%;"></td> <td style="width: 10%;"></td> <td style="width: 10%;"></td> <td style="width: 10%;"></td> <td style="width: 10%;"></td> <td style="width: 10%;"></td> <td style="width: 10%;"></td> <td style="width: 10%;"></td> <td style="width: 10%;"></td> </tr> <tr> <td></td> <td></td> <td colspan="8" style="text-align: center;"> <table border="1" style="width: 100%; border-collapse: collapse; text-align: center;"> <tr> <td style="width: 10%;"></td> <td style="width: 10%;"></td> <td style="width: 10%;"></td> <td style="width: 10%;"></td> <td style="width: 10%;"></td> <td style="width: 10%;"></td> <td style="width: 10%;"></td> <td style="width: 10%;"></td> <td style="width: 10%;"></td> <td style="width: 10%;"></td> </tr> <tr> <td></td> <td></td> <td colspan="8" style="text-align: center;"> <table border="1" style="width: 100%; border-collapse: collapse; text-align: center;"> <tr> <td style="width: 10%;"></td> <td style="width: 10%;"></td> <td style="width: 10%;"></td> <td style="width: 10%;"></td> <td style="width: 10%;"></td> <td style="width: 10%;"></td> <td style="width: 10%;"></td> <td style="width: 10%;"></td> <td style="width: 10%;"></td> <td style="width: 10%;"></td> </tr> <tr> <td></td> <td></td> <td colspan="8" style="text-align: center;"> <table border="1" style="width: 100%; border-collapse: collapse; text-align: center;"> <tr> <td style="width: 10%;"></td> <td style="width: 10%;"></td> <td style="width: 10%;"></td> <td style="width: 10%;"></td> <td style="width: 10%;"></td> <td style="width: 10%;"></td> <td style="width: 10%;"></td> <td style="width: 10%;"></td> <td style="width: 10%;"></td> <td style="width: 10%;"></td> </tr> <tr> <td></td> <td></td> <td colspan="8" style="text-align: center;"> <table border="1" style="width: 100%; border-collapse: collapse; text-align: center;"> <tr> <td style="width: 10%;"></td> <td style="width: 10%;"></td> <td style="width: 10%;"></td> <td style="width: 10%;"></td> <td style="width: 10%;"></td> <td style="width: 10%;"></td> <td style="width: 10%;"></td> <td style="width: 10%;"></td> <td style="width: 10%;"></td> <td style="width: 10%;"></td> </tr> <tr> <td></td> <td></td> <td colspan="8" style="text-align: center;"> <table border="1" style="width: 100%; border-collapse: collapse; text-align: center;"> <tr> <td
style="width: 10%;"></td> <td style="width: 10%;"></td> <td style="width: 10%;"></td> <td style="width: 10%;"></td> <td style="width: 10%;"></td> <td style="width: 10%;"></td> <td style="width: 10%;"></td> <td style="width: 10%;"></td> <td style="width: 10%;"></td> <td style="width: 10%;"></td> </tr> <tr> <td></td> <td></td> <td colspan="8" style="text-align: center;"> <table border="1" style="width: 100%; border-collapse: collapse; text-align: center;"> <tr> <td style="width: 10%;"></td> <td style="width: 10%;"></td> <td style="width: 10%;"></td> <td style="width: 10%;"></td> <td style="width: 10%;"></td> <td style="width: 10%;"></td> <td style="width: 10%;"></td> <td style="width: 10%;"></td> <td style="width: 10%;"></td> <td style="width: 10%;"></td> </tr> <tr> <td></td> <td></td> <td colspan="8" style="text-align: center;"> <table border="1" style="width: 100%; border-collapse: collapse; text-align: center;"> <tr> <td style="width: 10%;"></td> <td style="width: 10%;"></td> <td style="width: 10%;"></td> <td style="width: 10%;"></td> <td style="width: 10%;"></td> <td style="width: 10%;"></td> <td style="width: 10%;"></td> <td style="width: 10%;"></td> <td style="width: 10%;"></td> <td style="width: 10%;"></td> </tr> <tr> <td></td> <td></td> <td colspan="8" style="text-align: center;"> <table border="1" style="width: 100%; border-collapse: collapse; text-align: center;"> <tr> <td style="width: 10%;"></td> <td style="width: 10%;"></td> <td style="width: 10%;"></td> <td style="width: 10%;"></td> <td style="width: 10%;"></td> <td style="width: 10%;"></td> <td style="width: 10%;"></td> <td style="width: 10%;"></td> <td style="width: 10%;"></td> <td style="width: 10%;"></td> </tr> <tr> <td></td> <td></td> <td colspan="8" style="text-align: center;"> <table border="1" style="width: 100%; border-collapse: collapse; text-align: center;"> <tr> <td style="width: 10%;"></td> <td style="width: 10%;"></td> <td style="width: 10%;"></td> <td style="width: 10%;"></td> <td style="width: 10%;"></td> <td style="width: 10%;"></td> <td style="width: 10%;"></td> <td style="width: 10%;"></td> <td style="width: 10%;"></td> <td style="width: 10%;"></td> </tr> <tr> <td></td> <td></td> <td colspan="8" style="text-align: center;"> <table border="1" style="width: 100%; border-collapse: collapse; text-align: center;"> <tr> <td style="width: 10%;"></td> <td style="width: 10%;"></td> <td style="width: 10%;"></td> <td style="width: 10%;"></td> <td style="width: 10%;"></td> <td style="width: 10%;"></td> <td style="width: 10%;"></td> <td style="width: 10%;"></td> <td style="width: 10%;"></td> <td style="width: 10%;"></td> </tr> <tr> <td></td> <td></td> <td colspan="8" style="text-align: center;"> <table border="1" style="width: 100%; border-collapse: collapse; text-align: center;"> <tr> <td style="width: 10%;"></td> <td style="width: 10%;"></td> <td style="width: 10%;"></td> <td style="width: 10%;"></td> <td style="width: 10%;"></td> <td style="width: 10%;"></td> <td style="width: 10%;"></td> <td style="width: 10%;"></td> <td style="width: 10%;"></td> <td style="width: 10%;"></td> </tr> <tr> <td></td> <td></td> <td colspan="8" style="text-align: center;"> <table border="1" style="width: 100%; border-collapse: collapse; text-align: center;"> <tr> <td style="width: 10%;"></td> <td style="width: 10%;"></td> <td style="width: 10%;"></td> <td style="width: 10%;"></td> <td style="width: 10%;"></td> <td style="width: 10%;"></td> <td style="width: 10%;"></td> <td style="width: 10%;"></td> <td style="width: 10%;"></td> <td style="width: 10%;"></td> </tr> <tr> <td></td> <td></td> <td colspan="8" style="text-align: center;"> <table border="1" style="width: 100%; border-collapse: collapse; text-align: center;"> <tr> <td style="width: 10%;"></td> <td style="width: 10%;"></td> <td style="width: 10%;"></td> <td style="width: 10%;"></td> <td style="width: 10%;"></td> <td style="width: 10%;"></td> <td style="width: 10%;"></td> <td style="width: 10%;"></td> <td style="width: 10%;"></td> <td style="width: 10%;"></td> </tr> <tr> <td></td> <td></td> <td colspan="8" style="text-align: center;"> <table border="1" style="width: 100%; border-collapse: collapse; text-align: center;"> <tr> <td style="width: 10%;"></td> <td style="width: 10%;"></td> <td style="width: 10%;"></td> <td style="width: 10%;"></td> <td style="width: 10%;"></td> <td style="width: 10%;"></td> <td style="width: 10%;"></td> <td style="width: 10%;"></td> <td style="width: 10%;"></td> <td style="width: 10%;"></td> </tr> <tr> <td></td> <td></td> <td colspan="8" style="text-align: center;"> <table border="1" style="width: 100%; border-collapse: collapse; text-align: center;"> <tr> <td style="width: 10%;"></td> <td style="width: 10%;"></td> <td style="width: 10%;"></td> <td style="width: 10%;"></td> <td style="width: 10%;"></td> <td style="width: 10%;"></td> <td style="width: 10%;"></td> <td style="width: 10%;"></td> <td style="width: 10%;"></td> <td style="width: 10%;"></td> </tr> <tr> <td></td> <td></td> <td colspan="8" style="text-align: center;"> <table border="1" style="width: 100%; border-collapse: collapse; text-align: center;"> <tr> <td style="width: 10%;"></td> <td style="width: 10%;"></td> <td style="width: 10%;"></td> <td style="width: 10%;"></td> <td style="width: 10%;"></td> <td style="width: 10%;"></td> <td style="width: 10%;"></td> <td style="width: 10%;"></td> <td style="width: 10%;"></td> <td style="width: 10%;"></td> </tr> <tr> <td></td> <td></td> <td colspan="8" style="text-align: center;"> <table border="1" style="width: 100%; border-collapse: collapse; text-align: center;"> <tr> <td style="width: 10%;"></td> <td style="width: 10%;"></td> <td style="width: 10%;"></td> <td style="width: 10%;"></td> <td style="width: 10%;"></td> <td style="width: 10%;"></td> <td style="width: 10%;"></td> <td style="width: 10%;"></td> <td style="width: 10%;"></td> <td style="width: 10%;"></td> </tr> <tr> <td></td> <td></td> <td colspan="8" style="text-align: center;"> <table border="1" style="width: 100%; border-collapse: collapse; text-align: center;"> <tr> <td style="width: 10%;"></td> <td style="width: 10%;"></td> <td style="width: 10%;"></td> <td style="width: 10%;"></td> <td style="width: 10%;"></td> <td style="width: 10%;"></td> <td style="width: 10%;"></td> <td style="width: 10%;"></td> <td style="width: 10%;"></td> <td style="width: 10%;"></td> </tr> <tr> <td></td> <td></td> <td colspan="8" style="text-align: center;"> <table border="1" style="width: 100%; border-collapse: collapse; text-align: center;"> <tr> <td style="width: 10%;"></td> <td style="width: 10%;"></td> <td style="width: 10%;"></td> <td style="width: 10%;"></td> <td style="width: 10%;"></td> <td style="width: 10%;"></td> <td style="width: 10%;"></td> <td style="width: 10%;"></td> <td style="width: 10%;"></td> <td style="width: 10%;"></td> </tr> <tr> <td></td> <td></td> <td colspan="8" style="text-align: center;"> <table border="1" style="width: 100%; border-collapse: collapse; text-align: center;"> <tr> </tr></table></td></tr></table></td></tr></table></td></tr></table></td></tr></table></td></tr></table></td></tr></table></td></tr></table></td></tr></table></td></tr></table></td></tr></table></td></tr></table></td></tr></table></td></tr></table></td></tr></table></td></tr></table></td></tr></table></td></tr></table></td></tr></table></td></tr></table></td></tr></table></td></tr></table></td></tr></table></td></tr></table></td></tr></table></td></tr></table></td></tr></table></td></tr></table></td></tr></table></td></tr></table></td></tr></table></td></tr></table></td></tr></table></td></tr></table></td></tr></table></td></tr></table></td></tr></table></td></tr></table></td></tr></table></td></tr></table></td></tr></table>
 | | | | | | | | | | | | | | | | | | | | <table border="1" style="width: 100%; border-collapse: collapse; text-align: center;"> <tr> <td style="width: 10%;"></td> <td style="width: 10%;"></td> <td style="width: 10%;"></td> <td style="width: 10%;"></td> <td style="width: 10%;"></td> <td style="width: 10%;"></td> <td style="width: 10%;"></td> <td style="width: 10%;"></td> <td style="width: 10%;"></td> <td style="width: 10%;"></td> </tr> <tr> <td></td> <td></td> <td colspan="8" style="text-align: center;"> <table border="1" style="width: 100%; border-collapse: collapse; text-align: center;"> <tr> <td style="width: 10%;"></td> <td style="width: 10%;"></td> <td style="width: 10%;"></td> <td style="width: 10%;"></td> <td style="width: 10%;"></td> <td style="width: 10%;"></td> <td style="width: 10%;"></td> <td style="width: 10%;"></td> <td style="width: 10%;"></td> <td style="width: 10%;"></td> </tr> <tr> <td></td> <td></td> <td colspan="8" style="text-align: center;"> <table border="1" style="width: 100%; border-collapse: collapse; text-align: center;"> <tr> <td style="width: 10%;"></td> <td style="width: 10%;"></td> <td style="width: 10%;"></td> <td style="width: 10%;"></td> <td style="width: 10%;"></td> <td style="width: 10%;"></td> <td style="width: 10%;"></td> <td style="width: 10%;"></td> <td style="width: 10%;"></td> <td style="width: 10%;"></td> </tr> <tr> <td></td> <td></td> <td colspan="8" style="text-align: center;"> <table border="1" style="width: 100%; border-collapse: collapse; text-align: center;"> <tr> <td style="width: 10%;"></td> <td style="width: 10%;"></td> <td style="width: 10%;"></td> <td style="width: 10%;"></td> <td style="width: 10%;"></td> <td style="width: 10%;"></td> <td style="width: 10%;"></td> <td style="width: 10%;"></td> <td style="width: 10%;"></td> <td style="width: 10%;"></td> </tr> <tr> <td></td> <td></td> <td colspan="8" style="text-align: center;"> <table border="1" style="width: 100%; border-collapse: collapse; text-align: center;"> <tr> <td style="width: 10%;"></td> <td style="width: 10%;"></td> <td style="width: 10%;"></td> <td style="width: 10%;"></td> <td style="width: 10%;"></td> <td style="width: 10%;"></td> <td style="width: 10%;"></td> <td style="width: 10%;"></td> <td style="width: 10%;"></td> <td style="width: 10%;"></td> </tr> <tr> <td></td> <td></td> <td colspan="8" style="text-align: center;"> <table border="1" style="width: 100%; border-collapse: collapse; text-align: center;"> <tr> <td style="width: 10%;"></td> <td style="width: 10%;"></td> <td style="width: 10%;"></td> <td style="width: 10%;"></td> <td style="width: 10%;"></td> <td style="width: 10%;"></td> <td style="width: 10%;"></td> <td style="width: 10%;"></td> <td style="width: 10%;"></td> <td style="width: 10%;"></td> </tr> <tr> <td></td> <td></td> <td colspan="8" style="text-align: center;"> <table border="1" style="width: 100%; border-collapse: collapse; text-align: center;"> <tr> <td style="width: 10%;"></td> <td style="width: 10%;"></td> <td style="width: 10%;"></td> <td style="width: 10%;"></td> <td style="width: 10%;"></td> <td style="width: 10%;"></td> <td style="width: 10%;"></td> <td style="width: 10%;"></td> <td style="width: 10%;"></td> <td style="width: 10%;"></td> </tr> <tr> <td></td> <td></td> <td colspan="8" style="text-align: center;"> <table border="1" style="width: 100%; border-collapse: collapse; text-align: center;"> <tr> <td style="width: 10%;"></td> <td style="width: 10%;"></td> <td style="width: 10%;"></td> <td style="width: 10%;"></td> <td style="width: 10%;"></td> <td style="width: 10%;"></td> <td style="width: 10%;"></td> <td style="width: 10%;"></td> <td style="width: 10%;"></td> <td style="width: 10%;"></td> </tr> <tr> <td></td> <td></td> <td colspan="8" style="text-align: center;"> <table border="1" style="width: 100%; border-collapse: collapse; text-align: center;"> <tr> <td style="width: 10%;"></td> <td style="width: 10%;"></td> <td style="width: 10%;"></td> <td style="width: 10%;"></td> <td style="width: 10%;"></td> <td style="width: 10%;"></td> <td style="width: 10%;"></td> <td style="width: 10%;"></td> <td style="width: 10%;"></td> <td style="width: 10%;"></td> </tr> <tr> <td></td> <td></td> <td colspan="8" style="text-align: center;"> <table border="1" style="width: 100%; border-collapse: collapse; text-align: center;"> <tr> <td style="width: 10%;"></td> <td style="width: 10%;"></td> <td style="width: 10%;"></td> <td style="width: 10%;"></td> <td style="width: 10%;"></td> <td style="width: 10%;"></td> <td style="width: 10%;"></td> <td style="width: 10%;"></td> <td style="width: 10%;"></td> <td style="width: 10%;"></td> </tr> <tr> <td></td> <td></td> <td colspan="8" style="text-align: center;"> <table border="1" style="width: 100%; border-collapse: collapse; text-align: center;"> <tr> <td style="width: 10%;"></td> <td style="width: 10%;"></td> <td style="width: 10%;"></td> <td style="width: 10%;"></td> <td style="width: 10%;"></td> <td style="width: 10%;"></td> <td style="width: 10%;"></td> <td style="width: 10%;"></td> <td style="width: 10%;"></td> <td style="width: 10%;"></td> </tr> <tr> <td></td> <td></td> <td colspan="8" style="text-align: center;"> <table border="1" style="width: 100%; border-collapse: collapse; text-align: center;"> <tr> <td style="width: 10%;"></td> <td style="width: 10%;"></td> <td style="width: 10%;"></td> <td style="width: 10%;"></td> <td style="width: 10%;"></td> <td style="width: 10%;"></td> <td style="width: 10%;"></td> <td style="width: 10%;"></td> <td style="width: 10%;"></td> <td style="width: 10%;"></td> </tr> <tr> <td></td> <td></td> <td colspan="8" style="text-align: center;"> <table border="1" style="width: 100%; border-collapse: collapse; text-align: center;"> <tr> <td style="width: 10%;"></td> <td style="width: 10%;"></td> <td style="width: 10%;"></td> <td style="width: 10%;"></td> <td style="width: 10%;"></td> <td style="width: 10%;"></td> <td style="width: 10%;"></td> <td style="width: 10%;"></td> <td style="width: 10%;"></td> <td style="width: 10%;"></td> </tr> <tr> <td></td> <td></td> <td colspan="8" style="text-align: center;"> <table border="1" style="width: 100%; border-collapse: collapse; text-align: center;"> <tr> <td style="width: 10%;"></td> <td style="width: 10%;"></td> <td style="width: 10%;"></td> <td style="width: 10%;"></td> <td style="width: 10%;"></td> <td style="width: 10%;"></td> <td style="width: 10%;"></td> <td style="width: 10%;"></td> <td style="width: 10%;"></td> <td style="width: 10%;"></td> </tr> <tr> <td></td> <td></td> <td colspan="8" style="text-align: center;"> <table border="1" style="width: 100%; border-collapse: collapse; text-align: center;"> <tr> <td style="width: 10%;"></td> <td style="width: 10%;"></td> <td style="width: 10%;"></td> <td style="width: 10%;"></td> <td style="width: 10%;"></td> <td style="width: 10%;"></td> <td style="width: 10%;"></td> <td style="width: 10%;"></td> <td style="width: 10%;"></td> <td style="width: 10%;"></td> </tr> <tr> <td></td> <td></td> <td colspan="8" style="text-align: center;"> <table border="1" style="width: 100%; border-collapse: collapse; text-align: center;"> <tr> <td style="width: 10%;"></td> <td style="width: 10%;"></td> <td style="width: 10%;"></td> <td style="width: 10%;"></td> <td style="width: 10%;"></td> <td style="width: 10%;"></td> <td style="width: 10%;"></td> <td style="width: 10%;"></td> <td style="width: 10%;"></td> <td style="width: 10%;"></td> </tr> <tr> <td></td> <td></td> <td colspan="8" style="text-align: center;"> <table border="1" style="width: 100%; border-collapse: collapse; text-align: center;"> <tr> <td style="width: 10%;"></td> <td style="width: 10%;"></td> <td style="width: 10%;"></td> <td style="width: 10%;"></td> <td style="width: 10%;"></td> <td style="width: 10%;"></td> <td style="width: 10%;"></td> <td style="width:
10%;"></td> <td style="width: 10%;"></td> <td style="width: 10%;"></td> </tr> <tr> <td></td> <td></td> <td colspan="8" style="text-align: center;"> <table border="1" style="width: 100%; border-collapse: collapse; text-align: center;"> <tr> <td style="width: 10%;"></td> <td style="width: 10%;"></td> <td style="width: 10%;"></td> <td style="width: 10%;"></td> <td style="width: 10%;"></td> <td style="width: 10%;"></td> <td style="width: 10%;"></td> <td style="width: 10%;"></td> <td style="width: 10%;"></td> <td style="width: 10%;"></td> </tr> <tr> <td></td> <td></td> <td colspan="8" style="text-align: center;"> <table border="1" style="width: 100%; border-collapse: collapse; text-align: center;"> <tr> <td style="width: 10%;"></td> <td style="width: 10%;"></td> <td style="width: 10%;"></td> <td style="width: 10%;"></td> <td style="width: 10%;"></td> <td style="width: 10%;"></td> <td style="width: 10%;"></td> <td style="width: 10%;"></td> <td style="width: 10%;"></td> <td style="width: 10%;"></td> </tr> <tr> <td></td> <td></td> <td colspan="8" style="text-align: center;"> <table border="1" style="width: 100%; border-collapse: collapse; text-align: center;"> <tr> <td style="width: 10%;"></td> <td style="width: 10%;"></td> <td style="width: 10%;"></td> <td style="width: 10%;"></td> <td style="width: 10%;"></td> <td style="width: 10%;"></td> <td style="width: 10%;"></td> <td style="width: 10%;"></td> <td style="width: 10%;"></td> <td style="width: 10%;"></td> </tr> <tr> <td></td> <td></td> <td colspan="8" style="text-align: center;"> <table border="1" style="width: 100%; border-collapse: collapse; text-align: center;"> <tr> <td style="width: 10%;"></td> <td style="width: 10%;"></td> <td style="width: 10%;"></td> <td style="width: 10%;"></td> <td style="width: 10%;"></td> <td style="width: 10%;"></td> <td style="width: 10%;"></td> <td style="width: 10%;"></td> <td style="width: 10%;"></td> <td style="width: 10%;"></td> </tr> <tr> <td></td> <td></td> <td colspan="8" style="text-align: center;"> <table border="1" style="width: 100%; border-collapse: collapse; text-align: center;"> <tr> <td style="width: 10%;"></td> <td style="width: 10%;"></td> <td style="width: 10%;"></td> <td style="width: 10%;"></td> <td style="width: 10%;"></td> <td style="width: 10%;"></td> <td style="width: 10%;"></td> <td style="width: 10%;"></td> <td style="width: 10%;"></td> <td style="width: 10%;"></td> </tr> <tr> <td></td> <td></td> <td colspan="8" style="text-align: center;"> <table border="1" style="width: 100%; border-collapse: collapse; text-align: center;"> <tr> <td style="width: 10%;"></td> <td style="width: 10%;"></td> <td style="width: 10%;"></td> <td style="width: 10%;"></td> <td style="width: 10%;"></td> <td style="width: 10%;"></td> <td style="width: 10%;"></td> <td style="width: 10%;"></td> <td style="width: 10%;"></td> <td style="width: 10%;"></td> </tr> <tr> <td></td> <td></td> <td colspan="8" style="text-align: center;"> <table border="1" style="width: 100%; border-collapse: collapse; text-align: center;"> <tr> <td style="width: 10%;"></td> <td style="width: 10%;"></td> <td style="width: 10%;"></td> <td style="width: 10%;"></td> <td style="width: 10%;"></td> <td style="width: 10%;"></td> <td style="width: 10%;"></td> <td style="width: 10%;"></td> <td style="width: 10%;"></td> <td style="width: 10%;"></td> </tr> <tr> <td></td> <td></td> <td colspan="8" style="text-align: center;"> <table border="1" style="width: 100%; border-collapse: collapse; text-align: center;"> <tr> <td style="width: 10%;"></td> <td style="width: 10%;"></td> <td style="width: 10%;"></td> <td style="width: 10%;"></td> <td style="width: 10%;"></td> <td style="width: 10%;"></td> <td style="width: 10%;"></td> <td style="width: 10%;"></td> <td style="width: 10%;"></td> <td style="width: 10%;"></td> </tr> <tr> <td></td> <td></td> <td colspan="8" style="text-align: center;"> <table border="1" style="width: 100%; border-collapse: collapse; text-align: center;"> <tr> <td style="width: 10%;"></td> <td style="width: 10%;"></td> <td style="width: 10%;"></td> <td style="width: 10%;"></td> <td style="width: 10%;"></td> <td style="width: 10%;"></td> <td style="width: 10%;"></td> <td style="width: 10%;"></td> <td style="width: 10%;"></td> <td style="width: 10%;"></td> </tr> <tr> <td></td> <td></td> <td colspan="8" style="text-align: center;"> <table border="1" style="width: 100%; border-collapse: collapse; text-align: center;"> <tr> <td style="width: 10%;"></td> <td style="width: 10%;"></td> <td style="width: 10%;"></td> <td style="width: 10%;"></td> <td style="width: 10%;"></td> <td style="width: 10%;"></td> <td style="width: 10%;"></td> <td style="width: 10%;"></td> <td style="width: 10%;"></td> <td style="width: 10%;"></td> </tr> <tr> <td></td> <td></td> <td colspan="8" style="text-align: center;"> <table border="1" style="width: 100%; border-collapse: collapse; text-align: center;"> <tr> <td style="width: 10%;"></td> <td style="width: 10%;"></td> <td style="width: 10%;"></td> <td style="width: 10%;"></td> <td style="width: 10%;"></td> <td style="width: 10%;"></td> <td style="width: 10%;"></td> <td style="width: 10%;"></td> <td style="width: 10%;"></td> <td style="width: 10%;"></td> </tr> <tr> <td></td> <td></td> <td colspan="8" style="text-align: center;"> <table border="1" style="width: 100%; border-collapse: collapse; text-align: center;"> <tr> <td style="width: 10%;"></td> <td style="width: 10%;"></td> <td style="width: 10%;"></td> <td style="width: 10%;"></td> <td style="width: 10%;"></td> <td style="width: 10%;"></td> <td style="width: 10%;"></td> <td style="width: 10%;"></td> <td style="width: 10%;"></td> <td style="width: 10%;"></td> </tr> <tr> <td></td> <td></td> <td colspan="8" style="text-align: center;"> <table border="1" style="width: 100%; border-collapse: collapse; text-align: center;"> <tr> <td style="width: 10%;"></td> <td style="width: 10%;"></td> <td style="width: 10%;"></td> <td style="width: 10%;"></td> <td style="width: 10%;"></td> <td style="width: 10%;"></td> <td style="width: 10%;"></td> <td style="width: 10%;"></td> <td style="width: 10%;"></td> <td style="width: 10%;"></td> </tr> <tr> <td></td> <td></td> <td colspan="8" style="text-align: center;"> <table border="1" style="width: 100%; border-collapse: collapse; text-align: center;"> <tr> <td style="width: 10%;"></td> <td style="width: 10%;"></td> <td style="width: 10%;"></td> <td style="width: 10%;"></td> <td style="width: 10%;"></td> <td style="width: 10%;"></td> <td style="width: 10%;"></td> <td style="width: 10%;"></td> <td style="width: 10%;"></td> <td style="width: 10%;"></td> </tr> <tr> <td></td> <td></td> <td colspan="8" style="text-align: center;"> <table border="1" style="width: 100%; border-collapse: collapse; text-align: center;"> <tr> <td style="width: 10%;"></td> <td style="width: 10%;"></td> <td style="width: 10%;"></td> <td style="width: 10%;"></td> <td style="width: 10%;"></td> <td style="width: 10%;"></td> <td style="width: 10%;"></td> <td style="width: 10%;"></td> <td style="width: 10%;"></td> <td style="width: 10%;"></td> </tr> <tr> <td></td> <td></td> <td colspan="8" style="text-align: center;"> <table border="1" style="width: 100%; border-collapse: collapse; text-align: center;"> <tr> <td style="width: 10%;"></td> <td style="width: 10%;"></td> <td style="width: 10%;"></td> <td style="width: 10%;"></td> <td style="width: 10%;"></td> <td style="width: 10%;"></td> <td style="width: 10%;"></td> <td style="width: 10%;"></td> <td style="width: 10%;"></td> <td style="width: 10%;"></td> </tr> <tr> <td></td> <td></td> <td colspan="8" style="text-align: center;"> <table border="1" style="width: 100%; border-collapse: collapse; text-align: center;"> <tr> <td style="width: 10%;"></td> <td style="width: 10%;"></td> <td style="width: 10%;"></td> <td style="width: 10%;"></td> <td style="width: 10%;"></td> <td style="width: 10%;"></td> <td style="width: 10%;"></td> <td style="width: 10%;"></td> <td style="width: 10%;"></td> <td style="width: 10%;"></td> </tr> <tr> <td></td> <td></td> <td colspan="8" style="text-align: center;"> <table border="1" style="width: 100%; border-collapse: collapse; text-align: center;"> <tr> <td style="width: 10%;"></td> <td style="width: 10%;"></td> <td style="width: 10%;"></td> <td style="width: 10%;"></td> <td style="width: 10%;"></td> <td style="width: 10%;"></td> <td style="width: 10%;"></td> <td style="width: 10%;"></td> <td style="width: 10%;"></td> <td style="width: 10%;"></td> </tr> <tr> <td></td> <td></td> <td colspan="8" style="text-align: center;"> <table border="1" style="width: 100%; border-collapse: collapse; text-align: center;"> <tr> <td style="width: 10%;"></td> <td style="width: 10%;"></td> <td style="width: 10%;"></td> <td style="width: 10%;"></td> <td style="width: 10%;"></td> <td style="width: 10%;"></td> <td style="width: 10%;"></td> <td style="width: 10%;"></td> <td style="width: 10%;"></td> <td style="width: 10%;"></td> </tr> <tr> <td></td> <td></td> <td colspan="8" style="text-align: center;"> <table border="1" style="width: 100%; border-collapse: collapse; text-align: center;"> <tr> <td style="width: 10%;"></td> <td style="width: 10%;"></td> <td style="width: 10%;"></td> <td style="width: 10%;"></td> <td style="width: 10%;"></td> <td style="width: 10%;"></td> <td style="width: 10%;"></td> <td style="width: 10%;"></td> <td style="width: 10%;"></td> <td style="width: 10%;"></td> </tr> <tr> <td></td> <td></td> <td colspan="8" style="text-align: center;"> <table border="1" style="width: 100%; border-collapse: collapse; text-align: center;"> <tr> <td style="width: 10%;"></td> <td style="width: 10%;"></td> <td style="width: 10%;"></td> <td style="width: 10%;"></td> <td style="width: 10%;"></td> <td style="width: 10%;"></td> <td style="width: 10%;"></td> <td style="width: 10%;"></td> <td style="width: 10%;"></td> <td style="width: 10%;"></td> </tr> <tr> <td></td> <td></td> <td colspan="8" style="text-align: center;"> <table border="1"
style="width: 100%; border-collapse: collapse; text-align: center;"> <tr> <td style="width: 10%;"></td> <td style="width: 10%;"></td> <td style="width: 10%;"></td> <td style="width: 10%;"></td> <td style="width: 10%;"></td> <td style="width: 10%;"></td> <td style="width: 10%;"></td> <td style="width: 10%;"></td> <td style="width: 10%;"></td> <td style="width: 10%;"></td> </tr> <tr> <td></td> <td></td> <td colspan="8" style="text-align: center;"> <table border="1" style="width: 100%; border-collapse: collapse; text-align: center;"> <tr> </tr></table></td></tr></table></td></tr></table></td></tr></table></td></tr></table></td></tr></table></td></tr></table></td></tr></table></td></tr></table></td></tr></table></td></tr></table></td></tr></table></td></tr></table></td></tr></table></td></tr></table></td></tr></table></td></tr></table></td></tr></table></td></tr></table></td></tr></table></td></tr></table></td></tr></table></td></tr></table></td></tr></table></td></tr></table></td></tr></table></td></tr></table></td></tr></table></td></tr></table></td></tr></table></td></tr></table></td></tr></table></td></tr></table></td></tr></table></td></tr></table></td></tr></table></td></tr></table></td></tr></table></td></tr></table></td></tr></table> | | | | | | | | | | | | | | | | | | | | <table border="1" style="width: 100%; border-collapse: collapse; text-align: center;"> <tr> <td style="width: 10%;"></td> <td style="width: 10%;"></td> <td style="width: 10%;"></td> <td style="width: 10%;"></td> <td style="width: 10%;"></td> <td style="width: 10%;"></td> <td style="width: 10%;"></td> <td style="width: 10%;"></td> <td style="width: 10%;"></td> <td style="width: 10%;"></td> </tr> <tr> <td></td> <td></td> <td colspan="8" style="text-align: center;"> <table border="1" style="width: 100%; border-collapse: collapse; text-align: center;"> <tr> <td style="width: 10%;"></td> <td style="width: 10%;"></td> <td style="width: 10%;"></td> <td style="width: 10%;"></td> <td style="width: 10%;"></td> <td style="width: 10%;"></td> <td style="width: 10%;"></td> <td style="width: 10%;"></td> <td style="width: 10%;"></td> <td style="width: 10%;"></td> </tr> <tr> <td></td> <td></td> <td colspan="8" style="text-align: center;"> <table border="1" style="width: 100%; border-collapse: collapse; text-align: center;"> <tr> <td style="width: 10%;"></td> <td style="width: 10%;"></td> <td style="width: 10%;"></td> <td style="width: 10%;"></td> <td style="width: 10%;"></td> <td style="width: 10%;"></td> <td style="width: 10%;"></td> <td style="width: 10%;"></td> <td style="width: 10%;"></td> <td style="width: 10%;"></td> </tr> <tr> <td></td> <td></td> <td colspan="8" style="text-align: center;"> <table border="1" style="width: 100%; border-collapse: collapse; text-align: center;"> <tr> <td style="width: 10%;"></td> <td style="width: 10%;"></td> <td style="width: 10%;"></td> <td style="width: 10%;"></td> <td style="width: 10%;"></td> <td style="width: 10%;"></td> <td style="width: 10%;"></td> <td style="width: 10%;"></td> <td style="width: 10%;"></td> <td style="width: 10%;"></td> </tr> <tr> <td></td> <td></td> <td colspan="8" style="text-align: center;"> <table border="1" style="width: 100%; border-collapse: collapse; text-align: center;"> <tr> <td style="width: 10%;"></td> <td style="width: 10%;"></td> <td style="width: 10%;"></td> <td style="width: 10%;"></td> <td style="width: 10%;"></td> <td style="width: 10%;"></td> <td style="width: 10%;"></td> <td style="width: 10%;"></td> <td style="width: 10%;"></td> <td style="width: 10%;"></td> </tr> <tr> <td></td> <td></td> <td colspan="8" style="text-align: center;"> <table border="1" style="width: 100%; border-collapse: collapse; text-align: center;"> <tr> <td style="width: 10%;"></td> <td style="width: 10%;"></td> <td style="width: 10%;"></td> <td style="width: 10%;"></td> <td style="width: 10%;"></td> <td style="width: 10%;"></td> <td style="width: 10%;"></td> <td style="width: 10%;"></td> <td style="width: 10%;"></td> <td style="width: 10%;"></td> </tr> <tr> <td></td> <td></td> <td colspan="8" style="text-align: center;"> <table border="1" style="width: 100%; border-collapse: collapse; text-align: center;"> <tr> <td style="width: 10%;"></td> <td style="width: 10%;"></td> <td style="width: 10%;"></td> <td style="width: 10%;"></td> <td style="width: 10%;"></td> <td style="width: 10%;"></td> <td style="width: 10%;"></td> <td style="width: 10%;"></td> <td style="width: 10%;"></td> <td style="width: 10%;"></td> </tr> <tr> <td></td> <td></td> <td colspan="8" style="text-align: center;"> <table border="1" style="width: 100%; border-collapse: collapse; text-align: center;"> <tr> <td style="width: 10%;"></td> <td style="width: 10%;"></td> <td style="width: 10%;"></td> <td style="width: 10%;"></td> <td style="width: 10%;"></td> <td style="width: 10%;"></td> <td style="width: 10%;"></td> <td style="width: 10%;"></td> <td style="width: 10%;"></td> <td style="width: 10%;"></td> </tr> <tr> <td></td> <td></td> <td colspan="8" style="text-align: center;"> <table border="1" style="width: 100%; border-collapse: collapse; text-align: center;"> <tr> <td style="width: 10%;"></td> <td style="width: 10%;"></td> <td style="width: 10%;"></td> <td style="width: 10%;"></td> <td style="width: 10%;"></td> <td style="width: 10%;"></td> <td style="width: 10%;"></td> <td style="width: 10%;"></td> <td style="width: 10%;"></td> <td style="width: 10%;"></td> </tr> <tr> <td></td> <td></td> <td colspan="8" style="text-align: center;"> <table border="1" style="width: 100%; border-collapse: collapse; text-align: center;"> <tr> <td
style="width: 10%;"></td> <td style="width: 10%;"></td> <td style="width: 10%;"></td> <td style="width: 10%;"></td> <td style="width: 10%;"></td> <td style="width: 10%;"></td> <td style="width: 10%;"></td> <td style="width: 10%;"></td> <td style="width: 10%;"></td> <td style="width: 10%;"></td> </tr> <tr> <td></td> <td></td> <td colspan="8" style="text-align: center;"> <table border="1" style="width: 100%; border-collapse: collapse; text-align: center;"> <tr> <td style="width: 10%;"></td> <td style="width: 10%;"></td> <td style="width: 10%;"></td> <td style="width: 10%;"></td> <td style="width: 10%;"></td> <td style="width: 10%;"></td> <td style="width: 10%;"></td> <td style="width: 10%;"></td> <td style="width: 10%;"></td> <td style="width: 10%;"></td> </tr> <tr> <td></td> <td></td> <td colspan="8" style="text-align: center;"> <table border="1" style="width: 100%; border-collapse: collapse; text-align: center;"> <tr> <td style="width: 10%;"></td> <td style="width: 10%;"></td> <td style="width: 10%;"></td> <td style="width: 10%;"></td> <td style="width: 10%;"></td> <td style="width: 10%;"></td> <td style="width: 10%;"></td> <td style="width: 10%;"></td> <td style="width: 10%;"></td> <td style="width: 10%;"></td> </tr> <tr> <td></td> <td></td> <td colspan="8" style="text-align: center;"> <table border="1" style="width: 100%; border-collapse: collapse; text-align: center;"> <tr> <td style="width: 10%;"></td> <td style="width: 10%;"></td> <td style="width: 10%;"></td> <td style="width: 10%;"></td> <td style="width: 10%;"></td> <td style="width: 10%;"></td> <td style="width: 10%;"></td> <td style="width: 10%;"></td> <td style="width: 10%;"></td> <td style="width: 10%;"></td> </tr> <tr> <td></td> <td></td> <td colspan="8" style="text-align: center;"> <table border="1" style="width: 100%; border-collapse: collapse; text-align: center;"> <tr> <td style="width: 10%;"></td> <td style="width: 10%;"></td> <td style="width: 10%;"></td> <td style="width: 10%;"></td> <td style="width: 10%;"></td> <td style="width: 10%;"></td> <td style="width: 10%;"></td> <td style="width: 10%;"></td> <td style="width: 10%;"></td> <td style="width: 10%;"></td> </tr> <tr> <td></td> <td></td> <td colspan="8" style="text-align: center;"> <table border="1" style="width: 100%; border-collapse: collapse; text-align: center;"> <tr> <td style="width: 10%;"></td> <td style="width: 10%;"></td> <td style="width: 10%;"></td> <td style="width: 10%;"></td> <td style="width: 10%;"></td> <td style="width: 10%;"></td> <td style="width: 10%;"></td> <td style="width: 10%;"></td> <td style="width: 10%;"></td> <td style="width: 10%;"></td> </tr> <tr> <td></td> <td></td> <td colspan="8" style="text-align: center;"> <table border="1" style="width: 100%; border-collapse: collapse; text-align: center;"> <tr> <td style="width: 10%;"></td> <td style="width: 10%;"></td> <td style="width: 10%;"></td> <td style="width: 10%;"></td> <td style="width: 10%;"></td> <td style="width: 10%;"></td> <td style="width: 10%;"></td> <td style="width: 10%;"></td> <td style="width: 10%;"></td> <td style="width: 10%;"></td> </tr> <tr> <td></td> <td></td> <td colspan="8" style="text-align: center;"> <table border="1" style="width: 100%; border-collapse: collapse; text-align: center;"> <tr> <td style="width: 10%;"></td> <td style="width: 10%;"></td> <td style="width: 10%;"></td> <td style="width: 10%;"></td> <td style="width: 10%;"></td> <td style="width: 10%;"></td> <td style="width: 10%;"></td> <td style="width: 10%;"></td> <td style="width: 10%;"></td> <td style="width: 10%;"></td> </tr> <tr> <td></td> <td></td> <td colspan="8" style="text-align: center;"> <table border="1" style="width: 100%; border-collapse: collapse; text-align: center;"> <tr> <td style="width: 10%;"></td> <td style="width: 10%;"></td> <td style="width: 10%;"></td> <td style="width: 10%;"></td> <td style="width: 10%;"></td> <td style="width: 10%;"></td> <td style="width: 10%;"></td> <td style="width: 10%;"></td> <td style="width: 10%;"></td> <td style="width: 10%;"></td> </tr> <tr> <td></td> <td></td> <td colspan="8" style="text-align: center;"> <table border="1" style="width: 100%; border-collapse: collapse; text-align: center;"> <tr> <td style="width: 10%;"></td> <td style="width: 10%;"></td> <td style="width: 10%;"></td> <td style="width: 10%;"></td> <td style="width: 10%;"></td> <td style="width: 10%;"></td> <td style="width: 10%;"></td> <td style="width: 10%;"></td> <td style="width: 10%;"></td> <td style="width: 10%;"></td> </tr> <tr> <td></td> <td></td> <td colspan="8" style="text-align: center;"> <table border="1" style="width: 100%; border-collapse: collapse; text-align: center;"> <tr> <td style="width: 10%;"></td> <td style="width: 10%;"></td> <td style="width: 10%;"></td> <td style="width: 10%;"></td> <td style="width: 10%;"></td> <td style="width: 10%;"></td> <td style="width: 10%;"></td> <td style="width: 10%;"></td> <td style="width: 10%;"></td> <td style="width: 10%;"></td> </tr> <tr> <td></td> <td></td> <td colspan="8" style="text-align: center;"> <table border="1" style="width: 100%; border-collapse: collapse; text-align: center;"> <tr> <td style="width: 10%;"></td> <td style="width: 10%;"></td> <td style="width: 10%;"></td> <td style="width: 10%;"></td> <td style="width: 10%;"></td> <td style="width: 10%;"></td> <td style="width: 10%;"></td> <td style="width: 10%;"></td> <td style="width: 10%;"></td> <td style="width: 10%;"></td> </tr> <tr> <td></td> <td></td> <td colspan="8" style="text-align: center;"> <table border="1" style="width: 100%; border-collapse: collapse; text-align: center;"> <tr> <td style="width: 10%;"></td> <td style="width: 10%;"></td> <td style="width: 10%;"></td> <td style="width: 10%;"></td> <td style="width: 10%;"></td> <td style="width: 10%;"></td> <td style="width: 10%;"></td> <td style="width: 10%;"></td> <td style="width: 10%;"></td> <td style="width: 10%;"></td> </tr> <tr> <td></td> <td></td> <td colspan="8" style="text-align: center;"> <table border="1" style="width: 100%; border-collapse: collapse; text-align: center;"> <tr> <td style="width: 10%;"></td> <td style="width: 10%;"></td> <td style="width: 10%;"></td> <td style="width: 10%;"></td> <td style="width: 10%;"></td> <td style="width: 10%;"></td> <td style="width: 10%;"></td> <td style="width: 10%;"></td> <td style="width: 10%;"></td> <td style="width: 10%;"></td> </tr> <tr> <td></td> <td></td> <td colspan="8" style="text-align: center;"> <table border="1" style="width: 100%; border-collapse: collapse; text-align: center;"> <tr> <td style="width: 10%;"></td> <td style="width: 10%;"></td> <td style="width: 10%;"></td> <td style="width: 10%;"></td> <td style="width: 10%;"></td> <td style="width: 10%;"></td> <td style="width: 10%;"></td> <td style="width: 10%;"></td> <td style="width: 10%;"></td> <td style="width: 10%;"></td> </tr> <tr> <td></td> <td></td> <td colspan="8" style="text-align: center;"> <table border="1" style="width: 100%; border-collapse: collapse; text-align: center;"> <tr> <td style="width: 10%;"></td> <td style="width: 10%;"></td> <td style="width: 10%;"></td> <td style="width: 10%;"></td> <td style="width: 10%;"></td> <td style="width: 10%;"></td> <td style="width: 10%;"></td> <td style="width: 10%;"></td> <td style="width: 10%;"></td> <td style="width: 10%;"></td> </tr> <tr> <td></td> <td></td> <td colspan="8" style="text-align: center;"> <table border="1" style="width: 100%; border-collapse: collapse; text-align: center;"> <tr> <td style="width: 10%;"></td> <td style="width: 10%;"></td> <td style="width: 10%;"></td> <td style="width: 10%;"></td> <td style="width: 10%;"></td> <td style="width: 10%;"></td> <td style="width: 10%;"></td> <td style="width: 10%;"></td> <td style="width: 10%;"></td> <td style="width: 10%;"></td> </tr> <tr> <td></td> <td></td> <td colspan="8" style="text-align: center;"> <table border="1" style="width: 100%; border-collapse: collapse; text-align: center;"> <tr> <td style="width: 10%;"></td> <td style="width: 10%;"></td> <td style="width: 10%;"></td> <td style="width: 10%;"></td> <td style="width: 10%;"></td> <td style="width: 10%;"></td> <td style="width: 10%;"></td> <td style="width: 10%;"></td> <td style="width: 10%;"></td> <td style="width: 10%;"></td> </tr> <tr> <td></td> <td></td> <td colspan="8" style="text-align: center;"> <table border="1" style="width: 100%; border-collapse: collapse; text-align: center;"> <tr> <td style="width: 10%;"></td> <td style="width: 10%;"></td> <td style="width: 10%;"></td> <td style="width: 10%;"></td> <td style="width: 10%;"></td> <td style="width: 10%;"></td> <td style="width: 10%;"></td> <td style="width: 10%;"></td> <td style="width: 10%;"></td> <td style="width: 10%;"></td> </tr> <tr> <td></td> <td></td> <td colspan="8" style="text-align: center;"> <table border="1" style="width: 100%; border-collapse: collapse; text-align: center;"> <tr> <td style="width: 10%;"></td> <td style="width: 10%;"></td> <td style="width: 10%;"></td> <td style="width: 10%;"></td> <td style="width: 10%;"></td> <td style="width: 10%;"></td> <td style="width: 10%;"></td> <td style="width: 10%;"></td> <td style="width: 10%;"></td> <td style="width: 10%;"></td> </tr> <tr> <td></td> <td></td> <td colspan="8" style="text-align: center;"> <table border="1" style="width: 100%; border-collapse: collapse; text-align: center;"> <tr> <td style="width: 10%;"></td> <td style="width: 10%;"></td> <td style="width: 10%;"></td> <td style="width: 10%;"></td> <td style="width: 10%;"></td> <td style="width: 10%;"></td> <td style="width: 10%;"></td> <td style="width: 10%;"></td> <td style="width: 10%;"></td> <td style="width: 10%;"></td> </tr> <tr> <td></td> <td></td> <td colspan="8" style="text-align: center;"> <table border="1" style="width: 100%; border-collapse: collapse; text-align: center;"> <tr> <td style="width: 10%;"></td> <td style="width: 10%;"></td> <td style="width: 10%;"></td> <td style="width: 10%;"></td> <td style="width: 10%;"></td> <td style="width:
10%;"></td> <td style="width: 10%;"></td> <td style="width: 10%;"></td> <td style="width: 10%;"></td> <td style="width: 10%;"></td> </tr> <tr> <td></td> <td></td> <td colspan="8" style="text-align: center;"> <table border="1" style="width: 100%; border-collapse: collapse; text-align: center;"> <tr> <td style="width: 10%;"></td> <td style="width: 10%;"></td> <td style="width: 10%;"></td> <td style="width: 10%;"></td> <td style="width: 10%;"></td> <td style="width: 10%;"></td> <td style="width: 10%;"></td> <td style="width: 10%;"></td> <td style="width: 10%;"></td> <td style="width: 10%;"></td> </tr> <tr> <td></td> <td></td> <td colspan="8" style="text-align: center;"> <table border="1" style="width: 100%; border-collapse: collapse; text-align: center;"> <tr> <td style="width: 10%;"></td> <td style="width: 10%;"></td> <td style="width: 10%;"></td> <td style="width: 10%;"></td> <td style="width: 10%;"></td> <td style="width: 10%;"></td> <td style="width: 10%;"></td> <td style="width: 10%;"></td> <td style="width: 10%;"></td> <td style="width: 10%;"></td> </tr> <tr> <td></td> <td></td> <td colspan="8" style="text-align: center;"> <table border="1" style="width: 100%; border-collapse: collapse; text-align: center;"> <tr> <td style="width: 10%;"></td> <td style="width: 10%;"></td> <td style="width: 10%;"></td> <td style="width: 10%;"></td> <td style="width: 10%;"></td> <td style="width: 10%;"></td> <td style="width: 10%;"></td> <td style="width: 10%;"></td> <td style="width: 10%;"></td> <td style="width: 10%;"></td> </tr> <tr> <td></td> <td></td> <td colspan="8" style="text-align: center;"> <table border="1" style="width: 100%; border-collapse: collapse; text-align: center;"> <tr> <td style="width: 10%;"></td> <td style="width: 10%;"></td> <td style="width: 10%;"></td> <td style="width: 10%;"></td> <td style="width: 10%;"></td> <td style="width: 10%;"></td> <td style="width: 10%;"></td> <td style="width: 10%;"></td> <td style="width: 10%;"></td> <td style="width: 10%;"></td> </tr> <tr> <td></td> <td></td> <td colspan="8" style="text-align: center;"> <table border="1" style="width: 100%; border-collapse: collapse; text-align: center;"> <tr> <td style="width: 10%;"></td> <td style="width: 10%;"></td> <td style="width: 10%;"></td> <td style="width: 10%;"></td> <td style="width: 10%;"></td> <td style="width: 10%;"></td> <td style="width: 10%;"></td> <td style="width: 10%;"></td> <td style="width: 10%;"></td> <td style="width: 10%;"></td> </tr> <tr> <td></td> <td></td> <td colspan="8" style="text-align: center;"> <table border="1" style="width: 100%; border-collapse: collapse; text-align: center;"> <tr> <td style="width: 10%;"></td> <td style="width: 10%;"></td> <td style="width: 10%;"></td> <td style="width: 10%;"></td> <td style="width: 10%;"></td> <td style="width: 10%;"></td> <td style="width: 10%;"></td> <td style="width: 10%;"></td> <td style="width: 10%;"></td> <td style="width: 10%;"></td> </tr> <tr> <td></td> <td></td> <td colspan="8" style="text-align: center;"> <table border="1" style="width: 100%; border-collapse: collapse; text-align: center;"> <tr> <td style="width: 10%;"></td> <td style="width: 10%;"></td> <td style="width: 10%;"></td> <td style="width: 10%;"></td> <td style="width: 10%;"></td> <td style="width: 10%;"></td> <td style="width: 10%;"></td> <td style="width: 10%;"></td> <td style="width: 10%;"></td> <td style="width: 10%;"></td> </tr> <tr> <td></td> <td></td> <td colspan="8" style="text-align: center;"> <table border="1" style="width: 100%; border-collapse: collapse; text-align: center;"> <tr> </tr></table></td></tr></table></td></tr></table></td></tr></table></td></tr></table></td></tr></table></td></tr></table></td></tr></table></td></tr></table></td></tr></table></td></tr></table></td></tr></table></td></tr></table></td></tr></table></td></tr></table></td></tr></table></td></tr></table></td></tr></table></td></tr></table></td></tr></table></td></tr></table></td></tr></table></td></tr></table></td></tr></table></td></tr></table></td></tr></table></td></tr></table></td></tr></table></td></tr></table></td></tr></table></td></tr></table></td></tr></table></td></tr></table></td></tr></table></td></tr></table></td></tr></table></td></tr></table></td></tr></table></td></tr></table> | | | | | | | | | | | | | | | | | | | | <table border="1" style="width: 100%; border-collapse: collapse; text-align: center;"> <tr> <td style="width: 10%;"></td> <td style="width: 10%;"></td> <td style="width: 10%;"></td> <td style="width: 10%;"></td> <td style="width: 10%;"></td> <td style="width: 10%;"></td> <td style="width: 10%;"></td> <td style="width: 10%;"></td> <td style="width: 10%;"></td> <td style="width: 10%;"></td> </tr> <tr> <td></td> <td></td> <td colspan="8" style="text-align: center;"> <table border="1" style="width: 100%; border-collapse: collapse; text-align: center;"> <tr> <td style="width: 10%;"></td> <td style="width: 10%;"></td> <td style="width: 10%;"></td> <td style="width: 10%;"></td> <td style="width: 10%;"></td> <td style="width: 10%;"></td> <td style="width: 10%;"></td> <td style="width: 10%;"></td> <td style="width: 10%;"></td> <td style="width: 10%;"></td> </tr> <tr> <td></td> <td></td> <td colspan="8" style="text-align: center;"> <table border="1" style="width: 100%; border-collapse: collapse; text-align: center;"> <tr> <td style="width: 10%;"></td> <td style="width: 10%;"></td> <td style="width: 10%;"></td> <td style="width: 10%;"></td> <td style="width: 10%;"></td> <td style="width: 10%;"></td> <td style="width: 10%;"></td> <td style="width: 10%;"></td> <td style="width:
10%;"></td> <td style="width: 10%;"></td> </tr> <tr> <td></td> <td></td> <td colspan="8" style="text-align: center;"> <table border="1" style="width: 100%; border-collapse: collapse; text-align: center;"> <tr> <td style="width: 10%;"></td> <td style="width: 10%;"></td> <td style="width: 10%;"></td> <td style="width: 10%;"></td> <td style="width: 10%;"></td> <td style="width: 10%;"></td> <td style="width: 10%;"></td> <td style="width: 10%;"></td> <td style="width: 10%;"></td> <td style="width: 10%;"></td> </tr> <tr> <td></td> <td></td> <td colspan="8" style="text-align: center;"> <table border="1" style="width: 100%; border-collapse: collapse; text-align: center;"> <tr> <td style="width: 10%;"></td> <td style="width: 10%;"></td> <td style="width: 10%;"></td> <td style="width: 10%;"></td> <td style="width: 10%;"></td> <td style="width: 10%;"></td> <td style="width: 10%;"></td> <td style="width: 10%;"></td> <td style="width: 10%;"></td> <td style="width: 10%;"></td> </tr> <tr> <td></td> <td></td> <td colspan="8" style="text-align: center;"> <table border="1" style="width: 100%; border-collapse: collapse; text-align: center;"> <tr> <td style="width: 10%;"></td> <td style="width: 10%;"></td> <td style="width: 10%;"></td> <td style="width: 10%;"></td> <td style="width: 10%;"></td> <td style="width: 10%;"></td> <td style="width: 10%;"></td> <td style="width: 10%;"></td> <td style="width: 10%;"></td> <td style="width: 10%;"></td> </tr> <tr> <td></td> <td></td> <td colspan="8" style="text-align: center;"> <table border="1" style="width: 100%; border-collapse: collapse; text-align: center;"> <tr> <td style="width: 10%;"></td> <td style="width: 10%;"></td> <td style="width: 10%;"></td> <td style="width: 10%;"></td> <td style="width: 10%;"></td> <td style="width: 10%;"></td> <td style="width: 10%;"></td> <td style="width: 10%;"></td> <td style="width: 10%;"></td> <td style="width: 10%;"></td> </tr> <tr> <td></td> <td></td> <td colspan="8" style="text-align: center;"> <table border="1" style="width: 100%; border-collapse: collapse; text-align: center;"> <tr> <td style="width: 10%;"></td> <td style="width: 10%;"></td> <td style="width: 10%;"></td> <td style="width: 10%;"></td> <td style="width: 10%;"></td> <td style="width: 10%;"></td> <td style="width: 10%;"></td> <td style="width: 10%;"></td> <td style="width: 10%;"></td> <td style="width: 10%;"></td> </tr> <tr> <td></td> <td></td> <td colspan="8" style="text-align: center;"> <table border="1" style="width: 100%; border-collapse: collapse; text-align: center;"> <tr> <td style="width: 10%;"></td> <td style="width: 10%;"></td> <td style="width: 10%;"></td> <td style="width: 10%;"></td> <td style="width: 10%;"></td> <td style="width: 10%;"></td> <td style="width: 10%;"></td> <td style="width: 10%;"></td> <td style="width: 10%;"></td> <td style="width: 10%;"></td> </tr> <tr> <td></td> <td></td> <td colspan="8" style="text-align: center;"> <table border="1" style="width: 100%; border-collapse: collapse; text-align: center;"> <tr> <td style="width: 10%;"></td> <td style="width: 10%;"></td> <td style="width: 10%;"></td> <td style="width: 10%;"></td> <td style="width: 10%;"></td> <td style="width: 10%;"></td> <td style="width: 10%;"></td> <td style="width: 10%;"></td> <td style="width: 10%;"></td> <td style="width: 10%;"></td> </tr> <tr> <td></td> <td></td> <td colspan="8" style="text-align: center;"> <table border="1" style="width: 100%; border-collapse: collapse; text-align: center;"> <tr> <td style="width: 10%;"></td> <td style="width: 10%;"></td> <td style="width: 10%;"></td> <td style="width: 10%;"></td> <td style="width: 10%;"></td> <td style="width: 10%;"></td> <td style="width: 10%;"></td> <td style="width: 10%;"></td> <td style="width: 10%;"></td> <td style="width: 10%;"></td> </tr> <tr> <td></td> <td></td> <td colspan="8" style="text-align: center;"> <table border="1" style="width: 100%; border-collapse: collapse; text-align: center;"> <tr> <td style="width: 10%;"></td> <td style="width: 10%;"></td> <td style="width: 10%;"></td> <td style="width: 10%;"></td> <td style="width: 10%;"></td> <td style="width: 10%;"></td> <td style="width: 10%;"></td> <td style="width: 10%;"></td> <td style="width: 10%;"></td> <td style="width: 10%;"></td> </tr> <tr> <td></td> <td></td> <td colspan="8" style="text-align: center;"> <table border="1" style="width: 100%; border-collapse: collapse; text-align: center;"> <tr> <td style="width: 10%;"></td> <td style="width: 10%;"></td> <td style="width: 10%;"></td> <td style="width: 10%;"></td> <td style="width: 10%;"></td> <td style="width: 10%;"></td> <td style="width: 10%;"></td> <td style="width: 10%;"></td> <td style="width: 10%;"></td> <td style="width: 10%;"></td> </tr> <tr> <td></td> <td></td> <td colspan="8" style="text-align: center;"> <table border="1" style="width: 100%; border-collapse: collapse; text-align: center;"> <tr> <td style="width: 10%;"></td> <td style="width: 10%;"></td> <td style="width: 10%;"></td> <td style="width: 10%;"></td> <td style="width: 10%;"></td> <td style="width: 10%;"></td> <td style="width: 10%;"></td> <td style="width: 10%;"></td> <td style="width: 10%;"></td> <td style="width: 10%;"></td> </tr> <tr> <td></td> <td></td> <td colspan="8" style="text-align: center;"> <table border="1" style="width: 100%; border-collapse: collapse; text-align: center;"> <tr> <td style="width: 10%;"></td> <td style="width: 10%;"></td> <td style="width: 10%;"></td> <td style="width: 10%;"></td> <td style="width: 10%;"></td> <td style="width: 10%;"></td> <td style="width: 10%;"></td> <td style="width: 10%;"></td> <td style="width: 10%;"></td> <td style="width: 10%;"></td> </tr> <tr> <td></td> <td></td> <td colspan="8" style="text-align: center;"> <table border="1" style="width: 100%; border-collapse: collapse; text-align: center;"> <tr> <td style="width: 10%;"></td> <td style="width: 10%;"></td> <td style="width: 10%;"></td> <td style="width: 10%;"></td> <td style="width: 10%;"></td> <td style="width: 10%;"></td> <td style="width: 10%;"></td> <td style="width: 10%;"></td> <td style="width: 10%;"></td> <td style="width: 10%;"></td> </tr> <tr> <td></td> <td></td> <td colspan="8" style="text-align: center;"> <table border="1" style="width: 100%; border-collapse: collapse; text-align: center;"> <tr> <td style="width: 10%;"></td> <td style="width: 10%;"></td> <td style="width: 10%;"></td> <td style="width: 10%;"></td> <td style="width: 10%;"></td> <td style="width: 10%;"></td> <td style="width: 10%;"></td> <td style="width: 10%;"></td> <td style="width: 10%;"></td> <td style="width: 10%;"></td> </tr> <tr> <td></td> <td></td> <td colspan="8" style="text-align: center;"> <table border="1" style="width: 100%; border-collapse: collapse; text-align: center;"> <tr> <td style="width: 10%;"></td> <td style="width: 10%;"></td> <td style="width: 10%;"></td> <td style="width: 10%;"></td> <td style="width: 10%;"></td> <td style="width: 10%;"></td> <td style="width: 10%;"></td> <td style="width: 10%;"></td> <td style="width: 10%;"></td> <td style="width: 10%;"></td> </tr> <tr> <td></td> <td></td> <td colspan="8" style="text-align: center;"> <table border="1" style="width: 100%; border-collapse: collapse; text-align: center;"> <tr> <td style="width: 10%;"></td> <td style="width: 10%;"></td> <td style="width: 10%;"></td> <td style="width: 10%;"></td> <td style="width: 10%;"></td> <td style="width: 10%;"></td> <td style="width: 10%;"></td> <td style="width: 10%;"></td> <td style="width: 10%;"></td> <td style="width: 10%;"></td> </tr> <tr> <td></td> <td></td> <td colspan="8" style="text-align: center;"> <table border="1" style="width: 100%; border-collapse: collapse; text-align: center;"> <tr> <td style="width: 10%;"></td> <td style="width: 10%;"></td> <td style="width: 10%;"></td> <td style="width: 10%;"></td> <td style="width: 10%;"></td> <td style="width: 10%;"></td> <td style="width: 10%;"></td> <td style="width: 10%;"></td> <td style="width: 10%;"></td> <td style="width: 10%;"></td> </tr> <tr> <td></td> <td></td> <td colspan="8" style="text-align: center;"> <table border="1" style="width: 100%; border-collapse: collapse; text-align: center;"> <tr> <td style="width: 10%;"></td> <td style="width: 10%;"></td> <td style="width: 10%;"></td> <td style="width: 10%;"></td> <td style="width: 10%;"></td> <td style="width: 10%;"></td> <td style="width: 10%;"></td> <td style="width: 10%;"></td> <td style="width: 10%;"></td> <td style="width: 10%;"></td> </tr> <tr> <td></td> <td></td> <td colspan="8" style="text-align: center;"> <table border="1" style="width: 100%; border-collapse: collapse; text-align: center;"> <tr> <td style="width: 10%;"></td> <td style="width: 10%;"></td> <td style="width: 10%;"></td> <td style="width: 10%;"></td> <td style="width: 10%;"></td> <td style="width: 10%;"></td> <td style="width: 10%;"></td> <td style="width: 10%;"></td> <td style="width: 10%;"></td> <td style="width: 10%;"></td> </tr> <tr> <td></td> <td></td> <td colspan="8" style="text-align: center;"> <table border="1" style="width: 100%; border-collapse: collapse; text-align: center;"> <tr> <td style="width: 10%;"></td> <td style="width: 10%;"></td> <td style="width: 10%;"></td> <td style="width: 10%;"></td> <td style="width: 10%;"></td> <td style="width: 10%;"></td> <td style="width: 10%;"></td> <td style="width: 10%;"></td> <td style="width: 10%;"></td> <td style="width: 10%;"></td> </tr> <tr> <td></td> <td></td> <td colspan="8" style="text-align: center;"> <table border="1" style="width: 100%; border-collapse: collapse; text-align: center;"> <tr> <td style="width: 10%;"></td> <td style="width: 10%;"></td> <td style="width: 10%;"></td> <td style="width: 10%;"></td> <td style="width: 10%;"></td> <td style="width: 10%;"></td> <td style="width: 10%;"></td> <td style="width: 10%;"></td> <td style="width: 10%;"></td> <td style="width: 10%;"></td> </tr> <tr> <td></td> <td></td> <td colspan="8" style="text-align: center;"> <table border="1" style="width: 100%;
border-collapse: collapse; text-align: center;"> <tr> <td style="width: 10%;"></td> <td style="width: 10%;"></td> <td style="width: 10%;"></td> <td style="width: 10%;"></td> <td style="width: 10%;"></td> <td style="width: 10%;"></td> <td style="width: 10%;"></td> <td style="width: 10%;"></td> <td style="width: 10%;"></td> <td style="width: 10%;"></td> </tr> <tr> <td></td> <td></td> <td colspan="8" style="text-align: center;"> <table border="1" style="width: 100%; border-collapse: collapse; text-align: center;"> <tr> <td style="width: 10%;"></td> <td style="width: 10%;"></td> <td style="width: 10%;"></td> <td style="width: 10%;"></td> <td style="width: 10%;"></td> <td style="width: 10%;"></td> <td style="width: 10%;"></td> <td style="width: 10%;"></td> <td style="width: 10%;"></td> <td style="width: 10%;"></td> </tr> <tr> <td></td> <td></td> <td colspan="8" style="text-align: center;"> <table border="1" style="width: 100%; border-collapse: collapse; text-align: center;"> <tr> <td style="width: 10%;"></td> <td style="width: 10%;"></td> <td style="width: 10%;"></td> <td style="width: 10%;"></td> <td style="width: 10%;"></td> <td style="width: 10%;"></td> <td style="width: 10%;"></td> <td style="width: 10%;"></td> <td style="width: 10%;"></td> <td style="width: 10%;"></td> </tr> <tr> <td></td> <td></td> <td colspan="8" style="text-align: center;"> <table border="1" style="width: 100%; border-collapse: collapse; text-align: center;"> <tr> <td style="width: 10%;"></td> <td style="width: 10%;"></td> <td style="width: 10%;"></td> <td style="width: 10%;"></td> <td style="width: 10%;"></td> <td style="width: 10%;"></td> <td style="width: 10%;"></td> <td style="width: 10%;"></td> <td style="width: 10%;"></td> <td style="width: 10%;"></td> </tr> <tr> <td></td> <td></td> <td colspan="8" style="text-align: center;"> <table border="1" style="width: 100%; border-collapse: collapse; text-align: center;"> <tr> <td style="width: 10%;"></td> <td style="width: 10%;"></td> <td style="width: 10%;"></td> <td style="width: 10%;"></td> <td style="width: 10%;"></td> <td style="width: 10%;"></td> <td style="width: 10%;"></td> <td style="width: 10%;"></td> <td style="width: 10%;"></td> <td style="width: 10%;"></td> </tr> <tr> <td></td> <td></td> <td colspan="8" style="text-align: center;"> <table border="1" style="width: 100%; border-collapse: collapse; text-align: center;"> <tr> <td style="width: 10%;"></td> <td style="width: 10%;"></td> <td style="width: 10%;"></td> <td style="width: 10%;"></td> <td style="width: 10%;"></td> <td style="width: 10%;"></td> <td style="width: 10%;"></td> <td style="width: 10%;"></td> <td style="width: 10%;"></td> <td style="width: 10%;"></td> </tr> <tr> <td></td> <td></td> <td colspan="8" style="text-align: center;"> <table border="1" style="width: 100%; border-collapse: collapse; text-align: center;"> <tr> <td style="width: 10%;"></td> <td style="width: 10%;"></td> <td style="width: 10%;"></td> <td style="width: 10%;"></td> <td style="width: 10%;"></td> <td style="width: 10%;"></td> <td style="width: 10%;"></td> <td style="width: 10%;"></td> <td style="width: 10%;"></td> <td style="width: 10%;"></td> </tr> <tr> <td></td> <td></td> <td colspan="8" style="text-align: center;"> <table border="1" style="width: 100%; border-collapse: collapse; text-align: center;"> <tr> <td style="width: 10%;"></td> <td style="width: 10%;"></td> <td style="width: 10%;"></td> <td style="width: 10%;"></td> <td style="width: 10%;"></td> <td style="width: 10%;"></td> <td style="width: 10%;"></td> <td style="width: 10%;"></td> <td style="width: 10%;"></td> <td style="width: 10%;"></td> </tr> <tr> <td></td> <td></td> <td colspan="8" style="text-align: center;"> <table border="1" style="width: 100%; border-collapse: collapse; text-align: center;"> <tr> <td style="width: 10%;"></td> <td style="width: 10%;"></td> <td style="width: 10%;"></td> <td style="width: 10%;"></td> <td style="width: 10%;"></td> <td style="width: 10%;"></td> <td style="width: 10%;"></td> <td style="width: 10%;"></td> <td style="width: 10%;"></td> <td style="width: 10%;"></td> </tr> <tr> <td></td> <td></td> <td colspan="8" style="text-align: center;"> <table border="1" style="width: 100%; border-collapse: collapse; text-align: center;"> <tr> <td style="width: 10%;"></td> <td style="width: 10%;"></td> <td style="width: 10%;"></td> <td style="width: 10%;"></td> <td style="width: 10%;"></td> <td style="width: 10%;"></td> <td style="width: 10%;"></td> <td style="width: 10%;"></td> <td style="width: 10%;"></td> <td style="width: 10%;"></td> </tr> <tr> <td></td> <td></td> <td colspan="8" style="text-align: center;"> <table border="1" style="width: 100%; border-collapse: collapse; text-align: center;"> <tr> <td style="width: 10%;"></td> <td style="width: 10%;"></td> <td style="width: 10%;"></td> <td style="width: 10%;"></td> <td style="width: 10%;"></td> <td style="width: 10%;"></td> <td style="width: 10%;"></td> <td style="width: 10%;"></td> <td style="width: 10%;"></td> <td style="width: 10%;"></td> </tr> <tr> <td></td> <td></td> <td colspan="8" style="text-align: center;"> <table border="1" style="width: 100%; border-collapse: collapse; text-align: center;"> <tr> <td style="width: 10%;"></td> <td style="width: 10%;"></td> <td style="width: 10%;"></td> <td style="width: 10%;"></td> <td style="width: 10%;"></td> <td style="width: 10%;"></td> <td style="width: 10%;"></td> <td style="width: 10%;"></td> <td style="width: 10%;"></td> <td style="width: 10%;"></td> </tr> <tr> <td></td> <td></td> <td colspan="8" style="text-align: center;"> <table border="1" style="width: 100%; border-collapse: collapse; text-align: center;"> <tr> <td style="width: 10%;"></td> <td style="width: 10%;"></td> <td style="width: 10%;"></td> <td style="width: 10%;"></td> <td style="width: 10%;"></td> <td style="width: 10%;"></td> <td style="width: 10%;"></td> <td style="width: 10%;"></td> <td style="width: 10%;"></td> <td style="width: 10%;"></td> </tr> <tr> <td></td> <td></td> <td colspan="8" style="text-align: center;"> <table border="1" style="width: 100%; border-collapse: collapse; text-align: center;"> <tr> </tr></table></td></tr></table></td></tr></table></td></tr></table></td></tr></table></td></tr></table></td></tr></table></td></tr></table></td></tr></table></td></tr></table></td></tr></table></td></tr></table></td></tr></table></td></tr></table></td></tr></table></td></tr></table></td></tr></table></td></tr></table></td></tr></table></td></tr></table></td></tr></table></td></tr></table></td></tr></table></td></tr></table></td></tr></table></td></tr></table></td></tr></table></td></tr></table></td></tr></table></td></tr></table></td></tr></table></td></tr></table></td></tr></table></td></tr></table></td></tr></table></td></tr></table></td></tr></table></td></tr></table>
 | | | | | | | | | | | | | | | | | | | | <table border="1" style="width: 100%; border-collapse: collapse; text-align: center;"> <tr> <td style="width: 10%;"></td> <td style="width: 10%;"></td> <td style="width: 10%;"></td> <td style="width: 10%;"></td> <td style="width: 10%;"></td> <td style="width: 10%;"></td> <td style="width: 10%;"></td> <td style="width: 10%;"></td> <td style="width: 10%;"></td> <td style="width: 10%;"></td> </tr> <tr> <td></td> <td></td> <td colspan="8" style="text-align: center;"> <table border="1" style="width: 100%; border-collapse: collapse; text-align: center;"> <tr> <td style="width: 10%;"></td> <td style="width: 10%;"></td> <td style="width: 10%;"></td> <td style="width: 10%;"></td> <td style="width: 10%;"></td> <td style="width: 10%;"></td> <td style="width: 10%;"></td> <td style="width: 10%;"></td> <td style="width: 10%;"></td> <td style="width: 10%;"></td> </tr> <tr> <td></td> <td></td> <td colspan="8" style="text-align: center;"> <table border="1" style="width: 100%; border-collapse: collapse; text-align: center;"> <tr> <td style="width: 10%;"></td> <td style="width: 10%;"></td> <td style="width: 10%;"></td> <td style="width: 10%;"></td> <td style="width: 10%;"></td> <td style="width: 10%;"></td> <td style="width: 10%;"></td> <td style="width: 10%;"></td> <td style="width: 10%;"></td> <td style="width: 10%;"></td> </tr> <tr> <td></td> <td></td> <td colspan="8" style="text-align: center;"> <table border="1" style="width: 100%; border-collapse: collapse; text-align: center;"> <tr> <td style="width: 10%;"></td> <td style="width: 10%;"></td> <td style="width: 10%;"></td> <td style="width: 10%;"></td> <td style="width: 10%;"></td> <td style="width: 10%;"></td> <td style="width: 10%;"></td> <td style="width: 10%;"></td> <td style="width: 10%;"></td> <td style="width: 10%;"></td> </tr> <tr> <td></td> <td></td> <td colspan="8" style="text-align: center;"> <table border="1" style="width: 100%; border-collapse: collapse; text-align: center;"> <tr> <td style="width: 10%;"></td> <td style="width: 10%;"></td> <td style="width: 10%;"></td> <td style="width: 10%;"></td> <td style="width: 10%;"></td> <td style="width: 10%;"></td> <td style="width: 10%;"></td> <td style="width: 10%;"></td> <td style="width: 10%;"></td> <td style="width: 10%;"></td> </tr> <tr> <td></td> <td></td> <td colspan="8" style="text-align: center;"> <table border="1" style="width: 100%; border-collapse: collapse; text-align: center;"> <tr> <td style="width: 10%;"></td> <td style="width: 10%;"></td> <td style="width: 10%;"></td> <td style="width: 10%;"></td> <td style="width: 10%;"></td> <td style="width: 10%;"></td> <td style="width: 10%;"></td> <td style="width: 10%;"></td> <td style="width: 10%;"></td> <td style="width: 10%;"></td> </tr> <tr> <td></td> <td></td> <td colspan="8" style="text-align: center;"> <table border="1" style="width: 100%; border-collapse: collapse; text-align: center;"> <tr> <td style="width: 10%;"></td> <td style="width: 10%;"></td> <td style="width: 10%;"></td> <td style="width: 10%;"></td> <td style="width: 10%;"></td> <td style="width: 10%;"></td> <td style="width: 10%;"></td> <td style="width: 10%;"></td> <td style="width: 10%;"></td> <td style="width: 10%;"></td> </tr> <tr> <td></td> <td></td> <td colspan="8" style="text-align: center;"> <table border="1" style="width: 100%; border-collapse: collapse; text-align: center;"> <tr> <td style="width: 10%;"></td> <td style="width: 10%;"></td> <td style="width: 10%;"></td> <td style="width: 10%;"></td> <td style="width: 10%;"></td> <td style="width: 10%;"></td> <td style="width: 10%;"></td> <td style="width: 10%;"></td> <td style="width: 10%;"></td> <td style="width: 10%;"></td> </tr> <tr> <td></td> <td></td> <td colspan="8" style="text-align: center;"> <table border="1" style="width: 100%; border-collapse: collapse; text-align: center;"> <tr> <td style="width: 10%;"></td> <td style="width: 10%;"></td> <td style="width: 10%;"></td> <td style="width: 10%;"></td> <td style="width: 10%;"></td> <td style="width: 10%;"></td> <td style="width: 10%;"></td> <td style="width: 10%;"></td> <td style="width: 10%;"></td> <td style="width: 10%;"></td> </tr> <tr> <td></td> <td></td> <td colspan="8" style="text-align: center;"> <table border="1" style="width: 100%; border-collapse: collapse; text-align: center;"> <tr> <td style="width: 10%;"></td> <td style="width: 10%;"></td> <td style="width: 10%;"></td> <td style="width: 10%;"></td> <td style="width: 10%;"></td> <td style="width: 10%;"></td> <td style="width: 10%;"></td> <td style="width: 10%;"></td> <td style="width: 10%;"></td> <td style="width: 10%;"></td> </tr> <tr> <td></td> <td></td> <td colspan="8" style="text-align: center;"> <table border="1" style="width: 100%; border-collapse: collapse; text-align: center;"> <tr> <td style="width: 10%;"></td> <td style="width: 10%;"></td> <td style="width: 10%;"></td> <td style="width: 10%;"></td> <td style="width: 10%;"></td> <td style="width: 10%;"></td> <td style="width: 10%;"></td> <td style="width: 10%;"></td> <td style="width: 10%;"></td> <td style="width: 10%;"></td> </tr> <tr> <td></td> <td></td> <td colspan="8" style="text-align: center;"> <table border="1" style="width: 100%; border-collapse: collapse; text-align: center;"> <tr> <td style="width: 10%;"></td> <td style="width: 10%;"></td> <td style="width: 10%;"></td> <td style="width: 10%;"></td> <td style="width: 10%;"></td> <td style="width: 10%;"></td> <td style="width: 10%;"></td> <td style="width: 10%;"></td> <td style="width: 10%;"></td> <td style="width: 10%;"></td> </tr> <tr> <td></td> <td></td> <td colspan="8" style="text-align: center;"> <table border="1" style="width: 100%; border-collapse: collapse; text-align: center;"> <tr> <td style="width: 10%;"></td> <td style="width: 10%;"></td> <td style="width: 10%;"></td> <td style="width: 10%;"></td> <td style="width: 10%;"></td> <td style="width: 10%;"></td> <td style="width: 10%;"></td> <td style="width: 10%;"></td> <td style="width: 10%;"></td> <td style="width: 10%;"></td> </tr> <tr> <td></td> <td></td> <td colspan="8" style="text-align: center;"> <table border="1" style="width: 100%; border-collapse: collapse; text-align: center;"> <tr> <td style="width: 10%;"></td> <td style="width: 10%;"></td> <td style="width: 10%;"></td> <td style="width: 10%;"></td> <td style="width: 10%;"></td> <td style="width: 10%;"></td> <td style="width: 10%;"></td> <td style="width: 10%;"></td> <td style="width: 10%;"></td> <td style="width: 10%;"></td> </tr> <tr> <td></td> <td></td> <td colspan="8" style="text-align: center;"> <table border="1" style="width: 100%; border-collapse: collapse; text-align: center;"> <tr> <td style="width: 10%;"></td> <td style="width: 10%;"></td> <td style="width: 10%;"></td> <td style="width: 10%;"></td> <td style="width: 10%;"></td> <td style="width: 10%;"></td> <td style="width: 10%;"></td> <td style="width: 10%;"></td> <td style="width: 10%;"></td> <td style="width: 10%;"></td> </tr> <tr> <td></td> <td></td> <td colspan="8" style="text-align: center;"> <table border="1" style="width: 100%; border-collapse: collapse; text-align: center;"> <tr> <td style="width: 10%;"></td> <td style="width: 10%;"></td> <td style="width: 10%;"></td> <td style="width: 10%;"></td> <td style="width: 10%;"></td> <td style="width: 10%;"></td> <td style="width: 10%;"></td> <td style="width: 10%;"></td> <td style="width: 10%;"></td> <td style="width: 10%;"></td> </tr> <tr> <td></td> <td></td> <td colspan="8" style="text-align: center;"> <table border="1" style="width: 100%; border-collapse: collapse; text-align: center;"> <tr> <td style="width: 10%;"></td> <td style="width: 10%;"></td> <td style="width: 10%;"></td> <td style="width: 10%;"></td> <td style="width: 10%;"></td> <td style="width: 10%;"></td> <td style="width: 10%;"></td> <td style="width: 10%;"></td> <td style="width: 10%;"></td> <td style="width: 10%;"></td> </tr> <tr> <td></td> <td></td> <td colspan="8" style="text-align: center;"> <table border="1" style="width: 100%; border-collapse: collapse; text-align: center;"> <tr> <td style="width: 10%;"></td> <td style="width: 10%;"></td> <td style="width: 10%;"></td> <td style="width: 10%;"></td> <td style="width: 10%;"></td> <td style="width: 10%;"></td> <td style="width: 10%;"></td> <td style="width: 10%;"></td> <td style="width: 10%;"></td> <td style="width: 10%;"></td> </tr> <tr> <td></td> <td></td> <td colspan="8" style="text-align: center;"> <table border="1" style="width: 100%; border-collapse: collapse; text-align: center;"> <tr> <td style="width: 10%;"></td> <td style="width: 10%;"></td> <td style="width: 10%;"></td> <td style="width: 10%;"></td> <td style="width: 10%;"></td> <td style="width: 10%;"></td> <td style="width: 10%;"></td> <td style="width:
10%;"></td> <td style="width: 10%;"></td> <td style="width: 10%;"></td> </tr> <tr> <td></td> <td></td> <td colspan="8" style="text-align: center;"> <table border="1" style="width: 100%; border-collapse: collapse; text-align: center;"> <tr> <td style="width: 10%;"></td> <td style="width: 10%;"></td> <td style="width: 10%;"></td> <td style="width: 10%;"></td> <td style="width: 10%;"></td> <td style="width: 10%;"></td> <td style="width: 10%;"></td> <td style="width: 10%;"></td> <td style="width: 10%;"></td> <td style="width: 10%;"></td> </tr> <tr> <td></td> <td></td> <td colspan="8" style="text-align: center;"> <table border="1" style="width: 100%; border-collapse: collapse; text-align: center;"> <tr> <td style="width: 10%;"></td> <td style="width: 10%;"></td> <td style="width: 10%;"></td> <td style="width: 10%;"></td> <td style="width: 10%;"></td> <td style="width: 10%;"></td> <td style="width: 10%;"></td> <td style="width: 10%;"></td> <td style="width: 10%;"></td> <td style="width: 10%;"></td> </tr> <tr> <td></td> <td></td> <td colspan="8" style="text-align: center;"> <table border="1" style="width: 100%; border-collapse: collapse; text-align: center;"> <tr> <td style="width: 10%;"></td> <td style="width: 10%;"></td> <td style="width: 10%;"></td> <td style="width: 10%;"></td> <td style="width: 10%;"></td> <td style="width: 10%;"></td> <td style="width: 10%;"></td> <td style="width: 10%;"></td> <td style="width: 10%;"></td> <td style="width: 10%;"></td> </tr> <tr> <td></td> <td></td> <td colspan="8" style="text-align: center;"> <table border="1" style="width: 100%; border-collapse: collapse; text-align: center;"> <tr> <td style="width: 10%;"></td> <td style="width: 10%;"></td> <td style="width: 10%;"></td> <td style="width: 10%;"></td> <td style="width: 10%;"></td> <td style="width: 10%;"></td> <td style="width: 10%;"></td> <td style="width: 10%;"></td> <td style="width: 10%;"></td> <td style="width: 10%;"></td> </tr> <tr> <td></td> <td></td> <td colspan="8" style="text-align: center;"> <table border="1" style="width: 100%; border-collapse: collapse; text-align: center;"> <tr> <td style="width: 10%;"></td> <td style="width: 10%;"></td> <td style="width: 10%;"></td> <td style="width: 10%;"></td> <td style="width: 10%;"></td> <td style="width: 10%;"></td> <td style="width: 10%;"></td> <td style="width: 10%;"></td> <td style="width: 10%;"></td> <td style="width: 10%;"></td> </tr> <tr> <td></td> <td></td> <td colspan="8" style="text-align: center;"> <table border="1" style="width: 100%; border-collapse: collapse; text-align: center;"> <tr> <td style="width: 10%;"></td> <td style="width: 10%;"></td> <td style="width: 10%;"></td> <td style="width: 10%;"></td> <td style="width: 10%;"></td> <td style="width: 10%;"></td> <td style="width: 10%;"></td> <td style="width: 10%;"></td> <td style="width: 10%;"></td> <td style="width: 10%;"></td> </tr> <tr> <td></td> <td></td> <td colspan="8" style="text-align: center;"> <table border="1" style="width: 100%; border-collapse: collapse; text-align: center;"> <tr> <td style="width: 10%;"></td> <td style="width: 10%;"></td> <td style="width: 10%;"></td> <td style="width: 10%;"></td> <td style="width: 10%;"></td> <td style="width: 10%;"></td> <td style="width: 10%;"></td> <td style="width: 10%;"></td> <td style="width: 10%;"></td> <td style="width: 10%;"></td> </tr> <tr> <td></td> <td></td> <td colspan="8" style="text-align: center;"> <table border="1" style="width: 100%; border-collapse: collapse; text-align: center;"> <tr> <td style="width: 10%;"></td> <td style="width: 10%;"></td> <td style="width: 10%;"></td> <td style="width: 10%;"></td> <td style="width: 10%;"></td> <td style="width: 10%;"></td> <td style="width: 10%;"></td> <td style="width: 10%;"></td> <td style="width: 10%;"></td> <td style="width: 10%;"></td> </tr> <tr> <td></td> <td></td> <td colspan="8" style="text-align: center;"> <table border="1" style="width: 100%; border-collapse: collapse; text-align: center;"> <tr> <td style="width: 10%;"></td> <td style="width: 10%;"></td> <td style="width: 10%;"></td> <td style="width: 10%;"></td> <td style="width: 10%;"></td> <td style="width: 10%;"></td> <td style="width: 10%;"></td> <td style="width: 10%;"></td> <td style="width: 10%;"></td> <td style="width: 10%;"></td> </tr> <tr> <td></td> <td></td> <td colspan="8" style="text-align: center;"> <table border="1" style="width: 100%; border-collapse: collapse; text-align: center;"> <tr> <td style="width: 10%;"></td> <td style="width: 10%;"></td> <td style="width: 10%;"></td> <td style="width: 10%;"></td> <td style="width: 10%;"></td> <td style="width: 10%;"></td> <td style="width: 10%;"></td> <td style="width: 10%;"></td> <td style="width: 10%;"></td> <td style="width: 10%;"></td> </tr> <tr> <td></td> <td></td> <td colspan="8" style="text-align: center;"> <table border="1" style="width: 100%; border-collapse: collapse; text-align: center;"> <tr> <td style="width: 10%;"></td> <td style="width: 10%;"></td> <td style="width: 10%;"></td> <td style="width: 10%;"></td> <td style="width: 10%;"></td> <td style="width: 10%;"></td> <td style="width: 10%;"></td> <td style="width: 10%;"></td> <td style="width: 10%;"></td> <td style="width: 10%;"></td> </tr> <tr> <td></td> <td></td> <td colspan="8" style="text-align: center;"> <table border="1" style="width: 100%; border-collapse: collapse; text-align: center;"> <tr> <td style="width: 10%;"></td> <td style="width: 10%;"></td> <td style="width: 10%;"></td> <td style="width: 10%;"></td> <td style="width: 10%;"></td> <td style="width: 10%;"></td> <td style="width: 10%;"></td> <td style="width: 10%;"></td> <td style="width: 10%;"></td> <td style="width: 10%;"></td> </tr> <tr> <td></td> <td></td> <td colspan="8" style="text-align: center;"> <table border="1" style="width: 100%; border-collapse: collapse; text-align: center;"> <tr> <td style="width: 10%;"></td> <td style="width: 10%;"></td> <td style="width: 10%;"></td> <td style="width: 10%;"></td> <td style="width: 10%;"></td> <td style="width: 10%;"></td> <td style="width: 10%;"></td> <td style="width: 10%;"></td> <td style="width: 10%;"></td> <td style="width: 10%;"></td> </tr> <tr> <td></td> <td></td> <td colspan="8" style="text-align: center;"> <table border="1" style="width: 100%; border-collapse: collapse; text-align: center;"> <tr> <td style="width: 10%;"></td> <td style="width: 10%;"></td> <td style="width: 10%;"></td> <td style="width: 10%;"></td> <td style="width: 10%;"></td> <td style="width: 10%;"></td> <td style="width: 10%;"></td> <td style="width: 10%;"></td> <td style="width: 10%;"></td> <td style="width: 10%;"></td> </tr> <tr> <td></td> <td></td> <td colspan="8" style="text-align: center;"> <table border="1" style="width: 100%; border-collapse: collapse; text-align: center;"> <tr> <td style="width: 10%;"></td> <td style="width: 10%;"></td> <td style="width: 10%;"></td> <td style="width: 10%;"></td> <td style="width: 10%;"></td> <td style="width: 10%;"></td> <td style="width: 10%;"></td> <td style="width: 10%;"></td> <td style="width: 10%;"></td> <td style="width: 10%;"></td> </tr> <tr> <td></td> <td></td> <td colspan="8" style="text-align: center;"> <table border="1" style="width: 100%; border-collapse: collapse; text-align: center;"> <tr> <td style="width: 10%;"></td> <td style="width: 10%;"></td> <td style="width: 10%;"></td> <td style="width: 10%;"></td> <td style="width: 10%;"></td> <td style="width: 10%;"></td> <td style="width: 10%;"></td> <td style="width: 10%;"></td> <td style="width: 10%;"></td> <td style="width: 10%;"></td> </tr> <tr> <td></td> <td></td> <td colspan="8" style="text-align: center;"> <table border="1" style="width: 100%; border-collapse: collapse; text-align: center;"> <tr> <td style="width: 10%;"></td> <td style="width: 10%;"></td> <td style="width: 10%;"></td> <td style="width: 10%;"></td> <td style="width: 10%;"></td> <td style="width: 10%;"></td> <td style="width: 10%;"></td> <td style="width: 10%;"></td> <td style="width: 10%;"></td> <td style="width: 10%;"></td> </tr> <tr> <td></td> <td></td> <td colspan="8" style="text-align: center;"> <table border="1" style="width: 100%; border-collapse: collapse; text-align: center;"> <tr> </tr></table></td></tr></table></td></tr></table></td></tr></table></td></tr></table></td></tr></table></td></tr></table></td></tr></table></td></tr></table></td></tr></table></td></tr></table></td></tr></table></td></tr></table></td></tr></table></td></tr></table></td></tr></table></td></tr></table></td></tr></table></td></tr></table></td></tr></table></td></tr></table></td></tr></table></td></tr></table></td></tr></table></td></tr></table></td></tr></table></td></tr></table></td></tr></table></td></tr></table></td></tr></table></td></tr></table></td></tr></table></td></tr></table></td></tr></table></td></tr></table></td></tr></table></td></tr></table>
 | | | | | | | | | | | | | | | | | | | | <table border="1" style="width: 100%; border-collapse: collapse; text-align: center;"> <tr> <td style="width: 10%;"></td> <td style="width: 10%;"></td> <td style="width: 10%;"></td> <td style="width: 10%;"></td> <td style="width: 10%;"></td> <td style="width: 10%;"></td> <td style="width: 10%;"></td> <td style="width: 10%;"></td> <td style="width: 10%;"></td> <td style="width: 10%;"></td> </tr> <tr> <td></td> <td></td> <td colspan="8" style="text-align: center;"> <table border="1" style="width: 100%; border-collapse: collapse; text-align: center;"> <tr> <td style="width: 10%;"></td> <td style="width: 10%;"></td> <td style="width: 10%;"></td> <td style="width: 10%;"></td> <td style="width: 10%;"></td> <td style="width: 10%;"></td> <td style="width: 10%;"></td> <td style="width: 10%;"></td> <td style="width: 10%;"></td> <td style="width: 10%;"></td> </tr> <tr> <td></td> <td></td> <td colspan="8" style="text-align: center;"> <table border="1" style="width: 100%; border-collapse: collapse; text-align: center;"> <tr> <td style="width: 10%;"></td> <td style="width: 10%;"></td> <td style="width: 10%;"></td> <td style="width: 10%;"></td> <td style="width: 10%;"></td> <td style="width: 10%;"></td> <td style="width: 10%;"></td> <td style="width: 10%;"></td> <td style="width: 10%;"></td> <td style="width: 10%;"></td> </tr> <tr> <td></td> <td></td> <td colspan="8" style="text-align: center;"> <table border="1" style="width: 100%; border-collapse: collapse; text-align: center;"> <tr> <td style="width: 10%;"></td> <td style="width: 10%;"></td> <td style="width: 10%;"></td> <td style="width: 10%;"></td> <td style="width: 10%;"></td> <td style="width: 10%;"></td> <td style="width: 10%;"></td> <td style="width: 10%;"></td> <td style="width: 10%;"></td> <td style="width: 10%;"></td> </tr> <tr> <td></td> <td></td> <td colspan="8" style="text-align: center;"> <table border="1" style="width: 100%; border-collapse: collapse; text-align: center;"> <tr> <td style="width: 10%;"></td> <td style="width: 10%;"></td> <td style="width: 10%;"></td> <td style="width: 10%;"></td> <td style="width: 10%;"></td> <td style="width: 10%;"></td> <td style="width: 10%;"></td> <td style="width: 10%;"></td> <td style="width: 10%;"></td> <td style="width: 10%;"></td> </tr> <tr> <td></td> <td></td> <td colspan="8" style="text-align: center;"> <table border="1" style="width: 100%; border-collapse: collapse; text-align: center;"> <tr> <td style="width: 10%;"></td> <td style="width: 10%;"></td> <td style="width: 10%;"></td> <td style="width: 10%;"></td> <td style="width: 10%;"></td> <td style="width: 10%;"></td> <td style="width: 10%;"></td> <td style="width: 10%;"></td> <td style="width: 10%;"></td> <td style="width: 10%;"></td> </tr> <tr> <td></td> <td></td> <td colspan="8" style="text-align: center;"> <table border="1" style="width: 100%; border-collapse: collapse; text-align: center;"> <tr> <td style="width: 10%;"></td> <td style="width: 10%;"></td> <td style="width: 10%;"></td> <td style="width: 10%;"></td> <td style="width: 10%;"></td> <td style="width: 10%;"></td> <td style="width: 10%;"></td> <td style="width: 10%;"></td> <td style="width: 10%;"></td> <td style="width: 10%;"></td> </tr> <tr> <td></td> <td></td> <td colspan="8" style="text-align: center;"> <table border="1" style="width: 100%; border-collapse: collapse; text-align: center;"> <tr> <td style="width: 10%;"></td> <td style="width: 10%;"></td> <td style="width: 10%;"></td> <td style="width: 10%;"></td> <td style="width: 10%;"></td> <td style="width: 10%;"></td> <td style="width: 10%;"></td> <td style="width: 10%;"></td> <td style="width: 10%;"></td> <td style="width: 10%;"></td> </tr> <tr> <td></td> <td></td> <td colspan="8" style="text-align: center;"> <table border="1" style="width: 100%; border-collapse: collapse; text-align: center;"> <tr> <td style="width: 10%;"></td> <td style="width: 10%;"></td> <td style="width: 10%;"></td> <td style="width: 10%;"></td> <td style="width: 10%;"></td> <td style="width: 10%;"></td> <td style="width: 10%;"></td> <td style="width: 10%;"></td> <td style="width: 10%;"></td> <td style="width: 10%;"></td> </tr> <tr> <td></td> <td></td> <td colspan="8" style="text-align: center;"> <table border="1" style="width: 100%; border-collapse: collapse; text-align: center;"> <tr> <td style="width: 10%;"></td> <td style="width: 10%;"></td> <td style="width: 10%;"></td> <td style="width: 10%;"></td> <td style="width: 10%;"></td> <td style="width: 10%;"></td> <td style="width: 10%;"></td> <td style="width: 10%;"></td> <td style="width: 10%;"></td> <td style="width: 10%;"></td> </tr> <tr> <td></td> <td></td> <td colspan="8" style="text-align: center;"> <table border="1" style="width: 100%; border-collapse: collapse; text-align: center;"> <tr> <td style="width: 10%;"></td> <td style="width: 10%;"></td> <td style="width: 10%;"></td> <td style="width: 10%;"></td> <td style="width: 10%;"></td> <td style="width: 10%;"></td> <td style="width: 10%;"></td> <td style="width: 10%;"></td> <td style="width: 10%;"></td> <td style="width: 10%;"></td> </tr> <tr> <td></td> <td></td> <td colspan="8" style="text-align: center;"> <table border="1" style="width: 100%; border-collapse: collapse; text-align: center;"> <tr> <td style="width: 10%;"></td> <td style="width: 10%;"></td> <td style="width: 10%;"></td> <td style="width: 10%;"></td> <td style="width: 10%;"></td> <td style="width: 10%;"></td> <td style="width: 10%;"></td> <td style="width: 10%;"></td> <td style="width: 10%;"></td> <td style="width: 10%;"></td> </tr> <tr> <td></td> <td></td> <td colspan="8" style="text-align: center;"> <table border="1" style="width: 100%; border-collapse: collapse; text-align: center;"> <tr> <td style="width: 10%;"></td> <td style="width: 10%;"></td> <td style="width: 10%;"></td> <td style="width: 10%;"></td> <td style="width: 10%;"></td> <td style="width: 10%;"></td> <td style="width: 10%;"></td> <td style="width: 10%;"></td> <td style="width: 10%;"></td> <td style="width: 10%;"></td> </tr> <tr> <td></td> <td></td> <td colspan="8" style="text-align: center;"> <table border="1" style="width: 100%; border-collapse: collapse; text-align: center;"> <tr> <td style="width: 10%;"></td> <td style="width: 10%;"></td> <td style="width: 10%;"></td> <td style="width: 10%;"></td> <td style="width: 10%;"></td> <td style="width: 10%;"></td> <td style="width: 10%;"></td> <td style="width: 10%;"></td> <td style="width: 10%;"></td> <td style="width: 10%;"></td> </tr> <tr> <td></td> <td></td> <td colspan="8" style="text-align: center;"> <table border="1" style="width: 100%; border-collapse: collapse; text-align: center;"> <tr> <td style="width: 10%;"></td> <td style="width: 10%;"></td> <td
style="width: 10%;"></td> <td style="width: 10%;"></td> <td style="width: 10%;"></td> <td style="width: 10%;"></td> <td style="width: 10%;"></td> <td style="width: 10%;"></td> <td style="width: 10%;"></td> <td style="width: 10%;"></td> </tr> <tr> <td></td> <td></td> <td colspan="8" style="text-align: center;"> <table border="1" style="width: 100%; border-collapse: collapse; text-align: center;"> <tr> <td style="width: 10%;"></td> <td style="width: 10%;"></td> <td style="width: 10%;"></td> <td style="width: 10%;"></td> <td style="width: 10%;"></td> <td style="width: 10%;"></td> <td style="width: 10%;"></td> <td style="width: 10%;"></td> <td style="width: 10%;"></td> <td style="width: 10%;"></td> </tr> <tr> <td></td> <td></td> <td colspan="8" style="text-align: center;"> <table border="1" style="width: 100%; border-collapse: collapse; text-align: center;"> <tr> <td style="width: 10%;"></td> <td style="width: 10%;"></td> <td style="width: 10%;"></td> <td style="width: 10%;"></td> <td style="width: 10%;"></td> <td style="width: 10%;"></td> <td style="width: 10%;"></td> <td style="width: 10%;"></td> <td style="width: 10%;"></td> <td style="width: 10%;"></td> </tr> <tr> <td></td> <td></td> <td colspan="8" style="text-align: center;"> <table border="1" style="width: 100%; border-collapse: collapse; text-align: center;"> <tr> <td style="width: 10%;"></td> <td style="width: 10%;"></td> <td style="width: 10%;"></td> <td style="width: 10%;"></td> <td style="width: 10%;"></td> <td style="width: 10%;"></td> <td style="width: 10%;"></td> <td style="width: 10%;"></td> <td style="width: 10%;"></td> <td style="width: 10%;"></td> </tr> <tr> <td></td> <td></td> <td colspan="8" style="text-align: center;"> <table border="1" style="width: 100%; border-collapse: collapse; text-align: center;"> <tr> <td style="width: 10%;"></td> <td style="width: 10%;"></td> <td style="width: 10%;"></td> <td style="width: 10%;"></td> <td style="width: 10%;"></td> <td style="width: 10%;"></td> <td style="width: 10%;"></td> <td style="width: 10%;"></td> <td style="width: 10%;"></td> <td style="width: 10%;"></td> </tr> <tr> <td></td> <td></td> <td colspan="8" style="text-align: center;"> <table border="1" style="width: 100%; border-collapse: collapse; text-align: center;"> <tr> <td style="width: 10%;"></td> <td style="width: 10%;"></td> <td style="width: 10%;"></td> <td style="width: 10%;"></td> <td style="width: 10%;"></td> <td style="width: 10%;"></td> <td style="width: 10%;"></td> <td style="width: 10%;"></td> <td style="width: 10%;"></td> <td style="width: 10%;"></td> </tr> <tr> <td></td> <td></td> <td colspan="8" style="text-align: center;"> <table border="1" style="width: 100%; border-collapse: collapse; text-align: center;"> <tr> <td style="width: 10%;"></td> <td style="width: 10%;"></td> <td style="width: 10%;"></td> <td style="width: 10%;"></td> <td style="width: 10%;"></td> <td style="width: 10%;"></td> <td style="width: 10%;"></td> <td style="width: 10%;"></td> <td style="width: 10%;"></td> <td style="width: 10%;"></td> </tr> <tr> <td></td> <td></td> <td colspan="8" style="text-align: center;"> <table border="1" style="width: 100%; border-collapse: collapse; text-align: center;"> <tr> <td style="width: 10%;"></td> <td style="width: 10%;"></td> <td style="width: 10%;"></td> <td style="width: 10%;"></td> <td style="width: 10%;"></td> <td style="width: 10%;"></td> <td style="width: 10%;"></td> <td style="width: 10%;"></td> <td style="width: 10%;"></td> <td style="width: 10%;"></td> </tr> <tr> <td></td> <td></td> <td colspan="8" style="text-align: center;"> <table border="1" style="width: 100%; border-collapse: collapse; text-align: center;"> <tr> <td style="width: 10%;"></td> <td style="width: 10%;"></td> <td style="width: 10%;"></td> <td style="width: 10%;"></td> <td style="width: 10%;"></td> <td style="width: 10%;"></td> <td style="width: 10%;"></td> <td style="width: 10%;"></td> <td style="width: 10%;"></td> <td style="width: 10%;"></td> </tr> <tr> <td></td> <td></td> <td colspan="8" style="text-align: center;"> <table border="1" style="width: 100%; border-collapse: collapse; text-align: center;"> <tr> <td style="width: 10%;"></td> <td style="width: 10%;"></td> <td style="width: 10%;"></td> <td style="width: 10%;"></td> <td style="width: 10%;"></td> <td style="width: 10%;"></td> <td style="width: 10%;"></td> <td style="width: 10%;"></td> <td style="width: 10%;"></td> <td style="width: 10%;"></td> </tr> <tr> <td></td> <td></td> <td colspan="8" style="text-align: center;"> <table border="1" style="width: 100%; border-collapse: collapse; text-align: center;"> <tr> <td style="width: 10%;"></td> <td style="width: 10%;"></td> <td style="width: 10%;"></td> <td style="width: 10%;"></td> <td style="width: 10%;"></td> <td style="width: 10%;"></td> <td style="width: 10%;"></td> <td style="width: 10%;"></td> <td style="width: 10%;"></td> <td style="width: 10%;"></td> </tr> <tr> <td></td> <td></td> <td colspan="8" style="text-align: center;"> <table border="1" style="width: 100%; border-collapse: collapse; text-align: center;"> <tr> <td style="width: 10%;"></td> <td style="width: 10%;"></td> <td style="width: 10%;"></td> <td style="width: 10%;"></td> <td style="width: 10%;"></td> <td style="width: 10%;"></td> <td style="width: 10%;"></td> <td style="width: 10%;"></td> <td style="width: 10%;"></td> <td style="width: 10%;"></td> </tr> <tr> <td></td> <td></td> <td colspan="8" style="text-align: center;"> <table border="1" style="width: 100%; border-collapse: collapse; text-align: center;"> <tr> <td style="width: 10%;"></td> <td style="width: 10%;"></td> <td style="width: 10%;"></td> <td style="width: 10%;"></td> <td style="width: 10%;"></td> <td style="width: 10%;"></td> <td style="width: 10%;"></td> <td style="width: 10%;"></td> <td style="width: 10%;"></td> <td style="width: 10%;"></td> </tr> <tr> <td></td> <td></td> <td colspan="8" style="text-align: center;"> <table border="1" style="width: 100%; border-collapse: collapse; text-align: center;"> <tr> <td style="width: 10%;"></td> <td style="width: 10%;"></td> <td style="width: 10%;"></td> <td style="width: 10%;"></td> <td style="width: 10%;"></td> <td style="width: 10%;"></td> <td style="width: 10%;"></td> <td style="width: 10%;"></td> <td style="width: 10%;"></td> <td style="width: 10%;"></td> </tr> <tr> <td></td> <td></td> <td colspan="8" style="text-align: center;"> <table border="1" style="width: 100%; border-collapse: collapse; text-align: center;"> <tr> <td style="width: 10%;"></td> <td style="width: 10%;"></td> <td style="width: 10%;"></td> <td style="width: 10%;"></td> <td style="width: 10%;"></td> <td style="width: 10%;"></td> <td style="width: 10%;"></td> <td style="width: 10%;"></td> <td style="width: 10%;"></td> <td style="width: 10%;"></td> </tr> <tr> <td></td> <td></td> <td colspan="8" style="text-align: center;"> <table border="1" style="width: 100%; border-collapse: collapse; text-align: center;"> <tr> <td style="width: 10%;"></td> <td style="width: 10%;"></td> <td style="width: 10%;"></td> <td style="width: 10%;"></td> <td style="width: 10%;"></td> <td style="width: 10%;"></td> <td style="width: 10%;"></td> <td style="width: 10%;"></td> <td style="width: 10%;"></td> <td style="width: 10%;"></td> </tr> <tr> <td></td> <td></td> <td colspan="8" style="text-align: center;"> <table border="1" style="width: 100%; border-collapse: collapse; text-align: center;"> <tr> <td style="width: 10%;"></td> <td style="width: 10%;"></td> <td style="width: 10%;"></td> <td style="width: 10%;"></td> <td style="width: 10%;"></td> <td style="width: 10%;"></td> <td style="width: 10%;"></td> <td style="width: 10%;"></td> <td style="width: 10%;"></td> <td style="width: 10%;"></td> </tr> <tr> <td></td> <td></td> <td colspan="8" style="text-align: center;"> <table border="1" style="width: 100%; border-collapse: collapse; text-align: center;"> <tr> <td style="width: 10%;"></td> <td style="width: 10%;"></td> <td style="width: 10%;"></td> <td style="width: 10%;"></td> <td style="width: 10%;"></td> <td style="width: 10%;"></td> <td style="width: 10%;"></td> <td style="width: 10%;"></td> <td style="width: 10%;"></td> <td style="width: 10%;"></td> </tr> <tr> <td></td> <td></td> <td colspan="8" style="text-align: center;"> <table border="1" style="width: 100%; border-collapse: collapse; text-align: center;"> <tr> <td style="width: 10%;"></td> <td style="width: 10%;"></td> <td style="width: 10%;"></td> <td style="width: 10%;"></td> <td style="width: 10%;"></td> <td style="width: 10%;"></td> <td style="width: 10%;"></td> <td style="width: 10%;"></td> <td style="width: 10%;"></td> <td style="width: 10%;"></td> </tr> <tr> <td></td> <td></td> <td colspan="8" style="text-align: center;"> <table border="1" style="width: 100%; border-collapse: collapse; text-align: center;"> <tr> <td style="width: 10%;"></td> <td style="width: 10%;"></td> <td style="width: 10%;"></td> <td style="width: 10%;"></td> <td style="width: 10%;"></td> <td style="width: 10%;"></td> <td style="width: 10%;"></td> <td style="width: 10%;"></td> <td style="width: 10%;"></td> <td style="width: 10%;"></td> </tr> <tr> <td></td> <td></td> <td colspan="8" style="text-align: center;"> <table border="1" style="width: 100%; border-collapse: collapse; text-align: center;"> <tr> <td style="width: 10%;"></td> <td style="width: 10%;"></td> <td style="width: 10%;"></td> <td style="width: 10%;"></td> <td style="width: 10%;"></td> <td style="width: 10%;"></td> <td style="width: 10%;"></td> <td style="width: 10%;"></td> <td style="width: 10%;"></td> <td style="width: 10%;"></td> </tr> <tr> <td></td> <td></td> <td colspan="8" style="text-align: center;"> <table border="1" style="width: 100%; border-collapse: collapse; text-align: center;"> <tr>
</tr></table></td></tr></table></td></tr></table></td></tr></table></td></tr></table></td></tr></table></td></tr></table></td></tr></table></td></tr></table></td></tr></table></td></tr></table></td></tr></table></td></tr></table></td></tr></table></td></tr></table></td></tr></table></td></tr></table></td></tr></table></td></tr></table></td></tr></table></td></tr></table></td></tr></table></td></tr></table></td></tr></table></td></tr></table></td></tr></table></td></tr></table></td></tr></table></td></tr></table></td></tr></table></td></tr></table></td></tr></table></td></tr></table></td></tr></table></td></tr></table></td></tr></table> | | | | | | | | | | | | | | | | | | | | <table border="1" style="width: 100%; border-collapse: collapse; text-align: center;"> <tr> <td style="width: 10%;"></td> <td style="width: 10%;"></td> <td style="width: 10%;"></td> <td style="width: 10%;"></td> <td style="width: 10%;"></td> <td style="width: 10%;"></td> <td style="width: 10%;"></td> <td style="width: 10%;"></td> <td style="width: 10%;"></td> <td style="width: 10%;"></td> </tr> <tr> <td></td> <td></td> <td colspan="8" style="text-align: center;"> <table border="1" style="width: 100%; border-collapse: collapse; text-align: center;"> <tr> <td style="width: 10%;"></td> <td style="width: 10%;"></td> <td style="width: 10%;"></td> <td style="width: 10%;"></td> <td style="width: 10%;"></td> <td style="width: 10%;"></td> <td style="width: 10%;"></td> <td style="width: 10%;"></td> <td style="width: 10%;"></td> <td style="width: 10%;"></td> </tr> <tr> <td></td> <td></td> <td colspan="8" style="text-align: center;"> <table border="1" style="width: 100%; border-collapse: collapse; text-align: center;"> <tr> <td style="width: 10%;"></td> <td style="width: 10%;"></td> <td style="width: 10%;"></td> <td style="width: 10%;"></td> <td style="width: 10%;"></td> <td style="width: 10%;"></td> <td style="width: 10%;"></td> <td style="width: 10%;"></td> <td style="width: 10%;"></td> <td style="width: 10%;"></td> </tr> <tr> <td></td> <td></td> <td colspan="8" style="text-align: center;"> <table border="1" style="width: 100%; border-collapse: collapse; text-align: center;"> <tr> <td style="width: 10%;"></td> <td style="width: 10%;"></td> <td style="width: 10%;"></td> <td style="width: 10%;"></td> <td style="width: 10%;"></td> <td style="width: 10%;"></td> <td style="width: 10%;"></td> <td style="width: 10%;"></td> <td style="width: 10%;"></td> <td style="width: 10%;"></td> </tr> <tr> <td></td> <td></td> <td colspan="8" style="text-align: center;"> <table border="1" style="width: 100%; border-collapse: collapse; text-align: center;"> <tr> <td style="width: 10%;"></td> <td style="width: 10%;"></td> <td style="width: 10%;"></td> <td style="width: 10%;"></td> <td style="width: 10%;"></td> <td style="width: 10%;"></td> <td style="width: 10%;"></td> <td style="width: 10%;"></td> <td style="width: 10%;"></td> <td style="width: 10%;"></td> </tr> <tr> <td></td> <td></td> <td colspan="8" style="text-align: center;"> <table border="1" style="width: 100%; border-collapse: collapse; text-align: center;"> <tr> <td style="width: 10%;"></td> <td style="width: 10%;"></td> <td style="width: 10%;"></td> <td style="width: 10%;"></td> <td style="width: 10%;"></td> <td style="width: 10%;"></td> <td style="width: 10%;"></td> <td style="width: 10%;"></td> <td style="width: 10%;"></td> <td style="width: 10%;"></td> </tr> <tr> <td></td> <td></td> <td colspan="8" style="text-align: center;"> <table border="1" style="width: 100%; border-collapse: collapse; text-align: center;"> <tr> <td style="width: 10%;"></td> <td style="width: 10%;"></td> <td style="width: 10%;"></td> <td style="width: 10%;"></td> <td style="width: 10%;"></td> <td style="width: 10%;"></td> <td style="width: 10%;"></td> <td style="width: 10%;"></td> <td style="width: 10%;"></td> <td style="width: 10%;"></td> </tr> <tr> <td></td> <td></td> <td colspan="8" style="text-align: center;"> <table border="1" style="width: 100%; border-collapse: collapse; text-align: center;"> <tr> <td style="width: 10%;"></td> <td style="width: 10%;"></td> <td style="width: 10%;"></td> <td style="width: 10%;"></td> <td style="width: 10%;"></td> <td style="width: 10%;"></td> <td style="width: 10%;"></td> <td style="width: 10%;"></td> <td style="width: 10%;"></td> <td style="width: 10%;"></td> </tr> <tr> <td></td> <td></td> <td colspan="8" style="text-align: center;"> <table border="1" style="width: 100%; border-collapse: collapse; text-align: center;"> <tr> <td style="width: 10%;"></td> <td style="width: 10%;"></td> <td style="width: 10%;"></td> <td style="width: 10%;"></td> <td style="width: 10%;"></td> <td style="width: 10%;"></td> <td style="width: 10%;"></td> <td style="width: 10%;"></td> <td style="width: 10%;"></td> <td style="width: 10%;"></td> </tr> <tr> <td></td> <td></td> <td colspan="8" style="text-align: center;"> <table border="1" style="width: 100%; border-collapse: collapse; text-align: center;"> <tr> <td style="width: 10%;"></td> <td style="width: 10%;"></td> <td style="width: 10%;"></td> <td style="width: 10%;"></td> <td style="width: 10%;"></td> <td style="width: 10%;"></td> <td style="width: 10%;"></td> <td style="width: 10%;"></td> <td style="width: 10%;"></td> <td style="width: 10%;"></td> </tr> <tr> <td></td> <td></td> <td colspan="8" style="text-align: center;"> <table border="1" style="width: 100%; border-collapse: collapse; text-align: center;"> <tr> <td style="width: 10%;"></td> <td style="width: 10%;"></td> <td style="width: 10%;"></td> <td style="width: 10%;"></td> <td style="width: 10%;"></td>
<td style="width: 10%;"></td> <td style="width: 10%;"></td> <td style="width: 10%;"></td> <td style="width: 10%;"></td> <td style="width: 10%;"></td> </tr> <tr> <td></td> <td></td> <td colspan="8" style="text-align: center;"> <table border="1" style="width: 100%; border-collapse: collapse; text-align: center;"> <tr> <td style="width: 10%;"></td> <td style="width: 10%;"></td> <td style="width: 10%;"></td> <td style="width: 10%;"></td> <td style="width: 10%;"></td> <td style="width: 10%;"></td> <td style="width: 10%;"></td> <td style="width: 10%;"></td> <td style="width: 10%;"></td> <td style="width: 10%;"></td> </tr> <tr> <td></td> <td></td> <td colspan="8" style="text-align: center;"> <table border="1" style="width: 100%; border-collapse: collapse; text-align: center;"> <tr> <td style="width: 10%;"></td> <td style="width: 10%;"></td> <td style="width: 10%;"></td> <td style="width: 10%;"></td> <td style="width: 10%;"></td> <td style="width: 10%;"></td> <td style="width: 10%;"></td> <td style="width: 10%;"></td> <td style="width: 10%;"></td> <td style="width: 10%;"></td> </tr> <tr> <td></td> <td></td> <td colspan="8" style="text-align: center;"> <table border="1" style="width: 100%; border-collapse: collapse; text-align: center;"> <tr> <td style="width: 10%;"></td> <td style="width: 10%;"></td> <td style="width: 10%;"></td> <td style="width: 10%;"></td> <td style="width: 10%;"></td> <td style="width: 10%;"></td> <td style="width: 10%;"></td> <td style="width: 10%;"></td> <td style="width: 10%;"></td> <td style="width: 10%;"></td> </tr> <tr> <td></td> <td></td> <td colspan="8" style="text-align: center;"> <table border="1" style="width: 100%; border-collapse: collapse; text-align: center;"> <tr> <td style="width: 10%;"></td> <td style="width: 10%;"></td> <td style="width: 10%;"></td> <td style="width: 10%;"></td> <td style="width: 10%;"></td> <td style="width: 10%;"></td> <td style="width: 10%;"></td> <td style="width: 10%;"></td> <td style="width: 10%;"></td> <td style="width: 10%;"></td> </tr> <tr> <td></td> <td></td> <td colspan="8" style="text-align: center;"> <table border="1" style="width: 100%; border-collapse: collapse; text-align: center;"> <tr> <td style="width: 10%;"></td> <td style="width: 10%;"></td> <td style="width: 10%;"></td> <td style="width: 10%;"></td> <td style="width: 10%;"></td> <td style="width: 10%;"></td> <td style="width: 10%;"></td> <td style="width: 10%;"></td> <td style="width: 10%;"></td> <td style="width: 10%;"></td> </tr> <tr> <td></td> <td></td> <td colspan="8" style="text-align: center;"> <table border="1" style="width: 100%; border-collapse: collapse; text-align: center;"> <tr> <td style="width: 10%;"></td> <td style="width: 10%;"></td> <td style="width: 10%;"></td> <td style="width: 10%;"></td> <td style="width: 10%;"></td> <td style="width: 10%;"></td> <td style="width: 10%;"></td> <td style="width: 10%;"></td> <td style="width: 10%;"></td> <td style="width: 10%;"></td> </tr> <tr> <td></td> <td></td> <td colspan="8" style="text-align: center;"> <table border="1" style="width: 100%; border-collapse: collapse; text-align: center;"> <tr> <td style="width: 10%;"></td> <td style="width: 10%;"></td> <td style="width: 10%;"></td> <td style="width: 10%;"></td> <td style="width: 10%;"></td> <td style="width: 10%;"></td> <td style="width: 10%;"></td> <td style="width: 10%;"></td> <td style="width: 10%;"></td> <td style="width: 10%;"></td> </tr> <tr> <td></td> <td></td> <td colspan="8" style="text-align: center;"> <table border="1" style="width: 100%; border-collapse: collapse; text-align: center;"> <tr> <td style="width: 10%;"></td> <td style="width: 10%;"></td> <td style="width: 10%;"></td> <td style="width: 10%;"></td> <td style="width: 10%;"></td> <td style="width: 10%;"></td> <td style="width: 10%;"></td> <td style="width: 10%;"></td> <td style="width: 10%;"></td> <td style="width: 10%;"></td> </tr> <tr> <td></td> <td></td> <td colspan="8" style="text-align: center;"> <table border="1" style="width: 100%; border-collapse: collapse; text-align: center;"> <tr> <td style="width: 10%;"></td> <td style="width: 10%;"></td> <td style="width: 10%;"></td> <td style="width: 10%;"></td> <td style="width: 10%;"></td> <td style="width: 10%;"></td> <td style="width: 10%;"></td> <td style="width: 10%;"></td> <td style="width: 10%;"></td> <td style="width: 10%;"></td> </tr> <tr> <td></td> <td></td> <td colspan="8" style="text-align: center;"> <table border="1" style="width: 100%; border-collapse: collapse; text-align: center;"> <tr> <td style="width: 10%;"></td> <td style="width: 10%;"></td> <td style="width: 10%;"></td> <td style="width: 10%;"></td> <td style="width: 10%;"></td> <td style="width: 10%;"></td> <td style="width: 10%;"></td> <td style="width: 10%;"></td> <td style="width: 10%;"></td> <td style="width: 10%;"></td> </tr> <tr> <td></td> <td></td> <td colspan="8" style="text-align: center;"> <table border="1" style="width: 100%; border-collapse: collapse; text-align: center;"> <tr> <td style="width: 10%;"></td> <td style="width: 10%;"></td> <td style="width: 10%;"></td> <td style="width: 10%;"></td> <td style="width: 10%;"></td> <td style="width: 10%;"></td> <td style="width: 10%;"></td> <td style="width: 10%;"></td> <td style="width: 10%;"></td> <td style="width: 10%;"></td> </tr> <tr> <td></td> <td></td> <td colspan="8" style="text-align: center;"> <table border="1" style="width: 100%; border-collapse: collapse; text-align: center;"> <tr> <td style="width: 10%;"></td> <td style="width: 10%;"></td> <td style="width: 10%;"></td> <td style="width: 10%;"></td> <td style="width: 10%;"></td> <td style="width: 10%;"></td> <td style="width: 10%;"></td> <td style="width: 10%;"></td> <td style="width: 10%;"></td> <td style="width: 10%;"></td> </tr> <tr> <td></td> <td></td> <td colspan="8" style="text-align: center;"> <table border="1" style="width: 100%; border-collapse: collapse; text-align: center;"> <tr> <td style="width: 10%;"></td> <td style="width: 10%;"></td> <td style="width: 10%;"></td> <td style="width: 10%;"></td> <td style="width: 10%;"></td> <td style="width: 10%;"></td> <td style="width: 10%;"></td> <td style="width: 10%;"></td> <td style="width: 10%;"></td> <td style="width: 10%;"></td> </tr> <tr> <td></td> <td></td> <td colspan="8" style="text-align: center;"> <table border="1" style="width: 100%; border-collapse: collapse; text-align: center;"> <tr> <td style="width: 10%;"></td> <td style="width: 10%;"></td> <td style="width: 10%;"></td> <td style="width: 10%;"></td> <td style="width: 10%;"></td> <td style="width: 10%;"></td> <td style="width: 10%;"></td> <td style="width: 10%;"></td> <td style="width: 10%;"></td> <td style="width: 10%;"></td> </tr> <tr> <td></td> <td></td> <td colspan="8" style="text-align: center;"> <table border="1" style="width: 100%; border-collapse: collapse; text-align: center;"> <tr> <td style="width: 10%;"></td> <td style="width: 10%;"></td> <td style="width: 10%;"></td> <td style="width: 10%;"></td> <td style="width: 10%;"></td> <td style="width: 10%;"></td> <td style="width: 10%;"></td> <td style="width: 10%;"></td> <td style="width: 10%;"></td> <td style="width: 10%;"></td> </tr> <tr> <td></td> <td></td> <td colspan="8" style="text-align: center;"> <table border="1" style="width: 100%; border-collapse: collapse; text-align: center;"> <tr> <td style="width: 10%;"></td> <td style="width: 10%;"></td> <td style="width: 10%;"></td> <td style="width: 10%;"></td> <td style="width: 10%;"></td> <td style="width: 10%;"></td> <td style="width: 10%;"></td> <td style="width: 10%;"></td> <td style="width: 10%;"></td> <td style="width: 10%;"></td> </tr> <tr> <td></td> <td></td> <td colspan="8" style="text-align: center;"> <table border="1" style="width: 100%; border-collapse: collapse; text-align: center;"> <tr> <td style="width: 10%;"></td> <td style="width: 10%;"></td> <td style="width: 10%;"></td> <td style="width: 10%;"></td> <td style="width: 10%;"></td> <td style="width: 10%;"></td> <td style="width: 10%;"></td> <td style="width: 10%;"></td> <td style="width: 10%;"></td> <td style="width: 10%;"></td> </tr> <tr> <td></td> <td></td> <td colspan="8" style="text-align: center;"> <table border="1" style="width: 100%; border-collapse: collapse; text-align: center;"> <tr> <td style="width: 10%;"></td> <td style="width: 10%;"></td> <td style="width: 10%;"></td> <td style="width: 10%;"></td> <td style="width: 10%;"></td> <td style="width: 10%;"></td> <td style="width: 10%;"></td> <td style="width: 10%;"></td> <td style="width: 10%;"></td> <td style="width: 10%;"></td> </tr> <tr> <td></td> <td></td> <td colspan="8" style="text-align: center;"> <table border="1" style="width: 100%; border-collapse: collapse; text-align: center;"> <tr> <td style="width: 10%;"></td> <td style="width: 10%;"></td> <td style="width: 10%;"></td> <td style="width: 10%;"></td> <td style="width: 10%;"></td> <td style="width: 10%;"></td> <td style="width: 10%;"></td> <td style="width: 10%;"></td> <td style="width: 10%;"></td> <td style="width: 10%;"></td> </tr> <tr> <td></td> <td></td> <td colspan="8" style="text-align: center;"> <table border="1" style="width: 100%; border-collapse: collapse; text-align: center;"> <tr> <td style="width: 10%;"></td> <td style="width: 10%;"></td> <td style="width: 10%;"></td> <td style="width: 10%;"></td> <td style="width: 10%;"></td> <td style="width: 10%;"></td> <td style="width: 10%;"></td> <td style="width: 10%;"></td> <td style="width: 10%;"></td> <td style="width: 10%;"></td> </tr> <tr> <td></td> <td></td> <td colspan="8" style="text-align: center;"> <table border="1" style="width: 100%; border-collapse: collapse; text-align: center;"> <tr> <td style="width: 10%;"></td> <td style="width: 10%;"></td> <td style="width: 10%;"></td> <td style="width: 10%;"></td> <td style="width: 10%;"></td> <td style="width: 10%;"></td> <td style="width: 10%;"></td> <td style="width: 10%;"></td> <td style="width: 10%;"></td> <td style="width: 10%;"></td> </tr> <tr> <td></td>
<td></td> <td colspan="8" style="text-align: center;"> <table border="1" style="width: 100%; border-collapse: collapse; text-align: center;"> <tr> <td style="width: 10%;"></td> <td style="width: 10%;"></td> <td style="width: 10%;"></td> <td style="width: 10%;"></td> <td style="width: 10%;"></td> <td style="width: 10%;"></td> <td style="width: 10%;"></td> <td style="width: 10%;"></td> <td style="width: 10%;"></td> <td style="width: 10%;"></td> </tr> <tr> <td></td> <td></td> <td colspan="8" style="text-align: center;"> <table border="1" style="width: 100%; border-collapse: collapse; text-align: center;"> <tr> <td style="width: 10%;"></td> <td style="width: 10%;"></td> <td style="width: 10%;"></td> <td style="width: 10%;"></td> <td style="width: 10%;"></td> <td style="width: 10%;"></td> <td style="width: 10%;"></td> <td style="width: 10%;"></td> <td style="width: 10%;"></td> <td style="width: 10%;"></td> </tr> <tr> <td></td> <td></td> <td colspan="8" style="text-align: center;"> <table border="1" style="width: 100%; border-collapse: collapse; text-align: center;"> <tr> </tr></table></td></tr></table></td></tr></table></td></tr></table></td></tr></table></td></tr></table></td></tr></table></td></tr></table></td></tr></table></td></tr></table></td></tr></table></td></tr></table></td></tr></table></td></tr></table></td></tr></table></td></tr></table></td></tr></table></td></tr></table></td></tr></table></td></tr></table></td></tr></table></td></tr></table></td></tr></table></td></tr></table></td></tr></table></td></tr></table></td></tr></table></td></tr></table></td></tr></table></td></tr></table></td></tr></table></td></tr></table></td></tr></table></td></tr></table></td></tr></table> | | | | | | | | | | | | | | | | | | | | <table border="1" style="width: 100%; border-collapse: collapse; text-align: center;"> <tr> <td style="width: 10%;"></td> <td style="width: 10%;"></td> <td style="width: 10%;"></td> <td style="width: 10%;"></td> <td style="width: 10%;"></td> <td style="width: 10%;"></td> <td style="width: 10%;"></td> <td style="width: 10%;"></td> <td style="width: 10%;"></td> <td style="width: 10%;"></td> </tr> <tr> <td></td> <td></td> <td colspan="8" style="text-align: center;"> <table border="1" style="width: 100%; border-collapse: collapse; text-align: center;"> <tr> <td style="width: 10%;"></td> <td style="width: 10%;"></td> <td style="width: 10%;"></td> <td style="width: 10%;"></td> <td style="width: 10%;"></td> <td style="width: 10%;"></td> <td style="width: 10%;"></td> <td style="width: 10%;"></td> <td style="width: 10%;"></td> <td style="width: 10%;"></td> </tr> <tr> <td></td> <td></td> <td colspan="8" style="text-align: center;"> <table border="1" style="width: 100%; border-collapse: collapse; text-align: center;"> <tr> <td style="width: 10%;"></td> <td style="width: 10%;"></td> <td style="width: 10%;"></td> <td style="width: 10%;"></td> <td style="width: 10%;"></td> <td style="width: 10%;"></td> <td style="width: 10%;"></td> <td style="width: 10%;"></td> <td style="width: 10%;"></td> <td style="width: 10%;"></td> </tr> <tr> <td></td> <td></td> <td colspan="8" style="text-align: center;"> <table border="1" style="width: 100%; border-collapse: collapse; text-align: center;"> <tr> <td style="width: 10%;"></td> <td style="width: 10%;"></td> <td style="width: 10%;"></td> <td style="width: 10%;"></td> <td style="width: 10%;"></td> <td style="width: 10%;"></td> <td style="width: 10%;"></td> <td style="width: 10%;"></td> <td style="width: 10%;"></td> <td style="width: 10%;"></td> </tr> <tr> <td></td> <td></td> <td colspan="8" style="text-align: center;"> <table border="1" style="width: 100%; border-collapse: collapse; text-align: center;"> <tr> <td style="width: 10%;"></td> <td style="width: 10%;"></td> <td style="width: 10%;"></td> <td style="width: 10%;"></td> <td style="width: 10%;"></td> <td style="width: 10%;"></td> <td style="width: 10%;"></td> <td style="width: 10%;"></td> <td style="width: 10%;"></td> <td style="width: 10%;"></td> </tr> <tr> <td></td> <td></td> <td colspan="8" style="text-align: center;"> <table border="1" style="width: 100%; border-collapse: collapse; text-align: center;"> <tr> <td style="width: 10%;"></td> <td style="width: 10%;"></td> <td style="width: 10%;"></td> <td style="width: 10%;"></td> <td style="width: 10%;"></td> <td style="width: 10%;"></td> <td style="width: 10%;"></td> <td style="width: 10%;"></td> <td style="width: 10%;"></td> <td style="width: 10%;"></td> </tr> <tr> <td></td> <td></td> <td colspan="8" style="text-align: center;"> <table border="1" style="width: 100%; border-collapse: collapse; text-align: center;"> <tr> <td style="width: 10%;"></td> <td style="width: 10%;"></td> <td style="width: 10%;"></td> <td style="width: 10%;"></td> <td style="width: 10%;"></td> <td style="width: 10%;"></td> <td style="width: 10%;"></td> <td style="width: 10%;"></td> <td style="width: 10%;"></td> <td style="width: 10%;"></td> </tr> <tr> <td></td> <td></td> <td colspan="8" style="text-align: center;"> <table border="1" style="width: 100%; border-collapse: collapse; text-align: center;"> <tr> <td style="width: 10%;"></td> <td style="width: 10%;"></td> <td style="width: 10%;"></td> <td style="width: 10%;"></td> <td style="width: 10%;"></td> <td style="width: 10%;"></td> <td style="width: 10%;"></td> <td style="width: 10%;"></td> <td style="width: 10%;"></td> <td style="width: 10%;"></td> </tr> <tr> <td></td> <td></td> <td colspan="8" style="text-align: center;"> <table border="1" style="width: 100%; border-collapse: collapse; text-align: center;"> <tr> <td style="width:
10%;"></td> <td style="width: 10%;"></td> <td style="width: 10%;"></td> <td style="width: 10%;"></td> <td style="width: 10%;"></td> <td style="width: 10%;"></td> <td style="width: 10%;"></td> <td style="width: 10%;"></td> <td style="width: 10%;"></td> <td style="width: 10%;"></td> </tr> <tr> <td></td> <td></td> <td colspan="8" style="text-align: center;"> <table border="1" style="width: 100%; border-collapse: collapse; text-align: center;"> <tr> <td style="width: 10%;"></td> <td style="width: 10%;"></td> <td style="width: 10%;"></td> <td style="width: 10%;"></td> <td style="width: 10%;"></td> <td style="width: 10%;"></td> <td style="width: 10%;"></td> <td style="width: 10%;"></td> <td style="width: 10%;"></td> <td style="width: 10%;"></td> </tr> <tr> <td></td> <td></td> <td colspan="8" style="text-align: center;"> <table border="1" style="width: 100%; border-collapse: collapse; text-align: center;"> <tr> <td style="width: 10%;"></td> <td style="width: 10%;"></td> <td style="width: 10%;"></td> <td style="width: 10%;"></td> <td style="width: 10%;"></td> <td style="width: 10%;"></td> <td style="width: 10%;"></td> <td style="width: 10%;"></td> <td style="width: 10%;"></td> <td style="width: 10%;"></td> </tr> <tr> <td></td> <td></td> <td colspan="8" style="text-align: center;"> <table border="1" style="width: 100%; border-collapse: collapse; text-align: center;"> <tr> <td style="width: 10%;"></td> <td style="width: 10%;"></td> <td style="width: 10%;"></td> <td style="width: 10%;"></td> <td style="width: 10%;"></td> <td style="width: 10%;"></td> <td style="width: 10%;"></td> <td style="width: 10%;"></td> <td style="width: 10%;"></td> <td style="width: 10%;"></td> </tr> <tr> <td></td> <td></td> <td colspan="8" style="text-align: center;"> <table border="1" style="width: 100%; border-collapse: collapse; text-align: center;"> <tr> <td style="width: 10%;"></td> <td style="width: 10%;"></td> <td style="width: 10%;"></td> <td style="width: 10%;"></td> <td style="width: 10%;"></td> <td style="width: 10%;"></td> <td style="width: 10%;"></td> <td style="width: 10%;"></td> <td style="width: 10%;"></td> <td style="width: 10%;"></td> </tr> <tr> <td></td> <td></td> <td colspan="8" style="text-align: center;"> <table border="1" style="width: 100%; border-collapse: collapse; text-align: center;"> <tr> <td style="width: 10%;"></td> <td style="width: 10%;"></td> <td style="width: 10%;"></td> <td style="width: 10%;"></td> <td style="width: 10%;"></td> <td style="width: 10%;"></td> <td style="width: 10%;"></td> <td style="width: 10%;"></td> <td style="width: 10%;"></td> <td style="width: 10%;"></td> </tr> <tr> <td></td> <td></td> <td colspan="8" style="text-align: center;"> <table border="1" style="width: 100%; border-collapse: collapse; text-align: center;"> <tr> <td style="width: 10%;"></td> <td style="width: 10%;"></td> <td style="width: 10%;"></td> <td style="width: 10%;"></td> <td style="width: 10%;"></td> <td style="width: 10%;"></td> <td style="width: 10%;"></td> <td style="width: 10%;"></td> <td style="width: 10%;"></td> <td style="width: 10%;"></td> </tr> <tr> <td></td> <td></td> <td colspan="8" style="text-align: center;"> <table border="1" style="width: 100%; border-collapse: collapse; text-align: center;"> <tr> <td style="width: 10%;"></td> <td style="width: 10%;"></td> <td style="width: 10%;"></td> <td style="width: 10%;"></td> <td style="width: 10%;"></td> <td style="width: 10%;"></td> <td style="width: 10%;"></td> <td style="width: 10%;"></td> <td style="width: 10%;"></td> <td style="width: 10%;"></td> </tr> <tr> <td></td> <td></td> <td colspan="8" style="text-align: center;"> <table border="1" style="width: 100%; border-collapse: collapse; text-align: center;"> <tr> <td style="width: 10%;"></td> <td style="width: 10%;"></td> <td style="width: 10%;"></td> <td style="width: 10%;"></td> <td style="width: 10%;"></td> <td style="width: 10%;"></td> <td style="width: 10%;"></td> <td style="width: 10%;"></td> <td style="width: 10%;"></td> <td style="width: 10%;"></td> </tr> <tr> <td></td> <td></td> <td colspan="8" style="text-align: center;"> <table border="1" style="width: 100%; border-collapse: collapse; text-align: center;"> <tr> <td style="width: 10%;"></td> <td style="width: 10%;"></td> <td style="width: 10%;"></td> <td style="width: 10%;"></td> <td style="width: 10%;"></td> <td style="width: 10%;"></td> <td style="width: 10%;"></td> <td style="width: 10%;"></td> <td style="width: 10%;"></td> <td style="width: 10%;"></td> </tr> <tr> <td></td> <td></td> <td colspan="8" style="text-align: center;"> <table border="1" style="width: 100%; border-collapse: collapse; text-align: center;"> <tr> <td style="width: 10%;"></td> <td style="width: 10%;"></td> <td style="width: 10%;"></td> <td style="width: 10%;"></td> <td style="width: 10%;"></td> <td style="width: 10%;"></td> <td style="width: 10%;"></td> <td style="width: 10%;"></td> <td style="width: 10%;"></td> <td style="width: 10%;"></td> </tr> <tr> <td></td> <td></td> <td colspan="8" style="text-align: center;"> <table border="1" style="width: 100%; border-collapse: collapse; text-align: center;"> <tr> <td style="width: 10%;"></td> <td style="width: 10%;"></td> <td style="width: 10%;"></td> <td style="width: 10%;"></td> <td style="width: 10%;"></td> <td style="width: 10%;"></td> <td style="width: 10%;"></td> <td style="width: 10%;"></td> <td style="width: 10%;"></td> <td style="width: 10%;"></td> </tr> <tr> <td></td> <td></td> <td colspan="8" style="text-align: center;"> <table border="1" style="width: 100%; border-collapse: collapse; text-align: center;"> <tr> <td style="width: 10%;"></td> <td style="width: 10%;"></td> <td style="width: 10%;"></td> <td style="width: 10%;"></td> <td style="width: 10%;"></td> <td style="width: 10%;"></td> <td style="width: 10%;"></td> <td style="width: 10%;"></td> <td style="width: 10%;"></td> <td style="width: 10%;"></td> </tr> <tr> <td></td> <td></td> <td colspan="8" style="text-align: center;"> <table border="1" style="width: 100%; border-collapse: collapse; text-align: center;"> <tr> <td style="width: 10%;"></td> <td style="width: 10%;"></td> <td style="width: 10%;"></td> <td style="width: 10%;"></td> <td style="width: 10%;"></td> <td style="width: 10%;"></td> <td style="width: 10%;"></td> <td style="width: 10%;"></td> <td style="width: 10%;"></td> <td style="width: 10%;"></td> </tr> <tr> <td></td> <td></td> <td colspan="8" style="text-align: center;"> <table border="1" style="width: 100%; border-collapse: collapse; text-align: center;"> <tr> <td style="width: 10%;"></td> <td style="width: 10%;"></td> <td style="width: 10%;"></td> <td style="width: 10%;"></td> <td style="width: 10%;"></td> <td style="width: 10%;"></td> <td style="width: 10%;"></td> <td style="width: 10%;"></td> <td style="width: 10%;"></td> <td style="width: 10%;"></td> </tr> <tr> <td></td> <td></td> <td colspan="8" style="text-align: center;"> <table border="1" style="width: 100%; border-collapse: collapse; text-align: center;"> <tr> <td style="width: 10%;"></td> <td style="width: 10%;"></td> <td style="width: 10%;"></td> <td style="width: 10%;"></td> <td style="width: 10%;"></td> <td style="width: 10%;"></td> <td style="width: 10%;"></td> <td style="width: 10%;"></td> <td style="width: 10%;"></td> <td style="width: 10%;"></td> </tr> <tr> <td></td> <td></td> <td colspan="8" style="text-align: center;"> <table border="1" style="width: 100%; border-collapse: collapse; text-align: center;"> <tr> <td style="width: 10%;"></td> <td style="width: 10%;"></td> <td style="width: 10%;"></td> <td style="width: 10%;"></td> <td style="width: 10%;"></td> <td style="width: 10%;"></td> <td style="width: 10%;"></td> <td style="width: 10%;"></td> <td style="width: 10%;"></td> <td style="width: 10%;"></td> </tr> <tr> <td></td> <td></td> <td colspan="8" style="text-align: center;"> <table border="1" style="width: 100%; border-collapse: collapse; text-align: center;"> <tr> <td style="width: 10%;"></td> <td style="width: 10%;"></td> <td style="width: 10%;"></td> <td style="width: 10%;"></td> <td style="width: 10%;"></td> <td style="width: 10%;"></td> <td style="width: 10%;"></td> <td style="width: 10%;"></td> <td style="width: 10%;"></td> <td style="width: 10%;"></td> </tr> <tr> <td></td> <td></td> <td colspan="8" style="text-align: center;"> <table border="1" style="width: 100%; border-collapse: collapse; text-align: center;"> <tr> <td style="width: 10%;"></td> <td style="width: 10%;"></td> <td style="width: 10%;"></td> <td style="width: 10%;"></td> <td style="width: 10%;"></td> <td style="width: 10%;"></td> <td style="width: 10%;"></td> <td style="width: 10%;"></td> <td style="width: 10%;"></td> <td style="width: 10%;"></td> </tr> <tr> <td></td> <td></td> <td colspan="8" style="text-align: center;"> <table border="1" style="width: 100%; border-collapse: collapse; text-align: center;"> <tr> <td style="width: 10%;"></td> <td style="width: 10%;"></td> <td style="width: 10%;"></td> <td style="width: 10%;"></td> <td style="width: 10%;"></td> <td style="width: 10%;"></td> <td style="width: 10%;"></td> <td style="width: 10%;"></td> <td style="width: 10%;"></td> <td style="width: 10%;"></td> </tr> <tr> <td></td> <td></td> <td colspan="8" style="text-align: center;"> <table border="1" style="width: 100%; border-collapse: collapse; text-align: center;"> <tr> <td style="width: 10%;"></td> <td style="width: 10%;"></td> <td style="width: 10%;"></td> <td style="width: 10%;"></td> <td style="width: 10%;"></td> <td style="width: 10%;"></td> <td style="width: 10%;"></td> <td style="width: 10%;"></td> <td style="width: 10%;"></td> <td style="width: 10%;"></td> </tr> <tr> <td></td> <td></td> <td colspan="8" style="text-align: center;"> <table border="1" style="width: 100%; border-collapse: collapse; text-align: center;"> <tr> <td style="width: 10%;"></td> <td style="width: 10%;"></td> <td style="width: 10%;"></td> <td style="width: 10%;"></td> <td style="width: 10%;"></td> <td style="width: 10%;"></td> <td
style="width: 10%;"></td> <td style="width: 10%;"></td> <td style="width: 10%;"></td> <td style="width: 10%;"></td> </tr> <tr> <td></td> <td></td> <td colspan="8" style="text-align: center;"> <table border="1" style="width: 100%; border-collapse: collapse; text-align: center;"> <tr> <td style="width: 10%;"></td> <td style="width: 10%;"></td> <td style="width: 10%;"></td> <td style="width: 10%;"></td> <td style="width: 10%;"></td> <td style="width: 10%;"></td> <td style="width: 10%;"></td> <td style="width: 10%;"></td> <td style="width: 10%;"></td> <td style="width: 10%;"></td> </tr> <tr> <td></td> <td></td> <td colspan="8" style="text-align: center;"> <table border="1" style="width: 100%; border-collapse: collapse; text-align: center;"> <tr> <td style="width: 10%;"></td> <td style="width: 10%;"></td> <td style="width: 10%;"></td> <td style="width: 10%;"></td> <td style="width: 10%;"></td> <td style="width: 10%;"></td> <td style="width: 10%;"></td> <td style="width: 10%;"></td> <td style="width: 10%;"></td> <td style="width: 10%;"></td> </tr> <tr> <td></td> <td></td> <td colspan="8" style="text-align: center;"> <table border="1" style="width: 100%; border-collapse: collapse; text-align: center;"> <tr> <td style="width: 10%;"></td> <td style="width: 10%;"></td> <td style="width: 10%;"></td> <td style="width: 10%;"></td> <td style="width: 10%;"></td> <td style="width: 10%;"></td> <td style="width: 10%;"></td> <td style="width: 10%;"></td> <td style="width: 10%;"></td> <td style="width: 10%;"></td> </tr> <tr> <td></td> <td></td> <td colspan="8" style="text-align: center;"> <table border="1" style="width: 100%; border-collapse: collapse; text-align: center;"> <tr> </tr></table></td></tr></table></td></tr></table></td></tr></table></td></tr></table></td></tr></table></td></tr></table></td></tr></table></td></tr></table></td></tr></table></td></tr></table></td></tr></table></td></tr></table></td></tr></table></td></tr></table></td></tr></table></td></tr></table></td></tr></table></td></tr></table></td></tr></table></td></tr></table></td></tr></table></td></tr></table></td></tr></table></td></tr></table></td></tr></table></td></tr></table></td></tr></table></td></tr></table></td></tr></table></td></tr></table></td></tr></table></td></tr></table></td></tr></table> | | | | | | | | | | | | | | | | | | | | <table border="1" style="width: 100%; border-collapse: collapse; text-align: center;"> <tr> <td style="width: 10%;"></td> <td style="width: 10%;"></td> <td style="width: 10%;"></td> <td style="width: 10%;"></td> <td style="width: 10%;"></td> <td style="width: 10%;"></td> <td style="width: 10%;"></td> <td style="width: 10%;"></td> <td style="width: 10%;"></td> <td style="width: 10%;"></td> </tr> <tr> <td></td> <td></td> <td colspan="8" style="text-align: center;"> <table border="1" style="width: 100%; border-collapse: collapse; text-align: center;"> <tr> <td style="width: 10%;"></td> <td style="width: 10%;"></td> <td style="width: 10%;"></td> <td style="width: 10%;"></td> <td style="width: 10%;"></td> <td style="width: 10%;"></td> <td style="width: 10%;"></td> <td style="width: 10%;"></td> <td style="width: 10%;"></td> <td style="width: 10%;"></td> </tr> <tr> <td></td> <td></td> <td colspan="8" style="text-align: center;"> <table border="1" style="width: 100%; border-collapse: collapse; text-align: center;"> <tr> <td style="width: 10%;"></td> <td style="width: 10%;"></td> <td style="width: 10%;"></td> <td style="width: 10%;"></td> <td style="width: 10%;"></td> <td style="width: 10%;"></td> <td style="width: 10%;"></td> <td style="width: 10%;"></td> <td style="width: 10%;"></td> <td style="width: 10%;"></td> </tr> <tr> <td></td> <td></td> <td colspan="8" style="text-align: center;"> <table border="1" style="width: 100%; border-collapse: collapse; text-align: center;"> <tr> <td style="width: 10%;"></td> <td style="width: 10%;"></td> <td style="width: 10%;"></td> <td style="width: 10%;"></td> <td style="width: 10%;"></td> <td style="width: 10%;"></td> <td style="width: 10%;"></td> <td style="width: 10%;"></td> <td style="width: 10%;"></td> <td style="width: 10%;"></td> </tr> <tr> <td></td> <td></td> <td colspan="8" style="text-align: center;"> <table border="1" style="width: 100%; border-collapse: collapse; text-align: center;"> <tr> <td style="width: 10%;"></td> <td style="width: 10%;"></td> <td style="width: 10%;"></td> <td style="width: 10%;"></td> <td style="width: 10%;"></td> <td style="width: 10%;"></td> <td style="width: 10%;"></td> <td style="width: 10%;"></td> <td style="width: 10%;"></td> <td style="width: 10%;"></td> </tr> <tr> <td></td> <td></td> <td colspan="8" style="text-align: center;"> <table border="1" style="width: 100%; border-collapse: collapse; text-align: center;"> <tr> <td style="width: 10%;"></td> <td style="width: 10%;"></td> <td style="width: 10%;"></td> <td style="width: 10%;"></td> <td style="width: 10%;"></td> <td style="width: 10%;"></td> <td style="width: 10%;"></td> <td style="width: 10%;"></td> <td style="width: 10%;"></td> <td style="width: 10%;"></td> </tr> <tr> <td></td> <td></td> <td colspan="8" style="text-align: center;"> <table border="1" style="width: 100%; border-collapse: collapse; text-align: center;"> <tr> <td style="width: 10%;"></td> <td style="width: 10%;"></td> <td style="width: 10%;"></td> <td style="width: 10%;"></td> <td style="width: 10%;"></td> <td style="width: 10%;"></td> <td style="width: 10%;"></td> <td style="width: 10%;"></td> <td style="width: 10%;"></td> <td style="width: 10%;"></td> </tr> <tr> <td></td> <td></td> <td colspan="8" style="text-align:
center;"> <table border="1" style="width: 100%; border-collapse: collapse; text-align: center;"> <tr> <td style="width: 10%;"></td> <td style="width: 10%;"></td> <td style="width: 10%;"></td> <td style="width: 10%;"></td> <td style="width: 10%;"></td> <td style="width: 10%;"></td> <td style="width: 10%;"></td> <td style="width: 10%;"></td> <td style="width: 10%;"></td> <td style="width: 10%;"></td> </tr> <tr> <td></td> <td></td> <td colspan="8" style="text-align: center;"> <table border="1" style="width: 100%; border-collapse: collapse; text-align: center;"> <tr> <td style="width: 10%;"></td> <td style="width: 10%;"></td> <td style="width: 10%;"></td> <td style="width: 10%;"></td> <td style="width: 10%;"></td> <td style="width: 10%;"></td> <td style="width: 10%;"></td> <td style="width: 10%;"></td> <td style="width: 10%;"></td> <td style="width: 10%;"></td> </tr> <tr> <td></td> <td></td> <td colspan="8" style="text-align: center;"> <table border="1" style="width: 100%; border-collapse: collapse; text-align: center;"> <tr> <td style="width: 10%;"></td> <td style="width: 10%;"></td> <td style="width: 10%;"></td> <td style="width: 10%;"></td> <td style="width: 10%;"></td> <td style="width: 10%;"></td> <td style="width: 10%;"></td> <td style="width: 10%;"></td> <td style="width: 10%;"></td> <td style="width: 10%;"></td> </tr> <tr> <td></td> <td></td> <td colspan="8" style="text-align: center;"> <table border="1" style="width: 100%; border-collapse: collapse; text-align: center;"> <tr> <td style="width: 10%;"></td> <td style="width: 10%;"></td> <td style="width: 10%;"></td> <td style="width: 10%;"></td> <td style="width: 10%;"></td> <td style="width: 10%;"></td> <td style="width: 10%;"></td> <td style="width: 10%;"></td> <td style="width: 10%;"></td> <td style="width: 10%;"></td> </tr> <tr> <td></td> <td></td> <td colspan="8" style="text-align: center;"> <table border="1" style="width: 100%; border-collapse: collapse; text-align: center;"> <tr> <td style="width: 10%;"></td> <td style="width: 10%;"></td> <td style="width: 10%;"></td> <td style="width: 10%;"></td> <td style="width: 10%;"></td> <td style="width: 10%;"></td> <td style="width: 10%;"></td> <td style="width: 10%;"></td> <td style="width: 10%;"></td> <td style="width: 10%;"></td> </tr> <tr> <td></td> <td></td> <td colspan="8" style="text-align: center;"> <table border="1" style="width: 100%; border-collapse: collapse; text-align: center;"> <tr> <td style="width: 10%;"></td> <td style="width: 10%;"></td> <td style="width: 10%;"></td> <td style="width: 10%;"></td> <td style="width: 10%;"></td> <td style="width: 10%;"></td> <td style="width: 10%;"></td> <td style="width: 10%;"></td> <td style="width: 10%;"></td> <td style="width: 10%;"></td> </tr> <tr> <td></td> <td></td> <td colspan="8" style="text-align: center;"> <table border="1" style="width: 100%; border-collapse: collapse; text-align: center;"> <tr> <td style="width: 10%;"></td> <td style="width: 10%;"></td> <td style="width: 10%;"></td> <td style="width: 10%;"></td> <td style="width: 10%;"></td> <td style="width: 10%;"></td> <td style="width: 10%;"></td> <td style="width: 10%;"></td> <td style="width: 10%;"></td> <td style="width: 10%;"></td> </tr> <tr> <td></td> <td></td> <td colspan="8" style="text-align: center;"> <table border="1" style="width: 100%; border-collapse: collapse; text-align: center;"> <tr> <td style="width: 10%;"></td> <td style="width: 10%;"></td> <td style="width: 10%;"></td> <td style="width: 10%;"></td> <td style="width: 10%;"></td> <td style="width: 10%;"></td> <td style="width: 10%;"></td> <td style="width: 10%;"></td> <td style="width: 10%;"></td> <td style="width: 10%;"></td> </tr> <tr> <td></td> <td></td> <td colspan="8" style="text-align: center;"> <table border="1" style="width: 100%; border-collapse: collapse; text-align: center;"> <tr> <td style="width: 10%;"></td> <td style="width: 10%;"></td> <td style="width: 10%;"></td> <td style="width: 10%;"></td> <td style="width: 10%;"></td> <td style="width: 10%;"></td> <td style="width: 10%;"></td> <td style="width: 10%;"></td> <td style="width: 10%;"></td> <td style="width: 10%;"></td> </tr> <tr> <td></td> <td></td> <td colspan="8" style="text-align: center;"> <table border="1" style="width: 100%; border-collapse: collapse; text-align: center;"> <tr> <td style="width: 10%;"></td> <td style="width: 10%;"></td> <td style="width: 10%;"></td> <td style="width: 10%;"></td> <td style="width: 10%;"></td> <td style="width: 10%;"></td> <td style="width: 10%;"></td> <td style="width: 10%;"></td> <td style="width: 10%;"></td> <td style="width: 10%;"></td> </tr> <tr> <td></td> <td></td> <td colspan="8" style="text-align: center;"> <table border="1" style="width: 100%; border-collapse: collapse; text-align: center;"> <tr> <td style="width: 10%;"></td> <td style="width: 10%;"></td> <td style="width: 10%;"></td> <td style="width: 10%;"></td> <td style="width: 10%;"></td> <td style="width: 10%;"></td> <td style="width: 10%;"></td> <td style="width: 10%;"></td> <td style="width: 10%;"></td> <td style="width: 10%;"></td> </tr> <tr> <td></td> <td></td> <td colspan="8" style="text-align: center;"> <table border="1" style="width: 100%; border-collapse: collapse; text-align: center;"> <tr> <td style="width: 10%;"></td> <td style="width: 10%;"></td> <td style="width: 10%;"></td> <td style="width: 10%;"></td> <td style="width: 10%;"></td> <td style="width: 10%;"></td> <td style="width: 10%;"></td> <td style="width: 10%;"></td> <td style="width: 10%;"></td> <td style="width: 10%;"></td> </tr> <tr> <td></td> <td></td> <td colspan="8" style="text-align: center;"> <table border="1" style="width: 100%; border-collapse: collapse; text-align: center;"> <tr> <td style="width: 10%;"></td> <td style="width: 10%;"></td> <td style="width: 10%;"></td> <td style="width: 10%;"></td> <td style="width: 10%;"></td> <td style="width: 10%;"></td> <td style="width: 10%;"></td> <td style="width: 10%;"></td> <td style="width: 10%;"></td> <td style="width: 10%;"></td> </tr> <tr> <td></td> <td></td> <td colspan="8" style="text-align: center;"> <table border="1" style="width: 100%; border-collapse: collapse; text-align: center;"> <tr> <td style="width: 10%;"></td> <td style="width: 10%;"></td> <td style="width: 10%;"></td> <td style="width: 10%;"></td> <td style="width: 10%;"></td> <td style="width: 10%;"></td> <td style="width: 10%;"></td> <td style="width: 10%;"></td> <td style="width: 10%;"></td> <td style="width: 10%;"></td> </tr> <tr> <td></td> <td></td> <td colspan="8" style="text-align: center;"> <table border="1" style="width: 100%; border-collapse: collapse; text-align: center;"> <tr> <td style="width: 10%;"></td> <td style="width: 10%;"></td> <td style="width: 10%;"></td> <td style="width: 10%;"></td> <td style="width: 10%;"></td> <td style="width: 10%;"></td> <td style="width: 10%;"></td> <td style="width: 10%;"></td> <td style="width: 10%;"></td> <td style="width: 10%;"></td> </tr> <tr> <td></td> <td></td> <td colspan="8" style="text-align: center;"> <table border="1" style="width: 100%; border-collapse: collapse; text-align: center;"> <tr> <td style="width: 10%;"></td> <td style="width: 10%;"></td> <td style="width: 10%;"></td> <td style="width: 10%;"></td> <td style="width: 10%;"></td> <td style="width: 10%;"></td> <td style="width: 10%;"></td> <td style="width: 10%;"></td> <td style="width: 10%;"></td> <td style="width: 10%;"></td> </tr> <tr> <td></td> <td></td> <td colspan="8" style="text-align: center;"> <table border="1" style="width: 100%; border-collapse: collapse; text-align: center;"> <tr> <td style="width: 10%;"></td> <td style="width: 10%;"></td> <td style="width: 10%;"></td> <td style="width: 10%;"></td> <td style="width: 10%;"></td> <td style="width: 10%;"></td> <td style="width: 10%;"></td> <td style="width: 10%;"></td> <td style="width: 10%;"></td> <td style="width: 10%;"></td> </tr> <tr> <td></td> <td></td> <td colspan="8" style="text-align: center;"> <table border="1" style="width: 100%; border-collapse: collapse; text-align: center;"> <tr> <td style="width: 10%;"></td> <td style="width: 10%;"></td> <td style="width: 10%;"></td> <td style="width: 10%;"></td> <td style="width: 10%;"></td> <td style="width: 10%;"></td> <td style="width: 10%;"></td> <td style="width: 10%;"></td> <td style="width: 10%;"></td> <td style="width: 10%;"></td> </tr> <tr> <td></td> <td></td> <td colspan="8" style="text-align: center;"> <table border="1" style="width: 100%; border-collapse: collapse; text-align: center;"> <tr> <td style="width: 10%;"></td> <td style="width: 10%;"></td> <td style="width: 10%;"></td> <td style="width: 10%;"></td> <td style="width: 10%;"></td> <td style="width: 10%;"></td> <td style="width: 10%;"></td> <td style="width: 10%;"></td> <td style="width: 10%;"></td> <td style="width: 10%;"></td> </tr> <tr> <td></td> <td></td> <td colspan="8" style="text-align: center;"> <table border="1" style="width: 100%; border-collapse: collapse; text-align: center;"> <tr> <td style="width: 10%;"></td> <td style="width: 10%;"></td> <td style="width: 10%;"></td> <td style="width: 10%;"></td> <td style="width: 10%;"></td> <td style="width: 10%;"></td> <td style="width: 10%;"></td> <td style="width: 10%;"></td> <td style="width: 10%;"></td> <td style="width: 10%;"></td> </tr> <tr> <td></td> <td></td> <td colspan="8" style="text-align: center;"> <table border="1" style="width: 100%; border-collapse: collapse; text-align: center;"> <tr> <td style="width: 10%;"></td> <td style="width: 10%;"></td> <td style="width: 10%;"></td> <td style="width: 10%;"></td> <td style="width: 10%;"></td> <td style="width: 10%;"></td> <td style="width: 10%;"></td> <td style="width: 10%;"></td> <td style="width: 10%;"></td> <td style="width: 10%;"></td> </tr> <tr> <td></td> <td></td> <td colspan="8" style="text-align: center;"> <table border="1" style="width: 100%; border-collapse: collapse; text-align: center;"> <tr> <td style="width: 10%;"></td> <td style="width: 10%;"></td> <td
style="width: 10%;"></td> <td style="width: 10%;"></td> <td style="width: 10%;"></td> <td style="width: 10%;"></td> <td style="width: 10%;"></td> <td style="width: 10%;"></td> <td style="width: 10%;"></td> <td style="width: 10%;"></td> </tr> <tr> <td></td> <td></td> <td colspan="8" style="text-align: center;"> <table border="1" style="width: 100%; border-collapse: collapse; text-align: center;"> <tr> <td style="width: 10%;"></td> <td style="width: 10%;"></td> <td style="width: 10%;"></td> <td style="width: 10%;"></td> <td style="width: 10%;"></td> <td style="width: 10%;"></td> <td style="width: 10%;"></td> <td style="width: 10%;"></td> <td style="width: 10%;"></td> <td style="width: 10%;"></td> </tr> <tr> <td></td> <td></td> <td colspan="8" style="text-align: center;"> <table border="1" style="width: 100%; border-collapse: collapse; text-align: center;"> <tr> <td style="width: 10%;"></td> <td style="width: 10%;"></td> <td style="width: 10%;"></td> <td style="width: 10%;"></td> <td style="width: 10%;"></td> <td style="width: 10%;"></td> <td style="width: 10%;"></td> <td style="width: 10%;"></td> <td style="width: 10%;"></td> <td style="width: 10%;"></td> </tr> <tr> <td></td> <td></td> <td colspan="8" style="text-align: center;"> <table border="1" style="width: 100%; border-collapse: collapse; text-align: center;"> <tr> <td style="width: 10%;"></td> <td style="width: 10%;"></td> <td style="width: 10%;"></td> <td style="width: 10%;"></td> <td style="width: 10%;"></td> <td style="width: 10%;"></td> <td style="width: 10%;"></td> <td style="width: 10%;"></td> <td style="width: 10%;"></td> <td style="width: 10%;"></td> </tr> <tr> <td></td> <td></td> <td colspan="8" style="text-align: center;"> <table border="1" style="width: 100%; border-collapse: collapse; text-align: center;"> <tr> </tr></table></td></tr></table></td></tr></table></td></tr></table></td></tr></table></td></tr></table></td></tr></table></td></tr></table></td></tr></table></td></tr></table></td></tr></table></td></tr></table></td></tr></table></td></tr></table></td></tr></table></td></tr></table></td></tr></table></td></tr></table></td></tr></table></td></tr></table></td></tr></table></td></tr></table></td></tr></table></td></tr></table></td></tr></table></td></tr></table></td></tr></table></td></tr></table></td></tr></table></td></tr></table></td></tr></table></td></tr></table></td></tr></table> | | | | | | | | | | | | | | | | | | | | <table border="1" style="width: 100%; border-collapse: collapse; text-align: center;"> <tr> <td style="width: 10%;"></td> <td style="width: 10%;"></td> <td style="width: 10%;"></td> <td style="width: 10%;"></td> <td style="width: 10%;"></td> <td style="width: 10%;"></td> <td style="width: 10%;"></td> <td style="width: 10%;"></td> <td style="width: 10%;"></td> <td style="width: 10%;"></td> </tr> <tr> <td></td> <td></td> <td colspan="8" style="text-align: center;"> <table border="1" style="width: 100%; border-collapse: collapse; text-align: center;"> <tr> <td style="width: 10%;"></td> <td style="width: 10%;"></td> <td style="width: 10%;"></td> <td style="width: 10%;"></td> <td style="width: 10%;"></td> <td style="width: 10%;"></td> <td style="width: 10%;"></td> <td style="width: 10%;"></td> <td style="width: 10%;"></td> <td style="width: 10%;"></td> </tr> <tr> <td></td> <td></td> <td colspan="8" style="text-align: center;"> <table border="1" style="width: 100%; border-collapse: collapse; text-align: center;"> <tr> <td style="width: 10%;"></td> <td style="width: 10%;"></td> <td style="width: 10%;"></td> <td style="width: 10%;"></td> <td style="width: 10%;"></td> <td style="width: 10%;"></td> <td style="width: 10%;"></td> <td style="width: 10%;"></td> <td style="width: 10%;"></td> <td style="width: 10%;"></td> </tr> <tr> <td></td> <td></td> <td colspan="8" style="text-align: center;"> <table border="1" style="width: 100%; border-collapse: collapse; text-align: center;"> <tr> <td style="width: 10%;"></td> <td style="width: 10%;"></td> <td style="width: 10%;"></td> <td style="width: 10%;"></td> <td style="width: 10%;"></td> <td style="width: 10%;"></td> <td style="width: 10%;"></td> <td style="width: 10%;"></td> <td style="width: 10%;"></td> <td style="width: 10%;"></td> </tr> <tr> <td></td> <td></td> <td colspan="8" style="text-align: center;"> <table border="1" style="width: 100%; border-collapse: collapse; text-align: center;"> <tr> <td style="width: 10%;"></td> <td style="width: 10%;"></td> <td style="width: 10%;"></td> <td style="width: 10%;"></td> <td style="width: 10%;"></td> <td style="width: 10%;"></td> <td style="width: 10%;"></td> <td style="width: 10%;"></td> <td style="width: 10%;"></td> <td style="width: 10%;"></td> </tr> <tr> <td></td> <td></td> <td colspan="8" style="text-align: center;"> <table border="1" style="width: 100%; border-collapse: collapse; text-align: center;"> <tr> <td style="width: 10%;"></td> <td style="width: 10%;"></td> <td style="width: 10%;"></td> <td style="width: 10%;"></td> <td style="width: 10%;"></td> <td style="width: 10%;"></td> <td style="width: 10%;"></td> <td style="width: 10%;"></td> <td style="width: 10%;"></td> <td style="width: 10%;"></td> </tr> <tr> <td></td> <td></td> <td colspan="8" style="text-align: center;"> <table border="1" style="width: 100%; border-collapse: collapse; text-align: center;"> <tr> <td style="width: 10%;"></td> <td style="width: 10%;"></td> <td style="width: 10%;"></td> <td style="width: 10%;"></td> <td style="width: 10%;"></td> <td style="width: 10%;"></td> <td style="width: 10%;"></td> <td style="width: 10%;"></td> <td style="width:
10%;"></td> <td style="width: 10%;"></td> </tr> <tr> <td></td> <td></td> <td colspan="8" style="text-align: center;"> <table border="1" style="width: 100%; border-collapse: collapse; text-align: center;"> <tr> <td style="width: 10%;"></td> <td style="width: 10%;"></td> <td style="width: 10%;"></td> <td style="width: 10%;"></td> <td style="width: 10%;"></td> <td style="width: 10%;"></td> <td style="width: 10%;"></td> <td style="width: 10%;"></td> <td style="width: 10%;"></td> <td style="width: 10%;"></td> </tr> <tr> <td></td> <td></td> <td colspan="8" style="text-align: center;"> <table border="1" style="width: 100%; border-collapse: collapse; text-align: center;"> <tr> <td style="width: 10%;"></td> <td style="width: 10%;"></td> <td style="width: 10%;"></td> <td style="width: 10%;"></td> <td style="width: 10%;"></td> <td style="width: 10%;"></td> <td style="width: 10%;"></td> <td style="width: 10%;"></td> <td style="width: 10%;"></td> <td style="width: 10%;"></td> </tr> <tr> <td></td> <td></td> <td colspan="8" style="text-align: center;"> <table border="1" style="width: 100%; border-collapse: collapse; text-align: center;"> <tr> <td style="width: 10%;"></td> <td style="width: 10%;"></td> <td style="width: 10%;"></td> <td style="width: 10%;"></td> <td style="width: 10%;"></td> <td style="width: 10%;"></td> <td style="width: 10%;"></td> <td style="width: 10%;"></td> <td style="width: 10%;"></td> <td style="width: 10%;"></td> </tr> <tr> <td></td> <td></td> <td colspan="8" style="text-align: center;"> <table border="1" style="width: 100%; border-collapse: collapse; text-align: center;"> <tr> <td style="width: 10%;"></td> <td style="width: 10%;"></td> <td style="width: 10%;"></td> <td style="width: 10%;"></td> <td style="width: 10%;"></td> <td style="width: 10%;"></td> <td style="width: 10%;"></td> <td style="width: 10%;"></td> <td style="width: 10%;"></td> <td style="width: 10%;"></td> </tr> <tr> <td></td> <td></td> <td colspan="8" style="text-align: center;"> <table border="1" style="width: 100%; border-collapse: collapse; text-align: center;"> <tr> <td style="width: 10%;"></td> <td style="width: 10%;"></td> <td style="width: 10%;"></td> <td style="width: 10%;"></td> <td style="width: 10%;"></td> <td style="width: 10%;"></td> <td style="width: 10%;"></td> <td style="width: 10%;"></td> <td style="width: 10%;"></td> <td style="width: 10%;"></td> </tr> <tr> <td></td> <td></td> <td colspan="8" style="text-align: center;"> <table border="1" style="width: 100%; border-collapse: collapse; text-align: center;"> <tr> <td style="width: 10%;"></td> <td style="width: 10%;"></td> <td style="width: 10%;"></td> <td style="width: 10%;"></td> <td style="width: 10%;"></td> <td style="width: 10%;"></td> <td style="width: 10%;"></td> <td style="width: 10%;"></td> <td style="width: 10%;"></td> <td style="width: 10%;"></td> </tr> <tr> <td></td> <td></td> <td colspan="8" style="text-align: center;"> <table border="1" style="width: 100%; border-collapse: collapse; text-align: center;"> <tr> <td style="width: 10%;"></td> <td style="width: 10%;"></td> <td style="width: 10%;"></td> <td style="width: 10%;"></td> <td style="width: 10%;"></td> <td style="width: 10%;"></td> <td style="width: 10%;"></td> <td style="width: 10%;"></td> <td style="width: 10%;"></td> <td style="width: 10%;"></td> </tr> <tr> <td></td> <td></td> <td colspan="8" style="text-align: center;"> <table border="1" style="width: 100%; border-collapse: collapse; text-align: center;"> <tr> <td style="width: 10%;"></td> <td style="width: 10%;"></td> <td style="width: 10%;"></td> <td style="width: 10%;"></td> <td style="width: 10%;"></td> <td style="width: 10%;"></td> <td style="width: 10%;"></td> <td style="width: 10%;"></td> <td style="width: 10%;"></td> <td style="width: 10%;"></td> </tr> <tr> <td></td> <td></td> <td colspan="8" style="text-align: center;"> <table border="1" style="width: 100%; border-collapse: collapse; text-align: center;"> <tr> <td style="width: 10%;"></td> <td style="width: 10%;"></td> <td style="width: 10%;"></td> <td style="width: 10%;"></td> <td style="width: 10%;"></td> <td style="width: 10%;"></td> <td style="width: 10%;"></td> <td style="width: 10%;"></td> <td style="width: 10%;"></td> <td style="width: 10%;"></td> </tr> <tr> <td></td> <td></td> <td colspan="8" style="text-align: center;"> <table border="1" style="width: 100%; border-collapse: collapse; text-align: center;"> <tr> <td style="width: 10%;"></td> <td style="width: 10%;"></td> <td style="width: 10%;"></td> <td style="width: 10%;"></td> <td style="width: 10%;"></td> <td style="width: 10%;"></td> <td style="width: 10%;"></td> <td style="width: 10%;"></td> <td style="width: 10%;"></td> <td style="width: 10%;"></td> </tr> <tr> <td></td> <td></td> <td colspan="8" style="text-align: center;"> <table border="1" style="width: 100%; border-collapse: collapse; text-align: center;"> <tr> <td style="width: 10%;"></td> <td style="width: 10%;"></td> <td style="width: 10%;"></td> <td style="width: 10%;"></td> <td style="width: 10%;"></td> <td style="width: 10%;"></td> <td style="width: 10%;"></td> <td style="width: 10%;"></td> <td style="width: 10%;"></td> <td style="width: 10%;"></td> </tr> <tr> <td></td> <td></td> <td colspan="8" style="text-align: center;"> <table border="1" style="width: 100%; border-collapse: collapse; text-align: center;"> <tr> <td style="width: 10%;"></td> <td style="width: 10%;"></td> <td style="width: 10%;"></td> <td style="width: 10%;"></td> <td style="width: 10%;"></td> <td style="width: 10%;"></td> <td style="width: 10%;"></td> <td style="width: 10%;"></td> <td style="width: 10%;"></td> <td style="width: 10%;"></td> </tr> <tr> <td></td> <td></td> <td colspan="8" style="text-align: center;"> <table border="1" style="width: 100%; border-collapse: collapse; text-align: center;"> <tr> <td style="width: 10%;"></td> <td style="width: 10%;"></td> <td style="width: 10%;"></td> <td style="width: 10%;"></td> <td style="width: 10%;"></td> <td style="width: 10%;"></td> <td style="width: 10%;"></td> <td style="width: 10%;"></td> <td style="width: 10%;"></td> <td style="width: 10%;"></td> </tr> <tr> <td></td> <td></td> <td colspan="8" style="text-align: center;"> <table border="1" style="width: 100%; border-collapse: collapse; text-align: center;"> <tr> <td style="width: 10%;"></td> <td style="width: 10%;"></td> <td style="width: 10%;"></td> <td style="width: 10%;"></td> <td style="width: 10%;"></td> <td style="width: 10%;"></td> <td style="width: 10%;"></td> <td style="width: 10%;"></td> <td style="width: 10%;"></td> <td style="width: 10%;"></td> </tr> <tr> <td></td> <td></td> <td colspan="8" style="text-align: center;"> <table border="1" style="width: 100%; border-collapse: collapse; text-align: center;"> <tr> <td style="width: 10%;"></td> <td style="width: 10%;"></td> <td style="width: 10%;"></td> <td style="width: 10%;"></td> <td style="width: 10%;"></td> <td style="width: 10%;"></td> <td style="width: 10%;"></td> <td style="width: 10%;"></td> <td style="width: 10%;"></td> <td style="width: 10%;"></td> </tr> <tr> <td></td> <td></td> <td colspan="8" style="text-align: center;"> <table border="1" style="width: 100%; border-collapse: collapse; text-align: center;"> <tr> <td style="width: 10%;"></td> <td style="width: 10%;"></td> <td style="width: 10%;"></td> <td style="width: 10%;"></td> <td style="width: 10%;"></td> <td style="width: 10%;"></td> <td style="width: 10%;"></td> <td style="width: 10%;"></td> <td style="width: 10%;"></td> <td style="width: 10%;"></td> </tr> <tr> <td></td> <td></td> <td colspan="8" style="text-align: center;"> <table border="1" style="width: 100%; border-collapse: collapse; text-align: center;"> <tr> <td style="width: 10%;"></td> <td style="width: 10%;"></td> <td style="width: 10%;"></td> <td style="width: 10%;"></td> <td style="width: 10%;"></td> <td style="width: 10%;"></td> <td style="width: 10%;"></td> <td style="width: 10%;"></td> <td style="width: 10%;"></td> <td style="width: 10%;"></td> </tr> <tr> <td></td> <td></td> <td colspan="8" style="text-align: center;"> <table border="1" style="width: 100%; border-collapse: collapse; text-align: center;"> <tr> <td style="width: 10%;"></td> <td style="width: 10%;"></td> <td style="width: 10%;"></td> <td style="width: 10%;"></td> <td style="width: 10%;"></td> <td style="width: 10%;"></td> <td style="width: 10%;"></td> <td style="width: 10%;"></td> <td style="width: 10%;"></td> <td style="width: 10%;"></td> </tr> <tr> <td></td> <td></td> <td colspan="8" style="text-align: center;"> <table border="1" style="width: 100%; border-collapse: collapse; text-align: center;"> <tr> <td style="width: 10%;"></td> <td style="width: 10%;"></td> <td style="width: 10%;"></td> <td style="width: 10%;"></td> <td style="width: 10%;"></td> <td style="width: 10%;"></td> <td style="width: 10%;"></td> <td style="width: 10%;"></td> <td style="width: 10%;"></td> <td style="width: 10%;"></td> </tr> <tr> <td></td> <td></td> <td colspan="8" style="text-align: center;"> <table border="1" style="width: 100%; border-collapse: collapse; text-align: center;"> <tr> <td style="width: 10%;"></td> <td style="width: 10%;"></td> <td style="width: 10%;"></td> <td style="width: 10%;"></td> <td style="width: 10%;"></td> <td style="width: 10%;"></td> <td style="width: 10%;"></td> <td style="width: 10%;"></td> <td style="width: 10%;"></td> <td style="width: 10%;"></td> </tr> <tr> <td></td> <td></td> <td colspan="8" style="text-align: center;"> <table border="1" style="width: 100%; border-collapse: collapse; text-align: center;"> <tr> <td style="width: 10%;"></td> <td style="width: 10%;"></td> <td style="width: 10%;"></td> <td style="width: 10%;"></td> <td style="width: 10%;"></td> <td style="width: 10%;"></td> <td style="width: 10%;"></td> <td style="width: 10%;"></td> <td style="width: 10%;"></td> <td style="width: 10%;"></td> </tr> <tr> <td></td> <td></td> <td colspan="8" style="text-align: center;"> <table border="1" style="width: 100%;
border-collapse: collapse; text-align: center;"> <tr> <td style="width: 10%;"></td> <td style="width: 10%;"></td> <td style="width: 10%;"></td> <td style="width: 10%;"></td> <td style="width: 10%;"></td> <td style="width: 10%;"></td> <td style="width: 10%;"></td> <td style="width: 10%;"></td> <td style="width: 10%;"></td> <td style="width: 10%;"></td> </tr> <tr> <td></td> <td></td> <td colspan="8" style="text-align: center;"> <table border="1" style="width: 100%; border-collapse: collapse; text-align: center;"> <tr> <td style="width: 10%;"></td> <td style="width: 10%;"></td> <td style="width: 10%;"></td> <td style="width: 10%;"></td> <td style="width: 10%;"></td> <td style="width: 10%;"></td> <td style="width: 10%;"></td> <td style="width: 10%;"></td> <td style="width: 10%;"></td> <td style="width: 10%;"></td> </tr> <tr> <td></td> <td></td> <td colspan="8" style="text-align: center;"> <table border="1" style="width: 100%; border-collapse: collapse; text-align: center;"> <tr> <td style="width: 10%;"></td> <td style="width: 10%;"></td> <td style="width: 10%;"></td> <td style="width: 10%;"></td> <td style="width: 10%;"></td> <td style="width: 10%;"></td> <td style="width: 10%;"></td> <td style="width: 10%;"></td> <td style="width: 10%;"></td> <td style="width: 10%;"></td> </tr> <tr> <td></td> <td></td> <td colspan="8" style="text-align: center;"> <table border="1" style="width: 100%; border-collapse: collapse; text-align: center;"> <tr> </tr></table></td></tr></table></td></tr></table></td></tr></table></td></tr></table></td></tr></table></td></tr></table></td></tr></table></td></tr></table></td></tr></table></td></tr></table></td></tr></table></td></tr></table></td></tr></table></td></tr></table></td></tr></table></td></tr></table></td></tr></table></td></tr></table></td></tr></table></td></tr></table></td></tr></table></td></tr></table></td></tr></table></td></tr></table></td></tr></table></td></tr></table></td></tr></table></td></tr></table></td></tr></table></td></tr></table></td></tr></table> | | | | | | | | | | | | | | | | | | | | <table border="1" style="width: 100%; border-collapse: collapse; text-align: center;"> <tr> <td style="width: 10%;"></td> <td style="width: 10%;"></td> <td style="width: 10%;"></td> <td style="width: 10%;"></td> <td style="width: 10%;"></td> <td style="width: 10%;"></td> <td style="width: 10%;"></td> <td style="width: 10%;"></td> <td style="width: 10%;"></td> <td style="width: 10%;"></td> </tr> <tr> <td></td> <td></td> <td colspan="8" style="text-align: center;"> <table border="1" style="width: 100%; border-collapse: collapse; text-align: center;"> <tr> <td style="width: 10%;"></td> <td style="width: 10%;"></td> <td style="width: 10%;"></td> <td style="width: 10%;"></td> <td style="width: 10%;"></td> <td style="width: 10%;"></td> <td style="width: 10%;"></td> <td style="width: 10%;"></td> <td style="width: 10%;"></td> <td style="width: 10%;"></td> </tr> <tr> <td></td> <td></td> <td colspan="8" style="text-align: center;"> <table border="1" style="width: 100%; border-collapse: collapse; text-align: center;"> <tr> <td style="width: 10%;"></td> <td style="width: 10%;"></td> <td style="width: 10%;"></td> <td style="width: 10%;"></td> <td style="width: 10%;"></td> <td style="width: 10%;"></td> <td style="width: 10%;"></td> <td style="width: 10%;"></td> <td style="width: 10%;"></td> <td style="width: 10%;"></td> </tr> <tr> <td></td> <td></td> <td colspan="8" style="text-align: center;"> <table border="1" style="width: 100%; border-collapse: collapse; text-align: center;"> <tr> <td style="width: 10%;"></td> <td style="width: 10%;"></td> <td style="width: 10%;"></td> <td style="width: 10%;"></td> <td style="width: 10%;"></td> <td style="width: 10%;"></td> <td style="width: 10%;"></td> <td style="width: 10%;"></td> <td style="width: 10%;"></td> <td style="width: 10%;"></td> </tr> <tr> <td></td> <td></td> <td colspan="8" style="text-align: center;"> <table border="1" style="width: 100%; border-collapse: collapse; text-align: center;"> <tr> <td style="width: 10%;"></td> <td style="width: 10%;"></td> <td style="width: 10%;"></td> <td style="width: 10%;"></td> <td style="width: 10%;"></td> <td style="width: 10%;"></td> <td style="width: 10%;"></td> <td style="width: 10%;"></td> <td style="width: 10%;"></td> <td style="width: 10%;"></td> </tr> <tr> <td></td> <td></td> <td colspan="8" style="text-align: center;"> <table border="1" style="width: 100%; border-collapse: collapse; text-align: center;"> <tr> <td style="width: 10%;"></td> <td style="width: 10%;"></td> <td style="width: 10%;"></td> <td style="width: 10%;"></td> <td style="width: 10%;"></td> <td style="width: 10%;"></td> <td style="width: 10%;"></td> <td style="width: 10%;"></td> <td style="width: 10%;"></td> <td style="width: 10%;"></td> </tr> <tr> <td></td> <td></td> <td colspan="8" style="text-align: center;"> <table border="1" style="width: 100%; border-collapse: collapse; text-align: center;"> <tr> <td style="width: 10%;"></td> <td style="width: 10%;"></td> <td style="width: 10%;"></td> <td style="width: 10%;"></td> <td style="width: 10%;"></td> <td style="width: 10%;"></td> <td style="width: 10%;"></td> <td style="width: 10%;"></td> <td style="width: 10%;"></td> <td style="width: 10%;"></td> </tr> <tr> <td></td> <td></td> <td colspan="8" style="text-align: center;"> <table border="1" style="width: 100%; border-collapse: collapse; text-align: center;"> <tr> <td style="width: 10%;"></td> <td style="width: 10%;"></td> <td style="width: 10%;"></td> <td style="width: 10%;"></td> <td style="width: 10%;"></td> <td style="width:
10%;"></td> <td style="width: 10%;"></td> <td style="width: 10%;"></td> <td style="width: 10%;"></td> <td style="width: 10%;"></td> </tr> <tr> <td></td> <td></td> <td colspan="8" style="text-align: center;"> <table border="1" style="width: 100%; border-collapse: collapse; text-align: center;"> <tr> <td style="width: 10%;"></td> <td style="width: 10%;"></td> <td style="width: 10%;"></td> <td style="width: 10%;"></td> <td style="width: 10%;"></td> <td style="width: 10%;"></td> <td style="width: 10%;"></td> <td style="width: 10%;"></td> <td style="width: 10%;"></td> <td style="width: 10%;"></td> </tr> <tr> <td></td> <td></td> <td colspan="8" style="text-align: center;"> <table border="1" style="width: 100%; border-collapse: collapse; text-align: center;"> <tr> <td style="width: 10%;"></td> <td style="width: 10%;"></td> <td style="width: 10%;"></td> <td style="width: 10%;"></td> <td style="width: 10%;"></td> <td style="width: 10%;"></td> <td style="width: 10%;"></td> <td style="width: 10%;"></td> <td style="width: 10%;"></td> <td style="width: 10%;"></td> </tr> <tr> <td></td> <td></td> <td colspan="8" style="text-align: center;"> <table border="1" style="width: 100%; border-collapse: collapse; text-align: center;"> <tr> <td style="width: 10%;"></td> <td style="width: 10%;"></td> <td style="width: 10%;"></td> <td style="width: 10%;"></td> <td style="width: 10%;"></td> <td style="width: 10%;"></td> <td style="width: 10%;"></td> <td style="width: 10%;"></td> <td style="width: 10%;"></td> <td style="width: 10%;"></td> </tr> <tr> <td></td> <td></td> <td colspan="8" style="text-align: center;"> <table border="1" style="width: 100%; border-collapse: collapse; text-align: center;"> <tr> <td style="width: 10%;"></td> <td style="width: 10%;"></td> <td style="width: 10%;"></td> <td style="width: 10%;"></td> <td style="width: 10%;"></td> <td style="width: 10%;"></td> <td style="width: 10%;"></td> <td style="width: 10%;"></td> <td style="width: 10%;"></td> <td style="width: 10%;"></td> </tr> <tr> <td></td> <td></td> <td colspan="8" style="text-align: center;"> <table border="1" style="width: 100%; border-collapse: collapse; text-align: center;"> <tr> <td style="width: 10%;"></td> <td style="width: 10%;"></td> <td style="width: 10%;"></td> <td style="width: 10%;"></td> <td style="width: 10%;"></td> <td style="width: 10%;"></td> <td style="width: 10%;"></td> <td style="width: 10%;"></td> <td style="width: 10%;"></td> <td style="width: 10%;"></td> </tr> <tr> <td></td> <td></td> <td colspan="8" style="text-align: center;"> <table border="1" style="width: 100%; border-collapse: collapse; text-align: center;"> <tr> <td style="width: 10%;"></td> <td style="width: 10%;"></td> <td style="width: 10%;"></td> <td style="width: 10%;"></td> <td style="width: 10%;"></td> <td style="width: 10%;"></td> <td style="width: 10%;"></td> <td style="width: 10%;"></td> <td style="width: 10%;"></td> <td style="width: 10%;"></td> </tr> <tr> <td></td> <td></td> <td colspan="8" style="text-align: center;"> <table border="1" style="width: 100%; border-collapse: collapse; text-align: center;"> <tr> <td style="width: 10%;"></td> <td style="width: 10%;"></td> <td style="width: 10%;"></td> <td style="width: 10%;"></td> <td style="width: 10%;"></td> <td style="width: 10%;"></td> <td style="width: 10%;"></td> <td style="width: 10%;"></td> <td style="width: 10%;"></td> <td style="width: 10%;"></td> </tr> <tr> <td></td> <td></td> <td colspan="8" style="text-align: center;"> <table border="1" style="width: 100%; border-collapse: collapse; text-align: center;"> <tr> <td style="width: 10%;"></td> <td style="width: 10%;"></td> <td style="width: 10%;"></td> <td style="width: 10%;"></td> <td style="width: 10%;"></td> <td style="width: 10%;"></td> <td style="width: 10%;"></td> <td style="width: 10%;"></td> <td style="width: 10%;"></td> <td style="width: 10%;"></td> </tr> <tr> <td></td> <td></td> <td colspan="8" style="text-align: center;"> <table border="1" style="width: 100%; border-collapse: collapse; text-align: center;"> <tr> <td style="width: 10%;"></td> <td style="width: 10%;"></td> <td style="width: 10%;"></td> <td style="width: 10%;"></td> <td style="width: 10%;"></td> <td style="width: 10%;"></td> <td style="width: 10%;"></td> <td style="width: 10%;"></td> <td style="width: 10%;"></td> <td style="width: 10%;"></td> </tr> <tr> <td></td> <td></td> <td colspan="8" style="text-align: center;"> <table border="1" style="width: 100%; border-collapse: collapse; text-align: center;"> <tr> <td style="width: 10%;"></td> <td style="width: 10%;"></td> <td style="width: 10%;"></td> <td style="width: 10%;"></td> <td style="width: 10%;"></td> <td style="width: 10%;"></td> <td style="width: 10%;"></td> <td style="width: 10%;"></td> <td style="width: 10%;"></td> <td style="width: 10%;"></td> </tr> <tr> <td></td> <td></td> <td colspan="8" style="text-align: center;"> <table border="1" style="width: 100%; border-collapse: collapse; text-align: center;"> <tr> <td style="width: 10%;"></td> <td style="width: 10%;"></td> <td style="width: 10%;"></td> <td style="width: 10%;"></td> <td style="width: 10%;"></td> <td style="width: 10%;"></td> <td style="width: 10%;"></td> <td style="width: 10%;"></td> <td style="width: 10%;"></td> <td style="width: 10%;"></td> </tr> <tr> <td></td> <td></td> <td colspan="8" style="text-align: center;"> <table border="1" style="width: 100%; border-collapse: collapse; text-align: center;"> <tr> <td style="width: 10%;"></td> <td style="width: 10%;"></td> <td style="width: 10%;"></td> <td style="width: 10%;"></td> <td style="width: 10%;"></td> <td style="width: 10%;"></td> <td style="width: 10%;"></td> <td style="width: 10%;"></td> <td style="width: 10%;"></td> <td style="width: 10%;"></td> </tr> <tr> <td></td> <td></td> <td colspan="8" style="text-align: center;"> <table border="1" style="width: 100%; border-collapse: collapse; text-align: center;"> <tr> <td style="width: 10%;"></td> <td style="width: 10%;"></td> <td style="width: 10%;"></td> <td style="width: 10%;"></td> <td style="width: 10%;"></td> <td style="width: 10%;"></td> <td style="width: 10%;"></td> <td style="width: 10%;"></td> <td style="width: 10%;"></td> <td style="width: 10%;"></td> </tr> <tr> <td></td> <td></td> <td colspan="8" style="text-align: center;"> <table border="1" style="width: 100%; border-collapse: collapse; text-align: center;"> <tr> <td style="width: 10%;"></td> <td style="width: 10%;"></td> <td style="width: 10%;"></td> <td style="width: 10%;"></td> <td style="width: 10%;"></td> <td style="width: 10%;"></td> <td style="width: 10%;"></td> <td style="width: 10%;"></td> <td style="width: 10%;"></td> <td style="width: 10%;"></td> </tr> <tr> <td></td> <td></td> <td colspan="8" style="text-align: center;"> <table border="1" style="width: 100%; border-collapse: collapse; text-align: center;"> <tr> <td style="width: 10%;"></td> <td style="width: 10%;"></td> <td style="width: 10%;"></td> <td style="width: 10%;"></td> <td style="width: 10%;"></td> <td style="width: 10%;"></td> <td style="width: 10%;"></td> <td style="width: 10%;"></td> <td style="width: 10%;"></td> <td style="width: 10%;"></td> </tr> <tr> <td></td> <td></td> <td colspan="8" style="text-align: center;"> <table border="1" style="width: 100%; border-collapse: collapse; text-align: center;"> <tr> <td style="width: 10%;"></td> <td style="width: 10%;"></td> <td style="width: 10%;"></td> <td style="width: 10%;"></td> <td style="width: 10%;"></td> <td style="width: 10%;"></td> <td style="width: 10%;"></td> <td style="width: 10%;"></td> <td style="width: 10%;"></td> <td style="width: 10%;"></td> </tr> <tr> <td></td> <td></td> <td colspan="8" style="text-align: center;"> <table border="1" style="width: 100%; border-collapse: collapse; text-align: center;"> <tr> <td style="width: 10%;"></td> <td style="width: 10%;"></td> <td style="width: 10%;"></td> <td style="width: 10%;"></td> <td style="width: 10%;"></td> <td style="width: 10%;"></td> <td style="width: 10%;"></td> <td style="width: 10%;"></td> <td style="width: 10%;"></td> <td style="width: 10%;"></td> </tr> <tr> <td></td> <td></td> <td colspan="8" style="text-align: center;"> <table border="1" style="width: 100%; border-collapse: collapse; text-align: center;"> <tr> <td style="width: 10%;"></td> <td style="width: 10%;"></td> <td style="width: 10%;"></td> <td style="width: 10%;"></td> <td style="width: 10%;"></td> <td style="width: 10%;"></td> <td style="width: 10%;"></td> <td style="width: 10%;"></td> <td style="width: 10%;"></td> <td style="width: 10%;"></td> </tr> <tr> <td></td> <td></td> <td colspan="8" style="text-align: center;"> <table border="1" style="width: 100%; border-collapse: collapse; text-align: center;"> <tr> <td style="width: 10%;"></td> <td style="width: 10%;"></td> <td style="width: 10%;"></td> <td style="width: 10%;"></td> <td style="width: 10%;"></td> <td style="width: 10%;"></td> <td style="width: 10%;"></td> <td style="width: 10%;"></td> <td style="width: 10%;"></td> <td style="width: 10%;"></td> </tr> <tr> <td></td> <td></td> <td colspan="8" style="text-align: center;"> <table border="1" style="width: 100%; border-collapse: collapse; text-align: center;"> <tr> <td style="width: 10%;"></td> <td style="width: 10%;"></td> <td style="width: 10%;"></td> <td style="width: 10%;"></td> <td style="width: 10%;"></td> <td style="width: 10%;"></td> <td style="width: 10%;"></td> <td style="width: 10%;"></td> <td style="width: 10%;"></td> <td style="width: 10%;"></td> </tr> <tr> <td></td> <td></td> <td colspan="8" style="text-align: center;"> <table border="1" style="width: 100%; border-collapse: collapse; text-align: center;"> <tr> <td style="width: 10%;"></td> <td style="width: 10%;"></td> <td style="width: 10%;"></td> <td style="width: 10%;"></td> <td style="width: 10%;"></td> <td style="width: 10%;"></td> <td style="width: 10%;"></td> <td style="width: 10%;"></td> <td style="width: 10%;"></td> <td style="width: 10%;"></td> </tr> <tr> <td></td> <td></td> <td
colspan="8" style="text-align: center;"> <table border="1" style="width: 100%; border-collapse: collapse; text-align: center;"> <tr> <td style="width: 10%;"></td> <td style="width: 10%;"></td> <td style="width: 10%;"></td> <td style="width: 10%;"></td> <td style="width: 10%;"></td> <td style="width: 10%;"></td> <td style="width: 10%;"></td> <td style="width: 10%;"></td> <td style="width: 10%;"></td> <td style="width: 10%;"></td> </tr> <tr> <td></td> <td></td> <td colspan="8" style="text-align: center;"> <table border="1" style="width: 100%; border-collapse: collapse; text-align: center;"> <tr> </tr></table></td></tr></table></td></tr></table></td></tr></table></td></tr></table></td></tr></table></td></tr></table></td></tr></table></td></tr></table></td></tr></table></td></tr></table></td></tr></table></td></tr></table></td></tr></table></td></tr></table></td></tr></table></td></tr></table></td></tr></table></td></tr></table></td></tr></table></td></tr></table></td></tr></table></td></tr></table></td></tr></table></td></tr></table></td></tr></table></td></tr></table></td></tr></table></td></tr></table></td></tr></table></td></tr></table> | | | | | | | | | | | | | | | | | | | | <table border="1" style="width: 100%; border-collapse: collapse; text-align: center;"> <tr> <td style="width: 10%;"></td> <td style="width: 10%;"></td> <td style="width: 10%;"></td> <td style="width: 10%;"></td> <td style="width: 10%;"></td> <td style="width: 10%;"></td> <td style="width: 10%;"></td> <td style="width: 10%;"></td> <td style="width: 10%;"></td> <td style="width: 10%;"></td> </tr> <tr> <td></td> <td></td> <td colspan="8" style="text-align: center;"> <table border="1" style="width: 100%; border-collapse: collapse; text-align: center;"> <tr> <td style="width: 10%;"></td> <td style="width: 10%;"></td> <td style="width: 10%;"></td> <td style="width: 10%;"></td> <td style="width: 10%;"></td> <td style="width: 10%;"></td> <td style="width: 10%;"></td> <td style="width: 10%;"></td> <td style="width: 10%;"></td> <td style="width: 10%;"></td> </tr> <tr> <td></td> <td></td> <td colspan="8" style="text-align: center;"> <table border="1" style="width: 100%; border-collapse: collapse; text-align: center;"> <tr> <td style="width: 10%;"></td> <td style="width: 10%;"></td> <td style="width: 10%;"></td> <td style="width: 10%;"></td> <td style="width: 10%;"></td> <td style="width: 10%;"></td> <td style="width: 10%;"></td> <td style="width: 10%;"></td> <td style="width: 10%;"></td> <td style="width: 10%;"></td> </tr> <tr> <td></td> <td></td> <td colspan="8" style="text-align: center;"> <table border="1" style="width: 100%; border-collapse: collapse; text-align: center;"> <tr> <td style="width: 10%;"></td> <td style="width: 10%;"></td> <td style="width: 10%;"></td> <td style="width: 10%;"></td> <td style="width: 10%;"></td> <td style="width: 10%;"></td> <td style="width: 10%;"></td> <td style="width: 10%;"></td> <td style="width: 10%;"></td> <td style="width: 10%;"></td> </tr> <tr> <td></td> <td></td> <td colspan="8" style="text-align: center;"> <table border="1" style="width: 100%; border-collapse: collapse; text-align: center;"> <tr> <td style="width: 10%;"></td> <td style="width: 10%;"></td> <td style="width: 10%;"></td> <td style="width: 10%;"></td> <td style="width: 10%;"></td> <td style="width: 10%;"></td> <td style="width: 10%;"></td> <td style="width: 10%;"></td> <td style="width: 10%;"></td> <td style="width: 10%;"></td> </tr> <tr> <td></td> <td></td> <td colspan="8" style="text-align: center;"> <table border="1" style="width: 100%; border-collapse: collapse; text-align: center;"> <tr> <td style="width: 10%;"></td> <td style="width: 10%;"></td> <td style="width: 10%;"></td> <td style="width: 10%;"></td> <td style="width: 10%;"></td> <td style="width: 10%;"></td> <td style="width: 10%;"></td> <td style="width: 10%;"></td> <td style="width: 10%;"></td> <td style="width: 10%;"></td> </tr> <tr> <td></td> <td></td> <td colspan="8" style="text-align: center;"> <table border="1" style="width: 100%; border-collapse: collapse; text-align: center;"> <tr> <td style="width: 10%;"></td> <td style="width: 10%;"></td> <td style="width: 10%;"></td> <td style="width: 10%;"></td> <td style="width: 10%;"></td> <td style="width: 10%;"></td> <td style="width: 10%;"></td> <td style="width: 10%;"></td> <td style="width: 10%;"></td> <td style="width: 10%;"></td> </tr> <tr> <td></td> <td></td> <td colspan="8" style="text-align: center;"> <table border="1" style="width: 100%; border-collapse: collapse; text-align: center;"> <tr> <td style="width: 10%;"></td> <td style="width: 10%;"></td> <td style="width: 10%;"></td> <td style="width: 10%;"></td> <td style="width: 10%;"></td> <td style="width: 10%;"></td> <td style="width: 10%;"></td> <td style="width: 10%;"></td> <td style="width: 10%;"></td> <td style="width: 10%;"></td> </tr> <tr> <td></td> <td></td> <td colspan="8" style="text-align: center;"> <table border="1" style="width: 100%; border-collapse: collapse; text-align: center;"> <tr> <td style="width: 10%;"></td> <td style="width: 10%;"></td> <td style="width: 10%;"></td> <td style="width: 10%;"></td> <td style="width: 10%;"></td> <td style="width: 10%;"></td> <td style="width: 10%;"></td> <td style="width: 10%;"></td> <td style="width: 10%;"></td> <td style="width: 10%;"></td> </tr> <tr> <td></td> <td></td> <td colspan="8" style="text-align: center;"> <table border="1" style="width: 100%; border-collapse: collapse; text-align: center;"> <tr> <td style="width: 10%;"></td> <td style="width: 10%;"></td> <td style="width: 10%;"></td> <td style="width:
10%;"></td> <td style="width: 10%;"></td> <td style="width: 10%;"></td> <td style="width: 10%;"></td> <td style="width: 10%;"></td> <td style="width: 10%;"></td> <td style="width: 10%;"></td> </tr> <tr> <td></td> <td></td> <td colspan="8" style="text-align: center;"> <table border="1" style="width: 100%; border-collapse: collapse; text-align: center;"> <tr> <td style="width: 10%;"></td> <td style="width: 10%;"></td> <td style="width: 10%;"></td> <td style="width: 10%;"></td> <td style="width: 10%;"></td> <td style="width: 10%;"></td> <td style="width: 10%;"></td> <td style="width: 10%;"></td> <td style="width: 10%;"></td> <td style="width: 10%;"></td> </tr> <tr> <td></td> <td></td> <td colspan="8" style="text-align: center;"> <table border="1" style="width: 100%; border-collapse: collapse; text-align: center;"> <tr> <td style="width: 10%;"></td> <td style="width: 10%;"></td> <td style="width: 10%;"></td> <td style="width: 10%;"></td> <td style="width: 10%;"></td> <td style="width: 10%;"></td> <td style="width: 10%;"></td> <td style="width: 10%;"></td> <td style="width: 10%;"></td> <td style="width: 10%;"></td> </tr> <tr> <td></td> <td></td> <td colspan="8" style="text-align: center;"> <table border="1" style="width: 100%; border-collapse: collapse; text-align: center;"> <tr> <td style="width: 10%;"></td> <td style="width: 10%;"></td> <td style="width: 10%;"></td> <td style="width: 10%;"></td> <td style="width: 10%;"></td> <td style="width: 10%;"></td> <td style="width: 10%;"></td> <td style="width: 10%;"></td> <td style="width: 10%;"></td> <td style="width: 10%;"></td> </tr> <tr> <td></td> <td></td> <td colspan="8" style="text-align: center;"> <table border="1" style="width: 100%; border-collapse: collapse; text-align: center;"> <tr> <td style="width: 10%;"></td> <td style="width: 10%;"></td> <td style="width: 10%;"></td> <td style="width: 10%;"></td> <td style="width: 10%;"></td> <td style="width: 10%;"></td> <td style="width: 10%;"></td> <td style="width: 10%;"></td> <td style="width: 10%;"></td> <td style="width: 10%;"></td> </tr> <tr> <td></td> <td></td> <td colspan="8" style="text-align: center;"> <table border="1" style="width: 100%; border-collapse: collapse; text-align: center;"> <tr> <td style="width: 10%;"></td> <td style="width: 10%;"></td> <td style="width: 10%;"></td> <td style="width: 10%;"></td> <td style="width: 10%;"></td> <td style="width: 10%;"></td> <td style="width: 10%;"></td> <td style="width: 10%;"></td> <td style="width: 10%;"></td> <td style="width: 10%;"></td> </tr> <tr> <td></td> <td></td> <td colspan="8" style="text-align: center;"> <table border="1" style="width: 100%; border-collapse: collapse; text-align: center;"> <tr> <td style="width: 10%;"></td> <td style="width: 10%;"></td> <td style="width: 10%;"></td> <td style="width: 10%;"></td> <td style="width: 10%;"></td> <td style="width: 10%;"></td> <td style="width: 10%;"></td> <td style="width: 10%;"></td> <td style="width: 10%;"></td> <td style="width: 10%;"></td> </tr> <tr> <td></td> <td></td> <td colspan="8" style="text-align: center;"> <table border="1" style="width: 100%; border-collapse: collapse; text-align: center;"> <tr> <td style="width: 10%;"></td> <td style="width: 10%;"></td> <td style="width: 10%;"></td> <td style="width: 10%;"></td> <td style="width: 10%;"></td> <td style="width: 10%;"></td> <td style="width: 10%;"></td> <td style="width: 10%;"></td> <td style="width: 10%;"></td> <td style="width: 10%;"></td> </tr> <tr> <td></td> <td></td> <td colspan="8" style="text-align: center;"> <table border="1" style="width: 100%; border-collapse: collapse; text-align: center;"> <tr> <td style="width: 10%;"></td> <td style="width: 10%;"></td> <td style="width: 10%;"></td> <td style="width: 10%;"></td> <td style="width: 10%;"></td> <td style="width: 10%;"></td> <td style="width: 10%;"></td> <td style="width: 10%;"></td> <td style="width: 10%;"></td> <td style="width: 10%;"></td> </tr> <tr> <td></td> <td></td> <td colspan="8" style="text-align: center;"> <table border="1" style="width: 100%; border-collapse: collapse; text-align: center;"> <tr> <td style="width: 10%;"></td> <td style="width: 10%;"></td> <td style="width: 10%;"></td> <td style="width: 10%;"></td> <td style="width: 10%;"></td> <td style="width: 10%;"></td> <td style="width: 10%;"></td> <td style="width: 10%;"></td> <td style="width: 10%;"></td> <td style="width: 10%;"></td> </tr> <tr> <td></td> <td></td> <td colspan="8" style="text-align: center;"> <table border="1" style="width: 100%; border-collapse: collapse; text-align: center;"> <tr> <td style="width: 10%;"></td> <td style="width: 10%;"></td> <td style="width: 10%;"></td> <td style="width: 10%;"></td> <td style="width: 10%;"></td> <td style="width: 10%;"></td> <td style="width: 10%;"></td> <td style="width: 10%;"></td> <td style="width: 10%;"></td> <td style="width: 10%;"></td> </tr> <tr> <td></td> <td></td> <td colspan="8" style="text-align: center;"> <table border="1" style="width: 100%; border-collapse: collapse; text-align: center;"> <tr> <td style="width: 10%;"></td> <td style="width: 10%;"></td> <td style="width: 10%;"></td> <td style="width: 10%;"></td> <td style="width: 10%;"></td> <td style="width: 10%;"></td> <td style="width: 10%;"></td> <td style="width: 10%;"></td> <td style="width: 10%;"></td> <td style="width: 10%;"></td> </tr> <tr> <td></td> <td></td> <td colspan="8" style="text-align: center;"> <table border="1" style="width: 100%; border-collapse: collapse; text-align: center;"> <tr> <td style="width: 10%;"></td> <td style="width: 10%;"></td> <td style="width: 10%;"></td> <td style="width: 10%;"></td> <td style="width: 10%;"></td> <td style="width: 10%;"></td> <td style="width: 10%;"></td> <td style="width: 10%;"></td> <td style="width: 10%;"></td> <td style="width: 10%;"></td> </tr> <tr> <td></td> <td></td> <td colspan="8" style="text-align: center;"> <table border="1" style="width: 100%; border-collapse: collapse; text-align: center;"> <tr> <td style="width: 10%;"></td> <td style="width: 10%;"></td> <td style="width: 10%;"></td> <td style="width: 10%;"></td> <td style="width: 10%;"></td> <td style="width: 10%;"></td> <td style="width: 10%;"></td> <td style="width: 10%;"></td> <td style="width: 10%;"></td> <td style="width: 10%;"></td> </tr> <tr> <td></td> <td></td> <td colspan="8" style="text-align: center;"> <table border="1" style="width: 100%; border-collapse: collapse; text-align: center;"> <tr> <td style="width: 10%;"></td> <td style="width: 10%;"></td> <td style="width: 10%;"></td> <td style="width: 10%;"></td> <td style="width: 10%;"></td> <td style="width: 10%;"></td> <td style="width: 10%;"></td> <td style="width: 10%;"></td> <td style="width: 10%;"></td> <td style="width: 10%;"></td> </tr> <tr> <td></td> <td></td> <td colspan="8" style="text-align: center;"> <table border="1" style="width: 100%; border-collapse: collapse; text-align: center;"> <tr> <td style="width: 10%;"></td> <td style="width: 10%;"></td> <td style="width: 10%;"></td> <td style="width: 10%;"></td> <td style="width: 10%;"></td> <td style="width: 10%;"></td> <td style="width: 10%;"></td> <td style="width: 10%;"></td> <td style="width: 10%;"></td> <td style="width: 10%;"></td> </tr> <tr> <td></td> <td></td> <td colspan="8" style="text-align: center;"> <table border="1" style="width: 100%; border-collapse: collapse; text-align: center;"> <tr> <td style="width: 10%;"></td> <td style="width: 10%;"></td> <td style="width: 10%;"></td> <td style="width: 10%;"></td> <td style="width: 10%;"></td> <td style="width: 10%;"></td> <td style="width: 10%;"></td> <td style="width: 10%;"></td> <td style="width: 10%;"></td> <td style="width: 10%;"></td> </tr> <tr> <td></td> <td></td> <td colspan="8" style="text-align: center;"> <table border="1" style="width: 100%; border-collapse: collapse; text-align: center;"> <tr> <td style="width: 10%;"></td> <td style="width: 10%;"></td> <td style="width: 10%;"></td> <td style="width: 10%;"></td> <td style="width: 10%;"></td> <td style="width: 10%;"></td> <td style="width: 10%;"></td> <td style="width: 10%;"></td> <td style="width: 10%;"></td> <td style="width: 10%;"></td> </tr> <tr> <td></td> <td></td> <td colspan="8" style="text-align: center;"> <table border="1" style="width: 100%; border-collapse: collapse; text-align: center;"> <tr> <td style="width: 10%;"></td> <td style="width: 10%;"></td> <td style="width: 10%;"></td> <td style="width: 10%;"></td> <td style="width: 10%;"></td> <td style="width: 10%;"></td> <td style="width: 10%;"></td> <td style="width: 10%;"></td> <td style="width: 10%;"></td> <td style="width: 10%;"></td> </tr> <tr> <td></td> <td></td> <td colspan="8" style="text-align: center;"> <table border="1" style="width: 100%; border-collapse: collapse; text-align: center;"> <tr> <td style="width: 10%;"></td> <td style="width: 10%;"></td> <td style="width: 10%;"></td> <td style="width: 10%;"></td> <td style="width: 10%;"></td> <td style="width: 10%;"></td> <td style="width: 10%;"></td> <td style="width: 10%;"></td> <td style="width: 10%;"></td> <td style="width: 10%;"></td> </tr> <tr> <td></td> <td></td> <td colspan="8" style="text-align: center;"> <table border="1" style="width: 100%; border-collapse: collapse; text-align: center;"> <tr> </tr></table></td></tr></table></td></tr></table></td></tr></table></td></tr></table></td></tr></table></td></tr></table></td></tr></table></td></tr></table></td></tr></table></td></tr></table></td></tr></table></td></tr></table></td></tr></table></td></tr></table></td></tr></table></td></tr></table></td></tr></table></td></tr></table></td></tr></table></td></tr></table></td></tr></table></td></tr></table></td></tr></table></td></tr></table></td></tr></table></td></tr></table></td></tr></table></td></tr></table></td></tr></table>
 | | | | | | | | | | | | | | | | | | | | <table border="1" style="width: 100%; border-collapse: collapse; text-align: center;"> <tr> <td style="width: 10%;"></td> <td style="width: 10%;"></td> <td style="width: 10%;"></td> <td style="width: 10%;"></td> <td style="width: 10%;"></td> <td style="width: 10%;"></td> <td style="width: 10%;"></td> <td style="width: 10%;"></td> <td style="width: 10%;"></td> <td style="width: 10%;"></td> </tr> <tr> <td></td> <td></td> <td colspan="8" style="text-align: center;"> <table border="1" style="width: 100%; border-collapse: collapse; text-align: center;"> <tr> <td style="width: 10%;"></td> <td style="width: 10%;"></td> <td style="width: 10%;"></td> <td style="width: 10%;"></td> <td style="width: 10%;"></td> <td style="width: 10%;"></td> <td style="width: 10%;"></td> <td style="width: 10%;"></td> <td style="width: 10%;"></td> <td style="width: 10%;"></td> </tr> <tr> <td></td> <td></td> <td colspan="8" style="text-align: center;"> <table border="1" style="width: 100%; border-collapse: collapse; text-align: center;"> <tr> <td style="width: 10%;"></td> <td style="width: 10%;"></td> <td style="width: 10%;"></td> <td style="width: 10%;"></td> <td style="width: 10%;"></td> <td style="width: 10%;"></td> <td style="width: 10%;"></td> <td style="width: 10%;"></td> <td style="width: 10%;"></td> <td style="width: 10%;"></td> </tr> <tr> <td></td> <td></td> <td colspan="8" style="text-align: center;"> <table border="1" style="width: 100%; border-collapse: collapse; text-align: center;"> <tr> <td style="width: 10%;"></td> <td style="width: 10%;"></td> <td style="width: 10%;"></td> <td style="width: 10%;"></td> <td style="width: 10%;"></td> <td style="width: 10%;"></td> <td style="width: 10%;"></td> <td style="width: 10%;"></td> <td style="width: 10%;"></td> <td style="width: 10%;"></td> </tr> <tr> <td></td> <td></td> <td colspan="8" style="text-align: center;"> <table border="1" style="width: 100%; border-collapse: collapse; text-align: center;"> <tr> <td style="width: 10%;"></td> <td style="width: 10%;"></td> <td style="width: 10%;"></td> <td style="width: 10%;"></td> <td style="width: 10%;"></td> <td style="width: 10%;"></td> <td style="width: 10%;"></td> <td style="width: 10%;"></td> <td style="width: 10%;"></td> <td style="width: 10%;"></td> </tr> <tr> <td></td> <td></td> <td colspan="8" style="text-align: center;"> <table border="1" style="width: 100%; border-collapse: collapse; text-align: center;"> <tr> <td style="width: 10%;"></td> <td style="width: 10%;"></td> <td style="width: 10%;"></td> <td style="width: 10%;"></td> <td style="width: 10%;"></td> <td style="width: 10%;"></td> <td style="width: 10%;"></td> <td style="width: 10%;"></td> <td style="width: 10%;"></td> <td style="width: 10%;"></td> </tr> <tr> <td></td> <td></td> <td colspan="8" style="text-align: center;"> <table border="1" style="width: 100%; border-collapse: collapse; text-align: center;"> <tr> <td style="width: 10%;"></td> <td style="width: 10%;"></td> <td style="width: 10%;"></td> <td style="width: 10%;"></td> <td style="width: 10%;"></td> <td style="width: 10%;"></td> <td style="width: 10%;"></td> <td style="width: 10%;"></td> <td style="width: 10%;"></td> <td style="width: 10%;"></td> </tr> <tr> <td></td> <td></td> <td colspan="8" style="text-align: center;"> <table border="1" style="width: 100%; border-collapse: collapse; text-align: center;"> <tr> <td style="width: 10%;"></td> <td style="width: 10%;"></td> <td style="width: 10%;"></td> <td style="width: 10%;"></td> <td style="width: 10%;"></td> <td style="width: 10%;"></td> <td style="width: 10%;"></td> <td style="width: 10%;"></td> <td style="width: 10%;"></td> <td style="width: 10%;"></td> </tr> <tr> <td></td> <td></td> <td colspan="8" style="text-align: center;"> <table border="1" style="width: 100%; border-collapse: collapse; text-align: center;"> <tr> <td style="width: 10%;"></td> <td style="width: 10%;"></td> <td style="width: 10%;"></td> <td style="width: 10%;"></td> <td style="width: 10%;"></td> <td style="width: 10%;"></td> <td style="width: 10%;"></td> <td style="width: 10%;"></td> <td style="width: 10%;"></td> <td style="width: 10%;"></td> </tr> <tr> <td></td> <td></td> <td colspan="8" style="text-align: center;"> <table border="1" style="width: 100%; border-collapse: collapse; text-align: center;"> <tr> <td style="width: 10%;"></td> <td style="width: 10%;"></td> <td style="width: 10%;"></td> <td style="width: 10%;"></td> <td style="width: 10%;"></td> <td style="width: 10%;"></td> <td style="width: 10%;"></td> <td style="width: 10%;"></td> <td style="width: 10%;"></td> <td style="width: 10%;"></td> </tr> <tr> <td></td> <td></td> <td colspan="8" style="text-align: center;"> <table border="1" style="width: 100%; border-collapse: collapse; text-align: center;"> <tr> <td style="width: 10%;"></td> <td style="width: 10%;"></td> <td style="width: 10%;"></td> <td style="width: 10%;"></td> <td style="width: 10%;"></td> <td style="width: 10%;"></td> <td style="width: 10%;"></td> <td style="width: 10%;"></td> <td style="width: 10%;"></td> <td style="width: 10%;"></td> </tr> <tr> <td></td> <td></td> <td colspan="8" style="text-align: center;"> <table border="1" style="width: 100%; border-collapse: collapse; text-align: center;"> <tr> <td style="width: 10%;"></td> <td style="width: 10%;"></td> <td style="width: 10%;"></td> <td style="width: 10%;"></td> <td style="width: 10%;"></td> <td style="width: 10%;"></td> <td style="width: 10%;"></td> <td style="width: 10%;"></td> <td style="width: 10%;"></td> <td style="width: 10%;"></td> </tr> <tr> <td></td> <td></td> <td colspan="8" style="text-align: center;"> <table border="1" style="width: 100%; border-collapse: collapse; text-align: center;"> <tr> <td style="width: 10%;"></td> <td style="width: 10%;"></td> <td
style="width: 10%;"></td> <td style="width: 10%;"></td> <td style="width: 10%;"></td> <td style="width: 10%;"></td> <td style="width: 10%;"></td> <td style="width: 10%;"></td> <td style="width: 10%;"></td> <td style="width: 10%;"></td> </tr> <tr> <td></td> <td></td> <td colspan="8" style="text-align: center;"> <table border="1" style="width: 100%; border-collapse: collapse; text-align: center;"> <tr> <td style="width: 10%;"></td> <td style="width: 10%;"></td> <td style="width: 10%;"></td> <td style="width: 10%;"></td> <td style="width: 10%;"></td> <td style="width: 10%;"></td> <td style="width: 10%;"></td> <td style="width: 10%;"></td> <td style="width: 10%;"></td> <td style="width: 10%;"></td> </tr> <tr> <td></td> <td></td> <td colspan="8" style="text-align: center;"> <table border="1" style="width: 100%; border-collapse: collapse; text-align: center;"> <tr> <td style="width: 10%;"></td> <td style="width: 10%;"></td> <td style="width: 10%;"></td> <td style="width: 10%;"></td> <td style="width: 10%;"></td> <td style="width: 10%;"></td> <td style="width: 10%;"></td> <td style="width: 10%;"></td> <td style="width: 10%;"></td> <td style="width: 10%;"></td> </tr> <tr> <td></td> <td></td> <td colspan="8" style="text-align: center;"> <table border="1" style="width: 100%; border-collapse: collapse; text-align: center;"> <tr> <td style="width: 10%;"></td> <td style="width: 10%;"></td> <td style="width: 10%;"></td> <td style="width: 10%;"></td> <td style="width: 10%;"></td> <td style="width: 10%;"></td> <td style="width: 10%;"></td> <td style="width: 10%;"></td> <td style="width: 10%;"></td> <td style="width: 10%;"></td> </tr> <tr> <td></td> <td></td> <td colspan="8" style="text-align: center;"> <table border="1" style="width: 100%; border-collapse: collapse; text-align: center;"> <tr> <td style="width: 10%;"></td> <td style="width: 10%;"></td> <td style="width: 10%;"></td> <td style="width: 10%;"></td> <td style="width: 10%;"></td> <td style="width: 10%;"></td> <td style="width: 10%;"></td> <td style="width: 10%;"></td> <td style="width: 10%;"></td> <td style="width: 10%;"></td> </tr> <tr> <td></td> <td></td> <td colspan="8" style="text-align: center;"> <table border="1" style="width: 100%; border-collapse: collapse; text-align: center;"> <tr> <td style="width: 10%;"></td> <td style="width: 10%;"></td> <td style="width: 10%;"></td> <td style="width: 10%;"></td> <td style="width: 10%;"></td> <td style="width: 10%;"></td> <td style="width: 10%;"></td> <td style="width: 10%;"></td> <td style="width: 10%;"></td> <td style="width: 10%;"></td> </tr> <tr> <td></td> <td></td> <td colspan="8" style="text-align: center;"> <table border="1" style="width: 100%; border-collapse: collapse; text-align: center;"> <tr> <td style="width: 10%;"></td> <td style="width: 10%;"></td> <td style="width: 10%;"></td> <td style="width: 10%;"></td> <td style="width: 10%;"></td> <td style="width: 10%;"></td> <td style="width: 10%;"></td> <td style="width: 10%;"></td> <td style="width: 10%;"></td> <td style="width: 10%;"></td> </tr> <tr> <td></td> <td></td> <td colspan="8" style="text-align: center;"> <table border="1" style="width: 100%; border-collapse: collapse; text-align: center;"> <tr> <td style="width: 10%;"></td> <td style="width: 10%;"></td> <td style="width: 10%;"></td> <td style="width: 10%;"></td> <td style="width: 10%;"></td> <td style="width: 10%;"></td> <td style="width: 10%;"></td> <td style="width: 10%;"></td> <td style="width: 10%;"></td> <td style="width: 10%;"></td> </tr> <tr> <td></td> <td></td> <td colspan="8" style="text-align: center;"> <table border="1" style="width: 100%; border-collapse: collapse; text-align: center;"> <tr> <td style="width: 10%;"></td> <td style="width: 10%;"></td> <td style="width: 10%;"></td> <td style="width: 10%;"></td> <td style="width: 10%;"></td> <td style="width: 10%;"></td> <td style="width: 10%;"></td> <td style="width: 10%;"></td> <td style="width: 10%;"></td> <td style="width: 10%;"></td> </tr> <tr> <td></td> <td></td> <td colspan="8" style="text-align: center;"> <table border="1" style="width: 100%; border-collapse: collapse; text-align: center;"> <tr> <td style="width: 10%;"></td> <td style="width: 10%;"></td> <td style="width: 10%;"></td> <td style="width: 10%;"></td> <td style="width: 10%;"></td> <td style="width: 10%;"></td> <td style="width: 10%;"></td> <td style="width: 10%;"></td> <td style="width: 10%;"></td> <td style="width: 10%;"></td> </tr> <tr> <td></td> <td></td> <td colspan="8" style="text-align: center;"> <table border="1" style="width: 100%; border-collapse: collapse; text-align: center;"> <tr> <td style="width: 10%;"></td> <td style="width: 10%;"></td> <td style="width: 10%;"></td> <td style="width: 10%;"></td> <td style="width: 10%;"></td> <td style="width: 10%;"></td> <td style="width: 10%;"></td> <td style="width: 10%;"></td> <td style="width: 10%;"></td> <td style="width: 10%;"></td> </tr> <tr> <td></td> <td></td> <td colspan="8" style="text-align: center;"> <table border="1" style="width: 100%; border-collapse: collapse; text-align: center;"> <tr> <td style="width: 10%;"></td> <td style="width: 10%;"></td> <td style="width: 10%;"></td> <td style="width: 10%;"></td> <td style="width: 10%;"></td> <td style="width: 10%;"></td> <td style="width: 10%;"></td> <td style="width: 10%;"></td> <td style="width: 10%;"></td> <td style="width: 10%;"></td> </tr> <tr> <td></td> <td></td> <td colspan="8" style="text-align: center;"> <table border="1" style="width: 100%; border-collapse: collapse; text-align: center;"> <tr> <td style="width: 10%;"></td> <td style="width: 10%;"></td> <td style="width: 10%;"></td> <td style="width: 10%;"></td> <td style="width: 10%;"></td> <td style="width: 10%;"></td> <td style="width: 10%;"></td> <td style="width: 10%;"></td> <td style="width: 10%;"></td> <td style="width: 10%;"></td> </tr> <tr> <td></td> <td></td> <td colspan="8" style="text-align: center;"> <table border="1" style="width: 100%; border-collapse: collapse; text-align: center;"> <tr> <td style="width: 10%;"></td> <td style="width: 10%;"></td> <td style="width: 10%;"></td> <td style="width: 10%;"></td> <td style="width: 10%;"></td> <td style="width: 10%;"></td> <td style="width: 10%;"></td> <td style="width: 10%;"></td> <td style="width: 10%;"></td> <td style="width: 10%;"></td> </tr> <tr> <td></td> <td></td> <td colspan="8" style="text-align: center;"> <table border="1" style="width: 100%; border-collapse: collapse; text-align: center;"> <tr> <td style="width: 10%;"></td> <td style="width: 10%;"></td> <td style="width: 10%;"></td> <td style="width: 10%;"></td> <td style="width: 10%;"></td> <td style="width: 10%;"></td> <td style="width: 10%;"></td> <td style="width: 10%;"></td> <td style="width: 10%;"></td> <td style="width: 10%;"></td> </tr> <tr> <td></td> <td></td> <td colspan="8" style="text-align: center;"> <table border="1" style="width: 100%; border-collapse: collapse; text-align: center;"> <tr> <td style="width: 10%;"></td> <td style="width: 10%;"></td> <td style="width: 10%;"></td> <td style="width: 10%;"></td> <td style="width: 10%;"></td> <td style="width: 10%;"></td> <td style="width: 10%;"></td> <td style="width: 10%;"></td> <td style="width: 10%;"></td> <td style="width: 10%;"></td> </tr> <tr> <td></td> <td></td> <td colspan="8" style="text-align: center;"> <table border="1" style="width: 100%; border-collapse: collapse; text-align: center;"> <tr> </tr></table></td></tr></table></td></tr></table></td></tr></table></td></tr></table></td></tr></table></td></tr></table></td></tr></table></td></tr></table></td></tr></table></td></tr></table></td></tr></table></td></tr></table></td></tr></table></td></tr></table></td></tr></table></td></tr></table></td></tr></table></td></tr></table></td></tr></table></td></tr></table></td></tr></table></td></tr></table></td></tr></table></td></tr></table></td></tr></table></td></tr></table></td></tr></table></td></tr></table>
 | | | | | | | | | | | | | | | | | | | | <table border="1" style="width: 100%; border-collapse: collapse; text-align: center;"> <tr> <td style="width: 10%;"></td> <td style="width: 10%;"></td> <td style="width: 10%;"></td> <td style="width: 10%;"></td> <td style="width: 10%;"></td> <td style="width: 10%;"></td> <td style="width: 10%;"></td> <td style="width: 10%;"></td> <td style="width: 10%;"></td> <td style="width: 10%;"></td> </tr> <tr> <td></td> <td></td> <td colspan="8" style="text-align: center;"> <table border="1" style="width: 100%; border-collapse: collapse; text-align: center;"> <tr> <td style="width: 10%;"></td> <td style="width: 10%;"></td> <td style="width: 10%;"></td> <td style="width: 10%;"></td> <td style="width: 10%;"></td> <td style="width: 10%;"></td> <td style="width: 10%;"></td> <td style="width: 10%;"></td> <td style="width: 10%;"></td> <td style="width: 10%;"></td> </tr> <tr> <td></td> <td></td> <td colspan="8" style="text-align: center;"> <table border="1" style="width: 100%; border-collapse: collapse; text-align: center;"> <tr> <td style="width: 10%;"></td> <td style="width: 10%;"></td> <td style="width: 10%;"></td> <td style="width: 10%;"></td> <td style="width: 10%;"></td> <td style="width: 10%;"></td> <td style="width: 10%;"></td> <td style="width: 10%;"></td> <td style="width: 10%;"></td> <td style="width: 10%;"></td> </tr> <tr> <td></td> <td></td> <td colspan="8" style="text-align: center;"> <table border="1" style="width: 100%; border-collapse: collapse; text-align: center;"> <tr> <td style="width: 10%;"></td> <td style="width: 10%;"></td> <td style="width: 10%;"></td> <td style="width: 10%;"></td> <td style="width: 10%;"></td> <td style="width: 10%;"></td> <td style="width: 10%;"></td> <td style="width: 10%;"></td> <td style="width: 10%;"></td> <td style="width: 10%;"></td> </tr> <tr> <td></td> <td></td> <td colspan="8" style="text-align: center;"> <table border="1" style="width: 100%; border-collapse: collapse; text-align: center;"> <tr> <td style="width: 10%;"></td> <td style="width: 10%;"></td> <td style="width: 10%;"></td> <td style="width: 10%;"></td> <td style="width: 10%;"></td> <td style="width: 10%;"></td> <td style="width: 10%;"></td> <td style="width: 10%;"></td> <td style="width: 10%;"></td> <td style="width: 10%;"></td> </tr> <tr> <td></td> <td></td> <td colspan="8" style="text-align: center;"> <table border="1" style="width: 100%; border-collapse: collapse; text-align: center;"> <tr> <td style="width: 10%;"></td> <td style="width: 10%;"></td> <td style="width: 10%;"></td> <td style="width: 10%;"></td> <td style="width: 10%;"></td> <td style="width: 10%;"></td> <td style="width: 10%;"></td> <td style="width: 10%;"></td> <td style="width: 10%;"></td> <td style="width: 10%;"></td> </tr> <tr> <td></td> <td></td> <td colspan="8" style="text-align: center;"> <table border="1" style="width: 100%; border-collapse: collapse; text-align: center;"> <tr> <td style="width: 10%;"></td> <td style="width: 10%;"></td> <td style="width: 10%;"></td> <td style="width: 10%;"></td> <td style="width: 10%;"></td> <td style="width: 10%;"></td> <td style="width: 10%;"></td> <td style="width: 10%;"></td> <td style="width: 10%;"></td> <td style="width: 10%;"></td> </tr> <tr> <td></td> <td></td> <td colspan="8" style="text-align: center;"> <table border="1" style="width: 100%; border-collapse: collapse; text-align: center;"> <tr> <td style="width: 10%;"></td> <td style="width: 10%;"></td> <td style="width: 10%;"></td> <td style="width: 10%;"></td> <td style="width: 10%;"></td> <td style="width: 10%;"></td> <td style="width: 10%;"></td> <td style="width: 10%;"></td> <td style="width: 10%;"></td> <td style="width: 10%;"></td> </tr> <tr> <td></td> <td></td> <td colspan="8" style="text-align: center;"> <table border="1" style="width: 100%; border-collapse: collapse; text-align: center;"> <tr> <td style="width: 10%;"></td> <td style="width: 10%;"></td> <td style="width: 10%;"></td> <td style="width: 10%;"></td> <td style="width: 10%;"></td> <td style="width: 10%;"></td> <td style="width: 10%;"></td> <td style="width: 10%;"></td> <td style="width: 10%;"></td> <td style="width: 10%;"></td> </tr> <tr> <td></td> <td></td> <td colspan="8" style="text-align: center;"> <table border="1" style="width: 100%; border-collapse: collapse; text-align: center;"> <tr> <td style="width: 10%;"></td> <td style="width: 10%;"></td> <td style="width: 10%;"></td> <td style="width: 10%;"></td> <td style="width: 10%;"></td> <td style="width: 10%;"></td> <td style="width: 10%;"></td> <td style="width: 10%;"></td> <td style="width: 10%;"></td> <td style="width: 10%;"></td> </tr> <tr> <td></td> <td></td> <td colspan="8" style="text-align: center;"> <table border="1" style="width: 100%; border-collapse: collapse; text-align: center;"> <tr> <td style="width: 10%;"></td> <td style="width: 10%;"></td> <td style="width: 10%;"></td> <td style="width: 10%;"></td> <td style="width: 10%;"></td> <td style="width: 10%;"></td> <td style="width: 10%;"></td> <td style="width: 10%;"></td> <td style="width: 10%;"></td> <td style="width: 10%;"></td> </tr> <tr> <td></td> <td></td> <td colspan="8" style="text-align: center;"> <table border="1" style="width: 100%; border-collapse: collapse; text-align: center;"> <tr> <td style="width: 10%;"></td> <td style="width: 10%;"></td> <td style="width: 10%;"></td> <td style="width: 10%;"></td> <td style="width: 10%;"></td> <td style="width: 10%;"></td> <td style="width: 10%;"></td> <td style="width: 10%;"></td> <td style="width: 10%;"></td> <td style="width: 10%;"></td> </tr> <tr> <td></td> <td></td> <td colspan="8" style="text-align: center;"> <table border="1" style="width: 100%; border-collapse: collapse; text-align: center;"> <tr> <td style="width: 10%;"></td> <td style="width: 10%;"></td> <td style="width: 10%;"></td> <td style="width: 10%;"></td> <td style="width: 10%;"></td> <td style="width: 10%;"></td> <td style="width: 10%;"></td> <td style="width: 10%;"></td> <td style="width: 10%;"></td> <td style="width: 10%;"></td> </tr> <tr> <td></td> <td></td> <td colspan="8" style="text-align: center;"> <table border="1" style="width: 100%; border-collapse: collapse; text-align: center;"> <tr> <td style="width: 10%;"></td> <td style="width: 10%;"></td> <td style="width: 10%;"></td> <td style="width: 10%;"></td> <td style="width: 10%;"></td> <td style="width: 10%;"></td> <td style="width: 10%;"></td> <td style="width: 10%;"></td> <td style="width: 10%;"></td> <td style="width: 10%;"></td> </tr> <tr> <td></td> <td></td> <td colspan="8" style="text-align: center;"> <table border="1" style="width: 100%; border-collapse: collapse; text-align: center;"> <tr> <td style="width: 10%;"></td> <td style="width: 10%;"></td> <td style="width: 10%;"></td> <td style="width: 10%;"></td> <td style="width: 10%;"></td> <td style="width: 10%;"></td> <td style="width: 10%;"></td> <td style="width: 10%;"></td> <td style="width: 10%;"></td> <td style="width: 10%;"></td> </tr> <tr> <td></td> <td></td> <td colspan="8" style="text-align: center;"> <table border="1" style="width: 100%; border-collapse: collapse; text-align: center;"> <tr> <td style="width: 10%;"></td> <td style="width: 10%;"></td> <td style="width: 10%;"></td> <td style="width: 10%;"></td> <td style="width: 10%;"></td> <td style="width: 10%;"></td> <td style="width: 10%;"></td> <td style="width: 10%;"></td> <td style="width: 10%;"></td> <td style="width: 10%;"></td> </tr> <tr> <td></td> <td></td> <td colspan="8" style="text-align: center;"> <table border="1" style="width: 100%; border-collapse: collapse; text-align: center;"> <tr> <td style="width: 10%;"></td> <td
style="width: 10%;"></td> <td style="width: 10%;"></td> <td style="width: 10%;"></td> <td style="width: 10%;"></td> <td style="width: 10%;"></td> <td style="width: 10%;"></td> <td style="width: 10%;"></td> <td style="width: 10%;"></td> <td style="width: 10%;"></td> </tr> <tr> <td></td> <td></td> <td colspan="8" style="text-align: center;"> <table border="1" style="width: 100%; border-collapse: collapse; text-align: center;"> <tr> <td style="width: 10%;"></td> <td style="width: 10%;"></td> <td style="width: 10%;"></td> <td style="width: 10%;"></td> <td style="width: 10%;"></td> <td style="width: 10%;"></td> <td style="width: 10%;"></td> <td style="width: 10%;"></td> <td style="width: 10%;"></td> <td style="width: 10%;"></td> </tr> <tr> <td></td> <td></td> <td colspan="8" style="text-align: center;"> <table border="1" style="width: 100%; border-collapse: collapse; text-align: center;"> <tr> <td style="width: 10%;"></td> <td style="width: 10%;"></td> <td style="width: 10%;"></td> <td style="width: 10%;"></td> <td style="width: 10%;"></td> <td style="width: 10%;"></td> <td style="width: 10%;"></td> <td style="width: 10%;"></td> <td style="width: 10%;"></td> <td style="width: 10%;"></td> </tr> <tr> <td></td> <td></td> <td colspan="8" style="text-align: center;"> <table border="1" style="width: 100%; border-collapse: collapse; text-align: center;"> <tr> <td style="width: 10%;"></td> <td style="width: 10%;"></td> <td style="width: 10%;"></td> <td style="width: 10%;"></td> <td style="width: 10%;"></td> <td style="width: 10%;"></td> <td style="width: 10%;"></td> <td style="width: 10%;"></td> <td style="width: 10%;"></td> <td style="width: 10%;"></td> </tr> <tr> <td></td> <td></td> <td colspan="8" style="text-align: center;"> <table border="1" style="width: 100%; border-collapse: collapse; text-align: center;"> <tr> <td style="width: 10%;"></td> <td style="width: 10%;"></td> <td style="width: 10%;"></td> <td style="width: 10%;"></td> <td style="width: 10%;"></td> <td style="width: 10%;"></td> <td style="width: 10%;"></td> <td style="width: 10%;"></td> <td style="width: 10%;"></td> <td style="width: 10%;"></td> </tr> <tr> <td></td> <td></td> <td colspan="8" style="text-align: center;"> <table border="1" style="width: 100%; border-collapse: collapse; text-align: center;"> <tr> <td style="width: 10%;"></td> <td style="width: 10%;"></td> <td style="width: 10%;"></td> <td style="width: 10%;"></td> <td style="width: 10%;"></td> <td style="width: 10%;"></td> <td style="width: 10%;"></td> <td style="width: 10%;"></td> <td style="width: 10%;"></td> <td style="width: 10%;"></td> </tr> <tr> <td></td> <td></td> <td colspan="8" style="text-align: center;"> <table border="1" style="width: 100%; border-collapse: collapse; text-align: center;"> <tr> <td style="width: 10%;"></td> <td style="width: 10%;"></td> <td style="width: 10%;"></td> <td style="width: 10%;"></td> <td style="width: 10%;"></td> <td style="width: 10%;"></td> <td style="width: 10%;"></td> <td style="width: 10%;"></td> <td style="width: 10%;"></td> <td style="width: 10%;"></td> </tr> <tr> <td></td> <td></td> <td colspan="8" style="text-align: center;"> <table border="1" style="width: 100%; border-collapse: collapse; text-align: center;"> <tr> <td style="width: 10%;"></td> <td style="width: 10%;"></td> <td style="width: 10%;"></td> <td style="width: 10%;"></td> <td style="width: 10%;"></td> <td style="width: 10%;"></td> <td style="width: 10%;"></td> <td style="width: 10%;"></td> <td style="width: 10%;"></td> <td style="width: 10%;"></td> </tr> <tr> <td></td> <td></td> <td colspan="8" style="text-align: center;"> <table border="1" style="width: 100%; border-collapse: collapse; text-align: center;"> <tr> <td style="width: 10%;"></td> <td style="width: 10%;"></td> <td style="width: 10%;"></td> <td style="width: 10%;"></td> <td style="width: 10%;"></td> <td style="width: 10%;"></td> <td style="width: 10%;"></td> <td style="width: 10%;"></td> <td style="width: 10%;"></td> <td style="width: 10%;"></td> </tr> <tr> <td></td> <td></td> <td colspan="8" style="text-align: center;"> <table border="1" style="width: 100%; border-collapse: collapse; text-align: center;"> <tr> <td style="width: 10%;"></td> <td style="width: 10%;"></td> <td style="width: 10%;"></td> <td style="width: 10%;"></td> <td style="width: 10%;"></td> <td style="width: 10%;"></td> <td style="width: 10%;"></td> <td style="width: 10%;"></td> <td style="width: 10%;"></td> <td style="width: 10%;"></td> </tr> <tr> <td></td> <td></td> <td colspan="8" style="text-align: center;"> <table border="1" style="width: 100%; border-collapse: collapse; text-align: center;"> <tr> <td style="width: 10%;"></td> <td style="width: 10%;"></td> <td style="width: 10%;"></td> <td style="width: 10%;"></td> <td style="width: 10%;"></td> <td style="width: 10%;"></td> <td style="width: 10%;"></td> <td style="width: 10%;"></td> <td style="width: 10%;"></td> <td style="width: 10%;"></td> </tr> <tr> <td></td> <td></td> <td colspan="8" style="text-align: center;"> <table border="1" style="width: 100%; border-collapse: collapse; text-align: center;"> <tr> </tr></table></td></tr></table></td></tr></table></td></tr></table></td></tr></table></td></tr></table></td></tr></table></td></tr></table></td></tr></table></td></tr></table></td></tr></table></td></tr></table></td></tr></table></td></tr></table></td></tr></table></td></tr></table></td></tr></table></td></tr></table></td></tr></table></td></tr></table></td></tr></table></td></tr></table></td></tr></table></td></tr></table></td></tr></table></td></tr></table></td></tr></table></td></tr></table> | | | |
| | | | | | | | | | | | | | | | <table border="1" style="width: 100%; border-collapse: collapse; text-align: center;"> <tr> <td style="width: 10%;"></td> <td style="width: 10%;"></td> <td style="width: 10%;"></td> <td style="width: 10%;"></td> <td style="width: 10%;"></td> <td style="width: 10%;"></td> <td style="width: 10%;"></td> <td style="width: 10%;"></td> <td style="width: 10%;"></td> <td style="width: 10%;"></td> </tr> <tr> <td></td> <td></td> <td colspan="8" style="text-align: center;"> <table border="1" style="width: 100%; border-collapse: collapse; text-align: center;"> <tr> <td style="width: 10%;"></td> <td style="width: 10%;"></td> <td style="width: 10%;"></td> <td style="width: 10%;"></td> <td style="width: 10%;"></td> <td style="width: 10%;"></td> <td style="width: 10%;"></td> <td style="width: 10%;"></td> <td style="width: 10%;"></td> <td style="width: 10%;"></td> </tr> <tr> <td></td> <td></td> <td colspan="8" style="text-align: center;"> <table border="1" style="width: 100%; border-collapse: collapse; text-align: center;"> <tr> <td style="width: 10%;"></td> <td style="width: 10%;"></td> <td style="width: 10%;"></td> <td style="width: 10%;"></td> <td style="width: 10%;"></td> <td style="width: 10%;"></td> <td style="width: 10%;"></td> <td style="width: 10%;"></td> <td style="width: 10%;"></td> <td style="width: 10%;"></td> </tr> <tr> <td></td> <td></td> <td colspan="8" style="text-align: center;"> <table border="1" style="width: 100%; border-collapse: collapse; text-align: center;"> <tr> <td style="width: 10%;"></td> <td style="width: 10%;"></td> <td style="width: 10%;"></td> <td style="width: 10%;"></td> <td style="width: 10%;"></td> <td style="width: 10%;"></td> <td style="width: 10%;"></td> <td style="width: 10%;"></td> <td style="width: 10%;"></td> <td style="width: 10%;"></td> </tr> <tr> <td></td> <td></td> <td colspan="8" style="text-align: center;"> <table border="1" style="width: 100%; border-collapse: collapse; text-align: center;"> <tr> <td style="width: 10%;"></td> <td style="width: 10%;"></td> <td style="width: 10%;"></td> <td style="width: 10%;"></td> <td style="width: 10%;"></td> <td style="width: 10%;"></td> <td style="width: 10%;"></td> <td style="width: 10%;"></td> <td style="width: 10%;"></td> <td style="width: 10%;"></td> </tr> <tr> <td></td> <td></td> <td colspan="8" style="text-align: center;"> <table border="1" style="width: 100%; border-collapse: collapse; text-align: center;"> <tr> <td style="width: 10%;"></td> <td style="width: 10%;"></td> <td style="width: 10%;"></td> <td style="width: 10%;"></td> <td style="width: 10%;"></td> <td style="width: 10%;"></td> <td style="width: 10%;"></td> <td style="width: 10%;"></td> <td style="width: 10%;"></td> <td style="width: 10%;"></td> </tr> <tr> <td></td> <td></td> <td colspan="8" style="text-align: center;"> <table border="1" style="width: 100%; border-collapse: collapse; text-align: center;"> <tr> <td style="width: 10%;"></td> <td style="width: 10%;"></td> <td style="width: 10%;"></td> <td style="width: 10%;"></td> <td style="width: 10%;"></td> <td style="width: 10%;"></td> <td style="width: 10%;"></td> <td style="width: 10%;"></td> <td style="width: 10%;"></td> <td style="width: 10%;"></td> </tr> <tr> <td></td> <td></td> <td colspan="8" style="text-align: center;"> <table border="1" style="width: 100%; border-collapse: collapse; text-align: center;"> <tr> <td style="width: 10%;"></td> <td style="width: 10%;"></td> <td style="width: 10%;"></td> <td style="width: 10%;"></td> <td style="width: 10%;"></td> <td style="width: 10%;"></td> <td style="width: 10%;"></td> <td style="width: 10%;"></td> <td style="width: 10%;"></td> <td style="width: 10%;"></td> </tr> <tr> <td></td> <td></td> <td colspan="8" style="text-align: center;"> <table border="1" style="width: 100%; border-collapse: collapse; text-align: center;"> <tr> <td style="width: 10%;"></td> <td style="width: 10%;"></td> <td style="width: 10%;"></td> <td style="width: 10%;"></td> <td style="width: 10%;"></td> <td style="width: 10%;"></td> <td style="width: 10%;"></td> <td style="width: 10%;"></td> <td style="width: 10%;"></td> <td style="width: 10%;"></td> </tr> <tr> <td></td> <td></td> <td colspan="8" style="text-align: center;"> <table border="1" style="width: 100%; border-collapse: collapse; text-align: center;"> <tr> <td style="width: 10%;"></td> <td style="width: 10%;"></td> <td style="width: 10%;"></td> <td style="width: 10%;"></td> <td style="width: 10%;"></td> <td style="width: 10%;"></td> <td style="width: 10%;"></td> <td style="width: 10%;"></td> <td style="width: 10%;"></td> <td style="width: 10%;"></td> </tr> <tr> <td></td> <td></td> <td colspan="8" style="text-align: center;"> <table border="1" style="width: 100%; border-collapse: collapse; text-align: center;"> <tr> <td style="width: 10%;"></td> <td style="width: 10%;"></td> <td style="width: 10%;"></td> <td style="width: 10%;"></td> <td style="width: 10%;"></td> <td style="width: 10%;"></td> <td style="width: 10%;"></td> <td style="width: 10%;"></td> <td style="width: 10%;"></td> <td style="width: 10%;"></td> </tr> <tr> <td></td> <td></td> <td colspan="8" style="text-align: center;"> <table border="1" style="width: 100%; border-collapse: collapse; text-align: center;"> <tr> <td style="width: 10%;"></td> <td style="width: 10%;"></td> <td style="width: 10%;"></td> <td style="width: 10%;"></td> <td style="width: 10%;"></td> <td style="width: 10%;"></td> <td style="width: 10%;"></td> <td style="width: 10%;"></td> <td style="width: 10%;"></td> <td style="width: 10%;"></td> </tr> <tr> <td></td> <td></td> <td colspan="8" style="text-align: center;"> <table border="1" style="width: 100%; border-collapse: collapse; text-align: center;"> <tr> <td style="width: 10%;"></td> <td style="width: 10%;"></td> <td style="width: 10%;"></td> <td style="width: 10%;"></td> <td style="width: 10%;"></td> <td style="width: 10%;"></td> <td style="width: 10%;"></td> <td style="width: 10%;"></td> <td style="width: 10%;"></td> <td style="width: 10%;"></td> </tr> <tr> <td></td> <td></td> <td colspan="8" style="text-align: center;"> <table border="1" style="width: 100%; border-collapse: collapse; text-align: center;"> <tr> <td style="width: 10%;"></td> <td style="width: 10%;"></td> <td style="width: 10%;"></td> <td style="width: 10%;"></td> <td style="width: 10%;"></td> <td style="width: 10%;"></td> <td style="width: 10%;"></td> <td style="width: 10%;"></td> <td style="width: 10%;"></td> <td style="width: 10%;"></td> </tr> <tr> <td></td> <td></td> <td colspan="8" style="text-align: center;"> <table border="1" style="width: 100%; border-collapse: collapse; text-align: center;"> <tr> <td style="width: 10%;"></td> <td style="width: 10%;"></td> <td style="width: 10%;"></td> <td style="width: 10%;"></td> <td style="width: 10%;"></td> <td style="width: 10%;"></td> <td style="width: 10%;"></td> <td style="width: 10%;"></td> <td style="width: 10%;"></td> <td style="width: 10%;"></td> </tr> <tr> <td></td> <td></td> <td colspan="8" style="text-align: center;"> <table border="1" style="width: 100%; border-collapse: collapse; text-align: center;"> <tr> <td style="width: 10%;"></td> <td style="width: 10%;"></td> <td style="width: 10%;"></td> <td style="width: 10%;"></td> <td style="width: 10%;"></td> <td style="width: 10%;"></td> <td style="width: 10%;"></td> <td style="width: 10%;"></td> <td style="width: 10%;"></td> <td style="width: 10%;"></td> </tr> <tr> <td></td> <td></td> <td colspan="8" style="text-align: center;"> <table border="1" style="width: 100%; border-collapse: collapse; text-align: center;"> <tr> <td style="width: 10%;"></td> <td style="width: 10%;"></td> <td style="width: 10%;"></td> <td style="width: 10%;"></td> <td style="width: 10%;"></td> <td style="width: 10%;"></td> <td style="width: 10%;"></td> <td style="width: 10%;"></td> <td style="width: 10%;"></td> <td style="width: 10%;"></td> </tr> <tr> <td></td> <td></td> <td colspan="8" style="text-align: center;"> <table border="1" style="width: 100%; border-collapse: collapse; text-align: center;"> <tr> <td style="width: 10%;"></td> <td style="width: 10%;"></td> <td style="width: 10%;"></td> <td style="width: 10%;"></td> <td style="width: 10%;"></td> <td style="width: 10%;"></td> <td style="width: 10%;"></td> <td style="width: 10%;"></td> <td style="width: 10%;"></td> <td style="width: 10%;"></td> </tr> <tr> <td></td> <td></td> <td colspan="8" style="text-align: center;"> <table border="1" style="width: 100%; border-collapse: collapse; text-align: center;"> <tr> <td style="width: 10%;"></td> <td style="width: 10%;"></td> <td style="width: 10%;"></td> <td style="width: 10%;"></td> <td style="width: 10%;"></td> <td style="width: 10%;"></td> <td style="width: 10%;"></td> <td style="width: 10%;"></td> <td style="width: 10%;"></td> <td style="width: 10%;"></td> </tr> <tr> <td></td> <td></td> <td colspan="8" style="text-align: center;"> <table border="1" style="width: 100%; border-collapse: collapse; text-align: center;"> <tr> <td style="width: 10%;"></td> <td style="width: 10%;"></td> <td style="width: 10%;"></td> <td style="width: 10%;"></td> <td style="width: 10%;"></td> <td style="width: 10%;"></td> <td style="width: 10%;"></td> <td style="width: 10%;"></td> <td style="width: 10%;"></td> <td style="width: 10%;"></td> </tr> <tr> <td></td> <td></td> <td colspan="8" style="text-align: center;"> <table border="1" style="width: 100%; border-collapse: collapse; text-align: center;"> <tr> <td style="width: 10%;"></td> <td style="width: 10%;"></td> <td style="width: 10%;"></td> <td style="width: 10%;"></td> <td style="width: 10%;"></td> <td style="width: 10%;"></td> <td style="width: 10%;"></td> <td style="width: 10%;"></td> <td style="width: 10%;"></td> <td style="width: 10%;"></td> </tr> <tr> <td></td> <td></td> <td colspan="8" style="text-align: center;"> <table border="1" style="width: 100%; border-collapse: collapse; text-align: center;"> <tr> <td style="width: 10%;"></td>
<td style="width: 10%;"></td> <td style="width: 10%;"></td> <td style="width: 10%;"></td> <td style="width: 10%;"></td> <td style="width: 10%;"></td> <td style="width: 10%;"></td> <td style="width: 10%;"></td> <td style="width: 10%;"></td> <td style="width: 10%;"></td> </tr> <tr> <td></td> <td></td> <td colspan="8" style="text-align: center;"> <table border="1" style="width: 100%; border-collapse: collapse; text-align: center;"> <tr> <td style="width: 10%;"></td> <td style="width: 10%;"></td> <td style="width: 10%;"></td> <td style="width: 10%;"></td> <td style="width: 10%;"></td> <td style="width: 10%;"></td> <td style="width: 10%;"></td> <td style="width: 10%;"></td> <td style="width: 10%;"></td> <td style="width: 10%;"></td> </tr> <tr> <td></td> <td></td> <td colspan="8" style="text-align: center;"> <table border="1" style="width: 100%; border-collapse: collapse; text-align: center;"> <tr> <td style="width: 10%;"></td> <td style="width: 10%;"></td> <td style="width: 10%;"></td> <td style="width: 10%;"></td> <td style="width: 10%;"></td> <td style="width: 10%;"></td> <td style="width: 10%;"></td> <td style="width: 10%;"></td> <td style="width: 10%;"></td> <td style="width: 10%;"></td> </tr> <tr> <td></td> <td></td> <td colspan="8" style="text-align: center;"> <table border="1" style="width: 100%; border-collapse: collapse; text-align: center;"> <tr> <td style="width: 10%;"></td> <td style="width: 10%;"></td> <td style="width: 10%;"></td> <td style="width: 10%;"></td> <td style="width: 10%;"></td> <td style="width: 10%;"></td> <td style="width: 10%;"></td> <td style="width: 10%;"></td> <td style="width: 10%;"></td> <td style="width: 10%;"></td> </tr> <tr> <td></td> <td></td> <td colspan="8" style="text-align: center;"> <table border="1" style="width: 100%; border-collapse: collapse; text-align: center;"> <tr> <td style="width: 10%;"></td> <td style="width: 10%;"></td> <td style="width: 10%;"></td> <td style="width: 10%;"></td> <td style="width: 10%;"></td> <td style="width: 10%;"></td> <td style="width: 10%;"></td> <td style="width: 10%;"></td> <td style="width: 10%;"></td> <td style="width: 10%;"></td> </tr> <tr> <td></td> <td></td> <td colspan="8" style="text-align: center;"> <table border="1" style="width: 100%; border-collapse: collapse; text-align: center;"> <tr> </tr></table></td></tr></table></td></tr></table></td></tr></table></td></tr></table></td></tr></table></td></tr></table></td></tr></table></td></tr></table></td></tr></table></td></tr></table></td></tr></table></td></tr></table></td></tr></table></td></tr></table></td></tr></table></td></tr></table></td></tr></table></td></tr></table></td></tr></table></td></tr></table></td></tr></table></td></tr></table></td></tr></table></td></tr></table></td></tr></table></td></tr></table> | | | | | | | | | | | | | | | | | | | | <table border="1" style="width: 100%; border-collapse: collapse; text-align: center;"> <tr> <td style="width: 10%;"></td> <td style="width: 10%;"></td> <td style="width: 10%;"></td> <td style="width: 10%;"></td> <td style="width: 10%;"></td> <td style="width: 10%;"></td> <td style="width: 10%;"></td> <td style="width: 10%;"></td> <td style="width: 10%;"></td> <td style="width: 10%;"></td> </tr> <tr> <td></td> <td></td> <td colspan="8" style="text-align: center;"> <table border="1" style="width: 100%; border-collapse: collapse; text-align: center;"> <tr> <td style="width: 10%;"></td> <td style="width: 10%;"></td> <td style="width: 10%;"></td> <td style="width: 10%;"></td> <td style="width: 10%;"></td> <td style="width: 10%;"></td> <td style="width: 10%;"></td> <td style="width: 10%;"></td> <td style="width: 10%;"></td> <td style="width: 10%;"></td> </tr> <tr> <td></td> <td></td> <td colspan="8" style="text-align: center;"> <table border="1" style="width: 100%; border-collapse: collapse; text-align: center;"> <tr> <td style="width: 10%;"></td> <td style="width: 10%;"></td> <td style="width: 10%;"></td> <td style="width: 10%;"></td> <td style="width: 10%;"></td> <td style="width: 10%;"></td> <td style="width: 10%;"></td> <td style="width: 10%;"></td> <td style="width: 10%;"></td> <td style="width: 10%;"></td> </tr> <tr> <td></td> <td></td> <td colspan="8" style="text-align: center;"> <table border="1" style="width: 100%; border-collapse: collapse; text-align: center;"> <tr> <td style="width: 10%;"></td> <td style="width: 10%;"></td> <td style="width: 10%;"></td> <td style="width: 10%;"></td> <td style="width: 10%;"></td> <td style="width: 10%;"></td> <td style="width: 10%;"></td> <td style="width: 10%;"></td> <td style="width: 10%;"></td> <td style="width: 10%;"></td> </tr> <tr> <td></td> <td></td> <td colspan="8" style="text-align: center;"> <table border="1" style="width: 100%; border-collapse: collapse; text-align: center;"> <tr> <td style="width: 10%;"></td> <td style="width: 10%;"></td> <td style="width: 10%;"></td> <td style="width: 10%;"></td> <td style="width: 10%;"></td> <td style="width: 10%;"></td> <td style="width: 10%;"></td> <td style="width: 10%;"></td> <td style="width: 10%;"></td> <td style="width: 10%;"></td> </tr> <tr> <td></td> <td></td> <td colspan="8" style="text-align: center;"> <table border="1" style="width: 100%; border-collapse: collapse; text-align: center;"> <tr> <td style="width: 10%;"></td> <td style="width: 10%;"></td> <td style="width: 10%;"></td> <td style="width: 10%;"></td> <td style="width: 10%;"></td> <td style="width: 10%;"></td> <td style="width: 10%;"></td> <td style="width: 10%;"></td> <td style="width: 10%;"></td> <td style="width: 10%;"></td> </tr> <tr> <td></td> <td></td> <td
colspan="8" style="text-align: center;"> <table border="1" style="width: 100%; border-collapse: collapse; text-align: center;"> <tr> <td style="width: 10%;"></td> <td style="width: 10%;"></td> <td style="width: 10%;"></td> <td style="width: 10%;"></td> <td style="width: 10%;"></td> <td style="width: 10%;"></td> <td style="width: 10%;"></td> <td style="width: 10%;"></td> <td style="width: 10%;"></td> <td style="width: 10%;"></td> </tr> <tr> <td></td> <td></td> <td colspan="8" style="text-align: center;"> <table border="1" style="width: 100%; border-collapse: collapse; text-align: center;"> <tr> <td style="width: 10%;"></td> <td style="width: 10%;"></td> <td style="width: 10%;"></td> <td style="width: 10%;"></td> <td style="width: 10%;"></td> <td style="width: 10%;"></td> <td style="width: 10%;"></td> <td style="width: 10%;"></td> <td style="width: 10%;"></td> <td style="width: 10%;"></td> </tr> <tr> <td></td> <td></td> <td colspan="8" style="text-align: center;"> <table border="1" style="width: 100%; border-collapse: collapse; text-align: center;"> <tr> <td style="width: 10%;"></td> <td style="width: 10%;"></td> <td style="width: 10%;"></td> <td style="width: 10%;"></td> <td style="width: 10%;"></td> <td style="width: 10%;"></td> <td style="width: 10%;"></td> <td style="width: 10%;"></td> <td style="width: 10%;"></td> <td style="width: 10%;"></td> </tr> <tr> <td></td> <td></td> <td colspan="8" style="text-align: center;"> <table border="1" style="width: 100%; border-collapse: collapse; text-align: center;"> <tr> <td style="width: 10%;"></td> <td style="width: 10%;"></td> <td style="width: 10%;"></td> <td style="width: 10%;"></td> <td style="width: 10%;"></td> <td style="width: 10%;"></td> <td style="width: 10%;"></td> <td style="width: 10%;"></td> <td style="width: 10%;"></td> <td style="width: 10%;"></td> </tr> <tr> <td></td> <td></td> <td colspan="8" style="text-align: center;"> <table border="1" style="width: 100%; border-collapse: collapse; text-align: center;"> <tr> <td style="width: 10%;"></td> <td style="width: 10%;"></td> <td style="width: 10%;"></td> <td style="width: 10%;"></td> <td style="width: 10%;"></td> <td style="width: 10%;"></td> <td style="width: 10%;"></td> <td style="width: 10%;"></td> <td style="width: 10%;"></td> <td style="width: 10%;"></td> </tr> <tr> <td></td> <td></td> <td colspan="8" style="text-align: center;"> <table border="1" style="width: 100%; border-collapse: collapse; text-align: center;"> <tr> <td style="width: 10%;"></td> <td style="width: 10%;"></td> <td style="width: 10%;"></td> <td style="width: 10%;"></td> <td style="width: 10%;"></td> <td style="width: 10%;"></td> <td style="width: 10%;"></td> <td style="width: 10%;"></td> <td style="width: 10%;"></td> <td style="width: 10%;"></td> </tr> <tr> <td></td> <td></td> <td colspan="8" style="text-align: center;"> <table border="1" style="width: 100%; border-collapse: collapse; text-align: center;"> <tr> <td style="width: 10%;"></td> <td style="width: 10%;"></td> <td style="width: 10%;"></td> <td style="width: 10%;"></td> <td style="width: 10%;"></td> <td style="width: 10%;"></td> <td style="width: 10%;"></td> <td style="width: 10%;"></td> <td style="width: 10%;"></td> <td style="width: 10%;"></td> </tr> <tr> <td></td> <td></td> <td colspan="8" style="text-align: center;"> <table border="1" style="width: 100%; border-collapse: collapse; text-align: center;"> <tr> <td style="width: 10%;"></td> <td style="width: 10%;"></td> <td style="width: 10%;"></td> <td style="width: 10%;"></td> <td style="width: 10%;"></td> <td style="width: 10%;"></td> <td style="width: 10%;"></td> <td style="width: 10%;"></td> <td style="width: 10%;"></td> <td style="width: 10%;"></td> </tr> <tr> <td></td> <td></td> <td colspan="8" style="text-align: center;"> <table border="1" style="width: 100%; border-collapse: collapse; text-align: center;"> <tr> <td style="width: 10%;"></td> <td style="width: 10%;"></td> <td style="width: 10%;"></td> <td style="width: 10%;"></td> <td style="width: 10%;"></td> <td style="width: 10%;"></td> <td style="width: 10%;"></td> <td style="width: 10%;"></td> <td style="width: 10%;"></td> <td style="width: 10%;"></td> </tr> <tr> <td></td> <td></td> <td colspan="8" style="text-align: center;"> <table border="1" style="width: 100%; border-collapse: collapse; text-align: center;"> <tr> <td style="width: 10%;"></td> <td style="width: 10%;"></td> <td style="width: 10%;"></td> <td style="width: 10%;"></td> <td style="width: 10%;"></td> <td style="width: 10%;"></td> <td style="width: 10%;"></td> <td style="width: 10%;"></td> <td style="width: 10%;"></td> <td style="width: 10%;"></td> </tr> <tr> <td></td> <td></td> <td colspan="8" style="text-align: center;"> <table border="1" style="width: 100%; border-collapse: collapse; text-align: center;"> <tr> <td style="width: 10%;"></td> <td style="width: 10%;"></td> <td style="width: 10%;"></td> <td style="width: 10%;"></td> <td style="width: 10%;"></td> <td style="width: 10%;"></td> <td style="width: 10%;"></td> <td style="width: 10%;"></td> <td style="width: 10%;"></td> <td style="width: 10%;"></td> </tr> <tr> <td></td> <td></td> <td colspan="8" style="text-align: center;"> <table border="1" style="width: 100%; border-collapse: collapse; text-align: center;"> <tr> <td style="width: 10%;"></td> <td style="width: 10%;"></td> <td style="width: 10%;"></td> <td style="width: 10%;"></td> <td style="width: 10%;"></td> <td style="width: 10%;"></td> <td style="width: 10%;"></td> <td style="width: 10%;"></td> <td style="width: 10%;"></td> <td style="width: 10%;"></td> </tr> <tr> <td></td> <td></td> <td colspan="8" style="text-align: center;"> <table border="1" style="width: 100%; border-collapse: collapse; text-align: center;"> <tr> <td style="width: 10%;"></td> <td style="width: 10%;"></td> <td style="width: 10%;"></td> <td style="width: 10%;"></td> <td style="width: 10%;"></td> <td style="width: 10%;"></td> <td style="width: 10%;"></td> <td style="width: 10%;"></td> <td style="width: 10%;"></td> <td style="width: 10%;"></td> </tr> <tr> <td></td> <td></td> <td colspan="8" style="text-align: center;"> <table border="1" style="width: 100%; border-collapse: collapse; text-align: center;"> <tr> <td style="width: 10%;"></td> <td style="width: 10%;"></td> <td style="width: 10%;"></td> <td style="width: 10%;"></td> <td style="width: 10%;"></td> <td style="width: 10%;"></td> <td style="width: 10%;"></td> <td style="width: 10%;"></td> <td style="width: 10%;"></td> <td style="width: 10%;"></td> </tr> <tr> <td></td> <td></td> <td colspan="8" style="text-align: center;"> <table border="1" style="width: 100%; border-collapse: collapse; text-align: center;"> <tr> <td style="width: 10%;"></td> <td style="width: 10%;"></td> <td style="width: 10%;"></td> <td style="width: 10%;"></td> <td style="width: 10%;"></td> <td style="width: 10%;"></td> <td style="width: 10%;"></td> <td style="width: 10%;"></td> <td style="width: 10%;"></td> <td style="width: 10%;"></td> </tr> <tr> <td></td> <td></td> <td colspan="8" style="text-align: center;"> <table border="1" style="width: 100%; border-collapse: collapse; text-align: center;"> <tr> <td style="width: 10%;"></td> <td style="width: 10%;"></td> <td style="width: 10%;"></td> <td style="width: 10%;"></td> <td style="width: 10%;"></td> <td style="width: 10%;"></td> <td style="width: 10%;"></td> <td style="width: 10%;"></td> <td style="width: 10%;"></td> <td style="width: 10%;"></td> </tr> <tr> <td></td> <td></td> <td colspan="8" style="text-align: center;"> <table border="1" style="width: 100%; border-collapse: collapse; text-align: center;"> <tr> <td style="width: 10%;"></td> <td style="width: 10%;"></td> <td style="width: 10%;"></td> <td style="width: 10%;"></td> <td style="width: 10%;"></td> <td style="width: 10%;"></td> <td style="width: 10%;"></td> <td style="width: 10%;"></td> <td style="width: 10%;"></td> <td style="width: 10%;"></td> </tr> <tr> <td></td> <td></td> <td colspan="8" style="text-align: center;"> <table border="1" style="width: 100%; border-collapse: collapse; text-align: center;"> <tr> <td style="width: 10%;"></td> <td style="width: 10%;"></td> <td style="width: 10%;"></td> <td style="width: 10%;"></td> <td style="width: 10%;"></td> <td style="width: 10%;"></td> <td style="width: 10%;"></td> <td style="width: 10%;"></td> <td style="width: 10%;"></td> <td style="width: 10%;"></td> </tr> <tr> <td></td> <td></td> <td colspan="8" style="text-align: center;"> <table border="1" style="width: 100%; border-collapse: collapse; text-align: center;"> <tr> <td style="width: 10%;"></td> <td style="width: 10%;"></td> <td style="width: 10%;"></td> <td style="width: 10%;"></td> <td style="width: 10%;"></td> <td style="width: 10%;"></td> <td style="width: 10%;"></td> <td style="width: 10%;"></td> <td style="width: 10%;"></td> <td style="width: 10%;"></td> </tr> <tr> <td></td> <td></td> <td colspan="8" style="text-align: center;"> <table border="1" style="width: 100%; border-collapse: collapse; text-align: center;"> <tr> </tr></table></td></tr></table></td></tr></table></td></tr></table></td></tr></table></td></tr></table></td></tr></table></td></tr></table></td></tr></table></td></tr></table></td></tr></table></td></tr></table></td></tr></table></td></tr></table></td></tr></table></td></tr></table></td></tr></table></td></tr></table></td></tr></table></td></tr></table></td></tr></table></td></tr></table></td></tr></table></td></tr></table></td></tr></table></td></tr></table>
 | | | | | | | | | | | | | | | | | | | | <table border="1" style="width: 100%; border-collapse: collapse; text-align: center;"> <tr> <td style="width: 10%;"></td> <td style="width: 10%;"></td> <td style="width: 10%;"></td> <td style="width: 10%;"></td> <td style="width: 10%;"></td> <td style="width: 10%;"></td> <td style="width: 10%;"></td> <td style="width: 10%;"></td> <td style="width: 10%;"></td> <td style="width: 10%;"></td> </tr> <tr> <td></td> <td></td> <td colspan="8" style="text-align: center;"> <table border="1" style="width: 100%; border-collapse: collapse; text-align: center;"> <tr> <td style="width: 10%;"></td> <td style="width: 10%;"></td> <td style="width: 10%;"></td> <td style="width: 10%;"></td> <td style="width: 10%;"></td> <td style="width: 10%;"></td> <td style="width: 10%;"></td> <td style="width: 10%;"></td> <td style="width: 10%;"></td> <td style="width: 10%;"></td> </tr> <tr> <td></td> <td></td> <td colspan="8" style="text-align: center;"> <table border="1" style="width: 100%; border-collapse: collapse; text-align: center;"> <tr> <td style="width: 10%;"></td> <td style="width: 10%;"></td> <td style="width: 10%;"></td> <td style="width: 10%;"></td> <td style="width: 10%;"></td> <td style="width: 10%;"></td> <td style="width: 10%;"></td> <td style="width: 10%;"></td> <td style="width: 10%;"></td> <td style="width: 10%;"></td> </tr> <tr> <td></td> <td></td> <td colspan="8" style="text-align: center;"> <table border="1" style="width: 100%; border-collapse: collapse; text-align: center;"> <tr> <td style="width: 10%;"></td> <td style="width: 10%;"></td> <td style="width: 10%;"></td> <td style="width: 10%;"></td> <td style="width: 10%;"></td> <td style="width: 10%;"></td> <td style="width: 10%;"></td> <td style="width: 10%;"></td> <td style="width: 10%;"></td> <td style="width: 10%;"></td> </tr> <tr> <td></td> <td></td> <td colspan="8" style="text-align: center;"> <table border="1" style="width: 100%; border-collapse: collapse; text-align: center;"> <tr> <td style="width: 10%;"></td> <td style="width: 10%;"></td> <td style="width: 10%;"></td> <td style="width: 10%;"></td> <td style="width: 10%;"></td> <td style="width: 10%;"></td> <td style="width: 10%;"></td> <td style="width: 10%;"></td> <td style="width: 10%;"></td> <td style="width: 10%;"></td> </tr> <tr> <td></td> <td></td> <td colspan="8" style="text-align: center;"> <table border="1" style="width: 100%; border-collapse: collapse; text-align: center;"> <tr> <td style="width: 10%;"></td> <td style="width: 10%;"></td> <td style="width: 10%;"></td> <td style="width: 10%;"></td> <td style="width: 10%;"></td> <td style="width: 10%;"></td> <td style="width: 10%;"></td> <td style="width: 10%;"></td> <td style="width: 10%;"></td> <td style="width: 10%;"></td> </tr> <tr> <td></td> <td></td> <td colspan="8" style="text-align: center;"> <table border="1" style="width: 100%; border-collapse: collapse; text-align: center;"> <tr> <td style="width: 10%;"></td> <td style="width: 10%;"></td> <td style="width: 10%;"></td> <td style="width: 10%;"></td> <td style="width: 10%;"></td> <td style="width: 10%;"></td> <td style="width: 10%;"></td> <td style="width: 10%;"></td> <td style="width: 10%;"></td> <td style="width: 10%;"></td> </tr> <tr> <td></td> <td></td> <td colspan="8" style="text-align: center;"> <table border="1" style="width: 100%; border-collapse: collapse; text-align: center;"> <tr> <td style="width: 10%;"></td> <td style="width: 10%;"></td> <td style="width: 10%;"></td> <td style="width: 10%;"></td> <td style="width: 10%;"></td> <td style="width: 10%;"></td> <td style="width: 10%;"></td> <td style="width: 10%;"></td> <td style="width: 10%;"></td> <td style="width: 10%;"></td> </tr> <tr> <td></td> <td></td> <td colspan="8" style="text-align: center;"> <table border="1" style="width: 100%; border-collapse: collapse; text-align: center;"> <tr> <td style="width: 10%;"></td> <td style="width: 10%;"></td> <td style="width: 10%;"></td> <td style="width: 10%;"></td> <td style="width: 10%;"></td> <td style="width: 10%;"></td> <td style="width: 10%;"></td> <td style="width: 10%;"></td> <td style="width: 10%;"></td> <td style="width: 10%;"></td> </tr> <tr> <td></td> <td></td> <td colspan="8" style="text-align: center;"> <table border="1" style="width: 100%; border-collapse: collapse; text-align: center;"> <tr> <td style="width: 10%;"></td> <td style="width: 10%;"></td> <td style="width: 10%;"></td> <td style="width: 10%;"></td> <td style="width: 10%;"></td> <td style="width: 10%;"></td> <td style="width: 10%;"></td> <td style="width: 10%;"></td> <td style="width: 10%;"></td> <td style="width: 10%;"></td> </tr> <tr> <td></td> <td></td> <td colspan="8" style="text-align: center;"> <table border="1" style="width: 100%; border-collapse: collapse; text-align: center;"> <tr> <td style="width: 10%;"></td> <td style="width: 10%;"></td> <td style="width: 10%;"></td> <td style="width: 10%;"></td> <td style="width: 10%;"></td> <td style="width: 10%;"></td> <td style="width: 10%;"></td> <td style="width: 10%;"></td> <td style="width: 10%;"></td> <td style="width: 10%;"></td> </tr> <tr> <td></td> <td></td> <td colspan="8" style="text-align: center;"> <table border="1" style="width: 100%; border-collapse: collapse; text-align: center;"> <tr> <td style="width: 10%;"></td> <td style="width: 10%;"></td> <td style="width: 10%;"></td> <td style="width: 10%;"></td> <td style="width: 10%;"></td> <td style="width: 10%;"></td> <td style="width: 10%;"></td> <td style="width: 10%;"></td> <td style="width: 10%;"></td> <td style="width: 10%;"></td> </tr> <tr> <td></td> <td></td> <td colspan="8" style="text-align: center;"> <table border="1" style="width: 100%; border-collapse: collapse; text-align: center;"> <tr> <td style="width: 10%;"></td> <td style="width: 10%;"></td> <td style="width: 10%;"></td> <td style="width: 10%;"></td> <td style="width: 10%;"></td> <td style="width: 10%;"></td> <td style="width: 10%;"></td> <td style="width: 10%;"></td> <td style="width: 10%;"></td> <td style="width: 10%;"></td> </tr> <tr> <td></td> <td></td> <td colspan="8" style="text-align:
center;"> <table border="1" style="width: 100%; border-collapse: collapse; text-align: center;"> <tr> <td style="width: 10%;"></td> <td style="width: 10%;"></td> <td style="width: 10%;"></td> <td style="width: 10%;"></td> <td style="width: 10%;"></td> <td style="width: 10%;"></td> <td style="width: 10%;"></td> <td style="width: 10%;"></td> <td style="width: 10%;"></td> <td style="width: 10%;"></td> </tr> <tr> <td></td> <td></td> <td colspan="8" style="text-align: center;"> <table border="1" style="width: 100%; border-collapse: collapse; text-align: center;"> <tr> <td style="width: 10%;"></td> <td style="width: 10%;"></td> <td style="width: 10%;"></td> <td style="width: 10%;"></td> <td style="width: 10%;"></td> <td style="width: 10%;"></td> <td style="width: 10%;"></td> <td style="width: 10%;"></td> <td style="width: 10%;"></td> <td style="width: 10%;"></td> </tr> <tr> <td></td> <td></td> <td colspan="8" style="text-align: center;"> <table border="1" style="width: 100%; border-collapse: collapse; text-align: center;"> <tr> <td style="width: 10%;"></td> <td style="width: 10%;"></td> <td style="width: 10%;"></td> <td style="width: 10%;"></td> <td style="width: 10%;"></td> <td style="width: 10%;"></td> <td style="width: 10%;"></td> <td style="width: 10%;"></td> <td style="width: 10%;"></td> <td style="width: 10%;"></td> </tr> <tr> <td></td> <td></td> <td colspan="8" style="text-align: center;"> <table border="1" style="width: 100%; border-collapse: collapse; text-align: center;"> <tr> <td style="width: 10%;"></td> <td style="width: 10%;"></td> <td style="width: 10%;"></td> <td style="width: 10%;"></td> <td style="width: 10%;"></td> <td style="width: 10%;"></td> <td style="width: 10%;"></td> <td style="width: 10%;"></td> <td style="width: 10%;"></td> <td style="width: 10%;"></td> </tr> <tr> <td></td> <td></td> <td colspan="8" style="text-align: center;"> <table border="1" style="width: 100%; border-collapse: collapse; text-align: center;"> <tr> <td style="width: 10%;"></td> <td style="width: 10%;"></td> <td style="width: 10%;"></td> <td style="width: 10%;"></td> <td style="width: 10%;"></td> <td style="width: 10%;"></td> <td style="width: 10%;"></td> <td style="width: 10%;"></td> <td style="width: 10%;"></td> <td style="width: 10%;"></td> </tr> <tr> <td></td> <td></td> <td colspan="8" style="text-align: center;"> <table border="1" style="width: 100%; border-collapse: collapse; text-align: center;"> <tr> <td style="width: 10%;"></td> <td style="width: 10%;"></td> <td style="width: 10%;"></td> <td style="width: 10%;"></td> <td style="width: 10%;"></td> <td style="width: 10%;"></td> <td style="width: 10%;"></td> <td style="width: 10%;"></td> <td style="width: 10%;"></td> <td style="width: 10%;"></td> </tr> <tr> <td></td> <td></td> <td colspan="8" style="text-align: center;"> <table border="1" style="width: 100%; border-collapse: collapse; text-align: center;"> <tr> <td style="width: 10%;"></td> <td style="width: 10%;"></td> <td style="width: 10%;"></td> <td style="width: 10%;"></td> <td style="width: 10%;"></td> <td style="width: 10%;"></td> <td style="width: 10%;"></td> <td style="width: 10%;"></td> <td style="width: 10%;"></td> <td style="width: 10%;"></td> </tr> <tr> <td></td> <td></td> <td colspan="8" style="text-align: center;"> <table border="1" style="width: 100%; border-collapse: collapse; text-align: center;"> <tr> <td style="width: 10%;"></td> <td style="width: 10%;"></td> <td style="width: 10%;"></td> <td style="width: 10%;"></td> <td style="width: 10%;"></td> <td style="width: 10%;"></td> <td style="width: 10%;"></td> <td style="width: 10%;"></td> <td style="width: 10%;"></td> <td style="width: 10%;"></td> </tr> <tr> <td></td> <td></td> <td colspan="8" style="text-align: center;"> <table border="1" style="width: 100%; border-collapse: collapse; text-align: center;"> <tr> <td style="width: 10%;"></td> <td style="width: 10%;"></td> <td style="width: 10%;"></td> <td style="width: 10%;"></td> <td style="width: 10%;"></td> <td style="width: 10%;"></td> <td style="width: 10%;"></td> <td style="width: 10%;"></td> <td style="width: 10%;"></td> <td style="width: 10%;"></td> </tr> <tr> <td></td> <td></td> <td colspan="8" style="text-align: center;"> <table border="1" style="width: 100%; border-collapse: collapse; text-align: center;"> <tr> <td style="width: 10%;"></td> <td style="width: 10%;"></td> <td style="width: 10%;"></td> <td style="width: 10%;"></td> <td style="width: 10%;"></td> <td style="width: 10%;"></td> <td style="width: 10%;"></td> <td style="width: 10%;"></td> <td style="width: 10%;"></td> <td style="width: 10%;"></td> </tr> <tr> <td></td> <td></td> <td colspan="8" style="text-align: center;"> <table border="1" style="width: 100%; border-collapse: collapse; text-align: center;"> <tr> <td style="width: 10%;"></td> <td style="width: 10%;"></td> <td style="width: 10%;"></td> <td style="width: 10%;"></td> <td style="width: 10%;"></td> <td style="width: 10%;"></td> <td style="width: 10%;"></td> <td style="width: 10%;"></td> <td style="width: 10%;"></td> <td style="width: 10%;"></td> </tr> <tr> <td></td> <td></td> <td colspan="8" style="text-align: center;"> <table border="1" style="width: 100%; border-collapse: collapse; text-align: center;"> <tr> </tr></table></td></tr></table></td></tr></table></td></tr></table></td></tr></table></td></tr></table></td></tr></table></td></tr></table></td></tr></table></td></tr></table></td></tr></table></td></tr></table></td></tr></table></td></tr></table></td></tr></table></td></tr></table></td></tr></table></td></tr></table></td></tr></table></td></tr></table></td></tr></table></td></tr></table></td></tr></table></td></tr></table></td></tr></table>
 | | | | | | | | | | | | | | | | | | | | <table border="1" style="width: 100%; border-collapse: collapse; text-align: center;"> <tr> <td style="width: 10%;"></td> <td style="width: 10%;"></td> <td style="width: 10%;"></td> <td style="width: 10%;"></td> <td style="width: 10%;"></td> <td style="width: 10%;"></td> <td style="width: 10%;"></td> <td style="width: 10%;"></td> <td style="width: 10%;"></td> <td style="width: 10%;"></td> </tr> <tr> <td></td> <td></td> <td colspan="8" style="text-align: center;"> <table border="1" style="width: 100%; border-collapse: collapse; text-align: center;"> <tr> <td style="width: 10%;"></td> <td style="width: 10%;"></td> <td style="width: 10%;"></td> <td style="width: 10%;"></td> <td style="width: 10%;"></td> <td style="width: 10%;"></td> <td style="width: 10%;"></td> <td style="width: 10%;"></td> <td style="width: 10%;"></td> <td style="width: 10%;"></td> </tr> <tr> <td></td> <td></td> <td colspan="8" style="text-align: center;"> <table border="1" style="width: 100%; border-collapse: collapse; text-align: center;"> <tr> <td style="width: 10%;"></td> <td style="width: 10%;"></td> <td style="width: 10%;"></td> <td style="width: 10%;"></td> <td style="width: 10%;"></td> <td style="width: 10%;"></td> <td style="width: 10%;"></td> <td style="width: 10%;"></td> <td style="width: 10%;"></td> <td style="width: 10%;"></td> </tr> <tr> <td></td> <td></td> <td colspan="8" style="text-align: center;"> <table border="1" style="width: 100%; border-collapse: collapse; text-align: center;"> <tr> <td style="width: 10%;"></td> <td style="width: 10%;"></td> <td style="width: 10%;"></td> <td style="width: 10%;"></td> <td style="width: 10%;"></td> <td style="width: 10%;"></td> <td style="width: 10%;"></td> <td style="width: 10%;"></td> <td style="width: 10%;"></td> <td style="width: 10%;"></td> </tr> <tr> <td></td> <td></td> <td colspan="8" style="text-align: center;"> <table border="1" style="width: 100%; border-collapse: collapse; text-align: center;"> <tr> <td style="width: 10%;"></td> <td style="width: 10%;"></td> <td style="width: 10%;"></td> <td style="width: 10%;"></td> <td style="width: 10%;"></td> <td style="width: 10%;"></td> <td style="width: 10%;"></td> <td style="width: 10%;"></td> <td style="width: 10%;"></td> <td style="width: 10%;"></td> </tr> <tr> <td></td> <td></td> <td colspan="8" style="text-align: center;"> <table border="1" style="width: 100%; border-collapse: collapse; text-align: center;"> <tr> <td style="width: 10%;"></td> <td style="width: 10%;"></td> <td style="width: 10%;"></td> <td style="width: 10%;"></td> <td style="width: 10%;"></td> <td style="width: 10%;"></td> <td style="width: 10%;"></td> <td style="width: 10%;"></td> <td style="width: 10%;"></td> <td style="width: 10%;"></td> </tr> <tr> <td></td> <td></td> <td colspan="8" style="text-align: center;"> <table border="1" style="width: 100%; border-collapse: collapse; text-align: center;"> <tr> <td style="width: 10%;"></td> <td style="width: 10%;"></td> <td style="width: 10%;"></td> <td style="width: 10%;"></td> <td style="width: 10%;"></td> <td style="width: 10%;"></td> <td style="width: 10%;"></td> <td style="width: 10%;"></td> <td style="width: 10%;"></td> <td style="width: 10%;"></td> </tr> <tr> <td></td> <td></td> <td colspan="8" style="text-align: center;"> <table border="1" style="width: 100%; border-collapse: collapse; text-align: center;"> <tr> <td style="width: 10%;"></td> <td style="width: 10%;"></td> <td style="width: 10%;"></td> <td style="width: 10%;"></td> <td style="width: 10%;"></td> <td style="width: 10%;"></td> <td style="width: 10%;"></td> <td style="width: 10%;"></td> <td style="width: 10%;"></td> <td style="width: 10%;"></td> </tr> <tr> <td></td> <td></td> <td colspan="8" style="text-align: center;"> <table border="1" style="width: 100%; border-collapse: collapse; text-align: center;"> <tr> <td style="width: 10%;"></td> <td style="width: 10%;"></td> <td style="width: 10%;"></td> <td style="width: 10%;"></td> <td style="width: 10%;"></td> <td style="width: 10%;"></td> <td style="width: 10%;"></td> <td style="width: 10%;"></td> <td style="width: 10%;"></td> <td style="width: 10%;"></td> </tr> <tr> <td></td> <td></td> <td colspan="8" style="text-align: center;"> <table border="1" style="width: 100%; border-collapse: collapse; text-align: center;"> <tr> <td style="width: 10%;"></td> <td style="width: 10%;"></td> <td style="width: 10%;"></td> <td style="width: 10%;"></td> <td style="width: 10%;"></td> <td style="width: 10%;"></td> <td style="width: 10%;"></td> <td style="width: 10%;"></td> <td style="width: 10%;"></td> <td style="width: 10%;"></td> </tr> <tr> <td></td> <td></td> <td colspan="8" style="text-align: center;"> <table border="1" style="width: 100%; border-collapse: collapse; text-align: center;"> <tr> <td style="width: 10%;"></td> <td style="width: 10%;"></td> <td style="width: 10%;"></td> <td style="width: 10%;"></td> <td style="width: 10%;"></td> <td style="width: 10%;"></td> <td style="width: 10%;"></td> <td style="width: 10%;"></td> <td style="width: 10%;"></td> <td style="width: 10%;"></td> </tr> <tr> <td></td> <td></td> <td colspan="8" style="text-align: center;"> <table border="1" style="width: 100%; border-collapse: collapse; text-align: center;"> <tr> <td style="width: 10%;"></td> <td style="width: 10%;"></td> <td style="width: 10%;"></td> <td style="width: 10%;"></td> <td style="width: 10%;"></td> <td style="width: 10%;"></td> <td style="width: 10%;"></td> <td style="width: 10%;"></td> <td style="width: 10%;"></td> <td style="width: 10%;"></td> </tr> <tr> <td></td> <td></td> <td colspan="8" style="text-align: center;"> <table border="1" style="width: 100%; border-collapse: collapse; text-align: center;"> <tr> <td style="width: 10%;"></td> <td style="width: 10%;"></td> <td style="width: 10%;"></td> <td style="width: 10%;"></td> <td style="width: 10%;"></td> <td style="width: 10%;"></td> <td style="width: 10%;"></td> <td style="width: 10%;"></td> <td style="width: 10%;"></td> <td style="width: 10%;"></td> </tr> <tr> <td></td> <td></td> <td colspan="8" style="text-align: center;"> <table border="1" style="width: 100%; border-collapse: collapse; text-align: center;"> <tr> <td style="width: 10%;"></td> <td style="width: 10%;"></td> <td style="width: 10%;"></td> <td style="width: 10%;"></td> <td style="width: 10%;"></td> <td style="width: 10%;"></td> <td style="width: 10%;"></td> <td style="width: 10%;"></td> <td style="width: 10%;"></td> <td style="width: 10%;"></td> </tr> <tr> <td></td> <td></td> <td colspan="8" style="text-align: center;"> <table border="1" style="width: 100%; border-collapse: collapse; text-align: center;"> <tr> <td style="width: 10%;"></td> <td style="width: 10%;"></td> <td style="width: 10%;"></td> <td style="width: 10%;"></td> <td style="width: 10%;"></td> <td style="width: 10%;"></td> <td style="width: 10%;"></td> <td style="width: 10%;"></td> <td style="width: 10%;"></td> <td style="width: 10%;"></td> </tr> <tr> <td></td> <td></td> <td colspan="8" style="text-align: center;"> <table border="1" style="width: 100%; border-collapse: collapse; text-align: center;"> <tr> <td style="width: 10%;"></td> <td style="width: 10%;"></td> <td style="width: 10%;"></td> <td style="width: 10%;"></td> <td style="width: 10%;"></td> <td style="width: 10%;"></td> <td style="width: 10%;"></td> <td style="width: 10%;"></td> <td style="width: 10%;"></td> <td style="width: 10%;"></td> </tr> <tr> <td></td> <td></td> <td colspan="8" style="text-align: center;"> <table border="1" style="width: 100%; border-collapse: collapse; text-align: center;"> <tr> <td style="width: 10%;"></td> <td style="width: 10%;"></td> <td style="width: 10%;"></td> <td style="width: 10%;"></td> <td style="width: 10%;"></td> <td style="width: 10%;"></td> <td style="width: 10%;"></td> <td style="width: 10%;"></td> <td style="width: 10%;"></td> <td style="width: 10%;"></td> </tr> <tr> <td></td> <td></td> <td colspan="8" style="text-align: center;"> <table border="1" style="width: 100%; border-collapse: collapse; text-align: center;"> <tr> <td style="width: 10%;"></td> <td style="width: 10%;"></td> <td style="width: 10%;"></td> <td style="width: 10%;"></td> <td style="width: 10%;"></td> <td style="width: 10%;"></td> <td style="width: 10%;"></td> <td style="width: 10%;"></td> <td style="width: 10%;"></td> <td style="width: 10%;"></td> </tr> <tr> <td></td> <td></td> <td colspan="8" style="text-align: center;"> <table border="1" style="width: 100%; border-collapse: collapse; text-align: center;"> <tr> <td style="width: 10%;"></td> <td style="width: 10%;"></td> <td style="width: 10%;"></td> <td style="width: 10%;"></td> <td style="width: 10%;"></td> <td style="width: 10%;"></td> <td style="width: 10%;"></td> <td style="width: 10%;"></td> <td style="width: 10%;"></td> <td style="width: 10%;"></td> </tr> <tr> <td></td> <td></td> <td colspan="8" style="text-align: center;"> <table border="1" style="width: 100%; border-collapse: collapse; text-align: center;"> <tr> <td style="width: 10%;"></td> <td style="width: 10%;"></td> <td style="width: 10%;"></td> <td style="width: 10%;"></td> <td style="width: 10%;"></td> <td style="width: 10%;"></td> <td style="width: 10%;"></td> <td style="width: 10%;"></td> <td style="width: 10%;"></td> <td style="width: 10%;"></td> </tr> <tr> <td></td> <td></td> <td colspan="8" style="text-align: center;"> <table border="1" style="width: 100%; border-collapse: collapse; text-align: center;"> <tr> <td style="width: 10%;"></td> <td style="width: 10%;"></td> <td style="width: 10%;"></td> <td style="width: 10%;"></td> <td style="width: 10%;"></td> <td style="width: 10%;"></td> <td style="width: 10%;"></td> <td style="width: 10%;"></td> <td style="width: 10%;"></td> <td style="width: 10%;"></td> </tr> <tr> <td></td> <td></td> <td colspan="8" style="text-align: center;"> <table border="1" style="width: 100%;
border-collapse: collapse; text-align: center;"> <tr> <td style="width: 10%;"></td> <td style="width: 10%;"></td> <td style="width: 10%;"></td> <td style="width: 10%;"></td> <td style="width: 10%;"></td> <td style="width: 10%;"></td> <td style="width: 10%;"></td> <td style="width: 10%;"></td> <td style="width: 10%;"></td> <td style="width: 10%;"></td> </tr> <tr> <td></td> <td></td> <td colspan="8" style="text-align: center;"> <table border="1" style="width: 100%; border-collapse: collapse; text-align: center;"> <tr> <td style="width: 10%;"></td> <td style="width: 10%;"></td> <td style="width: 10%;"></td> <td style="width: 10%;"></td> <td style="width: 10%;"></td> <td style="width: 10%;"></td> <td style="width: 10%;"></td> <td style="width: 10%;"></td> <td style="width: 10%;"></td> <td style="width: 10%;"></td> </tr> <tr> <td></td> <td></td> <td colspan="8" style="text-align: center;"> <table border="1" style="width: 100%; border-collapse: collapse; text-align: center;"> <tr> </tr></table></td></tr></table></td></tr></table></td></tr></table></td></tr></table></td></tr></table></td></tr></table></td></tr></table></td></tr></table></td></tr></table></td></tr></table></td></tr></table></td></tr></table></td></tr></table></td></tr></table></td></tr></table></td></tr></table></td></tr></table></td></tr></table></td></tr></table></td></tr></table></td></tr></table></td></tr></table></td></tr></table> | | | | | | | | | | | | | | | | | | | | <table border="1" style="width: 100%; border-collapse: collapse; text-align: center;"> <tr> <td style="width: 10%;"></td> <td style="width: 10%;"></td> <td style="width: 10%;"></td> <td style="width: 10%;"></td> <td style="width: 10%;"></td> <td style="width: 10%;"></td> <td style="width: 10%;"></td> <td style="width: 10%;"></td> <td style="width: 10%;"></td> <td style="width: 10%;"></td> </tr> <tr> <td></td> <td></td> <td colspan="8" style="text-align: center;"> <table border="1" style="width: 100%; border-collapse: collapse; text-align: center;"> <tr> <td style="width: 10%;"></td> <td style="width: 10%;"></td> <td style="width: 10%;"></td> <td style="width: 10%;"></td> <td style="width: 10%;"></td> <td style="width: 10%;"></td> <td style="width: 10%;"></td> <td style="width: 10%;"></td> <td style="width: 10%;"></td> <td style="width: 10%;"></td> </tr> <tr> <td></td> <td></td> <td colspan="8" style="text-align: center;"> <table border="1" style="width: 100%; border-collapse: collapse; text-align: center;"> <tr> <td style="width: 10%;"></td> <td style="width: 10%;"></td> <td style="width: 10%;"></td> <td style="width: 10%;"></td> <td style="width: 10%;"></td> <td style="width: 10%;"></td> <td style="width: 10%;"></td> <td style="width: 10%;"></td> <td style="width: 10%;"></td> <td style="width: 10%;"></td> </tr> <tr> <td></td> <td></td> <td colspan="8" style="text-align: center;"> <table border="1" style="width: 100%; border-collapse: collapse; text-align: center;"> <tr> <td style="width: 10%;"></td> <td style="width: 10%;"></td> <td style="width: 10%;"></td> <td style="width: 10%;"></td> <td style="width: 10%;"></td> <td style="width: 10%;"></td> <td style="width: 10%;"></td> <td style="width: 10%;"></td> <td style="width: 10%;"></td> <td style="width: 10%;"></td> </tr> <tr> <td></td> <td></td> <td colspan="8" style="text-align: center;"> <table border="1" style="width: 100%; border-collapse: collapse; text-align: center;"> <tr> <td style="width: 10%;"></td> <td style="width: 10%;"></td> <td style="width: 10%;"></td> <td style="width: 10%;"></td> <td style="width: 10%;"></td> <td style="width: 10%;"></td> <td style="width: 10%;"></td> <td style="width: 10%;"></td> <td style="width: 10%;"></td> <td style="width: 10%;"></td> </tr> <tr> <td></td> <td></td> <td colspan="8" style="text-align: center;"> <table border="1" style="width: 100%; border-collapse: collapse; text-align: center;"> <tr> <td style="width: 10%;"></td> <td style="width: 10%;"></td> <td style="width: 10%;"></td> <td style="width: 10%;"></td> <td style="width: 10%;"></td> <td style="width: 10%;"></td> <td style="width: 10%;"></td> <td style="width: 10%;"></td> <td style="width: 10%;"></td> <td style="width: 10%;"></td> </tr> <tr> <td></td> <td></td> <td colspan="8" style="text-align: center;"> <table border="1" style="width: 100%; border-collapse: collapse; text-align: center;"> <tr> <td style="width: 10%;"></td> <td style="width: 10%;"></td> <td style="width: 10%;"></td> <td style="width: 10%;"></td> <td style="width: 10%;"></td> <td style="width: 10%;"></td> <td style="width: 10%;"></td> <td style="width: 10%;"></td> <td style="width: 10%;"></td> <td style="width: 10%;"></td> </tr> <tr> <td></td> <td></td> <td colspan="8" style="text-align: center;"> <table border="1" style="width: 100%; border-collapse: collapse; text-align: center;"> <tr> <td style="width: 10%;"></td> <td style="width: 10%;"></td> <td style="width: 10%;"></td> <td style="width: 10%;"></td> <td style="width: 10%;"></td> <td style="width: 10%;"></td> <td style="width: 10%;"></td> <td style="width: 10%;"></td> <td style="width: 10%;"></td> <td style="width: 10%;"></td> </tr> <tr> <td></td> <td></td> <td colspan="8" style="text-align: center;"> <table border="1" style="width: 100%; border-collapse: collapse; text-align: center;"> <tr> <td style="width: 10%;"></td> <td style="width: 10%;"></td> <td style="width: 10%;"></td> <td style="width: 10%;"></td> <td style="width: 10%;"></td> <td style="width: 10%;"></td> <td style="width: 10%;"></td> <td style="width: 10%;"></td> <td style="width: 10%;"></td> <td style="width: 10%;"></td> </tr> <tr>
<td></td> <td></td> <td colspan="8" style="text-align: center;"> <table border="1" style="width: 100%; border-collapse: collapse; text-align: center;"> <tr> <td style="width: 10%;"></td> <td style="width: 10%;"></td> <td style="width: 10%;"></td> <td style="width: 10%;"></td> <td style="width: 10%;"></td> <td style="width: 10%;"></td> <td style="width: 10%;"></td> <td style="width: 10%;"></td> <td style="width: 10%;"></td> <td style="width: 10%;"></td> </tr> <tr> <td></td> <td></td> <td colspan="8" style="text-align: center;"> <table border="1" style="width: 100%; border-collapse: collapse; text-align: center;"> <tr> <td style="width: 10%;"></td> <td style="width: 10%;"></td> <td style="width: 10%;"></td> <td style="width: 10%;"></td> <td style="width: 10%;"></td> <td style="width: 10%;"></td> <td style="width: 10%;"></td> <td style="width: 10%;"></td> <td style="width: 10%;"></td> <td style="width: 10%;"></td> </tr> <tr> <td></td> <td></td> <td colspan="8" style="text-align: center;"> <table border="1" style="width: 100%; border-collapse: collapse; text-align: center;"> <tr> <td style="width: 10%;"></td> <td style="width: 10%;"></td> <td style="width: 10%;"></td> <td style="width: 10%;"></td> <td style="width: 10%;"></td> <td style="width: 10%;"></td> <td style="width: 10%;"></td> <td style="width: 10%;"></td> <td style="width: 10%;"></td> <td style="width: 10%;"></td> </tr> <tr> <td></td> <td></td> <td colspan="8" style="text-align: center;"> <table border="1" style="width: 100%; border-collapse: collapse; text-align: center;"> <tr> <td style="width: 10%;"></td> <td style="width: 10%;"></td> <td style="width: 10%;"></td> <td style="width: 10%;"></td> <td style="width: 10%;"></td> <td style="width: 10%;"></td> <td style="width: 10%;"></td> <td style="width: 10%;"></td> <td style="width: 10%;"></td> <td style="width: 10%;"></td> </tr> <tr> <td></td> <td></td> <td colspan="8" style="text-align: center;"> <table border="1" style="width: 100%; border-collapse: collapse; text-align: center;"> <tr> <td style="width: 10%;"></td> <td style="width: 10%;"></td> <td style="width: 10%;"></td> <td style="width: 10%;"></td> <td style="width: 10%;"></td> <td style="width: 10%;"></td> <td style="width: 10%;"></td> <td style="width: 10%;"></td> <td style="width: 10%;"></td> <td style="width: 10%;"></td> </tr> <tr> <td></td> <td></td> <td colspan="8" style="text-align: center;"> <table border="1" style="width: 100%; border-collapse: collapse; text-align: center;"> <tr> <td style="width: 10%;"></td> <td style="width: 10%;"></td> <td style="width: 10%;"></td> <td style="width: 10%;"></td> <td style="width: 10%;"></td> <td style="width: 10%;"></td> <td style="width: 10%;"></td> <td style="width: 10%;"></td> <td style="width: 10%;"></td> <td style="width: 10%;"></td> </tr> <tr> <td></td> <td></td> <td colspan="8" style="text-align: center;"> <table border="1" style="width: 100%; border-collapse: collapse; text-align: center;"> <tr> <td style="width: 10%;"></td> <td style="width: 10%;"></td> <td style="width: 10%;"></td> <td style="width: 10%;"></td> <td style="width: 10%;"></td> <td style="width: 10%;"></td> <td style="width: 10%;"></td> <td style="width: 10%;"></td> <td style="width: 10%;"></td> <td style="width: 10%;"></td> </tr> <tr> <td></td> <td></td> <td colspan="8" style="text-align: center;"> <table border="1" style="width: 100%; border-collapse: collapse; text-align: center;"> <tr> <td style="width: 10%;"></td> <td style="width: 10%;"></td> <td style="width: 10%;"></td> <td style="width: 10%;"></td> <td style="width: 10%;"></td> <td style="width: 10%;"></td> <td style="width: 10%;"></td> <td style="width: 10%;"></td> <td style="width: 10%;"></td> <td style="width: 10%;"></td> </tr> <tr> <td></td> <td></td> <td colspan="8" style="text-align: center;"> <table border="1" style="width: 100%; border-collapse: collapse; text-align: center;"> <tr> <td style="width: 10%;"></td> <td style="width: 10%;"></td> <td style="width: 10%;"></td> <td style="width: 10%;"></td> <td style="width: 10%;"></td> <td style="width: 10%;"></td> <td style="width: 10%;"></td> <td style="width: 10%;"></td> <td style="width: 10%;"></td> <td style="width: 10%;"></td> </tr> <tr> <td></td> <td></td> <td colspan="8" style="text-align: center;"> <table border="1" style="width: 100%; border-collapse: collapse; text-align: center;"> <tr> <td style="width: 10%;"></td> <td style="width: 10%;"></td> <td style="width: 10%;"></td> <td style="width: 10%;"></td> <td style="width: 10%;"></td> <td style="width: 10%;"></td> <td style="width: 10%;"></td> <td style="width: 10%;"></td> <td style="width: 10%;"></td> <td style="width: 10%;"></td> </tr> <tr> <td></td> <td></td> <td colspan="8" style="text-align: center;"> <table border="1" style="width: 100%; border-collapse: collapse; text-align: center;"> <tr> <td style="width: 10%;"></td> <td style="width: 10%;"></td> <td style="width: 10%;"></td> <td style="width: 10%;"></td> <td style="width: 10%;"></td> <td style="width: 10%;"></td> <td style="width: 10%;"></td> <td style="width: 10%;"></td> <td style="width: 10%;"></td> <td style="width: 10%;"></td> </tr> <tr> <td></td> <td></td> <td colspan="8" style="text-align: center;"> <table border="1" style="width: 100%; border-collapse: collapse; text-align: center;"> <tr> <td style="width: 10%;"></td> <td style="width: 10%;"></td> <td style="width: 10%;"></td> <td style="width: 10%;"></td> <td style="width: 10%;"></td> <td style="width: 10%;"></td> <td style="width: 10%;"></td> <td style="width: 10%;"></td> <td style="width: 10%;"></td> <td style="width: 10%;"></td> </tr> <tr> <td></td> <td></td> <td colspan="8" style="text-align: center;"> <table border="1" style="width: 100%; border-collapse: collapse; text-align: center;"> <tr> <td style="width: 10%;"></td> <td style="width: 10%;"></td> <td style="width: 10%;"></td> <td style="width: 10%;"></td> <td style="width: 10%;"></td> <td style="width: 10%;"></td> <td style="width: 10%;"></td> <td style="width: 10%;"></td> <td style="width: 10%;"></td> <td style="width: 10%;"></td> </tr> <tr> <td></td> <td></td> <td colspan="8" style="text-align: center;"> <table border="1" style="width: 100%; border-collapse: collapse; text-align: center;"> <tr> </tr></table></td></tr></table></td></tr></table></td></tr></table></td></tr></table></td></tr></table></td></tr></table></td></tr></table></td></tr></table></td></tr></table></td></tr></table></td></tr></table></td></tr></table></td></tr></table></td></tr></table></td></tr></table></td></tr></table></td></tr></table></td></tr></table></td></tr></table></td></tr></table></td></tr></table></td></tr></table>
 | | | | | | | | | | | | | | | | | | | | <table border="1" style="width: 100%; border-collapse: collapse; text-align: center;"> <tr> <td style="width: 10%;"></td> <td style="width: 10%;"></td> <td style="width: 10%;"></td> <td style="width: 10%;"></td> <td style="width: 10%;"></td> <td style="width: 10%;"></td> <td style="width: 10%;"></td> <td style="width: 10%;"></td> <td style="width: 10%;"></td> <td style="width: 10%;"></td> </tr> <tr> <td></td> <td></td> <td colspan="8" style="text-align: center;"> <table border="1" style="width: 100%; border-collapse: collapse; text-align: center;"> <tr> <td style="width: 10%;"></td> <td style="width: 10%;"></td> <td style="width: 10%;"></td> <td style="width: 10%;"></td> <td style="width: 10%;"></td> <td style="width: 10%;"></td> <td style="width: 10%;"></td> <td style="width: 10%;"></td> <td style="width: 10%;"></td> <td style="width: 10%;"></td> </tr> <tr> <td></td> <td></td> <td colspan="8" style="text-align: center;"> <table border="1" style="width: 100%; border-collapse: collapse; text-align: center;"> <tr> <td style="width: 10%;"></td> <td style="width: 10%;"></td> <td style="width: 10%;"></td> <td style="width: 10%;"></td> <td style="width: 10%;"></td> <td style="width: 10%;"></td> <td style="width: 10%;"></td> <td style="width: 10%;"></td> <td style="width: 10%;"></td> <td style="width: 10%;"></td> </tr> <tr> <td></td> <td></td> <td colspan="8" style="text-align: center;"> <table border="1" style="width: 100%; border-collapse: collapse; text-align: center;"> <tr> <td style="width: 10%;"></td> <td style="width: 10%;"></td> <td style="width: 10%;"></td> <td style="width: 10%;"></td> <td style="width: 10%;"></td> <td style="width: 10%;"></td> <td style="width: 10%;"></td> <td style="width: 10%;"></td> <td style="width: 10%;"></td> <td style="width: 10%;"></td> </tr> <tr> <td></td> <td></td> <td colspan="8" style="text-align: center;"> <table border="1" style="width: 100%; border-collapse: collapse; text-align: center;"> <tr> <td style="width: 10%;"></td> <td style="width: 10%;"></td> <td style="width: 10%;"></td> <td style="width: 10%;"></td> <td style="width: 10%;"></td> <td style="width: 10%;"></td> <td style="width: 10%;"></td> <td style="width: 10%;"></td> <td style="width: 10%;"></td> <td style="width: 10%;"></td> </tr> <tr> <td></td> <td></td> <td colspan="8" style="text-align: center;"> <table border="1" style="width: 100%; border-collapse: collapse; text-align: center;"> <tr> <td style="width: 10%;"></td> <td style="width: 10%;"></td> <td style="width: 10%;"></td> <td style="width: 10%;"></td> <td style="width: 10%;"></td> <td style="width: 10%;"></td> <td style="width: 10%;"></td> <td style="width: 10%;"></td> <td style="width: 10%;"></td> <td style="width: 10%;"></td> </tr> <tr> <td></td> <td></td> <td colspan="8" style="text-align: center;"> <table border="1" style="width: 100%; border-collapse: collapse; text-align: center;"> <tr> <td style="width: 10%;"></td> <td style="width: 10%;"></td> <td style="width: 10%;"></td> <td style="width: 10%;"></td> <td style="width: 10%;"></td> <td style="width: 10%;"></td> <td style="width: 10%;"></td> <td style="width: 10%;"></td> <td style="width: 10%;"></td> <td style="width: 10%;"></td> </tr> <tr> <td></td> <td></td> <td colspan="8" style="text-align: center;"> <table border="1" style="width: 100%; border-collapse: collapse; text-align: center;"> <tr> <td style="width: 10%;"></td> <td style="width: 10%;"></td> <td style="width: 10%;"></td> <td style="width: 10%;"></td> <td style="width: 10%;"></td> <td style="width: 10%;"></td> <td style="width: 10%;"></td> <td style="width: 10%;"></td> <td style="width: 10%;"></td> <td style="width: 10%;"></td> </tr> <tr> <td></td> <td></td> <td colspan="8" style="text-align: center;"> <table border="1" style="width: 100%; border-collapse: collapse; text-align: center;"> <tr> <td style="width: 10%;"></td> <td style="width: 10%;"></td> <td style="width: 10%;"></td> <td style="width: 10%;"></td> <td style="width: 10%;"></td> <td style="width: 10%;"></td> <td style="width: 10%;"></td> <td style="width: 10%;"></td> <td style="width: 10%;"></td> <td style="width: 10%;"></td> </tr> <tr> <td></td> <td></td> <td colspan="8" style="text-align: center;"> <table border="1" style="width: 100%; border-collapse: collapse; text-align: center;"> <tr> <td style="width: 10%;"></td> <td style="width: 10%;"></td> <td style="width: 10%;"></td> <td style="width: 10%;"></td> <td style="width: 10%;"></td> <td style="width: 10%;"></td> <td style="width: 10%;"></td> <td style="width: 10%;"></td> <td style="width: 10%;"></td> <td style="width: 10%;"></td> </tr> <tr> <td></td> <td></td> <td colspan="8" style="text-align: center;"> <table border="1" style="width: 100%; border-collapse: collapse; text-align: center;"> <tr> <td style="width: 10%;"></td> <td style="width: 10%;"></td> <td style="width: 10%;"></td> <td style="width: 10%;"></td> <td style="width: 10%;"></td> <td style="width: 10%;"></td> <td style="width: 10%;"></td> <td style="width: 10%;"></td> <td style="width: 10%;"></td> <td style="width: 10%;"></td> </tr> <tr> <td></td> <td></td> <td colspan="8" style="text-align: center;"> <table border="1" style="width: 100%; border-collapse: collapse; text-align: center;"> <tr> <td style="width: 10%;"></td> <td style="width: 10%;"></td> <td style="width: 10%;"></td> <td style="width: 10%;"></td> <td style="width: 10%;"></td> <td style="width: 10%;"></td> <td style="width: 10%;"></td> <td style="width: 10%;"></td> <td style="width: 10%;"></td> <td style="width: 10%;"></td> </tr> <tr> <td></td> <td></td> <td colspan="8" style="text-align: center;"> <table border="1" style="width: 100%; border-collapse: collapse; text-align: center;"> <tr> <td style="width: 10%;"></td> <td style="width: 10%;"></td> <td style="width: 10%;"></td> <td style="width: 10%;"></td> <td style="width: 10%;"></td> <td style="width: 10%;"></td> <td style="width: 10%;"></td> <td style="width: 10%;"></td> <td style="width: 10%;"></td> <td style="width: 10%;"></td> </tr> <tr> <td></td> <td></td> <td colspan="8" style="text-align: center;"> <table border="1" style="width: 100%; border-collapse: collapse; text-align: center;"> <tr> <td style="width: 10%;"></td> <td style="width: 10%;"></td> <td style="width: 10%;"></td> <td style="width: 10%;"></td> <td style="width: 10%;"></td> <td style="width: 10%;"></td> <td style="width: 10%;"></td> <td style="width: 10%;"></td> <td style="width: 10%;"></td> <td style="width: 10%;"></td> </tr> <tr> <td></td> <td></td> <td colspan="8" style="text-align: center;"> <table border="1" style="width: 100%; border-collapse: collapse; text-align: center;"> <tr> <td style="width: 10%;"></td> <td style="width: 10%;"></td> <td style="width: 10%;"></td> <td style="width: 10%;"></td> <td style="width: 10%;"></td> <td style="width: 10%;"></td> <td style="width: 10%;"></td> <td style="width: 10%;"></td> <td style="width: 10%;"></td> <td style="width: 10%;"></td> </tr> <tr> <td></td> <td></td> <td colspan="8" style="text-align: center;"> <table border="1" style="width: 100%; border-collapse: collapse; text-align: center;"> <tr> <td style="width: 10%;"></td> <td style="width: 10%;"></td> <td style="width: 10%;"></td> <td style="width: 10%;"></td> <td style="width: 10%;"></td> <td style="width: 10%;"></td> <td style="width: 10%;"></td> <td style="width: 10%;"></td> <td style="width: 10%;"></td> <td style="width: 10%;"></td> </tr> <tr> <td></td> <td></td> <td colspan="8" style="text-align: center;"> <table border="1" style="width: 100%; border-collapse: collapse; text-align: center;"> <tr> <td style="width: 10%;"></td> <td style="width: 10%;"></td> <td style="width: 10%;"></td> <td style="width: 10%;"></td> <td style="width: 10%;"></td> <td style="width: 10%;"></td> <td style="width: 10%;"></td> <td style="width: 10%;"></td> <td style="width: 10%;"></td> <td style="width: 10%;"></td> </tr> <tr> <td></td> <td></td> <td colspan="8" style="text-align: center;"> <table border="1" style="width: 100%; border-collapse: collapse; text-align: center;"> <tr> <td style="width: 10%;"></td> <td style="width: 10%;"></td> <td style="width: 10%;"></td> <td style="width: 10%;"></td> <td style="width: 10%;"></td> <td style="width: 10%;"></td> <td style="width: 10%;"></td> <td style="width: 10%;"></td> <td style="width: 10%;"></td> <td style="width: 10%;"></td> </tr> <tr> <td></td> <td></td> <td colspan="8" style="text-align: center;"> <table border="1" style="width: 100%; border-collapse: collapse; text-align: center;"> <tr> <td style="width: 10%;"></td> <td style="width: 10%;"></td> <td style="width: 10%;"></td> <td style="width: 10%;"></td> <td style="width: 10%;"></td> <td style="width: 10%;"></td> <td style="width: 10%;"></td> <td style="width: 10%;"></td> <td style="width: 10%;"></td> <td style="width: 10%;"></td> </tr> <tr> <td></td> <td></td> <td colspan="8" style="text-align: center;"> <table border="1"
style="width: 100%; border-collapse: collapse; text-align: center;"> <tr> <td style="width: 10%;"></td> <td style="width: 10%;"></td> <td style="width: 10%;"></td> <td style="width: 10%;"></td> <td style="width: 10%;"></td> <td style="width: 10%;"></td> <td style="width: 10%;"></td> <td style="width: 10%;"></td> <td style="width: 10%;"></td> <td style="width: 10%;"></td> </tr> <tr> <td></td> <td></td> <td colspan="8" style="text-align: center;"> <table border="1" style="width: 100%; border-collapse: collapse; text-align: center;"> <tr> <td style="width: 10%;"></td> <td style="width: 10%;"></td> <td style="width: 10%;"></td> <td style="width: 10%;"></td> <td style="width: 10%;"></td> <td style="width: 10%;"></td> <td style="width: 10%;"></td> <td style="width: 10%;"></td> <td style="width: 10%;"></td> <td style="width: 10%;"></td> </tr> <tr> <td></td> <td></td> <td colspan="8" style="text-align: center;"> <table border="1" style="width: 100%; border-collapse: collapse; text-align: center;"> <tr> </tr></table></td></tr></table></td></tr></table></td></tr></table></td></tr></table></td></tr></table></td></tr></table></td></tr></table></td></tr></table></td></tr></table></td></tr></table></td></tr></table></td></tr></table></td></tr></table></td></tr></table></td></tr></table></td></tr></table></td></tr></table></td></tr></table></td></tr></table></td></tr></table></td></tr></table> | | | | | | | | | | | | | | | | | | | | <table border="1" style="width: 100%; border-collapse: collapse; text-align: center;"> <tr> <td style="width: 10%;"></td> <td style="width: 10%;"></td> <td style="width: 10%;"></td> <td style="width: 10%;"></td> <td style="width: 10%;"></td> <td style="width: 10%;"></td> <td style="width: 10%;"></td> <td style="width: 10%;"></td> <td style="width: 10%;"></td> <td style="width: 10%;"></td> </tr> <tr> <td></td> <td></td> <td colspan="8" style="text-align: center;"> <table border="1" style="width: 100%; border-collapse: collapse; text-align: center;"> <tr> <td style="width: 10%;"></td> <td style="width: 10%;"></td> <td style="width: 10%;"></td> <td style="width: 10%;"></td> <td style="width: 10%;"></td> <td style="width: 10%;"></td> <td style="width: 10%;"></td> <td style="width: 10%;"></td> <td style="width: 10%;"></td> <td style="width: 10%;"></td> </tr> <tr> <td></td> <td></td> <td colspan="8" style="text-align: center;"> <table border="1" style="width: 100%; border-collapse: collapse; text-align: center;"> <tr> <td style="width: 10%;"></td> <td style="width: 10%;"></td> <td style="width: 10%;"></td> <td style="width: 10%;"></td> <td style="width: 10%;"></td> <td style="width: 10%;"></td> <td style="width: 10%;"></td> <td style="width: 10%;"></td> <td style="width: 10%;"></td> <td style="width: 10%;"></td> </tr> <tr> <td></td> <td></td> <td colspan="8" style="text-align: center;"> <table border="1" style="width: 100%; border-collapse: collapse; text-align: center;"> <tr> <td style="width: 10%;"></td> <td style="width: 10%;"></td> <td style="width: 10%;"></td> <td style="width: 10%;"></td> <td style="width: 10%;"></td> <td style="width: 10%;"></td> <td style="width: 10%;"></td> <td style="width: 10%;"></td> <td style="width: 10%;"></td> <td style="width: 10%;"></td> </tr> <tr> <td></td> <td></td> <td colspan="8" style="text-align: center;"> <table border="1" style="width: 100%; border-collapse: collapse; text-align: center;"> <tr> <td style="width: 10%;"></td> <td style="width: 10%;"></td> <td style="width: 10%;"></td> <td style="width: 10%;"></td> <td style="width: 10%;"></td> <td style="width: 10%;"></td> <td style="width: 10%;"></td> <td style="width: 10%;"></td> <td style="width: 10%;"></td> <td style="width: 10%;"></td> </tr> <tr> <td></td> <td></td> <td colspan="8" style="text-align: center;"> <table border="1" style="width: 100%; border-collapse: collapse; text-align: center;"> <tr> <td style="width: 10%;"></td> <td style="width: 10%;"></td> <td style="width: 10%;"></td> <td style="width: 10%;"></td> <td style="width: 10%;"></td> <td style="width: 10%;"></td> <td style="width: 10%;"></td> <td style="width: 10%;"></td> <td style="width: 10%;"></td> <td style="width: 10%;"></td> </tr> <tr> <td></td> <td></td> <td colspan="8" style="text-align: center;"> <table border="1" style="width: 100%; border-collapse: collapse; text-align: center;"> <tr> <td style="width: 10%;"></td> <td style="width: 10%;"></td> <td style="width: 10%;"></td> <td style="width: 10%;"></td> <td style="width: 10%;"></td> <td style="width: 10%;"></td> <td style="width: 10%;"></td> <td style="width: 10%;"></td> <td style="width: 10%;"></td> <td style="width: 10%;"></td> </tr> <tr> <td></td> <td></td> <td colspan="8" style="text-align: center;"> <table border="1" style="width: 100%; border-collapse: collapse; text-align: center;"> <tr> <td style="width: 10%;"></td> <td style="width: 10%;"></td> <td style="width: 10%;"></td> <td style="width: 10%;"></td> <td style="width: 10%;"></td> <td style="width: 10%;"></td> <td style="width: 10%;"></td> <td style="width: 10%;"></td> <td style="width: 10%;"></td> <td style="width: 10%;"></td> </tr> <tr> <td></td> <td></td> <td colspan="8" style="text-align: center;"> <table border="1" style="width: 100%; border-collapse: collapse; text-align: center;"> <tr> <td style="width: 10%;"></td> <td style="width: 10%;"></td> <td style="width: 10%;"></td> <td style="width: 10%;"></td> <td style="width: 10%;"></td> <td style="width: 10%;"></td> <td style="width: 10%;"></td> <td style="width: 10%;"></td> <td style="width: 10%;"></td> <td style="width: 10%;"></td> </tr> <tr> <td></td>
<td></td> <td colspan="8" style="text-align: center;"> <table border="1" style="width: 100%; border-collapse: collapse; text-align: center;"> <tr> <td style="width: 10%;"></td> <td style="width: 10%;"></td> <td style="width: 10%;"></td> <td style="width: 10%;"></td> <td style="width: 10%;"></td> <td style="width: 10%;"></td> <td style="width: 10%;"></td> <td style="width: 10%;"></td> <td style="width: 10%;"></td> <td style="width: 10%;"></td> </tr> <tr> <td></td> <td></td> <td colspan="8" style="text-align: center;"> <table border="1" style="width: 100%; border-collapse: collapse; text-align: center;"> <tr> <td style="width: 10%;"></td> <td style="width: 10%;"></td> <td style="width: 10%;"></td> <td style="width: 10%;"></td> <td style="width: 10%;"></td> <td style="width: 10%;"></td> <td style="width: 10%;"></td> <td style="width: 10%;"></td> <td style="width: 10%;"></td> <td style="width: 10%;"></td> </tr> <tr> <td></td> <td></td> <td colspan="8" style="text-align: center;"> <table border="1" style="width: 100%; border-collapse: collapse; text-align: center;"> <tr> <td style="width: 10%;"></td> <td style="width: 10%;"></td> <td style="width: 10%;"></td> <td style="width: 10%;"></td> <td style="width: 10%;"></td> <td style="width: 10%;"></td> <td style="width: 10%;"></td> <td style="width: 10%;"></td> <td style="width: 10%;"></td> <td style="width: 10%;"></td> </tr> <tr> <td></td> <td></td> <td colspan="8" style="text-align: center;"> <table border="1" style="width: 100%; border-collapse: collapse; text-align: center;"> <tr> <td style="width: 10%;"></td> <td style="width: 10%;"></td> <td style="width: 10%;"></td> <td style="width: 10%;"></td> <td style="width: 10%;"></td> <td style="width: 10%;"></td> <td style="width: 10%;"></td> <td style="width: 10%;"></td> <td style="width: 10%;"></td> <td style="width: 10%;"></td> </tr> <tr> <td></td> <td></td> <td colspan="8" style="text-align: center;"> <table border="1" style="width: 100%; border-collapse: collapse; text-align: center;"> <tr> <td style="width: 10%;"></td> <td style="width: 10%;"></td> <td style="width: 10%;"></td> <td style="width: 10%;"></td> <td style="width: 10%;"></td> <td style="width: 10%;"></td> <td style="width: 10%;"></td> <td style="width: 10%;"></td> <td style="width: 10%;"></td> <td style="width: 10%;"></td> </tr> <tr> <td></td> <td></td> <td colspan="8" style="text-align: center;"> <table border="1" style="width: 100%; border-collapse: collapse; text-align: center;"> <tr> <td style="width: 10%;"></td> <td style="width: 10%;"></td> <td style="width: 10%;"></td> <td style="width: 10%;"></td> <td style="width: 10%;"></td> <td style="width: 10%;"></td> <td style="width: 10%;"></td> <td style="width: 10%;"></td> <td style="width: 10%;"></td> <td style="width: 10%;"></td> </tr> <tr> <td></td> <td></td> <td colspan="8" style="text-align: center;"> <table border="1" style="width: 100%; border-collapse: collapse; text-align: center;"> <tr> <td style="width: 10%;"></td> <td style="width: 10%;"></td> <td style="width: 10%;"></td> <td style="width: 10%;"></td> <td style="width: 10%;"></td> <td style="width: 10%;"></td> <td style="width: 10%;"></td> <td style="width: 10%;"></td> <td style="width: 10%;"></td> <td style="width: 10%;"></td> </tr> <tr> <td></td> <td></td> <td colspan="8" style="text-align: center;"> <table border="1" style="width: 100%; border-collapse: collapse; text-align: center;"> <tr> <td style="width: 10%;"></td> <td style="width: 10%;"></td> <td style="width: 10%;"></td> <td style="width: 10%;"></td> <td style="width: 10%;"></td> <td style="width: 10%;"></td> <td style="width: 10%;"></td> <td style="width: 10%;"></td> <td style="width: 10%;"></td> <td style="width: 10%;"></td> </tr> <tr> <td></td> <td></td> <td colspan="8" style="text-align: center;"> <table border="1" style="width: 100%; border-collapse: collapse; text-align: center;"> <tr> <td style="width: 10%;"></td> <td style="width: 10%;"></td> <td style="width: 10%;"></td> <td style="width: 10%;"></td> <td style="width: 10%;"></td> <td style="width: 10%;"></td> <td style="width: 10%;"></td> <td style="width: 10%;"></td> <td style="width: 10%;"></td> <td style="width: 10%;"></td> </tr> <tr> <td></td> <td></td> <td colspan="8" style="text-align: center;"> <table border="1" style="width: 100%; border-collapse: collapse; text-align: center;"> <tr> <td style="width: 10%;"></td> <td style="width: 10%;"></td> <td style="width: 10%;"></td> <td style="width: 10%;"></td> <td style="width: 10%;"></td> <td style="width: 10%;"></td> <td style="width: 10%;"></td> <td style="width: 10%;"></td> <td style="width: 10%;"></td> <td style="width: 10%;"></td> </tr> <tr> <td></td> <td></td> <td colspan="8" style="text-align: center;"> <table border="1" style="width: 100%; border-collapse: collapse; text-align: center;"> <tr> <td style="width: 10%;"></td> <td style="width: 10%;"></td> <td style="width: 10%;"></td> <td style="width: 10%;"></td> <td style="width: 10%;"></td> <td style="width: 10%;"></td> <td style="width: 10%;"></td> <td style="width: 10%;"></td> <td style="width: 10%;"></td> <td style="width: 10%;"></td> </tr> <tr> <td></td> <td></td> <td colspan="8" style="text-align: center;"> <table border="1" style="width: 100%; border-collapse: collapse; text-align: center;"> <tr> </tr></table></td></tr></table></td></tr></table></td></tr></table></td></tr></table></td></tr></table></td></tr></table></td></tr></table></td></tr></table></td></tr></table></td></tr></table></td></tr></table></td></tr></table></td></tr></table></td></tr></table></td></tr></table></td></tr></table></td></tr></table></td></tr></table></td></tr></table></td></tr></table>
 | | | | | | | | | | | | | | | | | | | | <table border="1" style="width: 100%; border-collapse: collapse; text-align: center;"> <tr> <td style="width: 10%;"></td> <td style="width: 10%;"></td> <td style="width: 10%;"></td> <td style="width: 10%;"></td> <td style="width: 10%;"></td> <td style="width: 10%;"></td> <td style="width: 10%;"></td> <td style="width: 10%;"></td> <td style="width: 10%;"></td> <td style="width: 10%;"></td> </tr> <tr> <td></td> <td></td> <td colspan="8" style="text-align: center;"> <table border="1" style="width: 100%; border-collapse: collapse; text-align: center;"> <tr> <td style="width: 10%;"></td> <td style="width: 10%;"></td> <td style="width: 10%;"></td> <td style="width: 10%;"></td> <td style="width: 10%;"></td> <td style="width: 10%;"></td> <td style="width: 10%;"></td> <td style="width: 10%;"></td> <td style="width: 10%;"></td> <td style="width: 10%;"></td> </tr> <tr> <td></td> <td></td> <td colspan="8" style="text-align: center;"> <table border="1" style="width: 100%; border-collapse: collapse; text-align: center;"> <tr> <td style="width: 10%;"></td> <td style="width: 10%;"></td> <td style="width: 10%;"></td> <td style="width: 10%;"></td> <td style="width: 10%;"></td> <td style="width: 10%;"></td> <td style="width: 10%;"></td> <td style="width: 10%;"></td> <td style="width: 10%;"></td> <td style="width: 10%;"></td> </tr> <tr> <td></td> <td></td> <td colspan="8" style="text-align: center;"> <table border="1" style="width: 100%; border-collapse: collapse; text-align: center;"> <tr> <td style="width: 10%;"></td> <td style="width: 10%;"></td> <td style="width: 10%;"></td> <td style="width: 10%;"></td> <td style="width: 10%;"></td> <td style="width: 10%;"></td> <td style="width: 10%;"></td> <td style="width: 10%;"></td> <td style="width: 10%;"></td> <td style="width: 10%;"></td> </tr> <tr> <td></td> <td></td> <td colspan="8" style="text-align: center;"> <table border="1" style="width: 100%; border-collapse: collapse; text-align: center;"> <tr> <td style="width: 10%;"></td> <td style="width: 10%;"></td> <td style="width: 10%;"></td> <td style="width: 10%;"></td> <td style="width: 10%;"></td> <td style="width: 10%;"></td> <td style="width: 10%;"></td> <td style="width: 10%;"></td> <td style="width: 10%;"></td> <td style="width: 10%;"></td> </tr> <tr> <td></td> <td></td> <td colspan="8" style="text-align: center;"> <table border="1" style="width: 100%; border-collapse: collapse; text-align: center;"> <tr> <td style="width: 10%;"></td> <td style="width: 10%;"></td> <td style="width: 10%;"></td> <td style="width: 10%;"></td> <td style="width: 10%;"></td> <td style="width: 10%;"></td> <td style="width: 10%;"></td> <td style="width: 10%;"></td> <td style="width: 10%;"></td> <td style="width: 10%;"></td> </tr> <tr> <td></td> <td></td> <td colspan="8" style="text-align: center;"> <table border="1" style="width: 100%; border-collapse: collapse; text-align: center;"> <tr> <td style="width: 10%;"></td> <td style="width: 10%;"></td> <td style="width: 10%;"></td> <td style="width: 10%;"></td> <td style="width: 10%;"></td> <td style="width: 10%;"></td> <td style="width: 10%;"></td> <td style="width: 10%;"></td> <td style="width: 10%;"></td> <td style="width: 10%;"></td> </tr> <tr> <td></td> <td></td> <td colspan="8" style="text-align: center;"> <table border="1" style="width: 100%; border-collapse: collapse; text-align: center;"> <tr> <td style="width: 10%;"></td> <td style="width: 10%;"></td> <td style="width: 10%;"></td> <td style="width: 10%;"></td> <td style="width: 10%;"></td> <td style="width: 10%;"></td> <td style="width: 10%;"></td> <td style="width: 10%;"></td> <td style="width: 10%;"></td> <td style="width: 10%;"></td> </tr> <tr> <td></td> <td></td> <td colspan="8" style="text-align: center;"> <table border="1" style="width: 100%; border-collapse: collapse; text-align: center;"> <tr> <td style="width: 10%;"></td> <td style="width: 10%;"></td> <td style="width: 10%;"></td> <td style="width: 10%;"></td> <td style="width: 10%;"></td> <td style="width: 10%;"></td> <td style="width: 10%;"></td> <td style="width: 10%;"></td> <td style="width: 10%;"></td> <td style="width: 10%;"></td> </tr> <tr> <td></td> <td></td> <td colspan="8" style="text-align: center;"> <table border="1" style="width: 100%; border-collapse: collapse; text-align: center;"> <tr> <td style="width: 10%;"></td> <td style="width: 10%;"></td> <td style="width: 10%;"></td> <td style="width: 10%;"></td> <td style="width: 10%;"></td> <td style="width: 10%;"></td> <td style="width: 10%;"></td> <td style="width: 10%;"></td> <td style="width: 10%;"></td> <td style="width: 10%;"></td> </tr> <tr> <td></td> <td></td> <td colspan="8" style="text-align: center;"> <table border="1" style="width: 100%; border-collapse: collapse; text-align: center;"> <tr> <td style="width: 10%;"></td> <td style="width: 10%;"></td> <td style="width: 10%;"></td> <td style="width: 10%;"></td> <td style="width: 10%;"></td> <td style="width: 10%;"></td> <td style="width: 10%;"></td> <td style="width: 10%;"></td> <td style="width: 10%;"></td> <td style="width: 10%;"></td> </tr> <tr> <td></td> <td></td> <td colspan="8" style="text-align: center;"> <table border="1" style="width: 100%; border-collapse: collapse; text-align: center;"> <tr> <td style="width: 10%;"></td> <td style="width: 10%;"></td> <td style="width: 10%;"></td> <td style="width: 10%;"></td> <td style="width: 10%;"></td> <td style="width: 10%;"></td> <td style="width: 10%;"></td> <td style="width: 10%;"></td> <td style="width: 10%;"></td> <td style="width: 10%;"></td> </tr> <tr> <td></td> <td></td> <td colspan="8" style="text-align: center;"> <table border="1" style="width: 100%; border-collapse: collapse; text-align: center;"> <tr> <td style="width: 10%;"></td> <td style="width: 10%;"></td> <td style="width: 10%;"></td> <td style="width: 10%;"></td> <td style="width: 10%;"></td> <td style="width: 10%;"></td> <td style="width: 10%;"></td> <td style="width: 10%;"></td> <td style="width: 10%;"></td> <td style="width: 10%;"></td> </tr> <tr> <td></td> <td></td> <td colspan="8" style="text-align: center;"> <table border="1" style="width: 100%; border-collapse: collapse; text-align: center;"> <tr> <td style="width: 10%;"></td> <td style="width: 10%;"></td> <td style="width: 10%;"></td> <td style="width: 10%;"></td> <td style="width: 10%;"></td> <td style="width: 10%;"></td> <td style="width: 10%;"></td> <td style="width: 10%;"></td> <td style="width: 10%;"></td> <td style="width: 10%;"></td> </tr> <tr> <td></td> <td></td> <td colspan="8" style="text-align: center;"> <table border="1" style="width: 100%; border-collapse: collapse; text-align: center;"> <tr> <td style="width: 10%;"></td> <td style="width: 10%;"></td> <td style="width: 10%;"></td> <td style="width: 10%;"></td> <td style="width: 10%;"></td> <td style="width: 10%;"></td> <td style="width: 10%;"></td> <td style="width: 10%;"></td> <td style="width: 10%;"></td> <td style="width: 10%;"></td> </tr> <tr> <td></td> <td></td> <td colspan="8" style="text-align: center;"> <table border="1" style="width: 100%; border-collapse: collapse; text-align: center;"> <tr> <td style="width: 10%;"></td> <td style="width: 10%;"></td> <td style="width: 10%;"></td> <td style="width: 10%;"></td> <td style="width: 10%;"></td> <td style="width: 10%;"></td> <td style="width: 10%;"></td> <td style="width: 10%;"></td> <td style="width: 10%;"></td> <td style="width: 10%;"></td> </tr> <tr> <td></td> <td></td> <td colspan="8" style="text-align: center;"> <table border="1" style="width: 100%; border-collapse: collapse; text-align: center;"> <tr> <td style="width: 10%;"></td> <td style="width: 10%;"></td> <td style="width: 10%;"></td> <td style="width: 10%;"></td> <td style="width: 10%;"></td> <td style="width: 10%;"></td> <td style="width: 10%;"></td> <td style="width: 10%;"></td> <td style="width: 10%;"></td> <td style="width: 10%;"></td> </tr> <tr> <td></td> <td></td> <td colspan="8" style="text-align: center;"> <table border="1" style="width: 100%; border-collapse: collapse; text-align: center;"> <tr> <td style="width: 10%;"></td> <td style="width: 10%;"></td> <td style="width: 10%;"></td> <td style="width: 10%;"></td> <td style="width: 10%;"></td> <td style="width: 10%;"></td> <td style="width: 10%;"></td> <td style="width: 10%;"></td> <td style="width: 10%;"></td> <td style="width: 10%;"></td> </tr> <tr> <td></td> <td></td> <td colspan="8" style="text-align: center;"> <table border="1" style="width: 100%; border-collapse: collapse; text-align: center;"> <tr> <td style="width: 10%;"></td> <td style="width: 10%;"></td> <td style="width: 10%;"></td> <td style="width: 10%;"></td> <td style="width: 10%;"></td> <td style="width: 10%;"></td> <td style="width: 10%;"></td> <td style="width: 10%;"></td> <td style="width: 10%;"></td> <td style="width: 10%;"></td> </tr> <tr> <td></td> <td></td> <td colspan="8" style="text-align: center;"> <table border="1" style="width: 100%; border-collapse: collapse; text-align: center;"> <tr> </tr></table></td></tr></table></td></tr></table></td></tr></table></td></tr></table></td></tr></table></td></tr></table></td></tr></table></td></tr></table></td></tr></table></td></tr></table></td></tr></table></td></tr></table></td></tr></table></td></tr></table></td></tr></table></td></tr></table></td></tr></table></td></tr></table></td></tr></table>
 | | | | | | | | | | | | | | | | | | | | <table border="1" style="width: 100%; border-collapse: collapse; text-align: center;"> <tr> <td style="width: 10%;"></td> <td style="width: 10%;"></td> <td style="width: 10%;"></td> <td style="width: 10%;"></td> <td style="width: 10%;"></td> <td style="width: 10%;"></td> <td style="width: 10%;"></td> <td style="width: 10%;"></td> <td style="width: 10%;"></td> <td style="width: 10%;"></td> </tr> <tr> <td></td> <td></td> <td colspan="8" style="text-align: center;"> <table border="1" style="width: 100%; border-collapse: collapse; text-align: center;"> <tr> <td style="width: 10%;"></td> <td style="width: 10%;"></td> <td style="width: 10%;"></td> <td style="width: 10%;"></td> <td style="width: 10%;"></td> <td style="width: 10%;"></td> <td style="width: 10%;"></td> <td style="width: 10%;"></td> <td style="width: 10%;"></td> <td style="width: 10%;"></td> </tr> <tr> <td></td> <td></td> <td colspan="8" style="text-align: center;"> <table border="1" style="width: 100%; border-collapse: collapse; text-align: center;"> <tr> <td style="width: 10%;"></td> <td style="width: 10%;"></td> <td style="width: 10%;"></td> <td style="width: 10%;"></td> <td style="width: 10%;"></td> <td style="width: 10%;"></td> <td style="width: 10%;"></td> <td style="width: 10%;"></td> <td style="width: 10%;"></td> <td style="width: 10%;"></td> </tr> <tr> <td></td> <td></td> <td colspan="8" style="text-align: center;"> <table border="1" style="width: 100%; border-collapse: collapse; text-align: center;"> <tr> <td style="width: 10%;"></td> <td style="width: 10%;"></td> <td style="width: 10%;"></td> <td style="width: 10%;"></td> <td style="width: 10%;"></td> <td style="width: 10%;"></td> <td style="width: 10%;"></td> <td style="width: 10%;"></td> <td style="width: 10%;"></td> <td style="width: 10%;"></td> </tr> <tr> <td></td> <td></td> <td colspan="8" style="text-align: center;"> <table border="1" style="width: 100%; border-collapse: collapse; text-align: center;"> <tr> <td style="width: 10%;"></td> <td style="width: 10%;"></td> <td style="width: 10%;"></td> <td style="width: 10%;"></td> <td style="width: 10%;"></td> <td style="width: 10%;"></td> <td style="width: 10%;"></td> <td style="width: 10%;"></td> <td style="width: 10%;"></td> <td style="width: 10%;"></td> </tr> <tr> <td></td> <td></td> <td colspan="8" style="text-align: center;"> <table border="1" style="width: 100%; border-collapse: collapse; text-align: center;"> <tr> <td style="width: 10%;"></td> <td style="width: 10%;"></td> <td style="width: 10%;"></td> <td style="width: 10%;"></td> <td style="width: 10%;"></td> <td style="width: 10%;"></td> <td style="width: 10%;"></td> <td style="width: 10%;"></td> <td style="width: 10%;"></td> <td style="width: 10%;"></td> </tr> <tr> <td></td> <td></td> <td colspan="8" style="text-align: center;"> <table border="1" style="width: 100%; border-collapse: collapse; text-align: center;"> <tr> <td style="width: 10%;"></td> <td style="width: 10%;"></td> <td style="width: 10%;"></td> <td style="width: 10%;"></td> <td style="width: 10%;"></td> <td style="width: 10%;"></td> <td style="width: 10%;"></td> <td style="width: 10%;"></td> <td style="width: 10%;"></td> <td style="width: 10%;"></td> </tr> <tr> <td></td> <td></td> <td colspan="8" style="text-align: center;"> <table border="1" style="width: 100%; border-collapse: collapse; text-align: center;"> <tr> <td style="width: 10%;"></td> <td style="width: 10%;"></td> <td style="width: 10%;"></td> <td style="width: 10%;"></td> <td style="width: 10%;"></td> <td style="width: 10%;"></td> <td style="width: 10%;"></td> <td style="width: 10%;"></td> <td style="width: 10%;"></td> <td style="width: 10%;"></td> </tr> <tr> <td></td> <td></td> <td colspan="8" style="text-align: center;"> <table border="1" style="width: 100%; border-collapse: collapse; text-align: center;"> <tr> <td style="width: 10%;"></td> <td style="width: 10%;"></td> <td style="width: 10%;"></td> <td style="width: 10%;"></td> <td style="width: 10%;"></td> <td style="width: 10%;"></td> <td style="width: 10%;"></td> <td style="width: 10%;"></td> <td style="width: 10%;"></td> <td style="width: 10%;"></td> </tr> <tr> <td></td> <td></td> <td colspan="8" style="text-align: center;"> <table border="1" style="width: 100%; border-collapse: collapse; text-align: center;"> <tr> <td style="width: 10%;"></td> <td style="width: 10%;"></td> <td style="width: 10%;"></td> <td style="width: 10%;"></td> <td style="width: 10%;"></td> <td style="width: 10%;"></td> <td style="width: 10%;"></td> <td style="width: 10%;"></td> <td style="width: 10%;"></td> <td style="width: 10%;"></td> </tr> <tr> <td></td> <td></td> <td colspan="8" style="text-align: center;"> <table border="1" style="width: 100%; border-collapse: collapse; text-align: center;"> <tr> <td style="width: 10%;"></td> <td style="width: 10%;"></td> <td style="width: 10%;"></td> <td style="width: 10%;"></td> <td style="width: 10%;"></td> <td style="width: 10%;"></td> <td style="width: 10%;"></td> <td style="width: 10%;"></td> <td style="width: 10%;"></td> <td style="width: 10%;"></td> </tr> <tr> <td></td> <td></td> <td colspan="8" style="text-align: center;"> <table border="1" style="width: 100%; border-collapse: collapse; text-align: center;"> <tr> <td style="width: 10%;"></td> <td style="width: 10%;"></td> <td style="width: 10%;"></td> <td style="width: 10%;"></td> <td style="width: 10%;"></td> <td style="width: 10%;"></td> <td style="width: 10%;"></td> <td style="width: 10%;"></td> <td style="width: 10%;"></td> <td style="width: 10%;"></td> </tr> <tr> <td></td> <td></td> <td colspan="8" style="text-align: center;"> <table border="1" style="width: 100%; border-collapse: collapse; text-align: center;"> <tr> <td style="width: 10%;"></td> <td style="width: 10%;"></td> <td style="width: 10%;"></td> <td style="width: 10%;"></td> <td style="width: 10%;"></td> <td style="width: 10%;"></td> <td style="width: 10%;"></td> <td style="width: 10%;"></td> <td style="width: 10%;"></td> <td style="width: 10%;"></td> </tr> <tr> <td></td> <td></td> <td colspan="8" style="text-align: center;"> <table border="1" style="width: 100%;
border-collapse: collapse; text-align: center;"> <tr> <td style="width: 10%;"></td> <td style="width: 10%;"></td> <td style="width: 10%;"></td> <td style="width: 10%;"></td> <td style="width: 10%;"></td> <td style="width: 10%;"></td> <td style="width: 10%;"></td> <td style="width: 10%;"></td> <td style="width: 10%;"></td> <td style="width: 10%;"></td> </tr> <tr> <td></td> <td></td> <td colspan="8" style="text-align: center;"> <table border="1" style="width: 100%; border-collapse: collapse; text-align: center;"> <tr> <td style="width: 10%;"></td> <td style="width: 10%;"></td> <td style="width: 10%;"></td> <td style="width: 10%;"></td> <td style="width: 10%;"></td> <td style="width: 10%;"></td> <td style="width: 10%;"></td> <td style="width: 10%;"></td> <td style="width: 10%;"></td> <td style="width: 10%;"></td> </tr> <tr> <td></td> <td></td> <td colspan="8" style="text-align: center;"> <table border="1" style="width: 100%; border-collapse: collapse; text-align: center;"> <tr> <td style="width: 10%;"></td> <td style="width: 10%;"></td> <td style="width: 10%;"></td> <td style="width: 10%;"></td> <td style="width: 10%;"></td> <td style="width: 10%;"></td> <td style="width: 10%;"></td> <td style="width: 10%;"></td> <td style="width: 10%;"></td> <td style="width: 10%;"></td> </tr> <tr> <td></td> <td></td> <td colspan="8" style="text-align: center;"> <table border="1" style="width: 100%; border-collapse: collapse; text-align: center;"> <tr> <td style="width: 10%;"></td> <td style="width: 10%;"></td> <td style="width: 10%;"></td> <td style="width: 10%;"></td> <td style="width: 10%;"></td> <td style="width: 10%;"></td> <td style="width: 10%;"></td> <td style="width: 10%;"></td> <td style="width: 10%;"></td> <td style="width: 10%;"></td> </tr> <tr> <td></td> <td></td> <td colspan="8" style="text-align: center;"> <table border="1" style="width: 100%; border-collapse: collapse; text-align: center;"> <tr> <td style="width: 10%;"></td> <td style="width: 10%;"></td> <td style="width: 10%;"></td> <td style="width: 10%;"></td> <td style="width: 10%;"></td> <td style="width: 10%;"></td> <td style="width: 10%;"></td> <td style="width: 10%;"></td> <td style="width: 10%;"></td> <td style="width: 10%;"></td> </tr> <tr> <td></td> <td></td> <td colspan="8" style="text-align: center;"> <table border="1" style="width: 100%; border-collapse: collapse; text-align: center;"> <tr> </tr></table></td></tr></table></td></tr></table></td></tr></table></td></tr></table></td></tr></table></td></tr></table></td></tr></table></td></tr></table></td></tr></table></td></tr></table></td></tr></table></td></tr></table></td></tr></table></td></tr></table></td></tr></table></td></tr></table></td></tr></table></td></tr></table> | | | | | | | | | | | | | | | | | | | | <table border="1" style="width: 100%; border-collapse: collapse; text-align: center;"> <tr> <td style="width: 10%;"></td> <td style="width: 10%;"></td> <td style="width: 10%;"></td> <td style="width: 10%;"></td> <td style="width: 10%;"></td> <td style="width: 10%;"></td> <td style="width: 10%;"></td> <td style="width: 10%;"></td> <td style="width: 10%;"></td> <td style="width: 10%;"></td> </tr> <tr> <td></td> <td></td> <td colspan="8" style="text-align: center;"> <table border="1" style="width: 100%; border-collapse: collapse; text-align: center;"> <tr> <td style="width: 10%;"></td> <td style="width: 10%;"></td> <td style="width: 10%;"></td> <td style="width: 10%;"></td> <td style="width: 10%;"></td> <td style="width: 10%;"></td> <td style="width: 10%;"></td> <td style="width: 10%;"></td> <td style="width: 10%;"></td> <td style="width: 10%;"></td> </tr> <tr> <td></td> <td></td> <td colspan="8" style="text-align: center;"> <table border="1" style="width: 100%; border-collapse: collapse; text-align: center;"> <tr> <td style="width: 10%;"></td> <td style="width: 10%;"></td> <td style="width: 10%;"></td> <td style="width: 10%;"></td> <td style="width: 10%;"></td> <td style="width: 10%;"></td> <td style="width: 10%;"></td> <td style="width: 10%;"></td> <td style="width: 10%;"></td> <td style="width: 10%;"></td> </tr> <tr> <td></td> <td></td> <td colspan="8" style="text-align: center;"> <table border="1" style="width: 100%; border-collapse: collapse; text-align: center;"> <tr> <td style="width: 10%;"></td> <td style="width: 10%;"></td> <td style="width: 10%;"></td> <td style="width: 10%;"></td> <td style="width: 10%;"></td> <td style="width: 10%;"></td> <td style="width: 10%;"></td> <td style="width: 10%;"></td> <td style="width: 10%;"></td> <td style="width: 10%;"></td> </tr> <tr> <td></td> <td></td> <td colspan="8" style="text-align: center;"> <table border="1" style="width: 100%; border-collapse: collapse; text-align: center;"> <tr> <td style="width: 10%;"></td> <td style="width: 10%;"></td> <td style="width: 10%;"></td> <td style="width: 10%;"></td> <td style="width: 10%;"></td> <td style="width: 10%;"></td> <td style="width: 10%;"></td> <td style="width: 10%;"></td> <td style="width: 10%;"></td> <td style="width: 10%;"></td> </tr> <tr> <td></td> <td></td> <td colspan="8" style="text-align: center;"> <table border="1" style="width: 100%; border-collapse: collapse; text-align: center;"> <tr> <td style="width: 10%;"></td> <td style="width: 10%;"></td> <td style="width: 10%;"></td> <td style="width: 10%;"></td> <td style="width: 10%;"></td> <td style="width: 10%;"></td> <td style="width: 10%;"></td> <td style="width: 10%;"></td> <td style="width: 10%;"></td> <td style="width: 10%;"></td> </tr> <tr> <td></td> <td></td> <td colspan="8" style="text-align: center;"> <table border="1"
style="width: 100%; border-collapse: collapse; text-align: center;"> <tr> <td style="width: 10%;"></td> <td style="width: 10%;"></td> <td style="width: 10%;"></td> <td style="width: 10%;"></td> <td style="width: 10%;"></td> <td style="width: 10%;"></td> <td style="width: 10%;"></td> <td style="width: 10%;"></td> <td style="width: 10%;"></td> <td style="width: 10%;"></td> </tr> <tr> <td></td> <td></td> <td colspan="8" style="text-align: center;"> <table border="1" style="width: 100%; border-collapse: collapse; text-align: center;"> <tr> <td style="width: 10%;"></td> <td style="width: 10%;"></td> <td style="width: 10%;"></td> <td style="width: 10%;"></td> <td style="width: 10%;"></td> <td style="width: 10%;"></td> <td style="width: 10%;"></td> <td style="width: 10%;"></td> <td style="width: 10%;"></td> <td style="width: 10%;"></td> </tr> <tr> <td></td> <td></td> <td colspan="8" style="text-align: center;"> <table border="1" style="width: 100%; border-collapse: collapse; text-align: center;"> <tr> <td style="width: 10%;"></td> <td style="width: 10%;"></td> <td style="width: 10%;"></td> <td style="width: 10%;"></td> <td style="width: 10%;"></td> <td style="width: 10%;"></td> <td style="width: 10%;"></td> <td style="width: 10%;"></td> <td style="width: 10%;"></td> <td style="width: 10%;"></td> </tr> <tr> <td></td> <td></td> <td colspan="8" style="text-align: center;"> <table border="1" style="width: 100%; border-collapse: collapse; text-align: center;"> <tr> <td style="width: 10%;"></td> <td style="width: 10%;"></td> <td style="width: 10%;"></td> <td style="width: 10%;"></td> <td style="width: 10%;"></td> <td style="width: 10%;"></td> <td style="width: 10%;"></td> <td style="width: 10%;"></td> <td style="width: 10%;"></td> <td style="width: 10%;"></td> </tr> <tr> <td></td> <td></td> <td colspan="8" style="text-align: center;"> <table border="1" style="width: 100%; border-collapse: collapse; text-align: center;"> <tr> <td style="width: 10%;"></td> <td style="width: 10%;"></td> <td style="width: 10%;"></td> <td style="width: 10%;"></td> <td style="width: 10%;"></td> <td style="width: 10%;"></td> <td style="width: 10%;"></td> <td style="width: 10%;"></td> <td style="width: 10%;"></td> <td style="width: 10%;"></td> </tr> <tr> <td></td> <td></td> <td colspan="8" style="text-align: center;"> <table border="1" style="width: 100%; border-collapse: collapse; text-align: center;"> <tr> <td style="width: 10%;"></td> <td style="width: 10%;"></td> <td style="width: 10%;"></td> <td style="width: 10%;"></td> <td style="width: 10%;"></td> <td style="width: 10%;"></td> <td style="width: 10%;"></td> <td style="width: 10%;"></td> <td style="width: 10%;"></td> <td style="width: 10%;"></td> </tr> <tr> <td></td> <td></td> <td colspan="8" style="text-align: center;"> <table border="1" style="width: 100%; border-collapse: collapse; text-align: center;"> <tr> <td style="width: 10%;"></td> <td style="width: 10%;"></td> <td style="width: 10%;"></td> <td style="width: 10%;"></td> <td style="width: 10%;"></td> <td style="width: 10%;"></td> <td style="width: 10%;"></td> <td style="width: 10%;"></td> <td style="width: 10%;"></td> <td style="width: 10%;"></td> </tr> <tr> <td></td> <td></td> <td colspan="8" style="text-align: center;"> <table border="1" style="width: 100%; border-collapse: collapse; text-align: center;"> <tr> <td style="width: 10%;"></td> <td style="width: 10%;"></td> <td style="width: 10%;"></td> <td style="width: 10%;"></td> <td style="width: 10%;"></td> <td style="width: 10%;"></td> <td style="width: 10%;"></td> <td style="width: 10%;"></td> <td style="width: 10%;"></td> <td style="width: 10%;"></td> </tr> <tr> <td></td> <td></td> <td colspan="8" style="text-align: center;"> <table border="1" style="width: 100%; border-collapse: collapse; text-align: center;"> <tr> <td style="width: 10%;"></td> <td style="width: 10%;"></td> <td style="width: 10%;"></td> <td style="width: 10%;"></td> <td style="width: 10%;"></td> <td style="width: 10%;"></td> <td style="width: 10%;"></td> <td style="width: 10%;"></td> <td style="width: 10%;"></td> <td style="width: 10%;"></td> </tr> <tr> <td></td> <td></td> <td colspan="8" style="text-align: center;"> <table border="1" style="width: 100%; border-collapse: collapse; text-align: center;"> <tr> <td style="width: 10%;"></td> <td style="width: 10%;"></td> <td style="width: 10%;"></td> <td style="width: 10%;"></td> <td style="width: 10%;"></td> <td style="width: 10%;"></td> <td style="width: 10%;"></td> <td style="width: 10%;"></td> <td style="width: 10%;"></td> <td style="width: 10%;"></td> </tr> <tr> <td></td> <td></td> <td colspan="8" style="text-align: center;"> <table border="1" style="width: 100%; border-collapse: collapse; text-align: center;"> <tr> <td style="width: 10%;"></td> <td style="width: 10%;"></td> <td style="width: 10%;"></td> <td style="width: 10%;"></td> <td style="width: 10%;"></td> <td style="width: 10%;"></td> <td style="width: 10%;"></td> <td style="width: 10%;"></td> <td style="width: 10%;"></td> <td style="width: 10%;"></td> </tr> <tr> <td></td> <td></td> <td colspan="8" style="text-align: center;"> <table border="1" style="width: 100%; border-collapse: collapse; text-align: center;"> <tr> </tr></table></td></tr></table></td></tr></table></td></tr></table></td></tr></table></td></tr></table></td></tr></table></td></tr></table></td></tr></table></td></tr></table></td></tr></table></td></tr></table></td></tr></table></td></tr></table></td></tr></table></td></tr></table></td></tr></table></td></tr></table> | | | | | | | | | | | | | | | | | | | | <table border="1"
style="width: 100%; border-collapse: collapse; text-align: center;"> <tr> <td style="width: 10%;"></td> <td style="width: 10%;"></td> <td style="width: 10%;"></td> <td style="width: 10%;"></td> <td style="width: 10%;"></td> <td style="width: 10%;"></td> <td style="width: 10%;"></td> <td style="width: 10%;"></td> <td style="width: 10%;"></td> <td style="width: 10%;"></td> </tr> <tr> <td></td> <td></td> <td colspan="8" style="text-align: center;"> <table border="1" style="width: 100%; border-collapse: collapse; text-align: center;"> <tr> <td style="width: 10%;"></td> <td style="width: 10%;"></td> <td style="width: 10%;"></td> <td style="width: 10%;"></td> <td style="width: 10%;"></td> <td style="width: 10%;"></td> <td style="width: 10%;"></td> <td style="width: 10%;"></td> <td style="width: 10%;"></td> <td style="width: 10%;"></td> </tr> <tr> <td></td> <td></td> <td colspan="8" style="text-align: center;"> <table border="1" style="width: 100%; border-collapse: collapse; text-align: center;"> <tr> <td style="width: 10%;"></td> <td style="width: 10%;"></td> <td style="width: 10%;"></td> <td style="width: 10%;"></td> <td style="width: 10%;"></td> <td style="width: 10%;"></td> <td style="width: 10%;"></td> <td style="width: 10%;"></td> <td style="width: 10%;"></td> <td style="width: 10%;"></td> </tr> <tr> <td></td> <td></td> <td colspan="8" style="text-align: center;"> <table border="1" style="width: 100%; border-collapse: collapse; text-align: center;"> <tr> <td style="width: 10%;"></td> <td style="width: 10%;"></td> <td style="width: 10%;"></td> <td style="width: 10%;"></td> <td style="width: 10%;"></td> <td style="width: 10%;"></td> <td style="width: 10%;"></td> <td style="width: 10%;"></td> <td style="width: 10%;"></td> <td style="width: 10%;"></td> </tr> <tr> <td></td> <td></td> <td colspan="8" style="text-align: center;"> <table border="1" style="width: 100%; border-collapse: collapse; text-align: center;"> <tr> <td style="width: 10%;"></td> <td style="width: 10%;"></td> <td style="width: 10%;"></td> <td style="width: 10%;"></td> <td style="width: 10%;"></td> <td style="width: 10%;"></td> <td style="width: 10%;"></td> <td style="width: 10%;"></td> <td style="width: 10%;"></td> <td style="width: 10%;"></td> </tr> <tr> <td></td> <td></td> <td colspan="8" style="text-align: center;"> <table border="1" style="width: 100%; border-collapse: collapse; text-align: center;"> <tr> <td style="width: 10%;"></td> <td style="width: 10%;"></td> <td style="width: 10%;"></td> <td style="width: 10%;"></td> <td style="width: 10%;"></td> <td style="width: 10%;"></td> <td style="width: 10%;"></td> <td style="width: 10%;"></td> <td style="width: 10%;"></td> <td style="width: 10%;"></td> </tr> <tr> <td></td> <td></td> <td colspan="8" style="text-align: center;"> <table border="1" style="width: 100%; border-collapse: collapse; text-align: center;"> <tr> <td style="width: 10%;"></td> <td style="width: 10%;"></td> <td style="width: 10%;"></td> <td style="width: 10%;"></td> <td style="width: 10%;"></td> <td style="width: 10%;"></td> <td style="width: 10%;"></td> <td style="width: 10%;"></td> <td style="width: 10%;"></td> <td style="width: 10%;"></td> </tr> <tr> <td></td> <td></td> <td colspan="8" style="text-align: center;"> <table border="1" style="width: 100%; border-collapse: collapse; text-align: center;"> <tr> <td style="width: 10%;"></td> <td style="width: 10%;"></td> <td style="width: 10%;"></td> <td style="width: 10%;"></td> <td style="width: 10%;"></td> <td style="width: 10%;"></td> <td style="width: 10%;"></td> <td style="width: 10%;"></td> <td style="width: 10%;"></td> <td style="width: 10%;"></td> </tr> <tr> <td></td> <td></td> <td colspan="8" style="text-align: center;"> <table border="1" style="width: 100%; border-collapse: collapse; text-align: center;"> <tr> <td style="width: 10%;"></td> <td style="width: 10%;"></td> <td style="width: 10%;"></td> <td style="width: 10%;"></td> <td style="width: 10%;"></td> <td style="width: 10%;"></td> <td style="width: 10%;"></td> <td style="width: 10%;"></td> <td style="width: 10%;"></td> <td style="width: 10%;"></td> </tr> <tr> <td></td> <td></td> <td colspan="8" style="text-align: center;"> <table border="1" style="width: 100%; border-collapse: collapse; text-align: center;"> <tr> <td style="width: 10%;"></td> <td style="width: 10%;"></td> <td style="width: 10%;"></td> <td style="width: 10%;"></td> <td style="width: 10%;"></td> <td style="width: 10%;"></td> <td style="width: 10%;"></td> <td style="width: 10%;"></td> <td style="width: 10%;"></td> <td style="width: 10%;"></td> </tr> <tr> <td></td> <td></td> <td colspan="8" style="text-align: center;"> <table border="1" style="width: 100%; border-collapse: collapse; text-align: center;"> <tr> <td style="width: 10%;"></td> <td style="width: 10%;"></td> <td style="width: 10%;"></td> <td style="width: 10%;"></td> <td style="width: 10%;"></td> <td style="width: 10%;"></td> <td style="width: 10%;"></td> <td style="width: 10%;"></td> <td style="width: 10%;"></td> <td style="width: 10%;"></td> </tr> <tr> <td></td> <td></td> <td colspan="8" style="text-align: center;"> <table border="1" style="width: 100%; border-collapse: collapse; text-align: center;"> <tr> <td style="width: 10%;"></td> <td style="width: 10%;"></td> <td style="width: 10%;"></td> <td style="width: 10%;"></td> <td style="width: 10%;"></td> <td style="width: 10%;"></td> <td style="width: 10%;"></td> <td style="width: 10%;"></td> <td style="width: 10%;"></td> <td style="width: 10%;"></td> </tr> <tr> <td></td> <td></td> <td colspan="8" style="text-align: center;"> <table border="1" style="width: 100%; border-collapse: collapse; text-align: center;"> <tr> <td style="width: 10%;"></td> <td style="width: 10%;"></td> <td style="width: 10%;"></td> <td style="width: 10%;"></td> <td style="width: 10%;"></td> <td style="width: 10%;"></td> <td style="width: 10%;"></td> <td style="width: 10%;"></td> <td style="width: 10%;"></td> <td style="width: 10%;"></td> </tr> <tr> <td></td> <td></td> <td colspan="8" style="text-align: center;"> <table border="1" style="width: 100%; border-collapse: collapse; text-align: center;"> <tr> <td style="width: 10%;"></td> <td style="width: 10%;"></td> <td style="width: 10%;"></td> <td style="width: 10%;"></td> <td style="width: 10%;"></td> <td style="width: 10%;"></td> <td style="width: 10%;"></td> <td style="width: 10%;"></td> <td style="width: 10%;"></td> <td style="width: 10%;"></td> </tr> <tr> <td></td> <td></td> <td colspan="8" style="text-align: center;"> <table border="1" style="width: 100%; border-collapse: collapse; text-align: center;"> <tr> <td style="width: 10%;"></td> <td style="width: 10%;"></td> <td style="width: 10%;"></td> <td style="width: 10%;"></td> <td style="width: 10%;"></td> <td style="width: 10%;"></td> <td style="width: 10%;"></td> <td style="width: 10%;"></td> <td style="width: 10%;"></td> <td style="width: 10%;"></td> </tr> <tr> <td></td> <td></td> <td colspan="8" style="text-align: center;"> <table border="1" style="width: 100%; border-collapse: collapse; text-align: center;"> <tr> <td style="width: 10%;"></td> <td style="width: 10%;"></td> <td style="width: 10%;"></td> <td style="width: 10%;"></td> <td style="width: 10%;"></td> <td style="width: 10%;"></td> <td style="width: 10%;"></td> <td style="width: 10%;"></td> <td style="width: 10%;"></td> <td style="width: 10%;"></td> </tr> <tr> <td></td> <td></td> <td colspan="8" style="text-align: center;"> <table border="1" style="width: 100%; border-collapse: collapse; text-align: center;"> <tr> </tr></table></td></tr></table></td></tr></table></td></tr></table></td></tr></table></td></tr></table></td></tr></table></td></tr></table></td></tr></table></td></tr></table></td></tr></table></td></tr></table></td></tr></table></td></tr></table></td></tr></table></td></tr></table></td></tr></table>
 | | | | | | | | | | | | | | | | | | | | <table border="1" style="width: 100%; border-collapse: collapse; text-align: center;"> <tr> <td style="width: 10%;"></td> <td style="width: 10%;"></td> <td style="width: 10%;"></td> <td style="width: 10%;"></td> <td style="width: 10%;"></td> <td style="width: 10%;"></td> <td style="width: 10%;"></td> <td style="width: 10%;"></td> <td style="width: 10%;"></td> <td style="width: 10%;"></td> </tr> <tr> <td></td> <td></td> <td colspan="8" style="text-align: center;"> <table border="1" style="width: 100%; border-collapse: collapse; text-align: center;"> <tr> <td style="width: 10%;"></td> <td style="width: 10%;"></td> <td style="width: 10%;"></td> <td style="width: 10%;"></td> <td style="width: 10%;"></td> <td style="width: 10%;"></td> <td style="width: 10%;"></td> <td style="width: 10%;"></td> <td style="width: 10%;"></td> <td style="width: 10%;"></td> </tr> <tr> <td></td> <td></td> <td colspan="8" style="text-align: center;"> <table border="1" style="width: 100%; border-collapse: collapse; text-align: center;"> <tr> <td style="width: 10%;"></td> <td style="width: 10%;"></td> <td style="width: 10%;"></td> <td style="width: 10%;"></td> <td style="width: 10%;"></td> <td style="width: 10%;"></td> <td style="width: 10%;"></td> <td style="width: 10%;"></td> <td style="width: 10%;"></td> <td style="width: 10%;"></td> </tr> <tr> <td></td> <td></td> <td colspan="8" style="text-align: center;"> <table border="1" style="width: 100%; border-collapse: collapse; text-align: center;"> <tr> <td style="width: 10%;"></td> <td style="width: 10%;"></td> <td style="width: 10%;"></td> <td style="width: 10%;"></td> <td style="width: 10%;"></td> <td style="width: 10%;"></td> <td style="width: 10%;"></td> <td style="width: 10%;"></td> <td style="width: 10%;"></td> <td style="width: 10%;"></td> </tr> <tr> <td></td> <td></td> <td colspan="8" style="text-align: center;"> <table border="1" style="width: 100%; border-collapse: collapse; text-align: center;"> <tr> <td style="width: 10%;"></td> <td style="width: 10%;"></td> <td style="width: 10%;"></td> <td style="width: 10%;"></td> <td style="width: 10%;"></td> <td style="width: 10%;"></td> <td style="width: 10%;"></td> <td style="width: 10%;"></td> <td style="width: 10%;"></td> <td style="width: 10%;"></td> </tr> <tr> <td></td> <td></td> <td colspan="8" style="text-align: center;"> <table border="1" style="width: 100%; border-collapse: collapse; text-align: center;"> <tr> <td style="width: 10%;"></td> <td style="width: 10%;"></td> <td style="width: 10%;"></td> <td style="width: 10%;"></td> <td style="width: 10%;"></td> <td style="width: 10%;"></td> <td style="width: 10%;"></td> <td style="width: 10%;"></td> <td style="width: 10%;"></td> <td style="width: 10%;"></td> </tr> <tr> <td></td> <td></td> <td colspan="8" style="text-align: center;"> <table border="1" style="width: 100%; border-collapse: collapse; text-align: center;"> <tr> <td style="width: 10%;"></td> <td style="width: 10%;"></td> <td style="width: 10%;"></td> <td style="width: 10%;"></td> <td style="width: 10%;"></td> <td style="width: 10%;"></td> <td style="width: 10%;"></td> <td style="width: 10%;"></td> <td style="width: 10%;"></td> <td style="width: 10%;"></td> </tr> <tr> <td></td> <td></td> <td colspan="8" style="text-align: center;"> <table border="1" style="width: 100%; border-collapse: collapse; text-align: center;"> <tr> <td style="width: 10%;"></td> <td style="width: 10%;"></td> <td style="width: 10%;"></td> <td style="width: 10%;"></td> <td style="width: 10%;"></td> <td style="width: 10%;"></td> <td style="width: 10%;"></td> <td style="width: 10%;"></td> <td style="width: 10%;"></td> <td style="width: 10%;"></td> </tr> <tr> <td></td> <td></td> <td colspan="8" style="text-align: center;"> <table border="1" style="width: 100%; border-collapse: collapse; text-align: center;"> <tr> <td style="width: 10%;"></td> <td style="width: 10%;"></td> <td style="width: 10%;"></td> <td style="width: 10%;"></td> <td style="width: 10%;"></td> <td style="width: 10%;"></td> <td style="width: 10%;"></td> <td style="width: 10%;"></td> <td style="width: 10%;"></td> <td style="width: 10%;"></td> </tr> <tr> <td></td> <td></td> <td colspan="8" style="text-align: center;"> <table border="1" style="width: 100%; border-collapse: collapse; text-align: center;"> <tr> <td style="width: 10%;"></td> <td style="width: 10%;"></td> <td style="width: 10%;"></td> <td style="width: 10%;"></td> <td style="width: 10%;"></td> <td style="width: 10%;"></td> <td style="width: 10%;"></td> <td style="width: 10%;"></td> <td style="width: 10%;"></td> <td style="width: 10%;"></td> </tr> <tr> <td></td> <td></td> <td colspan="8" style="text-align: center;"> <table border="1" style="width: 100%; border-collapse: collapse; text-align: center;"> <tr> <td style="width: 10%;"></td> <td style="width: 10%;"></td> <td style="width: 10%;"></td> <td style="width: 10%;"></td> <td style="width: 10%;"></td> <td style="width: 10%;"></td> <td style="width: 10%;"></td> <td style="width: 10%;"></td> <td style="width: 10%;"></td> <td style="width: 10%;"></td> </tr> <tr> <td></td> <td></td> <td colspan="8" style="text-align: center;"> <table border="1" style="width: 100%; border-collapse: collapse; text-align: center;"> <tr> <td style="width: 10%;"></td> <td style="width: 10%;"></td> <td style="width: 10%;"></td> <td style="width: 10%;"></td> <td style="width: 10%;"></td> <td style="width: 10%;"></td> <td style="width: 10%;"></td> <td style="width: 10%;"></td> <td style="width: 10%;"></td> <td style="width: 10%;"></td> </tr> <tr> <td></td> <td></td> <td colspan="8" style="text-align: center;"> <table border="1" style="width: 100%; border-collapse: collapse; text-align: center;"> <tr> <td style="width: 10%;"></td> <td style="width: 10%;"></td> <td style="width: 10%;"></td> <td style="width: 10%;"></td> <td style="width: 10%;"></td> <td style="width: 10%;"></td> <td style="width: 10%;"></td> <td style="width: 10%;"></td> <td style="width: 10%;"></td> <td style="width: 10%;"></td> </tr> <tr> <td></td> <td></td> <td colspan="8" style="text-align: center;"> <table border="1" style="width: 100%; border-collapse: collapse; text-align: center;"> <tr> <td style="width: 10%;"></td> <td style="width: 10%;"></td> <td style="width: 10%;"></td> <td style="width: 10%;"></td> <td style="width: 10%;"></td> <td style="width: 10%;"></td> <td style="width: 10%;"></td> <td style="width: 10%;"></td> <td style="width: 10%;"></td> <td style="width: 10%;"></td> </tr> <tr> <td></td> <td></td> <td colspan="8" style="text-align: center;"> <table border="1" style="width: 100%; border-collapse: collapse; text-align: center;"> <tr> <td style="width: 10%;"></td> <td style="width: 10%;"></td> <td style="width: 10%;"></td> <td style="width: 10%;"></td> <td style="width: 10%;"></td> <td style="width: 10%;"></td> <td style="width: 10%;"></td> <td style="width: 10%;"></td> <td style="width: 10%;"></td> <td style="width: 10%;"></td> </tr> <tr> <td></td> <td></td> <td colspan="8" style="text-align: center;"> <table border="1" style="width: 100%; border-collapse: collapse; text-align: center;"> <tr> </tr></table></td></tr></table></td></tr></table></td></tr></table></td></tr></table></td></tr></table></td></tr></table></td></tr></table></td></tr></table></td></tr></table></td></tr></table></td></tr></table></td></tr></table></td></tr></table></td></tr></table></td></tr></table>
 | | | | | | | | | | | | | | | | | | | | <table border="1" style="width: 100%; border-collapse: collapse; text-align: center;"> <tr> <td style="width: 10%;"></td> <td style="width: 10%;"></td> <td style="width: 10%;"></td> <td style="width: 10%;"></td> <td style="width: 10%;"></td> <td style="width: 10%;"></td> <td style="width: 10%;"></td> <td style="width: 10%;"></td> <td style="width: 10%;"></td> <td style="width: 10%;"></td> </tr> <tr> <td></td> <td></td> <td colspan="8" style="text-align: center;"> <table border="1" style="width: 100%; border-collapse: collapse; text-align: center;"> <tr> <td style="width: 10%;"></td> <td style="width: 10%;"></td> <td style="width: 10%;"></td> <td style="width: 10%;"></td> <td style="width: 10%;"></td> <td style="width: 10%;"></td> <td style="width: 10%;"></td> <td style="width: 10%;"></td> <td style="width: 10%;"></td> <td style="width: 10%;"></td> </tr> <tr> <td></td> <td></td> <td colspan="8" style="text-align: center;"> <table border="1" style="width: 100%; border-collapse: collapse; text-align: center;"> <tr> <td style="width: 10%;"></td> <td style="width: 10%;"></td> <td style="width: 10%;"></td> <td style="width: 10%;"></td> <td style="width: 10%;"></td> <td style="width: 10%;"></td> <td style="width: 10%;"></td> <td style="width: 10%;"></td> <td style="width: 10%;"></td> <td style="width: 10%;"></td> </tr> <tr> <td></td> <td></td> <td colspan="8" style="text-align: center;"> <table border="1" style="width: 100%; border-collapse: collapse; text-align: center;"> <tr> <td style="width: 10%;"></td> <td style="width: 10%;"></td> <td style="width: 10%;"></td> <td style="width: 10%;"></td> <td style="width: 10%;"></td> <td style="width: 10%;"></td> <td style="width: 10%;"></td> <td style="width: 10%;"></td> <td style="width: 10%;"></td> <td style="width: 10%;"></td> </tr> <tr> <td></td> <td></td> <td colspan="8" style="text-align: center;"> <table border="1" style="width: 100%; border-collapse: collapse; text-align: center;"> <tr> <td style="width: 10%;"></td> <td style="width: 10%;"></td> <td style="width: 10%;"></td> <td style="width: 10%;"></td> <td style="width: 10%;"></td> <td style="width: 10%;"></td> <td style="width: 10%;"></td> <td style="width: 10%;"></td> <td style="width: 10%;"></td> <td style="width: 10%;"></td> </tr> <tr> <td></td> <td></td> <td colspan="8" style="text-align: center;"> <table border="1" style="width: 100%; border-collapse: collapse; text-align: center;"> <tr> <td style="width: 10%;"></td> <td style="width: 10%;"></td> <td style="width: 10%;"></td> <td style="width: 10%;"></td> <td style="width: 10%;"></td> <td style="width: 10%;"></td> <td style="width: 10%;"></td> <td style="width: 10%;"></td> <td style="width: 10%;"></td> <td style="width: 10%;"></td> </tr> <tr> <td></td> <td></td> <td colspan="8" style="text-align: center;"> <table border="1" style="width: 100%; border-collapse: collapse; text-align: center;"> <tr> <td style="width: 10%;"></td> <td style="width: 10%;"></td> <td style="width: 10%;"></td> <td style="width: 10%;"></td> <td style="width: 10%;"></td> <td style="width: 10%;"></td> <td style="width: 10%;"></td> <td style="width: 10%;"></td> <td style="width: 10%;"></td> <td style="width: 10%;"></td> </tr> <tr> <td></td> <td></td> <td colspan="8" style="text-align: center;"> <table border="1" style="width: 100%; border-collapse: collapse; text-align: center;"> <tr> <td style="width: 10%;"></td> <td style="width: 10%;"></td> <td style="width: 10%;"></td> <td style="width: 10%;"></td> <td style="width: 10%;"></td> <td style="width: 10%;"></td> <td style="width: 10%;"></td> <td style="width: 10%;"></td> <td style="width: 10%;"></td> <td style="width: 10%;"></td> </tr> <tr> <td></td> <td></td> <td colspan="8" style="text-align: center;"> <table border="1" style="width: 100%; border-collapse: collapse; text-align: center;"> <tr> <td style="width: 10%;"></td> <td style="width: 10%;"></td> <td style="width: 10%;"></td> <td style="width: 10%;"></td> <td style="width: 10%;"></td> <td style="width: 10%;"></td> <td style="width: 10%;"></td> <td style="width: 10%;"></td> <td style="width: 10%;"></td> <td style="width: 10%;"></td> </tr> <tr> <td></td> <td></td> <td colspan="8" style="text-align: center;"> <table border="1" style="width: 100%; border-collapse: collapse; text-align: center;"> <tr> <td style="width: 10%;"></td> <td style="width: 10%;"></td> <td style="width: 10%;"></td> <td style="width: 10%;"></td> <td style="width: 10%;"></td> <td style="width: 10%;"></td> <td style="width: 10%;"></td> <td style="width: 10%;"></td> <td style="width: 10%;"></td> <td style="width: 10%;"></td> </tr> <tr> <td></td> <td></td> <td colspan="8" style="text-align: center;"> <table border="1" style="width: 100%; border-collapse: collapse; text-align: center;"> <tr> <td style="width: 10%;"></td> <td style="width: 10%;"></td> <td style="width: 10%;"></td> <td style="width: 10%;"></td> <td style="width: 10%;"></td> <td style="width: 10%;"></td> <td style="width: 10%;"></td> <td style="width: 10%;"></td> <td style="width: 10%;"></td> <td style="width: 10%;"></td> </tr> <tr> <td></td> <td></td> <td colspan="8" style="text-align: center;"> <table border="1" style="width: 100%; border-collapse: collapse; text-align: center;"> <tr> <td style="width: 10%;"></td> <td style="width: 10%;"></td> <td style="width: 10%;"></td> <td style="width: 10%;"></td> <td style="width: 10%;"></td> <td style="width: 10%;"></td> <td style="width: 10%;"></td> <td style="width: 10%;"></td> <td style="width: 10%;"></td> <td style="width: 10%;"></td> </tr> <tr> <td></td> <td></td> <td colspan="8" style="text-align: center;"> <table border="1" style="width: 100%; border-collapse: collapse; text-align: center;"> <tr> <td style="width: 10%;"></td> <td style="width: 10%;"></td> <td style="width: 10%;"></td> <td style="width: 10%;"></td> <td style="width: 10%;"></td> <td
style="width: 10%;"></td> <td style="width: 10%;"></td> <td style="width: 10%;"></td> <td style="width: 10%;"></td> <td style="width: 10%;"></td> </tr> <tr> <td></td> <td></td> <td colspan="8" style="text-align: center;"> <table border="1" style="width: 100%; border-collapse: collapse; text-align: center;"> <tr> <td style="width: 10%;"></td> <td style="width: 10%;"></td> <td style="width: 10%;"></td> <td style="width: 10%;"></td> <td style="width: 10%;"></td> <td style="width: 10%;"></td> <td style="width: 10%;"></td> <td style="width: 10%;"></td> <td style="width: 10%;"></td> <td style="width: 10%;"></td> </tr> <tr> <td></td> <td></td> <td colspan="8" style="text-align: center;"> <table border="1" style="width: 100%; border-collapse: collapse; text-align: center;"> <tr> </tr></table></td></tr></table></td></tr></table></td></tr></table></td></tr></table></td></tr></table></td></tr></table></td></tr></table></td></tr></table></td></tr></table></td></tr></table></td></tr></table></td></tr></table></td></tr></table></td></tr></table> | | | | | | | | | | | | | | | | | | | | <table border="1" style="width: 100%; border-collapse: collapse; text-align: center;"> <tr> <td style="width: 10%;"></td> <td style="width: 10%;"></td> <td style="width: 10%;"></td> <td style="width: 10%;"></td> <td style="width: 10%;"></td> <td style="width: 10%;"></td> <td style="width: 10%;"></td> <td style="width: 10%;"></td> <td style="width: 10%;"></td> <td style="width: 10%;"></td> </tr> <tr> <td></td> <td></td> <td colspan="8" style="text-align: center;"> <table border="1" style="width: 100%; border-collapse: collapse; text-align: center;"> <tr> <td style="width: 10%;"></td> <td style="width: 10%;"></td> <td style="width: 10%;"></td> <td style="width: 10%;"></td> <td style="width: 10%;"></td> <td style="width: 10%;"></td> <td style="width: 10%;"></td> <td style="width: 10%;"></td> <td style="width: 10%;"></td> <td style="width: 10%;"></td> </tr> <tr> <td></td> <td></td> <td colspan="8" style="text-align: center;"> <table border="1" style="width: 100%; border-collapse: collapse; text-align: center;"> <tr> <td style="width: 10%;"></td> <td style="width: 10%;"></td> <td style="width: 10%;"></td> <td style="width: 10%;"></td> <td style="width: 10%;"></td> <td style="width: 10%;"></td> <td style="width: 10%;"></td> <td style="width: 10%;"></td> <td style="width: 10%;"></td> <td style="width: 10%;"></td> </tr> <tr> <td></td> <td></td> <td colspan="8" style="text-align: center;"> <table border="1" style="width: 100%; border-collapse: collapse; text-align: center;"> <tr> <td style="width: 10%;"></td> <td style="width: 10%;"></td> <td style="width: 10%;"></td> <td style="width: 10%;"></td> <td style="width: 10%;"></td> <td style="width: 10%;"></td> <td style="width: 10%;"></td> <td style="width: 10%;"></td> <td style="width: 10%;"></td> <td style="width: 10%;"></td> </tr> <tr> <td></td> <td></td> <td colspan="8" style="text-align: center;"> <table border="1" style="width: 100%; border-collapse: collapse; text-align: center;"> <tr> <td style="width: 10%;"></td> <td style="width: 10%;"></td> <td style="width: 10%;"></td> <td style="width: 10%;"></td> <td style="width: 10%;"></td> <td style="width: 10%;"></td> <td style="width: 10%;"></td> <td style="width: 10%;"></td> <td style="width: 10%;"></td> <td style="width: 10%;"></td> </tr> <tr> <td></td> <td></td> <td colspan="8" style="text-align: center;"> <table border="1" style="width: 100%; border-collapse: collapse; text-align: center;"> <tr> <td style="width: 10%;"></td> <td style="width: 10%;"></td> <td style="width: 10%;"></td> <td style="width: 10%;"></td> <td style="width: 10%;"></td> <td style="width: 10%;"></td> <td style="width: 10%;"></td> <td style="width: 10%;"></td> <td style="width: 10%;"></td> <td style="width: 10%;"></td> </tr> <tr> <td></td> <td></td> <td colspan="8" style="text-align: center;"> <table border="1" style="width: 100%; border-collapse: collapse; text-align: center;"> <tr> <td style="width: 10%;"></td> <td style="width: 10%;"></td> <td style="width: 10%;"></td> <td style="width: 10%;"></td> <td style="width: 10%;"></td> <td style="width: 10%;"></td> <td style="width: 10%;"></td> <td style="width: 10%;"></td> <td style="width: 10%;"></td> <td style="width: 10%;"></td> </tr> <tr> <td></td> <td></td> <td colspan="8" style="text-align: center;"> <table border="1" style="width: 100%; border-collapse: collapse; text-align: center;"> <tr> <td style="width: 10%;"></td> <td style="width: 10%;"></td> <td style="width: 10%;"></td> <td style="width: 10%;"></td> <td style="width: 10%;"></td> <td style="width: 10%;"></td> <td style="width: 10%;"></td> <td style="width: 10%;"></td> <td style="width: 10%;"></td> <td style="width: 10%;"></td> </tr> <tr> <td></td> <td></td> <td colspan="8" style="text-align: center;"> <table border="1" style="width: 100%; border-collapse: collapse; text-align: center;"> <tr> <td style="width: 10%;"></td> <td style="width: 10%;"></td> <td style="width: 10%;"></td> <td style="width: 10%;"></td> <td style="width: 10%;"></td> <td style="width: 10%;"></td> <td style="width: 10%;"></td> <td style="width: 10%;"></td> <td style="width: 10%;"></td> <td style="width: 10%;"></td> </tr> <tr> <td></td> <td></td> <td colspan="8" style="text-align: center;"> <table border="1" style="width: 100%; border-collapse: collapse; text-align: center;"> <tr> <td style="width: 10%;"></td> <td style="width: 10%;"></td> <td style="width: 10%;"></td> <td style="width: 10%;"></td> <td style="width: 10%;"></td> <td style="width: 10%;"></td> <td style="width: 10%;"></td> <td
style="width: 10%;"></td> <td style="width: 10%;"></td> <td style="width: 10%;"></td> </tr> <tr> <td></td> <td></td> <td colspan="8" style="text-align: center;"> <table border="1" style="width: 100%; border-collapse: collapse; text-align: center;"> <tr> <td style="width: 10%;"></td> <td style="width: 10%;"></td> <td style="width: 10%;"></td> <td style="width: 10%;"></td> <td style="width: 10%;"></td> <td style="width: 10%;"></td> <td style="width: 10%;"></td> <td style="width: 10%;"></td> <td style="width: 10%;"></td> <td style="width: 10%;"></td> </tr> <tr> <td></td> <td></td> <td colspan="8" style="text-align: center;"> <table border="1" style="width: 100%; border-collapse: collapse; text-align: center;"> <tr> <td style="width: 10%;"></td> <td style="width: 10%;"></td> <td style="width: 10%;"></td> <td style="width: 10%;"></td> <td style="width: 10%;"></td> <td style="width: 10%;"></td> <td style="width: 10%;"></td> <td style="width: 10%;"></td> <td style="width: 10%;"></td> <td style="width: 10%;"></td> </tr> <tr> <td></td> <td></td> <td colspan="8" style="text-align: center;"> <table border="1" style="width: 100%; border-collapse: collapse; text-align: center;"> <tr> <td style="width: 10%;"></td> <td style="width: 10%;"></td> <td style="width: 10%;"></td> <td style="width: 10%;"></td> <td style="width: 10%;"></td> <td style="width: 10%;"></td> <td style="width: 10%;"></td> <td style="width: 10%;"></td> <td style="width: 10%;"></td> <td style="width: 10%;"></td> </tr> <tr> <td></td> <td></td> <td colspan="8" style="text-align: center;"> <table border="1" style="width: 100%; border-collapse: collapse; text-align: center;"> <tr> </tr></table></td></tr></table></td></tr></table></td></tr></table></td></tr></table></td></tr></table></td></tr></table></td></tr></table></td></tr></table></td></tr></table></td></tr></table></td></tr></table></td></tr></table></td></tr></table> | | | | | | | | | | | | | | | | | | | | <table border="1" style="width: 100%; border-collapse: collapse; text-align: center;"> <tr> <td style="width: 10%;"></td> <td style="width: 10%;"></td> <td style="width: 10%;"></td> <td style="width: 10%;"></td> <td style="width: 10%;"></td> <td style="width: 10%;"></td> <td style="width: 10%;"></td> <td style="width: 10%;"></td> <td style="width: 10%;"></td> <td style="width: 10%;"></td> </tr> <tr> <td></td> <td></td> <td colspan="8" style="text-align: center;"> <table border="1" style="width: 100%; border-collapse: collapse; text-align: center;"> <tr> <td style="width: 10%;"></td> <td style="width: 10%;"></td> <td style="width: 10%;"></td> <td style="width: 10%;"></td> <td style="width: 10%;"></td> <td style="width: 10%;"></td> <td style="width: 10%;"></td> <td style="width: 10%;"></td> <td style="width: 10%;"></td> <td style="width: 10%;"></td> </tr> <tr> <td></td> <td></td> <td colspan="8" style="text-align: center;"> <table border="1" style="width: 100%; border-collapse: collapse; text-align: center;"> <tr> <td style="width: 10%;"></td> <td style="width: 10%;"></td> <td style="width: 10%;"></td> <td style="width: 10%;"></td> <td style="width: 10%;"></td> <td style="width: 10%;"></td> <td style="width: 10%;"></td> <td style="width: 10%;"></td> <td style="width: 10%;"></td> <td style="width: 10%;"></td> </tr> <tr> <td></td> <td></td> <td colspan="8" style="text-align: center;"> <table border="1" style="width: 100%; border-collapse: collapse; text-align: center;"> <tr> <td style="width: 10%;"></td> <td style="width: 10%;"></td> <td style="width: 10%;"></td> <td style="width: 10%;"></td> <td style="width: 10%;"></td> <td style="width: 10%;"></td> <td style="width: 10%;"></td> <td style="width: 10%;"></td> <td style="width: 10%;"></td> <td style="width: 10%;"></td> </tr> <tr> <td></td> <td></td> <td colspan="8" style="text-align: center;"> <table border="1" style="width: 100%; border-collapse: collapse; text-align: center;"> <tr> <td style="width: 10%;"></td> <td style="width: 10%;"></td> <td style="width: 10%;"></td> <td style="width: 10%;"></td> <td style="width: 10%;"></td> <td style="width: 10%;"></td> <td style="width: 10%;"></td> <td style="width: 10%;"></td> <td style="width: 10%;"></td> <td style="width: 10%;"></td> </tr> <tr> <td></td> <td></td> <td colspan="8" style="text-align: center;"> <table border="1" style="width: 100%; border-collapse: collapse; text-align: center;"> <tr> <td style="width: 10%;"></td> <td style="width: 10%;"></td> <td style="width: 10%;"></td> <td style="width: 10%;"></td> <td style="width: 10%;"></td> <td style="width: 10%;"></td> <td style="width: 10%;"></td> <td style="width: 10%;"></td> <td style="width: 10%;"></td> <td style="width: 10%;"></td> </tr> <tr> <td></td> <td></td> <td colspan="8" style="text-align: center;"> <table border="1" style="width: 100%; border-collapse: collapse; text-align: center;"> <tr> <td style="width: 10%;"></td> <td style="width: 10%;"></td> <td style="width: 10%;"></td> <td style="width: 10%;"></td> <td style="width: 10%;"></td> <td style="width: 10%;"></td> <td style="width: 10%;"></td> <td style="width: 10%;"></td> <td style="width: 10%;"></td> <td style="width: 10%;"></td> </tr> <tr> <td></td> <td></td> <td colspan="8" style="text-align: center;"> <table border="1" style="width: 100%; border-collapse: collapse; text-align: center;"> <tr> <td style="width: 10%;"></td> <td style="width: 10%;"></td> <td style="width: 10%;"></td> <td style="width: 10%;"></td> <td style="width: 10%;"></td> <td style="width: 10%;"></td> <td style="width: 10%;"></td> <td style="width: 10%;"></td> <td style="width: 10%;"></td> <td style="width:
10%;"></td> </tr> <tr> <td></td> <td></td> <td colspan="8" style="text-align: center;"> <table border="1" style="width: 100%; border-collapse: collapse; text-align: center;"> <tr> <td style="width: 10%;"></td> <td style="width: 10%;"></td> <td style="width: 10%;"></td> <td style="width: 10%;"></td> <td style="width: 10%;"></td> <td style="width: 10%;"></td> <td style="width: 10%;"></td> <td style="width: 10%;"></td> <td style="width: 10%;"></td> <td style="width: 10%;"></td> </tr> <tr> <td></td> <td></td> <td colspan="8" style="text-align: center;"> <table border="1" style="width: 100%; border-collapse: collapse; text-align: center;"> <tr> <td style="width: 10%;"></td> <td style="width: 10%;"></td> <td style="width: 10%;"></td> <td style="width: 10%;"></td> <td style="width: 10%;"></td> <td style="width: 10%;"></td> <td style="width: 10%;"></td> <td style="width: 10%;"></td> <td style="width: 10%;"></td> <td style="width: 10%;"></td> </tr> <tr> <td></td> <td></td> <td colspan="8" style="text-align: center;"> <table border="1" style="width: 100%; border-collapse: collapse; text-align: center;"> <tr> <td style="width: 10%;"></td> <td style="width: 10%;"></td> <td style="width: 10%;"></td> <td style="width: 10%;"></td> <td style="width: 10%;"></td> <td style="width: 10%;"></td> <td style="width: 10%;"></td> <td style="width: 10%;"></td> <td style="width: 10%;"></td> <td style="width: 10%;"></td> </tr> <tr> <td></td> <td></td> <td colspan="8" style="text-align: center;"> <table border="1" style="width: 100%; border-collapse: collapse; text-align: center;"> <tr> <td style="width: 10%;"></td> <td style="width: 10%;"></td> <td style="width: 10%;"></td> <td style="width: 10%;"></td> <td style="width: 10%;"></td> <td style="width: 10%;"></td> <td style="width: 10%;"></td> <td style="width: 10%;"></td> <td style="width: 10%;"></td> <td style="width: 10%;"></td> </tr> <tr> <td></td> <td></td> <td colspan="8" style="text-align: center;"> <table border="1" style="width: 100%; border-collapse: collapse; text-align: center;"> <tr> </tr></table></td></tr></table></td></tr></table></td></tr></table></td></tr></table></td></tr></table></td></tr></table></td></tr></table></td></tr></table></td></tr></table></td></tr></table></td></tr></table></td></tr></table> | | | | | | | | | | | | | | | | | | | | <table border="1" style="width: 100%; border-collapse: collapse; text-align: center;"> <tr> <td style="width: 10%;"></td> <td style="width: 10%;"></td> <td style="width: 10%;"></td> <td style="width: 10%;"></td> <td style="width: 10%;"></td> <td style="width: 10%;"></td> <td style="width: 10%;"></td> <td style="width: 10%;"></td> <td style="width: 10%;"></td> <td style="width: 10%;"></td> </tr> <tr> <td></td> <td></td> <td colspan="8" style="text-align: center;"> <table border="1" style="width: 100%; border-collapse: collapse; text-align: center;"> <tr> <td style="width: 10%;"></td> <td style="width: 10%;"></td> <td style="width: 10%;"></td> <td style="width: 10%;"></td> <td style="width: 10%;"></td> <td style="width: 10%;"></td> <td style="width: 10%;"></td> <td style="width: 10%;"></td> <td style="width: 10%;"></td> <td style="width: 10%;"></td> </tr> <tr> <td></td> <td></td> <td colspan="8" style="text-align: center;"> <table border="1" style="width: 100%; border-collapse: collapse; text-align: center;"> <tr> <td style="width: 10%;"></td> <td style="width: 10%;"></td> <td style="width: 10%;"></td> <td style="width: 10%;"></td> <td style="width: 10%;"></td> <td style="width: 10%;"></td> <td style="width: 10%;"></td> <td style="width: 10%;"></td> <td style="width: 10%;"></td> <td style="width: 10%;"></td> </tr> <tr> <td></td> <td></td> <td colspan="8" style="text-align: center;"> <table border="1" style="width: 100%; border-collapse: collapse; text-align: center;"> <tr> <td style="width: 10%;"></td> <td style="width: 10%;"></td> <td style="width: 10%;"></td> <td style="width: 10%;"></td> <td style="width: 10%;"></td> <td style="width: 10%;"></td> <td style="width: 10%;"></td> <td style="width: 10%;"></td> <td style="width: 10%;"></td> <td style="width: 10%;"></td> </tr> <tr> <td></td> <td></td> <td colspan="8" style="text-align: center;"> <table border="1" style="width: 100%; border-collapse: collapse; text-align: center;"> <tr> <td style="width: 10%;"></td> <td style="width: 10%;"></td> <td style="width: 10%;"></td> <td style="width: 10%;"></td> <td style="width: 10%;"></td> <td style="width: 10%;"></td> <td style="width: 10%;"></td> <td style="width: 10%;"></td> <td style="width: 10%;"></td> <td style="width: 10%;"></td> </tr> <tr> <td></td> <td></td> <td colspan="8" style="text-align: center;"> <table border="1" style="width: 100%; border-collapse: collapse; text-align: center;"> <tr> <td style="width: 10%;"></td> <td style="width: 10%;"></td> <td style="width: 10%;"></td> <td style="width: 10%;"></td> <td style="width: 10%;"></td> <td style="width: 10%;"></td> <td style="width: 10%;"></td> <td style="width: 10%;"></td> <td style="width: 10%;"></td> <td style="width: 10%;"></td> </tr> <tr> <td></td> <td></td> <td colspan="8" style="text-align: center;"> <table border="1" style="width: 100%; border-collapse: collapse; text-align: center;"> <tr> <td style="width: 10%;"></td> <td style="width: 10%;"></td> <td style="width: 10%;"></td> <td style="width: 10%;"></td> <td style="width: 10%;"></td> <td style="width: 10%;"></td> <td style="width: 10%;"></td> <td style="width: 10%;"></td> <td style="width: 10%;"></td> <td style="width: 10%;"></td> </tr> <tr> <td></td> <td></td> <td colspan="8" style="text-align: center;"> <table
border="1" style="width: 100%; border-collapse: collapse; text-align: center;"> <tr> <td style="width: 10%;"></td> <td style="width: 10%;"></td> <td style="width: 10%;"></td> <td style="width: 10%;"></td> <td style="width: 10%;"></td> <td style="width: 10%;"></td> <td style="width: 10%;"></td> <td style="width: 10%;"></td> <td style="width: 10%;"></td> <td style="width: 10%;"></td> </tr> <tr> <td></td> <td></td> <td colspan="8" style="text-align: center;"> <table border="1" style="width: 100%; border-collapse: collapse; text-align: center;"> <tr> <td style="width: 10%;"></td> <td style="width: 10%;"></td> <td style="width: 10%;"></td> <td style="width: 10%;"></td> <td style="width: 10%;"></td> <td style="width: 10%;"></td> <td style="width: 10%;"></td> <td style="width: 10%;"></td> <td style="width: 10%;"></td> <td style="width: 10%;"></td> </tr> <tr> <td></td> <td></td> <td colspan="8" style="text-align: center;"> <table border="1" style="width: 100%; border-collapse: collapse; text-align: center;"> <tr> <td style="width: 10%;"></td> <td style="width: 10%;"></td> <td style="width: 10%;"></td> <td style="width: 10%;"></td> <td style="width: 10%;"></td> <td style="width: 10%;"></td> <td style="width: 10%;"></td> <td style="width: 10%;"></td> <td style="width: 10%;"></td> <td style="width: 10%;"></td> </tr> <tr> <td></td> <td></td> <td colspan="8" style="text-align: center;"> <table border="1" style="width: 100%; border-collapse: collapse; text-align: center;"> <tr> <td style="width: 10%;"></td> <td style="width: 10%;"></td> <td style="width: 10%;"></td> <td style="width: 10%;"></td> <td style="width: 10%;"></td> <td style="width: 10%;"></td> <td style="width: 10%;"></td> <td style="width: 10%;"></td> <td style="width: 10%;"></td> <td style="width: 10%;"></td> </tr> <tr> <td></td> <td></td> <td colspan="8" style="text-align: center;"> <table border="1" style="width: 100%; border-collapse: collapse; text-align: center;"> <tr> </tr></table></td></tr></table></td></tr></table></td></tr></table></td></tr></table></td></tr></table></td></tr></table></td></tr></table></td></tr></table></td></tr></table></td></tr></table></td></tr></table> | | | | | | | | | | | | | | | | | | | | <table border="1" style="width: 100%; border-collapse: collapse; text-align: center;"> <tr> <td style="width: 10%;"></td> <td style="width: 10%;"></td> <td style="width: 10%;"></td> <td style="width: 10%;"></td> <td style="width: 10%;"></td> <td style="width: 10%;"></td> <td style="width: 10%;"></td> <td style="width: 10%;"></td> <td style="width: 10%;"></td> <td style="width: 10%;"></td> </tr> <tr> <td></td> <td></td> <td colspan="8" style="text-align: center;"> <table border="1" style="width: 100%; border-collapse: collapse; text-align: center;"> <tr> <td style="width: 10%;"></td> <td style="width: 10%;"></td> <td style="width: 10%;"></td> <td style="width: 10%;"></td> <td style="width: 10%;"></td> <td style="width: 10%;"></td> <td style="width: 10%;"></td> <td style="width: 10%;"></td> <td style="width: 10%;"></td> <td style="width: 10%;"></td> </tr> <tr> <td></td> <td></td> <td colspan="8" style="text-align: center;"> <table border="1" style="width: 100%; border-collapse: collapse; text-align: center;"> <tr> <td style="width: 10%;"></td> <td style="width: 10%;"></td> <td style="width: 10%;"></td> <td style="width: 10%;"></td> <td style="width: 10%;"></td> <td style="width: 10%;"></td> <td style="width: 10%;"></td> <td style="width: 10%;"></td> <td style="width: 10%;"></td> <td style="width: 10%;"></td> </tr> <tr> <td></td> <td></td> <td colspan="8" style="text-align: center;"> <table border="1" style="width: 100%; border-collapse: collapse; text-align: center;"> <tr> <td style="width: 10%;"></td> <td style="width: 10%;"></td> <td style="width: 10%;"></td> <td style="width: 10%;"></td> <td style="width: 10%;"></td> <td style="width: 10%;"></td> <td style="width: 10%;"></td> <td style="width: 10%;"></td> <td style="width: 10%;"></td> <td style="width: 10%;"></td> </tr> <tr> <td></td> <td></td> <td colspan="8" style="text-align: center;"> <table border="1" style="width: 100%; border-collapse: collapse; text-align: center;"> <tr> <td style="width: 10%;"></td> <td style="width: 10%;"></td> <td style="width: 10%;"></td> <td style="width: 10%;"></td> <td style="width: 10%;"></td> <td style="width: 10%;"></td> <td style="width: 10%;"></td> <td style="width: 10%;"></td> <td style="width: 10%;"></td> <td style="width: 10%;"></td> </tr> <tr> <td></td> <td></td> <td colspan="8" style="text-align: center;"> <table border="1" style="width: 100%; border-collapse: collapse; text-align: center;"> <tr> <td style="width: 10%;"></td> <td style="width: 10%;"></td> <td style="width: 10%;"></td> <td style="width: 10%;"></td> <td style="width: 10%;"></td> <td style="width: 10%;"></td> <td style="width: 10%;"></td> <td style="width: 10%;"></td> <td style="width: 10%;"></td> <td style="width: 10%;"></td> </tr> <tr> <td></td> <td></td> <td colspan="8" style="text-align: center;"> <table border="1" style="width: 100%; border-collapse: collapse; text-align: center;"> <tr> <td style="width: 10%;"></td> <td style="width: 10%;"></td> <td style="width: 10%;"></td> <td style="width: 10%;"></td> <td style="width: 10%;"></td> <td style="width: 10%;"></td> <td style="width: 10%;"></td> <td style="width: 10%;"></td> <td style="width: 10%;"></td> <td style="width: 10%;"></td> </tr> <tr> <td></td> <td></td> <td colspan="8" style="text-align: center;"> <table border="1" style="width: 100%; border-collapse: collapse; text-align: center;"> <tr> <td style="width: 10%;"></td>
<td style="width: 10%;"></td> <td style="width: 10%;"></td> <td style="width: 10%;"></td> <td style="width: 10%;"></td> <td style="width: 10%;"></td> <td style="width: 10%;"></td> <td style="width: 10%;"></td> <td style="width: 10%;"></td> <td style="width: 10%;"></td> </tr> <tr> <td></td> <td></td> <td colspan="8" style="text-align: center;"> <table border="1" style="width: 100%; border-collapse: collapse; text-align: center;"> <tr> <td style="width: 10%;"></td> <td style="width: 10%;"></td> <td style="width: 10%;"></td> <td style="width: 10%;"></td> <td style="width: 10%;"></td> <td style="width: 10%;"></td> <td style="width: 10%;"></td> <td style="width: 10%;"></td> <td style="width: 10%;"></td> <td style="width: 10%;"></td> </tr> <tr> <td></td> <td></td> <td colspan="8" style="text-align: center;"> <table border="1" style="width: 100%; border-collapse: collapse; text-align: center;"> <tr> <td style="width: 10%;"></td> <td style="width: 10%;"></td> <td style="width: 10%;"></td> <td style="width: 10%;"></td> <td style="width: 10%;"></td> <td style="width: 10%;"></td> <td style="width: 10%;"></td> <td style="width: 10%;"></td> <td style="width: 10%;"></td> <td style="width: 10%;"></td> </tr> <tr> <td></td> <td></td> <td colspan="8" style="text-align: center;"> <table border="1" style="width: 100%; border-collapse: collapse; text-align: center;"> <tr> </tr></table></td></tr></table></td></tr></table></td></tr></table></td></tr></table></td></tr></table></td></tr></table></td></tr></table></td></tr></table></td></tr></table></td></tr></table> | | | | | | | | | | | | | | | | | | | | <table border="1" style="width: 100%; border-collapse: collapse; text-align: center;"> <tr> <td style="width: 10%;"></td> <td style="width: 10%;"></td> <td style="width: 10%;"></td> <td style="width: 10%;"></td> <td style="width: 10%;"></td> <td style="width: 10%;"></td> <td style="width: 10%;"></td> <td style="width: 10%;"></td> <td style="width: 10%;"></td> <td style="width: 10%;"></td> </tr> <tr> <td></td> <td></td> <td colspan="8" style="text-align: center;"> <table border="1" style="width: 100%; border-collapse: collapse; text-align: center;"> <tr> <td style="width: 10%;"></td> <td style="width: 10%;"></td> <td style="width: 10%;"></td> <td style="width: 10%;"></td> <td style="width: 10%;"></td> <td style="width: 10%;"></td> <td style="width: 10%;"></td> <td style="width: 10%;"></td> <td style="width: 10%;"></td> <td style="width: 10%;"></td> </tr> <tr> <td></td> <td></td> <td colspan="8" style="text-align: center;"> <table border="1" style="width: 100%; border-collapse: collapse; text-align: center;"> <tr> <td style="width: 10%;"></td> <td style="width: 10%;"></td> <td style="width: 10%;"></td> <td style="width: 10%;"></td> <td style="width: 10%;"></td> <td style="width: 10%;"></td> <td style="width: 10%;"></td> <td style="width: 10%;"></td> <td style="width: 10%;"></td> <td style="width: 10%;"></td> </tr> <tr> <td></td> <td></td> <td colspan="8" style="text-align: center;"> <table border="1" style="width: 100%; border-collapse: collapse; text-align: center;"> <tr> <td style="width: 10%;"></td> <td style="width: 10%;"></td> <td style="width: 10%;"></td> <td style="width: 10%;"></td> <td style="width: 10%;"></td> <td style="width: 10%;"></td> <td style="width: 10%;"></td> <td style="width: 10%;"></td> <td style="width: 10%;"></td> <td style="width: 10%;"></td> </tr> <tr> <td></td> <td></td> <td colspan="8" style="text-align: center;"> <table border="1" style="width: 100%; border-collapse: collapse; text-align: center;"> <tr> <td style="width: 10%;"></td> <td style="width: 10%;"></td> <td style="width: 10%;"></td> <td style="width: 10%;"></td> <td style="width: 10%;"></td> <td style="width: 10%;"></td> <td style="width: 10%;"></td> <td style="width: 10%;"></td> <td style="width: 10%;"></td> <td style="width: 10%;"></td> </tr> <tr> <td></td> <td></td> <td colspan="8" style="text-align: center;"> <table border="1" style="width: 100%; border-collapse: collapse; text-align: center;"> <tr> <td style="width: 10%;"></td> <td style="width: 10%;"></td> <td style="width: 10%;"></td> <td style="width: 10%;"></td> <td style="width: 10%;"></td> <td style="width: 10%;"></td> <td style="width: 10%;"></td> <td style="width: 10%;"></td> <td style="width: 10%;"></td> <td style="width: 10%;"></td> </tr> <tr> <td></td> <td></td> <td colspan="8" style="text-align: center;"> <table border="1" style="width: 100%; border-collapse: collapse; text-align: center;"> <tr> <td style="width: 10%;"></td> <td style="width: 10%;"></td> <td style="width: 10%;"></td> <td style="width: 10%;"></td> <td style="width: 10%;"></td> <td style="width: 10%;"></td> <td style="width: 10%;"></td> <td style="width: 10%;"></td> <td style="width: 10%;"></td> <td style="width: 10%;"></td> </tr> <tr> <td></td> <td></td> <td colspan="8" style="text-align: center;"> <table border="1" style="width: 100%; border-collapse: collapse; text-align: center;"> <tr> <td style="width: 10%;"></td> <td style="width: 10%;"></td> <td style="width: 10%;"></td> <td style="width: 10%;"></td> <td style="width: 10%;"></td> <td style="width: 10%;"></td> <td style="width: 10%;"></td> <td style="width: 10%;"></td> <td style="width: 10%;"></td> <td style="width: 10%;"></td> </tr> <tr> <td></td> <td></td> <td colspan="8" style="text-align: center;"> <table border="1" style="width: 100%; border-collapse: collapse; text-align: center;"> <tr> <td style="width: 10%;"></td> <td style="width: 10%;"></td> <td style="width: 10%;"></td> <td style="width: 10%;"></td> <td style="width: 10%;"></td> <td
style="width: 10%;"></td> <td style="width: 10%;"></td> <td style="width: 10%;"></td> <td style="width: 10%;"></td> <td style="width: 10%;"></td> </tr> <tr> <td></td> <td></td> <td colspan="8" style="text-align: center;"> <table border="1" style="width: 100%; border-collapse: collapse; text-align: center;"> <tr> </tr></table></td></tr></table></td></tr></table></td></tr></table></td></tr></table></td></tr></table></td></tr></table></td></tr></table></td></tr></table></td></tr></table> | | | | | | | | | | | | | | | | | | | | <table border="1" style="width: 100%; border-collapse: collapse; text-align: center;"> <tr> <td style="width: 10%;"></td> <td style="width: 10%;"></td> <td style="width: 10%;"></td> <td style="width: 10%;"></td> <td style="width: 10%;"></td> <td style="width: 10%;"></td> <td style="width: 10%;"></td> <td style="width: 10%;"></td> <td style="width: 10%;"></td> <td style="width: 10%;"></td> </tr> <tr> <td></td> <td></td> <td colspan="8" style="text-align: center;"> <table border="1" style="width: 100%; border-collapse: collapse; text-align: center;"> <tr> <td style="width: 10%;"></td> <td style="width: 10%;"></td> <td style="width: 10%;"></td> <td style="width: 10%;"></td> <td style="width: 10%;"></td> <td style="width: 10%;"></td> <td style="width: 10%;"></td> <td style="width: 10%;"></td> <td style="width: 10%;"></td> <td style="width: 10%;"></td> </tr> <tr> <td></td> <td></td> <td colspan="8" style="text-align: center;"> <table border="1" style="width: 100%; border-collapse: collapse; text-align: center;"> <tr> <td style="width: 10%;"></td> <td style="width: 10%;"></td> <td style="width: 10%;"></td> <td style="width: 10%;"></td> <td style="width: 10%;"></td> <td style="width: 10%;"></td> <td style="width: 10%;"></td> <td style="width: 10%;"></td> <td style="width: 10%;"></td> <td style="width: 10%;"></td> </tr> <tr> <td></td> <td></td> <td colspan="8" style="text-align: center;"> <table border="1" style="width: 100%; border-collapse: collapse; text-align: center;"> <tr> <td style="width: 10%;"></td> <td style="width: 10%;"></td> <td style="width: 10%;"></td> <td style="width: 10%;"></td> <td style="width: 10%;"></td> <td style="width: 10%;"></td> <td style="width: 10%;"></td> <td style="width: 10%;"></td> <td style="width: 10%;"></td> <td style="width: 10%;"></td> </tr> <tr> <td></td> <td></td> <td colspan="8" style="text-align: center;"> <table border="1" style="width: 100%; border-collapse: collapse; text-align: center;"> <tr> <td style="width: 10%;"></td> <td style="width: 10%;"></td> <td style="width: 10%;"></td> <td style="width: 10%;"></td> <td style="width: 10%;"></td> <td style="width: 10%;"></td> <td style="width: 10%;"></td> <td style="width: 10%;"></td> <td style="width: 10%;"></td> <td style="width: 10%;"></td> </tr> <tr> <td></td> <td></td> <td colspan="8" style="text-align: center;"> <table border="1" style="width: 100%; border-collapse: collapse; text-align: center;"> <tr> <td style="width: 10%;"></td> <td style="width: 10%;"></td> <td style="width: 10%;"></td> <td style="width: 10%;"></td> <td style="width: 10%;"></td> <td style="width: 10%;"></td> <td style="width: 10%;"></td> <td style="width: 10%;"></td> <td style="width: 10%;"></td> <td style="width: 10%;"></td> </tr> <tr> <td></td> <td></td> <td colspan="8" style="text-align: center;"> <table border="1" style="width: 100%; border-collapse: collapse; text-align: center;"> <tr> <td style="width: 10%;"></td> <td style="width: 10%;"></td> <td style="width: 10%;"></td> <td style="width: 10%;"></td> <td style="width: 10%;"></td> <td style="width: 10%;"></td> <td style="width: 10%;"></td> <td style="width: 10%;"></td> <td style="width: 10%;"></td> <td style="width: 10%;"></td> </tr> <tr> <td></td> <td></td> <td colspan="8" style="text-align: center;"> <table border="1" style="width: 100%; border-collapse: collapse; text-align: center;"> <tr> <td style="width: 10%;"></td> <td style="width: 10%;"></td> <td style="width: 10%;"></td> <td style="width: 10%;"></td> <td style="width: 10%;"></td> <td style="width: 10%;"></td> <td style="width: 10%;"></td> <td style="width: 10%;"></td> <td style="width: 10%;"></td> <td style="width: 10%;"></td> </tr> <tr> <td></td> <td></td> <td colspan="8" style="text-align: center;"> <table border="1" style="width: 100%; border-collapse: collapse; text-align: center;"> <tr> </tr></table></td></tr></table></td></tr></table></td></tr></table></td></tr></table></td></tr></table></td></tr></table></td></tr></table></td></tr></table>
 | | | | | | | | | | | | | | | | | | | | <table border="1" style="width: 100%; border-collapse: collapse; text-align: center;"> <tr> <td style="width: 10%;"></td> <td style="width: 10%;"></td> <td style="width: 10%;"></td> <td style="width: 10%;"></td> <td style="width: 10%;"></td> <td style="width: 10%;"></td> <td style="width: 10%;"></td> <td style="width: 10%;"></td> <td style="width: 10%;"></td> <td style="width: 10%;"></td> </tr> <tr> <td></td> <td></td> <td colspan="8" style="text-align: center;"> <table border="1" style="width: 100%; border-collapse: collapse; text-align: center;"> <tr> <td style="width: 10%;"></td> <td style="width: 10%;"></td> <td style="width: 10%;"></td> <td style="width: 10%;"></td> <td style="width: 10%;"></td> <td style="width: 10%;"></td> <td style="width: 10%;"></td> <td style="width: 10%;"></td> <td style="width: 10%;"></td> <td style="width: 10%;"></td> </tr> <tr> <td></td> <td></td> <td colspan="8" style="text-align: center;"> <table border="1" style="width: 100%; border-collapse: collapse; text-align: center;"> <tr> <td style="width: 10%;"></td> <td style="width: 10%;"></td> <td style="width: 10%;"></td> <td style="width: 10%;"></td> <td style="width: 10%;"></td> <td style="width: 10%;"></td> <td style="width: 10%;"></td> <td style="width: 10%;"></td> <td style="width: 10%;"></td> <td style="width: 10%;"></td> </tr> <tr> <td></td> <td></td> <td colspan="8" style="text-align: center;"> <table border="1" style="width: 100%; border-collapse: collapse; text-align: center;"> <tr> <td style="width: 10%;"></td> <td style="width: 10%;"></td> <td style="width: 10%;"></td> <td style="width: 10%;"></td> <td style="width: 10%;"></td> <td style="width: 10%;"></td> <td style="width: 10%;"></td> <td style="width: 10%;"></td> <td style="width: 10%;"></td> <td style="width: 10%;"></td> </tr> <tr> <td></td> <td></td> <td colspan="8" style="text-align: center;"> <table border="1" style="width: 100%; border-collapse: collapse; text-align: center;"> <tr> <td style="width: 10%;"></td> <td style="width: 10%;"></td> <td style="width: 10%;"></td> <td style="width: 10%;"></td> <td style="width: 10%;"></td> <td style="width: 10%;"></td> <td style="width: 10%;"></td> <td style="width: 10%;"></td> <td style="width: 10%;"></td> <td style="width: 10%;"></td> </tr> <tr> <td></td> <td></td> <td colspan="8" style="text-align: center;"> <table border="1" style="width: 100%; border-collapse: collapse; text-align: center;"> <tr> <td style="width: 10%;"></td> <td style="width: 10%;"></td> <td style="width: 10%;"></td> <td style="width: 10%;"></td> <td style="width: 10%;"></td> <td style="width: 10%;"></td> <td style="width: 10%;"></td> <td style="width: 10%;"></td> <td style="width: 10%;"></td> <td style="width: 10%;"></td> </tr> <tr> <td></td> <td></td> <td colspan="8" style="text-align: center;"> <table border="1" style="width: 100%; border-collapse: collapse; text-align: center;"> <tr> <td style="width: 10%;"></td> <td style="width: 10%;"></td> <td style="width: 10%;"></td> <td style="width: 10%;"></td> <td style="width: 10%;"></td> <td style="width: 10%;"></td> <td style="width: 10%;"></td> <td style="width: 10%;"></td> <td style="width: 10%;"></td> <td style="width: 10%;"></td> </tr> <tr> <td></td> <td></td> <td colspan="8" style="text-align: center;"> <table border="1" style="width: 100%; border-collapse: collapse; text-align: center;"> <tr> </tr></table></td></tr></table></td></tr></table></td></tr></table></td></tr></table></td></tr></table></td></tr></table></td></tr></table>
 | | | | | | | | | | | | | | | | | | | | <table border="1" style="width: 100%; border-collapse: collapse; text-align: center;"> <tr> <td style="width: 10%;"></td> <td style="width: 10%;"></td> <td style="width: 10%;"></td> <td style="width: 10%;"></td> <td style="width: 10%;"></td> <td style="width: 10%;"></td> <td style="width: 10%;"></td> <td style="width: 10%;"></td> <td style="width: 10%;"></td> <td style="width: 10%;"></td> </tr> <tr> <td></td> <td></td> <td colspan="8" style="text-align: center;"> <table border="1" style="width: 100%; border-collapse: collapse; text-align: center;"> <tr> <td style="width: 10%;"></td> <td style="width: 10%;"></td> <td style="width: 10%;"></td> <td style="width: 10%;"></td> <td style="width: 10%;"></td> <td style="width: 10%;"></td> <td style="width: 10%;"></td> <td style="width: 10%;"></td> <td style="width: 10%;"></td> <td style="width: 10%;"></td> </tr> <tr> <td></td> <td></td> <td colspan="8" style="text-align: center;"> <table border="1" style="width: 100%; border-collapse: collapse; text-align: center;"> <tr> <td style="width: 10%;"></td> <td style="width: 10%;"></td> <td style="width: 10%;"></td> <td style="width: 10%;"></td> <td style="width: 10%;"></td> <td style="width: 10%;"></td> <td style="width: 10%;"></td> <td style="width: 10%;"></td> <td style="width: 10%;"></td> <td style="width: 10%;"></td> </tr> <tr> <td></td> <td></td> <td colspan="8" style="text-align: center;"> <table border="1" style="width: 100%; border-collapse: collapse; text-align: center;"> <tr> <td style="width: 10%;"></td> <td style="width: 10%;"></td> <td style="width: 10%;"></td> <td style="width: 10%;"></td> <td style="width: 10%;"></td> <td style="width: 10%;"></td> <td style="width: 10%;"></td> <td style="width: 10%;"></td> <td style="width: 10%;"></td> <td style="width: 10%;"></td> </tr> <tr> <td></td> <td></td> <td colspan="8" style="text-align: center;"> <table border="1" style="width: 100%; border-collapse: collapse; text-align: center;"> <tr> <td style="width: 10%;"></td> <td style="width: 10%;"></td> <td style="width: 10%;"></td> <td style="width: 10%;"></td> <td style="width: 10%;"></td> <td style="width: 10%;"></td> <td style="width: 10%;"></td> <td style="width: 10%;"></td> <td style="width: 10%;"></td> <td style="width: 10%;"></td> </tr> <tr> <td></td> <td></td> <td colspan="8" style="text-align: center;"> <table border="1" style="width: 100%; border-collapse: collapse; text-align: center;"> <tr> <td style="width: 10%;"></td> <td style="width: 10%;"></td> <td style="width: 10%;"></td> <td style="width: 10%;"></td> <td style="width: 10%;"></td> <td style="width: 10%;"></td> <td style="width: 10%;"></td> <td style="width: 10%;"></td> <td style="width: 10%;"></td> <td style="width: 10%;"></td> </tr> <tr> <td></td> <td></td> <td colspan="8" style="text-align: center;"> <table border="1" style="width: 100%; border-collapse: collapse; text-align: center;"> <tr> </tr></table></td></tr></table></td></tr></table></td></tr></table></td></tr></table></td></tr></table></td></tr></table> | | | | | | | | | | | | | | | | | | | | <table border="1" style="width: 100%; border-collapse: collapse; text-align: center;"> <tr> <td style="width: 10%;"></td> <td style="width: 10%;"></td> <td style="width: 10%;"></td> <td style="width: 10%;"></td> <td style="width: 10%;"></td> <td style="width: 10%;"></td> <td style="width: 10%;"></td> <td style="width: 10%;"></td> <td style="width: 10%;"></td> <td style="width: 10%;"></td> </tr> <tr> <td></td> <td></td> <td colspan="8" style="text-align: center;"> <table border="1" style="width: 100%; border-collapse: collapse; text-align: center;"> <tr> <td style="width: 10%;"></td> <td style="width: 10%;"></td> <td style="width: 10%;"></td> <td style="width: 10%;"></td> <td style="width: 10%;"></td> <td style="width: 10%;"></td> <td style="width: 10%;"></td> <td style="width: 10%;"></td> <td style="width: 10%;"></td> <td style="width: 10%;"></td> </tr> <tr> <td></td> <td></td> <td colspan="8" style="text-align: center;"> <table border="1" style="width: 100%; border-collapse: collapse; text-align: center;"> <tr> <td style="width: 10%;"></td> <td style="width: 10%;"></td> <td style="width: 10%;"></td> <td style="width: 10%;"></td> <td style="width: 10%;"></td> <td style="width: 10%;"></td> <td style="width: 10%;"></td> <td
style="width: 10%;"></td> <td style="width: 10%;"></td> <td style="width: 10%;"></td> </tr> <tr> <td></td> <td></td> <td colspan="8" style="text-align: center;"> <table border="1" style="width: 100%; border-collapse: collapse; text-align: center;"> <tr> <td style="width: 10%;"></td> <td style="width: 10%;"></td> <td style="width: 10%;"></td> <td style="width: 10%;"></td> <td style="width: 10%;"></td> <td style="width: 10%;"></td> <td style="width: 10%;"></td> <td style="width: 10%;"></td> <td style="width: 10%;"></td> <td style="width: 10%;"></td> </tr> <tr> <td></td> <td></td> <td colspan="8" style="text-align: center;"> <table border="1" style="width: 100%; border-collapse: collapse; text-align: center;"> <tr> <td style="width: 10%;"></td> <td style="width: 10%;"></td> <td style="width: 10%;"></td> <td style="width: 10%;"></td> <td style="width: 10%;"></td> <td style="width: 10%;"></td> <td style="width: 10%;"></td> <td style="width: 10%;"></td> <td style="width: 10%;"></td> <td style="width: 10%;"></td> </tr> <tr> <td></td> <td></td> <td colspan="8" style="text-align: center;"> <table border="1" style="width: 100%; border-collapse: collapse; text-align: center;"> <tr> </tr></table></td></tr></table></td></tr></table></td></tr></table></td></tr></table></td></tr></table> | | | | | | | | | | | | | | | | | | | | <table border="1" style="width: 100%; border-collapse: collapse; text-align: center;"> <tr> <td style="width: 10%;"></td> <td style="width: 10%;"></td> <td style="width: 10%;"></td> <td style="width: 10%;"></td> <td style="width: 10%;"></td> <td style="width: 10%;"></td> <td style="width: 10%;"></td> <td style="width: 10%;"></td> <td style="width: 10%;"></td> <td style="width: 10%;"></td> </tr> <tr> <td></td> <td></td> <td colspan="8" style="text-align: center;"> <table border="1" style="width: 100%; border-collapse: collapse; text-align: center;"> <tr> <td style="width: 10%;"></td> <td style="width: 10%;"></td> <td style="width: 10%;"></td> <td style="width: 10%;"></td> <td style="width: 10%;"></td> <td style="width: 10%;"></td> <td style="width: 10%;"></td> <td style="width: 10%;"></td> <td style="width: 10%;"></td> <td style="width: 10%;"></td> </tr> <tr> <td></td> <td></td> <td colspan="8" style="text-align: center;"> <table border="1" style="width: 100%; border-collapse: collapse; text-align: center;"> <tr> <td style="width: 10%;"></td> <td style="width: 10%;"></td> <td style="width: 10%;"></td> <td style="width: 10%;"></td> <td style="width: 10%;"></td> <td style="width: 10%;"></td> <td style="width: 10%;"></td> <td style="width: 10%;"></td> <td style="width: 10%;"></td> <td style="width: 10%;"></td> </tr> <tr> <td></td> <td></td> <td colspan="8" style="text-align: center;"> <table border="1" style="width: 100%; border-collapse: collapse; text-align: center;"> <tr> <td style="width: 10%;"></td> <td style="width: 10%;"></td> <td style="width: 10%;"></td> <td style="width: 10%;"></td> <td style="width: 10%;"></td> <td style="width: 10%;"></td> <td style="width: 10%;"></td> <td style="width: 10%;"></td> <td style="width: 10%;"></td> <td style="width: 10%;"></td> </tr> <tr> <td></td> <td></td> <td colspan="8" style="text-align: center;"> <table border="1" style="width: 100%; border-collapse: collapse; text-align: center;"> <tr> </tr></table></td></tr></table></td></tr></table></td></tr></table></td></tr></table>
 | | | | | | | | | | | | | | | | | | | | <table border="1" style="width: 100%; border-collapse: collapse; text-align: center;"> <tr> <td style="width: 10%;"></td> <td style="width: 10%;"></td> <td style="width: 10%;"></td> <td style="width: 10%;"></td> <td style="width: 10%;"></td> <td style="width: 10%;"></td> <td style="width: 10%;"></td> <td style="width: 10%;"></td> <td style="width: 10%;"></td> <td style="width: 10%;"></td> </tr> <tr> <td></td> <td></td> <td colspan="8" style="text-align: center;"> <table border="1" style="width: 100%; border-collapse: collapse; text-align: center;"> <tr> <td style="width: 10%;"></td> <td style="width: 10%;"></td> <td style="width: 10%;"></td> <td style="width: 10%;"></td> <td style="width: 10%;"></td> <td style="width: 10%;"></td> <td style="width: 10%;"></td> <td style="width: 10%;"></td> <td style="width: 10%;"></td> <td style="width: 10%;"></td> </tr> <tr> <td></td> <td></td> <td colspan="8" style="text-align: center;"> <table border="1" style="width: 100%; border-collapse: collapse; text-align: center;"> <tr> <td style="width: 10%;"></td> <td style="width: 10%;"></td> <td style="width: 10%;"></td> <td style="width: 10%;"></td> <td style="width: 10%;"></td> <td style="width: 10%;"></td> <td style="width: 10%;"></td> <td style="width: 10%;"></td> <td style="width: 10%;"></td> <td style="width: 10%;"></td> </tr> <tr> <td></td> <td></td> <td colspan="8" style="text-align: center;"> <table border="1" style="width: 100%; border-collapse: collapse; text-align: center;"> <tr> </tr></table></td></tr></table></td></tr></table></td></tr></table> | | | | | | | | | | | | | | | | | | | | <table border="1" style="width: 100%; border-collapse: collapse; text-align: center;"> <tr> <td style="width: 10%;"></td> <td style="width: 10%;"></td> <td style="width: 10%;"></td> <td style="width: 10%;"></td> <td style="width: 10%;"></td> <td style="width: 10%;"></td> <td style="width: 10%;"></td> <td style="width: 10%;"></td> <td style="width: 10%;"></td> <td style="width: 10%;"></td> </tr> <tr> <td></td> <td></td> <td colspan="8" style="text-align: center;"> <table border="1" style="width: 100%; border-collapse: collapse; text-align: center;"> <tr> <td style="width: 10%;"></td> <td style="width: 10%;"></td> <td style="width: 10%;"></td> <td style="width: 10%;"></td> <td style="width: 10%;"></td> <td style="width: 10%;"></td> <td style="width: 10%;"></td> <td style="width: 10%;"></td> <td style="width: 10%;"></td> <td style="width: 10%;"></td> </tr> <tr> <td></td> <td></td> <td colspan="8" style="text-align: center;"> <table border="1" style="width: 100%; border-collapse: collapse; text-align: center;"> <tr> </tr></table></td></tr></table></td></tr></table>
 | | | | | | | | | | | | | | | | | | | | <table border="1" style="width: 100%; border-collapse: collapse; text-align: center;"> <tr> <td style="width: 10%;"></td> <td style="width: 10%;"></td> <td style="width: 10%;"></td> <td style="width: 10%;"></td> <td style="width: 10%;"></td> <td style="width: 10%;"></td> <td style="width: 10%;"></td> <td style="width: 10%;"></td> <td style="width: 10%;"></td> <td style="width: 10%;"></td> </tr> <tr> <td></td> <td></td> <td colspan="8" style="text-align: center;"> <table border="1" style="width: 100%; border-collapse: collapse; text-align: center;"> <tr> </tr></table></td></tr></table> | | | | | | | | | | | | | | | | | | | | <table border="1" style="width: 100%; border-collapse: collapse; text-align: center;"> <tr> </tr></table>
 | | | | | | | | | | | | | | | | | | | | | | | | | | | | | | | | | | | | | | | | | | | | | | | | | | | | | | | | | | | | | | | | | | | | | | | | | | | | | | | |
 | | | | | | | | | | | | | | | | | | | | | | | | | | | | | | | | | | | | | | | | | | | | | | | | | | | | | | | | | | | | | | | | | | | | | | | | | | | | | | | |
 | | | | | | | | | | | | | | | | | | | | | | | | | | | | | | | | | | | | | | | | | | | | | | | | | | | | | | | | | | | | | | | | | | | |
| | |

 | | | | | | | | | | | | | | | | | | | |

 | | | | | | | | | | | | | | | | | | | |

 | | | | | | | | | | | | | | | | | | | |

 | | | | | | | | | | | | | | | | | | | |

 | | | | | | | | | | | | | | | | | | | |

 | | | | | | | | | | | | | | | | | | | |

 | | | | | | | | | | | | | | | | | | | |

 | | | | | | | | | | | | | | | | | | | |

 | | | | | | | | | | | | | | | | | | | |

 | | | | | | | | | | | | | | | | | | | |

 | | | | | | | | | | | | | | | | | | | |

 | | | | | | | | | | | | | | | | | | | |

 | | | | | | | | | | | | | | | | | | | |

 | | | | | | | | | | | | | | | | | | | |

 | | | | | | | | | | | | | | | | | | | |

 | | | | | | | | | | | | | | | | | | | |

 | | | | | | | | | | | | | | | | | | | |

 | | | | | | | | | | | | | | | | | | | |

 | | | | | | | | | | | | | | | | | | | |

 | | | | | | | | | | | | | | | | | | | |

 | | | | | | | | | | | | | | | | | | | |

 | | | | | | | | | | | | | | | | | | | |

 | | | | | | | | | | | | | | | | | | | |

 | | | | | | | | | | | | | | | | | | | |

 | | | | | | | | | | | | | | | | | | | |

 | | | | | | | | | | | | | | | | | | | |

 | | | | | | | | | | | | | | | | | | | |

 | | | | | | | | | | | | | | | | | | | |
 | | | | | | | | | | | | | | | | | | | |

 | | | | | | | | | | | | | | | | | | | |

 | | | | | | | | | | | | | | | | | | | |
 | | | | | | | | | | | | | | | | | | | |

 | | | | | | | | | | | | | | | | | | | |

 | | | | | | | | | | | | | | | | | | | |
 | | | | | | | | | | | | | | | | | | | |
 | | | | | | | | | | | | | | | | | | | |

 | | | | | | | | | | | | | | | | | | | |
 | | | | | | | | | | | | | | | | | | | |
 | | | | | | | | | | | | | | | | | | | |

 | | | | | | | | | | | | | | | | | | | | | | | | | | | | | | | | | | | | | | | | | | | | | | | | | | | | | | | | | | | | | | | | | | | | | | | | | | | | | | | | | | | | | | | | | | | | | | | | | | | |
 | | | | | | | | | | | | | | | | | | | |
 | | | | | | | | | | | | | | | | | | | |
 | | | | | | | | | | | | | | | | | | | |
 | | | | | | | | | | | | | | | | | | | |
 | | | | | | | | | | | | | | | | | | | |
 | | | | | | | | | | | | | | | | | | | |
 | | | | | | | | | | | | | | | | | | | |
 | | | | | | | | | | | | | | | | | | | |
 | | | | | | | | | | | | | | | | | | | | | | | | | | | | | | | | | | | | | | | |
 | | | | | | | | | | | | | | | | | | | |
 | | | | | | | | | | | | | | | | | | | | | | | | | | | | | | | | | | | | | | | |
 | | | | | | | | | | | | | | | | | | | | | | | | | | | | | | | | | | | | | | | |
 | | | | | | | | | | | | | | | | | | | | | | | | | | | | | | | | | | | | | | | |
 | | | | | | | | | | | | | | | | | | | | | | | | | | | | | | | | | | | | | | | | | | | | | | | | | | | | | | | | | | | | | | | | | | | | | | | | | | | | | | | | | | | | | | | | | | | | | | | | | | | |
 | | | | | | | | | | | | | | | | | | | | | | | | | | | | | | | | | | | | | | | | | | | | | | | |
| | | <table border="1" style="width: 100%; border-collapse: collapse; text-align: center;"> <tr> <td style="width: 10%;"></td> <td style="width: 10%;"></td> <td style="width: 10%;"></td> <td style="width: 10%;"></td> <td style="width: 10%;"></td> <td style="width: 10%;"></td> <td style="width: 10%;"></td> <td style="width: 10%;"></td> <td style="width: 10%;"></td> <td style="width: 10%;"></td> </tr> <tr> <td></td> <td></td> <td colspan="8" style="text-align: center;"> <table border="1" style="width: 100%; border-collapse: collapse; text-align: center;"> <tr> <td style="width: 10%;"></td> <td style="width: 10%;"></td> <td style="width: 10%;"></td> <td style="width: 10%;"></td> <td style="width: 10%;"></td> <td style="width: 10%;"></td> <td style="width: 10%;"></td> <td style="width: 10%;"></td> <td style="width: 10%;"></td> <td style="width: 10%;"></td> </tr> <tr> <td></td> <td></td> <td colspan="8" style="text-align: center;"> <table border="1" style="width: 100%; border-collapse: collapse; text-align: center;"> <tr> <td style="width: 10%;"></td> <td style="width: 10%;"></td> <td style="width: 10%;"></td> <td style="width: 10%;"></td> <td style="width: 10%;"></td> <td style="width: 10%;"></td> <td style="width: 10%;"></td> <td style="width: 10%;"></td> <td style="width: 10%;"></td> <td style="width: 10%;"></td> </tr> <tr> <td></td> <td></td> <td colspan="8" style="text-align: center;"> <table border="1" style="width: 100%; border-collapse: collapse; text-align: center;"> <tr> <td style="width: 10%;"></td> <td style="width: 10%;"></td> <td style="width: 10%;"></td> <td style="width: 10%;"></td> <td style="width: 10%;"></td> <td style="width: 10%;"></td> <td style="width: 10%;"></td> <td style="width: 10%;"></td> <td style="width: 10%;"></td> <td style="width: 10%;"></td> </tr> <tr> <td></td> <td></td> <td colspan="8" style="text-align: center;"> <table border="1" style="width: 100%; border-collapse: collapse; text-align: center;"> <tr> <td style="width: 10%;"></td> <td style="width: 10%;"></td> <td style="width: 10%;"></td> <td style="width: 10%;"></td> <td style="width: 10%;"></td> <td style="width: 10%;"></td> <td style="width: 10%;"></td> <td style="width: 10%;"></td> <td style="width: 10%;"></td> <td style="width: 10%;"></td> </tr> <tr> <td></td> <td></td> <td colspan="8" style="text-align: center;"> <table border="1" style="width: 100%; border-collapse: collapse; text-align: center;"> <tr> <td style="width: 10%;"></td> <td style="width: 10%;"></td> <td style="width: 10%;"></td> <td style="width: 10%;"></td> <td style="width: 10%;"></td> <td style="width: 10%;"></td> <td style="width: 10%;"></td> <td style="width: 10%;"></td> <td style="width: 10%;"></td> <td style="width: 10%;"></td> </tr> <tr> <td></td> <td></td> <td colspan="8" style="text-align: center;"> <table border="1" style="width: 100%; border-collapse: collapse; text-align: center;"> <tr> <td style="width: 10%;"></td> <td style="width: 10%;"></td> <td style="width: 10%;"></td> <td style="width: 10%;"></td> <td style="width: 10%;"></td> <td style="width: 10%;"></td> <td style="width: 10%;"></td> <td style="width: 10%;"></td> <td style="width: 10%;"></td> <td style="width: 10%;"></td> </tr> <tr> <td></td> <td></td> <td colspan="8" style="text-align: center;"> <table border="1" style="width: 100%; border-collapse: collapse; text-align: center;"> <tr> <td style="width: 10%;"></td> <td style="width: 10%;"></td> <td style="width: 10%;"></td> <td style="width: 10%;"></td> <td style="width: 10%;"></td> <td style="width: 10%;"></td> <td style="width: 10%;"></td> <td style="width: 10%;"></td> <td style="width: 10%;"></td> <td style="width: 10%;"></td> </tr> <tr> <td></td> <td></td> <td colspan="8" style="text-align: center;"> <table border="1" style="width: 100%; border-collapse: collapse; text-align: center;"> <tr> <td style="width: 10%;"></td> <td style="width: 10%;"></td> <td style="width: 10%;"></td> <td style="width: 10%;"></td> <td style="width: 10%;"></td> <td style="width: 10%;"></td> <td style="width: 10%;"></td> <td style="width: 10%;"></td> <td style="width: 10%;"></td> <td style="width: 10%;"></td> </tr> <tr> <td></td> <td></td> <td colspan="8" style="text-align: center;"> <table border="1" style="width: 100%; border-collapse: collapse; text-align: center;"> <tr> <td style="width: 10%;"></td> <td style="width: 10%;"></td> <td style="width: 10%;"></td> <td style="width: 10%;"></td> <td style="width: 10%;"></td> <td style="width: 10%;"></td> <td style="width: 10%;"></td> <td style="width: 10%;"></td> <td style="width: 10%;"></td> <td style="width: 10%;"></td> </tr> <tr> <td></td> <td></td> <td colspan="8" style="text-align: center;"> <table border="1" style="width: 100%; border-collapse: collapse; text-align: center;"> <tr> <td style="width: 10%;"></td> <td style="width: 10%;"></td> <td style="width: 10%;"></td> <td style="width: 10%;"></td> <td style="width: 10%;"></td> <td style="width: 10%;"></td> <td style="width: 10%;"></td> <td style="width: 10%;"></td> <td style="width: 10%;"></td> <td style="width: 10%;"></td> </tr> <tr> <td></td> <td></td> <td colspan="8" style="text-align: center;"> <table border="1" style="width: 100%; border-collapse: collapse; text-align: center;"> <tr> <td style="width: 10%;"></td> <td style="width: 10%;"></td> <td style="width: 10%;"></td> <td style="width: 10%;"></td> <td style="width: 10%;"></td> <td style="width: 10%;"></td> <td style="width: 10%;"></td> <td style="width: 10%;"></td> <td style="width: 10%;"></td> <td style="width: 10%;"></td> </tr> <tr> <td></td> <td></td> <td colspan="8" style="text-align: center;"> <table border="1" style="width: 100%; border-collapse: collapse; text-align: center;"> <tr> <td style="width: 10%;"></td> <td style="width: 10%;"></td> <td style="width: 10%;"></td> <td style="width: 10%;"></td> <td style="width: 10%;"></td> <td style="width: 10%;"></td> <td style="width: 10%;"></td> <td style="width: 10%;"></td> <td style="width: 10%;"></td> <td style="width: 10%;"></td> </tr> <tr> <td></td> <td></td> <td colspan="8" style="text-align: center;"> <table border="1" style="width: 100%; border-collapse: collapse; text-align: center;"> <tr> <td style="width: 10%;"></td> <td style="width: 10%;"></td> <td style="width: 10%;"></td> <td style="width: 10%;"></td> <td style="width: 10%;"></td> <td style="width: 10%;"></td> <td style="width: 10%;"></td> <td style="width: 10%;"></td> <td style="width: 10%;"></td> <td style="width: 10%;"></td> </tr> <tr> <td></td> <td></td> <td colspan="8" style="text-align: center;"> <table border="1" style="width: 100%; border-collapse: collapse; text-align: center;"> <tr> <td style="width: 10%;"></td> <td style="width: 10%;"></td> <td style="width: 10%;"></td> <td style="width: 10%;"></td> <td style="width: 10%;"></td> <td style="width: 10%;"></td> <td style="width: 10%;"></td> <td style="width: 10%;"></td> <td style="width: 10%;"></td> <td style="width: 10%;"></td> </tr> <tr> <td></td> <td></td> <td colspan="8" style="text-align: center;"> <table border="1" style="width: 100%; border-collapse: collapse; text-align: center;"> <tr> <td style="width: 10%;"></td> <td style="width: 10%;"></td> <td style="width: 10%;"></td> <td style="width: 10%;"></td> <td style="width: 10%;"></td> <td style="width: 10%;"></td> <td style="width: 10%;"></td> <td style="width: 10%;"></td> <td style="width: 10%;"></td> <td style="width: 10%;"></td> </tr> <tr> <td></td> <td></td> <td colspan="8" style="text-align: center;"> <table border="1" style="width: 100%; border-collapse: collapse; text-align: center;"> <tr> <td style="width: 10%;"></td> <td style="width: 10%;"></td> <td style="width: 10%;"></td> <td style="width: 10%;"></td> <td style="width: 10%;"></td> <td style="width: 10%;"></td> <td style="width: 10%;"></td> <td style="width: 10%;"></td> <td style="width: 10%;"></td> <td style="width: 10%;"></td> </tr> <tr> <td></td> <td></td> <td colspan="8" style="text-align: center;"> <table border="1" style="width: 100%; border-collapse: collapse; text-align: center;"> <tr> <td style="width: 10%;"></td> <td style="width: 10%;"></td> <td style="width: 10%;"></td> <td style="width: 10%;"></td> <td style="width: 10%;"></td> <td style="width: 10%;"></td> <td style="width: 10%;"></td> <td style="width: 10%;"></td> <td style="width: 10%;"></td> <td style="width: 10%;"></td> </tr> <tr> <td></td> <td></td> <td colspan="8" style="text-align: center;"> <table border="1" style="width: 100%; border-collapse: collapse; text-align: center;"> <tr> <td style="width: 10%;"></td> <td style="width: 10%;"></td> <td style="width: 10%;"></td> <td style="width: 10%;"></td> <td style="width: 10%;"></td> <td style="width: 10%;"></td> <td style="width: 10%;"></td> <td style="width: 10%;"></td> <td style="width: 10%;"></td> <td style="width: 10%;"></td> </tr> <tr> <td></td> <td></td> <td colspan="8" style="text-align: center;"> <table border="1" style="width: 100%; border-collapse: collapse; text-align: center;"> <tr> <td style="width: 10%;"></td> <td style="width: 10%;"></td> <td style="width: 10%;"></td> <td style="width: 10%;"></td> <td style="width: 10%;"></td> <td style="width: 10%;"></td> <td style="width: 10%;"></td> <td style="width: 10%;"></td> <td style="width: 10%;"></td> <td style="width: 10%;"></td> </tr> <tr> <td></td> <td></td> <td colspan="8" style="text-align: center;"> <table border="1" style="width: 100%; border-collapse: collapse; text-align: center;"> <tr> <td style="width: 10%;"></td> <td style="width: 10%;"></td> <td style="width: 10%;"></td> <td style="width: 10%;"></td> <td style="width: 10%;"></td> <td style="width: 10%;"></td> <td style="width: 10%;"></td> <td style="width: 10%;"></td> <td style="width: 10%;"></td> <td style="width: 10%;"></td> </tr> <tr> <td></td> <td></td> <td colspan="8" style="text-align: center;"> <table border="1" style="width: 100%; border-collapse: collapse; text-align: center;"> <tr> <td style="width: 10%;"></td> <td style="width: 10%;"></td> <td
style="width: 10%;"></td> <td style="width: 10%;"></td> <td style="width: 10%;"></td> <td style="width: 10%;"></td> <td style="width: 10%;"></td> <td style="width: 10%;"></td> <td style="width: 10%;"></td> <td style="width: 10%;"></td> </tr> <tr> <td></td> <td></td> <td colspan="8" style="text-align: center;"> <table border="1" style="width: 100%; border-collapse: collapse; text-align: center;"> <tr> <td style="width: 10%;"></td> <td style="width: 10%;"></td> <td style="width: 10%;"></td> <td style="width: 10%;"></td> <td style="width: 10%;"></td> <td style="width: 10%;"></td> <td style="width: 10%;"></td> <td style="width: 10%;"></td> <td style="width: 10%;"></td> <td style="width: 10%;"></td> </tr> <tr> <td></td> <td></td> <td colspan="8" style="text-align: center;"> <table border="1" style="width: 100%; border-collapse: collapse; text-align: center;"> <tr> <td style="width: 10%;"></td> <td style="width: 10%;"></td> <td style="width: 10%;"></td> <td style="width: 10%;"></td> <td style="width: 10%;"></td> <td style="width: 10%;"></td> <td style="width: 10%;"></td> <td style="width: 10%;"></td> <td style="width: 10%;"></td> <td style="width: 10%;"></td> </tr> <tr> <td></td> <td></td> <td colspan="8" style="text-align: center;"> <table border="1" style="width: 100%; border-collapse: collapse; text-align: center;"> <tr> <td style="width: 10%;"></td> <td style="width: 10%;"></td> <td style="width: 10%;"></td> <td style="width: 10%;"></td> <td style="width: 10%;"></td> <td style="width: 10%;"></td> <td style="width: 10%;"></td> <td style="width: 10%;"></td> <td style="width: 10%;"></td> <td style="width: 10%;"></td> </tr> <tr> <td></td> <td></td> <td colspan="8" style="text-align: center;"> <table border="1" style="width: 100%; border-collapse: collapse; text-align: center;"> <tr> <td style="width: 10%;"></td> <td style="width: 10%;"></td> <td style="width: 10%;"></td> <td style="width: 10%;"></td> <td style="width: 10%;"></td> <td style="width: 10%;"></td> <td style="width: 10%;"></td> <td style="width: 10%;"></td> <td style="width: 10%;"></td> <td style="width: 10%;"></td> </tr> <tr> <td></td> <td></td> <td colspan="8" style="text-align: center;"> <table border="1" style="width: 100%; border-collapse: collapse; text-align: center;"> <tr> <td style="width: 10%;"></td> <td style="width: 10%;"></td> <td style="width: 10%;"></td> <td style="width: 10%;"></td> <td style="width: 10%;"></td> <td style="width: 10%;"></td> <td style="width: 10%;"></td> <td style="width: 10%;"></td> <td style="width: 10%;"></td> <td style="width: 10%;"></td> </tr> <tr> <td></td> <td></td> <td colspan="8" style="text-align: center;"> <table border="1" style="width: 100%; border-collapse: collapse; text-align: center;"> <tr> <td style="width: 10%;"></td> <td style="width: 10%;"></td> <td style="width: 10%;"></td> <td style="width: 10%;"></td> <td style="width: 10%;"></td> <td style="width: 10%;"></td> <td style="width: 10%;"></td> <td style="width: 10%;"></td> <td style="width: 10%;"></td> <td style="width: 10%;"></td> </tr> <tr> <td></td> <td></td> <td colspan="8" style="text-align: center;"> <table border="1" style="width: 100%; border-collapse: collapse; text-align: center;"> <tr> <td style="width: 10%;"></td> <td style="width: 10%;"></td> <td style="width: 10%;"></td> <td style="width: 10%;"></td> <td style="width: 10%;"></td> <td style="width: 10%;"></td> <td style="width: 10%;"></td> <td style="width: 10%;"></td> <td style="width: 10%;"></td> <td style="width: 10%;"></td> </tr> <tr> <td></td> <td></td> <td colspan="8" style="text-align: center;"> <table border="1" style="width: 100%; border-collapse: collapse; text-align: center;"> <tr> <td style="width: 10%;"></td> <td style="width: 10%;"></td> <td style="width: 10%;"></td> <td style="width: 10%;"></td> <td style="width: 10%;"></td> <td style="width: 10%;"></td> <td style="width: 10%;"></td> <td style="width: 10%;"></td> <td style="width: 10%;"></td> <td style="width: 10%;"></td> </tr> <tr> <td></td> <td></td> <td colspan="8" style="text-align: center;"> <table border="1" style="width: 100%; border-collapse: collapse; text-align: center;"> <tr> <td style="width: 10%;"></td> <td style="width: 10%;"></td> <td style="width: 10%;"></td> <td style="width: 10%;"></td> <td style="width: 10%;"></td> <td style="width: 10%;"></td> <td style="width: 10%;"></td> <td style="width: 10%;"></td> <td style="width: 10%;"></td> <td style="width: 10%;"></td> </tr> <tr> <td></td> <td></td> <td colspan="8" style="text-align: center;"> <table border="1" style="width: 100%; border-collapse: collapse; text-align: center;"> <tr> <td style="width: 10%;"></td> <td style="width: 10%;"></td> <td style="width: 10%;"></td> <td style="width: 10%;"></td> <td style="width: 10%;"></td> <td style="width: 10%;"></td> <td style="width: 10%;"></td> <td style="width: 10%;"></td> <td style="width: 10%;"></td> <td style="width: 10%;"></td> </tr> <tr> <td></td> <td></td> <td colspan="8" style="text-align: center;"> <table border="1" style="width: 100%; border-collapse: collapse; text-align: center;"> <tr> <td style="width: 10%;"></td> <td style="width: 10%;"></td> <td style="width: 10%;"></td> <td style="width: 10%;"></td> <td style="width: 10%;"></td> <td style="width: 10%;"></td> <td style="width: 10%;"></td> <td style="width: 10%;"></td> <td style="width: 10%;"></td> <td style="width: 10%;"></td> </tr> <tr> <td></td> <td></td> <td colspan="8" style="text-align: center;"> <table border="1" style="width: 100%; border-collapse: collapse; text-align: center;"> <tr> <td style="width: 10%;"></td> <td style="width: 10%;"></td> <td style="width: 10%;"></td> <td style="width: 10%;"></td> <td style="width: 10%;"></td> <td style="width: 10%;"></td> <td style="width: 10%;"></td> <td style="width: 10%;"></td> <td style="width: 10%;"></td> <td style="width: 10%;"></td> </tr> <tr> <td></td> <td></td> <td colspan="8" style="text-align: center;"> <table border="1" style="width: 100%; border-collapse: collapse; text-align: center;"> <tr> <td style="width: 10%;"></td> <td style="width: 10%;"></td> <td style="width: 10%;"></td> <td style="width: 10%;"></td> <td style="width: 10%;"></td> <td style="width: 10%;"></td> <td style="width: 10%;"></td> <td style="width: 10%;"></td> <td style="width: 10%;"></td> <td style="width: 10%;"></td> </tr> <tr> <td></td> <td></td> <td colspan="8" style="text-align: center;"> <table border="1" style="width: 100%; border-collapse: collapse; text-align: center;"> <tr> <td style="width: 10%;"></td> <td style="width: 10%;"></td> <td style="width: 10%;"></td> <td style="width: 10%;"></td> <td style="width: 10%;"></td> <td style="width: 10%;"></td> <td style="width: 10%;"></td> <td style="width: 10%;"></td> <td style="width: 10%;"></td> <td style="width: 10%;"></td> </tr> <tr> <td></td> <td></td> <td colspan="8" style="text-align: center;"> <table border="1" style="width: 100%; border-collapse: collapse; text-align: center;"> <tr> <td style="width: 10%;"></td> <td style="width: 10%;"></td> <td style="width: 10%;"></td> <td style="width: 10%;"></td> <td style="width: 10%;"></td> <td style="width: 10%;"></td> <td style="width: 10%;"></td> <td style="width: 10%;"></td> <td style="width: 10%;"></td> <td style="width: 10%;"></td> </tr> <tr> <td></td> <td></td> <td colspan="8" style="text-align: center;"> <table border="1" style="width: 100%; border-collapse: collapse; text-align: center;"> <tr> <td style="width: 10%;"></td> <td style="width: 10%;"></td> <td style="width: 10%;"></td> <td style="width: 10%;"></td> <td style="width: 10%;"></td> <td style="width: 10%;"></td> <td style="width: 10%;"></td> <td style="width: 10%;"></td> <td style="width: 10%;"></td> <td style="width: 10%;"></td> </tr> <tr> <td></td> <td></td> <td colspan="8" style="text-align: center;"> <table border="1" style="width: 100%; border-collapse: collapse; text-align: center;"> <tr> <td style="width: 10%;"></td> <td style="width: 10%;"></td> <td style="width: 10%;"></td> <td style="width: 10%;"></td> <td style="width: 10%;"></td> <td style="width: 10%;"></td> <td style="width: 10%;"></td> <td style="width: 10%;"></td> <td style="width: 10%;"></td> <td style="width: 10%;"></td> </tr> <tr> <td></td> <td></td> <td colspan="8" style="text-align: center;"> <table border="1" style="width: 100%; border-collapse: collapse; text-align: center;"> <tr> <td style="width: 10%;"></td> <td style="width: 10%;"></td> <td style="width: 10%;"></td> <td style="width: 10%;"></td> <td style="width: 10%;"></td> <td style="width: 10%;"></td> <td style="width: 10%;"></td> <td style="width: 10%;"></td> <td style="width: 10%;"></td> <td style="width: 10%;"></td> </tr> <tr> <td></td> <td></td> <td colspan="8" style="text-align: center;"> <table border="1" style="width: 100%; border-collapse: collapse; text-align: center;"> <tr> <td style="width: 10%;"></td> <td style="width: 10%;"></td> <td style="width: 10%;"></td> <td style="width: 10%;"></td> <td style="width: 10%;"></td> <td style="width: 10%;"></td> <td style="width: 10%;"></td> <td style="width: 10%;"></td> <td style="width: 10%;"></td> <td style="width: 10%;"></td> </tr> <tr> <td></td> <td></td> <td colspan="8" style="text-align: center;"> <table border="1" style="width: 100%; border-collapse: collapse; text-align: center;"> <tr> <td style="width: 10%;"></td> <td style="width: 10%;"></td> <td style="width: 10%;"></td> <td style="width: 10%;"></td> <td style="width: 10%;"></td> <td style="width: 10%;"></td> <td style="width: 10%;"></td> <td style="width: 10%;"></td> <td style="width: 10%;"></td> <td style="width: 10%;"></td> </tr> <tr> <td></td> <td></td> <td colspan="8" style="text-align: center;"> <table border="1" style="width: 100%; border-collapse: collapse; text-align: center;"> <tr> <td style="width: 10%;"></td> <td style="width: 10%;"></td> <td style="width: 10%;"></td> <td style="width: 10%;"></td> <td style="width: 10%;"></td> <td style="width: 10%;"></td> <td style="width: 10%;"></td> <td style="width:
10%;"></td> <td style="width: 10%;"></td> <td style="width: 10%;"></td> </tr> <tr> <td></td> <td></td> <td colspan="8" style="text-align: center;"> <table border="1" style="width: 100%; border-collapse: collapse; text-align: center;"> <tr> <td style="width: 10%;"></td> <td style="width: 10%;"></td> <td style="width: 10%;"></td> <td style="width: 10%;"></td> <td style="width: 10%;"></td> <td style="width: 10%;"></td> <td style="width: 10%;"></td> <td style="width: 10%;"></td> <td style="width: 10%;"></td> <td style="width: 10%;"></td> </tr> <tr> <td></td> <td></td> <td colspan="8" style="text-align: center;"> <table border="1" style="width: 100%; border-collapse: collapse; text-align: center;"> <tr> <td style="width: 10%;"></td> <td style="width: 10%;"></td> <td style="width: 10%;"></td> <td style="width: 10%;"></td> <td style="width: 10%;"></td> <td style="width: 10%;"></td> <td style="width: 10%;"></td> <td style="width: 10%;"></td> <td style="width: 10%;"></td> <td style="width: 10%;"></td> </tr> <tr> <td></td> <td></td> <td colspan="8" style="text-align: center;"> <table border="1" style="width: 100%; border-collapse: collapse; text-align: center;"> <tr> <td style="width: 10%;"></td> <td style="width: 10%;"></td> <td style="width: 10%;"></td> <td style="width: 10%;"></td> <td style="width: 10%;"></td> <td style="width: 10%;"></td> <td style="width: 10%;"></td> <td style="width: 10%;"></td> <td style="width: 10%;"></td> <td style="width: 10%;"></td> </tr> <tr> <td></td> <td></td> <td colspan="8" style="text-align: center;"> <table border="1" style="width: 100%; border-collapse: collapse; text-align: center;"> <tr> <td style="width: 10%;"></td> <td style="width: 10%;"></td> <td style="width: 10%;"></td> <td style="width: 10%;"></td> <td style="width: 10%;"></td> <td style="width: 10%;"></td> <td style="width: 10%;"></td> <td style="width: 10%;"></td> <td style="width: 10%;"></td> <td style="width: 10%;"></td> </tr> <tr> <td></td> <td></td> <td colspan="8" style="text-align: center;"> <table border="1" style="width: 100%; border-collapse: collapse; text-align: center;"> <tr> <td style="width: 10%;"></td> <td style="width: 10%;"></td> <td style="width: 10%;"></td> <td style="width: 10%;"></td> <td style="width: 10%;"></td> <td style="width: 10%;"></td> <td style="width: 10%;"></td> <td style="width: 10%;"></td> <td style="width: 10%;"></td> <td style="width: 10%;"></td> </tr> <tr> <td></td> <td></td> <td colspan="8" style="text-align: center;"> <table border="1" style="width: 100%; border-collapse: collapse; text-align: center;"> <tr> <td style="width: 10%;"></td> <td style="width: 10%;"></td> <td style="width: 10%;"></td> <td style="width: 10%;"></td> <td style="width: 10%;"></td> <td style="width: 10%;"></td> <td style="width: 10%;"></td> <td style="width: 10%;"></td> <td style="width: 10%;"></td> <td style="width: 10%;"></td> </tr> <tr> <td></td> <td></td> <td colspan="8" style="text-align: center;"> <table border="1" style="width: 100%; border-collapse: collapse; text-align: center;"> <tr> <td style="width: 10%;"></td> <td style="width: 10%;"></td> <td style="width: 10%;"></td> <td style="width: 10%;"></td> <td style="width: 10%;"></td> <td style="width: 10%;"></td> <td style="width: 10%;"></td> <td style="width: 10%;"></td> <td style="width: 10%;"></td> <td style="width: 10%;"></td> </tr> <tr> <td></td> <td></td> <td colspan="8" style="text-align: center;"> <table border="1" style="width: 100%; border-collapse: collapse; text-align: center;"> <tr> <td style="width: 10%;"></td> <td style="width: 10%;"></td> <td style="width: 10%;"></td> <td style="width: 10%;"></td> <td style="width: 10%;"></td> <td style="width: 10%;"></td> <td style="width: 10%;"></td> <td style="width: 10%;"></td> <td style="width: 10%;"></td> <td style="width: 10%;"></td> </tr> <tr> <td></td> <td></td> <td colspan="8" style="text-align: center;"> <table border="1" style="width: 100%; border-collapse: collapse; text-align: center;"> <tr> <td style="width: 10%;"></td> <td style="width: 10%;"></td> <td style="width: 10%;"></td> <td style="width: 10%;"></td> <td style="width: 10%;"></td> <td style="width: 10%;"></td> <td style="width: 10%;"></td> <td style="width: 10%;"></td> <td style="width: 10%;"></td> <td style="width: 10%;"></td> </tr> <tr> <td></td> <td></td> <td colspan="8" style="text-align: center;"> <table border="1" style="width: 100%; border-collapse: collapse; text-align: center;"> <tr> <td style="width: 10%;"></td> <td style="width: 10%;"></td> <td style="width: 10%;"></td> <td style="width: 10%;"></td> <td style="width: 10%;"></td> <td style="width: 10%;"></td> <td style="width: 10%;"></td> <td style="width: 10%;"></td> <td style="width: 10%;"></td> <td style="width: 10%;"></td> </tr> <tr> <td></td> <td></td> <td colspan="8" style="text-align: center;"> <table border="1" style="width: 100%; border-collapse: collapse; text-align: center;"> <tr> <td style="width: 10%;"></td> <td style="width: 10%;"></td> <td style="width: 10%;"></td> <td style="width: 10%;"></td> <td style="width: 10%;"></td> <td style="width: 10%;"></td> <td style="width: 10%;"></td> <td style="width: 10%;"></td> <td style="width: 10%;"></td> <td style="width: 10%;"></td> </tr> <tr> <td></td> <td></td> <td colspan="8" style="text-align: center;"> <table border="1" style="width: 100%; border-collapse: collapse; text-align: center;"> <tr> </tr></table></td></tr></table></td></tr></table></td></tr></table></td></tr></table></td></tr></table></td></tr></table></td></tr></table></td></tr></table></td></tr></table></td></tr></table></td></tr></table></td></tr></table></td></tr></table></td></tr></table></td></tr></table></td></tr></table></td></tr></table></td></tr></table></td></tr></table></td></tr></table></td></tr></table></td></tr></table></td></tr></table></td></tr></table></td></tr></table></td></tr></table></td></tr></table></td></tr></table></td></tr></table></td></tr></table></td></tr></table></td></tr></table></td></tr></table></td></tr></table></td></tr></table></td></tr></table></td></tr></table></td></tr></table></td></tr></table></td></tr></table></td></tr></table></td></tr></table></td></tr></table></td></tr></table></td></tr></table></td></tr></table></td></tr></table></td></tr></table></td></tr></table></td></tr></table></td></tr></table></td></tr></table></td></tr></table></td></tr></table>
 | | | | | | | | | | | | | | | | | | | | <table border="1" style="width: 100%; border-collapse: collapse; text-align: center;"> <tr> <td style="width: 10%;"></td> <td style="width: 10%;"></td> <td style="width: 10%;"></td> <td style="width: 10%;"></td> <td style="width: 10%;"></td> <td style="width: 10%;"></td> <td style="width: 10%;"></td> <td style="width: 10%;"></td> <td style="width: 10%;"></td> <td style="width: 10%;"></td> </tr> <tr> <td></td> <td></td> <td colspan="8" style="text-align: center;"> <table border="1" style="width: 100%; border-collapse: collapse; text-align: center;"> <tr> <td style="width: 10%;"></td> <td style="width: 10%;"></td> <td style="width: 10%;"></td> <td style="width: 10%;"></td> <td style="width: 10%;"></td> <td style="width: 10%;"></td> <td style="width: 10%;"></td> <td style="width: 10%;"></td> <td style="width: 10%;"></td> <td style="width: 10%;"></td> </tr> <tr> <td></td> <td></td> <td colspan="8" style="text-align: center;"> <table border="1" style="width: 100%; border-collapse: collapse; text-align: center;"> <tr> <td style="width: 10%;"></td> <td style="width: 10%;"></td> <td style="width: 10%;"></td> <td style="width: 10%;"></td> <td style="width: 10%;"></td> <td style="width: 10%;"></td> <td style="width: 10%;"></td> <td style="width: 10%;"></td> <td style="width: 10%;"></td> <td style="width: 10%;"></td> </tr> <tr> <td></td> <td></td> <td colspan="8" style="text-align: center;"> <table border="1" style="width: 100%; border-collapse: collapse; text-align: center;"> <tr> <td style="width: 10%;"></td> <td style="width: 10%;"></td> <td style="width: 10%;"></td> <td style="width: 10%;"></td> <td style="width: 10%;"></td> <td style="width: 10%;"></td> <td style="width: 10%;"></td> <td style="width: 10%;"></td> <td style="width: 10%;"></td> <td style="width: 10%;"></td> </tr> <tr> <td></td> <td></td> <td colspan="8" style="text-align: center;"> <table border="1" style="width: 100%; border-collapse: collapse; text-align: center;"> <tr> <td style="width: 10%;"></td> <td style="width: 10%;"></td> <td style="width: 10%;"></td> <td style="width: 10%;"></td> <td style="width: 10%;"></td> <td style="width: 10%;"></td> <td style="width: 10%;"></td> <td style="width: 10%;"></td> <td style="width: 10%;"></td> <td style="width: 10%;"></td> </tr> <tr> <td></td> <td></td> <td colspan="8" style="text-align: center;"> <table border="1" style="width: 100%; border-collapse: collapse; text-align: center;"> <tr> <td style="width: 10%;"></td> <td style="width: 10%;"></td> <td style="width: 10%;"></td> <td style="width: 10%;"></td> <td style="width: 10%;"></td> <td style="width: 10%;"></td> <td style="width: 10%;"></td> <td style="width: 10%;"></td> <td style="width: 10%;"></td> <td style="width: 10%;"></td> </tr> <tr> <td></td> <td></td> <td colspan="8" style="text-align: center;"> <table border="1" style="width: 100%; border-collapse: collapse; text-align: center;"> <tr> <td style="width: 10%;"></td> <td style="width: 10%;"></td> <td style="width: 10%;"></td> <td style="width: 10%;"></td> <td style="width: 10%;"></td> <td style="width: 10%;"></td> <td style="width: 10%;"></td> <td style="width: 10%;"></td> <td style="width: 10%;"></td> <td style="width: 10%;"></td> </tr> <tr> <td></td> <td></td> <td colspan="8" style="text-align: center;"> <table border="1" style="width: 100%; border-collapse: collapse; text-align: center;"> <tr> <td style="width: 10%;"></td> <td style="width: 10%;"></td> <td style="width: 10%;"></td> <td style="width: 10%;"></td> <td style="width: 10%;"></td> <td style="width: 10%;"></td> <td style="width: 10%;"></td> <td style="width: 10%;"></td> <td style="width: 10%;"></td> <td style="width: 10%;"></td> </tr> <tr> <td></td> <td></td> <td colspan="8" style="text-align: center;"> <table border="1" style="width: 100%; border-collapse: collapse; text-align: center;"> <tr> <td style="width: 10%;"></td> <td style="width: 10%;"></td> <td style="width: 10%;"></td> <td style="width: 10%;"></td> <td style="width: 10%;"></td> <td style="width: 10%;"></td> <td style="width: 10%;"></td> <td style="width: 10%;"></td> <td style="width: 10%;"></td> <td style="width: 10%;"></td> </tr> <tr> <td></td> <td></td> <td colspan="8" style="text-align: center;"> <table border="1" style="width: 100%; border-collapse: collapse; text-align: center;"> <tr> <td style="width: 10%;"></td> <td style="width: 10%;"></td> <td style="width: 10%;"></td> <td style="width: 10%;"></td> <td style="width: 10%;"></td> <td style="width: 10%;"></td> <td style="width: 10%;"></td> <td style="width: 10%;"></td> <td style="width: 10%;"></td> <td style="width: 10%;"></td> </tr> <tr> <td></td> <td></td> <td colspan="8" style="text-align: center;"> <table border="1" style="width: 100%; border-collapse: collapse; text-align: center;"> <tr> <td style="width: 10%;"></td> <td style="width: 10%;"></td> <td style="width: 10%;"></td> <td style="width: 10%;"></td> <td style="width: 10%;"></td> <td style="width: 10%;"></td> <td style="width: 10%;"></td> <td style="width: 10%;"></td> <td style="width: 10%;"></td> <td style="width: 10%;"></td> </tr> <tr> <td></td> <td></td> <td colspan="8" style="text-align: center;"> <table border="1" style="width: 100%; border-collapse: collapse; text-align: center;"> <tr> <td style="width: 10%;"></td> <td style="width: 10%;"></td> <td style="width: 10%;"></td> <td style="width: 10%;"></td> <td style="width: 10%;"></td> <td style="width: 10%;"></td> <td style="width: 10%;"></td> <td style="width: 10%;"></td> <td style="width: 10%;"></td> <td style="width: 10%;"></td> </tr> <tr> <td></td> <td></td> <td colspan="8" style="text-align: center;"> <table border="1" style="width: 100%; border-collapse: collapse; text-align: center;"> <tr> <td style="width: 10%;"></td> <td style="width: 10%;"></td> <td style="width: 10%;"></td> <td style="width: 10%;"></td> <td style="width: 10%;"></td> <td style="width: 10%;"></td> <td style="width: 10%;"></td> <td style="width: 10%;"></td> <td style="width: 10%;"></td> <td style="width: 10%;"></td> </tr> <tr> <td></td> <td></td> <td colspan="8" style="text-align: center;"> <table border="1" style="width: 100%; border-collapse: collapse; text-align: center;"> <tr> <td style="width: 10%;"></td> <td style="width: 10%;"></td> <td style="width: 10%;"></td> <td style="width: 10%;"></td> <td style="width: 10%;"></td> <td style="width: 10%;"></td> <td style="width: 10%;"></td> <td style="width: 10%;"></td> <td style="width: 10%;"></td> <td style="width: 10%;"></td> </tr> <tr> <td></td> <td></td> <td colspan="8" style="text-align: center;"> <table border="1" style="width: 100%; border-collapse: collapse; text-align: center;"> <tr> <td style="width: 10%;"></td> <td style="width: 10%;"></td> <td style="width: 10%;"></td> <td style="width: 10%;"></td> <td style="width: 10%;"></td> <td style="width: 10%;"></td> <td style="width: 10%;"></td> <td style="width: 10%;"></td> <td style="width: 10%;"></td> <td style="width: 10%;"></td> </tr> <tr> <td></td> <td></td> <td colspan="8" style="text-align: center;"> <table border="1" style="width: 100%; border-collapse: collapse; text-align: center;"> <tr> <td style="width: 10%;"></td> <td style="width: 10%;"></td> <td style="width: 10%;"></td> <td style="width: 10%;"></td> <td style="width: 10%;"></td> <td style="width: 10%;"></td> <td style="width: 10%;"></td> <td style="width: 10%;"></td> <td style="width: 10%;"></td> <td style="width: 10%;"></td> </tr> <tr> <td></td> <td></td> <td colspan="8" style="text-align: center;"> <table border="1" style="width: 100%; border-collapse: collapse; text-align: center;"> <tr> <td style="width: 10%;"></td> <td style="width: 10%;"></td> <td style="width: 10%;"></td> <td style="width: 10%;"></td> <td style="width: 10%;"></td> <td style="width: 10%;"></td> <td style="width: 10%;"></td> <td style="width: 10%;"></td> <td style="width: 10%;"></td> <td style="width: 10%;"></td> </tr> <tr> <td></td> <td></td> <td colspan="8" style="text-align: center;"> <table border="1" style="width: 100%; border-collapse: collapse; text-align: center;"> <tr> <td style="width: 10%;"></td> <td style="width: 10%;"></td> <td style="width: 10%;"></td> <td style="width: 10%;"></td> <td style="width: 10%;"></td> <td style="width: 10%;"></td> <td style="width: 10%;"></td> <td style="width: 10%;"></td> <td style="width: 10%;"></td> <td style="width: 10%;"></td> </tr> <tr> <td></td> <td></td> <td colspan="8" style="text-align: center;"> <table border="1" style="width: 100%; border-collapse: collapse; text-align: center;"> <tr> <td style="width: 10%;"></td> <td style="width: 10%;"></td> <td style="width: 10%;"></td> <td style="width: 10%;"></td> <td style="width: 10%;"></td> <td style="width:
10%;"></td> <td style="width: 10%;"></td> <td style="width: 10%;"></td> <td style="width: 10%;"></td> <td style="width: 10%;"></td> </tr> <tr> <td></td> <td></td> <td colspan="8" style="text-align: center;"> <table border="1" style="width: 100%; border-collapse: collapse; text-align: center;"> <tr> <td style="width: 10%;"></td> <td style="width: 10%;"></td> <td style="width: 10%;"></td> <td style="width: 10%;"></td> <td style="width: 10%;"></td> <td style="width: 10%;"></td> <td style="width: 10%;"></td> <td style="width: 10%;"></td> <td style="width: 10%;"></td> <td style="width: 10%;"></td> </tr> <tr> <td></td> <td></td> <td colspan="8" style="text-align: center;"> <table border="1" style="width: 100%; border-collapse: collapse; text-align: center;"> <tr> <td style="width: 10%;"></td> <td style="width: 10%;"></td> <td style="width: 10%;"></td> <td style="width: 10%;"></td> <td style="width: 10%;"></td> <td style="width: 10%;"></td> <td style="width: 10%;"></td> <td style="width: 10%;"></td> <td style="width: 10%;"></td> <td style="width: 10%;"></td> </tr> <tr> <td></td> <td></td> <td colspan="8" style="text-align: center;"> <table border="1" style="width: 100%; border-collapse: collapse; text-align: center;"> <tr> <td style="width: 10%;"></td> <td style="width: 10%;"></td> <td style="width: 10%;"></td> <td style="width: 10%;"></td> <td style="width: 10%;"></td> <td style="width: 10%;"></td> <td style="width: 10%;"></td> <td style="width: 10%;"></td> <td style="width: 10%;"></td> <td style="width: 10%;"></td> </tr> <tr> <td></td> <td></td> <td colspan="8" style="text-align: center;"> <table border="1" style="width: 100%; border-collapse: collapse; text-align: center;"> <tr> <td style="width: 10%;"></td> <td style="width: 10%;"></td> <td style="width: 10%;"></td> <td style="width: 10%;"></td> <td style="width: 10%;"></td> <td style="width: 10%;"></td> <td style="width: 10%;"></td> <td style="width: 10%;"></td> <td style="width: 10%;"></td> <td style="width: 10%;"></td> </tr> <tr> <td></td> <td></td> <td colspan="8" style="text-align: center;"> <table border="1" style="width: 100%; border-collapse: collapse; text-align: center;"> <tr> <td style="width: 10%;"></td> <td style="width: 10%;"></td> <td style="width: 10%;"></td> <td style="width: 10%;"></td> <td style="width: 10%;"></td> <td style="width: 10%;"></td> <td style="width: 10%;"></td> <td style="width: 10%;"></td> <td style="width: 10%;"></td> <td style="width: 10%;"></td> </tr> <tr> <td></td> <td></td> <td colspan="8" style="text-align: center;"> <table border="1" style="width: 100%; border-collapse: collapse; text-align: center;"> <tr> <td style="width: 10%;"></td> <td style="width: 10%;"></td> <td style="width: 10%;"></td> <td style="width: 10%;"></td> <td style="width: 10%;"></td> <td style="width: 10%;"></td> <td style="width: 10%;"></td> <td style="width: 10%;"></td> <td style="width: 10%;"></td> <td style="width: 10%;"></td> </tr> <tr> <td></td> <td></td> <td colspan="8" style="text-align: center;"> <table border="1" style="width: 100%; border-collapse: collapse; text-align: center;"> <tr> <td style="width: 10%;"></td> <td style="width: 10%;"></td> <td style="width: 10%;"></td> <td style="width: 10%;"></td> <td style="width: 10%;"></td> <td style="width: 10%;"></td> <td style="width: 10%;"></td> <td style="width: 10%;"></td> <td style="width: 10%;"></td> <td style="width: 10%;"></td> </tr> <tr> <td></td> <td></td> <td colspan="8" style="text-align: center;"> <table border="1" style="width: 100%; border-collapse: collapse; text-align: center;"> <tr> <td style="width: 10%;"></td> <td style="width: 10%;"></td> <td style="width: 10%;"></td> <td style="width: 10%;"></td> <td style="width: 10%;"></td> <td style="width: 10%;"></td> <td style="width: 10%;"></td> <td style="width: 10%;"></td> <td style="width: 10%;"></td> <td style="width: 10%;"></td> </tr> <tr> <td></td> <td></td> <td colspan="8" style="text-align: center;"> <table border="1" style="width: 100%; border-collapse: collapse; text-align: center;"> <tr> <td style="width: 10%;"></td> <td style="width: 10%;"></td> <td style="width: 10%;"></td> <td style="width: 10%;"></td> <td style="width: 10%;"></td> <td style="width: 10%;"></td> <td style="width: 10%;"></td> <td style="width: 10%;"></td> <td style="width: 10%;"></td> <td style="width: 10%;"></td> </tr> <tr> <td></td> <td></td> <td colspan="8" style="text-align: center;"> <table border="1" style="width: 100%; border-collapse: collapse; text-align: center;"> <tr> <td style="width: 10%;"></td> <td style="width: 10%;"></td> <td style="width: 10%;"></td> <td style="width: 10%;"></td> <td style="width: 10%;"></td> <td style="width: 10%;"></td> <td style="width: 10%;"></td> <td style="width: 10%;"></td> <td style="width: 10%;"></td> <td style="width: 10%;"></td> </tr> <tr> <td></td> <td></td> <td colspan="8" style="text-align: center;"> <table border="1" style="width: 100%; border-collapse: collapse; text-align: center;"> <tr> <td style="width: 10%;"></td> <td style="width: 10%;"></td> <td style="width: 10%;"></td> <td style="width: 10%;"></td> <td style="width: 10%;"></td> <td style="width: 10%;"></td> <td style="width: 10%;"></td> <td style="width: 10%;"></td> <td style="width: 10%;"></td> <td style="width: 10%;"></td> </tr> <tr> <td></td> <td></td> <td colspan="8" style="text-align: center;"> <table border="1" style="width: 100%; border-collapse: collapse; text-align: center;"> <tr> <td style="width: 10%;"></td> <td style="width: 10%;"></td> <td style="width: 10%;"></td> <td style="width: 10%;"></td> <td style="width: 10%;"></td> <td style="width: 10%;"></td> <td style="width: 10%;"></td> <td style="width: 10%;"></td> <td style="width: 10%;"></td> <td style="width: 10%;"></td> </tr> <tr> <td></td> <td></td> <td colspan="8" style="text-align: center;"> <table border="1" style="width: 100%; border-collapse: collapse; text-align: center;"> <tr> <td style="width: 10%;"></td> <td style="width: 10%;"></td> <td style="width: 10%;"></td> <td style="width: 10%;"></td> <td style="width: 10%;"></td> <td style="width: 10%;"></td> <td style="width: 10%;"></td> <td style="width: 10%;"></td> <td style="width: 10%;"></td> <td style="width: 10%;"></td> </tr> <tr> <td></td> <td></td> <td colspan="8" style="text-align: center;"> <table border="1" style="width: 100%; border-collapse: collapse; text-align: center;"> <tr> <td style="width: 10%;"></td> <td style="width: 10%;"></td> <td style="width: 10%;"></td> <td style="width: 10%;"></td> <td style="width: 10%;"></td> <td style="width: 10%;"></td> <td style="width: 10%;"></td> <td style="width: 10%;"></td> <td style="width: 10%;"></td> <td style="width: 10%;"></td> </tr> <tr> <td></td> <td></td> <td colspan="8" style="text-align: center;"> <table border="1" style="width: 100%; border-collapse: collapse; text-align: center;"> <tr> <td style="width: 10%;"></td> <td style="width: 10%;"></td> <td style="width: 10%;"></td> <td style="width: 10%;"></td> <td style="width: 10%;"></td> <td style="width: 10%;"></td> <td style="width: 10%;"></td> <td style="width: 10%;"></td> <td style="width: 10%;"></td> <td style="width: 10%;"></td> </tr> <tr> <td></td> <td></td> <td colspan="8" style="text-align: center;"> <table border="1" style="width: 100%; border-collapse: collapse; text-align: center;"> <tr> <td style="width: 10%;"></td> <td style="width: 10%;"></td> <td style="width: 10%;"></td> <td style="width: 10%;"></td> <td style="width: 10%;"></td> <td style="width: 10%;"></td> <td style="width: 10%;"></td> <td style="width: 10%;"></td> <td style="width: 10%;"></td> <td style="width: 10%;"></td> </tr> <tr> <td></td> <td></td> <td colspan="8" style="text-align: center;"> <table border="1" style="width: 100%; border-collapse: collapse; text-align: center;"> <tr> <td style="width: 10%;"></td> <td style="width: 10%;"></td> <td style="width: 10%;"></td> <td style="width: 10%;"></td> <td style="width: 10%;"></td> <td style="width: 10%;"></td> <td style="width: 10%;"></td> <td style="width: 10%;"></td> <td style="width: 10%;"></td> <td style="width: 10%;"></td> </tr> <tr> <td></td> <td></td> <td colspan="8" style="text-align: center;"> <table border="1" style="width: 100%; border-collapse: collapse; text-align: center;"> <tr> <td style="width: 10%;"></td> <td style="width: 10%;"></td> <td style="width: 10%;"></td> <td style="width: 10%;"></td> <td style="width: 10%;"></td> <td style="width: 10%;"></td> <td style="width: 10%;"></td> <td style="width: 10%;"></td> <td style="width: 10%;"></td> <td style="width: 10%;"></td> </tr> <tr> <td></td> <td></td> <td colspan="8" style="text-align: center;"> <table border="1" style="width: 100%; border-collapse: collapse; text-align: center;"> <tr> <td style="width: 10%;"></td> <td style="width: 10%;"></td> <td style="width: 10%;"></td> <td style="width: 10%;"></td> <td style="width: 10%;"></td> <td style="width: 10%;"></td> <td style="width: 10%;"></td> <td style="width: 10%;"></td> <td style="width: 10%;"></td> <td style="width: 10%;"></td> </tr> <tr> <td></td> <td></td> <td colspan="8" style="text-align: center;"> <table border="1" style="width: 100%; border-collapse: collapse; text-align: center;"> <tr> <td style="width: 10%;"></td> <td style="width: 10%;"></td> <td style="width: 10%;"></td> <td style="width: 10%;"></td> <td style="width: 10%;"></td> <td style="width: 10%;"></td> <td style="width: 10%;"></td> <td style="width: 10%;"></td> <td style="width: 10%;"></td> <td style="width: 10%;"></td> </tr> <tr> <td></td> <td></td> <td colspan="8" style="text-align: center;"> <table border="1" style="width: 100%; border-collapse: collapse; text-align: center;"> <tr> <td style="width: 10%;"></td> <td style="width: 10%;"></td> <td style="width: 10%;"></td> <td style="width: 10%;"></td> <td style="width: 10%;"></td> <td style="width: 10%;"></td> <td style="width: 10%;"></td> <td style="width: 10%;"></td> <td style="width: 10%;"></td> <td style="width: 10%;"></td> </tr> <tr> <td></td> <td></td> <td
colspan="8" style="text-align: center;"> <table border="1" style="width: 100%; border-collapse: collapse; text-align: center;"> <tr> <td style="width: 10%;"></td> <td style="width: 10%;"></td> <td style="width: 10%;"></td> <td style="width: 10%;"></td> <td style="width: 10%;"></td> <td style="width: 10%;"></td> <td style="width: 10%;"></td> <td style="width: 10%;"></td> <td style="width: 10%;"></td> <td style="width: 10%;"></td> </tr> <tr> <td></td> <td></td> <td colspan="8" style="text-align: center;"> <table border="1" style="width: 100%; border-collapse: collapse; text-align: center;"> <tr> <td style="width: 10%;"></td> <td style="width: 10%;"></td> <td style="width: 10%;"></td> <td style="width: 10%;"></td> <td style="width: 10%;"></td> <td style="width: 10%;"></td> <td style="width: 10%;"></td> <td style="width: 10%;"></td> <td style="width: 10%;"></td> <td style="width: 10%;"></td> </tr> <tr> <td></td> <td></td> <td colspan="8" style="text-align: center;"> <table border="1" style="width: 100%; border-collapse: collapse; text-align: center;"> <tr> <td style="width: 10%;"></td> <td style="width: 10%;"></td> <td style="width: 10%;"></td> <td style="width: 10%;"></td> <td style="width: 10%;"></td> <td style="width: 10%;"></td> <td style="width: 10%;"></td> <td style="width: 10%;"></td> <td style="width: 10%;"></td> <td style="width: 10%;"></td> </tr> <tr> <td></td> <td></td> <td colspan="8" style="text-align: center;"> <table border="1" style="width: 100%; border-collapse: collapse; text-align: center;"> <tr> <td style="width: 10%;"></td> <td style="width: 10%;"></td> <td style="width: 10%;"></td> <td style="width: 10%;"></td> <td style="width: 10%;"></td> <td style="width: 10%;"></td> <td style="width: 10%;"></td> <td style="width: 10%;"></td> <td style="width: 10%;"></td> <td style="width: 10%;"></td> </tr> <tr> <td></td> <td></td> <td colspan="8" style="text-align: center;"> <table border="1" style="width: 100%; border-collapse: collapse; text-align: center;"> <tr> <td style="width: 10%;"></td> <td style="width: 10%;"></td> <td style="width: 10%;"></td> <td style="width: 10%;"></td> <td style="width: 10%;"></td> <td style="width: 10%;"></td> <td style="width: 10%;"></td> <td style="width: 10%;"></td> <td style="width: 10%;"></td> <td style="width: 10%;"></td> </tr> <tr> <td></td> <td></td> <td colspan="8" style="text-align: center;"> <table border="1" style="width: 100%; border-collapse: collapse; text-align: center;"> <tr> <td style="width: 10%;"></td> <td style="width: 10%;"></td> <td style="width: 10%;"></td> <td style="width: 10%;"></td> <td style="width: 10%;"></td> <td style="width: 10%;"></td> <td style="width: 10%;"></td> <td style="width: 10%;"></td> <td style="width: 10%;"></td> <td style="width: 10%;"></td> </tr> <tr> <td></td> <td></td> <td colspan="8" style="text-align: center;"> <table border="1" style="width: 100%; border-collapse: collapse; text-align: center;"> <tr> <td style="width: 10%;"></td> <td style="width: 10%;"></td> <td style="width: 10%;"></td> <td style="width: 10%;"></td> <td style="width: 10%;"></td> <td style="width: 10%;"></td> <td style="width: 10%;"></td> <td style="width: 10%;"></td> <td style="width: 10%;"></td> <td style="width: 10%;"></td> </tr> <tr> <td></td> <td></td> <td colspan="8" style="text-align: center;"> <table border="1" style="width: 100%; border-collapse: collapse; text-align: center;"> <tr> <td style="width: 10%;"></td> <td style="width: 10%;"></td> <td style="width: 10%;"></td> <td style="width: 10%;"></td> <td style="width: 10%;"></td> <td style="width: 10%;"></td> <td style="width: 10%;"></td> <td style="width: 10%;"></td> <td style="width: 10%;"></td> <td style="width: 10%;"></td> </tr> <tr> <td></td> <td></td> <td colspan="8" style="text-align: center;"> <table border="1" style="width: 100%; border-collapse: collapse; text-align: center;"> <tr> <td style="width: 10%;"></td> <td style="width: 10%;"></td> <td style="width: 10%;"></td> <td style="width: 10%;"></td> <td style="width: 10%;"></td> <td style="width: 10%;"></td> <td style="width: 10%;"></td> <td style="width: 10%;"></td> <td style="width: 10%;"></td> <td style="width: 10%;"></td> </tr> <tr> <td></td> <td></td> <td colspan="8" style="text-align: center;"> <table border="1" style="width: 100%; border-collapse: collapse; text-align: center;"> <tr> <td style="width: 10%;"></td> <td style="width: 10%;"></td> <td style="width: 10%;"></td> <td style="width: 10%;"></td> <td style="width: 10%;"></td> <td style="width: 10%;"></td> <td style="width: 10%;"></td> <td style="width: 10%;"></td> <td style="width: 10%;"></td> <td style="width: 10%;"></td> </tr> <tr> <td></td> <td></td> <td colspan="8" style="text-align: center;"> <table border="1" style="width: 100%; border-collapse: collapse; text-align: center;"> <tr> <td style="width: 10%;"></td> <td style="width: 10%;"></td> <td style="width: 10%;"></td> <td style="width: 10%;"></td> <td style="width: 10%;"></td> <td style="width: 10%;"></td> <td style="width: 10%;"></td> <td style="width: 10%;"></td> <td style="width: 10%;"></td> <td style="width: 10%;"></td> </tr> <tr> <td></td> <td></td> <td colspan="8" style="text-align: center;"> <table border="1" style="width: 100%; border-collapse: collapse; text-align: center;"> <tr> <td style="width: 10%;"></td> <td style="width: 10%;"></td> <td style="width: 10%;"></td> <td style="width: 10%;"></td> <td style="width: 10%;"></td> <td style="width: 10%;"></td> <td style="width: 10%;"></td> <td style="width: 10%;"></td> <td style="width: 10%;"></td> <td style="width: 10%;"></td> </tr> <tr> <td></td> <td></td> <td colspan="8" style="text-align: center;"> <table border="1" style="width: 100%; border-collapse: collapse; text-align: center;"> <tr> <td style="width: 10%;"></td> <td style="width: 10%;"></td> <td style="width: 10%;"></td> <td style="width: 10%;"></td> <td style="width: 10%;"></td> <td style="width: 10%;"></td> <td style="width: 10%;"></td> <td style="width: 10%;"></td> <td style="width: 10%;"></td> <td style="width: 10%;"></td> </tr> <tr> <td></td> <td></td> <td colspan="8" style="text-align: center;"> <table border="1" style="width: 100%; border-collapse: collapse; text-align: center;"> <tr> </tr></table></td></tr></table></td></tr></table></td></tr></table></td></tr></table></td></tr></table></td></tr></table></td></tr></table></td></tr></table></td></tr></table></td></tr></table></td></tr></table></td></tr></table></td></tr></table></td></tr></table></td></tr></table></td></tr></table></td></tr></table></td></tr></table></td></tr></table></td></tr></table></td></tr></table></td></tr></table></td></tr></table></td></tr></table></td></tr></table></td></tr></table></td></tr></table></td></tr></table></td></tr></table></td></tr></table></td></tr></table></td></tr></table></td></tr></table></td></tr></table></td></tr></table></td></tr></table></td></tr></table></td></tr></table></td></tr></table></td></tr></table></td></tr></table></td></tr></table></td></tr></table></td></tr></table></td></tr></table></td></tr></table></td></tr></table></td></tr></table></td></tr></table></td></tr></table></td></tr></table></td></tr></table></td></tr></table>
 | | | | | | | | | | | | | | | | | | | | <table border="1" style="width: 100%; border-collapse: collapse; text-align: center;"> <tr> <td style="width: 10%;"></td> <td style="width: 10%;"></td> <td style="width: 10%;"></td> <td style="width: 10%;"></td> <td style="width: 10%;"></td> <td style="width: 10%;"></td> <td style="width: 10%;"></td> <td style="width: 10%;"></td> <td style="width: 10%;"></td> <td style="width: 10%;"></td> </tr> <tr> <td></td> <td></td> <td colspan="8" style="text-align: center;"> <table border="1" style="width: 100%; border-collapse: collapse; text-align: center;"> <tr> <td style="width: 10%;"></td> <td style="width: 10%;"></td> <td style="width: 10%;"></td> <td style="width: 10%;"></td> <td style="width: 10%;"></td> <td style="width: 10%;"></td> <td style="width: 10%;"></td> <td style="width: 10%;"></td> <td style="width: 10%;"></td> <td style="width: 10%;"></td> </tr> <tr> <td></td> <td></td> <td colspan="8" style="text-align: center;"> <table border="1" style="width: 100%; border-collapse: collapse; text-align: center;"> <tr> <td style="width: 10%;"></td> <td style="width: 10%;"></td> <td style="width: 10%;"></td> <td style="width: 10%;"></td> <td style="width: 10%;"></td> <td style="width: 10%;"></td> <td style="width: 10%;"></td> <td style="width: 10%;"></td> <td style="width: 10%;"></td> <td style="width: 10%;"></td> </tr> <tr> <td></td> <td></td> <td colspan="8" style="text-align: center;"> <table border="1" style="width: 100%; border-collapse: collapse; text-align: center;"> <tr> <td style="width: 10%;"></td> <td style="width: 10%;"></td> <td style="width: 10%;"></td> <td style="width: 10%;"></td> <td style="width: 10%;"></td> <td style="width: 10%;"></td> <td style="width: 10%;"></td> <td style="width: 10%;"></td> <td style="width: 10%;"></td> <td style="width: 10%;"></td> </tr> <tr> <td></td> <td></td> <td colspan="8" style="text-align: center;"> <table border="1" style="width: 100%; border-collapse: collapse; text-align: center;"> <tr> <td style="width: 10%;"></td> <td style="width: 10%;"></td> <td style="width: 10%;"></td> <td style="width: 10%;"></td> <td style="width: 10%;"></td> <td style="width: 10%;"></td> <td style="width: 10%;"></td> <td style="width: 10%;"></td> <td style="width: 10%;"></td> <td style="width: 10%;"></td> </tr> <tr> <td></td> <td></td> <td colspan="8" style="text-align: center;"> <table border="1" style="width: 100%; border-collapse: collapse; text-align: center;"> <tr> <td style="width: 10%;"></td> <td style="width: 10%;"></td> <td style="width: 10%;"></td> <td style="width: 10%;"></td> <td style="width: 10%;"></td> <td style="width: 10%;"></td> <td style="width: 10%;"></td> <td style="width: 10%;"></td> <td style="width: 10%;"></td> <td style="width: 10%;"></td> </tr> <tr> <td></td> <td></td> <td colspan="8" style="text-align: center;"> <table border="1" style="width: 100%; border-collapse: collapse; text-align: center;"> <tr> <td style="width: 10%;"></td> <td style="width: 10%;"></td> <td style="width: 10%;"></td> <td style="width: 10%;"></td> <td style="width: 10%;"></td> <td style="width: 10%;"></td> <td style="width: 10%;"></td> <td style="width: 10%;"></td> <td style="width: 10%;"></td> <td style="width: 10%;"></td> </tr> <tr> <td></td> <td></td> <td colspan="8" style="text-align: center;"> <table border="1" style="width: 100%; border-collapse: collapse; text-align: center;"> <tr> <td style="width: 10%;"></td> <td style="width: 10%;"></td> <td style="width: 10%;"></td> <td style="width: 10%;"></td> <td style="width: 10%;"></td> <td style="width: 10%;"></td> <td style="width: 10%;"></td> <td style="width: 10%;"></td> <td style="width: 10%;"></td> <td style="width: 10%;"></td> </tr> <tr> <td></td> <td></td> <td colspan="8" style="text-align: center;"> <table border="1" style="width: 100%; border-collapse: collapse; text-align: center;"> <tr> <td style="width: 10%;"></td> <td style="width: 10%;"></td> <td style="width: 10%;"></td> <td style="width: 10%;"></td> <td style="width: 10%;"></td> <td style="width: 10%;"></td> <td style="width: 10%;"></td> <td style="width: 10%;"></td> <td style="width: 10%;"></td> <td style="width: 10%;"></td> </tr> <tr> <td></td> <td></td> <td colspan="8" style="text-align: center;"> <table border="1" style="width: 100%; border-collapse: collapse; text-align: center;"> <tr> <td style="width: 10%;"></td> <td style="width: 10%;"></td> <td style="width: 10%;"></td> <td style="width: 10%;"></td> <td style="width: 10%;"></td> <td style="width: 10%;"></td> <td style="width: 10%;"></td> <td style="width: 10%;"></td> <td style="width: 10%;"></td> <td style="width: 10%;"></td> </tr> <tr> <td></td> <td></td> <td colspan="8" style="text-align: center;"> <table border="1" style="width: 100%; border-collapse: collapse; text-align: center;"> <tr> <td style="width: 10%;"></td> <td style="width: 10%;"></td> <td style="width: 10%;"></td> <td style="width: 10%;"></td> <td style="width: 10%;"></td> <td style="width: 10%;"></td> <td style="width: 10%;"></td> <td style="width: 10%;"></td> <td style="width: 10%;"></td> <td style="width: 10%;"></td> </tr> <tr> <td></td> <td></td> <td colspan="8" style="text-align: center;"> <table border="1" style="width: 100%; border-collapse: collapse; text-align: center;"> <tr> <td style="width: 10%;"></td> <td style="width: 10%;"></td> <td style="width: 10%;"></td> <td style="width: 10%;"></td> <td style="width: 10%;"></td> <td style="width: 10%;"></td> <td style="width: 10%;"></td> <td style="width: 10%;"></td> <td style="width: 10%;"></td> <td style="width: 10%;"></td> </tr> <tr> <td></td> <td></td> <td colspan="8" style="text-align: center;"> <table border="1" style="width: 100%; border-collapse: collapse; text-align: center;"> <tr> <td style="width: 10%;"></td> <td style="width: 10%;"></td> <td style="width: 10%;"></td> <td style="width: 10%;"></td> <td style="width: 10%;"></td> <td style="width: 10%;"></td> <td style="width: 10%;"></td> <td style="width: 10%;"></td> <td style="width: 10%;"></td> <td style="width: 10%;"></td> </tr> <tr> <td></td> <td></td> <td colspan="8" style="text-align: center;"> <table border="1" style="width: 100%; border-collapse: collapse; text-align: center;"> <tr> <td style="width: 10%;"></td> <td style="width: 10%;"></td> <td style="width: 10%;"></td> <td style="width: 10%;"></td> <td style="width: 10%;"></td> <td style="width: 10%;"></td> <td style="width: 10%;"></td> <td style="width: 10%;"></td> <td style="width: 10%;"></td> <td style="width: 10%;"></td> </tr> <tr> <td></td> <td></td> <td colspan="8" style="text-align: center;"> <table border="1" style="width: 100%; border-collapse: collapse; text-align: center;"> <tr> <td style="width: 10%;"></td> <td style="width: 10%;"></td> <td style="width: 10%;"></td> <td style="width: 10%;"></td> <td style="width: 10%;"></td> <td style="width: 10%;"></td> <td style="width: 10%;"></td> <td style="width: 10%;"></td> <td style="width: 10%;"></td> <td style="width: 10%;"></td> </tr> <tr> <td></td> <td></td> <td colspan="8" style="text-align: center;"> <table border="1" style="width: 100%; border-collapse: collapse; text-align: center;"> <tr> <td style="width: 10%;"></td> <td style="width: 10%;"></td> <td style="width: 10%;"></td> <td style="width: 10%;"></td> <td style="width: 10%;"></td> <td style="width: 10%;"></td> <td style="width: 10%;"></td> <td style="width: 10%;"></td> <td style="width: 10%;"></td> <td style="width: 10%;"></td> </tr> <tr> <td></td> <td></td> <td colspan="8" style="text-align: center;"> <table border="1" style="width: 100%; border-collapse: collapse; text-align: center;"> <tr> <td style="width: 10%;"></td> <td style="width: 10%;"></td> <td style="width: 10%;"></td> <td style="width: 10%;"></td> <td style="width: 10%;"></td> <td style="width: 10%;"></td> <td style="width: 10%;"></td> <td style="width: 10%;"></td> <td style="width: 10%;"></td> <td style="width: 10%;"></td> </tr> <tr>
<td></td> <td></td> <td colspan="8" style="text-align: center;"> <table border="1" style="width: 100%; border-collapse: collapse; text-align: center;"> <tr> <td style="width: 10%;"></td> <td style="width: 10%;"></td> <td style="width: 10%;"></td> <td style="width: 10%;"></td> <td style="width: 10%;"></td> <td style="width: 10%;"></td> <td style="width: 10%;"></td> <td style="width: 10%;"></td> <td style="width: 10%;"></td> <td style="width: 10%;"></td> </tr> <tr> <td></td> <td></td> <td colspan="8" style="text-align: center;"> <table border="1" style="width: 100%; border-collapse: collapse; text-align: center;"> <tr> <td style="width: 10%;"></td> <td style="width: 10%;"></td> <td style="width: 10%;"></td> <td style="width: 10%;"></td> <td style="width: 10%;"></td> <td style="width: 10%;"></td> <td style="width: 10%;"></td> <td style="width: 10%;"></td> <td style="width: 10%;"></td> <td style="width: 10%;"></td> </tr> <tr> <td></td> <td></td> <td colspan="8" style="text-align: center;"> <table border="1" style="width: 100%; border-collapse: collapse; text-align: center;"> <tr> <td style="width: 10%;"></td> <td style="width: 10%;"></td> <td style="width: 10%;"></td> <td style="width: 10%;"></td> <td style="width: 10%;"></td> <td style="width: 10%;"></td> <td style="width: 10%;"></td> <td style="width: 10%;"></td> <td style="width: 10%;"></td> <td style="width: 10%;"></td> </tr> <tr> <td></td> <td></td> <td colspan="8" style="text-align: center;"> <table border="1" style="width: 100%; border-collapse: collapse; text-align: center;"> <tr> <td style="width: 10%;"></td> <td style="width: 10%;"></td> <td style="width: 10%;"></td> <td style="width: 10%;"></td> <td style="width: 10%;"></td> <td style="width: 10%;"></td> <td style="width: 10%;"></td> <td style="width: 10%;"></td> <td style="width: 10%;"></td> <td style="width: 10%;"></td> </tr> <tr> <td></td> <td></td> <td colspan="8" style="text-align: center;"> <table border="1" style="width: 100%; border-collapse: collapse; text-align: center;"> <tr> <td style="width: 10%;"></td> <td style="width: 10%;"></td> <td style="width: 10%;"></td> <td style="width: 10%;"></td> <td style="width: 10%;"></td> <td style="width: 10%;"></td> <td style="width: 10%;"></td> <td style="width: 10%;"></td> <td style="width: 10%;"></td> <td style="width: 10%;"></td> </tr> <tr> <td></td> <td></td> <td colspan="8" style="text-align: center;"> <table border="1" style="width: 100%; border-collapse: collapse; text-align: center;"> <tr> <td style="width: 10%;"></td> <td style="width: 10%;"></td> <td style="width: 10%;"></td> <td style="width: 10%;"></td> <td style="width: 10%;"></td> <td style="width: 10%;"></td> <td style="width: 10%;"></td> <td style="width: 10%;"></td> <td style="width: 10%;"></td> <td style="width: 10%;"></td> </tr> <tr> <td></td> <td></td> <td colspan="8" style="text-align: center;"> <table border="1" style="width: 100%; border-collapse: collapse; text-align: center;"> <tr> <td style="width: 10%;"></td> <td style="width: 10%;"></td> <td style="width: 10%;"></td> <td style="width: 10%;"></td> <td style="width: 10%;"></td> <td style="width: 10%;"></td> <td style="width: 10%;"></td> <td style="width: 10%;"></td> <td style="width: 10%;"></td> <td style="width: 10%;"></td> </tr> <tr> <td></td> <td></td> <td colspan="8" style="text-align: center;"> <table border="1" style="width: 100%; border-collapse: collapse; text-align: center;"> <tr> <td style="width: 10%;"></td> <td style="width: 10%;"></td> <td style="width: 10%;"></td> <td style="width: 10%;"></td> <td style="width: 10%;"></td> <td style="width: 10%;"></td> <td style="width: 10%;"></td> <td style="width: 10%;"></td> <td style="width: 10%;"></td> <td style="width: 10%;"></td> </tr> <tr> <td></td> <td></td> <td colspan="8" style="text-align: center;"> <table border="1" style="width: 100%; border-collapse: collapse; text-align: center;"> <tr> <td style="width: 10%;"></td> <td style="width: 10%;"></td> <td style="width: 10%;"></td> <td style="width: 10%;"></td> <td style="width: 10%;"></td> <td style="width: 10%;"></td> <td style="width: 10%;"></td> <td style="width: 10%;"></td> <td style="width: 10%;"></td> <td style="width: 10%;"></td> </tr> <tr> <td></td> <td></td> <td colspan="8" style="text-align: center;"> <table border="1" style="width: 100%; border-collapse: collapse; text-align: center;"> <tr> <td style="width: 10%;"></td> <td style="width: 10%;"></td> <td style="width: 10%;"></td> <td style="width: 10%;"></td> <td style="width: 10%;"></td> <td style="width: 10%;"></td> <td style="width: 10%;"></td> <td style="width: 10%;"></td> <td style="width: 10%;"></td> <td style="width: 10%;"></td> </tr> <tr> <td></td> <td></td> <td colspan="8" style="text-align: center;"> <table border="1" style="width: 100%; border-collapse: collapse; text-align: center;"> <tr> <td style="width: 10%;"></td> <td style="width: 10%;"></td> <td style="width: 10%;"></td> <td style="width: 10%;"></td> <td style="width: 10%;"></td> <td style="width: 10%;"></td> <td style="width: 10%;"></td> <td style="width: 10%;"></td> <td style="width: 10%;"></td> <td style="width: 10%;"></td> </tr> <tr> <td></td> <td></td> <td colspan="8" style="text-align: center;"> <table border="1" style="width: 100%; border-collapse: collapse; text-align: center;"> <tr> <td style="width: 10%;"></td> <td style="width: 10%;"></td> <td style="width: 10%;"></td> <td style="width: 10%;"></td> <td style="width: 10%;"></td> <td style="width: 10%;"></td> <td style="width: 10%;"></td> <td style="width: 10%;"></td> <td style="width: 10%;"></td> <td style="width: 10%;"></td> </tr> <tr> <td></td> <td></td> <td colspan="8" style="text-align: center;"> <table border="1" style="width: 100%; border-collapse: collapse; text-align: center;"> <tr> <td style="width: 10%;"></td> <td style="width: 10%;"></td> <td style="width: 10%;"></td> <td style="width: 10%;"></td> <td style="width: 10%;"></td> <td style="width: 10%;"></td> <td style="width: 10%;"></td> <td style="width: 10%;"></td> <td style="width: 10%;"></td> <td style="width: 10%;"></td> </tr> <tr> <td></td> <td></td> <td colspan="8" style="text-align: center;"> <table border="1" style="width: 100%; border-collapse: collapse; text-align: center;"> <tr> <td style="width: 10%;"></td> <td style="width: 10%;"></td> <td style="width: 10%;"></td> <td style="width: 10%;"></td> <td style="width: 10%;"></td> <td style="width: 10%;"></td> <td style="width: 10%;"></td> <td style="width: 10%;"></td> <td style="width: 10%;"></td> <td style="width: 10%;"></td> </tr> <tr> <td></td> <td></td> <td colspan="8" style="text-align: center;"> <table border="1" style="width: 100%; border-collapse: collapse; text-align: center;"> <tr> <td style="width: 10%;"></td> <td style="width: 10%;"></td> <td style="width: 10%;"></td> <td style="width: 10%;"></td> <td style="width: 10%;"></td> <td style="width: 10%;"></td> <td style="width: 10%;"></td> <td style="width: 10%;"></td> <td style="width: 10%;"></td> <td style="width: 10%;"></td> </tr> <tr> <td></td> <td></td> <td colspan="8" style="text-align: center;"> <table border="1" style="width: 100%; border-collapse: collapse; text-align: center;"> <tr> <td style="width: 10%;"></td> <td style="width: 10%;"></td> <td style="width: 10%;"></td> <td style="width: 10%;"></td> <td style="width: 10%;"></td> <td style="width: 10%;"></td> <td style="width: 10%;"></td> <td style="width: 10%;"></td> <td style="width: 10%;"></td> <td style="width: 10%;"></td> </tr> <tr> <td></td> <td></td> <td colspan="8" style="text-align: center;"> <table border="1" style="width: 100%; border-collapse: collapse; text-align: center;"> <tr> <td style="width: 10%;"></td> <td style="width: 10%;"></td> <td style="width: 10%;"></td> <td style="width: 10%;"></td> <td style="width: 10%;"></td> <td style="width: 10%;"></td> <td style="width: 10%;"></td> <td style="width: 10%;"></td> <td style="width: 10%;"></td> <td style="width: 10%;"></td> </tr> <tr> <td></td> <td></td> <td colspan="8" style="text-align: center;"> <table border="1" style="width: 100%; border-collapse: collapse; text-align: center;"> <tr> <td style="width: 10%;"></td> <td style="width: 10%;"></td> <td style="width: 10%;"></td> <td style="width: 10%;"></td> <td style="width: 10%;"></td> <td style="width: 10%;"></td> <td style="width: 10%;"></td> <td style="width: 10%;"></td> <td style="width: 10%;"></td> <td style="width: 10%;"></td> </tr> <tr> <td></td> <td></td> <td colspan="8" style="text-align: center;"> <table border="1" style="width: 100%; border-collapse: collapse; text-align: center;"> <tr> <td style="width: 10%;"></td> <td style="width: 10%;"></td> <td style="width: 10%;"></td> <td style="width: 10%;"></td> <td style="width: 10%;"></td> <td style="width: 10%;"></td> <td style="width: 10%;"></td> <td style="width: 10%;"></td> <td style="width: 10%;"></td> <td style="width: 10%;"></td> </tr> <tr> <td></td> <td></td> <td colspan="8" style="text-align: center;"> <table border="1" style="width: 100%; border-collapse: collapse; text-align: center;"> <tr> <td style="width: 10%;"></td> <td style="width: 10%;"></td> <td style="width: 10%;"></td> <td style="width: 10%;"></td> <td style="width: 10%;"></td> <td style="width: 10%;"></td> <td style="width: 10%;"></td> <td style="width: 10%;"></td> <td style="width: 10%;"></td> <td style="width: 10%;"></td> </tr> <tr> <td></td> <td></td> <td colspan="8" style="text-align: center;"> <table border="1" style="width: 100%; border-collapse: collapse; text-align: center;"> <tr> <td style="width: 10%;"></td> <td style="width: 10%;"></td> <td style="width: 10%;"></td> <td style="width: 10%;"></td> <td style="width: 10%;"></td> <td style="width: 10%;"></td> <td style="width: 10%;"></td> <td style="width: 10%;"></td> <td style="width: 10%;"></td> <td style="width: 10%;"></td> </tr> <tr> <td></td> <td></td> <td colspan="8" style="text-align: center;"> <table border="1" style="width: 100%; border-collapse: collapse; text-align: center;"> <tr> <td
style="width: 10%;"></td> <td style="width: 10%;"></td> <td style="width: 10%;"></td> <td style="width: 10%;"></td> <td style="width: 10%;"></td> <td style="width: 10%;"></td> <td style="width: 10%;"></td> <td style="width: 10%;"></td> <td style="width: 10%;"></td> <td style="width: 10%;"></td> </tr> <tr> <td></td> <td></td> <td colspan="8" style="text-align: center;"> <table border="1" style="width: 100%; border-collapse: collapse; text-align: center;"> <tr> <td style="width: 10%;"></td> <td style="width: 10%;"></td> <td style="width: 10%;"></td> <td style="width: 10%;"></td> <td style="width: 10%;"></td> <td style="width: 10%;"></td> <td style="width: 10%;"></td> <td style="width: 10%;"></td> <td style="width: 10%;"></td> <td style="width: 10%;"></td> </tr> <tr> <td></td> <td></td> <td colspan="8" style="text-align: center;"> <table border="1" style="width: 100%; border-collapse: collapse; text-align: center;"> <tr> <td style="width: 10%;"></td> <td style="width: 10%;"></td> <td style="width: 10%;"></td> <td style="width: 10%;"></td> <td style="width: 10%;"></td> <td style="width: 10%;"></td> <td style="width: 10%;"></td> <td style="width: 10%;"></td> <td style="width: 10%;"></td> <td style="width: 10%;"></td> </tr> <tr> <td></td> <td></td> <td colspan="8" style="text-align: center;"> <table border="1" style="width: 100%; border-collapse: collapse; text-align: center;"> <tr> <td style="width: 10%;"></td> <td style="width: 10%;"></td> <td style="width: 10%;"></td> <td style="width: 10%;"></td> <td style="width: 10%;"></td> <td style="width: 10%;"></td> <td style="width: 10%;"></td> <td style="width: 10%;"></td> <td style="width: 10%;"></td> <td style="width: 10%;"></td> </tr> <tr> <td></td> <td></td> <td colspan="8" style="text-align: center;"> <table border="1" style="width: 100%; border-collapse: collapse; text-align: center;"> <tr> <td style="width: 10%;"></td> <td style="width: 10%;"></td> <td style="width: 10%;"></td> <td style="width: 10%;"></td> <td style="width: 10%;"></td> <td style="width: 10%;"></td> <td style="width: 10%;"></td> <td style="width: 10%;"></td> <td style="width: 10%;"></td> <td style="width: 10%;"></td> </tr> <tr> <td></td> <td></td> <td colspan="8" style="text-align: center;"> <table border="1" style="width: 100%; border-collapse: collapse; text-align: center;"> <tr> <td style="width: 10%;"></td> <td style="width: 10%;"></td> <td style="width: 10%;"></td> <td style="width: 10%;"></td> <td style="width: 10%;"></td> <td style="width: 10%;"></td> <td style="width: 10%;"></td> <td style="width: 10%;"></td> <td style="width: 10%;"></td> <td style="width: 10%;"></td> </tr> <tr> <td></td> <td></td> <td colspan="8" style="text-align: center;"> <table border="1" style="width: 100%; border-collapse: collapse; text-align: center;"> <tr> <td style="width: 10%;"></td> <td style="width: 10%;"></td> <td style="width: 10%;"></td> <td style="width: 10%;"></td> <td style="width: 10%;"></td> <td style="width: 10%;"></td> <td style="width: 10%;"></td> <td style="width: 10%;"></td> <td style="width: 10%;"></td> <td style="width: 10%;"></td> </tr> <tr> <td></td> <td></td> <td colspan="8" style="text-align: center;"> <table border="1" style="width: 100%; border-collapse: collapse; text-align: center;"> <tr> <td style="width: 10%;"></td> <td style="width: 10%;"></td> <td style="width: 10%;"></td> <td style="width: 10%;"></td> <td style="width: 10%;"></td> <td style="width: 10%;"></td> <td style="width: 10%;"></td> <td style="width: 10%;"></td> <td style="width: 10%;"></td> <td style="width: 10%;"></td> </tr> <tr> <td></td> <td></td> <td colspan="8" style="text-align: center;"> <table border="1" style="width: 100%; border-collapse: collapse; text-align: center;"> <tr> <td style="width: 10%;"></td> <td style="width: 10%;"></td> <td style="width: 10%;"></td> <td style="width: 10%;"></td> <td style="width: 10%;"></td> <td style="width: 10%;"></td> <td style="width: 10%;"></td> <td style="width: 10%;"></td> <td style="width: 10%;"></td> <td style="width: 10%;"></td> </tr> <tr> <td></td> <td></td> <td colspan="8" style="text-align: center;"> <table border="1" style="width: 100%; border-collapse: collapse; text-align: center;"> <tr> <td style="width: 10%;"></td> <td style="width: 10%;"></td> <td style="width: 10%;"></td> <td style="width: 10%;"></td> <td style="width: 10%;"></td> <td style="width: 10%;"></td> <td style="width: 10%;"></td> <td style="width: 10%;"></td> <td style="width: 10%;"></td> <td style="width: 10%;"></td> </tr> <tr> <td></td> <td></td> <td colspan="8" style="text-align: center;"> <table border="1" style="width: 100%; border-collapse: collapse; text-align: center;"> <tr> <td style="width: 10%;"></td> <td style="width: 10%;"></td> <td style="width: 10%;"></td> <td style="width: 10%;"></td> <td style="width: 10%;"></td> <td style="width: 10%;"></td> <td style="width: 10%;"></td> <td style="width: 10%;"></td> <td style="width: 10%;"></td> <td style="width: 10%;"></td> </tr> <tr> <td></td> <td></td> <td colspan="8" style="text-align: center;"> <table border="1" style="width: 100%; border-collapse: collapse; text-align: center;"> <tr> <td style="width: 10%;"></td> <td style="width: 10%;"></td> <td style="width: 10%;"></td> <td style="width: 10%;"></td> <td style="width: 10%;"></td> <td style="width: 10%;"></td> <td style="width: 10%;"></td> <td style="width: 10%;"></td> <td style="width: 10%;"></td> <td style="width: 10%;"></td> </tr> <tr> <td></td> <td></td> <td colspan="8" style="text-align: center;"> <table border="1" style="width: 100%; border-collapse: collapse; text-align: center;"> <tr> <td style="width: 10%;"></td> <td style="width: 10%;"></td> <td style="width: 10%;"></td> <td style="width: 10%;"></td> <td style="width: 10%;"></td> <td style="width: 10%;"></td> <td style="width: 10%;"></td> <td style="width: 10%;"></td> <td style="width: 10%;"></td> <td style="width: 10%;"></td> </tr> <tr> <td></td> <td></td> <td colspan="8" style="text-align: center;"> <table border="1" style="width: 100%; border-collapse: collapse; text-align: center;"> <tr> <td style="width: 10%;"></td> <td style="width: 10%;"></td> <td style="width: 10%;"></td> <td style="width: 10%;"></td> <td style="width: 10%;"></td> <td style="width: 10%;"></td> <td style="width: 10%;"></td> <td style="width: 10%;"></td> <td style="width: 10%;"></td> <td style="width: 10%;"></td> </tr> <tr> <td></td> <td></td> <td colspan="8" style="text-align: center;"> <table border="1" style="width: 100%; border-collapse: collapse; text-align: center;"> <tr> </tr></table></td></tr></table></td></tr></table></td></tr></table></td></tr></table></td></tr></table></td></tr></table></td></tr></table></td></tr></table></td></tr></table></td></tr></table></td></tr></table></td></tr></table></td></tr></table></td></tr></table></td></tr></table></td></tr></table></td></tr></table></td></tr></table></td></tr></table></td></tr></table></td></tr></table></td></tr></table></td></tr></table></td></tr></table></td></tr></table></td></tr></table></td></tr></table></td></tr></table></td></tr></table></td></tr></table></td></tr></table></td></tr></table></td></tr></table></td></tr></table></td></tr></table></td></tr></table></td></tr></table></td></tr></table></td></tr></table></td></tr></table></td></tr></table></td></tr></table></td></tr></table></td></tr></table></td></tr></table></td></tr></table></td></tr></table></td></tr></table></td></tr></table></td></tr></table></td></tr></table></td></tr></table>
 | | | | | | | | | | | | | | | | | | | | <table border="1" style="width: 100%; border-collapse: collapse; text-align: center;"> <tr> <td style="width: 10%;"></td> <td style="width: 10%;"></td> <td style="width: 10%;"></td> <td style="width: 10%;"></td> <td style="width: 10%;"></td> <td style="width: 10%;"></td> <td style="width: 10%;"></td> <td style="width: 10%;"></td> <td style="width: 10%;"></td> <td style="width: 10%;"></td> </tr> <tr> <td></td> <td></td> <td colspan="8" style="text-align: center;"> <table border="1" style="width: 100%; border-collapse: collapse; text-align: center;"> <tr> <td style="width: 10%;"></td> <td style="width: 10%;"></td> <td style="width: 10%;"></td> <td style="width: 10%;"></td> <td style="width: 10%;"></td> <td style="width: 10%;"></td> <td style="width: 10%;"></td> <td style="width: 10%;"></td> <td style="width: 10%;"></td> <td style="width: 10%;"></td> </tr> <tr> <td></td> <td></td> <td colspan="8" style="text-align: center;"> <table border="1" style="width: 100%; border-collapse: collapse; text-align: center;"> <tr> <td style="width: 10%;"></td> <td style="width: 10%;"></td> <td style="width: 10%;"></td> <td style="width: 10%;"></td> <td style="width: 10%;"></td> <td style="width: 10%;"></td> <td style="width: 10%;"></td> <td style="width: 10%;"></td> <td style="width: 10%;"></td> <td style="width: 10%;"></td> </tr> <tr> <td></td> <td></td> <td colspan="8" style="text-align: center;"> <table border="1" style="width: 100%; border-collapse: collapse; text-align: center;"> <tr> <td style="width: 10%;"></td> <td style="width: 10%;"></td> <td style="width: 10%;"></td> <td style="width: 10%;"></td> <td style="width: 10%;"></td> <td style="width: 10%;"></td> <td style="width: 10%;"></td> <td style="width: 10%;"></td> <td style="width: 10%;"></td> <td style="width: 10%;"></td> </tr> <tr> <td></td> <td></td> <td colspan="8" style="text-align: center;"> <table border="1" style="width: 100%; border-collapse: collapse; text-align: center;"> <tr> <td style="width: 10%;"></td> <td style="width: 10%;"></td> <td style="width: 10%;"></td> <td style="width: 10%;"></td> <td style="width: 10%;"></td> <td style="width: 10%;"></td> <td style="width: 10%;"></td> <td style="width: 10%;"></td> <td style="width: 10%;"></td> <td style="width: 10%;"></td> </tr> <tr> <td></td> <td></td> <td colspan="8" style="text-align: center;"> <table border="1" style="width: 100%; border-collapse: collapse; text-align: center;"> <tr> <td style="width: 10%;"></td> <td style="width: 10%;"></td> <td style="width: 10%;"></td> <td style="width: 10%;"></td> <td style="width: 10%;"></td> <td style="width: 10%;"></td> <td style="width: 10%;"></td> <td style="width: 10%;"></td> <td style="width: 10%;"></td> <td style="width: 10%;"></td> </tr> <tr> <td></td> <td></td> <td colspan="8" style="text-align: center;"> <table border="1" style="width: 100%; border-collapse: collapse; text-align: center;"> <tr> <td style="width: 10%;"></td> <td style="width: 10%;"></td> <td style="width: 10%;"></td> <td style="width: 10%;"></td> <td style="width: 10%;"></td> <td style="width: 10%;"></td> <td style="width: 10%;"></td> <td style="width: 10%;"></td> <td style="width: 10%;"></td> <td style="width: 10%;"></td> </tr> <tr> <td></td> <td></td> <td colspan="8" style="text-align: center;"> <table border="1" style="width: 100%; border-collapse: collapse; text-align: center;"> <tr> <td style="width: 10%;"></td> <td style="width: 10%;"></td> <td style="width: 10%;"></td> <td style="width: 10%;"></td> <td style="width: 10%;"></td> <td style="width: 10%;"></td> <td style="width: 10%;"></td> <td style="width: 10%;"></td> <td style="width: 10%;"></td> <td style="width: 10%;"></td> </tr> <tr> <td></td> <td></td> <td colspan="8" style="text-align: center;"> <table border="1" style="width: 100%; border-collapse: collapse; text-align: center;"> <tr> <td style="width: 10%;"></td> <td style="width: 10%;"></td> <td style="width: 10%;"></td> <td style="width: 10%;"></td> <td style="width: 10%;"></td> <td style="width: 10%;"></td> <td style="width: 10%;"></td> <td style="width: 10%;"></td> <td style="width: 10%;"></td> <td style="width: 10%;"></td> </tr> <tr> <td></td> <td></td> <td colspan="8" style="text-align: center;"> <table border="1" style="width: 100%; border-collapse: collapse; text-align: center;"> <tr> <td style="width: 10%;"></td> <td style="width: 10%;"></td> <td style="width: 10%;"></td> <td style="width: 10%;"></td> <td style="width: 10%;"></td> <td style="width: 10%;"></td> <td style="width: 10%;"></td> <td style="width: 10%;"></td> <td style="width: 10%;"></td> <td style="width: 10%;"></td> </tr> <tr> <td></td> <td></td> <td colspan="8" style="text-align: center;"> <table border="1" style="width: 100%; border-collapse: collapse; text-align: center;"> <tr> <td style="width: 10%;"></td> <td style="width: 10%;"></td> <td style="width: 10%;"></td> <td style="width: 10%;"></td> <td style="width: 10%;"></td> <td style="width: 10%;"></td> <td style="width: 10%;"></td> <td style="width: 10%;"></td> <td style="width: 10%;"></td> <td style="width: 10%;"></td> </tr> <tr> <td></td> <td></td> <td colspan="8" style="text-align: center;"> <table border="1" style="width: 100%; border-collapse: collapse; text-align: center;"> <tr> <td style="width: 10%;"></td> <td style="width: 10%;"></td> <td style="width: 10%;"></td> <td style="width: 10%;"></td> <td style="width: 10%;"></td> <td style="width: 10%;"></td> <td style="width: 10%;"></td> <td style="width: 10%;"></td> <td style="width: 10%;"></td> <td style="width: 10%;"></td> </tr> <tr> <td></td> <td></td> <td colspan="8" style="text-align: center;"> <table border="1" style="width: 100%; border-collapse: collapse; text-align: center;"> <tr> <td style="width: 10%;"></td> <td style="width: 10%;"></td> <td style="width: 10%;"></td> <td style="width: 10%;"></td> <td style="width: 10%;"></td> <td style="width: 10%;"></td> <td style="width: 10%;"></td> <td style="width: 10%;"></td> <td style="width: 10%;"></td> <td style="width: 10%;"></td> </tr> <tr> <td></td> <td></td> <td colspan="8" style="text-align: center;"> <table border="1" style="width: 100%; border-collapse: collapse; text-align: center;"> <tr> <td style="width: 10%;"></td> <td style="width: 10%;"></td> <td style="width: 10%;"></td> <td style="width: 10%;"></td> <td style="width: 10%;"></td> <td style="width: 10%;"></td> <td style="width: 10%;"></td> <td style="width: 10%;"></td> <td style="width: 10%;"></td> <td style="width: 10%;"></td> </tr> <tr> <td></td> <td></td> <td colspan="8" style="text-align: center;"> <table border="1" style="width: 100%; border-collapse: collapse; text-align: center;"> <tr> <td style="width: 10%;"></td> <td style="width: 10%;"></td> <td style="width: 10%;"></td> <td style="width: 10%;"></td> <td style="width: 10%;"></td> <td style="width: 10%;"></td> <td style="width: 10%;"></td> <td style="width: 10%;"></td> <td style="width: 10%;"></td> <td style="width: 10%;"></td> </tr> <tr> <td></td> <td></td> <td colspan="8" style="text-align: center;"> <table border="1" style="width: 100%; border-collapse: collapse; text-align: center;"> <tr> <td style="width: 10%;"></td> <td style="width: 10%;"></td> <td style="width: 10%;"></td> <td style="width: 10%;"></td> <td style="width: 10%;"></td> <td style="width: 10%;"></td> <td style="width: 10%;"></td> <td style="width: 10%;"></td> <td style="width: 10%;"></td> <td style="width: 10%;"></td> </tr> <tr> <td></td> <td></td> <td colspan="8" style="text-align: center;"> <table border="1" style="width: 100%; border-collapse: collapse; text-align: center;"> <tr>
<td style="width: 10%;"></td> <td style="width: 10%;"></td> <td style="width: 10%;"></td> <td style="width: 10%;"></td> <td style="width: 10%;"></td> <td style="width: 10%;"></td> <td style="width: 10%;"></td> <td style="width: 10%;"></td> <td style="width: 10%;"></td> <td style="width: 10%;"></td> </tr> <tr> <td></td> <td></td> <td colspan="8" style="text-align: center;"> <table border="1" style="width: 100%; border-collapse: collapse; text-align: center;"> <tr> <td style="width: 10%;"></td> <td style="width: 10%;"></td> <td style="width: 10%;"></td> <td style="width: 10%;"></td> <td style="width: 10%;"></td> <td style="width: 10%;"></td> <td style="width: 10%;"></td> <td style="width: 10%;"></td> <td style="width: 10%;"></td> <td style="width: 10%;"></td> </tr> <tr> <td></td> <td></td> <td colspan="8" style="text-align: center;"> <table border="1" style="width: 100%; border-collapse: collapse; text-align: center;"> <tr> <td style="width: 10%;"></td> <td style="width: 10%;"></td> <td style="width: 10%;"></td> <td style="width: 10%;"></td> <td style="width: 10%;"></td> <td style="width: 10%;"></td> <td style="width: 10%;"></td> <td style="width: 10%;"></td> <td style="width: 10%;"></td> <td style="width: 10%;"></td> </tr> <tr> <td></td> <td></td> <td colspan="8" style="text-align: center;"> <table border="1" style="width: 100%; border-collapse: collapse; text-align: center;"> <tr> <td style="width: 10%;"></td> <td style="width: 10%;"></td> <td style="width: 10%;"></td> <td style="width: 10%;"></td> <td style="width: 10%;"></td> <td style="width: 10%;"></td> <td style="width: 10%;"></td> <td style="width: 10%;"></td> <td style="width: 10%;"></td> <td style="width: 10%;"></td> </tr> <tr> <td></td> <td></td> <td colspan="8" style="text-align: center;"> <table border="1" style="width: 100%; border-collapse: collapse; text-align: center;"> <tr> <td style="width: 10%;"></td> <td style="width: 10%;"></td> <td style="width: 10%;"></td> <td style="width: 10%;"></td> <td style="width: 10%;"></td> <td style="width: 10%;"></td> <td style="width: 10%;"></td> <td style="width: 10%;"></td> <td style="width: 10%;"></td> <td style="width: 10%;"></td> </tr> <tr> <td></td> <td></td> <td colspan="8" style="text-align: center;"> <table border="1" style="width: 100%; border-collapse: collapse; text-align: center;"> <tr> <td style="width: 10%;"></td> <td style="width: 10%;"></td> <td style="width: 10%;"></td> <td style="width: 10%;"></td> <td style="width: 10%;"></td> <td style="width: 10%;"></td> <td style="width: 10%;"></td> <td style="width: 10%;"></td> <td style="width: 10%;"></td> <td style="width: 10%;"></td> </tr> <tr> <td></td> <td></td> <td colspan="8" style="text-align: center;"> <table border="1" style="width: 100%; border-collapse: collapse; text-align: center;"> <tr> <td style="width: 10%;"></td> <td style="width: 10%;"></td> <td style="width: 10%;"></td> <td style="width: 10%;"></td> <td style="width: 10%;"></td> <td style="width: 10%;"></td> <td style="width: 10%;"></td> <td style="width: 10%;"></td> <td style="width: 10%;"></td> <td style="width: 10%;"></td> </tr> <tr> <td></td> <td></td> <td colspan="8" style="text-align: center;"> <table border="1" style="width: 100%; border-collapse: collapse; text-align: center;"> <tr> <td style="width: 10%;"></td> <td style="width: 10%;"></td> <td style="width: 10%;"></td> <td style="width: 10%;"></td> <td style="width: 10%;"></td> <td style="width: 10%;"></td> <td style="width: 10%;"></td> <td style="width: 10%;"></td> <td style="width: 10%;"></td> <td style="width: 10%;"></td> </tr> <tr> <td></td> <td></td> <td colspan="8" style="text-align: center;"> <table border="1" style="width: 100%; border-collapse: collapse; text-align: center;"> <tr> <td style="width: 10%;"></td> <td style="width: 10%;"></td> <td style="width: 10%;"></td> <td style="width: 10%;"></td> <td style="width: 10%;"></td> <td style="width: 10%;"></td> <td style="width: 10%;"></td> <td style="width: 10%;"></td> <td style="width: 10%;"></td> <td style="width: 10%;"></td> </tr> <tr> <td></td> <td></td> <td colspan="8" style="text-align: center;"> <table border="1" style="width: 100%; border-collapse: collapse; text-align: center;"> <tr> <td style="width: 10%;"></td> <td style="width: 10%;"></td> <td style="width: 10%;"></td> <td style="width: 10%;"></td> <td style="width: 10%;"></td> <td style="width: 10%;"></td> <td style="width: 10%;"></td> <td style="width: 10%;"></td> <td style="width: 10%;"></td> <td style="width: 10%;"></td> </tr> <tr> <td></td> <td></td> <td colspan="8" style="text-align: center;"> <table border="1" style="width: 100%; border-collapse: collapse; text-align: center;"> <tr> <td style="width: 10%;"></td> <td style="width: 10%;"></td> <td style="width: 10%;"></td> <td style="width: 10%;"></td> <td style="width: 10%;"></td> <td style="width: 10%;"></td> <td style="width: 10%;"></td> <td style="width: 10%;"></td> <td style="width: 10%;"></td> <td style="width: 10%;"></td> </tr> <tr> <td></td> <td></td> <td colspan="8" style="text-align: center;"> <table border="1" style="width: 100%; border-collapse: collapse; text-align: center;"> <tr> <td style="width: 10%;"></td> <td style="width: 10%;"></td> <td style="width: 10%;"></td> <td style="width: 10%;"></td> <td style="width: 10%;"></td> <td style="width: 10%;"></td> <td style="width: 10%;"></td> <td style="width: 10%;"></td> <td style="width: 10%;"></td> <td style="width: 10%;"></td> </tr> <tr> <td></td> <td></td> <td colspan="8" style="text-align: center;"> <table border="1" style="width: 100%; border-collapse: collapse; text-align: center;"> <tr> <td style="width: 10%;"></td> <td style="width: 10%;"></td> <td style="width: 10%;"></td> <td style="width: 10%;"></td> <td style="width: 10%;"></td> <td style="width: 10%;"></td> <td style="width: 10%;"></td> <td style="width: 10%;"></td> <td style="width: 10%;"></td> <td style="width: 10%;"></td> </tr> <tr> <td></td> <td></td> <td colspan="8" style="text-align: center;"> <table border="1" style="width: 100%; border-collapse: collapse; text-align: center;"> <tr> <td style="width: 10%;"></td> <td style="width: 10%;"></td> <td style="width: 10%;"></td> <td style="width: 10%;"></td> <td style="width: 10%;"></td> <td style="width: 10%;"></td> <td style="width: 10%;"></td> <td style="width: 10%;"></td> <td style="width: 10%;"></td> <td style="width: 10%;"></td> </tr> <tr> <td></td> <td></td> <td colspan="8" style="text-align: center;"> <table border="1" style="width: 100%; border-collapse: collapse; text-align: center;"> <tr> <td style="width: 10%;"></td> <td style="width: 10%;"></td> <td style="width: 10%;"></td> <td style="width: 10%;"></td> <td style="width: 10%;"></td> <td style="width: 10%;"></td> <td style="width: 10%;"></td> <td style="width: 10%;"></td> <td style="width: 10%;"></td> <td style="width: 10%;"></td> </tr> <tr> <td></td> <td></td> <td colspan="8" style="text-align: center;"> <table border="1" style="width: 100%; border-collapse: collapse; text-align: center;"> <tr> <td style="width: 10%;"></td> <td style="width: 10%;"></td> <td style="width: 10%;"></td> <td style="width: 10%;"></td> <td style="width: 10%;"></td> <td style="width: 10%;"></td> <td style="width: 10%;"></td> <td style="width: 10%;"></td> <td style="width: 10%;"></td> <td style="width: 10%;"></td> </tr> <tr> <td></td> <td></td> <td colspan="8" style="text-align: center;"> <table border="1" style="width: 100%; border-collapse: collapse; text-align: center;"> <tr> <td style="width: 10%;"></td> <td style="width: 10%;"></td> <td style="width: 10%;"></td> <td style="width: 10%;"></td> <td style="width: 10%;"></td> <td style="width: 10%;"></td> <td style="width: 10%;"></td> <td style="width: 10%;"></td> <td style="width: 10%;"></td> <td style="width: 10%;"></td> </tr> <tr> <td></td> <td></td> <td colspan="8" style="text-align: center;"> <table border="1" style="width: 100%; border-collapse: collapse; text-align: center;"> <tr> <td style="width: 10%;"></td> <td style="width: 10%;"></td> <td style="width: 10%;"></td> <td style="width: 10%;"></td> <td style="width: 10%;"></td> <td style="width: 10%;"></td> <td style="width: 10%;"></td> <td style="width: 10%;"></td> <td style="width: 10%;"></td> <td style="width: 10%;"></td> </tr> <tr> <td></td> <td></td> <td colspan="8" style="text-align: center;"> <table border="1" style="width: 100%; border-collapse: collapse; text-align: center;"> <tr> <td style="width: 10%;"></td> <td style="width: 10%;"></td> <td style="width: 10%;"></td> <td style="width: 10%;"></td> <td style="width: 10%;"></td> <td style="width: 10%;"></td> <td style="width: 10%;"></td> <td style="width: 10%;"></td> <td style="width: 10%;"></td> <td style="width: 10%;"></td> </tr> <tr> <td></td> <td></td> <td colspan="8" style="text-align: center;"> <table border="1" style="width: 100%; border-collapse: collapse; text-align: center;"> <tr> <td style="width: 10%;"></td> <td style="width: 10%;"></td> <td style="width: 10%;"></td> <td style="width: 10%;"></td> <td style="width: 10%;"></td> <td style="width: 10%;"></td> <td style="width: 10%;"></td> <td style="width: 10%;"></td> <td style="width: 10%;"></td> <td style="width: 10%;"></td> </tr> <tr> <td></td> <td></td> <td colspan="8" style="text-align: center;"> <table border="1" style="width: 100%; border-collapse: collapse; text-align: center;"> <tr> <td style="width: 10%;"></td> <td style="width: 10%;"></td> <td style="width: 10%;"></td> <td style="width: 10%;"></td> <td style="width: 10%;"></td> <td style="width: 10%;"></td> <td style="width: 10%;"></td> <td style="width: 10%;"></td> <td style="width: 10%;"></td> <td style="width: 10%;"></td> </tr> <tr> <td></td> <td></td> <td colspan="8" style="text-align: center;"> <table border="1" style="width: 100%; border-collapse: collapse; text-align: center;"> <tr> <td style="width: 10%;"></td> <td style="width: 10%;"></td> <td style="width: 10%;"></td> <td style="width: 10%;"></td> <td style="width: 10%;"></td> <td style="width:
10%;"></td> <td style="width: 10%;"></td> <td style="width: 10%;"></td> <td style="width: 10%;"></td> <td style="width: 10%;"></td> </tr> <tr> <td></td> <td></td> <td colspan="8" style="text-align: center;"> <table border="1" style="width: 100%; border-collapse: collapse; text-align: center;"> <tr> <td style="width: 10%;"></td> <td style="width: 10%;"></td> <td style="width: 10%;"></td> <td style="width: 10%;"></td> <td style="width: 10%;"></td> <td style="width: 10%;"></td> <td style="width: 10%;"></td> <td style="width: 10%;"></td> <td style="width: 10%;"></td> <td style="width: 10%;"></td> </tr> <tr> <td></td> <td></td> <td colspan="8" style="text-align: center;"> <table border="1" style="width: 100%; border-collapse: collapse; text-align: center;"> <tr> <td style="width: 10%;"></td> <td style="width: 10%;"></td> <td style="width: 10%;"></td> <td style="width: 10%;"></td> <td style="width: 10%;"></td> <td style="width: 10%;"></td> <td style="width: 10%;"></td> <td style="width: 10%;"></td> <td style="width: 10%;"></td> <td style="width: 10%;"></td> </tr> <tr> <td></td> <td></td> <td colspan="8" style="text-align: center;"> <table border="1" style="width: 100%; border-collapse: collapse; text-align: center;"> <tr> <td style="width: 10%;"></td> <td style="width: 10%;"></td> <td style="width: 10%;"></td> <td style="width: 10%;"></td> <td style="width: 10%;"></td> <td style="width: 10%;"></td> <td style="width: 10%;"></td> <td style="width: 10%;"></td> <td style="width: 10%;"></td> <td style="width: 10%;"></td> </tr> <tr> <td></td> <td></td> <td colspan="8" style="text-align: center;"> <table border="1" style="width: 100%; border-collapse: collapse; text-align: center;"> <tr> <td style="width: 10%;"></td> <td style="width: 10%;"></td> <td style="width: 10%;"></td> <td style="width: 10%;"></td> <td style="width: 10%;"></td> <td style="width: 10%;"></td> <td style="width: 10%;"></td> <td style="width: 10%;"></td> <td style="width: 10%;"></td> <td style="width: 10%;"></td> </tr> <tr> <td></td> <td></td> <td colspan="8" style="text-align: center;"> <table border="1" style="width: 100%; border-collapse: collapse; text-align: center;"> <tr> <td style="width: 10%;"></td> <td style="width: 10%;"></td> <td style="width: 10%;"></td> <td style="width: 10%;"></td> <td style="width: 10%;"></td> <td style="width: 10%;"></td> <td style="width: 10%;"></td> <td style="width: 10%;"></td> <td style="width: 10%;"></td> <td style="width: 10%;"></td> </tr> <tr> <td></td> <td></td> <td colspan="8" style="text-align: center;"> <table border="1" style="width: 100%; border-collapse: collapse; text-align: center;"> <tr> <td style="width: 10%;"></td> <td style="width: 10%;"></td> <td style="width: 10%;"></td> <td style="width: 10%;"></td> <td style="width: 10%;"></td> <td style="width: 10%;"></td> <td style="width: 10%;"></td> <td style="width: 10%;"></td> <td style="width: 10%;"></td> <td style="width: 10%;"></td> </tr> <tr> <td></td> <td></td> <td colspan="8" style="text-align: center;"> <table border="1" style="width: 100%; border-collapse: collapse; text-align: center;"> <tr> <td style="width: 10%;"></td> <td style="width: 10%;"></td> <td style="width: 10%;"></td> <td style="width: 10%;"></td> <td style="width: 10%;"></td> <td style="width: 10%;"></td> <td style="width: 10%;"></td> <td style="width: 10%;"></td> <td style="width: 10%;"></td> <td style="width: 10%;"></td> </tr> <tr> <td></td> <td></td> <td colspan="8" style="text-align: center;"> <table border="1" style="width: 100%; border-collapse: collapse; text-align: center;"> <tr> <td style="width: 10%;"></td> <td style="width: 10%;"></td> <td style="width: 10%;"></td> <td style="width: 10%;"></td> <td style="width: 10%;"></td> <td style="width: 10%;"></td> <td style="width: 10%;"></td> <td style="width: 10%;"></td> <td style="width: 10%;"></td> <td style="width: 10%;"></td> </tr> <tr> <td></td> <td></td> <td colspan="8" style="text-align: center;"> <table border="1" style="width: 100%; border-collapse: collapse; text-align: center;"> <tr> <td style="width: 10%;"></td> <td style="width: 10%;"></td> <td style="width: 10%;"></td> <td style="width: 10%;"></td> <td style="width: 10%;"></td> <td style="width: 10%;"></td> <td style="width: 10%;"></td> <td style="width: 10%;"></td> <td style="width: 10%;"></td> <td style="width: 10%;"></td> </tr> <tr> <td></td> <td></td> <td colspan="8" style="text-align: center;"> <table border="1" style="width: 100%; border-collapse: collapse; text-align: center;"> <tr> <td style="width: 10%;"></td> <td style="width: 10%;"></td> <td style="width: 10%;"></td> <td style="width: 10%;"></td> <td style="width: 10%;"></td> <td style="width: 10%;"></td> <td style="width: 10%;"></td> <td style="width: 10%;"></td> <td style="width: 10%;"></td> <td style="width: 10%;"></td> </tr> <tr> <td></td> <td></td> <td colspan="8" style="text-align: center;"> <table border="1" style="width: 100%; border-collapse: collapse; text-align: center;"> <tr> <td style="width: 10%;"></td> <td style="width: 10%;"></td> <td style="width: 10%;"></td> <td style="width: 10%;"></td> <td style="width: 10%;"></td> <td style="width: 10%;"></td> <td style="width: 10%;"></td> <td style="width: 10%;"></td> <td style="width: 10%;"></td> <td style="width: 10%;"></td> </tr> <tr> <td></td> <td></td> <td colspan="8" style="text-align: center;"> <table border="1" style="width: 100%; border-collapse: collapse; text-align: center;"> <tr> <td style="width: 10%;"></td> <td style="width: 10%;"></td> <td style="width: 10%;"></td> <td style="width: 10%;"></td> <td style="width: 10%;"></td> <td style="width: 10%;"></td> <td style="width: 10%;"></td> <td style="width: 10%;"></td> <td style="width: 10%;"></td> <td style="width: 10%;"></td> </tr> <tr> <td></td> <td></td> <td colspan="8" style="text-align: center;"> <table border="1" style="width: 100%; border-collapse: collapse; text-align: center;"> <tr> <td style="width: 10%;"></td> <td style="width: 10%;"></td> <td style="width: 10%;"></td> <td style="width: 10%;"></td> <td style="width: 10%;"></td> <td style="width: 10%;"></td> <td style="width: 10%;"></td> <td style="width: 10%;"></td> <td style="width: 10%;"></td> <td style="width: 10%;"></td> </tr> <tr> <td></td> <td></td> <td colspan="8" style="text-align: center;"> <table border="1" style="width: 100%; border-collapse: collapse; text-align: center;"> <tr> </tr></table></td></tr></table></td></tr></table></td></tr></table></td></tr></table></td></tr></table></td></tr></table></td></tr></table></td></tr></table></td></tr></table></td></tr></table></td></tr></table></td></tr></table></td></tr></table></td></tr></table></td></tr></table></td></tr></table></td></tr></table></td></tr></table></td></tr></table></td></tr></table></td></tr></table></td></tr></table></td></tr></table></td></tr></table></td></tr></table></td></tr></table></td></tr></table></td></tr></table></td></tr></table></td></tr></table></td></tr></table></td></tr></table></td></tr></table></td></tr></table></td></tr></table></td></tr></table></td></tr></table></td></tr></table></td></tr></table></td></tr></table></td></tr></table></td></tr></table></td></tr></table></td></tr></table></td></tr></table></td></tr></table></td></tr></table></td></tr></table></td></tr></table></td></tr></table></td></tr></table>
 | | | | | | | | | | | | | | | | | | | | <table border="1" style="width: 100%; border-collapse: collapse; text-align: center;"> <tr> <td style="width: 10%;"></td> <td style="width: 10%;"></td> <td style="width: 10%;"></td> <td style="width: 10%;"></td> <td style="width: 10%;"></td> <td style="width: 10%;"></td> <td style="width: 10%;"></td> <td style="width: 10%;"></td> <td style="width: 10%;"></td> <td style="width: 10%;"></td> </tr> <tr> <td></td> <td></td> <td colspan="8" style="text-align: center;"> <table border="1" style="width: 100%; border-collapse: collapse; text-align: center;"> <tr> <td style="width: 10%;"></td> <td style="width: 10%;"></td> <td style="width: 10%;"></td> <td style="width: 10%;"></td> <td style="width: 10%;"></td> <td style="width: 10%;"></td> <td style="width: 10%;"></td> <td style="width: 10%;"></td> <td style="width: 10%;"></td> <td style="width: 10%;"></td> </tr> <tr> <td></td> <td></td> <td colspan="8" style="text-align: center;"> <table border="1" style="width: 100%; border-collapse: collapse; text-align: center;"> <tr> <td style="width: 10%;"></td> <td style="width: 10%;"></td> <td style="width: 10%;"></td> <td style="width: 10%;"></td> <td style="width: 10%;"></td> <td style="width: 10%;"></td> <td style="width: 10%;"></td> <td style="width: 10%;"></td> <td style="width: 10%;"></td> <td style="width: 10%;"></td> </tr> <tr> <td></td> <td></td> <td colspan="8" style="text-align: center;"> <table border="1" style="width: 100%; border-collapse: collapse; text-align: center;"> <tr> <td style="width: 10%;"></td> <td style="width: 10%;"></td> <td style="width: 10%;"></td> <td style="width: 10%;"></td> <td style="width: 10%;"></td> <td style="width: 10%;"></td> <td style="width: 10%;"></td> <td style="width: 10%;"></td> <td style="width: 10%;"></td> <td style="width: 10%;"></td> </tr> <tr> <td></td> <td></td> <td colspan="8" style="text-align: center;"> <table border="1" style="width: 100%; border-collapse: collapse; text-align: center;"> <tr> <td style="width: 10%;"></td> <td style="width: 10%;"></td> <td style="width: 10%;"></td> <td style="width: 10%;"></td> <td style="width: 10%;"></td> <td style="width: 10%;"></td> <td style="width: 10%;"></td> <td style="width: 10%;"></td> <td style="width: 10%;"></td> <td style="width: 10%;"></td> </tr> <tr> <td></td> <td></td> <td colspan="8" style="text-align: center;"> <table border="1" style="width: 100%; border-collapse: collapse; text-align: center;"> <tr> <td style="width: 10%;"></td> <td style="width: 10%;"></td> <td style="width: 10%;"></td> <td style="width: 10%;"></td> <td style="width: 10%;"></td> <td style="width: 10%;"></td> <td style="width: 10%;"></td> <td style="width: 10%;"></td> <td style="width: 10%;"></td> <td style="width: 10%;"></td> </tr> <tr> <td></td> <td></td> <td colspan="8" style="text-align: center;"> <table border="1" style="width: 100%; border-collapse: collapse; text-align: center;"> <tr> <td style="width: 10%;"></td> <td style="width: 10%;"></td> <td style="width: 10%;"></td> <td style="width: 10%;"></td> <td style="width: 10%;"></td> <td style="width: 10%;"></td> <td style="width: 10%;"></td> <td style="width: 10%;"></td> <td style="width: 10%;"></td> <td style="width: 10%;"></td> </tr> <tr> <td></td> <td></td> <td colspan="8" style="text-align: center;"> <table border="1" style="width: 100%; border-collapse: collapse; text-align: center;"> <tr> <td style="width: 10%;"></td> <td style="width: 10%;"></td> <td style="width: 10%;"></td> <td style="width: 10%;"></td> <td style="width: 10%;"></td> <td style="width: 10%;"></td> <td style="width: 10%;"></td> <td style="width: 10%;"></td> <td style="width: 10%;"></td> <td style="width: 10%;"></td> </tr> <tr> <td></td> <td></td> <td colspan="8" style="text-align: center;"> <table border="1" style="width: 100%; border-collapse: collapse; text-align: center;"> <tr> <td style="width: 10%;"></td> <td style="width: 10%;"></td> <td style="width: 10%;"></td> <td style="width: 10%;"></td> <td style="width: 10%;"></td> <td style="width: 10%;"></td> <td style="width: 10%;"></td> <td style="width: 10%;"></td> <td style="width: 10%;"></td> <td style="width: 10%;"></td> </tr> <tr> <td></td> <td></td> <td colspan="8" style="text-align: center;"> <table border="1" style="width: 100%; border-collapse: collapse; text-align: center;"> <tr> <td style="width: 10%;"></td> <td style="width: 10%;"></td> <td style="width: 10%;"></td> <td style="width: 10%;"></td> <td style="width: 10%;"></td> <td style="width: 10%;"></td> <td style="width: 10%;"></td> <td style="width: 10%;"></td> <td style="width: 10%;"></td> <td style="width: 10%;"></td> </tr> <tr> <td></td> <td></td> <td colspan="8" style="text-align: center;"> <table border="1" style="width: 100%; border-collapse: collapse; text-align: center;"> <tr> <td style="width: 10%;"></td> <td style="width: 10%;"></td> <td style="width: 10%;"></td> <td style="width: 10%;"></td> <td style="width: 10%;"></td> <td style="width: 10%;"></td> <td style="width: 10%;"></td> <td style="width: 10%;"></td> <td style="width: 10%;"></td> <td style="width: 10%;"></td> </tr> <tr> <td></td> <td></td> <td colspan="8" style="text-align: center;"> <table border="1" style="width: 100%; border-collapse: collapse; text-align: center;"> <tr> <td style="width: 10%;"></td> <td style="width: 10%;"></td> <td style="width: 10%;"></td> <td style="width: 10%;"></td> <td style="width: 10%;"></td> <td style="width: 10%;"></td> <td style="width: 10%;"></td> <td style="width: 10%;"></td> <td style="width: 10%;"></td> <td style="width: 10%;"></td> </tr> <tr> <td></td> <td></td> <td colspan="8" style="text-align: center;"> <table border="1" style="width: 100%; border-collapse: collapse; text-align: center;"> <tr> <td style="width: 10%;"></td> <td style="width: 10%;"></td> <td style="width: 10%;"></td> <td style="width: 10%;"></td> <td style="width: 10%;"></td> <td style="width: 10%;"></td> <td style="width: 10%;"></td> <td style="width: 10%;"></td> <td style="width: 10%;"></td> <td style="width: 10%;"></td> </tr> <tr> <td></td> <td></td> <td colspan="8" style="text-align: center;"> <table border="1" style="width: 100%; border-collapse: collapse; text-align: center;"> <tr> <td style="width: 10%;"></td> <td style="width: 10%;"></td> <td style="width: 10%;"></td> <td style="width: 10%;"></td> <td style="width: 10%;"></td> <td style="width: 10%;"></td> <td style="width: 10%;"></td> <td style="width: 10%;"></td> <td style="width: 10%;"></td> <td style="width: 10%;"></td> </tr> <tr> <td></td> <td></td> <td colspan="8" style="text-align: center;"> <table border="1" style="width: 100%; border-collapse: collapse; text-align: center;"> <tr> <td style="width: 10%;"></td> <td style="width: 10%;"></td> <td style="width: 10%;"></td> <td style="width: 10%;"></td> <td style="width: 10%;"></td> <td style="width: 10%;"></td> <td style="width: 10%;"></td> <td style="width: 10%;"></td> <td style="width: 10%;"></td> <td style="width: 10%;"></td> </tr> <tr> <td></td> <td></td> <td colspan="8" style="text-align: center;"> <table border="1" style="width: 100%; border-collapse: collapse; text-align: center;"> <tr> <td style="width: 10%;"></td> <td style="width: 10%;"></td> <td style="width: 10%;"></td> <td style="width: 10%;"></td> <td style="width: 10%;"></td> <td style="width: 10%;"></td> <td style="width: 10%;"></td> <td style="width: 10%;"></td> <td style="width: 10%;"></td> <td style="width: 10%;"></td> </tr> <tr> <td></td> <td></td> <td colspan="8" style="text-align: center;"> <table border="1" style="width: 100%; border-collapse: collapse; text-align: center;"> <tr> <td style="width: 10%;"></td> <td style="width: 10%;"></td> <td style="width: 10%;"></td> <td style="width: 10%;"></td> <td style="width: 10%;"></td> <td style="width: 10%;"></td> <td
style="width: 10%;"></td> <td style="width: 10%;"></td> <td style="width: 10%;"></td> <td style="width: 10%;"></td> </tr> <tr> <td></td> <td></td> <td colspan="8" style="text-align: center;"> <table border="1" style="width: 100%; border-collapse: collapse; text-align: center;"> <tr> <td style="width: 10%;"></td> <td style="width: 10%;"></td> <td style="width: 10%;"></td> <td style="width: 10%;"></td> <td style="width: 10%;"></td> <td style="width: 10%;"></td> <td style="width: 10%;"></td> <td style="width: 10%;"></td> <td style="width: 10%;"></td> <td style="width: 10%;"></td> </tr> <tr> <td></td> <td></td> <td colspan="8" style="text-align: center;"> <table border="1" style="width: 100%; border-collapse: collapse; text-align: center;"> <tr> <td style="width: 10%;"></td> <td style="width: 10%;"></td> <td style="width: 10%;"></td> <td style="width: 10%;"></td> <td style="width: 10%;"></td> <td style="width: 10%;"></td> <td style="width: 10%;"></td> <td style="width: 10%;"></td> <td style="width: 10%;"></td> <td style="width: 10%;"></td> </tr> <tr> <td></td> <td></td> <td colspan="8" style="text-align: center;"> <table border="1" style="width: 100%; border-collapse: collapse; text-align: center;"> <tr> <td style="width: 10%;"></td> <td style="width: 10%;"></td> <td style="width: 10%;"></td> <td style="width: 10%;"></td> <td style="width: 10%;"></td> <td style="width: 10%;"></td> <td style="width: 10%;"></td> <td style="width: 10%;"></td> <td style="width: 10%;"></td> <td style="width: 10%;"></td> </tr> <tr> <td></td> <td></td> <td colspan="8" style="text-align: center;"> <table border="1" style="width: 100%; border-collapse: collapse; text-align: center;"> <tr> <td style="width: 10%;"></td> <td style="width: 10%;"></td> <td style="width: 10%;"></td> <td style="width: 10%;"></td> <td style="width: 10%;"></td> <td style="width: 10%;"></td> <td style="width: 10%;"></td> <td style="width: 10%;"></td> <td style="width: 10%;"></td> <td style="width: 10%;"></td> </tr> <tr> <td></td> <td></td> <td colspan="8" style="text-align: center;"> <table border="1" style="width: 100%; border-collapse: collapse; text-align: center;"> <tr> <td style="width: 10%;"></td> <td style="width: 10%;"></td> <td style="width: 10%;"></td> <td style="width: 10%;"></td> <td style="width: 10%;"></td> <td style="width: 10%;"></td> <td style="width: 10%;"></td> <td style="width: 10%;"></td> <td style="width: 10%;"></td> <td style="width: 10%;"></td> </tr> <tr> <td></td> <td></td> <td colspan="8" style="text-align: center;"> <table border="1" style="width: 100%; border-collapse: collapse; text-align: center;"> <tr> <td style="width: 10%;"></td> <td style="width: 10%;"></td> <td style="width: 10%;"></td> <td style="width: 10%;"></td> <td style="width: 10%;"></td> <td style="width: 10%;"></td> <td style="width: 10%;"></td> <td style="width: 10%;"></td> <td style="width: 10%;"></td> <td style="width: 10%;"></td> </tr> <tr> <td></td> <td></td> <td colspan="8" style="text-align: center;"> <table border="1" style="width: 100%; border-collapse: collapse; text-align: center;"> <tr> <td style="width: 10%;"></td> <td style="width: 10%;"></td> <td style="width: 10%;"></td> <td style="width: 10%;"></td> <td style="width: 10%;"></td> <td style="width: 10%;"></td> <td style="width: 10%;"></td> <td style="width: 10%;"></td> <td style="width: 10%;"></td> <td style="width: 10%;"></td> </tr> <tr> <td></td> <td></td> <td colspan="8" style="text-align: center;"> <table border="1" style="width: 100%; border-collapse: collapse; text-align: center;"> <tr> <td style="width: 10%;"></td> <td style="width: 10%;"></td> <td style="width: 10%;"></td> <td style="width: 10%;"></td> <td style="width: 10%;"></td> <td style="width: 10%;"></td> <td style="width: 10%;"></td> <td style="width: 10%;"></td> <td style="width: 10%;"></td> <td style="width: 10%;"></td> </tr> <tr> <td></td> <td></td> <td colspan="8" style="text-align: center;"> <table border="1" style="width: 100%; border-collapse: collapse; text-align: center;"> <tr> <td style="width: 10%;"></td> <td style="width: 10%;"></td> <td style="width: 10%;"></td> <td style="width: 10%;"></td> <td style="width: 10%;"></td> <td style="width: 10%;"></td> <td style="width: 10%;"></td> <td style="width: 10%;"></td> <td style="width: 10%;"></td> <td style="width: 10%;"></td> </tr> <tr> <td></td> <td></td> <td colspan="8" style="text-align: center;"> <table border="1" style="width: 100%; border-collapse: collapse; text-align: center;"> <tr> <td style="width: 10%;"></td> <td style="width: 10%;"></td> <td style="width: 10%;"></td> <td style="width: 10%;"></td> <td style="width: 10%;"></td> <td style="width: 10%;"></td> <td style="width: 10%;"></td> <td style="width: 10%;"></td> <td style="width: 10%;"></td> <td style="width: 10%;"></td> </tr> <tr> <td></td> <td></td> <td colspan="8" style="text-align: center;"> <table border="1" style="width: 100%; border-collapse: collapse; text-align: center;"> <tr> <td style="width: 10%;"></td> <td style="width: 10%;"></td> <td style="width: 10%;"></td> <td style="width: 10%;"></td> <td style="width: 10%;"></td> <td style="width: 10%;"></td> <td style="width: 10%;"></td> <td style="width: 10%;"></td> <td style="width: 10%;"></td> <td style="width: 10%;"></td> </tr> <tr> <td></td> <td></td> <td colspan="8" style="text-align: center;"> <table border="1" style="width: 100%; border-collapse: collapse; text-align: center;"> <tr> <td style="width: 10%;"></td> <td style="width: 10%;"></td> <td style="width: 10%;"></td> <td style="width: 10%;"></td> <td style="width: 10%;"></td> <td style="width: 10%;"></td> <td style="width: 10%;"></td> <td style="width: 10%;"></td> <td style="width: 10%;"></td> <td style="width: 10%;"></td> </tr> <tr> <td></td> <td></td> <td colspan="8" style="text-align: center;"> <table border="1" style="width: 100%; border-collapse: collapse; text-align: center;"> <tr> <td style="width: 10%;"></td> <td style="width: 10%;"></td> <td style="width: 10%;"></td> <td style="width: 10%;"></td> <td style="width: 10%;"></td> <td style="width: 10%;"></td> <td style="width: 10%;"></td> <td style="width: 10%;"></td> <td style="width: 10%;"></td> <td style="width: 10%;"></td> </tr> <tr> <td></td> <td></td> <td colspan="8" style="text-align: center;"> <table border="1" style="width: 100%; border-collapse: collapse; text-align: center;"> <tr> <td style="width: 10%;"></td> <td style="width: 10%;"></td> <td style="width: 10%;"></td> <td style="width: 10%;"></td> <td style="width: 10%;"></td> <td style="width: 10%;"></td> <td style="width: 10%;"></td> <td style="width: 10%;"></td> <td style="width: 10%;"></td> <td style="width: 10%;"></td> </tr> <tr> <td></td> <td></td> <td colspan="8" style="text-align: center;"> <table border="1" style="width: 100%; border-collapse: collapse; text-align: center;"> <tr> <td style="width: 10%;"></td> <td style="width: 10%;"></td> <td style="width: 10%;"></td> <td style="width: 10%;"></td> <td style="width: 10%;"></td> <td style="width: 10%;"></td> <td style="width: 10%;"></td> <td style="width: 10%;"></td> <td style="width: 10%;"></td> <td style="width: 10%;"></td> </tr> <tr> <td></td> <td></td> <td colspan="8" style="text-align: center;"> <table border="1" style="width: 100%; border-collapse: collapse; text-align: center;"> <tr> <td style="width: 10%;"></td> <td style="width: 10%;"></td> <td style="width: 10%;"></td> <td style="width: 10%;"></td> <td style="width: 10%;"></td> <td style="width: 10%;"></td> <td style="width: 10%;"></td> <td style="width: 10%;"></td> <td style="width: 10%;"></td> <td style="width: 10%;"></td> </tr> <tr> <td></td> <td></td> <td colspan="8" style="text-align: center;"> <table border="1" style="width: 100%; border-collapse: collapse; text-align: center;"> <tr> <td style="width: 10%;"></td> <td style="width: 10%;"></td> <td style="width: 10%;"></td> <td style="width: 10%;"></td> <td style="width: 10%;"></td> <td style="width: 10%;"></td> <td style="width: 10%;"></td> <td style="width: 10%;"></td> <td style="width: 10%;"></td> <td style="width: 10%;"></td> </tr> <tr> <td></td> <td></td> <td colspan="8" style="text-align: center;"> <table border="1" style="width: 100%; border-collapse: collapse; text-align: center;"> <tr> <td style="width: 10%;"></td> <td style="width: 10%;"></td> <td style="width: 10%;"></td> <td style="width: 10%;"></td> <td style="width: 10%;"></td> <td style="width: 10%;"></td> <td style="width: 10%;"></td> <td style="width: 10%;"></td> <td style="width: 10%;"></td> <td style="width: 10%;"></td> </tr> <tr> <td></td> <td></td> <td colspan="8" style="text-align: center;"> <table border="1" style="width: 100%; border-collapse: collapse; text-align: center;"> <tr> <td style="width: 10%;"></td> <td style="width: 10%;"></td> <td style="width: 10%;"></td> <td style="width: 10%;"></td> <td style="width: 10%;"></td> <td style="width: 10%;"></td> <td style="width: 10%;"></td> <td style="width: 10%;"></td> <td style="width: 10%;"></td> <td style="width: 10%;"></td> </tr> <tr> <td></td> <td></td> <td colspan="8" style="text-align: center;"> <table border="1" style="width: 100%; border-collapse: collapse; text-align: center;"> <tr> <td style="width: 10%;"></td> <td style="width: 10%;"></td> <td style="width: 10%;"></td> <td style="width: 10%;"></td> <td style="width: 10%;"></td> <td style="width: 10%;"></td> <td style="width: 10%;"></td> <td style="width: 10%;"></td> <td style="width: 10%;"></td> <td style="width: 10%;"></td> </tr> <tr> <td></td> <td></td> <td colspan="8" style="text-align: center;"> <table border="1" style="width: 100%; border-collapse: collapse; text-align: center;"> <tr> <td style="width: 10%;"></td> <td style="width: 10%;"></td> <td style="width: 10%;"></td> <td style="width: 10%;"></td> <td style="width: 10%;"></td> <td style="width: 10%;"></td> <td style="width: 10%;"></td> <td style="width: 10%;"></td> <td style="width: 10%;"></td> <td style="width: 10%;"></td> </tr> <tr> <td></td> <td></td> <td colspan="8"
style="text-align: center;"> <table border="1" style="width: 100%; border-collapse: collapse; text-align: center;"> <tr> <td style="width: 10%;"></td> <td style="width: 10%;"></td> <td style="width: 10%;"></td> <td style="width: 10%;"></td> <td style="width: 10%;"></td> <td style="width: 10%;"></td> <td style="width: 10%;"></td> <td style="width: 10%;"></td> <td style="width: 10%;"></td> <td style="width: 10%;"></td> </tr> <tr> <td></td> <td></td> <td colspan="8" style="text-align: center;"> <table border="1" style="width: 100%; border-collapse: collapse; text-align: center;"> <tr> <td style="width: 10%;"></td> <td style="width: 10%;"></td> <td style="width: 10%;"></td> <td style="width: 10%;"></td> <td style="width: 10%;"></td> <td style="width: 10%;"></td> <td style="width: 10%;"></td> <td style="width: 10%;"></td> <td style="width: 10%;"></td> <td style="width: 10%;"></td> </tr> <tr> <td></td> <td></td> <td colspan="8" style="text-align: center;"> <table border="1" style="width: 100%; border-collapse: collapse; text-align: center;"> <tr> <td style="width: 10%;"></td> <td style="width: 10%;"></td> <td style="width: 10%;"></td> <td style="width: 10%;"></td> <td style="width: 10%;"></td> <td style="width: 10%;"></td> <td style="width: 10%;"></td> <td style="width: 10%;"></td> <td style="width: 10%;"></td> <td style="width: 10%;"></td> </tr> <tr> <td></td> <td></td> <td colspan="8" style="text-align: center;"> <table border="1" style="width: 100%; border-collapse: collapse; text-align: center;"> <tr> <td style="width: 10%;"></td> <td style="width: 10%;"></td> <td style="width: 10%;"></td> <td style="width: 10%;"></td> <td style="width: 10%;"></td> <td style="width: 10%;"></td> <td style="width: 10%;"></td> <td style="width: 10%;"></td> <td style="width: 10%;"></td> <td style="width: 10%;"></td> </tr> <tr> <td></td> <td></td> <td colspan="8" style="text-align: center;"> <table border="1" style="width: 100%; border-collapse: collapse; text-align: center;"> <tr> <td style="width: 10%;"></td> <td style="width: 10%;"></td> <td style="width: 10%;"></td> <td style="width: 10%;"></td> <td style="width: 10%;"></td> <td style="width: 10%;"></td> <td style="width: 10%;"></td> <td style="width: 10%;"></td> <td style="width: 10%;"></td> <td style="width: 10%;"></td> </tr> <tr> <td></td> <td></td> <td colspan="8" style="text-align: center;"> <table border="1" style="width: 100%; border-collapse: collapse; text-align: center;"> <tr> <td style="width: 10%;"></td> <td style="width: 10%;"></td> <td style="width: 10%;"></td> <td style="width: 10%;"></td> <td style="width: 10%;"></td> <td style="width: 10%;"></td> <td style="width: 10%;"></td> <td style="width: 10%;"></td> <td style="width: 10%;"></td> <td style="width: 10%;"></td> </tr> <tr> <td></td> <td></td> <td colspan="8" style="text-align: center;"> <table border="1" style="width: 100%; border-collapse: collapse; text-align: center;"> <tr> <td style="width: 10%;"></td> <td style="width: 10%;"></td> <td style="width: 10%;"></td> <td style="width: 10%;"></td> <td style="width: 10%;"></td> <td style="width: 10%;"></td> <td style="width: 10%;"></td> <td style="width: 10%;"></td> <td style="width: 10%;"></td> <td style="width: 10%;"></td> </tr> <tr> <td></td> <td></td> <td colspan="8" style="text-align: center;"> <table border="1" style="width: 100%; border-collapse: collapse; text-align: center;"> <tr> <td style="width: 10%;"></td> <td style="width: 10%;"></td> <td style="width: 10%;"></td> <td style="width: 10%;"></td> <td style="width: 10%;"></td> <td style="width: 10%;"></td> <td style="width: 10%;"></td> <td style="width: 10%;"></td> <td style="width: 10%;"></td> <td style="width: 10%;"></td> </tr> <tr> <td></td> <td></td> <td colspan="8" style="text-align: center;"> <table border="1" style="width: 100%; border-collapse: collapse; text-align: center;"> <tr> <td style="width: 10%;"></td> <td style="width: 10%;"></td> <td style="width: 10%;"></td> <td style="width: 10%;"></td> <td style="width: 10%;"></td> <td style="width: 10%;"></td> <td style="width: 10%;"></td> <td style="width: 10%;"></td> <td style="width: 10%;"></td> <td style="width: 10%;"></td> </tr> <tr> <td></td> <td></td> <td colspan="8" style="text-align: center;"> <table border="1" style="width: 100%; border-collapse: collapse; text-align: center;"> <tr> <td style="width: 10%;"></td> <td style="width: 10%;"></td> <td style="width: 10%;"></td> <td style="width: 10%;"></td> <td style="width: 10%;"></td> <td style="width: 10%;"></td> <td style="width: 10%;"></td> <td style="width: 10%;"></td> <td style="width: 10%;"></td> <td style="width: 10%;"></td> </tr> <tr> <td></td> <td></td> <td colspan="8" style="text-align: center;"> <table border="1" style="width: 100%; border-collapse: collapse; text-align: center;"> <tr> <td style="width: 10%;"></td> <td style="width: 10%;"></td> <td style="width: 10%;"></td> <td style="width: 10%;"></td> <td style="width: 10%;"></td> <td style="width: 10%;"></td> <td style="width: 10%;"></td> <td style="width: 10%;"></td> <td style="width: 10%;"></td> <td style="width: 10%;"></td> </tr> <tr> <td></td> <td></td> <td colspan="8" style="text-align: center;"> <table border="1" style="width: 100%; border-collapse: collapse; text-align: center;"> <tr> <td style="width: 10%;"></td> <td style="width: 10%;"></td> <td style="width: 10%;"></td> <td style="width: 10%;"></td> <td style="width: 10%;"></td> <td style="width: 10%;"></td> <td style="width: 10%;"></td> <td style="width: 10%;"></td> <td style="width: 10%;"></td> <td style="width: 10%;"></td> </tr> <tr> <td></td> <td></td> <td colspan="8" style="text-align: center;"> <table border="1" style="width: 100%; border-collapse: collapse; text-align: center;"> <tr> </tr></table></td></tr></table></td></tr></table></td></tr></table></td></tr></table></td></tr></table></td></tr></table></td></tr></table></td></tr></table></td></tr></table></td></tr></table></td></tr></table></td></tr></table></td></tr></table></td></tr></table></td></tr></table></td></tr></table></td></tr></table></td></tr></table></td></tr></table></td></tr></table></td></tr></table></td></tr></table></td></tr></table></td></tr></table></td></tr></table></td></tr></table></td></tr></table></td></tr></table></td></tr></table></td></tr></table></td></tr></table></td></tr></table></td></tr></table></td></tr></table></td></tr></table></td></tr></table></td></tr></table></td></tr></table></td></tr></table></td></tr></table></td></tr></table></td></tr></table></td></tr></table></td></tr></table></td></tr></table></td></tr></table></td></tr></table></td></tr></table></td></tr></table></td></tr></table>
 | | | | | | | | | | | | | | | | | | | | <table border="1" style="width: 100%; border-collapse: collapse; text-align: center;"> <tr> <td style="width: 10%;"></td> <td style="width: 10%;"></td> <td style="width: 10%;"></td> <td style="width: 10%;"></td> <td style="width: 10%;"></td> <td style="width: 10%;"></td> <td style="width: 10%;"></td> <td style="width: 10%;"></td> <td style="width: 10%;"></td> <td style="width: 10%;"></td> </tr> <tr> <td></td> <td></td> <td colspan="8" style="text-align: center;"> <table border="1" style="width: 100%; border-collapse: collapse; text-align: center;"> <tr> <td style="width: 10%;"></td> <td style="width: 10%;"></td> <td style="width: 10%;"></td> <td style="width: 10%;"></td> <td style="width: 10%;"></td> <td style="width: 10%;"></td> <td style="width: 10%;"></td> <td style="width: 10%;"></td> <td style="width: 10%;"></td> <td style="width: 10%;"></td> </tr> <tr> <td></td> <td></td> <td colspan="8" style="text-align: center;"> <table border="1" style="width: 100%; border-collapse: collapse; text-align: center;"> <tr> <td style="width: 10%;"></td> <td style="width: 10%;"></td> <td style="width: 10%;"></td> <td style="width: 10%;"></td> <td style="width: 10%;"></td> <td style="width: 10%;"></td> <td style="width: 10%;"></td> <td style="width: 10%;"></td> <td style="width: 10%;"></td> <td style="width: 10%;"></td> </tr> <tr> <td></td> <td></td> <td colspan="8" style="text-align: center;"> <table border="1" style="width: 100%; border-collapse: collapse; text-align: center;"> <tr> <td style="width: 10%;"></td> <td style="width: 10%;"></td> <td style="width: 10%;"></td> <td style="width: 10%;"></td> <td style="width: 10%;"></td> <td style="width: 10%;"></td> <td style="width: 10%;"></td> <td style="width: 10%;"></td> <td style="width: 10%;"></td> <td style="width: 10%;"></td> </tr> <tr> <td></td> <td></td> <td colspan="8" style="text-align: center;"> <table border="1" style="width: 100%; border-collapse: collapse; text-align: center;"> <tr> <td style="width: 10%;"></td> <td style="width: 10%;"></td> <td style="width: 10%;"></td> <td style="width: 10%;"></td> <td style="width: 10%;"></td> <td style="width: 10%;"></td> <td style="width: 10%;"></td> <td style="width: 10%;"></td> <td style="width: 10%;"></td> <td style="width: 10%;"></td> </tr> <tr> <td></td> <td></td> <td colspan="8" style="text-align: center;"> <table border="1" style="width: 100%; border-collapse: collapse; text-align: center;"> <tr> <td style="width: 10%;"></td> <td style="width: 10%;"></td> <td style="width: 10%;"></td> <td style="width: 10%;"></td> <td style="width: 10%;"></td> <td style="width: 10%;"></td> <td style="width: 10%;"></td> <td style="width: 10%;"></td> <td style="width: 10%;"></td> <td style="width: 10%;"></td> </tr> <tr> <td></td> <td></td> <td colspan="8" style="text-align: center;"> <table border="1" style="width: 100%; border-collapse: collapse; text-align: center;"> <tr> <td style="width: 10%;"></td> <td style="width: 10%;"></td> <td style="width: 10%;"></td> <td style="width: 10%;"></td> <td style="width: 10%;"></td> <td style="width: 10%;"></td> <td style="width: 10%;"></td> <td style="width: 10%;"></td> <td style="width: 10%;"></td> <td style="width: 10%;"></td> </tr> <tr> <td></td> <td></td> <td colspan="8" style="text-align: center;"> <table border="1" style="width: 100%; border-collapse: collapse; text-align: center;"> <tr> <td style="width: 10%;"></td> <td style="width: 10%;"></td> <td style="width: 10%;"></td> <td style="width: 10%;"></td> <td style="width: 10%;"></td> <td style="width: 10%;"></td> <td style="width: 10%;"></td> <td style="width: 10%;"></td> <td style="width: 10%;"></td> <td style="width: 10%;"></td> </tr> <tr> <td></td> <td></td> <td colspan="8" style="text-align: center;"> <table border="1" style="width: 100%; border-collapse: collapse; text-align: center;"> <tr> <td style="width: 10%;"></td> <td style="width: 10%;"></td> <td style="width: 10%;"></td> <td style="width: 10%;"></td> <td style="width: 10%;"></td> <td style="width: 10%;"></td> <td style="width: 10%;"></td> <td style="width: 10%;"></td> <td style="width: 10%;"></td> <td style="width: 10%;"></td> </tr> <tr> <td></td> <td></td> <td colspan="8" style="text-align: center;"> <table border="1" style="width: 100%; border-collapse: collapse; text-align: center;"> <tr> <td style="width: 10%;"></td> <td style="width: 10%;"></td> <td style="width: 10%;"></td> <td style="width: 10%;"></td> <td style="width: 10%;"></td> <td style="width: 10%;"></td> <td style="width: 10%;"></td> <td style="width: 10%;"></td> <td style="width: 10%;"></td> <td style="width: 10%;"></td> </tr> <tr> <td></td> <td></td> <td colspan="8" style="text-align: center;"> <table border="1" style="width: 100%; border-collapse: collapse; text-align: center;"> <tr> <td style="width: 10%;"></td> <td style="width: 10%;"></td> <td style="width: 10%;"></td> <td style="width: 10%;"></td> <td style="width: 10%;"></td> <td style="width: 10%;"></td> <td style="width: 10%;"></td> <td style="width: 10%;"></td> <td style="width: 10%;"></td> <td style="width: 10%;"></td> </tr> <tr> <td></td> <td></td> <td colspan="8" style="text-align: center;"> <table border="1" style="width: 100%; border-collapse: collapse; text-align: center;"> <tr> <td style="width: 10%;"></td> <td style="width: 10%;"></td> <td style="width: 10%;"></td> <td style="width: 10%;"></td> <td style="width: 10%;"></td> <td style="width: 10%;"></td> <td style="width: 10%;"></td> <td style="width: 10%;"></td> <td style="width: 10%;"></td> <td style="width: 10%;"></td> </tr> <tr> <td></td> <td></td> <td colspan="8" style="text-align: center;"> <table border="1" style="width: 100%; border-collapse: collapse; text-align: center;"> <tr> <td style="width: 10%;"></td> <td style="width: 10%;"></td> <td style="width: 10%;"></td> <td style="width: 10%;"></td> <td style="width: 10%;"></td> <td style="width: 10%;"></td> <td style="width: 10%;"></td> <td style="width: 10%;"></td> <td style="width: 10%;"></td> <td style="width: 10%;"></td> </tr> <tr> <td></td> <td></td> <td colspan="8" style="text-align: center;"> <table border="1" style="width: 100%; border-collapse: collapse; text-align: center;"> <tr> <td style="width: 10%;"></td> <td style="width: 10%;"></td> <td style="width: 10%;"></td> <td style="width: 10%;"></td> <td style="width: 10%;"></td> <td style="width: 10%;"></td> <td style="width: 10%;"></td> <td style="width: 10%;"></td> <td style="width: 10%;"></td> <td style="width: 10%;"></td> </tr> <tr> <td></td> <td></td> <td colspan="8" style="text-align: center;"> <table border="1" style="width: 100%; border-collapse: collapse; text-align: center;"> <tr> <td style="width: 10%;"></td> <td style="width: 10%;"></td> <td style="width: 10%;"></td> <td style="width: 10%;"></td> <td style="width: 10%;"></td> <td style="width: 10%;"></td> <td style="width: 10%;"></td> <td style="width: 10%;"></td> <td style="width: 10%;"></td> <td style="width: 10%;"></td> </tr> <tr> <td></td> <td></td> <td colspan="8" style="text-align: center;"> <table border="1" style="width: 100%; border-collapse: collapse; text-align: center;"> <tr> <td style="width: 10%;"></td> <td style="width: 10%;"></td> <td style="width: 10%;"></td> <td style="width: 10%;"></td> <td style="width: 10%;"></td> <td style="width: 10%;"></td> <td style="width: 10%;"></td> <td style="width: 10%;"></td> <td style="width: 10%;"></td> <td style="width: 10%;"></td> </tr> <tr> <td></td> <td></td> <td colspan="8" style="text-align: center;"> <table border="1" style="width: 100%; border-collapse: collapse; text-align: center;"> <tr> <td style="width: 10%;"></td> <td style="width: 10%;"></td> <td style="width: 10%;"></td> <td style="width: 10%;"></td> <td style="width: 10%;"></td> <td style="width: 10%;"></td> <td style="width: 10%;"></td> <td style="width: 10%;"></td> <td style="width: 10%;"></td> <td style="width: 10%;"></td> </tr> <tr> <td></td> <td></td> <td colspan="8" style="text-align: center;"> <table border="1" style="width: 100%; border-collapse: collapse; text-align: center;"> <tr> <td style="width: 10%;"></td> <td style="width: 10%;"></td> <td style="width: 10%;"></td> <td style="width: 10%;"></td> <td style="width: 10%;"></td> <td style="width: 10%;"></td> <td style="width: 10%;"></td> <td style="width: 10%;"></td> <td style="width: 10%;"></td> <td style="width: 10%;"></td> </tr> <tr> <td></td> <td></td> <td colspan="8" style="text-align: center;">
<table border="1" style="width: 100%; border-collapse: collapse; text-align: center;"> <tr> <td style="width: 10%;"></td> <td style="width: 10%;"></td> <td style="width: 10%;"></td> <td style="width: 10%;"></td> <td style="width: 10%;"></td> <td style="width: 10%;"></td> <td style="width: 10%;"></td> <td style="width: 10%;"></td> <td style="width: 10%;"></td> <td style="width: 10%;"></td> </tr> <tr> <td></td> <td></td> <td colspan="8" style="text-align: center;"> <table border="1" style="width: 100%; border-collapse: collapse; text-align: center;"> <tr> <td style="width: 10%;"></td> <td style="width: 10%;"></td> <td style="width: 10%;"></td> <td style="width: 10%;"></td> <td style="width: 10%;"></td> <td style="width: 10%;"></td> <td style="width: 10%;"></td> <td style="width: 10%;"></td> <td style="width: 10%;"></td> <td style="width: 10%;"></td> </tr> <tr> <td></td> <td></td> <td colspan="8" style="text-align: center;"> <table border="1" style="width: 100%; border-collapse: collapse; text-align: center;"> <tr> <td style="width: 10%;"></td> <td style="width: 10%;"></td> <td style="width: 10%;"></td> <td style="width: 10%;"></td> <td style="width: 10%;"></td> <td style="width: 10%;"></td> <td style="width: 10%;"></td> <td style="width: 10%;"></td> <td style="width: 10%;"></td> <td style="width: 10%;"></td> </tr> <tr> <td></td> <td></td> <td colspan="8" style="text-align: center;"> <table border="1" style="width: 100%; border-collapse: collapse; text-align: center;"> <tr> <td style="width: 10%;"></td> <td style="width: 10%;"></td> <td style="width: 10%;"></td> <td style="width: 10%;"></td> <td style="width: 10%;"></td> <td style="width: 10%;"></td> <td style="width: 10%;"></td> <td style="width: 10%;"></td> <td style="width: 10%;"></td> <td style="width: 10%;"></td> </tr> <tr> <td></td> <td></td> <td colspan="8" style="text-align: center;"> <table border="1" style="width: 100%; border-collapse: collapse; text-align: center;"> <tr> <td style="width: 10%;"></td> <td style="width: 10%;"></td> <td style="width: 10%;"></td> <td style="width: 10%;"></td> <td style="width: 10%;"></td> <td style="width: 10%;"></td> <td style="width: 10%;"></td> <td style="width: 10%;"></td> <td style="width: 10%;"></td> <td style="width: 10%;"></td> </tr> <tr> <td></td> <td></td> <td colspan="8" style="text-align: center;"> <table border="1" style="width: 100%; border-collapse: collapse; text-align: center;"> <tr> <td style="width: 10%;"></td> <td style="width: 10%;"></td> <td style="width: 10%;"></td> <td style="width: 10%;"></td> <td style="width: 10%;"></td> <td style="width: 10%;"></td> <td style="width: 10%;"></td> <td style="width: 10%;"></td> <td style="width: 10%;"></td> <td style="width: 10%;"></td> </tr> <tr> <td></td> <td></td> <td colspan="8" style="text-align: center;"> <table border="1" style="width: 100%; border-collapse: collapse; text-align: center;"> <tr> <td style="width: 10%;"></td> <td style="width: 10%;"></td> <td style="width: 10%;"></td> <td style="width: 10%;"></td> <td style="width: 10%;"></td> <td style="width: 10%;"></td> <td style="width: 10%;"></td> <td style="width: 10%;"></td> <td style="width: 10%;"></td> <td style="width: 10%;"></td> </tr> <tr> <td></td> <td></td> <td colspan="8" style="text-align: center;"> <table border="1" style="width: 100%; border-collapse: collapse; text-align: center;"> <tr> <td style="width: 10%;"></td> <td style="width: 10%;"></td> <td style="width: 10%;"></td> <td style="width: 10%;"></td> <td style="width: 10%;"></td> <td style="width: 10%;"></td> <td style="width: 10%;"></td> <td style="width: 10%;"></td> <td style="width: 10%;"></td> <td style="width: 10%;"></td> </tr> <tr> <td></td> <td></td> <td colspan="8" style="text-align: center;"> <table border="1" style="width: 100%; border-collapse: collapse; text-align: center;"> <tr> <td style="width: 10%;"></td> <td style="width: 10%;"></td> <td style="width: 10%;"></td> <td style="width: 10%;"></td> <td style="width: 10%;"></td> <td style="width: 10%;"></td> <td style="width: 10%;"></td> <td style="width: 10%;"></td> <td style="width: 10%;"></td> <td style="width: 10%;"></td> </tr> <tr> <td></td> <td></td> <td colspan="8" style="text-align: center;"> <table border="1" style="width: 100%; border-collapse: collapse; text-align: center;"> <tr> <td style="width: 10%;"></td> <td style="width: 10%;"></td> <td style="width: 10%;"></td> <td style="width: 10%;"></td> <td style="width: 10%;"></td> <td style="width: 10%;"></td> <td style="width: 10%;"></td> <td style="width: 10%;"></td> <td style="width: 10%;"></td> <td style="width: 10%;"></td> </tr> <tr> <td></td> <td></td> <td colspan="8" style="text-align: center;"> <table border="1" style="width: 100%; border-collapse: collapse; text-align: center;"> <tr> <td style="width: 10%;"></td> <td style="width: 10%;"></td> <td style="width: 10%;"></td> <td style="width: 10%;"></td> <td style="width: 10%;"></td> <td style="width: 10%;"></td> <td style="width: 10%;"></td> <td style="width: 10%;"></td> <td style="width: 10%;"></td> <td style="width: 10%;"></td> </tr> <tr> <td></td> <td></td> <td colspan="8" style="text-align: center;"> <table border="1" style="width: 100%; border-collapse: collapse; text-align: center;"> <tr> <td style="width: 10%;"></td> <td style="width: 10%;"></td> <td style="width: 10%;"></td> <td style="width: 10%;"></td> <td style="width: 10%;"></td> <td style="width: 10%;"></td> <td style="width: 10%;"></td> <td style="width: 10%;"></td> <td style="width: 10%;"></td> <td style="width: 10%;"></td> </tr> <tr> <td></td> <td></td> <td colspan="8" style="text-align: center;"> <table border="1" style="width: 100%; border-collapse: collapse; text-align: center;"> <tr> <td style="width: 10%;"></td> <td style="width: 10%;"></td> <td style="width: 10%;"></td> <td style="width: 10%;"></td> <td style="width: 10%;"></td> <td style="width: 10%;"></td> <td style="width: 10%;"></td> <td style="width: 10%;"></td> <td style="width: 10%;"></td> <td style="width: 10%;"></td> </tr> <tr> <td></td> <td></td> <td colspan="8" style="text-align: center;"> <table border="1" style="width: 100%; border-collapse: collapse; text-align: center;"> <tr> <td style="width: 10%;"></td> <td style="width: 10%;"></td> <td style="width: 10%;"></td> <td style="width: 10%;"></td> <td style="width: 10%;"></td> <td style="width: 10%;"></td> <td style="width: 10%;"></td> <td style="width: 10%;"></td> <td style="width: 10%;"></td> <td style="width: 10%;"></td> </tr> <tr> <td></td> <td></td> <td colspan="8" style="text-align: center;"> <table border="1" style="width: 100%; border-collapse: collapse; text-align: center;"> <tr> <td style="width: 10%;"></td> <td style="width: 10%;"></td> <td style="width: 10%;"></td> <td style="width: 10%;"></td> <td style="width: 10%;"></td> <td style="width: 10%;"></td> <td style="width: 10%;"></td> <td style="width: 10%;"></td> <td style="width: 10%;"></td> <td style="width: 10%;"></td> </tr> <tr> <td></td> <td></td> <td colspan="8" style="text-align: center;"> <table border="1" style="width: 100%; border-collapse: collapse; text-align: center;"> <tr> <td style="width: 10%;"></td> <td style="width: 10%;"></td> <td style="width: 10%;"></td> <td style="width: 10%;"></td> <td style="width: 10%;"></td> <td style="width: 10%;"></td> <td style="width: 10%;"></td> <td style="width: 10%;"></td> <td style="width: 10%;"></td> <td style="width: 10%;"></td> </tr> <tr> <td></td> <td></td> <td colspan="8" style="text-align: center;"> <table border="1" style="width: 100%; border-collapse: collapse; text-align: center;"> <tr> <td style="width: 10%;"></td> <td style="width: 10%;"></td> <td style="width: 10%;"></td> <td style="width: 10%;"></td> <td style="width: 10%;"></td> <td style="width: 10%;"></td> <td style="width: 10%;"></td> <td style="width: 10%;"></td> <td style="width: 10%;"></td> <td style="width: 10%;"></td> </tr> <tr> <td></td> <td></td> <td colspan="8" style="text-align: center;"> <table border="1" style="width: 100%; border-collapse: collapse; text-align: center;"> <tr> <td style="width: 10%;"></td> <td style="width: 10%;"></td> <td style="width: 10%;"></td> <td style="width: 10%;"></td> <td style="width: 10%;"></td> <td style="width: 10%;"></td> <td style="width: 10%;"></td> <td style="width: 10%;"></td> <td style="width: 10%;"></td> <td style="width: 10%;"></td> </tr> <tr> <td></td> <td></td> <td colspan="8" style="text-align: center;"> <table border="1" style="width: 100%; border-collapse: collapse; text-align: center;"> <tr> <td style="width: 10%;"></td> <td style="width: 10%;"></td> <td style="width: 10%;"></td> <td style="width: 10%;"></td> <td style="width: 10%;"></td> <td style="width: 10%;"></td> <td style="width: 10%;"></td> <td style="width: 10%;"></td> <td style="width: 10%;"></td> <td style="width: 10%;"></td> </tr> <tr> <td></td> <td></td> <td colspan="8" style="text-align: center;"> <table border="1" style="width: 100%; border-collapse: collapse; text-align: center;"> <tr> <td style="width: 10%;"></td> <td style="width: 10%;"></td> <td style="width: 10%;"></td> <td style="width: 10%;"></td> <td style="width: 10%;"></td> <td style="width: 10%;"></td> <td style="width: 10%;"></td> <td style="width: 10%;"></td> <td style="width: 10%;"></td> <td style="width: 10%;"></td> </tr> <tr> <td></td> <td></td> <td colspan="8" style="text-align: center;"> <table border="1" style="width: 100%; border-collapse: collapse; text-align: center;"> <tr> <td style="width: 10%;"></td> <td style="width: 10%;"></td> <td style="width: 10%;"></td> <td style="width: 10%;"></td> <td style="width: 10%;"></td> <td style="width: 10%;"></td> <td style="width: 10%;"></td> <td style="width: 10%;"></td> <td style="width: 10%;"></td> <td style="width: 10%;"></td> </tr> <tr> <td></td> <td></td> <td colspan="8" style="text-align: center;"> <table border="1" style="width: 100%; border-collapse: collapse; text-align: center;"> <tr> <td style="width: 10%;"></td> <td style="width: 10%;"></td> <td style="width:
10%;"></td> <td style="width: 10%;"></td> <td style="width: 10%;"></td> <td style="width: 10%;"></td> <td style="width: 10%;"></td> <td style="width: 10%;"></td> <td style="width: 10%;"></td> <td style="width: 10%;"></td> </tr> <tr> <td></td> <td></td> <td colspan="8" style="text-align: center;"> <table border="1" style="width: 100%; border-collapse: collapse; text-align: center;"> <tr> <td style="width: 10%;"></td> <td style="width: 10%;"></td> <td style="width: 10%;"></td> <td style="width: 10%;"></td> <td style="width: 10%;"></td> <td style="width: 10%;"></td> <td style="width: 10%;"></td> <td style="width: 10%;"></td> <td style="width: 10%;"></td> <td style="width: 10%;"></td> </tr> <tr> <td></td> <td></td> <td colspan="8" style="text-align: center;"> <table border="1" style="width: 100%; border-collapse: collapse; text-align: center;"> <tr> <td style="width: 10%;"></td> <td style="width: 10%;"></td> <td style="width: 10%;"></td> <td style="width: 10%;"></td> <td style="width: 10%;"></td> <td style="width: 10%;"></td> <td style="width: 10%;"></td> <td style="width: 10%;"></td> <td style="width: 10%;"></td> <td style="width: 10%;"></td> </tr> <tr> <td></td> <td></td> <td colspan="8" style="text-align: center;"> <table border="1" style="width: 100%; border-collapse: collapse; text-align: center;"> <tr> <td style="width: 10%;"></td> <td style="width: 10%;"></td> <td style="width: 10%;"></td> <td style="width: 10%;"></td> <td style="width: 10%;"></td> <td style="width: 10%;"></td> <td style="width: 10%;"></td> <td style="width: 10%;"></td> <td style="width: 10%;"></td> <td style="width: 10%;"></td> </tr> <tr> <td></td> <td></td> <td colspan="8" style="text-align: center;"> <table border="1" style="width: 100%; border-collapse: collapse; text-align: center;"> <tr> <td style="width: 10%;"></td> <td style="width: 10%;"></td> <td style="width: 10%;"></td> <td style="width: 10%;"></td> <td style="width: 10%;"></td> <td style="width: 10%;"></td> <td style="width: 10%;"></td> <td style="width: 10%;"></td> <td style="width: 10%;"></td> <td style="width: 10%;"></td> </tr> <tr> <td></td> <td></td> <td colspan="8" style="text-align: center;"> <table border="1" style="width: 100%; border-collapse: collapse; text-align: center;"> <tr> <td style="width: 10%;"></td> <td style="width: 10%;"></td> <td style="width: 10%;"></td> <td style="width: 10%;"></td> <td style="width: 10%;"></td> <td style="width: 10%;"></td> <td style="width: 10%;"></td> <td style="width: 10%;"></td> <td style="width: 10%;"></td> <td style="width: 10%;"></td> </tr> <tr> <td></td> <td></td> <td colspan="8" style="text-align: center;"> <table border="1" style="width: 100%; border-collapse: collapse; text-align: center;"> <tr> <td style="width: 10%;"></td> <td style="width: 10%;"></td> <td style="width: 10%;"></td> <td style="width: 10%;"></td> <td style="width: 10%;"></td> <td style="width: 10%;"></td> <td style="width: 10%;"></td> <td style="width: 10%;"></td> <td style="width: 10%;"></td> <td style="width: 10%;"></td> </tr> <tr> <td></td> <td></td> <td colspan="8" style="text-align: center;"> <table border="1" style="width: 100%; border-collapse: collapse; text-align: center;"> <tr> <td style="width: 10%;"></td> <td style="width: 10%;"></td> <td style="width: 10%;"></td> <td style="width: 10%;"></td> <td style="width: 10%;"></td> <td style="width: 10%;"></td> <td style="width: 10%;"></td> <td style="width: 10%;"></td> <td style="width: 10%;"></td> <td style="width: 10%;"></td> </tr> <tr> <td></td> <td></td> <td colspan="8" style="text-align: center;"> <table border="1" style="width: 100%; border-collapse: collapse; text-align: center;"> <tr> <td style="width: 10%;"></td> <td style="width: 10%;"></td> <td style="width: 10%;"></td> <td style="width: 10%;"></td> <td style="width: 10%;"></td> <td style="width: 10%;"></td> <td style="width: 10%;"></td> <td style="width: 10%;"></td> <td style="width: 10%;"></td> <td style="width: 10%;"></td> </tr> <tr> <td></td> <td></td> <td colspan="8" style="text-align: center;"> <table border="1" style="width: 100%; border-collapse: collapse; text-align: center;"> <tr> <td style="width: 10%;"></td> <td style="width: 10%;"></td> <td style="width: 10%;"></td> <td style="width: 10%;"></td> <td style="width: 10%;"></td> <td style="width: 10%;"></td> <td style="width: 10%;"></td> <td style="width: 10%;"></td> <td style="width: 10%;"></td> <td style="width: 10%;"></td> </tr> <tr> <td></td> <td></td> <td colspan="8" style="text-align: center;"> <table border="1" style="width: 100%; border-collapse: collapse; text-align: center;"> <tr> </tr></table></td></tr></table></td></tr></table></td></tr></table></td></tr></table></td></tr></table></td></tr></table></td></tr></table></td></tr></table></td></tr></table></td></tr></table></td></tr></table></td></tr></table></td></tr></table></td></tr></table></td></tr></table></td></tr></table></td></tr></table></td></tr></table></td></tr></table></td></tr></table></td></tr></table></td></tr></table></td></tr></table></td></tr></table></td></tr></table></td></tr></table></td></tr></table></td></tr></table></td></tr></table></td></tr></table></td></tr></table></td></tr></table></td></tr></table></td></tr></table></td></tr></table></td></tr></table></td></tr></table></td></tr></table></td></tr></table></td></tr></table></td></tr></table></td></tr></table></td></tr></table></td></tr></table></td></tr></table></td></tr></table></td></tr></table></td></tr></table></td></tr></table>
 | | | | | | | | | | | | | | | | | | | | <table border="1" style="width: 100%; border-collapse: collapse; text-align: center;"> <tr> <td style="width: 10%;"></td> <td style="width: 10%;"></td> <td style="width: 10%;"></td> <td style="width: 10%;"></td> <td style="width: 10%;"></td> <td style="width: 10%;"></td> <td style="width: 10%;"></td> <td style="width: 10%;"></td> <td style="width: 10%;"></td> <td style="width: 10%;"></td> </tr> <tr> <td></td> <td></td> <td colspan="8" style="text-align: center;"> <table border="1" style="width: 100%; border-collapse: collapse; text-align: center;"> <tr> <td style="width: 10%;"></td> <td style="width: 10%;"></td> <td style="width: 10%;"></td> <td style="width: 10%;"></td> <td style="width: 10%;"></td> <td style="width: 10%;"></td> <td style="width: 10%;"></td> <td style="width: 10%;"></td> <td style="width: 10%;"></td> <td style="width: 10%;"></td> </tr> <tr> <td></td> <td></td> <td colspan="8" style="text-align: center;"> <table border="1" style="width: 100%; border-collapse: collapse; text-align: center;"> <tr> <td style="width: 10%;"></td> <td style="width: 10%;"></td> <td style="width: 10%;"></td> <td style="width: 10%;"></td> <td style="width: 10%;"></td> <td style="width: 10%;"></td> <td style="width: 10%;"></td> <td style="width: 10%;"></td> <td style="width: 10%;"></td> <td style="width: 10%;"></td> </tr> <tr> <td></td> <td></td> <td colspan="8" style="text-align: center;"> <table border="1" style="width: 100%; border-collapse: collapse; text-align: center;"> <tr> <td style="width: 10%;"></td> <td style="width: 10%;"></td> <td style="width: 10%;"></td> <td style="width: 10%;"></td> <td style="width: 10%;"></td> <td style="width: 10%;"></td> <td style="width: 10%;"></td> <td style="width: 10%;"></td> <td style="width: 10%;"></td> <td style="width: 10%;"></td> </tr> <tr> <td></td> <td></td> <td colspan="8" style="text-align: center;"> <table border="1" style="width: 100%; border-collapse: collapse; text-align: center;"> <tr> <td style="width: 10%;"></td> <td style="width: 10%;"></td> <td style="width: 10%;"></td> <td style="width: 10%;"></td> <td style="width: 10%;"></td> <td style="width: 10%;"></td> <td style="width: 10%;"></td> <td style="width: 10%;"></td> <td style="width: 10%;"></td> <td style="width: 10%;"></td> </tr> <tr> <td></td> <td></td> <td colspan="8" style="text-align: center;"> <table border="1" style="width: 100%; border-collapse: collapse; text-align: center;"> <tr> <td style="width: 10%;"></td> <td style="width: 10%;"></td> <td style="width: 10%;"></td> <td style="width: 10%;"></td> <td style="width: 10%;"></td> <td style="width: 10%;"></td> <td style="width: 10%;"></td> <td style="width: 10%;"></td> <td style="width: 10%;"></td> <td style="width: 10%;"></td> </tr> <tr> <td></td> <td></td> <td colspan="8" style="text-align: center;"> <table border="1" style="width: 100%; border-collapse: collapse; text-align: center;"> <tr> <td style="width: 10%;"></td> <td style="width: 10%;"></td> <td style="width: 10%;"></td> <td style="width: 10%;"></td> <td style="width: 10%;"></td> <td style="width: 10%;"></td> <td style="width: 10%;"></td> <td style="width: 10%;"></td> <td style="width: 10%;"></td> <td style="width: 10%;"></td> </tr> <tr> <td></td> <td></td> <td colspan="8" style="text-align: center;"> <table border="1" style="width: 100%; border-collapse: collapse; text-align: center;"> <tr> <td style="width: 10%;"></td> <td style="width: 10%;"></td> <td style="width: 10%;"></td> <td style="width: 10%;"></td> <td style="width: 10%;"></td> <td style="width: 10%;"></td> <td style="width: 10%;"></td> <td style="width: 10%;"></td> <td style="width: 10%;"></td> <td style="width: 10%;"></td> </tr> <tr> <td></td> <td></td> <td colspan="8" style="text-align: center;"> <table border="1" style="width: 100%; border-collapse: collapse; text-align: center;"> <tr> <td style="width: 10%;"></td> <td style="width: 10%;"></td> <td style="width: 10%;"></td> <td style="width: 10%;"></td> <td style="width: 10%;"></td> <td style="width: 10%;"></td> <td style="width: 10%;"></td> <td style="width: 10%;"></td> <td style="width: 10%;"></td> <td style="width: 10%;"></td> </tr> <tr> <td></td> <td></td> <td colspan="8" style="text-align: center;"> <table border="1" style="width: 100%; border-collapse: collapse; text-align: center;"> <tr> <td style="width: 10%;"></td> <td style="width: 10%;"></td> <td style="width: 10%;"></td> <td style="width: 10%;"></td> <td style="width: 10%;"></td> <td style="width: 10%;"></td> <td style="width: 10%;"></td> <td style="width: 10%;"></td> <td style="width: 10%;"></td> <td style="width: 10%;"></td> </tr> <tr> <td></td> <td></td> <td colspan="8" style="text-align: center;"> <table border="1" style="width: 100%; border-collapse: collapse; text-align: center;"> <tr> <td style="width: 10%;"></td> <td style="width: 10%;"></td> <td style="width: 10%;"></td> <td style="width: 10%;"></td> <td style="width: 10%;"></td> <td style="width: 10%;"></td> <td style="width: 10%;"></td> <td style="width: 10%;"></td> <td style="width: 10%;"></td> <td style="width: 10%;"></td> </tr> <tr> <td></td> <td></td> <td colspan="8" style="text-align: center;"> <table border="1" style="width: 100%; border-collapse: collapse; text-align: center;"> <tr> <td style="width: 10%;"></td> <td style="width: 10%;"></td> <td style="width: 10%;"></td> <td style="width: 10%;"></td> <td style="width: 10%;"></td> <td style="width: 10%;"></td> <td style="width: 10%;"></td> <td style="width: 10%;"></td> <td style="width: 10%;"></td> <td style="width: 10%;"></td> </tr> <tr> <td></td> <td></td> <td colspan="8" style="text-align: center;"> <table border="1" style="width: 100%; border-collapse: collapse; text-align: center;"> <tr> <td style="width: 10%;"></td> <td style="width: 10%;"></td> <td style="width: 10%;"></td> <td style="width: 10%;"></td> <td style="width: 10%;"></td> <td style="width: 10%;"></td> <td style="width: 10%;"></td> <td style="width: 10%;"></td> <td style="width: 10%;"></td> <td style="width: 10%;"></td> </tr> <tr> <td></td> <td></td> <td colspan="8" style="text-align: center;"> <table border="1" style="width: 100%; border-collapse: collapse; text-align: center;"> <tr> <td style="width: 10%;"></td> <td style="width: 10%;"></td> <td style="width: 10%;"></td> <td style="width: 10%;"></td> <td style="width: 10%;"></td> <td style="width: 10%;"></td> <td style="width: 10%;"></td> <td style="width: 10%;"></td> <td style="width: 10%;"></td> <td style="width: 10%;"></td> </tr> <tr> <td></td> <td></td> <td colspan="8" style="text-align: center;"> <table border="1" style="width: 100%; border-collapse: collapse; text-align: center;"> <tr> <td style="width: 10%;"></td> <td style="width: 10%;"></td> <td style="width: 10%;"></td> <td style="width: 10%;"></td> <td style="width: 10%;"></td> <td style="width: 10%;"></td> <td style="width: 10%;"></td> <td style="width: 10%;"></td> <td style="width: 10%;"></td> <td style="width: 10%;"></td> </tr> <tr> <td></td> <td></td> <td colspan="8" style="text-align: center;"> <table border="1" style="width: 100%; border-collapse: collapse; text-align: center;"> <tr> <td style="width: 10%;"></td> <td style="width: 10%;"></td> <td style="width: 10%;"></td> <td style="width: 10%;"></td> <td style="width: 10%;"></td> <td style="width: 10%;"></td> <td style="width: 10%;"></td> <td style="width: 10%;"></td> <td style="width: 10%;"></td> <td style="width: 10%;"></td> </tr> <tr> <td></td> <td></td> <td colspan="8" style="text-align: center;"> <table border="1" style="width: 100%; border-collapse: collapse; text-align: center;"> <tr> <td style="width: 10%;"></td> <td style="width: 10%;"></td> <td style="width: 10%;"></td> <td style="width: 10%;"></td> <td style="width: 10%;"></td> <td style="width: 10%;"></td> <td style="width: 10%;"></td> <td style="width: 10%;"></td> <td style="width: 10%;"></td> <td style="width: 10%;"></td> </tr> <tr> <td></td> <td></td> <td colspan="8" style="text-align: center;"> <table border="1" style="width: 100%; border-collapse: collapse; text-align: center;"> <tr> <td style="width: 10%;"></td> <td style="width: 10%;"></td> <td style="width: 10%;"></td> <td style="width: 10%;"></td> <td style="width: 10%;"></td> <td style="width: 10%;"></td> <td style="width: 10%;"></td> <td style="width: 10%;"></td> <td style="width: 10%;"></td> <td style="width: 10%;"></td> </tr> <tr> <td></td> <td></td> <td colspan="8" style="text-align: center;"> <table border="1" style="width: 100%; border-collapse: collapse; text-align: center;"> <tr> <td style="width: 10%;"></td> <td style="width: 10%;"></td> <td style="width: 10%;"></td> <td style="width: 10%;"></td> <td style="width: 10%;"></td> <td style="width: 10%;"></td> <td style="width: 10%;"></td> <td style="width: 10%;"></td> <td style="width: 10%;"></td> <td style="width: 10%;"></td> </tr> <tr> <td></td> <td></td> <td colspan="8" style="text-align: center;"> <table border="1" style="width: 100%; border-collapse: collapse; text-align: center;"> <tr> <td style="width: 10%;"></td> <td style="width: 10%;"></td> <td style="width: 10%;"></td> <td style="width: 10%;"></td> <td style="width: 10%;"></td> <td style="width: 10%;"></td> <td style="width: 10%;"></td> <td style="width: 10%;"></td> <td style="width: 10%;"></td> <td style="width: 10%;"></td> </tr> <tr> <td></td> <td></td> <td colspan="8" style="text-align: center;"> <table border="1" style="width: 100%; border-collapse: collapse; text-align: center;"> <tr> <td style="width: 10%;"></td> <td style="width: 10%;"></td> <td style="width: 10%;"></td> <td style="width: 10%;"></td> <td
style="width: 10%;"></td> <td style="width: 10%;"></td> <td style="width: 10%;"></td> <td style="width: 10%;"></td> <td style="width: 10%;"></td> <td style="width: 10%;"></td> </tr> <tr> <td></td> <td></td> <td colspan="8" style="text-align: center;"> <table border="1" style="width: 100%; border-collapse: collapse; text-align: center;"> <tr> <td style="width: 10%;"></td> <td style="width: 10%;"></td> <td style="width: 10%;"></td> <td style="width: 10%;"></td> <td style="width: 10%;"></td> <td style="width: 10%;"></td> <td style="width: 10%;"></td> <td style="width: 10%;"></td> <td style="width: 10%;"></td> <td style="width: 10%;"></td> </tr> <tr> <td></td> <td></td> <td colspan="8" style="text-align: center;"> <table border="1" style="width: 100%; border-collapse: collapse; text-align: center;"> <tr> <td style="width: 10%;"></td> <td style="width: 10%;"></td> <td style="width: 10%;"></td> <td style="width: 10%;"></td> <td style="width: 10%;"></td> <td style="width: 10%;"></td> <td style="width: 10%;"></td> <td style="width: 10%;"></td> <td style="width: 10%;"></td> <td style="width: 10%;"></td> </tr> <tr> <td></td> <td></td> <td colspan="8" style="text-align: center;"> <table border="1" style="width: 100%; border-collapse: collapse; text-align: center;"> <tr> <td style="width: 10%;"></td> <td style="width: 10%;"></td> <td style="width: 10%;"></td> <td style="width: 10%;"></td> <td style="width: 10%;"></td> <td style="width: 10%;"></td> <td style="width: 10%;"></td> <td style="width: 10%;"></td> <td style="width: 10%;"></td> <td style="width: 10%;"></td> </tr> <tr> <td></td> <td></td> <td colspan="8" style="text-align: center;"> <table border="1" style="width: 100%; border-collapse: collapse; text-align: center;"> <tr> <td style="width: 10%;"></td> <td style="width: 10%;"></td> <td style="width: 10%;"></td> <td style="width: 10%;"></td> <td style="width: 10%;"></td> <td style="width: 10%;"></td> <td style="width: 10%;"></td> <td style="width: 10%;"></td> <td style="width: 10%;"></td> <td style="width: 10%;"></td> </tr> <tr> <td></td> <td></td> <td colspan="8" style="text-align: center;"> <table border="1" style="width: 100%; border-collapse: collapse; text-align: center;"> <tr> <td style="width: 10%;"></td> <td style="width: 10%;"></td> <td style="width: 10%;"></td> <td style="width: 10%;"></td> <td style="width: 10%;"></td> <td style="width: 10%;"></td> <td style="width: 10%;"></td> <td style="width: 10%;"></td> <td style="width: 10%;"></td> <td style="width: 10%;"></td> </tr> <tr> <td></td> <td></td> <td colspan="8" style="text-align: center;"> <table border="1" style="width: 100%; border-collapse: collapse; text-align: center;"> <tr> <td style="width: 10%;"></td> <td style="width: 10%;"></td> <td style="width: 10%;"></td> <td style="width: 10%;"></td> <td style="width: 10%;"></td> <td style="width: 10%;"></td> <td style="width: 10%;"></td> <td style="width: 10%;"></td> <td style="width: 10%;"></td> <td style="width: 10%;"></td> </tr> <tr> <td></td> <td></td> <td colspan="8" style="text-align: center;"> <table border="1" style="width: 100%; border-collapse: collapse; text-align: center;"> <tr> <td style="width: 10%;"></td> <td style="width: 10%;"></td> <td style="width: 10%;"></td> <td style="width: 10%;"></td> <td style="width: 10%;"></td> <td style="width: 10%;"></td> <td style="width: 10%;"></td> <td style="width: 10%;"></td> <td style="width: 10%;"></td> <td style="width: 10%;"></td> </tr> <tr> <td></td> <td></td> <td colspan="8" style="text-align: center;"> <table border="1" style="width: 100%; border-collapse: collapse; text-align: center;"> <tr> <td style="width: 10%;"></td> <td style="width: 10%;"></td> <td style="width: 10%;"></td> <td style="width: 10%;"></td> <td style="width: 10%;"></td> <td style="width: 10%;"></td> <td style="width: 10%;"></td> <td style="width: 10%;"></td> <td style="width: 10%;"></td> <td style="width: 10%;"></td> </tr> <tr> <td></td> <td></td> <td colspan="8" style="text-align: center;"> <table border="1" style="width: 100%; border-collapse: collapse; text-align: center;"> <tr> <td style="width: 10%;"></td> <td style="width: 10%;"></td> <td style="width: 10%;"></td> <td style="width: 10%;"></td> <td style="width: 10%;"></td> <td style="width: 10%;"></td> <td style="width: 10%;"></td> <td style="width: 10%;"></td> <td style="width: 10%;"></td> <td style="width: 10%;"></td> </tr> <tr> <td></td> <td></td> <td colspan="8" style="text-align: center;"> <table border="1" style="width: 100%; border-collapse: collapse; text-align: center;"> <tr> <td style="width: 10%;"></td> <td style="width: 10%;"></td> <td style="width: 10%;"></td> <td style="width: 10%;"></td> <td style="width: 10%;"></td> <td style="width: 10%;"></td> <td style="width: 10%;"></td> <td style="width: 10%;"></td> <td style="width: 10%;"></td> <td style="width: 10%;"></td> </tr> <tr> <td></td> <td></td> <td colspan="8" style="text-align: center;"> <table border="1" style="width: 100%; border-collapse: collapse; text-align: center;"> <tr> <td style="width: 10%;"></td> <td style="width: 10%;"></td> <td style="width: 10%;"></td> <td style="width: 10%;"></td> <td style="width: 10%;"></td> <td style="width: 10%;"></td> <td style="width: 10%;"></td> <td style="width: 10%;"></td> <td style="width: 10%;"></td> <td style="width: 10%;"></td> </tr> <tr> <td></td> <td></td> <td colspan="8" style="text-align: center;"> <table border="1" style="width: 100%; border-collapse: collapse; text-align: center;"> <tr> <td style="width: 10%;"></td> <td style="width: 10%;"></td> <td style="width: 10%;"></td> <td style="width: 10%;"></td> <td style="width: 10%;"></td> <td style="width: 10%;"></td> <td style="width: 10%;"></td> <td style="width: 10%;"></td> <td style="width: 10%;"></td> <td style="width: 10%;"></td> </tr> <tr> <td></td> <td></td> <td colspan="8" style="text-align: center;"> <table border="1" style="width: 100%; border-collapse: collapse; text-align: center;"> <tr> <td style="width: 10%;"></td> <td style="width: 10%;"></td> <td style="width: 10%;"></td> <td style="width: 10%;"></td> <td style="width: 10%;"></td> <td style="width: 10%;"></td> <td style="width: 10%;"></td> <td style="width: 10%;"></td> <td style="width: 10%;"></td> <td style="width: 10%;"></td> </tr> <tr> <td></td> <td></td> <td colspan="8" style="text-align: center;"> <table border="1" style="width: 100%; border-collapse: collapse; text-align: center;"> <tr> <td style="width: 10%;"></td> <td style="width: 10%;"></td> <td style="width: 10%;"></td> <td style="width: 10%;"></td> <td style="width: 10%;"></td> <td style="width: 10%;"></td> <td style="width: 10%;"></td> <td style="width: 10%;"></td> <td style="width: 10%;"></td> <td style="width: 10%;"></td> </tr> <tr> <td></td> <td></td> <td colspan="8" style="text-align: center;"> <table border="1" style="width: 100%; border-collapse: collapse; text-align: center;"> <tr> <td style="width: 10%;"></td> <td style="width: 10%;"></td> <td style="width: 10%;"></td> <td style="width: 10%;"></td> <td style="width: 10%;"></td> <td style="width: 10%;"></td> <td style="width: 10%;"></td> <td style="width: 10%;"></td> <td style="width: 10%;"></td> <td style="width: 10%;"></td> </tr> <tr> <td></td> <td></td> <td colspan="8" style="text-align: center;"> <table border="1" style="width: 100%; border-collapse: collapse; text-align: center;"> <tr> <td style="width: 10%;"></td> <td style="width: 10%;"></td> <td style="width: 10%;"></td> <td style="width: 10%;"></td> <td style="width: 10%;"></td> <td style="width: 10%;"></td> <td style="width: 10%;"></td> <td style="width: 10%;"></td> <td style="width: 10%;"></td> <td style="width: 10%;"></td> </tr> <tr> <td></td> <td></td> <td colspan="8" style="text-align: center;"> <table border="1" style="width: 100%; border-collapse: collapse; text-align: center;"> <tr> <td style="width: 10%;"></td> <td style="width: 10%;"></td> <td style="width: 10%;"></td> <td style="width: 10%;"></td> <td style="width: 10%;"></td> <td style="width: 10%;"></td> <td style="width: 10%;"></td> <td style="width: 10%;"></td> <td style="width: 10%;"></td> <td style="width: 10%;"></td> </tr> <tr> <td></td> <td></td> <td colspan="8" style="text-align: center;"> <table border="1" style="width: 100%; border-collapse: collapse; text-align: center;"> <tr> <td style="width: 10%;"></td> <td style="width: 10%;"></td> <td style="width: 10%;"></td> <td style="width: 10%;"></td> <td style="width: 10%;"></td> <td style="width: 10%;"></td> <td style="width: 10%;"></td> <td style="width: 10%;"></td> <td style="width: 10%;"></td> <td style="width: 10%;"></td> </tr> <tr> <td></td> <td></td> <td colspan="8" style="text-align: center;"> <table border="1" style="width: 100%; border-collapse: collapse; text-align: center;"> <tr> <td style="width: 10%;"></td> <td style="width: 10%;"></td> <td style="width: 10%;"></td> <td style="width: 10%;"></td> <td style="width: 10%;"></td> <td style="width: 10%;"></td> <td style="width: 10%;"></td> <td style="width: 10%;"></td> <td style="width: 10%;"></td> <td style="width: 10%;"></td> </tr> <tr> <td></td> <td></td> <td colspan="8" style="text-align: center;"> <table border="1" style="width: 100%; border-collapse: collapse; text-align: center;"> <tr> <td style="width: 10%;"></td> <td style="width: 10%;"></td> <td style="width: 10%;"></td> <td style="width: 10%;"></td> <td style="width: 10%;"></td> <td style="width: 10%;"></td> <td style="width: 10%;"></td> <td style="width: 10%;"></td> <td style="width: 10%;"></td> <td style="width: 10%;"></td> </tr> <tr> <td></td> <td></td> <td colspan="8" style="text-align: center;"> <table border="1" style="width: 100%; border-collapse: collapse; text-align: center;"> <tr> <td style="width: 10%;"></td> <td style="width: 10%;"></td> <td style="width: 10%;"></td> <td style="width: 10%;"></td> <td style="width: 10%;"></td> <td style="width: 10%;"></td> <td style="width: 10%;"></td> <td style="width: 10%;"></td> <td style="width: 10%;"></td> <td style="width:
10%;"></td> </tr> <tr> <td></td> <td></td> <td colspan="8" style="text-align: center;"> <table border="1" style="width: 100%; border-collapse: collapse; text-align: center;"> <tr> <td style="width: 10%;"></td> <td style="width: 10%;"></td> <td style="width: 10%;"></td> <td style="width: 10%;"></td> <td style="width: 10%;"></td> <td style="width: 10%;"></td> <td style="width: 10%;"></td> <td style="width: 10%;"></td> <td style="width: 10%;"></td> <td style="width: 10%;"></td> </tr> <tr> <td></td> <td></td> <td colspan="8" style="text-align: center;"> <table border="1" style="width: 100%; border-collapse: collapse; text-align: center;"> <tr> <td style="width: 10%;"></td> <td style="width: 10%;"></td> <td style="width: 10%;"></td> <td style="width: 10%;"></td> <td style="width: 10%;"></td> <td style="width: 10%;"></td> <td style="width: 10%;"></td> <td style="width: 10%;"></td> <td style="width: 10%;"></td> <td style="width: 10%;"></td> </tr> <tr> <td></td> <td></td> <td colspan="8" style="text-align: center;"> <table border="1" style="width: 100%; border-collapse: collapse; text-align: center;"> <tr> <td style="width: 10%;"></td> <td style="width: 10%;"></td> <td style="width: 10%;"></td> <td style="width: 10%;"></td> <td style="width: 10%;"></td> <td style="width: 10%;"></td> <td style="width: 10%;"></td> <td style="width: 10%;"></td> <td style="width: 10%;"></td> <td style="width: 10%;"></td> </tr> <tr> <td></td> <td></td> <td colspan="8" style="text-align: center;"> <table border="1" style="width: 100%; border-collapse: collapse; text-align: center;"> <tr> <td style="width: 10%;"></td> <td style="width: 10%;"></td> <td style="width: 10%;"></td> <td style="width: 10%;"></td> <td style="width: 10%;"></td> <td style="width: 10%;"></td> <td style="width: 10%;"></td> <td style="width: 10%;"></td> <td style="width: 10%;"></td> <td style="width: 10%;"></td> </tr> <tr> <td></td> <td></td> <td colspan="8" style="text-align: center;"> <table border="1" style="width: 100%; border-collapse: collapse; text-align: center;"> <tr> <td style="width: 10%;"></td> <td style="width: 10%;"></td> <td style="width: 10%;"></td> <td style="width: 10%;"></td> <td style="width: 10%;"></td> <td style="width: 10%;"></td> <td style="width: 10%;"></td> <td style="width: 10%;"></td> <td style="width: 10%;"></td> <td style="width: 10%;"></td> </tr> <tr> <td></td> <td></td> <td colspan="8" style="text-align: center;"> <table border="1" style="width: 100%; border-collapse: collapse; text-align: center;"> <tr> <td style="width: 10%;"></td> <td style="width: 10%;"></td> <td style="width: 10%;"></td> <td style="width: 10%;"></td> <td style="width: 10%;"></td> <td style="width: 10%;"></td> <td style="width: 10%;"></td> <td style="width: 10%;"></td> <td style="width: 10%;"></td> <td style="width: 10%;"></td> </tr> <tr> <td></td> <td></td> <td colspan="8" style="text-align: center;"> <table border="1" style="width: 100%; border-collapse: collapse; text-align: center;"> <tr> </tr></table></td></tr></table></td></tr></table></td></tr></table></td></tr></table></td></tr></table></td></tr></table></td></tr></table></td></tr></table></td></tr></table></td></tr></table></td></tr></table></td></tr></table></td></tr></table></td></tr></table></td></tr></table></td></tr></table></td></tr></table></td></tr></table></td></tr></table></td></tr></table></td></tr></table></td></tr></table></td></tr></table></td></tr></table></td></tr></table></td></tr></table></td></tr></table></td></tr></table></td></tr></table></td></tr></table></td></tr></table></td></tr></table></td></tr></table></td></tr></table></td></tr></table></td></tr></table></td></tr></table></td></tr></table></td></tr></table></td></tr></table></td></tr></table></td></tr></table></td></tr></table></td></tr></table></td></tr></table></td></tr></table></td></tr></table></td></tr></table> | | | | | | | | | | | | | | | | | | | | <table border="1" style="width: 100%; border-collapse: collapse; text-align: center;"> <tr> <td style="width: 10%;"></td> <td style="width: 10%;"></td> <td style="width: 10%;"></td> <td style="width: 10%;"></td> <td style="width: 10%;"></td> <td style="width: 10%;"></td> <td style="width: 10%;"></td> <td style="width: 10%;"></td> <td style="width: 10%;"></td> <td style="width: 10%;"></td> </tr> <tr> <td></td> <td></td> <td colspan="8" style="text-align: center;"> <table border="1" style="width: 100%; border-collapse: collapse; text-align: center;"> <tr> <td style="width: 10%;"></td> <td style="width: 10%;"></td> <td style="width: 10%;"></td> <td style="width: 10%;"></td> <td style="width: 10%;"></td> <td style="width: 10%;"></td> <td style="width: 10%;"></td> <td style="width: 10%;"></td> <td style="width: 10%;"></td> <td style="width: 10%;"></td> </tr> <tr> <td></td> <td></td> <td colspan="8" style="text-align: center;"> <table border="1" style="width: 100%; border-collapse: collapse; text-align: center;"> <tr> <td style="width: 10%;"></td> <td style="width: 10%;"></td> <td style="width: 10%;"></td> <td style="width: 10%;"></td> <td style="width: 10%;"></td> <td style="width: 10%;"></td> <td
style="width: 10%;"></td> <td style="width: 10%;"></td> <td style="width: 10%;"></td> <td style="width: 10%;"></td> </tr> <tr> <td></td> <td></td> <td colspan="8" style="text-align: center;"> <table border="1" style="width: 100%; border-collapse: collapse; text-align: center;"> <tr> <td style="width: 10%;"></td> <td style="width: 10%;"></td> <td style="width: 10%;"></td> <td style="width: 10%;"></td> <td style="width: 10%;"></td> <td style="width: 10%;"></td> <td style="width: 10%;"></td> <td style="width: 10%;"></td> <td style="width: 10%;"></td> <td style="width: 10%;"></td> </tr> <tr> <td></td> <td></td> <td colspan="8" style="text-align: center;"> <table border="1" style="width: 100%; border-collapse: collapse; text-align: center;"> <tr> <td style="width: 10%;"></td> <td style="width: 10%;"></td> <td style="width: 10%;"></td> <td style="width: 10%;"></td> <td style="width: 10%;"></td> <td style="width: 10%;"></td> <td style="width: 10%;"></td> <td style="width: 10%;"></td> <td style="width: 10%;"></td> <td style="width: 10%;"></td> </tr> <tr> <td></td> <td></td> <td colspan="8" style="text-align: center;"> <table border="1" style="width: 100%; border-collapse: collapse; text-align: center;"> <tr> <td style="width: 10%;"></td> <td style="width: 10%;"></td> <td style="width: 10%;"></td> <td style="width: 10%;"></td> <td style="width: 10%;"></td> <td style="width: 10%;"></td> <td style="width: 10%;"></td> <td style="width: 10%;"></td> <td style="width: 10%;"></td> <td style="width: 10%;"></td> </tr> <tr> <td></td> <td></td> <td colspan="8" style="text-align: center;"> <table border="1" style="width: 100%; border-collapse: collapse; text-align: center;"> <tr> <td style="width: 10%;"></td> <td style="width: 10%;"></td> <td style="width: 10%;"></td> <td style="width: 10%;"></td> <td style="width: 10%;"></td> <td style="width: 10%;"></td> <td style="width: 10%;"></td> <td style="width: 10%;"></td> <td style="width: 10%;"></td> <td style="width: 10%;"></td> </tr> <tr> <td></td> <td></td> <td colspan="8" style="text-align: center;"> <table border="1" style="width: 100%; border-collapse: collapse; text-align: center;"> <tr> <td style="width: 10%;"></td> <td style="width: 10%;"></td> <td style="width: 10%;"></td> <td style="width: 10%;"></td> <td style="width: 10%;"></td> <td style="width: 10%;"></td> <td style="width: 10%;"></td> <td style="width: 10%;"></td> <td style="width: 10%;"></td> <td style="width: 10%;"></td> </tr> <tr> <td></td> <td></td> <td colspan="8" style="text-align: center;"> <table border="1" style="width: 100%; border-collapse: collapse; text-align: center;"> <tr> <td style="width: 10%;"></td> <td style="width: 10%;"></td> <td style="width: 10%;"></td> <td style="width: 10%;"></td> <td style="width: 10%;"></td> <td style="width: 10%;"></td> <td style="width: 10%;"></td> <td style="width: 10%;"></td> <td style="width: 10%;"></td> <td style="width: 10%;"></td> </tr> <tr> <td></td> <td></td> <td colspan="8" style="text-align: center;"> <table border="1" style="width: 100%; border-collapse: collapse; text-align: center;"> <tr> <td style="width: 10%;"></td> <td style="width: 10%;"></td> <td style="width: 10%;"></td> <td style="width: 10%;"></td> <td style="width: 10%;"></td> <td style="width: 10%;"></td> <td style="width: 10%;"></td> <td style="width: 10%;"></td> <td style="width: 10%;"></td> <td style="width: 10%;"></td> </tr> <tr> <td></td> <td></td> <td colspan="8" style="text-align: center;"> <table border="1" style="width: 100%; border-collapse: collapse; text-align: center;"> <tr> <td style="width: 10%;"></td> <td style="width: 10%;"></td> <td style="width: 10%;"></td> <td style="width: 10%;"></td> <td style="width: 10%;"></td> <td style="width: 10%;"></td> <td style="width: 10%;"></td> <td style="width: 10%;"></td> <td style="width: 10%;"></td> <td style="width: 10%;"></td> </tr> <tr> <td></td> <td></td> <td colspan="8" style="text-align: center;"> <table border="1" style="width: 100%; border-collapse: collapse; text-align: center;"> <tr> <td style="width: 10%;"></td> <td style="width: 10%;"></td> <td style="width: 10%;"></td> <td style="width: 10%;"></td> <td style="width: 10%;"></td> <td style="width: 10%;"></td> <td style="width: 10%;"></td> <td style="width: 10%;"></td> <td style="width: 10%;"></td> <td style="width: 10%;"></td> </tr> <tr> <td></td> <td></td> <td colspan="8" style="text-align: center;"> <table border="1" style="width: 100%; border-collapse: collapse; text-align: center;"> <tr> <td style="width: 10%;"></td> <td style="width: 10%;"></td> <td style="width: 10%;"></td> <td style="width: 10%;"></td> <td style="width: 10%;"></td> <td style="width: 10%;"></td> <td style="width: 10%;"></td> <td style="width: 10%;"></td> <td style="width: 10%;"></td> <td style="width: 10%;"></td> </tr> <tr> <td></td> <td></td> <td colspan="8" style="text-align: center;"> <table border="1" style="width: 100%; border-collapse: collapse; text-align: center;"> <tr> <td style="width: 10%;"></td> <td style="width: 10%;"></td> <td style="width: 10%;"></td> <td style="width: 10%;"></td> <td style="width: 10%;"></td> <td style="width: 10%;"></td> <td style="width: 10%;"></td> <td style="width: 10%;"></td> <td style="width: 10%;"></td> <td style="width: 10%;"></td> </tr> <tr> <td></td> <td></td> <td colspan="8" style="text-align: center;"> <table border="1" style="width: 100%; border-collapse: collapse; text-align: center;"> <tr> <td style="width: 10%;"></td> <td style="width: 10%;"></td> <td style="width: 10%;"></td> <td style="width: 10%;"></td> <td style="width: 10%;"></td> <td style="width: 10%;"></td> <td style="width: 10%;"></td> <td style="width: 10%;"></td> <td style="width: 10%;"></td> <td style="width: 10%;"></td> </tr> <tr> <td></td> <td></td> <td colspan="8" style="text-align: center;"> <table border="1" style="width: 100%; border-collapse: collapse; text-align: center;"> <tr> <td style="width: 10%;"></td> <td style="width: 10%;"></td> <td style="width: 10%;"></td> <td style="width: 10%;"></td> <td style="width: 10%;"></td> <td style="width: 10%;"></td> <td style="width: 10%;"></td> <td style="width: 10%;"></td> <td style="width: 10%;"></td> <td style="width: 10%;"></td> </tr> <tr> <td></td> <td></td> <td colspan="8" style="text-align: center;"> <table border="1" style="width: 100%; border-collapse: collapse; text-align: center;"> <tr> <td style="width: 10%;"></td> <td style="width: 10%;"></td> <td style="width: 10%;"></td> <td style="width: 10%;"></td> <td style="width: 10%;"></td> <td style="width: 10%;"></td> <td style="width: 10%;"></td> <td style="width: 10%;"></td> <td style="width: 10%;"></td> <td style="width: 10%;"></td> </tr> <tr> <td></td> <td></td> <td colspan="8" style="text-align: center;"> <table border="1" style="width: 100%; border-collapse: collapse; text-align: center;"> <tr> <td style="width: 10%;"></td> <td style="width: 10%;"></td> <td style="width: 10%;"></td> <td style="width: 10%;"></td> <td style="width: 10%;"></td> <td style="width: 10%;"></td> <td style="width: 10%;"></td> <td style="width: 10%;"></td> <td style="width: 10%;"></td> <td style="width: 10%;"></td> </tr> <tr> <td></td> <td></td> <td colspan="8" style="text-align: center;"> <table border="1" style="width: 100%; border-collapse: collapse; text-align: center;"> <tr> <td style="width: 10%;"></td> <td style="width: 10%;"></td> <td style="width: 10%;"></td> <td style="width: 10%;"></td> <td style="width: 10%;"></td> <td style="width: 10%;"></td> <td style="width: 10%;"></td> <td style="width: 10%;"></td> <td style="width: 10%;"></td> <td style="width: 10%;"></td> </tr> <tr> <td></td> <td></td> <td colspan="8" style="text-align: center;"> <table border="1" style="width: 100%; border-collapse: collapse; text-align: center;"> <tr> <td style="width: 10%;"></td> <td style="width: 10%;"></td> <td style="width: 10%;"></td> <td style="width: 10%;"></td> <td style="width: 10%;"></td> <td style="width: 10%;"></td> <td style="width: 10%;"></td> <td style="width: 10%;"></td> <td style="width: 10%;"></td> <td style="width: 10%;"></td> </tr> <tr> <td></td> <td></td> <td colspan="8" style="text-align: center;"> <table border="1" style="width: 100%; border-collapse: collapse; text-align: center;"> <tr> <td style="width: 10%;"></td> <td style="width: 10%;"></td> <td style="width: 10%;"></td> <td style="width: 10%;"></td> <td style="width: 10%;"></td> <td style="width: 10%;"></td> <td style="width: 10%;"></td> <td style="width: 10%;"></td> <td style="width: 10%;"></td> <td style="width: 10%;"></td> </tr> <tr> <td></td> <td></td> <td colspan="8" style="text-align: center;"> <table border="1" style="width: 100%; border-collapse: collapse; text-align: center;"> <tr> <td style="width: 10%;"></td> <td style="width: 10%;"></td> <td style="width: 10%;"></td> <td style="width: 10%;"></td> <td style="width: 10%;"></td> <td style="width: 10%;"></td> <td style="width: 10%;"></td> <td style="width: 10%;"></td> <td style="width: 10%;"></td> <td style="width: 10%;"></td> </tr> <tr> <td></td> <td></td> <td colspan="8" style="text-align: center;"> <table border="1" style="width: 100%; border-collapse: collapse; text-align: center;"> <tr> <td style="width: 10%;"></td> <td style="width: 10%;"></td> <td style="width: 10%;"></td> <td style="width: 10%;"></td> <td style="width: 10%;"></td> <td style="width: 10%;"></td> <td style="width: 10%;"></td> <td style="width: 10%;"></td> <td style="width: 10%;"></td> <td style="width: 10%;"></td> </tr> <tr> <td></td> <td></td> <td colspan="8" style="text-align: center;"> <table border="1" style="width: 100%; border-collapse: collapse; text-align: center;"> <tr> <td style="width: 10%;"></td> <td style="width: 10%;"></td> <td style="width: 10%;"></td> <td style="width: 10%;"></td> <td style="width: 10%;"></td> <td style="width: 10%;"></td> <td style="width: 10%;"></td> <td style="width: 10%;"></td> <td style="width: 10%;"></td> <td style="width: 10%;"></td> </tr> <tr> <td></td> <td></td> <td colspan="8"
style="text-align: center;"> <table border="1" style="width: 100%; border-collapse: collapse; text-align: center;"> <tr> <td style="width: 10%;"></td> <td style="width: 10%;"></td> <td style="width: 10%;"></td> <td style="width: 10%;"></td> <td style="width: 10%;"></td> <td style="width: 10%;"></td> <td style="width: 10%;"></td> <td style="width: 10%;"></td> <td style="width: 10%;"></td> <td style="width: 10%;"></td> </tr> <tr> <td></td> <td></td> <td colspan="8" style="text-align: center;"> <table border="1" style="width: 100%; border-collapse: collapse; text-align: center;"> <tr> <td style="width: 10%;"></td> <td style="width: 10%;"></td> <td style="width: 10%;"></td> <td style="width: 10%;"></td> <td style="width: 10%;"></td> <td style="width: 10%;"></td> <td style="width: 10%;"></td> <td style="width: 10%;"></td> <td style="width: 10%;"></td> <td style="width: 10%;"></td> </tr> <tr> <td></td> <td></td> <td colspan="8" style="text-align: center;"> <table border="1" style="width: 100%; border-collapse: collapse; text-align: center;"> <tr> <td style="width: 10%;"></td> <td style="width: 10%;"></td> <td style="width: 10%;"></td> <td style="width: 10%;"></td> <td style="width: 10%;"></td> <td style="width: 10%;"></td> <td style="width: 10%;"></td> <td style="width: 10%;"></td> <td style="width: 10%;"></td> <td style="width: 10%;"></td> </tr> <tr> <td></td> <td></td> <td colspan="8" style="text-align: center;"> <table border="1" style="width: 100%; border-collapse: collapse; text-align: center;"> <tr> <td style="width: 10%;"></td> <td style="width: 10%;"></td> <td style="width: 10%;"></td> <td style="width: 10%;"></td> <td style="width: 10%;"></td> <td style="width: 10%;"></td> <td style="width: 10%;"></td> <td style="width: 10%;"></td> <td style="width: 10%;"></td> <td style="width: 10%;"></td> </tr> <tr> <td></td> <td></td> <td colspan="8" style="text-align: center;"> <table border="1" style="width: 100%; border-collapse: collapse; text-align: center;"> <tr> <td style="width: 10%;"></td> <td style="width: 10%;"></td> <td style="width: 10%;"></td> <td style="width: 10%;"></td> <td style="width: 10%;"></td> <td style="width: 10%;"></td> <td style="width: 10%;"></td> <td style="width: 10%;"></td> <td style="width: 10%;"></td> <td style="width: 10%;"></td> </tr> <tr> <td></td> <td></td> <td colspan="8" style="text-align: center;"> <table border="1" style="width: 100%; border-collapse: collapse; text-align: center;"> <tr> <td style="width: 10%;"></td> <td style="width: 10%;"></td> <td style="width: 10%;"></td> <td style="width: 10%;"></td> <td style="width: 10%;"></td> <td style="width: 10%;"></td> <td style="width: 10%;"></td> <td style="width: 10%;"></td> <td style="width: 10%;"></td> <td style="width: 10%;"></td> </tr> <tr> <td></td> <td></td> <td colspan="8" style="text-align: center;"> <table border="1" style="width: 100%; border-collapse: collapse; text-align: center;"> <tr> <td style="width: 10%;"></td> <td style="width: 10%;"></td> <td style="width: 10%;"></td> <td style="width: 10%;"></td> <td style="width: 10%;"></td> <td style="width: 10%;"></td> <td style="width: 10%;"></td> <td style="width: 10%;"></td> <td style="width: 10%;"></td> <td style="width: 10%;"></td> </tr> <tr> <td></td> <td></td> <td colspan="8" style="text-align: center;"> <table border="1" style="width: 100%; border-collapse: collapse; text-align: center;"> <tr> <td style="width: 10%;"></td> <td style="width: 10%;"></td> <td style="width: 10%;"></td> <td style="width: 10%;"></td> <td style="width: 10%;"></td> <td style="width: 10%;"></td> <td style="width: 10%;"></td> <td style="width: 10%;"></td> <td style="width: 10%;"></td> <td style="width: 10%;"></td> </tr> <tr> <td></td> <td></td> <td colspan="8" style="text-align: center;"> <table border="1" style="width: 100%; border-collapse: collapse; text-align: center;"> <tr> <td style="width: 10%;"></td> <td style="width: 10%;"></td> <td style="width: 10%;"></td> <td style="width: 10%;"></td> <td style="width: 10%;"></td> <td style="width: 10%;"></td> <td style="width: 10%;"></td> <td style="width: 10%;"></td> <td style="width: 10%;"></td> <td style="width: 10%;"></td> </tr> <tr> <td></td> <td></td> <td colspan="8" style="text-align: center;"> <table border="1" style="width: 100%; border-collapse: collapse; text-align: center;"> <tr> <td style="width: 10%;"></td> <td style="width: 10%;"></td> <td style="width: 10%;"></td> <td style="width: 10%;"></td> <td style="width: 10%;"></td> <td style="width: 10%;"></td> <td style="width: 10%;"></td> <td style="width: 10%;"></td> <td style="width: 10%;"></td> <td style="width: 10%;"></td> </tr> <tr> <td></td> <td></td> <td colspan="8" style="text-align: center;"> <table border="1" style="width: 100%; border-collapse: collapse; text-align: center;"> <tr> <td style="width: 10%;"></td> <td style="width: 10%;"></td> <td style="width: 10%;"></td> <td style="width: 10%;"></td> <td style="width: 10%;"></td> <td style="width: 10%;"></td> <td style="width: 10%;"></td> <td style="width: 10%;"></td> <td style="width: 10%;"></td> <td style="width: 10%;"></td> </tr> <tr> <td></td> <td></td> <td colspan="8" style="text-align: center;"> <table border="1" style="width: 100%; border-collapse: collapse; text-align: center;"> <tr> <td style="width: 10%;"></td> <td style="width: 10%;"></td> <td style="width: 10%;"></td> <td style="width: 10%;"></td> <td style="width: 10%;"></td> <td style="width: 10%;"></td> <td style="width: 10%;"></td> <td style="width: 10%;"></td> <td style="width: 10%;"></td> <td style="width: 10%;"></td> </tr> <tr> <td></td> <td></td> <td colspan="8" style="text-align: center;"> <table border="1" style="width: 100%; border-collapse: collapse; text-align: center;"> <tr> <td style="width: 10%;"></td> <td style="width: 10%;"></td> <td style="width: 10%;"></td> <td style="width: 10%;"></td> <td style="width: 10%;"></td> <td style="width: 10%;"></td> <td style="width: 10%;"></td> <td style="width: 10%;"></td> <td style="width: 10%;"></td> <td style="width: 10%;"></td> </tr> <tr> <td></td> <td></td> <td colspan="8" style="text-align: center;"> <table border="1" style="width: 100%; border-collapse: collapse; text-align: center;"> <tr> <td style="width: 10%;"></td> <td style="width: 10%;"></td> <td style="width: 10%;"></td> <td style="width: 10%;"></td> <td style="width: 10%;"></td> <td style="width: 10%;"></td> <td style="width: 10%;"></td> <td style="width: 10%;"></td> <td style="width: 10%;"></td> <td style="width: 10%;"></td> </tr> <tr> <td></td> <td></td> <td colspan="8" style="text-align: center;"> <table border="1" style="width: 100%; border-collapse: collapse; text-align: center;"> <tr> <td style="width: 10%;"></td> <td style="width: 10%;"></td> <td style="width: 10%;"></td> <td style="width: 10%;"></td> <td style="width: 10%;"></td> <td style="width: 10%;"></td> <td style="width: 10%;"></td> <td style="width: 10%;"></td> <td style="width: 10%;"></td> <td style="width: 10%;"></td> </tr> <tr> <td></td> <td></td> <td colspan="8" style="text-align: center;"> <table border="1" style="width: 100%; border-collapse: collapse; text-align: center;"> <tr> <td style="width: 10%;"></td> <td style="width: 10%;"></td> <td style="width: 10%;"></td> <td style="width: 10%;"></td> <td style="width: 10%;"></td> <td style="width: 10%;"></td> <td style="width: 10%;"></td> <td style="width: 10%;"></td> <td style="width: 10%;"></td> <td style="width: 10%;"></td> </tr> <tr> <td></td> <td></td> <td colspan="8" style="text-align: center;"> <table border="1" style="width: 100%; border-collapse: collapse; text-align: center;"> <tr> <td style="width: 10%;"></td> <td style="width: 10%;"></td> <td style="width: 10%;"></td> <td style="width: 10%;"></td> <td style="width: 10%;"></td> <td style="width: 10%;"></td> <td style="width: 10%;"></td> <td style="width: 10%;"></td> <td style="width: 10%;"></td> <td style="width: 10%;"></td> </tr> <tr> <td></td> <td></td> <td colspan="8" style="text-align: center;"> <table border="1" style="width: 100%; border-collapse: collapse; text-align: center;"> <tr> <td style="width: 10%;"></td> <td style="width: 10%;"></td> <td style="width: 10%;"></td> <td style="width: 10%;"></td> <td style="width: 10%;"></td> <td style="width: 10%;"></td> <td style="width: 10%;"></td> <td style="width: 10%;"></td> <td style="width: 10%;"></td> <td style="width: 10%;"></td> </tr> <tr> <td></td> <td></td> <td colspan="8" style="text-align: center;"> <table border="1" style="width: 100%; border-collapse: collapse; text-align: center;"> <tr> <td style="width: 10%;"></td> <td style="width: 10%;"></td> <td style="width: 10%;"></td> <td style="width: 10%;"></td> <td style="width: 10%;"></td> <td style="width: 10%;"></td> <td style="width: 10%;"></td> <td style="width: 10%;"></td> <td style="width: 10%;"></td> <td style="width: 10%;"></td> </tr> <tr> <td></td> <td></td> <td colspan="8" style="text-align: center;"> <table border="1" style="width: 100%; border-collapse: collapse; text-align: center;"> <tr> <td style="width: 10%;"></td> <td style="width: 10%;"></td> <td style="width: 10%;"></td> <td style="width: 10%;"></td> <td style="width: 10%;"></td> <td style="width: 10%;"></td> <td style="width: 10%;"></td> <td style="width: 10%;"></td> <td style="width: 10%;"></td> <td style="width: 10%;"></td> </tr> <tr> <td></td> <td></td> <td colspan="8" style="text-align: center;"> <table border="1" style="width: 100%; border-collapse: collapse; text-align: center;"> <tr> <td style="width: 10%;"></td> <td style="width: 10%;"></td> <td style="width: 10%;"></td> <td style="width: 10%;"></td> <td style="width: 10%;"></td> <td style="width: 10%;"></td> <td style="width: 10%;"></td> <td style="width: 10%;"></td> <td style="width: 10%;"></td> <td style="width: 10%;"></td> </tr> <tr> <td></td> <td></td> <td colspan="8" style="text-align: center;"> <table border="1" style="width: 100%; border-collapse: collapse; text-align: center;"> <tr> <td style="width: 10%;"></td> <td style="width:
10%;"></td> <td style="width: 10%;"></td> <td style="width: 10%;"></td> <td style="width: 10%;"></td> <td style="width: 10%;"></td> <td style="width: 10%;"></td> <td style="width: 10%;"></td> <td style="width: 10%;"></td> <td style="width: 10%;"></td> </tr> <tr> <td></td> <td></td> <td colspan="8" style="text-align: center;"> <table border="1" style="width: 100%; border-collapse: collapse; text-align: center;"> <tr> <td style="width: 10%;"></td> <td style="width: 10%;"></td> <td style="width: 10%;"></td> <td style="width: 10%;"></td> <td style="width: 10%;"></td> <td style="width: 10%;"></td> <td style="width: 10%;"></td> <td style="width: 10%;"></td> <td style="width: 10%;"></td> <td style="width: 10%;"></td> </tr> <tr> <td></td> <td></td> <td colspan="8" style="text-align: center;"> <table border="1" style="width: 100%; border-collapse: collapse; text-align: center;"> <tr> </tr></table></td></tr></table></td></tr></table></td></tr></table></td></tr></table></td></tr></table></td></tr></table></td></tr></table></td></tr></table></td></tr></table></td></tr></table></td></tr></table></td></tr></table></td></tr></table></td></tr></table></td></tr></table></td></tr></table></td></tr></table></td></tr></table></td></tr></table></td></tr></table></td></tr></table></td></tr></table></td></tr></table></td></tr></table></td></tr></table></td></tr></table></td></tr></table></td></tr></table></td></tr></table></td></tr></table></td></tr></table></td></tr></table></td></tr></table></td></tr></table></td></tr></table></td></tr></table></td></tr></table></td></tr></table></td></tr></table></td></tr></table></td></tr></table></td></tr></table></td></tr></table></td></tr></table></td></tr></table></td></tr></table></td></tr></table> | | | | | | | | | | | | | | | | | | | | <table border="1" style="width: 100%; border-collapse: collapse; text-align: center;"> <tr> <td style="width: 10%;"></td> <td style="width: 10%;"></td> <td style="width: 10%;"></td> <td style="width: 10%;"></td> <td style="width: 10%;"></td> <td style="width: 10%;"></td> <td style="width: 10%;"></td> <td style="width: 10%;"></td> <td style="width: 10%;"></td> <td style="width: 10%;"></td> </tr> <tr> <td></td> <td></td> <td colspan="8" style="text-align: center;"> <table border="1" style="width: 100%; border-collapse: collapse; text-align: center;"> <tr> <td style="width: 10%;"></td> <td style="width: 10%;"></td> <td style="width: 10%;"></td> <td style="width: 10%;"></td> <td style="width: 10%;"></td> <td style="width: 10%;"></td> <td style="width: 10%;"></td> <td style="width: 10%;"></td> <td style="width: 10%;"></td> <td style="width: 10%;"></td> </tr> <tr> <td></td> <td></td> <td colspan="8" style="text-align: center;"> <table border="1" style="width: 100%; border-collapse: collapse; text-align: center;"> <tr> <td style="width: 10%;"></td> <td style="width: 10%;"></td> <td style="width: 10%;"></td> <td style="width: 10%;"></td> <td style="width: 10%;"></td> <td style="width: 10%;"></td> <td style="width: 10%;"></td> <td style="width: 10%;"></td> <td style="width: 10%;"></td> <td style="width: 10%;"></td> </tr> <tr> <td></td> <td></td> <td colspan="8" style="text-align: center;"> <table border="1" style="width: 100%; border-collapse: collapse; text-align: center;"> <tr> <td style="width: 10%;"></td> <td style="width: 10%;"></td> <td style="width: 10%;"></td> <td style="width: 10%;"></td> <td style="width: 10%;"></td> <td style="width: 10%;"></td> <td style="width: 10%;"></td> <td style="width: 10%;"></td> <td style="width: 10%;"></td> <td style="width: 10%;"></td> </tr> <tr> <td></td> <td></td> <td colspan="8" style="text-align: center;"> <table border="1" style="width: 100%; border-collapse: collapse; text-align: center;"> <tr> <td style="width: 10%;"></td> <td style="width: 10%;"></td> <td style="width: 10%;"></td> <td style="width: 10%;"></td> <td style="width: 10%;"></td> <td style="width: 10%;"></td> <td style="width: 10%;"></td> <td style="width: 10%;"></td> <td style="width: 10%;"></td> <td style="width: 10%;"></td> </tr> <tr> <td></td> <td></td> <td colspan="8" style="text-align: center;"> <table border="1" style="width: 100%; border-collapse: collapse; text-align: center;"> <tr> <td style="width: 10%;"></td> <td style="width: 10%;"></td> <td style="width: 10%;"></td> <td style="width: 10%;"></td> <td style="width: 10%;"></td> <td style="width: 10%;"></td> <td style="width: 10%;"></td> <td style="width: 10%;"></td> <td style="width: 10%;"></td> <td style="width: 10%;"></td> </tr> <tr> <td></td> <td></td> <td colspan="8" style="text-align: center;"> <table border="1" style="width: 100%; border-collapse: collapse; text-align: center;"> <tr> <td style="width: 10%;"></td> <td style="width: 10%;"></td> <td style="width: 10%;"></td> <td style="width: 10%;"></td> <td style="width: 10%;"></td> <td style="width: 10%;"></td> <td style="width: 10%;"></td> <td style="width: 10%;"></td> <td style="width: 10%;"></td> <td style="width: 10%;"></td> </tr> <tr> <td></td> <td></td> <td colspan="8" style="text-align: center;"> <table border="1" style="width: 100%; border-collapse:
collapse; text-align: center;"> <tr> <td style="width: 10%;"></td> <td style="width: 10%;"></td> <td style="width: 10%;"></td> <td style="width: 10%;"></td> <td style="width: 10%;"></td> <td style="width: 10%;"></td> <td style="width: 10%;"></td> <td style="width: 10%;"></td> <td style="width: 10%;"></td> <td style="width: 10%;"></td> </tr> <tr> <td></td> <td></td> <td colspan="8" style="text-align: center;"> <table border="1" style="width: 100%; border-collapse: collapse; text-align: center;"> <tr> <td style="width: 10%;"></td> <td style="width: 10%;"></td> <td style="width: 10%;"></td> <td style="width: 10%;"></td> <td style="width: 10%;"></td> <td style="width: 10%;"></td> <td style="width: 10%;"></td> <td style="width: 10%;"></td> <td style="width: 10%;"></td> <td style="width: 10%;"></td> </tr> <tr> <td></td> <td></td> <td colspan="8" style="text-align: center;"> <table border="1" style="width: 100%; border-collapse: collapse; text-align: center;"> <tr> <td style="width: 10%;"></td> <td style="width: 10%;"></td> <td style="width: 10%;"></td> <td style="width: 10%;"></td> <td style="width: 10%;"></td> <td style="width: 10%;"></td> <td style="width: 10%;"></td> <td style="width: 10%;"></td> <td style="width: 10%;"></td> <td style="width: 10%;"></td> </tr> <tr> <td></td> <td></td> <td colspan="8" style="text-align: center;"> <table border="1" style="width: 100%; border-collapse: collapse; text-align: center;"> <tr> <td style="width: 10%;"></td> <td style="width: 10%;"></td> <td style="width: 10%;"></td> <td style="width: 10%;"></td> <td style="width: 10%;"></td> <td style="width: 10%;"></td> <td style="width: 10%;"></td> <td style="width: 10%;"></td> <td style="width: 10%;"></td> <td style="width: 10%;"></td> </tr> <tr> <td></td> <td></td> <td colspan="8" style="text-align: center;"> <table border="1" style="width: 100%; border-collapse: collapse; text-align: center;"> <tr> <td style="width: 10%;"></td> <td style="width: 10%;"></td> <td style="width: 10%;"></td> <td style="width: 10%;"></td> <td style="width: 10%;"></td> <td style="width: 10%;"></td> <td style="width: 10%;"></td> <td style="width: 10%;"></td> <td style="width: 10%;"></td> <td style="width: 10%;"></td> </tr> <tr> <td></td> <td></td> <td colspan="8" style="text-align: center;"> <table border="1" style="width: 100%; border-collapse: collapse; text-align: center;"> <tr> <td style="width: 10%;"></td> <td style="width: 10%;"></td> <td style="width: 10%;"></td> <td style="width: 10%;"></td> <td style="width: 10%;"></td> <td style="width: 10%;"></td> <td style="width: 10%;"></td> <td style="width: 10%;"></td> <td style="width: 10%;"></td> <td style="width: 10%;"></td> </tr> <tr> <td></td> <td></td> <td colspan="8" style="text-align: center;"> <table border="1" style="width: 100%; border-collapse: collapse; text-align: center;"> <tr> <td style="width: 10%;"></td> <td style="width: 10%;"></td> <td style="width: 10%;"></td> <td style="width: 10%;"></td> <td style="width: 10%;"></td> <td style="width: 10%;"></td> <td style="width: 10%;"></td> <td style="width: 10%;"></td> <td style="width: 10%;"></td> <td style="width: 10%;"></td> </tr> <tr> <td></td> <td></td> <td colspan="8" style="text-align: center;"> <table border="1" style="width: 100%; border-collapse: collapse; text-align: center;"> <tr> <td style="width: 10%;"></td> <td style="width: 10%;"></td> <td style="width: 10%;"></td> <td style="width: 10%;"></td> <td style="width: 10%;"></td> <td style="width: 10%;"></td> <td style="width: 10%;"></td> <td style="width: 10%;"></td> <td style="width: 10%;"></td> <td style="width: 10%;"></td> </tr> <tr> <td></td> <td></td> <td colspan="8" style="text-align: center;"> <table border="1" style="width: 100%; border-collapse: collapse; text-align: center;"> <tr> <td style="width: 10%;"></td> <td style="width: 10%;"></td> <td style="width: 10%;"></td> <td style="width: 10%;"></td> <td style="width: 10%;"></td> <td style="width: 10%;"></td> <td style="width: 10%;"></td> <td style="width: 10%;"></td> <td style="width: 10%;"></td> <td style="width: 10%;"></td> </tr> <tr> <td></td> <td></td> <td colspan="8" style="text-align: center;"> <table border="1" style="width: 100%; border-collapse: collapse; text-align: center;"> <tr> <td style="width: 10%;"></td> <td style="width: 10%;"></td> <td style="width: 10%;"></td> <td style="width: 10%;"></td> <td style="width: 10%;"></td> <td style="width: 10%;"></td> <td style="width: 10%;"></td> <td style="width: 10%;"></td> <td style="width: 10%;"></td> <td style="width: 10%;"></td> </tr> <tr> <td></td> <td></td> <td colspan="8" style="text-align: center;"> <table border="1" style="width: 100%; border-collapse: collapse; text-align: center;"> <tr> <td style="width: 10%;"></td> <td style="width: 10%;"></td> <td style="width: 10%;"></td> <td style="width: 10%;"></td> <td style="width: 10%;"></td> <td style="width: 10%;"></td> <td style="width: 10%;"></td> <td style="width: 10%;"></td> <td style="width: 10%;"></td> <td style="width: 10%;"></td> </tr> <tr> <td></td> <td></td> <td colspan="8" style="text-align: center;"> <table border="1" style="width: 100%; border-collapse: collapse; text-align: center;"> <tr> <td style="width: 10%;"></td> <td style="width: 10%;"></td> <td style="width: 10%;"></td> <td style="width: 10%;"></td> <td style="width: 10%;"></td> <td style="width: 10%;"></td> <td style="width: 10%;"></td> <td style="width: 10%;"></td> <td style="width: 10%;"></td> <td style="width: 10%;"></td> </tr> <tr> <td></td> <td></td> <td colspan="8" style="text-align: center;"> <table border="1" style="width: 100%; border-collapse: collapse; text-align: center;"> <tr> <td style="width: 10%;"></td> <td style="width: 10%;"></td> <td style="width: 10%;"></td> <td style="width: 10%;"></td> <td style="width: 10%;"></td> <td style="width: 10%;"></td> <td style="width: 10%;"></td> <td style="width: 10%;"></td> <td style="width: 10%;"></td> <td style="width: 10%;"></td> </tr> <tr> <td></td> <td></td> <td colspan="8" style="text-align: center;"> <table border="1" style="width: 100%; border-collapse: collapse; text-align: center;"> <tr> <td style="width: 10%;"></td> <td style="width: 10%;"></td> <td style="width: 10%;"></td> <td style="width: 10%;"></td> <td style="width: 10%;"></td> <td style="width: 10%;"></td> <td style="width: 10%;"></td> <td style="width: 10%;"></td> <td style="width: 10%;"></td> <td style="width: 10%;"></td> </tr> <tr> <td></td> <td></td> <td colspan="8" style="text-align: center;"> <table border="1" style="width: 100%; border-collapse: collapse; text-align: center;"> <tr> <td style="width: 10%;"></td> <td style="width: 10%;"></td> <td style="width: 10%;"></td> <td style="width: 10%;"></td> <td style="width: 10%;"></td> <td style="width: 10%;"></td> <td style="width: 10%;"></td> <td style="width: 10%;"></td> <td style="width: 10%;"></td> <td style="width: 10%;"></td> </tr> <tr> <td></td> <td></td> <td colspan="8" style="text-align: center;"> <table border="1" style="width: 100%; border-collapse: collapse; text-align: center;"> <tr> <td style="width: 10%;"></td> <td style="width: 10%;"></td> <td style="width: 10%;"></td> <td style="width: 10%;"></td> <td style="width: 10%;"></td> <td style="width: 10%;"></td> <td style="width: 10%;"></td> <td style="width: 10%;"></td> <td style="width: 10%;"></td> <td style="width: 10%;"></td> </tr> <tr> <td></td> <td></td> <td colspan="8" style="text-align: center;"> <table border="1" style="width: 100%; border-collapse: collapse; text-align: center;"> <tr> <td style="width: 10%;"></td> <td style="width: 10%;"></td> <td style="width: 10%;"></td> <td style="width: 10%;"></td> <td style="width: 10%;"></td> <td style="width: 10%;"></td> <td style="width: 10%;"></td> <td style="width: 10%;"></td> <td style="width: 10%;"></td> <td style="width: 10%;"></td> </tr> <tr> <td></td> <td></td> <td colspan="8" style="text-align: center;"> <table border="1" style="width: 100%; border-collapse: collapse; text-align: center;"> <tr> <td style="width: 10%;"></td> <td style="width: 10%;"></td> <td style="width: 10%;"></td> <td style="width: 10%;"></td> <td style="width: 10%;"></td> <td style="width: 10%;"></td> <td style="width: 10%;"></td> <td style="width: 10%;"></td> <td style="width: 10%;"></td> <td style="width: 10%;"></td> </tr> <tr> <td></td> <td></td> <td colspan="8" style="text-align: center;"> <table border="1" style="width: 100%; border-collapse: collapse; text-align: center;"> <tr> <td style="width: 10%;"></td> <td style="width: 10%;"></td> <td style="width: 10%;"></td> <td style="width: 10%;"></td> <td style="width: 10%;"></td> <td style="width: 10%;"></td> <td style="width: 10%;"></td> <td style="width: 10%;"></td> <td style="width: 10%;"></td> <td style="width: 10%;"></td> </tr> <tr> <td></td> <td></td> <td colspan="8" style="text-align: center;"> <table border="1" style="width: 100%; border-collapse: collapse; text-align: center;"> <tr> <td style="width: 10%;"></td> <td style="width: 10%;"></td> <td style="width: 10%;"></td> <td style="width: 10%;"></td> <td style="width: 10%;"></td> <td style="width: 10%;"></td> <td style="width: 10%;"></td> <td style="width: 10%;"></td> <td style="width: 10%;"></td> <td style="width: 10%;"></td> </tr> <tr> <td></td> <td></td> <td colspan="8" style="text-align: center;"> <table border="1" style="width: 100%; border-collapse: collapse; text-align: center;"> <tr> <td style="width: 10%;"></td> <td style="width: 10%;"></td> <td style="width: 10%;"></td> <td style="width: 10%;"></td> <td style="width: 10%;"></td> <td style="width: 10%;"></td> <td style="width: 10%;"></td> <td style="width: 10%;"></td> <td style="width: 10%;"></td> <td style="width: 10%;"></td> </tr> <tr> <td></td> <td></td> <td colspan="8" style="text-align: center;"> <table border="1" style="width: 100%; border-collapse: collapse; text-align: center;"> <tr> <td style="width: 10%;"></td> <td style="width: 10%;"></td> <td style="width: 10%;"></td> <td style="width: 10%;"></td> <td
style="width: 10%;"></td> <td style="width: 10%;"></td> <td style="width: 10%;"></td> <td style="width: 10%;"></td> <td style="width: 10%;"></td> <td style="width: 10%;"></td> </tr> <tr> <td></td> <td></td> <td colspan="8" style="text-align: center;"> <table border="1" style="width: 100%; border-collapse: collapse; text-align: center;"> <tr> <td style="width: 10%;"></td> <td style="width: 10%;"></td> <td style="width: 10%;"></td> <td style="width: 10%;"></td> <td style="width: 10%;"></td> <td style="width: 10%;"></td> <td style="width: 10%;"></td> <td style="width: 10%;"></td> <td style="width: 10%;"></td> <td style="width: 10%;"></td> </tr> <tr> <td></td> <td></td> <td colspan="8" style="text-align: center;"> <table border="1" style="width: 100%; border-collapse: collapse; text-align: center;"> <tr> <td style="width: 10%;"></td> <td style="width: 10%;"></td> <td style="width: 10%;"></td> <td style="width: 10%;"></td> <td style="width: 10%;"></td> <td style="width: 10%;"></td> <td style="width: 10%;"></td> <td style="width: 10%;"></td> <td style="width: 10%;"></td> <td style="width: 10%;"></td> </tr> <tr> <td></td> <td></td> <td colspan="8" style="text-align: center;"> <table border="1" style="width: 100%; border-collapse: collapse; text-align: center;"> <tr> <td style="width: 10%;"></td> <td style="width: 10%;"></td> <td style="width: 10%;"></td> <td style="width: 10%;"></td> <td style="width: 10%;"></td> <td style="width: 10%;"></td> <td style="width: 10%;"></td> <td style="width: 10%;"></td> <td style="width: 10%;"></td> <td style="width: 10%;"></td> </tr> <tr> <td></td> <td></td> <td colspan="8" style="text-align: center;"> <table border="1" style="width: 100%; border-collapse: collapse; text-align: center;"> <tr> <td style="width: 10%;"></td> <td style="width: 10%;"></td> <td style="width: 10%;"></td> <td style="width: 10%;"></td> <td style="width: 10%;"></td> <td style="width: 10%;"></td> <td style="width: 10%;"></td> <td style="width: 10%;"></td> <td style="width: 10%;"></td> <td style="width: 10%;"></td> </tr> <tr> <td></td> <td></td> <td colspan="8" style="text-align: center;"> <table border="1" style="width: 100%; border-collapse: collapse; text-align: center;"> <tr> <td style="width: 10%;"></td> <td style="width: 10%;"></td> <td style="width: 10%;"></td> <td style="width: 10%;"></td> <td style="width: 10%;"></td> <td style="width: 10%;"></td> <td style="width: 10%;"></td> <td style="width: 10%;"></td> <td style="width: 10%;"></td> <td style="width: 10%;"></td> </tr> <tr> <td></td> <td></td> <td colspan="8" style="text-align: center;"> <table border="1" style="width: 100%; border-collapse: collapse; text-align: center;"> <tr> <td style="width: 10%;"></td> <td style="width: 10%;"></td> <td style="width: 10%;"></td> <td style="width: 10%;"></td> <td style="width: 10%;"></td> <td style="width: 10%;"></td> <td style="width: 10%;"></td> <td style="width: 10%;"></td> <td style="width: 10%;"></td> <td style="width: 10%;"></td> </tr> <tr> <td></td> <td></td> <td colspan="8" style="text-align: center;"> <table border="1" style="width: 100%; border-collapse: collapse; text-align: center;"> <tr> <td style="width: 10%;"></td> <td style="width: 10%;"></td> <td style="width: 10%;"></td> <td style="width: 10%;"></td> <td style="width: 10%;"></td> <td style="width: 10%;"></td> <td style="width: 10%;"></td> <td style="width: 10%;"></td> <td style="width: 10%;"></td> <td style="width: 10%;"></td> </tr> <tr> <td></td> <td></td> <td colspan="8" style="text-align: center;"> <table border="1" style="width: 100%; border-collapse: collapse; text-align: center;"> <tr> <td style="width: 10%;"></td> <td style="width: 10%;"></td> <td style="width: 10%;"></td> <td style="width: 10%;"></td> <td style="width: 10%;"></td> <td style="width: 10%;"></td> <td style="width: 10%;"></td> <td style="width: 10%;"></td> <td style="width: 10%;"></td> <td style="width: 10%;"></td> </tr> <tr> <td></td> <td></td> <td colspan="8" style="text-align: center;"> <table border="1" style="width: 100%; border-collapse: collapse; text-align: center;"> <tr> <td style="width: 10%;"></td> <td style="width: 10%;"></td> <td style="width: 10%;"></td> <td style="width: 10%;"></td> <td style="width: 10%;"></td> <td style="width: 10%;"></td> <td style="width: 10%;"></td> <td style="width: 10%;"></td> <td style="width: 10%;"></td> <td style="width: 10%;"></td> </tr> <tr> <td></td> <td></td> <td colspan="8" style="text-align: center;"> <table border="1" style="width: 100%; border-collapse: collapse; text-align: center;"> <tr> <td style="width: 10%;"></td> <td style="width: 10%;"></td> <td style="width: 10%;"></td> <td style="width: 10%;"></td> <td style="width: 10%;"></td> <td style="width: 10%;"></td> <td style="width: 10%;"></td> <td style="width: 10%;"></td> <td style="width: 10%;"></td> <td style="width: 10%;"></td> </tr> <tr> <td></td> <td></td> <td colspan="8" style="text-align: center;"> <table border="1" style="width: 100%; border-collapse: collapse; text-align: center;"> <tr> <td style="width: 10%;"></td> <td style="width: 10%;"></td> <td style="width: 10%;"></td> <td style="width: 10%;"></td> <td style="width: 10%;"></td> <td style="width: 10%;"></td> <td style="width: 10%;"></td> <td style="width: 10%;"></td> <td style="width: 10%;"></td> <td style="width: 10%;"></td> </tr> <tr> <td></td> <td></td> <td colspan="8" style="text-align: center;"> <table border="1" style="width: 100%; border-collapse: collapse; text-align: center;"> <tr> <td style="width: 10%;"></td> <td style="width: 10%;"></td> <td style="width: 10%;"></td> <td style="width: 10%;"></td> <td style="width: 10%;"></td> <td style="width: 10%;"></td> <td style="width: 10%;"></td> <td style="width: 10%;"></td> <td style="width: 10%;"></td> <td style="width: 10%;"></td> </tr> <tr> <td></td> <td></td> <td colspan="8" style="text-align: center;"> <table border="1" style="width: 100%; border-collapse: collapse; text-align: center;"> <tr> <td style="width: 10%;"></td> <td style="width: 10%;"></td> <td style="width: 10%;"></td> <td style="width: 10%;"></td> <td style="width: 10%;"></td> <td style="width: 10%;"></td> <td style="width: 10%;"></td> <td style="width: 10%;"></td> <td style="width: 10%;"></td> <td style="width: 10%;"></td> </tr> <tr> <td></td> <td></td> <td colspan="8" style="text-align: center;"> <table border="1" style="width: 100%; border-collapse: collapse; text-align: center;"> <tr> <td style="width: 10%;"></td> <td style="width: 10%;"></td> <td style="width: 10%;"></td> <td style="width: 10%;"></td> <td style="width: 10%;"></td> <td style="width: 10%;"></td> <td style="width: 10%;"></td> <td style="width: 10%;"></td> <td style="width: 10%;"></td> <td style="width: 10%;"></td> </tr> <tr> <td></td> <td></td> <td colspan="8" style="text-align: center;"> <table border="1" style="width: 100%; border-collapse: collapse; text-align: center;"> <tr> <td style="width: 10%;"></td> <td style="width: 10%;"></td> <td style="width: 10%;"></td> <td style="width: 10%;"></td> <td style="width: 10%;"></td> <td style="width: 10%;"></td> <td style="width: 10%;"></td> <td style="width: 10%;"></td> <td style="width: 10%;"></td> <td style="width: 10%;"></td> </tr> <tr> <td></td> <td></td> <td colspan="8" style="text-align: center;"> <table border="1" style="width: 100%; border-collapse: collapse; text-align: center;"> <tr> <td style="width: 10%;"></td> <td style="width: 10%;"></td> <td style="width: 10%;"></td> <td style="width: 10%;"></td> <td style="width: 10%;"></td> <td style="width: 10%;"></td> <td style="width: 10%;"></td> <td style="width: 10%;"></td> <td style="width: 10%;"></td> <td style="width: 10%;"></td> </tr> <tr> <td></td> <td></td> <td colspan="8" style="text-align: center;"> <table border="1" style="width: 100%; border-collapse: collapse; text-align: center;"> <tr> <td style="width: 10%;"></td> <td style="width: 10%;"></td> <td style="width: 10%;"></td> <td style="width: 10%;"></td> <td style="width: 10%;"></td> <td style="width: 10%;"></td> <td style="width: 10%;"></td> <td style="width: 10%;"></td> <td style="width: 10%;"></td> <td style="width: 10%;"></td> </tr> <tr> <td></td> <td></td> <td colspan="8" style="text-align: center;"> <table border="1" style="width: 100%; border-collapse: collapse; text-align: center;"> <tr> </tr></table></td></tr></table></td></tr></table></td></tr></table></td></tr></table></td></tr></table></td></tr></table></td></tr></table></td></tr></table></td></tr></table></td></tr></table></td></tr></table></td></tr></table></td></tr></table></td></tr></table></td></tr></table></td></tr></table></td></tr></table></td></tr></table></td></tr></table></td></tr></table></td></tr></table></td></tr></table></td></tr></table></td></tr></table></td></tr></table></td></tr></table></td></tr></table></td></tr></table></td></tr></table></td></tr></table></td></tr></table></td></tr></table></td></tr></table></td></tr></table></td></tr></table></td></tr></table></td></tr></table></td></tr></table></td></tr></table></td></tr></table></td></tr></table></td></tr></table></td></tr></table></td></tr></table></td></tr></table></td></tr></table>
 | | | | | | | | | | | | | | | | | | | | <table border="1" style="width: 100%; border-collapse: collapse; text-align: center;"> <tr> <td style="width: 10%;"></td> <td style="width: 10%;"></td> <td style="width: 10%;"></td> <td style="width: 10%;"></td> <td style="width: 10%;"></td> <td style="width: 10%;"></td> <td style="width: 10%;"></td> <td style="width: 10%;"></td> <td style="width: 10%;"></td> <td style="width: 10%;"></td> </tr> <tr> <td></td> <td></td> <td colspan="8" style="text-align: center;"> <table border="1" style="width: 100%; border-collapse: collapse; text-align: center;"> <tr> <td style="width: 10%;"></td> <td style="width: 10%;"></td> <td style="width: 10%;"></td> <td style="width: 10%;"></td> <td style="width: 10%;"></td> <td style="width: 10%;"></td> <td style="width: 10%;"></td> <td style="width: 10%;"></td> <td style="width: 10%;"></td> <td style="width: 10%;"></td> </tr> <tr> <td></td> <td></td> <td colspan="8" style="text-align: center;"> <table border="1" style="width: 100%; border-collapse: collapse; text-align: center;"> <tr> <td style="width: 10%;"></td> <td style="width: 10%;"></td> <td style="width: 10%;"></td> <td style="width: 10%;"></td> <td style="width: 10%;"></td> <td style="width: 10%;"></td> <td style="width: 10%;"></td> <td style="width: 10%;"></td> <td style="width: 10%;"></td> <td style="width: 10%;"></td> </tr> <tr> <td></td> <td></td> <td colspan="8" style="text-align: center;"> <table border="1" style="width: 100%; border-collapse: collapse; text-align: center;"> <tr> <td style="width: 10%;"></td> <td style="width: 10%;"></td> <td style="width: 10%;"></td> <td style="width: 10%;"></td> <td style="width: 10%;"></td> <td style="width: 10%;"></td> <td style="width: 10%;"></td> <td style="width: 10%;"></td> <td style="width: 10%;"></td> <td style="width: 10%;"></td> </tr> <tr> <td></td> <td></td> <td colspan="8" style="text-align: center;"> <table border="1" style="width: 100%; border-collapse: collapse; text-align: center;"> <tr> <td style="width: 10%;"></td> <td style="width: 10%;"></td> <td style="width: 10%;"></td> <td style="width: 10%;"></td> <td style="width: 10%;"></td> <td style="width: 10%;"></td> <td style="width: 10%;"></td> <td style="width: 10%;"></td> <td style="width: 10%;"></td> <td style="width: 10%;"></td> </tr> <tr> <td></td> <td></td> <td colspan="8" style="text-align: center;"> <table border="1" style="width: 100%; border-collapse: collapse; text-align: center;"> <tr> <td style="width: 10%;"></td> <td style="width: 10%;"></td> <td style="width: 10%;"></td> <td style="width: 10%;"></td> <td style="width: 10%;"></td> <td style="width: 10%;"></td> <td style="width: 10%;"></td> <td style="width: 10%;"></td> <td style="width: 10%;"></td> <td style="width: 10%;"></td> </tr> <tr> <td></td> <td></td> <td colspan="8" style="text-align: center;"> <table border="1" style="width: 100%; border-collapse: collapse; text-align: center;"> <tr> <td style="width: 10%;"></td> <td style="width: 10%;"></td> <td style="width: 10%;"></td> <td style="width: 10%;"></td> <td style="width: 10%;"></td> <td style="width: 10%;"></td> <td style="width: 10%;"></td> <td style="width: 10%;"></td> <td style="width: 10%;"></td> <td style="width: 10%;"></td> </tr> <tr> <td></td> <td></td> <td colspan="8" style="text-align: center;"> <table border="1" style="width: 100%; border-collapse: collapse; text-align: center;"> <tr> <td style="width: 10%;"></td> <td style="width: 10%;"></td> <td style="width: 10%;"></td> <td style="width: 10%;"></td> <td style="width: 10%;"></td> <td style="width: 10%;"></td> <td style="width: 10%;"></td> <td style="width: 10%;"></td> <td style="width: 10%;"></td> <td style="width: 10%;"></td> </tr> <tr> <td></td> <td></td> <td colspan="8" style="text-align: center;"> <table border="1" style="width: 100%; border-collapse: collapse; text-align: center;"> <tr> <td style="width: 10%;"></td> <td style="width: 10%;"></td> <td style="width: 10%;"></td> <td style="width: 10%;"></td> <td style="width: 10%;"></td> <td style="width: 10%;"></td> <td style="width: 10%;"></td> <td style="width: 10%;"></td> <td style="width: 10%;"></td> <td style="width: 10%;"></td> </tr> <tr> <td></td> <td></td> <td colspan="8" style="text-align: center;"> <table border="1" style="width: 100%; border-collapse: collapse; text-align: center;"> <tr> <td style="width: 10%;"></td> <td style="width: 10%;"></td> <td style="width: 10%;"></td> <td style="width: 10%;"></td> <td style="width: 10%;"></td> <td style="width: 10%;"></td> <td style="width: 10%;"></td> <td style="width: 10%;"></td> <td style="width: 10%;"></td> <td style="width: 10%;"></td> </tr> <tr> <td></td> <td></td> <td colspan="8" style="text-align: center;"> <table border="1" style="width: 100%; border-collapse: collapse; text-align: center;"> <tr> <td style="width: 10%;"></td> <td style="width: 10%;"></td> <td style="width: 10%;"></td> <td style="width: 10%;"></td> <td style="width: 10%;"></td> <td style="width: 10%;"></td> <td style="width: 10%;"></td> <td style="width: 10%;"></td> <td style="width: 10%;"></td> <td style="width: 10%;"></td> </tr> <tr> <td></td> <td></td> <td colspan="8" style="text-align: center;"> <table border="1" style="width: 100%; border-collapse: collapse; text-align: center;"> <tr> <td style="width: 10%;"></td> <td style="width: 10%;"></td> <td style="width: 10%;"></td> <td style="width: 10%;"></td> <td style="width: 10%;"></td> <td style="width: 10%;"></td> <td style="width: 10%;"></td> <td style="width: 10%;"></td> <td style="width: 10%;"></td> <td style="width: 10%;"></td> </tr> <tr> <td></td> <td></td> <td colspan="8" style="text-align: center;"> <table border="1" style="width: 100%; border-collapse: collapse; text-align: center;"> <tr> <td style="width: 10%;"></td> <td style="width: 10%;"></td> <td style="width: 10%;"></td> <td style="width: 10%;"></td> <td style="width: 10%;"></td> <td style="width: 10%;"></td> <td style="width: 10%;"></td> <td style="width:
10%;"></td> <td style="width: 10%;"></td> <td style="width: 10%;"></td> </tr> <tr> <td></td> <td></td> <td colspan="8" style="text-align: center;"> <table border="1" style="width: 100%; border-collapse: collapse; text-align: center;"> <tr> <td style="width: 10%;"></td> <td style="width: 10%;"></td> <td style="width: 10%;"></td> <td style="width: 10%;"></td> <td style="width: 10%;"></td> <td style="width: 10%;"></td> <td style="width: 10%;"></td> <td style="width: 10%;"></td> <td style="width: 10%;"></td> <td style="width: 10%;"></td> </tr> <tr> <td></td> <td></td> <td colspan="8" style="text-align: center;"> <table border="1" style="width: 100%; border-collapse: collapse; text-align: center;"> <tr> <td style="width: 10%;"></td> <td style="width: 10%;"></td> <td style="width: 10%;"></td> <td style="width: 10%;"></td> <td style="width: 10%;"></td> <td style="width: 10%;"></td> <td style="width: 10%;"></td> <td style="width: 10%;"></td> <td style="width: 10%;"></td> <td style="width: 10%;"></td> </tr> <tr> <td></td> <td></td> <td colspan="8" style="text-align: center;"> <table border="1" style="width: 100%; border-collapse: collapse; text-align: center;"> <tr> <td style="width: 10%;"></td> <td style="width: 10%;"></td> <td style="width: 10%;"></td> <td style="width: 10%;"></td> <td style="width: 10%;"></td> <td style="width: 10%;"></td> <td style="width: 10%;"></td> <td style="width: 10%;"></td> <td style="width: 10%;"></td> <td style="width: 10%;"></td> </tr> <tr> <td></td> <td></td> <td colspan="8" style="text-align: center;"> <table border="1" style="width: 100%; border-collapse: collapse; text-align: center;"> <tr> <td style="width: 10%;"></td> <td style="width: 10%;"></td> <td style="width: 10%;"></td> <td style="width: 10%;"></td> <td style="width: 10%;"></td> <td style="width: 10%;"></td> <td style="width: 10%;"></td> <td style="width: 10%;"></td> <td style="width: 10%;"></td> <td style="width: 10%;"></td> </tr> <tr> <td></td> <td></td> <td colspan="8" style="text-align: center;"> <table border="1" style="width: 100%; border-collapse: collapse; text-align: center;"> <tr> <td style="width: 10%;"></td> <td style="width: 10%;"></td> <td style="width: 10%;"></td> <td style="width: 10%;"></td> <td style="width: 10%;"></td> <td style="width: 10%;"></td> <td style="width: 10%;"></td> <td style="width: 10%;"></td> <td style="width: 10%;"></td> <td style="width: 10%;"></td> </tr> <tr> <td></td> <td></td> <td colspan="8" style="text-align: center;"> <table border="1" style="width: 100%; border-collapse: collapse; text-align: center;"> <tr> <td style="width: 10%;"></td> <td style="width: 10%;"></td> <td style="width: 10%;"></td> <td style="width: 10%;"></td> <td style="width: 10%;"></td> <td style="width: 10%;"></td> <td style="width: 10%;"></td> <td style="width: 10%;"></td> <td style="width: 10%;"></td> <td style="width: 10%;"></td> </tr> <tr> <td></td> <td></td> <td colspan="8" style="text-align: center;"> <table border="1" style="width: 100%; border-collapse: collapse; text-align: center;"> <tr> <td style="width: 10%;"></td> <td style="width: 10%;"></td> <td style="width: 10%;"></td> <td style="width: 10%;"></td> <td style="width: 10%;"></td> <td style="width: 10%;"></td> <td style="width: 10%;"></td> <td style="width: 10%;"></td> <td style="width: 10%;"></td> <td style="width: 10%;"></td> </tr> <tr> <td></td> <td></td> <td colspan="8" style="text-align: center;"> <table border="1" style="width: 100%; border-collapse: collapse; text-align: center;"> <tr> <td style="width: 10%;"></td> <td style="width: 10%;"></td> <td style="width: 10%;"></td> <td style="width: 10%;"></td> <td style="width: 10%;"></td> <td style="width: 10%;"></td> <td style="width: 10%;"></td> <td style="width: 10%;"></td> <td style="width: 10%;"></td> <td style="width: 10%;"></td> </tr> <tr> <td></td> <td></td> <td colspan="8" style="text-align: center;"> <table border="1" style="width: 100%; border-collapse: collapse; text-align: center;"> <tr> <td style="width: 10%;"></td> <td style="width: 10%;"></td> <td style="width: 10%;"></td> <td style="width: 10%;"></td> <td style="width: 10%;"></td> <td style="width: 10%;"></td> <td style="width: 10%;"></td> <td style="width: 10%;"></td> <td style="width: 10%;"></td> <td style="width: 10%;"></td> </tr> <tr> <td></td> <td></td> <td colspan="8" style="text-align: center;"> <table border="1" style="width: 100%; border-collapse: collapse; text-align: center;"> <tr> <td style="width: 10%;"></td> <td style="width: 10%;"></td> <td style="width: 10%;"></td> <td style="width: 10%;"></td> <td style="width: 10%;"></td> <td style="width: 10%;"></td> <td style="width: 10%;"></td> <td style="width: 10%;"></td> <td style="width: 10%;"></td> <td style="width: 10%;"></td> </tr> <tr> <td></td> <td></td> <td colspan="8" style="text-align: center;"> <table border="1" style="width: 100%; border-collapse: collapse; text-align: center;"> <tr> <td style="width: 10%;"></td> <td style="width: 10%;"></td> <td style="width: 10%;"></td> <td style="width: 10%;"></td> <td style="width: 10%;"></td> <td style="width: 10%;"></td> <td style="width: 10%;"></td> <td style="width: 10%;"></td> <td style="width: 10%;"></td> <td style="width: 10%;"></td> </tr> <tr> <td></td> <td></td> <td colspan="8" style="text-align: center;"> <table border="1" style="width: 100%; border-collapse: collapse; text-align: center;"> <tr> <td style="width: 10%;"></td> <td style="width: 10%;"></td> <td style="width: 10%;"></td> <td style="width: 10%;"></td> <td style="width: 10%;"></td> <td style="width: 10%;"></td> <td style="width: 10%;"></td> <td style="width: 10%;"></td> <td style="width: 10%;"></td> <td style="width: 10%;"></td> </tr> <tr> <td></td> <td></td> <td colspan="8" style="text-align: center;"> <table border="1" style="width: 100%; border-collapse: collapse; text-align: center;"> <tr> <td style="width: 10%;"></td> <td style="width: 10%;"></td> <td style="width: 10%;"></td> <td style="width: 10%;"></td> <td style="width: 10%;"></td> <td style="width: 10%;"></td> <td style="width: 10%;"></td> <td style="width: 10%;"></td> <td style="width: 10%;"></td> <td style="width: 10%;"></td> </tr> <tr> <td></td> <td></td> <td colspan="8" style="text-align: center;"> <table border="1" style="width: 100%; border-collapse: collapse; text-align: center;"> <tr> <td style="width: 10%;"></td> <td style="width: 10%;"></td> <td style="width: 10%;"></td> <td style="width: 10%;"></td> <td style="width: 10%;"></td> <td style="width: 10%;"></td> <td style="width: 10%;"></td> <td style="width: 10%;"></td> <td style="width: 10%;"></td> <td style="width: 10%;"></td> </tr> <tr> <td></td> <td></td> <td colspan="8" style="text-align: center;"> <table border="1" style="width: 100%; border-collapse: collapse; text-align: center;"> <tr> <td style="width: 10%;"></td> <td style="width: 10%;"></td> <td style="width: 10%;"></td> <td style="width: 10%;"></td> <td style="width: 10%;"></td> <td style="width: 10%;"></td> <td style="width: 10%;"></td> <td style="width: 10%;"></td> <td style="width: 10%;"></td> <td style="width: 10%;"></td> </tr> <tr> <td></td> <td></td> <td colspan="8" style="text-align: center;"> <table border="1" style="width: 100%; border-collapse: collapse; text-align: center;"> <tr> <td style="width: 10%;"></td> <td style="width: 10%;"></td> <td style="width: 10%;"></td> <td style="width: 10%;"></td> <td style="width: 10%;"></td> <td style="width: 10%;"></td> <td style="width: 10%;"></td> <td style="width: 10%;"></td> <td style="width: 10%;"></td> <td style="width: 10%;"></td> </tr> <tr> <td></td> <td></td> <td colspan="8" style="text-align: center;"> <table border="1" style="width: 100%; border-collapse: collapse; text-align: center;"> <tr> <td style="width: 10%;"></td> <td style="width: 10%;"></td> <td style="width: 10%;"></td> <td style="width: 10%;"></td> <td style="width: 10%;"></td> <td style="width: 10%;"></td> <td style="width: 10%;"></td> <td style="width: 10%;"></td> <td style="width: 10%;"></td> <td style="width: 10%;"></td> </tr> <tr> <td></td> <td></td> <td colspan="8" style="text-align: center;"> <table border="1" style="width: 100%; border-collapse: collapse; text-align: center;"> <tr> <td style="width: 10%;"></td> <td style="width: 10%;"></td> <td style="width: 10%;"></td> <td style="width: 10%;"></td> <td style="width: 10%;"></td> <td style="width: 10%;"></td> <td style="width: 10%;"></td> <td style="width: 10%;"></td> <td style="width: 10%;"></td> <td style="width: 10%;"></td> </tr> <tr> <td></td> <td></td> <td colspan="8" style="text-align: center;"> <table border="1" style="width: 100%; border-collapse: collapse; text-align: center;"> <tr> <td style="width: 10%;"></td> <td style="width: 10%;"></td> <td style="width: 10%;"></td> <td style="width: 10%;"></td> <td style="width: 10%;"></td> <td style="width: 10%;"></td> <td style="width: 10%;"></td> <td style="width: 10%;"></td> <td style="width: 10%;"></td> <td style="width: 10%;"></td> </tr> <tr> <td></td> <td></td> <td colspan="8" style="text-align: center;"> <table border="1" style="width: 100%; border-collapse: collapse; text-align: center;"> <tr> <td style="width: 10%;"></td> <td style="width: 10%;"></td> <td style="width: 10%;"></td> <td style="width: 10%;"></td> <td style="width: 10%;"></td> <td style="width: 10%;"></td> <td style="width: 10%;"></td> <td style="width: 10%;"></td> <td style="width: 10%;"></td> <td style="width: 10%;"></td> </tr> <tr> <td></td> <td></td> <td colspan="8" style="text-align: center;"> <table border="1" style="width: 100%; border-collapse: collapse; text-align: center;"> <tr> <td style="width: 10%;"></td> <td style="width: 10%;"></td> <td style="width: 10%;"></td> <td style="width: 10%;"></td> <td style="width: 10%;"></td> <td style="width: 10%;"></td> <td style="width: 10%;"></td> <td style="width: 10%;"></td> <td style="width: 10%;"></td> <td style="width: 10%;"></td> </tr> <tr> <td></td> <td></td> <td colspan="8" style="text-align: center;"> <table border="1"
style="width: 100%; border-collapse: collapse; text-align: center;"> <tr> <td style="width: 10%;"></td> <td style="width: 10%;"></td> <td style="width: 10%;"></td> <td style="width: 10%;"></td> <td style="width: 10%;"></td> <td style="width: 10%;"></td> <td style="width: 10%;"></td> <td style="width: 10%;"></td> <td style="width: 10%;"></td> <td style="width: 10%;"></td> </tr> <tr> <td></td> <td></td> <td colspan="8" style="text-align: center;"> <table border="1" style="width: 100%; border-collapse: collapse; text-align: center;"> <tr> <td style="width: 10%;"></td> <td style="width: 10%;"></td> <td style="width: 10%;"></td> <td style="width: 10%;"></td> <td style="width: 10%;"></td> <td style="width: 10%;"></td> <td style="width: 10%;"></td> <td style="width: 10%;"></td> <td style="width: 10%;"></td> <td style="width: 10%;"></td> </tr> <tr> <td></td> <td></td> <td colspan="8" style="text-align: center;"> <table border="1" style="width: 100%; border-collapse: collapse; text-align: center;"> <tr> <td style="width: 10%;"></td> <td style="width: 10%;"></td> <td style="width: 10%;"></td> <td style="width: 10%;"></td> <td style="width: 10%;"></td> <td style="width: 10%;"></td> <td style="width: 10%;"></td> <td style="width: 10%;"></td> <td style="width: 10%;"></td> <td style="width: 10%;"></td> </tr> <tr> <td></td> <td></td> <td colspan="8" style="text-align: center;"> <table border="1" style="width: 100%; border-collapse: collapse; text-align: center;"> <tr> <td style="width: 10%;"></td> <td style="width: 10%;"></td> <td style="width: 10%;"></td> <td style="width: 10%;"></td> <td style="width: 10%;"></td> <td style="width: 10%;"></td> <td style="width: 10%;"></td> <td style="width: 10%;"></td> <td style="width: 10%;"></td> <td style="width: 10%;"></td> </tr> <tr> <td></td> <td></td> <td colspan="8" style="text-align: center;"> <table border="1" style="width: 100%; border-collapse: collapse; text-align: center;"> <tr> <td style="width: 10%;"></td> <td style="width: 10%;"></td> <td style="width: 10%;"></td> <td style="width: 10%;"></td> <td style="width: 10%;"></td> <td style="width: 10%;"></td> <td style="width: 10%;"></td> <td style="width: 10%;"></td> <td style="width: 10%;"></td> <td style="width: 10%;"></td> </tr> <tr> <td></td> <td></td> <td colspan="8" style="text-align: center;"> <table border="1" style="width: 100%; border-collapse: collapse; text-align: center;"> <tr> <td style="width: 10%;"></td> <td style="width: 10%;"></td> <td style="width: 10%;"></td> <td style="width: 10%;"></td> <td style="width: 10%;"></td> <td style="width: 10%;"></td> <td style="width: 10%;"></td> <td style="width: 10%;"></td> <td style="width: 10%;"></td> <td style="width: 10%;"></td> </tr> <tr> <td></td> <td></td> <td colspan="8" style="text-align: center;"> <table border="1" style="width: 100%; border-collapse: collapse; text-align: center;"> <tr> <td style="width: 10%;"></td> <td style="width: 10%;"></td> <td style="width: 10%;"></td> <td style="width: 10%;"></td> <td style="width: 10%;"></td> <td style="width: 10%;"></td> <td style="width: 10%;"></td> <td style="width: 10%;"></td> <td style="width: 10%;"></td> <td style="width: 10%;"></td> </tr> <tr> <td></td> <td></td> <td colspan="8" style="text-align: center;"> <table border="1" style="width: 100%; border-collapse: collapse; text-align: center;"> <tr> <td style="width: 10%;"></td> <td style="width: 10%;"></td> <td style="width: 10%;"></td> <td style="width: 10%;"></td> <td style="width: 10%;"></td> <td style="width: 10%;"></td> <td style="width: 10%;"></td> <td style="width: 10%;"></td> <td style="width: 10%;"></td> <td style="width: 10%;"></td> </tr> <tr> <td></td> <td></td> <td colspan="8" style="text-align: center;"> <table border="1" style="width: 100%; border-collapse: collapse; text-align: center;"> <tr> <td style="width: 10%;"></td> <td style="width: 10%;"></td> <td style="width: 10%;"></td> <td style="width: 10%;"></td> <td style="width: 10%;"></td> <td style="width: 10%;"></td> <td style="width: 10%;"></td> <td style="width: 10%;"></td> <td style="width: 10%;"></td> <td style="width: 10%;"></td> </tr> <tr> <td></td> <td></td> <td colspan="8" style="text-align: center;"> <table border="1" style="width: 100%; border-collapse: collapse; text-align: center;"> <tr> <td style="width: 10%;"></td> <td style="width: 10%;"></td> <td style="width: 10%;"></td> <td style="width: 10%;"></td> <td style="width: 10%;"></td> <td style="width: 10%;"></td> <td style="width: 10%;"></td> <td style="width: 10%;"></td> <td style="width: 10%;"></td> <td style="width: 10%;"></td> </tr> <tr> <td></td> <td></td> <td colspan="8" style="text-align: center;"> <table border="1" style="width: 100%; border-collapse: collapse; text-align: center;"> <tr> <td style="width: 10%;"></td> <td style="width: 10%;"></td> <td style="width: 10%;"></td> <td style="width: 10%;"></td> <td style="width: 10%;"></td> <td style="width: 10%;"></td> <td style="width: 10%;"></td> <td style="width: 10%;"></td> <td style="width: 10%;"></td> <td style="width: 10%;"></td> </tr> <tr> <td></td> <td></td> <td colspan="8" style="text-align: center;"> <table border="1" style="width: 100%; border-collapse: collapse; text-align: center;"> <tr> </tr></table></td></tr></table></td></tr></table></td></tr></table></td></tr></table></td></tr></table></td></tr></table></td></tr></table></td></tr></table></td></tr></table></td></tr></table></td></tr></table></td></tr></table></td></tr></table></td></tr></table></td></tr></table></td></tr></table></td></tr></table></td></tr></table></td></tr></table></td></tr></table></td></tr></table></td></tr></table></td></tr></table></td></tr></table></td></tr></table></td></tr></table></td></tr></table></td></tr></table></td></tr></table></td></tr></table></td></tr></table></td></tr></table></td></tr></table></td></tr></table></td></tr></table></td></tr></table></td></tr></table></td></tr></table></td></tr></table></td></tr></table></td></tr></table></td></tr></table></td></tr></table></td></tr></table></td></tr></table>
 | | | | | | | | | | | | | | | | | | | | <table border="1" style="width: 100%; border-collapse: collapse; text-align: center;"> <tr> <td style="width: 10%;"></td> <td style="width: 10%;"></td> <td style="width: 10%;"></td> <td style="width: 10%;"></td> <td style="width: 10%;"></td> <td style="width: 10%;"></td> <td style="width: 10%;"></td> <td style="width: 10%;"></td> <td style="width: 10%;"></td> <td style="width: 10%;"></td> </tr> <tr> <td></td> <td></td> <td colspan="8" style="text-align: center;"> <table border="1" style="width: 100%; border-collapse: collapse; text-align: center;"> <tr> <td style="width: 10%;"></td> <td style="width: 10%;"></td> <td style="width: 10%;"></td> <td style="width: 10%;"></td> <td style="width: 10%;"></td> <td style="width: 10%;"></td> <td style="width: 10%;"></td> <td style="width: 10%;"></td> <td style="width: 10%;"></td> <td style="width: 10%;"></td> </tr> <tr> <td></td> <td></td> <td colspan="8" style="text-align: center;"> <table border="1" style="width: 100%; border-collapse: collapse; text-align: center;"> <tr> <td style="width: 10%;"></td> <td style="width: 10%;"></td> <td style="width: 10%;"></td> <td style="width: 10%;"></td> <td style="width: 10%;"></td> <td style="width: 10%;"></td> <td style="width: 10%;"></td> <td style="width: 10%;"></td> <td style="width: 10%;"></td> <td style="width: 10%;"></td> </tr> <tr> <td></td> <td></td> <td colspan="8" style="text-align: center;"> <table border="1" style="width: 100%; border-collapse: collapse; text-align: center;"> <tr> <td style="width: 10%;"></td> <td style="width: 10%;"></td> <td style="width: 10%;"></td> <td style="width: 10%;"></td> <td style="width: 10%;"></td> <td style="width: 10%;"></td> <td style="width: 10%;"></td> <td style="width: 10%;"></td> <td style="width: 10%;"></td> <td style="width: 10%;"></td> </tr> <tr> <td></td> <td></td> <td colspan="8" style="text-align: center;"> <table border="1" style="width: 100%; border-collapse: collapse; text-align: center;"> <tr> <td style="width: 10%;"></td> <td style="width: 10%;"></td> <td style="width: 10%;"></td> <td style="width: 10%;"></td> <td style="width: 10%;"></td> <td style="width: 10%;"></td> <td style="width: 10%;"></td> <td style="width: 10%;"></td> <td style="width: 10%;"></td> <td style="width: 10%;"></td> </tr> <tr> <td></td> <td></td> <td colspan="8" style="text-align: center;"> <table border="1" style="width: 100%; border-collapse: collapse; text-align: center;"> <tr> <td style="width: 10%;"></td> <td style="width: 10%;"></td> <td style="width: 10%;"></td> <td style="width: 10%;"></td> <td style="width: 10%;"></td> <td style="width: 10%;"></td> <td style="width: 10%;"></td> <td style="width: 10%;"></td> <td style="width: 10%;"></td> <td style="width: 10%;"></td> </tr> <tr> <td></td> <td></td> <td colspan="8" style="text-align: center;"> <table border="1" style="width: 100%; border-collapse: collapse; text-align: center;"> <tr> <td style="width: 10%;"></td> <td style="width: 10%;"></td> <td style="width: 10%;"></td> <td style="width: 10%;"></td> <td style="width: 10%;"></td> <td style="width: 10%;"></td> <td style="width: 10%;"></td> <td style="width: 10%;"></td> <td style="width: 10%;"></td> <td style="width: 10%;"></td> </tr> <tr> <td></td> <td></td> <td colspan="8" style="text-align: center;"> <table border="1" style="width: 100%; border-collapse: collapse; text-align: center;"> <tr> <td style="width: 10%;"></td> <td style="width: 10%;"></td> <td style="width: 10%;"></td> <td style="width: 10%;"></td> <td style="width: 10%;"></td> <td style="width: 10%;"></td> <td style="width: 10%;"></td> <td style="width: 10%;"></td> <td style="width: 10%;"></td> <td style="width: 10%;"></td> </tr> <tr> <td></td> <td></td> <td colspan="8" style="text-align: center;"> <table border="1" style="width: 100%; border-collapse: collapse; text-align: center;"> <tr> <td style="width: 10%;"></td> <td style="width: 10%;"></td> <td style="width: 10%;"></td> <td style="width: 10%;"></td> <td style="width: 10%;"></td> <td style="width: 10%;"></td> <td style="width: 10%;"></td> <td style="width: 10%;"></td> <td style="width: 10%;"></td> <td style="width: 10%;"></td> </tr> <tr> <td></td> <td></td> <td colspan="8" style="text-align: center;"> <table border="1" style="width: 100%; border-collapse: collapse; text-align: center;"> <tr> <td style="width: 10%;"></td> <td style="width: 10%;"></td> <td style="width: 10%;"></td> <td style="width: 10%;"></td> <td style="width: 10%;"></td> <td style="width: 10%;"></td> <td style="width: 10%;"></td> <td style="width: 10%;"></td> <td style="width: 10%;"></td> <td style="width: 10%;"></td> </tr> <tr> <td></td> <td></td> <td colspan="8" style="text-align: center;"> <table border="1" style="width: 100%; border-collapse: collapse; text-align: center;"> <tr> <td style="width: 10%;"></td> <td style="width: 10%;"></td> <td style="width: 10%;"></td> <td style="width: 10%;"></td> <td style="width: 10%;"></td> <td style="width: 10%;"></td> <td style="width: 10%;"></td> <td style="width: 10%;"></td> <td style="width: 10%;"></td> <td style="width: 10%;"></td> </tr> <tr> <td></td> <td></td> <td colspan="8" style="text-align: center;"> <table border="1" style="width: 100%; border-collapse: collapse; text-align: center;"> <tr> <td style="width: 10%;"></td> <td style="width: 10%;"></td> <td style="width: 10%;"></td> <td style="width: 10%;"></td> <td style="width: 10%;"></td> <td style="width: 10%;"></td> <td style="width: 10%;"></td> <td style="width: 10%;"></td> <td style="width: 10%;"></td> <td style="width: 10%;"></td> </tr> <tr> <td></td> <td></td> <td colspan="8" style="text-align: center;"> <table border="1" style="width: 100%; border-collapse: collapse; text-align: center;"> <tr> <td style="width: 10%;"></td> <td style="width: 10%;"></td> <td style="width: 10%;"></td> <td style="width: 10%;"></td> <td style="width: 10%;"></td> <td style="width: 10%;"></td> <td style="width: 10%;"></td> <td style="width: 10%;"></td> <td style="width: 10%;"></td> <td style="width: 10%;"></td> </tr> <tr> <td></td> <td></td> <td colspan="8" style="text-align: center;"> <table border="1" style="width: 100%; border-collapse: collapse; text-align: center;"> <tr> <td style="width: 10%;"></td> <td style="width: 10%;"></td> <td style="width: 10%;"></td> <td style="width: 10%;"></td> <td style="width: 10%;"></td> <td style="width: 10%;"></td> <td style="width: 10%;"></td> <td style="width: 10%;"></td> <td style="width: 10%;"></td> <td style="width: 10%;"></td> </tr> <tr> <td></td> <td></td> <td colspan="8" style="text-align: center;"> <table border="1" style="width: 100%; border-collapse: collapse; text-align: center;"> <tr> <td style="width: 10%;"></td> <td style="width: 10%;"></td> <td style="width: 10%;"></td> <td style="width: 10%;"></td> <td style="width: 10%;"></td> <td style="width: 10%;"></td> <td style="width: 10%;"></td> <td style="width: 10%;"></td> <td style="width: 10%;"></td> <td style="width: 10%;"></td> </tr> <tr> <td></td> <td></td> <td colspan="8" style="text-align: center;"> <table border="1" style="width: 100%; border-collapse: collapse; text-align: center;"> <tr> <td style="width: 10%;"></td> <td style="width: 10%;"></td> <td style="width: 10%;"></td> <td style="width: 10%;"></td> <td style="width: 10%;"></td> <td style="width: 10%;"></td> <td style="width: 10%;"></td> <td style="width: 10%;"></td> <td style="width: 10%;"></td> <td style="width: 10%;"></td> </tr> <tr> <td></td> <td></td> <td colspan="8" style="text-align: center;"> <table border="1" style="width: 100%; border-collapse: collapse; text-align: center;"> <tr> <td style="width: 10%;"></td> <td style="width: 10%;"></td> <td style="width: 10%;"></td> <td style="width: 10%;"></td> <td style="width: 10%;"></td> <td style="width: 10%;"></td> <td style="width: 10%;"></td> <td style="width: 10%;"></td> <td style="width: 10%;"></td> <td style="width: 10%;"></td> </tr> <tr> <td></td> <td></td> <td colspan="8" style="text-align: center;"> <table border="1" style="width: 100%; border-collapse: collapse; text-align: center;"> <tr> <td style="width: 10%;"></td> <td style="width: 10%;"></td> <td style="width: 10%;"></td> <td style="width: 10%;"></td> <td style="width: 10%;"></td> <td style="width: 10%;"></td> <td style="width: 10%;"></td> <td style="width: 10%;"></td> <td style="width: 10%;"></td> <td style="width: 10%;"></td> </tr> <tr> <td></td> <td></td> <td colspan="8" style="text-align: center;"> <table border="1" style="width: 100%; border-collapse: collapse; text-align: center;"> <tr> <td style="width: 10%;"></td> <td style="width: 10%;"></td> <td style="width: 10%;"></td> <td style="width: 10%;"></td> <td style="width: 10%;"></td> <td style="width: 10%;"></td> <td style="width: 10%;"></td> <td style="width: 10%;"></td> <td style="width: 10%;"></td> <td style="width: 10%;"></td> </tr> <tr> <td></td> <td></td> <td colspan="8" style="text-align: center;"> <table border="1" style="width: 100%; border-collapse: collapse; text-align: center;"> <tr> <td style="width: 10%;"></td> <td style="width:
10%;"></td> <td style="width: 10%;"></td> <td style="width: 10%;"></td> <td style="width: 10%;"></td> <td style="width: 10%;"></td> <td style="width: 10%;"></td> <td style="width: 10%;"></td> <td style="width: 10%;"></td> <td style="width: 10%;"></td> </tr> <tr> <td></td> <td></td> <td colspan="8" style="text-align: center;"> <table border="1" style="width: 100%; border-collapse: collapse; text-align: center;"> <tr> <td style="width: 10%;"></td> <td style="width: 10%;"></td> <td style="width: 10%;"></td> <td style="width: 10%;"></td> <td style="width: 10%;"></td> <td style="width: 10%;"></td> <td style="width: 10%;"></td> <td style="width: 10%;"></td> <td style="width: 10%;"></td> <td style="width: 10%;"></td> </tr> <tr> <td></td> <td></td> <td colspan="8" style="text-align: center;"> <table border="1" style="width: 100%; border-collapse: collapse; text-align: center;"> <tr> <td style="width: 10%;"></td> <td style="width: 10%;"></td> <td style="width: 10%;"></td> <td style="width: 10%;"></td> <td style="width: 10%;"></td> <td style="width: 10%;"></td> <td style="width: 10%;"></td> <td style="width: 10%;"></td> <td style="width: 10%;"></td> <td style="width: 10%;"></td> </tr> <tr> <td></td> <td></td> <td colspan="8" style="text-align: center;"> <table border="1" style="width: 100%; border-collapse: collapse; text-align: center;"> <tr> <td style="width: 10%;"></td> <td style="width: 10%;"></td> <td style="width: 10%;"></td> <td style="width: 10%;"></td> <td style="width: 10%;"></td> <td style="width: 10%;"></td> <td style="width: 10%;"></td> <td style="width: 10%;"></td> <td style="width: 10%;"></td> <td style="width: 10%;"></td> </tr> <tr> <td></td> <td></td> <td colspan="8" style="text-align: center;"> <table border="1" style="width: 100%; border-collapse: collapse; text-align: center;"> <tr> <td style="width: 10%;"></td> <td style="width: 10%;"></td> <td style="width: 10%;"></td> <td style="width: 10%;"></td> <td style="width: 10%;"></td> <td style="width: 10%;"></td> <td style="width: 10%;"></td> <td style="width: 10%;"></td> <td style="width: 10%;"></td> <td style="width: 10%;"></td> </tr> <tr> <td></td> <td></td> <td colspan="8" style="text-align: center;"> <table border="1" style="width: 100%; border-collapse: collapse; text-align: center;"> <tr> <td style="width: 10%;"></td> <td style="width: 10%;"></td> <td style="width: 10%;"></td> <td style="width: 10%;"></td> <td style="width: 10%;"></td> <td style="width: 10%;"></td> <td style="width: 10%;"></td> <td style="width: 10%;"></td> <td style="width: 10%;"></td> <td style="width: 10%;"></td> </tr> <tr> <td></td> <td></td> <td colspan="8" style="text-align: center;"> <table border="1" style="width: 100%; border-collapse: collapse; text-align: center;"> <tr> <td style="width: 10%;"></td> <td style="width: 10%;"></td> <td style="width: 10%;"></td> <td style="width: 10%;"></td> <td style="width: 10%;"></td> <td style="width: 10%;"></td> <td style="width: 10%;"></td> <td style="width: 10%;"></td> <td style="width: 10%;"></td> <td style="width: 10%;"></td> </tr> <tr> <td></td> <td></td> <td colspan="8" style="text-align: center;"> <table border="1" style="width: 100%; border-collapse: collapse; text-align: center;"> <tr> <td style="width: 10%;"></td> <td style="width: 10%;"></td> <td style="width: 10%;"></td> <td style="width: 10%;"></td> <td style="width: 10%;"></td> <td style="width: 10%;"></td> <td style="width: 10%;"></td> <td style="width: 10%;"></td> <td style="width: 10%;"></td> <td style="width: 10%;"></td> </tr> <tr> <td></td> <td></td> <td colspan="8" style="text-align: center;"> <table border="1" style="width: 100%; border-collapse: collapse; text-align: center;"> <tr> <td style="width: 10%;"></td> <td style="width: 10%;"></td> <td style="width: 10%;"></td> <td style="width: 10%;"></td> <td style="width: 10%;"></td> <td style="width: 10%;"></td> <td style="width: 10%;"></td> <td style="width: 10%;"></td> <td style="width: 10%;"></td> <td style="width: 10%;"></td> </tr> <tr> <td></td> <td></td> <td colspan="8" style="text-align: center;"> <table border="1" style="width: 100%; border-collapse: collapse; text-align: center;"> <tr> <td style="width: 10%;"></td> <td style="width: 10%;"></td> <td style="width: 10%;"></td> <td style="width: 10%;"></td> <td style="width: 10%;"></td> <td style="width: 10%;"></td> <td style="width: 10%;"></td> <td style="width: 10%;"></td> <td style="width: 10%;"></td> <td style="width: 10%;"></td> </tr> <tr> <td></td> <td></td> <td colspan="8" style="text-align: center;"> <table border="1" style="width: 100%; border-collapse: collapse; text-align: center;"> <tr> <td style="width: 10%;"></td> <td style="width: 10%;"></td> <td style="width: 10%;"></td> <td style="width: 10%;"></td> <td style="width: 10%;"></td> <td style="width: 10%;"></td> <td style="width: 10%;"></td> <td style="width: 10%;"></td> <td style="width: 10%;"></td> <td style="width: 10%;"></td> </tr> <tr> <td></td> <td></td> <td colspan="8" style="text-align: center;"> <table border="1" style="width: 100%; border-collapse: collapse; text-align: center;"> <tr> <td style="width: 10%;"></td> <td style="width: 10%;"></td> <td style="width: 10%;"></td> <td style="width: 10%;"></td> <td style="width: 10%;"></td> <td style="width: 10%;"></td> <td style="width: 10%;"></td> <td style="width: 10%;"></td> <td style="width: 10%;"></td> <td style="width: 10%;"></td> </tr> <tr> <td></td> <td></td> <td colspan="8" style="text-align: center;"> <table border="1" style="width: 100%; border-collapse: collapse; text-align: center;"> <tr> <td style="width: 10%;"></td> <td style="width: 10%;"></td> <td style="width: 10%;"></td> <td style="width: 10%;"></td> <td style="width: 10%;"></td> <td style="width: 10%;"></td> <td style="width: 10%;"></td> <td style="width: 10%;"></td> <td style="width: 10%;"></td> <td style="width: 10%;"></td> </tr> <tr> <td></td> <td></td> <td colspan="8" style="text-align: center;"> <table border="1" style="width: 100%; border-collapse: collapse; text-align: center;"> <tr> <td style="width: 10%;"></td> <td style="width: 10%;"></td> <td style="width: 10%;"></td> <td style="width: 10%;"></td> <td style="width: 10%;"></td> <td style="width: 10%;"></td> <td style="width: 10%;"></td> <td style="width: 10%;"></td> <td style="width: 10%;"></td> <td style="width: 10%;"></td> </tr> <tr> <td></td> <td></td> <td colspan="8" style="text-align: center;"> <table border="1" style="width: 100%; border-collapse: collapse; text-align: center;"> <tr> <td style="width: 10%;"></td> <td style="width: 10%;"></td> <td style="width: 10%;"></td> <td style="width: 10%;"></td> <td style="width: 10%;"></td> <td style="width: 10%;"></td> <td style="width: 10%;"></td> <td style="width: 10%;"></td> <td style="width: 10%;"></td> <td style="width: 10%;"></td> </tr> <tr> <td></td> <td></td> <td colspan="8" style="text-align: center;"> <table border="1" style="width: 100%; border-collapse: collapse; text-align: center;"> <tr> <td style="width: 10%;"></td> <td style="width: 10%;"></td> <td style="width: 10%;"></td> <td style="width: 10%;"></td> <td style="width: 10%;"></td> <td style="width: 10%;"></td> <td style="width: 10%;"></td> <td style="width: 10%;"></td> <td style="width: 10%;"></td> <td style="width: 10%;"></td> </tr> <tr> <td></td> <td></td> <td colspan="8" style="text-align: center;"> <table border="1" style="width: 100%; border-collapse: collapse; text-align: center;"> <tr> <td style="width: 10%;"></td> <td style="width: 10%;"></td> <td style="width: 10%;"></td> <td style="width: 10%;"></td> <td style="width: 10%;"></td> <td style="width: 10%;"></td> <td style="width: 10%;"></td> <td style="width: 10%;"></td> <td style="width: 10%;"></td> <td style="width: 10%;"></td> </tr> <tr> <td></td> <td></td> <td colspan="8" style="text-align: center;"> <table border="1" style="width: 100%; border-collapse: collapse; text-align: center;"> <tr> <td style="width: 10%;"></td> <td style="width: 10%;"></td> <td style="width: 10%;"></td> <td style="width: 10%;"></td> <td style="width: 10%;"></td> <td style="width: 10%;"></td> <td style="width: 10%;"></td> <td style="width: 10%;"></td> <td style="width: 10%;"></td> <td style="width: 10%;"></td> </tr> <tr> <td></td> <td></td> <td colspan="8" style="text-align: center;"> <table border="1" style="width: 100%; border-collapse: collapse; text-align: center;"> <tr> <td style="width: 10%;"></td> <td style="width: 10%;"></td> <td style="width: 10%;"></td> <td style="width: 10%;"></td> <td style="width: 10%;"></td> <td style="width: 10%;"></td> <td style="width: 10%;"></td> <td style="width: 10%;"></td> <td style="width: 10%;"></td> <td style="width: 10%;"></td> </tr> <tr> <td></td> <td></td> <td colspan="8" style="text-align: center;"> <table border="1" style="width: 100%; border-collapse: collapse; text-align: center;"> <tr> <td style="width: 10%;"></td> <td style="width: 10%;"></td> <td style="width: 10%;"></td> <td style="width: 10%;"></td> <td style="width: 10%;"></td> <td style="width: 10%;"></td> <td style="width: 10%;"></td> <td style="width: 10%;"></td> <td style="width: 10%;"></td> <td style="width: 10%;"></td> </tr> <tr> <td></td> <td></td> <td colspan="8" style="text-align: center;"> <table border="1" style="width: 100%; border-collapse: collapse; text-align: center;"> <tr> <td style="width: 10%;"></td> <td style="width: 10%;"></td> <td style="width: 10%;"></td> <td style="width: 10%;"></td> <td style="width: 10%;"></td> <td style="width: 10%;"></td> <td style="width: 10%;"></td> <td style="width: 10%;"></td> <td style="width: 10%;"></td> <td style="width: 10%;"></td> </tr> <tr> <td></td> <td></td> <td colspan="8" style="text-align: center;"> <table border="1" style="width: 100%; border-collapse: collapse; text-align: center;"> <tr> <td style="width: 10%;"></td> <td style="width: 10%;"></td> <td style="width: 10%;"></td> <td style="width: 10%;"></td> <td style="width: 10%;"></td> <td style="width: 10%;"></td> <td style="width: 10%;"></td> <td
style="width: 10%;"></td> <td style="width: 10%;"></td> <td style="width: 10%;"></td> </tr> <tr> <td></td> <td></td> <td colspan="8" style="text-align: center;"> <table border="1" style="width: 100%; border-collapse: collapse; text-align: center;"> <tr> <td style="width: 10%;"></td> <td style="width: 10%;"></td> <td style="width: 10%;"></td> <td style="width: 10%;"></td> <td style="width: 10%;"></td> <td style="width: 10%;"></td> <td style="width: 10%;"></td> <td style="width: 10%;"></td> <td style="width: 10%;"></td> <td style="width: 10%;"></td> </tr> <tr> <td></td> <td></td> <td colspan="8" style="text-align: center;"> <table border="1" style="width: 100%; border-collapse: collapse; text-align: center;"> <tr> <td style="width: 10%;"></td> <td style="width: 10%;"></td> <td style="width: 10%;"></td> <td style="width: 10%;"></td> <td style="width: 10%;"></td> <td style="width: 10%;"></td> <td style="width: 10%;"></td> <td style="width: 10%;"></td> <td style="width: 10%;"></td> <td style="width: 10%;"></td> </tr> <tr> <td></td> <td></td> <td colspan="8" style="text-align: center;"> <table border="1" style="width: 100%; border-collapse: collapse; text-align: center;"> <tr> <td style="width: 10%;"></td> <td style="width: 10%;"></td> <td style="width: 10%;"></td> <td style="width: 10%;"></td> <td style="width: 10%;"></td> <td style="width: 10%;"></td> <td style="width: 10%;"></td> <td style="width: 10%;"></td> <td style="width: 10%;"></td> <td style="width: 10%;"></td> </tr> <tr> <td></td> <td></td> <td colspan="8" style="text-align: center;"> <table border="1" style="width: 100%; border-collapse: collapse; text-align: center;"> <tr> </tr></table></td></tr></table></td></tr></table></td></tr></table></td></tr></table></td></tr></table></td></tr></table></td></tr></table></td></tr></table></td></tr></table></td></tr></table></td></tr></table></td></tr></table></td></tr></table></td></tr></table></td></tr></table></td></tr></table></td></tr></table></td></tr></table></td></tr></table></td></tr></table></td></tr></table></td></tr></table></td></tr></table></td></tr></table></td></tr></table></td></tr></table></td></tr></table></td></tr></table></td></tr></table></td></tr></table></td></tr></table></td></tr></table></td></tr></table></td></tr></table></td></tr></table></td></tr></table></td></tr></table></td></tr></table></td></tr></table></td></tr></table></td></tr></table></td></tr></table></td></tr></table></td></tr></table> | | | | | | | | | | | | | | | | | | | | <table border="1" style="width: 100%; border-collapse: collapse; text-align: center;"> <tr> <td style="width: 10%;"></td> <td style="width: 10%;"></td> <td style="width: 10%;"></td> <td style="width: 10%;"></td> <td style="width: 10%;"></td> <td style="width: 10%;"></td> <td style="width: 10%;"></td> <td style="width: 10%;"></td> <td style="width: 10%;"></td> <td style="width: 10%;"></td> </tr> <tr> <td></td> <td></td> <td colspan="8" style="text-align: center;"> <table border="1" style="width: 100%; border-collapse: collapse; text-align: center;"> <tr> <td style="width: 10%;"></td> <td style="width: 10%;"></td> <td style="width: 10%;"></td> <td style="width: 10%;"></td> <td style="width: 10%;"></td> <td style="width: 10%;"></td> <td style="width: 10%;"></td> <td style="width: 10%;"></td> <td style="width: 10%;"></td> <td style="width: 10%;"></td> </tr> <tr> <td></td> <td></td> <td colspan="8" style="text-align: center;"> <table border="1" style="width: 100%; border-collapse: collapse; text-align: center;"> <tr> <td style="width: 10%;"></td> <td style="width: 10%;"></td> <td style="width: 10%;"></td> <td style="width: 10%;"></td> <td style="width: 10%;"></td> <td style="width: 10%;"></td> <td style="width: 10%;"></td> <td style="width: 10%;"></td> <td style="width: 10%;"></td> <td style="width: 10%;"></td> </tr> <tr> <td></td> <td></td> <td colspan="8" style="text-align: center;"> <table border="1" style="width: 100%; border-collapse: collapse; text-align: center;"> <tr> <td style="width: 10%;"></td> <td style="width: 10%;"></td> <td style="width: 10%;"></td> <td style="width: 10%;"></td> <td style="width: 10%;"></td> <td style="width: 10%;"></td> <td style="width: 10%;"></td> <td style="width: 10%;"></td> <td style="width: 10%;"></td> <td style="width: 10%;"></td> </tr> <tr> <td></td> <td></td> <td colspan="8" style="text-align: center;"> <table border="1" style="width: 100%; border-collapse: collapse; text-align: center;"> <tr> <td style="width: 10%;"></td> <td style="width: 10%;"></td> <td style="width: 10%;"></td> <td style="width: 10%;"></td> <td style="width: 10%;"></td> <td style="width: 10%;"></td> <td style="width: 10%;"></td> <td style="width: 10%;"></td> <td style="width: 10%;"></td> <td style="width: 10%;"></td> </tr> <tr> <td></td> <td></td> <td colspan="8" style="text-align: center;"> <table border="1" style="width: 100%; border-collapse: collapse; text-align: center;"> <tr> <td style="width: 10%;"></td> <td style="width: 10%;"></td> <td style="width: 10%;"></td> <td style="width: 10%;"></td> <td style="width: 10%;"></td> <td style="width: 10%;"></td> <td
style="width: 10%;"></td> <td style="width: 10%;"></td> <td style="width: 10%;"></td> <td style="width: 10%;"></td> </tr> <tr> <td></td> <td></td> <td colspan="8" style="text-align: center;"> <table border="1" style="width: 100%; border-collapse: collapse; text-align: center;"> <tr> <td style="width: 10%;"></td> <td style="width: 10%;"></td> <td style="width: 10%;"></td> <td style="width: 10%;"></td> <td style="width: 10%;"></td> <td style="width: 10%;"></td> <td style="width: 10%;"></td> <td style="width: 10%;"></td> <td style="width: 10%;"></td> <td style="width: 10%;"></td> </tr> <tr> <td></td> <td></td> <td colspan="8" style="text-align: center;"> <table border="1" style="width: 100%; border-collapse: collapse; text-align: center;"> <tr> <td style="width: 10%;"></td> <td style="width: 10%;"></td> <td style="width: 10%;"></td> <td style="width: 10%;"></td> <td style="width: 10%;"></td> <td style="width: 10%;"></td> <td style="width: 10%;"></td> <td style="width: 10%;"></td> <td style="width: 10%;"></td> <td style="width: 10%;"></td> </tr> <tr> <td></td> <td></td> <td colspan="8" style="text-align: center;"> <table border="1" style="width: 100%; border-collapse: collapse; text-align: center;"> <tr> <td style="width: 10%;"></td> <td style="width: 10%;"></td> <td style="width: 10%;"></td> <td style="width: 10%;"></td> <td style="width: 10%;"></td> <td style="width: 10%;"></td> <td style="width: 10%;"></td> <td style="width: 10%;"></td> <td style="width: 10%;"></td> <td style="width: 10%;"></td> </tr> <tr> <td></td> <td></td> <td colspan="8" style="text-align: center;"> <table border="1" style="width: 100%; border-collapse: collapse; text-align: center;"> <tr> <td style="width: 10%;"></td> <td style="width: 10%;"></td> <td style="width: 10%;"></td> <td style="width: 10%;"></td> <td style="width: 10%;"></td> <td style="width: 10%;"></td> <td style="width: 10%;"></td> <td style="width: 10%;"></td> <td style="width: 10%;"></td> <td style="width: 10%;"></td> </tr> <tr> <td></td> <td></td> <td colspan="8" style="text-align: center;"> <table border="1" style="width: 100%; border-collapse: collapse; text-align: center;"> <tr> <td style="width: 10%;"></td> <td style="width: 10%;"></td> <td style="width: 10%;"></td> <td style="width: 10%;"></td> <td style="width: 10%;"></td> <td style="width: 10%;"></td> <td style="width: 10%;"></td> <td style="width: 10%;"></td> <td style="width: 10%;"></td> <td style="width: 10%;"></td> </tr> <tr> <td></td> <td></td> <td colspan="8" style="text-align: center;"> <table border="1" style="width: 100%; border-collapse: collapse; text-align: center;"> <tr> <td style="width: 10%;"></td> <td style="width: 10%;"></td> <td style="width: 10%;"></td> <td style="width: 10%;"></td> <td style="width: 10%;"></td> <td style="width: 10%;"></td> <td style="width: 10%;"></td> <td style="width: 10%;"></td> <td style="width: 10%;"></td> <td style="width: 10%;"></td> </tr> <tr> <td></td> <td></td> <td colspan="8" style="text-align: center;"> <table border="1" style="width: 100%; border-collapse: collapse; text-align: center;"> <tr> <td style="width: 10%;"></td> <td style="width: 10%;"></td> <td style="width: 10%;"></td> <td style="width: 10%;"></td> <td style="width: 10%;"></td> <td style="width: 10%;"></td> <td style="width: 10%;"></td> <td style="width: 10%;"></td> <td style="width: 10%;"></td> <td style="width: 10%;"></td> </tr> <tr> <td></td> <td></td> <td colspan="8" style="text-align: center;"> <table border="1" style="width: 100%; border-collapse: collapse; text-align: center;"> <tr> <td style="width: 10%;"></td> <td style="width: 10%;"></td> <td style="width: 10%;"></td> <td style="width: 10%;"></td> <td style="width: 10%;"></td> <td style="width: 10%;"></td> <td style="width: 10%;"></td> <td style="width: 10%;"></td> <td style="width: 10%;"></td> <td style="width: 10%;"></td> </tr> <tr> <td></td> <td></td> <td colspan="8" style="text-align: center;"> <table border="1" style="width: 100%; border-collapse: collapse; text-align: center;"> <tr> <td style="width: 10%;"></td> <td style="width: 10%;"></td> <td style="width: 10%;"></td> <td style="width: 10%;"></td> <td style="width: 10%;"></td> <td style="width: 10%;"></td> <td style="width: 10%;"></td> <td style="width: 10%;"></td> <td style="width: 10%;"></td> <td style="width: 10%;"></td> </tr> <tr> <td></td> <td></td> <td colspan="8" style="text-align: center;"> <table border="1" style="width: 100%; border-collapse: collapse; text-align: center;"> <tr> <td style="width: 10%;"></td> <td style="width: 10%;"></td> <td style="width: 10%;"></td> <td style="width: 10%;"></td> <td style="width: 10%;"></td> <td style="width: 10%;"></td> <td style="width: 10%;"></td> <td style="width: 10%;"></td> <td style="width: 10%;"></td> <td style="width: 10%;"></td> </tr> <tr> <td></td> <td></td> <td colspan="8" style="text-align: center;"> <table border="1" style="width: 100%; border-collapse: collapse; text-align: center;"> <tr> <td style="width: 10%;"></td> <td style="width: 10%;"></td> <td style="width: 10%;"></td> <td style="width: 10%;"></td> <td style="width: 10%;"></td> <td style="width: 10%;"></td> <td style="width: 10%;"></td> <td style="width: 10%;"></td> <td style="width: 10%;"></td> <td style="width: 10%;"></td> </tr> <tr> <td></td> <td></td> <td colspan="8" style="text-align: center;"> <table border="1" style="width: 100%; border-collapse: collapse; text-align: center;"> <tr> <td style="width: 10%;"></td> <td style="width: 10%;"></td> <td style="width: 10%;"></td> <td style="width: 10%;"></td> <td style="width: 10%;"></td> <td style="width: 10%;"></td> <td style="width: 10%;"></td> <td style="width: 10%;"></td> <td style="width: 10%;"></td> <td style="width: 10%;"></td> </tr> <tr> <td></td> <td></td> <td colspan="8" style="text-align: center;"> <table border="1" style="width: 100%; border-collapse: collapse; text-align: center;"> <tr> <td style="width: 10%;"></td> <td style="width: 10%;"></td> <td style="width: 10%;"></td> <td style="width: 10%;"></td> <td style="width: 10%;"></td> <td style="width: 10%;"></td> <td style="width: 10%;"></td> <td style="width: 10%;"></td> <td style="width: 10%;"></td> <td style="width: 10%;"></td> </tr> <tr> <td></td> <td></td> <td colspan="8" style="text-align: center;"> <table border="1" style="width: 100%; border-collapse: collapse; text-align: center;"> <tr> <td style="width: 10%;"></td> <td style="width: 10%;"></td> <td style="width: 10%;"></td> <td style="width: 10%;"></td> <td style="width: 10%;"></td> <td style="width: 10%;"></td> <td style="width: 10%;"></td> <td style="width: 10%;"></td> <td style="width: 10%;"></td> <td style="width: 10%;"></td> </tr> <tr> <td></td> <td></td> <td colspan="8" style="text-align: center;"> <table border="1" style="width: 100%; border-collapse: collapse; text-align: center;"> <tr> <td style="width: 10%;"></td> <td style="width: 10%;"></td> <td style="width: 10%;"></td> <td style="width: 10%;"></td> <td style="width: 10%;"></td> <td style="width: 10%;"></td> <td style="width: 10%;"></td> <td style="width: 10%;"></td> <td style="width: 10%;"></td> <td style="width: 10%;"></td> </tr> <tr> <td></td> <td></td> <td colspan="8" style="text-align: center;"> <table border="1" style="width: 100%; border-collapse: collapse; text-align: center;"> <tr> <td style="width: 10%;"></td> <td style="width: 10%;"></td> <td style="width: 10%;"></td> <td style="width: 10%;"></td> <td style="width: 10%;"></td> <td style="width: 10%;"></td> <td style="width: 10%;"></td> <td style="width: 10%;"></td> <td style="width: 10%;"></td> <td style="width: 10%;"></td> </tr> <tr> <td></td> <td></td> <td colspan="8" style="text-align: center;"> <table border="1" style="width: 100%; border-collapse: collapse; text-align: center;"> <tr> <td style="width: 10%;"></td> <td style="width: 10%;"></td> <td style="width: 10%;"></td> <td style="width: 10%;"></td> <td style="width: 10%;"></td> <td style="width: 10%;"></td> <td style="width: 10%;"></td> <td style="width: 10%;"></td> <td style="width: 10%;"></td> <td style="width: 10%;"></td> </tr> <tr> <td></td> <td></td> <td colspan="8" style="text-align: center;"> <table border="1" style="width: 100%; border-collapse: collapse; text-align: center;"> <tr> <td style="width: 10%;"></td> <td style="width: 10%;"></td> <td style="width: 10%;"></td> <td style="width: 10%;"></td> <td style="width: 10%;"></td> <td style="width: 10%;"></td> <td style="width: 10%;"></td> <td style="width: 10%;"></td> <td style="width: 10%;"></td> <td style="width: 10%;"></td> </tr> <tr> <td></td> <td></td> <td colspan="8" style="text-align: center;"> <table border="1" style="width: 100%; border-collapse: collapse; text-align: center;"> <tr> <td style="width: 10%;"></td> <td style="width: 10%;"></td> <td style="width: 10%;"></td> <td style="width: 10%;"></td> <td style="width: 10%;"></td> <td style="width: 10%;"></td> <td style="width: 10%;"></td> <td style="width: 10%;"></td> <td style="width: 10%;"></td> <td style="width: 10%;"></td> </tr> <tr> <td></td> <td></td> <td colspan="8" style="text-align: center;"> <table border="1" style="width: 100%; border-collapse: collapse; text-align: center;"> <tr> <td style="width: 10%;"></td> <td style="width: 10%;"></td> <td style="width: 10%;"></td> <td style="width: 10%;"></td> <td style="width: 10%;"></td> <td style="width: 10%;"></td> <td style="width: 10%;"></td> <td style="width: 10%;"></td> <td style="width: 10%;"></td> <td style="width: 10%;"></td> </tr> <tr> <td></td> <td></td> <td colspan="8" style="text-align: center;"> <table border="1" style="width: 100%; border-collapse: collapse; text-align: center;"> <tr> <td style="width: 10%;"></td> <td style="width: 10%;"></td> <td style="width: 10%;"></td> <td style="width: 10%;"></td> <td style="width: 10%;"></td> <td style="width: 10%;"></td> <td style="width: 10%;"></td> <td style="width: 10%;"></td> <td style="width: 10%;"></td> <td style="width: 10%;"></td> </tr> <tr> <td></td> <td></td> <td colspan="8"
style="text-align: center;"> <table border="1" style="width: 100%; border-collapse: collapse; text-align: center;"> <tr> <td style="width: 10%;"></td> <td style="width: 10%;"></td> <td style="width: 10%;"></td> <td style="width: 10%;"></td> <td style="width: 10%;"></td> <td style="width: 10%;"></td> <td style="width: 10%;"></td> <td style="width: 10%;"></td> <td style="width: 10%;"></td> <td style="width: 10%;"></td> </tr> <tr> <td></td> <td></td> <td colspan="8" style="text-align: center;"> <table border="1" style="width: 100%; border-collapse: collapse; text-align: center;"> <tr> <td style="width: 10%;"></td> <td style="width: 10%;"></td> <td style="width: 10%;"></td> <td style="width: 10%;"></td> <td style="width: 10%;"></td> <td style="width: 10%;"></td> <td style="width: 10%;"></td> <td style="width: 10%;"></td> <td style="width: 10%;"></td> <td style="width: 10%;"></td> </tr> <tr> <td></td> <td></td> <td colspan="8" style="text-align: center;"> <table border="1" style="width: 100%; border-collapse: collapse; text-align: center;"> <tr> <td style="width: 10%;"></td> <td style="width: 10%;"></td> <td style="width: 10%;"></td> <td style="width: 10%;"></td> <td style="width: 10%;"></td> <td style="width: 10%;"></td> <td style="width: 10%;"></td> <td style="width: 10%;"></td> <td style="width: 10%;"></td> <td style="width: 10%;"></td> </tr> <tr> <td></td> <td></td> <td colspan="8" style="text-align: center;"> <table border="1" style="width: 100%; border-collapse: collapse; text-align: center;"> <tr> <td style="width: 10%;"></td> <td style="width: 10%;"></td> <td style="width: 10%;"></td> <td style="width: 10%;"></td> <td style="width: 10%;"></td> <td style="width: 10%;"></td> <td style="width: 10%;"></td> <td style="width: 10%;"></td> <td style="width: 10%;"></td> <td style="width: 10%;"></td> </tr> <tr> <td></td> <td></td> <td colspan="8" style="text-align: center;"> <table border="1" style="width: 100%; border-collapse: collapse; text-align: center;"> <tr> <td style="width: 10%;"></td> <td style="width: 10%;"></td> <td style="width: 10%;"></td> <td style="width: 10%;"></td> <td style="width: 10%;"></td> <td style="width: 10%;"></td> <td style="width: 10%;"></td> <td style="width: 10%;"></td> <td style="width: 10%;"></td> <td style="width: 10%;"></td> </tr> <tr> <td></td> <td></td> <td colspan="8" style="text-align: center;"> <table border="1" style="width: 100%; border-collapse: collapse; text-align: center;"> <tr> <td style="width: 10%;"></td> <td style="width: 10%;"></td> <td style="width: 10%;"></td> <td style="width: 10%;"></td> <td style="width: 10%;"></td> <td style="width: 10%;"></td> <td style="width: 10%;"></td> <td style="width: 10%;"></td> <td style="width: 10%;"></td> <td style="width: 10%;"></td> </tr> <tr> <td></td> <td></td> <td colspan="8" style="text-align: center;"> <table border="1" style="width: 100%; border-collapse: collapse; text-align: center;"> <tr> <td style="width: 10%;"></td> <td style="width: 10%;"></td> <td style="width: 10%;"></td> <td style="width: 10%;"></td> <td style="width: 10%;"></td> <td style="width: 10%;"></td> <td style="width: 10%;"></td> <td style="width: 10%;"></td> <td style="width: 10%;"></td> <td style="width: 10%;"></td> </tr> <tr> <td></td> <td></td> <td colspan="8" style="text-align: center;"> <table border="1" style="width: 100%; border-collapse: collapse; text-align: center;"> <tr> <td style="width: 10%;"></td> <td style="width: 10%;"></td> <td style="width: 10%;"></td> <td style="width: 10%;"></td> <td style="width: 10%;"></td> <td style="width: 10%;"></td> <td style="width: 10%;"></td> <td style="width: 10%;"></td> <td style="width: 10%;"></td> <td style="width: 10%;"></td> </tr> <tr> <td></td> <td></td> <td colspan="8" style="text-align: center;"> <table border="1" style="width: 100%; border-collapse: collapse; text-align: center;"> <tr> <td style="width: 10%;"></td> <td style="width: 10%;"></td> <td style="width: 10%;"></td> <td style="width: 10%;"></td> <td style="width: 10%;"></td> <td style="width: 10%;"></td> <td style="width: 10%;"></td> <td style="width: 10%;"></td> <td style="width: 10%;"></td> <td style="width: 10%;"></td> </tr> <tr> <td></td> <td></td> <td colspan="8" style="text-align: center;"> <table border="1" style="width: 100%; border-collapse: collapse; text-align: center;"> <tr> <td style="width: 10%;"></td> <td style="width: 10%;"></td> <td style="width: 10%;"></td> <td style="width: 10%;"></td> <td style="width: 10%;"></td> <td style="width: 10%;"></td> <td style="width: 10%;"></td> <td style="width: 10%;"></td> <td style="width: 10%;"></td> <td style="width: 10%;"></td> </tr> <tr> <td></td> <td></td> <td colspan="8" style="text-align: center;"> <table border="1" style="width: 100%; border-collapse: collapse; text-align: center;"> <tr> <td style="width: 10%;"></td> <td style="width: 10%;"></td> <td style="width: 10%;"></td> <td style="width: 10%;"></td> <td style="width: 10%;"></td> <td style="width: 10%;"></td> <td style="width: 10%;"></td> <td style="width: 10%;"></td> <td style="width: 10%;"></td> <td style="width: 10%;"></td> </tr> <tr> <td></td> <td></td> <td colspan="8" style="text-align: center;"> <table border="1" style="width: 100%; border-collapse: collapse; text-align: center;"> <tr> <td style="width: 10%;"></td> <td style="width: 10%;"></td> <td style="width: 10%;"></td> <td style="width: 10%;"></td> <td style="width: 10%;"></td> <td style="width: 10%;"></td> <td style="width: 10%;"></td> <td style="width: 10%;"></td> <td style="width: 10%;"></td> <td style="width: 10%;"></td> </tr> <tr> <td></td> <td></td> <td colspan="8" style="text-align: center;"> <table border="1" style="width: 100%; border-collapse: collapse; text-align: center;"> <tr> <td style="width: 10%;"></td> <td style="width: 10%;"></td> <td style="width: 10%;"></td> <td style="width: 10%;"></td> <td style="width: 10%;"></td> <td style="width: 10%;"></td> <td style="width: 10%;"></td> <td style="width: 10%;"></td> <td style="width: 10%;"></td> <td style="width: 10%;"></td> </tr> <tr> <td></td> <td></td> <td colspan="8" style="text-align: center;"> <table border="1" style="width: 100%; border-collapse: collapse; text-align: center;"> <tr> <td style="width: 10%;"></td> <td style="width: 10%;"></td> <td style="width: 10%;"></td> <td style="width: 10%;"></td> <td style="width: 10%;"></td> <td style="width: 10%;"></td> <td style="width: 10%;"></td> <td style="width: 10%;"></td> <td style="width: 10%;"></td> <td style="width: 10%;"></td> </tr> <tr> <td></td> <td></td> <td colspan="8" style="text-align: center;"> <table border="1" style="width: 100%; border-collapse: collapse; text-align: center;"> <tr> <td style="width: 10%;"></td> <td style="width: 10%;"></td> <td style="width: 10%;"></td> <td style="width: 10%;"></td> <td style="width: 10%;"></td> <td style="width: 10%;"></td> <td style="width: 10%;"></td> <td style="width: 10%;"></td> <td style="width: 10%;"></td> <td style="width: 10%;"></td> </tr> <tr> <td></td> <td></td> <td colspan="8" style="text-align: center;"> <table border="1" style="width: 100%; border-collapse: collapse; text-align: center;"> <tr> <td style="width: 10%;"></td> <td style="width: 10%;"></td> <td style="width: 10%;"></td> <td style="width: 10%;"></td> <td style="width: 10%;"></td> <td style="width: 10%;"></td> <td style="width: 10%;"></td> <td style="width: 10%;"></td> <td style="width: 10%;"></td> <td style="width: 10%;"></td> </tr> <tr> <td></td> <td></td> <td colspan="8" style="text-align: center;"> <table border="1" style="width: 100%; border-collapse: collapse; text-align: center;"> <tr> </tr></table></td></tr></table></td></tr></table></td></tr></table></td></tr></table></td></tr></table></td></tr></table></td></tr></table></td></tr></table></td></tr></table></td></tr></table></td></tr></table></td></tr></table></td></tr></table></td></tr></table></td></tr></table></td></tr></table></td></tr></table></td></tr></table></td></tr></table></td></tr></table></td></tr></table></td></tr></table></td></tr></table></td></tr></table></td></tr></table></td></tr></table></td></tr></table></td></tr></table></td></tr></table></td></tr></table></td></tr></table></td></tr></table></td></tr></table></td></tr></table></td></tr></table></td></tr></table></td></tr></table></td></tr></table></td></tr></table></td></tr></table></td></tr></table></td></tr></table></td></tr></table>
 | | | | | | | | | | | | | | | | | | | | <table border="1" style="width: 100%; border-collapse: collapse; text-align: center;"> <tr> <td style="width: 10%;"></td> <td style="width: 10%;"></td> <td style="width: 10%;"></td> <td style="width: 10%;"></td> <td style="width: 10%;"></td> <td style="width: 10%;"></td> <td style="width: 10%;"></td> <td style="width: 10%;"></td> <td style="width: 10%;"></td> <td style="width: 10%;"></td> </tr> <tr> <td></td> <td></td> <td colspan="8" style="text-align: center;"> <table border="1" style="width: 100%; border-collapse: collapse; text-align: center;"> <tr> <td style="width: 10%;"></td> <td style="width: 10%;"></td> <td style="width: 10%;"></td> <td style="width: 10%;"></td> <td style="width: 10%;"></td> <td style="width: 10%;"></td> <td style="width: 10%;"></td> <td style="width: 10%;"></td> <td style="width: 10%;"></td> <td style="width: 10%;"></td> </tr> <tr> <td></td> <td></td> <td colspan="8" style="text-align: center;"> <table border="1" style="width: 100%; border-collapse: collapse; text-align: center;"> <tr> <td style="width: 10%;"></td> <td style="width: 10%;"></td> <td style="width: 10%;"></td> <td style="width: 10%;"></td> <td style="width: 10%;"></td> <td style="width: 10%;"></td> <td style="width: 10%;"></td> <td style="width: 10%;"></td> <td style="width: 10%;"></td> <td style="width: 10%;"></td> </tr> <tr> <td></td> <td></td> <td colspan="8" style="text-align: center;"> <table border="1" style="width: 100%; border-collapse: collapse; text-align: center;"> <tr> <td style="width: 10%;"></td> <td style="width: 10%;"></td> <td style="width: 10%;"></td> <td style="width: 10%;"></td> <td style="width: 10%;"></td> <td style="width: 10%;"></td> <td style="width: 10%;"></td> <td style="width: 10%;"></td> <td style="width: 10%;"></td> <td style="width: 10%;"></td> </tr> <tr> <td></td> <td></td> <td colspan="8" style="text-align: center;"> <table border="1" style="width: 100%; border-collapse: collapse; text-align: center;"> <tr> <td style="width: 10%;"></td> <td style="width: 10%;"></td> <td style="width: 10%;"></td> <td style="width: 10%;"></td> <td style="width: 10%;"></td> <td style="width: 10%;"></td> <td style="width: 10%;"></td> <td style="width: 10%;"></td> <td style="width: 10%;"></td> <td style="width: 10%;"></td> </tr> <tr> <td></td> <td></td> <td colspan="8" style="text-align: center;"> <table border="1" style="width: 100%; border-collapse: collapse; text-align: center;"> <tr> <td style="width: 10%;"></td> <td style="width: 10%;"></td> <td style="width: 10%;"></td> <td style="width: 10%;"></td> <td style="width: 10%;"></td> <td style="width: 10%;"></td> <td style="width: 10%;"></td> <td style="width: 10%;"></td> <td style="width: 10%;"></td> <td style="width: 10%;"></td> </tr> <tr> <td></td> <td></td> <td colspan="8" style="text-align: center;"> <table border="1" style="width: 100%; border-collapse: collapse; text-align: center;"> <tr> <td style="width: 10%;"></td> <td style="width: 10%;"></td> <td style="width: 10%;"></td> <td style="width: 10%;"></td> <td style="width: 10%;"></td> <td style="width: 10%;"></td> <td style="width: 10%;"></td> <td style="width: 10%;"></td> <td style="width: 10%;"></td> <td style="width: 10%;"></td> </tr> <tr> <td></td> <td></td> <td colspan="8" style="text-align: center;"> <table border="1" style="width: 100%; border-collapse: collapse; text-align: center;"> <tr> <td style="width: 10%;"></td> <td style="width: 10%;"></td> <td style="width: 10%;"></td> <td style="width: 10%;"></td> <td style="width: 10%;"></td> <td style="width: 10%;"></td> <td style="width: 10%;"></td> <td style="width: 10%;"></td> <td style="width: 10%;"></td> <td style="width: 10%;"></td> </tr> <tr> <td></td> <td></td> <td colspan="8" style="text-align: center;"> <table border="1" style="width: 100%; border-collapse: collapse; text-align: center;"> <tr> <td style="width: 10%;"></td> <td style="width: 10%;"></td> <td style="width: 10%;"></td> <td style="width: 10%;"></td> <td style="width: 10%;"></td> <td style="width: 10%;"></td> <td style="width: 10%;"></td> <td style="width: 10%;"></td> <td style="width: 10%;"></td> <td style="width: 10%;"></td> </tr> <tr> <td></td> <td></td> <td colspan="8" style="text-align: center;"> <table border="1" style="width: 100%; border-collapse: collapse; text-align: center;"> <tr> <td style="width: 10%;"></td> <td style="width: 10%;"></td> <td style="width: 10%;"></td> <td style="width: 10%;"></td> <td style="width: 10%;"></td> <td style="width: 10%;"></td> <td style="width: 10%;"></td> <td style="width: 10%;"></td> <td style="width: 10%;"></td> <td style="width: 10%;"></td> </tr> <tr> <td></td> <td></td> <td colspan="8" style="text-align: center;"> <table border="1" style="width: 100%; border-collapse: collapse; text-align: center;"> <tr> <td style="width: 10%;"></td> <td style="width: 10%;"></td> <td style="width: 10%;"></td> <td style="width: 10%;"></td> <td style="width: 10%;"></td> <td style="width: 10%;"></td> <td style="width: 10%;"></td> <td style="width: 10%;"></td> <td style="width: 10%;"></td> <td style="width: 10%;"></td> </tr> <tr> <td></td> <td></td> <td colspan="8" style="text-align: center;"> <table border="1" style="width: 100%; border-collapse: collapse; text-align: center;"> <tr> <td style="width: 10%;"></td> <td style="width: 10%;"></td> <td style="width: 10%;"></td> <td style="width: 10%;"></td> <td style="width: 10%;"></td> <td style="width: 10%;"></td> <td style="width: 10%;"></td> <td style="width: 10%;"></td> <td style="width: 10%;"></td> <td style="width: 10%;"></td> </tr> <tr> <td></td> <td></td> <td colspan="8" style="text-align: center;"> <table border="1" style="width: 100%; border-collapse: collapse; text-align: center;"> <tr> <td style="width: 10%;"></td> <td style="width: 10%;"></td> <td style="width: 10%;"></td> <td style="width: 10%;"></td> <td style="width: 10%;"></td> <td style="width: 10%;"></td> <td style="width: 10%;"></td> <td style="width: 10%;"></td> <td style="width: 10%;"></td> <td style="width: 10%;"></td> </tr> <tr> <td></td> <td></td> <td colspan="8" style="text-align: center;"> <table border="1" style="width: 100%; border-collapse: collapse; text-align: center;"> <tr> <td style="width: 10%;"></td> <td style="width: 10%;"></td> <td style="width: 10%;"></td> <td style="width: 10%;"></td> <td style="width: 10%;"></td> <td style="width: 10%;"></td> <td style="width: 10%;"></td> <td style="width: 10%;"></td> <td style="width: 10%;"></td> <td style="width: 10%;"></td> </tr> <tr> <td></td> <td></td> <td colspan="8" style="text-align: center;"> <table border="1" style="width: 100%; border-collapse: collapse; text-align: center;"> <tr> <td style="width: 10%;"></td> <td
style="width: 10%;"></td> <td style="width: 10%;"></td> <td style="width: 10%;"></td> <td style="width: 10%;"></td> <td style="width: 10%;"></td> <td style="width: 10%;"></td> <td style="width: 10%;"></td> <td style="width: 10%;"></td> <td style="width: 10%;"></td> </tr> <tr> <td></td> <td></td> <td colspan="8" style="text-align: center;"> <table border="1" style="width: 100%; border-collapse: collapse; text-align: center;"> <tr> <td style="width: 10%;"></td> <td style="width: 10%;"></td> <td style="width: 10%;"></td> <td style="width: 10%;"></td> <td style="width: 10%;"></td> <td style="width: 10%;"></td> <td style="width: 10%;"></td> <td style="width: 10%;"></td> <td style="width: 10%;"></td> <td style="width: 10%;"></td> </tr> <tr> <td></td> <td></td> <td colspan="8" style="text-align: center;"> <table border="1" style="width: 100%; border-collapse: collapse; text-align: center;"> <tr> <td style="width: 10%;"></td> <td style="width: 10%;"></td> <td style="width: 10%;"></td> <td style="width: 10%;"></td> <td style="width: 10%;"></td> <td style="width: 10%;"></td> <td style="width: 10%;"></td> <td style="width: 10%;"></td> <td style="width: 10%;"></td> <td style="width: 10%;"></td> </tr> <tr> <td></td> <td></td> <td colspan="8" style="text-align: center;"> <table border="1" style="width: 100%; border-collapse: collapse; text-align: center;"> <tr> <td style="width: 10%;"></td> <td style="width: 10%;"></td> <td style="width: 10%;"></td> <td style="width: 10%;"></td> <td style="width: 10%;"></td> <td style="width: 10%;"></td> <td style="width: 10%;"></td> <td style="width: 10%;"></td> <td style="width: 10%;"></td> <td style="width: 10%;"></td> </tr> <tr> <td></td> <td></td> <td colspan="8" style="text-align: center;"> <table border="1" style="width: 100%; border-collapse: collapse; text-align: center;"> <tr> <td style="width: 10%;"></td> <td style="width: 10%;"></td> <td style="width: 10%;"></td> <td style="width: 10%;"></td> <td style="width: 10%;"></td> <td style="width: 10%;"></td> <td style="width: 10%;"></td> <td style="width: 10%;"></td> <td style="width: 10%;"></td> <td style="width: 10%;"></td> </tr> <tr> <td></td> <td></td> <td colspan="8" style="text-align: center;"> <table border="1" style="width: 100%; border-collapse: collapse; text-align: center;"> <tr> <td style="width: 10%;"></td> <td style="width: 10%;"></td> <td style="width: 10%;"></td> <td style="width: 10%;"></td> <td style="width: 10%;"></td> <td style="width: 10%;"></td> <td style="width: 10%;"></td> <td style="width: 10%;"></td> <td style="width: 10%;"></td> <td style="width: 10%;"></td> </tr> <tr> <td></td> <td></td> <td colspan="8" style="text-align: center;"> <table border="1" style="width: 100%; border-collapse: collapse; text-align: center;"> <tr> <td style="width: 10%;"></td> <td style="width: 10%;"></td> <td style="width: 10%;"></td> <td style="width: 10%;"></td> <td style="width: 10%;"></td> <td style="width: 10%;"></td> <td style="width: 10%;"></td> <td style="width: 10%;"></td> <td style="width: 10%;"></td> <td style="width: 10%;"></td> </tr> <tr> <td></td> <td></td> <td colspan="8" style="text-align: center;"> <table border="1" style="width: 100%; border-collapse: collapse; text-align: center;"> <tr> <td style="width: 10%;"></td> <td style="width: 10%;"></td> <td style="width: 10%;"></td> <td style="width: 10%;"></td> <td style="width: 10%;"></td> <td style="width: 10%;"></td> <td style="width: 10%;"></td> <td style="width: 10%;"></td> <td style="width: 10%;"></td> <td style="width: 10%;"></td> </tr> <tr> <td></td> <td></td> <td colspan="8" style="text-align: center;"> <table border="1" style="width: 100%; border-collapse: collapse; text-align: center;"> <tr> <td style="width: 10%;"></td> <td style="width: 10%;"></td> <td style="width: 10%;"></td> <td style="width: 10%;"></td> <td style="width: 10%;"></td> <td style="width: 10%;"></td> <td style="width: 10%;"></td> <td style="width: 10%;"></td> <td style="width: 10%;"></td> <td style="width: 10%;"></td> </tr> <tr> <td></td> <td></td> <td colspan="8" style="text-align: center;"> <table border="1" style="width: 100%; border-collapse: collapse; text-align: center;"> <tr> <td style="width: 10%;"></td> <td style="width: 10%;"></td> <td style="width: 10%;"></td> <td style="width: 10%;"></td> <td style="width: 10%;"></td> <td style="width: 10%;"></td> <td style="width: 10%;"></td> <td style="width: 10%;"></td> <td style="width: 10%;"></td> <td style="width: 10%;"></td> </tr> <tr> <td></td> <td></td> <td colspan="8" style="text-align: center;"> <table border="1" style="width: 100%; border-collapse: collapse; text-align: center;"> <tr> <td style="width: 10%;"></td> <td style="width: 10%;"></td> <td style="width: 10%;"></td> <td style="width: 10%;"></td> <td style="width: 10%;"></td> <td style="width: 10%;"></td> <td style="width: 10%;"></td> <td style="width: 10%;"></td> <td style="width: 10%;"></td> <td style="width: 10%;"></td> </tr> <tr> <td></td> <td></td> <td colspan="8" style="text-align: center;"> <table border="1" style="width: 100%; border-collapse: collapse; text-align: center;"> <tr> <td style="width: 10%;"></td> <td style="width: 10%;"></td> <td style="width: 10%;"></td> <td style="width: 10%;"></td> <td style="width: 10%;"></td> <td style="width: 10%;"></td> <td style="width: 10%;"></td> <td style="width: 10%;"></td> <td style="width: 10%;"></td> <td style="width: 10%;"></td> </tr> <tr> <td></td> <td></td> <td colspan="8" style="text-align: center;"> <table border="1" style="width: 100%; border-collapse: collapse; text-align: center;"> <tr> <td style="width: 10%;"></td> <td style="width: 10%;"></td> <td style="width: 10%;"></td> <td style="width: 10%;"></td> <td style="width: 10%;"></td> <td style="width: 10%;"></td> <td style="width: 10%;"></td> <td style="width: 10%;"></td> <td style="width: 10%;"></td> <td style="width: 10%;"></td> </tr> <tr> <td></td> <td></td> <td colspan="8" style="text-align: center;"> <table border="1" style="width: 100%; border-collapse: collapse; text-align: center;"> <tr> <td style="width: 10%;"></td> <td style="width: 10%;"></td> <td style="width: 10%;"></td> <td style="width: 10%;"></td> <td style="width: 10%;"></td> <td style="width: 10%;"></td> <td style="width: 10%;"></td> <td style="width: 10%;"></td> <td style="width: 10%;"></td> <td style="width: 10%;"></td> </tr> <tr> <td></td> <td></td> <td colspan="8" style="text-align: center;"> <table border="1" style="width: 100%; border-collapse: collapse; text-align: center;"> <tr> <td style="width: 10%;"></td> <td style="width: 10%;"></td> <td style="width: 10%;"></td> <td style="width: 10%;"></td> <td style="width: 10%;"></td> <td style="width: 10%;"></td> <td style="width: 10%;"></td> <td style="width: 10%;"></td> <td style="width: 10%;"></td> <td style="width: 10%;"></td> </tr> <tr> <td></td> <td></td> <td colspan="8" style="text-align: center;"> <table border="1" style="width: 100%; border-collapse: collapse; text-align: center;"> <tr> <td style="width: 10%;"></td> <td style="width: 10%;"></td> <td style="width: 10%;"></td> <td style="width: 10%;"></td> <td style="width: 10%;"></td> <td style="width: 10%;"></td> <td style="width: 10%;"></td> <td style="width: 10%;"></td> <td style="width: 10%;"></td> <td style="width: 10%;"></td> </tr> <tr> <td></td> <td></td> <td colspan="8" style="text-align: center;"> <table border="1" style="width: 100%; border-collapse: collapse; text-align: center;"> <tr> <td style="width: 10%;"></td> <td style="width: 10%;"></td> <td style="width: 10%;"></td> <td style="width: 10%;"></td> <td style="width: 10%;"></td> <td style="width: 10%;"></td> <td style="width: 10%;"></td> <td style="width: 10%;"></td> <td style="width: 10%;"></td> <td style="width: 10%;"></td> </tr> <tr> <td></td> <td></td> <td colspan="8" style="text-align: center;"> <table border="1" style="width: 100%; border-collapse: collapse; text-align: center;"> <tr> <td style="width: 10%;"></td> <td style="width: 10%;"></td> <td style="width: 10%;"></td> <td style="width: 10%;"></td> <td style="width: 10%;"></td> <td style="width: 10%;"></td> <td style="width: 10%;"></td> <td style="width: 10%;"></td> <td style="width: 10%;"></td> <td style="width: 10%;"></td> </tr> <tr> <td></td> <td></td> <td colspan="8" style="text-align: center;"> <table border="1" style="width: 100%; border-collapse: collapse; text-align: center;"> <tr> <td style="width: 10%;"></td> <td style="width: 10%;"></td> <td style="width: 10%;"></td> <td style="width: 10%;"></td> <td style="width: 10%;"></td> <td style="width: 10%;"></td> <td style="width: 10%;"></td> <td style="width: 10%;"></td> <td style="width: 10%;"></td> <td style="width: 10%;"></td> </tr> <tr> <td></td> <td></td> <td colspan="8" style="text-align: center;"> <table border="1" style="width: 100%; border-collapse: collapse; text-align: center;"> <tr> <td style="width: 10%;"></td> <td style="width: 10%;"></td> <td style="width: 10%;"></td> <td style="width: 10%;"></td> <td style="width: 10%;"></td> <td style="width: 10%;"></td> <td style="width: 10%;"></td> <td style="width: 10%;"></td> <td style="width: 10%;"></td> <td style="width: 10%;"></td> </tr> <tr> <td></td> <td></td> <td colspan="8" style="text-align: center;"> <table border="1" style="width: 100%; border-collapse: collapse; text-align: center;"> <tr> <td style="width: 10%;"></td> <td style="width: 10%;"></td> <td style="width: 10%;"></td> <td style="width: 10%;"></td> <td style="width: 10%;"></td> <td style="width: 10%;"></td> <td style="width: 10%;"></td> <td style="width: 10%;"></td> <td style="width: 10%;"></td> <td style="width: 10%;"></td> </tr> <tr> <td></td> <td></td> <td colspan="8" style="text-align: center;"> <table border="1" style="width: 100%; border-collapse: collapse; text-align: center;"> <tr> <td style="width: 10%;"></td> <td style="width: 10%;"></td> <td style="width: 10%;"></td> <td style="width: 10%;"></td> <td style="width: 10%;"></td> <td style="width: 10%;"></td> <td style="width:
10%;"></td> <td style="width: 10%;"></td> <td style="width: 10%;"></td> <td style="width: 10%;"></td> </tr> <tr> <td></td> <td></td> <td colspan="8" style="text-align: center;"> <table border="1" style="width: 100%; border-collapse: collapse; text-align: center;"> <tr> <td style="width: 10%;"></td> <td style="width: 10%;"></td> <td style="width: 10%;"></td> <td style="width: 10%;"></td> <td style="width: 10%;"></td> <td style="width: 10%;"></td> <td style="width: 10%;"></td> <td style="width: 10%;"></td> <td style="width: 10%;"></td> <td style="width: 10%;"></td> </tr> <tr> <td></td> <td></td> <td colspan="8" style="text-align: center;"> <table border="1" style="width: 100%; border-collapse: collapse; text-align: center;"> <tr> <td style="width: 10%;"></td> <td style="width: 10%;"></td> <td style="width: 10%;"></td> <td style="width: 10%;"></td> <td style="width: 10%;"></td> <td style="width: 10%;"></td> <td style="width: 10%;"></td> <td style="width: 10%;"></td> <td style="width: 10%;"></td> <td style="width: 10%;"></td> </tr> <tr> <td></td> <td></td> <td colspan="8" style="text-align: center;"> <table border="1" style="width: 100%; border-collapse: collapse; text-align: center;"> <tr> <td style="width: 10%;"></td> <td style="width: 10%;"></td> <td style="width: 10%;"></td> <td style="width: 10%;"></td> <td style="width: 10%;"></td> <td style="width: 10%;"></td> <td style="width: 10%;"></td> <td style="width: 10%;"></td> <td style="width: 10%;"></td> <td style="width: 10%;"></td> </tr> <tr> <td></td> <td></td> <td colspan="8" style="text-align: center;"> <table border="1" style="width: 100%; border-collapse: collapse; text-align: center;"> <tr> <td style="width: 10%;"></td> <td style="width: 10%;"></td> <td style="width: 10%;"></td> <td style="width: 10%;"></td> <td style="width: 10%;"></td> <td style="width: 10%;"></td> <td style="width: 10%;"></td> <td style="width: 10%;"></td> <td style="width: 10%;"></td> <td style="width: 10%;"></td> </tr> <tr> <td></td> <td></td> <td colspan="8" style="text-align: center;"> <table border="1" style="width: 100%; border-collapse: collapse; text-align: center;"> <tr> <td style="width: 10%;"></td> <td style="width: 10%;"></td> <td style="width: 10%;"></td> <td style="width: 10%;"></td> <td style="width: 10%;"></td> <td style="width: 10%;"></td> <td style="width: 10%;"></td> <td style="width: 10%;"></td> <td style="width: 10%;"></td> <td style="width: 10%;"></td> </tr> <tr> <td></td> <td></td> <td colspan="8" style="text-align: center;"> <table border="1" style="width: 100%; border-collapse: collapse; text-align: center;"> <tr> <td style="width: 10%;"></td> <td style="width: 10%;"></td> <td style="width: 10%;"></td> <td style="width: 10%;"></td> <td style="width: 10%;"></td> <td style="width: 10%;"></td> <td style="width: 10%;"></td> <td style="width: 10%;"></td> <td style="width: 10%;"></td> <td style="width: 10%;"></td> </tr> <tr> <td></td> <td></td> <td colspan="8" style="text-align: center;"> <table border="1" style="width: 100%; border-collapse: collapse; text-align: center;"> <tr> </tr></table></td></tr></table></td></tr></table></td></tr></table></td></tr></table></td></tr></table></td></tr></table></td></tr></table></td></tr></table></td></tr></table></td></tr></table></td></tr></table></td></tr></table></td></tr></table></td></tr></table></td></tr></table></td></tr></table></td></tr></table></td></tr></table></td></tr></table></td></tr></table></td></tr></table></td></tr></table></td></tr></table></td></tr></table></td></tr></table></td></tr></table></td></tr></table></td></tr></table></td></tr></table></td></tr></table></td></tr></table></td></tr></table></td></tr></table></td></tr></table></td></tr></table></td></tr></table></td></tr></table></td></tr></table></td></tr></table></td></tr></table></td></tr></table></td></tr></table> | | | | | | | | | | | | | | | | | | | | <table border="1" style="width: 100%; border-collapse: collapse; text-align: center;"> <tr> <td style="width: 10%;"></td> <td style="width: 10%;"></td> <td style="width: 10%;"></td> <td style="width: 10%;"></td> <td style="width: 10%;"></td> <td style="width: 10%;"></td> <td style="width: 10%;"></td> <td style="width: 10%;"></td> <td style="width: 10%;"></td> <td style="width: 10%;"></td> </tr> <tr> <td></td> <td></td> <td colspan="8" style="text-align: center;"> <table border="1" style="width: 100%; border-collapse: collapse; text-align: center;"> <tr> <td style="width: 10%;"></td> <td style="width: 10%;"></td> <td style="width: 10%;"></td> <td style="width: 10%;"></td> <td style="width: 10%;"></td> <td style="width: 10%;"></td> <td style="width: 10%;"></td> <td style="width: 10%;"></td> <td style="width: 10%;"></td> <td style="width: 10%;"></td> </tr> <tr> <td></td> <td></td> <td colspan="8" style="text-align: center;"> <table border="1" style="width: 100%; border-collapse: collapse; text-align: center;"> <tr> <td style="width: 10%;"></td> <td style="width: 10%;"></td> <td style="width: 10%;"></td> <td style="width: 10%;"></td> <td style="width: 10%;"></td> <td style="width: 10%;"></td> <td style="width:
10%;"></td> <td style="width: 10%;"></td> <td style="width: 10%;"></td> <td style="width: 10%;"></td> </tr> <tr> <td></td> <td></td> <td colspan="8" style="text-align: center;"> <table border="1" style="width: 100%; border-collapse: collapse; text-align: center;"> <tr> <td style="width: 10%;"></td> <td style="width: 10%;"></td> <td style="width: 10%;"></td> <td style="width: 10%;"></td> <td style="width: 10%;"></td> <td style="width: 10%;"></td> <td style="width: 10%;"></td> <td style="width: 10%;"></td> <td style="width: 10%;"></td> <td style="width: 10%;"></td> </tr> <tr> <td></td> <td></td> <td colspan="8" style="text-align: center;"> <table border="1" style="width: 100%; border-collapse: collapse; text-align: center;"> <tr> <td style="width: 10%;"></td> <td style="width: 10%;"></td> <td style="width: 10%;"></td> <td style="width: 10%;"></td> <td style="width: 10%;"></td> <td style="width: 10%;"></td> <td style="width: 10%;"></td> <td style="width: 10%;"></td> <td style="width: 10%;"></td> <td style="width: 10%;"></td> </tr> <tr> <td></td> <td></td> <td colspan="8" style="text-align: center;"> <table border="1" style="width: 100%; border-collapse: collapse; text-align: center;"> <tr> <td style="width: 10%;"></td> <td style="width: 10%;"></td> <td style="width: 10%;"></td> <td style="width: 10%;"></td> <td style="width: 10%;"></td> <td style="width: 10%;"></td> <td style="width: 10%;"></td> <td style="width: 10%;"></td> <td style="width: 10%;"></td> <td style="width: 10%;"></td> </tr> <tr> <td></td> <td></td> <td colspan="8" style="text-align: center;"> <table border="1" style="width: 100%; border-collapse: collapse; text-align: center;"> <tr> <td style="width: 10%;"></td> <td style="width: 10%;"></td> <td style="width: 10%;"></td> <td style="width: 10%;"></td> <td style="width: 10%;"></td> <td style="width: 10%;"></td> <td style="width: 10%;"></td> <td style="width: 10%;"></td> <td style="width: 10%;"></td> <td style="width: 10%;"></td> </tr> <tr> <td></td> <td></td> <td colspan="8" style="text-align: center;"> <table border="1" style="width: 100%; border-collapse: collapse; text-align: center;"> <tr> <td style="width: 10%;"></td> <td style="width: 10%;"></td> <td style="width: 10%;"></td> <td style="width: 10%;"></td> <td style="width: 10%;"></td> <td style="width: 10%;"></td> <td style="width: 10%;"></td> <td style="width: 10%;"></td> <td style="width: 10%;"></td> <td style="width: 10%;"></td> </tr> <tr> <td></td> <td></td> <td colspan="8" style="text-align: center;"> <table border="1" style="width: 100%; border-collapse: collapse; text-align: center;"> <tr> <td style="width: 10%;"></td> <td style="width: 10%;"></td> <td style="width: 10%;"></td> <td style="width: 10%;"></td> <td style="width: 10%;"></td> <td style="width: 10%;"></td> <td style="width: 10%;"></td> <td style="width: 10%;"></td> <td style="width: 10%;"></td> <td style="width: 10%;"></td> </tr> <tr> <td></td> <td></td> <td colspan="8" style="text-align: center;"> <table border="1" style="width: 100%; border-collapse: collapse; text-align: center;"> <tr> <td style="width: 10%;"></td> <td style="width: 10%;"></td> <td style="width: 10%;"></td> <td style="width: 10%;"></td> <td style="width: 10%;"></td> <td style="width: 10%;"></td> <td style="width: 10%;"></td> <td style="width: 10%;"></td> <td style="width: 10%;"></td> <td style="width: 10%;"></td> </tr> <tr> <td></td> <td></td> <td colspan="8" style="text-align: center;"> <table border="1" style="width: 100%; border-collapse: collapse; text-align: center;"> <tr> <td style="width: 10%;"></td> <td style="width: 10%;"></td> <td style="width: 10%;"></td> <td style="width: 10%;"></td> <td style="width: 10%;"></td> <td style="width: 10%;"></td> <td style="width: 10%;"></td> <td style="width: 10%;"></td> <td style="width: 10%;"></td> <td style="width: 10%;"></td> </tr> <tr> <td></td> <td></td> <td colspan="8" style="text-align: center;"> <table border="1" style="width: 100%; border-collapse: collapse; text-align: center;"> <tr> <td style="width: 10%;"></td> <td style="width: 10%;"></td> <td style="width: 10%;"></td> <td style="width: 10%;"></td> <td style="width: 10%;"></td> <td style="width: 10%;"></td> <td style="width: 10%;"></td> <td style="width: 10%;"></td> <td style="width: 10%;"></td> <td style="width: 10%;"></td> </tr> <tr> <td></td> <td></td> <td colspan="8" style="text-align: center;"> <table border="1" style="width: 100%; border-collapse: collapse; text-align: center;"> <tr> <td style="width: 10%;"></td> <td style="width: 10%;"></td> <td style="width: 10%;"></td> <td style="width: 10%;"></td> <td style="width: 10%;"></td> <td style="width: 10%;"></td> <td style="width: 10%;"></td> <td style="width: 10%;"></td> <td style="width: 10%;"></td> <td style="width: 10%;"></td> </tr> <tr> <td></td> <td></td> <td colspan="8" style="text-align: center;"> <table border="1" style="width: 100%; border-collapse: collapse; text-align: center;"> <tr> <td style="width: 10%;"></td> <td style="width: 10%;"></td> <td style="width: 10%;"></td> <td style="width: 10%;"></td> <td style="width: 10%;"></td> <td style="width: 10%;"></td> <td style="width: 10%;"></td> <td style="width: 10%;"></td> <td style="width: 10%;"></td> <td style="width: 10%;"></td> </tr> <tr> <td></td> <td></td> <td colspan="8" style="text-align: center;"> <table border="1" style="width: 100%; border-collapse: collapse; text-align: center;"> <tr> <td style="width: 10%;"></td> <td style="width: 10%;"></td> <td style="width: 10%;"></td> <td style="width: 10%;"></td> <td style="width: 10%;"></td> <td style="width: 10%;"></td> <td style="width: 10%;"></td> <td style="width: 10%;"></td> <td style="width: 10%;"></td> <td style="width: 10%;"></td> </tr> <tr> <td></td> <td></td> <td colspan="8" style="text-align: center;"> <table border="1" style="width: 100%; border-collapse: collapse; text-align: center;"> <tr> <td style="width: 10%;"></td> <td style="width: 10%;"></td> <td style="width: 10%;"></td> <td style="width: 10%;"></td> <td style="width: 10%;"></td> <td style="width: 10%;"></td> <td style="width: 10%;"></td> <td style="width: 10%;"></td> <td style="width: 10%;"></td> <td style="width: 10%;"></td> </tr> <tr> <td></td> <td></td> <td colspan="8" style="text-align: center;"> <table border="1" style="width: 100%; border-collapse: collapse; text-align: center;"> <tr> <td style="width: 10%;"></td> <td style="width: 10%;"></td> <td style="width: 10%;"></td> <td style="width: 10%;"></td> <td style="width: 10%;"></td> <td style="width: 10%;"></td> <td style="width: 10%;"></td> <td style="width: 10%;"></td> <td style="width: 10%;"></td> <td style="width: 10%;"></td> </tr> <tr> <td></td> <td></td> <td colspan="8" style="text-align: center;"> <table border="1" style="width: 100%; border-collapse: collapse; text-align: center;"> <tr> <td style="width: 10%;"></td> <td style="width: 10%;"></td> <td style="width: 10%;"></td> <td style="width: 10%;"></td> <td style="width: 10%;"></td> <td style="width: 10%;"></td> <td style="width: 10%;"></td> <td style="width: 10%;"></td> <td style="width: 10%;"></td> <td style="width: 10%;"></td> </tr> <tr> <td></td> <td></td> <td colspan="8" style="text-align: center;"> <table border="1" style="width: 100%; border-collapse: collapse; text-align: center;"> <tr> <td style="width: 10%;"></td> <td style="width: 10%;"></td> <td style="width: 10%;"></td> <td style="width: 10%;"></td> <td style="width: 10%;"></td> <td style="width: 10%;"></td> <td style="width: 10%;"></td> <td style="width: 10%;"></td> <td style="width: 10%;"></td> <td style="width: 10%;"></td> </tr> <tr> <td></td> <td></td> <td colspan="8" style="text-align: center;"> <table border="1" style="width: 100%; border-collapse: collapse; text-align: center;"> <tr> <td style="width: 10%;"></td> <td style="width: 10%;"></td> <td style="width: 10%;"></td> <td style="width: 10%;"></td> <td style="width: 10%;"></td> <td style="width: 10%;"></td> <td style="width: 10%;"></td> <td style="width: 10%;"></td> <td style="width: 10%;"></td> <td style="width: 10%;"></td> </tr> <tr> <td></td> <td></td> <td colspan="8" style="text-align: center;"> <table border="1" style="width: 100%; border-collapse: collapse; text-align: center;"> <tr> <td style="width: 10%;"></td> <td style="width: 10%;"></td> <td style="width: 10%;"></td> <td style="width: 10%;"></td> <td style="width: 10%;"></td> <td style="width: 10%;"></td> <td style="width: 10%;"></td> <td style="width: 10%;"></td> <td style="width: 10%;"></td> <td style="width: 10%;"></td> </tr> <tr> <td></td> <td></td> <td colspan="8" style="text-align: center;"> <table border="1" style="width: 100%; border-collapse: collapse; text-align: center;"> <tr> <td style="width: 10%;"></td> <td style="width: 10%;"></td> <td style="width: 10%;"></td> <td style="width: 10%;"></td> <td style="width: 10%;"></td> <td style="width: 10%;"></td> <td style="width: 10%;"></td> <td style="width: 10%;"></td> <td style="width: 10%;"></td> <td style="width: 10%;"></td> </tr> <tr> <td></td> <td></td> <td colspan="8" style="text-align: center;"> <table border="1" style="width: 100%; border-collapse: collapse; text-align: center;"> <tr> <td style="width: 10%;"></td> <td style="width: 10%;"></td> <td style="width: 10%;"></td> <td style="width: 10%;"></td> <td style="width: 10%;"></td> <td style="width: 10%;"></td> <td style="width: 10%;"></td> <td style="width: 10%;"></td> <td style="width: 10%;"></td> <td style="width: 10%;"></td> </tr> <tr> <td></td> <td></td> <td colspan="8" style="text-align: center;"> <table border="1" style="width: 100%; border-collapse: collapse; text-align: center;"> <tr> <td style="width: 10%;"></td> <td style="width: 10%;"></td> <td style="width: 10%;"></td> <td style="width: 10%;"></td> <td style="width: 10%;"></td> <td style="width: 10%;"></td> <td style="width: 10%;"></td> <td style="width: 10%;"></td> <td style="width: 10%;"></td> <td style="width: 10%;"></td> </tr> <tr> <td></td> <td></td> <td colspan="8" style="text-align:
center;"> <table border="1" style="width: 100%; border-collapse: collapse; text-align: center;"> <tr> <td style="width: 10%;"></td> <td style="width: 10%;"></td> <td style="width: 10%;"></td> <td style="width: 10%;"></td> <td style="width: 10%;"></td> <td style="width: 10%;"></td> <td style="width: 10%;"></td> <td style="width: 10%;"></td> <td style="width: 10%;"></td> <td style="width: 10%;"></td> </tr> <tr> <td></td> <td></td> <td colspan="8" style="text-align: center;"> <table border="1" style="width: 100%; border-collapse: collapse; text-align: center;"> <tr> <td style="width: 10%;"></td> <td style="width: 10%;"></td> <td style="width: 10%;"></td> <td style="width: 10%;"></td> <td style="width: 10%;"></td> <td style="width: 10%;"></td> <td style="width: 10%;"></td> <td style="width: 10%;"></td> <td style="width: 10%;"></td> <td style="width: 10%;"></td> </tr> <tr> <td></td> <td></td> <td colspan="8" style="text-align: center;"> <table border="1" style="width: 100%; border-collapse: collapse; text-align: center;"> <tr> <td style="width: 10%;"></td> <td style="width: 10%;"></td> <td style="width: 10%;"></td> <td style="width: 10%;"></td> <td style="width: 10%;"></td> <td style="width: 10%;"></td> <td style="width: 10%;"></td> <td style="width: 10%;"></td> <td style="width: 10%;"></td> <td style="width: 10%;"></td> </tr> <tr> <td></td> <td></td> <td colspan="8" style="text-align: center;"> <table border="1" style="width: 100%; border-collapse: collapse; text-align: center;"> <tr> <td style="width: 10%;"></td> <td style="width: 10%;"></td> <td style="width: 10%;"></td> <td style="width: 10%;"></td> <td style="width: 10%;"></td> <td style="width: 10%;"></td> <td style="width: 10%;"></td> <td style="width: 10%;"></td> <td style="width: 10%;"></td> <td style="width: 10%;"></td> </tr> <tr> <td></td> <td></td> <td colspan="8" style="text-align: center;"> <table border="1" style="width: 100%; border-collapse: collapse; text-align: center;"> <tr> <td style="width: 10%;"></td> <td style="width: 10%;"></td> <td style="width: 10%;"></td> <td style="width: 10%;"></td> <td style="width: 10%;"></td> <td style="width: 10%;"></td> <td style="width: 10%;"></td> <td style="width: 10%;"></td> <td style="width: 10%;"></td> <td style="width: 10%;"></td> </tr> <tr> <td></td> <td></td> <td colspan="8" style="text-align: center;"> <table border="1" style="width: 100%; border-collapse: collapse; text-align: center;"> <tr> <td style="width: 10%;"></td> <td style="width: 10%;"></td> <td style="width: 10%;"></td> <td style="width: 10%;"></td> <td style="width: 10%;"></td> <td style="width: 10%;"></td> <td style="width: 10%;"></td> <td style="width: 10%;"></td> <td style="width: 10%;"></td> <td style="width: 10%;"></td> </tr> <tr> <td></td> <td></td> <td colspan="8" style="text-align: center;"> <table border="1" style="width: 100%; border-collapse: collapse; text-align: center;"> <tr> <td style="width: 10%;"></td> <td style="width: 10%;"></td> <td style="width: 10%;"></td> <td style="width: 10%;"></td> <td style="width: 10%;"></td> <td style="width: 10%;"></td> <td style="width: 10%;"></td> <td style="width: 10%;"></td> <td style="width: 10%;"></td> <td style="width: 10%;"></td> </tr> <tr> <td></td> <td></td> <td colspan="8" style="text-align: center;"> <table border="1" style="width: 100%; border-collapse: collapse; text-align: center;"> <tr> <td style="width: 10%;"></td> <td style="width: 10%;"></td> <td style="width: 10%;"></td> <td style="width: 10%;"></td> <td style="width: 10%;"></td> <td style="width: 10%;"></td> <td style="width: 10%;"></td> <td style="width: 10%;"></td> <td style="width: 10%;"></td> <td style="width: 10%;"></td> </tr> <tr> <td></td> <td></td> <td colspan="8" style="text-align: center;"> <table border="1" style="width: 100%; border-collapse: collapse; text-align: center;"> <tr> <td style="width: 10%;"></td> <td style="width: 10%;"></td> <td style="width: 10%;"></td> <td style="width: 10%;"></td> <td style="width: 10%;"></td> <td style="width: 10%;"></td> <td style="width: 10%;"></td> <td style="width: 10%;"></td> <td style="width: 10%;"></td> <td style="width: 10%;"></td> </tr> <tr> <td></td> <td></td> <td colspan="8" style="text-align: center;"> <table border="1" style="width: 100%; border-collapse: collapse; text-align: center;"> <tr> <td style="width: 10%;"></td> <td style="width: 10%;"></td> <td style="width: 10%;"></td> <td style="width: 10%;"></td> <td style="width: 10%;"></td> <td style="width: 10%;"></td> <td style="width: 10%;"></td> <td style="width: 10%;"></td> <td style="width: 10%;"></td> <td style="width: 10%;"></td> </tr> <tr> <td></td> <td></td> <td colspan="8" style="text-align: center;"> <table border="1" style="width: 100%; border-collapse: collapse; text-align: center;"> <tr> <td style="width: 10%;"></td> <td style="width: 10%;"></td> <td style="width: 10%;"></td> <td style="width: 10%;"></td> <td style="width: 10%;"></td> <td style="width: 10%;"></td> <td style="width: 10%;"></td> <td style="width: 10%;"></td> <td style="width: 10%;"></td> <td style="width: 10%;"></td> </tr> <tr> <td></td> <td></td> <td colspan="8" style="text-align: center;"> <table border="1" style="width: 100%; border-collapse: collapse; text-align: center;"> <tr> <td style="width: 10%;"></td> <td style="width: 10%;"></td> <td style="width: 10%;"></td> <td style="width: 10%;"></td> <td style="width: 10%;"></td> <td style="width: 10%;"></td> <td style="width: 10%;"></td> <td style="width: 10%;"></td> <td style="width: 10%;"></td> <td style="width: 10%;"></td> </tr> <tr> <td></td> <td></td> <td colspan="8" style="text-align: center;"> <table border="1" style="width: 100%; border-collapse: collapse; text-align: center;"> <tr> <td style="width: 10%;"></td> <td style="width: 10%;"></td> <td style="width: 10%;"></td> <td style="width: 10%;"></td> <td style="width: 10%;"></td> <td style="width: 10%;"></td> <td style="width: 10%;"></td> <td style="width: 10%;"></td> <td style="width: 10%;"></td> <td style="width: 10%;"></td> </tr> <tr> <td></td> <td></td> <td colspan="8" style="text-align: center;"> <table border="1" style="width: 100%; border-collapse: collapse; text-align: center;"> <tr> <td style="width: 10%;"></td> <td style="width: 10%;"></td> <td style="width: 10%;"></td> <td style="width: 10%;"></td> <td style="width: 10%;"></td> <td style="width: 10%;"></td> <td style="width: 10%;"></td> <td style="width: 10%;"></td> <td style="width: 10%;"></td> <td style="width: 10%;"></td> </tr> <tr> <td></td> <td></td> <td colspan="8" style="text-align: center;"> <table border="1" style="width: 100%; border-collapse: collapse; text-align: center;"> <tr> <td style="width: 10%;"></td> <td style="width: 10%;"></td> <td style="width: 10%;"></td> <td style="width: 10%;"></td> <td style="width: 10%;"></td> <td style="width: 10%;"></td> <td style="width: 10%;"></td> <td style="width: 10%;"></td> <td style="width: 10%;"></td> <td style="width: 10%;"></td> </tr> <tr> <td></td> <td></td> <td colspan="8" style="text-align: center;"> <table border="1" style="width: 100%; border-collapse: collapse; text-align: center;"> <tr> <td style="width: 10%;"></td> <td style="width: 10%;"></td> <td style="width: 10%;"></td> <td style="width: 10%;"></td> <td style="width: 10%;"></td> <td style="width: 10%;"></td> <td style="width: 10%;"></td> <td style="width: 10%;"></td> <td style="width: 10%;"></td> <td style="width: 10%;"></td> </tr> <tr> <td></td> <td></td> <td colspan="8" style="text-align: center;"> <table border="1" style="width: 100%; border-collapse: collapse; text-align: center;"> <tr> <td style="width: 10%;"></td> <td style="width: 10%;"></td> <td style="width: 10%;"></td> <td style="width: 10%;"></td> <td style="width: 10%;"></td> <td style="width: 10%;"></td> <td style="width: 10%;"></td> <td style="width: 10%;"></td> <td style="width: 10%;"></td> <td style="width: 10%;"></td> </tr> <tr> <td></td> <td></td> <td colspan="8" style="text-align: center;"> <table border="1" style="width: 100%; border-collapse: collapse; text-align: center;"> <tr> </tr></table></td></tr></table></td></tr></table></td></tr></table></td></tr></table></td></tr></table></td></tr></table></td></tr></table></td></tr></table></td></tr></table></td></tr></table></td></tr></table></td></tr></table></td></tr></table></td></tr></table></td></tr></table></td></tr></table></td></tr></table></td></tr></table></td></tr></table></td></tr></table></td></tr></table></td></tr></table></td></tr></table></td></tr></table></td></tr></table></td></tr></table></td></tr></table></td></tr></table></td></tr></table></td></tr></table></td></tr></table></td></tr></table></td></tr></table></td></tr></table></td></tr></table></td></tr></table></td></tr></table></td></tr></table></td></tr></table></td></tr></table></td></tr></table>
 | | | | | | | | | | | | | | | | | | | | <table border="1" style="width: 100%; border-collapse: collapse; text-align: center;"> <tr> <td style="width: 10%;"></td> <td style="width: 10%;"></td> <td style="width: 10%;"></td> <td style="width: 10%;"></td> <td style="width: 10%;"></td> <td style="width: 10%;"></td> <td style="width: 10%;"></td> <td style="width: 10%;"></td> <td style="width: 10%;"></td> <td style="width: 10%;"></td> </tr> <tr> <td></td> <td></td> <td colspan="8" style="text-align: center;"> <table border="1" style="width: 100%; border-collapse: collapse; text-align: center;"> <tr> <td style="width: 10%;"></td> <td style="width: 10%;"></td> <td style="width: 10%;"></td> <td style="width: 10%;"></td> <td style="width: 10%;"></td> <td style="width: 10%;"></td> <td style="width: 10%;"></td> <td style="width: 10%;"></td> <td style="width: 10%;"></td> <td style="width: 10%;"></td> </tr> <tr> <td></td> <td></td> <td colspan="8" style="text-align: center;"> <table border="1" style="width: 100%; border-collapse: collapse; text-align: center;"> <tr> <td style="width: 10%;"></td> <td style="width: 10%;"></td> <td style="width: 10%;"></td> <td style="width: 10%;"></td> <td style="width: 10%;"></td> <td style="width: 10%;"></td> <td style="width: 10%;"></td> <td style="width: 10%;"></td> <td style="width: 10%;"></td> <td style="width: 10%;"></td> </tr> <tr> <td></td> <td></td> <td colspan="8" style="text-align: center;"> <table border="1" style="width: 100%; border-collapse: collapse; text-align: center;"> <tr> <td style="width: 10%;"></td> <td style="width: 10%;"></td> <td style="width: 10%;"></td> <td style="width: 10%;"></td> <td style="width: 10%;"></td> <td style="width: 10%;"></td> <td style="width: 10%;"></td> <td style="width: 10%;"></td> <td style="width: 10%;"></td> <td style="width: 10%;"></td> </tr> <tr> <td></td> <td></td> <td colspan="8" style="text-align: center;"> <table border="1" style="width: 100%; border-collapse: collapse; text-align: center;"> <tr> <td style="width: 10%;"></td> <td style="width: 10%;"></td> <td style="width: 10%;"></td> <td style="width: 10%;"></td> <td style="width: 10%;"></td> <td style="width: 10%;"></td> <td style="width: 10%;"></td> <td style="width: 10%;"></td> <td style="width: 10%;"></td> <td style="width: 10%;"></td> </tr> <tr> <td></td> <td></td> <td colspan="8" style="text-align: center;"> <table border="1" style="width: 100%; border-collapse: collapse; text-align: center;"> <tr> <td style="width: 10%;"></td> <td style="width: 10%;"></td> <td style="width: 10%;"></td> <td style="width: 10%;"></td> <td style="width: 10%;"></td> <td style="width: 10%;"></td> <td style="width: 10%;"></td> <td style="width: 10%;"></td> <td style="width: 10%;"></td> <td style="width: 10%;"></td> </tr> <tr> <td></td> <td></td> <td colspan="8" style="text-align: center;"> <table border="1" style="width: 100%; border-collapse: collapse; text-align: center;"> <tr> <td style="width: 10%;"></td> <td style="width: 10%;"></td> <td style="width: 10%;"></td> <td style="width: 10%;"></td> <td style="width: 10%;"></td> <td style="width: 10%;"></td> <td style="width: 10%;"></td> <td style="width: 10%;"></td> <td style="width: 10%;"></td> <td style="width: 10%;"></td> </tr> <tr> <td></td> <td></td> <td colspan="8" style="text-align: center;"> <table border="1" style="width: 100%; border-collapse: collapse; text-align: center;"> <tr> <td style="width: 10%;"></td> <td style="width: 10%;"></td> <td style="width: 10%;"></td> <td style="width: 10%;"></td> <td style="width: 10%;"></td> <td style="width: 10%;"></td> <td style="width: 10%;"></td> <td style="width: 10%;"></td> <td style="width: 10%;"></td> <td style="width: 10%;"></td> </tr> <tr> <td></td> <td></td> <td colspan="8" style="text-align: center;"> <table border="1" style="width: 100%; border-collapse: collapse; text-align: center;"> <tr> <td style="width: 10%;"></td> <td style="width: 10%;"></td> <td style="width: 10%;"></td> <td style="width: 10%;"></td> <td style="width: 10%;"></td> <td style="width: 10%;"></td> <td style="width: 10%;"></td> <td style="width: 10%;"></td> <td style="width: 10%;"></td> <td style="width: 10%;"></td> </tr> <tr> <td></td> <td></td> <td colspan="8" style="text-align: center;"> <table border="1" style="width: 100%; border-collapse: collapse; text-align: center;"> <tr> <td style="width: 10%;"></td> <td style="width: 10%;"></td> <td style="width: 10%;"></td> <td style="width: 10%;"></td> <td style="width: 10%;"></td> <td style="width: 10%;"></td> <td style="width: 10%;"></td> <td style="width: 10%;"></td> <td style="width: 10%;"></td> <td style="width: 10%;"></td> </tr> <tr> <td></td> <td></td> <td colspan="8" style="text-align: center;"> <table border="1" style="width: 100%; border-collapse: collapse; text-align: center;"> <tr> <td style="width: 10%;"></td> <td style="width: 10%;"></td> <td style="width: 10%;"></td> <td style="width: 10%;"></td> <td style="width: 10%;"></td> <td style="width: 10%;"></td> <td style="width: 10%;"></td> <td style="width: 10%;"></td> <td style="width: 10%;"></td> <td style="width: 10%;"></td> </tr> <tr> <td></td> <td></td> <td colspan="8" style="text-align: center;"> <table border="1" style="width: 100%; border-collapse: collapse; text-align: center;"> <tr> <td style="width: 10%;"></td> <td style="width: 10%;"></td> <td style="width: 10%;"></td> <td style="width: 10%;"></td> <td style="width: 10%;"></td> <td style="width: 10%;"></td> <td style="width: 10%;"></td> <td style="width: 10%;"></td> <td style="width: 10%;"></td> <td style="width: 10%;"></td> </tr> <tr> <td></td> <td></td> <td colspan="8" style="text-align: center;"> <table border="1" style="width: 100%; border-collapse: collapse; text-align: center;"> <tr> <td style="width: 10%;"></td> <td style="width: 10%;"></td> <td style="width: 10%;"></td> <td style="width: 10%;"></td> <td style="width: 10%;"></td> <td style="width: 10%;"></td> <td style="width: 10%;"></td> <td style="width: 10%;"></td> <td style="width: 10%;"></td> <td style="width: 10%;"></td> </tr> <tr> <td></td> <td></td> <td colspan="8" style="text-align: center;"> <table border="1" style="width: 100%; border-collapse: collapse; text-align: center;"> <tr> <td style="width: 10%;"></td> <td style="width: 10%;"></td> <td style="width: 10%;"></td> <td
style="width: 10%;"></td> <td style="width: 10%;"></td> <td style="width: 10%;"></td> <td style="width: 10%;"></td> <td style="width: 10%;"></td> <td style="width: 10%;"></td> <td style="width: 10%;"></td> </tr> <tr> <td></td> <td></td> <td colspan="8" style="text-align: center;"> <table border="1" style="width: 100%; border-collapse: collapse; text-align: center;"> <tr> <td style="width: 10%;"></td> <td style="width: 10%;"></td> <td style="width: 10%;"></td> <td style="width: 10%;"></td> <td style="width: 10%;"></td> <td style="width: 10%;"></td> <td style="width: 10%;"></td> <td style="width: 10%;"></td> <td style="width: 10%;"></td> <td style="width: 10%;"></td> </tr> <tr> <td></td> <td></td> <td colspan="8" style="text-align: center;"> <table border="1" style="width: 100%; border-collapse: collapse; text-align: center;"> <tr> <td style="width: 10%;"></td> <td style="width: 10%;"></td> <td style="width: 10%;"></td> <td style="width: 10%;"></td> <td style="width: 10%;"></td> <td style="width: 10%;"></td> <td style="width: 10%;"></td> <td style="width: 10%;"></td> <td style="width: 10%;"></td> <td style="width: 10%;"></td> </tr> <tr> <td></td> <td></td> <td colspan="8" style="text-align: center;"> <table border="1" style="width: 100%; border-collapse: collapse; text-align: center;"> <tr> <td style="width: 10%;"></td> <td style="width: 10%;"></td> <td style="width: 10%;"></td> <td style="width: 10%;"></td> <td style="width: 10%;"></td> <td style="width: 10%;"></td> <td style="width: 10%;"></td> <td style="width: 10%;"></td> <td style="width: 10%;"></td> <td style="width: 10%;"></td> </tr> <tr> <td></td> <td></td> <td colspan="8" style="text-align: center;"> <table border="1" style="width: 100%; border-collapse: collapse; text-align: center;"> <tr> <td style="width: 10%;"></td> <td style="width: 10%;"></td> <td style="width: 10%;"></td> <td style="width: 10%;"></td> <td style="width: 10%;"></td> <td style="width: 10%;"></td> <td style="width: 10%;"></td> <td style="width: 10%;"></td> <td style="width: 10%;"></td> <td style="width: 10%;"></td> </tr> <tr> <td></td> <td></td> <td colspan="8" style="text-align: center;"> <table border="1" style="width: 100%; border-collapse: collapse; text-align: center;"> <tr> <td style="width: 10%;"></td> <td style="width: 10%;"></td> <td style="width: 10%;"></td> <td style="width: 10%;"></td> <td style="width: 10%;"></td> <td style="width: 10%;"></td> <td style="width: 10%;"></td> <td style="width: 10%;"></td> <td style="width: 10%;"></td> <td style="width: 10%;"></td> </tr> <tr> <td></td> <td></td> <td colspan="8" style="text-align: center;"> <table border="1" style="width: 100%; border-collapse: collapse; text-align: center;"> <tr> <td style="width: 10%;"></td> <td style="width: 10%;"></td> <td style="width: 10%;"></td> <td style="width: 10%;"></td> <td style="width: 10%;"></td> <td style="width: 10%;"></td> <td style="width: 10%;"></td> <td style="width: 10%;"></td> <td style="width: 10%;"></td> <td style="width: 10%;"></td> </tr> <tr> <td></td> <td></td> <td colspan="8" style="text-align: center;"> <table border="1" style="width: 100%; border-collapse: collapse; text-align: center;"> <tr> <td style="width: 10%;"></td> <td style="width: 10%;"></td> <td style="width: 10%;"></td> <td style="width: 10%;"></td> <td style="width: 10%;"></td> <td style="width: 10%;"></td> <td style="width: 10%;"></td> <td style="width: 10%;"></td> <td style="width: 10%;"></td> <td style="width: 10%;"></td> </tr> <tr> <td></td> <td></td> <td colspan="8" style="text-align: center;"> <table border="1" style="width: 100%; border-collapse: collapse; text-align: center;"> <tr> <td style="width: 10%;"></td> <td style="width: 10%;"></td> <td style="width: 10%;"></td> <td style="width: 10%;"></td> <td style="width: 10%;"></td> <td style="width: 10%;"></td> <td style="width: 10%;"></td> <td style="width: 10%;"></td> <td style="width: 10%;"></td> <td style="width: 10%;"></td> </tr> <tr> <td></td> <td></td> <td colspan="8" style="text-align: center;"> <table border="1" style="width: 100%; border-collapse: collapse; text-align: center;"> <tr> <td style="width: 10%;"></td> <td style="width: 10%;"></td> <td style="width: 10%;"></td> <td style="width: 10%;"></td> <td style="width: 10%;"></td> <td style="width: 10%;"></td> <td style="width: 10%;"></td> <td style="width: 10%;"></td> <td style="width: 10%;"></td> <td style="width: 10%;"></td> </tr> <tr> <td></td> <td></td> <td colspan="8" style="text-align: center;"> <table border="1" style="width: 100%; border-collapse: collapse; text-align: center;"> <tr> <td style="width: 10%;"></td> <td style="width: 10%;"></td> <td style="width: 10%;"></td> <td style="width: 10%;"></td> <td style="width: 10%;"></td> <td style="width: 10%;"></td> <td style="width: 10%;"></td> <td style="width: 10%;"></td> <td style="width: 10%;"></td> <td style="width: 10%;"></td> </tr> <tr> <td></td> <td></td> <td colspan="8" style="text-align: center;"> <table border="1" style="width: 100%; border-collapse: collapse; text-align: center;"> <tr> <td style="width: 10%;"></td> <td style="width: 10%;"></td> <td style="width: 10%;"></td> <td style="width: 10%;"></td> <td style="width: 10%;"></td> <td style="width: 10%;"></td> <td style="width: 10%;"></td> <td style="width: 10%;"></td> <td style="width: 10%;"></td> <td style="width: 10%;"></td> </tr> <tr> <td></td> <td></td> <td colspan="8" style="text-align: center;"> <table border="1" style="width: 100%; border-collapse: collapse; text-align: center;"> <tr> <td style="width: 10%;"></td> <td style="width: 10%;"></td> <td style="width: 10%;"></td> <td style="width: 10%;"></td> <td style="width: 10%;"></td> <td style="width: 10%;"></td> <td style="width: 10%;"></td> <td style="width: 10%;"></td> <td style="width: 10%;"></td> <td style="width: 10%;"></td> </tr> <tr> <td></td> <td></td> <td colspan="8" style="text-align: center;"> <table border="1" style="width: 100%; border-collapse: collapse; text-align: center;"> <tr> <td style="width: 10%;"></td> <td style="width: 10%;"></td> <td style="width: 10%;"></td> <td style="width: 10%;"></td> <td style="width: 10%;"></td> <td style="width: 10%;"></td> <td style="width: 10%;"></td> <td style="width: 10%;"></td> <td style="width: 10%;"></td> <td style="width: 10%;"></td> </tr> <tr> <td></td> <td></td> <td colspan="8" style="text-align: center;"> <table border="1" style="width: 100%; border-collapse: collapse; text-align: center;"> <tr> <td style="width: 10%;"></td> <td style="width: 10%;"></td> <td style="width: 10%;"></td> <td style="width: 10%;"></td> <td style="width: 10%;"></td> <td style="width: 10%;"></td> <td style="width: 10%;"></td> <td style="width: 10%;"></td> <td style="width: 10%;"></td> <td style="width: 10%;"></td> </tr> <tr> <td></td> <td></td> <td colspan="8" style="text-align: center;"> <table border="1" style="width: 100%; border-collapse: collapse; text-align: center;"> <tr> <td style="width: 10%;"></td> <td style="width: 10%;"></td> <td style="width: 10%;"></td> <td style="width: 10%;"></td> <td style="width: 10%;"></td> <td style="width: 10%;"></td> <td style="width: 10%;"></td> <td style="width: 10%;"></td> <td style="width: 10%;"></td> <td style="width: 10%;"></td> </tr> <tr> <td></td> <td></td> <td colspan="8" style="text-align: center;"> <table border="1" style="width: 100%; border-collapse: collapse; text-align: center;"> <tr> <td style="width: 10%;"></td> <td style="width: 10%;"></td> <td style="width: 10%;"></td> <td style="width: 10%;"></td> <td style="width: 10%;"></td> <td style="width: 10%;"></td> <td style="width: 10%;"></td> <td style="width: 10%;"></td> <td style="width: 10%;"></td> <td style="width: 10%;"></td> </tr> <tr> <td></td> <td></td> <td colspan="8" style="text-align: center;"> <table border="1" style="width: 100%; border-collapse: collapse; text-align: center;"> <tr> <td style="width: 10%;"></td> <td style="width: 10%;"></td> <td style="width: 10%;"></td> <td style="width: 10%;"></td> <td style="width: 10%;"></td> <td style="width: 10%;"></td> <td style="width: 10%;"></td> <td style="width: 10%;"></td> <td style="width: 10%;"></td> <td style="width: 10%;"></td> </tr> <tr> <td></td> <td></td> <td colspan="8" style="text-align: center;"> <table border="1" style="width: 100%; border-collapse: collapse; text-align: center;"> <tr> <td style="width: 10%;"></td> <td style="width: 10%;"></td> <td style="width: 10%;"></td> <td style="width: 10%;"></td> <td style="width: 10%;"></td> <td style="width: 10%;"></td> <td style="width: 10%;"></td> <td style="width: 10%;"></td> <td style="width: 10%;"></td> <td style="width: 10%;"></td> </tr> <tr> <td></td> <td></td> <td colspan="8" style="text-align: center;"> <table border="1" style="width: 100%; border-collapse: collapse; text-align: center;"> <tr> <td style="width: 10%;"></td> <td style="width: 10%;"></td> <td style="width: 10%;"></td> <td style="width: 10%;"></td> <td style="width: 10%;"></td> <td style="width: 10%;"></td> <td style="width: 10%;"></td> <td style="width: 10%;"></td> <td style="width: 10%;"></td> <td style="width: 10%;"></td> </tr> <tr> <td></td> <td></td> <td colspan="8" style="text-align: center;"> <table border="1" style="width: 100%; border-collapse: collapse; text-align: center;"> <tr> <td style="width: 10%;"></td> <td style="width: 10%;"></td> <td style="width: 10%;"></td> <td style="width: 10%;"></td> <td style="width: 10%;"></td> <td style="width: 10%;"></td> <td style="width: 10%;"></td> <td style="width: 10%;"></td> <td style="width: 10%;"></td> <td style="width: 10%;"></td> </tr> <tr> <td></td> <td></td> <td colspan="8" style="text-align: center;"> <table border="1" style="width: 100%; border-collapse: collapse; text-align: center;"> <tr> <td style="width: 10%;"></td> <td style="width: 10%;"></td> <td style="width: 10%;"></td> <td style="width: 10%;"></td> <td style="width: 10%;"></td> <td style="width: 10%;"></td> <td style="width: 10%;"></td> <td style="width: 10%;"></td> <td style="width:
10%;"></td> <td style="width: 10%;"></td> </tr> <tr> <td></td> <td></td> <td colspan="8" style="text-align: center;"> <table border="1" style="width: 100%; border-collapse: collapse; text-align: center;"> <tr> <td style="width: 10%;"></td> <td style="width: 10%;"></td> <td style="width: 10%;"></td> <td style="width: 10%;"></td> <td style="width: 10%;"></td> <td style="width: 10%;"></td> <td style="width: 10%;"></td> <td style="width: 10%;"></td> <td style="width: 10%;"></td> <td style="width: 10%;"></td> </tr> <tr> <td></td> <td></td> <td colspan="8" style="text-align: center;"> <table border="1" style="width: 100%; border-collapse: collapse; text-align: center;"> <tr> <td style="width: 10%;"></td> <td style="width: 10%;"></td> <td style="width: 10%;"></td> <td style="width: 10%;"></td> <td style="width: 10%;"></td> <td style="width: 10%;"></td> <td style="width: 10%;"></td> <td style="width: 10%;"></td> <td style="width: 10%;"></td> <td style="width: 10%;"></td> </tr> <tr> <td></td> <td></td> <td colspan="8" style="text-align: center;"> <table border="1" style="width: 100%; border-collapse: collapse; text-align: center;"> <tr> <td style="width: 10%;"></td> <td style="width: 10%;"></td> <td style="width: 10%;"></td> <td style="width: 10%;"></td> <td style="width: 10%;"></td> <td style="width: 10%;"></td> <td style="width: 10%;"></td> <td style="width: 10%;"></td> <td style="width: 10%;"></td> <td style="width: 10%;"></td> </tr> <tr> <td></td> <td></td> <td colspan="8" style="text-align: center;"> <table border="1" style="width: 100%; border-collapse: collapse; text-align: center;"> <tr> <td style="width: 10%;"></td> <td style="width: 10%;"></td> <td style="width: 10%;"></td> <td style="width: 10%;"></td> <td style="width: 10%;"></td> <td style="width: 10%;"></td> <td style="width: 10%;"></td> <td style="width: 10%;"></td> <td style="width: 10%;"></td> <td style="width: 10%;"></td> </tr> <tr> <td></td> <td></td> <td colspan="8" style="text-align: center;"> <table border="1" style="width: 100%; border-collapse: collapse; text-align: center;"> <tr> <td style="width: 10%;"></td> <td style="width: 10%;"></td> <td style="width: 10%;"></td> <td style="width: 10%;"></td> <td style="width: 10%;"></td> <td style="width: 10%;"></td> <td style="width: 10%;"></td> <td style="width: 10%;"></td> <td style="width: 10%;"></td> <td style="width: 10%;"></td> </tr> <tr> <td></td> <td></td> <td colspan="8" style="text-align: center;"> <table border="1" style="width: 100%; border-collapse: collapse; text-align: center;"> <tr> </tr></table></td></tr></table></td></tr></table></td></tr></table></td></tr></table></td></tr></table></td></tr></table></td></tr></table></td></tr></table></td></tr></table></td></tr></table></td></tr></table></td></tr></table></td></tr></table></td></tr></table></td></tr></table></td></tr></table></td></tr></table></td></tr></table></td></tr></table></td></tr></table></td></tr></table></td></tr></table></td></tr></table></td></tr></table></td></tr></table></td></tr></table></td></tr></table></td></tr></table></td></tr></table></td></tr></table></td></tr></table></td></tr></table></td></tr></table></td></tr></table></td></tr></table></td></tr></table></td></tr></table></td></tr></table></td></tr></table></td></tr></table> | | | | | | | | | | | | | | | | | | | | <table border="1" style="width: 100%; border-collapse: collapse; text-align: center;"> <tr> <td style="width: 10%;"></td> <td style="width: 10%;"></td> <td style="width: 10%;"></td> <td style="width: 10%;"></td> <td style="width: 10%;"></td> <td style="width: 10%;"></td> <td style="width: 10%;"></td> <td style="width: 10%;"></td> <td style="width: 10%;"></td> <td style="width: 10%;"></td> </tr> <tr> <td></td> <td></td> <td colspan="8" style="text-align: center;"> <table border="1" style="width: 100%; border-collapse: collapse; text-align: center;"> <tr> <td style="width: 10%;"></td> <td style="width: 10%;"></td> <td style="width: 10%;"></td> <td style="width: 10%;"></td> <td style="width: 10%;"></td> <td style="width: 10%;"></td> <td style="width: 10%;"></td> <td style="width: 10%;"></td> <td style="width: 10%;"></td> <td style="width: 10%;"></td> </tr> <tr> <td></td> <td></td> <td colspan="8" style="text-align: center;"> <table border="1" style="width: 100%; border-collapse: collapse; text-align: center;"> <tr> <td style="width: 10%;"></td> <td style="width: 10%;"></td> <td style="width: 10%;"></td> <td style="width: 10%;"></td> <td style="width: 10%;"></td> <td style="width: 10%;"></td> <td style="width: 10%;"></td> <td style="width: 10%;"></td> <td style="width: 10%;"></td> <td style="width: 10%;"></td> </tr> <tr> <td></td> <td></td> <td colspan="8" style="text-align: center;"> <table border="1" style="width: 100%; border-collapse: collapse; text-align: center;"> <tr> <td style="width: 10%;"></td> <td style="width: 10%;"></td> <td style="width: 10%;"></td> <td style="width: 10%;"></td> <td style="width: 10%;"></td> <td style="width: 10%;"></td> <td style="width: 10%;"></td> <td style="width: 10%;"></td> <td style="width: 10%;"></td> <td style="width: 10%;"></td>
</tr> <tr> <td></td> <td></td> <td colspan="8" style="text-align: center;"> <table border="1" style="width: 100%; border-collapse: collapse; text-align: center;"> <tr> <td style="width: 10%;"></td> <td style="width: 10%;"></td> <td style="width: 10%;"></td> <td style="width: 10%;"></td> <td style="width: 10%;"></td> <td style="width: 10%;"></td> <td style="width: 10%;"></td> <td style="width: 10%;"></td> <td style="width: 10%;"></td> <td style="width: 10%;"></td> </tr> <tr> <td></td> <td></td> <td colspan="8" style="text-align: center;"> <table border="1" style="width: 100%; border-collapse: collapse; text-align: center;"> <tr> <td style="width: 10%;"></td> <td style="width: 10%;"></td> <td style="width: 10%;"></td> <td style="width: 10%;"></td> <td style="width: 10%;"></td> <td style="width: 10%;"></td> <td style="width: 10%;"></td> <td style="width: 10%;"></td> <td style="width: 10%;"></td> <td style="width: 10%;"></td> </tr> <tr> <td></td> <td></td> <td colspan="8" style="text-align: center;"> <table border="1" style="width: 100%; border-collapse: collapse; text-align: center;"> <tr> <td style="width: 10%;"></td> <td style="width: 10%;"></td> <td style="width: 10%;"></td> <td style="width: 10%;"></td> <td style="width: 10%;"></td> <td style="width: 10%;"></td> <td style="width: 10%;"></td> <td style="width: 10%;"></td> <td style="width: 10%;"></td> <td style="width: 10%;"></td> </tr> <tr> <td></td> <td></td> <td colspan="8" style="text-align: center;"> <table border="1" style="width: 100%; border-collapse: collapse; text-align: center;"> <tr> <td style="width: 10%;"></td> <td style="width: 10%;"></td> <td style="width: 10%;"></td> <td style="width: 10%;"></td> <td style="width: 10%;"></td> <td style="width: 10%;"></td> <td style="width: 10%;"></td> <td style="width: 10%;"></td> <td style="width: 10%;"></td> <td style="width: 10%;"></td> </tr> <tr> <td></td> <td></td> <td colspan="8" style="text-align: center;"> <table border="1" style="width: 100%; border-collapse: collapse; text-align: center;"> <tr> <td style="width: 10%;"></td> <td style="width: 10%;"></td> <td style="width: 10%;"></td> <td style="width: 10%;"></td> <td style="width: 10%;"></td> <td style="width: 10%;"></td> <td style="width: 10%;"></td> <td style="width: 10%;"></td> <td style="width: 10%;"></td> <td style="width: 10%;"></td> </tr> <tr> <td></td> <td></td> <td colspan="8" style="text-align: center;"> <table border="1" style="width: 100%; border-collapse: collapse; text-align: center;"> <tr> <td style="width: 10%;"></td> <td style="width: 10%;"></td> <td style="width: 10%;"></td> <td style="width: 10%;"></td> <td style="width: 10%;"></td> <td style="width: 10%;"></td> <td style="width: 10%;"></td> <td style="width: 10%;"></td> <td style="width: 10%;"></td> <td style="width: 10%;"></td> </tr> <tr> <td></td> <td></td> <td colspan="8" style="text-align: center;"> <table border="1" style="width: 100%; border-collapse: collapse; text-align: center;"> <tr> <td style="width: 10%;"></td> <td style="width: 10%;"></td> <td style="width: 10%;"></td> <td style="width: 10%;"></td> <td style="width: 10%;"></td> <td style="width: 10%;"></td> <td style="width: 10%;"></td> <td style="width: 10%;"></td> <td style="width: 10%;"></td> <td style="width: 10%;"></td> </tr> <tr> <td></td> <td></td> <td colspan="8" style="text-align: center;"> <table border="1" style="width: 100%; border-collapse: collapse; text-align: center;"> <tr> <td style="width: 10%;"></td> <td style="width: 10%;"></td> <td style="width: 10%;"></td> <td style="width: 10%;"></td> <td style="width: 10%;"></td> <td style="width: 10%;"></td> <td style="width: 10%;"></td> <td style="width: 10%;"></td> <td style="width: 10%;"></td> <td style="width: 10%;"></td> </tr> <tr> <td></td> <td></td> <td colspan="8" style="text-align: center;"> <table border="1" style="width: 100%; border-collapse: collapse; text-align: center;"> <tr> <td style="width: 10%;"></td> <td style="width: 10%;"></td> <td style="width: 10%;"></td> <td style="width: 10%;"></td> <td style="width: 10%;"></td> <td style="width: 10%;"></td> <td style="width: 10%;"></td> <td style="width: 10%;"></td> <td style="width: 10%;"></td> <td style="width: 10%;"></td> </tr> <tr> <td></td> <td></td> <td colspan="8" style="text-align: center;"> <table border="1" style="width: 100%; border-collapse: collapse; text-align: center;"> <tr> <td style="width: 10%;"></td> <td style="width: 10%;"></td> <td style="width: 10%;"></td> <td style="width: 10%;"></td> <td style="width: 10%;"></td> <td style="width: 10%;"></td> <td style="width: 10%;"></td> <td style="width: 10%;"></td> <td style="width: 10%;"></td> <td style="width: 10%;"></td> </tr> <tr> <td></td> <td></td> <td colspan="8" style="text-align: center;"> <table border="1" style="width: 100%; border-collapse: collapse; text-align: center;"> <tr> <td style="width: 10%;"></td> <td style="width: 10%;"></td> <td style="width: 10%;"></td> <td style="width: 10%;"></td> <td style="width: 10%;"></td> <td style="width: 10%;"></td> <td style="width: 10%;"></td> <td style="width: 10%;"></td> <td style="width: 10%;"></td> <td style="width: 10%;"></td> </tr> <tr> <td></td> <td></td> <td colspan="8" style="text-align: center;"> <table border="1" style="width: 100%; border-collapse: collapse; text-align: center;"> <tr> <td style="width: 10%;"></td> <td style="width: 10%;"></td> <td style="width: 10%;"></td> <td style="width: 10%;"></td> <td style="width: 10%;"></td> <td style="width: 10%;"></td> <td style="width: 10%;"></td> <td style="width: 10%;"></td> <td style="width: 10%;"></td> <td style="width: 10%;"></td> </tr> <tr> <td></td> <td></td> <td colspan="8" style="text-align: center;"> <table border="1" style="width: 100%; border-collapse: collapse; text-align: center;"> <tr> <td style="width: 10%;"></td> <td style="width: 10%;"></td> <td style="width: 10%;"></td> <td style="width: 10%;"></td> <td style="width: 10%;"></td> <td style="width: 10%;"></td> <td style="width: 10%;"></td> <td style="width: 10%;"></td> <td style="width: 10%;"></td> <td style="width: 10%;"></td> </tr> <tr> <td></td> <td></td> <td colspan="8" style="text-align: center;"> <table border="1" style="width: 100%; border-collapse: collapse; text-align: center;"> <tr> <td style="width: 10%;"></td> <td style="width: 10%;"></td> <td style="width: 10%;"></td> <td style="width: 10%;"></td> <td style="width: 10%;"></td> <td style="width: 10%;"></td> <td style="width: 10%;"></td> <td style="width: 10%;"></td> <td style="width: 10%;"></td> <td style="width: 10%;"></td> </tr> <tr> <td></td> <td></td> <td colspan="8" style="text-align: center;"> <table border="1" style="width: 100%; border-collapse: collapse; text-align: center;"> <tr> <td style="width: 10%;"></td> <td style="width: 10%;"></td> <td style="width: 10%;"></td> <td style="width: 10%;"></td> <td style="width: 10%;"></td> <td style="width: 10%;"></td> <td style="width: 10%;"></td> <td style="width: 10%;"></td> <td style="width: 10%;"></td> <td style="width: 10%;"></td> </tr> <tr> <td></td> <td></td> <td colspan="8" style="text-align: center;"> <table border="1" style="width: 100%; border-collapse: collapse; text-align: center;"> <tr> <td style="width: 10%;"></td> <td style="width: 10%;"></td> <td style="width: 10%;"></td> <td style="width: 10%;"></td> <td style="width: 10%;"></td> <td style="width: 10%;"></td> <td style="width: 10%;"></td> <td style="width: 10%;"></td> <td style="width: 10%;"></td> <td style="width: 10%;"></td> </tr> <tr> <td></td> <td></td> <td colspan="8" style="text-align: center;"> <table border="1" style="width: 100%; border-collapse: collapse; text-align: center;"> <tr> <td style="width: 10%;"></td> <td style="width: 10%;"></td> <td style="width: 10%;"></td> <td style="width: 10%;"></td> <td style="width: 10%;"></td> <td style="width: 10%;"></td> <td style="width: 10%;"></td> <td style="width: 10%;"></td> <td style="width: 10%;"></td> <td style="width: 10%;"></td> </tr> <tr> <td></td> <td></td> <td colspan="8" style="text-align: center;"> <table border="1" style="width: 100%; border-collapse: collapse; text-align: center;"> <tr> <td style="width: 10%;"></td> <td style="width: 10%;"></td> <td style="width: 10%;"></td> <td style="width: 10%;"></td> <td style="width: 10%;"></td> <td style="width: 10%;"></td> <td style="width: 10%;"></td> <td style="width: 10%;"></td> <td style="width: 10%;"></td> <td style="width: 10%;"></td> </tr> <tr> <td></td> <td></td> <td colspan="8" style="text-align: center;"> <table border="1" style="width: 100%; border-collapse: collapse; text-align: center;"> <tr> <td style="width: 10%;"></td> <td style="width: 10%;"></td> <td style="width: 10%;"></td> <td style="width: 10%;"></td> <td style="width: 10%;"></td> <td style="width: 10%;"></td> <td style="width: 10%;"></td> <td style="width: 10%;"></td> <td style="width: 10%;"></td> <td style="width: 10%;"></td> </tr> <tr> <td></td> <td></td> <td colspan="8" style="text-align: center;"> <table border="1" style="width: 100%; border-collapse: collapse; text-align: center;"> <tr> <td style="width: 10%;"></td> <td style="width: 10%;"></td> <td style="width: 10%;"></td> <td style="width: 10%;"></td> <td style="width: 10%;"></td> <td style="width: 10%;"></td> <td style="width: 10%;"></td> <td style="width: 10%;"></td> <td style="width: 10%;"></td> <td style="width: 10%;"></td> </tr> <tr> <td></td> <td></td> <td colspan="8" style="text-align: center;"> <table border="1" style="width: 100%; border-collapse: collapse; text-align: center;"> <tr> <td style="width: 10%;"></td> <td style="width: 10%;"></td> <td style="width: 10%;"></td> <td style="width: 10%;"></td> <td style="width: 10%;"></td> <td style="width: 10%;"></td> <td style="width: 10%;"></td> <td style="width: 10%;"></td> <td style="width: 10%;"></td> <td style="width: 10%;"></td> </tr> <tr> <td></td> <td></td> <td colspan="8" style="text-align: center;"> <table border="1" style="width: 100%; border-collapse: collapse; text-align: center;"> <tr> <td
style="width: 10%;"></td> <td style="width: 10%;"></td> <td style="width: 10%;"></td> <td style="width: 10%;"></td> <td style="width: 10%;"></td> <td style="width: 10%;"></td> <td style="width: 10%;"></td> <td style="width: 10%;"></td> <td style="width: 10%;"></td> <td style="width: 10%;"></td> </tr> <tr> <td></td> <td></td> <td colspan="8" style="text-align: center;"> <table border="1" style="width: 100%; border-collapse: collapse; text-align: center;"> <tr> <td style="width: 10%;"></td> <td style="width: 10%;"></td> <td style="width: 10%;"></td> <td style="width: 10%;"></td> <td style="width: 10%;"></td> <td style="width: 10%;"></td> <td style="width: 10%;"></td> <td style="width: 10%;"></td> <td style="width: 10%;"></td> <td style="width: 10%;"></td> </tr> <tr> <td></td> <td></td> <td colspan="8" style="text-align: center;"> <table border="1" style="width: 100%; border-collapse: collapse; text-align: center;"> <tr> <td style="width: 10%;"></td> <td style="width: 10%;"></td> <td style="width: 10%;"></td> <td style="width: 10%;"></td> <td style="width: 10%;"></td> <td style="width: 10%;"></td> <td style="width: 10%;"></td> <td style="width: 10%;"></td> <td style="width: 10%;"></td> <td style="width: 10%;"></td> </tr> <tr> <td></td> <td></td> <td colspan="8" style="text-align: center;"> <table border="1" style="width: 100%; border-collapse: collapse; text-align: center;"> <tr> <td style="width: 10%;"></td> <td style="width: 10%;"></td> <td style="width: 10%;"></td> <td style="width: 10%;"></td> <td style="width: 10%;"></td> <td style="width: 10%;"></td> <td style="width: 10%;"></td> <td style="width: 10%;"></td> <td style="width: 10%;"></td> <td style="width: 10%;"></td> </tr> <tr> <td></td> <td></td> <td colspan="8" style="text-align: center;"> <table border="1" style="width: 100%; border-collapse: collapse; text-align: center;"> <tr> <td style="width: 10%;"></td> <td style="width: 10%;"></td> <td style="width: 10%;"></td> <td style="width: 10%;"></td> <td style="width: 10%;"></td> <td style="width: 10%;"></td> <td style="width: 10%;"></td> <td style="width: 10%;"></td> <td style="width: 10%;"></td> <td style="width: 10%;"></td> </tr> <tr> <td></td> <td></td> <td colspan="8" style="text-align: center;"> <table border="1" style="width: 100%; border-collapse: collapse; text-align: center;"> <tr> <td style="width: 10%;"></td> <td style="width: 10%;"></td> <td style="width: 10%;"></td> <td style="width: 10%;"></td> <td style="width: 10%;"></td> <td style="width: 10%;"></td> <td style="width: 10%;"></td> <td style="width: 10%;"></td> <td style="width: 10%;"></td> <td style="width: 10%;"></td> </tr> <tr> <td></td> <td></td> <td colspan="8" style="text-align: center;"> <table border="1" style="width: 100%; border-collapse: collapse; text-align: center;"> <tr> <td style="width: 10%;"></td> <td style="width: 10%;"></td> <td style="width: 10%;"></td> <td style="width: 10%;"></td> <td style="width: 10%;"></td> <td style="width: 10%;"></td> <td style="width: 10%;"></td> <td style="width: 10%;"></td> <td style="width: 10%;"></td> <td style="width: 10%;"></td> </tr> <tr> <td></td> <td></td> <td colspan="8" style="text-align: center;"> <table border="1" style="width: 100%; border-collapse: collapse; text-align: center;"> <tr> <td style="width: 10%;"></td> <td style="width: 10%;"></td> <td style="width: 10%;"></td> <td style="width: 10%;"></td> <td style="width: 10%;"></td> <td style="width: 10%;"></td> <td style="width: 10%;"></td> <td style="width: 10%;"></td> <td style="width: 10%;"></td> <td style="width: 10%;"></td> </tr> <tr> <td></td> <td></td> <td colspan="8" style="text-align: center;"> <table border="1" style="width: 100%; border-collapse: collapse; text-align: center;"> <tr> <td style="width: 10%;"></td> <td style="width: 10%;"></td> <td style="width: 10%;"></td> <td style="width: 10%;"></td> <td style="width: 10%;"></td> <td style="width: 10%;"></td> <td style="width: 10%;"></td> <td style="width: 10%;"></td> <td style="width: 10%;"></td> <td style="width: 10%;"></td> </tr> <tr> <td></td> <td></td> <td colspan="8" style="text-align: center;"> <table border="1" style="width: 100%; border-collapse: collapse; text-align: center;"> <tr> <td style="width: 10%;"></td> <td style="width: 10%;"></td> <td style="width: 10%;"></td> <td style="width: 10%;"></td> <td style="width: 10%;"></td> <td style="width: 10%;"></td> <td style="width: 10%;"></td> <td style="width: 10%;"></td> <td style="width: 10%;"></td> <td style="width: 10%;"></td> </tr> <tr> <td></td> <td></td> <td colspan="8" style="text-align: center;"> <table border="1" style="width: 100%; border-collapse: collapse; text-align: center;"> <tr> <td style="width: 10%;"></td> <td style="width: 10%;"></td> <td style="width: 10%;"></td> <td style="width: 10%;"></td> <td style="width: 10%;"></td> <td style="width: 10%;"></td> <td style="width: 10%;"></td> <td style="width: 10%;"></td> <td style="width: 10%;"></td> <td style="width: 10%;"></td> </tr> <tr> <td></td> <td></td> <td colspan="8" style="text-align: center;"> <table border="1" style="width: 100%; border-collapse: collapse; text-align: center;"> <tr> <td style="width: 10%;"></td> <td style="width: 10%;"></td> <td style="width: 10%;"></td> <td style="width: 10%;"></td> <td style="width: 10%;"></td> <td style="width: 10%;"></td> <td style="width: 10%;"></td> <td style="width: 10%;"></td> <td style="width: 10%;"></td> <td style="width: 10%;"></td> </tr> <tr> <td></td> <td></td> <td colspan="8" style="text-align: center;"> <table border="1" style="width: 100%; border-collapse: collapse; text-align: center;"> <tr> <td style="width: 10%;"></td> <td style="width: 10%;"></td> <td style="width: 10%;"></td> <td style="width: 10%;"></td> <td style="width: 10%;"></td> <td style="width: 10%;"></td> <td style="width: 10%;"></td> <td style="width: 10%;"></td> <td style="width: 10%;"></td> <td style="width: 10%;"></td> </tr> <tr> <td></td> <td></td> <td colspan="8" style="text-align: center;"> <table border="1" style="width: 100%; border-collapse: collapse; text-align: center;"> <tr> <td style="width: 10%;"></td> <td style="width: 10%;"></td> <td style="width: 10%;"></td> <td style="width: 10%;"></td> <td style="width: 10%;"></td> <td style="width: 10%;"></td> <td style="width: 10%;"></td> <td style="width: 10%;"></td> <td style="width: 10%;"></td> <td style="width: 10%;"></td> </tr> <tr> <td></td> <td></td> <td colspan="8" style="text-align: center;"> <table border="1" style="width: 100%; border-collapse: collapse; text-align: center;"> <tr> </tr></table></td></tr></table></td></tr></table></td></tr></table></td></tr></table></td></tr></table></td></tr></table></td></tr></table></td></tr></table></td></tr></table></td></tr></table></td></tr></table></td></tr></table></td></tr></table></td></tr></table></td></tr></table></td></tr></table></td></tr></table></td></tr></table></td></tr></table></td></tr></table></td></tr></table></td></tr></table></td></tr></table></td></tr></table></td></tr></table></td></tr></table></td></tr></table></td></tr></table></td></tr></table></td></tr></table></td></tr></table></td></tr></table></td></tr></table></td></tr></table></td></tr></table></td></tr></table></td></tr></table></td></tr></table></td></tr></table>
 | | | | | | | | | | | | | | | | | | | | <table border="1" style="width: 100%; border-collapse: collapse; text-align: center;"> <tr> <td style="width: 10%;"></td> <td style="width: 10%;"></td> <td style="width: 10%;"></td> <td style="width: 10%;"></td> <td style="width: 10%;"></td> <td style="width: 10%;"></td> <td style="width: 10%;"></td> <td style="width: 10%;"></td> <td style="width: 10%;"></td> <td style="width: 10%;"></td> </tr> <tr> <td></td> <td></td> <td colspan="8" style="text-align: center;"> <table border="1" style="width: 100%; border-collapse: collapse; text-align: center;"> <tr> <td style="width: 10%;"></td> <td style="width: 10%;"></td> <td style="width: 10%;"></td> <td style="width: 10%;"></td> <td style="width: 10%;"></td> <td style="width: 10%;"></td> <td style="width: 10%;"></td> <td style="width: 10%;"></td> <td style="width: 10%;"></td> <td style="width: 10%;"></td> </tr> <tr> <td></td> <td></td> <td colspan="8" style="text-align: center;"> <table border="1" style="width: 100%; border-collapse: collapse; text-align: center;"> <tr> <td style="width: 10%;"></td> <td style="width: 10%;"></td> <td style="width: 10%;"></td> <td style="width: 10%;"></td> <td style="width: 10%;"></td> <td style="width: 10%;"></td> <td style="width: 10%;"></td> <td style="width: 10%;"></td> <td style="width: 10%;"></td> <td style="width: 10%;"></td> </tr> <tr> <td></td> <td></td> <td colspan="8" style="text-align: center;"> <table border="1" style="width: 100%; border-collapse: collapse; text-align: center;"> <tr> <td style="width: 10%;"></td> <td style="width: 10%;"></td> <td style="width: 10%;"></td> <td style="width: 10%;"></td> <td style="width: 10%;"></td> <td style="width: 10%;"></td> <td style="width: 10%;"></td> <td style="width: 10%;"></td> <td style="width: 10%;"></td> <td style="width: 10%;"></td> </tr> <tr> <td></td> <td></td> <td colspan="8" style="text-align: center;"> <table border="1" style="width: 100%; border-collapse: collapse; text-align: center;"> <tr> <td style="width: 10%;"></td> <td style="width: 10%;"></td> <td style="width: 10%;"></td> <td style="width: 10%;"></td> <td style="width: 10%;"></td> <td style="width: 10%;"></td> <td style="width: 10%;"></td> <td style="width: 10%;"></td> <td style="width: 10%;"></td> <td style="width: 10%;"></td> </tr> <tr> <td></td> <td></td> <td colspan="8" style="text-align: center;"> <table border="1" style="width: 100%; border-collapse: collapse; text-align: center;"> <tr> <td style="width: 10%;"></td> <td style="width: 10%;"></td> <td style="width: 10%;"></td> <td style="width: 10%;"></td> <td style="width: 10%;"></td> <td style="width: 10%;"></td> <td style="width: 10%;"></td> <td style="width: 10%;"></td> <td style="width: 10%;"></td> <td style="width: 10%;"></td> </tr> <tr> <td></td> <td></td> <td colspan="8" style="text-align: center;"> <table border="1" style="width: 100%; border-collapse: collapse; text-align: center;"> <tr> <td style="width: 10%;"></td> <td style="width: 10%;"></td> <td style="width: 10%;"></td> <td style="width: 10%;"></td> <td style="width: 10%;"></td> <td style="width: 10%;"></td> <td style="width: 10%;"></td> <td style="width: 10%;"></td> <td style="width: 10%;"></td> <td style="width: 10%;"></td> </tr> <tr> <td></td> <td></td> <td colspan="8" style="text-align: center;"> <table border="1" style="width: 100%; border-collapse: collapse; text-align: center;"> <tr> <td style="width: 10%;"></td> <td style="width: 10%;"></td> <td style="width: 10%;"></td> <td style="width: 10%;"></td> <td style="width: 10%;"></td> <td style="width: 10%;"></td> <td style="width: 10%;"></td> <td style="width: 10%;"></td> <td style="width: 10%;"></td> <td style="width: 10%;"></td> </tr> <tr> <td></td> <td></td> <td colspan="8" style="text-align: center;"> <table border="1" style="width: 100%; border-collapse: collapse; text-align: center;"> <tr> <td style="width: 10%;"></td> <td style="width: 10%;"></td> <td style="width: 10%;"></td> <td style="width: 10%;"></td> <td style="width: 10%;"></td> <td style="width: 10%;"></td> <td style="width: 10%;"></td> <td style="width: 10%;"></td> <td style="width: 10%;"></td> <td style="width: 10%;"></td> </tr> <tr> <td></td> <td></td> <td colspan="8" style="text-align: center;"> <table border="1" style="width: 100%; border-collapse: collapse; text-align: center;"> <tr> <td style="width: 10%;"></td> <td style="width: 10%;"></td> <td style="width: 10%;"></td> <td style="width: 10%;"></td> <td style="width: 10%;"></td> <td style="width: 10%;"></td> <td style="width: 10%;"></td> <td style="width: 10%;"></td> <td style="width: 10%;"></td> <td style="width: 10%;"></td> </tr> <tr> <td></td> <td></td> <td colspan="8" style="text-align: center;"> <table border="1" style="width: 100%; border-collapse: collapse; text-align: center;"> <tr> <td style="width: 10%;"></td> <td style="width: 10%;"></td> <td style="width: 10%;"></td> <td style="width: 10%;"></td> <td style="width: 10%;"></td> <td style="width: 10%;"></td> <td style="width: 10%;"></td> <td style="width: 10%;"></td> <td style="width: 10%;"></td> <td style="width: 10%;"></td> </tr> <tr> <td></td> <td></td> <td colspan="8" style="text-align: center;"> <table border="1" style="width: 100%; border-collapse: collapse; text-align: center;"> <tr> <td style="width: 10%;"></td> <td style="width: 10%;"></td> <td style="width: 10%;"></td> <td style="width: 10%;"></td> <td style="width: 10%;"></td> <td style="width: 10%;"></td> <td style="width: 10%;"></td> <td style="width: 10%;"></td> <td style="width: 10%;"></td> <td style="width: 10%;"></td> </tr> <tr> <td></td> <td></td> <td colspan="8" style="text-align: center;"> <table border="1" style="width: 100%; border-collapse: collapse; text-align: center;"> <tr> <td style="width: 10%;"></td> <td style="width: 10%;"></td> <td style="width: 10%;"></td> <td style="width: 10%;"></td> <td style="width: 10%;"></td> <td style="width: 10%;"></td> <td style="width: 10%;"></td> <td style="width: 10%;"></td> <td style="width: 10%;"></td> <td style="width: 10%;"></td> </tr> <tr> <td></td> <td></td> <td colspan="8" style="text-align: center;"> <table border="1" style="width: 100%; border-collapse: collapse; text-align: center;"> <tr> <td style="width: 10%;"></td> <td style="width: 10%;"></td> <td style="width: 10%;"></td> <td style="width: 10%;"></td> <td style="width: 10%;"></td> <td style="width: 10%;"></td> <td style="width: 10%;"></td> <td style="width: 10%;"></td> <td style="width: 10%;"></td> <td style="width: 10%;"></td> </tr> <tr> <td></td> <td></td> <td colspan="8" style="text-align: center;"> <table border="1" style="width: 100%; border-collapse: collapse; text-align: center;"> <tr> <td style="width: 10%;"></td> <td style="width: 10%;"></td> <td style="width: 10%;"></td> <td style="width: 10%;"></td> <td style="width: 10%;"></td> <td style="width: 10%;"></td> <td style="width: 10%;"></td> <td style="width: 10%;"></td> <td style="width: 10%;"></td> <td style="width: 10%;"></td> </tr> <tr> <td></td> <td></td> <td colspan="8" style="text-align: center;"> <table border="1" style="width: 100%; border-collapse: collapse; text-align: center;"> <tr> <td style="width: 10%;"></td> <td style="width: 10%;"></td> <td style="width: 10%;"></td> <td style="width: 10%;"></td> <td style="width: 10%;"></td> <td style="width: 10%;"></td> <td style="width: 10%;"></td> <td style="width: 10%;"></td> <td style="width: 10%;"></td> <td style="width: 10%;"></td> </tr> <tr> <td></td> <td></td> <td colspan="8" style="text-align: center;"> <table border="1" style="width: 100%; border-collapse: collapse; text-align: center;"> <tr> <td style="width: 10%;"></td> <td style="width: 10%;"></td> <td style="width: 10%;"></td> <td style="width: 10%;"></td> <td style="width: 10%;"></td> <td style="width: 10%;"></td> <td style="width: 10%;"></td> <td style="width:
10%;"></td> <td style="width: 10%;"></td> <td style="width: 10%;"></td> </tr> <tr> <td></td> <td></td> <td colspan="8" style="text-align: center;"> <table border="1" style="width: 100%; border-collapse: collapse; text-align: center;"> <tr> <td style="width: 10%;"></td> <td style="width: 10%;"></td> <td style="width: 10%;"></td> <td style="width: 10%;"></td> <td style="width: 10%;"></td> <td style="width: 10%;"></td> <td style="width: 10%;"></td> <td style="width: 10%;"></td> <td style="width: 10%;"></td> <td style="width: 10%;"></td> </tr> <tr> <td></td> <td></td> <td colspan="8" style="text-align: center;"> <table border="1" style="width: 100%; border-collapse: collapse; text-align: center;"> <tr> <td style="width: 10%;"></td> <td style="width: 10%;"></td> <td style="width: 10%;"></td> <td style="width: 10%;"></td> <td style="width: 10%;"></td> <td style="width: 10%;"></td> <td style="width: 10%;"></td> <td style="width: 10%;"></td> <td style="width: 10%;"></td> <td style="width: 10%;"></td> </tr> <tr> <td></td> <td></td> <td colspan="8" style="text-align: center;"> <table border="1" style="width: 100%; border-collapse: collapse; text-align: center;"> <tr> <td style="width: 10%;"></td> <td style="width: 10%;"></td> <td style="width: 10%;"></td> <td style="width: 10%;"></td> <td style="width: 10%;"></td> <td style="width: 10%;"></td> <td style="width: 10%;"></td> <td style="width: 10%;"></td> <td style="width: 10%;"></td> <td style="width: 10%;"></td> </tr> <tr> <td></td> <td></td> <td colspan="8" style="text-align: center;"> <table border="1" style="width: 100%; border-collapse: collapse; text-align: center;"> <tr> <td style="width: 10%;"></td> <td style="width: 10%;"></td> <td style="width: 10%;"></td> <td style="width: 10%;"></td> <td style="width: 10%;"></td> <td style="width: 10%;"></td> <td style="width: 10%;"></td> <td style="width: 10%;"></td> <td style="width: 10%;"></td> <td style="width: 10%;"></td> </tr> <tr> <td></td> <td></td> <td colspan="8" style="text-align: center;"> <table border="1" style="width: 100%; border-collapse: collapse; text-align: center;"> <tr> <td style="width: 10%;"></td> <td style="width: 10%;"></td> <td style="width: 10%;"></td> <td style="width: 10%;"></td> <td style="width: 10%;"></td> <td style="width: 10%;"></td> <td style="width: 10%;"></td> <td style="width: 10%;"></td> <td style="width: 10%;"></td> <td style="width: 10%;"></td> </tr> <tr> <td></td> <td></td> <td colspan="8" style="text-align: center;"> <table border="1" style="width: 100%; border-collapse: collapse; text-align: center;"> <tr> <td style="width: 10%;"></td> <td style="width: 10%;"></td> <td style="width: 10%;"></td> <td style="width: 10%;"></td> <td style="width: 10%;"></td> <td style="width: 10%;"></td> <td style="width: 10%;"></td> <td style="width: 10%;"></td> <td style="width: 10%;"></td> <td style="width: 10%;"></td> </tr> <tr> <td></td> <td></td> <td colspan="8" style="text-align: center;"> <table border="1" style="width: 100%; border-collapse: collapse; text-align: center;"> <tr> <td style="width: 10%;"></td> <td style="width: 10%;"></td> <td style="width: 10%;"></td> <td style="width: 10%;"></td> <td style="width: 10%;"></td> <td style="width: 10%;"></td> <td style="width: 10%;"></td> <td style="width: 10%;"></td> <td style="width: 10%;"></td> <td style="width: 10%;"></td> </tr> <tr> <td></td> <td></td> <td colspan="8" style="text-align: center;"> <table border="1" style="width: 100%; border-collapse: collapse; text-align: center;"> <tr> <td style="width: 10%;"></td> <td style="width: 10%;"></td> <td style="width: 10%;"></td> <td style="width: 10%;"></td> <td style="width: 10%;"></td> <td style="width: 10%;"></td> <td style="width: 10%;"></td> <td style="width: 10%;"></td> <td style="width: 10%;"></td> <td style="width: 10%;"></td> </tr> <tr> <td></td> <td></td> <td colspan="8" style="text-align: center;"> <table border="1" style="width: 100%; border-collapse: collapse; text-align: center;"> <tr> <td style="width: 10%;"></td> <td style="width: 10%;"></td> <td style="width: 10%;"></td> <td style="width: 10%;"></td> <td style="width: 10%;"></td> <td style="width: 10%;"></td> <td style="width: 10%;"></td> <td style="width: 10%;"></td> <td style="width: 10%;"></td> <td style="width: 10%;"></td> </tr> <tr> <td></td> <td></td> <td colspan="8" style="text-align: center;"> <table border="1" style="width: 100%; border-collapse: collapse; text-align: center;"> <tr> <td style="width: 10%;"></td> <td style="width: 10%;"></td> <td style="width: 10%;"></td> <td style="width: 10%;"></td> <td style="width: 10%;"></td> <td style="width: 10%;"></td> <td style="width: 10%;"></td> <td style="width: 10%;"></td> <td style="width: 10%;"></td> <td style="width: 10%;"></td> </tr> <tr> <td></td> <td></td> <td colspan="8" style="text-align: center;"> <table border="1" style="width: 100%; border-collapse: collapse; text-align: center;"> <tr> <td style="width: 10%;"></td> <td style="width: 10%;"></td> <td style="width: 10%;"></td> <td style="width: 10%;"></td> <td style="width: 10%;"></td> <td style="width: 10%;"></td> <td style="width: 10%;"></td> <td style="width: 10%;"></td> <td style="width: 10%;"></td> <td style="width: 10%;"></td> </tr> <tr> <td></td> <td></td> <td colspan="8" style="text-align: center;"> <table border="1" style="width: 100%; border-collapse: collapse; text-align: center;"> <tr> <td style="width: 10%;"></td> <td style="width: 10%;"></td> <td style="width: 10%;"></td> <td style="width: 10%;"></td> <td style="width: 10%;"></td> <td style="width: 10%;"></td> <td style="width: 10%;"></td> <td style="width: 10%;"></td> <td style="width: 10%;"></td> <td style="width: 10%;"></td> </tr> <tr> <td></td> <td></td> <td colspan="8" style="text-align: center;"> <table border="1" style="width: 100%; border-collapse: collapse; text-align: center;"> <tr> <td style="width: 10%;"></td> <td style="width: 10%;"></td> <td style="width: 10%;"></td> <td style="width: 10%;"></td> <td style="width: 10%;"></td> <td style="width: 10%;"></td> <td style="width: 10%;"></td> <td style="width: 10%;"></td> <td style="width: 10%;"></td> <td style="width: 10%;"></td> </tr> <tr> <td></td> <td></td> <td colspan="8" style="text-align: center;"> <table border="1" style="width: 100%; border-collapse: collapse; text-align: center;"> <tr> <td style="width: 10%;"></td> <td style="width: 10%;"></td> <td style="width: 10%;"></td> <td style="width: 10%;"></td> <td style="width: 10%;"></td> <td style="width: 10%;"></td> <td style="width: 10%;"></td> <td style="width: 10%;"></td> <td style="width: 10%;"></td> <td style="width: 10%;"></td> </tr> <tr> <td></td> <td></td> <td colspan="8" style="text-align: center;"> <table border="1" style="width: 100%; border-collapse: collapse; text-align: center;"> <tr> <td style="width: 10%;"></td> <td style="width: 10%;"></td> <td style="width: 10%;"></td> <td style="width: 10%;"></td> <td style="width: 10%;"></td> <td style="width: 10%;"></td> <td style="width: 10%;"></td> <td style="width: 10%;"></td> <td style="width: 10%;"></td> <td style="width: 10%;"></td> </tr> <tr> <td></td> <td></td> <td colspan="8" style="text-align: center;"> <table border="1" style="width: 100%; border-collapse: collapse; text-align: center;"> <tr> <td style="width: 10%;"></td> <td style="width: 10%;"></td> <td style="width: 10%;"></td> <td style="width: 10%;"></td> <td style="width: 10%;"></td> <td style="width: 10%;"></td> <td style="width: 10%;"></td> <td style="width: 10%;"></td> <td style="width: 10%;"></td> <td style="width: 10%;"></td> </tr> <tr> <td></td> <td></td> <td colspan="8" style="text-align: center;"> <table border="1" style="width: 100%; border-collapse: collapse; text-align: center;"> <tr> <td style="width: 10%;"></td> <td style="width: 10%;"></td> <td style="width: 10%;"></td> <td style="width: 10%;"></td> <td style="width: 10%;"></td> <td style="width: 10%;"></td> <td style="width: 10%;"></td> <td style="width: 10%;"></td> <td style="width: 10%;"></td> <td style="width: 10%;"></td> </tr> <tr> <td></td> <td></td> <td colspan="8" style="text-align: center;"> <table border="1" style="width: 100%; border-collapse: collapse; text-align: center;"> <tr> <td style="width: 10%;"></td> <td style="width: 10%;"></td> <td style="width: 10%;"></td> <td style="width: 10%;"></td> <td style="width: 10%;"></td> <td style="width: 10%;"></td> <td style="width: 10%;"></td> <td style="width: 10%;"></td> <td style="width: 10%;"></td> <td style="width: 10%;"></td> </tr> <tr> <td></td> <td></td> <td colspan="8" style="text-align: center;"> <table border="1" style="width: 100%; border-collapse: collapse; text-align: center;"> <tr> <td style="width: 10%;"></td> <td style="width: 10%;"></td> <td style="width: 10%;"></td> <td style="width: 10%;"></td> <td style="width: 10%;"></td> <td style="width: 10%;"></td> <td style="width: 10%;"></td> <td style="width: 10%;"></td> <td style="width: 10%;"></td> <td style="width: 10%;"></td> </tr> <tr> <td></td> <td></td> <td colspan="8" style="text-align: center;"> <table border="1" style="width: 100%; border-collapse: collapse; text-align: center;"> <tr> <td style="width: 10%;"></td> <td style="width: 10%;"></td> <td style="width: 10%;"></td> <td style="width: 10%;"></td> <td style="width: 10%;"></td> <td style="width: 10%;"></td> <td style="width: 10%;"></td> <td style="width: 10%;"></td> <td style="width: 10%;"></td> <td style="width: 10%;"></td> </tr> <tr> <td></td> <td></td> <td colspan="8" style="text-align: center;"> <table border="1" style="width: 100%; border-collapse: collapse; text-align: center;"> <tr> <td style="width: 10%;"></td> <td style="width: 10%;"></td> <td style="width: 10%;"></td> <td style="width: 10%;"></td> <td style="width: 10%;"></td> <td style="width: 10%;"></td> <td style="width: 10%;"></td> <td style="width: 10%;"></td> <td style="width: 10%;"></td> <td style="width: 10%;"></td> </tr> <tr> <td></td> <td></td> <td colspan="8" style="text-align: center;"> <table border="1"
style="width: 100%; border-collapse: collapse; text-align: center;"> <tr> </tr></table></td></tr></table></td></tr></table></td></tr></table></td></tr></table></td></tr></table></td></tr></table></td></tr></table></td></tr></table></td></tr></table></td></tr></table></td></tr></table></td></tr></table></td></tr></table></td></tr></table></td></tr></table></td></tr></table></td></tr></table></td></tr></table></td></tr></table></td></tr></table></td></tr></table></td></tr></table></td></tr></table></td></tr></table></td></tr></table></td></tr></table></td></tr></table></td></tr></table></td></tr></table></td></tr></table></td></tr></table></td></tr></table></td></tr></table></td></tr></table></td></tr></table></td></tr></table></td></tr></table></td></tr></table> | | | | | | | | | | | | | | | | | | | | <table border="1" style="width: 100%; border-collapse: collapse; text-align: center;"> <tr> <td style="width: 10%;"></td> <td style="width: 10%;"></td> <td style="width: 10%;"></td> <td style="width: 10%;"></td> <td style="width: 10%;"></td> <td style="width: 10%;"></td> <td style="width: 10%;"></td> <td style="width: 10%;"></td> <td style="width: 10%;"></td> <td style="width: 10%;"></td> </tr> <tr> <td></td> <td></td> <td colspan="8" style="text-align: center;"> <table border="1" style="width: 100%; border-collapse: collapse; text-align: center;"> <tr> <td style="width: 10%;"></td> <td style="width: 10%;"></td> <td style="width: 10%;"></td> <td style="width: 10%;"></td> <td style="width: 10%;"></td> <td style="width: 10%;"></td> <td style="width: 10%;"></td> <td style="width: 10%;"></td> <td style="width: 10%;"></td> <td style="width: 10%;"></td> </tr> <tr> <td></td> <td></td> <td colspan="8" style="text-align: center;"> <table border="1" style="width: 100%; border-collapse: collapse; text-align: center;"> <tr> <td style="width: 10%;"></td> <td style="width: 10%;"></td> <td style="width: 10%;"></td> <td style="width: 10%;"></td> <td style="width: 10%;"></td> <td style="width: 10%;"></td> <td style="width: 10%;"></td> <td style="width: 10%;"></td> <td style="width: 10%;"></td> <td style="width: 10%;"></td> </tr> <tr> <td></td> <td></td> <td colspan="8" style="text-align: center;"> <table border="1" style="width: 100%; border-collapse: collapse; text-align: center;"> <tr> <td style="width: 10%;"></td> <td style="width: 10%;"></td> <td style="width: 10%;"></td> <td style="width: 10%;"></td> <td style="width: 10%;"></td> <td style="width: 10%;"></td> <td style="width: 10%;"></td> <td style="width: 10%;"></td> <td style="width: 10%;"></td> <td style="width: 10%;"></td> </tr> <tr> <td></td> <td></td> <td colspan="8" style="text-align: center;"> <table border="1" style="width: 100%; border-collapse: collapse; text-align: center;"> <tr> <td style="width: 10%;"></td> <td style="width: 10%;"></td> <td style="width: 10%;"></td> <td style="width: 10%;"></td> <td style="width: 10%;"></td> <td style="width: 10%;"></td> <td style="width: 10%;"></td> <td style="width: 10%;"></td> <td style="width: 10%;"></td> <td style="width: 10%;"></td> </tr> <tr> <td></td> <td></td> <td colspan="8" style="text-align: center;"> <table border="1" style="width: 100%; border-collapse: collapse; text-align: center;"> <tr> <td style="width: 10%;"></td> <td style="width: 10%;"></td> <td style="width: 10%;"></td> <td style="width: 10%;"></td> <td style="width: 10%;"></td> <td style="width: 10%;"></td> <td style="width: 10%;"></td> <td style="width: 10%;"></td> <td style="width: 10%;"></td> <td style="width: 10%;"></td> </tr> <tr> <td></td> <td></td> <td colspan="8" style="text-align: center;"> <table border="1" style="width: 100%; border-collapse: collapse; text-align: center;"> <tr> <td style="width: 10%;"></td> <td style="width: 10%;"></td> <td style="width: 10%;"></td> <td style="width: 10%;"></td> <td style="width: 10%;"></td> <td style="width: 10%;"></td> <td style="width: 10%;"></td> <td style="width: 10%;"></td> <td style="width: 10%;"></td> <td style="width: 10%;"></td> </tr> <tr> <td></td> <td></td> <td colspan="8" style="text-align: center;"> <table border="1" style="width: 100%; border-collapse: collapse; text-align: center;"> <tr> <td style="width: 10%;"></td> <td style="width: 10%;"></td> <td style="width: 10%;"></td> <td style="width: 10%;"></td> <td style="width: 10%;"></td> <td style="width: 10%;"></td> <td style="width: 10%;"></td> <td style="width: 10%;"></td> <td style="width: 10%;"></td> <td style="width: 10%;"></td> </tr> <tr> <td></td> <td></td> <td colspan="8" style="text-align: center;"> <table border="1" style="width: 100%; border-collapse: collapse; text-align: center;"> <tr> <td style="width: 10%;"></td> <td style="width: 10%;"></td> <td style="width: 10%;"></td> <td style="width: 10%;"></td> <td style="width: 10%;"></td> <td style="width: 10%;"></td> <td style="width: 10%;"></td> <td style="width: 10%;"></td> <td style="width: 10%;"></td> <td style="width: 10%;"></td> </tr> <tr> <td></td> <td></td> <td colspan="8" style="text-align: center;"> <table border="1" style="width: 100%; border-collapse: collapse; text-align: center;"> <tr> <td
style="width: 10%;"></td> <td style="width: 10%;"></td> <td style="width: 10%;"></td> <td style="width: 10%;"></td> <td style="width: 10%;"></td> <td style="width: 10%;"></td> <td style="width: 10%;"></td> <td style="width: 10%;"></td> <td style="width: 10%;"></td> <td style="width: 10%;"></td> </tr> <tr> <td></td> <td></td> <td colspan="8" style="text-align: center;"> <table border="1" style="width: 100%; border-collapse: collapse; text-align: center;"> <tr> <td style="width: 10%;"></td> <td style="width: 10%;"></td> <td style="width: 10%;"></td> <td style="width: 10%;"></td> <td style="width: 10%;"></td> <td style="width: 10%;"></td> <td style="width: 10%;"></td> <td style="width: 10%;"></td> <td style="width: 10%;"></td> <td style="width: 10%;"></td> </tr> <tr> <td></td> <td></td> <td colspan="8" style="text-align: center;"> <table border="1" style="width: 100%; border-collapse: collapse; text-align: center;"> <tr> <td style="width: 10%;"></td> <td style="width: 10%;"></td> <td style="width: 10%;"></td> <td style="width: 10%;"></td> <td style="width: 10%;"></td> <td style="width: 10%;"></td> <td style="width: 10%;"></td> <td style="width: 10%;"></td> <td style="width: 10%;"></td> <td style="width: 10%;"></td> </tr> <tr> <td></td> <td></td> <td colspan="8" style="text-align: center;"> <table border="1" style="width: 100%; border-collapse: collapse; text-align: center;"> <tr> <td style="width: 10%;"></td> <td style="width: 10%;"></td> <td style="width: 10%;"></td> <td style="width: 10%;"></td> <td style="width: 10%;"></td> <td style="width: 10%;"></td> <td style="width: 10%;"></td> <td style="width: 10%;"></td> <td style="width: 10%;"></td> <td style="width: 10%;"></td> </tr> <tr> <td></td> <td></td> <td colspan="8" style="text-align: center;"> <table border="1" style="width: 100%; border-collapse: collapse; text-align: center;"> <tr> <td style="width: 10%;"></td> <td style="width: 10%;"></td> <td style="width: 10%;"></td> <td style="width: 10%;"></td> <td style="width: 10%;"></td> <td style="width: 10%;"></td> <td style="width: 10%;"></td> <td style="width: 10%;"></td> <td style="width: 10%;"></td> <td style="width: 10%;"></td> </tr> <tr> <td></td> <td></td> <td colspan="8" style="text-align: center;"> <table border="1" style="width: 100%; border-collapse: collapse; text-align: center;"> <tr> <td style="width: 10%;"></td> <td style="width: 10%;"></td> <td style="width: 10%;"></td> <td style="width: 10%;"></td> <td style="width: 10%;"></td> <td style="width: 10%;"></td> <td style="width: 10%;"></td> <td style="width: 10%;"></td> <td style="width: 10%;"></td> <td style="width: 10%;"></td> </tr> <tr> <td></td> <td></td> <td colspan="8" style="text-align: center;"> <table border="1" style="width: 100%; border-collapse: collapse; text-align: center;"> <tr> <td style="width: 10%;"></td> <td style="width: 10%;"></td> <td style="width: 10%;"></td> <td style="width: 10%;"></td> <td style="width: 10%;"></td> <td style="width: 10%;"></td> <td style="width: 10%;"></td> <td style="width: 10%;"></td> <td style="width: 10%;"></td> <td style="width: 10%;"></td> </tr> <tr> <td></td> <td></td> <td colspan="8" style="text-align: center;"> <table border="1" style="width: 100%; border-collapse: collapse; text-align: center;"> <tr> <td style="width: 10%;"></td> <td style="width: 10%;"></td> <td style="width: 10%;"></td> <td style="width: 10%;"></td> <td style="width: 10%;"></td> <td style="width: 10%;"></td> <td style="width: 10%;"></td> <td style="width: 10%;"></td> <td style="width: 10%;"></td> <td style="width: 10%;"></td> </tr> <tr> <td></td> <td></td> <td colspan="8" style="text-align: center;"> <table border="1" style="width: 100%; border-collapse: collapse; text-align: center;"> <tr> <td style="width: 10%;"></td> <td style="width: 10%;"></td> <td style="width: 10%;"></td> <td style="width: 10%;"></td> <td style="width: 10%;"></td> <td style="width: 10%;"></td> <td style="width: 10%;"></td> <td style="width: 10%;"></td> <td style="width: 10%;"></td> <td style="width: 10%;"></td> </tr> <tr> <td></td> <td></td> <td colspan="8" style="text-align: center;"> <table border="1" style="width: 100%; border-collapse: collapse; text-align: center;"> <tr> <td style="width: 10%;"></td> <td style="width: 10%;"></td> <td style="width: 10%;"></td> <td style="width: 10%;"></td> <td style="width: 10%;"></td> <td style="width: 10%;"></td> <td style="width: 10%;"></td> <td style="width: 10%;"></td> <td style="width: 10%;"></td> <td style="width: 10%;"></td> </tr> <tr> <td></td> <td></td> <td colspan="8" style="text-align: center;"> <table border="1" style="width: 100%; border-collapse: collapse; text-align: center;"> <tr> <td style="width: 10%;"></td> <td style="width: 10%;"></td> <td style="width: 10%;"></td> <td style="width: 10%;"></td> <td style="width: 10%;"></td> <td style="width: 10%;"></td> <td style="width: 10%;"></td> <td style="width: 10%;"></td> <td style="width: 10%;"></td> <td style="width: 10%;"></td> </tr> <tr> <td></td> <td></td> <td colspan="8" style="text-align: center;"> <table border="1" style="width: 100%; border-collapse: collapse; text-align: center;"> <tr> <td style="width: 10%;"></td> <td style="width: 10%;"></td> <td style="width: 10%;"></td> <td style="width: 10%;"></td> <td style="width: 10%;"></td> <td style="width: 10%;"></td> <td style="width: 10%;"></td> <td style="width: 10%;"></td> <td style="width: 10%;"></td> <td style="width: 10%;"></td> </tr> <tr> <td></td> <td></td> <td colspan="8" style="text-align: center;"> <table border="1" style="width: 100%; border-collapse: collapse; text-align: center;"> <tr> <td style="width: 10%;"></td> <td style="width: 10%;"></td> <td style="width: 10%;"></td> <td style="width: 10%;"></td> <td style="width: 10%;"></td> <td style="width: 10%;"></td> <td style="width: 10%;"></td> <td style="width: 10%;"></td> <td style="width: 10%;"></td> <td style="width: 10%;"></td> </tr> <tr> <td></td> <td></td> <td colspan="8" style="text-align: center;"> <table border="1" style="width: 100%; border-collapse: collapse; text-align: center;"> <tr> <td style="width: 10%;"></td> <td style="width: 10%;"></td> <td style="width: 10%;"></td> <td style="width: 10%;"></td> <td style="width: 10%;"></td> <td style="width: 10%;"></td> <td style="width: 10%;"></td> <td style="width: 10%;"></td> <td style="width: 10%;"></td> <td style="width: 10%;"></td> </tr> <tr> <td></td> <td></td> <td colspan="8" style="text-align: center;"> <table border="1" style="width: 100%; border-collapse: collapse; text-align: center;"> <tr> <td style="width: 10%;"></td> <td style="width: 10%;"></td> <td style="width: 10%;"></td> <td style="width: 10%;"></td> <td style="width: 10%;"></td> <td style="width: 10%;"></td> <td style="width: 10%;"></td> <td style="width: 10%;"></td> <td style="width: 10%;"></td> <td style="width: 10%;"></td> </tr> <tr> <td></td> <td></td> <td colspan="8" style="text-align: center;"> <table border="1" style="width: 100%; border-collapse: collapse; text-align: center;"> <tr> <td style="width: 10%;"></td> <td style="width: 10%;"></td> <td style="width: 10%;"></td> <td style="width: 10%;"></td> <td style="width: 10%;"></td> <td style="width: 10%;"></td> <td style="width: 10%;"></td> <td style="width: 10%;"></td> <td style="width: 10%;"></td> <td style="width: 10%;"></td> </tr> <tr> <td></td> <td></td> <td colspan="8" style="text-align: center;"> <table border="1" style="width: 100%; border-collapse: collapse; text-align: center;"> <tr> <td style="width: 10%;"></td> <td style="width: 10%;"></td> <td style="width: 10%;"></td> <td style="width: 10%;"></td> <td style="width: 10%;"></td> <td style="width: 10%;"></td> <td style="width: 10%;"></td> <td style="width: 10%;"></td> <td style="width: 10%;"></td> <td style="width: 10%;"></td> </tr> <tr> <td></td> <td></td> <td colspan="8" style="text-align: center;"> <table border="1" style="width: 100%; border-collapse: collapse; text-align: center;"> <tr> <td style="width: 10%;"></td> <td style="width: 10%;"></td> <td style="width: 10%;"></td> <td style="width: 10%;"></td> <td style="width: 10%;"></td> <td style="width: 10%;"></td> <td style="width: 10%;"></td> <td style="width: 10%;"></td> <td style="width: 10%;"></td> <td style="width: 10%;"></td> </tr> <tr> <td></td> <td></td> <td colspan="8" style="text-align: center;"> <table border="1" style="width: 100%; border-collapse: collapse; text-align: center;"> <tr> <td style="width: 10%;"></td> <td style="width: 10%;"></td> <td style="width: 10%;"></td> <td style="width: 10%;"></td> <td style="width: 10%;"></td> <td style="width: 10%;"></td> <td style="width: 10%;"></td> <td style="width: 10%;"></td> <td style="width: 10%;"></td> <td style="width: 10%;"></td> </tr> <tr> <td></td> <td></td> <td colspan="8" style="text-align: center;"> <table border="1" style="width: 100%; border-collapse: collapse; text-align: center;"> <tr> <td style="width: 10%;"></td> <td style="width: 10%;"></td> <td style="width: 10%;"></td> <td style="width: 10%;"></td> <td style="width: 10%;"></td> <td style="width: 10%;"></td> <td style="width: 10%;"></td> <td style="width: 10%;"></td> <td style="width: 10%;"></td> <td style="width: 10%;"></td> </tr> <tr> <td></td> <td></td> <td colspan="8" style="text-align: center;"> <table border="1" style="width: 100%; border-collapse: collapse; text-align: center;"> <tr> <td style="width: 10%;"></td> <td style="width: 10%;"></td> <td style="width: 10%;"></td> <td style="width: 10%;"></td> <td style="width: 10%;"></td> <td style="width: 10%;"></td> <td style="width: 10%;"></td> <td style="width: 10%;"></td> <td style="width: 10%;"></td> <td style="width: 10%;"></td> </tr> <tr> <td></td> <td></td> <td colspan="8" style="text-align: center;"> <table border="1" style="width: 100%; border-collapse: collapse; text-align: center;"> <tr> <td style="width: 10%;"></td> <td style="width: 10%;"></td> <td style="width: 10%;"></td> <td style="width: 10%;"></td> <td style="width: 10%;"></td> <td style="width:
10%;"></td> <td style="width: 10%;"></td> <td style="width: 10%;"></td> <td style="width: 10%;"></td> <td style="width: 10%;"></td> </tr> <tr> <td></td> <td></td> <td colspan="8" style="text-align: center;"> <table border="1" style="width: 100%; border-collapse: collapse; text-align: center;"> <tr> <td style="width: 10%;"></td> <td style="width: 10%;"></td> <td style="width: 10%;"></td> <td style="width: 10%;"></td> <td style="width: 10%;"></td> <td style="width: 10%;"></td> <td style="width: 10%;"></td> <td style="width: 10%;"></td> <td style="width: 10%;"></td> <td style="width: 10%;"></td> </tr> <tr> <td></td> <td></td> <td colspan="8" style="text-align: center;"> <table border="1" style="width: 100%; border-collapse: collapse; text-align: center;"> <tr> <td style="width: 10%;"></td> <td style="width: 10%;"></td> <td style="width: 10%;"></td> <td style="width: 10%;"></td> <td style="width: 10%;"></td> <td style="width: 10%;"></td> <td style="width: 10%;"></td> <td style="width: 10%;"></td> <td style="width: 10%;"></td> <td style="width: 10%;"></td> </tr> <tr> <td></td> <td></td> <td colspan="8" style="text-align: center;"> <table border="1" style="width: 100%; border-collapse: collapse; text-align: center;"> <tr> <td style="width: 10%;"></td> <td style="width: 10%;"></td> <td style="width: 10%;"></td> <td style="width: 10%;"></td> <td style="width: 10%;"></td> <td style="width: 10%;"></td> <td style="width: 10%;"></td> <td style="width: 10%;"></td> <td style="width: 10%;"></td> <td style="width: 10%;"></td> </tr> <tr> <td></td> <td></td> <td colspan="8" style="text-align: center;"> <table border="1" style="width: 100%; border-collapse: collapse; text-align: center;"> <tr> <td style="width: 10%;"></td> <td style="width: 10%;"></td> <td style="width: 10%;"></td> <td style="width: 10%;"></td> <td style="width: 10%;"></td> <td style="width: 10%;"></td> <td style="width: 10%;"></td> <td style="width: 10%;"></td> <td style="width: 10%;"></td> <td style="width: 10%;"></td> </tr> <tr> <td></td> <td></td> <td colspan="8" style="text-align: center;"> <table border="1" style="width: 100%; border-collapse: collapse; text-align: center;"> <tr> <td style="width: 10%;"></td> <td style="width: 10%;"></td> <td style="width: 10%;"></td> <td style="width: 10%;"></td> <td style="width: 10%;"></td> <td style="width: 10%;"></td> <td style="width: 10%;"></td> <td style="width: 10%;"></td> <td style="width: 10%;"></td> <td style="width: 10%;"></td> </tr> <tr> <td></td> <td></td> <td colspan="8" style="text-align: center;"> <table border="1" style="width: 100%; border-collapse: collapse; text-align: center;"> <tr> <td style="width: 10%;"></td> <td style="width: 10%;"></td> <td style="width: 10%;"></td> <td style="width: 10%;"></td> <td style="width: 10%;"></td> <td style="width: 10%;"></td> <td style="width: 10%;"></td> <td style="width: 10%;"></td> <td style="width: 10%;"></td> <td style="width: 10%;"></td> </tr> <tr> <td></td> <td></td> <td colspan="8" style="text-align: center;"> <table border="1" style="width: 100%; border-collapse: collapse; text-align: center;"> <tr> </tr></table></td></tr></table></td></tr></table></td></tr></table></td></tr></table></td></tr></table></td></tr></table></td></tr></table></td></tr></table></td></tr></table></td></tr></table></td></tr></table></td></tr></table></td></tr></table></td></tr></table></td></tr></table></td></tr></table></td></tr></table></td></tr></table></td></tr></table></td></tr></table></td></tr></table></td></tr></table></td></tr></table></td></tr></table></td></tr></table></td></tr></table></td></tr></table></td></tr></table></td></tr></table></td></tr></table></td></tr></table></td></tr></table></td></tr></table></td></tr></table></td></tr></table></td></tr></table></td></tr></table> | | | | | | | | | | | | | | | | | | | | <table border="1" style="width: 100%; border-collapse: collapse; text-align: center;"> <tr> <td style="width: 10%;"></td> <td style="width: 10%;"></td> <td style="width: 10%;"></td> <td style="width: 10%;"></td> <td style="width: 10%;"></td> <td style="width: 10%;"></td> <td style="width: 10%;"></td> <td style="width: 10%;"></td> <td style="width: 10%;"></td> <td style="width: 10%;"></td> </tr> <tr> <td></td> <td></td> <td colspan="8" style="text-align: center;"> <table border="1" style="width: 100%; border-collapse: collapse; text-align: center;"> <tr> <td style="width: 10%;"></td> <td style="width: 10%;"></td> <td style="width: 10%;"></td> <td style="width: 10%;"></td> <td style="width: 10%;"></td> <td style="width: 10%;"></td> <td style="width: 10%;"></td> <td style="width: 10%;"></td> <td style="width: 10%;"></td> <td style="width: 10%;"></td> </tr> <tr> <td></td> <td></td> <td colspan="8" style="text-align: center;"> <table border="1" style="width: 100%; border-collapse: collapse; text-align: center;"> <tr> <td style="width: 10%;"></td> <td style="width: 10%;"></td> <td style="width: 10%;"></td> <td style="width: 10%;"></td> <td style="width: 10%;"></td> <td style="width: 10%;"></td> <td style="width: 10%;"></td> <td style="width: 10%;"></td> <td style="width:
10%;"></td> <td style="width: 10%;"></td> </tr> <tr> <td></td> <td></td> <td colspan="8" style="text-align: center;"> <table border="1" style="width: 100%; border-collapse: collapse; text-align: center;"> <tr> <td style="width: 10%;"></td> <td style="width: 10%;"></td> <td style="width: 10%;"></td> <td style="width: 10%;"></td> <td style="width: 10%;"></td> <td style="width: 10%;"></td> <td style="width: 10%;"></td> <td style="width: 10%;"></td> <td style="width: 10%;"></td> <td style="width: 10%;"></td> </tr> <tr> <td></td> <td></td> <td colspan="8" style="text-align: center;"> <table border="1" style="width: 100%; border-collapse: collapse; text-align: center;"> <tr> <td style="width: 10%;"></td> <td style="width: 10%;"></td> <td style="width: 10%;"></td> <td style="width: 10%;"></td> <td style="width: 10%;"></td> <td style="width: 10%;"></td> <td style="width: 10%;"></td> <td style="width: 10%;"></td> <td style="width: 10%;"></td> <td style="width: 10%;"></td> </tr> <tr> <td></td> <td></td> <td colspan="8" style="text-align: center;"> <table border="1" style="width: 100%; border-collapse: collapse; text-align: center;"> <tr> <td style="width: 10%;"></td> <td style="width: 10%;"></td> <td style="width: 10%;"></td> <td style="width: 10%;"></td> <td style="width: 10%;"></td> <td style="width: 10%;"></td> <td style="width: 10%;"></td> <td style="width: 10%;"></td> <td style="width: 10%;"></td> <td style="width: 10%;"></td> </tr> <tr> <td></td> <td></td> <td colspan="8" style="text-align: center;"> <table border="1" style="width: 100%; border-collapse: collapse; text-align: center;"> <tr> <td style="width: 10%;"></td> <td style="width: 10%;"></td> <td style="width: 10%;"></td> <td style="width: 10%;"></td> <td style="width: 10%;"></td> <td style="width: 10%;"></td> <td style="width: 10%;"></td> <td style="width: 10%;"></td> <td style="width: 10%;"></td> <td style="width: 10%;"></td> </tr> <tr> <td></td> <td></td> <td colspan="8" style="text-align: center;"> <table border="1" style="width: 100%; border-collapse: collapse; text-align: center;"> <tr> <td style="width: 10%;"></td> <td style="width: 10%;"></td> <td style="width: 10%;"></td> <td style="width: 10%;"></td> <td style="width: 10%;"></td> <td style="width: 10%;"></td> <td style="width: 10%;"></td> <td style="width: 10%;"></td> <td style="width: 10%;"></td> <td style="width: 10%;"></td> </tr> <tr> <td></td> <td></td> <td colspan="8" style="text-align: center;"> <table border="1" style="width: 100%; border-collapse: collapse; text-align: center;"> <tr> <td style="width: 10%;"></td> <td style="width: 10%;"></td> <td style="width: 10%;"></td> <td style="width: 10%;"></td> <td style="width: 10%;"></td> <td style="width: 10%;"></td> <td style="width: 10%;"></td> <td style="width: 10%;"></td> <td style="width: 10%;"></td> <td style="width: 10%;"></td> </tr> <tr> <td></td> <td></td> <td colspan="8" style="text-align: center;"> <table border="1" style="width: 100%; border-collapse: collapse; text-align: center;"> <tr> <td style="width: 10%;"></td> <td style="width: 10%;"></td> <td style="width: 10%;"></td> <td style="width: 10%;"></td> <td style="width: 10%;"></td> <td style="width: 10%;"></td> <td style="width: 10%;"></td> <td style="width: 10%;"></td> <td style="width: 10%;"></td> <td style="width: 10%;"></td> </tr> <tr> <td></td> <td></td> <td colspan="8" style="text-align: center;"> <table border="1" style="width: 100%; border-collapse: collapse; text-align: center;"> <tr> <td style="width: 10%;"></td> <td style="width: 10%;"></td> <td style="width: 10%;"></td> <td style="width: 10%;"></td> <td style="width: 10%;"></td> <td style="width: 10%;"></td> <td style="width: 10%;"></td> <td style="width: 10%;"></td> <td style="width: 10%;"></td> <td style="width: 10%;"></td> </tr> <tr> <td></td> <td></td> <td colspan="8" style="text-align: center;"> <table border="1" style="width: 100%; border-collapse: collapse; text-align: center;"> <tr> <td style="width: 10%;"></td> <td style="width: 10%;"></td> <td style="width: 10%;"></td> <td style="width: 10%;"></td> <td style="width: 10%;"></td> <td style="width: 10%;"></td> <td style="width: 10%;"></td> <td style="width: 10%;"></td> <td style="width: 10%;"></td> <td style="width: 10%;"></td> </tr> <tr> <td></td> <td></td> <td colspan="8" style="text-align: center;"> <table border="1" style="width: 100%; border-collapse: collapse; text-align: center;"> <tr> <td style="width: 10%;"></td> <td style="width: 10%;"></td> <td style="width: 10%;"></td> <td style="width: 10%;"></td> <td style="width: 10%;"></td> <td style="width: 10%;"></td> <td style="width: 10%;"></td> <td style="width: 10%;"></td> <td style="width: 10%;"></td> <td style="width: 10%;"></td> </tr> <tr> <td></td> <td></td> <td colspan="8" style="text-align: center;"> <table border="1" style="width: 100%; border-collapse: collapse; text-align: center;"> <tr> <td style="width: 10%;"></td> <td style="width: 10%;"></td> <td style="width: 10%;"></td> <td style="width: 10%;"></td> <td style="width: 10%;"></td> <td style="width: 10%;"></td> <td style="width: 10%;"></td> <td style="width: 10%;"></td> <td style="width: 10%;"></td> <td style="width: 10%;"></td> </tr> <tr> <td></td> <td></td> <td colspan="8" style="text-align: center;"> <table border="1" style="width: 100%; border-collapse: collapse; text-align: center;"> <tr> <td style="width: 10%;"></td> <td style="width: 10%;"></td> <td style="width: 10%;"></td> <td style="width: 10%;"></td> <td style="width: 10%;"></td> <td style="width: 10%;"></td> <td style="width: 10%;"></td> <td style="width: 10%;"></td> <td style="width: 10%;"></td> <td style="width: 10%;"></td> </tr> <tr> <td></td> <td></td> <td colspan="8" style="text-align: center;"> <table border="1" style="width: 100%; border-collapse: collapse; text-align: center;"> <tr> <td style="width: 10%;"></td> <td style="width: 10%;"></td> <td style="width: 10%;"></td> <td style="width: 10%;"></td> <td style="width: 10%;"></td> <td style="width: 10%;"></td> <td style="width: 10%;"></td> <td style="width: 10%;"></td> <td style="width: 10%;"></td> <td style="width: 10%;"></td> </tr> <tr> <td></td> <td></td> <td colspan="8" style="text-align: center;"> <table border="1" style="width: 100%; border-collapse: collapse; text-align: center;"> <tr> <td style="width: 10%;"></td> <td style="width: 10%;"></td> <td style="width: 10%;"></td> <td style="width: 10%;"></td> <td style="width: 10%;"></td> <td style="width: 10%;"></td> <td style="width: 10%;"></td> <td style="width: 10%;"></td> <td style="width: 10%;"></td> <td style="width: 10%;"></td> </tr> <tr> <td></td> <td></td> <td colspan="8" style="text-align: center;"> <table border="1" style="width: 100%; border-collapse: collapse; text-align: center;"> <tr> <td style="width: 10%;"></td> <td style="width: 10%;"></td> <td style="width: 10%;"></td> <td style="width: 10%;"></td> <td style="width: 10%;"></td> <td style="width: 10%;"></td> <td style="width: 10%;"></td> <td style="width: 10%;"></td> <td style="width: 10%;"></td> <td style="width: 10%;"></td> </tr> <tr> <td></td> <td></td> <td colspan="8" style="text-align: center;"> <table border="1" style="width: 100%; border-collapse: collapse; text-align: center;"> <tr> <td style="width: 10%;"></td> <td style="width: 10%;"></td> <td style="width: 10%;"></td> <td style="width: 10%;"></td> <td style="width: 10%;"></td> <td style="width: 10%;"></td> <td style="width: 10%;"></td> <td style="width: 10%;"></td> <td style="width: 10%;"></td> <td style="width: 10%;"></td> </tr> <tr> <td></td> <td></td> <td colspan="8" style="text-align: center;"> <table border="1" style="width: 100%; border-collapse: collapse; text-align: center;"> <tr> <td style="width: 10%;"></td> <td style="width: 10%;"></td> <td style="width: 10%;"></td> <td style="width: 10%;"></td> <td style="width: 10%;"></td> <td style="width: 10%;"></td> <td style="width: 10%;"></td> <td style="width: 10%;"></td> <td style="width: 10%;"></td> <td style="width: 10%;"></td> </tr> <tr> <td></td> <td></td> <td colspan="8" style="text-align: center;"> <table border="1" style="width: 100%; border-collapse: collapse; text-align: center;"> <tr> <td style="width: 10%;"></td> <td style="width: 10%;"></td> <td style="width: 10%;"></td> <td style="width: 10%;"></td> <td style="width: 10%;"></td> <td style="width: 10%;"></td> <td style="width: 10%;"></td> <td style="width: 10%;"></td> <td style="width: 10%;"></td> <td style="width: 10%;"></td> </tr> <tr> <td></td> <td></td> <td colspan="8" style="text-align: center;"> <table border="1" style="width: 100%; border-collapse: collapse; text-align: center;"> <tr> <td style="width: 10%;"></td> <td style="width: 10%;"></td> <td style="width: 10%;"></td> <td style="width: 10%;"></td> <td style="width: 10%;"></td> <td style="width: 10%;"></td> <td style="width: 10%;"></td> <td style="width: 10%;"></td> <td style="width: 10%;"></td> <td style="width: 10%;"></td> </tr> <tr> <td></td> <td></td> <td colspan="8" style="text-align: center;"> <table border="1" style="width: 100%; border-collapse: collapse; text-align: center;"> <tr> <td style="width: 10%;"></td> <td style="width: 10%;"></td> <td style="width: 10%;"></td> <td style="width: 10%;"></td> <td style="width: 10%;"></td> <td style="width: 10%;"></td> <td style="width: 10%;"></td> <td style="width: 10%;"></td> <td style="width: 10%;"></td> <td style="width: 10%;"></td> </tr> <tr> <td></td> <td></td> <td colspan="8" style="text-align: center;"> <table border="1" style="width: 100%; border-collapse: collapse; text-align: center;"> <tr> <td style="width: 10%;"></td> <td style="width: 10%;"></td> <td style="width: 10%;"></td> <td style="width: 10%;"></td> <td style="width: 10%;"></td> <td style="width: 10%;"></td> <td style="width: 10%;"></td> <td style="width: 10%;"></td> <td style="width: 10%;"></td> <td style="width: 10%;"></td> </tr> <tr> <td></td> <td></td> <td colspan="8" style="text-align: center;"> <table border="1" style="width: 100%;
border-collapse: collapse; text-align: center;"> <tr> <td style="width: 10%;"></td> <td style="width: 10%;"></td> <td style="width: 10%;"></td> <td style="width: 10%;"></td> <td style="width: 10%;"></td> <td style="width: 10%;"></td> <td style="width: 10%;"></td> <td style="width: 10%;"></td> <td style="width: 10%;"></td> <td style="width: 10%;"></td> </tr> <tr> <td></td> <td></td> <td colspan="8" style="text-align: center;"> <table border="1" style="width: 100%; border-collapse: collapse; text-align: center;"> <tr> <td style="width: 10%;"></td> <td style="width: 10%;"></td> <td style="width: 10%;"></td> <td style="width: 10%;"></td> <td style="width: 10%;"></td> <td style="width: 10%;"></td> <td style="width: 10%;"></td> <td style="width: 10%;"></td> <td style="width: 10%;"></td> <td style="width: 10%;"></td> </tr> <tr> <td></td> <td></td> <td colspan="8" style="text-align: center;"> <table border="1" style="width: 100%; border-collapse: collapse; text-align: center;"> <tr> <td style="width: 10%;"></td> <td style="width: 10%;"></td> <td style="width: 10%;"></td> <td style="width: 10%;"></td> <td style="width: 10%;"></td> <td style="width: 10%;"></td> <td style="width: 10%;"></td> <td style="width: 10%;"></td> <td style="width: 10%;"></td> <td style="width: 10%;"></td> </tr> <tr> <td></td> <td></td> <td colspan="8" style="text-align: center;"> <table border="1" style="width: 100%; border-collapse: collapse; text-align: center;"> <tr> <td style="width: 10%;"></td> <td style="width: 10%;"></td> <td style="width: 10%;"></td> <td style="width: 10%;"></td> <td style="width: 10%;"></td> <td style="width: 10%;"></td> <td style="width: 10%;"></td> <td style="width: 10%;"></td> <td style="width: 10%;"></td> <td style="width: 10%;"></td> </tr> <tr> <td></td> <td></td> <td colspan="8" style="text-align: center;"> <table border="1" style="width: 100%; border-collapse: collapse; text-align: center;"> <tr> <td style="width: 10%;"></td> <td style="width: 10%;"></td> <td style="width: 10%;"></td> <td style="width: 10%;"></td> <td style="width: 10%;"></td> <td style="width: 10%;"></td> <td style="width: 10%;"></td> <td style="width: 10%;"></td> <td style="width: 10%;"></td> <td style="width: 10%;"></td> </tr> <tr> <td></td> <td></td> <td colspan="8" style="text-align: center;"> <table border="1" style="width: 100%; border-collapse: collapse; text-align: center;"> <tr> <td style="width: 10%;"></td> <td style="width: 10%;"></td> <td style="width: 10%;"></td> <td style="width: 10%;"></td> <td style="width: 10%;"></td> <td style="width: 10%;"></td> <td style="width: 10%;"></td> <td style="width: 10%;"></td> <td style="width: 10%;"></td> <td style="width: 10%;"></td> </tr> <tr> <td></td> <td></td> <td colspan="8" style="text-align: center;"> <table border="1" style="width: 100%; border-collapse: collapse; text-align: center;"> <tr> <td style="width: 10%;"></td> <td style="width: 10%;"></td> <td style="width: 10%;"></td> <td style="width: 10%;"></td> <td style="width: 10%;"></td> <td style="width: 10%;"></td> <td style="width: 10%;"></td> <td style="width: 10%;"></td> <td style="width: 10%;"></td> <td style="width: 10%;"></td> </tr> <tr> <td></td> <td></td> <td colspan="8" style="text-align: center;"> <table border="1" style="width: 100%; border-collapse: collapse; text-align: center;"> <tr> <td style="width: 10%;"></td> <td style="width: 10%;"></td> <td style="width: 10%;"></td> <td style="width: 10%;"></td> <td style="width: 10%;"></td> <td style="width: 10%;"></td> <td style="width: 10%;"></td> <td style="width: 10%;"></td> <td style="width: 10%;"></td> <td style="width: 10%;"></td> </tr> <tr> <td></td> <td></td> <td colspan="8" style="text-align: center;"> <table border="1" style="width: 100%; border-collapse: collapse; text-align: center;"> <tr> <td style="width: 10%;"></td> <td style="width: 10%;"></td> <td style="width: 10%;"></td> <td style="width: 10%;"></td> <td style="width: 10%;"></td> <td style="width: 10%;"></td> <td style="width: 10%;"></td> <td style="width: 10%;"></td> <td style="width: 10%;"></td> <td style="width: 10%;"></td> </tr> <tr> <td></td> <td></td> <td colspan="8" style="text-align: center;"> <table border="1" style="width: 100%; border-collapse: collapse; text-align: center;"> <tr> <td style="width: 10%;"></td> <td style="width: 10%;"></td> <td style="width: 10%;"></td> <td style="width: 10%;"></td> <td style="width: 10%;"></td> <td style="width: 10%;"></td> <td style="width: 10%;"></td> <td style="width: 10%;"></td> <td style="width: 10%;"></td> <td style="width: 10%;"></td> </tr> <tr> <td></td> <td></td> <td colspan="8" style="text-align: center;"> <table border="1" style="width: 100%; border-collapse: collapse; text-align: center;"> <tr> <td style="width: 10%;"></td> <td style="width: 10%;"></td> <td style="width: 10%;"></td> <td style="width: 10%;"></td> <td style="width: 10%;"></td> <td style="width: 10%;"></td> <td style="width: 10%;"></td> <td style="width: 10%;"></td> <td style="width: 10%;"></td> <td style="width: 10%;"></td> </tr> <tr> <td></td> <td></td> <td colspan="8" style="text-align: center;"> <table border="1" style="width: 100%; border-collapse: collapse; text-align: center;"> <tr> <td style="width: 10%;"></td> <td style="width: 10%;"></td> <td style="width: 10%;"></td> <td style="width: 10%;"></td> <td style="width: 10%;"></td> <td style="width: 10%;"></td> <td style="width: 10%;"></td> <td style="width: 10%;"></td> <td style="width: 10%;"></td> <td style="width: 10%;"></td> </tr> <tr> <td></td> <td></td> <td colspan="8" style="text-align: center;"> <table border="1" style="width: 100%; border-collapse: collapse; text-align: center;"> <tr> </tr></table></td></tr></table></td></tr></table></td></tr></table></td></tr></table></td></tr></table></td></tr></table></td></tr></table></td></tr></table></td></tr></table></td></tr></table></td></tr></table></td></tr></table></td></tr></table></td></tr></table></td></tr></table></td></tr></table></td></tr></table></td></tr></table></td></tr></table></td></tr></table></td></tr></table></td></tr></table></td></tr></table></td></tr></table></td></tr></table></td></tr></table></td></tr></table></td></tr></table></td></tr></table></td></tr></table></td></tr></table></td></tr></table></td></tr></table></td></tr></table></td></tr></table></td></tr></table>
 | | | | | | | | | | | | | | | | | | | | <table border="1" style="width: 100%; border-collapse: collapse; text-align: center;"> <tr> <td style="width: 10%;"></td> <td style="width: 10%;"></td> <td style="width: 10%;"></td> <td style="width: 10%;"></td> <td style="width: 10%;"></td> <td style="width: 10%;"></td> <td style="width: 10%;"></td> <td style="width: 10%;"></td> <td style="width: 10%;"></td> <td style="width: 10%;"></td> </tr> <tr> <td></td> <td></td> <td colspan="8" style="text-align: center;"> <table border="1" style="width: 100%; border-collapse: collapse; text-align: center;"> <tr> <td style="width: 10%;"></td> <td style="width: 10%;"></td> <td style="width: 10%;"></td> <td style="width: 10%;"></td> <td style="width: 10%;"></td> <td style="width: 10%;"></td> <td style="width: 10%;"></td> <td style="width: 10%;"></td> <td style="width: 10%;"></td> <td style="width: 10%;"></td> </tr> <tr> <td></td> <td></td> <td colspan="8" style="text-align: center;"> <table border="1" style="width: 100%; border-collapse: collapse; text-align: center;"> <tr> <td style="width: 10%;"></td> <td style="width: 10%;"></td> <td style="width: 10%;"></td> <td style="width: 10%;"></td> <td style="width: 10%;"></td> <td style="width: 10%;"></td> <td style="width: 10%;"></td> <td style="width: 10%;"></td> <td style="width: 10%;"></td> <td style="width: 10%;"></td> </tr> <tr> <td></td> <td></td> <td colspan="8" style="text-align: center;"> <table border="1" style="width: 100%; border-collapse: collapse; text-align: center;"> <tr> <td style="width: 10%;"></td> <td style="width: 10%;"></td> <td style="width: 10%;"></td> <td style="width: 10%;"></td> <td style="width: 10%;"></td> <td style="width: 10%;"></td> <td style="width: 10%;"></td> <td style="width: 10%;"></td> <td style="width: 10%;"></td> <td style="width: 10%;"></td> </tr> <tr> <td></td> <td></td> <td colspan="8" style="text-align: center;"> <table border="1" style="width: 100%; border-collapse: collapse; text-align: center;"> <tr> <td style="width: 10%;"></td> <td style="width: 10%;"></td> <td style="width: 10%;"></td> <td style="width: 10%;"></td> <td style="width: 10%;"></td> <td style="width: 10%;"></td> <td style="width: 10%;"></td> <td style="width: 10%;"></td> <td style="width: 10%;"></td> <td style="width: 10%;"></td> </tr> <tr> <td></td> <td></td> <td colspan="8" style="text-align: center;"> <table border="1" style="width: 100%; border-collapse: collapse; text-align: center;"> <tr> <td style="width: 10%;"></td> <td style="width: 10%;"></td> <td style="width: 10%;"></td> <td style="width: 10%;"></td> <td style="width: 10%;"></td> <td style="width: 10%;"></td> <td style="width: 10%;"></td> <td style="width: 10%;"></td> <td style="width: 10%;"></td> <td style="width: 10%;"></td> </tr> <tr> <td></td> <td></td> <td colspan="8" style="text-align: center;"> <table border="1" style="width: 100%; border-collapse: collapse; text-align: center;"> <tr> <td style="width: 10%;"></td> <td style="width: 10%;"></td> <td style="width: 10%;"></td> <td style="width: 10%;"></td> <td style="width: 10%;"></td> <td style="width: 10%;"></td> <td style="width: 10%;"></td> <td style="width: 10%;"></td> <td style="width: 10%;"></td> <td style="width: 10%;"></td> </tr> <tr> <td></td> <td></td> <td colspan="8" style="text-align: center;"> <table border="1" style="width: 100%; border-collapse: collapse; text-align: center;"> <tr> <td style="width: 10%;"></td> <td style="width: 10%;"></td> <td style="width: 10%;"></td> <td style="width: 10%;"></td> <td style="width: 10%;"></td> <td style="width: 10%;"></td> <td style="width: 10%;"></td> <td style="width: 10%;"></td> <td style="width: 10%;"></td> <td style="width: 10%;"></td> </tr> <tr> <td></td> <td></td> <td colspan="8" style="text-align: center;"> <table border="1" style="width: 100%; border-collapse: collapse; text-align: center;"> <tr> <td style="width: 10%;"></td> <td style="width: 10%;"></td> <td style="width: 10%;"></td> <td style="width: 10%;"></td> <td style="width: 10%;"></td> <td style="width: 10%;"></td> <td style="width: 10%;"></td> <td style="width: 10%;"></td> <td style="width: 10%;"></td> <td style="width: 10%;"></td> </tr> <tr> <td></td> <td></td> <td colspan="8" style="text-align: center;"> <table border="1" style="width: 100%; border-collapse: collapse; text-align: center;"> <tr> <td style="width: 10%;"></td> <td style="width: 10%;"></td> <td style="width: 10%;"></td> <td style="width: 10%;"></td> <td style="width: 10%;"></td> <td style="width: 10%;"></td> <td style="width: 10%;"></td> <td style="width: 10%;"></td> <td style="width: 10%;"></td> <td style="width: 10%;"></td> </tr> <tr> <td></td> <td></td> <td colspan="8" style="text-align: center;"> <table border="1" style="width: 100%; border-collapse: collapse; text-align: center;"> <tr> <td style="width: 10%;"></td> <td style="width: 10%;"></td> <td style="width: 10%;"></td> <td style="width: 10%;"></td> <td style="width: 10%;"></td> <td style="width: 10%;"></td> <td style="width: 10%;"></td> <td style="width: 10%;"></td> <td style="width: 10%;"></td> <td style="width: 10%;"></td> </tr> <tr> <td></td> <td></td> <td colspan="8" style="text-align: center;"> <table border="1" style="width: 100%; border-collapse: collapse; text-align: center;"> <tr> <td style="width: 10%;"></td> <td style="width: 10%;"></td> <td style="width: 10%;"></td> <td style="width: 10%;"></td> <td style="width: 10%;"></td> <td style="width: 10%;"></td> <td style="width: 10%;"></td> <td style="width: 10%;"></td> <td style="width: 10%;"></td> <td style="width: 10%;"></td> </tr> <tr> <td></td> <td></td> <td colspan="8" style="text-align: center;"> <table border="1" style="width: 100%; border-collapse: collapse; text-align: center;"> <tr> <td style="width: 10%;"></td> <td style="width: 10%;"></td> <td style="width: 10%;"></td> <td style="width: 10%;"></td> <td style="width: 10%;"></td> <td style="width: 10%;"></td> <td style="width: 10%;"></td> <td style="width: 10%;"></td> <td style="width: 10%;"></td> <td style="width: 10%;"></td> </tr> <tr> <td></td> <td></td> <td colspan="8" style="text-align: center;"> <table border="1" style="width: 100%; border-collapse: collapse; text-align: center;"> <tr> <td style="width: 10%;"></td> <td style="width: 10%;"></td> <td style="width: 10%;"></td> <td style="width: 10%;"></td> <td style="width: 10%;"></td> <td style="width: 10%;"></td> <td style="width: 10%;"></td> <td style="width: 10%;"></td> <td style="width: 10%;"></td> <td style="width: 10%;"></td> </tr> <tr> <td></td> <td></td> <td colspan="8" style="text-align: center;"> <table border="1" style="width: 100%; border-collapse: collapse; text-align: center;"> <tr> <td style="width: 10%;"></td> <td style="width: 10%;"></td> <td style="width: 10%;"></td> <td style="width: 10%;"></td> <td style="width: 10%;"></td> <td style="width: 10%;"></td> <td style="width: 10%;"></td> <td style="width: 10%;"></td> <td style="width: 10%;"></td> <td style="width: 10%;"></td> </tr> <tr> <td></td> <td></td> <td colspan="8" style="text-align: center;"> <table border="1" style="width: 100%; border-collapse: collapse; text-align: center;"> <tr> <td style="width: 10%;"></td> <td style="width: 10%;"></td> <td style="width: 10%;"></td> <td style="width: 10%;"></td> <td style="width: 10%;"></td> <td style="width: 10%;"></td> <td style="width: 10%;"></td> <td style="width: 10%;"></td> <td style="width: 10%;"></td> <td style="width: 10%;"></td> </tr> <tr> <td></td> <td></td> <td colspan="8" style="text-align: center;"> <table border="1" style="width: 100%; border-collapse: collapse; text-align: center;"> <tr> <td style="width: 10%;"></td> <td style="width: 10%;"></td> <td style="width: 10%;"></td> <td style="width: 10%;"></td> <td style="width: 10%;"></td> <td style="width: 10%;"></td> <td style="width: 10%;"></td> <td style="width: 10%;"></td> <td style="width: 10%;"></td> <td style="width: 10%;"></td> </tr> <tr> <td></td> <td></td> <td colspan="8" style="text-align: center;"> <table border="1" style="width: 100%; border-collapse: collapse; text-align: center;"> <tr> <td style="width: 10%;"></td> <td style="width: 10%;"></td> <td style="width: 10%;"></td> <td style="width: 10%;"></td> <td style="width: 10%;"></td> <td style="width: 10%;"></td> <td style="width: 10%;"></td> <td style="width: 10%;"></td> <td style="width: 10%;"></td> <td style="width: 10%;"></td> </tr> <tr> <td></td> <td></td> <td colspan="8" style="text-align: center;"> <table border="1" style="width: 100%; border-collapse: collapse; text-align: center;"> <tr> <td style="width: 10%;"></td> <td style="width: 10%;"></td> <td style="width: 10%;"></td> <td style="width: 10%;"></td> <td style="width: 10%;"></td> <td style="width: 10%;"></td> <td style="width: 10%;"></td> <td style="width:
10%;"></td> <td style="width: 10%;"></td> <td style="width: 10%;"></td> </tr> <tr> <td></td> <td></td> <td colspan="8" style="text-align: center;"> <table border="1" style="width: 100%; border-collapse: collapse; text-align: center;"> <tr> <td style="width: 10%;"></td> <td style="width: 10%;"></td> <td style="width: 10%;"></td> <td style="width: 10%;"></td> <td style="width: 10%;"></td> <td style="width: 10%;"></td> <td style="width: 10%;"></td> <td style="width: 10%;"></td> <td style="width: 10%;"></td> <td style="width: 10%;"></td> </tr> <tr> <td></td> <td></td> <td colspan="8" style="text-align: center;"> <table border="1" style="width: 100%; border-collapse: collapse; text-align: center;"> <tr> <td style="width: 10%;"></td> <td style="width: 10%;"></td> <td style="width: 10%;"></td> <td style="width: 10%;"></td> <td style="width: 10%;"></td> <td style="width: 10%;"></td> <td style="width: 10%;"></td> <td style="width: 10%;"></td> <td style="width: 10%;"></td> <td style="width: 10%;"></td> </tr> <tr> <td></td> <td></td> <td colspan="8" style="text-align: center;"> <table border="1" style="width: 100%; border-collapse: collapse; text-align: center;"> <tr> <td style="width: 10%;"></td> <td style="width: 10%;"></td> <td style="width: 10%;"></td> <td style="width: 10%;"></td> <td style="width: 10%;"></td> <td style="width: 10%;"></td> <td style="width: 10%;"></td> <td style="width: 10%;"></td> <td style="width: 10%;"></td> <td style="width: 10%;"></td> </tr> <tr> <td></td> <td></td> <td colspan="8" style="text-align: center;"> <table border="1" style="width: 100%; border-collapse: collapse; text-align: center;"> <tr> <td style="width: 10%;"></td> <td style="width: 10%;"></td> <td style="width: 10%;"></td> <td style="width: 10%;"></td> <td style="width: 10%;"></td> <td style="width: 10%;"></td> <td style="width: 10%;"></td> <td style="width: 10%;"></td> <td style="width: 10%;"></td> <td style="width: 10%;"></td> </tr> <tr> <td></td> <td></td> <td colspan="8" style="text-align: center;"> <table border="1" style="width: 100%; border-collapse: collapse; text-align: center;"> <tr> <td style="width: 10%;"></td> <td style="width: 10%;"></td> <td style="width: 10%;"></td> <td style="width: 10%;"></td> <td style="width: 10%;"></td> <td style="width: 10%;"></td> <td style="width: 10%;"></td> <td style="width: 10%;"></td> <td style="width: 10%;"></td> <td style="width: 10%;"></td> </tr> <tr> <td></td> <td></td> <td colspan="8" style="text-align: center;"> <table border="1" style="width: 100%; border-collapse: collapse; text-align: center;"> <tr> <td style="width: 10%;"></td> <td style="width: 10%;"></td> <td style="width: 10%;"></td> <td style="width: 10%;"></td> <td style="width: 10%;"></td> <td style="width: 10%;"></td> <td style="width: 10%;"></td> <td style="width: 10%;"></td> <td style="width: 10%;"></td> <td style="width: 10%;"></td> </tr> <tr> <td></td> <td></td> <td colspan="8" style="text-align: center;"> <table border="1" style="width: 100%; border-collapse: collapse; text-align: center;"> <tr> <td style="width: 10%;"></td> <td style="width: 10%;"></td> <td style="width: 10%;"></td> <td style="width: 10%;"></td> <td style="width: 10%;"></td> <td style="width: 10%;"></td> <td style="width: 10%;"></td> <td style="width: 10%;"></td> <td style="width: 10%;"></td> <td style="width: 10%;"></td> </tr> <tr> <td></td> <td></td> <td colspan="8" style="text-align: center;"> <table border="1" style="width: 100%; border-collapse: collapse; text-align: center;"> <tr> <td style="width: 10%;"></td> <td style="width: 10%;"></td> <td style="width: 10%;"></td> <td style="width: 10%;"></td> <td style="width: 10%;"></td> <td style="width: 10%;"></td> <td style="width: 10%;"></td> <td style="width: 10%;"></td> <td style="width: 10%;"></td> <td style="width: 10%;"></td> </tr> <tr> <td></td> <td></td> <td colspan="8" style="text-align: center;"> <table border="1" style="width: 100%; border-collapse: collapse; text-align: center;"> <tr> <td style="width: 10%;"></td> <td style="width: 10%;"></td> <td style="width: 10%;"></td> <td style="width: 10%;"></td> <td style="width: 10%;"></td> <td style="width: 10%;"></td> <td style="width: 10%;"></td> <td style="width: 10%;"></td> <td style="width: 10%;"></td> <td style="width: 10%;"></td> </tr> <tr> <td></td> <td></td> <td colspan="8" style="text-align: center;"> <table border="1" style="width: 100%; border-collapse: collapse; text-align: center;"> <tr> <td style="width: 10%;"></td> <td style="width: 10%;"></td> <td style="width: 10%;"></td> <td style="width: 10%;"></td> <td style="width: 10%;"></td> <td style="width: 10%;"></td> <td style="width: 10%;"></td> <td style="width: 10%;"></td> <td style="width: 10%;"></td> <td style="width: 10%;"></td> </tr> <tr> <td></td> <td></td> <td colspan="8" style="text-align: center;"> <table border="1" style="width: 100%; border-collapse: collapse; text-align: center;"> <tr> <td style="width: 10%;"></td> <td style="width: 10%;"></td> <td style="width: 10%;"></td> <td style="width: 10%;"></td> <td style="width: 10%;"></td> <td style="width: 10%;"></td> <td style="width: 10%;"></td> <td style="width: 10%;"></td> <td style="width: 10%;"></td> <td style="width: 10%;"></td> </tr> <tr> <td></td> <td></td> <td colspan="8" style="text-align: center;"> <table border="1" style="width: 100%; border-collapse: collapse; text-align: center;"> <tr> <td style="width: 10%;"></td> <td style="width: 10%;"></td> <td style="width: 10%;"></td> <td style="width: 10%;"></td> <td style="width: 10%;"></td> <td style="width: 10%;"></td> <td style="width: 10%;"></td> <td style="width: 10%;"></td> <td style="width: 10%;"></td> <td style="width: 10%;"></td> </tr> <tr> <td></td> <td></td> <td colspan="8" style="text-align: center;"> <table border="1" style="width: 100%; border-collapse: collapse; text-align: center;"> <tr> <td style="width: 10%;"></td> <td style="width: 10%;"></td> <td style="width: 10%;"></td> <td style="width: 10%;"></td> <td style="width: 10%;"></td> <td style="width: 10%;"></td> <td style="width: 10%;"></td> <td style="width: 10%;"></td> <td style="width: 10%;"></td> <td style="width: 10%;"></td> </tr> <tr> <td></td> <td></td> <td colspan="8" style="text-align: center;"> <table border="1" style="width: 100%; border-collapse: collapse; text-align: center;"> <tr> <td style="width: 10%;"></td> <td style="width: 10%;"></td> <td style="width: 10%;"></td> <td style="width: 10%;"></td> <td style="width: 10%;"></td> <td style="width: 10%;"></td> <td style="width: 10%;"></td> <td style="width: 10%;"></td> <td style="width: 10%;"></td> <td style="width: 10%;"></td> </tr> <tr> <td></td> <td></td> <td colspan="8" style="text-align: center;"> <table border="1" style="width: 100%; border-collapse: collapse; text-align: center;"> <tr> <td style="width: 10%;"></td> <td style="width: 10%;"></td> <td style="width: 10%;"></td> <td style="width: 10%;"></td> <td style="width: 10%;"></td> <td style="width: 10%;"></td> <td style="width: 10%;"></td> <td style="width: 10%;"></td> <td style="width: 10%;"></td> <td style="width: 10%;"></td> </tr> <tr> <td></td> <td></td> <td colspan="8" style="text-align: center;"> <table border="1" style="width: 100%; border-collapse: collapse; text-align: center;"> <tr> <td style="width: 10%;"></td> <td style="width: 10%;"></td> <td style="width: 10%;"></td> <td style="width: 10%;"></td> <td style="width: 10%;"></td> <td style="width: 10%;"></td> <td style="width: 10%;"></td> <td style="width: 10%;"></td> <td style="width: 10%;"></td> <td style="width: 10%;"></td> </tr> <tr> <td></td> <td></td> <td colspan="8" style="text-align: center;"> <table border="1" style="width: 100%; border-collapse: collapse; text-align: center;"> <tr> </tr></table></td></tr></table></td></tr></table></td></tr></table></td></tr></table></td></tr></table></td></tr></table></td></tr></table></td></tr></table></td></tr></table></td></tr></table></td></tr></table></td></tr></table></td></tr></table></td></tr></table></td></tr></table></td></tr></table></td></tr></table></td></tr></table></td></tr></table></td></tr></table></td></tr></table></td></tr></table></td></tr></table></td></tr></table></td></tr></table></td></tr></table></td></tr></table></td></tr></table></td></tr></table></td></tr></table></td></tr></table></td></tr></table></td></tr></table></td></tr></table></td></tr></table>
 | | | | | | | | | | | | | | | | | | | | <table border="1" style="width: 100%; border-collapse: collapse; text-align: center;"> <tr> <td style="width: 10%;"></td> <td style="width: 10%;"></td> <td style="width: 10%;"></td> <td style="width: 10%;"></td> <td style="width: 10%;"></td> <td style="width: 10%;"></td> <td style="width: 10%;"></td> <td style="width: 10%;"></td> <td style="width: 10%;"></td> <td style="width: 10%;"></td> </tr> <tr> <td></td> <td></td> <td colspan="8" style="text-align: center;"> <table border="1" style="width: 100%; border-collapse: collapse; text-align: center;"> <tr> <td style="width: 10%;"></td> <td style="width: 10%;"></td> <td style="width: 10%;"></td> <td style="width: 10%;"></td> <td style="width: 10%;"></td> <td style="width: 10%;"></td> <td style="width: 10%;"></td> <td style="width: 10%;"></td> <td style="width: 10%;"></td> <td style="width: 10%;"></td> </tr> <tr> <td></td> <td></td> <td colspan="8" style="text-align: center;"> <table border="1" style="width: 100%; border-collapse: collapse; text-align: center;"> <tr> <td style="width: 10%;"></td> <td style="width: 10%;"></td> <td style="width: 10%;"></td> <td style="width: 10%;"></td> <td style="width: 10%;"></td> <td style="width: 10%;"></td> <td style="width: 10%;"></td> <td style="width: 10%;"></td> <td style="width: 10%;"></td> <td style="width: 10%;"></td> </tr> <tr> <td></td> <td></td> <td colspan="8" style="text-align: center;"> <table border="1" style="width: 100%; border-collapse: collapse; text-align: center;"> <tr> <td style="width: 10%;"></td> <td style="width: 10%;"></td> <td style="width: 10%;"></td> <td style="width: 10%;"></td> <td style="width: 10%;"></td> <td style="width: 10%;"></td> <td style="width: 10%;"></td> <td style="width: 10%;"></td> <td style="width: 10%;"></td> <td style="width: 10%;"></td> </tr> <tr> <td></td> <td></td> <td colspan="8" style="text-align: center;"> <table border="1" style="width: 100%; border-collapse: collapse; text-align: center;"> <tr> <td style="width: 10%;"></td> <td style="width: 10%;"></td> <td style="width: 10%;"></td> <td style="width: 10%;"></td> <td style="width: 10%;"></td> <td style="width: 10%;"></td> <td style="width: 10%;"></td> <td style="width: 10%;"></td> <td style="width: 10%;"></td> <td style="width: 10%;"></td> </tr> <tr> <td></td> <td></td> <td colspan="8" style="text-align: center;"> <table border="1" style="width: 100%; border-collapse: collapse; text-align: center;"> <tr> <td style="width: 10%;"></td> <td style="width: 10%;"></td> <td style="width: 10%;"></td> <td style="width: 10%;"></td> <td style="width: 10%;"></td> <td style="width: 10%;"></td> <td style="width: 10%;"></td> <td style="width: 10%;"></td> <td style="width: 10%;"></td> <td style="width: 10%;"></td> </tr> <tr> <td></td> <td></td> <td colspan="8" style="text-align: center;"> <table border="1" style="width: 100%; border-collapse: collapse; text-align: center;"> <tr> <td style="width: 10%;"></td> <td style="width: 10%;"></td> <td style="width: 10%;"></td> <td style="width: 10%;"></td> <td style="width: 10%;"></td> <td style="width: 10%;"></td> <td style="width: 10%;"></td> <td style="width: 10%;"></td> <td style="width: 10%;"></td> <td style="width: 10%;"></td> </tr> <tr> <td></td> <td></td> <td colspan="8" style="text-align: center;"> <table border="1" style="width: 100%; border-collapse: collapse; text-align: center;"> <tr> <td style="width: 10%;"></td> <td style="width: 10%;"></td> <td style="width: 10%;"></td> <td style="width: 10%;"></td> <td style="width: 10%;"></td> <td style="width: 10%;"></td> <td style="width: 10%;"></td> <td style="width: 10%;"></td> <td style="width: 10%;"></td> <td style="width: 10%;"></td> </tr> <tr> <td></td> <td></td> <td colspan="8" style="text-align: center;"> <table border="1" style="width: 100%; border-collapse: collapse; text-align: center;"> <tr> <td style="width: 10%;"></td> <td style="width: 10%;"></td> <td style="width: 10%;"></td> <td style="width: 10%;"></td> <td style="width: 10%;"></td> <td style="width: 10%;"></td> <td style="width: 10%;"></td> <td style="width: 10%;"></td> <td style="width: 10%;"></td> <td style="width: 10%;"></td> </tr> <tr> <td></td> <td></td> <td colspan="8" style="text-align: center;"> <table border="1" style="width: 100%; border-collapse: collapse; text-align: center;"> <tr> <td style="width: 10%;"></td> <td style="width: 10%;"></td> <td style="width: 10%;"></td> <td style="width: 10%;"></td> <td style="width: 10%;"></td> <td style="width: 10%;"></td> <td style="width: 10%;"></td> <td style="width: 10%;"></td> <td style="width: 10%;"></td> <td style="width: 10%;"></td> </tr> <tr> <td></td> <td></td> <td colspan="8" style="text-align: center;"> <table border="1" style="width: 100%; border-collapse: collapse; text-align: center;"> <tr> <td style="width: 10%;"></td> <td style="width: 10%;"></td> <td style="width: 10%;"></td> <td style="width: 10%;"></td> <td style="width: 10%;"></td> <td style="width: 10%;"></td> <td style="width: 10%;"></td> <td style="width: 10%;"></td> <td style="width: 10%;"></td> <td style="width: 10%;"></td> </tr> <tr> <td></td> <td></td> <td colspan="8" style="text-align: center;"> <table border="1" style="width: 100%; border-collapse: collapse; text-align: center;"> <tr> <td style="width: 10%;"></td> <td style="width: 10%;"></td> <td style="width: 10%;"></td> <td style="width: 10%;"></td> <td style="width: 10%;"></td> <td style="width: 10%;"></td> <td style="width: 10%;"></td> <td style="width: 10%;"></td> <td style="width: 10%;"></td> <td style="width: 10%;"></td> </tr> <tr> <td></td> <td></td> <td colspan="8" style="text-align: center;"> <table border="1" style="width: 100%; border-collapse: collapse; text-align: center;"> <tr> <td style="width: 10%;"></td> <td style="width: 10%;"></td> <td style="width: 10%;"></td> <td style="width: 10%;"></td> <td style="width: 10%;"></td> <td style="width: 10%;"></td> <td style="width: 10%;"></td> <td style="width: 10%;"></td> <td style="width: 10%;"></td> <td style="width: 10%;"></td> </tr> <tr> <td></td> <td></td> <td colspan="8" style="text-align: center;"> <table border="1" style="width: 100%; border-collapse: collapse; text-align: center;"> <tr> <td style="width: 10%;"></td> <td style="width: 10%;"></td> <td style="width: 10%;"></td> <td style="width: 10%;"></td> <td style="width: 10%;"></td> <td style="width: 10%;"></td> <td style="width: 10%;"></td> <td style="width: 10%;"></td> <td style="width: 10%;"></td> <td style="width: 10%;"></td> </tr> <tr> <td></td> <td></td> <td colspan="8" style="text-align: center;"> <table border="1" style="width: 100%; border-collapse: collapse; text-align: center;"> <tr> <td style="width: 10%;"></td> <td style="width: 10%;"></td> <td
style="width: 10%;"></td> <td style="width: 10%;"></td> <td style="width: 10%;"></td> <td style="width: 10%;"></td> <td style="width: 10%;"></td> <td style="width: 10%;"></td> <td style="width: 10%;"></td> <td style="width: 10%;"></td> </tr> <tr> <td></td> <td></td> <td colspan="8" style="text-align: center;"> <table border="1" style="width: 100%; border-collapse: collapse; text-align: center;"> <tr> <td style="width: 10%;"></td> <td style="width: 10%;"></td> <td style="width: 10%;"></td> <td style="width: 10%;"></td> <td style="width: 10%;"></td> <td style="width: 10%;"></td> <td style="width: 10%;"></td> <td style="width: 10%;"></td> <td style="width: 10%;"></td> <td style="width: 10%;"></td> </tr> <tr> <td></td> <td></td> <td colspan="8" style="text-align: center;"> <table border="1" style="width: 100%; border-collapse: collapse; text-align: center;"> <tr> <td style="width: 10%;"></td> <td style="width: 10%;"></td> <td style="width: 10%;"></td> <td style="width: 10%;"></td> <td style="width: 10%;"></td> <td style="width: 10%;"></td> <td style="width: 10%;"></td> <td style="width: 10%;"></td> <td style="width: 10%;"></td> <td style="width: 10%;"></td> </tr> <tr> <td></td> <td></td> <td colspan="8" style="text-align: center;"> <table border="1" style="width: 100%; border-collapse: collapse; text-align: center;"> <tr> <td style="width: 10%;"></td> <td style="width: 10%;"></td> <td style="width: 10%;"></td> <td style="width: 10%;"></td> <td style="width: 10%;"></td> <td style="width: 10%;"></td> <td style="width: 10%;"></td> <td style="width: 10%;"></td> <td style="width: 10%;"></td> <td style="width: 10%;"></td> </tr> <tr> <td></td> <td></td> <td colspan="8" style="text-align: center;"> <table border="1" style="width: 100%; border-collapse: collapse; text-align: center;"> <tr> <td style="width: 10%;"></td> <td style="width: 10%;"></td> <td style="width: 10%;"></td> <td style="width: 10%;"></td> <td style="width: 10%;"></td> <td style="width: 10%;"></td> <td style="width: 10%;"></td> <td style="width: 10%;"></td> <td style="width: 10%;"></td> <td style="width: 10%;"></td> </tr> <tr> <td></td> <td></td> <td colspan="8" style="text-align: center;"> <table border="1" style="width: 100%; border-collapse: collapse; text-align: center;"> <tr> <td style="width: 10%;"></td> <td style="width: 10%;"></td> <td style="width: 10%;"></td> <td style="width: 10%;"></td> <td style="width: 10%;"></td> <td style="width: 10%;"></td> <td style="width: 10%;"></td> <td style="width: 10%;"></td> <td style="width: 10%;"></td> <td style="width: 10%;"></td> </tr> <tr> <td></td> <td></td> <td colspan="8" style="text-align: center;"> <table border="1" style="width: 100%; border-collapse: collapse; text-align: center;"> <tr> <td style="width: 10%;"></td> <td style="width: 10%;"></td> <td style="width: 10%;"></td> <td style="width: 10%;"></td> <td style="width: 10%;"></td> <td style="width: 10%;"></td> <td style="width: 10%;"></td> <td style="width: 10%;"></td> <td style="width: 10%;"></td> <td style="width: 10%;"></td> </tr> <tr> <td></td> <td></td> <td colspan="8" style="text-align: center;"> <table border="1" style="width: 100%; border-collapse: collapse; text-align: center;"> <tr> <td style="width: 10%;"></td> <td style="width: 10%;"></td> <td style="width: 10%;"></td> <td style="width: 10%;"></td> <td style="width: 10%;"></td> <td style="width: 10%;"></td> <td style="width: 10%;"></td> <td style="width: 10%;"></td> <td style="width: 10%;"></td> <td style="width: 10%;"></td> </tr> <tr> <td></td> <td></td> <td colspan="8" style="text-align: center;"> <table border="1" style="width: 100%; border-collapse: collapse; text-align: center;"> <tr> <td style="width: 10%;"></td> <td style="width: 10%;"></td> <td style="width: 10%;"></td> <td style="width: 10%;"></td> <td style="width: 10%;"></td> <td style="width: 10%;"></td> <td style="width: 10%;"></td> <td style="width: 10%;"></td> <td style="width: 10%;"></td> <td style="width: 10%;"></td> </tr> <tr> <td></td> <td></td> <td colspan="8" style="text-align: center;"> <table border="1" style="width: 100%; border-collapse: collapse; text-align: center;"> <tr> <td style="width: 10%;"></td> <td style="width: 10%;"></td> <td style="width: 10%;"></td> <td style="width: 10%;"></td> <td style="width: 10%;"></td> <td style="width: 10%;"></td> <td style="width: 10%;"></td> <td style="width: 10%;"></td> <td style="width: 10%;"></td> <td style="width: 10%;"></td> </tr> <tr> <td></td> <td></td> <td colspan="8" style="text-align: center;"> <table border="1" style="width: 100%; border-collapse: collapse; text-align: center;"> <tr> <td style="width: 10%;"></td> <td style="width: 10%;"></td> <td style="width: 10%;"></td> <td style="width: 10%;"></td> <td style="width: 10%;"></td> <td style="width: 10%;"></td> <td style="width: 10%;"></td> <td style="width: 10%;"></td> <td style="width: 10%;"></td> <td style="width: 10%;"></td> </tr> <tr> <td></td> <td></td> <td colspan="8" style="text-align: center;"> <table border="1" style="width: 100%; border-collapse: collapse; text-align: center;"> <tr> <td style="width: 10%;"></td> <td style="width: 10%;"></td> <td style="width: 10%;"></td> <td style="width: 10%;"></td> <td style="width: 10%;"></td> <td style="width: 10%;"></td> <td style="width: 10%;"></td> <td style="width: 10%;"></td> <td style="width: 10%;"></td> <td style="width: 10%;"></td> </tr> <tr> <td></td> <td></td> <td colspan="8" style="text-align: center;"> <table border="1" style="width: 100%; border-collapse: collapse; text-align: center;"> <tr> <td style="width: 10%;"></td> <td style="width: 10%;"></td> <td style="width: 10%;"></td> <td style="width: 10%;"></td> <td style="width: 10%;"></td> <td style="width: 10%;"></td> <td style="width: 10%;"></td> <td style="width: 10%;"></td> <td style="width: 10%;"></td> <td style="width: 10%;"></td> </tr> <tr> <td></td> <td></td> <td colspan="8" style="text-align: center;"> <table border="1" style="width: 100%; border-collapse: collapse; text-align: center;"> <tr> <td style="width: 10%;"></td> <td style="width: 10%;"></td> <td style="width: 10%;"></td> <td style="width: 10%;"></td> <td style="width: 10%;"></td> <td style="width: 10%;"></td> <td style="width: 10%;"></td> <td style="width: 10%;"></td> <td style="width: 10%;"></td> <td style="width: 10%;"></td> </tr> <tr> <td></td> <td></td> <td colspan="8" style="text-align: center;"> <table border="1" style="width: 100%; border-collapse: collapse; text-align: center;"> <tr> <td style="width: 10%;"></td> <td style="width: 10%;"></td> <td style="width: 10%;"></td> <td style="width: 10%;"></td> <td style="width: 10%;"></td> <td style="width: 10%;"></td> <td style="width: 10%;"></td> <td style="width: 10%;"></td> <td style="width: 10%;"></td> <td style="width: 10%;"></td> </tr> <tr> <td></td> <td></td> <td colspan="8" style="text-align: center;"> <table border="1" style="width: 100%; border-collapse: collapse; text-align: center;"> <tr> <td style="width: 10%;"></td> <td style="width: 10%;"></td> <td style="width: 10%;"></td> <td style="width: 10%;"></td> <td style="width: 10%;"></td> <td style="width: 10%;"></td> <td style="width: 10%;"></td> <td style="width: 10%;"></td> <td style="width: 10%;"></td> <td style="width: 10%;"></td> </tr> <tr> <td></td> <td></td> <td colspan="8" style="text-align: center;"> <table border="1" style="width: 100%; border-collapse: collapse; text-align: center;"> <tr> <td style="width: 10%;"></td> <td style="width: 10%;"></td> <td style="width: 10%;"></td> <td style="width: 10%;"></td> <td style="width: 10%;"></td> <td style="width: 10%;"></td> <td style="width: 10%;"></td> <td style="width: 10%;"></td> <td style="width: 10%;"></td> <td style="width: 10%;"></td> </tr> <tr> <td></td> <td></td> <td colspan="8" style="text-align: center;"> <table border="1" style="width: 100%; border-collapse: collapse; text-align: center;"> <tr> <td style="width: 10%;"></td> <td style="width: 10%;"></td> <td style="width: 10%;"></td> <td style="width: 10%;"></td> <td style="width: 10%;"></td> <td style="width: 10%;"></td> <td style="width: 10%;"></td> <td style="width: 10%;"></td> <td style="width: 10%;"></td> <td style="width: 10%;"></td> </tr> <tr> <td></td> <td></td> <td colspan="8" style="text-align: center;"> <table border="1" style="width: 100%; border-collapse: collapse; text-align: center;"> <tr> <td style="width: 10%;"></td> <td style="width: 10%;"></td> <td style="width: 10%;"></td> <td style="width: 10%;"></td> <td style="width: 10%;"></td> <td style="width: 10%;"></td> <td style="width: 10%;"></td> <td style="width: 10%;"></td> <td style="width: 10%;"></td> <td style="width: 10%;"></td> </tr> <tr> <td></td> <td></td> <td colspan="8" style="text-align: center;"> <table border="1" style="width: 100%; border-collapse: collapse; text-align: center;"> <tr> <td style="width: 10%;"></td> <td style="width: 10%;"></td> <td style="width: 10%;"></td> <td style="width: 10%;"></td> <td style="width: 10%;"></td> <td style="width: 10%;"></td> <td style="width: 10%;"></td> <td style="width: 10%;"></td> <td style="width: 10%;"></td> <td style="width: 10%;"></td> </tr> <tr> <td></td> <td></td> <td colspan="8" style="text-align: center;"> <table border="1" style="width: 100%; border-collapse: collapse; text-align: center;"> <tr> </tr></table></td></tr></table></td></tr></table></td></tr></table></td></tr></table></td></tr></table></td></tr></table></td></tr></table></td></tr></table></td></tr></table></td></tr></table></td></tr></table></td></tr></table></td></tr></table></td></tr></table></td></tr></table></td></tr></table></td></tr></table></td></tr></table></td></tr></table></td></tr></table></td></tr></table></td></tr></table></td></tr></table></td></tr></table></td></tr></table></td></tr></table></td></tr></table></td></tr></table></td></tr></table></td></tr></table></td></tr></table></td></tr></table></td></tr></table></td></tr></table>
 | | | | | | | | | | | | | | | | | | | | <table border="1" style="width: 100%; border-collapse: collapse; text-align: center;"> <tr> <td style="width: 10%;"></td> <td style="width: 10%;"></td> <td style="width: 10%;"></td> <td style="width: 10%;"></td> <td style="width: 10%;"></td> <td style="width: 10%;"></td> <td style="width: 10%;"></td> <td style="width: 10%;"></td> <td style="width: 10%;"></td> <td style="width: 10%;"></td> </tr> <tr> <td></td> <td></td> <td colspan="8" style="text-align: center;"> <table border="1" style="width: 100%; border-collapse: collapse; text-align: center;"> <tr> <td style="width: 10%;"></td> <td style="width: 10%;"></td> <td style="width: 10%;"></td> <td style="width: 10%;"></td> <td style="width: 10%;"></td> <td style="width: 10%;"></td> <td style="width: 10%;"></td> <td style="width: 10%;"></td> <td style="width: 10%;"></td> <td style="width: 10%;"></td> </tr> <tr> <td></td> <td></td> <td colspan="8" style="text-align: center;"> <table border="1" style="width: 100%; border-collapse: collapse; text-align: center;"> <tr> <td style="width: 10%;"></td> <td style="width: 10%;"></td> <td style="width: 10%;"></td> <td style="width: 10%;"></td> <td style="width: 10%;"></td> <td style="width: 10%;"></td> <td style="width: 10%;"></td> <td style="width: 10%;"></td> <td style="width: 10%;"></td> <td style="width: 10%;"></td> </tr> <tr> <td></td> <td></td> <td colspan="8" style="text-align: center;"> <table border="1" style="width: 100%; border-collapse: collapse; text-align: center;"> <tr> <td style="width: 10%;"></td> <td style="width: 10%;"></td> <td style="width: 10%;"></td> <td style="width: 10%;"></td> <td style="width: 10%;"></td> <td style="width: 10%;"></td> <td style="width: 10%;"></td> <td style="width: 10%;"></td> <td style="width: 10%;"></td> <td style="width: 10%;"></td> </tr> <tr> <td></td> <td></td> <td colspan="8" style="text-align: center;"> <table border="1" style="width: 100%; border-collapse: collapse; text-align: center;"> <tr> <td style="width: 10%;"></td> <td style="width: 10%;"></td> <td style="width: 10%;"></td> <td style="width: 10%;"></td> <td style="width: 10%;"></td> <td style="width: 10%;"></td> <td style="width: 10%;"></td> <td style="width: 10%;"></td> <td style="width: 10%;"></td> <td style="width: 10%;"></td> </tr> <tr> <td></td> <td></td> <td colspan="8" style="text-align: center;"> <table border="1" style="width: 100%; border-collapse: collapse; text-align: center;"> <tr> <td style="width: 10%;"></td> <td style="width: 10%;"></td> <td style="width: 10%;"></td> <td style="width: 10%;"></td> <td style="width: 10%;"></td> <td style="width: 10%;"></td> <td style="width: 10%;"></td> <td style="width: 10%;"></td> <td style="width: 10%;"></td> <td style="width: 10%;"></td> </tr> <tr> <td></td> <td></td> <td colspan="8" style="text-align: center;"> <table border="1" style="width: 100%; border-collapse: collapse; text-align: center;"> <tr> <td style="width: 10%;"></td> <td style="width: 10%;"></td> <td style="width: 10%;"></td> <td style="width: 10%;"></td> <td style="width: 10%;"></td> <td style="width: 10%;"></td> <td style="width: 10%;"></td> <td style="width: 10%;"></td> <td style="width: 10%;"></td> <td style="width: 10%;"></td> </tr> <tr> <td></td> <td></td> <td colspan="8" style="text-align: center;"> <table border="1" style="width: 100%; border-collapse: collapse; text-align: center;"> <tr> <td style="width: 10%;"></td> <td style="width: 10%;"></td> <td style="width: 10%;"></td> <td style="width: 10%;"></td> <td style="width: 10%;"></td> <td style="width: 10%;"></td> <td style="width: 10%;"></td> <td style="width: 10%;"></td> <td style="width: 10%;"></td> <td style="width: 10%;"></td> </tr> <tr> <td></td> <td></td> <td colspan="8" style="text-align: center;"> <table border="1" style="width: 100%; border-collapse: collapse; text-align: center;"> <tr> <td style="width: 10%;"></td> <td style="width: 10%;"></td> <td style="width: 10%;"></td> <td style="width: 10%;"></td> <td style="width: 10%;"></td> <td style="width: 10%;"></td> <td style="width: 10%;"></td> <td style="width: 10%;"></td> <td style="width: 10%;"></td> <td style="width: 10%;"></td> </tr> <tr> <td></td> <td></td> <td colspan="8" style="text-align: center;"> <table border="1" style="width: 100%; border-collapse: collapse; text-align: center;"> <tr> <td style="width: 10%;"></td> <td style="width: 10%;"></td> <td style="width: 10%;"></td> <td style="width: 10%;"></td> <td style="width: 10%;"></td> <td style="width: 10%;"></td> <td style="width: 10%;"></td> <td style="width: 10%;"></td> <td style="width: 10%;"></td> <td style="width: 10%;"></td> </tr> <tr> <td></td> <td></td> <td colspan="8" style="text-align: center;"> <table border="1" style="width: 100%; border-collapse: collapse; text-align: center;"> <tr> <td style="width: 10%;"></td> <td style="width: 10%;"></td> <td style="width: 10%;"></td> <td style="width: 10%;"></td> <td style="width: 10%;"></td> <td style="width: 10%;"></td> <td style="width: 10%;"></td> <td style="width: 10%;"></td> <td style="width: 10%;"></td> <td style="width: 10%;"></td> </tr> <tr> <td></td> <td></td> <td colspan="8" style="text-align: center;"> <table
border="1" style="width: 100%; border-collapse: collapse; text-align: center;"> <tr> <td style="width: 10%;"></td> <td style="width: 10%;"></td> <td style="width: 10%;"></td> <td style="width: 10%;"></td> <td style="width: 10%;"></td> <td style="width: 10%;"></td> <td style="width: 10%;"></td> <td style="width: 10%;"></td> <td style="width: 10%;"></td> <td style="width: 10%;"></td> </tr> <tr> <td></td> <td></td> <td colspan="8" style="text-align: center;"> <table border="1" style="width: 100%; border-collapse: collapse; text-align: center;"> <tr> <td style="width: 10%;"></td> <td style="width: 10%;"></td> <td style="width: 10%;"></td> <td style="width: 10%;"></td> <td style="width: 10%;"></td> <td style="width: 10%;"></td> <td style="width: 10%;"></td> <td style="width: 10%;"></td> <td style="width: 10%;"></td> <td style="width: 10%;"></td> </tr> <tr> <td></td> <td></td> <td colspan="8" style="text-align: center;"> <table border="1" style="width: 100%; border-collapse: collapse; text-align: center;"> <tr> <td style="width: 10%;"></td> <td style="width: 10%;"></td> <td style="width: 10%;"></td> <td style="width: 10%;"></td> <td style="width: 10%;"></td> <td style="width: 10%;"></td> <td style="width: 10%;"></td> <td style="width: 10%;"></td> <td style="width: 10%;"></td> <td style="width: 10%;"></td> </tr> <tr> <td></td> <td></td> <td colspan="8" style="text-align: center;"> <table border="1" style="width: 100%; border-collapse: collapse; text-align: center;"> <tr> <td style="width: 10%;"></td> <td style="width: 10%;"></td> <td style="width: 10%;"></td> <td style="width: 10%;"></td> <td style="width: 10%;"></td> <td style="width: 10%;"></td> <td style="width: 10%;"></td> <td style="width: 10%;"></td> <td style="width: 10%;"></td> <td style="width: 10%;"></td> </tr> <tr> <td></td> <td></td> <td colspan="8" style="text-align: center;"> <table border="1" style="width: 100%; border-collapse: collapse; text-align: center;"> <tr> <td style="width: 10%;"></td> <td style="width: 10%;"></td> <td style="width: 10%;"></td> <td style="width: 10%;"></td> <td style="width: 10%;"></td> <td style="width: 10%;"></td> <td style="width: 10%;"></td> <td style="width: 10%;"></td> <td style="width: 10%;"></td> <td style="width: 10%;"></td> </tr> <tr> <td></td> <td></td> <td colspan="8" style="text-align: center;"> <table border="1" style="width: 100%; border-collapse: collapse; text-align: center;"> <tr> <td style="width: 10%;"></td> <td style="width: 10%;"></td> <td style="width: 10%;"></td> <td style="width: 10%;"></td> <td style="width: 10%;"></td> <td style="width: 10%;"></td> <td style="width: 10%;"></td> <td style="width: 10%;"></td> <td style="width: 10%;"></td> <td style="width: 10%;"></td> </tr> <tr> <td></td> <td></td> <td colspan="8" style="text-align: center;"> <table border="1" style="width: 100%; border-collapse: collapse; text-align: center;"> <tr> <td style="width: 10%;"></td> <td style="width: 10%;"></td> <td style="width: 10%;"></td> <td style="width: 10%;"></td> <td style="width: 10%;"></td> <td style="width: 10%;"></td> <td style="width: 10%;"></td> <td style="width: 10%;"></td> <td style="width: 10%;"></td> <td style="width: 10%;"></td> </tr> <tr> <td></td> <td></td> <td colspan="8" style="text-align: center;"> <table border="1" style="width: 100%; border-collapse: collapse; text-align: center;"> <tr> <td style="width: 10%;"></td> <td style="width: 10%;"></td> <td style="width: 10%;"></td> <td style="width: 10%;"></td> <td style="width: 10%;"></td> <td style="width: 10%;"></td> <td style="width: 10%;"></td> <td style="width: 10%;"></td> <td style="width: 10%;"></td> <td style="width: 10%;"></td> </tr> <tr> <td></td> <td></td> <td colspan="8" style="text-align: center;"> <table border="1" style="width: 100%; border-collapse: collapse; text-align: center;"> <tr> <td style="width: 10%;"></td> <td style="width: 10%;"></td> <td style="width: 10%;"></td> <td style="width: 10%;"></td> <td style="width: 10%;"></td> <td style="width: 10%;"></td> <td style="width: 10%;"></td> <td style="width: 10%;"></td> <td style="width: 10%;"></td> <td style="width: 10%;"></td> </tr> <tr> <td></td> <td></td> <td colspan="8" style="text-align: center;"> <table border="1" style="width: 100%; border-collapse: collapse; text-align: center;"> <tr> <td style="width: 10%;"></td> <td style="width: 10%;"></td> <td style="width: 10%;"></td> <td style="width: 10%;"></td> <td style="width: 10%;"></td> <td style="width: 10%;"></td> <td style="width: 10%;"></td> <td style="width: 10%;"></td> <td style="width: 10%;"></td> <td style="width: 10%;"></td> </tr> <tr> <td></td> <td></td> <td colspan="8" style="text-align: center;"> <table border="1" style="width: 100%; border-collapse: collapse; text-align: center;"> <tr> <td style="width: 10%;"></td> <td style="width: 10%;"></td> <td style="width: 10%;"></td> <td style="width: 10%;"></td> <td style="width: 10%;"></td> <td style="width: 10%;"></td> <td style="width: 10%;"></td> <td style="width: 10%;"></td> <td style="width: 10%;"></td> <td style="width: 10%;"></td> </tr> <tr> <td></td> <td></td> <td colspan="8" style="text-align: center;"> <table border="1" style="width: 100%; border-collapse: collapse; text-align: center;"> <tr> <td style="width: 10%;"></td> <td style="width: 10%;"></td> <td style="width: 10%;"></td> <td style="width: 10%;"></td> <td style="width: 10%;"></td> <td style="width: 10%;"></td> <td style="width: 10%;"></td> <td style="width: 10%;"></td> <td style="width: 10%;"></td> <td style="width: 10%;"></td> </tr> <tr> <td></td> <td></td> <td colspan="8" style="text-align: center;"> <table border="1" style="width: 100%; border-collapse: collapse; text-align: center;"> <tr> <td style="width: 10%;"></td> <td style="width: 10%;"></td> <td style="width: 10%;"></td> <td style="width: 10%;"></td> <td style="width: 10%;"></td> <td style="width: 10%;"></td> <td style="width: 10%;"></td> <td style="width: 10%;"></td> <td style="width: 10%;"></td> <td style="width: 10%;"></td> </tr> <tr> <td></td> <td></td> <td colspan="8" style="text-align: center;"> <table border="1" style="width: 100%; border-collapse: collapse; text-align: center;"> <tr> <td style="width: 10%;"></td> <td style="width: 10%;"></td> <td style="width: 10%;"></td> <td style="width: 10%;"></td> <td style="width: 10%;"></td> <td style="width: 10%;"></td> <td style="width: 10%;"></td> <td style="width: 10%;"></td> <td style="width: 10%;"></td> <td style="width: 10%;"></td> </tr> <tr> <td></td> <td></td> <td colspan="8" style="text-align: center;"> <table border="1" style="width: 100%; border-collapse: collapse; text-align: center;"> <tr> <td style="width: 10%;"></td> <td style="width: 10%;"></td> <td style="width: 10%;"></td> <td style="width: 10%;"></td> <td style="width: 10%;"></td> <td style="width: 10%;"></td> <td style="width: 10%;"></td> <td style="width: 10%;"></td> <td style="width: 10%;"></td> <td style="width: 10%;"></td> </tr> <tr> <td></td> <td></td> <td colspan="8" style="text-align: center;"> <table border="1" style="width: 100%; border-collapse: collapse; text-align: center;"> <tr> <td style="width: 10%;"></td> <td style="width: 10%;"></td> <td style="width: 10%;"></td> <td style="width: 10%;"></td> <td style="width: 10%;"></td> <td style="width: 10%;"></td> <td style="width: 10%;"></td> <td style="width: 10%;"></td> <td style="width: 10%;"></td> <td style="width: 10%;"></td> </tr> <tr> <td></td> <td></td> <td colspan="8" style="text-align: center;"> <table border="1" style="width: 100%; border-collapse: collapse; text-align: center;"> <tr> <td style="width: 10%;"></td> <td style="width: 10%;"></td> <td style="width: 10%;"></td> <td style="width: 10%;"></td> <td style="width: 10%;"></td> <td style="width: 10%;"></td> <td style="width: 10%;"></td> <td style="width: 10%;"></td> <td style="width: 10%;"></td> <td style="width: 10%;"></td> </tr> <tr> <td></td> <td></td> <td colspan="8" style="text-align: center;"> <table border="1" style="width: 100%; border-collapse: collapse; text-align: center;"> <tr> <td style="width: 10%;"></td> <td style="width: 10%;"></td> <td style="width: 10%;"></td> <td style="width: 10%;"></td> <td style="width: 10%;"></td> <td style="width: 10%;"></td> <td style="width: 10%;"></td> <td style="width: 10%;"></td> <td style="width: 10%;"></td> <td style="width: 10%;"></td> </tr> <tr> <td></td> <td></td> <td colspan="8" style="text-align: center;"> <table border="1" style="width: 100%; border-collapse: collapse; text-align: center;"> <tr> <td style="width: 10%;"></td> <td style="width: 10%;"></td> <td style="width: 10%;"></td> <td style="width: 10%;"></td> <td style="width: 10%;"></td> <td style="width: 10%;"></td> <td style="width: 10%;"></td> <td style="width: 10%;"></td> <td style="width: 10%;"></td> <td style="width: 10%;"></td> </tr> <tr> <td></td> <td></td> <td colspan="8" style="text-align: center;"> <table border="1" style="width: 100%; border-collapse: collapse; text-align: center;"> <tr> <td style="width: 10%;"></td> <td style="width: 10%;"></td> <td style="width: 10%;"></td> <td style="width: 10%;"></td> <td style="width: 10%;"></td> <td style="width: 10%;"></td> <td style="width: 10%;"></td> <td style="width: 10%;"></td> <td style="width: 10%;"></td> <td style="width: 10%;"></td> </tr> <tr> <td></td> <td></td> <td colspan="8" style="text-align: center;"> <table border="1" style="width: 100%; border-collapse: collapse; text-align: center;"> <tr> <td style="width: 10%;"></td> <td style="width: 10%;"></td> <td style="width: 10%;"></td> <td style="width: 10%;"></td> <td style="width: 10%;"></td> <td style="width: 10%;"></td> <td style="width: 10%;"></td> <td style="width: 10%;"></td> <td style="width: 10%;"></td> <td style="width: 10%;"></td> </tr> <tr> <td></td> <td></td> <td colspan="8" style="text-align: center;"> <table border="1" style="width: 100%; border-collapse: collapse; text-align: center;"> <tr> <td style="width: 10%;"></td> <td style="width: 10%;"></td> <td style="width:
10%;"></td> <td style="width: 10%;"></td> <td style="width: 10%;"></td> <td style="width: 10%;"></td> <td style="width: 10%;"></td> <td style="width: 10%;"></td> <td style="width: 10%;"></td> <td style="width: 10%;"></td> </tr> <tr> <td></td> <td></td> <td colspan="8" style="text-align: center;"> <table border="1" style="width: 100%; border-collapse: collapse; text-align: center;"> <tr> </tr></table></td></tr></table></td></tr></table></td></tr></table></td></tr></table></td></tr></table></td></tr></table></td></tr></table></td></tr></table></td></tr></table></td></tr></table></td></tr></table></td></tr></table></td></tr></table></td></tr></table></td></tr></table></td></tr></table></td></tr></table></td></tr></table></td></tr></table></td></tr></table></td></tr></table></td></tr></table></td></tr></table></td></tr></table></td></tr></table></td></tr></table></td></tr></table></td></tr></table></td></tr></table></td></tr></table></td></tr></table></td></tr></table></td></tr></table> | | | | | | | | | | | | | | | | | | | | <table border="1" style="width: 100%; border-collapse: collapse; text-align: center;"> <tr> <td style="width: 10%;"></td> <td style="width: 10%;"></td> <td style="width: 10%;"></td> <td style="width: 10%;"></td> <td style="width: 10%;"></td> <td style="width: 10%;"></td> <td style="width: 10%;"></td> <td style="width: 10%;"></td> <td style="width: 10%;"></td> <td style="width: 10%;"></td> </tr> <tr> <td></td> <td></td> <td colspan="8" style="text-align: center;"> <table border="1" style="width: 100%; border-collapse: collapse; text-align: center;"> <tr> <td style="width: 10%;"></td> <td style="width: 10%;"></td> <td style="width: 10%;"></td> <td style="width: 10%;"></td> <td style="width: 10%;"></td> <td style="width: 10%;"></td> <td style="width: 10%;"></td> <td style="width: 10%;"></td> <td style="width: 10%;"></td> <td style="width: 10%;"></td> </tr> <tr> <td></td> <td></td> <td colspan="8" style="text-align: center;"> <table border="1" style="width: 100%; border-collapse: collapse; text-align: center;"> <tr> <td style="width: 10%;"></td> <td style="width: 10%;"></td> <td style="width: 10%;"></td> <td style="width: 10%;"></td> <td style="width: 10%;"></td> <td style="width: 10%;"></td> <td style="width: 10%;"></td> <td style="width: 10%;"></td> <td style="width: 10%;"></td> <td style="width: 10%;"></td> </tr> <tr> <td></td> <td></td> <td colspan="8" style="text-align: center;"> <table border="1" style="width: 100%; border-collapse: collapse; text-align: center;"> <tr> <td style="width: 10%;"></td> <td style="width: 10%;"></td> <td style="width: 10%;"></td> <td style="width: 10%;"></td> <td style="width: 10%;"></td> <td style="width: 10%;"></td> <td style="width: 10%;"></td> <td style="width: 10%;"></td> <td style="width: 10%;"></td> <td style="width: 10%;"></td> </tr> <tr> <td></td> <td></td> <td colspan="8" style="text-align: center;"> <table border="1" style="width: 100%; border-collapse: collapse; text-align: center;"> <tr> <td style="width: 10%;"></td> <td style="width: 10%;"></td> <td style="width: 10%;"></td> <td style="width: 10%;"></td> <td style="width: 10%;"></td> <td style="width: 10%;"></td> <td style="width: 10%;"></td> <td style="width: 10%;"></td> <td style="width: 10%;"></td> <td style="width: 10%;"></td> </tr> <tr> <td></td> <td></td> <td colspan="8" style="text-align: center;"> <table border="1" style="width: 100%; border-collapse: collapse; text-align: center;"> <tr> <td style="width: 10%;"></td> <td style="width: 10%;"></td> <td style="width: 10%;"></td> <td style="width: 10%;"></td> <td style="width: 10%;"></td> <td style="width: 10%;"></td> <td style="width: 10%;"></td> <td style="width: 10%;"></td> <td style="width: 10%;"></td> <td style="width: 10%;"></td> </tr> <tr> <td></td> <td></td> <td colspan="8" style="text-align: center;"> <table border="1" style="width: 100%; border-collapse: collapse; text-align: center;"> <tr> <td style="width: 10%;"></td> <td style="width: 10%;"></td> <td style="width: 10%;"></td> <td style="width: 10%;"></td> <td style="width: 10%;"></td> <td style="width: 10%;"></td> <td style="width: 10%;"></td> <td style="width: 10%;"></td> <td style="width: 10%;"></td> <td style="width: 10%;"></td> </tr> <tr> <td></td> <td></td> <td colspan="8" style="text-align: center;"> <table border="1" style="width: 100%; border-collapse: collapse; text-align: center;"> <tr> <td style="width: 10%;"></td> <td style="width: 10%;"></td> <td style="width: 10%;"></td> <td style="width: 10%;"></td> <td style="width: 10%;"></td> <td style="width: 10%;"></td> <td style="width: 10%;"></td> <td style="width: 10%;"></td> <td style="width: 10%;"></td> <td style="width: 10%;"></td> </tr> <tr> <td></td> <td></td> <td colspan="8" style="text-align: center;"> <table border="1" style="width: 100%; border-collapse: collapse; text-align: center;"> <tr> <td style="width: 10%;"></td> <td style="width: 10%;"></td> <td style="width: 10%;"></td> <td style="width: 10%;"></td> <td style="width: 10%;"></td> <td style="width: 10%;"></td> <td style="width: 10%;"></td> <td style="width: 10%;"></td> <td
style="width: 10%;"></td> <td style="width: 10%;"></td> </tr> <tr> <td></td> <td></td> <td colspan="8" style="text-align: center;"> <table border="1" style="width: 100%; border-collapse: collapse; text-align: center;"> <tr> <td style="width: 10%;"></td> <td style="width: 10%;"></td> <td style="width: 10%;"></td> <td style="width: 10%;"></td> <td style="width: 10%;"></td> <td style="width: 10%;"></td> <td style="width: 10%;"></td> <td style="width: 10%;"></td> <td style="width: 10%;"></td> <td style="width: 10%;"></td> </tr> <tr> <td></td> <td></td> <td colspan="8" style="text-align: center;"> <table border="1" style="width: 100%; border-collapse: collapse; text-align: center;"> <tr> <td style="width: 10%;"></td> <td style="width: 10%;"></td> <td style="width: 10%;"></td> <td style="width: 10%;"></td> <td style="width: 10%;"></td> <td style="width: 10%;"></td> <td style="width: 10%;"></td> <td style="width: 10%;"></td> <td style="width: 10%;"></td> <td style="width: 10%;"></td> </tr> <tr> <td></td> <td></td> <td colspan="8" style="text-align: center;"> <table border="1" style="width: 100%; border-collapse: collapse; text-align: center;"> <tr> <td style="width: 10%;"></td> <td style="width: 10%;"></td> <td style="width: 10%;"></td> <td style="width: 10%;"></td> <td style="width: 10%;"></td> <td style="width: 10%;"></td> <td style="width: 10%;"></td> <td style="width: 10%;"></td> <td style="width: 10%;"></td> <td style="width: 10%;"></td> </tr> <tr> <td></td> <td></td> <td colspan="8" style="text-align: center;"> <table border="1" style="width: 100%; border-collapse: collapse; text-align: center;"> <tr> <td style="width: 10%;"></td> <td style="width: 10%;"></td> <td style="width: 10%;"></td> <td style="width: 10%;"></td> <td style="width: 10%;"></td> <td style="width: 10%;"></td> <td style="width: 10%;"></td> <td style="width: 10%;"></td> <td style="width: 10%;"></td> <td style="width: 10%;"></td> </tr> <tr> <td></td> <td></td> <td colspan="8" style="text-align: center;"> <table border="1" style="width: 100%; border-collapse: collapse; text-align: center;"> <tr> <td style="width: 10%;"></td> <td style="width: 10%;"></td> <td style="width: 10%;"></td> <td style="width: 10%;"></td> <td style="width: 10%;"></td> <td style="width: 10%;"></td> <td style="width: 10%;"></td> <td style="width: 10%;"></td> <td style="width: 10%;"></td> <td style="width: 10%;"></td> </tr> <tr> <td></td> <td></td> <td colspan="8" style="text-align: center;"> <table border="1" style="width: 100%; border-collapse: collapse; text-align: center;"> <tr> <td style="width: 10%;"></td> <td style="width: 10%;"></td> <td style="width: 10%;"></td> <td style="width: 10%;"></td> <td style="width: 10%;"></td> <td style="width: 10%;"></td> <td style="width: 10%;"></td> <td style="width: 10%;"></td> <td style="width: 10%;"></td> <td style="width: 10%;"></td> </tr> <tr> <td></td> <td></td> <td colspan="8" style="text-align: center;"> <table border="1" style="width: 100%; border-collapse: collapse; text-align: center;"> <tr> <td style="width: 10%;"></td> <td style="width: 10%;"></td> <td style="width: 10%;"></td> <td style="width: 10%;"></td> <td style="width: 10%;"></td> <td style="width: 10%;"></td> <td style="width: 10%;"></td> <td style="width: 10%;"></td> <td style="width: 10%;"></td> <td style="width: 10%;"></td> </tr> <tr> <td></td> <td></td> <td colspan="8" style="text-align: center;"> <table border="1" style="width: 100%; border-collapse: collapse; text-align: center;"> <tr> <td style="width: 10%;"></td> <td style="width: 10%;"></td> <td style="width: 10%;"></td> <td style="width: 10%;"></td> <td style="width: 10%;"></td> <td style="width: 10%;"></td> <td style="width: 10%;"></td> <td style="width: 10%;"></td> <td style="width: 10%;"></td> <td style="width: 10%;"></td> </tr> <tr> <td></td> <td></td> <td colspan="8" style="text-align: center;"> <table border="1" style="width: 100%; border-collapse: collapse; text-align: center;"> <tr> <td style="width: 10%;"></td> <td style="width: 10%;"></td> <td style="width: 10%;"></td> <td style="width: 10%;"></td> <td style="width: 10%;"></td> <td style="width: 10%;"></td> <td style="width: 10%;"></td> <td style="width: 10%;"></td> <td style="width: 10%;"></td> <td style="width: 10%;"></td> </tr> <tr> <td></td> <td></td> <td colspan="8" style="text-align: center;"> <table border="1" style="width: 100%; border-collapse: collapse; text-align: center;"> <tr> <td style="width: 10%;"></td> <td style="width: 10%;"></td> <td style="width: 10%;"></td> <td style="width: 10%;"></td> <td style="width: 10%;"></td> <td style="width: 10%;"></td> <td style="width: 10%;"></td> <td style="width: 10%;"></td> <td style="width: 10%;"></td> <td style="width: 10%;"></td> </tr> <tr> <td></td> <td></td> <td colspan="8" style="text-align: center;"> <table border="1" style="width: 100%; border-collapse: collapse; text-align: center;"> <tr> <td style="width: 10%;"></td> <td style="width: 10%;"></td> <td style="width: 10%;"></td> <td style="width: 10%;"></td> <td style="width: 10%;"></td> <td style="width: 10%;"></td> <td style="width: 10%;"></td> <td style="width: 10%;"></td> <td style="width: 10%;"></td> <td style="width: 10%;"></td> </tr> <tr> <td></td> <td></td> <td colspan="8" style="text-align: center;"> <table border="1" style="width: 100%; border-collapse: collapse; text-align: center;"> <tr> <td style="width: 10%;"></td> <td style="width: 10%;"></td> <td style="width: 10%;"></td> <td style="width: 10%;"></td> <td style="width: 10%;"></td> <td style="width: 10%;"></td> <td style="width: 10%;"></td> <td style="width: 10%;"></td> <td style="width: 10%;"></td> <td style="width: 10%;"></td> </tr> <tr> <td></td> <td></td> <td colspan="8" style="text-align: center;"> <table border="1" style="width: 100%; border-collapse: collapse; text-align: center;"> <tr> <td style="width: 10%;"></td> <td style="width: 10%;"></td> <td style="width: 10%;"></td> <td style="width: 10%;"></td> <td style="width: 10%;"></td> <td style="width: 10%;"></td> <td style="width: 10%;"></td> <td style="width: 10%;"></td> <td style="width: 10%;"></td> <td style="width: 10%;"></td> </tr> <tr> <td></td> <td></td> <td colspan="8" style="text-align: center;"> <table border="1" style="width: 100%; border-collapse: collapse; text-align: center;"> <tr> <td style="width: 10%;"></td> <td style="width: 10%;"></td> <td style="width: 10%;"></td> <td style="width: 10%;"></td> <td style="width: 10%;"></td> <td style="width: 10%;"></td> <td style="width: 10%;"></td> <td style="width: 10%;"></td> <td style="width: 10%;"></td> <td style="width: 10%;"></td> </tr> <tr> <td></td> <td></td> <td colspan="8" style="text-align: center;"> <table border="1" style="width: 100%; border-collapse: collapse; text-align: center;"> <tr> <td style="width: 10%;"></td> <td style="width: 10%;"></td> <td style="width: 10%;"></td> <td style="width: 10%;"></td> <td style="width: 10%;"></td> <td style="width: 10%;"></td> <td style="width: 10%;"></td> <td style="width: 10%;"></td> <td style="width: 10%;"></td> <td style="width: 10%;"></td> </tr> <tr> <td></td> <td></td> <td colspan="8" style="text-align: center;"> <table border="1" style="width: 100%; border-collapse: collapse; text-align: center;"> <tr> <td style="width: 10%;"></td> <td style="width: 10%;"></td> <td style="width: 10%;"></td> <td style="width: 10%;"></td> <td style="width: 10%;"></td> <td style="width: 10%;"></td> <td style="width: 10%;"></td> <td style="width: 10%;"></td> <td style="width: 10%;"></td> <td style="width: 10%;"></td> </tr> <tr> <td></td> <td></td> <td colspan="8" style="text-align: center;"> <table border="1" style="width: 100%; border-collapse: collapse; text-align: center;"> <tr> <td style="width: 10%;"></td> <td style="width: 10%;"></td> <td style="width: 10%;"></td> <td style="width: 10%;"></td> <td style="width: 10%;"></td> <td style="width: 10%;"></td> <td style="width: 10%;"></td> <td style="width: 10%;"></td> <td style="width: 10%;"></td> <td style="width: 10%;"></td> </tr> <tr> <td></td> <td></td> <td colspan="8" style="text-align: center;"> <table border="1" style="width: 100%; border-collapse: collapse; text-align: center;"> <tr> <td style="width: 10%;"></td> <td style="width: 10%;"></td> <td style="width: 10%;"></td> <td style="width: 10%;"></td> <td style="width: 10%;"></td> <td style="width: 10%;"></td> <td style="width: 10%;"></td> <td style="width: 10%;"></td> <td style="width: 10%;"></td> <td style="width: 10%;"></td> </tr> <tr> <td></td> <td></td> <td colspan="8" style="text-align: center;"> <table border="1" style="width: 100%; border-collapse: collapse; text-align: center;"> <tr> <td style="width: 10%;"></td> <td style="width: 10%;"></td> <td style="width: 10%;"></td> <td style="width: 10%;"></td> <td style="width: 10%;"></td> <td style="width: 10%;"></td> <td style="width: 10%;"></td> <td style="width: 10%;"></td> <td style="width: 10%;"></td> <td style="width: 10%;"></td> </tr> <tr> <td></td> <td></td> <td colspan="8" style="text-align: center;"> <table border="1" style="width: 100%; border-collapse: collapse; text-align: center;"> <tr> <td style="width: 10%;"></td> <td style="width: 10%;"></td> <td style="width: 10%;"></td> <td style="width: 10%;"></td> <td style="width: 10%;"></td> <td style="width: 10%;"></td> <td style="width: 10%;"></td> <td style="width: 10%;"></td> <td style="width: 10%;"></td> <td style="width: 10%;"></td> </tr> <tr> <td></td> <td></td> <td colspan="8" style="text-align: center;"> <table border="1" style="width: 100%; border-collapse: collapse; text-align: center;"> <tr> <td style="width: 10%;"></td> <td style="width: 10%;"></td> <td style="width: 10%;"></td> <td style="width: 10%;"></td> <td style="width: 10%;"></td> <td style="width: 10%;"></td> <td style="width: 10%;"></td> <td style="width: 10%;"></td> <td style="width: 10%;"></td> <td style="width: 10%;"></td> </tr> <tr> <td></td> <td></td> <td colspan="8" style="text-align: center;"> <table border="1" style="width: 100%;
border-collapse: collapse; text-align: center;"> <tr> <td style="width: 10%;"></td> <td style="width: 10%;"></td> <td style="width: 10%;"></td> <td style="width: 10%;"></td> <td style="width: 10%;"></td> <td style="width: 10%;"></td> <td style="width: 10%;"></td> <td style="width: 10%;"></td> <td style="width: 10%;"></td> <td style="width: 10%;"></td> </tr> <tr> <td></td> <td></td> <td colspan="8" style="text-align: center;"> <table border="1" style="width: 100%; border-collapse: collapse; text-align: center;"> <tr> <td style="width: 10%;"></td> <td style="width: 10%;"></td> <td style="width: 10%;"></td> <td style="width: 10%;"></td> <td style="width: 10%;"></td> <td style="width: 10%;"></td> <td style="width: 10%;"></td> <td style="width: 10%;"></td> <td style="width: 10%;"></td> <td style="width: 10%;"></td> </tr> <tr> <td></td> <td></td> <td colspan="8" style="text-align: center;"> <table border="1" style="width: 100%; border-collapse: collapse; text-align: center;"> <tr> </tr></table></td></tr></table></td></tr></table></td></tr></table></td></tr></table></td></tr></table></td></tr></table></td></tr></table></td></tr></table></td></tr></table></td></tr></table></td></tr></table></td></tr></table></td></tr></table></td></tr></table></td></tr></table></td></tr></table></td></tr></table></td></tr></table></td></tr></table></td></tr></table></td></tr></table></td></tr></table></td></tr></table></td></tr></table></td></tr></table></td></tr></table></td></tr></table></td></tr></table></td></tr></table></td></tr></table></td></tr></table></td></tr></table> | | | | | | | | | | | | | | | | | | | | <table border="1" style="width: 100%; border-collapse: collapse; text-align: center;"> <tr> <td style="width: 10%;"></td> <td style="width: 10%;"></td> <td style="width: 10%;"></td> <td style="width: 10%;"></td> <td style="width: 10%;"></td> <td style="width: 10%;"></td> <td style="width: 10%;"></td> <td style="width: 10%;"></td> <td style="width: 10%;"></td> <td style="width: 10%;"></td> </tr> <tr> <td></td> <td></td> <td colspan="8" style="text-align: center;"> <table border="1" style="width: 100%; border-collapse: collapse; text-align: center;"> <tr> <td style="width: 10%;"></td> <td style="width: 10%;"></td> <td style="width: 10%;"></td> <td style="width: 10%;"></td> <td style="width: 10%;"></td> <td style="width: 10%;"></td> <td style="width: 10%;"></td> <td style="width: 10%;"></td> <td style="width: 10%;"></td> <td style="width: 10%;"></td> </tr> <tr> <td></td> <td></td> <td colspan="8" style="text-align: center;"> <table border="1" style="width: 100%; border-collapse: collapse; text-align: center;"> <tr> <td style="width: 10%;"></td> <td style="width: 10%;"></td> <td style="width: 10%;"></td> <td style="width: 10%;"></td> <td style="width: 10%;"></td> <td style="width: 10%;"></td> <td style="width: 10%;"></td> <td style="width: 10%;"></td> <td style="width: 10%;"></td> <td style="width: 10%;"></td> </tr> <tr> <td></td> <td></td> <td colspan="8" style="text-align: center;"> <table border="1" style="width: 100%; border-collapse: collapse; text-align: center;"> <tr> <td style="width: 10%;"></td> <td style="width: 10%;"></td> <td style="width: 10%;"></td> <td style="width: 10%;"></td> <td style="width: 10%;"></td> <td style="width: 10%;"></td> <td style="width: 10%;"></td> <td style="width: 10%;"></td> <td style="width: 10%;"></td> <td style="width: 10%;"></td> </tr> <tr> <td></td> <td></td> <td colspan="8" style="text-align: center;"> <table border="1" style="width: 100%; border-collapse: collapse; text-align: center;"> <tr> <td style="width: 10%;"></td> <td style="width: 10%;"></td> <td style="width: 10%;"></td> <td style="width: 10%;"></td> <td style="width: 10%;"></td> <td style="width: 10%;"></td> <td style="width: 10%;"></td> <td style="width: 10%;"></td> <td style="width: 10%;"></td> <td style="width: 10%;"></td> </tr> <tr> <td></td> <td></td> <td colspan="8" style="text-align: center;"> <table border="1" style="width: 100%; border-collapse: collapse; text-align: center;"> <tr> <td style="width: 10%;"></td> <td style="width: 10%;"></td> <td style="width: 10%;"></td> <td style="width: 10%;"></td> <td style="width: 10%;"></td> <td style="width: 10%;"></td> <td style="width: 10%;"></td> <td style="width: 10%;"></td> <td style="width: 10%;"></td> <td style="width: 10%;"></td> </tr> <tr> <td></td> <td></td> <td colspan="8" style="text-align: center;"> <table border="1" style="width: 100%; border-collapse: collapse; text-align: center;"> <tr> <td style="width: 10%;"></td> <td style="width: 10%;"></td> <td style="width: 10%;"></td> <td style="width: 10%;"></td> <td style="width: 10%;"></td> <td style="width: 10%;"></td> <td style="width: 10%;"></td> <td style="width: 10%;"></td> <td style="width: 10%;"></td> <td style="width: 10%;"></td> </tr> <tr> <td></td> <td></td> <td colspan="8" style="text-align: center;"> <table border="1" style="width: 100%; border-collapse: collapse; text-align: center;"> <tr> <td style="width: 10%;"></td> <td style="width: 10%;"></td> <td style="width: 10%;"></td> <td style="width: 10%;"></td> <td
style="width: 10%;"></td> <td style="width: 10%;"></td> <td style="width: 10%;"></td> <td style="width: 10%;"></td> <td style="width: 10%;"></td> <td style="width: 10%;"></td> </tr> <tr> <td></td> <td></td> <td colspan="8" style="text-align: center;"> <table border="1" style="width: 100%; border-collapse: collapse; text-align: center;"> <tr> <td style="width: 10%;"></td> <td style="width: 10%;"></td> <td style="width: 10%;"></td> <td style="width: 10%;"></td> <td style="width: 10%;"></td> <td style="width: 10%;"></td> <td style="width: 10%;"></td> <td style="width: 10%;"></td> <td style="width: 10%;"></td> <td style="width: 10%;"></td> </tr> <tr> <td></td> <td></td> <td colspan="8" style="text-align: center;"> <table border="1" style="width: 100%; border-collapse: collapse; text-align: center;"> <tr> <td style="width: 10%;"></td> <td style="width: 10%;"></td> <td style="width: 10%;"></td> <td style="width: 10%;"></td> <td style="width: 10%;"></td> <td style="width: 10%;"></td> <td style="width: 10%;"></td> <td style="width: 10%;"></td> <td style="width: 10%;"></td> <td style="width: 10%;"></td> </tr> <tr> <td></td> <td></td> <td colspan="8" style="text-align: center;"> <table border="1" style="width: 100%; border-collapse: collapse; text-align: center;"> <tr> <td style="width: 10%;"></td> <td style="width: 10%;"></td> <td style="width: 10%;"></td> <td style="width: 10%;"></td> <td style="width: 10%;"></td> <td style="width: 10%;"></td> <td style="width: 10%;"></td> <td style="width: 10%;"></td> <td style="width: 10%;"></td> <td style="width: 10%;"></td> </tr> <tr> <td></td> <td></td> <td colspan="8" style="text-align: center;"> <table border="1" style="width: 100%; border-collapse: collapse; text-align: center;"> <tr> <td style="width: 10%;"></td> <td style="width: 10%;"></td> <td style="width: 10%;"></td> <td style="width: 10%;"></td> <td style="width: 10%;"></td> <td style="width: 10%;"></td> <td style="width: 10%;"></td> <td style="width: 10%;"></td> <td style="width: 10%;"></td> <td style="width: 10%;"></td> </tr> <tr> <td></td> <td></td> <td colspan="8" style="text-align: center;"> <table border="1" style="width: 100%; border-collapse: collapse; text-align: center;"> <tr> <td style="width: 10%;"></td> <td style="width: 10%;"></td> <td style="width: 10%;"></td> <td style="width: 10%;"></td> <td style="width: 10%;"></td> <td style="width: 10%;"></td> <td style="width: 10%;"></td> <td style="width: 10%;"></td> <td style="width: 10%;"></td> <td style="width: 10%;"></td> </tr> <tr> <td></td> <td></td> <td colspan="8" style="text-align: center;"> <table border="1" style="width: 100%; border-collapse: collapse; text-align: center;"> <tr> <td style="width: 10%;"></td> <td style="width: 10%;"></td> <td style="width: 10%;"></td> <td style="width: 10%;"></td> <td style="width: 10%;"></td> <td style="width: 10%;"></td> <td style="width: 10%;"></td> <td style="width: 10%;"></td> <td style="width: 10%;"></td> <td style="width: 10%;"></td> </tr> <tr> <td></td> <td></td> <td colspan="8" style="text-align: center;"> <table border="1" style="width: 100%; border-collapse: collapse; text-align: center;"> <tr> <td style="width: 10%;"></td> <td style="width: 10%;"></td> <td style="width: 10%;"></td> <td style="width: 10%;"></td> <td style="width: 10%;"></td> <td style="width: 10%;"></td> <td style="width: 10%;"></td> <td style="width: 10%;"></td> <td style="width: 10%;"></td> <td style="width: 10%;"></td> </tr> <tr> <td></td> <td></td> <td colspan="8" style="text-align: center;"> <table border="1" style="width: 100%; border-collapse: collapse; text-align: center;"> <tr> <td style="width: 10%;"></td> <td style="width: 10%;"></td> <td style="width: 10%;"></td> <td style="width: 10%;"></td> <td style="width: 10%;"></td> <td style="width: 10%;"></td> <td style="width: 10%;"></td> <td style="width: 10%;"></td> <td style="width: 10%;"></td> <td style="width: 10%;"></td> </tr> <tr> <td></td> <td></td> <td colspan="8" style="text-align: center;"> <table border="1" style="width: 100%; border-collapse: collapse; text-align: center;"> <tr> <td style="width: 10%;"></td> <td style="width: 10%;"></td> <td style="width: 10%;"></td> <td style="width: 10%;"></td> <td style="width: 10%;"></td> <td style="width: 10%;"></td> <td style="width: 10%;"></td> <td style="width: 10%;"></td> <td style="width: 10%;"></td> <td style="width: 10%;"></td> </tr> <tr> <td></td> <td></td> <td colspan="8" style="text-align: center;"> <table border="1" style="width: 100%; border-collapse: collapse; text-align: center;"> <tr> <td style="width: 10%;"></td> <td style="width: 10%;"></td> <td style="width: 10%;"></td> <td style="width: 10%;"></td> <td style="width: 10%;"></td> <td style="width: 10%;"></td> <td style="width: 10%;"></td> <td style="width: 10%;"></td> <td style="width: 10%;"></td> <td style="width: 10%;"></td> </tr> <tr> <td></td> <td></td> <td colspan="8" style="text-align: center;"> <table border="1" style="width: 100%; border-collapse: collapse; text-align: center;"> <tr> <td style="width: 10%;"></td> <td style="width: 10%;"></td> <td style="width: 10%;"></td> <td style="width: 10%;"></td> <td style="width: 10%;"></td> <td style="width: 10%;"></td> <td style="width: 10%;"></td> <td style="width: 10%;"></td> <td style="width: 10%;"></td> <td style="width: 10%;"></td> </tr> <tr> <td></td> <td></td> <td colspan="8" style="text-align: center;"> <table border="1" style="width: 100%; border-collapse: collapse; text-align: center;"> <tr> <td style="width: 10%;"></td> <td style="width: 10%;"></td> <td style="width: 10%;"></td> <td style="width: 10%;"></td> <td style="width: 10%;"></td> <td style="width: 10%;"></td> <td style="width: 10%;"></td> <td style="width: 10%;"></td> <td style="width: 10%;"></td> <td style="width: 10%;"></td> </tr> <tr> <td></td> <td></td> <td colspan="8" style="text-align: center;"> <table border="1" style="width: 100%; border-collapse: collapse; text-align: center;"> <tr> <td style="width: 10%;"></td> <td style="width: 10%;"></td> <td style="width: 10%;"></td> <td style="width: 10%;"></td> <td style="width: 10%;"></td> <td style="width: 10%;"></td> <td style="width: 10%;"></td> <td style="width: 10%;"></td> <td style="width: 10%;"></td> <td style="width: 10%;"></td> </tr> <tr> <td></td> <td></td> <td colspan="8" style="text-align: center;"> <table border="1" style="width: 100%; border-collapse: collapse; text-align: center;"> <tr> <td style="width: 10%;"></td> <td style="width: 10%;"></td> <td style="width: 10%;"></td> <td style="width: 10%;"></td> <td style="width: 10%;"></td> <td style="width: 10%;"></td> <td style="width: 10%;"></td> <td style="width: 10%;"></td> <td style="width: 10%;"></td> <td style="width: 10%;"></td> </tr> <tr> <td></td> <td></td> <td colspan="8" style="text-align: center;"> <table border="1" style="width: 100%; border-collapse: collapse; text-align: center;"> <tr> <td style="width: 10%;"></td> <td style="width: 10%;"></td> <td style="width: 10%;"></td> <td style="width: 10%;"></td> <td style="width: 10%;"></td> <td style="width: 10%;"></td> <td style="width: 10%;"></td> <td style="width: 10%;"></td> <td style="width: 10%;"></td> <td style="width: 10%;"></td> </tr> <tr> <td></td> <td></td> <td colspan="8" style="text-align: center;"> <table border="1" style="width: 100%; border-collapse: collapse; text-align: center;"> <tr> <td style="width: 10%;"></td> <td style="width: 10%;"></td> <td style="width: 10%;"></td> <td style="width: 10%;"></td> <td style="width: 10%;"></td> <td style="width: 10%;"></td> <td style="width: 10%;"></td> <td style="width: 10%;"></td> <td style="width: 10%;"></td> <td style="width: 10%;"></td> </tr> <tr> <td></td> <td></td> <td colspan="8" style="text-align: center;"> <table border="1" style="width: 100%; border-collapse: collapse; text-align: center;"> <tr> <td style="width: 10%;"></td> <td style="width: 10%;"></td> <td style="width: 10%;"></td> <td style="width: 10%;"></td> <td style="width: 10%;"></td> <td style="width: 10%;"></td> <td style="width: 10%;"></td> <td style="width: 10%;"></td> <td style="width: 10%;"></td> <td style="width: 10%;"></td> </tr> <tr> <td></td> <td></td> <td colspan="8" style="text-align: center;"> <table border="1" style="width: 100%; border-collapse: collapse; text-align: center;"> <tr> <td style="width: 10%;"></td> <td style="width: 10%;"></td> <td style="width: 10%;"></td> <td style="width: 10%;"></td> <td style="width: 10%;"></td> <td style="width: 10%;"></td> <td style="width: 10%;"></td> <td style="width: 10%;"></td> <td style="width: 10%;"></td> <td style="width: 10%;"></td> </tr> <tr> <td></td> <td></td> <td colspan="8" style="text-align: center;"> <table border="1" style="width: 100%; border-collapse: collapse; text-align: center;"> <tr> <td style="width: 10%;"></td> <td style="width: 10%;"></td> <td style="width: 10%;"></td> <td style="width: 10%;"></td> <td style="width: 10%;"></td> <td style="width: 10%;"></td> <td style="width: 10%;"></td> <td style="width: 10%;"></td> <td style="width: 10%;"></td> <td style="width: 10%;"></td> </tr> <tr> <td></td> <td></td> <td colspan="8" style="text-align: center;"> <table border="1" style="width: 100%; border-collapse: collapse; text-align: center;"> <tr> <td style="width: 10%;"></td> <td style="width: 10%;"></td> <td style="width: 10%;"></td> <td style="width: 10%;"></td> <td style="width: 10%;"></td> <td style="width: 10%;"></td> <td style="width: 10%;"></td> <td style="width: 10%;"></td> <td style="width: 10%;"></td> <td style="width: 10%;"></td> </tr> <tr> <td></td> <td></td> <td colspan="8" style="text-align: center;"> <table border="1" style="width: 100%; border-collapse: collapse; text-align: center;"> <tr> <td style="width: 10%;"></td> <td style="width: 10%;"></td> <td style="width: 10%;"></td> <td style="width: 10%;"></td> <td style="width: 10%;"></td> <td style="width: 10%;"></td> <td style="width: 10%;"></td> <td style="width: 10%;"></td> <td style="width: 10%;"></td> <td style="width:
10%;"></td> </tr> <tr> <td></td> <td></td> <td colspan="8" style="text-align: center;"> <table border="1" style="width: 100%; border-collapse: collapse; text-align: center;"> <tr> <td style="width: 10%;"></td> <td style="width: 10%;"></td> <td style="width: 10%;"></td> <td style="width: 10%;"></td> <td style="width: 10%;"></td> <td style="width: 10%;"></td> <td style="width: 10%;"></td> <td style="width: 10%;"></td> <td style="width: 10%;"></td> <td style="width: 10%;"></td> </tr> <tr> <td></td> <td></td> <td colspan="8" style="text-align: center;"> <table border="1" style="width: 100%; border-collapse: collapse; text-align: center;"> <tr> <td style="width: 10%;"></td> <td style="width: 10%;"></td> <td style="width: 10%;"></td> <td style="width: 10%;"></td> <td style="width: 10%;"></td> <td style="width: 10%;"></td> <td style="width: 10%;"></td> <td style="width: 10%;"></td> <td style="width: 10%;"></td> <td style="width: 10%;"></td> </tr> <tr> <td></td> <td></td> <td colspan="8" style="text-align: center;"> <table border="1" style="width: 100%; border-collapse: collapse; text-align: center;"> <tr> </tr></table></td></tr></table></td></tr></table></td></tr></table></td></tr></table></td></tr></table></td></tr></table></td></tr></table></td></tr></table></td></tr></table></td></tr></table></td></tr></table></td></tr></table></td></tr></table></td></tr></table></td></tr></table></td></tr></table></td></tr></table></td></tr></table></td></tr></table></td></tr></table></td></tr></table></td></tr></table></td></tr></table></td></tr></table></td></tr></table></td></tr></table></td></tr></table></td></tr></table></td></tr></table></td></tr></table></td></tr></table> | | | | | | | | | | | | | | | | | | | | <table border="1" style="width: 100%; border-collapse: collapse; text-align: center;"> <tr> <td style="width: 10%;"></td> <td style="width: 10%;"></td> <td style="width: 10%;"></td> <td style="width: 10%;"></td> <td style="width: 10%;"></td> <td style="width: 10%;"></td> <td style="width: 10%;"></td> <td style="width: 10%;"></td> <td style="width: 10%;"></td> <td style="width: 10%;"></td> </tr> <tr> <td></td> <td></td> <td colspan="8" style="text-align: center;"> <table border="1" style="width: 100%; border-collapse: collapse; text-align: center;"> <tr> <td style="width: 10%;"></td> <td style="width: 10%;"></td> <td style="width: 10%;"></td> <td style="width: 10%;"></td> <td style="width: 10%;"></td> <td style="width: 10%;"></td> <td style="width: 10%;"></td> <td style="width: 10%;"></td> <td style="width: 10%;"></td> <td style="width: 10%;"></td> </tr> <tr> <td></td> <td></td> <td colspan="8" style="text-align: center;"> <table border="1" style="width: 100%; border-collapse: collapse; text-align: center;"> <tr> <td style="width: 10%;"></td> <td style="width: 10%;"></td> <td style="width: 10%;"></td> <td style="width: 10%;"></td> <td style="width: 10%;"></td> <td style="width: 10%;"></td> <td style="width: 10%;"></td> <td style="width: 10%;"></td> <td style="width: 10%;"></td> <td style="width: 10%;"></td> </tr> <tr> <td></td> <td></td> <td colspan="8" style="text-align: center;"> <table border="1" style="width: 100%; border-collapse: collapse; text-align: center;"> <tr> <td style="width: 10%;"></td> <td style="width: 10%;"></td> <td style="width: 10%;"></td> <td style="width: 10%;"></td> <td style="width: 10%;"></td> <td style="width: 10%;"></td> <td style="width: 10%;"></td> <td style="width: 10%;"></td> <td style="width: 10%;"></td> <td style="width: 10%;"></td> </tr> <tr> <td></td> <td></td> <td colspan="8" style="text-align: center;"> <table border="1" style="width: 100%; border-collapse: collapse; text-align: center;"> <tr> <td style="width: 10%;"></td> <td style="width: 10%;"></td> <td style="width: 10%;"></td> <td style="width: 10%;"></td> <td style="width: 10%;"></td> <td style="width: 10%;"></td> <td style="width: 10%;"></td> <td style="width: 10%;"></td> <td style="width: 10%;"></td> <td style="width: 10%;"></td> </tr> <tr> <td></td> <td></td> <td colspan="8" style="text-align: center;"> <table border="1" style="width: 100%; border-collapse: collapse; text-align: center;"> <tr> <td style="width: 10%;"></td> <td style="width: 10%;"></td> <td style="width: 10%;"></td> <td style="width: 10%;"></td> <td style="width: 10%;"></td> <td style="width: 10%;"></td> <td style="width: 10%;"></td> <td style="width: 10%;"></td> <td style="width: 10%;"></td> <td style="width: 10%;"></td> </tr> <tr> <td></td> <td></td> <td colspan="8" style="text-align: center;"> <table border="1" style="width: 100%; border-collapse: collapse; text-align: center;"> <tr> <td style="width: 10%;"></td> <td style="width: 10%;"></td> <td style="width: 10%;"></td> <td style="width: 10%;"></td> <td style="width: 10%;"></td> <td style="width: 10%;"></td> <td style="width: 10%;"></td> <td style="width: 10%;"></td> <td style="width: 10%;"></td> <td style="width: 10%;"></td> </tr> <tr> <td></td> <td></td> <td colspan="8" style="text-align: center;"> <table border="1" style="width: 100%; border-collapse: collapse; text-align: center;"> <tr> <td style="width:
10%;"></td> <td style="width: 10%;"></td> <td style="width: 10%;"></td> <td style="width: 10%;"></td> <td style="width: 10%;"></td> <td style="width: 10%;"></td> <td style="width: 10%;"></td> <td style="width: 10%;"></td> <td style="width: 10%;"></td> <td style="width: 10%;"></td> </tr> <tr> <td></td> <td></td> <td colspan="8" style="text-align: center;"> <table border="1" style="width: 100%; border-collapse: collapse; text-align: center;"> <tr> <td style="width: 10%;"></td> <td style="width: 10%;"></td> <td style="width: 10%;"></td> <td style="width: 10%;"></td> <td style="width: 10%;"></td> <td style="width: 10%;"></td> <td style="width: 10%;"></td> <td style="width: 10%;"></td> <td style="width: 10%;"></td> <td style="width: 10%;"></td> </tr> <tr> <td></td> <td></td> <td colspan="8" style="text-align: center;"> <table border="1" style="width: 100%; border-collapse: collapse; text-align: center;"> <tr> <td style="width: 10%;"></td> <td style="width: 10%;"></td> <td style="width: 10%;"></td> <td style="width: 10%;"></td> <td style="width: 10%;"></td> <td style="width: 10%;"></td> <td style="width: 10%;"></td> <td style="width: 10%;"></td> <td style="width: 10%;"></td> <td style="width: 10%;"></td> </tr> <tr> <td></td> <td></td> <td colspan="8" style="text-align: center;"> <table border="1" style="width: 100%; border-collapse: collapse; text-align: center;"> <tr> <td style="width: 10%;"></td> <td style="width: 10%;"></td> <td style="width: 10%;"></td> <td style="width: 10%;"></td> <td style="width: 10%;"></td> <td style="width: 10%;"></td> <td style="width: 10%;"></td> <td style="width: 10%;"></td> <td style="width: 10%;"></td> <td style="width: 10%;"></td> </tr> <tr> <td></td> <td></td> <td colspan="8" style="text-align: center;"> <table border="1" style="width: 100%; border-collapse: collapse; text-align: center;"> <tr> <td style="width: 10%;"></td> <td style="width: 10%;"></td> <td style="width: 10%;"></td> <td style="width: 10%;"></td> <td style="width: 10%;"></td> <td style="width: 10%;"></td> <td style="width: 10%;"></td> <td style="width: 10%;"></td> <td style="width: 10%;"></td> <td style="width: 10%;"></td> </tr> <tr> <td></td> <td></td> <td colspan="8" style="text-align: center;"> <table border="1" style="width: 100%; border-collapse: collapse; text-align: center;"> <tr> <td style="width: 10%;"></td> <td style="width: 10%;"></td> <td style="width: 10%;"></td> <td style="width: 10%;"></td> <td style="width: 10%;"></td> <td style="width: 10%;"></td> <td style="width: 10%;"></td> <td style="width: 10%;"></td> <td style="width: 10%;"></td> <td style="width: 10%;"></td> </tr> <tr> <td></td> <td></td> <td colspan="8" style="text-align: center;"> <table border="1" style="width: 100%; border-collapse: collapse; text-align: center;"> <tr> <td style="width: 10%;"></td> <td style="width: 10%;"></td> <td style="width: 10%;"></td> <td style="width: 10%;"></td> <td style="width: 10%;"></td> <td style="width: 10%;"></td> <td style="width: 10%;"></td> <td style="width: 10%;"></td> <td style="width: 10%;"></td> <td style="width: 10%;"></td> </tr> <tr> <td></td> <td></td> <td colspan="8" style="text-align: center;"> <table border="1" style="width: 100%; border-collapse: collapse; text-align: center;"> <tr> <td style="width: 10%;"></td> <td style="width: 10%;"></td> <td style="width: 10%;"></td> <td style="width: 10%;"></td> <td style="width: 10%;"></td> <td style="width: 10%;"></td> <td style="width: 10%;"></td> <td style="width: 10%;"></td> <td style="width: 10%;"></td> <td style="width: 10%;"></td> </tr> <tr> <td></td> <td></td> <td colspan="8" style="text-align: center;"> <table border="1" style="width: 100%; border-collapse: collapse; text-align: center;"> <tr> <td style="width: 10%;"></td> <td style="width: 10%;"></td> <td style="width: 10%;"></td> <td style="width: 10%;"></td> <td style="width: 10%;"></td> <td style="width: 10%;"></td> <td style="width: 10%;"></td> <td style="width: 10%;"></td> <td style="width: 10%;"></td> <td style="width: 10%;"></td> </tr> <tr> <td></td> <td></td> <td colspan="8" style="text-align: center;"> <table border="1" style="width: 100%; border-collapse: collapse; text-align: center;"> <tr> <td style="width: 10%;"></td> <td style="width: 10%;"></td> <td style="width: 10%;"></td> <td style="width: 10%;"></td> <td style="width: 10%;"></td> <td style="width: 10%;"></td> <td style="width: 10%;"></td> <td style="width: 10%;"></td> <td style="width: 10%;"></td> <td style="width: 10%;"></td> </tr> <tr> <td></td> <td></td> <td colspan="8" style="text-align: center;"> <table border="1" style="width: 100%; border-collapse: collapse; text-align: center;"> <tr> <td style="width: 10%;"></td> <td style="width: 10%;"></td> <td style="width: 10%;"></td> <td style="width: 10%;"></td> <td style="width: 10%;"></td> <td style="width: 10%;"></td> <td style="width: 10%;"></td> <td style="width: 10%;"></td> <td style="width: 10%;"></td> <td style="width: 10%;"></td> </tr> <tr> <td></td> <td></td> <td colspan="8" style="text-align: center;"> <table border="1" style="width: 100%; border-collapse: collapse; text-align: center;"> <tr> <td style="width: 10%;"></td> <td style="width: 10%;"></td> <td style="width: 10%;"></td> <td style="width: 10%;"></td> <td style="width: 10%;"></td> <td style="width: 10%;"></td> <td style="width: 10%;"></td> <td style="width: 10%;"></td> <td style="width: 10%;"></td> <td style="width: 10%;"></td> </tr> <tr> <td></td> <td></td> <td colspan="8" style="text-align: center;"> <table border="1" style="width: 100%; border-collapse: collapse; text-align: center;"> <tr> <td style="width: 10%;"></td> <td style="width: 10%;"></td> <td style="width: 10%;"></td> <td style="width: 10%;"></td> <td style="width: 10%;"></td> <td style="width: 10%;"></td> <td style="width: 10%;"></td> <td style="width: 10%;"></td> <td style="width: 10%;"></td> <td style="width: 10%;"></td> </tr> <tr> <td></td> <td></td> <td colspan="8" style="text-align: center;"> <table border="1" style="width: 100%; border-collapse: collapse; text-align: center;"> <tr> <td style="width: 10%;"></td> <td style="width: 10%;"></td> <td style="width: 10%;"></td> <td style="width: 10%;"></td> <td style="width: 10%;"></td> <td style="width: 10%;"></td> <td style="width: 10%;"></td> <td style="width: 10%;"></td> <td style="width: 10%;"></td> <td style="width: 10%;"></td> </tr> <tr> <td></td> <td></td> <td colspan="8" style="text-align: center;"> <table border="1" style="width: 100%; border-collapse: collapse; text-align: center;"> <tr> <td style="width: 10%;"></td> <td style="width: 10%;"></td> <td style="width: 10%;"></td> <td style="width: 10%;"></td> <td style="width: 10%;"></td> <td style="width: 10%;"></td> <td style="width: 10%;"></td> <td style="width: 10%;"></td> <td style="width: 10%;"></td> <td style="width: 10%;"></td> </tr> <tr> <td></td> <td></td> <td colspan="8" style="text-align: center;"> <table border="1" style="width: 100%; border-collapse: collapse; text-align: center;"> <tr> <td style="width: 10%;"></td> <td style="width: 10%;"></td> <td style="width: 10%;"></td> <td style="width: 10%;"></td> <td style="width: 10%;"></td> <td style="width: 10%;"></td> <td style="width: 10%;"></td> <td style="width: 10%;"></td> <td style="width: 10%;"></td> <td style="width: 10%;"></td> </tr> <tr> <td></td> <td></td> <td colspan="8" style="text-align: center;"> <table border="1" style="width: 100%; border-collapse: collapse; text-align: center;"> <tr> <td style="width: 10%;"></td> <td style="width: 10%;"></td> <td style="width: 10%;"></td> <td style="width: 10%;"></td> <td style="width: 10%;"></td> <td style="width: 10%;"></td> <td style="width: 10%;"></td> <td style="width: 10%;"></td> <td style="width: 10%;"></td> <td style="width: 10%;"></td> </tr> <tr> <td></td> <td></td> <td colspan="8" style="text-align: center;"> <table border="1" style="width: 100%; border-collapse: collapse; text-align: center;"> <tr> <td style="width: 10%;"></td> <td style="width: 10%;"></td> <td style="width: 10%;"></td> <td style="width: 10%;"></td> <td style="width: 10%;"></td> <td style="width: 10%;"></td> <td style="width: 10%;"></td> <td style="width: 10%;"></td> <td style="width: 10%;"></td> <td style="width: 10%;"></td> </tr> <tr> <td></td> <td></td> <td colspan="8" style="text-align: center;"> <table border="1" style="width: 100%; border-collapse: collapse; text-align: center;"> <tr> <td style="width: 10%;"></td> <td style="width: 10%;"></td> <td style="width: 10%;"></td> <td style="width: 10%;"></td> <td style="width: 10%;"></td> <td style="width: 10%;"></td> <td style="width: 10%;"></td> <td style="width: 10%;"></td> <td style="width: 10%;"></td> <td style="width: 10%;"></td> </tr> <tr> <td></td> <td></td> <td colspan="8" style="text-align: center;"> <table border="1" style="width: 100%; border-collapse: collapse; text-align: center;"> <tr> <td style="width: 10%;"></td> <td style="width: 10%;"></td> <td style="width: 10%;"></td> <td style="width: 10%;"></td> <td style="width: 10%;"></td> <td style="width: 10%;"></td> <td style="width: 10%;"></td> <td style="width: 10%;"></td> <td style="width: 10%;"></td> <td style="width: 10%;"></td> </tr> <tr> <td></td> <td></td> <td colspan="8" style="text-align: center;"> <table border="1" style="width: 100%; border-collapse: collapse; text-align: center;"> <tr> <td style="width: 10%;"></td> <td style="width: 10%;"></td> <td style="width: 10%;"></td> <td style="width: 10%;"></td> <td style="width: 10%;"></td> <td style="width: 10%;"></td> <td style="width: 10%;"></td> <td style="width: 10%;"></td> <td style="width: 10%;"></td> <td style="width: 10%;"></td> </tr> <tr> <td></td> <td></td> <td colspan="8" style="text-align: center;"> <table border="1" style="width: 100%; border-collapse: collapse; text-align: center;"> <tr> <td style="width: 10%;"></td> <td style="width: 10%;"></td> <td style="width: 10%;"></td> <td style="width: 10%;"></td> <td style="width: 10%;"></td> <td style="width: 10%;"></td> <td
style="width: 10%;"></td> <td style="width: 10%;"></td> <td style="width: 10%;"></td> <td style="width: 10%;"></td> </tr> <tr> <td></td> <td></td> <td colspan="8" style="text-align: center;"> <table border="1" style="width: 100%; border-collapse: collapse; text-align: center;"> <tr> <td style="width: 10%;"></td> <td style="width: 10%;"></td> <td style="width: 10%;"></td> <td style="width: 10%;"></td> <td style="width: 10%;"></td> <td style="width: 10%;"></td> <td style="width: 10%;"></td> <td style="width: 10%;"></td> <td style="width: 10%;"></td> <td style="width: 10%;"></td> </tr> <tr> <td></td> <td></td> <td colspan="8" style="text-align: center;"> <table border="1" style="width: 100%; border-collapse: collapse; text-align: center;"> <tr> </tr></table></td></tr></table></td></tr></table></td></tr></table></td></tr></table></td></tr></table></td></tr></table></td></tr></table></td></tr></table></td></tr></table></td></tr></table></td></tr></table></td></tr></table></td></tr></table></td></tr></table></td></tr></table></td></tr></table></td></tr></table></td></tr></table></td></tr></table></td></tr></table></td></tr></table></td></tr></table></td></tr></table></td></tr></table></td></tr></table></td></tr></table></td></tr></table></td></tr></table></td></tr></table></td></tr></table> | | | | | | | | | | | | | | | | | | | | <table border="1" style="width: 100%; border-collapse: collapse; text-align: center;"> <tr> <td style="width: 10%;"></td> <td style="width: 10%;"></td> <td style="width: 10%;"></td> <td style="width: 10%;"></td> <td style="width: 10%;"></td> <td style="width: 10%;"></td> <td style="width: 10%;"></td> <td style="width: 10%;"></td> <td style="width: 10%;"></td> <td style="width: 10%;"></td> </tr> <tr> <td></td> <td></td> <td colspan="8" style="text-align: center;"> <table border="1" style="width: 100%; border-collapse: collapse; text-align: center;"> <tr> <td style="width: 10%;"></td> <td style="width: 10%;"></td> <td style="width: 10%;"></td> <td style="width: 10%;"></td> <td style="width: 10%;"></td> <td style="width: 10%;"></td> <td style="width: 10%;"></td> <td style="width: 10%;"></td> <td style="width: 10%;"></td> <td style="width: 10%;"></td> </tr> <tr> <td></td> <td></td> <td colspan="8" style="text-align: center;"> <table border="1" style="width: 100%; border-collapse: collapse; text-align: center;"> <tr> <td style="width: 10%;"></td> <td style="width: 10%;"></td> <td style="width: 10%;"></td> <td style="width: 10%;"></td> <td style="width: 10%;"></td> <td style="width: 10%;"></td> <td style="width: 10%;"></td> <td style="width: 10%;"></td> <td style="width: 10%;"></td> <td style="width: 10%;"></td> </tr> <tr> <td></td> <td></td> <td colspan="8" style="text-align: center;"> <table border="1" style="width: 100%; border-collapse: collapse; text-align: center;"> <tr> <td style="width: 10%;"></td> <td style="width: 10%;"></td> <td style="width: 10%;"></td> <td style="width: 10%;"></td> <td style="width: 10%;"></td> <td style="width: 10%;"></td> <td style="width: 10%;"></td> <td style="width: 10%;"></td> <td style="width: 10%;"></td> <td style="width: 10%;"></td> </tr> <tr> <td></td> <td></td> <td colspan="8" style="text-align: center;"> <table border="1" style="width: 100%; border-collapse: collapse; text-align: center;"> <tr> <td style="width: 10%;"></td> <td style="width: 10%;"></td> <td style="width: 10%;"></td> <td style="width: 10%;"></td> <td style="width: 10%;"></td> <td style="width: 10%;"></td> <td style="width: 10%;"></td> <td style="width: 10%;"></td> <td style="width: 10%;"></td> <td style="width: 10%;"></td> </tr> <tr> <td></td> <td></td> <td colspan="8" style="text-align: center;"> <table border="1" style="width: 100%; border-collapse: collapse; text-align: center;"> <tr> <td style="width: 10%;"></td> <td style="width: 10%;"></td> <td style="width: 10%;"></td> <td style="width: 10%;"></td> <td style="width: 10%;"></td> <td style="width: 10%;"></td> <td style="width: 10%;"></td> <td style="width: 10%;"></td> <td style="width: 10%;"></td> <td style="width: 10%;"></td> </tr> <tr> <td></td> <td></td> <td colspan="8" style="text-align: center;"> <table border="1" style="width: 100%; border-collapse: collapse; text-align: center;"> <tr> <td style="width: 10%;"></td> <td style="width: 10%;"></td> <td style="width: 10%;"></td> <td style="width: 10%;"></td> <td style="width: 10%;"></td> <td style="width: 10%;"></td> <td style="width: 10%;"></td> <td style="width: 10%;"></td> <td style="width: 10%;"></td> <td style="width: 10%;"></td> </tr> <tr> <td></td> <td></td> <td colspan="8" style="text-align: center;"> <table border="1" style="width: 100%; border-collapse: collapse; text-align: center;"> <tr> <td style="width: 10%;"></td> <td style="width: 10%;"></td> <td style="width: 10%;"></td> <td style="width: 10%;"></td> <td style="width: 10%;"></td> <td style="width: 10%;"></td> <td style="width: 10%;"></td> <td style="width: 10%;"></td> <td style="width: 10%;"></td> <td style="width: 10%;"></td> </tr> <tr> <td></td> <td></td> <td colspan="8" style="text-align: center;"> <table border="1"
style="width: 100%; border-collapse: collapse; text-align: center;"> <tr> <td style="width: 10%;"></td> <td style="width: 10%;"></td> <td style="width: 10%;"></td> <td style="width: 10%;"></td> <td style="width: 10%;"></td> <td style="width: 10%;"></td> <td style="width: 10%;"></td> <td style="width: 10%;"></td> <td style="width: 10%;"></td> <td style="width: 10%;"></td> </tr> <tr> <td></td> <td></td> <td colspan="8" style="text-align: center;"> <table border="1" style="width: 100%; border-collapse: collapse; text-align: center;"> <tr> <td style="width: 10%;"></td> <td style="width: 10%;"></td> <td style="width: 10%;"></td> <td style="width: 10%;"></td> <td style="width: 10%;"></td> <td style="width: 10%;"></td> <td style="width: 10%;"></td> <td style="width: 10%;"></td> <td style="width: 10%;"></td> <td style="width: 10%;"></td> </tr> <tr> <td></td> <td></td> <td colspan="8" style="text-align: center;"> <table border="1" style="width: 100%; border-collapse: collapse; text-align: center;"> <tr> <td style="width: 10%;"></td> <td style="width: 10%;"></td> <td style="width: 10%;"></td> <td style="width: 10%;"></td> <td style="width: 10%;"></td> <td style="width: 10%;"></td> <td style="width: 10%;"></td> <td style="width: 10%;"></td> <td style="width: 10%;"></td> <td style="width: 10%;"></td> </tr> <tr> <td></td> <td></td> <td colspan="8" style="text-align: center;"> <table border="1" style="width: 100%; border-collapse: collapse; text-align: center;"> <tr> <td style="width: 10%;"></td> <td style="width: 10%;"></td> <td style="width: 10%;"></td> <td style="width: 10%;"></td> <td style="width: 10%;"></td> <td style="width: 10%;"></td> <td style="width: 10%;"></td> <td style="width: 10%;"></td> <td style="width: 10%;"></td> <td style="width: 10%;"></td> </tr> <tr> <td></td> <td></td> <td colspan="8" style="text-align: center;"> <table border="1" style="width: 100%; border-collapse: collapse; text-align: center;"> <tr> <td style="width: 10%;"></td> <td style="width: 10%;"></td> <td style="width: 10%;"></td> <td style="width: 10%;"></td> <td style="width: 10%;"></td> <td style="width: 10%;"></td> <td style="width: 10%;"></td> <td style="width: 10%;"></td> <td style="width: 10%;"></td> <td style="width: 10%;"></td> </tr> <tr> <td></td> <td></td> <td colspan="8" style="text-align: center;"> <table border="1" style="width: 100%; border-collapse: collapse; text-align: center;"> <tr> <td style="width: 10%;"></td> <td style="width: 10%;"></td> <td style="width: 10%;"></td> <td style="width: 10%;"></td> <td style="width: 10%;"></td> <td style="width: 10%;"></td> <td style="width: 10%;"></td> <td style="width: 10%;"></td> <td style="width: 10%;"></td> <td style="width: 10%;"></td> </tr> <tr> <td></td> <td></td> <td colspan="8" style="text-align: center;"> <table border="1" style="width: 100%; border-collapse: collapse; text-align: center;"> <tr> <td style="width: 10%;"></td> <td style="width: 10%;"></td> <td style="width: 10%;"></td> <td style="width: 10%;"></td> <td style="width: 10%;"></td> <td style="width: 10%;"></td> <td style="width: 10%;"></td> <td style="width: 10%;"></td> <td style="width: 10%;"></td> <td style="width: 10%;"></td> </tr> <tr> <td></td> <td></td> <td colspan="8" style="text-align: center;"> <table border="1" style="width: 100%; border-collapse: collapse; text-align: center;"> <tr> <td style="width: 10%;"></td> <td style="width: 10%;"></td> <td style="width: 10%;"></td> <td style="width: 10%;"></td> <td style="width: 10%;"></td> <td style="width: 10%;"></td> <td style="width: 10%;"></td> <td style="width: 10%;"></td> <td style="width: 10%;"></td> <td style="width: 10%;"></td> </tr> <tr> <td></td> <td></td> <td colspan="8" style="text-align: center;"> <table border="1" style="width: 100%; border-collapse: collapse; text-align: center;"> <tr> <td style="width: 10%;"></td> <td style="width: 10%;"></td> <td style="width: 10%;"></td> <td style="width: 10%;"></td> <td style="width: 10%;"></td> <td style="width: 10%;"></td> <td style="width: 10%;"></td> <td style="width: 10%;"></td> <td style="width: 10%;"></td> <td style="width: 10%;"></td> </tr> <tr> <td></td> <td></td> <td colspan="8" style="text-align: center;"> <table border="1" style="width: 100%; border-collapse: collapse; text-align: center;"> <tr> <td style="width: 10%;"></td> <td style="width: 10%;"></td> <td style="width: 10%;"></td> <td style="width: 10%;"></td> <td style="width: 10%;"></td> <td style="width: 10%;"></td> <td style="width: 10%;"></td> <td style="width: 10%;"></td> <td style="width: 10%;"></td> <td style="width: 10%;"></td> </tr> <tr> <td></td> <td></td> <td colspan="8" style="text-align: center;"> <table border="1" style="width: 100%; border-collapse: collapse; text-align: center;"> <tr> <td style="width: 10%;"></td> <td style="width: 10%;"></td> <td style="width: 10%;"></td> <td style="width: 10%;"></td> <td style="width: 10%;"></td> <td style="width: 10%;"></td> <td style="width: 10%;"></td> <td style="width: 10%;"></td> <td style="width: 10%;"></td> <td style="width: 10%;"></td> </tr> <tr> <td></td> <td></td> <td colspan="8" style="text-align: center;"> <table border="1" style="width: 100%; border-collapse: collapse; text-align: center;"> <tr> <td style="width: 10%;"></td> <td style="width: 10%;"></td> <td style="width: 10%;"></td> <td style="width: 10%;"></td> <td style="width: 10%;"></td> <td style="width: 10%;"></td> <td style="width: 10%;"></td> <td style="width: 10%;"></td> <td style="width: 10%;"></td> <td style="width: 10%;"></td> </tr> <tr> <td></td> <td></td> <td colspan="8" style="text-align: center;"> <table border="1" style="width: 100%; border-collapse: collapse; text-align: center;"> <tr> <td style="width: 10%;"></td> <td style="width: 10%;"></td> <td style="width: 10%;"></td> <td style="width: 10%;"></td> <td style="width: 10%;"></td> <td style="width: 10%;"></td> <td style="width: 10%;"></td> <td style="width: 10%;"></td> <td style="width: 10%;"></td> <td style="width: 10%;"></td> </tr> <tr> <td></td> <td></td> <td colspan="8" style="text-align: center;"> <table border="1" style="width: 100%; border-collapse: collapse; text-align: center;"> <tr> <td style="width: 10%;"></td> <td style="width: 10%;"></td> <td style="width: 10%;"></td> <td style="width: 10%;"></td> <td style="width: 10%;"></td> <td style="width: 10%;"></td> <td style="width: 10%;"></td> <td style="width: 10%;"></td> <td style="width: 10%;"></td> <td style="width: 10%;"></td> </tr> <tr> <td></td> <td></td> <td colspan="8" style="text-align: center;"> <table border="1" style="width: 100%; border-collapse: collapse; text-align: center;"> <tr> <td style="width: 10%;"></td> <td style="width: 10%;"></td> <td style="width: 10%;"></td> <td style="width: 10%;"></td> <td style="width: 10%;"></td> <td style="width: 10%;"></td> <td style="width: 10%;"></td> <td style="width: 10%;"></td> <td style="width: 10%;"></td> <td style="width: 10%;"></td> </tr> <tr> <td></td> <td></td> <td colspan="8" style="text-align: center;"> <table border="1" style="width: 100%; border-collapse: collapse; text-align: center;"> <tr> <td style="width: 10%;"></td> <td style="width: 10%;"></td> <td style="width: 10%;"></td> <td style="width: 10%;"></td> <td style="width: 10%;"></td> <td style="width: 10%;"></td> <td style="width: 10%;"></td> <td style="width: 10%;"></td> <td style="width: 10%;"></td> <td style="width: 10%;"></td> </tr> <tr> <td></td> <td></td> <td colspan="8" style="text-align: center;"> <table border="1" style="width: 100%; border-collapse: collapse; text-align: center;"> <tr> <td style="width: 10%;"></td> <td style="width: 10%;"></td> <td style="width: 10%;"></td> <td style="width: 10%;"></td> <td style="width: 10%;"></td> <td style="width: 10%;"></td> <td style="width: 10%;"></td> <td style="width: 10%;"></td> <td style="width: 10%;"></td> <td style="width: 10%;"></td> </tr> <tr> <td></td> <td></td> <td colspan="8" style="text-align: center;"> <table border="1" style="width: 100%; border-collapse: collapse; text-align: center;"> <tr> <td style="width: 10%;"></td> <td style="width: 10%;"></td> <td style="width: 10%;"></td> <td style="width: 10%;"></td> <td style="width: 10%;"></td> <td style="width: 10%;"></td> <td style="width: 10%;"></td> <td style="width: 10%;"></td> <td style="width: 10%;"></td> <td style="width: 10%;"></td> </tr> <tr> <td></td> <td></td> <td colspan="8" style="text-align: center;"> <table border="1" style="width: 100%; border-collapse: collapse; text-align: center;"> <tr> <td style="width: 10%;"></td> <td style="width: 10%;"></td> <td style="width: 10%;"></td> <td style="width: 10%;"></td> <td style="width: 10%;"></td> <td style="width: 10%;"></td> <td style="width: 10%;"></td> <td style="width: 10%;"></td> <td style="width: 10%;"></td> <td style="width: 10%;"></td> </tr> <tr> <td></td> <td></td> <td colspan="8" style="text-align: center;"> <table border="1" style="width: 100%; border-collapse: collapse; text-align: center;"> <tr> <td style="width: 10%;"></td> <td style="width: 10%;"></td> <td style="width: 10%;"></td> <td style="width: 10%;"></td> <td style="width: 10%;"></td> <td style="width: 10%;"></td> <td style="width: 10%;"></td> <td style="width: 10%;"></td> <td style="width: 10%;"></td> <td style="width: 10%;"></td> </tr> <tr> <td></td> <td></td> <td colspan="8" style="text-align: center;"> <table border="1" style="width: 100%; border-collapse: collapse; text-align: center;"> <tr> <td style="width: 10%;"></td> <td style="width: 10%;"></td> <td style="width: 10%;"></td> <td style="width: 10%;"></td> <td style="width: 10%;"></td> <td style="width: 10%;"></td> <td style="width: 10%;"></td> <td style="width: 10%;"></td> <td style="width: 10%;"></td> <td style="width: 10%;"></td> </tr> <tr> <td></td> <td></td> <td colspan="8" style="text-align: center;"> <table border="1" style="width: 100%; border-collapse: collapse; text-align: center;"> <tr>
</tr></table></td></tr></table></td></tr></table></td></tr></table></td></tr></table></td></tr></table></td></tr></table></td></tr></table></td></tr></table></td></tr></table></td></tr></table></td></tr></table></td></tr></table></td></tr></table></td></tr></table></td></tr></table></td></tr></table></td></tr></table></td></tr></table></td></tr></table></td></tr></table></td></tr></table></td></tr></table></td></tr></table></td></tr></table></td></tr></table></td></tr></table></td></tr></table></td></tr></table></td></tr></table> | | | | | | | | | | | | | | | | | | | | <table border="1" style="width: 100%; border-collapse: collapse; text-align: center;"> <tr> <td style="width: 10%;"></td> <td style="width: 10%;"></td> <td style="width: 10%;"></td> <td style="width: 10%;"></td> <td style="width: 10%;"></td> <td style="width: 10%;"></td> <td style="width: 10%;"></td> <td style="width: 10%;"></td> <td style="width: 10%;"></td> <td style="width: 10%;"></td> </tr> <tr> <td></td> <td></td> <td colspan="8" style="text-align: center;"> <table border="1" style="width: 100%; border-collapse: collapse; text-align: center;"> <tr> <td style="width: 10%;"></td> <td style="width: 10%;"></td> <td style="width: 10%;"></td> <td style="width: 10%;"></td> <td style="width: 10%;"></td> <td style="width: 10%;"></td> <td style="width: 10%;"></td> <td style="width: 10%;"></td> <td style="width: 10%;"></td> <td style="width: 10%;"></td> </tr> <tr> <td></td> <td></td> <td colspan="8" style="text-align: center;"> <table border="1" style="width: 100%; border-collapse: collapse; text-align: center;"> <tr> <td style="width: 10%;"></td> <td style="width: 10%;"></td> <td style="width: 10%;"></td> <td style="width: 10%;"></td> <td style="width: 10%;"></td> <td style="width: 10%;"></td> <td style="width: 10%;"></td> <td style="width: 10%;"></td> <td style="width: 10%;"></td> <td style="width: 10%;"></td> </tr> <tr> <td></td> <td></td> <td colspan="8" style="text-align: center;"> <table border="1" style="width: 100%; border-collapse: collapse; text-align: center;"> <tr> <td style="width: 10%;"></td> <td style="width: 10%;"></td> <td style="width: 10%;"></td> <td style="width: 10%;"></td> <td style="width: 10%;"></td> <td style="width: 10%;"></td> <td style="width: 10%;"></td> <td style="width: 10%;"></td> <td style="width: 10%;"></td> <td style="width: 10%;"></td> </tr> <tr> <td></td> <td></td> <td colspan="8" style="text-align: center;"> <table border="1" style="width: 100%; border-collapse: collapse; text-align: center;"> <tr> <td style="width: 10%;"></td> <td style="width: 10%;"></td> <td style="width: 10%;"></td> <td style="width: 10%;"></td> <td style="width: 10%;"></td> <td style="width: 10%;"></td> <td style="width: 10%;"></td> <td style="width: 10%;"></td> <td style="width: 10%;"></td> <td style="width: 10%;"></td> </tr> <tr> <td></td> <td></td> <td colspan="8" style="text-align: center;"> <table border="1" style="width: 100%; border-collapse: collapse; text-align: center;"> <tr> <td style="width: 10%;"></td> <td style="width: 10%;"></td> <td style="width: 10%;"></td> <td style="width: 10%;"></td> <td style="width: 10%;"></td> <td style="width: 10%;"></td> <td style="width: 10%;"></td> <td style="width: 10%;"></td> <td style="width: 10%;"></td> <td style="width: 10%;"></td> </tr> <tr> <td></td> <td></td> <td colspan="8" style="text-align: center;"> <table border="1" style="width: 100%; border-collapse: collapse; text-align: center;"> <tr> <td style="width: 10%;"></td> <td style="width: 10%;"></td> <td style="width: 10%;"></td> <td style="width: 10%;"></td> <td style="width: 10%;"></td> <td style="width: 10%;"></td> <td style="width: 10%;"></td> <td style="width: 10%;"></td> <td style="width: 10%;"></td> <td style="width: 10%;"></td> </tr> <tr> <td></td> <td></td> <td colspan="8" style="text-align: center;"> <table border="1" style="width: 100%; border-collapse: collapse; text-align: center;"> <tr> <td style="width: 10%;"></td> <td style="width: 10%;"></td> <td style="width: 10%;"></td> <td style="width: 10%;"></td> <td style="width: 10%;"></td> <td style="width: 10%;"></td> <td style="width: 10%;"></td> <td style="width: 10%;"></td> <td style="width: 10%;"></td> <td style="width: 10%;"></td> </tr> <tr> <td></td> <td></td> <td colspan="8" style="text-align: center;"> <table border="1" style="width: 100%; border-collapse: collapse; text-align: center;"> <tr> <td style="width: 10%;"></td> <td style="width: 10%;"></td> <td style="width: 10%;"></td> <td style="width: 10%;"></td> <td style="width: 10%;"></td> <td style="width: 10%;"></td> <td style="width: 10%;"></td> <td style="width: 10%;"></td> <td style="width: 10%;"></td> <td style="width: 10%;"></td> </tr> <tr> <td></td> <td></td> <td colspan="8" style="text-align: center;"> <table border="1" style="width: 100%; border-collapse: collapse; text-align: center;"> <tr> <td style="width: 10%;"></td> <td style="width: 10%;"></td> <td style="width: 10%;"></td> <td style="width: 10%;"></td> <td style="width: 10%;"></td> <td style="width: 10%;"></td> <td style="width: 10%;"></td> <td style="width: 10%;"></td>
<td style="width: 10%;"></td> <td style="width: 10%;"></td> </tr> <tr> <td></td> <td></td> <td colspan="8" style="text-align: center;"> <table border="1" style="width: 100%; border-collapse: collapse; text-align: center;"> <tr> <td style="width: 10%;"></td> <td style="width: 10%;"></td> <td style="width: 10%;"></td> <td style="width: 10%;"></td> <td style="width: 10%;"></td> <td style="width: 10%;"></td> <td style="width: 10%;"></td> <td style="width: 10%;"></td> <td style="width: 10%;"></td> <td style="width: 10%;"></td> </tr> <tr> <td></td> <td></td> <td colspan="8" style="text-align: center;"> <table border="1" style="width: 100%; border-collapse: collapse; text-align: center;"> <tr> <td style="width: 10%;"></td> <td style="width: 10%;"></td> <td style="width: 10%;"></td> <td style="width: 10%;"></td> <td style="width: 10%;"></td> <td style="width: 10%;"></td> <td style="width: 10%;"></td> <td style="width: 10%;"></td> <td style="width: 10%;"></td> <td style="width: 10%;"></td> </tr> <tr> <td></td> <td></td> <td colspan="8" style="text-align: center;"> <table border="1" style="width: 100%; border-collapse: collapse; text-align: center;"> <tr> <td style="width: 10%;"></td> <td style="width: 10%;"></td> <td style="width: 10%;"></td> <td style="width: 10%;"></td> <td style="width: 10%;"></td> <td style="width: 10%;"></td> <td style="width: 10%;"></td> <td style="width: 10%;"></td> <td style="width: 10%;"></td> <td style="width: 10%;"></td> </tr> <tr> <td></td> <td></td> <td colspan="8" style="text-align: center;"> <table border="1" style="width: 100%; border-collapse: collapse; text-align: center;"> <tr> <td style="width: 10%;"></td> <td style="width: 10%;"></td> <td style="width: 10%;"></td> <td style="width: 10%;"></td> <td style="width: 10%;"></td> <td style="width: 10%;"></td> <td style="width: 10%;"></td> <td style="width: 10%;"></td> <td style="width: 10%;"></td> <td style="width: 10%;"></td> </tr> <tr> <td></td> <td></td> <td colspan="8" style="text-align: center;"> <table border="1" style="width: 100%; border-collapse: collapse; text-align: center;"> <tr> <td style="width: 10%;"></td> <td style="width: 10%;"></td> <td style="width: 10%;"></td> <td style="width: 10%;"></td> <td style="width: 10%;"></td> <td style="width: 10%;"></td> <td style="width: 10%;"></td> <td style="width: 10%;"></td> <td style="width: 10%;"></td> <td style="width: 10%;"></td> </tr> <tr> <td></td> <td></td> <td colspan="8" style="text-align: center;"> <table border="1" style="width: 100%; border-collapse: collapse; text-align: center;"> <tr> <td style="width: 10%;"></td> <td style="width: 10%;"></td> <td style="width: 10%;"></td> <td style="width: 10%;"></td> <td style="width: 10%;"></td> <td style="width: 10%;"></td> <td style="width: 10%;"></td> <td style="width: 10%;"></td> <td style="width: 10%;"></td> <td style="width: 10%;"></td> </tr> <tr> <td></td> <td></td> <td colspan="8" style="text-align: center;"> <table border="1" style="width: 100%; border-collapse: collapse; text-align: center;"> <tr> <td style="width: 10%;"></td> <td style="width: 10%;"></td> <td style="width: 10%;"></td> <td style="width: 10%;"></td> <td style="width: 10%;"></td> <td style="width: 10%;"></td> <td style="width: 10%;"></td> <td style="width: 10%;"></td> <td style="width: 10%;"></td> <td style="width: 10%;"></td> </tr> <tr> <td></td> <td></td> <td colspan="8" style="text-align: center;"> <table border="1" style="width: 100%; border-collapse: collapse; text-align: center;"> <tr> <td style="width: 10%;"></td> <td style="width: 10%;"></td> <td style="width: 10%;"></td> <td style="width: 10%;"></td> <td style="width: 10%;"></td> <td style="width: 10%;"></td> <td style="width: 10%;"></td> <td style="width: 10%;"></td> <td style="width: 10%;"></td> <td style="width: 10%;"></td> </tr> <tr> <td></td> <td></td> <td colspan="8" style="text-align: center;"> <table border="1" style="width: 100%; border-collapse: collapse; text-align: center;"> <tr> <td style="width: 10%;"></td> <td style="width: 10%;"></td> <td style="width: 10%;"></td> <td style="width: 10%;"></td> <td style="width: 10%;"></td> <td style="width: 10%;"></td> <td style="width: 10%;"></td> <td style="width: 10%;"></td> <td style="width: 10%;"></td> <td style="width: 10%;"></td> </tr> <tr> <td></td> <td></td> <td colspan="8" style="text-align: center;"> <table border="1" style="width: 100%; border-collapse: collapse; text-align: center;"> <tr> <td style="width: 10%;"></td> <td style="width: 10%;"></td> <td style="width: 10%;"></td> <td style="width: 10%;"></td> <td style="width: 10%;"></td> <td style="width: 10%;"></td> <td style="width: 10%;"></td> <td style="width: 10%;"></td> <td style="width: 10%;"></td> <td style="width: 10%;"></td> </tr> <tr> <td></td> <td></td> <td colspan="8" style="text-align: center;"> <table border="1" style="width: 100%; border-collapse: collapse; text-align: center;"> <tr> <td style="width: 10%;"></td> <td style="width: 10%;"></td> <td style="width: 10%;"></td> <td style="width: 10%;"></td> <td style="width: 10%;"></td> <td style="width: 10%;"></td> <td style="width: 10%;"></td> <td style="width: 10%;"></td> <td style="width: 10%;"></td> <td style="width: 10%;"></td> </tr> <tr> <td></td> <td></td> <td colspan="8" style="text-align: center;"> <table border="1" style="width: 100%; border-collapse: collapse; text-align: center;"> <tr> <td style="width: 10%;"></td> <td style="width: 10%;"></td> <td style="width: 10%;"></td> <td style="width: 10%;"></td> <td style="width: 10%;"></td> <td style="width: 10%;"></td> <td style="width: 10%;"></td> <td style="width: 10%;"></td> <td style="width: 10%;"></td> <td style="width: 10%;"></td> </tr> <tr> <td></td> <td></td> <td colspan="8" style="text-align: center;"> <table border="1" style="width: 100%; border-collapse: collapse; text-align: center;"> <tr> <td style="width: 10%;"></td> <td style="width: 10%;"></td> <td style="width: 10%;"></td> <td style="width: 10%;"></td> <td style="width: 10%;"></td> <td style="width: 10%;"></td> <td style="width: 10%;"></td> <td style="width: 10%;"></td> <td style="width: 10%;"></td> <td style="width: 10%;"></td> </tr> <tr> <td></td> <td></td> <td colspan="8" style="text-align: center;"> <table border="1" style="width: 100%; border-collapse: collapse; text-align: center;"> <tr> <td style="width: 10%;"></td> <td style="width: 10%;"></td> <td style="width: 10%;"></td> <td style="width: 10%;"></td> <td style="width: 10%;"></td> <td style="width: 10%;"></td> <td style="width: 10%;"></td> <td style="width: 10%;"></td> <td style="width: 10%;"></td> <td style="width: 10%;"></td> </tr> <tr> <td></td> <td></td> <td colspan="8" style="text-align: center;"> <table border="1" style="width: 100%; border-collapse: collapse; text-align: center;"> <tr> <td style="width: 10%;"></td> <td style="width: 10%;"></td> <td style="width: 10%;"></td> <td style="width: 10%;"></td> <td style="width: 10%;"></td> <td style="width: 10%;"></td> <td style="width: 10%;"></td> <td style="width: 10%;"></td> <td style="width: 10%;"></td> <td style="width: 10%;"></td> </tr> <tr> <td></td> <td></td> <td colspan="8" style="text-align: center;"> <table border="1" style="width: 100%; border-collapse: collapse; text-align: center;"> <tr> <td style="width: 10%;"></td> <td style="width: 10%;"></td> <td style="width: 10%;"></td> <td style="width: 10%;"></td> <td style="width: 10%;"></td> <td style="width: 10%;"></td> <td style="width: 10%;"></td> <td style="width: 10%;"></td> <td style="width: 10%;"></td> <td style="width: 10%;"></td> </tr> <tr> <td></td> <td></td> <td colspan="8" style="text-align: center;"> <table border="1" style="width: 100%; border-collapse: collapse; text-align: center;"> <tr> <td style="width: 10%;"></td> <td style="width: 10%;"></td> <td style="width: 10%;"></td> <td style="width: 10%;"></td> <td style="width: 10%;"></td> <td style="width: 10%;"></td> <td style="width: 10%;"></td> <td style="width: 10%;"></td> <td style="width: 10%;"></td> <td style="width: 10%;"></td> </tr> <tr> <td></td> <td></td> <td colspan="8" style="text-align: center;"> <table border="1" style="width: 100%; border-collapse: collapse; text-align: center;"> <tr> <td style="width: 10%;"></td> <td style="width: 10%;"></td> <td style="width: 10%;"></td> <td style="width: 10%;"></td> <td style="width: 10%;"></td> <td style="width: 10%;"></td> <td style="width: 10%;"></td> <td style="width: 10%;"></td> <td style="width: 10%;"></td> <td style="width: 10%;"></td> </tr> <tr> <td></td> <td></td> <td colspan="8" style="text-align: center;"> <table border="1" style="width: 100%; border-collapse: collapse; text-align: center;"> <tr> </tr></table></td></tr></table></td></tr></table></td></tr></table></td></tr></table></td></tr></table></td></tr></table></td></tr></table></td></tr></table></td></tr></table></td></tr></table></td></tr></table></td></tr></table></td></tr></table></td></tr></table></td></tr></table></td></tr></table></td></tr></table></td></tr></table></td></tr></table></td></tr></table></td></tr></table></td></tr></table></td></tr></table></td></tr></table></td></tr></table></td></tr></table></td></tr></table></td></tr></table>
 | | | | | | | | | | | | | | | | | | | | <table border="1" style="width: 100%; border-collapse: collapse; text-align: center;"> <tr> <td style="width: 10%;"></td> <td style="width: 10%;"></td> <td style="width: 10%;"></td> <td style="width: 10%;"></td> <td style="width: 10%;"></td> <td style="width: 10%;"></td> <td style="width: 10%;"></td> <td style="width: 10%;"></td> <td style="width: 10%;"></td> <td style="width: 10%;"></td> </tr> <tr> <td></td> <td></td> <td colspan="8" style="text-align: center;"> <table border="1" style="width: 100%; border-collapse: collapse; text-align: center;"> <tr> <td style="width: 10%;"></td> <td style="width: 10%;"></td> <td style="width: 10%;"></td> <td style="width: 10%;"></td> <td style="width: 10%;"></td> <td style="width: 10%;"></td> <td style="width: 10%;"></td> <td style="width: 10%;"></td> <td style="width: 10%;"></td> <td style="width: 10%;"></td> </tr> <tr> <td></td> <td></td> <td colspan="8" style="text-align: center;"> <table border="1" style="width: 100%; border-collapse: collapse; text-align: center;"> <tr> <td style="width: 10%;"></td> <td style="width: 10%;"></td> <td style="width: 10%;"></td> <td style="width: 10%;"></td> <td style="width: 10%;"></td> <td style="width: 10%;"></td> <td style="width: 10%;"></td> <td style="width: 10%;"></td> <td style="width: 10%;"></td> <td style="width: 10%;"></td> </tr> <tr> <td></td> <td></td> <td colspan="8" style="text-align: center;"> <table border="1" style="width: 100%; border-collapse: collapse; text-align: center;"> <tr> <td style="width: 10%;"></td> <td style="width: 10%;"></td> <td style="width: 10%;"></td> <td style="width: 10%;"></td> <td style="width: 10%;"></td> <td style="width: 10%;"></td> <td style="width: 10%;"></td> <td style="width: 10%;"></td> <td style="width: 10%;"></td> <td style="width: 10%;"></td> </tr> <tr> <td></td> <td></td> <td colspan="8" style="text-align: center;"> <table border="1" style="width: 100%; border-collapse: collapse; text-align: center;"> <tr> <td style="width: 10%;"></td> <td style="width: 10%;"></td> <td style="width: 10%;"></td> <td style="width: 10%;"></td> <td style="width: 10%;"></td> <td style="width: 10%;"></td> <td style="width: 10%;"></td> <td style="width: 10%;"></td> <td style="width: 10%;"></td> <td style="width: 10%;"></td> </tr> <tr> <td></td> <td></td> <td colspan="8" style="text-align: center;"> <table border="1" style="width: 100%; border-collapse: collapse; text-align: center;"> <tr> <td style="width: 10%;"></td> <td style="width: 10%;"></td> <td style="width: 10%;"></td> <td style="width: 10%;"></td> <td style="width: 10%;"></td> <td style="width: 10%;"></td> <td style="width: 10%;"></td> <td style="width: 10%;"></td> <td style="width: 10%;"></td> <td style="width: 10%;"></td> </tr> <tr> <td></td> <td></td> <td colspan="8" style="text-align: center;"> <table border="1" style="width: 100%; border-collapse: collapse; text-align: center;"> <tr> <td style="width: 10%;"></td> <td style="width: 10%;"></td> <td style="width: 10%;"></td> <td style="width: 10%;"></td> <td style="width: 10%;"></td> <td style="width: 10%;"></td> <td style="width: 10%;"></td> <td style="width: 10%;"></td> <td style="width: 10%;"></td> <td style="width: 10%;"></td> </tr> <tr> <td></td> <td></td> <td colspan="8" style="text-align: center;"> <table border="1" style="width: 100%; border-collapse: collapse; text-align: center;"> <tr> <td style="width: 10%;"></td> <td style="width: 10%;"></td> <td style="width: 10%;"></td> <td style="width: 10%;"></td> <td style="width: 10%;"></td> <td style="width: 10%;"></td> <td style="width: 10%;"></td> <td style="width: 10%;"></td> <td style="width: 10%;"></td> <td style="width: 10%;"></td> </tr> <tr> <td></td> <td></td> <td colspan="8" style="text-align: center;"> <table border="1" style="width: 100%; border-collapse: collapse; text-align: center;"> <tr> <td style="width: 10%;"></td> <td style="width: 10%;"></td> <td style="width: 10%;"></td> <td style="width: 10%;"></td> <td style="width: 10%;"></td> <td style="width: 10%;"></td> <td style="width: 10%;"></td> <td style="width: 10%;"></td> <td style="width: 10%;"></td> <td style="width: 10%;"></td> </tr> <tr> <td></td> <td></td> <td colspan="8" style="text-align: center;"> <table border="1" style="width: 100%; border-collapse: collapse; text-align: center;"> <tr> <td style="width: 10%;"></td> <td style="width: 10%;"></td> <td style="width: 10%;"></td> <td style="width: 10%;"></td> <td style="width: 10%;"></td> <td style="width: 10%;"></td> <td style="width: 10%;"></td> <td style="width: 10%;"></td> <td style="width: 10%;"></td> <td style="width: 10%;"></td> </tr> <tr> <td></td> <td></td> <td colspan="8" style="text-align: center;"> <table border="1" style="width: 100%; border-collapse: collapse; text-align: center;"> <tr> <td style="width: 10%;"></td> <td style="width: 10%;"></td> <td style="width: 10%;"></td> <td style="width: 10%;"></td> <td style="width: 10%;"></td> <td style="width: 10%;"></td> <td style="width: 10%;"></td> <td style="width: 10%;"></td> <td style="width: 10%;"></td> <td style="width: 10%;"></td> </tr> <tr> <td></td> <td></td> <td colspan="8" style="text-align: center;"> <table border="1" style="width: 100%; border-collapse: collapse; text-align: center;"> <tr> <td style="width: 10%;"></td> <td style="width: 10%;"></td> <td style="width: 10%;"></td> <td style="width: 10%;"></td> <td style="width: 10%;"></td> <td style="width: 10%;"></td> <td style="width: 10%;"></td> <td style="width: 10%;"></td> <td style="width: 10%;"></td> <td style="width: 10%;"></td> </tr> <tr> <td></td> <td></td> <td colspan="8" style="text-align: center;"> <table border="1" style="width: 100%; border-collapse: collapse; text-align: center;"> <tr> <td style="width: 10%;"></td> <td style="width: 10%;"></td> <td style="width: 10%;"></td> <td style="width: 10%;"></td> <td style="width: 10%;"></td> <td style="width: 10%;"></td> <td style="width:
10%;"></td> <td style="width: 10%;"></td> <td style="width: 10%;"></td> <td style="width: 10%;"></td> </tr> <tr> <td></td> <td></td> <td colspan="8" style="text-align: center;"> <table border="1" style="width: 100%; border-collapse: collapse; text-align: center;"> <tr> <td style="width: 10%;"></td> <td style="width: 10%;"></td> <td style="width: 10%;"></td> <td style="width: 10%;"></td> <td style="width: 10%;"></td> <td style="width: 10%;"></td> <td style="width: 10%;"></td> <td style="width: 10%;"></td> <td style="width: 10%;"></td> <td style="width: 10%;"></td> </tr> <tr> <td></td> <td></td> <td colspan="8" style="text-align: center;"> <table border="1" style="width: 100%; border-collapse: collapse; text-align: center;"> <tr> <td style="width: 10%;"></td> <td style="width: 10%;"></td> <td style="width: 10%;"></td> <td style="width: 10%;"></td> <td style="width: 10%;"></td> <td style="width: 10%;"></td> <td style="width: 10%;"></td> <td style="width: 10%;"></td> <td style="width: 10%;"></td> <td style="width: 10%;"></td> </tr> <tr> <td></td> <td></td> <td colspan="8" style="text-align: center;"> <table border="1" style="width: 100%; border-collapse: collapse; text-align: center;"> <tr> <td style="width: 10%;"></td> <td style="width: 10%;"></td> <td style="width: 10%;"></td> <td style="width: 10%;"></td> <td style="width: 10%;"></td> <td style="width: 10%;"></td> <td style="width: 10%;"></td> <td style="width: 10%;"></td> <td style="width: 10%;"></td> <td style="width: 10%;"></td> </tr> <tr> <td></td> <td></td> <td colspan="8" style="text-align: center;"> <table border="1" style="width: 100%; border-collapse: collapse; text-align: center;"> <tr> <td style="width: 10%;"></td> <td style="width: 10%;"></td> <td style="width: 10%;"></td> <td style="width: 10%;"></td> <td style="width: 10%;"></td> <td style="width: 10%;"></td> <td style="width: 10%;"></td> <td style="width: 10%;"></td> <td style="width: 10%;"></td> <td style="width: 10%;"></td> </tr> <tr> <td></td> <td></td> <td colspan="8" style="text-align: center;"> <table border="1" style="width: 100%; border-collapse: collapse; text-align: center;"> <tr> <td style="width: 10%;"></td> <td style="width: 10%;"></td> <td style="width: 10%;"></td> <td style="width: 10%;"></td> <td style="width: 10%;"></td> <td style="width: 10%;"></td> <td style="width: 10%;"></td> <td style="width: 10%;"></td> <td style="width: 10%;"></td> <td style="width: 10%;"></td> </tr> <tr> <td></td> <td></td> <td colspan="8" style="text-align: center;"> <table border="1" style="width: 100%; border-collapse: collapse; text-align: center;"> <tr> <td style="width: 10%;"></td> <td style="width: 10%;"></td> <td style="width: 10%;"></td> <td style="width: 10%;"></td> <td style="width: 10%;"></td> <td style="width: 10%;"></td> <td style="width: 10%;"></td> <td style="width: 10%;"></td> <td style="width: 10%;"></td> <td style="width: 10%;"></td> </tr> <tr> <td></td> <td></td> <td colspan="8" style="text-align: center;"> <table border="1" style="width: 100%; border-collapse: collapse; text-align: center;"> <tr> <td style="width: 10%;"></td> <td style="width: 10%;"></td> <td style="width: 10%;"></td> <td style="width: 10%;"></td> <td style="width: 10%;"></td> <td style="width: 10%;"></td> <td style="width: 10%;"></td> <td style="width: 10%;"></td> <td style="width: 10%;"></td> <td style="width: 10%;"></td> </tr> <tr> <td></td> <td></td> <td colspan="8" style="text-align: center;"> <table border="1" style="width: 100%; border-collapse: collapse; text-align: center;"> <tr> <td style="width: 10%;"></td> <td style="width: 10%;"></td> <td style="width: 10%;"></td> <td style="width: 10%;"></td> <td style="width: 10%;"></td> <td style="width: 10%;"></td> <td style="width: 10%;"></td> <td style="width: 10%;"></td> <td style="width: 10%;"></td> <td style="width: 10%;"></td> </tr> <tr> <td></td> <td></td> <td colspan="8" style="text-align: center;"> <table border="1" style="width: 100%; border-collapse: collapse; text-align: center;"> <tr> <td style="width: 10%;"></td> <td style="width: 10%;"></td> <td style="width: 10%;"></td> <td style="width: 10%;"></td> <td style="width: 10%;"></td> <td style="width: 10%;"></td> <td style="width: 10%;"></td> <td style="width: 10%;"></td> <td style="width: 10%;"></td> <td style="width: 10%;"></td> </tr> <tr> <td></td> <td></td> <td colspan="8" style="text-align: center;"> <table border="1" style="width: 100%; border-collapse: collapse; text-align: center;"> <tr> <td style="width: 10%;"></td> <td style="width: 10%;"></td> <td style="width: 10%;"></td> <td style="width: 10%;"></td> <td style="width: 10%;"></td> <td style="width: 10%;"></td> <td style="width: 10%;"></td> <td style="width: 10%;"></td> <td style="width: 10%;"></td> <td style="width: 10%;"></td> </tr> <tr> <td></td> <td></td> <td colspan="8" style="text-align: center;"> <table border="1" style="width: 100%; border-collapse: collapse; text-align: center;"> <tr> <td style="width: 10%;"></td> <td style="width: 10%;"></td> <td style="width: 10%;"></td> <td style="width: 10%;"></td> <td style="width: 10%;"></td> <td style="width: 10%;"></td> <td style="width: 10%;"></td> <td style="width: 10%;"></td> <td style="width: 10%;"></td> <td style="width: 10%;"></td> </tr> <tr> <td></td> <td></td> <td colspan="8" style="text-align: center;"> <table border="1" style="width: 100%; border-collapse: collapse; text-align: center;"> <tr> <td style="width: 10%;"></td> <td style="width: 10%;"></td> <td style="width: 10%;"></td> <td style="width: 10%;"></td> <td style="width: 10%;"></td> <td style="width: 10%;"></td> <td style="width: 10%;"></td> <td style="width: 10%;"></td> <td style="width: 10%;"></td> <td style="width: 10%;"></td> </tr> <tr> <td></td> <td></td> <td colspan="8" style="text-align: center;"> <table border="1" style="width: 100%; border-collapse: collapse; text-align: center;"> <tr> <td style="width: 10%;"></td> <td style="width: 10%;"></td> <td style="width: 10%;"></td> <td style="width: 10%;"></td> <td style="width: 10%;"></td> <td style="width: 10%;"></td> <td style="width: 10%;"></td> <td style="width: 10%;"></td> <td style="width: 10%;"></td> <td style="width: 10%;"></td> </tr> <tr> <td></td> <td></td> <td colspan="8" style="text-align: center;"> <table border="1" style="width: 100%; border-collapse: collapse; text-align: center;"> <tr> <td style="width: 10%;"></td> <td style="width: 10%;"></td> <td style="width: 10%;"></td> <td style="width: 10%;"></td> <td style="width: 10%;"></td> <td style="width: 10%;"></td> <td style="width: 10%;"></td> <td style="width: 10%;"></td> <td style="width: 10%;"></td> <td style="width: 10%;"></td> </tr> <tr> <td></td> <td></td> <td colspan="8" style="text-align: center;"> <table border="1" style="width: 100%; border-collapse: collapse; text-align: center;"> <tr> </tr></table></td></tr></table></td></tr></table></td></tr></table></td></tr></table></td></tr></table></td></tr></table></td></tr></table></td></tr></table></td></tr></table></td></tr></table></td></tr></table></td></tr></table></td></tr></table></td></tr></table></td></tr></table></td></tr></table></td></tr></table></td></tr></table></td></tr></table></td></tr></table></td></tr></table></td></tr></table></td></tr></table></td></tr></table></td></tr></table></td></tr></table></td></tr></table>
 | | | | | | | | | | | | | | | | | | | | <table border="1" style="width: 100%; border-collapse: collapse; text-align: center;"> <tr> <td style="width: 10%;"></td> <td style="width: 10%;"></td> <td style="width: 10%;"></td> <td style="width: 10%;"></td> <td style="width: 10%;"></td> <td style="width: 10%;"></td> <td style="width: 10%;"></td> <td style="width: 10%;"></td> <td style="width: 10%;"></td> <td style="width: 10%;"></td> </tr> <tr> <td></td> <td></td> <td colspan="8" style="text-align: center;"> <table border="1" style="width: 100%; border-collapse: collapse; text-align: center;"> <tr> <td style="width: 10%;"></td> <td style="width: 10%;"></td> <td style="width: 10%;"></td> <td style="width: 10%;"></td> <td style="width: 10%;"></td> <td style="width: 10%;"></td> <td style="width: 10%;"></td> <td style="width: 10%;"></td> <td style="width: 10%;"></td> <td style="width: 10%;"></td> </tr> <tr> <td></td> <td></td> <td colspan="8" style="text-align: center;"> <table border="1" style="width: 100%; border-collapse: collapse; text-align: center;"> <tr> <td style="width: 10%;"></td> <td style="width: 10%;"></td> <td style="width: 10%;"></td> <td style="width: 10%;"></td> <td style="width: 10%;"></td> <td style="width: 10%;"></td> <td style="width: 10%;"></td> <td style="width: 10%;"></td> <td style="width: 10%;"></td> <td style="width: 10%;"></td> </tr> <tr> <td></td> <td></td> <td colspan="8" style="text-align: center;"> <table border="1" style="width: 100%; border-collapse: collapse; text-align: center;"> <tr> <td style="width: 10%;"></td> <td style="width: 10%;"></td> <td style="width: 10%;"></td> <td style="width: 10%;"></td> <td style="width: 10%;"></td> <td style="width: 10%;"></td> <td style="width: 10%;"></td> <td style="width: 10%;"></td> <td style="width: 10%;"></td> <td style="width: 10%;"></td> </tr> <tr> <td></td> <td></td> <td colspan="8" style="text-align: center;"> <table border="1" style="width: 100%; border-collapse: collapse; text-align: center;"> <tr> <td style="width: 10%;"></td> <td style="width: 10%;"></td> <td style="width: 10%;"></td> <td style="width: 10%;"></td> <td style="width: 10%;"></td> <td style="width: 10%;"></td> <td style="width: 10%;"></td> <td style="width: 10%;"></td> <td style="width: 10%;"></td> <td style="width: 10%;"></td> </tr> <tr> <td></td> <td></td> <td colspan="8" style="text-align: center;"> <table border="1" style="width: 100%; border-collapse: collapse; text-align: center;"> <tr> <td style="width: 10%;"></td> <td style="width: 10%;"></td> <td style="width: 10%;"></td> <td style="width: 10%;"></td> <td style="width: 10%;"></td> <td style="width: 10%;"></td> <td style="width: 10%;"></td> <td style="width: 10%;"></td> <td style="width: 10%;"></td> <td style="width: 10%;"></td> </tr> <tr> <td></td> <td></td> <td colspan="8" style="text-align: center;"> <table border="1" style="width: 100%; border-collapse: collapse; text-align: center;"> <tr> <td style="width: 10%;"></td> <td style="width: 10%;"></td> <td style="width: 10%;"></td> <td style="width: 10%;"></td> <td style="width: 10%;"></td> <td style="width: 10%;"></td> <td style="width: 10%;"></td> <td style="width: 10%;"></td> <td style="width: 10%;"></td> <td style="width: 10%;"></td> </tr> <tr> <td></td> <td></td> <td colspan="8" style="text-align: center;"> <table border="1" style="width: 100%; border-collapse: collapse; text-align: center;"> <tr> <td style="width: 10%;"></td> <td style="width: 10%;"></td> <td style="width: 10%;"></td> <td style="width: 10%;"></td> <td style="width: 10%;"></td> <td style="width: 10%;"></td> <td style="width: 10%;"></td> <td style="width: 10%;"></td> <td style="width: 10%;"></td> <td style="width: 10%;"></td> </tr> <tr> <td></td> <td></td> <td colspan="8" style="text-align: center;"> <table border="1" style="width: 100%; border-collapse: collapse; text-align: center;"> <tr> <td style="width: 10%;"></td> <td style="width: 10%;"></td> <td style="width: 10%;"></td> <td style="width: 10%;"></td> <td style="width: 10%;"></td> <td style="width: 10%;"></td> <td style="width: 10%;"></td> <td style="width: 10%;"></td> <td style="width: 10%;"></td> <td style="width: 10%;"></td> </tr> <tr> <td></td> <td></td> <td colspan="8" style="text-align: center;"> <table border="1" style="width: 100%; border-collapse: collapse; text-align: center;"> <tr> <td style="width: 10%;"></td> <td style="width: 10%;"></td> <td style="width: 10%;"></td> <td style="width: 10%;"></td> <td style="width: 10%;"></td> <td style="width: 10%;"></td> <td style="width: 10%;"></td> <td style="width: 10%;"></td> <td style="width: 10%;"></td> <td style="width: 10%;"></td> </tr> <tr> <td></td> <td></td> <td colspan="8" style="text-align: center;"> <table border="1" style="width: 100%; border-collapse: collapse; text-align: center;"> <tr> <td style="width: 10%;"></td> <td style="width: 10%;"></td> <td style="width: 10%;"></td> <td style="width: 10%;"></td> <td style="width: 10%;"></td> <td style="width: 10%;"></td> <td style="width: 10%;"></td> <td style="width: 10%;"></td> <td style="width: 10%;"></td> <td style="width: 10%;"></td> </tr> <tr> <td></td> <td></td> <td colspan="8" style="text-align: center;"> <table border="1" style="width: 100%; border-collapse: collapse; text-align: center;"> <tr> <td style="width: 10%;"></td> <td style="width: 10%;"></td> <td style="width: 10%;"></td> <td style="width: 10%;"></td> <td style="width: 10%;"></td> <td style="width: 10%;"></td> <td style="width: 10%;"></td> <td style="width: 10%;"></td> <td style="width: 10%;"></td> <td style="width: 10%;"></td> </tr> <tr> <td></td> <td></td> <td colspan="8" style="text-align: center;"> <table border="1" style="width: 100%; border-collapse: collapse; text-align: center;"> <tr> <td style="width: 10%;"></td> <td style="width: 10%;"></td> <td style="width: 10%;"></td> <td style="width: 10%;"></td> <td style="width: 10%;"></td> <td style="width: 10%;"></td> <td style="width: 10%;"></td> <td style="width: 10%;"></td> <td style="width: 10%;"></td> <td style="width: 10%;"></td> </tr> <tr> <td></td> <td></td> <td colspan="8" style="text-align: center;"> <table border="1" style="width: 100%; border-collapse: collapse; text-align: center;"> <tr> <td style="width: 10%;"></td> <td style="width: 10%;"></td> <td style="width: 10%;"></td> <td style="width: 10%;"></td> <td style="width: 10%;"></td> <td style="width: 10%;"></td> <td style="width: 10%;"></td> <td style="width: 10%;"></td> <td style="width: 10%;"></td> <td style="width: 10%;"></td> </tr> <tr> <td></td> <td></td> <td colspan="8" style="text-align: center;"> <table border="1" style="width: 100%; border-collapse: collapse; text-align: center;"> <tr> <td style="width: 10%;"></td> <td style="width: 10%;"></td> <td style="width: 10%;"></td> <td style="width: 10%;"></td> <td style="width: 10%;"></td> <td style="width: 10%;"></td> <td style="width: 10%;"></td> <td style="width: 10%;"></td> <td style="width: 10%;"></td> <td style="width: 10%;"></td> </tr> <tr> <td></td> <td></td> <td colspan="8" style="text-align: center;"> <table border="1" style="width: 100%; border-collapse: collapse; text-align: center;"> <tr> <td style="width: 10%;"></td> <td style="width: 10%;"></td> <td style="width: 10%;"></td> <td style="width: 10%;"></td> <td style="width: 10%;"></td> <td style="width: 10%;"></td> <td style="width: 10%;"></td> <td style="width: 10%;"></td> <td style="width: 10%;"></td> <td style="width: 10%;"></td> </tr> <tr> <td></td> <td></td> <td colspan="8" style="text-align: center;"> <table border="1" style="width: 100%; border-collapse: collapse; text-align: center;"> <tr> <td style="width: 10%;"></td> <td style="width: 10%;"></td> <td style="width: 10%;"></td> <td style="width: 10%;"></td> <td style="width: 10%;"></td> <td style="width:
10%;"></td> <td style="width: 10%;"></td> <td style="width: 10%;"></td> <td style="width: 10%;"></td> <td style="width: 10%;"></td> </tr> <tr> <td></td> <td></td> <td colspan="8" style="text-align: center;"> <table border="1" style="width: 100%; border-collapse: collapse; text-align: center;"> <tr> <td style="width: 10%;"></td> <td style="width: 10%;"></td> <td style="width: 10%;"></td> <td style="width: 10%;"></td> <td style="width: 10%;"></td> <td style="width: 10%;"></td> <td style="width: 10%;"></td> <td style="width: 10%;"></td> <td style="width: 10%;"></td> <td style="width: 10%;"></td> </tr> <tr> <td></td> <td></td> <td colspan="8" style="text-align: center;"> <table border="1" style="width: 100%; border-collapse: collapse; text-align: center;"> <tr> <td style="width: 10%;"></td> <td style="width: 10%;"></td> <td style="width: 10%;"></td> <td style="width: 10%;"></td> <td style="width: 10%;"></td> <td style="width: 10%;"></td> <td style="width: 10%;"></td> <td style="width: 10%;"></td> <td style="width: 10%;"></td> <td style="width: 10%;"></td> </tr> <tr> <td></td> <td></td> <td colspan="8" style="text-align: center;"> <table border="1" style="width: 100%; border-collapse: collapse; text-align: center;"> <tr> <td style="width: 10%;"></td> <td style="width: 10%;"></td> <td style="width: 10%;"></td> <td style="width: 10%;"></td> <td style="width: 10%;"></td> <td style="width: 10%;"></td> <td style="width: 10%;"></td> <td style="width: 10%;"></td> <td style="width: 10%;"></td> <td style="width: 10%;"></td> </tr> <tr> <td></td> <td></td> <td colspan="8" style="text-align: center;"> <table border="1" style="width: 100%; border-collapse: collapse; text-align: center;"> <tr> <td style="width: 10%;"></td> <td style="width: 10%;"></td> <td style="width: 10%;"></td> <td style="width: 10%;"></td> <td style="width: 10%;"></td> <td style="width: 10%;"></td> <td style="width: 10%;"></td> <td style="width: 10%;"></td> <td style="width: 10%;"></td> <td style="width: 10%;"></td> </tr> <tr> <td></td> <td></td> <td colspan="8" style="text-align: center;"> <table border="1" style="width: 100%; border-collapse: collapse; text-align: center;"> <tr> <td style="width: 10%;"></td> <td style="width: 10%;"></td> <td style="width: 10%;"></td> <td style="width: 10%;"></td> <td style="width: 10%;"></td> <td style="width: 10%;"></td> <td style="width: 10%;"></td> <td style="width: 10%;"></td> <td style="width: 10%;"></td> <td style="width: 10%;"></td> </tr> <tr> <td></td> <td></td> <td colspan="8" style="text-align: center;"> <table border="1" style="width: 100%; border-collapse: collapse; text-align: center;"> <tr> <td style="width: 10%;"></td> <td style="width: 10%;"></td> <td style="width: 10%;"></td> <td style="width: 10%;"></td> <td style="width: 10%;"></td> <td style="width: 10%;"></td> <td style="width: 10%;"></td> <td style="width: 10%;"></td> <td style="width: 10%;"></td> <td style="width: 10%;"></td> </tr> <tr> <td></td> <td></td> <td colspan="8" style="text-align: center;"> <table border="1" style="width: 100%; border-collapse: collapse; text-align: center;"> <tr> <td style="width: 10%;"></td> <td style="width: 10%;"></td> <td style="width: 10%;"></td> <td style="width: 10%;"></td> <td style="width: 10%;"></td> <td style="width: 10%;"></td> <td style="width: 10%;"></td> <td style="width: 10%;"></td> <td style="width: 10%;"></td> <td style="width: 10%;"></td> </tr> <tr> <td></td> <td></td> <td colspan="8" style="text-align: center;"> <table border="1" style="width: 100%; border-collapse: collapse; text-align: center;"> <tr> <td style="width: 10%;"></td> <td style="width: 10%;"></td> <td style="width: 10%;"></td> <td style="width: 10%;"></td> <td style="width: 10%;"></td> <td style="width: 10%;"></td> <td style="width: 10%;"></td> <td style="width: 10%;"></td> <td style="width: 10%;"></td> <td style="width: 10%;"></td> </tr> <tr> <td></td> <td></td> <td colspan="8" style="text-align: center;"> <table border="1" style="width: 100%; border-collapse: collapse; text-align: center;"> <tr> <td style="width: 10%;"></td> <td style="width: 10%;"></td> <td style="width: 10%;"></td> <td style="width: 10%;"></td> <td style="width: 10%;"></td> <td style="width: 10%;"></td> <td style="width: 10%;"></td> <td style="width: 10%;"></td> <td style="width: 10%;"></td> <td style="width: 10%;"></td> </tr> <tr> <td></td> <td></td> <td colspan="8" style="text-align: center;"> <table border="1" style="width: 100%; border-collapse: collapse; text-align: center;"> <tr> </tr></table></td></tr></table></td></tr></table></td></tr></table></td></tr></table></td></tr></table></td></tr></table></td></tr></table></td></tr></table></td></tr></table></td></tr></table></td></tr></table></td></tr></table></td></tr></table></td></tr></table></td></tr></table></td></tr></table></td></tr></table></td></tr></table></td></tr></table></td></tr></table></td></tr></table></td></tr></table></td></tr></table></td></tr></table></td></tr></table></td></tr></table> | | | | | | | | | | | | | | | | | | | | <table border="1" style="width: 100%; border-collapse: collapse; text-align: center;">
<tr> <td style="width: 10%;"></td> <td style="width: 10%;"></td> <td style="width: 10%;"></td> <td style="width: 10%;"></td> <td style="width: 10%;"></td> <td style="width: 10%;"></td> <td style="width: 10%;"></td> <td style="width: 10%;"></td> <td style="width: 10%;"></td> <td style="width: 10%;"></td> </tr> <tr> <td></td> <td></td> <td colspan="8" style="text-align: center;"> <table border="1" style="width: 100%; border-collapse: collapse; text-align: center;"> <tr> <td style="width: 10%;"></td> <td style="width: 10%;"></td> <td style="width: 10%;"></td> <td style="width: 10%;"></td> <td style="width: 10%;"></td> <td style="width: 10%;"></td> <td style="width: 10%;"></td> <td style="width: 10%;"></td> <td style="width: 10%;"></td> <td style="width: 10%;"></td> </tr> <tr> <td></td> <td></td> <td colspan="8" style="text-align: center;"> <table border="1" style="width: 100%; border-collapse: collapse; text-align: center;"> <tr> <td style="width: 10%;"></td> <td style="width: 10%;"></td> <td style="width: 10%;"></td> <td style="width: 10%;"></td> <td style="width: 10%;"></td> <td style="width: 10%;"></td> <td style="width: 10%;"></td> <td style="width: 10%;"></td> <td style="width: 10%;"></td> <td style="width: 10%;"></td> </tr> <tr> <td></td> <td></td> <td colspan="8" style="text-align: center;"> <table border="1" style="width: 100%; border-collapse: collapse; text-align: center;"> <tr> <td style="width: 10%;"></td> <td style="width: 10%;"></td> <td style="width: 10%;"></td> <td style="width: 10%;"></td> <td style="width: 10%;"></td> <td style="width: 10%;"></td> <td style="width: 10%;"></td> <td style="width: 10%;"></td> <td style="width: 10%;"></td> <td style="width: 10%;"></td> </tr> <tr> <td></td> <td></td> <td colspan="8" style="text-align: center;"> <table border="1" style="width: 100%; border-collapse: collapse; text-align: center;"> <tr> <td style="width: 10%;"></td> <td style="width: 10%;"></td> <td style="width: 10%;"></td> <td style="width: 10%;"></td> <td style="width: 10%;"></td> <td style="width: 10%;"></td> <td style="width: 10%;"></td> <td style="width: 10%;"></td> <td style="width: 10%;"></td> <td style="width: 10%;"></td> </tr> <tr> <td></td> <td></td> <td colspan="8" style="text-align: center;"> <table border="1" style="width: 100%; border-collapse: collapse; text-align: center;"> <tr> <td style="width: 10%;"></td> <td style="width: 10%;"></td> <td style="width: 10%;"></td> <td style="width: 10%;"></td> <td style="width: 10%;"></td> <td style="width: 10%;"></td> <td style="width: 10%;"></td> <td style="width: 10%;"></td> <td style="width: 10%;"></td> <td style="width: 10%;"></td> </tr> <tr> <td></td> <td></td> <td colspan="8" style="text-align: center;"> <table border="1" style="width: 100%; border-collapse: collapse; text-align: center;"> <tr> <td style="width: 10%;"></td> <td style="width: 10%;"></td> <td style="width: 10%;"></td> <td style="width: 10%;"></td> <td style="width: 10%;"></td> <td style="width: 10%;"></td> <td style="width: 10%;"></td> <td style="width: 10%;"></td> <td style="width: 10%;"></td> <td style="width: 10%;"></td> </tr> <tr> <td></td> <td></td> <td colspan="8" style="text-align: center;"> <table border="1" style="width: 100%; border-collapse: collapse; text-align: center;"> <tr> <td style="width: 10%;"></td> <td style="width: 10%;"></td> <td style="width: 10%;"></td> <td style="width: 10%;"></td> <td style="width: 10%;"></td> <td style="width: 10%;"></td> <td style="width: 10%;"></td> <td style="width: 10%;"></td> <td style="width: 10%;"></td> <td style="width: 10%;"></td> </tr> <tr> <td></td> <td></td> <td colspan="8" style="text-align: center;"> <table border="1" style="width: 100%; border-collapse: collapse; text-align: center;"> <tr> <td style="width: 10%;"></td> <td style="width: 10%;"></td> <td style="width: 10%;"></td> <td style="width: 10%;"></td> <td style="width: 10%;"></td> <td style="width: 10%;"></td> <td style="width: 10%;"></td> <td style="width: 10%;"></td> <td style="width: 10%;"></td> <td style="width: 10%;"></td> </tr> <tr> <td></td> <td></td> <td colspan="8" style="text-align: center;"> <table border="1" style="width: 100%; border-collapse: collapse; text-align: center;"> <tr> <td style="width: 10%;"></td> <td style="width: 10%;"></td> <td style="width: 10%;"></td> <td style="width: 10%;"></td> <td style="width: 10%;"></td> <td style="width: 10%;"></td> <td style="width: 10%;"></td> <td style="width: 10%;"></td> <td style="width: 10%;"></td> <td style="width: 10%;"></td> </tr> <tr> <td></td> <td></td> <td colspan="8" style="text-align: center;"> <table border="1" style="width: 100%; border-collapse: collapse; text-align: center;"> <tr> <td style="width: 10%;"></td> <td style="width: 10%;"></td> <td style="width: 10%;"></td> <td style="width: 10%;"></td> <td style="width: 10%;"></td> <td style="width: 10%;"></td> <td style="width: 10%;"></td> <td style="width: 10%;"></td> <td style="width: 10%;"></td> <td style="width: 10%;"></td> </tr> <tr> <td></td> <td></td> <td colspan="8" style="text-align: center;"> <table border="1" style="width: 100%; border-collapse: collapse; text-align: center;"> <tr> <td style="width: 10%;"></td> <td style="width: 10%;"></td> <td style="width: 10%;"></td> <td style="width: 10%;"></td> <td style="width: 10%;"></td> <td style="width: 10%;"></td> <td style="width: 10%;"></td> <td style="width: 10%;"></td> <td style="width: 10%;"></td> <td style="width: 10%;"></td> </tr> <tr> <td></td> <td></td> <td colspan="8" style="text-align: center;"> <table border="1" style="width: 100%; border-collapse: collapse; text-align: center;"> <tr> <td style="width: 10%;"></td> <td style="width: 10%;"></td> <td style="width: 10%;"></td> <td style="width: 10%;"></td> <td style="width: 10%;"></td> <td style="width: 10%;"></td> <td style="width: 10%;"></td> <td style="width: 10%;"></td> <td style="width: 10%;"></td> <td style="width: 10%;"></td> </tr> <tr> <td></td> <td></td> <td colspan="8" style="text-align: center;"> <table border="1" style="width: 100%; border-collapse: collapse; text-align: center;"> <tr> <td style="width: 10%;"></td> <td style="width: 10%;"></td> <td style="width: 10%;"></td> <td style="width: 10%;"></td> <td style="width: 10%;"></td> <td style="width: 10%;"></td> <td style="width: 10%;"></td> <td style="width: 10%;"></td> <td style="width: 10%;"></td> <td style="width: 10%;"></td> </tr> <tr> <td></td> <td></td> <td colspan="8" style="text-align: center;"> <table border="1" style="width: 100%; border-collapse: collapse; text-align: center;"> <tr> <td style="width: 10%;"></td> <td style="width: 10%;"></td> <td style="width: 10%;"></td> <td style="width: 10%;"></td> <td style="width: 10%;"></td> <td style="width: 10%;"></td> <td style="width: 10%;"></td> <td style="width: 10%;"></td> <td style="width: 10%;"></td> <td style="width: 10%;"></td> </tr> <tr> <td></td> <td></td> <td colspan="8" style="text-align: center;"> <table border="1" style="width: 100%; border-collapse: collapse; text-align: center;"> <tr> <td style="width: 10%;"></td> <td style="width: 10%;"></td> <td style="width: 10%;"></td> <td style="width: 10%;"></td> <td style="width: 10%;"></td> <td style="width: 10%;"></td> <td style="width: 10%;"></td> <td style="width: 10%;"></td> <td style="width: 10%;"></td> <td style="width: 10%;"></td> </tr> <tr> <td></td> <td></td> <td colspan="8" style="text-align: center;"> <table border="1" style="width: 100%; border-collapse: collapse; text-align: center;"> <tr> <td style="width: 10%;"></td> <td style="width: 10%;"></td> <td style="width: 10%;"></td> <td style="width: 10%;"></td> <td style="width: 10%;"></td> <td style="width: 10%;"></td> <td style="width: 10%;"></td> <td style="width: 10%;"></td> <td style="width: 10%;"></td> <td style="width: 10%;"></td> </tr> <tr> <td></td> <td></td> <td colspan="8" style="text-align: center;"> <table border="1" style="width: 100%; border-collapse: collapse; text-align: center;"> <tr> <td style="width: 10%;"></td> <td style="width: 10%;"></td> <td style="width: 10%;"></td> <td style="width: 10%;"></td> <td style="width: 10%;"></td> <td style="width: 10%;"></td> <td style="width: 10%;"></td> <td style="width: 10%;"></td> <td style="width: 10%;"></td> <td style="width: 10%;"></td> </tr> <tr> <td></td> <td></td> <td colspan="8" style="text-align: center;"> <table border="1" style="width: 100%; border-collapse: collapse; text-align: center;"> <tr> <td style="width: 10%;"></td> <td style="width: 10%;"></td> <td style="width: 10%;"></td> <td style="width: 10%;"></td> <td style="width: 10%;"></td> <td style="width: 10%;"></td> <td style="width: 10%;"></td> <td style="width: 10%;"></td> <td style="width: 10%;"></td> <td style="width: 10%;"></td> </tr> <tr> <td></td> <td></td> <td colspan="8" style="text-align: center;"> <table border="1" style="width: 100%; border-collapse: collapse; text-align: center;"> <tr> <td style="width: 10%;"></td> <td style="width: 10%;"></td> <td style="width: 10%;"></td> <td style="width: 10%;"></td> <td style="width: 10%;"></td> <td style="width: 10%;"></td> <td style="width: 10%;"></td> <td style="width: 10%;"></td> <td style="width: 10%;"></td> <td style="width: 10%;"></td> </tr> <tr> <td></td> <td></td> <td colspan="8" style="text-align: center;"> <table border="1" style="width: 100%; border-collapse: collapse; text-align: center;"> <tr> <td style="width: 10%;"></td> <td style="width: 10%;"></td> <td style="width: 10%;"></td> <td style="width: 10%;"></td> <td style="width: 10%;"></td> <td style="width: 10%;"></td> <td style="width: 10%;"></td> <td style="width: 10%;"></td> <td style="width: 10%;"></td> <td style="width: 10%;"></td> </tr> <tr> <td></td> <td></td> <td colspan="8" style="text-align: center;"> <table border="1" style="width: 100%; border-collapse: collapse; text-align: center;"> <tr> <td style="width: 10%;"></td> <td style="width: 10%;"></td> <td style="width: 10%;"></td> <td style="width: 10%;"></td> <td style="width: 10%;"></td> <td
style="width: 10%;"></td> <td style="width: 10%;"></td> <td style="width: 10%;"></td> <td style="width: 10%;"></td> <td style="width: 10%;"></td> </tr> <tr> <td></td> <td></td> <td colspan="8" style="text-align: center;"> <table border="1" style="width: 100%; border-collapse: collapse; text-align: center;"> <tr> <td style="width: 10%;"></td> <td style="width: 10%;"></td> <td style="width: 10%;"></td> <td style="width: 10%;"></td> <td style="width: 10%;"></td> <td style="width: 10%;"></td> <td style="width: 10%;"></td> <td style="width: 10%;"></td> <td style="width: 10%;"></td> <td style="width: 10%;"></td> </tr> <tr> <td></td> <td></td> <td colspan="8" style="text-align: center;"> <table border="1" style="width: 100%; border-collapse: collapse; text-align: center;"> <tr> <td style="width: 10%;"></td> <td style="width: 10%;"></td> <td style="width: 10%;"></td> <td style="width: 10%;"></td> <td style="width: 10%;"></td> <td style="width: 10%;"></td> <td style="width: 10%;"></td> <td style="width: 10%;"></td> <td style="width: 10%;"></td> <td style="width: 10%;"></td> </tr> <tr> <td></td> <td></td> <td colspan="8" style="text-align: center;"> <table border="1" style="width: 100%; border-collapse: collapse; text-align: center;"> <tr> <td style="width: 10%;"></td> <td style="width: 10%;"></td> <td style="width: 10%;"></td> <td style="width: 10%;"></td> <td style="width: 10%;"></td> <td style="width: 10%;"></td> <td style="width: 10%;"></td> <td style="width: 10%;"></td> <td style="width: 10%;"></td> <td style="width: 10%;"></td> </tr> <tr> <td></td> <td></td> <td colspan="8" style="text-align: center;"> <table border="1" style="width: 100%; border-collapse: collapse; text-align: center;"> <tr> </tr></table></td></tr></table></td></tr></table></td></tr></table></td></tr></table></td></tr></table></td></tr></table></td></tr></table></td></tr></table></td></tr></table></td></tr></table></td></tr></table></td></tr></table></td></tr></table></td></tr></table></td></tr></table></td></tr></table></td></tr></table></td></tr></table></td></tr></table></td></tr></table></td></tr></table></td></tr></table></td></tr></table></td></tr></table></td></tr></table> | | | | | | | | | | | | | | | | | | | | <table border="1" style="width: 100%; border-collapse: collapse; text-align: center;"> <tr> <td style="width: 10%;"></td> <td style="width: 10%;"></td> <td style="width: 10%;"></td> <td style="width: 10%;"></td> <td style="width: 10%;"></td> <td style="width: 10%;"></td> <td style="width: 10%;"></td> <td style="width: 10%;"></td> <td style="width: 10%;"></td> <td style="width: 10%;"></td> </tr> <tr> <td></td> <td></td> <td colspan="8" style="text-align: center;"> <table border="1" style="width: 100%; border-collapse: collapse; text-align: center;"> <tr> <td style="width: 10%;"></td> <td style="width: 10%;"></td> <td style="width: 10%;"></td> <td style="width: 10%;"></td> <td style="width: 10%;"></td> <td style="width: 10%;"></td> <td style="width: 10%;"></td> <td style="width: 10%;"></td> <td style="width: 10%;"></td> <td style="width: 10%;"></td> </tr> <tr> <td></td> <td></td> <td colspan="8" style="text-align: center;"> <table border="1" style="width: 100%; border-collapse: collapse; text-align: center;"> <tr> <td style="width: 10%;"></td> <td style="width: 10%;"></td> <td style="width: 10%;"></td> <td style="width: 10%;"></td> <td style="width: 10%;"></td> <td style="width: 10%;"></td> <td style="width: 10%;"></td> <td style="width: 10%;"></td> <td style="width: 10%;"></td> <td style="width: 10%;"></td> </tr> <tr> <td></td> <td></td> <td colspan="8" style="text-align: center;"> <table border="1" style="width: 100%; border-collapse: collapse; text-align: center;"> <tr> <td style="width: 10%;"></td> <td style="width: 10%;"></td> <td style="width: 10%;"></td> <td style="width: 10%;"></td> <td style="width: 10%;"></td> <td style="width: 10%;"></td> <td style="width: 10%;"></td> <td style="width: 10%;"></td> <td style="width: 10%;"></td> <td style="width: 10%;"></td> </tr> <tr> <td></td> <td></td> <td colspan="8" style="text-align: center;"> <table border="1" style="width: 100%; border-collapse: collapse; text-align: center;"> <tr> <td style="width: 10%;"></td> <td style="width: 10%;"></td> <td style="width: 10%;"></td> <td style="width: 10%;"></td> <td style="width: 10%;"></td> <td style="width: 10%;"></td> <td style="width: 10%;"></td> <td style="width: 10%;"></td> <td style="width: 10%;"></td> <td style="width: 10%;"></td> </tr> <tr> <td></td> <td></td> <td colspan="8" style="text-align: center;"> <table border="1" style="width: 100%; border-collapse: collapse; text-align: center;"> <tr> <td style="width: 10%;"></td> <td style="width: 10%;"></td> <td style="width: 10%;"></td> <td style="width: 10%;"></td> <td style="width: 10%;"></td> <td style="width: 10%;"></td> <td style="width: 10%;"></td> <td style="width: 10%;"></td> <td style="width: 10%;"></td> <td style="width: 10%;"></td> </tr> <tr> <td></td> <td></td> <td colspan="8" style="text-align: center;"> <table border="1" style="width: 100%; border-collapse: collapse; text-align: center;">
<tr> <td style="width: 10%;"></td> <td style="width: 10%;"></td> <td style="width: 10%;"></td> <td style="width: 10%;"></td> <td style="width: 10%;"></td> <td style="width: 10%;"></td> <td style="width: 10%;"></td> <td style="width: 10%;"></td> <td style="width: 10%;"></td> <td style="width: 10%;"></td> </tr> <tr> <td></td> <td></td> <td colspan="8" style="text-align: center;"> <table border="1" style="width: 100%; border-collapse: collapse; text-align: center;"> <tr> <td style="width: 10%;"></td> <td style="width: 10%;"></td> <td style="width: 10%;"></td> <td style="width: 10%;"></td> <td style="width: 10%;"></td> <td style="width: 10%;"></td> <td style="width: 10%;"></td> <td style="width: 10%;"></td> <td style="width: 10%;"></td> <td style="width: 10%;"></td> </tr> <tr> <td></td> <td></td> <td colspan="8" style="text-align: center;"> <table border="1" style="width: 100%; border-collapse: collapse; text-align: center;"> <tr> <td style="width: 10%;"></td> <td style="width: 10%;"></td> <td style="width: 10%;"></td> <td style="width: 10%;"></td> <td style="width: 10%;"></td> <td style="width: 10%;"></td> <td style="width: 10%;"></td> <td style="width: 10%;"></td> <td style="width: 10%;"></td> <td style="width: 10%;"></td> </tr> <tr> <td></td> <td></td> <td colspan="8" style="text-align: center;"> <table border="1" style="width: 100%; border-collapse: collapse; text-align: center;"> <tr> <td style="width: 10%;"></td> <td style="width: 10%;"></td> <td style="width: 10%;"></td> <td style="width: 10%;"></td> <td style="width: 10%;"></td> <td style="width: 10%;"></td> <td style="width: 10%;"></td> <td style="width: 10%;"></td> <td style="width: 10%;"></td> <td style="width: 10%;"></td> </tr> <tr> <td></td> <td></td> <td colspan="8" style="text-align: center;"> <table border="1" style="width: 100%; border-collapse: collapse; text-align: center;"> <tr> <td style="width: 10%;"></td> <td style="width: 10%;"></td> <td style="width: 10%;"></td> <td style="width: 10%;"></td> <td style="width: 10%;"></td> <td style="width: 10%;"></td> <td style="width: 10%;"></td> <td style="width: 10%;"></td> <td style="width: 10%;"></td> <td style="width: 10%;"></td> </tr> <tr> <td></td> <td></td> <td colspan="8" style="text-align: center;"> <table border="1" style="width: 100%; border-collapse: collapse; text-align: center;"> <tr> <td style="width: 10%;"></td> <td style="width: 10%;"></td> <td style="width: 10%;"></td> <td style="width: 10%;"></td> <td style="width: 10%;"></td> <td style="width: 10%;"></td> <td style="width: 10%;"></td> <td style="width: 10%;"></td> <td style="width: 10%;"></td> <td style="width: 10%;"></td> </tr> <tr> <td></td> <td></td> <td colspan="8" style="text-align: center;"> <table border="1" style="width: 100%; border-collapse: collapse; text-align: center;"> <tr> <td style="width: 10%;"></td> <td style="width: 10%;"></td> <td style="width: 10%;"></td> <td style="width: 10%;"></td> <td style="width: 10%;"></td> <td style="width: 10%;"></td> <td style="width: 10%;"></td> <td style="width: 10%;"></td> <td style="width: 10%;"></td> <td style="width: 10%;"></td> </tr> <tr> <td></td> <td></td> <td colspan="8" style="text-align: center;"> <table border="1" style="width: 100%; border-collapse: collapse; text-align: center;"> <tr> <td style="width: 10%;"></td> <td style="width: 10%;"></td> <td style="width: 10%;"></td> <td style="width: 10%;"></td> <td style="width: 10%;"></td> <td style="width: 10%;"></td> <td style="width: 10%;"></td> <td style="width: 10%;"></td> <td style="width: 10%;"></td> <td style="width: 10%;"></td> </tr> <tr> <td></td> <td></td> <td colspan="8" style="text-align: center;"> <table border="1" style="width: 100%; border-collapse: collapse; text-align: center;"> <tr> <td style="width: 10%;"></td> <td style="width: 10%;"></td> <td style="width: 10%;"></td> <td style="width: 10%;"></td> <td style="width: 10%;"></td> <td style="width: 10%;"></td> <td style="width: 10%;"></td> <td style="width: 10%;"></td> <td style="width: 10%;"></td> <td style="width: 10%;"></td> </tr> <tr> <td></td> <td></td> <td colspan="8" style="text-align: center;"> <table border="1" style="width: 100%; border-collapse: collapse; text-align: center;"> <tr> <td style="width: 10%;"></td> <td style="width: 10%;"></td> <td style="width: 10%;"></td> <td style="width: 10%;"></td> <td style="width: 10%;"></td> <td style="width: 10%;"></td> <td style="width: 10%;"></td> <td style="width: 10%;"></td> <td style="width: 10%;"></td> <td style="width: 10%;"></td> </tr> <tr> <td></td> <td></td> <td colspan="8" style="text-align: center;"> <table border="1" style="width: 100%; border-collapse: collapse; text-align: center;"> <tr> <td style="width: 10%;"></td> <td style="width: 10%;"></td> <td style="width: 10%;"></td> <td style="width: 10%;"></td> <td style="width: 10%;"></td> <td style="width: 10%;"></td> <td style="width: 10%;"></td> <td style="width: 10%;"></td> <td style="width: 10%;"></td> <td style="width: 10%;"></td> </tr> <tr> <td></td> <td></td> <td colspan="8" style="text-align: center;"> <table border="1" style="width: 100%; border-collapse: collapse; text-align: center;"> <tr> <td style="width: 10%;"></td> <td style="width: 10%;"></td> <td style="width: 10%;"></td> <td style="width: 10%;"></td> <td style="width: 10%;"></td> <td style="width: 10%;"></td> <td style="width: 10%;"></td> <td style="width: 10%;"></td> <td style="width: 10%;"></td> <td style="width: 10%;"></td> </tr> <tr> <td></td> <td></td> <td colspan="8" style="text-align: center;"> <table border="1" style="width: 100%; border-collapse: collapse; text-align: center;"> <tr> <td style="width: 10%;"></td> <td style="width: 10%;"></td> <td style="width: 10%;"></td> <td style="width: 10%;"></td> <td style="width: 10%;"></td> <td style="width: 10%;"></td> <td style="width: 10%;"></td> <td style="width: 10%;"></td> <td style="width: 10%;"></td> <td style="width: 10%;"></td> </tr> <tr> <td></td> <td></td> <td colspan="8" style="text-align: center;"> <table border="1" style="width: 100%; border-collapse: collapse; text-align: center;"> <tr> <td style="width: 10%;"></td> <td style="width: 10%;"></td> <td style="width: 10%;"></td> <td style="width: 10%;"></td> <td style="width: 10%;"></td> <td style="width: 10%;"></td> <td style="width: 10%;"></td> <td style="width: 10%;"></td> <td style="width: 10%;"></td> <td style="width: 10%;"></td> </tr> <tr> <td></td> <td></td> <td colspan="8" style="text-align: center;"> <table border="1" style="width: 100%; border-collapse: collapse; text-align: center;"> <tr> <td style="width: 10%;"></td> <td style="width: 10%;"></td> <td style="width: 10%;"></td> <td style="width: 10%;"></td> <td style="width: 10%;"></td> <td style="width: 10%;"></td> <td style="width: 10%;"></td> <td style="width: 10%;"></td> <td style="width: 10%;"></td> <td style="width: 10%;"></td> </tr> <tr> <td></td> <td></td> <td colspan="8" style="text-align: center;"> <table border="1" style="width: 100%; border-collapse: collapse; text-align: center;"> <tr> <td style="width: 10%;"></td> <td style="width: 10%;"></td> <td style="width: 10%;"></td> <td style="width: 10%;"></td> <td style="width: 10%;"></td> <td style="width: 10%;"></td> <td style="width: 10%;"></td> <td style="width: 10%;"></td> <td style="width: 10%;"></td> <td style="width: 10%;"></td> </tr> <tr> <td></td> <td></td> <td colspan="8" style="text-align: center;"> <table border="1" style="width: 100%; border-collapse: collapse; text-align: center;"> <tr> <td style="width: 10%;"></td> <td style="width: 10%;"></td> <td style="width: 10%;"></td> <td style="width: 10%;"></td> <td style="width: 10%;"></td> <td style="width: 10%;"></td> <td style="width: 10%;"></td> <td style="width: 10%;"></td> <td style="width: 10%;"></td> <td style="width: 10%;"></td> </tr> <tr> <td></td> <td></td> <td colspan="8" style="text-align: center;"> <table border="1" style="width: 100%; border-collapse: collapse; text-align: center;"> <tr> <td style="width: 10%;"></td> <td style="width: 10%;"></td> <td style="width: 10%;"></td> <td style="width: 10%;"></td> <td style="width: 10%;"></td> <td style="width: 10%;"></td> <td style="width: 10%;"></td> <td style="width: 10%;"></td> <td style="width: 10%;"></td> <td style="width: 10%;"></td> </tr> <tr> <td></td> <td></td> <td colspan="8" style="text-align: center;"> <table border="1" style="width: 100%; border-collapse: collapse; text-align: center;"> <tr> </tr></table></td></tr></table></td></tr></table></td></tr></table></td></tr></table></td></tr></table></td></tr></table></td></tr></table></td></tr></table></td></tr></table></td></tr></table></td></tr></table></td></tr></table></td></tr></table></td></tr></table></td></tr></table></td></tr></table></td></tr></table></td></tr></table></td></tr></table></td></tr></table></td></tr></table></td></tr></table></td></tr></table></td></tr></table>
 | | | | | | | | | | | | | | | | | | | | <table border="1" style="width: 100%; border-collapse: collapse; text-align: center;"> <tr> <td style="width: 10%;"></td> <td style="width: 10%;"></td> <td style="width: 10%;"></td> <td style="width: 10%;"></td> <td style="width: 10%;"></td> <td style="width: 10%;"></td> <td style="width: 10%;"></td> <td style="width: 10%;"></td> <td style="width: 10%;"></td> <td style="width: 10%;"></td> </tr> <tr> <td></td> <td></td> <td colspan="8" style="text-align: center;"> <table border="1" style="width: 100%; border-collapse: collapse; text-align: center;"> <tr> <td style="width: 10%;"></td> <td style="width: 10%;"></td> <td style="width: 10%;"></td> <td style="width: 10%;"></td> <td style="width: 10%;"></td> <td style="width: 10%;"></td> <td style="width: 10%;"></td> <td style="width: 10%;"></td> <td style="width: 10%;"></td> <td style="width: 10%;"></td> </tr> <tr> <td></td> <td></td> <td colspan="8" style="text-align: center;"> <table border="1" style="width: 100%; border-collapse: collapse; text-align: center;"> <tr> <td style="width: 10%;"></td> <td style="width: 10%;"></td> <td style="width: 10%;"></td> <td style="width: 10%;"></td> <td style="width: 10%;"></td> <td style="width: 10%;"></td> <td style="width: 10%;"></td> <td style="width: 10%;"></td> <td style="width: 10%;"></td> <td style="width: 10%;"></td> </tr> <tr> <td></td> <td></td> <td colspan="8" style="text-align: center;"> <table border="1" style="width: 100%; border-collapse: collapse; text-align: center;"> <tr> <td style="width: 10%;"></td> <td style="width: 10%;"></td> <td style="width: 10%;"></td> <td style="width: 10%;"></td> <td style="width: 10%;"></td> <td style="width: 10%;"></td> <td style="width: 10%;"></td> <td style="width: 10%;"></td> <td style="width: 10%;"></td> <td style="width: 10%;"></td> </tr> <tr> <td></td> <td></td> <td colspan="8" style="text-align: center;"> <table border="1" style="width: 100%; border-collapse: collapse; text-align: center;"> <tr> <td style="width: 10%;"></td> <td style="width: 10%;"></td> <td style="width: 10%;"></td> <td style="width: 10%;"></td> <td style="width: 10%;"></td> <td style="width: 10%;"></td> <td style="width: 10%;"></td> <td style="width: 10%;"></td> <td style="width: 10%;"></td> <td style="width: 10%;"></td> </tr> <tr> <td></td> <td></td> <td colspan="8" style="text-align: center;"> <table border="1" style="width: 100%; border-collapse: collapse; text-align: center;"> <tr> <td style="width: 10%;"></td> <td style="width: 10%;"></td> <td style="width: 10%;"></td> <td style="width: 10%;"></td> <td style="width: 10%;"></td> <td style="width: 10%;"></td> <td style="width: 10%;"></td> <td style="width: 10%;"></td> <td style="width: 10%;"></td> <td style="width: 10%;"></td> </tr> <tr> <td></td> <td></td> <td colspan="8" style="text-align: center;"> <table border="1" style="width: 100%; border-collapse: collapse; text-align: center;"> <tr> <td style="width: 10%;"></td> <td style="width: 10%;"></td> <td style="width: 10%;"></td> <td style="width: 10%;"></td> <td style="width: 10%;"></td> <td style="width: 10%;"></td> <td style="width: 10%;"></td> <td style="width: 10%;"></td> <td style="width: 10%;"></td> <td style="width: 10%;"></td> </tr> <tr> <td></td> <td></td> <td colspan="8" style="text-align: center;"> <table border="1" style="width: 100%; border-collapse: collapse; text-align: center;"> <tr> <td style="width: 10%;"></td> <td style="width: 10%;"></td> <td style="width: 10%;"></td> <td style="width: 10%;"></td> <td style="width: 10%;"></td> <td style="width: 10%;"></td> <td style="width: 10%;"></td> <td style="width: 10%;"></td> <td style="width: 10%;"></td> <td style="width: 10%;"></td> </tr> <tr> <td></td> <td></td> <td colspan="8" style="text-align: center;"> <table border="1" style="width: 100%; border-collapse: collapse; text-align: center;"> <tr> <td style="width: 10%;"></td> <td style="width: 10%;"></td> <td style="width: 10%;"></td> <td style="width: 10%;"></td> <td style="width: 10%;"></td> <td style="width: 10%;"></td> <td style="width: 10%;"></td> <td style="width: 10%;"></td> <td style="width: 10%;"></td> <td style="width: 10%;"></td> </tr> <tr> <td></td> <td></td> <td colspan="8" style="text-align: center;"> <table border="1" style="width: 100%; border-collapse: collapse; text-align: center;"> <tr> <td style="width: 10%;"></td> <td style="width: 10%;"></td> <td style="width: 10%;"></td> <td style="width: 10%;"></td> <td style="width: 10%;"></td> <td style="width: 10%;"></td> <td style="width: 10%;"></td> <td style="width: 10%;"></td> <td style="width: 10%;"></td> <td style="width: 10%;"></td> </tr> <tr> <td></td> <td></td> <td colspan="8" style="text-align: center;"> <table border="1" style="width: 100%; border-collapse: collapse; text-align: center;"> <tr> <td style="width: 10%;"></td> <td style="width: 10%;"></td> <td style="width: 10%;"></td> <td style="width: 10%;"></td> <td style="width: 10%;"></td> <td style="width: 10%;"></td> <td style="width: 10%;"></td> <td style="width: 10%;"></td> <td style="width: 10%;"></td> <td style="width: 10%;"></td> </tr> <tr> <td></td> <td></td> <td colspan="8" style="text-align: center;"> <table border="1" style="width: 100%; border-collapse: collapse; text-align: center;"> <tr> <td style="width: 10%;"></td> <td style="width: 10%;"></td> <td style="width: 10%;"></td> <td style="width: 10%;"></td> <td style="width: 10%;"></td> <td style="width: 10%;"></td> <td style="width: 10%;"></td> <td style="width: 10%;"></td> <td style="width: 10%;"></td> <td style="width: 10%;"></td> </tr> <tr> <td></td> <td></td> <td colspan="8" style="text-align: center;"> <table border="1" style="width: 100%; border-collapse: collapse; text-align: center;"> <tr> <td style="width: 10%;"></td> <td style="width: 10%;"></td> <td style="width: 10%;"></td> <td style="width: 10%;"></td> <td style="width: 10%;"></td> <td style="width: 10%;"></td> <td style="width: 10%;"></td> <td style="width: 10%;"></td> <td style="width: 10%;"></td> <td style="width: 10%;"></td> </tr> <tr> <td></td> <td></td> <td colspan="8" style="text-align: center;"> <table border="1" style="width: 100%; border-collapse: collapse; text-align: center;"> <tr> <td style="width: 10%;"></td>
<td style="width: 10%;"></td> <td style="width: 10%;"></td> <td style="width: 10%;"></td> <td style="width: 10%;"></td> <td style="width: 10%;"></td> <td style="width: 10%;"></td> <td style="width: 10%;"></td> <td style="width: 10%;"></td> <td style="width: 10%;"></td> </tr> <tr> <td></td> <td></td> <td colspan="8" style="text-align: center;"> <table border="1" style="width: 100%; border-collapse: collapse; text-align: center;"> <tr> <td style="width: 10%;"></td> <td style="width: 10%;"></td> <td style="width: 10%;"></td> <td style="width: 10%;"></td> <td style="width: 10%;"></td> <td style="width: 10%;"></td> <td style="width: 10%;"></td> <td style="width: 10%;"></td> <td style="width: 10%;"></td> <td style="width: 10%;"></td> </tr> <tr> <td></td> <td></td> <td colspan="8" style="text-align: center;"> <table border="1" style="width: 100%; border-collapse: collapse; text-align: center;"> <tr> <td style="width: 10%;"></td> <td style="width: 10%;"></td> <td style="width: 10%;"></td> <td style="width: 10%;"></td> <td style="width: 10%;"></td> <td style="width: 10%;"></td> <td style="width: 10%;"></td> <td style="width: 10%;"></td> <td style="width: 10%;"></td> <td style="width: 10%;"></td> </tr> <tr> <td></td> <td></td> <td colspan="8" style="text-align: center;"> <table border="1" style="width: 100%; border-collapse: collapse; text-align: center;"> <tr> <td style="width: 10%;"></td> <td style="width: 10%;"></td> <td style="width: 10%;"></td> <td style="width: 10%;"></td> <td style="width: 10%;"></td> <td style="width: 10%;"></td> <td style="width: 10%;"></td> <td style="width: 10%;"></td> <td style="width: 10%;"></td> <td style="width: 10%;"></td> </tr> <tr> <td></td> <td></td> <td colspan="8" style="text-align: center;"> <table border="1" style="width: 100%; border-collapse: collapse; text-align: center;"> <tr> <td style="width: 10%;"></td> <td style="width: 10%;"></td> <td style="width: 10%;"></td> <td style="width: 10%;"></td> <td style="width: 10%;"></td> <td style="width: 10%;"></td> <td style="width: 10%;"></td> <td style="width: 10%;"></td> <td style="width: 10%;"></td> <td style="width: 10%;"></td> </tr> <tr> <td></td> <td></td> <td colspan="8" style="text-align: center;"> <table border="1" style="width: 100%; border-collapse: collapse; text-align: center;"> <tr> <td style="width: 10%;"></td> <td style="width: 10%;"></td> <td style="width: 10%;"></td> <td style="width: 10%;"></td> <td style="width: 10%;"></td> <td style="width: 10%;"></td> <td style="width: 10%;"></td> <td style="width: 10%;"></td> <td style="width: 10%;"></td> <td style="width: 10%;"></td> </tr> <tr> <td></td> <td></td> <td colspan="8" style="text-align: center;"> <table border="1" style="width: 100%; border-collapse: collapse; text-align: center;"> <tr> <td style="width: 10%;"></td> <td style="width: 10%;"></td> <td style="width: 10%;"></td> <td style="width: 10%;"></td> <td style="width: 10%;"></td> <td style="width: 10%;"></td> <td style="width: 10%;"></td> <td style="width: 10%;"></td> <td style="width: 10%;"></td> <td style="width: 10%;"></td> </tr> <tr> <td></td> <td></td> <td colspan="8" style="text-align: center;"> <table border="1" style="width: 100%; border-collapse: collapse; text-align: center;"> <tr> <td style="width: 10%;"></td> <td style="width: 10%;"></td> <td style="width: 10%;"></td> <td style="width: 10%;"></td> <td style="width: 10%;"></td> <td style="width: 10%;"></td> <td style="width: 10%;"></td> <td style="width: 10%;"></td> <td style="width: 10%;"></td> <td style="width: 10%;"></td> </tr> <tr> <td></td> <td></td> <td colspan="8" style="text-align: center;"> <table border="1" style="width: 100%; border-collapse: collapse; text-align: center;"> <tr> <td style="width: 10%;"></td> <td style="width: 10%;"></td> <td style="width: 10%;"></td> <td style="width: 10%;"></td> <td style="width: 10%;"></td> <td style="width: 10%;"></td> <td style="width: 10%;"></td> <td style="width: 10%;"></td> <td style="width: 10%;"></td> <td style="width: 10%;"></td> </tr> <tr> <td></td> <td></td> <td colspan="8" style="text-align: center;"> <table border="1" style="width: 100%; border-collapse: collapse; text-align: center;"> <tr> <td style="width: 10%;"></td> <td style="width: 10%;"></td> <td style="width: 10%;"></td> <td style="width: 10%;"></td> <td style="width: 10%;"></td> <td style="width: 10%;"></td> <td style="width: 10%;"></td> <td style="width: 10%;"></td> <td style="width: 10%;"></td> <td style="width: 10%;"></td> </tr> <tr> <td></td> <td></td> <td colspan="8" style="text-align: center;"> <table border="1" style="width: 100%; border-collapse: collapse; text-align: center;"> <tr> </tr></table></td></tr></table></td></tr></table></td></tr></table></td></tr></table></td></tr></table></td></tr></table></td></tr></table></td></tr></table></td></tr></table></td></tr></table></td></tr></table></td></tr></table></td></tr></table></td></tr></table></td></tr></table></td></tr></table></td></tr></table></td></tr></table></td></tr></table></td></tr></table></td></tr></table></td></tr></table></td></tr></table> | | | | | | | | | | | | | | | | | | | |
<table border="1" style="width: 100%; border-collapse: collapse; text-align: center;"> <tr> <td style="width: 10%;"></td> <td style="width: 10%;"></td> <td style="width: 10%;"></td> <td style="width: 10%;"></td> <td style="width: 10%;"></td> <td style="width: 10%;"></td> <td style="width: 10%;"></td> <td style="width: 10%;"></td> <td style="width: 10%;"></td> <td style="width: 10%;"></td> </tr> <tr> <td></td> <td></td> <td colspan="8" style="text-align: center;"> <table border="1" style="width: 100%; border-collapse: collapse; text-align: center;"> <tr> <td style="width: 10%;"></td> <td style="width: 10%;"></td> <td style="width: 10%;"></td> <td style="width: 10%;"></td> <td style="width: 10%;"></td> <td style="width: 10%;"></td> <td style="width: 10%;"></td> <td style="width: 10%;"></td> <td style="width: 10%;"></td> <td style="width: 10%;"></td> </tr> <tr> <td></td> <td></td> <td colspan="8" style="text-align: center;"> <table border="1" style="width: 100%; border-collapse: collapse; text-align: center;"> <tr> <td style="width: 10%;"></td> <td style="width: 10%;"></td> <td style="width: 10%;"></td> <td style="width: 10%;"></td> <td style="width: 10%;"></td> <td style="width: 10%;"></td> <td style="width: 10%;"></td> <td style="width: 10%;"></td> <td style="width: 10%;"></td> <td style="width: 10%;"></td> </tr> <tr> <td></td> <td></td> <td colspan="8" style="text-align: center;"> <table border="1" style="width: 100%; border-collapse: collapse; text-align: center;"> <tr> <td style="width: 10%;"></td> <td style="width: 10%;"></td> <td style="width: 10%;"></td> <td style="width: 10%;"></td> <td style="width: 10%;"></td> <td style="width: 10%;"></td> <td style="width: 10%;"></td> <td style="width: 10%;"></td> <td style="width: 10%;"></td> <td style="width: 10%;"></td> </tr> <tr> <td></td> <td></td> <td colspan="8" style="text-align: center;"> <table border="1" style="width: 100%; border-collapse: collapse; text-align: center;"> <tr> <td style="width: 10%;"></td> <td style="width: 10%;"></td> <td style="width: 10%;"></td> <td style="width: 10%;"></td> <td style="width: 10%;"></td> <td style="width: 10%;"></td> <td style="width: 10%;"></td> <td style="width: 10%;"></td> <td style="width: 10%;"></td> <td style="width: 10%;"></td> </tr> <tr> <td></td> <td></td> <td colspan="8" style="text-align: center;"> <table border="1" style="width: 100%; border-collapse: collapse; text-align: center;"> <tr> <td style="width: 10%;"></td> <td style="width: 10%;"></td> <td style="width: 10%;"></td> <td style="width: 10%;"></td> <td style="width: 10%;"></td> <td style="width: 10%;"></td> <td style="width: 10%;"></td> <td style="width: 10%;"></td> <td style="width: 10%;"></td> <td style="width: 10%;"></td> </tr> <tr> <td></td> <td></td> <td colspan="8" style="text-align: center;"> <table border="1" style="width: 100%; border-collapse: collapse; text-align: center;"> <tr> <td style="width: 10%;"></td> <td style="width: 10%;"></td> <td style="width: 10%;"></td> <td style="width: 10%;"></td> <td style="width: 10%;"></td> <td style="width: 10%;"></td> <td style="width: 10%;"></td> <td style="width: 10%;"></td> <td style="width: 10%;"></td> <td style="width: 10%;"></td> </tr> <tr> <td></td> <td></td> <td colspan="8" style="text-align: center;"> <table border="1" style="width: 100%; border-collapse: collapse; text-align: center;"> <tr> <td style="width: 10%;"></td> <td style="width: 10%;"></td> <td style="width: 10%;"></td> <td style="width: 10%;"></td> <td style="width: 10%;"></td> <td style="width: 10%;"></td> <td style="width: 10%;"></td> <td style="width: 10%;"></td> <td style="width: 10%;"></td> <td style="width: 10%;"></td> </tr> <tr> <td></td> <td></td> <td colspan="8" style="text-align: center;"> <table border="1" style="width: 100%; border-collapse: collapse; text-align: center;"> <tr> <td style="width: 10%;"></td> <td style="width: 10%;"></td> <td style="width: 10%;"></td> <td style="width: 10%;"></td> <td style="width: 10%;"></td> <td style="width: 10%;"></td> <td style="width: 10%;"></td> <td style="width: 10%;"></td> <td style="width: 10%;"></td> <td style="width: 10%;"></td> </tr> <tr> <td></td> <td></td> <td colspan="8" style="text-align: center;"> <table border="1" style="width: 100%; border-collapse: collapse; text-align: center;"> <tr> <td style="width: 10%;"></td> <td style="width: 10%;"></td> <td style="width: 10%;"></td> <td style="width: 10%;"></td> <td style="width: 10%;"></td> <td style="width: 10%;"></td> <td style="width: 10%;"></td> <td style="width: 10%;"></td> <td style="width: 10%;"></td> <td style="width: 10%;"></td> </tr> <tr> <td></td> <td></td> <td colspan="8" style="text-align: center;"> <table border="1" style="width: 100%; border-collapse: collapse; text-align: center;"> <tr> <td style="width: 10%;"></td> <td style="width: 10%;"></td> <td style="width: 10%;"></td> <td style="width: 10%;"></td> <td style="width: 10%;"></td> <td style="width: 10%;"></td> <td style="width: 10%;"></td> <td style="width: 10%;"></td> <td style="width: 10%;"></td> <td style="width: 10%;"></td> </tr> <tr> <td></td> <td></td> <td colspan="8" style="text-align: center;"> <table border="1" style="width: 100%; border-collapse: collapse; text-align: center;"> <tr> <td style="width: 10%;"></td> <td style="width: 10%;"></td> <td style="width: 10%;"></td> <td style="width: 10%;"></td> <td style="width: 10%;"></td> <td style="width: 10%;"></td> <td style="width: 10%;"></td> <td style="width: 10%;"></td> <td style="width: 10%;"></td> <td style="width: 10%;"></td> </tr> <tr> <td></td> <td></td> <td colspan="8" style="text-align: center;"> <table border="1" style="width: 100%; border-collapse: collapse; text-align: center;"> <tr> <td style="width: 10%;"></td> <td style="width: 10%;"></td> <td style="width: 10%;"></td> <td style="width: 10%;"></td> <td style="width: 10%;"></td> <td style="width: 10%;"></td> <td style="width: 10%;"></td> <td style="width: 10%;"></td> <td style="width: 10%;"></td> <td style="width: 10%;"></td> </tr> <tr> <td></td> <td></td> <td colspan="8" style="text-align: center;"> <table border="1" style="width: 100%; border-collapse: collapse; text-align: center;"> <tr> <td style="width: 10%;"></td> <td style="width: 10%;"></td> <td style="width: 10%;"></td> <td style="width: 10%;"></td> <td style="width: 10%;"></td> <td style="width: 10%;"></td> <td style="width: 10%;"></td> <td style="width: 10%;"></td> <td style="width: 10%;"></td> <td style="width: 10%;"></td> </tr> <tr> <td></td> <td></td> <td colspan="8" style="text-align: center;"> <table border="1" style="width: 100%; border-collapse: collapse; text-align: center;"> <tr> <td style="width: 10%;"></td> <td style="width: 10%;"></td> <td style="width: 10%;"></td> <td style="width: 10%;"></td> <td style="width: 10%;"></td> <td style="width: 10%;"></td> <td style="width: 10%;"></td> <td style="width: 10%;"></td> <td style="width: 10%;"></td> <td style="width: 10%;"></td> </tr> <tr> <td></td> <td></td> <td colspan="8" style="text-align: center;"> <table border="1" style="width: 100%; border-collapse: collapse; text-align: center;"> <tr> <td style="width: 10%;"></td> <td style="width: 10%;"></td> <td style="width: 10%;"></td> <td style="width: 10%;"></td> <td style="width: 10%;"></td> <td style="width: 10%;"></td> <td style="width: 10%;"></td> <td style="width: 10%;"></td> <td style="width: 10%;"></td> <td style="width: 10%;"></td> </tr> <tr> <td></td> <td></td> <td colspan="8" style="text-align: center;"> <table border="1" style="width: 100%; border-collapse: collapse; text-align: center;"> <tr> <td style="width: 10%;"></td> <td style="width: 10%;"></td> <td style="width: 10%;"></td> <td style="width: 10%;"></td> <td style="width: 10%;"></td> <td style="width: 10%;"></td> <td style="width: 10%;"></td> <td style="width: 10%;"></td> <td style="width: 10%;"></td> <td style="width: 10%;"></td> </tr> <tr> <td></td> <td></td> <td colspan="8" style="text-align: center;"> <table border="1" style="width: 100%; border-collapse: collapse; text-align: center;"> <tr> <td style="width: 10%;"></td> <td style="width: 10%;"></td> <td style="width: 10%;"></td> <td style="width: 10%;"></td> <td style="width: 10%;"></td> <td style="width: 10%;"></td> <td style="width: 10%;"></td> <td style="width: 10%;"></td> <td style="width: 10%;"></td> <td style="width: 10%;"></td> </tr> <tr> <td></td> <td></td> <td colspan="8" style="text-align: center;"> <table border="1" style="width: 100%; border-collapse: collapse; text-align: center;"> <tr> <td style="width: 10%;"></td> <td style="width: 10%;"></td> <td style="width: 10%;"></td> <td style="width: 10%;"></td> <td style="width: 10%;"></td> <td style="width: 10%;"></td> <td style="width: 10%;"></td> <td style="width: 10%;"></td> <td style="width: 10%;"></td> <td style="width: 10%;"></td> </tr> <tr> <td></td> <td></td> <td colspan="8" style="text-align: center;"> <table border="1" style="width: 100%; border-collapse: collapse; text-align: center;"> <tr> <td style="width: 10%;"></td> <td style="width: 10%;"></td> <td style="width: 10%;"></td> <td style="width: 10%;"></td> <td style="width: 10%;"></td> <td style="width: 10%;"></td> <td style="width: 10%;"></td> <td style="width: 10%;"></td> <td style="width: 10%;"></td> <td style="width: 10%;"></td> </tr> <tr> <td></td> <td></td> <td colspan="8" style="text-align: center;"> <table border="1" style="width: 100%; border-collapse: collapse; text-align: center;"> <tr> <td style="width: 10%;"></td> <td style="width: 10%;"></td> <td style="width: 10%;"></td> <td style="width: 10%;"></td> <td style="width: 10%;"></td> <td style="width: 10%;"></td> <td style="width: 10%;"></td> <td style="width: 10%;"></td> <td style="width: 10%;"></td> <td style="width: 10%;"></td> </tr> <tr> <td></td> <td></td> <td colspan="8" style="text-align: center;"> <table border="1" style="width: 100%; border-collapse: collapse; text-align: center;"> <tr> <td style="width: 10%;"></td> <td style="width: 10%;"></td> <td style="width:
10%;"></td> <td style="width: 10%;"></td> <td style="width: 10%;"></td> <td style="width: 10%;"></td> <td style="width: 10%;"></td> <td style="width: 10%;"></td> <td style="width: 10%;"></td> <td style="width: 10%;"></td> </tr> <tr> <td></td> <td></td> <td colspan="8" style="text-align: center;"> <table border="1" style="width: 100%; border-collapse: collapse; text-align: center;"> <tr> </tr></table></td></tr></table></td></tr></table></td></tr></table></td></tr></table></td></tr></table></td></tr></table></td></tr></table></td></tr></table></td></tr></table></td></tr></table></td></tr></table></td></tr></table></td></tr></table></td></tr></table></td></tr></table></td></tr></table></td></tr></table></td></tr></table></td></tr></table></td></tr></table></td></tr></table></td></tr></table> | | | | | | | | | | | | | | | | | | | | <table border="1" style="width: 100%; border-collapse: collapse; text-align: center;"> <tr> <td style="width: 10%;"></td> <td style="width: 10%;"></td> <td style="width: 10%;"></td> <td style="width: 10%;"></td> <td style="width: 10%;"></td> <td style="width: 10%;"></td> <td style="width: 10%;"></td> <td style="width: 10%;"></td> <td style="width: 10%;"></td> <td style="width: 10%;"></td> </tr> <tr> <td></td> <td></td> <td colspan="8" style="text-align: center;"> <table border="1" style="width: 100%; border-collapse: collapse; text-align: center;"> <tr> <td style="width: 10%;"></td> <td style="width: 10%;"></td> <td style="width: 10%;"></td> <td style="width: 10%;"></td> <td style="width: 10%;"></td> <td style="width: 10%;"></td> <td style="width: 10%;"></td> <td style="width: 10%;"></td> <td style="width: 10%;"></td> <td style="width: 10%;"></td> </tr> <tr> <td></td> <td></td> <td colspan="8" style="text-align: center;"> <table border="1" style="width: 100%; border-collapse: collapse; text-align: center;"> <tr> <td style="width: 10%;"></td> <td style="width: 10%;"></td> <td style="width: 10%;"></td> <td style="width: 10%;"></td> <td style="width: 10%;"></td> <td style="width: 10%;"></td> <td style="width: 10%;"></td> <td style="width: 10%;"></td> <td style="width: 10%;"></td> <td style="width: 10%;"></td> </tr> <tr> <td></td> <td></td> <td colspan="8" style="text-align: center;"> <table border="1" style="width: 100%; border-collapse: collapse; text-align: center;"> <tr> <td style="width: 10%;"></td> <td style="width: 10%;"></td> <td style="width: 10%;"></td> <td style="width: 10%;"></td> <td style="width: 10%;"></td> <td style="width: 10%;"></td> <td style="width: 10%;"></td> <td style="width: 10%;"></td> <td style="width: 10%;"></td> <td style="width: 10%;"></td> </tr> <tr> <td></td> <td></td> <td colspan="8" style="text-align: center;"> <table border="1" style="width: 100%; border-collapse: collapse; text-align: center;"> <tr> <td style="width: 10%;"></td> <td style="width: 10%;"></td> <td style="width: 10%;"></td> <td style="width: 10%;"></td> <td style="width: 10%;"></td> <td style="width: 10%;"></td> <td style="width: 10%;"></td> <td style="width: 10%;"></td> <td style="width: 10%;"></td> <td style="width: 10%;"></td> </tr> <tr> <td></td> <td></td> <td colspan="8" style="text-align: center;"> <table border="1" style="width: 100%; border-collapse: collapse; text-align: center;"> <tr> <td style="width: 10%;"></td> <td style="width: 10%;"></td> <td style="width: 10%;"></td> <td style="width: 10%;"></td> <td style="width: 10%;"></td> <td style="width: 10%;"></td> <td style="width: 10%;"></td> <td style="width: 10%;"></td> <td style="width: 10%;"></td> <td style="width: 10%;"></td> </tr> <tr> <td></td> <td></td> <td colspan="8" style="text-align: center;"> <table border="1" style="width: 100%; border-collapse: collapse; text-align: center;"> <tr> <td style="width: 10%;"></td> <td style="width: 10%;"></td> <td style="width: 10%;"></td> <td style="width: 10%;"></td> <td style="width: 10%;"></td> <td style="width: 10%;"></td> <td style="width: 10%;"></td> <td style="width: 10%;"></td> <td style="width: 10%;"></td> <td style="width: 10%;"></td> </tr> <tr> <td></td> <td></td> <td colspan="8" style="text-align: center;"> <table border="1" style="width: 100%; border-collapse: collapse; text-align: center;"> <tr> <td style="width: 10%;"></td> <td style="width: 10%;"></td> <td style="width: 10%;"></td> <td style="width: 10%;"></td> <td style="width: 10%;"></td> <td style="width: 10%;"></td> <td style="width: 10%;"></td> <td style="width: 10%;"></td> <td style="width: 10%;"></td> <td style="width: 10%;"></td> </tr> <tr> <td></td> <td></td> <td colspan="8" style="text-align: center;"> <table border="1" style="width: 100%; border-collapse: collapse; text-align: center;"> <tr> <td style="width: 10%;"></td> <td style="width: 10%;"></td> <td style="width: 10%;"></td> <td style="width: 10%;"></td> <td style="width: 10%;"></td> <td style="width: 10%;"></td> <td style="width: 10%;"></td> <td style="width: 10%;"></td> <td style="width: 10%;"></td> <td style="width: 10%;"></td> </tr> <tr> <td></td> <td></td> <td colspan="8" style="text-align: center;"> <table border="1" style="width: 100%; border-collapse: collapse;
text-align: center;"> <tr> <td style="width: 10%;"></td> <td style="width: 10%;"></td> <td style="width: 10%;"></td> <td style="width: 10%;"></td> <td style="width: 10%;"></td> <td style="width: 10%;"></td> <td style="width: 10%;"></td> <td style="width: 10%;"></td> <td style="width: 10%;"></td> <td style="width: 10%;"></td> </tr> <tr> <td></td> <td></td> <td colspan="8" style="text-align: center;"> <table border="1" style="width: 100%; border-collapse: collapse; text-align: center;"> <tr> <td style="width: 10%;"></td> <td style="width: 10%;"></td> <td style="width: 10%;"></td> <td style="width: 10%;"></td> <td style="width: 10%;"></td> <td style="width: 10%;"></td> <td style="width: 10%;"></td> <td style="width: 10%;"></td> <td style="width: 10%;"></td> <td style="width: 10%;"></td> </tr> <tr> <td></td> <td></td> <td colspan="8" style="text-align: center;"> <table border="1" style="width: 100%; border-collapse: collapse; text-align: center;"> <tr> <td style="width: 10%;"></td> <td style="width: 10%;"></td> <td style="width: 10%;"></td> <td style="width: 10%;"></td> <td style="width: 10%;"></td> <td style="width: 10%;"></td> <td style="width: 10%;"></td> <td style="width: 10%;"></td> <td style="width: 10%;"></td> <td style="width: 10%;"></td> </tr> <tr> <td></td> <td></td> <td colspan="8" style="text-align: center;"> <table border="1" style="width: 100%; border-collapse: collapse; text-align: center;"> <tr> <td style="width: 10%;"></td> <td style="width: 10%;"></td> <td style="width: 10%;"></td> <td style="width: 10%;"></td> <td style="width: 10%;"></td> <td style="width: 10%;"></td> <td style="width: 10%;"></td> <td style="width: 10%;"></td> <td style="width: 10%;"></td> <td style="width: 10%;"></td> </tr> <tr> <td></td> <td></td> <td colspan="8" style="text-align: center;"> <table border="1" style="width: 100%; border-collapse: collapse; text-align: center;"> <tr> <td style="width: 10%;"></td> <td style="width: 10%;"></td> <td style="width: 10%;"></td> <td style="width: 10%;"></td> <td style="width: 10%;"></td> <td style="width: 10%;"></td> <td style="width: 10%;"></td> <td style="width: 10%;"></td> <td style="width: 10%;"></td> <td style="width: 10%;"></td> </tr> <tr> <td></td> <td></td> <td colspan="8" style="text-align: center;"> <table border="1" style="width: 100%; border-collapse: collapse; text-align: center;"> <tr> <td style="width: 10%;"></td> <td style="width: 10%;"></td> <td style="width: 10%;"></td> <td style="width: 10%;"></td> <td style="width: 10%;"></td> <td style="width: 10%;"></td> <td style="width: 10%;"></td> <td style="width: 10%;"></td> <td style="width: 10%;"></td> <td style="width: 10%;"></td> </tr> <tr> <td></td> <td></td> <td colspan="8" style="text-align: center;"> <table border="1" style="width: 100%; border-collapse: collapse; text-align: center;"> <tr> <td style="width: 10%;"></td> <td style="width: 10%;"></td> <td style="width: 10%;"></td> <td style="width: 10%;"></td> <td style="width: 10%;"></td> <td style="width: 10%;"></td> <td style="width: 10%;"></td> <td style="width: 10%;"></td> <td style="width: 10%;"></td> <td style="width: 10%;"></td> </tr> <tr> <td></td> <td></td> <td colspan="8" style="text-align: center;"> <table border="1" style="width: 100%; border-collapse: collapse; text-align: center;"> <tr> <td style="width: 10%;"></td> <td style="width: 10%;"></td> <td style="width: 10%;"></td> <td style="width: 10%;"></td> <td style="width: 10%;"></td> <td style="width: 10%;"></td> <td style="width: 10%;"></td> <td style="width: 10%;"></td> <td style="width: 10%;"></td> <td style="width: 10%;"></td> </tr> <tr> <td></td> <td></td> <td colspan="8" style="text-align: center;"> <table border="1" style="width: 100%; border-collapse: collapse; text-align: center;"> <tr> <td style="width: 10%;"></td> <td style="width: 10%;"></td> <td style="width: 10%;"></td> <td style="width: 10%;"></td> <td style="width: 10%;"></td> <td style="width: 10%;"></td> <td style="width: 10%;"></td> <td style="width: 10%;"></td> <td style="width: 10%;"></td> <td style="width: 10%;"></td> </tr> <tr> <td></td> <td></td> <td colspan="8" style="text-align: center;"> <table border="1" style="width: 100%; border-collapse: collapse; text-align: center;"> <tr> <td style="width: 10%;"></td> <td style="width: 10%;"></td> <td style="width: 10%;"></td> <td style="width: 10%;"></td> <td style="width: 10%;"></td> <td style="width: 10%;"></td> <td style="width: 10%;"></td> <td style="width: 10%;"></td> <td style="width: 10%;"></td> <td style="width: 10%;"></td> </tr> <tr> <td></td> <td></td> <td colspan="8" style="text-align: center;"> <table border="1" style="width: 100%; border-collapse: collapse; text-align: center;"> <tr> <td style="width: 10%;"></td> <td style="width: 10%;"></td> <td style="width: 10%;"></td> <td style="width: 10%;"></td> <td style="width: 10%;"></td> <td style="width: 10%;"></td> <td style="width: 10%;"></td> <td style="width: 10%;"></td> <td style="width: 10%;"></td> <td style="width: 10%;"></td> </tr> <tr> <td></td> <td></td> <td colspan="8" style="text-align: center;"> <table border="1" style="width: 100%; border-collapse: collapse; text-align: center;"> <tr> <td style="width: 10%;"></td> <td style="width: 10%;"></td> <td style="width: 10%;"></td> <td style="width: 10%;"></td> <td style="width: 10%;"></td> <td style="width: 10%;"></td> <td style="width: 10%;"></td> <td style="width: 10%;"></td> <td style="width: 10%;"></td> <td style="width: 10%;"></td> </tr> <tr> <td></td> <td></td> <td colspan="8" style="text-align: center;"> <table border="1" style="width: 100%; border-collapse: collapse; text-align: center;"> <tr> </tr></table></td></tr></table></td></tr></table></td></tr></table></td></tr></table></td></tr></table></td></tr></table></td></tr></table></td></tr></table></td></tr></table></td></tr></table></td></tr></table></td></tr></table></td></tr></table></td></tr></table></td></tr></table></td></tr></table></td></tr></table></td></tr></table></td></tr></table></td></tr></table></td></tr></table>
 | | | | | | | | | | | | | | | | | | | | <table border="1" style="width: 100%; border-collapse: collapse; text-align: center;"> <tr> <td style="width: 10%;"></td> <td style="width: 10%;"></td> <td style="width: 10%;"></td> <td style="width: 10%;"></td> <td style="width: 10%;"></td> <td style="width: 10%;"></td> <td style="width: 10%;"></td> <td style="width: 10%;"></td> <td style="width: 10%;"></td> <td style="width: 10%;"></td> </tr> <tr> <td></td> <td></td> <td colspan="8" style="text-align: center;"> <table border="1" style="width: 100%; border-collapse: collapse; text-align: center;"> <tr> <td style="width: 10%;"></td> <td style="width: 10%;"></td> <td style="width: 10%;"></td> <td style="width: 10%;"></td> <td style="width: 10%;"></td> <td style="width: 10%;"></td> <td style="width: 10%;"></td> <td style="width: 10%;"></td> <td style="width: 10%;"></td> <td style="width: 10%;"></td> </tr> <tr> <td></td> <td></td> <td colspan="8" style="text-align: center;"> <table border="1" style="width: 100%; border-collapse: collapse; text-align: center;"> <tr> <td style="width: 10%;"></td> <td style="width: 10%;"></td> <td style="width: 10%;"></td> <td style="width: 10%;"></td> <td style="width: 10%;"></td> <td style="width: 10%;"></td> <td style="width: 10%;"></td> <td style="width: 10%;"></td> <td style="width: 10%;"></td> <td style="width: 10%;"></td> </tr> <tr> <td></td> <td></td> <td colspan="8" style="text-align: center;"> <table border="1" style="width: 100%; border-collapse: collapse; text-align: center;"> <tr> <td style="width: 10%;"></td> <td style="width: 10%;"></td> <td style="width: 10%;"></td> <td style="width: 10%;"></td> <td style="width: 10%;"></td> <td style="width: 10%;"></td> <td style="width: 10%;"></td> <td style="width: 10%;"></td> <td style="width: 10%;"></td> <td style="width: 10%;"></td> </tr> <tr> <td></td> <td></td> <td colspan="8" style="text-align: center;"> <table border="1" style="width: 100%; border-collapse: collapse; text-align: center;"> <tr> <td style="width: 10%;"></td> <td style="width: 10%;"></td> <td style="width: 10%;"></td> <td style="width: 10%;"></td> <td style="width: 10%;"></td> <td style="width: 10%;"></td> <td style="width: 10%;"></td> <td style="width: 10%;"></td> <td style="width: 10%;"></td> <td style="width: 10%;"></td> </tr> <tr> <td></td> <td></td> <td colspan="8" style="text-align: center;"> <table border="1" style="width: 100%; border-collapse: collapse; text-align: center;"> <tr> <td style="width: 10%;"></td> <td style="width: 10%;"></td> <td style="width: 10%;"></td> <td style="width: 10%;"></td> <td style="width: 10%;"></td> <td style="width: 10%;"></td> <td style="width: 10%;"></td> <td style="width: 10%;"></td> <td style="width: 10%;"></td> <td style="width: 10%;"></td> </tr> <tr> <td></td> <td></td> <td colspan="8" style="text-align: center;"> <table border="1" style="width: 100%; border-collapse: collapse; text-align: center;"> <tr> <td style="width: 10%;"></td> <td style="width: 10%;"></td> <td style="width: 10%;"></td> <td style="width: 10%;"></td> <td style="width: 10%;"></td> <td style="width: 10%;"></td> <td style="width: 10%;"></td> <td style="width: 10%;"></td> <td style="width: 10%;"></td> <td style="width: 10%;"></td> </tr> <tr> <td></td> <td></td> <td colspan="8" style="text-align: center;"> <table border="1" style="width: 100%; border-collapse: collapse; text-align: center;"> <tr> <td style="width: 10%;"></td> <td style="width: 10%;"></td> <td style="width: 10%;"></td> <td style="width: 10%;"></td> <td style="width: 10%;"></td> <td style="width: 10%;"></td> <td style="width: 10%;"></td> <td style="width: 10%;"></td> <td style="width: 10%;"></td> <td style="width: 10%;"></td> </tr> <tr> <td></td> <td></td> <td colspan="8" style="text-align: center;"> <table border="1" style="width: 100%; border-collapse: collapse; text-align: center;"> <tr> <td style="width: 10%;"></td> <td style="width: 10%;"></td> <td style="width: 10%;"></td> <td style="width: 10%;"></td> <td style="width: 10%;"></td> <td style="width: 10%;"></td> <td style="width: 10%;"></td> <td style="width: 10%;"></td> <td style="width: 10%;"></td> <td style="width: 10%;"></td> </tr> <tr> <td></td> <td></td> <td colspan="8" style="text-align: center;"> <table border="1" style="width: 100%; border-collapse: collapse; text-align: center;"> <tr> <td style="width: 10%;"></td> <td style="width: 10%;"></td> <td style="width: 10%;"></td> <td style="width: 10%;"></td> <td style="width: 10%;"></td> <td style="width: 10%;"></td> <td style="width: 10%;"></td> <td style="width: 10%;"></td> <td style="width: 10%;"></td> <td style="width: 10%;"></td> </tr> <tr> <td></td> <td></td> <td colspan="8" style="text-align: center;"> <table border="1" style="width: 100%; border-collapse: collapse; text-align: center;"> <tr> <td style="width: 10%;"></td> <td style="width: 10%;"></td> <td style="width: 10%;"></td> <td style="width: 10%;"></td> <td style="width: 10%;"></td> <td style="width: 10%;"></td> <td style="width: 10%;"></td> <td style="width: 10%;"></td> <td style="width: 10%;"></td> <td style="width: 10%;"></td> </tr> <tr> <td></td> <td></td> <td colspan="8" style="text-align: center;"> <table border="1" style="width: 100%; border-collapse: collapse; text-align: center;"> <tr> <td style="width: 10%;"></td> <td style="width: 10%;"></td> <td style="width: 10%;"></td> <td style="width: 10%;"></td> <td style="width: 10%;"></td> <td style="width: 10%;"></td> <td style="width: 10%;"></td> <td style="width: 10%;"></td> <td style="width: 10%;"></td> <td style="width: 10%;"></td> </tr> <tr> <td></td> <td></td> <td colspan="8" style="text-align: center;"> <table border="1" style="width: 100%; border-collapse: collapse; text-align: center;"> <tr> <td style="width: 10%;"></td> <td style="width: 10%;"></td> <td style="width: 10%;"></td> <td style="width: 10%;"></td> <td style="width: 10%;"></td> <td style="width: 10%;"></td> <td style="width: 10%;"></td> <td style="width: 10%;"></td> <td style="width: 10%;"></td> <td style="width: 10%;"></td> </tr> <tr> <td></td> <td></td> <td colspan="8" style="text-align: center;"> <table border="1" style="width: 100%; border-collapse: collapse; text-align: center;"> <tr> <td style="width: 10%;"></td> <td style="width: 10%;"></td> <td style="width: 10%;"></td> <td style="width: 10%;"></td> <td style="width: 10%;"></td> <td style="width: 10%;"></td> <td style="width: 10%;"></td> <td style="width: 10%;"></td> <td style="width: 10%;"></td> <td style="width: 10%;"></td> </tr> <tr> <td></td> <td></td> <td colspan="8" style="text-align: center;"> <table border="1" style="width: 100%; border-collapse: collapse; text-align: center;"> <tr> <td style="width: 10%;"></td> <td style="width: 10%;"></td> <td style="width: 10%;"></td> <td style="width: 10%;"></td> <td style="width: 10%;"></td> <td style="width: 10%;"></td> <td style="width: 10%;"></td> <td style="width: 10%;"></td> <td style="width: 10%;"></td> <td style="width: 10%;"></td> </tr> <tr> <td></td> <td></td> <td colspan="8" style="text-align: center;"> <table border="1" style="width: 100%; border-collapse: collapse; text-align: center;"> <tr> <td style="width: 10%;"></td> <td style="width: 10%;"></td> <td style="width: 10%;"></td> <td style="width: 10%;"></td> <td style="width: 10%;"></td> <td style="width: 10%;"></td> <td style="width: 10%;"></td> <td style="width: 10%;"></td> <td style="width: 10%;"></td> <td style="width: 10%;"></td> </tr> <tr> <td></td> <td></td> <td colspan="8" style="text-align: center;"> <table border="1" style="width: 100%; border-collapse: collapse; text-align: center;"> <tr> <td style="width: 10%;"></td> <td style="width: 10%;"></td> <td style="width: 10%;"></td> <td style="width: 10%;"></td> <td style="width: 10%;"></td> <td style="width: 10%;"></td> <td style="width: 10%;"></td> <td style="width: 10%;"></td> <td style="width: 10%;"></td> <td style="width: 10%;"></td> </tr> <tr> <td></td> <td></td> <td colspan="8" style="text-align: center;"> <table border="1" style="width: 100%; border-collapse: collapse; text-align: center;"> <tr> <td style="width: 10%;"></td> <td style="width: 10%;"></td> <td style="width: 10%;"></td> <td style="width: 10%;"></td> <td style="width: 10%;"></td> <td style="width: 10%;"></td> <td style="width: 10%;"></td> <td style="width: 10%;"></td> <td style="width: 10%;"></td> <td style="width: 10%;"></td> </tr> <tr> <td></td> <td></td> <td colspan="8" style="text-align: center;"> <table border="1" style="width: 100%; border-collapse: collapse; text-align: center;"> <tr> <td style="width: 10%;"></td> <td style="width: 10%;"></td> <td style="width: 10%;"></td> <td style="width: 10%;"></td> <td style="width: 10%;"></td> <td style="width: 10%;"></td> <td style="width: 10%;"></td> <td style="width: 10%;"></td> <td style="width: 10%;"></td> <td style="width: 10%;"></td> </tr> <tr> <td></td> <td></td> <td colspan="8" style="text-align: center;"> <table border="1" style="width: 100%; border-collapse: collapse; text-align: center;"> <tr> <td style="width: 10%;"></td> <td style="width: 10%;"></td>
<td style="width: 10%;"></td> <td style="width: 10%;"></td> <td style="width: 10%;"></td> <td style="width: 10%;"></td> <td style="width: 10%;"></td> <td style="width: 10%;"></td> <td style="width: 10%;"></td> <td style="width: 10%;"></td> </tr> <tr> <td></td> <td></td> <td colspan="8" style="text-align: center;"> <table border="1" style="width: 100%; border-collapse: collapse; text-align: center;"> <tr> </tr></table></td></tr></table></td></tr></table></td></tr></table></td></tr></table></td></tr></table></td></tr></table></td></tr></table></td></tr></table></td></tr></table></td></tr></table></td></tr></table></td></tr></table></td></tr></table></td></tr></table></td></tr></table></td></tr></table></td></tr></table></td></tr></table></td></tr></table></td></tr></table> | | | | | | | | | | | | | | | | | | | | <table border="1" style="width: 100%; border-collapse: collapse; text-align: center;"> <tr> <td style="width: 10%;"></td> <td style="width: 10%;"></td> <td style="width: 10%;"></td> <td style="width: 10%;"></td> <td style="width: 10%;"></td> <td style="width: 10%;"></td> <td style="width: 10%;"></td> <td style="width: 10%;"></td> <td style="width: 10%;"></td> <td style="width: 10%;"></td> </tr> <tr> <td></td> <td></td> <td colspan="8" style="text-align: center;"> <table border="1" style="width: 100%; border-collapse: collapse; text-align: center;"> <tr> <td style="width: 10%;"></td> <td style="width: 10%;"></td> <td style="width: 10%;"></td> <td style="width: 10%;"></td> <td style="width: 10%;"></td> <td style="width: 10%;"></td> <td style="width: 10%;"></td> <td style="width: 10%;"></td> <td style="width: 10%;"></td> <td style="width: 10%;"></td> </tr> <tr> <td></td> <td></td> <td colspan="8" style="text-align: center;"> <table border="1" style="width: 100%; border-collapse: collapse; text-align: center;"> <tr> <td style="width: 10%;"></td> <td style="width: 10%;"></td> <td style="width: 10%;"></td> <td style="width: 10%;"></td> <td style="width: 10%;"></td> <td style="width: 10%;"></td> <td style="width: 10%;"></td> <td style="width: 10%;"></td> <td style="width: 10%;"></td> <td style="width: 10%;"></td> </tr> <tr> <td></td> <td></td> <td colspan="8" style="text-align: center;"> <table border="1" style="width: 100%; border-collapse: collapse; text-align: center;"> <tr> <td style="width: 10%;"></td> <td style="width: 10%;"></td> <td style="width: 10%;"></td> <td style="width: 10%;"></td> <td style="width: 10%;"></td> <td style="width: 10%;"></td> <td style="width: 10%;"></td> <td style="width: 10%;"></td> <td style="width: 10%;"></td> <td style="width: 10%;"></td> </tr> <tr> <td></td> <td></td> <td colspan="8" style="text-align: center;"> <table border="1" style="width: 100%; border-collapse: collapse; text-align: center;"> <tr> <td style="width: 10%;"></td> <td style="width: 10%;"></td> <td style="width: 10%;"></td> <td style="width: 10%;"></td> <td style="width: 10%;"></td> <td style="width: 10%;"></td> <td style="width: 10%;"></td> <td style="width: 10%;"></td> <td style="width: 10%;"></td> <td style="width: 10%;"></td> </tr> <tr> <td></td> <td></td> <td colspan="8" style="text-align: center;"> <table border="1" style="width: 100%; border-collapse: collapse; text-align: center;"> <tr> <td style="width: 10%;"></td> <td style="width: 10%;"></td> <td style="width: 10%;"></td> <td style="width: 10%;"></td> <td style="width: 10%;"></td> <td style="width: 10%;"></td> <td style="width: 10%;"></td> <td style="width: 10%;"></td> <td style="width: 10%;"></td> <td style="width: 10%;"></td> </tr> <tr> <td></td> <td></td> <td colspan="8" style="text-align: center;"> <table border="1" style="width: 100%; border-collapse: collapse; text-align: center;"> <tr> <td style="width: 10%;"></td> <td style="width: 10%;"></td> <td style="width: 10%;"></td> <td style="width: 10%;"></td> <td style="width: 10%;"></td> <td style="width: 10%;"></td> <td style="width: 10%;"></td> <td style="width: 10%;"></td> <td style="width: 10%;"></td> <td style="width: 10%;"></td> </tr> <tr> <td></td> <td></td> <td colspan="8" style="text-align: center;"> <table border="1" style="width: 100%; border-collapse: collapse; text-align: center;"> <tr> <td style="width: 10%;"></td> <td style="width: 10%;"></td> <td style="width: 10%;"></td> <td style="width: 10%;"></td> <td style="width: 10%;"></td> <td style="width: 10%;"></td> <td style="width: 10%;"></td> <td style="width: 10%;"></td> <td style="width: 10%;"></td> <td style="width: 10%;"></td> </tr> <tr> <td></td> <td></td> <td colspan="8" style="text-align: center;"> <table border="1" style="width: 100%; border-collapse: collapse; text-align: center;"> <tr> <td style="width: 10%;"></td> <td style="width: 10%;"></td> <td style="width: 10%;"></td> <td style="width: 10%;"></td> <td style="width: 10%;"></td> <td style="width: 10%;"></td> <td style="width: 10%;"></td> <td style="width: 10%;"></td> <td style="width: 10%;"></td> <td style="width: 10%;"></td> </tr> <tr> <td></td> <td></td> <td colspan="8" style="text-align: center;"> <table border="1" style="width: 100%; border-collapse: collapse; text-align: center;">
<tr> <td style="width: 10%;"></td> <td style="width: 10%;"></td> <td style="width: 10%;"></td> <td style="width: 10%;"></td> <td style="width: 10%;"></td> <td style="width: 10%;"></td> <td style="width: 10%;"></td> <td style="width: 10%;"></td> <td style="width: 10%;"></td> <td style="width: 10%;"></td> </tr> <tr> <td></td> <td></td> <td colspan="8" style="text-align: center;"> <table border="1" style="width: 100%; border-collapse: collapse; text-align: center;"> <tr> <td style="width: 10%;"></td> <td style="width: 10%;"></td> <td style="width: 10%;"></td> <td style="width: 10%;"></td> <td style="width: 10%;"></td> <td style="width: 10%;"></td> <td style="width: 10%;"></td> <td style="width: 10%;"></td> <td style="width: 10%;"></td> <td style="width: 10%;"></td> </tr> <tr> <td></td> <td></td> <td colspan="8" style="text-align: center;"> <table border="1" style="width: 100%; border-collapse: collapse; text-align: center;"> <tr> <td style="width: 10%;"></td> <td style="width: 10%;"></td> <td style="width: 10%;"></td> <td style="width: 10%;"></td> <td style="width: 10%;"></td> <td style="width: 10%;"></td> <td style="width: 10%;"></td> <td style="width: 10%;"></td> <td style="width: 10%;"></td> <td style="width: 10%;"></td> </tr> <tr> <td></td> <td></td> <td colspan="8" style="text-align: center;"> <table border="1" style="width: 100%; border-collapse: collapse; text-align: center;"> <tr> <td style="width: 10%;"></td> <td style="width: 10%;"></td> <td style="width: 10%;"></td> <td style="width: 10%;"></td> <td style="width: 10%;"></td> <td style="width: 10%;"></td> <td style="width: 10%;"></td> <td style="width: 10%;"></td> <td style="width: 10%;"></td> <td style="width: 10%;"></td> </tr> <tr> <td></td> <td></td> <td colspan="8" style="text-align: center;"> <table border="1" style="width: 100%; border-collapse: collapse; text-align: center;"> <tr> <td style="width: 10%;"></td> <td style="width: 10%;"></td> <td style="width: 10%;"></td> <td style="width: 10%;"></td> <td style="width: 10%;"></td> <td style="width: 10%;"></td> <td style="width: 10%;"></td> <td style="width: 10%;"></td> <td style="width: 10%;"></td> <td style="width: 10%;"></td> </tr> <tr> <td></td> <td></td> <td colspan="8" style="text-align: center;"> <table border="1" style="width: 100%; border-collapse: collapse; text-align: center;"> <tr> <td style="width: 10%;"></td> <td style="width: 10%;"></td> <td style="width: 10%;"></td> <td style="width: 10%;"></td> <td style="width: 10%;"></td> <td style="width: 10%;"></td> <td style="width: 10%;"></td> <td style="width: 10%;"></td> <td style="width: 10%;"></td> <td style="width: 10%;"></td> </tr> <tr> <td></td> <td></td> <td colspan="8" style="text-align: center;"> <table border="1" style="width: 100%; border-collapse: collapse; text-align: center;"> <tr> <td style="width: 10%;"></td> <td style="width: 10%;"></td> <td style="width: 10%;"></td> <td style="width: 10%;"></td> <td style="width: 10%;"></td> <td style="width: 10%;"></td> <td style="width: 10%;"></td> <td style="width: 10%;"></td> <td style="width: 10%;"></td> <td style="width: 10%;"></td> </tr> <tr> <td></td> <td></td> <td colspan="8" style="text-align: center;"> <table border="1" style="width: 100%; border-collapse: collapse; text-align: center;"> <tr> <td style="width: 10%;"></td> <td style="width: 10%;"></td> <td style="width: 10%;"></td> <td style="width: 10%;"></td> <td style="width: 10%;"></td> <td style="width: 10%;"></td> <td style="width: 10%;"></td> <td style="width: 10%;"></td> <td style="width: 10%;"></td> <td style="width: 10%;"></td> </tr> <tr> <td></td> <td></td> <td colspan="8" style="text-align: center;"> <table border="1" style="width: 100%; border-collapse: collapse; text-align: center;"> <tr> <td style="width: 10%;"></td> <td style="width: 10%;"></td> <td style="width: 10%;"></td> <td style="width: 10%;"></td> <td style="width: 10%;"></td> <td style="width: 10%;"></td> <td style="width: 10%;"></td> <td style="width: 10%;"></td> <td style="width: 10%;"></td> <td style="width: 10%;"></td> </tr> <tr> <td></td> <td></td> <td colspan="8" style="text-align: center;"> <table border="1" style="width: 100%; border-collapse: collapse; text-align: center;"> <tr> <td style="width: 10%;"></td> <td style="width: 10%;"></td> <td style="width: 10%;"></td> <td style="width: 10%;"></td> <td style="width: 10%;"></td> <td style="width: 10%;"></td> <td style="width: 10%;"></td> <td style="width: 10%;"></td> <td style="width: 10%;"></td> <td style="width: 10%;"></td> </tr> <tr> <td></td> <td></td> <td colspan="8" style="text-align: center;"> <table border="1" style="width: 100%; border-collapse: collapse; text-align: center;"> <tr> </tr></table></td></tr></table></td></tr></table></td></tr></table></td></tr></table></td></tr></table></td></tr></table></td></tr></table></td></tr></table></td></tr></table></td></tr></table></td></tr></table></td></tr></table></td></tr></table></td></tr></table></td></tr></table></td></tr></table></td></tr></table></td></tr></table></td></tr></table> | | | | | | | | | | | | | | | | | | | | <table border="1" style="width: 100%;
border-collapse: collapse; text-align: center;"> <tr> <td style="width: 10%;"></td> <td style="width: 10%;"></td> <td style="width: 10%;"></td> <td style="width: 10%;"></td> <td style="width: 10%;"></td> <td style="width: 10%;"></td> <td style="width: 10%;"></td> <td style="width: 10%;"></td> <td style="width: 10%;"></td> <td style="width: 10%;"></td> </tr> <tr> <td></td> <td></td> <td colspan="8" style="text-align: center;"> <table border="1" style="width: 100%; border-collapse: collapse; text-align: center;"> <tr> <td style="width: 10%;"></td> <td style="width: 10%;"></td> <td style="width: 10%;"></td> <td style="width: 10%;"></td> <td style="width: 10%;"></td> <td style="width: 10%;"></td> <td style="width: 10%;"></td> <td style="width: 10%;"></td> <td style="width: 10%;"></td> <td style="width: 10%;"></td> </tr> <tr> <td></td> <td></td> <td colspan="8" style="text-align: center;"> <table border="1" style="width: 100%; border-collapse: collapse; text-align: center;"> <tr> <td style="width: 10%;"></td> <td style="width: 10%;"></td> <td style="width: 10%;"></td> <td style="width: 10%;"></td> <td style="width: 10%;"></td> <td style="width: 10%;"></td> <td style="width: 10%;"></td> <td style="width: 10%;"></td> <td style="width: 10%;"></td> <td style="width: 10%;"></td> </tr> <tr> <td></td> <td></td> <td colspan="8" style="text-align: center;"> <table border="1" style="width: 100%; border-collapse: collapse; text-align: center;"> <tr> <td style="width: 10%;"></td> <td style="width: 10%;"></td> <td style="width: 10%;"></td> <td style="width: 10%;"></td> <td style="width: 10%;"></td> <td style="width: 10%;"></td> <td style="width: 10%;"></td> <td style="width: 10%;"></td> <td style="width: 10%;"></td> <td style="width: 10%;"></td> </tr> <tr> <td></td> <td></td> <td colspan="8" style="text-align: center;"> <table border="1" style="width: 100%; border-collapse: collapse; text-align: center;"> <tr> <td style="width: 10%;"></td> <td style="width: 10%;"></td> <td style="width: 10%;"></td> <td style="width: 10%;"></td> <td style="width: 10%;"></td> <td style="width: 10%;"></td> <td style="width: 10%;"></td> <td style="width: 10%;"></td> <td style="width: 10%;"></td> <td style="width: 10%;"></td> </tr> <tr> <td></td> <td></td> <td colspan="8" style="text-align: center;"> <table border="1" style="width: 100%; border-collapse: collapse; text-align: center;"> <tr> <td style="width: 10%;"></td> <td style="width: 10%;"></td> <td style="width: 10%;"></td> <td style="width: 10%;"></td> <td style="width: 10%;"></td> <td style="width: 10%;"></td> <td style="width: 10%;"></td> <td style="width: 10%;"></td> <td style="width: 10%;"></td> <td style="width: 10%;"></td> </tr> <tr> <td></td> <td></td> <td colspan="8" style="text-align: center;"> <table border="1" style="width: 100%; border-collapse: collapse; text-align: center;"> <tr> <td style="width: 10%;"></td> <td style="width: 10%;"></td> <td style="width: 10%;"></td> <td style="width: 10%;"></td> <td style="width: 10%;"></td> <td style="width: 10%;"></td> <td style="width: 10%;"></td> <td style="width: 10%;"></td> <td style="width: 10%;"></td> <td style="width: 10%;"></td> </tr> <tr> <td></td> <td></td> <td colspan="8" style="text-align: center;"> <table border="1" style="width: 100%; border-collapse: collapse; text-align: center;"> <tr> <td style="width: 10%;"></td> <td style="width: 10%;"></td> <td style="width: 10%;"></td> <td style="width: 10%;"></td> <td style="width: 10%;"></td> <td style="width: 10%;"></td> <td style="width: 10%;"></td> <td style="width: 10%;"></td> <td style="width: 10%;"></td> <td style="width: 10%;"></td> </tr> <tr> <td></td> <td></td> <td colspan="8" style="text-align: center;"> <table border="1" style="width: 100%; border-collapse: collapse; text-align: center;"> <tr> <td style="width: 10%;"></td> <td style="width: 10%;"></td> <td style="width: 10%;"></td> <td style="width: 10%;"></td> <td style="width: 10%;"></td> <td style="width: 10%;"></td> <td style="width: 10%;"></td> <td style="width: 10%;"></td> <td style="width: 10%;"></td> <td style="width: 10%;"></td> </tr> <tr> <td></td> <td></td> <td colspan="8" style="text-align: center;"> <table border="1" style="width: 100%; border-collapse: collapse; text-align: center;"> <tr> <td style="width: 10%;"></td> <td style="width: 10%;"></td> <td style="width: 10%;"></td> <td style="width: 10%;"></td> <td style="width: 10%;"></td> <td style="width: 10%;"></td> <td style="width: 10%;"></td> <td style="width: 10%;"></td> <td style="width: 10%;"></td> <td style="width: 10%;"></td> </tr> <tr> <td></td> <td></td> <td colspan="8" style="text-align: center;"> <table border="1" style="width: 100%; border-collapse: collapse; text-align: center;"> <tr> <td style="width: 10%;"></td> <td style="width: 10%;"></td> <td style="width: 10%;"></td> <td style="width: 10%;"></td> <td style="width: 10%;"></td> <td style="width: 10%;"></td> <td style="width: 10%;"></td> <td style="width: 10%;"></td> <td style="width: 10%;"></td> <td style="width: 10%;"></td> </tr> <tr> <td></td> <td></td> <td colspan="8" style="text-align: center;"> <table border="1" style="width: 100%; border-collapse: collapse; text-align: center;"> <tr> <td style="width: 10%;"></td> <td style="width: 10%;"></td> <td style="width: 10%;"></td> <td style="width: 10%;"></td> <td style="width: 10%;"></td> <td style="width: 10%;"></td> <td style="width: 10%;"></td> <td style="width: 10%;"></td> <td style="width: 10%;"></td> <td style="width: 10%;"></td> </tr> <tr> <td></td> <td></td> <td colspan="8" style="text-align: center;"> <table border="1" style="width: 100%; border-collapse: collapse; text-align: center;"> <tr> <td style="width: 10%;"></td> <td style="width: 10%;"></td> <td style="width: 10%;"></td> <td style="width: 10%;"></td> <td style="width: 10%;"></td> <td style="width: 10%;"></td> <td style="width: 10%;"></td> <td style="width: 10%;"></td> <td style="width: 10%;"></td> <td style="width: 10%;"></td> </tr> <tr> <td></td> <td></td> <td colspan="8" style="text-align: center;"> <table border="1" style="width: 100%; border-collapse: collapse; text-align: center;"> <tr> <td style="width: 10%;"></td> <td style="width: 10%;"></td> <td style="width: 10%;"></td> <td style="width: 10%;"></td> <td style="width: 10%;"></td> <td style="width: 10%;"></td> <td style="width: 10%;"></td> <td style="width: 10%;"></td> <td style="width: 10%;"></td> <td style="width: 10%;"></td> </tr> <tr> <td></td> <td></td> <td colspan="8" style="text-align: center;"> <table border="1" style="width: 100%; border-collapse: collapse; text-align: center;"> <tr> <td style="width: 10%;"></td> <td style="width: 10%;"></td> <td style="width: 10%;"></td> <td style="width: 10%;"></td> <td style="width: 10%;"></td> <td style="width: 10%;"></td> <td style="width: 10%;"></td> <td style="width: 10%;"></td> <td style="width: 10%;"></td> <td style="width: 10%;"></td> </tr> <tr> <td></td> <td></td> <td colspan="8" style="text-align: center;"> <table border="1" style="width: 100%; border-collapse: collapse; text-align: center;"> <tr> <td style="width: 10%;"></td> <td style="width: 10%;"></td> <td style="width: 10%;"></td> <td style="width: 10%;"></td> <td style="width: 10%;"></td> <td style="width: 10%;"></td> <td style="width: 10%;"></td> <td style="width: 10%;"></td> <td style="width: 10%;"></td> <td style="width: 10%;"></td> </tr> <tr> <td></td> <td></td> <td colspan="8" style="text-align: center;"> <table border="1" style="width: 100%; border-collapse: collapse; text-align: center;"> <tr> <td style="width: 10%;"></td> <td style="width: 10%;"></td> <td style="width: 10%;"></td> <td style="width: 10%;"></td> <td style="width: 10%;"></td> <td style="width: 10%;"></td> <td style="width: 10%;"></td> <td style="width: 10%;"></td> <td style="width: 10%;"></td> <td style="width: 10%;"></td> </tr> <tr> <td></td> <td></td> <td colspan="8" style="text-align: center;"> <table border="1" style="width: 100%; border-collapse: collapse; text-align: center;"> <tr> <td style="width: 10%;"></td> <td style="width: 10%;"></td> <td style="width: 10%;"></td> <td style="width: 10%;"></td> <td style="width: 10%;"></td> <td style="width: 10%;"></td> <td style="width: 10%;"></td> <td style="width: 10%;"></td> <td style="width: 10%;"></td> <td style="width: 10%;"></td> </tr> <tr> <td></td> <td></td> <td colspan="8" style="text-align: center;"> <table border="1" style="width: 100%; border-collapse: collapse; text-align: center;"> <tr> </tr></table></td></tr></table></td></tr></table></td></tr></table></td></tr></table></td></tr></table></td></tr></table></td></tr></table></td></tr></table></td></tr></table></td></tr></table></td></tr></table></td></tr></table></td></tr></table></td></tr></table></td></tr></table></td></tr></table></td></tr></table></td></tr></table>
 | | | | | | | | | | | | | | | | | | | | <table border="1" style="width: 100%; border-collapse: collapse; text-align: center;"> <tr> <td style="width: 10%;"></td> <td style="width: 10%;"></td> <td style="width: 10%;"></td> <td style="width: 10%;"></td> <td style="width: 10%;"></td> <td style="width: 10%;"></td> <td style="width: 10%;"></td> <td style="width: 10%;"></td> <td style="width: 10%;"></td> <td style="width: 10%;"></td> </tr> <tr> <td></td> <td></td> <td colspan="8" style="text-align: center;"> <table border="1" style="width: 100%; border-collapse: collapse; text-align: center;"> <tr> <td style="width: 10%;"></td> <td style="width: 10%;"></td> <td style="width: 10%;"></td> <td style="width: 10%;"></td> <td style="width: 10%;"></td> <td style="width: 10%;"></td> <td style="width: 10%;"></td> <td style="width: 10%;"></td> <td style="width: 10%;"></td> <td style="width: 10%;"></td> </tr> <tr> <td></td> <td></td> <td colspan="8" style="text-align: center;"> <table border="1" style="width: 100%; border-collapse: collapse; text-align: center;"> <tr> <td style="width: 10%;"></td> <td style="width: 10%;"></td> <td style="width: 10%;"></td> <td style="width: 10%;"></td> <td style="width: 10%;"></td> <td style="width: 10%;"></td> <td style="width: 10%;"></td> <td style="width: 10%;"></td> <td style="width: 10%;"></td> <td style="width: 10%;"></td> </tr> <tr> <td></td> <td></td> <td colspan="8" style="text-align: center;"> <table border="1" style="width: 100%; border-collapse: collapse; text-align: center;"> <tr> <td style="width: 10%;"></td> <td style="width: 10%;"></td> <td style="width: 10%;"></td> <td style="width: 10%;"></td> <td style="width: 10%;"></td> <td style="width: 10%;"></td> <td style="width: 10%;"></td> <td style="width: 10%;"></td> <td style="width: 10%;"></td> <td style="width: 10%;"></td> </tr> <tr> <td></td> <td></td> <td colspan="8" style="text-align: center;"> <table border="1" style="width: 100%; border-collapse: collapse; text-align: center;"> <tr> <td style="width: 10%;"></td> <td style="width: 10%;"></td> <td style="width: 10%;"></td> <td style="width: 10%;"></td> <td style="width: 10%;"></td> <td style="width: 10%;"></td> <td style="width: 10%;"></td> <td style="width: 10%;"></td> <td style="width: 10%;"></td> <td style="width: 10%;"></td> </tr> <tr> <td></td> <td></td> <td colspan="8" style="text-align: center;"> <table border="1" style="width: 100%; border-collapse: collapse; text-align: center;"> <tr> <td style="width: 10%;"></td> <td style="width: 10%;"></td> <td style="width: 10%;"></td> <td style="width: 10%;"></td> <td style="width: 10%;"></td> <td style="width: 10%;"></td> <td style="width: 10%;"></td> <td style="width: 10%;"></td> <td style="width: 10%;"></td> <td style="width: 10%;"></td> </tr> <tr> <td></td> <td></td> <td colspan="8" style="text-align: center;"> <table border="1" style="width: 100%; border-collapse: collapse; text-align: center;"> <tr> <td style="width: 10%;"></td> <td style="width: 10%;"></td> <td style="width: 10%;"></td> <td style="width: 10%;"></td> <td style="width: 10%;"></td> <td style="width: 10%;"></td> <td style="width: 10%;"></td> <td style="width: 10%;"></td> <td style="width: 10%;"></td> <td style="width: 10%;"></td> </tr> <tr> <td></td> <td></td> <td colspan="8" style="text-align: center;"> <table border="1" style="width: 100%; border-collapse: collapse; text-align: center;"> <tr> <td style="width: 10%;"></td> <td style="width: 10%;"></td> <td style="width: 10%;"></td> <td style="width: 10%;"></td> <td style="width: 10%;"></td> <td style="width: 10%;"></td> <td style="width: 10%;"></td> <td style="width: 10%;"></td> <td style="width: 10%;"></td> <td style="width: 10%;"></td> </tr> <tr> <td></td> <td></td> <td colspan="8" style="text-align: center;"> <table border="1" style="width: 100%; border-collapse: collapse; text-align: center;"> <tr> <td style="width: 10%;"></td> <td style="width: 10%;"></td> <td style="width: 10%;"></td> <td style="width: 10%;"></td> <td style="width: 10%;"></td> <td style="width: 10%;"></td> <td style="width: 10%;"></td> <td style="width: 10%;"></td> <td style="width: 10%;"></td> <td style="width: 10%;"></td> </tr> <tr> <td></td> <td></td> <td colspan="8" style="text-align: center;"> <table border="1" style="width: 100%; border-collapse: collapse; text-align: center;"> <tr> <td style="width: 10%;"></td> <td style="width: 10%;"></td> <td style="width: 10%;"></td> <td style="width: 10%;"></td> <td style="width: 10%;"></td> <td style="width: 10%;"></td> <td style="width: 10%;"></td> <td style="width: 10%;"></td> <td style="width: 10%;"></td> <td style="width: 10%;"></td> </tr> <tr> <td></td> <td></td> <td colspan="8" style="text-align: center;"> <table border="1" style="width: 100%; border-collapse: collapse; text-align: center;"> <tr> <td style="width: 10%;"></td> <td style="width: 10%;"></td> <td style="width: 10%;"></td> <td style="width: 10%;"></td> <td style="width: 10%;"></td> <td style="width: 10%;"></td> <td style="width: 10%;"></td> <td style="width: 10%;"></td> <td style="width: 10%;"></td> <td style="width: 10%;"></td> </tr> <tr> <td></td> <td></td> <td colspan="8" style="text-align: center;"> <table border="1" style="width: 100%; border-collapse: collapse; text-align: center;"> <tr> <td style="width: 10%;"></td> <td style="width: 10%;"></td> <td style="width: 10%;"></td> <td style="width: 10%;"></td> <td style="width: 10%;"></td> <td style="width: 10%;"></td> <td style="width: 10%;"></td> <td style="width: 10%;"></td> <td style="width: 10%;"></td> <td style="width: 10%;"></td> </tr> <tr> <td></td> <td></td> <td colspan="8" style="text-align: center;"> <table border="1" style="width: 100%; border-collapse: collapse; text-align: center;"> <tr> <td style="width: 10%;"></td> <td style="width: 10%;"></td> <td style="width: 10%;"></td> <td style="width: 10%;"></td> <td style="width: 10%;"></td> <td style="width: 10%;"></td> <td style="width: 10%;"></td> <td style="width: 10%;"></td> <td style="width: 10%;"></td> <td style="width: 10%;"></td> </tr> <tr> <td></td> <td></td> <td colspan="8" style="text-align: center;"> <table border="1" style="width: 100%; border-collapse: collapse; text-align: center;"> <tr> <td style="width: 10%;"></td> <td style="width: 10%;"></td> <td style="width:
10%;"></td> <td style="width: 10%;"></td> <td style="width: 10%;"></td> <td style="width: 10%;"></td> <td style="width: 10%;"></td> <td style="width: 10%;"></td> <td style="width: 10%;"></td> <td style="width: 10%;"></td> </tr> <tr> <td></td> <td></td> <td colspan="8" style="text-align: center;"> <table border="1" style="width: 100%; border-collapse: collapse; text-align: center;"> <tr> <td style="width: 10%;"></td> <td style="width: 10%;"></td> <td style="width: 10%;"></td> <td style="width: 10%;"></td> <td style="width: 10%;"></td> <td style="width: 10%;"></td> <td style="width: 10%;"></td> <td style="width: 10%;"></td> <td style="width: 10%;"></td> <td style="width: 10%;"></td> </tr> <tr> <td></td> <td></td> <td colspan="8" style="text-align: center;"> <table border="1" style="width: 100%; border-collapse: collapse; text-align: center;"> <tr> <td style="width: 10%;"></td> <td style="width: 10%;"></td> <td style="width: 10%;"></td> <td style="width: 10%;"></td> <td style="width: 10%;"></td> <td style="width: 10%;"></td> <td style="width: 10%;"></td> <td style="width: 10%;"></td> <td style="width: 10%;"></td> <td style="width: 10%;"></td> </tr> <tr> <td></td> <td></td> <td colspan="8" style="text-align: center;"> <table border="1" style="width: 100%; border-collapse: collapse; text-align: center;"> <tr> <td style="width: 10%;"></td> <td style="width: 10%;"></td> <td style="width: 10%;"></td> <td style="width: 10%;"></td> <td style="width: 10%;"></td> <td style="width: 10%;"></td> <td style="width: 10%;"></td> <td style="width: 10%;"></td> <td style="width: 10%;"></td> <td style="width: 10%;"></td> </tr> <tr> <td></td> <td></td> <td colspan="8" style="text-align: center;"> <table border="1" style="width: 100%; border-collapse: collapse; text-align: center;"> <tr> </tr></table></td></tr></table></td></tr></table></td></tr></table></td></tr></table></td></tr></table></td></tr></table></td></tr></table></td></tr></table></td></tr></table></td></tr></table></td></tr></table></td></tr></table></td></tr></table></td></tr></table></td></tr></table></td></tr></table></td></tr></table> | | | | | | | | | | | | | | | | | | | | <table border="1" style="width: 100%; border-collapse: collapse; text-align: center;"> <tr> <td style="width: 10%;"></td> <td style="width: 10%;"></td> <td style="width: 10%;"></td> <td style="width: 10%;"></td> <td style="width: 10%;"></td> <td style="width: 10%;"></td> <td style="width: 10%;"></td> <td style="width: 10%;"></td> <td style="width: 10%;"></td> <td style="width: 10%;"></td> </tr> <tr> <td></td> <td></td> <td colspan="8" style="text-align: center;"> <table border="1" style="width: 100%; border-collapse: collapse; text-align: center;"> <tr> <td style="width: 10%;"></td> <td style="width: 10%;"></td> <td style="width: 10%;"></td> <td style="width: 10%;"></td> <td style="width: 10%;"></td> <td style="width: 10%;"></td> <td style="width: 10%;"></td> <td style="width: 10%;"></td> <td style="width: 10%;"></td> <td style="width: 10%;"></td> </tr> <tr> <td></td> <td></td> <td colspan="8" style="text-align: center;"> <table border="1" style="width: 100%; border-collapse: collapse; text-align: center;"> <tr> <td style="width: 10%;"></td> <td style="width: 10%;"></td> <td style="width: 10%;"></td> <td style="width: 10%;"></td> <td style="width: 10%;"></td> <td style="width: 10%;"></td> <td style="width: 10%;"></td> <td style="width: 10%;"></td> <td style="width: 10%;"></td> <td style="width: 10%;"></td> </tr> <tr> <td></td> <td></td> <td colspan="8" style="text-align: center;"> <table border="1" style="width: 100%; border-collapse: collapse; text-align: center;"> <tr> <td style="width: 10%;"></td> <td style="width: 10%;"></td> <td style="width: 10%;"></td> <td style="width: 10%;"></td> <td style="width: 10%;"></td> <td style="width: 10%;"></td> <td style="width: 10%;"></td> <td style="width: 10%;"></td> <td style="width: 10%;"></td> <td style="width: 10%;"></td> </tr> <tr> <td></td> <td></td> <td colspan="8" style="text-align: center;"> <table border="1" style="width: 100%; border-collapse: collapse; text-align: center;"> <tr> <td style="width: 10%;"></td> <td style="width: 10%;"></td> <td style="width: 10%;"></td> <td style="width: 10%;"></td> <td style="width: 10%;"></td> <td style="width: 10%;"></td> <td style="width: 10%;"></td> <td style="width: 10%;"></td> <td style="width: 10%;"></td> <td style="width: 10%;"></td> </tr> <tr> <td></td> <td></td> <td colspan="8" style="text-align: center;"> <table border="1" style="width: 100%; border-collapse: collapse; text-align: center;"> <tr> <td style="width: 10%;"></td> <td style="width: 10%;"></td> <td style="width: 10%;"></td> <td style="width: 10%;"></td> <td style="width: 10%;"></td> <td style="width: 10%;"></td> <td style="width: 10%;"></td> <td style="width: 10%;"></td> <td style="width: 10%;"></td> <td style="width: 10%;"></td> </tr> <tr> <td></td> <td></td> <td colspan="8" style="text-align: center;"> <table border="1" style="width: 100%; border-collapse: collapse; text-align: center;"> <tr> <td style="width: 10%;"></td> <td style="width: 10%;"></td> <td
style="width: 10%;"></td> <td style="width: 10%;"></td> <td style="width: 10%;"></td> <td style="width: 10%;"></td> <td style="width: 10%;"></td> <td style="width: 10%;"></td> <td style="width: 10%;"></td> <td style="width: 10%;"></td> </tr> <tr> <td></td> <td></td> <td colspan="8" style="text-align: center;"> <table border="1" style="width: 100%; border-collapse: collapse; text-align: center;"> <tr> <td style="width: 10%;"></td> <td style="width: 10%;"></td> <td style="width: 10%;"></td> <td style="width: 10%;"></td> <td style="width: 10%;"></td> <td style="width: 10%;"></td> <td style="width: 10%;"></td> <td style="width: 10%;"></td> <td style="width: 10%;"></td> <td style="width: 10%;"></td> </tr> <tr> <td></td> <td></td> <td colspan="8" style="text-align: center;"> <table border="1" style="width: 100%; border-collapse: collapse; text-align: center;"> <tr> <td style="width: 10%;"></td> <td style="width: 10%;"></td> <td style="width: 10%;"></td> <td style="width: 10%;"></td> <td style="width: 10%;"></td> <td style="width: 10%;"></td> <td style="width: 10%;"></td> <td style="width: 10%;"></td> <td style="width: 10%;"></td> <td style="width: 10%;"></td> </tr> <tr> <td></td> <td></td> <td colspan="8" style="text-align: center;"> <table border="1" style="width: 100%; border-collapse: collapse; text-align: center;"> <tr> <td style="width: 10%;"></td> <td style="width: 10%;"></td> <td style="width: 10%;"></td> <td style="width: 10%;"></td> <td style="width: 10%;"></td> <td style="width: 10%;"></td> <td style="width: 10%;"></td> <td style="width: 10%;"></td> <td style="width: 10%;"></td> <td style="width: 10%;"></td> </tr> <tr> <td></td> <td></td> <td colspan="8" style="text-align: center;"> <table border="1" style="width: 100%; border-collapse: collapse; text-align: center;"> <tr> <td style="width: 10%;"></td> <td style="width: 10%;"></td> <td style="width: 10%;"></td> <td style="width: 10%;"></td> <td style="width: 10%;"></td> <td style="width: 10%;"></td> <td style="width: 10%;"></td> <td style="width: 10%;"></td> <td style="width: 10%;"></td> <td style="width: 10%;"></td> </tr> <tr> <td></td> <td></td> <td colspan="8" style="text-align: center;"> <table border="1" style="width: 100%; border-collapse: collapse; text-align: center;"> <tr> <td style="width: 10%;"></td> <td style="width: 10%;"></td> <td style="width: 10%;"></td> <td style="width: 10%;"></td> <td style="width: 10%;"></td> <td style="width: 10%;"></td> <td style="width: 10%;"></td> <td style="width: 10%;"></td> <td style="width: 10%;"></td> <td style="width: 10%;"></td> </tr> <tr> <td></td> <td></td> <td colspan="8" style="text-align: center;"> <table border="1" style="width: 100%; border-collapse: collapse; text-align: center;"> <tr> <td style="width: 10%;"></td> <td style="width: 10%;"></td> <td style="width: 10%;"></td> <td style="width: 10%;"></td> <td style="width: 10%;"></td> <td style="width: 10%;"></td> <td style="width: 10%;"></td> <td style="width: 10%;"></td> <td style="width: 10%;"></td> <td style="width: 10%;"></td> </tr> <tr> <td></td> <td></td> <td colspan="8" style="text-align: center;"> <table border="1" style="width: 100%; border-collapse: collapse; text-align: center;"> <tr> <td style="width: 10%;"></td> <td style="width: 10%;"></td> <td style="width: 10%;"></td> <td style="width: 10%;"></td> <td style="width: 10%;"></td> <td style="width: 10%;"></td> <td style="width: 10%;"></td> <td style="width: 10%;"></td> <td style="width: 10%;"></td> <td style="width: 10%;"></td> </tr> <tr> <td></td> <td></td> <td colspan="8" style="text-align: center;"> <table border="1" style="width: 100%; border-collapse: collapse; text-align: center;"> <tr> <td style="width: 10%;"></td> <td style="width: 10%;"></td> <td style="width: 10%;"></td> <td style="width: 10%;"></td> <td style="width: 10%;"></td> <td style="width: 10%;"></td> <td style="width: 10%;"></td> <td style="width: 10%;"></td> <td style="width: 10%;"></td> <td style="width: 10%;"></td> </tr> <tr> <td></td> <td></td> <td colspan="8" style="text-align: center;"> <table border="1" style="width: 100%; border-collapse: collapse; text-align: center;"> <tr> <td style="width: 10%;"></td> <td style="width: 10%;"></td> <td style="width: 10%;"></td> <td style="width: 10%;"></td> <td style="width: 10%;"></td> <td style="width: 10%;"></td> <td style="width: 10%;"></td> <td style="width: 10%;"></td> <td style="width: 10%;"></td> <td style="width: 10%;"></td> </tr> <tr> <td></td> <td></td> <td colspan="8" style="text-align: center;"> <table border="1" style="width: 100%; border-collapse: collapse; text-align: center;"> <tr> </tr></table></td></tr></table></td></tr></table></td></tr></table></td></tr></table></td></tr></table></td></tr></table></td></tr></table></td></tr></table></td></tr></table></td></tr></table></td></tr></table></td></tr></table></td></tr></table></td></tr></table></td></tr></table></td></tr></table> | | | | | | | | | | | | | | | | | | | | <table border="1" style="width: 100%; border-collapse: collapse; text-align: center;"> <tr> <td style="width: 10%;"></td> <td style="width: 10%;"></td> <td
style="width: 10%;"></td> <td style="width: 10%;"></td> <td style="width: 10%;"></td> <td style="width: 10%;"></td> <td style="width: 10%;"></td> <td style="width: 10%;"></td> <td style="width: 10%;"></td> <td style="width: 10%;"></td> </tr> <tr> <td></td> <td></td> <td colspan="8" style="text-align: center;"> <table border="1" style="width: 100%; border-collapse: collapse; text-align: center;"> <tr> <td style="width: 10%;"></td> <td style="width: 10%;"></td> <td style="width: 10%;"></td> <td style="width: 10%;"></td> <td style="width: 10%;"></td> <td style="width: 10%;"></td> <td style="width: 10%;"></td> <td style="width: 10%;"></td> <td style="width: 10%;"></td> <td style="width: 10%;"></td> </tr> <tr> <td></td> <td></td> <td colspan="8" style="text-align: center;"> <table border="1" style="width: 100%; border-collapse: collapse; text-align: center;"> <tr> <td style="width: 10%;"></td> <td style="width: 10%;"></td> <td style="width: 10%;"></td> <td style="width: 10%;"></td> <td style="width: 10%;"></td> <td style="width: 10%;"></td> <td style="width: 10%;"></td> <td style="width: 10%;"></td> <td style="width: 10%;"></td> <td style="width: 10%;"></td> </tr> <tr> <td></td> <td></td> <td colspan="8" style="text-align: center;"> <table border="1" style="width: 100%; border-collapse: collapse; text-align: center;"> <tr> <td style="width: 10%;"></td> <td style="width: 10%;"></td> <td style="width: 10%;"></td> <td style="width: 10%;"></td> <td style="width: 10%;"></td> <td style="width: 10%;"></td> <td style="width: 10%;"></td> <td style="width: 10%;"></td> <td style="width: 10%;"></td> <td style="width: 10%;"></td> </tr> <tr> <td></td> <td></td> <td colspan="8" style="text-align: center;"> <table border="1" style="width: 100%; border-collapse: collapse; text-align: center;"> <tr> <td style="width: 10%;"></td> <td style="width: 10%;"></td> <td style="width: 10%;"></td> <td style="width: 10%;"></td> <td style="width: 10%;"></td> <td style="width: 10%;"></td> <td style="width: 10%;"></td> <td style="width: 10%;"></td> <td style="width: 10%;"></td> <td style="width: 10%;"></td> </tr> <tr> <td></td> <td></td> <td colspan="8" style="text-align: center;"> <table border="1" style="width: 100%; border-collapse: collapse; text-align: center;"> <tr> <td style="width: 10%;"></td> <td style="width: 10%;"></td> <td style="width: 10%;"></td> <td style="width: 10%;"></td> <td style="width: 10%;"></td> <td style="width: 10%;"></td> <td style="width: 10%;"></td> <td style="width: 10%;"></td> <td style="width: 10%;"></td> <td style="width: 10%;"></td> </tr> <tr> <td></td> <td></td> <td colspan="8" style="text-align: center;"> <table border="1" style="width: 100%; border-collapse: collapse; text-align: center;"> <tr> <td style="width: 10%;"></td> <td style="width: 10%;"></td> <td style="width: 10%;"></td> <td style="width: 10%;"></td> <td style="width: 10%;"></td> <td style="width: 10%;"></td> <td style="width: 10%;"></td> <td style="width: 10%;"></td> <td style="width: 10%;"></td> <td style="width: 10%;"></td> </tr> <tr> <td></td> <td></td> <td colspan="8" style="text-align: center;"> <table border="1" style="width: 100%; border-collapse: collapse; text-align: center;"> <tr> <td style="width: 10%;"></td> <td style="width: 10%;"></td> <td style="width: 10%;"></td> <td style="width: 10%;"></td> <td style="width: 10%;"></td> <td style="width: 10%;"></td> <td style="width: 10%;"></td> <td style="width: 10%;"></td> <td style="width: 10%;"></td> <td style="width: 10%;"></td> </tr> <tr> <td></td> <td></td> <td colspan="8" style="text-align: center;"> <table border="1" style="width: 100%; border-collapse: collapse; text-align: center;"> <tr> <td style="width: 10%;"></td> <td style="width: 10%;"></td> <td style="width: 10%;"></td> <td style="width: 10%;"></td> <td style="width: 10%;"></td> <td style="width: 10%;"></td> <td style="width: 10%;"></td> <td style="width: 10%;"></td> <td style="width: 10%;"></td> <td style="width: 10%;"></td> </tr> <tr> <td></td> <td></td> <td colspan="8" style="text-align: center;"> <table border="1" style="width: 100%; border-collapse: collapse; text-align: center;"> <tr> <td style="width: 10%;"></td> <td style="width: 10%;"></td> <td style="width: 10%;"></td> <td style="width: 10%;"></td> <td style="width: 10%;"></td> <td style="width: 10%;"></td> <td style="width: 10%;"></td> <td style="width: 10%;"></td> <td style="width: 10%;"></td> <td style="width: 10%;"></td> </tr> <tr> <td></td> <td></td> <td colspan="8" style="text-align: center;"> <table border="1" style="width: 100%; border-collapse: collapse; text-align: center;"> <tr> <td style="width: 10%;"></td> <td style="width: 10%;"></td> <td style="width: 10%;"></td> <td style="width: 10%;"></td> <td style="width: 10%;"></td> <td style="width: 10%;"></td> <td style="width: 10%;"></td> <td style="width: 10%;"></td> <td style="width: 10%;"></td> <td style="width: 10%;"></td> </tr> <tr> <td></td> <td></td> <td colspan="8" style="text-align: center;"> <table border="1" style="width: 100%; border-collapse: collapse; text-align: center;"> <tr> <td style="width: 10%;"></td> <td style="width: 10%;"></td> <td style="width: 10%;"></td> <td style="width: 10%;"></td> <td style="width: 10%;"></td> <td style="width: 10%;"></td> <td style="width: 10%;"></td> <td style="width: 10%;"></td> <td style="width: 10%;"></td> <td style="width: 10%;"></td> </tr> <tr> <td></td> <td></td> <td colspan="8" style="text-align: center;"> <table border="1" style="width: 100%; border-collapse: collapse; text-align: center;"> <tr> <td style="width: 10%;"></td> <td style="width: 10%;"></td> <td style="width: 10%;"></td> <td style="width: 10%;"></td> <td style="width: 10%;"></td> <td style="width: 10%;"></td> <td style="width: 10%;"></td> <td style="width: 10%;"></td> <td style="width: 10%;"></td> <td style="width: 10%;"></td> </tr> <tr> <td></td> <td></td> <td colspan="8" style="text-align: center;"> <table border="1" style="width: 100%; border-collapse: collapse; text-align: center;"> <tr> <td style="width: 10%;"></td> <td style="width: 10%;"></td> <td style="width: 10%;"></td> <td style="width: 10%;"></td> <td style="width: 10%;"></td> <td style="width: 10%;"></td> <td style="width: 10%;"></td> <td style="width: 10%;"></td> <td style="width: 10%;"></td> <td style="width: 10%;"></td> </tr> <tr> <td></td> <td></td> <td colspan="8" style="text-align: center;"> <table border="1" style="width: 100%; border-collapse: collapse; text-align: center;"> <tr> <td style="width: 10%;"></td> <td style="width: 10%;"></td> <td style="width: 10%;"></td> <td style="width: 10%;"></td> <td style="width: 10%;"></td> <td style="width: 10%;"></td> <td style="width: 10%;"></td> <td style="width: 10%;"></td> <td style="width: 10%;"></td> <td style="width: 10%;"></td> </tr> <tr> <td></td> <td></td> <td colspan="8" style="text-align: center;"> <table border="1" style="width: 100%; border-collapse: collapse; text-align: center;"> <tr> </tr></table></td></tr></table></td></tr></table></td></tr></table></td></tr></table></td></tr></table></td></tr></table></td></tr></table></td></tr></table></td></tr></table></td></tr></table></td></tr></table></td></tr></table></td></tr></table></td></tr></table></td></tr></table>
 | | | | | | | | | | | | | | | | | | | | <table border="1" style="width: 100%; border-collapse: collapse; text-align: center;"> <tr> <td style="width: 10%;"></td> <td style="width: 10%;"></td> <td style="width: 10%;"></td> <td style="width: 10%;"></td> <td style="width: 10%;"></td> <td style="width: 10%;"></td> <td style="width: 10%;"></td> <td style="width: 10%;"></td> <td style="width: 10%;"></td> <td style="width: 10%;"></td> </tr> <tr> <td></td> <td></td> <td colspan="8" style="text-align: center;"> <table border="1" style="width: 100%; border-collapse: collapse; text-align: center;"> <tr> <td style="width: 10%;"></td> <td style="width: 10%;"></td> <td style="width: 10%;"></td> <td style="width: 10%;"></td> <td style="width: 10%;"></td> <td style="width: 10%;"></td> <td style="width: 10%;"></td> <td style="width: 10%;"></td> <td style="width: 10%;"></td> <td style="width: 10%;"></td> </tr> <tr> <td></td> <td></td> <td colspan="8" style="text-align: center;"> <table border="1" style="width: 100%; border-collapse: collapse; text-align: center;"> <tr> <td style="width: 10%;"></td> <td style="width: 10%;"></td> <td style="width: 10%;"></td> <td style="width: 10%;"></td> <td style="width: 10%;"></td> <td style="width: 10%;"></td> <td style="width: 10%;"></td> <td style="width: 10%;"></td> <td style="width: 10%;"></td> <td style="width: 10%;"></td> </tr> <tr> <td></td> <td></td> <td colspan="8" style="text-align: center;"> <table border="1" style="width: 100%; border-collapse: collapse; text-align: center;"> <tr> <td style="width: 10%;"></td> <td style="width: 10%;"></td> <td style="width: 10%;"></td> <td style="width: 10%;"></td> <td style="width: 10%;"></td> <td style="width: 10%;"></td> <td style="width: 10%;"></td> <td style="width: 10%;"></td> <td style="width: 10%;"></td> <td style="width: 10%;"></td> </tr> <tr> <td></td> <td></td> <td colspan="8" style="text-align: center;"> <table border="1" style="width: 100%; border-collapse: collapse; text-align: center;"> <tr> <td style="width: 10%;"></td> <td style="width: 10%;"></td> <td style="width: 10%;"></td> <td style="width: 10%;"></td> <td style="width: 10%;"></td> <td style="width: 10%;"></td> <td style="width: 10%;"></td> <td style="width: 10%;"></td> <td style="width: 10%;"></td> <td style="width: 10%;"></td> </tr> <tr> <td></td> <td></td> <td colspan="8" style="text-align: center;"> <table border="1" style="width: 100%; border-collapse: collapse; text-align: center;"> <tr> <td style="width: 10%;"></td> <td style="width: 10%;"></td> <td style="width: 10%;"></td> <td style="width: 10%;"></td> <td style="width: 10%;"></td> <td style="width: 10%;"></td> <td style="width: 10%;"></td> <td style="width: 10%;"></td> <td style="width: 10%;"></td> <td style="width: 10%;"></td> </tr> <tr> <td></td> <td></td> <td colspan="8" style="text-align: center;"> <table border="1" style="width: 100%; border-collapse: collapse; text-align: center;"> <tr> <td style="width: 10%;"></td> <td style="width: 10%;"></td> <td style="width: 10%;"></td> <td style="width: 10%;"></td> <td style="width: 10%;"></td> <td style="width: 10%;"></td> <td style="width: 10%;"></td> <td style="width: 10%;"></td> <td style="width: 10%;"></td> <td style="width: 10%;"></td> </tr> <tr> <td></td> <td></td> <td colspan="8" style="text-align: center;"> <table border="1" style="width: 100%; border-collapse: collapse; text-align: center;"> <tr> <td style="width: 10%;"></td> <td style="width: 10%;"></td> <td style="width: 10%;"></td> <td style="width: 10%;"></td> <td style="width: 10%;"></td> <td style="width: 10%;"></td> <td style="width: 10%;"></td> <td style="width: 10%;"></td> <td style="width: 10%;"></td> <td style="width: 10%;"></td> </tr> <tr> <td></td> <td></td> <td colspan="8" style="text-align: center;"> <table border="1" style="width: 100%; border-collapse: collapse; text-align: center;"> <tr> <td style="width: 10%;"></td> <td style="width: 10%;"></td> <td style="width: 10%;"></td> <td style="width: 10%;"></td> <td style="width: 10%;"></td> <td style="width: 10%;"></td> <td style="width: 10%;"></td> <td style="width: 10%;"></td> <td style="width: 10%;"></td> <td style="width: 10%;"></td> </tr> <tr> <td></td> <td></td> <td colspan="8" style="text-align: center;"> <table border="1" style="width: 100%; border-collapse: collapse; text-align: center;"> <tr> <td style="width: 10%;"></td> <td style="width: 10%;"></td> <td style="width: 10%;"></td> <td style="width: 10%;"></td> <td style="width: 10%;"></td> <td style="width: 10%;"></td> <td style="width: 10%;"></td> <td style="width: 10%;"></td> <td style="width: 10%;"></td> <td style="width: 10%;"></td> </tr> <tr> <td></td> <td></td> <td colspan="8" style="text-align: center;"> <table border="1" style="width: 100%; border-collapse: collapse; text-align: center;"> <tr> <td style="width: 10%;"></td> <td style="width: 10%;"></td> <td style="width: 10%;"></td> <td style="width: 10%;"></td> <td style="width: 10%;"></td> <td style="width: 10%;"></td> <td style="width: 10%;"></td> <td style="width: 10%;"></td> <td style="width: 10%;"></td> <td style="width: 10%;"></td> </tr> <tr> <td></td> <td></td> <td colspan="8" style="text-align: center;"> <table border="1" style="width: 100%; border-collapse: collapse; text-align: center;"> <tr> <td style="width: 10%;"></td> <td style="width: 10%;"></td> <td style="width: 10%;"></td> <td style="width: 10%;"></td> <td style="width: 10%;"></td> <td style="width: 10%;"></td> <td style="width: 10%;"></td> <td style="width: 10%;"></td> <td style="width: 10%;"></td> <td style="width: 10%;"></td> </tr> <tr> <td></td> <td></td> <td colspan="8" style="text-align: center;"> <table border="1" style="width: 100%; border-collapse: collapse; text-align: center;"> <tr> <td style="width: 10%;"></td> <td style="width: 10%;"></td> <td style="width: 10%;"></td> <td style="width: 10%;"></td> <td style="width: 10%;"></td> <td style="width: 10%;"></td> <td style="width: 10%;"></td> <td style="width: 10%;"></td> <td style="width: 10%;"></td> <td style="width: 10%;"></td> </tr> <tr> <td></td> <td></td> <td colspan="8" style="text-align: center;"> <table border="1" style="width: 100%; border-collapse: collapse; text-align: center;"> <tr> <td style="width: 10%;"></td> <td style="width: 10%;"></td> <td style="width: 10%;"></td> <td style="width: 10%;"></td> <td style="width: 10%;"></td> <td style="width: 10%;"></td> <td style="width: 10%;"></td> <td style="width: 10%;"></td> <td style="width: 10%;"></td> <td style="width: 10%;"></td> </tr> <tr> <td></td> <td></td> <td colspan="8" style="text-align: center;"> <table border="1" style="width: 100%; border-collapse: collapse; text-align: center;"> <tr> </tr></table></td></tr></table></td></tr></table></td></tr></table></td></tr></table></td></tr></table></td></tr></table></td></tr></table></td></tr></table></td></tr></table></td></tr></table></td></tr></table></td></tr></table></td></tr></table></td></tr></table>
 | | | | | | | | | | | | | | | | | | | | <table border="1" style="width: 100%; border-collapse: collapse; text-align: center;"> <tr> <td style="width: 10%;"></td> <td style="width: 10%;"></td> <td style="width: 10%;"></td> <td style="width: 10%;"></td> <td style="width: 10%;"></td> <td style="width: 10%;"></td> <td style="width: 10%;"></td> <td style="width: 10%;"></td> <td style="width: 10%;"></td> <td style="width: 10%;"></td> </tr> <tr> <td></td> <td></td> <td colspan="8" style="text-align: center;"> <table border="1" style="width: 100%; border-collapse: collapse; text-align: center;"> <tr> <td style="width: 10%;"></td> <td style="width: 10%;"></td> <td style="width: 10%;"></td> <td style="width: 10%;"></td> <td style="width: 10%;"></td> <td style="width: 10%;"></td> <td style="width: 10%;"></td> <td style="width: 10%;"></td> <td style="width: 10%;"></td> <td style="width: 10%;"></td> </tr> <tr> <td></td> <td></td> <td colspan="8" style="text-align: center;"> <table border="1" style="width: 100%; border-collapse: collapse; text-align: center;"> <tr> <td style="width: 10%;"></td> <td style="width: 10%;"></td> <td style="width: 10%;"></td> <td style="width: 10%;"></td> <td style="width: 10%;"></td> <td style="width: 10%;"></td> <td style="width: 10%;"></td> <td style="width: 10%;"></td> <td style="width: 10%;"></td> <td style="width: 10%;"></td> </tr> <tr> <td></td> <td></td> <td colspan="8" style="text-align: center;"> <table border="1" style="width: 100%; border-collapse: collapse; text-align: center;"> <tr> <td style="width: 10%;"></td> <td style="width: 10%;"></td> <td style="width: 10%;"></td> <td style="width: 10%;"></td> <td style="width: 10%;"></td> <td style="width: 10%;"></td> <td style="width: 10%;"></td> <td style="width: 10%;"></td> <td style="width: 10%;"></td> <td style="width: 10%;"></td> </tr> <tr> <td></td> <td></td> <td colspan="8" style="text-align: center;"> <table border="1" style="width: 100%; border-collapse: collapse; text-align: center;"> <tr> <td style="width: 10%;"></td> <td style="width: 10%;"></td> <td style="width: 10%;"></td> <td style="width: 10%;"></td> <td style="width: 10%;"></td> <td style="width: 10%;"></td> <td style="width: 10%;"></td> <td style="width: 10%;"></td> <td style="width: 10%;"></td> <td style="width: 10%;"></td> </tr> <tr> <td></td> <td></td> <td colspan="8" style="text-align: center;"> <table border="1" style="width: 100%; border-collapse: collapse; text-align: center;"> <tr> <td style="width: 10%;"></td> <td style="width: 10%;"></td> <td style="width: 10%;"></td> <td style="width: 10%;"></td> <td style="width: 10%;"></td> <td style="width: 10%;"></td> <td style="width: 10%;"></td> <td style="width: 10%;"></td> <td style="width: 10%;"></td> <td style="width: 10%;"></td> </tr> <tr> <td></td> <td></td> <td colspan="8" style="text-align: center;"> <table border="1" style="width: 100%; border-collapse: collapse; text-align: center;"> <tr> <td style="width: 10%;"></td> <td style="width: 10%;"></td> <td style="width: 10%;"></td> <td style="width: 10%;"></td> <td style="width: 10%;"></td> <td style="width: 10%;"></td> <td style="width: 10%;"></td> <td style="width: 10%;"></td> <td style="width: 10%;"></td> <td style="width: 10%;"></td> </tr> <tr> <td></td> <td></td> <td colspan="8" style="text-align: center;"> <table border="1" style="width: 100%; border-collapse: collapse; text-align: center;"> <tr> <td style="width: 10%;"></td> <td style="width: 10%;"></td> <td style="width: 10%;"></td> <td style="width: 10%;"></td> <td style="width: 10%;"></td> <td style="width: 10%;"></td> <td style="width: 10%;"></td> <td style="width: 10%;"></td> <td style="width: 10%;"></td> <td style="width: 10%;"></td> </tr> <tr> <td></td> <td></td> <td colspan="8" style="text-align: center;"> <table border="1" style="width: 100%; border-collapse: collapse; text-align: center;"> <tr> <td style="width: 10%;"></td> <td style="width: 10%;"></td> <td style="width: 10%;"></td> <td style="width: 10%;"></td> <td style="width: 10%;"></td> <td style="width: 10%;"></td> <td style="width: 10%;"></td> <td style="width: 10%;"></td> <td style="width: 10%;"></td> <td style="width: 10%;"></td> </tr> <tr> <td></td> <td></td> <td colspan="8" style="text-align: center;"> <table border="1" style="width: 100%; border-collapse: collapse; text-align: center;"> <tr> <td style="width: 10%;"></td> <td style="width: 10%;"></td> <td style="width: 10%;"></td> <td style="width: 10%;"></td> <td style="width: 10%;"></td> <td style="width: 10%;"></td> <td style="width: 10%;"></td> <td style="width: 10%;"></td> <td style="width: 10%;"></td> <td style="width: 10%;"></td> </tr> <tr> <td></td> <td></td> <td colspan="8" style="text-align: center;"> <table border="1" style="width: 100%; border-collapse: collapse; text-align: center;"> <tr> <td style="width: 10%;"></td> <td style="width: 10%;"></td> <td style="width: 10%;"></td> <td style="width: 10%;"></td> <td style="width: 10%;"></td> <td style="width: 10%;"></td> <td style="width: 10%;"></td> <td style="width: 10%;"></td> <td style="width: 10%;"></td> <td style="width: 10%;"></td> </tr> <tr> <td></td> <td></td> <td colspan="8" style="text-align: center;"> <table border="1" style="width: 100%; border-collapse: collapse; text-align: center;"> <tr> <td style="width: 10%;"></td> <td style="width: 10%;"></td> <td style="width: 10%;"></td> <td style="width: 10%;"></td> <td style="width: 10%;"></td> <td style="width: 10%;"></td> <td style="width: 10%;"></td> <td style="width: 10%;"></td> <td style="width: 10%;"></td> <td style="width: 10%;"></td> </tr> <tr> <td></td> <td></td> <td colspan="8" style="text-align: center;"> <table border="1" style="width: 100%; border-collapse: collapse; text-align: center;"> <tr> <td style="width: 10%;"></td> <td style="width: 10%;"></td> <td style="width: 10%;"></td> <td style="width: 10%;"></td> <td style="width: 10%;"></td> <td style="width: 10%;"></td> <td style="width: 10%;"></td> <td style="width: 10%;"></td> <td style="width: 10%;"></td> <td style="width: 10%;"></td>
</tr> <tr> <td></td> <td></td> <td colspan="8" style="text-align: center;"> <table border="1" style="width: 100%; border-collapse: collapse; text-align: center;"> <tr> </tr></table></td></tr></table></td></tr></table></td></tr></table></td></tr></table></td></tr></table></td></tr></table></td></tr></table></td></tr></table></td></tr></table></td></tr></table></td></tr></table></td></tr></table></td></tr></table> | | | | | | | | | | | | | | | | | | | | <table border="1" style="width: 100%; border-collapse: collapse; text-align: center;"> <tr> <td style="width: 10%;"></td> <td style="width: 10%;"></td> <td style="width: 10%;"></td> <td style="width: 10%;"></td> <td style="width: 10%;"></td> <td style="width: 10%;"></td> <td style="width: 10%;"></td> <td style="width: 10%;"></td> <td style="width: 10%;"></td> <td style="width: 10%;"></td> </tr> <tr> <td></td> <td></td> <td colspan="8" style="text-align: center;"> <table border="1" style="width: 100%; border-collapse: collapse; text-align: center;"> <tr> <td style="width: 10%;"></td> <td style="width: 10%;"></td> <td style="width: 10%;"></td> <td style="width: 10%;"></td> <td style="width: 10%;"></td> <td style="width: 10%;"></td> <td style="width: 10%;"></td> <td style="width: 10%;"></td> <td style="width: 10%;"></td> <td style="width: 10%;"></td> </tr> <tr> <td></td> <td></td> <td colspan="8" style="text-align: center;"> <table border="1" style="width: 100%; border-collapse: collapse; text-align: center;"> <tr> <td style="width: 10%;"></td> <td style="width: 10%;"></td> <td style="width: 10%;"></td> <td style="width: 10%;"></td> <td style="width: 10%;"></td> <td style="width: 10%;"></td> <td style="width: 10%;"></td> <td style="width: 10%;"></td> <td style="width: 10%;"></td> <td style="width: 10%;"></td> </tr> <tr> <td></td> <td></td> <td colspan="8" style="text-align: center;"> <table border="1" style="width: 100%; border-collapse: collapse; text-align: center;"> <tr> <td style="width: 10%;"></td> <td style="width: 10%;"></td> <td style="width: 10%;"></td> <td style="width: 10%;"></td> <td style="width: 10%;"></td> <td style="width: 10%;"></td> <td style="width: 10%;"></td> <td style="width: 10%;"></td> <td style="width: 10%;"></td> <td style="width: 10%;"></td> </tr> <tr> <td></td> <td></td> <td colspan="8" style="text-align: center;"> <table border="1" style="width: 100%; border-collapse: collapse; text-align: center;"> <tr> <td style="width: 10%;"></td> <td style="width: 10%;"></td> <td style="width: 10%;"></td> <td style="width: 10%;"></td> <td style="width: 10%;"></td> <td style="width: 10%;"></td> <td style="width: 10%;"></td> <td style="width: 10%;"></td> <td style="width: 10%;"></td> <td style="width: 10%;"></td> </tr> <tr> <td></td> <td></td> <td colspan="8" style="text-align: center;"> <table border="1" style="width: 100%; border-collapse: collapse; text-align: center;"> <tr> <td style="width: 10%;"></td> <td style="width: 10%;"></td> <td style="width: 10%;"></td> <td style="width: 10%;"></td> <td style="width: 10%;"></td> <td style="width: 10%;"></td> <td style="width: 10%;"></td> <td style="width: 10%;"></td> <td style="width: 10%;"></td> <td style="width: 10%;"></td> </tr> <tr> <td></td> <td></td> <td colspan="8" style="text-align: center;"> <table border="1" style="width: 100%; border-collapse: collapse; text-align: center;"> <tr> <td style="width: 10%;"></td> <td style="width: 10%;"></td> <td style="width: 10%;"></td> <td style="width: 10%;"></td> <td style="width: 10%;"></td> <td style="width: 10%;"></td> <td style="width: 10%;"></td> <td style="width: 10%;"></td> <td style="width: 10%;"></td> <td style="width: 10%;"></td> </tr> <tr> <td></td> <td></td> <td colspan="8" style="text-align: center;"> <table border="1" style="width: 100%; border-collapse: collapse; text-align: center;"> <tr> <td style="width: 10%;"></td> <td style="width: 10%;"></td> <td style="width: 10%;"></td> <td style="width: 10%;"></td> <td style="width: 10%;"></td> <td style="width: 10%;"></td> <td style="width: 10%;"></td> <td style="width: 10%;"></td> <td style="width: 10%;"></td> <td style="width: 10%;"></td> </tr> <tr> <td></td> <td></td> <td colspan="8" style="text-align: center;"> <table border="1" style="width: 100%; border-collapse: collapse; text-align: center;"> <tr> <td style="width: 10%;"></td> <td style="width: 10%;"></td> <td style="width: 10%;"></td> <td style="width: 10%;"></td> <td style="width: 10%;"></td> <td style="width: 10%;"></td> <td style="width: 10%;"></td> <td style="width: 10%;"></td> <td style="width: 10%;"></td> <td style="width: 10%;"></td> </tr> <tr> <td></td> <td></td> <td colspan="8" style="text-align: center;"> <table border="1" style="width: 100%; border-collapse: collapse; text-align: center;"> <tr> <td style="width: 10%;"></td> <td style="width: 10%;"></td> <td style="width: 10%;"></td> <td style="width: 10%;"></td> <td style="width: 10%;"></td> <td style="width: 10%;"></td> <td style="width: 10%;"></td> <td style="width: 10%;"></td> <td style="width: 10%;"></td> <td style="width: 10%;"></td> </tr> <tr> <td></td> <td></td> <td colspan="8"
style="text-align: center;"> <table border="1" style="width: 100%; border-collapse: collapse; text-align: center;"> <tr> <td style="width: 10%;"></td> <td style="width: 10%;"></td> <td style="width: 10%;"></td> <td style="width: 10%;"></td> <td style="width: 10%;"></td> <td style="width: 10%;"></td> <td style="width: 10%;"></td> <td style="width: 10%;"></td> <td style="width: 10%;"></td> <td style="width: 10%;"></td> </tr> <tr> <td></td> <td></td> <td colspan="8" style="text-align: center;"> <table border="1" style="width: 100%; border-collapse: collapse; text-align: center;"> <tr> <td style="width: 10%;"></td> <td style="width: 10%;"></td> <td style="width: 10%;"></td> <td style="width: 10%;"></td> <td style="width: 10%;"></td> <td style="width: 10%;"></td> <td style="width: 10%;"></td> <td style="width: 10%;"></td> <td style="width: 10%;"></td> <td style="width: 10%;"></td> </tr> <tr> <td></td> <td></td> <td colspan="8" style="text-align: center;"> <table border="1" style="width: 100%; border-collapse: collapse; text-align: center;"> <tr> </tr></table></td></tr></table></td></tr></table></td></tr></table></td></tr></table></td></tr></table></td></tr></table></td></tr></table></td></tr></table></td></tr></table></td></tr></table></td></tr></table></td></tr></table> | | | | | | | | | | | | | | | | | | | | <table border="1" style="width: 100%; border-collapse: collapse; text-align: center;"> <tr> <td style="width: 10%;"></td> <td style="width: 10%;"></td> <td style="width: 10%;"></td> <td style="width: 10%;"></td> <td style="width: 10%;"></td> <td style="width: 10%;"></td> <td style="width: 10%;"></td> <td style="width: 10%;"></td> <td style="width: 10%;"></td> <td style="width: 10%;"></td> </tr> <tr> <td></td> <td></td> <td colspan="8" style="text-align: center;"> <table border="1" style="width: 100%; border-collapse: collapse; text-align: center;"> <tr> <td style="width: 10%;"></td> <td style="width: 10%;"></td> <td style="width: 10%;"></td> <td style="width: 10%;"></td> <td style="width: 10%;"></td> <td style="width: 10%;"></td> <td style="width: 10%;"></td> <td style="width: 10%;"></td> <td style="width: 10%;"></td> <td style="width: 10%;"></td> </tr> <tr> <td></td> <td></td> <td colspan="8" style="text-align: center;"> <table border="1" style="width: 100%; border-collapse: collapse; text-align: center;"> <tr> <td style="width: 10%;"></td> <td style="width: 10%;"></td> <td style="width: 10%;"></td> <td style="width: 10%;"></td> <td style="width: 10%;"></td> <td style="width: 10%;"></td> <td style="width: 10%;"></td> <td style="width: 10%;"></td> <td style="width: 10%;"></td> <td style="width: 10%;"></td> </tr> <tr> <td></td> <td></td> <td colspan="8" style="text-align: center;"> <table border="1" style="width: 100%; border-collapse: collapse; text-align: center;"> <tr> <td style="width: 10%;"></td> <td style="width: 10%;"></td> <td style="width: 10%;"></td> <td style="width: 10%;"></td> <td style="width: 10%;"></td> <td style="width: 10%;"></td> <td style="width: 10%;"></td> <td style="width: 10%;"></td> <td style="width: 10%;"></td> <td style="width: 10%;"></td> </tr> <tr> <td></td> <td></td> <td colspan="8" style="text-align: center;"> <table border="1" style="width: 100%; border-collapse: collapse; text-align: center;"> <tr> <td style="width: 10%;"></td> <td style="width: 10%;"></td> <td style="width: 10%;"></td> <td style="width: 10%;"></td> <td style="width: 10%;"></td> <td style="width: 10%;"></td> <td style="width: 10%;"></td> <td style="width: 10%;"></td> <td style="width: 10%;"></td> <td style="width: 10%;"></td> </tr> <tr> <td></td> <td></td> <td colspan="8" style="text-align: center;"> <table border="1" style="width: 100%; border-collapse: collapse; text-align: center;"> <tr> <td style="width: 10%;"></td> <td style="width: 10%;"></td> <td style="width: 10%;"></td> <td style="width: 10%;"></td> <td style="width: 10%;"></td> <td style="width: 10%;"></td> <td style="width: 10%;"></td> <td style="width: 10%;"></td> <td style="width: 10%;"></td> <td style="width: 10%;"></td> </tr> <tr> <td></td> <td></td> <td colspan="8" style="text-align: center;"> <table border="1" style="width: 100%; border-collapse: collapse; text-align: center;"> <tr> <td style="width: 10%;"></td> <td style="width: 10%;"></td> <td style="width: 10%;"></td> <td style="width: 10%;"></td> <td style="width: 10%;"></td> <td style="width: 10%;"></td> <td style="width: 10%;"></td> <td style="width: 10%;"></td> <td style="width: 10%;"></td> <td style="width: 10%;"></td> </tr> <tr> <td></td> <td></td> <td colspan="8" style="text-align: center;"> <table border="1" style="width: 100%; border-collapse: collapse; text-align: center;"> <tr> <td style="width: 10%;"></td> <td style="width: 10%;"></td> <td style="width: 10%;"></td> <td style="width: 10%;"></td> <td style="width: 10%;"></td> <td style="width: 10%;"></td> <td style="width: 10%;"></td> <td style="width: 10%;"></td> <td style="width: 10%;"></td> <td style="width: 10%;"></td> </tr> <tr> <td></td> <td></td> <td colspan="8" style="text-align: center;"> <table border="1" style="width: 100%;
border-collapse: collapse; text-align: center;"> <tr> <td style="width: 10%;"></td> <td style="width: 10%;"></td> <td style="width: 10%;"></td> <td style="width: 10%;"></td> <td style="width: 10%;"></td> <td style="width: 10%;"></td> <td style="width: 10%;"></td> <td style="width: 10%;"></td> <td style="width: 10%;"></td> <td style="width: 10%;"></td> </tr> <tr> <td></td> <td></td> <td colspan="8" style="text-align: center;"> <table border="1" style="width: 100%; border-collapse: collapse; text-align: center;"> <tr> <td style="width: 10%;"></td> <td style="width: 10%;"></td> <td style="width: 10%;"></td> <td style="width: 10%;"></td> <td style="width: 10%;"></td> <td style="width: 10%;"></td> <td style="width: 10%;"></td> <td style="width: 10%;"></td> <td style="width: 10%;"></td> <td style="width: 10%;"></td> </tr> <tr> <td></td> <td></td> <td colspan="8" style="text-align: center;"> <table border="1" style="width: 100%; border-collapse: collapse; text-align: center;"> <tr> <td style="width: 10%;"></td> <td style="width: 10%;"></td> <td style="width: 10%;"></td> <td style="width: 10%;"></td> <td style="width: 10%;"></td> <td style="width: 10%;"></td> <td style="width: 10%;"></td> <td style="width: 10%;"></td> <td style="width: 10%;"></td> <td style="width: 10%;"></td> </tr> <tr> <td></td> <td></td> <td colspan="8" style="text-align: center;"> <table border="1" style="width: 100%; border-collapse: collapse; text-align: center;"> <tr> </tr></table></td></tr></table></td></tr></table></td></tr></table></td></tr></table></td></tr></table></td></tr></table></td></tr></table></td></tr></table></td></tr></table></td></tr></table></td></tr></table> | | | | | | | | | | | | | | | | | | | | <table border="1" style="width: 100%; border-collapse: collapse; text-align: center;"> <tr> <td style="width: 10%;"></td> <td style="width: 10%;"></td> <td style="width: 10%;"></td> <td style="width: 10%;"></td> <td style="width: 10%;"></td> <td style="width: 10%;"></td> <td style="width: 10%;"></td> <td style="width: 10%;"></td> <td style="width: 10%;"></td> <td style="width: 10%;"></td> </tr> <tr> <td></td> <td></td> <td colspan="8" style="text-align: center;"> <table border="1" style="width: 100%; border-collapse: collapse; text-align: center;"> <tr> <td style="width: 10%;"></td> <td style="width: 10%;"></td> <td style="width: 10%;"></td> <td style="width: 10%;"></td> <td style="width: 10%;"></td> <td style="width: 10%;"></td> <td style="width: 10%;"></td> <td style="width: 10%;"></td> <td style="width: 10%;"></td> <td style="width: 10%;"></td> </tr> <tr> <td></td> <td></td> <td colspan="8" style="text-align: center;"> <table border="1" style="width: 100%; border-collapse: collapse; text-align: center;"> <tr> <td style="width: 10%;"></td> <td style="width: 10%;"></td> <td style="width: 10%;"></td> <td style="width: 10%;"></td> <td style="width: 10%;"></td> <td style="width: 10%;"></td> <td style="width: 10%;"></td> <td style="width: 10%;"></td> <td style="width: 10%;"></td> <td style="width: 10%;"></td> </tr> <tr> <td></td> <td></td> <td colspan="8" style="text-align: center;"> <table border="1" style="width: 100%; border-collapse: collapse; text-align: center;"> <tr> <td style="width: 10%;"></td> <td style="width: 10%;"></td> <td style="width: 10%;"></td> <td style="width: 10%;"></td> <td style="width: 10%;"></td> <td style="width: 10%;"></td> <td style="width: 10%;"></td> <td style="width: 10%;"></td> <td style="width: 10%;"></td> <td style="width: 10%;"></td> </tr> <tr> <td></td> <td></td> <td colspan="8" style="text-align: center;"> <table border="1" style="width: 100%; border-collapse: collapse; text-align: center;"> <tr> <td style="width: 10%;"></td> <td style="width: 10%;"></td> <td style="width: 10%;"></td> <td style="width: 10%;"></td> <td style="width: 10%;"></td> <td style="width: 10%;"></td> <td style="width: 10%;"></td> <td style="width: 10%;"></td> <td style="width: 10%;"></td> <td style="width: 10%;"></td> </tr> <tr> <td></td> <td></td> <td colspan="8" style="text-align: center;"> <table border="1" style="width: 100%; border-collapse: collapse; text-align: center;"> <tr> <td style="width: 10%;"></td> <td style="width: 10%;"></td> <td style="width: 10%;"></td> <td style="width: 10%;"></td> <td style="width: 10%;"></td> <td style="width: 10%;"></td> <td style="width: 10%;"></td> <td style="width: 10%;"></td> <td style="width: 10%;"></td> <td style="width: 10%;"></td> </tr> <tr> <td></td> <td></td> <td colspan="8" style="text-align: center;"> <table border="1" style="width: 100%; border-collapse: collapse; text-align: center;"> <tr> <td style="width: 10%;"></td> <td style="width: 10%;"></td> <td style="width: 10%;"></td> <td style="width: 10%;"></td> <td style="width: 10%;"></td> <td style="width: 10%;"></td> <td style="width: 10%;"></td> <td style="width: 10%;"></td> <td style="width: 10%;"></td> <td style="width: 10%;"></td> </tr> <tr> <td></td> <td></td> <td colspan="8" style="text-align: center;"> <table border="1" style="width: 100%; border-collapse: collapse; text-align: center;"> <tr> <td style="width: 10%;"></td> <td
style="width: 10%;"></td> <td style="width: 10%;"></td> <td style="width: 10%;"></td> <td style="width: 10%;"></td> <td style="width: 10%;"></td> <td style="width: 10%;"></td> <td style="width: 10%;"></td> <td style="width: 10%;"></td> <td style="width: 10%;"></td> </tr> <tr> <td></td> <td></td> <td colspan="8" style="text-align: center;"> <table border="1" style="width: 100%; border-collapse: collapse; text-align: center;"> <tr> <td style="width: 10%;"></td> <td style="width: 10%;"></td> <td style="width: 10%;"></td> <td style="width: 10%;"></td> <td style="width: 10%;"></td> <td style="width: 10%;"></td> <td style="width: 10%;"></td> <td style="width: 10%;"></td> <td style="width: 10%;"></td> <td style="width: 10%;"></td> </tr> <tr> <td></td> <td></td> <td colspan="8" style="text-align: center;"> <table border="1" style="width: 100%; border-collapse: collapse; text-align: center;"> <tr> <td style="width: 10%;"></td> <td style="width: 10%;"></td> <td style="width: 10%;"></td> <td style="width: 10%;"></td> <td style="width: 10%;"></td> <td style="width: 10%;"></td> <td style="width: 10%;"></td> <td style="width: 10%;"></td> <td style="width: 10%;"></td> <td style="width: 10%;"></td> </tr> <tr> <td></td> <td></td> <td colspan="8" style="text-align: center;"> <table border="1" style="width: 100%; border-collapse: collapse; text-align: center;"> <tr> </tr></table></td></tr></table></td></tr></table></td></tr></table></td></tr></table></td></tr></table></td></tr></table></td></tr></table></td></tr></table></td></tr></table></td></tr></table> | | | | | | | | | | | | | | | | | | | | <table border="1" style="width: 100%; border-collapse: collapse; text-align: center;"> <tr> <td style="width: 10%;"></td> <td style="width: 10%;"></td> <td style="width: 10%;"></td> <td style="width: 10%;"></td> <td style="width: 10%;"></td> <td style="width: 10%;"></td> <td style="width: 10%;"></td> <td style="width: 10%;"></td> <td style="width: 10%;"></td> <td style="width: 10%;"></td> </tr> <tr> <td></td> <td></td> <td colspan="8" style="text-align: center;"> <table border="1" style="width: 100%; border-collapse: collapse; text-align: center;"> <tr> <td style="width: 10%;"></td> <td style="width: 10%;"></td> <td style="width: 10%;"></td> <td style="width: 10%;"></td> <td style="width: 10%;"></td> <td style="width: 10%;"></td> <td style="width: 10%;"></td> <td style="width: 10%;"></td> <td style="width: 10%;"></td> <td style="width: 10%;"></td> </tr> <tr> <td></td> <td></td> <td colspan="8" style="text-align: center;"> <table border="1" style="width: 100%; border-collapse: collapse; text-align: center;"> <tr> <td style="width: 10%;"></td> <td style="width: 10%;"></td> <td style="width: 10%;"></td> <td style="width: 10%;"></td> <td style="width: 10%;"></td> <td style="width: 10%;"></td> <td style="width: 10%;"></td> <td style="width: 10%;"></td> <td style="width: 10%;"></td> <td style="width: 10%;"></td> </tr> <tr> <td></td> <td></td> <td colspan="8" style="text-align: center;"> <table border="1" style="width: 100%; border-collapse: collapse; text-align: center;"> <tr> <td style="width: 10%;"></td> <td style="width: 10%;"></td> <td style="width: 10%;"></td> <td style="width: 10%;"></td> <td style="width: 10%;"></td> <td style="width: 10%;"></td> <td style="width: 10%;"></td> <td style="width: 10%;"></td> <td style="width: 10%;"></td> <td style="width: 10%;"></td> </tr> <tr> <td></td> <td></td> <td colspan="8" style="text-align: center;"> <table border="1" style="width: 100%; border-collapse: collapse; text-align: center;"> <tr> <td style="width: 10%;"></td> <td style="width: 10%;"></td> <td style="width: 10%;"></td> <td style="width: 10%;"></td> <td style="width: 10%;"></td> <td style="width: 10%;"></td> <td style="width: 10%;"></td> <td style="width: 10%;"></td> <td style="width: 10%;"></td> <td style="width: 10%;"></td> </tr> <tr> <td></td> <td></td> <td colspan="8" style="text-align: center;"> <table border="1" style="width: 100%; border-collapse: collapse; text-align: center;"> <tr> <td style="width: 10%;"></td> <td style="width: 10%;"></td> <td style="width: 10%;"></td> <td style="width: 10%;"></td> <td style="width: 10%;"></td> <td style="width: 10%;"></td> <td style="width: 10%;"></td> <td style="width: 10%;"></td> <td style="width: 10%;"></td> <td style="width: 10%;"></td> </tr> <tr> <td></td> <td></td> <td colspan="8" style="text-align: center;"> <table border="1" style="width: 100%; border-collapse: collapse; text-align: center;"> <tr> <td style="width: 10%;"></td> <td style="width: 10%;"></td> <td style="width: 10%;"></td> <td style="width: 10%;"></td> <td style="width: 10%;"></td> <td style="width: 10%;"></td> <td style="width: 10%;"></td> <td style="width: 10%;"></td> <td style="width: 10%;"></td> <td style="width: 10%;"></td> </tr> <tr> <td></td> <td></td> <td colspan="8" style="text-align: center;"> <table border="1" style="width: 100%; border-collapse: collapse; text-align: center;"> <tr> <td style="width: 10%;"></td> <td style="width: 10%;"></td> <td style="width: 10%;"></td> <td style="width: 10%;"></td> <td style="width:
10%;"></td> <td style="width: 10%;"></td> <td style="width: 10%;"></td> <td style="width: 10%;"></td> <td style="width: 10%;"></td> <td style="width: 10%;"></td> </tr> <tr> <td></td> <td></td> <td colspan="8" style="text-align: center;"> <table border="1" style="width: 100%; border-collapse: collapse; text-align: center;"> <tr> <td style="width: 10%;"></td> <td style="width: 10%;"></td> <td style="width: 10%;"></td> <td style="width: 10%;"></td> <td style="width: 10%;"></td> <td style="width: 10%;"></td> <td style="width: 10%;"></td> <td style="width: 10%;"></td> <td style="width: 10%;"></td> <td style="width: 10%;"></td> </tr> <tr> <td></td> <td></td> <td colspan="8" style="text-align: center;"> <table border="1" style="width: 100%; border-collapse: collapse; text-align: center;"> <tr> </tr></table></td></tr></table></td></tr></table></td></tr></table></td></tr></table></td></tr></table></td></tr></table></td></tr></table></td></tr></table></td></tr></table> | | | | | | | | | | | | | | | | | | | | <table border="1" style="width: 100%; border-collapse: collapse; text-align: center;"> <tr> <td style="width: 10%;"></td> <td style="width: 10%;"></td> <td style="width: 10%;"></td> <td style="width: 10%;"></td> <td style="width: 10%;"></td> <td style="width: 10%;"></td> <td style="width: 10%;"></td> <td style="width: 10%;"></td> <td style="width: 10%;"></td> <td style="width: 10%;"></td> </tr> <tr> <td></td> <td></td> <td colspan="8" style="text-align: center;"> <table border="1" style="width: 100%; border-collapse: collapse; text-align: center;"> <tr> <td style="width: 10%;"></td> <td style="width: 10%;"></td> <td style="width: 10%;"></td> <td style="width: 10%;"></td> <td style="width: 10%;"></td> <td style="width: 10%;"></td> <td style="width: 10%;"></td> <td style="width: 10%;"></td> <td style="width: 10%;"></td> <td style="width: 10%;"></td> </tr> <tr> <td></td> <td></td> <td colspan="8" style="text-align: center;"> <table border="1" style="width: 100%; border-collapse: collapse; text-align: center;"> <tr> <td style="width: 10%;"></td> <td style="width: 10%;"></td> <td style="width: 10%;"></td> <td style="width: 10%;"></td> <td style="width: 10%;"></td> <td style="width: 10%;"></td> <td style="width: 10%;"></td> <td style="width: 10%;"></td> <td style="width: 10%;"></td> <td style="width: 10%;"></td> </tr> <tr> <td></td> <td></td> <td colspan="8" style="text-align: center;"> <table border="1" style="width: 100%; border-collapse: collapse; text-align: center;"> <tr> <td style="width: 10%;"></td> <td style="width: 10%;"></td> <td style="width: 10%;"></td> <td style="width: 10%;"></td> <td style="width: 10%;"></td> <td style="width: 10%;"></td> <td style="width: 10%;"></td> <td style="width: 10%;"></td> <td style="width: 10%;"></td> <td style="width: 10%;"></td> </tr> <tr> <td></td> <td></td> <td colspan="8" style="text-align: center;"> <table border="1" style="width: 100%; border-collapse: collapse; text-align: center;"> <tr> <td style="width: 10%;"></td> <td style="width: 10%;"></td> <td style="width: 10%;"></td> <td style="width: 10%;"></td> <td style="width: 10%;"></td> <td style="width: 10%;"></td> <td style="width: 10%;"></td> <td style="width: 10%;"></td> <td style="width: 10%;"></td> <td style="width: 10%;"></td> </tr> <tr> <td></td> <td></td> <td colspan="8" style="text-align: center;"> <table border="1" style="width: 100%; border-collapse: collapse; text-align: center;"> <tr> <td style="width: 10%;"></td> <td style="width: 10%;"></td> <td style="width: 10%;"></td> <td style="width: 10%;"></td> <td style="width: 10%;"></td> <td style="width: 10%;"></td> <td style="width: 10%;"></td> <td style="width: 10%;"></td> <td style="width: 10%;"></td> <td style="width: 10%;"></td> </tr> <tr> <td></td> <td></td> <td colspan="8" style="text-align: center;"> <table border="1" style="width: 100%; border-collapse: collapse; text-align: center;"> <tr> <td style="width: 10%;"></td> <td style="width: 10%;"></td> <td style="width: 10%;"></td> <td style="width: 10%;"></td> <td style="width: 10%;"></td> <td style="width: 10%;"></td> <td style="width: 10%;"></td> <td style="width: 10%;"></td> <td style="width: 10%;"></td> <td style="width: 10%;"></td> </tr> <tr> <td></td> <td></td> <td colspan="8" style="text-align: center;"> <table border="1" style="width: 100%; border-collapse: collapse; text-align: center;"> <tr> <td style="width: 10%;"></td> <td style="width: 10%;"></td> <td style="width: 10%;"></td> <td style="width: 10%;"></td> <td style="width: 10%;"></td> <td style="width: 10%;"></td> <td style="width: 10%;"></td> <td style="width: 10%;"></td> <td style="width: 10%;"></td> <td style="width: 10%;"></td> </tr> <tr> <td></td> <td></td> <td colspan="8" style="text-align: center;"> <table border="1" style="width: 100%; border-collapse: collapse; text-align: center;"> <tr> </tr></table></td></tr></table></td></tr></table></td></tr></table></td></tr></table></td></tr></table></td></tr></table></td></tr></table></td></tr></table>
 | | | | | | | | | | | | | | | | | | | | <table border="1" style="width: 100%; border-collapse: collapse; text-align: center;"> <tr> <td style="width: 10%;"></td> <td style="width: 10%;"></td> <td style="width: 10%;"></td> <td style="width: 10%;"></td> <td style="width: 10%;"></td> <td style="width: 10%;"></td> <td style="width: 10%;"></td> <td style="width: 10%;"></td> <td style="width: 10%;"></td> <td style="width: 10%;"></td> </tr> <tr> <td></td> <td></td> <td colspan="8" style="text-align: center;"> <table border="1" style="width: 100%; border-collapse: collapse; text-align: center;"> <tr> <td style="width: 10%;"></td> <td style="width: 10%;"></td> <td style="width: 10%;"></td> <td style="width: 10%;"></td> <td style="width: 10%;"></td> <td style="width: 10%;"></td> <td style="width: 10%;"></td> <td style="width: 10%;"></td> <td style="width: 10%;"></td> <td style="width: 10%;"></td> </tr> <tr> <td></td> <td></td> <td colspan="8" style="text-align: center;"> <table border="1" style="width: 100%; border-collapse: collapse; text-align: center;"> <tr> <td style="width: 10%;"></td> <td style="width: 10%;"></td> <td style="width: 10%;"></td> <td style="width: 10%;"></td> <td style="width: 10%;"></td> <td style="width: 10%;"></td> <td style="width: 10%;"></td> <td style="width: 10%;"></td> <td style="width: 10%;"></td> <td style="width: 10%;"></td> </tr> <tr> <td></td> <td></td> <td colspan="8" style="text-align: center;"> <table border="1" style="width: 100%; border-collapse: collapse; text-align: center;"> <tr> <td style="width: 10%;"></td> <td style="width: 10%;"></td> <td style="width: 10%;"></td> <td style="width: 10%;"></td> <td style="width: 10%;"></td> <td style="width: 10%;"></td> <td style="width: 10%;"></td> <td style="width: 10%;"></td> <td style="width: 10%;"></td> <td style="width: 10%;"></td> </tr> <tr> <td></td> <td></td> <td colspan="8" style="text-align: center;"> <table border="1" style="width: 100%; border-collapse: collapse; text-align: center;"> <tr> <td style="width: 10%;"></td> <td style="width: 10%;"></td> <td style="width: 10%;"></td> <td style="width: 10%;"></td> <td style="width: 10%;"></td> <td style="width: 10%;"></td> <td style="width: 10%;"></td> <td style="width: 10%;"></td> <td style="width: 10%;"></td> <td style="width: 10%;"></td> </tr> <tr> <td></td> <td></td> <td colspan="8" style="text-align: center;"> <table border="1" style="width: 100%; border-collapse: collapse; text-align: center;"> <tr> <td style="width: 10%;"></td> <td style="width: 10%;"></td> <td style="width: 10%;"></td> <td style="width: 10%;"></td> <td style="width: 10%;"></td> <td style="width: 10%;"></td> <td style="width: 10%;"></td> <td style="width: 10%;"></td> <td style="width: 10%;"></td> <td style="width: 10%;"></td> </tr> <tr> <td></td> <td></td> <td colspan="8" style="text-align: center;"> <table border="1" style="width: 100%; border-collapse: collapse; text-align: center;"> <tr> <td style="width: 10%;"></td> <td style="width: 10%;"></td> <td style="width: 10%;"></td> <td style="width: 10%;"></td> <td style="width: 10%;"></td> <td style="width: 10%;"></td> <td style="width: 10%;"></td> <td style="width: 10%;"></td> <td style="width: 10%;"></td> <td style="width: 10%;"></td> </tr> <tr> <td></td> <td></td> <td colspan="8" style="text-align: center;"> <table border="1" style="width: 100%; border-collapse: collapse; text-align: center;"> <tr> </tr></table></td></tr></table></td></tr></table></td></tr></table></td></tr></table></td></tr></table></td></tr></table></td></tr></table>
 | | | | | | | | | | | | | | | | | | | | <table border="1" style="width: 100%; border-collapse: collapse; text-align: center;"> <tr> <td style="width: 10%;"></td> <td style="width: 10%;"></td> <td style="width: 10%;"></td> <td style="width: 10%;"></td> <td style="width: 10%;"></td> <td style="width: 10%;"></td> <td style="width: 10%;"></td> <td style="width: 10%;"></td> <td style="width: 10%;"></td> <td style="width: 10%;"></td> </tr> <tr> <td></td> <td></td> <td colspan="8" style="text-align: center;"> <table border="1" style="width: 100%; border-collapse: collapse; text-align: center;"> <tr> <td style="width: 10%;"></td> <td style="width: 10%;"></td> <td style="width: 10%;"></td> <td style="width: 10%;"></td> <td style="width: 10%;"></td> <td style="width: 10%;"></td> <td style="width: 10%;"></td> <td style="width: 10%;"></td> <td style="width: 10%;"></td> <td style="width: 10%;"></td> </tr> <tr> <td></td> <td></td> <td colspan="8" style="text-align: center;"> <table border="1" style="width: 100%; border-collapse: collapse; text-align: center;"> <tr> <td style="width: 10%;"></td> <td style="width: 10%;"></td> <td style="width: 10%;"></td> <td style="width: 10%;"></td> <td style="width: 10%;"></td> <td style="width: 10%;"></td> <td style="width: 10%;"></td> <td style="width: 10%;"></td> <td style="width: 10%;"></td> <td style="width: 10%;"></td> </tr> <tr> <td></td> <td></td> <td colspan="8" style="text-align: center;"> <table border="1" style="width: 100%; border-collapse: collapse; text-align: center;"> <tr> <td style="width: 10%;"></td> <td style="width: 10%;"></td> <td style="width: 10%;"></td> <td style="width: 10%;"></td> <td style="width: 10%;"></td> <td style="width: 10%;"></td> <td style="width: 10%;"></td> <td style="width: 10%;"></td> <td style="width: 10%;"></td> <td style="width: 10%;"></td> </tr> <tr> <td></td> <td></td> <td colspan="8" style="text-align: center;"> <table border="1" style="width: 100%; border-collapse: collapse; text-align: center;"> <tr> <td style="width: 10%;"></td> <td style="width: 10%;"></td> <td style="width: 10%;"></td> <td style="width: 10%;"></td> <td style="width: 10%;"></td> <td style="width: 10%;"></td> <td style="width: 10%;"></td> <td style="width: 10%;"></td> <td style="width: 10%;"></td> <td style="width: 10%;"></td> </tr> <tr> <td></td> <td></td> <td colspan="8" style="text-align: center;"> <table border="1" style="width: 100%; border-collapse: collapse; text-align: center;"> <tr> <td style="width: 10%;"></td> <td style="width: 10%;"></td> <td style="width: 10%;"></td> <td style="width: 10%;"></td> <td style="width: 10%;"></td> <td style="width: 10%;"></td> <td style="width: 10%;"></td> <td style="width: 10%;"></td> <td style="width: 10%;"></td> <td style="width: 10%;"></td> </tr> <tr> <td></td> <td></td> <td colspan="8" style="text-align: center;"> <table border="1" style="width: 100%; border-collapse: collapse; text-align: center;"> <tr> </tr></table></td></tr></table></td></tr></table></td></tr></table></td></tr></table></td></tr></table></td></tr></table>
 | | | | | | | | | | | | | | | | | | | | <table border="1" style="width: 100%; border-collapse: collapse; text-align: center;"> <tr> <td style="width: 10%;"></td> <td style="width: 10%;"></td> <td style="width: 10%;"></td> <td style="width: 10%;"></td> <td style="width: 10%;"></td> <td style="width: 10%;"></td> <td style="width: 10%;"></td> <td style="width: 10%;"></td> <td style="width: 10%;"></td> <td style="width: 10%;"></td> </tr> <tr> <td></td> <td></td> <td colspan="8" style="text-align: center;"> <table border="1" style="width: 100%; border-collapse: collapse; text-align: center;"> <tr> <td style="width: 10%;"></td> <td style="width: 10%;"></td> <td style="width: 10%;"></td> <td style="width: 10%;"></td> <td style="width: 10%;"></td> <td style="width: 10%;"></td> <td style="width: 10%;"></td> <td style="width: 10%;"></td> <td style="width: 10%;"></td> <td style="width: 10%;"></td> </tr> <tr> <td></td> <td></td> <td colspan="8" style="text-align: center;"> <table border="1" style="width: 100%; border-collapse: collapse; text-align: center;"> <tr> <td style="width: 10%;"></td> <td style="width: 10%;"></td> <td style="width: 10%;"></td> <td style="width: 10%;"></td> <td style="width: 10%;"></td> <td style="width: 10%;"></td> <td style="width: 10%;"></td> <td style="width: 10%;"></td> <td style="width: 10%;"></td> <td style="width: 10%;"></td> </tr> <tr> <td></td> <td></td> <td colspan="8" style="text-align: center;"> <table border="1" style="width: 100%; border-collapse: collapse; text-align: center;"> <tr> <td style="width: 10%;"></td> <td style="width: 10%;"></td> <td style="width: 10%;"></td> <td style="width: 10%;"></td> <td style="width: 10%;"></td> <td style="width: 10%;"></td> <td style="width: 10%;"></td> <td style="width: 10%;"></td> <td style="width: 10%;"></td> <td style="width: 10%;"></td> </tr> <tr> <td></td> <td></td> <td colspan="8" style="text-align: center;"> <table border="1" style="width: 100%; border-collapse: collapse; text-align: center;"> <tr> <td style="width: 10%;"></td> <td style="width: 10%;"></td> <td style="width: 10%;"></td> <td style="width: 10%;"></td> <td style="width: 10%;"></td> <td style="width: 10%;"></td> <td style="width: 10%;"></td> <td style="width: 10%;"></td> <td style="width: 10%;"></td> <td style="width: 10%;"></td> </tr> <tr> <td></td> <td></td> <td colspan="8" style="text-align: center;"> <table border="1" style="width: 100%; border-collapse: collapse; text-align: center;"> <tr> </tr></table></td></tr></table></td></tr></table></td></tr></table></td></tr></table></td></tr></table> | | | | | | | | | | | | | | | | | | | | <table border="1" style="width: 100%; border-collapse: collapse; text-align: center;"> <tr> <td style="width: 10%;"></td> <td style="width: 10%;"></td> <td style="width: 10%;"></td> <td style="width: 10%;"></td> <td style="width: 10%;"></td> <td style="width: 10%;"></td> <td style="width: 10%;"></td> <td style="width: 10%;"></td> <td style="width: 10%;"></td> <td style="width: 10%;"></td> </tr> <tr> <td></td> <td></td> <td colspan="8" style="text-align: center;"> <table border="1" style="width: 100%; border-collapse: collapse; text-align: center;"> <tr> <td style="width: 10%;"></td> <td style="width: 10%;"></td> <td style="width: 10%;"></td> <td style="width: 10%;"></td> <td style="width: 10%;"></td> <td style="width: 10%;"></td> <td style="width: 10%;"></td> <td style="width: 10%;"></td> <td style="width: 10%;"></td> <td style="width: 10%;"></td> </tr> <tr> <td></td> <td></td> <td colspan="8" style="text-align: center;"> <table border="1" style="width: 100%; border-collapse: collapse; text-align: center;"> <tr> <td style="width: 10%;"></td> <td style="width: 10%;"></td> <td style="width: 10%;"></td> <td style="width: 10%;"></td> <td style="width: 10%;"></td> <td style="width: 10%;"></td> <td style="width: 10%;"></td> <td style="width: 10%;"></td> <td style="width: 10%;"></td> <td style="width: 10%;"></td> </tr> <tr> <td></td> <td></td> <td
colspan="8" style="text-align: center;"> <table border="1" style="width: 100%; border-collapse: collapse; text-align: center;"> <tr> <td style="width: 10%;"></td> <td style="width: 10%;"></td> <td style="width: 10%;"></td> <td style="width: 10%;"></td> <td style="width: 10%;"></td> <td style="width: 10%;"></td> <td style="width: 10%;"></td> <td style="width: 10%;"></td> <td style="width: 10%;"></td> <td style="width: 10%;"></td> </tr> <tr> <td></td> <td></td> <td colspan="8" style="text-align: center;"> <table border="1" style="width: 100%; border-collapse: collapse; text-align: center;"> <tr> </tr></table></td></tr></table></td></tr></table></td></tr></table></td></tr></table> | | | | | | | | | | | | | | | | | | | | <table border="1" style="width: 100%; border-collapse: collapse; text-align: center;"> <tr> <td style="width: 10%;"></td> <td style="width: 10%;"></td> <td style="width: 10%;"></td> <td style="width: 10%;"></td> <td style="width: 10%;"></td> <td style="width: 10%;"></td> <td style="width: 10%;"></td> <td style="width: 10%;"></td> <td style="width: 10%;"></td> <td style="width: 10%;"></td> </tr> <tr> <td></td> <td></td> <td colspan="8" style="text-align: center;"> <table border="1" style="width: 100%; border-collapse: collapse; text-align: center;"> <tr> <td style="width: 10%;"></td> <td style="width: 10%;"></td> <td style="width: 10%;"></td> <td style="width: 10%;"></td> <td style="width: 10%;"></td> <td style="width: 10%;"></td> <td style="width: 10%;"></td> <td style="width: 10%;"></td> <td style="width: 10%;"></td> <td style="width: 10%;"></td> </tr> <tr> <td></td> <td></td> <td colspan="8" style="text-align: center;"> <table border="1" style="width: 100%; border-collapse: collapse; text-align: center;"> <tr> <td style="width: 10%;"></td> <td style="width: 10%;"></td> <td style="width: 10%;"></td> <td style="width: 10%;"></td> <td style="width: 10%;"></td> <td style="width: 10%;"></td> <td style="width: 10%;"></td> <td style="width: 10%;"></td> <td style="width: 10%;"></td> <td style="width: 10%;"></td> </tr> <tr> <td></td> <td></td> <td colspan="8" style="text-align: center;"> <table border="1" style="width: 100%; border-collapse: collapse; text-align: center;"> <tr> </tr></table></td></tr></table></td></tr></table></td></tr></table>
 | | | | | | | | | | | | | | | | | | | | <table border="1" style="width: 100%; border-collapse: collapse; text-align: center;"> <tr> <td style="width: 10%;"></td> <td style="width: 10%;"></td> <td style="width: 10%;"></td> <td style="width: 10%;"></td> <td style="width: 10%;"></td> <td style="width: 10%;"></td> <td style="width: 10%;"></td> <td style="width: 10%;"></td> <td style="width: 10%;"></td> <td style="width: 10%;"></td> </tr> <tr> <td></td> <td></td> <td colspan="8" style="text-align: center;"> <table border="1" style="width: 100%; border-collapse: collapse; text-align: center;"> <tr> <td style="width: 10%;"></td> <td style="width: 10%;"></td> <td style="width: 10%;"></td> <td style="width: 10%;"></td> <td style="width: 10%;"></td> <td style="width: 10%;"></td> <td style="width: 10%;"></td> <td style="width: 10%;"></td> <td style="width: 10%;"></td> <td style="width: 10%;"></td> </tr> <tr> <td></td> <td></td> <td colspan="8" style="text-align: center;"> <table border="1" style="width: 100%; border-collapse: collapse; text-align: center;"> <tr> </tr></table></td></tr></table></td></tr></table> | | | | | | | | | | | | | | | | | | | | <table border="1" style="width: 100%; border-collapse: collapse; text-align: center;"> <tr> <td style="width: 10%;"></td> <td style="width: 10%;"></td> <td style="width: 10%;"></td> <td style="width: 10%;"></td> <td style="width: 10%;"></td> <td style="width: 10%;"></td> <td style="width: 10%;"></td> <td style="width: 10%;"></td> <td style="width: 10%;"></td> <td style="width: 10%;"></td> </tr> <tr> <td></td> <td></td> <td colspan="8" style="text-align: center;"> <table border="1" style="width: 100%; border-collapse: collapse; text-align: center;"> <tr> </tr></table></td></tr></table>
 | | | | | | | | | | | | | | | | | | | | <table border="1" style="width: 100%; border-collapse: collapse; text-align: center;"> <tr> </tr></table> | | | | | | | | | | | | | | | | | | | | | | | | | | | | | | | | | | | | | | | | | | | | | | | | | | | | | | | | | | | |
 | | | | | | | | | | | | | | | | | | | | | | | | | | | | | | | | | | | | | | | |
 | | | | | | | | | | | | | | | | | | | | | | | | | | | | | | | | | | | | | | | | | | | | | | | | | | | | | | | | | | | | | | | | | | | | | | | | | | | | | | | |
 | | | | | | | | | | | | | | | | | | | | | | | | | | | | | | | | | | | | | | | | | | | | | | | | | | | | | | | | | | | | | | | | | | | |
| | |

 | | | | | | | | | | | | | | | | | | | |

 | | | | | | | | | | | | | | | | | | | |

 | | | | | | | | | | | | | | | | | | | |

 | | | | | | | | | | | | | | | | | | | |

 | | | | | | | | | | | | | | | | | | | |

 | | | | | | | | | | | | | | | | | | | |

 | | | | | | | | | | | | | | | | | | | |

 | | | | | | | | | | | | | | | | | | | |

 | | | | | | | | | | | | | | | | | | | |

 | | | | | | | | | | | | | | | | | | | |

 | | | | | | | | | | | | | | | | | | | |

 | | | | | | | | | | | | | | | | | | | |

 | | | | | | | | | | | | | | | | | | | |

 | | | | | | | | | | | | | | | | | | | |

 | | | | | | | | | | | | | | | | | | | |

 | | | | | | | | | | | | | | | | | | | |

 | | | | | | | | | | | | | | | | | | | |

 | | | | | | | | | | | | | | | | | | | |

 | | | | | | | | | | | | | | | | | | | |

 | | | | | | | | | | | | | | | | | | | |

 | | | | | | | | | | | | | | | | | | | |

 | | | | | | | | | | | | | | | | | | | |

 | | | | | | | | | | | | | | | | | | | |

 | | | | | | | | | | | | | | | | | | | |

 | | | | | | | | | | | | | | | | | | | |

 | | | | | | | | | | | | | | | | | | | |

 | | | | | | | | | | | | | | | | | | | |

 | | | | | | | | | | | | | | | | | | | |
 | | | | | | | | | | | | | | | | | | | |

 | | | | | | | | | | | | | | | | | | | |

 | | | | | | | | | | | | | | | | | | | |
 | | | | | | | | | | | | | | | | | | | |

 | | | | | | | | | | | | | | | | | | | |

 | | | | | | | | | | | | | | | | | | | |
 | | | | | | | | | | | | | | | | | | | |
 | | | | | | | | | | | | | | | | | | | |

 | | | | | | | | | | | | | | | | | | | |
 | | | | | | | | | | | | | | | | | | | |
 | | | | | | | | | | | | | | | | | | | |

 | | | | | | | | | | | | | | | | | | | | | | | | | | | | | | | | | | | | | | | | | | | | | | | | | | | | | | | | | | | | | | | | | | | | | | | | | | | | | | | | | | | | | | | | | | | | | | | | | | | |
 | | | | | | | | | | | | | | | | | | | |
 | | | | | | | | | | | | | | | | | | | |
 | | | | | | | | | | | | | | | | | | | |
 | | | | | | | | | | | | | | | | | | | |
 | | | | | | | | | | | | | | | | | | | |
 | | | | | | | | | | | | | | | | | | | |
 | | | | | | | | | | | | | | | | | | | |
 | | | | | | | | | | | | | | | | | | | |
 | | | | | | | | | | | | | | | | | | | | | | | | | | | | | | | | | | | | | | | |
 | | | | | | | | | | | | | | | | | | | |
 | | | | | | | | | | | | | | | | | | | | | | | | | | | | | | | | | | | | | | | |
 | | | | | | | | | | | | | | | | | | | | | | | | | | | | | | | | | | | | | | | |
 | | | | | | | | | | | | | | | | | | | | | | | | | | | | | | | | | | | | | | | |
 | | | | | | | | | | | | | | | | | | | | | | | | | | | | | | | | | | | | | | | | | | | | | | | | | | | | | | | | | | | | | | | | | | | | | | | | | | | | | | | | | | | | | | | | | | | | | | | | | | | |
 | | | | | | | | | | | | | | | | | | | | | | | | | | | | | | | | | | | | | | | | | | | | | | | |
| | | <table border="1" style="width: 100%; border-collapse: collapse; text-align: center;"> <tr> <td style="width: 10%;"></td> <td style="width: 10%;"></td> <td style="width: 10%;"></td> <td style="width: 10%;"></td> <td style="width: 10%;"></td> <td style="width: 10%;"></td> <td style="width: 10%;"></td> <td style="width: 10%;"></td> <td style="width: 10%;"></td> <td style="width: 10%;"></td> </tr> <tr> <td></td> <td></td> <td colspan="8" style="text-align: center;"> <table border="1" style="width: 100%; border-collapse: collapse; text-align: center;"> <tr> <td style="width: 10%;"></td> <td style="width: 10%;"></td> <td style="width: 10%;"></td> <td style="width: 10%;"></td> <td style="width: 10%;"></td> <td style="width: 10%;"></td> <td style="width: 10%;"></td> <td style="width: 10%;"></td> <td style="width: 10%;"></td> <td style="width: 10%;"></td> </tr> <tr> <td></td> <td></td> <td colspan="8" style="text-align: center;"> <table border="1" style="width: 100%; border-collapse: collapse; text-align: center;"> <tr> <td style="width: 10%;"></td> <td style="width: 10%;"></td> <td style="width: 10%;"></td> <td style="width: 10%;"></td> <td style="width: 10%;"></td> <td style="width: 10%;"></td> <td style="width: 10%;"></td> <td style="width: 10%;"></td> <td style="width: 10%;"></td> <td style="width: 10%;"></td> </tr> <tr> <td></td> <td></td> <td colspan="8" style="text-align: center;"> <table border="1" style="width: 100%; border-collapse: collapse; text-align: center;"> <tr> <td style="width: 10%;"></td> <td style="width: 10%;"></td> <td style="width: 10%;"></td> <td style="width: 10%;"></td> <td style="width: 10%;"></td> <td style="width: 10%;"></td> <td style="width: 10%;"></td> <td style="width: 10%;"></td> <td style="width: 10%;"></td> <td style="width: 10%;"></td> </tr> <tr> <td></td> <td></td> <td colspan="8" style="text-align: center;"> <table border="1" style="width: 100%; border-collapse: collapse; text-align: center;"> <tr> <td style="width: 10%;"></td> <td style="width: 10%;"></td> <td style="width: 10%;"></td> <td style="width: 10%;"></td> <td style="width: 10%;"></td> <td style="width: 10%;"></td> <td style="width: 10%;"></td> <td style="width: 10%;"></td> <td style="width: 10%;"></td> <td style="width: 10%;"></td> </tr> <tr> <td></td> <td></td> <td colspan="8" style="text-align: center;"> <table border="1" style="width: 100%; border-collapse: collapse; text-align: center;"> <tr> <td style="width: 10%;"></td> <td style="width: 10%;"></td> <td style="width: 10%;"></td> <td style="width: 10%;"></td> <td style="width: 10%;"></td> <td style="width: 10%;"></td> <td style="width: 10%;"></td> <td style="width: 10%;"></td> <td style="width: 10%;"></td> <td style="width: 10%;"></td> </tr> <tr> <td></td> <td></td> <td colspan="8" style="text-align: center;"> <table border="1" style="width: 100%; border-collapse: collapse; text-align: center;"> <tr> <td style="width: 10%;"></td> <td style="width: 10%;"></td> <td style="width: 10%;"></td> <td style="width: 10%;"></td> <td style="width: 10%;"></td> <td style="width: 10%;"></td> <td style="width: 10%;"></td> <td style="width: 10%;"></td> <td style="width: 10%;"></td> <td style="width: 10%;"></td> </tr> <tr> <td></td> <td></td> <td colspan="8" style="text-align: center;"> <table border="1" style="width: 100%; border-collapse: collapse; text-align: center;"> <tr> <td style="width: 10%;"></td> <td style="width: 10%;"></td> <td style="width: 10%;"></td> <td style="width: 10%;"></td> <td style="width: 10%;"></td> <td style="width: 10%;"></td> <td style="width: 10%;"></td> <td style="width: 10%;"></td> <td style="width: 10%;"></td> <td style="width: 10%;"></td> </tr> <tr> <td></td> <td></td> <td colspan="8" style="text-align: center;"> <table border="1" style="width: 100%; border-collapse: collapse; text-align: center;"> <tr> <td style="width: 10%;"></td> <td style="width: 10%;"></td> <td style="width: 10%;"></td> <td style="width: 10%;"></td> <td style="width: 10%;"></td> <td style="width: 10%;"></td> <td style="width: 10%;"></td> <td style="width: 10%;"></td> <td style="width: 10%;"></td> <td style="width: 10%;"></td> </tr> <tr> <td></td> <td></td> <td colspan="8" style="text-align: center;"> <table border="1" style="width: 100%; border-collapse: collapse; text-align: center;"> <tr> <td style="width: 10%;"></td> <td style="width: 10%;"></td> <td style="width: 10%;"></td> <td style="width: 10%;"></td> <td style="width: 10%;"></td> <td style="width: 10%;"></td> <td style="width: 10%;"></td> <td style="width: 10%;"></td> <td style="width: 10%;"></td> <td style="width: 10%;"></td> </tr> <tr> <td></td> <td></td> <td colspan="8" style="text-align: center;"> <table border="1" style="width: 100%; border-collapse: collapse; text-align: center;"> <tr> <td style="width: 10%;"></td> <td style="width: 10%;"></td> <td style="width: 10%;"></td> <td style="width: 10%;"></td> <td style="width: 10%;"></td> <td style="width: 10%;"></td> <td style="width: 10%;"></td> <td style="width: 10%;"></td> <td style="width: 10%;"></td> <td style="width: 10%;"></td> </tr> <tr> <td></td> <td></td> <td colspan="8" style="text-align: center;"> <table border="1" style="width: 100%; border-collapse: collapse; text-align: center;"> <tr> <td style="width: 10%;"></td> <td style="width: 10%;"></td> <td style="width: 10%;"></td> <td style="width: 10%;"></td> <td style="width: 10%;"></td> <td style="width: 10%;"></td> <td style="width: 10%;"></td> <td style="width: 10%;"></td> <td style="width: 10%;"></td> <td style="width: 10%;"></td> </tr> <tr> <td></td> <td></td> <td colspan="8" style="text-align: center;"> <table border="1" style="width: 100%; border-collapse: collapse; text-align: center;"> <tr> <td style="width: 10%;"></td> <td style="width: 10%;"></td> <td style="width: 10%;"></td> <td style="width: 10%;"></td> <td style="width: 10%;"></td> <td style="width: 10%;"></td> <td style="width: 10%;"></td> <td style="width: 10%;"></td> <td style="width: 10%;"></td> <td style="width: 10%;"></td> </tr> <tr> <td></td> <td></td> <td colspan="8" style="text-align: center;"> <table border="1" style="width: 100%; border-collapse: collapse; text-align: center;"> <tr> <td style="width: 10%;"></td> <td style="width: 10%;"></td> <td style="width: 10%;"></td> <td style="width: 10%;"></td> <td style="width: 10%;"></td> <td style="width: 10%;"></td> <td style="width: 10%;"></td> <td style="width: 10%;"></td> <td style="width: 10%;"></td> <td style="width: 10%;"></td> </tr> <tr> <td></td> <td></td> <td colspan="8" style="text-align: center;"> <table border="1" style="width: 100%; border-collapse: collapse; text-align: center;"> <tr> <td style="width: 10%;"></td> <td style="width: 10%;"></td> <td style="width: 10%;"></td> <td style="width: 10%;"></td> <td style="width: 10%;"></td> <td style="width: 10%;"></td> <td style="width: 10%;"></td> <td style="width: 10%;"></td> <td style="width: 10%;"></td> <td style="width: 10%;"></td> </tr> <tr> <td></td> <td></td> <td colspan="8" style="text-align: center;"> <table border="1" style="width: 100%; border-collapse: collapse; text-align: center;"> <tr> <td style="width: 10%;"></td> <td style="width: 10%;"></td> <td style="width: 10%;"></td> <td style="width: 10%;"></td> <td style="width: 10%;"></td> <td style="width: 10%;"></td> <td style="width: 10%;"></td> <td style="width: 10%;"></td> <td style="width: 10%;"></td> <td style="width: 10%;"></td> </tr> <tr> <td></td> <td></td> <td colspan="8" style="text-align: center;"> <table border="1" style="width: 100%; border-collapse: collapse; text-align: center;"> <tr> <td style="width: 10%;"></td> <td style="width: 10%;"></td> <td style="width: 10%;"></td> <td style="width: 10%;"></td> <td style="width: 10%;"></td> <td style="width: 10%;"></td> <td style="width: 10%;"></td> <td style="width: 10%;"></td> <td style="width: 10%;"></td> <td style="width: 10%;"></td> </tr> <tr> <td></td> <td></td> <td colspan="8" style="text-align: center;"> <table border="1" style="width: 100%; border-collapse: collapse; text-align: center;"> <tr> <td style="width: 10%;"></td> <td style="width: 10%;"></td> <td style="width: 10%;"></td> <td style="width: 10%;"></td> <td style="width: 10%;"></td> <td style="width: 10%;"></td> <td style="width: 10%;"></td> <td style="width: 10%;"></td> <td style="width: 10%;"></td> <td style="width: 10%;"></td> </tr> <tr> <td></td> <td></td> <td colspan="8" style="text-align: center;"> <table border="1" style="width: 100%; border-collapse: collapse; text-align: center;"> <tr> <td style="width: 10%;"></td> <td style="width: 10%;"></td> <td style="width: 10%;"></td> <td style="width: 10%;"></td> <td style="width: 10%;"></td> <td style="width: 10%;"></td> <td style="width: 10%;"></td> <td style="width: 10%;"></td> <td style="width: 10%;"></td> <td style="width: 10%;"></td> </tr> <tr> <td></td> <td></td> <td colspan="8" style="text-align: center;"> <table border="1" style="width: 100%; border-collapse: collapse; text-align: center;"> <tr> <td style="width: 10%;"></td> <td style="width: 10%;"></td> <td style="width: 10%;"></td> <td style="width: 10%;"></td> <td style="width: 10%;"></td> <td style="width: 10%;"></td> <td style="width: 10%;"></td> <td style="width: 10%;"></td> <td style="width: 10%;"></td> <td style="width: 10%;"></td> </tr> <tr> <td></td> <td></td> <td colspan="8" style="text-align: center;"> <table border="1" style="width: 100%; border-collapse: collapse; text-align: center;"> <tr> <td style="width: 10%;"></td> <td style="width: 10%;"></td> <td style="width: 10%;"></td> <td style="width: 10%;"></td> <td style="width: 10%;"></td> <td style="width: 10%;"></td> <td style="width: 10%;"></td> <td style="width: 10%;"></td> <td style="width: 10%;"></td> <td style="width: 10%;"></td> </tr> <tr> <td></td> <td></td> <td colspan="8" style="text-align: center;"> <table border="1" style="width: 100%; border-collapse: collapse; text-align: center;"> <tr> <td style="width: 10%;"></td> <td style="width: 10%;"></td> <td
style="width: 10%;"></td> <td style="width: 10%;"></td> <td style="width: 10%;"></td> <td style="width: 10%;"></td> <td style="width: 10%;"></td> <td style="width: 10%;"></td> <td style="width: 10%;"></td> <td style="width: 10%;"></td> </tr> <tr> <td></td> <td></td> <td colspan="8" style="text-align: center;"> <table border="1" style="width: 100%; border-collapse: collapse; text-align: center;"> <tr> <td style="width: 10%;"></td> <td style="width: 10%;"></td> <td style="width: 10%;"></td> <td style="width: 10%;"></td> <td style="width: 10%;"></td> <td style="width: 10%;"></td> <td style="width: 10%;"></td> <td style="width: 10%;"></td> <td style="width: 10%;"></td> <td style="width: 10%;"></td> </tr> <tr> <td></td> <td></td> <td colspan="8" style="text-align: center;"> <table border="1" style="width: 100%; border-collapse: collapse; text-align: center;"> <tr> <td style="width: 10%;"></td> <td style="width: 10%;"></td> <td style="width: 10%;"></td> <td style="width: 10%;"></td> <td style="width: 10%;"></td> <td style="width: 10%;"></td> <td style="width: 10%;"></td> <td style="width: 10%;"></td> <td style="width: 10%;"></td> <td style="width: 10%;"></td> </tr> <tr> <td></td> <td></td> <td colspan="8" style="text-align: center;"> <table border="1" style="width: 100%; border-collapse: collapse; text-align: center;"> <tr> <td style="width: 10%;"></td> <td style="width: 10%;"></td> <td style="width: 10%;"></td> <td style="width: 10%;"></td> <td style="width: 10%;"></td> <td style="width: 10%;"></td> <td style="width: 10%;"></td> <td style="width: 10%;"></td> <td style="width: 10%;"></td> <td style="width: 10%;"></td> </tr> <tr> <td></td> <td></td> <td colspan="8" style="text-align: center;"> <table border="1" style="width: 100%; border-collapse: collapse; text-align: center;"> <tr> <td style="width: 10%;"></td> <td style="width: 10%;"></td> <td style="width: 10%;"></td> <td style="width: 10%;"></td> <td style="width: 10%;"></td> <td style="width: 10%;"></td> <td style="width: 10%;"></td> <td style="width: 10%;"></td> <td style="width: 10%;"></td> <td style="width: 10%;"></td> </tr> <tr> <td></td> <td></td> <td colspan="8" style="text-align: center;"> <table border="1" style="width: 100%; border-collapse: collapse; text-align: center;"> <tr> <td style="width: 10%;"></td> <td style="width: 10%;"></td> <td style="width: 10%;"></td> <td style="width: 10%;"></td> <td style="width: 10%;"></td> <td style="width: 10%;"></td> <td style="width: 10%;"></td> <td style="width: 10%;"></td> <td style="width: 10%;"></td> <td style="width: 10%;"></td> </tr> <tr> <td></td> <td></td> <td colspan="8" style="text-align: center;"> <table border="1" style="width: 100%; border-collapse: collapse; text-align: center;"> <tr> <td style="width: 10%;"></td> <td style="width: 10%;"></td> <td style="width: 10%;"></td> <td style="width: 10%;"></td> <td style="width: 10%;"></td> <td style="width: 10%;"></td> <td style="width: 10%;"></td> <td style="width: 10%;"></td> <td style="width: 10%;"></td> <td style="width: 10%;"></td> </tr> <tr> <td></td> <td></td> <td colspan="8" style="text-align: center;"> <table border="1" style="width: 100%; border-collapse: collapse; text-align: center;"> <tr> <td style="width: 10%;"></td> <td style="width: 10%;"></td> <td style="width: 10%;"></td> <td style="width: 10%;"></td> <td style="width: 10%;"></td> <td style="width: 10%;"></td> <td style="width: 10%;"></td> <td style="width: 10%;"></td> <td style="width: 10%;"></td> <td style="width: 10%;"></td> </tr> <tr> <td></td> <td></td> <td colspan="8" style="text-align: center;"> <table border="1" style="width: 100%; border-collapse: collapse; text-align: center;"> <tr> <td style="width: 10%;"></td> <td style="width: 10%;"></td> <td style="width: 10%;"></td> <td style="width: 10%;"></td> <td style="width: 10%;"></td> <td style="width: 10%;"></td> <td style="width: 10%;"></td> <td style="width: 10%;"></td> <td style="width: 10%;"></td> <td style="width: 10%;"></td> </tr> <tr> <td></td> <td></td> <td colspan="8" style="text-align: center;"> <table border="1" style="width: 100%; border-collapse: collapse; text-align: center;"> <tr> <td style="width: 10%;"></td> <td style="width: 10%;"></td> <td style="width: 10%;"></td> <td style="width: 10%;"></td> <td style="width: 10%;"></td> <td style="width: 10%;"></td> <td style="width: 10%;"></td> <td style="width: 10%;"></td> <td style="width: 10%;"></td> <td style="width: 10%;"></td> </tr> <tr> <td></td> <td></td> <td colspan="8" style="text-align: center;"> <table border="1" style="width: 100%; border-collapse: collapse; text-align: center;"> <tr> <td style="width: 10%;"></td> <td style="width: 10%;"></td> <td style="width: 10%;"></td> <td style="width: 10%;"></td> <td style="width: 10%;"></td> <td style="width: 10%;"></td> <td style="width: 10%;"></td> <td style="width: 10%;"></td> <td style="width: 10%;"></td> <td style="width: 10%;"></td> </tr> <tr> <td></td> <td></td> <td colspan="8" style="text-align: center;"> <table border="1" style="width: 100%; border-collapse: collapse; text-align: center;"> <tr> <td style="width: 10%;"></td> <td style="width: 10%;"></td> <td style="width: 10%;"></td> <td style="width: 10%;"></td> <td style="width: 10%;"></td> <td style="width: 10%;"></td> <td style="width: 10%;"></td> <td style="width: 10%;"></td> <td style="width: 10%;"></td> <td style="width: 10%;"></td> </tr> <tr> <td></td> <td></td> <td colspan="8" style="text-align: center;"> <table border="1" style="width: 100%; border-collapse: collapse; text-align: center;"> <tr> <td style="width: 10%;"></td> <td style="width: 10%;"></td> <td style="width: 10%;"></td> <td style="width: 10%;"></td> <td style="width: 10%;"></td> <td style="width: 10%;"></td> <td style="width: 10%;"></td> <td style="width: 10%;"></td> <td style="width: 10%;"></td> <td style="width: 10%;"></td> </tr> <tr> <td></td> <td></td> <td colspan="8" style="text-align: center;"> <table border="1" style="width: 100%; border-collapse: collapse; text-align: center;"> <tr> <td style="width: 10%;"></td> <td style="width: 10%;"></td> <td style="width: 10%;"></td> <td style="width: 10%;"></td> <td style="width: 10%;"></td> <td style="width: 10%;"></td> <td style="width: 10%;"></td> <td style="width: 10%;"></td> <td style="width: 10%;"></td> <td style="width: 10%;"></td> </tr> <tr> <td></td> <td></td> <td colspan="8" style="text-align: center;"> <table border="1" style="width: 100%; border-collapse: collapse; text-align: center;"> <tr> <td style="width: 10%;"></td> <td style="width: 10%;"></td> <td style="width: 10%;"></td> <td style="width: 10%;"></td> <td style="width: 10%;"></td> <td style="width: 10%;"></td> <td style="width: 10%;"></td> <td style="width: 10%;"></td> <td style="width: 10%;"></td> <td style="width: 10%;"></td> </tr> <tr> <td></td> <td></td> <td colspan="8" style="text-align: center;"> <table border="1" style="width: 100%; border-collapse: collapse; text-align: center;"> <tr> <td style="width: 10%;"></td> <td style="width: 10%;"></td> <td style="width: 10%;"></td> <td style="width: 10%;"></td> <td style="width: 10%;"></td> <td style="width: 10%;"></td> <td style="width: 10%;"></td> <td style="width: 10%;"></td> <td style="width: 10%;"></td> <td style="width: 10%;"></td> </tr> <tr> <td></td> <td></td> <td colspan="8" style="text-align: center;"> <table border="1" style="width: 100%; border-collapse: collapse; text-align: center;"> <tr> <td style="width: 10%;"></td> <td style="width: 10%;"></td> <td style="width: 10%;"></td> <td style="width: 10%;"></td> <td style="width: 10%;"></td> <td style="width: 10%;"></td> <td style="width: 10%;"></td> <td style="width: 10%;"></td> <td style="width: 10%;"></td> <td style="width: 10%;"></td> </tr> <tr> <td></td> <td></td> <td colspan="8" style="text-align: center;"> <table border="1" style="width: 100%; border-collapse: collapse; text-align: center;"> <tr> <td style="width: 10%;"></td> <td style="width: 10%;"></td> <td style="width: 10%;"></td> <td style="width: 10%;"></td> <td style="width: 10%;"></td> <td style="width: 10%;"></td> <td style="width: 10%;"></td> <td style="width: 10%;"></td> <td style="width: 10%;"></td> <td style="width: 10%;"></td> </tr> <tr> <td></td> <td></td> <td colspan="8" style="text-align: center;"> <table border="1" style="width: 100%; border-collapse: collapse; text-align: center;"> <tr> <td style="width: 10%;"></td> <td style="width: 10%;"></td> <td style="width: 10%;"></td> <td style="width: 10%;"></td> <td style="width: 10%;"></td> <td style="width: 10%;"></td> <td style="width: 10%;"></td> <td style="width: 10%;"></td> <td style="width: 10%;"></td> <td style="width: 10%;"></td> </tr> <tr> <td></td> <td></td> <td colspan="8" style="text-align: center;"> <table border="1" style="width: 100%; border-collapse: collapse; text-align: center;"> <tr> <td style="width: 10%;"></td> <td style="width: 10%;"></td> <td style="width: 10%;"></td> <td style="width: 10%;"></td> <td style="width: 10%;"></td> <td style="width: 10%;"></td> <td style="width: 10%;"></td> <td style="width: 10%;"></td> <td style="width: 10%;"></td> <td style="width: 10%;"></td> </tr> <tr> <td></td> <td></td> <td colspan="8" style="text-align: center;"> <table border="1" style="width: 100%; border-collapse: collapse; text-align: center;"> <tr> <td style="width: 10%;"></td> <td style="width: 10%;"></td> <td style="width: 10%;"></td> <td style="width: 10%;"></td> <td style="width: 10%;"></td> <td style="width: 10%;"></td> <td style="width: 10%;"></td> <td style="width: 10%;"></td> <td style="width: 10%;"></td> <td style="width: 10%;"></td> </tr> <tr> <td></td> <td></td> <td colspan="8" style="text-align: center;"> <table border="1" style="width: 100%; border-collapse: collapse; text-align: center;"> <tr> <td style="width: 10%;"></td> <td style="width: 10%;"></td> <td style="width: 10%;"></td> <td style="width: 10%;"></td> <td style="width: 10%;"></td> <td style="width: 10%;"></td> <td style="width: 10%;"></td> <td style="width:
10%;"></td> <td style="width: 10%;"></td> <td style="width: 10%;"></td> </tr> <tr> <td></td> <td></td> <td colspan="8" style="text-align: center;"> <table border="1" style="width: 100%; border-collapse: collapse; text-align: center;"> <tr> <td style="width: 10%;"></td> <td style="width: 10%;"></td> <td style="width: 10%;"></td> <td style="width: 10%;"></td> <td style="width: 10%;"></td> <td style="width: 10%;"></td> <td style="width: 10%;"></td> <td style="width: 10%;"></td> <td style="width: 10%;"></td> <td style="width: 10%;"></td> </tr> <tr> <td></td> <td></td> <td colspan="8" style="text-align: center;"> <table border="1" style="width: 100%; border-collapse: collapse; text-align: center;"> <tr> <td style="width: 10%;"></td> <td style="width: 10%;"></td> <td style="width: 10%;"></td> <td style="width: 10%;"></td> <td style="width: 10%;"></td> <td style="width: 10%;"></td> <td style="width: 10%;"></td> <td style="width: 10%;"></td> <td style="width: 10%;"></td> <td style="width: 10%;"></td> </tr> <tr> <td></td> <td></td> <td colspan="8" style="text-align: center;"> <table border="1" style="width: 100%; border-collapse: collapse; text-align: center;"> <tr> <td style="width: 10%;"></td> <td style="width: 10%;"></td> <td style="width: 10%;"></td> <td style="width: 10%;"></td> <td style="width: 10%;"></td> <td style="width: 10%;"></td> <td style="width: 10%;"></td> <td style="width: 10%;"></td> <td style="width: 10%;"></td> <td style="width: 10%;"></td> </tr> <tr> <td></td> <td></td> <td colspan="8" style="text-align: center;"> <table border="1" style="width: 100%; border-collapse: collapse; text-align: center;"> <tr> <td style="width: 10%;"></td> <td style="width: 10%;"></td> <td style="width: 10%;"></td> <td style="width: 10%;"></td> <td style="width: 10%;"></td> <td style="width: 10%;"></td> <td style="width: 10%;"></td> <td style="width: 10%;"></td> <td style="width: 10%;"></td> <td style="width: 10%;"></td> </tr> <tr> <td></td> <td></td> <td colspan="8" style="text-align: center;"> <table border="1" style="width: 100%; border-collapse: collapse; text-align: center;"> <tr> <td style="width: 10%;"></td> <td style="width: 10%;"></td> <td style="width: 10%;"></td> <td style="width: 10%;"></td> <td style="width: 10%;"></td> <td style="width: 10%;"></td> <td style="width: 10%;"></td> <td style="width: 10%;"></td> <td style="width: 10%;"></td> <td style="width: 10%;"></td> </tr> <tr> <td></td> <td></td> <td colspan="8" style="text-align: center;"> <table border="1" style="width: 100%; border-collapse: collapse; text-align: center;"> <tr> <td style="width: 10%;"></td> <td style="width: 10%;"></td> <td style="width: 10%;"></td> <td style="width: 10%;"></td> <td style="width: 10%;"></td> <td style="width: 10%;"></td> <td style="width: 10%;"></td> <td style="width: 10%;"></td> <td style="width: 10%;"></td> <td style="width: 10%;"></td> </tr> <tr> <td></td> <td></td> <td colspan="8" style="text-align: center;"> <table border="1" style="width: 100%; border-collapse: collapse; text-align: center;"> <tr> <td style="width: 10%;"></td> <td style="width: 10%;"></td> <td style="width: 10%;"></td> <td style="width: 10%;"></td> <td style="width: 10%;"></td> <td style="width: 10%;"></td> <td style="width: 10%;"></td> <td style="width: 10%;"></td> <td style="width: 10%;"></td> <td style="width: 10%;"></td> </tr> <tr> <td></td> <td></td> <td colspan="8" style="text-align: center;"> <table border="1" style="width: 100%; border-collapse: collapse; text-align: center;"> <tr> <td style="width: 10%;"></td> <td style="width: 10%;"></td> <td style="width: 10%;"></td> <td style="width: 10%;"></td> <td style="width: 10%;"></td> <td style="width: 10%;"></td> <td style="width: 10%;"></td> <td style="width: 10%;"></td> <td style="width: 10%;"></td> <td style="width: 10%;"></td> </tr> <tr> <td></td> <td></td> <td colspan="8" style="text-align: center;"> <table border="1" style="width: 100%; border-collapse: collapse; text-align: center;"> <tr> <td style="width: 10%;"></td> <td style="width: 10%;"></td> <td style="width: 10%;"></td> <td style="width: 10%;"></td> <td style="width: 10%;"></td> <td style="width: 10%;"></td> <td style="width: 10%;"></td> <td style="width: 10%;"></td> <td style="width: 10%;"></td> <td style="width: 10%;"></td> </tr> <tr> <td></td> <td></td> <td colspan="8" style="text-align: center;"> <table border="1" style="width: 100%; border-collapse: collapse; text-align: center;"> <tr> <td style="width: 10%;"></td> <td style="width: 10%;"></td> <td style="width: 10%;"></td> <td style="width: 10%;"></td> <td style="width: 10%;"></td> <td style="width: 10%;"></td> <td style="width: 10%;"></td> <td style="width: 10%;"></td> <td style="width: 10%;"></td> <td style="width: 10%;"></td> </tr> <tr> <td></td> <td></td> <td colspan="8" style="text-align: center;"> <table border="1" style="width: 100%; border-collapse: collapse; text-align: center;"> <tr> </tr></table></td></tr></table></td></tr></table></td></tr></table></td></tr></table></td></tr></table></td></tr></table></td></tr></table></td></tr></table></td></tr></table></td></tr></table></td></tr></table></td></tr></table></td></tr></table></td></tr></table></td></tr></table></td></tr></table></td></tr></table></td></tr></table></td></tr></table></td></tr></table></td></tr></table></td></tr></table></td></tr></table></td></tr></table></td></tr></table></td></tr></table></td></tr></table></td></tr></table></td></tr></table></td></tr></table></td></tr></table></td></tr></table></td></tr></table></td></tr></table></td></tr></table></td></tr></table></td></tr></table></td></tr></table></td></tr></table></td></tr></table></td></tr></table></td></tr></table></td></tr></table></td></tr></table></td></tr></table></td></tr></table></td></tr></table></td></tr></table></td></tr></table></td></tr></table></td></tr></table></td></tr></table></td></tr></table>
 | | | | | | | | | | | | | | | | | | | | <table border="1" style="width: 100%; border-collapse: collapse; text-align: center;"> <tr> <td style="width: 10%;"></td> <td style="width: 10%;"></td> <td style="width: 10%;"></td> <td style="width: 10%;"></td> <td style="width: 10%;"></td> <td style="width: 10%;"></td> <td style="width: 10%;"></td> <td style="width: 10%;"></td> <td style="width: 10%;"></td> <td style="width: 10%;"></td> </tr> <tr> <td></td> <td></td> <td colspan="8" style="text-align: center;"> <table border="1" style="width: 100%; border-collapse: collapse; text-align: center;"> <tr> <td style="width: 10%;"></td> <td style="width: 10%;"></td> <td style="width: 10%;"></td> <td style="width: 10%;"></td> <td style="width: 10%;"></td> <td style="width: 10%;"></td> <td style="width: 10%;"></td> <td style="width: 10%;"></td> <td style="width: 10%;"></td> <td style="width: 10%;"></td> </tr> <tr> <td></td> <td></td> <td colspan="8" style="text-align: center;"> <table border="1" style="width: 100%; border-collapse: collapse; text-align: center;"> <tr> <td style="width: 10%;"></td> <td style="width: 10%;"></td> <td style="width: 10%;"></td> <td style="width: 10%;"></td> <td style="width: 10%;"></td> <td style="width: 10%;"></td> <td style="width: 10%;"></td> <td style="width: 10%;"></td> <td style="width: 10%;"></td> <td style="width: 10%;"></td> </tr> <tr> <td></td> <td></td> <td colspan="8" style="text-align: center;"> <table border="1" style="width: 100%; border-collapse: collapse; text-align: center;"> <tr> <td style="width: 10%;"></td> <td style="width: 10%;"></td> <td style="width: 10%;"></td> <td style="width: 10%;"></td> <td style="width: 10%;"></td> <td style="width: 10%;"></td> <td style="width: 10%;"></td> <td style="width: 10%;"></td> <td style="width: 10%;"></td> <td style="width: 10%;"></td> </tr> <tr> <td></td> <td></td> <td colspan="8" style="text-align: center;"> <table border="1" style="width: 100%; border-collapse: collapse; text-align: center;"> <tr> <td style="width: 10%;"></td> <td style="width: 10%;"></td> <td style="width: 10%;"></td> <td style="width: 10%;"></td> <td style="width: 10%;"></td> <td style="width: 10%;"></td> <td style="width: 10%;"></td> <td style="width: 10%;"></td> <td style="width: 10%;"></td> <td style="width: 10%;"></td> </tr> <tr> <td></td> <td></td> <td colspan="8" style="text-align: center;"> <table border="1" style="width: 100%; border-collapse: collapse; text-align: center;"> <tr> <td style="width: 10%;"></td> <td style="width: 10%;"></td> <td style="width: 10%;"></td> <td style="width: 10%;"></td> <td style="width: 10%;"></td> <td style="width: 10%;"></td> <td style="width: 10%;"></td> <td style="width: 10%;"></td> <td style="width: 10%;"></td> <td style="width: 10%;"></td> </tr> <tr> <td></td> <td></td> <td colspan="8" style="text-align: center;"> <table border="1" style="width: 100%; border-collapse: collapse; text-align: center;"> <tr> <td style="width: 10%;"></td> <td style="width: 10%;"></td> <td style="width: 10%;"></td> <td style="width: 10%;"></td> <td style="width: 10%;"></td> <td style="width: 10%;"></td> <td style="width: 10%;"></td> <td style="width: 10%;"></td> <td style="width: 10%;"></td> <td style="width: 10%;"></td> </tr> <tr> <td></td> <td></td> <td colspan="8" style="text-align: center;"> <table border="1" style="width: 100%; border-collapse: collapse; text-align: center;"> <tr> <td style="width: 10%;"></td> <td style="width: 10%;"></td> <td style="width: 10%;"></td> <td style="width: 10%;"></td> <td style="width: 10%;"></td> <td style="width: 10%;"></td> <td style="width: 10%;"></td> <td style="width: 10%;"></td> <td style="width: 10%;"></td> <td style="width: 10%;"></td> </tr> <tr> <td></td> <td></td> <td colspan="8" style="text-align: center;"> <table border="1" style="width: 100%; border-collapse: collapse; text-align: center;"> <tr> <td style="width: 10%;"></td> <td style="width: 10%;"></td> <td style="width: 10%;"></td> <td style="width: 10%;"></td> <td style="width: 10%;"></td> <td style="width: 10%;"></td> <td style="width: 10%;"></td> <td style="width: 10%;"></td> <td style="width: 10%;"></td> <td style="width: 10%;"></td> </tr> <tr> <td></td> <td></td> <td colspan="8" style="text-align: center;"> <table border="1" style="width: 100%; border-collapse: collapse; text-align: center;"> <tr> <td style="width: 10%;"></td> <td style="width: 10%;"></td> <td style="width: 10%;"></td> <td style="width: 10%;"></td> <td style="width: 10%;"></td> <td style="width: 10%;"></td> <td style="width: 10%;"></td> <td style="width: 10%;"></td> <td style="width: 10%;"></td> <td style="width: 10%;"></td> </tr> <tr> <td></td> <td></td> <td colspan="8" style="text-align: center;"> <table border="1" style="width: 100%; border-collapse: collapse; text-align: center;"> <tr> <td style="width: 10%;"></td> <td style="width: 10%;"></td> <td style="width: 10%;"></td> <td style="width: 10%;"></td> <td style="width: 10%;"></td> <td style="width: 10%;"></td> <td style="width: 10%;"></td> <td style="width: 10%;"></td> <td style="width: 10%;"></td> <td style="width: 10%;"></td> </tr> <tr> <td></td> <td></td> <td colspan="8" style="text-align: center;"> <table border="1" style="width: 100%; border-collapse: collapse; text-align: center;"> <tr> <td style="width: 10%;"></td> <td style="width: 10%;"></td> <td style="width: 10%;"></td> <td style="width: 10%;"></td> <td style="width: 10%;"></td> <td style="width: 10%;"></td> <td style="width: 10%;"></td> <td style="width: 10%;"></td> <td style="width: 10%;"></td> <td style="width: 10%;"></td> </tr> <tr> <td></td> <td></td> <td colspan="8" style="text-align: center;"> <table border="1" style="width: 100%; border-collapse: collapse; text-align: center;"> <tr> <td style="width: 10%;"></td> <td style="width: 10%;"></td> <td style="width: 10%;"></td> <td style="width: 10%;"></td> <td style="width: 10%;"></td> <td style="width: 10%;"></td> <td style="width: 10%;"></td> <td style="width: 10%;"></td> <td style="width: 10%;"></td> <td style="width: 10%;"></td> </tr> <tr> <td></td> <td></td> <td colspan="8" style="text-align: center;"> <table border="1" style="width: 100%; border-collapse: collapse; text-align: center;"> <tr> <td style="width: 10%;"></td> <td style="width: 10%;"></td> <td style="width: 10%;"></td> <td style="width: 10%;"></td> <td style="width: 10%;"></td> <td style="width: 10%;"></td> <td style="width: 10%;"></td> <td style="width: 10%;"></td> <td style="width: 10%;"></td> <td style="width: 10%;"></td> </tr> <tr> <td></td> <td></td> <td colspan="8" style="text-align: center;"> <table border="1" style="width: 100%; border-collapse: collapse; text-align: center;"> <tr> <td style="width: 10%;"></td> <td style="width: 10%;"></td> <td style="width: 10%;"></td> <td style="width: 10%;"></td> <td style="width: 10%;"></td> <td style="width: 10%;"></td> <td style="width: 10%;"></td> <td style="width: 10%;"></td> <td style="width: 10%;"></td> <td style="width: 10%;"></td> </tr> <tr> <td></td> <td></td> <td colspan="8" style="text-align: center;"> <table border="1" style="width: 100%; border-collapse: collapse; text-align: center;"> <tr> <td style="width: 10%;"></td> <td style="width: 10%;"></td> <td style="width: 10%;"></td> <td style="width: 10%;"></td> <td style="width: 10%;"></td> <td style="width: 10%;"></td> <td style="width: 10%;"></td> <td style="width: 10%;"></td> <td style="width: 10%;"></td> <td style="width: 10%;"></td> </tr> <tr> <td></td> <td></td> <td colspan="8" style="text-align: center;"> <table border="1" style="width: 100%; border-collapse: collapse; text-align: center;"> <tr> <td style="width: 10%;"></td> <td style="width: 10%;"></td> <td style="width: 10%;"></td> <td style="width: 10%;"></td> <td style="width: 10%;"></td> <td style="width: 10%;"></td> <td style="width: 10%;"></td> <td style="width: 10%;"></td> <td style="width: 10%;"></td> <td style="width: 10%;"></td> </tr> <tr> <td></td> <td></td> <td colspan="8" style="text-align: center;"> <table border="1" style="width: 100%; border-collapse: collapse; text-align: center;"> <tr> <td style="width: 10%;"></td> <td style="width: 10%;"></td> <td style="width: 10%;"></td> <td style="width: 10%;"></td> <td style="width: 10%;"></td> <td style="width: 10%;"></td> <td style="width: 10%;"></td> <td style="width: 10%;"></td> <td style="width: 10%;"></td> <td style="width: 10%;"></td> </tr> <tr> <td></td> <td></td> <td colspan="8" style="text-align: center;"> <table border="1" style="width: 100%; border-collapse: collapse; text-align: center;"> <tr> <td style="width: 10%;"></td> <td style="width: 10%;"></td> <td style="width: 10%;"></td> <td style="width: 10%;"></td> <td style="width: 10%;"></td> <td style="width:
10%;"></td> <td style="width: 10%;"></td> <td style="width: 10%;"></td> <td style="width: 10%;"></td> <td style="width: 10%;"></td> </tr> <tr> <td></td> <td></td> <td colspan="8" style="text-align: center;"> <table border="1" style="width: 100%; border-collapse: collapse; text-align: center;"> <tr> <td style="width: 10%;"></td> <td style="width: 10%;"></td> <td style="width: 10%;"></td> <td style="width: 10%;"></td> <td style="width: 10%;"></td> <td style="width: 10%;"></td> <td style="width: 10%;"></td> <td style="width: 10%;"></td> <td style="width: 10%;"></td> <td style="width: 10%;"></td> </tr> <tr> <td></td> <td></td> <td colspan="8" style="text-align: center;"> <table border="1" style="width: 100%; border-collapse: collapse; text-align: center;"> <tr> <td style="width: 10%;"></td> <td style="width: 10%;"></td> <td style="width: 10%;"></td> <td style="width: 10%;"></td> <td style="width: 10%;"></td> <td style="width: 10%;"></td> <td style="width: 10%;"></td> <td style="width: 10%;"></td> <td style="width: 10%;"></td> <td style="width: 10%;"></td> </tr> <tr> <td></td> <td></td> <td colspan="8" style="text-align: center;"> <table border="1" style="width: 100%; border-collapse: collapse; text-align: center;"> <tr> <td style="width: 10%;"></td> <td style="width: 10%;"></td> <td style="width: 10%;"></td> <td style="width: 10%;"></td> <td style="width: 10%;"></td> <td style="width: 10%;"></td> <td style="width: 10%;"></td> <td style="width: 10%;"></td> <td style="width: 10%;"></td> <td style="width: 10%;"></td> </tr> <tr> <td></td> <td></td> <td colspan="8" style="text-align: center;"> <table border="1" style="width: 100%; border-collapse: collapse; text-align: center;"> <tr> <td style="width: 10%;"></td> <td style="width: 10%;"></td> <td style="width: 10%;"></td> <td style="width: 10%;"></td> <td style="width: 10%;"></td> <td style="width: 10%;"></td> <td style="width: 10%;"></td> <td style="width: 10%;"></td> <td style="width: 10%;"></td> <td style="width: 10%;"></td> </tr> <tr> <td></td> <td></td> <td colspan="8" style="text-align: center;"> <table border="1" style="width: 100%; border-collapse: collapse; text-align: center;"> <tr> <td style="width: 10%;"></td> <td style="width: 10%;"></td> <td style="width: 10%;"></td> <td style="width: 10%;"></td> <td style="width: 10%;"></td> <td style="width: 10%;"></td> <td style="width: 10%;"></td> <td style="width: 10%;"></td> <td style="width: 10%;"></td> <td style="width: 10%;"></td> </tr> <tr> <td></td> <td></td> <td colspan="8" style="text-align: center;"> <table border="1" style="width: 100%; border-collapse: collapse; text-align: center;"> <tr> <td style="width: 10%;"></td> <td style="width: 10%;"></td> <td style="width: 10%;"></td> <td style="width: 10%;"></td> <td style="width: 10%;"></td> <td style="width: 10%;"></td> <td style="width: 10%;"></td> <td style="width: 10%;"></td> <td style="width: 10%;"></td> <td style="width: 10%;"></td> </tr> <tr> <td></td> <td></td> <td colspan="8" style="text-align: center;"> <table border="1" style="width: 100%; border-collapse: collapse; text-align: center;"> <tr> <td style="width: 10%;"></td> <td style="width: 10%;"></td> <td style="width: 10%;"></td> <td style="width: 10%;"></td> <td style="width: 10%;"></td> <td style="width: 10%;"></td> <td style="width: 10%;"></td> <td style="width: 10%;"></td> <td style="width: 10%;"></td> <td style="width: 10%;"></td> </tr> <tr> <td></td> <td></td> <td colspan="8" style="text-align: center;"> <table border="1" style="width: 100%; border-collapse: collapse; text-align: center;"> <tr> <td style="width: 10%;"></td> <td style="width: 10%;"></td> <td style="width: 10%;"></td> <td style="width: 10%;"></td> <td style="width: 10%;"></td> <td style="width: 10%;"></td> <td style="width: 10%;"></td> <td style="width: 10%;"></td> <td style="width: 10%;"></td> <td style="width: 10%;"></td> </tr> <tr> <td></td> <td></td> <td colspan="8" style="text-align: center;"> <table border="1" style="width: 100%; border-collapse: collapse; text-align: center;"> <tr> <td style="width: 10%;"></td> <td style="width: 10%;"></td> <td style="width: 10%;"></td> <td style="width: 10%;"></td> <td style="width: 10%;"></td> <td style="width: 10%;"></td> <td style="width: 10%;"></td> <td style="width: 10%;"></td> <td style="width: 10%;"></td> <td style="width: 10%;"></td> </tr> <tr> <td></td> <td></td> <td colspan="8" style="text-align: center;"> <table border="1" style="width: 100%; border-collapse: collapse; text-align: center;"> <tr> <td style="width: 10%;"></td> <td style="width: 10%;"></td> <td style="width: 10%;"></td> <td style="width: 10%;"></td> <td style="width: 10%;"></td> <td style="width: 10%;"></td> <td style="width: 10%;"></td> <td style="width: 10%;"></td> <td style="width: 10%;"></td> <td style="width: 10%;"></td> </tr> <tr> <td></td> <td></td> <td colspan="8" style="text-align: center;"> <table border="1" style="width: 100%; border-collapse: collapse; text-align: center;"> <tr> <td style="width: 10%;"></td> <td style="width: 10%;"></td> <td style="width: 10%;"></td> <td style="width: 10%;"></td> <td style="width: 10%;"></td> <td style="width: 10%;"></td> <td style="width: 10%;"></td> <td style="width: 10%;"></td> <td style="width: 10%;"></td> <td style="width: 10%;"></td> </tr> <tr> <td></td> <td></td> <td colspan="8" style="text-align: center;"> <table border="1" style="width: 100%; border-collapse: collapse; text-align: center;"> <tr> <td style="width: 10%;"></td> <td style="width: 10%;"></td> <td style="width: 10%;"></td> <td style="width: 10%;"></td> <td style="width: 10%;"></td> <td style="width: 10%;"></td> <td style="width: 10%;"></td> <td style="width: 10%;"></td> <td style="width: 10%;"></td> <td style="width: 10%;"></td> </tr> <tr> <td></td> <td></td> <td colspan="8" style="text-align: center;"> <table border="1" style="width: 100%; border-collapse: collapse; text-align: center;"> <tr> <td style="width: 10%;"></td> <td style="width: 10%;"></td> <td style="width: 10%;"></td> <td style="width: 10%;"></td> <td style="width: 10%;"></td> <td style="width: 10%;"></td> <td style="width: 10%;"></td> <td style="width: 10%;"></td> <td style="width: 10%;"></td> <td style="width: 10%;"></td> </tr> <tr> <td></td> <td></td> <td colspan="8" style="text-align: center;"> <table border="1" style="width: 100%; border-collapse: collapse; text-align: center;"> <tr> <td style="width: 10%;"></td> <td style="width: 10%;"></td> <td style="width: 10%;"></td> <td style="width: 10%;"></td> <td style="width: 10%;"></td> <td style="width: 10%;"></td> <td style="width: 10%;"></td> <td style="width: 10%;"></td> <td style="width: 10%;"></td> <td style="width: 10%;"></td> </tr> <tr> <td></td> <td></td> <td colspan="8" style="text-align: center;"> <table border="1" style="width: 100%; border-collapse: collapse; text-align: center;"> <tr> <td style="width: 10%;"></td> <td style="width: 10%;"></td> <td style="width: 10%;"></td> <td style="width: 10%;"></td> <td style="width: 10%;"></td> <td style="width: 10%;"></td> <td style="width: 10%;"></td> <td style="width: 10%;"></td> <td style="width: 10%;"></td> <td style="width: 10%;"></td> </tr> <tr> <td></td> <td></td> <td colspan="8" style="text-align: center;"> <table border="1" style="width: 100%; border-collapse: collapse; text-align: center;"> <tr> <td style="width: 10%;"></td> <td style="width: 10%;"></td> <td style="width: 10%;"></td> <td style="width: 10%;"></td> <td style="width: 10%;"></td> <td style="width: 10%;"></td> <td style="width: 10%;"></td> <td style="width: 10%;"></td> <td style="width: 10%;"></td> <td style="width: 10%;"></td> </tr> <tr> <td></td> <td></td> <td colspan="8" style="text-align: center;"> <table border="1" style="width: 100%; border-collapse: collapse; text-align: center;"> <tr> <td style="width: 10%;"></td> <td style="width: 10%;"></td> <td style="width: 10%;"></td> <td style="width: 10%;"></td> <td style="width: 10%;"></td> <td style="width: 10%;"></td> <td style="width: 10%;"></td> <td style="width: 10%;"></td> <td style="width: 10%;"></td> <td style="width: 10%;"></td> </tr> <tr> <td></td> <td></td> <td colspan="8" style="text-align: center;"> <table border="1" style="width: 100%; border-collapse: collapse; text-align: center;"> <tr> <td style="width: 10%;"></td> <td style="width: 10%;"></td> <td style="width: 10%;"></td> <td style="width: 10%;"></td> <td style="width: 10%;"></td> <td style="width: 10%;"></td> <td style="width: 10%;"></td> <td style="width: 10%;"></td> <td style="width: 10%;"></td> <td style="width: 10%;"></td> </tr> <tr> <td></td> <td></td> <td colspan="8" style="text-align: center;"> <table border="1" style="width: 100%; border-collapse: collapse; text-align: center;"> <tr> <td style="width: 10%;"></td> <td style="width: 10%;"></td> <td style="width: 10%;"></td> <td style="width: 10%;"></td> <td style="width: 10%;"></td> <td style="width: 10%;"></td> <td style="width: 10%;"></td> <td style="width: 10%;"></td> <td style="width: 10%;"></td> <td style="width: 10%;"></td> </tr> <tr> <td></td> <td></td> <td colspan="8" style="text-align: center;"> <table border="1" style="width: 100%; border-collapse: collapse; text-align: center;"> <tr> <td style="width: 10%;"></td> <td style="width: 10%;"></td> <td style="width: 10%;"></td> <td style="width: 10%;"></td> <td style="width: 10%;"></td> <td style="width: 10%;"></td> <td style="width: 10%;"></td> <td style="width: 10%;"></td> <td style="width: 10%;"></td> <td style="width: 10%;"></td> </tr> <tr> <td></td> <td></td> <td colspan="8" style="text-align: center;"> <table border="1" style="width: 100%; border-collapse: collapse; text-align: center;"> <tr> <td style="width: 10%;"></td> <td style="width: 10%;"></td> <td style="width: 10%;"></td> <td style="width: 10%;"></td> <td style="width: 10%;"></td> <td style="width: 10%;"></td> <td style="width: 10%;"></td> <td style="width: 10%;"></td> <td style="width: 10%;"></td> <td style="width: 10%;"></td> </tr> <tr> <td></td> <td></td> <td
colspan="8" style="text-align: center;"> <table border="1" style="width: 100%; border-collapse: collapse; text-align: center;"> <tr> <td style="width: 10%;"></td> <td style="width: 10%;"></td> <td style="width: 10%;"></td> <td style="width: 10%;"></td> <td style="width: 10%;"></td> <td style="width: 10%;"></td> <td style="width: 10%;"></td> <td style="width: 10%;"></td> <td style="width: 10%;"></td> <td style="width: 10%;"></td> </tr> <tr> <td></td> <td></td> <td colspan="8" style="text-align: center;"> <table border="1" style="width: 100%; border-collapse: collapse; text-align: center;"> <tr> <td style="width: 10%;"></td> <td style="width: 10%;"></td> <td style="width: 10%;"></td> <td style="width: 10%;"></td> <td style="width: 10%;"></td> <td style="width: 10%;"></td> <td style="width: 10%;"></td> <td style="width: 10%;"></td> <td style="width: 10%;"></td> <td style="width: 10%;"></td> </tr> <tr> <td></td> <td></td> <td colspan="8" style="text-align: center;"> <table border="1" style="width: 100%; border-collapse: collapse; text-align: center;"> <tr> <td style="width: 10%;"></td> <td style="width: 10%;"></td> <td style="width: 10%;"></td> <td style="width: 10%;"></td> <td style="width: 10%;"></td> <td style="width: 10%;"></td> <td style="width: 10%;"></td> <td style="width: 10%;"></td> <td style="width: 10%;"></td> <td style="width: 10%;"></td> </tr> <tr> <td></td> <td></td> <td colspan="8" style="text-align: center;"> <table border="1" style="width: 100%; border-collapse: collapse; text-align: center;"> <tr> <td style="width: 10%;"></td> <td style="width: 10%;"></td> <td style="width: 10%;"></td> <td style="width: 10%;"></td> <td style="width: 10%;"></td> <td style="width: 10%;"></td> <td style="width: 10%;"></td> <td style="width: 10%;"></td> <td style="width: 10%;"></td> <td style="width: 10%;"></td> </tr> <tr> <td></td> <td></td> <td colspan="8" style="text-align: center;"> <table border="1" style="width: 100%; border-collapse: collapse; text-align: center;"> <tr> <td style="width: 10%;"></td> <td style="width: 10%;"></td> <td style="width: 10%;"></td> <td style="width: 10%;"></td> <td style="width: 10%;"></td> <td style="width: 10%;"></td> <td style="width: 10%;"></td> <td style="width: 10%;"></td> <td style="width: 10%;"></td> <td style="width: 10%;"></td> </tr> <tr> <td></td> <td></td> <td colspan="8" style="text-align: center;"> <table border="1" style="width: 100%; border-collapse: collapse; text-align: center;"> <tr> <td style="width: 10%;"></td> <td style="width: 10%;"></td> <td style="width: 10%;"></td> <td style="width: 10%;"></td> <td style="width: 10%;"></td> <td style="width: 10%;"></td> <td style="width: 10%;"></td> <td style="width: 10%;"></td> <td style="width: 10%;"></td> <td style="width: 10%;"></td> </tr> <tr> <td></td> <td></td> <td colspan="8" style="text-align: center;"> <table border="1" style="width: 100%; border-collapse: collapse; text-align: center;"> <tr> <td style="width: 10%;"></td> <td style="width: 10%;"></td> <td style="width: 10%;"></td> <td style="width: 10%;"></td> <td style="width: 10%;"></td> <td style="width: 10%;"></td> <td style="width: 10%;"></td> <td style="width: 10%;"></td> <td style="width: 10%;"></td> <td style="width: 10%;"></td> </tr> <tr> <td></td> <td></td> <td colspan="8" style="text-align: center;"> <table border="1" style="width: 100%; border-collapse: collapse; text-align: center;"> <tr> <td style="width: 10%;"></td> <td style="width: 10%;"></td> <td style="width: 10%;"></td> <td style="width: 10%;"></td> <td style="width: 10%;"></td> <td style="width: 10%;"></td> <td style="width: 10%;"></td> <td style="width: 10%;"></td> <td style="width: 10%;"></td> <td style="width: 10%;"></td> </tr> <tr> <td></td> <td></td> <td colspan="8" style="text-align: center;"> <table border="1" style="width: 100%; border-collapse: collapse; text-align: center;"> <tr> <td style="width: 10%;"></td> <td style="width: 10%;"></td> <td style="width: 10%;"></td> <td style="width: 10%;"></td> <td style="width: 10%;"></td> <td style="width: 10%;"></td> <td style="width: 10%;"></td> <td style="width: 10%;"></td> <td style="width: 10%;"></td> <td style="width: 10%;"></td> </tr> <tr> <td></td> <td></td> <td colspan="8" style="text-align: center;"> <table border="1" style="width: 100%; border-collapse: collapse; text-align: center;"> <tr> <td style="width: 10%;"></td> <td style="width: 10%;"></td> <td style="width: 10%;"></td> <td style="width: 10%;"></td> <td style="width: 10%;"></td> <td style="width: 10%;"></td> <td style="width: 10%;"></td> <td style="width: 10%;"></td> <td style="width: 10%;"></td> <td style="width: 10%;"></td> </tr> <tr> <td></td> <td></td> <td colspan="8" style="text-align: center;"> <table border="1" style="width: 100%; border-collapse: collapse; text-align: center;"> <tr> <td style="width: 10%;"></td> <td style="width: 10%;"></td> <td style="width: 10%;"></td> <td style="width: 10%;"></td> <td style="width: 10%;"></td> <td style="width: 10%;"></td> <td style="width: 10%;"></td> <td style="width: 10%;"></td> <td style="width: 10%;"></td> <td style="width: 10%;"></td> </tr> <tr> <td></td> <td></td> <td colspan="8" style="text-align: center;"> <table border="1" style="width: 100%; border-collapse: collapse; text-align: center;"> <tr> <td style="width: 10%;"></td> <td style="width: 10%;"></td> <td style="width: 10%;"></td> <td style="width: 10%;"></td> <td style="width: 10%;"></td> <td style="width: 10%;"></td> <td style="width: 10%;"></td> <td style="width: 10%;"></td> <td style="width: 10%;"></td> <td style="width: 10%;"></td> </tr> <tr> <td></td> <td></td> <td colspan="8" style="text-align: center;"> <table border="1" style="width: 100%; border-collapse: collapse; text-align: center;"> <tr> </tr></table></td></tr></table></td></tr></table></td></tr></table></td></tr></table></td></tr></table></td></tr></table></td></tr></table></td></tr></table></td></tr></table></td></tr></table></td></tr></table></td></tr></table></td></tr></table></td></tr></table></td></tr></table></td></tr></table></td></tr></table></td></tr></table></td></tr></table></td></tr></table></td></tr></table></td></tr></table></td></tr></table></td></tr></table></td></tr></table></td></tr></table></td></tr></table></td></tr></table></td></tr></table></td></tr></table></td></tr></table></td></tr></table></td></tr></table></td></tr></table></td></tr></table></td></tr></table></td></tr></table></td></tr></table></td></tr></table></td></tr></table></td></tr></table></td></tr></table></td></tr></table></td></tr></table></td></tr></table></td></tr></table></td></tr></table></td></tr></table></td></tr></table></td></tr></table></td></tr></table></td></tr></table>
 | | | | | | | | | | | | | | | | | | | | <table border="1" style="width: 100%; border-collapse: collapse; text-align: center;"> <tr> <td style="width: 10%;"></td> <td style="width: 10%;"></td> <td style="width: 10%;"></td> <td style="width: 10%;"></td> <td style="width: 10%;"></td> <td style="width: 10%;"></td> <td style="width: 10%;"></td> <td style="width: 10%;"></td> <td style="width: 10%;"></td> <td style="width: 10%;"></td> </tr> <tr> <td></td> <td></td> <td colspan="8" style="text-align: center;"> <table border="1" style="width: 100%; border-collapse: collapse; text-align: center;"> <tr> <td style="width: 10%;"></td> <td style="width: 10%;"></td> <td style="width: 10%;"></td> <td style="width: 10%;"></td> <td style="width: 10%;"></td> <td style="width: 10%;"></td> <td style="width: 10%;"></td> <td style="width: 10%;"></td> <td style="width: 10%;"></td> <td style="width: 10%;"></td> </tr> <tr> <td></td> <td></td> <td colspan="8" style="text-align: center;"> <table border="1" style="width: 100%; border-collapse: collapse; text-align: center;"> <tr> <td style="width: 10%;"></td> <td style="width: 10%;"></td> <td style="width: 10%;"></td> <td style="width: 10%;"></td> <td style="width: 10%;"></td> <td style="width: 10%;"></td> <td style="width: 10%;"></td> <td style="width: 10%;"></td> <td style="width: 10%;"></td> <td style="width: 10%;"></td> </tr> <tr> <td></td> <td></td> <td colspan="8" style="text-align: center;"> <table border="1" style="width: 100%; border-collapse: collapse; text-align: center;"> <tr> <td style="width: 10%;"></td> <td style="width: 10%;"></td> <td style="width: 10%;"></td> <td style="width: 10%;"></td> <td style="width: 10%;"></td> <td style="width: 10%;"></td> <td style="width: 10%;"></td> <td style="width: 10%;"></td> <td style="width: 10%;"></td> <td style="width: 10%;"></td> </tr> <tr> <td></td> <td></td> <td colspan="8" style="text-align: center;"> <table border="1" style="width: 100%; border-collapse: collapse; text-align: center;"> <tr> <td style="width: 10%;"></td> <td style="width: 10%;"></td> <td style="width: 10%;"></td> <td style="width: 10%;"></td> <td style="width: 10%;"></td> <td style="width: 10%;"></td> <td style="width: 10%;"></td> <td style="width: 10%;"></td> <td style="width: 10%;"></td> <td style="width: 10%;"></td> </tr> <tr> <td></td> <td></td> <td colspan="8" style="text-align: center;"> <table border="1" style="width: 100%; border-collapse: collapse; text-align: center;"> <tr> <td style="width: 10%;"></td> <td style="width: 10%;"></td> <td style="width: 10%;"></td> <td style="width: 10%;"></td> <td style="width: 10%;"></td> <td style="width: 10%;"></td> <td style="width: 10%;"></td> <td style="width: 10%;"></td> <td style="width: 10%;"></td> <td style="width: 10%;"></td> </tr> <tr> <td></td> <td></td> <td colspan="8" style="text-align: center;"> <table border="1" style="width: 100%; border-collapse: collapse; text-align: center;"> <tr> <td style="width: 10%;"></td> <td style="width: 10%;"></td> <td style="width: 10%;"></td> <td style="width: 10%;"></td> <td style="width: 10%;"></td> <td style="width: 10%;"></td> <td style="width: 10%;"></td> <td style="width: 10%;"></td> <td style="width: 10%;"></td> <td style="width: 10%;"></td> </tr> <tr> <td></td> <td></td> <td colspan="8" style="text-align: center;"> <table border="1" style="width: 100%; border-collapse: collapse; text-align: center;"> <tr> <td style="width: 10%;"></td> <td style="width: 10%;"></td> <td style="width: 10%;"></td> <td style="width: 10%;"></td> <td style="width: 10%;"></td> <td style="width: 10%;"></td> <td style="width: 10%;"></td> <td style="width: 10%;"></td> <td style="width: 10%;"></td> <td style="width: 10%;"></td> </tr> <tr> <td></td> <td></td> <td colspan="8" style="text-align: center;"> <table border="1" style="width: 100%; border-collapse: collapse; text-align: center;"> <tr> <td style="width: 10%;"></td> <td style="width: 10%;"></td> <td style="width: 10%;"></td> <td style="width: 10%;"></td> <td style="width: 10%;"></td> <td style="width: 10%;"></td> <td style="width: 10%;"></td> <td style="width: 10%;"></td> <td style="width: 10%;"></td> <td style="width: 10%;"></td> </tr> <tr> <td></td> <td></td> <td colspan="8" style="text-align: center;"> <table border="1" style="width: 100%; border-collapse: collapse; text-align: center;"> <tr> <td style="width: 10%;"></td> <td style="width: 10%;"></td> <td style="width: 10%;"></td> <td style="width: 10%;"></td> <td style="width: 10%;"></td> <td style="width: 10%;"></td> <td style="width: 10%;"></td> <td style="width: 10%;"></td> <td style="width: 10%;"></td> <td style="width: 10%;"></td> </tr> <tr> <td></td> <td></td> <td colspan="8" style="text-align: center;"> <table border="1" style="width: 100%; border-collapse: collapse; text-align: center;"> <tr> <td style="width: 10%;"></td> <td style="width: 10%;"></td> <td style="width: 10%;"></td> <td style="width: 10%;"></td> <td style="width: 10%;"></td> <td style="width: 10%;"></td> <td style="width: 10%;"></td> <td style="width: 10%;"></td> <td style="width: 10%;"></td> <td style="width: 10%;"></td> </tr> <tr> <td></td> <td></td> <td colspan="8" style="text-align: center;"> <table border="1" style="width: 100%; border-collapse: collapse; text-align: center;"> <tr> <td style="width: 10%;"></td> <td style="width: 10%;"></td> <td style="width: 10%;"></td> <td style="width: 10%;"></td> <td style="width: 10%;"></td> <td style="width: 10%;"></td> <td style="width: 10%;"></td> <td style="width: 10%;"></td> <td style="width: 10%;"></td> <td style="width: 10%;"></td> </tr> <tr> <td></td> <td></td> <td colspan="8" style="text-align: center;"> <table border="1" style="width: 100%; border-collapse: collapse; text-align: center;"> <tr> <td style="width: 10%;"></td> <td style="width: 10%;"></td> <td style="width: 10%;"></td> <td style="width: 10%;"></td> <td style="width: 10%;"></td> <td style="width: 10%;"></td> <td style="width: 10%;"></td> <td style="width: 10%;"></td> <td style="width: 10%;"></td> <td style="width: 10%;"></td> </tr> <tr> <td></td> <td></td> <td colspan="8" style="text-align: center;"> <table border="1" style="width: 100%; border-collapse: collapse; text-align: center;"> <tr> <td style="width: 10%;"></td> <td style="width: 10%;"></td> <td style="width: 10%;"></td> <td style="width: 10%;"></td> <td style="width: 10%;"></td> <td style="width: 10%;"></td> <td style="width: 10%;"></td> <td style="width: 10%;"></td> <td style="width: 10%;"></td> <td style="width: 10%;"></td> </tr> <tr> <td></td> <td></td> <td colspan="8" style="text-align: center;"> <table border="1" style="width: 100%; border-collapse: collapse; text-align: center;"> <tr> <td style="width: 10%;"></td> <td style="width: 10%;"></td> <td style="width: 10%;"></td> <td style="width: 10%;"></td> <td style="width: 10%;"></td> <td style="width: 10%;"></td> <td style="width: 10%;"></td> <td style="width: 10%;"></td> <td style="width: 10%;"></td> <td style="width: 10%;"></td> </tr> <tr> <td></td> <td></td> <td colspan="8" style="text-align: center;"> <table border="1" style="width: 100%; border-collapse: collapse; text-align: center;"> <tr> <td style="width: 10%;"></td> <td style="width: 10%;"></td> <td style="width: 10%;"></td> <td style="width: 10%;"></td> <td style="width: 10%;"></td> <td style="width: 10%;"></td> <td style="width: 10%;"></td> <td style="width: 10%;"></td> <td style="width: 10%;"></td> <td style="width: 10%;"></td> </tr> <tr> <td></td> <td></td> <td colspan="8" style="text-align: center;"> <table border="1" style="width: 100%; border-collapse: collapse; text-align: center;"> <tr> <td style="width: 10%;"></td> <td style="width: 10%;"></td> <td style="width: 10%;"></td> <td style="width: 10%;"></td> <td style="width: 10%;"></td> <td style="width: 10%;"></td> <td style="width: 10%;"></td> <td style="width: 10%;"></td> <td style="width: 10%;"></td> <td style="width: 10%;"></td> </tr> <tr>
<td></td> <td></td> <td colspan="8" style="text-align: center;"> <table border="1" style="width: 100%; border-collapse: collapse; text-align: center;"> <tr> <td style="width: 10%;"></td> <td style="width: 10%;"></td> <td style="width: 10%;"></td> <td style="width: 10%;"></td> <td style="width: 10%;"></td> <td style="width: 10%;"></td> <td style="width: 10%;"></td> <td style="width: 10%;"></td> <td style="width: 10%;"></td> <td style="width: 10%;"></td> </tr> <tr> <td></td> <td></td> <td colspan="8" style="text-align: center;"> <table border="1" style="width: 100%; border-collapse: collapse; text-align: center;"> <tr> <td style="width: 10%;"></td> <td style="width: 10%;"></td> <td style="width: 10%;"></td> <td style="width: 10%;"></td> <td style="width: 10%;"></td> <td style="width: 10%;"></td> <td style="width: 10%;"></td> <td style="width: 10%;"></td> <td style="width: 10%;"></td> <td style="width: 10%;"></td> </tr> <tr> <td></td> <td></td> <td colspan="8" style="text-align: center;"> <table border="1" style="width: 100%; border-collapse: collapse; text-align: center;"> <tr> <td style="width: 10%;"></td> <td style="width: 10%;"></td> <td style="width: 10%;"></td> <td style="width: 10%;"></td> <td style="width: 10%;"></td> <td style="width: 10%;"></td> <td style="width: 10%;"></td> <td style="width: 10%;"></td> <td style="width: 10%;"></td> <td style="width: 10%;"></td> </tr> <tr> <td></td> <td></td> <td colspan="8" style="text-align: center;"> <table border="1" style="width: 100%; border-collapse: collapse; text-align: center;"> <tr> <td style="width: 10%;"></td> <td style="width: 10%;"></td> <td style="width: 10%;"></td> <td style="width: 10%;"></td> <td style="width: 10%;"></td> <td style="width: 10%;"></td> <td style="width: 10%;"></td> <td style="width: 10%;"></td> <td style="width: 10%;"></td> <td style="width: 10%;"></td> </tr> <tr> <td></td> <td></td> <td colspan="8" style="text-align: center;"> <table border="1" style="width: 100%; border-collapse: collapse; text-align: center;"> <tr> <td style="width: 10%;"></td> <td style="width: 10%;"></td> <td style="width: 10%;"></td> <td style="width: 10%;"></td> <td style="width: 10%;"></td> <td style="width: 10%;"></td> <td style="width: 10%;"></td> <td style="width: 10%;"></td> <td style="width: 10%;"></td> <td style="width: 10%;"></td> </tr> <tr> <td></td> <td></td> <td colspan="8" style="text-align: center;"> <table border="1" style="width: 100%; border-collapse: collapse; text-align: center;"> <tr> <td style="width: 10%;"></td> <td style="width: 10%;"></td> <td style="width: 10%;"></td> <td style="width: 10%;"></td> <td style="width: 10%;"></td> <td style="width: 10%;"></td> <td style="width: 10%;"></td> <td style="width: 10%;"></td> <td style="width: 10%;"></td> <td style="width: 10%;"></td> </tr> <tr> <td></td> <td></td> <td colspan="8" style="text-align: center;"> <table border="1" style="width: 100%; border-collapse: collapse; text-align: center;"> <tr> <td style="width: 10%;"></td> <td style="width: 10%;"></td> <td style="width: 10%;"></td> <td style="width: 10%;"></td> <td style="width: 10%;"></td> <td style="width: 10%;"></td> <td style="width: 10%;"></td> <td style="width: 10%;"></td> <td style="width: 10%;"></td> <td style="width: 10%;"></td> </tr> <tr> <td></td> <td></td> <td colspan="8" style="text-align: center;"> <table border="1" style="width: 100%; border-collapse: collapse; text-align: center;"> <tr> <td style="width: 10%;"></td> <td style="width: 10%;"></td> <td style="width: 10%;"></td> <td style="width: 10%;"></td> <td style="width: 10%;"></td> <td style="width: 10%;"></td> <td style="width: 10%;"></td> <td style="width: 10%;"></td> <td style="width: 10%;"></td> <td style="width: 10%;"></td> </tr> <tr> <td></td> <td></td> <td colspan="8" style="text-align: center;"> <table border="1" style="width: 100%; border-collapse: collapse; text-align: center;"> <tr> <td style="width: 10%;"></td> <td style="width: 10%;"></td> <td style="width: 10%;"></td> <td style="width: 10%;"></td> <td style="width: 10%;"></td> <td style="width: 10%;"></td> <td style="width: 10%;"></td> <td style="width: 10%;"></td> <td style="width: 10%;"></td> <td style="width: 10%;"></td> </tr> <tr> <td></td> <td></td> <td colspan="8" style="text-align: center;"> <table border="1" style="width: 100%; border-collapse: collapse; text-align: center;"> <tr> <td style="width: 10%;"></td> <td style="width: 10%;"></td> <td style="width: 10%;"></td> <td style="width: 10%;"></td> <td style="width: 10%;"></td> <td style="width: 10%;"></td> <td style="width: 10%;"></td> <td style="width: 10%;"></td> <td style="width: 10%;"></td> <td style="width: 10%;"></td> </tr> <tr> <td></td> <td></td> <td colspan="8" style="text-align: center;"> <table border="1" style="width: 100%; border-collapse: collapse; text-align: center;"> <tr> <td style="width: 10%;"></td> <td style="width: 10%;"></td> <td style="width: 10%;"></td> <td style="width: 10%;"></td> <td style="width: 10%;"></td> <td style="width: 10%;"></td> <td style="width: 10%;"></td> <td style="width: 10%;"></td> <td style="width: 10%;"></td> <td style="width: 10%;"></td> </tr> <tr> <td></td> <td></td> <td colspan="8" style="text-align: center;"> <table border="1" style="width: 100%; border-collapse: collapse; text-align: center;"> <tr> <td style="width: 10%;"></td> <td style="width: 10%;"></td> <td style="width: 10%;"></td> <td style="width: 10%;"></td> <td style="width: 10%;"></td> <td style="width: 10%;"></td> <td style="width: 10%;"></td> <td style="width: 10%;"></td> <td style="width: 10%;"></td> <td style="width: 10%;"></td> </tr> <tr> <td></td> <td></td> <td colspan="8" style="text-align: center;"> <table border="1" style="width: 100%; border-collapse: collapse; text-align: center;"> <tr> <td style="width: 10%;"></td> <td style="width: 10%;"></td> <td style="width: 10%;"></td> <td style="width: 10%;"></td> <td style="width: 10%;"></td> <td style="width: 10%;"></td> <td style="width: 10%;"></td> <td style="width: 10%;"></td> <td style="width: 10%;"></td> <td style="width: 10%;"></td> </tr> <tr> <td></td> <td></td> <td colspan="8" style="text-align: center;"> <table border="1" style="width: 100%; border-collapse: collapse; text-align: center;"> <tr> <td style="width: 10%;"></td> <td style="width: 10%;"></td> <td style="width: 10%;"></td> <td style="width: 10%;"></td> <td style="width: 10%;"></td> <td style="width: 10%;"></td> <td style="width: 10%;"></td> <td style="width: 10%;"></td> <td style="width: 10%;"></td> <td style="width: 10%;"></td> </tr> <tr> <td></td> <td></td> <td colspan="8" style="text-align: center;"> <table border="1" style="width: 100%; border-collapse: collapse; text-align: center;"> <tr> <td style="width: 10%;"></td> <td style="width: 10%;"></td> <td style="width: 10%;"></td> <td style="width: 10%;"></td> <td style="width: 10%;"></td> <td style="width: 10%;"></td> <td style="width: 10%;"></td> <td style="width: 10%;"></td> <td style="width: 10%;"></td> <td style="width: 10%;"></td> </tr> <tr> <td></td> <td></td> <td colspan="8" style="text-align: center;"> <table border="1" style="width: 100%; border-collapse: collapse; text-align: center;"> <tr> <td style="width: 10%;"></td> <td style="width: 10%;"></td> <td style="width: 10%;"></td> <td style="width: 10%;"></td> <td style="width: 10%;"></td> <td style="width: 10%;"></td> <td style="width: 10%;"></td> <td style="width: 10%;"></td> <td style="width: 10%;"></td> <td style="width: 10%;"></td> </tr> <tr> <td></td> <td></td> <td colspan="8" style="text-align: center;"> <table border="1" style="width: 100%; border-collapse: collapse; text-align: center;"> <tr> <td style="width: 10%;"></td> <td style="width: 10%;"></td> <td style="width: 10%;"></td> <td style="width: 10%;"></td> <td style="width: 10%;"></td> <td style="width: 10%;"></td> <td style="width: 10%;"></td> <td style="width: 10%;"></td> <td style="width: 10%;"></td> <td style="width: 10%;"></td> </tr> <tr> <td></td> <td></td> <td colspan="8" style="text-align: center;"> <table border="1" style="width: 100%; border-collapse: collapse; text-align: center;"> <tr> <td style="width: 10%;"></td> <td style="width: 10%;"></td> <td style="width: 10%;"></td> <td style="width: 10%;"></td> <td style="width: 10%;"></td> <td style="width: 10%;"></td> <td style="width: 10%;"></td> <td style="width: 10%;"></td> <td style="width: 10%;"></td> <td style="width: 10%;"></td> </tr> <tr> <td></td> <td></td> <td colspan="8" style="text-align: center;"> <table border="1" style="width: 100%; border-collapse: collapse; text-align: center;"> <tr> <td style="width: 10%;"></td> <td style="width: 10%;"></td> <td style="width: 10%;"></td> <td style="width: 10%;"></td> <td style="width: 10%;"></td> <td style="width: 10%;"></td> <td style="width: 10%;"></td> <td style="width: 10%;"></td> <td style="width: 10%;"></td> <td style="width: 10%;"></td> </tr> <tr> <td></td> <td></td> <td colspan="8" style="text-align: center;"> <table border="1" style="width: 100%; border-collapse: collapse; text-align: center;"> <tr> <td style="width: 10%;"></td> <td style="width: 10%;"></td> <td style="width: 10%;"></td> <td style="width: 10%;"></td> <td style="width: 10%;"></td> <td style="width: 10%;"></td> <td style="width: 10%;"></td> <td style="width: 10%;"></td> <td style="width: 10%;"></td> <td style="width: 10%;"></td> </tr> <tr> <td></td> <td></td> <td colspan="8" style="text-align: center;"> <table border="1" style="width: 100%; border-collapse: collapse; text-align: center;"> <tr> <td style="width: 10%;"></td> <td style="width: 10%;"></td> <td style="width: 10%;"></td> <td style="width: 10%;"></td> <td style="width: 10%;"></td> <td style="width: 10%;"></td> <td style="width: 10%;"></td> <td style="width: 10%;"></td> <td style="width: 10%;"></td> <td style="width: 10%;"></td> </tr> <tr> <td></td> <td></td> <td colspan="8" style="text-align: center;"> <table border="1" style="width: 100%; border-collapse: collapse; text-align: center;"> <tr> <td
style="width: 10%;"></td> <td style="width: 10%;"></td> <td style="width: 10%;"></td> <td style="width: 10%;"></td> <td style="width: 10%;"></td> <td style="width: 10%;"></td> <td style="width: 10%;"></td> <td style="width: 10%;"></td> <td style="width: 10%;"></td> <td style="width: 10%;"></td> </tr> <tr> <td></td> <td></td> <td colspan="8" style="text-align: center;"> <table border="1" style="width: 100%; border-collapse: collapse; text-align: center;"> <tr> <td style="width: 10%;"></td> <td style="width: 10%;"></td> <td style="width: 10%;"></td> <td style="width: 10%;"></td> <td style="width: 10%;"></td> <td style="width: 10%;"></td> <td style="width: 10%;"></td> <td style="width: 10%;"></td> <td style="width: 10%;"></td> <td style="width: 10%;"></td> </tr> <tr> <td></td> <td></td> <td colspan="8" style="text-align: center;"> <table border="1" style="width: 100%; border-collapse: collapse; text-align: center;"> <tr> <td style="width: 10%;"></td> <td style="width: 10%;"></td> <td style="width: 10%;"></td> <td style="width: 10%;"></td> <td style="width: 10%;"></td> <td style="width: 10%;"></td> <td style="width: 10%;"></td> <td style="width: 10%;"></td> <td style="width: 10%;"></td> <td style="width: 10%;"></td> </tr> <tr> <td></td> <td></td> <td colspan="8" style="text-align: center;"> <table border="1" style="width: 100%; border-collapse: collapse; text-align: center;"> <tr> <td style="width: 10%;"></td> <td style="width: 10%;"></td> <td style="width: 10%;"></td> <td style="width: 10%;"></td> <td style="width: 10%;"></td> <td style="width: 10%;"></td> <td style="width: 10%;"></td> <td style="width: 10%;"></td> <td style="width: 10%;"></td> <td style="width: 10%;"></td> </tr> <tr> <td></td> <td></td> <td colspan="8" style="text-align: center;"> <table border="1" style="width: 100%; border-collapse: collapse; text-align: center;"> <tr> <td style="width: 10%;"></td> <td style="width: 10%;"></td> <td style="width: 10%;"></td> <td style="width: 10%;"></td> <td style="width: 10%;"></td> <td style="width: 10%;"></td> <td style="width: 10%;"></td> <td style="width: 10%;"></td> <td style="width: 10%;"></td> <td style="width: 10%;"></td> </tr> <tr> <td></td> <td></td> <td colspan="8" style="text-align: center;"> <table border="1" style="width: 100%; border-collapse: collapse; text-align: center;"> <tr> <td style="width: 10%;"></td> <td style="width: 10%;"></td> <td style="width: 10%;"></td> <td style="width: 10%;"></td> <td style="width: 10%;"></td> <td style="width: 10%;"></td> <td style="width: 10%;"></td> <td style="width: 10%;"></td> <td style="width: 10%;"></td> <td style="width: 10%;"></td> </tr> <tr> <td></td> <td></td> <td colspan="8" style="text-align: center;"> <table border="1" style="width: 100%; border-collapse: collapse; text-align: center;"> <tr> <td style="width: 10%;"></td> <td style="width: 10%;"></td> <td style="width: 10%;"></td> <td style="width: 10%;"></td> <td style="width: 10%;"></td> <td style="width: 10%;"></td> <td style="width: 10%;"></td> <td style="width: 10%;"></td> <td style="width: 10%;"></td> <td style="width: 10%;"></td> </tr> <tr> <td></td> <td></td> <td colspan="8" style="text-align: center;"> <table border="1" style="width: 100%; border-collapse: collapse; text-align: center;"> <tr> <td style="width: 10%;"></td> <td style="width: 10%;"></td> <td style="width: 10%;"></td> <td style="width: 10%;"></td> <td style="width: 10%;"></td> <td style="width: 10%;"></td> <td style="width: 10%;"></td> <td style="width: 10%;"></td> <td style="width: 10%;"></td> <td style="width: 10%;"></td> </tr> <tr> <td></td> <td></td> <td colspan="8" style="text-align: center;"> <table border="1" style="width: 100%; border-collapse: collapse; text-align: center;"> <tr> <td style="width: 10%;"></td> <td style="width: 10%;"></td> <td style="width: 10%;"></td> <td style="width: 10%;"></td> <td style="width: 10%;"></td> <td style="width: 10%;"></td> <td style="width: 10%;"></td> <td style="width: 10%;"></td> <td style="width: 10%;"></td> <td style="width: 10%;"></td> </tr> <tr> <td></td> <td></td> <td colspan="8" style="text-align: center;"> <table border="1" style="width: 100%; border-collapse: collapse; text-align: center;"> <tr> <td style="width: 10%;"></td> <td style="width: 10%;"></td> <td style="width: 10%;"></td> <td style="width: 10%;"></td> <td style="width: 10%;"></td> <td style="width: 10%;"></td> <td style="width: 10%;"></td> <td style="width: 10%;"></td> <td style="width: 10%;"></td> <td style="width: 10%;"></td> </tr> <tr> <td></td> <td></td> <td colspan="8" style="text-align: center;"> <table border="1" style="width: 100%; border-collapse: collapse; text-align: center;"> <tr> <td style="width: 10%;"></td> <td style="width: 10%;"></td> <td style="width: 10%;"></td> <td style="width: 10%;"></td> <td style="width: 10%;"></td> <td style="width: 10%;"></td> <td style="width: 10%;"></td> <td style="width: 10%;"></td> <td style="width: 10%;"></td> <td style="width: 10%;"></td> </tr> <tr> <td></td> <td></td> <td colspan="8" style="text-align: center;"> <table border="1" style="width: 100%; border-collapse: collapse; text-align: center;"> <tr> <td style="width: 10%;"></td> <td style="width: 10%;"></td> <td style="width: 10%;"></td> <td style="width: 10%;"></td> <td style="width: 10%;"></td> <td style="width: 10%;"></td> <td style="width: 10%;"></td> <td style="width: 10%;"></td> <td style="width: 10%;"></td> <td style="width: 10%;"></td> </tr> <tr> <td></td> <td></td> <td colspan="8" style="text-align: center;"> <table border="1" style="width: 100%; border-collapse: collapse; text-align: center;"> <tr> <td style="width: 10%;"></td> <td style="width: 10%;"></td> <td style="width: 10%;"></td> <td style="width: 10%;"></td> <td style="width: 10%;"></td> <td style="width: 10%;"></td> <td style="width: 10%;"></td> <td style="width: 10%;"></td> <td style="width: 10%;"></td> <td style="width: 10%;"></td> </tr> <tr> <td></td> <td></td> <td colspan="8" style="text-align: center;"> <table border="1" style="width: 100%; border-collapse: collapse; text-align: center;"> <tr> </tr></table></td></tr></table></td></tr></table></td></tr></table></td></tr></table></td></tr></table></td></tr></table></td></tr></table></td></tr></table></td></tr></table></td></tr></table></td></tr></table></td></tr></table></td></tr></table></td></tr></table></td></tr></table></td></tr></table></td></tr></table></td></tr></table></td></tr></table></td></tr></table></td></tr></table></td></tr></table></td></tr></table></td></tr></table></td></tr></table></td></tr></table></td></tr></table></td></tr></table></td></tr></table></td></tr></table></td></tr></table></td></tr></table></td></tr></table></td></tr></table></td></tr></table></td></tr></table></td></tr></table></td></tr></table></td></tr></table></td></tr></table></td></tr></table></td></tr></table></td></tr></table></td></tr></table></td></tr></table></td></tr></table></td></tr></table></td></tr></table></td></tr></table></td></tr></table></td></tr></table>
 | | | | | | | | | | | | | | | | | | | | <table border="1" style="width: 100%; border-collapse: collapse; text-align: center;"> <tr> <td style="width: 10%;"></td> <td style="width: 10%;"></td> <td style="width: 10%;"></td> <td style="width: 10%;"></td> <td style="width: 10%;"></td> <td style="width: 10%;"></td> <td style="width: 10%;"></td> <td style="width: 10%;"></td> <td style="width: 10%;"></td> <td style="width: 10%;"></td> </tr> <tr> <td></td> <td></td> <td colspan="8" style="text-align: center;"> <table border="1" style="width: 100%; border-collapse: collapse; text-align: center;"> <tr> <td style="width: 10%;"></td> <td style="width: 10%;"></td> <td style="width: 10%;"></td> <td style="width: 10%;"></td> <td style="width: 10%;"></td> <td style="width: 10%;"></td> <td style="width: 10%;"></td> <td style="width: 10%;"></td> <td style="width: 10%;"></td> <td style="width: 10%;"></td> </tr> <tr> <td></td> <td></td> <td colspan="8" style="text-align: center;"> <table border="1" style="width: 100%; border-collapse: collapse; text-align: center;"> <tr> <td style="width: 10%;"></td> <td style="width: 10%;"></td> <td style="width: 10%;"></td> <td style="width: 10%;"></td> <td style="width: 10%;"></td> <td style="width: 10%;"></td> <td style="width: 10%;"></td> <td style="width: 10%;"></td> <td style="width: 10%;"></td> <td style="width: 10%;"></td> </tr> <tr> <td></td> <td></td> <td colspan="8" style="text-align: center;"> <table border="1" style="width: 100%; border-collapse: collapse; text-align: center;"> <tr> <td style="width: 10%;"></td> <td style="width: 10%;"></td> <td style="width: 10%;"></td> <td style="width: 10%;"></td> <td style="width: 10%;"></td> <td style="width: 10%;"></td> <td style="width: 10%;"></td> <td style="width: 10%;"></td> <td style="width: 10%;"></td> <td style="width: 10%;"></td> </tr> <tr> <td></td> <td></td> <td colspan="8" style="text-align: center;"> <table border="1" style="width: 100%; border-collapse: collapse; text-align: center;"> <tr> <td style="width: 10%;"></td> <td style="width: 10%;"></td> <td style="width: 10%;"></td> <td style="width: 10%;"></td> <td style="width: 10%;"></td> <td style="width: 10%;"></td> <td style="width: 10%;"></td> <td style="width: 10%;"></td> <td style="width: 10%;"></td> <td style="width: 10%;"></td> </tr> <tr> <td></td> <td></td> <td colspan="8" style="text-align: center;"> <table border="1" style="width: 100%; border-collapse: collapse; text-align: center;"> <tr> <td style="width: 10%;"></td> <td style="width: 10%;"></td> <td style="width: 10%;"></td> <td style="width: 10%;"></td> <td style="width: 10%;"></td> <td style="width: 10%;"></td> <td style="width: 10%;"></td> <td style="width: 10%;"></td> <td style="width: 10%;"></td> <td style="width: 10%;"></td> </tr> <tr> <td></td> <td></td> <td colspan="8" style="text-align: center;"> <table border="1" style="width: 100%; border-collapse: collapse; text-align: center;"> <tr> <td style="width: 10%;"></td> <td style="width: 10%;"></td> <td style="width: 10%;"></td> <td style="width: 10%;"></td> <td style="width: 10%;"></td> <td style="width: 10%;"></td> <td style="width: 10%;"></td> <td style="width: 10%;"></td> <td style="width: 10%;"></td> <td style="width: 10%;"></td> </tr> <tr> <td></td> <td></td> <td colspan="8" style="text-align: center;"> <table border="1" style="width: 100%; border-collapse: collapse; text-align: center;"> <tr> <td style="width: 10%;"></td> <td style="width: 10%;"></td> <td style="width: 10%;"></td> <td style="width: 10%;"></td> <td style="width: 10%;"></td> <td style="width: 10%;"></td> <td style="width: 10%;"></td> <td style="width: 10%;"></td> <td style="width: 10%;"></td> <td style="width: 10%;"></td> </tr> <tr> <td></td> <td></td> <td colspan="8" style="text-align: center;"> <table border="1" style="width: 100%; border-collapse: collapse; text-align: center;"> <tr> <td style="width: 10%;"></td> <td style="width: 10%;"></td> <td style="width: 10%;"></td> <td style="width: 10%;"></td> <td style="width: 10%;"></td> <td style="width: 10%;"></td> <td style="width: 10%;"></td> <td style="width: 10%;"></td> <td style="width: 10%;"></td> <td style="width: 10%;"></td> </tr> <tr> <td></td> <td></td> <td colspan="8" style="text-align: center;"> <table border="1" style="width: 100%; border-collapse: collapse; text-align: center;"> <tr> <td style="width: 10%;"></td> <td style="width: 10%;"></td> <td style="width: 10%;"></td> <td style="width: 10%;"></td> <td style="width: 10%;"></td> <td style="width: 10%;"></td> <td style="width: 10%;"></td> <td style="width: 10%;"></td> <td style="width: 10%;"></td> <td style="width: 10%;"></td> </tr> <tr> <td></td> <td></td> <td colspan="8" style="text-align: center;"> <table border="1" style="width: 100%; border-collapse: collapse; text-align: center;"> <tr> <td style="width: 10%;"></td> <td style="width: 10%;"></td> <td style="width: 10%;"></td> <td style="width: 10%;"></td> <td style="width: 10%;"></td> <td style="width: 10%;"></td> <td style="width: 10%;"></td> <td style="width: 10%;"></td> <td style="width: 10%;"></td> <td style="width: 10%;"></td> </tr> <tr> <td></td> <td></td> <td colspan="8" style="text-align: center;"> <table border="1" style="width: 100%; border-collapse: collapse; text-align: center;"> <tr> <td style="width: 10%;"></td> <td style="width: 10%;"></td> <td style="width: 10%;"></td> <td style="width: 10%;"></td> <td style="width: 10%;"></td> <td style="width: 10%;"></td> <td style="width: 10%;"></td> <td style="width: 10%;"></td> <td style="width: 10%;"></td> <td style="width: 10%;"></td> </tr> <tr> <td></td> <td></td> <td colspan="8" style="text-align: center;"> <table border="1" style="width: 100%; border-collapse: collapse; text-align: center;"> <tr> <td style="width: 10%;"></td> <td style="width: 10%;"></td> <td style="width: 10%;"></td> <td style="width: 10%;"></td> <td style="width: 10%;"></td> <td style="width: 10%;"></td> <td style="width: 10%;"></td> <td style="width: 10%;"></td> <td style="width: 10%;"></td> <td style="width: 10%;"></td> </tr> <tr> <td></td> <td></td> <td colspan="8" style="text-align: center;"> <table border="1" style="width: 100%; border-collapse: collapse; text-align: center;"> <tr> <td style="width: 10%;"></td> <td style="width: 10%;"></td> <td style="width: 10%;"></td> <td style="width: 10%;"></td> <td style="width: 10%;"></td> <td style="width: 10%;"></td> <td style="width: 10%;"></td> <td style="width: 10%;"></td> <td style="width: 10%;"></td> <td style="width: 10%;"></td> </tr> <tr> <td></td> <td></td> <td colspan="8" style="text-align: center;"> <table border="1" style="width: 100%; border-collapse: collapse; text-align: center;"> <tr> <td style="width: 10%;"></td> <td style="width: 10%;"></td> <td style="width: 10%;"></td> <td style="width: 10%;"></td> <td style="width: 10%;"></td> <td style="width: 10%;"></td> <td style="width: 10%;"></td> <td style="width: 10%;"></td> <td style="width: 10%;"></td> <td style="width: 10%;"></td> </tr> <tr> <td></td> <td></td> <td colspan="8" style="text-align: center;"> <table border="1" style="width: 100%; border-collapse: collapse; text-align: center;"> <tr> <td style="width: 10%;"></td> <td style="width: 10%;"></td> <td style="width: 10%;"></td> <td style="width: 10%;"></td> <td style="width: 10%;"></td> <td style="width: 10%;"></td> <td style="width: 10%;"></td> <td style="width: 10%;"></td> <td style="width: 10%;"></td> <td style="width: 10%;"></td> </tr> <tr> <td></td> <td></td> <td colspan="8" style="text-align: center;"> <table border="1" style="width: 100%; border-collapse: collapse; text-align: center;"> <tr>
<td style="width: 10%;"></td> <td style="width: 10%;"></td> <td style="width: 10%;"></td> <td style="width: 10%;"></td> <td style="width: 10%;"></td> <td style="width: 10%;"></td> <td style="width: 10%;"></td> <td style="width: 10%;"></td> <td style="width: 10%;"></td> <td style="width: 10%;"></td> </tr> <tr> <td></td> <td></td> <td colspan="8" style="text-align: center;"> <table border="1" style="width: 100%; border-collapse: collapse; text-align: center;"> <tr> <td style="width: 10%;"></td> <td style="width: 10%;"></td> <td style="width: 10%;"></td> <td style="width: 10%;"></td> <td style="width: 10%;"></td> <td style="width: 10%;"></td> <td style="width: 10%;"></td> <td style="width: 10%;"></td> <td style="width: 10%;"></td> <td style="width: 10%;"></td> </tr> <tr> <td></td> <td></td> <td colspan="8" style="text-align: center;"> <table border="1" style="width: 100%; border-collapse: collapse; text-align: center;"> <tr> <td style="width: 10%;"></td> <td style="width: 10%;"></td> <td style="width: 10%;"></td> <td style="width: 10%;"></td> <td style="width: 10%;"></td> <td style="width: 10%;"></td> <td style="width: 10%;"></td> <td style="width: 10%;"></td> <td style="width: 10%;"></td> <td style="width: 10%;"></td> </tr> <tr> <td></td> <td></td> <td colspan="8" style="text-align: center;"> <table border="1" style="width: 100%; border-collapse: collapse; text-align: center;"> <tr> <td style="width: 10%;"></td> <td style="width: 10%;"></td> <td style="width: 10%;"></td> <td style="width: 10%;"></td> <td style="width: 10%;"></td> <td style="width: 10%;"></td> <td style="width: 10%;"></td> <td style="width: 10%;"></td> <td style="width: 10%;"></td> <td style="width: 10%;"></td> </tr> <tr> <td></td> <td></td> <td colspan="8" style="text-align: center;"> <table border="1" style="width: 100%; border-collapse: collapse; text-align: center;"> <tr> <td style="width: 10%;"></td> <td style="width: 10%;"></td> <td style="width: 10%;"></td> <td style="width: 10%;"></td> <td style="width: 10%;"></td> <td style="width: 10%;"></td> <td style="width: 10%;"></td> <td style="width: 10%;"></td> <td style="width: 10%;"></td> <td style="width: 10%;"></td> </tr> <tr> <td></td> <td></td> <td colspan="8" style="text-align: center;"> <table border="1" style="width: 100%; border-collapse: collapse; text-align: center;"> <tr> <td style="width: 10%;"></td> <td style="width: 10%;"></td> <td style="width: 10%;"></td> <td style="width: 10%;"></td> <td style="width: 10%;"></td> <td style="width: 10%;"></td> <td style="width: 10%;"></td> <td style="width: 10%;"></td> <td style="width: 10%;"></td> <td style="width: 10%;"></td> </tr> <tr> <td></td> <td></td> <td colspan="8" style="text-align: center;"> <table border="1" style="width: 100%; border-collapse: collapse; text-align: center;"> <tr> <td style="width: 10%;"></td> <td style="width: 10%;"></td> <td style="width: 10%;"></td> <td style="width: 10%;"></td> <td style="width: 10%;"></td> <td style="width: 10%;"></td> <td style="width: 10%;"></td> <td style="width: 10%;"></td> <td style="width: 10%;"></td> <td style="width: 10%;"></td> </tr> <tr> <td></td> <td></td> <td colspan="8" style="text-align: center;"> <table border="1" style="width: 100%; border-collapse: collapse; text-align: center;"> <tr> <td style="width: 10%;"></td> <td style="width: 10%;"></td> <td style="width: 10%;"></td> <td style="width: 10%;"></td> <td style="width: 10%;"></td> <td style="width: 10%;"></td> <td style="width: 10%;"></td> <td style="width: 10%;"></td> <td style="width: 10%;"></td> <td style="width: 10%;"></td> </tr> <tr> <td></td> <td></td> <td colspan="8" style="text-align: center;"> <table border="1" style="width: 100%; border-collapse: collapse; text-align: center;"> <tr> <td style="width: 10%;"></td> <td style="width: 10%;"></td> <td style="width: 10%;"></td> <td style="width: 10%;"></td> <td style="width: 10%;"></td> <td style="width: 10%;"></td> <td style="width: 10%;"></td> <td style="width: 10%;"></td> <td style="width: 10%;"></td> <td style="width: 10%;"></td> </tr> <tr> <td></td> <td></td> <td colspan="8" style="text-align: center;"> <table border="1" style="width: 100%; border-collapse: collapse; text-align: center;"> <tr> <td style="width: 10%;"></td> <td style="width: 10%;"></td> <td style="width: 10%;"></td> <td style="width: 10%;"></td> <td style="width: 10%;"></td> <td style="width: 10%;"></td> <td style="width: 10%;"></td> <td style="width: 10%;"></td> <td style="width: 10%;"></td> <td style="width: 10%;"></td> </tr> <tr> <td></td> <td></td> <td colspan="8" style="text-align: center;"> <table border="1" style="width: 100%; border-collapse: collapse; text-align: center;"> <tr> <td style="width: 10%;"></td> <td style="width: 10%;"></td> <td style="width: 10%;"></td> <td style="width: 10%;"></td> <td style="width: 10%;"></td> <td style="width: 10%;"></td> <td style="width: 10%;"></td> <td style="width: 10%;"></td> <td style="width: 10%;"></td> <td style="width: 10%;"></td> </tr> <tr> <td></td> <td></td> <td colspan="8" style="text-align: center;"> <table border="1" style="width: 100%; border-collapse: collapse; text-align: center;"> <tr> <td style="width: 10%;"></td> <td style="width: 10%;"></td> <td style="width: 10%;"></td> <td style="width: 10%;"></td> <td style="width: 10%;"></td> <td style="width: 10%;"></td> <td style="width: 10%;"></td> <td style="width: 10%;"></td> <td style="width: 10%;"></td> <td style="width: 10%;"></td> </tr> <tr> <td></td> <td></td> <td colspan="8" style="text-align: center;"> <table border="1" style="width: 100%; border-collapse: collapse; text-align: center;"> <tr> <td style="width: 10%;"></td> <td style="width: 10%;"></td> <td style="width: 10%;"></td> <td style="width: 10%;"></td> <td style="width: 10%;"></td> <td style="width: 10%;"></td> <td style="width: 10%;"></td> <td style="width: 10%;"></td> <td style="width: 10%;"></td> <td style="width: 10%;"></td> </tr> <tr> <td></td> <td></td> <td colspan="8" style="text-align: center;"> <table border="1" style="width: 100%; border-collapse: collapse; text-align: center;"> <tr> <td style="width: 10%;"></td> <td style="width: 10%;"></td> <td style="width: 10%;"></td> <td style="width: 10%;"></td> <td style="width: 10%;"></td> <td style="width: 10%;"></td> <td style="width: 10%;"></td> <td style="width: 10%;"></td> <td style="width: 10%;"></td> <td style="width: 10%;"></td> </tr> <tr> <td></td> <td></td> <td colspan="8" style="text-align: center;"> <table border="1" style="width: 100%; border-collapse: collapse; text-align: center;"> <tr> <td style="width: 10%;"></td> <td style="width: 10%;"></td> <td style="width: 10%;"></td> <td style="width: 10%;"></td> <td style="width: 10%;"></td> <td style="width: 10%;"></td> <td style="width: 10%;"></td> <td style="width: 10%;"></td> <td style="width: 10%;"></td> <td style="width: 10%;"></td> </tr> <tr> <td></td> <td></td> <td colspan="8" style="text-align: center;"> <table border="1" style="width: 100%; border-collapse: collapse; text-align: center;"> <tr> <td style="width: 10%;"></td> <td style="width: 10%;"></td> <td style="width: 10%;"></td> <td style="width: 10%;"></td> <td style="width: 10%;"></td> <td style="width: 10%;"></td> <td style="width: 10%;"></td> <td style="width: 10%;"></td> <td style="width: 10%;"></td> <td style="width: 10%;"></td> </tr> <tr> <td></td> <td></td> <td colspan="8" style="text-align: center;"> <table border="1" style="width: 100%; border-collapse: collapse; text-align: center;"> <tr> <td style="width: 10%;"></td> <td style="width: 10%;"></td> <td style="width: 10%;"></td> <td style="width: 10%;"></td> <td style="width: 10%;"></td> <td style="width: 10%;"></td> <td style="width: 10%;"></td> <td style="width: 10%;"></td> <td style="width: 10%;"></td> <td style="width: 10%;"></td> </tr> <tr> <td></td> <td></td> <td colspan="8" style="text-align: center;"> <table border="1" style="width: 100%; border-collapse: collapse; text-align: center;"> <tr> <td style="width: 10%;"></td> <td style="width: 10%;"></td> <td style="width: 10%;"></td> <td style="width: 10%;"></td> <td style="width: 10%;"></td> <td style="width: 10%;"></td> <td style="width: 10%;"></td> <td style="width: 10%;"></td> <td style="width: 10%;"></td> <td style="width: 10%;"></td> </tr> <tr> <td></td> <td></td> <td colspan="8" style="text-align: center;"> <table border="1" style="width: 100%; border-collapse: collapse; text-align: center;"> <tr> <td style="width: 10%;"></td> <td style="width: 10%;"></td> <td style="width: 10%;"></td> <td style="width: 10%;"></td> <td style="width: 10%;"></td> <td style="width: 10%;"></td> <td style="width: 10%;"></td> <td style="width: 10%;"></td> <td style="width: 10%;"></td> <td style="width: 10%;"></td> </tr> <tr> <td></td> <td></td> <td colspan="8" style="text-align: center;"> <table border="1" style="width: 100%; border-collapse: collapse; text-align: center;"> <tr> <td style="width: 10%;"></td> <td style="width: 10%;"></td> <td style="width: 10%;"></td> <td style="width: 10%;"></td> <td style="width: 10%;"></td> <td style="width: 10%;"></td> <td style="width: 10%;"></td> <td style="width: 10%;"></td> <td style="width: 10%;"></td> <td style="width: 10%;"></td> </tr> <tr> <td></td> <td></td> <td colspan="8" style="text-align: center;"> <table border="1" style="width: 100%; border-collapse: collapse; text-align: center;"> <tr> <td style="width: 10%;"></td> <td style="width: 10%;"></td> <td style="width: 10%;"></td> <td style="width: 10%;"></td> <td style="width: 10%;"></td> <td style="width: 10%;"></td> <td style="width: 10%;"></td> <td style="width: 10%;"></td> <td style="width: 10%;"></td> <td style="width: 10%;"></td> </tr> <tr> <td></td> <td></td> <td colspan="8" style="text-align: center;"> <table border="1" style="width: 100%; border-collapse: collapse; text-align: center;"> <tr> <td style="width: 10%;"></td> <td style="width: 10%;"></td> <td style="width: 10%;"></td> <td style="width: 10%;"></td> <td style="width: 10%;"></td> <td style="width:
10%;"></td> <td style="width: 10%;"></td> <td style="width: 10%;"></td> <td style="width: 10%;"></td> <td style="width: 10%;"></td> </tr> <tr> <td></td> <td></td> <td colspan="8" style="text-align: center;"> <table border="1" style="width: 100%; border-collapse: collapse; text-align: center;"> <tr> <td style="width: 10%;"></td> <td style="width: 10%;"></td> <td style="width: 10%;"></td> <td style="width: 10%;"></td> <td style="width: 10%;"></td> <td style="width: 10%;"></td> <td style="width: 10%;"></td> <td style="width: 10%;"></td> <td style="width: 10%;"></td> <td style="width: 10%;"></td> </tr> <tr> <td></td> <td></td> <td colspan="8" style="text-align: center;"> <table border="1" style="width: 100%; border-collapse: collapse; text-align: center;"> <tr> <td style="width: 10%;"></td> <td style="width: 10%;"></td> <td style="width: 10%;"></td> <td style="width: 10%;"></td> <td style="width: 10%;"></td> <td style="width: 10%;"></td> <td style="width: 10%;"></td> <td style="width: 10%;"></td> <td style="width: 10%;"></td> <td style="width: 10%;"></td> </tr> <tr> <td></td> <td></td> <td colspan="8" style="text-align: center;"> <table border="1" style="width: 100%; border-collapse: collapse; text-align: center;"> <tr> <td style="width: 10%;"></td> <td style="width: 10%;"></td> <td style="width: 10%;"></td> <td style="width: 10%;"></td> <td style="width: 10%;"></td> <td style="width: 10%;"></td> <td style="width: 10%;"></td> <td style="width: 10%;"></td> <td style="width: 10%;"></td> <td style="width: 10%;"></td> </tr> <tr> <td></td> <td></td> <td colspan="8" style="text-align: center;"> <table border="1" style="width: 100%; border-collapse: collapse; text-align: center;"> <tr> <td style="width: 10%;"></td> <td style="width: 10%;"></td> <td style="width: 10%;"></td> <td style="width: 10%;"></td> <td style="width: 10%;"></td> <td style="width: 10%;"></td> <td style="width: 10%;"></td> <td style="width: 10%;"></td> <td style="width: 10%;"></td> <td style="width: 10%;"></td> </tr> <tr> <td></td> <td></td> <td colspan="8" style="text-align: center;"> <table border="1" style="width: 100%; border-collapse: collapse; text-align: center;"> <tr> <td style="width: 10%;"></td> <td style="width: 10%;"></td> <td style="width: 10%;"></td> <td style="width: 10%;"></td> <td style="width: 10%;"></td> <td style="width: 10%;"></td> <td style="width: 10%;"></td> <td style="width: 10%;"></td> <td style="width: 10%;"></td> <td style="width: 10%;"></td> </tr> <tr> <td></td> <td></td> <td colspan="8" style="text-align: center;"> <table border="1" style="width: 100%; border-collapse: collapse; text-align: center;"> <tr> <td style="width: 10%;"></td> <td style="width: 10%;"></td> <td style="width: 10%;"></td> <td style="width: 10%;"></td> <td style="width: 10%;"></td> <td style="width: 10%;"></td> <td style="width: 10%;"></td> <td style="width: 10%;"></td> <td style="width: 10%;"></td> <td style="width: 10%;"></td> </tr> <tr> <td></td> <td></td> <td colspan="8" style="text-align: center;"> <table border="1" style="width: 100%; border-collapse: collapse; text-align: center;"> <tr> <td style="width: 10%;"></td> <td style="width: 10%;"></td> <td style="width: 10%;"></td> <td style="width: 10%;"></td> <td style="width: 10%;"></td> <td style="width: 10%;"></td> <td style="width: 10%;"></td> <td style="width: 10%;"></td> <td style="width: 10%;"></td> <td style="width: 10%;"></td> </tr> <tr> <td></td> <td></td> <td colspan="8" style="text-align: center;"> <table border="1" style="width: 100%; border-collapse: collapse; text-align: center;"> <tr> <td style="width: 10%;"></td> <td style="width: 10%;"></td> <td style="width: 10%;"></td> <td style="width: 10%;"></td> <td style="width: 10%;"></td> <td style="width: 10%;"></td> <td style="width: 10%;"></td> <td style="width: 10%;"></td> <td style="width: 10%;"></td> <td style="width: 10%;"></td> </tr> <tr> <td></td> <td></td> <td colspan="8" style="text-align: center;"> <table border="1" style="width: 100%; border-collapse: collapse; text-align: center;"> <tr> <td style="width: 10%;"></td> <td style="width: 10%;"></td> <td style="width: 10%;"></td> <td style="width: 10%;"></td> <td style="width: 10%;"></td> <td style="width: 10%;"></td> <td style="width: 10%;"></td> <td style="width: 10%;"></td> <td style="width: 10%;"></td> <td style="width: 10%;"></td> </tr> <tr> <td></td> <td></td> <td colspan="8" style="text-align: center;"> <table border="1" style="width: 100%; border-collapse: collapse; text-align: center;"> <tr> <td style="width: 10%;"></td> <td style="width: 10%;"></td> <td style="width: 10%;"></td> <td style="width: 10%;"></td> <td style="width: 10%;"></td> <td style="width: 10%;"></td> <td style="width: 10%;"></td> <td style="width: 10%;"></td> <td style="width: 10%;"></td> <td style="width: 10%;"></td> </tr> <tr> <td></td> <td></td> <td colspan="8" style="text-align: center;"> <table border="1" style="width: 100%; border-collapse: collapse; text-align: center;"> <tr> <td style="width: 10%;"></td> <td style="width: 10%;"></td> <td style="width: 10%;"></td> <td style="width: 10%;"></td> <td style="width: 10%;"></td> <td style="width: 10%;"></td> <td style="width: 10%;"></td> <td style="width: 10%;"></td> <td style="width: 10%;"></td> <td style="width: 10%;"></td> </tr> <tr> <td></td> <td></td> <td colspan="8" style="text-align: center;"> <table border="1" style="width: 100%; border-collapse: collapse; text-align: center;"> <tr> <td style="width: 10%;"></td> <td style="width: 10%;"></td> <td style="width: 10%;"></td> <td style="width: 10%;"></td> <td style="width: 10%;"></td> <td style="width: 10%;"></td> <td style="width: 10%;"></td> <td style="width: 10%;"></td> <td style="width: 10%;"></td> <td style="width: 10%;"></td> </tr> <tr> <td></td> <td></td> <td colspan="8" style="text-align: center;"> <table border="1" style="width: 100%; border-collapse: collapse; text-align: center;"> <tr> </tr></table></td></tr></table></td></tr></table></td></tr></table></td></tr></table></td></tr></table></td></tr></table></td></tr></table></td></tr></table></td></tr></table></td></tr></table></td></tr></table></td></tr></table></td></tr></table></td></tr></table></td></tr></table></td></tr></table></td></tr></table></td></tr></table></td></tr></table></td></tr></table></td></tr></table></td></tr></table></td></tr></table></td></tr></table></td></tr></table></td></tr></table></td></tr></table></td></tr></table></td></tr></table></td></tr></table></td></tr></table></td></tr></table></td></tr></table></td></tr></table></td></tr></table></td></tr></table></td></tr></table></td></tr></table></td></tr></table></td></tr></table></td></tr></table></td></tr></table></td></tr></table></td></tr></table></td></tr></table></td></tr></table></td></tr></table></td></tr></table></td></tr></table></td></tr></table>
 | | | | | | | | | | | | | | | | | | | | <table border="1" style="width: 100%; border-collapse: collapse; text-align: center;"> <tr> <td style="width: 10%;"></td> <td style="width: 10%;"></td> <td style="width: 10%;"></td> <td style="width: 10%;"></td> <td style="width: 10%;"></td> <td style="width: 10%;"></td> <td style="width: 10%;"></td> <td style="width: 10%;"></td> <td style="width: 10%;"></td> <td style="width: 10%;"></td> </tr> <tr> <td></td> <td></td> <td colspan="8" style="text-align: center;"> <table border="1" style="width: 100%; border-collapse: collapse; text-align: center;"> <tr> <td style="width: 10%;"></td> <td style="width: 10%;"></td> <td style="width: 10%;"></td> <td style="width: 10%;"></td> <td style="width: 10%;"></td> <td style="width: 10%;"></td> <td style="width: 10%;"></td> <td style="width: 10%;"></td> <td style="width: 10%;"></td> <td style="width: 10%;"></td> </tr> <tr> <td></td> <td></td> <td colspan="8" style="text-align: center;"> <table border="1" style="width: 100%; border-collapse: collapse; text-align: center;"> <tr> <td style="width: 10%;"></td> <td style="width: 10%;"></td> <td style="width: 10%;"></td> <td style="width: 10%;"></td> <td style="width: 10%;"></td> <td style="width: 10%;"></td> <td style="width: 10%;"></td> <td style="width: 10%;"></td> <td style="width: 10%;"></td> <td style="width: 10%;"></td> </tr> <tr> <td></td> <td></td> <td colspan="8" style="text-align: center;"> <table border="1" style="width: 100%; border-collapse: collapse; text-align: center;"> <tr> <td style="width: 10%;"></td> <td style="width: 10%;"></td> <td style="width: 10%;"></td> <td style="width: 10%;"></td> <td style="width: 10%;"></td> <td style="width: 10%;"></td> <td style="width: 10%;"></td> <td style="width: 10%;"></td> <td style="width: 10%;"></td> <td style="width: 10%;"></td> </tr> <tr> <td></td> <td></td> <td colspan="8" style="text-align: center;"> <table border="1" style="width: 100%; border-collapse: collapse; text-align: center;"> <tr> <td style="width: 10%;"></td> <td style="width: 10%;"></td> <td style="width: 10%;"></td> <td style="width: 10%;"></td> <td style="width: 10%;"></td> <td style="width: 10%;"></td> <td style="width: 10%;"></td> <td style="width: 10%;"></td> <td style="width: 10%;"></td> <td style="width: 10%;"></td> </tr> <tr> <td></td> <td></td> <td colspan="8" style="text-align: center;"> <table border="1" style="width: 100%; border-collapse: collapse; text-align: center;"> <tr> <td style="width: 10%;"></td> <td style="width: 10%;"></td> <td style="width: 10%;"></td> <td style="width: 10%;"></td> <td style="width: 10%;"></td> <td style="width: 10%;"></td> <td style="width: 10%;"></td> <td style="width: 10%;"></td> <td style="width: 10%;"></td> <td style="width: 10%;"></td> </tr> <tr> <td></td> <td></td> <td colspan="8" style="text-align: center;"> <table border="1" style="width: 100%; border-collapse: collapse; text-align: center;"> <tr> <td style="width: 10%;"></td> <td style="width: 10%;"></td> <td style="width: 10%;"></td> <td style="width: 10%;"></td> <td style="width: 10%;"></td> <td style="width: 10%;"></td> <td style="width: 10%;"></td> <td style="width: 10%;"></td> <td style="width: 10%;"></td> <td style="width: 10%;"></td> </tr> <tr> <td></td> <td></td> <td colspan="8" style="text-align: center;"> <table border="1" style="width: 100%; border-collapse: collapse; text-align: center;"> <tr> <td style="width: 10%;"></td> <td style="width: 10%;"></td> <td style="width: 10%;"></td> <td style="width: 10%;"></td> <td style="width: 10%;"></td> <td style="width: 10%;"></td> <td style="width: 10%;"></td> <td style="width: 10%;"></td> <td style="width: 10%;"></td> <td style="width: 10%;"></td> </tr> <tr> <td></td> <td></td> <td colspan="8" style="text-align: center;"> <table border="1" style="width: 100%; border-collapse: collapse; text-align: center;"> <tr> <td style="width: 10%;"></td> <td style="width: 10%;"></td> <td style="width: 10%;"></td> <td style="width: 10%;"></td> <td style="width: 10%;"></td> <td style="width: 10%;"></td> <td style="width: 10%;"></td> <td style="width: 10%;"></td> <td style="width: 10%;"></td> <td style="width: 10%;"></td> </tr> <tr> <td></td> <td></td> <td colspan="8" style="text-align: center;"> <table border="1" style="width: 100%; border-collapse: collapse; text-align: center;"> <tr> <td style="width: 10%;"></td> <td style="width: 10%;"></td> <td style="width: 10%;"></td> <td style="width: 10%;"></td> <td style="width: 10%;"></td> <td style="width: 10%;"></td> <td style="width: 10%;"></td> <td style="width: 10%;"></td> <td style="width: 10%;"></td> <td style="width: 10%;"></td> </tr> <tr> <td></td> <td></td> <td colspan="8" style="text-align: center;"> <table border="1" style="width: 100%; border-collapse: collapse; text-align: center;"> <tr> <td style="width: 10%;"></td> <td style="width: 10%;"></td> <td style="width: 10%;"></td> <td style="width: 10%;"></td> <td style="width: 10%;"></td> <td style="width: 10%;"></td> <td style="width: 10%;"></td> <td style="width: 10%;"></td> <td style="width: 10%;"></td> <td style="width: 10%;"></td> </tr> <tr> <td></td> <td></td> <td colspan="8" style="text-align: center;"> <table border="1" style="width: 100%; border-collapse: collapse; text-align: center;"> <tr> <td style="width: 10%;"></td> <td style="width: 10%;"></td> <td style="width: 10%;"></td> <td style="width: 10%;"></td> <td style="width: 10%;"></td> <td style="width: 10%;"></td> <td style="width: 10%;"></td> <td style="width: 10%;"></td> <td style="width: 10%;"></td> <td style="width: 10%;"></td> </tr> <tr> <td></td> <td></td> <td colspan="8" style="text-align: center;"> <table border="1" style="width: 100%; border-collapse: collapse; text-align: center;"> <tr> <td style="width: 10%;"></td> <td style="width: 10%;"></td> <td style="width: 10%;"></td> <td style="width: 10%;"></td> <td style="width: 10%;"></td> <td style="width: 10%;"></td> <td style="width: 10%;"></td> <td style="width: 10%;"></td> <td style="width: 10%;"></td> <td style="width: 10%;"></td> </tr> <tr> <td></td> <td></td> <td colspan="8" style="text-align: center;"> <table border="1" style="width: 100%; border-collapse: collapse; text-align: center;"> <tr> <td style="width: 10%;"></td> <td style="width: 10%;"></td> <td style="width: 10%;"></td> <td style="width: 10%;"></td> <td style="width: 10%;"></td> <td style="width: 10%;"></td> <td style="width: 10%;"></td> <td style="width: 10%;"></td> <td style="width: 10%;"></td> <td style="width: 10%;"></td> </tr> <tr> <td></td> <td></td> <td colspan="8" style="text-align: center;"> <table border="1" style="width: 100%; border-collapse: collapse; text-align: center;"> <tr> <td style="width: 10%;"></td> <td style="width: 10%;"></td> <td style="width: 10%;"></td> <td style="width: 10%;"></td> <td style="width: 10%;"></td> <td style="width: 10%;"></td> <td style="width: 10%;"></td> <td style="width: 10%;"></td> <td style="width: 10%;"></td> <td style="width: 10%;"></td> </tr> <tr> <td></td> <td></td> <td colspan="8" style="text-align: center;"> <table border="1" style="width: 100%; border-collapse: collapse; text-align: center;"> <tr> <td style="width: 10%;"></td> <td style="width: 10%;"></td> <td style="width: 10%;"></td> <td style="width: 10%;"></td> <td style="width: 10%;"></td> <td style="width: 10%;"></td> <td style="width: 10%;"></td> <td style="width: 10%;"></td> <td style="width: 10%;"></td> <td style="width: 10%;"></td> </tr> <tr> <td></td> <td></td> <td colspan="8" style="text-align: center;"> <table border="1" style="width: 100%; border-collapse: collapse; text-align: center;"> <tr> <td style="width: 10%;"></td> <td style="width: 10%;"></td> <td style="width: 10%;"></td> <td style="width: 10%;"></td> <td style="width: 10%;"></td> <td style="width: 10%;"></td> <td
style="width: 10%;"></td> <td style="width: 10%;"></td> <td style="width: 10%;"></td> <td style="width: 10%;"></td> </tr> <tr> <td></td> <td></td> <td colspan="8" style="text-align: center;"> <table border="1" style="width: 100%; border-collapse: collapse; text-align: center;"> <tr> <td style="width: 10%;"></td> <td style="width: 10%;"></td> <td style="width: 10%;"></td> <td style="width: 10%;"></td> <td style="width: 10%;"></td> <td style="width: 10%;"></td> <td style="width: 10%;"></td> <td style="width: 10%;"></td> <td style="width: 10%;"></td> <td style="width: 10%;"></td> </tr> <tr> <td></td> <td></td> <td colspan="8" style="text-align: center;"> <table border="1" style="width: 100%; border-collapse: collapse; text-align: center;"> <tr> <td style="width: 10%;"></td> <td style="width: 10%;"></td> <td style="width: 10%;"></td> <td style="width: 10%;"></td> <td style="width: 10%;"></td> <td style="width: 10%;"></td> <td style="width: 10%;"></td> <td style="width: 10%;"></td> <td style="width: 10%;"></td> <td style="width: 10%;"></td> </tr> <tr> <td></td> <td></td> <td colspan="8" style="text-align: center;"> <table border="1" style="width: 100%; border-collapse: collapse; text-align: center;"> <tr> <td style="width: 10%;"></td> <td style="width: 10%;"></td> <td style="width: 10%;"></td> <td style="width: 10%;"></td> <td style="width: 10%;"></td> <td style="width: 10%;"></td> <td style="width: 10%;"></td> <td style="width: 10%;"></td> <td style="width: 10%;"></td> <td style="width: 10%;"></td> </tr> <tr> <td></td> <td></td> <td colspan="8" style="text-align: center;"> <table border="1" style="width: 100%; border-collapse: collapse; text-align: center;"> <tr> <td style="width: 10%;"></td> <td style="width: 10%;"></td> <td style="width: 10%;"></td> <td style="width: 10%;"></td> <td style="width: 10%;"></td> <td style="width: 10%;"></td> <td style="width: 10%;"></td> <td style="width: 10%;"></td> <td style="width: 10%;"></td> <td style="width: 10%;"></td> </tr> <tr> <td></td> <td></td> <td colspan="8" style="text-align: center;"> <table border="1" style="width: 100%; border-collapse: collapse; text-align: center;"> <tr> <td style="width: 10%;"></td> <td style="width: 10%;"></td> <td style="width: 10%;"></td> <td style="width: 10%;"></td> <td style="width: 10%;"></td> <td style="width: 10%;"></td> <td style="width: 10%;"></td> <td style="width: 10%;"></td> <td style="width: 10%;"></td> <td style="width: 10%;"></td> </tr> <tr> <td></td> <td></td> <td colspan="8" style="text-align: center;"> <table border="1" style="width: 100%; border-collapse: collapse; text-align: center;"> <tr> <td style="width: 10%;"></td> <td style="width: 10%;"></td> <td style="width: 10%;"></td> <td style="width: 10%;"></td> <td style="width: 10%;"></td> <td style="width: 10%;"></td> <td style="width: 10%;"></td> <td style="width: 10%;"></td> <td style="width: 10%;"></td> <td style="width: 10%;"></td> </tr> <tr> <td></td> <td></td> <td colspan="8" style="text-align: center;"> <table border="1" style="width: 100%; border-collapse: collapse; text-align: center;"> <tr> <td style="width: 10%;"></td> <td style="width: 10%;"></td> <td style="width: 10%;"></td> <td style="width: 10%;"></td> <td style="width: 10%;"></td> <td style="width: 10%;"></td> <td style="width: 10%;"></td> <td style="width: 10%;"></td> <td style="width: 10%;"></td> <td style="width: 10%;"></td> </tr> <tr> <td></td> <td></td> <td colspan="8" style="text-align: center;"> <table border="1" style="width: 100%; border-collapse: collapse; text-align: center;"> <tr> <td style="width: 10%;"></td> <td style="width: 10%;"></td> <td style="width: 10%;"></td> <td style="width: 10%;"></td> <td style="width: 10%;"></td> <td style="width: 10%;"></td> <td style="width: 10%;"></td> <td style="width: 10%;"></td> <td style="width: 10%;"></td> <td style="width: 10%;"></td> </tr> <tr> <td></td> <td></td> <td colspan="8" style="text-align: center;"> <table border="1" style="width: 100%; border-collapse: collapse; text-align: center;"> <tr> <td style="width: 10%;"></td> <td style="width: 10%;"></td> <td style="width: 10%;"></td> <td style="width: 10%;"></td> <td style="width: 10%;"></td> <td style="width: 10%;"></td> <td style="width: 10%;"></td> <td style="width: 10%;"></td> <td style="width: 10%;"></td> <td style="width: 10%;"></td> </tr> <tr> <td></td> <td></td> <td colspan="8" style="text-align: center;"> <table border="1" style="width: 100%; border-collapse: collapse; text-align: center;"> <tr> <td style="width: 10%;"></td> <td style="width: 10%;"></td> <td style="width: 10%;"></td> <td style="width: 10%;"></td> <td style="width: 10%;"></td> <td style="width: 10%;"></td> <td style="width: 10%;"></td> <td style="width: 10%;"></td> <td style="width: 10%;"></td> <td style="width: 10%;"></td> </tr> <tr> <td></td> <td></td> <td colspan="8" style="text-align: center;"> <table border="1" style="width: 100%; border-collapse: collapse; text-align: center;"> <tr> <td style="width: 10%;"></td> <td style="width: 10%;"></td> <td style="width: 10%;"></td> <td style="width: 10%;"></td> <td style="width: 10%;"></td> <td style="width: 10%;"></td> <td style="width: 10%;"></td> <td style="width: 10%;"></td> <td style="width: 10%;"></td> <td style="width: 10%;"></td> </tr> <tr> <td></td> <td></td> <td colspan="8" style="text-align: center;"> <table border="1" style="width: 100%; border-collapse: collapse; text-align: center;"> <tr> <td style="width: 10%;"></td> <td style="width: 10%;"></td> <td style="width: 10%;"></td> <td style="width: 10%;"></td> <td style="width: 10%;"></td> <td style="width: 10%;"></td> <td style="width: 10%;"></td> <td style="width: 10%;"></td> <td style="width: 10%;"></td> <td style="width: 10%;"></td> </tr> <tr> <td></td> <td></td> <td colspan="8" style="text-align: center;"> <table border="1" style="width: 100%; border-collapse: collapse; text-align: center;"> <tr> <td style="width: 10%;"></td> <td style="width: 10%;"></td> <td style="width: 10%;"></td> <td style="width: 10%;"></td> <td style="width: 10%;"></td> <td style="width: 10%;"></td> <td style="width: 10%;"></td> <td style="width: 10%;"></td> <td style="width: 10%;"></td> <td style="width: 10%;"></td> </tr> <tr> <td></td> <td></td> <td colspan="8" style="text-align: center;"> <table border="1" style="width: 100%; border-collapse: collapse; text-align: center;"> <tr> <td style="width: 10%;"></td> <td style="width: 10%;"></td> <td style="width: 10%;"></td> <td style="width: 10%;"></td> <td style="width: 10%;"></td> <td style="width: 10%;"></td> <td style="width: 10%;"></td> <td style="width: 10%;"></td> <td style="width: 10%;"></td> <td style="width: 10%;"></td> </tr> <tr> <td></td> <td></td> <td colspan="8" style="text-align: center;"> <table border="1" style="width: 100%; border-collapse: collapse; text-align: center;"> <tr> <td style="width: 10%;"></td> <td style="width: 10%;"></td> <td style="width: 10%;"></td> <td style="width: 10%;"></td> <td style="width: 10%;"></td> <td style="width: 10%;"></td> <td style="width: 10%;"></td> <td style="width: 10%;"></td> <td style="width: 10%;"></td> <td style="width: 10%;"></td> </tr> <tr> <td></td> <td></td> <td colspan="8" style="text-align: center;"> <table border="1" style="width: 100%; border-collapse: collapse; text-align: center;"> <tr> <td style="width: 10%;"></td> <td style="width: 10%;"></td> <td style="width: 10%;"></td> <td style="width: 10%;"></td> <td style="width: 10%;"></td> <td style="width: 10%;"></td> <td style="width: 10%;"></td> <td style="width: 10%;"></td> <td style="width: 10%;"></td> <td style="width: 10%;"></td> </tr> <tr> <td></td> <td></td> <td colspan="8" style="text-align: center;"> <table border="1" style="width: 100%; border-collapse: collapse; text-align: center;"> <tr> <td style="width: 10%;"></td> <td style="width: 10%;"></td> <td style="width: 10%;"></td> <td style="width: 10%;"></td> <td style="width: 10%;"></td> <td style="width: 10%;"></td> <td style="width: 10%;"></td> <td style="width: 10%;"></td> <td style="width: 10%;"></td> <td style="width: 10%;"></td> </tr> <tr> <td></td> <td></td> <td colspan="8" style="text-align: center;"> <table border="1" style="width: 100%; border-collapse: collapse; text-align: center;"> <tr> <td style="width: 10%;"></td> <td style="width: 10%;"></td> <td style="width: 10%;"></td> <td style="width: 10%;"></td> <td style="width: 10%;"></td> <td style="width: 10%;"></td> <td style="width: 10%;"></td> <td style="width: 10%;"></td> <td style="width: 10%;"></td> <td style="width: 10%;"></td> </tr> <tr> <td></td> <td></td> <td colspan="8" style="text-align: center;"> <table border="1" style="width: 100%; border-collapse: collapse; text-align: center;"> <tr> <td style="width: 10%;"></td> <td style="width: 10%;"></td> <td style="width: 10%;"></td> <td style="width: 10%;"></td> <td style="width: 10%;"></td> <td style="width: 10%;"></td> <td style="width: 10%;"></td> <td style="width: 10%;"></td> <td style="width: 10%;"></td> <td style="width: 10%;"></td> </tr> <tr> <td></td> <td></td> <td colspan="8" style="text-align: center;"> <table border="1" style="width: 100%; border-collapse: collapse; text-align: center;"> <tr> <td style="width: 10%;"></td> <td style="width: 10%;"></td> <td style="width: 10%;"></td> <td style="width: 10%;"></td> <td style="width: 10%;"></td> <td style="width: 10%;"></td> <td style="width: 10%;"></td> <td style="width: 10%;"></td> <td style="width: 10%;"></td> <td style="width: 10%;"></td> </tr> <tr> <td></td> <td></td> <td colspan="8" style="text-align: center;"> <table border="1" style="width: 100%; border-collapse: collapse; text-align: center;"> <tr> <td style="width: 10%;"></td> <td style="width: 10%;"></td> <td style="width: 10%;"></td> <td style="width: 10%;"></td> <td style="width: 10%;"></td> <td style="width: 10%;"></td> <td style="width: 10%;"></td> <td style="width: 10%;"></td> <td style="width: 10%;"></td> <td style="width: 10%;"></td> </tr> <tr> <td></td> <td></td> <td colspan="8"
style="text-align: center;"> <table border="1" style="width: 100%; border-collapse: collapse; text-align: center;"> <tr> <td style="width: 10%;"></td> <td style="width: 10%;"></td> <td style="width: 10%;"></td> <td style="width: 10%;"></td> <td style="width: 10%;"></td> <td style="width: 10%;"></td> <td style="width: 10%;"></td> <td style="width: 10%;"></td> <td style="width: 10%;"></td> <td style="width: 10%;"></td> </tr> <tr> <td></td> <td></td> <td colspan="8" style="text-align: center;"> <table border="1" style="width: 100%; border-collapse: collapse; text-align: center;"> <tr> <td style="width: 10%;"></td> <td style="width: 10%;"></td> <td style="width: 10%;"></td> <td style="width: 10%;"></td> <td style="width: 10%;"></td> <td style="width: 10%;"></td> <td style="width: 10%;"></td> <td style="width: 10%;"></td> <td style="width: 10%;"></td> <td style="width: 10%;"></td> </tr> <tr> <td></td> <td></td> <td colspan="8" style="text-align: center;"> <table border="1" style="width: 100%; border-collapse: collapse; text-align: center;"> <tr> <td style="width: 10%;"></td> <td style="width: 10%;"></td> <td style="width: 10%;"></td> <td style="width: 10%;"></td> <td style="width: 10%;"></td> <td style="width: 10%;"></td> <td style="width: 10%;"></td> <td style="width: 10%;"></td> <td style="width: 10%;"></td> <td style="width: 10%;"></td> </tr> <tr> <td></td> <td></td> <td colspan="8" style="text-align: center;"> <table border="1" style="width: 100%; border-collapse: collapse; text-align: center;"> <tr> <td style="width: 10%;"></td> <td style="width: 10%;"></td> <td style="width: 10%;"></td> <td style="width: 10%;"></td> <td style="width: 10%;"></td> <td style="width: 10%;"></td> <td style="width: 10%;"></td> <td style="width: 10%;"></td> <td style="width: 10%;"></td> <td style="width: 10%;"></td> </tr> <tr> <td></td> <td></td> <td colspan="8" style="text-align: center;"> <table border="1" style="width: 100%; border-collapse: collapse; text-align: center;"> <tr> <td style="width: 10%;"></td> <td style="width: 10%;"></td> <td style="width: 10%;"></td> <td style="width: 10%;"></td> <td style="width: 10%;"></td> <td style="width: 10%;"></td> <td style="width: 10%;"></td> <td style="width: 10%;"></td> <td style="width: 10%;"></td> <td style="width: 10%;"></td> </tr> <tr> <td></td> <td></td> <td colspan="8" style="text-align: center;"> <table border="1" style="width: 100%; border-collapse: collapse; text-align: center;"> <tr> <td style="width: 10%;"></td> <td style="width: 10%;"></td> <td style="width: 10%;"></td> <td style="width: 10%;"></td> <td style="width: 10%;"></td> <td style="width: 10%;"></td> <td style="width: 10%;"></td> <td style="width: 10%;"></td> <td style="width: 10%;"></td> <td style="width: 10%;"></td> </tr> <tr> <td></td> <td></td> <td colspan="8" style="text-align: center;"> <table border="1" style="width: 100%; border-collapse: collapse; text-align: center;"> <tr> <td style="width: 10%;"></td> <td style="width: 10%;"></td> <td style="width: 10%;"></td> <td style="width: 10%;"></td> <td style="width: 10%;"></td> <td style="width: 10%;"></td> <td style="width: 10%;"></td> <td style="width: 10%;"></td> <td style="width: 10%;"></td> <td style="width: 10%;"></td> </tr> <tr> <td></td> <td></td> <td colspan="8" style="text-align: center;"> <table border="1" style="width: 100%; border-collapse: collapse; text-align: center;"> <tr> <td style="width: 10%;"></td> <td style="width: 10%;"></td> <td style="width: 10%;"></td> <td style="width: 10%;"></td> <td style="width: 10%;"></td> <td style="width: 10%;"></td> <td style="width: 10%;"></td> <td style="width: 10%;"></td> <td style="width: 10%;"></td> <td style="width: 10%;"></td> </tr> <tr> <td></td> <td></td> <td colspan="8" style="text-align: center;"> <table border="1" style="width: 100%; border-collapse: collapse; text-align: center;"> <tr> <td style="width: 10%;"></td> <td style="width: 10%;"></td> <td style="width: 10%;"></td> <td style="width: 10%;"></td> <td style="width: 10%;"></td> <td style="width: 10%;"></td> <td style="width: 10%;"></td> <td style="width: 10%;"></td> <td style="width: 10%;"></td> <td style="width: 10%;"></td> </tr> <tr> <td></td> <td></td> <td colspan="8" style="text-align: center;"> <table border="1" style="width: 100%; border-collapse: collapse; text-align: center;"> <tr> <td style="width: 10%;"></td> <td style="width: 10%;"></td> <td style="width: 10%;"></td> <td style="width: 10%;"></td> <td style="width: 10%;"></td> <td style="width: 10%;"></td> <td style="width: 10%;"></td> <td style="width: 10%;"></td> <td style="width: 10%;"></td> <td style="width: 10%;"></td> </tr> <tr> <td></td> <td></td> <td colspan="8" style="text-align: center;"> <table border="1" style="width: 100%; border-collapse: collapse; text-align: center;"> <tr> <td style="width: 10%;"></td> <td style="width: 10%;"></td> <td style="width: 10%;"></td> <td style="width: 10%;"></td> <td style="width: 10%;"></td> <td style="width: 10%;"></td> <td style="width: 10%;"></td> <td style="width: 10%;"></td> <td style="width: 10%;"></td> <td style="width: 10%;"></td> </tr> <tr> <td></td> <td></td> <td colspan="8" style="text-align: center;"> <table border="1" style="width: 100%; border-collapse: collapse; text-align: center;"> <tr> </tr></table></td></tr></table></td></tr></table></td></tr></table></td></tr></table></td></tr></table></td></tr></table></td></tr></table></td></tr></table></td></tr></table></td></tr></table></td></tr></table></td></tr></table></td></tr></table></td></tr></table></td></tr></table></td></tr></table></td></tr></table></td></tr></table></td></tr></table></td></tr></table></td></tr></table></td></tr></table></td></tr></table></td></tr></table></td></tr></table></td></tr></table></td></tr></table></td></tr></table></td></tr></table></td></tr></table></td></tr></table></td></tr></table></td></tr></table></td></tr></table></td></tr></table></td></tr></table></td></tr></table></td></tr></table></td></tr></table></td></tr></table></td></tr></table></td></tr></table></td></tr></table></td></tr></table></td></tr></table></td></tr></table></td></tr></table></td></tr></table></td></tr></table>
 | | | | | | | | | | | | | | | | | | | | <table border="1" style="width: 100%; border-collapse: collapse; text-align: center;"> <tr> <td style="width: 10%;"></td> <td style="width: 10%;"></td> <td style="width: 10%;"></td> <td style="width: 10%;"></td> <td style="width: 10%;"></td> <td style="width: 10%;"></td> <td style="width: 10%;"></td> <td style="width: 10%;"></td> <td style="width: 10%;"></td> <td style="width: 10%;"></td> </tr> <tr> <td></td> <td></td> <td colspan="8" style="text-align: center;"> <table border="1" style="width: 100%; border-collapse: collapse; text-align: center;"> <tr> <td style="width: 10%;"></td> <td style="width: 10%;"></td> <td style="width: 10%;"></td> <td style="width: 10%;"></td> <td style="width: 10%;"></td> <td style="width: 10%;"></td> <td style="width: 10%;"></td> <td style="width: 10%;"></td> <td style="width: 10%;"></td> <td style="width: 10%;"></td> </tr> <tr> <td></td> <td></td> <td colspan="8" style="text-align: center;"> <table border="1" style="width: 100%; border-collapse: collapse; text-align: center;"> <tr> <td style="width: 10%;"></td> <td style="width: 10%;"></td> <td style="width: 10%;"></td> <td style="width: 10%;"></td> <td style="width: 10%;"></td> <td style="width: 10%;"></td> <td style="width: 10%;"></td> <td style="width: 10%;"></td> <td style="width: 10%;"></td> <td style="width: 10%;"></td> </tr> <tr> <td></td> <td></td> <td colspan="8" style="text-align: center;"> <table border="1" style="width: 100%; border-collapse: collapse; text-align: center;"> <tr> <td style="width: 10%;"></td> <td style="width: 10%;"></td> <td style="width: 10%;"></td> <td style="width: 10%;"></td> <td style="width: 10%;"></td> <td style="width: 10%;"></td> <td style="width: 10%;"></td> <td style="width: 10%;"></td> <td style="width: 10%;"></td> <td style="width: 10%;"></td> </tr> <tr> <td></td> <td></td> <td colspan="8" style="text-align: center;"> <table border="1" style="width: 100%; border-collapse: collapse; text-align: center;"> <tr> <td style="width: 10%;"></td> <td style="width: 10%;"></td> <td style="width: 10%;"></td> <td style="width: 10%;"></td> <td style="width: 10%;"></td> <td style="width: 10%;"></td> <td style="width: 10%;"></td> <td style="width: 10%;"></td> <td style="width: 10%;"></td> <td style="width: 10%;"></td> </tr> <tr> <td></td> <td></td> <td colspan="8" style="text-align: center;"> <table border="1" style="width: 100%; border-collapse: collapse; text-align: center;"> <tr> <td style="width: 10%;"></td> <td style="width: 10%;"></td> <td style="width: 10%;"></td> <td style="width: 10%;"></td> <td style="width: 10%;"></td> <td style="width: 10%;"></td> <td style="width: 10%;"></td> <td style="width: 10%;"></td> <td style="width: 10%;"></td> <td style="width: 10%;"></td> </tr> <tr> <td></td> <td></td> <td colspan="8" style="text-align: center;"> <table border="1" style="width: 100%; border-collapse: collapse; text-align: center;"> <tr> <td style="width: 10%;"></td> <td style="width: 10%;"></td> <td style="width: 10%;"></td> <td style="width: 10%;"></td> <td style="width: 10%;"></td> <td style="width: 10%;"></td> <td style="width: 10%;"></td> <td style="width: 10%;"></td> <td style="width: 10%;"></td> <td style="width: 10%;"></td> </tr> <tr> <td></td> <td></td> <td colspan="8" style="text-align: center;"> <table border="1" style="width: 100%; border-collapse: collapse; text-align: center;"> <tr> <td style="width: 10%;"></td> <td style="width: 10%;"></td> <td style="width: 10%;"></td> <td style="width: 10%;"></td> <td style="width: 10%;"></td> <td style="width: 10%;"></td> <td style="width: 10%;"></td> <td style="width: 10%;"></td> <td style="width: 10%;"></td> <td style="width: 10%;"></td> </tr> <tr> <td></td> <td></td> <td colspan="8" style="text-align: center;"> <table border="1" style="width: 100%; border-collapse: collapse; text-align: center;"> <tr> <td style="width: 10%;"></td> <td style="width: 10%;"></td> <td style="width: 10%;"></td> <td style="width: 10%;"></td> <td style="width: 10%;"></td> <td style="width: 10%;"></td> <td style="width: 10%;"></td> <td style="width: 10%;"></td> <td style="width: 10%;"></td> <td style="width: 10%;"></td> </tr> <tr> <td></td> <td></td> <td colspan="8" style="text-align: center;"> <table border="1" style="width: 100%; border-collapse: collapse; text-align: center;"> <tr> <td style="width: 10%;"></td> <td style="width: 10%;"></td> <td style="width: 10%;"></td> <td style="width: 10%;"></td> <td style="width: 10%;"></td> <td style="width: 10%;"></td> <td style="width: 10%;"></td> <td style="width: 10%;"></td> <td style="width: 10%;"></td> <td style="width: 10%;"></td> </tr> <tr> <td></td> <td></td> <td colspan="8" style="text-align: center;"> <table border="1" style="width: 100%; border-collapse: collapse; text-align: center;"> <tr> <td style="width: 10%;"></td> <td style="width: 10%;"></td> <td style="width: 10%;"></td> <td style="width: 10%;"></td> <td style="width: 10%;"></td> <td style="width: 10%;"></td> <td style="width: 10%;"></td> <td style="width: 10%;"></td> <td style="width: 10%;"></td> <td style="width: 10%;"></td> </tr> <tr> <td></td> <td></td> <td colspan="8" style="text-align: center;"> <table border="1" style="width: 100%; border-collapse: collapse; text-align: center;"> <tr> <td style="width: 10%;"></td> <td style="width: 10%;"></td> <td style="width: 10%;"></td> <td style="width: 10%;"></td> <td style="width: 10%;"></td> <td style="width: 10%;"></td> <td style="width: 10%;"></td> <td style="width: 10%;"></td> <td style="width: 10%;"></td> <td style="width: 10%;"></td> </tr> <tr> <td></td> <td></td> <td colspan="8" style="text-align: center;"> <table border="1" style="width: 100%; border-collapse: collapse; text-align: center;"> <tr> <td style="width: 10%;"></td> <td style="width: 10%;"></td> <td style="width: 10%;"></td> <td style="width: 10%;"></td> <td style="width: 10%;"></td> <td style="width: 10%;"></td> <td style="width: 10%;"></td> <td style="width: 10%;"></td> <td style="width: 10%;"></td> <td style="width: 10%;"></td> </tr> <tr> <td></td> <td></td> <td colspan="8" style="text-align: center;"> <table border="1" style="width: 100%; border-collapse: collapse; text-align: center;"> <tr> <td style="width: 10%;"></td> <td style="width: 10%;"></td> <td style="width: 10%;"></td> <td style="width: 10%;"></td> <td style="width: 10%;"></td> <td style="width: 10%;"></td> <td style="width: 10%;"></td> <td style="width: 10%;"></td> <td style="width: 10%;"></td> <td style="width: 10%;"></td> </tr> <tr> <td></td> <td></td> <td colspan="8" style="text-align: center;"> <table border="1" style="width: 100%; border-collapse: collapse; text-align: center;"> <tr> <td style="width: 10%;"></td> <td style="width: 10%;"></td> <td style="width: 10%;"></td> <td style="width: 10%;"></td> <td style="width: 10%;"></td> <td style="width: 10%;"></td> <td style="width: 10%;"></td> <td style="width: 10%;"></td> <td style="width: 10%;"></td> <td style="width: 10%;"></td> </tr> <tr> <td></td> <td></td> <td colspan="8" style="text-align: center;"> <table border="1" style="width: 100%; border-collapse: collapse; text-align: center;"> <tr> <td style="width: 10%;"></td> <td style="width: 10%;"></td> <td style="width: 10%;"></td> <td style="width: 10%;"></td> <td style="width: 10%;"></td> <td style="width: 10%;"></td> <td style="width: 10%;"></td> <td style="width: 10%;"></td> <td style="width: 10%;"></td> <td style="width: 10%;"></td> </tr> <tr> <td></td> <td></td> <td colspan="8" style="text-align: center;"> <table border="1" style="width: 100%; border-collapse: collapse; text-align: center;"> <tr> <td style="width: 10%;"></td> <td style="width: 10%;"></td> <td style="width: 10%;"></td> <td style="width: 10%;"></td> <td style="width: 10%;"></td> <td style="width: 10%;"></td> <td style="width: 10%;"></td> <td style="width: 10%;"></td> <td style="width: 10%;"></td> <td style="width: 10%;"></td> </tr> <tr> <td></td> <td></td> <td colspan="8" style="text-align: center;"> <table border="1" style="width: 100%; border-collapse: collapse; text-align: center;"> <tr> <td style="width: 10%;"></td> <td style="width: 10%;"></td> <td style="width: 10%;"></td> <td style="width: 10%;"></td> <td style="width: 10%;"></td> <td style="width: 10%;"></td> <td style="width: 10%;"></td> <td style="width: 10%;"></td> <td style="width: 10%;"></td> <td style="width: 10%;"></td> </tr> <tr> <td></td> <td></td> <td colspan="8" style="text-align: center;">
<table border="1" style="width: 100%; border-collapse: collapse; text-align: center;"> <tr> <td style="width: 10%;"></td> <td style="width: 10%;"></td> <td style="width: 10%;"></td> <td style="width: 10%;"></td> <td style="width: 10%;"></td> <td style="width: 10%;"></td> <td style="width: 10%;"></td> <td style="width: 10%;"></td> <td style="width: 10%;"></td> <td style="width: 10%;"></td> </tr> <tr> <td></td> <td></td> <td colspan="8" style="text-align: center;"> <table border="1" style="width: 100%; border-collapse: collapse; text-align: center;"> <tr> <td style="width: 10%;"></td> <td style="width: 10%;"></td> <td style="width: 10%;"></td> <td style="width: 10%;"></td> <td style="width: 10%;"></td> <td style="width: 10%;"></td> <td style="width: 10%;"></td> <td style="width: 10%;"></td> <td style="width: 10%;"></td> <td style="width: 10%;"></td> </tr> <tr> <td></td> <td></td> <td colspan="8" style="text-align: center;"> <table border="1" style="width: 100%; border-collapse: collapse; text-align: center;"> <tr> <td style="width: 10%;"></td> <td style="width: 10%;"></td> <td style="width: 10%;"></td> <td style="width: 10%;"></td> <td style="width: 10%;"></td> <td style="width: 10%;"></td> <td style="width: 10%;"></td> <td style="width: 10%;"></td> <td style="width: 10%;"></td> <td style="width: 10%;"></td> </tr> <tr> <td></td> <td></td> <td colspan="8" style="text-align: center;"> <table border="1" style="width: 100%; border-collapse: collapse; text-align: center;"> <tr> <td style="width: 10%;"></td> <td style="width: 10%;"></td> <td style="width: 10%;"></td> <td style="width: 10%;"></td> <td style="width: 10%;"></td> <td style="width: 10%;"></td> <td style="width: 10%;"></td> <td style="width: 10%;"></td> <td style="width: 10%;"></td> <td style="width: 10%;"></td> </tr> <tr> <td></td> <td></td> <td colspan="8" style="text-align: center;"> <table border="1" style="width: 100%; border-collapse: collapse; text-align: center;"> <tr> <td style="width: 10%;"></td> <td style="width: 10%;"></td> <td style="width: 10%;"></td> <td style="width: 10%;"></td> <td style="width: 10%;"></td> <td style="width: 10%;"></td> <td style="width: 10%;"></td> <td style="width: 10%;"></td> <td style="width: 10%;"></td> <td style="width: 10%;"></td> </tr> <tr> <td></td> <td></td> <td colspan="8" style="text-align: center;"> <table border="1" style="width: 100%; border-collapse: collapse; text-align: center;"> <tr> <td style="width: 10%;"></td> <td style="width: 10%;"></td> <td style="width: 10%;"></td> <td style="width: 10%;"></td> <td style="width: 10%;"></td> <td style="width: 10%;"></td> <td style="width: 10%;"></td> <td style="width: 10%;"></td> <td style="width: 10%;"></td> <td style="width: 10%;"></td> </tr> <tr> <td></td> <td></td> <td colspan="8" style="text-align: center;"> <table border="1" style="width: 100%; border-collapse: collapse; text-align: center;"> <tr> <td style="width: 10%;"></td> <td style="width: 10%;"></td> <td style="width: 10%;"></td> <td style="width: 10%;"></td> <td style="width: 10%;"></td> <td style="width: 10%;"></td> <td style="width: 10%;"></td> <td style="width: 10%;"></td> <td style="width: 10%;"></td> <td style="width: 10%;"></td> </tr> <tr> <td></td> <td></td> <td colspan="8" style="text-align: center;"> <table border="1" style="width: 100%; border-collapse: collapse; text-align: center;"> <tr> <td style="width: 10%;"></td> <td style="width: 10%;"></td> <td style="width: 10%;"></td> <td style="width: 10%;"></td> <td style="width: 10%;"></td> <td style="width: 10%;"></td> <td style="width: 10%;"></td> <td style="width: 10%;"></td> <td style="width: 10%;"></td> <td style="width: 10%;"></td> </tr> <tr> <td></td> <td></td> <td colspan="8" style="text-align: center;"> <table border="1" style="width: 100%; border-collapse: collapse; text-align: center;"> <tr> <td style="width: 10%;"></td> <td style="width: 10%;"></td> <td style="width: 10%;"></td> <td style="width: 10%;"></td> <td style="width: 10%;"></td> <td style="width: 10%;"></td> <td style="width: 10%;"></td> <td style="width: 10%;"></td> <td style="width: 10%;"></td> <td style="width: 10%;"></td> </tr> <tr> <td></td> <td></td> <td colspan="8" style="text-align: center;"> <table border="1" style="width: 100%; border-collapse: collapse; text-align: center;"> <tr> <td style="width: 10%;"></td> <td style="width: 10%;"></td> <td style="width: 10%;"></td> <td style="width: 10%;"></td> <td style="width: 10%;"></td> <td style="width: 10%;"></td> <td style="width: 10%;"></td> <td style="width: 10%;"></td> <td style="width: 10%;"></td> <td style="width: 10%;"></td> </tr> <tr> <td></td> <td></td> <td colspan="8" style="text-align: center;"> <table border="1" style="width: 100%; border-collapse: collapse; text-align: center;"> <tr> <td style="width: 10%;"></td> <td style="width: 10%;"></td> <td style="width: 10%;"></td> <td style="width: 10%;"></td> <td style="width: 10%;"></td> <td style="width: 10%;"></td> <td style="width: 10%;"></td> <td style="width: 10%;"></td> <td style="width: 10%;"></td> <td style="width: 10%;"></td> </tr> <tr> <td></td> <td></td> <td colspan="8" style="text-align: center;"> <table border="1" style="width: 100%; border-collapse: collapse; text-align: center;"> <tr> <td style="width: 10%;"></td> <td style="width: 10%;"></td> <td style="width: 10%;"></td> <td style="width: 10%;"></td> <td style="width: 10%;"></td> <td style="width: 10%;"></td> <td style="width: 10%;"></td> <td style="width: 10%;"></td> <td style="width: 10%;"></td> <td style="width: 10%;"></td> </tr> <tr> <td></td> <td></td> <td colspan="8" style="text-align: center;"> <table border="1" style="width: 100%; border-collapse: collapse; text-align: center;"> <tr> <td style="width: 10%;"></td> <td style="width: 10%;"></td> <td style="width: 10%;"></td> <td style="width: 10%;"></td> <td style="width: 10%;"></td> <td style="width: 10%;"></td> <td style="width: 10%;"></td> <td style="width: 10%;"></td> <td style="width: 10%;"></td> <td style="width: 10%;"></td> </tr> <tr> <td></td> <td></td> <td colspan="8" style="text-align: center;"> <table border="1" style="width: 100%; border-collapse: collapse; text-align: center;"> <tr> <td style="width: 10%;"></td> <td style="width: 10%;"></td> <td style="width: 10%;"></td> <td style="width: 10%;"></td> <td style="width: 10%;"></td> <td style="width: 10%;"></td> <td style="width: 10%;"></td> <td style="width: 10%;"></td> <td style="width: 10%;"></td> <td style="width: 10%;"></td> </tr> <tr> <td></td> <td></td> <td colspan="8" style="text-align: center;"> <table border="1" style="width: 100%; border-collapse: collapse; text-align: center;"> <tr> <td style="width: 10%;"></td> <td style="width: 10%;"></td> <td style="width: 10%;"></td> <td style="width: 10%;"></td> <td style="width: 10%;"></td> <td style="width: 10%;"></td> <td style="width: 10%;"></td> <td style="width: 10%;"></td> <td style="width: 10%;"></td> <td style="width: 10%;"></td> </tr> <tr> <td></td> <td></td> <td colspan="8" style="text-align: center;"> <table border="1" style="width: 100%; border-collapse: collapse; text-align: center;"> <tr> <td style="width: 10%;"></td> <td style="width: 10%;"></td> <td style="width: 10%;"></td> <td style="width: 10%;"></td> <td style="width: 10%;"></td> <td style="width: 10%;"></td> <td style="width: 10%;"></td> <td style="width: 10%;"></td> <td style="width: 10%;"></td> <td style="width: 10%;"></td> </tr> <tr> <td></td> <td></td> <td colspan="8" style="text-align: center;"> <table border="1" style="width: 100%; border-collapse: collapse; text-align: center;"> <tr> <td style="width: 10%;"></td> <td style="width: 10%;"></td> <td style="width: 10%;"></td> <td style="width: 10%;"></td> <td style="width: 10%;"></td> <td style="width: 10%;"></td> <td style="width: 10%;"></td> <td style="width: 10%;"></td> <td style="width: 10%;"></td> <td style="width: 10%;"></td> </tr> <tr> <td></td> <td></td> <td colspan="8" style="text-align: center;"> <table border="1" style="width: 100%; border-collapse: collapse; text-align: center;"> <tr> <td style="width: 10%;"></td> <td style="width: 10%;"></td> <td style="width: 10%;"></td> <td style="width: 10%;"></td> <td style="width: 10%;"></td> <td style="width: 10%;"></td> <td style="width: 10%;"></td> <td style="width: 10%;"></td> <td style="width: 10%;"></td> <td style="width: 10%;"></td> </tr> <tr> <td></td> <td></td> <td colspan="8" style="text-align: center;"> <table border="1" style="width: 100%; border-collapse: collapse; text-align: center;"> <tr> <td style="width: 10%;"></td> <td style="width: 10%;"></td> <td style="width: 10%;"></td> <td style="width: 10%;"></td> <td style="width: 10%;"></td> <td style="width: 10%;"></td> <td style="width: 10%;"></td> <td style="width: 10%;"></td> <td style="width: 10%;"></td> <td style="width: 10%;"></td> </tr> <tr> <td></td> <td></td> <td colspan="8" style="text-align: center;"> <table border="1" style="width: 100%; border-collapse: collapse; text-align: center;"> <tr> <td style="width: 10%;"></td> <td style="width: 10%;"></td> <td style="width: 10%;"></td> <td style="width: 10%;"></td> <td style="width: 10%;"></td> <td style="width: 10%;"></td> <td style="width: 10%;"></td> <td style="width: 10%;"></td> <td style="width: 10%;"></td> <td style="width: 10%;"></td> </tr> <tr> <td></td> <td></td> <td colspan="8" style="text-align: center;"> <table border="1" style="width: 100%; border-collapse: collapse; text-align: center;"> <tr> <td style="width: 10%;"></td> <td style="width: 10%;"></td> <td style="width: 10%;"></td> <td style="width: 10%;"></td> <td style="width: 10%;"></td> <td style="width: 10%;"></td> <td style="width: 10%;"></td> <td style="width: 10%;"></td> <td style="width: 10%;"></td> <td style="width: 10%;"></td> </tr> <tr> <td></td> <td></td> <td colspan="8" style="text-align: center;"> <table border="1" style="width: 100%; border-collapse: collapse; text-align: center;"> <tr> <td style="width: 10%;"></td> <td style="width: 10%;"></td> <td style="width:
10%;"></td> <td style="width: 10%;"></td> <td style="width: 10%;"></td> <td style="width: 10%;"></td> <td style="width: 10%;"></td> <td style="width: 10%;"></td> <td style="width: 10%;"></td> <td style="width: 10%;"></td> </tr> <tr> <td></td> <td></td> <td colspan="8" style="text-align: center;"> <table border="1" style="width: 100%; border-collapse: collapse; text-align: center;"> <tr> <td style="width: 10%;"></td> <td style="width: 10%;"></td> <td style="width: 10%;"></td> <td style="width: 10%;"></td> <td style="width: 10%;"></td> <td style="width: 10%;"></td> <td style="width: 10%;"></td> <td style="width: 10%;"></td> <td style="width: 10%;"></td> <td style="width: 10%;"></td> </tr> <tr> <td></td> <td></td> <td colspan="8" style="text-align: center;"> <table border="1" style="width: 100%; border-collapse: collapse; text-align: center;"> <tr> <td style="width: 10%;"></td> <td style="width: 10%;"></td> <td style="width: 10%;"></td> <td style="width: 10%;"></td> <td style="width: 10%;"></td> <td style="width: 10%;"></td> <td style="width: 10%;"></td> <td style="width: 10%;"></td> <td style="width: 10%;"></td> <td style="width: 10%;"></td> </tr> <tr> <td></td> <td></td> <td colspan="8" style="text-align: center;"> <table border="1" style="width: 100%; border-collapse: collapse; text-align: center;"> <tr> <td style="width: 10%;"></td> <td style="width: 10%;"></td> <td style="width: 10%;"></td> <td style="width: 10%;"></td> <td style="width: 10%;"></td> <td style="width: 10%;"></td> <td style="width: 10%;"></td> <td style="width: 10%;"></td> <td style="width: 10%;"></td> <td style="width: 10%;"></td> </tr> <tr> <td></td> <td></td> <td colspan="8" style="text-align: center;"> <table border="1" style="width: 100%; border-collapse: collapse; text-align: center;"> <tr> <td style="width: 10%;"></td> <td style="width: 10%;"></td> <td style="width: 10%;"></td> <td style="width: 10%;"></td> <td style="width: 10%;"></td> <td style="width: 10%;"></td> <td style="width: 10%;"></td> <td style="width: 10%;"></td> <td style="width: 10%;"></td> <td style="width: 10%;"></td> </tr> <tr> <td></td> <td></td> <td colspan="8" style="text-align: center;"> <table border="1" style="width: 100%; border-collapse: collapse; text-align: center;"> <tr> <td style="width: 10%;"></td> <td style="width: 10%;"></td> <td style="width: 10%;"></td> <td style="width: 10%;"></td> <td style="width: 10%;"></td> <td style="width: 10%;"></td> <td style="width: 10%;"></td> <td style="width: 10%;"></td> <td style="width: 10%;"></td> <td style="width: 10%;"></td> </tr> <tr> <td></td> <td></td> <td colspan="8" style="text-align: center;"> <table border="1" style="width: 100%; border-collapse: collapse; text-align: center;"> <tr> <td style="width: 10%;"></td> <td style="width: 10%;"></td> <td style="width: 10%;"></td> <td style="width: 10%;"></td> <td style="width: 10%;"></td> <td style="width: 10%;"></td> <td style="width: 10%;"></td> <td style="width: 10%;"></td> <td style="width: 10%;"></td> <td style="width: 10%;"></td> </tr> <tr> <td></td> <td></td> <td colspan="8" style="text-align: center;"> <table border="1" style="width: 100%; border-collapse: collapse; text-align: center;"> <tr> <td style="width: 10%;"></td> <td style="width: 10%;"></td> <td style="width: 10%;"></td> <td style="width: 10%;"></td> <td style="width: 10%;"></td> <td style="width: 10%;"></td> <td style="width: 10%;"></td> <td style="width: 10%;"></td> <td style="width: 10%;"></td> <td style="width: 10%;"></td> </tr> <tr> <td></td> <td></td> <td colspan="8" style="text-align: center;"> <table border="1" style="width: 100%; border-collapse: collapse; text-align: center;"> <tr> <td style="width: 10%;"></td> <td style="width: 10%;"></td> <td style="width: 10%;"></td> <td style="width: 10%;"></td> <td style="width: 10%;"></td> <td style="width: 10%;"></td> <td style="width: 10%;"></td> <td style="width: 10%;"></td> <td style="width: 10%;"></td> <td style="width: 10%;"></td> </tr> <tr> <td></td> <td></td> <td colspan="8" style="text-align: center;"> <table border="1" style="width: 100%; border-collapse: collapse; text-align: center;"> <tr> </tr></table></td></tr></table></td></tr></table></td></tr></table></td></tr></table></td></tr></table></td></tr></table></td></tr></table></td></tr></table></td></tr></table></td></tr></table></td></tr></table></td></tr></table></td></tr></table></td></tr></table></td></tr></table></td></tr></table></td></tr></table></td></tr></table></td></tr></table></td></tr></table></td></tr></table></td></tr></table></td></tr></table></td></tr></table></td></tr></table></td></tr></table></td></tr></table></td></tr></table></td></tr></table></td></tr></table></td></tr></table></td></tr></table></td></tr></table></td></tr></table></td></tr></table></td></tr></table></td></tr></table></td></tr></table></td></tr></table></td></tr></table></td></tr></table></td></tr></table></td></tr></table></td></tr></table></td></tr></table></td></tr></table></td></tr></table></td></tr></table>
 | | | | | | | | | | | | | | | | | | | | <table border="1" style="width: 100%; border-collapse: collapse; text-align: center;"> <tr> <td style="width: 10%;"></td> <td style="width: 10%;"></td> <td style="width: 10%;"></td> <td style="width: 10%;"></td> <td style="width: 10%;"></td> <td style="width: 10%;"></td> <td style="width: 10%;"></td> <td style="width: 10%;"></td> <td style="width: 10%;"></td> <td style="width: 10%;"></td> </tr> <tr> <td></td> <td></td> <td colspan="8" style="text-align: center;"> <table border="1" style="width: 100%; border-collapse: collapse; text-align: center;"> <tr> <td style="width: 10%;"></td> <td style="width: 10%;"></td> <td style="width: 10%;"></td> <td style="width: 10%;"></td> <td style="width: 10%;"></td> <td style="width: 10%;"></td> <td style="width: 10%;"></td> <td style="width: 10%;"></td> <td style="width: 10%;"></td> <td style="width: 10%;"></td> </tr> <tr> <td></td> <td></td> <td colspan="8" style="text-align: center;"> <table border="1" style="width: 100%; border-collapse: collapse; text-align: center;"> <tr> <td style="width: 10%;"></td> <td style="width: 10%;"></td> <td style="width: 10%;"></td> <td style="width: 10%;"></td> <td style="width: 10%;"></td> <td style="width: 10%;"></td> <td style="width: 10%;"></td> <td style="width: 10%;"></td> <td style="width: 10%;"></td> <td style="width: 10%;"></td> </tr> <tr> <td></td> <td></td> <td colspan="8" style="text-align: center;"> <table border="1" style="width: 100%; border-collapse: collapse; text-align: center;"> <tr> <td style="width: 10%;"></td> <td style="width: 10%;"></td> <td style="width: 10%;"></td> <td style="width: 10%;"></td> <td style="width: 10%;"></td> <td style="width: 10%;"></td> <td style="width: 10%;"></td> <td style="width: 10%;"></td> <td style="width: 10%;"></td> <td style="width: 10%;"></td> </tr> <tr> <td></td> <td></td> <td colspan="8" style="text-align: center;"> <table border="1" style="width: 100%; border-collapse: collapse; text-align: center;"> <tr> <td style="width: 10%;"></td> <td style="width: 10%;"></td> <td style="width: 10%;"></td> <td style="width: 10%;"></td> <td style="width: 10%;"></td> <td style="width: 10%;"></td> <td style="width: 10%;"></td> <td style="width: 10%;"></td> <td style="width: 10%;"></td> <td style="width: 10%;"></td> </tr> <tr> <td></td> <td></td> <td colspan="8" style="text-align: center;"> <table border="1" style="width: 100%; border-collapse: collapse; text-align: center;"> <tr> <td style="width: 10%;"></td> <td style="width: 10%;"></td> <td style="width: 10%;"></td> <td style="width: 10%;"></td> <td style="width: 10%;"></td> <td style="width: 10%;"></td> <td style="width: 10%;"></td> <td style="width: 10%;"></td> <td style="width: 10%;"></td> <td style="width: 10%;"></td> </tr> <tr> <td></td> <td></td> <td colspan="8" style="text-align: center;"> <table border="1" style="width: 100%; border-collapse: collapse; text-align: center;"> <tr> <td style="width: 10%;"></td> <td style="width: 10%;"></td> <td style="width: 10%;"></td> <td style="width: 10%;"></td> <td style="width: 10%;"></td> <td style="width: 10%;"></td> <td style="width: 10%;"></td> <td style="width: 10%;"></td> <td style="width: 10%;"></td> <td style="width: 10%;"></td> </tr> <tr> <td></td> <td></td> <td colspan="8" style="text-align: center;"> <table border="1" style="width: 100%; border-collapse: collapse; text-align: center;"> <tr> <td style="width: 10%;"></td> <td style="width: 10%;"></td> <td style="width: 10%;"></td> <td style="width: 10%;"></td> <td style="width: 10%;"></td> <td style="width: 10%;"></td> <td style="width: 10%;"></td> <td style="width: 10%;"></td> <td style="width: 10%;"></td> <td style="width: 10%;"></td> </tr> <tr> <td></td> <td></td> <td colspan="8" style="text-align: center;"> <table border="1" style="width: 100%; border-collapse: collapse; text-align: center;"> <tr> <td style="width: 10%;"></td> <td style="width: 10%;"></td> <td style="width: 10%;"></td> <td style="width: 10%;"></td> <td style="width: 10%;"></td> <td style="width: 10%;"></td> <td style="width: 10%;"></td> <td style="width: 10%;"></td> <td style="width: 10%;"></td> <td style="width: 10%;"></td> </tr> <tr> <td></td> <td></td> <td colspan="8" style="text-align: center;"> <table border="1" style="width: 100%; border-collapse: collapse; text-align: center;"> <tr> <td style="width: 10%;"></td> <td style="width: 10%;"></td> <td style="width: 10%;"></td> <td style="width: 10%;"></td> <td style="width: 10%;"></td> <td style="width: 10%;"></td> <td style="width: 10%;"></td> <td style="width: 10%;"></td> <td style="width: 10%;"></td> <td style="width: 10%;"></td> </tr> <tr> <td></td> <td></td> <td colspan="8" style="text-align: center;"> <table border="1" style="width: 100%; border-collapse: collapse; text-align: center;"> <tr> <td style="width: 10%;"></td> <td style="width: 10%;"></td> <td style="width: 10%;"></td> <td style="width: 10%;"></td> <td style="width: 10%;"></td> <td style="width: 10%;"></td> <td style="width: 10%;"></td> <td style="width: 10%;"></td> <td style="width: 10%;"></td> <td style="width: 10%;"></td> </tr> <tr> <td></td> <td></td> <td colspan="8" style="text-align: center;"> <table border="1" style="width: 100%; border-collapse: collapse; text-align: center;"> <tr> <td style="width: 10%;"></td> <td style="width: 10%;"></td> <td style="width: 10%;"></td> <td style="width: 10%;"></td> <td style="width: 10%;"></td> <td style="width: 10%;"></td> <td style="width: 10%;"></td> <td style="width: 10%;"></td> <td style="width: 10%;"></td> <td style="width: 10%;"></td> </tr> <tr> <td></td> <td></td> <td colspan="8" style="text-align: center;"> <table border="1" style="width: 100%; border-collapse: collapse; text-align: center;"> <tr> <td style="width: 10%;"></td> <td style="width: 10%;"></td> <td style="width: 10%;"></td> <td style="width: 10%;"></td> <td style="width: 10%;"></td> <td style="width: 10%;"></td> <td style="width: 10%;"></td> <td style="width: 10%;"></td> <td style="width: 10%;"></td> <td style="width: 10%;"></td> </tr> <tr> <td></td> <td></td> <td colspan="8" style="text-align: center;"> <table border="1" style="width: 100%; border-collapse: collapse; text-align: center;"> <tr> <td style="width: 10%;"></td> <td style="width: 10%;"></td> <td style="width: 10%;"></td> <td style="width: 10%;"></td> <td style="width: 10%;"></td> <td style="width: 10%;"></td> <td style="width: 10%;"></td> <td style="width: 10%;"></td> <td style="width: 10%;"></td> <td style="width: 10%;"></td> </tr> <tr> <td></td> <td></td> <td colspan="8" style="text-align: center;"> <table border="1" style="width: 100%; border-collapse: collapse; text-align: center;"> <tr> <td style="width: 10%;"></td> <td style="width: 10%;"></td> <td style="width: 10%;"></td> <td style="width: 10%;"></td> <td style="width: 10%;"></td> <td style="width: 10%;"></td> <td style="width: 10%;"></td> <td style="width: 10%;"></td> <td style="width: 10%;"></td> <td style="width: 10%;"></td> </tr> <tr> <td></td> <td></td> <td colspan="8" style="text-align: center;"> <table border="1" style="width: 100%; border-collapse: collapse; text-align: center;"> <tr> <td style="width: 10%;"></td> <td style="width: 10%;"></td> <td style="width: 10%;"></td> <td style="width: 10%;"></td> <td style="width: 10%;"></td> <td style="width: 10%;"></td> <td style="width: 10%;"></td> <td style="width: 10%;"></td> <td style="width: 10%;"></td> <td style="width: 10%;"></td> </tr> <tr> <td></td> <td></td> <td colspan="8" style="text-align: center;"> <table border="1" style="width: 100%; border-collapse: collapse; text-align: center;"> <tr> <td style="width: 10%;"></td> <td style="width: 10%;"></td> <td style="width: 10%;"></td> <td style="width: 10%;"></td> <td style="width: 10%;"></td> <td style="width: 10%;"></td> <td style="width: 10%;"></td> <td style="width: 10%;"></td> <td style="width: 10%;"></td> <td style="width: 10%;"></td> </tr> <tr> <td></td> <td></td> <td colspan="8" style="text-align: center;"> <table border="1" style="width: 100%; border-collapse: collapse; text-align: center;"> <tr> <td style="width: 10%;"></td> <td style="width: 10%;"></td> <td style="width: 10%;"></td> <td style="width: 10%;"></td> <td style="width: 10%;"></td> <td style="width: 10%;"></td> <td style="width: 10%;"></td> <td style="width: 10%;"></td> <td style="width: 10%;"></td> <td style="width: 10%;"></td> </tr> <tr> <td></td> <td></td> <td colspan="8" style="text-align: center;"> <table border="1" style="width: 100%; border-collapse: collapse; text-align: center;"> <tr> <td style="width: 10%;"></td> <td style="width: 10%;"></td> <td style="width: 10%;"></td> <td style="width: 10%;"></td> <td style="width: 10%;"></td> <td style="width: 10%;"></td> <td style="width: 10%;"></td> <td style="width: 10%;"></td> <td style="width: 10%;"></td> <td style="width: 10%;"></td> </tr> <tr> <td></td> <td></td> <td colspan="8" style="text-align: center;"> <table border="1" style="width: 100%; border-collapse: collapse; text-align: center;"> <tr> <td style="width: 10%;"></td> <td style="width: 10%;"></td> <td style="width: 10%;"></td> <td style="width: 10%;"></td> <td style="width: 10%;"></td> <td style="width: 10%;"></td> <td style="width: 10%;"></td> <td style="width: 10%;"></td> <td style="width: 10%;"></td> <td style="width: 10%;"></td> </tr> <tr> <td></td> <td></td> <td colspan="8" style="text-align: center;"> <table border="1" style="width: 100%; border-collapse: collapse; text-align: center;"> <tr> <td style="width: 10%;"></td> <td style="width: 10%;"></td> <td style="width: 10%;"></td> <td style="width: 10%;"></td> <td
style="width: 10%;"></td> <td style="width: 10%;"></td> <td style="width: 10%;"></td> <td style="width: 10%;"></td> <td style="width: 10%;"></td> <td style="width: 10%;"></td> </tr> <tr> <td></td> <td></td> <td colspan="8" style="text-align: center;"> <table border="1" style="width: 100%; border-collapse: collapse; text-align: center;"> <tr> <td style="width: 10%;"></td> <td style="width: 10%;"></td> <td style="width: 10%;"></td> <td style="width: 10%;"></td> <td style="width: 10%;"></td> <td style="width: 10%;"></td> <td style="width: 10%;"></td> <td style="width: 10%;"></td> <td style="width: 10%;"></td> <td style="width: 10%;"></td> </tr> <tr> <td></td> <td></td> <td colspan="8" style="text-align: center;"> <table border="1" style="width: 100%; border-collapse: collapse; text-align: center;"> <tr> <td style="width: 10%;"></td> <td style="width: 10%;"></td> <td style="width: 10%;"></td> <td style="width: 10%;"></td> <td style="width: 10%;"></td> <td style="width: 10%;"></td> <td style="width: 10%;"></td> <td style="width: 10%;"></td> <td style="width: 10%;"></td> <td style="width: 10%;"></td> </tr> <tr> <td></td> <td></td> <td colspan="8" style="text-align: center;"> <table border="1" style="width: 100%; border-collapse: collapse; text-align: center;"> <tr> <td style="width: 10%;"></td> <td style="width: 10%;"></td> <td style="width: 10%;"></td> <td style="width: 10%;"></td> <td style="width: 10%;"></td> <td style="width: 10%;"></td> <td style="width: 10%;"></td> <td style="width: 10%;"></td> <td style="width: 10%;"></td> <td style="width: 10%;"></td> </tr> <tr> <td></td> <td></td> <td colspan="8" style="text-align: center;"> <table border="1" style="width: 100%; border-collapse: collapse; text-align: center;"> <tr> <td style="width: 10%;"></td> <td style="width: 10%;"></td> <td style="width: 10%;"></td> <td style="width: 10%;"></td> <td style="width: 10%;"></td> <td style="width: 10%;"></td> <td style="width: 10%;"></td> <td style="width: 10%;"></td> <td style="width: 10%;"></td> <td style="width: 10%;"></td> </tr> <tr> <td></td> <td></td> <td colspan="8" style="text-align: center;"> <table border="1" style="width: 100%; border-collapse: collapse; text-align: center;"> <tr> <td style="width: 10%;"></td> <td style="width: 10%;"></td> <td style="width: 10%;"></td> <td style="width: 10%;"></td> <td style="width: 10%;"></td> <td style="width: 10%;"></td> <td style="width: 10%;"></td> <td style="width: 10%;"></td> <td style="width: 10%;"></td> <td style="width: 10%;"></td> </tr> <tr> <td></td> <td></td> <td colspan="8" style="text-align: center;"> <table border="1" style="width: 100%; border-collapse: collapse; text-align: center;"> <tr> <td style="width: 10%;"></td> <td style="width: 10%;"></td> <td style="width: 10%;"></td> <td style="width: 10%;"></td> <td style="width: 10%;"></td> <td style="width: 10%;"></td> <td style="width: 10%;"></td> <td style="width: 10%;"></td> <td style="width: 10%;"></td> <td style="width: 10%;"></td> </tr> <tr> <td></td> <td></td> <td colspan="8" style="text-align: center;"> <table border="1" style="width: 100%; border-collapse: collapse; text-align: center;"> <tr> <td style="width: 10%;"></td> <td style="width: 10%;"></td> <td style="width: 10%;"></td> <td style="width: 10%;"></td> <td style="width: 10%;"></td> <td style="width: 10%;"></td> <td style="width: 10%;"></td> <td style="width: 10%;"></td> <td style="width: 10%;"></td> <td style="width: 10%;"></td> </tr> <tr> <td></td> <td></td> <td colspan="8" style="text-align: center;"> <table border="1" style="width: 100%; border-collapse: collapse; text-align: center;"> <tr> <td style="width: 10%;"></td> <td style="width: 10%;"></td> <td style="width: 10%;"></td> <td style="width: 10%;"></td> <td style="width: 10%;"></td> <td style="width: 10%;"></td> <td style="width: 10%;"></td> <td style="width: 10%;"></td> <td style="width: 10%;"></td> <td style="width: 10%;"></td> </tr> <tr> <td></td> <td></td> <td colspan="8" style="text-align: center;"> <table border="1" style="width: 100%; border-collapse: collapse; text-align: center;"> <tr> <td style="width: 10%;"></td> <td style="width: 10%;"></td> <td style="width: 10%;"></td> <td style="width: 10%;"></td> <td style="width: 10%;"></td> <td style="width: 10%;"></td> <td style="width: 10%;"></td> <td style="width: 10%;"></td> <td style="width: 10%;"></td> <td style="width: 10%;"></td> </tr> <tr> <td></td> <td></td> <td colspan="8" style="text-align: center;"> <table border="1" style="width: 100%; border-collapse: collapse; text-align: center;"> <tr> <td style="width: 10%;"></td> <td style="width: 10%;"></td> <td style="width: 10%;"></td> <td style="width: 10%;"></td> <td style="width: 10%;"></td> <td style="width: 10%;"></td> <td style="width: 10%;"></td> <td style="width: 10%;"></td> <td style="width: 10%;"></td> <td style="width: 10%;"></td> </tr> <tr> <td></td> <td></td> <td colspan="8" style="text-align: center;"> <table border="1" style="width: 100%; border-collapse: collapse; text-align: center;"> <tr> <td style="width: 10%;"></td> <td style="width: 10%;"></td> <td style="width: 10%;"></td> <td style="width: 10%;"></td> <td style="width: 10%;"></td> <td style="width: 10%;"></td> <td style="width: 10%;"></td> <td style="width: 10%;"></td> <td style="width: 10%;"></td> <td style="width: 10%;"></td> </tr> <tr> <td></td> <td></td> <td colspan="8" style="text-align: center;"> <table border="1" style="width: 100%; border-collapse: collapse; text-align: center;"> <tr> <td style="width: 10%;"></td> <td style="width: 10%;"></td> <td style="width: 10%;"></td> <td style="width: 10%;"></td> <td style="width: 10%;"></td> <td style="width: 10%;"></td> <td style="width: 10%;"></td> <td style="width: 10%;"></td> <td style="width: 10%;"></td> <td style="width: 10%;"></td> </tr> <tr> <td></td> <td></td> <td colspan="8" style="text-align: center;"> <table border="1" style="width: 100%; border-collapse: collapse; text-align: center;"> <tr> <td style="width: 10%;"></td> <td style="width: 10%;"></td> <td style="width: 10%;"></td> <td style="width: 10%;"></td> <td style="width: 10%;"></td> <td style="width: 10%;"></td> <td style="width: 10%;"></td> <td style="width: 10%;"></td> <td style="width: 10%;"></td> <td style="width: 10%;"></td> </tr> <tr> <td></td> <td></td> <td colspan="8" style="text-align: center;"> <table border="1" style="width: 100%; border-collapse: collapse; text-align: center;"> <tr> <td style="width: 10%;"></td> <td style="width: 10%;"></td> <td style="width: 10%;"></td> <td style="width: 10%;"></td> <td style="width: 10%;"></td> <td style="width: 10%;"></td> <td style="width: 10%;"></td> <td style="width: 10%;"></td> <td style="width: 10%;"></td> <td style="width: 10%;"></td> </tr> <tr> <td></td> <td></td> <td colspan="8" style="text-align: center;"> <table border="1" style="width: 100%; border-collapse: collapse; text-align: center;"> <tr> <td style="width: 10%;"></td> <td style="width: 10%;"></td> <td style="width: 10%;"></td> <td style="width: 10%;"></td> <td style="width: 10%;"></td> <td style="width: 10%;"></td> <td style="width: 10%;"></td> <td style="width: 10%;"></td> <td style="width: 10%;"></td> <td style="width: 10%;"></td> </tr> <tr> <td></td> <td></td> <td colspan="8" style="text-align: center;"> <table border="1" style="width: 100%; border-collapse: collapse; text-align: center;"> <tr> <td style="width: 10%;"></td> <td style="width: 10%;"></td> <td style="width: 10%;"></td> <td style="width: 10%;"></td> <td style="width: 10%;"></td> <td style="width: 10%;"></td> <td style="width: 10%;"></td> <td style="width: 10%;"></td> <td style="width: 10%;"></td> <td style="width: 10%;"></td> </tr> <tr> <td></td> <td></td> <td colspan="8" style="text-align: center;"> <table border="1" style="width: 100%; border-collapse: collapse; text-align: center;"> <tr> <td style="width: 10%;"></td> <td style="width: 10%;"></td> <td style="width: 10%;"></td> <td style="width: 10%;"></td> <td style="width: 10%;"></td> <td style="width: 10%;"></td> <td style="width: 10%;"></td> <td style="width: 10%;"></td> <td style="width: 10%;"></td> <td style="width: 10%;"></td> </tr> <tr> <td></td> <td></td> <td colspan="8" style="text-align: center;"> <table border="1" style="width: 100%; border-collapse: collapse; text-align: center;"> <tr> <td style="width: 10%;"></td> <td style="width: 10%;"></td> <td style="width: 10%;"></td> <td style="width: 10%;"></td> <td style="width: 10%;"></td> <td style="width: 10%;"></td> <td style="width: 10%;"></td> <td style="width: 10%;"></td> <td style="width: 10%;"></td> <td style="width: 10%;"></td> </tr> <tr> <td></td> <td></td> <td colspan="8" style="text-align: center;"> <table border="1" style="width: 100%; border-collapse: collapse; text-align: center;"> <tr> <td style="width: 10%;"></td> <td style="width: 10%;"></td> <td style="width: 10%;"></td> <td style="width: 10%;"></td> <td style="width: 10%;"></td> <td style="width: 10%;"></td> <td style="width: 10%;"></td> <td style="width: 10%;"></td> <td style="width: 10%;"></td> <td style="width: 10%;"></td> </tr> <tr> <td></td> <td></td> <td colspan="8" style="text-align: center;"> <table border="1" style="width: 100%; border-collapse: collapse; text-align: center;"> <tr> <td style="width: 10%;"></td> <td style="width: 10%;"></td> <td style="width: 10%;"></td> <td style="width: 10%;"></td> <td style="width: 10%;"></td> <td style="width: 10%;"></td> <td style="width: 10%;"></td> <td style="width: 10%;"></td> <td style="width: 10%;"></td> <td style="width: 10%;"></td> </tr> <tr> <td></td> <td></td> <td colspan="8" style="text-align: center;"> <table border="1" style="width: 100%; border-collapse: collapse; text-align: center;"> <tr> <td style="width: 10%;"></td> <td style="width: 10%;"></td> <td style="width: 10%;"></td> <td style="width: 10%;"></td> <td style="width: 10%;"></td> <td style="width: 10%;"></td> <td style="width: 10%;"></td> <td style="width: 10%;"></td> <td style="width: 10%;"></td> <td style="width:
10%;"></td> </tr> <tr> <td></td> <td></td> <td colspan="8" style="text-align: center;"> <table border="1" style="width: 100%; border-collapse: collapse; text-align: center;"> <tr> <td style="width: 10%;"></td> <td style="width: 10%;"></td> <td style="width: 10%;"></td> <td style="width: 10%;"></td> <td style="width: 10%;"></td> <td style="width: 10%;"></td> <td style="width: 10%;"></td> <td style="width: 10%;"></td> <td style="width: 10%;"></td> <td style="width: 10%;"></td> </tr> <tr> <td></td> <td></td> <td colspan="8" style="text-align: center;"> <table border="1" style="width: 100%; border-collapse: collapse; text-align: center;"> <tr> <td style="width: 10%;"></td> <td style="width: 10%;"></td> <td style="width: 10%;"></td> <td style="width: 10%;"></td> <td style="width: 10%;"></td> <td style="width: 10%;"></td> <td style="width: 10%;"></td> <td style="width: 10%;"></td> <td style="width: 10%;"></td> <td style="width: 10%;"></td> </tr> <tr> <td></td> <td></td> <td colspan="8" style="text-align: center;"> <table border="1" style="width: 100%; border-collapse: collapse; text-align: center;"> <tr> <td style="width: 10%;"></td> <td style="width: 10%;"></td> <td style="width: 10%;"></td> <td style="width: 10%;"></td> <td style="width: 10%;"></td> <td style="width: 10%;"></td> <td style="width: 10%;"></td> <td style="width: 10%;"></td> <td style="width: 10%;"></td> <td style="width: 10%;"></td> </tr> <tr> <td></td> <td></td> <td colspan="8" style="text-align: center;"> <table border="1" style="width: 100%; border-collapse: collapse; text-align: center;"> <tr> <td style="width: 10%;"></td> <td style="width: 10%;"></td> <td style="width: 10%;"></td> <td style="width: 10%;"></td> <td style="width: 10%;"></td> <td style="width: 10%;"></td> <td style="width: 10%;"></td> <td style="width: 10%;"></td> <td style="width: 10%;"></td> <td style="width: 10%;"></td> </tr> <tr> <td></td> <td></td> <td colspan="8" style="text-align: center;"> <table border="1" style="width: 100%; border-collapse: collapse; text-align: center;"> <tr> <td style="width: 10%;"></td> <td style="width: 10%;"></td> <td style="width: 10%;"></td> <td style="width: 10%;"></td> <td style="width: 10%;"></td> <td style="width: 10%;"></td> <td style="width: 10%;"></td> <td style="width: 10%;"></td> <td style="width: 10%;"></td> <td style="width: 10%;"></td> </tr> <tr> <td></td> <td></td> <td colspan="8" style="text-align: center;"> <table border="1" style="width: 100%; border-collapse: collapse; text-align: center;"> <tr> </tr></table></td></tr></table></td></tr></table></td></tr></table></td></tr></table></td></tr></table></td></tr></table></td></tr></table></td></tr></table></td></tr></table></td></tr></table></td></tr></table></td></tr></table></td></tr></table></td></tr></table></td></tr></table></td></tr></table></td></tr></table></td></tr></table></td></tr></table></td></tr></table></td></tr></table></td></tr></table></td></tr></table></td></tr></table></td></tr></table></td></tr></table></td></tr></table></td></tr></table></td></tr></table></td></tr></table></td></tr></table></td></tr></table></td></tr></table></td></tr></table></td></tr></table></td></tr></table></td></tr></table></td></tr></table></td></tr></table></td></tr></table></td></tr></table></td></tr></table></td></tr></table></td></tr></table></td></tr></table></td></tr></table></td></tr></table> | | | | | | | | | | | | | | | | | | | | <table border="1" style="width: 100%; border-collapse: collapse; text-align: center;"> <tr> <td style="width: 10%;"></td> <td style="width: 10%;"></td> <td style="width: 10%;"></td> <td style="width: 10%;"></td> <td style="width: 10%;"></td> <td style="width: 10%;"></td> <td style="width: 10%;"></td> <td style="width: 10%;"></td> <td style="width: 10%;"></td> <td style="width: 10%;"></td> </tr> <tr> <td></td> <td></td> <td colspan="8" style="text-align: center;"> <table border="1" style="width: 100%; border-collapse: collapse; text-align: center;"> <tr> <td style="width: 10%;"></td> <td style="width: 10%;"></td> <td style="width: 10%;"></td> <td style="width: 10%;"></td> <td style="width: 10%;"></td> <td style="width: 10%;"></td> <td style="width: 10%;"></td> <td style="width: 10%;"></td> <td style="width: 10%;"></td> <td style="width: 10%;"></td> </tr> <tr> <td></td> <td></td> <td colspan="8" style="text-align: center;"> <table border="1" style="width: 100%; border-collapse: collapse; text-align: center;"> <tr> <td style="width: 10%;"></td> <td style="width: 10%;"></td> <td style="width: 10%;"></td> <td style="width: 10%;"></td> <td style="width: 10%;"></td> <td style="width: 10%;"></td> <td
style="width: 10%;"></td> <td style="width: 10%;"></td> <td style="width: 10%;"></td> <td style="width: 10%;"></td> </tr> <tr> <td></td> <td></td> <td colspan="8" style="text-align: center;"> <table border="1" style="width: 100%; border-collapse: collapse; text-align: center;"> <tr> <td style="width: 10%;"></td> <td style="width: 10%;"></td> <td style="width: 10%;"></td> <td style="width: 10%;"></td> <td style="width: 10%;"></td> <td style="width: 10%;"></td> <td style="width: 10%;"></td> <td style="width: 10%;"></td> <td style="width: 10%;"></td> <td style="width: 10%;"></td> </tr> <tr> <td></td> <td></td> <td colspan="8" style="text-align: center;"> <table border="1" style="width: 100%; border-collapse: collapse; text-align: center;"> <tr> <td style="width: 10%;"></td> <td style="width: 10%;"></td> <td style="width: 10%;"></td> <td style="width: 10%;"></td> <td style="width: 10%;"></td> <td style="width: 10%;"></td> <td style="width: 10%;"></td> <td style="width: 10%;"></td> <td style="width: 10%;"></td> <td style="width: 10%;"></td> </tr> <tr> <td></td> <td></td> <td colspan="8" style="text-align: center;"> <table border="1" style="width: 100%; border-collapse: collapse; text-align: center;"> <tr> <td style="width: 10%;"></td> <td style="width: 10%;"></td> <td style="width: 10%;"></td> <td style="width: 10%;"></td> <td style="width: 10%;"></td> <td style="width: 10%;"></td> <td style="width: 10%;"></td> <td style="width: 10%;"></td> <td style="width: 10%;"></td> <td style="width: 10%;"></td> </tr> <tr> <td></td> <td></td> <td colspan="8" style="text-align: center;"> <table border="1" style="width: 100%; border-collapse: collapse; text-align: center;"> <tr> <td style="width: 10%;"></td> <td style="width: 10%;"></td> <td style="width: 10%;"></td> <td style="width: 10%;"></td> <td style="width: 10%;"></td> <td style="width: 10%;"></td> <td style="width: 10%;"></td> <td style="width: 10%;"></td> <td style="width: 10%;"></td> <td style="width: 10%;"></td> </tr> <tr> <td></td> <td></td> <td colspan="8" style="text-align: center;"> <table border="1" style="width: 100%; border-collapse: collapse; text-align: center;"> <tr> <td style="width: 10%;"></td> <td style="width: 10%;"></td> <td style="width: 10%;"></td> <td style="width: 10%;"></td> <td style="width: 10%;"></td> <td style="width: 10%;"></td> <td style="width: 10%;"></td> <td style="width: 10%;"></td> <td style="width: 10%;"></td> <td style="width: 10%;"></td> </tr> <tr> <td></td> <td></td> <td colspan="8" style="text-align: center;"> <table border="1" style="width: 100%; border-collapse: collapse; text-align: center;"> <tr> <td style="width: 10%;"></td> <td style="width: 10%;"></td> <td style="width: 10%;"></td> <td style="width: 10%;"></td> <td style="width: 10%;"></td> <td style="width: 10%;"></td> <td style="width: 10%;"></td> <td style="width: 10%;"></td> <td style="width: 10%;"></td> <td style="width: 10%;"></td> </tr> <tr> <td></td> <td></td> <td colspan="8" style="text-align: center;"> <table border="1" style="width: 100%; border-collapse: collapse; text-align: center;"> <tr> <td style="width: 10%;"></td> <td style="width: 10%;"></td> <td style="width: 10%;"></td> <td style="width: 10%;"></td> <td style="width: 10%;"></td> <td style="width: 10%;"></td> <td style="width: 10%;"></td> <td style="width: 10%;"></td> <td style="width: 10%;"></td> <td style="width: 10%;"></td> </tr> <tr> <td></td> <td></td> <td colspan="8" style="text-align: center;"> <table border="1" style="width: 100%; border-collapse: collapse; text-align: center;"> <tr> <td style="width: 10%;"></td> <td style="width: 10%;"></td> <td style="width: 10%;"></td> <td style="width: 10%;"></td> <td style="width: 10%;"></td> <td style="width: 10%;"></td> <td style="width: 10%;"></td> <td style="width: 10%;"></td> <td style="width: 10%;"></td> <td style="width: 10%;"></td> </tr> <tr> <td></td> <td></td> <td colspan="8" style="text-align: center;"> <table border="1" style="width: 100%; border-collapse: collapse; text-align: center;"> <tr> <td style="width: 10%;"></td> <td style="width: 10%;"></td> <td style="width: 10%;"></td> <td style="width: 10%;"></td> <td style="width: 10%;"></td> <td style="width: 10%;"></td> <td style="width: 10%;"></td> <td style="width: 10%;"></td> <td style="width: 10%;"></td> <td style="width: 10%;"></td> </tr> <tr> <td></td> <td></td> <td colspan="8" style="text-align: center;"> <table border="1" style="width: 100%; border-collapse: collapse; text-align: center;"> <tr> <td style="width: 10%;"></td> <td style="width: 10%;"></td> <td style="width: 10%;"></td> <td style="width: 10%;"></td> <td style="width: 10%;"></td> <td style="width: 10%;"></td> <td style="width: 10%;"></td> <td style="width: 10%;"></td> <td style="width: 10%;"></td> <td style="width: 10%;"></td> </tr> <tr> <td></td> <td></td> <td colspan="8" style="text-align: center;"> <table border="1" style="width: 100%; border-collapse: collapse; text-align: center;"> <tr> <td style="width: 10%;"></td> <td style="width: 10%;"></td> <td style="width: 10%;"></td> <td style="width: 10%;"></td> <td style="width: 10%;"></td> <td style="width: 10%;"></td> <td style="width: 10%;"></td> <td style="width: 10%;"></td> <td style="width: 10%;"></td> <td style="width: 10%;"></td> </tr> <tr> <td></td> <td></td> <td colspan="8" style="text-align: center;"> <table border="1" style="width: 100%; border-collapse: collapse; text-align: center;"> <tr> <td style="width: 10%;"></td> <td style="width: 10%;"></td> <td style="width: 10%;"></td> <td style="width: 10%;"></td> <td style="width: 10%;"></td> <td style="width: 10%;"></td> <td style="width: 10%;"></td> <td style="width: 10%;"></td> <td style="width: 10%;"></td> <td style="width: 10%;"></td> </tr> <tr> <td></td> <td></td> <td colspan="8" style="text-align: center;"> <table border="1" style="width: 100%; border-collapse: collapse; text-align: center;"> <tr> <td style="width: 10%;"></td> <td style="width: 10%;"></td> <td style="width: 10%;"></td> <td style="width: 10%;"></td> <td style="width: 10%;"></td> <td style="width: 10%;"></td> <td style="width: 10%;"></td> <td style="width: 10%;"></td> <td style="width: 10%;"></td> <td style="width: 10%;"></td> </tr> <tr> <td></td> <td></td> <td colspan="8" style="text-align: center;"> <table border="1" style="width: 100%; border-collapse: collapse; text-align: center;"> <tr> <td style="width: 10%;"></td> <td style="width: 10%;"></td> <td style="width: 10%;"></td> <td style="width: 10%;"></td> <td style="width: 10%;"></td> <td style="width: 10%;"></td> <td style="width: 10%;"></td> <td style="width: 10%;"></td> <td style="width: 10%;"></td> <td style="width: 10%;"></td> </tr> <tr> <td></td> <td></td> <td colspan="8" style="text-align: center;"> <table border="1" style="width: 100%; border-collapse: collapse; text-align: center;"> <tr> <td style="width: 10%;"></td> <td style="width: 10%;"></td> <td style="width: 10%;"></td> <td style="width: 10%;"></td> <td style="width: 10%;"></td> <td style="width: 10%;"></td> <td style="width: 10%;"></td> <td style="width: 10%;"></td> <td style="width: 10%;"></td> <td style="width: 10%;"></td> </tr> <tr> <td></td> <td></td> <td colspan="8" style="text-align: center;"> <table border="1" style="width: 100%; border-collapse: collapse; text-align: center;"> <tr> <td style="width: 10%;"></td> <td style="width: 10%;"></td> <td style="width: 10%;"></td> <td style="width: 10%;"></td> <td style="width: 10%;"></td> <td style="width: 10%;"></td> <td style="width: 10%;"></td> <td style="width: 10%;"></td> <td style="width: 10%;"></td> <td style="width: 10%;"></td> </tr> <tr> <td></td> <td></td> <td colspan="8" style="text-align: center;"> <table border="1" style="width: 100%; border-collapse: collapse; text-align: center;"> <tr> <td style="width: 10%;"></td> <td style="width: 10%;"></td> <td style="width: 10%;"></td> <td style="width: 10%;"></td> <td style="width: 10%;"></td> <td style="width: 10%;"></td> <td style="width: 10%;"></td> <td style="width: 10%;"></td> <td style="width: 10%;"></td> <td style="width: 10%;"></td> </tr> <tr> <td></td> <td></td> <td colspan="8" style="text-align: center;"> <table border="1" style="width: 100%; border-collapse: collapse; text-align: center;"> <tr> <td style="width: 10%;"></td> <td style="width: 10%;"></td> <td style="width: 10%;"></td> <td style="width: 10%;"></td> <td style="width: 10%;"></td> <td style="width: 10%;"></td> <td style="width: 10%;"></td> <td style="width: 10%;"></td> <td style="width: 10%;"></td> <td style="width: 10%;"></td> </tr> <tr> <td></td> <td></td> <td colspan="8" style="text-align: center;"> <table border="1" style="width: 100%; border-collapse: collapse; text-align: center;"> <tr> <td style="width: 10%;"></td> <td style="width: 10%;"></td> <td style="width: 10%;"></td> <td style="width: 10%;"></td> <td style="width: 10%;"></td> <td style="width: 10%;"></td> <td style="width: 10%;"></td> <td style="width: 10%;"></td> <td style="width: 10%;"></td> <td style="width: 10%;"></td> </tr> <tr> <td></td> <td></td> <td colspan="8" style="text-align: center;"> <table border="1" style="width: 100%; border-collapse: collapse; text-align: center;"> <tr> <td style="width: 10%;"></td> <td style="width: 10%;"></td> <td style="width: 10%;"></td> <td style="width: 10%;"></td> <td style="width: 10%;"></td> <td style="width: 10%;"></td> <td style="width: 10%;"></td> <td style="width: 10%;"></td> <td style="width: 10%;"></td> <td style="width: 10%;"></td> </tr> <tr> <td></td> <td></td> <td colspan="8" style="text-align: center;"> <table border="1" style="width: 100%; border-collapse: collapse; text-align: center;"> <tr> <td style="width: 10%;"></td> <td style="width: 10%;"></td> <td style="width: 10%;"></td> <td style="width: 10%;"></td> <td style="width: 10%;"></td> <td style="width: 10%;"></td> <td style="width: 10%;"></td> <td style="width: 10%;"></td> <td style="width: 10%;"></td> <td style="width: 10%;"></td> </tr> <tr> <td></td> <td></td> <td colspan="8"
style="text-align: center;"> <table border="1" style="width: 100%; border-collapse: collapse; text-align: center;"> <tr> <td style="width: 10%;"></td> <td style="width: 10%;"></td> <td style="width: 10%;"></td> <td style="width: 10%;"></td> <td style="width: 10%;"></td> <td style="width: 10%;"></td> <td style="width: 10%;"></td> <td style="width: 10%;"></td> <td style="width: 10%;"></td> <td style="width: 10%;"></td> </tr> <tr> <td></td> <td></td> <td colspan="8" style="text-align: center;"> <table border="1" style="width: 100%; border-collapse: collapse; text-align: center;"> <tr> <td style="width: 10%;"></td> <td style="width: 10%;"></td> <td style="width: 10%;"></td> <td style="width: 10%;"></td> <td style="width: 10%;"></td> <td style="width: 10%;"></td> <td style="width: 10%;"></td> <td style="width: 10%;"></td> <td style="width: 10%;"></td> <td style="width: 10%;"></td> </tr> <tr> <td></td> <td></td> <td colspan="8" style="text-align: center;"> <table border="1" style="width: 100%; border-collapse: collapse; text-align: center;"> <tr> <td style="width: 10%;"></td> <td style="width: 10%;"></td> <td style="width: 10%;"></td> <td style="width: 10%;"></td> <td style="width: 10%;"></td> <td style="width: 10%;"></td> <td style="width: 10%;"></td> <td style="width: 10%;"></td> <td style="width: 10%;"></td> <td style="width: 10%;"></td> </tr> <tr> <td></td> <td></td> <td colspan="8" style="text-align: center;"> <table border="1" style="width: 100%; border-collapse: collapse; text-align: center;"> <tr> <td style="width: 10%;"></td> <td style="width: 10%;"></td> <td style="width: 10%;"></td> <td style="width: 10%;"></td> <td style="width: 10%;"></td> <td style="width: 10%;"></td> <td style="width: 10%;"></td> <td style="width: 10%;"></td> <td style="width: 10%;"></td> <td style="width: 10%;"></td> </tr> <tr> <td></td> <td></td> <td colspan="8" style="text-align: center;"> <table border="1" style="width: 100%; border-collapse: collapse; text-align: center;"> <tr> <td style="width: 10%;"></td> <td style="width: 10%;"></td> <td style="width: 10%;"></td> <td style="width: 10%;"></td> <td style="width: 10%;"></td> <td style="width: 10%;"></td> <td style="width: 10%;"></td> <td style="width: 10%;"></td> <td style="width: 10%;"></td> <td style="width: 10%;"></td> </tr> <tr> <td></td> <td></td> <td colspan="8" style="text-align: center;"> <table border="1" style="width: 100%; border-collapse: collapse; text-align: center;"> <tr> <td style="width: 10%;"></td> <td style="width: 10%;"></td> <td style="width: 10%;"></td> <td style="width: 10%;"></td> <td style="width: 10%;"></td> <td style="width: 10%;"></td> <td style="width: 10%;"></td> <td style="width: 10%;"></td> <td style="width: 10%;"></td> <td style="width: 10%;"></td> </tr> <tr> <td></td> <td></td> <td colspan="8" style="text-align: center;"> <table border="1" style="width: 100%; border-collapse: collapse; text-align: center;"> <tr> <td style="width: 10%;"></td> <td style="width: 10%;"></td> <td style="width: 10%;"></td> <td style="width: 10%;"></td> <td style="width: 10%;"></td> <td style="width: 10%;"></td> <td style="width: 10%;"></td> <td style="width: 10%;"></td> <td style="width: 10%;"></td> <td style="width: 10%;"></td> </tr> <tr> <td></td> <td></td> <td colspan="8" style="text-align: center;"> <table border="1" style="width: 100%; border-collapse: collapse; text-align: center;"> <tr> <td style="width: 10%;"></td> <td style="width: 10%;"></td> <td style="width: 10%;"></td> <td style="width: 10%;"></td> <td style="width: 10%;"></td> <td style="width: 10%;"></td> <td style="width: 10%;"></td> <td style="width: 10%;"></td> <td style="width: 10%;"></td> <td style="width: 10%;"></td> </tr> <tr> <td></td> <td></td> <td colspan="8" style="text-align: center;"> <table border="1" style="width: 100%; border-collapse: collapse; text-align: center;"> <tr> <td style="width: 10%;"></td> <td style="width: 10%;"></td> <td style="width: 10%;"></td> <td style="width: 10%;"></td> <td style="width: 10%;"></td> <td style="width: 10%;"></td> <td style="width: 10%;"></td> <td style="width: 10%;"></td> <td style="width: 10%;"></td> <td style="width: 10%;"></td> </tr> <tr> <td></td> <td></td> <td colspan="8" style="text-align: center;"> <table border="1" style="width: 100%; border-collapse: collapse; text-align: center;"> <tr> <td style="width: 10%;"></td> <td style="width: 10%;"></td> <td style="width: 10%;"></td> <td style="width: 10%;"></td> <td style="width: 10%;"></td> <td style="width: 10%;"></td> <td style="width: 10%;"></td> <td style="width: 10%;"></td> <td style="width: 10%;"></td> <td style="width: 10%;"></td> </tr> <tr> <td></td> <td></td> <td colspan="8" style="text-align: center;"> <table border="1" style="width: 100%; border-collapse: collapse; text-align: center;"> <tr> <td style="width: 10%;"></td> <td style="width: 10%;"></td> <td style="width: 10%;"></td> <td style="width: 10%;"></td> <td style="width: 10%;"></td> <td style="width: 10%;"></td> <td style="width: 10%;"></td> <td style="width: 10%;"></td> <td style="width: 10%;"></td> <td style="width: 10%;"></td> </tr> <tr> <td></td> <td></td> <td colspan="8" style="text-align: center;"> <table border="1" style="width: 100%; border-collapse: collapse; text-align: center;"> <tr> <td style="width: 10%;"></td> <td style="width: 10%;"></td> <td style="width: 10%;"></td> <td style="width: 10%;"></td> <td style="width: 10%;"></td> <td style="width: 10%;"></td> <td style="width: 10%;"></td> <td style="width: 10%;"></td> <td style="width: 10%;"></td> <td style="width: 10%;"></td> </tr> <tr> <td></td> <td></td> <td colspan="8" style="text-align: center;"> <table border="1" style="width: 100%; border-collapse: collapse; text-align: center;"> <tr> <td style="width: 10%;"></td> <td style="width: 10%;"></td> <td style="width: 10%;"></td> <td style="width: 10%;"></td> <td style="width: 10%;"></td> <td style="width: 10%;"></td> <td style="width: 10%;"></td> <td style="width: 10%;"></td> <td style="width: 10%;"></td> <td style="width: 10%;"></td> </tr> <tr> <td></td> <td></td> <td colspan="8" style="text-align: center;"> <table border="1" style="width: 100%; border-collapse: collapse; text-align: center;"> <tr> <td style="width: 10%;"></td> <td style="width: 10%;"></td> <td style="width: 10%;"></td> <td style="width: 10%;"></td> <td style="width: 10%;"></td> <td style="width: 10%;"></td> <td style="width: 10%;"></td> <td style="width: 10%;"></td> <td style="width: 10%;"></td> <td style="width: 10%;"></td> </tr> <tr> <td></td> <td></td> <td colspan="8" style="text-align: center;"> <table border="1" style="width: 100%; border-collapse: collapse; text-align: center;"> <tr> <td style="width: 10%;"></td> <td style="width: 10%;"></td> <td style="width: 10%;"></td> <td style="width: 10%;"></td> <td style="width: 10%;"></td> <td style="width: 10%;"></td> <td style="width: 10%;"></td> <td style="width: 10%;"></td> <td style="width: 10%;"></td> <td style="width: 10%;"></td> </tr> <tr> <td></td> <td></td> <td colspan="8" style="text-align: center;"> <table border="1" style="width: 100%; border-collapse: collapse; text-align: center;"> <tr> <td style="width: 10%;"></td> <td style="width: 10%;"></td> <td style="width: 10%;"></td> <td style="width: 10%;"></td> <td style="width: 10%;"></td> <td style="width: 10%;"></td> <td style="width: 10%;"></td> <td style="width: 10%;"></td> <td style="width: 10%;"></td> <td style="width: 10%;"></td> </tr> <tr> <td></td> <td></td> <td colspan="8" style="text-align: center;"> <table border="1" style="width: 100%; border-collapse: collapse; text-align: center;"> <tr> <td style="width: 10%;"></td> <td style="width: 10%;"></td> <td style="width: 10%;"></td> <td style="width: 10%;"></td> <td style="width: 10%;"></td> <td style="width: 10%;"></td> <td style="width: 10%;"></td> <td style="width: 10%;"></td> <td style="width: 10%;"></td> <td style="width: 10%;"></td> </tr> <tr> <td></td> <td></td> <td colspan="8" style="text-align: center;"> <table border="1" style="width: 100%; border-collapse: collapse; text-align: center;"> <tr> <td style="width: 10%;"></td> <td style="width: 10%;"></td> <td style="width: 10%;"></td> <td style="width: 10%;"></td> <td style="width: 10%;"></td> <td style="width: 10%;"></td> <td style="width: 10%;"></td> <td style="width: 10%;"></td> <td style="width: 10%;"></td> <td style="width: 10%;"></td> </tr> <tr> <td></td> <td></td> <td colspan="8" style="text-align: center;"> <table border="1" style="width: 100%; border-collapse: collapse; text-align: center;"> <tr> <td style="width: 10%;"></td> <td style="width: 10%;"></td> <td style="width: 10%;"></td> <td style="width: 10%;"></td> <td style="width: 10%;"></td> <td style="width: 10%;"></td> <td style="width: 10%;"></td> <td style="width: 10%;"></td> <td style="width: 10%;"></td> <td style="width: 10%;"></td> </tr> <tr> <td></td> <td></td> <td colspan="8" style="text-align: center;"> <table border="1" style="width: 100%; border-collapse: collapse; text-align: center;"> <tr> <td style="width: 10%;"></td> <td style="width: 10%;"></td> <td style="width: 10%;"></td> <td style="width: 10%;"></td> <td style="width: 10%;"></td> <td style="width: 10%;"></td> <td style="width: 10%;"></td> <td style="width: 10%;"></td> <td style="width: 10%;"></td> <td style="width: 10%;"></td> </tr> <tr> <td></td> <td></td> <td colspan="8" style="text-align: center;"> <table border="1" style="width: 100%; border-collapse: collapse; text-align: center;"> <tr> <td style="width: 10%;"></td> <td style="width: 10%;"></td> <td style="width: 10%;"></td> <td style="width: 10%;"></td> <td style="width: 10%;"></td> <td style="width: 10%;"></td> <td style="width: 10%;"></td> <td style="width: 10%;"></td> <td style="width: 10%;"></td> <td style="width: 10%;"></td> </tr> <tr> <td></td> <td></td> <td colspan="8" style="text-align: center;"> <table border="1" style="width: 100%; border-collapse: collapse; text-align: center;"> <tr> <td style="width: 10%;"></td> <td style="width:
10%;"></td> <td style="width: 10%;"></td> <td style="width: 10%;"></td> <td style="width: 10%;"></td> <td style="width: 10%;"></td> <td style="width: 10%;"></td> <td style="width: 10%;"></td> <td style="width: 10%;"></td> <td style="width: 10%;"></td> </tr> <tr> <td></td> <td></td> <td colspan="8" style="text-align: center;"> <table border="1" style="width: 100%; border-collapse: collapse; text-align: center;"> <tr> </tr></table></td></tr></table></td></tr></table></td></tr></table></td></tr></table></td></tr></table></td></tr></table></td></tr></table></td></tr></table></td></tr></table></td></tr></table></td></tr></table></td></tr></table></td></tr></table></td></tr></table></td></tr></table></td></tr></table></td></tr></table></td></tr></table></td></tr></table></td></tr></table></td></tr></table></td></tr></table></td></tr></table></td></tr></table></td></tr></table></td></tr></table></td></tr></table></td></tr></table></td></tr></table></td></tr></table></td></tr></table></td></tr></table></td></tr></table></td></tr></table></td></tr></table></td></tr></table></td></tr></table></td></tr></table></td></tr></table></td></tr></table></td></tr></table></td></tr></table></td></tr></table></td></tr></table></td></tr></table></td></tr></table> | | | | | | | | | | | | | | | | | | | | <table border="1" style="width: 100%; border-collapse: collapse; text-align: center;"> <tr> <td style="width: 10%;"></td> <td style="width: 10%;"></td> <td style="width: 10%;"></td> <td style="width: 10%;"></td> <td style="width: 10%;"></td> <td style="width: 10%;"></td> <td style="width: 10%;"></td> <td style="width: 10%;"></td> <td style="width: 10%;"></td> <td style="width: 10%;"></td> </tr> <tr> <td></td> <td></td> <td colspan="8" style="text-align: center;"> <table border="1" style="width: 100%; border-collapse: collapse; text-align: center;"> <tr> <td style="width: 10%;"></td> <td style="width: 10%;"></td> <td style="width: 10%;"></td> <td style="width: 10%;"></td> <td style="width: 10%;"></td> <td style="width: 10%;"></td> <td style="width: 10%;"></td> <td style="width: 10%;"></td> <td style="width: 10%;"></td> <td style="width: 10%;"></td> </tr> <tr> <td></td> <td></td> <td colspan="8" style="text-align: center;"> <table border="1" style="width: 100%; border-collapse: collapse; text-align: center;"> <tr> <td style="width: 10%;"></td> <td style="width: 10%;"></td> <td style="width: 10%;"></td> <td style="width: 10%;"></td> <td style="width: 10%;"></td> <td style="width: 10%;"></td> <td style="width: 10%;"></td> <td style="width: 10%;"></td> <td style="width: 10%;"></td> <td style="width: 10%;"></td> </tr> <tr> <td></td> <td></td> <td colspan="8" style="text-align: center;"> <table border="1" style="width: 100%; border-collapse: collapse; text-align: center;"> <tr> <td style="width: 10%;"></td> <td style="width: 10%;"></td> <td style="width: 10%;"></td> <td style="width: 10%;"></td> <td style="width: 10%;"></td> <td style="width: 10%;"></td> <td style="width: 10%;"></td> <td style="width: 10%;"></td> <td style="width: 10%;"></td> <td style="width: 10%;"></td> </tr> <tr> <td></td> <td></td> <td colspan="8" style="text-align: center;"> <table border="1" style="width: 100%; border-collapse: collapse; text-align: center;"> <tr> <td style="width: 10%;"></td> <td style="width: 10%;"></td> <td style="width: 10%;"></td> <td style="width: 10%;"></td> <td style="width: 10%;"></td> <td style="width: 10%;"></td> <td style="width: 10%;"></td> <td style="width: 10%;"></td> <td style="width: 10%;"></td> <td style="width: 10%;"></td> </tr> <tr> <td></td> <td></td> <td colspan="8" style="text-align: center;"> <table border="1" style="width: 100%; border-collapse: collapse; text-align: center;"> <tr> <td style="width: 10%;"></td> <td style="width: 10%;"></td> <td style="width: 10%;"></td> <td style="width: 10%;"></td> <td style="width: 10%;"></td> <td style="width: 10%;"></td> <td style="width: 10%;"></td> <td style="width: 10%;"></td> <td style="width: 10%;"></td> <td style="width: 10%;"></td> </tr> <tr> <td></td> <td></td> <td colspan="8" style="text-align: center;"> <table border="1" style="width: 100%; border-collapse: collapse; text-align: center;"> <tr> <td style="width: 10%;"></td> <td style="width: 10%;"></td> <td style="width: 10%;"></td> <td style="width: 10%;"></td> <td style="width: 10%;"></td> <td style="width: 10%;"></td> <td style="width: 10%;"></td> <td style="width: 10%;"></td> <td style="width: 10%;"></td> <td style="width: 10%;"></td> </tr> <tr> <td></td> <td></td> <td colspan="8" style="text-align: center;"> <table border="1" style="width: 100%; border-collapse:
collapse; text-align: center;"> <tr> <td style="width: 10%;"></td> <td style="width: 10%;"></td> <td style="width: 10%;"></td> <td style="width: 10%;"></td> <td style="width: 10%;"></td> <td style="width: 10%;"></td> <td style="width: 10%;"></td> <td style="width: 10%;"></td> <td style="width: 10%;"></td> <td style="width: 10%;"></td> </tr> <tr> <td></td> <td></td> <td colspan="8" style="text-align: center;"> <table border="1" style="width: 100%; border-collapse: collapse; text-align: center;"> <tr> <td style="width: 10%;"></td> <td style="width: 10%;"></td> <td style="width: 10%;"></td> <td style="width: 10%;"></td> <td style="width: 10%;"></td> <td style="width: 10%;"></td> <td style="width: 10%;"></td> <td style="width: 10%;"></td> <td style="width: 10%;"></td> <td style="width: 10%;"></td> </tr> <tr> <td></td> <td></td> <td colspan="8" style="text-align: center;"> <table border="1" style="width: 100%; border-collapse: collapse; text-align: center;"> <tr> <td style="width: 10%;"></td> <td style="width: 10%;"></td> <td style="width: 10%;"></td> <td style="width: 10%;"></td> <td style="width: 10%;"></td> <td style="width: 10%;"></td> <td style="width: 10%;"></td> <td style="width: 10%;"></td> <td style="width: 10%;"></td> <td style="width: 10%;"></td> </tr> <tr> <td></td> <td></td> <td colspan="8" style="text-align: center;"> <table border="1" style="width: 100%; border-collapse: collapse; text-align: center;"> <tr> <td style="width: 10%;"></td> <td style="width: 10%;"></td> <td style="width: 10%;"></td> <td style="width: 10%;"></td> <td style="width: 10%;"></td> <td style="width: 10%;"></td> <td style="width: 10%;"></td> <td style="width: 10%;"></td> <td style="width: 10%;"></td> <td style="width: 10%;"></td> </tr> <tr> <td></td> <td></td> <td colspan="8" style="text-align: center;"> <table border="1" style="width: 100%; border-collapse: collapse; text-align: center;"> <tr> <td style="width: 10%;"></td> <td style="width: 10%;"></td> <td style="width: 10%;"></td> <td style="width: 10%;"></td> <td style="width: 10%;"></td> <td style="width: 10%;"></td> <td style="width: 10%;"></td> <td style="width: 10%;"></td> <td style="width: 10%;"></td> <td style="width: 10%;"></td> </tr> <tr> <td></td> <td></td> <td colspan="8" style="text-align: center;"> <table border="1" style="width: 100%; border-collapse: collapse; text-align: center;"> <tr> <td style="width: 10%;"></td> <td style="width: 10%;"></td> <td style="width: 10%;"></td> <td style="width: 10%;"></td> <td style="width: 10%;"></td> <td style="width: 10%;"></td> <td style="width: 10%;"></td> <td style="width: 10%;"></td> <td style="width: 10%;"></td> <td style="width: 10%;"></td> </tr> <tr> <td></td> <td></td> <td colspan="8" style="text-align: center;"> <table border="1" style="width: 100%; border-collapse: collapse; text-align: center;"> <tr> <td style="width: 10%;"></td> <td style="width: 10%;"></td> <td style="width: 10%;"></td> <td style="width: 10%;"></td> <td style="width: 10%;"></td> <td style="width: 10%;"></td> <td style="width: 10%;"></td> <td style="width: 10%;"></td> <td style="width: 10%;"></td> <td style="width: 10%;"></td> </tr> <tr> <td></td> <td></td> <td colspan="8" style="text-align: center;"> <table border="1" style="width: 100%; border-collapse: collapse; text-align: center;"> <tr> <td style="width: 10%;"></td> <td style="width: 10%;"></td> <td style="width: 10%;"></td> <td style="width: 10%;"></td> <td style="width: 10%;"></td> <td style="width: 10%;"></td> <td style="width: 10%;"></td> <td style="width: 10%;"></td> <td style="width: 10%;"></td> <td style="width: 10%;"></td> </tr> <tr> <td></td> <td></td> <td colspan="8" style="text-align: center;"> <table border="1" style="width: 100%; border-collapse: collapse; text-align: center;"> <tr> <td style="width: 10%;"></td> <td style="width: 10%;"></td> <td style="width: 10%;"></td> <td style="width: 10%;"></td> <td style="width: 10%;"></td> <td style="width: 10%;"></td> <td style="width: 10%;"></td> <td style="width: 10%;"></td> <td style="width: 10%;"></td> <td style="width: 10%;"></td> </tr> <tr> <td></td> <td></td> <td colspan="8" style="text-align: center;"> <table border="1" style="width: 100%; border-collapse: collapse; text-align: center;"> <tr> <td style="width: 10%;"></td> <td style="width: 10%;"></td> <td style="width: 10%;"></td> <td style="width: 10%;"></td> <td style="width: 10%;"></td> <td style="width: 10%;"></td> <td style="width: 10%;"></td> <td style="width: 10%;"></td> <td style="width: 10%;"></td> <td style="width: 10%;"></td> </tr> <tr> <td></td> <td></td> <td colspan="8" style="text-align: center;"> <table border="1" style="width: 100%; border-collapse: collapse; text-align: center;"> <tr> <td style="width: 10%;"></td> <td style="width: 10%;"></td> <td style="width: 10%;"></td> <td style="width: 10%;"></td> <td style="width: 10%;"></td> <td style="width: 10%;"></td> <td style="width: 10%;"></td> <td style="width: 10%;"></td> <td style="width: 10%;"></td> <td style="width: 10%;"></td> </tr> <tr> <td></td> <td></td> <td colspan="8" style="text-align: center;"> <table border="1" style="width: 100%; border-collapse: collapse; text-align: center;"> <tr> <td style="width: 10%;"></td> <td style="width: 10%;"></td> <td style="width: 10%;"></td> <td style="width: 10%;"></td> <td style="width: 10%;"></td> <td style="width: 10%;"></td> <td style="width: 10%;"></td> <td style="width: 10%;"></td> <td style="width: 10%;"></td> <td style="width: 10%;"></td> </tr> <tr> <td></td> <td></td> <td colspan="8" style="text-align: center;"> <table border="1" style="width: 100%; border-collapse: collapse; text-align: center;"> <tr> <td style="width: 10%;"></td> <td style="width: 10%;"></td> <td style="width: 10%;"></td> <td style="width: 10%;"></td> <td style="width: 10%;"></td> <td style="width: 10%;"></td> <td style="width: 10%;"></td> <td style="width: 10%;"></td> <td style="width: 10%;"></td> <td style="width: 10%;"></td> </tr> <tr> <td></td> <td></td> <td colspan="8" style="text-align: center;"> <table border="1" style="width: 100%; border-collapse: collapse; text-align: center;"> <tr> <td style="width: 10%;"></td> <td style="width: 10%;"></td> <td style="width: 10%;"></td> <td style="width: 10%;"></td> <td style="width: 10%;"></td> <td style="width: 10%;"></td> <td style="width: 10%;"></td> <td style="width: 10%;"></td> <td style="width: 10%;"></td> <td style="width: 10%;"></td> </tr> <tr> <td></td> <td></td> <td colspan="8" style="text-align: center;"> <table border="1" style="width: 100%; border-collapse: collapse; text-align: center;"> <tr> <td style="width: 10%;"></td> <td style="width: 10%;"></td> <td style="width: 10%;"></td> <td style="width: 10%;"></td> <td style="width: 10%;"></td> <td style="width: 10%;"></td> <td style="width: 10%;"></td> <td style="width: 10%;"></td> <td style="width: 10%;"></td> <td style="width: 10%;"></td> </tr> <tr> <td></td> <td></td> <td colspan="8" style="text-align: center;"> <table border="1" style="width: 100%; border-collapse: collapse; text-align: center;"> <tr> <td style="width: 10%;"></td> <td style="width: 10%;"></td> <td style="width: 10%;"></td> <td style="width: 10%;"></td> <td style="width: 10%;"></td> <td style="width: 10%;"></td> <td style="width: 10%;"></td> <td style="width: 10%;"></td> <td style="width: 10%;"></td> <td style="width: 10%;"></td> </tr> <tr> <td></td> <td></td> <td colspan="8" style="text-align: center;"> <table border="1" style="width: 100%; border-collapse: collapse; text-align: center;"> <tr> <td style="width: 10%;"></td> <td style="width: 10%;"></td> <td style="width: 10%;"></td> <td style="width: 10%;"></td> <td style="width: 10%;"></td> <td style="width: 10%;"></td> <td style="width: 10%;"></td> <td style="width: 10%;"></td> <td style="width: 10%;"></td> <td style="width: 10%;"></td> </tr> <tr> <td></td> <td></td> <td colspan="8" style="text-align: center;"> <table border="1" style="width: 100%; border-collapse: collapse; text-align: center;"> <tr> <td style="width: 10%;"></td> <td style="width: 10%;"></td> <td style="width: 10%;"></td> <td style="width: 10%;"></td> <td style="width: 10%;"></td> <td style="width: 10%;"></td> <td style="width: 10%;"></td> <td style="width: 10%;"></td> <td style="width: 10%;"></td> <td style="width: 10%;"></td> </tr> <tr> <td></td> <td></td> <td colspan="8" style="text-align: center;"> <table border="1" style="width: 100%; border-collapse: collapse; text-align: center;"> <tr> <td style="width: 10%;"></td> <td style="width: 10%;"></td> <td style="width: 10%;"></td> <td style="width: 10%;"></td> <td style="width: 10%;"></td> <td style="width: 10%;"></td> <td style="width: 10%;"></td> <td style="width: 10%;"></td> <td style="width: 10%;"></td> <td style="width: 10%;"></td> </tr> <tr> <td></td> <td></td> <td colspan="8" style="text-align: center;"> <table border="1" style="width: 100%; border-collapse: collapse; text-align: center;"> <tr> <td style="width: 10%;"></td> <td style="width: 10%;"></td> <td style="width: 10%;"></td> <td style="width: 10%;"></td> <td style="width: 10%;"></td> <td style="width: 10%;"></td> <td style="width: 10%;"></td> <td style="width: 10%;"></td> <td style="width: 10%;"></td> <td style="width: 10%;"></td> </tr> <tr> <td></td> <td></td> <td colspan="8" style="text-align: center;"> <table border="1" style="width: 100%; border-collapse: collapse; text-align: center;"> <tr> <td style="width: 10%;"></td> <td style="width: 10%;"></td> <td style="width: 10%;"></td> <td style="width: 10%;"></td> <td style="width: 10%;"></td> <td style="width: 10%;"></td> <td style="width: 10%;"></td> <td style="width: 10%;"></td> <td style="width: 10%;"></td> <td style="width: 10%;"></td> </tr> <tr> <td></td> <td></td> <td colspan="8" style="text-align: center;"> <table border="1" style="width: 100%; border-collapse: collapse; text-align: center;"> <tr> <td style="width: 10%;"></td> <td style="width: 10%;"></td> <td style="width: 10%;"></td> <td style="width: 10%;"></td> <td
style="width: 10%;"></td> <td style="width: 10%;"></td> <td style="width: 10%;"></td> <td style="width: 10%;"></td> <td style="width: 10%;"></td> <td style="width: 10%;"></td> </tr> <tr> <td></td> <td></td> <td colspan="8" style="text-align: center;"> <table border="1" style="width: 100%; border-collapse: collapse; text-align: center;"> <tr> <td style="width: 10%;"></td> <td style="width: 10%;"></td> <td style="width: 10%;"></td> <td style="width: 10%;"></td> <td style="width: 10%;"></td> <td style="width: 10%;"></td> <td style="width: 10%;"></td> <td style="width: 10%;"></td> <td style="width: 10%;"></td> <td style="width: 10%;"></td> </tr> <tr> <td></td> <td></td> <td colspan="8" style="text-align: center;"> <table border="1" style="width: 100%; border-collapse: collapse; text-align: center;"> <tr> <td style="width: 10%;"></td> <td style="width: 10%;"></td> <td style="width: 10%;"></td> <td style="width: 10%;"></td> <td style="width: 10%;"></td> <td style="width: 10%;"></td> <td style="width: 10%;"></td> <td style="width: 10%;"></td> <td style="width: 10%;"></td> <td style="width: 10%;"></td> </tr> <tr> <td></td> <td></td> <td colspan="8" style="text-align: center;"> <table border="1" style="width: 100%; border-collapse: collapse; text-align: center;"> <tr> <td style="width: 10%;"></td> <td style="width: 10%;"></td> <td style="width: 10%;"></td> <td style="width: 10%;"></td> <td style="width: 10%;"></td> <td style="width: 10%;"></td> <td style="width: 10%;"></td> <td style="width: 10%;"></td> <td style="width: 10%;"></td> <td style="width: 10%;"></td> </tr> <tr> <td></td> <td></td> <td colspan="8" style="text-align: center;"> <table border="1" style="width: 100%; border-collapse: collapse; text-align: center;"> <tr> <td style="width: 10%;"></td> <td style="width: 10%;"></td> <td style="width: 10%;"></td> <td style="width: 10%;"></td> <td style="width: 10%;"></td> <td style="width: 10%;"></td> <td style="width: 10%;"></td> <td style="width: 10%;"></td> <td style="width: 10%;"></td> <td style="width: 10%;"></td> </tr> <tr> <td></td> <td></td> <td colspan="8" style="text-align: center;"> <table border="1" style="width: 100%; border-collapse: collapse; text-align: center;"> <tr> <td style="width: 10%;"></td> <td style="width: 10%;"></td> <td style="width: 10%;"></td> <td style="width: 10%;"></td> <td style="width: 10%;"></td> <td style="width: 10%;"></td> <td style="width: 10%;"></td> <td style="width: 10%;"></td> <td style="width: 10%;"></td> <td style="width: 10%;"></td> </tr> <tr> <td></td> <td></td> <td colspan="8" style="text-align: center;"> <table border="1" style="width: 100%; border-collapse: collapse; text-align: center;"> <tr> <td style="width: 10%;"></td> <td style="width: 10%;"></td> <td style="width: 10%;"></td> <td style="width: 10%;"></td> <td style="width: 10%;"></td> <td style="width: 10%;"></td> <td style="width: 10%;"></td> <td style="width: 10%;"></td> <td style="width: 10%;"></td> <td style="width: 10%;"></td> </tr> <tr> <td></td> <td></td> <td colspan="8" style="text-align: center;"> <table border="1" style="width: 100%; border-collapse: collapse; text-align: center;"> <tr> <td style="width: 10%;"></td> <td style="width: 10%;"></td> <td style="width: 10%;"></td> <td style="width: 10%;"></td> <td style="width: 10%;"></td> <td style="width: 10%;"></td> <td style="width: 10%;"></td> <td style="width: 10%;"></td> <td style="width: 10%;"></td> <td style="width: 10%;"></td> </tr> <tr> <td></td> <td></td> <td colspan="8" style="text-align: center;"> <table border="1" style="width: 100%; border-collapse: collapse; text-align: center;"> <tr> <td style="width: 10%;"></td> <td style="width: 10%;"></td> <td style="width: 10%;"></td> <td style="width: 10%;"></td> <td style="width: 10%;"></td> <td style="width: 10%;"></td> <td style="width: 10%;"></td> <td style="width: 10%;"></td> <td style="width: 10%;"></td> <td style="width: 10%;"></td> </tr> <tr> <td></td> <td></td> <td colspan="8" style="text-align: center;"> <table border="1" style="width: 100%; border-collapse: collapse; text-align: center;"> <tr> <td style="width: 10%;"></td> <td style="width: 10%;"></td> <td style="width: 10%;"></td> <td style="width: 10%;"></td> <td style="width: 10%;"></td> <td style="width: 10%;"></td> <td style="width: 10%;"></td> <td style="width: 10%;"></td> <td style="width: 10%;"></td> <td style="width: 10%;"></td> </tr> <tr> <td></td> <td></td> <td colspan="8" style="text-align: center;"> <table border="1" style="width: 100%; border-collapse: collapse; text-align: center;"> <tr> <td style="width: 10%;"></td> <td style="width: 10%;"></td> <td style="width: 10%;"></td> <td style="width: 10%;"></td> <td style="width: 10%;"></td> <td style="width: 10%;"></td> <td style="width: 10%;"></td> <td style="width: 10%;"></td> <td style="width: 10%;"></td> <td style="width: 10%;"></td> </tr> <tr> <td></td> <td></td> <td colspan="8" style="text-align: center;"> <table border="1" style="width: 100%; border-collapse: collapse; text-align: center;"> <tr> <td style="width: 10%;"></td> <td style="width: 10%;"></td> <td style="width: 10%;"></td> <td style="width: 10%;"></td> <td style="width: 10%;"></td> <td style="width: 10%;"></td> <td style="width: 10%;"></td> <td style="width: 10%;"></td> <td style="width: 10%;"></td> <td style="width: 10%;"></td> </tr> <tr> <td></td> <td></td> <td colspan="8" style="text-align: center;"> <table border="1" style="width: 100%; border-collapse: collapse; text-align: center;"> <tr> <td style="width: 10%;"></td> <td style="width: 10%;"></td> <td style="width: 10%;"></td> <td style="width: 10%;"></td> <td style="width: 10%;"></td> <td style="width: 10%;"></td> <td style="width: 10%;"></td> <td style="width: 10%;"></td> <td style="width: 10%;"></td> <td style="width: 10%;"></td> </tr> <tr> <td></td> <td></td> <td colspan="8" style="text-align: center;"> <table border="1" style="width: 100%; border-collapse: collapse; text-align: center;"> <tr> <td style="width: 10%;"></td> <td style="width: 10%;"></td> <td style="width: 10%;"></td> <td style="width: 10%;"></td> <td style="width: 10%;"></td> <td style="width: 10%;"></td> <td style="width: 10%;"></td> <td style="width: 10%;"></td> <td style="width: 10%;"></td> <td style="width: 10%;"></td> </tr> <tr> <td></td> <td></td> <td colspan="8" style="text-align: center;"> <table border="1" style="width: 100%; border-collapse: collapse; text-align: center;"> <tr> <td style="width: 10%;"></td> <td style="width: 10%;"></td> <td style="width: 10%;"></td> <td style="width: 10%;"></td> <td style="width: 10%;"></td> <td style="width: 10%;"></td> <td style="width: 10%;"></td> <td style="width: 10%;"></td> <td style="width: 10%;"></td> <td style="width: 10%;"></td> </tr> <tr> <td></td> <td></td> <td colspan="8" style="text-align: center;"> <table border="1" style="width: 100%; border-collapse: collapse; text-align: center;"> <tr> <td style="width: 10%;"></td> <td style="width: 10%;"></td> <td style="width: 10%;"></td> <td style="width: 10%;"></td> <td style="width: 10%;"></td> <td style="width: 10%;"></td> <td style="width: 10%;"></td> <td style="width: 10%;"></td> <td style="width: 10%;"></td> <td style="width: 10%;"></td> </tr> <tr> <td></td> <td></td> <td colspan="8" style="text-align: center;"> <table border="1" style="width: 100%; border-collapse: collapse; text-align: center;"> <tr> <td style="width: 10%;"></td> <td style="width: 10%;"></td> <td style="width: 10%;"></td> <td style="width: 10%;"></td> <td style="width: 10%;"></td> <td style="width: 10%;"></td> <td style="width: 10%;"></td> <td style="width: 10%;"></td> <td style="width: 10%;"></td> <td style="width: 10%;"></td> </tr> <tr> <td></td> <td></td> <td colspan="8" style="text-align: center;"> <table border="1" style="width: 100%; border-collapse: collapse; text-align: center;"> <tr> </tr></table></td></tr></table></td></tr></table></td></tr></table></td></tr></table></td></tr></table></td></tr></table></td></tr></table></td></tr></table></td></tr></table></td></tr></table></td></tr></table></td></tr></table></td></tr></table></td></tr></table></td></tr></table></td></tr></table></td></tr></table></td></tr></table></td></tr></table></td></tr></table></td></tr></table></td></tr></table></td></tr></table></td></tr></table></td></tr></table></td></tr></table></td></tr></table></td></tr></table></td></tr></table></td></tr></table></td></tr></table></td></tr></table></td></tr></table></td></tr></table></td></tr></table></td></tr></table></td></tr></table></td></tr></table></td></tr></table></td></tr></table></td></tr></table></td></tr></table></td></tr></table></td></tr></table></td></tr></table>
 | | | | | | | | | | | | | | | | | | | | <table border="1" style="width: 100%; border-collapse: collapse; text-align: center;"> <tr> <td style="width: 10%;"></td> <td style="width: 10%;"></td> <td style="width: 10%;"></td> <td style="width: 10%;"></td> <td style="width: 10%;"></td> <td style="width: 10%;"></td> <td style="width: 10%;"></td> <td style="width: 10%;"></td> <td style="width: 10%;"></td> <td style="width: 10%;"></td> </tr> <tr> <td></td> <td></td> <td colspan="8" style="text-align: center;"> <table border="1" style="width: 100%; border-collapse: collapse; text-align: center;"> <tr> <td style="width: 10%;"></td> <td style="width: 10%;"></td> <td style="width: 10%;"></td> <td style="width: 10%;"></td> <td style="width: 10%;"></td> <td style="width: 10%;"></td> <td style="width: 10%;"></td> <td style="width: 10%;"></td> <td style="width: 10%;"></td> <td style="width: 10%;"></td> </tr> <tr> <td></td> <td></td> <td colspan="8" style="text-align: center;"> <table border="1" style="width: 100%; border-collapse: collapse; text-align: center;"> <tr> <td style="width: 10%;"></td> <td style="width: 10%;"></td> <td style="width: 10%;"></td> <td style="width: 10%;"></td> <td style="width: 10%;"></td> <td style="width: 10%;"></td> <td style="width: 10%;"></td> <td style="width: 10%;"></td> <td style="width: 10%;"></td> <td style="width: 10%;"></td> </tr> <tr> <td></td> <td></td> <td colspan="8" style="text-align: center;"> <table border="1" style="width: 100%; border-collapse: collapse; text-align: center;"> <tr> <td style="width: 10%;"></td> <td style="width: 10%;"></td> <td style="width: 10%;"></td> <td style="width: 10%;"></td> <td style="width: 10%;"></td> <td style="width: 10%;"></td> <td style="width: 10%;"></td> <td style="width: 10%;"></td> <td style="width: 10%;"></td> <td style="width: 10%;"></td> </tr> <tr> <td></td> <td></td> <td colspan="8" style="text-align: center;"> <table border="1" style="width: 100%; border-collapse: collapse; text-align: center;"> <tr> <td style="width: 10%;"></td> <td style="width: 10%;"></td> <td style="width: 10%;"></td> <td style="width: 10%;"></td> <td style="width: 10%;"></td> <td style="width: 10%;"></td> <td style="width: 10%;"></td> <td style="width: 10%;"></td> <td style="width: 10%;"></td> <td style="width: 10%;"></td> </tr> <tr> <td></td> <td></td> <td colspan="8" style="text-align: center;"> <table border="1" style="width: 100%; border-collapse: collapse; text-align: center;"> <tr> <td style="width: 10%;"></td> <td style="width: 10%;"></td> <td style="width: 10%;"></td> <td style="width: 10%;"></td> <td style="width: 10%;"></td> <td style="width: 10%;"></td> <td style="width: 10%;"></td> <td style="width: 10%;"></td> <td style="width: 10%;"></td> <td style="width: 10%;"></td> </tr> <tr> <td></td> <td></td> <td colspan="8" style="text-align: center;"> <table border="1" style="width: 100%; border-collapse: collapse; text-align: center;"> <tr> <td style="width: 10%;"></td> <td style="width: 10%;"></td> <td style="width: 10%;"></td> <td style="width: 10%;"></td> <td style="width: 10%;"></td> <td style="width: 10%;"></td> <td style="width: 10%;"></td> <td style="width: 10%;"></td> <td style="width: 10%;"></td> <td style="width: 10%;"></td> </tr> <tr> <td></td> <td></td> <td colspan="8" style="text-align: center;"> <table border="1" style="width: 100%; border-collapse: collapse; text-align: center;"> <tr> <td style="width: 10%;"></td> <td style="width: 10%;"></td> <td style="width: 10%;"></td> <td style="width: 10%;"></td> <td style="width: 10%;"></td> <td style="width: 10%;"></td> <td style="width: 10%;"></td> <td style="width: 10%;"></td> <td style="width: 10%;"></td> <td style="width: 10%;"></td> </tr> <tr> <td></td> <td></td> <td colspan="8" style="text-align: center;"> <table border="1" style="width: 100%; border-collapse: collapse; text-align: center;"> <tr> <td style="width: 10%;"></td> <td style="width: 10%;"></td> <td style="width: 10%;"></td> <td style="width: 10%;"></td> <td style="width: 10%;"></td> <td style="width: 10%;"></td> <td style="width: 10%;"></td> <td style="width: 10%;"></td> <td style="width: 10%;"></td> <td style="width: 10%;"></td> </tr> <tr> <td></td> <td></td> <td colspan="8" style="text-align: center;"> <table border="1" style="width: 100%; border-collapse: collapse; text-align: center;"> <tr> <td style="width: 10%;"></td> <td style="width: 10%;"></td> <td style="width: 10%;"></td> <td style="width: 10%;"></td> <td style="width: 10%;"></td> <td style="width: 10%;"></td> <td style="width: 10%;"></td> <td style="width: 10%;"></td> <td style="width: 10%;"></td> <td style="width: 10%;"></td> </tr> <tr> <td></td> <td></td> <td colspan="8" style="text-align: center;"> <table border="1" style="width: 100%; border-collapse: collapse; text-align: center;"> <tr> <td style="width: 10%;"></td> <td style="width: 10%;"></td> <td style="width: 10%;"></td> <td style="width: 10%;"></td> <td style="width: 10%;"></td> <td style="width: 10%;"></td> <td style="width: 10%;"></td> <td style="width: 10%;"></td> <td style="width: 10%;"></td> <td style="width: 10%;"></td> </tr> <tr> <td></td> <td></td> <td colspan="8" style="text-align: center;"> <table border="1" style="width: 100%; border-collapse: collapse; text-align: center;"> <tr> <td style="width: 10%;"></td> <td style="width: 10%;"></td> <td style="width: 10%;"></td> <td style="width: 10%;"></td> <td style="width: 10%;"></td> <td style="width: 10%;"></td> <td style="width: 10%;"></td> <td style="width: 10%;"></td> <td style="width: 10%;"></td> <td style="width: 10%;"></td> </tr> <tr> <td></td> <td></td> <td colspan="8" style="text-align: center;"> <table border="1" style="width: 100%; border-collapse: collapse; text-align: center;"> <tr> <td style="width: 10%;"></td> <td style="width: 10%;"></td> <td style="width: 10%;"></td> <td style="width: 10%;"></td> <td style="width: 10%;"></td> <td style="width: 10%;"></td> <td style="width: 10%;"></td> <td style="width:
10%;"></td> <td style="width: 10%;"></td> <td style="width: 10%;"></td> </tr> <tr> <td></td> <td></td> <td colspan="8" style="text-align: center;"> <table border="1" style="width: 100%; border-collapse: collapse; text-align: center;"> <tr> <td style="width: 10%;"></td> <td style="width: 10%;"></td> <td style="width: 10%;"></td> <td style="width: 10%;"></td> <td style="width: 10%;"></td> <td style="width: 10%;"></td> <td style="width: 10%;"></td> <td style="width: 10%;"></td> <td style="width: 10%;"></td> <td style="width: 10%;"></td> </tr> <tr> <td></td> <td></td> <td colspan="8" style="text-align: center;"> <table border="1" style="width: 100%; border-collapse: collapse; text-align: center;"> <tr> <td style="width: 10%;"></td> <td style="width: 10%;"></td> <td style="width: 10%;"></td> <td style="width: 10%;"></td> <td style="width: 10%;"></td> <td style="width: 10%;"></td> <td style="width: 10%;"></td> <td style="width: 10%;"></td> <td style="width: 10%;"></td> <td style="width: 10%;"></td> </tr> <tr> <td></td> <td></td> <td colspan="8" style="text-align: center;"> <table border="1" style="width: 100%; border-collapse: collapse; text-align: center;"> <tr> <td style="width: 10%;"></td> <td style="width: 10%;"></td> <td style="width: 10%;"></td> <td style="width: 10%;"></td> <td style="width: 10%;"></td> <td style="width: 10%;"></td> <td style="width: 10%;"></td> <td style="width: 10%;"></td> <td style="width: 10%;"></td> <td style="width: 10%;"></td> </tr> <tr> <td></td> <td></td> <td colspan="8" style="text-align: center;"> <table border="1" style="width: 100%; border-collapse: collapse; text-align: center;"> <tr> <td style="width: 10%;"></td> <td style="width: 10%;"></td> <td style="width: 10%;"></td> <td style="width: 10%;"></td> <td style="width: 10%;"></td> <td style="width: 10%;"></td> <td style="width: 10%;"></td> <td style="width: 10%;"></td> <td style="width: 10%;"></td> <td style="width: 10%;"></td> </tr> <tr> <td></td> <td></td> <td colspan="8" style="text-align: center;"> <table border="1" style="width: 100%; border-collapse: collapse; text-align: center;"> <tr> <td style="width: 10%;"></td> <td style="width: 10%;"></td> <td style="width: 10%;"></td> <td style="width: 10%;"></td> <td style="width: 10%;"></td> <td style="width: 10%;"></td> <td style="width: 10%;"></td> <td style="width: 10%;"></td> <td style="width: 10%;"></td> <td style="width: 10%;"></td> </tr> <tr> <td></td> <td></td> <td colspan="8" style="text-align: center;"> <table border="1" style="width: 100%; border-collapse: collapse; text-align: center;"> <tr> <td style="width: 10%;"></td> <td style="width: 10%;"></td> <td style="width: 10%;"></td> <td style="width: 10%;"></td> <td style="width: 10%;"></td> <td style="width: 10%;"></td> <td style="width: 10%;"></td> <td style="width: 10%;"></td> <td style="width: 10%;"></td> <td style="width: 10%;"></td> </tr> <tr> <td></td> <td></td> <td colspan="8" style="text-align: center;"> <table border="1" style="width: 100%; border-collapse: collapse; text-align: center;"> <tr> <td style="width: 10%;"></td> <td style="width: 10%;"></td> <td style="width: 10%;"></td> <td style="width: 10%;"></td> <td style="width: 10%;"></td> <td style="width: 10%;"></td> <td style="width: 10%;"></td> <td style="width: 10%;"></td> <td style="width: 10%;"></td> <td style="width: 10%;"></td> </tr> <tr> <td></td> <td></td> <td colspan="8" style="text-align: center;"> <table border="1" style="width: 100%; border-collapse: collapse; text-align: center;"> <tr> <td style="width: 10%;"></td> <td style="width: 10%;"></td> <td style="width: 10%;"></td> <td style="width: 10%;"></td> <td style="width: 10%;"></td> <td style="width: 10%;"></td> <td style="width: 10%;"></td> <td style="width: 10%;"></td> <td style="width: 10%;"></td> <td style="width: 10%;"></td> </tr> <tr> <td></td> <td></td> <td colspan="8" style="text-align: center;"> <table border="1" style="width: 100%; border-collapse: collapse; text-align: center;"> <tr> <td style="width: 10%;"></td> <td style="width: 10%;"></td> <td style="width: 10%;"></td> <td style="width: 10%;"></td> <td style="width: 10%;"></td> <td style="width: 10%;"></td> <td style="width: 10%;"></td> <td style="width: 10%;"></td> <td style="width: 10%;"></td> <td style="width: 10%;"></td> </tr> <tr> <td></td> <td></td> <td colspan="8" style="text-align: center;"> <table border="1" style="width: 100%; border-collapse: collapse; text-align: center;"> <tr> <td style="width: 10%;"></td> <td style="width: 10%;"></td> <td style="width: 10%;"></td> <td style="width: 10%;"></td> <td style="width: 10%;"></td> <td style="width: 10%;"></td> <td style="width: 10%;"></td> <td style="width: 10%;"></td> <td style="width: 10%;"></td> <td style="width: 10%;"></td> </tr> <tr> <td></td> <td></td> <td colspan="8" style="text-align: center;"> <table border="1" style="width: 100%; border-collapse: collapse; text-align: center;"> <tr> <td style="width: 10%;"></td> <td style="width: 10%;"></td> <td style="width: 10%;"></td> <td style="width: 10%;"></td> <td style="width: 10%;"></td> <td style="width: 10%;"></td> <td style="width: 10%;"></td> <td style="width: 10%;"></td> <td style="width: 10%;"></td> <td style="width: 10%;"></td> </tr> <tr> <td></td> <td></td> <td colspan="8" style="text-align: center;"> <table border="1" style="width: 100%; border-collapse: collapse; text-align: center;"> <tr> <td style="width: 10%;"></td> <td style="width: 10%;"></td> <td style="width: 10%;"></td> <td style="width: 10%;"></td> <td style="width: 10%;"></td> <td style="width: 10%;"></td> <td style="width: 10%;"></td> <td style="width: 10%;"></td> <td style="width: 10%;"></td> <td style="width: 10%;"></td> </tr> <tr> <td></td> <td></td> <td colspan="8" style="text-align: center;"> <table border="1" style="width: 100%; border-collapse: collapse; text-align: center;"> <tr> <td style="width: 10%;"></td> <td style="width: 10%;"></td> <td style="width: 10%;"></td> <td style="width: 10%;"></td> <td style="width: 10%;"></td> <td style="width: 10%;"></td> <td style="width: 10%;"></td> <td style="width: 10%;"></td> <td style="width: 10%;"></td> <td style="width: 10%;"></td> </tr> <tr> <td></td> <td></td> <td colspan="8" style="text-align: center;"> <table border="1" style="width: 100%; border-collapse: collapse; text-align: center;"> <tr> <td style="width: 10%;"></td> <td style="width: 10%;"></td> <td style="width: 10%;"></td> <td style="width: 10%;"></td> <td style="width: 10%;"></td> <td style="width: 10%;"></td> <td style="width: 10%;"></td> <td style="width: 10%;"></td> <td style="width: 10%;"></td> <td style="width: 10%;"></td> </tr> <tr> <td></td> <td></td> <td colspan="8" style="text-align: center;"> <table border="1" style="width: 100%; border-collapse: collapse; text-align: center;"> <tr> <td style="width: 10%;"></td> <td style="width: 10%;"></td> <td style="width: 10%;"></td> <td style="width: 10%;"></td> <td style="width: 10%;"></td> <td style="width: 10%;"></td> <td style="width: 10%;"></td> <td style="width: 10%;"></td> <td style="width: 10%;"></td> <td style="width: 10%;"></td> </tr> <tr> <td></td> <td></td> <td colspan="8" style="text-align: center;"> <table border="1" style="width: 100%; border-collapse: collapse; text-align: center;"> <tr> <td style="width: 10%;"></td> <td style="width: 10%;"></td> <td style="width: 10%;"></td> <td style="width: 10%;"></td> <td style="width: 10%;"></td> <td style="width: 10%;"></td> <td style="width: 10%;"></td> <td style="width: 10%;"></td> <td style="width: 10%;"></td> <td style="width: 10%;"></td> </tr> <tr> <td></td> <td></td> <td colspan="8" style="text-align: center;"> <table border="1" style="width: 100%; border-collapse: collapse; text-align: center;"> <tr> <td style="width: 10%;"></td> <td style="width: 10%;"></td> <td style="width: 10%;"></td> <td style="width: 10%;"></td> <td style="width: 10%;"></td> <td style="width: 10%;"></td> <td style="width: 10%;"></td> <td style="width: 10%;"></td> <td style="width: 10%;"></td> <td style="width: 10%;"></td> </tr> <tr> <td></td> <td></td> <td colspan="8" style="text-align: center;"> <table border="1" style="width: 100%; border-collapse: collapse; text-align: center;"> <tr> <td style="width: 10%;"></td> <td style="width: 10%;"></td> <td style="width: 10%;"></td> <td style="width: 10%;"></td> <td style="width: 10%;"></td> <td style="width: 10%;"></td> <td style="width: 10%;"></td> <td style="width: 10%;"></td> <td style="width: 10%;"></td> <td style="width: 10%;"></td> </tr> <tr> <td></td> <td></td> <td colspan="8" style="text-align: center;"> <table border="1" style="width: 100%; border-collapse: collapse; text-align: center;"> <tr> <td style="width: 10%;"></td> <td style="width: 10%;"></td> <td style="width: 10%;"></td> <td style="width: 10%;"></td> <td style="width: 10%;"></td> <td style="width: 10%;"></td> <td style="width: 10%;"></td> <td style="width: 10%;"></td> <td style="width: 10%;"></td> <td style="width: 10%;"></td> </tr> <tr> <td></td> <td></td> <td colspan="8" style="text-align: center;"> <table border="1" style="width: 100%; border-collapse: collapse; text-align: center;"> <tr> <td style="width: 10%;"></td> <td style="width: 10%;"></td> <td style="width: 10%;"></td> <td style="width: 10%;"></td> <td style="width: 10%;"></td> <td style="width: 10%;"></td> <td style="width: 10%;"></td> <td style="width: 10%;"></td> <td style="width: 10%;"></td> <td style="width: 10%;"></td> </tr> <tr> <td></td> <td></td> <td colspan="8" style="text-align: center;"> <table border="1" style="width: 100%; border-collapse: collapse; text-align: center;"> <tr> <td style="width: 10%;"></td> <td style="width: 10%;"></td> <td style="width: 10%;"></td> <td style="width: 10%;"></td> <td style="width: 10%;"></td> <td style="width: 10%;"></td> <td style="width: 10%;"></td> <td style="width: 10%;"></td> <td style="width: 10%;"></td> <td style="width: 10%;"></td> </tr> <tr> <td></td> <td></td> <td colspan="8" style="text-align: center;"> <table border="1"
style="width: 100%; border-collapse: collapse; text-align: center;"> <tr> <td style="width: 10%;"></td> <td style="width: 10%;"></td> <td style="width: 10%;"></td> <td style="width: 10%;"></td> <td style="width: 10%;"></td> <td style="width: 10%;"></td> <td style="width: 10%;"></td> <td style="width: 10%;"></td> <td style="width: 10%;"></td> <td style="width: 10%;"></td> </tr> <tr> <td></td> <td></td> <td colspan="8" style="text-align: center;"> <table border="1" style="width: 100%; border-collapse: collapse; text-align: center;"> <tr> <td style="width: 10%;"></td> <td style="width: 10%;"></td> <td style="width: 10%;"></td> <td style="width: 10%;"></td> <td style="width: 10%;"></td> <td style="width: 10%;"></td> <td style="width: 10%;"></td> <td style="width: 10%;"></td> <td style="width: 10%;"></td> <td style="width: 10%;"></td> </tr> <tr> <td></td> <td></td> <td colspan="8" style="text-align: center;"> <table border="1" style="width: 100%; border-collapse: collapse; text-align: center;"> <tr> <td style="width: 10%;"></td> <td style="width: 10%;"></td> <td style="width: 10%;"></td> <td style="width: 10%;"></td> <td style="width: 10%;"></td> <td style="width: 10%;"></td> <td style="width: 10%;"></td> <td style="width: 10%;"></td> <td style="width: 10%;"></td> <td style="width: 10%;"></td> </tr> <tr> <td></td> <td></td> <td colspan="8" style="text-align: center;"> <table border="1" style="width: 100%; border-collapse: collapse; text-align: center;"> <tr> <td style="width: 10%;"></td> <td style="width: 10%;"></td> <td style="width: 10%;"></td> <td style="width: 10%;"></td> <td style="width: 10%;"></td> <td style="width: 10%;"></td> <td style="width: 10%;"></td> <td style="width: 10%;"></td> <td style="width: 10%;"></td> <td style="width: 10%;"></td> </tr> <tr> <td></td> <td></td> <td colspan="8" style="text-align: center;"> <table border="1" style="width: 100%; border-collapse: collapse; text-align: center;"> <tr> <td style="width: 10%;"></td> <td style="width: 10%;"></td> <td style="width: 10%;"></td> <td style="width: 10%;"></td> <td style="width: 10%;"></td> <td style="width: 10%;"></td> <td style="width: 10%;"></td> <td style="width: 10%;"></td> <td style="width: 10%;"></td> <td style="width: 10%;"></td> </tr> <tr> <td></td> <td></td> <td colspan="8" style="text-align: center;"> <table border="1" style="width: 100%; border-collapse: collapse; text-align: center;"> <tr> <td style="width: 10%;"></td> <td style="width: 10%;"></td> <td style="width: 10%;"></td> <td style="width: 10%;"></td> <td style="width: 10%;"></td> <td style="width: 10%;"></td> <td style="width: 10%;"></td> <td style="width: 10%;"></td> <td style="width: 10%;"></td> <td style="width: 10%;"></td> </tr> <tr> <td></td> <td></td> <td colspan="8" style="text-align: center;"> <table border="1" style="width: 100%; border-collapse: collapse; text-align: center;"> <tr> <td style="width: 10%;"></td> <td style="width: 10%;"></td> <td style="width: 10%;"></td> <td style="width: 10%;"></td> <td style="width: 10%;"></td> <td style="width: 10%;"></td> <td style="width: 10%;"></td> <td style="width: 10%;"></td> <td style="width: 10%;"></td> <td style="width: 10%;"></td> </tr> <tr> <td></td> <td></td> <td colspan="8" style="text-align: center;"> <table border="1" style="width: 100%; border-collapse: collapse; text-align: center;"> <tr> <td style="width: 10%;"></td> <td style="width: 10%;"></td> <td style="width: 10%;"></td> <td style="width: 10%;"></td> <td style="width: 10%;"></td> <td style="width: 10%;"></td> <td style="width: 10%;"></td> <td style="width: 10%;"></td> <td style="width: 10%;"></td> <td style="width: 10%;"></td> </tr> <tr> <td></td> <td></td> <td colspan="8" style="text-align: center;"> <table border="1" style="width: 100%; border-collapse: collapse; text-align: center;"> <tr> <td style="width: 10%;"></td> <td style="width: 10%;"></td> <td style="width: 10%;"></td> <td style="width: 10%;"></td> <td style="width: 10%;"></td> <td style="width: 10%;"></td> <td style="width: 10%;"></td> <td style="width: 10%;"></td> <td style="width: 10%;"></td> <td style="width: 10%;"></td> </tr> <tr> <td></td> <td></td> <td colspan="8" style="text-align: center;"> <table border="1" style="width: 100%; border-collapse: collapse; text-align: center;"> <tr> <td style="width: 10%;"></td> <td style="width: 10%;"></td> <td style="width: 10%;"></td> <td style="width: 10%;"></td> <td style="width: 10%;"></td> <td style="width: 10%;"></td> <td style="width: 10%;"></td> <td style="width: 10%;"></td> <td style="width: 10%;"></td> <td style="width: 10%;"></td> </tr> <tr> <td></td> <td></td> <td colspan="8" style="text-align: center;"> <table border="1" style="width: 100%; border-collapse: collapse; text-align: center;"> <tr> </tr></table></td></tr></table></td></tr></table></td></tr></table></td></tr></table></td></tr></table></td></tr></table></td></tr></table></td></tr></table></td></tr></table></td></tr></table></td></tr></table></td></tr></table></td></tr></table></td></tr></table></td></tr></table></td></tr></table></td></tr></table></td></tr></table></td></tr></table></td></tr></table></td></tr></table></td></tr></table></td></tr></table></td></tr></table></td></tr></table></td></tr></table></td></tr></table></td></tr></table></td></tr></table></td></tr></table></td></tr></table></td></tr></table></td></tr></table></td></tr></table></td></tr></table></td></tr></table></td></tr></table></td></tr></table></td></tr></table></td></tr></table></td></tr></table></td></tr></table></td></tr></table></td></tr></table>
 | | | | | | | | | | | | | | | | | | | | <table border="1" style="width: 100%; border-collapse: collapse; text-align: center;"> <tr> <td style="width: 10%;"></td> <td style="width: 10%;"></td> <td style="width: 10%;"></td> <td style="width: 10%;"></td> <td style="width: 10%;"></td> <td style="width: 10%;"></td> <td style="width: 10%;"></td> <td style="width: 10%;"></td> <td style="width: 10%;"></td> <td style="width: 10%;"></td> </tr> <tr> <td></td> <td></td> <td colspan="8" style="text-align: center;"> <table border="1" style="width: 100%; border-collapse: collapse; text-align: center;"> <tr> <td style="width: 10%;"></td> <td style="width: 10%;"></td> <td style="width: 10%;"></td> <td style="width: 10%;"></td> <td style="width: 10%;"></td> <td style="width: 10%;"></td> <td style="width: 10%;"></td> <td style="width: 10%;"></td> <td style="width: 10%;"></td> <td style="width: 10%;"></td> </tr> <tr> <td></td> <td></td> <td colspan="8" style="text-align: center;"> <table border="1" style="width: 100%; border-collapse: collapse; text-align: center;"> <tr> <td style="width: 10%;"></td> <td style="width: 10%;"></td> <td style="width: 10%;"></td> <td style="width: 10%;"></td> <td style="width: 10%;"></td> <td style="width: 10%;"></td> <td style="width: 10%;"></td> <td style="width: 10%;"></td> <td style="width: 10%;"></td> <td style="width: 10%;"></td> </tr> <tr> <td></td> <td></td> <td colspan="8" style="text-align: center;"> <table border="1" style="width: 100%; border-collapse: collapse; text-align: center;"> <tr> <td style="width: 10%;"></td> <td style="width: 10%;"></td> <td style="width: 10%;"></td> <td style="width: 10%;"></td> <td style="width: 10%;"></td> <td style="width: 10%;"></td> <td style="width: 10%;"></td> <td style="width: 10%;"></td> <td style="width: 10%;"></td> <td style="width: 10%;"></td> </tr> <tr> <td></td> <td></td> <td colspan="8" style="text-align: center;"> <table border="1" style="width: 100%; border-collapse: collapse; text-align: center;"> <tr> <td style="width: 10%;"></td> <td style="width: 10%;"></td> <td style="width: 10%;"></td> <td style="width: 10%;"></td> <td style="width: 10%;"></td> <td style="width: 10%;"></td> <td style="width: 10%;"></td> <td style="width: 10%;"></td> <td style="width: 10%;"></td> <td style="width: 10%;"></td> </tr> <tr> <td></td> <td></td> <td colspan="8" style="text-align: center;"> <table border="1" style="width: 100%; border-collapse: collapse; text-align: center;"> <tr> <td style="width: 10%;"></td> <td style="width: 10%;"></td> <td style="width: 10%;"></td> <td style="width: 10%;"></td> <td style="width: 10%;"></td> <td style="width: 10%;"></td> <td style="width: 10%;"></td> <td style="width: 10%;"></td> <td style="width: 10%;"></td> <td style="width: 10%;"></td> </tr> <tr> <td></td> <td></td> <td colspan="8" style="text-align: center;"> <table border="1" style="width: 100%; border-collapse: collapse; text-align: center;"> <tr> <td style="width: 10%;"></td> <td style="width: 10%;"></td> <td style="width: 10%;"></td> <td style="width: 10%;"></td> <td style="width: 10%;"></td> <td style="width: 10%;"></td> <td style="width: 10%;"></td> <td style="width: 10%;"></td> <td style="width: 10%;"></td> <td style="width: 10%;"></td> </tr> <tr> <td></td> <td></td> <td colspan="8" style="text-align: center;"> <table border="1" style="width: 100%; border-collapse: collapse; text-align: center;"> <tr> <td style="width: 10%;"></td> <td style="width: 10%;"></td> <td style="width: 10%;"></td> <td style="width: 10%;"></td> <td style="width: 10%;"></td> <td style="width: 10%;"></td> <td style="width: 10%;"></td> <td style="width: 10%;"></td> <td style="width: 10%;"></td> <td style="width: 10%;"></td> </tr> <tr> <td></td> <td></td> <td colspan="8" style="text-align: center;"> <table border="1" style="width: 100%; border-collapse: collapse; text-align: center;"> <tr> <td style="width: 10%;"></td> <td style="width: 10%;"></td> <td style="width: 10%;"></td> <td style="width: 10%;"></td> <td style="width: 10%;"></td> <td style="width: 10%;"></td> <td style="width: 10%;"></td> <td style="width: 10%;"></td> <td style="width: 10%;"></td> <td style="width: 10%;"></td> </tr> <tr> <td></td> <td></td> <td colspan="8" style="text-align: center;"> <table border="1" style="width: 100%; border-collapse: collapse; text-align: center;"> <tr> <td style="width: 10%;"></td> <td style="width: 10%;"></td> <td style="width: 10%;"></td> <td style="width: 10%;"></td> <td style="width: 10%;"></td> <td style="width: 10%;"></td> <td style="width: 10%;"></td> <td style="width: 10%;"></td> <td style="width: 10%;"></td> <td style="width: 10%;"></td> </tr> <tr> <td></td> <td></td> <td colspan="8" style="text-align: center;"> <table border="1" style="width: 100%; border-collapse: collapse; text-align: center;"> <tr> <td style="width: 10%;"></td> <td style="width: 10%;"></td> <td style="width: 10%;"></td> <td style="width: 10%;"></td> <td style="width: 10%;"></td> <td style="width: 10%;"></td> <td style="width: 10%;"></td> <td style="width: 10%;"></td> <td style="width: 10%;"></td> <td style="width: 10%;"></td> </tr> <tr> <td></td> <td></td> <td colspan="8" style="text-align: center;"> <table border="1" style="width: 100%; border-collapse: collapse; text-align: center;"> <tr> <td style="width: 10%;"></td> <td style="width: 10%;"></td> <td style="width: 10%;"></td> <td style="width: 10%;"></td> <td style="width: 10%;"></td> <td style="width: 10%;"></td> <td style="width: 10%;"></td> <td style="width: 10%;"></td> <td style="width: 10%;"></td> <td style="width: 10%;"></td> </tr> <tr> <td></td> <td></td> <td colspan="8" style="text-align: center;"> <table border="1" style="width: 100%; border-collapse: collapse; text-align: center;"> <tr> <td style="width: 10%;"></td> <td style="width: 10%;"></td> <td style="width: 10%;"></td> <td style="width: 10%;"></td> <td style="width: 10%;"></td> <td style="width: 10%;"></td> <td style="width: 10%;"></td> <td style="width: 10%;"></td> <td style="width: 10%;"></td> <td style="width: 10%;"></td> </tr> <tr> <td></td> <td></td> <td colspan="8" style="text-align: center;"> <table border="1" style="width: 100%; border-collapse: collapse; text-align: center;"> <tr> <td style="width: 10%;"></td> <td style="width: 10%;"></td> <td style="width: 10%;"></td> <td style="width: 10%;"></td> <td style="width: 10%;"></td> <td style="width: 10%;"></td> <td style="width: 10%;"></td> <td style="width: 10%;"></td> <td style="width: 10%;"></td> <td style="width: 10%;"></td> </tr> <tr> <td></td> <td></td> <td colspan="8" style="text-align: center;"> <table border="1" style="width: 100%; border-collapse: collapse; text-align: center;"> <tr> <td style="width: 10%;"></td> <td style="width: 10%;"></td> <td style="width: 10%;"></td> <td style="width: 10%;"></td> <td style="width: 10%;"></td> <td style="width: 10%;"></td> <td style="width: 10%;"></td> <td style="width: 10%;"></td> <td style="width: 10%;"></td> <td style="width: 10%;"></td> </tr> <tr> <td></td> <td></td> <td colspan="8" style="text-align: center;"> <table border="1" style="width: 100%; border-collapse: collapse; text-align: center;"> <tr> <td style="width: 10%;"></td> <td style="width: 10%;"></td> <td style="width: 10%;"></td> <td style="width: 10%;"></td> <td style="width: 10%;"></td> <td style="width: 10%;"></td> <td style="width: 10%;"></td> <td style="width: 10%;"></td> <td style="width: 10%;"></td> <td style="width: 10%;"></td> </tr> <tr> <td></td> <td></td> <td colspan="8" style="text-align: center;"> <table border="1" style="width: 100%; border-collapse: collapse; text-align: center;"> <tr> <td style="width: 10%;"></td> <td style="width: 10%;"></td> <td style="width: 10%;"></td> <td style="width: 10%;"></td> <td style="width: 10%;"></td> <td style="width: 10%;"></td> <td style="width: 10%;"></td> <td style="width: 10%;"></td> <td style="width: 10%;"></td> <td style="width: 10%;"></td> </tr> <tr> <td></td> <td></td> <td colspan="8" style="text-align: center;"> <table border="1" style="width: 100%; border-collapse: collapse; text-align: center;"> <tr> <td style="width: 10%;"></td> <td style="width: 10%;"></td> <td style="width: 10%;"></td> <td style="width: 10%;"></td> <td style="width: 10%;"></td> <td style="width: 10%;"></td> <td style="width: 10%;"></td> <td style="width: 10%;"></td> <td style="width: 10%;"></td> <td style="width: 10%;"></td> </tr> <tr> <td></td> <td></td> <td colspan="8" style="text-align: center;"> <table border="1" style="width: 100%; border-collapse: collapse; text-align: center;"> <tr> <td style="width: 10%;"></td> <td style="width: 10%;"></td> <td style="width: 10%;"></td> <td style="width: 10%;"></td> <td style="width: 10%;"></td> <td style="width: 10%;"></td> <td style="width: 10%;"></td> <td style="width: 10%;"></td> <td style="width: 10%;"></td> <td style="width: 10%;"></td> </tr> <tr> <td></td> <td></td> <td colspan="8" style="text-align: center;"> <table border="1" style="width: 100%; border-collapse: collapse; text-align: center;"> <tr> <td style="width: 10%;"></td> <td style="width:
10%;"></td> <td style="width: 10%;"></td> <td style="width: 10%;"></td> <td style="width: 10%;"></td> <td style="width: 10%;"></td> <td style="width: 10%;"></td> <td style="width: 10%;"></td> <td style="width: 10%;"></td> <td style="width: 10%;"></td> </tr> <tr> <td></td> <td></td> <td colspan="8" style="text-align: center;"> <table border="1" style="width: 100%; border-collapse: collapse; text-align: center;"> <tr> <td style="width: 10%;"></td> <td style="width: 10%;"></td> <td style="width: 10%;"></td> <td style="width: 10%;"></td> <td style="width: 10%;"></td> <td style="width: 10%;"></td> <td style="width: 10%;"></td> <td style="width: 10%;"></td> <td style="width: 10%;"></td> <td style="width: 10%;"></td> </tr> <tr> <td></td> <td></td> <td colspan="8" style="text-align: center;"> <table border="1" style="width: 100%; border-collapse: collapse; text-align: center;"> <tr> <td style="width: 10%;"></td> <td style="width: 10%;"></td> <td style="width: 10%;"></td> <td style="width: 10%;"></td> <td style="width: 10%;"></td> <td style="width: 10%;"></td> <td style="width: 10%;"></td> <td style="width: 10%;"></td> <td style="width: 10%;"></td> <td style="width: 10%;"></td> </tr> <tr> <td></td> <td></td> <td colspan="8" style="text-align: center;"> <table border="1" style="width: 100%; border-collapse: collapse; text-align: center;"> <tr> <td style="width: 10%;"></td> <td style="width: 10%;"></td> <td style="width: 10%;"></td> <td style="width: 10%;"></td> <td style="width: 10%;"></td> <td style="width: 10%;"></td> <td style="width: 10%;"></td> <td style="width: 10%;"></td> <td style="width: 10%;"></td> <td style="width: 10%;"></td> </tr> <tr> <td></td> <td></td> <td colspan="8" style="text-align: center;"> <table border="1" style="width: 100%; border-collapse: collapse; text-align: center;"> <tr> <td style="width: 10%;"></td> <td style="width: 10%;"></td> <td style="width: 10%;"></td> <td style="width: 10%;"></td> <td style="width: 10%;"></td> <td style="width: 10%;"></td> <td style="width: 10%;"></td> <td style="width: 10%;"></td> <td style="width: 10%;"></td> <td style="width: 10%;"></td> </tr> <tr> <td></td> <td></td> <td colspan="8" style="text-align: center;"> <table border="1" style="width: 100%; border-collapse: collapse; text-align: center;"> <tr> <td style="width: 10%;"></td> <td style="width: 10%;"></td> <td style="width: 10%;"></td> <td style="width: 10%;"></td> <td style="width: 10%;"></td> <td style="width: 10%;"></td> <td style="width: 10%;"></td> <td style="width: 10%;"></td> <td style="width: 10%;"></td> <td style="width: 10%;"></td> </tr> <tr> <td></td> <td></td> <td colspan="8" style="text-align: center;"> <table border="1" style="width: 100%; border-collapse: collapse; text-align: center;"> <tr> <td style="width: 10%;"></td> <td style="width: 10%;"></td> <td style="width: 10%;"></td> <td style="width: 10%;"></td> <td style="width: 10%;"></td> <td style="width: 10%;"></td> <td style="width: 10%;"></td> <td style="width: 10%;"></td> <td style="width: 10%;"></td> <td style="width: 10%;"></td> </tr> <tr> <td></td> <td></td> <td colspan="8" style="text-align: center;"> <table border="1" style="width: 100%; border-collapse: collapse; text-align: center;"> <tr> <td style="width: 10%;"></td> <td style="width: 10%;"></td> <td style="width: 10%;"></td> <td style="width: 10%;"></td> <td style="width: 10%;"></td> <td style="width: 10%;"></td> <td style="width: 10%;"></td> <td style="width: 10%;"></td> <td style="width: 10%;"></td> <td style="width: 10%;"></td> </tr> <tr> <td></td> <td></td> <td colspan="8" style="text-align: center;"> <table border="1" style="width: 100%; border-collapse: collapse; text-align: center;"> <tr> <td style="width: 10%;"></td> <td style="width: 10%;"></td> <td style="width: 10%;"></td> <td style="width: 10%;"></td> <td style="width: 10%;"></td> <td style="width: 10%;"></td> <td style="width: 10%;"></td> <td style="width: 10%;"></td> <td style="width: 10%;"></td> <td style="width: 10%;"></td> </tr> <tr> <td></td> <td></td> <td colspan="8" style="text-align: center;"> <table border="1" style="width: 100%; border-collapse: collapse; text-align: center;"> <tr> <td style="width: 10%;"></td> <td style="width: 10%;"></td> <td style="width: 10%;"></td> <td style="width: 10%;"></td> <td style="width: 10%;"></td> <td style="width: 10%;"></td> <td style="width: 10%;"></td> <td style="width: 10%;"></td> <td style="width: 10%;"></td> <td style="width: 10%;"></td> </tr> <tr> <td></td> <td></td> <td colspan="8" style="text-align: center;"> <table border="1" style="width: 100%; border-collapse: collapse; text-align: center;"> <tr> <td style="width: 10%;"></td> <td style="width: 10%;"></td> <td style="width: 10%;"></td> <td style="width: 10%;"></td> <td style="width: 10%;"></td> <td style="width: 10%;"></td> <td style="width: 10%;"></td> <td style="width: 10%;"></td> <td style="width: 10%;"></td> <td style="width: 10%;"></td> </tr> <tr> <td></td> <td></td> <td colspan="8" style="text-align: center;"> <table border="1" style="width: 100%; border-collapse: collapse; text-align: center;"> <tr> <td style="width: 10%;"></td> <td style="width: 10%;"></td> <td style="width: 10%;"></td> <td style="width: 10%;"></td> <td style="width: 10%;"></td> <td style="width: 10%;"></td> <td style="width: 10%;"></td> <td style="width: 10%;"></td> <td style="width: 10%;"></td> <td style="width: 10%;"></td> </tr> <tr> <td></td> <td></td> <td colspan="8" style="text-align: center;"> <table border="1" style="width: 100%; border-collapse: collapse; text-align: center;"> <tr> <td style="width: 10%;"></td> <td style="width: 10%;"></td> <td style="width: 10%;"></td> <td style="width: 10%;"></td> <td style="width: 10%;"></td> <td style="width: 10%;"></td> <td style="width: 10%;"></td> <td style="width: 10%;"></td> <td style="width: 10%;"></td> <td style="width: 10%;"></td> </tr> <tr> <td></td> <td></td> <td colspan="8" style="text-align: center;"> <table border="1" style="width: 100%; border-collapse: collapse; text-align: center;"> <tr> <td style="width: 10%;"></td> <td style="width: 10%;"></td> <td style="width: 10%;"></td> <td style="width: 10%;"></td> <td style="width: 10%;"></td> <td style="width: 10%;"></td> <td style="width: 10%;"></td> <td style="width: 10%;"></td> <td style="width: 10%;"></td> <td style="width: 10%;"></td> </tr> <tr> <td></td> <td></td> <td colspan="8" style="text-align: center;"> <table border="1" style="width: 100%; border-collapse: collapse; text-align: center;"> <tr> <td style="width: 10%;"></td> <td style="width: 10%;"></td> <td style="width: 10%;"></td> <td style="width: 10%;"></td> <td style="width: 10%;"></td> <td style="width: 10%;"></td> <td style="width: 10%;"></td> <td style="width: 10%;"></td> <td style="width: 10%;"></td> <td style="width: 10%;"></td> </tr> <tr> <td></td> <td></td> <td colspan="8" style="text-align: center;"> <table border="1" style="width: 100%; border-collapse: collapse; text-align: center;"> <tr> <td style="width: 10%;"></td> <td style="width: 10%;"></td> <td style="width: 10%;"></td> <td style="width: 10%;"></td> <td style="width: 10%;"></td> <td style="width: 10%;"></td> <td style="width: 10%;"></td> <td style="width: 10%;"></td> <td style="width: 10%;"></td> <td style="width: 10%;"></td> </tr> <tr> <td></td> <td></td> <td colspan="8" style="text-align: center;"> <table border="1" style="width: 100%; border-collapse: collapse; text-align: center;"> <tr> <td style="width: 10%;"></td> <td style="width: 10%;"></td> <td style="width: 10%;"></td> <td style="width: 10%;"></td> <td style="width: 10%;"></td> <td style="width: 10%;"></td> <td style="width: 10%;"></td> <td style="width: 10%;"></td> <td style="width: 10%;"></td> <td style="width: 10%;"></td> </tr> <tr> <td></td> <td></td> <td colspan="8" style="text-align: center;"> <table border="1" style="width: 100%; border-collapse: collapse; text-align: center;"> <tr> <td style="width: 10%;"></td> <td style="width: 10%;"></td> <td style="width: 10%;"></td> <td style="width: 10%;"></td> <td style="width: 10%;"></td> <td style="width: 10%;"></td> <td style="width: 10%;"></td> <td style="width: 10%;"></td> <td style="width: 10%;"></td> <td style="width: 10%;"></td> </tr> <tr> <td></td> <td></td> <td colspan="8" style="text-align: center;"> <table border="1" style="width: 100%; border-collapse: collapse; text-align: center;"> <tr> <td style="width: 10%;"></td> <td style="width: 10%;"></td> <td style="width: 10%;"></td> <td style="width: 10%;"></td> <td style="width: 10%;"></td> <td style="width: 10%;"></td> <td style="width: 10%;"></td> <td style="width: 10%;"></td> <td style="width: 10%;"></td> <td style="width: 10%;"></td> </tr> <tr> <td></td> <td></td> <td colspan="8" style="text-align: center;"> <table border="1" style="width: 100%; border-collapse: collapse; text-align: center;"> <tr> <td style="width: 10%;"></td> <td style="width: 10%;"></td> <td style="width: 10%;"></td> <td style="width: 10%;"></td> <td style="width: 10%;"></td> <td style="width: 10%;"></td> <td style="width: 10%;"></td> <td style="width: 10%;"></td> <td style="width: 10%;"></td> <td style="width: 10%;"></td> </tr> <tr> <td></td> <td></td> <td colspan="8" style="text-align: center;"> <table border="1" style="width: 100%; border-collapse: collapse; text-align: center;"> <tr> <td style="width: 10%;"></td> <td style="width: 10%;"></td> <td style="width: 10%;"></td> <td style="width: 10%;"></td> <td style="width: 10%;"></td> <td style="width: 10%;"></td> <td style="width: 10%;"></td> <td style="width: 10%;"></td> <td style="width: 10%;"></td> <td style="width: 10%;"></td> </tr> <tr> <td></td> <td></td> <td colspan="8" style="text-align: center;"> <table border="1" style="width: 100%; border-collapse: collapse; text-align: center;"> <tr> <td style="width: 10%;"></td> <td style="width: 10%;"></td> <td style="width: 10%;"></td> <td style="width: 10%;"></td> <td style="width: 10%;"></td> <td style="width: 10%;"></td> <td style="width: 10%;"></td> <td
style="width: 10%;"></td> <td style="width: 10%;"></td> <td style="width: 10%;"></td> </tr> <tr> <td></td> <td></td> <td colspan="8" style="text-align: center;"> <table border="1" style="width: 100%; border-collapse: collapse; text-align: center;"> <tr> <td style="width: 10%;"></td> <td style="width: 10%;"></td> <td style="width: 10%;"></td> <td style="width: 10%;"></td> <td style="width: 10%;"></td> <td style="width: 10%;"></td> <td style="width: 10%;"></td> <td style="width: 10%;"></td> <td style="width: 10%;"></td> <td style="width: 10%;"></td> </tr> <tr> <td></td> <td></td> <td colspan="8" style="text-align: center;"> <table border="1" style="width: 100%; border-collapse: collapse; text-align: center;"> <tr> <td style="width: 10%;"></td> <td style="width: 10%;"></td> <td style="width: 10%;"></td> <td style="width: 10%;"></td> <td style="width: 10%;"></td> <td style="width: 10%;"></td> <td style="width: 10%;"></td> <td style="width: 10%;"></td> <td style="width: 10%;"></td> <td style="width: 10%;"></td> </tr> <tr> <td></td> <td></td> <td colspan="8" style="text-align: center;"> <table border="1" style="width: 100%; border-collapse: collapse; text-align: center;"> <tr> </tr></table></td></tr></table></td></tr></table></td></tr></table></td></tr></table></td></tr></table></td></tr></table></td></tr></table></td></tr></table></td></tr></table></td></tr></table></td></tr></table></td></tr></table></td></tr></table></td></tr></table></td></tr></table></td></tr></table></td></tr></table></td></tr></table></td></tr></table></td></tr></table></td></tr></table></td></tr></table></td></tr></table></td></tr></table></td></tr></table></td></tr></table></td></tr></table></td></tr></table></td></tr></table></td></tr></table></td></tr></table></td></tr></table></td></tr></table></td></tr></table></td></tr></table></td></tr></table></td></tr></table></td></tr></table></td></tr></table></td></tr></table></td></tr></table></td></tr></table></td></tr></table> | | | | | | | | | | | | | | | | | | | | <table border="1" style="width: 100%; border-collapse: collapse; text-align: center;"> <tr> <td style="width: 10%;"></td> <td style="width: 10%;"></td> <td style="width: 10%;"></td> <td style="width: 10%;"></td> <td style="width: 10%;"></td> <td style="width: 10%;"></td> <td style="width: 10%;"></td> <td style="width: 10%;"></td> <td style="width: 10%;"></td> <td style="width: 10%;"></td> </tr> <tr> <td></td> <td></td> <td colspan="8" style="text-align: center;"> <table border="1" style="width: 100%; border-collapse: collapse; text-align: center;"> <tr> <td style="width: 10%;"></td> <td style="width: 10%;"></td> <td style="width: 10%;"></td> <td style="width: 10%;"></td> <td style="width: 10%;"></td> <td style="width: 10%;"></td> <td style="width: 10%;"></td> <td style="width: 10%;"></td> <td style="width: 10%;"></td> <td style="width: 10%;"></td> </tr> <tr> <td></td> <td></td> <td colspan="8" style="text-align: center;"> <table border="1" style="width: 100%; border-collapse: collapse; text-align: center;"> <tr> <td style="width: 10%;"></td> <td style="width: 10%;"></td> <td style="width: 10%;"></td> <td style="width: 10%;"></td> <td style="width: 10%;"></td> <td style="width: 10%;"></td> <td style="width: 10%;"></td> <td style="width: 10%;"></td> <td style="width: 10%;"></td> <td style="width: 10%;"></td> </tr> <tr> <td></td> <td></td> <td colspan="8" style="text-align: center;"> <table border="1" style="width: 100%; border-collapse: collapse; text-align: center;"> <tr> <td style="width: 10%;"></td> <td style="width: 10%;"></td> <td style="width: 10%;"></td> <td style="width: 10%;"></td> <td style="width: 10%;"></td> <td style="width: 10%;"></td> <td style="width: 10%;"></td> <td style="width: 10%;"></td> <td style="width: 10%;"></td> <td style="width: 10%;"></td> </tr> <tr> <td></td> <td></td> <td colspan="8" style="text-align: center;"> <table border="1" style="width: 100%; border-collapse: collapse; text-align: center;"> <tr> <td style="width: 10%;"></td> <td style="width: 10%;"></td> <td style="width: 10%;"></td> <td style="width: 10%;"></td> <td style="width: 10%;"></td> <td style="width: 10%;"></td> <td style="width: 10%;"></td> <td style="width: 10%;"></td> <td style="width: 10%;"></td> <td style="width: 10%;"></td> </tr> <tr> <td></td> <td></td> <td colspan="8" style="text-align: center;"> <table border="1" style="width: 100%; border-collapse: collapse; text-align: center;"> <tr> <td style="width: 10%;"></td> <td style="width: 10%;"></td> <td style="width: 10%;"></td> <td style="width: 10%;"></td> <td style="width: 10%;"></td> <td style="width: 10%;"></td> <td
style="width: 10%;"></td> <td style="width: 10%;"></td> <td style="width: 10%;"></td> <td style="width: 10%;"></td> </tr> <tr> <td></td> <td></td> <td colspan="8" style="text-align: center;"> <table border="1" style="width: 100%; border-collapse: collapse; text-align: center;"> <tr> <td style="width: 10%;"></td> <td style="width: 10%;"></td> <td style="width: 10%;"></td> <td style="width: 10%;"></td> <td style="width: 10%;"></td> <td style="width: 10%;"></td> <td style="width: 10%;"></td> <td style="width: 10%;"></td> <td style="width: 10%;"></td> <td style="width: 10%;"></td> </tr> <tr> <td></td> <td></td> <td colspan="8" style="text-align: center;"> <table border="1" style="width: 100%; border-collapse: collapse; text-align: center;"> <tr> <td style="width: 10%;"></td> <td style="width: 10%;"></td> <td style="width: 10%;"></td> <td style="width: 10%;"></td> <td style="width: 10%;"></td> <td style="width: 10%;"></td> <td style="width: 10%;"></td> <td style="width: 10%;"></td> <td style="width: 10%;"></td> <td style="width: 10%;"></td> </tr> <tr> <td></td> <td></td> <td colspan="8" style="text-align: center;"> <table border="1" style="width: 100%; border-collapse: collapse; text-align: center;"> <tr> <td style="width: 10%;"></td> <td style="width: 10%;"></td> <td style="width: 10%;"></td> <td style="width: 10%;"></td> <td style="width: 10%;"></td> <td style="width: 10%;"></td> <td style="width: 10%;"></td> <td style="width: 10%;"></td> <td style="width: 10%;"></td> <td style="width: 10%;"></td> </tr> <tr> <td></td> <td></td> <td colspan="8" style="text-align: center;"> <table border="1" style="width: 100%; border-collapse: collapse; text-align: center;"> <tr> <td style="width: 10%;"></td> <td style="width: 10%;"></td> <td style="width: 10%;"></td> <td style="width: 10%;"></td> <td style="width: 10%;"></td> <td style="width: 10%;"></td> <td style="width: 10%;"></td> <td style="width: 10%;"></td> <td style="width: 10%;"></td> <td style="width: 10%;"></td> </tr> <tr> <td></td> <td></td> <td colspan="8" style="text-align: center;"> <table border="1" style="width: 100%; border-collapse: collapse; text-align: center;"> <tr> <td style="width: 10%;"></td> <td style="width: 10%;"></td> <td style="width: 10%;"></td> <td style="width: 10%;"></td> <td style="width: 10%;"></td> <td style="width: 10%;"></td> <td style="width: 10%;"></td> <td style="width: 10%;"></td> <td style="width: 10%;"></td> <td style="width: 10%;"></td> </tr> <tr> <td></td> <td></td> <td colspan="8" style="text-align: center;"> <table border="1" style="width: 100%; border-collapse: collapse; text-align: center;"> <tr> <td style="width: 10%;"></td> <td style="width: 10%;"></td> <td style="width: 10%;"></td> <td style="width: 10%;"></td> <td style="width: 10%;"></td> <td style="width: 10%;"></td> <td style="width: 10%;"></td> <td style="width: 10%;"></td> <td style="width: 10%;"></td> <td style="width: 10%;"></td> </tr> <tr> <td></td> <td></td> <td colspan="8" style="text-align: center;"> <table border="1" style="width: 100%; border-collapse: collapse; text-align: center;"> <tr> <td style="width: 10%;"></td> <td style="width: 10%;"></td> <td style="width: 10%;"></td> <td style="width: 10%;"></td> <td style="width: 10%;"></td> <td style="width: 10%;"></td> <td style="width: 10%;"></td> <td style="width: 10%;"></td> <td style="width: 10%;"></td> <td style="width: 10%;"></td> </tr> <tr> <td></td> <td></td> <td colspan="8" style="text-align: center;"> <table border="1" style="width: 100%; border-collapse: collapse; text-align: center;"> <tr> <td style="width: 10%;"></td> <td style="width: 10%;"></td> <td style="width: 10%;"></td> <td style="width: 10%;"></td> <td style="width: 10%;"></td> <td style="width: 10%;"></td> <td style="width: 10%;"></td> <td style="width: 10%;"></td> <td style="width: 10%;"></td> <td style="width: 10%;"></td> </tr> <tr> <td></td> <td></td> <td colspan="8" style="text-align: center;"> <table border="1" style="width: 100%; border-collapse: collapse; text-align: center;"> <tr> <td style="width: 10%;"></td> <td style="width: 10%;"></td> <td style="width: 10%;"></td> <td style="width: 10%;"></td> <td style="width: 10%;"></td> <td style="width: 10%;"></td> <td style="width: 10%;"></td> <td style="width: 10%;"></td> <td style="width: 10%;"></td> <td style="width: 10%;"></td> </tr> <tr> <td></td> <td></td> <td colspan="8" style="text-align: center;"> <table border="1" style="width: 100%; border-collapse: collapse; text-align: center;"> <tr> <td style="width: 10%;"></td> <td style="width: 10%;"></td> <td style="width: 10%;"></td> <td style="width: 10%;"></td> <td style="width: 10%;"></td> <td style="width: 10%;"></td> <td style="width: 10%;"></td> <td style="width: 10%;"></td> <td style="width: 10%;"></td> <td style="width: 10%;"></td> </tr> <tr> <td></td> <td></td> <td colspan="8" style="text-align: center;"> <table border="1" style="width: 100%; border-collapse: collapse; text-align: center;"> <tr> <td style="width: 10%;"></td> <td style="width: 10%;"></td> <td style="width: 10%;"></td> <td style="width: 10%;"></td> <td style="width: 10%;"></td> <td style="width: 10%;"></td> <td style="width: 10%;"></td> <td style="width: 10%;"></td> <td style="width: 10%;"></td> <td style="width: 10%;"></td> </tr> <tr> <td></td> <td></td> <td colspan="8" style="text-align: center;"> <table border="1" style="width: 100%; border-collapse: collapse; text-align: center;"> <tr> <td style="width: 10%;"></td> <td style="width: 10%;"></td> <td style="width: 10%;"></td> <td style="width: 10%;"></td> <td style="width: 10%;"></td> <td style="width: 10%;"></td> <td style="width: 10%;"></td> <td style="width: 10%;"></td> <td style="width: 10%;"></td> <td style="width: 10%;"></td> </tr> <tr> <td></td> <td></td> <td colspan="8" style="text-align: center;"> <table border="1" style="width: 100%; border-collapse: collapse; text-align: center;"> <tr> <td style="width: 10%;"></td> <td style="width: 10%;"></td> <td style="width: 10%;"></td> <td style="width: 10%;"></td> <td style="width: 10%;"></td> <td style="width: 10%;"></td> <td style="width: 10%;"></td> <td style="width: 10%;"></td> <td style="width: 10%;"></td> <td style="width: 10%;"></td> </tr> <tr> <td></td> <td></td> <td colspan="8" style="text-align: center;"> <table border="1" style="width: 100%; border-collapse: collapse; text-align: center;"> <tr> <td style="width: 10%;"></td> <td style="width: 10%;"></td> <td style="width: 10%;"></td> <td style="width: 10%;"></td> <td style="width: 10%;"></td> <td style="width: 10%;"></td> <td style="width: 10%;"></td> <td style="width: 10%;"></td> <td style="width: 10%;"></td> <td style="width: 10%;"></td> </tr> <tr> <td></td> <td></td> <td colspan="8" style="text-align: center;"> <table border="1" style="width: 100%; border-collapse: collapse; text-align: center;"> <tr> <td style="width: 10%;"></td> <td style="width: 10%;"></td> <td style="width: 10%;"></td> <td style="width: 10%;"></td> <td style="width: 10%;"></td> <td style="width: 10%;"></td> <td style="width: 10%;"></td> <td style="width: 10%;"></td> <td style="width: 10%;"></td> <td style="width: 10%;"></td> </tr> <tr> <td></td> <td></td> <td colspan="8" style="text-align: center;"> <table border="1" style="width: 100%; border-collapse: collapse; text-align: center;"> <tr> <td style="width: 10%;"></td> <td style="width: 10%;"></td> <td style="width: 10%;"></td> <td style="width: 10%;"></td> <td style="width: 10%;"></td> <td style="width: 10%;"></td> <td style="width: 10%;"></td> <td style="width: 10%;"></td> <td style="width: 10%;"></td> <td style="width: 10%;"></td> </tr> <tr> <td></td> <td></td> <td colspan="8" style="text-align: center;"> <table border="1" style="width: 100%; border-collapse: collapse; text-align: center;"> <tr> <td style="width: 10%;"></td> <td style="width: 10%;"></td> <td style="width: 10%;"></td> <td style="width: 10%;"></td> <td style="width: 10%;"></td> <td style="width: 10%;"></td> <td style="width: 10%;"></td> <td style="width: 10%;"></td> <td style="width: 10%;"></td> <td style="width: 10%;"></td> </tr> <tr> <td></td> <td></td> <td colspan="8" style="text-align: center;"> <table border="1" style="width: 100%; border-collapse: collapse; text-align: center;"> <tr> <td style="width: 10%;"></td> <td style="width: 10%;"></td> <td style="width: 10%;"></td> <td style="width: 10%;"></td> <td style="width: 10%;"></td> <td style="width: 10%;"></td> <td style="width: 10%;"></td> <td style="width: 10%;"></td> <td style="width: 10%;"></td> <td style="width: 10%;"></td> </tr> <tr> <td></td> <td></td> <td colspan="8" style="text-align: center;"> <table border="1" style="width: 100%; border-collapse: collapse; text-align: center;"> <tr> <td style="width: 10%;"></td> <td style="width: 10%;"></td> <td style="width: 10%;"></td> <td style="width: 10%;"></td> <td style="width: 10%;"></td> <td style="width: 10%;"></td> <td style="width: 10%;"></td> <td style="width: 10%;"></td> <td style="width: 10%;"></td> <td style="width: 10%;"></td> </tr> <tr> <td></td> <td></td> <td colspan="8" style="text-align: center;"> <table border="1" style="width: 100%; border-collapse: collapse; text-align: center;"> <tr> <td style="width: 10%;"></td> <td style="width: 10%;"></td> <td style="width: 10%;"></td> <td style="width: 10%;"></td> <td style="width: 10%;"></td> <td style="width: 10%;"></td> <td style="width: 10%;"></td> <td style="width: 10%;"></td> <td style="width: 10%;"></td> <td style="width: 10%;"></td> </tr> <tr> <td></td> <td></td> <td colspan="8" style="text-align: center;"> <table border="1" style="width: 100%; border-collapse: collapse; text-align: center;"> <tr> <td style="width: 10%;"></td> <td style="width: 10%;"></td> <td style="width: 10%;"></td> <td style="width: 10%;"></td> <td style="width: 10%;"></td> <td style="width: 10%;"></td> <td style="width: 10%;"></td> <td style="width: 10%;"></td> <td style="width: 10%;"></td> <td style="width: 10%;"></td> </tr> <tr> <td></td> <td></td> <td colspan="8"
style="text-align: center;"> <table border="1" style="width: 100%; border-collapse: collapse; text-align: center;"> <tr> <td style="width: 10%;"></td> <td style="width: 10%;"></td> <td style="width: 10%;"></td> <td style="width: 10%;"></td> <td style="width: 10%;"></td> <td style="width: 10%;"></td> <td style="width: 10%;"></td> <td style="width: 10%;"></td> <td style="width: 10%;"></td> <td style="width: 10%;"></td> </tr> <tr> <td></td> <td></td> <td colspan="8" style="text-align: center;"> <table border="1" style="width: 100%; border-collapse: collapse; text-align: center;"> <tr> <td style="width: 10%;"></td> <td style="width: 10%;"></td> <td style="width: 10%;"></td> <td style="width: 10%;"></td> <td style="width: 10%;"></td> <td style="width: 10%;"></td> <td style="width: 10%;"></td> <td style="width: 10%;"></td> <td style="width: 10%;"></td> <td style="width: 10%;"></td> </tr> <tr> <td></td> <td></td> <td colspan="8" style="text-align: center;"> <table border="1" style="width: 100%; border-collapse: collapse; text-align: center;"> <tr> <td style="width: 10%;"></td> <td style="width: 10%;"></td> <td style="width: 10%;"></td> <td style="width: 10%;"></td> <td style="width: 10%;"></td> <td style="width: 10%;"></td> <td style="width: 10%;"></td> <td style="width: 10%;"></td> <td style="width: 10%;"></td> <td style="width: 10%;"></td> </tr> <tr> <td></td> <td></td> <td colspan="8" style="text-align: center;"> <table border="1" style="width: 100%; border-collapse: collapse; text-align: center;"> <tr> <td style="width: 10%;"></td> <td style="width: 10%;"></td> <td style="width: 10%;"></td> <td style="width: 10%;"></td> <td style="width: 10%;"></td> <td style="width: 10%;"></td> <td style="width: 10%;"></td> <td style="width: 10%;"></td> <td style="width: 10%;"></td> <td style="width: 10%;"></td> </tr> <tr> <td></td> <td></td> <td colspan="8" style="text-align: center;"> <table border="1" style="width: 100%; border-collapse: collapse; text-align: center;"> <tr> <td style="width: 10%;"></td> <td style="width: 10%;"></td> <td style="width: 10%;"></td> <td style="width: 10%;"></td> <td style="width: 10%;"></td> <td style="width: 10%;"></td> <td style="width: 10%;"></td> <td style="width: 10%;"></td> <td style="width: 10%;"></td> <td style="width: 10%;"></td> </tr> <tr> <td></td> <td></td> <td colspan="8" style="text-align: center;"> <table border="1" style="width: 100%; border-collapse: collapse; text-align: center;"> <tr> <td style="width: 10%;"></td> <td style="width: 10%;"></td> <td style="width: 10%;"></td> <td style="width: 10%;"></td> <td style="width: 10%;"></td> <td style="width: 10%;"></td> <td style="width: 10%;"></td> <td style="width: 10%;"></td> <td style="width: 10%;"></td> <td style="width: 10%;"></td> </tr> <tr> <td></td> <td></td> <td colspan="8" style="text-align: center;"> <table border="1" style="width: 100%; border-collapse: collapse; text-align: center;"> <tr> <td style="width: 10%;"></td> <td style="width: 10%;"></td> <td style="width: 10%;"></td> <td style="width: 10%;"></td> <td style="width: 10%;"></td> <td style="width: 10%;"></td> <td style="width: 10%;"></td> <td style="width: 10%;"></td> <td style="width: 10%;"></td> <td style="width: 10%;"></td> </tr> <tr> <td></td> <td></td> <td colspan="8" style="text-align: center;"> <table border="1" style="width: 100%; border-collapse: collapse; text-align: center;"> <tr> <td style="width: 10%;"></td> <td style="width: 10%;"></td> <td style="width: 10%;"></td> <td style="width: 10%;"></td> <td style="width: 10%;"></td> <td style="width: 10%;"></td> <td style="width: 10%;"></td> <td style="width: 10%;"></td> <td style="width: 10%;"></td> <td style="width: 10%;"></td> </tr> <tr> <td></td> <td></td> <td colspan="8" style="text-align: center;"> <table border="1" style="width: 100%; border-collapse: collapse; text-align: center;"> <tr> <td style="width: 10%;"></td> <td style="width: 10%;"></td> <td style="width: 10%;"></td> <td style="width: 10%;"></td> <td style="width: 10%;"></td> <td style="width: 10%;"></td> <td style="width: 10%;"></td> <td style="width: 10%;"></td> <td style="width: 10%;"></td> <td style="width: 10%;"></td> </tr> <tr> <td></td> <td></td> <td colspan="8" style="text-align: center;"> <table border="1" style="width: 100%; border-collapse: collapse; text-align: center;"> <tr> <td style="width: 10%;"></td> <td style="width: 10%;"></td> <td style="width: 10%;"></td> <td style="width: 10%;"></td> <td style="width: 10%;"></td> <td style="width: 10%;"></td> <td style="width: 10%;"></td> <td style="width: 10%;"></td> <td style="width: 10%;"></td> <td style="width: 10%;"></td> </tr> <tr> <td></td> <td></td> <td colspan="8" style="text-align: center;"> <table border="1" style="width: 100%; border-collapse: collapse; text-align: center;"> <tr> <td style="width: 10%;"></td> <td style="width: 10%;"></td> <td style="width: 10%;"></td> <td style="width: 10%;"></td> <td style="width: 10%;"></td> <td style="width: 10%;"></td> <td style="width: 10%;"></td> <td style="width: 10%;"></td> <td style="width: 10%;"></td> <td style="width: 10%;"></td> </tr> <tr> <td></td> <td></td> <td colspan="8" style="text-align: center;"> <table border="1" style="width: 100%; border-collapse: collapse; text-align: center;"> <tr> <td style="width: 10%;"></td> <td style="width: 10%;"></td> <td style="width: 10%;"></td> <td style="width: 10%;"></td> <td style="width: 10%;"></td> <td style="width: 10%;"></td> <td style="width: 10%;"></td> <td style="width: 10%;"></td> <td style="width: 10%;"></td> <td style="width: 10%;"></td> </tr> <tr> <td></td> <td></td> <td colspan="8" style="text-align: center;"> <table border="1" style="width: 100%; border-collapse: collapse; text-align: center;"> <tr> <td style="width: 10%;"></td> <td style="width: 10%;"></td> <td style="width: 10%;"></td> <td style="width: 10%;"></td> <td style="width: 10%;"></td> <td style="width: 10%;"></td> <td style="width: 10%;"></td> <td style="width: 10%;"></td> <td style="width: 10%;"></td> <td style="width: 10%;"></td> </tr> <tr> <td></td> <td></td> <td colspan="8" style="text-align: center;"> <table border="1" style="width: 100%; border-collapse: collapse; text-align: center;"> <tr> <td style="width: 10%;"></td> <td style="width: 10%;"></td> <td style="width: 10%;"></td> <td style="width: 10%;"></td> <td style="width: 10%;"></td> <td style="width: 10%;"></td> <td style="width: 10%;"></td> <td style="width: 10%;"></td> <td style="width: 10%;"></td> <td style="width: 10%;"></td> </tr> <tr> <td></td> <td></td> <td colspan="8" style="text-align: center;"> <table border="1" style="width: 100%; border-collapse: collapse; text-align: center;"> <tr> <td style="width: 10%;"></td> <td style="width: 10%;"></td> <td style="width: 10%;"></td> <td style="width: 10%;"></td> <td style="width: 10%;"></td> <td style="width: 10%;"></td> <td style="width: 10%;"></td> <td style="width: 10%;"></td> <td style="width: 10%;"></td> <td style="width: 10%;"></td> </tr> <tr> <td></td> <td></td> <td colspan="8" style="text-align: center;"> <table border="1" style="width: 100%; border-collapse: collapse; text-align: center;"> <tr> </tr></table></td></tr></table></td></tr></table></td></tr></table></td></tr></table></td></tr></table></td></tr></table></td></tr></table></td></tr></table></td></tr></table></td></tr></table></td></tr></table></td></tr></table></td></tr></table></td></tr></table></td></tr></table></td></tr></table></td></tr></table></td></tr></table></td></tr></table></td></tr></table></td></tr></table></td></tr></table></td></tr></table></td></tr></table></td></tr></table></td></tr></table></td></tr></table></td></tr></table></td></tr></table></td></tr></table></td></tr></table></td></tr></table></td></tr></table></td></tr></table></td></tr></table></td></tr></table></td></tr></table></td></tr></table></td></tr></table></td></tr></table></td></tr></table></td></tr></table>
 | | | | | | | | | | | | | | | | | | | | <table border="1" style="width: 100%; border-collapse: collapse; text-align: center;"> <tr> <td style="width: 10%;"></td> <td style="width: 10%;"></td> <td style="width: 10%;"></td> <td style="width: 10%;"></td> <td style="width: 10%;"></td> <td style="width: 10%;"></td> <td style="width: 10%;"></td> <td style="width: 10%;"></td> <td style="width: 10%;"></td> <td style="width: 10%;"></td> </tr> <tr> <td></td> <td></td> <td colspan="8" style="text-align: center;"> <table border="1" style="width: 100%; border-collapse: collapse; text-align: center;"> <tr> <td style="width: 10%;"></td> <td style="width: 10%;"></td> <td style="width: 10%;"></td> <td style="width: 10%;"></td> <td style="width: 10%;"></td> <td style="width: 10%;"></td> <td style="width: 10%;"></td> <td style="width: 10%;"></td> <td style="width: 10%;"></td> <td style="width: 10%;"></td> </tr> <tr> <td></td> <td></td> <td colspan="8" style="text-align: center;"> <table border="1" style="width: 100%; border-collapse: collapse; text-align: center;"> <tr> <td style="width: 10%;"></td> <td style="width: 10%;"></td> <td style="width: 10%;"></td> <td style="width: 10%;"></td> <td style="width: 10%;"></td> <td style="width: 10%;"></td> <td style="width: 10%;"></td> <td style="width: 10%;"></td> <td style="width: 10%;"></td> <td style="width: 10%;"></td> </tr> <tr> <td></td> <td></td> <td colspan="8" style="text-align: center;"> <table border="1" style="width: 100%; border-collapse: collapse; text-align: center;"> <tr> <td style="width: 10%;"></td> <td style="width: 10%;"></td> <td style="width: 10%;"></td> <td style="width: 10%;"></td> <td style="width: 10%;"></td> <td style="width: 10%;"></td> <td style="width: 10%;"></td> <td style="width: 10%;"></td> <td style="width: 10%;"></td> <td style="width: 10%;"></td> </tr> <tr> <td></td> <td></td> <td colspan="8" style="text-align: center;"> <table border="1" style="width: 100%; border-collapse: collapse; text-align: center;"> <tr> <td style="width: 10%;"></td> <td style="width: 10%;"></td> <td style="width: 10%;"></td> <td style="width: 10%;"></td> <td style="width: 10%;"></td> <td style="width: 10%;"></td> <td style="width: 10%;"></td> <td style="width: 10%;"></td> <td style="width: 10%;"></td> <td style="width: 10%;"></td> </tr> <tr> <td></td> <td></td> <td colspan="8" style="text-align: center;"> <table border="1" style="width: 100%; border-collapse: collapse; text-align: center;"> <tr> <td style="width: 10%;"></td> <td style="width: 10%;"></td> <td style="width: 10%;"></td> <td style="width: 10%;"></td> <td style="width: 10%;"></td> <td style="width: 10%;"></td> <td style="width: 10%;"></td> <td style="width: 10%;"></td> <td style="width: 10%;"></td> <td style="width: 10%;"></td> </tr> <tr> <td></td> <td></td> <td colspan="8" style="text-align: center;"> <table border="1" style="width: 100%; border-collapse: collapse; text-align: center;"> <tr> <td style="width: 10%;"></td> <td style="width: 10%;"></td> <td style="width: 10%;"></td> <td style="width: 10%;"></td> <td style="width: 10%;"></td> <td style="width: 10%;"></td> <td style="width: 10%;"></td> <td style="width: 10%;"></td> <td style="width: 10%;"></td> <td style="width: 10%;"></td> </tr> <tr> <td></td> <td></td> <td colspan="8" style="text-align: center;"> <table border="1" style="width: 100%; border-collapse: collapse; text-align: center;"> <tr> <td style="width: 10%;"></td> <td style="width: 10%;"></td> <td style="width: 10%;"></td> <td style="width: 10%;"></td> <td style="width: 10%;"></td> <td style="width: 10%;"></td> <td style="width: 10%;"></td> <td style="width: 10%;"></td> <td style="width: 10%;"></td> <td style="width: 10%;"></td> </tr> <tr> <td></td> <td></td> <td colspan="8" style="text-align: center;"> <table border="1" style="width: 100%; border-collapse: collapse; text-align: center;"> <tr> <td style="width: 10%;"></td> <td style="width: 10%;"></td> <td style="width: 10%;"></td> <td style="width: 10%;"></td> <td style="width: 10%;"></td> <td style="width: 10%;"></td> <td style="width: 10%;"></td> <td style="width: 10%;"></td> <td style="width: 10%;"></td> <td style="width: 10%;"></td> </tr> <tr> <td></td> <td></td> <td colspan="8" style="text-align: center;"> <table border="1" style="width: 100%; border-collapse: collapse; text-align: center;"> <tr> <td style="width: 10%;"></td> <td style="width: 10%;"></td> <td style="width: 10%;"></td> <td style="width: 10%;"></td> <td style="width: 10%;"></td> <td style="width: 10%;"></td> <td style="width: 10%;"></td> <td style="width: 10%;"></td> <td style="width: 10%;"></td> <td style="width: 10%;"></td> </tr> <tr> <td></td> <td></td> <td colspan="8" style="text-align: center;"> <table border="1" style="width: 100%; border-collapse: collapse; text-align: center;"> <tr> <td style="width: 10%;"></td> <td style="width: 10%;"></td> <td style="width: 10%;"></td> <td style="width: 10%;"></td> <td style="width: 10%;"></td> <td style="width: 10%;"></td> <td style="width: 10%;"></td> <td style="width: 10%;"></td> <td style="width: 10%;"></td> <td style="width: 10%;"></td> </tr> <tr> <td></td> <td></td> <td colspan="8" style="text-align: center;"> <table border="1" style="width: 100%; border-collapse: collapse; text-align: center;"> <tr> <td style="width: 10%;"></td> <td style="width: 10%;"></td> <td style="width: 10%;"></td> <td style="width: 10%;"></td> <td style="width: 10%;"></td> <td style="width: 10%;"></td> <td style="width: 10%;"></td> <td style="width: 10%;"></td> <td style="width: 10%;"></td> <td style="width: 10%;"></td> </tr> <tr> <td></td> <td></td> <td colspan="8" style="text-align: center;"> <table border="1" style="width: 100%; border-collapse: collapse; text-align: center;"> <tr> <td style="width: 10%;"></td> <td style="width: 10%;"></td> <td style="width: 10%;"></td> <td style="width: 10%;"></td> <td style="width: 10%;"></td> <td style="width: 10%;"></td> <td style="width: 10%;"></td> <td style="width: 10%;"></td> <td style="width: 10%;"></td> <td style="width: 10%;"></td> </tr> <tr> <td></td> <td></td> <td colspan="8" style="text-align: center;"> <table border="1" style="width: 100%; border-collapse: collapse; text-align: center;"> <tr> <td style="width: 10%;"></td> <td style="width: 10%;"></td> <td style="width: 10%;"></td> <td style="width: 10%;"></td> <td style="width: 10%;"></td> <td style="width: 10%;"></td> <td style="width: 10%;"></td> <td style="width: 10%;"></td> <td style="width: 10%;"></td> <td style="width: 10%;"></td> </tr> <tr> <td></td> <td></td> <td colspan="8" style="text-align: center;"> <table border="1" style="width: 100%; border-collapse: collapse; text-align: center;"> <tr> <td style="width: 10%;"></td> <td
style="width: 10%;"></td> <td style="width: 10%;"></td> <td style="width: 10%;"></td> <td style="width: 10%;"></td> <td style="width: 10%;"></td> <td style="width: 10%;"></td> <td style="width: 10%;"></td> <td style="width: 10%;"></td> <td style="width: 10%;"></td> </tr> <tr> <td></td> <td></td> <td colspan="8" style="text-align: center;"> <table border="1" style="width: 100%; border-collapse: collapse; text-align: center;"> <tr> <td style="width: 10%;"></td> <td style="width: 10%;"></td> <td style="width: 10%;"></td> <td style="width: 10%;"></td> <td style="width: 10%;"></td> <td style="width: 10%;"></td> <td style="width: 10%;"></td> <td style="width: 10%;"></td> <td style="width: 10%;"></td> <td style="width: 10%;"></td> </tr> <tr> <td></td> <td></td> <td colspan="8" style="text-align: center;"> <table border="1" style="width: 100%; border-collapse: collapse; text-align: center;"> <tr> <td style="width: 10%;"></td> <td style="width: 10%;"></td> <td style="width: 10%;"></td> <td style="width: 10%;"></td> <td style="width: 10%;"></td> <td style="width: 10%;"></td> <td style="width: 10%;"></td> <td style="width: 10%;"></td> <td style="width: 10%;"></td> <td style="width: 10%;"></td> </tr> <tr> <td></td> <td></td> <td colspan="8" style="text-align: center;"> <table border="1" style="width: 100%; border-collapse: collapse; text-align: center;"> <tr> <td style="width: 10%;"></td> <td style="width: 10%;"></td> <td style="width: 10%;"></td> <td style="width: 10%;"></td> <td style="width: 10%;"></td> <td style="width: 10%;"></td> <td style="width: 10%;"></td> <td style="width: 10%;"></td> <td style="width: 10%;"></td> <td style="width: 10%;"></td> </tr> <tr> <td></td> <td></td> <td colspan="8" style="text-align: center;"> <table border="1" style="width: 100%; border-collapse: collapse; text-align: center;"> <tr> <td style="width: 10%;"></td> <td style="width: 10%;"></td> <td style="width: 10%;"></td> <td style="width: 10%;"></td> <td style="width: 10%;"></td> <td style="width: 10%;"></td> <td style="width: 10%;"></td> <td style="width: 10%;"></td> <td style="width: 10%;"></td> <td style="width: 10%;"></td> </tr> <tr> <td></td> <td></td> <td colspan="8" style="text-align: center;"> <table border="1" style="width: 100%; border-collapse: collapse; text-align: center;"> <tr> <td style="width: 10%;"></td> <td style="width: 10%;"></td> <td style="width: 10%;"></td> <td style="width: 10%;"></td> <td style="width: 10%;"></td> <td style="width: 10%;"></td> <td style="width: 10%;"></td> <td style="width: 10%;"></td> <td style="width: 10%;"></td> <td style="width: 10%;"></td> </tr> <tr> <td></td> <td></td> <td colspan="8" style="text-align: center;"> <table border="1" style="width: 100%; border-collapse: collapse; text-align: center;"> <tr> <td style="width: 10%;"></td> <td style="width: 10%;"></td> <td style="width: 10%;"></td> <td style="width: 10%;"></td> <td style="width: 10%;"></td> <td style="width: 10%;"></td> <td style="width: 10%;"></td> <td style="width: 10%;"></td> <td style="width: 10%;"></td> <td style="width: 10%;"></td> </tr> <tr> <td></td> <td></td> <td colspan="8" style="text-align: center;"> <table border="1" style="width: 100%; border-collapse: collapse; text-align: center;"> <tr> <td style="width: 10%;"></td> <td style="width: 10%;"></td> <td style="width: 10%;"></td> <td style="width: 10%;"></td> <td style="width: 10%;"></td> <td style="width: 10%;"></td> <td style="width: 10%;"></td> <td style="width: 10%;"></td> <td style="width: 10%;"></td> <td style="width: 10%;"></td> </tr> <tr> <td></td> <td></td> <td colspan="8" style="text-align: center;"> <table border="1" style="width: 100%; border-collapse: collapse; text-align: center;"> <tr> <td style="width: 10%;"></td> <td style="width: 10%;"></td> <td style="width: 10%;"></td> <td style="width: 10%;"></td> <td style="width: 10%;"></td> <td style="width: 10%;"></td> <td style="width: 10%;"></td> <td style="width: 10%;"></td> <td style="width: 10%;"></td> <td style="width: 10%;"></td> </tr> <tr> <td></td> <td></td> <td colspan="8" style="text-align: center;"> <table border="1" style="width: 100%; border-collapse: collapse; text-align: center;"> <tr> <td style="width: 10%;"></td> <td style="width: 10%;"></td> <td style="width: 10%;"></td> <td style="width: 10%;"></td> <td style="width: 10%;"></td> <td style="width: 10%;"></td> <td style="width: 10%;"></td> <td style="width: 10%;"></td> <td style="width: 10%;"></td> <td style="width: 10%;"></td> </tr> <tr> <td></td> <td></td> <td colspan="8" style="text-align: center;"> <table border="1" style="width: 100%; border-collapse: collapse; text-align: center;"> <tr> <td style="width: 10%;"></td> <td style="width: 10%;"></td> <td style="width: 10%;"></td> <td style="width: 10%;"></td> <td style="width: 10%;"></td> <td style="width: 10%;"></td> <td style="width: 10%;"></td> <td style="width: 10%;"></td> <td style="width: 10%;"></td> <td style="width: 10%;"></td> </tr> <tr> <td></td> <td></td> <td colspan="8" style="text-align: center;"> <table border="1" style="width: 100%; border-collapse: collapse; text-align: center;"> <tr> <td style="width: 10%;"></td> <td style="width: 10%;"></td> <td style="width: 10%;"></td> <td style="width: 10%;"></td> <td style="width: 10%;"></td> <td style="width: 10%;"></td> <td style="width: 10%;"></td> <td style="width: 10%;"></td> <td style="width: 10%;"></td> <td style="width: 10%;"></td> </tr> <tr> <td></td> <td></td> <td colspan="8" style="text-align: center;"> <table border="1" style="width: 100%; border-collapse: collapse; text-align: center;"> <tr> <td style="width: 10%;"></td> <td style="width: 10%;"></td> <td style="width: 10%;"></td> <td style="width: 10%;"></td> <td style="width: 10%;"></td> <td style="width: 10%;"></td> <td style="width: 10%;"></td> <td style="width: 10%;"></td> <td style="width: 10%;"></td> <td style="width: 10%;"></td> </tr> <tr> <td></td> <td></td> <td colspan="8" style="text-align: center;"> <table border="1" style="width: 100%; border-collapse: collapse; text-align: center;"> <tr> <td style="width: 10%;"></td> <td style="width: 10%;"></td> <td style="width: 10%;"></td> <td style="width: 10%;"></td> <td style="width: 10%;"></td> <td style="width: 10%;"></td> <td style="width: 10%;"></td> <td style="width: 10%;"></td> <td style="width: 10%;"></td> <td style="width: 10%;"></td> </tr> <tr> <td></td> <td></td> <td colspan="8" style="text-align: center;"> <table border="1" style="width: 100%; border-collapse: collapse; text-align: center;"> <tr> <td style="width: 10%;"></td> <td style="width: 10%;"></td> <td style="width: 10%;"></td> <td style="width: 10%;"></td> <td style="width: 10%;"></td> <td style="width: 10%;"></td> <td style="width: 10%;"></td> <td style="width: 10%;"></td> <td style="width: 10%;"></td> <td style="width: 10%;"></td> </tr> <tr> <td></td> <td></td> <td colspan="8" style="text-align: center;"> <table border="1" style="width: 100%; border-collapse: collapse; text-align: center;"> <tr> <td style="width: 10%;"></td> <td style="width: 10%;"></td> <td style="width: 10%;"></td> <td style="width: 10%;"></td> <td style="width: 10%;"></td> <td style="width: 10%;"></td> <td style="width: 10%;"></td> <td style="width: 10%;"></td> <td style="width: 10%;"></td> <td style="width: 10%;"></td> </tr> <tr> <td></td> <td></td> <td colspan="8" style="text-align: center;"> <table border="1" style="width: 100%; border-collapse: collapse; text-align: center;"> <tr> <td style="width: 10%;"></td> <td style="width: 10%;"></td> <td style="width: 10%;"></td> <td style="width: 10%;"></td> <td style="width: 10%;"></td> <td style="width: 10%;"></td> <td style="width: 10%;"></td> <td style="width: 10%;"></td> <td style="width: 10%;"></td> <td style="width: 10%;"></td> </tr> <tr> <td></td> <td></td> <td colspan="8" style="text-align: center;"> <table border="1" style="width: 100%; border-collapse: collapse; text-align: center;"> <tr> <td style="width: 10%;"></td> <td style="width: 10%;"></td> <td style="width: 10%;"></td> <td style="width: 10%;"></td> <td style="width: 10%;"></td> <td style="width: 10%;"></td> <td style="width: 10%;"></td> <td style="width: 10%;"></td> <td style="width: 10%;"></td> <td style="width: 10%;"></td> </tr> <tr> <td></td> <td></td> <td colspan="8" style="text-align: center;"> <table border="1" style="width: 100%; border-collapse: collapse; text-align: center;"> <tr> <td style="width: 10%;"></td> <td style="width: 10%;"></td> <td style="width: 10%;"></td> <td style="width: 10%;"></td> <td style="width: 10%;"></td> <td style="width: 10%;"></td> <td style="width: 10%;"></td> <td style="width: 10%;"></td> <td style="width: 10%;"></td> <td style="width: 10%;"></td> </tr> <tr> <td></td> <td></td> <td colspan="8" style="text-align: center;"> <table border="1" style="width: 100%; border-collapse: collapse; text-align: center;"> <tr> <td style="width: 10%;"></td> <td style="width: 10%;"></td> <td style="width: 10%;"></td> <td style="width: 10%;"></td> <td style="width: 10%;"></td> <td style="width: 10%;"></td> <td style="width: 10%;"></td> <td style="width: 10%;"></td> <td style="width: 10%;"></td> <td style="width: 10%;"></td> </tr> <tr> <td></td> <td></td> <td colspan="8" style="text-align: center;"> <table border="1" style="width: 100%; border-collapse: collapse; text-align: center;"> <tr> <td style="width: 10%;"></td> <td style="width: 10%;"></td> <td style="width: 10%;"></td> <td style="width: 10%;"></td> <td style="width: 10%;"></td> <td style="width: 10%;"></td> <td style="width: 10%;"></td> <td style="width: 10%;"></td> <td style="width: 10%;"></td> <td style="width: 10%;"></td> </tr> <tr> <td></td> <td></td> <td colspan="8" style="text-align: center;"> <table border="1" style="width: 100%; border-collapse: collapse; text-align: center;"> <tr> <td style="width: 10%;"></td> <td style="width: 10%;"></td> <td style="width: 10%;"></td> <td style="width: 10%;"></td> <td style="width: 10%;"></td> <td style="width: 10%;"></td> <td style="width:
10%;"></td> <td style="width: 10%;"></td> <td style="width: 10%;"></td> <td style="width: 10%;"></td> </tr> <tr> <td></td> <td></td> <td colspan="8" style="text-align: center;"> <table border="1" style="width: 100%; border-collapse: collapse; text-align: center;"> <tr> <td style="width: 10%;"></td> <td style="width: 10%;"></td> <td style="width: 10%;"></td> <td style="width: 10%;"></td> <td style="width: 10%;"></td> <td style="width: 10%;"></td> <td style="width: 10%;"></td> <td style="width: 10%;"></td> <td style="width: 10%;"></td> <td style="width: 10%;"></td> </tr> <tr> <td></td> <td></td> <td colspan="8" style="text-align: center;"> <table border="1" style="width: 100%; border-collapse: collapse; text-align: center;"> <tr> <td style="width: 10%;"></td> <td style="width: 10%;"></td> <td style="width: 10%;"></td> <td style="width: 10%;"></td> <td style="width: 10%;"></td> <td style="width: 10%;"></td> <td style="width: 10%;"></td> <td style="width: 10%;"></td> <td style="width: 10%;"></td> <td style="width: 10%;"></td> </tr> <tr> <td></td> <td></td> <td colspan="8" style="text-align: center;"> <table border="1" style="width: 100%; border-collapse: collapse; text-align: center;"> <tr> <td style="width: 10%;"></td> <td style="width: 10%;"></td> <td style="width: 10%;"></td> <td style="width: 10%;"></td> <td style="width: 10%;"></td> <td style="width: 10%;"></td> <td style="width: 10%;"></td> <td style="width: 10%;"></td> <td style="width: 10%;"></td> <td style="width: 10%;"></td> </tr> <tr> <td></td> <td></td> <td colspan="8" style="text-align: center;"> <table border="1" style="width: 100%; border-collapse: collapse; text-align: center;"> <tr> <td style="width: 10%;"></td> <td style="width: 10%;"></td> <td style="width: 10%;"></td> <td style="width: 10%;"></td> <td style="width: 10%;"></td> <td style="width: 10%;"></td> <td style="width: 10%;"></td> <td style="width: 10%;"></td> <td style="width: 10%;"></td> <td style="width: 10%;"></td> </tr> <tr> <td></td> <td></td> <td colspan="8" style="text-align: center;"> <table border="1" style="width: 100%; border-collapse: collapse; text-align: center;"> <tr> <td style="width: 10%;"></td> <td style="width: 10%;"></td> <td style="width: 10%;"></td> <td style="width: 10%;"></td> <td style="width: 10%;"></td> <td style="width: 10%;"></td> <td style="width: 10%;"></td> <td style="width: 10%;"></td> <td style="width: 10%;"></td> <td style="width: 10%;"></td> </tr> <tr> <td></td> <td></td> <td colspan="8" style="text-align: center;"> <table border="1" style="width: 100%; border-collapse: collapse; text-align: center;"> <tr> </tr></table></td></tr></table></td></tr></table></td></tr></table></td></tr></table></td></tr></table></td></tr></table></td></tr></table></td></tr></table></td></tr></table></td></tr></table></td></tr></table></td></tr></table></td></tr></table></td></tr></table></td></tr></table></td></tr></table></td></tr></table></td></tr></table></td></tr></table></td></tr></table></td></tr></table></td></tr></table></td></tr></table></td></tr></table></td></tr></table></td></tr></table></td></tr></table></td></tr></table></td></tr></table></td></tr></table></td></tr></table></td></tr></table></td></tr></table></td></tr></table></td></tr></table></td></tr></table></td></tr></table></td></tr></table></td></tr></table></td></tr></table></td></tr></table> | | | | | | | | | | | | | | | | | | | | <table border="1" style="width: 100%; border-collapse: collapse; text-align: center;"> <tr> <td style="width: 10%;"></td> <td style="width: 10%;"></td> <td style="width: 10%;"></td> <td style="width: 10%;"></td> <td style="width: 10%;"></td> <td style="width: 10%;"></td> <td style="width: 10%;"></td> <td style="width: 10%;"></td> <td style="width: 10%;"></td> <td style="width: 10%;"></td> </tr> <tr> <td></td> <td></td> <td colspan="8" style="text-align: center;"> <table border="1" style="width: 100%; border-collapse: collapse; text-align: center;"> <tr> <td style="width: 10%;"></td> <td style="width: 10%;"></td> <td style="width: 10%;"></td> <td style="width: 10%;"></td> <td style="width: 10%;"></td> <td style="width: 10%;"></td> <td style="width: 10%;"></td> <td style="width: 10%;"></td> <td style="width: 10%;"></td> <td style="width: 10%;"></td> </tr> <tr> <td></td> <td></td> <td colspan="8" style="text-align: center;"> <table border="1" style="width: 100%; border-collapse: collapse; text-align: center;"> <tr> <td style="width: 10%;"></td> <td style="width: 10%;"></td> <td style="width: 10%;"></td> <td style="width: 10%;"></td> <td style="width: 10%;"></td> <td style="width: 10%;"></td> <td style="width:
10%;"></td> <td style="width: 10%;"></td> <td style="width: 10%;"></td> <td style="width: 10%;"></td> </tr> <tr> <td></td> <td></td> <td colspan="8" style="text-align: center;"> <table border="1" style="width: 100%; border-collapse: collapse; text-align: center;"> <tr> <td style="width: 10%;"></td> <td style="width: 10%;"></td> <td style="width: 10%;"></td> <td style="width: 10%;"></td> <td style="width: 10%;"></td> <td style="width: 10%;"></td> <td style="width: 10%;"></td> <td style="width: 10%;"></td> <td style="width: 10%;"></td> <td style="width: 10%;"></td> </tr> <tr> <td></td> <td></td> <td colspan="8" style="text-align: center;"> <table border="1" style="width: 100%; border-collapse: collapse; text-align: center;"> <tr> <td style="width: 10%;"></td> <td style="width: 10%;"></td> <td style="width: 10%;"></td> <td style="width: 10%;"></td> <td style="width: 10%;"></td> <td style="width: 10%;"></td> <td style="width: 10%;"></td> <td style="width: 10%;"></td> <td style="width: 10%;"></td> <td style="width: 10%;"></td> </tr> <tr> <td></td> <td></td> <td colspan="8" style="text-align: center;"> <table border="1" style="width: 100%; border-collapse: collapse; text-align: center;"> <tr> <td style="width: 10%;"></td> <td style="width: 10%;"></td> <td style="width: 10%;"></td> <td style="width: 10%;"></td> <td style="width: 10%;"></td> <td style="width: 10%;"></td> <td style="width: 10%;"></td> <td style="width: 10%;"></td> <td style="width: 10%;"></td> <td style="width: 10%;"></td> </tr> <tr> <td></td> <td></td> <td colspan="8" style="text-align: center;"> <table border="1" style="width: 100%; border-collapse: collapse; text-align: center;"> <tr> <td style="width: 10%;"></td> <td style="width: 10%;"></td> <td style="width: 10%;"></td> <td style="width: 10%;"></td> <td style="width: 10%;"></td> <td style="width: 10%;"></td> <td style="width: 10%;"></td> <td style="width: 10%;"></td> <td style="width: 10%;"></td> <td style="width: 10%;"></td> </tr> <tr> <td></td> <td></td> <td colspan="8" style="text-align: center;"> <table border="1" style="width: 100%; border-collapse: collapse; text-align: center;"> <tr> <td style="width: 10%;"></td> <td style="width: 10%;"></td> <td style="width: 10%;"></td> <td style="width: 10%;"></td> <td style="width: 10%;"></td> <td style="width: 10%;"></td> <td style="width: 10%;"></td> <td style="width: 10%;"></td> <td style="width: 10%;"></td> <td style="width: 10%;"></td> </tr> <tr> <td></td> <td></td> <td colspan="8" style="text-align: center;"> <table border="1" style="width: 100%; border-collapse: collapse; text-align: center;"> <tr> <td style="width: 10%;"></td> <td style="width: 10%;"></td> <td style="width: 10%;"></td> <td style="width: 10%;"></td> <td style="width: 10%;"></td> <td style="width: 10%;"></td> <td style="width: 10%;"></td> <td style="width: 10%;"></td> <td style="width: 10%;"></td> <td style="width: 10%;"></td> </tr> <tr> <td></td> <td></td> <td colspan="8" style="text-align: center;"> <table border="1" style="width: 100%; border-collapse: collapse; text-align: center;"> <tr> <td style="width: 10%;"></td> <td style="width: 10%;"></td> <td style="width: 10%;"></td> <td style="width: 10%;"></td> <td style="width: 10%;"></td> <td style="width: 10%;"></td> <td style="width: 10%;"></td> <td style="width: 10%;"></td> <td style="width: 10%;"></td> <td style="width: 10%;"></td> </tr> <tr> <td></td> <td></td> <td colspan="8" style="text-align: center;"> <table border="1" style="width: 100%; border-collapse: collapse; text-align: center;"> <tr> <td style="width: 10%;"></td> <td style="width: 10%;"></td> <td style="width: 10%;"></td> <td style="width: 10%;"></td> <td style="width: 10%;"></td> <td style="width: 10%;"></td> <td style="width: 10%;"></td> <td style="width: 10%;"></td> <td style="width: 10%;"></td> <td style="width: 10%;"></td> </tr> <tr> <td></td> <td></td> <td colspan="8" style="text-align: center;"> <table border="1" style="width: 100%; border-collapse: collapse; text-align: center;"> <tr> <td style="width: 10%;"></td> <td style="width: 10%;"></td> <td style="width: 10%;"></td> <td style="width: 10%;"></td> <td style="width: 10%;"></td> <td style="width: 10%;"></td> <td style="width: 10%;"></td> <td style="width: 10%;"></td> <td style="width: 10%;"></td> <td style="width: 10%;"></td> </tr> <tr> <td></td> <td></td> <td colspan="8" style="text-align: center;"> <table border="1" style="width: 100%; border-collapse: collapse; text-align: center;"> <tr> <td style="width: 10%;"></td> <td style="width: 10%;"></td> <td style="width: 10%;"></td> <td style="width: 10%;"></td> <td style="width: 10%;"></td> <td style="width: 10%;"></td> <td style="width: 10%;"></td> <td style="width: 10%;"></td> <td style="width: 10%;"></td> <td style="width: 10%;"></td> </tr> <tr> <td></td> <td></td> <td colspan="8" style="text-align: center;"> <table border="1" style="width: 100%; border-collapse: collapse; text-align: center;"> <tr> <td style="width: 10%;"></td> <td style="width: 10%;"></td> <td style="width: 10%;"></td> <td style="width: 10%;"></td> <td style="width: 10%;"></td> <td style="width: 10%;"></td> <td style="width: 10%;"></td> <td style="width: 10%;"></td> <td style="width: 10%;"></td> <td style="width: 10%;"></td> </tr> <tr> <td></td> <td></td> <td colspan="8" style="text-align: center;"> <table border="1" style="width: 100%; border-collapse: collapse; text-align: center;"> <tr> <td style="width: 10%;"></td> <td style="width: 10%;"></td> <td style="width: 10%;"></td> <td style="width: 10%;"></td> <td style="width: 10%;"></td> <td style="width: 10%;"></td> <td style="width: 10%;"></td> <td style="width: 10%;"></td> <td style="width: 10%;"></td> <td style="width: 10%;"></td> </tr> <tr> <td></td> <td></td> <td colspan="8" style="text-align: center;"> <table border="1" style="width: 100%; border-collapse: collapse; text-align: center;"> <tr> <td style="width: 10%;"></td> <td style="width: 10%;"></td> <td style="width: 10%;"></td> <td style="width: 10%;"></td> <td style="width: 10%;"></td> <td style="width: 10%;"></td> <td style="width: 10%;"></td> <td style="width: 10%;"></td> <td style="width: 10%;"></td> <td style="width: 10%;"></td> </tr> <tr> <td></td> <td></td> <td colspan="8" style="text-align: center;"> <table border="1" style="width: 100%; border-collapse: collapse; text-align: center;"> <tr> <td style="width: 10%;"></td> <td style="width: 10%;"></td> <td style="width: 10%;"></td> <td style="width: 10%;"></td> <td style="width: 10%;"></td> <td style="width: 10%;"></td> <td style="width: 10%;"></td> <td style="width: 10%;"></td> <td style="width: 10%;"></td> <td style="width: 10%;"></td> </tr> <tr> <td></td> <td></td> <td colspan="8" style="text-align: center;"> <table border="1" style="width: 100%; border-collapse: collapse; text-align: center;"> <tr> <td style="width: 10%;"></td> <td style="width: 10%;"></td> <td style="width: 10%;"></td> <td style="width: 10%;"></td> <td style="width: 10%;"></td> <td style="width: 10%;"></td> <td style="width: 10%;"></td> <td style="width: 10%;"></td> <td style="width: 10%;"></td> <td style="width: 10%;"></td> </tr> <tr> <td></td> <td></td> <td colspan="8" style="text-align: center;"> <table border="1" style="width: 100%; border-collapse: collapse; text-align: center;"> <tr> <td style="width: 10%;"></td> <td style="width: 10%;"></td> <td style="width: 10%;"></td> <td style="width: 10%;"></td> <td style="width: 10%;"></td> <td style="width: 10%;"></td> <td style="width: 10%;"></td> <td style="width: 10%;"></td> <td style="width: 10%;"></td> <td style="width: 10%;"></td> </tr> <tr> <td></td> <td></td> <td colspan="8" style="text-align: center;"> <table border="1" style="width: 100%; border-collapse: collapse; text-align: center;"> <tr> <td style="width: 10%;"></td> <td style="width: 10%;"></td> <td style="width: 10%;"></td> <td style="width: 10%;"></td> <td style="width: 10%;"></td> <td style="width: 10%;"></td> <td style="width: 10%;"></td> <td style="width: 10%;"></td> <td style="width: 10%;"></td> <td style="width: 10%;"></td> </tr> <tr> <td></td> <td></td> <td colspan="8" style="text-align: center;"> <table border="1" style="width: 100%; border-collapse: collapse; text-align: center;"> <tr> <td style="width: 10%;"></td> <td style="width: 10%;"></td> <td style="width: 10%;"></td> <td style="width: 10%;"></td> <td style="width: 10%;"></td> <td style="width: 10%;"></td> <td style="width: 10%;"></td> <td style="width: 10%;"></td> <td style="width: 10%;"></td> <td style="width: 10%;"></td> </tr> <tr> <td></td> <td></td> <td colspan="8" style="text-align: center;"> <table border="1" style="width: 100%; border-collapse: collapse; text-align: center;"> <tr> <td style="width: 10%;"></td> <td style="width: 10%;"></td> <td style="width: 10%;"></td> <td style="width: 10%;"></td> <td style="width: 10%;"></td> <td style="width: 10%;"></td> <td style="width: 10%;"></td> <td style="width: 10%;"></td> <td style="width: 10%;"></td> <td style="width: 10%;"></td> </tr> <tr> <td></td> <td></td> <td colspan="8" style="text-align: center;"> <table border="1" style="width: 100%; border-collapse: collapse; text-align: center;"> <tr> <td style="width: 10%;"></td> <td style="width: 10%;"></td> <td style="width: 10%;"></td> <td style="width: 10%;"></td> <td style="width: 10%;"></td> <td style="width: 10%;"></td> <td style="width: 10%;"></td> <td style="width: 10%;"></td> <td style="width: 10%;"></td> <td style="width: 10%;"></td> </tr> <tr> <td></td> <td></td> <td colspan="8" style="text-align: center;"> <table border="1" style="width: 100%; border-collapse: collapse; text-align: center;"> <tr> <td style="width: 10%;"></td> <td style="width: 10%;"></td> <td style="width: 10%;"></td> <td style="width: 10%;"></td> <td style="width: 10%;"></td> <td style="width: 10%;"></td> <td style="width: 10%;"></td> <td style="width: 10%;"></td> <td style="width: 10%;"></td> <td style="width: 10%;"></td> </tr> <tr> <td></td> <td></td> <td colspan="8" style="text-align:
center;"> <table border="1" style="width: 100%; border-collapse: collapse; text-align: center;"> <tr> <td style="width: 10%;"></td> <td style="width: 10%;"></td> <td style="width: 10%;"></td> <td style="width: 10%;"></td> <td style="width: 10%;"></td> <td style="width: 10%;"></td> <td style="width: 10%;"></td> <td style="width: 10%;"></td> <td style="width: 10%;"></td> <td style="width: 10%;"></td> </tr> <tr> <td></td> <td></td> <td colspan="8" style="text-align: center;"> <table border="1" style="width: 100%; border-collapse: collapse; text-align: center;"> <tr> <td style="width: 10%;"></td> <td style="width: 10%;"></td> <td style="width: 10%;"></td> <td style="width: 10%;"></td> <td style="width: 10%;"></td> <td style="width: 10%;"></td> <td style="width: 10%;"></td> <td style="width: 10%;"></td> <td style="width: 10%;"></td> <td style="width: 10%;"></td> </tr> <tr> <td></td> <td></td> <td colspan="8" style="text-align: center;"> <table border="1" style="width: 100%; border-collapse: collapse; text-align: center;"> <tr> <td style="width: 10%;"></td> <td style="width: 10%;"></td> <td style="width: 10%;"></td> <td style="width: 10%;"></td> <td style="width: 10%;"></td> <td style="width: 10%;"></td> <td style="width: 10%;"></td> <td style="width: 10%;"></td> <td style="width: 10%;"></td> <td style="width: 10%;"></td> </tr> <tr> <td></td> <td></td> <td colspan="8" style="text-align: center;"> <table border="1" style="width: 100%; border-collapse: collapse; text-align: center;"> <tr> <td style="width: 10%;"></td> <td style="width: 10%;"></td> <td style="width: 10%;"></td> <td style="width: 10%;"></td> <td style="width: 10%;"></td> <td style="width: 10%;"></td> <td style="width: 10%;"></td> <td style="width: 10%;"></td> <td style="width: 10%;"></td> <td style="width: 10%;"></td> </tr> <tr> <td></td> <td></td> <td colspan="8" style="text-align: center;"> <table border="1" style="width: 100%; border-collapse: collapse; text-align: center;"> <tr> <td style="width: 10%;"></td> <td style="width: 10%;"></td> <td style="width: 10%;"></td> <td style="width: 10%;"></td> <td style="width: 10%;"></td> <td style="width: 10%;"></td> <td style="width: 10%;"></td> <td style="width: 10%;"></td> <td style="width: 10%;"></td> <td style="width: 10%;"></td> </tr> <tr> <td></td> <td></td> <td colspan="8" style="text-align: center;"> <table border="1" style="width: 100%; border-collapse: collapse; text-align: center;"> <tr> <td style="width: 10%;"></td> <td style="width: 10%;"></td> <td style="width: 10%;"></td> <td style="width: 10%;"></td> <td style="width: 10%;"></td> <td style="width: 10%;"></td> <td style="width: 10%;"></td> <td style="width: 10%;"></td> <td style="width: 10%;"></td> <td style="width: 10%;"></td> </tr> <tr> <td></td> <td></td> <td colspan="8" style="text-align: center;"> <table border="1" style="width: 100%; border-collapse: collapse; text-align: center;"> <tr> <td style="width: 10%;"></td> <td style="width: 10%;"></td> <td style="width: 10%;"></td> <td style="width: 10%;"></td> <td style="width: 10%;"></td> <td style="width: 10%;"></td> <td style="width: 10%;"></td> <td style="width: 10%;"></td> <td style="width: 10%;"></td> <td style="width: 10%;"></td> </tr> <tr> <td></td> <td></td> <td colspan="8" style="text-align: center;"> <table border="1" style="width: 100%; border-collapse: collapse; text-align: center;"> <tr> <td style="width: 10%;"></td> <td style="width: 10%;"></td> <td style="width: 10%;"></td> <td style="width: 10%;"></td> <td style="width: 10%;"></td> <td style="width: 10%;"></td> <td style="width: 10%;"></td> <td style="width: 10%;"></td> <td style="width: 10%;"></td> <td style="width: 10%;"></td> </tr> <tr> <td></td> <td></td> <td colspan="8" style="text-align: center;"> <table border="1" style="width: 100%; border-collapse: collapse; text-align: center;"> <tr> <td style="width: 10%;"></td> <td style="width: 10%;"></td> <td style="width: 10%;"></td> <td style="width: 10%;"></td> <td style="width: 10%;"></td> <td style="width: 10%;"></td> <td style="width: 10%;"></td> <td style="width: 10%;"></td> <td style="width: 10%;"></td> <td style="width: 10%;"></td> </tr> <tr> <td></td> <td></td> <td colspan="8" style="text-align: center;"> <table border="1" style="width: 100%; border-collapse: collapse; text-align: center;"> <tr> <td style="width: 10%;"></td> <td style="width: 10%;"></td> <td style="width: 10%;"></td> <td style="width: 10%;"></td> <td style="width: 10%;"></td> <td style="width: 10%;"></td> <td style="width: 10%;"></td> <td style="width: 10%;"></td> <td style="width: 10%;"></td> <td style="width: 10%;"></td> </tr> <tr> <td></td> <td></td> <td colspan="8" style="text-align: center;"> <table border="1" style="width: 100%; border-collapse: collapse; text-align: center;"> <tr> <td style="width: 10%;"></td> <td style="width: 10%;"></td> <td style="width: 10%;"></td> <td style="width: 10%;"></td> <td style="width: 10%;"></td> <td style="width: 10%;"></td> <td style="width: 10%;"></td> <td style="width: 10%;"></td> <td style="width: 10%;"></td> <td style="width: 10%;"></td> </tr> <tr> <td></td> <td></td> <td colspan="8" style="text-align: center;"> <table border="1" style="width: 100%; border-collapse: collapse; text-align: center;"> <tr> <td style="width: 10%;"></td> <td style="width: 10%;"></td> <td style="width: 10%;"></td> <td style="width: 10%;"></td> <td style="width: 10%;"></td> <td style="width: 10%;"></td> <td style="width: 10%;"></td> <td style="width: 10%;"></td> <td style="width: 10%;"></td> <td style="width: 10%;"></td> </tr> <tr> <td></td> <td></td> <td colspan="8" style="text-align: center;"> <table border="1" style="width: 100%; border-collapse: collapse; text-align: center;"> <tr> <td style="width: 10%;"></td> <td style="width: 10%;"></td> <td style="width: 10%;"></td> <td style="width: 10%;"></td> <td style="width: 10%;"></td> <td style="width: 10%;"></td> <td style="width: 10%;"></td> <td style="width: 10%;"></td> <td style="width: 10%;"></td> <td style="width: 10%;"></td> </tr> <tr> <td></td> <td></td> <td colspan="8" style="text-align: center;"> <table border="1" style="width: 100%; border-collapse: collapse; text-align: center;"> <tr> <td style="width: 10%;"></td> <td style="width: 10%;"></td> <td style="width: 10%;"></td> <td style="width: 10%;"></td> <td style="width: 10%;"></td> <td style="width: 10%;"></td> <td style="width: 10%;"></td> <td style="width: 10%;"></td> <td style="width: 10%;"></td> <td style="width: 10%;"></td> </tr> <tr> <td></td> <td></td> <td colspan="8" style="text-align: center;"> <table border="1" style="width: 100%; border-collapse: collapse; text-align: center;"> <tr> <td style="width: 10%;"></td> <td style="width: 10%;"></td> <td style="width: 10%;"></td> <td style="width: 10%;"></td> <td style="width: 10%;"></td> <td style="width: 10%;"></td> <td style="width: 10%;"></td> <td style="width: 10%;"></td> <td style="width: 10%;"></td> <td style="width: 10%;"></td> </tr> <tr> <td></td> <td></td> <td colspan="8" style="text-align: center;"> <table border="1" style="width: 100%; border-collapse: collapse; text-align: center;"> <tr> <td style="width: 10%;"></td> <td style="width: 10%;"></td> <td style="width: 10%;"></td> <td style="width: 10%;"></td> <td style="width: 10%;"></td> <td style="width: 10%;"></td> <td style="width: 10%;"></td> <td style="width: 10%;"></td> <td style="width: 10%;"></td> <td style="width: 10%;"></td> </tr> <tr> <td></td> <td></td> <td colspan="8" style="text-align: center;"> <table border="1" style="width: 100%; border-collapse: collapse; text-align: center;"> <tr> </tr></table></td></tr></table></td></tr></table></td></tr></table></td></tr></table></td></tr></table></td></tr></table></td></tr></table></td></tr></table></td></tr></table></td></tr></table></td></tr></table></td></tr></table></td></tr></table></td></tr></table></td></tr></table></td></tr></table></td></tr></table></td></tr></table></td></tr></table></td></tr></table></td></tr></table></td></tr></table></td></tr></table></td></tr></table></td></tr></table></td></tr></table></td></tr></table></td></tr></table></td></tr></table></td></tr></table></td></tr></table></td></tr></table></td></tr></table></td></tr></table></td></tr></table></td></tr></table></td></tr></table></td></tr></table></td></tr></table></td></tr></table>
 | | | | | | | | | | | | | | | | | | | | <table border="1" style="width: 100%; border-collapse: collapse; text-align: center;"> <tr> <td style="width: 10%;"></td> <td style="width: 10%;"></td> <td style="width: 10%;"></td> <td style="width: 10%;"></td> <td style="width: 10%;"></td> <td style="width: 10%;"></td> <td style="width: 10%;"></td> <td style="width: 10%;"></td> <td style="width: 10%;"></td> <td style="width: 10%;"></td> </tr> <tr> <td></td> <td></td> <td colspan="8" style="text-align: center;"> <table border="1" style="width: 100%; border-collapse: collapse; text-align: center;"> <tr> <td style="width: 10%;"></td> <td style="width: 10%;"></td> <td style="width: 10%;"></td> <td style="width: 10%;"></td> <td style="width: 10%;"></td> <td style="width: 10%;"></td> <td style="width: 10%;"></td> <td style="width: 10%;"></td> <td style="width: 10%;"></td> <td style="width: 10%;"></td> </tr> <tr> <td></td> <td></td> <td colspan="8" style="text-align: center;"> <table border="1" style="width: 100%; border-collapse: collapse; text-align: center;"> <tr> <td style="width: 10%;"></td> <td style="width: 10%;"></td> <td style="width: 10%;"></td> <td style="width: 10%;"></td> <td style="width: 10%;"></td> <td style="width: 10%;"></td> <td style="width: 10%;"></td> <td style="width: 10%;"></td> <td style="width: 10%;"></td> <td style="width: 10%;"></td> </tr> <tr> <td></td> <td></td> <td colspan="8" style="text-align: center;"> <table border="1" style="width: 100%; border-collapse: collapse; text-align: center;"> <tr> <td style="width: 10%;"></td> <td style="width: 10%;"></td> <td style="width: 10%;"></td> <td style="width: 10%;"></td> <td style="width: 10%;"></td> <td style="width: 10%;"></td> <td style="width: 10%;"></td> <td style="width: 10%;"></td> <td style="width: 10%;"></td> <td style="width: 10%;"></td> </tr> <tr> <td></td> <td></td> <td colspan="8" style="text-align: center;"> <table border="1" style="width: 100%; border-collapse: collapse; text-align: center;"> <tr> <td style="width: 10%;"></td> <td style="width: 10%;"></td> <td style="width: 10%;"></td> <td style="width: 10%;"></td> <td style="width: 10%;"></td> <td style="width: 10%;"></td> <td style="width: 10%;"></td> <td style="width: 10%;"></td> <td style="width: 10%;"></td> <td style="width: 10%;"></td> </tr> <tr> <td></td> <td></td> <td colspan="8" style="text-align: center;"> <table border="1" style="width: 100%; border-collapse: collapse; text-align: center;"> <tr> <td style="width: 10%;"></td> <td style="width: 10%;"></td> <td style="width: 10%;"></td> <td style="width: 10%;"></td> <td style="width: 10%;"></td> <td style="width: 10%;"></td> <td style="width: 10%;"></td> <td style="width: 10%;"></td> <td style="width: 10%;"></td> <td style="width: 10%;"></td> </tr> <tr> <td></td> <td></td> <td colspan="8" style="text-align: center;"> <table border="1" style="width: 100%; border-collapse: collapse; text-align: center;"> <tr> <td style="width: 10%;"></td> <td style="width: 10%;"></td> <td style="width: 10%;"></td> <td style="width: 10%;"></td> <td style="width: 10%;"></td> <td style="width: 10%;"></td> <td style="width: 10%;"></td> <td style="width: 10%;"></td> <td style="width: 10%;"></td> <td style="width: 10%;"></td> </tr> <tr> <td></td> <td></td> <td colspan="8" style="text-align: center;"> <table border="1" style="width: 100%; border-collapse: collapse; text-align: center;"> <tr> <td style="width: 10%;"></td> <td style="width: 10%;"></td> <td style="width: 10%;"></td> <td style="width: 10%;"></td> <td style="width: 10%;"></td> <td style="width: 10%;"></td> <td style="width: 10%;"></td> <td style="width: 10%;"></td> <td style="width: 10%;"></td> <td style="width: 10%;"></td> </tr> <tr> <td></td> <td></td> <td colspan="8" style="text-align: center;"> <table border="1" style="width: 100%; border-collapse: collapse; text-align: center;"> <tr> <td style="width: 10%;"></td> <td style="width: 10%;"></td> <td style="width: 10%;"></td> <td style="width: 10%;"></td> <td style="width: 10%;"></td> <td style="width: 10%;"></td> <td style="width: 10%;"></td> <td style="width: 10%;"></td> <td style="width: 10%;"></td> <td style="width: 10%;"></td> </tr> <tr> <td></td> <td></td> <td colspan="8" style="text-align: center;"> <table border="1" style="width: 100%; border-collapse: collapse; text-align: center;"> <tr> <td style="width: 10%;"></td> <td style="width: 10%;"></td> <td style="width: 10%;"></td> <td style="width: 10%;"></td> <td style="width: 10%;"></td> <td style="width: 10%;"></td> <td style="width: 10%;"></td> <td style="width: 10%;"></td> <td style="width: 10%;"></td> <td style="width: 10%;"></td> </tr> <tr> <td></td> <td></td> <td colspan="8" style="text-align: center;"> <table border="1" style="width: 100%; border-collapse: collapse; text-align: center;"> <tr> <td style="width: 10%;"></td> <td style="width: 10%;"></td> <td style="width: 10%;"></td> <td style="width: 10%;"></td> <td style="width: 10%;"></td> <td style="width: 10%;"></td> <td style="width: 10%;"></td> <td style="width: 10%;"></td> <td style="width: 10%;"></td> <td style="width: 10%;"></td> </tr> <tr> <td></td> <td></td> <td colspan="8" style="text-align: center;"> <table border="1" style="width: 100%; border-collapse: collapse; text-align: center;"> <tr> <td style="width: 10%;"></td> <td style="width: 10%;"></td> <td style="width: 10%;"></td> <td style="width: 10%;"></td> <td style="width: 10%;"></td> <td style="width: 10%;"></td> <td style="width: 10%;"></td> <td style="width: 10%;"></td> <td style="width: 10%;"></td> <td style="width: 10%;"></td> </tr> <tr> <td></td> <td></td> <td colspan="8" style="text-align: center;"> <table border="1" style="width: 100%; border-collapse: collapse; text-align: center;"> <tr> <td style="width: 10%;"></td> <td style="width: 10%;"></td> <td style="width: 10%;"></td> <td style="width: 10%;"></td> <td style="width: 10%;"></td> <td style="width: 10%;"></td> <td style="width: 10%;"></td> <td style="width: 10%;"></td> <td style="width: 10%;"></td> <td style="width: 10%;"></td> </tr> <tr> <td></td> <td></td> <td colspan="8" style="text-align: center;"> <table border="1" style="width: 100%; border-collapse: collapse; text-align: center;"> <tr> <td style="width: 10%;"></td> <td style="width: 10%;"></td> <td style="width: 10%;"></td> <td
style="width: 10%;"></td> <td style="width: 10%;"></td> <td style="width: 10%;"></td> <td style="width: 10%;"></td> <td style="width: 10%;"></td> <td style="width: 10%;"></td> <td style="width: 10%;"></td> </tr> <tr> <td></td> <td></td> <td colspan="8" style="text-align: center;"> <table border="1" style="width: 100%; border-collapse: collapse; text-align: center;"> <tr> <td style="width: 10%;"></td> <td style="width: 10%;"></td> <td style="width: 10%;"></td> <td style="width: 10%;"></td> <td style="width: 10%;"></td> <td style="width: 10%;"></td> <td style="width: 10%;"></td> <td style="width: 10%;"></td> <td style="width: 10%;"></td> <td style="width: 10%;"></td> </tr> <tr> <td></td> <td></td> <td colspan="8" style="text-align: center;"> <table border="1" style="width: 100%; border-collapse: collapse; text-align: center;"> <tr> <td style="width: 10%;"></td> <td style="width: 10%;"></td> <td style="width: 10%;"></td> <td style="width: 10%;"></td> <td style="width: 10%;"></td> <td style="width: 10%;"></td> <td style="width: 10%;"></td> <td style="width: 10%;"></td> <td style="width: 10%;"></td> <td style="width: 10%;"></td> </tr> <tr> <td></td> <td></td> <td colspan="8" style="text-align: center;"> <table border="1" style="width: 100%; border-collapse: collapse; text-align: center;"> <tr> <td style="width: 10%;"></td> <td style="width: 10%;"></td> <td style="width: 10%;"></td> <td style="width: 10%;"></td> <td style="width: 10%;"></td> <td style="width: 10%;"></td> <td style="width: 10%;"></td> <td style="width: 10%;"></td> <td style="width: 10%;"></td> <td style="width: 10%;"></td> </tr> <tr> <td></td> <td></td> <td colspan="8" style="text-align: center;"> <table border="1" style="width: 100%; border-collapse: collapse; text-align: center;"> <tr> <td style="width: 10%;"></td> <td style="width: 10%;"></td> <td style="width: 10%;"></td> <td style="width: 10%;"></td> <td style="width: 10%;"></td> <td style="width: 10%;"></td> <td style="width: 10%;"></td> <td style="width: 10%;"></td> <td style="width: 10%;"></td> <td style="width: 10%;"></td> </tr> <tr> <td></td> <td></td> <td colspan="8" style="text-align: center;"> <table border="1" style="width: 100%; border-collapse: collapse; text-align: center;"> <tr> <td style="width: 10%;"></td> <td style="width: 10%;"></td> <td style="width: 10%;"></td> <td style="width: 10%;"></td> <td style="width: 10%;"></td> <td style="width: 10%;"></td> <td style="width: 10%;"></td> <td style="width: 10%;"></td> <td style="width: 10%;"></td> <td style="width: 10%;"></td> </tr> <tr> <td></td> <td></td> <td colspan="8" style="text-align: center;"> <table border="1" style="width: 100%; border-collapse: collapse; text-align: center;"> <tr> <td style="width: 10%;"></td> <td style="width: 10%;"></td> <td style="width: 10%;"></td> <td style="width: 10%;"></td> <td style="width: 10%;"></td> <td style="width: 10%;"></td> <td style="width: 10%;"></td> <td style="width: 10%;"></td> <td style="width: 10%;"></td> <td style="width: 10%;"></td> </tr> <tr> <td></td> <td></td> <td colspan="8" style="text-align: center;"> <table border="1" style="width: 100%; border-collapse: collapse; text-align: center;"> <tr> <td style="width: 10%;"></td> <td style="width: 10%;"></td> <td style="width: 10%;"></td> <td style="width: 10%;"></td> <td style="width: 10%;"></td> <td style="width: 10%;"></td> <td style="width: 10%;"></td> <td style="width: 10%;"></td> <td style="width: 10%;"></td> <td style="width: 10%;"></td> </tr> <tr> <td></td> <td></td> <td colspan="8" style="text-align: center;"> <table border="1" style="width: 100%; border-collapse: collapse; text-align: center;"> <tr> <td style="width: 10%;"></td> <td style="width: 10%;"></td> <td style="width: 10%;"></td> <td style="width: 10%;"></td> <td style="width: 10%;"></td> <td style="width: 10%;"></td> <td style="width: 10%;"></td> <td style="width: 10%;"></td> <td style="width: 10%;"></td> <td style="width: 10%;"></td> </tr> <tr> <td></td> <td></td> <td colspan="8" style="text-align: center;"> <table border="1" style="width: 100%; border-collapse: collapse; text-align: center;"> <tr> <td style="width: 10%;"></td> <td style="width: 10%;"></td> <td style="width: 10%;"></td> <td style="width: 10%;"></td> <td style="width: 10%;"></td> <td style="width: 10%;"></td> <td style="width: 10%;"></td> <td style="width: 10%;"></td> <td style="width: 10%;"></td> <td style="width: 10%;"></td> </tr> <tr> <td></td> <td></td> <td colspan="8" style="text-align: center;"> <table border="1" style="width: 100%; border-collapse: collapse; text-align: center;"> <tr> <td style="width: 10%;"></td> <td style="width: 10%;"></td> <td style="width: 10%;"></td> <td style="width: 10%;"></td> <td style="width: 10%;"></td> <td style="width: 10%;"></td> <td style="width: 10%;"></td> <td style="width: 10%;"></td> <td style="width: 10%;"></td> <td style="width: 10%;"></td> </tr> <tr> <td></td> <td></td> <td colspan="8" style="text-align: center;"> <table border="1" style="width: 100%; border-collapse: collapse; text-align: center;"> <tr> <td style="width: 10%;"></td> <td style="width: 10%;"></td> <td style="width: 10%;"></td> <td style="width: 10%;"></td> <td style="width: 10%;"></td> <td style="width: 10%;"></td> <td style="width: 10%;"></td> <td style="width: 10%;"></td> <td style="width: 10%;"></td> <td style="width: 10%;"></td> </tr> <tr> <td></td> <td></td> <td colspan="8" style="text-align: center;"> <table border="1" style="width: 100%; border-collapse: collapse; text-align: center;"> <tr> <td style="width: 10%;"></td> <td style="width: 10%;"></td> <td style="width: 10%;"></td> <td style="width: 10%;"></td> <td style="width: 10%;"></td> <td style="width: 10%;"></td> <td style="width: 10%;"></td> <td style="width: 10%;"></td> <td style="width: 10%;"></td> <td style="width: 10%;"></td> </tr> <tr> <td></td> <td></td> <td colspan="8" style="text-align: center;"> <table border="1" style="width: 100%; border-collapse: collapse; text-align: center;"> <tr> <td style="width: 10%;"></td> <td style="width: 10%;"></td> <td style="width: 10%;"></td> <td style="width: 10%;"></td> <td style="width: 10%;"></td> <td style="width: 10%;"></td> <td style="width: 10%;"></td> <td style="width: 10%;"></td> <td style="width: 10%;"></td> <td style="width: 10%;"></td> </tr> <tr> <td></td> <td></td> <td colspan="8" style="text-align: center;"> <table border="1" style="width: 100%; border-collapse: collapse; text-align: center;"> <tr> <td style="width: 10%;"></td> <td style="width: 10%;"></td> <td style="width: 10%;"></td> <td style="width: 10%;"></td> <td style="width: 10%;"></td> <td style="width: 10%;"></td> <td style="width: 10%;"></td> <td style="width: 10%;"></td> <td style="width: 10%;"></td> <td style="width: 10%;"></td> </tr> <tr> <td></td> <td></td> <td colspan="8" style="text-align: center;"> <table border="1" style="width: 100%; border-collapse: collapse; text-align: center;"> <tr> <td style="width: 10%;"></td> <td style="width: 10%;"></td> <td style="width: 10%;"></td> <td style="width: 10%;"></td> <td style="width: 10%;"></td> <td style="width: 10%;"></td> <td style="width: 10%;"></td> <td style="width: 10%;"></td> <td style="width: 10%;"></td> <td style="width: 10%;"></td> </tr> <tr> <td></td> <td></td> <td colspan="8" style="text-align: center;"> <table border="1" style="width: 100%; border-collapse: collapse; text-align: center;"> <tr> <td style="width: 10%;"></td> <td style="width: 10%;"></td> <td style="width: 10%;"></td> <td style="width: 10%;"></td> <td style="width: 10%;"></td> <td style="width: 10%;"></td> <td style="width: 10%;"></td> <td style="width: 10%;"></td> <td style="width: 10%;"></td> <td style="width: 10%;"></td> </tr> <tr> <td></td> <td></td> <td colspan="8" style="text-align: center;"> <table border="1" style="width: 100%; border-collapse: collapse; text-align: center;"> <tr> <td style="width: 10%;"></td> <td style="width: 10%;"></td> <td style="width: 10%;"></td> <td style="width: 10%;"></td> <td style="width: 10%;"></td> <td style="width: 10%;"></td> <td style="width: 10%;"></td> <td style="width: 10%;"></td> <td style="width: 10%;"></td> <td style="width: 10%;"></td> </tr> <tr> <td></td> <td></td> <td colspan="8" style="text-align: center;"> <table border="1" style="width: 100%; border-collapse: collapse; text-align: center;"> <tr> <td style="width: 10%;"></td> <td style="width: 10%;"></td> <td style="width: 10%;"></td> <td style="width: 10%;"></td> <td style="width: 10%;"></td> <td style="width: 10%;"></td> <td style="width: 10%;"></td> <td style="width: 10%;"></td> <td style="width: 10%;"></td> <td style="width: 10%;"></td> </tr> <tr> <td></td> <td></td> <td colspan="8" style="text-align: center;"> <table border="1" style="width: 100%; border-collapse: collapse; text-align: center;"> <tr> <td style="width: 10%;"></td> <td style="width: 10%;"></td> <td style="width: 10%;"></td> <td style="width: 10%;"></td> <td style="width: 10%;"></td> <td style="width: 10%;"></td> <td style="width: 10%;"></td> <td style="width: 10%;"></td> <td style="width: 10%;"></td> <td style="width: 10%;"></td> </tr> <tr> <td></td> <td></td> <td colspan="8" style="text-align: center;"> <table border="1" style="width: 100%; border-collapse: collapse; text-align: center;"> <tr> <td style="width: 10%;"></td> <td style="width: 10%;"></td> <td style="width: 10%;"></td> <td style="width: 10%;"></td> <td style="width: 10%;"></td> <td style="width: 10%;"></td> <td style="width: 10%;"></td> <td style="width: 10%;"></td> <td style="width: 10%;"></td> <td style="width: 10%;"></td> </tr> <tr> <td></td> <td></td> <td colspan="8" style="text-align: center;"> <table border="1" style="width: 100%; border-collapse: collapse; text-align: center;"> <tr> <td style="width: 10%;"></td> <td style="width: 10%;"></td> <td style="width: 10%;"></td> <td style="width: 10%;"></td> <td style="width: 10%;"></td> <td style="width: 10%;"></td> <td style="width: 10%;"></td> <td style="width: 10%;"></td> <td style="width:
10%;"></td> <td style="width: 10%;"></td> </tr> <tr> <td></td> <td></td> <td colspan="8" style="text-align: center;"> <table border="1" style="width: 100%; border-collapse: collapse; text-align: center;"> <tr> <td style="width: 10%;"></td> <td style="width: 10%;"></td> <td style="width: 10%;"></td> <td style="width: 10%;"></td> <td style="width: 10%;"></td> <td style="width: 10%;"></td> <td style="width: 10%;"></td> <td style="width: 10%;"></td> <td style="width: 10%;"></td> <td style="width: 10%;"></td> </tr> <tr> <td></td> <td></td> <td colspan="8" style="text-align: center;"> <table border="1" style="width: 100%; border-collapse: collapse; text-align: center;"> <tr> <td style="width: 10%;"></td> <td style="width: 10%;"></td> <td style="width: 10%;"></td> <td style="width: 10%;"></td> <td style="width: 10%;"></td> <td style="width: 10%;"></td> <td style="width: 10%;"></td> <td style="width: 10%;"></td> <td style="width: 10%;"></td> <td style="width: 10%;"></td> </tr> <tr> <td></td> <td></td> <td colspan="8" style="text-align: center;"> <table border="1" style="width: 100%; border-collapse: collapse; text-align: center;"> <tr> <td style="width: 10%;"></td> <td style="width: 10%;"></td> <td style="width: 10%;"></td> <td style="width: 10%;"></td> <td style="width: 10%;"></td> <td style="width: 10%;"></td> <td style="width: 10%;"></td> <td style="width: 10%;"></td> <td style="width: 10%;"></td> <td style="width: 10%;"></td> </tr> <tr> <td></td> <td></td> <td colspan="8" style="text-align: center;"> <table border="1" style="width: 100%; border-collapse: collapse; text-align: center;"> <tr> <td style="width: 10%;"></td> <td style="width: 10%;"></td> <td style="width: 10%;"></td> <td style="width: 10%;"></td> <td style="width: 10%;"></td> <td style="width: 10%;"></td> <td style="width: 10%;"></td> <td style="width: 10%;"></td> <td style="width: 10%;"></td> <td style="width: 10%;"></td> </tr> <tr> <td></td> <td></td> <td colspan="8" style="text-align: center;"> <table border="1" style="width: 100%; border-collapse: collapse; text-align: center;"> <tr> </tr></table></td></tr></table></td></tr></table></td></tr></table></td></tr></table></td></tr></table></td></tr></table></td></tr></table></td></tr></table></td></tr></table></td></tr></table></td></tr></table></td></tr></table></td></tr></table></td></tr></table></td></tr></table></td></tr></table></td></tr></table></td></tr></table></td></tr></table></td></tr></table></td></tr></table></td></tr></table></td></tr></table></td></tr></table></td></tr></table></td></tr></table></td></tr></table></td></tr></table></td></tr></table></td></tr></table></td></tr></table></td></tr></table></td></tr></table></td></tr></table></td></tr></table></td></tr></table></td></tr></table></td></tr></table></td></tr></table> | | | | | | | | | | | | | | | | | | | | <table border="1" style="width: 100%; border-collapse: collapse; text-align: center;"> <tr> <td style="width: 10%;"></td> <td style="width: 10%;"></td> <td style="width: 10%;"></td> <td style="width: 10%;"></td> <td style="width: 10%;"></td> <td style="width: 10%;"></td> <td style="width: 10%;"></td> <td style="width: 10%;"></td> <td style="width: 10%;"></td> <td style="width: 10%;"></td> </tr> <tr> <td></td> <td></td> <td colspan="8" style="text-align: center;"> <table border="1" style="width: 100%; border-collapse: collapse; text-align: center;"> <tr> <td style="width: 10%;"></td> <td style="width: 10%;"></td> <td style="width: 10%;"></td> <td style="width: 10%;"></td> <td style="width: 10%;"></td> <td style="width: 10%;"></td> <td style="width: 10%;"></td> <td style="width: 10%;"></td> <td style="width: 10%;"></td> <td style="width: 10%;"></td> </tr> <tr> <td></td> <td></td> <td colspan="8" style="text-align: center;"> <table border="1" style="width: 100%; border-collapse: collapse; text-align: center;"> <tr> <td style="width: 10%;"></td> <td style="width: 10%;"></td> <td style="width: 10%;"></td> <td style="width: 10%;"></td> <td style="width: 10%;"></td> <td style="width: 10%;"></td> <td style="width: 10%;"></td> <td style="width: 10%;"></td> <td style="width: 10%;"></td> <td style="width: 10%;"></td> </tr> <tr> <td></td> <td></td> <td colspan="8" style="text-align: center;"> <table border="1" style="width: 100%; border-collapse: collapse; text-align: center;"> <tr> <td style="width: 10%;"></td> <td style="width: 10%;"></td> <td style="width: 10%;"></td> <td style="width: 10%;"></td> <td style="width: 10%;"></td> <td style="width: 10%;"></td> <td style="width: 10%;"></td> <td style="width: 10%;"></td> <td style="width: 10%;"></td> <td style="width: 10%;"></td>
</tr> <tr> <td></td> <td></td> <td colspan="8" style="text-align: center;"> <table border="1" style="width: 100%; border-collapse: collapse; text-align: center;"> <tr> <td style="width: 10%;"></td> <td style="width: 10%;"></td> <td style="width: 10%;"></td> <td style="width: 10%;"></td> <td style="width: 10%;"></td> <td style="width: 10%;"></td> <td style="width: 10%;"></td> <td style="width: 10%;"></td> <td style="width: 10%;"></td> <td style="width: 10%;"></td> </tr> <tr> <td></td> <td></td> <td colspan="8" style="text-align: center;"> <table border="1" style="width: 100%; border-collapse: collapse; text-align: center;"> <tr> <td style="width: 10%;"></td> <td style="width: 10%;"></td> <td style="width: 10%;"></td> <td style="width: 10%;"></td> <td style="width: 10%;"></td> <td style="width: 10%;"></td> <td style="width: 10%;"></td> <td style="width: 10%;"></td> <td style="width: 10%;"></td> <td style="width: 10%;"></td> </tr> <tr> <td></td> <td></td> <td colspan="8" style="text-align: center;"> <table border="1" style="width: 100%; border-collapse: collapse; text-align: center;"> <tr> <td style="width: 10%;"></td> <td style="width: 10%;"></td> <td style="width: 10%;"></td> <td style="width: 10%;"></td> <td style="width: 10%;"></td> <td style="width: 10%;"></td> <td style="width: 10%;"></td> <td style="width: 10%;"></td> <td style="width: 10%;"></td> <td style="width: 10%;"></td> </tr> <tr> <td></td> <td></td> <td colspan="8" style="text-align: center;"> <table border="1" style="width: 100%; border-collapse: collapse; text-align: center;"> <tr> <td style="width: 10%;"></td> <td style="width: 10%;"></td> <td style="width: 10%;"></td> <td style="width: 10%;"></td> <td style="width: 10%;"></td> <td style="width: 10%;"></td> <td style="width: 10%;"></td> <td style="width: 10%;"></td> <td style="width: 10%;"></td> <td style="width: 10%;"></td> </tr> <tr> <td></td> <td></td> <td colspan="8" style="text-align: center;"> <table border="1" style="width: 100%; border-collapse: collapse; text-align: center;"> <tr> <td style="width: 10%;"></td> <td style="width: 10%;"></td> <td style="width: 10%;"></td> <td style="width: 10%;"></td> <td style="width: 10%;"></td> <td style="width: 10%;"></td> <td style="width: 10%;"></td> <td style="width: 10%;"></td> <td style="width: 10%;"></td> <td style="width: 10%;"></td> </tr> <tr> <td></td> <td></td> <td colspan="8" style="text-align: center;"> <table border="1" style="width: 100%; border-collapse: collapse; text-align: center;"> <tr> <td style="width: 10%;"></td> <td style="width: 10%;"></td> <td style="width: 10%;"></td> <td style="width: 10%;"></td> <td style="width: 10%;"></td> <td style="width: 10%;"></td> <td style="width: 10%;"></td> <td style="width: 10%;"></td> <td style="width: 10%;"></td> <td style="width: 10%;"></td> </tr> <tr> <td></td> <td></td> <td colspan="8" style="text-align: center;"> <table border="1" style="width: 100%; border-collapse: collapse; text-align: center;"> <tr> <td style="width: 10%;"></td> <td style="width: 10%;"></td> <td style="width: 10%;"></td> <td style="width: 10%;"></td> <td style="width: 10%;"></td> <td style="width: 10%;"></td> <td style="width: 10%;"></td> <td style="width: 10%;"></td> <td style="width: 10%;"></td> <td style="width: 10%;"></td> </tr> <tr> <td></td> <td></td> <td colspan="8" style="text-align: center;"> <table border="1" style="width: 100%; border-collapse: collapse; text-align: center;"> <tr> <td style="width: 10%;"></td> <td style="width: 10%;"></td> <td style="width: 10%;"></td> <td style="width: 10%;"></td> <td style="width: 10%;"></td> <td style="width: 10%;"></td> <td style="width: 10%;"></td> <td style="width: 10%;"></td> <td style="width: 10%;"></td> <td style="width: 10%;"></td> </tr> <tr> <td></td> <td></td> <td colspan="8" style="text-align: center;"> <table border="1" style="width: 100%; border-collapse: collapse; text-align: center;"> <tr> <td style="width: 10%;"></td> <td style="width: 10%;"></td> <td style="width: 10%;"></td> <td style="width: 10%;"></td> <td style="width: 10%;"></td> <td style="width: 10%;"></td> <td style="width: 10%;"></td> <td style="width: 10%;"></td> <td style="width: 10%;"></td> <td style="width: 10%;"></td> </tr> <tr> <td></td> <td></td> <td colspan="8" style="text-align: center;"> <table border="1" style="width: 100%; border-collapse: collapse; text-align: center;"> <tr> <td style="width: 10%;"></td> <td style="width: 10%;"></td> <td style="width: 10%;"></td> <td style="width: 10%;"></td> <td style="width: 10%;"></td> <td style="width: 10%;"></td> <td style="width: 10%;"></td> <td style="width: 10%;"></td> <td style="width: 10%;"></td> <td style="width: 10%;"></td> </tr> <tr> <td></td> <td></td> <td colspan="8" style="text-align: center;"> <table border="1" style="width: 100%; border-collapse: collapse; text-align: center;"> <tr> <td style="width: 10%;"></td> <td style="width: 10%;"></td> <td style="width: 10%;"></td> <td style="width: 10%;"></td> <td style="width: 10%;"></td> <td style="width: 10%;"></td> <td style="width: 10%;"></td> <td style="width: 10%;"></td> <td style="width: 10%;"></td> <td style="width: 10%;"></td> </tr> <tr> <td></td> <td></td> <td colspan="8" style="text-align: center;"> <table border="1" style="width: 100%; border-collapse: collapse; text-align: center;"> <tr> <td style="width: 10%;"></td> <td style="width: 10%;"></td> <td style="width: 10%;"></td> <td style="width: 10%;"></td> <td style="width: 10%;"></td> <td style="width: 10%;"></td> <td style="width: 10%;"></td> <td style="width: 10%;"></td> <td style="width: 10%;"></td> <td style="width: 10%;"></td> </tr> <tr> <td></td> <td></td> <td colspan="8" style="text-align: center;"> <table border="1" style="width: 100%; border-collapse: collapse; text-align: center;"> <tr> <td style="width: 10%;"></td> <td style="width: 10%;"></td> <td style="width: 10%;"></td> <td style="width: 10%;"></td> <td style="width: 10%;"></td> <td style="width: 10%;"></td> <td style="width: 10%;"></td> <td style="width: 10%;"></td> <td style="width: 10%;"></td> <td style="width: 10%;"></td> </tr> <tr> <td></td> <td></td> <td colspan="8" style="text-align: center;"> <table border="1" style="width: 100%; border-collapse: collapse; text-align: center;"> <tr> <td style="width: 10%;"></td> <td style="width: 10%;"></td> <td style="width: 10%;"></td> <td style="width: 10%;"></td> <td style="width: 10%;"></td> <td style="width: 10%;"></td> <td style="width: 10%;"></td> <td style="width: 10%;"></td> <td style="width: 10%;"></td> <td style="width: 10%;"></td> </tr> <tr> <td></td> <td></td> <td colspan="8" style="text-align: center;"> <table border="1" style="width: 100%; border-collapse: collapse; text-align: center;"> <tr> <td style="width: 10%;"></td> <td style="width: 10%;"></td> <td style="width: 10%;"></td> <td style="width: 10%;"></td> <td style="width: 10%;"></td> <td style="width: 10%;"></td> <td style="width: 10%;"></td> <td style="width: 10%;"></td> <td style="width: 10%;"></td> <td style="width: 10%;"></td> </tr> <tr> <td></td> <td></td> <td colspan="8" style="text-align: center;"> <table border="1" style="width: 100%; border-collapse: collapse; text-align: center;"> <tr> <td style="width: 10%;"></td> <td style="width: 10%;"></td> <td style="width: 10%;"></td> <td style="width: 10%;"></td> <td style="width: 10%;"></td> <td style="width: 10%;"></td> <td style="width: 10%;"></td> <td style="width: 10%;"></td> <td style="width: 10%;"></td> <td style="width: 10%;"></td> </tr> <tr> <td></td> <td></td> <td colspan="8" style="text-align: center;"> <table border="1" style="width: 100%; border-collapse: collapse; text-align: center;"> <tr> <td style="width: 10%;"></td> <td style="width: 10%;"></td> <td style="width: 10%;"></td> <td style="width: 10%;"></td> <td style="width: 10%;"></td> <td style="width: 10%;"></td> <td style="width: 10%;"></td> <td style="width: 10%;"></td> <td style="width: 10%;"></td> <td style="width: 10%;"></td> </tr> <tr> <td></td> <td></td> <td colspan="8" style="text-align: center;"> <table border="1" style="width: 100%; border-collapse: collapse; text-align: center;"> <tr> <td style="width: 10%;"></td> <td style="width: 10%;"></td> <td style="width: 10%;"></td> <td style="width: 10%;"></td> <td style="width: 10%;"></td> <td style="width: 10%;"></td> <td style="width: 10%;"></td> <td style="width: 10%;"></td> <td style="width: 10%;"></td> <td style="width: 10%;"></td> </tr> <tr> <td></td> <td></td> <td colspan="8" style="text-align: center;"> <table border="1" style="width: 100%; border-collapse: collapse; text-align: center;"> <tr> <td style="width: 10%;"></td> <td style="width: 10%;"></td> <td style="width: 10%;"></td> <td style="width: 10%;"></td> <td style="width: 10%;"></td> <td style="width: 10%;"></td> <td style="width: 10%;"></td> <td style="width: 10%;"></td> <td style="width: 10%;"></td> <td style="width: 10%;"></td> </tr> <tr> <td></td> <td></td> <td colspan="8" style="text-align: center;"> <table border="1" style="width: 100%; border-collapse: collapse; text-align: center;"> <tr> <td style="width: 10%;"></td> <td style="width: 10%;"></td> <td style="width: 10%;"></td> <td style="width: 10%;"></td> <td style="width: 10%;"></td> <td style="width: 10%;"></td> <td style="width: 10%;"></td> <td style="width: 10%;"></td> <td style="width: 10%;"></td> <td style="width: 10%;"></td> </tr> <tr> <td></td> <td></td> <td colspan="8" style="text-align: center;"> <table border="1" style="width: 100%; border-collapse: collapse; text-align: center;"> <tr> <td style="width: 10%;"></td> <td style="width: 10%;"></td> <td style="width: 10%;"></td> <td style="width: 10%;"></td> <td style="width: 10%;"></td> <td style="width: 10%;"></td> <td style="width: 10%;"></td> <td style="width: 10%;"></td> <td style="width: 10%;"></td> <td style="width: 10%;"></td> </tr> <tr> <td></td> <td></td> <td colspan="8" style="text-align: center;"> <table border="1" style="width: 100%; border-collapse: collapse; text-align: center;"> <tr> <td
style="width: 10%;"></td> <td style="width: 10%;"></td> <td style="width: 10%;"></td> <td style="width: 10%;"></td> <td style="width: 10%;"></td> <td style="width: 10%;"></td> <td style="width: 10%;"></td> <td style="width: 10%;"></td> <td style="width: 10%;"></td> <td style="width: 10%;"></td> </tr> <tr> <td></td> <td></td> <td colspan="8" style="text-align: center;"> <table border="1" style="width: 100%; border-collapse: collapse; text-align: center;"> <tr> <td style="width: 10%;"></td> <td style="width: 10%;"></td> <td style="width: 10%;"></td> <td style="width: 10%;"></td> <td style="width: 10%;"></td> <td style="width: 10%;"></td> <td style="width: 10%;"></td> <td style="width: 10%;"></td> <td style="width: 10%;"></td> <td style="width: 10%;"></td> </tr> <tr> <td></td> <td></td> <td colspan="8" style="text-align: center;"> <table border="1" style="width: 100%; border-collapse: collapse; text-align: center;"> <tr> <td style="width: 10%;"></td> <td style="width: 10%;"></td> <td style="width: 10%;"></td> <td style="width: 10%;"></td> <td style="width: 10%;"></td> <td style="width: 10%;"></td> <td style="width: 10%;"></td> <td style="width: 10%;"></td> <td style="width: 10%;"></td> <td style="width: 10%;"></td> </tr> <tr> <td></td> <td></td> <td colspan="8" style="text-align: center;"> <table border="1" style="width: 100%; border-collapse: collapse; text-align: center;"> <tr> <td style="width: 10%;"></td> <td style="width: 10%;"></td> <td style="width: 10%;"></td> <td style="width: 10%;"></td> <td style="width: 10%;"></td> <td style="width: 10%;"></td> <td style="width: 10%;"></td> <td style="width: 10%;"></td> <td style="width: 10%;"></td> <td style="width: 10%;"></td> </tr> <tr> <td></td> <td></td> <td colspan="8" style="text-align: center;"> <table border="1" style="width: 100%; border-collapse: collapse; text-align: center;"> <tr> <td style="width: 10%;"></td> <td style="width: 10%;"></td> <td style="width: 10%;"></td> <td style="width: 10%;"></td> <td style="width: 10%;"></td> <td style="width: 10%;"></td> <td style="width: 10%;"></td> <td style="width: 10%;"></td> <td style="width: 10%;"></td> <td style="width: 10%;"></td> </tr> <tr> <td></td> <td></td> <td colspan="8" style="text-align: center;"> <table border="1" style="width: 100%; border-collapse: collapse; text-align: center;"> <tr> <td style="width: 10%;"></td> <td style="width: 10%;"></td> <td style="width: 10%;"></td> <td style="width: 10%;"></td> <td style="width: 10%;"></td> <td style="width: 10%;"></td> <td style="width: 10%;"></td> <td style="width: 10%;"></td> <td style="width: 10%;"></td> <td style="width: 10%;"></td> </tr> <tr> <td></td> <td></td> <td colspan="8" style="text-align: center;"> <table border="1" style="width: 100%; border-collapse: collapse; text-align: center;"> <tr> <td style="width: 10%;"></td> <td style="width: 10%;"></td> <td style="width: 10%;"></td> <td style="width: 10%;"></td> <td style="width: 10%;"></td> <td style="width: 10%;"></td> <td style="width: 10%;"></td> <td style="width: 10%;"></td> <td style="width: 10%;"></td> <td style="width: 10%;"></td> </tr> <tr> <td></td> <td></td> <td colspan="8" style="text-align: center;"> <table border="1" style="width: 100%; border-collapse: collapse; text-align: center;"> <tr> <td style="width: 10%;"></td> <td style="width: 10%;"></td> <td style="width: 10%;"></td> <td style="width: 10%;"></td> <td style="width: 10%;"></td> <td style="width: 10%;"></td> <td style="width: 10%;"></td> <td style="width: 10%;"></td> <td style="width: 10%;"></td> <td style="width: 10%;"></td> </tr> <tr> <td></td> <td></td> <td colspan="8" style="text-align: center;"> <table border="1" style="width: 100%; border-collapse: collapse; text-align: center;"> <tr> <td style="width: 10%;"></td> <td style="width: 10%;"></td> <td style="width: 10%;"></td> <td style="width: 10%;"></td> <td style="width: 10%;"></td> <td style="width: 10%;"></td> <td style="width: 10%;"></td> <td style="width: 10%;"></td> <td style="width: 10%;"></td> <td style="width: 10%;"></td> </tr> <tr> <td></td> <td></td> <td colspan="8" style="text-align: center;"> <table border="1" style="width: 100%; border-collapse: collapse; text-align: center;"> <tr> <td style="width: 10%;"></td> <td style="width: 10%;"></td> <td style="width: 10%;"></td> <td style="width: 10%;"></td> <td style="width: 10%;"></td> <td style="width: 10%;"></td> <td style="width: 10%;"></td> <td style="width: 10%;"></td> <td style="width: 10%;"></td> <td style="width: 10%;"></td> </tr> <tr> <td></td> <td></td> <td colspan="8" style="text-align: center;"> <table border="1" style="width: 100%; border-collapse: collapse; text-align: center;"> <tr> <td style="width: 10%;"></td> <td style="width: 10%;"></td> <td style="width: 10%;"></td> <td style="width: 10%;"></td> <td style="width: 10%;"></td> <td style="width: 10%;"></td> <td style="width: 10%;"></td> <td style="width: 10%;"></td> <td style="width: 10%;"></td> <td style="width: 10%;"></td> </tr> <tr> <td></td> <td></td> <td colspan="8" style="text-align: center;"> <table border="1" style="width: 100%; border-collapse: collapse; text-align: center;"> <tr> <td style="width: 10%;"></td> <td style="width: 10%;"></td> <td style="width: 10%;"></td> <td style="width: 10%;"></td> <td style="width: 10%;"></td> <td style="width: 10%;"></td> <td style="width: 10%;"></td> <td style="width: 10%;"></td> <td style="width: 10%;"></td> <td style="width: 10%;"></td> </tr> <tr> <td></td> <td></td> <td colspan="8" style="text-align: center;"> <table border="1" style="width: 100%; border-collapse: collapse; text-align: center;"> <tr> <td style="width: 10%;"></td> <td style="width: 10%;"></td> <td style="width: 10%;"></td> <td style="width: 10%;"></td> <td style="width: 10%;"></td> <td style="width: 10%;"></td> <td style="width: 10%;"></td> <td style="width: 10%;"></td> <td style="width: 10%;"></td> <td style="width: 10%;"></td> </tr> <tr> <td></td> <td></td> <td colspan="8" style="text-align: center;"> <table border="1" style="width: 100%; border-collapse: collapse; text-align: center;"> <tr> </tr></table></td></tr></table></td></tr></table></td></tr></table></td></tr></table></td></tr></table></td></tr></table></td></tr></table></td></tr></table></td></tr></table></td></tr></table></td></tr></table></td></tr></table></td></tr></table></td></tr></table></td></tr></table></td></tr></table></td></tr></table></td></tr></table></td></tr></table></td></tr></table></td></tr></table></td></tr></table></td></tr></table></td></tr></table></td></tr></table></td></tr></table></td></tr></table></td></tr></table></td></tr></table></td></tr></table></td></tr></table></td></tr></table></td></tr></table></td></tr></table></td></tr></table></td></tr></table></td></tr></table></td></tr></table>
 | | | | | | | | | | | | | | | | | | | | <table border="1" style="width: 100%; border-collapse: collapse; text-align: center;"> <tr> <td style="width: 10%;"></td> <td style="width: 10%;"></td> <td style="width: 10%;"></td> <td style="width: 10%;"></td> <td style="width: 10%;"></td> <td style="width: 10%;"></td> <td style="width: 10%;"></td> <td style="width: 10%;"></td> <td style="width: 10%;"></td> <td style="width: 10%;"></td> </tr> <tr> <td></td> <td></td> <td colspan="8" style="text-align: center;"> <table border="1" style="width: 100%; border-collapse: collapse; text-align: center;"> <tr> <td style="width: 10%;"></td> <td style="width: 10%;"></td> <td style="width: 10%;"></td> <td style="width: 10%;"></td> <td style="width: 10%;"></td> <td style="width: 10%;"></td> <td style="width: 10%;"></td> <td style="width: 10%;"></td> <td style="width: 10%;"></td> <td style="width: 10%;"></td> </tr> <tr> <td></td> <td></td> <td colspan="8" style="text-align: center;"> <table border="1" style="width: 100%; border-collapse: collapse; text-align: center;"> <tr> <td style="width: 10%;"></td> <td style="width: 10%;"></td> <td style="width: 10%;"></td> <td style="width: 10%;"></td> <td style="width: 10%;"></td> <td style="width: 10%;"></td> <td style="width: 10%;"></td> <td style="width: 10%;"></td> <td style="width: 10%;"></td> <td style="width: 10%;"></td> </tr> <tr> <td></td> <td></td> <td colspan="8" style="text-align: center;"> <table border="1" style="width: 100%; border-collapse: collapse; text-align: center;"> <tr> <td style="width: 10%;"></td> <td style="width: 10%;"></td> <td style="width: 10%;"></td> <td style="width: 10%;"></td> <td style="width: 10%;"></td> <td style="width: 10%;"></td> <td style="width: 10%;"></td> <td style="width: 10%;"></td> <td style="width: 10%;"></td> <td style="width: 10%;"></td> </tr> <tr> <td></td> <td></td> <td colspan="8" style="text-align: center;"> <table border="1" style="width: 100%; border-collapse: collapse; text-align: center;"> <tr> <td style="width: 10%;"></td> <td style="width: 10%;"></td> <td style="width: 10%;"></td> <td style="width: 10%;"></td> <td style="width: 10%;"></td> <td style="width: 10%;"></td> <td style="width: 10%;"></td> <td style="width: 10%;"></td> <td style="width: 10%;"></td> <td style="width: 10%;"></td> </tr> <tr> <td></td> <td></td> <td colspan="8" style="text-align: center;"> <table border="1" style="width: 100%; border-collapse: collapse; text-align: center;"> <tr> <td style="width: 10%;"></td> <td style="width: 10%;"></td> <td style="width: 10%;"></td> <td style="width: 10%;"></td> <td style="width: 10%;"></td> <td style="width: 10%;"></td> <td style="width: 10%;"></td> <td style="width: 10%;"></td> <td style="width: 10%;"></td> <td style="width: 10%;"></td> </tr> <tr> <td></td> <td></td> <td colspan="8" style="text-align: center;"> <table border="1" style="width: 100%; border-collapse: collapse; text-align: center;"> <tr> <td style="width: 10%;"></td> <td style="width: 10%;"></td> <td style="width: 10%;"></td> <td style="width: 10%;"></td> <td style="width: 10%;"></td> <td style="width: 10%;"></td> <td style="width: 10%;"></td> <td style="width: 10%;"></td> <td style="width: 10%;"></td> <td style="width: 10%;"></td> </tr> <tr> <td></td> <td></td> <td colspan="8" style="text-align: center;"> <table border="1" style="width: 100%; border-collapse: collapse; text-align: center;"> <tr> <td style="width: 10%;"></td> <td style="width: 10%;"></td> <td style="width: 10%;"></td> <td style="width: 10%;"></td> <td style="width: 10%;"></td> <td style="width: 10%;"></td> <td style="width: 10%;"></td> <td style="width: 10%;"></td> <td style="width: 10%;"></td> <td style="width: 10%;"></td> </tr> <tr> <td></td> <td></td> <td colspan="8" style="text-align: center;"> <table border="1" style="width: 100%; border-collapse: collapse; text-align: center;"> <tr> <td style="width: 10%;"></td> <td style="width: 10%;"></td> <td style="width: 10%;"></td> <td style="width: 10%;"></td> <td style="width: 10%;"></td> <td style="width: 10%;"></td> <td style="width: 10%;"></td> <td style="width: 10%;"></td> <td style="width: 10%;"></td> <td style="width: 10%;"></td> </tr> <tr> <td></td> <td></td> <td colspan="8" style="text-align: center;"> <table border="1" style="width: 100%; border-collapse: collapse; text-align: center;"> <tr> <td style="width: 10%;"></td> <td style="width: 10%;"></td> <td style="width: 10%;"></td> <td style="width: 10%;"></td> <td style="width: 10%;"></td> <td style="width: 10%;"></td> <td style="width: 10%;"></td> <td style="width: 10%;"></td> <td style="width: 10%;"></td> <td style="width: 10%;"></td> </tr> <tr> <td></td> <td></td> <td colspan="8" style="text-align: center;"> <table border="1" style="width: 100%; border-collapse: collapse; text-align: center;"> <tr> <td style="width: 10%;"></td> <td style="width: 10%;"></td> <td style="width: 10%;"></td> <td style="width: 10%;"></td> <td style="width: 10%;"></td> <td style="width: 10%;"></td> <td style="width: 10%;"></td> <td style="width: 10%;"></td> <td style="width: 10%;"></td> <td style="width: 10%;"></td> </tr> <tr> <td></td> <td></td> <td colspan="8" style="text-align: center;"> <table border="1" style="width: 100%; border-collapse: collapse; text-align: center;"> <tr> <td style="width: 10%;"></td> <td style="width: 10%;"></td> <td style="width: 10%;"></td> <td style="width: 10%;"></td> <td style="width: 10%;"></td> <td style="width: 10%;"></td> <td style="width: 10%;"></td> <td style="width: 10%;"></td> <td style="width: 10%;"></td> <td style="width: 10%;"></td> </tr> <tr> <td></td> <td></td> <td colspan="8" style="text-align: center;"> <table border="1" style="width: 100%; border-collapse: collapse; text-align: center;"> <tr> <td style="width: 10%;"></td> <td style="width: 10%;"></td> <td style="width: 10%;"></td> <td style="width: 10%;"></td> <td style="width: 10%;"></td> <td style="width: 10%;"></td> <td style="width: 10%;"></td> <td style="width: 10%;"></td> <td style="width: 10%;"></td> <td style="width: 10%;"></td> </tr> <tr> <td></td> <td></td> <td colspan="8" style="text-align: center;"> <table border="1" style="width: 100%; border-collapse: collapse; text-align: center;"> <tr> <td style="width: 10%;"></td> <td style="width: 10%;"></td> <td style="width: 10%;"></td> <td style="width: 10%;"></td> <td style="width: 10%;"></td> <td style="width: 10%;"></td> <td style="width: 10%;"></td> <td style="width: 10%;"></td> <td style="width: 10%;"></td> <td style="width: 10%;"></td> </tr> <tr> <td></td> <td></td> <td colspan="8" style="text-align: center;"> <table border="1" style="width: 100%; border-collapse: collapse; text-align: center;"> <tr> <td style="width: 10%;"></td> <td style="width: 10%;"></td> <td style="width: 10%;"></td> <td style="width: 10%;"></td> <td style="width: 10%;"></td> <td style="width: 10%;"></td> <td style="width: 10%;"></td> <td style="width: 10%;"></td> <td style="width: 10%;"></td> <td style="width: 10%;"></td> </tr> <tr> <td></td> <td></td> <td colspan="8" style="text-align: center;"> <table border="1" style="width: 100%; border-collapse: collapse; text-align: center;"> <tr> <td style="width: 10%;"></td> <td style="width: 10%;"></td> <td style="width: 10%;"></td> <td style="width: 10%;"></td> <td style="width: 10%;"></td> <td style="width: 10%;"></td> <td style="width: 10%;"></td> <td style="width: 10%;"></td> <td style="width: 10%;"></td> <td style="width: 10%;"></td> </tr> <tr> <td></td> <td></td> <td colspan="8" style="text-align: center;"> <table border="1" style="width: 100%; border-collapse: collapse; text-align: center;"> <tr> <td style="width: 10%;"></td> <td style="width: 10%;"></td> <td style="width: 10%;"></td> <td style="width: 10%;"></td> <td style="width: 10%;"></td> <td style="width: 10%;"></td> <td style="width: 10%;"></td> <td style="width:
10%;"></td> <td style="width: 10%;"></td> <td style="width: 10%;"></td> </tr> <tr> <td></td> <td></td> <td colspan="8" style="text-align: center;"> <table border="1" style="width: 100%; border-collapse: collapse; text-align: center;"> <tr> <td style="width: 10%;"></td> <td style="width: 10%;"></td> <td style="width: 10%;"></td> <td style="width: 10%;"></td> <td style="width: 10%;"></td> <td style="width: 10%;"></td> <td style="width: 10%;"></td> <td style="width: 10%;"></td> <td style="width: 10%;"></td> <td style="width: 10%;"></td> </tr> <tr> <td></td> <td></td> <td colspan="8" style="text-align: center;"> <table border="1" style="width: 100%; border-collapse: collapse; text-align: center;"> <tr> <td style="width: 10%;"></td> <td style="width: 10%;"></td> <td style="width: 10%;"></td> <td style="width: 10%;"></td> <td style="width: 10%;"></td> <td style="width: 10%;"></td> <td style="width: 10%;"></td> <td style="width: 10%;"></td> <td style="width: 10%;"></td> <td style="width: 10%;"></td> </tr> <tr> <td></td> <td></td> <td colspan="8" style="text-align: center;"> <table border="1" style="width: 100%; border-collapse: collapse; text-align: center;"> <tr> <td style="width: 10%;"></td> <td style="width: 10%;"></td> <td style="width: 10%;"></td> <td style="width: 10%;"></td> <td style="width: 10%;"></td> <td style="width: 10%;"></td> <td style="width: 10%;"></td> <td style="width: 10%;"></td> <td style="width: 10%;"></td> <td style="width: 10%;"></td> </tr> <tr> <td></td> <td></td> <td colspan="8" style="text-align: center;"> <table border="1" style="width: 100%; border-collapse: collapse; text-align: center;"> <tr> <td style="width: 10%;"></td> <td style="width: 10%;"></td> <td style="width: 10%;"></td> <td style="width: 10%;"></td> <td style="width: 10%;"></td> <td style="width: 10%;"></td> <td style="width: 10%;"></td> <td style="width: 10%;"></td> <td style="width: 10%;"></td> <td style="width: 10%;"></td> </tr> <tr> <td></td> <td></td> <td colspan="8" style="text-align: center;"> <table border="1" style="width: 100%; border-collapse: collapse; text-align: center;"> <tr> <td style="width: 10%;"></td> <td style="width: 10%;"></td> <td style="width: 10%;"></td> <td style="width: 10%;"></td> <td style="width: 10%;"></td> <td style="width: 10%;"></td> <td style="width: 10%;"></td> <td style="width: 10%;"></td> <td style="width: 10%;"></td> <td style="width: 10%;"></td> </tr> <tr> <td></td> <td></td> <td colspan="8" style="text-align: center;"> <table border="1" style="width: 100%; border-collapse: collapse; text-align: center;"> <tr> <td style="width: 10%;"></td> <td style="width: 10%;"></td> <td style="width: 10%;"></td> <td style="width: 10%;"></td> <td style="width: 10%;"></td> <td style="width: 10%;"></td> <td style="width: 10%;"></td> <td style="width: 10%;"></td> <td style="width: 10%;"></td> <td style="width: 10%;"></td> </tr> <tr> <td></td> <td></td> <td colspan="8" style="text-align: center;"> <table border="1" style="width: 100%; border-collapse: collapse; text-align: center;"> <tr> <td style="width: 10%;"></td> <td style="width: 10%;"></td> <td style="width: 10%;"></td> <td style="width: 10%;"></td> <td style="width: 10%;"></td> <td style="width: 10%;"></td> <td style="width: 10%;"></td> <td style="width: 10%;"></td> <td style="width: 10%;"></td> <td style="width: 10%;"></td> </tr> <tr> <td></td> <td></td> <td colspan="8" style="text-align: center;"> <table border="1" style="width: 100%; border-collapse: collapse; text-align: center;"> <tr> <td style="width: 10%;"></td> <td style="width: 10%;"></td> <td style="width: 10%;"></td> <td style="width: 10%;"></td> <td style="width: 10%;"></td> <td style="width: 10%;"></td> <td style="width: 10%;"></td> <td style="width: 10%;"></td> <td style="width: 10%;"></td> <td style="width: 10%;"></td> </tr> <tr> <td></td> <td></td> <td colspan="8" style="text-align: center;"> <table border="1" style="width: 100%; border-collapse: collapse; text-align: center;"> <tr> <td style="width: 10%;"></td> <td style="width: 10%;"></td> <td style="width: 10%;"></td> <td style="width: 10%;"></td> <td style="width: 10%;"></td> <td style="width: 10%;"></td> <td style="width: 10%;"></td> <td style="width: 10%;"></td> <td style="width: 10%;"></td> <td style="width: 10%;"></td> </tr> <tr> <td></td> <td></td> <td colspan="8" style="text-align: center;"> <table border="1" style="width: 100%; border-collapse: collapse; text-align: center;"> <tr> <td style="width: 10%;"></td> <td style="width: 10%;"></td> <td style="width: 10%;"></td> <td style="width: 10%;"></td> <td style="width: 10%;"></td> <td style="width: 10%;"></td> <td style="width: 10%;"></td> <td style="width: 10%;"></td> <td style="width: 10%;"></td> <td style="width: 10%;"></td> </tr> <tr> <td></td> <td></td> <td colspan="8" style="text-align: center;"> <table border="1" style="width: 100%; border-collapse: collapse; text-align: center;"> <tr> <td style="width: 10%;"></td> <td style="width: 10%;"></td> <td style="width: 10%;"></td> <td style="width: 10%;"></td> <td style="width: 10%;"></td> <td style="width: 10%;"></td> <td style="width: 10%;"></td> <td style="width: 10%;"></td> <td style="width: 10%;"></td> <td style="width: 10%;"></td> </tr> <tr> <td></td> <td></td> <td colspan="8" style="text-align: center;"> <table border="1" style="width: 100%; border-collapse: collapse; text-align: center;"> <tr> <td style="width: 10%;"></td> <td style="width: 10%;"></td> <td style="width: 10%;"></td> <td style="width: 10%;"></td> <td style="width: 10%;"></td> <td style="width: 10%;"></td> <td style="width: 10%;"></td> <td style="width: 10%;"></td> <td style="width: 10%;"></td> <td style="width: 10%;"></td> </tr> <tr> <td></td> <td></td> <td colspan="8" style="text-align: center;"> <table border="1" style="width: 100%; border-collapse: collapse; text-align: center;"> <tr> <td style="width: 10%;"></td> <td style="width: 10%;"></td> <td style="width: 10%;"></td> <td style="width: 10%;"></td> <td style="width: 10%;"></td> <td style="width: 10%;"></td> <td style="width: 10%;"></td> <td style="width: 10%;"></td> <td style="width: 10%;"></td> <td style="width: 10%;"></td> </tr> <tr> <td></td> <td></td> <td colspan="8" style="text-align: center;"> <table border="1" style="width: 100%; border-collapse: collapse; text-align: center;"> <tr> <td style="width: 10%;"></td> <td style="width: 10%;"></td> <td style="width: 10%;"></td> <td style="width: 10%;"></td> <td style="width: 10%;"></td> <td style="width: 10%;"></td> <td style="width: 10%;"></td> <td style="width: 10%;"></td> <td style="width: 10%;"></td> <td style="width: 10%;"></td> </tr> <tr> <td></td> <td></td> <td colspan="8" style="text-align: center;"> <table border="1" style="width: 100%; border-collapse: collapse; text-align: center;"> <tr> <td style="width: 10%;"></td> <td style="width: 10%;"></td> <td style="width: 10%;"></td> <td style="width: 10%;"></td> <td style="width: 10%;"></td> <td style="width: 10%;"></td> <td style="width: 10%;"></td> <td style="width: 10%;"></td> <td style="width: 10%;"></td> <td style="width: 10%;"></td> </tr> <tr> <td></td> <td></td> <td colspan="8" style="text-align: center;"> <table border="1" style="width: 100%; border-collapse: collapse; text-align: center;"> <tr> <td style="width: 10%;"></td> <td style="width: 10%;"></td> <td style="width: 10%;"></td> <td style="width: 10%;"></td> <td style="width: 10%;"></td> <td style="width: 10%;"></td> <td style="width: 10%;"></td> <td style="width: 10%;"></td> <td style="width: 10%;"></td> <td style="width: 10%;"></td> </tr> <tr> <td></td> <td></td> <td colspan="8" style="text-align: center;"> <table border="1" style="width: 100%; border-collapse: collapse; text-align: center;"> <tr> <td style="width: 10%;"></td> <td style="width: 10%;"></td> <td style="width: 10%;"></td> <td style="width: 10%;"></td> <td style="width: 10%;"></td> <td style="width: 10%;"></td> <td style="width: 10%;"></td> <td style="width: 10%;"></td> <td style="width: 10%;"></td> <td style="width: 10%;"></td> </tr> <tr> <td></td> <td></td> <td colspan="8" style="text-align: center;"> <table border="1" style="width: 100%; border-collapse: collapse; text-align: center;"> <tr> <td style="width: 10%;"></td> <td style="width: 10%;"></td> <td style="width: 10%;"></td> <td style="width: 10%;"></td> <td style="width: 10%;"></td> <td style="width: 10%;"></td> <td style="width: 10%;"></td> <td style="width: 10%;"></td> <td style="width: 10%;"></td> <td style="width: 10%;"></td> </tr> <tr> <td></td> <td></td> <td colspan="8" style="text-align: center;"> <table border="1" style="width: 100%; border-collapse: collapse; text-align: center;"> <tr> <td style="width: 10%;"></td> <td style="width: 10%;"></td> <td style="width: 10%;"></td> <td style="width: 10%;"></td> <td style="width: 10%;"></td> <td style="width: 10%;"></td> <td style="width: 10%;"></td> <td style="width: 10%;"></td> <td style="width: 10%;"></td> <td style="width: 10%;"></td> </tr> <tr> <td></td> <td></td> <td colspan="8" style="text-align: center;"> <table border="1" style="width: 100%; border-collapse: collapse; text-align: center;"> <tr> <td style="width: 10%;"></td> <td style="width: 10%;"></td> <td style="width: 10%;"></td> <td style="width: 10%;"></td> <td style="width: 10%;"></td> <td style="width: 10%;"></td> <td style="width: 10%;"></td> <td style="width: 10%;"></td> <td style="width: 10%;"></td> <td style="width: 10%;"></td> </tr> <tr> <td></td> <td></td> <td colspan="8" style="text-align: center;"> <table border="1" style="width: 100%; border-collapse: collapse; text-align: center;"> <tr>
</tr></table></td></tr></table></td></tr></table></td></tr></table></td></tr></table></td></tr></table></td></tr></table></td></tr></table></td></tr></table></td></tr></table></td></tr></table></td></tr></table></td></tr></table></td></tr></table></td></tr></table></td></tr></table></td></tr></table></td></tr></table></td></tr></table></td></tr></table></td></tr></table></td></tr></table></td></tr></table></td></tr></table></td></tr></table></td></tr></table></td></tr></table></td></tr></table></td></tr></table></td></tr></table></td></tr></table></td></tr></table></td></tr></table></td></tr></table></td></tr></table></td></tr></table></td></tr></table></td></tr></table> | | | | | | | | | | | | | | | | | | | | <table border="1" style="width: 100%; border-collapse: collapse; text-align: center;"> <tr> <td style="width: 10%;"></td> <td style="width: 10%;"></td> <td style="width: 10%;"></td> <td style="width: 10%;"></td> <td style="width: 10%;"></td> <td style="width: 10%;"></td> <td style="width: 10%;"></td> <td style="width: 10%;"></td> <td style="width: 10%;"></td> <td style="width: 10%;"></td> </tr> <tr> <td></td> <td></td> <td colspan="8" style="text-align: center;"> <table border="1" style="width: 100%; border-collapse: collapse; text-align: center;"> <tr> <td style="width: 10%;"></td> <td style="width: 10%;"></td> <td style="width: 10%;"></td> <td style="width: 10%;"></td> <td style="width: 10%;"></td> <td style="width: 10%;"></td> <td style="width: 10%;"></td> <td style="width: 10%;"></td> <td style="width: 10%;"></td> <td style="width: 10%;"></td> </tr> <tr> <td></td> <td></td> <td colspan="8" style="text-align: center;"> <table border="1" style="width: 100%; border-collapse: collapse; text-align: center;"> <tr> <td style="width: 10%;"></td> <td style="width: 10%;"></td> <td style="width: 10%;"></td> <td style="width: 10%;"></td> <td style="width: 10%;"></td> <td style="width: 10%;"></td> <td style="width: 10%;"></td> <td style="width: 10%;"></td> <td style="width: 10%;"></td> <td style="width: 10%;"></td> </tr> <tr> <td></td> <td></td> <td colspan="8" style="text-align: center;"> <table border="1" style="width: 100%; border-collapse: collapse; text-align: center;"> <tr> <td style="width: 10%;"></td> <td style="width: 10%;"></td> <td style="width: 10%;"></td> <td style="width: 10%;"></td> <td style="width: 10%;"></td> <td style="width: 10%;"></td> <td style="width: 10%;"></td> <td style="width: 10%;"></td> <td style="width: 10%;"></td> <td style="width: 10%;"></td> </tr> <tr> <td></td> <td></td> <td colspan="8" style="text-align: center;"> <table border="1" style="width: 100%; border-collapse: collapse; text-align: center;"> <tr> <td style="width: 10%;"></td> <td style="width: 10%;"></td> <td style="width: 10%;"></td> <td style="width: 10%;"></td> <td style="width: 10%;"></td> <td style="width: 10%;"></td> <td style="width: 10%;"></td> <td style="width: 10%;"></td> <td style="width: 10%;"></td> <td style="width: 10%;"></td> </tr> <tr> <td></td> <td></td> <td colspan="8" style="text-align: center;"> <table border="1" style="width: 100%; border-collapse: collapse; text-align: center;"> <tr> <td style="width: 10%;"></td> <td style="width: 10%;"></td> <td style="width: 10%;"></td> <td style="width: 10%;"></td> <td style="width: 10%;"></td> <td style="width: 10%;"></td> <td style="width: 10%;"></td> <td style="width: 10%;"></td> <td style="width: 10%;"></td> <td style="width: 10%;"></td> </tr> <tr> <td></td> <td></td> <td colspan="8" style="text-align: center;"> <table border="1" style="width: 100%; border-collapse: collapse; text-align: center;"> <tr> <td style="width: 10%;"></td> <td style="width: 10%;"></td> <td style="width: 10%;"></td> <td style="width: 10%;"></td> <td style="width: 10%;"></td> <td style="width: 10%;"></td> <td style="width: 10%;"></td> <td style="width: 10%;"></td> <td style="width: 10%;"></td> <td style="width: 10%;"></td> </tr> <tr> <td></td> <td></td> <td colspan="8" style="text-align: center;"> <table border="1" style="width: 100%; border-collapse: collapse; text-align: center;"> <tr> <td style="width: 10%;"></td> <td style="width: 10%;"></td> <td style="width: 10%;"></td> <td style="width: 10%;"></td> <td style="width: 10%;"></td> <td style="width: 10%;"></td> <td style="width: 10%;"></td> <td style="width: 10%;"></td> <td style="width: 10%;"></td> <td style="width: 10%;"></td> </tr> <tr> <td></td> <td></td> <td colspan="8" style="text-align: center;"> <table border="1" style="width: 100%; border-collapse: collapse; text-align: center;"> <tr> <td style="width: 10%;"></td> <td style="width: 10%;"></td> <td style="width:
10%;"></td> <td style="width: 10%;"></td> <td style="width: 10%;"></td> <td style="width: 10%;"></td> <td style="width: 10%;"></td> <td style="width: 10%;"></td> <td style="width: 10%;"></td> <td style="width: 10%;"></td> </tr> <tr> <td></td> <td></td> <td colspan="8" style="text-align: center;"> <table border="1" style="width: 100%; border-collapse: collapse; text-align: center;"> <tr> <td style="width: 10%;"></td> <td style="width: 10%;"></td> <td style="width: 10%;"></td> <td style="width: 10%;"></td> <td style="width: 10%;"></td> <td style="width: 10%;"></td> <td style="width: 10%;"></td> <td style="width: 10%;"></td> <td style="width: 10%;"></td> <td style="width: 10%;"></td> </tr> <tr> <td></td> <td></td> <td colspan="8" style="text-align: center;"> <table border="1" style="width: 100%; border-collapse: collapse; text-align: center;"> <tr> <td style="width: 10%;"></td> <td style="width: 10%;"></td> <td style="width: 10%;"></td> <td style="width: 10%;"></td> <td style="width: 10%;"></td> <td style="width: 10%;"></td> <td style="width: 10%;"></td> <td style="width: 10%;"></td> <td style="width: 10%;"></td> <td style="width: 10%;"></td> </tr> <tr> <td></td> <td></td> <td colspan="8" style="text-align: center;"> <table border="1" style="width: 100%; border-collapse: collapse; text-align: center;"> <tr> <td style="width: 10%;"></td> <td style="width: 10%;"></td> <td style="width: 10%;"></td> <td style="width: 10%;"></td> <td style="width: 10%;"></td> <td style="width: 10%;"></td> <td style="width: 10%;"></td> <td style="width: 10%;"></td> <td style="width: 10%;"></td> <td style="width: 10%;"></td> </tr> <tr> <td></td> <td></td> <td colspan="8" style="text-align: center;"> <table border="1" style="width: 100%; border-collapse: collapse; text-align: center;"> <tr> <td style="width: 10%;"></td> <td style="width: 10%;"></td> <td style="width: 10%;"></td> <td style="width: 10%;"></td> <td style="width: 10%;"></td> <td style="width: 10%;"></td> <td style="width: 10%;"></td> <td style="width: 10%;"></td> <td style="width: 10%;"></td> <td style="width: 10%;"></td> </tr> <tr> <td></td> <td></td> <td colspan="8" style="text-align: center;"> <table border="1" style="width: 100%; border-collapse: collapse; text-align: center;"> <tr> <td style="width: 10%;"></td> <td style="width: 10%;"></td> <td style="width: 10%;"></td> <td style="width: 10%;"></td> <td style="width: 10%;"></td> <td style="width: 10%;"></td> <td style="width: 10%;"></td> <td style="width: 10%;"></td> <td style="width: 10%;"></td> <td style="width: 10%;"></td> </tr> <tr> <td></td> <td></td> <td colspan="8" style="text-align: center;"> <table border="1" style="width: 100%; border-collapse: collapse; text-align: center;"> <tr> <td style="width: 10%;"></td> <td style="width: 10%;"></td> <td style="width: 10%;"></td> <td style="width: 10%;"></td> <td style="width: 10%;"></td> <td style="width: 10%;"></td> <td style="width: 10%;"></td> <td style="width: 10%;"></td> <td style="width: 10%;"></td> <td style="width: 10%;"></td> </tr> <tr> <td></td> <td></td> <td colspan="8" style="text-align: center;"> <table border="1" style="width: 100%; border-collapse: collapse; text-align: center;"> <tr> <td style="width: 10%;"></td> <td style="width: 10%;"></td> <td style="width: 10%;"></td> <td style="width: 10%;"></td> <td style="width: 10%;"></td> <td style="width: 10%;"></td> <td style="width: 10%;"></td> <td style="width: 10%;"></td> <td style="width: 10%;"></td> <td style="width: 10%;"></td> </tr> <tr> <td></td> <td></td> <td colspan="8" style="text-align: center;"> <table border="1" style="width: 100%; border-collapse: collapse; text-align: center;"> <tr> <td style="width: 10%;"></td> <td style="width: 10%;"></td> <td style="width: 10%;"></td> <td style="width: 10%;"></td> <td style="width: 10%;"></td> <td style="width: 10%;"></td> <td style="width: 10%;"></td> <td style="width: 10%;"></td> <td style="width: 10%;"></td> <td style="width: 10%;"></td> </tr> <tr> <td></td> <td></td> <td colspan="8" style="text-align: center;"> <table border="1" style="width: 100%; border-collapse: collapse; text-align: center;"> <tr> <td style="width: 10%;"></td> <td style="width: 10%;"></td> <td style="width: 10%;"></td> <td style="width: 10%;"></td> <td style="width: 10%;"></td> <td style="width: 10%;"></td> <td style="width: 10%;"></td> <td style="width: 10%;"></td> <td style="width: 10%;"></td> <td style="width: 10%;"></td> </tr> <tr> <td></td> <td></td> <td colspan="8" style="text-align: center;"> <table border="1" style="width: 100%; border-collapse: collapse; text-align: center;"> <tr> <td style="width: 10%;"></td> <td style="width: 10%;"></td> <td style="width: 10%;"></td> <td style="width: 10%;"></td> <td style="width: 10%;"></td> <td style="width: 10%;"></td> <td style="width: 10%;"></td> <td style="width: 10%;"></td> <td style="width: 10%;"></td> <td style="width: 10%;"></td> </tr> <tr> <td></td> <td></td> <td colspan="8" style="text-align: center;"> <table border="1" style="width: 100%; border-collapse: collapse; text-align: center;"> <tr> <td style="width: 10%;"></td> <td style="width: 10%;"></td> <td style="width: 10%;"></td> <td style="width: 10%;"></td> <td style="width: 10%;"></td> <td style="width: 10%;"></td> <td style="width: 10%;"></td> <td style="width: 10%;"></td> <td style="width: 10%;"></td> <td style="width: 10%;"></td> </tr> <tr> <td></td> <td></td> <td colspan="8" style="text-align: center;"> <table border="1" style="width: 100%; border-collapse: collapse; text-align: center;"> <tr> <td style="width: 10%;"></td> <td style="width: 10%;"></td> <td style="width: 10%;"></td> <td style="width: 10%;"></td> <td style="width: 10%;"></td> <td style="width: 10%;"></td> <td style="width: 10%;"></td> <td style="width: 10%;"></td> <td style="width: 10%;"></td> <td style="width: 10%;"></td> </tr> <tr> <td></td> <td></td> <td colspan="8" style="text-align: center;"> <table border="1" style="width: 100%; border-collapse: collapse; text-align: center;"> <tr> <td style="width: 10%;"></td> <td style="width: 10%;"></td> <td style="width: 10%;"></td> <td style="width: 10%;"></td> <td style="width: 10%;"></td> <td style="width: 10%;"></td> <td style="width: 10%;"></td> <td style="width: 10%;"></td> <td style="width: 10%;"></td> <td style="width: 10%;"></td> </tr> <tr> <td></td> <td></td> <td colspan="8" style="text-align: center;"> <table border="1" style="width: 100%; border-collapse: collapse; text-align: center;"> <tr> <td style="width: 10%;"></td> <td style="width: 10%;"></td> <td style="width: 10%;"></td> <td style="width: 10%;"></td> <td style="width: 10%;"></td> <td style="width: 10%;"></td> <td style="width: 10%;"></td> <td style="width: 10%;"></td> <td style="width: 10%;"></td> <td style="width: 10%;"></td> </tr> <tr> <td></td> <td></td> <td colspan="8" style="text-align: center;"> <table border="1" style="width: 100%; border-collapse: collapse; text-align: center;"> <tr> <td style="width: 10%;"></td> <td style="width: 10%;"></td> <td style="width: 10%;"></td> <td style="width: 10%;"></td> <td style="width: 10%;"></td> <td style="width: 10%;"></td> <td style="width: 10%;"></td> <td style="width: 10%;"></td> <td style="width: 10%;"></td> <td style="width: 10%;"></td> </tr> <tr> <td></td> <td></td> <td colspan="8" style="text-align: center;"> <table border="1" style="width: 100%; border-collapse: collapse; text-align: center;"> <tr> <td style="width: 10%;"></td> <td style="width: 10%;"></td> <td style="width: 10%;"></td> <td style="width: 10%;"></td> <td style="width: 10%;"></td> <td style="width: 10%;"></td> <td style="width: 10%;"></td> <td style="width: 10%;"></td> <td style="width: 10%;"></td> <td style="width: 10%;"></td> </tr> <tr> <td></td> <td></td> <td colspan="8" style="text-align: center;"> <table border="1" style="width: 100%; border-collapse: collapse; text-align: center;"> <tr> <td style="width: 10%;"></td> <td style="width: 10%;"></td> <td style="width: 10%;"></td> <td style="width: 10%;"></td> <td style="width: 10%;"></td> <td style="width: 10%;"></td> <td style="width: 10%;"></td> <td style="width: 10%;"></td> <td style="width: 10%;"></td> <td style="width: 10%;"></td> </tr> <tr> <td></td> <td></td> <td colspan="8" style="text-align: center;"> <table border="1" style="width: 100%; border-collapse: collapse; text-align: center;"> <tr> <td style="width: 10%;"></td> <td style="width: 10%;"></td> <td style="width: 10%;"></td> <td style="width: 10%;"></td> <td style="width: 10%;"></td> <td style="width: 10%;"></td> <td style="width: 10%;"></td> <td style="width: 10%;"></td> <td style="width: 10%;"></td> <td style="width: 10%;"></td> </tr> <tr> <td></td> <td></td> <td colspan="8" style="text-align: center;"> <table border="1" style="width: 100%; border-collapse: collapse; text-align: center;"> <tr> <td style="width: 10%;"></td> <td style="width: 10%;"></td> <td style="width: 10%;"></td> <td style="width: 10%;"></td> <td style="width: 10%;"></td> <td style="width: 10%;"></td> <td style="width: 10%;"></td> <td style="width: 10%;"></td> <td style="width: 10%;"></td> <td style="width: 10%;"></td> </tr> <tr> <td></td> <td></td> <td colspan="8" style="text-align: center;"> <table border="1" style="width: 100%; border-collapse: collapse; text-align: center;"> <tr> <td style="width: 10%;"></td> <td style="width: 10%;"></td> <td style="width: 10%;"></td> <td style="width: 10%;"></td> <td style="width: 10%;"></td> <td style="width: 10%;"></td> <td style="width: 10%;"></td> <td style="width: 10%;"></td> <td style="width: 10%;"></td> <td style="width: 10%;"></td> </tr> <tr> <td></td> <td></td> <td colspan="8" style="text-align: center;"> <table border="1" style="width: 100%; border-collapse: collapse; text-align: center;"> <tr> <td style="width: 10%;"></td> <td style="width: 10%;"></td> <td style="width: 10%;"></td> <td style="width: 10%;"></td> <td style="width: 10%;"></td> <td style="width: 10%;"></td> <td style="width: 10%;"></td> <td style="width: 10%;"></td> <td
style="width: 10%;"></td> <td style="width: 10%;"></td> </tr> <tr> <td></td> <td></td> <td colspan="8" style="text-align: center;"> <table border="1" style="width: 100%; border-collapse: collapse; text-align: center;"> <tr> <td style="width: 10%;"></td> <td style="width: 10%;"></td> <td style="width: 10%;"></td> <td style="width: 10%;"></td> <td style="width: 10%;"></td> <td style="width: 10%;"></td> <td style="width: 10%;"></td> <td style="width: 10%;"></td> <td style="width: 10%;"></td> <td style="width: 10%;"></td> </tr> <tr> <td></td> <td></td> <td colspan="8" style="text-align: center;"> <table border="1" style="width: 100%; border-collapse: collapse; text-align: center;"> <tr> <td style="width: 10%;"></td> <td style="width: 10%;"></td> <td style="width: 10%;"></td> <td style="width: 10%;"></td> <td style="width: 10%;"></td> <td style="width: 10%;"></td> <td style="width: 10%;"></td> <td style="width: 10%;"></td> <td style="width: 10%;"></td> <td style="width: 10%;"></td> </tr> <tr> <td></td> <td></td> <td colspan="8" style="text-align: center;"> <table border="1" style="width: 100%; border-collapse: collapse; text-align: center;"> <tr> <td style="width: 10%;"></td> <td style="width: 10%;"></td> <td style="width: 10%;"></td> <td style="width: 10%;"></td> <td style="width: 10%;"></td> <td style="width: 10%;"></td> <td style="width: 10%;"></td> <td style="width: 10%;"></td> <td style="width: 10%;"></td> <td style="width: 10%;"></td> </tr> <tr> <td></td> <td></td> <td colspan="8" style="text-align: center;"> <table border="1" style="width: 100%; border-collapse: collapse; text-align: center;"> <tr> <td style="width: 10%;"></td> <td style="width: 10%;"></td> <td style="width: 10%;"></td> <td style="width: 10%;"></td> <td style="width: 10%;"></td> <td style="width: 10%;"></td> <td style="width: 10%;"></td> <td style="width: 10%;"></td> <td style="width: 10%;"></td> <td style="width: 10%;"></td> </tr> <tr> <td></td> <td></td> <td colspan="8" style="text-align: center;"> <table border="1" style="width: 100%; border-collapse: collapse; text-align: center;"> <tr> <td style="width: 10%;"></td> <td style="width: 10%;"></td> <td style="width: 10%;"></td> <td style="width: 10%;"></td> <td style="width: 10%;"></td> <td style="width: 10%;"></td> <td style="width: 10%;"></td> <td style="width: 10%;"></td> <td style="width: 10%;"></td> <td style="width: 10%;"></td> </tr> <tr> <td></td> <td></td> <td colspan="8" style="text-align: center;"> <table border="1" style="width: 100%; border-collapse: collapse; text-align: center;"> <tr> <td style="width: 10%;"></td> <td style="width: 10%;"></td> <td style="width: 10%;"></td> <td style="width: 10%;"></td> <td style="width: 10%;"></td> <td style="width: 10%;"></td> <td style="width: 10%;"></td> <td style="width: 10%;"></td> <td style="width: 10%;"></td> <td style="width: 10%;"></td> </tr> <tr> <td></td> <td></td> <td colspan="8" style="text-align: center;"> <table border="1" style="width: 100%; border-collapse: collapse; text-align: center;"> <tr> </tr></table></td></tr></table></td></tr></table></td></tr></table></td></tr></table></td></tr></table></td></tr></table></td></tr></table></td></tr></table></td></tr></table></td></tr></table></td></tr></table></td></tr></table></td></tr></table></td></tr></table></td></tr></table></td></tr></table></td></tr></table></td></tr></table></td></tr></table></td></tr></table></td></tr></table></td></tr></table></td></tr></table></td></tr></table></td></tr></table></td></tr></table></td></tr></table></td></tr></table></td></tr></table></td></tr></table></td></tr></table></td></tr></table></td></tr></table></td></tr></table></td></tr></table></td></tr></table> | | | | | | | | | | | | | | | | | | | | <table border="1" style="width: 100%; border-collapse: collapse; text-align: center;"> <tr> <td style="width: 10%;"></td> <td style="width: 10%;"></td> <td style="width: 10%;"></td> <td style="width: 10%;"></td> <td style="width: 10%;"></td> <td style="width: 10%;"></td> <td style="width: 10%;"></td> <td style="width: 10%;"></td> <td style="width: 10%;"></td> <td style="width: 10%;"></td> </tr> <tr> <td></td> <td></td> <td colspan="8" style="text-align: center;"> <table border="1" style="width: 100%; border-collapse: collapse; text-align: center;"> <tr> <td style="width: 10%;"></td> <td style="width: 10%;"></td> <td style="width: 10%;"></td> <td style="width: 10%;"></td> <td style="width: 10%;"></td> <td style="width: 10%;"></td> <td style="width: 10%;"></td> <td style="width: 10%;"></td> <td style="width: 10%;"></td> <td style="width: 10%;"></td> </tr> <tr> <td></td> <td></td> <td
colspan="8" style="text-align: center;"> <table border="1" style="width: 100%; border-collapse: collapse; text-align: center;"> <tr> <td style="width: 10%;"></td> <td style="width: 10%;"></td> <td style="width: 10%;"></td> <td style="width: 10%;"></td> <td style="width: 10%;"></td> <td style="width: 10%;"></td> <td style="width: 10%;"></td> <td style="width: 10%;"></td> <td style="width: 10%;"></td> <td style="width: 10%;"></td> </tr> <tr> <td></td> <td></td> <td colspan="8" style="text-align: center;"> <table border="1" style="width: 100%; border-collapse: collapse; text-align: center;"> <tr> <td style="width: 10%;"></td> <td style="width: 10%;"></td> <td style="width: 10%;"></td> <td style="width: 10%;"></td> <td style="width: 10%;"></td> <td style="width: 10%;"></td> <td style="width: 10%;"></td> <td style="width: 10%;"></td> <td style="width: 10%;"></td> <td style="width: 10%;"></td> </tr> <tr> <td></td> <td></td> <td colspan="8" style="text-align: center;"> <table border="1" style="width: 100%; border-collapse: collapse; text-align: center;"> <tr> <td style="width: 10%;"></td> <td style="width: 10%;"></td> <td style="width: 10%;"></td> <td style="width: 10%;"></td> <td style="width: 10%;"></td> <td style="width: 10%;"></td> <td style="width: 10%;"></td> <td style="width: 10%;"></td> <td style="width: 10%;"></td> <td style="width: 10%;"></td> </tr> <tr> <td></td> <td></td> <td colspan="8" style="text-align: center;"> <table border="1" style="width: 100%; border-collapse: collapse; text-align: center;"> <tr> <td style="width: 10%;"></td> <td style="width: 10%;"></td> <td style="width: 10%;"></td> <td style="width: 10%;"></td> <td style="width: 10%;"></td> <td style="width: 10%;"></td> <td style="width: 10%;"></td> <td style="width: 10%;"></td> <td style="width: 10%;"></td> <td style="width: 10%;"></td> </tr> <tr> <td></td> <td></td> <td colspan="8" style="text-align: center;"> <table border="1" style="width: 100%; border-collapse: collapse; text-align: center;"> <tr> <td style="width: 10%;"></td> <td style="width: 10%;"></td> <td style="width: 10%;"></td> <td style="width: 10%;"></td> <td style="width: 10%;"></td> <td style="width: 10%;"></td> <td style="width: 10%;"></td> <td style="width: 10%;"></td> <td style="width: 10%;"></td> <td style="width: 10%;"></td> </tr> <tr> <td></td> <td></td> <td colspan="8" style="text-align: center;"> <table border="1" style="width: 100%; border-collapse: collapse; text-align: center;"> <tr> <td style="width: 10%;"></td> <td style="width: 10%;"></td> <td style="width: 10%;"></td> <td style="width: 10%;"></td> <td style="width: 10%;"></td> <td style="width: 10%;"></td> <td style="width: 10%;"></td> <td style="width: 10%;"></td> <td style="width: 10%;"></td> <td style="width: 10%;"></td> </tr> <tr> <td></td> <td></td> <td colspan="8" style="text-align: center;"> <table border="1" style="width: 100%; border-collapse: collapse; text-align: center;"> <tr> <td style="width: 10%;"></td> <td style="width: 10%;"></td> <td style="width: 10%;"></td> <td style="width: 10%;"></td> <td style="width: 10%;"></td> <td style="width: 10%;"></td> <td style="width: 10%;"></td> <td style="width: 10%;"></td> <td style="width: 10%;"></td> <td style="width: 10%;"></td> </tr> <tr> <td></td> <td></td> <td colspan="8" style="text-align: center;"> <table border="1" style="width: 100%; border-collapse: collapse; text-align: center;"> <tr> <td style="width: 10%;"></td> <td style="width: 10%;"></td> <td style="width: 10%;"></td> <td style="width: 10%;"></td> <td style="width: 10%;"></td> <td style="width: 10%;"></td> <td style="width: 10%;"></td> <td style="width: 10%;"></td> <td style="width: 10%;"></td> <td style="width: 10%;"></td> </tr> <tr> <td></td> <td></td> <td colspan="8" style="text-align: center;"> <table border="1" style="width: 100%; border-collapse: collapse; text-align: center;"> <tr> <td style="width: 10%;"></td> <td style="width: 10%;"></td> <td style="width: 10%;"></td> <td style="width: 10%;"></td> <td style="width: 10%;"></td> <td style="width: 10%;"></td> <td style="width: 10%;"></td> <td style="width: 10%;"></td> <td style="width: 10%;"></td> <td style="width: 10%;"></td> </tr> <tr> <td></td> <td></td> <td colspan="8" style="text-align: center;"> <table border="1" style="width: 100%; border-collapse: collapse; text-align: center;"> <tr> <td style="width: 10%;"></td> <td style="width: 10%;"></td> <td style="width: 10%;"></td> <td style="width: 10%;"></td> <td style="width: 10%;"></td> <td style="width: 10%;"></td> <td style="width: 10%;"></td> <td style="width: 10%;"></td> <td style="width: 10%;"></td> <td style="width: 10%;"></td> </tr> <tr> <td></td> <td></td> <td colspan="8" style="text-align: center;"> <table border="1" style="width: 100%; border-collapse: collapse; text-align: center;"> <tr> <td style="width: 10%;"></td> <td style="width: 10%;"></td> <td style="width: 10%;"></td> <td style="width: 10%;"></td> <td style="width: 10%;"></td> <td style="width: 10%;"></td> <td style="width: 10%;"></td> <td style="width: 10%;"></td> <td style="width: 10%;"></td> <td style="width: 10%;"></td> </tr> <tr> <td></td> <td></td> <td colspan="8" style="text-align: center;"> <table border="1" style="width: 100%; border-collapse: collapse; text-align: center;"> <tr> <td style="width: 10%;"></td> <td style="width: 10%;"></td> <td style="width: 10%;"></td> <td style="width: 10%;"></td> <td style="width: 10%;"></td> <td style="width: 10%;"></td> <td style="width: 10%;"></td> <td style="width: 10%;"></td> <td style="width: 10%;"></td> <td style="width: 10%;"></td> </tr> <tr> <td></td> <td></td> <td colspan="8" style="text-align: center;"> <table border="1" style="width: 100%; border-collapse: collapse; text-align: center;"> <tr> <td style="width: 10%;"></td> <td style="width: 10%;"></td> <td style="width: 10%;"></td> <td style="width: 10%;"></td> <td style="width: 10%;"></td> <td style="width: 10%;"></td> <td style="width: 10%;"></td> <td style="width: 10%;"></td> <td style="width: 10%;"></td> <td style="width: 10%;"></td> </tr> <tr> <td></td> <td></td> <td colspan="8" style="text-align: center;"> <table border="1" style="width: 100%; border-collapse: collapse; text-align: center;"> <tr> <td style="width: 10%;"></td> <td style="width: 10%;"></td> <td style="width: 10%;"></td> <td style="width: 10%;"></td> <td style="width: 10%;"></td> <td style="width: 10%;"></td> <td style="width: 10%;"></td> <td style="width: 10%;"></td> <td style="width: 10%;"></td> <td style="width: 10%;"></td> </tr> <tr> <td></td> <td></td> <td colspan="8" style="text-align: center;"> <table border="1" style="width: 100%; border-collapse: collapse; text-align: center;"> <tr> <td style="width: 10%;"></td> <td style="width: 10%;"></td> <td style="width: 10%;"></td> <td style="width: 10%;"></td> <td style="width: 10%;"></td> <td style="width: 10%;"></td> <td style="width: 10%;"></td> <td style="width: 10%;"></td> <td style="width: 10%;"></td> <td style="width: 10%;"></td> </tr> <tr> <td></td> <td></td> <td colspan="8" style="text-align: center;"> <table border="1" style="width: 100%; border-collapse: collapse; text-align: center;"> <tr> <td style="width: 10%;"></td> <td style="width: 10%;"></td> <td style="width: 10%;"></td> <td style="width: 10%;"></td> <td style="width: 10%;"></td> <td style="width: 10%;"></td> <td style="width: 10%;"></td> <td style="width: 10%;"></td> <td style="width: 10%;"></td> <td style="width: 10%;"></td> </tr> <tr> <td></td> <td></td> <td colspan="8" style="text-align: center;"> <table border="1" style="width: 100%; border-collapse: collapse; text-align: center;"> <tr> <td style="width: 10%;"></td> <td style="width: 10%;"></td> <td style="width: 10%;"></td> <td style="width: 10%;"></td> <td style="width: 10%;"></td> <td style="width: 10%;"></td> <td style="width: 10%;"></td> <td style="width: 10%;"></td> <td style="width: 10%;"></td> <td style="width: 10%;"></td> </tr> <tr> <td></td> <td></td> <td colspan="8" style="text-align: center;"> <table border="1" style="width: 100%; border-collapse: collapse; text-align: center;"> <tr> <td style="width: 10%;"></td> <td style="width: 10%;"></td> <td style="width: 10%;"></td> <td style="width: 10%;"></td> <td style="width: 10%;"></td> <td style="width: 10%;"></td> <td style="width: 10%;"></td> <td style="width: 10%;"></td> <td style="width: 10%;"></td> <td style="width: 10%;"></td> </tr> <tr> <td></td> <td></td> <td colspan="8" style="text-align: center;"> <table border="1" style="width: 100%; border-collapse: collapse; text-align: center;"> <tr> <td style="width: 10%;"></td> <td style="width: 10%;"></td> <td style="width: 10%;"></td> <td style="width: 10%;"></td> <td style="width: 10%;"></td> <td style="width: 10%;"></td> <td style="width: 10%;"></td> <td style="width: 10%;"></td> <td style="width: 10%;"></td> <td style="width: 10%;"></td> </tr> <tr> <td></td> <td></td> <td colspan="8" style="text-align: center;"> <table border="1" style="width: 100%; border-collapse: collapse; text-align: center;"> <tr> <td style="width: 10%;"></td> <td style="width: 10%;"></td> <td style="width: 10%;"></td> <td style="width: 10%;"></td> <td style="width: 10%;"></td> <td style="width: 10%;"></td> <td style="width: 10%;"></td> <td style="width: 10%;"></td> <td style="width: 10%;"></td> <td style="width: 10%;"></td> </tr> <tr> <td></td> <td></td> <td colspan="8" style="text-align: center;"> <table border="1" style="width: 100%; border-collapse: collapse; text-align: center;"> <tr> <td style="width: 10%;"></td> <td style="width: 10%;"></td> <td style="width: 10%;"></td> <td style="width: 10%;"></td> <td style="width: 10%;"></td> <td style="width: 10%;"></td> <td style="width: 10%;"></td> <td style="width: 10%;"></td> <td style="width: 10%;"></td> <td style="width: 10%;"></td> </tr> <tr> <td></td> <td></td> <td colspan="8" style="text-align: center;"> <table border="1" style="width: 100%; border-collapse: collapse; text-align: center;"> <tr> <td style="width: 10%;"></td> <td
style="width: 10%;"></td> <td style="width: 10%;"></td> <td style="width: 10%;"></td> <td style="width: 10%;"></td> <td style="width: 10%;"></td> <td style="width: 10%;"></td> <td style="width: 10%;"></td> <td style="width: 10%;"></td> <td style="width: 10%;"></td> </tr> <tr> <td></td> <td></td> <td colspan="8" style="text-align: center;"> <table border="1" style="width: 100%; border-collapse: collapse; text-align: center;"> <tr> <td style="width: 10%;"></td> <td style="width: 10%;"></td> <td style="width: 10%;"></td> <td style="width: 10%;"></td> <td style="width: 10%;"></td> <td style="width: 10%;"></td> <td style="width: 10%;"></td> <td style="width: 10%;"></td> <td style="width: 10%;"></td> <td style="width: 10%;"></td> </tr> <tr> <td></td> <td></td> <td colspan="8" style="text-align: center;"> <table border="1" style="width: 100%; border-collapse: collapse; text-align: center;"> <tr> <td style="width: 10%;"></td> <td style="width: 10%;"></td> <td style="width: 10%;"></td> <td style="width: 10%;"></td> <td style="width: 10%;"></td> <td style="width: 10%;"></td> <td style="width: 10%;"></td> <td style="width: 10%;"></td> <td style="width: 10%;"></td> <td style="width: 10%;"></td> </tr> <tr> <td></td> <td></td> <td colspan="8" style="text-align: center;"> <table border="1" style="width: 100%; border-collapse: collapse; text-align: center;"> <tr> <td style="width: 10%;"></td> <td style="width: 10%;"></td> <td style="width: 10%;"></td> <td style="width: 10%;"></td> <td style="width: 10%;"></td> <td style="width: 10%;"></td> <td style="width: 10%;"></td> <td style="width: 10%;"></td> <td style="width: 10%;"></td> <td style="width: 10%;"></td> </tr> <tr> <td></td> <td></td> <td colspan="8" style="text-align: center;"> <table border="1" style="width: 100%; border-collapse: collapse; text-align: center;"> <tr> <td style="width: 10%;"></td> <td style="width: 10%;"></td> <td style="width: 10%;"></td> <td style="width: 10%;"></td> <td style="width: 10%;"></td> <td style="width: 10%;"></td> <td style="width: 10%;"></td> <td style="width: 10%;"></td> <td style="width: 10%;"></td> <td style="width: 10%;"></td> </tr> <tr> <td></td> <td></td> <td colspan="8" style="text-align: center;"> <table border="1" style="width: 100%; border-collapse: collapse; text-align: center;"> <tr> <td style="width: 10%;"></td> <td style="width: 10%;"></td> <td style="width: 10%;"></td> <td style="width: 10%;"></td> <td style="width: 10%;"></td> <td style="width: 10%;"></td> <td style="width: 10%;"></td> <td style="width: 10%;"></td> <td style="width: 10%;"></td> <td style="width: 10%;"></td> </tr> <tr> <td></td> <td></td> <td colspan="8" style="text-align: center;"> <table border="1" style="width: 100%; border-collapse: collapse; text-align: center;"> <tr> <td style="width: 10%;"></td> <td style="width: 10%;"></td> <td style="width: 10%;"></td> <td style="width: 10%;"></td> <td style="width: 10%;"></td> <td style="width: 10%;"></td> <td style="width: 10%;"></td> <td style="width: 10%;"></td> <td style="width: 10%;"></td> <td style="width: 10%;"></td> </tr> <tr> <td></td> <td></td> <td colspan="8" style="text-align: center;"> <table border="1" style="width: 100%; border-collapse: collapse; text-align: center;"> <tr> <td style="width: 10%;"></td> <td style="width: 10%;"></td> <td style="width: 10%;"></td> <td style="width: 10%;"></td> <td style="width: 10%;"></td> <td style="width: 10%;"></td> <td style="width: 10%;"></td> <td style="width: 10%;"></td> <td style="width: 10%;"></td> <td style="width: 10%;"></td> </tr> <tr> <td></td> <td></td> <td colspan="8" style="text-align: center;"> <table border="1" style="width: 100%; border-collapse: collapse; text-align: center;"> <tr> <td style="width: 10%;"></td> <td style="width: 10%;"></td> <td style="width: 10%;"></td> <td style="width: 10%;"></td> <td style="width: 10%;"></td> <td style="width: 10%;"></td> <td style="width: 10%;"></td> <td style="width: 10%;"></td> <td style="width: 10%;"></td> <td style="width: 10%;"></td> </tr> <tr> <td></td> <td></td> <td colspan="8" style="text-align: center;"> <table border="1" style="width: 100%; border-collapse: collapse; text-align: center;"> <tr> <td style="width: 10%;"></td> <td style="width: 10%;"></td> <td style="width: 10%;"></td> <td style="width: 10%;"></td> <td style="width: 10%;"></td> <td style="width: 10%;"></td> <td style="width: 10%;"></td> <td style="width: 10%;"></td> <td style="width: 10%;"></td> <td style="width: 10%;"></td> </tr> <tr> <td></td> <td></td> <td colspan="8" style="text-align: center;"> <table border="1" style="width: 100%; border-collapse: collapse; text-align: center;"> <tr> <td style="width: 10%;"></td> <td style="width: 10%;"></td> <td style="width: 10%;"></td> <td style="width: 10%;"></td> <td style="width: 10%;"></td> <td style="width: 10%;"></td> <td style="width: 10%;"></td> <td style="width: 10%;"></td> <td style="width: 10%;"></td> <td style="width: 10%;"></td> </tr> <tr> <td></td> <td></td> <td colspan="8" style="text-align: center;"> <table border="1" style="width: 100%; border-collapse: collapse; text-align: center;"> <tr> <td style="width: 10%;"></td> <td style="width: 10%;"></td> <td style="width: 10%;"></td> <td style="width: 10%;"></td> <td style="width: 10%;"></td> <td style="width: 10%;"></td> <td style="width: 10%;"></td> <td style="width: 10%;"></td> <td style="width: 10%;"></td> <td style="width: 10%;"></td> </tr> <tr> <td></td> <td></td> <td colspan="8" style="text-align: center;"> <table border="1" style="width: 100%; border-collapse: collapse; text-align: center;"> <tr> </tr></table></td></tr></table></td></tr></table></td></tr></table></td></tr></table></td></tr></table></td></tr></table></td></tr></table></td></tr></table></td></tr></table></td></tr></table></td></tr></table></td></tr></table></td></tr></table></td></tr></table></td></tr></table></td></tr></table></td></tr></table></td></tr></table></td></tr></table></td></tr></table></td></tr></table></td></tr></table></td></tr></table></td></tr></table></td></tr></table></td></tr></table></td></tr></table></td></tr></table></td></tr></table></td></tr></table></td></tr></table></td></tr></table></td></tr></table></td></tr></table></td></tr></table>
 | | | | | | | | | | | | | | | | | | | | <table border="1" style="width: 100%; border-collapse: collapse; text-align: center;"> <tr> <td style="width: 10%;"></td> <td style="width: 10%;"></td> <td style="width: 10%;"></td> <td style="width: 10%;"></td> <td style="width: 10%;"></td> <td style="width: 10%;"></td> <td style="width: 10%;"></td> <td style="width: 10%;"></td> <td style="width: 10%;"></td> <td style="width: 10%;"></td> </tr> <tr> <td></td> <td></td> <td colspan="8" style="text-align: center;"> <table border="1" style="width: 100%; border-collapse: collapse; text-align: center;"> <tr> <td style="width: 10%;"></td> <td style="width: 10%;"></td> <td style="width: 10%;"></td> <td style="width: 10%;"></td> <td style="width: 10%;"></td> <td style="width: 10%;"></td> <td style="width: 10%;"></td> <td style="width: 10%;"></td> <td style="width: 10%;"></td> <td style="width: 10%;"></td> </tr> <tr> <td></td> <td></td> <td colspan="8" style="text-align: center;"> <table border="1" style="width: 100%; border-collapse: collapse; text-align: center;"> <tr> <td style="width: 10%;"></td> <td style="width: 10%;"></td> <td style="width: 10%;"></td> <td style="width: 10%;"></td> <td style="width: 10%;"></td> <td style="width: 10%;"></td> <td style="width: 10%;"></td> <td style="width: 10%;"></td> <td style="width: 10%;"></td> <td style="width: 10%;"></td> </tr> <tr> <td></td> <td></td> <td colspan="8" style="text-align: center;"> <table border="1" style="width: 100%; border-collapse: collapse; text-align: center;"> <tr> <td style="width: 10%;"></td> <td style="width: 10%;"></td> <td style="width: 10%;"></td> <td style="width: 10%;"></td> <td style="width: 10%;"></td> <td style="width: 10%;"></td> <td style="width: 10%;"></td> <td style="width: 10%;"></td> <td style="width: 10%;"></td> <td style="width: 10%;"></td> </tr> <tr> <td></td> <td></td> <td colspan="8" style="text-align: center;"> <table border="1" style="width: 100%; border-collapse: collapse; text-align: center;"> <tr> <td style="width: 10%;"></td> <td style="width: 10%;"></td> <td style="width: 10%;"></td> <td style="width: 10%;"></td> <td style="width: 10%;"></td> <td style="width: 10%;"></td> <td style="width: 10%;"></td> <td style="width: 10%;"></td> <td style="width: 10%;"></td> <td style="width: 10%;"></td> </tr> <tr> <td></td> <td></td> <td colspan="8" style="text-align: center;"> <table border="1" style="width: 100%; border-collapse: collapse; text-align: center;"> <tr> <td style="width: 10%;"></td> <td style="width: 10%;"></td> <td style="width: 10%;"></td> <td style="width: 10%;"></td> <td style="width: 10%;"></td> <td style="width: 10%;"></td> <td style="width: 10%;"></td> <td style="width: 10%;"></td> <td style="width: 10%;"></td> <td style="width: 10%;"></td> </tr> <tr> <td></td> <td></td> <td colspan="8" style="text-align: center;"> <table border="1" style="width: 100%; border-collapse: collapse; text-align: center;"> <tr> <td style="width: 10%;"></td> <td style="width: 10%;"></td> <td style="width: 10%;"></td> <td style="width: 10%;"></td> <td style="width: 10%;"></td> <td style="width: 10%;"></td> <td style="width: 10%;"></td> <td style="width: 10%;"></td> <td style="width: 10%;"></td> <td style="width: 10%;"></td> </tr> <tr> <td></td> <td></td> <td colspan="8" style="text-align: center;"> <table border="1" style="width: 100%; border-collapse: collapse; text-align: center;"> <tr> <td style="width: 10%;"></td> <td style="width: 10%;"></td> <td style="width: 10%;"></td> <td style="width: 10%;"></td> <td style="width: 10%;"></td> <td style="width: 10%;"></td> <td style="width: 10%;"></td> <td style="width: 10%;"></td> <td style="width: 10%;"></td> <td style="width: 10%;"></td> </tr> <tr> <td></td> <td></td> <td colspan="8" style="text-align: center;"> <table border="1" style="width: 100%; border-collapse: collapse; text-align: center;"> <tr> <td style="width: 10%;"></td> <td style="width: 10%;"></td> <td style="width: 10%;"></td> <td style="width: 10%;"></td> <td style="width: 10%;"></td> <td style="width: 10%;"></td> <td style="width: 10%;"></td> <td style="width: 10%;"></td> <td style="width: 10%;"></td> <td style="width: 10%;"></td> </tr> <tr> <td></td> <td></td> <td colspan="8" style="text-align: center;"> <table border="1" style="width: 100%; border-collapse: collapse; text-align: center;"> <tr> <td style="width: 10%;"></td> <td style="width: 10%;"></td> <td style="width: 10%;"></td> <td style="width: 10%;"></td> <td style="width: 10%;"></td> <td style="width: 10%;"></td> <td style="width: 10%;"></td> <td style="width: 10%;"></td> <td style="width: 10%;"></td> <td style="width: 10%;"></td> </tr> <tr> <td></td> <td></td> <td colspan="8" style="text-align: center;"> <table border="1" style="width: 100%; border-collapse: collapse; text-align: center;"> <tr> <td style="width: 10%;"></td> <td style="width: 10%;"></td> <td style="width: 10%;"></td> <td style="width: 10%;"></td> <td style="width: 10%;"></td> <td style="width: 10%;"></td> <td style="width: 10%;"></td> <td style="width: 10%;"></td> <td style="width: 10%;"></td> <td style="width: 10%;"></td> </tr> <tr> <td></td> <td></td> <td colspan="8" style="text-align: center;"> <table border="1" style="width: 100%; border-collapse: collapse; text-align: center;"> <tr> <td style="width: 10%;"></td> <td style="width: 10%;"></td> <td style="width: 10%;"></td> <td style="width: 10%;"></td> <td style="width: 10%;"></td> <td style="width: 10%;"></td> <td style="width: 10%;"></td> <td style="width: 10%;"></td> <td style="width: 10%;"></td> <td style="width: 10%;"></td> </tr> <tr> <td></td> <td></td> <td colspan="8" style="text-align: center;"> <table border="1" style="width: 100%; border-collapse: collapse; text-align: center;"> <tr> <td style="width: 10%;"></td> <td style="width: 10%;"></td> <td style="width: 10%;"></td> <td style="width: 10%;"></td> <td style="width: 10%;"></td> <td style="width: 10%;"></td> <td style="width: 10%;"></td> <td style="width: 10%;"></td> <td style="width: 10%;"></td> <td style="width: 10%;"></td> </tr> <tr> <td></td> <td></td> <td colspan="8" style="text-align: center;"> <table border="1" style="width: 100%; border-collapse: collapse; text-align: center;"> <tr> <td style="width: 10%;"></td> <td style="width: 10%;"></td> <td style="width: 10%;"></td> <td style="width: 10%;"></td> <td style="width: 10%;"></td> <td style="width: 10%;"></td> <td style="width: 10%;"></td> <td style="width: 10%;"></td> <td style="width: 10%;"></td> <td style="width: 10%;"></td> </tr> <tr> <td></td> <td></td> <td colspan="8" style="text-align: center;"> <table border="1" style="width: 100%; border-collapse: collapse; text-align: center;"> <tr> <td style="width: 10%;"></td> <td style="width: 10%;"></td> <td style="width: 10%;"></td> <td style="width: 10%;"></td> <td style="width: 10%;"></td> <td style="width: 10%;"></td> <td style="width: 10%;"></td> <td style="width: 10%;"></td> <td style="width: 10%;"></td> <td style="width: 10%;"></td> </tr> <tr> <td></td> <td></td> <td colspan="8" style="text-align: center;"> <table border="1" style="width: 100%; border-collapse: collapse; text-align: center;"> <tr> <td style="width: 10%;"></td> <td style="width: 10%;"></td> <td style="width: 10%;"></td> <td style="width: 10%;"></td> <td style="width: 10%;"></td> <td style="width: 10%;"></td> <td style="width: 10%;"></td> <td style="width: 10%;"></td> <td style="width: 10%;"></td> <td style="width: 10%;"></td> </tr> <tr> <td></td> <td></td> <td colspan="8" style="text-align: center;"> <table border="1" style="width: 100%; border-collapse: collapse; text-align: center;"> <tr> <td style="width: 10%;"></td> <td style="width: 10%;"></td> <td style="width: 10%;"></td> <td style="width: 10%;"></td> <td style="width: 10%;"></td> <td style="width: 10%;"></td> <td style="width: 10%;"></td> <td style="width: 10%;"></td> <td style="width: 10%;"></td> <td style="width: 10%;"></td> </tr> <tr> <td></td> <td></td> <td colspan="8" style="text-align: center;"> <table border="1" style="width: 100%; border-collapse: collapse; text-align: center;"> <tr> <td style="width: 10%;"></td> <td style="width: 10%;"></td> <td style="width: 10%;"></td> <td style="width: 10%;"></td> <td style="width: 10%;"></td> <td style="width: 10%;"></td> <td style="width: 10%;"></td> <td style="width: 10%;"></td> <td style="width: 10%;"></td> <td style="width: 10%;"></td> </tr> <tr> <td></td>
<td></td> <td colspan="8" style="text-align: center;"> <table border="1" style="width: 100%; border-collapse: collapse; text-align: center;"> <tr> <td style="width: 10%;"></td> <td style="width: 10%;"></td> <td style="width: 10%;"></td> <td style="width: 10%;"></td> <td style="width: 10%;"></td> <td style="width: 10%;"></td> <td style="width: 10%;"></td> <td style="width: 10%;"></td> <td style="width: 10%;"></td> <td style="width: 10%;"></td> </tr> <tr> <td></td> <td></td> <td colspan="8" style="text-align: center;"> <table border="1" style="width: 100%; border-collapse: collapse; text-align: center;"> <tr> <td style="width: 10%;"></td> <td style="width: 10%;"></td> <td style="width: 10%;"></td> <td style="width: 10%;"></td> <td style="width: 10%;"></td> <td style="width: 10%;"></td> <td style="width: 10%;"></td> <td style="width: 10%;"></td> <td style="width: 10%;"></td> <td style="width: 10%;"></td> </tr> <tr> <td></td> <td></td> <td colspan="8" style="text-align: center;"> <table border="1" style="width: 100%; border-collapse: collapse; text-align: center;"> <tr> <td style="width: 10%;"></td> <td style="width: 10%;"></td> <td style="width: 10%;"></td> <td style="width: 10%;"></td> <td style="width: 10%;"></td> <td style="width: 10%;"></td> <td style="width: 10%;"></td> <td style="width: 10%;"></td> <td style="width: 10%;"></td> <td style="width: 10%;"></td> </tr> <tr> <td></td> <td></td> <td colspan="8" style="text-align: center;"> <table border="1" style="width: 100%; border-collapse: collapse; text-align: center;"> <tr> <td style="width: 10%;"></td> <td style="width: 10%;"></td> <td style="width: 10%;"></td> <td style="width: 10%;"></td> <td style="width: 10%;"></td> <td style="width: 10%;"></td> <td style="width: 10%;"></td> <td style="width: 10%;"></td> <td style="width: 10%;"></td> <td style="width: 10%;"></td> </tr> <tr> <td></td> <td></td> <td colspan="8" style="text-align: center;"> <table border="1" style="width: 100%; border-collapse: collapse; text-align: center;"> <tr> <td style="width: 10%;"></td> <td style="width: 10%;"></td> <td style="width: 10%;"></td> <td style="width: 10%;"></td> <td style="width: 10%;"></td> <td style="width: 10%;"></td> <td style="width: 10%;"></td> <td style="width: 10%;"></td> <td style="width: 10%;"></td> <td style="width: 10%;"></td> </tr> <tr> <td></td> <td></td> <td colspan="8" style="text-align: center;"> <table border="1" style="width: 100%; border-collapse: collapse; text-align: center;"> <tr> <td style="width: 10%;"></td> <td style="width: 10%;"></td> <td style="width: 10%;"></td> <td style="width: 10%;"></td> <td style="width: 10%;"></td> <td style="width: 10%;"></td> <td style="width: 10%;"></td> <td style="width: 10%;"></td> <td style="width: 10%;"></td> <td style="width: 10%;"></td> </tr> <tr> <td></td> <td></td> <td colspan="8" style="text-align: center;"> <table border="1" style="width: 100%; border-collapse: collapse; text-align: center;"> <tr> <td style="width: 10%;"></td> <td style="width: 10%;"></td> <td style="width: 10%;"></td> <td style="width: 10%;"></td> <td style="width: 10%;"></td> <td style="width: 10%;"></td> <td style="width: 10%;"></td> <td style="width: 10%;"></td> <td style="width: 10%;"></td> <td style="width: 10%;"></td> </tr> <tr> <td></td> <td></td> <td colspan="8" style="text-align: center;"> <table border="1" style="width: 100%; border-collapse: collapse; text-align: center;"> <tr> <td style="width: 10%;"></td> <td style="width: 10%;"></td> <td style="width: 10%;"></td> <td style="width: 10%;"></td> <td style="width: 10%;"></td> <td style="width: 10%;"></td> <td style="width: 10%;"></td> <td style="width: 10%;"></td> <td style="width: 10%;"></td> <td style="width: 10%;"></td> </tr> <tr> <td></td> <td></td> <td colspan="8" style="text-align: center;"> <table border="1" style="width: 100%; border-collapse: collapse; text-align: center;"> <tr> <td style="width: 10%;"></td> <td style="width: 10%;"></td> <td style="width: 10%;"></td> <td style="width: 10%;"></td> <td style="width: 10%;"></td> <td style="width: 10%;"></td> <td style="width: 10%;"></td> <td style="width: 10%;"></td> <td style="width: 10%;"></td> <td style="width: 10%;"></td> </tr> <tr> <td></td> <td></td> <td colspan="8" style="text-align: center;"> <table border="1" style="width: 100%; border-collapse: collapse; text-align: center;"> <tr> <td style="width: 10%;"></td> <td style="width: 10%;"></td> <td style="width: 10%;"></td> <td style="width: 10%;"></td> <td style="width: 10%;"></td> <td style="width: 10%;"></td> <td style="width: 10%;"></td> <td style="width: 10%;"></td> <td style="width: 10%;"></td> <td style="width: 10%;"></td> </tr> <tr> <td></td> <td></td> <td colspan="8" style="text-align: center;"> <table border="1" style="width: 100%; border-collapse: collapse; text-align: center;"> <tr> <td style="width: 10%;"></td> <td style="width: 10%;"></td> <td style="width: 10%;"></td> <td style="width: 10%;"></td> <td style="width: 10%;"></td> <td style="width: 10%;"></td> <td style="width: 10%;"></td> <td style="width: 10%;"></td> <td style="width: 10%;"></td> <td style="width: 10%;"></td> </tr> <tr> <td></td> <td></td> <td colspan="8" style="text-align: center;"> <table border="1" style="width: 100%; border-collapse: collapse; text-align: center;"> <tr> <td style="width: 10%;"></td> <td style="width: 10%;"></td> <td style="width: 10%;"></td> <td style="width: 10%;"></td> <td style="width: 10%;"></td> <td style="width: 10%;"></td> <td style="width: 10%;"></td> <td style="width: 10%;"></td> <td style="width: 10%;"></td> <td style="width: 10%;"></td> </tr> <tr> <td></td> <td></td> <td colspan="8" style="text-align: center;"> <table border="1" style="width: 100%; border-collapse: collapse; text-align: center;"> <tr> <td style="width: 10%;"></td> <td style="width: 10%;"></td> <td style="width: 10%;"></td> <td style="width: 10%;"></td> <td style="width: 10%;"></td> <td style="width: 10%;"></td> <td style="width: 10%;"></td> <td style="width: 10%;"></td> <td style="width: 10%;"></td> <td style="width: 10%;"></td> </tr> <tr> <td></td> <td></td> <td colspan="8" style="text-align: center;"> <table border="1" style="width: 100%; border-collapse: collapse; text-align: center;"> <tr> <td style="width: 10%;"></td> <td style="width: 10%;"></td> <td style="width: 10%;"></td> <td style="width: 10%;"></td> <td style="width: 10%;"></td> <td style="width: 10%;"></td> <td style="width: 10%;"></td> <td style="width: 10%;"></td> <td style="width: 10%;"></td> <td style="width: 10%;"></td> </tr> <tr> <td></td> <td></td> <td colspan="8" style="text-align: center;"> <table border="1" style="width: 100%; border-collapse: collapse; text-align: center;"> <tr> <td style="width: 10%;"></td> <td style="width: 10%;"></td> <td style="width: 10%;"></td> <td style="width: 10%;"></td> <td style="width: 10%;"></td> <td style="width: 10%;"></td> <td style="width: 10%;"></td> <td style="width: 10%;"></td> <td style="width: 10%;"></td> <td style="width: 10%;"></td> </tr> <tr> <td></td> <td></td> <td colspan="8" style="text-align: center;"> <table border="1" style="width: 100%; border-collapse: collapse; text-align: center;"> <tr> <td style="width: 10%;"></td> <td style="width: 10%;"></td> <td style="width: 10%;"></td> <td style="width: 10%;"></td> <td style="width: 10%;"></td> <td style="width: 10%;"></td> <td style="width: 10%;"></td> <td style="width: 10%;"></td> <td style="width: 10%;"></td> <td style="width: 10%;"></td> </tr> <tr> <td></td> <td></td> <td colspan="8" style="text-align: center;"> <table border="1" style="width: 100%; border-collapse: collapse; text-align: center;"> <tr> </tr></table></td></tr></table></td></tr></table></td></tr></table></td></tr></table></td></tr></table></td></tr></table></td></tr></table></td></tr></table></td></tr></table></td></tr></table></td></tr></table></td></tr></table></td></tr></table></td></tr></table></td></tr></table></td></tr></table></td></tr></table></td></tr></table></td></tr></table></td></tr></table></td></tr></table></td></tr></table></td></tr></table></td></tr></table></td></tr></table></td></tr></table></td></tr></table></td></tr></table></td></tr></table></td></tr></table></td></tr></table></td></tr></table></td></tr></table></td></tr></table>
 | | | | | | | | | | | | | | | | | | | | <table border="1" style="width: 100%; border-collapse: collapse; text-align: center;"> <tr> <td style="width: 10%;"></td> <td style="width: 10%;"></td> <td style="width: 10%;"></td> <td style="width: 10%;"></td> <td style="width: 10%;"></td> <td style="width: 10%;"></td> <td style="width: 10%;"></td> <td style="width: 10%;"></td> <td style="width: 10%;"></td> <td style="width: 10%;"></td> </tr> <tr> <td></td> <td></td> <td colspan="8" style="text-align: center;"> <table border="1" style="width: 100%; border-collapse: collapse; text-align: center;"> <tr> <td style="width: 10%;"></td> <td style="width: 10%;"></td> <td style="width: 10%;"></td> <td style="width: 10%;"></td> <td style="width: 10%;"></td> <td style="width: 10%;"></td> <td style="width: 10%;"></td> <td style="width: 10%;"></td> <td style="width: 10%;"></td> <td style="width: 10%;"></td> </tr> <tr> <td></td> <td></td> <td colspan="8" style="text-align: center;"> <table border="1" style="width: 100%; border-collapse: collapse; text-align: center;"> <tr> <td style="width: 10%;"></td> <td style="width: 10%;"></td> <td style="width: 10%;"></td> <td style="width: 10%;"></td> <td style="width: 10%;"></td> <td style="width: 10%;"></td> <td style="width: 10%;"></td> <td style="width: 10%;"></td> <td style="width: 10%;"></td> <td style="width: 10%;"></td> </tr> <tr> <td></td> <td></td> <td colspan="8" style="text-align: center;"> <table border="1" style="width: 100%; border-collapse: collapse; text-align: center;"> <tr> <td style="width: 10%;"></td> <td style="width: 10%;"></td> <td style="width: 10%;"></td> <td style="width: 10%;"></td> <td style="width: 10%;"></td> <td style="width: 10%;"></td> <td style="width: 10%;"></td> <td style="width: 10%;"></td> <td style="width: 10%;"></td> <td style="width: 10%;"></td> </tr> <tr> <td></td> <td></td> <td colspan="8" style="text-align: center;"> <table border="1" style="width: 100%; border-collapse: collapse; text-align: center;"> <tr> <td style="width: 10%;"></td> <td style="width: 10%;"></td> <td style="width: 10%;"></td> <td style="width: 10%;"></td> <td style="width: 10%;"></td> <td style="width: 10%;"></td> <td style="width: 10%;"></td> <td style="width: 10%;"></td> <td style="width: 10%;"></td> <td style="width: 10%;"></td> </tr> <tr> <td></td> <td></td> <td colspan="8" style="text-align: center;"> <table border="1" style="width: 100%; border-collapse: collapse; text-align: center;"> <tr> <td style="width: 10%;"></td> <td style="width: 10%;"></td> <td style="width: 10%;"></td> <td style="width: 10%;"></td> <td style="width: 10%;"></td> <td style="width: 10%;"></td> <td style="width: 10%;"></td> <td style="width: 10%;"></td> <td style="width: 10%;"></td> <td style="width: 10%;"></td> </tr> <tr> <td></td> <td></td> <td colspan="8" style="text-align: center;"> <table border="1" style="width: 100%; border-collapse: collapse; text-align: center;"> <tr> <td style="width: 10%;"></td> <td style="width: 10%;"></td> <td style="width: 10%;"></td> <td style="width: 10%;"></td> <td style="width: 10%;"></td> <td style="width: 10%;"></td> <td style="width: 10%;"></td> <td style="width: 10%;"></td> <td style="width: 10%;"></td> <td style="width: 10%;"></td> </tr> <tr> <td></td> <td></td> <td colspan="8" style="text-align: center;"> <table border="1" style="width: 100%; border-collapse: collapse; text-align: center;"> <tr> <td style="width: 10%;"></td> <td style="width: 10%;"></td> <td style="width: 10%;"></td> <td style="width: 10%;"></td> <td style="width: 10%;"></td> <td style="width: 10%;"></td> <td style="width: 10%;"></td> <td style="width: 10%;"></td> <td style="width: 10%;"></td> <td style="width: 10%;"></td> </tr> <tr> <td></td> <td></td> <td colspan="8" style="text-align: center;"> <table border="1" style="width: 100%; border-collapse: collapse; text-align: center;"> <tr> <td style="width: 10%;"></td> <td style="width: 10%;"></td> <td style="width: 10%;"></td> <td style="width: 10%;"></td> <td style="width: 10%;"></td> <td style="width: 10%;"></td> <td style="width: 10%;"></td> <td style="width: 10%;"></td> <td style="width: 10%;"></td> <td style="width: 10%;"></td> </tr> <tr> <td></td> <td></td> <td colspan="8" style="text-align: center;"> <table border="1" style="width: 100%; border-collapse: collapse; text-align: center;"> <tr> <td style="width: 10%;"></td> <td style="width: 10%;"></td> <td style="width: 10%;"></td> <td style="width: 10%;"></td> <td style="width: 10%;"></td> <td style="width: 10%;"></td> <td style="width: 10%;"></td> <td style="width: 10%;"></td> <td style="width: 10%;"></td> <td style="width: 10%;"></td> </tr> <tr> <td></td> <td></td> <td colspan="8" style="text-align: center;"> <table border="1" style="width: 100%; border-collapse: collapse; text-align: center;"> <tr> <td style="width: 10%;"></td> <td style="width: 10%;"></td> <td style="width: 10%;"></td> <td style="width: 10%;"></td> <td style="width: 10%;"></td> <td style="width: 10%;"></td> <td style="width: 10%;"></td> <td style="width: 10%;"></td> <td style="width: 10%;"></td> <td style="width: 10%;"></td> </tr> <tr> <td></td> <td></td> <td colspan="8" style="text-align: center;"> <table border="1" style="width: 100%; border-collapse: collapse; text-align: center;"> <tr> <td style="width: 10%;"></td> <td style="width: 10%;"></td> <td style="width: 10%;"></td> <td style="width: 10%;"></td> <td style="width: 10%;"></td> <td style="width: 10%;"></td> <td style="width: 10%;"></td> <td style="width: 10%;"></td> <td style="width: 10%;"></td> <td style="width: 10%;"></td> </tr> <tr> <td></td> <td></td> <td colspan="8" style="text-align: center;"> <table border="1" style="width: 100%; border-collapse: collapse; text-align: center;"> <tr> <td style="width: 10%;"></td> <td style="width: 10%;"></td> <td style="width: 10%;"></td> <td style="width: 10%;"></td> <td style="width: 10%;"></td> <td style="width: 10%;"></td> <td style="width: 10%;"></td> <td style="width: 10%;"></td> <td style="width: 10%;"></td> <td style="width: 10%;"></td> </tr> <tr> <td></td> <td></td> <td colspan="8" style="text-align: center;"> <table border="1" style="width: 100%; border-collapse: collapse; text-align: center;"> <tr> <td style="width: 10%;"></td> <td style="width: 10%;"></td> <td style="width: 10%;"></td> <td style="width: 10%;"></td> <td style="width: 10%;"></td> <td
style="width: 10%;"></td> <td style="width: 10%;"></td> <td style="width: 10%;"></td> <td style="width: 10%;"></td> <td style="width: 10%;"></td> </tr> <tr> <td></td> <td></td> <td colspan="8" style="text-align: center;"> <table border="1" style="width: 100%; border-collapse: collapse; text-align: center;"> <tr> <td style="width: 10%;"></td> <td style="width: 10%;"></td> <td style="width: 10%;"></td> <td style="width: 10%;"></td> <td style="width: 10%;"></td> <td style="width: 10%;"></td> <td style="width: 10%;"></td> <td style="width: 10%;"></td> <td style="width: 10%;"></td> <td style="width: 10%;"></td> </tr> <tr> <td></td> <td></td> <td colspan="8" style="text-align: center;"> <table border="1" style="width: 100%; border-collapse: collapse; text-align: center;"> <tr> <td style="width: 10%;"></td> <td style="width: 10%;"></td> <td style="width: 10%;"></td> <td style="width: 10%;"></td> <td style="width: 10%;"></td> <td style="width: 10%;"></td> <td style="width: 10%;"></td> <td style="width: 10%;"></td> <td style="width: 10%;"></td> <td style="width: 10%;"></td> </tr> <tr> <td></td> <td></td> <td colspan="8" style="text-align: center;"> <table border="1" style="width: 100%; border-collapse: collapse; text-align: center;"> <tr> <td style="width: 10%;"></td> <td style="width: 10%;"></td> <td style="width: 10%;"></td> <td style="width: 10%;"></td> <td style="width: 10%;"></td> <td style="width: 10%;"></td> <td style="width: 10%;"></td> <td style="width: 10%;"></td> <td style="width: 10%;"></td> <td style="width: 10%;"></td> </tr> <tr> <td></td> <td></td> <td colspan="8" style="text-align: center;"> <table border="1" style="width: 100%; border-collapse: collapse; text-align: center;"> <tr> <td style="width: 10%;"></td> <td style="width: 10%;"></td> <td style="width: 10%;"></td> <td style="width: 10%;"></td> <td style="width: 10%;"></td> <td style="width: 10%;"></td> <td style="width: 10%;"></td> <td style="width: 10%;"></td> <td style="width: 10%;"></td> <td style="width: 10%;"></td> </tr> <tr> <td></td> <td></td> <td colspan="8" style="text-align: center;"> <table border="1" style="width: 100%; border-collapse: collapse; text-align: center;"> <tr> <td style="width: 10%;"></td> <td style="width: 10%;"></td> <td style="width: 10%;"></td> <td style="width: 10%;"></td> <td style="width: 10%;"></td> <td style="width: 10%;"></td> <td style="width: 10%;"></td> <td style="width: 10%;"></td> <td style="width: 10%;"></td> <td style="width: 10%;"></td> </tr> <tr> <td></td> <td></td> <td colspan="8" style="text-align: center;"> <table border="1" style="width: 100%; border-collapse: collapse; text-align: center;"> <tr> <td style="width: 10%;"></td> <td style="width: 10%;"></td> <td style="width: 10%;"></td> <td style="width: 10%;"></td> <td style="width: 10%;"></td> <td style="width: 10%;"></td> <td style="width: 10%;"></td> <td style="width: 10%;"></td> <td style="width: 10%;"></td> <td style="width: 10%;"></td> </tr> <tr> <td></td> <td></td> <td colspan="8" style="text-align: center;"> <table border="1" style="width: 100%; border-collapse: collapse; text-align: center;"> <tr> <td style="width: 10%;"></td> <td style="width: 10%;"></td> <td style="width: 10%;"></td> <td style="width: 10%;"></td> <td style="width: 10%;"></td> <td style="width: 10%;"></td> <td style="width: 10%;"></td> <td style="width: 10%;"></td> <td style="width: 10%;"></td> <td style="width: 10%;"></td> </tr> <tr> <td></td> <td></td> <td colspan="8" style="text-align: center;"> <table border="1" style="width: 100%; border-collapse: collapse; text-align: center;"> <tr> <td style="width: 10%;"></td> <td style="width: 10%;"></td> <td style="width: 10%;"></td> <td style="width: 10%;"></td> <td style="width: 10%;"></td> <td style="width: 10%;"></td> <td style="width: 10%;"></td> <td style="width: 10%;"></td> <td style="width: 10%;"></td> <td style="width: 10%;"></td> </tr> <tr> <td></td> <td></td> <td colspan="8" style="text-align: center;"> <table border="1" style="width: 100%; border-collapse: collapse; text-align: center;"> <tr> <td style="width: 10%;"></td> <td style="width: 10%;"></td> <td style="width: 10%;"></td> <td style="width: 10%;"></td> <td style="width: 10%;"></td> <td style="width: 10%;"></td> <td style="width: 10%;"></td> <td style="width: 10%;"></td> <td style="width: 10%;"></td> <td style="width: 10%;"></td> </tr> <tr> <td></td> <td></td> <td colspan="8" style="text-align: center;"> <table border="1" style="width: 100%; border-collapse: collapse; text-align: center;"> <tr> <td style="width: 10%;"></td> <td style="width: 10%;"></td> <td style="width: 10%;"></td> <td style="width: 10%;"></td> <td style="width: 10%;"></td> <td style="width: 10%;"></td> <td style="width: 10%;"></td> <td style="width: 10%;"></td> <td style="width: 10%;"></td> <td style="width: 10%;"></td> </tr> <tr> <td></td> <td></td> <td colspan="8" style="text-align: center;"> <table border="1" style="width: 100%; border-collapse: collapse; text-align: center;"> <tr> <td style="width: 10%;"></td> <td style="width: 10%;"></td> <td style="width: 10%;"></td> <td style="width: 10%;"></td> <td style="width: 10%;"></td> <td style="width: 10%;"></td> <td style="width: 10%;"></td> <td style="width: 10%;"></td> <td style="width: 10%;"></td> <td style="width: 10%;"></td> </tr> <tr> <td></td> <td></td> <td colspan="8" style="text-align: center;"> <table border="1" style="width: 100%; border-collapse: collapse; text-align: center;"> <tr> <td style="width: 10%;"></td> <td style="width: 10%;"></td> <td style="width: 10%;"></td> <td style="width: 10%;"></td> <td style="width: 10%;"></td> <td style="width: 10%;"></td> <td style="width: 10%;"></td> <td style="width: 10%;"></td> <td style="width: 10%;"></td> <td style="width: 10%;"></td> </tr> <tr> <td></td> <td></td> <td colspan="8" style="text-align: center;"> <table border="1" style="width: 100%; border-collapse: collapse; text-align: center;"> <tr> <td style="width: 10%;"></td> <td style="width: 10%;"></td> <td style="width: 10%;"></td> <td style="width: 10%;"></td> <td style="width: 10%;"></td> <td style="width: 10%;"></td> <td style="width: 10%;"></td> <td style="width: 10%;"></td> <td style="width: 10%;"></td> <td style="width: 10%;"></td> </tr> <tr> <td></td> <td></td> <td colspan="8" style="text-align: center;"> <table border="1" style="width: 100%; border-collapse: collapse; text-align: center;"> <tr> <td style="width: 10%;"></td> <td style="width: 10%;"></td> <td style="width: 10%;"></td> <td style="width: 10%;"></td> <td style="width: 10%;"></td> <td style="width: 10%;"></td> <td style="width: 10%;"></td> <td style="width: 10%;"></td> <td style="width: 10%;"></td> <td style="width: 10%;"></td> </tr> <tr> <td></td> <td></td> <td colspan="8" style="text-align: center;"> <table border="1" style="width: 100%; border-collapse: collapse; text-align: center;"> <tr> <td style="width: 10%;"></td> <td style="width: 10%;"></td> <td style="width: 10%;"></td> <td style="width: 10%;"></td> <td style="width: 10%;"></td> <td style="width: 10%;"></td> <td style="width: 10%;"></td> <td style="width: 10%;"></td> <td style="width: 10%;"></td> <td style="width: 10%;"></td> </tr> <tr> <td></td> <td></td> <td colspan="8" style="text-align: center;"> <table border="1" style="width: 100%; border-collapse: collapse; text-align: center;"> <tr> <td style="width: 10%;"></td> <td style="width: 10%;"></td> <td style="width: 10%;"></td> <td style="width: 10%;"></td> <td style="width: 10%;"></td> <td style="width: 10%;"></td> <td style="width: 10%;"></td> <td style="width: 10%;"></td> <td style="width: 10%;"></td> <td style="width: 10%;"></td> </tr> <tr> <td></td> <td></td> <td colspan="8" style="text-align: center;"> <table border="1" style="width: 100%; border-collapse: collapse; text-align: center;"> <tr> <td style="width: 10%;"></td> <td style="width: 10%;"></td> <td style="width: 10%;"></td> <td style="width: 10%;"></td> <td style="width: 10%;"></td> <td style="width: 10%;"></td> <td style="width: 10%;"></td> <td style="width: 10%;"></td> <td style="width: 10%;"></td> <td style="width: 10%;"></td> </tr> <tr> <td></td> <td></td> <td colspan="8" style="text-align: center;"> <table border="1" style="width: 100%; border-collapse: collapse; text-align: center;"> <tr> <td style="width: 10%;"></td> <td style="width: 10%;"></td> <td style="width: 10%;"></td> <td style="width: 10%;"></td> <td style="width: 10%;"></td> <td style="width: 10%;"></td> <td style="width: 10%;"></td> <td style="width: 10%;"></td> <td style="width: 10%;"></td> <td style="width: 10%;"></td> </tr> <tr> <td></td> <td></td> <td colspan="8" style="text-align: center;"> <table border="1" style="width: 100%; border-collapse: collapse; text-align: center;"> <tr> <td style="width: 10%;"></td> <td style="width: 10%;"></td> <td style="width: 10%;"></td> <td style="width: 10%;"></td> <td style="width: 10%;"></td> <td style="width: 10%;"></td> <td style="width: 10%;"></td> <td style="width: 10%;"></td> <td style="width: 10%;"></td> <td style="width: 10%;"></td> </tr> <tr> <td></td> <td></td> <td colspan="8" style="text-align: center;"> <table border="1" style="width: 100%; border-collapse: collapse; text-align: center;"> <tr> </tr></table></td></tr></table></td></tr></table></td></tr></table></td></tr></table></td></tr></table></td></tr></table></td></tr></table></td></tr></table></td></tr></table></td></tr></table></td></tr></table></td></tr></table></td></tr></table></td></tr></table></td></tr></table></td></tr></table></td></tr></table></td></tr></table></td></tr></table></td></tr></table></td></tr></table></td></tr></table></td></tr></table></td></tr></table></td></tr></table></td></tr></table></td></tr></table></td></tr></table></td></tr></table></td></tr></table></td></tr></table></td></tr></table></td></tr></table>
 | | | | | | | | | | | | | | | | | | | | <table border="1" style="width: 100%; border-collapse: collapse; text-align: center;"> <tr> <td style="width: 10%;"></td> <td style="width: 10%;"></td> <td style="width: 10%;"></td> <td style="width: 10%;"></td> <td style="width: 10%;"></td> <td style="width: 10%;"></td> <td style="width: 10%;"></td> <td style="width: 10%;"></td> <td style="width: 10%;"></td> <td style="width: 10%;"></td> </tr> <tr> <td></td> <td></td> <td colspan="8" style="text-align: center;"> <table border="1" style="width: 100%; border-collapse: collapse; text-align: center;"> <tr> <td style="width: 10%;"></td> <td style="width: 10%;"></td> <td style="width: 10%;"></td> <td style="width: 10%;"></td> <td style="width: 10%;"></td> <td style="width: 10%;"></td> <td style="width: 10%;"></td> <td style="width: 10%;"></td> <td style="width: 10%;"></td> <td style="width: 10%;"></td> </tr> <tr> <td></td> <td></td> <td colspan="8" style="text-align: center;"> <table border="1" style="width: 100%; border-collapse: collapse; text-align: center;"> <tr> <td style="width: 10%;"></td> <td style="width: 10%;"></td> <td style="width: 10%;"></td> <td style="width: 10%;"></td> <td style="width: 10%;"></td> <td style="width: 10%;"></td> <td style="width: 10%;"></td> <td style="width: 10%;"></td> <td style="width: 10%;"></td> <td style="width: 10%;"></td> </tr> <tr> <td></td> <td></td> <td colspan="8" style="text-align: center;"> <table border="1" style="width: 100%; border-collapse: collapse; text-align: center;"> <tr> <td style="width: 10%;"></td> <td style="width: 10%;"></td> <td style="width: 10%;"></td> <td style="width: 10%;"></td> <td style="width: 10%;"></td> <td style="width: 10%;"></td> <td style="width: 10%;"></td> <td style="width: 10%;"></td> <td style="width: 10%;"></td> <td style="width: 10%;"></td> </tr> <tr> <td></td> <td></td> <td colspan="8" style="text-align: center;"> <table border="1" style="width: 100%; border-collapse: collapse; text-align: center;"> <tr> <td style="width: 10%;"></td> <td style="width: 10%;"></td> <td style="width: 10%;"></td> <td style="width: 10%;"></td> <td style="width: 10%;"></td> <td style="width: 10%;"></td> <td style="width: 10%;"></td> <td style="width: 10%;"></td> <td style="width: 10%;"></td> <td style="width: 10%;"></td> </tr> <tr> <td></td> <td></td> <td colspan="8" style="text-align: center;"> <table border="1" style="width: 100%; border-collapse: collapse; text-align: center;"> <tr> <td style="width: 10%;"></td> <td style="width: 10%;"></td> <td style="width: 10%;"></td> <td style="width: 10%;"></td> <td style="width: 10%;"></td> <td style="width: 10%;"></td> <td style="width: 10%;"></td> <td style="width: 10%;"></td> <td style="width: 10%;"></td> <td style="width: 10%;"></td> </tr> <tr> <td></td> <td></td> <td colspan="8" style="text-align: center;"> <table border="1" style="width: 100%; border-collapse: collapse; text-align: center;"> <tr> <td style="width: 10%;"></td> <td style="width: 10%;"></td> <td style="width: 10%;"></td> <td style="width: 10%;"></td> <td style="width: 10%;"></td> <td style="width: 10%;"></td> <td style="width: 10%;"></td> <td style="width: 10%;"></td> <td style="width: 10%;"></td> <td style="width: 10%;"></td> </tr> <tr> <td></td> <td></td> <td colspan="8" style="text-align: center;"> <table border="1" style="width: 100%; border-collapse: collapse; text-align: center;"> <tr> <td style="width: 10%;"></td> <td style="width: 10%;"></td> <td style="width: 10%;"></td> <td style="width: 10%;"></td> <td style="width: 10%;"></td> <td style="width: 10%;"></td> <td style="width: 10%;"></td> <td style="width: 10%;"></td> <td style="width: 10%;"></td> <td style="width: 10%;"></td> </tr> <tr> <td></td> <td></td> <td colspan="8" style="text-align: center;"> <table border="1" style="width: 100%; border-collapse: collapse; text-align: center;"> <tr> <td style="width: 10%;"></td> <td style="width: 10%;"></td> <td style="width: 10%;"></td> <td style="width: 10%;"></td> <td style="width: 10%;"></td> <td style="width: 10%;"></td> <td style="width: 10%;"></td> <td style="width: 10%;"></td> <td style="width: 10%;"></td> <td style="width: 10%;"></td> </tr> <tr> <td></td> <td></td> <td colspan="8" style="text-align: center;"> <table border="1" style="width: 100%; border-collapse: collapse; text-align: center;"> <tr> <td style="width: 10%;"></td> <td style="width: 10%;"></td> <td style="width: 10%;"></td> <td style="width: 10%;"></td> <td style="width: 10%;"></td> <td style="width: 10%;"></td> <td style="width: 10%;"></td> <td style="width: 10%;"></td> <td style="width: 10%;"></td> <td style="width: 10%;"></td> </tr> <tr> <td></td> <td></td> <td colspan="8" style="text-align: center;"> <table border="1" style="width: 100%; border-collapse: collapse; text-align: center;"> <tr> <td
style="width: 10%;"></td> <td style="width: 10%;"></td> <td style="width: 10%;"></td> <td style="width: 10%;"></td> <td style="width: 10%;"></td> <td style="width: 10%;"></td> <td style="width: 10%;"></td> <td style="width: 10%;"></td> <td style="width: 10%;"></td> <td style="width: 10%;"></td> </tr> <tr> <td></td> <td></td> <td colspan="8" style="text-align: center;"> <table border="1" style="width: 100%; border-collapse: collapse; text-align: center;"> <tr> <td style="width: 10%;"></td> <td style="width: 10%;"></td> <td style="width: 10%;"></td> <td style="width: 10%;"></td> <td style="width: 10%;"></td> <td style="width: 10%;"></td> <td style="width: 10%;"></td> <td style="width: 10%;"></td> <td style="width: 10%;"></td> <td style="width: 10%;"></td> </tr> <tr> <td></td> <td></td> <td colspan="8" style="text-align: center;"> <table border="1" style="width: 100%; border-collapse: collapse; text-align: center;"> <tr> <td style="width: 10%;"></td> <td style="width: 10%;"></td> <td style="width: 10%;"></td> <td style="width: 10%;"></td> <td style="width: 10%;"></td> <td style="width: 10%;"></td> <td style="width: 10%;"></td> <td style="width: 10%;"></td> <td style="width: 10%;"></td> <td style="width: 10%;"></td> </tr> <tr> <td></td> <td></td> <td colspan="8" style="text-align: center;"> <table border="1" style="width: 100%; border-collapse: collapse; text-align: center;"> <tr> <td style="width: 10%;"></td> <td style="width: 10%;"></td> <td style="width: 10%;"></td> <td style="width: 10%;"></td> <td style="width: 10%;"></td> <td style="width: 10%;"></td> <td style="width: 10%;"></td> <td style="width: 10%;"></td> <td style="width: 10%;"></td> <td style="width: 10%;"></td> </tr> <tr> <td></td> <td></td> <td colspan="8" style="text-align: center;"> <table border="1" style="width: 100%; border-collapse: collapse; text-align: center;"> <tr> <td style="width: 10%;"></td> <td style="width: 10%;"></td> <td style="width: 10%;"></td> <td style="width: 10%;"></td> <td style="width: 10%;"></td> <td style="width: 10%;"></td> <td style="width: 10%;"></td> <td style="width: 10%;"></td> <td style="width: 10%;"></td> <td style="width: 10%;"></td> </tr> <tr> <td></td> <td></td> <td colspan="8" style="text-align: center;"> <table border="1" style="width: 100%; border-collapse: collapse; text-align: center;"> <tr> <td style="width: 10%;"></td> <td style="width: 10%;"></td> <td style="width: 10%;"></td> <td style="width: 10%;"></td> <td style="width: 10%;"></td> <td style="width: 10%;"></td> <td style="width: 10%;"></td> <td style="width: 10%;"></td> <td style="width: 10%;"></td> <td style="width: 10%;"></td> </tr> <tr> <td></td> <td></td> <td colspan="8" style="text-align: center;"> <table border="1" style="width: 100%; border-collapse: collapse; text-align: center;"> <tr> <td style="width: 10%;"></td> <td style="width: 10%;"></td> <td style="width: 10%;"></td> <td style="width: 10%;"></td> <td style="width: 10%;"></td> <td style="width: 10%;"></td> <td style="width: 10%;"></td> <td style="width: 10%;"></td> <td style="width: 10%;"></td> <td style="width: 10%;"></td> </tr> <tr> <td></td> <td></td> <td colspan="8" style="text-align: center;"> <table border="1" style="width: 100%; border-collapse: collapse; text-align: center;"> <tr> <td style="width: 10%;"></td> <td style="width: 10%;"></td> <td style="width: 10%;"></td> <td style="width: 10%;"></td> <td style="width: 10%;"></td> <td style="width: 10%;"></td> <td style="width: 10%;"></td> <td style="width: 10%;"></td> <td style="width: 10%;"></td> <td style="width: 10%;"></td> </tr> <tr> <td></td> <td></td> <td colspan="8" style="text-align: center;"> <table border="1" style="width: 100%; border-collapse: collapse; text-align: center;"> <tr> <td style="width: 10%;"></td> <td style="width: 10%;"></td> <td style="width: 10%;"></td> <td style="width: 10%;"></td> <td style="width: 10%;"></td> <td style="width: 10%;"></td> <td style="width: 10%;"></td> <td style="width: 10%;"></td> <td style="width: 10%;"></td> <td style="width: 10%;"></td> </tr> <tr> <td></td> <td></td> <td colspan="8" style="text-align: center;"> <table border="1" style="width: 100%; border-collapse: collapse; text-align: center;"> <tr> <td style="width: 10%;"></td> <td style="width: 10%;"></td> <td style="width: 10%;"></td> <td style="width: 10%;"></td> <td style="width: 10%;"></td> <td style="width: 10%;"></td> <td style="width: 10%;"></td> <td style="width: 10%;"></td> <td style="width: 10%;"></td> <td style="width: 10%;"></td> </tr> <tr> <td></td> <td></td> <td colspan="8" style="text-align: center;"> <table border="1" style="width: 100%; border-collapse: collapse; text-align: center;"> <tr> <td style="width: 10%;"></td> <td style="width: 10%;"></td> <td style="width: 10%;"></td> <td style="width: 10%;"></td> <td style="width: 10%;"></td> <td style="width: 10%;"></td> <td style="width: 10%;"></td> <td style="width: 10%;"></td> <td style="width: 10%;"></td> <td style="width: 10%;"></td> </tr> <tr> <td></td> <td></td> <td colspan="8" style="text-align: center;"> <table border="1" style="width: 100%; border-collapse: collapse; text-align: center;"> <tr> <td style="width: 10%;"></td> <td style="width: 10%;"></td> <td style="width: 10%;"></td> <td style="width: 10%;"></td> <td style="width: 10%;"></td> <td style="width: 10%;"></td> <td style="width: 10%;"></td> <td style="width: 10%;"></td> <td style="width: 10%;"></td> <td style="width: 10%;"></td> </tr> <tr> <td></td> <td></td> <td colspan="8" style="text-align: center;"> <table border="1" style="width: 100%; border-collapse: collapse; text-align: center;"> <tr> <td style="width: 10%;"></td> <td style="width: 10%;"></td> <td style="width: 10%;"></td> <td style="width: 10%;"></td> <td style="width: 10%;"></td> <td style="width: 10%;"></td> <td style="width: 10%;"></td> <td style="width: 10%;"></td> <td style="width: 10%;"></td> <td style="width: 10%;"></td> </tr> <tr> <td></td> <td></td> <td colspan="8" style="text-align: center;"> <table border="1" style="width: 100%; border-collapse: collapse; text-align: center;"> <tr> <td style="width: 10%;"></td> <td style="width: 10%;"></td> <td style="width: 10%;"></td> <td style="width: 10%;"></td> <td style="width: 10%;"></td> <td style="width: 10%;"></td> <td style="width: 10%;"></td> <td style="width: 10%;"></td> <td style="width: 10%;"></td> <td style="width: 10%;"></td> </tr> <tr> <td></td> <td></td> <td colspan="8" style="text-align: center;"> <table border="1" style="width: 100%; border-collapse: collapse; text-align: center;"> <tr> <td style="width: 10%;"></td> <td style="width: 10%;"></td> <td style="width: 10%;"></td> <td style="width: 10%;"></td> <td style="width: 10%;"></td> <td style="width: 10%;"></td> <td style="width: 10%;"></td> <td style="width: 10%;"></td> <td style="width: 10%;"></td> <td style="width: 10%;"></td> </tr> <tr> <td></td> <td></td> <td colspan="8" style="text-align: center;"> <table border="1" style="width: 100%; border-collapse: collapse; text-align: center;"> <tr> <td style="width: 10%;"></td> <td style="width: 10%;"></td> <td style="width: 10%;"></td> <td style="width: 10%;"></td> <td style="width: 10%;"></td> <td style="width: 10%;"></td> <td style="width: 10%;"></td> <td style="width: 10%;"></td> <td style="width: 10%;"></td> <td style="width: 10%;"></td> </tr> <tr> <td></td> <td></td> <td colspan="8" style="text-align: center;"> <table border="1" style="width: 100%; border-collapse: collapse; text-align: center;"> <tr> <td style="width: 10%;"></td> <td style="width: 10%;"></td> <td style="width: 10%;"></td> <td style="width: 10%;"></td> <td style="width: 10%;"></td> <td style="width: 10%;"></td> <td style="width: 10%;"></td> <td style="width: 10%;"></td> <td style="width: 10%;"></td> <td style="width: 10%;"></td> </tr> <tr> <td></td> <td></td> <td colspan="8" style="text-align: center;"> <table border="1" style="width: 100%; border-collapse: collapse; text-align: center;"> <tr> <td style="width: 10%;"></td> <td style="width: 10%;"></td> <td style="width: 10%;"></td> <td style="width: 10%;"></td> <td style="width: 10%;"></td> <td style="width: 10%;"></td> <td style="width: 10%;"></td> <td style="width: 10%;"></td> <td style="width: 10%;"></td> <td style="width: 10%;"></td> </tr> <tr> <td></td> <td></td> <td colspan="8" style="text-align: center;"> <table border="1" style="width: 100%; border-collapse: collapse; text-align: center;"> <tr> <td style="width: 10%;"></td> <td style="width: 10%;"></td> <td style="width: 10%;"></td> <td style="width: 10%;"></td> <td style="width: 10%;"></td> <td style="width: 10%;"></td> <td style="width: 10%;"></td> <td style="width: 10%;"></td> <td style="width: 10%;"></td> <td style="width: 10%;"></td> </tr> <tr> <td></td> <td></td> <td colspan="8" style="text-align: center;"> <table border="1" style="width: 100%; border-collapse: collapse; text-align: center;"> <tr> <td style="width: 10%;"></td> <td style="width: 10%;"></td> <td style="width: 10%;"></td> <td style="width: 10%;"></td> <td style="width: 10%;"></td> <td style="width: 10%;"></td> <td style="width: 10%;"></td> <td style="width: 10%;"></td> <td style="width: 10%;"></td> <td style="width: 10%;"></td> </tr> <tr> <td></td> <td></td> <td colspan="8" style="text-align: center;"> <table border="1" style="width: 100%; border-collapse: collapse; text-align: center;"> <tr> <td style="width: 10%;"></td> <td style="width: 10%;"></td> <td style="width: 10%;"></td> <td style="width: 10%;"></td> <td style="width: 10%;"></td> <td style="width: 10%;"></td> <td style="width: 10%;"></td> <td style="width: 10%;"></td> <td style="width: 10%;"></td> <td style="width: 10%;"></td> </tr> <tr> <td></td> <td></td> <td colspan="8" style="text-align: center;"> <table border="1" style="width: 100%; border-collapse: collapse; text-align: center;"> <tr> <td style="width: 10%;"></td> <td style="width: 10%;"></td> <td style="width: 10%;"></td> <td style="width: 10%;"></td> <td style="width: 10%;"></td> <td style="width:
10%;"></td> <td style="width: 10%;"></td> <td style="width: 10%;"></td> <td style="width: 10%;"></td> <td style="width: 10%;"></td> </tr> <tr> <td></td> <td></td> <td colspan="8" style="text-align: center;"> <table border="1" style="width: 100%; border-collapse: collapse; text-align: center;"> <tr> </tr></table></td></tr></table></td></tr></table></td></tr></table></td></tr></table></td></tr></table></td></tr></table></td></tr></table></td></tr></table></td></tr></table></td></tr></table></td></tr></table></td></tr></table></td></tr></table></td></tr></table></td></tr></table></td></tr></table></td></tr></table></td></tr></table></td></tr></table></td></tr></table></td></tr></table></td></tr></table></td></tr></table></td></tr></table></td></tr></table></td></tr></table></td></tr></table></td></tr></table></td></tr></table></td></tr></table></td></tr></table></td></tr></table> | | | | | | | | | | | | | | | | | | | | <table border="1" style="width: 100%; border-collapse: collapse; text-align: center;"> <tr> <td style="width: 10%;"></td> <td style="width: 10%;"></td> <td style="width: 10%;"></td> <td style="width: 10%;"></td> <td style="width: 10%;"></td> <td style="width: 10%;"></td> <td style="width: 10%;"></td> <td style="width: 10%;"></td> <td style="width: 10%;"></td> <td style="width: 10%;"></td> </tr> <tr> <td></td> <td></td> <td colspan="8" style="text-align: center;"> <table border="1" style="width: 100%; border-collapse: collapse; text-align: center;"> <tr> <td style="width: 10%;"></td> <td style="width: 10%;"></td> <td style="width: 10%;"></td> <td style="width: 10%;"></td> <td style="width: 10%;"></td> <td style="width: 10%;"></td> <td style="width: 10%;"></td> <td style="width: 10%;"></td> <td style="width: 10%;"></td> <td style="width: 10%;"></td> </tr> <tr> <td></td> <td></td> <td colspan="8" style="text-align: center;"> <table border="1" style="width: 100%; border-collapse: collapse; text-align: center;"> <tr> <td style="width: 10%;"></td> <td style="width: 10%;"></td> <td style="width: 10%;"></td> <td style="width: 10%;"></td> <td style="width: 10%;"></td> <td style="width: 10%;"></td> <td style="width: 10%;"></td> <td style="width: 10%;"></td> <td style="width: 10%;"></td> <td style="width: 10%;"></td> </tr> <tr> <td></td> <td></td> <td colspan="8" style="text-align: center;"> <table border="1" style="width: 100%; border-collapse: collapse; text-align: center;"> <tr> <td style="width: 10%;"></td> <td style="width: 10%;"></td> <td style="width: 10%;"></td> <td style="width: 10%;"></td> <td style="width: 10%;"></td> <td style="width: 10%;"></td> <td style="width: 10%;"></td> <td style="width: 10%;"></td> <td style="width: 10%;"></td> <td style="width: 10%;"></td> </tr> <tr> <td></td> <td></td> <td colspan="8" style="text-align: center;"> <table border="1" style="width: 100%; border-collapse: collapse; text-align: center;"> <tr> <td style="width: 10%;"></td> <td style="width: 10%;"></td> <td style="width: 10%;"></td> <td style="width: 10%;"></td> <td style="width: 10%;"></td> <td style="width: 10%;"></td> <td style="width: 10%;"></td> <td style="width: 10%;"></td> <td style="width: 10%;"></td> <td style="width: 10%;"></td> </tr> <tr> <td></td> <td></td> <td colspan="8" style="text-align: center;"> <table border="1" style="width: 100%; border-collapse: collapse; text-align: center;"> <tr> <td style="width: 10%;"></td> <td style="width: 10%;"></td> <td style="width: 10%;"></td> <td style="width: 10%;"></td> <td style="width: 10%;"></td> <td style="width: 10%;"></td> <td style="width: 10%;"></td> <td style="width: 10%;"></td> <td style="width: 10%;"></td> <td style="width: 10%;"></td> </tr> <tr> <td></td> <td></td> <td colspan="8" style="text-align: center;"> <table border="1" style="width: 100%; border-collapse: collapse; text-align: center;"> <tr> <td style="width: 10%;"></td> <td style="width: 10%;"></td> <td style="width: 10%;"></td> <td style="width: 10%;"></td> <td style="width: 10%;"></td> <td style="width: 10%;"></td> <td style="width: 10%;"></td> <td style="width: 10%;"></td> <td style="width: 10%;"></td> <td style="width: 10%;"></td> </tr> <tr> <td></td> <td></td> <td colspan="8" style="text-align: center;"> <table border="1" style="width: 100%; border-collapse: collapse; text-align: center;"> <tr> <td style="width: 10%;"></td> <td style="width: 10%;"></td> <td style="width: 10%;"></td> <td style="width: 10%;"></td> <td style="width: 10%;"></td> <td style="width: 10%;"></td> <td style="width: 10%;"></td> <td style="width: 10%;"></td> <td style="width: 10%;"></td> <td style="width: 10%;"></td> </tr> <tr> <td></td> <td></td> <td
colspan="8" style="text-align: center;"> <table border="1" style="width: 100%; border-collapse: collapse; text-align: center;"> <tr> <td style="width: 10%;"></td> <td style="width: 10%;"></td> <td style="width: 10%;"></td> <td style="width: 10%;"></td> <td style="width: 10%;"></td> <td style="width: 10%;"></td> <td style="width: 10%;"></td> <td style="width: 10%;"></td> <td style="width: 10%;"></td> <td style="width: 10%;"></td> </tr> <tr> <td></td> <td></td> <td colspan="8" style="text-align: center;"> <table border="1" style="width: 100%; border-collapse: collapse; text-align: center;"> <tr> <td style="width: 10%;"></td> <td style="width: 10%;"></td> <td style="width: 10%;"></td> <td style="width: 10%;"></td> <td style="width: 10%;"></td> <td style="width: 10%;"></td> <td style="width: 10%;"></td> <td style="width: 10%;"></td> <td style="width: 10%;"></td> <td style="width: 10%;"></td> </tr> <tr> <td></td> <td></td> <td colspan="8" style="text-align: center;"> <table border="1" style="width: 100%; border-collapse: collapse; text-align: center;"> <tr> <td style="width: 10%;"></td> <td style="width: 10%;"></td> <td style="width: 10%;"></td> <td style="width: 10%;"></td> <td style="width: 10%;"></td> <td style="width: 10%;"></td> <td style="width: 10%;"></td> <td style="width: 10%;"></td> <td style="width: 10%;"></td> <td style="width: 10%;"></td> </tr> <tr> <td></td> <td></td> <td colspan="8" style="text-align: center;"> <table border="1" style="width: 100%; border-collapse: collapse; text-align: center;"> <tr> <td style="width: 10%;"></td> <td style="width: 10%;"></td> <td style="width: 10%;"></td> <td style="width: 10%;"></td> <td style="width: 10%;"></td> <td style="width: 10%;"></td> <td style="width: 10%;"></td> <td style="width: 10%;"></td> <td style="width: 10%;"></td> <td style="width: 10%;"></td> </tr> <tr> <td></td> <td></td> <td colspan="8" style="text-align: center;"> <table border="1" style="width: 100%; border-collapse: collapse; text-align: center;"> <tr> <td style="width: 10%;"></td> <td style="width: 10%;"></td> <td style="width: 10%;"></td> <td style="width: 10%;"></td> <td style="width: 10%;"></td> <td style="width: 10%;"></td> <td style="width: 10%;"></td> <td style="width: 10%;"></td> <td style="width: 10%;"></td> <td style="width: 10%;"></td> </tr> <tr> <td></td> <td></td> <td colspan="8" style="text-align: center;"> <table border="1" style="width: 100%; border-collapse: collapse; text-align: center;"> <tr> <td style="width: 10%;"></td> <td style="width: 10%;"></td> <td style="width: 10%;"></td> <td style="width: 10%;"></td> <td style="width: 10%;"></td> <td style="width: 10%;"></td> <td style="width: 10%;"></td> <td style="width: 10%;"></td> <td style="width: 10%;"></td> <td style="width: 10%;"></td> </tr> <tr> <td></td> <td></td> <td colspan="8" style="text-align: center;"> <table border="1" style="width: 100%; border-collapse: collapse; text-align: center;"> <tr> <td style="width: 10%;"></td> <td style="width: 10%;"></td> <td style="width: 10%;"></td> <td style="width: 10%;"></td> <td style="width: 10%;"></td> <td style="width: 10%;"></td> <td style="width: 10%;"></td> <td style="width: 10%;"></td> <td style="width: 10%;"></td> <td style="width: 10%;"></td> </tr> <tr> <td></td> <td></td> <td colspan="8" style="text-align: center;"> <table border="1" style="width: 100%; border-collapse: collapse; text-align: center;"> <tr> <td style="width: 10%;"></td> <td style="width: 10%;"></td> <td style="width: 10%;"></td> <td style="width: 10%;"></td> <td style="width: 10%;"></td> <td style="width: 10%;"></td> <td style="width: 10%;"></td> <td style="width: 10%;"></td> <td style="width: 10%;"></td> <td style="width: 10%;"></td> </tr> <tr> <td></td> <td></td> <td colspan="8" style="text-align: center;"> <table border="1" style="width: 100%; border-collapse: collapse; text-align: center;"> <tr> <td style="width: 10%;"></td> <td style="width: 10%;"></td> <td style="width: 10%;"></td> <td style="width: 10%;"></td> <td style="width: 10%;"></td> <td style="width: 10%;"></td> <td style="width: 10%;"></td> <td style="width: 10%;"></td> <td style="width: 10%;"></td> <td style="width: 10%;"></td> </tr> <tr> <td></td> <td></td> <td colspan="8" style="text-align: center;"> <table border="1" style="width: 100%; border-collapse: collapse; text-align: center;"> <tr> <td style="width: 10%;"></td> <td style="width: 10%;"></td> <td style="width: 10%;"></td> <td style="width: 10%;"></td> <td style="width: 10%;"></td> <td style="width: 10%;"></td> <td style="width: 10%;"></td> <td style="width: 10%;"></td> <td style="width: 10%;"></td> <td style="width: 10%;"></td> </tr> <tr> <td></td> <td></td> <td colspan="8" style="text-align: center;"> <table border="1" style="width: 100%; border-collapse: collapse; text-align: center;"> <tr> <td style="width: 10%;"></td> <td style="width: 10%;"></td> <td style="width: 10%;"></td> <td style="width: 10%;"></td> <td style="width: 10%;"></td> <td style="width: 10%;"></td> <td style="width: 10%;"></td> <td style="width: 10%;"></td> <td style="width: 10%;"></td> <td style="width: 10%;"></td> </tr> <tr> <td></td> <td></td> <td colspan="8" style="text-align: center;"> <table border="1" style="width: 100%; border-collapse: collapse; text-align: center;"> <tr> <td style="width: 10%;"></td> <td style="width: 10%;"></td> <td style="width: 10%;"></td> <td style="width: 10%;"></td> <td style="width: 10%;"></td> <td style="width: 10%;"></td> <td style="width: 10%;"></td> <td style="width: 10%;"></td> <td style="width: 10%;"></td> <td style="width: 10%;"></td> </tr> <tr> <td></td> <td></td> <td colspan="8" style="text-align: center;"> <table border="1" style="width: 100%; border-collapse: collapse; text-align: center;"> <tr> <td style="width: 10%;"></td> <td style="width: 10%;"></td> <td style="width: 10%;"></td> <td style="width: 10%;"></td> <td style="width: 10%;"></td> <td style="width: 10%;"></td> <td style="width: 10%;"></td> <td style="width: 10%;"></td> <td style="width: 10%;"></td> <td style="width: 10%;"></td> </tr> <tr> <td></td> <td></td> <td colspan="8" style="text-align: center;"> <table border="1" style="width: 100%; border-collapse: collapse; text-align: center;"> <tr> <td style="width: 10%;"></td> <td style="width: 10%;"></td> <td style="width: 10%;"></td> <td style="width: 10%;"></td> <td style="width: 10%;"></td> <td style="width: 10%;"></td> <td style="width: 10%;"></td> <td style="width: 10%;"></td> <td style="width: 10%;"></td> <td style="width: 10%;"></td> </tr> <tr> <td></td> <td></td> <td colspan="8" style="text-align: center;"> <table border="1" style="width: 100%; border-collapse: collapse; text-align: center;"> <tr> <td style="width: 10%;"></td> <td style="width: 10%;"></td> <td style="width: 10%;"></td> <td style="width: 10%;"></td> <td style="width: 10%;"></td> <td style="width: 10%;"></td> <td style="width: 10%;"></td> <td style="width: 10%;"></td> <td style="width: 10%;"></td> <td style="width: 10%;"></td> </tr> <tr> <td></td> <td></td> <td colspan="8" style="text-align: center;"> <table border="1" style="width: 100%; border-collapse: collapse; text-align: center;"> <tr> <td style="width: 10%;"></td> <td style="width: 10%;"></td> <td style="width: 10%;"></td> <td style="width: 10%;"></td> <td style="width: 10%;"></td> <td style="width: 10%;"></td> <td style="width: 10%;"></td> <td style="width: 10%;"></td> <td style="width: 10%;"></td> <td style="width: 10%;"></td> </tr> <tr> <td></td> <td></td> <td colspan="8" style="text-align: center;"> <table border="1" style="width: 100%; border-collapse: collapse; text-align: center;"> <tr> <td style="width: 10%;"></td> <td style="width: 10%;"></td> <td style="width: 10%;"></td> <td style="width: 10%;"></td> <td style="width: 10%;"></td> <td style="width: 10%;"></td> <td style="width: 10%;"></td> <td style="width: 10%;"></td> <td style="width: 10%;"></td> <td style="width: 10%;"></td> </tr> <tr> <td></td> <td></td> <td colspan="8" style="text-align: center;"> <table border="1" style="width: 100%; border-collapse: collapse; text-align: center;"> <tr> <td style="width: 10%;"></td> <td style="width: 10%;"></td> <td style="width: 10%;"></td> <td style="width: 10%;"></td> <td style="width: 10%;"></td> <td style="width: 10%;"></td> <td style="width: 10%;"></td> <td style="width: 10%;"></td> <td style="width: 10%;"></td> <td style="width: 10%;"></td> </tr> <tr> <td></td> <td></td> <td colspan="8" style="text-align: center;"> <table border="1" style="width: 100%; border-collapse: collapse; text-align: center;"> <tr> <td style="width: 10%;"></td> <td style="width: 10%;"></td> <td style="width: 10%;"></td> <td style="width: 10%;"></td> <td style="width: 10%;"></td> <td style="width: 10%;"></td> <td style="width: 10%;"></td> <td style="width: 10%;"></td> <td style="width: 10%;"></td> <td style="width: 10%;"></td> </tr> <tr> <td></td> <td></td> <td colspan="8" style="text-align: center;"> <table border="1" style="width: 100%; border-collapse: collapse; text-align: center;"> <tr> <td style="width: 10%;"></td> <td style="width: 10%;"></td> <td style="width: 10%;"></td> <td style="width: 10%;"></td> <td style="width: 10%;"></td> <td style="width: 10%;"></td> <td style="width: 10%;"></td> <td style="width: 10%;"></td> <td style="width: 10%;"></td> <td style="width: 10%;"></td> </tr> <tr> <td></td> <td></td> <td colspan="8" style="text-align: center;"> <table border="1" style="width: 100%; border-collapse: collapse; text-align: center;"> <tr> <td style="width: 10%;"></td> <td style="width: 10%;"></td> <td style="width: 10%;"></td> <td style="width: 10%;"></td> <td style="width: 10%;"></td> <td style="width: 10%;"></td> <td style="width: 10%;"></td> <td style="width: 10%;"></td> <td style="width: 10%;"></td> <td style="width: 10%;"></td> </tr> <tr> <td></td> <td></td> <td colspan="8" style="text-align: center;"> <table border="1" style="width: 100%; border-collapse: collapse; text-align: center;"> <tr> <td style="width: 10%;"></td> <td
style="width: 10%;"></td> <td style="width: 10%;"></td> <td style="width: 10%;"></td> <td style="width: 10%;"></td> <td style="width: 10%;"></td> <td style="width: 10%;"></td> <td style="width: 10%;"></td> <td style="width: 10%;"></td> <td style="width: 10%;"></td> </tr> <tr> <td></td> <td></td> <td colspan="8" style="text-align: center;"> <table border="1" style="width: 100%; border-collapse: collapse; text-align: center;"> <tr> <td style="width: 10%;"></td> <td style="width: 10%;"></td> <td style="width: 10%;"></td> <td style="width: 10%;"></td> <td style="width: 10%;"></td> <td style="width: 10%;"></td> <td style="width: 10%;"></td> <td style="width: 10%;"></td> <td style="width: 10%;"></td> <td style="width: 10%;"></td> </tr> <tr> <td></td> <td></td> <td colspan="8" style="text-align: center;"> <table border="1" style="width: 100%; border-collapse: collapse; text-align: center;"> <tr> </tr></table></td></tr></table></td></tr></table></td></tr></table></td></tr></table></td></tr></table></td></tr></table></td></tr></table></td></tr></table></td></tr></table></td></tr></table></td></tr></table></td></tr></table></td></tr></table></td></tr></table></td></tr></table></td></tr></table></td></tr></table></td></tr></table></td></tr></table></td></tr></table></td></tr></table></td></tr></table></td></tr></table></td></tr></table></td></tr></table></td></tr></table></td></tr></table></td></tr></table></td></tr></table></td></tr></table></td></tr></table> | | | | | | | | | | | | | | | | | | | | <table border="1" style="width: 100%; border-collapse: collapse; text-align: center;"> <tr> <td style="width: 10%;"></td> <td style="width: 10%;"></td> <td style="width: 10%;"></td> <td style="width: 10%;"></td> <td style="width: 10%;"></td> <td style="width: 10%;"></td> <td style="width: 10%;"></td> <td style="width: 10%;"></td> <td style="width: 10%;"></td> <td style="width: 10%;"></td> </tr> <tr> <td></td> <td></td> <td colspan="8" style="text-align: center;"> <table border="1" style="width: 100%; border-collapse: collapse; text-align: center;"> <tr> <td style="width: 10%;"></td> <td style="width: 10%;"></td> <td style="width: 10%;"></td> <td style="width: 10%;"></td> <td style="width: 10%;"></td> <td style="width: 10%;"></td> <td style="width: 10%;"></td> <td style="width: 10%;"></td> <td style="width: 10%;"></td> <td style="width: 10%;"></td> </tr> <tr> <td></td> <td></td> <td colspan="8" style="text-align: center;"> <table border="1" style="width: 100%; border-collapse: collapse; text-align: center;"> <tr> <td style="width: 10%;"></td> <td style="width: 10%;"></td> <td style="width: 10%;"></td> <td style="width: 10%;"></td> <td style="width: 10%;"></td> <td style="width: 10%;"></td> <td style="width: 10%;"></td> <td style="width: 10%;"></td> <td style="width: 10%;"></td> <td style="width: 10%;"></td> </tr> <tr> <td></td> <td></td> <td colspan="8" style="text-align: center;"> <table border="1" style="width: 100%; border-collapse: collapse; text-align: center;"> <tr> <td style="width: 10%;"></td> <td style="width: 10%;"></td> <td style="width: 10%;"></td> <td style="width: 10%;"></td> <td style="width: 10%;"></td> <td style="width: 10%;"></td> <td style="width: 10%;"></td> <td style="width: 10%;"></td> <td style="width: 10%;"></td> <td style="width: 10%;"></td> </tr> <tr> <td></td> <td></td> <td colspan="8" style="text-align: center;"> <table border="1" style="width: 100%; border-collapse: collapse; text-align: center;"> <tr> <td style="width: 10%;"></td> <td style="width: 10%;"></td> <td style="width: 10%;"></td> <td style="width: 10%;"></td> <td style="width: 10%;"></td> <td style="width: 10%;"></td> <td style="width: 10%;"></td> <td style="width: 10%;"></td> <td style="width: 10%;"></td> <td style="width: 10%;"></td> </tr> <tr> <td></td> <td></td> <td colspan="8" style="text-align: center;"> <table border="1" style="width: 100%; border-collapse: collapse; text-align: center;"> <tr> <td style="width: 10%;"></td> <td style="width: 10%;"></td> <td style="width: 10%;"></td> <td style="width: 10%;"></td> <td style="width: 10%;"></td> <td style="width: 10%;"></td> <td style="width: 10%;"></td> <td style="width: 10%;"></td> <td style="width: 10%;"></td> <td style="width: 10%;"></td> </tr> <tr> <td></td> <td></td> <td colspan="8" style="text-align: center;"> <table border="1" style="width: 100%; border-collapse: collapse; text-align: center;"> <tr> <td style="width: 10%;"></td> <td style="width: 10%;"></td> <td style="width: 10%;"></td> <td style="width: 10%;"></td> <td style="width: 10%;"></td> <td style="width: 10%;"></td> <td style="width: 10%;"></td> <td
style="width: 10%;"></td> <td style="width: 10%;"></td> <td style="width: 10%;"></td> </tr> <tr> <td></td> <td></td> <td colspan="8" style="text-align: center;"> <table border="1" style="width: 100%; border-collapse: collapse; text-align: center;"> <tr> <td style="width: 10%;"></td> <td style="width: 10%;"></td> <td style="width: 10%;"></td> <td style="width: 10%;"></td> <td style="width: 10%;"></td> <td style="width: 10%;"></td> <td style="width: 10%;"></td> <td style="width: 10%;"></td> <td style="width: 10%;"></td> <td style="width: 10%;"></td> </tr> <tr> <td></td> <td></td> <td colspan="8" style="text-align: center;"> <table border="1" style="width: 100%; border-collapse: collapse; text-align: center;"> <tr> <td style="width: 10%;"></td> <td style="width: 10%;"></td> <td style="width: 10%;"></td> <td style="width: 10%;"></td> <td style="width: 10%;"></td> <td style="width: 10%;"></td> <td style="width: 10%;"></td> <td style="width: 10%;"></td> <td style="width: 10%;"></td> <td style="width: 10%;"></td> </tr> <tr> <td></td> <td></td> <td colspan="8" style="text-align: center;"> <table border="1" style="width: 100%; border-collapse: collapse; text-align: center;"> <tr> <td style="width: 10%;"></td> <td style="width: 10%;"></td> <td style="width: 10%;"></td> <td style="width: 10%;"></td> <td style="width: 10%;"></td> <td style="width: 10%;"></td> <td style="width: 10%;"></td> <td style="width: 10%;"></td> <td style="width: 10%;"></td> <td style="width: 10%;"></td> </tr> <tr> <td></td> <td></td> <td colspan="8" style="text-align: center;"> <table border="1" style="width: 100%; border-collapse: collapse; text-align: center;"> <tr> <td style="width: 10%;"></td> <td style="width: 10%;"></td> <td style="width: 10%;"></td> <td style="width: 10%;"></td> <td style="width: 10%;"></td> <td style="width: 10%;"></td> <td style="width: 10%;"></td> <td style="width: 10%;"></td> <td style="width: 10%;"></td> <td style="width: 10%;"></td> </tr> <tr> <td></td> <td></td> <td colspan="8" style="text-align: center;"> <table border="1" style="width: 100%; border-collapse: collapse; text-align: center;"> <tr> <td style="width: 10%;"></td> <td style="width: 10%;"></td> <td style="width: 10%;"></td> <td style="width: 10%;"></td> <td style="width: 10%;"></td> <td style="width: 10%;"></td> <td style="width: 10%;"></td> <td style="width: 10%;"></td> <td style="width: 10%;"></td> <td style="width: 10%;"></td> </tr> <tr> <td></td> <td></td> <td colspan="8" style="text-align: center;"> <table border="1" style="width: 100%; border-collapse: collapse; text-align: center;"> <tr> <td style="width: 10%;"></td> <td style="width: 10%;"></td> <td style="width: 10%;"></td> <td style="width: 10%;"></td> <td style="width: 10%;"></td> <td style="width: 10%;"></td> <td style="width: 10%;"></td> <td style="width: 10%;"></td> <td style="width: 10%;"></td> <td style="width: 10%;"></td> </tr> <tr> <td></td> <td></td> <td colspan="8" style="text-align: center;"> <table border="1" style="width: 100%; border-collapse: collapse; text-align: center;"> <tr> <td style="width: 10%;"></td> <td style="width: 10%;"></td> <td style="width: 10%;"></td> <td style="width: 10%;"></td> <td style="width: 10%;"></td> <td style="width: 10%;"></td> <td style="width: 10%;"></td> <td style="width: 10%;"></td> <td style="width: 10%;"></td> <td style="width: 10%;"></td> </tr> <tr> <td></td> <td></td> <td colspan="8" style="text-align: center;"> <table border="1" style="width: 100%; border-collapse: collapse; text-align: center;"> <tr> <td style="width: 10%;"></td> <td style="width: 10%;"></td> <td style="width: 10%;"></td> <td style="width: 10%;"></td> <td style="width: 10%;"></td> <td style="width: 10%;"></td> <td style="width: 10%;"></td> <td style="width: 10%;"></td> <td style="width: 10%;"></td> <td style="width: 10%;"></td> </tr> <tr> <td></td> <td></td> <td colspan="8" style="text-align: center;"> <table border="1" style="width: 100%; border-collapse: collapse; text-align: center;"> <tr> <td style="width: 10%;"></td> <td style="width: 10%;"></td> <td style="width: 10%;"></td> <td style="width: 10%;"></td> <td style="width: 10%;"></td> <td style="width: 10%;"></td> <td style="width: 10%;"></td> <td style="width: 10%;"></td> <td style="width: 10%;"></td> <td style="width: 10%;"></td> </tr> <tr> <td></td> <td></td> <td colspan="8" style="text-align: center;"> <table border="1" style="width: 100%; border-collapse: collapse; text-align: center;"> <tr> <td style="width: 10%;"></td> <td style="width: 10%;"></td> <td style="width: 10%;"></td> <td style="width: 10%;"></td> <td style="width: 10%;"></td> <td style="width: 10%;"></td> <td style="width: 10%;"></td> <td style="width: 10%;"></td> <td style="width: 10%;"></td> <td style="width: 10%;"></td> </tr> <tr> <td></td> <td></td> <td colspan="8" style="text-align: center;"> <table border="1" style="width: 100%; border-collapse: collapse; text-align: center;"> <tr> <td style="width: 10%;"></td> <td style="width: 10%;"></td> <td style="width: 10%;"></td> <td style="width: 10%;"></td> <td style="width: 10%;"></td> <td style="width: 10%;"></td> <td style="width: 10%;"></td> <td style="width: 10%;"></td> <td style="width: 10%;"></td> <td style="width: 10%;"></td> </tr> <tr> <td></td> <td></td> <td colspan="8" style="text-align: center;"> <table border="1" style="width: 100%; border-collapse: collapse; text-align: center;"> <tr> <td style="width: 10%;"></td> <td style="width: 10%;"></td> <td style="width: 10%;"></td> <td style="width: 10%;"></td> <td style="width: 10%;"></td> <td style="width: 10%;"></td> <td style="width: 10%;"></td> <td style="width: 10%;"></td> <td style="width: 10%;"></td> <td style="width: 10%;"></td> </tr> <tr> <td></td> <td></td> <td colspan="8" style="text-align: center;"> <table border="1" style="width: 100%; border-collapse: collapse; text-align: center;"> <tr> <td style="width: 10%;"></td> <td style="width: 10%;"></td> <td style="width: 10%;"></td> <td style="width: 10%;"></td> <td style="width: 10%;"></td> <td style="width: 10%;"></td> <td style="width: 10%;"></td> <td style="width: 10%;"></td> <td style="width: 10%;"></td> <td style="width: 10%;"></td> </tr> <tr> <td></td> <td></td> <td colspan="8" style="text-align: center;"> <table border="1" style="width: 100%; border-collapse: collapse; text-align: center;"> <tr> <td style="width: 10%;"></td> <td style="width: 10%;"></td> <td style="width: 10%;"></td> <td style="width: 10%;"></td> <td style="width: 10%;"></td> <td style="width: 10%;"></td> <td style="width: 10%;"></td> <td style="width: 10%;"></td> <td style="width: 10%;"></td> <td style="width: 10%;"></td> </tr> <tr> <td></td> <td></td> <td colspan="8" style="text-align: center;"> <table border="1" style="width: 100%; border-collapse: collapse; text-align: center;"> <tr> <td style="width: 10%;"></td> <td style="width: 10%;"></td> <td style="width: 10%;"></td> <td style="width: 10%;"></td> <td style="width: 10%;"></td> <td style="width: 10%;"></td> <td style="width: 10%;"></td> <td style="width: 10%;"></td> <td style="width: 10%;"></td> <td style="width: 10%;"></td> </tr> <tr> <td></td> <td></td> <td colspan="8" style="text-align: center;"> <table border="1" style="width: 100%; border-collapse: collapse; text-align: center;"> <tr> <td style="width: 10%;"></td> <td style="width: 10%;"></td> <td style="width: 10%;"></td> <td style="width: 10%;"></td> <td style="width: 10%;"></td> <td style="width: 10%;"></td> <td style="width: 10%;"></td> <td style="width: 10%;"></td> <td style="width: 10%;"></td> <td style="width: 10%;"></td> </tr> <tr> <td></td> <td></td> <td colspan="8" style="text-align: center;"> <table border="1" style="width: 100%; border-collapse: collapse; text-align: center;"> <tr> <td style="width: 10%;"></td> <td style="width: 10%;"></td> <td style="width: 10%;"></td> <td style="width: 10%;"></td> <td style="width: 10%;"></td> <td style="width: 10%;"></td> <td style="width: 10%;"></td> <td style="width: 10%;"></td> <td style="width: 10%;"></td> <td style="width: 10%;"></td> </tr> <tr> <td></td> <td></td> <td colspan="8" style="text-align: center;"> <table border="1" style="width: 100%; border-collapse: collapse; text-align: center;"> <tr> <td style="width: 10%;"></td> <td style="width: 10%;"></td> <td style="width: 10%;"></td> <td style="width: 10%;"></td> <td style="width: 10%;"></td> <td style="width: 10%;"></td> <td style="width: 10%;"></td> <td style="width: 10%;"></td> <td style="width: 10%;"></td> <td style="width: 10%;"></td> </tr> <tr> <td></td> <td></td> <td colspan="8" style="text-align: center;"> <table border="1" style="width: 100%; border-collapse: collapse; text-align: center;"> <tr> <td style="width: 10%;"></td> <td style="width: 10%;"></td> <td style="width: 10%;"></td> <td style="width: 10%;"></td> <td style="width: 10%;"></td> <td style="width: 10%;"></td> <td style="width: 10%;"></td> <td style="width: 10%;"></td> <td style="width: 10%;"></td> <td style="width: 10%;"></td> </tr> <tr> <td></td> <td></td> <td colspan="8" style="text-align: center;"> <table border="1" style="width: 100%; border-collapse: collapse; text-align: center;"> <tr> <td style="width: 10%;"></td> <td style="width: 10%;"></td> <td style="width: 10%;"></td> <td style="width: 10%;"></td> <td style="width: 10%;"></td> <td style="width: 10%;"></td> <td style="width: 10%;"></td> <td style="width: 10%;"></td> <td style="width: 10%;"></td> <td style="width: 10%;"></td> </tr> <tr> <td></td> <td></td> <td colspan="8" style="text-align: center;"> <table border="1" style="width: 100%; border-collapse: collapse; text-align: center;"> <tr> <td style="width: 10%;"></td> <td style="width: 10%;"></td> <td style="width: 10%;"></td> <td style="width: 10%;"></td> <td style="width: 10%;"></td> <td style="width: 10%;"></td> <td style="width: 10%;"></td> <td style="width: 10%;"></td> <td style="width: 10%;"></td> <td style="width: 10%;"></td> </tr> <tr> <td></td> <td></td> <td colspan="8" style="text-align: center;"> <table
border="1" style="width: 100%; border-collapse: collapse; text-align: center;"> <tr> <td style="width: 10%;"></td> <td style="width: 10%;"></td> <td style="width: 10%;"></td> <td style="width: 10%;"></td> <td style="width: 10%;"></td> <td style="width: 10%;"></td> <td style="width: 10%;"></td> <td style="width: 10%;"></td> <td style="width: 10%;"></td> <td style="width: 10%;"></td> </tr> <tr> <td></td> <td></td> <td colspan="8" style="text-align: center;"> <table border="1" style="width: 100%; border-collapse: collapse; text-align: center;"> <tr> <td style="width: 10%;"></td> <td style="width: 10%;"></td> <td style="width: 10%;"></td> <td style="width: 10%;"></td> <td style="width: 10%;"></td> <td style="width: 10%;"></td> <td style="width: 10%;"></td> <td style="width: 10%;"></td> <td style="width: 10%;"></td> <td style="width: 10%;"></td> </tr> <tr> <td></td> <td></td> <td colspan="8" style="text-align: center;"> <table border="1" style="width: 100%; border-collapse: collapse; text-align: center;"> <tr> </tr></table></td></tr></table></td></tr></table></td></tr></table></td></tr></table></td></tr></table></td></tr></table></td></tr></table></td></tr></table></td></tr></table></td></tr></table></td></tr></table></td></tr></table></td></tr></table></td></tr></table></td></tr></table></td></tr></table></td></tr></table></td></tr></table></td></tr></table></td></tr></table></td></tr></table></td></tr></table></td></tr></table></td></tr></table></td></tr></table></td></tr></table></td></tr></table></td></tr></table></td></tr></table></td></tr></table> | | | | | | | | | | | | | | | | | | | | <table border="1" style="width: 100%; border-collapse: collapse; text-align: center;"> <tr> <td style="width: 10%;"></td> <td style="width: 10%;"></td> <td style="width: 10%;"></td> <td style="width: 10%;"></td> <td style="width: 10%;"></td> <td style="width: 10%;"></td> <td style="width: 10%;"></td> <td style="width: 10%;"></td> <td style="width: 10%;"></td> <td style="width: 10%;"></td> </tr> <tr> <td></td> <td></td> <td colspan="8" style="text-align: center;"> <table border="1" style="width: 100%; border-collapse: collapse; text-align: center;"> <tr> <td style="width: 10%;"></td> <td style="width: 10%;"></td> <td style="width: 10%;"></td> <td style="width: 10%;"></td> <td style="width: 10%;"></td> <td style="width: 10%;"></td> <td style="width: 10%;"></td> <td style="width: 10%;"></td> <td style="width: 10%;"></td> <td style="width: 10%;"></td> </tr> <tr> <td></td> <td></td> <td colspan="8" style="text-align: center;"> <table border="1" style="width: 100%; border-collapse: collapse; text-align: center;"> <tr> <td style="width: 10%;"></td> <td style="width: 10%;"></td> <td style="width: 10%;"></td> <td style="width: 10%;"></td> <td style="width: 10%;"></td> <td style="width: 10%;"></td> <td style="width: 10%;"></td> <td style="width: 10%;"></td> <td style="width: 10%;"></td> <td style="width: 10%;"></td> </tr> <tr> <td></td> <td></td> <td colspan="8" style="text-align: center;"> <table border="1" style="width: 100%; border-collapse: collapse; text-align: center;"> <tr> <td style="width: 10%;"></td> <td style="width: 10%;"></td> <td style="width: 10%;"></td> <td style="width: 10%;"></td> <td style="width: 10%;"></td> <td style="width: 10%;"></td> <td style="width: 10%;"></td> <td style="width: 10%;"></td> <td style="width: 10%;"></td> <td style="width: 10%;"></td> </tr> <tr> <td></td> <td></td> <td colspan="8" style="text-align: center;"> <table border="1" style="width: 100%; border-collapse: collapse; text-align: center;"> <tr> <td style="width: 10%;"></td> <td style="width: 10%;"></td> <td style="width: 10%;"></td> <td style="width: 10%;"></td> <td style="width: 10%;"></td> <td style="width: 10%;"></td> <td style="width: 10%;"></td> <td style="width: 10%;"></td> <td style="width: 10%;"></td> <td style="width: 10%;"></td> </tr> <tr> <td></td> <td></td> <td colspan="8" style="text-align: center;"> <table border="1" style="width: 100%; border-collapse: collapse; text-align: center;"> <tr> <td style="width: 10%;"></td> <td style="width: 10%;"></td> <td style="width: 10%;"></td> <td style="width: 10%;"></td> <td style="width: 10%;"></td> <td style="width: 10%;"></td> <td style="width: 10%;"></td> <td style="width: 10%;"></td> <td style="width: 10%;"></td> <td style="width: 10%;"></td> </tr> <tr> <td></td> <td></td> <td colspan="8" style="text-align: center;"> <table border="1" style="width: 100%; border-collapse: collapse; text-align: center;"> <tr> <td style="width: 10%;"></td> <td style="width: 10%;"></td> <td style="width: 10%;"></td> <td style="width: 10%;"></td>
<td style="width: 10%;"></td> <td style="width: 10%;"></td> <td style="width: 10%;"></td> <td style="width: 10%;"></td> <td style="width: 10%;"></td> <td style="width: 10%;"></td> </tr> <tr> <td></td> <td></td> <td colspan="8" style="text-align: center;"> <table border="1" style="width: 100%; border-collapse: collapse; text-align: center;"> <tr> <td style="width: 10%;"></td> <td style="width: 10%;"></td> <td style="width: 10%;"></td> <td style="width: 10%;"></td> <td style="width: 10%;"></td> <td style="width: 10%;"></td> <td style="width: 10%;"></td> <td style="width: 10%;"></td> <td style="width: 10%;"></td> <td style="width: 10%;"></td> </tr> <tr> <td></td> <td></td> <td colspan="8" style="text-align: center;"> <table border="1" style="width: 100%; border-collapse: collapse; text-align: center;"> <tr> <td style="width: 10%;"></td> <td style="width: 10%;"></td> <td style="width: 10%;"></td> <td style="width: 10%;"></td> <td style="width: 10%;"></td> <td style="width: 10%;"></td> <td style="width: 10%;"></td> <td style="width: 10%;"></td> <td style="width: 10%;"></td> <td style="width: 10%;"></td> </tr> <tr> <td></td> <td></td> <td colspan="8" style="text-align: center;"> <table border="1" style="width: 100%; border-collapse: collapse; text-align: center;"> <tr> <td style="width: 10%;"></td> <td style="width: 10%;"></td> <td style="width: 10%;"></td> <td style="width: 10%;"></td> <td style="width: 10%;"></td> <td style="width: 10%;"></td> <td style="width: 10%;"></td> <td style="width: 10%;"></td> <td style="width: 10%;"></td> <td style="width: 10%;"></td> </tr> <tr> <td></td> <td></td> <td colspan="8" style="text-align: center;"> <table border="1" style="width: 100%; border-collapse: collapse; text-align: center;"> <tr> <td style="width: 10%;"></td> <td style="width: 10%;"></td> <td style="width: 10%;"></td> <td style="width: 10%;"></td> <td style="width: 10%;"></td> <td style="width: 10%;"></td> <td style="width: 10%;"></td> <td style="width: 10%;"></td> <td style="width: 10%;"></td> <td style="width: 10%;"></td> </tr> <tr> <td></td> <td></td> <td colspan="8" style="text-align: center;"> <table border="1" style="width: 100%; border-collapse: collapse; text-align: center;"> <tr> <td style="width: 10%;"></td> <td style="width: 10%;"></td> <td style="width: 10%;"></td> <td style="width: 10%;"></td> <td style="width: 10%;"></td> <td style="width: 10%;"></td> <td style="width: 10%;"></td> <td style="width: 10%;"></td> <td style="width: 10%;"></td> <td style="width: 10%;"></td> </tr> <tr> <td></td> <td></td> <td colspan="8" style="text-align: center;"> <table border="1" style="width: 100%; border-collapse: collapse; text-align: center;"> <tr> <td style="width: 10%;"></td> <td style="width: 10%;"></td> <td style="width: 10%;"></td> <td style="width: 10%;"></td> <td style="width: 10%;"></td> <td style="width: 10%;"></td> <td style="width: 10%;"></td> <td style="width: 10%;"></td> <td style="width: 10%;"></td> <td style="width: 10%;"></td> </tr> <tr> <td></td> <td></td> <td colspan="8" style="text-align: center;"> <table border="1" style="width: 100%; border-collapse: collapse; text-align: center;"> <tr> <td style="width: 10%;"></td> <td style="width: 10%;"></td> <td style="width: 10%;"></td> <td style="width: 10%;"></td> <td style="width: 10%;"></td> <td style="width: 10%;"></td> <td style="width: 10%;"></td> <td style="width: 10%;"></td> <td style="width: 10%;"></td> <td style="width: 10%;"></td> </tr> <tr> <td></td> <td></td> <td colspan="8" style="text-align: center;"> <table border="1" style="width: 100%; border-collapse: collapse; text-align: center;"> <tr> <td style="width: 10%;"></td> <td style="width: 10%;"></td> <td style="width: 10%;"></td> <td style="width: 10%;"></td> <td style="width: 10%;"></td> <td style="width: 10%;"></td> <td style="width: 10%;"></td> <td style="width: 10%;"></td> <td style="width: 10%;"></td> <td style="width: 10%;"></td> </tr> <tr> <td></td> <td></td> <td colspan="8" style="text-align: center;"> <table border="1" style="width: 100%; border-collapse: collapse; text-align: center;"> <tr> <td style="width: 10%;"></td> <td style="width: 10%;"></td> <td style="width: 10%;"></td> <td style="width: 10%;"></td> <td style="width: 10%;"></td> <td style="width: 10%;"></td> <td style="width: 10%;"></td> <td style="width: 10%;"></td> <td style="width: 10%;"></td> <td style="width: 10%;"></td> </tr> <tr> <td></td> <td></td> <td colspan="8" style="text-align: center;"> <table border="1" style="width: 100%; border-collapse: collapse; text-align: center;"> <tr> <td style="width: 10%;"></td> <td style="width: 10%;"></td> <td style="width: 10%;"></td> <td style="width: 10%;"></td> <td style="width: 10%;"></td> <td style="width: 10%;"></td> <td style="width: 10%;"></td> <td style="width: 10%;"></td> <td style="width: 10%;"></td> <td style="width: 10%;"></td> </tr> <tr> <td></td> <td></td> <td colspan="8" style="text-align: center;"> <table border="1" style="width: 100%; border-collapse: collapse; text-align: center;"> <tr> <td style="width: 10%;"></td> <td style="width: 10%;"></td> <td style="width: 10%;"></td> <td style="width: 10%;"></td> <td style="width: 10%;"></td> <td style="width: 10%;"></td> <td style="width: 10%;"></td> <td style="width: 10%;"></td> <td style="width: 10%;"></td> <td style="width: 10%;"></td> </tr> <tr> <td></td> <td></td> <td colspan="8" style="text-align: center;"> <table border="1" style="width: 100%; border-collapse: collapse; text-align: center;"> <tr> <td style="width: 10%;"></td> <td style="width: 10%;"></td> <td style="width: 10%;"></td> <td style="width: 10%;"></td> <td style="width: 10%;"></td> <td style="width: 10%;"></td> <td style="width: 10%;"></td> <td style="width: 10%;"></td> <td style="width: 10%;"></td> <td style="width: 10%;"></td> </tr> <tr> <td></td> <td></td> <td colspan="8" style="text-align: center;"> <table border="1" style="width: 100%; border-collapse: collapse; text-align: center;"> <tr> <td style="width: 10%;"></td> <td style="width: 10%;"></td> <td style="width: 10%;"></td> <td style="width: 10%;"></td> <td style="width: 10%;"></td> <td style="width: 10%;"></td> <td style="width: 10%;"></td> <td style="width: 10%;"></td> <td style="width: 10%;"></td> <td style="width: 10%;"></td> </tr> <tr> <td></td> <td></td> <td colspan="8" style="text-align: center;"> <table border="1" style="width: 100%; border-collapse: collapse; text-align: center;"> <tr> <td style="width: 10%;"></td> <td style="width: 10%;"></td> <td style="width: 10%;"></td> <td style="width: 10%;"></td> <td style="width: 10%;"></td> <td style="width: 10%;"></td> <td style="width: 10%;"></td> <td style="width: 10%;"></td> <td style="width: 10%;"></td> <td style="width: 10%;"></td> </tr> <tr> <td></td> <td></td> <td colspan="8" style="text-align: center;"> <table border="1" style="width: 100%; border-collapse: collapse; text-align: center;"> <tr> <td style="width: 10%;"></td> <td style="width: 10%;"></td> <td style="width: 10%;"></td> <td style="width: 10%;"></td> <td style="width: 10%;"></td> <td style="width: 10%;"></td> <td style="width: 10%;"></td> <td style="width: 10%;"></td> <td style="width: 10%;"></td> <td style="width: 10%;"></td> </tr> <tr> <td></td> <td></td> <td colspan="8" style="text-align: center;"> <table border="1" style="width: 100%; border-collapse: collapse; text-align: center;"> <tr> <td style="width: 10%;"></td> <td style="width: 10%;"></td> <td style="width: 10%;"></td> <td style="width: 10%;"></td> <td style="width: 10%;"></td> <td style="width: 10%;"></td> <td style="width: 10%;"></td> <td style="width: 10%;"></td> <td style="width: 10%;"></td> <td style="width: 10%;"></td> </tr> <tr> <td></td> <td></td> <td colspan="8" style="text-align: center;"> <table border="1" style="width: 100%; border-collapse: collapse; text-align: center;"> <tr> <td style="width: 10%;"></td> <td style="width: 10%;"></td> <td style="width: 10%;"></td> <td style="width: 10%;"></td> <td style="width: 10%;"></td> <td style="width: 10%;"></td> <td style="width: 10%;"></td> <td style="width: 10%;"></td> <td style="width: 10%;"></td> <td style="width: 10%;"></td> </tr> <tr> <td></td> <td></td> <td colspan="8" style="text-align: center;"> <table border="1" style="width: 100%; border-collapse: collapse; text-align: center;"> <tr> <td style="width: 10%;"></td> <td style="width: 10%;"></td> <td style="width: 10%;"></td> <td style="width: 10%;"></td> <td style="width: 10%;"></td> <td style="width: 10%;"></td> <td style="width: 10%;"></td> <td style="width: 10%;"></td> <td style="width: 10%;"></td> <td style="width: 10%;"></td> </tr> <tr> <td></td> <td></td> <td colspan="8" style="text-align: center;"> <table border="1" style="width: 100%; border-collapse: collapse; text-align: center;"> <tr> <td style="width: 10%;"></td> <td style="width: 10%;"></td> <td style="width: 10%;"></td> <td style="width: 10%;"></td> <td style="width: 10%;"></td> <td style="width: 10%;"></td> <td style="width: 10%;"></td> <td style="width: 10%;"></td> <td style="width: 10%;"></td> <td style="width: 10%;"></td> </tr> <tr> <td></td> <td></td> <td colspan="8" style="text-align: center;"> <table border="1" style="width: 100%; border-collapse: collapse; text-align: center;"> <tr> <td style="width: 10%;"></td> <td style="width: 10%;"></td> <td style="width: 10%;"></td> <td style="width: 10%;"></td> <td style="width: 10%;"></td> <td style="width: 10%;"></td> <td style="width: 10%;"></td> <td style="width: 10%;"></td> <td style="width: 10%;"></td> <td style="width: 10%;"></td> </tr> <tr> <td></td> <td></td> <td colspan="8" style="text-align: center;"> <table border="1" style="width: 100%; border-collapse: collapse; text-align: center;"> <tr> <td style="width: 10%;"></td> <td style="width: 10%;"></td> <td style="width: 10%;"></td> <td style="width: 10%;"></td> <td style="width: 10%;"></td> <td style="width: 10%;"></td> <td style="width: 10%;"></td> <td style="width: 10%;"></td> <td style="width: 10%;"></td> <td style="width:
10%;"></td> </tr> <tr> <td></td> <td></td> <td colspan="8" style="text-align: center;"> <table border="1" style="width: 100%; border-collapse: collapse; text-align: center;"> <tr> <td style="width: 10%;"></td> <td style="width: 10%;"></td> <td style="width: 10%;"></td> <td style="width: 10%;"></td> <td style="width: 10%;"></td> <td style="width: 10%;"></td> <td style="width: 10%;"></td> <td style="width: 10%;"></td> <td style="width: 10%;"></td> <td style="width: 10%;"></td> </tr> <tr> <td></td> <td></td> <td colspan="8" style="text-align: center;"> <table border="1" style="width: 100%; border-collapse: collapse; text-align: center;"> <tr> </tr></table></td></tr></table></td></tr></table></td></tr></table></td></tr></table></td></tr></table></td></tr></table></td></tr></table></td></tr></table></td></tr></table></td></tr></table></td></tr></table></td></tr></table></td></tr></table></td></tr></table></td></tr></table></td></tr></table></td></tr></table></td></tr></table></td></tr></table></td></tr></table></td></tr></table></td></tr></table></td></tr></table></td></tr></table></td></tr></table></td></tr></table></td></tr></table></td></tr></table></td></tr></table> | | | | | | | | | | | | | | | | | | | | <table border="1" style="width: 100%; border-collapse: collapse; text-align: center;"> <tr> <td style="width: 10%;"></td> <td style="width: 10%;"></td> <td style="width: 10%;"></td> <td style="width: 10%;"></td> <td style="width: 10%;"></td> <td style="width: 10%;"></td> <td style="width: 10%;"></td> <td style="width: 10%;"></td> <td style="width: 10%;"></td> <td style="width: 10%;"></td> </tr> <tr> <td></td> <td></td> <td colspan="8" style="text-align: center;"> <table border="1" style="width: 100%; border-collapse: collapse; text-align: center;"> <tr> <td style="width: 10%;"></td> <td style="width: 10%;"></td> <td style="width: 10%;"></td> <td style="width: 10%;"></td> <td style="width: 10%;"></td> <td style="width: 10%;"></td> <td style="width: 10%;"></td> <td style="width: 10%;"></td> <td style="width: 10%;"></td> <td style="width: 10%;"></td> </tr> <tr> <td></td> <td></td> <td colspan="8" style="text-align: center;"> <table border="1" style="width: 100%; border-collapse: collapse; text-align: center;"> <tr> <td style="width: 10%;"></td> <td style="width: 10%;"></td> <td style="width: 10%;"></td> <td style="width: 10%;"></td> <td style="width: 10%;"></td> <td style="width: 10%;"></td> <td style="width: 10%;"></td> <td style="width: 10%;"></td> <td style="width: 10%;"></td> <td style="width: 10%;"></td> </tr> <tr> <td></td> <td></td> <td colspan="8" style="text-align: center;"> <table border="1" style="width: 100%; border-collapse: collapse; text-align: center;"> <tr> <td style="width: 10%;"></td> <td style="width: 10%;"></td> <td style="width: 10%;"></td> <td style="width: 10%;"></td> <td style="width: 10%;"></td> <td style="width: 10%;"></td> <td style="width: 10%;"></td> <td style="width: 10%;"></td> <td style="width: 10%;"></td> <td style="width: 10%;"></td> </tr> <tr> <td></td> <td></td> <td colspan="8" style="text-align: center;"> <table border="1" style="width: 100%; border-collapse: collapse; text-align: center;"> <tr> <td style="width: 10%;"></td> <td style="width: 10%;"></td> <td style="width: 10%;"></td> <td style="width: 10%;"></td> <td style="width: 10%;"></td> <td style="width: 10%;"></td> <td style="width: 10%;"></td> <td style="width: 10%;"></td> <td style="width: 10%;"></td> <td style="width: 10%;"></td> </tr> <tr> <td></td> <td></td> <td colspan="8" style="text-align: center;"> <table border="1" style="width: 100%; border-collapse: collapse; text-align: center;"> <tr> <td style="width: 10%;"></td> <td style="width: 10%;"></td> <td style="width: 10%;"></td> <td style="width: 10%;"></td> <td style="width: 10%;"></td> <td style="width: 10%;"></td> <td style="width: 10%;"></td> <td style="width: 10%;"></td> <td style="width: 10%;"></td> <td style="width: 10%;"></td> </tr> <tr> <td></td> <td></td> <td colspan="8" style="text-align: center;"> <table border="1" style="width: 100%; border-collapse: collapse; text-align: center;"> <tr> <td style="width: 10%;"></td> <td style="width: 10%;"></td> <td style="width: 10%;"></td> <td style="width: 10%;"></td> <td style="width: 10%;"></td> <td style="width: 10%;"></td> <td style="width: 10%;"></td> <td style="width: 10%;"></td> <td style="width: 10%;"></td> <td style="width: 10%;"></td> </tr> <tr> <td></td> <td></td> <td colspan="8" style="text-align: center;"> <table border="1" style="width: 100%; border-collapse: collapse; text-align: center;"> <tr> <td style="width: 10%;"></td> <td
style="width: 10%;"></td> <td style="width: 10%;"></td> <td style="width: 10%;"></td> <td style="width: 10%;"></td> <td style="width: 10%;"></td> <td style="width: 10%;"></td> <td style="width: 10%;"></td> <td style="width: 10%;"></td> <td style="width: 10%;"></td> </tr> <tr> <td></td> <td></td> <td colspan="8" style="text-align: center;"> <table border="1" style="width: 100%; border-collapse: collapse; text-align: center;"> <tr> <td style="width: 10%;"></td> <td style="width: 10%;"></td> <td style="width: 10%;"></td> <td style="width: 10%;"></td> <td style="width: 10%;"></td> <td style="width: 10%;"></td> <td style="width: 10%;"></td> <td style="width: 10%;"></td> <td style="width: 10%;"></td> <td style="width: 10%;"></td> </tr> <tr> <td></td> <td></td> <td colspan="8" style="text-align: center;"> <table border="1" style="width: 100%; border-collapse: collapse; text-align: center;"> <tr> <td style="width: 10%;"></td> <td style="width: 10%;"></td> <td style="width: 10%;"></td> <td style="width: 10%;"></td> <td style="width: 10%;"></td> <td style="width: 10%;"></td> <td style="width: 10%;"></td> <td style="width: 10%;"></td> <td style="width: 10%;"></td> <td style="width: 10%;"></td> </tr> <tr> <td></td> <td></td> <td colspan="8" style="text-align: center;"> <table border="1" style="width: 100%; border-collapse: collapse; text-align: center;"> <tr> <td style="width: 10%;"></td> <td style="width: 10%;"></td> <td style="width: 10%;"></td> <td style="width: 10%;"></td> <td style="width: 10%;"></td> <td style="width: 10%;"></td> <td style="width: 10%;"></td> <td style="width: 10%;"></td> <td style="width: 10%;"></td> <td style="width: 10%;"></td> </tr> <tr> <td></td> <td></td> <td colspan="8" style="text-align: center;"> <table border="1" style="width: 100%; border-collapse: collapse; text-align: center;"> <tr> <td style="width: 10%;"></td> <td style="width: 10%;"></td> <td style="width: 10%;"></td> <td style="width: 10%;"></td> <td style="width: 10%;"></td> <td style="width: 10%;"></td> <td style="width: 10%;"></td> <td style="width: 10%;"></td> <td style="width: 10%;"></td> <td style="width: 10%;"></td> </tr> <tr> <td></td> <td></td> <td colspan="8" style="text-align: center;"> <table border="1" style="width: 100%; border-collapse: collapse; text-align: center;"> <tr> <td style="width: 10%;"></td> <td style="width: 10%;"></td> <td style="width: 10%;"></td> <td style="width: 10%;"></td> <td style="width: 10%;"></td> <td style="width: 10%;"></td> <td style="width: 10%;"></td> <td style="width: 10%;"></td> <td style="width: 10%;"></td> <td style="width: 10%;"></td> </tr> <tr> <td></td> <td></td> <td colspan="8" style="text-align: center;"> <table border="1" style="width: 100%; border-collapse: collapse; text-align: center;"> <tr> <td style="width: 10%;"></td> <td style="width: 10%;"></td> <td style="width: 10%;"></td> <td style="width: 10%;"></td> <td style="width: 10%;"></td> <td style="width: 10%;"></td> <td style="width: 10%;"></td> <td style="width: 10%;"></td> <td style="width: 10%;"></td> <td style="width: 10%;"></td> </tr> <tr> <td></td> <td></td> <td colspan="8" style="text-align: center;"> <table border="1" style="width: 100%; border-collapse: collapse; text-align: center;"> <tr> <td style="width: 10%;"></td> <td style="width: 10%;"></td> <td style="width: 10%;"></td> <td style="width: 10%;"></td> <td style="width: 10%;"></td> <td style="width: 10%;"></td> <td style="width: 10%;"></td> <td style="width: 10%;"></td> <td style="width: 10%;"></td> <td style="width: 10%;"></td> </tr> <tr> <td></td> <td></td> <td colspan="8" style="text-align: center;"> <table border="1" style="width: 100%; border-collapse: collapse; text-align: center;"> <tr> <td style="width: 10%;"></td> <td style="width: 10%;"></td> <td style="width: 10%;"></td> <td style="width: 10%;"></td> <td style="width: 10%;"></td> <td style="width: 10%;"></td> <td style="width: 10%;"></td> <td style="width: 10%;"></td> <td style="width: 10%;"></td> <td style="width: 10%;"></td> </tr> <tr> <td></td> <td></td> <td colspan="8" style="text-align: center;"> <table border="1" style="width: 100%; border-collapse: collapse; text-align: center;"> <tr> <td style="width: 10%;"></td> <td style="width: 10%;"></td> <td style="width: 10%;"></td> <td style="width: 10%;"></td> <td style="width: 10%;"></td> <td style="width: 10%;"></td> <td style="width: 10%;"></td> <td style="width: 10%;"></td> <td style="width: 10%;"></td> <td style="width: 10%;"></td> </tr> <tr> <td></td> <td></td> <td colspan="8" style="text-align: center;"> <table border="1" style="width: 100%; border-collapse: collapse; text-align: center;"> <tr> <td style="width: 10%;"></td> <td style="width: 10%;"></td> <td style="width: 10%;"></td> <td style="width: 10%;"></td> <td style="width: 10%;"></td> <td style="width: 10%;"></td> <td style="width: 10%;"></td> <td style="width: 10%;"></td> <td style="width: 10%;"></td> <td style="width: 10%;"></td> </tr> <tr> <td></td> <td></td> <td colspan="8" style="text-align: center;"> <table border="1" style="width: 100%; border-collapse: collapse; text-align: center;"> <tr> <td style="width: 10%;"></td> <td style="width: 10%;"></td> <td style="width: 10%;"></td> <td style="width: 10%;"></td> <td style="width: 10%;"></td> <td style="width: 10%;"></td> <td style="width: 10%;"></td> <td style="width: 10%;"></td> <td style="width: 10%;"></td> <td style="width: 10%;"></td> </tr> <tr> <td></td> <td></td> <td colspan="8" style="text-align: center;"> <table border="1" style="width: 100%; border-collapse: collapse; text-align: center;"> <tr> <td style="width: 10%;"></td> <td style="width: 10%;"></td> <td style="width: 10%;"></td> <td style="width: 10%;"></td> <td style="width: 10%;"></td> <td style="width: 10%;"></td> <td style="width: 10%;"></td> <td style="width: 10%;"></td> <td style="width: 10%;"></td> <td style="width: 10%;"></td> </tr> <tr> <td></td> <td></td> <td colspan="8" style="text-align: center;"> <table border="1" style="width: 100%; border-collapse: collapse; text-align: center;"> <tr> <td style="width: 10%;"></td> <td style="width: 10%;"></td> <td style="width: 10%;"></td> <td style="width: 10%;"></td> <td style="width: 10%;"></td> <td style="width: 10%;"></td> <td style="width: 10%;"></td> <td style="width: 10%;"></td> <td style="width: 10%;"></td> <td style="width: 10%;"></td> </tr> <tr> <td></td> <td></td> <td colspan="8" style="text-align: center;"> <table border="1" style="width: 100%; border-collapse: collapse; text-align: center;"> <tr> <td style="width: 10%;"></td> <td style="width: 10%;"></td> <td style="width: 10%;"></td> <td style="width: 10%;"></td> <td style="width: 10%;"></td> <td style="width: 10%;"></td> <td style="width: 10%;"></td> <td style="width: 10%;"></td> <td style="width: 10%;"></td> <td style="width: 10%;"></td> </tr> <tr> <td></td> <td></td> <td colspan="8" style="text-align: center;"> <table border="1" style="width: 100%; border-collapse: collapse; text-align: center;"> <tr> <td style="width: 10%;"></td> <td style="width: 10%;"></td> <td style="width: 10%;"></td> <td style="width: 10%;"></td> <td style="width: 10%;"></td> <td style="width: 10%;"></td> <td style="width: 10%;"></td> <td style="width: 10%;"></td> <td style="width: 10%;"></td> <td style="width: 10%;"></td> </tr> <tr> <td></td> <td></td> <td colspan="8" style="text-align: center;"> <table border="1" style="width: 100%; border-collapse: collapse; text-align: center;"> <tr> <td style="width: 10%;"></td> <td style="width: 10%;"></td> <td style="width: 10%;"></td> <td style="width: 10%;"></td> <td style="width: 10%;"></td> <td style="width: 10%;"></td> <td style="width: 10%;"></td> <td style="width: 10%;"></td> <td style="width: 10%;"></td> <td style="width: 10%;"></td> </tr> <tr> <td></td> <td></td> <td colspan="8" style="text-align: center;"> <table border="1" style="width: 100%; border-collapse: collapse; text-align: center;"> <tr> <td style="width: 10%;"></td> <td style="width: 10%;"></td> <td style="width: 10%;"></td> <td style="width: 10%;"></td> <td style="width: 10%;"></td> <td style="width: 10%;"></td> <td style="width: 10%;"></td> <td style="width: 10%;"></td> <td style="width: 10%;"></td> <td style="width: 10%;"></td> </tr> <tr> <td></td> <td></td> <td colspan="8" style="text-align: center;"> <table border="1" style="width: 100%; border-collapse: collapse; text-align: center;"> <tr> <td style="width: 10%;"></td> <td style="width: 10%;"></td> <td style="width: 10%;"></td> <td style="width: 10%;"></td> <td style="width: 10%;"></td> <td style="width: 10%;"></td> <td style="width: 10%;"></td> <td style="width: 10%;"></td> <td style="width: 10%;"></td> <td style="width: 10%;"></td> </tr> <tr> <td></td> <td></td> <td colspan="8" style="text-align: center;"> <table border="1" style="width: 100%; border-collapse: collapse; text-align: center;"> <tr> <td style="width: 10%;"></td> <td style="width: 10%;"></td> <td style="width: 10%;"></td> <td style="width: 10%;"></td> <td style="width: 10%;"></td> <td style="width: 10%;"></td> <td style="width: 10%;"></td> <td style="width: 10%;"></td> <td style="width: 10%;"></td> <td style="width: 10%;"></td> </tr> <tr> <td></td> <td></td> <td colspan="8" style="text-align: center;"> <table border="1" style="width: 100%; border-collapse: collapse; text-align: center;"> <tr> <td style="width: 10%;"></td> <td style="width: 10%;"></td> <td style="width: 10%;"></td> <td style="width: 10%;"></td> <td style="width: 10%;"></td> <td style="width: 10%;"></td> <td style="width: 10%;"></td> <td style="width: 10%;"></td> <td style="width: 10%;"></td> <td style="width: 10%;"></td> </tr> <tr> <td></td> <td></td> <td colspan="8" style="text-align: center;"> <table border="1" style="width: 100%; border-collapse: collapse; text-align: center;"> <tr>
</tr></table></td></tr></table></td></tr></table></td></tr></table></td></tr></table></td></tr></table></td></tr></table></td></tr></table></td></tr></table></td></tr></table></td></tr></table></td></tr></table></td></tr></table></td></tr></table></td></tr></table></td></tr></table></td></tr></table></td></tr></table></td></tr></table></td></tr></table></td></tr></table></td></tr></table></td></tr></table></td></tr></table></td></tr></table></td></tr></table></td></tr></table></td></tr></table></td></tr></table> | | | | | | | | | | | | | | | | | | | | <table border="1" style="width: 100%; border-collapse: collapse; text-align: center;"> <tr> <td style="width: 10%;"></td> <td style="width: 10%;"></td> <td style="width: 10%;"></td> <td style="width: 10%;"></td> <td style="width: 10%;"></td> <td style="width: 10%;"></td> <td style="width: 10%;"></td> <td style="width: 10%;"></td> <td style="width: 10%;"></td> <td style="width: 10%;"></td> </tr> <tr> <td></td> <td></td> <td colspan="8" style="text-align: center;"> <table border="1" style="width: 100%; border-collapse: collapse; text-align: center;"> <tr> <td style="width: 10%;"></td> <td style="width: 10%;"></td> <td style="width: 10%;"></td> <td style="width: 10%;"></td> <td style="width: 10%;"></td> <td style="width: 10%;"></td> <td style="width: 10%;"></td> <td style="width: 10%;"></td> <td style="width: 10%;"></td> <td style="width: 10%;"></td> </tr> <tr> <td></td> <td></td> <td colspan="8" style="text-align: center;"> <table border="1" style="width: 100%; border-collapse: collapse; text-align: center;"> <tr> <td style="width: 10%;"></td> <td style="width: 10%;"></td> <td style="width: 10%;"></td> <td style="width: 10%;"></td> <td style="width: 10%;"></td> <td style="width: 10%;"></td> <td style="width: 10%;"></td> <td style="width: 10%;"></td> <td style="width: 10%;"></td> <td style="width: 10%;"></td> </tr> <tr> <td></td> <td></td> <td colspan="8" style="text-align: center;"> <table border="1" style="width: 100%; border-collapse: collapse; text-align: center;"> <tr> <td style="width: 10%;"></td> <td style="width: 10%;"></td> <td style="width: 10%;"></td> <td style="width: 10%;"></td> <td style="width: 10%;"></td> <td style="width: 10%;"></td> <td style="width: 10%;"></td> <td style="width: 10%;"></td> <td style="width: 10%;"></td> <td style="width: 10%;"></td> </tr> <tr> <td></td> <td></td> <td colspan="8" style="text-align: center;"> <table border="1" style="width: 100%; border-collapse: collapse; text-align: center;"> <tr> <td style="width: 10%;"></td> <td style="width: 10%;"></td> <td style="width: 10%;"></td> <td style="width: 10%;"></td> <td style="width: 10%;"></td> <td style="width: 10%;"></td> <td style="width: 10%;"></td> <td style="width: 10%;"></td> <td style="width: 10%;"></td> <td style="width: 10%;"></td> </tr> <tr> <td></td> <td></td> <td colspan="8" style="text-align: center;"> <table border="1" style="width: 100%; border-collapse: collapse; text-align: center;"> <tr> <td style="width: 10%;"></td> <td style="width: 10%;"></td> <td style="width: 10%;"></td> <td style="width: 10%;"></td> <td style="width: 10%;"></td> <td style="width: 10%;"></td> <td style="width: 10%;"></td> <td style="width: 10%;"></td> <td style="width: 10%;"></td> <td style="width: 10%;"></td> </tr> <tr> <td></td> <td></td> <td colspan="8" style="text-align: center;"> <table border="1" style="width: 100%; border-collapse: collapse; text-align: center;"> <tr> <td style="width: 10%;"></td> <td style="width: 10%;"></td> <td style="width: 10%;"></td> <td style="width: 10%;"></td> <td style="width: 10%;"></td> <td style="width: 10%;"></td> <td style="width: 10%;"></td> <td style="width: 10%;"></td> <td style="width: 10%;"></td> <td style="width: 10%;"></td> </tr> <tr> <td></td> <td></td> <td colspan="8" style="text-align: center;"> <table border="1" style="width: 100%; border-collapse: collapse; text-align: center;"> <tr> <td style="width: 10%;"></td> <td style="width: 10%;"></td> <td style="width: 10%;"></td> <td style="width: 10%;"></td> <td style="width: 10%;"></td> <td style="width: 10%;"></td> <td style="width: 10%;"></td> <td style="width: 10%;"></td> <td style="width: 10%;"></td> <td style="width: 10%;"></td> </tr> <tr> <td></td> <td></td> <td colspan="8" style="text-align: center;"> <table border="1" style="width: 100%; border-collapse: collapse; text-align: center;"> <tr> <td style="width: 10%;"></td> <td style="width: 10%;"></td> <td style="width: 10%;"></td> <td style="width: 10%;"></td> <td style="width: 10%;"></td> <td style="width: 10%;"></td> <td style="width: 10%;"></td> <td style="width: 10%;"></td>
<td style="width: 10%;"></td> <td style="width: 10%;"></td> </tr> <tr> <td></td> <td></td> <td colspan="8" style="text-align: center;"> <table border="1" style="width: 100%; border-collapse: collapse; text-align: center;"> <tr> <td style="width: 10%;"></td> <td style="width: 10%;"></td> <td style="width: 10%;"></td> <td style="width: 10%;"></td> <td style="width: 10%;"></td> <td style="width: 10%;"></td> <td style="width: 10%;"></td> <td style="width: 10%;"></td> <td style="width: 10%;"></td> <td style="width: 10%;"></td> </tr> <tr> <td></td> <td></td> <td colspan="8" style="text-align: center;"> <table border="1" style="width: 100%; border-collapse: collapse; text-align: center;"> <tr> <td style="width: 10%;"></td> <td style="width: 10%;"></td> <td style="width: 10%;"></td> <td style="width: 10%;"></td> <td style="width: 10%;"></td> <td style="width: 10%;"></td> <td style="width: 10%;"></td> <td style="width: 10%;"></td> <td style="width: 10%;"></td> <td style="width: 10%;"></td> </tr> <tr> <td></td> <td></td> <td colspan="8" style="text-align: center;"> <table border="1" style="width: 100%; border-collapse: collapse; text-align: center;"> <tr> <td style="width: 10%;"></td> <td style="width: 10%;"></td> <td style="width: 10%;"></td> <td style="width: 10%;"></td> <td style="width: 10%;"></td> <td style="width: 10%;"></td> <td style="width: 10%;"></td> <td style="width: 10%;"></td> <td style="width: 10%;"></td> <td style="width: 10%;"></td> </tr> <tr> <td></td> <td></td> <td colspan="8" style="text-align: center;"> <table border="1" style="width: 100%; border-collapse: collapse; text-align: center;"> <tr> <td style="width: 10%;"></td> <td style="width: 10%;"></td> <td style="width: 10%;"></td> <td style="width: 10%;"></td> <td style="width: 10%;"></td> <td style="width: 10%;"></td> <td style="width: 10%;"></td> <td style="width: 10%;"></td> <td style="width: 10%;"></td> <td style="width: 10%;"></td> </tr> <tr> <td></td> <td></td> <td colspan="8" style="text-align: center;"> <table border="1" style="width: 100%; border-collapse: collapse; text-align: center;"> <tr> <td style="width: 10%;"></td> <td style="width: 10%;"></td> <td style="width: 10%;"></td> <td style="width: 10%;"></td> <td style="width: 10%;"></td> <td style="width: 10%;"></td> <td style="width: 10%;"></td> <td style="width: 10%;"></td> <td style="width: 10%;"></td> <td style="width: 10%;"></td> </tr> <tr> <td></td> <td></td> <td colspan="8" style="text-align: center;"> <table border="1" style="width: 100%; border-collapse: collapse; text-align: center;"> <tr> <td style="width: 10%;"></td> <td style="width: 10%;"></td> <td style="width: 10%;"></td> <td style="width: 10%;"></td> <td style="width: 10%;"></td> <td style="width: 10%;"></td> <td style="width: 10%;"></td> <td style="width: 10%;"></td> <td style="width: 10%;"></td> <td style="width: 10%;"></td> </tr> <tr> <td></td> <td></td> <td colspan="8" style="text-align: center;"> <table border="1" style="width: 100%; border-collapse: collapse; text-align: center;"> <tr> <td style="width: 10%;"></td> <td style="width: 10%;"></td> <td style="width: 10%;"></td> <td style="width: 10%;"></td> <td style="width: 10%;"></td> <td style="width: 10%;"></td> <td style="width: 10%;"></td> <td style="width: 10%;"></td> <td style="width: 10%;"></td> <td style="width: 10%;"></td> </tr> <tr> <td></td> <td></td> <td colspan="8" style="text-align: center;"> <table border="1" style="width: 100%; border-collapse: collapse; text-align: center;"> <tr> <td style="width: 10%;"></td> <td style="width: 10%;"></td> <td style="width: 10%;"></td> <td style="width: 10%;"></td> <td style="width: 10%;"></td> <td style="width: 10%;"></td> <td style="width: 10%;"></td> <td style="width: 10%;"></td> <td style="width: 10%;"></td> <td style="width: 10%;"></td> </tr> <tr> <td></td> <td></td> <td colspan="8" style="text-align: center;"> <table border="1" style="width: 100%; border-collapse: collapse; text-align: center;"> <tr> <td style="width: 10%;"></td> <td style="width: 10%;"></td> <td style="width: 10%;"></td> <td style="width: 10%;"></td> <td style="width: 10%;"></td> <td style="width: 10%;"></td> <td style="width: 10%;"></td> <td style="width: 10%;"></td> <td style="width: 10%;"></td> <td style="width: 10%;"></td> </tr> <tr> <td></td> <td></td> <td colspan="8" style="text-align: center;"> <table border="1" style="width: 100%; border-collapse: collapse; text-align: center;"> <tr> <td style="width: 10%;"></td> <td style="width: 10%;"></td> <td style="width: 10%;"></td> <td style="width: 10%;"></td> <td style="width: 10%;"></td> <td style="width: 10%;"></td> <td style="width: 10%;"></td> <td style="width: 10%;"></td> <td style="width: 10%;"></td> <td style="width: 10%;"></td> </tr> <tr> <td></td> <td></td> <td colspan="8" style="text-align: center;"> <table border="1" style="width: 100%; border-collapse: collapse; text-align: center;"> <tr> <td style="width: 10%;"></td> <td style="width: 10%;"></td> <td style="width: 10%;"></td> <td style="width: 10%;"></td> <td style="width: 10%;"></td> <td style="width: 10%;"></td> <td style="width: 10%;"></td> <td style="width: 10%;"></td> <td style="width: 10%;"></td> <td style="width: 10%;"></td> </tr> <tr> <td></td> <td></td> <td colspan="8" style="text-align: center;"> <table border="1" style="width: 100%; border-collapse: collapse; text-align: center;"> <tr> <td style="width: 10%;"></td> <td style="width: 10%;"></td> <td style="width: 10%;"></td> <td style="width: 10%;"></td> <td style="width: 10%;"></td> <td style="width: 10%;"></td> <td style="width: 10%;"></td> <td style="width: 10%;"></td> <td style="width: 10%;"></td> <td style="width: 10%;"></td> </tr> <tr> <td></td> <td></td> <td colspan="8" style="text-align: center;"> <table border="1" style="width: 100%; border-collapse: collapse; text-align: center;"> <tr> <td style="width: 10%;"></td> <td style="width: 10%;"></td> <td style="width: 10%;"></td> <td style="width: 10%;"></td> <td style="width: 10%;"></td> <td style="width: 10%;"></td> <td style="width: 10%;"></td> <td style="width: 10%;"></td> <td style="width: 10%;"></td> <td style="width: 10%;"></td> </tr> <tr> <td></td> <td></td> <td colspan="8" style="text-align: center;"> <table border="1" style="width: 100%; border-collapse: collapse; text-align: center;"> <tr> <td style="width: 10%;"></td> <td style="width: 10%;"></td> <td style="width: 10%;"></td> <td style="width: 10%;"></td> <td style="width: 10%;"></td> <td style="width: 10%;"></td> <td style="width: 10%;"></td> <td style="width: 10%;"></td> <td style="width: 10%;"></td> <td style="width: 10%;"></td> </tr> <tr> <td></td> <td></td> <td colspan="8" style="text-align: center;"> <table border="1" style="width: 100%; border-collapse: collapse; text-align: center;"> <tr> <td style="width: 10%;"></td> <td style="width: 10%;"></td> <td style="width: 10%;"></td> <td style="width: 10%;"></td> <td style="width: 10%;"></td> <td style="width: 10%;"></td> <td style="width: 10%;"></td> <td style="width: 10%;"></td> <td style="width: 10%;"></td> <td style="width: 10%;"></td> </tr> <tr> <td></td> <td></td> <td colspan="8" style="text-align: center;"> <table border="1" style="width: 100%; border-collapse: collapse; text-align: center;"> <tr> <td style="width: 10%;"></td> <td style="width: 10%;"></td> <td style="width: 10%;"></td> <td style="width: 10%;"></td> <td style="width: 10%;"></td> <td style="width: 10%;"></td> <td style="width: 10%;"></td> <td style="width: 10%;"></td> <td style="width: 10%;"></td> <td style="width: 10%;"></td> </tr> <tr> <td></td> <td></td> <td colspan="8" style="text-align: center;"> <table border="1" style="width: 100%; border-collapse: collapse; text-align: center;"> <tr> <td style="width: 10%;"></td> <td style="width: 10%;"></td> <td style="width: 10%;"></td> <td style="width: 10%;"></td> <td style="width: 10%;"></td> <td style="width: 10%;"></td> <td style="width: 10%;"></td> <td style="width: 10%;"></td> <td style="width: 10%;"></td> <td style="width: 10%;"></td> </tr> <tr> <td></td> <td></td> <td colspan="8" style="text-align: center;"> <table border="1" style="width: 100%; border-collapse: collapse; text-align: center;"> <tr> <td style="width: 10%;"></td> <td style="width: 10%;"></td> <td style="width: 10%;"></td> <td style="width: 10%;"></td> <td style="width: 10%;"></td> <td style="width: 10%;"></td> <td style="width: 10%;"></td> <td style="width: 10%;"></td> <td style="width: 10%;"></td> <td style="width: 10%;"></td> </tr> <tr> <td></td> <td></td> <td colspan="8" style="text-align: center;"> <table border="1" style="width: 100%; border-collapse: collapse; text-align: center;"> <tr> </tr></table></td></tr></table></td></tr></table></td></tr></table></td></tr></table></td></tr></table></td></tr></table></td></tr></table></td></tr></table></td></tr></table></td></tr></table></td></tr></table></td></tr></table></td></tr></table></td></tr></table></td></tr></table></td></tr></table></td></tr></table></td></tr></table></td></tr></table></td></tr></table></td></tr></table></td></tr></table></td></tr></table></td></tr></table></td></tr></table></td></tr></table></td></tr></table>
 | | | | | | | | | | | | | | | | | | | | <table border="1" style="width: 100%; border-collapse: collapse; text-align: center;"> <tr> <td style="width: 10%;"></td> <td style="width: 10%;"></td> <td style="width: 10%;"></td> <td style="width: 10%;"></td> <td style="width: 10%;"></td> <td style="width: 10%;"></td> <td style="width: 10%;"></td> <td style="width: 10%;"></td> <td style="width: 10%;"></td> <td style="width: 10%;"></td> </tr> <tr> <td></td> <td></td> <td colspan="8" style="text-align: center;"> <table border="1" style="width: 100%; border-collapse: collapse; text-align: center;"> <tr> <td style="width: 10%;"></td> <td style="width: 10%;"></td> <td style="width: 10%;"></td> <td style="width: 10%;"></td> <td style="width: 10%;"></td> <td style="width: 10%;"></td> <td style="width: 10%;"></td> <td style="width: 10%;"></td> <td style="width: 10%;"></td> <td style="width: 10%;"></td> </tr> <tr> <td></td> <td></td> <td colspan="8" style="text-align: center;"> <table border="1" style="width: 100%; border-collapse: collapse; text-align: center;"> <tr> <td style="width: 10%;"></td> <td style="width: 10%;"></td> <td style="width: 10%;"></td> <td style="width: 10%;"></td> <td style="width: 10%;"></td> <td style="width: 10%;"></td> <td style="width: 10%;"></td> <td style="width: 10%;"></td> <td style="width: 10%;"></td> <td style="width: 10%;"></td> </tr> <tr> <td></td> <td></td> <td colspan="8" style="text-align: center;"> <table border="1" style="width: 100%; border-collapse: collapse; text-align: center;"> <tr> <td style="width: 10%;"></td> <td style="width: 10%;"></td> <td style="width: 10%;"></td> <td style="width: 10%;"></td> <td style="width: 10%;"></td> <td style="width: 10%;"></td> <td style="width: 10%;"></td> <td style="width: 10%;"></td> <td style="width: 10%;"></td> <td style="width: 10%;"></td> </tr> <tr> <td></td> <td></td> <td colspan="8" style="text-align: center;"> <table border="1" style="width: 100%; border-collapse: collapse; text-align: center;"> <tr> <td style="width: 10%;"></td> <td style="width: 10%;"></td> <td style="width: 10%;"></td> <td style="width: 10%;"></td> <td style="width: 10%;"></td> <td style="width: 10%;"></td> <td style="width: 10%;"></td> <td style="width: 10%;"></td> <td style="width: 10%;"></td> <td style="width: 10%;"></td> </tr> <tr> <td></td> <td></td> <td colspan="8" style="text-align: center;"> <table border="1" style="width: 100%; border-collapse: collapse; text-align: center;"> <tr> <td style="width: 10%;"></td> <td style="width: 10%;"></td> <td style="width: 10%;"></td> <td style="width: 10%;"></td> <td style="width: 10%;"></td> <td style="width: 10%;"></td> <td style="width: 10%;"></td> <td style="width: 10%;"></td> <td style="width: 10%;"></td> <td style="width: 10%;"></td> </tr> <tr> <td></td> <td></td> <td colspan="8" style="text-align: center;"> <table border="1" style="width: 100%; border-collapse: collapse; text-align: center;"> <tr> <td style="width: 10%;"></td> <td style="width: 10%;"></td> <td style="width: 10%;"></td> <td style="width: 10%;"></td> <td style="width: 10%;"></td> <td style="width: 10%;"></td> <td style="width: 10%;"></td> <td style="width: 10%;"></td> <td style="width: 10%;"></td> <td style="width: 10%;"></td> </tr> <tr> <td></td> <td></td> <td colspan="8" style="text-align: center;"> <table border="1" style="width: 100%; border-collapse: collapse; text-align: center;"> <tr> <td style="width: 10%;"></td> <td style="width: 10%;"></td> <td style="width: 10%;"></td> <td style="width: 10%;"></td> <td style="width: 10%;"></td> <td style="width: 10%;"></td> <td style="width: 10%;"></td> <td style="width: 10%;"></td> <td style="width: 10%;"></td> <td style="width: 10%;"></td> </tr> <tr> <td></td> <td></td> <td colspan="8" style="text-align: center;"> <table border="1" style="width: 100%; border-collapse: collapse; text-align: center;"> <tr> <td style="width: 10%;"></td> <td style="width: 10%;"></td> <td style="width: 10%;"></td> <td style="width: 10%;"></td> <td style="width: 10%;"></td> <td style="width: 10%;"></td> <td style="width: 10%;"></td> <td style="width: 10%;"></td> <td style="width: 10%;"></td> <td style="width: 10%;"></td> </tr> <tr> <td></td> <td></td> <td colspan="8" style="text-align: center;"> <table border="1" style="width: 100%; border-collapse: collapse; text-align: center;"> <tr> <td style="width: 10%;"></td> <td style="width: 10%;"></td> <td style="width: 10%;"></td> <td style="width: 10%;"></td> <td style="width: 10%;"></td> <td style="width: 10%;"></td> <td style="width: 10%;"></td> <td style="width: 10%;"></td> <td style="width: 10%;"></td> <td style="width: 10%;"></td> </tr> <tr> <td></td> <td></td> <td colspan="8" style="text-align: center;"> <table border="1" style="width: 100%; border-collapse: collapse; text-align: center;"> <tr> <td style="width: 10%;"></td> <td style="width: 10%;"></td> <td style="width: 10%;"></td> <td style="width: 10%;"></td> <td style="width: 10%;"></td> <td style="width: 10%;"></td> <td style="width: 10%;"></td> <td style="width: 10%;"></td> <td style="width: 10%;"></td> <td style="width: 10%;"></td> </tr> <tr> <td></td> <td></td> <td colspan="8" style="text-align: center;"> <table border="1" style="width: 100%; border-collapse: collapse; text-align: center;"> <tr> <td style="width: 10%;"></td> <td style="width: 10%;"></td> <td style="width: 10%;"></td> <td style="width: 10%;"></td> <td style="width: 10%;"></td> <td style="width: 10%;"></td> <td style="width:
10%;"></td> <td style="width: 10%;"></td> <td style="width: 10%;"></td> <td style="width: 10%;"></td> </tr> <tr> <td></td> <td></td> <td colspan="8" style="text-align: center;"> <table border="1" style="width: 100%; border-collapse: collapse; text-align: center;"> <tr> <td style="width: 10%;"></td> <td style="width: 10%;"></td> <td style="width: 10%;"></td> <td style="width: 10%;"></td> <td style="width: 10%;"></td> <td style="width: 10%;"></td> <td style="width: 10%;"></td> <td style="width: 10%;"></td> <td style="width: 10%;"></td> <td style="width: 10%;"></td> </tr> <tr> <td></td> <td></td> <td colspan="8" style="text-align: center;"> <table border="1" style="width: 100%; border-collapse: collapse; text-align: center;"> <tr> <td style="width: 10%;"></td> <td style="width: 10%;"></td> <td style="width: 10%;"></td> <td style="width: 10%;"></td> <td style="width: 10%;"></td> <td style="width: 10%;"></td> <td style="width: 10%;"></td> <td style="width: 10%;"></td> <td style="width: 10%;"></td> <td style="width: 10%;"></td> </tr> <tr> <td></td> <td></td> <td colspan="8" style="text-align: center;"> <table border="1" style="width: 100%; border-collapse: collapse; text-align: center;"> <tr> <td style="width: 10%;"></td> <td style="width: 10%;"></td> <td style="width: 10%;"></td> <td style="width: 10%;"></td> <td style="width: 10%;"></td> <td style="width: 10%;"></td> <td style="width: 10%;"></td> <td style="width: 10%;"></td> <td style="width: 10%;"></td> <td style="width: 10%;"></td> </tr> <tr> <td></td> <td></td> <td colspan="8" style="text-align: center;"> <table border="1" style="width: 100%; border-collapse: collapse; text-align: center;"> <tr> <td style="width: 10%;"></td> <td style="width: 10%;"></td> <td style="width: 10%;"></td> <td style="width: 10%;"></td> <td style="width: 10%;"></td> <td style="width: 10%;"></td> <td style="width: 10%;"></td> <td style="width: 10%;"></td> <td style="width: 10%;"></td> <td style="width: 10%;"></td> </tr> <tr> <td></td> <td></td> <td colspan="8" style="text-align: center;"> <table border="1" style="width: 100%; border-collapse: collapse; text-align: center;"> <tr> <td style="width: 10%;"></td> <td style="width: 10%;"></td> <td style="width: 10%;"></td> <td style="width: 10%;"></td> <td style="width: 10%;"></td> <td style="width: 10%;"></td> <td style="width: 10%;"></td> <td style="width: 10%;"></td> <td style="width: 10%;"></td> <td style="width: 10%;"></td> </tr> <tr> <td></td> <td></td> <td colspan="8" style="text-align: center;"> <table border="1" style="width: 100%; border-collapse: collapse; text-align: center;"> <tr> <td style="width: 10%;"></td> <td style="width: 10%;"></td> <td style="width: 10%;"></td> <td style="width: 10%;"></td> <td style="width: 10%;"></td> <td style="width: 10%;"></td> <td style="width: 10%;"></td> <td style="width: 10%;"></td> <td style="width: 10%;"></td> <td style="width: 10%;"></td> </tr> <tr> <td></td> <td></td> <td colspan="8" style="text-align: center;"> <table border="1" style="width: 100%; border-collapse: collapse; text-align: center;"> <tr> <td style="width: 10%;"></td> <td style="width: 10%;"></td> <td style="width: 10%;"></td> <td style="width: 10%;"></td> <td style="width: 10%;"></td> <td style="width: 10%;"></td> <td style="width: 10%;"></td> <td style="width: 10%;"></td> <td style="width: 10%;"></td> <td style="width: 10%;"></td> </tr> <tr> <td></td> <td></td> <td colspan="8" style="text-align: center;"> <table border="1" style="width: 100%; border-collapse: collapse; text-align: center;"> <tr> <td style="width: 10%;"></td> <td style="width: 10%;"></td> <td style="width: 10%;"></td> <td style="width: 10%;"></td> <td style="width: 10%;"></td> <td style="width: 10%;"></td> <td style="width: 10%;"></td> <td style="width: 10%;"></td> <td style="width: 10%;"></td> <td style="width: 10%;"></td> </tr> <tr> <td></td> <td></td> <td colspan="8" style="text-align: center;"> <table border="1" style="width: 100%; border-collapse: collapse; text-align: center;"> <tr> <td style="width: 10%;"></td> <td style="width: 10%;"></td> <td style="width: 10%;"></td> <td style="width: 10%;"></td> <td style="width: 10%;"></td> <td style="width: 10%;"></td> <td style="width: 10%;"></td> <td style="width: 10%;"></td> <td style="width: 10%;"></td> <td style="width: 10%;"></td> </tr> <tr> <td></td> <td></td> <td colspan="8" style="text-align: center;"> <table border="1" style="width: 100%; border-collapse: collapse; text-align: center;"> <tr> <td style="width: 10%;"></td> <td style="width: 10%;"></td> <td style="width: 10%;"></td> <td style="width: 10%;"></td> <td style="width: 10%;"></td> <td style="width: 10%;"></td> <td style="width: 10%;"></td> <td style="width: 10%;"></td> <td style="width: 10%;"></td> <td style="width: 10%;"></td> </tr> <tr> <td></td> <td></td> <td colspan="8" style="text-align: center;"> <table border="1" style="width: 100%; border-collapse: collapse; text-align: center;"> <tr> <td style="width: 10%;"></td> <td style="width: 10%;"></td> <td style="width: 10%;"></td> <td style="width: 10%;"></td> <td style="width: 10%;"></td> <td style="width: 10%;"></td> <td style="width: 10%;"></td> <td style="width: 10%;"></td> <td style="width: 10%;"></td> <td style="width: 10%;"></td> </tr> <tr> <td></td> <td></td> <td colspan="8" style="text-align: center;"> <table border="1" style="width: 100%; border-collapse: collapse; text-align: center;"> <tr> <td style="width: 10%;"></td> <td style="width: 10%;"></td> <td style="width: 10%;"></td> <td style="width: 10%;"></td> <td style="width: 10%;"></td> <td style="width: 10%;"></td> <td style="width: 10%;"></td> <td style="width: 10%;"></td> <td style="width: 10%;"></td> <td style="width: 10%;"></td> </tr> <tr> <td></td> <td></td> <td colspan="8" style="text-align: center;"> <table border="1" style="width: 100%; border-collapse: collapse; text-align: center;"> <tr> <td style="width: 10%;"></td> <td style="width: 10%;"></td> <td style="width: 10%;"></td> <td style="width: 10%;"></td> <td style="width: 10%;"></td> <td style="width: 10%;"></td> <td style="width: 10%;"></td> <td style="width: 10%;"></td> <td style="width: 10%;"></td> <td style="width: 10%;"></td> </tr> <tr> <td></td> <td></td> <td colspan="8" style="text-align: center;"> <table border="1" style="width: 100%; border-collapse: collapse; text-align: center;"> <tr> <td style="width: 10%;"></td> <td style="width: 10%;"></td> <td style="width: 10%;"></td> <td style="width: 10%;"></td> <td style="width: 10%;"></td> <td style="width: 10%;"></td> <td style="width: 10%;"></td> <td style="width: 10%;"></td> <td style="width: 10%;"></td> <td style="width: 10%;"></td> </tr> <tr> <td></td> <td></td> <td colspan="8" style="text-align: center;"> <table border="1" style="width: 100%; border-collapse: collapse; text-align: center;"> <tr> </tr></table></td></tr></table></td></tr></table></td></tr></table></td></tr></table></td></tr></table></td></tr></table></td></tr></table></td></tr></table></td></tr></table></td></tr></table></td></tr></table></td></tr></table></td></tr></table></td></tr></table></td></tr></table></td></tr></table></td></tr></table></td></tr></table></td></tr></table></td></tr></table></td></tr></table></td></tr></table></td></tr></table></td></tr></table></td></tr></table></td></tr></table>
 | | | | | | | | | | | | | | | | | | | | <table border="1" style="width: 100%; border-collapse: collapse; text-align: center;"> <tr> <td style="width: 10%;"></td> <td style="width: 10%;"></td> <td style="width: 10%;"></td> <td style="width: 10%;"></td> <td style="width: 10%;"></td> <td style="width: 10%;"></td> <td style="width: 10%;"></td> <td style="width: 10%;"></td> <td style="width: 10%;"></td> <td style="width: 10%;"></td> </tr> <tr> <td></td> <td></td> <td colspan="8" style="text-align: center;"> <table border="1" style="width: 100%; border-collapse: collapse; text-align: center;"> <tr> <td style="width: 10%;"></td> <td style="width: 10%;"></td> <td style="width: 10%;"></td> <td style="width: 10%;"></td> <td style="width: 10%;"></td> <td style="width: 10%;"></td> <td style="width: 10%;"></td> <td style="width: 10%;"></td> <td style="width: 10%;"></td> <td style="width: 10%;"></td> </tr> <tr> <td></td> <td></td> <td colspan="8" style="text-align: center;"> <table border="1" style="width: 100%; border-collapse: collapse; text-align: center;"> <tr> <td style="width: 10%;"></td> <td style="width: 10%;"></td> <td style="width: 10%;"></td> <td style="width: 10%;"></td> <td style="width: 10%;"></td> <td style="width: 10%;"></td> <td style="width: 10%;"></td> <td style="width: 10%;"></td> <td style="width: 10%;"></td> <td style="width: 10%;"></td> </tr> <tr> <td></td> <td></td> <td colspan="8" style="text-align: center;"> <table border="1" style="width: 100%; border-collapse: collapse; text-align: center;"> <tr> <td style="width: 10%;"></td> <td style="width: 10%;"></td> <td style="width: 10%;"></td> <td style="width: 10%;"></td> <td style="width: 10%;"></td> <td style="width: 10%;"></td> <td style="width: 10%;"></td> <td style="width: 10%;"></td> <td style="width: 10%;"></td> <td style="width: 10%;"></td> </tr> <tr> <td></td> <td></td> <td colspan="8" style="text-align: center;"> <table border="1" style="width: 100%; border-collapse: collapse; text-align: center;"> <tr> <td style="width: 10%;"></td> <td style="width: 10%;"></td> <td style="width: 10%;"></td> <td style="width: 10%;"></td> <td style="width: 10%;"></td> <td style="width: 10%;"></td> <td style="width: 10%;"></td> <td style="width: 10%;"></td> <td style="width: 10%;"></td> <td style="width: 10%;"></td> </tr> <tr> <td></td> <td></td> <td colspan="8" style="text-align: center;"> <table border="1" style="width: 100%; border-collapse: collapse; text-align: center;"> <tr> <td style="width: 10%;"></td> <td style="width: 10%;"></td> <td style="width: 10%;"></td> <td style="width: 10%;"></td> <td style="width: 10%;"></td> <td style="width: 10%;"></td> <td style="width: 10%;"></td> <td style="width: 10%;"></td> <td style="width: 10%;"></td> <td style="width: 10%;"></td> </tr> <tr> <td></td> <td></td> <td colspan="8" style="text-align: center;"> <table border="1" style="width: 100%; border-collapse: collapse; text-align: center;"> <tr> <td style="width: 10%;"></td> <td style="width: 10%;"></td> <td style="width: 10%;"></td> <td style="width: 10%;"></td> <td style="width: 10%;"></td> <td style="width: 10%;"></td> <td style="width: 10%;"></td> <td style="width: 10%;"></td> <td style="width: 10%;"></td> <td style="width: 10%;"></td> </tr> <tr> <td></td> <td></td> <td colspan="8" style="text-align: center;"> <table border="1" style="width: 100%; border-collapse: collapse; text-align: center;"> <tr> <td style="width: 10%;"></td> <td style="width: 10%;"></td> <td style="width: 10%;"></td> <td style="width: 10%;"></td> <td style="width: 10%;"></td> <td style="width: 10%;"></td> <td style="width: 10%;"></td> <td style="width: 10%;"></td> <td style="width: 10%;"></td> <td style="width: 10%;"></td> </tr> <tr> <td></td> <td></td> <td colspan="8" style="text-align: center;"> <table border="1" style="width: 100%; border-collapse: collapse; text-align: center;"> <tr> <td style="width: 10%;"></td> <td style="width: 10%;"></td> <td style="width: 10%;"></td> <td style="width: 10%;"></td> <td style="width: 10%;"></td> <td style="width: 10%;"></td> <td style="width: 10%;"></td> <td style="width: 10%;"></td> <td style="width: 10%;"></td> <td style="width: 10%;"></td> </tr> <tr> <td></td> <td></td> <td colspan="8" style="text-align: center;"> <table border="1" style="width: 100%; border-collapse: collapse; text-align: center;"> <tr> <td style="width: 10%;"></td> <td style="width: 10%;"></td> <td style="width: 10%;"></td> <td style="width: 10%;"></td> <td style="width: 10%;"></td> <td style="width: 10%;"></td> <td style="width: 10%;"></td> <td style="width: 10%;"></td> <td style="width: 10%;"></td> <td style="width: 10%;"></td> </tr> <tr> <td></td> <td></td> <td colspan="8" style="text-align: center;"> <table border="1" style="width: 100%; border-collapse: collapse; text-align: center;"> <tr> <td style="width: 10%;"></td> <td style="width: 10%;"></td> <td style="width: 10%;"></td> <td style="width: 10%;"></td> <td style="width: 10%;"></td> <td style="width: 10%;"></td> <td style="width: 10%;"></td> <td style="width: 10%;"></td> <td style="width: 10%;"></td> <td style="width: 10%;"></td> </tr> <tr> <td></td> <td></td> <td colspan="8" style="text-align: center;"> <table border="1" style="width: 100%; border-collapse: collapse; text-align: center;"> <tr> <td style="width: 10%;"></td> <td style="width: 10%;"></td> <td style="width: 10%;"></td> <td style="width: 10%;"></td> <td style="width: 10%;"></td> <td style="width: 10%;"></td> <td style="width: 10%;"></td> <td style="width: 10%;"></td> <td style="width: 10%;"></td> <td style="width: 10%;"></td> </tr> <tr> <td></td> <td></td> <td colspan="8" style="text-align: center;"> <table border="1" style="width: 100%; border-collapse: collapse; text-align: center;"> <tr> <td style="width: 10%;"></td> <td style="width: 10%;"></td> <td style="width: 10%;"></td> <td style="width: 10%;"></td> <td style="width: 10%;"></td> <td style="width: 10%;"></td> <td style="width: 10%;"></td> <td style="width: 10%;"></td> <td style="width: 10%;"></td> <td style="width: 10%;"></td> </tr> <tr> <td></td> <td></td> <td colspan="8" style="text-align: center;"> <table border="1" style="width: 100%; border-collapse: collapse; text-align: center;"> <tr> <td style="width: 10%;"></td> <td style="width: 10%;"></td> <td style="width: 10%;"></td> <td style="width: 10%;"></td> <td style="width: 10%;"></td> <td style="width: 10%;"></td> <td style="width: 10%;"></td> <td style="width: 10%;"></td> <td style="width: 10%;"></td> <td style="width: 10%;"></td> </tr> <tr> <td></td> <td></td> <td colspan="8" style="text-align: center;"> <table border="1" style="width: 100%; border-collapse: collapse; text-align: center;"> <tr> <td style="width: 10%;"></td> <td style="width: 10%;"></td> <td style="width: 10%;"></td> <td style="width: 10%;"></td> <td style="width: 10%;"></td> <td style="width: 10%;"></td> <td style="width: 10%;"></td> <td style="width: 10%;"></td> <td style="width: 10%;"></td> <td style="width: 10%;"></td> </tr> <tr> <td></td> <td></td> <td colspan="8" style="text-align: center;"> <table border="1" style="width: 100%; border-collapse: collapse; text-align: center;"> <tr> <td style="width: 10%;"></td> <td style="width: 10%;"></td> <td style="width: 10%;"></td> <td style="width: 10%;"></td> <td style="width: 10%;"></td> <td style="width:
10%;"></td> <td style="width: 10%;"></td> <td style="width: 10%;"></td> <td style="width: 10%;"></td> <td style="width: 10%;"></td> </tr> <tr> <td></td> <td></td> <td colspan="8" style="text-align: center;"> <table border="1" style="width: 100%; border-collapse: collapse; text-align: center;"> <tr> <td style="width: 10%;"></td> <td style="width: 10%;"></td> <td style="width: 10%;"></td> <td style="width: 10%;"></td> <td style="width: 10%;"></td> <td style="width: 10%;"></td> <td style="width: 10%;"></td> <td style="width: 10%;"></td> <td style="width: 10%;"></td> <td style="width: 10%;"></td> </tr> <tr> <td></td> <td></td> <td colspan="8" style="text-align: center;"> <table border="1" style="width: 100%; border-collapse: collapse; text-align: center;"> <tr> <td style="width: 10%;"></td> <td style="width: 10%;"></td> <td style="width: 10%;"></td> <td style="width: 10%;"></td> <td style="width: 10%;"></td> <td style="width: 10%;"></td> <td style="width: 10%;"></td> <td style="width: 10%;"></td> <td style="width: 10%;"></td> <td style="width: 10%;"></td> </tr> <tr> <td></td> <td></td> <td colspan="8" style="text-align: center;"> <table border="1" style="width: 100%; border-collapse: collapse; text-align: center;"> <tr> <td style="width: 10%;"></td> <td style="width: 10%;"></td> <td style="width: 10%;"></td> <td style="width: 10%;"></td> <td style="width: 10%;"></td> <td style="width: 10%;"></td> <td style="width: 10%;"></td> <td style="width: 10%;"></td> <td style="width: 10%;"></td> <td style="width: 10%;"></td> </tr> <tr> <td></td> <td></td> <td colspan="8" style="text-align: center;"> <table border="1" style="width: 100%; border-collapse: collapse; text-align: center;"> <tr> <td style="width: 10%;"></td> <td style="width: 10%;"></td> <td style="width: 10%;"></td> <td style="width: 10%;"></td> <td style="width: 10%;"></td> <td style="width: 10%;"></td> <td style="width: 10%;"></td> <td style="width: 10%;"></td> <td style="width: 10%;"></td> <td style="width: 10%;"></td> </tr> <tr> <td></td> <td></td> <td colspan="8" style="text-align: center;"> <table border="1" style="width: 100%; border-collapse: collapse; text-align: center;"> <tr> <td style="width: 10%;"></td> <td style="width: 10%;"></td> <td style="width: 10%;"></td> <td style="width: 10%;"></td> <td style="width: 10%;"></td> <td style="width: 10%;"></td> <td style="width: 10%;"></td> <td style="width: 10%;"></td> <td style="width: 10%;"></td> <td style="width: 10%;"></td> </tr> <tr> <td></td> <td></td> <td colspan="8" style="text-align: center;"> <table border="1" style="width: 100%; border-collapse: collapse; text-align: center;"> <tr> <td style="width: 10%;"></td> <td style="width: 10%;"></td> <td style="width: 10%;"></td> <td style="width: 10%;"></td> <td style="width: 10%;"></td> <td style="width: 10%;"></td> <td style="width: 10%;"></td> <td style="width: 10%;"></td> <td style="width: 10%;"></td> <td style="width: 10%;"></td> </tr> <tr> <td></td> <td></td> <td colspan="8" style="text-align: center;"> <table border="1" style="width: 100%; border-collapse: collapse; text-align: center;"> <tr> <td style="width: 10%;"></td> <td style="width: 10%;"></td> <td style="width: 10%;"></td> <td style="width: 10%;"></td> <td style="width: 10%;"></td> <td style="width: 10%;"></td> <td style="width: 10%;"></td> <td style="width: 10%;"></td> <td style="width: 10%;"></td> <td style="width: 10%;"></td> </tr> <tr> <td></td> <td></td> <td colspan="8" style="text-align: center;"> <table border="1" style="width: 100%; border-collapse: collapse; text-align: center;"> <tr> <td style="width: 10%;"></td> <td style="width: 10%;"></td> <td style="width: 10%;"></td> <td style="width: 10%;"></td> <td style="width: 10%;"></td> <td style="width: 10%;"></td> <td style="width: 10%;"></td> <td style="width: 10%;"></td> <td style="width: 10%;"></td> <td style="width: 10%;"></td> </tr> <tr> <td></td> <td></td> <td colspan="8" style="text-align: center;"> <table border="1" style="width: 100%; border-collapse: collapse; text-align: center;"> <tr> <td style="width: 10%;"></td> <td style="width: 10%;"></td> <td style="width: 10%;"></td> <td style="width: 10%;"></td> <td style="width: 10%;"></td> <td style="width: 10%;"></td> <td style="width: 10%;"></td> <td style="width: 10%;"></td> <td style="width: 10%;"></td> <td style="width: 10%;"></td> </tr> <tr> <td></td> <td></td> <td colspan="8" style="text-align: center;"> <table border="1" style="width: 100%; border-collapse: collapse; text-align: center;"> <tr> </tr></table></td></tr></table></td></tr></table></td></tr></table></td></tr></table></td></tr></table></td></tr></table></td></tr></table></td></tr></table></td></tr></table></td></tr></table></td></tr></table></td></tr></table></td></tr></table></td></tr></table></td></tr></table></td></tr></table></td></tr></table></td></tr></table></td></tr></table></td></tr></table></td></tr></table></td></tr></table></td></tr></table></td></tr></table></td></tr></table>
 | | | | | | | | | | | | | | | | | | | | <table border="1" style="width: 100%; border-collapse: collapse; text-align: center;"> <tr> <td style="width: 10%;"></td> <td style="width: 10%;"></td> <td style="width: 10%;"></td> <td style="width: 10%;"></td> <td style="width: 10%;"></td> <td style="width: 10%;"></td> <td style="width: 10%;"></td> <td style="width: 10%;"></td> <td style="width: 10%;"></td> <td style="width: 10%;"></td> </tr> <tr> <td></td> <td></td> <td colspan="8" style="text-align: center;"> <table border="1" style="width: 100%; border-collapse: collapse; text-align: center;"> <tr> <td style="width: 10%;"></td> <td style="width: 10%;"></td> <td style="width: 10%;"></td> <td style="width: 10%;"></td> <td style="width: 10%;"></td> <td style="width: 10%;"></td> <td style="width: 10%;"></td> <td style="width: 10%;"></td> <td style="width: 10%;"></td> <td style="width: 10%;"></td> </tr> <tr> <td></td> <td></td> <td colspan="8" style="text-align: center;"> <table border="1" style="width: 100%; border-collapse: collapse; text-align: center;"> <tr> <td style="width: 10%;"></td> <td style="width: 10%;"></td> <td style="width: 10%;"></td> <td style="width: 10%;"></td> <td style="width: 10%;"></td> <td style="width: 10%;"></td> <td style="width: 10%;"></td> <td style="width: 10%;"></td> <td style="width: 10%;"></td> <td style="width: 10%;"></td> </tr> <tr> <td></td> <td></td> <td colspan="8" style="text-align: center;"> <table border="1" style="width: 100%; border-collapse: collapse; text-align: center;"> <tr> <td style="width: 10%;"></td> <td style="width: 10%;"></td> <td style="width: 10%;"></td> <td style="width: 10%;"></td> <td style="width: 10%;"></td> <td style="width: 10%;"></td> <td style="width: 10%;"></td> <td style="width: 10%;"></td> <td style="width: 10%;"></td> <td style="width: 10%;"></td> </tr> <tr> <td></td> <td></td> <td colspan="8" style="text-align: center;"> <table border="1" style="width: 100%; border-collapse: collapse; text-align: center;"> <tr> <td style="width: 10%;"></td> <td style="width: 10%;"></td> <td style="width: 10%;"></td> <td style="width: 10%;"></td> <td style="width: 10%;"></td> <td style="width: 10%;"></td> <td style="width: 10%;"></td> <td style="width: 10%;"></td> <td style="width: 10%;"></td> <td style="width: 10%;"></td> </tr> <tr> <td></td> <td></td> <td colspan="8" style="text-align: center;"> <table border="1" style="width: 100%; border-collapse: collapse; text-align: center;"> <tr> <td style="width: 10%;"></td> <td style="width: 10%;"></td> <td style="width: 10%;"></td> <td style="width: 10%;"></td> <td style="width: 10%;"></td> <td style="width: 10%;"></td> <td style="width: 10%;"></td> <td style="width: 10%;"></td> <td style="width: 10%;"></td> <td style="width: 10%;"></td> </tr> <tr> <td></td> <td></td> <td colspan="8" style="text-align: center;"> <table border="1" style="width: 100%; border-collapse: collapse; text-align: center;"> <tr> <td style="width: 10%;"></td> <td style="width: 10%;"></td> <td style="width: 10%;"></td> <td style="width: 10%;"></td> <td style="width: 10%;"></td> <td style="width: 10%;"></td> <td style="width: 10%;"></td> <td style="width: 10%;"></td> <td style="width: 10%;"></td> <td style="width: 10%;"></td> </tr> <tr> <td></td> <td></td> <td colspan="8" style="text-align: center;"> <table border="1" style="width: 100%; border-collapse: collapse; text-align: center;"> <tr> <td style="width: 10%;"></td> <td style="width: 10%;"></td> <td style="width: 10%;"></td> <td style="width: 10%;"></td> <td style="width: 10%;"></td> <td style="width: 10%;"></td> <td style="width: 10%;"></td> <td style="width: 10%;"></td> <td style="width: 10%;"></td> <td style="width: 10%;"></td> </tr> <tr> <td></td> <td></td> <td colspan="8" style="text-align: center;"> <table border="1" style="width: 100%; border-collapse: collapse; text-align: center;"> <tr> <td style="width: 10%;"></td> <td style="width: 10%;"></td> <td style="width: 10%;"></td> <td style="width: 10%;"></td> <td style="width: 10%;"></td> <td style="width: 10%;"></td> <td style="width: 10%;"></td> <td style="width: 10%;"></td> <td style="width: 10%;"></td> <td style="width: 10%;"></td> </tr> <tr> <td></td> <td></td> <td colspan="8" style="text-align: center;"> <table border="1" style="width: 100%; border-collapse: collapse; text-align: center;"> <tr> <td style="width: 10%;"></td> <td style="width: 10%;"></td> <td style="width: 10%;"></td> <td style="width: 10%;"></td> <td style="width: 10%;"></td> <td style="width: 10%;"></td> <td style="width: 10%;"></td> <td style="width: 10%;"></td> <td style="width: 10%;"></td> <td style="width: 10%;"></td> </tr> <tr> <td></td> <td></td> <td colspan="8" style="text-align: center;"> <table border="1" style="width: 100%; border-collapse: collapse; text-align: center;"> <tr> <td style="width: 10%;"></td> <td style="width: 10%;"></td> <td style="width: 10%;"></td> <td style="width: 10%;"></td> <td style="width: 10%;"></td> <td style="width: 10%;"></td> <td style="width: 10%;"></td> <td style="width: 10%;"></td> <td style="width: 10%;"></td> <td style="width: 10%;"></td> </tr> <tr> <td></td> <td></td> <td colspan="8" style="text-align: center;"> <table border="1" style="width: 100%; border-collapse: collapse; text-align: center;"> <tr> <td style="width: 10%;"></td> <td style="width: 10%;"></td> <td style="width: 10%;"></td> <td style="width: 10%;"></td> <td style="width: 10%;"></td> <td style="width: 10%;"></td> <td style="width: 10%;"></td> <td style="width: 10%;"></td> <td style="width: 10%;"></td> <td style="width: 10%;"></td> </tr> <tr> <td></td> <td></td> <td colspan="8" style="text-align: center;"> <table border="1" style="width: 100%; border-collapse: collapse; text-align: center;"> <tr> <td style="width: 10%;"></td> <td style="width: 10%;"></td> <td style="width: 10%;"></td> <td style="width: 10%;"></td> <td style="width: 10%;"></td> <td style="width: 10%;"></td> <td style="width: 10%;"></td> <td style="width: 10%;"></td> <td style="width: 10%;"></td> <td style="width: 10%;"></td> </tr> <tr> <td></td> <td></td> <td colspan="8" style="text-align: center;"> <table border="1" style="width: 100%; border-collapse: collapse; text-align: center;"> <tr> <td style="width: 10%;"></td> <td style="width: 10%;"></td> <td style="width: 10%;"></td> <td style="width: 10%;"></td> <td style="width: 10%;"></td> <td style="width: 10%;"></td> <td style="width: 10%;"></td> <td style="width: 10%;"></td> <td style="width: 10%;"></td> <td style="width: 10%;"></td> </tr> <tr> <td></td> <td></td> <td colspan="8" style="text-align: center;"> <table border="1" style="width: 100%; border-collapse: collapse; text-align: center;"> <tr> <td style="width: 10%;"></td> <td style="width: 10%;"></td> <td style="width: 10%;"></td> <td style="width: 10%;"></td> <td style="width: 10%;"></td> <td style="width: 10%;"></td> <td style="width: 10%;"></td> <td style="width: 10%;"></td> <td style="width: 10%;"></td> <td style="width: 10%;"></td> </tr> <tr> <td></td> <td></td> <td colspan="8" style="text-align: center;"> <table border="1" style="width: 100%; border-collapse: collapse; text-align: center;"> <tr> <td style="width: 10%;"></td> <td style="width: 10%;"></td> <td style="width: 10%;"></td> <td style="width: 10%;"></td> <td style="width: 10%;"></td> <td style="width: 10%;"></td> <td style="width: 10%;"></td> <td style="width: 10%;"></td> <td style="width: 10%;"></td> <td style="width: 10%;"></td> </tr> <tr> <td></td> <td></td> <td colspan="8" style="text-align: center;"> <table border="1" style="width: 100%; border-collapse: collapse; text-align: center;"> <tr> <td style="width: 10%;"></td> <td style="width: 10%;"></td> <td style="width: 10%;"></td> <td style="width: 10%;"></td> <td style="width: 10%;"></td> <td style="width: 10%;"></td> <td style="width: 10%;"></td> <td style="width: 10%;"></td> <td style="width: 10%;"></td> <td style="width: 10%;"></td> </tr> <tr> <td></td> <td></td> <td colspan="8" style="text-align: center;"> <table border="1" style="width: 100%; border-collapse: collapse; text-align: center;"> <tr> <td style="width: 10%;"></td> <td style="width: 10%;"></td> <td style="width: 10%;"></td> <td style="width: 10%;"></td> <td style="width: 10%;"></td> <td style="width: 10%;"></td> <td style="width: 10%;"></td> <td style="width: 10%;"></td> <td style="width: 10%;"></td> <td style="width: 10%;"></td> </tr> <tr> <td></td> <td></td> <td colspan="8" style="text-align: center;"> <table border="1" style="width: 100%; border-collapse: collapse; text-align: center;"> <tr> <td style="width: 10%;"></td> <td style="width: 10%;"></td> <td style="width: 10%;"></td> <td style="width: 10%;"></td> <td style="width: 10%;"></td> <td style="width: 10%;"></td> <td style="width: 10%;"></td> <td style="width: 10%;"></td> <td style="width: 10%;"></td> <td style="width: 10%;"></td> </tr> <tr> <td></td> <td></td> <td colspan="8" style="text-align: center;"> <table border="1" style="width: 100%; border-collapse: collapse; text-align: center;"> <tr> <td style="width: 10%;"></td> <td style="width: 10%;"></td> <td style="width: 10%;"></td> <td style="width: 10%;"></td> <td style="width: 10%;"></td> <td style="width: 10%;"></td> <td style="width: 10%;"></td> <td style="width: 10%;"></td> <td style="width: 10%;"></td> <td style="width: 10%;"></td> </tr> <tr> <td></td> <td></td> <td colspan="8" style="text-align: center;"> <table border="1" style="width: 100%; border-collapse: collapse; text-align: center;"> <tr> <td style="width: 10%;"></td> <td style="width: 10%;"></td> <td style="width: 10%;"></td> <td style="width: 10%;"></td> <td style="width: 10%;"></td> <td
style="width: 10%;"></td> <td style="width: 10%;"></td> <td style="width: 10%;"></td> <td style="width: 10%;"></td> <td style="width: 10%;"></td> </tr> <tr> <td></td> <td></td> <td colspan="8" style="text-align: center;"> <table border="1" style="width: 100%; border-collapse: collapse; text-align: center;"> <tr> <td style="width: 10%;"></td> <td style="width: 10%;"></td> <td style="width: 10%;"></td> <td style="width: 10%;"></td> <td style="width: 10%;"></td> <td style="width: 10%;"></td> <td style="width: 10%;"></td> <td style="width: 10%;"></td> <td style="width: 10%;"></td> <td style="width: 10%;"></td> </tr> <tr> <td></td> <td></td> <td colspan="8" style="text-align: center;"> <table border="1" style="width: 100%; border-collapse: collapse; text-align: center;"> <tr> <td style="width: 10%;"></td> <td style="width: 10%;"></td> <td style="width: 10%;"></td> <td style="width: 10%;"></td> <td style="width: 10%;"></td> <td style="width: 10%;"></td> <td style="width: 10%;"></td> <td style="width: 10%;"></td> <td style="width: 10%;"></td> <td style="width: 10%;"></td> </tr> <tr> <td></td> <td></td> <td colspan="8" style="text-align: center;"> <table border="1" style="width: 100%; border-collapse: collapse; text-align: center;"> <tr> <td style="width: 10%;"></td> <td style="width: 10%;"></td> <td style="width: 10%;"></td> <td style="width: 10%;"></td> <td style="width: 10%;"></td> <td style="width: 10%;"></td> <td style="width: 10%;"></td> <td style="width: 10%;"></td> <td style="width: 10%;"></td> <td style="width: 10%;"></td> </tr> <tr> <td></td> <td></td> <td colspan="8" style="text-align: center;"> <table border="1" style="width: 100%; border-collapse: collapse; text-align: center;"> <tr> </tr></table></td></tr></table></td></tr></table></td></tr></table></td></tr></table></td></tr></table></td></tr></table></td></tr></table></td></tr></table></td></tr></table></td></tr></table></td></tr></table></td></tr></table></td></tr></table></td></tr></table></td></tr></table></td></tr></table></td></tr></table></td></tr></table></td></tr></table></td></tr></table></td></tr></table></td></tr></table></td></tr></table></td></tr></table> | | | | | | | | | | | | | | | | | | | | <table border="1" style="width: 100%; border-collapse: collapse; text-align: center;"> <tr> <td style="width: 10%;"></td> <td style="width: 10%;"></td> <td style="width: 10%;"></td> <td style="width: 10%;"></td> <td style="width: 10%;"></td> <td style="width: 10%;"></td> <td style="width: 10%;"></td> <td style="width: 10%;"></td> <td style="width: 10%;"></td> <td style="width: 10%;"></td> </tr> <tr> <td></td> <td></td> <td colspan="8" style="text-align: center;"> <table border="1" style="width: 100%; border-collapse: collapse; text-align: center;"> <tr> <td style="width: 10%;"></td> <td style="width: 10%;"></td> <td style="width: 10%;"></td> <td style="width: 10%;"></td> <td style="width: 10%;"></td> <td style="width: 10%;"></td> <td style="width: 10%;"></td> <td style="width: 10%;"></td> <td style="width: 10%;"></td> <td style="width: 10%;"></td> </tr> <tr> <td></td> <td></td> <td colspan="8" style="text-align: center;"> <table border="1" style="width: 100%; border-collapse: collapse; text-align: center;"> <tr> <td style="width: 10%;"></td> <td style="width: 10%;"></td> <td style="width: 10%;"></td> <td style="width: 10%;"></td> <td style="width: 10%;"></td> <td style="width: 10%;"></td> <td style="width: 10%;"></td> <td style="width: 10%;"></td> <td style="width: 10%;"></td> <td style="width: 10%;"></td> </tr> <tr> <td></td> <td></td> <td colspan="8" style="text-align: center;"> <table border="1" style="width: 100%; border-collapse: collapse; text-align: center;"> <tr> <td style="width: 10%;"></td> <td style="width: 10%;"></td> <td style="width: 10%;"></td> <td style="width: 10%;"></td> <td style="width: 10%;"></td> <td style="width: 10%;"></td> <td style="width: 10%;"></td> <td style="width: 10%;"></td> <td style="width: 10%;"></td> <td style="width: 10%;"></td> </tr> <tr> <td></td> <td></td> <td colspan="8" style="text-align: center;"> <table border="1" style="width: 100%; border-collapse: collapse; text-align: center;"> <tr> <td style="width: 10%;"></td> <td style="width: 10%;"></td> <td style="width: 10%;"></td> <td style="width: 10%;"></td> <td style="width: 10%;"></td> <td style="width: 10%;"></td> <td style="width: 10%;"></td> <td style="width: 10%;"></td> <td style="width: 10%;"></td> <td style="width: 10%;"></td> </tr> <tr> <td></td> <td></td> <td colspan="8" style="text-align: center;"> <table border="1" style="width: 100%; border-collapse: collapse; text-align: center;">
<tr> <td style="width: 10%;"></td> <td style="width: 10%;"></td> <td style="width: 10%;"></td> <td style="width: 10%;"></td> <td style="width: 10%;"></td> <td style="width: 10%;"></td> <td style="width: 10%;"></td> <td style="width: 10%;"></td> <td style="width: 10%;"></td> <td style="width: 10%;"></td> </tr> <tr> <td></td> <td></td> <td colspan="8" style="text-align: center;"> <table border="1" style="width: 100%; border-collapse: collapse; text-align: center;"> <tr> <td style="width: 10%;"></td> <td style="width: 10%;"></td> <td style="width: 10%;"></td> <td style="width: 10%;"></td> <td style="width: 10%;"></td> <td style="width: 10%;"></td> <td style="width: 10%;"></td> <td style="width: 10%;"></td> <td style="width: 10%;"></td> <td style="width: 10%;"></td> </tr> <tr> <td></td> <td></td> <td colspan="8" style="text-align: center;"> <table border="1" style="width: 100%; border-collapse: collapse; text-align: center;"> <tr> <td style="width: 10%;"></td> <td style="width: 10%;"></td> <td style="width: 10%;"></td> <td style="width: 10%;"></td> <td style="width: 10%;"></td> <td style="width: 10%;"></td> <td style="width: 10%;"></td> <td style="width: 10%;"></td> <td style="width: 10%;"></td> <td style="width: 10%;"></td> </tr> <tr> <td></td> <td></td> <td colspan="8" style="text-align: center;"> <table border="1" style="width: 100%; border-collapse: collapse; text-align: center;"> <tr> <td style="width: 10%;"></td> <td style="width: 10%;"></td> <td style="width: 10%;"></td> <td style="width: 10%;"></td> <td style="width: 10%;"></td> <td style="width: 10%;"></td> <td style="width: 10%;"></td> <td style="width: 10%;"></td> <td style="width: 10%;"></td> <td style="width: 10%;"></td> </tr> <tr> <td></td> <td></td> <td colspan="8" style="text-align: center;"> <table border="1" style="width: 100%; border-collapse: collapse; text-align: center;"> <tr> <td style="width: 10%;"></td> <td style="width: 10%;"></td> <td style="width: 10%;"></td> <td style="width: 10%;"></td> <td style="width: 10%;"></td> <td style="width: 10%;"></td> <td style="width: 10%;"></td> <td style="width: 10%;"></td> <td style="width: 10%;"></td> <td style="width: 10%;"></td> </tr> <tr> <td></td> <td></td> <td colspan="8" style="text-align: center;"> <table border="1" style="width: 100%; border-collapse: collapse; text-align: center;"> <tr> <td style="width: 10%;"></td> <td style="width: 10%;"></td> <td style="width: 10%;"></td> <td style="width: 10%;"></td> <td style="width: 10%;"></td> <td style="width: 10%;"></td> <td style="width: 10%;"></td> <td style="width: 10%;"></td> <td style="width: 10%;"></td> <td style="width: 10%;"></td> </tr> <tr> <td></td> <td></td> <td colspan="8" style="text-align: center;"> <table border="1" style="width: 100%; border-collapse: collapse; text-align: center;"> <tr> <td style="width: 10%;"></td> <td style="width: 10%;"></td> <td style="width: 10%;"></td> <td style="width: 10%;"></td> <td style="width: 10%;"></td> <td style="width: 10%;"></td> <td style="width: 10%;"></td> <td style="width: 10%;"></td> <td style="width: 10%;"></td> <td style="width: 10%;"></td> </tr> <tr> <td></td> <td></td> <td colspan="8" style="text-align: center;"> <table border="1" style="width: 100%; border-collapse: collapse; text-align: center;"> <tr> <td style="width: 10%;"></td> <td style="width: 10%;"></td> <td style="width: 10%;"></td> <td style="width: 10%;"></td> <td style="width: 10%;"></td> <td style="width: 10%;"></td> <td style="width: 10%;"></td> <td style="width: 10%;"></td> <td style="width: 10%;"></td> <td style="width: 10%;"></td> </tr> <tr> <td></td> <td></td> <td colspan="8" style="text-align: center;"> <table border="1" style="width: 100%; border-collapse: collapse; text-align: center;"> <tr> <td style="width: 10%;"></td> <td style="width: 10%;"></td> <td style="width: 10%;"></td> <td style="width: 10%;"></td> <td style="width: 10%;"></td> <td style="width: 10%;"></td> <td style="width: 10%;"></td> <td style="width: 10%;"></td> <td style="width: 10%;"></td> <td style="width: 10%;"></td> </tr> <tr> <td></td> <td></td> <td colspan="8" style="text-align: center;"> <table border="1" style="width: 100%; border-collapse: collapse; text-align: center;"> <tr> <td style="width: 10%;"></td> <td style="width: 10%;"></td> <td style="width: 10%;"></td> <td style="width: 10%;"></td> <td style="width: 10%;"></td> <td style="width: 10%;"></td> <td style="width: 10%;"></td> <td style="width: 10%;"></td> <td style="width: 10%;"></td> <td style="width: 10%;"></td> </tr> <tr> <td></td> <td></td> <td colspan="8" style="text-align: center;"> <table border="1" style="width: 100%; border-collapse: collapse; text-align: center;"> <tr> <td style="width: 10%;"></td> <td style="width: 10%;"></td> <td style="width: 10%;"></td> <td style="width: 10%;"></td> <td style="width: 10%;"></td> <td style="width: 10%;"></td> <td style="width: 10%;"></td> <td style="width: 10%;"></td> <td style="width: 10%;"></td> <td style="width: 10%;"></td> </tr> <tr> <td></td> <td></td> <td colspan="8" style="text-align: center;"> <table border="1" style="width: 100%; border-collapse: collapse; text-align: center;"> <tr> <td style="width: 10%;"></td> <td style="width: 10%;"></td> <td style="width: 10%;"></td> <td style="width: 10%;"></td> <td style="width: 10%;"></td> <td style="width: 10%;"></td> <td style="width: 10%;"></td> <td style="width: 10%;"></td> <td style="width: 10%;"></td> <td style="width: 10%;"></td> </tr> <tr> <td></td> <td></td> <td colspan="8" style="text-align: center;"> <table border="1" style="width: 100%; border-collapse: collapse; text-align: center;"> <tr> <td style="width: 10%;"></td> <td style="width: 10%;"></td> <td style="width: 10%;"></td> <td style="width: 10%;"></td> <td style="width: 10%;"></td> <td style="width: 10%;"></td> <td style="width: 10%;"></td> <td style="width: 10%;"></td> <td style="width: 10%;"></td> <td style="width: 10%;"></td> </tr> <tr> <td></td> <td></td> <td colspan="8" style="text-align: center;"> <table border="1" style="width: 100%; border-collapse: collapse; text-align: center;"> <tr> <td style="width: 10%;"></td> <td style="width: 10%;"></td> <td style="width: 10%;"></td> <td style="width: 10%;"></td> <td style="width: 10%;"></td> <td style="width: 10%;"></td> <td style="width: 10%;"></td> <td style="width: 10%;"></td> <td style="width: 10%;"></td> <td style="width: 10%;"></td> </tr> <tr> <td></td> <td></td> <td colspan="8" style="text-align: center;"> <table border="1" style="width: 100%; border-collapse: collapse; text-align: center;"> <tr> <td style="width: 10%;"></td> <td style="width: 10%;"></td> <td style="width: 10%;"></td> <td style="width: 10%;"></td> <td style="width: 10%;"></td> <td style="width: 10%;"></td> <td style="width: 10%;"></td> <td style="width: 10%;"></td> <td style="width: 10%;"></td> <td style="width: 10%;"></td> </tr> <tr> <td></td> <td></td> <td colspan="8" style="text-align: center;"> <table border="1" style="width: 100%; border-collapse: collapse; text-align: center;"> <tr> <td style="width: 10%;"></td> <td style="width: 10%;"></td> <td style="width: 10%;"></td> <td style="width: 10%;"></td> <td style="width: 10%;"></td> <td style="width: 10%;"></td> <td style="width: 10%;"></td> <td style="width: 10%;"></td> <td style="width: 10%;"></td> <td style="width: 10%;"></td> </tr> <tr> <td></td> <td></td> <td colspan="8" style="text-align: center;"> <table border="1" style="width: 100%; border-collapse: collapse; text-align: center;"> <tr> <td style="width: 10%;"></td> <td style="width: 10%;"></td> <td style="width: 10%;"></td> <td style="width: 10%;"></td> <td style="width: 10%;"></td> <td style="width: 10%;"></td> <td style="width: 10%;"></td> <td style="width: 10%;"></td> <td style="width: 10%;"></td> <td style="width: 10%;"></td> </tr> <tr> <td></td> <td></td> <td colspan="8" style="text-align: center;"> <table border="1" style="width: 100%; border-collapse: collapse; text-align: center;"> <tr> <td style="width: 10%;"></td> <td style="width: 10%;"></td> <td style="width: 10%;"></td> <td style="width: 10%;"></td> <td style="width: 10%;"></td> <td style="width: 10%;"></td> <td style="width: 10%;"></td> <td style="width: 10%;"></td> <td style="width: 10%;"></td> <td style="width: 10%;"></td> </tr> <tr> <td></td> <td></td> <td colspan="8" style="text-align: center;"> <table border="1" style="width: 100%; border-collapse: collapse; text-align: center;"> <tr> </tr></table></td></tr></table></td></tr></table></td></tr></table></td></tr></table></td></tr></table></td></tr></table></td></tr></table></td></tr></table></td></tr></table></td></tr></table></td></tr></table></td></tr></table></td></tr></table></td></tr></table></td></tr></table></td></tr></table></td></tr></table></td></tr></table></td></tr></table></td></tr></table></td></tr></table></td></tr></table></td></tr></table>
 | | | | | | | | | | | | | | | | | | | | <table border="1" style="width: 100%; border-collapse: collapse; text-align: center;"> <tr> <td style="width: 10%;"></td> <td style="width: 10%;"></td> <td style="width: 10%;"></td> <td style="width: 10%;"></td> <td style="width: 10%;"></td> <td style="width: 10%;"></td> <td style="width: 10%;"></td> <td style="width: 10%;"></td> <td style="width: 10%;"></td> <td style="width: 10%;"></td> </tr> <tr> <td></td> <td></td> <td colspan="8" style="text-align: center;"> <table border="1" style="width: 100%; border-collapse: collapse; text-align: center;"> <tr> <td style="width: 10%;"></td> <td style="width: 10%;"></td> <td style="width: 10%;"></td> <td style="width: 10%;"></td> <td style="width: 10%;"></td> <td style="width: 10%;"></td> <td style="width: 10%;"></td> <td style="width: 10%;"></td> <td style="width: 10%;"></td> <td style="width: 10%;"></td> </tr> <tr> <td></td> <td></td> <td colspan="8" style="text-align: center;"> <table border="1" style="width: 100%; border-collapse: collapse; text-align: center;"> <tr> <td style="width: 10%;"></td> <td style="width: 10%;"></td> <td style="width: 10%;"></td> <td style="width: 10%;"></td> <td style="width: 10%;"></td> <td style="width: 10%;"></td> <td style="width: 10%;"></td> <td style="width: 10%;"></td> <td style="width: 10%;"></td> <td style="width: 10%;"></td> </tr> <tr> <td></td> <td></td> <td colspan="8" style="text-align: center;"> <table border="1" style="width: 100%; border-collapse: collapse; text-align: center;"> <tr> <td style="width: 10%;"></td> <td style="width: 10%;"></td> <td style="width: 10%;"></td> <td style="width: 10%;"></td> <td style="width: 10%;"></td> <td style="width: 10%;"></td> <td style="width: 10%;"></td> <td style="width: 10%;"></td> <td style="width: 10%;"></td> <td style="width: 10%;"></td> </tr> <tr> <td></td> <td></td> <td colspan="8" style="text-align: center;"> <table border="1" style="width: 100%; border-collapse: collapse; text-align: center;"> <tr> <td style="width: 10%;"></td> <td style="width: 10%;"></td> <td style="width: 10%;"></td> <td style="width: 10%;"></td> <td style="width: 10%;"></td> <td style="width: 10%;"></td> <td style="width: 10%;"></td> <td style="width: 10%;"></td> <td style="width: 10%;"></td> <td style="width: 10%;"></td> </tr> <tr> <td></td> <td></td> <td colspan="8" style="text-align: center;"> <table border="1" style="width: 100%; border-collapse: collapse; text-align: center;"> <tr> <td style="width: 10%;"></td> <td style="width: 10%;"></td> <td style="width: 10%;"></td> <td style="width: 10%;"></td> <td style="width: 10%;"></td> <td style="width: 10%;"></td> <td style="width: 10%;"></td> <td style="width: 10%;"></td> <td style="width: 10%;"></td> <td style="width: 10%;"></td> </tr> <tr> <td></td> <td></td> <td colspan="8" style="text-align: center;"> <table border="1" style="width: 100%; border-collapse: collapse; text-align: center;"> <tr> <td style="width: 10%;"></td> <td style="width: 10%;"></td> <td style="width: 10%;"></td> <td style="width: 10%;"></td> <td style="width: 10%;"></td> <td style="width: 10%;"></td> <td style="width: 10%;"></td> <td style="width: 10%;"></td> <td style="width: 10%;"></td> <td style="width: 10%;"></td> </tr> <tr> <td></td> <td></td> <td colspan="8" style="text-align: center;"> <table border="1" style="width: 100%; border-collapse: collapse; text-align: center;"> <tr> <td style="width: 10%;"></td> <td style="width: 10%;"></td> <td style="width: 10%;"></td> <td style="width: 10%;"></td> <td style="width: 10%;"></td> <td style="width: 10%;"></td> <td style="width: 10%;"></td> <td style="width: 10%;"></td> <td style="width: 10%;"></td> <td style="width: 10%;"></td> </tr> <tr> <td></td> <td></td> <td colspan="8" style="text-align: center;"> <table border="1" style="width: 100%; border-collapse: collapse; text-align: center;"> <tr> <td style="width: 10%;"></td> <td style="width: 10%;"></td> <td style="width: 10%;"></td> <td style="width: 10%;"></td> <td style="width: 10%;"></td> <td style="width: 10%;"></td> <td style="width: 10%;"></td> <td style="width: 10%;"></td> <td style="width: 10%;"></td> <td style="width: 10%;"></td> </tr> <tr> <td></td> <td></td> <td colspan="8" style="text-align: center;"> <table border="1" style="width: 100%; border-collapse: collapse; text-align: center;"> <tr> <td style="width: 10%;"></td> <td style="width: 10%;"></td> <td style="width: 10%;"></td> <td style="width: 10%;"></td> <td style="width: 10%;"></td> <td style="width: 10%;"></td> <td style="width: 10%;"></td> <td style="width: 10%;"></td> <td style="width: 10%;"></td> <td style="width: 10%;"></td> </tr> <tr> <td></td> <td></td> <td colspan="8" style="text-align: center;"> <table border="1" style="width: 100%; border-collapse: collapse; text-align: center;"> <tr> <td style="width: 10%;"></td> <td style="width: 10%;"></td> <td style="width: 10%;"></td> <td style="width: 10%;"></td> <td style="width: 10%;"></td> <td style="width: 10%;"></td> <td style="width: 10%;"></td> <td style="width: 10%;"></td> <td style="width: 10%;"></td> <td style="width: 10%;"></td> </tr> <tr> <td></td> <td></td> <td colspan="8" style="text-align: center;"> <table border="1" style="width: 100%; border-collapse: collapse; text-align: center;"> <tr> <td style="width: 10%;"></td> <td style="width: 10%;"></td> <td style="width: 10%;"></td> <td style="width: 10%;"></td> <td style="width: 10%;"></td> <td style="width: 10%;"></td> <td style="width: 10%;"></td> <td style="width: 10%;"></td> <td style="width: 10%;"></td> <td style="width: 10%;"></td> </tr> <tr> <td></td> <td></td> <td colspan="8" style="text-align: center;"> <table border="1" style="width: 100%; border-collapse: collapse; text-align: center;"> <tr> <td style="width: 10%;"></td>
<td style="width: 10%;"></td> <td style="width: 10%;"></td> <td style="width: 10%;"></td> <td style="width: 10%;"></td> <td style="width: 10%;"></td> <td style="width: 10%;"></td> <td style="width: 10%;"></td> <td style="width: 10%;"></td> <td style="width: 10%;"></td> </tr> <tr> <td></td> <td></td> <td colspan="8" style="text-align: center;"> <table border="1" style="width: 100%; border-collapse: collapse; text-align: center;"> <tr> <td style="width: 10%;"></td> <td style="width: 10%;"></td> <td style="width: 10%;"></td> <td style="width: 10%;"></td> <td style="width: 10%;"></td> <td style="width: 10%;"></td> <td style="width: 10%;"></td> <td style="width: 10%;"></td> <td style="width: 10%;"></td> <td style="width: 10%;"></td> </tr> <tr> <td></td> <td></td> <td colspan="8" style="text-align: center;"> <table border="1" style="width: 100%; border-collapse: collapse; text-align: center;"> <tr> <td style="width: 10%;"></td> <td style="width: 10%;"></td> <td style="width: 10%;"></td> <td style="width: 10%;"></td> <td style="width: 10%;"></td> <td style="width: 10%;"></td> <td style="width: 10%;"></td> <td style="width: 10%;"></td> <td style="width: 10%;"></td> <td style="width: 10%;"></td> </tr> <tr> <td></td> <td></td> <td colspan="8" style="text-align: center;"> <table border="1" style="width: 100%; border-collapse: collapse; text-align: center;"> <tr> <td style="width: 10%;"></td> <td style="width: 10%;"></td> <td style="width: 10%;"></td> <td style="width: 10%;"></td> <td style="width: 10%;"></td> <td style="width: 10%;"></td> <td style="width: 10%;"></td> <td style="width: 10%;"></td> <td style="width: 10%;"></td> <td style="width: 10%;"></td> </tr> <tr> <td></td> <td></td> <td colspan="8" style="text-align: center;"> <table border="1" style="width: 100%; border-collapse: collapse; text-align: center;"> <tr> <td style="width: 10%;"></td> <td style="width: 10%;"></td> <td style="width: 10%;"></td> <td style="width: 10%;"></td> <td style="width: 10%;"></td> <td style="width: 10%;"></td> <td style="width: 10%;"></td> <td style="width: 10%;"></td> <td style="width: 10%;"></td> <td style="width: 10%;"></td> </tr> <tr> <td></td> <td></td> <td colspan="8" style="text-align: center;"> <table border="1" style="width: 100%; border-collapse: collapse; text-align: center;"> <tr> <td style="width: 10%;"></td> <td style="width: 10%;"></td> <td style="width: 10%;"></td> <td style="width: 10%;"></td> <td style="width: 10%;"></td> <td style="width: 10%;"></td> <td style="width: 10%;"></td> <td style="width: 10%;"></td> <td style="width: 10%;"></td> <td style="width: 10%;"></td> </tr> <tr> <td></td> <td></td> <td colspan="8" style="text-align: center;"> <table border="1" style="width: 100%; border-collapse: collapse; text-align: center;"> <tr> <td style="width: 10%;"></td> <td style="width: 10%;"></td> <td style="width: 10%;"></td> <td style="width: 10%;"></td> <td style="width: 10%;"></td> <td style="width: 10%;"></td> <td style="width: 10%;"></td> <td style="width: 10%;"></td> <td style="width: 10%;"></td> <td style="width: 10%;"></td> </tr> <tr> <td></td> <td></td> <td colspan="8" style="text-align: center;"> <table border="1" style="width: 100%; border-collapse: collapse; text-align: center;"> <tr> <td style="width: 10%;"></td> <td style="width: 10%;"></td> <td style="width: 10%;"></td> <td style="width: 10%;"></td> <td style="width: 10%;"></td> <td style="width: 10%;"></td> <td style="width: 10%;"></td> <td style="width: 10%;"></td> <td style="width: 10%;"></td> <td style="width: 10%;"></td> </tr> <tr> <td></td> <td></td> <td colspan="8" style="text-align: center;"> <table border="1" style="width: 100%; border-collapse: collapse; text-align: center;"> <tr> <td style="width: 10%;"></td> <td style="width: 10%;"></td> <td style="width: 10%;"></td> <td style="width: 10%;"></td> <td style="width: 10%;"></td> <td style="width: 10%;"></td> <td style="width: 10%;"></td> <td style="width: 10%;"></td> <td style="width: 10%;"></td> <td style="width: 10%;"></td> </tr> <tr> <td></td> <td></td> <td colspan="8" style="text-align: center;"> <table border="1" style="width: 100%; border-collapse: collapse; text-align: center;"> <tr> <td style="width: 10%;"></td> <td style="width: 10%;"></td> <td style="width: 10%;"></td> <td style="width: 10%;"></td> <td style="width: 10%;"></td> <td style="width: 10%;"></td> <td style="width: 10%;"></td> <td style="width: 10%;"></td> <td style="width: 10%;"></td> <td style="width: 10%;"></td> </tr> <tr> <td></td> <td></td> <td colspan="8" style="text-align: center;"> <table border="1" style="width: 100%; border-collapse: collapse; text-align: center;"> <tr> </tr></table></td></tr></table></td></tr></table></td></tr></table></td></tr></table></td></tr></table></td></tr></table></td></tr></table></td></tr></table></td></tr></table></td></tr></table></td></tr></table></td></tr></table></td></tr></table></td></tr></table></td></tr></table></td></tr></table></td></tr></table></td></tr></table></td></tr></table></td></tr></table></td></tr></table></td></tr></table>
 | | | | | | | | | | | | | | | | | | | | <table border="1" style="width: 100%; border-collapse: collapse; text-align: center;"> <tr> <td style="width: 10%;"></td> <td style="width: 10%;"></td> <td style="width: 10%;"></td> <td style="width: 10%;"></td> <td style="width: 10%;"></td> <td style="width: 10%;"></td> <td style="width: 10%;"></td> <td style="width: 10%;"></td> <td style="width: 10%;"></td> <td style="width: 10%;"></td> </tr> <tr> <td></td> <td></td> <td colspan="8" style="text-align: center;"> <table border="1" style="width: 100%; border-collapse: collapse; text-align: center;"> <tr> <td style="width: 10%;"></td> <td style="width: 10%;"></td> <td style="width: 10%;"></td> <td style="width: 10%;"></td> <td style="width: 10%;"></td> <td style="width: 10%;"></td> <td style="width: 10%;"></td> <td style="width: 10%;"></td> <td style="width: 10%;"></td> <td style="width: 10%;"></td> </tr> <tr> <td></td> <td></td> <td colspan="8" style="text-align: center;"> <table border="1" style="width: 100%; border-collapse: collapse; text-align: center;"> <tr> <td style="width: 10%;"></td> <td style="width: 10%;"></td> <td style="width: 10%;"></td> <td style="width: 10%;"></td> <td style="width: 10%;"></td> <td style="width: 10%;"></td> <td style="width: 10%;"></td> <td style="width: 10%;"></td> <td style="width: 10%;"></td> <td style="width: 10%;"></td> </tr> <tr> <td></td> <td></td> <td colspan="8" style="text-align: center;"> <table border="1" style="width: 100%; border-collapse: collapse; text-align: center;"> <tr> <td style="width: 10%;"></td> <td style="width: 10%;"></td> <td style="width: 10%;"></td> <td style="width: 10%;"></td> <td style="width: 10%;"></td> <td style="width: 10%;"></td> <td style="width: 10%;"></td> <td style="width: 10%;"></td> <td style="width: 10%;"></td> <td style="width: 10%;"></td> </tr> <tr> <td></td> <td></td> <td colspan="8" style="text-align: center;"> <table border="1" style="width: 100%; border-collapse: collapse; text-align: center;"> <tr> <td style="width: 10%;"></td> <td style="width: 10%;"></td> <td style="width: 10%;"></td> <td style="width: 10%;"></td> <td style="width: 10%;"></td> <td style="width: 10%;"></td> <td style="width: 10%;"></td> <td style="width: 10%;"></td> <td style="width: 10%;"></td> <td style="width: 10%;"></td> </tr> <tr> <td></td> <td></td> <td colspan="8" style="text-align: center;"> <table border="1" style="width: 100%; border-collapse: collapse; text-align: center;"> <tr> <td style="width: 10%;"></td> <td style="width: 10%;"></td> <td style="width: 10%;"></td> <td style="width: 10%;"></td> <td style="width: 10%;"></td> <td style="width: 10%;"></td> <td style="width: 10%;"></td> <td style="width: 10%;"></td> <td style="width: 10%;"></td> <td style="width: 10%;"></td> </tr> <tr> <td></td> <td></td> <td colspan="8" style="text-align: center;"> <table border="1" style="width: 100%; border-collapse: collapse; text-align: center;"> <tr> <td style="width: 10%;"></td> <td style="width: 10%;"></td> <td style="width: 10%;"></td> <td style="width: 10%;"></td> <td style="width: 10%;"></td> <td style="width: 10%;"></td> <td style="width: 10%;"></td> <td style="width: 10%;"></td> <td style="width: 10%;"></td> <td style="width: 10%;"></td> </tr> <tr> <td></td> <td></td> <td colspan="8" style="text-align: center;"> <table border="1" style="width: 100%; border-collapse: collapse; text-align: center;"> <tr> <td style="width: 10%;"></td> <td style="width: 10%;"></td> <td style="width: 10%;"></td> <td style="width: 10%;"></td> <td style="width: 10%;"></td> <td style="width: 10%;"></td> <td style="width: 10%;"></td> <td style="width: 10%;"></td> <td style="width: 10%;"></td> <td style="width: 10%;"></td> </tr> <tr> <td></td> <td></td> <td colspan="8" style="text-align: center;"> <table border="1" style="width: 100%; border-collapse: collapse; text-align: center;"> <tr> <td style="width: 10%;"></td> <td style="width: 10%;"></td> <td style="width: 10%;"></td> <td style="width: 10%;"></td> <td style="width: 10%;"></td> <td style="width: 10%;"></td> <td style="width: 10%;"></td> <td style="width: 10%;"></td> <td style="width: 10%;"></td> <td style="width: 10%;"></td> </tr> <tr> <td></td> <td></td> <td colspan="8" style="text-align: center;"> <table border="1" style="width: 100%; border-collapse: collapse; text-align: center;"> <tr> <td style="width: 10%;"></td> <td style="width: 10%;"></td> <td style="width: 10%;"></td> <td style="width: 10%;"></td> <td style="width: 10%;"></td> <td style="width: 10%;"></td> <td style="width: 10%;"></td> <td style="width: 10%;"></td> <td style="width: 10%;"></td> <td style="width: 10%;"></td> </tr> <tr> <td></td> <td></td> <td colspan="8" style="text-align: center;"> <table border="1" style="width: 100%; border-collapse: collapse; text-align: center;"> <tr> <td style="width: 10%;"></td> <td style="width: 10%;"></td> <td style="width: 10%;"></td> <td style="width: 10%;"></td> <td style="width: 10%;"></td> <td style="width: 10%;"></td> <td style="width: 10%;"></td> <td style="width: 10%;"></td> <td style="width: 10%;"></td> <td style="width: 10%;"></td> </tr> <tr> <td></td> <td></td> <td colspan="8" style="text-align: center;"> <table border="1" style="width: 100%; border-collapse: collapse; text-align: center;"> <tr> <td style="width: 10%;"></td> <td style="width: 10%;"></td> <td style="width: 10%;"></td> <td style="width: 10%;"></td> <td style="width: 10%;"></td> <td style="width: 10%;"></td> <td style="width: 10%;"></td> <td style="width: 10%;"></td> <td style="width: 10%;"></td> <td style="width: 10%;"></td> </tr> <tr> <td></td> <td></td> <td colspan="8" style="text-align: center;"> <table border="1" style="width: 100%; border-collapse: collapse; text-align: center;"> <tr> <td style="width: 10%;"></td> <td style="width: 10%;"></td> <td style="width: 10%;"></td> <td style="width: 10%;"></td> <td style="width: 10%;"></td> <td style="width: 10%;"></td> <td style="width: 10%;"></td> <td style="width: 10%;"></td> <td style="width: 10%;"></td> <td style="width: 10%;"></td> </tr> <tr> <td></td> <td></td> <td colspan="8" style="text-align: center;"> <table border="1" style="width: 100%; border-collapse: collapse; text-align: center;"> <tr> <td style="width: 10%;"></td> <td style="width: 10%;"></td> <td style="width: 10%;"></td> <td style="width: 10%;"></td> <td style="width: 10%;"></td> <td style="width: 10%;"></td> <td style="width: 10%;"></td> <td style="width: 10%;"></td> <td style="width: 10%;"></td> <td style="width: 10%;"></td> </tr> <tr> <td></td> <td></td> <td colspan="8" style="text-align: center;"> <table border="1" style="width: 100%; border-collapse: collapse; text-align: center;"> <tr> <td style="width: 10%;"></td> <td style="width: 10%;"></td> <td style="width: 10%;"></td> <td style="width: 10%;"></td> <td style="width: 10%;"></td> <td style="width: 10%;"></td> <td style="width: 10%;"></td> <td style="width: 10%;"></td> <td style="width: 10%;"></td> <td style="width: 10%;"></td> </tr> <tr> <td></td> <td></td> <td colspan="8" style="text-align: center;"> <table border="1" style="width: 100%; border-collapse: collapse; text-align: center;"> <tr> <td style="width: 10%;"></td> <td style="width: 10%;"></td> <td style="width: 10%;"></td> <td style="width: 10%;"></td> <td style="width: 10%;"></td> <td style="width: 10%;"></td> <td style="width: 10%;"></td> <td style="width: 10%;"></td> <td style="width: 10%;"></td> <td style="width: 10%;"></td> </tr> <tr> <td></td> <td></td> <td colspan="8" style="text-align: center;"> <table border="1" style="width: 100%; border-collapse: collapse; text-align: center;"> <tr> <td style="width: 10%;"></td> <td style="width: 10%;"></td> <td style="width: 10%;"></td> <td style="width: 10%;"></td> <td style="width: 10%;"></td> <td style="width: 10%;"></td> <td style="width: 10%;"></td> <td style="width: 10%;"></td> <td style="width: 10%;"></td> <td style="width: 10%;"></td> </tr> <tr> <td></td> <td></td> <td colspan="8" style="text-align: center;"> <table border="1" style="width: 100%; border-collapse: collapse; text-align: center;"> <tr> <td style="width: 10%;"></td> <td style="width: 10%;"></td> <td style="width: 10%;"></td> <td style="width: 10%;"></td> <td style="width: 10%;"></td> <td style="width: 10%;"></td> <td style="width: 10%;"></td> <td style="width: 10%;"></td> <td style="width: 10%;"></td> <td style="width: 10%;"></td> </tr> <tr> <td></td> <td></td> <td colspan="8" style="text-align: center;"> <table border="1" style="width: 100%; border-collapse: collapse; text-align: center;"> <tr> <td style="width: 10%;"></td> <td style="width: 10%;"></td> <td style="width: 10%;"></td> <td style="width: 10%;"></td> <td style="width: 10%;"></td> <td style="width: 10%;"></td> <td style="width: 10%;"></td> <td style="width: 10%;"></td> <td style="width: 10%;"></td> <td style="width: 10%;"></td> </tr> <tr> <td></td> <td></td> <td colspan="8" style="text-align: center;"> <table border="1" style="width: 100%; border-collapse: collapse; text-align: center;"> <tr> <td style="width: 10%;"></td> <td style="width: 10%;"></td> <td style="width: 10%;"></td> <td style="width: 10%;"></td> <td style="width: 10%;"></td> <td style="width: 10%;"></td> <td style="width: 10%;"></td> <td style="width: 10%;"></td> <td style="width: 10%;"></td> <td style="width: 10%;"></td> </tr> <tr> <td></td> <td></td> <td colspan="8" style="text-align: center;"> <table border="1" style="width: 100%; border-collapse: collapse; text-align: center;"> <tr> <td style="width: 10%;"></td> <td style="width: 10%;"></td> <td style="width:
10%;"></td> <td style="width: 10%;"></td> <td style="width: 10%;"></td> <td style="width: 10%;"></td> <td style="width: 10%;"></td> <td style="width: 10%;"></td> <td style="width: 10%;"></td> <td style="width: 10%;"></td> </tr> <tr> <td></td> <td></td> <td colspan="8" style="text-align: center;"> <table border="1" style="width: 100%; border-collapse: collapse; text-align: center;"> <tr> </tr></table></td></tr></table></td></tr></table></td></tr></table></td></tr></table></td></tr></table></td></tr></table></td></tr></table></td></tr></table></td></tr></table></td></tr></table></td></tr></table></td></tr></table></td></tr></table></td></tr></table></td></tr></table></td></tr></table></td></tr></table></td></tr></table></td></tr></table></td></tr></table></td></tr></table> | | | | | | | | | | | | | | | | | | | | <table border="1" style="width: 100%; border-collapse: collapse; text-align: center;"> <tr> <td style="width: 10%;"></td> <td style="width: 10%;"></td> <td style="width: 10%;"></td> <td style="width: 10%;"></td> <td style="width: 10%;"></td> <td style="width: 10%;"></td> <td style="width: 10%;"></td> <td style="width: 10%;"></td> <td style="width: 10%;"></td> <td style="width: 10%;"></td> </tr> <tr> <td></td> <td></td> <td colspan="8" style="text-align: center;"> <table border="1" style="width: 100%; border-collapse: collapse; text-align: center;"> <tr> <td style="width: 10%;"></td> <td style="width: 10%;"></td> <td style="width: 10%;"></td> <td style="width: 10%;"></td> <td style="width: 10%;"></td> <td style="width: 10%;"></td> <td style="width: 10%;"></td> <td style="width: 10%;"></td> <td style="width: 10%;"></td> <td style="width: 10%;"></td> </tr> <tr> <td></td> <td></td> <td colspan="8" style="text-align: center;"> <table border="1" style="width: 100%; border-collapse: collapse; text-align: center;"> <tr> <td style="width: 10%;"></td> <td style="width: 10%;"></td> <td style="width: 10%;"></td> <td style="width: 10%;"></td> <td style="width: 10%;"></td> <td style="width: 10%;"></td> <td style="width: 10%;"></td> <td style="width: 10%;"></td> <td style="width: 10%;"></td> <td style="width: 10%;"></td> </tr> <tr> <td></td> <td></td> <td colspan="8" style="text-align: center;"> <table border="1" style="width: 100%; border-collapse: collapse; text-align: center;"> <tr> <td style="width: 10%;"></td> <td style="width: 10%;"></td> <td style="width: 10%;"></td> <td style="width: 10%;"></td> <td style="width: 10%;"></td> <td style="width: 10%;"></td> <td style="width: 10%;"></td> <td style="width: 10%;"></td> <td style="width: 10%;"></td> <td style="width: 10%;"></td> </tr> <tr> <td></td> <td></td> <td colspan="8" style="text-align: center;"> <table border="1" style="width: 100%; border-collapse: collapse; text-align: center;"> <tr> <td style="width: 10%;"></td> <td style="width: 10%;"></td> <td style="width: 10%;"></td> <td style="width: 10%;"></td> <td style="width: 10%;"></td> <td style="width: 10%;"></td> <td style="width: 10%;"></td> <td style="width: 10%;"></td> <td style="width: 10%;"></td> <td style="width: 10%;"></td> </tr> <tr> <td></td> <td></td> <td colspan="8" style="text-align: center;"> <table border="1" style="width: 100%; border-collapse: collapse; text-align: center;"> <tr> <td style="width: 10%;"></td> <td style="width: 10%;"></td> <td style="width: 10%;"></td> <td style="width: 10%;"></td> <td style="width: 10%;"></td> <td style="width: 10%;"></td> <td style="width: 10%;"></td> <td style="width: 10%;"></td> <td style="width: 10%;"></td> <td style="width: 10%;"></td> </tr> <tr> <td></td> <td></td> <td colspan="8" style="text-align: center;"> <table border="1" style="width: 100%; border-collapse: collapse; text-align: center;"> <tr> <td style="width: 10%;"></td> <td style="width: 10%;"></td> <td style="width: 10%;"></td> <td style="width: 10%;"></td> <td style="width: 10%;"></td> <td style="width: 10%;"></td> <td style="width: 10%;"></td> <td style="width: 10%;"></td> <td style="width: 10%;"></td> <td style="width: 10%;"></td> </tr> <tr> <td></td> <td></td> <td colspan="8" style="text-align: center;"> <table border="1" style="width: 100%; border-collapse: collapse; text-align: center;"> <tr> <td style="width: 10%;"></td> <td style="width: 10%;"></td> <td style="width: 10%;"></td> <td style="width: 10%;"></td> <td style="width: 10%;"></td> <td style="width: 10%;"></td> <td style="width: 10%;"></td> <td style="width: 10%;"></td> <td style="width: 10%;"></td> <td style="width: 10%;"></td> </tr> <tr> <td></td> <td></td> <td colspan="8" style="text-align: center;"> <table border="1" style="width: 100%; border-collapse: collapse;
text-align: center;"> <tr> <td style="width: 10%;"></td> <td style="width: 10%;"></td> <td style="width: 10%;"></td> <td style="width: 10%;"></td> <td style="width: 10%;"></td> <td style="width: 10%;"></td> <td style="width: 10%;"></td> <td style="width: 10%;"></td> <td style="width: 10%;"></td> <td style="width: 10%;"></td> </tr> <tr> <td></td> <td></td> <td colspan="8" style="text-align: center;"> <table border="1" style="width: 100%; border-collapse: collapse; text-align: center;"> <tr> <td style="width: 10%;"></td> <td style="width: 10%;"></td> <td style="width: 10%;"></td> <td style="width: 10%;"></td> <td style="width: 10%;"></td> <td style="width: 10%;"></td> <td style="width: 10%;"></td> <td style="width: 10%;"></td> <td style="width: 10%;"></td> <td style="width: 10%;"></td> </tr> <tr> <td></td> <td></td> <td colspan="8" style="text-align: center;"> <table border="1" style="width: 100%; border-collapse: collapse; text-align: center;"> <tr> <td style="width: 10%;"></td> <td style="width: 10%;"></td> <td style="width: 10%;"></td> <td style="width: 10%;"></td> <td style="width: 10%;"></td> <td style="width: 10%;"></td> <td style="width: 10%;"></td> <td style="width: 10%;"></td> <td style="width: 10%;"></td> <td style="width: 10%;"></td> </tr> <tr> <td></td> <td></td> <td colspan="8" style="text-align: center;"> <table border="1" style="width: 100%; border-collapse: collapse; text-align: center;"> <tr> <td style="width: 10%;"></td> <td style="width: 10%;"></td> <td style="width: 10%;"></td> <td style="width: 10%;"></td> <td style="width: 10%;"></td> <td style="width: 10%;"></td> <td style="width: 10%;"></td> <td style="width: 10%;"></td> <td style="width: 10%;"></td> <td style="width: 10%;"></td> </tr> <tr> <td></td> <td></td> <td colspan="8" style="text-align: center;"> <table border="1" style="width: 100%; border-collapse: collapse; text-align: center;"> <tr> <td style="width: 10%;"></td> <td style="width: 10%;"></td> <td style="width: 10%;"></td> <td style="width: 10%;"></td> <td style="width: 10%;"></td> <td style="width: 10%;"></td> <td style="width: 10%;"></td> <td style="width: 10%;"></td> <td style="width: 10%;"></td> <td style="width: 10%;"></td> </tr> <tr> <td></td> <td></td> <td colspan="8" style="text-align: center;"> <table border="1" style="width: 100%; border-collapse: collapse; text-align: center;"> <tr> <td style="width: 10%;"></td> <td style="width: 10%;"></td> <td style="width: 10%;"></td> <td style="width: 10%;"></td> <td style="width: 10%;"></td> <td style="width: 10%;"></td> <td style="width: 10%;"></td> <td style="width: 10%;"></td> <td style="width: 10%;"></td> <td style="width: 10%;"></td> </tr> <tr> <td></td> <td></td> <td colspan="8" style="text-align: center;"> <table border="1" style="width: 100%; border-collapse: collapse; text-align: center;"> <tr> <td style="width: 10%;"></td> <td style="width: 10%;"></td> <td style="width: 10%;"></td> <td style="width: 10%;"></td> <td style="width: 10%;"></td> <td style="width: 10%;"></td> <td style="width: 10%;"></td> <td style="width: 10%;"></td> <td style="width: 10%;"></td> <td style="width: 10%;"></td> </tr> <tr> <td></td> <td></td> <td colspan="8" style="text-align: center;"> <table border="1" style="width: 100%; border-collapse: collapse; text-align: center;"> <tr> <td style="width: 10%;"></td> <td style="width: 10%;"></td> <td style="width: 10%;"></td> <td style="width: 10%;"></td> <td style="width: 10%;"></td> <td style="width: 10%;"></td> <td style="width: 10%;"></td> <td style="width: 10%;"></td> <td style="width: 10%;"></td> <td style="width: 10%;"></td> </tr> <tr> <td></td> <td></td> <td colspan="8" style="text-align: center;"> <table border="1" style="width: 100%; border-collapse: collapse; text-align: center;"> <tr> <td style="width: 10%;"></td> <td style="width: 10%;"></td> <td style="width: 10%;"></td> <td style="width: 10%;"></td> <td style="width: 10%;"></td> <td style="width: 10%;"></td> <td style="width: 10%;"></td> <td style="width: 10%;"></td> <td style="width: 10%;"></td> <td style="width: 10%;"></td> </tr> <tr> <td></td> <td></td> <td colspan="8" style="text-align: center;"> <table border="1" style="width: 100%; border-collapse: collapse; text-align: center;"> <tr> <td style="width: 10%;"></td> <td style="width: 10%;"></td> <td style="width: 10%;"></td> <td style="width: 10%;"></td> <td style="width: 10%;"></td> <td style="width: 10%;"></td> <td style="width: 10%;"></td> <td style="width: 10%;"></td> <td style="width: 10%;"></td> <td style="width: 10%;"></td> </tr> <tr> <td></td> <td></td> <td colspan="8" style="text-align: center;"> <table border="1" style="width: 100%; border-collapse: collapse; text-align: center;"> <tr> <td style="width: 10%;"></td> <td style="width: 10%;"></td> <td style="width: 10%;"></td> <td style="width: 10%;"></td> <td style="width: 10%;"></td> <td style="width: 10%;"></td> <td style="width: 10%;"></td> <td style="width: 10%;"></td> <td style="width: 10%;"></td> <td style="width: 10%;"></td> </tr> <tr> <td></td> <td></td> <td colspan="8" style="text-align: center;"> <table border="1" style="width: 100%; border-collapse: collapse; text-align: center;"> <tr> <td style="width: 10%;"></td> <td style="width: 10%;"></td> <td style="width: 10%;"></td> <td style="width: 10%;"></td> <td style="width: 10%;"></td> <td style="width: 10%;"></td> <td style="width: 10%;"></td> <td style="width: 10%;"></td> <td style="width: 10%;"></td> <td style="width: 10%;"></td> </tr> <tr> <td></td> <td></td> <td colspan="8" style="text-align: center;"> <table border="1" style="width: 100%; border-collapse: collapse; text-align: center;"> <tr> </tr></table></td></tr></table></td></tr></table></td></tr></table></td></tr></table></td></tr></table></td></tr></table></td></tr></table></td></tr></table></td></tr></table></td></tr></table></td></tr></table></td></tr></table></td></tr></table></td></tr></table></td></tr></table></td></tr></table></td></tr></table></td></tr></table></td></tr></table></td></tr></table>
 | | | | | | | | | | | | | | | | | | | | <table border="1" style="width: 100%; border-collapse: collapse; text-align: center;"> <tr> <td style="width: 10%;"></td> <td style="width: 10%;"></td> <td style="width: 10%;"></td> <td style="width: 10%;"></td> <td style="width: 10%;"></td> <td style="width: 10%;"></td> <td style="width: 10%;"></td> <td style="width: 10%;"></td> <td style="width: 10%;"></td> <td style="width: 10%;"></td> </tr> <tr> <td></td> <td></td> <td colspan="8" style="text-align: center;"> <table border="1" style="width: 100%; border-collapse: collapse; text-align: center;"> <tr> <td style="width: 10%;"></td> <td style="width: 10%;"></td> <td style="width: 10%;"></td> <td style="width: 10%;"></td> <td style="width: 10%;"></td> <td style="width: 10%;"></td> <td style="width: 10%;"></td> <td style="width: 10%;"></td> <td style="width: 10%;"></td> <td style="width: 10%;"></td> </tr> <tr> <td></td> <td></td> <td colspan="8" style="text-align: center;"> <table border="1" style="width: 100%; border-collapse: collapse; text-align: center;"> <tr> <td style="width: 10%;"></td> <td style="width: 10%;"></td> <td style="width: 10%;"></td> <td style="width: 10%;"></td> <td style="width: 10%;"></td> <td style="width: 10%;"></td> <td style="width: 10%;"></td> <td style="width: 10%;"></td> <td style="width: 10%;"></td> <td style="width: 10%;"></td> </tr> <tr> <td></td> <td></td> <td colspan="8" style="text-align: center;"> <table border="1" style="width: 100%; border-collapse: collapse; text-align: center;"> <tr> <td style="width: 10%;"></td> <td style="width: 10%;"></td> <td style="width: 10%;"></td> <td style="width: 10%;"></td> <td style="width: 10%;"></td> <td style="width: 10%;"></td> <td style="width: 10%;"></td> <td style="width: 10%;"></td> <td style="width: 10%;"></td> <td style="width: 10%;"></td> </tr> <tr> <td></td> <td></td> <td colspan="8" style="text-align: center;"> <table border="1" style="width: 100%; border-collapse: collapse; text-align: center;"> <tr> <td style="width: 10%;"></td> <td style="width: 10%;"></td> <td style="width: 10%;"></td> <td style="width: 10%;"></td> <td style="width: 10%;"></td> <td style="width: 10%;"></td> <td style="width: 10%;"></td> <td style="width: 10%;"></td> <td style="width: 10%;"></td> <td style="width: 10%;"></td> </tr> <tr> <td></td> <td></td> <td colspan="8" style="text-align: center;"> <table border="1" style="width: 100%; border-collapse: collapse; text-align: center;"> <tr> <td style="width: 10%;"></td> <td style="width: 10%;"></td> <td style="width: 10%;"></td> <td style="width: 10%;"></td> <td style="width: 10%;"></td> <td style="width: 10%;"></td> <td style="width: 10%;"></td> <td style="width: 10%;"></td> <td style="width: 10%;"></td> <td style="width: 10%;"></td> </tr> <tr> <td></td> <td></td> <td colspan="8" style="text-align: center;"> <table border="1" style="width: 100%; border-collapse: collapse; text-align: center;"> <tr> <td style="width: 10%;"></td> <td style="width: 10%;"></td> <td style="width: 10%;"></td> <td style="width: 10%;"></td> <td style="width: 10%;"></td> <td style="width: 10%;"></td> <td style="width: 10%;"></td> <td style="width: 10%;"></td> <td style="width: 10%;"></td> <td style="width: 10%;"></td> </tr> <tr> <td></td> <td></td> <td colspan="8" style="text-align: center;"> <table border="1" style="width: 100%; border-collapse: collapse; text-align: center;"> <tr> <td style="width: 10%;"></td> <td style="width: 10%;"></td> <td style="width: 10%;"></td> <td style="width: 10%;"></td> <td style="width: 10%;"></td> <td style="width: 10%;"></td> <td style="width: 10%;"></td> <td style="width: 10%;"></td> <td style="width: 10%;"></td> <td style="width: 10%;"></td> </tr> <tr> <td></td> <td></td> <td colspan="8" style="text-align: center;"> <table border="1" style="width: 100%; border-collapse: collapse; text-align: center;"> <tr> <td style="width: 10%;"></td> <td style="width: 10%;"></td> <td style="width: 10%;"></td> <td style="width: 10%;"></td> <td style="width: 10%;"></td> <td style="width: 10%;"></td> <td style="width: 10%;"></td> <td style="width: 10%;"></td> <td style="width: 10%;"></td> <td style="width: 10%;"></td> </tr> <tr> <td></td> <td></td> <td colspan="8" style="text-align: center;"> <table border="1" style="width: 100%; border-collapse: collapse; text-align: center;"> <tr> <td style="width: 10%;"></td> <td style="width: 10%;"></td> <td style="width: 10%;"></td> <td style="width: 10%;"></td> <td style="width: 10%;"></td> <td style="width: 10%;"></td> <td style="width: 10%;"></td> <td style="width: 10%;"></td> <td style="width: 10%;"></td> <td style="width: 10%;"></td> </tr> <tr> <td></td> <td></td> <td colspan="8" style="text-align: center;"> <table border="1" style="width: 100%; border-collapse: collapse; text-align: center;"> <tr> <td style="width: 10%;"></td> <td style="width: 10%;"></td> <td style="width: 10%;"></td> <td style="width: 10%;"></td> <td style="width: 10%;"></td> <td style="width: 10%;"></td> <td style="width: 10%;"></td> <td style="width: 10%;"></td> <td style="width: 10%;"></td> <td style="width: 10%;"></td> </tr> <tr> <td></td> <td></td> <td colspan="8" style="text-align: center;"> <table border="1" style="width: 100%; border-collapse: collapse; text-align: center;"> <tr> <td style="width: 10%;"></td> <td style="width: 10%;"></td> <td style="width: 10%;"></td> <td style="width: 10%;"></td> <td style="width: 10%;"></td> <td style="width: 10%;"></td> <td style="width: 10%;"></td> <td style="width: 10%;"></td> <td style="width: 10%;"></td> <td style="width: 10%;"></td> </tr> <tr> <td></td> <td></td> <td colspan="8" style="text-align: center;"> <table border="1" style="width: 100%; border-collapse: collapse; text-align: center;"> <tr> <td style="width: 10%;"></td> <td style="width: 10%;"></td> <td style="width: 10%;"></td> <td style="width: 10%;"></td> <td style="width: 10%;"></td> <td style="width: 10%;"></td> <td style="width: 10%;"></td> <td style="width: 10%;"></td> <td style="width: 10%;"></td> <td style="width: 10%;"></td> </tr> <tr> <td></td> <td></td> <td colspan="8" style="text-align: center;"> <table border="1" style="width: 100%; border-collapse: collapse; text-align: center;"> <tr> <td style="width: 10%;"></td> <td style="width: 10%;"></td> <td style="width: 10%;"></td> <td style="width: 10%;"></td> <td style="width: 10%;"></td> <td style="width: 10%;"></td> <td style="width: 10%;"></td> <td style="width: 10%;"></td> <td style="width: 10%;"></td> <td style="width: 10%;"></td> </tr> <tr> <td></td> <td></td> <td colspan="8" style="text-align: center;"> <table border="1" style="width: 100%; border-collapse: collapse; text-align: center;"> <tr> <td style="width: 10%;"></td> <td style="width: 10%;"></td> <td style="width: 10%;"></td> <td style="width: 10%;"></td> <td style="width: 10%;"></td> <td style="width: 10%;"></td> <td style="width: 10%;"></td> <td style="width: 10%;"></td> <td style="width: 10%;"></td> <td style="width: 10%;"></td> </tr> <tr> <td></td> <td></td> <td colspan="8" style="text-align: center;"> <table border="1" style="width: 100%; border-collapse: collapse; text-align: center;"> <tr> <td style="width: 10%;"></td> <td style="width: 10%;"></td> <td style="width: 10%;"></td> <td style="width: 10%;"></td> <td style="width: 10%;"></td> <td style="width: 10%;"></td> <td style="width: 10%;"></td> <td style="width: 10%;"></td> <td style="width: 10%;"></td> <td style="width: 10%;"></td> </tr> <tr> <td></td> <td></td> <td colspan="8" style="text-align: center;"> <table border="1" style="width: 100%; border-collapse: collapse; text-align: center;"> <tr> <td style="width: 10%;"></td> <td style="width: 10%;"></td> <td style="width: 10%;"></td> <td style="width: 10%;"></td> <td style="width: 10%;"></td> <td style="width: 10%;"></td> <td style="width: 10%;"></td> <td style="width: 10%;"></td> <td style="width: 10%;"></td> <td style="width: 10%;"></td> </tr> <tr> <td></td> <td></td> <td colspan="8" style="text-align: center;"> <table border="1" style="width: 100%; border-collapse: collapse; text-align: center;"> <tr> <td style="width: 10%;"></td> <td style="width: 10%;"></td> <td style="width: 10%;"></td> <td style="width: 10%;"></td> <td style="width: 10%;"></td> <td style="width: 10%;"></td> <td style="width: 10%;"></td> <td style="width: 10%;"></td> <td style="width: 10%;"></td> <td style="width: 10%;"></td> </tr> <tr> <td></td> <td></td> <td colspan="8" style="text-align: center;"> <table border="1" style="width: 100%; border-collapse: collapse; text-align: center;"> <tr> <td style="width: 10%;"></td> <td style="width: 10%;"></td>
<td style="width: 10%;"></td> <td style="width: 10%;"></td> <td style="width: 10%;"></td> <td style="width: 10%;"></td> <td style="width: 10%;"></td> <td style="width: 10%;"></td> <td style="width: 10%;"></td> <td style="width: 10%;"></td> </tr> <tr> <td></td> <td></td> <td colspan="8" style="text-align: center;"> <table border="1" style="width: 100%; border-collapse: collapse; text-align: center;"> <tr> </tr></table></td></tr></table></td></tr></table></td></tr></table></td></tr></table></td></tr></table></td></tr></table></td></tr></table></td></tr></table></td></tr></table></td></tr></table></td></tr></table></td></tr></table></td></tr></table></td></tr></table></td></tr></table></td></tr></table></td></tr></table></td></tr></table></td></tr></table> | | | | | | | | | | | | | | | | | | | | <table border="1" style="width: 100%; border-collapse: collapse; text-align: center;"> <tr> <td style="width: 10%;"></td> <td style="width: 10%;"></td> <td style="width: 10%;"></td> <td style="width: 10%;"></td> <td style="width: 10%;"></td> <td style="width: 10%;"></td> <td style="width: 10%;"></td> <td style="width: 10%;"></td> <td style="width: 10%;"></td> <td style="width: 10%;"></td> </tr> <tr> <td></td> <td></td> <td colspan="8" style="text-align: center;"> <table border="1" style="width: 100%; border-collapse: collapse; text-align: center;"> <tr> <td style="width: 10%;"></td> <td style="width: 10%;"></td> <td style="width: 10%;"></td> <td style="width: 10%;"></td> <td style="width: 10%;"></td> <td style="width: 10%;"></td> <td style="width: 10%;"></td> <td style="width: 10%;"></td> <td style="width: 10%;"></td> <td style="width: 10%;"></td> </tr> <tr> <td></td> <td></td> <td colspan="8" style="text-align: center;"> <table border="1" style="width: 100%; border-collapse: collapse; text-align: center;"> <tr> <td style="width: 10%;"></td> <td style="width: 10%;"></td> <td style="width: 10%;"></td> <td style="width: 10%;"></td> <td style="width: 10%;"></td> <td style="width: 10%;"></td> <td style="width: 10%;"></td> <td style="width: 10%;"></td> <td style="width: 10%;"></td> <td style="width: 10%;"></td> </tr> <tr> <td></td> <td></td> <td colspan="8" style="text-align: center;"> <table border="1" style="width: 100%; border-collapse: collapse; text-align: center;"> <tr> <td style="width: 10%;"></td> <td style="width: 10%;"></td> <td style="width: 10%;"></td> <td style="width: 10%;"></td> <td style="width: 10%;"></td> <td style="width: 10%;"></td> <td style="width: 10%;"></td> <td style="width: 10%;"></td> <td style="width: 10%;"></td> <td style="width: 10%;"></td> </tr> <tr> <td></td> <td></td> <td colspan="8" style="text-align: center;"> <table border="1" style="width: 100%; border-collapse: collapse; text-align: center;"> <tr> <td style="width: 10%;"></td> <td style="width: 10%;"></td> <td style="width: 10%;"></td> <td style="width: 10%;"></td> <td style="width: 10%;"></td> <td style="width: 10%;"></td> <td style="width: 10%;"></td> <td style="width: 10%;"></td> <td style="width: 10%;"></td> <td style="width: 10%;"></td> </tr> <tr> <td></td> <td></td> <td colspan="8" style="text-align: center;"> <table border="1" style="width: 100%; border-collapse: collapse; text-align: center;"> <tr> <td style="width: 10%;"></td> <td style="width: 10%;"></td> <td style="width: 10%;"></td> <td style="width: 10%;"></td> <td style="width: 10%;"></td> <td style="width: 10%;"></td> <td style="width: 10%;"></td> <td style="width: 10%;"></td> <td style="width: 10%;"></td> <td style="width: 10%;"></td> </tr> <tr> <td></td> <td></td> <td colspan="8" style="text-align: center;"> <table border="1" style="width: 100%; border-collapse: collapse; text-align: center;"> <tr> <td style="width: 10%;"></td> <td style="width: 10%;"></td> <td style="width: 10%;"></td> <td style="width: 10%;"></td> <td style="width: 10%;"></td> <td style="width: 10%;"></td> <td style="width: 10%;"></td> <td style="width: 10%;"></td> <td style="width: 10%;"></td> <td style="width: 10%;"></td> </tr> <tr> <td></td> <td></td> <td colspan="8" style="text-align: center;"> <table border="1" style="width: 100%; border-collapse: collapse; text-align: center;"> <tr> <td style="width: 10%;"></td> <td style="width: 10%;"></td> <td style="width: 10%;"></td> <td style="width: 10%;"></td> <td style="width: 10%;"></td> <td style="width: 10%;"></td> <td style="width: 10%;"></td> <td style="width: 10%;"></td> <td style="width: 10%;"></td> <td style="width: 10%;"></td> </tr> <tr> <td></td> <td></td> <td colspan="8" style="text-align: center;"> <table border="1" style="width: 100%; border-collapse: collapse; text-align: center;">
<tr> <td style="width: 10%;"></td> <td style="width: 10%;"></td> <td style="width: 10%;"></td> <td style="width: 10%;"></td> <td style="width: 10%;"></td> <td style="width: 10%;"></td> <td style="width: 10%;"></td> <td style="width: 10%;"></td> <td style="width: 10%;"></td> <td style="width: 10%;"></td> </tr> <tr> <td></td> <td></td> <td colspan="8" style="text-align: center;"> <table border="1" style="width: 100%; border-collapse: collapse; text-align: center;"> <tr> <td style="width: 10%;"></td> <td style="width: 10%;"></td> <td style="width: 10%;"></td> <td style="width: 10%;"></td> <td style="width: 10%;"></td> <td style="width: 10%;"></td> <td style="width: 10%;"></td> <td style="width: 10%;"></td> <td style="width: 10%;"></td> <td style="width: 10%;"></td> </tr> <tr> <td></td> <td></td> <td colspan="8" style="text-align: center;"> <table border="1" style="width: 100%; border-collapse: collapse; text-align: center;"> <tr> <td style="width: 10%;"></td> <td style="width: 10%;"></td> <td style="width: 10%;"></td> <td style="width: 10%;"></td> <td style="width: 10%;"></td> <td style="width: 10%;"></td> <td style="width: 10%;"></td> <td style="width: 10%;"></td> <td style="width: 10%;"></td> <td style="width: 10%;"></td> </tr> <tr> <td></td> <td></td> <td colspan="8" style="text-align: center;"> <table border="1" style="width: 100%; border-collapse: collapse; text-align: center;"> <tr> <td style="width: 10%;"></td> <td style="width: 10%;"></td> <td style="width: 10%;"></td> <td style="width: 10%;"></td> <td style="width: 10%;"></td> <td style="width: 10%;"></td> <td style="width: 10%;"></td> <td style="width: 10%;"></td> <td style="width: 10%;"></td> <td style="width: 10%;"></td> </tr> <tr> <td></td> <td></td> <td colspan="8" style="text-align: center;"> <table border="1" style="width: 100%; border-collapse: collapse; text-align: center;"> <tr> <td style="width: 10%;"></td> <td style="width: 10%;"></td> <td style="width: 10%;"></td> <td style="width: 10%;"></td> <td style="width: 10%;"></td> <td style="width: 10%;"></td> <td style="width: 10%;"></td> <td style="width: 10%;"></td> <td style="width: 10%;"></td> <td style="width: 10%;"></td> </tr> <tr> <td></td> <td></td> <td colspan="8" style="text-align: center;"> <table border="1" style="width: 100%; border-collapse: collapse; text-align: center;"> <tr> <td style="width: 10%;"></td> <td style="width: 10%;"></td> <td style="width: 10%;"></td> <td style="width: 10%;"></td> <td style="width: 10%;"></td> <td style="width: 10%;"></td> <td style="width: 10%;"></td> <td style="width: 10%;"></td> <td style="width: 10%;"></td> <td style="width: 10%;"></td> </tr> <tr> <td></td> <td></td> <td colspan="8" style="text-align: center;"> <table border="1" style="width: 100%; border-collapse: collapse; text-align: center;"> <tr> <td style="width: 10%;"></td> <td style="width: 10%;"></td> <td style="width: 10%;"></td> <td style="width: 10%;"></td> <td style="width: 10%;"></td> <td style="width: 10%;"></td> <td style="width: 10%;"></td> <td style="width: 10%;"></td> <td style="width: 10%;"></td> <td style="width: 10%;"></td> </tr> <tr> <td></td> <td></td> <td colspan="8" style="text-align: center;"> <table border="1" style="width: 100%; border-collapse: collapse; text-align: center;"> <tr> <td style="width: 10%;"></td> <td style="width: 10%;"></td> <td style="width: 10%;"></td> <td style="width: 10%;"></td> <td style="width: 10%;"></td> <td style="width: 10%;"></td> <td style="width: 10%;"></td> <td style="width: 10%;"></td> <td style="width: 10%;"></td> <td style="width: 10%;"></td> </tr> <tr> <td></td> <td></td> <td colspan="8" style="text-align: center;"> <table border="1" style="width: 100%; border-collapse: collapse; text-align: center;"> <tr> <td style="width: 10%;"></td> <td style="width: 10%;"></td> <td style="width: 10%;"></td> <td style="width: 10%;"></td> <td style="width: 10%;"></td> <td style="width: 10%;"></td> <td style="width: 10%;"></td> <td style="width: 10%;"></td> <td style="width: 10%;"></td> <td style="width: 10%;"></td> </tr> <tr> <td></td> <td></td> <td colspan="8" style="text-align: center;"> <table border="1" style="width: 100%; border-collapse: collapse; text-align: center;"> <tr> <td style="width: 10%;"></td> <td style="width: 10%;"></td> <td style="width: 10%;"></td> <td style="width: 10%;"></td> <td style="width: 10%;"></td> <td style="width: 10%;"></td> <td style="width: 10%;"></td> <td style="width: 10%;"></td> <td style="width: 10%;"></td> <td style="width: 10%;"></td> </tr> <tr> <td></td> <td></td> <td colspan="8" style="text-align: center;"> <table border="1" style="width: 100%; border-collapse: collapse; text-align: center;"> <tr> </tr></table></td></tr></table></td></tr></table></td></tr></table></td></tr></table></td></tr></table></td></tr></table></td></tr></table></td></tr></table></td></tr></table></td></tr></table></td></tr></table></td></tr></table></td></tr></table></td></tr></table></td></tr></table></td></tr></table></td></tr></table></td></tr></table>
 | | | | | | | | | | | | | | | | | | | | <table border="1" style="width: 100%; border-collapse: collapse; text-align: center;"> <tr> <td style="width: 10%;"></td> <td style="width: 10%;"></td> <td style="width: 10%;"></td> <td style="width: 10%;"></td> <td style="width: 10%;"></td> <td style="width: 10%;"></td> <td style="width: 10%;"></td> <td style="width: 10%;"></td> <td style="width: 10%;"></td> <td style="width: 10%;"></td> </tr> <tr> <td></td> <td></td> <td colspan="8" style="text-align: center;"> <table border="1" style="width: 100%; border-collapse: collapse; text-align: center;"> <tr> <td style="width: 10%;"></td> <td style="width: 10%;"></td> <td style="width: 10%;"></td> <td style="width: 10%;"></td> <td style="width: 10%;"></td> <td style="width: 10%;"></td> <td style="width: 10%;"></td> <td style="width: 10%;"></td> <td style="width: 10%;"></td> <td style="width: 10%;"></td> </tr> <tr> <td></td> <td></td> <td colspan="8" style="text-align: center;"> <table border="1" style="width: 100%; border-collapse: collapse; text-align: center;"> <tr> <td style="width: 10%;"></td> <td style="width: 10%;"></td> <td style="width: 10%;"></td> <td style="width: 10%;"></td> <td style="width: 10%;"></td> <td style="width: 10%;"></td> <td style="width: 10%;"></td> <td style="width: 10%;"></td> <td style="width: 10%;"></td> <td style="width: 10%;"></td> </tr> <tr> <td></td> <td></td> <td colspan="8" style="text-align: center;"> <table border="1" style="width: 100%; border-collapse: collapse; text-align: center;"> <tr> <td style="width: 10%;"></td> <td style="width: 10%;"></td> <td style="width: 10%;"></td> <td style="width: 10%;"></td> <td style="width: 10%;"></td> <td style="width: 10%;"></td> <td style="width: 10%;"></td> <td style="width: 10%;"></td> <td style="width: 10%;"></td> <td style="width: 10%;"></td> </tr> <tr> <td></td> <td></td> <td colspan="8" style="text-align: center;"> <table border="1" style="width: 100%; border-collapse: collapse; text-align: center;"> <tr> <td style="width: 10%;"></td> <td style="width: 10%;"></td> <td style="width: 10%;"></td> <td style="width: 10%;"></td> <td style="width: 10%;"></td> <td style="width: 10%;"></td> <td style="width: 10%;"></td> <td style="width: 10%;"></td> <td style="width: 10%;"></td> <td style="width: 10%;"></td> </tr> <tr> <td></td> <td></td> <td colspan="8" style="text-align: center;"> <table border="1" style="width: 100%; border-collapse: collapse; text-align: center;"> <tr> <td style="width: 10%;"></td> <td style="width: 10%;"></td> <td style="width: 10%;"></td> <td style="width: 10%;"></td> <td style="width: 10%;"></td> <td style="width: 10%;"></td> <td style="width: 10%;"></td> <td style="width: 10%;"></td> <td style="width: 10%;"></td> <td style="width: 10%;"></td> </tr> <tr> <td></td> <td></td> <td colspan="8" style="text-align: center;"> <table border="1" style="width: 100%; border-collapse: collapse; text-align: center;"> <tr> <td style="width: 10%;"></td> <td style="width: 10%;"></td> <td style="width: 10%;"></td> <td style="width: 10%;"></td> <td style="width: 10%;"></td> <td style="width: 10%;"></td> <td style="width: 10%;"></td> <td style="width: 10%;"></td> <td style="width: 10%;"></td> <td style="width: 10%;"></td> </tr> <tr> <td></td> <td></td> <td colspan="8" style="text-align: center;"> <table border="1" style="width: 100%; border-collapse: collapse; text-align: center;"> <tr> <td style="width: 10%;"></td> <td style="width: 10%;"></td> <td style="width: 10%;"></td> <td style="width: 10%;"></td> <td style="width: 10%;"></td> <td style="width: 10%;"></td> <td style="width: 10%;"></td> <td style="width: 10%;"></td> <td style="width: 10%;"></td> <td style="width: 10%;"></td> </tr> <tr> <td></td> <td></td> <td colspan="8" style="text-align: center;"> <table border="1" style="width: 100%; border-collapse: collapse; text-align: center;"> <tr> <td style="width: 10%;"></td> <td style="width: 10%;"></td> <td style="width: 10%;"></td> <td style="width: 10%;"></td> <td style="width: 10%;"></td> <td style="width: 10%;"></td> <td style="width: 10%;"></td> <td style="width: 10%;"></td> <td style="width: 10%;"></td> <td style="width: 10%;"></td> </tr> <tr> <td></td> <td></td> <td colspan="8" style="text-align: center;"> <table border="1" style="width: 100%; border-collapse: collapse; text-align: center;"> <tr> <td style="width: 10%;"></td> <td style="width: 10%;"></td> <td style="width: 10%;"></td> <td style="width: 10%;"></td> <td style="width: 10%;"></td> <td style="width: 10%;"></td> <td style="width: 10%;"></td> <td style="width: 10%;"></td> <td style="width: 10%;"></td> <td style="width: 10%;"></td> </tr> <tr> <td></td> <td></td> <td colspan="8" style="text-align: center;"> <table border="1" style="width: 100%; border-collapse: collapse; text-align: center;"> <tr> <td style="width: 10%;"></td> <td style="width: 10%;"></td> <td style="width: 10%;"></td> <td style="width: 10%;"></td> <td style="width: 10%;"></td> <td style="width: 10%;"></td> <td style="width: 10%;"></td> <td style="width: 10%;"></td> <td style="width: 10%;"></td> <td style="width: 10%;"></td> </tr> <tr> <td></td> <td></td> <td colspan="8" style="text-align: center;"> <table border="1" style="width: 100%; border-collapse: collapse; text-align: center;"> <tr> <td style="width: 10%;"></td> <td style="width: 10%;"></td> <td style="width: 10%;"></td> <td style="width: 10%;"></td> <td style="width: 10%;"></td> <td style="width: 10%;"></td> <td style="width: 10%;"></td> <td style="width: 10%;"></td> <td style="width: 10%;"></td> <td style="width: 10%;"></td> </tr> <tr> <td></td> <td></td> <td colspan="8" style="text-align: center;"> <table border="1" style="width: 100%; border-collapse: collapse; text-align: center;"> <tr> <td style="width: 10%;"></td> <td style="width: 10%;"></td> <td style="width: 10%;"></td> <td style="width: 10%;"></td> <td style="width: 10%;"></td> <td style="width: 10%;"></td> <td style="width: 10%;"></td> <td style="width: 10%;"></td> <td style="width: 10%;"></td> <td style="width: 10%;"></td> </tr> <tr> <td></td> <td></td> <td colspan="8" style="text-align: center;"> <table border="1" style="width: 100%; border-collapse: collapse; text-align: center;"> <tr> <td style="width: 10%;"></td> <td style="width: 10%;"></td> <td style="width: 10%;"></td> <td style="width: 10%;"></td> <td style="width: 10%;"></td> <td style="width: 10%;"></td> <td style="width: 10%;"></td> <td style="width: 10%;"></td> <td style="width: 10%;"></td> <td style="width: 10%;"></td> </tr> <tr> <td></td> <td></td> <td colspan="8" style="text-align: center;"> <table border="1" style="width: 100%; border-collapse: collapse; text-align: center;"> <tr> <td style="width: 10%;"></td> <td style="width: 10%;"></td> <td style="width: 10%;"></td> <td style="width: 10%;"></td> <td style="width: 10%;"></td> <td style="width: 10%;"></td> <td style="width: 10%;"></td> <td style="width: 10%;"></td> <td style="width: 10%;"></td> <td style="width: 10%;"></td> </tr> <tr> <td></td> <td></td> <td colspan="8" style="text-align: center;"> <table border="1" style="width: 100%; border-collapse: collapse; text-align: center;"> <tr> <td style="width: 10%;"></td> <td style="width: 10%;"></td> <td style="width: 10%;"></td> <td style="width: 10%;"></td> <td style="width: 10%;"></td> <td style="width: 10%;"></td> <td style="width: 10%;"></td> <td style="width: 10%;"></td> <td style="width: 10%;"></td> <td style="width: 10%;"></td> </tr> <tr> <td></td> <td></td> <td colspan="8" style="text-align: center;"> <table border="1" style="width: 100%; border-collapse: collapse; text-align: center;"> <tr> <td style="width: 10%;"></td> <td style="width: 10%;"></td> <td style="width: 10%;"></td> <td style="width: 10%;"></td> <td style="width: 10%;"></td> <td style="width: 10%;"></td> <td style="width: 10%;"></td> <td style="width: 10%;"></td> <td style="width: 10%;"></td> <td style="width: 10%;"></td> </tr> <tr> <td></td> <td></td> <td colspan="8" style="text-align: center;"> <table border="1" style="width: 100%; border-collapse: collapse; text-align: center;"> <tr> </tr></table></td></tr></table></td></tr></table></td></tr></table></td></tr></table></td></tr></table></td></tr></table></td></tr></table></td></tr></table></td></tr></table></td></tr></table></td></tr></table></td></tr></table></td></tr></table></td></tr></table></td></tr></table></td></tr></table></td></tr></table>
 | | | | | | | | | | | | | | | | | | | | <table border="1" style="width: 100%; border-collapse: collapse; text-align: center;"> <tr> <td style="width: 10%;"></td> <td style="width: 10%;"></td> <td style="width: 10%;"></td> <td style="width: 10%;"></td> <td style="width: 10%;"></td> <td style="width: 10%;"></td> <td style="width: 10%;"></td> <td style="width: 10%;"></td> <td style="width: 10%;"></td> <td style="width: 10%;"></td> </tr> <tr> <td></td> <td></td> <td colspan="8" style="text-align: center;"> <table border="1" style="width: 100%; border-collapse: collapse; text-align: center;"> <tr> <td style="width: 10%;"></td> <td style="width: 10%;"></td> <td style="width: 10%;"></td> <td style="width: 10%;"></td> <td style="width: 10%;"></td> <td style="width: 10%;"></td> <td style="width: 10%;"></td> <td style="width: 10%;"></td> <td style="width: 10%;"></td> <td style="width: 10%;"></td> </tr> <tr> <td></td> <td></td> <td colspan="8" style="text-align: center;"> <table border="1" style="width: 100%; border-collapse: collapse; text-align: center;"> <tr> <td style="width: 10%;"></td> <td style="width: 10%;"></td> <td style="width: 10%;"></td> <td style="width: 10%;"></td> <td style="width: 10%;"></td> <td style="width: 10%;"></td> <td style="width: 10%;"></td> <td style="width: 10%;"></td> <td style="width: 10%;"></td> <td style="width: 10%;"></td> </tr> <tr> <td></td> <td></td> <td colspan="8" style="text-align: center;"> <table border="1" style="width: 100%; border-collapse: collapse; text-align: center;"> <tr> <td style="width: 10%;"></td> <td style="width: 10%;"></td> <td style="width: 10%;"></td> <td style="width: 10%;"></td> <td style="width: 10%;"></td> <td style="width: 10%;"></td> <td style="width: 10%;"></td> <td style="width: 10%;"></td> <td style="width: 10%;"></td> <td style="width: 10%;"></td> </tr> <tr> <td></td> <td></td> <td colspan="8" style="text-align: center;"> <table border="1" style="width: 100%; border-collapse: collapse; text-align: center;"> <tr> <td style="width: 10%;"></td> <td style="width: 10%;"></td> <td style="width: 10%;"></td> <td style="width: 10%;"></td> <td style="width: 10%;"></td> <td style="width: 10%;"></td> <td style="width: 10%;"></td> <td style="width: 10%;"></td> <td style="width: 10%;"></td> <td style="width: 10%;"></td> </tr> <tr> <td></td> <td></td> <td colspan="8" style="text-align: center;"> <table border="1" style="width: 100%; border-collapse: collapse; text-align: center;"> <tr> <td style="width: 10%;"></td> <td style="width: 10%;"></td> <td style="width: 10%;"></td> <td style="width: 10%;"></td> <td style="width: 10%;"></td> <td style="width: 10%;"></td> <td style="width: 10%;"></td> <td style="width: 10%;"></td> <td style="width: 10%;"></td> <td style="width: 10%;"></td> </tr> <tr> <td></td> <td></td> <td colspan="8" style="text-align: center;"> <table border="1" style="width: 100%; border-collapse: collapse; text-align: center;"> <tr> <td style="width: 10%;"></td> <td style="width: 10%;"></td> <td style="width: 10%;"></td> <td style="width: 10%;"></td> <td style="width: 10%;"></td> <td style="width: 10%;"></td> <td style="width: 10%;"></td> <td style="width: 10%;"></td> <td style="width: 10%;"></td> <td style="width: 10%;"></td> </tr> <tr> <td></td> <td></td> <td colspan="8" style="text-align: center;"> <table border="1" style="width: 100%; border-collapse: collapse; text-align: center;"> <tr> <td style="width: 10%;"></td> <td style="width: 10%;"></td> <td style="width: 10%;"></td> <td style="width: 10%;"></td> <td style="width: 10%;"></td> <td style="width: 10%;"></td> <td style="width: 10%;"></td> <td style="width: 10%;"></td> <td style="width: 10%;"></td> <td style="width: 10%;"></td> </tr> <tr> <td></td> <td></td> <td colspan="8" style="text-align: center;"> <table border="1" style="width: 100%; border-collapse: collapse; text-align: center;"> <tr> <td style="width: 10%;"></td> <td style="width: 10%;"></td> <td style="width: 10%;"></td> <td style="width: 10%;"></td> <td style="width: 10%;"></td> <td style="width: 10%;"></td> <td style="width: 10%;"></td> <td style="width: 10%;"></td> <td style="width: 10%;"></td> <td style="width: 10%;"></td> </tr> <tr> <td></td> <td></td> <td colspan="8" style="text-align: center;"> <table border="1" style="width: 100%; border-collapse: collapse; text-align: center;"> <tr> <td style="width: 10%;"></td> <td style="width: 10%;"></td> <td style="width: 10%;"></td> <td style="width: 10%;"></td> <td style="width: 10%;"></td> <td style="width: 10%;"></td> <td style="width: 10%;"></td> <td style="width: 10%;"></td> <td style="width: 10%;"></td> <td style="width: 10%;"></td> </tr> <tr> <td></td> <td></td> <td colspan="8" style="text-align: center;"> <table border="1" style="width: 100%; border-collapse: collapse; text-align: center;"> <tr> <td style="width: 10%;"></td> <td style="width: 10%;"></td> <td style="width: 10%;"></td> <td style="width: 10%;"></td> <td style="width: 10%;"></td> <td style="width: 10%;"></td> <td style="width: 10%;"></td> <td style="width: 10%;"></td> <td style="width: 10%;"></td> <td style="width: 10%;"></td> </tr> <tr> <td></td> <td></td> <td colspan="8" style="text-align: center;"> <table border="1" style="width: 100%; border-collapse: collapse; text-align: center;"> <tr> <td style="width: 10%;"></td> <td style="width: 10%;"></td> <td style="width: 10%;"></td> <td style="width: 10%;"></td> <td style="width: 10%;"></td> <td style="width: 10%;"></td> <td style="width: 10%;"></td> <td style="width: 10%;"></td> <td style="width: 10%;"></td> <td style="width: 10%;"></td> </tr> <tr> <td></td> <td></td> <td colspan="8" style="text-align: center;"> <table border="1" style="width: 100%; border-collapse: collapse; text-align: center;"> <tr> <td style="width: 10%;"></td> <td style="width: 10%;"></td> <td style="width: 10%;"></td>
<td style="width: 10%;"></td> <td style="width: 10%;"></td> <td style="width: 10%;"></td> <td style="width: 10%;"></td> <td style="width: 10%;"></td> <td style="width: 10%;"></td> <td style="width: 10%;"></td> </tr> <tr> <td></td> <td></td> <td colspan="8" style="text-align: center;"> <table border="1" style="width: 100%; border-collapse: collapse; text-align: center;"> <tr> <td style="width: 10%;"></td> <td style="width: 10%;"></td> <td style="width: 10%;"></td> <td style="width: 10%;"></td> <td style="width: 10%;"></td> <td style="width: 10%;"></td> <td style="width: 10%;"></td> <td style="width: 10%;"></td> <td style="width: 10%;"></td> <td style="width: 10%;"></td> </tr> <tr> <td></td> <td></td> <td colspan="8" style="text-align: center;"> <table border="1" style="width: 100%; border-collapse: collapse; text-align: center;"> <tr> <td style="width: 10%;"></td> <td style="width: 10%;"></td> <td style="width: 10%;"></td> <td style="width: 10%;"></td> <td style="width: 10%;"></td> <td style="width: 10%;"></td> <td style="width: 10%;"></td> <td style="width: 10%;"></td> <td style="width: 10%;"></td> <td style="width: 10%;"></td> </tr> <tr> <td></td> <td></td> <td colspan="8" style="text-align: center;"> <table border="1" style="width: 100%; border-collapse: collapse; text-align: center;"> <tr> <td style="width: 10%;"></td> <td style="width: 10%;"></td> <td style="width: 10%;"></td> <td style="width: 10%;"></td> <td style="width: 10%;"></td> <td style="width: 10%;"></td> <td style="width: 10%;"></td> <td style="width: 10%;"></td> <td style="width: 10%;"></td> <td style="width: 10%;"></td> </tr> <tr> <td></td> <td></td> <td colspan="8" style="text-align: center;"> <table border="1" style="width: 100%; border-collapse: collapse; text-align: center;"> <tr> </tr></table></td></tr></table></td></tr></table></td></tr></table></td></tr></table></td></tr></table></td></tr></table></td></tr></table></td></tr></table></td></tr></table></td></tr></table></td></tr></table></td></tr></table></td></tr></table></td></tr></table></td></tr></table></td></tr></table> | | | | | | | | | | | | | | | | | | | | <table border="1" style="width: 100%; border-collapse: collapse; text-align: center;"> <tr> <td style="width: 10%;"></td> <td style="width: 10%;"></td> <td style="width: 10%;"></td> <td style="width: 10%;"></td> <td style="width: 10%;"></td> <td style="width: 10%;"></td> <td style="width: 10%;"></td> <td style="width: 10%;"></td> <td style="width: 10%;"></td> <td style="width: 10%;"></td> </tr> <tr> <td></td> <td></td> <td colspan="8" style="text-align: center;"> <table border="1" style="width: 100%; border-collapse: collapse; text-align: center;"> <tr> <td style="width: 10%;"></td> <td style="width: 10%;"></td> <td style="width: 10%;"></td> <td style="width: 10%;"></td> <td style="width: 10%;"></td> <td style="width: 10%;"></td> <td style="width: 10%;"></td> <td style="width: 10%;"></td> <td style="width: 10%;"></td> <td style="width: 10%;"></td> </tr> <tr> <td></td> <td></td> <td colspan="8" style="text-align: center;"> <table border="1" style="width: 100%; border-collapse: collapse; text-align: center;"> <tr> <td style="width: 10%;"></td> <td style="width: 10%;"></td> <td style="width: 10%;"></td> <td style="width: 10%;"></td> <td style="width: 10%;"></td> <td style="width: 10%;"></td> <td style="width: 10%;"></td> <td style="width: 10%;"></td> <td style="width: 10%;"></td> <td style="width: 10%;"></td> </tr> <tr> <td></td> <td></td> <td colspan="8" style="text-align: center;"> <table border="1" style="width: 100%; border-collapse: collapse; text-align: center;"> <tr> <td style="width: 10%;"></td> <td style="width: 10%;"></td> <td style="width: 10%;"></td> <td style="width: 10%;"></td> <td style="width: 10%;"></td> <td style="width: 10%;"></td> <td style="width: 10%;"></td> <td style="width: 10%;"></td> <td style="width: 10%;"></td> <td style="width: 10%;"></td> </tr> <tr> <td></td> <td></td> <td colspan="8" style="text-align: center;"> <table border="1" style="width: 100%; border-collapse: collapse; text-align: center;"> <tr> <td style="width: 10%;"></td> <td style="width: 10%;"></td> <td style="width: 10%;"></td> <td style="width: 10%;"></td> <td style="width: 10%;"></td> <td style="width: 10%;"></td> <td style="width: 10%;"></td> <td style="width: 10%;"></td> <td style="width: 10%;"></td> <td style="width: 10%;"></td> </tr> <tr> <td></td> <td></td> <td colspan="8" style="text-align: center;"> <table border="1" style="width: 100%; border-collapse: collapse; text-align: center;"> <tr> <td style="width: 10%;"></td> <td style="width: 10%;"></td> <td style="width:
10%;"></td> <td style="width: 10%;"></td> <td style="width: 10%;"></td> <td style="width: 10%;"></td> <td style="width: 10%;"></td> <td style="width: 10%;"></td> <td style="width: 10%;"></td> <td style="width: 10%;"></td> </tr> <tr> <td></td> <td></td> <td colspan="8" style="text-align: center;"> <table border="1" style="width: 100%; border-collapse: collapse; text-align: center;"> <tr> <td style="width: 10%;"></td> <td style="width: 10%;"></td> <td style="width: 10%;"></td> <td style="width: 10%;"></td> <td style="width: 10%;"></td> <td style="width: 10%;"></td> <td style="width: 10%;"></td> <td style="width: 10%;"></td> <td style="width: 10%;"></td> <td style="width: 10%;"></td> </tr> <tr> <td></td> <td></td> <td colspan="8" style="text-align: center;"> <table border="1" style="width: 100%; border-collapse: collapse; text-align: center;"> <tr> <td style="width: 10%;"></td> <td style="width: 10%;"></td> <td style="width: 10%;"></td> <td style="width: 10%;"></td> <td style="width: 10%;"></td> <td style="width: 10%;"></td> <td style="width: 10%;"></td> <td style="width: 10%;"></td> <td style="width: 10%;"></td> <td style="width: 10%;"></td> </tr> <tr> <td></td> <td></td> <td colspan="8" style="text-align: center;"> <table border="1" style="width: 100%; border-collapse: collapse; text-align: center;"> <tr> <td style="width: 10%;"></td> <td style="width: 10%;"></td> <td style="width: 10%;"></td> <td style="width: 10%;"></td> <td style="width: 10%;"></td> <td style="width: 10%;"></td> <td style="width: 10%;"></td> <td style="width: 10%;"></td> <td style="width: 10%;"></td> <td style="width: 10%;"></td> </tr> <tr> <td></td> <td></td> <td colspan="8" style="text-align: center;"> <table border="1" style="width: 100%; border-collapse: collapse; text-align: center;"> <tr> <td style="width: 10%;"></td> <td style="width: 10%;"></td> <td style="width: 10%;"></td> <td style="width: 10%;"></td> <td style="width: 10%;"></td> <td style="width: 10%;"></td> <td style="width: 10%;"></td> <td style="width: 10%;"></td> <td style="width: 10%;"></td> <td style="width: 10%;"></td> </tr> <tr> <td></td> <td></td> <td colspan="8" style="text-align: center;"> <table border="1" style="width: 100%; border-collapse: collapse; text-align: center;"> <tr> <td style="width: 10%;"></td> <td style="width: 10%;"></td> <td style="width: 10%;"></td> <td style="width: 10%;"></td> <td style="width: 10%;"></td> <td style="width: 10%;"></td> <td style="width: 10%;"></td> <td style="width: 10%;"></td> <td style="width: 10%;"></td> <td style="width: 10%;"></td> </tr> <tr> <td></td> <td></td> <td colspan="8" style="text-align: center;"> <table border="1" style="width: 100%; border-collapse: collapse; text-align: center;"> <tr> <td style="width: 10%;"></td> <td style="width: 10%;"></td> <td style="width: 10%;"></td> <td style="width: 10%;"></td> <td style="width: 10%;"></td> <td style="width: 10%;"></td> <td style="width: 10%;"></td> <td style="width: 10%;"></td> <td style="width: 10%;"></td> <td style="width: 10%;"></td> </tr> <tr> <td></td> <td></td> <td colspan="8" style="text-align: center;"> <table border="1" style="width: 100%; border-collapse: collapse; text-align: center;"> <tr> <td style="width: 10%;"></td> <td style="width: 10%;"></td> <td style="width: 10%;"></td> <td style="width: 10%;"></td> <td style="width: 10%;"></td> <td style="width: 10%;"></td> <td style="width: 10%;"></td> <td style="width: 10%;"></td> <td style="width: 10%;"></td> <td style="width: 10%;"></td> </tr> <tr> <td></td> <td></td> <td colspan="8" style="text-align: center;"> <table border="1" style="width: 100%; border-collapse: collapse; text-align: center;"> <tr> <td style="width: 10%;"></td> <td style="width: 10%;"></td> <td style="width: 10%;"></td> <td style="width: 10%;"></td> <td style="width: 10%;"></td> <td style="width: 10%;"></td> <td style="width: 10%;"></td> <td style="width: 10%;"></td> <td style="width: 10%;"></td> <td style="width: 10%;"></td> </tr> <tr> <td></td> <td></td> <td colspan="8" style="text-align: center;"> <table border="1" style="width: 100%; border-collapse: collapse; text-align: center;"> <tr> <td style="width: 10%;"></td> <td style="width: 10%;"></td> <td style="width: 10%;"></td> <td style="width: 10%;"></td> <td style="width: 10%;"></td> <td style="width: 10%;"></td> <td style="width: 10%;"></td> <td style="width: 10%;"></td> <td style="width: 10%;"></td> <td style="width: 10%;"></td> </tr> <tr> <td></td> <td></td> <td colspan="8" style="text-align: center;"> <table border="1" style="width: 100%; border-collapse: collapse; text-align: center;"> <tr> </tr></table></td></tr></table></td></tr></table></td></tr></table></td></tr></table></td></tr></table></td></tr></table></td></tr></table></td></tr></table></td></tr></table></td></tr></table></td></tr></table></td></tr></table></td></tr></table></td></tr></table></td></tr></table>
 | | | | | | | | | | | | | | | | | | | | <table border="1" style="width: 100%; border-collapse: collapse; text-align: center;"> <tr> <td style="width: 10%;"></td> <td style="width: 10%;"></td> <td style="width: 10%;"></td> <td style="width: 10%;"></td> <td style="width: 10%;"></td> <td style="width: 10%;"></td> <td style="width: 10%;"></td> <td style="width: 10%;"></td> <td style="width: 10%;"></td> <td style="width: 10%;"></td> </tr> <tr> <td></td> <td></td> <td colspan="8" style="text-align: center;"> <table border="1" style="width: 100%; border-collapse: collapse; text-align: center;"> <tr> <td style="width: 10%;"></td> <td style="width: 10%;"></td> <td style="width: 10%;"></td> <td style="width: 10%;"></td> <td style="width: 10%;"></td> <td style="width: 10%;"></td> <td style="width: 10%;"></td> <td style="width: 10%;"></td> <td style="width: 10%;"></td> <td style="width: 10%;"></td> </tr> <tr> <td></td> <td></td> <td colspan="8" style="text-align: center;"> <table border="1" style="width: 100%; border-collapse: collapse; text-align: center;"> <tr> <td style="width: 10%;"></td> <td style="width: 10%;"></td> <td style="width: 10%;"></td> <td style="width: 10%;"></td> <td style="width: 10%;"></td> <td style="width: 10%;"></td> <td style="width: 10%;"></td> <td style="width: 10%;"></td> <td style="width: 10%;"></td> <td style="width: 10%;"></td> </tr> <tr> <td></td> <td></td> <td colspan="8" style="text-align: center;"> <table border="1" style="width: 100%; border-collapse: collapse; text-align: center;"> <tr> <td style="width: 10%;"></td> <td style="width: 10%;"></td> <td style="width: 10%;"></td> <td style="width: 10%;"></td> <td style="width: 10%;"></td> <td style="width: 10%;"></td> <td style="width: 10%;"></td> <td style="width: 10%;"></td> <td style="width: 10%;"></td> <td style="width: 10%;"></td> </tr> <tr> <td></td> <td></td> <td colspan="8" style="text-align: center;"> <table border="1" style="width: 100%; border-collapse: collapse; text-align: center;"> <tr> <td style="width: 10%;"></td> <td style="width: 10%;"></td> <td style="width: 10%;"></td> <td style="width: 10%;"></td> <td style="width: 10%;"></td> <td style="width: 10%;"></td> <td style="width: 10%;"></td> <td style="width: 10%;"></td> <td style="width: 10%;"></td> <td style="width: 10%;"></td> </tr> <tr> <td></td> <td></td> <td colspan="8" style="text-align: center;"> <table border="1" style="width: 100%; border-collapse: collapse; text-align: center;"> <tr> <td style="width: 10%;"></td> <td style="width: 10%;"></td> <td style="width: 10%;"></td> <td style="width: 10%;"></td> <td style="width: 10%;"></td> <td style="width: 10%;"></td> <td style="width: 10%;"></td> <td style="width: 10%;"></td> <td style="width: 10%;"></td> <td style="width: 10%;"></td> </tr> <tr> <td></td> <td></td> <td colspan="8" style="text-align: center;"> <table border="1" style="width: 100%; border-collapse: collapse; text-align: center;"> <tr> <td style="width: 10%;"></td> <td style="width: 10%;"></td> <td style="width: 10%;"></td> <td style="width: 10%;"></td> <td style="width: 10%;"></td> <td style="width: 10%;"></td> <td style="width: 10%;"></td> <td style="width: 10%;"></td> <td style="width: 10%;"></td> <td style="width: 10%;"></td> </tr> <tr> <td></td> <td></td> <td colspan="8" style="text-align: center;"> <table border="1" style="width: 100%; border-collapse: collapse; text-align: center;"> <tr> <td style="width: 10%;"></td> <td style="width: 10%;"></td> <td style="width: 10%;"></td> <td style="width: 10%;"></td> <td style="width: 10%;"></td> <td style="width: 10%;"></td> <td style="width: 10%;"></td> <td style="width: 10%;"></td> <td style="width: 10%;"></td> <td style="width: 10%;"></td> </tr> <tr> <td></td> <td></td> <td colspan="8" style="text-align: center;"> <table border="1" style="width: 100%; border-collapse: collapse; text-align: center;"> <tr> <td style="width: 10%;"></td> <td style="width: 10%;"></td> <td style="width: 10%;"></td> <td style="width: 10%;"></td> <td style="width: 10%;"></td> <td style="width: 10%;"></td> <td style="width: 10%;"></td> <td style="width: 10%;"></td> <td style="width: 10%;"></td> <td style="width: 10%;"></td> </tr> <tr> <td></td> <td></td> <td colspan="8" style="text-align: center;"> <table border="1" style="width: 100%; border-collapse: collapse; text-align: center;"> <tr> <td style="width: 10%;"></td> <td style="width: 10%;"></td> <td style="width: 10%;"></td> <td style="width: 10%;"></td> <td style="width: 10%;"></td> <td style="width: 10%;"></td> <td style="width: 10%;"></td> <td style="width: 10%;"></td> <td style="width: 10%;"></td> <td style="width: 10%;"></td> </tr> <tr> <td></td> <td></td> <td colspan="8" style="text-align: center;"> <table border="1" style="width: 100%; border-collapse: collapse; text-align: center;"> <tr> <td style="width: 10%;"></td> <td style="width: 10%;"></td> <td style="width: 10%;"></td> <td style="width: 10%;"></td> <td style="width: 10%;"></td> <td style="width: 10%;"></td> <td style="width: 10%;"></td> <td style="width: 10%;"></td> <td style="width: 10%;"></td> <td style="width: 10%;"></td> </tr> <tr> <td></td> <td></td> <td colspan="8" style="text-align: center;"> <table border="1" style="width: 100%; border-collapse: collapse; text-align: center;"> <tr> <td style="width: 10%;"></td> <td style="width: 10%;"></td> <td style="width: 10%;"></td> <td style="width: 10%;"></td> <td style="width: 10%;"></td> <td style="width: 10%;"></td> <td style="width: 10%;"></td> <td style="width: 10%;"></td> <td style="width: 10%;"></td> <td style="width: 10%;"></td> </tr> <tr> <td></td> <td></td> <td colspan="8" style="text-align: center;"> <table border="1" style="width: 100%; border-collapse: collapse; text-align: center;"> <tr> <td style="width: 10%;"></td> <td style="width: 10%;"></td> <td style="width: 10%;"></td> <td style="width: 10%;"></td> <td style="width: 10%;"></td> <td style="width: 10%;"></td> <td style="width: 10%;"></td> <td style="width: 10%;"></td> <td style="width: 10%;"></td> <td style="width: 10%;"></td> </tr> <tr> <td></td> <td></td> <td colspan="8" style="text-align: center;"> <table border="1" style="width: 100%; border-collapse: collapse; text-align: center;"> <tr> <td style="width: 10%;"></td> <td style="width: 10%;"></td> <td style="width: 10%;"></td> <td style="width: 10%;"></td> <td style="width: 10%;"></td> <td style="width: 10%;"></td> <td style="width: 10%;"></td> <td style="width: 10%;"></td> <td style="width: 10%;"></td> <td style="width: 10%;"></td> </tr> <tr> <td></td> <td></td> <td colspan="8" style="text-align: center;"> <table border="1" style="width: 100%; border-collapse: collapse; text-align: center;"> <tr> </tr></table></td></tr></table></td></tr></table></td></tr></table></td></tr></table></td></tr></table></td></tr></table></td></tr></table></td></tr></table></td></tr></table></td></tr></table></td></tr></table></td></tr></table></td></tr></table></td></tr></table>
 | | | | | | | | | | | | | | | | | | | | <table border="1" style="width: 100%; border-collapse: collapse; text-align: center;"> <tr> <td style="width: 10%;"></td> <td style="width: 10%;"></td> <td style="width: 10%;"></td> <td style="width: 10%;"></td> <td style="width: 10%;"></td> <td style="width: 10%;"></td> <td style="width: 10%;"></td> <td style="width: 10%;"></td> <td style="width: 10%;"></td> <td style="width: 10%;"></td> </tr> <tr> <td></td> <td></td> <td colspan="8" style="text-align: center;"> <table border="1" style="width: 100%; border-collapse: collapse; text-align: center;"> <tr> <td style="width: 10%;"></td> <td style="width: 10%;"></td> <td style="width: 10%;"></td> <td style="width: 10%;"></td> <td style="width: 10%;"></td> <td style="width: 10%;"></td> <td style="width: 10%;"></td> <td style="width: 10%;"></td> <td style="width: 10%;"></td> <td style="width: 10%;"></td> </tr> <tr> <td></td> <td></td> <td colspan="8" style="text-align: center;"> <table border="1" style="width: 100%; border-collapse: collapse; text-align: center;"> <tr> <td style="width: 10%;"></td> <td style="width: 10%;"></td> <td style="width: 10%;"></td> <td style="width: 10%;"></td> <td style="width: 10%;"></td> <td style="width: 10%;"></td> <td style="width: 10%;"></td> <td style="width: 10%;"></td> <td style="width: 10%;"></td> <td style="width: 10%;"></td> </tr> <tr> <td></td> <td></td> <td colspan="8" style="text-align: center;"> <table border="1" style="width: 100%; border-collapse: collapse; text-align: center;"> <tr> <td style="width: 10%;"></td> <td style="width: 10%;"></td> <td style="width: 10%;"></td> <td style="width: 10%;"></td> <td style="width: 10%;"></td> <td style="width: 10%;"></td> <td style="width: 10%;"></td> <td style="width: 10%;"></td> <td style="width: 10%;"></td> <td style="width: 10%;"></td> </tr> <tr> <td></td> <td></td> <td colspan="8" style="text-align: center;"> <table border="1" style="width: 100%; border-collapse: collapse; text-align: center;"> <tr> <td style="width: 10%;"></td> <td style="width: 10%;"></td> <td style="width: 10%;"></td> <td style="width: 10%;"></td> <td style="width: 10%;"></td> <td style="width: 10%;"></td> <td style="width: 10%;"></td> <td style="width: 10%;"></td> <td style="width: 10%;"></td> <td style="width: 10%;"></td> </tr> <tr> <td></td> <td></td> <td colspan="8" style="text-align: center;"> <table border="1" style="width: 100%; border-collapse: collapse; text-align: center;"> <tr> <td style="width: 10%;"></td> <td style="width: 10%;"></td> <td style="width: 10%;"></td> <td style="width: 10%;"></td> <td style="width: 10%;"></td> <td style="width: 10%;"></td> <td style="width: 10%;"></td> <td style="width: 10%;"></td> <td style="width: 10%;"></td> <td style="width: 10%;"></td> </tr> <tr> <td></td> <td></td> <td colspan="8" style="text-align: center;"> <table border="1" style="width: 100%; border-collapse: collapse; text-align: center;"> <tr> <td style="width: 10%;"></td> <td style="width: 10%;"></td> <td style="width: 10%;"></td> <td style="width: 10%;"></td> <td style="width: 10%;"></td> <td style="width: 10%;"></td> <td style="width: 10%;"></td> <td style="width: 10%;"></td> <td style="width: 10%;"></td> <td style="width: 10%;"></td> </tr> <tr> <td></td> <td></td> <td colspan="8" style="text-align: center;"> <table border="1" style="width: 100%; border-collapse: collapse; text-align: center;"> <tr> <td style="width: 10%;"></td> <td style="width: 10%;"></td> <td style="width: 10%;"></td> <td style="width: 10%;"></td> <td style="width: 10%;"></td> <td style="width: 10%;"></td> <td style="width: 10%;"></td> <td style="width: 10%;"></td> <td style="width: 10%;"></td> <td style="width: 10%;"></td> </tr> <tr> <td></td> <td></td> <td colspan="8" style="text-align: center;"> <table border="1" style="width: 100%; border-collapse: collapse; text-align: center;"> <tr> <td style="width: 10%;"></td> <td style="width: 10%;"></td> <td style="width: 10%;"></td> <td style="width: 10%;"></td> <td style="width: 10%;"></td> <td style="width: 10%;"></td> <td style="width: 10%;"></td> <td style="width: 10%;"></td> <td style="width: 10%;"></td> <td style="width: 10%;"></td> </tr> <tr> <td></td> <td></td> <td colspan="8" style="text-align: center;"> <table border="1" style="width: 100%; border-collapse: collapse; text-align: center;"> <tr> <td style="width: 10%;"></td> <td style="width: 10%;"></td> <td style="width: 10%;"></td> <td style="width: 10%;"></td> <td style="width: 10%;"></td> <td style="width: 10%;"></td> <td style="width: 10%;"></td> <td style="width: 10%;"></td> <td style="width: 10%;"></td> <td style="width: 10%;"></td> </tr> <tr> <td></td> <td></td> <td colspan="8" style="text-align: center;"> <table border="1" style="width: 100%; border-collapse: collapse; text-align: center;"> <tr> <td style="width: 10%;"></td> <td style="width: 10%;"></td> <td style="width: 10%;"></td> <td style="width: 10%;"></td> <td style="width: 10%;"></td> <td style="width: 10%;"></td> <td style="width: 10%;"></td> <td style="width: 10%;"></td> <td style="width: 10%;"></td> <td style="width: 10%;"></td> </tr> <tr> <td></td> <td></td> <td colspan="8" style="text-align: center;"> <table border="1" style="width: 100%; border-collapse: collapse; text-align: center;"> <tr> <td style="width: 10%;"></td> <td style="width: 10%;"></td> <td style="width: 10%;"></td> <td style="width: 10%;"></td> <td style="width: 10%;"></td> <td style="width: 10%;"></td> <td style="width: 10%;"></td> <td style="width: 10%;"></td> <td style="width: 10%;"></td> <td style="width: 10%;"></td> </tr> <tr> <td></td> <td></td> <td colspan="8" style="text-align: center;"> <table border="1" style="width: 100%; border-collapse: collapse; text-align: center;"> <tr> <td style="width: 10%;"></td> <td style="width: 10%;"></td> <td style="width: 10%;"></td> <td style="width: 10%;"></td> <td style="width: 10%;"></td> <td style="width: 10%;"></td> <td style="width: 10%;"></td> <td style="width: 10%;"></td> <td style="width: 10%;"></td> <td style="width: 10%;"></td> </tr> <tr> <td></td> <td></td> <td colspan="8" style="text-align: center;"> <table border="1" style="width: 100%; border-collapse: collapse; text-align: center;"> <tr> </tr></table></td></tr></table></td></tr></table></td></tr></table></td></tr></table></td></tr></table></td></tr></table></td></tr></table></td></tr></table></td></tr></table></td></tr></table></td></tr></table></td></tr></table></td></tr></table>
 | | | | | | | | | | | | | | | | | | | | <table border="1" style="width: 100%; border-collapse: collapse; text-align: center;"> <tr> <td style="width: 10%;"></td> <td style="width: 10%;"></td> <td style="width: 10%;"></td> <td style="width: 10%;"></td> <td style="width: 10%;"></td> <td style="width: 10%;"></td> <td style="width: 10%;"></td> <td style="width: 10%;"></td> <td style="width: 10%;"></td> <td style="width: 10%;"></td> </tr> <tr> <td></td> <td></td> <td colspan="8" style="text-align: center;"> <table border="1" style="width: 100%; border-collapse: collapse; text-align: center;"> <tr> <td style="width: 10%;"></td> <td style="width: 10%;"></td> <td style="width: 10%;"></td> <td style="width: 10%;"></td> <td style="width: 10%;"></td> <td style="width: 10%;"></td> <td style="width: 10%;"></td> <td style="width: 10%;"></td> <td style="width: 10%;"></td> <td style="width: 10%;"></td> </tr> <tr> <td></td> <td></td> <td colspan="8" style="text-align: center;"> <table border="1" style="width: 100%; border-collapse: collapse; text-align: center;"> <tr> <td style="width: 10%;"></td> <td style="width: 10%;"></td> <td style="width: 10%;"></td> <td style="width: 10%;"></td> <td style="width: 10%;"></td> <td style="width: 10%;"></td> <td style="width: 10%;"></td> <td style="width: 10%;"></td> <td style="width: 10%;"></td> <td style="width: 10%;"></td> </tr> <tr> <td></td> <td></td> <td colspan="8" style="text-align: center;"> <table border="1" style="width: 100%; border-collapse: collapse; text-align: center;"> <tr> <td style="width: 10%;"></td> <td style="width: 10%;"></td> <td style="width: 10%;"></td> <td style="width: 10%;"></td> <td style="width: 10%;"></td> <td style="width: 10%;"></td> <td style="width: 10%;"></td> <td style="width: 10%;"></td> <td style="width: 10%;"></td> <td style="width: 10%;"></td> </tr> <tr> <td></td> <td></td> <td colspan="8" style="text-align: center;"> <table border="1" style="width: 100%; border-collapse: collapse; text-align: center;"> <tr> <td style="width: 10%;"></td> <td style="width: 10%;"></td> <td style="width: 10%;"></td> <td style="width: 10%;"></td> <td style="width: 10%;"></td> <td style="width: 10%;"></td> <td style="width: 10%;"></td> <td style="width: 10%;"></td> <td style="width: 10%;"></td> <td style="width: 10%;"></td> </tr> <tr> <td></td> <td></td> <td colspan="8" style="text-align: center;"> <table border="1" style="width: 100%; border-collapse: collapse; text-align: center;"> <tr> <td style="width: 10%;"></td> <td style="width: 10%;"></td> <td style="width: 10%;"></td> <td style="width: 10%;"></td> <td style="width: 10%;"></td> <td style="width: 10%;"></td> <td style="width: 10%;"></td> <td style="width: 10%;"></td> <td style="width: 10%;"></td> <td style="width: 10%;"></td> </tr> <tr> <td></td> <td></td> <td colspan="8" style="text-align: center;"> <table border="1" style="width: 100%; border-collapse: collapse; text-align: center;"> <tr> <td style="width: 10%;"></td> <td style="width: 10%;"></td> <td style="width: 10%;"></td> <td style="width: 10%;"></td> <td style="width: 10%;"></td> <td style="width: 10%;"></td> <td style="width: 10%;"></td> <td style="width: 10%;"></td> <td style="width: 10%;"></td> <td style="width: 10%;"></td> </tr> <tr> <td></td> <td></td> <td colspan="8" style="text-align: center;"> <table border="1" style="width: 100%; border-collapse: collapse; text-align: center;"> <tr> <td style="width: 10%;"></td> <td style="width: 10%;"></td> <td style="width: 10%;"></td> <td style="width: 10%;"></td> <td style="width: 10%;"></td> <td style="width: 10%;"></td> <td style="width: 10%;"></td> <td style="width: 10%;"></td> <td style="width: 10%;"></td> <td style="width: 10%;"></td> </tr> <tr> <td></td> <td></td> <td colspan="8" style="text-align: center;"> <table border="1" style="width: 100%; border-collapse: collapse; text-align: center;"> <tr> <td style="width: 10%;"></td> <td style="width: 10%;"></td> <td style="width: 10%;"></td> <td style="width: 10%;"></td> <td style="width: 10%;"></td> <td style="width: 10%;"></td> <td style="width: 10%;"></td> <td style="width: 10%;"></td> <td style="width: 10%;"></td> <td style="width: 10%;"></td> </tr> <tr> <td></td> <td></td> <td colspan="8" style="text-align: center;"> <table border="1" style="width: 100%; border-collapse: collapse; text-align: center;"> <tr> <td style="width: 10%;"></td> <td style="width: 10%;"></td> <td style="width: 10%;"></td> <td style="width: 10%;"></td> <td style="width: 10%;"></td> <td style="width: 10%;"></td> <td style="width: 10%;"></td> <td style="width: 10%;"></td> <td style="width: 10%;"></td> <td style="width: 10%;"></td> </tr> <tr> <td></td> <td></td> <td colspan="8" style="text-align: center;"> <table border="1" style="width: 100%; border-collapse: collapse; text-align: center;"> <tr> <td style="width: 10%;"></td> <td style="width: 10%;"></td> <td style="width: 10%;"></td> <td style="width: 10%;"></td> <td style="width: 10%;"></td> <td style="width: 10%;"></td> <td style="width: 10%;"></td> <td style="width: 10%;"></td> <td style="width: 10%;"></td> <td style="width: 10%;"></td> </tr> <tr> <td></td> <td></td> <td colspan="8" style="text-align: center;"> <table border="1" style="width: 100%; border-collapse: collapse; text-align: center;"> <tr> <td style="width: 10%;"></td> <td style="width: 10%;"></td> <td style="width: 10%;"></td> <td style="width: 10%;"></td> <td style="width: 10%;"></td> <td style="width: 10%;"></td> <td style="width: 10%;"></td> <td style="width: 10%;"></td> <td style="width: 10%;"></td> <td style="width: 10%;"></td> </tr> <tr> <td></td>
<td></td> <td colspan="8" style="text-align: center;"> <table border="1" style="width: 100%; border-collapse: collapse; text-align: center;"> <tr> </tr></table></td></tr></table></td></tr></table></td></tr></table></td></tr></table></td></tr></table></td></tr></table></td></tr></table></td></tr></table></td></tr></table></td></tr></table></td></tr></table></td></tr></table> | | | | | | | | | | | | | | | | | | | | <table border="1" style="width: 100%; border-collapse: collapse; text-align: center;"> <tr> <td style="width: 10%;"></td> <td style="width: 10%;"></td> <td style="width: 10%;"></td> <td style="width: 10%;"></td> <td style="width: 10%;"></td> <td style="width: 10%;"></td> <td style="width: 10%;"></td> <td style="width: 10%;"></td> <td style="width: 10%;"></td> <td style="width: 10%;"></td> </tr> <tr> <td></td> <td></td> <td colspan="8" style="text-align: center;"> <table border="1" style="width: 100%; border-collapse: collapse; text-align: center;"> <tr> <td style="width: 10%;"></td> <td style="width: 10%;"></td> <td style="width: 10%;"></td> <td style="width: 10%;"></td> <td style="width: 10%;"></td> <td style="width: 10%;"></td> <td style="width: 10%;"></td> <td style="width: 10%;"></td> <td style="width: 10%;"></td> <td style="width: 10%;"></td> </tr> <tr> <td></td> <td></td> <td colspan="8" style="text-align: center;"> <table border="1" style="width: 100%; border-collapse: collapse; text-align: center;"> <tr> <td style="width: 10%;"></td> <td style="width: 10%;"></td> <td style="width: 10%;"></td> <td style="width: 10%;"></td> <td style="width: 10%;"></td> <td style="width: 10%;"></td> <td style="width: 10%;"></td> <td style="width: 10%;"></td> <td style="width: 10%;"></td> <td style="width: 10%;"></td> </tr> <tr> <td></td> <td></td> <td colspan="8" style="text-align: center;"> <table border="1" style="width: 100%; border-collapse: collapse; text-align: center;"> <tr> <td style="width: 10%;"></td> <td style="width: 10%;"></td> <td style="width: 10%;"></td> <td style="width: 10%;"></td> <td style="width: 10%;"></td> <td style="width: 10%;"></td> <td style="width: 10%;"></td> <td style="width: 10%;"></td> <td style="width: 10%;"></td> <td style="width: 10%;"></td> </tr> <tr> <td></td> <td></td> <td colspan="8" style="text-align: center;"> <table border="1" style="width: 100%; border-collapse: collapse; text-align: center;"> <tr> <td style="width: 10%;"></td> <td style="width: 10%;"></td> <td style="width: 10%;"></td> <td style="width: 10%;"></td> <td style="width: 10%;"></td> <td style="width: 10%;"></td> <td style="width: 10%;"></td> <td style="width: 10%;"></td> <td style="width: 10%;"></td> <td style="width: 10%;"></td> </tr> <tr> <td></td> <td></td> <td colspan="8" style="text-align: center;"> <table border="1" style="width: 100%; border-collapse: collapse; text-align: center;"> <tr> <td style="width: 10%;"></td> <td style="width: 10%;"></td> <td style="width: 10%;"></td> <td style="width: 10%;"></td> <td style="width: 10%;"></td> <td style="width: 10%;"></td> <td style="width: 10%;"></td> <td style="width: 10%;"></td> <td style="width: 10%;"></td> <td style="width: 10%;"></td> </tr> <tr> <td></td> <td></td> <td colspan="8" style="text-align: center;"> <table border="1" style="width: 100%; border-collapse: collapse; text-align: center;"> <tr> <td style="width: 10%;"></td> <td style="width: 10%;"></td> <td style="width: 10%;"></td> <td style="width: 10%;"></td> <td style="width: 10%;"></td> <td style="width: 10%;"></td> <td style="width: 10%;"></td> <td style="width: 10%;"></td> <td style="width: 10%;"></td> <td style="width: 10%;"></td> </tr> <tr> <td></td> <td></td> <td colspan="8" style="text-align: center;"> <table border="1" style="width: 100%; border-collapse: collapse; text-align: center;"> <tr> <td style="width: 10%;"></td> <td style="width: 10%;"></td> <td style="width: 10%;"></td> <td style="width: 10%;"></td> <td style="width: 10%;"></td> <td style="width: 10%;"></td> <td style="width: 10%;"></td> <td style="width: 10%;"></td> <td style="width: 10%;"></td> <td style="width: 10%;"></td> </tr> <tr> <td></td> <td></td> <td colspan="8" style="text-align: center;"> <table border="1" style="width: 100%; border-collapse: collapse; text-align: center;"> <tr> <td style="width: 10%;"></td> <td style="width: 10%;"></td> <td style="width: 10%;"></td> <td style="width: 10%;"></td> <td style="width: 10%;"></td> <td style="width: 10%;"></td> <td style="width: 10%;"></td> <td style="width: 10%;"></td> <td style="width: 10%;"></td> <td style="width: 10%;"></td> </tr> <tr> <td></td> <td></td> <td colspan="8" style="text-align: center;">
<table border="1" style="width: 100%; border-collapse: collapse; text-align: center;"> <tr> <td style="width: 10%;"></td> <td style="width: 10%;"></td> <td style="width: 10%;"></td> <td style="width: 10%;"></td> <td style="width: 10%;"></td> <td style="width: 10%;"></td> <td style="width: 10%;"></td> <td style="width: 10%;"></td> <td style="width: 10%;"></td> <td style="width: 10%;"></td> </tr> <tr> <td></td> <td></td> <td colspan="8" style="text-align: center;"> <table border="1" style="width: 100%; border-collapse: collapse; text-align: center;"> <tr> <td style="width: 10%;"></td> <td style="width: 10%;"></td> <td style="width: 10%;"></td> <td style="width: 10%;"></td> <td style="width: 10%;"></td> <td style="width: 10%;"></td> <td style="width: 10%;"></td> <td style="width: 10%;"></td> <td style="width: 10%;"></td> <td style="width: 10%;"></td> </tr> <tr> <td></td> <td></td> <td colspan="8" style="text-align: center;"> <table border="1" style="width: 100%; border-collapse: collapse; text-align: center;"> <tr> </tr></table></td></tr></table></td></tr></table></td></tr></table></td></tr></table></td></tr></table></td></tr></table></td></tr></table></td></tr></table></td></tr></table></td></tr></table></td></tr></table> | | | | | | | | | | | | | | | | | | | | <table border="1" style="width: 100%; border-collapse: collapse; text-align: center;"> <tr> <td style="width: 10%;"></td> <td style="width: 10%;"></td> <td style="width: 10%;"></td> <td style="width: 10%;"></td> <td style="width: 10%;"></td> <td style="width: 10%;"></td> <td style="width: 10%;"></td> <td style="width: 10%;"></td> <td style="width: 10%;"></td> <td style="width: 10%;"></td> </tr> <tr> <td></td> <td></td> <td colspan="8" style="text-align: center;"> <table border="1" style="width: 100%; border-collapse: collapse; text-align: center;"> <tr> <td style="width: 10%;"></td> <td style="width: 10%;"></td> <td style="width: 10%;"></td> <td style="width: 10%;"></td> <td style="width: 10%;"></td> <td style="width: 10%;"></td> <td style="width: 10%;"></td> <td style="width: 10%;"></td> <td style="width: 10%;"></td> <td style="width: 10%;"></td> </tr> <tr> <td></td> <td></td> <td colspan="8" style="text-align: center;"> <table border="1" style="width: 100%; border-collapse: collapse; text-align: center;"> <tr> <td style="width: 10%;"></td> <td style="width: 10%;"></td> <td style="width: 10%;"></td> <td style="width: 10%;"></td> <td style="width: 10%;"></td> <td style="width: 10%;"></td> <td style="width: 10%;"></td> <td style="width: 10%;"></td> <td style="width: 10%;"></td> <td style="width: 10%;"></td> </tr> <tr> <td></td> <td></td> <td colspan="8" style="text-align: center;"> <table border="1" style="width: 100%; border-collapse: collapse; text-align: center;"> <tr> <td style="width: 10%;"></td> <td style="width: 10%;"></td> <td style="width: 10%;"></td> <td style="width: 10%;"></td> <td style="width: 10%;"></td> <td style="width: 10%;"></td> <td style="width: 10%;"></td> <td style="width: 10%;"></td> <td style="width: 10%;"></td> <td style="width: 10%;"></td> </tr> <tr> <td></td> <td></td> <td colspan="8" style="text-align: center;"> <table border="1" style="width: 100%; border-collapse: collapse; text-align: center;"> <tr> <td style="width: 10%;"></td> <td style="width: 10%;"></td> <td style="width: 10%;"></td> <td style="width: 10%;"></td> <td style="width: 10%;"></td> <td style="width: 10%;"></td> <td style="width: 10%;"></td> <td style="width: 10%;"></td> <td style="width: 10%;"></td> <td style="width: 10%;"></td> </tr> <tr> <td></td> <td></td> <td colspan="8" style="text-align: center;"> <table border="1" style="width: 100%; border-collapse: collapse; text-align: center;"> <tr> <td style="width: 10%;"></td> <td style="width: 10%;"></td> <td style="width: 10%;"></td> <td style="width: 10%;"></td> <td style="width: 10%;"></td> <td style="width: 10%;"></td> <td style="width: 10%;"></td> <td style="width: 10%;"></td> <td style="width: 10%;"></td> <td style="width: 10%;"></td> </tr> <tr> <td></td> <td></td> <td colspan="8" style="text-align: center;"> <table border="1" style="width: 100%; border-collapse: collapse; text-align: center;"> <tr> <td style="width: 10%;"></td> <td style="width: 10%;"></td> <td style="width: 10%;"></td> <td style="width: 10%;"></td> <td style="width: 10%;"></td> <td style="width: 10%;"></td> <td style="width: 10%;"></td> <td style="width: 10%;"></td> <td style="width: 10%;"></td> <td style="width: 10%;"></td> </tr> <tr> <td></td> <td></td> <td colspan="8" style="text-align: center;"> <table border="1" style="width: 100%; border-collapse: collapse; text-align:
center;"> <tr> <td style="width: 10%;"></td> <td style="width: 10%;"></td> <td style="width: 10%;"></td> <td style="width: 10%;"></td> <td style="width: 10%;"></td> <td style="width: 10%;"></td> <td style="width: 10%;"></td> <td style="width: 10%;"></td> <td style="width: 10%;"></td> <td style="width: 10%;"></td> </tr> <tr> <td></td> <td></td> <td colspan="8" style="text-align: center;"> <table border="1" style="width: 100%; border-collapse: collapse; text-align: center;"> <tr> <td style="width: 10%;"></td> <td style="width: 10%;"></td> <td style="width: 10%;"></td> <td style="width: 10%;"></td> <td style="width: 10%;"></td> <td style="width: 10%;"></td> <td style="width: 10%;"></td> <td style="width: 10%;"></td> <td style="width: 10%;"></td> <td style="width: 10%;"></td> </tr> <tr> <td></td> <td></td> <td colspan="8" style="text-align: center;"> <table border="1" style="width: 100%; border-collapse: collapse; text-align: center;"> <tr> <td style="width: 10%;"></td> <td style="width: 10%;"></td> <td style="width: 10%;"></td> <td style="width: 10%;"></td> <td style="width: 10%;"></td> <td style="width: 10%;"></td> <td style="width: 10%;"></td> <td style="width: 10%;"></td> <td style="width: 10%;"></td> <td style="width: 10%;"></td> </tr> <tr> <td></td> <td></td> <td colspan="8" style="text-align: center;"> <table border="1" style="width: 100%; border-collapse: collapse; text-align: center;"> <tr> </tr></table></td></tr></table></td></tr></table></td></tr></table></td></tr></table></td></tr></table></td></tr></table></td></tr></table></td></tr></table></td></tr></table></td></tr></table> | | | | | | | | | | | | | | | | | | | | <table border="1" style="width: 100%; border-collapse: collapse; text-align: center;"> <tr> <td style="width: 10%;"></td> <td style="width: 10%;"></td> <td style="width: 10%;"></td> <td style="width: 10%;"></td> <td style="width: 10%;"></td> <td style="width: 10%;"></td> <td style="width: 10%;"></td> <td style="width: 10%;"></td> <td style="width: 10%;"></td> <td style="width: 10%;"></td> </tr> <tr> <td></td> <td></td> <td colspan="8" style="text-align: center;"> <table border="1" style="width: 100%; border-collapse: collapse; text-align: center;"> <tr> <td style="width: 10%;"></td> <td style="width: 10%;"></td> <td style="width: 10%;"></td> <td style="width: 10%;"></td> <td style="width: 10%;"></td> <td style="width: 10%;"></td> <td style="width: 10%;"></td> <td style="width: 10%;"></td> <td style="width: 10%;"></td> <td style="width: 10%;"></td> </tr> <tr> <td></td> <td></td> <td colspan="8" style="text-align: center;"> <table border="1" style="width: 100%; border-collapse: collapse; text-align: center;"> <tr> <td style="width: 10%;"></td> <td style="width: 10%;"></td> <td style="width: 10%;"></td> <td style="width: 10%;"></td> <td style="width: 10%;"></td> <td style="width: 10%;"></td> <td style="width: 10%;"></td> <td style="width: 10%;"></td> <td style="width: 10%;"></td> <td style="width: 10%;"></td> </tr> <tr> <td></td> <td></td> <td colspan="8" style="text-align: center;"> <table border="1" style="width: 100%; border-collapse: collapse; text-align: center;"> <tr> <td style="width: 10%;"></td> <td style="width: 10%;"></td> <td style="width: 10%;"></td> <td style="width: 10%;"></td> <td style="width: 10%;"></td> <td style="width: 10%;"></td> <td style="width: 10%;"></td> <td style="width: 10%;"></td> <td style="width: 10%;"></td> <td style="width: 10%;"></td> </tr> <tr> <td></td> <td></td> <td colspan="8" style="text-align: center;"> <table border="1" style="width: 100%; border-collapse: collapse; text-align: center;"> <tr> <td style="width: 10%;"></td> <td style="width: 10%;"></td> <td style="width: 10%;"></td> <td style="width: 10%;"></td> <td style="width: 10%;"></td> <td style="width: 10%;"></td> <td style="width: 10%;"></td> <td style="width: 10%;"></td> <td style="width: 10%;"></td> <td style="width: 10%;"></td> </tr> <tr> <td></td> <td></td> <td colspan="8" style="text-align: center;"> <table border="1" style="width: 100%; border-collapse: collapse; text-align: center;"> <tr> <td style="width: 10%;"></td> <td style="width: 10%;"></td> <td style="width: 10%;"></td> <td style="width: 10%;"></td> <td style="width: 10%;"></td> <td style="width: 10%;"></td> <td style="width: 10%;"></td> <td style="width: 10%;"></td> <td style="width: 10%;"></td> <td style="width: 10%;"></td> </tr> <tr> <td></td> <td></td> <td colspan="8" style="text-align: center;"> <table border="1" style="width: 100%; border-collapse: collapse; text-align: center;"> <tr> <td style="width: 10%;"></td> <td style="width: 10%;"></td> <td style="width:
10%;"></td> <td style="width: 10%;"></td> <td style="width: 10%;"></td> <td style="width: 10%;"></td> <td style="width: 10%;"></td> <td style="width: 10%;"></td> <td style="width: 10%;"></td> <td style="width: 10%;"></td> </tr> <tr> <td></td> <td></td> <td colspan="8" style="text-align: center;"> <table border="1" style="width: 100%; border-collapse: collapse; text-align: center;"> <tr> <td style="width: 10%;"></td> <td style="width: 10%;"></td> <td style="width: 10%;"></td> <td style="width: 10%;"></td> <td style="width: 10%;"></td> <td style="width: 10%;"></td> <td style="width: 10%;"></td> <td style="width: 10%;"></td> <td style="width: 10%;"></td> <td style="width: 10%;"></td> </tr> <tr> <td></td> <td></td> <td colspan="8" style="text-align: center;"> <table border="1" style="width: 100%; border-collapse: collapse; text-align: center;"> <tr> <td style="width: 10%;"></td> <td style="width: 10%;"></td> <td style="width: 10%;"></td> <td style="width: 10%;"></td> <td style="width: 10%;"></td> <td style="width: 10%;"></td> <td style="width: 10%;"></td> <td style="width: 10%;"></td> <td style="width: 10%;"></td> <td style="width: 10%;"></td> </tr> <tr> <td></td> <td></td> <td colspan="8" style="text-align: center;"> <table border="1" style="width: 100%; border-collapse: collapse; text-align: center;"> <tr> </tr></table></td></tr></table></td></tr></table></td></tr></table></td></tr></table></td></tr></table></td></tr></table></td></tr></table></td></tr></table></td></tr></table> | | | | | | | | | | | | | | | | | | | | <table border="1" style="width: 100%; border-collapse: collapse; text-align: center;"> <tr> <td style="width: 10%;"></td> <td style="width: 10%;"></td> <td style="width: 10%;"></td> <td style="width: 10%;"></td> <td style="width: 10%;"></td> <td style="width: 10%;"></td> <td style="width: 10%;"></td> <td style="width: 10%;"></td> <td style="width: 10%;"></td> <td style="width: 10%;"></td> </tr> <tr> <td></td> <td></td> <td colspan="8" style="text-align: center;"> <table border="1" style="width: 100%; border-collapse: collapse; text-align: center;"> <tr> <td style="width: 10%;"></td> <td style="width: 10%;"></td> <td style="width: 10%;"></td> <td style="width: 10%;"></td> <td style="width: 10%;"></td> <td style="width: 10%;"></td> <td style="width: 10%;"></td> <td style="width: 10%;"></td> <td style="width: 10%;"></td> <td style="width: 10%;"></td> </tr> <tr> <td></td> <td></td> <td colspan="8" style="text-align: center;"> <table border="1" style="width: 100%; border-collapse: collapse; text-align: center;"> <tr> <td style="width: 10%;"></td> <td style="width: 10%;"></td> <td style="width: 10%;"></td> <td style="width: 10%;"></td> <td style="width: 10%;"></td> <td style="width: 10%;"></td> <td style="width: 10%;"></td> <td style="width: 10%;"></td> <td style="width: 10%;"></td> <td style="width: 10%;"></td> </tr> <tr> <td></td> <td></td> <td colspan="8" style="text-align: center;"> <table border="1" style="width: 100%; border-collapse: collapse; text-align: center;"> <tr> <td style="width: 10%;"></td> <td style="width: 10%;"></td> <td style="width: 10%;"></td> <td style="width: 10%;"></td> <td style="width: 10%;"></td> <td style="width: 10%;"></td> <td style="width: 10%;"></td> <td style="width: 10%;"></td> <td style="width: 10%;"></td> <td style="width: 10%;"></td> </tr> <tr> <td></td> <td></td> <td colspan="8" style="text-align: center;"> <table border="1" style="width: 100%; border-collapse: collapse; text-align: center;"> <tr> <td style="width: 10%;"></td> <td style="width: 10%;"></td> <td style="width: 10%;"></td> <td style="width: 10%;"></td> <td style="width: 10%;"></td> <td style="width: 10%;"></td> <td style="width: 10%;"></td> <td style="width: 10%;"></td> <td style="width: 10%;"></td> <td style="width: 10%;"></td> </tr> <tr> <td></td> <td></td> <td colspan="8" style="text-align: center;"> <table border="1" style="width: 100%; border-collapse: collapse; text-align: center;"> <tr> <td style="width: 10%;"></td> <td style="width: 10%;"></td> <td style="width: 10%;"></td> <td style="width: 10%;"></td> <td style="width: 10%;"></td> <td style="width: 10%;"></td> <td style="width: 10%;"></td> <td style="width: 10%;"></td> <td style="width: 10%;"></td> <td style="width: 10%;"></td> </tr> <tr> <td></td> <td></td> <td colspan="8" style="text-align: center;"> <table border="1" style="width: 100%; border-collapse: collapse; text-align: center;"> <tr> <td style="width: 10%;"></td> <td style="width: 10%;"></td> <td style="width: 10%;"></td> <td style="width: 10%;"></td> <td style="width: 10%;"></td> <td style="width: 10%;"></td> <td
style="width: 10%;"></td> <td style="width: 10%;"></td> <td style="width: 10%;"></td> <td style="width: 10%;"></td> </tr> <tr> <td></td> <td></td> <td colspan="8" style="text-align: center;"> <table border="1" style="width: 100%; border-collapse: collapse; text-align: center;"> <tr> <td style="width: 10%;"></td> <td style="width: 10%;"></td> <td style="width: 10%;"></td> <td style="width: 10%;"></td> <td style="width: 10%;"></td> <td style="width: 10%;"></td> <td style="width: 10%;"></td> <td style="width: 10%;"></td> <td style="width: 10%;"></td> <td style="width: 10%;"></td> </tr> <tr> <td></td> <td></td> <td colspan="8" style="text-align: center;"> <table border="1" style="width: 100%; border-collapse: collapse; text-align: center;"> <tr> </tr></table></td></tr></table></td></tr></table></td></tr></table></td></tr></table></td></tr></table></td></tr></table></td></tr></table></td></tr></table> | | | | | | | | | | | | | | | | | | | | <table border="1" style="width: 100%; border-collapse: collapse; text-align: center;"> <tr> <td style="width: 10%;"></td> <td style="width: 10%;"></td> <td style="width: 10%;"></td> <td style="width: 10%;"></td> <td style="width: 10%;"></td> <td style="width: 10%;"></td> <td style="width: 10%;"></td> <td style="width: 10%;"></td> <td style="width: 10%;"></td> <td style="width: 10%;"></td> </tr> <tr> <td></td> <td></td> <td colspan="8" style="text-align: center;"> <table border="1" style="width: 100%; border-collapse: collapse; text-align: center;"> <tr> <td style="width: 10%;"></td> <td style="width: 10%;"></td> <td style="width: 10%;"></td> <td style="width: 10%;"></td> <td style="width: 10%;"></td> <td style="width: 10%;"></td> <td style="width: 10%;"></td> <td style="width: 10%;"></td> <td style="width: 10%;"></td> <td style="width: 10%;"></td> </tr> <tr> <td></td> <td></td> <td colspan="8" style="text-align: center;"> <table border="1" style="width: 100%; border-collapse: collapse; text-align: center;"> <tr> <td style="width: 10%;"></td> <td style="width: 10%;"></td> <td style="width: 10%;"></td> <td style="width: 10%;"></td> <td style="width: 10%;"></td> <td style="width: 10%;"></td> <td style="width: 10%;"></td> <td style="width: 10%;"></td> <td style="width: 10%;"></td> <td style="width: 10%;"></td> </tr> <tr> <td></td> <td></td> <td colspan="8" style="text-align: center;"> <table border="1" style="width: 100%; border-collapse: collapse; text-align: center;"> <tr> <td style="width: 10%;"></td> <td style="width: 10%;"></td> <td style="width: 10%;"></td> <td style="width: 10%;"></td> <td style="width: 10%;"></td> <td style="width: 10%;"></td> <td style="width: 10%;"></td> <td style="width: 10%;"></td> <td style="width: 10%;"></td> <td style="width: 10%;"></td> </tr> <tr> <td></td> <td></td> <td colspan="8" style="text-align: center;"> <table border="1" style="width: 100%; border-collapse: collapse; text-align: center;"> <tr> <td style="width: 10%;"></td> <td style="width: 10%;"></td> <td style="width: 10%;"></td> <td style="width: 10%;"></td> <td style="width: 10%;"></td> <td style="width: 10%;"></td> <td style="width: 10%;"></td> <td style="width: 10%;"></td> <td style="width: 10%;"></td> <td style="width: 10%;"></td> </tr> <tr> <td></td> <td></td> <td colspan="8" style="text-align: center;"> <table border="1" style="width: 100%; border-collapse: collapse; text-align: center;"> <tr> <td style="width: 10%;"></td> <td style="width: 10%;"></td> <td style="width: 10%;"></td> <td style="width: 10%;"></td> <td style="width: 10%;"></td> <td style="width: 10%;"></td> <td style="width: 10%;"></td> <td style="width: 10%;"></td> <td style="width: 10%;"></td> <td style="width: 10%;"></td> </tr> <tr> <td></td> <td></td> <td colspan="8" style="text-align: center;"> <table border="1" style="width: 100%; border-collapse: collapse; text-align: center;"> <tr> <td style="width: 10%;"></td> <td style="width: 10%;"></td> <td style="width: 10%;"></td> <td style="width: 10%;"></td> <td style="width: 10%;"></td> <td style="width: 10%;"></td> <td style="width: 10%;"></td> <td style="width: 10%;"></td> <td style="width: 10%;"></td> <td style="width: 10%;"></td> </tr> <tr> <td></td> <td></td> <td colspan="8" style="text-align: center;"> <table border="1" style="width: 100%; border-collapse: collapse; text-align: center;"> <tr> </tr></table></td></tr></table></td></tr></table></td></tr></table></td></tr></table></td></tr></table></td></tr></table></td></tr></table>
 | | | | | | | | | | | | | | | | | | | | <table border="1" style="width: 100%; border-collapse: collapse; text-align: center;"> <tr> <td style="width: 10%;"></td> <td style="width: 10%;"></td> <td style="width: 10%;"></td> <td style="width: 10%;"></td> <td style="width: 10%;"></td> <td style="width: 10%;"></td> <td style="width: 10%;"></td> <td style="width: 10%;"></td> <td style="width: 10%;"></td> <td style="width: 10%;"></td> </tr> <tr> <td></td> <td></td> <td colspan="8" style="text-align: center;"> <table border="1" style="width: 100%; border-collapse: collapse; text-align: center;"> <tr> <td style="width: 10%;"></td> <td style="width: 10%;"></td> <td style="width: 10%;"></td> <td style="width: 10%;"></td> <td style="width: 10%;"></td> <td style="width: 10%;"></td> <td style="width: 10%;"></td> <td style="width: 10%;"></td> <td style="width: 10%;"></td> <td style="width: 10%;"></td> </tr> <tr> <td></td> <td></td> <td colspan="8" style="text-align: center;"> <table border="1" style="width: 100%; border-collapse: collapse; text-align: center;"> <tr> <td style="width: 10%;"></td> <td style="width: 10%;"></td> <td style="width: 10%;"></td> <td style="width: 10%;"></td> <td style="width: 10%;"></td> <td style="width: 10%;"></td> <td style="width: 10%;"></td> <td style="width: 10%;"></td> <td style="width: 10%;"></td> <td style="width: 10%;"></td> </tr> <tr> <td></td> <td></td> <td colspan="8" style="text-align: center;"> <table border="1" style="width: 100%; border-collapse: collapse; text-align: center;"> <tr> <td style="width: 10%;"></td> <td style="width: 10%;"></td> <td style="width: 10%;"></td> <td style="width: 10%;"></td> <td style="width: 10%;"></td> <td style="width: 10%;"></td> <td style="width: 10%;"></td> <td style="width: 10%;"></td> <td style="width: 10%;"></td> <td style="width: 10%;"></td> </tr> <tr> <td></td> <td></td> <td colspan="8" style="text-align: center;"> <table border="1" style="width: 100%; border-collapse: collapse; text-align: center;"> <tr> <td style="width: 10%;"></td> <td style="width: 10%;"></td> <td style="width: 10%;"></td> <td style="width: 10%;"></td> <td style="width: 10%;"></td> <td style="width: 10%;"></td> <td style="width: 10%;"></td> <td style="width: 10%;"></td> <td style="width: 10%;"></td> <td style="width: 10%;"></td> </tr> <tr> <td></td> <td></td> <td colspan="8" style="text-align: center;"> <table border="1" style="width: 100%; border-collapse: collapse; text-align: center;"> <tr> <td style="width: 10%;"></td> <td style="width: 10%;"></td> <td style="width: 10%;"></td> <td style="width: 10%;"></td> <td style="width: 10%;"></td> <td style="width: 10%;"></td> <td style="width: 10%;"></td> <td style="width: 10%;"></td> <td style="width: 10%;"></td> <td style="width: 10%;"></td> </tr> <tr> <td></td> <td></td> <td colspan="8" style="text-align: center;"> <table border="1" style="width: 100%; border-collapse: collapse; text-align: center;"> <tr> </tr></table></td></tr></table></td></tr></table></td></tr></table></td></tr></table></td></tr></table></td></tr></table>
 | | | | | | | | | | | | | | | | | | | | <table border="1" style="width: 100%; border-collapse: collapse; text-align: center;"> <tr> <td style="width: 10%;"></td> <td style="width: 10%;"></td> <td style="width: 10%;"></td> <td style="width: 10%;"></td> <td style="width: 10%;"></td> <td style="width: 10%;"></td> <td style="width: 10%;"></td> <td style="width: 10%;"></td> <td style="width: 10%;"></td> <td style="width: 10%;"></td> </tr> <tr> <td></td> <td></td> <td colspan="8" style="text-align: center;"> <table border="1" style="width: 100%; border-collapse: collapse; text-align: center;"> <tr> <td style="width: 10%;"></td> <td style="width: 10%;"></td> <td style="width: 10%;"></td> <td style="width: 10%;"></td> <td style="width: 10%;"></td> <td style="width: 10%;"></td> <td style="width: 10%;"></td> <td style="width: 10%;"></td> <td style="width: 10%;"></td> <td style="width: 10%;"></td> </tr> <tr> <td></td> <td></td> <td colspan="8" style="text-align: center;"> <table border="1" style="width: 100%; border-collapse: collapse; text-align: center;"> <tr> <td style="width: 10%;"></td> <td style="width: 10%;"></td> <td style="width: 10%;"></td> <td style="width: 10%;"></td> <td style="width: 10%;"></td> <td style="width: 10%;"></td> <td style="width: 10%;"></td> <td style="width: 10%;"></td> <td style="width: 10%;"></td> <td style="width: 10%;"></td> </tr> <tr> <td></td> <td></td> <td colspan="8" style="text-align: center;"> <table border="1" style="width: 100%; border-collapse: collapse; text-align: center;"> <tr> <td style="width: 10%;"></td> <td style="width: 10%;"></td> <td style="width: 10%;"></td> <td style="width: 10%;"></td> <td style="width: 10%;"></td> <td style="width: 10%;"></td> <td style="width: 10%;"></td> <td style="width: 10%;"></td> <td style="width: 10%;"></td> <td style="width: 10%;"></td> </tr> <tr> <td></td> <td></td> <td colspan="8" style="text-align: center;"> <table border="1" style="width: 100%; border-collapse: collapse; text-align: center;"> <tr> <td style="width: 10%;"></td> <td style="width: 10%;"></td> <td style="width: 10%;"></td> <td style="width: 10%;"></td> <td style="width: 10%;"></td> <td style="width: 10%;"></td> <td style="width: 10%;"></td> <td style="width: 10%;"></td> <td style="width: 10%;"></td> <td style="width: 10%;"></td> </tr> <tr> <td></td> <td></td> <td colspan="8" style="text-align: center;"> <table border="1" style="width: 100%; border-collapse: collapse; text-align: center;"> <tr> </tr></table></td></tr></table></td></tr></table></td></tr></table></td></tr></table></td></tr></table>
 | | | | | | | | | | | | | | | | | | | | <table border="1" style="width: 100%; border-collapse: collapse; text-align: center;"> <tr> <td style="width: 10%;"></td> <td style="width: 10%;"></td> <td style="width: 10%;"></td> <td style="width: 10%;"></td> <td style="width: 10%;"></td> <td style="width: 10%;"></td> <td style="width: 10%;"></td> <td style="width: 10%;"></td> <td style="width: 10%;"></td> <td style="width: 10%;"></td> </tr> <tr> <td></td> <td></td> <td colspan="8" style="text-align: center;"> <table border="1" style="width: 100%; border-collapse: collapse; text-align: center;"> <tr> <td style="width: 10%;"></td> <td style="width: 10%;"></td> <td style="width: 10%;"></td> <td style="width: 10%;"></td> <td style="width: 10%;"></td> <td style="width: 10%;"></td> <td style="width: 10%;"></td> <td style="width: 10%;"></td> <td style="width: 10%;"></td> <td style="width: 10%;"></td> </tr> <tr> <td></td> <td></td> <td colspan="8" style="text-align: center;"> <table border="1" style="width: 100%; border-collapse: collapse; text-align: center;"> <tr> <td style="width: 10%;"></td> <td style="width: 10%;"></td> <td style="width: 10%;"></td> <td style="width: 10%;"></td> <td style="width: 10%;"></td> <td style="width: 10%;"></td> <td style="width: 10%;"></td> <td style="width: 10%;"></td> <td style="width: 10%;"></td> <td style="width: 10%;"></td> </tr> <tr> <td></td> <td></td> <td colspan="8" style="text-align: center;"> <table border="1" style="width: 100%; border-collapse: collapse; text-align: center;"> <tr> <td style="width: 10%;"></td> <td style="width: 10%;"></td> <td style="width: 10%;"></td> <td style="width: 10%;"></td> <td style="width: 10%;"></td> <td style="width: 10%;"></td> <td style="width: 10%;"></td> <td style="width: 10%;"></td> <td style="width: 10%;"></td> <td style="width: 10%;"></td> </tr> <tr> <td></td> <td></td> <td colspan="8" style="text-align: center;"> <table border="1" style="width: 100%; border-collapse: collapse; text-align: center;"> <tr> </tr></table></td></tr></table></td></tr></table></td></tr></table></td></tr></table> | | | | | | | | | | | | | | | | | | | | <table border="1" style="width: 100%; border-collapse: collapse; text-align: center;"> <tr> <td style="width: 10%;"></td> <td style="width: 10%;"></td> <td style="width: 10%;"></td> <td style="width: 10%;"></td> <td style="width: 10%;"></td> <td style="width: 10%;"></td> <td style="width: 10%;"></td> <td style="width: 10%;"></td> <td style="width: 10%;"></td> <td style="width: 10%;"></td> </tr> <tr> <td></td> <td></td> <td colspan="8" style="text-align: center;"> <table border="1" style="width: 100%; border-collapse: collapse; text-align: center;"> <tr> <td style="width: 10%;"></td> <td style="width: 10%;"></td> <td style="width: 10%;"></td> <td style="width: 10%;"></td> <td style="width: 10%;"></td> <td style="width: 10%;"></td> <td style="width: 10%;"></td> <td style="width: 10%;"></td> <td style="width: 10%;"></td> <td style="width: 10%;"></td> </tr> <tr> <td></td> <td></td> <td colspan="8" style="text-align: center;"> <table
border="1" style="width: 100%; border-collapse: collapse; text-align: center;"> <tr> <td style="width: 10%;"></td> <td style="width: 10%;"></td> <td style="width: 10%;"></td> <td style="width: 10%;"></td> <td style="width: 10%;"></td> <td style="width: 10%;"></td> <td style="width: 10%;"></td> <td style="width: 10%;"></td> <td style="width: 10%;"></td> <td style="width: 10%;"></td> </tr> <tr> <td></td> <td></td> <td colspan="8" style="text-align: center;"> <table border="1" style="width: 100%; border-collapse: collapse; text-align: center;"> <tr> </tr></table></td></tr></table></td></tr></table></td></tr></table> | | | | | | | | | | | | | | | | | | | | <table border="1" style="width: 100%; border-collapse: collapse; text-align: center;"> <tr> <td style="width: 10%;"></td> <td style="width: 10%;"></td> <td style="width: 10%;"></td> <td style="width: 10%;"></td> <td style="width: 10%;"></td> <td style="width: 10%;"></td> <td style="width: 10%;"></td> <td style="width: 10%;"></td> <td style="width: 10%;"></td> <td style="width: 10%;"></td> </tr> <tr> <td></td> <td></td> <td colspan="8" style="text-align: center;"> <table border="1" style="width: 100%; border-collapse: collapse; text-align: center;"> <tr> <td style="width: 10%;"></td> <td style="width: 10%;"></td> <td style="width: 10%;"></td> <td style="width: 10%;"></td> <td style="width: 10%;"></td> <td style="width: 10%;"></td> <td style="width: 10%;"></td> <td style="width: 10%;"></td> <td style="width: 10%;"></td> <td style="width: 10%;"></td> </tr> <tr> <td></td> <td></td> <td colspan="8" style="text-align: center;"> <table border="1" style="width: 100%; border-collapse: collapse; text-align: center;"> <tr> </tr></table></td></tr></table></td></tr></table>
 | | | | | | | | | | | | | | | | | | | | <table border="1" style="width: 100%; border-collapse: collapse; text-align: center;"> <tr> <td style="width: 10%;"></td> <td style="width: 10%;"></td> <td style="width: 10%;"></td> <td style="width: 10%;"></td> <td style="width: 10%;"></td> <td style="width: 10%;"></td> <td style="width: 10%;"></td> <td style="width: 10%;"></td> <td style="width: 10%;"></td> <td style="width: 10%;"></td> </tr> <tr> <td></td> <td></td> <td colspan="8" style="text-align: center;"> <table border="1" style="width: 100%; border-collapse: collapse; text-align: center;"> <tr> </tr></table></td></tr></table> | | | | | | | | | | | | | | | | | | | | <table border="1" style="width: 100%; border-collapse: collapse; text-align: center;"> <tr> </tr></table>
 | | | | | | | | | | | | | | | | | | | | | | | | | | | | | | | | | | | | | | | | | | | | | | | | | | | | | | | | | | | | | | | | | | | | | | | | | | | | | | | |
 | | | | | | | | | | | | | | | | | | | | | | | | | | | | | | | | | | | | | | | |
 | | | | | | | | | | | | | | | | | | | | | | | | | | | | | | | | | | | | | | | | | | | | | | | | | | | | | | | | | | | | | | | | | | | | | | | | | | | | | | | |
 | | | | | | | | | | | | | | | | | | | | | | | | | | | | | | | | | | | | | | | | | | | | | | | | | | | | | | | | | | | | | | | | | | | |
| | |

 | | | | | | | | | | | | | | | | | | | |

 | | | | | | | | | | | | | | | | | | | |

 | | | | | | | | | | | | | | | | | | | |

 | | | | | | | | | | | | | | | | | | | |

 | | | | | | | | | | | | | | | | | | | |

 | | | | | | | | | | | | | | | | | | | |

 | | | | | | | | | | | | | | | | | | | |

 | | | | | | | | | | | | | | | | | | | |

 | | | | | | | | | | | | | | | | | | | |

 | | | | | | | | | | | | | | | | | | | |

 | | | | | | | | | | | | | | | | | | | |

 | | | | | | | | | | | | | | | | | | | |

 | | | | | | | | | | | | | | | | | | | |

 | | | | | | | | | | | | | | | | | | | |

 | | | | | | | | | | | | | | | | | | | |

 | | | | | | | | | | | | | | | | | | | |

 | | | | | | | | | | | | | | | | | | | |

 | | | | | | | | | | | | | | | | | | | |

 | | | | | | | | | | | | | | | | | | | |

 | | | | | | | | | | | | | | | | | | | |

 | | | | | | | | | | | | | | | | | | | |

 | | | | | | | | | | | | | | | | | | | |

 | | | | | | | | | | | | | | | | | | | |

 | | | | | | | | | | | | | | | | | | | |

 | | | | | | | | | | | | | | | | | | | |

 | | | | | | | | | | | | | | | | | | | |

 | | | | | | | | | | | | | | | | | | | |

 | | | | | | | | | | | | | | | | | | | |
 | | | | | | | | | | | | | | | | | | | |

 | | | | | | | | | | | | | | | | | | | |

 | | | | | | | | | | | | | | | | | | | |
 | | | | | | | | | | | | | | | | | | | |

 | | | | | | | | | | | | | | | | | | | |

 | | | | | | | | | | | | | | | | | | | |
 | | | | | | | | | | | | | | | | | | | |
 | | | | | | | | | | | | | | | | | | | |

 | | | | | | | | | | | | | | | | | | | |
 | | | | | | | | | | | | | | | | | | | |
 | | | | | | | | | | | | | | | | | | | |

 | | | | | | | | | | | | | | | | | | | | | | | | | | | | | | | | | | | | | | | | | | | | | | | | | | | | | | | | | | | | | | | | | | | | | | | | | | | | | | | | | | | | | | | | | | | | | | | | | | | |
 | | | | | | | | | | | | | | | | | | | |
 | | | | | | | | | | | | | | | | | | | |
 | | | | | | | | | | | | | | | | | | | |
 | | | | | | | | | | | | | | | | | | | |
 | | | | | | | | | | | | | | | | | | | |
 | | | | | | | | | | | | | | | | | | | |
 | | | | | | | | | | | | | | | | | | | |
 | | | | | | | | | | | | | | | | | | | |
 | | | | | | | | | | | | | | | | | | | | | | | | | | | | | | | | | | | | | | | |
 | | | | | | | | | | | | | | | | | | | |
 | | | | | | | | | | | | | | | | | | | | | | | | | | | | | | | | | | | | | | | |
 | | | | | | | | | | | | | | | | | | | | | | | | | | | | | | | | | | | | | | | |
 | | | | | | | | | | | | | | | | | | | | | | | | | | | | | | | | | | | | | | | |
 | | | | | | | | | | | | | | | | | | | | | | | | | | | | | | | | | | | | | | | | | | | | | | | | | | | | | | | | | | | | | | | | | | | | | | | | | | | | | | | | | | | | | | | | | | | | | | | | | | | |
 | | | | | | | | | | | | | | | | | | | | | | | | | | | | | | | | | | | | | | | | | | | | | | | |
| | | <table border="1" style="width: 100%; border-collapse: collapse; text-align: center;"> <tr> <td style="width: 10%;"></td> <td style="width: 10%;"></td> <td style="width: 10%;"></td> <td style="width: 10%;"></td> <td style="width: 10%;"></td> <td style="width: 10%;"></td> <td style="width: 10%;"></td> <td style="width: 10%;"></td> <td style="width: 10%;"></td> <td style="width: 10%;"></td> </tr> <tr> <td></td> <td></td> <td colspan="8" style="text-align: center;"> <table border="1" style="width: 100%; border-collapse: collapse; text-align: center;"> <tr> <td style="width: 10%;"></td> <td style="width: 10%;"></td> <td style="width: 10%;"></td> <td style="width: 10%;"></td> <td style="width: 10%;"></td> <td style="width: 10%;"></td> <td style="width: 10%;"></td> <td style="width: 10%;"></td> <td style="width: 10%;"></td> <td style="width: 10%;"></td> </tr> <tr> <td></td> <td></td> <td colspan="8" style="text-align: center;"> <table border="1" style="width: 100%; border-collapse: collapse; text-align: center;"> <tr> <td style="width: 10%;"></td> <td style="width: 10%;"></td> <td style="width: 10%;"></td> <td style="width: 10%;"></td> <td style="width: 10%;"></td> <td style="width: 10%;"></td> <td style="width: 10%;"></td> <td style="width: 10%;"></td> <td style="width: 10%;"></td> <td style="width: 10%;"></td> </tr> <tr> <td></td> <td></td> <td colspan="8" style="text-align: center;"> <table border="1" style="width: 100%; border-collapse: collapse; text-align: center;"> <tr> <td style="width: 10%;"></td> <td style="width: 10%;"></td> <td style="width: 10%;"></td> <td style="width: 10%;"></td> <td style="width: 10%;"></td> <td style="width: 10%;"></td> <td style="width: 10%;"></td> <td style="width: 10%;"></td> <td style="width: 10%;"></td> <td style="width: 10%;"></td> </tr> <tr> <td></td> <td></td> <td colspan="8" style="text-align: center;"> <table border="1" style="width: 100%; border-collapse: collapse; text-align: center;"> <tr> <td style="width: 10%;"></td> <td style="width: 10%;"></td> <td style="width: 10%;"></td> <td style="width: 10%;"></td> <td style="width: 10%;"></td> <td style="width: 10%;"></td> <td style="width: 10%;"></td> <td style="width: 10%;"></td> <td style="width: 10%;"></td> <td style="width: 10%;"></td> </tr> <tr> <td></td> <td></td> <td colspan="8" style="text-align: center;"> <table border="1" style="width: 100%; border-collapse: collapse; text-align: center;"> <tr> <td style="width: 10%;"></td> <td style="width: 10%;"></td> <td style="width: 10%;"></td> <td style="width: 10%;"></td> <td style="width: 10%;"></td> <td style="width: 10%;"></td> <td style="width: 10%;"></td> <td style="width: 10%;"></td> <td style="width: 10%;"></td> <td style="width: 10%;"></td> </tr> <tr> <td></td> <td></td> <td colspan="8" style="text-align: center;"> <table border="1" style="width: 100%; border-collapse: collapse; text-align: center;"> <tr> <td style="width: 10%;"></td> <td style="width: 10%;"></td> <td style="width: 10%;"></td> <td style="width: 10%;"></td> <td style="width: 10%;"></td> <td style="width: 10%;"></td> <td style="width: 10%;"></td> <td style="width: 10%;"></td> <td style="width: 10%;"></td> <td style="width: 10%;"></td> </tr> <tr> <td></td> <td></td> <td colspan="8" style="text-align: center;"> <table border="1" style="width: 100%; border-collapse: collapse; text-align: center;"> <tr> <td style="width: 10%;"></td> <td style="width: 10%;"></td> <td style="width: 10%;"></td> <td style="width: 10%;"></td> <td style="width: 10%;"></td> <td style="width: 10%;"></td> <td style="width: 10%;"></td> <td style="width: 10%;"></td> <td style="width: 10%;"></td> <td style="width: 10%;"></td> </tr> <tr> <td></td> <td></td> <td colspan="8" style="text-align: center;"> <table border="1" style="width: 100%; border-collapse: collapse; text-align: center;"> <tr> <td style="width: 10%;"></td> <td style="width: 10%;"></td> <td style="width: 10%;"></td> <td style="width: 10%;"></td> <td style="width: 10%;"></td> <td style="width: 10%;"></td> <td style="width: 10%;"></td> <td style="width: 10%;"></td> <td style="width: 10%;"></td> <td style="width: 10%;"></td> </tr> <tr> <td></td> <td></td> <td colspan="8" style="text-align: center;"> <table border="1" style="width: 100%; border-collapse: collapse; text-align: center;"> <tr> <td style="width: 10%;"></td> <td style="width: 10%;"></td> <td style="width: 10%;"></td> <td style="width: 10%;"></td> <td style="width: 10%;"></td> <td style="width: 10%;"></td> <td style="width: 10%;"></td> <td style="width: 10%;"></td> <td style="width: 10%;"></td> <td style="width: 10%;"></td> </tr> <tr> <td></td> <td></td> <td colspan="8" style="text-align: center;"> <table border="1" style="width: 100%; border-collapse: collapse; text-align: center;"> <tr> <td style="width: 10%;"></td> <td style="width: 10%;"></td> <td style="width: 10%;"></td> <td style="width: 10%;"></td> <td style="width: 10%;"></td> <td style="width: 10%;"></td> <td style="width: 10%;"></td> <td style="width: 10%;"></td> <td style="width: 10%;"></td> <td style="width: 10%;"></td> </tr> <tr> <td></td> <td></td> <td colspan="8" style="text-align: center;"> <table border="1" style="width: 100%; border-collapse: collapse; text-align: center;"> <tr> <td style="width: 10%;"></td> <td style="width: 10%;"></td> <td style="width: 10%;"></td> <td style="width: 10%;"></td> <td style="width: 10%;"></td> <td style="width: 10%;"></td> <td style="width: 10%;"></td> <td style="width: 10%;"></td> <td style="width: 10%;"></td> <td style="width: 10%;"></td> </tr> <tr> <td></td> <td></td> <td colspan="8" style="text-align: center;"> <table border="1" style="width: 100%; border-collapse: collapse; text-align: center;"> <tr> <td style="width: 10%;"></td> <td style="width: 10%;"></td> <td style="width: 10%;"></td> <td style="width: 10%;"></td> <td style="width: 10%;"></td> <td style="width: 10%;"></td> <td style="width: 10%;"></td> <td style="width: 10%;"></td> <td style="width: 10%;"></td> <td style="width: 10%;"></td> </tr> <tr> <td></td> <td></td> <td colspan="8" style="text-align: center;"> <table border="1" style="width: 100%; border-collapse: collapse; text-align: center;"> <tr> <td style="width: 10%;"></td> <td style="width: 10%;"></td> <td style="width: 10%;"></td> <td style="width: 10%;"></td> <td style="width: 10%;"></td> <td style="width: 10%;"></td> <td style="width: 10%;"></td> <td style="width: 10%;"></td> <td style="width: 10%;"></td> <td style="width: 10%;"></td> </tr> <tr> <td></td> <td></td> <td colspan="8" style="text-align: center;"> <table border="1" style="width: 100%; border-collapse: collapse; text-align: center;"> <tr> <td style="width: 10%;"></td> <td style="width: 10%;"></td> <td style="width: 10%;"></td> <td style="width: 10%;"></td> <td style="width: 10%;"></td> <td style="width: 10%;"></td> <td style="width: 10%;"></td> <td style="width: 10%;"></td> <td style="width: 10%;"></td> <td style="width: 10%;"></td> </tr> <tr> <td></td> <td></td> <td colspan="8" style="text-align: center;"> <table border="1" style="width: 100%; border-collapse: collapse; text-align: center;"> <tr> <td style="width: 10%;"></td> <td style="width: 10%;"></td> <td style="width: 10%;"></td> <td style="width: 10%;"></td> <td style="width: 10%;"></td> <td style="width: 10%;"></td> <td style="width: 10%;"></td> <td style="width: 10%;"></td> <td style="width: 10%;"></td> <td style="width: 10%;"></td> </tr> <tr> <td></td> <td></td> <td colspan="8" style="text-align: center;"> <table border="1" style="width: 100%; border-collapse: collapse; text-align: center;"> <tr> <td style="width: 10%;"></td> <td style="width: 10%;"></td> <td style="width: 10%;"></td> <td style="width: 10%;"></td> <td style="width: 10%;"></td> <td style="width: 10%;"></td> <td style="width: 10%;"></td> <td style="width: 10%;"></td> <td style="width: 10%;"></td> <td style="width: 10%;"></td> </tr> <tr> <td></td> <td></td> <td colspan="8" style="text-align: center;"> <table border="1" style="width: 100%; border-collapse: collapse; text-align: center;"> <tr> <td style="width: 10%;"></td> <td style="width: 10%;"></td> <td style="width: 10%;"></td> <td style="width: 10%;"></td> <td style="width: 10%;"></td> <td style="width: 10%;"></td> <td style="width: 10%;"></td> <td style="width: 10%;"></td> <td style="width: 10%;"></td> <td style="width: 10%;"></td> </tr> <tr> <td></td> <td></td> <td colspan="8" style="text-align: center;"> <table border="1" style="width: 100%; border-collapse: collapse; text-align: center;"> <tr> <td style="width: 10%;"></td> <td style="width: 10%;"></td> <td style="width: 10%;"></td> <td style="width: 10%;"></td> <td style="width: 10%;"></td> <td style="width: 10%;"></td> <td style="width: 10%;"></td> <td style="width: 10%;"></td> <td style="width: 10%;"></td> <td style="width: 10%;"></td> </tr> <tr> <td></td> <td></td> <td colspan="8" style="text-align: center;"> <table border="1" style="width: 100%; border-collapse: collapse; text-align: center;"> <tr> <td style="width: 10%;"></td> <td style="width: 10%;"></td> <td style="width: 10%;"></td> <td style="width: 10%;"></td> <td style="width: 10%;"></td> <td style="width: 10%;"></td> <td style="width: 10%;"></td> <td style="width: 10%;"></td> <td style="width: 10%;"></td> <td style="width: 10%;"></td> </tr> <tr> <td></td> <td></td> <td colspan="8" style="text-align: center;"> <table border="1" style="width: 100%; border-collapse: collapse; text-align: center;"> <tr> <td style="width: 10%;"></td> <td style="width: 10%;"></td> <td style="width: 10%;"></td> <td style="width: 10%;"></td> <td style="width: 10%;"></td> <td style="width: 10%;"></td> <td style="width: 10%;"></td> <td style="width: 10%;"></td> <td style="width: 10%;"></td> <td style="width: 10%;"></td> </tr> <tr> <td></td> <td></td> <td colspan="8" style="text-align: center;"> <table border="1" style="width: 100%; border-collapse: collapse; text-align: center;"> <tr> <td style="width: 10%;"></td> <td style="width: 10%;"></td> <td
style="width: 10%;"></td> <td style="width: 10%;"></td> <td style="width: 10%;"></td> <td style="width: 10%;"></td> <td style="width: 10%;"></td> <td style="width: 10%;"></td> <td style="width: 10%;"></td> <td style="width: 10%;"></td> </tr> <tr> <td></td> <td></td> <td colspan="8" style="text-align: center;"> <table border="1" style="width: 100%; border-collapse: collapse; text-align: center;"> <tr> <td style="width: 10%;"></td> <td style="width: 10%;"></td> <td style="width: 10%;"></td> <td style="width: 10%;"></td> <td style="width: 10%;"></td> <td style="width: 10%;"></td> <td style="width: 10%;"></td> <td style="width: 10%;"></td> <td style="width: 10%;"></td> <td style="width: 10%;"></td> </tr> <tr> <td></td> <td></td> <td colspan="8" style="text-align: center;"> <table border="1" style="width: 100%; border-collapse: collapse; text-align: center;"> <tr> <td style="width: 10%;"></td> <td style="width: 10%;"></td> <td style="width: 10%;"></td> <td style="width: 10%;"></td> <td style="width: 10%;"></td> <td style="width: 10%;"></td> <td style="width: 10%;"></td> <td style="width: 10%;"></td> <td style="width: 10%;"></td> <td style="width: 10%;"></td> </tr> <tr> <td></td> <td></td> <td colspan="8" style="text-align: center;"> <table border="1" style="width: 100%; border-collapse: collapse; text-align: center;"> <tr> <td style="width: 10%;"></td> <td style="width: 10%;"></td> <td style="width: 10%;"></td> <td style="width: 10%;"></td> <td style="width: 10%;"></td> <td style="width: 10%;"></td> <td style="width: 10%;"></td> <td style="width: 10%;"></td> <td style="width: 10%;"></td> <td style="width: 10%;"></td> </tr> <tr> <td></td> <td></td> <td colspan="8" style="text-align: center;"> <table border="1" style="width: 100%; border-collapse: collapse; text-align: center;"> <tr> <td style="width: 10%;"></td> <td style="width: 10%;"></td> <td style="width: 10%;"></td> <td style="width: 10%;"></td> <td style="width: 10%;"></td> <td style="width: 10%;"></td> <td style="width: 10%;"></td> <td style="width: 10%;"></td> <td style="width: 10%;"></td> <td style="width: 10%;"></td> </tr> <tr> <td></td> <td></td> <td colspan="8" style="text-align: center;"> <table border="1" style="width: 100%; border-collapse: collapse; text-align: center;"> <tr> <td style="width: 10%;"></td> <td style="width: 10%;"></td> <td style="width: 10%;"></td> <td style="width: 10%;"></td> <td style="width: 10%;"></td> <td style="width: 10%;"></td> <td style="width: 10%;"></td> <td style="width: 10%;"></td> <td style="width: 10%;"></td> <td style="width: 10%;"></td> </tr> <tr> <td></td> <td></td> <td colspan="8" style="text-align: center;"> <table border="1" style="width: 100%; border-collapse: collapse; text-align: center;"> <tr> <td style="width: 10%;"></td> <td style="width: 10%;"></td> <td style="width: 10%;"></td> <td style="width: 10%;"></td> <td style="width: 10%;"></td> <td style="width: 10%;"></td> <td style="width: 10%;"></td> <td style="width: 10%;"></td> <td style="width: 10%;"></td> <td style="width: 10%;"></td> </tr> <tr> <td></td> <td></td> <td colspan="8" style="text-align: center;"> <table border="1" style="width: 100%; border-collapse: collapse; text-align: center;"> <tr> <td style="width: 10%;"></td> <td style="width: 10%;"></td> <td style="width: 10%;"></td> <td style="width: 10%;"></td> <td style="width: 10%;"></td> <td style="width: 10%;"></td> <td style="width: 10%;"></td> <td style="width: 10%;"></td> <td style="width: 10%;"></td> <td style="width: 10%;"></td> </tr> <tr> <td></td> <td></td> <td colspan="8" style="text-align: center;"> <table border="1" style="width: 100%; border-collapse: collapse; text-align: center;"> <tr> <td style="width: 10%;"></td> <td style="width: 10%;"></td> <td style="width: 10%;"></td> <td style="width: 10%;"></td> <td style="width: 10%;"></td> <td style="width: 10%;"></td> <td style="width: 10%;"></td> <td style="width: 10%;"></td> <td style="width: 10%;"></td> <td style="width: 10%;"></td> </tr> <tr> <td></td> <td></td> <td colspan="8" style="text-align: center;"> <table border="1" style="width: 100%; border-collapse: collapse; text-align: center;"> <tr> <td style="width: 10%;"></td> <td style="width: 10%;"></td> <td style="width: 10%;"></td> <td style="width: 10%;"></td> <td style="width: 10%;"></td> <td style="width: 10%;"></td> <td style="width: 10%;"></td> <td style="width: 10%;"></td> <td style="width: 10%;"></td> <td style="width: 10%;"></td> </tr> <tr> <td></td> <td></td> <td colspan="8" style="text-align: center;"> <table border="1" style="width: 100%; border-collapse: collapse; text-align: center;"> <tr> <td style="width: 10%;"></td> <td style="width: 10%;"></td> <td style="width: 10%;"></td> <td style="width: 10%;"></td> <td style="width: 10%;"></td> <td style="width: 10%;"></td> <td style="width: 10%;"></td> <td style="width: 10%;"></td> <td style="width: 10%;"></td> <td style="width: 10%;"></td> </tr> <tr> <td></td> <td></td> <td colspan="8" style="text-align: center;"> <table border="1" style="width: 100%; border-collapse: collapse; text-align: center;"> <tr> <td style="width: 10%;"></td> <td style="width: 10%;"></td> <td style="width: 10%;"></td> <td style="width: 10%;"></td> <td style="width: 10%;"></td> <td style="width: 10%;"></td> <td style="width: 10%;"></td> <td style="width: 10%;"></td> <td style="width: 10%;"></td> <td style="width: 10%;"></td> </tr> <tr> <td></td> <td></td> <td colspan="8" style="text-align: center;"> <table border="1" style="width: 100%; border-collapse: collapse; text-align: center;"> <tr> <td style="width: 10%;"></td> <td style="width: 10%;"></td> <td style="width: 10%;"></td> <td style="width: 10%;"></td> <td style="width: 10%;"></td> <td style="width: 10%;"></td> <td style="width: 10%;"></td> <td style="width: 10%;"></td> <td style="width: 10%;"></td> <td style="width: 10%;"></td> </tr> <tr> <td></td> <td></td> <td colspan="8" style="text-align: center;"> <table border="1" style="width: 100%; border-collapse: collapse; text-align: center;"> <tr> <td style="width: 10%;"></td> <td style="width: 10%;"></td> <td style="width: 10%;"></td> <td style="width: 10%;"></td> <td style="width: 10%;"></td> <td style="width: 10%;"></td> <td style="width: 10%;"></td> <td style="width: 10%;"></td> <td style="width: 10%;"></td> <td style="width: 10%;"></td> </tr> <tr> <td></td> <td></td> <td colspan="8" style="text-align: center;"> <table border="1" style="width: 100%; border-collapse: collapse; text-align: center;"> <tr> <td style="width: 10%;"></td> <td style="width: 10%;"></td> <td style="width: 10%;"></td> <td style="width: 10%;"></td> <td style="width: 10%;"></td> <td style="width: 10%;"></td> <td style="width: 10%;"></td> <td style="width: 10%;"></td> <td style="width: 10%;"></td> <td style="width: 10%;"></td> </tr> <tr> <td></td> <td></td> <td colspan="8" style="text-align: center;"> <table border="1" style="width: 100%; border-collapse: collapse; text-align: center;"> <tr> <td style="width: 10%;"></td> <td style="width: 10%;"></td> <td style="width: 10%;"></td> <td style="width: 10%;"></td> <td style="width: 10%;"></td> <td style="width: 10%;"></td> <td style="width: 10%;"></td> <td style="width: 10%;"></td> <td style="width: 10%;"></td> <td style="width: 10%;"></td> </tr> <tr> <td></td> <td></td> <td colspan="8" style="text-align: center;"> <table border="1" style="width: 100%; border-collapse: collapse; text-align: center;"> <tr> <td style="width: 10%;"></td> <td style="width: 10%;"></td> <td style="width: 10%;"></td> <td style="width: 10%;"></td> <td style="width: 10%;"></td> <td style="width: 10%;"></td> <td style="width: 10%;"></td> <td style="width: 10%;"></td> <td style="width: 10%;"></td> <td style="width: 10%;"></td> </tr> <tr> <td></td> <td></td> <td colspan="8" style="text-align: center;"> <table border="1" style="width: 100%; border-collapse: collapse; text-align: center;"> <tr> <td style="width: 10%;"></td> <td style="width: 10%;"></td> <td style="width: 10%;"></td> <td style="width: 10%;"></td> <td style="width: 10%;"></td> <td style="width: 10%;"></td> <td style="width: 10%;"></td> <td style="width: 10%;"></td> <td style="width: 10%;"></td> <td style="width: 10%;"></td> </tr> <tr> <td></td> <td></td> <td colspan="8" style="text-align: center;"> <table border="1" style="width: 100%; border-collapse: collapse; text-align: center;"> <tr> <td style="width: 10%;"></td> <td style="width: 10%;"></td> <td style="width: 10%;"></td> <td style="width: 10%;"></td> <td style="width: 10%;"></td> <td style="width: 10%;"></td> <td style="width: 10%;"></td> <td style="width: 10%;"></td> <td style="width: 10%;"></td> <td style="width: 10%;"></td> </tr> <tr> <td></td> <td></td> <td colspan="8" style="text-align: center;"> <table border="1" style="width: 100%; border-collapse: collapse; text-align: center;"> <tr> <td style="width: 10%;"></td> <td style="width: 10%;"></td> <td style="width: 10%;"></td> <td style="width: 10%;"></td> <td style="width: 10%;"></td> <td style="width: 10%;"></td> <td style="width: 10%;"></td> <td style="width: 10%;"></td> <td style="width: 10%;"></td> <td style="width: 10%;"></td> </tr> <tr> <td></td> <td></td> <td colspan="8" style="text-align: center;"> <table border="1" style="width: 100%; border-collapse: collapse; text-align: center;"> <tr> <td style="width: 10%;"></td> <td style="width: 10%;"></td> <td style="width: 10%;"></td> <td style="width: 10%;"></td> <td style="width: 10%;"></td> <td style="width: 10%;"></td> <td style="width: 10%;"></td> <td style="width: 10%;"></td> <td style="width: 10%;"></td> <td style="width: 10%;"></td> </tr> <tr> <td></td> <td></td> <td colspan="8" style="text-align: center;"> <table border="1" style="width: 100%; border-collapse: collapse; text-align: center;"> <tr> <td style="width: 10%;"></td> <td style="width: 10%;"></td> <td style="width: 10%;"></td> <td style="width: 10%;"></td> <td style="width: 10%;"></td> <td style="width: 10%;"></td> <td style="width: 10%;"></td> <td style="width:
10%;"></td> <td style="width: 10%;"></td> <td style="width: 10%;"></td> </tr> <tr> <td></td> <td></td> <td colspan="8" style="text-align: center;"> <table border="1" style="width: 100%; border-collapse: collapse; text-align: center;"> <tr> <td style="width: 10%;"></td> <td style="width: 10%;"></td> <td style="width: 10%;"></td> <td style="width: 10%;"></td> <td style="width: 10%;"></td> <td style="width: 10%;"></td> <td style="width: 10%;"></td> <td style="width: 10%;"></td> <td style="width: 10%;"></td> <td style="width: 10%;"></td> </tr> <tr> <td></td> <td></td> <td colspan="8" style="text-align: center;"> <table border="1" style="width: 100%; border-collapse: collapse; text-align: center;"> <tr> <td style="width: 10%;"></td> <td style="width: 10%;"></td> <td style="width: 10%;"></td> <td style="width: 10%;"></td> <td style="width: 10%;"></td> <td style="width: 10%;"></td> <td style="width: 10%;"></td> <td style="width: 10%;"></td> <td style="width: 10%;"></td> <td style="width: 10%;"></td> </tr> <tr> <td></td> <td></td> <td colspan="8" style="text-align: center;"> <table border="1" style="width: 100%; border-collapse: collapse; text-align: center;"> <tr> <td style="width: 10%;"></td> <td style="width: 10%;"></td> <td style="width: 10%;"></td> <td style="width: 10%;"></td> <td style="width: 10%;"></td> <td style="width: 10%;"></td> <td style="width: 10%;"></td> <td style="width: 10%;"></td> <td style="width: 10%;"></td> <td style="width: 10%;"></td> </tr> <tr> <td></td> <td></td> <td colspan="8" style="text-align: center;"> <table border="1" style="width: 100%; border-collapse: collapse; text-align: center;"> <tr> <td style="width: 10%;"></td> <td style="width: 10%;"></td> <td style="width: 10%;"></td> <td style="width: 10%;"></td> <td style="width: 10%;"></td> <td style="width: 10%;"></td> <td style="width: 10%;"></td> <td style="width: 10%;"></td> <td style="width: 10%;"></td> <td style="width: 10%;"></td> </tr> <tr> <td></td> <td></td> <td colspan="8" style="text-align: center;"> <table border="1" style="width: 100%; border-collapse: collapse; text-align: center;"> <tr> <td style="width: 10%;"></td> <td style="width: 10%;"></td> <td style="width: 10%;"></td> <td style="width: 10%;"></td> <td style="width: 10%;"></td> <td style="width: 10%;"></td> <td style="width: 10%;"></td> <td style="width: 10%;"></td> <td style="width: 10%;"></td> <td style="width: 10%;"></td> </tr> <tr> <td></td> <td></td> <td colspan="8" style="text-align: center;"> <table border="1" style="width: 100%; border-collapse: collapse; text-align: center;"> <tr> <td style="width: 10%;"></td> <td style="width: 10%;"></td> <td style="width: 10%;"></td> <td style="width: 10%;"></td> <td style="width: 10%;"></td> <td style="width: 10%;"></td> <td style="width: 10%;"></td> <td style="width: 10%;"></td> <td style="width: 10%;"></td> <td style="width: 10%;"></td> </tr> <tr> <td></td> <td></td> <td colspan="8" style="text-align: center;"> <table border="1" style="width: 100%; border-collapse: collapse; text-align: center;"> <tr> <td style="width: 10%;"></td> <td style="width: 10%;"></td> <td style="width: 10%;"></td> <td style="width: 10%;"></td> <td style="width: 10%;"></td> <td style="width: 10%;"></td> <td style="width: 10%;"></td> <td style="width: 10%;"></td> <td style="width: 10%;"></td> <td style="width: 10%;"></td> </tr> <tr> <td></td> <td></td> <td colspan="8" style="text-align: center;"> <table border="1" style="width: 100%; border-collapse: collapse; text-align: center;"> <tr> <td style="width: 10%;"></td> <td style="width: 10%;"></td> <td style="width: 10%;"></td> <td style="width: 10%;"></td> <td style="width: 10%;"></td> <td style="width: 10%;"></td> <td style="width: 10%;"></td> <td style="width: 10%;"></td> <td style="width: 10%;"></td> <td style="width: 10%;"></td> </tr> <tr> <td></td> <td></td> <td colspan="8" style="text-align: center;"> <table border="1" style="width: 100%; border-collapse: collapse; text-align: center;"> <tr> <td style="width: 10%;"></td> <td style="width: 10%;"></td> <td style="width: 10%;"></td> <td style="width: 10%;"></td> <td style="width: 10%;"></td> <td style="width: 10%;"></td> <td style="width: 10%;"></td> <td style="width: 10%;"></td> <td style="width: 10%;"></td> <td style="width: 10%;"></td> </tr> <tr> <td></td> <td></td> <td colspan="8" style="text-align: center;"> <table border="1" style="width: 100%; border-collapse: collapse; text-align: center;"> <tr> </tr></table></td></tr></table></td></tr></table></td></tr></table></td></tr></table></td></tr></table></td></tr></table></td></tr></table></td></tr></table></td></tr></table></td></tr></table></td></tr></table></td></tr></table></td></tr></table></td></tr></table></td></tr></table></td></tr></table></td></tr></table></td></tr></table></td></tr></table></td></tr></table></td></tr></table></td></tr></table></td></tr></table></td></tr></table></td></tr></table></td></tr></table></td></tr></table></td></tr></table></td></tr></table></td></tr></table></td></tr></table></td></tr></table></td></tr></table></td></tr></table></td></tr></table></td></tr></table></td></tr></table></td></tr></table></td></tr></table></td></tr></table></td></tr></table></td></tr></table></td></tr></table></td></tr></table></td></tr></table></td></tr></table></td></tr></table></td></tr></table></td></tr></table></td></tr></table></td></tr></table></td></tr></table>
 | | | | | | | | | | | | | | | | | | | | <table border="1" style="width: 100%; border-collapse: collapse; text-align: center;"> <tr> <td style="width: 10%;"></td> <td style="width: 10%;"></td> <td style="width: 10%;"></td> <td style="width: 10%;"></td> <td style="width: 10%;"></td> <td style="width: 10%;"></td> <td style="width: 10%;"></td> <td style="width: 10%;"></td> <td style="width: 10%;"></td> <td style="width: 10%;"></td> </tr> <tr> <td></td> <td></td> <td colspan="8" style="text-align: center;"> <table border="1" style="width: 100%; border-collapse: collapse; text-align: center;"> <tr> <td style="width: 10%;"></td> <td style="width: 10%;"></td> <td style="width: 10%;"></td> <td style="width: 10%;"></td> <td style="width: 10%;"></td> <td style="width: 10%;"></td> <td style="width: 10%;"></td> <td style="width: 10%;"></td> <td style="width: 10%;"></td> <td style="width: 10%;"></td> </tr> <tr> <td></td> <td></td> <td colspan="8" style="text-align: center;"> <table border="1" style="width: 100%; border-collapse: collapse; text-align: center;"> <tr> <td style="width: 10%;"></td> <td style="width: 10%;"></td> <td style="width: 10%;"></td> <td style="width: 10%;"></td> <td style="width: 10%;"></td> <td style="width: 10%;"></td> <td style="width: 10%;"></td> <td style="width: 10%;"></td> <td style="width: 10%;"></td> <td style="width: 10%;"></td> </tr> <tr> <td></td> <td></td> <td colspan="8" style="text-align: center;"> <table border="1" style="width: 100%; border-collapse: collapse; text-align: center;"> <tr> <td style="width: 10%;"></td> <td style="width: 10%;"></td> <td style="width: 10%;"></td> <td style="width: 10%;"></td> <td style="width: 10%;"></td> <td style="width: 10%;"></td> <td style="width: 10%;"></td> <td style="width: 10%;"></td> <td style="width: 10%;"></td> <td style="width: 10%;"></td> </tr> <tr> <td></td> <td></td> <td colspan="8" style="text-align: center;"> <table border="1" style="width: 100%; border-collapse: collapse; text-align: center;"> <tr> <td style="width: 10%;"></td> <td style="width: 10%;"></td> <td style="width: 10%;"></td> <td style="width: 10%;"></td> <td style="width: 10%;"></td> <td style="width: 10%;"></td> <td style="width: 10%;"></td> <td style="width: 10%;"></td> <td style="width: 10%;"></td> <td style="width: 10%;"></td> </tr> <tr> <td></td> <td></td> <td colspan="8" style="text-align: center;"> <table border="1" style="width: 100%; border-collapse: collapse; text-align: center;"> <tr> <td style="width: 10%;"></td> <td style="width: 10%;"></td> <td style="width: 10%;"></td> <td style="width: 10%;"></td> <td style="width: 10%;"></td> <td style="width: 10%;"></td> <td style="width: 10%;"></td> <td style="width: 10%;"></td> <td style="width: 10%;"></td> <td style="width: 10%;"></td> </tr> <tr> <td></td> <td></td> <td colspan="8" style="text-align: center;"> <table border="1" style="width: 100%; border-collapse: collapse; text-align: center;"> <tr> <td style="width: 10%;"></td> <td style="width: 10%;"></td> <td style="width: 10%;"></td> <td style="width: 10%;"></td> <td style="width: 10%;"></td> <td style="width: 10%;"></td> <td style="width: 10%;"></td> <td style="width: 10%;"></td> <td style="width: 10%;"></td> <td style="width: 10%;"></td> </tr> <tr> <td></td> <td></td> <td colspan="8" style="text-align: center;"> <table border="1" style="width: 100%; border-collapse: collapse; text-align: center;"> <tr> <td style="width: 10%;"></td> <td style="width: 10%;"></td> <td style="width: 10%;"></td> <td style="width: 10%;"></td> <td style="width: 10%;"></td> <td style="width: 10%;"></td> <td style="width: 10%;"></td> <td style="width: 10%;"></td> <td style="width: 10%;"></td> <td style="width: 10%;"></td> </tr> <tr> <td></td> <td></td> <td colspan="8" style="text-align: center;"> <table border="1" style="width: 100%; border-collapse: collapse; text-align: center;"> <tr> <td style="width: 10%;"></td> <td style="width: 10%;"></td> <td style="width: 10%;"></td> <td style="width: 10%;"></td> <td style="width: 10%;"></td> <td style="width: 10%;"></td> <td style="width: 10%;"></td> <td style="width: 10%;"></td> <td style="width: 10%;"></td> <td style="width: 10%;"></td> </tr> <tr> <td></td> <td></td> <td colspan="8" style="text-align: center;"> <table border="1" style="width: 100%; border-collapse: collapse; text-align: center;"> <tr> <td style="width: 10%;"></td> <td style="width: 10%;"></td> <td style="width: 10%;"></td> <td style="width: 10%;"></td> <td style="width: 10%;"></td> <td style="width: 10%;"></td> <td style="width: 10%;"></td> <td style="width: 10%;"></td> <td style="width: 10%;"></td> <td style="width: 10%;"></td> </tr> <tr> <td></td> <td></td> <td colspan="8" style="text-align: center;"> <table border="1" style="width: 100%; border-collapse: collapse; text-align: center;"> <tr> <td style="width: 10%;"></td> <td style="width: 10%;"></td> <td style="width: 10%;"></td> <td style="width: 10%;"></td> <td style="width: 10%;"></td> <td style="width: 10%;"></td> <td style="width: 10%;"></td> <td style="width: 10%;"></td> <td style="width: 10%;"></td> <td style="width: 10%;"></td> </tr> <tr> <td></td> <td></td> <td colspan="8" style="text-align: center;"> <table border="1" style="width: 100%; border-collapse: collapse; text-align: center;"> <tr> <td style="width: 10%;"></td> <td style="width: 10%;"></td> <td style="width: 10%;"></td> <td style="width: 10%;"></td> <td style="width: 10%;"></td> <td style="width: 10%;"></td> <td style="width: 10%;"></td> <td style="width: 10%;"></td> <td style="width: 10%;"></td> <td style="width: 10%;"></td> </tr> <tr> <td></td> <td></td> <td colspan="8" style="text-align: center;"> <table border="1" style="width: 100%; border-collapse: collapse; text-align: center;"> <tr> <td style="width: 10%;"></td> <td style="width: 10%;"></td> <td style="width: 10%;"></td> <td style="width: 10%;"></td> <td style="width: 10%;"></td> <td style="width: 10%;"></td> <td style="width: 10%;"></td> <td style="width: 10%;"></td> <td style="width: 10%;"></td> <td style="width: 10%;"></td> </tr> <tr> <td></td> <td></td> <td colspan="8" style="text-align: center;"> <table border="1" style="width: 100%; border-collapse: collapse; text-align: center;"> <tr> <td style="width: 10%;"></td> <td style="width: 10%;"></td> <td style="width: 10%;"></td> <td style="width: 10%;"></td> <td style="width: 10%;"></td> <td style="width: 10%;"></td> <td style="width: 10%;"></td> <td style="width: 10%;"></td> <td style="width: 10%;"></td> <td style="width: 10%;"></td> </tr> <tr> <td></td> <td></td> <td colspan="8" style="text-align: center;"> <table border="1" style="width: 100%; border-collapse: collapse; text-align: center;"> <tr> <td style="width: 10%;"></td> <td style="width: 10%;"></td> <td style="width: 10%;"></td> <td style="width: 10%;"></td> <td style="width: 10%;"></td> <td style="width: 10%;"></td> <td style="width: 10%;"></td> <td style="width: 10%;"></td> <td style="width: 10%;"></td> <td style="width: 10%;"></td> </tr> <tr> <td></td> <td></td> <td colspan="8" style="text-align: center;"> <table border="1" style="width: 100%; border-collapse: collapse; text-align: center;"> <tr> <td style="width: 10%;"></td> <td style="width: 10%;"></td> <td style="width: 10%;"></td> <td style="width: 10%;"></td> <td style="width: 10%;"></td> <td style="width: 10%;"></td> <td style="width: 10%;"></td> <td style="width: 10%;"></td> <td style="width: 10%;"></td> <td style="width: 10%;"></td> </tr> <tr> <td></td> <td></td> <td colspan="8" style="text-align: center;"> <table border="1" style="width: 100%; border-collapse: collapse; text-align: center;"> <tr> <td style="width: 10%;"></td> <td style="width: 10%;"></td> <td style="width: 10%;"></td> <td style="width: 10%;"></td> <td style="width: 10%;"></td> <td style="width: 10%;"></td> <td style="width: 10%;"></td> <td style="width: 10%;"></td> <td style="width: 10%;"></td> <td style="width: 10%;"></td> </tr> <tr> <td></td> <td></td> <td colspan="8" style="text-align: center;"> <table border="1" style="width: 100%; border-collapse: collapse; text-align: center;"> <tr> <td style="width: 10%;"></td> <td style="width: 10%;"></td> <td style="width: 10%;"></td> <td style="width: 10%;"></td> <td style="width: 10%;"></td> <td style="width: 10%;"></td> <td style="width: 10%;"></td> <td style="width: 10%;"></td> <td style="width: 10%;"></td> <td style="width: 10%;"></td> </tr> <tr> <td></td> <td></td> <td colspan="8" style="text-align: center;"> <table border="1" style="width: 100%; border-collapse: collapse; text-align: center;"> <tr> <td style="width: 10%;"></td> <td style="width: 10%;"></td> <td style="width: 10%;"></td> <td style="width: 10%;"></td> <td style="width: 10%;"></td> <td style="width:
10%;"></td> <td style="width: 10%;"></td> <td style="width: 10%;"></td> <td style="width: 10%;"></td> <td style="width: 10%;"></td> </tr> <tr> <td></td> <td></td> <td colspan="8" style="text-align: center;"> <table border="1" style="width: 100%; border-collapse: collapse; text-align: center;"> <tr> <td style="width: 10%;"></td> <td style="width: 10%;"></td> <td style="width: 10%;"></td> <td style="width: 10%;"></td> <td style="width: 10%;"></td> <td style="width: 10%;"></td> <td style="width: 10%;"></td> <td style="width: 10%;"></td> <td style="width: 10%;"></td> <td style="width: 10%;"></td> </tr> <tr> <td></td> <td></td> <td colspan="8" style="text-align: center;"> <table border="1" style="width: 100%; border-collapse: collapse; text-align: center;"> <tr> <td style="width: 10%;"></td> <td style="width: 10%;"></td> <td style="width: 10%;"></td> <td style="width: 10%;"></td> <td style="width: 10%;"></td> <td style="width: 10%;"></td> <td style="width: 10%;"></td> <td style="width: 10%;"></td> <td style="width: 10%;"></td> <td style="width: 10%;"></td> </tr> <tr> <td></td> <td></td> <td colspan="8" style="text-align: center;"> <table border="1" style="width: 100%; border-collapse: collapse; text-align: center;"> <tr> <td style="width: 10%;"></td> <td style="width: 10%;"></td> <td style="width: 10%;"></td> <td style="width: 10%;"></td> <td style="width: 10%;"></td> <td style="width: 10%;"></td> <td style="width: 10%;"></td> <td style="width: 10%;"></td> <td style="width: 10%;"></td> <td style="width: 10%;"></td> </tr> <tr> <td></td> <td></td> <td colspan="8" style="text-align: center;"> <table border="1" style="width: 100%; border-collapse: collapse; text-align: center;"> <tr> <td style="width: 10%;"></td> <td style="width: 10%;"></td> <td style="width: 10%;"></td> <td style="width: 10%;"></td> <td style="width: 10%;"></td> <td style="width: 10%;"></td> <td style="width: 10%;"></td> <td style="width: 10%;"></td> <td style="width: 10%;"></td> <td style="width: 10%;"></td> </tr> <tr> <td></td> <td></td> <td colspan="8" style="text-align: center;"> <table border="1" style="width: 100%; border-collapse: collapse; text-align: center;"> <tr> <td style="width: 10%;"></td> <td style="width: 10%;"></td> <td style="width: 10%;"></td> <td style="width: 10%;"></td> <td style="width: 10%;"></td> <td style="width: 10%;"></td> <td style="width: 10%;"></td> <td style="width: 10%;"></td> <td style="width: 10%;"></td> <td style="width: 10%;"></td> </tr> <tr> <td></td> <td></td> <td colspan="8" style="text-align: center;"> <table border="1" style="width: 100%; border-collapse: collapse; text-align: center;"> <tr> <td style="width: 10%;"></td> <td style="width: 10%;"></td> <td style="width: 10%;"></td> <td style="width: 10%;"></td> <td style="width: 10%;"></td> <td style="width: 10%;"></td> <td style="width: 10%;"></td> <td style="width: 10%;"></td> <td style="width: 10%;"></td> <td style="width: 10%;"></td> </tr> <tr> <td></td> <td></td> <td colspan="8" style="text-align: center;"> <table border="1" style="width: 100%; border-collapse: collapse; text-align: center;"> <tr> <td style="width: 10%;"></td> <td style="width: 10%;"></td> <td style="width: 10%;"></td> <td style="width: 10%;"></td> <td style="width: 10%;"></td> <td style="width: 10%;"></td> <td style="width: 10%;"></td> <td style="width: 10%;"></td> <td style="width: 10%;"></td> <td style="width: 10%;"></td> </tr> <tr> <td></td> <td></td> <td colspan="8" style="text-align: center;"> <table border="1" style="width: 100%; border-collapse: collapse; text-align: center;"> <tr> <td style="width: 10%;"></td> <td style="width: 10%;"></td> <td style="width: 10%;"></td> <td style="width: 10%;"></td> <td style="width: 10%;"></td> <td style="width: 10%;"></td> <td style="width: 10%;"></td> <td style="width: 10%;"></td> <td style="width: 10%;"></td> <td style="width: 10%;"></td> </tr> <tr> <td></td> <td></td> <td colspan="8" style="text-align: center;"> <table border="1" style="width: 100%; border-collapse: collapse; text-align: center;"> <tr> <td style="width: 10%;"></td> <td style="width: 10%;"></td> <td style="width: 10%;"></td> <td style="width: 10%;"></td> <td style="width: 10%;"></td> <td style="width: 10%;"></td> <td style="width: 10%;"></td> <td style="width: 10%;"></td> <td style="width: 10%;"></td> <td style="width: 10%;"></td> </tr> <tr> <td></td> <td></td> <td colspan="8" style="text-align: center;"> <table border="1" style="width: 100%; border-collapse: collapse; text-align: center;"> <tr> <td style="width: 10%;"></td> <td style="width: 10%;"></td> <td style="width: 10%;"></td> <td style="width: 10%;"></td> <td style="width: 10%;"></td> <td style="width: 10%;"></td> <td style="width: 10%;"></td> <td style="width: 10%;"></td> <td style="width: 10%;"></td> <td style="width: 10%;"></td> </tr> <tr> <td></td> <td></td> <td colspan="8" style="text-align: center;"> <table border="1" style="width: 100%; border-collapse: collapse; text-align: center;"> <tr> <td style="width: 10%;"></td> <td style="width: 10%;"></td> <td style="width: 10%;"></td> <td style="width: 10%;"></td> <td style="width: 10%;"></td> <td style="width: 10%;"></td> <td style="width: 10%;"></td> <td style="width: 10%;"></td> <td style="width: 10%;"></td> <td style="width: 10%;"></td> </tr> <tr> <td></td> <td></td> <td colspan="8" style="text-align: center;"> <table border="1" style="width: 100%; border-collapse: collapse; text-align: center;"> <tr> <td style="width: 10%;"></td> <td style="width: 10%;"></td> <td style="width: 10%;"></td> <td style="width: 10%;"></td> <td style="width: 10%;"></td> <td style="width: 10%;"></td> <td style="width: 10%;"></td> <td style="width: 10%;"></td> <td style="width: 10%;"></td> <td style="width: 10%;"></td> </tr> <tr> <td></td> <td></td> <td colspan="8" style="text-align: center;"> <table border="1" style="width: 100%; border-collapse: collapse; text-align: center;"> <tr> <td style="width: 10%;"></td> <td style="width: 10%;"></td> <td style="width: 10%;"></td> <td style="width: 10%;"></td> <td style="width: 10%;"></td> <td style="width: 10%;"></td> <td style="width: 10%;"></td> <td style="width: 10%;"></td> <td style="width: 10%;"></td> <td style="width: 10%;"></td> </tr> <tr> <td></td> <td></td> <td colspan="8" style="text-align: center;"> <table border="1" style="width: 100%; border-collapse: collapse; text-align: center;"> <tr> <td style="width: 10%;"></td> <td style="width: 10%;"></td> <td style="width: 10%;"></td> <td style="width: 10%;"></td> <td style="width: 10%;"></td> <td style="width: 10%;"></td> <td style="width: 10%;"></td> <td style="width: 10%;"></td> <td style="width: 10%;"></td> <td style="width: 10%;"></td> </tr> <tr> <td></td> <td></td> <td colspan="8" style="text-align: center;"> <table border="1" style="width: 100%; border-collapse: collapse; text-align: center;"> <tr> <td style="width: 10%;"></td> <td style="width: 10%;"></td> <td style="width: 10%;"></td> <td style="width: 10%;"></td> <td style="width: 10%;"></td> <td style="width: 10%;"></td> <td style="width: 10%;"></td> <td style="width: 10%;"></td> <td style="width: 10%;"></td> <td style="width: 10%;"></td> </tr> <tr> <td></td> <td></td> <td colspan="8" style="text-align: center;"> <table border="1" style="width: 100%; border-collapse: collapse; text-align: center;"> <tr> <td style="width: 10%;"></td> <td style="width: 10%;"></td> <td style="width: 10%;"></td> <td style="width: 10%;"></td> <td style="width: 10%;"></td> <td style="width: 10%;"></td> <td style="width: 10%;"></td> <td style="width: 10%;"></td> <td style="width: 10%;"></td> <td style="width: 10%;"></td> </tr> <tr> <td></td> <td></td> <td colspan="8" style="text-align: center;"> <table border="1" style="width: 100%; border-collapse: collapse; text-align: center;"> <tr> <td style="width: 10%;"></td> <td style="width: 10%;"></td> <td style="width: 10%;"></td> <td style="width: 10%;"></td> <td style="width: 10%;"></td> <td style="width: 10%;"></td> <td style="width: 10%;"></td> <td style="width: 10%;"></td> <td style="width: 10%;"></td> <td style="width: 10%;"></td> </tr> <tr> <td></td> <td></td> <td colspan="8" style="text-align: center;"> <table border="1" style="width: 100%; border-collapse: collapse; text-align: center;"> <tr> <td style="width: 10%;"></td> <td style="width: 10%;"></td> <td style="width: 10%;"></td> <td style="width: 10%;"></td> <td style="width: 10%;"></td> <td style="width: 10%;"></td> <td style="width: 10%;"></td> <td style="width: 10%;"></td> <td style="width: 10%;"></td> <td style="width: 10%;"></td> </tr> <tr> <td></td> <td></td> <td colspan="8" style="text-align: center;"> <table border="1" style="width: 100%; border-collapse: collapse; text-align: center;"> <tr> <td style="width: 10%;"></td> <td style="width: 10%;"></td> <td style="width: 10%;"></td> <td style="width: 10%;"></td> <td style="width: 10%;"></td> <td style="width: 10%;"></td> <td style="width: 10%;"></td> <td style="width: 10%;"></td> <td style="width: 10%;"></td> <td style="width: 10%;"></td> </tr> <tr> <td></td> <td></td> <td colspan="8" style="text-align: center;"> <table border="1" style="width: 100%; border-collapse: collapse; text-align: center;"> <tr> <td style="width: 10%;"></td> <td style="width: 10%;"></td> <td style="width: 10%;"></td> <td style="width: 10%;"></td> <td style="width: 10%;"></td> <td style="width: 10%;"></td> <td style="width: 10%;"></td> <td style="width: 10%;"></td> <td style="width: 10%;"></td> <td style="width: 10%;"></td> </tr> <tr> <td></td> <td></td> <td colspan="8" style="text-align: center;"> <table border="1" style="width: 100%; border-collapse: collapse; text-align: center;"> <tr> <td style="width: 10%;"></td> <td style="width: 10%;"></td> <td style="width: 10%;"></td> <td style="width: 10%;"></td> <td style="width: 10%;"></td> <td style="width: 10%;"></td> <td style="width: 10%;"></td> <td style="width: 10%;"></td> <td style="width: 10%;"></td> <td style="width: 10%;"></td> </tr> <tr> <td></td> <td></td> <td
colspan="8" style="text-align: center;"> <table border="1" style="width: 100%; border-collapse: collapse; text-align: center;"> <tr> <td style="width: 10%;"></td> <td style="width: 10%;"></td> <td style="width: 10%;"></td> <td style="width: 10%;"></td> <td style="width: 10%;"></td> <td style="width: 10%;"></td> <td style="width: 10%;"></td> <td style="width: 10%;"></td> <td style="width: 10%;"></td> <td style="width: 10%;"></td> </tr> <tr> <td></td> <td></td> <td colspan="8" style="text-align: center;"> <table border="1" style="width: 100%; border-collapse: collapse; text-align: center;"> <tr> <td style="width: 10%;"></td> <td style="width: 10%;"></td> <td style="width: 10%;"></td> <td style="width: 10%;"></td> <td style="width: 10%;"></td> <td style="width: 10%;"></td> <td style="width: 10%;"></td> <td style="width: 10%;"></td> <td style="width: 10%;"></td> <td style="width: 10%;"></td> </tr> <tr> <td></td> <td></td> <td colspan="8" style="text-align: center;"> <table border="1" style="width: 100%; border-collapse: collapse; text-align: center;"> <tr> <td style="width: 10%;"></td> <td style="width: 10%;"></td> <td style="width: 10%;"></td> <td style="width: 10%;"></td> <td style="width: 10%;"></td> <td style="width: 10%;"></td> <td style="width: 10%;"></td> <td style="width: 10%;"></td> <td style="width: 10%;"></td> <td style="width: 10%;"></td> </tr> <tr> <td></td> <td></td> <td colspan="8" style="text-align: center;"> <table border="1" style="width: 100%; border-collapse: collapse; text-align: center;"> <tr> <td style="width: 10%;"></td> <td style="width: 10%;"></td> <td style="width: 10%;"></td> <td style="width: 10%;"></td> <td style="width: 10%;"></td> <td style="width: 10%;"></td> <td style="width: 10%;"></td> <td style="width: 10%;"></td> <td style="width: 10%;"></td> <td style="width: 10%;"></td> </tr> <tr> <td></td> <td></td> <td colspan="8" style="text-align: center;"> <table border="1" style="width: 100%; border-collapse: collapse; text-align: center;"> <tr> <td style="width: 10%;"></td> <td style="width: 10%;"></td> <td style="width: 10%;"></td> <td style="width: 10%;"></td> <td style="width: 10%;"></td> <td style="width: 10%;"></td> <td style="width: 10%;"></td> <td style="width: 10%;"></td> <td style="width: 10%;"></td> <td style="width: 10%;"></td> </tr> <tr> <td></td> <td></td> <td colspan="8" style="text-align: center;"> <table border="1" style="width: 100%; border-collapse: collapse; text-align: center;"> <tr> <td style="width: 10%;"></td> <td style="width: 10%;"></td> <td style="width: 10%;"></td> <td style="width: 10%;"></td> <td style="width: 10%;"></td> <td style="width: 10%;"></td> <td style="width: 10%;"></td> <td style="width: 10%;"></td> <td style="width: 10%;"></td> <td style="width: 10%;"></td> </tr> <tr> <td></td> <td></td> <td colspan="8" style="text-align: center;"> <table border="1" style="width: 100%; border-collapse: collapse; text-align: center;"> <tr> <td style="width: 10%;"></td> <td style="width: 10%;"></td> <td style="width: 10%;"></td> <td style="width: 10%;"></td> <td style="width: 10%;"></td> <td style="width: 10%;"></td> <td style="width: 10%;"></td> <td style="width: 10%;"></td> <td style="width: 10%;"></td> <td style="width: 10%;"></td> </tr> <tr> <td></td> <td></td> <td colspan="8" style="text-align: center;"> <table border="1" style="width: 100%; border-collapse: collapse; text-align: center;"> <tr> <td style="width: 10%;"></td> <td style="width: 10%;"></td> <td style="width: 10%;"></td> <td style="width: 10%;"></td> <td style="width: 10%;"></td> <td style="width: 10%;"></td> <td style="width: 10%;"></td> <td style="width: 10%;"></td> <td style="width: 10%;"></td> <td style="width: 10%;"></td> </tr> <tr> <td></td> <td></td> <td colspan="8" style="text-align: center;"> <table border="1" style="width: 100%; border-collapse: collapse; text-align: center;"> <tr> <td style="width: 10%;"></td> <td style="width: 10%;"></td> <td style="width: 10%;"></td> <td style="width: 10%;"></td> <td style="width: 10%;"></td> <td style="width: 10%;"></td> <td style="width: 10%;"></td> <td style="width: 10%;"></td> <td style="width: 10%;"></td> <td style="width: 10%;"></td> </tr> <tr> <td></td> <td></td> <td colspan="8" style="text-align: center;"> <table border="1" style="width: 100%; border-collapse: collapse; text-align: center;"> <tr> <td style="width: 10%;"></td> <td style="width: 10%;"></td> <td style="width: 10%;"></td> <td style="width: 10%;"></td> <td style="width: 10%;"></td> <td style="width: 10%;"></td> <td style="width: 10%;"></td> <td style="width: 10%;"></td> <td style="width: 10%;"></td> <td style="width: 10%;"></td> </tr> <tr> <td></td> <td></td> <td colspan="8" style="text-align: center;"> <table border="1" style="width: 100%; border-collapse: collapse; text-align: center;"> <tr> <td style="width: 10%;"></td> <td style="width: 10%;"></td> <td style="width: 10%;"></td> <td style="width: 10%;"></td> <td style="width: 10%;"></td> <td style="width: 10%;"></td> <td style="width: 10%;"></td> <td style="width: 10%;"></td> <td style="width: 10%;"></td> <td style="width: 10%;"></td> </tr> <tr> <td></td> <td></td> <td colspan="8" style="text-align: center;"> <table border="1" style="width: 100%; border-collapse: collapse; text-align: center;"> <tr> </tr></table></td></tr></table></td></tr></table></td></tr></table></td></tr></table></td></tr></table></td></tr></table></td></tr></table></td></tr></table></td></tr></table></td></tr></table></td></tr></table></td></tr></table></td></tr></table></td></tr></table></td></tr></table></td></tr></table></td></tr></table></td></tr></table></td></tr></table></td></tr></table></td></tr></table></td></tr></table></td></tr></table></td></tr></table></td></tr></table></td></tr></table></td></tr></table></td></tr></table></td></tr></table></td></tr></table></td></tr></table></td></tr></table></td></tr></table></td></tr></table></td></tr></table></td></tr></table></td></tr></table></td></tr></table></td></tr></table></td></tr></table></td></tr></table></td></tr></table></td></tr></table></td></tr></table></td></tr></table></td></tr></table></td></tr></table></td></tr></table></td></tr></table></td></tr></table></td></tr></table>
 | | | | | | | | | | | | | | | | | | | | <table border="1" style="width: 100%; border-collapse: collapse; text-align: center;"> <tr> <td style="width: 10%;"></td> <td style="width: 10%;"></td> <td style="width: 10%;"></td> <td style="width: 10%;"></td> <td style="width: 10%;"></td> <td style="width: 10%;"></td> <td style="width: 10%;"></td> <td style="width: 10%;"></td> <td style="width: 10%;"></td> <td style="width: 10%;"></td> </tr> <tr> <td></td> <td></td> <td colspan="8" style="text-align: center;"> <table border="1" style="width: 100%; border-collapse: collapse; text-align: center;"> <tr> <td style="width: 10%;"></td> <td style="width: 10%;"></td> <td style="width: 10%;"></td> <td style="width: 10%;"></td> <td style="width: 10%;"></td> <td style="width: 10%;"></td> <td style="width: 10%;"></td> <td style="width: 10%;"></td> <td style="width: 10%;"></td> <td style="width: 10%;"></td> </tr> <tr> <td></td> <td></td> <td colspan="8" style="text-align: center;"> <table border="1" style="width: 100%; border-collapse: collapse; text-align: center;"> <tr> <td style="width: 10%;"></td> <td style="width: 10%;"></td> <td style="width: 10%;"></td> <td style="width: 10%;"></td> <td style="width: 10%;"></td> <td style="width: 10%;"></td> <td style="width: 10%;"></td> <td style="width: 10%;"></td> <td style="width: 10%;"></td> <td style="width: 10%;"></td> </tr> <tr> <td></td> <td></td> <td colspan="8" style="text-align: center;"> <table border="1" style="width: 100%; border-collapse: collapse; text-align: center;"> <tr> <td style="width: 10%;"></td> <td style="width: 10%;"></td> <td style="width: 10%;"></td> <td style="width: 10%;"></td> <td style="width: 10%;"></td> <td style="width: 10%;"></td> <td style="width: 10%;"></td> <td style="width: 10%;"></td> <td style="width: 10%;"></td> <td style="width: 10%;"></td> </tr> <tr> <td></td> <td></td> <td colspan="8" style="text-align: center;"> <table border="1" style="width: 100%; border-collapse: collapse; text-align: center;"> <tr> <td style="width: 10%;"></td> <td style="width: 10%;"></td> <td style="width: 10%;"></td> <td style="width: 10%;"></td> <td style="width: 10%;"></td> <td style="width: 10%;"></td> <td style="width: 10%;"></td> <td style="width: 10%;"></td> <td style="width: 10%;"></td> <td style="width: 10%;"></td> </tr> <tr> <td></td> <td></td> <td colspan="8" style="text-align: center;"> <table border="1" style="width: 100%; border-collapse: collapse; text-align: center;"> <tr> <td style="width: 10%;"></td> <td style="width: 10%;"></td> <td style="width: 10%;"></td> <td style="width: 10%;"></td> <td style="width: 10%;"></td> <td style="width: 10%;"></td> <td style="width: 10%;"></td> <td style="width: 10%;"></td> <td style="width: 10%;"></td> <td style="width: 10%;"></td> </tr> <tr> <td></td> <td></td> <td colspan="8" style="text-align: center;"> <table border="1" style="width: 100%; border-collapse: collapse; text-align: center;"> <tr> <td style="width: 10%;"></td> <td style="width: 10%;"></td> <td style="width: 10%;"></td> <td style="width: 10%;"></td> <td style="width: 10%;"></td> <td style="width: 10%;"></td> <td style="width: 10%;"></td> <td style="width: 10%;"></td> <td style="width: 10%;"></td> <td style="width: 10%;"></td> </tr> <tr> <td></td> <td></td> <td colspan="8" style="text-align: center;"> <table border="1" style="width: 100%; border-collapse: collapse; text-align: center;"> <tr> <td style="width: 10%;"></td> <td style="width: 10%;"></td> <td style="width: 10%;"></td> <td style="width: 10%;"></td> <td style="width: 10%;"></td> <td style="width: 10%;"></td> <td style="width: 10%;"></td> <td style="width: 10%;"></td> <td style="width: 10%;"></td> <td style="width: 10%;"></td> </tr> <tr> <td></td> <td></td> <td colspan="8" style="text-align: center;"> <table border="1" style="width: 100%; border-collapse: collapse; text-align: center;"> <tr> <td style="width: 10%;"></td> <td style="width: 10%;"></td> <td style="width: 10%;"></td> <td style="width: 10%;"></td> <td style="width: 10%;"></td> <td style="width: 10%;"></td> <td style="width: 10%;"></td> <td style="width: 10%;"></td> <td style="width: 10%;"></td> <td style="width: 10%;"></td> </tr> <tr> <td></td> <td></td> <td colspan="8" style="text-align: center;"> <table border="1" style="width: 100%; border-collapse: collapse; text-align: center;"> <tr> <td style="width: 10%;"></td> <td style="width: 10%;"></td> <td style="width: 10%;"></td> <td style="width: 10%;"></td> <td style="width: 10%;"></td> <td style="width: 10%;"></td> <td style="width: 10%;"></td> <td style="width: 10%;"></td> <td style="width: 10%;"></td> <td style="width: 10%;"></td> </tr> <tr> <td></td> <td></td> <td colspan="8" style="text-align: center;"> <table border="1" style="width: 100%; border-collapse: collapse; text-align: center;"> <tr> <td style="width: 10%;"></td> <td style="width: 10%;"></td> <td style="width: 10%;"></td> <td style="width: 10%;"></td> <td style="width: 10%;"></td> <td style="width: 10%;"></td> <td style="width: 10%;"></td> <td style="width: 10%;"></td> <td style="width: 10%;"></td> <td style="width: 10%;"></td> </tr> <tr> <td></td> <td></td> <td colspan="8" style="text-align: center;"> <table border="1" style="width: 100%; border-collapse: collapse; text-align: center;"> <tr> <td style="width: 10%;"></td> <td style="width: 10%;"></td> <td style="width: 10%;"></td> <td style="width: 10%;"></td> <td style="width: 10%;"></td> <td style="width: 10%;"></td> <td style="width: 10%;"></td> <td style="width: 10%;"></td> <td style="width: 10%;"></td> <td style="width: 10%;"></td> </tr> <tr> <td></td> <td></td> <td colspan="8" style="text-align: center;"> <table border="1" style="width: 100%; border-collapse: collapse; text-align: center;"> <tr> <td style="width: 10%;"></td> <td style="width: 10%;"></td> <td style="width: 10%;"></td> <td style="width: 10%;"></td> <td style="width: 10%;"></td> <td style="width: 10%;"></td> <td style="width: 10%;"></td> <td style="width: 10%;"></td> <td style="width: 10%;"></td> <td style="width: 10%;"></td> </tr> <tr> <td></td> <td></td> <td colspan="8" style="text-align: center;"> <table border="1" style="width: 100%; border-collapse: collapse; text-align: center;"> <tr> <td style="width: 10%;"></td> <td style="width: 10%;"></td> <td style="width: 10%;"></td> <td style="width: 10%;"></td> <td style="width: 10%;"></td> <td style="width: 10%;"></td> <td style="width: 10%;"></td> <td style="width: 10%;"></td> <td style="width: 10%;"></td> <td style="width: 10%;"></td> </tr> <tr> <td></td> <td></td> <td colspan="8" style="text-align: center;"> <table border="1" style="width: 100%; border-collapse: collapse; text-align: center;"> <tr> <td style="width: 10%;"></td> <td style="width: 10%;"></td> <td style="width: 10%;"></td> <td style="width: 10%;"></td> <td style="width: 10%;"></td> <td style="width: 10%;"></td> <td style="width: 10%;"></td> <td style="width: 10%;"></td> <td style="width: 10%;"></td> <td style="width: 10%;"></td> </tr> <tr> <td></td> <td></td> <td colspan="8" style="text-align: center;"> <table border="1" style="width: 100%; border-collapse: collapse; text-align: center;"> <tr> <td style="width: 10%;"></td> <td style="width: 10%;"></td> <td style="width: 10%;"></td> <td style="width: 10%;"></td> <td style="width: 10%;"></td> <td style="width: 10%;"></td> <td style="width: 10%;"></td> <td style="width: 10%;"></td> <td style="width: 10%;"></td> <td style="width: 10%;"></td> </tr> <tr> <td></td> <td></td> <td colspan="8" style="text-align: center;"> <table border="1" style="width: 100%; border-collapse: collapse; text-align: center;"> <tr> <td style="width: 10%;"></td> <td style="width: 10%;"></td> <td style="width: 10%;"></td> <td style="width: 10%;"></td> <td style="width: 10%;"></td> <td style="width: 10%;"></td> <td style="width: 10%;"></td> <td style="width: 10%;"></td> <td style="width: 10%;"></td> <td style="width: 10%;"></td> </tr> <tr>
<td></td> <td></td> <td colspan="8" style="text-align: center;"> <table border="1" style="width: 100%; border-collapse: collapse; text-align: center;"> <tr> <td style="width: 10%;"></td> <td style="width: 10%;"></td> <td style="width: 10%;"></td> <td style="width: 10%;"></td> <td style="width: 10%;"></td> <td style="width: 10%;"></td> <td style="width: 10%;"></td> <td style="width: 10%;"></td> <td style="width: 10%;"></td> <td style="width: 10%;"></td> </tr> <tr> <td></td> <td></td> <td colspan="8" style="text-align: center;"> <table border="1" style="width: 100%; border-collapse: collapse; text-align: center;"> <tr> <td style="width: 10%;"></td> <td style="width: 10%;"></td> <td style="width: 10%;"></td> <td style="width: 10%;"></td> <td style="width: 10%;"></td> <td style="width: 10%;"></td> <td style="width: 10%;"></td> <td style="width: 10%;"></td> <td style="width: 10%;"></td> <td style="width: 10%;"></td> </tr> <tr> <td></td> <td></td> <td colspan="8" style="text-align: center;"> <table border="1" style="width: 100%; border-collapse: collapse; text-align: center;"> <tr> <td style="width: 10%;"></td> <td style="width: 10%;"></td> <td style="width: 10%;"></td> <td style="width: 10%;"></td> <td style="width: 10%;"></td> <td style="width: 10%;"></td> <td style="width: 10%;"></td> <td style="width: 10%;"></td> <td style="width: 10%;"></td> <td style="width: 10%;"></td> </tr> <tr> <td></td> <td></td> <td colspan="8" style="text-align: center;"> <table border="1" style="width: 100%; border-collapse: collapse; text-align: center;"> <tr> <td style="width: 10%;"></td> <td style="width: 10%;"></td> <td style="width: 10%;"></td> <td style="width: 10%;"></td> <td style="width: 10%;"></td> <td style="width: 10%;"></td> <td style="width: 10%;"></td> <td style="width: 10%;"></td> <td style="width: 10%;"></td> <td style="width: 10%;"></td> </tr> <tr> <td></td> <td></td> <td colspan="8" style="text-align: center;"> <table border="1" style="width: 100%; border-collapse: collapse; text-align: center;"> <tr> <td style="width: 10%;"></td> <td style="width: 10%;"></td> <td style="width: 10%;"></td> <td style="width: 10%;"></td> <td style="width: 10%;"></td> <td style="width: 10%;"></td> <td style="width: 10%;"></td> <td style="width: 10%;"></td> <td style="width: 10%;"></td> <td style="width: 10%;"></td> </tr> <tr> <td></td> <td></td> <td colspan="8" style="text-align: center;"> <table border="1" style="width: 100%; border-collapse: collapse; text-align: center;"> <tr> <td style="width: 10%;"></td> <td style="width: 10%;"></td> <td style="width: 10%;"></td> <td style="width: 10%;"></td> <td style="width: 10%;"></td> <td style="width: 10%;"></td> <td style="width: 10%;"></td> <td style="width: 10%;"></td> <td style="width: 10%;"></td> <td style="width: 10%;"></td> </tr> <tr> <td></td> <td></td> <td colspan="8" style="text-align: center;"> <table border="1" style="width: 100%; border-collapse: collapse; text-align: center;"> <tr> <td style="width: 10%;"></td> <td style="width: 10%;"></td> <td style="width: 10%;"></td> <td style="width: 10%;"></td> <td style="width: 10%;"></td> <td style="width: 10%;"></td> <td style="width: 10%;"></td> <td style="width: 10%;"></td> <td style="width: 10%;"></td> <td style="width: 10%;"></td> </tr> <tr> <td></td> <td></td> <td colspan="8" style="text-align: center;"> <table border="1" style="width: 100%; border-collapse: collapse; text-align: center;"> <tr> <td style="width: 10%;"></td> <td style="width: 10%;"></td> <td style="width: 10%;"></td> <td style="width: 10%;"></td> <td style="width: 10%;"></td> <td style="width: 10%;"></td> <td style="width: 10%;"></td> <td style="width: 10%;"></td> <td style="width: 10%;"></td> <td style="width: 10%;"></td> </tr> <tr> <td></td> <td></td> <td colspan="8" style="text-align: center;"> <table border="1" style="width: 100%; border-collapse: collapse; text-align: center;"> <tr> <td style="width: 10%;"></td> <td style="width: 10%;"></td> <td style="width: 10%;"></td> <td style="width: 10%;"></td> <td style="width: 10%;"></td> <td style="width: 10%;"></td> <td style="width: 10%;"></td> <td style="width: 10%;"></td> <td style="width: 10%;"></td> <td style="width: 10%;"></td> </tr> <tr> <td></td> <td></td> <td colspan="8" style="text-align: center;"> <table border="1" style="width: 100%; border-collapse: collapse; text-align: center;"> <tr> <td style="width: 10%;"></td> <td style="width: 10%;"></td> <td style="width: 10%;"></td> <td style="width: 10%;"></td> <td style="width: 10%;"></td> <td style="width: 10%;"></td> <td style="width: 10%;"></td> <td style="width: 10%;"></td> <td style="width: 10%;"></td> <td style="width: 10%;"></td> </tr> <tr> <td></td> <td></td> <td colspan="8" style="text-align: center;"> <table border="1" style="width: 100%; border-collapse: collapse; text-align: center;"> <tr> <td style="width: 10%;"></td> <td style="width: 10%;"></td> <td style="width: 10%;"></td> <td style="width: 10%;"></td> <td style="width: 10%;"></td> <td style="width: 10%;"></td> <td style="width: 10%;"></td> <td style="width: 10%;"></td> <td style="width: 10%;"></td> <td style="width: 10%;"></td> </tr> <tr> <td></td> <td></td> <td colspan="8" style="text-align: center;"> <table border="1" style="width: 100%; border-collapse: collapse; text-align: center;"> <tr> <td style="width: 10%;"></td> <td style="width: 10%;"></td> <td style="width: 10%;"></td> <td style="width: 10%;"></td> <td style="width: 10%;"></td> <td style="width: 10%;"></td> <td style="width: 10%;"></td> <td style="width: 10%;"></td> <td style="width: 10%;"></td> <td style="width: 10%;"></td> </tr> <tr> <td></td> <td></td> <td colspan="8" style="text-align: center;"> <table border="1" style="width: 100%; border-collapse: collapse; text-align: center;"> <tr> <td style="width: 10%;"></td> <td style="width: 10%;"></td> <td style="width: 10%;"></td> <td style="width: 10%;"></td> <td style="width: 10%;"></td> <td style="width: 10%;"></td> <td style="width: 10%;"></td> <td style="width: 10%;"></td> <td style="width: 10%;"></td> <td style="width: 10%;"></td> </tr> <tr> <td></td> <td></td> <td colspan="8" style="text-align: center;"> <table border="1" style="width: 100%; border-collapse: collapse; text-align: center;"> <tr> <td style="width: 10%;"></td> <td style="width: 10%;"></td> <td style="width: 10%;"></td> <td style="width: 10%;"></td> <td style="width: 10%;"></td> <td style="width: 10%;"></td> <td style="width: 10%;"></td> <td style="width: 10%;"></td> <td style="width: 10%;"></td> <td style="width: 10%;"></td> </tr> <tr> <td></td> <td></td> <td colspan="8" style="text-align: center;"> <table border="1" style="width: 100%; border-collapse: collapse; text-align: center;"> <tr> <td style="width: 10%;"></td> <td style="width: 10%;"></td> <td style="width: 10%;"></td> <td style="width: 10%;"></td> <td style="width: 10%;"></td> <td style="width: 10%;"></td> <td style="width: 10%;"></td> <td style="width: 10%;"></td> <td style="width: 10%;"></td> <td style="width: 10%;"></td> </tr> <tr> <td></td> <td></td> <td colspan="8" style="text-align: center;"> <table border="1" style="width: 100%; border-collapse: collapse; text-align: center;"> <tr> <td style="width: 10%;"></td> <td style="width: 10%;"></td> <td style="width: 10%;"></td> <td style="width: 10%;"></td> <td style="width: 10%;"></td> <td style="width: 10%;"></td> <td style="width: 10%;"></td> <td style="width: 10%;"></td> <td style="width: 10%;"></td> <td style="width: 10%;"></td> </tr> <tr> <td></td> <td></td> <td colspan="8" style="text-align: center;"> <table border="1" style="width: 100%; border-collapse: collapse; text-align: center;"> <tr> <td style="width: 10%;"></td> <td style="width: 10%;"></td> <td style="width: 10%;"></td> <td style="width: 10%;"></td> <td style="width: 10%;"></td> <td style="width: 10%;"></td> <td style="width: 10%;"></td> <td style="width: 10%;"></td> <td style="width: 10%;"></td> <td style="width: 10%;"></td> </tr> <tr> <td></td> <td></td> <td colspan="8" style="text-align: center;"> <table border="1" style="width: 100%; border-collapse: collapse; text-align: center;"> <tr> <td style="width: 10%;"></td> <td style="width: 10%;"></td> <td style="width: 10%;"></td> <td style="width: 10%;"></td> <td style="width: 10%;"></td> <td style="width: 10%;"></td> <td style="width: 10%;"></td> <td style="width: 10%;"></td> <td style="width: 10%;"></td> <td style="width: 10%;"></td> </tr> <tr> <td></td> <td></td> <td colspan="8" style="text-align: center;"> <table border="1" style="width: 100%; border-collapse: collapse; text-align: center;"> <tr> <td style="width: 10%;"></td> <td style="width: 10%;"></td> <td style="width: 10%;"></td> <td style="width: 10%;"></td> <td style="width: 10%;"></td> <td style="width: 10%;"></td> <td style="width: 10%;"></td> <td style="width: 10%;"></td> <td style="width: 10%;"></td> <td style="width: 10%;"></td> </tr> <tr> <td></td> <td></td> <td colspan="8" style="text-align: center;"> <table border="1" style="width: 100%; border-collapse: collapse; text-align: center;"> <tr> <td style="width: 10%;"></td> <td style="width: 10%;"></td> <td style="width: 10%;"></td> <td style="width: 10%;"></td> <td style="width: 10%;"></td> <td style="width: 10%;"></td> <td style="width: 10%;"></td> <td style="width: 10%;"></td> <td style="width: 10%;"></td> <td style="width: 10%;"></td> </tr> <tr> <td></td> <td></td> <td colspan="8" style="text-align: center;"> <table border="1" style="width: 100%; border-collapse: collapse; text-align: center;"> <tr> <td style="width: 10%;"></td> <td style="width: 10%;"></td> <td style="width: 10%;"></td> <td style="width: 10%;"></td> <td style="width: 10%;"></td> <td style="width: 10%;"></td> <td style="width: 10%;"></td> <td style="width: 10%;"></td> <td style="width: 10%;"></td> <td style="width: 10%;"></td> </tr> <tr> <td></td> <td></td> <td colspan="8" style="text-align: center;"> <table border="1" style="width: 100%; border-collapse: collapse; text-align: center;"> <tr> <td
style="width: 10%;"></td> <td style="width: 10%;"></td> <td style="width: 10%;"></td> <td style="width: 10%;"></td> <td style="width: 10%;"></td> <td style="width: 10%;"></td> <td style="width: 10%;"></td> <td style="width: 10%;"></td> <td style="width: 10%;"></td> <td style="width: 10%;"></td> </tr> <tr> <td></td> <td></td> <td colspan="8" style="text-align: center;"> <table border="1" style="width: 100%; border-collapse: collapse; text-align: center;"> <tr> <td style="width: 10%;"></td> <td style="width: 10%;"></td> <td style="width: 10%;"></td> <td style="width: 10%;"></td> <td style="width: 10%;"></td> <td style="width: 10%;"></td> <td style="width: 10%;"></td> <td style="width: 10%;"></td> <td style="width: 10%;"></td> <td style="width: 10%;"></td> </tr> <tr> <td></td> <td></td> <td colspan="8" style="text-align: center;"> <table border="1" style="width: 100%; border-collapse: collapse; text-align: center;"> <tr> <td style="width: 10%;"></td> <td style="width: 10%;"></td> <td style="width: 10%;"></td> <td style="width: 10%;"></td> <td style="width: 10%;"></td> <td style="width: 10%;"></td> <td style="width: 10%;"></td> <td style="width: 10%;"></td> <td style="width: 10%;"></td> <td style="width: 10%;"></td> </tr> <tr> <td></td> <td></td> <td colspan="8" style="text-align: center;"> <table border="1" style="width: 100%; border-collapse: collapse; text-align: center;"> <tr> <td style="width: 10%;"></td> <td style="width: 10%;"></td> <td style="width: 10%;"></td> <td style="width: 10%;"></td> <td style="width: 10%;"></td> <td style="width: 10%;"></td> <td style="width: 10%;"></td> <td style="width: 10%;"></td> <td style="width: 10%;"></td> <td style="width: 10%;"></td> </tr> <tr> <td></td> <td></td> <td colspan="8" style="text-align: center;"> <table border="1" style="width: 100%; border-collapse: collapse; text-align: center;"> <tr> <td style="width: 10%;"></td> <td style="width: 10%;"></td> <td style="width: 10%;"></td> <td style="width: 10%;"></td> <td style="width: 10%;"></td> <td style="width: 10%;"></td> <td style="width: 10%;"></td> <td style="width: 10%;"></td> <td style="width: 10%;"></td> <td style="width: 10%;"></td> </tr> <tr> <td></td> <td></td> <td colspan="8" style="text-align: center;"> <table border="1" style="width: 100%; border-collapse: collapse; text-align: center;"> <tr> <td style="width: 10%;"></td> <td style="width: 10%;"></td> <td style="width: 10%;"></td> <td style="width: 10%;"></td> <td style="width: 10%;"></td> <td style="width: 10%;"></td> <td style="width: 10%;"></td> <td style="width: 10%;"></td> <td style="width: 10%;"></td> <td style="width: 10%;"></td> </tr> <tr> <td></td> <td></td> <td colspan="8" style="text-align: center;"> <table border="1" style="width: 100%; border-collapse: collapse; text-align: center;"> <tr> <td style="width: 10%;"></td> <td style="width: 10%;"></td> <td style="width: 10%;"></td> <td style="width: 10%;"></td> <td style="width: 10%;"></td> <td style="width: 10%;"></td> <td style="width: 10%;"></td> <td style="width: 10%;"></td> <td style="width: 10%;"></td> <td style="width: 10%;"></td> </tr> <tr> <td></td> <td></td> <td colspan="8" style="text-align: center;"> <table border="1" style="width: 100%; border-collapse: collapse; text-align: center;"> <tr> <td style="width: 10%;"></td> <td style="width: 10%;"></td> <td style="width: 10%;"></td> <td style="width: 10%;"></td> <td style="width: 10%;"></td> <td style="width: 10%;"></td> <td style="width: 10%;"></td> <td style="width: 10%;"></td> <td style="width: 10%;"></td> <td style="width: 10%;"></td> </tr> <tr> <td></td> <td></td> <td colspan="8" style="text-align: center;"> <table border="1" style="width: 100%; border-collapse: collapse; text-align: center;"> <tr> <td style="width: 10%;"></td> <td style="width: 10%;"></td> <td style="width: 10%;"></td> <td style="width: 10%;"></td> <td style="width: 10%;"></td> <td style="width: 10%;"></td> <td style="width: 10%;"></td> <td style="width: 10%;"></td> <td style="width: 10%;"></td> <td style="width: 10%;"></td> </tr> <tr> <td></td> <td></td> <td colspan="8" style="text-align: center;"> <table border="1" style="width: 100%; border-collapse: collapse; text-align: center;"> <tr> <td style="width: 10%;"></td> <td style="width: 10%;"></td> <td style="width: 10%;"></td> <td style="width: 10%;"></td> <td style="width: 10%;"></td> <td style="width: 10%;"></td> <td style="width: 10%;"></td> <td style="width: 10%;"></td> <td style="width: 10%;"></td> <td style="width: 10%;"></td> </tr> <tr> <td></td> <td></td> <td colspan="8" style="text-align: center;"> <table border="1" style="width: 100%; border-collapse: collapse; text-align: center;"> <tr> <td style="width: 10%;"></td> <td style="width: 10%;"></td> <td style="width: 10%;"></td> <td style="width: 10%;"></td> <td style="width: 10%;"></td> <td style="width: 10%;"></td> <td style="width: 10%;"></td> <td style="width: 10%;"></td> <td style="width: 10%;"></td> <td style="width: 10%;"></td> </tr> <tr> <td></td> <td></td> <td colspan="8" style="text-align: center;"> <table border="1" style="width: 100%; border-collapse: collapse; text-align: center;"> <tr> <td style="width: 10%;"></td> <td style="width: 10%;"></td> <td style="width: 10%;"></td> <td style="width: 10%;"></td> <td style="width: 10%;"></td> <td style="width: 10%;"></td> <td style="width: 10%;"></td> <td style="width: 10%;"></td> <td style="width: 10%;"></td> <td style="width: 10%;"></td> </tr> <tr> <td></td> <td></td> <td colspan="8" style="text-align: center;"> <table border="1" style="width: 100%; border-collapse: collapse; text-align: center;"> <tr> </tr></table></td></tr></table></td></tr></table></td></tr></table></td></tr></table></td></tr></table></td></tr></table></td></tr></table></td></tr></table></td></tr></table></td></tr></table></td></tr></table></td></tr></table></td></tr></table></td></tr></table></td></tr></table></td></tr></table></td></tr></table></td></tr></table></td></tr></table></td></tr></table></td></tr></table></td></tr></table></td></tr></table></td></tr></table></td></tr></table></td></tr></table></td></tr></table></td></tr></table></td></tr></table></td></tr></table></td></tr></table></td></tr></table></td></tr></table></td></tr></table></td></tr></table></td></tr></table></td></tr></table></td></tr></table></td></tr></table></td></tr></table></td></tr></table></td></tr></table></td></tr></table></td></tr></table></td></tr></table></td></tr></table></td></tr></table></td></tr></table></td></tr></table></td></tr></table>
 | | | | | | | | | | | | | | | | | | | | <table border="1" style="width: 100%; border-collapse: collapse; text-align: center;"> <tr> <td style="width: 10%;"></td> <td style="width: 10%;"></td> <td style="width: 10%;"></td> <td style="width: 10%;"></td> <td style="width: 10%;"></td> <td style="width: 10%;"></td> <td style="width: 10%;"></td> <td style="width: 10%;"></td> <td style="width: 10%;"></td> <td style="width: 10%;"></td> </tr> <tr> <td></td> <td></td> <td colspan="8" style="text-align: center;"> <table border="1" style="width: 100%; border-collapse: collapse; text-align: center;"> <tr> <td style="width: 10%;"></td> <td style="width: 10%;"></td> <td style="width: 10%;"></td> <td style="width: 10%;"></td> <td style="width: 10%;"></td> <td style="width: 10%;"></td> <td style="width: 10%;"></td> <td style="width: 10%;"></td> <td style="width: 10%;"></td> <td style="width: 10%;"></td> </tr> <tr> <td></td> <td></td> <td colspan="8" style="text-align: center;"> <table border="1" style="width: 100%; border-collapse: collapse; text-align: center;"> <tr> <td style="width: 10%;"></td> <td style="width: 10%;"></td> <td style="width: 10%;"></td> <td style="width: 10%;"></td> <td style="width: 10%;"></td> <td style="width: 10%;"></td> <td style="width: 10%;"></td> <td style="width: 10%;"></td> <td style="width: 10%;"></td> <td style="width: 10%;"></td> </tr> <tr> <td></td> <td></td> <td colspan="8" style="text-align: center;"> <table border="1" style="width: 100%; border-collapse: collapse; text-align: center;"> <tr> <td style="width: 10%;"></td> <td style="width: 10%;"></td> <td style="width: 10%;"></td> <td style="width: 10%;"></td> <td style="width: 10%;"></td> <td style="width: 10%;"></td> <td style="width: 10%;"></td> <td style="width: 10%;"></td> <td style="width: 10%;"></td> <td style="width: 10%;"></td> </tr> <tr> <td></td> <td></td> <td colspan="8" style="text-align: center;"> <table border="1" style="width: 100%; border-collapse: collapse; text-align: center;"> <tr> <td style="width: 10%;"></td> <td style="width: 10%;"></td> <td style="width: 10%;"></td> <td style="width: 10%;"></td> <td style="width: 10%;"></td> <td style="width: 10%;"></td> <td style="width: 10%;"></td> <td style="width: 10%;"></td> <td style="width: 10%;"></td> <td style="width: 10%;"></td> </tr> <tr> <td></td> <td></td> <td colspan="8" style="text-align: center;"> <table border="1" style="width: 100%; border-collapse: collapse; text-align: center;"> <tr> <td style="width: 10%;"></td> <td style="width: 10%;"></td> <td style="width: 10%;"></td> <td style="width: 10%;"></td> <td style="width: 10%;"></td> <td style="width: 10%;"></td> <td style="width: 10%;"></td> <td style="width: 10%;"></td> <td style="width: 10%;"></td> <td style="width: 10%;"></td> </tr> <tr> <td></td> <td></td> <td colspan="8" style="text-align: center;"> <table border="1" style="width: 100%; border-collapse: collapse; text-align: center;"> <tr> <td style="width: 10%;"></td> <td style="width: 10%;"></td> <td style="width: 10%;"></td> <td style="width: 10%;"></td> <td style="width: 10%;"></td> <td style="width: 10%;"></td> <td style="width: 10%;"></td> <td style="width: 10%;"></td> <td style="width: 10%;"></td> <td style="width: 10%;"></td> </tr> <tr> <td></td> <td></td> <td colspan="8" style="text-align: center;"> <table border="1" style="width: 100%; border-collapse: collapse; text-align: center;"> <tr> <td style="width: 10%;"></td> <td style="width: 10%;"></td> <td style="width: 10%;"></td> <td style="width: 10%;"></td> <td style="width: 10%;"></td> <td style="width: 10%;"></td> <td style="width: 10%;"></td> <td style="width: 10%;"></td> <td style="width: 10%;"></td> <td style="width: 10%;"></td> </tr> <tr> <td></td> <td></td> <td colspan="8" style="text-align: center;"> <table border="1" style="width: 100%; border-collapse: collapse; text-align: center;"> <tr> <td style="width: 10%;"></td> <td style="width: 10%;"></td> <td style="width: 10%;"></td> <td style="width: 10%;"></td> <td style="width: 10%;"></td> <td style="width: 10%;"></td> <td style="width: 10%;"></td> <td style="width: 10%;"></td> <td style="width: 10%;"></td> <td style="width: 10%;"></td> </tr> <tr> <td></td> <td></td> <td colspan="8" style="text-align: center;"> <table border="1" style="width: 100%; border-collapse: collapse; text-align: center;"> <tr> <td style="width: 10%;"></td> <td style="width: 10%;"></td> <td style="width: 10%;"></td> <td style="width: 10%;"></td> <td style="width: 10%;"></td> <td style="width: 10%;"></td> <td style="width: 10%;"></td> <td style="width: 10%;"></td> <td style="width: 10%;"></td> <td style="width: 10%;"></td> </tr> <tr> <td></td> <td></td> <td colspan="8" style="text-align: center;"> <table border="1" style="width: 100%; border-collapse: collapse; text-align: center;"> <tr> <td style="width: 10%;"></td> <td style="width: 10%;"></td> <td style="width: 10%;"></td> <td style="width: 10%;"></td> <td style="width: 10%;"></td> <td style="width: 10%;"></td> <td style="width: 10%;"></td> <td style="width: 10%;"></td> <td style="width: 10%;"></td> <td style="width: 10%;"></td> </tr> <tr> <td></td> <td></td> <td colspan="8" style="text-align: center;"> <table border="1" style="width: 100%; border-collapse: collapse; text-align: center;"> <tr> <td style="width: 10%;"></td> <td style="width: 10%;"></td> <td style="width: 10%;"></td> <td style="width: 10%;"></td> <td style="width: 10%;"></td> <td style="width: 10%;"></td> <td style="width: 10%;"></td> <td style="width: 10%;"></td> <td style="width: 10%;"></td> <td style="width: 10%;"></td> </tr> <tr> <td></td> <td></td> <td colspan="8" style="text-align: center;"> <table border="1" style="width: 100%; border-collapse: collapse; text-align: center;"> <tr> <td style="width: 10%;"></td> <td style="width: 10%;"></td> <td style="width: 10%;"></td> <td style="width: 10%;"></td> <td style="width: 10%;"></td> <td style="width: 10%;"></td> <td style="width: 10%;"></td> <td style="width: 10%;"></td> <td style="width: 10%;"></td> <td style="width: 10%;"></td> </tr> <tr> <td></td> <td></td> <td colspan="8" style="text-align: center;"> <table border="1" style="width: 100%; border-collapse: collapse; text-align: center;"> <tr> <td style="width: 10%;"></td> <td style="width: 10%;"></td> <td style="width: 10%;"></td> <td style="width: 10%;"></td> <td style="width: 10%;"></td> <td style="width: 10%;"></td> <td style="width: 10%;"></td> <td style="width: 10%;"></td> <td style="width: 10%;"></td> <td style="width: 10%;"></td> </tr> <tr> <td></td> <td></td> <td colspan="8" style="text-align: center;"> <table border="1" style="width: 100%; border-collapse: collapse; text-align: center;"> <tr> <td style="width: 10%;"></td> <td style="width: 10%;"></td> <td style="width: 10%;"></td> <td style="width: 10%;"></td> <td style="width: 10%;"></td> <td style="width: 10%;"></td> <td style="width: 10%;"></td> <td style="width: 10%;"></td> <td style="width: 10%;"></td> <td style="width: 10%;"></td> </tr> <tr> <td></td> <td></td> <td colspan="8" style="text-align: center;"> <table border="1" style="width: 100%; border-collapse: collapse; text-align: center;"> <tr> <td style="width: 10%;"></td> <td style="width: 10%;"></td> <td style="width: 10%;"></td> <td style="width: 10%;"></td> <td style="width: 10%;"></td> <td style="width: 10%;"></td> <td style="width: 10%;"></td> <td style="width: 10%;"></td> <td style="width: 10%;"></td> <td style="width: 10%;"></td> </tr> <tr> <td></td> <td></td> <td colspan="8" style="text-align: center;"> <table border="1" style="width: 100%; border-collapse: collapse; text-align: center;"> <tr>
<td style="width: 10%;"></td> <td style="width: 10%;"></td> <td style="width: 10%;"></td> <td style="width: 10%;"></td> <td style="width: 10%;"></td> <td style="width: 10%;"></td> <td style="width: 10%;"></td> <td style="width: 10%;"></td> <td style="width: 10%;"></td> <td style="width: 10%;"></td> </tr> <tr> <td></td> <td></td> <td colspan="8" style="text-align: center;"> <table border="1" style="width: 100%; border-collapse: collapse; text-align: center;"> <tr> <td style="width: 10%;"></td> <td style="width: 10%;"></td> <td style="width: 10%;"></td> <td style="width: 10%;"></td> <td style="width: 10%;"></td> <td style="width: 10%;"></td> <td style="width: 10%;"></td> <td style="width: 10%;"></td> <td style="width: 10%;"></td> <td style="width: 10%;"></td> </tr> <tr> <td></td> <td></td> <td colspan="8" style="text-align: center;"> <table border="1" style="width: 100%; border-collapse: collapse; text-align: center;"> <tr> <td style="width: 10%;"></td> <td style="width: 10%;"></td> <td style="width: 10%;"></td> <td style="width: 10%;"></td> <td style="width: 10%;"></td> <td style="width: 10%;"></td> <td style="width: 10%;"></td> <td style="width: 10%;"></td> <td style="width: 10%;"></td> <td style="width: 10%;"></td> </tr> <tr> <td></td> <td></td> <td colspan="8" style="text-align: center;"> <table border="1" style="width: 100%; border-collapse: collapse; text-align: center;"> <tr> <td style="width: 10%;"></td> <td style="width: 10%;"></td> <td style="width: 10%;"></td> <td style="width: 10%;"></td> <td style="width: 10%;"></td> <td style="width: 10%;"></td> <td style="width: 10%;"></td> <td style="width: 10%;"></td> <td style="width: 10%;"></td> <td style="width: 10%;"></td> </tr> <tr> <td></td> <td></td> <td colspan="8" style="text-align: center;"> <table border="1" style="width: 100%; border-collapse: collapse; text-align: center;"> <tr> <td style="width: 10%;"></td> <td style="width: 10%;"></td> <td style="width: 10%;"></td> <td style="width: 10%;"></td> <td style="width: 10%;"></td> <td style="width: 10%;"></td> <td style="width: 10%;"></td> <td style="width: 10%;"></td> <td style="width: 10%;"></td> <td style="width: 10%;"></td> </tr> <tr> <td></td> <td></td> <td colspan="8" style="text-align: center;"> <table border="1" style="width: 100%; border-collapse: collapse; text-align: center;"> <tr> <td style="width: 10%;"></td> <td style="width: 10%;"></td> <td style="width: 10%;"></td> <td style="width: 10%;"></td> <td style="width: 10%;"></td> <td style="width: 10%;"></td> <td style="width: 10%;"></td> <td style="width: 10%;"></td> <td style="width: 10%;"></td> <td style="width: 10%;"></td> </tr> <tr> <td></td> <td></td> <td colspan="8" style="text-align: center;"> <table border="1" style="width: 100%; border-collapse: collapse; text-align: center;"> <tr> <td style="width: 10%;"></td> <td style="width: 10%;"></td> <td style="width: 10%;"></td> <td style="width: 10%;"></td> <td style="width: 10%;"></td> <td style="width: 10%;"></td> <td style="width: 10%;"></td> <td style="width: 10%;"></td> <td style="width: 10%;"></td> <td style="width: 10%;"></td> </tr> <tr> <td></td> <td></td> <td colspan="8" style="text-align: center;"> <table border="1" style="width: 100%; border-collapse: collapse; text-align: center;"> <tr> <td style="width: 10%;"></td> <td style="width: 10%;"></td> <td style="width: 10%;"></td> <td style="width: 10%;"></td> <td style="width: 10%;"></td> <td style="width: 10%;"></td> <td style="width: 10%;"></td> <td style="width: 10%;"></td> <td style="width: 10%;"></td> <td style="width: 10%;"></td> </tr> <tr> <td></td> <td></td> <td colspan="8" style="text-align: center;"> <table border="1" style="width: 100%; border-collapse: collapse; text-align: center;"> <tr> <td style="width: 10%;"></td> <td style="width: 10%;"></td> <td style="width: 10%;"></td> <td style="width: 10%;"></td> <td style="width: 10%;"></td> <td style="width: 10%;"></td> <td style="width: 10%;"></td> <td style="width: 10%;"></td> <td style="width: 10%;"></td> <td style="width: 10%;"></td> </tr> <tr> <td></td> <td></td> <td colspan="8" style="text-align: center;"> <table border="1" style="width: 100%; border-collapse: collapse; text-align: center;"> <tr> <td style="width: 10%;"></td> <td style="width: 10%;"></td> <td style="width: 10%;"></td> <td style="width: 10%;"></td> <td style="width: 10%;"></td> <td style="width: 10%;"></td> <td style="width: 10%;"></td> <td style="width: 10%;"></td> <td style="width: 10%;"></td> <td style="width: 10%;"></td> </tr> <tr> <td></td> <td></td> <td colspan="8" style="text-align: center;"> <table border="1" style="width: 100%; border-collapse: collapse; text-align: center;"> <tr> <td style="width: 10%;"></td> <td style="width: 10%;"></td> <td style="width: 10%;"></td> <td style="width: 10%;"></td> <td style="width: 10%;"></td> <td style="width: 10%;"></td> <td style="width: 10%;"></td> <td style="width: 10%;"></td> <td style="width: 10%;"></td> <td style="width: 10%;"></td> </tr> <tr> <td></td> <td></td> <td colspan="8" style="text-align: center;"> <table border="1" style="width: 100%; border-collapse: collapse; text-align: center;"> <tr> <td style="width: 10%;"></td> <td style="width: 10%;"></td> <td style="width: 10%;"></td> <td style="width: 10%;"></td> <td style="width: 10%;"></td> <td style="width: 10%;"></td> <td style="width: 10%;"></td> <td style="width: 10%;"></td> <td style="width: 10%;"></td> <td style="width: 10%;"></td> </tr> <tr> <td></td> <td></td> <td colspan="8" style="text-align: center;"> <table border="1" style="width: 100%; border-collapse: collapse; text-align: center;"> <tr> <td style="width: 10%;"></td> <td style="width: 10%;"></td> <td style="width: 10%;"></td> <td style="width: 10%;"></td> <td style="width: 10%;"></td> <td style="width: 10%;"></td> <td style="width: 10%;"></td> <td style="width: 10%;"></td> <td style="width: 10%;"></td> <td style="width: 10%;"></td> </tr> <tr> <td></td> <td></td> <td colspan="8" style="text-align: center;"> <table border="1" style="width: 100%; border-collapse: collapse; text-align: center;"> <tr> <td style="width: 10%;"></td> <td style="width: 10%;"></td> <td style="width: 10%;"></td> <td style="width: 10%;"></td> <td style="width: 10%;"></td> <td style="width: 10%;"></td> <td style="width: 10%;"></td> <td style="width: 10%;"></td> <td style="width: 10%;"></td> <td style="width: 10%;"></td> </tr> <tr> <td></td> <td></td> <td colspan="8" style="text-align: center;"> <table border="1" style="width: 100%; border-collapse: collapse; text-align: center;"> <tr> <td style="width: 10%;"></td> <td style="width: 10%;"></td> <td style="width: 10%;"></td> <td style="width: 10%;"></td> <td style="width: 10%;"></td> <td style="width: 10%;"></td> <td style="width: 10%;"></td> <td style="width: 10%;"></td> <td style="width: 10%;"></td> <td style="width: 10%;"></td> </tr> <tr> <td></td> <td></td> <td colspan="8" style="text-align: center;"> <table border="1" style="width: 100%; border-collapse: collapse; text-align: center;"> <tr> <td style="width: 10%;"></td> <td style="width: 10%;"></td> <td style="width: 10%;"></td> <td style="width: 10%;"></td> <td style="width: 10%;"></td> <td style="width: 10%;"></td> <td style="width: 10%;"></td> <td style="width: 10%;"></td> <td style="width: 10%;"></td> <td style="width: 10%;"></td> </tr> <tr> <td></td> <td></td> <td colspan="8" style="text-align: center;"> <table border="1" style="width: 100%; border-collapse: collapse; text-align: center;"> <tr> <td style="width: 10%;"></td> <td style="width: 10%;"></td> <td style="width: 10%;"></td> <td style="width: 10%;"></td> <td style="width: 10%;"></td> <td style="width: 10%;"></td> <td style="width: 10%;"></td> <td style="width: 10%;"></td> <td style="width: 10%;"></td> <td style="width: 10%;"></td> </tr> <tr> <td></td> <td></td> <td colspan="8" style="text-align: center;"> <table border="1" style="width: 100%; border-collapse: collapse; text-align: center;"> <tr> <td style="width: 10%;"></td> <td style="width: 10%;"></td> <td style="width: 10%;"></td> <td style="width: 10%;"></td> <td style="width: 10%;"></td> <td style="width: 10%;"></td> <td style="width: 10%;"></td> <td style="width: 10%;"></td> <td style="width: 10%;"></td> <td style="width: 10%;"></td> </tr> <tr> <td></td> <td></td> <td colspan="8" style="text-align: center;"> <table border="1" style="width: 100%; border-collapse: collapse; text-align: center;"> <tr> <td style="width: 10%;"></td> <td style="width: 10%;"></td> <td style="width: 10%;"></td> <td style="width: 10%;"></td> <td style="width: 10%;"></td> <td style="width: 10%;"></td> <td style="width: 10%;"></td> <td style="width: 10%;"></td> <td style="width: 10%;"></td> <td style="width: 10%;"></td> </tr> <tr> <td></td> <td></td> <td colspan="8" style="text-align: center;"> <table border="1" style="width: 100%; border-collapse: collapse; text-align: center;"> <tr> <td style="width: 10%;"></td> <td style="width: 10%;"></td> <td style="width: 10%;"></td> <td style="width: 10%;"></td> <td style="width: 10%;"></td> <td style="width: 10%;"></td> <td style="width: 10%;"></td> <td style="width: 10%;"></td> <td style="width: 10%;"></td> <td style="width: 10%;"></td> </tr> <tr> <td></td> <td></td> <td colspan="8" style="text-align: center;"> <table border="1" style="width: 100%; border-collapse: collapse; text-align: center;"> <tr> <td style="width: 10%;"></td> <td style="width: 10%;"></td> <td style="width: 10%;"></td> <td style="width: 10%;"></td> <td style="width: 10%;"></td> <td style="width: 10%;"></td> <td style="width: 10%;"></td> <td style="width: 10%;"></td> <td style="width: 10%;"></td> <td style="width: 10%;"></td> </tr> <tr> <td></td> <td></td> <td colspan="8" style="text-align: center;"> <table border="1" style="width: 100%; border-collapse: collapse; text-align: center;"> <tr> <td style="width: 10%;"></td> <td style="width: 10%;"></td> <td style="width: 10%;"></td> <td style="width: 10%;"></td> <td style="width: 10%;"></td> <td style="width:
10%;"></td> <td style="width: 10%;"></td> <td style="width: 10%;"></td> <td style="width: 10%;"></td> <td style="width: 10%;"></td> </tr> <tr> <td></td> <td></td> <td colspan="8" style="text-align: center;"> <table border="1" style="width: 100%; border-collapse: collapse; text-align: center;"> <tr> <td style="width: 10%;"></td> <td style="width: 10%;"></td> <td style="width: 10%;"></td> <td style="width: 10%;"></td> <td style="width: 10%;"></td> <td style="width: 10%;"></td> <td style="width: 10%;"></td> <td style="width: 10%;"></td> <td style="width: 10%;"></td> <td style="width: 10%;"></td> </tr> <tr> <td></td> <td></td> <td colspan="8" style="text-align: center;"> <table border="1" style="width: 100%; border-collapse: collapse; text-align: center;"> <tr> <td style="width: 10%;"></td> <td style="width: 10%;"></td> <td style="width: 10%;"></td> <td style="width: 10%;"></td> <td style="width: 10%;"></td> <td style="width: 10%;"></td> <td style="width: 10%;"></td> <td style="width: 10%;"></td> <td style="width: 10%;"></td> <td style="width: 10%;"></td> </tr> <tr> <td></td> <td></td> <td colspan="8" style="text-align: center;"> <table border="1" style="width: 100%; border-collapse: collapse; text-align: center;"> <tr> <td style="width: 10%;"></td> <td style="width: 10%;"></td> <td style="width: 10%;"></td> <td style="width: 10%;"></td> <td style="width: 10%;"></td> <td style="width: 10%;"></td> <td style="width: 10%;"></td> <td style="width: 10%;"></td> <td style="width: 10%;"></td> <td style="width: 10%;"></td> </tr> <tr> <td></td> <td></td> <td colspan="8" style="text-align: center;"> <table border="1" style="width: 100%; border-collapse: collapse; text-align: center;"> <tr> <td style="width: 10%;"></td> <td style="width: 10%;"></td> <td style="width: 10%;"></td> <td style="width: 10%;"></td> <td style="width: 10%;"></td> <td style="width: 10%;"></td> <td style="width: 10%;"></td> <td style="width: 10%;"></td> <td style="width: 10%;"></td> <td style="width: 10%;"></td> </tr> <tr> <td></td> <td></td> <td colspan="8" style="text-align: center;"> <table border="1" style="width: 100%; border-collapse: collapse; text-align: center;"> <tr> <td style="width: 10%;"></td> <td style="width: 10%;"></td> <td style="width: 10%;"></td> <td style="width: 10%;"></td> <td style="width: 10%;"></td> <td style="width: 10%;"></td> <td style="width: 10%;"></td> <td style="width: 10%;"></td> <td style="width: 10%;"></td> <td style="width: 10%;"></td> </tr> <tr> <td></td> <td></td> <td colspan="8" style="text-align: center;"> <table border="1" style="width: 100%; border-collapse: collapse; text-align: center;"> <tr> <td style="width: 10%;"></td> <td style="width: 10%;"></td> <td style="width: 10%;"></td> <td style="width: 10%;"></td> <td style="width: 10%;"></td> <td style="width: 10%;"></td> <td style="width: 10%;"></td> <td style="width: 10%;"></td> <td style="width: 10%;"></td> <td style="width: 10%;"></td> </tr> <tr> <td></td> <td></td> <td colspan="8" style="text-align: center;"> <table border="1" style="width: 100%; border-collapse: collapse; text-align: center;"> <tr> <td style="width: 10%;"></td> <td style="width: 10%;"></td> <td style="width: 10%;"></td> <td style="width: 10%;"></td> <td style="width: 10%;"></td> <td style="width: 10%;"></td> <td style="width: 10%;"></td> <td style="width: 10%;"></td> <td style="width: 10%;"></td> <td style="width: 10%;"></td> </tr> <tr> <td></td> <td></td> <td colspan="8" style="text-align: center;"> <table border="1" style="width: 100%; border-collapse: collapse; text-align: center;"> <tr> <td style="width: 10%;"></td> <td style="width: 10%;"></td> <td style="width: 10%;"></td> <td style="width: 10%;"></td> <td style="width: 10%;"></td> <td style="width: 10%;"></td> <td style="width: 10%;"></td> <td style="width: 10%;"></td> <td style="width: 10%;"></td> <td style="width: 10%;"></td> </tr> <tr> <td></td> <td></td> <td colspan="8" style="text-align: center;"> <table border="1" style="width: 100%; border-collapse: collapse; text-align: center;"> <tr> <td style="width: 10%;"></td> <td style="width: 10%;"></td> <td style="width: 10%;"></td> <td style="width: 10%;"></td> <td style="width: 10%;"></td> <td style="width: 10%;"></td> <td style="width: 10%;"></td> <td style="width: 10%;"></td> <td style="width: 10%;"></td> <td style="width: 10%;"></td> </tr> <tr> <td></td> <td></td> <td colspan="8" style="text-align: center;"> <table border="1" style="width: 100%; border-collapse: collapse; text-align: center;"> <tr> <td style="width: 10%;"></td> <td style="width: 10%;"></td> <td style="width: 10%;"></td> <td style="width: 10%;"></td> <td style="width: 10%;"></td> <td style="width: 10%;"></td> <td style="width: 10%;"></td> <td style="width: 10%;"></td> <td style="width: 10%;"></td> <td style="width: 10%;"></td> </tr> <tr> <td></td> <td></td> <td colspan="8" style="text-align: center;"> <table border="1" style="width: 100%; border-collapse: collapse; text-align: center;"> <tr> <td style="width: 10%;"></td> <td style="width: 10%;"></td> <td style="width: 10%;"></td> <td style="width: 10%;"></td> <td style="width: 10%;"></td> <td style="width: 10%;"></td> <td style="width: 10%;"></td> <td style="width: 10%;"></td> <td style="width: 10%;"></td> <td style="width: 10%;"></td> </tr> <tr> <td></td> <td></td> <td colspan="8" style="text-align: center;"> <table border="1" style="width: 100%; border-collapse: collapse; text-align: center;"> <tr> </tr></table></td></tr></table></td></tr></table></td></tr></table></td></tr></table></td></tr></table></td></tr></table></td></tr></table></td></tr></table></td></tr></table></td></tr></table></td></tr></table></td></tr></table></td></tr></table></td></tr></table></td></tr></table></td></tr></table></td></tr></table></td></tr></table></td></tr></table></td></tr></table></td></tr></table></td></tr></table></td></tr></table></td></tr></table></td></tr></table></td></tr></table></td></tr></table></td></tr></table></td></tr></table></td></tr></table></td></tr></table></td></tr></table></td></tr></table></td></tr></table></td></tr></table></td></tr></table></td></tr></table></td></tr></table></td></tr></table></td></tr></table></td></tr></table></td></tr></table></td></tr></table></td></tr></table></td></tr></table></td></tr></table></td></tr></table></td></tr></table></td></tr></table>
 | | | | | | | | | | | | | | | | | | | | <table border="1" style="width: 100%; border-collapse: collapse; text-align: center;"> <tr> <td style="width: 10%;"></td> <td style="width: 10%;"></td> <td style="width: 10%;"></td> <td style="width: 10%;"></td> <td style="width: 10%;"></td> <td style="width: 10%;"></td> <td style="width: 10%;"></td> <td style="width: 10%;"></td> <td style="width: 10%;"></td> <td style="width: 10%;"></td> </tr> <tr> <td></td> <td></td> <td colspan="8" style="text-align: center;"> <table border="1" style="width: 100%; border-collapse: collapse; text-align: center;"> <tr> <td style="width: 10%;"></td> <td style="width: 10%;"></td> <td style="width: 10%;"></td> <td style="width: 10%;"></td> <td style="width: 10%;"></td> <td style="width: 10%;"></td> <td style="width: 10%;"></td> <td style="width: 10%;"></td> <td style="width: 10%;"></td> <td style="width: 10%;"></td> </tr> <tr> <td></td> <td></td> <td colspan="8" style="text-align: center;"> <table border="1" style="width: 100%; border-collapse: collapse; text-align: center;"> <tr> <td style="width: 10%;"></td> <td style="width: 10%;"></td> <td style="width: 10%;"></td> <td style="width: 10%;"></td> <td style="width: 10%;"></td> <td style="width: 10%;"></td> <td style="width: 10%;"></td> <td style="width: 10%;"></td> <td style="width: 10%;"></td> <td style="width: 10%;"></td> </tr> <tr> <td></td> <td></td> <td colspan="8" style="text-align: center;"> <table border="1" style="width: 100%; border-collapse: collapse; text-align: center;"> <tr> <td style="width: 10%;"></td> <td style="width: 10%;"></td> <td style="width: 10%;"></td> <td style="width: 10%;"></td> <td style="width: 10%;"></td> <td style="width: 10%;"></td> <td style="width: 10%;"></td> <td style="width: 10%;"></td> <td style="width: 10%;"></td> <td style="width: 10%;"></td> </tr> <tr> <td></td> <td></td> <td colspan="8" style="text-align: center;"> <table border="1" style="width: 100%; border-collapse: collapse; text-align: center;"> <tr> <td style="width: 10%;"></td> <td style="width: 10%;"></td> <td style="width: 10%;"></td> <td style="width: 10%;"></td> <td style="width: 10%;"></td> <td style="width: 10%;"></td> <td style="width: 10%;"></td> <td style="width: 10%;"></td> <td style="width: 10%;"></td> <td style="width: 10%;"></td> </tr> <tr> <td></td> <td></td> <td colspan="8" style="text-align: center;"> <table border="1" style="width: 100%; border-collapse: collapse; text-align: center;"> <tr> <td style="width: 10%;"></td> <td style="width: 10%;"></td> <td style="width: 10%;"></td> <td style="width: 10%;"></td> <td style="width: 10%;"></td> <td style="width: 10%;"></td> <td style="width: 10%;"></td> <td style="width: 10%;"></td> <td style="width: 10%;"></td> <td style="width: 10%;"></td> </tr> <tr> <td></td> <td></td> <td colspan="8" style="text-align: center;"> <table border="1" style="width: 100%; border-collapse: collapse; text-align: center;"> <tr> <td style="width: 10%;"></td> <td style="width: 10%;"></td> <td style="width: 10%;"></td> <td style="width: 10%;"></td> <td style="width: 10%;"></td> <td style="width: 10%;"></td> <td style="width: 10%;"></td> <td style="width: 10%;"></td> <td style="width: 10%;"></td> <td style="width: 10%;"></td> </tr> <tr> <td></td> <td></td> <td colspan="8" style="text-align: center;"> <table border="1" style="width: 100%; border-collapse: collapse; text-align: center;"> <tr> <td style="width: 10%;"></td> <td style="width: 10%;"></td> <td style="width: 10%;"></td> <td style="width: 10%;"></td> <td style="width: 10%;"></td> <td style="width: 10%;"></td> <td style="width: 10%;"></td> <td style="width: 10%;"></td> <td style="width: 10%;"></td> <td style="width: 10%;"></td> </tr> <tr> <td></td> <td></td> <td colspan="8" style="text-align: center;"> <table border="1" style="width: 100%; border-collapse: collapse; text-align: center;"> <tr> <td style="width: 10%;"></td> <td style="width: 10%;"></td> <td style="width: 10%;"></td> <td style="width: 10%;"></td> <td style="width: 10%;"></td> <td style="width: 10%;"></td> <td style="width: 10%;"></td> <td style="width: 10%;"></td> <td style="width: 10%;"></td> <td style="width: 10%;"></td> </tr> <tr> <td></td> <td></td> <td colspan="8" style="text-align: center;"> <table border="1" style="width: 100%; border-collapse: collapse; text-align: center;"> <tr> <td style="width: 10%;"></td> <td style="width: 10%;"></td> <td style="width: 10%;"></td> <td style="width: 10%;"></td> <td style="width: 10%;"></td> <td style="width: 10%;"></td> <td style="width: 10%;"></td> <td style="width: 10%;"></td> <td style="width: 10%;"></td> <td style="width: 10%;"></td> </tr> <tr> <td></td> <td></td> <td colspan="8" style="text-align: center;"> <table border="1" style="width: 100%; border-collapse: collapse; text-align: center;"> <tr> <td style="width: 10%;"></td> <td style="width: 10%;"></td> <td style="width: 10%;"></td> <td style="width: 10%;"></td> <td style="width: 10%;"></td> <td style="width: 10%;"></td> <td style="width: 10%;"></td> <td style="width: 10%;"></td> <td style="width: 10%;"></td> <td style="width: 10%;"></td> </tr> <tr> <td></td> <td></td> <td colspan="8" style="text-align: center;"> <table border="1" style="width: 100%; border-collapse: collapse; text-align: center;"> <tr> <td style="width: 10%;"></td> <td style="width: 10%;"></td> <td style="width: 10%;"></td> <td style="width: 10%;"></td> <td style="width: 10%;"></td> <td style="width: 10%;"></td> <td style="width: 10%;"></td> <td style="width: 10%;"></td> <td style="width: 10%;"></td> <td style="width: 10%;"></td> </tr> <tr> <td></td> <td></td> <td colspan="8" style="text-align: center;"> <table border="1" style="width: 100%; border-collapse: collapse; text-align: center;"> <tr> <td style="width: 10%;"></td> <td style="width: 10%;"></td> <td style="width: 10%;"></td> <td style="width: 10%;"></td> <td style="width: 10%;"></td> <td style="width: 10%;"></td> <td style="width: 10%;"></td> <td style="width: 10%;"></td> <td style="width: 10%;"></td> <td style="width: 10%;"></td> </tr> <tr> <td></td> <td></td> <td colspan="8" style="text-align: center;"> <table border="1" style="width: 100%; border-collapse: collapse; text-align: center;"> <tr> <td style="width: 10%;"></td> <td style="width: 10%;"></td> <td style="width: 10%;"></td> <td style="width: 10%;"></td> <td style="width: 10%;"></td> <td style="width: 10%;"></td> <td style="width: 10%;"></td> <td style="width: 10%;"></td> <td style="width: 10%;"></td> <td style="width: 10%;"></td> </tr> <tr> <td></td> <td></td> <td colspan="8" style="text-align: center;"> <table border="1" style="width: 100%; border-collapse: collapse; text-align: center;"> <tr> <td style="width: 10%;"></td> <td style="width: 10%;"></td> <td style="width: 10%;"></td> <td style="width: 10%;"></td> <td style="width: 10%;"></td> <td style="width: 10%;"></td> <td style="width: 10%;"></td> <td style="width: 10%;"></td> <td style="width: 10%;"></td> <td style="width: 10%;"></td> </tr> <tr> <td></td> <td></td> <td colspan="8" style="text-align: center;"> <table border="1" style="width: 100%; border-collapse: collapse; text-align: center;"> <tr> <td style="width: 10%;"></td> <td style="width: 10%;"></td> <td style="width: 10%;"></td> <td style="width: 10%;"></td> <td style="width: 10%;"></td> <td style="width: 10%;"></td> <td style="width: 10%;"></td> <td style="width: 10%;"></td> <td style="width: 10%;"></td> <td style="width: 10%;"></td> </tr> <tr> <td></td> <td></td> <td colspan="8" style="text-align: center;"> <table border="1" style="width: 100%; border-collapse: collapse; text-align: center;"> <tr> <td style="width: 10%;"></td> <td style="width: 10%;"></td> <td style="width: 10%;"></td> <td style="width: 10%;"></td> <td style="width: 10%;"></td> <td style="width: 10%;"></td> <td
style="width: 10%;"></td> <td style="width: 10%;"></td> <td style="width: 10%;"></td> <td style="width: 10%;"></td> </tr> <tr> <td></td> <td></td> <td colspan="8" style="text-align: center;"> <table border="1" style="width: 100%; border-collapse: collapse; text-align: center;"> <tr> <td style="width: 10%;"></td> <td style="width: 10%;"></td> <td style="width: 10%;"></td> <td style="width: 10%;"></td> <td style="width: 10%;"></td> <td style="width: 10%;"></td> <td style="width: 10%;"></td> <td style="width: 10%;"></td> <td style="width: 10%;"></td> <td style="width: 10%;"></td> </tr> <tr> <td></td> <td></td> <td colspan="8" style="text-align: center;"> <table border="1" style="width: 100%; border-collapse: collapse; text-align: center;"> <tr> <td style="width: 10%;"></td> <td style="width: 10%;"></td> <td style="width: 10%;"></td> <td style="width: 10%;"></td> <td style="width: 10%;"></td> <td style="width: 10%;"></td> <td style="width: 10%;"></td> <td style="width: 10%;"></td> <td style="width: 10%;"></td> <td style="width: 10%;"></td> </tr> <tr> <td></td> <td></td> <td colspan="8" style="text-align: center;"> <table border="1" style="width: 100%; border-collapse: collapse; text-align: center;"> <tr> <td style="width: 10%;"></td> <td style="width: 10%;"></td> <td style="width: 10%;"></td> <td style="width: 10%;"></td> <td style="width: 10%;"></td> <td style="width: 10%;"></td> <td style="width: 10%;"></td> <td style="width: 10%;"></td> <td style="width: 10%;"></td> <td style="width: 10%;"></td> </tr> <tr> <td></td> <td></td> <td colspan="8" style="text-align: center;"> <table border="1" style="width: 100%; border-collapse: collapse; text-align: center;"> <tr> <td style="width: 10%;"></td> <td style="width: 10%;"></td> <td style="width: 10%;"></td> <td style="width: 10%;"></td> <td style="width: 10%;"></td> <td style="width: 10%;"></td> <td style="width: 10%;"></td> <td style="width: 10%;"></td> <td style="width: 10%;"></td> <td style="width: 10%;"></td> </tr> <tr> <td></td> <td></td> <td colspan="8" style="text-align: center;"> <table border="1" style="width: 100%; border-collapse: collapse; text-align: center;"> <tr> <td style="width: 10%;"></td> <td style="width: 10%;"></td> <td style="width: 10%;"></td> <td style="width: 10%;"></td> <td style="width: 10%;"></td> <td style="width: 10%;"></td> <td style="width: 10%;"></td> <td style="width: 10%;"></td> <td style="width: 10%;"></td> <td style="width: 10%;"></td> </tr> <tr> <td></td> <td></td> <td colspan="8" style="text-align: center;"> <table border="1" style="width: 100%; border-collapse: collapse; text-align: center;"> <tr> <td style="width: 10%;"></td> <td style="width: 10%;"></td> <td style="width: 10%;"></td> <td style="width: 10%;"></td> <td style="width: 10%;"></td> <td style="width: 10%;"></td> <td style="width: 10%;"></td> <td style="width: 10%;"></td> <td style="width: 10%;"></td> <td style="width: 10%;"></td> </tr> <tr> <td></td> <td></td> <td colspan="8" style="text-align: center;"> <table border="1" style="width: 100%; border-collapse: collapse; text-align: center;"> <tr> <td style="width: 10%;"></td> <td style="width: 10%;"></td> <td style="width: 10%;"></td> <td style="width: 10%;"></td> <td style="width: 10%;"></td> <td style="width: 10%;"></td> <td style="width: 10%;"></td> <td style="width: 10%;"></td> <td style="width: 10%;"></td> <td style="width: 10%;"></td> </tr> <tr> <td></td> <td></td> <td colspan="8" style="text-align: center;"> <table border="1" style="width: 100%; border-collapse: collapse; text-align: center;"> <tr> <td style="width: 10%;"></td> <td style="width: 10%;"></td> <td style="width: 10%;"></td> <td style="width: 10%;"></td> <td style="width: 10%;"></td> <td style="width: 10%;"></td> <td style="width: 10%;"></td> <td style="width: 10%;"></td> <td style="width: 10%;"></td> <td style="width: 10%;"></td> </tr> <tr> <td></td> <td></td> <td colspan="8" style="text-align: center;"> <table border="1" style="width: 100%; border-collapse: collapse; text-align: center;"> <tr> <td style="width: 10%;"></td> <td style="width: 10%;"></td> <td style="width: 10%;"></td> <td style="width: 10%;"></td> <td style="width: 10%;"></td> <td style="width: 10%;"></td> <td style="width: 10%;"></td> <td style="width: 10%;"></td> <td style="width: 10%;"></td> <td style="width: 10%;"></td> </tr> <tr> <td></td> <td></td> <td colspan="8" style="text-align: center;"> <table border="1" style="width: 100%; border-collapse: collapse; text-align: center;"> <tr> <td style="width: 10%;"></td> <td style="width: 10%;"></td> <td style="width: 10%;"></td> <td style="width: 10%;"></td> <td style="width: 10%;"></td> <td style="width: 10%;"></td> <td style="width: 10%;"></td> <td style="width: 10%;"></td> <td style="width: 10%;"></td> <td style="width: 10%;"></td> </tr> <tr> <td></td> <td></td> <td colspan="8" style="text-align: center;"> <table border="1" style="width: 100%; border-collapse: collapse; text-align: center;"> <tr> <td style="width: 10%;"></td> <td style="width: 10%;"></td> <td style="width: 10%;"></td> <td style="width: 10%;"></td> <td style="width: 10%;"></td> <td style="width: 10%;"></td> <td style="width: 10%;"></td> <td style="width: 10%;"></td> <td style="width: 10%;"></td> <td style="width: 10%;"></td> </tr> <tr> <td></td> <td></td> <td colspan="8" style="text-align: center;"> <table border="1" style="width: 100%; border-collapse: collapse; text-align: center;"> <tr> <td style="width: 10%;"></td> <td style="width: 10%;"></td> <td style="width: 10%;"></td> <td style="width: 10%;"></td> <td style="width: 10%;"></td> <td style="width: 10%;"></td> <td style="width: 10%;"></td> <td style="width: 10%;"></td> <td style="width: 10%;"></td> <td style="width: 10%;"></td> </tr> <tr> <td></td> <td></td> <td colspan="8" style="text-align: center;"> <table border="1" style="width: 100%; border-collapse: collapse; text-align: center;"> <tr> <td style="width: 10%;"></td> <td style="width: 10%;"></td> <td style="width: 10%;"></td> <td style="width: 10%;"></td> <td style="width: 10%;"></td> <td style="width: 10%;"></td> <td style="width: 10%;"></td> <td style="width: 10%;"></td> <td style="width: 10%;"></td> <td style="width: 10%;"></td> </tr> <tr> <td></td> <td></td> <td colspan="8" style="text-align: center;"> <table border="1" style="width: 100%; border-collapse: collapse; text-align: center;"> <tr> <td style="width: 10%;"></td> <td style="width: 10%;"></td> <td style="width: 10%;"></td> <td style="width: 10%;"></td> <td style="width: 10%;"></td> <td style="width: 10%;"></td> <td style="width: 10%;"></td> <td style="width: 10%;"></td> <td style="width: 10%;"></td> <td style="width: 10%;"></td> </tr> <tr> <td></td> <td></td> <td colspan="8" style="text-align: center;"> <table border="1" style="width: 100%; border-collapse: collapse; text-align: center;"> <tr> <td style="width: 10%;"></td> <td style="width: 10%;"></td> <td style="width: 10%;"></td> <td style="width: 10%;"></td> <td style="width: 10%;"></td> <td style="width: 10%;"></td> <td style="width: 10%;"></td> <td style="width: 10%;"></td> <td style="width: 10%;"></td> <td style="width: 10%;"></td> </tr> <tr> <td></td> <td></td> <td colspan="8" style="text-align: center;"> <table border="1" style="width: 100%; border-collapse: collapse; text-align: center;"> <tr> <td style="width: 10%;"></td> <td style="width: 10%;"></td> <td style="width: 10%;"></td> <td style="width: 10%;"></td> <td style="width: 10%;"></td> <td style="width: 10%;"></td> <td style="width: 10%;"></td> <td style="width: 10%;"></td> <td style="width: 10%;"></td> <td style="width: 10%;"></td> </tr> <tr> <td></td> <td></td> <td colspan="8" style="text-align: center;"> <table border="1" style="width: 100%; border-collapse: collapse; text-align: center;"> <tr> <td style="width: 10%;"></td> <td style="width: 10%;"></td> <td style="width: 10%;"></td> <td style="width: 10%;"></td> <td style="width: 10%;"></td> <td style="width: 10%;"></td> <td style="width: 10%;"></td> <td style="width: 10%;"></td> <td style="width: 10%;"></td> <td style="width: 10%;"></td> </tr> <tr> <td></td> <td></td> <td colspan="8" style="text-align: center;"> <table border="1" style="width: 100%; border-collapse: collapse; text-align: center;"> <tr> <td style="width: 10%;"></td> <td style="width: 10%;"></td> <td style="width: 10%;"></td> <td style="width: 10%;"></td> <td style="width: 10%;"></td> <td style="width: 10%;"></td> <td style="width: 10%;"></td> <td style="width: 10%;"></td> <td style="width: 10%;"></td> <td style="width: 10%;"></td> </tr> <tr> <td></td> <td></td> <td colspan="8" style="text-align: center;"> <table border="1" style="width: 100%; border-collapse: collapse; text-align: center;"> <tr> <td style="width: 10%;"></td> <td style="width: 10%;"></td> <td style="width: 10%;"></td> <td style="width: 10%;"></td> <td style="width: 10%;"></td> <td style="width: 10%;"></td> <td style="width: 10%;"></td> <td style="width: 10%;"></td> <td style="width: 10%;"></td> <td style="width: 10%;"></td> </tr> <tr> <td></td> <td></td> <td colspan="8" style="text-align: center;"> <table border="1" style="width: 100%; border-collapse: collapse; text-align: center;"> <tr> <td style="width: 10%;"></td> <td style="width: 10%;"></td> <td style="width: 10%;"></td> <td style="width: 10%;"></td> <td style="width: 10%;"></td> <td style="width: 10%;"></td> <td style="width: 10%;"></td> <td style="width: 10%;"></td> <td style="width: 10%;"></td> <td style="width: 10%;"></td> </tr> <tr> <td></td> <td></td> <td colspan="8" style="text-align: center;"> <table border="1" style="width: 100%; border-collapse: collapse; text-align: center;"> <tr> <td style="width: 10%;"></td> <td style="width: 10%;"></td> <td style="width: 10%;"></td> <td style="width: 10%;"></td> <td style="width: 10%;"></td> <td style="width: 10%;"></td> <td style="width: 10%;"></td> <td style="width: 10%;"></td> <td style="width: 10%;"></td> <td style="width: 10%;"></td> </tr> <tr> <td></td> <td></td> <td colspan="8"
style="text-align: center;"> <table border="1" style="width: 100%; border-collapse: collapse; text-align: center;"> <tr> <td style="width: 10%;"></td> <td style="width: 10%;"></td> <td style="width: 10%;"></td> <td style="width: 10%;"></td> <td style="width: 10%;"></td> <td style="width: 10%;"></td> <td style="width: 10%;"></td> <td style="width: 10%;"></td> <td style="width: 10%;"></td> <td style="width: 10%;"></td> </tr> <tr> <td></td> <td></td> <td colspan="8" style="text-align: center;"> <table border="1" style="width: 100%; border-collapse: collapse; text-align: center;"> <tr> <td style="width: 10%;"></td> <td style="width: 10%;"></td> <td style="width: 10%;"></td> <td style="width: 10%;"></td> <td style="width: 10%;"></td> <td style="width: 10%;"></td> <td style="width: 10%;"></td> <td style="width: 10%;"></td> <td style="width: 10%;"></td> <td style="width: 10%;"></td> </tr> <tr> <td></td> <td></td> <td colspan="8" style="text-align: center;"> <table border="1" style="width: 100%; border-collapse: collapse; text-align: center;"> <tr> <td style="width: 10%;"></td> <td style="width: 10%;"></td> <td style="width: 10%;"></td> <td style="width: 10%;"></td> <td style="width: 10%;"></td> <td style="width: 10%;"></td> <td style="width: 10%;"></td> <td style="width: 10%;"></td> <td style="width: 10%;"></td> <td style="width: 10%;"></td> </tr> <tr> <td></td> <td></td> <td colspan="8" style="text-align: center;"> <table border="1" style="width: 100%; border-collapse: collapse; text-align: center;"> <tr> <td style="width: 10%;"></td> <td style="width: 10%;"></td> <td style="width: 10%;"></td> <td style="width: 10%;"></td> <td style="width: 10%;"></td> <td style="width: 10%;"></td> <td style="width: 10%;"></td> <td style="width: 10%;"></td> <td style="width: 10%;"></td> <td style="width: 10%;"></td> </tr> <tr> <td></td> <td></td> <td colspan="8" style="text-align: center;"> <table border="1" style="width: 100%; border-collapse: collapse; text-align: center;"> <tr> <td style="width: 10%;"></td> <td style="width: 10%;"></td> <td style="width: 10%;"></td> <td style="width: 10%;"></td> <td style="width: 10%;"></td> <td style="width: 10%;"></td> <td style="width: 10%;"></td> <td style="width: 10%;"></td> <td style="width: 10%;"></td> <td style="width: 10%;"></td> </tr> <tr> <td></td> <td></td> <td colspan="8" style="text-align: center;"> <table border="1" style="width: 100%; border-collapse: collapse; text-align: center;"> <tr> <td style="width: 10%;"></td> <td style="width: 10%;"></td> <td style="width: 10%;"></td> <td style="width: 10%;"></td> <td style="width: 10%;"></td> <td style="width: 10%;"></td> <td style="width: 10%;"></td> <td style="width: 10%;"></td> <td style="width: 10%;"></td> <td style="width: 10%;"></td> </tr> <tr> <td></td> <td></td> <td colspan="8" style="text-align: center;"> <table border="1" style="width: 100%; border-collapse: collapse; text-align: center;"> <tr> <td style="width: 10%;"></td> <td style="width: 10%;"></td> <td style="width: 10%;"></td> <td style="width: 10%;"></td> <td style="width: 10%;"></td> <td style="width: 10%;"></td> <td style="width: 10%;"></td> <td style="width: 10%;"></td> <td style="width: 10%;"></td> <td style="width: 10%;"></td> </tr> <tr> <td></td> <td></td> <td colspan="8" style="text-align: center;"> <table border="1" style="width: 100%; border-collapse: collapse; text-align: center;"> <tr> <td style="width: 10%;"></td> <td style="width: 10%;"></td> <td style="width: 10%;"></td> <td style="width: 10%;"></td> <td style="width: 10%;"></td> <td style="width: 10%;"></td> <td style="width: 10%;"></td> <td style="width: 10%;"></td> <td style="width: 10%;"></td> <td style="width: 10%;"></td> </tr> <tr> <td></td> <td></td> <td colspan="8" style="text-align: center;"> <table border="1" style="width: 100%; border-collapse: collapse; text-align: center;"> <tr> <td style="width: 10%;"></td> <td style="width: 10%;"></td> <td style="width: 10%;"></td> <td style="width: 10%;"></td> <td style="width: 10%;"></td> <td style="width: 10%;"></td> <td style="width: 10%;"></td> <td style="width: 10%;"></td> <td style="width: 10%;"></td> <td style="width: 10%;"></td> </tr> <tr> <td></td> <td></td> <td colspan="8" style="text-align: center;"> <table border="1" style="width: 100%; border-collapse: collapse; text-align: center;"> <tr> <td style="width: 10%;"></td> <td style="width: 10%;"></td> <td style="width: 10%;"></td> <td style="width: 10%;"></td> <td style="width: 10%;"></td> <td style="width: 10%;"></td> <td style="width: 10%;"></td> <td style="width: 10%;"></td> <td style="width: 10%;"></td> <td style="width: 10%;"></td> </tr> <tr> <td></td> <td></td> <td colspan="8" style="text-align: center;"> <table border="1" style="width: 100%; border-collapse: collapse; text-align: center;"> <tr> </tr></table></td></tr></table></td></tr></table></td></tr></table></td></tr></table></td></tr></table></td></tr></table></td></tr></table></td></tr></table></td></tr></table></td></tr></table></td></tr></table></td></tr></table></td></tr></table></td></tr></table></td></tr></table></td></tr></table></td></tr></table></td></tr></table></td></tr></table></td></tr></table></td></tr></table></td></tr></table></td></tr></table></td></tr></table></td></tr></table></td></tr></table></td></tr></table></td></tr></table></td></tr></table></td></tr></table></td></tr></table></td></tr></table></td></tr></table></td></tr></table></td></tr></table></td></tr></table></td></tr></table></td></tr></table></td></tr></table></td></tr></table></td></tr></table></td></tr></table></td></tr></table></td></tr></table></td></tr></table></td></tr></table></td></tr></table></td></tr></table>
 | | | | | | | | | | | | | | | | | | | | <table border="1" style="width: 100%; border-collapse: collapse; text-align: center;"> <tr> <td style="width: 10%;"></td> <td style="width: 10%;"></td> <td style="width: 10%;"></td> <td style="width: 10%;"></td> <td style="width: 10%;"></td> <td style="width: 10%;"></td> <td style="width: 10%;"></td> <td style="width: 10%;"></td> <td style="width: 10%;"></td> <td style="width: 10%;"></td> </tr> <tr> <td></td> <td></td> <td colspan="8" style="text-align: center;"> <table border="1" style="width: 100%; border-collapse: collapse; text-align: center;"> <tr> <td style="width: 10%;"></td> <td style="width: 10%;"></td> <td style="width: 10%;"></td> <td style="width: 10%;"></td> <td style="width: 10%;"></td> <td style="width: 10%;"></td> <td style="width: 10%;"></td> <td style="width: 10%;"></td> <td style="width: 10%;"></td> <td style="width: 10%;"></td> </tr> <tr> <td></td> <td></td> <td colspan="8" style="text-align: center;"> <table border="1" style="width: 100%; border-collapse: collapse; text-align: center;"> <tr> <td style="width: 10%;"></td> <td style="width: 10%;"></td> <td style="width: 10%;"></td> <td style="width: 10%;"></td> <td style="width: 10%;"></td> <td style="width: 10%;"></td> <td style="width: 10%;"></td> <td style="width: 10%;"></td> <td style="width: 10%;"></td> <td style="width: 10%;"></td> </tr> <tr> <td></td> <td></td> <td colspan="8" style="text-align: center;"> <table border="1" style="width: 100%; border-collapse: collapse; text-align: center;"> <tr> <td style="width: 10%;"></td> <td style="width: 10%;"></td> <td style="width: 10%;"></td> <td style="width: 10%;"></td> <td style="width: 10%;"></td> <td style="width: 10%;"></td> <td style="width: 10%;"></td> <td style="width: 10%;"></td> <td style="width: 10%;"></td> <td style="width: 10%;"></td> </tr> <tr> <td></td> <td></td> <td colspan="8" style="text-align: center;"> <table border="1" style="width: 100%; border-collapse: collapse; text-align: center;"> <tr> <td style="width: 10%;"></td> <td style="width: 10%;"></td> <td style="width: 10%;"></td> <td style="width: 10%;"></td> <td style="width: 10%;"></td> <td style="width: 10%;"></td> <td style="width: 10%;"></td> <td style="width: 10%;"></td> <td style="width: 10%;"></td> <td style="width: 10%;"></td> </tr> <tr> <td></td> <td></td> <td colspan="8" style="text-align: center;"> <table border="1" style="width: 100%; border-collapse: collapse; text-align: center;"> <tr> <td style="width: 10%;"></td> <td style="width: 10%;"></td> <td style="width: 10%;"></td> <td style="width: 10%;"></td> <td style="width: 10%;"></td> <td style="width: 10%;"></td> <td style="width: 10%;"></td> <td style="width: 10%;"></td> <td style="width: 10%;"></td> <td style="width: 10%;"></td> </tr> <tr> <td></td> <td></td> <td colspan="8" style="text-align: center;"> <table border="1" style="width: 100%; border-collapse: collapse; text-align: center;"> <tr> <td style="width: 10%;"></td> <td style="width: 10%;"></td> <td style="width: 10%;"></td> <td style="width: 10%;"></td> <td style="width: 10%;"></td> <td style="width: 10%;"></td> <td style="width: 10%;"></td> <td style="width: 10%;"></td> <td style="width: 10%;"></td> <td style="width: 10%;"></td> </tr> <tr> <td></td> <td></td> <td colspan="8" style="text-align: center;"> <table border="1" style="width: 100%; border-collapse: collapse; text-align: center;"> <tr> <td style="width: 10%;"></td> <td style="width: 10%;"></td> <td style="width: 10%;"></td> <td style="width: 10%;"></td> <td style="width: 10%;"></td> <td style="width: 10%;"></td> <td style="width: 10%;"></td> <td style="width: 10%;"></td> <td style="width: 10%;"></td> <td style="width: 10%;"></td> </tr> <tr> <td></td> <td></td> <td colspan="8" style="text-align: center;"> <table border="1" style="width: 100%; border-collapse: collapse; text-align: center;"> <tr> <td style="width: 10%;"></td> <td style="width: 10%;"></td> <td style="width: 10%;"></td> <td style="width: 10%;"></td> <td style="width: 10%;"></td> <td style="width: 10%;"></td> <td style="width: 10%;"></td> <td style="width: 10%;"></td> <td style="width: 10%;"></td> <td style="width: 10%;"></td> </tr> <tr> <td></td> <td></td> <td colspan="8" style="text-align: center;"> <table border="1" style="width: 100%; border-collapse: collapse; text-align: center;"> <tr> <td style="width: 10%;"></td> <td style="width: 10%;"></td> <td style="width: 10%;"></td> <td style="width: 10%;"></td> <td style="width: 10%;"></td> <td style="width: 10%;"></td> <td style="width: 10%;"></td> <td style="width: 10%;"></td> <td style="width: 10%;"></td> <td style="width: 10%;"></td> </tr> <tr> <td></td> <td></td> <td colspan="8" style="text-align: center;"> <table border="1" style="width: 100%; border-collapse: collapse; text-align: center;"> <tr> <td style="width: 10%;"></td> <td style="width: 10%;"></td> <td style="width: 10%;"></td> <td style="width: 10%;"></td> <td style="width: 10%;"></td> <td style="width: 10%;"></td> <td style="width: 10%;"></td> <td style="width: 10%;"></td> <td style="width: 10%;"></td> <td style="width: 10%;"></td> </tr> <tr> <td></td> <td></td> <td colspan="8" style="text-align: center;"> <table border="1" style="width: 100%; border-collapse: collapse; text-align: center;"> <tr> <td style="width: 10%;"></td> <td style="width: 10%;"></td> <td style="width: 10%;"></td> <td style="width: 10%;"></td> <td style="width: 10%;"></td> <td style="width: 10%;"></td> <td style="width: 10%;"></td> <td style="width: 10%;"></td> <td style="width: 10%;"></td> <td style="width: 10%;"></td> </tr> <tr> <td></td> <td></td> <td colspan="8" style="text-align: center;"> <table border="1" style="width: 100%; border-collapse: collapse; text-align: center;"> <tr> <td style="width: 10%;"></td> <td style="width: 10%;"></td> <td style="width: 10%;"></td> <td style="width: 10%;"></td> <td style="width: 10%;"></td> <td style="width: 10%;"></td> <td style="width: 10%;"></td> <td style="width: 10%;"></td> <td style="width: 10%;"></td> <td style="width: 10%;"></td> </tr> <tr> <td></td> <td></td> <td colspan="8" style="text-align: center;"> <table border="1" style="width: 100%; border-collapse: collapse; text-align: center;"> <tr> <td style="width: 10%;"></td> <td style="width: 10%;"></td> <td style="width: 10%;"></td> <td style="width: 10%;"></td> <td style="width: 10%;"></td> <td style="width: 10%;"></td> <td style="width: 10%;"></td> <td style="width: 10%;"></td> <td style="width: 10%;"></td> <td style="width: 10%;"></td> </tr> <tr> <td></td> <td></td> <td colspan="8" style="text-align: center;"> <table border="1" style="width: 100%; border-collapse: collapse; text-align: center;"> <tr> <td style="width: 10%;"></td> <td style="width: 10%;"></td> <td style="width: 10%;"></td> <td style="width: 10%;"></td> <td style="width: 10%;"></td> <td style="width: 10%;"></td> <td style="width: 10%;"></td> <td style="width: 10%;"></td> <td style="width: 10%;"></td> <td style="width: 10%;"></td> </tr> <tr> <td></td> <td></td> <td colspan="8" style="text-align: center;"> <table border="1" style="width: 100%; border-collapse: collapse; text-align: center;"> <tr> <td style="width: 10%;"></td> <td style="width: 10%;"></td> <td style="width: 10%;"></td> <td style="width: 10%;"></td> <td style="width: 10%;"></td> <td style="width: 10%;"></td> <td style="width: 10%;"></td> <td style="width: 10%;"></td> <td style="width: 10%;"></td> <td style="width: 10%;"></td> </tr> <tr> <td></td> <td></td> <td colspan="8" style="text-align: center;"> <table border="1" style="width: 100%; border-collapse: collapse; text-align: center;"> <tr> <td style="width: 10%;"></td> <td style="width: 10%;"></td> <td style="width: 10%;"></td> <td style="width: 10%;"></td> <td style="width: 10%;"></td> <td style="width: 10%;"></td> <td style="width: 10%;"></td> <td style="width: 10%;"></td> <td style="width: 10%;"></td> <td style="width: 10%;"></td> </tr> <tr> <td></td> <td></td> <td colspan="8" style="text-align: center;"> <table border="1" style="width: 100%; border-collapse: collapse; text-align: center;"> <tr> <td style="width: 10%;"></td> <td style="width: 10%;"></td> <td style="width: 10%;"></td> <td style="width: 10%;"></td> <td style="width: 10%;"></td> <td style="width: 10%;"></td> <td style="width: 10%;"></td> <td style="width: 10%;"></td> <td style="width: 10%;"></td> <td style="width: 10%;"></td> </tr> <tr> <td></td> <td></td> <td colspan="8" style="text-align: center;">
<table border="1" style="width: 100%; border-collapse: collapse; text-align: center;"> <tr> <td style="width: 10%;"></td> <td style="width: 10%;"></td> <td style="width: 10%;"></td> <td style="width: 10%;"></td> <td style="width: 10%;"></td> <td style="width: 10%;"></td> <td style="width: 10%;"></td> <td style="width: 10%;"></td> <td style="width: 10%;"></td> <td style="width: 10%;"></td> </tr> <tr> <td></td> <td></td> <td colspan="8" style="text-align: center;"> <table border="1" style="width: 100%; border-collapse: collapse; text-align: center;"> <tr> <td style="width: 10%;"></td> <td style="width: 10%;"></td> <td style="width: 10%;"></td> <td style="width: 10%;"></td> <td style="width: 10%;"></td> <td style="width: 10%;"></td> <td style="width: 10%;"></td> <td style="width: 10%;"></td> <td style="width: 10%;"></td> <td style="width: 10%;"></td> </tr> <tr> <td></td> <td></td> <td colspan="8" style="text-align: center;"> <table border="1" style="width: 100%; border-collapse: collapse; text-align: center;"> <tr> <td style="width: 10%;"></td> <td style="width: 10%;"></td> <td style="width: 10%;"></td> <td style="width: 10%;"></td> <td style="width: 10%;"></td> <td style="width: 10%;"></td> <td style="width: 10%;"></td> <td style="width: 10%;"></td> <td style="width: 10%;"></td> <td style="width: 10%;"></td> </tr> <tr> <td></td> <td></td> <td colspan="8" style="text-align: center;"> <table border="1" style="width: 100%; border-collapse: collapse; text-align: center;"> <tr> <td style="width: 10%;"></td> <td style="width: 10%;"></td> <td style="width: 10%;"></td> <td style="width: 10%;"></td> <td style="width: 10%;"></td> <td style="width: 10%;"></td> <td style="width: 10%;"></td> <td style="width: 10%;"></td> <td style="width: 10%;"></td> <td style="width: 10%;"></td> </tr> <tr> <td></td> <td></td> <td colspan="8" style="text-align: center;"> <table border="1" style="width: 100%; border-collapse: collapse; text-align: center;"> <tr> <td style="width: 10%;"></td> <td style="width: 10%;"></td> <td style="width: 10%;"></td> <td style="width: 10%;"></td> <td style="width: 10%;"></td> <td style="width: 10%;"></td> <td style="width: 10%;"></td> <td style="width: 10%;"></td> <td style="width: 10%;"></td> <td style="width: 10%;"></td> </tr> <tr> <td></td> <td></td> <td colspan="8" style="text-align: center;"> <table border="1" style="width: 100%; border-collapse: collapse; text-align: center;"> <tr> <td style="width: 10%;"></td> <td style="width: 10%;"></td> <td style="width: 10%;"></td> <td style="width: 10%;"></td> <td style="width: 10%;"></td> <td style="width: 10%;"></td> <td style="width: 10%;"></td> <td style="width: 10%;"></td> <td style="width: 10%;"></td> <td style="width: 10%;"></td> </tr> <tr> <td></td> <td></td> <td colspan="8" style="text-align: center;"> <table border="1" style="width: 100%; border-collapse: collapse; text-align: center;"> <tr> <td style="width: 10%;"></td> <td style="width: 10%;"></td> <td style="width: 10%;"></td> <td style="width: 10%;"></td> <td style="width: 10%;"></td> <td style="width: 10%;"></td> <td style="width: 10%;"></td> <td style="width: 10%;"></td> <td style="width: 10%;"></td> <td style="width: 10%;"></td> </tr> <tr> <td></td> <td></td> <td colspan="8" style="text-align: center;"> <table border="1" style="width: 100%; border-collapse: collapse; text-align: center;"> <tr> <td style="width: 10%;"></td> <td style="width: 10%;"></td> <td style="width: 10%;"></td> <td style="width: 10%;"></td> <td style="width: 10%;"></td> <td style="width: 10%;"></td> <td style="width: 10%;"></td> <td style="width: 10%;"></td> <td style="width: 10%;"></td> <td style="width: 10%;"></td> </tr> <tr> <td></td> <td></td> <td colspan="8" style="text-align: center;"> <table border="1" style="width: 100%; border-collapse: collapse; text-align: center;"> <tr> <td style="width: 10%;"></td> <td style="width: 10%;"></td> <td style="width: 10%;"></td> <td style="width: 10%;"></td> <td style="width: 10%;"></td> <td style="width: 10%;"></td> <td style="width: 10%;"></td> <td style="width: 10%;"></td> <td style="width: 10%;"></td> <td style="width: 10%;"></td> </tr> <tr> <td></td> <td></td> <td colspan="8" style="text-align: center;"> <table border="1" style="width: 100%; border-collapse: collapse; text-align: center;"> <tr> <td style="width: 10%;"></td> <td style="width: 10%;"></td> <td style="width: 10%;"></td> <td style="width: 10%;"></td> <td style="width: 10%;"></td> <td style="width: 10%;"></td> <td style="width: 10%;"></td> <td style="width: 10%;"></td> <td style="width: 10%;"></td> <td style="width: 10%;"></td> </tr> <tr> <td></td> <td></td> <td colspan="8" style="text-align: center;"> <table border="1" style="width: 100%; border-collapse: collapse; text-align: center;"> <tr> <td style="width: 10%;"></td> <td style="width: 10%;"></td> <td style="width: 10%;"></td> <td style="width: 10%;"></td> <td style="width: 10%;"></td> <td style="width: 10%;"></td> <td style="width: 10%;"></td> <td style="width: 10%;"></td> <td style="width: 10%;"></td> <td style="width: 10%;"></td> </tr> <tr> <td></td> <td></td> <td colspan="8" style="text-align: center;"> <table border="1" style="width: 100%; border-collapse: collapse; text-align: center;"> <tr> <td style="width: 10%;"></td> <td style="width: 10%;"></td> <td style="width: 10%;"></td> <td style="width: 10%;"></td> <td style="width: 10%;"></td> <td style="width: 10%;"></td> <td style="width: 10%;"></td> <td style="width: 10%;"></td> <td style="width: 10%;"></td> <td style="width: 10%;"></td> </tr> <tr> <td></td> <td></td> <td colspan="8" style="text-align: center;"> <table border="1" style="width: 100%; border-collapse: collapse; text-align: center;"> <tr> <td style="width: 10%;"></td> <td style="width: 10%;"></td> <td style="width: 10%;"></td> <td style="width: 10%;"></td> <td style="width: 10%;"></td> <td style="width: 10%;"></td> <td style="width: 10%;"></td> <td style="width: 10%;"></td> <td style="width: 10%;"></td> <td style="width: 10%;"></td> </tr> <tr> <td></td> <td></td> <td colspan="8" style="text-align: center;"> <table border="1" style="width: 100%; border-collapse: collapse; text-align: center;"> <tr> <td style="width: 10%;"></td> <td style="width: 10%;"></td> <td style="width: 10%;"></td> <td style="width: 10%;"></td> <td style="width: 10%;"></td> <td style="width: 10%;"></td> <td style="width: 10%;"></td> <td style="width: 10%;"></td> <td style="width: 10%;"></td> <td style="width: 10%;"></td> </tr> <tr> <td></td> <td></td> <td colspan="8" style="text-align: center;"> <table border="1" style="width: 100%; border-collapse: collapse; text-align: center;"> <tr> <td style="width: 10%;"></td> <td style="width: 10%;"></td> <td style="width: 10%;"></td> <td style="width: 10%;"></td> <td style="width: 10%;"></td> <td style="width: 10%;"></td> <td style="width: 10%;"></td> <td style="width: 10%;"></td> <td style="width: 10%;"></td> <td style="width: 10%;"></td> </tr> <tr> <td></td> <td></td> <td colspan="8" style="text-align: center;"> <table border="1" style="width: 100%; border-collapse: collapse; text-align: center;"> <tr> <td style="width: 10%;"></td> <td style="width: 10%;"></td> <td style="width: 10%;"></td> <td style="width: 10%;"></td> <td style="width: 10%;"></td> <td style="width: 10%;"></td> <td style="width: 10%;"></td> <td style="width: 10%;"></td> <td style="width: 10%;"></td> <td style="width: 10%;"></td> </tr> <tr> <td></td> <td></td> <td colspan="8" style="text-align: center;"> <table border="1" style="width: 100%; border-collapse: collapse; text-align: center;"> <tr> <td style="width: 10%;"></td> <td style="width: 10%;"></td> <td style="width: 10%;"></td> <td style="width: 10%;"></td> <td style="width: 10%;"></td> <td style="width: 10%;"></td> <td style="width: 10%;"></td> <td style="width: 10%;"></td> <td style="width: 10%;"></td> <td style="width: 10%;"></td> </tr> <tr> <td></td> <td></td> <td colspan="8" style="text-align: center;"> <table border="1" style="width: 100%; border-collapse: collapse; text-align: center;"> <tr> <td style="width: 10%;"></td> <td style="width: 10%;"></td> <td style="width: 10%;"></td> <td style="width: 10%;"></td> <td style="width: 10%;"></td> <td style="width: 10%;"></td> <td style="width: 10%;"></td> <td style="width: 10%;"></td> <td style="width: 10%;"></td> <td style="width: 10%;"></td> </tr> <tr> <td></td> <td></td> <td colspan="8" style="text-align: center;"> <table border="1" style="width: 100%; border-collapse: collapse; text-align: center;"> <tr> <td style="width: 10%;"></td> <td style="width: 10%;"></td> <td style="width: 10%;"></td> <td style="width: 10%;"></td> <td style="width: 10%;"></td> <td style="width: 10%;"></td> <td style="width: 10%;"></td> <td style="width: 10%;"></td> <td style="width: 10%;"></td> <td style="width: 10%;"></td> </tr> <tr> <td></td> <td></td> <td colspan="8" style="text-align: center;"> <table border="1" style="width: 100%; border-collapse: collapse; text-align: center;"> <tr> <td style="width: 10%;"></td> <td style="width: 10%;"></td> <td style="width: 10%;"></td> <td style="width: 10%;"></td> <td style="width: 10%;"></td> <td style="width: 10%;"></td> <td style="width: 10%;"></td> <td style="width: 10%;"></td> <td style="width: 10%;"></td> <td style="width: 10%;"></td> </tr> <tr> <td></td> <td></td> <td colspan="8" style="text-align: center;"> <table border="1" style="width: 100%; border-collapse: collapse; text-align: center;"> <tr> <td style="width: 10%;"></td> <td style="width: 10%;"></td> <td style="width: 10%;"></td> <td style="width: 10%;"></td> <td style="width: 10%;"></td> <td style="width: 10%;"></td> <td style="width: 10%;"></td> <td style="width: 10%;"></td> <td style="width: 10%;"></td> <td style="width: 10%;"></td> </tr> <tr> <td></td> <td></td> <td colspan="8" style="text-align: center;"> <table border="1" style="width: 100%; border-collapse: collapse; text-align: center;"> <tr> <td style="width: 10%;"></td> <td style="width: 10%;"></td> <td style="width:
10%;"></td> <td style="width: 10%;"></td> <td style="width: 10%;"></td> <td style="width: 10%;"></td> <td style="width: 10%;"></td> <td style="width: 10%;"></td> <td style="width: 10%;"></td> <td style="width: 10%;"></td> </tr> <tr> <td></td> <td></td> <td colspan="8" style="text-align: center;"> <table border="1" style="width: 100%; border-collapse: collapse; text-align: center;"> <tr> <td style="width: 10%;"></td> <td style="width: 10%;"></td> <td style="width: 10%;"></td> <td style="width: 10%;"></td> <td style="width: 10%;"></td> <td style="width: 10%;"></td> <td style="width: 10%;"></td> <td style="width: 10%;"></td> <td style="width: 10%;"></td> <td style="width: 10%;"></td> </tr> <tr> <td></td> <td></td> <td colspan="8" style="text-align: center;"> <table border="1" style="width: 100%; border-collapse: collapse; text-align: center;"> <tr> <td style="width: 10%;"></td> <td style="width: 10%;"></td> <td style="width: 10%;"></td> <td style="width: 10%;"></td> <td style="width: 10%;"></td> <td style="width: 10%;"></td> <td style="width: 10%;"></td> <td style="width: 10%;"></td> <td style="width: 10%;"></td> <td style="width: 10%;"></td> </tr> <tr> <td></td> <td></td> <td colspan="8" style="text-align: center;"> <table border="1" style="width: 100%; border-collapse: collapse; text-align: center;"> <tr> <td style="width: 10%;"></td> <td style="width: 10%;"></td> <td style="width: 10%;"></td> <td style="width: 10%;"></td> <td style="width: 10%;"></td> <td style="width: 10%;"></td> <td style="width: 10%;"></td> <td style="width: 10%;"></td> <td style="width: 10%;"></td> <td style="width: 10%;"></td> </tr> <tr> <td></td> <td></td> <td colspan="8" style="text-align: center;"> <table border="1" style="width: 100%; border-collapse: collapse; text-align: center;"> <tr> <td style="width: 10%;"></td> <td style="width: 10%;"></td> <td style="width: 10%;"></td> <td style="width: 10%;"></td> <td style="width: 10%;"></td> <td style="width: 10%;"></td> <td style="width: 10%;"></td> <td style="width: 10%;"></td> <td style="width: 10%;"></td> <td style="width: 10%;"></td> </tr> <tr> <td></td> <td></td> <td colspan="8" style="text-align: center;"> <table border="1" style="width: 100%; border-collapse: collapse; text-align: center;"> <tr> <td style="width: 10%;"></td> <td style="width: 10%;"></td> <td style="width: 10%;"></td> <td style="width: 10%;"></td> <td style="width: 10%;"></td> <td style="width: 10%;"></td> <td style="width: 10%;"></td> <td style="width: 10%;"></td> <td style="width: 10%;"></td> <td style="width: 10%;"></td> </tr> <tr> <td></td> <td></td> <td colspan="8" style="text-align: center;"> <table border="1" style="width: 100%; border-collapse: collapse; text-align: center;"> <tr> <td style="width: 10%;"></td> <td style="width: 10%;"></td> <td style="width: 10%;"></td> <td style="width: 10%;"></td> <td style="width: 10%;"></td> <td style="width: 10%;"></td> <td style="width: 10%;"></td> <td style="width: 10%;"></td> <td style="width: 10%;"></td> <td style="width: 10%;"></td> </tr> <tr> <td></td> <td></td> <td colspan="8" style="text-align: center;"> <table border="1" style="width: 100%; border-collapse: collapse; text-align: center;"> <tr> <td style="width: 10%;"></td> <td style="width: 10%;"></td> <td style="width: 10%;"></td> <td style="width: 10%;"></td> <td style="width: 10%;"></td> <td style="width: 10%;"></td> <td style="width: 10%;"></td> <td style="width: 10%;"></td> <td style="width: 10%;"></td> <td style="width: 10%;"></td> </tr> <tr> <td></td> <td></td> <td colspan="8" style="text-align: center;"> <table border="1" style="width: 100%; border-collapse: collapse; text-align: center;"> <tr> </tr></table></td></tr></table></td></tr></table></td></tr></table></td></tr></table></td></tr></table></td></tr></table></td></tr></table></td></tr></table></td></tr></table></td></tr></table></td></tr></table></td></tr></table></td></tr></table></td></tr></table></td></tr></table></td></tr></table></td></tr></table></td></tr></table></td></tr></table></td></tr></table></td></tr></table></td></tr></table></td></tr></table></td></tr></table></td></tr></table></td></tr></table></td></tr></table></td></tr></table></td></tr></table></td></tr></table></td></tr></table></td></tr></table></td></tr></table></td></tr></table></td></tr></table></td></tr></table></td></tr></table></td></tr></table></td></tr></table></td></tr></table></td></tr></table></td></tr></table></td></tr></table></td></tr></table></td></tr></table></td></tr></table></td></tr></table>
 | | | | | | | | | | | | | | | | | | | | <table border="1" style="width: 100%; border-collapse: collapse; text-align: center;"> <tr> <td style="width: 10%;"></td> <td style="width: 10%;"></td> <td style="width: 10%;"></td> <td style="width: 10%;"></td> <td style="width: 10%;"></td> <td style="width: 10%;"></td> <td style="width: 10%;"></td> <td style="width: 10%;"></td> <td style="width: 10%;"></td> <td style="width: 10%;"></td> </tr> <tr> <td></td> <td></td> <td colspan="8" style="text-align: center;"> <table border="1" style="width: 100%; border-collapse: collapse; text-align: center;"> <tr> <td style="width: 10%;"></td> <td style="width: 10%;"></td> <td style="width: 10%;"></td> <td style="width: 10%;"></td> <td style="width: 10%;"></td> <td style="width: 10%;"></td> <td style="width: 10%;"></td> <td style="width: 10%;"></td> <td style="width: 10%;"></td> <td style="width: 10%;"></td> </tr> <tr> <td></td> <td></td> <td colspan="8" style="text-align: center;"> <table border="1" style="width: 100%; border-collapse: collapse; text-align: center;"> <tr> <td style="width: 10%;"></td> <td style="width: 10%;"></td> <td style="width: 10%;"></td> <td style="width: 10%;"></td> <td style="width: 10%;"></td> <td style="width: 10%;"></td> <td style="width: 10%;"></td> <td style="width: 10%;"></td> <td style="width: 10%;"></td> <td style="width: 10%;"></td> </tr> <tr> <td></td> <td></td> <td colspan="8" style="text-align: center;"> <table border="1" style="width: 100%; border-collapse: collapse; text-align: center;"> <tr> <td style="width: 10%;"></td> <td style="width: 10%;"></td> <td style="width: 10%;"></td> <td style="width: 10%;"></td> <td style="width: 10%;"></td> <td style="width: 10%;"></td> <td style="width: 10%;"></td> <td style="width: 10%;"></td> <td style="width: 10%;"></td> <td style="width: 10%;"></td> </tr> <tr> <td></td> <td></td> <td colspan="8" style="text-align: center;"> <table border="1" style="width: 100%; border-collapse: collapse; text-align: center;"> <tr> <td style="width: 10%;"></td> <td style="width: 10%;"></td> <td style="width: 10%;"></td> <td style="width: 10%;"></td> <td style="width: 10%;"></td> <td style="width: 10%;"></td> <td style="width: 10%;"></td> <td style="width: 10%;"></td> <td style="width: 10%;"></td> <td style="width: 10%;"></td> </tr> <tr> <td></td> <td></td> <td colspan="8" style="text-align: center;"> <table border="1" style="width: 100%; border-collapse: collapse; text-align: center;"> <tr> <td style="width: 10%;"></td> <td style="width: 10%;"></td> <td style="width: 10%;"></td> <td style="width: 10%;"></td> <td style="width: 10%;"></td> <td style="width: 10%;"></td> <td style="width: 10%;"></td> <td style="width: 10%;"></td> <td style="width: 10%;"></td> <td style="width: 10%;"></td> </tr> <tr> <td></td> <td></td> <td colspan="8" style="text-align: center;"> <table border="1" style="width: 100%; border-collapse: collapse; text-align: center;"> <tr> <td style="width: 10%;"></td> <td style="width: 10%;"></td> <td style="width: 10%;"></td> <td style="width: 10%;"></td> <td style="width: 10%;"></td> <td style="width: 10%;"></td> <td style="width: 10%;"></td> <td style="width: 10%;"></td> <td style="width: 10%;"></td> <td style="width: 10%;"></td> </tr> <tr> <td></td> <td></td> <td colspan="8" style="text-align: center;"> <table border="1" style="width: 100%; border-collapse: collapse; text-align: center;"> <tr> <td style="width: 10%;"></td> <td style="width: 10%;"></td> <td style="width: 10%;"></td> <td style="width: 10%;"></td> <td style="width: 10%;"></td> <td style="width: 10%;"></td> <td style="width: 10%;"></td> <td style="width: 10%;"></td> <td style="width: 10%;"></td> <td style="width: 10%;"></td> </tr> <tr> <td></td> <td></td> <td colspan="8" style="text-align: center;"> <table border="1" style="width: 100%; border-collapse: collapse; text-align: center;"> <tr> <td style="width: 10%;"></td> <td style="width: 10%;"></td> <td style="width: 10%;"></td> <td style="width: 10%;"></td> <td style="width: 10%;"></td> <td style="width: 10%;"></td> <td style="width: 10%;"></td> <td style="width: 10%;"></td> <td style="width: 10%;"></td> <td style="width: 10%;"></td> </tr> <tr> <td></td> <td></td> <td colspan="8" style="text-align: center;"> <table border="1" style="width: 100%; border-collapse: collapse; text-align: center;"> <tr> <td style="width: 10%;"></td> <td style="width: 10%;"></td> <td style="width: 10%;"></td> <td style="width: 10%;"></td> <td style="width: 10%;"></td> <td style="width: 10%;"></td> <td style="width: 10%;"></td> <td style="width: 10%;"></td> <td style="width: 10%;"></td> <td style="width: 10%;"></td> </tr> <tr> <td></td> <td></td> <td colspan="8" style="text-align: center;"> <table border="1" style="width: 100%; border-collapse: collapse; text-align: center;"> <tr> <td style="width: 10%;"></td> <td style="width: 10%;"></td> <td style="width: 10%;"></td> <td style="width: 10%;"></td> <td style="width: 10%;"></td> <td style="width: 10%;"></td> <td style="width: 10%;"></td> <td style="width: 10%;"></td> <td style="width: 10%;"></td> <td style="width: 10%;"></td> </tr> <tr> <td></td> <td></td> <td colspan="8" style="text-align: center;"> <table border="1" style="width: 100%; border-collapse: collapse; text-align: center;"> <tr> <td style="width: 10%;"></td> <td style="width: 10%;"></td> <td style="width: 10%;"></td> <td style="width: 10%;"></td> <td style="width: 10%;"></td> <td style="width: 10%;"></td> <td style="width: 10%;"></td> <td style="width: 10%;"></td> <td style="width: 10%;"></td> <td style="width: 10%;"></td> </tr> <tr> <td></td> <td></td> <td colspan="8" style="text-align: center;"> <table border="1" style="width: 100%; border-collapse: collapse; text-align: center;"> <tr> <td style="width: 10%;"></td> <td style="width: 10%;"></td> <td style="width: 10%;"></td> <td style="width: 10%;"></td> <td style="width: 10%;"></td> <td style="width: 10%;"></td> <td style="width: 10%;"></td> <td style="width: 10%;"></td> <td style="width: 10%;"></td> <td style="width: 10%;"></td> </tr> <tr> <td></td> <td></td> <td colspan="8" style="text-align: center;"> <table border="1" style="width: 100%; border-collapse: collapse; text-align: center;"> <tr> <td style="width: 10%;"></td> <td style="width: 10%;"></td> <td style="width: 10%;"></td> <td style="width: 10%;"></td> <td style="width: 10%;"></td> <td style="width: 10%;"></td> <td style="width: 10%;"></td> <td style="width: 10%;"></td> <td style="width: 10%;"></td> <td style="width: 10%;"></td> </tr> <tr> <td></td> <td></td> <td colspan="8" style="text-align: center;"> <table border="1" style="width: 100%; border-collapse: collapse; text-align: center;"> <tr> <td style="width: 10%;"></td> <td style="width: 10%;"></td> <td style="width: 10%;"></td> <td style="width: 10%;"></td> <td style="width: 10%;"></td> <td style="width: 10%;"></td> <td style="width: 10%;"></td> <td style="width: 10%;"></td> <td style="width: 10%;"></td> <td style="width: 10%;"></td> </tr> <tr> <td></td> <td></td> <td colspan="8" style="text-align: center;"> <table border="1" style="width: 100%; border-collapse: collapse; text-align: center;"> <tr> <td style="width: 10%;"></td> <td style="width: 10%;"></td> <td style="width: 10%;"></td> <td style="width: 10%;"></td> <td style="width: 10%;"></td> <td style="width: 10%;"></td> <td style="width: 10%;"></td> <td style="width: 10%;"></td> <td style="width: 10%;"></td> <td style="width: 10%;"></td> </tr> <tr> <td></td> <td></td> <td colspan="8" style="text-align: center;"> <table border="1" style="width: 100%; border-collapse: collapse; text-align: center;"> <tr> <td style="width: 10%;"></td> <td style="width: 10%;"></td> <td style="width: 10%;"></td> <td style="width: 10%;"></td> <td style="width: 10%;"></td> <td style="width: 10%;"></td> <td style="width: 10%;"></td> <td style="width: 10%;"></td> <td style="width: 10%;"></td> <td style="width: 10%;"></td> </tr> <tr> <td></td> <td></td> <td colspan="8" style="text-align: center;"> <table border="1" style="width: 100%; border-collapse: collapse; text-align: center;"> <tr> <td style="width: 10%;"></td> <td style="width: 10%;"></td> <td style="width: 10%;"></td> <td style="width: 10%;"></td> <td style="width: 10%;"></td> <td style="width: 10%;"></td> <td style="width: 10%;"></td> <td style="width: 10%;"></td> <td style="width: 10%;"></td> <td style="width: 10%;"></td> </tr> <tr> <td></td> <td></td> <td colspan="8" style="text-align: center;"> <table border="1" style="width: 100%; border-collapse: collapse; text-align: center;"> <tr> <td style="width: 10%;"></td> <td style="width: 10%;"></td> <td style="width: 10%;"></td> <td style="width: 10%;"></td> <td style="width: 10%;"></td> <td style="width: 10%;"></td> <td style="width: 10%;"></td> <td style="width: 10%;"></td> <td style="width: 10%;"></td> <td style="width: 10%;"></td> </tr> <tr> <td></td> <td></td> <td colspan="8" style="text-align: center;"> <table border="1" style="width: 100%; border-collapse: collapse; text-align: center;"> <tr> <td style="width: 10%;"></td> <td style="width: 10%;"></td> <td style="width: 10%;"></td> <td style="width: 10%;"></td> <td style="width: 10%;"></td> <td style="width: 10%;"></td> <td style="width: 10%;"></td> <td style="width: 10%;"></td> <td style="width: 10%;"></td> <td style="width: 10%;"></td> </tr> <tr> <td></td> <td></td> <td colspan="8" style="text-align: center;"> <table border="1" style="width: 100%; border-collapse: collapse; text-align: center;"> <tr> <td style="width: 10%;"></td> <td style="width: 10%;"></td> <td style="width: 10%;"></td> <td style="width: 10%;"></td> <td
style="width: 10%;"></td> <td style="width: 10%;"></td> <td style="width: 10%;"></td> <td style="width: 10%;"></td> <td style="width: 10%;"></td> <td style="width: 10%;"></td> </tr> <tr> <td></td> <td></td> <td colspan="8" style="text-align: center;"> <table border="1" style="width: 100%; border-collapse: collapse; text-align: center;"> <tr> <td style="width: 10%;"></td> <td style="width: 10%;"></td> <td style="width: 10%;"></td> <td style="width: 10%;"></td> <td style="width: 10%;"></td> <td style="width: 10%;"></td> <td style="width: 10%;"></td> <td style="width: 10%;"></td> <td style="width: 10%;"></td> <td style="width: 10%;"></td> </tr> <tr> <td></td> <td></td> <td colspan="8" style="text-align: center;"> <table border="1" style="width: 100%; border-collapse: collapse; text-align: center;"> <tr> <td style="width: 10%;"></td> <td style="width: 10%;"></td> <td style="width: 10%;"></td> <td style="width: 10%;"></td> <td style="width: 10%;"></td> <td style="width: 10%;"></td> <td style="width: 10%;"></td> <td style="width: 10%;"></td> <td style="width: 10%;"></td> <td style="width: 10%;"></td> </tr> <tr> <td></td> <td></td> <td colspan="8" style="text-align: center;"> <table border="1" style="width: 100%; border-collapse: collapse; text-align: center;"> <tr> <td style="width: 10%;"></td> <td style="width: 10%;"></td> <td style="width: 10%;"></td> <td style="width: 10%;"></td> <td style="width: 10%;"></td> <td style="width: 10%;"></td> <td style="width: 10%;"></td> <td style="width: 10%;"></td> <td style="width: 10%;"></td> <td style="width: 10%;"></td> </tr> <tr> <td></td> <td></td> <td colspan="8" style="text-align: center;"> <table border="1" style="width: 100%; border-collapse: collapse; text-align: center;"> <tr> <td style="width: 10%;"></td> <td style="width: 10%;"></td> <td style="width: 10%;"></td> <td style="width: 10%;"></td> <td style="width: 10%;"></td> <td style="width: 10%;"></td> <td style="width: 10%;"></td> <td style="width: 10%;"></td> <td style="width: 10%;"></td> <td style="width: 10%;"></td> </tr> <tr> <td></td> <td></td> <td colspan="8" style="text-align: center;"> <table border="1" style="width: 100%; border-collapse: collapse; text-align: center;"> <tr> <td style="width: 10%;"></td> <td style="width: 10%;"></td> <td style="width: 10%;"></td> <td style="width: 10%;"></td> <td style="width: 10%;"></td> <td style="width: 10%;"></td> <td style="width: 10%;"></td> <td style="width: 10%;"></td> <td style="width: 10%;"></td> <td style="width: 10%;"></td> </tr> <tr> <td></td> <td></td> <td colspan="8" style="text-align: center;"> <table border="1" style="width: 100%; border-collapse: collapse; text-align: center;"> <tr> <td style="width: 10%;"></td> <td style="width: 10%;"></td> <td style="width: 10%;"></td> <td style="width: 10%;"></td> <td style="width: 10%;"></td> <td style="width: 10%;"></td> <td style="width: 10%;"></td> <td style="width: 10%;"></td> <td style="width: 10%;"></td> <td style="width: 10%;"></td> </tr> <tr> <td></td> <td></td> <td colspan="8" style="text-align: center;"> <table border="1" style="width: 100%; border-collapse: collapse; text-align: center;"> <tr> <td style="width: 10%;"></td> <td style="width: 10%;"></td> <td style="width: 10%;"></td> <td style="width: 10%;"></td> <td style="width: 10%;"></td> <td style="width: 10%;"></td> <td style="width: 10%;"></td> <td style="width: 10%;"></td> <td style="width: 10%;"></td> <td style="width: 10%;"></td> </tr> <tr> <td></td> <td></td> <td colspan="8" style="text-align: center;"> <table border="1" style="width: 100%; border-collapse: collapse; text-align: center;"> <tr> <td style="width: 10%;"></td> <td style="width: 10%;"></td> <td style="width: 10%;"></td> <td style="width: 10%;"></td> <td style="width: 10%;"></td> <td style="width: 10%;"></td> <td style="width: 10%;"></td> <td style="width: 10%;"></td> <td style="width: 10%;"></td> <td style="width: 10%;"></td> </tr> <tr> <td></td> <td></td> <td colspan="8" style="text-align: center;"> <table border="1" style="width: 100%; border-collapse: collapse; text-align: center;"> <tr> <td style="width: 10%;"></td> <td style="width: 10%;"></td> <td style="width: 10%;"></td> <td style="width: 10%;"></td> <td style="width: 10%;"></td> <td style="width: 10%;"></td> <td style="width: 10%;"></td> <td style="width: 10%;"></td> <td style="width: 10%;"></td> <td style="width: 10%;"></td> </tr> <tr> <td></td> <td></td> <td colspan="8" style="text-align: center;"> <table border="1" style="width: 100%; border-collapse: collapse; text-align: center;"> <tr> <td style="width: 10%;"></td> <td style="width: 10%;"></td> <td style="width: 10%;"></td> <td style="width: 10%;"></td> <td style="width: 10%;"></td> <td style="width: 10%;"></td> <td style="width: 10%;"></td> <td style="width: 10%;"></td> <td style="width: 10%;"></td> <td style="width: 10%;"></td> </tr> <tr> <td></td> <td></td> <td colspan="8" style="text-align: center;"> <table border="1" style="width: 100%; border-collapse: collapse; text-align: center;"> <tr> <td style="width: 10%;"></td> <td style="width: 10%;"></td> <td style="width: 10%;"></td> <td style="width: 10%;"></td> <td style="width: 10%;"></td> <td style="width: 10%;"></td> <td style="width: 10%;"></td> <td style="width: 10%;"></td> <td style="width: 10%;"></td> <td style="width: 10%;"></td> </tr> <tr> <td></td> <td></td> <td colspan="8" style="text-align: center;"> <table border="1" style="width: 100%; border-collapse: collapse; text-align: center;"> <tr> <td style="width: 10%;"></td> <td style="width: 10%;"></td> <td style="width: 10%;"></td> <td style="width: 10%;"></td> <td style="width: 10%;"></td> <td style="width: 10%;"></td> <td style="width: 10%;"></td> <td style="width: 10%;"></td> <td style="width: 10%;"></td> <td style="width: 10%;"></td> </tr> <tr> <td></td> <td></td> <td colspan="8" style="text-align: center;"> <table border="1" style="width: 100%; border-collapse: collapse; text-align: center;"> <tr> <td style="width: 10%;"></td> <td style="width: 10%;"></td> <td style="width: 10%;"></td> <td style="width: 10%;"></td> <td style="width: 10%;"></td> <td style="width: 10%;"></td> <td style="width: 10%;"></td> <td style="width: 10%;"></td> <td style="width: 10%;"></td> <td style="width: 10%;"></td> </tr> <tr> <td></td> <td></td> <td colspan="8" style="text-align: center;"> <table border="1" style="width: 100%; border-collapse: collapse; text-align: center;"> <tr> <td style="width: 10%;"></td> <td style="width: 10%;"></td> <td style="width: 10%;"></td> <td style="width: 10%;"></td> <td style="width: 10%;"></td> <td style="width: 10%;"></td> <td style="width: 10%;"></td> <td style="width: 10%;"></td> <td style="width: 10%;"></td> <td style="width: 10%;"></td> </tr> <tr> <td></td> <td></td> <td colspan="8" style="text-align: center;"> <table border="1" style="width: 100%; border-collapse: collapse; text-align: center;"> <tr> <td style="width: 10%;"></td> <td style="width: 10%;"></td> <td style="width: 10%;"></td> <td style="width: 10%;"></td> <td style="width: 10%;"></td> <td style="width: 10%;"></td> <td style="width: 10%;"></td> <td style="width: 10%;"></td> <td style="width: 10%;"></td> <td style="width: 10%;"></td> </tr> <tr> <td></td> <td></td> <td colspan="8" style="text-align: center;"> <table border="1" style="width: 100%; border-collapse: collapse; text-align: center;"> <tr> <td style="width: 10%;"></td> <td style="width: 10%;"></td> <td style="width: 10%;"></td> <td style="width: 10%;"></td> <td style="width: 10%;"></td> <td style="width: 10%;"></td> <td style="width: 10%;"></td> <td style="width: 10%;"></td> <td style="width: 10%;"></td> <td style="width: 10%;"></td> </tr> <tr> <td></td> <td></td> <td colspan="8" style="text-align: center;"> <table border="1" style="width: 100%; border-collapse: collapse; text-align: center;"> <tr> <td style="width: 10%;"></td> <td style="width: 10%;"></td> <td style="width: 10%;"></td> <td style="width: 10%;"></td> <td style="width: 10%;"></td> <td style="width: 10%;"></td> <td style="width: 10%;"></td> <td style="width: 10%;"></td> <td style="width: 10%;"></td> <td style="width: 10%;"></td> </tr> <tr> <td></td> <td></td> <td colspan="8" style="text-align: center;"> <table border="1" style="width: 100%; border-collapse: collapse; text-align: center;"> <tr> <td style="width: 10%;"></td> <td style="width: 10%;"></td> <td style="width: 10%;"></td> <td style="width: 10%;"></td> <td style="width: 10%;"></td> <td style="width: 10%;"></td> <td style="width: 10%;"></td> <td style="width: 10%;"></td> <td style="width: 10%;"></td> <td style="width: 10%;"></td> </tr> <tr> <td></td> <td></td> <td colspan="8" style="text-align: center;"> <table border="1" style="width: 100%; border-collapse: collapse; text-align: center;"> <tr> <td style="width: 10%;"></td> <td style="width: 10%;"></td> <td style="width: 10%;"></td> <td style="width: 10%;"></td> <td style="width: 10%;"></td> <td style="width: 10%;"></td> <td style="width: 10%;"></td> <td style="width: 10%;"></td> <td style="width: 10%;"></td> <td style="width: 10%;"></td> </tr> <tr> <td></td> <td></td> <td colspan="8" style="text-align: center;"> <table border="1" style="width: 100%; border-collapse: collapse; text-align: center;"> <tr> <td style="width: 10%;"></td> <td style="width: 10%;"></td> <td style="width: 10%;"></td> <td style="width: 10%;"></td> <td style="width: 10%;"></td> <td style="width: 10%;"></td> <td style="width: 10%;"></td> <td style="width: 10%;"></td> <td style="width: 10%;"></td> <td style="width: 10%;"></td> </tr> <tr> <td></td> <td></td> <td colspan="8" style="text-align: center;"> <table border="1" style="width: 100%; border-collapse: collapse; text-align: center;"> <tr> <td style="width: 10%;"></td> <td style="width: 10%;"></td> <td style="width: 10%;"></td> <td style="width: 10%;"></td> <td style="width: 10%;"></td> <td style="width: 10%;"></td> <td style="width: 10%;"></td> <td style="width: 10%;"></td> <td style="width: 10%;"></td> <td style="width:
10%;"></td> </tr> <tr> <td></td> <td></td> <td colspan="8" style="text-align: center;"> <table border="1" style="width: 100%; border-collapse: collapse; text-align: center;"> <tr> <td style="width: 10%;"></td> <td style="width: 10%;"></td> <td style="width: 10%;"></td> <td style="width: 10%;"></td> <td style="width: 10%;"></td> <td style="width: 10%;"></td> <td style="width: 10%;"></td> <td style="width: 10%;"></td> <td style="width: 10%;"></td> <td style="width: 10%;"></td> </tr> <tr> <td></td> <td></td> <td colspan="8" style="text-align: center;"> <table border="1" style="width: 100%; border-collapse: collapse; text-align: center;"> <tr> <td style="width: 10%;"></td> <td style="width: 10%;"></td> <td style="width: 10%;"></td> <td style="width: 10%;"></td> <td style="width: 10%;"></td> <td style="width: 10%;"></td> <td style="width: 10%;"></td> <td style="width: 10%;"></td> <td style="width: 10%;"></td> <td style="width: 10%;"></td> </tr> <tr> <td></td> <td></td> <td colspan="8" style="text-align: center;"> <table border="1" style="width: 100%; border-collapse: collapse; text-align: center;"> <tr> <td style="width: 10%;"></td> <td style="width: 10%;"></td> <td style="width: 10%;"></td> <td style="width: 10%;"></td> <td style="width: 10%;"></td> <td style="width: 10%;"></td> <td style="width: 10%;"></td> <td style="width: 10%;"></td> <td style="width: 10%;"></td> <td style="width: 10%;"></td> </tr> <tr> <td></td> <td></td> <td colspan="8" style="text-align: center;"> <table border="1" style="width: 100%; border-collapse: collapse; text-align: center;"> <tr> <td style="width: 10%;"></td> <td style="width: 10%;"></td> <td style="width: 10%;"></td> <td style="width: 10%;"></td> <td style="width: 10%;"></td> <td style="width: 10%;"></td> <td style="width: 10%;"></td> <td style="width: 10%;"></td> <td style="width: 10%;"></td> <td style="width: 10%;"></td> </tr> <tr> <td></td> <td></td> <td colspan="8" style="text-align: center;"> <table border="1" style="width: 100%; border-collapse: collapse; text-align: center;"> <tr> </tr></table></td></tr></table></td></tr></table></td></tr></table></td></tr></table></td></tr></table></td></tr></table></td></tr></table></td></tr></table></td></tr></table></td></tr></table></td></tr></table></td></tr></table></td></tr></table></td></tr></table></td></tr></table></td></tr></table></td></tr></table></td></tr></table></td></tr></table></td></tr></table></td></tr></table></td></tr></table></td></tr></table></td></tr></table></td></tr></table></td></tr></table></td></tr></table></td></tr></table></td></tr></table></td></tr></table></td></tr></table></td></tr></table></td></tr></table></td></tr></table></td></tr></table></td></tr></table></td></tr></table></td></tr></table></td></tr></table></td></tr></table></td></tr></table></td></tr></table></td></tr></table></td></tr></table></td></tr></table></td></tr></table> | | | | | | | | | | | | | | | | | | | | <table border="1" style="width: 100%; border-collapse: collapse; text-align: center;"> <tr> <td style="width: 10%;"></td> <td style="width: 10%;"></td> <td style="width: 10%;"></td> <td style="width: 10%;"></td> <td style="width: 10%;"></td> <td style="width: 10%;"></td> <td style="width: 10%;"></td> <td style="width: 10%;"></td> <td style="width: 10%;"></td> <td style="width: 10%;"></td> </tr> <tr> <td></td> <td></td> <td colspan="8" style="text-align: center;"> <table border="1" style="width: 100%; border-collapse: collapse; text-align: center;"> <tr> <td style="width: 10%;"></td> <td style="width: 10%;"></td> <td style="width: 10%;"></td> <td style="width: 10%;"></td> <td style="width: 10%;"></td> <td style="width: 10%;"></td> <td style="width: 10%;"></td> <td style="width: 10%;"></td> <td style="width: 10%;"></td> <td style="width: 10%;"></td> </tr> <tr> <td></td> <td></td> <td colspan="8" style="text-align: center;"> <table border="1" style="width: 100%; border-collapse: collapse; text-align: center;"> <tr> <td style="width: 10%;"></td> <td style="width: 10%;"></td> <td style="width: 10%;"></td> <td style="width: 10%;"></td> <td style="width: 10%;"></td> <td style="width: 10%;"></td> <td
style="width: 10%;"></td> <td style="width: 10%;"></td> <td style="width: 10%;"></td> <td style="width: 10%;"></td> </tr> <tr> <td></td> <td></td> <td colspan="8" style="text-align: center;"> <table border="1" style="width: 100%; border-collapse: collapse; text-align: center;"> <tr> <td style="width: 10%;"></td> <td style="width: 10%;"></td> <td style="width: 10%;"></td> <td style="width: 10%;"></td> <td style="width: 10%;"></td> <td style="width: 10%;"></td> <td style="width: 10%;"></td> <td style="width: 10%;"></td> <td style="width: 10%;"></td> <td style="width: 10%;"></td> </tr> <tr> <td></td> <td></td> <td colspan="8" style="text-align: center;"> <table border="1" style="width: 100%; border-collapse: collapse; text-align: center;"> <tr> <td style="width: 10%;"></td> <td style="width: 10%;"></td> <td style="width: 10%;"></td> <td style="width: 10%;"></td> <td style="width: 10%;"></td> <td style="width: 10%;"></td> <td style="width: 10%;"></td> <td style="width: 10%;"></td> <td style="width: 10%;"></td> <td style="width: 10%;"></td> </tr> <tr> <td></td> <td></td> <td colspan="8" style="text-align: center;"> <table border="1" style="width: 100%; border-collapse: collapse; text-align: center;"> <tr> <td style="width: 10%;"></td> <td style="width: 10%;"></td> <td style="width: 10%;"></td> <td style="width: 10%;"></td> <td style="width: 10%;"></td> <td style="width: 10%;"></td> <td style="width: 10%;"></td> <td style="width: 10%;"></td> <td style="width: 10%;"></td> <td style="width: 10%;"></td> </tr> <tr> <td></td> <td></td> <td colspan="8" style="text-align: center;"> <table border="1" style="width: 100%; border-collapse: collapse; text-align: center;"> <tr> <td style="width: 10%;"></td> <td style="width: 10%;"></td> <td style="width: 10%;"></td> <td style="width: 10%;"></td> <td style="width: 10%;"></td> <td style="width: 10%;"></td> <td style="width: 10%;"></td> <td style="width: 10%;"></td> <td style="width: 10%;"></td> <td style="width: 10%;"></td> </tr> <tr> <td></td> <td></td> <td colspan="8" style="text-align: center;"> <table border="1" style="width: 100%; border-collapse: collapse; text-align: center;"> <tr> <td style="width: 10%;"></td> <td style="width: 10%;"></td> <td style="width: 10%;"></td> <td style="width: 10%;"></td> <td style="width: 10%;"></td> <td style="width: 10%;"></td> <td style="width: 10%;"></td> <td style="width: 10%;"></td> <td style="width: 10%;"></td> <td style="width: 10%;"></td> </tr> <tr> <td></td> <td></td> <td colspan="8" style="text-align: center;"> <table border="1" style="width: 100%; border-collapse: collapse; text-align: center;"> <tr> <td style="width: 10%;"></td> <td style="width: 10%;"></td> <td style="width: 10%;"></td> <td style="width: 10%;"></td> <td style="width: 10%;"></td> <td style="width: 10%;"></td> <td style="width: 10%;"></td> <td style="width: 10%;"></td> <td style="width: 10%;"></td> <td style="width: 10%;"></td> </tr> <tr> <td></td> <td></td> <td colspan="8" style="text-align: center;"> <table border="1" style="width: 100%; border-collapse: collapse; text-align: center;"> <tr> <td style="width: 10%;"></td> <td style="width: 10%;"></td> <td style="width: 10%;"></td> <td style="width: 10%;"></td> <td style="width: 10%;"></td> <td style="width: 10%;"></td> <td style="width: 10%;"></td> <td style="width: 10%;"></td> <td style="width: 10%;"></td> <td style="width: 10%;"></td> </tr> <tr> <td></td> <td></td> <td colspan="8" style="text-align: center;"> <table border="1" style="width: 100%; border-collapse: collapse; text-align: center;"> <tr> <td style="width: 10%;"></td> <td style="width: 10%;"></td> <td style="width: 10%;"></td> <td style="width: 10%;"></td> <td style="width: 10%;"></td> <td style="width: 10%;"></td> <td style="width: 10%;"></td> <td style="width: 10%;"></td> <td style="width: 10%;"></td> <td style="width: 10%;"></td> </tr> <tr> <td></td> <td></td> <td colspan="8" style="text-align: center;"> <table border="1" style="width: 100%; border-collapse: collapse; text-align: center;"> <tr> <td style="width: 10%;"></td> <td style="width: 10%;"></td> <td style="width: 10%;"></td> <td style="width: 10%;"></td> <td style="width: 10%;"></td> <td style="width: 10%;"></td> <td style="width: 10%;"></td> <td style="width: 10%;"></td> <td style="width: 10%;"></td> <td style="width: 10%;"></td> </tr> <tr> <td></td> <td></td> <td colspan="8" style="text-align: center;"> <table border="1" style="width: 100%; border-collapse: collapse; text-align: center;"> <tr> <td style="width: 10%;"></td> <td style="width: 10%;"></td> <td style="width: 10%;"></td> <td style="width: 10%;"></td> <td style="width: 10%;"></td> <td style="width: 10%;"></td> <td style="width: 10%;"></td> <td style="width: 10%;"></td> <td style="width: 10%;"></td> <td style="width: 10%;"></td> </tr> <tr> <td></td> <td></td> <td colspan="8" style="text-align: center;"> <table border="1" style="width: 100%; border-collapse: collapse; text-align: center;"> <tr> <td style="width: 10%;"></td> <td style="width: 10%;"></td> <td style="width: 10%;"></td> <td style="width: 10%;"></td> <td style="width: 10%;"></td> <td style="width: 10%;"></td> <td style="width: 10%;"></td> <td style="width: 10%;"></td> <td style="width: 10%;"></td> <td style="width: 10%;"></td> </tr> <tr> <td></td> <td></td> <td colspan="8" style="text-align: center;"> <table border="1" style="width: 100%; border-collapse: collapse; text-align: center;"> <tr> <td style="width: 10%;"></td> <td style="width: 10%;"></td> <td style="width: 10%;"></td> <td style="width: 10%;"></td> <td style="width: 10%;"></td> <td style="width: 10%;"></td> <td style="width: 10%;"></td> <td style="width: 10%;"></td> <td style="width: 10%;"></td> <td style="width: 10%;"></td> </tr> <tr> <td></td> <td></td> <td colspan="8" style="text-align: center;"> <table border="1" style="width: 100%; border-collapse: collapse; text-align: center;"> <tr> <td style="width: 10%;"></td> <td style="width: 10%;"></td> <td style="width: 10%;"></td> <td style="width: 10%;"></td> <td style="width: 10%;"></td> <td style="width: 10%;"></td> <td style="width: 10%;"></td> <td style="width: 10%;"></td> <td style="width: 10%;"></td> <td style="width: 10%;"></td> </tr> <tr> <td></td> <td></td> <td colspan="8" style="text-align: center;"> <table border="1" style="width: 100%; border-collapse: collapse; text-align: center;"> <tr> <td style="width: 10%;"></td> <td style="width: 10%;"></td> <td style="width: 10%;"></td> <td style="width: 10%;"></td> <td style="width: 10%;"></td> <td style="width: 10%;"></td> <td style="width: 10%;"></td> <td style="width: 10%;"></td> <td style="width: 10%;"></td> <td style="width: 10%;"></td> </tr> <tr> <td></td> <td></td> <td colspan="8" style="text-align: center;"> <table border="1" style="width: 100%; border-collapse: collapse; text-align: center;"> <tr> <td style="width: 10%;"></td> <td style="width: 10%;"></td> <td style="width: 10%;"></td> <td style="width: 10%;"></td> <td style="width: 10%;"></td> <td style="width: 10%;"></td> <td style="width: 10%;"></td> <td style="width: 10%;"></td> <td style="width: 10%;"></td> <td style="width: 10%;"></td> </tr> <tr> <td></td> <td></td> <td colspan="8" style="text-align: center;"> <table border="1" style="width: 100%; border-collapse: collapse; text-align: center;"> <tr> <td style="width: 10%;"></td> <td style="width: 10%;"></td> <td style="width: 10%;"></td> <td style="width: 10%;"></td> <td style="width: 10%;"></td> <td style="width: 10%;"></td> <td style="width: 10%;"></td> <td style="width: 10%;"></td> <td style="width: 10%;"></td> <td style="width: 10%;"></td> </tr> <tr> <td></td> <td></td> <td colspan="8" style="text-align: center;"> <table border="1" style="width: 100%; border-collapse: collapse; text-align: center;"> <tr> <td style="width: 10%;"></td> <td style="width: 10%;"></td> <td style="width: 10%;"></td> <td style="width: 10%;"></td> <td style="width: 10%;"></td> <td style="width: 10%;"></td> <td style="width: 10%;"></td> <td style="width: 10%;"></td> <td style="width: 10%;"></td> <td style="width: 10%;"></td> </tr> <tr> <td></td> <td></td> <td colspan="8" style="text-align: center;"> <table border="1" style="width: 100%; border-collapse: collapse; text-align: center;"> <tr> <td style="width: 10%;"></td> <td style="width: 10%;"></td> <td style="width: 10%;"></td> <td style="width: 10%;"></td> <td style="width: 10%;"></td> <td style="width: 10%;"></td> <td style="width: 10%;"></td> <td style="width: 10%;"></td> <td style="width: 10%;"></td> <td style="width: 10%;"></td> </tr> <tr> <td></td> <td></td> <td colspan="8" style="text-align: center;"> <table border="1" style="width: 100%; border-collapse: collapse; text-align: center;"> <tr> <td style="width: 10%;"></td> <td style="width: 10%;"></td> <td style="width: 10%;"></td> <td style="width: 10%;"></td> <td style="width: 10%;"></td> <td style="width: 10%;"></td> <td style="width: 10%;"></td> <td style="width: 10%;"></td> <td style="width: 10%;"></td> <td style="width: 10%;"></td> </tr> <tr> <td></td> <td></td> <td colspan="8" style="text-align: center;"> <table border="1" style="width: 100%; border-collapse: collapse; text-align: center;"> <tr> <td style="width: 10%;"></td> <td style="width: 10%;"></td> <td style="width: 10%;"></td> <td style="width: 10%;"></td> <td style="width: 10%;"></td> <td style="width: 10%;"></td> <td style="width: 10%;"></td> <td style="width: 10%;"></td> <td style="width: 10%;"></td> <td style="width: 10%;"></td> </tr> <tr> <td></td> <td></td> <td colspan="8" style="text-align: center;"> <table border="1" style="width: 100%; border-collapse: collapse; text-align: center;"> <tr> <td style="width: 10%;"></td> <td style="width: 10%;"></td> <td style="width: 10%;"></td> <td style="width: 10%;"></td> <td style="width: 10%;"></td> <td style="width: 10%;"></td> <td style="width: 10%;"></td> <td style="width: 10%;"></td> <td style="width: 10%;"></td> <td style="width: 10%;"></td> </tr> <tr> <td></td> <td></td> <td colspan="8"
style="text-align: center;"> <table border="1" style="width: 100%; border-collapse: collapse; text-align: center;"> <tr> <td style="width: 10%;"></td> <td style="width: 10%;"></td> <td style="width: 10%;"></td> <td style="width: 10%;"></td> <td style="width: 10%;"></td> <td style="width: 10%;"></td> <td style="width: 10%;"></td> <td style="width: 10%;"></td> <td style="width: 10%;"></td> <td style="width: 10%;"></td> </tr> <tr> <td></td> <td></td> <td colspan="8" style="text-align: center;"> <table border="1" style="width: 100%; border-collapse: collapse; text-align: center;"> <tr> <td style="width: 10%;"></td> <td style="width: 10%;"></td> <td style="width: 10%;"></td> <td style="width: 10%;"></td> <td style="width: 10%;"></td> <td style="width: 10%;"></td> <td style="width: 10%;"></td> <td style="width: 10%;"></td> <td style="width: 10%;"></td> <td style="width: 10%;"></td> </tr> <tr> <td></td> <td></td> <td colspan="8" style="text-align: center;"> <table border="1" style="width: 100%; border-collapse: collapse; text-align: center;"> <tr> <td style="width: 10%;"></td> <td style="width: 10%;"></td> <td style="width: 10%;"></td> <td style="width: 10%;"></td> <td style="width: 10%;"></td> <td style="width: 10%;"></td> <td style="width: 10%;"></td> <td style="width: 10%;"></td> <td style="width: 10%;"></td> <td style="width: 10%;"></td> </tr> <tr> <td></td> <td></td> <td colspan="8" style="text-align: center;"> <table border="1" style="width: 100%; border-collapse: collapse; text-align: center;"> <tr> <td style="width: 10%;"></td> <td style="width: 10%;"></td> <td style="width: 10%;"></td> <td style="width: 10%;"></td> <td style="width: 10%;"></td> <td style="width: 10%;"></td> <td style="width: 10%;"></td> <td style="width: 10%;"></td> <td style="width: 10%;"></td> <td style="width: 10%;"></td> </tr> <tr> <td></td> <td></td> <td colspan="8" style="text-align: center;"> <table border="1" style="width: 100%; border-collapse: collapse; text-align: center;"> <tr> <td style="width: 10%;"></td> <td style="width: 10%;"></td> <td style="width: 10%;"></td> <td style="width: 10%;"></td> <td style="width: 10%;"></td> <td style="width: 10%;"></td> <td style="width: 10%;"></td> <td style="width: 10%;"></td> <td style="width: 10%;"></td> <td style="width: 10%;"></td> </tr> <tr> <td></td> <td></td> <td colspan="8" style="text-align: center;"> <table border="1" style="width: 100%; border-collapse: collapse; text-align: center;"> <tr> <td style="width: 10%;"></td> <td style="width: 10%;"></td> <td style="width: 10%;"></td> <td style="width: 10%;"></td> <td style="width: 10%;"></td> <td style="width: 10%;"></td> <td style="width: 10%;"></td> <td style="width: 10%;"></td> <td style="width: 10%;"></td> <td style="width: 10%;"></td> </tr> <tr> <td></td> <td></td> <td colspan="8" style="text-align: center;"> <table border="1" style="width: 100%; border-collapse: collapse; text-align: center;"> <tr> <td style="width: 10%;"></td> <td style="width: 10%;"></td> <td style="width: 10%;"></td> <td style="width: 10%;"></td> <td style="width: 10%;"></td> <td style="width: 10%;"></td> <td style="width: 10%;"></td> <td style="width: 10%;"></td> <td style="width: 10%;"></td> <td style="width: 10%;"></td> </tr> <tr> <td></td> <td></td> <td colspan="8" style="text-align: center;"> <table border="1" style="width: 100%; border-collapse: collapse; text-align: center;"> <tr> <td style="width: 10%;"></td> <td style="width: 10%;"></td> <td style="width: 10%;"></td> <td style="width: 10%;"></td> <td style="width: 10%;"></td> <td style="width: 10%;"></td> <td style="width: 10%;"></td> <td style="width: 10%;"></td> <td style="width: 10%;"></td> <td style="width: 10%;"></td> </tr> <tr> <td></td> <td></td> <td colspan="8" style="text-align: center;"> <table border="1" style="width: 100%; border-collapse: collapse; text-align: center;"> <tr> <td style="width: 10%;"></td> <td style="width: 10%;"></td> <td style="width: 10%;"></td> <td style="width: 10%;"></td> <td style="width: 10%;"></td> <td style="width: 10%;"></td> <td style="width: 10%;"></td> <td style="width: 10%;"></td> <td style="width: 10%;"></td> <td style="width: 10%;"></td> </tr> <tr> <td></td> <td></td> <td colspan="8" style="text-align: center;"> <table border="1" style="width: 100%; border-collapse: collapse; text-align: center;"> <tr> <td style="width: 10%;"></td> <td style="width: 10%;"></td> <td style="width: 10%;"></td> <td style="width: 10%;"></td> <td style="width: 10%;"></td> <td style="width: 10%;"></td> <td style="width: 10%;"></td> <td style="width: 10%;"></td> <td style="width: 10%;"></td> <td style="width: 10%;"></td> </tr> <tr> <td></td> <td></td> <td colspan="8" style="text-align: center;"> <table border="1" style="width: 100%; border-collapse: collapse; text-align: center;"> <tr> <td style="width: 10%;"></td> <td style="width: 10%;"></td> <td style="width: 10%;"></td> <td style="width: 10%;"></td> <td style="width: 10%;"></td> <td style="width: 10%;"></td> <td style="width: 10%;"></td> <td style="width: 10%;"></td> <td style="width: 10%;"></td> <td style="width: 10%;"></td> </tr> <tr> <td></td> <td></td> <td colspan="8" style="text-align: center;"> <table border="1" style="width: 100%; border-collapse: collapse; text-align: center;"> <tr> <td style="width: 10%;"></td> <td style="width: 10%;"></td> <td style="width: 10%;"></td> <td style="width: 10%;"></td> <td style="width: 10%;"></td> <td style="width: 10%;"></td> <td style="width: 10%;"></td> <td style="width: 10%;"></td> <td style="width: 10%;"></td> <td style="width: 10%;"></td> </tr> <tr> <td></td> <td></td> <td colspan="8" style="text-align: center;"> <table border="1" style="width: 100%; border-collapse: collapse; text-align: center;"> <tr> <td style="width: 10%;"></td> <td style="width: 10%;"></td> <td style="width: 10%;"></td> <td style="width: 10%;"></td> <td style="width: 10%;"></td> <td style="width: 10%;"></td> <td style="width: 10%;"></td> <td style="width: 10%;"></td> <td style="width: 10%;"></td> <td style="width: 10%;"></td> </tr> <tr> <td></td> <td></td> <td colspan="8" style="text-align: center;"> <table border="1" style="width: 100%; border-collapse: collapse; text-align: center;"> <tr> <td style="width: 10%;"></td> <td style="width: 10%;"></td> <td style="width: 10%;"></td> <td style="width: 10%;"></td> <td style="width: 10%;"></td> <td style="width: 10%;"></td> <td style="width: 10%;"></td> <td style="width: 10%;"></td> <td style="width: 10%;"></td> <td style="width: 10%;"></td> </tr> <tr> <td></td> <td></td> <td colspan="8" style="text-align: center;"> <table border="1" style="width: 100%; border-collapse: collapse; text-align: center;"> <tr> <td style="width: 10%;"></td> <td style="width: 10%;"></td> <td style="width: 10%;"></td> <td style="width: 10%;"></td> <td style="width: 10%;"></td> <td style="width: 10%;"></td> <td style="width: 10%;"></td> <td style="width: 10%;"></td> <td style="width: 10%;"></td> <td style="width: 10%;"></td> </tr> <tr> <td></td> <td></td> <td colspan="8" style="text-align: center;"> <table border="1" style="width: 100%; border-collapse: collapse; text-align: center;"> <tr> <td style="width: 10%;"></td> <td style="width: 10%;"></td> <td style="width: 10%;"></td> <td style="width: 10%;"></td> <td style="width: 10%;"></td> <td style="width: 10%;"></td> <td style="width: 10%;"></td> <td style="width: 10%;"></td> <td style="width: 10%;"></td> <td style="width: 10%;"></td> </tr> <tr> <td></td> <td></td> <td colspan="8" style="text-align: center;"> <table border="1" style="width: 100%; border-collapse: collapse; text-align: center;"> <tr> <td style="width: 10%;"></td> <td style="width: 10%;"></td> <td style="width: 10%;"></td> <td style="width: 10%;"></td> <td style="width: 10%;"></td> <td style="width: 10%;"></td> <td style="width: 10%;"></td> <td style="width: 10%;"></td> <td style="width: 10%;"></td> <td style="width: 10%;"></td> </tr> <tr> <td></td> <td></td> <td colspan="8" style="text-align: center;"> <table border="1" style="width: 100%; border-collapse: collapse; text-align: center;"> <tr> <td style="width: 10%;"></td> <td style="width: 10%;"></td> <td style="width: 10%;"></td> <td style="width: 10%;"></td> <td style="width: 10%;"></td> <td style="width: 10%;"></td> <td style="width: 10%;"></td> <td style="width: 10%;"></td> <td style="width: 10%;"></td> <td style="width: 10%;"></td> </tr> <tr> <td></td> <td></td> <td colspan="8" style="text-align: center;"> <table border="1" style="width: 100%; border-collapse: collapse; text-align: center;"> <tr> <td style="width: 10%;"></td> <td style="width: 10%;"></td> <td style="width: 10%;"></td> <td style="width: 10%;"></td> <td style="width: 10%;"></td> <td style="width: 10%;"></td> <td style="width: 10%;"></td> <td style="width: 10%;"></td> <td style="width: 10%;"></td> <td style="width: 10%;"></td> </tr> <tr> <td></td> <td></td> <td colspan="8" style="text-align: center;"> <table border="1" style="width: 100%; border-collapse: collapse; text-align: center;"> <tr> <td style="width: 10%;"></td> <td style="width: 10%;"></td> <td style="width: 10%;"></td> <td style="width: 10%;"></td> <td style="width: 10%;"></td> <td style="width: 10%;"></td> <td style="width: 10%;"></td> <td style="width: 10%;"></td> <td style="width: 10%;"></td> <td style="width: 10%;"></td> </tr> <tr> <td></td> <td></td> <td colspan="8" style="text-align: center;"> <table border="1" style="width: 100%; border-collapse: collapse; text-align: center;"> <tr> <td style="width: 10%;"></td> <td style="width: 10%;"></td> <td style="width: 10%;"></td> <td style="width: 10%;"></td> <td style="width: 10%;"></td> <td style="width: 10%;"></td> <td style="width: 10%;"></td> <td style="width: 10%;"></td> <td style="width: 10%;"></td> <td style="width: 10%;"></td> </tr> <tr> <td></td> <td></td> <td colspan="8" style="text-align: center;"> <table border="1" style="width: 100%; border-collapse: collapse; text-align: center;"> <tr>
</tr></table></td></tr></table></td></tr></table></td></tr></table></td></tr></table></td></tr></table></td></tr></table></td></tr></table></td></tr></table></td></tr></table></td></tr></table></td></tr></table></td></tr></table></td></tr></table></td></tr></table></td></tr></table></td></tr></table></td></tr></table></td></tr></table></td></tr></table></td></tr></table></td></tr></table></td></tr></table></td></tr></table></td></tr></table></td></tr></table></td></tr></table></td></tr></table></td></tr></table></td></tr></table></td></tr></table></td></tr></table></td></tr></table></td></tr></table></td></tr></table></td></tr></table></td></tr></table></td></tr></table></td></tr></table></td></tr></table></td></tr></table></td></tr></table></td></tr></table></td></tr></table></td></tr></table></td></tr></table> | | | | | | | | | | | | | | | | | | | | <table border="1" style="width: 100%; border-collapse: collapse; text-align: center;"> <tr> <td style="width: 10%;"></td> <td style="width: 10%;"></td> <td style="width: 10%;"></td> <td style="width: 10%;"></td> <td style="width: 10%;"></td> <td style="width: 10%;"></td> <td style="width: 10%;"></td> <td style="width: 10%;"></td> <td style="width: 10%;"></td> <td style="width: 10%;"></td> </tr> <tr> <td></td> <td></td> <td colspan="8" style="text-align: center;"> <table border="1" style="width: 100%; border-collapse: collapse; text-align: center;"> <tr> <td style="width: 10%;"></td> <td style="width: 10%;"></td> <td style="width: 10%;"></td> <td style="width: 10%;"></td> <td style="width: 10%;"></td> <td style="width: 10%;"></td> <td style="width: 10%;"></td> <td style="width: 10%;"></td> <td style="width: 10%;"></td> <td style="width: 10%;"></td> </tr> <tr> <td></td> <td></td> <td colspan="8" style="text-align: center;"> <table border="1" style="width: 100%; border-collapse: collapse; text-align: center;"> <tr> <td style="width: 10%;"></td> <td style="width: 10%;"></td> <td style="width: 10%;"></td> <td style="width: 10%;"></td> <td style="width: 10%;"></td> <td style="width: 10%;"></td> <td style="width: 10%;"></td> <td style="width: 10%;"></td> <td style="width: 10%;"></td> <td style="width: 10%;"></td> </tr> <tr> <td></td> <td></td> <td colspan="8" style="text-align: center;"> <table border="1" style="width: 100%; border-collapse: collapse; text-align: center;"> <tr> <td style="width: 10%;"></td> <td style="width: 10%;"></td> <td style="width: 10%;"></td> <td style="width: 10%;"></td> <td style="width: 10%;"></td> <td style="width: 10%;"></td> <td style="width: 10%;"></td> <td style="width: 10%;"></td> <td style="width: 10%;"></td> <td style="width: 10%;"></td> </tr> <tr> <td></td> <td></td> <td colspan="8" style="text-align: center;"> <table border="1" style="width: 100%; border-collapse: collapse; text-align: center;"> <tr> <td style="width: 10%;"></td> <td style="width: 10%;"></td> <td style="width: 10%;"></td> <td style="width: 10%;"></td> <td style="width: 10%;"></td> <td style="width: 10%;"></td> <td style="width: 10%;"></td> <td style="width: 10%;"></td> <td style="width: 10%;"></td> <td style="width: 10%;"></td> </tr> <tr> <td></td> <td></td> <td colspan="8" style="text-align: center;"> <table border="1" style="width: 100%; border-collapse: collapse; text-align: center;"> <tr> <td style="width: 10%;"></td> <td style="width: 10%;"></td> <td style="width: 10%;"></td> <td style="width: 10%;"></td> <td style="width: 10%;"></td> <td style="width: 10%;"></td> <td style="width: 10%;"></td> <td style="width: 10%;"></td> <td style="width: 10%;"></td> <td style="width: 10%;"></td> </tr> <tr> <td></td> <td></td> <td colspan="8" style="text-align: center;"> <table border="1" style="width: 100%; border-collapse: collapse; text-align: center;"> <tr> <td style="width: 10%;"></td> <td style="width: 10%;"></td> <td style="width: 10%;"></td> <td style="width: 10%;"></td> <td style="width: 10%;"></td> <td style="width: 10%;"></td> <td style="width: 10%;"></td> <td style="width: 10%;"></td> <td style="width: 10%;"></td> <td style="width: 10%;"></td> </tr> <tr> <td></td> <td></td> <td colspan="8" style="text-align: center;"> <table
border="1" style="width: 100%; border-collapse: collapse; text-align: center;"> <tr> <td style="width: 10%;"></td> <td style="width: 10%;"></td> <td style="width: 10%;"></td> <td style="width: 10%;"></td> <td style="width: 10%;"></td> <td style="width: 10%;"></td> <td style="width: 10%;"></td> <td style="width: 10%;"></td> <td style="width: 10%;"></td> <td style="width: 10%;"></td> </tr> <tr> <td></td> <td></td> <td colspan="8" style="text-align: center;"> <table border="1" style="width: 100%; border-collapse: collapse; text-align: center;"> <tr> <td style="width: 10%;"></td> <td style="width: 10%;"></td> <td style="width: 10%;"></td> <td style="width: 10%;"></td> <td style="width: 10%;"></td> <td style="width: 10%;"></td> <td style="width: 10%;"></td> <td style="width: 10%;"></td> <td style="width: 10%;"></td> <td style="width: 10%;"></td> </tr> <tr> <td></td> <td></td> <td colspan="8" style="text-align: center;"> <table border="1" style="width: 100%; border-collapse: collapse; text-align: center;"> <tr> <td style="width: 10%;"></td> <td style="width: 10%;"></td> <td style="width: 10%;"></td> <td style="width: 10%;"></td> <td style="width: 10%;"></td> <td style="width: 10%;"></td> <td style="width: 10%;"></td> <td style="width: 10%;"></td> <td style="width: 10%;"></td> <td style="width: 10%;"></td> </tr> <tr> <td></td> <td></td> <td colspan="8" style="text-align: center;"> <table border="1" style="width: 100%; border-collapse: collapse; text-align: center;"> <tr> <td style="width: 10%;"></td> <td style="width: 10%;"></td> <td style="width: 10%;"></td> <td style="width: 10%;"></td> <td style="width: 10%;"></td> <td style="width: 10%;"></td> <td style="width: 10%;"></td> <td style="width: 10%;"></td> <td style="width: 10%;"></td> <td style="width: 10%;"></td> </tr> <tr> <td></td> <td></td> <td colspan="8" style="text-align: center;"> <table border="1" style="width: 100%; border-collapse: collapse; text-align: center;"> <tr> <td style="width: 10%;"></td> <td style="width: 10%;"></td> <td style="width: 10%;"></td> <td style="width: 10%;"></td> <td style="width: 10%;"></td> <td style="width: 10%;"></td> <td style="width: 10%;"></td> <td style="width: 10%;"></td> <td style="width: 10%;"></td> <td style="width: 10%;"></td> </tr> <tr> <td></td> <td></td> <td colspan="8" style="text-align: center;"> <table border="1" style="width: 100%; border-collapse: collapse; text-align: center;"> <tr> <td style="width: 10%;"></td> <td style="width: 10%;"></td> <td style="width: 10%;"></td> <td style="width: 10%;"></td> <td style="width: 10%;"></td> <td style="width: 10%;"></td> <td style="width: 10%;"></td> <td style="width: 10%;"></td> <td style="width: 10%;"></td> <td style="width: 10%;"></td> </tr> <tr> <td></td> <td></td> <td colspan="8" style="text-align: center;"> <table border="1" style="width: 100%; border-collapse: collapse; text-align: center;"> <tr> <td style="width: 10%;"></td> <td style="width: 10%;"></td> <td style="width: 10%;"></td> <td style="width: 10%;"></td> <td style="width: 10%;"></td> <td style="width: 10%;"></td> <td style="width: 10%;"></td> <td style="width: 10%;"></td> <td style="width: 10%;"></td> <td style="width: 10%;"></td> </tr> <tr> <td></td> <td></td> <td colspan="8" style="text-align: center;"> <table border="1" style="width: 100%; border-collapse: collapse; text-align: center;"> <tr> <td style="width: 10%;"></td> <td style="width: 10%;"></td> <td style="width: 10%;"></td> <td style="width: 10%;"></td> <td style="width: 10%;"></td> <td style="width: 10%;"></td> <td style="width: 10%;"></td> <td style="width: 10%;"></td> <td style="width: 10%;"></td> <td style="width: 10%;"></td> </tr> <tr> <td></td> <td></td> <td colspan="8" style="text-align: center;"> <table border="1" style="width: 100%; border-collapse: collapse; text-align: center;"> <tr> <td style="width: 10%;"></td> <td style="width: 10%;"></td> <td style="width: 10%;"></td> <td style="width: 10%;"></td> <td style="width: 10%;"></td> <td style="width: 10%;"></td> <td style="width: 10%;"></td> <td style="width: 10%;"></td> <td style="width: 10%;"></td> <td style="width: 10%;"></td> </tr> <tr> <td></td> <td></td> <td colspan="8" style="text-align: center;"> <table border="1" style="width: 100%; border-collapse: collapse; text-align: center;"> <tr> <td style="width: 10%;"></td> <td style="width: 10%;"></td> <td style="width: 10%;"></td> <td style="width: 10%;"></td> <td style="width: 10%;"></td> <td style="width: 10%;"></td> <td style="width: 10%;"></td> <td style="width: 10%;"></td> <td style="width: 10%;"></td> <td style="width: 10%;"></td> </tr> <tr> <td></td> <td></td> <td colspan="8" style="text-align: center;"> <table border="1" style="width: 100%; border-collapse: collapse; text-align: center;"> <tr> <td style="width: 10%;"></td> <td style="width: 10%;"></td> <td style="width: 10%;"></td> <td style="width: 10%;"></td> <td style="width: 10%;"></td> <td style="width: 10%;"></td> <td style="width: 10%;"></td> <td style="width: 10%;"></td> <td style="width: 10%;"></td> <td style="width: 10%;"></td> </tr> <tr> <td></td> <td></td> <td colspan="8" style="text-align: center;"> <table border="1" style="width: 100%; border-collapse: collapse; text-align: center;"> <tr> <td style="width: 10%;"></td> <td style="width: 10%;"></td> <td style="width: 10%;"></td> <td style="width: 10%;"></td> <td style="width: 10%;"></td> <td style="width: 10%;"></td> <td style="width: 10%;"></td> <td style="width: 10%;"></td> <td style="width: 10%;"></td> <td style="width: 10%;"></td> </tr> <tr> <td></td> <td></td> <td colspan="8" style="text-align: center;"> <table border="1" style="width: 100%; border-collapse: collapse; text-align: center;"> <tr> <td style="width: 10%;"></td> <td style="width: 10%;"></td> <td style="width: 10%;"></td> <td style="width: 10%;"></td> <td style="width: 10%;"></td> <td style="width: 10%;"></td> <td style="width: 10%;"></td> <td style="width: 10%;"></td> <td style="width: 10%;"></td> <td style="width: 10%;"></td> </tr> <tr> <td></td> <td></td> <td colspan="8" style="text-align: center;"> <table border="1" style="width: 100%; border-collapse: collapse; text-align: center;"> <tr> <td style="width: 10%;"></td> <td style="width: 10%;"></td> <td style="width: 10%;"></td> <td style="width: 10%;"></td> <td style="width: 10%;"></td> <td style="width: 10%;"></td> <td style="width: 10%;"></td> <td style="width: 10%;"></td> <td style="width: 10%;"></td> <td style="width: 10%;"></td> </tr> <tr> <td></td> <td></td> <td colspan="8" style="text-align: center;"> <table border="1" style="width: 100%; border-collapse: collapse; text-align: center;"> <tr> <td style="width: 10%;"></td> <td style="width: 10%;"></td> <td style="width: 10%;"></td> <td style="width: 10%;"></td> <td style="width: 10%;"></td> <td style="width: 10%;"></td> <td style="width: 10%;"></td> <td style="width: 10%;"></td> <td style="width: 10%;"></td> <td style="width: 10%;"></td> </tr> <tr> <td></td> <td></td> <td colspan="8" style="text-align: center;"> <table border="1" style="width: 100%; border-collapse: collapse; text-align: center;"> <tr> <td style="width: 10%;"></td> <td style="width: 10%;"></td> <td style="width: 10%;"></td> <td style="width: 10%;"></td> <td style="width: 10%;"></td> <td style="width: 10%;"></td> <td style="width: 10%;"></td> <td style="width: 10%;"></td> <td style="width: 10%;"></td> <td style="width: 10%;"></td> </tr> <tr> <td></td> <td></td> <td colspan="8" style="text-align: center;"> <table border="1" style="width: 100%; border-collapse: collapse; text-align: center;"> <tr> <td style="width: 10%;"></td> <td style="width: 10%;"></td> <td style="width: 10%;"></td> <td style="width: 10%;"></td> <td style="width: 10%;"></td> <td style="width: 10%;"></td> <td style="width: 10%;"></td> <td style="width: 10%;"></td> <td style="width: 10%;"></td> <td style="width: 10%;"></td> </tr> <tr> <td></td> <td></td> <td colspan="8" style="text-align: center;"> <table border="1" style="width: 100%; border-collapse: collapse; text-align: center;"> <tr> <td style="width: 10%;"></td> <td style="width: 10%;"></td> <td style="width: 10%;"></td> <td style="width: 10%;"></td> <td style="width: 10%;"></td> <td style="width: 10%;"></td> <td style="width: 10%;"></td> <td style="width: 10%;"></td> <td style="width: 10%;"></td> <td style="width: 10%;"></td> </tr> <tr> <td></td> <td></td> <td colspan="8" style="text-align: center;"> <table border="1" style="width: 100%; border-collapse: collapse; text-align: center;"> <tr> <td style="width: 10%;"></td> <td style="width: 10%;"></td> <td style="width: 10%;"></td> <td style="width: 10%;"></td> <td style="width: 10%;"></td> <td style="width: 10%;"></td> <td style="width: 10%;"></td> <td style="width: 10%;"></td> <td style="width: 10%;"></td> <td style="width: 10%;"></td> </tr> <tr> <td></td> <td></td> <td colspan="8" style="text-align: center;"> <table border="1" style="width: 100%; border-collapse: collapse; text-align: center;"> <tr> <td style="width: 10%;"></td> <td style="width: 10%;"></td> <td style="width: 10%;"></td> <td style="width: 10%;"></td> <td style="width: 10%;"></td> <td style="width: 10%;"></td> <td style="width: 10%;"></td> <td style="width: 10%;"></td> <td style="width: 10%;"></td> <td style="width: 10%;"></td> </tr> <tr> <td></td> <td></td> <td colspan="8" style="text-align: center;"> <table border="1" style="width: 100%; border-collapse: collapse; text-align: center;"> <tr> <td style="width: 10%;"></td> <td style="width: 10%;"></td> <td style="width: 10%;"></td> <td style="width: 10%;"></td> <td style="width: 10%;"></td> <td style="width: 10%;"></td> <td style="width: 10%;"></td> <td style="width: 10%;"></td> <td style="width: 10%;"></td> <td style="width: 10%;"></td> </tr> <tr> <td></td> <td></td> <td colspan="8" style="text-align: center;"> <table border="1" style="width: 100%; border-collapse: collapse; text-align: center;"> <tr> <td style="width: 10%;"></td> <td style="width: 10%;"></td> <td style="width:
10%;"></td> <td style="width: 10%;"></td> <td style="width: 10%;"></td> <td style="width: 10%;"></td> <td style="width: 10%;"></td> <td style="width: 10%;"></td> <td style="width: 10%;"></td> <td style="width: 10%;"></td> </tr> <tr> <td></td> <td></td> <td colspan="8" style="text-align: center;"> <table border="1" style="width: 100%; border-collapse: collapse; text-align: center;"> <tr> <td style="width: 10%;"></td> <td style="width: 10%;"></td> <td style="width: 10%;"></td> <td style="width: 10%;"></td> <td style="width: 10%;"></td> <td style="width: 10%;"></td> <td style="width: 10%;"></td> <td style="width: 10%;"></td> <td style="width: 10%;"></td> <td style="width: 10%;"></td> </tr> <tr> <td></td> <td></td> <td colspan="8" style="text-align: center;"> <table border="1" style="width: 100%; border-collapse: collapse; text-align: center;"> <tr> <td style="width: 10%;"></td> <td style="width: 10%;"></td> <td style="width: 10%;"></td> <td style="width: 10%;"></td> <td style="width: 10%;"></td> <td style="width: 10%;"></td> <td style="width: 10%;"></td> <td style="width: 10%;"></td> <td style="width: 10%;"></td> <td style="width: 10%;"></td> </tr> <tr> <td></td> <td></td> <td colspan="8" style="text-align: center;"> <table border="1" style="width: 100%; border-collapse: collapse; text-align: center;"> <tr> <td style="width: 10%;"></td> <td style="width: 10%;"></td> <td style="width: 10%;"></td> <td style="width: 10%;"></td> <td style="width: 10%;"></td> <td style="width: 10%;"></td> <td style="width: 10%;"></td> <td style="width: 10%;"></td> <td style="width: 10%;"></td> <td style="width: 10%;"></td> </tr> <tr> <td></td> <td></td> <td colspan="8" style="text-align: center;"> <table border="1" style="width: 100%; border-collapse: collapse; text-align: center;"> <tr> <td style="width: 10%;"></td> <td style="width: 10%;"></td> <td style="width: 10%;"></td> <td style="width: 10%;"></td> <td style="width: 10%;"></td> <td style="width: 10%;"></td> <td style="width: 10%;"></td> <td style="width: 10%;"></td> <td style="width: 10%;"></td> <td style="width: 10%;"></td> </tr> <tr> <td></td> <td></td> <td colspan="8" style="text-align: center;"> <table border="1" style="width: 100%; border-collapse: collapse; text-align: center;"> <tr> <td style="width: 10%;"></td> <td style="width: 10%;"></td> <td style="width: 10%;"></td> <td style="width: 10%;"></td> <td style="width: 10%;"></td> <td style="width: 10%;"></td> <td style="width: 10%;"></td> <td style="width: 10%;"></td> <td style="width: 10%;"></td> <td style="width: 10%;"></td> </tr> <tr> <td></td> <td></td> <td colspan="8" style="text-align: center;"> <table border="1" style="width: 100%; border-collapse: collapse; text-align: center;"> <tr> <td style="width: 10%;"></td> <td style="width: 10%;"></td> <td style="width: 10%;"></td> <td style="width: 10%;"></td> <td style="width: 10%;"></td> <td style="width: 10%;"></td> <td style="width: 10%;"></td> <td style="width: 10%;"></td> <td style="width: 10%;"></td> <td style="width: 10%;"></td> </tr> <tr> <td></td> <td></td> <td colspan="8" style="text-align: center;"> <table border="1" style="width: 100%; border-collapse: collapse; text-align: center;"> <tr> <td style="width: 10%;"></td> <td style="width: 10%;"></td> <td style="width: 10%;"></td> <td style="width: 10%;"></td> <td style="width: 10%;"></td> <td style="width: 10%;"></td> <td style="width: 10%;"></td> <td style="width: 10%;"></td> <td style="width: 10%;"></td> <td style="width: 10%;"></td> </tr> <tr> <td></td> <td></td> <td colspan="8" style="text-align: center;"> <table border="1" style="width: 100%; border-collapse: collapse; text-align: center;"> <tr> <td style="width: 10%;"></td> <td style="width: 10%;"></td> <td style="width: 10%;"></td> <td style="width: 10%;"></td> <td style="width: 10%;"></td> <td style="width: 10%;"></td> <td style="width: 10%;"></td> <td style="width: 10%;"></td> <td style="width: 10%;"></td> <td style="width: 10%;"></td> </tr> <tr> <td></td> <td></td> <td colspan="8" style="text-align: center;"> <table border="1" style="width: 100%; border-collapse: collapse; text-align: center;"> <tr> <td style="width: 10%;"></td> <td style="width: 10%;"></td> <td style="width: 10%;"></td> <td style="width: 10%;"></td> <td style="width: 10%;"></td> <td style="width: 10%;"></td> <td style="width: 10%;"></td> <td style="width: 10%;"></td> <td style="width: 10%;"></td> <td style="width: 10%;"></td> </tr> <tr> <td></td> <td></td> <td colspan="8" style="text-align: center;"> <table border="1" style="width: 100%; border-collapse: collapse; text-align: center;"> <tr> <td style="width: 10%;"></td> <td style="width: 10%;"></td> <td style="width: 10%;"></td> <td style="width: 10%;"></td> <td style="width: 10%;"></td> <td style="width: 10%;"></td> <td style="width: 10%;"></td> <td style="width: 10%;"></td> <td style="width: 10%;"></td> <td style="width: 10%;"></td> </tr> <tr> <td></td> <td></td> <td colspan="8" style="text-align: center;"> <table border="1" style="width: 100%; border-collapse: collapse; text-align: center;"> <tr> <td style="width: 10%;"></td> <td style="width: 10%;"></td> <td style="width: 10%;"></td> <td style="width: 10%;"></td> <td style="width: 10%;"></td> <td style="width: 10%;"></td> <td style="width: 10%;"></td> <td style="width: 10%;"></td> <td style="width: 10%;"></td> <td style="width: 10%;"></td> </tr> <tr> <td></td> <td></td> <td colspan="8" style="text-align: center;"> <table border="1" style="width: 100%; border-collapse: collapse; text-align: center;"> <tr> <td style="width: 10%;"></td> <td style="width: 10%;"></td> <td style="width: 10%;"></td> <td style="width: 10%;"></td> <td style="width: 10%;"></td> <td style="width: 10%;"></td> <td style="width: 10%;"></td> <td style="width: 10%;"></td> <td style="width: 10%;"></td> <td style="width: 10%;"></td> </tr> <tr> <td></td> <td></td> <td colspan="8" style="text-align: center;"> <table border="1" style="width: 100%; border-collapse: collapse; text-align: center;"> <tr> <td style="width: 10%;"></td> <td style="width: 10%;"></td> <td style="width: 10%;"></td> <td style="width: 10%;"></td> <td style="width: 10%;"></td> <td style="width: 10%;"></td> <td style="width: 10%;"></td> <td style="width: 10%;"></td> <td style="width: 10%;"></td> <td style="width: 10%;"></td> </tr> <tr> <td></td> <td></td> <td colspan="8" style="text-align: center;"> <table border="1" style="width: 100%; border-collapse: collapse; text-align: center;"> <tr> <td style="width: 10%;"></td> <td style="width: 10%;"></td> <td style="width: 10%;"></td> <td style="width: 10%;"></td> <td style="width: 10%;"></td> <td style="width: 10%;"></td> <td style="width: 10%;"></td> <td style="width: 10%;"></td> <td style="width: 10%;"></td> <td style="width: 10%;"></td> </tr> <tr> <td></td> <td></td> <td colspan="8" style="text-align: center;"> <table border="1" style="width: 100%; border-collapse: collapse; text-align: center;"> <tr> <td style="width: 10%;"></td> <td style="width: 10%;"></td> <td style="width: 10%;"></td> <td style="width: 10%;"></td> <td style="width: 10%;"></td> <td style="width: 10%;"></td> <td style="width: 10%;"></td> <td style="width: 10%;"></td> <td style="width: 10%;"></td> <td style="width: 10%;"></td> </tr> <tr> <td></td> <td></td> <td colspan="8" style="text-align: center;"> <table border="1" style="width: 100%; border-collapse: collapse; text-align: center;"> <tr> </tr></table></td></tr></table></td></tr></table></td></tr></table></td></tr></table></td></tr></table></td></tr></table></td></tr></table></td></tr></table></td></tr></table></td></tr></table></td></tr></table></td></tr></table></td></tr></table></td></tr></table></td></tr></table></td></tr></table></td></tr></table></td></tr></table></td></tr></table></td></tr></table></td></tr></table></td></tr></table></td></tr></table></td></tr></table></td></tr></table></td></tr></table></td></tr></table></td></tr></table></td></tr></table></td></tr></table></td></tr></table></td></tr></table></td></tr></table></td></tr></table></td></tr></table></td></tr></table></td></tr></table></td></tr></table></td></tr></table></td></tr></table></td></tr></table></td></tr></table></td></tr></table></td></tr></table>
 | | | | | | | | | | | | | | | | | | | | <table border="1" style="width: 100%; border-collapse: collapse; text-align: center;"> <tr> <td style="width: 10%;"></td> <td style="width: 10%;"></td> <td style="width: 10%;"></td> <td style="width: 10%;"></td> <td style="width: 10%;"></td> <td style="width: 10%;"></td> <td style="width: 10%;"></td> <td style="width: 10%;"></td> <td style="width: 10%;"></td> <td style="width: 10%;"></td> </tr> <tr> <td></td> <td></td> <td colspan="8" style="text-align: center;"> <table border="1" style="width: 100%; border-collapse: collapse; text-align: center;"> <tr> <td style="width: 10%;"></td> <td style="width: 10%;"></td> <td style="width: 10%;"></td> <td style="width: 10%;"></td> <td style="width: 10%;"></td> <td style="width: 10%;"></td> <td style="width: 10%;"></td> <td style="width: 10%;"></td> <td style="width: 10%;"></td> <td style="width: 10%;"></td> </tr> <tr> <td></td> <td></td> <td colspan="8" style="text-align: center;"> <table border="1" style="width: 100%; border-collapse: collapse; text-align: center;"> <tr> <td style="width: 10%;"></td> <td style="width: 10%;"></td> <td style="width: 10%;"></td> <td style="width: 10%;"></td> <td style="width: 10%;"></td> <td style="width: 10%;"></td> <td style="width: 10%;"></td> <td style="width: 10%;"></td> <td style="width: 10%;"></td> <td style="width: 10%;"></td> </tr> <tr> <td></td> <td></td> <td colspan="8" style="text-align: center;"> <table border="1" style="width: 100%; border-collapse: collapse; text-align: center;"> <tr> <td style="width: 10%;"></td> <td style="width: 10%;"></td> <td style="width: 10%;"></td> <td style="width: 10%;"></td> <td style="width: 10%;"></td> <td style="width: 10%;"></td> <td style="width: 10%;"></td> <td style="width: 10%;"></td> <td style="width: 10%;"></td> <td style="width: 10%;"></td> </tr> <tr> <td></td> <td></td> <td colspan="8" style="text-align: center;"> <table border="1" style="width: 100%; border-collapse: collapse; text-align: center;"> <tr> <td style="width: 10%;"></td> <td style="width: 10%;"></td> <td style="width: 10%;"></td> <td style="width: 10%;"></td> <td style="width: 10%;"></td> <td style="width: 10%;"></td> <td style="width: 10%;"></td> <td style="width: 10%;"></td> <td style="width: 10%;"></td> <td style="width: 10%;"></td> </tr> <tr> <td></td> <td></td> <td colspan="8" style="text-align: center;"> <table border="1" style="width: 100%; border-collapse: collapse; text-align: center;"> <tr> <td style="width: 10%;"></td> <td style="width: 10%;"></td> <td style="width: 10%;"></td> <td style="width: 10%;"></td> <td style="width: 10%;"></td> <td style="width: 10%;"></td> <td style="width: 10%;"></td> <td style="width: 10%;"></td> <td style="width: 10%;"></td> <td style="width: 10%;"></td> </tr> <tr> <td></td> <td></td> <td colspan="8" style="text-align: center;"> <table border="1" style="width: 100%; border-collapse: collapse; text-align: center;"> <tr> <td style="width: 10%;"></td> <td style="width: 10%;"></td> <td style="width: 10%;"></td> <td style="width: 10%;"></td> <td style="width: 10%;"></td> <td style="width: 10%;"></td> <td style="width: 10%;"></td> <td style="width: 10%;"></td> <td style="width: 10%;"></td> <td style="width: 10%;"></td> </tr> <tr> <td></td> <td></td> <td colspan="8" style="text-align: center;"> <table border="1" style="width: 100%; border-collapse: collapse; text-align: center;"> <tr> <td style="width: 10%;"></td> <td style="width: 10%;"></td> <td style="width: 10%;"></td> <td style="width: 10%;"></td> <td style="width: 10%;"></td> <td style="width: 10%;"></td> <td style="width: 10%;"></td> <td style="width: 10%;"></td> <td style="width: 10%;"></td> <td style="width: 10%;"></td> </tr> <tr> <td></td> <td></td> <td colspan="8" style="text-align: center;"> <table border="1" style="width: 100%; border-collapse: collapse; text-align: center;"> <tr> <td style="width: 10%;"></td> <td style="width: 10%;"></td> <td style="width: 10%;"></td> <td style="width: 10%;"></td> <td style="width: 10%;"></td> <td style="width: 10%;"></td> <td style="width: 10%;"></td> <td style="width: 10%;"></td> <td style="width: 10%;"></td> <td style="width: 10%;"></td> </tr> <tr> <td></td> <td></td> <td colspan="8" style="text-align: center;"> <table border="1" style="width: 100%; border-collapse: collapse; text-align: center;"> <tr> <td style="width: 10%;"></td> <td style="width: 10%;"></td> <td style="width: 10%;"></td> <td style="width: 10%;"></td> <td style="width: 10%;"></td> <td style="width: 10%;"></td> <td style="width: 10%;"></td> <td style="width: 10%;"></td> <td style="width: 10%;"></td> <td style="width: 10%;"></td> </tr> <tr> <td></td> <td></td> <td colspan="8" style="text-align: center;"> <table border="1" style="width: 100%; border-collapse: collapse; text-align: center;"> <tr> <td style="width: 10%;"></td> <td style="width: 10%;"></td> <td style="width: 10%;"></td> <td style="width: 10%;"></td> <td style="width: 10%;"></td> <td style="width: 10%;"></td> <td style="width: 10%;"></td> <td style="width: 10%;"></td> <td style="width: 10%;"></td> <td style="width: 10%;"></td> </tr> <tr> <td></td> <td></td> <td colspan="8" style="text-align: center;"> <table border="1" style="width: 100%; border-collapse: collapse; text-align: center;"> <tr> <td style="width: 10%;"></td> <td style="width: 10%;"></td> <td style="width: 10%;"></td> <td style="width: 10%;"></td> <td style="width: 10%;"></td> <td style="width: 10%;"></td> <td style="width: 10%;"></td> <td style="width: 10%;"></td> <td style="width: 10%;"></td> <td style="width: 10%;"></td> </tr> <tr> <td></td> <td></td> <td colspan="8" style="text-align: center;"> <table border="1" style="width: 100%; border-collapse: collapse; text-align: center;"> <tr> <td style="width: 10%;"></td> <td style="width: 10%;"></td> <td style="width: 10%;"></td> <td style="width: 10%;"></td> <td style="width: 10%;"></td> <td style="width: 10%;"></td> <td
style="width: 10%;"></td> <td style="width: 10%;"></td> <td style="width: 10%;"></td> <td style="width: 10%;"></td> </tr> <tr> <td></td> <td></td> <td colspan="8" style="text-align: center;"> <table border="1" style="width: 100%; border-collapse: collapse; text-align: center;"> <tr> <td style="width: 10%;"></td> <td style="width: 10%;"></td> <td style="width: 10%;"></td> <td style="width: 10%;"></td> <td style="width: 10%;"></td> <td style="width: 10%;"></td> <td style="width: 10%;"></td> <td style="width: 10%;"></td> <td style="width: 10%;"></td> <td style="width: 10%;"></td> </tr> <tr> <td></td> <td></td> <td colspan="8" style="text-align: center;"> <table border="1" style="width: 100%; border-collapse: collapse; text-align: center;"> <tr> <td style="width: 10%;"></td> <td style="width: 10%;"></td> <td style="width: 10%;"></td> <td style="width: 10%;"></td> <td style="width: 10%;"></td> <td style="width: 10%;"></td> <td style="width: 10%;"></td> <td style="width: 10%;"></td> <td style="width: 10%;"></td> <td style="width: 10%;"></td> </tr> <tr> <td></td> <td></td> <td colspan="8" style="text-align: center;"> <table border="1" style="width: 100%; border-collapse: collapse; text-align: center;"> <tr> <td style="width: 10%;"></td> <td style="width: 10%;"></td> <td style="width: 10%;"></td> <td style="width: 10%;"></td> <td style="width: 10%;"></td> <td style="width: 10%;"></td> <td style="width: 10%;"></td> <td style="width: 10%;"></td> <td style="width: 10%;"></td> <td style="width: 10%;"></td> </tr> <tr> <td></td> <td></td> <td colspan="8" style="text-align: center;"> <table border="1" style="width: 100%; border-collapse: collapse; text-align: center;"> <tr> <td style="width: 10%;"></td> <td style="width: 10%;"></td> <td style="width: 10%;"></td> <td style="width: 10%;"></td> <td style="width: 10%;"></td> <td style="width: 10%;"></td> <td style="width: 10%;"></td> <td style="width: 10%;"></td> <td style="width: 10%;"></td> <td style="width: 10%;"></td> </tr> <tr> <td></td> <td></td> <td colspan="8" style="text-align: center;"> <table border="1" style="width: 100%; border-collapse: collapse; text-align: center;"> <tr> <td style="width: 10%;"></td> <td style="width: 10%;"></td> <td style="width: 10%;"></td> <td style="width: 10%;"></td> <td style="width: 10%;"></td> <td style="width: 10%;"></td> <td style="width: 10%;"></td> <td style="width: 10%;"></td> <td style="width: 10%;"></td> <td style="width: 10%;"></td> </tr> <tr> <td></td> <td></td> <td colspan="8" style="text-align: center;"> <table border="1" style="width: 100%; border-collapse: collapse; text-align: center;"> <tr> <td style="width: 10%;"></td> <td style="width: 10%;"></td> <td style="width: 10%;"></td> <td style="width: 10%;"></td> <td style="width: 10%;"></td> <td style="width: 10%;"></td> <td style="width: 10%;"></td> <td style="width: 10%;"></td> <td style="width: 10%;"></td> <td style="width: 10%;"></td> </tr> <tr> <td></td> <td></td> <td colspan="8" style="text-align: center;"> <table border="1" style="width: 100%; border-collapse: collapse; text-align: center;"> <tr> <td style="width: 10%;"></td> <td style="width: 10%;"></td> <td style="width: 10%;"></td> <td style="width: 10%;"></td> <td style="width: 10%;"></td> <td style="width: 10%;"></td> <td style="width: 10%;"></td> <td style="width: 10%;"></td> <td style="width: 10%;"></td> <td style="width: 10%;"></td> </tr> <tr> <td></td> <td></td> <td colspan="8" style="text-align: center;"> <table border="1" style="width: 100%; border-collapse: collapse; text-align: center;"> <tr> <td style="width: 10%;"></td> <td style="width: 10%;"></td> <td style="width: 10%;"></td> <td style="width: 10%;"></td> <td style="width: 10%;"></td> <td style="width: 10%;"></td> <td style="width: 10%;"></td> <td style="width: 10%;"></td> <td style="width: 10%;"></td> <td style="width: 10%;"></td> </tr> <tr> <td></td> <td></td> <td colspan="8" style="text-align: center;"> <table border="1" style="width: 100%; border-collapse: collapse; text-align: center;"> <tr> <td style="width: 10%;"></td> <td style="width: 10%;"></td> <td style="width: 10%;"></td> <td style="width: 10%;"></td> <td style="width: 10%;"></td> <td style="width: 10%;"></td> <td style="width: 10%;"></td> <td style="width: 10%;"></td> <td style="width: 10%;"></td> <td style="width: 10%;"></td> </tr> <tr> <td></td> <td></td> <td colspan="8" style="text-align: center;"> <table border="1" style="width: 100%; border-collapse: collapse; text-align: center;"> <tr> <td style="width: 10%;"></td> <td style="width: 10%;"></td> <td style="width: 10%;"></td> <td style="width: 10%;"></td> <td style="width: 10%;"></td> <td style="width: 10%;"></td> <td style="width: 10%;"></td> <td style="width: 10%;"></td> <td style="width: 10%;"></td> <td style="width: 10%;"></td> </tr> <tr> <td></td> <td></td> <td colspan="8" style="text-align: center;"> <table border="1" style="width: 100%; border-collapse: collapse; text-align: center;"> <tr> <td style="width: 10%;"></td> <td style="width: 10%;"></td> <td style="width: 10%;"></td> <td style="width: 10%;"></td> <td style="width: 10%;"></td> <td style="width: 10%;"></td> <td style="width: 10%;"></td> <td style="width: 10%;"></td> <td style="width: 10%;"></td> <td style="width: 10%;"></td> </tr> <tr> <td></td> <td></td> <td colspan="8" style="text-align: center;"> <table border="1" style="width: 100%; border-collapse: collapse; text-align: center;"> <tr> <td style="width: 10%;"></td> <td style="width: 10%;"></td> <td style="width: 10%;"></td> <td style="width: 10%;"></td> <td style="width: 10%;"></td> <td style="width: 10%;"></td> <td style="width: 10%;"></td> <td style="width: 10%;"></td> <td style="width: 10%;"></td> <td style="width: 10%;"></td> </tr> <tr> <td></td> <td></td> <td colspan="8" style="text-align: center;"> <table border="1" style="width: 100%; border-collapse: collapse; text-align: center;"> <tr> <td style="width: 10%;"></td> <td style="width: 10%;"></td> <td style="width: 10%;"></td> <td style="width: 10%;"></td> <td style="width: 10%;"></td> <td style="width: 10%;"></td> <td style="width: 10%;"></td> <td style="width: 10%;"></td> <td style="width: 10%;"></td> <td style="width: 10%;"></td> </tr> <tr> <td></td> <td></td> <td colspan="8" style="text-align: center;"> <table border="1" style="width: 100%; border-collapse: collapse; text-align: center;"> <tr> <td style="width: 10%;"></td> <td style="width: 10%;"></td> <td style="width: 10%;"></td> <td style="width: 10%;"></td> <td style="width: 10%;"></td> <td style="width: 10%;"></td> <td style="width: 10%;"></td> <td style="width: 10%;"></td> <td style="width: 10%;"></td> <td style="width: 10%;"></td> </tr> <tr> <td></td> <td></td> <td colspan="8" style="text-align: center;"> <table border="1" style="width: 100%; border-collapse: collapse; text-align: center;"> <tr> <td style="width: 10%;"></td> <td style="width: 10%;"></td> <td style="width: 10%;"></td> <td style="width: 10%;"></td> <td style="width: 10%;"></td> <td style="width: 10%;"></td> <td style="width: 10%;"></td> <td style="width: 10%;"></td> <td style="width: 10%;"></td> <td style="width: 10%;"></td> </tr> <tr> <td></td> <td></td> <td colspan="8" style="text-align: center;"> <table border="1" style="width: 100%; border-collapse: collapse; text-align: center;"> <tr> <td style="width: 10%;"></td> <td style="width: 10%;"></td> <td style="width: 10%;"></td> <td style="width: 10%;"></td> <td style="width: 10%;"></td> <td style="width: 10%;"></td> <td style="width: 10%;"></td> <td style="width: 10%;"></td> <td style="width: 10%;"></td> <td style="width: 10%;"></td> </tr> <tr> <td></td> <td></td> <td colspan="8" style="text-align: center;"> <table border="1" style="width: 100%; border-collapse: collapse; text-align: center;"> <tr> <td style="width: 10%;"></td> <td style="width: 10%;"></td> <td style="width: 10%;"></td> <td style="width: 10%;"></td> <td style="width: 10%;"></td> <td style="width: 10%;"></td> <td style="width: 10%;"></td> <td style="width: 10%;"></td> <td style="width: 10%;"></td> <td style="width: 10%;"></td> </tr> <tr> <td></td> <td></td> <td colspan="8" style="text-align: center;"> <table border="1" style="width: 100%; border-collapse: collapse; text-align: center;"> <tr> <td style="width: 10%;"></td> <td style="width: 10%;"></td> <td style="width: 10%;"></td> <td style="width: 10%;"></td> <td style="width: 10%;"></td> <td style="width: 10%;"></td> <td style="width: 10%;"></td> <td style="width: 10%;"></td> <td style="width: 10%;"></td> <td style="width: 10%;"></td> </tr> <tr> <td></td> <td></td> <td colspan="8" style="text-align: center;"> <table border="1" style="width: 100%; border-collapse: collapse; text-align: center;"> <tr> <td style="width: 10%;"></td> <td style="width: 10%;"></td> <td style="width: 10%;"></td> <td style="width: 10%;"></td> <td style="width: 10%;"></td> <td style="width: 10%;"></td> <td style="width: 10%;"></td> <td style="width: 10%;"></td> <td style="width: 10%;"></td> <td style="width: 10%;"></td> </tr> <tr> <td></td> <td></td> <td colspan="8" style="text-align: center;"> <table border="1" style="width: 100%; border-collapse: collapse; text-align: center;"> <tr> <td style="width: 10%;"></td> <td style="width: 10%;"></td> <td style="width: 10%;"></td> <td style="width: 10%;"></td> <td style="width: 10%;"></td> <td style="width: 10%;"></td> <td style="width: 10%;"></td> <td style="width: 10%;"></td> <td style="width: 10%;"></td> <td style="width: 10%;"></td> </tr> <tr> <td></td> <td></td> <td colspan="8" style="text-align: center;"> <table border="1" style="width: 100%; border-collapse: collapse; text-align: center;"> <tr> <td style="width: 10%;"></td> <td style="width: 10%;"></td> <td style="width: 10%;"></td> <td style="width: 10%;"></td> <td style="width: 10%;"></td> <td style="width: 10%;"></td> <td style="width: 10%;"></td> <td style="width: 10%;"></td> <td style="width: 10%;"></td> <td style="width: 10%;"></td> </tr> <tr> <td></td> <td></td> <td colspan="8"
style="text-align: center;"> <table border="1" style="width: 100%; border-collapse: collapse; text-align: center;"> <tr> <td style="width: 10%;"></td> <td style="width: 10%;"></td> <td style="width: 10%;"></td> <td style="width: 10%;"></td> <td style="width: 10%;"></td> <td style="width: 10%;"></td> <td style="width: 10%;"></td> <td style="width: 10%;"></td> <td style="width: 10%;"></td> <td style="width: 10%;"></td> </tr> <tr> <td></td> <td></td> <td colspan="8" style="text-align: center;"> <table border="1" style="width: 100%; border-collapse: collapse; text-align: center;"> <tr> <td style="width: 10%;"></td> <td style="width: 10%;"></td> <td style="width: 10%;"></td> <td style="width: 10%;"></td> <td style="width: 10%;"></td> <td style="width: 10%;"></td> <td style="width: 10%;"></td> <td style="width: 10%;"></td> <td style="width: 10%;"></td> <td style="width: 10%;"></td> </tr> <tr> <td></td> <td></td> <td colspan="8" style="text-align: center;"> <table border="1" style="width: 100%; border-collapse: collapse; text-align: center;"> <tr> <td style="width: 10%;"></td> <td style="width: 10%;"></td> <td style="width: 10%;"></td> <td style="width: 10%;"></td> <td style="width: 10%;"></td> <td style="width: 10%;"></td> <td style="width: 10%;"></td> <td style="width: 10%;"></td> <td style="width: 10%;"></td> <td style="width: 10%;"></td> </tr> <tr> <td></td> <td></td> <td colspan="8" style="text-align: center;"> <table border="1" style="width: 100%; border-collapse: collapse; text-align: center;"> <tr> <td style="width: 10%;"></td> <td style="width: 10%;"></td> <td style="width: 10%;"></td> <td style="width: 10%;"></td> <td style="width: 10%;"></td> <td style="width: 10%;"></td> <td style="width: 10%;"></td> <td style="width: 10%;"></td> <td style="width: 10%;"></td> <td style="width: 10%;"></td> </tr> <tr> <td></td> <td></td> <td colspan="8" style="text-align: center;"> <table border="1" style="width: 100%; border-collapse: collapse; text-align: center;"> <tr> <td style="width: 10%;"></td> <td style="width: 10%;"></td> <td style="width: 10%;"></td> <td style="width: 10%;"></td> <td style="width: 10%;"></td> <td style="width: 10%;"></td> <td style="width: 10%;"></td> <td style="width: 10%;"></td> <td style="width: 10%;"></td> <td style="width: 10%;"></td> </tr> <tr> <td></td> <td></td> <td colspan="8" style="text-align: center;"> <table border="1" style="width: 100%; border-collapse: collapse; text-align: center;"> <tr> <td style="width: 10%;"></td> <td style="width: 10%;"></td> <td style="width: 10%;"></td> <td style="width: 10%;"></td> <td style="width: 10%;"></td> <td style="width: 10%;"></td> <td style="width: 10%;"></td> <td style="width: 10%;"></td> <td style="width: 10%;"></td> <td style="width: 10%;"></td> </tr> <tr> <td></td> <td></td> <td colspan="8" style="text-align: center;"> <table border="1" style="width: 100%; border-collapse: collapse; text-align: center;"> <tr> <td style="width: 10%;"></td> <td style="width: 10%;"></td> <td style="width: 10%;"></td> <td style="width: 10%;"></td> <td style="width: 10%;"></td> <td style="width: 10%;"></td> <td style="width: 10%;"></td> <td style="width: 10%;"></td> <td style="width: 10%;"></td> <td style="width: 10%;"></td> </tr> <tr> <td></td> <td></td> <td colspan="8" style="text-align: center;"> <table border="1" style="width: 100%; border-collapse: collapse; text-align: center;"> <tr> <td style="width: 10%;"></td> <td style="width: 10%;"></td> <td style="width: 10%;"></td> <td style="width: 10%;"></td> <td style="width: 10%;"></td> <td style="width: 10%;"></td> <td style="width: 10%;"></td> <td style="width: 10%;"></td> <td style="width: 10%;"></td> <td style="width: 10%;"></td> </tr> <tr> <td></td> <td></td> <td colspan="8" style="text-align: center;"> <table border="1" style="width: 100%; border-collapse: collapse; text-align: center;"> <tr> <td style="width: 10%;"></td> <td style="width: 10%;"></td> <td style="width: 10%;"></td> <td style="width: 10%;"></td> <td style="width: 10%;"></td> <td style="width: 10%;"></td> <td style="width: 10%;"></td> <td style="width: 10%;"></td> <td style="width: 10%;"></td> <td style="width: 10%;"></td> </tr> <tr> <td></td> <td></td> <td colspan="8" style="text-align: center;"> <table border="1" style="width: 100%; border-collapse: collapse; text-align: center;"> <tr> </tr></table></td></tr></table></td></tr></table></td></tr></table></td></tr></table></td></tr></table></td></tr></table></td></tr></table></td></tr></table></td></tr></table></td></tr></table></td></tr></table></td></tr></table></td></tr></table></td></tr></table></td></tr></table></td></tr></table></td></tr></table></td></tr></table></td></tr></table></td></tr></table></td></tr></table></td></tr></table></td></tr></table></td></tr></table></td></tr></table></td></tr></table></td></tr></table></td></tr></table></td></tr></table></td></tr></table></td></tr></table></td></tr></table></td></tr></table></td></tr></table></td></tr></table></td></tr></table></td></tr></table></td></tr></table></td></tr></table></td></tr></table></td></tr></table></td></tr></table></td></tr></table>
 | | | | | | | | | | | | | | | | | | | | <table border="1" style="width: 100%; border-collapse: collapse; text-align: center;"> <tr> <td style="width: 10%;"></td> <td style="width: 10%;"></td> <td style="width: 10%;"></td> <td style="width: 10%;"></td> <td style="width: 10%;"></td> <td style="width: 10%;"></td> <td style="width: 10%;"></td> <td style="width: 10%;"></td> <td style="width: 10%;"></td> <td style="width: 10%;"></td> </tr> <tr> <td></td> <td></td> <td colspan="8" style="text-align: center;"> <table border="1" style="width: 100%; border-collapse: collapse; text-align: center;"> <tr> <td style="width: 10%;"></td> <td style="width: 10%;"></td> <td style="width: 10%;"></td> <td style="width: 10%;"></td> <td style="width: 10%;"></td> <td style="width: 10%;"></td> <td style="width: 10%;"></td> <td style="width: 10%;"></td> <td style="width: 10%;"></td> <td style="width: 10%;"></td> </tr> <tr> <td></td> <td></td> <td colspan="8" style="text-align: center;"> <table border="1" style="width: 100%; border-collapse: collapse; text-align: center;"> <tr> <td style="width: 10%;"></td> <td style="width: 10%;"></td> <td style="width: 10%;"></td> <td style="width: 10%;"></td> <td style="width: 10%;"></td> <td style="width: 10%;"></td> <td style="width: 10%;"></td> <td style="width: 10%;"></td> <td style="width: 10%;"></td> <td style="width: 10%;"></td> </tr> <tr> <td></td> <td></td> <td colspan="8" style="text-align: center;"> <table border="1" style="width: 100%; border-collapse: collapse; text-align: center;"> <tr> <td style="width: 10%;"></td> <td style="width: 10%;"></td> <td style="width: 10%;"></td> <td style="width: 10%;"></td> <td style="width: 10%;"></td> <td style="width: 10%;"></td> <td style="width: 10%;"></td> <td style="width: 10%;"></td> <td style="width: 10%;"></td> <td style="width: 10%;"></td> </tr> <tr> <td></td> <td></td> <td colspan="8" style="text-align: center;"> <table border="1" style="width: 100%; border-collapse: collapse; text-align: center;"> <tr> <td style="width: 10%;"></td> <td style="width: 10%;"></td> <td style="width: 10%;"></td> <td style="width: 10%;"></td> <td style="width: 10%;"></td> <td style="width: 10%;"></td> <td style="width: 10%;"></td> <td style="width: 10%;"></td> <td style="width: 10%;"></td> <td style="width: 10%;"></td> </tr> <tr> <td></td> <td></td> <td colspan="8" style="text-align: center;"> <table border="1" style="width: 100%; border-collapse: collapse; text-align: center;"> <tr> <td style="width: 10%;"></td> <td style="width: 10%;"></td> <td style="width: 10%;"></td> <td style="width: 10%;"></td> <td style="width: 10%;"></td> <td style="width: 10%;"></td> <td style="width: 10%;"></td> <td style="width: 10%;"></td> <td style="width: 10%;"></td> <td style="width: 10%;"></td> </tr> <tr> <td></td> <td></td> <td colspan="8" style="text-align: center;"> <table border="1" style="width: 100%; border-collapse: collapse; text-align: center;"> <tr> <td style="width: 10%;"></td> <td style="width: 10%;"></td> <td style="width: 10%;"></td> <td style="width: 10%;"></td> <td style="width: 10%;"></td> <td style="width: 10%;"></td> <td style="width: 10%;"></td> <td style="width: 10%;"></td> <td style="width: 10%;"></td> <td style="width: 10%;"></td> </tr> <tr> <td></td> <td></td> <td colspan="8" style="text-align: center;"> <table border="1" style="width: 100%; border-collapse: collapse; text-align: center;"> <tr> <td style="width: 10%;"></td> <td style="width: 10%;"></td> <td style="width: 10%;"></td> <td style="width: 10%;"></td> <td style="width: 10%;"></td> <td style="width: 10%;"></td> <td style="width: 10%;"></td> <td style="width: 10%;"></td> <td style="width: 10%;"></td> <td style="width: 10%;"></td> </tr> <tr> <td></td> <td></td> <td colspan="8" style="text-align: center;"> <table border="1" style="width: 100%; border-collapse: collapse; text-align: center;"> <tr> <td style="width: 10%;"></td> <td style="width: 10%;"></td> <td style="width: 10%;"></td> <td style="width: 10%;"></td> <td style="width: 10%;"></td> <td style="width: 10%;"></td> <td style="width: 10%;"></td> <td style="width: 10%;"></td> <td style="width: 10%;"></td> <td style="width: 10%;"></td> </tr> <tr> <td></td> <td></td> <td colspan="8" style="text-align: center;"> <table border="1" style="width: 100%; border-collapse: collapse; text-align: center;"> <tr> <td style="width: 10%;"></td> <td style="width: 10%;"></td> <td style="width: 10%;"></td> <td style="width: 10%;"></td> <td style="width: 10%;"></td> <td style="width: 10%;"></td> <td style="width: 10%;"></td> <td style="width: 10%;"></td> <td style="width: 10%;"></td> <td style="width: 10%;"></td> </tr> <tr> <td></td> <td></td> <td colspan="8" style="text-align: center;"> <table border="1" style="width: 100%; border-collapse: collapse; text-align: center;"> <tr> <td style="width: 10%;"></td> <td style="width: 10%;"></td> <td style="width: 10%;"></td> <td style="width: 10%;"></td> <td style="width: 10%;"></td> <td style="width: 10%;"></td> <td style="width: 10%;"></td> <td style="width: 10%;"></td> <td style="width: 10%;"></td> <td style="width: 10%;"></td> </tr> <tr> <td></td> <td></td> <td colspan="8" style="text-align: center;"> <table border="1" style="width: 100%; border-collapse: collapse; text-align: center;"> <tr> <td style="width: 10%;"></td> <td style="width: 10%;"></td> <td style="width: 10%;"></td> <td style="width: 10%;"></td> <td style="width: 10%;"></td> <td style="width: 10%;"></td> <td style="width: 10%;"></td> <td style="width: 10%;"></td> <td style="width: 10%;"></td> <td style="width: 10%;"></td> </tr> <tr> <td></td> <td></td> <td colspan="8" style="text-align: center;"> <table border="1" style="width: 100%; border-collapse: collapse; text-align: center;"> <tr> <td style="width: 10%;"></td> <td style="width: 10%;"></td> <td style="width: 10%;"></td> <td style="width: 10%;"></td> <td style="width: 10%;"></td> <td style="width: 10%;"></td> <td style="width: 10%;"></td> <td style="width: 10%;"></td> <td style="width: 10%;"></td> <td style="width: 10%;"></td> </tr> <tr> <td></td> <td></td> <td colspan="8" style="text-align: center;"> <table border="1" style="width: 100%; border-collapse: collapse; text-align: center;"> <tr> <td style="width: 10%;"></td> <td style="width: 10%;"></td> <td style="width: 10%;"></td> <td style="width: 10%;"></td> <td style="width: 10%;"></td> <td style="width: 10%;"></td> <td style="width: 10%;"></td> <td style="width: 10%;"></td> <td style="width: 10%;"></td> <td style="width: 10%;"></td> </tr> <tr> <td></td> <td></td> <td colspan="8" style="text-align: center;"> <table border="1" style="width: 100%; border-collapse: collapse; text-align: center;"> <tr> <td style="width: 10%;"></td> <td style="width: 10%;"></td> <td style="width: 10%;"></td> <td style="width: 10%;"></td> <td style="width: 10%;"></td> <td style="width: 10%;"></td> <td style="width: 10%;"></td> <td style="width: 10%;"></td> <td style="width: 10%;"></td> <td style="width: 10%;"></td> </tr> <tr> <td></td> <td></td> <td colspan="8" style="text-align: center;"> <table border="1" style="width: 100%; border-collapse: collapse; text-align: center;"> <tr> <td style="width: 10%;"></td> <td style="width: 10%;"></td> <td style="width: 10%;"></td> <td style="width: 10%;"></td> <td style="width: 10%;"></td> <td style="width: 10%;"></td> <td style="width: 10%;"></td> <td style="width: 10%;"></td> <td style="width: 10%;"></td> <td style="width: 10%;"></td> </tr> <tr> <td></td> <td></td> <td colspan="8" style="text-align: center;"> <table border="1" style="width: 100%; border-collapse: collapse; text-align: center;"> <tr> <td style="width: 10%;"></td> <td style="width: 10%;"></td> <td style="width: 10%;"></td> <td style="width: 10%;"></td> <td style="width: 10%;"></td> <td style="width: 10%;"></td> <td style="width: 10%;"></td> <td style="width: 10%;"></td> <td style="width: 10%;"></td> <td style="width: 10%;"></td> </tr> <tr> <td></td> <td></td> <td colspan="8" style="text-align: center;"> <table border="1" style="width: 100%; border-collapse: collapse; text-align: center;"> <tr> <td style="width: 10%;"></td> <td style="width: 10%;"></td> <td style="width: 10%;"></td> <td style="width: 10%;"></td> <td style="width: 10%;"></td> <td style="width: 10%;"></td> <td style="width: 10%;"></td> <td style="width: 10%;"></td> <td style="width: 10%;"></td> <td style="width: 10%;"></td> </tr> <tr> <td></td> <td></td> <td colspan="8" style="text-align: center;"> <table border="1" style="width: 100%; border-collapse: collapse; text-align: center;"> <tr> <td style="width: 10%;"></td> <td style="width: 10%;"></td> <td style="width: 10%;"></td> <td style="width: 10%;"></td> <td style="width: 10%;"></td> <td style="width: 10%;"></td> <td style="width: 10%;"></td> <td style="width: 10%;"></td> <td style="width: 10%;"></td> <td style="width: 10%;"></td> </tr> <tr> <td></td> <td></td> <td colspan="8" style="text-align: center;"> <table border="1" style="width: 100%; border-collapse: collapse; text-align: center;"> <tr> <td
style="width: 10%;"></td> <td style="width: 10%;"></td> <td style="width: 10%;"></td> <td style="width: 10%;"></td> <td style="width: 10%;"></td> <td style="width: 10%;"></td> <td style="width: 10%;"></td> <td style="width: 10%;"></td> <td style="width: 10%;"></td> <td style="width: 10%;"></td> </tr> <tr> <td></td> <td></td> <td colspan="8" style="text-align: center;"> <table border="1" style="width: 100%; border-collapse: collapse; text-align: center;"> <tr> <td style="width: 10%;"></td> <td style="width: 10%;"></td> <td style="width: 10%;"></td> <td style="width: 10%;"></td> <td style="width: 10%;"></td> <td style="width: 10%;"></td> <td style="width: 10%;"></td> <td style="width: 10%;"></td> <td style="width: 10%;"></td> <td style="width: 10%;"></td> </tr> <tr> <td></td> <td></td> <td colspan="8" style="text-align: center;"> <table border="1" style="width: 100%; border-collapse: collapse; text-align: center;"> <tr> <td style="width: 10%;"></td> <td style="width: 10%;"></td> <td style="width: 10%;"></td> <td style="width: 10%;"></td> <td style="width: 10%;"></td> <td style="width: 10%;"></td> <td style="width: 10%;"></td> <td style="width: 10%;"></td> <td style="width: 10%;"></td> <td style="width: 10%;"></td> </tr> <tr> <td></td> <td></td> <td colspan="8" style="text-align: center;"> <table border="1" style="width: 100%; border-collapse: collapse; text-align: center;"> <tr> <td style="width: 10%;"></td> <td style="width: 10%;"></td> <td style="width: 10%;"></td> <td style="width: 10%;"></td> <td style="width: 10%;"></td> <td style="width: 10%;"></td> <td style="width: 10%;"></td> <td style="width: 10%;"></td> <td style="width: 10%;"></td> <td style="width: 10%;"></td> </tr> <tr> <td></td> <td></td> <td colspan="8" style="text-align: center;"> <table border="1" style="width: 100%; border-collapse: collapse; text-align: center;"> <tr> <td style="width: 10%;"></td> <td style="width: 10%;"></td> <td style="width: 10%;"></td> <td style="width: 10%;"></td> <td style="width: 10%;"></td> <td style="width: 10%;"></td> <td style="width: 10%;"></td> <td style="width: 10%;"></td> <td style="width: 10%;"></td> <td style="width: 10%;"></td> </tr> <tr> <td></td> <td></td> <td colspan="8" style="text-align: center;"> <table border="1" style="width: 100%; border-collapse: collapse; text-align: center;"> <tr> <td style="width: 10%;"></td> <td style="width: 10%;"></td> <td style="width: 10%;"></td> <td style="width: 10%;"></td> <td style="width: 10%;"></td> <td style="width: 10%;"></td> <td style="width: 10%;"></td> <td style="width: 10%;"></td> <td style="width: 10%;"></td> <td style="width: 10%;"></td> </tr> <tr> <td></td> <td></td> <td colspan="8" style="text-align: center;"> <table border="1" style="width: 100%; border-collapse: collapse; text-align: center;"> <tr> <td style="width: 10%;"></td> <td style="width: 10%;"></td> <td style="width: 10%;"></td> <td style="width: 10%;"></td> <td style="width: 10%;"></td> <td style="width: 10%;"></td> <td style="width: 10%;"></td> <td style="width: 10%;"></td> <td style="width: 10%;"></td> <td style="width: 10%;"></td> </tr> <tr> <td></td> <td></td> <td colspan="8" style="text-align: center;"> <table border="1" style="width: 100%; border-collapse: collapse; text-align: center;"> <tr> <td style="width: 10%;"></td> <td style="width: 10%;"></td> <td style="width: 10%;"></td> <td style="width: 10%;"></td> <td style="width: 10%;"></td> <td style="width: 10%;"></td> <td style="width: 10%;"></td> <td style="width: 10%;"></td> <td style="width: 10%;"></td> <td style="width: 10%;"></td> </tr> <tr> <td></td> <td></td> <td colspan="8" style="text-align: center;"> <table border="1" style="width: 100%; border-collapse: collapse; text-align: center;"> <tr> <td style="width: 10%;"></td> <td style="width: 10%;"></td> <td style="width: 10%;"></td> <td style="width: 10%;"></td> <td style="width: 10%;"></td> <td style="width: 10%;"></td> <td style="width: 10%;"></td> <td style="width: 10%;"></td> <td style="width: 10%;"></td> <td style="width: 10%;"></td> </tr> <tr> <td></td> <td></td> <td colspan="8" style="text-align: center;"> <table border="1" style="width: 100%; border-collapse: collapse; text-align: center;"> <tr> <td style="width: 10%;"></td> <td style="width: 10%;"></td> <td style="width: 10%;"></td> <td style="width: 10%;"></td> <td style="width: 10%;"></td> <td style="width: 10%;"></td> <td style="width: 10%;"></td> <td style="width: 10%;"></td> <td style="width: 10%;"></td> <td style="width: 10%;"></td> </tr> <tr> <td></td> <td></td> <td colspan="8" style="text-align: center;"> <table border="1" style="width: 100%; border-collapse: collapse; text-align: center;"> <tr> <td style="width: 10%;"></td> <td style="width: 10%;"></td> <td style="width: 10%;"></td> <td style="width: 10%;"></td> <td style="width: 10%;"></td> <td style="width: 10%;"></td> <td style="width: 10%;"></td> <td style="width: 10%;"></td> <td style="width: 10%;"></td> <td style="width: 10%;"></td> </tr> <tr> <td></td> <td></td> <td colspan="8" style="text-align: center;"> <table border="1" style="width: 100%; border-collapse: collapse; text-align: center;"> <tr> <td style="width: 10%;"></td> <td style="width: 10%;"></td> <td style="width: 10%;"></td> <td style="width: 10%;"></td> <td style="width: 10%;"></td> <td style="width: 10%;"></td> <td style="width: 10%;"></td> <td style="width: 10%;"></td> <td style="width: 10%;"></td> <td style="width: 10%;"></td> </tr> <tr> <td></td> <td></td> <td colspan="8" style="text-align: center;"> <table border="1" style="width: 100%; border-collapse: collapse; text-align: center;"> <tr> <td style="width: 10%;"></td> <td style="width: 10%;"></td> <td style="width: 10%;"></td> <td style="width: 10%;"></td> <td style="width: 10%;"></td> <td style="width: 10%;"></td> <td style="width: 10%;"></td> <td style="width: 10%;"></td> <td style="width: 10%;"></td> <td style="width: 10%;"></td> </tr> <tr> <td></td> <td></td> <td colspan="8" style="text-align: center;"> <table border="1" style="width: 100%; border-collapse: collapse; text-align: center;"> <tr> <td style="width: 10%;"></td> <td style="width: 10%;"></td> <td style="width: 10%;"></td> <td style="width: 10%;"></td> <td style="width: 10%;"></td> <td style="width: 10%;"></td> <td style="width: 10%;"></td> <td style="width: 10%;"></td> <td style="width: 10%;"></td> <td style="width: 10%;"></td> </tr> <tr> <td></td> <td></td> <td colspan="8" style="text-align: center;"> <table border="1" style="width: 100%; border-collapse: collapse; text-align: center;"> <tr> <td style="width: 10%;"></td> <td style="width: 10%;"></td> <td style="width: 10%;"></td> <td style="width: 10%;"></td> <td style="width: 10%;"></td> <td style="width: 10%;"></td> <td style="width: 10%;"></td> <td style="width: 10%;"></td> <td style="width: 10%;"></td> <td style="width: 10%;"></td> </tr> <tr> <td></td> <td></td> <td colspan="8" style="text-align: center;"> <table border="1" style="width: 100%; border-collapse: collapse; text-align: center;"> <tr> <td style="width: 10%;"></td> <td style="width: 10%;"></td> <td style="width: 10%;"></td> <td style="width: 10%;"></td> <td style="width: 10%;"></td> <td style="width: 10%;"></td> <td style="width: 10%;"></td> <td style="width: 10%;"></td> <td style="width: 10%;"></td> <td style="width: 10%;"></td> </tr> <tr> <td></td> <td></td> <td colspan="8" style="text-align: center;"> <table border="1" style="width: 100%; border-collapse: collapse; text-align: center;"> <tr> <td style="width: 10%;"></td> <td style="width: 10%;"></td> <td style="width: 10%;"></td> <td style="width: 10%;"></td> <td style="width: 10%;"></td> <td style="width: 10%;"></td> <td style="width: 10%;"></td> <td style="width: 10%;"></td> <td style="width: 10%;"></td> <td style="width: 10%;"></td> </tr> <tr> <td></td> <td></td> <td colspan="8" style="text-align: center;"> <table border="1" style="width: 100%; border-collapse: collapse; text-align: center;"> <tr> <td style="width: 10%;"></td> <td style="width: 10%;"></td> <td style="width: 10%;"></td> <td style="width: 10%;"></td> <td style="width: 10%;"></td> <td style="width: 10%;"></td> <td style="width: 10%;"></td> <td style="width: 10%;"></td> <td style="width: 10%;"></td> <td style="width: 10%;"></td> </tr> <tr> <td></td> <td></td> <td colspan="8" style="text-align: center;"> <table border="1" style="width: 100%; border-collapse: collapse; text-align: center;"> <tr> <td style="width: 10%;"></td> <td style="width: 10%;"></td> <td style="width: 10%;"></td> <td style="width: 10%;"></td> <td style="width: 10%;"></td> <td style="width: 10%;"></td> <td style="width: 10%;"></td> <td style="width: 10%;"></td> <td style="width: 10%;"></td> <td style="width: 10%;"></td> </tr> <tr> <td></td> <td></td> <td colspan="8" style="text-align: center;"> <table border="1" style="width: 100%; border-collapse: collapse; text-align: center;"> <tr> <td style="width: 10%;"></td> <td style="width: 10%;"></td> <td style="width: 10%;"></td> <td style="width: 10%;"></td> <td style="width: 10%;"></td> <td style="width: 10%;"></td> <td style="width: 10%;"></td> <td style="width: 10%;"></td> <td style="width: 10%;"></td> <td style="width: 10%;"></td> </tr> <tr> <td></td> <td></td> <td colspan="8" style="text-align: center;"> <table border="1" style="width: 100%; border-collapse: collapse; text-align: center;"> <tr> <td style="width: 10%;"></td> <td style="width: 10%;"></td> <td style="width: 10%;"></td> <td style="width: 10%;"></td> <td style="width: 10%;"></td> <td style="width: 10%;"></td> <td style="width: 10%;"></td> <td style="width: 10%;"></td> <td style="width: 10%;"></td> <td style="width: 10%;"></td> </tr> <tr> <td></td> <td></td> <td colspan="8" style="text-align: center;"> <table border="1" style="width: 100%; border-collapse: collapse; text-align: center;"> <tr> <td style="width: 10%;"></td> <td style="width: 10%;"></td> <td style="width: 10%;"></td> <td style="width: 10%;"></td> <td style="width: 10%;"></td> <td style="width:
10%;"></td> <td style="width: 10%;"></td> <td style="width: 10%;"></td> <td style="width: 10%;"></td> <td style="width: 10%;"></td> </tr> <tr> <td></td> <td></td> <td colspan="8" style="text-align: center;"> <table border="1" style="width: 100%; border-collapse: collapse; text-align: center;"> <tr> <td style="width: 10%;"></td> <td style="width: 10%;"></td> <td style="width: 10%;"></td> <td style="width: 10%;"></td> <td style="width: 10%;"></td> <td style="width: 10%;"></td> <td style="width: 10%;"></td> <td style="width: 10%;"></td> <td style="width: 10%;"></td> <td style="width: 10%;"></td> </tr> <tr> <td></td> <td></td> <td colspan="8" style="text-align: center;"> <table border="1" style="width: 100%; border-collapse: collapse; text-align: center;"> <tr> </tr></table></td></tr></table></td></tr></table></td></tr></table></td></tr></table></td></tr></table></td></tr></table></td></tr></table></td></tr></table></td></tr></table></td></tr></table></td></tr></table></td></tr></table></td></tr></table></td></tr></table></td></tr></table></td></tr></table></td></tr></table></td></tr></table></td></tr></table></td></tr></table></td></tr></table></td></tr></table></td></tr></table></td></tr></table></td></tr></table></td></tr></table></td></tr></table></td></tr></table></td></tr></table></td></tr></table></td></tr></table></td></tr></table></td></tr></table></td></tr></table></td></tr></table></td></tr></table></td></tr></table></td></tr></table></td></tr></table></td></tr></table></td></tr></table></td></tr></table> | | | | | | | | | | | | | | | | | | | | <table border="1" style="width: 100%; border-collapse: collapse; text-align: center;"> <tr> <td style="width: 10%;"></td> <td style="width: 10%;"></td> <td style="width: 10%;"></td> <td style="width: 10%;"></td> <td style="width: 10%;"></td> <td style="width: 10%;"></td> <td style="width: 10%;"></td> <td style="width: 10%;"></td> <td style="width: 10%;"></td> <td style="width: 10%;"></td> </tr> <tr> <td></td> <td></td> <td colspan="8" style="text-align: center;"> <table border="1" style="width: 100%; border-collapse: collapse; text-align: center;"> <tr> <td style="width: 10%;"></td> <td style="width: 10%;"></td> <td style="width: 10%;"></td> <td style="width: 10%;"></td> <td style="width: 10%;"></td> <td style="width: 10%;"></td> <td style="width: 10%;"></td> <td style="width: 10%;"></td> <td style="width: 10%;"></td> <td style="width: 10%;"></td> </tr> <tr> <td></td> <td></td> <td colspan="8" style="text-align: center;"> <table border="1" style="width: 100%; border-collapse: collapse; text-align: center;"> <tr> <td style="width: 10%;"></td> <td style="width: 10%;"></td> <td style="width: 10%;"></td> <td style="width: 10%;"></td> <td style="width: 10%;"></td> <td style="width: 10%;"></td> <td style="width: 10%;"></td> <td style="width: 10%;"></td> <td style="width: 10%;"></td> <td style="width: 10%;"></td> </tr> <tr> <td></td> <td></td> <td colspan="8" style="text-align: center;"> <table border="1" style="width: 100%; border-collapse: collapse; text-align: center;"> <tr> <td style="width: 10%;"></td> <td style="width: 10%;"></td> <td style="width: 10%;"></td> <td style="width: 10%;"></td> <td style="width: 10%;"></td> <td style="width: 10%;"></td> <td style="width: 10%;"></td> <td style="width: 10%;"></td> <td style="width: 10%;"></td> <td style="width: 10%;"></td> </tr> <tr> <td></td> <td></td> <td colspan="8" style="text-align: center;"> <table border="1" style="width: 100%; border-collapse: collapse; text-align: center;"> <tr> <td style="width: 10%;"></td> <td style="width: 10%;"></td> <td style="width: 10%;"></td> <td style="width: 10%;"></td> <td style="width: 10%;"></td> <td style="width: 10%;"></td> <td style="width: 10%;"></td> <td style="width: 10%;"></td> <td style="width: 10%;"></td> <td style="width: 10%;"></td> </tr> <tr> <td></td> <td></td> <td colspan="8" style="text-align: center;"> <table border="1" style="width: 100%; border-collapse: collapse; text-align: center;"> <tr> <td style="width: 10%;"></td> <td style="width: 10%;"></td> <td style="width: 10%;"></td> <td style="width: 10%;"></td> <td style="width:
10%;"></td> <td style="width: 10%;"></td> <td style="width: 10%;"></td> <td style="width: 10%;"></td> <td style="width: 10%;"></td> <td style="width: 10%;"></td> </tr> <tr> <td></td> <td></td> <td colspan="8" style="text-align: center;"> <table border="1" style="width: 100%; border-collapse: collapse; text-align: center;"> <tr> <td style="width: 10%;"></td> <td style="width: 10%;"></td> <td style="width: 10%;"></td> <td style="width: 10%;"></td> <td style="width: 10%;"></td> <td style="width: 10%;"></td> <td style="width: 10%;"></td> <td style="width: 10%;"></td> <td style="width: 10%;"></td> <td style="width: 10%;"></td> </tr> <tr> <td></td> <td></td> <td colspan="8" style="text-align: center;"> <table border="1" style="width: 100%; border-collapse: collapse; text-align: center;"> <tr> <td style="width: 10%;"></td> <td style="width: 10%;"></td> <td style="width: 10%;"></td> <td style="width: 10%;"></td> <td style="width: 10%;"></td> <td style="width: 10%;"></td> <td style="width: 10%;"></td> <td style="width: 10%;"></td> <td style="width: 10%;"></td> <td style="width: 10%;"></td> </tr> <tr> <td></td> <td></td> <td colspan="8" style="text-align: center;"> <table border="1" style="width: 100%; border-collapse: collapse; text-align: center;"> <tr> <td style="width: 10%;"></td> <td style="width: 10%;"></td> <td style="width: 10%;"></td> <td style="width: 10%;"></td> <td style="width: 10%;"></td> <td style="width: 10%;"></td> <td style="width: 10%;"></td> <td style="width: 10%;"></td> <td style="width: 10%;"></td> <td style="width: 10%;"></td> </tr> <tr> <td></td> <td></td> <td colspan="8" style="text-align: center;"> <table border="1" style="width: 100%; border-collapse: collapse; text-align: center;"> <tr> <td style="width: 10%;"></td> <td style="width: 10%;"></td> <td style="width: 10%;"></td> <td style="width: 10%;"></td> <td style="width: 10%;"></td> <td style="width: 10%;"></td> <td style="width: 10%;"></td> <td style="width: 10%;"></td> <td style="width: 10%;"></td> <td style="width: 10%;"></td> </tr> <tr> <td></td> <td></td> <td colspan="8" style="text-align: center;"> <table border="1" style="width: 100%; border-collapse: collapse; text-align: center;"> <tr> <td style="width: 10%;"></td> <td style="width: 10%;"></td> <td style="width: 10%;"></td> <td style="width: 10%;"></td> <td style="width: 10%;"></td> <td style="width: 10%;"></td> <td style="width: 10%;"></td> <td style="width: 10%;"></td> <td style="width: 10%;"></td> <td style="width: 10%;"></td> </tr> <tr> <td></td> <td></td> <td colspan="8" style="text-align: center;"> <table border="1" style="width: 100%; border-collapse: collapse; text-align: center;"> <tr> <td style="width: 10%;"></td> <td style="width: 10%;"></td> <td style="width: 10%;"></td> <td style="width: 10%;"></td> <td style="width: 10%;"></td> <td style="width: 10%;"></td> <td style="width: 10%;"></td> <td style="width: 10%;"></td> <td style="width: 10%;"></td> <td style="width: 10%;"></td> </tr> <tr> <td></td> <td></td> <td colspan="8" style="text-align: center;"> <table border="1" style="width: 100%; border-collapse: collapse; text-align: center;"> <tr> <td style="width: 10%;"></td> <td style="width: 10%;"></td> <td style="width: 10%;"></td> <td style="width: 10%;"></td> <td style="width: 10%;"></td> <td style="width: 10%;"></td> <td style="width: 10%;"></td> <td style="width: 10%;"></td> <td style="width: 10%;"></td> <td style="width: 10%;"></td> </tr> <tr> <td></td> <td></td> <td colspan="8" style="text-align: center;"> <table border="1" style="width: 100%; border-collapse: collapse; text-align: center;"> <tr> <td style="width: 10%;"></td> <td style="width: 10%;"></td> <td style="width: 10%;"></td> <td style="width: 10%;"></td> <td style="width: 10%;"></td> <td style="width: 10%;"></td> <td style="width: 10%;"></td> <td style="width: 10%;"></td> <td style="width: 10%;"></td> <td style="width: 10%;"></td> </tr> <tr> <td></td> <td></td> <td colspan="8" style="text-align: center;"> <table border="1" style="width: 100%; border-collapse: collapse; text-align: center;"> <tr> <td style="width: 10%;"></td> <td style="width: 10%;"></td> <td style="width: 10%;"></td> <td style="width: 10%;"></td> <td style="width: 10%;"></td> <td style="width: 10%;"></td> <td style="width: 10%;"></td> <td style="width: 10%;"></td> <td style="width: 10%;"></td> <td style="width: 10%;"></td> </tr> <tr> <td></td> <td></td> <td colspan="8" style="text-align: center;"> <table border="1" style="width: 100%; border-collapse: collapse; text-align: center;"> <tr> <td style="width: 10%;"></td> <td style="width: 10%;"></td> <td style="width: 10%;"></td> <td style="width: 10%;"></td> <td style="width: 10%;"></td> <td style="width: 10%;"></td> <td style="width: 10%;"></td> <td style="width: 10%;"></td> <td style="width: 10%;"></td> <td style="width: 10%;"></td> </tr> <tr> <td></td> <td></td> <td colspan="8" style="text-align: center;"> <table border="1" style="width: 100%; border-collapse: collapse; text-align: center;"> <tr> <td style="width: 10%;"></td> <td style="width: 10%;"></td> <td style="width: 10%;"></td> <td style="width: 10%;"></td> <td style="width: 10%;"></td> <td style="width: 10%;"></td> <td style="width: 10%;"></td> <td style="width: 10%;"></td> <td style="width: 10%;"></td> <td style="width: 10%;"></td> </tr> <tr> <td></td> <td></td> <td colspan="8" style="text-align: center;"> <table border="1" style="width: 100%; border-collapse: collapse; text-align: center;"> <tr> <td style="width: 10%;"></td> <td style="width: 10%;"></td> <td style="width: 10%;"></td> <td style="width: 10%;"></td> <td style="width: 10%;"></td> <td style="width: 10%;"></td> <td style="width: 10%;"></td> <td style="width: 10%;"></td> <td style="width: 10%;"></td> <td style="width: 10%;"></td> </tr> <tr> <td></td> <td></td> <td colspan="8" style="text-align: center;"> <table border="1" style="width: 100%; border-collapse: collapse; text-align: center;"> <tr> <td style="width: 10%;"></td> <td style="width: 10%;"></td> <td style="width: 10%;"></td> <td style="width: 10%;"></td> <td style="width: 10%;"></td> <td style="width: 10%;"></td> <td style="width: 10%;"></td> <td style="width: 10%;"></td> <td style="width: 10%;"></td> <td style="width: 10%;"></td> </tr> <tr> <td></td> <td></td> <td colspan="8" style="text-align: center;"> <table border="1" style="width: 100%; border-collapse: collapse; text-align: center;"> <tr> <td style="width: 10%;"></td> <td style="width: 10%;"></td> <td style="width: 10%;"></td> <td style="width: 10%;"></td> <td style="width: 10%;"></td> <td style="width: 10%;"></td> <td style="width: 10%;"></td> <td style="width: 10%;"></td> <td style="width: 10%;"></td> <td style="width: 10%;"></td> </tr> <tr> <td></td> <td></td> <td colspan="8" style="text-align: center;"> <table border="1" style="width: 100%; border-collapse: collapse; text-align: center;"> <tr> <td style="width: 10%;"></td> <td style="width: 10%;"></td> <td style="width: 10%;"></td> <td style="width: 10%;"></td> <td style="width: 10%;"></td> <td style="width: 10%;"></td> <td style="width: 10%;"></td> <td style="width: 10%;"></td> <td style="width: 10%;"></td> <td style="width: 10%;"></td> </tr> <tr> <td></td> <td></td> <td colspan="8" style="text-align: center;"> <table border="1" style="width: 100%; border-collapse: collapse; text-align: center;"> <tr> <td style="width: 10%;"></td> <td style="width: 10%;"></td> <td style="width: 10%;"></td> <td style="width: 10%;"></td> <td style="width: 10%;"></td> <td style="width: 10%;"></td> <td style="width: 10%;"></td> <td style="width: 10%;"></td> <td style="width: 10%;"></td> <td style="width: 10%;"></td> </tr> <tr> <td></td> <td></td> <td colspan="8" style="text-align: center;"> <table border="1" style="width: 100%; border-collapse: collapse; text-align: center;"> <tr> <td style="width: 10%;"></td> <td style="width: 10%;"></td> <td style="width: 10%;"></td> <td style="width: 10%;"></td> <td style="width: 10%;"></td> <td style="width: 10%;"></td> <td style="width: 10%;"></td> <td style="width: 10%;"></td> <td style="width: 10%;"></td> <td style="width: 10%;"></td> </tr> <tr> <td></td> <td></td> <td colspan="8" style="text-align: center;"> <table border="1" style="width: 100%; border-collapse: collapse; text-align: center;"> <tr> <td style="width: 10%;"></td> <td style="width: 10%;"></td> <td style="width: 10%;"></td> <td style="width: 10%;"></td> <td style="width: 10%;"></td> <td style="width: 10%;"></td> <td style="width: 10%;"></td> <td style="width: 10%;"></td> <td style="width: 10%;"></td> <td style="width: 10%;"></td> </tr> <tr> <td></td> <td></td> <td colspan="8" style="text-align: center;"> <table border="1" style="width: 100%; border-collapse: collapse; text-align: center;"> <tr> <td style="width: 10%;"></td> <td style="width: 10%;"></td> <td style="width: 10%;"></td> <td style="width: 10%;"></td> <td style="width: 10%;"></td> <td style="width: 10%;"></td> <td style="width: 10%;"></td> <td style="width: 10%;"></td> <td style="width: 10%;"></td> <td style="width: 10%;"></td> </tr> <tr> <td></td> <td></td> <td colspan="8" style="text-align: center;"> <table border="1" style="width: 100%; border-collapse: collapse; text-align: center;"> <tr> <td style="width: 10%;"></td> <td style="width: 10%;"></td> <td style="width: 10%;"></td> <td style="width: 10%;"></td> <td style="width: 10%;"></td> <td style="width: 10%;"></td> <td style="width: 10%;"></td> <td style="width: 10%;"></td> <td style="width: 10%;"></td> <td style="width: 10%;"></td> </tr> <tr> <td></td> <td></td> <td colspan="8" style="text-align: center;"> <table border="1" style="width: 100%; border-collapse: collapse; text-align: center;"> <tr> <td style="width: 10%;"></td> <td style="width: 10%;"></td> <td style="width: 10%;"></td> <td style="width: 10%;"></td> <td style="width: 10%;"></td> <td style="width: 10%;"></td> <td style="width: 10%;"></td> <td style="width: 10%;"></td> <td style="width: 10%;"></td> <td style="width: 10%;"></td> </tr>
<tr> <td></td> <td></td> <td colspan="8" style="text-align: center;"> <table border="1" style="width: 100%; border-collapse: collapse; text-align: center;"> <tr> <td style="width: 10%;"></td> <td style="width: 10%;"></td> <td style="width: 10%;"></td> <td style="width: 10%;"></td> <td style="width: 10%;"></td> <td style="width: 10%;"></td> <td style="width: 10%;"></td> <td style="width: 10%;"></td> <td style="width: 10%;"></td> <td style="width: 10%;"></td> </tr> <tr> <td></td> <td></td> <td colspan="8" style="text-align: center;"> <table border="1" style="width: 100%; border-collapse: collapse; text-align: center;"> <tr> <td style="width: 10%;"></td> <td style="width: 10%;"></td> <td style="width: 10%;"></td> <td style="width: 10%;"></td> <td style="width: 10%;"></td> <td style="width: 10%;"></td> <td style="width: 10%;"></td> <td style="width: 10%;"></td> <td style="width: 10%;"></td> <td style="width: 10%;"></td> </tr> <tr> <td></td> <td></td> <td colspan="8" style="text-align: center;"> <table border="1" style="width: 100%; border-collapse: collapse; text-align: center;"> <tr> <td style="width: 10%;"></td> <td style="width: 10%;"></td> <td style="width: 10%;"></td> <td style="width: 10%;"></td> <td style="width: 10%;"></td> <td style="width: 10%;"></td> <td style="width: 10%;"></td> <td style="width: 10%;"></td> <td style="width: 10%;"></td> <td style="width: 10%;"></td> </tr> <tr> <td></td> <td></td> <td colspan="8" style="text-align: center;"> <table border="1" style="width: 100%; border-collapse: collapse; text-align: center;"> <tr> <td style="width: 10%;"></td> <td style="width: 10%;"></td> <td style="width: 10%;"></td> <td style="width: 10%;"></td> <td style="width: 10%;"></td> <td style="width: 10%;"></td> <td style="width: 10%;"></td> <td style="width: 10%;"></td> <td style="width: 10%;"></td> <td style="width: 10%;"></td> </tr> <tr> <td></td> <td></td> <td colspan="8" style="text-align: center;"> <table border="1" style="width: 100%; border-collapse: collapse; text-align: center;"> <tr> <td style="width: 10%;"></td> <td style="width: 10%;"></td> <td style="width: 10%;"></td> <td style="width: 10%;"></td> <td style="width: 10%;"></td> <td style="width: 10%;"></td> <td style="width: 10%;"></td> <td style="width: 10%;"></td> <td style="width: 10%;"></td> <td style="width: 10%;"></td> </tr> <tr> <td></td> <td></td> <td colspan="8" style="text-align: center;"> <table border="1" style="width: 100%; border-collapse: collapse; text-align: center;"> <tr> <td style="width: 10%;"></td> <td style="width: 10%;"></td> <td style="width: 10%;"></td> <td style="width: 10%;"></td> <td style="width: 10%;"></td> <td style="width: 10%;"></td> <td style="width: 10%;"></td> <td style="width: 10%;"></td> <td style="width: 10%;"></td> <td style="width: 10%;"></td> </tr> <tr> <td></td> <td></td> <td colspan="8" style="text-align: center;"> <table border="1" style="width: 100%; border-collapse: collapse; text-align: center;"> <tr> <td style="width: 10%;"></td> <td style="width: 10%;"></td> <td style="width: 10%;"></td> <td style="width: 10%;"></td> <td style="width: 10%;"></td> <td style="width: 10%;"></td> <td style="width: 10%;"></td> <td style="width: 10%;"></td> <td style="width: 10%;"></td> <td style="width: 10%;"></td> </tr> <tr> <td></td> <td></td> <td colspan="8" style="text-align: center;"> <table border="1" style="width: 100%; border-collapse: collapse; text-align: center;"> <tr> <td style="width: 10%;"></td> <td style="width: 10%;"></td> <td style="width: 10%;"></td> <td style="width: 10%;"></td> <td style="width: 10%;"></td> <td style="width: 10%;"></td> <td style="width: 10%;"></td> <td style="width: 10%;"></td> <td style="width: 10%;"></td> <td style="width: 10%;"></td> </tr> <tr> <td></td> <td></td> <td colspan="8" style="text-align: center;"> <table border="1" style="width: 100%; border-collapse: collapse; text-align: center;"> <tr> <td style="width: 10%;"></td> <td style="width: 10%;"></td> <td style="width: 10%;"></td> <td style="width: 10%;"></td> <td style="width: 10%;"></td> <td style="width: 10%;"></td> <td style="width: 10%;"></td> <td style="width: 10%;"></td> <td style="width: 10%;"></td> <td style="width: 10%;"></td> </tr> <tr> <td></td> <td></td> <td colspan="8" style="text-align: center;"> <table border="1" style="width: 100%; border-collapse: collapse; text-align: center;"> <tr> <td style="width: 10%;"></td> <td style="width: 10%;"></td> <td style="width: 10%;"></td> <td style="width: 10%;"></td> <td style="width: 10%;"></td> <td style="width: 10%;"></td> <td style="width: 10%;"></td> <td style="width: 10%;"></td> <td style="width: 10%;"></td> <td style="width: 10%;"></td> </tr> <tr> <td></td> <td></td> <td colspan="8" style="text-align: center;"> <table border="1" style="width: 100%; border-collapse: collapse; text-align: center;"> <tr> <td style="width: 10%;"></td> <td style="width: 10%;"></td> <td style="width: 10%;"></td> <td style="width: 10%;"></td> <td style="width: 10%;"></td> <td style="width: 10%;"></td> <td style="width: 10%;"></td> <td style="width: 10%;"></td> <td style="width: 10%;"></td> <td style="width: 10%;"></td> </tr> <tr> <td></td> <td></td> <td colspan="8" style="text-align: center;"> <table border="1" style="width: 100%; border-collapse: collapse; text-align: center;"> <tr> <td style="width: 10%;"></td> <td style="width: 10%;"></td> <td style="width: 10%;"></td> <td style="width: 10%;"></td> <td style="width: 10%;"></td> <td style="width: 10%;"></td> <td style="width: 10%;"></td> <td style="width: 10%;"></td> <td style="width: 10%;"></td> <td style="width: 10%;"></td> </tr> <tr> <td></td> <td></td> <td colspan="8" style="text-align: center;"> <table border="1" style="width: 100%; border-collapse: collapse; text-align: center;"> <tr> <td style="width: 10%;"></td> <td style="width: 10%;"></td> <td style="width: 10%;"></td> <td style="width: 10%;"></td> <td style="width: 10%;"></td> <td style="width: 10%;"></td> <td style="width: 10%;"></td> <td style="width: 10%;"></td> <td style="width: 10%;"></td> <td style="width: 10%;"></td> </tr> <tr> <td></td> <td></td> <td colspan="8" style="text-align: center;"> <table border="1" style="width: 100%; border-collapse: collapse; text-align: center;"> <tr> <td style="width: 10%;"></td> <td style="width: 10%;"></td> <td style="width: 10%;"></td> <td style="width: 10%;"></td> <td style="width: 10%;"></td> <td style="width: 10%;"></td> <td style="width: 10%;"></td> <td style="width: 10%;"></td> <td style="width: 10%;"></td> <td style="width: 10%;"></td> </tr> <tr> <td></td> <td></td> <td colspan="8" style="text-align: center;"> <table border="1" style="width: 100%; border-collapse: collapse; text-align: center;"> <tr> </tr></table></td></tr></table></td></tr></table></td></tr></table></td></tr></table></td></tr></table></td></tr></table></td></tr></table></td></tr></table></td></tr></table></td></tr></table></td></tr></table></td></tr></table></td></tr></table></td></tr></table></td></tr></table></td></tr></table></td></tr></table></td></tr></table></td></tr></table></td></tr></table></td></tr></table></td></tr></table></td></tr></table></td></tr></table></td></tr></table></td></tr></table></td></tr></table></td></tr></table></td></tr></table></td></tr></table></td></tr></table></td></tr></table></td></tr></table></td></tr></table></td></tr></table></td></tr></table></td></tr></table></td></tr></table></td></tr></table></td></tr></table></td></tr></table>
 | | | | | | | | | | | | | | | | | | | | <table border="1" style="width: 100%; border-collapse: collapse; text-align: center;"> <tr> <td style="width: 10%;"></td> <td style="width: 10%;"></td> <td style="width: 10%;"></td> <td style="width: 10%;"></td> <td style="width: 10%;"></td> <td style="width: 10%;"></td> <td style="width: 10%;"></td> <td style="width: 10%;"></td> <td style="width: 10%;"></td> <td style="width: 10%;"></td> </tr> <tr> <td></td> <td></td> <td colspan="8" style="text-align: center;"> <table border="1" style="width: 100%; border-collapse: collapse; text-align: center;"> <tr> <td style="width: 10%;"></td> <td style="width: 10%;"></td> <td style="width: 10%;"></td> <td style="width: 10%;"></td> <td style="width: 10%;"></td> <td style="width: 10%;"></td> <td style="width: 10%;"></td> <td style="width: 10%;"></td> <td style="width: 10%;"></td> <td style="width: 10%;"></td> </tr> <tr> <td></td> <td></td> <td colspan="8" style="text-align: center;"> <table border="1" style="width: 100%; border-collapse: collapse; text-align: center;"> <tr> <td style="width: 10%;"></td> <td style="width: 10%;"></td> <td style="width: 10%;"></td> <td style="width: 10%;"></td> <td style="width: 10%;"></td> <td style="width: 10%;"></td> <td style="width: 10%;"></td> <td style="width: 10%;"></td> <td style="width: 10%;"></td> <td style="width: 10%;"></td> </tr> <tr> <td></td> <td></td> <td colspan="8" style="text-align: center;"> <table border="1" style="width: 100%; border-collapse: collapse; text-align: center;"> <tr> <td style="width: 10%;"></td> <td style="width: 10%;"></td> <td style="width: 10%;"></td> <td style="width: 10%;"></td> <td style="width: 10%;"></td> <td style="width: 10%;"></td> <td style="width: 10%;"></td> <td style="width: 10%;"></td> <td style="width: 10%;"></td> <td style="width: 10%;"></td> </tr> <tr> <td></td> <td></td> <td colspan="8" style="text-align: center;"> <table border="1" style="width: 100%; border-collapse: collapse; text-align: center;"> <tr> <td style="width: 10%;"></td> <td style="width: 10%;"></td> <td style="width: 10%;"></td> <td style="width: 10%;"></td> <td style="width: 10%;"></td> <td style="width: 10%;"></td> <td style="width: 10%;"></td> <td style="width: 10%;"></td> <td style="width: 10%;"></td> <td style="width: 10%;"></td> </tr> <tr> <td></td> <td></td> <td colspan="8" style="text-align: center;"> <table border="1" style="width: 100%; border-collapse: collapse; text-align: center;"> <tr> <td style="width: 10%;"></td> <td style="width: 10%;"></td> <td style="width: 10%;"></td> <td style="width: 10%;"></td> <td style="width: 10%;"></td> <td style="width: 10%;"></td> <td style="width: 10%;"></td> <td style="width: 10%;"></td> <td style="width: 10%;"></td> <td style="width: 10%;"></td> </tr> <tr> <td></td> <td></td> <td colspan="8" style="text-align: center;"> <table border="1" style="width: 100%; border-collapse: collapse; text-align: center;"> <tr> <td style="width: 10%;"></td> <td style="width: 10%;"></td> <td style="width: 10%;"></td> <td style="width: 10%;"></td> <td style="width: 10%;"></td> <td style="width: 10%;"></td> <td style="width: 10%;"></td> <td style="width: 10%;"></td> <td style="width: 10%;"></td> <td style="width: 10%;"></td> </tr> <tr> <td></td> <td></td> <td colspan="8" style="text-align: center;"> <table border="1" style="width: 100%; border-collapse: collapse; text-align: center;"> <tr> <td style="width: 10%;"></td> <td style="width: 10%;"></td> <td style="width: 10%;"></td> <td style="width: 10%;"></td> <td style="width: 10%;"></td> <td style="width: 10%;"></td> <td style="width: 10%;"></td> <td style="width: 10%;"></td> <td style="width: 10%;"></td> <td style="width: 10%;"></td> </tr> <tr> <td></td> <td></td> <td colspan="8" style="text-align: center;"> <table border="1" style="width: 100%; border-collapse: collapse; text-align: center;"> <tr> <td style="width: 10%;"></td> <td style="width: 10%;"></td> <td style="width: 10%;"></td> <td style="width: 10%;"></td> <td style="width: 10%;"></td> <td style="width: 10%;"></td> <td style="width: 10%;"></td> <td style="width: 10%;"></td> <td style="width: 10%;"></td> <td style="width: 10%;"></td> </tr> <tr> <td></td> <td></td> <td colspan="8" style="text-align: center;"> <table border="1" style="width: 100%; border-collapse: collapse; text-align: center;"> <tr> <td style="width: 10%;"></td> <td style="width: 10%;"></td> <td style="width: 10%;"></td> <td style="width: 10%;"></td> <td style="width: 10%;"></td> <td style="width: 10%;"></td> <td style="width: 10%;"></td> <td style="width: 10%;"></td> <td style="width: 10%;"></td> <td style="width: 10%;"></td> </tr> <tr> <td></td> <td></td> <td colspan="8" style="text-align: center;"> <table border="1" style="width: 100%; border-collapse: collapse; text-align: center;"> <tr> <td style="width: 10%;"></td> <td style="width: 10%;"></td> <td style="width: 10%;"></td> <td style="width: 10%;"></td> <td style="width: 10%;"></td> <td style="width: 10%;"></td> <td style="width: 10%;"></td> <td style="width: 10%;"></td> <td style="width: 10%;"></td> <td style="width: 10%;"></td> </tr> <tr> <td></td> <td></td> <td colspan="8" style="text-align: center;"> <table border="1" style="width: 100%; border-collapse: collapse; text-align: center;"> <tr> <td style="width: 10%;"></td> <td style="width: 10%;"></td> <td style="width: 10%;"></td> <td style="width: 10%;"></td> <td style="width: 10%;"></td> <td style="width: 10%;"></td> <td style="width: 10%;"></td> <td style="width: 10%;"></td> <td style="width: 10%;"></td> <td style="width: 10%;"></td> </tr> <tr> <td></td> <td></td> <td colspan="8" style="text-align: center;"> <table border="1" style="width: 100%; border-collapse: collapse; text-align: center;"> <tr> <td style="width: 10%;"></td> <td style="width: 10%;"></td> <td style="width: 10%;"></td> <td style="width: 10%;"></td> <td style="width: 10%;"></td> <td style="width: 10%;"></td> <td style="width: 10%;"></td> <td style="width: 10%;"></td> <td style="width: 10%;"></td> <td style="width: 10%;"></td> </tr> <tr> <td></td> <td></td> <td colspan="8" style="text-align: center;"> <table border="1" style="width: 100%; border-collapse: collapse; text-align: center;"> <tr> <td style="width: 10%;"></td> <td style="width: 10%;"></td> <td style="width: 10%;"></td> <td style="width: 10%;"></td> <td style="width: 10%;"></td> <td style="width: 10%;"></td> <td style="width: 10%;"></td> <td style="width: 10%;"></td> <td style="width: 10%;"></td> <td style="width: 10%;"></td> </tr> <tr> <td></td> <td></td> <td colspan="8" style="text-align: center;"> <table border="1" style="width: 100%; border-collapse: collapse; text-align: center;">
<tr> <td style="width: 10%;"></td> <td style="width: 10%;"></td> <td style="width: 10%;"></td> <td style="width: 10%;"></td> <td style="width: 10%;"></td> <td style="width: 10%;"></td> <td style="width: 10%;"></td> <td style="width: 10%;"></td> <td style="width: 10%;"></td> <td style="width: 10%;"></td> </tr> <tr> <td></td> <td></td> <td colspan="8" style="text-align: center;"> <table border="1" style="width: 100%; border-collapse: collapse; text-align: center;"> <tr> <td style="width: 10%;"></td> <td style="width: 10%;"></td> <td style="width: 10%;"></td> <td style="width: 10%;"></td> <td style="width: 10%;"></td> <td style="width: 10%;"></td> <td style="width: 10%;"></td> <td style="width: 10%;"></td> <td style="width: 10%;"></td> <td style="width: 10%;"></td> </tr> <tr> <td></td> <td></td> <td colspan="8" style="text-align: center;"> <table border="1" style="width: 100%; border-collapse: collapse; text-align: center;"> <tr> <td style="width: 10%;"></td> <td style="width: 10%;"></td> <td style="width: 10%;"></td> <td style="width: 10%;"></td> <td style="width: 10%;"></td> <td style="width: 10%;"></td> <td style="width: 10%;"></td> <td style="width: 10%;"></td> <td style="width: 10%;"></td> <td style="width: 10%;"></td> </tr> <tr> <td></td> <td></td> <td colspan="8" style="text-align: center;"> <table border="1" style="width: 100%; border-collapse: collapse; text-align: center;"> <tr> <td style="width: 10%;"></td> <td style="width: 10%;"></td> <td style="width: 10%;"></td> <td style="width: 10%;"></td> <td style="width: 10%;"></td> <td style="width: 10%;"></td> <td style="width: 10%;"></td> <td style="width: 10%;"></td> <td style="width: 10%;"></td> <td style="width: 10%;"></td> </tr> <tr> <td></td> <td></td> <td colspan="8" style="text-align: center;"> <table border="1" style="width: 100%; border-collapse: collapse; text-align: center;"> <tr> <td style="width: 10%;"></td> <td style="width: 10%;"></td> <td style="width: 10%;"></td> <td style="width: 10%;"></td> <td style="width: 10%;"></td> <td style="width: 10%;"></td> <td style="width: 10%;"></td> <td style="width: 10%;"></td> <td style="width: 10%;"></td> <td style="width: 10%;"></td> </tr> <tr> <td></td> <td></td> <td colspan="8" style="text-align: center;"> <table border="1" style="width: 100%; border-collapse: collapse; text-align: center;"> <tr> <td style="width: 10%;"></td> <td style="width: 10%;"></td> <td style="width: 10%;"></td> <td style="width: 10%;"></td> <td style="width: 10%;"></td> <td style="width: 10%;"></td> <td style="width: 10%;"></td> <td style="width: 10%;"></td> <td style="width: 10%;"></td> <td style="width: 10%;"></td> </tr> <tr> <td></td> <td></td> <td colspan="8" style="text-align: center;"> <table border="1" style="width: 100%; border-collapse: collapse; text-align: center;"> <tr> <td style="width: 10%;"></td> <td style="width: 10%;"></td> <td style="width: 10%;"></td> <td style="width: 10%;"></td> <td style="width: 10%;"></td> <td style="width: 10%;"></td> <td style="width: 10%;"></td> <td style="width: 10%;"></td> <td style="width: 10%;"></td> <td style="width: 10%;"></td> </tr> <tr> <td></td> <td></td> <td colspan="8" style="text-align: center;"> <table border="1" style="width: 100%; border-collapse: collapse; text-align: center;"> <tr> <td style="width: 10%;"></td> <td style="width: 10%;"></td> <td style="width: 10%;"></td> <td style="width: 10%;"></td> <td style="width: 10%;"></td> <td style="width: 10%;"></td> <td style="width: 10%;"></td> <td style="width: 10%;"></td> <td style="width: 10%;"></td> <td style="width: 10%;"></td> </tr> <tr> <td></td> <td></td> <td colspan="8" style="text-align: center;"> <table border="1" style="width: 100%; border-collapse: collapse; text-align: center;"> <tr> <td style="width: 10%;"></td> <td style="width: 10%;"></td> <td style="width: 10%;"></td> <td style="width: 10%;"></td> <td style="width: 10%;"></td> <td style="width: 10%;"></td> <td style="width: 10%;"></td> <td style="width: 10%;"></td> <td style="width: 10%;"></td> <td style="width: 10%;"></td> </tr> <tr> <td></td> <td></td> <td colspan="8" style="text-align: center;"> <table border="1" style="width: 100%; border-collapse: collapse; text-align: center;"> <tr> <td style="width: 10%;"></td> <td style="width: 10%;"></td> <td style="width: 10%;"></td> <td style="width: 10%;"></td> <td style="width: 10%;"></td> <td style="width: 10%;"></td> <td style="width: 10%;"></td> <td style="width: 10%;"></td> <td style="width: 10%;"></td> <td style="width: 10%;"></td> </tr> <tr> <td></td> <td></td> <td colspan="8" style="text-align: center;"> <table border="1" style="width: 100%; border-collapse: collapse; text-align: center;"> <tr> <td style="width: 10%;"></td> <td style="width: 10%;"></td> <td style="width: 10%;"></td> <td style="width: 10%;"></td> <td style="width: 10%;"></td> <td style="width: 10%;"></td> <td style="width: 10%;"></td> <td style="width: 10%;"></td> <td style="width: 10%;"></td> <td style="width: 10%;"></td> </tr> <tr> <td></td> <td></td> <td colspan="8" style="text-align: center;"> <table border="1" style="width: 100%; border-collapse: collapse; text-align: center;"> <tr> <td style="width: 10%;"></td> <td style="width: 10%;"></td> <td style="width: 10%;"></td> <td style="width: 10%;"></td> <td style="width: 10%;"></td> <td style="width: 10%;"></td> <td style="width: 10%;"></td> <td style="width: 10%;"></td> <td style="width: 10%;"></td> <td style="width: 10%;"></td> </tr> <tr> <td></td> <td></td> <td colspan="8" style="text-align: center;"> <table border="1" style="width: 100%; border-collapse: collapse; text-align: center;"> <tr> <td style="width: 10%;"></td> <td style="width: 10%;"></td> <td style="width: 10%;"></td> <td style="width: 10%;"></td> <td style="width: 10%;"></td> <td style="width: 10%;"></td> <td style="width: 10%;"></td> <td style="width: 10%;"></td> <td style="width: 10%;"></td> <td style="width: 10%;"></td> </tr> <tr> <td></td> <td></td> <td colspan="8" style="text-align: center;"> <table border="1" style="width: 100%; border-collapse: collapse; text-align: center;"> <tr> <td style="width: 10%;"></td> <td style="width: 10%;"></td> <td style="width: 10%;"></td> <td style="width: 10%;"></td> <td style="width: 10%;"></td> <td style="width: 10%;"></td> <td style="width: 10%;"></td> <td style="width: 10%;"></td> <td style="width: 10%;"></td> <td style="width: 10%;"></td> </tr> <tr> <td></td> <td></td> <td colspan="8" style="text-align: center;"> <table border="1" style="width: 100%; border-collapse: collapse; text-align: center;"> <tr> <td style="width: 10%;"></td> <td style="width: 10%;"></td> <td style="width: 10%;"></td> <td style="width: 10%;"></td> <td style="width: 10%;"></td> <td style="width: 10%;"></td> <td style="width: 10%;"></td> <td style="width: 10%;"></td> <td style="width: 10%;"></td> <td style="width: 10%;"></td> </tr> <tr> <td></td> <td></td> <td colspan="8" style="text-align: center;"> <table border="1" style="width: 100%; border-collapse: collapse; text-align: center;"> <tr> <td style="width: 10%;"></td> <td style="width: 10%;"></td> <td style="width: 10%;"></td> <td style="width: 10%;"></td> <td style="width: 10%;"></td> <td style="width: 10%;"></td> <td style="width: 10%;"></td> <td style="width: 10%;"></td> <td style="width: 10%;"></td> <td style="width: 10%;"></td> </tr> <tr> <td></td> <td></td> <td colspan="8" style="text-align: center;"> <table border="1" style="width: 100%; border-collapse: collapse; text-align: center;"> <tr> <td style="width: 10%;"></td> <td style="width: 10%;"></td> <td style="width: 10%;"></td> <td style="width: 10%;"></td> <td style="width: 10%;"></td> <td style="width: 10%;"></td> <td style="width: 10%;"></td> <td style="width: 10%;"></td> <td style="width: 10%;"></td> <td style="width: 10%;"></td> </tr> <tr> <td></td> <td></td> <td colspan="8" style="text-align: center;"> <table border="1" style="width: 100%; border-collapse: collapse; text-align: center;"> <tr> <td style="width: 10%;"></td> <td style="width: 10%;"></td> <td style="width: 10%;"></td> <td style="width: 10%;"></td> <td style="width: 10%;"></td> <td style="width: 10%;"></td> <td style="width: 10%;"></td> <td style="width: 10%;"></td> <td style="width: 10%;"></td> <td style="width: 10%;"></td> </tr> <tr> <td></td> <td></td> <td colspan="8" style="text-align: center;"> <table border="1" style="width: 100%; border-collapse: collapse; text-align: center;"> <tr> <td style="width: 10%;"></td> <td style="width: 10%;"></td> <td style="width: 10%;"></td> <td style="width: 10%;"></td> <td style="width: 10%;"></td> <td style="width: 10%;"></td> <td style="width: 10%;"></td> <td style="width: 10%;"></td> <td style="width: 10%;"></td> <td style="width: 10%;"></td> </tr> <tr> <td></td> <td></td> <td colspan="8" style="text-align: center;"> <table border="1" style="width: 100%; border-collapse: collapse; text-align: center;"> <tr> <td style="width: 10%;"></td> <td style="width: 10%;"></td> <td style="width: 10%;"></td> <td style="width: 10%;"></td> <td style="width: 10%;"></td> <td style="width: 10%;"></td> <td style="width: 10%;"></td> <td style="width: 10%;"></td> <td style="width: 10%;"></td> <td style="width: 10%;"></td> </tr> <tr> <td></td> <td></td> <td colspan="8" style="text-align: center;"> <table border="1" style="width: 100%; border-collapse: collapse; text-align: center;"> <tr> <td style="width: 10%;"></td> <td style="width: 10%;"></td> <td style="width: 10%;"></td> <td style="width: 10%;"></td> <td style="width: 10%;"></td> <td style="width: 10%;"></td> <td style="width: 10%;"></td> <td style="width: 10%;"></td> <td style="width: 10%;"></td> <td style="width: 10%;"></td> </tr> <tr> <td></td> <td></td> <td colspan="8" style="text-align: center;"> <table border="1" style="width: 100%; border-collapse: collapse; text-align: center;"> <tr> <td style="width: 10%;"></td> <td style="width: 10%;"></td> <td style="width: 10%;"></td> <td style="width: 10%;"></td> <td style="width: 10%;"></td> <td
style="width: 10%;"></td> <td style="width: 10%;"></td> <td style="width: 10%;"></td> <td style="width: 10%;"></td> <td style="width: 10%;"></td> </tr> <tr> <td></td> <td></td> <td colspan="8" style="text-align: center;"> <table border="1" style="width: 100%; border-collapse: collapse; text-align: center;"> <tr> <td style="width: 10%;"></td> <td style="width: 10%;"></td> <td style="width: 10%;"></td> <td style="width: 10%;"></td> <td style="width: 10%;"></td> <td style="width: 10%;"></td> <td style="width: 10%;"></td> <td style="width: 10%;"></td> <td style="width: 10%;"></td> <td style="width: 10%;"></td> </tr> <tr> <td></td> <td></td> <td colspan="8" style="text-align: center;"> <table border="1" style="width: 100%; border-collapse: collapse; text-align: center;"> <tr> <td style="width: 10%;"></td> <td style="width: 10%;"></td> <td style="width: 10%;"></td> <td style="width: 10%;"></td> <td style="width: 10%;"></td> <td style="width: 10%;"></td> <td style="width: 10%;"></td> <td style="width: 10%;"></td> <td style="width: 10%;"></td> <td style="width: 10%;"></td> </tr> <tr> <td></td> <td></td> <td colspan="8" style="text-align: center;"> <table border="1" style="width: 100%; border-collapse: collapse; text-align: center;"> <tr> <td style="width: 10%;"></td> <td style="width: 10%;"></td> <td style="width: 10%;"></td> <td style="width: 10%;"></td> <td style="width: 10%;"></td> <td style="width: 10%;"></td> <td style="width: 10%;"></td> <td style="width: 10%;"></td> <td style="width: 10%;"></td> <td style="width: 10%;"></td> </tr> <tr> <td></td> <td></td> <td colspan="8" style="text-align: center;"> <table border="1" style="width: 100%; border-collapse: collapse; text-align: center;"> <tr> <td style="width: 10%;"></td> <td style="width: 10%;"></td> <td style="width: 10%;"></td> <td style="width: 10%;"></td> <td style="width: 10%;"></td> <td style="width: 10%;"></td> <td style="width: 10%;"></td> <td style="width: 10%;"></td> <td style="width: 10%;"></td> <td style="width: 10%;"></td> </tr> <tr> <td></td> <td></td> <td colspan="8" style="text-align: center;"> <table border="1" style="width: 100%; border-collapse: collapse; text-align: center;"> <tr> </tr></table></td></tr></table></td></tr></table></td></tr></table></td></tr></table></td></tr></table></td></tr></table></td></tr></table></td></tr></table></td></tr></table></td></tr></table></td></tr></table></td></tr></table></td></tr></table></td></tr></table></td></tr></table></td></tr></table></td></tr></table></td></tr></table></td></tr></table></td></tr></table></td></tr></table></td></tr></table></td></tr></table></td></tr></table></td></tr></table></td></tr></table></td></tr></table></td></tr></table></td></tr></table></td></tr></table></td></tr></table></td></tr></table></td></tr></table></td></tr></table></td></tr></table></td></tr></table></td></tr></table></td></tr></table></td></tr></table></td></tr></table> | | | | | | | | | | | | | | | | | | | | <table border="1" style="width: 100%; border-collapse: collapse; text-align: center;"> <tr> <td style="width: 10%;"></td> <td style="width: 10%;"></td> <td style="width: 10%;"></td> <td style="width: 10%;"></td> <td style="width: 10%;"></td> <td style="width: 10%;"></td> <td style="width: 10%;"></td> <td style="width: 10%;"></td> <td style="width: 10%;"></td> <td style="width: 10%;"></td> </tr> <tr> <td></td> <td></td> <td colspan="8" style="text-align: center;"> <table border="1" style="width: 100%; border-collapse: collapse; text-align: center;"> <tr> <td style="width: 10%;"></td> <td style="width: 10%;"></td> <td style="width: 10%;"></td> <td style="width: 10%;"></td> <td style="width: 10%;"></td> <td style="width: 10%;"></td> <td style="width: 10%;"></td> <td style="width: 10%;"></td> <td style="width: 10%;"></td> <td style="width: 10%;"></td> </tr> <tr> <td></td> <td></td> <td colspan="8" style="text-align: center;"> <table border="1" style="width: 100%; border-collapse: collapse; text-align: center;"> <tr> <td style="width: 10%;"></td> <td style="width: 10%;"></td> <td style="width: 10%;"></td> <td style="width: 10%;"></td> <td style="width: 10%;"></td> <td
style="width: 10%;"></td> <td style="width: 10%;"></td> <td style="width: 10%;"></td> <td style="width: 10%;"></td> <td style="width: 10%;"></td> </tr> <tr> <td></td> <td></td> <td colspan="8" style="text-align: center;"> <table border="1" style="width: 100%; border-collapse: collapse; text-align: center;"> <tr> <td style="width: 10%;"></td> <td style="width: 10%;"></td> <td style="width: 10%;"></td> <td style="width: 10%;"></td> <td style="width: 10%;"></td> <td style="width: 10%;"></td> <td style="width: 10%;"></td> <td style="width: 10%;"></td> <td style="width: 10%;"></td> <td style="width: 10%;"></td> </tr> <tr> <td></td> <td></td> <td colspan="8" style="text-align: center;"> <table border="1" style="width: 100%; border-collapse: collapse; text-align: center;"> <tr> <td style="width: 10%;"></td> <td style="width: 10%;"></td> <td style="width: 10%;"></td> <td style="width: 10%;"></td> <td style="width: 10%;"></td> <td style="width: 10%;"></td> <td style="width: 10%;"></td> <td style="width: 10%;"></td> <td style="width: 10%;"></td> <td style="width: 10%;"></td> </tr> <tr> <td></td> <td></td> <td colspan="8" style="text-align: center;"> <table border="1" style="width: 100%; border-collapse: collapse; text-align: center;"> <tr> <td style="width: 10%;"></td> <td style="width: 10%;"></td> <td style="width: 10%;"></td> <td style="width: 10%;"></td> <td style="width: 10%;"></td> <td style="width: 10%;"></td> <td style="width: 10%;"></td> <td style="width: 10%;"></td> <td style="width: 10%;"></td> <td style="width: 10%;"></td> </tr> <tr> <td></td> <td></td> <td colspan="8" style="text-align: center;"> <table border="1" style="width: 100%; border-collapse: collapse; text-align: center;"> <tr> <td style="width: 10%;"></td> <td style="width: 10%;"></td> <td style="width: 10%;"></td> <td style="width: 10%;"></td> <td style="width: 10%;"></td> <td style="width: 10%;"></td> <td style="width: 10%;"></td> <td style="width: 10%;"></td> <td style="width: 10%;"></td> <td style="width: 10%;"></td> </tr> <tr> <td></td> <td></td> <td colspan="8" style="text-align: center;"> <table border="1" style="width: 100%; border-collapse: collapse; text-align: center;"> <tr> <td style="width: 10%;"></td> <td style="width: 10%;"></td> <td style="width: 10%;"></td> <td style="width: 10%;"></td> <td style="width: 10%;"></td> <td style="width: 10%;"></td> <td style="width: 10%;"></td> <td style="width: 10%;"></td> <td style="width: 10%;"></td> <td style="width: 10%;"></td> </tr> <tr> <td></td> <td></td> <td colspan="8" style="text-align: center;"> <table border="1" style="width: 100%; border-collapse: collapse; text-align: center;"> <tr> <td style="width: 10%;"></td> <td style="width: 10%;"></td> <td style="width: 10%;"></td> <td style="width: 10%;"></td> <td style="width: 10%;"></td> <td style="width: 10%;"></td> <td style="width: 10%;"></td> <td style="width: 10%;"></td> <td style="width: 10%;"></td> <td style="width: 10%;"></td> </tr> <tr> <td></td> <td></td> <td colspan="8" style="text-align: center;"> <table border="1" style="width: 100%; border-collapse: collapse; text-align: center;"> <tr> <td style="width: 10%;"></td> <td style="width: 10%;"></td> <td style="width: 10%;"></td> <td style="width: 10%;"></td> <td style="width: 10%;"></td> <td style="width: 10%;"></td> <td style="width: 10%;"></td> <td style="width: 10%;"></td> <td style="width: 10%;"></td> <td style="width: 10%;"></td> </tr> <tr> <td></td> <td></td> <td colspan="8" style="text-align: center;"> <table border="1" style="width: 100%; border-collapse: collapse; text-align: center;"> <tr> <td style="width: 10%;"></td> <td style="width: 10%;"></td> <td style="width: 10%;"></td> <td style="width: 10%;"></td> <td style="width: 10%;"></td> <td style="width: 10%;"></td> <td style="width: 10%;"></td> <td style="width: 10%;"></td> <td style="width: 10%;"></td> <td style="width: 10%;"></td> </tr> <tr> <td></td> <td></td> <td colspan="8" style="text-align: center;"> <table border="1" style="width: 100%; border-collapse: collapse; text-align: center;"> <tr> <td style="width: 10%;"></td> <td style="width: 10%;"></td> <td style="width: 10%;"></td> <td style="width: 10%;"></td> <td style="width: 10%;"></td> <td style="width: 10%;"></td> <td style="width: 10%;"></td> <td style="width: 10%;"></td> <td style="width: 10%;"></td> <td style="width: 10%;"></td> </tr> <tr> <td></td> <td></td> <td colspan="8" style="text-align: center;"> <table border="1" style="width: 100%; border-collapse: collapse; text-align: center;"> <tr> <td style="width: 10%;"></td> <td style="width: 10%;"></td> <td style="width: 10%;"></td> <td style="width: 10%;"></td> <td style="width: 10%;"></td> <td style="width: 10%;"></td> <td style="width: 10%;"></td> <td style="width: 10%;"></td> <td style="width: 10%;"></td> <td style="width: 10%;"></td> </tr> <tr> <td></td> <td></td> <td colspan="8" style="text-align: center;"> <table border="1" style="width: 100%; border-collapse: collapse; text-align: center;"> <tr> <td style="width: 10%;"></td> <td style="width: 10%;"></td> <td style="width: 10%;"></td> <td style="width: 10%;"></td> <td style="width: 10%;"></td> <td style="width: 10%;"></td> <td style="width: 10%;"></td> <td style="width: 10%;"></td> <td style="width: 10%;"></td> <td style="width: 10%;"></td> </tr> <tr> <td></td> <td></td> <td colspan="8" style="text-align: center;"> <table border="1" style="width: 100%; border-collapse: collapse; text-align: center;"> <tr> <td style="width: 10%;"></td> <td style="width: 10%;"></td> <td style="width: 10%;"></td> <td style="width: 10%;"></td> <td style="width: 10%;"></td> <td style="width: 10%;"></td> <td style="width: 10%;"></td> <td style="width: 10%;"></td> <td style="width: 10%;"></td> <td style="width: 10%;"></td> </tr> <tr> <td></td> <td></td> <td colspan="8" style="text-align: center;"> <table border="1" style="width: 100%; border-collapse: collapse; text-align: center;"> <tr> <td style="width: 10%;"></td> <td style="width: 10%;"></td> <td style="width: 10%;"></td> <td style="width: 10%;"></td> <td style="width: 10%;"></td> <td style="width: 10%;"></td> <td style="width: 10%;"></td> <td style="width: 10%;"></td> <td style="width: 10%;"></td> <td style="width: 10%;"></td> </tr> <tr> <td></td> <td></td> <td colspan="8" style="text-align: center;"> <table border="1" style="width: 100%; border-collapse: collapse; text-align: center;"> <tr> <td style="width: 10%;"></td> <td style="width: 10%;"></td> <td style="width: 10%;"></td> <td style="width: 10%;"></td> <td style="width: 10%;"></td> <td style="width: 10%;"></td> <td style="width: 10%;"></td> <td style="width: 10%;"></td> <td style="width: 10%;"></td> <td style="width: 10%;"></td> </tr> <tr> <td></td> <td></td> <td colspan="8" style="text-align: center;"> <table border="1" style="width: 100%; border-collapse: collapse; text-align: center;"> <tr> <td style="width: 10%;"></td> <td style="width: 10%;"></td> <td style="width: 10%;"></td> <td style="width: 10%;"></td> <td style="width: 10%;"></td> <td style="width: 10%;"></td> <td style="width: 10%;"></td> <td style="width: 10%;"></td> <td style="width: 10%;"></td> <td style="width: 10%;"></td> </tr> <tr> <td></td> <td></td> <td colspan="8" style="text-align: center;"> <table border="1" style="width: 100%; border-collapse: collapse; text-align: center;"> <tr> <td style="width: 10%;"></td> <td style="width: 10%;"></td> <td style="width: 10%;"></td> <td style="width: 10%;"></td> <td style="width: 10%;"></td> <td style="width: 10%;"></td> <td style="width: 10%;"></td> <td style="width: 10%;"></td> <td style="width: 10%;"></td> <td style="width: 10%;"></td> </tr> <tr> <td></td> <td></td> <td colspan="8" style="text-align: center;"> <table border="1" style="width: 100%; border-collapse: collapse; text-align: center;"> <tr> <td style="width: 10%;"></td> <td style="width: 10%;"></td> <td style="width: 10%;"></td> <td style="width: 10%;"></td> <td style="width: 10%;"></td> <td style="width: 10%;"></td> <td style="width: 10%;"></td> <td style="width: 10%;"></td> <td style="width: 10%;"></td> <td style="width: 10%;"></td> </tr> <tr> <td></td> <td></td> <td colspan="8" style="text-align: center;"> <table border="1" style="width: 100%; border-collapse: collapse; text-align: center;"> <tr> <td style="width: 10%;"></td> <td style="width: 10%;"></td> <td style="width: 10%;"></td> <td style="width: 10%;"></td> <td style="width: 10%;"></td> <td style="width: 10%;"></td> <td style="width: 10%;"></td> <td style="width: 10%;"></td> <td style="width: 10%;"></td> <td style="width: 10%;"></td> </tr> <tr> <td></td> <td></td> <td colspan="8" style="text-align: center;"> <table border="1" style="width: 100%; border-collapse: collapse; text-align: center;"> <tr> <td style="width: 10%;"></td> <td style="width: 10%;"></td> <td style="width: 10%;"></td> <td style="width: 10%;"></td> <td style="width: 10%;"></td> <td style="width: 10%;"></td> <td style="width: 10%;"></td> <td style="width: 10%;"></td> <td style="width: 10%;"></td> <td style="width: 10%;"></td> </tr> <tr> <td></td> <td></td> <td colspan="8" style="text-align: center;"> <table border="1" style="width: 100%; border-collapse: collapse; text-align: center;"> <tr> <td style="width: 10%;"></td> <td style="width: 10%;"></td> <td style="width: 10%;"></td> <td style="width: 10%;"></td> <td style="width: 10%;"></td> <td style="width: 10%;"></td> <td style="width: 10%;"></td> <td style="width: 10%;"></td> <td style="width: 10%;"></td> <td style="width: 10%;"></td> </tr> <tr> <td></td> <td></td> <td colspan="8" style="text-align: center;"> <table border="1" style="width: 100%; border-collapse: collapse; text-align: center;"> <tr> <td style="width: 10%;"></td> <td style="width: 10%;"></td> <td style="width: 10%;"></td> <td style="width: 10%;"></td> <td style="width: 10%;"></td> <td style="width: 10%;"></td> <td style="width: 10%;"></td> <td style="width: 10%;"></td> <td style="width: 10%;"></td> <td style="width: 10%;"></td> </tr> <tr> <td></td>
<td></td> <td colspan="8" style="text-align: center;"> <table border="1" style="width: 100%; border-collapse: collapse; text-align: center;"> <tr> <td style="width: 10%;"></td> <td style="width: 10%;"></td> <td style="width: 10%;"></td> <td style="width: 10%;"></td> <td style="width: 10%;"></td> <td style="width: 10%;"></td> <td style="width: 10%;"></td> <td style="width: 10%;"></td> <td style="width: 10%;"></td> <td style="width: 10%;"></td> </tr> <tr> <td></td> <td></td> <td colspan="8" style="text-align: center;"> <table border="1" style="width: 100%; border-collapse: collapse; text-align: center;"> <tr> <td style="width: 10%;"></td> <td style="width: 10%;"></td> <td style="width: 10%;"></td> <td style="width: 10%;"></td> <td style="width: 10%;"></td> <td style="width: 10%;"></td> <td style="width: 10%;"></td> <td style="width: 10%;"></td> <td style="width: 10%;"></td> <td style="width: 10%;"></td> </tr> <tr> <td></td> <td></td> <td colspan="8" style="text-align: center;"> <table border="1" style="width: 100%; border-collapse: collapse; text-align: center;"> <tr> <td style="width: 10%;"></td> <td style="width: 10%;"></td> <td style="width: 10%;"></td> <td style="width: 10%;"></td> <td style="width: 10%;"></td> <td style="width: 10%;"></td> <td style="width: 10%;"></td> <td style="width: 10%;"></td> <td style="width: 10%;"></td> <td style="width: 10%;"></td> </tr> <tr> <td></td> <td></td> <td colspan="8" style="text-align: center;"> <table border="1" style="width: 100%; border-collapse: collapse; text-align: center;"> <tr> <td style="width: 10%;"></td> <td style="width: 10%;"></td> <td style="width: 10%;"></td> <td style="width: 10%;"></td> <td style="width: 10%;"></td> <td style="width: 10%;"></td> <td style="width: 10%;"></td> <td style="width: 10%;"></td> <td style="width: 10%;"></td> <td style="width: 10%;"></td> </tr> <tr> <td></td> <td></td> <td colspan="8" style="text-align: center;"> <table border="1" style="width: 100%; border-collapse: collapse; text-align: center;"> <tr> <td style="width: 10%;"></td> <td style="width: 10%;"></td> <td style="width: 10%;"></td> <td style="width: 10%;"></td> <td style="width: 10%;"></td> <td style="width: 10%;"></td> <td style="width: 10%;"></td> <td style="width: 10%;"></td> <td style="width: 10%;"></td> <td style="width: 10%;"></td> </tr> <tr> <td></td> <td></td> <td colspan="8" style="text-align: center;"> <table border="1" style="width: 100%; border-collapse: collapse; text-align: center;"> <tr> <td style="width: 10%;"></td> <td style="width: 10%;"></td> <td style="width: 10%;"></td> <td style="width: 10%;"></td> <td style="width: 10%;"></td> <td style="width: 10%;"></td> <td style="width: 10%;"></td> <td style="width: 10%;"></td> <td style="width: 10%;"></td> <td style="width: 10%;"></td> </tr> <tr> <td></td> <td></td> <td colspan="8" style="text-align: center;"> <table border="1" style="width: 100%; border-collapse: collapse; text-align: center;"> <tr> <td style="width: 10%;"></td> <td style="width: 10%;"></td> <td style="width: 10%;"></td> <td style="width: 10%;"></td> <td style="width: 10%;"></td> <td style="width: 10%;"></td> <td style="width: 10%;"></td> <td style="width: 10%;"></td> <td style="width: 10%;"></td> <td style="width: 10%;"></td> </tr> <tr> <td></td> <td></td> <td colspan="8" style="text-align: center;"> <table border="1" style="width: 100%; border-collapse: collapse; text-align: center;"> <tr> <td style="width: 10%;"></td> <td style="width: 10%;"></td> <td style="width: 10%;"></td> <td style="width: 10%;"></td> <td style="width: 10%;"></td> <td style="width: 10%;"></td> <td style="width: 10%;"></td> <td style="width: 10%;"></td> <td style="width: 10%;"></td> <td style="width: 10%;"></td> </tr> <tr> <td></td> <td></td> <td colspan="8" style="text-align: center;"> <table border="1" style="width: 100%; border-collapse: collapse; text-align: center;"> <tr> <td style="width: 10%;"></td> <td style="width: 10%;"></td> <td style="width: 10%;"></td> <td style="width: 10%;"></td> <td style="width: 10%;"></td> <td style="width: 10%;"></td> <td style="width: 10%;"></td> <td style="width: 10%;"></td> <td style="width: 10%;"></td> <td style="width: 10%;"></td> </tr> <tr> <td></td> <td></td> <td colspan="8" style="text-align: center;"> <table border="1" style="width: 100%; border-collapse: collapse; text-align: center;"> <tr> <td style="width: 10%;"></td> <td style="width: 10%;"></td> <td style="width: 10%;"></td> <td style="width: 10%;"></td> <td style="width: 10%;"></td> <td style="width: 10%;"></td> <td style="width: 10%;"></td> <td style="width: 10%;"></td> <td style="width: 10%;"></td> <td style="width: 10%;"></td> </tr> <tr> <td></td> <td></td> <td colspan="8" style="text-align: center;"> <table border="1" style="width: 100%; border-collapse: collapse; text-align: center;"> <tr> <td style="width: 10%;"></td> <td style="width: 10%;"></td> <td style="width: 10%;"></td> <td style="width: 10%;"></td> <td style="width: 10%;"></td> <td style="width: 10%;"></td> <td style="width: 10%;"></td> <td style="width: 10%;"></td> <td style="width: 10%;"></td> <td style="width: 10%;"></td> </tr> <tr> <td></td> <td></td> <td colspan="8" style="text-align: center;"> <table border="1" style="width: 100%; border-collapse: collapse; text-align: center;"> <tr> <td style="width: 10%;"></td> <td style="width: 10%;"></td> <td style="width: 10%;"></td> <td style="width: 10%;"></td> <td style="width: 10%;"></td> <td style="width: 10%;"></td> <td style="width: 10%;"></td> <td style="width: 10%;"></td> <td style="width: 10%;"></td> <td style="width: 10%;"></td> </tr> <tr> <td></td> <td></td> <td colspan="8" style="text-align: center;"> <table border="1" style="width: 100%; border-collapse: collapse; text-align: center;"> <tr> <td style="width: 10%;"></td> <td style="width: 10%;"></td> <td style="width: 10%;"></td> <td style="width: 10%;"></td> <td style="width: 10%;"></td> <td style="width: 10%;"></td> <td style="width: 10%;"></td> <td style="width: 10%;"></td> <td style="width: 10%;"></td> <td style="width: 10%;"></td> </tr> <tr> <td></td> <td></td> <td colspan="8" style="text-align: center;"> <table border="1" style="width: 100%; border-collapse: collapse; text-align: center;"> <tr> <td style="width: 10%;"></td> <td style="width: 10%;"></td> <td style="width: 10%;"></td> <td style="width: 10%;"></td> <td style="width: 10%;"></td> <td style="width: 10%;"></td> <td style="width: 10%;"></td> <td style="width: 10%;"></td> <td style="width: 10%;"></td> <td style="width: 10%;"></td> </tr> <tr> <td></td> <td></td> <td colspan="8" style="text-align: center;"> <table border="1" style="width: 100%; border-collapse: collapse; text-align: center;"> <tr> <td style="width: 10%;"></td> <td style="width: 10%;"></td> <td style="width: 10%;"></td> <td style="width: 10%;"></td> <td style="width: 10%;"></td> <td style="width: 10%;"></td> <td style="width: 10%;"></td> <td style="width: 10%;"></td> <td style="width: 10%;"></td> <td style="width: 10%;"></td> </tr> <tr> <td></td> <td></td> <td colspan="8" style="text-align: center;"> <table border="1" style="width: 100%; border-collapse: collapse; text-align: center;"> <tr> </tr></table></td></tr></table></td></tr></table></td></tr></table></td></tr></table></td></tr></table></td></tr></table></td></tr></table></td></tr></table></td></tr></table></td></tr></table></td></tr></table></td></tr></table></td></tr></table></td></tr></table></td></tr></table></td></tr></table></td></tr></table></td></tr></table></td></tr></table></td></tr></table></td></tr></table></td></tr></table></td></tr></table></td></tr></table></td></tr></table></td></tr></table></td></tr></table></td></tr></table></td></tr></table></td></tr></table></td></tr></table></td></tr></table></td></tr></table></td></tr></table></td></tr></table></td></tr></table></td></tr></table></td></tr></table></td></tr></table>
 | | | | | | | | | | | | | | | | | | | | <table border="1" style="width: 100%; border-collapse: collapse; text-align: center;"> <tr> <td style="width: 10%;"></td> <td style="width: 10%;"></td> <td style="width: 10%;"></td> <td style="width: 10%;"></td> <td style="width: 10%;"></td> <td style="width: 10%;"></td> <td style="width: 10%;"></td> <td style="width: 10%;"></td> <td style="width: 10%;"></td> <td style="width: 10%;"></td> </tr> <tr> <td></td> <td></td> <td colspan="8" style="text-align: center;"> <table border="1" style="width: 100%; border-collapse: collapse; text-align: center;"> <tr> <td style="width: 10%;"></td> <td style="width: 10%;"></td> <td style="width: 10%;"></td> <td style="width: 10%;"></td> <td style="width: 10%;"></td> <td style="width: 10%;"></td> <td style="width: 10%;"></td> <td style="width: 10%;"></td> <td style="width: 10%;"></td> <td style="width: 10%;"></td> </tr> <tr> <td></td> <td></td> <td colspan="8" style="text-align: center;"> <table border="1" style="width: 100%; border-collapse: collapse; text-align: center;"> <tr> <td style="width: 10%;"></td> <td style="width: 10%;"></td> <td style="width: 10%;"></td> <td style="width: 10%;"></td> <td style="width: 10%;"></td> <td style="width: 10%;"></td> <td style="width: 10%;"></td> <td style="width: 10%;"></td> <td style="width: 10%;"></td> <td style="width: 10%;"></td> </tr> <tr> <td></td> <td></td> <td colspan="8" style="text-align: center;"> <table border="1" style="width: 100%; border-collapse: collapse; text-align: center;"> <tr> <td style="width: 10%;"></td> <td style="width: 10%;"></td> <td style="width: 10%;"></td> <td style="width: 10%;"></td> <td style="width: 10%;"></td> <td style="width: 10%;"></td> <td style="width: 10%;"></td> <td style="width: 10%;"></td> <td style="width: 10%;"></td> <td style="width: 10%;"></td> </tr> <tr> <td></td> <td></td> <td colspan="8" style="text-align: center;"> <table border="1" style="width: 100%; border-collapse: collapse; text-align: center;"> <tr> <td style="width: 10%;"></td> <td style="width: 10%;"></td> <td style="width: 10%;"></td> <td style="width: 10%;"></td> <td style="width: 10%;"></td> <td style="width: 10%;"></td> <td style="width: 10%;"></td> <td style="width: 10%;"></td> <td style="width: 10%;"></td> <td style="width: 10%;"></td> </tr> <tr> <td></td> <td></td> <td colspan="8" style="text-align: center;"> <table border="1" style="width: 100%; border-collapse: collapse; text-align: center;"> <tr> <td style="width: 10%;"></td> <td style="width: 10%;"></td> <td style="width: 10%;"></td> <td style="width: 10%;"></td> <td style="width: 10%;"></td> <td style="width: 10%;"></td> <td style="width: 10%;"></td> <td style="width: 10%;"></td> <td style="width: 10%;"></td> <td style="width: 10%;"></td> </tr> <tr> <td></td> <td></td> <td colspan="8" style="text-align: center;"> <table border="1" style="width: 100%; border-collapse: collapse; text-align: center;"> <tr> <td style="width: 10%;"></td> <td style="width: 10%;"></td> <td style="width: 10%;"></td> <td style="width: 10%;"></td> <td style="width: 10%;"></td> <td style="width: 10%;"></td> <td style="width: 10%;"></td> <td style="width: 10%;"></td> <td style="width: 10%;"></td> <td style="width: 10%;"></td> </tr> <tr> <td></td> <td></td> <td colspan="8" style="text-align: center;"> <table border="1" style="width: 100%; border-collapse: collapse; text-align: center;"> <tr> <td style="width: 10%;"></td> <td style="width: 10%;"></td> <td style="width: 10%;"></td> <td style="width: 10%;"></td> <td style="width: 10%;"></td> <td style="width: 10%;"></td> <td style="width: 10%;"></td> <td style="width: 10%;"></td> <td style="width: 10%;"></td> <td style="width: 10%;"></td> </tr> <tr> <td></td> <td></td> <td colspan="8" style="text-align: center;"> <table border="1" style="width: 100%; border-collapse: collapse; text-align: center;"> <tr> <td style="width: 10%;"></td> <td style="width: 10%;"></td> <td style="width: 10%;"></td> <td style="width: 10%;"></td> <td style="width: 10%;"></td> <td style="width: 10%;"></td> <td style="width: 10%;"></td> <td style="width: 10%;"></td> <td style="width: 10%;"></td> <td style="width: 10%;"></td> </tr> <tr> <td></td> <td></td> <td colspan="8" style="text-align: center;"> <table border="1" style="width: 100%; border-collapse: collapse; text-align: center;"> <tr> <td style="width: 10%;"></td> <td style="width: 10%;"></td> <td style="width: 10%;"></td> <td style="width: 10%;"></td> <td style="width: 10%;"></td> <td style="width: 10%;"></td> <td style="width: 10%;"></td> <td style="width: 10%;"></td> <td style="width: 10%;"></td> <td style="width: 10%;"></td> </tr> <tr> <td></td> <td></td> <td colspan="8" style="text-align: center;"> <table border="1" style="width: 100%; border-collapse: collapse; text-align: center;"> <tr> <td style="width: 10%;"></td> <td style="width: 10%;"></td> <td style="width: 10%;"></td> <td style="width: 10%;"></td> <td style="width: 10%;"></td> <td style="width: 10%;"></td> <td style="width: 10%;"></td> <td style="width: 10%;"></td> <td style="width: 10%;"></td> <td style="width: 10%;"></td> </tr> <tr> <td></td> <td></td> <td colspan="8" style="text-align: center;"> <table border="1" style="width: 100%; border-collapse: collapse; text-align: center;"> <tr> <td style="width: 10%;"></td> <td style="width: 10%;"></td> <td style="width: 10%;"></td> <td style="width: 10%;"></td> <td style="width: 10%;"></td> <td style="width: 10%;"></td> <td style="width: 10%;"></td> <td style="width: 10%;"></td> <td style="width: 10%;"></td> <td style="width: 10%;"></td> </tr> <tr> <td></td> <td></td> <td colspan="8" style="text-align: center;"> <table border="1" style="width: 100%; border-collapse: collapse; text-align: center;"> <tr> <td style="width: 10%;"></td> <td style="width: 10%;"></td> <td style="width: 10%;"></td> <td style="width: 10%;"></td> <td style="width: 10%;"></td> <td style="width: 10%;"></td> <td style="width: 10%;"></td> <td style="width: 10%;"></td> <td style="width: 10%;"></td> <td style="width: 10%;"></td> </tr> <tr> <td></td> <td></td> <td colspan="8" style="text-align: center;"> <table border="1" style="width: 100%; border-collapse: collapse; text-align: center;"> <tr> <td style="width: 10%;"></td> <td style="width:
10%;"></td> <td style="width: 10%;"></td> <td style="width: 10%;"></td> <td style="width: 10%;"></td> <td style="width: 10%;"></td> <td style="width: 10%;"></td> <td style="width: 10%;"></td> <td style="width: 10%;"></td> <td style="width: 10%;"></td> </tr> <tr> <td></td> <td></td> <td colspan="8" style="text-align: center;"> <table border="1" style="width: 100%; border-collapse: collapse; text-align: center;"> <tr> <td style="width: 10%;"></td> <td style="width: 10%;"></td> <td style="width: 10%;"></td> <td style="width: 10%;"></td> <td style="width: 10%;"></td> <td style="width: 10%;"></td> <td style="width: 10%;"></td> <td style="width: 10%;"></td> <td style="width: 10%;"></td> <td style="width: 10%;"></td> </tr> <tr> <td></td> <td></td> <td colspan="8" style="text-align: center;"> <table border="1" style="width: 100%; border-collapse: collapse; text-align: center;"> <tr> <td style="width: 10%;"></td> <td style="width: 10%;"></td> <td style="width: 10%;"></td> <td style="width: 10%;"></td> <td style="width: 10%;"></td> <td style="width: 10%;"></td> <td style="width: 10%;"></td> <td style="width: 10%;"></td> <td style="width: 10%;"></td> <td style="width: 10%;"></td> </tr> <tr> <td></td> <td></td> <td colspan="8" style="text-align: center;"> <table border="1" style="width: 100%; border-collapse: collapse; text-align: center;"> <tr> <td style="width: 10%;"></td> <td style="width: 10%;"></td> <td style="width: 10%;"></td> <td style="width: 10%;"></td> <td style="width: 10%;"></td> <td style="width: 10%;"></td> <td style="width: 10%;"></td> <td style="width: 10%;"></td> <td style="width: 10%;"></td> <td style="width: 10%;"></td> </tr> <tr> <td></td> <td></td> <td colspan="8" style="text-align: center;"> <table border="1" style="width: 100%; border-collapse: collapse; text-align: center;"> <tr> <td style="width: 10%;"></td> <td style="width: 10%;"></td> <td style="width: 10%;"></td> <td style="width: 10%;"></td> <td style="width: 10%;"></td> <td style="width: 10%;"></td> <td style="width: 10%;"></td> <td style="width: 10%;"></td> <td style="width: 10%;"></td> <td style="width: 10%;"></td> </tr> <tr> <td></td> <td></td> <td colspan="8" style="text-align: center;"> <table border="1" style="width: 100%; border-collapse: collapse; text-align: center;"> <tr> <td style="width: 10%;"></td> <td style="width: 10%;"></td> <td style="width: 10%;"></td> <td style="width: 10%;"></td> <td style="width: 10%;"></td> <td style="width: 10%;"></td> <td style="width: 10%;"></td> <td style="width: 10%;"></td> <td style="width: 10%;"></td> <td style="width: 10%;"></td> </tr> <tr> <td></td> <td></td> <td colspan="8" style="text-align: center;"> <table border="1" style="width: 100%; border-collapse: collapse; text-align: center;"> <tr> <td style="width: 10%;"></td> <td style="width: 10%;"></td> <td style="width: 10%;"></td> <td style="width: 10%;"></td> <td style="width: 10%;"></td> <td style="width: 10%;"></td> <td style="width: 10%;"></td> <td style="width: 10%;"></td> <td style="width: 10%;"></td> <td style="width: 10%;"></td> </tr> <tr> <td></td> <td></td> <td colspan="8" style="text-align: center;"> <table border="1" style="width: 100%; border-collapse: collapse; text-align: center;"> <tr> <td style="width: 10%;"></td> <td style="width: 10%;"></td> <td style="width: 10%;"></td> <td style="width: 10%;"></td> <td style="width: 10%;"></td> <td style="width: 10%;"></td> <td style="width: 10%;"></td> <td style="width: 10%;"></td> <td style="width: 10%;"></td> <td style="width: 10%;"></td> </tr> <tr> <td></td> <td></td> <td colspan="8" style="text-align: center;"> <table border="1" style="width: 100%; border-collapse: collapse; text-align: center;"> <tr> <td style="width: 10%;"></td> <td style="width: 10%;"></td> <td style="width: 10%;"></td> <td style="width: 10%;"></td> <td style="width: 10%;"></td> <td style="width: 10%;"></td> <td style="width: 10%;"></td> <td style="width: 10%;"></td> <td style="width: 10%;"></td> <td style="width: 10%;"></td> </tr> <tr> <td></td> <td></td> <td colspan="8" style="text-align: center;"> <table border="1" style="width: 100%; border-collapse: collapse; text-align: center;"> <tr> <td style="width: 10%;"></td> <td style="width: 10%;"></td> <td style="width: 10%;"></td> <td style="width: 10%;"></td> <td style="width: 10%;"></td> <td style="width: 10%;"></td> <td style="width: 10%;"></td> <td style="width: 10%;"></td> <td style="width: 10%;"></td> <td style="width: 10%;"></td> </tr> <tr> <td></td> <td></td> <td colspan="8" style="text-align: center;"> <table border="1" style="width: 100%; border-collapse: collapse; text-align: center;"> <tr> <td style="width: 10%;"></td> <td style="width: 10%;"></td> <td style="width: 10%;"></td> <td style="width: 10%;"></td> <td style="width: 10%;"></td> <td style="width: 10%;"></td> <td style="width: 10%;"></td> <td style="width: 10%;"></td> <td style="width: 10%;"></td> <td style="width: 10%;"></td> </tr> <tr> <td></td> <td></td> <td colspan="8" style="text-align: center;"> <table border="1" style="width: 100%; border-collapse: collapse; text-align: center;"> <tr> <td style="width: 10%;"></td> <td style="width: 10%;"></td> <td style="width: 10%;"></td> <td style="width: 10%;"></td> <td style="width: 10%;"></td> <td style="width: 10%;"></td> <td style="width: 10%;"></td> <td style="width: 10%;"></td> <td style="width: 10%;"></td> <td style="width: 10%;"></td> </tr> <tr> <td></td> <td></td> <td colspan="8" style="text-align: center;"> <table border="1" style="width: 100%; border-collapse: collapse; text-align: center;"> <tr> <td style="width: 10%;"></td> <td style="width: 10%;"></td> <td style="width: 10%;"></td> <td style="width: 10%;"></td> <td style="width: 10%;"></td> <td style="width: 10%;"></td> <td style="width: 10%;"></td> <td style="width: 10%;"></td> <td style="width: 10%;"></td> <td style="width: 10%;"></td> </tr> <tr> <td></td> <td></td> <td colspan="8" style="text-align: center;"> <table border="1" style="width: 100%; border-collapse: collapse; text-align: center;"> <tr> <td style="width: 10%;"></td> <td style="width: 10%;"></td> <td style="width: 10%;"></td> <td style="width: 10%;"></td> <td style="width: 10%;"></td> <td style="width: 10%;"></td> <td style="width: 10%;"></td> <td style="width: 10%;"></td> <td style="width: 10%;"></td> <td style="width: 10%;"></td> </tr> <tr> <td></td> <td></td> <td colspan="8" style="text-align: center;"> <table border="1" style="width: 100%; border-collapse: collapse; text-align: center;"> <tr> <td style="width: 10%;"></td> <td style="width: 10%;"></td> <td style="width: 10%;"></td> <td style="width: 10%;"></td> <td style="width: 10%;"></td> <td style="width: 10%;"></td> <td style="width: 10%;"></td> <td style="width: 10%;"></td> <td style="width: 10%;"></td> <td style="width: 10%;"></td> </tr> <tr> <td></td> <td></td> <td colspan="8" style="text-align: center;"> <table border="1" style="width: 100%; border-collapse: collapse; text-align: center;"> <tr> <td style="width: 10%;"></td> <td style="width: 10%;"></td> <td style="width: 10%;"></td> <td style="width: 10%;"></td> <td style="width: 10%;"></td> <td style="width: 10%;"></td> <td style="width: 10%;"></td> <td style="width: 10%;"></td> <td style="width: 10%;"></td> <td style="width: 10%;"></td> </tr> <tr> <td></td> <td></td> <td colspan="8" style="text-align: center;"> <table border="1" style="width: 100%; border-collapse: collapse; text-align: center;"> <tr> <td style="width: 10%;"></td> <td style="width: 10%;"></td> <td style="width: 10%;"></td> <td style="width: 10%;"></td> <td style="width: 10%;"></td> <td style="width: 10%;"></td> <td style="width: 10%;"></td> <td style="width: 10%;"></td> <td style="width: 10%;"></td> <td style="width: 10%;"></td> </tr> <tr> <td></td> <td></td> <td colspan="8" style="text-align: center;"> <table border="1" style="width: 100%; border-collapse: collapse; text-align: center;"> <tr> <td style="width: 10%;"></td> <td style="width: 10%;"></td> <td style="width: 10%;"></td> <td style="width: 10%;"></td> <td style="width: 10%;"></td> <td style="width: 10%;"></td> <td style="width: 10%;"></td> <td style="width: 10%;"></td> <td style="width: 10%;"></td> <td style="width: 10%;"></td> </tr> <tr> <td></td> <td></td> <td colspan="8" style="text-align: center;"> <table border="1" style="width: 100%; border-collapse: collapse; text-align: center;"> <tr> <td style="width: 10%;"></td> <td style="width: 10%;"></td> <td style="width: 10%;"></td> <td style="width: 10%;"></td> <td style="width: 10%;"></td> <td style="width: 10%;"></td> <td style="width: 10%;"></td> <td style="width: 10%;"></td> <td style="width: 10%;"></td> <td style="width: 10%;"></td> </tr> <tr> <td></td> <td></td> <td colspan="8" style="text-align: center;"> <table border="1" style="width: 100%; border-collapse: collapse; text-align: center;"> <tr> <td style="width: 10%;"></td> <td style="width: 10%;"></td> <td style="width: 10%;"></td> <td style="width: 10%;"></td> <td style="width: 10%;"></td> <td style="width: 10%;"></td> <td style="width: 10%;"></td> <td style="width: 10%;"></td> <td style="width: 10%;"></td> <td style="width: 10%;"></td> </tr> <tr> <td></td> <td></td> <td colspan="8" style="text-align: center;"> <table border="1" style="width: 100%; border-collapse: collapse; text-align: center;"> <tr> <td style="width: 10%;"></td> <td style="width: 10%;"></td> <td style="width: 10%;"></td> <td style="width: 10%;"></td> <td style="width: 10%;"></td> <td style="width: 10%;"></td> <td style="width: 10%;"></td> <td style="width: 10%;"></td> <td style="width: 10%;"></td> <td style="width: 10%;"></td> </tr> <tr> <td></td> <td></td> <td colspan="8" style="text-align: center;"> <table border="1" style="width: 100%; border-collapse: collapse; text-align: center;"> <tr> <td style="width: 10%;"></td> <td style="width: 10%;"></td> <td style="width: 10%;"></td> <td style="width: 10%;"></td> <td style="width: 10%;"></td> <td style="width: 10%;"></td> <td style="width: 10%;"></td> <td
style="width: 10%;"></td> <td style="width: 10%;"></td> <td style="width: 10%;"></td> </tr> <tr> <td></td> <td></td> <td colspan="8" style="text-align: center;"> <table border="1" style="width: 100%; border-collapse: collapse; text-align: center;"> <tr> <td style="width: 10%;"></td> <td style="width: 10%;"></td> <td style="width: 10%;"></td> <td style="width: 10%;"></td> <td style="width: 10%;"></td> <td style="width: 10%;"></td> <td style="width: 10%;"></td> <td style="width: 10%;"></td> <td style="width: 10%;"></td> <td style="width: 10%;"></td> </tr> <tr> <td></td> <td></td> <td colspan="8" style="text-align: center;"> <table border="1" style="width: 100%; border-collapse: collapse; text-align: center;"> <tr> <td style="width: 10%;"></td> <td style="width: 10%;"></td> <td style="width: 10%;"></td> <td style="width: 10%;"></td> <td style="width: 10%;"></td> <td style="width: 10%;"></td> <td style="width: 10%;"></td> <td style="width: 10%;"></td> <td style="width: 10%;"></td> <td style="width: 10%;"></td> </tr> <tr> <td></td> <td></td> <td colspan="8" style="text-align: center;"> <table border="1" style="width: 100%; border-collapse: collapse; text-align: center;"> <tr> <td style="width: 10%;"></td> <td style="width: 10%;"></td> <td style="width: 10%;"></td> <td style="width: 10%;"></td> <td style="width: 10%;"></td> <td style="width: 10%;"></td> <td style="width: 10%;"></td> <td style="width: 10%;"></td> <td style="width: 10%;"></td> <td style="width: 10%;"></td> </tr> <tr> <td></td> <td></td> <td colspan="8" style="text-align: center;"> <table border="1" style="width: 100%; border-collapse: collapse; text-align: center;"> <tr> </tr></table></td></tr></table></td></tr></table></td></tr></table></td></tr></table></td></tr></table></td></tr></table></td></tr></table></td></tr></table></td></tr></table></td></tr></table></td></tr></table></td></tr></table></td></tr></table></td></tr></table></td></tr></table></td></tr></table></td></tr></table></td></tr></table></td></tr></table></td></tr></table></td></tr></table></td></tr></table></td></tr></table></td></tr></table></td></tr></table></td></tr></table></td></tr></table></td></tr></table></td></tr></table></td></tr></table></td></tr></table></td></tr></table></td></tr></table></td></tr></table></td></tr></table></td></tr></table></td></tr></table></td></tr></table> | | | | | | | | | | | | | | | | | | | | <table border="1" style="width: 100%; border-collapse: collapse; text-align: center;"> <tr> <td style="width: 10%;"></td> <td style="width: 10%;"></td> <td style="width: 10%;"></td> <td style="width: 10%;"></td> <td style="width: 10%;"></td> <td style="width: 10%;"></td> <td style="width: 10%;"></td> <td style="width: 10%;"></td> <td style="width: 10%;"></td> <td style="width: 10%;"></td> </tr> <tr> <td></td> <td></td> <td colspan="8" style="text-align: center;"> <table border="1" style="width: 100%; border-collapse: collapse; text-align: center;"> <tr> <td style="width: 10%;"></td> <td style="width: 10%;"></td> <td style="width: 10%;"></td> <td style="width: 10%;"></td> <td style="width: 10%;"></td> <td style="width: 10%;"></td> <td style="width: 10%;"></td> <td style="width: 10%;"></td> <td style="width: 10%;"></td> <td style="width: 10%;"></td> </tr> <tr> <td></td> <td></td> <td colspan="8" style="text-align: center;"> <table border="1" style="width: 100%; border-collapse: collapse; text-align: center;"> <tr> <td style="width: 10%;"></td> <td style="width: 10%;"></td> <td style="width: 10%;"></td> <td style="width: 10%;"></td> <td style="width: 10%;"></td> <td style="width: 10%;"></td> <td style="width: 10%;"></td> <td style="width: 10%;"></td> <td style="width: 10%;"></td> <td style="width: 10%;"></td> </tr> <tr> <td></td> <td></td> <td colspan="8" style="text-align: center;"> <table border="1" style="width: 100%; border-collapse: collapse; text-align: center;"> <tr> <td style="width: 10%;"></td> <td style="width: 10%;"></td> <td style="width: 10%;"></td> <td style="width: 10%;"></td> <td style="width: 10%;"></td> <td style="width: 10%;"></td> <td style="width: 10%;"></td> <td style="width: 10%;"></td> <td
style="width: 10%;"></td> <td style="width: 10%;"></td> </tr> <tr> <td></td> <td></td> <td colspan="8" style="text-align: center;"> <table border="1" style="width: 100%; border-collapse: collapse; text-align: center;"> <tr> <td style="width: 10%;"></td> <td style="width: 10%;"></td> <td style="width: 10%;"></td> <td style="width: 10%;"></td> <td style="width: 10%;"></td> <td style="width: 10%;"></td> <td style="width: 10%;"></td> <td style="width: 10%;"></td> <td style="width: 10%;"></td> <td style="width: 10%;"></td> </tr> <tr> <td></td> <td></td> <td colspan="8" style="text-align: center;"> <table border="1" style="width: 100%; border-collapse: collapse; text-align: center;"> <tr> <td style="width: 10%;"></td> <td style="width: 10%;"></td> <td style="width: 10%;"></td> <td style="width: 10%;"></td> <td style="width: 10%;"></td> <td style="width: 10%;"></td> <td style="width: 10%;"></td> <td style="width: 10%;"></td> <td style="width: 10%;"></td> <td style="width: 10%;"></td> </tr> <tr> <td></td> <td></td> <td colspan="8" style="text-align: center;"> <table border="1" style="width: 100%; border-collapse: collapse; text-align: center;"> <tr> <td style="width: 10%;"></td> <td style="width: 10%;"></td> <td style="width: 10%;"></td> <td style="width: 10%;"></td> <td style="width: 10%;"></td> <td style="width: 10%;"></td> <td style="width: 10%;"></td> <td style="width: 10%;"></td> <td style="width: 10%;"></td> <td style="width: 10%;"></td> </tr> <tr> <td></td> <td></td> <td colspan="8" style="text-align: center;"> <table border="1" style="width: 100%; border-collapse: collapse; text-align: center;"> <tr> <td style="width: 10%;"></td> <td style="width: 10%;"></td> <td style="width: 10%;"></td> <td style="width: 10%;"></td> <td style="width: 10%;"></td> <td style="width: 10%;"></td> <td style="width: 10%;"></td> <td style="width: 10%;"></td> <td style="width: 10%;"></td> <td style="width: 10%;"></td> </tr> <tr> <td></td> <td></td> <td colspan="8" style="text-align: center;"> <table border="1" style="width: 100%; border-collapse: collapse; text-align: center;"> <tr> <td style="width: 10%;"></td> <td style="width: 10%;"></td> <td style="width: 10%;"></td> <td style="width: 10%;"></td> <td style="width: 10%;"></td> <td style="width: 10%;"></td> <td style="width: 10%;"></td> <td style="width: 10%;"></td> <td style="width: 10%;"></td> <td style="width: 10%;"></td> </tr> <tr> <td></td> <td></td> <td colspan="8" style="text-align: center;"> <table border="1" style="width: 100%; border-collapse: collapse; text-align: center;"> <tr> <td style="width: 10%;"></td> <td style="width: 10%;"></td> <td style="width: 10%;"></td> <td style="width: 10%;"></td> <td style="width: 10%;"></td> <td style="width: 10%;"></td> <td style="width: 10%;"></td> <td style="width: 10%;"></td> <td style="width: 10%;"></td> <td style="width: 10%;"></td> </tr> <tr> <td></td> <td></td> <td colspan="8" style="text-align: center;"> <table border="1" style="width: 100%; border-collapse: collapse; text-align: center;"> <tr> <td style="width: 10%;"></td> <td style="width: 10%;"></td> <td style="width: 10%;"></td> <td style="width: 10%;"></td> <td style="width: 10%;"></td> <td style="width: 10%;"></td> <td style="width: 10%;"></td> <td style="width: 10%;"></td> <td style="width: 10%;"></td> <td style="width: 10%;"></td> </tr> <tr> <td></td> <td></td> <td colspan="8" style="text-align: center;"> <table border="1" style="width: 100%; border-collapse: collapse; text-align: center;"> <tr> <td style="width: 10%;"></td> <td style="width: 10%;"></td> <td style="width: 10%;"></td> <td style="width: 10%;"></td> <td style="width: 10%;"></td> <td style="width: 10%;"></td> <td style="width: 10%;"></td> <td style="width: 10%;"></td> <td style="width: 10%;"></td> <td style="width: 10%;"></td> </tr> <tr> <td></td> <td></td> <td colspan="8" style="text-align: center;"> <table border="1" style="width: 100%; border-collapse: collapse; text-align: center;"> <tr> <td style="width: 10%;"></td> <td style="width: 10%;"></td> <td style="width: 10%;"></td> <td style="width: 10%;"></td> <td style="width: 10%;"></td> <td style="width: 10%;"></td> <td style="width: 10%;"></td> <td style="width: 10%;"></td> <td style="width: 10%;"></td> <td style="width: 10%;"></td> </tr> <tr> <td></td> <td></td> <td colspan="8" style="text-align: center;"> <table border="1" style="width: 100%; border-collapse: collapse; text-align: center;"> <tr> <td style="width: 10%;"></td> <td style="width: 10%;"></td> <td style="width: 10%;"></td> <td style="width: 10%;"></td> <td style="width: 10%;"></td> <td style="width: 10%;"></td> <td style="width: 10%;"></td> <td style="width: 10%;"></td> <td style="width: 10%;"></td> <td style="width: 10%;"></td> </tr> <tr> <td></td> <td></td> <td colspan="8" style="text-align: center;"> <table border="1" style="width: 100%; border-collapse: collapse; text-align: center;"> <tr> <td style="width: 10%;"></td> <td style="width: 10%;"></td> <td style="width: 10%;"></td> <td style="width: 10%;"></td> <td style="width: 10%;"></td> <td style="width: 10%;"></td> <td style="width: 10%;"></td> <td style="width: 10%;"></td> <td style="width: 10%;"></td> <td style="width: 10%;"></td> </tr> <tr> <td></td> <td></td> <td colspan="8" style="text-align: center;"> <table border="1" style="width: 100%; border-collapse: collapse; text-align: center;"> <tr> <td style="width: 10%;"></td> <td style="width: 10%;"></td> <td style="width: 10%;"></td> <td style="width: 10%;"></td> <td style="width: 10%;"></td> <td style="width: 10%;"></td> <td style="width: 10%;"></td> <td style="width: 10%;"></td> <td style="width: 10%;"></td> <td style="width: 10%;"></td> </tr> <tr> <td></td> <td></td> <td colspan="8" style="text-align: center;"> <table border="1" style="width: 100%; border-collapse: collapse; text-align: center;"> <tr> <td style="width: 10%;"></td> <td style="width: 10%;"></td> <td style="width: 10%;"></td> <td style="width: 10%;"></td> <td style="width: 10%;"></td> <td style="width: 10%;"></td> <td style="width: 10%;"></td> <td style="width: 10%;"></td> <td style="width: 10%;"></td> <td style="width: 10%;"></td> </tr> <tr> <td></td> <td></td> <td colspan="8" style="text-align: center;"> <table border="1" style="width: 100%; border-collapse: collapse; text-align: center;"> <tr> <td style="width: 10%;"></td> <td style="width: 10%;"></td> <td style="width: 10%;"></td> <td style="width: 10%;"></td> <td style="width: 10%;"></td> <td style="width: 10%;"></td> <td style="width: 10%;"></td> <td style="width: 10%;"></td> <td style="width: 10%;"></td> <td style="width: 10%;"></td> </tr> <tr> <td></td> <td></td> <td colspan="8" style="text-align: center;"> <table border="1" style="width: 100%; border-collapse: collapse; text-align: center;"> <tr> <td style="width: 10%;"></td> <td style="width: 10%;"></td> <td style="width: 10%;"></td> <td style="width: 10%;"></td> <td style="width: 10%;"></td> <td style="width: 10%;"></td> <td style="width: 10%;"></td> <td style="width: 10%;"></td> <td style="width: 10%;"></td> <td style="width: 10%;"></td> </tr> <tr> <td></td> <td></td> <td colspan="8" style="text-align: center;"> <table border="1" style="width: 100%; border-collapse: collapse; text-align: center;"> <tr> <td style="width: 10%;"></td> <td style="width: 10%;"></td> <td style="width: 10%;"></td> <td style="width: 10%;"></td> <td style="width: 10%;"></td> <td style="width: 10%;"></td> <td style="width: 10%;"></td> <td style="width: 10%;"></td> <td style="width: 10%;"></td> <td style="width: 10%;"></td> </tr> <tr> <td></td> <td></td> <td colspan="8" style="text-align: center;"> <table border="1" style="width: 100%; border-collapse: collapse; text-align: center;"> <tr> <td style="width: 10%;"></td> <td style="width: 10%;"></td> <td style="width: 10%;"></td> <td style="width: 10%;"></td> <td style="width: 10%;"></td> <td style="width: 10%;"></td> <td style="width: 10%;"></td> <td style="width: 10%;"></td> <td style="width: 10%;"></td> <td style="width: 10%;"></td> </tr> <tr> <td></td> <td></td> <td colspan="8" style="text-align: center;"> <table border="1" style="width: 100%; border-collapse: collapse; text-align: center;"> <tr> <td style="width: 10%;"></td> <td style="width: 10%;"></td> <td style="width: 10%;"></td> <td style="width: 10%;"></td> <td style="width: 10%;"></td> <td style="width: 10%;"></td> <td style="width: 10%;"></td> <td style="width: 10%;"></td> <td style="width: 10%;"></td> <td style="width: 10%;"></td> </tr> <tr> <td></td> <td></td> <td colspan="8" style="text-align: center;"> <table border="1" style="width: 100%; border-collapse: collapse; text-align: center;"> <tr> <td style="width: 10%;"></td> <td style="width: 10%;"></td> <td style="width: 10%;"></td> <td style="width: 10%;"></td> <td style="width: 10%;"></td> <td style="width: 10%;"></td> <td style="width: 10%;"></td> <td style="width: 10%;"></td> <td style="width: 10%;"></td> <td style="width: 10%;"></td> </tr> <tr> <td></td> <td></td> <td colspan="8" style="text-align: center;"> <table border="1" style="width: 100%; border-collapse: collapse; text-align: center;"> <tr> <td style="width: 10%;"></td> <td style="width: 10%;"></td> <td style="width: 10%;"></td> <td style="width: 10%;"></td> <td style="width: 10%;"></td> <td style="width: 10%;"></td> <td style="width: 10%;"></td> <td style="width: 10%;"></td> <td style="width: 10%;"></td> <td style="width: 10%;"></td> </tr> <tr> <td></td> <td></td> <td colspan="8" style="text-align: center;"> <table border="1" style="width: 100%; border-collapse: collapse; text-align: center;"> <tr> <td style="width: 10%;"></td> <td style="width: 10%;"></td> <td style="width: 10%;"></td> <td style="width: 10%;"></td> <td style="width: 10%;"></td> <td style="width: 10%;"></td> <td style="width: 10%;"></td> <td style="width: 10%;"></td> <td style="width: 10%;"></td> <td style="width: 10%;"></td> </tr> <tr> <td></td> <td></td> <td colspan="8" style="text-align: center;"> <table border="1" style="width: 100%;
border-collapse: collapse; text-align: center;"> <tr> <td style="width: 10%;"></td> <td style="width: 10%;"></td> <td style="width: 10%;"></td> <td style="width: 10%;"></td> <td style="width: 10%;"></td> <td style="width: 10%;"></td> <td style="width: 10%;"></td> <td style="width: 10%;"></td> <td style="width: 10%;"></td> <td style="width: 10%;"></td> </tr> <tr> <td></td> <td></td> <td colspan="8" style="text-align: center;"> <table border="1" style="width: 100%; border-collapse: collapse; text-align: center;"> <tr> <td style="width: 10%;"></td> <td style="width: 10%;"></td> <td style="width: 10%;"></td> <td style="width: 10%;"></td> <td style="width: 10%;"></td> <td style="width: 10%;"></td> <td style="width: 10%;"></td> <td style="width: 10%;"></td> <td style="width: 10%;"></td> <td style="width: 10%;"></td> </tr> <tr> <td></td> <td></td> <td colspan="8" style="text-align: center;"> <table border="1" style="width: 100%; border-collapse: collapse; text-align: center;"> <tr> <td style="width: 10%;"></td> <td style="width: 10%;"></td> <td style="width: 10%;"></td> <td style="width: 10%;"></td> <td style="width: 10%;"></td> <td style="width: 10%;"></td> <td style="width: 10%;"></td> <td style="width: 10%;"></td> <td style="width: 10%;"></td> <td style="width: 10%;"></td> </tr> <tr> <td></td> <td></td> <td colspan="8" style="text-align: center;"> <table border="1" style="width: 100%; border-collapse: collapse; text-align: center;"> <tr> <td style="width: 10%;"></td> <td style="width: 10%;"></td> <td style="width: 10%;"></td> <td style="width: 10%;"></td> <td style="width: 10%;"></td> <td style="width: 10%;"></td> <td style="width: 10%;"></td> <td style="width: 10%;"></td> <td style="width: 10%;"></td> <td style="width: 10%;"></td> </tr> <tr> <td></td> <td></td> <td colspan="8" style="text-align: center;"> <table border="1" style="width: 100%; border-collapse: collapse; text-align: center;"> <tr> <td style="width: 10%;"></td> <td style="width: 10%;"></td> <td style="width: 10%;"></td> <td style="width: 10%;"></td> <td style="width: 10%;"></td> <td style="width: 10%;"></td> <td style="width: 10%;"></td> <td style="width: 10%;"></td> <td style="width: 10%;"></td> <td style="width: 10%;"></td> </tr> <tr> <td></td> <td></td> <td colspan="8" style="text-align: center;"> <table border="1" style="width: 100%; border-collapse: collapse; text-align: center;"> <tr> <td style="width: 10%;"></td> <td style="width: 10%;"></td> <td style="width: 10%;"></td> <td style="width: 10%;"></td> <td style="width: 10%;"></td> <td style="width: 10%;"></td> <td style="width: 10%;"></td> <td style="width: 10%;"></td> <td style="width: 10%;"></td> <td style="width: 10%;"></td> </tr> <tr> <td></td> <td></td> <td colspan="8" style="text-align: center;"> <table border="1" style="width: 100%; border-collapse: collapse; text-align: center;"> <tr> <td style="width: 10%;"></td> <td style="width: 10%;"></td> <td style="width: 10%;"></td> <td style="width: 10%;"></td> <td style="width: 10%;"></td> <td style="width: 10%;"></td> <td style="width: 10%;"></td> <td style="width: 10%;"></td> <td style="width: 10%;"></td> <td style="width: 10%;"></td> </tr> <tr> <td></td> <td></td> <td colspan="8" style="text-align: center;"> <table border="1" style="width: 100%; border-collapse: collapse; text-align: center;"> <tr> <td style="width: 10%;"></td> <td style="width: 10%;"></td> <td style="width: 10%;"></td> <td style="width: 10%;"></td> <td style="width: 10%;"></td> <td style="width: 10%;"></td> <td style="width: 10%;"></td> <td style="width: 10%;"></td> <td style="width: 10%;"></td> <td style="width: 10%;"></td> </tr> <tr> <td></td> <td></td> <td colspan="8" style="text-align: center;"> <table border="1" style="width: 100%; border-collapse: collapse; text-align: center;"> <tr> <td style="width: 10%;"></td> <td style="width: 10%;"></td> <td style="width: 10%;"></td> <td style="width: 10%;"></td> <td style="width: 10%;"></td> <td style="width: 10%;"></td> <td style="width: 10%;"></td> <td style="width: 10%;"></td> <td style="width: 10%;"></td> <td style="width: 10%;"></td> </tr> <tr> <td></td> <td></td> <td colspan="8" style="text-align: center;"> <table border="1" style="width: 100%; border-collapse: collapse; text-align: center;"> <tr> <td style="width: 10%;"></td> <td style="width: 10%;"></td> <td style="width: 10%;"></td> <td style="width: 10%;"></td> <td style="width: 10%;"></td> <td style="width: 10%;"></td> <td style="width: 10%;"></td> <td style="width: 10%;"></td> <td style="width: 10%;"></td> <td style="width: 10%;"></td> </tr> <tr> <td></td> <td></td> <td colspan="8" style="text-align: center;"> <table border="1" style="width: 100%; border-collapse: collapse; text-align: center;"> <tr> <td style="width: 10%;"></td> <td style="width: 10%;"></td> <td style="width: 10%;"></td> <td style="width: 10%;"></td> <td style="width: 10%;"></td> <td style="width: 10%;"></td> <td style="width: 10%;"></td> <td style="width: 10%;"></td> <td style="width: 10%;"></td> <td style="width: 10%;"></td> </tr> <tr> <td></td> <td></td> <td colspan="8" style="text-align: center;"> <table border="1" style="width: 100%; border-collapse: collapse; text-align: center;"> <tr> <td style="width: 10%;"></td> <td style="width: 10%;"></td> <td style="width: 10%;"></td> <td style="width: 10%;"></td> <td style="width: 10%;"></td> <td style="width: 10%;"></td> <td style="width: 10%;"></td> <td style="width: 10%;"></td> <td style="width: 10%;"></td> <td style="width: 10%;"></td> </tr> <tr> <td></td> <td></td> <td colspan="8" style="text-align: center;"> <table border="1" style="width: 100%; border-collapse: collapse; text-align: center;"> <tr> </tr></table></td></tr></table></td></tr></table></td></tr></table></td></tr></table></td></tr></table></td></tr></table></td></tr></table></td></tr></table></td></tr></table></td></tr></table></td></tr></table></td></tr></table></td></tr></table></td></tr></table></td></tr></table></td></tr></table></td></tr></table></td></tr></table></td></tr></table></td></tr></table></td></tr></table></td></tr></table></td></tr></table></td></tr></table></td></tr></table></td></tr></table></td></tr></table></td></tr></table></td></tr></table></td></tr></table></td></tr></table></td></tr></table></td></tr></table></td></tr></table></td></tr></table></td></tr></table></td></tr></table>
 | | | | | | | | | | | | | | | | | | | | <table border="1" style="width: 100%; border-collapse: collapse; text-align: center;"> <tr> <td style="width: 10%;"></td> <td style="width: 10%;"></td> <td style="width: 10%;"></td> <td style="width: 10%;"></td> <td style="width: 10%;"></td> <td style="width: 10%;"></td> <td style="width: 10%;"></td> <td style="width: 10%;"></td> <td style="width: 10%;"></td> <td style="width: 10%;"></td> </tr> <tr> <td></td> <td></td> <td colspan="8" style="text-align: center;"> <table border="1" style="width: 100%; border-collapse: collapse; text-align: center;"> <tr> <td style="width: 10%;"></td> <td style="width: 10%;"></td> <td style="width: 10%;"></td> <td style="width: 10%;"></td> <td style="width: 10%;"></td> <td style="width: 10%;"></td> <td style="width: 10%;"></td> <td style="width: 10%;"></td> <td style="width: 10%;"></td> <td style="width: 10%;"></td> </tr> <tr> <td></td> <td></td> <td colspan="8" style="text-align: center;"> <table border="1" style="width: 100%; border-collapse: collapse; text-align: center;"> <tr> <td style="width: 10%;"></td> <td style="width: 10%;"></td> <td style="width: 10%;"></td> <td style="width: 10%;"></td> <td style="width: 10%;"></td> <td style="width: 10%;"></td> <td style="width: 10%;"></td> <td style="width: 10%;"></td> <td style="width: 10%;"></td> <td style="width: 10%;"></td> </tr> <tr> <td></td> <td></td> <td colspan="8" style="text-align: center;"> <table border="1" style="width: 100%; border-collapse: collapse; text-align: center;"> <tr> <td style="width: 10%;"></td> <td style="width: 10%;"></td> <td style="width: 10%;"></td> <td style="width: 10%;"></td> <td style="width: 10%;"></td> <td style="width: 10%;"></td> <td style="width: 10%;"></td> <td style="width: 10%;"></td> <td style="width: 10%;"></td> <td style="width: 10%;"></td> </tr> <tr> <td></td> <td></td> <td colspan="8" style="text-align: center;"> <table border="1" style="width: 100%; border-collapse: collapse; text-align: center;"> <tr> <td style="width: 10%;"></td> <td style="width: 10%;"></td> <td style="width: 10%;"></td> <td style="width: 10%;"></td> <td style="width: 10%;"></td> <td style="width: 10%;"></td> <td style="width: 10%;"></td> <td style="width: 10%;"></td> <td style="width: 10%;"></td> <td style="width: 10%;"></td> </tr> <tr> <td></td> <td></td> <td colspan="8" style="text-align: center;"> <table border="1" style="width: 100%; border-collapse: collapse; text-align: center;"> <tr> <td style="width: 10%;"></td> <td style="width: 10%;"></td> <td style="width: 10%;"></td> <td style="width: 10%;"></td> <td style="width: 10%;"></td> <td style="width: 10%;"></td> <td style="width: 10%;"></td> <td style="width: 10%;"></td> <td style="width: 10%;"></td> <td style="width: 10%;"></td> </tr> <tr> <td></td> <td></td> <td colspan="8" style="text-align: center;"> <table border="1" style="width: 100%; border-collapse: collapse; text-align: center;"> <tr> <td style="width: 10%;"></td> <td style="width: 10%;"></td> <td style="width: 10%;"></td> <td style="width: 10%;"></td> <td style="width: 10%;"></td> <td style="width: 10%;"></td> <td style="width: 10%;"></td> <td style="width: 10%;"></td> <td style="width: 10%;"></td> <td style="width: 10%;"></td> </tr> <tr> <td></td> <td></td> <td colspan="8" style="text-align: center;"> <table border="1" style="width: 100%; border-collapse: collapse; text-align: center;"> <tr> <td style="width: 10%;"></td> <td style="width: 10%;"></td> <td style="width: 10%;"></td> <td style="width: 10%;"></td> <td style="width: 10%;"></td> <td style="width: 10%;"></td> <td style="width: 10%;"></td> <td style="width: 10%;"></td> <td style="width: 10%;"></td> <td style="width: 10%;"></td> </tr> <tr> <td></td> <td></td> <td colspan="8" style="text-align: center;"> <table border="1" style="width: 100%; border-collapse: collapse; text-align: center;"> <tr> <td style="width: 10%;"></td> <td style="width: 10%;"></td> <td style="width: 10%;"></td> <td style="width: 10%;"></td> <td style="width: 10%;"></td> <td style="width: 10%;"></td> <td style="width: 10%;"></td> <td style="width: 10%;"></td> <td style="width: 10%;"></td> <td style="width: 10%;"></td> </tr> <tr> <td></td> <td></td> <td colspan="8" style="text-align: center;"> <table border="1" style="width: 100%; border-collapse: collapse; text-align: center;"> <tr> <td style="width: 10%;"></td> <td style="width: 10%;"></td> <td style="width: 10%;"></td> <td style="width: 10%;"></td> <td style="width: 10%;"></td> <td style="width: 10%;"></td> <td style="width: 10%;"></td> <td style="width: 10%;"></td> <td style="width: 10%;"></td> <td style="width: 10%;"></td> </tr> <tr> <td></td> <td></td> <td colspan="8" style="text-align: center;"> <table border="1" style="width: 100%; border-collapse: collapse; text-align: center;"> <tr> <td style="width: 10%;"></td> <td style="width: 10%;"></td> <td style="width: 10%;"></td> <td style="width: 10%;"></td> <td style="width: 10%;"></td> <td style="width: 10%;"></td> <td style="width: 10%;"></td> <td style="width: 10%;"></td> <td style="width: 10%;"></td> <td style="width: 10%;"></td> </tr> <tr> <td></td> <td></td> <td colspan="8" style="text-align: center;"> <table border="1" style="width: 100%; border-collapse: collapse; text-align: center;"> <tr> <td style="width: 10%;"></td> <td style="width: 10%;"></td> <td style="width: 10%;"></td> <td style="width: 10%;"></td> <td style="width: 10%;"></td> <td style="width: 10%;"></td> <td style="width: 10%;"></td> <td style="width: 10%;"></td> <td style="width: 10%;"></td> <td style="width: 10%;"></td> </tr> <tr> <td></td> <td></td> <td colspan="8" style="text-align: center;"> <table border="1" style="width: 100%; border-collapse: collapse; text-align: center;"> <tr> <td style="width: 10%;"></td> <td style="width: 10%;"></td> <td style="width: 10%;"></td> <td style="width: 10%;"></td> <td style="width: 10%;"></td> <td style="width: 10%;"></td> <td style="width: 10%;"></td> <td style="width: 10%;"></td> <td style="width: 10%;"></td> <td style="width: 10%;"></td> </tr> <tr> <td></td> <td></td> <td colspan="8" style="text-align: center;"> <table border="1" style="width: 100%; border-collapse: collapse; text-align: center;"> <tr> <td style="width: 10%;"></td> <td style="width: 10%;"></td> <td style="width: 10%;"></td> <td style="width: 10%;"></td> <td style="width: 10%;"></td> <td style="width: 10%;"></td> <td style="width: 10%;"></td> <td style="width: 10%;"></td> <td style="width: 10%;"></td> <td style="width: 10%;"></td> </tr> <tr> <td></td> <td></td> <td colspan="8" style="text-align: center;"> <table border="1" style="width: 100%; border-collapse: collapse; text-align: center;"> <tr> <td style="width: 10%;"></td> <td style="width: 10%;"></td> <td style="width: 10%;"></td> <td style="width: 10%;"></td> <td style="width: 10%;"></td> <td style="width: 10%;"></td> <td style="width: 10%;"></td> <td style="width: 10%;"></td> <td style="width: 10%;"></td> <td style="width: 10%;"></td> </tr> <tr> <td></td> <td></td> <td colspan="8" style="text-align: center;"> <table border="1" style="width: 100%; border-collapse: collapse; text-align: center;"> <tr> <td style="width: 10%;"></td> <td style="width: 10%;"></td> <td style="width: 10%;"></td> <td style="width: 10%;"></td> <td style="width: 10%;"></td> <td style="width: 10%;"></td> <td style="width: 10%;"></td> <td style="width: 10%;"></td> <td style="width: 10%;"></td> <td style="width: 10%;"></td> </tr> <tr> <td></td> <td></td> <td colspan="8" style="text-align: center;"> <table border="1" style="width: 100%; border-collapse: collapse; text-align: center;"> <tr> <td style="width: 10%;"></td> <td style="width: 10%;"></td> <td style="width: 10%;"></td> <td style="width: 10%;"></td> <td style="width: 10%;"></td> <td style="width:
10%;"></td> <td style="width: 10%;"></td> <td style="width: 10%;"></td> <td style="width: 10%;"></td> <td style="width: 10%;"></td> </tr> <tr> <td></td> <td></td> <td colspan="8" style="text-align: center;"> <table border="1" style="width: 100%; border-collapse: collapse; text-align: center;"> <tr> <td style="width: 10%;"></td> <td style="width: 10%;"></td> <td style="width: 10%;"></td> <td style="width: 10%;"></td> <td style="width: 10%;"></td> <td style="width: 10%;"></td> <td style="width: 10%;"></td> <td style="width: 10%;"></td> <td style="width: 10%;"></td> <td style="width: 10%;"></td> </tr> <tr> <td></td> <td></td> <td colspan="8" style="text-align: center;"> <table border="1" style="width: 100%; border-collapse: collapse; text-align: center;"> <tr> <td style="width: 10%;"></td> <td style="width: 10%;"></td> <td style="width: 10%;"></td> <td style="width: 10%;"></td> <td style="width: 10%;"></td> <td style="width: 10%;"></td> <td style="width: 10%;"></td> <td style="width: 10%;"></td> <td style="width: 10%;"></td> <td style="width: 10%;"></td> </tr> <tr> <td></td> <td></td> <td colspan="8" style="text-align: center;"> <table border="1" style="width: 100%; border-collapse: collapse; text-align: center;"> <tr> <td style="width: 10%;"></td> <td style="width: 10%;"></td> <td style="width: 10%;"></td> <td style="width: 10%;"></td> <td style="width: 10%;"></td> <td style="width: 10%;"></td> <td style="width: 10%;"></td> <td style="width: 10%;"></td> <td style="width: 10%;"></td> <td style="width: 10%;"></td> </tr> <tr> <td></td> <td></td> <td colspan="8" style="text-align: center;"> <table border="1" style="width: 100%; border-collapse: collapse; text-align: center;"> <tr> <td style="width: 10%;"></td> <td style="width: 10%;"></td> <td style="width: 10%;"></td> <td style="width: 10%;"></td> <td style="width: 10%;"></td> <td style="width: 10%;"></td> <td style="width: 10%;"></td> <td style="width: 10%;"></td> <td style="width: 10%;"></td> <td style="width: 10%;"></td> </tr> <tr> <td></td> <td></td> <td colspan="8" style="text-align: center;"> <table border="1" style="width: 100%; border-collapse: collapse; text-align: center;"> <tr> <td style="width: 10%;"></td> <td style="width: 10%;"></td> <td style="width: 10%;"></td> <td style="width: 10%;"></td> <td style="width: 10%;"></td> <td style="width: 10%;"></td> <td style="width: 10%;"></td> <td style="width: 10%;"></td> <td style="width: 10%;"></td> <td style="width: 10%;"></td> </tr> <tr> <td></td> <td></td> <td colspan="8" style="text-align: center;"> <table border="1" style="width: 100%; border-collapse: collapse; text-align: center;"> <tr> <td style="width: 10%;"></td> <td style="width: 10%;"></td> <td style="width: 10%;"></td> <td style="width: 10%;"></td> <td style="width: 10%;"></td> <td style="width: 10%;"></td> <td style="width: 10%;"></td> <td style="width: 10%;"></td> <td style="width: 10%;"></td> <td style="width: 10%;"></td> </tr> <tr> <td></td> <td></td> <td colspan="8" style="text-align: center;"> <table border="1" style="width: 100%; border-collapse: collapse; text-align: center;"> <tr> <td style="width: 10%;"></td> <td style="width: 10%;"></td> <td style="width: 10%;"></td> <td style="width: 10%;"></td> <td style="width: 10%;"></td> <td style="width: 10%;"></td> <td style="width: 10%;"></td> <td style="width: 10%;"></td> <td style="width: 10%;"></td> <td style="width: 10%;"></td> </tr> <tr> <td></td> <td></td> <td colspan="8" style="text-align: center;"> <table border="1" style="width: 100%; border-collapse: collapse; text-align: center;"> <tr> <td style="width: 10%;"></td> <td style="width: 10%;"></td> <td style="width: 10%;"></td> <td style="width: 10%;"></td> <td style="width: 10%;"></td> <td style="width: 10%;"></td> <td style="width: 10%;"></td> <td style="width: 10%;"></td> <td style="width: 10%;"></td> <td style="width: 10%;"></td> </tr> <tr> <td></td> <td></td> <td colspan="8" style="text-align: center;"> <table border="1" style="width: 100%; border-collapse: collapse; text-align: center;"> <tr> <td style="width: 10%;"></td> <td style="width: 10%;"></td> <td style="width: 10%;"></td> <td style="width: 10%;"></td> <td style="width: 10%;"></td> <td style="width: 10%;"></td> <td style="width: 10%;"></td> <td style="width: 10%;"></td> <td style="width: 10%;"></td> <td style="width: 10%;"></td> </tr> <tr> <td></td> <td></td> <td colspan="8" style="text-align: center;"> <table border="1" style="width: 100%; border-collapse: collapse; text-align: center;"> <tr> <td style="width: 10%;"></td> <td style="width: 10%;"></td> <td style="width: 10%;"></td> <td style="width: 10%;"></td> <td style="width: 10%;"></td> <td style="width: 10%;"></td> <td style="width: 10%;"></td> <td style="width: 10%;"></td> <td style="width: 10%;"></td> <td style="width: 10%;"></td> </tr> <tr> <td></td> <td></td> <td colspan="8" style="text-align: center;"> <table border="1" style="width: 100%; border-collapse: collapse; text-align: center;"> <tr> <td style="width: 10%;"></td> <td style="width: 10%;"></td> <td style="width: 10%;"></td> <td style="width: 10%;"></td> <td style="width: 10%;"></td> <td style="width: 10%;"></td> <td style="width: 10%;"></td> <td style="width: 10%;"></td> <td style="width: 10%;"></td> <td style="width: 10%;"></td> </tr> <tr> <td></td> <td></td> <td colspan="8" style="text-align: center;"> <table border="1" style="width: 100%; border-collapse: collapse; text-align: center;"> <tr> <td style="width: 10%;"></td> <td style="width: 10%;"></td> <td style="width: 10%;"></td> <td style="width: 10%;"></td> <td style="width: 10%;"></td> <td style="width: 10%;"></td> <td style="width: 10%;"></td> <td style="width: 10%;"></td> <td style="width: 10%;"></td> <td style="width: 10%;"></td> </tr> <tr> <td></td> <td></td> <td colspan="8" style="text-align: center;"> <table border="1" style="width: 100%; border-collapse: collapse; text-align: center;"> <tr> <td style="width: 10%;"></td> <td style="width: 10%;"></td> <td style="width: 10%;"></td> <td style="width: 10%;"></td> <td style="width: 10%;"></td> <td style="width: 10%;"></td> <td style="width: 10%;"></td> <td style="width: 10%;"></td> <td style="width: 10%;"></td> <td style="width: 10%;"></td> </tr> <tr> <td></td> <td></td> <td colspan="8" style="text-align: center;"> <table border="1" style="width: 100%; border-collapse: collapse; text-align: center;"> <tr> <td style="width: 10%;"></td> <td style="width: 10%;"></td> <td style="width: 10%;"></td> <td style="width: 10%;"></td> <td style="width: 10%;"></td> <td style="width: 10%;"></td> <td style="width: 10%;"></td> <td style="width: 10%;"></td> <td style="width: 10%;"></td> <td style="width: 10%;"></td> </tr> <tr> <td></td> <td></td> <td colspan="8" style="text-align: center;"> <table border="1" style="width: 100%; border-collapse: collapse; text-align: center;"> <tr> <td style="width: 10%;"></td> <td style="width: 10%;"></td> <td style="width: 10%;"></td> <td style="width: 10%;"></td> <td style="width: 10%;"></td> <td style="width: 10%;"></td> <td style="width: 10%;"></td> <td style="width: 10%;"></td> <td style="width: 10%;"></td> <td style="width: 10%;"></td> </tr> <tr> <td></td> <td></td> <td colspan="8" style="text-align: center;"> <table border="1" style="width: 100%; border-collapse: collapse; text-align: center;"> <tr> <td style="width: 10%;"></td> <td style="width: 10%;"></td> <td style="width: 10%;"></td> <td style="width: 10%;"></td> <td style="width: 10%;"></td> <td style="width: 10%;"></td> <td style="width: 10%;"></td> <td style="width: 10%;"></td> <td style="width: 10%;"></td> <td style="width: 10%;"></td> </tr> <tr> <td></td> <td></td> <td colspan="8" style="text-align: center;"> <table border="1" style="width: 100%; border-collapse: collapse; text-align: center;"> <tr> <td style="width: 10%;"></td> <td style="width: 10%;"></td> <td style="width: 10%;"></td> <td style="width: 10%;"></td> <td style="width: 10%;"></td> <td style="width: 10%;"></td> <td style="width: 10%;"></td> <td style="width: 10%;"></td> <td style="width: 10%;"></td> <td style="width: 10%;"></td> </tr> <tr> <td></td> <td></td> <td colspan="8" style="text-align: center;"> <table border="1" style="width: 100%; border-collapse: collapse; text-align: center;"> <tr> <td style="width: 10%;"></td> <td style="width: 10%;"></td> <td style="width: 10%;"></td> <td style="width: 10%;"></td> <td style="width: 10%;"></td> <td style="width: 10%;"></td> <td style="width: 10%;"></td> <td style="width: 10%;"></td> <td style="width: 10%;"></td> <td style="width: 10%;"></td> </tr> <tr> <td></td> <td></td> <td colspan="8" style="text-align: center;"> <table border="1" style="width: 100%; border-collapse: collapse; text-align: center;"> <tr> <td style="width: 10%;"></td> <td style="width: 10%;"></td> <td style="width: 10%;"></td> <td style="width: 10%;"></td> <td style="width: 10%;"></td> <td style="width: 10%;"></td> <td style="width: 10%;"></td> <td style="width: 10%;"></td> <td style="width: 10%;"></td> <td style="width: 10%;"></td> </tr> <tr> <td></td> <td></td> <td colspan="8" style="text-align: center;"> <table border="1" style="width: 100%; border-collapse: collapse; text-align: center;"> <tr> </tr></table></td></tr></table></td></tr></table></td></tr></table></td></tr></table></td></tr></table></td></tr></table></td></tr></table></td></tr></table></td></tr></table></td></tr></table></td></tr></table></td></tr></table></td></tr></table></td></tr></table></td></tr></table></td></tr></table></td></tr></table></td></tr></table></td></tr></table></td></tr></table></td></tr></table></td></tr></table></td></tr></table></td></tr></table></td></tr></table></td></tr></table></td></tr></table></td></tr></table></td></tr></table></td></tr></table></td></tr></table></td></tr></table></td></tr></table></td></tr></table></td></tr></table></td></tr></table>
 | | | | | | | | | | | | | | | | | | | | <table border="1" style="width: 100%; border-collapse: collapse; text-align: center;"> <tr> <td style="width: 10%;"></td> <td style="width: 10%;"></td> <td style="width: 10%;"></td> <td style="width: 10%;"></td> <td style="width: 10%;"></td> <td style="width: 10%;"></td> <td style="width: 10%;"></td> <td style="width: 10%;"></td> <td style="width: 10%;"></td> <td style="width: 10%;"></td> </tr> <tr> <td></td> <td></td> <td colspan="8" style="text-align: center;"> <table border="1" style="width: 100%; border-collapse: collapse; text-align: center;"> <tr> <td style="width: 10%;"></td> <td style="width: 10%;"></td> <td style="width: 10%;"></td> <td style="width: 10%;"></td> <td style="width: 10%;"></td> <td style="width: 10%;"></td> <td style="width: 10%;"></td> <td style="width: 10%;"></td> <td style="width: 10%;"></td> <td style="width: 10%;"></td> </tr> <tr> <td></td> <td></td> <td colspan="8" style="text-align: center;"> <table border="1" style="width: 100%; border-collapse: collapse; text-align: center;"> <tr> <td style="width: 10%;"></td> <td style="width: 10%;"></td> <td style="width: 10%;"></td> <td style="width: 10%;"></td> <td style="width: 10%;"></td> <td style="width: 10%;"></td> <td style="width: 10%;"></td> <td style="width: 10%;"></td> <td style="width: 10%;"></td> <td style="width: 10%;"></td> </tr> <tr> <td></td> <td></td> <td colspan="8" style="text-align: center;"> <table border="1" style="width: 100%; border-collapse: collapse; text-align: center;"> <tr> <td style="width: 10%;"></td> <td style="width: 10%;"></td> <td style="width: 10%;"></td> <td style="width: 10%;"></td> <td style="width: 10%;"></td> <td style="width: 10%;"></td> <td style="width: 10%;"></td> <td style="width: 10%;"></td> <td style="width: 10%;"></td> <td style="width: 10%;"></td> </tr> <tr> <td></td> <td></td> <td colspan="8" style="text-align: center;"> <table border="1" style="width: 100%; border-collapse: collapse; text-align: center;"> <tr> <td style="width: 10%;"></td> <td style="width: 10%;"></td> <td style="width: 10%;"></td> <td style="width: 10%;"></td> <td style="width: 10%;"></td> <td style="width: 10%;"></td> <td style="width: 10%;"></td> <td style="width: 10%;"></td> <td style="width: 10%;"></td> <td style="width: 10%;"></td> </tr> <tr> <td></td> <td></td> <td colspan="8" style="text-align: center;"> <table border="1" style="width: 100%; border-collapse: collapse; text-align: center;"> <tr> <td style="width: 10%;"></td> <td style="width: 10%;"></td> <td style="width: 10%;"></td> <td style="width: 10%;"></td> <td style="width: 10%;"></td> <td style="width: 10%;"></td> <td style="width: 10%;"></td> <td style="width: 10%;"></td> <td style="width: 10%;"></td> <td style="width: 10%;"></td> </tr> <tr> <td></td> <td></td> <td colspan="8" style="text-align: center;"> <table border="1" style="width: 100%; border-collapse: collapse; text-align: center;"> <tr> <td style="width: 10%;"></td> <td style="width: 10%;"></td> <td style="width: 10%;"></td> <td style="width: 10%;"></td> <td style="width: 10%;"></td> <td style="width: 10%;"></td> <td style="width: 10%;"></td> <td style="width: 10%;"></td> <td style="width: 10%;"></td> <td style="width: 10%;"></td> </tr> <tr> <td></td> <td></td> <td colspan="8" style="text-align: center;"> <table border="1" style="width: 100%; border-collapse: collapse; text-align: center;"> <tr> <td style="width: 10%;"></td> <td style="width: 10%;"></td> <td style="width: 10%;"></td> <td style="width: 10%;"></td> <td style="width: 10%;"></td> <td style="width: 10%;"></td> <td style="width: 10%;"></td> <td style="width: 10%;"></td> <td style="width: 10%;"></td> <td style="width: 10%;"></td> </tr> <tr> <td></td> <td></td> <td colspan="8" style="text-align: center;"> <table border="1" style="width: 100%; border-collapse: collapse; text-align: center;"> <tr> <td style="width: 10%;"></td> <td style="width: 10%;"></td> <td style="width: 10%;"></td> <td style="width: 10%;"></td> <td style="width: 10%;"></td> <td style="width: 10%;"></td> <td style="width: 10%;"></td> <td style="width: 10%;"></td> <td style="width: 10%;"></td> <td style="width: 10%;"></td> </tr> <tr> <td></td> <td></td> <td colspan="8" style="text-align: center;"> <table border="1" style="width: 100%;
border-collapse: collapse; text-align: center;"> <tr> <td style="width: 10%;"></td> <td style="width: 10%;"></td> <td style="width: 10%;"></td> <td style="width: 10%;"></td> <td style="width: 10%;"></td> <td style="width: 10%;"></td> <td style="width: 10%;"></td> <td style="width: 10%;"></td> <td style="width: 10%;"></td> <td style="width: 10%;"></td> </tr> <tr> <td></td> <td></td> <td colspan="8" style="text-align: center;"> <table border="1" style="width: 100%; border-collapse: collapse; text-align: center;"> <tr> <td style="width: 10%;"></td> <td style="width: 10%;"></td> <td style="width: 10%;"></td> <td style="width: 10%;"></td> <td style="width: 10%;"></td> <td style="width: 10%;"></td> <td style="width: 10%;"></td> <td style="width: 10%;"></td> <td style="width: 10%;"></td> <td style="width: 10%;"></td> </tr> <tr> <td></td> <td></td> <td colspan="8" style="text-align: center;"> <table border="1" style="width: 100%; border-collapse: collapse; text-align: center;"> <tr> <td style="width: 10%;"></td> <td style="width: 10%;"></td> <td style="width: 10%;"></td> <td style="width: 10%;"></td> <td style="width: 10%;"></td> <td style="width: 10%;"></td> <td style="width: 10%;"></td> <td style="width: 10%;"></td> <td style="width: 10%;"></td> <td style="width: 10%;"></td> </tr> <tr> <td></td> <td></td> <td colspan="8" style="text-align: center;"> <table border="1" style="width: 100%; border-collapse: collapse; text-align: center;"> <tr> <td style="width: 10%;"></td> <td style="width: 10%;"></td> <td style="width: 10%;"></td> <td style="width: 10%;"></td> <td style="width: 10%;"></td> <td style="width: 10%;"></td> <td style="width: 10%;"></td> <td style="width: 10%;"></td> <td style="width: 10%;"></td> <td style="width: 10%;"></td> </tr> <tr> <td></td> <td></td> <td colspan="8" style="text-align: center;"> <table border="1" style="width: 100%; border-collapse: collapse; text-align: center;"> <tr> <td style="width: 10%;"></td> <td style="width: 10%;"></td> <td style="width: 10%;"></td> <td style="width: 10%;"></td> <td style="width: 10%;"></td> <td style="width: 10%;"></td> <td style="width: 10%;"></td> <td style="width: 10%;"></td> <td style="width: 10%;"></td> <td style="width: 10%;"></td> </tr> <tr> <td></td> <td></td> <td colspan="8" style="text-align: center;"> <table border="1" style="width: 100%; border-collapse: collapse; text-align: center;"> <tr> <td style="width: 10%;"></td> <td style="width: 10%;"></td> <td style="width: 10%;"></td> <td style="width: 10%;"></td> <td style="width: 10%;"></td> <td style="width: 10%;"></td> <td style="width: 10%;"></td> <td style="width: 10%;"></td> <td style="width: 10%;"></td> <td style="width: 10%;"></td> </tr> <tr> <td></td> <td></td> <td colspan="8" style="text-align: center;"> <table border="1" style="width: 100%; border-collapse: collapse; text-align: center;"> <tr> <td style="width: 10%;"></td> <td style="width: 10%;"></td> <td style="width: 10%;"></td> <td style="width: 10%;"></td> <td style="width: 10%;"></td> <td style="width: 10%;"></td> <td style="width: 10%;"></td> <td style="width: 10%;"></td> <td style="width: 10%;"></td> <td style="width: 10%;"></td> </tr> <tr> <td></td> <td></td> <td colspan="8" style="text-align: center;"> <table border="1" style="width: 100%; border-collapse: collapse; text-align: center;"> <tr> <td style="width: 10%;"></td> <td style="width: 10%;"></td> <td style="width: 10%;"></td> <td style="width: 10%;"></td> <td style="width: 10%;"></td> <td style="width: 10%;"></td> <td style="width: 10%;"></td> <td style="width: 10%;"></td> <td style="width: 10%;"></td> <td style="width: 10%;"></td> </tr> <tr> <td></td> <td></td> <td colspan="8" style="text-align: center;"> <table border="1" style="width: 100%; border-collapse: collapse; text-align: center;"> <tr> <td style="width: 10%;"></td> <td style="width: 10%;"></td> <td style="width: 10%;"></td> <td style="width: 10%;"></td> <td style="width: 10%;"></td> <td style="width: 10%;"></td> <td style="width: 10%;"></td> <td style="width: 10%;"></td> <td style="width: 10%;"></td> <td style="width: 10%;"></td> </tr> <tr> <td></td> <td></td> <td colspan="8" style="text-align: center;"> <table border="1" style="width: 100%; border-collapse: collapse; text-align: center;"> <tr> <td style="width: 10%;"></td> <td style="width: 10%;"></td> <td style="width: 10%;"></td> <td style="width: 10%;"></td> <td style="width: 10%;"></td> <td style="width: 10%;"></td> <td style="width: 10%;"></td> <td style="width: 10%;"></td> <td style="width: 10%;"></td> <td style="width: 10%;"></td> </tr> <tr> <td></td> <td></td> <td colspan="8" style="text-align: center;"> <table border="1" style="width: 100%; border-collapse: collapse; text-align: center;"> <tr> <td style="width: 10%;"></td> <td style="width: 10%;"></td> <td style="width: 10%;"></td> <td style="width: 10%;"></td> <td style="width: 10%;"></td> <td style="width: 10%;"></td> <td style="width: 10%;"></td> <td style="width: 10%;"></td> <td style="width: 10%;"></td> <td style="width: 10%;"></td> </tr> <tr> <td></td> <td></td> <td colspan="8" style="text-align: center;"> <table border="1" style="width: 100%; border-collapse: collapse; text-align: center;"> <tr> <td style="width: 10%;"></td> <td style="width: 10%;"></td> <td style="width: 10%;"></td> <td style="width: 10%;"></td> <td style="width: 10%;"></td> <td style="width: 10%;"></td> <td style="width: 10%;"></td> <td style="width: 10%;"></td> <td style="width: 10%;"></td> <td style="width: 10%;"></td> </tr> <tr> <td></td> <td></td> <td colspan="8" style="text-align: center;"> <table border="1" style="width: 100%; border-collapse: collapse; text-align: center;"> <tr> <td style="width: 10%;"></td> <td style="width: 10%;"></td> <td style="width: 10%;"></td> <td style="width: 10%;"></td> <td style="width: 10%;"></td> <td style="width: 10%;"></td> <td style="width: 10%;"></td> <td style="width: 10%;"></td> <td style="width: 10%;"></td> <td style="width: 10%;"></td> </tr> <tr> <td></td> <td></td> <td colspan="8" style="text-align: center;"> <table border="1" style="width: 100%; border-collapse: collapse; text-align: center;"> <tr> <td style="width: 10%;"></td> <td style="width: 10%;"></td> <td style="width: 10%;"></td> <td style="width: 10%;"></td> <td style="width: 10%;"></td> <td style="width: 10%;"></td> <td style="width: 10%;"></td> <td style="width: 10%;"></td> <td style="width: 10%;"></td> <td style="width: 10%;"></td> </tr> <tr> <td></td> <td></td> <td colspan="8" style="text-align: center;"> <table border="1" style="width: 100%; border-collapse: collapse; text-align: center;"> <tr> <td style="width: 10%;"></td> <td style="width: 10%;"></td> <td style="width: 10%;"></td> <td style="width: 10%;"></td> <td style="width: 10%;"></td> <td style="width: 10%;"></td> <td style="width: 10%;"></td> <td style="width: 10%;"></td> <td style="width: 10%;"></td> <td style="width: 10%;"></td> </tr> <tr> <td></td> <td></td> <td colspan="8" style="text-align: center;"> <table border="1" style="width: 100%; border-collapse: collapse; text-align: center;"> <tr> <td style="width: 10%;"></td> <td style="width: 10%;"></td> <td style="width: 10%;"></td> <td style="width: 10%;"></td> <td style="width: 10%;"></td> <td style="width: 10%;"></td> <td style="width: 10%;"></td> <td style="width: 10%;"></td> <td style="width: 10%;"></td> <td style="width: 10%;"></td> </tr> <tr> <td></td> <td></td> <td colspan="8" style="text-align: center;"> <table border="1" style="width: 100%; border-collapse: collapse; text-align: center;"> <tr> <td style="width: 10%;"></td> <td style="width: 10%;"></td> <td style="width: 10%;"></td> <td style="width: 10%;"></td> <td style="width: 10%;"></td> <td style="width: 10%;"></td> <td style="width: 10%;"></td> <td style="width: 10%;"></td> <td style="width: 10%;"></td> <td style="width: 10%;"></td> </tr> <tr> <td></td> <td></td> <td colspan="8" style="text-align: center;"> <table border="1" style="width: 100%; border-collapse: collapse; text-align: center;"> <tr> <td style="width: 10%;"></td> <td style="width: 10%;"></td> <td style="width: 10%;"></td> <td style="width: 10%;"></td> <td style="width: 10%;"></td> <td style="width: 10%;"></td> <td style="width: 10%;"></td> <td style="width: 10%;"></td> <td style="width: 10%;"></td> <td style="width: 10%;"></td> </tr> <tr> <td></td> <td></td> <td colspan="8" style="text-align: center;"> <table border="1" style="width: 100%; border-collapse: collapse; text-align: center;"> <tr> <td style="width: 10%;"></td> <td style="width: 10%;"></td> <td style="width: 10%;"></td> <td style="width: 10%;"></td> <td style="width: 10%;"></td> <td style="width: 10%;"></td> <td style="width: 10%;"></td> <td style="width: 10%;"></td> <td style="width: 10%;"></td> <td style="width: 10%;"></td> </tr> <tr> <td></td> <td></td> <td colspan="8" style="text-align: center;"> <table border="1" style="width: 100%; border-collapse: collapse; text-align: center;"> <tr> <td style="width: 10%;"></td> <td style="width: 10%;"></td> <td style="width: 10%;"></td> <td style="width: 10%;"></td> <td style="width: 10%;"></td> <td style="width: 10%;"></td> <td style="width: 10%;"></td> <td style="width: 10%;"></td> <td style="width: 10%;"></td> <td style="width: 10%;"></td> </tr> <tr> <td></td> <td></td> <td colspan="8" style="text-align: center;"> <table border="1" style="width: 100%; border-collapse: collapse; text-align: center;"> <tr> <td style="width: 10%;"></td> <td style="width: 10%;"></td> <td style="width: 10%;"></td> <td style="width: 10%;"></td> <td style="width: 10%;"></td> <td style="width: 10%;"></td> <td style="width: 10%;"></td> <td style="width: 10%;"></td> <td style="width: 10%;"></td> <td style="width: 10%;"></td> </tr> <tr> <td></td> <td></td> <td colspan="8" style="text-align: center;"> <table border="1" style="width: 100%; border-collapse: collapse; text-align: center;"> <tr> <td style="width: 10%;"></td> <td style="width: 10%;"></td> <td style="width: 10%;"></td> <td style="width:
10%;"></td> <td style="width: 10%;"></td> <td style="width: 10%;"></td> <td style="width: 10%;"></td> <td style="width: 10%;"></td> <td style="width: 10%;"></td> <td style="width: 10%;"></td> </tr> <tr> <td></td> <td></td> <td colspan="8" style="text-align: center;"> <table border="1" style="width: 100%; border-collapse: collapse; text-align: center;"> <tr> <td style="width: 10%;"></td> <td style="width: 10%;"></td> <td style="width: 10%;"></td> <td style="width: 10%;"></td> <td style="width: 10%;"></td> <td style="width: 10%;"></td> <td style="width: 10%;"></td> <td style="width: 10%;"></td> <td style="width: 10%;"></td> <td style="width: 10%;"></td> </tr> <tr> <td></td> <td></td> <td colspan="8" style="text-align: center;"> <table border="1" style="width: 100%; border-collapse: collapse; text-align: center;"> <tr> <td style="width: 10%;"></td> <td style="width: 10%;"></td> <td style="width: 10%;"></td> <td style="width: 10%;"></td> <td style="width: 10%;"></td> <td style="width: 10%;"></td> <td style="width: 10%;"></td> <td style="width: 10%;"></td> <td style="width: 10%;"></td> <td style="width: 10%;"></td> </tr> <tr> <td></td> <td></td> <td colspan="8" style="text-align: center;"> <table border="1" style="width: 100%; border-collapse: collapse; text-align: center;"> <tr> <td style="width: 10%;"></td> <td style="width: 10%;"></td> <td style="width: 10%;"></td> <td style="width: 10%;"></td> <td style="width: 10%;"></td> <td style="width: 10%;"></td> <td style="width: 10%;"></td> <td style="width: 10%;"></td> <td style="width: 10%;"></td> <td style="width: 10%;"></td> </tr> <tr> <td></td> <td></td> <td colspan="8" style="text-align: center;"> <table border="1" style="width: 100%; border-collapse: collapse; text-align: center;"> <tr> <td style="width: 10%;"></td> <td style="width: 10%;"></td> <td style="width: 10%;"></td> <td style="width: 10%;"></td> <td style="width: 10%;"></td> <td style="width: 10%;"></td> <td style="width: 10%;"></td> <td style="width: 10%;"></td> <td style="width: 10%;"></td> <td style="width: 10%;"></td> </tr> <tr> <td></td> <td></td> <td colspan="8" style="text-align: center;"> <table border="1" style="width: 100%; border-collapse: collapse; text-align: center;"> <tr> </tr></table></td></tr></table></td></tr></table></td></tr></table></td></tr></table></td></tr></table></td></tr></table></td></tr></table></td></tr></table></td></tr></table></td></tr></table></td></tr></table></td></tr></table></td></tr></table></td></tr></table></td></tr></table></td></tr></table></td></tr></table></td></tr></table></td></tr></table></td></tr></table></td></tr></table></td></tr></table></td></tr></table></td></tr></table></td></tr></table></td></tr></table></td></tr></table></td></tr></table></td></tr></table></td></tr></table></td></tr></table></td></tr></table></td></tr></table></td></tr></table></td></tr></table> | | | | | | | | | | | | | | | | | | | | <table border="1" style="width: 100%; border-collapse: collapse; text-align: center;"> <tr> <td style="width: 10%;"></td> <td style="width: 10%;"></td> <td style="width: 10%;"></td> <td style="width: 10%;"></td> <td style="width: 10%;"></td> <td style="width: 10%;"></td> <td style="width: 10%;"></td> <td style="width: 10%;"></td> <td style="width: 10%;"></td> <td style="width: 10%;"></td> </tr> <tr> <td></td> <td></td> <td colspan="8" style="text-align: center;"> <table border="1" style="width: 100%; border-collapse: collapse; text-align: center;"> <tr> <td style="width: 10%;"></td> <td style="width: 10%;"></td> <td style="width: 10%;"></td> <td style="width: 10%;"></td> <td style="width: 10%;"></td> <td style="width: 10%;"></td> <td style="width: 10%;"></td> <td style="width: 10%;"></td> <td style="width: 10%;"></td> <td style="width: 10%;"></td> </tr> <tr> <td></td> <td></td> <td colspan="8" style="text-align: center;"> <table border="1" style="width: 100%; border-collapse: collapse; text-align: center;"> <tr> <td style="width: 10%;"></td> <td style="width: 10%;"></td> <td style="width: 10%;"></td> <td style="width: 10%;"></td> <td style="width: 10%;"></td> <td style="width: 10%;"></td> <td style="width:
10%;"></td> <td style="width: 10%;"></td> <td style="width: 10%;"></td> <td style="width: 10%;"></td> </tr> <tr> <td></td> <td></td> <td colspan="8" style="text-align: center;"> <table border="1" style="width: 100%; border-collapse: collapse; text-align: center;"> <tr> <td style="width: 10%;"></td> <td style="width: 10%;"></td> <td style="width: 10%;"></td> <td style="width: 10%;"></td> <td style="width: 10%;"></td> <td style="width: 10%;"></td> <td style="width: 10%;"></td> <td style="width: 10%;"></td> <td style="width: 10%;"></td> <td style="width: 10%;"></td> </tr> <tr> <td></td> <td></td> <td colspan="8" style="text-align: center;"> <table border="1" style="width: 100%; border-collapse: collapse; text-align: center;"> <tr> <td style="width: 10%;"></td> <td style="width: 10%;"></td> <td style="width: 10%;"></td> <td style="width: 10%;"></td> <td style="width: 10%;"></td> <td style="width: 10%;"></td> <td style="width: 10%;"></td> <td style="width: 10%;"></td> <td style="width: 10%;"></td> <td style="width: 10%;"></td> </tr> <tr> <td></td> <td></td> <td colspan="8" style="text-align: center;"> <table border="1" style="width: 100%; border-collapse: collapse; text-align: center;"> <tr> <td style="width: 10%;"></td> <td style="width: 10%;"></td> <td style="width: 10%;"></td> <td style="width: 10%;"></td> <td style="width: 10%;"></td> <td style="width: 10%;"></td> <td style="width: 10%;"></td> <td style="width: 10%;"></td> <td style="width: 10%;"></td> <td style="width: 10%;"></td> </tr> <tr> <td></td> <td></td> <td colspan="8" style="text-align: center;"> <table border="1" style="width: 100%; border-collapse: collapse; text-align: center;"> <tr> <td style="width: 10%;"></td> <td style="width: 10%;"></td> <td style="width: 10%;"></td> <td style="width: 10%;"></td> <td style="width: 10%;"></td> <td style="width: 10%;"></td> <td style="width: 10%;"></td> <td style="width: 10%;"></td> <td style="width: 10%;"></td> <td style="width: 10%;"></td> </tr> <tr> <td></td> <td></td> <td colspan="8" style="text-align: center;"> <table border="1" style="width: 100%; border-collapse: collapse; text-align: center;"> <tr> <td style="width: 10%;"></td> <td style="width: 10%;"></td> <td style="width: 10%;"></td> <td style="width: 10%;"></td> <td style="width: 10%;"></td> <td style="width: 10%;"></td> <td style="width: 10%;"></td> <td style="width: 10%;"></td> <td style="width: 10%;"></td> <td style="width: 10%;"></td> </tr> <tr> <td></td> <td></td> <td colspan="8" style="text-align: center;"> <table border="1" style="width: 100%; border-collapse: collapse; text-align: center;"> <tr> <td style="width: 10%;"></td> <td style="width: 10%;"></td> <td style="width: 10%;"></td> <td style="width: 10%;"></td> <td style="width: 10%;"></td> <td style="width: 10%;"></td> <td style="width: 10%;"></td> <td style="width: 10%;"></td> <td style="width: 10%;"></td> <td style="width: 10%;"></td> </tr> <tr> <td></td> <td></td> <td colspan="8" style="text-align: center;"> <table border="1" style="width: 100%; border-collapse: collapse; text-align: center;"> <tr> <td style="width: 10%;"></td> <td style="width: 10%;"></td> <td style="width: 10%;"></td> <td style="width: 10%;"></td> <td style="width: 10%;"></td> <td style="width: 10%;"></td> <td style="width: 10%;"></td> <td style="width: 10%;"></td> <td style="width: 10%;"></td> <td style="width: 10%;"></td> </tr> <tr> <td></td> <td></td> <td colspan="8" style="text-align: center;"> <table border="1" style="width: 100%; border-collapse: collapse; text-align: center;"> <tr> <td style="width: 10%;"></td> <td style="width: 10%;"></td> <td style="width: 10%;"></td> <td style="width: 10%;"></td> <td style="width: 10%;"></td> <td style="width: 10%;"></td> <td style="width: 10%;"></td> <td style="width: 10%;"></td> <td style="width: 10%;"></td> <td style="width: 10%;"></td> </tr> <tr> <td></td> <td></td> <td colspan="8" style="text-align: center;"> <table border="1" style="width: 100%; border-collapse: collapse; text-align: center;"> <tr> <td style="width: 10%;"></td> <td style="width: 10%;"></td> <td style="width: 10%;"></td> <td style="width: 10%;"></td> <td style="width: 10%;"></td> <td style="width: 10%;"></td> <td style="width: 10%;"></td> <td style="width: 10%;"></td> <td style="width: 10%;"></td> <td style="width: 10%;"></td> </tr> <tr> <td></td> <td></td> <td colspan="8" style="text-align: center;"> <table border="1" style="width: 100%; border-collapse: collapse; text-align: center;"> <tr> <td style="width: 10%;"></td> <td style="width: 10%;"></td> <td style="width: 10%;"></td> <td style="width: 10%;"></td> <td style="width: 10%;"></td> <td style="width: 10%;"></td> <td style="width: 10%;"></td> <td style="width: 10%;"></td> <td style="width: 10%;"></td> <td style="width: 10%;"></td> </tr> <tr> <td></td> <td></td> <td colspan="8" style="text-align: center;"> <table border="1" style="width: 100%; border-collapse: collapse; text-align: center;"> <tr> <td style="width: 10%;"></td> <td style="width: 10%;"></td> <td style="width: 10%;"></td> <td style="width: 10%;"></td> <td style="width: 10%;"></td> <td style="width: 10%;"></td> <td style="width: 10%;"></td> <td style="width: 10%;"></td> <td style="width: 10%;"></td> <td style="width: 10%;"></td> </tr> <tr> <td></td> <td></td> <td colspan="8" style="text-align: center;"> <table border="1" style="width: 100%; border-collapse: collapse; text-align: center;"> <tr> <td style="width: 10%;"></td> <td style="width: 10%;"></td> <td style="width: 10%;"></td> <td style="width: 10%;"></td> <td style="width: 10%;"></td> <td style="width: 10%;"></td> <td style="width: 10%;"></td> <td style="width: 10%;"></td> <td style="width: 10%;"></td> <td style="width: 10%;"></td> </tr> <tr> <td></td> <td></td> <td colspan="8" style="text-align: center;"> <table border="1" style="width: 100%; border-collapse: collapse; text-align: center;"> <tr> <td style="width: 10%;"></td> <td style="width: 10%;"></td> <td style="width: 10%;"></td> <td style="width: 10%;"></td> <td style="width: 10%;"></td> <td style="width: 10%;"></td> <td style="width: 10%;"></td> <td style="width: 10%;"></td> <td style="width: 10%;"></td> <td style="width: 10%;"></td> </tr> <tr> <td></td> <td></td> <td colspan="8" style="text-align: center;"> <table border="1" style="width: 100%; border-collapse: collapse; text-align: center;"> <tr> <td style="width: 10%;"></td> <td style="width: 10%;"></td> <td style="width: 10%;"></td> <td style="width: 10%;"></td> <td style="width: 10%;"></td> <td style="width: 10%;"></td> <td style="width: 10%;"></td> <td style="width: 10%;"></td> <td style="width: 10%;"></td> <td style="width: 10%;"></td> </tr> <tr> <td></td> <td></td> <td colspan="8" style="text-align: center;"> <table border="1" style="width: 100%; border-collapse: collapse; text-align: center;"> <tr> <td style="width: 10%;"></td> <td style="width: 10%;"></td> <td style="width: 10%;"></td> <td style="width: 10%;"></td> <td style="width: 10%;"></td> <td style="width: 10%;"></td> <td style="width: 10%;"></td> <td style="width: 10%;"></td> <td style="width: 10%;"></td> <td style="width: 10%;"></td> </tr> <tr> <td></td> <td></td> <td colspan="8" style="text-align: center;"> <table border="1" style="width: 100%; border-collapse: collapse; text-align: center;"> <tr> <td style="width: 10%;"></td> <td style="width: 10%;"></td> <td style="width: 10%;"></td> <td style="width: 10%;"></td> <td style="width: 10%;"></td> <td style="width: 10%;"></td> <td style="width: 10%;"></td> <td style="width: 10%;"></td> <td style="width: 10%;"></td> <td style="width: 10%;"></td> </tr> <tr> <td></td> <td></td> <td colspan="8" style="text-align: center;"> <table border="1" style="width: 100%; border-collapse: collapse; text-align: center;"> <tr> <td style="width: 10%;"></td> <td style="width: 10%;"></td> <td style="width: 10%;"></td> <td style="width: 10%;"></td> <td style="width: 10%;"></td> <td style="width: 10%;"></td> <td style="width: 10%;"></td> <td style="width: 10%;"></td> <td style="width: 10%;"></td> <td style="width: 10%;"></td> </tr> <tr> <td></td> <td></td> <td colspan="8" style="text-align: center;"> <table border="1" style="width: 100%; border-collapse: collapse; text-align: center;"> <tr> <td style="width: 10%;"></td> <td style="width: 10%;"></td> <td style="width: 10%;"></td> <td style="width: 10%;"></td> <td style="width: 10%;"></td> <td style="width: 10%;"></td> <td style="width: 10%;"></td> <td style="width: 10%;"></td> <td style="width: 10%;"></td> <td style="width: 10%;"></td> </tr> <tr> <td></td> <td></td> <td colspan="8" style="text-align: center;"> <table border="1" style="width: 100%; border-collapse: collapse; text-align: center;"> <tr> <td style="width: 10%;"></td> <td style="width: 10%;"></td> <td style="width: 10%;"></td> <td style="width: 10%;"></td> <td style="width: 10%;"></td> <td style="width: 10%;"></td> <td style="width: 10%;"></td> <td style="width: 10%;"></td> <td style="width: 10%;"></td> <td style="width: 10%;"></td> </tr> <tr> <td></td> <td></td> <td colspan="8" style="text-align: center;"> <table border="1" style="width: 100%; border-collapse: collapse; text-align: center;"> <tr> <td style="width: 10%;"></td> <td style="width: 10%;"></td> <td style="width: 10%;"></td> <td style="width: 10%;"></td> <td style="width: 10%;"></td> <td style="width: 10%;"></td> <td style="width: 10%;"></td> <td style="width: 10%;"></td> <td style="width: 10%;"></td> <td style="width: 10%;"></td> </tr> <tr> <td></td> <td></td> <td colspan="8" style="text-align: center;"> <table border="1" style="width: 100%; border-collapse: collapse; text-align: center;"> <tr> <td style="width: 10%;"></td> <td style="width: 10%;"></td> <td style="width: 10%;"></td> <td style="width: 10%;"></td> <td style="width: 10%;"></td> <td style="width: 10%;"></td> <td style="width: 10%;"></td> <td style="width: 10%;"></td> <td style="width: 10%;"></td> <td style="width: 10%;"></td> </tr> <tr> <td></td> <td></td> <td colspan="8" style="text-align:
center;"> <table border="1" style="width: 100%; border-collapse: collapse; text-align: center;"> <tr> <td style="width: 10%;"></td> <td style="width: 10%;"></td> <td style="width: 10%;"></td> <td style="width: 10%;"></td> <td style="width: 10%;"></td> <td style="width: 10%;"></td> <td style="width: 10%;"></td> <td style="width: 10%;"></td> <td style="width: 10%;"></td> <td style="width: 10%;"></td> </tr> <tr> <td></td> <td></td> <td colspan="8" style="text-align: center;"> <table border="1" style="width: 100%; border-collapse: collapse; text-align: center;"> <tr> <td style="width: 10%;"></td> <td style="width: 10%;"></td> <td style="width: 10%;"></td> <td style="width: 10%;"></td> <td style="width: 10%;"></td> <td style="width: 10%;"></td> <td style="width: 10%;"></td> <td style="width: 10%;"></td> <td style="width: 10%;"></td> <td style="width: 10%;"></td> </tr> <tr> <td></td> <td></td> <td colspan="8" style="text-align: center;"> <table border="1" style="width: 100%; border-collapse: collapse; text-align: center;"> <tr> <td style="width: 10%;"></td> <td style="width: 10%;"></td> <td style="width: 10%;"></td> <td style="width: 10%;"></td> <td style="width: 10%;"></td> <td style="width: 10%;"></td> <td style="width: 10%;"></td> <td style="width: 10%;"></td> <td style="width: 10%;"></td> <td style="width: 10%;"></td> </tr> <tr> <td></td> <td></td> <td colspan="8" style="text-align: center;"> <table border="1" style="width: 100%; border-collapse: collapse; text-align: center;"> <tr> <td style="width: 10%;"></td> <td style="width: 10%;"></td> <td style="width: 10%;"></td> <td style="width: 10%;"></td> <td style="width: 10%;"></td> <td style="width: 10%;"></td> <td style="width: 10%;"></td> <td style="width: 10%;"></td> <td style="width: 10%;"></td> <td style="width: 10%;"></td> </tr> <tr> <td></td> <td></td> <td colspan="8" style="text-align: center;"> <table border="1" style="width: 100%; border-collapse: collapse; text-align: center;"> <tr> <td style="width: 10%;"></td> <td style="width: 10%;"></td> <td style="width: 10%;"></td> <td style="width: 10%;"></td> <td style="width: 10%;"></td> <td style="width: 10%;"></td> <td style="width: 10%;"></td> <td style="width: 10%;"></td> <td style="width: 10%;"></td> <td style="width: 10%;"></td> </tr> <tr> <td></td> <td></td> <td colspan="8" style="text-align: center;"> <table border="1" style="width: 100%; border-collapse: collapse; text-align: center;"> <tr> <td style="width: 10%;"></td> <td style="width: 10%;"></td> <td style="width: 10%;"></td> <td style="width: 10%;"></td> <td style="width: 10%;"></td> <td style="width: 10%;"></td> <td style="width: 10%;"></td> <td style="width: 10%;"></td> <td style="width: 10%;"></td> <td style="width: 10%;"></td> </tr> <tr> <td></td> <td></td> <td colspan="8" style="text-align: center;"> <table border="1" style="width: 100%; border-collapse: collapse; text-align: center;"> <tr> <td style="width: 10%;"></td> <td style="width: 10%;"></td> <td style="width: 10%;"></td> <td style="width: 10%;"></td> <td style="width: 10%;"></td> <td style="width: 10%;"></td> <td style="width: 10%;"></td> <td style="width: 10%;"></td> <td style="width: 10%;"></td> <td style="width: 10%;"></td> </tr> <tr> <td></td> <td></td> <td colspan="8" style="text-align: center;"> <table border="1" style="width: 100%; border-collapse: collapse; text-align: center;"> <tr> <td style="width: 10%;"></td> <td style="width: 10%;"></td> <td style="width: 10%;"></td> <td style="width: 10%;"></td> <td style="width: 10%;"></td> <td style="width: 10%;"></td> <td style="width: 10%;"></td> <td style="width: 10%;"></td> <td style="width: 10%;"></td> <td style="width: 10%;"></td> </tr> <tr> <td></td> <td></td> <td colspan="8" style="text-align: center;"> <table border="1" style="width: 100%; border-collapse: collapse; text-align: center;"> <tr> <td style="width: 10%;"></td> <td style="width: 10%;"></td> <td style="width: 10%;"></td> <td style="width: 10%;"></td> <td style="width: 10%;"></td> <td style="width: 10%;"></td> <td style="width: 10%;"></td> <td style="width: 10%;"></td> <td style="width: 10%;"></td> <td style="width: 10%;"></td> </tr> <tr> <td></td> <td></td> <td colspan="8" style="text-align: center;"> <table border="1" style="width: 100%; border-collapse: collapse; text-align: center;"> <tr> <td style="width: 10%;"></td> <td style="width: 10%;"></td> <td style="width: 10%;"></td> <td style="width: 10%;"></td> <td style="width: 10%;"></td> <td style="width: 10%;"></td> <td style="width: 10%;"></td> <td style="width: 10%;"></td> <td style="width: 10%;"></td> <td style="width: 10%;"></td> </tr> <tr> <td></td> <td></td> <td colspan="8" style="text-align: center;"> <table border="1" style="width: 100%; border-collapse: collapse; text-align: center;"> <tr> </tr></table></td></tr></table></td></tr></table></td></tr></table></td></tr></table></td></tr></table></td></tr></table></td></tr></table></td></tr></table></td></tr></table></td></tr></table></td></tr></table></td></tr></table></td></tr></table></td></tr></table></td></tr></table></td></tr></table></td></tr></table></td></tr></table></td></tr></table></td></tr></table></td></tr></table></td></tr></table></td></tr></table></td></tr></table></td></tr></table></td></tr></table></td></tr></table></td></tr></table></td></tr></table></td></tr></table></td></tr></table></td></tr></table></td></tr></table></td></tr></table>
 | | | | | | | | | | | | | | | | | | | | <table border="1" style="width: 100%; border-collapse: collapse; text-align: center;"> <tr> <td style="width: 10%;"></td> <td style="width: 10%;"></td> <td style="width: 10%;"></td> <td style="width: 10%;"></td> <td style="width: 10%;"></td> <td style="width: 10%;"></td> <td style="width: 10%;"></td> <td style="width: 10%;"></td> <td style="width: 10%;"></td> <td style="width: 10%;"></td> </tr> <tr> <td></td> <td></td> <td colspan="8" style="text-align: center;"> <table border="1" style="width: 100%; border-collapse: collapse; text-align: center;"> <tr> <td style="width: 10%;"></td> <td style="width: 10%;"></td> <td style="width: 10%;"></td> <td style="width: 10%;"></td> <td style="width: 10%;"></td> <td style="width: 10%;"></td> <td style="width: 10%;"></td> <td style="width: 10%;"></td> <td style="width: 10%;"></td> <td style="width: 10%;"></td> </tr> <tr> <td></td> <td></td> <td colspan="8" style="text-align: center;"> <table border="1" style="width: 100%; border-collapse: collapse; text-align: center;"> <tr> <td style="width: 10%;"></td> <td style="width: 10%;"></td> <td style="width: 10%;"></td> <td style="width: 10%;"></td> <td style="width: 10%;"></td> <td style="width: 10%;"></td> <td style="width: 10%;"></td> <td style="width: 10%;"></td> <td style="width: 10%;"></td> <td style="width: 10%;"></td> </tr> <tr> <td></td> <td></td> <td colspan="8" style="text-align: center;"> <table border="1" style="width: 100%; border-collapse: collapse; text-align: center;"> <tr> <td style="width: 10%;"></td> <td style="width: 10%;"></td> <td style="width: 10%;"></td> <td style="width: 10%;"></td> <td style="width: 10%;"></td> <td style="width: 10%;"></td> <td style="width: 10%;"></td> <td style="width: 10%;"></td> <td style="width: 10%;"></td> <td style="width: 10%;"></td> </tr> <tr> <td></td> <td></td> <td colspan="8" style="text-align: center;"> <table border="1" style="width: 100%; border-collapse: collapse; text-align: center;"> <tr> <td style="width: 10%;"></td> <td style="width: 10%;"></td> <td style="width: 10%;"></td> <td style="width: 10%;"></td> <td style="width: 10%;"></td> <td style="width: 10%;"></td> <td style="width: 10%;"></td> <td style="width: 10%;"></td> <td style="width: 10%;"></td> <td style="width: 10%;"></td> </tr> <tr> <td></td> <td></td> <td colspan="8" style="text-align: center;"> <table border="1" style="width: 100%; border-collapse: collapse; text-align: center;"> <tr> <td style="width: 10%;"></td> <td style="width: 10%;"></td> <td style="width: 10%;"></td> <td style="width: 10%;"></td> <td style="width: 10%;"></td> <td style="width: 10%;"></td> <td style="width: 10%;"></td> <td style="width: 10%;"></td> <td style="width: 10%;"></td> <td style="width: 10%;"></td> </tr> <tr> <td></td> <td></td> <td colspan="8" style="text-align: center;"> <table border="1" style="width: 100%; border-collapse: collapse; text-align: center;"> <tr> <td style="width: 10%;"></td> <td style="width: 10%;"></td> <td style="width: 10%;"></td> <td style="width: 10%;"></td> <td style="width: 10%;"></td> <td style="width: 10%;"></td> <td style="width: 10%;"></td> <td style="width: 10%;"></td> <td style="width: 10%;"></td> <td style="width: 10%;"></td> </tr> <tr> <td></td> <td></td> <td colspan="8" style="text-align: center;"> <table border="1" style="width: 100%; border-collapse: collapse; text-align: center;"> <tr> <td style="width: 10%;"></td> <td style="width: 10%;"></td> <td style="width: 10%;"></td> <td style="width: 10%;"></td> <td style="width: 10%;"></td> <td style="width: 10%;"></td> <td style="width: 10%;"></td> <td style="width: 10%;"></td> <td style="width: 10%;"></td> <td style="width: 10%;"></td> </tr> <tr> <td></td> <td></td> <td colspan="8" style="text-align: center;"> <table border="1" style="width: 100%; border-collapse: collapse; text-align: center;"> <tr> <td style="width: 10%;"></td> <td style="width: 10%;"></td> <td style="width: 10%;"></td> <td style="width: 10%;"></td> <td style="width: 10%;"></td> <td style="width: 10%;"></td> <td style="width: 10%;"></td> <td style="width: 10%;"></td> <td style="width: 10%;"></td> <td style="width: 10%;"></td> </tr> <tr> <td></td> <td></td> <td colspan="8" style="text-align: center;"> <table border="1" style="width: 100%; border-collapse: collapse; text-align: center;"> <tr> <td style="width: 10%;"></td> <td style="width: 10%;"></td> <td style="width: 10%;"></td> <td style="width: 10%;"></td> <td style="width: 10%;"></td> <td style="width: 10%;"></td> <td style="width: 10%;"></td> <td style="width: 10%;"></td> <td style="width: 10%;"></td> <td style="width: 10%;"></td> </tr> <tr> <td></td> <td></td> <td colspan="8" style="text-align: center;"> <table border="1" style="width: 100%; border-collapse: collapse; text-align: center;"> <tr> <td style="width: 10%;"></td> <td style="width: 10%;"></td> <td style="width: 10%;"></td> <td style="width: 10%;"></td> <td style="width: 10%;"></td> <td style="width: 10%;"></td> <td style="width: 10%;"></td> <td style="width: 10%;"></td> <td style="width: 10%;"></td> <td style="width: 10%;"></td> </tr> <tr> <td></td> <td></td> <td colspan="8" style="text-align: center;"> <table border="1" style="width: 100%; border-collapse: collapse; text-align: center;"> <tr> <td style="width: 10%;"></td> <td style="width: 10%;"></td> <td style="width: 10%;"></td> <td style="width: 10%;"></td> <td style="width: 10%;"></td> <td style="width: 10%;"></td> <td style="width: 10%;"></td> <td style="width: 10%;"></td> <td style="width: 10%;"></td> <td style="width: 10%;"></td> </tr> <tr> <td></td> <td></td> <td colspan="8" style="text-align: center;"> <table border="1" style="width: 100%; border-collapse: collapse; text-align: center;"> <tr> <td style="width: 10%;"></td> <td style="width: 10%;"></td> <td style="width: 10%;"></td> <td style="width: 10%;"></td> <td style="width: 10%;"></td> <td style="width: 10%;"></td> <td style="width: 10%;"></td> <td style="width: 10%;"></td> <td style="width: 10%;"></td> <td style="width: 10%;"></td> </tr> <tr> <td></td> <td></td> <td colspan="8" style="text-align: center;"> <table border="1" style="width: 100%; border-collapse: collapse; text-align: center;"> <tr> <td style="width: 10%;"></td> <td style="width: 10%;"></td> <td style="width: 10%;"></td> <td style="width: 10%;"></td> <td style="width: 10%;"></td> <td style="width: 10%;"></td> <td style="width: 10%;"></td> <td style="width: 10%;"></td> <td style="width: 10%;"></td> <td style="width: 10%;"></td> </tr> <tr> <td></td> <td></td> <td colspan="8" style="text-align: center;"> <table border="1" style="width: 100%; border-collapse: collapse; text-align: center;"> <tr> <td style="width: 10%;"></td> <td style="width: 10%;"></td> <td style="width: 10%;"></td> <td style="width: 10%;"></td> <td style="width: 10%;"></td> <td style="width: 10%;"></td> <td style="width: 10%;"></td> <td style="width: 10%;"></td> <td style="width: 10%;"></td> <td style="width: 10%;"></td> </tr> <tr> <td></td> <td></td> <td colspan="8" style="text-align: center;"> <table border="1" style="width: 100%; border-collapse: collapse; text-align: center;"> <tr> <td style="width: 10%;"></td> <td style="width: 10%;"></td> <td style="width: 10%;"></td> <td style="width: 10%;"></td> <td style="width: 10%;"></td> <td style="width: 10%;"></td> <td style="width: 10%;"></td> <td style="width: 10%;"></td> <td style="width: 10%;"></td> <td style="width: 10%;"></td> </tr> <tr> <td></td> <td></td> <td colspan="8" style="text-align: center;"> <table border="1" style="width: 100%; border-collapse: collapse; text-align: center;"> <tr> <td style="width: 10%;"></td> <td style="width: 10%;"></td> <td style="width: 10%;"></td> <td style="width: 10%;"></td> <td style="width: 10%;"></td> <td style="width: 10%;"></td> <td style="width: 10%;"></td> <td style="width: 10%;"></td> <td style="width: 10%;"></td> <td style="width: 10%;"></td> </tr> <tr> <td></td> <td></td> <td colspan="8" style="text-align: center;"> <table border="1" style="width: 100%; border-collapse: collapse; text-align: center;"> <tr> <td style="width: 10%;"></td> <td style="width: 10%;"></td> <td style="width: 10%;"></td> <td style="width: 10%;"></td> <td style="width: 10%;"></td> <td style="width: 10%;"></td> <td style="width: 10%;"></td> <td style="width: 10%;"></td> <td style="width: 10%;"></td> <td style="width: 10%;"></td> </tr> <tr> <td></td> <td></td> <td colspan="8" style="text-align: center;"> <table border="1" style="width: 100%; border-collapse: collapse; text-align: center;"> <tr> <td style="width: 10%;"></td> <td style="width: 10%;"></td> <td style="width: 10%;"></td> <td style="width: 10%;"></td> <td style="width: 10%;"></td> <td style="width: 10%;"></td> <td
style="width: 10%;"></td> <td style="width: 10%;"></td> <td style="width: 10%;"></td> <td style="width: 10%;"></td> </tr> <tr> <td></td> <td></td> <td colspan="8" style="text-align: center;"> <table border="1" style="width: 100%; border-collapse: collapse; text-align: center;"> <tr> <td style="width: 10%;"></td> <td style="width: 10%;"></td> <td style="width: 10%;"></td> <td style="width: 10%;"></td> <td style="width: 10%;"></td> <td style="width: 10%;"></td> <td style="width: 10%;"></td> <td style="width: 10%;"></td> <td style="width: 10%;"></td> <td style="width: 10%;"></td> </tr> <tr> <td></td> <td></td> <td colspan="8" style="text-align: center;"> <table border="1" style="width: 100%; border-collapse: collapse; text-align: center;"> <tr> <td style="width: 10%;"></td> <td style="width: 10%;"></td> <td style="width: 10%;"></td> <td style="width: 10%;"></td> <td style="width: 10%;"></td> <td style="width: 10%;"></td> <td style="width: 10%;"></td> <td style="width: 10%;"></td> <td style="width: 10%;"></td> <td style="width: 10%;"></td> </tr> <tr> <td></td> <td></td> <td colspan="8" style="text-align: center;"> <table border="1" style="width: 100%; border-collapse: collapse; text-align: center;"> <tr> <td style="width: 10%;"></td> <td style="width: 10%;"></td> <td style="width: 10%;"></td> <td style="width: 10%;"></td> <td style="width: 10%;"></td> <td style="width: 10%;"></td> <td style="width: 10%;"></td> <td style="width: 10%;"></td> <td style="width: 10%;"></td> <td style="width: 10%;"></td> </tr> <tr> <td></td> <td></td> <td colspan="8" style="text-align: center;"> <table border="1" style="width: 100%; border-collapse: collapse; text-align: center;"> <tr> <td style="width: 10%;"></td> <td style="width: 10%;"></td> <td style="width: 10%;"></td> <td style="width: 10%;"></td> <td style="width: 10%;"></td> <td style="width: 10%;"></td> <td style="width: 10%;"></td> <td style="width: 10%;"></td> <td style="width: 10%;"></td> <td style="width: 10%;"></td> </tr> <tr> <td></td> <td></td> <td colspan="8" style="text-align: center;"> <table border="1" style="width: 100%; border-collapse: collapse; text-align: center;"> <tr> <td style="width: 10%;"></td> <td style="width: 10%;"></td> <td style="width: 10%;"></td> <td style="width: 10%;"></td> <td style="width: 10%;"></td> <td style="width: 10%;"></td> <td style="width: 10%;"></td> <td style="width: 10%;"></td> <td style="width: 10%;"></td> <td style="width: 10%;"></td> </tr> <tr> <td></td> <td></td> <td colspan="8" style="text-align: center;"> <table border="1" style="width: 100%; border-collapse: collapse; text-align: center;"> <tr> <td style="width: 10%;"></td> <td style="width: 10%;"></td> <td style="width: 10%;"></td> <td style="width: 10%;"></td> <td style="width: 10%;"></td> <td style="width: 10%;"></td> <td style="width: 10%;"></td> <td style="width: 10%;"></td> <td style="width: 10%;"></td> <td style="width: 10%;"></td> </tr> <tr> <td></td> <td></td> <td colspan="8" style="text-align: center;"> <table border="1" style="width: 100%; border-collapse: collapse; text-align: center;"> <tr> <td style="width: 10%;"></td> <td style="width: 10%;"></td> <td style="width: 10%;"></td> <td style="width: 10%;"></td> <td style="width: 10%;"></td> <td style="width: 10%;"></td> <td style="width: 10%;"></td> <td style="width: 10%;"></td> <td style="width: 10%;"></td> <td style="width: 10%;"></td> </tr> <tr> <td></td> <td></td> <td colspan="8" style="text-align: center;"> <table border="1" style="width: 100%; border-collapse: collapse; text-align: center;"> <tr> <td style="width: 10%;"></td> <td style="width: 10%;"></td> <td style="width: 10%;"></td> <td style="width: 10%;"></td> <td style="width: 10%;"></td> <td style="width: 10%;"></td> <td style="width: 10%;"></td> <td style="width: 10%;"></td> <td style="width: 10%;"></td> <td style="width: 10%;"></td> </tr> <tr> <td></td> <td></td> <td colspan="8" style="text-align: center;"> <table border="1" style="width: 100%; border-collapse: collapse; text-align: center;"> <tr> <td style="width: 10%;"></td> <td style="width: 10%;"></td> <td style="width: 10%;"></td> <td style="width: 10%;"></td> <td style="width: 10%;"></td> <td style="width: 10%;"></td> <td style="width: 10%;"></td> <td style="width: 10%;"></td> <td style="width: 10%;"></td> <td style="width: 10%;"></td> </tr> <tr> <td></td> <td></td> <td colspan="8" style="text-align: center;"> <table border="1" style="width: 100%; border-collapse: collapse; text-align: center;"> <tr> <td style="width: 10%;"></td> <td style="width: 10%;"></td> <td style="width: 10%;"></td> <td style="width: 10%;"></td> <td style="width: 10%;"></td> <td style="width: 10%;"></td> <td style="width: 10%;"></td> <td style="width: 10%;"></td> <td style="width: 10%;"></td> <td style="width: 10%;"></td> </tr> <tr> <td></td> <td></td> <td colspan="8" style="text-align: center;"> <table border="1" style="width: 100%; border-collapse: collapse; text-align: center;"> <tr> <td style="width: 10%;"></td> <td style="width: 10%;"></td> <td style="width: 10%;"></td> <td style="width: 10%;"></td> <td style="width: 10%;"></td> <td style="width: 10%;"></td> <td style="width: 10%;"></td> <td style="width: 10%;"></td> <td style="width: 10%;"></td> <td style="width: 10%;"></td> </tr> <tr> <td></td> <td></td> <td colspan="8" style="text-align: center;"> <table border="1" style="width: 100%; border-collapse: collapse; text-align: center;"> <tr> <td style="width: 10%;"></td> <td style="width: 10%;"></td> <td style="width: 10%;"></td> <td style="width: 10%;"></td> <td style="width: 10%;"></td> <td style="width: 10%;"></td> <td style="width: 10%;"></td> <td style="width: 10%;"></td> <td style="width: 10%;"></td> <td style="width: 10%;"></td> </tr> <tr> <td></td> <td></td> <td colspan="8" style="text-align: center;"> <table border="1" style="width: 100%; border-collapse: collapse; text-align: center;"> <tr> <td style="width: 10%;"></td> <td style="width: 10%;"></td> <td style="width: 10%;"></td> <td style="width: 10%;"></td> <td style="width: 10%;"></td> <td style="width: 10%;"></td> <td style="width: 10%;"></td> <td style="width: 10%;"></td> <td style="width: 10%;"></td> <td style="width: 10%;"></td> </tr> <tr> <td></td> <td></td> <td colspan="8" style="text-align: center;"> <table border="1" style="width: 100%; border-collapse: collapse; text-align: center;"> <tr> <td style="width: 10%;"></td> <td style="width: 10%;"></td> <td style="width: 10%;"></td> <td style="width: 10%;"></td> <td style="width: 10%;"></td> <td style="width: 10%;"></td> <td style="width: 10%;"></td> <td style="width: 10%;"></td> <td style="width: 10%;"></td> <td style="width: 10%;"></td> </tr> <tr> <td></td> <td></td> <td colspan="8" style="text-align: center;"> <table border="1" style="width: 100%; border-collapse: collapse; text-align: center;"> <tr> </tr></table></td></tr></table></td></tr></table></td></tr></table></td></tr></table></td></tr></table></td></tr></table></td></tr></table></td></tr></table></td></tr></table></td></tr></table></td></tr></table></td></tr></table></td></tr></table></td></tr></table></td></tr></table></td></tr></table></td></tr></table></td></tr></table></td></tr></table></td></tr></table></td></tr></table></td></tr></table></td></tr></table></td></tr></table></td></tr></table></td></tr></table></td></tr></table></td></tr></table></td></tr></table></td></tr></table></td></tr></table></td></tr></table></td></tr></table>
 | | | | | | | | | | | | | | | | | | | | <table border="1" style="width: 100%; border-collapse: collapse; text-align: center;"> <tr> <td style="width: 10%;"></td> <td style="width: 10%;"></td> <td style="width: 10%;"></td> <td style="width: 10%;"></td> <td style="width: 10%;"></td> <td style="width: 10%;"></td> <td style="width: 10%;"></td> <td style="width: 10%;"></td> <td style="width: 10%;"></td> <td style="width: 10%;"></td> </tr> <tr> <td></td> <td></td> <td colspan="8" style="text-align: center;"> <table border="1" style="width: 100%; border-collapse: collapse; text-align: center;"> <tr> <td style="width: 10%;"></td> <td style="width: 10%;"></td> <td style="width: 10%;"></td> <td style="width: 10%;"></td> <td style="width: 10%;"></td> <td style="width: 10%;"></td> <td style="width: 10%;"></td> <td style="width: 10%;"></td> <td style="width: 10%;"></td> <td style="width: 10%;"></td> </tr> <tr> <td></td> <td></td> <td colspan="8" style="text-align: center;"> <table border="1" style="width: 100%; border-collapse: collapse; text-align: center;"> <tr> <td style="width: 10%;"></td> <td style="width: 10%;"></td> <td style="width: 10%;"></td> <td style="width: 10%;"></td> <td style="width: 10%;"></td> <td style="width: 10%;"></td> <td style="width: 10%;"></td> <td style="width: 10%;"></td> <td style="width: 10%;"></td> <td style="width: 10%;"></td> </tr> <tr> <td></td> <td></td> <td colspan="8" style="text-align: center;"> <table border="1" style="width: 100%; border-collapse: collapse; text-align: center;"> <tr> <td style="width: 10%;"></td> <td style="width: 10%;"></td> <td style="width: 10%;"></td> <td style="width: 10%;"></td> <td style="width: 10%;"></td> <td style="width: 10%;"></td> <td style="width: 10%;"></td> <td style="width: 10%;"></td> <td style="width: 10%;"></td> <td style="width: 10%;"></td> </tr> <tr> <td></td> <td></td> <td colspan="8" style="text-align: center;"> <table border="1" style="width: 100%; border-collapse: collapse; text-align: center;"> <tr> <td style="width: 10%;"></td> <td style="width: 10%;"></td> <td style="width: 10%;"></td> <td style="width: 10%;"></td> <td style="width: 10%;"></td> <td style="width: 10%;"></td> <td style="width: 10%;"></td> <td style="width: 10%;"></td> <td style="width: 10%;"></td> <td style="width: 10%;"></td> </tr> <tr> <td></td> <td></td> <td colspan="8" style="text-align: center;"> <table border="1" style="width: 100%; border-collapse: collapse; text-align: center;"> <tr> <td style="width: 10%;"></td> <td style="width: 10%;"></td> <td style="width: 10%;"></td> <td style="width: 10%;"></td> <td style="width: 10%;"></td> <td style="width: 10%;"></td> <td style="width: 10%;"></td> <td style="width: 10%;"></td> <td style="width: 10%;"></td> <td style="width: 10%;"></td> </tr> <tr> <td></td> <td></td> <td colspan="8" style="text-align: center;"> <table border="1" style="width: 100%; border-collapse: collapse; text-align: center;"> <tr> <td style="width: 10%;"></td> <td style="width: 10%;"></td> <td style="width: 10%;"></td> <td style="width: 10%;"></td> <td style="width: 10%;"></td> <td style="width: 10%;"></td> <td style="width: 10%;"></td> <td style="width: 10%;"></td> <td style="width: 10%;"></td> <td style="width: 10%;"></td> </tr> <tr> <td></td> <td></td> <td colspan="8" style="text-align: center;"> <table border="1" style="width: 100%; border-collapse: collapse; text-align: center;"> <tr> <td style="width: 10%;"></td> <td style="width: 10%;"></td> <td style="width: 10%;"></td> <td style="width: 10%;"></td> <td style="width: 10%;"></td> <td style="width: 10%;"></td> <td style="width: 10%;"></td> <td style="width: 10%;"></td> <td style="width: 10%;"></td> <td style="width: 10%;"></td> </tr> <tr> <td></td> <td></td> <td colspan="8" style="text-align: center;"> <table border="1" style="width: 100%; border-collapse: collapse; text-align: center;"> <tr> <td style="width: 10%;"></td> <td style="width: 10%;"></td> <td style="width: 10%;"></td> <td style="width: 10%;"></td> <td style="width: 10%;"></td> <td style="width: 10%;"></td> <td style="width: 10%;"></td> <td style="width: 10%;"></td> <td style="width: 10%;"></td> <td style="width: 10%;"></td> </tr> <tr> <td></td> <td></td> <td colspan="8" style="text-align: center;"> <table border="1" style="width: 100%; border-collapse: collapse; text-align: center;"> <tr> <td style="width: 10%;"></td> <td style="width: 10%;"></td> <td style="width: 10%;"></td> <td style="width: 10%;"></td> <td style="width: 10%;"></td> <td style="width: 10%;"></td> <td style="width: 10%;"></td> <td style="width: 10%;"></td> <td style="width: 10%;"></td> <td style="width: 10%;"></td> </tr> <tr> <td></td> <td></td> <td colspan="8" style="text-align: center;"> <table border="1" style="width: 100%; border-collapse: collapse; text-align: center;"> <tr> <td style="width: 10%;"></td> <td style="width: 10%;"></td> <td style="width: 10%;"></td> <td style="width: 10%;"></td> <td style="width: 10%;"></td> <td style="width: 10%;"></td> <td style="width: 10%;"></td> <td style="width: 10%;"></td> <td style="width: 10%;"></td> <td style="width: 10%;"></td> </tr> <tr> <td></td> <td></td> <td colspan="8" style="text-align: center;"> <table border="1" style="width: 100%; border-collapse: collapse; text-align: center;"> <tr> <td style="width: 10%;"></td> <td style="width: 10%;"></td> <td style="width: 10%;"></td> <td style="width: 10%;"></td> <td style="width: 10%;"></td> <td style="width: 10%;"></td> <td style="width: 10%;"></td> <td style="width: 10%;"></td> <td style="width: 10%;"></td> <td style="width: 10%;"></td> </tr> <tr> <td></td> <td></td> <td colspan="8" style="text-align: center;"> <table border="1" style="width: 100%; border-collapse: collapse; text-align: center;"> <tr> <td style="width: 10%;"></td> <td style="width: 10%;"></td> <td style="width: 10%;"></td> <td style="width: 10%;"></td> <td style="width: 10%;"></td> <td style="width: 10%;"></td> <td style="width: 10%;"></td> <td style="width: 10%;"></td> <td style="width: 10%;"></td> <td style="width: 10%;"></td> </tr> <tr> <td></td> <td></td> <td colspan="8" style="text-align: center;"> <table border="1" style="width: 100%; border-collapse: collapse; text-align: center;"> <tr> <td style="width: 10%;"></td> <td style="width: 10%;"></td> <td style="width: 10%;"></td> <td style="width: 10%;"></td> <td style="width: 10%;"></td> <td style="width: 10%;"></td> <td style="width: 10%;"></td> <td style="width: 10%;"></td> <td style="width: 10%;"></td> <td style="width: 10%;"></td> </tr> <tr> <td></td> <td></td> <td colspan="8" style="text-align: center;"> <table border="1" style="width: 100%; border-collapse: collapse; text-align: center;"> <tr> <td style="width:
10%;"></td> <td style="width: 10%;"></td> <td style="width: 10%;"></td> <td style="width: 10%;"></td> <td style="width: 10%;"></td> <td style="width: 10%;"></td> <td style="width: 10%;"></td> <td style="width: 10%;"></td> <td style="width: 10%;"></td> <td style="width: 10%;"></td> </tr> <tr> <td></td> <td></td> <td colspan="8" style="text-align: center;"> <table border="1" style="width: 100%; border-collapse: collapse; text-align: center;"> <tr> <td style="width: 10%;"></td> <td style="width: 10%;"></td> <td style="width: 10%;"></td> <td style="width: 10%;"></td> <td style="width: 10%;"></td> <td style="width: 10%;"></td> <td style="width: 10%;"></td> <td style="width: 10%;"></td> <td style="width: 10%;"></td> <td style="width: 10%;"></td> </tr> <tr> <td></td> <td></td> <td colspan="8" style="text-align: center;"> <table border="1" style="width: 100%; border-collapse: collapse; text-align: center;"> <tr> <td style="width: 10%;"></td> <td style="width: 10%;"></td> <td style="width: 10%;"></td> <td style="width: 10%;"></td> <td style="width: 10%;"></td> <td style="width: 10%;"></td> <td style="width: 10%;"></td> <td style="width: 10%;"></td> <td style="width: 10%;"></td> <td style="width: 10%;"></td> </tr> <tr> <td></td> <td></td> <td colspan="8" style="text-align: center;"> <table border="1" style="width: 100%; border-collapse: collapse; text-align: center;"> <tr> <td style="width: 10%;"></td> <td style="width: 10%;"></td> <td style="width: 10%;"></td> <td style="width: 10%;"></td> <td style="width: 10%;"></td> <td style="width: 10%;"></td> <td style="width: 10%;"></td> <td style="width: 10%;"></td> <td style="width: 10%;"></td> <td style="width: 10%;"></td> </tr> <tr> <td></td> <td></td> <td colspan="8" style="text-align: center;"> <table border="1" style="width: 100%; border-collapse: collapse; text-align: center;"> <tr> <td style="width: 10%;"></td> <td style="width: 10%;"></td> <td style="width: 10%;"></td> <td style="width: 10%;"></td> <td style="width: 10%;"></td> <td style="width: 10%;"></td> <td style="width: 10%;"></td> <td style="width: 10%;"></td> <td style="width: 10%;"></td> <td style="width: 10%;"></td> </tr> <tr> <td></td> <td></td> <td colspan="8" style="text-align: center;"> <table border="1" style="width: 100%; border-collapse: collapse; text-align: center;"> <tr> <td style="width: 10%;"></td> <td style="width: 10%;"></td> <td style="width: 10%;"></td> <td style="width: 10%;"></td> <td style="width: 10%;"></td> <td style="width: 10%;"></td> <td style="width: 10%;"></td> <td style="width: 10%;"></td> <td style="width: 10%;"></td> <td style="width: 10%;"></td> </tr> <tr> <td></td> <td></td> <td colspan="8" style="text-align: center;"> <table border="1" style="width: 100%; border-collapse: collapse; text-align: center;"> <tr> <td style="width: 10%;"></td> <td style="width: 10%;"></td> <td style="width: 10%;"></td> <td style="width: 10%;"></td> <td style="width: 10%;"></td> <td style="width: 10%;"></td> <td style="width: 10%;"></td> <td style="width: 10%;"></td> <td style="width: 10%;"></td> <td style="width: 10%;"></td> </tr> <tr> <td></td> <td></td> <td colspan="8" style="text-align: center;"> <table border="1" style="width: 100%; border-collapse: collapse; text-align: center;"> <tr> <td style="width: 10%;"></td> <td style="width: 10%;"></td> <td style="width: 10%;"></td> <td style="width: 10%;"></td> <td style="width: 10%;"></td> <td style="width: 10%;"></td> <td style="width: 10%;"></td> <td style="width: 10%;"></td> <td style="width: 10%;"></td> <td style="width: 10%;"></td> </tr> <tr> <td></td> <td></td> <td colspan="8" style="text-align: center;"> <table border="1" style="width: 100%; border-collapse: collapse; text-align: center;"> <tr> <td style="width: 10%;"></td> <td style="width: 10%;"></td> <td style="width: 10%;"></td> <td style="width: 10%;"></td> <td style="width: 10%;"></td> <td style="width: 10%;"></td> <td style="width: 10%;"></td> <td style="width: 10%;"></td> <td style="width: 10%;"></td> <td style="width: 10%;"></td> </tr> <tr> <td></td> <td></td> <td colspan="8" style="text-align: center;"> <table border="1" style="width: 100%; border-collapse: collapse; text-align: center;"> <tr> <td style="width: 10%;"></td> <td style="width: 10%;"></td> <td style="width: 10%;"></td> <td style="width: 10%;"></td> <td style="width: 10%;"></td> <td style="width: 10%;"></td> <td style="width: 10%;"></td> <td style="width: 10%;"></td> <td style="width: 10%;"></td> <td style="width: 10%;"></td> </tr> <tr> <td></td> <td></td> <td colspan="8" style="text-align: center;"> <table border="1" style="width: 100%; border-collapse: collapse; text-align: center;"> <tr> <td style="width: 10%;"></td> <td style="width: 10%;"></td> <td style="width: 10%;"></td> <td style="width: 10%;"></td> <td style="width: 10%;"></td> <td style="width: 10%;"></td> <td style="width: 10%;"></td> <td style="width: 10%;"></td> <td style="width: 10%;"></td> <td style="width: 10%;"></td> </tr> <tr> <td></td> <td></td> <td colspan="8" style="text-align: center;"> <table border="1" style="width: 100%; border-collapse: collapse; text-align: center;"> <tr> <td style="width: 10%;"></td> <td style="width: 10%;"></td> <td style="width: 10%;"></td> <td style="width: 10%;"></td> <td style="width: 10%;"></td> <td style="width: 10%;"></td> <td style="width: 10%;"></td> <td style="width: 10%;"></td> <td style="width: 10%;"></td> <td style="width: 10%;"></td> </tr> <tr> <td></td> <td></td> <td colspan="8" style="text-align: center;"> <table border="1" style="width: 100%; border-collapse: collapse; text-align: center;"> <tr> <td style="width: 10%;"></td> <td style="width: 10%;"></td> <td style="width: 10%;"></td> <td style="width: 10%;"></td> <td style="width: 10%;"></td> <td style="width: 10%;"></td> <td style="width: 10%;"></td> <td style="width: 10%;"></td> <td style="width: 10%;"></td> <td style="width: 10%;"></td> </tr> <tr> <td></td> <td></td> <td colspan="8" style="text-align: center;"> <table border="1" style="width: 100%; border-collapse: collapse; text-align: center;"> <tr> <td style="width: 10%;"></td> <td style="width: 10%;"></td> <td style="width: 10%;"></td> <td style="width: 10%;"></td> <td style="width: 10%;"></td> <td style="width: 10%;"></td> <td style="width: 10%;"></td> <td style="width: 10%;"></td> <td style="width: 10%;"></td> <td style="width: 10%;"></td> </tr> <tr> <td></td> <td></td> <td colspan="8" style="text-align: center;"> <table border="1" style="width: 100%; border-collapse: collapse; text-align: center;"> <tr> <td style="width: 10%;"></td> <td style="width: 10%;"></td> <td style="width: 10%;"></td> <td style="width: 10%;"></td> <td style="width: 10%;"></td> <td style="width: 10%;"></td> <td style="width: 10%;"></td> <td style="width: 10%;"></td> <td style="width: 10%;"></td> <td style="width: 10%;"></td> </tr> <tr> <td></td> <td></td> <td colspan="8" style="text-align: center;"> <table border="1" style="width: 100%; border-collapse: collapse; text-align: center;"> <tr> <td style="width: 10%;"></td> <td style="width: 10%;"></td> <td style="width: 10%;"></td> <td style="width: 10%;"></td> <td style="width: 10%;"></td> <td style="width: 10%;"></td> <td style="width: 10%;"></td> <td style="width: 10%;"></td> <td style="width: 10%;"></td> <td style="width: 10%;"></td> </tr> <tr> <td></td> <td></td> <td colspan="8" style="text-align: center;"> <table border="1" style="width: 100%; border-collapse: collapse; text-align: center;"> <tr> <td style="width: 10%;"></td> <td style="width: 10%;"></td> <td style="width: 10%;"></td> <td style="width: 10%;"></td> <td style="width: 10%;"></td> <td style="width: 10%;"></td> <td style="width: 10%;"></td> <td style="width: 10%;"></td> <td style="width: 10%;"></td> <td style="width: 10%;"></td> </tr> <tr> <td></td> <td></td> <td colspan="8" style="text-align: center;"> <table border="1" style="width: 100%; border-collapse: collapse; text-align: center;"> <tr> <td style="width: 10%;"></td> <td style="width: 10%;"></td> <td style="width: 10%;"></td> <td style="width: 10%;"></td> <td style="width: 10%;"></td> <td style="width: 10%;"></td> <td style="width: 10%;"></td> <td style="width: 10%;"></td> <td style="width: 10%;"></td> <td style="width: 10%;"></td> </tr> <tr> <td></td> <td></td> <td colspan="8" style="text-align: center;"> <table border="1" style="width: 100%; border-collapse: collapse; text-align: center;"> <tr> </tr></table></td></tr></table></td></tr></table></td></tr></table></td></tr></table></td></tr></table></td></tr></table></td></tr></table></td></tr></table></td></tr></table></td></tr></table></td></tr></table></td></tr></table></td></tr></table></td></tr></table></td></tr></table></td></tr></table></td></tr></table></td></tr></table></td></tr></table></td></tr></table></td></tr></table></td></tr></table></td></tr></table></td></tr></table></td></tr></table></td></tr></table></td></tr></table></td></tr></table></td></tr></table></td></tr></table></td></tr></table></td></tr></table>
 | | | | | | | | | | | | | | | | | | | | <table border="1" style="width: 100%; border-collapse: collapse; text-align: center;"> <tr> <td style="width: 10%;"></td> <td style="width: 10%;"></td> <td style="width: 10%;"></td> <td style="width: 10%;"></td> <td style="width: 10%;"></td> <td style="width: 10%;"></td> <td style="width: 10%;"></td> <td style="width: 10%;"></td> <td style="width: 10%;"></td> <td style="width: 10%;"></td> </tr> <tr> <td></td> <td></td> <td colspan="8" style="text-align: center;"> <table border="1" style="width: 100%; border-collapse: collapse; text-align: center;"> <tr> <td style="width: 10%;"></td> <td style="width: 10%;"></td> <td style="width: 10%;"></td> <td style="width: 10%;"></td> <td style="width: 10%;"></td> <td style="width: 10%;"></td> <td style="width: 10%;"></td> <td style="width: 10%;"></td> <td style="width: 10%;"></td> <td style="width: 10%;"></td> </tr> <tr> <td></td> <td></td> <td colspan="8" style="text-align: center;"> <table border="1" style="width: 100%; border-collapse: collapse; text-align: center;"> <tr> <td style="width: 10%;"></td> <td style="width: 10%;"></td> <td style="width: 10%;"></td> <td style="width: 10%;"></td> <td style="width: 10%;"></td> <td style="width: 10%;"></td> <td style="width: 10%;"></td> <td style="width: 10%;"></td> <td style="width: 10%;"></td> <td style="width: 10%;"></td> </tr> <tr> <td></td> <td></td> <td colspan="8" style="text-align: center;"> <table border="1" style="width: 100%; border-collapse: collapse; text-align: center;"> <tr> <td style="width: 10%;"></td> <td style="width: 10%;"></td> <td style="width: 10%;"></td> <td style="width: 10%;"></td> <td style="width: 10%;"></td> <td style="width: 10%;"></td> <td style="width: 10%;"></td> <td style="width: 10%;"></td> <td style="width: 10%;"></td> <td style="width: 10%;"></td> </tr> <tr> <td></td> <td></td> <td colspan="8" style="text-align: center;"> <table border="1" style="width: 100%; border-collapse: collapse; text-align: center;"> <tr> <td style="width: 10%;"></td> <td style="width: 10%;"></td> <td style="width: 10%;"></td> <td style="width: 10%;"></td> <td style="width: 10%;"></td> <td style="width: 10%;"></td> <td style="width: 10%;"></td> <td style="width: 10%;"></td> <td style="width: 10%;"></td> <td style="width: 10%;"></td> </tr> <tr> <td></td> <td></td> <td colspan="8" style="text-align: center;"> <table border="1" style="width: 100%; border-collapse: collapse; text-align: center;"> <tr> <td style="width: 10%;"></td> <td style="width: 10%;"></td> <td style="width: 10%;"></td> <td style="width: 10%;"></td> <td style="width: 10%;"></td> <td style="width: 10%;"></td> <td style="width: 10%;"></td> <td style="width: 10%;"></td> <td style="width: 10%;"></td> <td style="width: 10%;"></td> </tr> <tr> <td></td> <td></td> <td colspan="8" style="text-align: center;"> <table border="1" style="width: 100%; border-collapse: collapse; text-align: center;"> <tr> <td style="width: 10%;"></td> <td style="width: 10%;"></td> <td style="width: 10%;"></td> <td style="width: 10%;"></td> <td style="width: 10%;"></td> <td style="width: 10%;"></td> <td style="width: 10%;"></td> <td style="width: 10%;"></td> <td style="width: 10%;"></td> <td style="width: 10%;"></td> </tr> <tr> <td></td> <td></td> <td colspan="8" style="text-align: center;"> <table border="1" style="width: 100%; border-collapse: collapse; text-align: center;"> <tr> <td style="width: 10%;"></td> <td style="width: 10%;"></td> <td style="width: 10%;"></td> <td style="width: 10%;"></td> <td style="width: 10%;"></td> <td style="width: 10%;"></td> <td style="width: 10%;"></td> <td style="width: 10%;"></td> <td style="width: 10%;"></td> <td style="width: 10%;"></td> </tr> <tr> <td></td> <td></td> <td colspan="8" style="text-align: center;"> <table border="1" style="width: 100%; border-collapse: collapse; text-align: center;"> <tr> <td style="width: 10%;"></td> <td style="width: 10%;"></td> <td style="width: 10%;"></td> <td style="width: 10%;"></td> <td style="width: 10%;"></td> <td style="width: 10%;"></td> <td style="width: 10%;"></td> <td style="width: 10%;"></td> <td style="width: 10%;"></td> <td style="width: 10%;"></td> </tr> <tr> <td></td> <td></td> <td colspan="8" style="text-align: center;"> <table border="1" style="width: 100%; border-collapse: collapse; text-align: center;"> <tr> <td style="width: 10%;"></td> <td style="width: 10%;"></td> <td style="width: 10%;"></td> <td style="width: 10%;"></td> <td style="width: 10%;"></td> <td style="width: 10%;"></td> <td style="width: 10%;"></td> <td style="width: 10%;"></td> <td style="width: 10%;"></td> <td style="width: 10%;"></td> </tr> <tr> <td></td> <td></td> <td colspan="8" style="text-align: center;"> <table border="1" style="width: 100%; border-collapse: collapse; text-align: center;"> <tr> <td style="width: 10%;"></td> <td style="width: 10%;"></td> <td style="width: 10%;"></td> <td style="width: 10%;"></td> <td style="width: 10%;"></td> <td style="width: 10%;"></td> <td style="width: 10%;"></td> <td style="width: 10%;"></td> <td style="width: 10%;"></td> <td style="width: 10%;"></td> </tr> <tr> <td></td> <td></td> <td
colspan="8" style="text-align: center;"> <table border="1" style="width: 100%; border-collapse: collapse; text-align: center;"> <tr> <td style="width: 10%;"></td> <td style="width: 10%;"></td> <td style="width: 10%;"></td> <td style="width: 10%;"></td> <td style="width: 10%;"></td> <td style="width: 10%;"></td> <td style="width: 10%;"></td> <td style="width: 10%;"></td> <td style="width: 10%;"></td> <td style="width: 10%;"></td> </tr> <tr> <td></td> <td></td> <td colspan="8" style="text-align: center;"> <table border="1" style="width: 100%; border-collapse: collapse; text-align: center;"> <tr> <td style="width: 10%;"></td> <td style="width: 10%;"></td> <td style="width: 10%;"></td> <td style="width: 10%;"></td> <td style="width: 10%;"></td> <td style="width: 10%;"></td> <td style="width: 10%;"></td> <td style="width: 10%;"></td> <td style="width: 10%;"></td> <td style="width: 10%;"></td> </tr> <tr> <td></td> <td></td> <td colspan="8" style="text-align: center;"> <table border="1" style="width: 100%; border-collapse: collapse; text-align: center;"> <tr> <td style="width: 10%;"></td> <td style="width: 10%;"></td> <td style="width: 10%;"></td> <td style="width: 10%;"></td> <td style="width: 10%;"></td> <td style="width: 10%;"></td> <td style="width: 10%;"></td> <td style="width: 10%;"></td> <td style="width: 10%;"></td> <td style="width: 10%;"></td> </tr> <tr> <td></td> <td></td> <td colspan="8" style="text-align: center;"> <table border="1" style="width: 100%; border-collapse: collapse; text-align: center;"> <tr> <td style="width: 10%;"></td> <td style="width: 10%;"></td> <td style="width: 10%;"></td> <td style="width: 10%;"></td> <td style="width: 10%;"></td> <td style="width: 10%;"></td> <td style="width: 10%;"></td> <td style="width: 10%;"></td> <td style="width: 10%;"></td> <td style="width: 10%;"></td> </tr> <tr> <td></td> <td></td> <td colspan="8" style="text-align: center;"> <table border="1" style="width: 100%; border-collapse: collapse; text-align: center;"> <tr> <td style="width: 10%;"></td> <td style="width: 10%;"></td> <td style="width: 10%;"></td> <td style="width: 10%;"></td> <td style="width: 10%;"></td> <td style="width: 10%;"></td> <td style="width: 10%;"></td> <td style="width: 10%;"></td> <td style="width: 10%;"></td> <td style="width: 10%;"></td> </tr> <tr> <td></td> <td></td> <td colspan="8" style="text-align: center;"> <table border="1" style="width: 100%; border-collapse: collapse; text-align: center;"> <tr> <td style="width: 10%;"></td> <td style="width: 10%;"></td> <td style="width: 10%;"></td> <td style="width: 10%;"></td> <td style="width: 10%;"></td> <td style="width: 10%;"></td> <td style="width: 10%;"></td> <td style="width: 10%;"></td> <td style="width: 10%;"></td> <td style="width: 10%;"></td> </tr> <tr> <td></td> <td></td> <td colspan="8" style="text-align: center;"> <table border="1" style="width: 100%; border-collapse: collapse; text-align: center;"> <tr> <td style="width: 10%;"></td> <td style="width: 10%;"></td> <td style="width: 10%;"></td> <td style="width: 10%;"></td> <td style="width: 10%;"></td> <td style="width: 10%;"></td> <td style="width: 10%;"></td> <td style="width: 10%;"></td> <td style="width: 10%;"></td> <td style="width: 10%;"></td> </tr> <tr> <td></td> <td></td> <td colspan="8" style="text-align: center;"> <table border="1" style="width: 100%; border-collapse: collapse; text-align: center;"> <tr> <td style="width: 10%;"></td> <td style="width: 10%;"></td> <td style="width: 10%;"></td> <td style="width: 10%;"></td> <td style="width: 10%;"></td> <td style="width: 10%;"></td> <td style="width: 10%;"></td> <td style="width: 10%;"></td> <td style="width: 10%;"></td> <td style="width: 10%;"></td> </tr> <tr> <td></td> <td></td> <td colspan="8" style="text-align: center;"> <table border="1" style="width: 100%; border-collapse: collapse; text-align: center;"> <tr> <td style="width: 10%;"></td> <td style="width: 10%;"></td> <td style="width: 10%;"></td> <td style="width: 10%;"></td> <td style="width: 10%;"></td> <td style="width: 10%;"></td> <td style="width: 10%;"></td> <td style="width: 10%;"></td> <td style="width: 10%;"></td> <td style="width: 10%;"></td> </tr> <tr> <td></td> <td></td> <td colspan="8" style="text-align: center;"> <table border="1" style="width: 100%; border-collapse: collapse; text-align: center;"> <tr> <td style="width: 10%;"></td> <td style="width: 10%;"></td> <td style="width: 10%;"></td> <td style="width: 10%;"></td> <td style="width: 10%;"></td> <td style="width: 10%;"></td> <td style="width: 10%;"></td> <td style="width: 10%;"></td> <td style="width: 10%;"></td> <td style="width: 10%;"></td> </tr> <tr> <td></td> <td></td> <td colspan="8" style="text-align: center;"> <table border="1" style="width: 100%; border-collapse: collapse; text-align: center;"> <tr> <td style="width: 10%;"></td> <td style="width: 10%;"></td> <td style="width: 10%;"></td> <td style="width: 10%;"></td> <td style="width: 10%;"></td> <td style="width: 10%;"></td> <td style="width: 10%;"></td> <td style="width: 10%;"></td> <td style="width: 10%;"></td> <td style="width: 10%;"></td> </tr> <tr> <td></td> <td></td> <td colspan="8" style="text-align: center;"> <table border="1" style="width: 100%; border-collapse: collapse; text-align: center;"> <tr> <td style="width: 10%;"></td> <td style="width: 10%;"></td> <td style="width: 10%;"></td> <td style="width: 10%;"></td> <td style="width: 10%;"></td> <td style="width: 10%;"></td> <td style="width: 10%;"></td> <td style="width: 10%;"></td> <td style="width: 10%;"></td> <td style="width: 10%;"></td> </tr> <tr> <td></td> <td></td> <td colspan="8" style="text-align: center;"> <table border="1" style="width: 100%; border-collapse: collapse; text-align: center;"> <tr> <td style="width: 10%;"></td> <td style="width: 10%;"></td> <td style="width: 10%;"></td> <td style="width: 10%;"></td> <td style="width: 10%;"></td> <td style="width: 10%;"></td> <td style="width: 10%;"></td> <td style="width: 10%;"></td> <td style="width: 10%;"></td> <td style="width: 10%;"></td> </tr> <tr> <td></td> <td></td> <td colspan="8" style="text-align: center;"> <table border="1" style="width: 100%; border-collapse: collapse; text-align: center;"> <tr> <td style="width: 10%;"></td> <td style="width: 10%;"></td> <td style="width: 10%;"></td> <td style="width: 10%;"></td> <td style="width: 10%;"></td> <td style="width: 10%;"></td> <td style="width: 10%;"></td> <td style="width: 10%;"></td> <td style="width: 10%;"></td> <td style="width: 10%;"></td> </tr> <tr> <td></td> <td></td> <td colspan="8" style="text-align: center;"> <table border="1" style="width: 100%; border-collapse: collapse; text-align: center;"> <tr> <td style="width: 10%;"></td> <td style="width: 10%;"></td> <td style="width: 10%;"></td> <td style="width: 10%;"></td> <td style="width: 10%;"></td> <td style="width: 10%;"></td> <td style="width: 10%;"></td> <td style="width: 10%;"></td> <td style="width: 10%;"></td> <td style="width: 10%;"></td> </tr> <tr> <td></td> <td></td> <td colspan="8" style="text-align: center;"> <table border="1" style="width: 100%; border-collapse: collapse; text-align: center;"> <tr> <td style="width: 10%;"></td> <td style="width: 10%;"></td> <td style="width: 10%;"></td> <td style="width: 10%;"></td> <td style="width: 10%;"></td> <td style="width: 10%;"></td> <td style="width: 10%;"></td> <td style="width: 10%;"></td> <td style="width: 10%;"></td> <td style="width: 10%;"></td> </tr> <tr> <td></td> <td></td> <td colspan="8" style="text-align: center;"> <table border="1" style="width: 100%; border-collapse: collapse; text-align: center;"> <tr> <td style="width: 10%;"></td> <td style="width: 10%;"></td> <td style="width: 10%;"></td> <td style="width: 10%;"></td> <td style="width: 10%;"></td> <td style="width: 10%;"></td> <td style="width: 10%;"></td> <td style="width: 10%;"></td> <td style="width: 10%;"></td> <td style="width: 10%;"></td> </tr> <tr> <td></td> <td></td> <td colspan="8" style="text-align: center;"> <table border="1" style="width: 100%; border-collapse: collapse; text-align: center;"> <tr> <td style="width: 10%;"></td> <td style="width: 10%;"></td> <td style="width: 10%;"></td> <td style="width: 10%;"></td> <td style="width: 10%;"></td> <td style="width: 10%;"></td> <td style="width: 10%;"></td> <td style="width: 10%;"></td> <td style="width: 10%;"></td> <td style="width: 10%;"></td> </tr> <tr> <td></td> <td></td> <td colspan="8" style="text-align: center;"> <table border="1" style="width: 100%; border-collapse: collapse; text-align: center;"> <tr> <td style="width: 10%;"></td> <td style="width: 10%;"></td> <td style="width: 10%;"></td> <td style="width: 10%;"></td> <td style="width: 10%;"></td> <td style="width: 10%;"></td> <td style="width: 10%;"></td> <td style="width: 10%;"></td> <td style="width: 10%;"></td> <td style="width: 10%;"></td> </tr> <tr> <td></td> <td></td> <td colspan="8" style="text-align: center;"> <table border="1" style="width: 100%; border-collapse: collapse; text-align: center;"> <tr> <td style="width: 10%;"></td> <td style="width: 10%;"></td> <td style="width: 10%;"></td> <td style="width: 10%;"></td> <td style="width: 10%;"></td> <td style="width: 10%;"></td> <td style="width: 10%;"></td> <td style="width: 10%;"></td> <td style="width: 10%;"></td> <td style="width: 10%;"></td> </tr> <tr> <td></td> <td></td> <td colspan="8" style="text-align: center;"> <table border="1" style="width: 100%; border-collapse: collapse; text-align: center;"> <tr>
</tr></table></td></tr></table></td></tr></table></td></tr></table></td></tr></table></td></tr></table></td></tr></table></td></tr></table></td></tr></table></td></tr></table></td></tr></table></td></tr></table></td></tr></table></td></tr></table></td></tr></table></td></tr></table></td></tr></table></td></tr></table></td></tr></table></td></tr></table></td></tr></table></td></tr></table></td></tr></table></td></tr></table></td></tr></table></td></tr></table></td></tr></table></td></tr></table></td></tr></table></td></tr></table></td></tr></table></td></tr></table> | | | | | | | | | | | | | | | | | | | | <table border="1" style="width: 100%; border-collapse: collapse; text-align: center;"> <tr> <td style="width: 10%;"></td> <td style="width: 10%;"></td> <td style="width: 10%;"></td> <td style="width: 10%;"></td> <td style="width: 10%;"></td> <td style="width: 10%;"></td> <td style="width: 10%;"></td> <td style="width: 10%;"></td> <td style="width: 10%;"></td> <td style="width: 10%;"></td> </tr> <tr> <td></td> <td></td> <td colspan="8" style="text-align: center;"> <table border="1" style="width: 100%; border-collapse: collapse; text-align: center;"> <tr> <td style="width: 10%;"></td> <td style="width: 10%;"></td> <td style="width: 10%;"></td> <td style="width: 10%;"></td> <td style="width: 10%;"></td> <td style="width: 10%;"></td> <td style="width: 10%;"></td> <td style="width: 10%;"></td> <td style="width: 10%;"></td> <td style="width: 10%;"></td> </tr> <tr> <td></td> <td></td> <td colspan="8" style="text-align: center;"> <table border="1" style="width: 100%; border-collapse: collapse; text-align: center;"> <tr> <td style="width: 10%;"></td> <td style="width: 10%;"></td> <td style="width: 10%;"></td> <td style="width: 10%;"></td> <td style="width: 10%;"></td> <td style="width: 10%;"></td> <td style="width: 10%;"></td> <td style="width: 10%;"></td> <td style="width: 10%;"></td> <td style="width: 10%;"></td> </tr> <tr> <td></td> <td></td> <td colspan="8" style="text-align: center;"> <table border="1" style="width: 100%; border-collapse: collapse; text-align: center;"> <tr> <td style="width: 10%;"></td> <td style="width: 10%;"></td> <td style="width: 10%;"></td> <td style="width: 10%;"></td> <td style="width: 10%;"></td> <td style="width: 10%;"></td> <td style="width: 10%;"></td> <td style="width: 10%;"></td> <td style="width: 10%;"></td> <td style="width: 10%;"></td> </tr> <tr> <td></td> <td></td> <td colspan="8" style="text-align: center;"> <table border="1" style="width: 100%; border-collapse: collapse; text-align: center;"> <tr> <td style="width: 10%;"></td> <td style="width: 10%;"></td> <td style="width: 10%;"></td> <td style="width: 10%;"></td> <td style="width: 10%;"></td> <td style="width: 10%;"></td> <td style="width: 10%;"></td> <td style="width: 10%;"></td> <td style="width: 10%;"></td> <td style="width: 10%;"></td> </tr> <tr> <td></td> <td></td> <td colspan="8" style="text-align: center;"> <table border="1" style="width: 100%; border-collapse: collapse; text-align: center;"> <tr> <td style="width: 10%;"></td> <td style="width: 10%;"></td> <td style="width: 10%;"></td> <td style="width: 10%;"></td> <td style="width: 10%;"></td> <td style="width: 10%;"></td> <td style="width: 10%;"></td> <td style="width: 10%;"></td> <td style="width: 10%;"></td> <td style="width: 10%;"></td> </tr> <tr> <td></td> <td></td> <td colspan="8" style="text-align: center;"> <table border="1" style="width: 100%; border-collapse: collapse; text-align: center;"> <tr> <td style="width: 10%;"></td> <td style="width: 10%;"></td> <td style="width: 10%;"></td> <td style="width: 10%;"></td> <td style="width: 10%;"></td> <td style="width: 10%;"></td> <td style="width: 10%;"></td> <td style="width: 10%;"></td> <td style="width: 10%;"></td> <td style="width: 10%;"></td> </tr> <tr> <td></td> <td></td> <td colspan="8" style="text-align: center;"> <table border="1" style="width: 100%; border-collapse: collapse; text-align: center;"> <tr> <td style="width: 10%;"></td> <td style="width: 10%;"></td> <td style="width: 10%;"></td> <td style="width: 10%;"></td> <td style="width: 10%;"></td> <td style="width:
10%;"></td> <td style="width: 10%;"></td> <td style="width: 10%;"></td> <td style="width: 10%;"></td> <td style="width: 10%;"></td> </tr> <tr> <td></td> <td></td> <td colspan="8" style="text-align: center;"> <table border="1" style="width: 100%; border-collapse: collapse; text-align: center;"> <tr> <td style="width: 10%;"></td> <td style="width: 10%;"></td> <td style="width: 10%;"></td> <td style="width: 10%;"></td> <td style="width: 10%;"></td> <td style="width: 10%;"></td> <td style="width: 10%;"></td> <td style="width: 10%;"></td> <td style="width: 10%;"></td> <td style="width: 10%;"></td> </tr> <tr> <td></td> <td></td> <td colspan="8" style="text-align: center;"> <table border="1" style="width: 100%; border-collapse: collapse; text-align: center;"> <tr> <td style="width: 10%;"></td> <td style="width: 10%;"></td> <td style="width: 10%;"></td> <td style="width: 10%;"></td> <td style="width: 10%;"></td> <td style="width: 10%;"></td> <td style="width: 10%;"></td> <td style="width: 10%;"></td> <td style="width: 10%;"></td> <td style="width: 10%;"></td> </tr> <tr> <td></td> <td></td> <td colspan="8" style="text-align: center;"> <table border="1" style="width: 100%; border-collapse: collapse; text-align: center;"> <tr> <td style="width: 10%;"></td> <td style="width: 10%;"></td> <td style="width: 10%;"></td> <td style="width: 10%;"></td> <td style="width: 10%;"></td> <td style="width: 10%;"></td> <td style="width: 10%;"></td> <td style="width: 10%;"></td> <td style="width: 10%;"></td> <td style="width: 10%;"></td> </tr> <tr> <td></td> <td></td> <td colspan="8" style="text-align: center;"> <table border="1" style="width: 100%; border-collapse: collapse; text-align: center;"> <tr> <td style="width: 10%;"></td> <td style="width: 10%;"></td> <td style="width: 10%;"></td> <td style="width: 10%;"></td> <td style="width: 10%;"></td> <td style="width: 10%;"></td> <td style="width: 10%;"></td> <td style="width: 10%;"></td> <td style="width: 10%;"></td> <td style="width: 10%;"></td> </tr> <tr> <td></td> <td></td> <td colspan="8" style="text-align: center;"> <table border="1" style="width: 100%; border-collapse: collapse; text-align: center;"> <tr> <td style="width: 10%;"></td> <td style="width: 10%;"></td> <td style="width: 10%;"></td> <td style="width: 10%;"></td> <td style="width: 10%;"></td> <td style="width: 10%;"></td> <td style="width: 10%;"></td> <td style="width: 10%;"></td> <td style="width: 10%;"></td> <td style="width: 10%;"></td> </tr> <tr> <td></td> <td></td> <td colspan="8" style="text-align: center;"> <table border="1" style="width: 100%; border-collapse: collapse; text-align: center;"> <tr> <td style="width: 10%;"></td> <td style="width: 10%;"></td> <td style="width: 10%;"></td> <td style="width: 10%;"></td> <td style="width: 10%;"></td> <td style="width: 10%;"></td> <td style="width: 10%;"></td> <td style="width: 10%;"></td> <td style="width: 10%;"></td> <td style="width: 10%;"></td> </tr> <tr> <td></td> <td></td> <td colspan="8" style="text-align: center;"> <table border="1" style="width: 100%; border-collapse: collapse; text-align: center;"> <tr> <td style="width: 10%;"></td> <td style="width: 10%;"></td> <td style="width: 10%;"></td> <td style="width: 10%;"></td> <td style="width: 10%;"></td> <td style="width: 10%;"></td> <td style="width: 10%;"></td> <td style="width: 10%;"></td> <td style="width: 10%;"></td> <td style="width: 10%;"></td> </tr> <tr> <td></td> <td></td> <td colspan="8" style="text-align: center;"> <table border="1" style="width: 100%; border-collapse: collapse; text-align: center;"> <tr> <td style="width: 10%;"></td> <td style="width: 10%;"></td> <td style="width: 10%;"></td> <td style="width: 10%;"></td> <td style="width: 10%;"></td> <td style="width: 10%;"></td> <td style="width: 10%;"></td> <td style="width: 10%;"></td> <td style="width: 10%;"></td> <td style="width: 10%;"></td> </tr> <tr> <td></td> <td></td> <td colspan="8" style="text-align: center;"> <table border="1" style="width: 100%; border-collapse: collapse; text-align: center;"> <tr> <td style="width: 10%;"></td> <td style="width: 10%;"></td> <td style="width: 10%;"></td> <td style="width: 10%;"></td> <td style="width: 10%;"></td> <td style="width: 10%;"></td> <td style="width: 10%;"></td> <td style="width: 10%;"></td> <td style="width: 10%;"></td> <td style="width: 10%;"></td> </tr> <tr> <td></td> <td></td> <td colspan="8" style="text-align: center;"> <table border="1" style="width: 100%; border-collapse: collapse; text-align: center;"> <tr> <td style="width: 10%;"></td> <td style="width: 10%;"></td> <td style="width: 10%;"></td> <td style="width: 10%;"></td> <td style="width: 10%;"></td> <td style="width: 10%;"></td> <td style="width: 10%;"></td> <td style="width: 10%;"></td> <td style="width: 10%;"></td> <td style="width: 10%;"></td> </tr> <tr> <td></td> <td></td> <td colspan="8" style="text-align: center;"> <table border="1" style="width: 100%; border-collapse: collapse; text-align: center;"> <tr> <td style="width: 10%;"></td> <td style="width: 10%;"></td> <td style="width: 10%;"></td> <td style="width: 10%;"></td> <td style="width: 10%;"></td> <td style="width: 10%;"></td> <td style="width: 10%;"></td> <td style="width: 10%;"></td> <td style="width: 10%;"></td> <td style="width: 10%;"></td> </tr> <tr> <td></td> <td></td> <td colspan="8" style="text-align: center;"> <table border="1" style="width: 100%; border-collapse: collapse; text-align: center;"> <tr> <td style="width: 10%;"></td> <td style="width: 10%;"></td> <td style="width: 10%;"></td> <td style="width: 10%;"></td> <td style="width: 10%;"></td> <td style="width: 10%;"></td> <td style="width: 10%;"></td> <td style="width: 10%;"></td> <td style="width: 10%;"></td> <td style="width: 10%;"></td> </tr> <tr> <td></td> <td></td> <td colspan="8" style="text-align: center;"> <table border="1" style="width: 100%; border-collapse: collapse; text-align: center;"> <tr> <td style="width: 10%;"></td> <td style="width: 10%;"></td> <td style="width: 10%;"></td> <td style="width: 10%;"></td> <td style="width: 10%;"></td> <td style="width: 10%;"></td> <td style="width: 10%;"></td> <td style="width: 10%;"></td> <td style="width: 10%;"></td> <td style="width: 10%;"></td> </tr> <tr> <td></td> <td></td> <td colspan="8" style="text-align: center;"> <table border="1" style="width: 100%; border-collapse: collapse; text-align: center;"> <tr> <td style="width: 10%;"></td> <td style="width: 10%;"></td> <td style="width: 10%;"></td> <td style="width: 10%;"></td> <td style="width: 10%;"></td> <td style="width: 10%;"></td> <td style="width: 10%;"></td> <td style="width: 10%;"></td> <td style="width: 10%;"></td> <td style="width: 10%;"></td> </tr> <tr> <td></td> <td></td> <td colspan="8" style="text-align: center;"> <table border="1" style="width: 100%; border-collapse: collapse; text-align: center;"> <tr> <td style="width: 10%;"></td> <td style="width: 10%;"></td> <td style="width: 10%;"></td> <td style="width: 10%;"></td> <td style="width: 10%;"></td> <td style="width: 10%;"></td> <td style="width: 10%;"></td> <td style="width: 10%;"></td> <td style="width: 10%;"></td> <td style="width: 10%;"></td> </tr> <tr> <td></td> <td></td> <td colspan="8" style="text-align: center;"> <table border="1" style="width: 100%; border-collapse: collapse; text-align: center;"> <tr> <td style="width: 10%;"></td> <td style="width: 10%;"></td> <td style="width: 10%;"></td> <td style="width: 10%;"></td> <td style="width: 10%;"></td> <td style="width: 10%;"></td> <td style="width: 10%;"></td> <td style="width: 10%;"></td> <td style="width: 10%;"></td> <td style="width: 10%;"></td> </tr> <tr> <td></td> <td></td> <td colspan="8" style="text-align: center;"> <table border="1" style="width: 100%; border-collapse: collapse; text-align: center;"> <tr> <td style="width: 10%;"></td> <td style="width: 10%;"></td> <td style="width: 10%;"></td> <td style="width: 10%;"></td> <td style="width: 10%;"></td> <td style="width: 10%;"></td> <td style="width: 10%;"></td> <td style="width: 10%;"></td> <td style="width: 10%;"></td> <td style="width: 10%;"></td> </tr> <tr> <td></td> <td></td> <td colspan="8" style="text-align: center;"> <table border="1" style="width: 100%; border-collapse: collapse; text-align: center;"> <tr> <td style="width: 10%;"></td> <td style="width: 10%;"></td> <td style="width: 10%;"></td> <td style="width: 10%;"></td> <td style="width: 10%;"></td> <td style="width: 10%;"></td> <td style="width: 10%;"></td> <td style="width: 10%;"></td> <td style="width: 10%;"></td> <td style="width: 10%;"></td> </tr> <tr> <td></td> <td></td> <td colspan="8" style="text-align: center;"> <table border="1" style="width: 100%; border-collapse: collapse; text-align: center;"> <tr> <td style="width: 10%;"></td> <td style="width: 10%;"></td> <td style="width: 10%;"></td> <td style="width: 10%;"></td> <td style="width: 10%;"></td> <td style="width: 10%;"></td> <td style="width: 10%;"></td> <td style="width: 10%;"></td> <td style="width: 10%;"></td> <td style="width: 10%;"></td> </tr> <tr> <td></td> <td></td> <td colspan="8" style="text-align: center;"> <table border="1" style="width: 100%; border-collapse: collapse; text-align: center;"> <tr> <td style="width: 10%;"></td> <td style="width: 10%;"></td> <td style="width: 10%;"></td> <td style="width: 10%;"></td> <td style="width: 10%;"></td> <td style="width: 10%;"></td> <td style="width: 10%;"></td> <td style="width: 10%;"></td> <td style="width: 10%;"></td> <td style="width: 10%;"></td> </tr> <tr> <td></td> <td></td> <td colspan="8" style="text-align: center;"> <table border="1" style="width: 100%; border-collapse: collapse; text-align: center;"> <tr> <td style="width: 10%;"></td> <td style="width: 10%;"></td> <td style="width: 10%;"></td> <td style="width: 10%;"></td> <td style="width: 10%;"></td> <td style="width: 10%;"></td> <td style="width: 10%;"></td> <td style="width: 10%;"></td> <td style="width: 10%;"></td> <td style="width: 10%;"></td> </tr> <tr> <td></td> <td></td> <td
colspan="8" style="text-align: center;"> <table border="1" style="width: 100%; border-collapse: collapse; text-align: center;"> <tr> <td style="width: 10%;"></td> <td style="width: 10%;"></td> <td style="width: 10%;"></td> <td style="width: 10%;"></td> <td style="width: 10%;"></td> <td style="width: 10%;"></td> <td style="width: 10%;"></td> <td style="width: 10%;"></td> <td style="width: 10%;"></td> <td style="width: 10%;"></td> </tr> <tr> <td></td> <td></td> <td colspan="8" style="text-align: center;"> <table border="1" style="width: 100%; border-collapse: collapse; text-align: center;"> <tr> </tr></table></td></tr></table></td></tr></table></td></tr></table></td></tr></table></td></tr></table></td></tr></table></td></tr></table></td></tr></table></td></tr></table></td></tr></table></td></tr></table></td></tr></table></td></tr></table></td></tr></table></td></tr></table></td></tr></table></td></tr></table></td></tr></table></td></tr></table></td></tr></table></td></tr></table></td></tr></table></td></tr></table></td></tr></table></td></tr></table></td></tr></table></td></tr></table></td></tr></table></td></tr></table></td></tr></table> | | | | | | | | | | | | | | | | | | | | <table border="1" style="width: 100%; border-collapse: collapse; text-align: center;"> <tr> <td style="width: 10%;"></td> <td style="width: 10%;"></td> <td style="width: 10%;"></td> <td style="width: 10%;"></td> <td style="width: 10%;"></td> <td style="width: 10%;"></td> <td style="width: 10%;"></td> <td style="width: 10%;"></td> <td style="width: 10%;"></td> <td style="width: 10%;"></td> </tr> <tr> <td></td> <td></td> <td colspan="8" style="text-align: center;"> <table border="1" style="width: 100%; border-collapse: collapse; text-align: center;"> <tr> <td style="width: 10%;"></td> <td style="width: 10%;"></td> <td style="width: 10%;"></td> <td style="width: 10%;"></td> <td style="width: 10%;"></td> <td style="width: 10%;"></td> <td style="width: 10%;"></td> <td style="width: 10%;"></td> <td style="width: 10%;"></td> <td style="width: 10%;"></td> </tr> <tr> <td></td> <td></td> <td colspan="8" style="text-align: center;"> <table border="1" style="width: 100%; border-collapse: collapse; text-align: center;"> <tr> <td style="width: 10%;"></td> <td style="width: 10%;"></td> <td style="width: 10%;"></td> <td style="width: 10%;"></td> <td style="width: 10%;"></td> <td style="width: 10%;"></td> <td style="width: 10%;"></td> <td style="width: 10%;"></td> <td style="width: 10%;"></td> <td style="width: 10%;"></td> </tr> <tr> <td></td> <td></td> <td colspan="8" style="text-align: center;"> <table border="1" style="width: 100%; border-collapse: collapse; text-align: center;"> <tr> <td style="width: 10%;"></td> <td style="width: 10%;"></td> <td style="width: 10%;"></td> <td style="width: 10%;"></td> <td style="width: 10%;"></td> <td style="width: 10%;"></td> <td style="width: 10%;"></td> <td style="width: 10%;"></td> <td style="width: 10%;"></td> <td style="width: 10%;"></td> </tr> <tr> <td></td> <td></td> <td colspan="8" style="text-align: center;"> <table border="1" style="width: 100%; border-collapse: collapse; text-align: center;"> <tr> <td style="width: 10%;"></td> <td style="width: 10%;"></td> <td style="width: 10%;"></td> <td style="width: 10%;"></td> <td style="width: 10%;"></td> <td style="width: 10%;"></td> <td style="width: 10%;"></td> <td style="width: 10%;"></td> <td style="width: 10%;"></td> <td style="width: 10%;"></td> </tr> <tr> <td></td> <td></td> <td colspan="8" style="text-align: center;"> <table border="1" style="width: 100%; border-collapse: collapse; text-align: center;"> <tr> <td style="width: 10%;"></td> <td style="width: 10%;"></td> <td style="width: 10%;"></td> <td style="width: 10%;"></td> <td style="width: 10%;"></td> <td style="width: 10%;"></td> <td style="width: 10%;"></td> <td style="width: 10%;"></td> <td style="width: 10%;"></td> <td style="width: 10%;"></td> </tr> <tr> <td></td> <td></td> <td colspan="8" style="text-align: center;"> <table border="1" style="width: 100%; border-collapse: collapse; text-align: center;"> <tr> <td style="width: 10%;"></td> <td style="width:
10%;"></td> <td style="width: 10%;"></td> <td style="width: 10%;"></td> <td style="width: 10%;"></td> <td style="width: 10%;"></td> <td style="width: 10%;"></td> <td style="width: 10%;"></td> <td style="width: 10%;"></td> <td style="width: 10%;"></td> </tr> <tr> <td></td> <td></td> <td colspan="8" style="text-align: center;"> <table border="1" style="width: 100%; border-collapse: collapse; text-align: center;"> <tr> <td style="width: 10%;"></td> <td style="width: 10%;"></td> <td style="width: 10%;"></td> <td style="width: 10%;"></td> <td style="width: 10%;"></td> <td style="width: 10%;"></td> <td style="width: 10%;"></td> <td style="width: 10%;"></td> <td style="width: 10%;"></td> <td style="width: 10%;"></td> </tr> <tr> <td></td> <td></td> <td colspan="8" style="text-align: center;"> <table border="1" style="width: 100%; border-collapse: collapse; text-align: center;"> <tr> <td style="width: 10%;"></td> <td style="width: 10%;"></td> <td style="width: 10%;"></td> <td style="width: 10%;"></td> <td style="width: 10%;"></td> <td style="width: 10%;"></td> <td style="width: 10%;"></td> <td style="width: 10%;"></td> <td style="width: 10%;"></td> <td style="width: 10%;"></td> </tr> <tr> <td></td> <td></td> <td colspan="8" style="text-align: center;"> <table border="1" style="width: 100%; border-collapse: collapse; text-align: center;"> <tr> <td style="width: 10%;"></td> <td style="width: 10%;"></td> <td style="width: 10%;"></td> <td style="width: 10%;"></td> <td style="width: 10%;"></td> <td style="width: 10%;"></td> <td style="width: 10%;"></td> <td style="width: 10%;"></td> <td style="width: 10%;"></td> <td style="width: 10%;"></td> </tr> <tr> <td></td> <td></td> <td colspan="8" style="text-align: center;"> <table border="1" style="width: 100%; border-collapse: collapse; text-align: center;"> <tr> <td style="width: 10%;"></td> <td style="width: 10%;"></td> <td style="width: 10%;"></td> <td style="width: 10%;"></td> <td style="width: 10%;"></td> <td style="width: 10%;"></td> <td style="width: 10%;"></td> <td style="width: 10%;"></td> <td style="width: 10%;"></td> <td style="width: 10%;"></td> </tr> <tr> <td></td> <td></td> <td colspan="8" style="text-align: center;"> <table border="1" style="width: 100%; border-collapse: collapse; text-align: center;"> <tr> <td style="width: 10%;"></td> <td style="width: 10%;"></td> <td style="width: 10%;"></td> <td style="width: 10%;"></td> <td style="width: 10%;"></td> <td style="width: 10%;"></td> <td style="width: 10%;"></td> <td style="width: 10%;"></td> <td style="width: 10%;"></td> <td style="width: 10%;"></td> </tr> <tr> <td></td> <td></td> <td colspan="8" style="text-align: center;"> <table border="1" style="width: 100%; border-collapse: collapse; text-align: center;"> <tr> <td style="width: 10%;"></td> <td style="width: 10%;"></td> <td style="width: 10%;"></td> <td style="width: 10%;"></td> <td style="width: 10%;"></td> <td style="width: 10%;"></td> <td style="width: 10%;"></td> <td style="width: 10%;"></td> <td style="width: 10%;"></td> <td style="width: 10%;"></td> </tr> <tr> <td></td> <td></td> <td colspan="8" style="text-align: center;"> <table border="1" style="width: 100%; border-collapse: collapse; text-align: center;"> <tr> <td style="width: 10%;"></td> <td style="width: 10%;"></td> <td style="width: 10%;"></td> <td style="width: 10%;"></td> <td style="width: 10%;"></td> <td style="width: 10%;"></td> <td style="width: 10%;"></td> <td style="width: 10%;"></td> <td style="width: 10%;"></td> <td style="width: 10%;"></td> </tr> <tr> <td></td> <td></td> <td colspan="8" style="text-align: center;"> <table border="1" style="width: 100%; border-collapse: collapse; text-align: center;"> <tr> <td style="width: 10%;"></td> <td style="width: 10%;"></td> <td style="width: 10%;"></td> <td style="width: 10%;"></td> <td style="width: 10%;"></td> <td style="width: 10%;"></td> <td style="width: 10%;"></td> <td style="width: 10%;"></td> <td style="width: 10%;"></td> <td style="width: 10%;"></td> </tr> <tr> <td></td> <td></td> <td colspan="8" style="text-align: center;"> <table border="1" style="width: 100%; border-collapse: collapse; text-align: center;"> <tr> <td style="width: 10%;"></td> <td style="width: 10%;"></td> <td style="width: 10%;"></td> <td style="width: 10%;"></td> <td style="width: 10%;"></td> <td style="width: 10%;"></td> <td style="width: 10%;"></td> <td style="width: 10%;"></td> <td style="width: 10%;"></td> <td style="width: 10%;"></td> </tr> <tr> <td></td> <td></td> <td colspan="8" style="text-align: center;"> <table border="1" style="width: 100%; border-collapse: collapse; text-align: center;"> <tr> <td style="width: 10%;"></td> <td style="width: 10%;"></td> <td style="width: 10%;"></td> <td style="width: 10%;"></td> <td style="width: 10%;"></td> <td style="width: 10%;"></td> <td style="width: 10%;"></td> <td style="width: 10%;"></td> <td style="width: 10%;"></td> <td style="width: 10%;"></td> </tr> <tr> <td></td> <td></td> <td colspan="8" style="text-align: center;"> <table border="1" style="width: 100%; border-collapse: collapse; text-align: center;"> <tr> <td style="width: 10%;"></td> <td style="width: 10%;"></td> <td style="width: 10%;"></td> <td style="width: 10%;"></td> <td style="width: 10%;"></td> <td style="width: 10%;"></td> <td style="width: 10%;"></td> <td style="width: 10%;"></td> <td style="width: 10%;"></td> <td style="width: 10%;"></td> </tr> <tr> <td></td> <td></td> <td colspan="8" style="text-align: center;"> <table border="1" style="width: 100%; border-collapse: collapse; text-align: center;"> <tr> <td style="width: 10%;"></td> <td style="width: 10%;"></td> <td style="width: 10%;"></td> <td style="width: 10%;"></td> <td style="width: 10%;"></td> <td style="width: 10%;"></td> <td style="width: 10%;"></td> <td style="width: 10%;"></td> <td style="width: 10%;"></td> <td style="width: 10%;"></td> </tr> <tr> <td></td> <td></td> <td colspan="8" style="text-align: center;"> <table border="1" style="width: 100%; border-collapse: collapse; text-align: center;"> <tr> <td style="width: 10%;"></td> <td style="width: 10%;"></td> <td style="width: 10%;"></td> <td style="width: 10%;"></td> <td style="width: 10%;"></td> <td style="width: 10%;"></td> <td style="width: 10%;"></td> <td style="width: 10%;"></td> <td style="width: 10%;"></td> <td style="width: 10%;"></td> </tr> <tr> <td></td> <td></td> <td colspan="8" style="text-align: center;"> <table border="1" style="width: 100%; border-collapse: collapse; text-align: center;"> <tr> <td style="width: 10%;"></td> <td style="width: 10%;"></td> <td style="width: 10%;"></td> <td style="width: 10%;"></td> <td style="width: 10%;"></td> <td style="width: 10%;"></td> <td style="width: 10%;"></td> <td style="width: 10%;"></td> <td style="width: 10%;"></td> <td style="width: 10%;"></td> </tr> <tr> <td></td> <td></td> <td colspan="8" style="text-align: center;"> <table border="1" style="width: 100%; border-collapse: collapse; text-align: center;"> <tr> <td style="width: 10%;"></td> <td style="width: 10%;"></td> <td style="width: 10%;"></td> <td style="width: 10%;"></td> <td style="width: 10%;"></td> <td style="width: 10%;"></td> <td style="width: 10%;"></td> <td style="width: 10%;"></td> <td style="width: 10%;"></td> <td style="width: 10%;"></td> </tr> <tr> <td></td> <td></td> <td colspan="8" style="text-align: center;"> <table border="1" style="width: 100%; border-collapse: collapse; text-align: center;"> <tr> <td style="width: 10%;"></td> <td style="width: 10%;"></td> <td style="width: 10%;"></td> <td style="width: 10%;"></td> <td style="width: 10%;"></td> <td style="width: 10%;"></td> <td style="width: 10%;"></td> <td style="width: 10%;"></td> <td style="width: 10%;"></td> <td style="width: 10%;"></td> </tr> <tr> <td></td> <td></td> <td colspan="8" style="text-align: center;"> <table border="1" style="width: 100%; border-collapse: collapse; text-align: center;"> <tr> <td style="width: 10%;"></td> <td style="width: 10%;"></td> <td style="width: 10%;"></td> <td style="width: 10%;"></td> <td style="width: 10%;"></td> <td style="width: 10%;"></td> <td style="width: 10%;"></td> <td style="width: 10%;"></td> <td style="width: 10%;"></td> <td style="width: 10%;"></td> </tr> <tr> <td></td> <td></td> <td colspan="8" style="text-align: center;"> <table border="1" style="width: 100%; border-collapse: collapse; text-align: center;"> <tr> <td style="width: 10%;"></td> <td style="width: 10%;"></td> <td style="width: 10%;"></td> <td style="width: 10%;"></td> <td style="width: 10%;"></td> <td style="width: 10%;"></td> <td style="width: 10%;"></td> <td style="width: 10%;"></td> <td style="width: 10%;"></td> <td style="width: 10%;"></td> </tr> <tr> <td></td> <td></td> <td colspan="8" style="text-align: center;"> <table border="1" style="width: 100%; border-collapse: collapse; text-align: center;"> <tr> <td style="width: 10%;"></td> <td style="width: 10%;"></td> <td style="width: 10%;"></td> <td style="width: 10%;"></td> <td style="width: 10%;"></td> <td style="width: 10%;"></td> <td style="width: 10%;"></td> <td style="width: 10%;"></td> <td style="width: 10%;"></td> <td style="width: 10%;"></td> </tr> <tr> <td></td> <td></td> <td colspan="8" style="text-align: center;"> <table border="1" style="width: 100%; border-collapse: collapse; text-align: center;"> <tr> <td style="width: 10%;"></td> <td style="width: 10%;"></td> <td style="width: 10%;"></td> <td style="width: 10%;"></td> <td style="width: 10%;"></td> <td style="width: 10%;"></td> <td style="width: 10%;"></td> <td style="width: 10%;"></td> <td style="width: 10%;"></td> <td style="width: 10%;"></td> </tr> <tr> <td></td> <td></td> <td colspan="8" style="text-align: center;"> <table border="1" style="width: 100%; border-collapse: collapse; text-align: center;"> <tr> <td style="width: 10%;"></td> <td style="width: 10%;"></td> <td style="width: 10%;"></td> <td style="width: 10%;"></td> <td style="width: 10%;"></td> <td style="width: 10%;"></td> <td style="width: 10%;"></td> <td
style="width: 10%;"></td> <td style="width: 10%;"></td> <td style="width: 10%;"></td> </tr> <tr> <td></td> <td></td> <td colspan="8" style="text-align: center;"> <table border="1" style="width: 100%; border-collapse: collapse; text-align: center;"> <tr> <td style="width: 10%;"></td> <td style="width: 10%;"></td> <td style="width: 10%;"></td> <td style="width: 10%;"></td> <td style="width: 10%;"></td> <td style="width: 10%;"></td> <td style="width: 10%;"></td> <td style="width: 10%;"></td> <td style="width: 10%;"></td> <td style="width: 10%;"></td> </tr> <tr> <td></td> <td></td> <td colspan="8" style="text-align: center;"> <table border="1" style="width: 100%; border-collapse: collapse; text-align: center;"> <tr> </tr></table></td></tr></table></td></tr></table></td></tr></table></td></tr></table></td></tr></table></td></tr></table></td></tr></table></td></tr></table></td></tr></table></td></tr></table></td></tr></table></td></tr></table></td></tr></table></td></tr></table></td></tr></table></td></tr></table></td></tr></table></td></tr></table></td></tr></table></td></tr></table></td></tr></table></td></tr></table></td></tr></table></td></tr></table></td></tr></table></td></tr></table></td></tr></table></td></tr></table></td></tr></table> | | | | | | | | | | | | | | | | | | | | <table border="1" style="width: 100%; border-collapse: collapse; text-align: center;"> <tr> <td style="width: 10%;"></td> <td style="width: 10%;"></td> <td style="width: 10%;"></td> <td style="width: 10%;"></td> <td style="width: 10%;"></td> <td style="width: 10%;"></td> <td style="width: 10%;"></td> <td style="width: 10%;"></td> <td style="width: 10%;"></td> <td style="width: 10%;"></td> </tr> <tr> <td></td> <td></td> <td colspan="8" style="text-align: center;"> <table border="1" style="width: 100%; border-collapse: collapse; text-align: center;"> <tr> <td style="width: 10%;"></td> <td style="width: 10%;"></td> <td style="width: 10%;"></td> <td style="width: 10%;"></td> <td style="width: 10%;"></td> <td style="width: 10%;"></td> <td style="width: 10%;"></td> <td style="width: 10%;"></td> <td style="width: 10%;"></td> <td style="width: 10%;"></td> </tr> <tr> <td></td> <td></td> <td colspan="8" style="text-align: center;"> <table border="1" style="width: 100%; border-collapse: collapse; text-align: center;"> <tr> <td style="width: 10%;"></td> <td style="width: 10%;"></td> <td style="width: 10%;"></td> <td style="width: 10%;"></td> <td style="width: 10%;"></td> <td style="width: 10%;"></td> <td style="width: 10%;"></td> <td style="width: 10%;"></td> <td style="width: 10%;"></td> <td style="width: 10%;"></td> </tr> <tr> <td></td> <td></td> <td colspan="8" style="text-align: center;"> <table border="1" style="width: 100%; border-collapse: collapse; text-align: center;"> <tr> <td style="width: 10%;"></td> <td style="width: 10%;"></td> <td style="width: 10%;"></td> <td style="width: 10%;"></td> <td style="width: 10%;"></td> <td style="width: 10%;"></td> <td style="width: 10%;"></td> <td style="width: 10%;"></td> <td style="width: 10%;"></td> <td style="width: 10%;"></td> </tr> <tr> <td></td> <td></td> <td colspan="8" style="text-align: center;"> <table border="1" style="width: 100%; border-collapse: collapse; text-align: center;"> <tr> <td style="width: 10%;"></td> <td style="width: 10%;"></td> <td style="width: 10%;"></td> <td style="width: 10%;"></td> <td style="width: 10%;"></td> <td style="width: 10%;"></td> <td style="width: 10%;"></td> <td style="width: 10%;"></td> <td style="width: 10%;"></td> <td style="width: 10%;"></td> </tr> <tr> <td></td> <td></td> <td colspan="8" style="text-align: center;"> <table border="1" style="width: 100%; border-collapse: collapse; text-align: center;"> <tr> <td style="width: 10%;"></td> <td style="width: 10%;"></td> <td style="width: 10%;"></td> <td style="width: 10%;"></td> <td style="width: 10%;"></td> <td style="width: 10%;"></td> <td style="width: 10%;"></td> <td style="width: 10%;"></td> <td style="width: 10%;"></td> <td style="width: 10%;"></td> </tr> <tr> <td></td> <td></td> <td colspan="8" style="text-align: center;"> <table border="1" style="width: 100%;
border-collapse: collapse; text-align: center;"> <tr> <td style="width: 10%;"></td> <td style="width: 10%;"></td> <td style="width: 10%;"></td> <td style="width: 10%;"></td> <td style="width: 10%;"></td> <td style="width: 10%;"></td> <td style="width: 10%;"></td> <td style="width: 10%;"></td> <td style="width: 10%;"></td> <td style="width: 10%;"></td> </tr> <tr> <td></td> <td></td> <td colspan="8" style="text-align: center;"> <table border="1" style="width: 100%; border-collapse: collapse; text-align: center;"> <tr> <td style="width: 10%;"></td> <td style="width: 10%;"></td> <td style="width: 10%;"></td> <td style="width: 10%;"></td> <td style="width: 10%;"></td> <td style="width: 10%;"></td> <td style="width: 10%;"></td> <td style="width: 10%;"></td> <td style="width: 10%;"></td> <td style="width: 10%;"></td> </tr> <tr> <td></td> <td></td> <td colspan="8" style="text-align: center;"> <table border="1" style="width: 100%; border-collapse: collapse; text-align: center;"> <tr> <td style="width: 10%;"></td> <td style="width: 10%;"></td> <td style="width: 10%;"></td> <td style="width: 10%;"></td> <td style="width: 10%;"></td> <td style="width: 10%;"></td> <td style="width: 10%;"></td> <td style="width: 10%;"></td> <td style="width: 10%;"></td> <td style="width: 10%;"></td> </tr> <tr> <td></td> <td></td> <td colspan="8" style="text-align: center;"> <table border="1" style="width: 100%; border-collapse: collapse; text-align: center;"> <tr> <td style="width: 10%;"></td> <td style="width: 10%;"></td> <td style="width: 10%;"></td> <td style="width: 10%;"></td> <td style="width: 10%;"></td> <td style="width: 10%;"></td> <td style="width: 10%;"></td> <td style="width: 10%;"></td> <td style="width: 10%;"></td> <td style="width: 10%;"></td> </tr> <tr> <td></td> <td></td> <td colspan="8" style="text-align: center;"> <table border="1" style="width: 100%; border-collapse: collapse; text-align: center;"> <tr> <td style="width: 10%;"></td> <td style="width: 10%;"></td> <td style="width: 10%;"></td> <td style="width: 10%;"></td> <td style="width: 10%;"></td> <td style="width: 10%;"></td> <td style="width: 10%;"></td> <td style="width: 10%;"></td> <td style="width: 10%;"></td> <td style="width: 10%;"></td> </tr> <tr> <td></td> <td></td> <td colspan="8" style="text-align: center;"> <table border="1" style="width: 100%; border-collapse: collapse; text-align: center;"> <tr> <td style="width: 10%;"></td> <td style="width: 10%;"></td> <td style="width: 10%;"></td> <td style="width: 10%;"></td> <td style="width: 10%;"></td> <td style="width: 10%;"></td> <td style="width: 10%;"></td> <td style="width: 10%;"></td> <td style="width: 10%;"></td> <td style="width: 10%;"></td> </tr> <tr> <td></td> <td></td> <td colspan="8" style="text-align: center;"> <table border="1" style="width: 100%; border-collapse: collapse; text-align: center;"> <tr> <td style="width: 10%;"></td> <td style="width: 10%;"></td> <td style="width: 10%;"></td> <td style="width: 10%;"></td> <td style="width: 10%;"></td> <td style="width: 10%;"></td> <td style="width: 10%;"></td> <td style="width: 10%;"></td> <td style="width: 10%;"></td> <td style="width: 10%;"></td> </tr> <tr> <td></td> <td></td> <td colspan="8" style="text-align: center;"> <table border="1" style="width: 100%; border-collapse: collapse; text-align: center;"> <tr> <td style="width: 10%;"></td> <td style="width: 10%;"></td> <td style="width: 10%;"></td> <td style="width: 10%;"></td> <td style="width: 10%;"></td> <td style="width: 10%;"></td> <td style="width: 10%;"></td> <td style="width: 10%;"></td> <td style="width: 10%;"></td> <td style="width: 10%;"></td> </tr> <tr> <td></td> <td></td> <td colspan="8" style="text-align: center;"> <table border="1" style="width: 100%; border-collapse: collapse; text-align: center;"> <tr> <td style="width: 10%;"></td> <td style="width: 10%;"></td> <td style="width: 10%;"></td> <td style="width: 10%;"></td> <td style="width: 10%;"></td> <td style="width: 10%;"></td> <td style="width: 10%;"></td> <td style="width: 10%;"></td> <td style="width: 10%;"></td> <td style="width: 10%;"></td> </tr> <tr> <td></td> <td></td> <td colspan="8" style="text-align: center;"> <table border="1" style="width: 100%; border-collapse: collapse; text-align: center;"> <tr> <td style="width: 10%;"></td> <td style="width: 10%;"></td> <td style="width: 10%;"></td> <td style="width: 10%;"></td> <td style="width: 10%;"></td> <td style="width: 10%;"></td> <td style="width: 10%;"></td> <td style="width: 10%;"></td> <td style="width: 10%;"></td> <td style="width: 10%;"></td> </tr> <tr> <td></td> <td></td> <td colspan="8" style="text-align: center;"> <table border="1" style="width: 100%; border-collapse: collapse; text-align: center;"> <tr> <td style="width: 10%;"></td> <td style="width: 10%;"></td> <td style="width: 10%;"></td> <td style="width: 10%;"></td> <td style="width: 10%;"></td> <td style="width: 10%;"></td> <td style="width: 10%;"></td> <td style="width: 10%;"></td> <td style="width: 10%;"></td> <td style="width: 10%;"></td> </tr> <tr> <td></td> <td></td> <td colspan="8" style="text-align: center;"> <table border="1" style="width: 100%; border-collapse: collapse; text-align: center;"> <tr> <td style="width: 10%;"></td> <td style="width: 10%;"></td> <td style="width: 10%;"></td> <td style="width: 10%;"></td> <td style="width: 10%;"></td> <td style="width: 10%;"></td> <td style="width: 10%;"></td> <td style="width: 10%;"></td> <td style="width: 10%;"></td> <td style="width: 10%;"></td> </tr> <tr> <td></td> <td></td> <td colspan="8" style="text-align: center;"> <table border="1" style="width: 100%; border-collapse: collapse; text-align: center;"> <tr> <td style="width: 10%;"></td> <td style="width: 10%;"></td> <td style="width: 10%;"></td> <td style="width: 10%;"></td> <td style="width: 10%;"></td> <td style="width: 10%;"></td> <td style="width: 10%;"></td> <td style="width: 10%;"></td> <td style="width: 10%;"></td> <td style="width: 10%;"></td> </tr> <tr> <td></td> <td></td> <td colspan="8" style="text-align: center;"> <table border="1" style="width: 100%; border-collapse: collapse; text-align: center;"> <tr> <td style="width: 10%;"></td> <td style="width: 10%;"></td> <td style="width: 10%;"></td> <td style="width: 10%;"></td> <td style="width: 10%;"></td> <td style="width: 10%;"></td> <td style="width: 10%;"></td> <td style="width: 10%;"></td> <td style="width: 10%;"></td> <td style="width: 10%;"></td> </tr> <tr> <td></td> <td></td> <td colspan="8" style="text-align: center;"> <table border="1" style="width: 100%; border-collapse: collapse; text-align: center;"> <tr> <td style="width: 10%;"></td> <td style="width: 10%;"></td> <td style="width: 10%;"></td> <td style="width: 10%;"></td> <td style="width: 10%;"></td> <td style="width: 10%;"></td> <td style="width: 10%;"></td> <td style="width: 10%;"></td> <td style="width: 10%;"></td> <td style="width: 10%;"></td> </tr> <tr> <td></td> <td></td> <td colspan="8" style="text-align: center;"> <table border="1" style="width: 100%; border-collapse: collapse; text-align: center;"> <tr> <td style="width: 10%;"></td> <td style="width: 10%;"></td> <td style="width: 10%;"></td> <td style="width: 10%;"></td> <td style="width: 10%;"></td> <td style="width: 10%;"></td> <td style="width: 10%;"></td> <td style="width: 10%;"></td> <td style="width: 10%;"></td> <td style="width: 10%;"></td> </tr> <tr> <td></td> <td></td> <td colspan="8" style="text-align: center;"> <table border="1" style="width: 100%; border-collapse: collapse; text-align: center;"> <tr> <td style="width: 10%;"></td> <td style="width: 10%;"></td> <td style="width: 10%;"></td> <td style="width: 10%;"></td> <td style="width: 10%;"></td> <td style="width: 10%;"></td> <td style="width: 10%;"></td> <td style="width: 10%;"></td> <td style="width: 10%;"></td> <td style="width: 10%;"></td> </tr> <tr> <td></td> <td></td> <td colspan="8" style="text-align: center;"> <table border="1" style="width: 100%; border-collapse: collapse; text-align: center;"> <tr> <td style="width: 10%;"></td> <td style="width: 10%;"></td> <td style="width: 10%;"></td> <td style="width: 10%;"></td> <td style="width: 10%;"></td> <td style="width: 10%;"></td> <td style="width: 10%;"></td> <td style="width: 10%;"></td> <td style="width: 10%;"></td> <td style="width: 10%;"></td> </tr> <tr> <td></td> <td></td> <td colspan="8" style="text-align: center;"> <table border="1" style="width: 100%; border-collapse: collapse; text-align: center;"> <tr> <td style="width: 10%;"></td> <td style="width: 10%;"></td> <td style="width: 10%;"></td> <td style="width: 10%;"></td> <td style="width: 10%;"></td> <td style="width: 10%;"></td> <td style="width: 10%;"></td> <td style="width: 10%;"></td> <td style="width: 10%;"></td> <td style="width: 10%;"></td> </tr> <tr> <td></td> <td></td> <td colspan="8" style="text-align: center;"> <table border="1" style="width: 100%; border-collapse: collapse; text-align: center;"> <tr> <td style="width: 10%;"></td> <td style="width: 10%;"></td> <td style="width: 10%;"></td> <td style="width: 10%;"></td> <td style="width: 10%;"></td> <td style="width: 10%;"></td> <td style="width: 10%;"></td> <td style="width: 10%;"></td> <td style="width: 10%;"></td> <td style="width: 10%;"></td> </tr> <tr> <td></td> <td></td> <td colspan="8" style="text-align: center;"> <table border="1" style="width: 100%; border-collapse: collapse; text-align: center;"> <tr> <td style="width: 10%;"></td> <td style="width: 10%;"></td> <td style="width: 10%;"></td> <td style="width: 10%;"></td> <td style="width: 10%;"></td> <td style="width: 10%;"></td> <td style="width: 10%;"></td> <td style="width: 10%;"></td> <td style="width: 10%;"></td> <td style="width: 10%;"></td> </tr> <tr> <td></td> <td></td> <td colspan="8" style="text-align: center;"> <table border="1" style="width: 100%; border-collapse: collapse; text-align: center;"> <tr> <td style="width: 10%;"></td> <td style="width: 10%;"></td> <td style="width: 10%;"></td> <td style="width:
10%;"></td> <td style="width: 10%;"></td> <td style="width: 10%;"></td> <td style="width: 10%;"></td> <td style="width: 10%;"></td> <td style="width: 10%;"></td> <td style="width: 10%;"></td> </tr> <tr> <td></td> <td></td> <td colspan="8" style="text-align: center;"> <table border="1" style="width: 100%; border-collapse: collapse; text-align: center;"> <tr> </tr></table></td></tr></table></td></tr></table></td></tr></table></td></tr></table></td></tr></table></td></tr></table></td></tr></table></td></tr></table></td></tr></table></td></tr></table></td></tr></table></td></tr></table></td></tr></table></td></tr></table></td></tr></table></td></tr></table></td></tr></table></td></tr></table></td></tr></table></td></tr></table></td></tr></table></td></tr></table></td></tr></table></td></tr></table></td></tr></table></td></tr></table></td></tr></table></td></tr></table> | | | | | | | | | | | | | | | | | | | | <table border="1" style="width: 100%; border-collapse: collapse; text-align: center;"> <tr> <td style="width: 10%;"></td> <td style="width: 10%;"></td> <td style="width: 10%;"></td> <td style="width: 10%;"></td> <td style="width: 10%;"></td> <td style="width: 10%;"></td> <td style="width: 10%;"></td> <td style="width: 10%;"></td> <td style="width: 10%;"></td> <td style="width: 10%;"></td> </tr> <tr> <td></td> <td></td> <td colspan="8" style="text-align: center;"> <table border="1" style="width: 100%; border-collapse: collapse; text-align: center;"> <tr> <td style="width: 10%;"></td> <td style="width: 10%;"></td> <td style="width: 10%;"></td> <td style="width: 10%;"></td> <td style="width: 10%;"></td> <td style="width: 10%;"></td> <td style="width: 10%;"></td> <td style="width: 10%;"></td> <td style="width: 10%;"></td> <td style="width: 10%;"></td> </tr> <tr> <td></td> <td></td> <td colspan="8" style="text-align: center;"> <table border="1" style="width: 100%; border-collapse: collapse; text-align: center;"> <tr> <td style="width: 10%;"></td> <td style="width: 10%;"></td> <td style="width: 10%;"></td> <td style="width: 10%;"></td> <td style="width: 10%;"></td> <td style="width: 10%;"></td> <td style="width: 10%;"></td> <td style="width: 10%;"></td> <td style="width: 10%;"></td> <td style="width: 10%;"></td> </tr> <tr> <td></td> <td></td> <td colspan="8" style="text-align: center;"> <table border="1" style="width: 100%; border-collapse: collapse; text-align: center;"> <tr> <td style="width: 10%;"></td> <td style="width: 10%;"></td> <td style="width: 10%;"></td> <td style="width: 10%;"></td> <td style="width: 10%;"></td> <td style="width: 10%;"></td> <td style="width: 10%;"></td> <td style="width: 10%;"></td> <td style="width: 10%;"></td> <td style="width: 10%;"></td> </tr> <tr> <td></td> <td></td> <td colspan="8" style="text-align: center;"> <table border="1" style="width: 100%; border-collapse: collapse; text-align: center;"> <tr> <td style="width: 10%;"></td> <td style="width: 10%;"></td> <td style="width: 10%;"></td> <td style="width: 10%;"></td> <td style="width: 10%;"></td> <td style="width: 10%;"></td> <td style="width: 10%;"></td> <td style="width: 10%;"></td> <td style="width: 10%;"></td> <td style="width: 10%;"></td> </tr> <tr> <td></td> <td></td> <td colspan="8" style="text-align: center;"> <table border="1" style="width: 100%; border-collapse: collapse; text-align: center;"> <tr> <td style="width: 10%;"></td> <td style="width: 10%;"></td> <td style="width: 10%;"></td> <td style="width: 10%;"></td> <td style="width: 10%;"></td> <td style="width: 10%;"></td> <td style="width: 10%;"></td> <td style="width: 10%;"></td> <td style="width: 10%;"></td> <td style="width: 10%;"></td> </tr> <tr> <td></td> <td></td> <td colspan="8" style="text-align: center;"> <table border="1" style="width: 100%; border-collapse: collapse; text-align: center;"> <tr> <td style="width: 10%;"></td> <td style="width: 10%;"></td> <td style="width: 10%;"></td> <td style="width: 10%;"></td> <td style="width: 10%;"></td> <td style="width: 10%;"></td> <td style="width: 10%;"></td> <td style="width: 10%;"></td> <td style="width: 10%;"></td> <td style="width: 10%;"></td> </tr> <tr> <td></td> <td></td>
<td colspan="8" style="text-align: center;"> <table border="1" style="width: 100%; border-collapse: collapse; text-align: center;"> <tr> <td style="width: 10%;"></td> <td style="width: 10%;"></td> <td style="width: 10%;"></td> <td style="width: 10%;"></td> <td style="width: 10%;"></td> <td style="width: 10%;"></td> <td style="width: 10%;"></td> <td style="width: 10%;"></td> <td style="width: 10%;"></td> <td style="width: 10%;"></td> </tr> <tr> <td></td> <td></td> <td colspan="8" style="text-align: center;"> <table border="1" style="width: 100%; border-collapse: collapse; text-align: center;"> <tr> <td style="width: 10%;"></td> <td style="width: 10%;"></td> <td style="width: 10%;"></td> <td style="width: 10%;"></td> <td style="width: 10%;"></td> <td style="width: 10%;"></td> <td style="width: 10%;"></td> <td style="width: 10%;"></td> <td style="width: 10%;"></td> <td style="width: 10%;"></td> </tr> <tr> <td></td> <td></td> <td colspan="8" style="text-align: center;"> <table border="1" style="width: 100%; border-collapse: collapse; text-align: center;"> <tr> <td style="width: 10%;"></td> <td style="width: 10%;"></td> <td style="width: 10%;"></td> <td style="width: 10%;"></td> <td style="width: 10%;"></td> <td style="width: 10%;"></td> <td style="width: 10%;"></td> <td style="width: 10%;"></td> <td style="width: 10%;"></td> <td style="width: 10%;"></td> </tr> <tr> <td></td> <td></td> <td colspan="8" style="text-align: center;"> <table border="1" style="width: 100%; border-collapse: collapse; text-align: center;"> <tr> <td style="width: 10%;"></td> <td style="width: 10%;"></td> <td style="width: 10%;"></td> <td style="width: 10%;"></td> <td style="width: 10%;"></td> <td style="width: 10%;"></td> <td style="width: 10%;"></td> <td style="width: 10%;"></td> <td style="width: 10%;"></td> <td style="width: 10%;"></td> </tr> <tr> <td></td> <td></td> <td colspan="8" style="text-align: center;"> <table border="1" style="width: 100%; border-collapse: collapse; text-align: center;"> <tr> <td style="width: 10%;"></td> <td style="width: 10%;"></td> <td style="width: 10%;"></td> <td style="width: 10%;"></td> <td style="width: 10%;"></td> <td style="width: 10%;"></td> <td style="width: 10%;"></td> <td style="width: 10%;"></td> <td style="width: 10%;"></td> <td style="width: 10%;"></td> </tr> <tr> <td></td> <td></td> <td colspan="8" style="text-align: center;"> <table border="1" style="width: 100%; border-collapse: collapse; text-align: center;"> <tr> <td style="width: 10%;"></td> <td style="width: 10%;"></td> <td style="width: 10%;"></td> <td style="width: 10%;"></td> <td style="width: 10%;"></td> <td style="width: 10%;"></td> <td style="width: 10%;"></td> <td style="width: 10%;"></td> <td style="width: 10%;"></td> <td style="width: 10%;"></td> </tr> <tr> <td></td> <td></td> <td colspan="8" style="text-align: center;"> <table border="1" style="width: 100%; border-collapse: collapse; text-align: center;"> <tr> <td style="width: 10%;"></td> <td style="width: 10%;"></td> <td style="width: 10%;"></td> <td style="width: 10%;"></td> <td style="width: 10%;"></td> <td style="width: 10%;"></td> <td style="width: 10%;"></td> <td style="width: 10%;"></td> <td style="width: 10%;"></td> <td style="width: 10%;"></td> </tr> <tr> <td></td> <td></td> <td colspan="8" style="text-align: center;"> <table border="1" style="width: 100%; border-collapse: collapse; text-align: center;"> <tr> <td style="width: 10%;"></td> <td style="width: 10%;"></td> <td style="width: 10%;"></td> <td style="width: 10%;"></td> <td style="width: 10%;"></td> <td style="width: 10%;"></td> <td style="width: 10%;"></td> <td style="width: 10%;"></td> <td style="width: 10%;"></td> <td style="width: 10%;"></td> </tr> <tr> <td></td> <td></td> <td colspan="8" style="text-align: center;"> <table border="1" style="width: 100%; border-collapse: collapse; text-align: center;"> <tr> <td style="width: 10%;"></td> <td style="width: 10%;"></td> <td style="width: 10%;"></td> <td style="width: 10%;"></td> <td style="width: 10%;"></td> <td style="width: 10%;"></td> <td style="width: 10%;"></td> <td style="width: 10%;"></td> <td style="width: 10%;"></td> <td style="width: 10%;"></td> </tr> <tr> <td></td> <td></td> <td colspan="8" style="text-align: center;"> <table border="1" style="width: 100%; border-collapse: collapse; text-align: center;"> <tr> <td style="width: 10%;"></td> <td style="width: 10%;"></td> <td style="width: 10%;"></td> <td style="width: 10%;"></td> <td style="width: 10%;"></td> <td style="width: 10%;"></td> <td style="width: 10%;"></td> <td style="width: 10%;"></td> <td style="width: 10%;"></td> <td style="width: 10%;"></td> </tr> <tr> <td></td> <td></td> <td colspan="8" style="text-align: center;"> <table border="1" style="width: 100%; border-collapse: collapse; text-align: center;"> <tr> <td style="width: 10%;"></td> <td style="width: 10%;"></td> <td style="width: 10%;"></td> <td style="width: 10%;"></td> <td style="width: 10%;"></td> <td style="width: 10%;"></td> <td style="width: 10%;"></td> <td style="width: 10%;"></td> <td style="width: 10%;"></td> <td style="width: 10%;"></td> </tr> <tr> <td></td> <td></td> <td colspan="8" style="text-align: center;"> <table border="1" style="width: 100%; border-collapse: collapse; text-align: center;"> <tr> <td style="width: 10%;"></td> <td style="width: 10%;"></td> <td style="width: 10%;"></td> <td style="width: 10%;"></td> <td style="width: 10%;"></td> <td style="width: 10%;"></td> <td style="width: 10%;"></td> <td style="width: 10%;"></td> <td style="width: 10%;"></td> <td style="width: 10%;"></td> </tr> <tr> <td></td> <td></td> <td colspan="8" style="text-align: center;"> <table border="1" style="width: 100%; border-collapse: collapse; text-align: center;"> <tr> <td style="width: 10%;"></td> <td style="width: 10%;"></td> <td style="width: 10%;"></td> <td style="width: 10%;"></td> <td style="width: 10%;"></td> <td style="width: 10%;"></td> <td style="width: 10%;"></td> <td style="width: 10%;"></td> <td style="width: 10%;"></td> <td style="width: 10%;"></td> </tr> <tr> <td></td> <td></td> <td colspan="8" style="text-align: center;"> <table border="1" style="width: 100%; border-collapse: collapse; text-align: center;"> <tr> <td style="width: 10%;"></td> <td style="width: 10%;"></td> <td style="width: 10%;"></td> <td style="width: 10%;"></td> <td style="width: 10%;"></td> <td style="width: 10%;"></td> <td style="width: 10%;"></td> <td style="width: 10%;"></td> <td style="width: 10%;"></td> <td style="width: 10%;"></td> </tr> <tr> <td></td> <td></td> <td colspan="8" style="text-align: center;"> <table border="1" style="width: 100%; border-collapse: collapse; text-align: center;"> <tr> <td style="width: 10%;"></td> <td style="width: 10%;"></td> <td style="width: 10%;"></td> <td style="width: 10%;"></td> <td style="width: 10%;"></td> <td style="width: 10%;"></td> <td style="width: 10%;"></td> <td style="width: 10%;"></td> <td style="width: 10%;"></td> <td style="width: 10%;"></td> </tr> <tr> <td></td> <td></td> <td colspan="8" style="text-align: center;"> <table border="1" style="width: 100%; border-collapse: collapse; text-align: center;"> <tr> <td style="width: 10%;"></td> <td style="width: 10%;"></td> <td style="width: 10%;"></td> <td style="width: 10%;"></td> <td style="width: 10%;"></td> <td style="width: 10%;"></td> <td style="width: 10%;"></td> <td style="width: 10%;"></td> <td style="width: 10%;"></td> <td style="width: 10%;"></td> </tr> <tr> <td></td> <td></td> <td colspan="8" style="text-align: center;"> <table border="1" style="width: 100%; border-collapse: collapse; text-align: center;"> <tr> <td style="width: 10%;"></td> <td style="width: 10%;"></td> <td style="width: 10%;"></td> <td style="width: 10%;"></td> <td style="width: 10%;"></td> <td style="width: 10%;"></td> <td style="width: 10%;"></td> <td style="width: 10%;"></td> <td style="width: 10%;"></td> <td style="width: 10%;"></td> </tr> <tr> <td></td> <td></td> <td colspan="8" style="text-align: center;"> <table border="1" style="width: 100%; border-collapse: collapse; text-align: center;"> <tr> <td style="width: 10%;"></td> <td style="width: 10%;"></td> <td style="width: 10%;"></td> <td style="width: 10%;"></td> <td style="width: 10%;"></td> <td style="width: 10%;"></td> <td style="width: 10%;"></td> <td style="width: 10%;"></td> <td style="width: 10%;"></td> <td style="width: 10%;"></td> </tr> <tr> <td></td> <td></td> <td colspan="8" style="text-align: center;"> <table border="1" style="width: 100%; border-collapse: collapse; text-align: center;"> <tr> <td style="width: 10%;"></td> <td style="width: 10%;"></td> <td style="width: 10%;"></td> <td style="width: 10%;"></td> <td style="width: 10%;"></td> <td style="width: 10%;"></td> <td style="width: 10%;"></td> <td style="width: 10%;"></td> <td style="width: 10%;"></td> <td style="width: 10%;"></td> </tr> <tr> <td></td> <td></td> <td colspan="8" style="text-align: center;"> <table border="1" style="width: 100%; border-collapse: collapse; text-align: center;"> <tr> <td style="width: 10%;"></td> <td style="width: 10%;"></td> <td style="width: 10%;"></td> <td style="width: 10%;"></td> <td style="width: 10%;"></td> <td style="width: 10%;"></td> <td style="width: 10%;"></td> <td style="width: 10%;"></td> <td style="width: 10%;"></td> <td style="width: 10%;"></td> </tr> <tr> <td></td> <td></td> <td colspan="8" style="text-align: center;"> <table border="1" style="width: 100%; border-collapse: collapse; text-align: center;"> <tr> </tr></table></td></tr></table></td></tr></table></td></tr></table></td></tr></table></td></tr></table></td></tr></table></td></tr></table></td></tr></table></td></tr></table></td></tr></table></td></tr></table></td></tr></table></td></tr></table></td></tr></table></td></tr></table></td></tr></table></td></tr></table></td></tr></table></td></tr></table></td></tr></table></td></tr></table></td></tr></table></td></tr></table></td></tr></table></td></tr></table></td></tr></table></td></tr></table>
 | | | | | | | | | | | | | | | | | | | | <table border="1" style="width: 100%; border-collapse: collapse; text-align: center;"> <tr> <td style="width: 10%;"></td> <td style="width: 10%;"></td> <td style="width: 10%;"></td> <td style="width: 10%;"></td> <td style="width: 10%;"></td> <td style="width: 10%;"></td> <td style="width: 10%;"></td> <td style="width: 10%;"></td> <td style="width: 10%;"></td> <td style="width: 10%;"></td> </tr> <tr> <td></td> <td></td> <td colspan="8" style="text-align: center;"> <table border="1" style="width: 100%; border-collapse: collapse; text-align: center;"> <tr> <td style="width: 10%;"></td> <td style="width: 10%;"></td> <td style="width: 10%;"></td> <td style="width: 10%;"></td> <td style="width: 10%;"></td> <td style="width: 10%;"></td> <td style="width: 10%;"></td> <td style="width: 10%;"></td> <td style="width: 10%;"></td> <td style="width: 10%;"></td> </tr> <tr> <td></td> <td></td> <td colspan="8" style="text-align: center;"> <table border="1" style="width: 100%; border-collapse: collapse; text-align: center;"> <tr> <td style="width: 10%;"></td> <td style="width: 10%;"></td> <td style="width: 10%;"></td> <td style="width: 10%;"></td> <td style="width: 10%;"></td> <td style="width: 10%;"></td> <td style="width: 10%;"></td> <td style="width: 10%;"></td> <td style="width: 10%;"></td> <td style="width: 10%;"></td> </tr> <tr> <td></td> <td></td> <td colspan="8" style="text-align: center;"> <table border="1" style="width: 100%; border-collapse: collapse; text-align: center;"> <tr> <td style="width: 10%;"></td> <td style="width: 10%;"></td> <td style="width: 10%;"></td> <td style="width: 10%;"></td> <td style="width: 10%;"></td> <td style="width: 10%;"></td> <td style="width: 10%;"></td> <td style="width: 10%;"></td> <td style="width: 10%;"></td> <td style="width: 10%;"></td> </tr> <tr> <td></td> <td></td> <td colspan="8" style="text-align: center;"> <table border="1" style="width: 100%; border-collapse: collapse; text-align: center;"> <tr> <td style="width: 10%;"></td> <td style="width: 10%;"></td> <td style="width: 10%;"></td> <td style="width: 10%;"></td> <td style="width: 10%;"></td> <td style="width: 10%;"></td> <td style="width: 10%;"></td> <td style="width: 10%;"></td> <td style="width: 10%;"></td> <td style="width: 10%;"></td> </tr> <tr> <td></td> <td></td> <td colspan="8" style="text-align: center;"> <table border="1" style="width: 100%; border-collapse: collapse; text-align: center;"> <tr> <td style="width: 10%;"></td> <td style="width: 10%;"></td> <td style="width: 10%;"></td> <td style="width: 10%;"></td> <td style="width: 10%;"></td> <td style="width: 10%;"></td> <td style="width: 10%;"></td> <td style="width: 10%;"></td> <td style="width: 10%;"></td> <td style="width: 10%;"></td> </tr> <tr> <td></td> <td></td> <td colspan="8" style="text-align: center;"> <table border="1" style="width: 100%; border-collapse: collapse; text-align: center;"> <tr> <td style="width: 10%;"></td> <td style="width: 10%;"></td> <td style="width: 10%;"></td> <td style="width: 10%;"></td> <td style="width: 10%;"></td> <td style="width: 10%;"></td> <td style="width: 10%;"></td> <td style="width: 10%;"></td> <td style="width: 10%;"></td> <td style="width: 10%;"></td> </tr> <tr> <td></td> <td></td> <td colspan="8" style="text-align: center;"> <table border="1" style="width: 100%; border-collapse: collapse; text-align: center;"> <tr> <td style="width: 10%;"></td> <td style="width: 10%;"></td> <td style="width: 10%;"></td> <td style="width: 10%;"></td> <td style="width: 10%;"></td> <td style="width: 10%;"></td> <td style="width: 10%;"></td> <td style="width: 10%;"></td> <td style="width: 10%;"></td> <td style="width: 10%;"></td> </tr> <tr> <td></td> <td></td> <td colspan="8" style="text-align: center;"> <table border="1" style="width: 100%; border-collapse: collapse; text-align: center;"> <tr> <td style="width: 10%;"></td> <td style="width: 10%;"></td> <td style="width: 10%;"></td> <td style="width: 10%;"></td> <td style="width: 10%;"></td> <td style="width: 10%;"></td> <td style="width: 10%;"></td> <td style="width: 10%;"></td> <td style="width: 10%;"></td> <td
style="width: 10%;"></td> </tr> <tr> <td></td> <td></td> <td colspan="8" style="text-align: center;"> <table border="1" style="width: 100%; border-collapse: collapse; text-align: center;"> <tr> <td style="width: 10%;"></td> <td style="width: 10%;"></td> <td style="width: 10%;"></td> <td style="width: 10%;"></td> <td style="width: 10%;"></td> <td style="width: 10%;"></td> <td style="width: 10%;"></td> <td style="width: 10%;"></td> <td style="width: 10%;"></td> <td style="width: 10%;"></td> </tr> <tr> <td></td> <td></td> <td colspan="8" style="text-align: center;"> <table border="1" style="width: 100%; border-collapse: collapse; text-align: center;"> <tr> <td style="width: 10%;"></td> <td style="width: 10%;"></td> <td style="width: 10%;"></td> <td style="width: 10%;"></td> <td style="width: 10%;"></td> <td style="width: 10%;"></td> <td style="width: 10%;"></td> <td style="width: 10%;"></td> <td style="width: 10%;"></td> <td style="width: 10%;"></td> </tr> <tr> <td></td> <td></td> <td colspan="8" style="text-align: center;"> <table border="1" style="width: 100%; border-collapse: collapse; text-align: center;"> <tr> <td style="width: 10%;"></td> <td style="width: 10%;"></td> <td style="width: 10%;"></td> <td style="width: 10%;"></td> <td style="width: 10%;"></td> <td style="width: 10%;"></td> <td style="width: 10%;"></td> <td style="width: 10%;"></td> <td style="width: 10%;"></td> <td style="width: 10%;"></td> </tr> <tr> <td></td> <td></td> <td colspan="8" style="text-align: center;"> <table border="1" style="width: 100%; border-collapse: collapse; text-align: center;"> <tr> <td style="width: 10%;"></td> <td style="width: 10%;"></td> <td style="width: 10%;"></td> <td style="width: 10%;"></td> <td style="width: 10%;"></td> <td style="width: 10%;"></td> <td style="width: 10%;"></td> <td style="width: 10%;"></td> <td style="width: 10%;"></td> <td style="width: 10%;"></td> </tr> <tr> <td></td> <td></td> <td colspan="8" style="text-align: center;"> <table border="1" style="width: 100%; border-collapse: collapse; text-align: center;"> <tr> <td style="width: 10%;"></td> <td style="width: 10%;"></td> <td style="width: 10%;"></td> <td style="width: 10%;"></td> <td style="width: 10%;"></td> <td style="width: 10%;"></td> <td style="width: 10%;"></td> <td style="width: 10%;"></td> <td style="width: 10%;"></td> <td style="width: 10%;"></td> </tr> <tr> <td></td> <td></td> <td colspan="8" style="text-align: center;"> <table border="1" style="width: 100%; border-collapse: collapse; text-align: center;"> <tr> <td style="width: 10%;"></td> <td style="width: 10%;"></td> <td style="width: 10%;"></td> <td style="width: 10%;"></td> <td style="width: 10%;"></td> <td style="width: 10%;"></td> <td style="width: 10%;"></td> <td style="width: 10%;"></td> <td style="width: 10%;"></td> <td style="width: 10%;"></td> </tr> <tr> <td></td> <td></td> <td colspan="8" style="text-align: center;"> <table border="1" style="width: 100%; border-collapse: collapse; text-align: center;"> <tr> <td style="width: 10%;"></td> <td style="width: 10%;"></td> <td style="width: 10%;"></td> <td style="width: 10%;"></td> <td style="width: 10%;"></td> <td style="width: 10%;"></td> <td style="width: 10%;"></td> <td style="width: 10%;"></td> <td style="width: 10%;"></td> <td style="width: 10%;"></td> </tr> <tr> <td></td> <td></td> <td colspan="8" style="text-align: center;"> <table border="1" style="width: 100%; border-collapse: collapse; text-align: center;"> <tr> <td style="width: 10%;"></td> <td style="width: 10%;"></td> <td style="width: 10%;"></td> <td style="width: 10%;"></td> <td style="width: 10%;"></td> <td style="width: 10%;"></td> <td style="width: 10%;"></td> <td style="width: 10%;"></td> <td style="width: 10%;"></td> <td style="width: 10%;"></td> </tr> <tr> <td></td> <td></td> <td colspan="8" style="text-align: center;"> <table border="1" style="width: 100%; border-collapse: collapse; text-align: center;"> <tr> <td style="width: 10%;"></td> <td style="width: 10%;"></td> <td style="width: 10%;"></td> <td style="width: 10%;"></td> <td style="width: 10%;"></td> <td style="width: 10%;"></td> <td style="width: 10%;"></td> <td style="width: 10%;"></td> <td style="width: 10%;"></td> <td style="width: 10%;"></td> </tr> <tr> <td></td> <td></td> <td colspan="8" style="text-align: center;"> <table border="1" style="width: 100%; border-collapse: collapse; text-align: center;"> <tr> <td style="width: 10%;"></td> <td style="width: 10%;"></td> <td style="width: 10%;"></td> <td style="width: 10%;"></td> <td style="width: 10%;"></td> <td style="width: 10%;"></td> <td style="width: 10%;"></td> <td style="width: 10%;"></td> <td style="width: 10%;"></td> <td style="width: 10%;"></td> </tr> <tr> <td></td> <td></td> <td colspan="8" style="text-align: center;"> <table border="1" style="width: 100%; border-collapse: collapse; text-align: center;"> <tr> <td style="width: 10%;"></td> <td style="width: 10%;"></td> <td style="width: 10%;"></td> <td style="width: 10%;"></td> <td style="width: 10%;"></td> <td style="width: 10%;"></td> <td style="width: 10%;"></td> <td style="width: 10%;"></td> <td style="width: 10%;"></td> <td style="width: 10%;"></td> </tr> <tr> <td></td> <td></td> <td colspan="8" style="text-align: center;"> <table border="1" style="width: 100%; border-collapse: collapse; text-align: center;"> <tr> <td style="width: 10%;"></td> <td style="width: 10%;"></td> <td style="width: 10%;"></td> <td style="width: 10%;"></td> <td style="width: 10%;"></td> <td style="width: 10%;"></td> <td style="width: 10%;"></td> <td style="width: 10%;"></td> <td style="width: 10%;"></td> <td style="width: 10%;"></td> </tr> <tr> <td></td> <td></td> <td colspan="8" style="text-align: center;"> <table border="1" style="width: 100%; border-collapse: collapse; text-align: center;"> <tr> <td style="width: 10%;"></td> <td style="width: 10%;"></td> <td style="width: 10%;"></td> <td style="width: 10%;"></td> <td style="width: 10%;"></td> <td style="width: 10%;"></td> <td style="width: 10%;"></td> <td style="width: 10%;"></td> <td style="width: 10%;"></td> <td style="width: 10%;"></td> </tr> <tr> <td></td> <td></td> <td colspan="8" style="text-align: center;"> <table border="1" style="width: 100%; border-collapse: collapse; text-align: center;"> <tr> <td style="width: 10%;"></td> <td style="width: 10%;"></td> <td style="width: 10%;"></td> <td style="width: 10%;"></td> <td style="width: 10%;"></td> <td style="width: 10%;"></td> <td style="width: 10%;"></td> <td style="width: 10%;"></td> <td style="width: 10%;"></td> <td style="width: 10%;"></td> </tr> <tr> <td></td> <td></td> <td colspan="8" style="text-align: center;"> <table border="1" style="width: 100%; border-collapse: collapse; text-align: center;"> <tr> <td style="width: 10%;"></td> <td style="width: 10%;"></td> <td style="width: 10%;"></td> <td style="width: 10%;"></td> <td style="width: 10%;"></td> <td style="width: 10%;"></td> <td style="width: 10%;"></td> <td style="width: 10%;"></td> <td style="width: 10%;"></td> <td style="width: 10%;"></td> </tr> <tr> <td></td> <td></td> <td colspan="8" style="text-align: center;"> <table border="1" style="width: 100%; border-collapse: collapse; text-align: center;"> <tr> <td style="width: 10%;"></td> <td style="width: 10%;"></td> <td style="width: 10%;"></td> <td style="width: 10%;"></td> <td style="width: 10%;"></td> <td style="width: 10%;"></td> <td style="width: 10%;"></td> <td style="width: 10%;"></td> <td style="width: 10%;"></td> <td style="width: 10%;"></td> </tr> <tr> <td></td> <td></td> <td colspan="8" style="text-align: center;"> <table border="1" style="width: 100%; border-collapse: collapse; text-align: center;"> <tr> <td style="width: 10%;"></td> <td style="width: 10%;"></td> <td style="width: 10%;"></td> <td style="width: 10%;"></td> <td style="width: 10%;"></td> <td style="width: 10%;"></td> <td style="width: 10%;"></td> <td style="width: 10%;"></td> <td style="width: 10%;"></td> <td style="width: 10%;"></td> </tr> <tr> <td></td> <td></td> <td colspan="8" style="text-align: center;"> <table border="1" style="width: 100%; border-collapse: collapse; text-align: center;"> <tr> </tr></table></td></tr></table></td></tr></table></td></tr></table></td></tr></table></td></tr></table></td></tr></table></td></tr></table></td></tr></table></td></tr></table></td></tr></table></td></tr></table></td></tr></table></td></tr></table></td></tr></table></td></tr></table></td></tr></table></td></tr></table></td></tr></table></td></tr></table></td></tr></table></td></tr></table></td></tr></table></td></tr></table></td></tr></table></td></tr></table></td></tr></table>
 | | | | | | | | | | | | | | | | | | | | <table border="1" style="width: 100%; border-collapse: collapse; text-align: center;"> <tr> <td style="width: 10%;"></td> <td style="width: 10%;"></td> <td style="width: 10%;"></td> <td style="width: 10%;"></td> <td style="width: 10%;"></td> <td style="width: 10%;"></td> <td style="width: 10%;"></td> <td style="width: 10%;"></td> <td style="width: 10%;"></td> <td style="width: 10%;"></td> </tr> <tr> <td></td> <td></td> <td colspan="8" style="text-align: center;"> <table border="1" style="width: 100%; border-collapse: collapse; text-align: center;"> <tr> <td style="width: 10%;"></td> <td style="width: 10%;"></td> <td style="width: 10%;"></td> <td style="width: 10%;"></td> <td style="width: 10%;"></td> <td style="width: 10%;"></td> <td style="width: 10%;"></td> <td style="width: 10%;"></td> <td style="width: 10%;"></td> <td style="width: 10%;"></td> </tr> <tr> <td></td> <td></td> <td colspan="8" style="text-align: center;"> <table border="1" style="width: 100%; border-collapse: collapse; text-align: center;"> <tr> <td style="width: 10%;"></td> <td style="width: 10%;"></td> <td style="width: 10%;"></td> <td style="width: 10%;"></td> <td style="width: 10%;"></td> <td style="width: 10%;"></td> <td style="width: 10%;"></td> <td style="width: 10%;"></td> <td style="width: 10%;"></td> <td style="width: 10%;"></td> </tr> <tr> <td></td> <td></td> <td colspan="8" style="text-align: center;"> <table border="1" style="width: 100%; border-collapse: collapse; text-align: center;"> <tr> <td style="width: 10%;"></td> <td style="width: 10%;"></td> <td style="width: 10%;"></td> <td style="width: 10%;"></td> <td style="width: 10%;"></td> <td style="width: 10%;"></td> <td style="width: 10%;"></td> <td style="width: 10%;"></td> <td style="width: 10%;"></td> <td style="width: 10%;"></td> </tr> <tr> <td></td> <td></td> <td colspan="8" style="text-align: center;"> <table border="1" style="width: 100%; border-collapse: collapse; text-align: center;"> <tr> <td style="width: 10%;"></td> <td style="width: 10%;"></td> <td style="width: 10%;"></td> <td style="width: 10%;"></td> <td style="width: 10%;"></td> <td style="width: 10%;"></td> <td style="width: 10%;"></td> <td style="width: 10%;"></td> <td style="width: 10%;"></td> <td style="width: 10%;"></td> </tr> <tr> <td></td> <td></td> <td colspan="8" style="text-align: center;"> <table border="1" style="width: 100%; border-collapse: collapse; text-align: center;"> <tr> <td style="width: 10%;"></td> <td style="width: 10%;"></td> <td style="width: 10%;"></td> <td style="width: 10%;"></td> <td style="width: 10%;"></td> <td style="width: 10%;"></td> <td style="width: 10%;"></td> <td style="width: 10%;"></td> <td style="width: 10%;"></td> <td style="width: 10%;"></td> </tr> <tr> <td></td> <td></td> <td colspan="8" style="text-align: center;"> <table border="1" style="width: 100%; border-collapse: collapse; text-align: center;"> <tr> <td style="width: 10%;"></td> <td style="width: 10%;"></td> <td style="width: 10%;"></td> <td style="width: 10%;"></td> <td style="width: 10%;"></td> <td style="width: 10%;"></td> <td style="width: 10%;"></td> <td style="width: 10%;"></td> <td style="width: 10%;"></td> <td style="width: 10%;"></td> </tr> <tr> <td></td> <td></td> <td colspan="8" style="text-align: center;"> <table border="1" style="width: 100%; border-collapse: collapse; text-align: center;"> <tr> <td style="width: 10%;"></td> <td style="width: 10%;"></td> <td style="width: 10%;"></td> <td style="width: 10%;"></td> <td style="width: 10%;"></td> <td style="width: 10%;"></td> <td style="width: 10%;"></td> <td style="width: 10%;"></td> <td style="width: 10%;"></td> <td style="width: 10%;"></td> </tr> <tr> <td></td> <td></td> <td colspan="8" style="text-align: center;"> <table border="1" style="width: 100%; border-collapse: collapse; text-align: center;"> <tr> <td style="width: 10%;"></td> <td style="width: 10%;"></td> <td style="width: 10%;"></td> <td style="width: 10%;"></td> <td style="width: 10%;"></td> <td style="width: 10%;"></td> <td style="width: 10%;"></td> <td style="width: 10%;"></td> <td style="width: 10%;"></td> <td style="width: 10%;"></td> </tr> <tr> <td></td> <td></td> <td colspan="8" style="text-align: center;"> <table border="1" style="width: 100%; border-collapse: collapse; text-align: center;"> <tr> <td style="width: 10%;"></td> <td style="width: 10%;"></td> <td style="width: 10%;"></td> <td style="width: 10%;"></td> <td style="width: 10%;"></td> <td style="width: 10%;"></td> <td style="width: 10%;"></td> <td style="width: 10%;"></td> <td style="width: 10%;"></td> <td style="width: 10%;"></td> </tr> <tr> <td></td> <td></td> <td colspan="8" style="text-align: center;"> <table border="1" style="width: 100%; border-collapse: collapse; text-align: center;"> <tr> <td style="width: 10%;"></td> <td style="width: 10%;"></td> <td style="width: 10%;"></td> <td style="width: 10%;"></td> <td style="width: 10%;"></td> <td style="width: 10%;"></td> <td style="width: 10%;"></td> <td style="width: 10%;"></td> <td style="width: 10%;"></td> <td style="width: 10%;"></td> </tr> <tr> <td></td> <td></td> <td colspan="8" style="text-align: center;"> <table border="1" style="width: 100%; border-collapse: collapse; text-align: center;"> <tr> <td style="width: 10%;"></td> <td style="width: 10%;"></td> <td style="width: 10%;"></td> <td style="width: 10%;"></td> <td style="width: 10%;"></td> <td style="width: 10%;"></td> <td style="width: 10%;"></td> <td style="width:
10%;"></td> <td style="width: 10%;"></td> <td style="width: 10%;"></td> </tr> <tr> <td></td> <td></td> <td colspan="8" style="text-align: center;"> <table border="1" style="width: 100%; border-collapse: collapse; text-align: center;"> <tr> <td style="width: 10%;"></td> <td style="width: 10%;"></td> <td style="width: 10%;"></td> <td style="width: 10%;"></td> <td style="width: 10%;"></td> <td style="width: 10%;"></td> <td style="width: 10%;"></td> <td style="width: 10%;"></td> <td style="width: 10%;"></td> <td style="width: 10%;"></td> </tr> <tr> <td></td> <td></td> <td colspan="8" style="text-align: center;"> <table border="1" style="width: 100%; border-collapse: collapse; text-align: center;"> <tr> <td style="width: 10%;"></td> <td style="width: 10%;"></td> <td style="width: 10%;"></td> <td style="width: 10%;"></td> <td style="width: 10%;"></td> <td style="width: 10%;"></td> <td style="width: 10%;"></td> <td style="width: 10%;"></td> <td style="width: 10%;"></td> <td style="width: 10%;"></td> </tr> <tr> <td></td> <td></td> <td colspan="8" style="text-align: center;"> <table border="1" style="width: 100%; border-collapse: collapse; text-align: center;"> <tr> <td style="width: 10%;"></td> <td style="width: 10%;"></td> <td style="width: 10%;"></td> <td style="width: 10%;"></td> <td style="width: 10%;"></td> <td style="width: 10%;"></td> <td style="width: 10%;"></td> <td style="width: 10%;"></td> <td style="width: 10%;"></td> <td style="width: 10%;"></td> </tr> <tr> <td></td> <td></td> <td colspan="8" style="text-align: center;"> <table border="1" style="width: 100%; border-collapse: collapse; text-align: center;"> <tr> <td style="width: 10%;"></td> <td style="width: 10%;"></td> <td style="width: 10%;"></td> <td style="width: 10%;"></td> <td style="width: 10%;"></td> <td style="width: 10%;"></td> <td style="width: 10%;"></td> <td style="width: 10%;"></td> <td style="width: 10%;"></td> <td style="width: 10%;"></td> </tr> <tr> <td></td> <td></td> <td colspan="8" style="text-align: center;"> <table border="1" style="width: 100%; border-collapse: collapse; text-align: center;"> <tr> <td style="width: 10%;"></td> <td style="width: 10%;"></td> <td style="width: 10%;"></td> <td style="width: 10%;"></td> <td style="width: 10%;"></td> <td style="width: 10%;"></td> <td style="width: 10%;"></td> <td style="width: 10%;"></td> <td style="width: 10%;"></td> <td style="width: 10%;"></td> </tr> <tr> <td></td> <td></td> <td colspan="8" style="text-align: center;"> <table border="1" style="width: 100%; border-collapse: collapse; text-align: center;"> <tr> <td style="width: 10%;"></td> <td style="width: 10%;"></td> <td style="width: 10%;"></td> <td style="width: 10%;"></td> <td style="width: 10%;"></td> <td style="width: 10%;"></td> <td style="width: 10%;"></td> <td style="width: 10%;"></td> <td style="width: 10%;"></td> <td style="width: 10%;"></td> </tr> <tr> <td></td> <td></td> <td colspan="8" style="text-align: center;"> <table border="1" style="width: 100%; border-collapse: collapse; text-align: center;"> <tr> <td style="width: 10%;"></td> <td style="width: 10%;"></td> <td style="width: 10%;"></td> <td style="width: 10%;"></td> <td style="width: 10%;"></td> <td style="width: 10%;"></td> <td style="width: 10%;"></td> <td style="width: 10%;"></td> <td style="width: 10%;"></td> <td style="width: 10%;"></td> </tr> <tr> <td></td> <td></td> <td colspan="8" style="text-align: center;"> <table border="1" style="width: 100%; border-collapse: collapse; text-align: center;"> <tr> <td style="width: 10%;"></td> <td style="width: 10%;"></td> <td style="width: 10%;"></td> <td style="width: 10%;"></td> <td style="width: 10%;"></td> <td style="width: 10%;"></td> <td style="width: 10%;"></td> <td style="width: 10%;"></td> <td style="width: 10%;"></td> <td style="width: 10%;"></td> </tr> <tr> <td></td> <td></td> <td colspan="8" style="text-align: center;"> <table border="1" style="width: 100%; border-collapse: collapse; text-align: center;"> <tr> <td style="width: 10%;"></td> <td style="width: 10%;"></td> <td style="width: 10%;"></td> <td style="width: 10%;"></td> <td style="width: 10%;"></td> <td style="width: 10%;"></td> <td style="width: 10%;"></td> <td style="width: 10%;"></td> <td style="width: 10%;"></td> <td style="width: 10%;"></td> </tr> <tr> <td></td> <td></td> <td colspan="8" style="text-align: center;"> <table border="1" style="width: 100%; border-collapse: collapse; text-align: center;"> <tr> <td style="width: 10%;"></td> <td style="width: 10%;"></td> <td style="width: 10%;"></td> <td style="width: 10%;"></td> <td style="width: 10%;"></td> <td style="width: 10%;"></td> <td style="width: 10%;"></td> <td style="width: 10%;"></td> <td style="width: 10%;"></td> <td style="width: 10%;"></td> </tr> <tr> <td></td> <td></td> <td colspan="8" style="text-align: center;"> <table border="1" style="width: 100%; border-collapse: collapse; text-align: center;"> <tr> <td style="width: 10%;"></td> <td style="width: 10%;"></td> <td style="width: 10%;"></td> <td style="width: 10%;"></td> <td style="width: 10%;"></td> <td style="width: 10%;"></td> <td style="width: 10%;"></td> <td style="width: 10%;"></td> <td style="width: 10%;"></td> <td style="width: 10%;"></td> </tr> <tr> <td></td> <td></td> <td colspan="8" style="text-align: center;"> <table border="1" style="width: 100%; border-collapse: collapse; text-align: center;"> <tr> <td style="width: 10%;"></td> <td style="width: 10%;"></td> <td style="width: 10%;"></td> <td style="width: 10%;"></td> <td style="width: 10%;"></td> <td style="width: 10%;"></td> <td style="width: 10%;"></td> <td style="width: 10%;"></td> <td style="width: 10%;"></td> <td style="width: 10%;"></td> </tr> <tr> <td></td> <td></td> <td colspan="8" style="text-align: center;"> <table border="1" style="width: 100%; border-collapse: collapse; text-align: center;"> <tr> <td style="width: 10%;"></td> <td style="width: 10%;"></td> <td style="width: 10%;"></td> <td style="width: 10%;"></td> <td style="width: 10%;"></td> <td style="width: 10%;"></td> <td style="width: 10%;"></td> <td style="width: 10%;"></td> <td style="width: 10%;"></td> <td style="width: 10%;"></td> </tr> <tr> <td></td> <td></td> <td colspan="8" style="text-align: center;"> <table border="1" style="width: 100%; border-collapse: collapse; text-align: center;"> <tr> </tr></table></td></tr></table></td></tr></table></td></tr></table></td></tr></table></td></tr></table></td></tr></table></td></tr></table></td></tr></table></td></tr></table></td></tr></table></td></tr></table></td></tr></table></td></tr></table></td></tr></table></td></tr></table></td></tr></table></td></tr></table></td></tr></table></td></tr></table></td></tr></table></td></tr></table></td></tr></table></td></tr></table></td></tr></table></td></tr></table>
 | | | | | | | | | | | | | | | | | | | | <table border="1" style="width: 100%; border-collapse: collapse; text-align: center;"> <tr> <td style="width: 10%;"></td> <td style="width: 10%;"></td> <td style="width: 10%;"></td> <td style="width: 10%;"></td> <td style="width: 10%;"></td> <td style="width: 10%;"></td> <td style="width: 10%;"></td> <td style="width: 10%;"></td> <td style="width: 10%;"></td> <td style="width: 10%;"></td> </tr> <tr> <td></td> <td></td> <td colspan="8" style="text-align: center;"> <table border="1" style="width: 100%; border-collapse: collapse; text-align: center;"> <tr> <td style="width: 10%;"></td> <td style="width: 10%;"></td> <td style="width: 10%;"></td> <td style="width: 10%;"></td> <td style="width: 10%;"></td> <td style="width: 10%;"></td> <td style="width: 10%;"></td> <td style="width: 10%;"></td> <td style="width: 10%;"></td> <td style="width: 10%;"></td> </tr> <tr> <td></td> <td></td> <td colspan="8" style="text-align: center;"> <table border="1" style="width: 100%; border-collapse: collapse; text-align: center;"> <tr> <td style="width: 10%;"></td> <td style="width: 10%;"></td> <td style="width: 10%;"></td> <td style="width: 10%;"></td> <td style="width: 10%;"></td> <td style="width: 10%;"></td> <td style="width: 10%;"></td> <td style="width: 10%;"></td> <td style="width: 10%;"></td> <td style="width: 10%;"></td> </tr> <tr> <td></td> <td></td> <td colspan="8" style="text-align: center;"> <table border="1" style="width: 100%; border-collapse: collapse; text-align: center;"> <tr> <td style="width: 10%;"></td> <td style="width: 10%;"></td> <td style="width: 10%;"></td> <td style="width: 10%;"></td> <td style="width: 10%;"></td> <td style="width: 10%;"></td> <td style="width: 10%;"></td> <td style="width: 10%;"></td> <td style="width: 10%;"></td> <td style="width: 10%;"></td> </tr> <tr> <td></td> <td></td> <td colspan="8" style="text-align: center;"> <table border="1" style="width: 100%; border-collapse: collapse; text-align: center;"> <tr> <td style="width: 10%;"></td> <td style="width: 10%;"></td> <td style="width: 10%;"></td> <td style="width: 10%;"></td> <td style="width: 10%;"></td> <td style="width: 10%;"></td> <td style="width: 10%;"></td> <td style="width: 10%;"></td> <td style="width: 10%;"></td> <td style="width: 10%;"></td> </tr> <tr> <td></td> <td></td> <td colspan="8" style="text-align: center;"> <table border="1" style="width: 100%; border-collapse: collapse; text-align: center;"> <tr> <td style="width: 10%;"></td> <td style="width: 10%;"></td> <td style="width: 10%;"></td> <td style="width: 10%;"></td> <td style="width: 10%;"></td> <td style="width: 10%;"></td> <td style="width: 10%;"></td> <td style="width: 10%;"></td> <td style="width: 10%;"></td> <td style="width: 10%;"></td> </tr> <tr> <td></td> <td></td> <td colspan="8" style="text-align: center;"> <table border="1" style="width: 100%; border-collapse: collapse; text-align: center;"> <tr> <td style="width: 10%;"></td> <td style="width: 10%;"></td> <td style="width: 10%;"></td> <td style="width: 10%;"></td> <td style="width: 10%;"></td> <td style="width: 10%;"></td> <td style="width: 10%;"></td> <td style="width: 10%;"></td> <td style="width: 10%;"></td> <td style="width: 10%;"></td> </tr> <tr> <td></td> <td></td> <td colspan="8" style="text-align: center;"> <table border="1" style="width: 100%; border-collapse: collapse; text-align: center;"> <tr> <td style="width: 10%;"></td> <td style="width: 10%;"></td> <td style="width: 10%;"></td> <td style="width: 10%;"></td> <td style="width: 10%;"></td> <td style="width: 10%;"></td> <td style="width: 10%;"></td> <td style="width: 10%;"></td> <td style="width: 10%;"></td> <td style="width: 10%;"></td> </tr> <tr> <td></td> <td></td> <td colspan="8" style="text-align: center;"> <table border="1" style="width: 100%; border-collapse: collapse; text-align: center;"> <tr> <td style="width: 10%;"></td> <td style="width: 10%;"></td> <td style="width: 10%;"></td> <td style="width: 10%;"></td> <td style="width: 10%;"></td> <td style="width: 10%;"></td> <td style="width: 10%;"></td> <td style="width: 10%;"></td> <td style="width: 10%;"></td> <td style="width: 10%;"></td> </tr> <tr> <td></td> <td></td> <td colspan="8" style="text-align: center;"> <table border="1" style="width: 100%; border-collapse: collapse; text-align: center;"> <tr> <td style="width: 10%;"></td> <td style="width: 10%;"></td> <td style="width: 10%;"></td> <td style="width: 10%;"></td> <td style="width: 10%;"></td> <td style="width: 10%;"></td> <td style="width: 10%;"></td> <td style="width: 10%;"></td> <td style="width: 10%;"></td> <td style="width: 10%;"></td> </tr> <tr> <td></td> <td></td> <td colspan="8" style="text-align: center;"> <table border="1" style="width: 100%; border-collapse: collapse; text-align: center;"> <tr> <td style="width: 10%;"></td> <td style="width: 10%;"></td> <td style="width: 10%;"></td> <td style="width: 10%;"></td> <td style="width: 10%;"></td> <td style="width: 10%;"></td> <td style="width: 10%;"></td> <td style="width: 10%;"></td> <td style="width: 10%;"></td> <td style="width: 10%;"></td> </tr> <tr> <td></td> <td></td> <td colspan="8" style="text-align: center;"> <table border="1" style="width: 100%; border-collapse: collapse; text-align: center;"> <tr> <td style="width: 10%;"></td> <td style="width: 10%;"></td> <td style="width: 10%;"></td> <td style="width: 10%;"></td> <td style="width: 10%;"></td> <td style="width: 10%;"></td> <td style="width: 10%;"></td> <td style="width: 10%;"></td> <td style="width: 10%;"></td> <td style="width: 10%;"></td> </tr> <tr> <td></td> <td></td> <td colspan="8" style="text-align: center;"> <table border="1" style="width: 100%; border-collapse: collapse; text-align: center;"> <tr> <td style="width: 10%;"></td> <td style="width: 10%;"></td> <td style="width: 10%;"></td> <td style="width: 10%;"></td> <td style="width: 10%;"></td> <td style="width: 10%;"></td> <td style="width: 10%;"></td> <td style="width: 10%;"></td> <td style="width: 10%;"></td> <td style="width: 10%;"></td> </tr> <tr> <td></td> <td></td> <td colspan="8" style="text-align: center;"> <table border="1" style="width: 100%; border-collapse: collapse; text-align: center;"> <tr> <td style="width: 10%;"></td> <td style="width: 10%;"></td> <td style="width: 10%;"></td> <td style="width: 10%;"></td> <td style="width: 10%;"></td> <td style="width: 10%;"></td> <td style="width: 10%;"></td> <td style="width: 10%;"></td> <td style="width: 10%;"></td> <td style="width: 10%;"></td> </tr> <tr> <td></td> <td></td> <td colspan="8" style="text-align: center;"> <table border="1" style="width: 100%; border-collapse: collapse; text-align: center;"> <tr> <td style="width: 10%;"></td> <td style="width: 10%;"></td> <td style="width: 10%;"></td> <td style="width: 10%;"></td> <td style="width: 10%;"></td> <td style="width: 10%;"></td> <td style="width: 10%;"></td> <td style="width: 10%;"></td> <td style="width: 10%;"></td> <td style="width: 10%;"></td> </tr> <tr> <td></td> <td></td> <td colspan="8" style="text-align: center;"> <table border="1" style="width: 100%; border-collapse: collapse; text-align: center;"> <tr> <td style="width: 10%;"></td> <td style="width: 10%;"></td> <td style="width: 10%;"></td> <td style="width: 10%;"></td> <td style="width: 10%;"></td> <td style="width: 10%;"></td> <td style="width:
10%;"></td> <td style="width: 10%;"></td> <td style="width: 10%;"></td> <td style="width: 10%;"></td> </tr> <tr> <td></td> <td></td> <td colspan="8" style="text-align: center;"> <table border="1" style="width: 100%; border-collapse: collapse; text-align: center;"> <tr> <td style="width: 10%;"></td> <td style="width: 10%;"></td> <td style="width: 10%;"></td> <td style="width: 10%;"></td> <td style="width: 10%;"></td> <td style="width: 10%;"></td> <td style="width: 10%;"></td> <td style="width: 10%;"></td> <td style="width: 10%;"></td> <td style="width: 10%;"></td> </tr> <tr> <td></td> <td></td> <td colspan="8" style="text-align: center;"> <table border="1" style="width: 100%; border-collapse: collapse; text-align: center;"> <tr> <td style="width: 10%;"></td> <td style="width: 10%;"></td> <td style="width: 10%;"></td> <td style="width: 10%;"></td> <td style="width: 10%;"></td> <td style="width: 10%;"></td> <td style="width: 10%;"></td> <td style="width: 10%;"></td> <td style="width: 10%;"></td> <td style="width: 10%;"></td> </tr> <tr> <td></td> <td></td> <td colspan="8" style="text-align: center;"> <table border="1" style="width: 100%; border-collapse: collapse; text-align: center;"> <tr> <td style="width: 10%;"></td> <td style="width: 10%;"></td> <td style="width: 10%;"></td> <td style="width: 10%;"></td> <td style="width: 10%;"></td> <td style="width: 10%;"></td> <td style="width: 10%;"></td> <td style="width: 10%;"></td> <td style="width: 10%;"></td> <td style="width: 10%;"></td> </tr> <tr> <td></td> <td></td> <td colspan="8" style="text-align: center;"> <table border="1" style="width: 100%; border-collapse: collapse; text-align: center;"> <tr> <td style="width: 10%;"></td> <td style="width: 10%;"></td> <td style="width: 10%;"></td> <td style="width: 10%;"></td> <td style="width: 10%;"></td> <td style="width: 10%;"></td> <td style="width: 10%;"></td> <td style="width: 10%;"></td> <td style="width: 10%;"></td> <td style="width: 10%;"></td> </tr> <tr> <td></td> <td></td> <td colspan="8" style="text-align: center;"> <table border="1" style="width: 100%; border-collapse: collapse; text-align: center;"> <tr> <td style="width: 10%;"></td> <td style="width: 10%;"></td> <td style="width: 10%;"></td> <td style="width: 10%;"></td> <td style="width: 10%;"></td> <td style="width: 10%;"></td> <td style="width: 10%;"></td> <td style="width: 10%;"></td> <td style="width: 10%;"></td> <td style="width: 10%;"></td> </tr> <tr> <td></td> <td></td> <td colspan="8" style="text-align: center;"> <table border="1" style="width: 100%; border-collapse: collapse; text-align: center;"> <tr> <td style="width: 10%;"></td> <td style="width: 10%;"></td> <td style="width: 10%;"></td> <td style="width: 10%;"></td> <td style="width: 10%;"></td> <td style="width: 10%;"></td> <td style="width: 10%;"></td> <td style="width: 10%;"></td> <td style="width: 10%;"></td> <td style="width: 10%;"></td> </tr> <tr> <td></td> <td></td> <td colspan="8" style="text-align: center;"> <table border="1" style="width: 100%; border-collapse: collapse; text-align: center;"> <tr> <td style="width: 10%;"></td> <td style="width: 10%;"></td> <td style="width: 10%;"></td> <td style="width: 10%;"></td> <td style="width: 10%;"></td> <td style="width: 10%;"></td> <td style="width: 10%;"></td> <td style="width: 10%;"></td> <td style="width: 10%;"></td> <td style="width: 10%;"></td> </tr> <tr> <td></td> <td></td> <td colspan="8" style="text-align: center;"> <table border="1" style="width: 100%; border-collapse: collapse; text-align: center;"> <tr> <td style="width: 10%;"></td> <td style="width: 10%;"></td> <td style="width: 10%;"></td> <td style="width: 10%;"></td> <td style="width: 10%;"></td> <td style="width: 10%;"></td> <td style="width: 10%;"></td> <td style="width: 10%;"></td> <td style="width: 10%;"></td> <td style="width: 10%;"></td> </tr> <tr> <td></td> <td></td> <td colspan="8" style="text-align: center;"> <table border="1" style="width: 100%; border-collapse: collapse; text-align: center;"> <tr> </tr></table></td></tr></table></td></tr></table></td></tr></table></td></tr></table></td></tr></table></td></tr></table></td></tr></table></td></tr></table></td></tr></table></td></tr></table></td></tr></table></td></tr></table></td></tr></table></td></tr></table></td></tr></table></td></tr></table></td></tr></table></td></tr></table></td></tr></table></td></tr></table></td></tr></table></td></tr></table></td></tr></table></td></tr></table>
 | | | | | | | | | | | | | | | | | | | | <table border="1" style="width: 100%; border-collapse: collapse; text-align: center;"> <tr> <td style="width: 10%;"></td> <td style="width: 10%;"></td> <td style="width: 10%;"></td> <td style="width: 10%;"></td> <td style="width: 10%;"></td> <td style="width: 10%;"></td> <td style="width: 10%;"></td> <td style="width: 10%;"></td> <td style="width: 10%;"></td> <td style="width: 10%;"></td> </tr> <tr> <td></td> <td></td> <td colspan="8" style="text-align: center;"> <table border="1" style="width: 100%; border-collapse: collapse; text-align: center;"> <tr> <td style="width: 10%;"></td> <td style="width: 10%;"></td> <td style="width: 10%;"></td> <td style="width: 10%;"></td> <td style="width: 10%;"></td> <td style="width: 10%;"></td> <td style="width: 10%;"></td> <td style="width: 10%;"></td> <td style="width: 10%;"></td> <td style="width: 10%;"></td> </tr> <tr> <td></td> <td></td> <td colspan="8" style="text-align: center;"> <table border="1" style="width: 100%; border-collapse: collapse; text-align: center;"> <tr> <td style="width: 10%;"></td> <td style="width: 10%;"></td> <td style="width: 10%;"></td> <td style="width: 10%;"></td> <td style="width: 10%;"></td> <td style="width: 10%;"></td> <td style="width: 10%;"></td> <td style="width: 10%;"></td> <td style="width: 10%;"></td> <td style="width: 10%;"></td> </tr> <tr> <td></td> <td></td> <td colspan="8" style="text-align: center;"> <table border="1" style="width: 100%; border-collapse: collapse; text-align: center;"> <tr> <td style="width: 10%;"></td> <td style="width: 10%;"></td> <td style="width: 10%;"></td> <td style="width: 10%;"></td> <td style="width: 10%;"></td> <td style="width: 10%;"></td> <td style="width: 10%;"></td> <td style="width: 10%;"></td> <td style="width: 10%;"></td> <td style="width: 10%;"></td> </tr> <tr> <td></td> <td></td> <td colspan="8" style="text-align: center;"> <table border="1" style="width: 100%; border-collapse: collapse; text-align: center;"> <tr> <td style="width: 10%;"></td> <td style="width: 10%;"></td> <td style="width: 10%;"></td> <td style="width: 10%;"></td> <td style="width: 10%;"></td> <td style="width: 10%;"></td> <td style="width: 10%;"></td> <td style="width: 10%;"></td> <td style="width: 10%;"></td> <td style="width: 10%;"></td> </tr> <tr> <td></td> <td></td> <td colspan="8" style="text-align: center;"> <table border="1" style="width: 100%; border-collapse: collapse; text-align: center;"> <tr> <td style="width: 10%;"></td> <td style="width: 10%;"></td> <td style="width: 10%;"></td> <td style="width: 10%;"></td> <td style="width: 10%;"></td> <td style="width: 10%;"></td> <td style="width: 10%;"></td> <td style="width: 10%;"></td> <td style="width: 10%;"></td> <td style="width: 10%;"></td> </tr> <tr> <td></td> <td></td> <td colspan="8" style="text-align: center;"> <table border="1" style="width: 100%; border-collapse: collapse; text-align: center;"> <tr> <td style="width: 10%;"></td> <td style="width: 10%;"></td> <td style="width: 10%;"></td> <td style="width: 10%;"></td> <td style="width: 10%;"></td> <td style="width: 10%;"></td> <td style="width: 10%;"></td> <td style="width: 10%;"></td> <td style="width: 10%;"></td> <td style="width: 10%;"></td> </tr> <tr> <td></td> <td></td> <td colspan="8" style="text-align: center;"> <table border="1" style="width: 100%; border-collapse: collapse; text-align: center;"> <tr> <td style="width: 10%;"></td> <td style="width: 10%;"></td> <td style="width: 10%;"></td> <td style="width: 10%;"></td> <td style="width: 10%;"></td> <td style="width: 10%;"></td> <td style="width: 10%;"></td> <td style="width: 10%;"></td> <td style="width: 10%;"></td> <td style="width: 10%;"></td> </tr> <tr> <td></td> <td></td> <td colspan="8" style="text-align: center;"> <table border="1" style="width: 100%; border-collapse: collapse; text-align: center;"> <tr> <td style="width: 10%;"></td> <td style="width: 10%;"></td> <td style="width: 10%;"></td> <td style="width: 10%;"></td> <td style="width: 10%;"></td> <td style="width: 10%;"></td> <td style="width: 10%;"></td> <td style="width: 10%;"></td> <td style="width: 10%;"></td> <td style="width: 10%;"></td> </tr> <tr> <td></td> <td></td> <td colspan="8" style="text-align: center;"> <table border="1" style="width: 100%; border-collapse: collapse; text-align: center;"> <tr> <td style="width: 10%;"></td> <td style="width: 10%;"></td> <td style="width: 10%;"></td> <td style="width: 10%;"></td> <td style="width: 10%;"></td> <td style="width: 10%;"></td> <td style="width: 10%;"></td> <td style="width: 10%;"></td> <td style="width: 10%;"></td> <td style="width: 10%;"></td> </tr> <tr> <td></td> <td></td> <td colspan="8" style="text-align: center;"> <table border="1" style="width: 100%; border-collapse: collapse; text-align: center;"> <tr> <td style="width: 10%;"></td> <td style="width: 10%;"></td> <td style="width: 10%;"></td> <td style="width: 10%;"></td> <td style="width: 10%;"></td> <td style="width: 10%;"></td> <td style="width: 10%;"></td> <td style="width: 10%;"></td> <td style="width: 10%;"></td> <td style="width: 10%;"></td> </tr> <tr> <td></td> <td></td> <td colspan="8" style="text-align: center;"> <table border="1" style="width: 100%; border-collapse: collapse; text-align: center;"> <tr> <td style="width: 10%;"></td> <td style="width: 10%;"></td> <td style="width: 10%;"></td> <td style="width: 10%;"></td> <td style="width: 10%;"></td> <td style="width: 10%;"></td> <td style="width: 10%;"></td> <td style="width: 10%;"></td> <td style="width: 10%;"></td> <td style="width: 10%;"></td> </tr> <tr> <td></td> <td></td> <td colspan="8" style="text-align: center;"> <table border="1" style="width: 100%; border-collapse: collapse; text-align: center;"> <tr> <td style="width: 10%;"></td> <td style="width: 10%;"></td> <td style="width: 10%;"></td> <td style="width: 10%;"></td> <td style="width: 10%;"></td> <td style="width: 10%;"></td> <td style="width: 10%;"></td> <td style="width: 10%;"></td> <td style="width: 10%;"></td> <td style="width: 10%;"></td> </tr> <tr> <td></td> <td></td> <td colspan="8" style="text-align: center;"> <table border="1" style="width: 100%; border-collapse: collapse; text-align: center;"> <tr> <td style="width: 10%;"></td> <td style="width: 10%;"></td> <td style="width: 10%;"></td> <td style="width: 10%;"></td> <td style="width: 10%;"></td> <td style="width: 10%;"></td> <td style="width: 10%;"></td> <td style="width: 10%;"></td> <td style="width: 10%;"></td> <td style="width: 10%;"></td> </tr> <tr> <td></td> <td></td> <td colspan="8" style="text-align: center;"> <table border="1" style="width: 100%; border-collapse: collapse; text-align: center;"> <tr> <td style="width: 10%;"></td> <td style="width: 10%;"></td> <td style="width: 10%;"></td> <td style="width: 10%;"></td> <td style="width: 10%;"></td> <td style="width: 10%;"></td> <td style="width: 10%;"></td> <td style="width: 10%;"></td> <td style="width: 10%;"></td> <td style="width: 10%;"></td> </tr> <tr> <td></td> <td></td> <td colspan="8" style="text-align: center;"> <table border="1" style="width: 100%; border-collapse: collapse; text-align: center;"> <tr> <td style="width: 10%;"></td> <td style="width: 10%;"></td> <td style="width: 10%;"></td> <td style="width: 10%;"></td> <td style="width: 10%;"></td> <td style="width: 10%;"></td> <td style="width: 10%;"></td> <td style="width: 10%;"></td> <td style="width: 10%;"></td> <td style="width: 10%;"></td> </tr> <tr> <td></td> <td></td> <td colspan="8" style="text-align: center;"> <table border="1" style="width: 100%; border-collapse: collapse; text-align: center;"> <tr> <td style="width: 10%;"></td> <td style="width: 10%;"></td> <td style="width: 10%;"></td> <td style="width: 10%;"></td> <td style="width: 10%;"></td> <td style="width: 10%;"></td> <td style="width: 10%;"></td> <td style="width: 10%;"></td> <td style="width: 10%;"></td> <td style="width: 10%;"></td> </tr> <tr> <td></td> <td></td> <td colspan="8" style="text-align: center;"> <table border="1" style="width: 100%; border-collapse: collapse; text-align: center;"> <tr> <td style="width: 10%;"></td> <td style="width: 10%;"></td> <td style="width: 10%;"></td> <td style="width: 10%;"></td> <td style="width: 10%;"></td> <td style="width: 10%;"></td> <td style="width: 10%;"></td> <td style="width: 10%;"></td> <td style="width: 10%;"></td> <td style="width: 10%;"></td> </tr> <tr> <td></td> <td></td> <td colspan="8" style="text-align: center;"> <table border="1" style="width: 100%; border-collapse: collapse; text-align: center;"> <tr> <td style="width: 10%;"></td> <td style="width: 10%;"></td> <td style="width: 10%;"></td> <td style="width: 10%;"></td> <td style="width: 10%;"></td> <td style="width: 10%;"></td> <td style="width: 10%;"></td> <td style="width: 10%;"></td> <td style="width: 10%;"></td> <td style="width: 10%;"></td> </tr> <tr> <td></td> <td></td> <td colspan="8" style="text-align: center;"> <table border="1" style="width: 100%; border-collapse: collapse; text-align: center;"> <tr> <td style="width: 10%;"></td> <td style="width: 10%;"></td> <td style="width: 10%;"></td> <td style="width: 10%;"></td> <td style="width: 10%;"></td> <td style="width: 10%;"></td> <td style="width: 10%;"></td> <td style="width: 10%;"></td> <td style="width: 10%;"></td> <td style="width: 10%;"></td> </tr> <tr> <td></td> <td></td> <td colspan="8" style="text-align: center;"> <table border="1" style="width: 100%; border-collapse: collapse; text-align: center;"> <tr> <td style="width: 10%;"></td> <td style="width: 10%;"></td> <td style="width: 10%;"></td> <td style="width: 10%;"></td> <td style="width: 10%;"></td> <td style="width: 10%;"></td> <td
style="width: 10%;"></td> <td style="width: 10%;"></td> <td style="width: 10%;"></td> <td style="width: 10%;"></td> </tr> <tr> <td></td> <td></td> <td colspan="8" style="text-align: center;"> <table border="1" style="width: 100%; border-collapse: collapse; text-align: center;"> <tr> <td style="width: 10%;"></td> <td style="width: 10%;"></td> <td style="width: 10%;"></td> <td style="width: 10%;"></td> <td style="width: 10%;"></td> <td style="width: 10%;"></td> <td style="width: 10%;"></td> <td style="width: 10%;"></td> <td style="width: 10%;"></td> <td style="width: 10%;"></td> </tr> <tr> <td></td> <td></td> <td colspan="8" style="text-align: center;"> <table border="1" style="width: 100%; border-collapse: collapse; text-align: center;"> <tr> <td style="width: 10%;"></td> <td style="width: 10%;"></td> <td style="width: 10%;"></td> <td style="width: 10%;"></td> <td style="width: 10%;"></td> <td style="width: 10%;"></td> <td style="width: 10%;"></td> <td style="width: 10%;"></td> <td style="width: 10%;"></td> <td style="width: 10%;"></td> </tr> <tr> <td></td> <td></td> <td colspan="8" style="text-align: center;"> <table border="1" style="width: 100%; border-collapse: collapse; text-align: center;"> <tr> </tr></table></td></tr></table></td></tr></table></td></tr></table></td></tr></table></td></tr></table></td></tr></table></td></tr></table></td></tr></table></td></tr></table></td></tr></table></td></tr></table></td></tr></table></td></tr></table></td></tr></table></td></tr></table></td></tr></table></td></tr></table></td></tr></table></td></tr></table></td></tr></table></td></tr></table></td></tr></table></td></tr></table> | | | | | | | | | | | | | | | | | | | | <table border="1" style="width: 100%; border-collapse: collapse; text-align: center;"> <tr> <td style="width: 10%;"></td> <td style="width: 10%;"></td> <td style="width: 10%;"></td> <td style="width: 10%;"></td> <td style="width: 10%;"></td> <td style="width: 10%;"></td> <td style="width: 10%;"></td> <td style="width: 10%;"></td> <td style="width: 10%;"></td> <td style="width: 10%;"></td> </tr> <tr> <td></td> <td></td> <td colspan="8" style="text-align: center;"> <table border="1" style="width: 100%; border-collapse: collapse; text-align: center;"> <tr> <td style="width: 10%;"></td> <td style="width: 10%;"></td> <td style="width: 10%;"></td> <td style="width: 10%;"></td> <td style="width: 10%;"></td> <td style="width: 10%;"></td> <td style="width: 10%;"></td> <td style="width: 10%;"></td> <td style="width: 10%;"></td> <td style="width: 10%;"></td> </tr> <tr> <td></td> <td></td> <td colspan="8" style="text-align: center;"> <table border="1" style="width: 100%; border-collapse: collapse; text-align: center;"> <tr> <td style="width: 10%;"></td> <td style="width: 10%;"></td> <td style="width: 10%;"></td> <td style="width: 10%;"></td> <td style="width: 10%;"></td> <td style="width: 10%;"></td> <td style="width: 10%;"></td> <td style="width: 10%;"></td> <td style="width: 10%;"></td> <td style="width: 10%;"></td> </tr> <tr> <td></td> <td></td> <td colspan="8" style="text-align: center;"> <table border="1" style="width: 100%; border-collapse: collapse; text-align: center;"> <tr> <td style="width: 10%;"></td> <td style="width: 10%;"></td> <td style="width: 10%;"></td> <td style="width: 10%;"></td> <td style="width: 10%;"></td> <td style="width: 10%;"></td> <td style="width: 10%;"></td> <td style="width: 10%;"></td> <td style="width: 10%;"></td> <td style="width: 10%;"></td> </tr> <tr> <td></td> <td></td> <td colspan="8" style="text-align: center;"> <table border="1" style="width: 100%; border-collapse: collapse; text-align: center;"> <tr> <td style="width: 10%;"></td> <td style="width: 10%;"></td> <td style="width: 10%;"></td> <td style="width: 10%;"></td> <td style="width: 10%;"></td> <td style="width: 10%;"></td> <td style="width: 10%;"></td> <td style="width: 10%;"></td> <td style="width: 10%;"></td> <td style="width: 10%;"></td> </tr> <tr> <td></td> <td></td> <td colspan="8" style="text-align: center;"> <table border="1" style="width: 100%; border-collapse: collapse; text-align: center;"> <tr> <td style="width:
10%;"></td> <td style="width: 10%;"></td> <td style="width: 10%;"></td> <td style="width: 10%;"></td> <td style="width: 10%;"></td> <td style="width: 10%;"></td> <td style="width: 10%;"></td> <td style="width: 10%;"></td> <td style="width: 10%;"></td> <td style="width: 10%;"></td> </tr> <tr> <td></td> <td></td> <td colspan="8" style="text-align: center;"> <table border="1" style="width: 100%; border-collapse: collapse; text-align: center;"> <tr> <td style="width: 10%;"></td> <td style="width: 10%;"></td> <td style="width: 10%;"></td> <td style="width: 10%;"></td> <td style="width: 10%;"></td> <td style="width: 10%;"></td> <td style="width: 10%;"></td> <td style="width: 10%;"></td> <td style="width: 10%;"></td> <td style="width: 10%;"></td> </tr> <tr> <td></td> <td></td> <td colspan="8" style="text-align: center;"> <table border="1" style="width: 100%; border-collapse: collapse; text-align: center;"> <tr> <td style="width: 10%;"></td> <td style="width: 10%;"></td> <td style="width: 10%;"></td> <td style="width: 10%;"></td> <td style="width: 10%;"></td> <td style="width: 10%;"></td> <td style="width: 10%;"></td> <td style="width: 10%;"></td> <td style="width: 10%;"></td> <td style="width: 10%;"></td> </tr> <tr> <td></td> <td></td> <td colspan="8" style="text-align: center;"> <table border="1" style="width: 100%; border-collapse: collapse; text-align: center;"> <tr> <td style="width: 10%;"></td> <td style="width: 10%;"></td> <td style="width: 10%;"></td> <td style="width: 10%;"></td> <td style="width: 10%;"></td> <td style="width: 10%;"></td> <td style="width: 10%;"></td> <td style="width: 10%;"></td> <td style="width: 10%;"></td> <td style="width: 10%;"></td> </tr> <tr> <td></td> <td></td> <td colspan="8" style="text-align: center;"> <table border="1" style="width: 100%; border-collapse: collapse; text-align: center;"> <tr> <td style="width: 10%;"></td> <td style="width: 10%;"></td> <td style="width: 10%;"></td> <td style="width: 10%;"></td> <td style="width: 10%;"></td> <td style="width: 10%;"></td> <td style="width: 10%;"></td> <td style="width: 10%;"></td> <td style="width: 10%;"></td> <td style="width: 10%;"></td> </tr> <tr> <td></td> <td></td> <td colspan="8" style="text-align: center;"> <table border="1" style="width: 100%; border-collapse: collapse; text-align: center;"> <tr> <td style="width: 10%;"></td> <td style="width: 10%;"></td> <td style="width: 10%;"></td> <td style="width: 10%;"></td> <td style="width: 10%;"></td> <td style="width: 10%;"></td> <td style="width: 10%;"></td> <td style="width: 10%;"></td> <td style="width: 10%;"></td> <td style="width: 10%;"></td> </tr> <tr> <td></td> <td></td> <td colspan="8" style="text-align: center;"> <table border="1" style="width: 100%; border-collapse: collapse; text-align: center;"> <tr> <td style="width: 10%;"></td> <td style="width: 10%;"></td> <td style="width: 10%;"></td> <td style="width: 10%;"></td> <td style="width: 10%;"></td> <td style="width: 10%;"></td> <td style="width: 10%;"></td> <td style="width: 10%;"></td> <td style="width: 10%;"></td> <td style="width: 10%;"></td> </tr> <tr> <td></td> <td></td> <td colspan="8" style="text-align: center;"> <table border="1" style="width: 100%; border-collapse: collapse; text-align: center;"> <tr> <td style="width: 10%;"></td> <td style="width: 10%;"></td> <td style="width: 10%;"></td> <td style="width: 10%;"></td> <td style="width: 10%;"></td> <td style="width: 10%;"></td> <td style="width: 10%;"></td> <td style="width: 10%;"></td> <td style="width: 10%;"></td> <td style="width: 10%;"></td> </tr> <tr> <td></td> <td></td> <td colspan="8" style="text-align: center;"> <table border="1" style="width: 100%; border-collapse: collapse; text-align: center;"> <tr> <td style="width: 10%;"></td> <td style="width: 10%;"></td> <td style="width: 10%;"></td> <td style="width: 10%;"></td> <td style="width: 10%;"></td> <td style="width: 10%;"></td> <td style="width: 10%;"></td> <td style="width: 10%;"></td> <td style="width: 10%;"></td> <td style="width: 10%;"></td> </tr> <tr> <td></td> <td></td> <td colspan="8" style="text-align: center;"> <table border="1" style="width: 100%; border-collapse: collapse; text-align: center;"> <tr> <td style="width: 10%;"></td> <td style="width: 10%;"></td> <td style="width: 10%;"></td> <td style="width: 10%;"></td> <td style="width: 10%;"></td> <td style="width: 10%;"></td> <td style="width: 10%;"></td> <td style="width: 10%;"></td> <td style="width: 10%;"></td> <td style="width: 10%;"></td> </tr> <tr> <td></td> <td></td> <td colspan="8" style="text-align: center;"> <table border="1" style="width: 100%; border-collapse: collapse; text-align: center;"> <tr> <td style="width: 10%;"></td> <td style="width: 10%;"></td> <td style="width: 10%;"></td> <td style="width: 10%;"></td> <td style="width: 10%;"></td> <td style="width: 10%;"></td> <td style="width: 10%;"></td> <td style="width: 10%;"></td> <td style="width: 10%;"></td> <td style="width: 10%;"></td> </tr> <tr> <td></td> <td></td> <td colspan="8" style="text-align: center;"> <table border="1" style="width: 100%; border-collapse: collapse; text-align: center;"> <tr> <td style="width: 10%;"></td> <td style="width: 10%;"></td> <td style="width: 10%;"></td> <td style="width: 10%;"></td> <td style="width: 10%;"></td> <td style="width: 10%;"></td> <td style="width: 10%;"></td> <td style="width: 10%;"></td> <td style="width: 10%;"></td> <td style="width: 10%;"></td> </tr> <tr> <td></td> <td></td> <td colspan="8" style="text-align: center;"> <table border="1" style="width: 100%; border-collapse: collapse; text-align: center;"> <tr> <td style="width: 10%;"></td> <td style="width: 10%;"></td> <td style="width: 10%;"></td> <td style="width: 10%;"></td> <td style="width: 10%;"></td> <td style="width: 10%;"></td> <td style="width: 10%;"></td> <td style="width: 10%;"></td> <td style="width: 10%;"></td> <td style="width: 10%;"></td> </tr> <tr> <td></td> <td></td> <td colspan="8" style="text-align: center;"> <table border="1" style="width: 100%; border-collapse: collapse; text-align: center;"> <tr> <td style="width: 10%;"></td> <td style="width: 10%;"></td> <td style="width: 10%;"></td> <td style="width: 10%;"></td> <td style="width: 10%;"></td> <td style="width: 10%;"></td> <td style="width: 10%;"></td> <td style="width: 10%;"></td> <td style="width: 10%;"></td> <td style="width: 10%;"></td> </tr> <tr> <td></td> <td></td> <td colspan="8" style="text-align: center;"> <table border="1" style="width: 100%; border-collapse: collapse; text-align: center;"> <tr> <td style="width: 10%;"></td> <td style="width: 10%;"></td> <td style="width: 10%;"></td> <td style="width: 10%;"></td> <td style="width: 10%;"></td> <td style="width: 10%;"></td> <td style="width: 10%;"></td> <td style="width: 10%;"></td> <td style="width: 10%;"></td> <td style="width: 10%;"></td> </tr> <tr> <td></td> <td></td> <td colspan="8" style="text-align: center;"> <table border="1" style="width: 100%; border-collapse: collapse; text-align: center;"> <tr> <td style="width: 10%;"></td> <td style="width: 10%;"></td> <td style="width: 10%;"></td> <td style="width: 10%;"></td> <td style="width: 10%;"></td> <td style="width: 10%;"></td> <td style="width: 10%;"></td> <td style="width: 10%;"></td> <td style="width: 10%;"></td> <td style="width: 10%;"></td> </tr> <tr> <td></td> <td></td> <td colspan="8" style="text-align: center;"> <table border="1" style="width: 100%; border-collapse: collapse; text-align: center;"> <tr> <td style="width: 10%;"></td> <td style="width: 10%;"></td> <td style="width: 10%;"></td> <td style="width: 10%;"></td> <td style="width: 10%;"></td> <td style="width: 10%;"></td> <td style="width: 10%;"></td> <td style="width: 10%;"></td> <td style="width: 10%;"></td> <td style="width: 10%;"></td> </tr> <tr> <td></td> <td></td> <td colspan="8" style="text-align: center;"> <table border="1" style="width: 100%; border-collapse: collapse; text-align: center;"> <tr> </tr></table></td></tr></table></td></tr></table></td></tr></table></td></tr></table></td></tr></table></td></tr></table></td></tr></table></td></tr></table></td></tr></table></td></tr></table></td></tr></table></td></tr></table></td></tr></table></td></tr></table></td></tr></table></td></tr></table></td></tr></table></td></tr></table></td></tr></table></td></tr></table></td></tr></table></td></tr></table>
 | | | | | | | | | | | | | | | | | | | | <table border="1" style="width: 100%; border-collapse: collapse; text-align: center;"> <tr> <td style="width: 10%;"></td> <td style="width: 10%;"></td> <td style="width: 10%;"></td> <td style="width: 10%;"></td> <td style="width: 10%;"></td> <td style="width: 10%;"></td> <td style="width: 10%;"></td> <td style="width: 10%;"></td> <td style="width: 10%;"></td> <td style="width: 10%;"></td> </tr> <tr> <td></td> <td></td> <td colspan="8" style="text-align: center;"> <table border="1" style="width: 100%; border-collapse: collapse; text-align: center;"> <tr> <td style="width: 10%;"></td> <td style="width: 10%;"></td> <td style="width: 10%;"></td> <td style="width: 10%;"></td> <td style="width: 10%;"></td> <td style="width: 10%;"></td> <td style="width: 10%;"></td> <td style="width: 10%;"></td> <td style="width: 10%;"></td> <td style="width: 10%;"></td> </tr> <tr> <td></td> <td></td> <td colspan="8" style="text-align: center;"> <table border="1" style="width: 100%; border-collapse: collapse; text-align: center;"> <tr> <td style="width: 10%;"></td> <td style="width: 10%;"></td> <td style="width: 10%;"></td> <td style="width: 10%;"></td> <td style="width: 10%;"></td> <td style="width: 10%;"></td> <td style="width: 10%;"></td> <td style="width: 10%;"></td> <td style="width: 10%;"></td> <td style="width: 10%;"></td> </tr> <tr> <td></td> <td></td> <td colspan="8" style="text-align: center;"> <table border="1" style="width: 100%; border-collapse: collapse; text-align: center;"> <tr> <td style="width: 10%;"></td> <td style="width: 10%;"></td> <td style="width: 10%;"></td> <td style="width: 10%;"></td> <td style="width: 10%;"></td> <td style="width: 10%;"></td> <td style="width: 10%;"></td> <td style="width: 10%;"></td> <td style="width: 10%;"></td> <td style="width: 10%;"></td> </tr> <tr> <td></td> <td></td> <td colspan="8" style="text-align: center;"> <table border="1" style="width: 100%; border-collapse: collapse; text-align: center;"> <tr> <td style="width: 10%;"></td> <td style="width: 10%;"></td> <td style="width: 10%;"></td> <td style="width: 10%;"></td> <td style="width: 10%;"></td> <td style="width: 10%;"></td> <td style="width: 10%;"></td> <td style="width: 10%;"></td> <td style="width: 10%;"></td> <td style="width: 10%;"></td> </tr> <tr> <td></td> <td></td> <td colspan="8" style="text-align: center;"> <table border="1" style="width: 100%; border-collapse: collapse; text-align: center;"> <tr> <td style="width: 10%;"></td> <td style="width: 10%;"></td> <td style="width: 10%;"></td> <td style="width: 10%;"></td> <td style="width: 10%;"></td> <td style="width: 10%;"></td> <td style="width: 10%;"></td> <td style="width: 10%;"></td> <td style="width: 10%;"></td> <td style="width: 10%;"></td> </tr> <tr> <td></td> <td></td> <td colspan="8" style="text-align: center;"> <table border="1" style="width: 100%; border-collapse: collapse; text-align: center;"> <tr> <td style="width: 10%;"></td> <td style="width: 10%;"></td> <td style="width: 10%;"></td> <td style="width: 10%;"></td> <td style="width: 10%;"></td> <td style="width: 10%;"></td> <td style="width: 10%;"></td> <td style="width: 10%;"></td> <td style="width: 10%;"></td> <td style="width: 10%;"></td> </tr> <tr> <td></td> <td></td> <td colspan="8" style="text-align: center;"> <table border="1" style="width: 100%; border-collapse: collapse; text-align: center;"> <tr> <td style="width: 10%;"></td> <td style="width: 10%;"></td> <td style="width: 10%;"></td> <td style="width: 10%;"></td> <td style="width: 10%;"></td> <td style="width: 10%;"></td> <td style="width: 10%;"></td> <td style="width: 10%;"></td> <td style="width: 10%;"></td> <td style="width: 10%;"></td> </tr> <tr> <td></td> <td></td> <td colspan="8" style="text-align: center;"> <table border="1" style="width: 100%; border-collapse: collapse; text-align: center;"> <tr> <td style="width: 10%;"></td> <td style="width: 10%;"></td> <td style="width: 10%;"></td> <td style="width: 10%;"></td> <td style="width: 10%;"></td> <td style="width: 10%;"></td> <td style="width: 10%;"></td> <td style="width: 10%;"></td> <td style="width: 10%;"></td> <td style="width: 10%;"></td> </tr> <tr> <td></td> <td></td> <td colspan="8" style="text-align: center;"> <table border="1" style="width: 100%; border-collapse: collapse; text-align: center;"> <tr> <td style="width: 10%;"></td> <td style="width: 10%;"></td> <td style="width: 10%;"></td> <td style="width: 10%;"></td> <td style="width: 10%;"></td> <td style="width: 10%;"></td> <td style="width: 10%;"></td> <td style="width: 10%;"></td> <td style="width: 10%;"></td> <td style="width: 10%;"></td> </tr> <tr> <td></td> <td></td> <td colspan="8" style="text-align: center;"> <table border="1" style="width: 100%; border-collapse: collapse; text-align: center;"> <tr> <td style="width: 10%;"></td> <td style="width: 10%;"></td> <td style="width: 10%;"></td> <td style="width: 10%;"></td> <td style="width: 10%;"></td> <td style="width: 10%;"></td> <td style="width: 10%;"></td> <td style="width: 10%;"></td> <td style="width: 10%;"></td> <td style="width: 10%;"></td> </tr> <tr> <td></td> <td></td> <td colspan="8" style="text-align: center;"> <table border="1" style="width: 100%; border-collapse: collapse; text-align: center;"> <tr> <td style="width: 10%;"></td> <td style="width: 10%;"></td> <td style="width: 10%;"></td> <td style="width: 10%;"></td> <td style="width: 10%;"></td> <td style="width: 10%;"></td> <td style="width: 10%;"></td> <td style="width: 10%;"></td> <td style="width: 10%;"></td> <td style="width: 10%;"></td> </tr> <tr> <td></td> <td></td> <td colspan="8" style="text-align: center;"> <table border="1" style="width: 100%; border-collapse: collapse; text-align: center;"> <tr> <td style="width: 10%;"></td> <td style="width:
10%;"></td> <td style="width: 10%;"></td> <td style="width: 10%;"></td> <td style="width: 10%;"></td> <td style="width: 10%;"></td> <td style="width: 10%;"></td> <td style="width: 10%;"></td> <td style="width: 10%;"></td> <td style="width: 10%;"></td> </tr> <tr> <td></td> <td></td> <td colspan="8" style="text-align: center;"> <table border="1" style="width: 100%; border-collapse: collapse; text-align: center;"> <tr> <td style="width: 10%;"></td> <td style="width: 10%;"></td> <td style="width: 10%;"></td> <td style="width: 10%;"></td> <td style="width: 10%;"></td> <td style="width: 10%;"></td> <td style="width: 10%;"></td> <td style="width: 10%;"></td> <td style="width: 10%;"></td> <td style="width: 10%;"></td> </tr> <tr> <td></td> <td></td> <td colspan="8" style="text-align: center;"> <table border="1" style="width: 100%; border-collapse: collapse; text-align: center;"> <tr> <td style="width: 10%;"></td> <td style="width: 10%;"></td> <td style="width: 10%;"></td> <td style="width: 10%;"></td> <td style="width: 10%;"></td> <td style="width: 10%;"></td> <td style="width: 10%;"></td> <td style="width: 10%;"></td> <td style="width: 10%;"></td> <td style="width: 10%;"></td> </tr> <tr> <td></td> <td></td> <td colspan="8" style="text-align: center;"> <table border="1" style="width: 100%; border-collapse: collapse; text-align: center;"> <tr> <td style="width: 10%;"></td> <td style="width: 10%;"></td> <td style="width: 10%;"></td> <td style="width: 10%;"></td> <td style="width: 10%;"></td> <td style="width: 10%;"></td> <td style="width: 10%;"></td> <td style="width: 10%;"></td> <td style="width: 10%;"></td> <td style="width: 10%;"></td> </tr> <tr> <td></td> <td></td> <td colspan="8" style="text-align: center;"> <table border="1" style="width: 100%; border-collapse: collapse; text-align: center;"> <tr> <td style="width: 10%;"></td> <td style="width: 10%;"></td> <td style="width: 10%;"></td> <td style="width: 10%;"></td> <td style="width: 10%;"></td> <td style="width: 10%;"></td> <td style="width: 10%;"></td> <td style="width: 10%;"></td> <td style="width: 10%;"></td> <td style="width: 10%;"></td> </tr> <tr> <td></td> <td></td> <td colspan="8" style="text-align: center;"> <table border="1" style="width: 100%; border-collapse: collapse; text-align: center;"> <tr> <td style="width: 10%;"></td> <td style="width: 10%;"></td> <td style="width: 10%;"></td> <td style="width: 10%;"></td> <td style="width: 10%;"></td> <td style="width: 10%;"></td> <td style="width: 10%;"></td> <td style="width: 10%;"></td> <td style="width: 10%;"></td> <td style="width: 10%;"></td> </tr> <tr> <td></td> <td></td> <td colspan="8" style="text-align: center;"> <table border="1" style="width: 100%; border-collapse: collapse; text-align: center;"> <tr> <td style="width: 10%;"></td> <td style="width: 10%;"></td> <td style="width: 10%;"></td> <td style="width: 10%;"></td> <td style="width: 10%;"></td> <td style="width: 10%;"></td> <td style="width: 10%;"></td> <td style="width: 10%;"></td> <td style="width: 10%;"></td> <td style="width: 10%;"></td> </tr> <tr> <td></td> <td></td> <td colspan="8" style="text-align: center;"> <table border="1" style="width: 100%; border-collapse: collapse; text-align: center;"> <tr> <td style="width: 10%;"></td> <td style="width: 10%;"></td> <td style="width: 10%;"></td> <td style="width: 10%;"></td> <td style="width: 10%;"></td> <td style="width: 10%;"></td> <td style="width: 10%;"></td> <td style="width: 10%;"></td> <td style="width: 10%;"></td> <td style="width: 10%;"></td> </tr> <tr> <td></td> <td></td> <td colspan="8" style="text-align: center;"> <table border="1" style="width: 100%; border-collapse: collapse; text-align: center;"> <tr> <td style="width: 10%;"></td> <td style="width: 10%;"></td> <td style="width: 10%;"></td> <td style="width: 10%;"></td> <td style="width: 10%;"></td> <td style="width: 10%;"></td> <td style="width: 10%;"></td> <td style="width: 10%;"></td> <td style="width: 10%;"></td> <td style="width: 10%;"></td> </tr> <tr> <td></td> <td></td> <td colspan="8" style="text-align: center;"> <table border="1" style="width: 100%; border-collapse: collapse; text-align: center;"> <tr> </tr></table></td></tr></table></td></tr></table></td></tr></table></td></tr></table></td></tr></table></td></tr></table></td></tr></table></td></tr></table></td></tr></table></td></tr></table></td></tr></table></td></tr></table></td></tr></table></td></tr></table></td></tr></table></td></tr></table></td></tr></table></td></tr></table></td></tr></table></td></tr></table></td></tr></table>
 | | | | | | | | | | | | | | | | | | | | <table border="1" style="width: 100%; border-collapse: collapse; text-align: center;"> <tr> <td style="width: 10%;"></td> <td style="width: 10%;"></td> <td style="width: 10%;"></td> <td style="width: 10%;"></td> <td style="width: 10%;"></td> <td style="width: 10%;"></td> <td style="width: 10%;"></td> <td style="width: 10%;"></td> <td style="width: 10%;"></td> <td style="width: 10%;"></td> </tr> <tr> <td></td> <td></td> <td colspan="8" style="text-align: center;"> <table border="1" style="width: 100%; border-collapse: collapse; text-align: center;"> <tr> <td style="width: 10%;"></td> <td style="width: 10%;"></td> <td style="width: 10%;"></td> <td style="width: 10%;"></td> <td style="width: 10%;"></td> <td style="width: 10%;"></td> <td style="width: 10%;"></td> <td style="width: 10%;"></td> <td style="width: 10%;"></td> <td style="width: 10%;"></td> </tr> <tr> <td></td> <td></td> <td colspan="8" style="text-align: center;"> <table border="1" style="width: 100%; border-collapse: collapse; text-align: center;"> <tr> <td style="width: 10%;"></td> <td style="width: 10%;"></td> <td style="width: 10%;"></td> <td style="width: 10%;"></td> <td style="width: 10%;"></td> <td style="width: 10%;"></td> <td style="width: 10%;"></td> <td style="width: 10%;"></td> <td style="width: 10%;"></td> <td style="width: 10%;"></td> </tr> <tr> <td></td> <td></td> <td colspan="8" style="text-align: center;"> <table border="1" style="width: 100%; border-collapse: collapse; text-align: center;"> <tr> <td style="width: 10%;"></td> <td style="width: 10%;"></td> <td style="width: 10%;"></td> <td style="width: 10%;"></td> <td style="width: 10%;"></td> <td style="width: 10%;"></td> <td style="width: 10%;"></td> <td style="width: 10%;"></td> <td style="width: 10%;"></td> <td style="width: 10%;"></td> </tr> <tr> <td></td> <td></td> <td colspan="8" style="text-align: center;"> <table border="1" style="width: 100%; border-collapse: collapse; text-align: center;"> <tr> <td style="width: 10%;"></td> <td style="width: 10%;"></td> <td style="width: 10%;"></td> <td style="width: 10%;"></td> <td style="width: 10%;"></td> <td style="width: 10%;"></td> <td style="width: 10%;"></td> <td style="width: 10%;"></td> <td style="width: 10%;"></td> <td style="width: 10%;"></td> </tr> <tr> <td></td> <td></td> <td colspan="8" style="text-align: center;"> <table border="1" style="width: 100%; border-collapse: collapse; text-align: center;"> <tr> <td style="width: 10%;"></td> <td style="width: 10%;"></td> <td style="width: 10%;"></td> <td style="width: 10%;"></td> <td style="width: 10%;"></td> <td style="width: 10%;"></td> <td style="width: 10%;"></td> <td style="width: 10%;"></td> <td style="width: 10%;"></td> <td style="width: 10%;"></td> </tr> <tr> <td></td> <td></td> <td colspan="8" style="text-align: center;"> <table border="1" style="width: 100%; border-collapse: collapse; text-align: center;"> <tr> <td style="width: 10%;"></td> <td style="width: 10%;"></td> <td style="width: 10%;"></td> <td style="width: 10%;"></td> <td style="width: 10%;"></td> <td style="width: 10%;"></td> <td style="width: 10%;"></td> <td style="width: 10%;"></td> <td style="width: 10%;"></td> <td style="width: 10%;"></td> </tr> <tr> <td></td> <td></td> <td colspan="8" style="text-align: center;"> <table border="1" style="width: 100%; border-collapse: collapse; text-align: center;"> <tr> <td style="width: 10%;"></td> <td style="width: 10%;"></td> <td style="width: 10%;"></td> <td style="width: 10%;"></td> <td style="width: 10%;"></td> <td style="width: 10%;"></td> <td style="width: 10%;"></td> <td style="width: 10%;"></td> <td style="width: 10%;"></td> <td style="width: 10%;"></td> </tr> <tr> <td></td> <td></td> <td colspan="8" style="text-align: center;"> <table border="1" style="width: 100%; border-collapse: collapse; text-align: center;"> <tr> <td style="width: 10%;"></td> <td style="width: 10%;"></td> <td style="width: 10%;"></td> <td style="width: 10%;"></td> <td style="width: 10%;"></td> <td style="width: 10%;"></td> <td style="width: 10%;"></td> <td style="width: 10%;"></td> <td style="width: 10%;"></td> <td style="width: 10%;"></td> </tr> <tr> <td></td> <td></td> <td colspan="8" style="text-align: center;"> <table border="1" style="width: 100%; border-collapse: collapse; text-align: center;"> <tr> <td style="width: 10%;"></td> <td style="width: 10%;"></td> <td style="width: 10%;"></td> <td style="width: 10%;"></td> <td style="width: 10%;"></td> <td style="width: 10%;"></td> <td style="width: 10%;"></td> <td style="width: 10%;"></td> <td style="width: 10%;"></td> <td style="width: 10%;"></td> </tr> <tr> <td></td> <td></td> <td colspan="8" style="text-align: center;"> <table border="1" style="width: 100%; border-collapse: collapse; text-align: center;"> <tr> <td style="width: 10%;"></td> <td style="width: 10%;"></td> <td style="width: 10%;"></td> <td style="width: 10%;"></td> <td style="width: 10%;"></td> <td style="width: 10%;"></td> <td style="width: 10%;"></td> <td style="width: 10%;"></td> <td style="width: 10%;"></td> <td style="width: 10%;"></td> </tr> <tr> <td></td> <td></td> <td colspan="8" style="text-align: center;"> <table border="1" style="width: 100%; border-collapse: collapse; text-align: center;"> <tr> <td style="width: 10%;"></td> <td style="width: 10%;"></td> <td style="width: 10%;"></td> <td style="width: 10%;"></td> <td style="width: 10%;"></td> <td style="width: 10%;"></td> <td style="width: 10%;"></td> <td style="width: 10%;"></td> <td style="width: 10%;"></td> <td style="width: 10%;"></td> </tr> <tr> <td></td> <td></td> <td colspan="8" style="text-align: center;"> <table border="1" style="width: 100%; border-collapse: collapse; text-align: center;"> <tr> <td style="width: 10%;"></td> <td style="width: 10%;"></td> <td style="width: 10%;"></td> <td style="width: 10%;"></td> <td style="width: 10%;"></td> <td style="width: 10%;"></td> <td style="width: 10%;"></td> <td style="width: 10%;"></td> <td style="width: 10%;"></td> <td style="width: 10%;"></td> </tr> <tr> <td></td> <td></td> <td colspan="8" style="text-align: center;"> <table border="1" style="width: 100%; border-collapse: collapse; text-align: center;"> <tr> <td style="width: 10%;"></td> <td style="width: 10%;"></td> <td style="width: 10%;"></td> <td style="width: 10%;"></td> <td style="width: 10%;"></td> <td style="width: 10%;"></td> <td style="width: 10%;"></td> <td style="width: 10%;"></td> <td style="width: 10%;"></td> <td style="width: 10%;"></td> </tr> <tr> <td></td> <td></td> <td colspan="8" style="text-align: center;"> <table border="1" style="width: 100%; border-collapse: collapse; text-align: center;"> <tr> <td style="width: 10%;"></td> <td style="width: 10%;"></td> <td style="width: 10%;"></td> <td style="width: 10%;"></td> <td style="width: 10%;"></td> <td style="width: 10%;"></td> <td style="width: 10%;"></td> <td style="width: 10%;"></td> <td style="width: 10%;"></td> <td style="width: 10%;"></td> </tr> <tr> <td></td> <td></td> <td colspan="8" style="text-align: center;"> <table border="1" style="width: 100%; border-collapse: collapse; text-align: center;"> <tr> <td style="width: 10%;"></td> <td style="width: 10%;"></td> <td style="width: 10%;"></td> <td style="width: 10%;"></td> <td style="width: 10%;"></td> <td style="width: 10%;"></td> <td style="width: 10%;"></td> <td style="width: 10%;"></td> <td style="width: 10%;"></td> <td style="width: 10%;"></td> </tr> <tr> <td></td> <td></td> <td colspan="8" style="text-align: center;"> <table border="1" style="width: 100%; border-collapse: collapse; text-align: center;"> <tr> <td style="width: 10%;"></td> <td style="width: 10%;"></td> <td style="width: 10%;"></td> <td style="width: 10%;"></td> <td style="width: 10%;"></td> <td style="width: 10%;"></td> <td style="width: 10%;"></td> <td style="width: 10%;"></td> <td style="width: 10%;"></td> <td style="width: 10%;"></td> </tr> <tr> <td></td> <td></td> <td colspan="8" style="text-align: center;"> <table border="1" style="width: 100%; border-collapse: collapse; text-align: center;"> <tr> <td style="width: 10%;"></td> <td style="width: 10%;"></td> <td style="width: 10%;"></td> <td style="width: 10%;"></td> <td style="width: 10%;"></td> <td style="width: 10%;"></td> <td style="width: 10%;"></td> <td style="width: 10%;"></td> <td style="width: 10%;"></td> <td style="width: 10%;"></td> </tr> <tr> <td></td> <td></td> <td colspan="8" style="text-align: center;"> <table border="1" style="width: 100%; border-collapse: collapse; text-align: center;"> <tr> <td style="width: 10%;"></td> <td style="width: 10%;"></td> <td style="width: 10%;"></td> <td style="width: 10%;"></td> <td style="width: 10%;"></td> <td style="width: 10%;"></td> <td style="width: 10%;"></td> <td style="width: 10%;"></td> <td style="width: 10%;"></td> <td style="width: 10%;"></td> </tr> <tr> <td></td> <td></td> <td colspan="8" style="text-align: center;"> <table border="1" style="width: 100%; border-collapse: collapse; text-align: center;"> <tr> <td style="width: 10%;"></td> <td style="width: 10%;"></td> <td style="width: 10%;"></td> <td style="width: 10%;"></td> <td style="width: 10%;"></td> <td style="width: 10%;"></td> <td style="width: 10%;"></td> <td style="width: 10%;"></td> <td style="width: 10%;"></td> <td style="width: 10%;"></td> </tr> <tr> <td></td> <td></td> <td colspan="8" style="text-align: center;"> <table border="1" style="width: 100%; border-collapse: collapse; text-align: center;"> <tr>
</tr></table></td></tr></table></td></tr></table></td></tr></table></td></tr></table></td></tr></table></td></tr></table></td></tr></table></td></tr></table></td></tr></table></td></tr></table></td></tr></table></td></tr></table></td></tr></table></td></tr></table></td></tr></table></td></tr></table></td></tr></table></td></tr></table></td></tr></table></td></tr></table> | | | | | | | | | | | | | | | | | | | | <table border="1" style="width: 100%; border-collapse: collapse; text-align: center;"> <tr> <td style="width: 10%;"></td> <td style="width: 10%;"></td> <td style="width: 10%;"></td> <td style="width: 10%;"></td> <td style="width: 10%;"></td> <td style="width: 10%;"></td> <td style="width: 10%;"></td> <td style="width: 10%;"></td> <td style="width: 10%;"></td> <td style="width: 10%;"></td> </tr> <tr> <td></td> <td></td> <td colspan="8" style="text-align: center;"> <table border="1" style="width: 100%; border-collapse: collapse; text-align: center;"> <tr> <td style="width: 10%;"></td> <td style="width: 10%;"></td> <td style="width: 10%;"></td> <td style="width: 10%;"></td> <td style="width: 10%;"></td> <td style="width: 10%;"></td> <td style="width: 10%;"></td> <td style="width: 10%;"></td> <td style="width: 10%;"></td> <td style="width: 10%;"></td> </tr> <tr> <td></td> <td></td> <td colspan="8" style="text-align: center;"> <table border="1" style="width: 100%; border-collapse: collapse; text-align: center;"> <tr> <td style="width: 10%;"></td> <td style="width: 10%;"></td> <td style="width: 10%;"></td> <td style="width: 10%;"></td> <td style="width: 10%;"></td> <td style="width: 10%;"></td> <td style="width: 10%;"></td> <td style="width: 10%;"></td> <td style="width: 10%;"></td> <td style="width: 10%;"></td> </tr> <tr> <td></td> <td></td> <td colspan="8" style="text-align: center;"> <table border="1" style="width: 100%; border-collapse: collapse; text-align: center;"> <tr> <td style="width: 10%;"></td> <td style="width: 10%;"></td> <td style="width: 10%;"></td> <td style="width: 10%;"></td> <td style="width: 10%;"></td> <td style="width: 10%;"></td> <td style="width: 10%;"></td> <td style="width: 10%;"></td> <td style="width: 10%;"></td> <td style="width: 10%;"></td> </tr> <tr> <td></td> <td></td> <td colspan="8" style="text-align: center;"> <table border="1" style="width: 100%; border-collapse: collapse; text-align: center;"> <tr> <td style="width: 10%;"></td> <td style="width: 10%;"></td> <td style="width: 10%;"></td> <td style="width: 10%;"></td> <td style="width: 10%;"></td> <td style="width: 10%;"></td> <td style="width: 10%;"></td> <td style="width: 10%;"></td> <td style="width: 10%;"></td> <td style="width: 10%;"></td> </tr> <tr> <td></td> <td></td> <td colspan="8" style="text-align: center;"> <table border="1" style="width: 100%; border-collapse: collapse; text-align: center;"> <tr> <td style="width: 10%;"></td> <td style="width: 10%;"></td> <td style="width: 10%;"></td> <td style="width: 10%;"></td> <td style="width: 10%;"></td> <td style="width: 10%;"></td> <td style="width: 10%;"></td> <td style="width: 10%;"></td> <td style="width: 10%;"></td> <td style="width: 10%;"></td> </tr> <tr> <td></td> <td></td> <td colspan="8" style="text-align: center;"> <table border="1" style="width: 100%; border-collapse: collapse; text-align: center;"> <tr> <td style="width: 10%;"></td> <td style="width: 10%;"></td> <td style="width: 10%;"></td> <td style="width: 10%;"></td> <td style="width: 10%;"></td> <td style="width: 10%;"></td> <td style="width: 10%;"></td> <td style="width: 10%;"></td> <td style="width: 10%;"></td> <td style="width: 10%;"></td> </tr> <tr> <td></td> <td></td> <td colspan="8" style="text-align: center;"> <table border="1" style="width: 100%; border-collapse: collapse; text-align: center;"> <tr> <td style="width: 10%;"></td> <td style="width: 10%;"></td> <td style="width: 10%;"></td> <td style="width: 10%;"></td> <td style="width: 10%;"></td> <td style="width: 10%;"></td> <td style="width: 10%;"></td> <td style="width: 10%;"></td> <td style="width: 10%;"></td> <td style="width: 10%;"></td> </tr> <tr> <td></td> <td></td> <td colspan="8" style="text-align:
center;"> <table border="1" style="width: 100%; border-collapse: collapse; text-align: center;"> <tr> <td style="width: 10%;"></td> <td style="width: 10%;"></td> <td style="width: 10%;"></td> <td style="width: 10%;"></td> <td style="width: 10%;"></td> <td style="width: 10%;"></td> <td style="width: 10%;"></td> <td style="width: 10%;"></td> <td style="width: 10%;"></td> <td style="width: 10%;"></td> </tr> <tr> <td></td> <td></td> <td colspan="8" style="text-align: center;"> <table border="1" style="width: 100%; border-collapse: collapse; text-align: center;"> <tr> <td style="width: 10%;"></td> <td style="width: 10%;"></td> <td style="width: 10%;"></td> <td style="width: 10%;"></td> <td style="width: 10%;"></td> <td style="width: 10%;"></td> <td style="width: 10%;"></td> <td style="width: 10%;"></td> <td style="width: 10%;"></td> <td style="width: 10%;"></td> </tr> <tr> <td></td> <td></td> <td colspan="8" style="text-align: center;"> <table border="1" style="width: 100%; border-collapse: collapse; text-align: center;"> <tr> <td style="width: 10%;"></td> <td style="width: 10%;"></td> <td style="width: 10%;"></td> <td style="width: 10%;"></td> <td style="width: 10%;"></td> <td style="width: 10%;"></td> <td style="width: 10%;"></td> <td style="width: 10%;"></td> <td style="width: 10%;"></td> <td style="width: 10%;"></td> </tr> <tr> <td></td> <td></td> <td colspan="8" style="text-align: center;"> <table border="1" style="width: 100%; border-collapse: collapse; text-align: center;"> <tr> <td style="width: 10%;"></td> <td style="width: 10%;"></td> <td style="width: 10%;"></td> <td style="width: 10%;"></td> <td style="width: 10%;"></td> <td style="width: 10%;"></td> <td style="width: 10%;"></td> <td style="width: 10%;"></td> <td style="width: 10%;"></td> <td style="width: 10%;"></td> </tr> <tr> <td></td> <td></td> <td colspan="8" style="text-align: center;"> <table border="1" style="width: 100%; border-collapse: collapse; text-align: center;"> <tr> <td style="width: 10%;"></td> <td style="width: 10%;"></td> <td style="width: 10%;"></td> <td style="width: 10%;"></td> <td style="width: 10%;"></td> <td style="width: 10%;"></td> <td style="width: 10%;"></td> <td style="width: 10%;"></td> <td style="width: 10%;"></td> <td style="width: 10%;"></td> </tr> <tr> <td></td> <td></td> <td colspan="8" style="text-align: center;"> <table border="1" style="width: 100%; border-collapse: collapse; text-align: center;"> <tr> <td style="width: 10%;"></td> <td style="width: 10%;"></td> <td style="width: 10%;"></td> <td style="width: 10%;"></td> <td style="width: 10%;"></td> <td style="width: 10%;"></td> <td style="width: 10%;"></td> <td style="width: 10%;"></td> <td style="width: 10%;"></td> <td style="width: 10%;"></td> </tr> <tr> <td></td> <td></td> <td colspan="8" style="text-align: center;"> <table border="1" style="width: 100%; border-collapse: collapse; text-align: center;"> <tr> <td style="width: 10%;"></td> <td style="width: 10%;"></td> <td style="width: 10%;"></td> <td style="width: 10%;"></td> <td style="width: 10%;"></td> <td style="width: 10%;"></td> <td style="width: 10%;"></td> <td style="width: 10%;"></td> <td style="width: 10%;"></td> <td style="width: 10%;"></td> </tr> <tr> <td></td> <td></td> <td colspan="8" style="text-align: center;"> <table border="1" style="width: 100%; border-collapse: collapse; text-align: center;"> <tr> <td style="width: 10%;"></td> <td style="width: 10%;"></td> <td style="width: 10%;"></td> <td style="width: 10%;"></td> <td style="width: 10%;"></td> <td style="width: 10%;"></td> <td style="width: 10%;"></td> <td style="width: 10%;"></td> <td style="width: 10%;"></td> <td style="width: 10%;"></td> </tr> <tr> <td></td> <td></td> <td colspan="8" style="text-align: center;"> <table border="1" style="width: 100%; border-collapse: collapse; text-align: center;"> <tr> <td style="width: 10%;"></td> <td style="width: 10%;"></td> <td style="width: 10%;"></td> <td style="width: 10%;"></td> <td style="width: 10%;"></td> <td style="width: 10%;"></td> <td style="width: 10%;"></td> <td style="width: 10%;"></td> <td style="width: 10%;"></td> <td style="width: 10%;"></td> </tr> <tr> <td></td> <td></td> <td colspan="8" style="text-align: center;"> <table border="1" style="width: 100%; border-collapse: collapse; text-align: center;"> <tr> <td style="width: 10%;"></td> <td style="width: 10%;"></td> <td style="width: 10%;"></td> <td style="width: 10%;"></td> <td style="width: 10%;"></td> <td style="width: 10%;"></td> <td style="width: 10%;"></td> <td style="width: 10%;"></td> <td style="width: 10%;"></td> <td style="width: 10%;"></td> </tr> <tr> <td></td> <td></td> <td colspan="8" style="text-align: center;"> <table border="1" style="width: 100%; border-collapse: collapse; text-align: center;"> <tr> <td style="width: 10%;"></td> <td style="width: 10%;"></td> <td style="width: 10%;"></td> <td style="width: 10%;"></td> <td style="width: 10%;"></td> <td style="width: 10%;"></td> <td style="width: 10%;"></td> <td style="width: 10%;"></td> <td style="width: 10%;"></td> <td style="width: 10%;"></td> </tr> <tr> <td></td> <td></td> <td colspan="8" style="text-align: center;"> <table border="1" style="width: 100%; border-collapse: collapse; text-align: center;"> <tr> </tr></table></td></tr></table></td></tr></table></td></tr></table></td></tr></table></td></tr></table></td></tr></table></td></tr></table></td></tr></table></td></tr></table></td></tr></table></td></tr></table></td></tr></table></td></tr></table></td></tr></table></td></tr></table></td></tr></table></td></tr></table></td></tr></table></td></tr></table>
 | | | | | | | | | | | | | | | | | | | | <table border="1" style="width: 100%; border-collapse: collapse; text-align: center;"> <tr> <td style="width: 10%;"></td> <td style="width: 10%;"></td> <td style="width: 10%;"></td> <td style="width: 10%;"></td> <td style="width: 10%;"></td> <td style="width: 10%;"></td> <td style="width: 10%;"></td> <td style="width: 10%;"></td> <td style="width: 10%;"></td> <td style="width: 10%;"></td> </tr> <tr> <td></td> <td></td> <td colspan="8" style="text-align: center;"> <table border="1" style="width: 100%; border-collapse: collapse; text-align: center;"> <tr> <td style="width: 10%;"></td> <td style="width: 10%;"></td> <td style="width: 10%;"></td> <td style="width: 10%;"></td> <td style="width: 10%;"></td> <td style="width: 10%;"></td> <td style="width: 10%;"></td> <td style="width: 10%;"></td> <td style="width: 10%;"></td> <td style="width: 10%;"></td> </tr> <tr> <td></td> <td></td> <td colspan="8" style="text-align: center;"> <table border="1" style="width: 100%; border-collapse: collapse; text-align: center;"> <tr> <td style="width: 10%;"></td> <td style="width: 10%;"></td> <td style="width: 10%;"></td> <td style="width: 10%;"></td> <td style="width: 10%;"></td> <td style="width: 10%;"></td> <td style="width: 10%;"></td> <td style="width: 10%;"></td> <td style="width: 10%;"></td> <td style="width: 10%;"></td> </tr> <tr> <td></td> <td></td> <td colspan="8" style="text-align: center;"> <table border="1" style="width: 100%; border-collapse: collapse; text-align: center;"> <tr> <td style="width: 10%;"></td> <td style="width: 10%;"></td> <td style="width: 10%;"></td> <td style="width: 10%;"></td> <td style="width: 10%;"></td> <td style="width: 10%;"></td> <td style="width: 10%;"></td> <td style="width: 10%;"></td> <td style="width: 10%;"></td> <td style="width: 10%;"></td> </tr> <tr> <td></td> <td></td> <td colspan="8" style="text-align: center;"> <table border="1" style="width: 100%; border-collapse: collapse; text-align: center;"> <tr> <td style="width: 10%;"></td> <td style="width: 10%;"></td> <td style="width: 10%;"></td> <td style="width: 10%;"></td> <td style="width: 10%;"></td> <td style="width: 10%;"></td> <td style="width: 10%;"></td> <td style="width: 10%;"></td> <td style="width: 10%;"></td> <td style="width: 10%;"></td> </tr> <tr> <td></td> <td></td> <td colspan="8" style="text-align: center;"> <table border="1" style="width: 100%; border-collapse: collapse; text-align: center;"> <tr> <td style="width: 10%;"></td> <td style="width: 10%;"></td> <td style="width: 10%;"></td> <td style="width: 10%;"></td> <td style="width: 10%;"></td> <td style="width: 10%;"></td> <td style="width: 10%;"></td> <td style="width: 10%;"></td> <td style="width: 10%;"></td> <td style="width: 10%;"></td> </tr> <tr> <td></td> <td></td> <td colspan="8" style="text-align: center;"> <table border="1" style="width: 100%; border-collapse: collapse; text-align: center;"> <tr> <td style="width: 10%;"></td> <td style="width: 10%;"></td> <td style="width: 10%;"></td> <td style="width: 10%;"></td> <td style="width: 10%;"></td> <td style="width: 10%;"></td> <td style="width: 10%;"></td> <td style="width: 10%;"></td> <td style="width: 10%;"></td> <td style="width: 10%;"></td> </tr> <tr> <td></td> <td></td> <td colspan="8" style="text-align: center;"> <table border="1" style="width: 100%; border-collapse: collapse; text-align: center;"> <tr> <td style="width: 10%;"></td> <td style="width: 10%;"></td> <td style="width: 10%;"></td> <td style="width: 10%;"></td> <td style="width: 10%;"></td> <td style="width: 10%;"></td> <td style="width: 10%;"></td> <td style="width: 10%;"></td> <td style="width: 10%;"></td> <td style="width: 10%;"></td> </tr> <tr> <td></td> <td></td> <td colspan="8" style="text-align: center;"> <table border="1" style="width: 100%; border-collapse: collapse; text-align: center;"> <tr> <td style="width: 10%;"></td> <td style="width: 10%;"></td> <td style="width: 10%;"></td> <td style="width: 10%;"></td> <td style="width: 10%;"></td> <td style="width: 10%;"></td> <td style="width: 10%;"></td> <td style="width: 10%;"></td> <td style="width: 10%;"></td> <td style="width: 10%;"></td> </tr> <tr> <td></td> <td></td> <td colspan="8" style="text-align: center;"> <table border="1" style="width: 100%; border-collapse: collapse; text-align: center;"> <tr> <td style="width: 10%;"></td> <td style="width: 10%;"></td> <td style="width: 10%;"></td> <td style="width: 10%;"></td> <td style="width: 10%;"></td> <td style="width: 10%;"></td> <td style="width: 10%;"></td> <td style="width: 10%;"></td> <td style="width: 10%;"></td> <td style="width: 10%;"></td> </tr> <tr> <td></td> <td></td> <td colspan="8" style="text-align: center;"> <table border="1" style="width: 100%; border-collapse: collapse; text-align: center;"> <tr> <td style="width: 10%;"></td> <td style="width: 10%;"></td> <td style="width: 10%;"></td> <td style="width: 10%;"></td> <td style="width: 10%;"></td> <td style="width: 10%;"></td> <td style="width: 10%;"></td> <td style="width: 10%;"></td> <td style="width: 10%;"></td> <td style="width: 10%;"></td> </tr> <tr> <td></td> <td></td> <td colspan="8" style="text-align: center;"> <table border="1" style="width: 100%; border-collapse: collapse; text-align: center;"> <tr> <td style="width: 10%;"></td> <td style="width: 10%;"></td> <td style="width: 10%;"></td> <td style="width: 10%;"></td> <td style="width: 10%;"></td> <td style="width: 10%;"></td> <td style="width: 10%;"></td> <td style="width: 10%;"></td> <td style="width: 10%;"></td> <td style="width: 10%;"></td> </tr> <tr> <td></td> <td></td> <td colspan="8" style="text-align: center;"> <table border="1" style="width: 100%; border-collapse: collapse; text-align: center;"> <tr> <td style="width: 10%;"></td> <td style="width: 10%;"></td> <td style="width: 10%;"></td> <td style="width: 10%;"></td> <td style="width: 10%;"></td> <td style="width: 10%;"></td> <td style="width: 10%;"></td> <td style="width: 10%;"></td> <td style="width: 10%;"></td> <td style="width: 10%;"></td> </tr> <tr> <td></td> <td></td> <td colspan="8" style="text-align: center;"> <table border="1" style="width: 100%; border-collapse: collapse; text-align: center;"> <tr> <td style="width: 10%;"></td> <td style="width: 10%;"></td> <td style="width: 10%;"></td> <td style="width: 10%;"></td> <td style="width: 10%;"></td> <td style="width: 10%;"></td> <td style="width: 10%;"></td> <td style="width: 10%;"></td> <td style="width: 10%;"></td> <td style="width: 10%;"></td> </tr> <tr> <td></td> <td></td> <td colspan="8" style="text-align: center;"> <table border="1" style="width: 100%; border-collapse: collapse; text-align: center;"> <tr> <td style="width: 10%;"></td> <td style="width: 10%;"></td> <td style="width: 10%;"></td> <td style="width: 10%;"></td> <td style="width: 10%;"></td> <td style="width: 10%;"></td> <td style="width: 10%;"></td> <td style="width: 10%;"></td> <td style="width: 10%;"></td> <td style="width: 10%;"></td> </tr> <tr> <td></td> <td></td> <td colspan="8" style="text-align: center;"> <table border="1" style="width: 100%; border-collapse: collapse; text-align: center;"> <tr> <td style="width: 10%;"></td> <td style="width: 10%;"></td> <td style="width: 10%;"></td> <td style="width: 10%;"></td> <td style="width: 10%;"></td> <td style="width: 10%;"></td> <td style="width: 10%;"></td> <td style="width: 10%;"></td> <td style="width: 10%;"></td> <td style="width: 10%;"></td> </tr> <tr> <td></td> <td></td> <td colspan="8" style="text-align: center;"> <table border="1" style="width: 100%; border-collapse: collapse; text-align: center;"> <tr> <td style="width: 10%;"></td> <td style="width: 10%;"></td> <td style="width: 10%;"></td> <td style="width: 10%;"></td> <td style="width: 10%;"></td> <td style="width: 10%;"></td> <td style="width: 10%;"></td> <td style="width: 10%;"></td> <td style="width: 10%;"></td> <td style="width: 10%;"></td> </tr> <tr> <td></td> <td></td> <td colspan="8" style="text-align: center;"> <table border="1" style="width: 100%; border-collapse: collapse; text-align: center;"> <tr> <td style="width: 10%;"></td> <td style="width: 10%;"></td> <td style="width: 10%;"></td> <td style="width: 10%;"></td> <td style="width: 10%;"></td> <td style="width: 10%;"></td> <td style="width: 10%;"></td> <td style="width: 10%;"></td> <td style="width: 10%;"></td> <td style="width: 10%;"></td> </tr> <tr> <td></td> <td></td> <td colspan="8" style="text-align: center;"> <table border="1" style="width: 100%; border-collapse: collapse; text-align:
center;"> <tr> </tr></table></td></tr></table></td></tr></table></td></tr></table></td></tr></table></td></tr></table></td></tr></table></td></tr></table></td></tr></table></td></tr></table></td></tr></table></td></tr></table></td></tr></table></td></tr></table></td></tr></table></td></tr></table></td></tr></table></td></tr></table></td></tr></table> | | | | | | | | | | | | | | | | | | | | <table border="1" style="width: 100%; border-collapse: collapse; text-align: center;"> <tr> <td style="width: 10%;"></td> <td style="width: 10%;"></td> <td style="width: 10%;"></td> <td style="width: 10%;"></td> <td style="width: 10%;"></td> <td style="width: 10%;"></td> <td style="width: 10%;"></td> <td style="width: 10%;"></td> <td style="width: 10%;"></td> <td style="width: 10%;"></td> </tr> <tr> <td></td> <td></td> <td colspan="8" style="text-align: center;"> <table border="1" style="width: 100%; border-collapse: collapse; text-align: center;"> <tr> <td style="width: 10%;"></td> <td style="width: 10%;"></td> <td style="width: 10%;"></td> <td style="width: 10%;"></td> <td style="width: 10%;"></td> <td style="width: 10%;"></td> <td style="width: 10%;"></td> <td style="width: 10%;"></td> <td style="width: 10%;"></td> <td style="width: 10%;"></td> </tr> <tr> <td></td> <td></td> <td colspan="8" style="text-align: center;"> <table border="1" style="width: 100%; border-collapse: collapse; text-align: center;"> <tr> <td style="width: 10%;"></td> <td style="width: 10%;"></td> <td style="width: 10%;"></td> <td style="width: 10%;"></td> <td style="width: 10%;"></td> <td style="width: 10%;"></td> <td style="width: 10%;"></td> <td style="width: 10%;"></td> <td style="width: 10%;"></td> <td style="width: 10%;"></td> </tr> <tr> <td></td> <td></td> <td colspan="8" style="text-align: center;"> <table border="1" style="width: 100%; border-collapse: collapse; text-align: center;"> <tr> <td style="width: 10%;"></td> <td style="width: 10%;"></td> <td style="width: 10%;"></td> <td style="width: 10%;"></td> <td style="width: 10%;"></td> <td style="width: 10%;"></td> <td style="width: 10%;"></td> <td style="width: 10%;"></td> <td style="width: 10%;"></td> <td style="width: 10%;"></td> </tr> <tr> <td></td> <td></td> <td colspan="8" style="text-align: center;"> <table border="1" style="width: 100%; border-collapse: collapse; text-align: center;"> <tr> <td style="width: 10%;"></td> <td style="width: 10%;"></td> <td style="width: 10%;"></td> <td style="width: 10%;"></td> <td style="width: 10%;"></td> <td style="width: 10%;"></td> <td style="width: 10%;"></td> <td style="width: 10%;"></td> <td style="width: 10%;"></td> <td style="width: 10%;"></td> </tr> <tr> <td></td> <td></td> <td colspan="8" style="text-align: center;"> <table border="1" style="width: 100%; border-collapse: collapse; text-align: center;"> <tr> <td style="width: 10%;"></td> <td style="width: 10%;"></td> <td style="width: 10%;"></td> <td style="width: 10%;"></td> <td style="width: 10%;"></td> <td style="width: 10%;"></td> <td style="width: 10%;"></td> <td style="width: 10%;"></td> <td style="width: 10%;"></td> <td style="width: 10%;"></td> </tr> <tr> <td></td> <td></td> <td colspan="8" style="text-align: center;"> <table border="1" style="width: 100%; border-collapse: collapse; text-align: center;"> <tr> <td style="width: 10%;"></td> <td style="width: 10%;"></td> <td style="width: 10%;"></td> <td style="width: 10%;"></td> <td style="width: 10%;"></td> <td style="width: 10%;"></td> <td style="width: 10%;"></td> <td style="width: 10%;"></td> <td style="width: 10%;"></td> <td style="width: 10%;"></td> </tr> <tr> <td></td> <td></td> <td colspan="8" style="text-align: center;"> <table border="1" style="width: 100%; border-collapse: collapse; text-align: center;"> <tr> <td style="width: 10%;"></td> <td style="width: 10%;"></td> <td style="width: 10%;"></td> <td style="width: 10%;"></td> <td style="width: 10%;"></td> <td style="width: 10%;"></td> <td style="width: 10%;"></td> <td style="width: 10%;"></td> <td style="width: 10%;"></td> <td style="width: 10%;"></td> </tr> <tr> <td></td> <td></td> <td colspan="8" style="text-align: center;"> <table
border="1" style="width: 100%; border-collapse: collapse; text-align: center;"> <tr> <td style="width: 10%;"></td> <td style="width: 10%;"></td> <td style="width: 10%;"></td> <td style="width: 10%;"></td> <td style="width: 10%;"></td> <td style="width: 10%;"></td> <td style="width: 10%;"></td> <td style="width: 10%;"></td> <td style="width: 10%;"></td> <td style="width: 10%;"></td> </tr> <tr> <td></td> <td></td> <td colspan="8" style="text-align: center;"> <table border="1" style="width: 100%; border-collapse: collapse; text-align: center;"> <tr> <td style="width: 10%;"></td> <td style="width: 10%;"></td> <td style="width: 10%;"></td> <td style="width: 10%;"></td> <td style="width: 10%;"></td> <td style="width: 10%;"></td> <td style="width: 10%;"></td> <td style="width: 10%;"></td> <td style="width: 10%;"></td> <td style="width: 10%;"></td> </tr> <tr> <td></td> <td></td> <td colspan="8" style="text-align: center;"> <table border="1" style="width: 100%; border-collapse: collapse; text-align: center;"> <tr> <td style="width: 10%;"></td> <td style="width: 10%;"></td> <td style="width: 10%;"></td> <td style="width: 10%;"></td> <td style="width: 10%;"></td> <td style="width: 10%;"></td> <td style="width: 10%;"></td> <td style="width: 10%;"></td> <td style="width: 10%;"></td> <td style="width: 10%;"></td> </tr> <tr> <td></td> <td></td> <td colspan="8" style="text-align: center;"> <table border="1" style="width: 100%; border-collapse: collapse; text-align: center;"> <tr> <td style="width: 10%;"></td> <td style="width: 10%;"></td> <td style="width: 10%;"></td> <td style="width: 10%;"></td> <td style="width: 10%;"></td> <td style="width: 10%;"></td> <td style="width: 10%;"></td> <td style="width: 10%;"></td> <td style="width: 10%;"></td> <td style="width: 10%;"></td> </tr> <tr> <td></td> <td></td> <td colspan="8" style="text-align: center;"> <table border="1" style="width: 100%; border-collapse: collapse; text-align: center;"> <tr> <td style="width: 10%;"></td> <td style="width: 10%;"></td> <td style="width: 10%;"></td> <td style="width: 10%;"></td> <td style="width: 10%;"></td> <td style="width: 10%;"></td> <td style="width: 10%;"></td> <td style="width: 10%;"></td> <td style="width: 10%;"></td> <td style="width: 10%;"></td> </tr> <tr> <td></td> <td></td> <td colspan="8" style="text-align: center;"> <table border="1" style="width: 100%; border-collapse: collapse; text-align: center;"> <tr> <td style="width: 10%;"></td> <td style="width: 10%;"></td> <td style="width: 10%;"></td> <td style="width: 10%;"></td> <td style="width: 10%;"></td> <td style="width: 10%;"></td> <td style="width: 10%;"></td> <td style="width: 10%;"></td> <td style="width: 10%;"></td> <td style="width: 10%;"></td> </tr> <tr> <td></td> <td></td> <td colspan="8" style="text-align: center;"> <table border="1" style="width: 100%; border-collapse: collapse; text-align: center;"> <tr> <td style="width: 10%;"></td> <td style="width: 10%;"></td> <td style="width: 10%;"></td> <td style="width: 10%;"></td> <td style="width: 10%;"></td> <td style="width: 10%;"></td> <td style="width: 10%;"></td> <td style="width: 10%;"></td> <td style="width: 10%;"></td> <td style="width: 10%;"></td> </tr> <tr> <td></td> <td></td> <td colspan="8" style="text-align: center;"> <table border="1" style="width: 100%; border-collapse: collapse; text-align: center;"> <tr> <td style="width: 10%;"></td> <td style="width: 10%;"></td> <td style="width: 10%;"></td> <td style="width: 10%;"></td> <td style="width: 10%;"></td> <td style="width: 10%;"></td> <td style="width: 10%;"></td> <td style="width: 10%;"></td> <td style="width: 10%;"></td> <td style="width: 10%;"></td> </tr> <tr> <td></td> <td></td> <td colspan="8" style="text-align: center;"> <table border="1" style="width: 100%; border-collapse: collapse; text-align: center;"> <tr> <td style="width: 10%;"></td> <td style="width: 10%;"></td> <td style="width: 10%;"></td> <td style="width: 10%;"></td> <td style="width: 10%;"></td> <td style="width: 10%;"></td> <td style="width: 10%;"></td> <td style="width: 10%;"></td> <td style="width: 10%;"></td> <td style="width: 10%;"></td> </tr> <tr> <td></td> <td></td> <td colspan="8" style="text-align: center;"> <table border="1" style="width: 100%; border-collapse: collapse; text-align: center;"> <tr> </tr></table></td></tr></table></td></tr></table></td></tr></table></td></tr></table></td></tr></table></td></tr></table></td></tr></table></td></tr></table></td></tr></table></td></tr></table></td></tr></table></td></tr></table></td></tr></table></td></tr></table></td></tr></table></td></tr></table></td></tr></table>
 | | | | | | | | | | | | | | | | | | | | <table border="1" style="width: 100%; border-collapse: collapse; text-align: center;"> <tr> <td style="width: 10%;"></td> <td style="width: 10%;"></td> <td style="width: 10%;"></td> <td style="width: 10%;"></td> <td style="width: 10%;"></td> <td style="width: 10%;"></td> <td style="width: 10%;"></td> <td style="width: 10%;"></td> <td style="width: 10%;"></td> <td style="width: 10%;"></td> </tr> <tr> <td></td> <td></td> <td colspan="8" style="text-align: center;"> <table border="1" style="width: 100%; border-collapse: collapse; text-align: center;"> <tr> <td style="width: 10%;"></td> <td style="width: 10%;"></td> <td style="width: 10%;"></td> <td style="width: 10%;"></td> <td style="width: 10%;"></td> <td style="width: 10%;"></td> <td style="width: 10%;"></td> <td style="width: 10%;"></td> <td style="width: 10%;"></td> <td style="width: 10%;"></td> </tr> <tr> <td></td> <td></td> <td colspan="8" style="text-align: center;"> <table border="1" style="width: 100%; border-collapse: collapse; text-align: center;"> <tr> <td style="width: 10%;"></td> <td style="width: 10%;"></td> <td style="width: 10%;"></td> <td style="width: 10%;"></td> <td style="width: 10%;"></td> <td style="width: 10%;"></td> <td style="width: 10%;"></td> <td style="width: 10%;"></td> <td style="width: 10%;"></td> <td style="width: 10%;"></td> </tr> <tr> <td></td> <td></td> <td colspan="8" style="text-align: center;"> <table border="1" style="width: 100%; border-collapse: collapse; text-align: center;"> <tr> <td style="width: 10%;"></td> <td style="width: 10%;"></td> <td style="width: 10%;"></td> <td style="width: 10%;"></td> <td style="width: 10%;"></td> <td style="width: 10%;"></td> <td style="width: 10%;"></td> <td style="width: 10%;"></td> <td style="width: 10%;"></td> <td style="width: 10%;"></td> </tr> <tr> <td></td> <td></td> <td colspan="8" style="text-align: center;"> <table border="1" style="width: 100%; border-collapse: collapse; text-align: center;"> <tr> <td style="width: 10%;"></td> <td style="width: 10%;"></td> <td style="width: 10%;"></td> <td style="width: 10%;"></td> <td style="width: 10%;"></td> <td style="width: 10%;"></td> <td style="width: 10%;"></td> <td style="width: 10%;"></td> <td style="width: 10%;"></td> <td style="width: 10%;"></td> </tr> <tr> <td></td> <td></td> <td colspan="8" style="text-align: center;"> <table border="1" style="width: 100%; border-collapse: collapse; text-align: center;"> <tr> <td style="width: 10%;"></td> <td style="width: 10%;"></td> <td style="width: 10%;"></td> <td style="width: 10%;"></td> <td style="width: 10%;"></td> <td style="width: 10%;"></td> <td style="width: 10%;"></td> <td style="width: 10%;"></td> <td style="width: 10%;"></td> <td style="width: 10%;"></td> </tr> <tr> <td></td> <td></td> <td colspan="8" style="text-align: center;"> <table border="1" style="width: 100%; border-collapse: collapse; text-align: center;"> <tr> <td style="width: 10%;"></td> <td style="width: 10%;"></td> <td style="width: 10%;"></td> <td style="width: 10%;"></td> <td style="width: 10%;"></td> <td style="width: 10%;"></td> <td style="width: 10%;"></td> <td style="width: 10%;"></td> <td style="width: 10%;"></td> <td style="width: 10%;"></td> </tr> <tr> <td></td> <td></td> <td colspan="8" style="text-align: center;"> <table border="1" style="width: 100%; border-collapse: collapse; text-align: center;"> <tr> <td style="width: 10%;"></td> <td style="width: 10%;"></td> <td style="width: 10%;"></td> <td style="width: 10%;"></td> <td style="width: 10%;"></td> <td style="width: 10%;"></td> <td style="width: 10%;"></td> <td style="width: 10%;"></td> <td style="width: 10%;"></td> <td style="width: 10%;"></td> </tr> <tr> <td></td> <td></td> <td colspan="8" style="text-align: center;"> <table border="1" style="width: 100%; border-collapse: collapse; text-align: center;"> <tr> <td style="width: 10%;"></td> <td style="width: 10%;"></td> <td style="width: 10%;"></td> <td style="width: 10%;"></td> <td style="width: 10%;"></td> <td style="width: 10%;"></td> <td style="width: 10%;"></td> <td style="width: 10%;"></td> <td style="width: 10%;"></td> <td style="width: 10%;"></td> </tr> <tr> <td></td> <td></td> <td colspan="8" style="text-align: center;"> <table border="1" style="width: 100%; border-collapse: collapse; text-align: center;"> <tr> <td style="width: 10%;"></td> <td style="width: 10%;"></td> <td style="width: 10%;"></td> <td style="width: 10%;"></td> <td style="width: 10%;"></td> <td style="width: 10%;"></td> <td style="width: 10%;"></td> <td style="width: 10%;"></td> <td style="width: 10%;"></td> <td style="width: 10%;"></td> </tr> <tr> <td></td> <td></td> <td colspan="8" style="text-align: center;"> <table border="1" style="width: 100%; border-collapse: collapse; text-align: center;"> <tr> <td style="width: 10%;"></td> <td style="width: 10%;"></td> <td style="width: 10%;"></td> <td style="width: 10%;"></td> <td style="width: 10%;"></td> <td style="width: 10%;"></td> <td style="width: 10%;"></td> <td style="width: 10%;"></td> <td style="width: 10%;"></td> <td style="width: 10%;"></td> </tr> <tr> <td></td> <td></td> <td colspan="8" style="text-align: center;"> <table border="1" style="width: 100%; border-collapse: collapse; text-align: center;"> <tr> <td style="width: 10%;"></td> <td style="width: 10%;"></td> <td style="width: 10%;"></td> <td style="width: 10%;"></td> <td style="width: 10%;"></td> <td style="width: 10%;"></td> <td style="width: 10%;"></td> <td style="width: 10%;"></td> <td style="width: 10%;"></td> <td style="width: 10%;"></td> </tr> <tr> <td></td> <td></td> <td colspan="8" style="text-align: center;"> <table border="1" style="width: 100%; border-collapse: collapse; text-align: center;"> <tr> <td style="width: 10%;"></td> <td style="width: 10%;"></td> <td style="width: 10%;"></td> <td style="width: 10%;"></td> <td style="width: 10%;"></td> <td style="width: 10%;"></td> <td style="width: 10%;"></td> <td style="width: 10%;"></td> <td style="width: 10%;"></td> <td style="width: 10%;"></td> </tr> <tr> <td></td> <td></td> <td colspan="8" style="text-align: center;"> <table border="1" style="width: 100%; border-collapse: collapse; text-align: center;"> <tr> <td style="width: 10%;"></td> <td style="width: 10%;"></td> <td style="width: 10%;"></td> <td style="width: 10%;"></td> <td style="width: 10%;"></td> <td style="width: 10%;"></td> <td style="width: 10%;"></td> <td style="width: 10%;"></td> <td style="width: 10%;"></td> <td style="width: 10%;"></td> </tr> <tr> <td></td> <td></td> <td colspan="8" style="text-align: center;"> <table border="1" style="width: 100%; border-collapse: collapse; text-align: center;"> <tr> <td style="width: 10%;"></td> <td style="width: 10%;"></td> <td style="width: 10%;"></td> <td style="width: 10%;"></td> <td style="width: 10%;"></td> <td style="width: 10%;"></td> <td style="width: 10%;"></td> <td style="width: 10%;"></td> <td style="width: 10%;"></td> <td style="width: 10%;"></td> </tr> <tr> <td></td> <td></td> <td colspan="8" style="text-align: center;"> <table border="1" style="width: 100%; border-collapse: collapse; text-align: center;"> <tr> <td style="width: 10%;"></td> <td style="width: 10%;"></td> <td style="width: 10%;"></td> <td style="width: 10%;"></td> <td style="width: 10%;"></td> <td style="width: 10%;"></td> <td style="width: 10%;"></td> <td style="width: 10%;"></td> <td style="width: 10%;"></td> <td style="width: 10%;"></td> </tr> <tr> <td></td> <td></td> <td colspan="8" style="text-align: center;"> <table border="1" style="width: 100%; border-collapse: collapse; text-align: center;"> <tr> </tr></table></td></tr></table></td></tr></table></td></tr></table></td></tr></table></td></tr></table></td></tr></table></td></tr></table></td></tr></table></td></tr></table></td></tr></table></td></tr></table></td></tr></table></td></tr></table></td></tr></table></td></tr></table></td></tr></table>
 | | | | | | | | | | | | | | | | | | | | <table border="1" style="width: 100%; border-collapse: collapse; text-align: center;"> <tr> <td style="width: 10%;"></td> <td style="width: 10%;"></td> <td style="width: 10%;"></td> <td style="width: 10%;"></td> <td style="width: 10%;"></td> <td style="width: 10%;"></td> <td style="width: 10%;"></td> <td style="width: 10%;"></td> <td style="width: 10%;"></td> <td style="width: 10%;"></td> </tr> <tr> <td></td> <td></td> <td colspan="8" style="text-align: center;"> <table border="1" style="width: 100%; border-collapse: collapse; text-align: center;"> <tr> <td style="width: 10%;"></td> <td style="width: 10%;"></td> <td style="width: 10%;"></td> <td style="width: 10%;"></td> <td style="width: 10%;"></td> <td style="width: 10%;"></td> <td style="width: 10%;"></td> <td style="width: 10%;"></td> <td style="width: 10%;"></td> <td style="width: 10%;"></td> </tr> <tr> <td></td> <td></td> <td colspan="8" style="text-align: center;"> <table border="1" style="width: 100%; border-collapse: collapse; text-align: center;"> <tr> <td style="width: 10%;"></td> <td style="width: 10%;"></td> <td style="width: 10%;"></td> <td style="width: 10%;"></td> <td style="width: 10%;"></td> <td style="width: 10%;"></td> <td style="width: 10%;"></td> <td style="width: 10%;"></td> <td style="width: 10%;"></td> <td style="width: 10%;"></td> </tr> <tr> <td></td> <td></td> <td colspan="8" style="text-align: center;"> <table border="1" style="width: 100%; border-collapse: collapse; text-align: center;"> <tr> <td style="width: 10%;"></td> <td style="width: 10%;"></td> <td style="width: 10%;"></td> <td style="width: 10%;"></td> <td style="width: 10%;"></td> <td style="width: 10%;"></td> <td style="width: 10%;"></td> <td style="width: 10%;"></td> <td style="width: 10%;"></td> <td style="width: 10%;"></td> </tr> <tr> <td></td> <td></td> <td colspan="8" style="text-align: center;"> <table border="1" style="width: 100%; border-collapse: collapse; text-align: center;"> <tr> <td style="width: 10%;"></td> <td style="width: 10%;"></td> <td style="width: 10%;"></td> <td style="width: 10%;"></td> <td style="width: 10%;"></td> <td style="width: 10%;"></td> <td style="width: 10%;"></td> <td style="width: 10%;"></td> <td style="width: 10%;"></td> <td style="width: 10%;"></td> </tr> <tr> <td></td> <td></td> <td colspan="8" style="text-align: center;"> <table border="1" style="width: 100%; border-collapse: collapse; text-align: center;"> <tr> <td style="width: 10%;"></td> <td style="width: 10%;"></td> <td style="width: 10%;"></td> <td style="width: 10%;"></td> <td style="width: 10%;"></td> <td style="width: 10%;"></td> <td style="width: 10%;"></td> <td style="width: 10%;"></td> <td style="width: 10%;"></td> <td style="width: 10%;"></td> </tr> <tr> <td></td> <td></td> <td colspan="8" style="text-align: center;"> <table border="1" style="width: 100%; border-collapse: collapse; text-align: center;"> <tr> <td style="width: 10%;"></td> <td style="width: 10%;"></td> <td style="width: 10%;"></td> <td style="width: 10%;"></td> <td style="width: 10%;"></td> <td style="width: 10%;"></td> <td style="width: 10%;"></td> <td style="width: 10%;"></td> <td style="width: 10%;"></td> <td style="width: 10%;"></td> </tr> <tr> <td></td> <td></td> <td colspan="8" style="text-align: center;"> <table border="1" style="width: 100%; border-collapse: collapse; text-align: center;"> <tr> <td style="width: 10%;"></td> <td style="width: 10%;"></td> <td style="width: 10%;"></td> <td style="width: 10%;"></td> <td style="width: 10%;"></td> <td style="width: 10%;"></td> <td style="width: 10%;"></td> <td style="width: 10%;"></td> <td style="width: 10%;"></td> <td style="width: 10%;"></td> </tr> <tr> <td></td> <td></td> <td colspan="8" style="text-align: center;"> <table border="1" style="width: 100%; border-collapse: collapse; text-align: center;"> <tr> <td style="width: 10%;"></td> <td style="width: 10%;"></td> <td style="width: 10%;"></td> <td style="width: 10%;"></td> <td style="width: 10%;"></td> <td style="width: 10%;"></td> <td style="width: 10%;"></td> <td style="width: 10%;"></td> <td style="width: 10%;"></td> <td style="width: 10%;"></td> </tr> <tr> <td></td> <td></td> <td colspan="8" style="text-align: center;"> <table border="1" style="width: 100%; border-collapse: collapse; text-align: center;"> <tr> <td style="width: 10%;"></td> <td style="width: 10%;"></td> <td style="width: 10%;"></td> <td style="width: 10%;"></td> <td style="width: 10%;"></td> <td style="width: 10%;"></td> <td style="width: 10%;"></td> <td style="width: 10%;"></td> <td style="width: 10%;"></td> <td style="width: 10%;"></td> </tr> <tr> <td></td> <td></td> <td colspan="8" style="text-align: center;"> <table border="1" style="width: 100%; border-collapse: collapse; text-align: center;"> <tr> <td style="width: 10%;"></td> <td style="width: 10%;"></td> <td style="width: 10%;"></td> <td style="width: 10%;"></td> <td style="width: 10%;"></td> <td style="width: 10%;"></td> <td style="width: 10%;"></td> <td style="width: 10%;"></td> <td style="width: 10%;"></td> <td style="width: 10%;"></td> </tr> <tr> <td></td> <td></td> <td colspan="8" style="text-align: center;"> <table border="1" style="width: 100%; border-collapse: collapse; text-align: center;"> <tr> <td style="width: 10%;"></td> <td style="width: 10%;"></td> <td style="width: 10%;"></td> <td style="width: 10%;"></td> <td style="width: 10%;"></td> <td style="width: 10%;"></td> <td style="width: 10%;"></td> <td style="width: 10%;"></td> <td style="width: 10%;"></td> <td style="width: 10%;"></td> </tr> <tr> <td></td> <td></td> <td colspan="8" style="text-align: center;"> <table border="1" style="width: 100%; border-collapse: collapse; text-align: center;"> <tr> <td
style="width: 10%;"></td> <td style="width: 10%;"></td> <td style="width: 10%;"></td> <td style="width: 10%;"></td> <td style="width: 10%;"></td> <td style="width: 10%;"></td> <td style="width: 10%;"></td> <td style="width: 10%;"></td> <td style="width: 10%;"></td> <td style="width: 10%;"></td> </tr> <tr> <td></td> <td></td> <td colspan="8" style="text-align: center;"> <table border="1" style="width: 100%; border-collapse: collapse; text-align: center;"> <tr> <td style="width: 10%;"></td> <td style="width: 10%;"></td> <td style="width: 10%;"></td> <td style="width: 10%;"></td> <td style="width: 10%;"></td> <td style="width: 10%;"></td> <td style="width: 10%;"></td> <td style="width: 10%;"></td> <td style="width: 10%;"></td> <td style="width: 10%;"></td> </tr> <tr> <td></td> <td></td> <td colspan="8" style="text-align: center;"> <table border="1" style="width: 100%; border-collapse: collapse; text-align: center;"> <tr> <td style="width: 10%;"></td> <td style="width: 10%;"></td> <td style="width: 10%;"></td> <td style="width: 10%;"></td> <td style="width: 10%;"></td> <td style="width: 10%;"></td> <td style="width: 10%;"></td> <td style="width: 10%;"></td> <td style="width: 10%;"></td> <td style="width: 10%;"></td> </tr> <tr> <td></td> <td></td> <td colspan="8" style="text-align: center;"> <table border="1" style="width: 100%; border-collapse: collapse; text-align: center;"> <tr> </tr></table></td></tr></table></td></tr></table></td></tr></table></td></tr></table></td></tr></table></td></tr></table></td></tr></table></td></tr></table></td></tr></table></td></tr></table></td></tr></table></td></tr></table></td></tr></table></td></tr></table></td></tr></table> | | | | | | | | | | | | | | | | | | | | <table border="1" style="width: 100%; border-collapse: collapse; text-align: center;"> <tr> <td style="width: 10%;"></td> <td style="width: 10%;"></td> <td style="width: 10%;"></td> <td style="width: 10%;"></td> <td style="width: 10%;"></td> <td style="width: 10%;"></td> <td style="width: 10%;"></td> <td style="width: 10%;"></td> <td style="width: 10%;"></td> <td style="width: 10%;"></td> </tr> <tr> <td></td> <td></td> <td colspan="8" style="text-align: center;"> <table border="1" style="width: 100%; border-collapse: collapse; text-align: center;"> <tr> <td style="width: 10%;"></td> <td style="width: 10%;"></td> <td style="width: 10%;"></td> <td style="width: 10%;"></td> <td style="width: 10%;"></td> <td style="width: 10%;"></td> <td style="width: 10%;"></td> <td style="width: 10%;"></td> <td style="width: 10%;"></td> <td style="width: 10%;"></td> </tr> <tr> <td></td> <td></td> <td colspan="8" style="text-align: center;"> <table border="1" style="width: 100%; border-collapse: collapse; text-align: center;"> <tr> <td style="width: 10%;"></td> <td style="width: 10%;"></td> <td style="width: 10%;"></td> <td style="width: 10%;"></td> <td style="width: 10%;"></td> <td style="width: 10%;"></td> <td style="width: 10%;"></td> <td style="width: 10%;"></td> <td style="width: 10%;"></td> <td style="width: 10%;"></td> </tr> <tr> <td></td> <td></td> <td colspan="8" style="text-align: center;"> <table border="1" style="width: 100%; border-collapse: collapse; text-align: center;"> <tr> <td style="width: 10%;"></td> <td style="width: 10%;"></td> <td style="width: 10%;"></td> <td style="width: 10%;"></td> <td style="width: 10%;"></td> <td style="width: 10%;"></td> <td style="width: 10%;"></td> <td style="width: 10%;"></td> <td style="width: 10%;"></td> <td style="width: 10%;"></td> </tr> <tr> <td></td> <td></td> <td colspan="8" style="text-align: center;"> <table border="1" style="width: 100%; border-collapse: collapse; text-align: center;"> <tr> <td style="width: 10%;"></td> <td style="width: 10%;"></td> <td style="width: 10%;"></td> <td style="width: 10%;"></td> <td style="width: 10%;"></td> <td style="width: 10%;"></td> <td style="width: 10%;"></td> <td style="width: 10%;"></td> <td style="width: 10%;"></td> <td style="width: 10%;"></td> </tr> <tr> <td></td> <td></td> <td colspan="8" style="text-align: center;"> <table border="1" style="width: 100%; border-collapse: collapse; text-align:
center;"> <tr> <td style="width: 10%;"></td> <td style="width: 10%;"></td> <td style="width: 10%;"></td> <td style="width: 10%;"></td> <td style="width: 10%;"></td> <td style="width: 10%;"></td> <td style="width: 10%;"></td> <td style="width: 10%;"></td> <td style="width: 10%;"></td> <td style="width: 10%;"></td> </tr> <tr> <td></td> <td></td> <td colspan="8" style="text-align: center;"> <table border="1" style="width: 100%; border-collapse: collapse; text-align: center;"> <tr> <td style="width: 10%;"></td> <td style="width: 10%;"></td> <td style="width: 10%;"></td> <td style="width: 10%;"></td> <td style="width: 10%;"></td> <td style="width: 10%;"></td> <td style="width: 10%;"></td> <td style="width: 10%;"></td> <td style="width: 10%;"></td> <td style="width: 10%;"></td> </tr> <tr> <td></td> <td></td> <td colspan="8" style="text-align: center;"> <table border="1" style="width: 100%; border-collapse: collapse; text-align: center;"> <tr> <td style="width: 10%;"></td> <td style="width: 10%;"></td> <td style="width: 10%;"></td> <td style="width: 10%;"></td> <td style="width: 10%;"></td> <td style="width: 10%;"></td> <td style="width: 10%;"></td> <td style="width: 10%;"></td> <td style="width: 10%;"></td> <td style="width: 10%;"></td> </tr> <tr> <td></td> <td></td> <td colspan="8" style="text-align: center;"> <table border="1" style="width: 100%; border-collapse: collapse; text-align: center;"> <tr> <td style="width: 10%;"></td> <td style="width: 10%;"></td> <td style="width: 10%;"></td> <td style="width: 10%;"></td> <td style="width: 10%;"></td> <td style="width: 10%;"></td> <td style="width: 10%;"></td> <td style="width: 10%;"></td> <td style="width: 10%;"></td> <td style="width: 10%;"></td> </tr> <tr> <td></td> <td></td> <td colspan="8" style="text-align: center;"> <table border="1" style="width: 100%; border-collapse: collapse; text-align: center;"> <tr> <td style="width: 10%;"></td> <td style="width: 10%;"></td> <td style="width: 10%;"></td> <td style="width: 10%;"></td> <td style="width: 10%;"></td> <td style="width: 10%;"></td> <td style="width: 10%;"></td> <td style="width: 10%;"></td> <td style="width: 10%;"></td> <td style="width: 10%;"></td> </tr> <tr> <td></td> <td></td> <td colspan="8" style="text-align: center;"> <table border="1" style="width: 100%; border-collapse: collapse; text-align: center;"> <tr> <td style="width: 10%;"></td> <td style="width: 10%;"></td> <td style="width: 10%;"></td> <td style="width: 10%;"></td> <td style="width: 10%;"></td> <td style="width: 10%;"></td> <td style="width: 10%;"></td> <td style="width: 10%;"></td> <td style="width: 10%;"></td> <td style="width: 10%;"></td> </tr> <tr> <td></td> <td></td> <td colspan="8" style="text-align: center;"> <table border="1" style="width: 100%; border-collapse: collapse; text-align: center;"> <tr> <td style="width: 10%;"></td> <td style="width: 10%;"></td> <td style="width: 10%;"></td> <td style="width: 10%;"></td> <td style="width: 10%;"></td> <td style="width: 10%;"></td> <td style="width: 10%;"></td> <td style="width: 10%;"></td> <td style="width: 10%;"></td> <td style="width: 10%;"></td> </tr> <tr> <td></td> <td></td> <td colspan="8" style="text-align: center;"> <table border="1" style="width: 100%; border-collapse: collapse; text-align: center;"> <tr> <td style="width: 10%;"></td> <td style="width: 10%;"></td> <td style="width: 10%;"></td> <td style="width: 10%;"></td> <td style="width: 10%;"></td> <td style="width: 10%;"></td> <td style="width: 10%;"></td> <td style="width: 10%;"></td> <td style="width: 10%;"></td> <td style="width: 10%;"></td> </tr> <tr> <td></td> <td></td> <td colspan="8" style="text-align: center;"> <table border="1" style="width: 100%; border-collapse: collapse; text-align: center;"> <tr> <td style="width: 10%;"></td> <td style="width: 10%;"></td> <td style="width: 10%;"></td> <td style="width: 10%;"></td> <td style="width: 10%;"></td> <td style="width: 10%;"></td> <td style="width: 10%;"></td> <td style="width: 10%;"></td> <td style="width: 10%;"></td> <td style="width: 10%;"></td> </tr> <tr> <td></td> <td></td> <td colspan="8" style="text-align: center;"> <table border="1" style="width: 100%; border-collapse: collapse; text-align: center;"> <tr> </tr></table></td></tr></table></td></tr></table></td></tr></table></td></tr></table></td></tr></table></td></tr></table></td></tr></table></td></tr></table></td></tr></table></td></tr></table></td></tr></table></td></tr></table></td></tr></table></td></tr></table>
 | | | | | | | | | | | | | | | | | | | | <table border="1" style="width: 100%; border-collapse: collapse; text-align: center;"> <tr> <td style="width: 10%;"></td> <td style="width: 10%;"></td> <td style="width: 10%;"></td> <td style="width: 10%;"></td> <td style="width: 10%;"></td> <td style="width: 10%;"></td> <td style="width: 10%;"></td> <td style="width: 10%;"></td> <td style="width: 10%;"></td> <td style="width: 10%;"></td> </tr> <tr> <td></td> <td></td> <td colspan="8" style="text-align: center;"> <table border="1" style="width: 100%; border-collapse: collapse; text-align: center;"> <tr> <td style="width: 10%;"></td> <td style="width: 10%;"></td> <td style="width: 10%;"></td> <td style="width: 10%;"></td> <td style="width: 10%;"></td> <td style="width: 10%;"></td> <td style="width: 10%;"></td> <td style="width: 10%;"></td> <td style="width: 10%;"></td> <td style="width: 10%;"></td> </tr> <tr> <td></td> <td></td> <td colspan="8" style="text-align: center;"> <table border="1" style="width: 100%; border-collapse: collapse; text-align: center;"> <tr> <td style="width: 10%;"></td> <td style="width: 10%;"></td> <td style="width: 10%;"></td> <td style="width: 10%;"></td> <td style="width: 10%;"></td> <td style="width: 10%;"></td> <td style="width: 10%;"></td> <td style="width: 10%;"></td> <td style="width: 10%;"></td> <td style="width: 10%;"></td> </tr> <tr> <td></td> <td></td> <td colspan="8" style="text-align: center;"> <table border="1" style="width: 100%; border-collapse: collapse; text-align: center;"> <tr> <td style="width: 10%;"></td> <td style="width: 10%;"></td> <td style="width: 10%;"></td> <td style="width: 10%;"></td> <td style="width: 10%;"></td> <td style="width: 10%;"></td> <td style="width: 10%;"></td> <td style="width: 10%;"></td> <td style="width: 10%;"></td> <td style="width: 10%;"></td> </tr> <tr> <td></td> <td></td> <td colspan="8" style="text-align: center;"> <table border="1" style="width: 100%; border-collapse: collapse; text-align: center;"> <tr> <td style="width: 10%;"></td> <td style="width: 10%;"></td> <td style="width: 10%;"></td> <td style="width: 10%;"></td> <td style="width: 10%;"></td> <td style="width: 10%;"></td> <td style="width: 10%;"></td> <td style="width: 10%;"></td> <td style="width: 10%;"></td> <td style="width: 10%;"></td> </tr> <tr> <td></td> <td></td> <td colspan="8" style="text-align: center;"> <table border="1" style="width: 100%; border-collapse: collapse; text-align: center;"> <tr> <td style="width: 10%;"></td> <td style="width: 10%;"></td> <td style="width: 10%;"></td> <td style="width: 10%;"></td> <td style="width: 10%;"></td> <td style="width: 10%;"></td> <td style="width: 10%;"></td> <td style="width: 10%;"></td> <td style="width: 10%;"></td> <td style="width: 10%;"></td> </tr> <tr> <td></td> <td></td> <td colspan="8" style="text-align: center;"> <table border="1" style="width: 100%; border-collapse: collapse; text-align: center;"> <tr> <td style="width: 10%;"></td> <td style="width: 10%;"></td> <td style="width: 10%;"></td> <td style="width: 10%;"></td> <td style="width: 10%;"></td> <td style="width: 10%;"></td> <td style="width: 10%;"></td> <td style="width: 10%;"></td> <td style="width: 10%;"></td> <td style="width: 10%;"></td> </tr> <tr> <td></td> <td></td> <td colspan="8" style="text-align: center;"> <table border="1" style="width: 100%; border-collapse: collapse; text-align: center;"> <tr> <td style="width: 10%;"></td> <td style="width: 10%;"></td> <td style="width: 10%;"></td> <td style="width: 10%;"></td> <td style="width: 10%;"></td> <td style="width: 10%;"></td> <td style="width: 10%;"></td> <td style="width: 10%;"></td> <td style="width: 10%;"></td> <td style="width: 10%;"></td> </tr> <tr> <td></td> <td></td> <td colspan="8" style="text-align: center;"> <table border="1" style="width: 100%; border-collapse: collapse; text-align: center;"> <tr> <td style="width: 10%;"></td> <td style="width: 10%;"></td> <td style="width: 10%;"></td> <td style="width: 10%;"></td> <td style="width: 10%;"></td> <td style="width: 10%;"></td> <td style="width: 10%;"></td> <td style="width: 10%;"></td> <td style="width: 10%;"></td> <td style="width: 10%;"></td> </tr> <tr> <td></td> <td></td> <td colspan="8" style="text-align: center;"> <table border="1" style="width: 100%; border-collapse: collapse; text-align: center;"> <tr> <td style="width: 10%;"></td> <td style="width: 10%;"></td> <td style="width: 10%;"></td> <td style="width: 10%;"></td> <td style="width: 10%;"></td> <td style="width: 10%;"></td> <td style="width: 10%;"></td> <td style="width: 10%;"></td> <td style="width: 10%;"></td> <td style="width: 10%;"></td> </tr> <tr> <td></td> <td></td> <td colspan="8" style="text-align: center;"> <table border="1" style="width: 100%; border-collapse: collapse; text-align: center;"> <tr> <td style="width: 10%;"></td> <td style="width: 10%;"></td> <td style="width: 10%;"></td> <td style="width: 10%;"></td> <td style="width: 10%;"></td> <td style="width: 10%;"></td> <td style="width: 10%;"></td> <td style="width: 10%;"></td> <td style="width: 10%;"></td> <td style="width: 10%;"></td> </tr> <tr> <td></td> <td></td> <td colspan="8" style="text-align: center;"> <table border="1" style="width: 100%; border-collapse: collapse; text-align: center;"> <tr> <td style="width: 10%;"></td> <td style="width: 10%;"></td> <td style="width: 10%;"></td> <td style="width: 10%;"></td> <td style="width: 10%;"></td> <td style="width: 10%;"></td> <td style="width: 10%;"></td> <td style="width: 10%;"></td> <td style="width: 10%;"></td> <td style="width: 10%;"></td> </tr> <tr> <td></td> <td></td> <td colspan="8" style="text-align: center;"> <table border="1" style="width: 100%; border-collapse: collapse; text-align: center;"> <tr> <td style="width: 10%;"></td> <td style="width: 10%;"></td> <td style="width: 10%;"></td> <td style="width: 10%;"></td> <td style="width: 10%;"></td> <td style="width: 10%;"></td> <td style="width: 10%;"></td> <td style="width: 10%;"></td> <td style="width: 10%;"></td> <td style="width: 10%;"></td> </tr> <tr> <td></td> <td></td> <td colspan="8" style="text-align: center;"> <table border="1" style="width: 100%; border-collapse: collapse; text-align: center;"> <tr> </tr></table></td></tr></table></td></tr></table></td></tr></table></td></tr></table></td></tr></table></td></tr></table></td></tr></table></td></tr></table></td></tr></table></td></tr></table></td></tr></table></td></tr></table></td></tr></table>
 | | | | | | | | | | | | | | | | | | | | <table border="1" style="width: 100%; border-collapse: collapse; text-align: center;"> <tr> <td style="width: 10%;"></td> <td style="width: 10%;"></td> <td style="width: 10%;"></td> <td style="width: 10%;"></td> <td style="width: 10%;"></td> <td style="width: 10%;"></td> <td style="width: 10%;"></td> <td style="width: 10%;"></td> <td style="width: 10%;"></td> <td style="width: 10%;"></td> </tr> <tr> <td></td> <td></td> <td colspan="8" style="text-align: center;"> <table border="1" style="width: 100%; border-collapse: collapse; text-align: center;"> <tr> <td style="width: 10%;"></td> <td style="width: 10%;"></td> <td style="width: 10%;"></td> <td style="width: 10%;"></td> <td style="width: 10%;"></td> <td style="width: 10%;"></td> <td style="width: 10%;"></td> <td style="width: 10%;"></td> <td style="width: 10%;"></td> <td style="width: 10%;"></td> </tr> <tr> <td></td> <td></td> <td colspan="8" style="text-align: center;"> <table border="1" style="width: 100%; border-collapse: collapse; text-align: center;"> <tr> <td style="width: 10%;"></td> <td style="width: 10%;"></td> <td style="width: 10%;"></td> <td style="width: 10%;"></td> <td style="width: 10%;"></td> <td style="width: 10%;"></td> <td style="width: 10%;"></td> <td style="width: 10%;"></td> <td style="width: 10%;"></td> <td style="width: 10%;"></td> </tr> <tr> <td></td> <td></td> <td colspan="8" style="text-align: center;"> <table border="1" style="width: 100%; border-collapse: collapse; text-align: center;"> <tr> <td style="width: 10%;"></td> <td style="width: 10%;"></td> <td style="width: 10%;"></td> <td style="width: 10%;"></td> <td style="width: 10%;"></td> <td style="width: 10%;"></td> <td style="width: 10%;"></td> <td style="width: 10%;"></td> <td style="width: 10%;"></td> <td style="width: 10%;"></td> </tr> <tr> <td></td> <td></td> <td colspan="8" style="text-align: center;"> <table border="1" style="width: 100%; border-collapse: collapse; text-align: center;"> <tr> <td style="width: 10%;"></td> <td style="width: 10%;"></td> <td style="width: 10%;"></td> <td style="width: 10%;"></td> <td style="width: 10%;"></td> <td style="width: 10%;"></td> <td style="width: 10%;"></td> <td style="width: 10%;"></td> <td style="width: 10%;"></td> <td style="width: 10%;"></td> </tr> <tr> <td></td> <td></td> <td colspan="8" style="text-align: center;"> <table border="1" style="width: 100%; border-collapse: collapse; text-align: center;"> <tr> <td style="width: 10%;"></td> <td style="width: 10%;"></td> <td style="width: 10%;"></td> <td style="width: 10%;"></td> <td style="width: 10%;"></td> <td style="width: 10%;"></td> <td style="width: 10%;"></td> <td style="width: 10%;"></td> <td style="width: 10%;"></td> <td style="width: 10%;"></td> </tr> <tr> <td></td> <td></td> <td colspan="8" style="text-align: center;"> <table border="1" style="width: 100%; border-collapse: collapse; text-align: center;"> <tr> <td style="width: 10%;"></td> <td style="width: 10%;"></td> <td style="width: 10%;"></td> <td style="width: 10%;"></td> <td style="width: 10%;"></td> <td style="width: 10%;"></td> <td style="width: 10%;"></td> <td style="width: 10%;"></td> <td style="width: 10%;"></td> <td style="width: 10%;"></td> </tr> <tr> <td></td> <td></td> <td colspan="8" style="text-align: center;"> <table border="1" style="width: 100%; border-collapse: collapse; text-align: center;"> <tr> <td style="width: 10%;"></td> <td style="width: 10%;"></td> <td style="width: 10%;"></td> <td style="width: 10%;"></td> <td style="width: 10%;"></td> <td style="width: 10%;"></td> <td style="width: 10%;"></td> <td style="width: 10%;"></td> <td style="width: 10%;"></td> <td style="width: 10%;"></td> </tr> <tr> <td></td> <td></td> <td colspan="8" style="text-align: center;"> <table border="1" style="width: 100%; border-collapse: collapse; text-align: center;"> <tr> <td style="width: 10%;"></td> <td style="width: 10%;"></td> <td style="width: 10%;"></td> <td style="width: 10%;"></td> <td style="width: 10%;"></td> <td style="width: 10%;"></td> <td style="width: 10%;"></td> <td style="width: 10%;"></td> <td style="width: 10%;"></td> <td style="width: 10%;"></td> </tr> <tr> <td></td> <td></td> <td colspan="8" style="text-align: center;"> <table border="1" style="width: 100%; border-collapse: collapse; text-align: center;"> <tr> <td style="width: 10%;"></td> <td style="width: 10%;"></td> <td style="width: 10%;"></td> <td style="width: 10%;"></td> <td style="width: 10%;"></td> <td style="width: 10%;"></td> <td style="width: 10%;"></td> <td style="width: 10%;"></td> <td style="width: 10%;"></td> <td style="width: 10%;"></td> </tr> <tr> <td></td> <td></td> <td colspan="8" style="text-align: center;"> <table border="1" style="width: 100%; border-collapse: collapse; text-align: center;"> <tr> <td style="width: 10%;"></td> <td style="width: 10%;"></td> <td style="width: 10%;"></td> <td style="width: 10%;"></td> <td style="width: 10%;"></td> <td style="width: 10%;"></td> <td style="width: 10%;"></td> <td style="width: 10%;"></td> <td style="width: 10%;"></td> <td style="width: 10%;"></td> </tr> <tr> <td></td> <td></td> <td colspan="8" style="text-align: center;"> <table border="1" style="width: 100%; border-collapse: collapse; text-align: center;"> <tr> <td style="width: 10%;"></td> <td style="width: 10%;"></td> <td style="width: 10%;"></td> <td style="width: 10%;"></td> <td style="width: 10%;"></td> <td style="width: 10%;"></td> <td style="width: 10%;"></td> <td style="width: 10%;"></td> <td style="width: 10%;"></td> <td style="width: 10%;"></td> </tr> <tr> <td></td> <td></td> <td colspan="8" style="text-align: center;"> <table border="1" style="width: 100%; border-collapse: collapse; text-align: center;"> <tr> </tr></table></td></tr></table></td></tr></table></td></tr></table></td></tr></table></td></tr></table></td></tr></table></td></tr></table></td></tr></table></td></tr></table></td></tr></table></td></tr></table></td></tr></table>
 | | | | | | | | | | | | | | | | | | | | <table border="1" style="width: 100%; border-collapse: collapse; text-align: center;"> <tr> <td style="width: 10%;"></td> <td style="width: 10%;"></td> <td style="width: 10%;"></td> <td style="width: 10%;"></td> <td style="width: 10%;"></td> <td style="width: 10%;"></td> <td style="width: 10%;"></td> <td style="width: 10%;"></td> <td style="width: 10%;"></td> <td style="width: 10%;"></td> </tr> <tr> <td></td> <td></td> <td colspan="8" style="text-align: center;"> <table border="1" style="width: 100%; border-collapse: collapse; text-align: center;"> <tr> <td style="width: 10%;"></td> <td style="width: 10%;"></td> <td style="width: 10%;"></td> <td style="width: 10%;"></td> <td style="width: 10%;"></td> <td style="width: 10%;"></td> <td style="width: 10%;"></td> <td style="width: 10%;"></td> <td style="width: 10%;"></td> <td style="width: 10%;"></td> </tr> <tr> <td></td> <td></td> <td colspan="8" style="text-align: center;"> <table border="1" style="width: 100%; border-collapse: collapse; text-align: center;"> <tr> <td style="width: 10%;"></td> <td style="width: 10%;"></td> <td style="width: 10%;"></td> <td style="width: 10%;"></td> <td style="width: 10%;"></td> <td style="width: 10%;"></td> <td style="width: 10%;"></td> <td style="width: 10%;"></td> <td style="width: 10%;"></td> <td style="width: 10%;"></td> </tr> <tr> <td></td> <td></td> <td colspan="8" style="text-align: center;"> <table border="1" style="width: 100%; border-collapse: collapse; text-align: center;"> <tr> <td style="width: 10%;"></td> <td style="width: 10%;"></td> <td style="width: 10%;"></td> <td style="width: 10%;"></td> <td style="width: 10%;"></td> <td style="width: 10%;"></td> <td style="width: 10%;"></td> <td style="width: 10%;"></td> <td style="width: 10%;"></td> <td style="width: 10%;"></td> </tr> <tr> <td></td> <td></td> <td colspan="8" style="text-align: center;"> <table border="1" style="width: 100%; border-collapse: collapse; text-align: center;"> <tr> <td style="width: 10%;"></td> <td style="width: 10%;"></td> <td style="width: 10%;"></td> <td style="width: 10%;"></td> <td style="width: 10%;"></td> <td style="width: 10%;"></td> <td style="width: 10%;"></td> <td style="width: 10%;"></td> <td style="width: 10%;"></td> <td style="width: 10%;"></td> </tr> <tr> <td></td> <td></td> <td colspan="8" style="text-align: center;"> <table border="1" style="width: 100%; border-collapse: collapse; text-align: center;"> <tr> <td style="width: 10%;"></td> <td style="width: 10%;"></td> <td style="width: 10%;"></td> <td style="width: 10%;"></td> <td style="width: 10%;"></td> <td style="width: 10%;"></td> <td style="width: 10%;"></td> <td style="width: 10%;"></td> <td style="width: 10%;"></td> <td style="width: 10%;"></td> </tr> <tr> <td></td> <td></td> <td colspan="8" style="text-align: center;"> <table border="1" style="width: 100%; border-collapse: collapse; text-align: center;"> <tr> <td style="width: 10%;"></td> <td style="width: 10%;"></td> <td style="width: 10%;"></td> <td style="width: 10%;"></td> <td style="width: 10%;"></td> <td style="width: 10%;"></td> <td style="width: 10%;"></td> <td style="width: 10%;"></td> <td style="width: 10%;"></td> <td style="width: 10%;"></td> </tr> <tr> <td></td> <td></td> <td colspan="8" style="text-align: center;"> <table border="1" style="width: 100%; border-collapse: collapse; text-align: center;"> <tr> <td style="width: 10%;"></td> <td style="width: 10%;"></td> <td style="width: 10%;"></td> <td style="width: 10%;"></td> <td style="width: 10%;"></td> <td style="width: 10%;"></td> <td style="width: 10%;"></td> <td style="width: 10%;"></td> <td style="width: 10%;"></td> <td style="width: 10%;"></td> </tr> <tr> <td></td> <td></td> <td colspan="8" style="text-align: center;"> <table border="1" style="width: 100%; border-collapse: collapse; text-align: center;"> <tr> <td style="width: 10%;"></td> <td style="width: 10%;"></td> <td style="width: 10%;"></td> <td style="width: 10%;"></td> <td style="width: 10%;"></td> <td style="width: 10%;"></td> <td style="width: 10%;"></td> <td style="width: 10%;"></td> <td style="width: 10%;"></td> <td style="width: 10%;"></td> </tr> <tr> <td></td> <td></td> <td colspan="8" style="text-align: center;"> <table border="1" style="width: 100%; border-collapse: collapse; text-align: center;"> <tr> <td style="width: 10%;"></td> <td style="width: 10%;"></td> <td style="width: 10%;"></td> <td style="width: 10%;"></td> <td style="width: 10%;"></td> <td style="width: 10%;"></td> <td style="width: 10%;"></td> <td style="width: 10%;"></td> <td style="width: 10%;"></td> <td style="width: 10%;"></td> </tr> <tr> <td></td> <td></td> <td colspan="8" style="text-align: center;"> <table border="1" style="width: 100%; border-collapse: collapse; text-align: center;"> <tr> <td style="width: 10%;"></td> <td style="width: 10%;"></td> <td style="width: 10%;"></td> <td style="width: 10%;"></td> <td style="width: 10%;"></td> <td style="width: 10%;"></td> <td style="width: 10%;"></td> <td style="width: 10%;"></td> <td style="width: 10%;"></td> <td style="width: 10%;"></td> </tr> <tr> <td></td> <td></td> <td colspan="8" style="text-align: center;"> <table border="1" style="width: 100%; border-collapse: collapse; text-align: center;"> <tr> </tr></table></td></tr></table></td></tr></table></td></tr></table></td></tr></table></td></tr></table></td></tr></table></td></tr></table></td></tr></table></td></tr></table></td></tr></table></td></tr></table>
 | | | | | | | | | | | | | | | | | | | | <table border="1" style="width: 100%; border-collapse: collapse; text-align: center;"> <tr> <td style="width: 10%;"></td> <td style="width: 10%;"></td> <td style="width: 10%;"></td> <td style="width: 10%;"></td> <td style="width: 10%;"></td> <td style="width: 10%;"></td> <td style="width: 10%;"></td> <td style="width: 10%;"></td> <td style="width: 10%;"></td> <td style="width: 10%;"></td> </tr> <tr> <td></td> <td></td> <td colspan="8" style="text-align: center;"> <table border="1" style="width: 100%; border-collapse: collapse; text-align: center;"> <tr> <td style="width: 10%;"></td> <td style="width: 10%;"></td> <td style="width: 10%;"></td> <td style="width: 10%;"></td> <td style="width: 10%;"></td> <td style="width: 10%;"></td> <td style="width: 10%;"></td> <td style="width: 10%;"></td> <td style="width: 10%;"></td> <td style="width: 10%;"></td> </tr> <tr> <td></td> <td></td> <td colspan="8" style="text-align: center;"> <table border="1" style="width: 100%; border-collapse: collapse; text-align: center;"> <tr> <td style="width: 10%;"></td> <td style="width: 10%;"></td> <td style="width: 10%;"></td> <td style="width: 10%;"></td> <td style="width: 10%;"></td> <td style="width: 10%;"></td> <td style="width: 10%;"></td> <td style="width: 10%;"></td> <td style="width: 10%;"></td> <td style="width: 10%;"></td> </tr> <tr> <td></td> <td></td> <td colspan="8" style="text-align: center;"> <table border="1" style="width: 100%; border-collapse: collapse; text-align: center;"> <tr> <td style="width: 10%;"></td> <td style="width: 10%;"></td> <td style="width: 10%;"></td> <td style="width: 10%;"></td> <td style="width: 10%;"></td> <td style="width: 10%;"></td> <td style="width: 10%;"></td> <td style="width: 10%;"></td> <td style="width: 10%;"></td> <td style="width: 10%;"></td> </tr> <tr> <td></td> <td></td> <td colspan="8" style="text-align: center;"> <table border="1" style="width: 100%; border-collapse: collapse; text-align: center;"> <tr> <td style="width: 10%;"></td> <td style="width: 10%;"></td> <td style="width: 10%;"></td> <td style="width: 10%;"></td> <td style="width: 10%;"></td> <td style="width: 10%;"></td> <td style="width: 10%;"></td> <td style="width: 10%;"></td> <td style="width: 10%;"></td> <td style="width: 10%;"></td> </tr> <tr> <td></td> <td></td> <td colspan="8" style="text-align: center;"> <table border="1" style="width: 100%; border-collapse: collapse; text-align: center;"> <tr> <td style="width: 10%;"></td> <td style="width: 10%;"></td> <td style="width: 10%;"></td> <td style="width: 10%;"></td> <td style="width: 10%;"></td> <td style="width: 10%;"></td> <td style="width: 10%;"></td> <td style="width: 10%;"></td> <td style="width: 10%;"></td> <td style="width: 10%;"></td> </tr> <tr> <td></td> <td></td> <td colspan="8" style="text-align: center;"> <table border="1" style="width: 100%; border-collapse: collapse; text-align: center;"> <tr> <td style="width: 10%;"></td> <td style="width: 10%;"></td> <td style="width: 10%;"></td> <td style="width: 10%;"></td> <td style="width: 10%;"></td> <td style="width: 10%;"></td> <td style="width: 10%;"></td> <td style="width: 10%;"></td> <td style="width: 10%;"></td> <td style="width: 10%;"></td> </tr> <tr> <td></td> <td></td> <td colspan="8" style="text-align: center;"> <table border="1" style="width: 100%; border-collapse: collapse; text-align: center;"> <tr> <td style="width: 10%;"></td> <td style="width: 10%;"></td> <td style="width: 10%;"></td> <td style="width: 10%;"></td> <td style="width: 10%;"></td> <td style="width: 10%;"></td> <td style="width: 10%;"></td> <td style="width: 10%;"></td> <td style="width: 10%;"></td> <td style="width: 10%;"></td> </tr> <tr> <td></td> <td></td> <td colspan="8" style="text-align: center;"> <table border="1" style="width: 100%; border-collapse: collapse; text-align: center;"> <tr> <td style="width: 10%;"></td> <td style="width: 10%;"></td> <td style="width: 10%;"></td> <td style="width: 10%;"></td> <td style="width: 10%;"></td> <td style="width: 10%;"></td> <td style="width: 10%;"></td> <td style="width: 10%;"></td> <td style="width: 10%;"></td> <td style="width:
10%;"></td> </tr> <tr> <td></td> <td></td> <td colspan="8" style="text-align: center;"> <table border="1" style="width: 100%; border-collapse: collapse; text-align: center;"> <tr> <td style="width: 10%;"></td> <td style="width: 10%;"></td> <td style="width: 10%;"></td> <td style="width: 10%;"></td> <td style="width: 10%;"></td> <td style="width: 10%;"></td> <td style="width: 10%;"></td> <td style="width: 10%;"></td> <td style="width: 10%;"></td> <td style="width: 10%;"></td> </tr> <tr> <td></td> <td></td> <td colspan="8" style="text-align: center;"> <table border="1" style="width: 100%; border-collapse: collapse; text-align: center;"> <tr> </tr></table></td></tr></table></td></tr></table></td></tr></table></td></tr></table></td></tr></table></td></tr></table></td></tr></table></td></tr></table></td></tr></table></td></tr></table> | | | | | | | | | | | | | | | | | | | | <table border="1" style="width: 100%; border-collapse: collapse; text-align: center;"> <tr> <td style="width: 10%;"></td> <td style="width: 10%;"></td> <td style="width: 10%;"></td> <td style="width: 10%;"></td> <td style="width: 10%;"></td> <td style="width: 10%;"></td> <td style="width: 10%;"></td> <td style="width: 10%;"></td> <td style="width: 10%;"></td> <td style="width: 10%;"></td> </tr> <tr> <td></td> <td></td> <td colspan="8" style="text-align: center;"> <table border="1" style="width: 100%; border-collapse: collapse; text-align: center;"> <tr> <td style="width: 10%;"></td> <td style="width: 10%;"></td> <td style="width: 10%;"></td> <td style="width: 10%;"></td> <td style="width: 10%;"></td> <td style="width: 10%;"></td> <td style="width: 10%;"></td> <td style="width: 10%;"></td> <td style="width: 10%;"></td> <td style="width: 10%;"></td> </tr> <tr> <td></td> <td></td> <td colspan="8" style="text-align: center;"> <table border="1" style="width: 100%; border-collapse: collapse; text-align: center;"> <tr> <td style="width: 10%;"></td> <td style="width: 10%;"></td> <td style="width: 10%;"></td> <td style="width: 10%;"></td> <td style="width: 10%;"></td> <td style="width: 10%;"></td> <td style="width: 10%;"></td> <td style="width: 10%;"></td> <td style="width: 10%;"></td> <td style="width: 10%;"></td> </tr> <tr> <td></td> <td></td> <td colspan="8" style="text-align: center;"> <table border="1" style="width: 100%; border-collapse: collapse; text-align: center;"> <tr> <td style="width: 10%;"></td> <td style="width: 10%;"></td> <td style="width: 10%;"></td> <td style="width: 10%;"></td> <td style="width: 10%;"></td> <td style="width: 10%;"></td> <td style="width: 10%;"></td> <td style="width: 10%;"></td> <td style="width: 10%;"></td> <td style="width: 10%;"></td> </tr> <tr> <td></td> <td></td> <td colspan="8" style="text-align: center;"> <table border="1" style="width: 100%; border-collapse: collapse; text-align: center;"> <tr> <td style="width: 10%;"></td> <td style="width: 10%;"></td> <td style="width: 10%;"></td> <td style="width: 10%;"></td> <td style="width: 10%;"></td> <td style="width: 10%;"></td> <td style="width: 10%;"></td> <td style="width: 10%;"></td> <td style="width: 10%;"></td> <td style="width: 10%;"></td> </tr> <tr> <td></td> <td></td> <td colspan="8" style="text-align: center;"> <table border="1" style="width: 100%; border-collapse: collapse; text-align: center;"> <tr> <td style="width: 10%;"></td> <td style="width: 10%;"></td> <td style="width: 10%;"></td> <td style="width: 10%;"></td> <td style="width: 10%;"></td> <td style="width: 10%;"></td> <td style="width: 10%;"></td> <td style="width: 10%;"></td> <td style="width: 10%;"></td> <td style="width: 10%;"></td> </tr> <tr> <td></td> <td></td> <td colspan="8" style="text-align: center;"> <table border="1" style="width: 100%; border-collapse: collapse; text-align: center;"> <tr> <td style="width: 10%;"></td> <td style="width: 10%;"></td> <td style="width: 10%;"></td> <td style="width: 10%;"></td> <td style="width: 10%;"></td> <td style="width: 10%;"></td> <td style="width: 10%;"></td> <td style="width: 10%;"></td> <td style="width: 10%;"></td> <td style="width: 10%;"></td> </tr> <tr> <td></td> <td></td> <td colspan="8" style="text-align:
center;"> <table border="1" style="width: 100%; border-collapse: collapse; text-align: center;"> <tr> <td style="width: 10%;"></td> <td style="width: 10%;"></td> <td style="width: 10%;"></td> <td style="width: 10%;"></td> <td style="width: 10%;"></td> <td style="width: 10%;"></td> <td style="width: 10%;"></td> <td style="width: 10%;"></td> <td style="width: 10%;"></td> <td style="width: 10%;"></td> </tr> <tr> <td></td> <td></td> <td colspan="8" style="text-align: center;"> <table border="1" style="width: 100%; border-collapse: collapse; text-align: center;"> <tr> <td style="width: 10%;"></td> <td style="width: 10%;"></td> <td style="width: 10%;"></td> <td style="width: 10%;"></td> <td style="width: 10%;"></td> <td style="width: 10%;"></td> <td style="width: 10%;"></td> <td style="width: 10%;"></td> <td style="width: 10%;"></td> <td style="width: 10%;"></td> </tr> <tr> <td></td> <td></td> <td colspan="8" style="text-align: center;"> <table border="1" style="width: 100%; border-collapse: collapse; text-align: center;"> <tr> </tr></table></td></tr></table></td></tr></table></td></tr></table></td></tr></table></td></tr></table></td></tr></table></td></tr></table></td></tr></table></td></tr></table> | | | | | | | | | | | | | | | | | | | | <table border="1" style="width: 100%; border-collapse: collapse; text-align: center;"> <tr> <td style="width: 10%;"></td> <td style="width: 10%;"></td> <td style="width: 10%;"></td> <td style="width: 10%;"></td> <td style="width: 10%;"></td> <td style="width: 10%;"></td> <td style="width: 10%;"></td> <td style="width: 10%;"></td> <td style="width: 10%;"></td> <td style="width: 10%;"></td> </tr> <tr> <td></td> <td></td> <td colspan="8" style="text-align: center;"> <table border="1" style="width: 100%; border-collapse: collapse; text-align: center;"> <tr> <td style="width: 10%;"></td> <td style="width: 10%;"></td> <td style="width: 10%;"></td> <td style="width: 10%;"></td> <td style="width: 10%;"></td> <td style="width: 10%;"></td> <td style="width: 10%;"></td> <td style="width: 10%;"></td> <td style="width: 10%;"></td> <td style="width: 10%;"></td> </tr> <tr> <td></td> <td></td> <td colspan="8" style="text-align: center;"> <table border="1" style="width: 100%; border-collapse: collapse; text-align: center;"> <tr> <td style="width: 10%;"></td> <td style="width: 10%;"></td> <td style="width: 10%;"></td> <td style="width: 10%;"></td> <td style="width: 10%;"></td> <td style="width: 10%;"></td> <td style="width: 10%;"></td> <td style="width: 10%;"></td> <td style="width: 10%;"></td> <td style="width: 10%;"></td> </tr> <tr> <td></td> <td></td> <td colspan="8" style="text-align: center;"> <table border="1" style="width: 100%; border-collapse: collapse; text-align: center;"> <tr> <td style="width: 10%;"></td> <td style="width: 10%;"></td> <td style="width: 10%;"></td> <td style="width: 10%;"></td> <td style="width: 10%;"></td> <td style="width: 10%;"></td> <td style="width: 10%;"></td> <td style="width: 10%;"></td> <td style="width: 10%;"></td> <td style="width: 10%;"></td> </tr> <tr> <td></td> <td></td> <td colspan="8" style="text-align: center;"> <table border="1" style="width: 100%; border-collapse: collapse; text-align: center;"> <tr> <td style="width: 10%;"></td> <td style="width: 10%;"></td> <td style="width: 10%;"></td> <td style="width: 10%;"></td> <td style="width: 10%;"></td> <td style="width: 10%;"></td> <td style="width: 10%;"></td> <td style="width: 10%;"></td> <td style="width: 10%;"></td> <td style="width: 10%;"></td> </tr> <tr> <td></td> <td></td> <td colspan="8" style="text-align: center;"> <table border="1" style="width: 100%; border-collapse: collapse; text-align: center;"> <tr> <td style="width: 10%;"></td> <td style="width: 10%;"></td> <td style="width: 10%;"></td> <td style="width: 10%;"></td> <td style="width: 10%;"></td> <td style="width: 10%;"></td> <td style="width: 10%;"></td> <td style="width: 10%;"></td> <td style="width: 10%;"></td> <td style="width: 10%;"></td> </tr> <tr> <td></td> <td></td> <td colspan="8" style="text-align: center;"> <table border="1" style="width: 100%; border-collapse: collapse; text-align: center;">
<tr> <td style="width: 10%;"></td> <td style="width: 10%;"></td> <td style="width: 10%;"></td> <td style="width: 10%;"></td> <td style="width: 10%;"></td> <td style="width: 10%;"></td> <td style="width: 10%;"></td> <td style="width: 10%;"></td> <td style="width: 10%;"></td> <td style="width: 10%;"></td> </tr> <tr> <td></td> <td></td> <td colspan="8" style="text-align: center;"> <table border="1" style="width: 100%; border-collapse: collapse; text-align: center;"> <tr> <td style="width: 10%;"></td> <td style="width: 10%;"></td> <td style="width: 10%;"></td> <td style="width: 10%;"></td> <td style="width: 10%;"></td> <td style="width: 10%;"></td> <td style="width: 10%;"></td> <td style="width: 10%;"></td> <td style="width: 10%;"></td> <td style="width: 10%;"></td> </tr> <tr> <td></td> <td></td> <td colspan="8" style="text-align: center;"> <table border="1" style="width: 100%; border-collapse: collapse; text-align: center;"> <tr> </tr></table></td></tr></table></td></tr></table></td></tr></table></td></tr></table></td></tr></table></td></tr></table></td></tr></table></td></tr></table> | | | | | | | | | | | | | | | | | | | | <table border="1" style="width: 100%; border-collapse: collapse; text-align: center;"> <tr> <td style="width: 10%;"></td> <td style="width: 10%;"></td> <td style="width: 10%;"></td> <td style="width: 10%;"></td> <td style="width: 10%;"></td> <td style="width: 10%;"></td> <td style="width: 10%;"></td> <td style="width: 10%;"></td> <td style="width: 10%;"></td> <td style="width: 10%;"></td> </tr> <tr> <td></td> <td></td> <td colspan="8" style="text-align: center;"> <table border="1" style="width: 100%; border-collapse: collapse; text-align: center;"> <tr> <td style="width: 10%;"></td> <td style="width: 10%;"></td> <td style="width: 10%;"></td> <td style="width: 10%;"></td> <td style="width: 10%;"></td> <td style="width: 10%;"></td> <td style="width: 10%;"></td> <td style="width: 10%;"></td> <td style="width: 10%;"></td> <td style="width: 10%;"></td> </tr> <tr> <td></td> <td></td> <td colspan="8" style="text-align: center;"> <table border="1" style="width: 100%; border-collapse: collapse; text-align: center;"> <tr> <td style="width: 10%;"></td> <td style="width: 10%;"></td> <td style="width: 10%;"></td> <td style="width: 10%;"></td> <td style="width: 10%;"></td> <td style="width: 10%;"></td> <td style="width: 10%;"></td> <td style="width: 10%;"></td> <td style="width: 10%;"></td> <td style="width: 10%;"></td> </tr> <tr> <td></td> <td></td> <td colspan="8" style="text-align: center;"> <table border="1" style="width: 100%; border-collapse: collapse; text-align: center;"> <tr> <td style="width: 10%;"></td> <td style="width: 10%;"></td> <td style="width: 10%;"></td> <td style="width: 10%;"></td> <td style="width: 10%;"></td> <td style="width: 10%;"></td> <td style="width: 10%;"></td> <td style="width: 10%;"></td> <td style="width: 10%;"></td> <td style="width: 10%;"></td> </tr> <tr> <td></td> <td></td> <td colspan="8" style="text-align: center;"> <table border="1" style="width: 100%; border-collapse: collapse; text-align: center;"> <tr> <td style="width: 10%;"></td> <td style="width: 10%;"></td> <td style="width: 10%;"></td> <td style="width: 10%;"></td> <td style="width: 10%;"></td> <td style="width: 10%;"></td> <td style="width: 10%;"></td> <td style="width: 10%;"></td> <td style="width: 10%;"></td> <td style="width: 10%;"></td> </tr> <tr> <td></td> <td></td> <td colspan="8" style="text-align: center;"> <table border="1" style="width: 100%; border-collapse: collapse; text-align: center;"> <tr> <td style="width: 10%;"></td> <td style="width: 10%;"></td> <td style="width: 10%;"></td> <td style="width: 10%;"></td> <td style="width: 10%;"></td> <td style="width: 10%;"></td> <td style="width: 10%;"></td> <td style="width: 10%;"></td> <td style="width: 10%;"></td> <td style="width: 10%;"></td> </tr> <tr> <td></td> <td></td> <td colspan="8" style="text-align: center;"> <table border="1" style="width: 100%; border-collapse: collapse; text-align: center;"> <tr> <td style="width: 10%;"></td> <td style="width: 10%;"></td> <td style="width: 10%;"></td> <td style="width:
10%;"></td> <td style="width: 10%;"></td> <td style="width: 10%;"></td> <td style="width: 10%;"></td> <td style="width: 10%;"></td> <td style="width: 10%;"></td> <td style="width: 10%;"></td> </tr> <tr> <td></td> <td></td> <td colspan="8" style="text-align: center;"> <table border="1" style="width: 100%; border-collapse: collapse; text-align: center;"> <tr> </tr></table></td></tr></table></td></tr></table></td></tr></table></td></tr></table></td></tr></table></td></tr></table></td></tr></table> | | | | | | | | | | | | | | | | | | | | <table border="1" style="width: 100%; border-collapse: collapse; text-align: center;"> <tr> <td style="width: 10%;"></td> <td style="width: 10%;"></td> <td style="width: 10%;"></td> <td style="width: 10%;"></td> <td style="width: 10%;"></td> <td style="width: 10%;"></td> <td style="width: 10%;"></td> <td style="width: 10%;"></td> <td style="width: 10%;"></td> <td style="width: 10%;"></td> </tr> <tr> <td></td> <td></td> <td colspan="8" style="text-align: center;"> <table border="1" style="width: 100%; border-collapse: collapse; text-align: center;"> <tr> <td style="width: 10%;"></td> <td style="width: 10%;"></td> <td style="width: 10%;"></td> <td style="width: 10%;"></td> <td style="width: 10%;"></td> <td style="width: 10%;"></td> <td style="width: 10%;"></td> <td style="width: 10%;"></td> <td style="width: 10%;"></td> <td style="width: 10%;"></td> </tr> <tr> <td></td> <td></td> <td colspan="8" style="text-align: center;"> <table border="1" style="width: 100%; border-collapse: collapse; text-align: center;"> <tr> <td style="width: 10%;"></td> <td style="width: 10%;"></td> <td style="width: 10%;"></td> <td style="width: 10%;"></td> <td style="width: 10%;"></td> <td style="width: 10%;"></td> <td style="width: 10%;"></td> <td style="width: 10%;"></td> <td style="width: 10%;"></td> <td style="width: 10%;"></td> </tr> <tr> <td></td> <td></td> <td colspan="8" style="text-align: center;"> <table border="1" style="width: 100%; border-collapse: collapse; text-align: center;"> <tr> <td style="width: 10%;"></td> <td style="width: 10%;"></td> <td style="width: 10%;"></td> <td style="width: 10%;"></td> <td style="width: 10%;"></td> <td style="width: 10%;"></td> <td style="width: 10%;"></td> <td style="width: 10%;"></td> <td style="width: 10%;"></td> <td style="width: 10%;"></td> </tr> <tr> <td></td> <td></td> <td colspan="8" style="text-align: center;"> <table border="1" style="width: 100%; border-collapse: collapse; text-align: center;"> <tr> <td style="width: 10%;"></td> <td style="width: 10%;"></td> <td style="width: 10%;"></td> <td style="width: 10%;"></td> <td style="width: 10%;"></td> <td style="width: 10%;"></td> <td style="width: 10%;"></td> <td style="width: 10%;"></td> <td style="width: 10%;"></td> <td style="width: 10%;"></td> </tr> <tr> <td></td> <td></td> <td colspan="8" style="text-align: center;"> <table border="1" style="width: 100%; border-collapse: collapse; text-align: center;"> <tr> <td style="width: 10%;"></td> <td style="width: 10%;"></td> <td style="width: 10%;"></td> <td style="width: 10%;"></td> <td style="width: 10%;"></td> <td style="width: 10%;"></td> <td style="width: 10%;"></td> <td style="width: 10%;"></td> <td style="width: 10%;"></td> <td style="width: 10%;"></td> </tr> <tr> <td></td> <td></td> <td colspan="8" style="text-align: center;"> <table border="1" style="width: 100%; border-collapse: collapse; text-align: center;"> <tr> </tr></table></td></tr></table></td></tr></table></td></tr></table></td></tr></table></td></tr></table></td></tr></table>
 | | | | | | | | | | | | | | | | | | | | <table border="1" style="width: 100%; border-collapse: collapse; text-align: center;"> <tr> <td style="width: 10%;"></td> <td style="width: 10%;"></td> <td style="width: 10%;"></td> <td style="width: 10%;"></td> <td style="width: 10%;"></td> <td style="width: 10%;"></td> <td style="width: 10%;"></td> <td style="width: 10%;"></td> <td style="width: 10%;"></td> <td style="width: 10%;"></td> </tr> <tr> <td></td> <td></td> <td colspan="8" style="text-align: center;"> <table border="1" style="width: 100%; border-collapse: collapse; text-align: center;"> <tr> <td style="width: 10%;"></td> <td style="width: 10%;"></td> <td style="width: 10%;"></td> <td style="width: 10%;"></td> <td style="width: 10%;"></td> <td style="width: 10%;"></td> <td style="width: 10%;"></td> <td style="width: 10%;"></td> <td style="width: 10%;"></td> <td style="width: 10%;"></td> </tr> <tr> <td></td> <td></td> <td colspan="8" style="text-align: center;"> <table border="1" style="width: 100%; border-collapse: collapse; text-align: center;"> <tr> <td style="width: 10%;"></td> <td style="width: 10%;"></td> <td style="width: 10%;"></td> <td style="width: 10%;"></td> <td style="width: 10%;"></td> <td style="width: 10%;"></td> <td style="width: 10%;"></td> <td style="width: 10%;"></td> <td style="width: 10%;"></td> <td style="width: 10%;"></td> </tr> <tr> <td></td> <td></td> <td colspan="8" style="text-align: center;"> <table border="1" style="width: 100%; border-collapse: collapse; text-align: center;"> <tr> <td style="width: 10%;"></td> <td style="width: 10%;"></td> <td style="width: 10%;"></td> <td style="width: 10%;"></td> <td style="width: 10%;"></td> <td style="width: 10%;"></td> <td style="width: 10%;"></td> <td style="width: 10%;"></td> <td style="width: 10%;"></td> <td style="width: 10%;"></td> </tr> <tr> <td></td> <td></td> <td colspan="8" style="text-align: center;"> <table border="1" style="width: 100%; border-collapse: collapse; text-align: center;"> <tr> <td style="width: 10%;"></td> <td style="width: 10%;"></td> <td style="width: 10%;"></td> <td style="width: 10%;"></td> <td style="width: 10%;"></td> <td style="width: 10%;"></td> <td style="width: 10%;"></td> <td style="width: 10%;"></td> <td style="width: 10%;"></td> <td style="width: 10%;"></td> </tr> <tr> <td></td> <td></td> <td colspan="8" style="text-align: center;"> <table border="1" style="width: 100%; border-collapse: collapse; text-align: center;"> <tr> </tr></table></td></tr></table></td></tr></table></td></tr></table></td></tr></table></td></tr></table>
 | | | | | | | | | | | | | | | | | | | | <table border="1" style="width: 100%; border-collapse: collapse; text-align: center;"> <tr> <td style="width: 10%;"></td> <td style="width: 10%;"></td> <td style="width: 10%;"></td> <td style="width: 10%;"></td> <td style="width: 10%;"></td> <td style="width: 10%;"></td> <td style="width: 10%;"></td> <td style="width: 10%;"></td> <td style="width: 10%;"></td> <td style="width: 10%;"></td> </tr> <tr> <td></td> <td></td> <td colspan="8" style="text-align: center;"> <table border="1" style="width: 100%; border-collapse: collapse; text-align: center;"> <tr> <td style="width: 10%;"></td> <td style="width: 10%;"></td> <td style="width: 10%;"></td> <td style="width: 10%;"></td> <td style="width: 10%;"></td> <td style="width: 10%;"></td> <td style="width: 10%;"></td> <td style="width: 10%;"></td> <td style="width: 10%;"></td> <td style="width: 10%;"></td> </tr> <tr> <td></td> <td></td> <td colspan="8" style="text-align: center;"> <table border="1" style="width: 100%; border-collapse: collapse; text-align: center;"> <tr> <td style="width: 10%;"></td> <td style="width: 10%;"></td> <td style="width: 10%;"></td> <td style="width: 10%;"></td> <td style="width: 10%;"></td> <td style="width: 10%;"></td> <td style="width: 10%;"></td> <td style="width: 10%;"></td> <td style="width: 10%;"></td> <td style="width: 10%;"></td> </tr> <tr> <td></td> <td></td> <td colspan="8" style="text-align: center;"> <table border="1" style="width: 100%; border-collapse: collapse; text-align: center;"> <tr> <td style="width: 10%;"></td> <td style="width: 10%;"></td> <td style="width: 10%;"></td> <td style="width: 10%;"></td> <td style="width: 10%;"></td> <td style="width: 10%;"></td> <td style="width: 10%;"></td> <td style="width: 10%;"></td> <td style="width: 10%;"></td> <td style="width: 10%;"></td> </tr> <tr> <td></td> <td></td> <td colspan="8" style="text-align: center;"> <table border="1" style="width: 100%; border-collapse: collapse; text-align: center;"> <tr> </tr></table></td></tr></table></td></tr></table></td></tr></table></td></tr></table>
 | | | | | | | | | | | | | | | | | | | | <table border="1" style="width: 100%; border-collapse: collapse; text-align: center;"> <tr> <td style="width: 10%;"></td> <td style="width: 10%;"></td> <td style="width: 10%;"></td> <td style="width: 10%;"></td> <td style="width: 10%;"></td> <td style="width: 10%;"></td> <td style="width: 10%;"></td> <td style="width: 10%;"></td> <td style="width: 10%;"></td> <td style="width: 10%;"></td> </tr> <tr> <td></td> <td></td> <td colspan="8" style="text-align: center;"> <table border="1" style="width: 100%; border-collapse: collapse; text-align: center;"> <tr> <td style="width: 10%;"></td> <td style="width: 10%;"></td> <td style="width: 10%;"></td> <td style="width: 10%;"></td> <td style="width: 10%;"></td> <td style="width: 10%;"></td> <td style="width: 10%;"></td> <td style="width: 10%;"></td> <td style="width: 10%;"></td> <td style="width: 10%;"></td> </tr> <tr> <td></td> <td></td> <td colspan="8" style="text-align: center;"> <table border="1" style="width: 100%; border-collapse: collapse; text-align: center;"> <tr> <td style="width: 10%;"></td> <td style="width: 10%;"></td> <td style="width: 10%;"></td> <td style="width: 10%;"></td> <td style="width: 10%;"></td> <td style="width: 10%;"></td> <td style="width: 10%;"></td> <td style="width: 10%;"></td> <td style="width: 10%;"></td> <td style="width: 10%;"></td> </tr> <tr> <td></td> <td></td> <td colspan="8" style="text-align: center;"> <table border="1" style="width: 100%; border-collapse: collapse; text-align: center;"> <tr> </tr></table></td></tr></table></td></tr></table></td></tr></table> | | | | | | | | | | | | | | | | | | | | <table border="1" style="width: 100%; border-collapse: collapse; text-align: center;"> <tr> <td style="width: 10%;"></td> <td style="width: 10%;"></td> <td style="width: 10%;"></td> <td style="width: 10%;"></td> <td style="width: 10%;"></td> <td style="width: 10%;"></td> <td style="width: 10%;"></td> <td style="width: 10%;"></td> <td style="width: 10%;"></td> <td style="width: 10%;"></td> </tr> <tr> <td></td> <td></td> <td colspan="8" style="text-align: center;"> <table border="1" style="width: 100%; border-collapse: collapse; text-align: center;"> <tr> <td style="width: 10%;"></td> <td style="width: 10%;"></td> <td style="width: 10%;"></td> <td style="width: 10%;"></td> <td style="width: 10%;"></td> <td style="width: 10%;"></td> <td style="width: 10%;"></td> <td style="width: 10%;"></td> <td style="width: 10%;"></td> <td style="width: 10%;"></td> </tr> <tr>
<td></td> <td></td> <td colspan="8" style="text-align: center;"> <table border="1" style="width: 100%; border-collapse: collapse; text-align: center;"> <tr> </tr></table></td></tr></table></td></tr></table> | | | | | | | | | | | | | | | | | | | | <table border="1" style="width: 100%; border-collapse: collapse; text-align: center;"> <tr> <td style="width: 10%;"></td> <td style="width: 10%;"></td> <td style="width: 10%;"></td> <td style="width: 10%;"></td> <td style="width: 10%;"></td> <td style="width: 10%;"></td> <td style="width: 10%;"></td> <td style="width: 10%;"></td> <td style="width: 10%;"></td> <td style="width: 10%;"></td> </tr> <tr> <td></td> <td></td> <td colspan="8" style="text-align: center;"> <table border="1" style="width: 100%; border-collapse: collapse; text-align: center;"> <tr> </tr></table></td></tr></table>
 | | | | | | | | | | | | | | | | | | | | <table border="1" style="width: 100%; border-collapse: collapse; text-align: center;"> <tr> </tr></table> | | | | | | | | | | | | | | | | | | | | | | | | | | | | | | | | | | | | | | | | | | | | | | | | | | | | | | | | | | | |
 | | | | | | | | | | | | | | | | | | | | | | | | | | | | | | | | | | | | | | | |
 | | | | | | | | | | | | | | | | | | | | | | | | | | | | | | | | | | | | | | | |
 | | | | | | | | | | | | | | | | | | | | | | | | | | | | | | | | | | | | | | | | | | | | | | | | | | | | | | | | | | | | | | | | | | | | | | | | | | | | | | | |
 | | | | | | | | | | | | | | | | | | | | | | | | | | | | | | | | | | | | | | | | | | | | | | | | | | | | | | | | | | | | | | | | | | | |
| | |

 | | | | | | | | | | | | | | | | | | | |

 | | | | | | | | | | | | | | | | | | | |

 | | | | | | | | | | | | | | | | | | | |

 | | | | | | | | | | | | | | | | | | | |

 | | | | | | | | | | | | | | | | | | | |

 | | | | | | | | | | | | | | | | | | | |

 | | | | | | | | | | | | | | | | | | | |

 | | | | | | | | | | | | | | | | | | | |

 | | | | | | | | | | | | | | | | | | | |

 | | | | | | | | | | | | | | | | | | | |

 | | | | | | | | | | | | | | | | | | | |

 | | | | | | | | | | | | | | | | | | | |

 | | | | | | | | | | | | | | | | | | | |

 | | | | | | | | | | | | | | | | | | | |

 | | | | | | | | | | | | | | | | | | | |

 | | | | | | | | | | | | | | | | | | | |

 | | | | | | | | | | | | | | | | | | | |

 | | | | | | | | | | | | | | | | | | | |

 | | | | | | | | | | | | | | | | | | | |

 | | | | | | | | | | | | | | | | | | | |

 | | | | | | | | | | | | | | | | | | | |

 | | | | | | | | | | | | | | | | | | | |

 | | | | | | | | | | | | | | | | | | | |

 | | | | | | | | | | | | | | | | | | | |

 | | | | | | | | | | | | | | | | | | | |

 | | | | | | | | | | | | | | | | | | | |

 | | | | | | | | | | | | | | | | | | | |

 | | | | | | | | | | | | | | | | | | | |
 | | | | | | | | | | | | | | | | | | | |

 | | | | | | | | | | | | | | | | | | | |

 | | | | | | | | | | | | | | | | | | | |
 | | | | | | | | | | | | | | | | | | | |

 | | | | | | | | | | | | | | | | | | | |

 | | | | | | | | | | | | | | | | | | | |
 | | | | | | | | | | | | | | | | | | | |
 | | | | | | | | | | | | | | | | | | | |

 | | | | | | | | | | | | | | | | | | | |
 | | | | | | | | | | | | | | | | | | | |
 | | | | | | | | | | | | | | | | | | | |

 | | | | | | | | | | | | | | | | | | | | | | | | | | | | | | | | | | | | | | | | | | | | | | | | | | | | | | | | | | | | | | | | | | | | | | | | | | | | | | | | | | | | | | | | | | | | | | | | | | | |
 | | | | | | | | | | | | | | | | | | | |
 | | | | | | | | | | | | | | | | | | | |
 | | | | | | | | | | | | | | | | | | | |
 | | | | | | | | | | | | | | | | | | | |
 | | | | | | | | | | | | | | | | | | | |
 | | | | | | | | | | | | | | | | | | | |
 | | | | | | | | | | | | | | | | | | | |
 | | | | | | | | | | | | | | | | | | | |
 | | | | | | | | | | | | | | | | | | | | | | | | | | | | | | | | | | | | | | | |
 | | | | | | | | | | | | | | | | | | | |
 | | | | | | | | | | | | | | | | | | | | | | | | | | | | | | | | | | | | | | | |
 | | | | | | | | | | | | | | | | | | | | | | | | | | | | | | | | | | | | | | | |
 | | | | | | | | | | | | | | | | | | | | | | | | | | | | | | | | | | | | | | | |
 | | | | | | | | | | | | | | | | | | | | | | | | | | | | | | | | | | | | | | | | | | | | | | | | | | | | | | | | | | | | | | | | | | | | | | | | | | | | | | | | | | | | | | | | | | | | | | | | | | | |
 | | | | | | | | | | | | | | | | | | | | | | | | | | | | | | | | | | | | | | | | | | | | | | | |
| | | <table border="1" style="width: 100%; border-collapse: collapse; text-align: center;"> <tr> <td style="width: 10%;"></td> <td style="width: 10%;"></td> <td style="width: 10%;"></td> <td style="width: 10%;"></td> <td style="width: 10%;"></td> <td style="width: 10%;"></td> <td style="width: 10%;"></td> <td style="width: 10%;"></td> <td style="width: 10%;"></td> <td style="width: 10%;"></td> </tr> <tr> <td></td> <td></td> <td colspan="8" style="text-align: center;"> <table border="1" style="width: 100%; border-collapse: collapse; text-align: center;"> <tr> <td style="width: 10%;"></td> <td style="width: 10%;"></td> <td style="width: 10%;"></td> <td style="width: 10%;"></td> <td style="width: 10%;"></td> <td style="width: 10%;"></td> <td style="width: 10%;"></td> <td style="width: 10%;"></td> <td style="width: 10%;"></td> <td style="width: 10%;"></td> </tr> <tr> <td></td> <td></td> <td colspan="8" style="text-align: center;"> <table border="1" style="width: 100%; border-collapse: collapse; text-align: center;"> <tr> <td style="width: 10%;"></td> <td style="width: 10%;"></td> <td style="width: 10%;"></td> <td style="width: 10%;"></td> <td style="width: 10%;"></td> <td style="width: 10%;"></td> <td style="width: 10%;"></td> <td style="width: 10%;"></td> <td style="width: 10%;"></td> <td style="width: 10%;"></td> </tr> <tr> <td></td> <td></td> <td colspan="8" style="text-align: center;"> <table border="1" style="width: 100%; border-collapse: collapse; text-align: center;"> <tr> <td style="width: 10%;"></td> <td style="width: 10%;"></td> <td style="width: 10%;"></td> <td style="width: 10%;"></td> <td style="width: 10%;"></td> <td style="width: 10%;"></td> <td style="width: 10%;"></td> <td style="width: 10%;"></td> <td style="width: 10%;"></td> <td style="width: 10%;"></td> </tr> <tr> <td></td> <td></td> <td colspan="8" style="text-align: center;"> <table border="1" style="width: 100%; border-collapse: collapse; text-align: center;"> <tr> <td style="width: 10%;"></td> <td style="width: 10%;"></td> <td style="width: 10%;"></td> <td style="width: 10%;"></td> <td style="width: 10%;"></td> <td style="width: 10%;"></td> <td style="width: 10%;"></td> <td style="width: 10%;"></td> <td style="width: 10%;"></td> <td style="width: 10%;"></td> </tr> <tr> <td></td> <td></td> <td colspan="8" style="text-align: center;"> <table border="1" style="width: 100%; border-collapse: collapse; text-align: center;"> <tr> <td style="width: 10%;"></td> <td style="width: 10%;"></td> <td style="width: 10%;"></td> <td style="width: 10%;"></td> <td style="width: 10%;"></td> <td style="width: 10%;"></td> <td style="width: 10%;"></td> <td style="width: 10%;"></td> <td style="width: 10%;"></td> <td style="width: 10%;"></td> </tr> <tr> <td></td> <td></td> <td colspan="8" style="text-align: center;"> <table border="1" style="width: 100%; border-collapse: collapse; text-align: center;"> <tr> <td style="width: 10%;"></td> <td style="width: 10%;"></td> <td style="width: 10%;"></td> <td style="width: 10%;"></td> <td style="width: 10%;"></td> <td style="width: 10%;"></td> <td style="width: 10%;"></td> <td style="width: 10%;"></td> <td style="width: 10%;"></td> <td style="width: 10%;"></td> </tr> <tr> <td></td> <td></td> <td colspan="8" style="text-align: center;"> <table border="1" style="width: 100%; border-collapse: collapse; text-align: center;"> <tr> <td style="width: 10%;"></td> <td style="width: 10%;"></td> <td style="width: 10%;"></td> <td style="width: 10%;"></td> <td style="width: 10%;"></td> <td style="width: 10%;"></td> <td style="width: 10%;"></td> <td style="width: 10%;"></td> <td style="width: 10%;"></td> <td style="width: 10%;"></td> </tr> <tr> <td></td> <td></td> <td colspan="8" style="text-align: center;"> <table border="1" style="width: 100%; border-collapse: collapse; text-align: center;"> <tr> <td style="width: 10%;"></td> <td style="width: 10%;"></td> <td style="width: 10%;"></td> <td style="width: 10%;"></td> <td style="width: 10%;"></td> <td style="width: 10%;"></td> <td style="width: 10%;"></td> <td style="width: 10%;"></td> <td style="width: 10%;"></td> <td style="width: 10%;"></td> </tr> <tr> <td></td> <td></td> <td colspan="8" style="text-align: center;"> <table border="1" style="width: 100%; border-collapse: collapse; text-align: center;"> <tr> <td style="width: 10%;"></td> <td style="width: 10%;"></td> <td style="width: 10%;"></td> <td style="width: 10%;"></td> <td style="width: 10%;"></td> <td style="width: 10%;"></td> <td style="width: 10%;"></td> <td style="width: 10%;"></td> <td style="width: 10%;"></td> <td style="width: 10%;"></td> </tr> <tr> <td></td> <td></td> <td colspan="8" style="text-align: center;"> <table border="1" style="width: 100%; border-collapse: collapse; text-align: center;"> <tr> <td style="width: 10%;"></td> <td style="width: 10%;"></td> <td style="width: 10%;"></td> <td style="width: 10%;"></td> <td style="width: 10%;"></td> <td style="width: 10%;"></td> <td style="width: 10%;"></td> <td style="width: 10%;"></td> <td style="width: 10%;"></td> <td style="width: 10%;"></td> </tr> <tr> <td></td> <td></td> <td colspan="8" style="text-align: center;"> <table border="1" style="width: 100%; border-collapse: collapse; text-align: center;"> <tr> <td style="width: 10%;"></td> <td style="width: 10%;"></td> <td style="width: 10%;"></td> <td style="width: 10%;"></td> <td style="width: 10%;"></td> <td style="width: 10%;"></td> <td style="width: 10%;"></td> <td style="width: 10%;"></td> <td style="width: 10%;"></td> <td style="width: 10%;"></td> </tr> <tr> <td></td> <td></td> <td colspan="8" style="text-align: center;"> <table border="1" style="width: 100%; border-collapse: collapse; text-align: center;"> <tr> <td style="width: 10%;"></td> <td style="width: 10%;"></td> <td style="width: 10%;"></td> <td style="width: 10%;"></td> <td style="width: 10%;"></td> <td style="width: 10%;"></td> <td style="width: 10%;"></td> <td style="width: 10%;"></td> <td style="width: 10%;"></td> <td style="width: 10%;"></td> </tr> <tr> <td></td> <td></td> <td colspan="8" style="text-align: center;"> <table border="1" style="width: 100%; border-collapse: collapse; text-align: center;"> <tr> <td style="width: 10%;"></td> <td style="width: 10%;"></td> <td style="width: 10%;"></td> <td style="width: 10%;"></td> <td style="width: 10%;"></td> <td style="width: 10%;"></td> <td style="width: 10%;"></td> <td style="width: 10%;"></td> <td style="width: 10%;"></td> <td style="width: 10%;"></td> </tr> <tr> <td></td> <td></td> <td colspan="8" style="text-align: center;"> <table border="1" style="width: 100%; border-collapse: collapse; text-align: center;"> <tr> <td style="width: 10%;"></td> <td style="width: 10%;"></td> <td style="width: 10%;"></td> <td style="width: 10%;"></td> <td style="width: 10%;"></td> <td style="width: 10%;"></td> <td style="width: 10%;"></td> <td style="width: 10%;"></td> <td style="width: 10%;"></td> <td style="width: 10%;"></td> </tr> <tr> <td></td> <td></td> <td colspan="8" style="text-align: center;"> <table border="1" style="width: 100%; border-collapse: collapse; text-align: center;"> <tr> <td style="width: 10%;"></td> <td style="width: 10%;"></td> <td style="width: 10%;"></td> <td style="width: 10%;"></td> <td style="width: 10%;"></td> <td style="width: 10%;"></td> <td style="width: 10%;"></td> <td style="width: 10%;"></td> <td style="width: 10%;"></td> <td style="width: 10%;"></td> </tr> <tr> <td></td> <td></td> <td colspan="8" style="text-align: center;"> <table border="1" style="width: 100%; border-collapse: collapse; text-align: center;"> <tr> <td style="width: 10%;"></td> <td style="width: 10%;"></td> <td style="width: 10%;"></td> <td style="width: 10%;"></td> <td style="width: 10%;"></td> <td style="width: 10%;"></td> <td style="width: 10%;"></td> <td style="width: 10%;"></td> <td style="width: 10%;"></td> <td style="width: 10%;"></td> </tr> <tr> <td></td> <td></td> <td colspan="8" style="text-align: center;"> <table border="1" style="width: 100%; border-collapse: collapse; text-align: center;"> <tr> <td style="width: 10%;"></td> <td style="width: 10%;"></td> <td style="width: 10%;"></td> <td style="width: 10%;"></td> <td style="width: 10%;"></td> <td style="width: 10%;"></td> <td style="width: 10%;"></td> <td style="width: 10%;"></td> <td style="width: 10%;"></td> <td style="width: 10%;"></td> </tr> <tr> <td></td> <td></td> <td colspan="8" style="text-align: center;"> <table border="1" style="width: 100%; border-collapse: collapse; text-align: center;"> <tr> <td style="width: 10%;"></td> <td style="width: 10%;"></td> <td style="width: 10%;"></td> <td style="width: 10%;"></td> <td style="width: 10%;"></td> <td style="width: 10%;"></td> <td style="width: 10%;"></td> <td style="width: 10%;"></td> <td style="width: 10%;"></td> <td style="width: 10%;"></td> </tr> <tr> <td></td> <td></td> <td colspan="8" style="text-align: center;"> <table border="1" style="width: 100%; border-collapse: collapse; text-align: center;"> <tr> <td style="width: 10%;"></td> <td style="width: 10%;"></td> <td style="width: 10%;"></td> <td style="width: 10%;"></td> <td style="width: 10%;"></td> <td style="width: 10%;"></td> <td style="width: 10%;"></td> <td style="width: 10%;"></td> <td style="width: 10%;"></td> <td style="width: 10%;"></td> </tr> <tr> <td></td> <td></td> <td colspan="8" style="text-align: center;"> <table border="1" style="width: 100%; border-collapse: collapse; text-align: center;"> <tr> <td style="width: 10%;"></td> <td style="width: 10%;"></td> <td style="width: 10%;"></td> <td style="width: 10%;"></td> <td style="width: 10%;"></td> <td style="width: 10%;"></td> <td style="width: 10%;"></td> <td style="width: 10%;"></td> <td style="width: 10%;"></td> <td style="width: 10%;"></td> </tr> <tr> <td></td> <td></td> <td colspan="8" style="text-align: center;"> <table border="1" style="width: 100%; border-collapse: collapse; text-align: center;"> <tr> <td style="width: 10%;"></td> <td style="width: 10%;"></td> <td
style="width: 10%;"></td> <td style="width: 10%;"></td> <td style="width: 10%;"></td> <td style="width: 10%;"></td> <td style="width: 10%;"></td> <td style="width: 10%;"></td> <td style="width: 10%;"></td> <td style="width: 10%;"></td> </tr> <tr> <td></td> <td></td> <td colspan="8" style="text-align: center;"> <table border="1" style="width: 100%; border-collapse: collapse; text-align: center;"> <tr> <td style="width: 10%;"></td> <td style="width: 10%;"></td> <td style="width: 10%;"></td> <td style="width: 10%;"></td> <td style="width: 10%;"></td> <td style="width: 10%;"></td> <td style="width: 10%;"></td> <td style="width: 10%;"></td> <td style="width: 10%;"></td> <td style="width: 10%;"></td> </tr> <tr> <td></td> <td></td> <td colspan="8" style="text-align: center;"> <table border="1" style="width: 100%; border-collapse: collapse; text-align: center;"> <tr> <td style="width: 10%;"></td> <td style="width: 10%;"></td> <td style="width: 10%;"></td> <td style="width: 10%;"></td> <td style="width: 10%;"></td> <td style="width: 10%;"></td> <td style="width: 10%;"></td> <td style="width: 10%;"></td> <td style="width: 10%;"></td> <td style="width: 10%;"></td> </tr> <tr> <td></td> <td></td> <td colspan="8" style="text-align: center;"> <table border="1" style="width: 100%; border-collapse: collapse; text-align: center;"> <tr> <td style="width: 10%;"></td> <td style="width: 10%;"></td> <td style="width: 10%;"></td> <td style="width: 10%;"></td> <td style="width: 10%;"></td> <td style="width: 10%;"></td> <td style="width: 10%;"></td> <td style="width: 10%;"></td> <td style="width: 10%;"></td> <td style="width: 10%;"></td> </tr> <tr> <td></td> <td></td> <td colspan="8" style="text-align: center;"> <table border="1" style="width: 100%; border-collapse: collapse; text-align: center;"> <tr> <td style="width: 10%;"></td> <td style="width: 10%;"></td> <td style="width: 10%;"></td> <td style="width: 10%;"></td> <td style="width: 10%;"></td> <td style="width: 10%;"></td> <td style="width: 10%;"></td> <td style="width: 10%;"></td> <td style="width: 10%;"></td> <td style="width: 10%;"></td> </tr> <tr> <td></td> <td></td> <td colspan="8" style="text-align: center;"> <table border="1" style="width: 100%; border-collapse: collapse; text-align: center;"> <tr> <td style="width: 10%;"></td> <td style="width: 10%;"></td> <td style="width: 10%;"></td> <td style="width: 10%;"></td> <td style="width: 10%;"></td> <td style="width: 10%;"></td> <td style="width: 10%;"></td> <td style="width: 10%;"></td> <td style="width: 10%;"></td> <td style="width: 10%;"></td> </tr> <tr> <td></td> <td></td> <td colspan="8" style="text-align: center;"> <table border="1" style="width: 100%; border-collapse: collapse; text-align: center;"> <tr> <td style="width: 10%;"></td> <td style="width: 10%;"></td> <td style="width: 10%;"></td> <td style="width: 10%;"></td> <td style="width: 10%;"></td> <td style="width: 10%;"></td> <td style="width: 10%;"></td> <td style="width: 10%;"></td> <td style="width: 10%;"></td> <td style="width: 10%;"></td> </tr> <tr> <td></td> <td></td> <td colspan="8" style="text-align: center;"> <table border="1" style="width: 100%; border-collapse: collapse; text-align: center;"> <tr> <td style="width: 10%;"></td> <td style="width: 10%;"></td> <td style="width: 10%;"></td> <td style="width: 10%;"></td> <td style="width: 10%;"></td> <td style="width: 10%;"></td> <td style="width: 10%;"></td> <td style="width: 10%;"></td> <td style="width: 10%;"></td> <td style="width: 10%;"></td> </tr> <tr> <td></td> <td></td> <td colspan="8" style="text-align: center;"> <table border="1" style="width: 100%; border-collapse: collapse; text-align: center;"> <tr> <td style="width: 10%;"></td> <td style="width: 10%;"></td> <td style="width: 10%;"></td> <td style="width: 10%;"></td> <td style="width: 10%;"></td> <td style="width: 10%;"></td> <td style="width: 10%;"></td> <td style="width: 10%;"></td> <td style="width: 10%;"></td> <td style="width: 10%;"></td> </tr> <tr> <td></td> <td></td> <td colspan="8" style="text-align: center;"> <table border="1" style="width: 100%; border-collapse: collapse; text-align: center;"> <tr> <td style="width: 10%;"></td> <td style="width: 10%;"></td> <td style="width: 10%;"></td> <td style="width: 10%;"></td> <td style="width: 10%;"></td> <td style="width: 10%;"></td> <td style="width: 10%;"></td> <td style="width: 10%;"></td> <td style="width: 10%;"></td> <td style="width: 10%;"></td> </tr> <tr> <td></td> <td></td> <td colspan="8" style="text-align: center;"> <table border="1" style="width: 100%; border-collapse: collapse; text-align: center;"> <tr> <td style="width: 10%;"></td> <td style="width: 10%;"></td> <td style="width: 10%;"></td> <td style="width: 10%;"></td> <td style="width: 10%;"></td> <td style="width: 10%;"></td> <td style="width: 10%;"></td> <td style="width: 10%;"></td> <td style="width: 10%;"></td> <td style="width: 10%;"></td> </tr> <tr> <td></td> <td></td> <td colspan="8" style="text-align: center;"> <table border="1" style="width: 100%; border-collapse: collapse; text-align: center;"> <tr> <td style="width: 10%;"></td> <td style="width: 10%;"></td> <td style="width: 10%;"></td> <td style="width: 10%;"></td> <td style="width: 10%;"></td> <td style="width: 10%;"></td> <td style="width: 10%;"></td> <td style="width: 10%;"></td> <td style="width: 10%;"></td> <td style="width: 10%;"></td> </tr> <tr> <td></td> <td></td> <td colspan="8" style="text-align: center;"> <table border="1" style="width: 100%; border-collapse: collapse; text-align: center;"> <tr> <td style="width: 10%;"></td> <td style="width: 10%;"></td> <td style="width: 10%;"></td> <td style="width: 10%;"></td> <td style="width: 10%;"></td> <td style="width: 10%;"></td> <td style="width: 10%;"></td> <td style="width: 10%;"></td> <td style="width: 10%;"></td> <td style="width: 10%;"></td> </tr> <tr> <td></td> <td></td> <td colspan="8" style="text-align: center;"> <table border="1" style="width: 100%; border-collapse: collapse; text-align: center;"> <tr> <td style="width: 10%;"></td> <td style="width: 10%;"></td> <td style="width: 10%;"></td> <td style="width: 10%;"></td> <td style="width: 10%;"></td> <td style="width: 10%;"></td> <td style="width: 10%;"></td> <td style="width: 10%;"></td> <td style="width: 10%;"></td> <td style="width: 10%;"></td> </tr> <tr> <td></td> <td></td> <td colspan="8" style="text-align: center;"> <table border="1" style="width: 100%; border-collapse: collapse; text-align: center;"> <tr> <td style="width: 10%;"></td> <td style="width: 10%;"></td> <td style="width: 10%;"></td> <td style="width: 10%;"></td> <td style="width: 10%;"></td> <td style="width: 10%;"></td> <td style="width: 10%;"></td> <td style="width: 10%;"></td> <td style="width: 10%;"></td> <td style="width: 10%;"></td> </tr> <tr> <td></td> <td></td> <td colspan="8" style="text-align: center;"> <table border="1" style="width: 100%; border-collapse: collapse; text-align: center;"> <tr> <td style="width: 10%;"></td> <td style="width: 10%;"></td> <td style="width: 10%;"></td> <td style="width: 10%;"></td> <td style="width: 10%;"></td> <td style="width: 10%;"></td> <td style="width: 10%;"></td> <td style="width: 10%;"></td> <td style="width: 10%;"></td> <td style="width: 10%;"></td> </tr> <tr> <td></td> <td></td> <td colspan="8" style="text-align: center;"> <table border="1" style="width: 100%; border-collapse: collapse; text-align: center;"> <tr> <td style="width: 10%;"></td> <td style="width: 10%;"></td> <td style="width: 10%;"></td> <td style="width: 10%;"></td> <td style="width: 10%;"></td> <td style="width: 10%;"></td> <td style="width: 10%;"></td> <td style="width: 10%;"></td> <td style="width: 10%;"></td> <td style="width: 10%;"></td> </tr> <tr> <td></td> <td></td> <td colspan="8" style="text-align: center;"> <table border="1" style="width: 100%; border-collapse: collapse; text-align: center;"> <tr> <td style="width: 10%;"></td> <td style="width: 10%;"></td> <td style="width: 10%;"></td> <td style="width: 10%;"></td> <td style="width: 10%;"></td> <td style="width: 10%;"></td> <td style="width: 10%;"></td> <td style="width: 10%;"></td> <td style="width: 10%;"></td> <td style="width: 10%;"></td> </tr> <tr> <td></td> <td></td> <td colspan="8" style="text-align: center;"> <table border="1" style="width: 100%; border-collapse: collapse; text-align: center;"> <tr> <td style="width: 10%;"></td> <td style="width: 10%;"></td> <td style="width: 10%;"></td> <td style="width: 10%;"></td> <td style="width: 10%;"></td> <td style="width: 10%;"></td> <td style="width: 10%;"></td> <td style="width: 10%;"></td> <td style="width: 10%;"></td> <td style="width: 10%;"></td> </tr> <tr> <td></td> <td></td> <td colspan="8" style="text-align: center;"> <table border="1" style="width: 100%; border-collapse: collapse; text-align: center;"> <tr> <td style="width: 10%;"></td> <td style="width: 10%;"></td> <td style="width: 10%;"></td> <td style="width: 10%;"></td> <td style="width: 10%;"></td> <td style="width: 10%;"></td> <td style="width: 10%;"></td> <td style="width: 10%;"></td> <td style="width: 10%;"></td> <td style="width: 10%;"></td> </tr> <tr> <td></td> <td></td> <td colspan="8" style="text-align: center;"> <table border="1" style="width: 100%; border-collapse: collapse; text-align: center;"> <tr> <td style="width: 10%;"></td> <td style="width: 10%;"></td> <td style="width: 10%;"></td> <td style="width: 10%;"></td> <td style="width: 10%;"></td> <td style="width: 10%;"></td> <td style="width: 10%;"></td> <td style="width: 10%;"></td> <td style="width: 10%;"></td> <td style="width: 10%;"></td> </tr> <tr> <td></td> <td></td> <td colspan="8" style="text-align: center;"> <table border="1" style="width: 100%; border-collapse: collapse; text-align: center;"> <tr> <td style="width: 10%;"></td> <td style="width: 10%;"></td> <td style="width: 10%;"></td> <td style="width: 10%;"></td> <td style="width: 10%;"></td> <td style="width: 10%;"></td> <td style="width: 10%;"></td> <td style="width:
10%;"></td> <td style="width: 10%;"></td> <td style="width: 10%;"></td> </tr> <tr> <td></td> <td></td> <td colspan="8" style="text-align: center;"> <table border="1" style="width: 100%; border-collapse: collapse; text-align: center;"> <tr> <td style="width: 10%;"></td> <td style="width: 10%;"></td> <td style="width: 10%;"></td> <td style="width: 10%;"></td> <td style="width: 10%;"></td> <td style="width: 10%;"></td> <td style="width: 10%;"></td> <td style="width: 10%;"></td> <td style="width: 10%;"></td> <td style="width: 10%;"></td> </tr> <tr> <td></td> <td></td> <td colspan="8" style="text-align: center;"> <table border="1" style="width: 100%; border-collapse: collapse; text-align: center;"> <tr> <td style="width: 10%;"></td> <td style="width: 10%;"></td> <td style="width: 10%;"></td> <td style="width: 10%;"></td> <td style="width: 10%;"></td> <td style="width: 10%;"></td> <td style="width: 10%;"></td> <td style="width: 10%;"></td> <td style="width: 10%;"></td> <td style="width: 10%;"></td> </tr> <tr> <td></td> <td></td> <td colspan="8" style="text-align: center;"> <table border="1" style="width: 100%; border-collapse: collapse; text-align: center;"> <tr> <td style="width: 10%;"></td> <td style="width: 10%;"></td> <td style="width: 10%;"></td> <td style="width: 10%;"></td> <td style="width: 10%;"></td> <td style="width: 10%;"></td> <td style="width: 10%;"></td> <td style="width: 10%;"></td> <td style="width: 10%;"></td> <td style="width: 10%;"></td> </tr> <tr> <td></td> <td></td> <td colspan="8" style="text-align: center;"> <table border="1" style="width: 100%; border-collapse: collapse; text-align: center;"> <tr> <td style="width: 10%;"></td> <td style="width: 10%;"></td> <td style="width: 10%;"></td> <td style="width: 10%;"></td> <td style="width: 10%;"></td> <td style="width: 10%;"></td> <td style="width: 10%;"></td> <td style="width: 10%;"></td> <td style="width: 10%;"></td> <td style="width: 10%;"></td> </tr> <tr> <td></td> <td></td> <td colspan="8" style="text-align: center;"> <table border="1" style="width: 100%; border-collapse: collapse; text-align: center;"> <tr> <td style="width: 10%;"></td> <td style="width: 10%;"></td> <td style="width: 10%;"></td> <td style="width: 10%;"></td> <td style="width: 10%;"></td> <td style="width: 10%;"></td> <td style="width: 10%;"></td> <td style="width: 10%;"></td> <td style="width: 10%;"></td> <td style="width: 10%;"></td> </tr> <tr> <td></td> <td></td> <td colspan="8" style="text-align: center;"> <table border="1" style="width: 100%; border-collapse: collapse; text-align: center;"> <tr> <td style="width: 10%;"></td> <td style="width: 10%;"></td> <td style="width: 10%;"></td> <td style="width: 10%;"></td> <td style="width: 10%;"></td> <td style="width: 10%;"></td> <td style="width: 10%;"></td> <td style="width: 10%;"></td> <td style="width: 10%;"></td> <td style="width: 10%;"></td> </tr> <tr> <td></td> <td></td> <td colspan="8" style="text-align: center;"> <table border="1" style="width: 100%; border-collapse: collapse; text-align: center;"> <tr> <td style="width: 10%;"></td> <td style="width: 10%;"></td> <td style="width: 10%;"></td> <td style="width: 10%;"></td> <td style="width: 10%;"></td> <td style="width: 10%;"></td> <td style="width: 10%;"></td> <td style="width: 10%;"></td> <td style="width: 10%;"></td> <td style="width: 10%;"></td> </tr> <tr> <td></td> <td></td> <td colspan="8" style="text-align: center;"> <table border="1" style="width: 100%; border-collapse: collapse; text-align: center;"> <tr> <td style="width: 10%;"></td> <td style="width: 10%;"></td> <td style="width: 10%;"></td> <td style="width: 10%;"></td> <td style="width: 10%;"></td> <td style="width: 10%;"></td> <td style="width: 10%;"></td> <td style="width: 10%;"></td> <td style="width: 10%;"></td> <td style="width: 10%;"></td> </tr> <tr> <td></td> <td></td> <td colspan="8" style="text-align: center;"> <table border="1" style="width: 100%; border-collapse: collapse; text-align: center;"> <tr> </tr></table></td></tr></table></td></tr></table></td></tr></table></td></tr></table></td></tr></table></td></tr></table></td></tr></table></td></tr></table></td></tr></table></td></tr></table></td></tr></table></td></tr></table></td></tr></table></td></tr></table></td></tr></table></td></tr></table></td></tr></table></td></tr></table></td></tr></table></td></tr></table></td></tr></table></td></tr></table></td></tr></table></td></tr></table></td></tr></table></td></tr></table></td></tr></table></td></tr></table></td></tr></table></td></tr></table></td></tr></table></td></tr></table></td></tr></table></td></tr></table></td></tr></table></td></tr></table></td></tr></table></td></tr></table></td></tr></table></td></tr></table></td></tr></table></td></tr></table></td></tr></table></td></tr></table></td></tr></table></td></tr></table></td></tr></table></td></tr></table></td></tr></table></td></tr></table></td></tr></table>
 | | | | | | | | | | | | | | | | | | | | <table border="1" style="width: 100%; border-collapse: collapse; text-align: center;"> <tr> <td style="width: 10%;"></td> <td style="width: 10%;"></td> <td style="width: 10%;"></td> <td style="width: 10%;"></td> <td style="width: 10%;"></td> <td style="width: 10%;"></td> <td style="width: 10%;"></td> <td style="width: 10%;"></td> <td style="width: 10%;"></td> <td style="width: 10%;"></td> </tr> <tr> <td></td> <td></td> <td colspan="8" style="text-align: center;"> <table border="1" style="width: 100%; border-collapse: collapse; text-align: center;"> <tr> <td style="width: 10%;"></td> <td style="width: 10%;"></td> <td style="width: 10%;"></td> <td style="width: 10%;"></td> <td style="width: 10%;"></td> <td style="width: 10%;"></td> <td style="width: 10%;"></td> <td style="width: 10%;"></td> <td style="width: 10%;"></td> <td style="width: 10%;"></td> </tr> <tr> <td></td> <td></td> <td colspan="8" style="text-align: center;"> <table border="1" style="width: 100%; border-collapse: collapse; text-align: center;"> <tr> <td style="width: 10%;"></td> <td style="width: 10%;"></td> <td style="width: 10%;"></td> <td style="width: 10%;"></td> <td style="width: 10%;"></td> <td style="width: 10%;"></td> <td style="width: 10%;"></td> <td style="width: 10%;"></td> <td style="width: 10%;"></td> <td style="width: 10%;"></td> </tr> <tr> <td></td> <td></td> <td colspan="8" style="text-align: center;"> <table border="1" style="width: 100%; border-collapse: collapse; text-align: center;"> <tr> <td style="width: 10%;"></td> <td style="width: 10%;"></td> <td style="width: 10%;"></td> <td style="width: 10%;"></td> <td style="width: 10%;"></td> <td style="width: 10%;"></td> <td style="width: 10%;"></td> <td style="width: 10%;"></td> <td style="width: 10%;"></td> <td style="width: 10%;"></td> </tr> <tr> <td></td> <td></td> <td colspan="8" style="text-align: center;"> <table border="1" style="width: 100%; border-collapse: collapse; text-align: center;"> <tr> <td style="width: 10%;"></td> <td style="width: 10%;"></td> <td style="width: 10%;"></td> <td style="width: 10%;"></td> <td style="width: 10%;"></td> <td style="width: 10%;"></td> <td style="width: 10%;"></td> <td style="width: 10%;"></td> <td style="width: 10%;"></td> <td style="width: 10%;"></td> </tr> <tr> <td></td> <td></td> <td colspan="8" style="text-align: center;"> <table border="1" style="width: 100%; border-collapse: collapse; text-align: center;"> <tr> <td style="width: 10%;"></td> <td style="width: 10%;"></td> <td style="width: 10%;"></td> <td style="width: 10%;"></td> <td style="width: 10%;"></td> <td style="width: 10%;"></td> <td style="width: 10%;"></td> <td style="width: 10%;"></td> <td style="width: 10%;"></td> <td style="width: 10%;"></td> </tr> <tr> <td></td> <td></td> <td colspan="8" style="text-align: center;"> <table border="1" style="width: 100%; border-collapse: collapse; text-align: center;"> <tr> <td style="width: 10%;"></td> <td style="width: 10%;"></td> <td style="width: 10%;"></td> <td style="width: 10%;"></td> <td style="width: 10%;"></td> <td style="width: 10%;"></td> <td style="width: 10%;"></td> <td style="width: 10%;"></td> <td style="width: 10%;"></td> <td style="width: 10%;"></td> </tr> <tr> <td></td> <td></td> <td colspan="8" style="text-align: center;"> <table border="1" style="width: 100%; border-collapse: collapse; text-align: center;"> <tr> <td style="width: 10%;"></td> <td style="width: 10%;"></td> <td style="width: 10%;"></td> <td style="width: 10%;"></td> <td style="width: 10%;"></td> <td style="width: 10%;"></td> <td style="width: 10%;"></td> <td style="width: 10%;"></td> <td style="width: 10%;"></td> <td style="width: 10%;"></td> </tr> <tr> <td></td> <td></td> <td colspan="8" style="text-align: center;"> <table border="1" style="width: 100%; border-collapse: collapse; text-align: center;"> <tr> <td style="width: 10%;"></td> <td style="width: 10%;"></td> <td style="width: 10%;"></td> <td style="width: 10%;"></td> <td style="width: 10%;"></td> <td style="width: 10%;"></td> <td style="width: 10%;"></td> <td style="width: 10%;"></td> <td style="width: 10%;"></td> <td style="width: 10%;"></td> </tr> <tr> <td></td> <td></td> <td colspan="8" style="text-align: center;"> <table border="1" style="width: 100%; border-collapse: collapse; text-align: center;"> <tr> <td style="width: 10%;"></td> <td style="width: 10%;"></td> <td style="width: 10%;"></td> <td style="width: 10%;"></td> <td style="width: 10%;"></td> <td style="width: 10%;"></td> <td style="width: 10%;"></td> <td style="width: 10%;"></td> <td style="width: 10%;"></td> <td style="width: 10%;"></td> </tr> <tr> <td></td> <td></td> <td colspan="8" style="text-align: center;"> <table border="1" style="width: 100%; border-collapse: collapse; text-align: center;"> <tr> <td style="width: 10%;"></td> <td style="width: 10%;"></td> <td style="width: 10%;"></td> <td style="width: 10%;"></td> <td style="width: 10%;"></td> <td style="width: 10%;"></td> <td style="width: 10%;"></td> <td style="width: 10%;"></td> <td style="width: 10%;"></td> <td style="width: 10%;"></td> </tr> <tr> <td></td> <td></td> <td colspan="8" style="text-align: center;"> <table border="1" style="width: 100%; border-collapse: collapse; text-align: center;"> <tr> <td style="width: 10%;"></td> <td style="width: 10%;"></td> <td style="width: 10%;"></td> <td style="width: 10%;"></td> <td style="width: 10%;"></td> <td style="width: 10%;"></td> <td style="width: 10%;"></td> <td style="width: 10%;"></td> <td style="width: 10%;"></td> <td style="width: 10%;"></td> </tr> <tr> <td></td> <td></td> <td colspan="8" style="text-align: center;"> <table border="1" style="width: 100%; border-collapse: collapse; text-align: center;"> <tr> <td style="width: 10%;"></td> <td style="width: 10%;"></td> <td style="width: 10%;"></td> <td style="width: 10%;"></td> <td style="width: 10%;"></td> <td style="width: 10%;"></td> <td style="width: 10%;"></td> <td style="width: 10%;"></td> <td style="width: 10%;"></td> <td style="width: 10%;"></td> </tr> <tr> <td></td> <td></td> <td colspan="8" style="text-align: center;"> <table border="1" style="width: 100%; border-collapse: collapse; text-align: center;"> <tr> <td style="width: 10%;"></td> <td style="width: 10%;"></td> <td style="width: 10%;"></td> <td style="width: 10%;"></td> <td style="width: 10%;"></td> <td style="width: 10%;"></td> <td style="width: 10%;"></td> <td style="width: 10%;"></td> <td style="width: 10%;"></td> <td style="width: 10%;"></td> </tr> <tr> <td></td> <td></td> <td colspan="8" style="text-align: center;"> <table border="1" style="width: 100%; border-collapse: collapse; text-align: center;"> <tr> <td style="width: 10%;"></td> <td style="width: 10%;"></td> <td style="width: 10%;"></td> <td style="width: 10%;"></td> <td style="width: 10%;"></td> <td style="width: 10%;"></td> <td style="width: 10%;"></td> <td style="width: 10%;"></td> <td style="width: 10%;"></td> <td style="width: 10%;"></td> </tr> <tr> <td></td> <td></td> <td colspan="8" style="text-align: center;"> <table border="1" style="width: 100%; border-collapse: collapse; text-align: center;"> <tr> <td style="width: 10%;"></td> <td style="width: 10%;"></td> <td style="width: 10%;"></td> <td style="width: 10%;"></td> <td style="width: 10%;"></td> <td style="width: 10%;"></td> <td style="width: 10%;"></td> <td style="width: 10%;"></td> <td style="width: 10%;"></td> <td style="width: 10%;"></td> </tr> <tr> <td></td> <td></td> <td colspan="8" style="text-align: center;"> <table border="1" style="width: 100%; border-collapse: collapse; text-align: center;"> <tr> <td style="width: 10%;"></td> <td style="width: 10%;"></td> <td style="width: 10%;"></td> <td style="width: 10%;"></td> <td style="width: 10%;"></td> <td style="width: 10%;"></td> <td style="width: 10%;"></td> <td style="width: 10%;"></td> <td style="width: 10%;"></td> <td style="width: 10%;"></td> </tr> <tr> <td></td> <td></td> <td colspan="8" style="text-align: center;"> <table border="1" style="width: 100%; border-collapse: collapse; text-align: center;"> <tr> <td style="width: 10%;"></td> <td style="width: 10%;"></td> <td style="width: 10%;"></td> <td style="width: 10%;"></td> <td style="width: 10%;"></td> <td style="width: 10%;"></td> <td style="width: 10%;"></td> <td style="width: 10%;"></td> <td style="width: 10%;"></td> <td style="width: 10%;"></td> </tr> <tr> <td></td> <td></td> <td colspan="8" style="text-align: center;"> <table border="1" style="width: 100%; border-collapse: collapse; text-align: center;"> <tr> <td style="width: 10%;"></td> <td style="width: 10%;"></td> <td style="width: 10%;"></td> <td style="width: 10%;"></td> <td style="width: 10%;"></td> <td style="width:
10%;"></td> <td style="width: 10%;"></td> <td style="width: 10%;"></td> <td style="width: 10%;"></td> <td style="width: 10%;"></td> </tr> <tr> <td></td> <td></td> <td colspan="8" style="text-align: center;"> <table border="1" style="width: 100%; border-collapse: collapse; text-align: center;"> <tr> <td style="width: 10%;"></td> <td style="width: 10%;"></td> <td style="width: 10%;"></td> <td style="width: 10%;"></td> <td style="width: 10%;"></td> <td style="width: 10%;"></td> <td style="width: 10%;"></td> <td style="width: 10%;"></td> <td style="width: 10%;"></td> <td style="width: 10%;"></td> </tr> <tr> <td></td> <td></td> <td colspan="8" style="text-align: center;"> <table border="1" style="width: 100%; border-collapse: collapse; text-align: center;"> <tr> <td style="width: 10%;"></td> <td style="width: 10%;"></td> <td style="width: 10%;"></td> <td style="width: 10%;"></td> <td style="width: 10%;"></td> <td style="width: 10%;"></td> <td style="width: 10%;"></td> <td style="width: 10%;"></td> <td style="width: 10%;"></td> <td style="width: 10%;"></td> </tr> <tr> <td></td> <td></td> <td colspan="8" style="text-align: center;"> <table border="1" style="width: 100%; border-collapse: collapse; text-align: center;"> <tr> <td style="width: 10%;"></td> <td style="width: 10%;"></td> <td style="width: 10%;"></td> <td style="width: 10%;"></td> <td style="width: 10%;"></td> <td style="width: 10%;"></td> <td style="width: 10%;"></td> <td style="width: 10%;"></td> <td style="width: 10%;"></td> <td style="width: 10%;"></td> </tr> <tr> <td></td> <td></td> <td colspan="8" style="text-align: center;"> <table border="1" style="width: 100%; border-collapse: collapse; text-align: center;"> <tr> <td style="width: 10%;"></td> <td style="width: 10%;"></td> <td style="width: 10%;"></td> <td style="width: 10%;"></td> <td style="width: 10%;"></td> <td style="width: 10%;"></td> <td style="width: 10%;"></td> <td style="width: 10%;"></td> <td style="width: 10%;"></td> <td style="width: 10%;"></td> </tr> <tr> <td></td> <td></td> <td colspan="8" style="text-align: center;"> <table border="1" style="width: 100%; border-collapse: collapse; text-align: center;"> <tr> <td style="width: 10%;"></td> <td style="width: 10%;"></td> <td style="width: 10%;"></td> <td style="width: 10%;"></td> <td style="width: 10%;"></td> <td style="width: 10%;"></td> <td style="width: 10%;"></td> <td style="width: 10%;"></td> <td style="width: 10%;"></td> <td style="width: 10%;"></td> </tr> <tr> <td></td> <td></td> <td colspan="8" style="text-align: center;"> <table border="1" style="width: 100%; border-collapse: collapse; text-align: center;"> <tr> <td style="width: 10%;"></td> <td style="width: 10%;"></td> <td style="width: 10%;"></td> <td style="width: 10%;"></td> <td style="width: 10%;"></td> <td style="width: 10%;"></td> <td style="width: 10%;"></td> <td style="width: 10%;"></td> <td style="width: 10%;"></td> <td style="width: 10%;"></td> </tr> <tr> <td></td> <td></td> <td colspan="8" style="text-align: center;"> <table border="1" style="width: 100%; border-collapse: collapse; text-align: center;"> <tr> <td style="width: 10%;"></td> <td style="width: 10%;"></td> <td style="width: 10%;"></td> <td style="width: 10%;"></td> <td style="width: 10%;"></td> <td style="width: 10%;"></td> <td style="width: 10%;"></td> <td style="width: 10%;"></td> <td style="width: 10%;"></td> <td style="width: 10%;"></td> </tr> <tr> <td></td> <td></td> <td colspan="8" style="text-align: center;"> <table border="1" style="width: 100%; border-collapse: collapse; text-align: center;"> <tr> <td style="width: 10%;"></td> <td style="width: 10%;"></td> <td style="width: 10%;"></td> <td style="width: 10%;"></td> <td style="width: 10%;"></td> <td style="width: 10%;"></td> <td style="width: 10%;"></td> <td style="width: 10%;"></td> <td style="width: 10%;"></td> <td style="width: 10%;"></td> </tr> <tr> <td></td> <td></td> <td colspan="8" style="text-align: center;"> <table border="1" style="width: 100%; border-collapse: collapse; text-align: center;"> <tr> <td style="width: 10%;"></td> <td style="width: 10%;"></td> <td style="width: 10%;"></td> <td style="width: 10%;"></td> <td style="width: 10%;"></td> <td style="width: 10%;"></td> <td style="width: 10%;"></td> <td style="width: 10%;"></td> <td style="width: 10%;"></td> <td style="width: 10%;"></td> </tr> <tr> <td></td> <td></td> <td colspan="8" style="text-align: center;"> <table border="1" style="width: 100%; border-collapse: collapse; text-align: center;"> <tr> <td style="width: 10%;"></td> <td style="width: 10%;"></td> <td style="width: 10%;"></td> <td style="width: 10%;"></td> <td style="width: 10%;"></td> <td style="width: 10%;"></td> <td style="width: 10%;"></td> <td style="width: 10%;"></td> <td style="width: 10%;"></td> <td style="width: 10%;"></td> </tr> <tr> <td></td> <td></td> <td colspan="8" style="text-align: center;"> <table border="1" style="width: 100%; border-collapse: collapse; text-align: center;"> <tr> <td style="width: 10%;"></td> <td style="width: 10%;"></td> <td style="width: 10%;"></td> <td style="width: 10%;"></td> <td style="width: 10%;"></td> <td style="width: 10%;"></td> <td style="width: 10%;"></td> <td style="width: 10%;"></td> <td style="width: 10%;"></td> <td style="width: 10%;"></td> </tr> <tr> <td></td> <td></td> <td colspan="8" style="text-align: center;"> <table border="1" style="width: 100%; border-collapse: collapse; text-align: center;"> <tr> <td style="width: 10%;"></td> <td style="width: 10%;"></td> <td style="width: 10%;"></td> <td style="width: 10%;"></td> <td style="width: 10%;"></td> <td style="width: 10%;"></td> <td style="width: 10%;"></td> <td style="width: 10%;"></td> <td style="width: 10%;"></td> <td style="width: 10%;"></td> </tr> <tr> <td></td> <td></td> <td colspan="8" style="text-align: center;"> <table border="1" style="width: 100%; border-collapse: collapse; text-align: center;"> <tr> <td style="width: 10%;"></td> <td style="width: 10%;"></td> <td style="width: 10%;"></td> <td style="width: 10%;"></td> <td style="width: 10%;"></td> <td style="width: 10%;"></td> <td style="width: 10%;"></td> <td style="width: 10%;"></td> <td style="width: 10%;"></td> <td style="width: 10%;"></td> </tr> <tr> <td></td> <td></td> <td colspan="8" style="text-align: center;"> <table border="1" style="width: 100%; border-collapse: collapse; text-align: center;"> <tr> <td style="width: 10%;"></td> <td style="width: 10%;"></td> <td style="width: 10%;"></td> <td style="width: 10%;"></td> <td style="width: 10%;"></td> <td style="width: 10%;"></td> <td style="width: 10%;"></td> <td style="width: 10%;"></td> <td style="width: 10%;"></td> <td style="width: 10%;"></td> </tr> <tr> <td></td> <td></td> <td colspan="8" style="text-align: center;"> <table border="1" style="width: 100%; border-collapse: collapse; text-align: center;"> <tr> <td style="width: 10%;"></td> <td style="width: 10%;"></td> <td style="width: 10%;"></td> <td style="width: 10%;"></td> <td style="width: 10%;"></td> <td style="width: 10%;"></td> <td style="width: 10%;"></td> <td style="width: 10%;"></td> <td style="width: 10%;"></td> <td style="width: 10%;"></td> </tr> <tr> <td></td> <td></td> <td colspan="8" style="text-align: center;"> <table border="1" style="width: 100%; border-collapse: collapse; text-align: center;"> <tr> <td style="width: 10%;"></td> <td style="width: 10%;"></td> <td style="width: 10%;"></td> <td style="width: 10%;"></td> <td style="width: 10%;"></td> <td style="width: 10%;"></td> <td style="width: 10%;"></td> <td style="width: 10%;"></td> <td style="width: 10%;"></td> <td style="width: 10%;"></td> </tr> <tr> <td></td> <td></td> <td colspan="8" style="text-align: center;"> <table border="1" style="width: 100%; border-collapse: collapse; text-align: center;"> <tr> <td style="width: 10%;"></td> <td style="width: 10%;"></td> <td style="width: 10%;"></td> <td style="width: 10%;"></td> <td style="width: 10%;"></td> <td style="width: 10%;"></td> <td style="width: 10%;"></td> <td style="width: 10%;"></td> <td style="width: 10%;"></td> <td style="width: 10%;"></td> </tr> <tr> <td></td> <td></td> <td colspan="8" style="text-align: center;"> <table border="1" style="width: 100%; border-collapse: collapse; text-align: center;"> <tr> <td style="width: 10%;"></td> <td style="width: 10%;"></td> <td style="width: 10%;"></td> <td style="width: 10%;"></td> <td style="width: 10%;"></td> <td style="width: 10%;"></td> <td style="width: 10%;"></td> <td style="width: 10%;"></td> <td style="width: 10%;"></td> <td style="width: 10%;"></td> </tr> <tr> <td></td> <td></td> <td colspan="8" style="text-align: center;"> <table border="1" style="width: 100%; border-collapse: collapse; text-align: center;"> <tr> <td style="width: 10%;"></td> <td style="width: 10%;"></td> <td style="width: 10%;"></td> <td style="width: 10%;"></td> <td style="width: 10%;"></td> <td style="width: 10%;"></td> <td style="width: 10%;"></td> <td style="width: 10%;"></td> <td style="width: 10%;"></td> <td style="width: 10%;"></td> </tr> <tr> <td></td> <td></td> <td colspan="8" style="text-align: center;"> <table border="1" style="width: 100%; border-collapse: collapse; text-align: center;"> <tr> <td style="width: 10%;"></td> <td style="width: 10%;"></td> <td style="width: 10%;"></td> <td style="width: 10%;"></td> <td style="width: 10%;"></td> <td style="width: 10%;"></td> <td style="width: 10%;"></td> <td style="width: 10%;"></td> <td style="width: 10%;"></td> <td style="width: 10%;"></td> </tr> <tr> <td></td> <td></td> <td colspan="8" style="text-align: center;"> <table border="1" style="width: 100%; border-collapse: collapse; text-align: center;"> <tr> <td style="width: 10%;"></td> <td style="width: 10%;"></td> <td style="width: 10%;"></td> <td style="width: 10%;"></td> <td style="width: 10%;"></td> <td style="width: 10%;"></td> <td style="width: 10%;"></td> <td style="width: 10%;"></td> <td style="width: 10%;"></td> <td style="width: 10%;"></td> </tr> <tr> <td></td> <td></td> <td
colspan="8" style="text-align: center;"> <table border="1" style="width: 100%; border-collapse: collapse; text-align: center;"> <tr> <td style="width: 10%;"></td> <td style="width: 10%;"></td> <td style="width: 10%;"></td> <td style="width: 10%;"></td> <td style="width: 10%;"></td> <td style="width: 10%;"></td> <td style="width: 10%;"></td> <td style="width: 10%;"></td> <td style="width: 10%;"></td> <td style="width: 10%;"></td> </tr> <tr> <td></td> <td></td> <td colspan="8" style="text-align: center;"> <table border="1" style="width: 100%; border-collapse: collapse; text-align: center;"> <tr> <td style="width: 10%;"></td> <td style="width: 10%;"></td> <td style="width: 10%;"></td> <td style="width: 10%;"></td> <td style="width: 10%;"></td> <td style="width: 10%;"></td> <td style="width: 10%;"></td> <td style="width: 10%;"></td> <td style="width: 10%;"></td> <td style="width: 10%;"></td> </tr> <tr> <td></td> <td></td> <td colspan="8" style="text-align: center;"> <table border="1" style="width: 100%; border-collapse: collapse; text-align: center;"> <tr> <td style="width: 10%;"></td> <td style="width: 10%;"></td> <td style="width: 10%;"></td> <td style="width: 10%;"></td> <td style="width: 10%;"></td> <td style="width: 10%;"></td> <td style="width: 10%;"></td> <td style="width: 10%;"></td> <td style="width: 10%;"></td> <td style="width: 10%;"></td> </tr> <tr> <td></td> <td></td> <td colspan="8" style="text-align: center;"> <table border="1" style="width: 100%; border-collapse: collapse; text-align: center;"> <tr> <td style="width: 10%;"></td> <td style="width: 10%;"></td> <td style="width: 10%;"></td> <td style="width: 10%;"></td> <td style="width: 10%;"></td> <td style="width: 10%;"></td> <td style="width: 10%;"></td> <td style="width: 10%;"></td> <td style="width: 10%;"></td> <td style="width: 10%;"></td> </tr> <tr> <td></td> <td></td> <td colspan="8" style="text-align: center;"> <table border="1" style="width: 100%; border-collapse: collapse; text-align: center;"> <tr> <td style="width: 10%;"></td> <td style="width: 10%;"></td> <td style="width: 10%;"></td> <td style="width: 10%;"></td> <td style="width: 10%;"></td> <td style="width: 10%;"></td> <td style="width: 10%;"></td> <td style="width: 10%;"></td> <td style="width: 10%;"></td> <td style="width: 10%;"></td> </tr> <tr> <td></td> <td></td> <td colspan="8" style="text-align: center;"> <table border="1" style="width: 100%; border-collapse: collapse; text-align: center;"> <tr> <td style="width: 10%;"></td> <td style="width: 10%;"></td> <td style="width: 10%;"></td> <td style="width: 10%;"></td> <td style="width: 10%;"></td> <td style="width: 10%;"></td> <td style="width: 10%;"></td> <td style="width: 10%;"></td> <td style="width: 10%;"></td> <td style="width: 10%;"></td> </tr> <tr> <td></td> <td></td> <td colspan="8" style="text-align: center;"> <table border="1" style="width: 100%; border-collapse: collapse; text-align: center;"> <tr> <td style="width: 10%;"></td> <td style="width: 10%;"></td> <td style="width: 10%;"></td> <td style="width: 10%;"></td> <td style="width: 10%;"></td> <td style="width: 10%;"></td> <td style="width: 10%;"></td> <td style="width: 10%;"></td> <td style="width: 10%;"></td> <td style="width: 10%;"></td> </tr> <tr> <td></td> <td></td> <td colspan="8" style="text-align: center;"> <table border="1" style="width: 100%; border-collapse: collapse; text-align: center;"> <tr> <td style="width: 10%;"></td> <td style="width: 10%;"></td> <td style="width: 10%;"></td> <td style="width: 10%;"></td> <td style="width: 10%;"></td> <td style="width: 10%;"></td> <td style="width: 10%;"></td> <td style="width: 10%;"></td> <td style="width: 10%;"></td> <td style="width: 10%;"></td> </tr> <tr> <td></td> <td></td> <td colspan="8" style="text-align: center;"> <table border="1" style="width: 100%; border-collapse: collapse; text-align: center;"> <tr> <td style="width: 10%;"></td> <td style="width: 10%;"></td> <td style="width: 10%;"></td> <td style="width: 10%;"></td> <td style="width: 10%;"></td> <td style="width: 10%;"></td> <td style="width: 10%;"></td> <td style="width: 10%;"></td> <td style="width: 10%;"></td> <td style="width: 10%;"></td> </tr> <tr> <td></td> <td></td> <td colspan="8" style="text-align: center;"> <table border="1" style="width: 100%; border-collapse: collapse; text-align: center;"> <tr> <td style="width: 10%;"></td> <td style="width: 10%;"></td> <td style="width: 10%;"></td> <td style="width: 10%;"></td> <td style="width: 10%;"></td> <td style="width: 10%;"></td> <td style="width: 10%;"></td> <td style="width: 10%;"></td> <td style="width: 10%;"></td> <td style="width: 10%;"></td> </tr> <tr> <td></td> <td></td> <td colspan="8" style="text-align: center;"> <table border="1" style="width: 100%; border-collapse: collapse; text-align: center;"> <tr> </tr></table></td></tr></table></td></tr></table></td></tr></table></td></tr></table></td></tr></table></td></tr></table></td></tr></table></td></tr></table></td></tr></table></td></tr></table></td></tr></table></td></tr></table></td></tr></table></td></tr></table></td></tr></table></td></tr></table></td></tr></table></td></tr></table></td></tr></table></td></tr></table></td></tr></table></td></tr></table></td></tr></table></td></tr></table></td></tr></table></td></tr></table></td></tr></table></td></tr></table></td></tr></table></td></tr></table></td></tr></table></td></tr></table></td></tr></table></td></tr></table></td></tr></table></td></tr></table></td></tr></table></td></tr></table></td></tr></table></td></tr></table></td></tr></table></td></tr></table></td></tr></table></td></tr></table></td></tr></table></td></tr></table></td></tr></table></td></tr></table></td></tr></table></td></tr></table>
 | | | | | | | | | | | | | | | | | | | | <table border="1" style="width: 100%; border-collapse: collapse; text-align: center;"> <tr> <td style="width: 10%;"></td> <td style="width: 10%;"></td> <td style="width: 10%;"></td> <td style="width: 10%;"></td> <td style="width: 10%;"></td> <td style="width: 10%;"></td> <td style="width: 10%;"></td> <td style="width: 10%;"></td> <td style="width: 10%;"></td> <td style="width: 10%;"></td> </tr> <tr> <td></td> <td></td> <td colspan="8" style="text-align: center;"> <table border="1" style="width: 100%; border-collapse: collapse; text-align: center;"> <tr> <td style="width: 10%;"></td> <td style="width: 10%;"></td> <td style="width: 10%;"></td> <td style="width: 10%;"></td> <td style="width: 10%;"></td> <td style="width: 10%;"></td> <td style="width: 10%;"></td> <td style="width: 10%;"></td> <td style="width: 10%;"></td> <td style="width: 10%;"></td> </tr> <tr> <td></td> <td></td> <td colspan="8" style="text-align: center;"> <table border="1" style="width: 100%; border-collapse: collapse; text-align: center;"> <tr> <td style="width: 10%;"></td> <td style="width: 10%;"></td> <td style="width: 10%;"></td> <td style="width: 10%;"></td> <td style="width: 10%;"></td> <td style="width: 10%;"></td> <td style="width: 10%;"></td> <td style="width: 10%;"></td> <td style="width: 10%;"></td> <td style="width: 10%;"></td> </tr> <tr> <td></td> <td></td> <td colspan="8" style="text-align: center;"> <table border="1" style="width: 100%; border-collapse: collapse; text-align: center;"> <tr> <td style="width: 10%;"></td> <td style="width: 10%;"></td> <td style="width: 10%;"></td> <td style="width: 10%;"></td> <td style="width: 10%;"></td> <td style="width: 10%;"></td> <td style="width: 10%;"></td> <td style="width: 10%;"></td> <td style="width: 10%;"></td> <td style="width: 10%;"></td> </tr> <tr> <td></td> <td></td> <td colspan="8" style="text-align: center;"> <table border="1" style="width: 100%; border-collapse: collapse; text-align: center;"> <tr> <td style="width: 10%;"></td> <td style="width: 10%;"></td> <td style="width: 10%;"></td> <td style="width: 10%;"></td> <td style="width: 10%;"></td> <td style="width: 10%;"></td> <td style="width: 10%;"></td> <td style="width: 10%;"></td> <td style="width: 10%;"></td> <td style="width: 10%;"></td> </tr> <tr> <td></td> <td></td> <td colspan="8" style="text-align: center;"> <table border="1" style="width: 100%; border-collapse: collapse; text-align: center;"> <tr> <td style="width: 10%;"></td> <td style="width: 10%;"></td> <td style="width: 10%;"></td> <td style="width: 10%;"></td> <td style="width: 10%;"></td> <td style="width: 10%;"></td> <td style="width: 10%;"></td> <td style="width: 10%;"></td> <td style="width: 10%;"></td> <td style="width: 10%;"></td> </tr> <tr> <td></td> <td></td> <td colspan="8" style="text-align: center;"> <table border="1" style="width: 100%; border-collapse: collapse; text-align: center;"> <tr> <td style="width: 10%;"></td> <td style="width: 10%;"></td> <td style="width: 10%;"></td> <td style="width: 10%;"></td> <td style="width: 10%;"></td> <td style="width: 10%;"></td> <td style="width: 10%;"></td> <td style="width: 10%;"></td> <td style="width: 10%;"></td> <td style="width: 10%;"></td> </tr> <tr> <td></td> <td></td> <td colspan="8" style="text-align: center;"> <table border="1" style="width: 100%; border-collapse: collapse; text-align: center;"> <tr> <td style="width: 10%;"></td> <td style="width: 10%;"></td> <td style="width: 10%;"></td> <td style="width: 10%;"></td> <td style="width: 10%;"></td> <td style="width: 10%;"></td> <td style="width: 10%;"></td> <td style="width: 10%;"></td> <td style="width: 10%;"></td> <td style="width: 10%;"></td> </tr> <tr> <td></td> <td></td> <td colspan="8" style="text-align: center;"> <table border="1" style="width: 100%; border-collapse: collapse; text-align: center;"> <tr> <td style="width: 10%;"></td> <td style="width: 10%;"></td> <td style="width: 10%;"></td> <td style="width: 10%;"></td> <td style="width: 10%;"></td> <td style="width: 10%;"></td> <td style="width: 10%;"></td> <td style="width: 10%;"></td> <td style="width: 10%;"></td> <td style="width: 10%;"></td> </tr> <tr> <td></td> <td></td> <td colspan="8" style="text-align: center;"> <table border="1" style="width: 100%; border-collapse: collapse; text-align: center;"> <tr> <td style="width: 10%;"></td> <td style="width: 10%;"></td> <td style="width: 10%;"></td> <td style="width: 10%;"></td> <td style="width: 10%;"></td> <td style="width: 10%;"></td> <td style="width: 10%;"></td> <td style="width: 10%;"></td> <td style="width: 10%;"></td> <td style="width: 10%;"></td> </tr> <tr> <td></td> <td></td> <td colspan="8" style="text-align: center;"> <table border="1" style="width: 100%; border-collapse: collapse; text-align: center;"> <tr> <td style="width: 10%;"></td> <td style="width: 10%;"></td> <td style="width: 10%;"></td> <td style="width: 10%;"></td> <td style="width: 10%;"></td> <td style="width: 10%;"></td> <td style="width: 10%;"></td> <td style="width: 10%;"></td> <td style="width: 10%;"></td> <td style="width: 10%;"></td> </tr> <tr> <td></td> <td></td> <td colspan="8" style="text-align: center;"> <table border="1" style="width: 100%; border-collapse: collapse; text-align: center;"> <tr> <td style="width: 10%;"></td> <td style="width: 10%;"></td> <td style="width: 10%;"></td> <td style="width: 10%;"></td> <td style="width: 10%;"></td> <td style="width: 10%;"></td> <td style="width: 10%;"></td> <td style="width: 10%;"></td> <td style="width: 10%;"></td> <td style="width: 10%;"></td> </tr> <tr> <td></td> <td></td> <td colspan="8" style="text-align: center;"> <table border="1" style="width: 100%; border-collapse: collapse; text-align: center;"> <tr> <td style="width: 10%;"></td> <td style="width: 10%;"></td> <td style="width: 10%;"></td> <td style="width: 10%;"></td> <td style="width: 10%;"></td> <td style="width: 10%;"></td> <td style="width: 10%;"></td> <td style="width: 10%;"></td> <td style="width: 10%;"></td> <td style="width: 10%;"></td> </tr> <tr> <td></td> <td></td> <td colspan="8" style="text-align: center;"> <table border="1" style="width: 100%; border-collapse: collapse; text-align: center;"> <tr> <td style="width: 10%;"></td> <td style="width: 10%;"></td> <td style="width: 10%;"></td> <td style="width: 10%;"></td> <td style="width: 10%;"></td> <td style="width: 10%;"></td> <td style="width: 10%;"></td> <td style="width: 10%;"></td> <td style="width: 10%;"></td> <td style="width: 10%;"></td> </tr> <tr> <td></td> <td></td> <td colspan="8" style="text-align: center;"> <table border="1" style="width: 100%; border-collapse: collapse; text-align: center;"> <tr> <td style="width: 10%;"></td> <td style="width: 10%;"></td> <td style="width: 10%;"></td> <td style="width: 10%;"></td> <td style="width: 10%;"></td> <td style="width: 10%;"></td> <td style="width: 10%;"></td> <td style="width: 10%;"></td> <td style="width: 10%;"></td> <td style="width: 10%;"></td> </tr> <tr> <td></td> <td></td> <td colspan="8" style="text-align: center;"> <table border="1" style="width: 100%; border-collapse: collapse; text-align: center;"> <tr> <td style="width: 10%;"></td> <td style="width: 10%;"></td> <td style="width: 10%;"></td> <td style="width: 10%;"></td> <td style="width: 10%;"></td> <td style="width: 10%;"></td> <td style="width: 10%;"></td> <td style="width: 10%;"></td> <td style="width: 10%;"></td> <td style="width: 10%;"></td> </tr> <tr> <td></td> <td></td> <td colspan="8" style="text-align: center;"> <table border="1" style="width: 100%; border-collapse: collapse; text-align: center;"> <tr> <td style="width: 10%;"></td> <td style="width: 10%;"></td> <td style="width: 10%;"></td> <td style="width: 10%;"></td> <td style="width: 10%;"></td> <td style="width: 10%;"></td> <td style="width: 10%;"></td> <td style="width: 10%;"></td> <td style="width: 10%;"></td> <td style="width: 10%;"></td> </tr> <tr>
<td></td> <td></td> <td colspan="8" style="text-align: center;"> <table border="1" style="width: 100%; border-collapse: collapse; text-align: center;"> <tr> <td style="width: 10%;"></td> <td style="width: 10%;"></td> <td style="width: 10%;"></td> <td style="width: 10%;"></td> <td style="width: 10%;"></td> <td style="width: 10%;"></td> <td style="width: 10%;"></td> <td style="width: 10%;"></td> <td style="width: 10%;"></td> <td style="width: 10%;"></td> </tr> <tr> <td></td> <td></td> <td colspan="8" style="text-align: center;"> <table border="1" style="width: 100%; border-collapse: collapse; text-align: center;"> <tr> <td style="width: 10%;"></td> <td style="width: 10%;"></td> <td style="width: 10%;"></td> <td style="width: 10%;"></td> <td style="width: 10%;"></td> <td style="width: 10%;"></td> <td style="width: 10%;"></td> <td style="width: 10%;"></td> <td style="width: 10%;"></td> <td style="width: 10%;"></td> </tr> <tr> <td></td> <td></td> <td colspan="8" style="text-align: center;"> <table border="1" style="width: 100%; border-collapse: collapse; text-align: center;"> <tr> <td style="width: 10%;"></td> <td style="width: 10%;"></td> <td style="width: 10%;"></td> <td style="width: 10%;"></td> <td style="width: 10%;"></td> <td style="width: 10%;"></td> <td style="width: 10%;"></td> <td style="width: 10%;"></td> <td style="width: 10%;"></td> <td style="width: 10%;"></td> </tr> <tr> <td></td> <td></td> <td colspan="8" style="text-align: center;"> <table border="1" style="width: 100%; border-collapse: collapse; text-align: center;"> <tr> <td style="width: 10%;"></td> <td style="width: 10%;"></td> <td style="width: 10%;"></td> <td style="width: 10%;"></td> <td style="width: 10%;"></td> <td style="width: 10%;"></td> <td style="width: 10%;"></td> <td style="width: 10%;"></td> <td style="width: 10%;"></td> <td style="width: 10%;"></td> </tr> <tr> <td></td> <td></td> <td colspan="8" style="text-align: center;"> <table border="1" style="width: 100%; border-collapse: collapse; text-align: center;"> <tr> <td style="width: 10%;"></td> <td style="width: 10%;"></td> <td style="width: 10%;"></td> <td style="width: 10%;"></td> <td style="width: 10%;"></td> <td style="width: 10%;"></td> <td style="width: 10%;"></td> <td style="width: 10%;"></td> <td style="width: 10%;"></td> <td style="width: 10%;"></td> </tr> <tr> <td></td> <td></td> <td colspan="8" style="text-align: center;"> <table border="1" style="width: 100%; border-collapse: collapse; text-align: center;"> <tr> <td style="width: 10%;"></td> <td style="width: 10%;"></td> <td style="width: 10%;"></td> <td style="width: 10%;"></td> <td style="width: 10%;"></td> <td style="width: 10%;"></td> <td style="width: 10%;"></td> <td style="width: 10%;"></td> <td style="width: 10%;"></td> <td style="width: 10%;"></td> </tr> <tr> <td></td> <td></td> <td colspan="8" style="text-align: center;"> <table border="1" style="width: 100%; border-collapse: collapse; text-align: center;"> <tr> <td style="width: 10%;"></td> <td style="width: 10%;"></td> <td style="width: 10%;"></td> <td style="width: 10%;"></td> <td style="width: 10%;"></td> <td style="width: 10%;"></td> <td style="width: 10%;"></td> <td style="width: 10%;"></td> <td style="width: 10%;"></td> <td style="width: 10%;"></td> </tr> <tr> <td></td> <td></td> <td colspan="8" style="text-align: center;"> <table border="1" style="width: 100%; border-collapse: collapse; text-align: center;"> <tr> <td style="width: 10%;"></td> <td style="width: 10%;"></td> <td style="width: 10%;"></td> <td style="width: 10%;"></td> <td style="width: 10%;"></td> <td style="width: 10%;"></td> <td style="width: 10%;"></td> <td style="width: 10%;"></td> <td style="width: 10%;"></td> <td style="width: 10%;"></td> </tr> <tr> <td></td> <td></td> <td colspan="8" style="text-align: center;"> <table border="1" style="width: 100%; border-collapse: collapse; text-align: center;"> <tr> <td style="width: 10%;"></td> <td style="width: 10%;"></td> <td style="width: 10%;"></td> <td style="width: 10%;"></td> <td style="width: 10%;"></td> <td style="width: 10%;"></td> <td style="width: 10%;"></td> <td style="width: 10%;"></td> <td style="width: 10%;"></td> <td style="width: 10%;"></td> </tr> <tr> <td></td> <td></td> <td colspan="8" style="text-align: center;"> <table border="1" style="width: 100%; border-collapse: collapse; text-align: center;"> <tr> <td style="width: 10%;"></td> <td style="width: 10%;"></td> <td style="width: 10%;"></td> <td style="width: 10%;"></td> <td style="width: 10%;"></td> <td style="width: 10%;"></td> <td style="width: 10%;"></td> <td style="width: 10%;"></td> <td style="width: 10%;"></td> <td style="width: 10%;"></td> </tr> <tr> <td></td> <td></td> <td colspan="8" style="text-align: center;"> <table border="1" style="width: 100%; border-collapse: collapse; text-align: center;"> <tr> <td style="width: 10%;"></td> <td style="width: 10%;"></td> <td style="width: 10%;"></td> <td style="width: 10%;"></td> <td style="width: 10%;"></td> <td style="width: 10%;"></td> <td style="width: 10%;"></td> <td style="width: 10%;"></td> <td style="width: 10%;"></td> <td style="width: 10%;"></td> </tr> <tr> <td></td> <td></td> <td colspan="8" style="text-align: center;"> <table border="1" style="width: 100%; border-collapse: collapse; text-align: center;"> <tr> <td style="width: 10%;"></td> <td style="width: 10%;"></td> <td style="width: 10%;"></td> <td style="width: 10%;"></td> <td style="width: 10%;"></td> <td style="width: 10%;"></td> <td style="width: 10%;"></td> <td style="width: 10%;"></td> <td style="width: 10%;"></td> <td style="width: 10%;"></td> </tr> <tr> <td></td> <td></td> <td colspan="8" style="text-align: center;"> <table border="1" style="width: 100%; border-collapse: collapse; text-align: center;"> <tr> <td style="width: 10%;"></td> <td style="width: 10%;"></td> <td style="width: 10%;"></td> <td style="width: 10%;"></td> <td style="width: 10%;"></td> <td style="width: 10%;"></td> <td style="width: 10%;"></td> <td style="width: 10%;"></td> <td style="width: 10%;"></td> <td style="width: 10%;"></td> </tr> <tr> <td></td> <td></td> <td colspan="8" style="text-align: center;"> <table border="1" style="width: 100%; border-collapse: collapse; text-align: center;"> <tr> <td style="width: 10%;"></td> <td style="width: 10%;"></td> <td style="width: 10%;"></td> <td style="width: 10%;"></td> <td style="width: 10%;"></td> <td style="width: 10%;"></td> <td style="width: 10%;"></td> <td style="width: 10%;"></td> <td style="width: 10%;"></td> <td style="width: 10%;"></td> </tr> <tr> <td></td> <td></td> <td colspan="8" style="text-align: center;"> <table border="1" style="width: 100%; border-collapse: collapse; text-align: center;"> <tr> <td style="width: 10%;"></td> <td style="width: 10%;"></td> <td style="width: 10%;"></td> <td style="width: 10%;"></td> <td style="width: 10%;"></td> <td style="width: 10%;"></td> <td style="width: 10%;"></td> <td style="width: 10%;"></td> <td style="width: 10%;"></td> <td style="width: 10%;"></td> </tr> <tr> <td></td> <td></td> <td colspan="8" style="text-align: center;"> <table border="1" style="width: 100%; border-collapse: collapse; text-align: center;"> <tr> <td style="width: 10%;"></td> <td style="width: 10%;"></td> <td style="width: 10%;"></td> <td style="width: 10%;"></td> <td style="width: 10%;"></td> <td style="width: 10%;"></td> <td style="width: 10%;"></td> <td style="width: 10%;"></td> <td style="width: 10%;"></td> <td style="width: 10%;"></td> </tr> <tr> <td></td> <td></td> <td colspan="8" style="text-align: center;"> <table border="1" style="width: 100%; border-collapse: collapse; text-align: center;"> <tr> <td style="width: 10%;"></td> <td style="width: 10%;"></td> <td style="width: 10%;"></td> <td style="width: 10%;"></td> <td style="width: 10%;"></td> <td style="width: 10%;"></td> <td style="width: 10%;"></td> <td style="width: 10%;"></td> <td style="width: 10%;"></td> <td style="width: 10%;"></td> </tr> <tr> <td></td> <td></td> <td colspan="8" style="text-align: center;"> <table border="1" style="width: 100%; border-collapse: collapse; text-align: center;"> <tr> <td style="width: 10%;"></td> <td style="width: 10%;"></td> <td style="width: 10%;"></td> <td style="width: 10%;"></td> <td style="width: 10%;"></td> <td style="width: 10%;"></td> <td style="width: 10%;"></td> <td style="width: 10%;"></td> <td style="width: 10%;"></td> <td style="width: 10%;"></td> </tr> <tr> <td></td> <td></td> <td colspan="8" style="text-align: center;"> <table border="1" style="width: 100%; border-collapse: collapse; text-align: center;"> <tr> <td style="width: 10%;"></td> <td style="width: 10%;"></td> <td style="width: 10%;"></td> <td style="width: 10%;"></td> <td style="width: 10%;"></td> <td style="width: 10%;"></td> <td style="width: 10%;"></td> <td style="width: 10%;"></td> <td style="width: 10%;"></td> <td style="width: 10%;"></td> </tr> <tr> <td></td> <td></td> <td colspan="8" style="text-align: center;"> <table border="1" style="width: 100%; border-collapse: collapse; text-align: center;"> <tr> <td style="width: 10%;"></td> <td style="width: 10%;"></td> <td style="width: 10%;"></td> <td style="width: 10%;"></td> <td style="width: 10%;"></td> <td style="width: 10%;"></td> <td style="width: 10%;"></td> <td style="width: 10%;"></td> <td style="width: 10%;"></td> <td style="width: 10%;"></td> </tr> <tr> <td></td> <td></td> <td colspan="8" style="text-align: center;"> <table border="1" style="width: 100%; border-collapse: collapse; text-align: center;"> <tr> <td style="width: 10%;"></td> <td style="width: 10%;"></td> <td style="width: 10%;"></td> <td style="width: 10%;"></td> <td style="width: 10%;"></td> <td style="width: 10%;"></td> <td style="width: 10%;"></td> <td style="width: 10%;"></td> <td style="width: 10%;"></td> <td style="width: 10%;"></td> </tr> <tr> <td></td> <td></td> <td colspan="8" style="text-align: center;"> <table border="1" style="width: 100%; border-collapse: collapse; text-align: center;"> <tr> <td
style="width: 10%;"></td> <td style="width: 10%;"></td> <td style="width: 10%;"></td> <td style="width: 10%;"></td> <td style="width: 10%;"></td> <td style="width: 10%;"></td> <td style="width: 10%;"></td> <td style="width: 10%;"></td> <td style="width: 10%;"></td> <td style="width: 10%;"></td> </tr> <tr> <td></td> <td></td> <td colspan="8" style="text-align: center;"> <table border="1" style="width: 100%; border-collapse: collapse; text-align: center;"> <tr> <td style="width: 10%;"></td> <td style="width: 10%;"></td> <td style="width: 10%;"></td> <td style="width: 10%;"></td> <td style="width: 10%;"></td> <td style="width: 10%;"></td> <td style="width: 10%;"></td> <td style="width: 10%;"></td> <td style="width: 10%;"></td> <td style="width: 10%;"></td> </tr> <tr> <td></td> <td></td> <td colspan="8" style="text-align: center;"> <table border="1" style="width: 100%; border-collapse: collapse; text-align: center;"> <tr> <td style="width: 10%;"></td> <td style="width: 10%;"></td> <td style="width: 10%;"></td> <td style="width: 10%;"></td> <td style="width: 10%;"></td> <td style="width: 10%;"></td> <td style="width: 10%;"></td> <td style="width: 10%;"></td> <td style="width: 10%;"></td> <td style="width: 10%;"></td> </tr> <tr> <td></td> <td></td> <td colspan="8" style="text-align: center;"> <table border="1" style="width: 100%; border-collapse: collapse; text-align: center;"> <tr> <td style="width: 10%;"></td> <td style="width: 10%;"></td> <td style="width: 10%;"></td> <td style="width: 10%;"></td> <td style="width: 10%;"></td> <td style="width: 10%;"></td> <td style="width: 10%;"></td> <td style="width: 10%;"></td> <td style="width: 10%;"></td> <td style="width: 10%;"></td> </tr> <tr> <td></td> <td></td> <td colspan="8" style="text-align: center;"> <table border="1" style="width: 100%; border-collapse: collapse; text-align: center;"> <tr> <td style="width: 10%;"></td> <td style="width: 10%;"></td> <td style="width: 10%;"></td> <td style="width: 10%;"></td> <td style="width: 10%;"></td> <td style="width: 10%;"></td> <td style="width: 10%;"></td> <td style="width: 10%;"></td> <td style="width: 10%;"></td> <td style="width: 10%;"></td> </tr> <tr> <td></td> <td></td> <td colspan="8" style="text-align: center;"> <table border="1" style="width: 100%; border-collapse: collapse; text-align: center;"> <tr> <td style="width: 10%;"></td> <td style="width: 10%;"></td> <td style="width: 10%;"></td> <td style="width: 10%;"></td> <td style="width: 10%;"></td> <td style="width: 10%;"></td> <td style="width: 10%;"></td> <td style="width: 10%;"></td> <td style="width: 10%;"></td> <td style="width: 10%;"></td> </tr> <tr> <td></td> <td></td> <td colspan="8" style="text-align: center;"> <table border="1" style="width: 100%; border-collapse: collapse; text-align: center;"> <tr> <td style="width: 10%;"></td> <td style="width: 10%;"></td> <td style="width: 10%;"></td> <td style="width: 10%;"></td> <td style="width: 10%;"></td> <td style="width: 10%;"></td> <td style="width: 10%;"></td> <td style="width: 10%;"></td> <td style="width: 10%;"></td> <td style="width: 10%;"></td> </tr> <tr> <td></td> <td></td> <td colspan="8" style="text-align: center;"> <table border="1" style="width: 100%; border-collapse: collapse; text-align: center;"> <tr> <td style="width: 10%;"></td> <td style="width: 10%;"></td> <td style="width: 10%;"></td> <td style="width: 10%;"></td> <td style="width: 10%;"></td> <td style="width: 10%;"></td> <td style="width: 10%;"></td> <td style="width: 10%;"></td> <td style="width: 10%;"></td> <td style="width: 10%;"></td> </tr> <tr> <td></td> <td></td> <td colspan="8" style="text-align: center;"> <table border="1" style="width: 100%; border-collapse: collapse; text-align: center;"> <tr> <td style="width: 10%;"></td> <td style="width: 10%;"></td> <td style="width: 10%;"></td> <td style="width: 10%;"></td> <td style="width: 10%;"></td> <td style="width: 10%;"></td> <td style="width: 10%;"></td> <td style="width: 10%;"></td> <td style="width: 10%;"></td> <td style="width: 10%;"></td> </tr> <tr> <td></td> <td></td> <td colspan="8" style="text-align: center;"> <table border="1" style="width: 100%; border-collapse: collapse; text-align: center;"> <tr> <td style="width: 10%;"></td> <td style="width: 10%;"></td> <td style="width: 10%;"></td> <td style="width: 10%;"></td> <td style="width: 10%;"></td> <td style="width: 10%;"></td> <td style="width: 10%;"></td> <td style="width: 10%;"></td> <td style="width: 10%;"></td> <td style="width: 10%;"></td> </tr> <tr> <td></td> <td></td> <td colspan="8" style="text-align: center;"> <table border="1" style="width: 100%; border-collapse: collapse; text-align: center;"> <tr> <td style="width: 10%;"></td> <td style="width: 10%;"></td> <td style="width: 10%;"></td> <td style="width: 10%;"></td> <td style="width: 10%;"></td> <td style="width: 10%;"></td> <td style="width: 10%;"></td> <td style="width: 10%;"></td> <td style="width: 10%;"></td> <td style="width: 10%;"></td> </tr> <tr> <td></td> <td></td> <td colspan="8" style="text-align: center;"> <table border="1" style="width: 100%; border-collapse: collapse; text-align: center;"> <tr> </tr></table></td></tr></table></td></tr></table></td></tr></table></td></tr></table></td></tr></table></td></tr></table></td></tr></table></td></tr></table></td></tr></table></td></tr></table></td></tr></table></td></tr></table></td></tr></table></td></tr></table></td></tr></table></td></tr></table></td></tr></table></td></tr></table></td></tr></table></td></tr></table></td></tr></table></td></tr></table></td></tr></table></td></tr></table></td></tr></table></td></tr></table></td></tr></table></td></tr></table></td></tr></table></td></tr></table></td></tr></table></td></tr></table></td></tr></table></td></tr></table></td></tr></table></td></tr></table></td></tr></table></td></tr></table></td></tr></table></td></tr></table></td></tr></table></td></tr></table></td></tr></table></td></tr></table></td></tr></table></td></tr></table></td></tr></table></td></tr></table></td></tr></table>
 | | | | | | | | | | | | | | | | | | | | <table border="1" style="width: 100%; border-collapse: collapse; text-align: center;"> <tr> <td style="width: 10%;"></td> <td style="width: 10%;"></td> <td style="width: 10%;"></td> <td style="width: 10%;"></td> <td style="width: 10%;"></td> <td style="width: 10%;"></td> <td style="width: 10%;"></td> <td style="width: 10%;"></td> <td style="width: 10%;"></td> <td style="width: 10%;"></td> </tr> <tr> <td></td> <td></td> <td colspan="8" style="text-align: center;"> <table border="1" style="width: 100%; border-collapse: collapse; text-align: center;"> <tr> <td style="width: 10%;"></td> <td style="width: 10%;"></td> <td style="width: 10%;"></td> <td style="width: 10%;"></td> <td style="width: 10%;"></td> <td style="width: 10%;"></td> <td style="width: 10%;"></td> <td style="width: 10%;"></td> <td style="width: 10%;"></td> <td style="width: 10%;"></td> </tr> <tr> <td></td> <td></td> <td colspan="8" style="text-align: center;"> <table border="1" style="width: 100%; border-collapse: collapse; text-align: center;"> <tr> <td style="width: 10%;"></td> <td style="width: 10%;"></td> <td style="width: 10%;"></td> <td style="width: 10%;"></td> <td style="width: 10%;"></td> <td style="width: 10%;"></td> <td style="width: 10%;"></td> <td style="width: 10%;"></td> <td style="width: 10%;"></td> <td style="width: 10%;"></td> </tr> <tr> <td></td> <td></td> <td colspan="8" style="text-align: center;"> <table border="1" style="width: 100%; border-collapse: collapse; text-align: center;"> <tr> <td style="width: 10%;"></td> <td style="width: 10%;"></td> <td style="width: 10%;"></td> <td style="width: 10%;"></td> <td style="width: 10%;"></td> <td style="width: 10%;"></td> <td style="width: 10%;"></td> <td style="width: 10%;"></td> <td style="width: 10%;"></td> <td style="width: 10%;"></td> </tr> <tr> <td></td> <td></td> <td colspan="8" style="text-align: center;"> <table border="1" style="width: 100%; border-collapse: collapse; text-align: center;"> <tr> <td style="width: 10%;"></td> <td style="width: 10%;"></td> <td style="width: 10%;"></td> <td style="width: 10%;"></td> <td style="width: 10%;"></td> <td style="width: 10%;"></td> <td style="width: 10%;"></td> <td style="width: 10%;"></td> <td style="width: 10%;"></td> <td style="width: 10%;"></td> </tr> <tr> <td></td> <td></td> <td colspan="8" style="text-align: center;"> <table border="1" style="width: 100%; border-collapse: collapse; text-align: center;"> <tr> <td style="width: 10%;"></td> <td style="width: 10%;"></td> <td style="width: 10%;"></td> <td style="width: 10%;"></td> <td style="width: 10%;"></td> <td style="width: 10%;"></td> <td style="width: 10%;"></td> <td style="width: 10%;"></td> <td style="width: 10%;"></td> <td style="width: 10%;"></td> </tr> <tr> <td></td> <td></td> <td colspan="8" style="text-align: center;"> <table border="1" style="width: 100%; border-collapse: collapse; text-align: center;"> <tr> <td style="width: 10%;"></td> <td style="width: 10%;"></td> <td style="width: 10%;"></td> <td style="width: 10%;"></td> <td style="width: 10%;"></td> <td style="width: 10%;"></td> <td style="width: 10%;"></td> <td style="width: 10%;"></td> <td style="width: 10%;"></td> <td style="width: 10%;"></td> </tr> <tr> <td></td> <td></td> <td colspan="8" style="text-align: center;"> <table border="1" style="width: 100%; border-collapse: collapse; text-align: center;"> <tr> <td style="width: 10%;"></td> <td style="width: 10%;"></td> <td style="width: 10%;"></td> <td style="width: 10%;"></td> <td style="width: 10%;"></td> <td style="width: 10%;"></td> <td style="width: 10%;"></td> <td style="width: 10%;"></td> <td style="width: 10%;"></td> <td style="width: 10%;"></td> </tr> <tr> <td></td> <td></td> <td colspan="8" style="text-align: center;"> <table border="1" style="width: 100%; border-collapse: collapse; text-align: center;"> <tr> <td style="width: 10%;"></td> <td style="width: 10%;"></td> <td style="width: 10%;"></td> <td style="width: 10%;"></td> <td style="width: 10%;"></td> <td style="width: 10%;"></td> <td style="width: 10%;"></td> <td style="width: 10%;"></td> <td style="width: 10%;"></td> <td style="width: 10%;"></td> </tr> <tr> <td></td> <td></td> <td colspan="8" style="text-align: center;"> <table border="1" style="width: 100%; border-collapse: collapse; text-align: center;"> <tr> <td style="width: 10%;"></td> <td style="width: 10%;"></td> <td style="width: 10%;"></td> <td style="width: 10%;"></td> <td style="width: 10%;"></td> <td style="width: 10%;"></td> <td style="width: 10%;"></td> <td style="width: 10%;"></td> <td style="width: 10%;"></td> <td style="width: 10%;"></td> </tr> <tr> <td></td> <td></td> <td colspan="8" style="text-align: center;"> <table border="1" style="width: 100%; border-collapse: collapse; text-align: center;"> <tr> <td style="width: 10%;"></td> <td style="width: 10%;"></td> <td style="width: 10%;"></td> <td style="width: 10%;"></td> <td style="width: 10%;"></td> <td style="width: 10%;"></td> <td style="width: 10%;"></td> <td style="width: 10%;"></td> <td style="width: 10%;"></td> <td style="width: 10%;"></td> </tr> <tr> <td></td> <td></td> <td colspan="8" style="text-align: center;"> <table border="1" style="width: 100%; border-collapse: collapse; text-align: center;"> <tr> <td style="width: 10%;"></td> <td style="width: 10%;"></td> <td style="width: 10%;"></td> <td style="width: 10%;"></td> <td style="width: 10%;"></td> <td style="width: 10%;"></td> <td style="width: 10%;"></td> <td style="width: 10%;"></td> <td style="width: 10%;"></td> <td style="width: 10%;"></td> </tr> <tr> <td></td> <td></td> <td colspan="8" style="text-align: center;"> <table border="1" style="width: 100%; border-collapse: collapse; text-align: center;"> <tr> <td style="width: 10%;"></td> <td style="width: 10%;"></td> <td style="width: 10%;"></td> <td style="width: 10%;"></td> <td style="width: 10%;"></td> <td style="width: 10%;"></td> <td style="width: 10%;"></td> <td style="width: 10%;"></td> <td style="width: 10%;"></td> <td style="width: 10%;"></td> </tr> <tr> <td></td> <td></td> <td colspan="8" style="text-align: center;"> <table border="1" style="width: 100%; border-collapse: collapse; text-align: center;"> <tr> <td style="width: 10%;"></td> <td style="width: 10%;"></td> <td style="width: 10%;"></td> <td style="width: 10%;"></td> <td style="width: 10%;"></td> <td style="width: 10%;"></td> <td style="width: 10%;"></td> <td style="width: 10%;"></td> <td style="width: 10%;"></td> <td style="width: 10%;"></td> </tr> <tr> <td></td> <td></td> <td colspan="8" style="text-align: center;"> <table border="1" style="width: 100%; border-collapse: collapse; text-align: center;"> <tr> <td style="width: 10%;"></td> <td style="width: 10%;"></td> <td style="width: 10%;"></td> <td style="width: 10%;"></td> <td style="width: 10%;"></td> <td style="width: 10%;"></td> <td style="width: 10%;"></td> <td style="width: 10%;"></td> <td style="width: 10%;"></td> <td style="width: 10%;"></td> </tr> <tr> <td></td> <td></td> <td colspan="8" style="text-align: center;"> <table border="1" style="width: 100%; border-collapse: collapse; text-align: center;"> <tr> <td style="width: 10%;"></td> <td style="width: 10%;"></td> <td style="width: 10%;"></td> <td style="width: 10%;"></td> <td style="width: 10%;"></td> <td style="width: 10%;"></td> <td style="width: 10%;"></td> <td style="width: 10%;"></td> <td style="width: 10%;"></td> <td style="width: 10%;"></td> </tr> <tr> <td></td> <td></td> <td colspan="8" style="text-align: center;"> <table border="1" style="width: 100%; border-collapse: collapse; text-align: center;"> <tr>
<td style="width: 10%;"></td> <td style="width: 10%;"></td> <td style="width: 10%;"></td> <td style="width: 10%;"></td> <td style="width: 10%;"></td> <td style="width: 10%;"></td> <td style="width: 10%;"></td> <td style="width: 10%;"></td> <td style="width: 10%;"></td> <td style="width: 10%;"></td> </tr> <tr> <td></td> <td></td> <td colspan="8" style="text-align: center;"> <table border="1" style="width: 100%; border-collapse: collapse; text-align: center;"> <tr> <td style="width: 10%;"></td> <td style="width: 10%;"></td> <td style="width: 10%;"></td> <td style="width: 10%;"></td> <td style="width: 10%;"></td> <td style="width: 10%;"></td> <td style="width: 10%;"></td> <td style="width: 10%;"></td> <td style="width: 10%;"></td> <td style="width: 10%;"></td> </tr> <tr> <td></td> <td></td> <td colspan="8" style="text-align: center;"> <table border="1" style="width: 100%; border-collapse: collapse; text-align: center;"> <tr> <td style="width: 10%;"></td> <td style="width: 10%;"></td> <td style="width: 10%;"></td> <td style="width: 10%;"></td> <td style="width: 10%;"></td> <td style="width: 10%;"></td> <td style="width: 10%;"></td> <td style="width: 10%;"></td> <td style="width: 10%;"></td> <td style="width: 10%;"></td> </tr> <tr> <td></td> <td></td> <td colspan="8" style="text-align: center;"> <table border="1" style="width: 100%; border-collapse: collapse; text-align: center;"> <tr> <td style="width: 10%;"></td> <td style="width: 10%;"></td> <td style="width: 10%;"></td> <td style="width: 10%;"></td> <td style="width: 10%;"></td> <td style="width: 10%;"></td> <td style="width: 10%;"></td> <td style="width: 10%;"></td> <td style="width: 10%;"></td> <td style="width: 10%;"></td> </tr> <tr> <td></td> <td></td> <td colspan="8" style="text-align: center;"> <table border="1" style="width: 100%; border-collapse: collapse; text-align: center;"> <tr> <td style="width: 10%;"></td> <td style="width: 10%;"></td> <td style="width: 10%;"></td> <td style="width: 10%;"></td> <td style="width: 10%;"></td> <td style="width: 10%;"></td> <td style="width: 10%;"></td> <td style="width: 10%;"></td> <td style="width: 10%;"></td> <td style="width: 10%;"></td> </tr> <tr> <td></td> <td></td> <td colspan="8" style="text-align: center;"> <table border="1" style="width: 100%; border-collapse: collapse; text-align: center;"> <tr> <td style="width: 10%;"></td> <td style="width: 10%;"></td> <td style="width: 10%;"></td> <td style="width: 10%;"></td> <td style="width: 10%;"></td> <td style="width: 10%;"></td> <td style="width: 10%;"></td> <td style="width: 10%;"></td> <td style="width: 10%;"></td> <td style="width: 10%;"></td> </tr> <tr> <td></td> <td></td> <td colspan="8" style="text-align: center;"> <table border="1" style="width: 100%; border-collapse: collapse; text-align: center;"> <tr> <td style="width: 10%;"></td> <td style="width: 10%;"></td> <td style="width: 10%;"></td> <td style="width: 10%;"></td> <td style="width: 10%;"></td> <td style="width: 10%;"></td> <td style="width: 10%;"></td> <td style="width: 10%;"></td> <td style="width: 10%;"></td> <td style="width: 10%;"></td> </tr> <tr> <td></td> <td></td> <td colspan="8" style="text-align: center;"> <table border="1" style="width: 100%; border-collapse: collapse; text-align: center;"> <tr> <td style="width: 10%;"></td> <td style="width: 10%;"></td> <td style="width: 10%;"></td> <td style="width: 10%;"></td> <td style="width: 10%;"></td> <td style="width: 10%;"></td> <td style="width: 10%;"></td> <td style="width: 10%;"></td> <td style="width: 10%;"></td> <td style="width: 10%;"></td> </tr> <tr> <td></td> <td></td> <td colspan="8" style="text-align: center;"> <table border="1" style="width: 100%; border-collapse: collapse; text-align: center;"> <tr> <td style="width: 10%;"></td> <td style="width: 10%;"></td> <td style="width: 10%;"></td> <td style="width: 10%;"></td> <td style="width: 10%;"></td> <td style="width: 10%;"></td> <td style="width: 10%;"></td> <td style="width: 10%;"></td> <td style="width: 10%;"></td> <td style="width: 10%;"></td> </tr> <tr> <td></td> <td></td> <td colspan="8" style="text-align: center;"> <table border="1" style="width: 100%; border-collapse: collapse; text-align: center;"> <tr> <td style="width: 10%;"></td> <td style="width: 10%;"></td> <td style="width: 10%;"></td> <td style="width: 10%;"></td> <td style="width: 10%;"></td> <td style="width: 10%;"></td> <td style="width: 10%;"></td> <td style="width: 10%;"></td> <td style="width: 10%;"></td> <td style="width: 10%;"></td> </tr> <tr> <td></td> <td></td> <td colspan="8" style="text-align: center;"> <table border="1" style="width: 100%; border-collapse: collapse; text-align: center;"> <tr> <td style="width: 10%;"></td> <td style="width: 10%;"></td> <td style="width: 10%;"></td> <td style="width: 10%;"></td> <td style="width: 10%;"></td> <td style="width: 10%;"></td> <td style="width: 10%;"></td> <td style="width: 10%;"></td> <td style="width: 10%;"></td> <td style="width: 10%;"></td> </tr> <tr> <td></td> <td></td> <td colspan="8" style="text-align: center;"> <table border="1" style="width: 100%; border-collapse: collapse; text-align: center;"> <tr> <td style="width: 10%;"></td> <td style="width: 10%;"></td> <td style="width: 10%;"></td> <td style="width: 10%;"></td> <td style="width: 10%;"></td> <td style="width: 10%;"></td> <td style="width: 10%;"></td> <td style="width: 10%;"></td> <td style="width: 10%;"></td> <td style="width: 10%;"></td> </tr> <tr> <td></td> <td></td> <td colspan="8" style="text-align: center;"> <table border="1" style="width: 100%; border-collapse: collapse; text-align: center;"> <tr> <td style="width: 10%;"></td> <td style="width: 10%;"></td> <td style="width: 10%;"></td> <td style="width: 10%;"></td> <td style="width: 10%;"></td> <td style="width: 10%;"></td> <td style="width: 10%;"></td> <td style="width: 10%;"></td> <td style="width: 10%;"></td> <td style="width: 10%;"></td> </tr> <tr> <td></td> <td></td> <td colspan="8" style="text-align: center;"> <table border="1" style="width: 100%; border-collapse: collapse; text-align: center;"> <tr> <td style="width: 10%;"></td> <td style="width: 10%;"></td> <td style="width: 10%;"></td> <td style="width: 10%;"></td> <td style="width: 10%;"></td> <td style="width: 10%;"></td> <td style="width: 10%;"></td> <td style="width: 10%;"></td> <td style="width: 10%;"></td> <td style="width: 10%;"></td> </tr> <tr> <td></td> <td></td> <td colspan="8" style="text-align: center;"> <table border="1" style="width: 100%; border-collapse: collapse; text-align: center;"> <tr> <td style="width: 10%;"></td> <td style="width: 10%;"></td> <td style="width: 10%;"></td> <td style="width: 10%;"></td> <td style="width: 10%;"></td> <td style="width: 10%;"></td> <td style="width: 10%;"></td> <td style="width: 10%;"></td> <td style="width: 10%;"></td> <td style="width: 10%;"></td> </tr> <tr> <td></td> <td></td> <td colspan="8" style="text-align: center;"> <table border="1" style="width: 100%; border-collapse: collapse; text-align: center;"> <tr> <td style="width: 10%;"></td> <td style="width: 10%;"></td> <td style="width: 10%;"></td> <td style="width: 10%;"></td> <td style="width: 10%;"></td> <td style="width: 10%;"></td> <td style="width: 10%;"></td> <td style="width: 10%;"></td> <td style="width: 10%;"></td> <td style="width: 10%;"></td> </tr> <tr> <td></td> <td></td> <td colspan="8" style="text-align: center;"> <table border="1" style="width: 100%; border-collapse: collapse; text-align: center;"> <tr> <td style="width: 10%;"></td> <td style="width: 10%;"></td> <td style="width: 10%;"></td> <td style="width: 10%;"></td> <td style="width: 10%;"></td> <td style="width: 10%;"></td> <td style="width: 10%;"></td> <td style="width: 10%;"></td> <td style="width: 10%;"></td> <td style="width: 10%;"></td> </tr> <tr> <td></td> <td></td> <td colspan="8" style="text-align: center;"> <table border="1" style="width: 100%; border-collapse: collapse; text-align: center;"> <tr> <td style="width: 10%;"></td> <td style="width: 10%;"></td> <td style="width: 10%;"></td> <td style="width: 10%;"></td> <td style="width: 10%;"></td> <td style="width: 10%;"></td> <td style="width: 10%;"></td> <td style="width: 10%;"></td> <td style="width: 10%;"></td> <td style="width: 10%;"></td> </tr> <tr> <td></td> <td></td> <td colspan="8" style="text-align: center;"> <table border="1" style="width: 100%; border-collapse: collapse; text-align: center;"> <tr> <td style="width: 10%;"></td> <td style="width: 10%;"></td> <td style="width: 10%;"></td> <td style="width: 10%;"></td> <td style="width: 10%;"></td> <td style="width: 10%;"></td> <td style="width: 10%;"></td> <td style="width: 10%;"></td> <td style="width: 10%;"></td> <td style="width: 10%;"></td> </tr> <tr> <td></td> <td></td> <td colspan="8" style="text-align: center;"> <table border="1" style="width: 100%; border-collapse: collapse; text-align: center;"> <tr> <td style="width: 10%;"></td> <td style="width: 10%;"></td> <td style="width: 10%;"></td> <td style="width: 10%;"></td> <td style="width: 10%;"></td> <td style="width: 10%;"></td> <td style="width: 10%;"></td> <td style="width: 10%;"></td> <td style="width: 10%;"></td> <td style="width: 10%;"></td> </tr> <tr> <td></td> <td></td> <td colspan="8" style="text-align: center;"> <table border="1" style="width: 100%; border-collapse: collapse; text-align: center;"> <tr> <td style="width: 10%;"></td> <td style="width: 10%;"></td> <td style="width: 10%;"></td> <td style="width: 10%;"></td> <td style="width: 10%;"></td> <td style="width: 10%;"></td> <td style="width: 10%;"></td> <td style="width: 10%;"></td> <td style="width: 10%;"></td> <td style="width: 10%;"></td> </tr> <tr> <td></td> <td></td> <td colspan="8" style="text-align: center;"> <table border="1" style="width: 100%; border-collapse: collapse; text-align: center;"> <tr> <td style="width: 10%;"></td> <td style="width: 10%;"></td> <td style="width: 10%;"></td> <td style="width: 10%;"></td> <td style="width: 10%;"></td> <td style="width:
10%;"></td> <td style="width: 10%;"></td> <td style="width: 10%;"></td> <td style="width: 10%;"></td> <td style="width: 10%;"></td> </tr> <tr> <td></td> <td></td> <td colspan="8" style="text-align: center;"> <table border="1" style="width: 100%; border-collapse: collapse; text-align: center;"> <tr> <td style="width: 10%;"></td> <td style="width: 10%;"></td> <td style="width: 10%;"></td> <td style="width: 10%;"></td> <td style="width: 10%;"></td> <td style="width: 10%;"></td> <td style="width: 10%;"></td> <td style="width: 10%;"></td> <td style="width: 10%;"></td> <td style="width: 10%;"></td> </tr> <tr> <td></td> <td></td> <td colspan="8" style="text-align: center;"> <table border="1" style="width: 100%; border-collapse: collapse; text-align: center;"> <tr> <td style="width: 10%;"></td> <td style="width: 10%;"></td> <td style="width: 10%;"></td> <td style="width: 10%;"></td> <td style="width: 10%;"></td> <td style="width: 10%;"></td> <td style="width: 10%;"></td> <td style="width: 10%;"></td> <td style="width: 10%;"></td> <td style="width: 10%;"></td> </tr> <tr> <td></td> <td></td> <td colspan="8" style="text-align: center;"> <table border="1" style="width: 100%; border-collapse: collapse; text-align: center;"> <tr> <td style="width: 10%;"></td> <td style="width: 10%;"></td> <td style="width: 10%;"></td> <td style="width: 10%;"></td> <td style="width: 10%;"></td> <td style="width: 10%;"></td> <td style="width: 10%;"></td> <td style="width: 10%;"></td> <td style="width: 10%;"></td> <td style="width: 10%;"></td> </tr> <tr> <td></td> <td></td> <td colspan="8" style="text-align: center;"> <table border="1" style="width: 100%; border-collapse: collapse; text-align: center;"> <tr> <td style="width: 10%;"></td> <td style="width: 10%;"></td> <td style="width: 10%;"></td> <td style="width: 10%;"></td> <td style="width: 10%;"></td> <td style="width: 10%;"></td> <td style="width: 10%;"></td> <td style="width: 10%;"></td> <td style="width: 10%;"></td> <td style="width: 10%;"></td> </tr> <tr> <td></td> <td></td> <td colspan="8" style="text-align: center;"> <table border="1" style="width: 100%; border-collapse: collapse; text-align: center;"> <tr> <td style="width: 10%;"></td> <td style="width: 10%;"></td> <td style="width: 10%;"></td> <td style="width: 10%;"></td> <td style="width: 10%;"></td> <td style="width: 10%;"></td> <td style="width: 10%;"></td> <td style="width: 10%;"></td> <td style="width: 10%;"></td> <td style="width: 10%;"></td> </tr> <tr> <td></td> <td></td> <td colspan="8" style="text-align: center;"> <table border="1" style="width: 100%; border-collapse: collapse; text-align: center;"> <tr> <td style="width: 10%;"></td> <td style="width: 10%;"></td> <td style="width: 10%;"></td> <td style="width: 10%;"></td> <td style="width: 10%;"></td> <td style="width: 10%;"></td> <td style="width: 10%;"></td> <td style="width: 10%;"></td> <td style="width: 10%;"></td> <td style="width: 10%;"></td> </tr> <tr> <td></td> <td></td> <td colspan="8" style="text-align: center;"> <table border="1" style="width: 100%; border-collapse: collapse; text-align: center;"> <tr> <td style="width: 10%;"></td> <td style="width: 10%;"></td> <td style="width: 10%;"></td> <td style="width: 10%;"></td> <td style="width: 10%;"></td> <td style="width: 10%;"></td> <td style="width: 10%;"></td> <td style="width: 10%;"></td> <td style="width: 10%;"></td> <td style="width: 10%;"></td> </tr> <tr> <td></td> <td></td> <td colspan="8" style="text-align: center;"> <table border="1" style="width: 100%; border-collapse: collapse; text-align: center;"> <tr> <td style="width: 10%;"></td> <td style="width: 10%;"></td> <td style="width: 10%;"></td> <td style="width: 10%;"></td> <td style="width: 10%;"></td> <td style="width: 10%;"></td> <td style="width: 10%;"></td> <td style="width: 10%;"></td> <td style="width: 10%;"></td> <td style="width: 10%;"></td> </tr> <tr> <td></td> <td></td> <td colspan="8" style="text-align: center;"> <table border="1" style="width: 100%; border-collapse: collapse; text-align: center;"> <tr> <td style="width: 10%;"></td> <td style="width: 10%;"></td> <td style="width: 10%;"></td> <td style="width: 10%;"></td> <td style="width: 10%;"></td> <td style="width: 10%;"></td> <td style="width: 10%;"></td> <td style="width: 10%;"></td> <td style="width: 10%;"></td> <td style="width: 10%;"></td> </tr> <tr> <td></td> <td></td> <td colspan="8" style="text-align: center;"> <table border="1" style="width: 100%; border-collapse: collapse; text-align: center;"> <tr> <td style="width: 10%;"></td> <td style="width: 10%;"></td> <td style="width: 10%;"></td> <td style="width: 10%;"></td> <td style="width: 10%;"></td> <td style="width: 10%;"></td> <td style="width: 10%;"></td> <td style="width: 10%;"></td> <td style="width: 10%;"></td> <td style="width: 10%;"></td> </tr> <tr> <td></td> <td></td> <td colspan="8" style="text-align: center;"> <table border="1" style="width: 100%; border-collapse: collapse; text-align: center;"> <tr> </tr></table></td></tr></table></td></tr></table></td></tr></table></td></tr></table></td></tr></table></td></tr></table></td></tr></table></td></tr></table></td></tr></table></td></tr></table></td></tr></table></td></tr></table></td></tr></table></td></tr></table></td></tr></table></td></tr></table></td></tr></table></td></tr></table></td></tr></table></td></tr></table></td></tr></table></td></tr></table></td></tr></table></td></tr></table></td></tr></table></td></tr></table></td></tr></table></td></tr></table></td></tr></table></td></tr></table></td></tr></table></td></tr></table></td></tr></table></td></tr></table></td></tr></table></td></tr></table></td></tr></table></td></tr></table></td></tr></table></td></tr></table></td></tr></table></td></tr></table></td></tr></table></td></tr></table></td></tr></table></td></tr></table></td></tr></table></td></tr></table>
 | | | | | | | | | | | | | | | | | | | | <table border="1" style="width: 100%; border-collapse: collapse; text-align: center;"> <tr> <td style="width: 10%;"></td> <td style="width: 10%;"></td> <td style="width: 10%;"></td> <td style="width: 10%;"></td> <td style="width: 10%;"></td> <td style="width: 10%;"></td> <td style="width: 10%;"></td> <td style="width: 10%;"></td> <td style="width: 10%;"></td> <td style="width: 10%;"></td> </tr> <tr> <td></td> <td></td> <td colspan="8" style="text-align: center;"> <table border="1" style="width: 100%; border-collapse: collapse; text-align: center;"> <tr> <td style="width: 10%;"></td> <td style="width: 10%;"></td> <td style="width: 10%;"></td> <td style="width: 10%;"></td> <td style="width: 10%;"></td> <td style="width: 10%;"></td> <td style="width: 10%;"></td> <td style="width: 10%;"></td> <td style="width: 10%;"></td> <td style="width: 10%;"></td> </tr> <tr> <td></td> <td></td> <td colspan="8" style="text-align: center;"> <table border="1" style="width: 100%; border-collapse: collapse; text-align: center;"> <tr> <td style="width: 10%;"></td> <td style="width: 10%;"></td> <td style="width: 10%;"></td> <td style="width: 10%;"></td> <td style="width: 10%;"></td> <td style="width: 10%;"></td> <td style="width: 10%;"></td> <td style="width: 10%;"></td> <td style="width: 10%;"></td> <td style="width: 10%;"></td> </tr> <tr> <td></td> <td></td> <td colspan="8" style="text-align: center;"> <table border="1" style="width: 100%; border-collapse: collapse; text-align: center;"> <tr> <td style="width: 10%;"></td> <td style="width: 10%;"></td> <td style="width: 10%;"></td> <td style="width: 10%;"></td> <td style="width: 10%;"></td> <td style="width: 10%;"></td> <td style="width: 10%;"></td> <td style="width: 10%;"></td> <td style="width: 10%;"></td> <td style="width: 10%;"></td> </tr> <tr> <td></td> <td></td> <td colspan="8" style="text-align: center;"> <table border="1" style="width: 100%; border-collapse: collapse; text-align: center;"> <tr> <td style="width: 10%;"></td> <td style="width: 10%;"></td> <td style="width: 10%;"></td> <td style="width: 10%;"></td> <td style="width: 10%;"></td> <td style="width: 10%;"></td> <td style="width: 10%;"></td> <td style="width: 10%;"></td> <td style="width: 10%;"></td> <td style="width: 10%;"></td> </tr> <tr> <td></td> <td></td> <td colspan="8" style="text-align: center;"> <table border="1" style="width: 100%; border-collapse: collapse; text-align: center;"> <tr> <td style="width: 10%;"></td> <td style="width: 10%;"></td> <td style="width: 10%;"></td> <td style="width: 10%;"></td> <td style="width: 10%;"></td> <td style="width: 10%;"></td> <td style="width: 10%;"></td> <td style="width: 10%;"></td> <td style="width: 10%;"></td> <td style="width: 10%;"></td> </tr> <tr> <td></td> <td></td> <td colspan="8" style="text-align: center;"> <table border="1" style="width: 100%; border-collapse: collapse; text-align: center;"> <tr> <td style="width: 10%;"></td> <td style="width: 10%;"></td> <td style="width: 10%;"></td> <td style="width: 10%;"></td> <td style="width: 10%;"></td> <td style="width: 10%;"></td> <td style="width: 10%;"></td> <td style="width: 10%;"></td> <td style="width: 10%;"></td> <td style="width: 10%;"></td> </tr> <tr> <td></td> <td></td> <td colspan="8" style="text-align: center;"> <table border="1" style="width: 100%; border-collapse: collapse; text-align: center;"> <tr> <td style="width: 10%;"></td> <td style="width: 10%;"></td> <td style="width: 10%;"></td> <td style="width: 10%;"></td> <td style="width: 10%;"></td> <td style="width: 10%;"></td> <td style="width: 10%;"></td> <td style="width: 10%;"></td> <td style="width: 10%;"></td> <td style="width: 10%;"></td> </tr> <tr> <td></td> <td></td> <td colspan="8" style="text-align: center;"> <table border="1" style="width: 100%; border-collapse: collapse; text-align: center;"> <tr> <td style="width: 10%;"></td> <td style="width: 10%;"></td> <td style="width: 10%;"></td> <td style="width: 10%;"></td> <td style="width: 10%;"></td> <td style="width: 10%;"></td> <td style="width: 10%;"></td> <td style="width: 10%;"></td> <td style="width: 10%;"></td> <td style="width: 10%;"></td> </tr> <tr> <td></td> <td></td> <td colspan="8" style="text-align: center;"> <table border="1" style="width: 100%; border-collapse: collapse; text-align: center;"> <tr> <td style="width: 10%;"></td> <td style="width: 10%;"></td> <td style="width: 10%;"></td> <td style="width: 10%;"></td> <td style="width: 10%;"></td> <td style="width: 10%;"></td> <td style="width: 10%;"></td> <td style="width: 10%;"></td> <td style="width: 10%;"></td> <td style="width: 10%;"></td> </tr> <tr> <td></td> <td></td> <td colspan="8" style="text-align: center;"> <table border="1" style="width: 100%; border-collapse: collapse; text-align: center;"> <tr> <td style="width: 10%;"></td> <td style="width: 10%;"></td> <td style="width: 10%;"></td> <td style="width: 10%;"></td> <td style="width: 10%;"></td> <td style="width: 10%;"></td> <td style="width: 10%;"></td> <td style="width: 10%;"></td> <td style="width: 10%;"></td> <td style="width: 10%;"></td> </tr> <tr> <td></td> <td></td> <td colspan="8" style="text-align: center;"> <table border="1" style="width: 100%; border-collapse: collapse; text-align: center;"> <tr> <td style="width: 10%;"></td> <td style="width: 10%;"></td> <td style="width: 10%;"></td> <td style="width: 10%;"></td> <td style="width: 10%;"></td> <td style="width: 10%;"></td> <td style="width: 10%;"></td> <td style="width: 10%;"></td> <td style="width: 10%;"></td> <td style="width: 10%;"></td> </tr> <tr> <td></td> <td></td> <td colspan="8" style="text-align: center;"> <table border="1" style="width: 100%; border-collapse: collapse; text-align: center;"> <tr> <td style="width: 10%;"></td> <td style="width: 10%;"></td> <td style="width: 10%;"></td> <td style="width: 10%;"></td> <td style="width: 10%;"></td> <td style="width: 10%;"></td> <td style="width: 10%;"></td> <td style="width: 10%;"></td> <td style="width: 10%;"></td> <td style="width: 10%;"></td> </tr> <tr> <td></td> <td></td> <td colspan="8" style="text-align: center;"> <table border="1" style="width: 100%; border-collapse: collapse; text-align: center;"> <tr> <td style="width: 10%;"></td> <td style="width: 10%;"></td> <td style="width: 10%;"></td> <td style="width: 10%;"></td> <td style="width: 10%;"></td> <td style="width: 10%;"></td> <td style="width: 10%;"></td> <td style="width: 10%;"></td> <td style="width: 10%;"></td> <td style="width: 10%;"></td> </tr> <tr> <td></td> <td></td> <td colspan="8" style="text-align: center;"> <table border="1" style="width: 100%; border-collapse: collapse; text-align: center;"> <tr> <td style="width: 10%;"></td> <td style="width: 10%;"></td> <td style="width: 10%;"></td> <td style="width: 10%;"></td> <td style="width: 10%;"></td> <td style="width: 10%;"></td> <td style="width: 10%;"></td> <td style="width: 10%;"></td> <td style="width: 10%;"></td> <td style="width: 10%;"></td> </tr> <tr> <td></td> <td></td> <td colspan="8" style="text-align: center;"> <table border="1" style="width: 100%; border-collapse: collapse; text-align: center;"> <tr> <td style="width: 10%;"></td> <td style="width: 10%;"></td> <td style="width: 10%;"></td> <td style="width: 10%;"></td> <td style="width: 10%;"></td> <td style="width: 10%;"></td> <td style="width: 10%;"></td> <td style="width: 10%;"></td> <td style="width: 10%;"></td> <td style="width: 10%;"></td> </tr> <tr> <td></td> <td></td> <td colspan="8" style="text-align: center;"> <table border="1" style="width: 100%; border-collapse: collapse; text-align: center;"> <tr> <td style="width: 10%;"></td> <td style="width: 10%;"></td> <td style="width: 10%;"></td> <td style="width: 10%;"></td> <td style="width: 10%;"></td> <td style="width: 10%;"></td> <td
style="width: 10%;"></td> <td style="width: 10%;"></td> <td style="width: 10%;"></td> <td style="width: 10%;"></td> </tr> <tr> <td></td> <td></td> <td colspan="8" style="text-align: center;"> <table border="1" style="width: 100%; border-collapse: collapse; text-align: center;"> <tr> <td style="width: 10%;"></td> <td style="width: 10%;"></td> <td style="width: 10%;"></td> <td style="width: 10%;"></td> <td style="width: 10%;"></td> <td style="width: 10%;"></td> <td style="width: 10%;"></td> <td style="width: 10%;"></td> <td style="width: 10%;"></td> <td style="width: 10%;"></td> </tr> <tr> <td></td> <td></td> <td colspan="8" style="text-align: center;"> <table border="1" style="width: 100%; border-collapse: collapse; text-align: center;"> <tr> <td style="width: 10%;"></td> <td style="width: 10%;"></td> <td style="width: 10%;"></td> <td style="width: 10%;"></td> <td style="width: 10%;"></td> <td style="width: 10%;"></td> <td style="width: 10%;"></td> <td style="width: 10%;"></td> <td style="width: 10%;"></td> <td style="width: 10%;"></td> </tr> <tr> <td></td> <td></td> <td colspan="8" style="text-align: center;"> <table border="1" style="width: 100%; border-collapse: collapse; text-align: center;"> <tr> <td style="width: 10%;"></td> <td style="width: 10%;"></td> <td style="width: 10%;"></td> <td style="width: 10%;"></td> <td style="width: 10%;"></td> <td style="width: 10%;"></td> <td style="width: 10%;"></td> <td style="width: 10%;"></td> <td style="width: 10%;"></td> <td style="width: 10%;"></td> </tr> <tr> <td></td> <td></td> <td colspan="8" style="text-align: center;"> <table border="1" style="width: 100%; border-collapse: collapse; text-align: center;"> <tr> <td style="width: 10%;"></td> <td style="width: 10%;"></td> <td style="width: 10%;"></td> <td style="width: 10%;"></td> <td style="width: 10%;"></td> <td style="width: 10%;"></td> <td style="width: 10%;"></td> <td style="width: 10%;"></td> <td style="width: 10%;"></td> <td style="width: 10%;"></td> </tr> <tr> <td></td> <td></td> <td colspan="8" style="text-align: center;"> <table border="1" style="width: 100%; border-collapse: collapse; text-align: center;"> <tr> <td style="width: 10%;"></td> <td style="width: 10%;"></td> <td style="width: 10%;"></td> <td style="width: 10%;"></td> <td style="width: 10%;"></td> <td style="width: 10%;"></td> <td style="width: 10%;"></td> <td style="width: 10%;"></td> <td style="width: 10%;"></td> <td style="width: 10%;"></td> </tr> <tr> <td></td> <td></td> <td colspan="8" style="text-align: center;"> <table border="1" style="width: 100%; border-collapse: collapse; text-align: center;"> <tr> <td style="width: 10%;"></td> <td style="width: 10%;"></td> <td style="width: 10%;"></td> <td style="width: 10%;"></td> <td style="width: 10%;"></td> <td style="width: 10%;"></td> <td style="width: 10%;"></td> <td style="width: 10%;"></td> <td style="width: 10%;"></td> <td style="width: 10%;"></td> </tr> <tr> <td></td> <td></td> <td colspan="8" style="text-align: center;"> <table border="1" style="width: 100%; border-collapse: collapse; text-align: center;"> <tr> <td style="width: 10%;"></td> <td style="width: 10%;"></td> <td style="width: 10%;"></td> <td style="width: 10%;"></td> <td style="width: 10%;"></td> <td style="width: 10%;"></td> <td style="width: 10%;"></td> <td style="width: 10%;"></td> <td style="width: 10%;"></td> <td style="width: 10%;"></td> </tr> <tr> <td></td> <td></td> <td colspan="8" style="text-align: center;"> <table border="1" style="width: 100%; border-collapse: collapse; text-align: center;"> <tr> <td style="width: 10%;"></td> <td style="width: 10%;"></td> <td style="width: 10%;"></td> <td style="width: 10%;"></td> <td style="width: 10%;"></td> <td style="width: 10%;"></td> <td style="width: 10%;"></td> <td style="width: 10%;"></td> <td style="width: 10%;"></td> <td style="width: 10%;"></td> </tr> <tr> <td></td> <td></td> <td colspan="8" style="text-align: center;"> <table border="1" style="width: 100%; border-collapse: collapse; text-align: center;"> <tr> <td style="width: 10%;"></td> <td style="width: 10%;"></td> <td style="width: 10%;"></td> <td style="width: 10%;"></td> <td style="width: 10%;"></td> <td style="width: 10%;"></td> <td style="width: 10%;"></td> <td style="width: 10%;"></td> <td style="width: 10%;"></td> <td style="width: 10%;"></td> </tr> <tr> <td></td> <td></td> <td colspan="8" style="text-align: center;"> <table border="1" style="width: 100%; border-collapse: collapse; text-align: center;"> <tr> <td style="width: 10%;"></td> <td style="width: 10%;"></td> <td style="width: 10%;"></td> <td style="width: 10%;"></td> <td style="width: 10%;"></td> <td style="width: 10%;"></td> <td style="width: 10%;"></td> <td style="width: 10%;"></td> <td style="width: 10%;"></td> <td style="width: 10%;"></td> </tr> <tr> <td></td> <td></td> <td colspan="8" style="text-align: center;"> <table border="1" style="width: 100%; border-collapse: collapse; text-align: center;"> <tr> <td style="width: 10%;"></td> <td style="width: 10%;"></td> <td style="width: 10%;"></td> <td style="width: 10%;"></td> <td style="width: 10%;"></td> <td style="width: 10%;"></td> <td style="width: 10%;"></td> <td style="width: 10%;"></td> <td style="width: 10%;"></td> <td style="width: 10%;"></td> </tr> <tr> <td></td> <td></td> <td colspan="8" style="text-align: center;"> <table border="1" style="width: 100%; border-collapse: collapse; text-align: center;"> <tr> <td style="width: 10%;"></td> <td style="width: 10%;"></td> <td style="width: 10%;"></td> <td style="width: 10%;"></td> <td style="width: 10%;"></td> <td style="width: 10%;"></td> <td style="width: 10%;"></td> <td style="width: 10%;"></td> <td style="width: 10%;"></td> <td style="width: 10%;"></td> </tr> <tr> <td></td> <td></td> <td colspan="8" style="text-align: center;"> <table border="1" style="width: 100%; border-collapse: collapse; text-align: center;"> <tr> <td style="width: 10%;"></td> <td style="width: 10%;"></td> <td style="width: 10%;"></td> <td style="width: 10%;"></td> <td style="width: 10%;"></td> <td style="width: 10%;"></td> <td style="width: 10%;"></td> <td style="width: 10%;"></td> <td style="width: 10%;"></td> <td style="width: 10%;"></td> </tr> <tr> <td></td> <td></td> <td colspan="8" style="text-align: center;"> <table border="1" style="width: 100%; border-collapse: collapse; text-align: center;"> <tr> <td style="width: 10%;"></td> <td style="width: 10%;"></td> <td style="width: 10%;"></td> <td style="width: 10%;"></td> <td style="width: 10%;"></td> <td style="width: 10%;"></td> <td style="width: 10%;"></td> <td style="width: 10%;"></td> <td style="width: 10%;"></td> <td style="width: 10%;"></td> </tr> <tr> <td></td> <td></td> <td colspan="8" style="text-align: center;"> <table border="1" style="width: 100%; border-collapse: collapse; text-align: center;"> <tr> <td style="width: 10%;"></td> <td style="width: 10%;"></td> <td style="width: 10%;"></td> <td style="width: 10%;"></td> <td style="width: 10%;"></td> <td style="width: 10%;"></td> <td style="width: 10%;"></td> <td style="width: 10%;"></td> <td style="width: 10%;"></td> <td style="width: 10%;"></td> </tr> <tr> <td></td> <td></td> <td colspan="8" style="text-align: center;"> <table border="1" style="width: 100%; border-collapse: collapse; text-align: center;"> <tr> <td style="width: 10%;"></td> <td style="width: 10%;"></td> <td style="width: 10%;"></td> <td style="width: 10%;"></td> <td style="width: 10%;"></td> <td style="width: 10%;"></td> <td style="width: 10%;"></td> <td style="width: 10%;"></td> <td style="width: 10%;"></td> <td style="width: 10%;"></td> </tr> <tr> <td></td> <td></td> <td colspan="8" style="text-align: center;"> <table border="1" style="width: 100%; border-collapse: collapse; text-align: center;"> <tr> <td style="width: 10%;"></td> <td style="width: 10%;"></td> <td style="width: 10%;"></td> <td style="width: 10%;"></td> <td style="width: 10%;"></td> <td style="width: 10%;"></td> <td style="width: 10%;"></td> <td style="width: 10%;"></td> <td style="width: 10%;"></td> <td style="width: 10%;"></td> </tr> <tr> <td></td> <td></td> <td colspan="8" style="text-align: center;"> <table border="1" style="width: 100%; border-collapse: collapse; text-align: center;"> <tr> <td style="width: 10%;"></td> <td style="width: 10%;"></td> <td style="width: 10%;"></td> <td style="width: 10%;"></td> <td style="width: 10%;"></td> <td style="width: 10%;"></td> <td style="width: 10%;"></td> <td style="width: 10%;"></td> <td style="width: 10%;"></td> <td style="width: 10%;"></td> </tr> <tr> <td></td> <td></td> <td colspan="8" style="text-align: center;"> <table border="1" style="width: 100%; border-collapse: collapse; text-align: center;"> <tr> <td style="width: 10%;"></td> <td style="width: 10%;"></td> <td style="width: 10%;"></td> <td style="width: 10%;"></td> <td style="width: 10%;"></td> <td style="width: 10%;"></td> <td style="width: 10%;"></td> <td style="width: 10%;"></td> <td style="width: 10%;"></td> <td style="width: 10%;"></td> </tr> <tr> <td></td> <td></td> <td colspan="8" style="text-align: center;"> <table border="1" style="width: 100%; border-collapse: collapse; text-align: center;"> <tr> <td style="width: 10%;"></td> <td style="width: 10%;"></td> <td style="width: 10%;"></td> <td style="width: 10%;"></td> <td style="width: 10%;"></td> <td style="width: 10%;"></td> <td style="width: 10%;"></td> <td style="width: 10%;"></td> <td style="width: 10%;"></td> <td style="width: 10%;"></td> </tr> <tr> <td></td> <td></td> <td colspan="8" style="text-align: center;"> <table border="1" style="width: 100%; border-collapse: collapse; text-align: center;"> <tr> <td style="width: 10%;"></td> <td style="width: 10%;"></td> <td style="width: 10%;"></td> <td style="width: 10%;"></td> <td style="width: 10%;"></td> <td style="width: 10%;"></td> <td style="width: 10%;"></td> <td style="width: 10%;"></td> <td style="width: 10%;"></td> <td style="width: 10%;"></td> </tr> <tr> <td></td> <td></td> <td colspan="8"
style="text-align: center;"> <table border="1" style="width: 100%; border-collapse: collapse; text-align: center;"> <tr> <td style="width: 10%;"></td> <td style="width: 10%;"></td> <td style="width: 10%;"></td> <td style="width: 10%;"></td> <td style="width: 10%;"></td> <td style="width: 10%;"></td> <td style="width: 10%;"></td> <td style="width: 10%;"></td> <td style="width: 10%;"></td> <td style="width: 10%;"></td> </tr> <tr> <td></td> <td></td> <td colspan="8" style="text-align: center;"> <table border="1" style="width: 100%; border-collapse: collapse; text-align: center;"> <tr> <td style="width: 10%;"></td> <td style="width: 10%;"></td> <td style="width: 10%;"></td> <td style="width: 10%;"></td> <td style="width: 10%;"></td> <td style="width: 10%;"></td> <td style="width: 10%;"></td> <td style="width: 10%;"></td> <td style="width: 10%;"></td> <td style="width: 10%;"></td> </tr> <tr> <td></td> <td></td> <td colspan="8" style="text-align: center;"> <table border="1" style="width: 100%; border-collapse: collapse; text-align: center;"> <tr> <td style="width: 10%;"></td> <td style="width: 10%;"></td> <td style="width: 10%;"></td> <td style="width: 10%;"></td> <td style="width: 10%;"></td> <td style="width: 10%;"></td> <td style="width: 10%;"></td> <td style="width: 10%;"></td> <td style="width: 10%;"></td> <td style="width: 10%;"></td> </tr> <tr> <td></td> <td></td> <td colspan="8" style="text-align: center;"> <table border="1" style="width: 100%; border-collapse: collapse; text-align: center;"> <tr> <td style="width: 10%;"></td> <td style="width: 10%;"></td> <td style="width: 10%;"></td> <td style="width: 10%;"></td> <td style="width: 10%;"></td> <td style="width: 10%;"></td> <td style="width: 10%;"></td> <td style="width: 10%;"></td> <td style="width: 10%;"></td> <td style="width: 10%;"></td> </tr> <tr> <td></td> <td></td> <td colspan="8" style="text-align: center;"> <table border="1" style="width: 100%; border-collapse: collapse; text-align: center;"> <tr> <td style="width: 10%;"></td> <td style="width: 10%;"></td> <td style="width: 10%;"></td> <td style="width: 10%;"></td> <td style="width: 10%;"></td> <td style="width: 10%;"></td> <td style="width: 10%;"></td> <td style="width: 10%;"></td> <td style="width: 10%;"></td> <td style="width: 10%;"></td> </tr> <tr> <td></td> <td></td> <td colspan="8" style="text-align: center;"> <table border="1" style="width: 100%; border-collapse: collapse; text-align: center;"> <tr> <td style="width: 10%;"></td> <td style="width: 10%;"></td> <td style="width: 10%;"></td> <td style="width: 10%;"></td> <td style="width: 10%;"></td> <td style="width: 10%;"></td> <td style="width: 10%;"></td> <td style="width: 10%;"></td> <td style="width: 10%;"></td> <td style="width: 10%;"></td> </tr> <tr> <td></td> <td></td> <td colspan="8" style="text-align: center;"> <table border="1" style="width: 100%; border-collapse: collapse; text-align: center;"> <tr> <td style="width: 10%;"></td> <td style="width: 10%;"></td> <td style="width: 10%;"></td> <td style="width: 10%;"></td> <td style="width: 10%;"></td> <td style="width: 10%;"></td> <td style="width: 10%;"></td> <td style="width: 10%;"></td> <td style="width: 10%;"></td> <td style="width: 10%;"></td> </tr> <tr> <td></td> <td></td> <td colspan="8" style="text-align: center;"> <table border="1" style="width: 100%; border-collapse: collapse; text-align: center;"> <tr> <td style="width: 10%;"></td> <td style="width: 10%;"></td> <td style="width: 10%;"></td> <td style="width: 10%;"></td> <td style="width: 10%;"></td> <td style="width: 10%;"></td> <td style="width: 10%;"></td> <td style="width: 10%;"></td> <td style="width: 10%;"></td> <td style="width: 10%;"></td> </tr> <tr> <td></td> <td></td> <td colspan="8" style="text-align: center;"> <table border="1" style="width: 100%; border-collapse: collapse; text-align: center;"> <tr> <td style="width: 10%;"></td> <td style="width: 10%;"></td> <td style="width: 10%;"></td> <td style="width: 10%;"></td> <td style="width: 10%;"></td> <td style="width: 10%;"></td> <td style="width: 10%;"></td> <td style="width: 10%;"></td> <td style="width: 10%;"></td> <td style="width: 10%;"></td> </tr> <tr> <td></td> <td></td> <td colspan="8" style="text-align: center;"> <table border="1" style="width: 100%; border-collapse: collapse; text-align: center;"> <tr> </tr></table></td></tr></table></td></tr></table></td></tr></table></td></tr></table></td></tr></table></td></tr></table></td></tr></table></td></tr></table></td></tr></table></td></tr></table></td></tr></table></td></tr></table></td></tr></table></td></tr></table></td></tr></table></td></tr></table></td></tr></table></td></tr></table></td></tr></table></td></tr></table></td></tr></table></td></tr></table></td></tr></table></td></tr></table></td></tr></table></td></tr></table></td></tr></table></td></tr></table></td></tr></table></td></tr></table></td></tr></table></td></tr></table></td></tr></table></td></tr></table></td></tr></table></td></tr></table></td></tr></table></td></tr></table></td></tr></table></td></tr></table></td></tr></table></td></tr></table></td></tr></table></td></tr></table></td></tr></table></td></tr></table></td></tr></table>
 | | | | | | | | | | | | | | | | | | | | <table border="1" style="width: 100%; border-collapse: collapse; text-align: center;"> <tr> <td style="width: 10%;"></td> <td style="width: 10%;"></td> <td style="width: 10%;"></td> <td style="width: 10%;"></td> <td style="width: 10%;"></td> <td style="width: 10%;"></td> <td style="width: 10%;"></td> <td style="width: 10%;"></td> <td style="width: 10%;"></td> <td style="width: 10%;"></td> </tr> <tr> <td></td> <td></td> <td colspan="8" style="text-align: center;"> <table border="1" style="width: 100%; border-collapse: collapse; text-align: center;"> <tr> <td style="width: 10%;"></td> <td style="width: 10%;"></td> <td style="width: 10%;"></td> <td style="width: 10%;"></td> <td style="width: 10%;"></td> <td style="width: 10%;"></td> <td style="width: 10%;"></td> <td style="width: 10%;"></td> <td style="width: 10%;"></td> <td style="width: 10%;"></td> </tr> <tr> <td></td> <td></td> <td colspan="8" style="text-align: center;"> <table border="1" style="width: 100%; border-collapse: collapse; text-align: center;"> <tr> <td style="width: 10%;"></td> <td style="width: 10%;"></td> <td style="width: 10%;"></td> <td style="width: 10%;"></td> <td style="width: 10%;"></td> <td style="width: 10%;"></td> <td style="width: 10%;"></td> <td style="width: 10%;"></td> <td style="width: 10%;"></td> <td style="width: 10%;"></td> </tr> <tr> <td></td> <td></td> <td colspan="8" style="text-align: center;"> <table border="1" style="width: 100%; border-collapse: collapse; text-align: center;"> <tr> <td style="width: 10%;"></td> <td style="width: 10%;"></td> <td style="width: 10%;"></td> <td style="width: 10%;"></td> <td style="width: 10%;"></td> <td style="width: 10%;"></td> <td style="width: 10%;"></td> <td style="width: 10%;"></td> <td style="width: 10%;"></td> <td style="width: 10%;"></td> </tr> <tr> <td></td> <td></td> <td colspan="8" style="text-align: center;"> <table border="1" style="width: 100%; border-collapse: collapse; text-align: center;"> <tr> <td style="width: 10%;"></td> <td style="width: 10%;"></td> <td style="width: 10%;"></td> <td style="width: 10%;"></td> <td style="width: 10%;"></td> <td style="width: 10%;"></td> <td style="width: 10%;"></td> <td style="width: 10%;"></td> <td style="width: 10%;"></td> <td style="width: 10%;"></td> </tr> <tr> <td></td> <td></td> <td colspan="8" style="text-align: center;"> <table border="1" style="width: 100%; border-collapse: collapse; text-align: center;"> <tr> <td style="width: 10%;"></td> <td style="width: 10%;"></td> <td style="width: 10%;"></td> <td style="width: 10%;"></td> <td style="width: 10%;"></td> <td style="width: 10%;"></td> <td style="width: 10%;"></td> <td style="width: 10%;"></td> <td style="width: 10%;"></td> <td style="width: 10%;"></td> </tr> <tr> <td></td> <td></td> <td colspan="8" style="text-align: center;"> <table border="1" style="width: 100%; border-collapse: collapse; text-align: center;"> <tr> <td style="width: 10%;"></td> <td style="width: 10%;"></td> <td style="width: 10%;"></td> <td style="width: 10%;"></td> <td style="width: 10%;"></td> <td style="width: 10%;"></td> <td style="width: 10%;"></td> <td style="width: 10%;"></td> <td style="width: 10%;"></td> <td style="width: 10%;"></td> </tr> <tr> <td></td> <td></td> <td colspan="8" style="text-align: center;"> <table border="1" style="width: 100%; border-collapse: collapse; text-align: center;"> <tr> <td style="width: 10%;"></td> <td style="width: 10%;"></td> <td style="width: 10%;"></td> <td style="width: 10%;"></td> <td style="width: 10%;"></td> <td style="width: 10%;"></td> <td style="width: 10%;"></td> <td style="width: 10%;"></td> <td style="width: 10%;"></td> <td style="width: 10%;"></td> </tr> <tr> <td></td> <td></td> <td colspan="8" style="text-align: center;"> <table border="1" style="width: 100%; border-collapse: collapse; text-align: center;"> <tr> <td style="width: 10%;"></td> <td style="width: 10%;"></td> <td style="width: 10%;"></td> <td style="width: 10%;"></td> <td style="width: 10%;"></td> <td style="width: 10%;"></td> <td style="width: 10%;"></td> <td style="width: 10%;"></td> <td style="width: 10%;"></td> <td style="width: 10%;"></td> </tr> <tr> <td></td> <td></td> <td colspan="8" style="text-align: center;"> <table border="1" style="width: 100%; border-collapse: collapse; text-align: center;"> <tr> <td style="width: 10%;"></td> <td style="width: 10%;"></td> <td style="width: 10%;"></td> <td style="width: 10%;"></td> <td style="width: 10%;"></td> <td style="width: 10%;"></td> <td style="width: 10%;"></td> <td style="width: 10%;"></td> <td style="width: 10%;"></td> <td style="width: 10%;"></td> </tr> <tr> <td></td> <td></td> <td colspan="8" style="text-align: center;"> <table border="1" style="width: 100%; border-collapse: collapse; text-align: center;"> <tr> <td style="width: 10%;"></td> <td style="width: 10%;"></td> <td style="width: 10%;"></td> <td style="width: 10%;"></td> <td style="width: 10%;"></td> <td style="width: 10%;"></td> <td style="width: 10%;"></td> <td style="width: 10%;"></td> <td style="width: 10%;"></td> <td style="width: 10%;"></td> </tr> <tr> <td></td> <td></td> <td colspan="8" style="text-align: center;"> <table border="1" style="width: 100%; border-collapse: collapse; text-align: center;"> <tr> <td style="width: 10%;"></td> <td style="width: 10%;"></td> <td style="width: 10%;"></td> <td style="width: 10%;"></td> <td style="width: 10%;"></td> <td style="width: 10%;"></td> <td style="width: 10%;"></td> <td style="width: 10%;"></td> <td style="width: 10%;"></td> <td style="width: 10%;"></td> </tr> <tr> <td></td> <td></td> <td colspan="8" style="text-align: center;"> <table border="1" style="width: 100%; border-collapse: collapse; text-align: center;"> <tr> <td style="width: 10%;"></td> <td style="width: 10%;"></td> <td style="width: 10%;"></td> <td style="width: 10%;"></td> <td style="width: 10%;"></td> <td style="width: 10%;"></td> <td style="width: 10%;"></td> <td style="width: 10%;"></td> <td style="width: 10%;"></td> <td style="width: 10%;"></td> </tr> <tr> <td></td> <td></td> <td colspan="8" style="text-align: center;"> <table border="1" style="width: 100%; border-collapse: collapse; text-align: center;"> <tr> <td style="width: 10%;"></td> <td style="width: 10%;"></td> <td style="width: 10%;"></td> <td style="width: 10%;"></td> <td style="width: 10%;"></td> <td style="width: 10%;"></td> <td style="width: 10%;"></td> <td style="width: 10%;"></td> <td style="width: 10%;"></td> <td style="width: 10%;"></td> </tr> <tr> <td></td> <td></td> <td colspan="8" style="text-align: center;"> <table border="1" style="width: 100%; border-collapse: collapse; text-align: center;"> <tr> <td style="width: 10%;"></td> <td style="width: 10%;"></td> <td style="width: 10%;"></td> <td style="width: 10%;"></td> <td style="width: 10%;"></td> <td style="width: 10%;"></td> <td style="width: 10%;"></td> <td style="width: 10%;"></td> <td style="width: 10%;"></td> <td style="width: 10%;"></td> </tr> <tr> <td></td> <td></td> <td colspan="8" style="text-align: center;"> <table border="1" style="width: 100%; border-collapse: collapse; text-align: center;"> <tr> <td style="width: 10%;"></td> <td style="width: 10%;"></td> <td style="width: 10%;"></td> <td style="width: 10%;"></td> <td style="width: 10%;"></td> <td style="width: 10%;"></td> <td style="width: 10%;"></td> <td style="width: 10%;"></td> <td style="width: 10%;"></td> <td style="width: 10%;"></td> </tr> <tr> <td></td> <td></td> <td colspan="8" style="text-align: center;"> <table border="1" style="width: 100%; border-collapse: collapse; text-align: center;"> <tr> <td style="width: 10%;"></td> <td style="width: 10%;"></td> <td style="width: 10%;"></td> <td style="width: 10%;"></td> <td style="width: 10%;"></td> <td style="width: 10%;"></td> <td style="width: 10%;"></td> <td style="width: 10%;"></td> <td style="width: 10%;"></td> <td style="width: 10%;"></td> </tr> <tr> <td></td> <td></td> <td colspan="8" style="text-align: center;"> <table border="1" style="width: 100%; border-collapse: collapse; text-align: center;"> <tr> <td style="width: 10%;"></td> <td style="width: 10%;"></td> <td style="width: 10%;"></td> <td style="width: 10%;"></td> <td style="width: 10%;"></td> <td style="width: 10%;"></td> <td style="width: 10%;"></td> <td style="width: 10%;"></td> <td style="width: 10%;"></td> <td style="width: 10%;"></td> </tr> <tr> <td></td> <td></td> <td colspan="8" style="text-align: center;">
<table border="1" style="width: 100%; border-collapse: collapse; text-align: center;"> <tr> <td style="width: 10%;"></td> <td style="width: 10%;"></td> <td style="width: 10%;"></td> <td style="width: 10%;"></td> <td style="width: 10%;"></td> <td style="width: 10%;"></td> <td style="width: 10%;"></td> <td style="width: 10%;"></td> <td style="width: 10%;"></td> <td style="width: 10%;"></td> </tr> <tr> <td></td> <td></td> <td colspan="8" style="text-align: center;"> <table border="1" style="width: 100%; border-collapse: collapse; text-align: center;"> <tr> <td style="width: 10%;"></td> <td style="width: 10%;"></td> <td style="width: 10%;"></td> <td style="width: 10%;"></td> <td style="width: 10%;"></td> <td style="width: 10%;"></td> <td style="width: 10%;"></td> <td style="width: 10%;"></td> <td style="width: 10%;"></td> <td style="width: 10%;"></td> </tr> <tr> <td></td> <td></td> <td colspan="8" style="text-align: center;"> <table border="1" style="width: 100%; border-collapse: collapse; text-align: center;"> <tr> <td style="width: 10%;"></td> <td style="width: 10%;"></td> <td style="width: 10%;"></td> <td style="width: 10%;"></td> <td style="width: 10%;"></td> <td style="width: 10%;"></td> <td style="width: 10%;"></td> <td style="width: 10%;"></td> <td style="width: 10%;"></td> <td style="width: 10%;"></td> </tr> <tr> <td></td> <td></td> <td colspan="8" style="text-align: center;"> <table border="1" style="width: 100%; border-collapse: collapse; text-align: center;"> <tr> <td style="width: 10%;"></td> <td style="width: 10%;"></td> <td style="width: 10%;"></td> <td style="width: 10%;"></td> <td style="width: 10%;"></td> <td style="width: 10%;"></td> <td style="width: 10%;"></td> <td style="width: 10%;"></td> <td style="width: 10%;"></td> <td style="width: 10%;"></td> </tr> <tr> <td></td> <td></td> <td colspan="8" style="text-align: center;"> <table border="1" style="width: 100%; border-collapse: collapse; text-align: center;"> <tr> <td style="width: 10%;"></td> <td style="width: 10%;"></td> <td style="width: 10%;"></td> <td style="width: 10%;"></td> <td style="width: 10%;"></td> <td style="width: 10%;"></td> <td style="width: 10%;"></td> <td style="width: 10%;"></td> <td style="width: 10%;"></td> <td style="width: 10%;"></td> </tr> <tr> <td></td> <td></td> <td colspan="8" style="text-align: center;"> <table border="1" style="width: 100%; border-collapse: collapse; text-align: center;"> <tr> <td style="width: 10%;"></td> <td style="width: 10%;"></td> <td style="width: 10%;"></td> <td style="width: 10%;"></td> <td style="width: 10%;"></td> <td style="width: 10%;"></td> <td style="width: 10%;"></td> <td style="width: 10%;"></td> <td style="width: 10%;"></td> <td style="width: 10%;"></td> </tr> <tr> <td></td> <td></td> <td colspan="8" style="text-align: center;"> <table border="1" style="width: 100%; border-collapse: collapse; text-align: center;"> <tr> <td style="width: 10%;"></td> <td style="width: 10%;"></td> <td style="width: 10%;"></td> <td style="width: 10%;"></td> <td style="width: 10%;"></td> <td style="width: 10%;"></td> <td style="width: 10%;"></td> <td style="width: 10%;"></td> <td style="width: 10%;"></td> <td style="width: 10%;"></td> </tr> <tr> <td></td> <td></td> <td colspan="8" style="text-align: center;"> <table border="1" style="width: 100%; border-collapse: collapse; text-align: center;"> <tr> <td style="width: 10%;"></td> <td style="width: 10%;"></td> <td style="width: 10%;"></td> <td style="width: 10%;"></td> <td style="width: 10%;"></td> <td style="width: 10%;"></td> <td style="width: 10%;"></td> <td style="width: 10%;"></td> <td style="width: 10%;"></td> <td style="width: 10%;"></td> </tr> <tr> <td></td> <td></td> <td colspan="8" style="text-align: center;"> <table border="1" style="width: 100%; border-collapse: collapse; text-align: center;"> <tr> <td style="width: 10%;"></td> <td style="width: 10%;"></td> <td style="width: 10%;"></td> <td style="width: 10%;"></td> <td style="width: 10%;"></td> <td style="width: 10%;"></td> <td style="width: 10%;"></td> <td style="width: 10%;"></td> <td style="width: 10%;"></td> <td style="width: 10%;"></td> </tr> <tr> <td></td> <td></td> <td colspan="8" style="text-align: center;"> <table border="1" style="width: 100%; border-collapse: collapse; text-align: center;"> <tr> <td style="width: 10%;"></td> <td style="width: 10%;"></td> <td style="width: 10%;"></td> <td style="width: 10%;"></td> <td style="width: 10%;"></td> <td style="width: 10%;"></td> <td style="width: 10%;"></td> <td style="width: 10%;"></td> <td style="width: 10%;"></td> <td style="width: 10%;"></td> </tr> <tr> <td></td> <td></td> <td colspan="8" style="text-align: center;"> <table border="1" style="width: 100%; border-collapse: collapse; text-align: center;"> <tr> <td style="width: 10%;"></td> <td style="width: 10%;"></td> <td style="width: 10%;"></td> <td style="width: 10%;"></td> <td style="width: 10%;"></td> <td style="width: 10%;"></td> <td style="width: 10%;"></td> <td style="width: 10%;"></td> <td style="width: 10%;"></td> <td style="width: 10%;"></td> </tr> <tr> <td></td> <td></td> <td colspan="8" style="text-align: center;"> <table border="1" style="width: 100%; border-collapse: collapse; text-align: center;"> <tr> <td style="width: 10%;"></td> <td style="width: 10%;"></td> <td style="width: 10%;"></td> <td style="width: 10%;"></td> <td style="width: 10%;"></td> <td style="width: 10%;"></td> <td style="width: 10%;"></td> <td style="width: 10%;"></td> <td style="width: 10%;"></td> <td style="width: 10%;"></td> </tr> <tr> <td></td> <td></td> <td colspan="8" style="text-align: center;"> <table border="1" style="width: 100%; border-collapse: collapse; text-align: center;"> <tr> <td style="width: 10%;"></td> <td style="width: 10%;"></td> <td style="width: 10%;"></td> <td style="width: 10%;"></td> <td style="width: 10%;"></td> <td style="width: 10%;"></td> <td style="width: 10%;"></td> <td style="width: 10%;"></td> <td style="width: 10%;"></td> <td style="width: 10%;"></td> </tr> <tr> <td></td> <td></td> <td colspan="8" style="text-align: center;"> <table border="1" style="width: 100%; border-collapse: collapse; text-align: center;"> <tr> <td style="width: 10%;"></td> <td style="width: 10%;"></td> <td style="width: 10%;"></td> <td style="width: 10%;"></td> <td style="width: 10%;"></td> <td style="width: 10%;"></td> <td style="width: 10%;"></td> <td style="width: 10%;"></td> <td style="width: 10%;"></td> <td style="width: 10%;"></td> </tr> <tr> <td></td> <td></td> <td colspan="8" style="text-align: center;"> <table border="1" style="width: 100%; border-collapse: collapse; text-align: center;"> <tr> <td style="width: 10%;"></td> <td style="width: 10%;"></td> <td style="width: 10%;"></td> <td style="width: 10%;"></td> <td style="width: 10%;"></td> <td style="width: 10%;"></td> <td style="width: 10%;"></td> <td style="width: 10%;"></td> <td style="width: 10%;"></td> <td style="width: 10%;"></td> </tr> <tr> <td></td> <td></td> <td colspan="8" style="text-align: center;"> <table border="1" style="width: 100%; border-collapse: collapse; text-align: center;"> <tr> <td style="width: 10%;"></td> <td style="width: 10%;"></td> <td style="width: 10%;"></td> <td style="width: 10%;"></td> <td style="width: 10%;"></td> <td style="width: 10%;"></td> <td style="width: 10%;"></td> <td style="width: 10%;"></td> <td style="width: 10%;"></td> <td style="width: 10%;"></td> </tr> <tr> <td></td> <td></td> <td colspan="8" style="text-align: center;"> <table border="1" style="width: 100%; border-collapse: collapse; text-align: center;"> <tr> <td style="width: 10%;"></td> <td style="width: 10%;"></td> <td style="width: 10%;"></td> <td style="width: 10%;"></td> <td style="width: 10%;"></td> <td style="width: 10%;"></td> <td style="width: 10%;"></td> <td style="width: 10%;"></td> <td style="width: 10%;"></td> <td style="width: 10%;"></td> </tr> <tr> <td></td> <td></td> <td colspan="8" style="text-align: center;"> <table border="1" style="width: 100%; border-collapse: collapse; text-align: center;"> <tr> <td style="width: 10%;"></td> <td style="width: 10%;"></td> <td style="width: 10%;"></td> <td style="width: 10%;"></td> <td style="width: 10%;"></td> <td style="width: 10%;"></td> <td style="width: 10%;"></td> <td style="width: 10%;"></td> <td style="width: 10%;"></td> <td style="width: 10%;"></td> </tr> <tr> <td></td> <td></td> <td colspan="8" style="text-align: center;"> <table border="1" style="width: 100%; border-collapse: collapse; text-align: center;"> <tr> <td style="width: 10%;"></td> <td style="width: 10%;"></td> <td style="width: 10%;"></td> <td style="width: 10%;"></td> <td style="width: 10%;"></td> <td style="width: 10%;"></td> <td style="width: 10%;"></td> <td style="width: 10%;"></td> <td style="width: 10%;"></td> <td style="width: 10%;"></td> </tr> <tr> <td></td> <td></td> <td colspan="8" style="text-align: center;"> <table border="1" style="width: 100%; border-collapse: collapse; text-align: center;"> <tr> <td style="width: 10%;"></td> <td style="width: 10%;"></td> <td style="width: 10%;"></td> <td style="width: 10%;"></td> <td style="width: 10%;"></td> <td style="width: 10%;"></td> <td style="width: 10%;"></td> <td style="width: 10%;"></td> <td style="width: 10%;"></td> <td style="width: 10%;"></td> </tr> <tr> <td></td> <td></td> <td colspan="8" style="text-align: center;"> <table border="1" style="width: 100%; border-collapse: collapse; text-align: center;"> <tr> <td style="width: 10%;"></td> <td style="width: 10%;"></td> <td style="width: 10%;"></td> <td style="width: 10%;"></td> <td style="width: 10%;"></td> <td style="width: 10%;"></td> <td style="width: 10%;"></td> <td style="width: 10%;"></td> <td style="width: 10%;"></td> <td style="width: 10%;"></td> </tr> <tr> <td></td> <td></td> <td colspan="8" style="text-align: center;"> <table border="1" style="width: 100%; border-collapse: collapse; text-align: center;"> <tr> <td style="width: 10%;"></td> <td style="width: 10%;"></td> <td style="width:
10%;"></td> <td style="width: 10%;"></td> <td style="width: 10%;"></td> <td style="width: 10%;"></td> <td style="width: 10%;"></td> <td style="width: 10%;"></td> <td style="width: 10%;"></td> <td style="width: 10%;"></td> </tr> <tr> <td></td> <td></td> <td colspan="8" style="text-align: center;"> <table border="1" style="width: 100%; border-collapse: collapse; text-align: center;"> <tr> <td style="width: 10%;"></td> <td style="width: 10%;"></td> <td style="width: 10%;"></td> <td style="width: 10%;"></td> <td style="width: 10%;"></td> <td style="width: 10%;"></td> <td style="width: 10%;"></td> <td style="width: 10%;"></td> <td style="width: 10%;"></td> <td style="width: 10%;"></td> </tr> <tr> <td></td> <td></td> <td colspan="8" style="text-align: center;"> <table border="1" style="width: 100%; border-collapse: collapse; text-align: center;"> <tr> <td style="width: 10%;"></td> <td style="width: 10%;"></td> <td style="width: 10%;"></td> <td style="width: 10%;"></td> <td style="width: 10%;"></td> <td style="width: 10%;"></td> <td style="width: 10%;"></td> <td style="width: 10%;"></td> <td style="width: 10%;"></td> <td style="width: 10%;"></td> </tr> <tr> <td></td> <td></td> <td colspan="8" style="text-align: center;"> <table border="1" style="width: 100%; border-collapse: collapse; text-align: center;"> <tr> <td style="width: 10%;"></td> <td style="width: 10%;"></td> <td style="width: 10%;"></td> <td style="width: 10%;"></td> <td style="width: 10%;"></td> <td style="width: 10%;"></td> <td style="width: 10%;"></td> <td style="width: 10%;"></td> <td style="width: 10%;"></td> <td style="width: 10%;"></td> </tr> <tr> <td></td> <td></td> <td colspan="8" style="text-align: center;"> <table border="1" style="width: 100%; border-collapse: collapse; text-align: center;"> <tr> <td style="width: 10%;"></td> <td style="width: 10%;"></td> <td style="width: 10%;"></td> <td style="width: 10%;"></td> <td style="width: 10%;"></td> <td style="width: 10%;"></td> <td style="width: 10%;"></td> <td style="width: 10%;"></td> <td style="width: 10%;"></td> <td style="width: 10%;"></td> </tr> <tr> <td></td> <td></td> <td colspan="8" style="text-align: center;"> <table border="1" style="width: 100%; border-collapse: collapse; text-align: center;"> <tr> <td style="width: 10%;"></td> <td style="width: 10%;"></td> <td style="width: 10%;"></td> <td style="width: 10%;"></td> <td style="width: 10%;"></td> <td style="width: 10%;"></td> <td style="width: 10%;"></td> <td style="width: 10%;"></td> <td style="width: 10%;"></td> <td style="width: 10%;"></td> </tr> <tr> <td></td> <td></td> <td colspan="8" style="text-align: center;"> <table border="1" style="width: 100%; border-collapse: collapse; text-align: center;"> <tr> <td style="width: 10%;"></td> <td style="width: 10%;"></td> <td style="width: 10%;"></td> <td style="width: 10%;"></td> <td style="width: 10%;"></td> <td style="width: 10%;"></td> <td style="width: 10%;"></td> <td style="width: 10%;"></td> <td style="width: 10%;"></td> <td style="width: 10%;"></td> </tr> <tr> <td></td> <td></td> <td colspan="8" style="text-align: center;"> <table border="1" style="width: 100%; border-collapse: collapse; text-align: center;"> <tr> </tr></table></td></tr></table></td></tr></table></td></tr></table></td></tr></table></td></tr></table></td></tr></table></td></tr></table></td></tr></table></td></tr></table></td></tr></table></td></tr></table></td></tr></table></td></tr></table></td></tr></table></td></tr></table></td></tr></table></td></tr></table></td></tr></table></td></tr></table></td></tr></table></td></tr></table></td></tr></table></td></tr></table></td></tr></table></td></tr></table></td></tr></table></td></tr></table></td></tr></table></td></tr></table></td></tr></table></td></tr></table></td></tr></table></td></tr></table></td></tr></table></td></tr></table></td></tr></table></td></tr></table></td></tr></table></td></tr></table></td></tr></table></td></tr></table></td></tr></table></td></tr></table></td></tr></table></td></tr></table></td></tr></table>
 | | | | | | | | | | | | | | | | | | | | <table border="1" style="width: 100%; border-collapse: collapse; text-align: center;"> <tr> <td style="width: 10%;"></td> <td style="width: 10%;"></td> <td style="width: 10%;"></td> <td style="width: 10%;"></td> <td style="width: 10%;"></td> <td style="width: 10%;"></td> <td style="width: 10%;"></td> <td style="width: 10%;"></td> <td style="width: 10%;"></td> <td style="width: 10%;"></td> </tr> <tr> <td></td> <td></td> <td colspan="8" style="text-align: center;"> <table border="1" style="width: 100%; border-collapse: collapse; text-align: center;"> <tr> <td style="width: 10%;"></td> <td style="width: 10%;"></td> <td style="width: 10%;"></td> <td style="width: 10%;"></td> <td style="width: 10%;"></td> <td style="width: 10%;"></td> <td style="width: 10%;"></td> <td style="width: 10%;"></td> <td style="width: 10%;"></td> <td style="width: 10%;"></td> </tr> <tr> <td></td> <td></td> <td colspan="8" style="text-align: center;"> <table border="1" style="width: 100%; border-collapse: collapse; text-align: center;"> <tr> <td style="width: 10%;"></td> <td style="width: 10%;"></td> <td style="width: 10%;"></td> <td style="width: 10%;"></td> <td style="width: 10%;"></td> <td style="width: 10%;"></td> <td style="width: 10%;"></td> <td style="width: 10%;"></td> <td style="width: 10%;"></td> <td style="width: 10%;"></td> </tr> <tr> <td></td> <td></td> <td colspan="8" style="text-align: center;"> <table border="1" style="width: 100%; border-collapse: collapse; text-align: center;"> <tr> <td style="width: 10%;"></td> <td style="width: 10%;"></td> <td style="width: 10%;"></td> <td style="width: 10%;"></td> <td style="width: 10%;"></td> <td style="width: 10%;"></td> <td style="width: 10%;"></td> <td style="width: 10%;"></td> <td style="width: 10%;"></td> <td style="width: 10%;"></td> </tr> <tr> <td></td> <td></td> <td colspan="8" style="text-align: center;"> <table border="1" style="width: 100%; border-collapse: collapse; text-align: center;"> <tr> <td style="width: 10%;"></td> <td style="width: 10%;"></td> <td style="width: 10%;"></td> <td style="width: 10%;"></td> <td style="width: 10%;"></td> <td style="width: 10%;"></td> <td style="width: 10%;"></td> <td style="width: 10%;"></td> <td style="width: 10%;"></td> <td style="width: 10%;"></td> </tr> <tr> <td></td> <td></td> <td colspan="8" style="text-align: center;"> <table border="1" style="width: 100%; border-collapse: collapse; text-align: center;"> <tr> <td style="width: 10%;"></td> <td style="width: 10%;"></td> <td style="width: 10%;"></td> <td style="width: 10%;"></td> <td style="width: 10%;"></td> <td style="width: 10%;"></td> <td style="width: 10%;"></td> <td style="width: 10%;"></td> <td style="width: 10%;"></td> <td style="width: 10%;"></td> </tr> <tr> <td></td> <td></td> <td colspan="8" style="text-align: center;"> <table border="1" style="width: 100%; border-collapse: collapse; text-align: center;"> <tr> <td style="width: 10%;"></td> <td style="width: 10%;"></td> <td style="width: 10%;"></td> <td style="width: 10%;"></td> <td style="width: 10%;"></td> <td style="width: 10%;"></td> <td style="width: 10%;"></td> <td style="width: 10%;"></td> <td style="width: 10%;"></td> <td style="width: 10%;"></td> </tr> <tr> <td></td> <td></td> <td colspan="8" style="text-align: center;"> <table border="1" style="width: 100%; border-collapse: collapse; text-align: center;"> <tr> <td style="width: 10%;"></td> <td style="width: 10%;"></td> <td style="width: 10%;"></td> <td style="width: 10%;"></td> <td style="width: 10%;"></td> <td style="width: 10%;"></td> <td style="width: 10%;"></td> <td style="width: 10%;"></td> <td style="width: 10%;"></td> <td style="width: 10%;"></td> </tr> <tr> <td></td> <td></td> <td colspan="8" style="text-align: center;"> <table border="1" style="width: 100%; border-collapse: collapse; text-align: center;"> <tr> <td style="width: 10%;"></td> <td style="width: 10%;"></td> <td style="width: 10%;"></td> <td style="width: 10%;"></td> <td style="width: 10%;"></td> <td style="width: 10%;"></td> <td style="width: 10%;"></td> <td style="width: 10%;"></td> <td style="width: 10%;"></td> <td style="width: 10%;"></td> </tr> <tr> <td></td> <td></td> <td colspan="8" style="text-align: center;"> <table border="1" style="width: 100%; border-collapse: collapse; text-align: center;"> <tr> <td style="width: 10%;"></td> <td style="width: 10%;"></td> <td style="width: 10%;"></td> <td style="width: 10%;"></td> <td style="width: 10%;"></td> <td style="width: 10%;"></td> <td style="width: 10%;"></td> <td style="width: 10%;"></td> <td style="width: 10%;"></td> <td style="width: 10%;"></td> </tr> <tr> <td></td> <td></td> <td colspan="8" style="text-align: center;"> <table border="1" style="width: 100%; border-collapse: collapse; text-align: center;"> <tr> <td style="width: 10%;"></td> <td style="width: 10%;"></td> <td style="width: 10%;"></td> <td style="width: 10%;"></td> <td style="width: 10%;"></td> <td style="width: 10%;"></td> <td style="width: 10%;"></td> <td style="width: 10%;"></td> <td style="width: 10%;"></td> <td style="width: 10%;"></td> </tr> <tr> <td></td> <td></td> <td colspan="8" style="text-align: center;"> <table border="1" style="width: 100%; border-collapse: collapse; text-align: center;"> <tr> <td style="width: 10%;"></td> <td style="width: 10%;"></td> <td style="width: 10%;"></td> <td style="width: 10%;"></td> <td style="width: 10%;"></td> <td style="width: 10%;"></td> <td style="width: 10%;"></td> <td style="width: 10%;"></td> <td style="width: 10%;"></td> <td style="width: 10%;"></td> </tr> <tr> <td></td> <td></td> <td colspan="8" style="text-align: center;"> <table border="1" style="width: 100%; border-collapse: collapse; text-align: center;"> <tr> <td style="width: 10%;"></td> <td style="width: 10%;"></td> <td style="width: 10%;"></td> <td style="width: 10%;"></td> <td style="width: 10%;"></td> <td style="width: 10%;"></td> <td style="width: 10%;"></td> <td style="width: 10%;"></td> <td style="width: 10%;"></td> <td style="width: 10%;"></td> </tr> <tr> <td></td> <td></td> <td colspan="8" style="text-align: center;"> <table border="1" style="width: 100%; border-collapse: collapse; text-align: center;"> <tr> <td style="width: 10%;"></td> <td style="width: 10%;"></td> <td style="width: 10%;"></td> <td style="width: 10%;"></td> <td style="width: 10%;"></td> <td style="width: 10%;"></td> <td style="width: 10%;"></td> <td style="width: 10%;"></td> <td style="width: 10%;"></td> <td style="width: 10%;"></td> </tr> <tr> <td></td> <td></td> <td colspan="8" style="text-align: center;"> <table border="1" style="width: 100%; border-collapse: collapse; text-align: center;"> <tr> <td style="width: 10%;"></td> <td style="width: 10%;"></td> <td style="width: 10%;"></td> <td style="width: 10%;"></td> <td style="width: 10%;"></td> <td style="width: 10%;"></td> <td style="width: 10%;"></td> <td style="width: 10%;"></td> <td style="width: 10%;"></td> <td style="width: 10%;"></td> </tr> <tr> <td></td> <td></td> <td colspan="8" style="text-align: center;"> <table border="1" style="width: 100%; border-collapse: collapse; text-align: center;"> <tr> <td style="width: 10%;"></td> <td style="width: 10%;"></td> <td style="width: 10%;"></td> <td style="width: 10%;"></td> <td style="width: 10%;"></td> <td style="width: 10%;"></td> <td style="width: 10%;"></td> <td style="width: 10%;"></td> <td style="width: 10%;"></td> <td style="width: 10%;"></td> </tr> <tr> <td></td> <td></td> <td colspan="8" style="text-align: center;"> <table border="1" style="width: 100%; border-collapse: collapse; text-align: center;"> <tr> <td style="width: 10%;"></td> <td style="width: 10%;"></td> <td style="width: 10%;"></td> <td style="width: 10%;"></td> <td style="width: 10%;"></td> <td style="width: 10%;"></td> <td style="width: 10%;"></td> <td style="width: 10%;"></td> <td style="width: 10%;"></td> <td style="width: 10%;"></td> </tr> <tr> <td></td> <td></td> <td colspan="8" style="text-align: center;"> <table border="1" style="width: 100%; border-collapse: collapse; text-align: center;"> <tr> <td style="width: 10%;"></td> <td style="width: 10%;"></td> <td style="width: 10%;"></td> <td style="width: 10%;"></td> <td style="width: 10%;"></td> <td style="width: 10%;"></td> <td style="width: 10%;"></td> <td style="width: 10%;"></td> <td style="width: 10%;"></td> <td style="width: 10%;"></td> </tr> <tr> <td></td> <td></td> <td colspan="8" style="text-align: center;"> <table border="1" style="width: 100%; border-collapse: collapse; text-align: center;"> <tr> <td style="width: 10%;"></td> <td style="width: 10%;"></td> <td style="width: 10%;"></td> <td style="width: 10%;"></td> <td style="width: 10%;"></td> <td style="width: 10%;"></td> <td style="width: 10%;"></td> <td style="width: 10%;"></td> <td style="width: 10%;"></td> <td style="width: 10%;"></td> </tr> <tr> <td></td> <td></td> <td colspan="8" style="text-align: center;"> <table border="1" style="width: 100%; border-collapse: collapse; text-align: center;"> <tr> <td style="width: 10%;"></td> <td style="width: 10%;"></td> <td style="width: 10%;"></td> <td style="width: 10%;"></td> <td style="width: 10%;"></td> <td style="width: 10%;"></td> <td style="width: 10%;"></td> <td style="width: 10%;"></td> <td style="width: 10%;"></td> <td style="width: 10%;"></td> </tr> <tr> <td></td> <td></td> <td colspan="8" style="text-align: center;"> <table border="1" style="width: 100%; border-collapse: collapse; text-align: center;"> <tr> <td style="width: 10%;"></td> <td style="width: 10%;"></td> <td style="width: 10%;"></td> <td style="width: 10%;"></td> <td
style="width: 10%;"></td> <td style="width: 10%;"></td> <td style="width: 10%;"></td> <td style="width: 10%;"></td> <td style="width: 10%;"></td> <td style="width: 10%;"></td> </tr> <tr> <td></td> <td></td> <td colspan="8" style="text-align: center;"> <table border="1" style="width: 100%; border-collapse: collapse; text-align: center;"> <tr> <td style="width: 10%;"></td> <td style="width: 10%;"></td> <td style="width: 10%;"></td> <td style="width: 10%;"></td> <td style="width: 10%;"></td> <td style="width: 10%;"></td> <td style="width: 10%;"></td> <td style="width: 10%;"></td> <td style="width: 10%;"></td> <td style="width: 10%;"></td> </tr> <tr> <td></td> <td></td> <td colspan="8" style="text-align: center;"> <table border="1" style="width: 100%; border-collapse: collapse; text-align: center;"> <tr> <td style="width: 10%;"></td> <td style="width: 10%;"></td> <td style="width: 10%;"></td> <td style="width: 10%;"></td> <td style="width: 10%;"></td> <td style="width: 10%;"></td> <td style="width: 10%;"></td> <td style="width: 10%;"></td> <td style="width: 10%;"></td> <td style="width: 10%;"></td> </tr> <tr> <td></td> <td></td> <td colspan="8" style="text-align: center;"> <table border="1" style="width: 100%; border-collapse: collapse; text-align: center;"> <tr> <td style="width: 10%;"></td> <td style="width: 10%;"></td> <td style="width: 10%;"></td> <td style="width: 10%;"></td> <td style="width: 10%;"></td> <td style="width: 10%;"></td> <td style="width: 10%;"></td> <td style="width: 10%;"></td> <td style="width: 10%;"></td> <td style="width: 10%;"></td> </tr> <tr> <td></td> <td></td> <td colspan="8" style="text-align: center;"> <table border="1" style="width: 100%; border-collapse: collapse; text-align: center;"> <tr> <td style="width: 10%;"></td> <td style="width: 10%;"></td> <td style="width: 10%;"></td> <td style="width: 10%;"></td> <td style="width: 10%;"></td> <td style="width: 10%;"></td> <td style="width: 10%;"></td> <td style="width: 10%;"></td> <td style="width: 10%;"></td> <td style="width: 10%;"></td> </tr> <tr> <td></td> <td></td> <td colspan="8" style="text-align: center;"> <table border="1" style="width: 100%; border-collapse: collapse; text-align: center;"> <tr> <td style="width: 10%;"></td> <td style="width: 10%;"></td> <td style="width: 10%;"></td> <td style="width: 10%;"></td> <td style="width: 10%;"></td> <td style="width: 10%;"></td> <td style="width: 10%;"></td> <td style="width: 10%;"></td> <td style="width: 10%;"></td> <td style="width: 10%;"></td> </tr> <tr> <td></td> <td></td> <td colspan="8" style="text-align: center;"> <table border="1" style="width: 100%; border-collapse: collapse; text-align: center;"> <tr> <td style="width: 10%;"></td> <td style="width: 10%;"></td> <td style="width: 10%;"></td> <td style="width: 10%;"></td> <td style="width: 10%;"></td> <td style="width: 10%;"></td> <td style="width: 10%;"></td> <td style="width: 10%;"></td> <td style="width: 10%;"></td> <td style="width: 10%;"></td> </tr> <tr> <td></td> <td></td> <td colspan="8" style="text-align: center;"> <table border="1" style="width: 100%; border-collapse: collapse; text-align: center;"> <tr> <td style="width: 10%;"></td> <td style="width: 10%;"></td> <td style="width: 10%;"></td> <td style="width: 10%;"></td> <td style="width: 10%;"></td> <td style="width: 10%;"></td> <td style="width: 10%;"></td> <td style="width: 10%;"></td> <td style="width: 10%;"></td> <td style="width: 10%;"></td> </tr> <tr> <td></td> <td></td> <td colspan="8" style="text-align: center;"> <table border="1" style="width: 100%; border-collapse: collapse; text-align: center;"> <tr> <td style="width: 10%;"></td> <td style="width: 10%;"></td> <td style="width: 10%;"></td> <td style="width: 10%;"></td> <td style="width: 10%;"></td> <td style="width: 10%;"></td> <td style="width: 10%;"></td> <td style="width: 10%;"></td> <td style="width: 10%;"></td> <td style="width: 10%;"></td> </tr> <tr> <td></td> <td></td> <td colspan="8" style="text-align: center;"> <table border="1" style="width: 100%; border-collapse: collapse; text-align: center;"> <tr> <td style="width: 10%;"></td> <td style="width: 10%;"></td> <td style="width: 10%;"></td> <td style="width: 10%;"></td> <td style="width: 10%;"></td> <td style="width: 10%;"></td> <td style="width: 10%;"></td> <td style="width: 10%;"></td> <td style="width: 10%;"></td> <td style="width: 10%;"></td> </tr> <tr> <td></td> <td></td> <td colspan="8" style="text-align: center;"> <table border="1" style="width: 100%; border-collapse: collapse; text-align: center;"> <tr> <td style="width: 10%;"></td> <td style="width: 10%;"></td> <td style="width: 10%;"></td> <td style="width: 10%;"></td> <td style="width: 10%;"></td> <td style="width: 10%;"></td> <td style="width: 10%;"></td> <td style="width: 10%;"></td> <td style="width: 10%;"></td> <td style="width: 10%;"></td> </tr> <tr> <td></td> <td></td> <td colspan="8" style="text-align: center;"> <table border="1" style="width: 100%; border-collapse: collapse; text-align: center;"> <tr> <td style="width: 10%;"></td> <td style="width: 10%;"></td> <td style="width: 10%;"></td> <td style="width: 10%;"></td> <td style="width: 10%;"></td> <td style="width: 10%;"></td> <td style="width: 10%;"></td> <td style="width: 10%;"></td> <td style="width: 10%;"></td> <td style="width: 10%;"></td> </tr> <tr> <td></td> <td></td> <td colspan="8" style="text-align: center;"> <table border="1" style="width: 100%; border-collapse: collapse; text-align: center;"> <tr> <td style="width: 10%;"></td> <td style="width: 10%;"></td> <td style="width: 10%;"></td> <td style="width: 10%;"></td> <td style="width: 10%;"></td> <td style="width: 10%;"></td> <td style="width: 10%;"></td> <td style="width: 10%;"></td> <td style="width: 10%;"></td> <td style="width: 10%;"></td> </tr> <tr> <td></td> <td></td> <td colspan="8" style="text-align: center;"> <table border="1" style="width: 100%; border-collapse: collapse; text-align: center;"> <tr> <td style="width: 10%;"></td> <td style="width: 10%;"></td> <td style="width: 10%;"></td> <td style="width: 10%;"></td> <td style="width: 10%;"></td> <td style="width: 10%;"></td> <td style="width: 10%;"></td> <td style="width: 10%;"></td> <td style="width: 10%;"></td> <td style="width: 10%;"></td> </tr> <tr> <td></td> <td></td> <td colspan="8" style="text-align: center;"> <table border="1" style="width: 100%; border-collapse: collapse; text-align: center;"> <tr> <td style="width: 10%;"></td> <td style="width: 10%;"></td> <td style="width: 10%;"></td> <td style="width: 10%;"></td> <td style="width: 10%;"></td> <td style="width: 10%;"></td> <td style="width: 10%;"></td> <td style="width: 10%;"></td> <td style="width: 10%;"></td> <td style="width: 10%;"></td> </tr> <tr> <td></td> <td></td> <td colspan="8" style="text-align: center;"> <table border="1" style="width: 100%; border-collapse: collapse; text-align: center;"> <tr> <td style="width: 10%;"></td> <td style="width: 10%;"></td> <td style="width: 10%;"></td> <td style="width: 10%;"></td> <td style="width: 10%;"></td> <td style="width: 10%;"></td> <td style="width: 10%;"></td> <td style="width: 10%;"></td> <td style="width: 10%;"></td> <td style="width: 10%;"></td> </tr> <tr> <td></td> <td></td> <td colspan="8" style="text-align: center;"> <table border="1" style="width: 100%; border-collapse: collapse; text-align: center;"> <tr> <td style="width: 10%;"></td> <td style="width: 10%;"></td> <td style="width: 10%;"></td> <td style="width: 10%;"></td> <td style="width: 10%;"></td> <td style="width: 10%;"></td> <td style="width: 10%;"></td> <td style="width: 10%;"></td> <td style="width: 10%;"></td> <td style="width: 10%;"></td> </tr> <tr> <td></td> <td></td> <td colspan="8" style="text-align: center;"> <table border="1" style="width: 100%; border-collapse: collapse; text-align: center;"> <tr> <td style="width: 10%;"></td> <td style="width: 10%;"></td> <td style="width: 10%;"></td> <td style="width: 10%;"></td> <td style="width: 10%;"></td> <td style="width: 10%;"></td> <td style="width: 10%;"></td> <td style="width: 10%;"></td> <td style="width: 10%;"></td> <td style="width: 10%;"></td> </tr> <tr> <td></td> <td></td> <td colspan="8" style="text-align: center;"> <table border="1" style="width: 100%; border-collapse: collapse; text-align: center;"> <tr> <td style="width: 10%;"></td> <td style="width: 10%;"></td> <td style="width: 10%;"></td> <td style="width: 10%;"></td> <td style="width: 10%;"></td> <td style="width: 10%;"></td> <td style="width: 10%;"></td> <td style="width: 10%;"></td> <td style="width: 10%;"></td> <td style="width: 10%;"></td> </tr> <tr> <td></td> <td></td> <td colspan="8" style="text-align: center;"> <table border="1" style="width: 100%; border-collapse: collapse; text-align: center;"> <tr> <td style="width: 10%;"></td> <td style="width: 10%;"></td> <td style="width: 10%;"></td> <td style="width: 10%;"></td> <td style="width: 10%;"></td> <td style="width: 10%;"></td> <td style="width: 10%;"></td> <td style="width: 10%;"></td> <td style="width: 10%;"></td> <td style="width: 10%;"></td> </tr> <tr> <td></td> <td></td> <td colspan="8" style="text-align: center;"> <table border="1" style="width: 100%; border-collapse: collapse; text-align: center;"> <tr> <td style="width: 10%;"></td> <td style="width: 10%;"></td> <td style="width: 10%;"></td> <td style="width: 10%;"></td> <td style="width: 10%;"></td> <td style="width: 10%;"></td> <td style="width: 10%;"></td> <td style="width: 10%;"></td> <td style="width: 10%;"></td> <td style="width: 10%;"></td> </tr> <tr> <td></td> <td></td> <td colspan="8" style="text-align: center;"> <table border="1" style="width: 100%; border-collapse: collapse; text-align: center;"> <tr> <td style="width: 10%;"></td> <td style="width: 10%;"></td> <td style="width: 10%;"></td> <td style="width: 10%;"></td> <td style="width: 10%;"></td> <td style="width: 10%;"></td> <td style="width: 10%;"></td> <td style="width: 10%;"></td> <td style="width: 10%;"></td> <td style="width:
10%;"></td> </tr> <tr> <td></td> <td></td> <td colspan="8" style="text-align: center;"> <table border="1" style="width: 100%; border-collapse: collapse; text-align: center;"> <tr> <td style="width: 10%;"></td> <td style="width: 10%;"></td> <td style="width: 10%;"></td> <td style="width: 10%;"></td> <td style="width: 10%;"></td> <td style="width: 10%;"></td> <td style="width: 10%;"></td> <td style="width: 10%;"></td> <td style="width: 10%;"></td> <td style="width: 10%;"></td> </tr> <tr> <td></td> <td></td> <td colspan="8" style="text-align: center;"> <table border="1" style="width: 100%; border-collapse: collapse; text-align: center;"> <tr> <td style="width: 10%;"></td> <td style="width: 10%;"></td> <td style="width: 10%;"></td> <td style="width: 10%;"></td> <td style="width: 10%;"></td> <td style="width: 10%;"></td> <td style="width: 10%;"></td> <td style="width: 10%;"></td> <td style="width: 10%;"></td> <td style="width: 10%;"></td> </tr> <tr> <td></td> <td></td> <td colspan="8" style="text-align: center;"> <table border="1" style="width: 100%; border-collapse: collapse; text-align: center;"> <tr> <td style="width: 10%;"></td> <td style="width: 10%;"></td> <td style="width: 10%;"></td> <td style="width: 10%;"></td> <td style="width: 10%;"></td> <td style="width: 10%;"></td> <td style="width: 10%;"></td> <td style="width: 10%;"></td> <td style="width: 10%;"></td> <td style="width: 10%;"></td> </tr> <tr> <td></td> <td></td> <td colspan="8" style="text-align: center;"> <table border="1" style="width: 100%; border-collapse: collapse; text-align: center;"> <tr> </tr></table></td></tr></table></td></tr></table></td></tr></table></td></tr></table></td></tr></table></td></tr></table></td></tr></table></td></tr></table></td></tr></table></td></tr></table></td></tr></table></td></tr></table></td></tr></table></td></tr></table></td></tr></table></td></tr></table></td></tr></table></td></tr></table></td></tr></table></td></tr></table></td></tr></table></td></tr></table></td></tr></table></td></tr></table></td></tr></table></td></tr></table></td></tr></table></td></tr></table></td></tr></table></td></tr></table></td></tr></table></td></tr></table></td></tr></table></td></tr></table></td></tr></table></td></tr></table></td></tr></table></td></tr></table></td></tr></table></td></tr></table></td></tr></table></td></tr></table></td></tr></table></td></tr></table></td></tr></table> | | | | | | | | | | | | | | | | | | | | <table border="1" style="width: 100%; border-collapse: collapse; text-align: center;"> <tr> <td style="width: 10%;"></td> <td style="width: 10%;"></td> <td style="width: 10%;"></td> <td style="width: 10%;"></td> <td style="width: 10%;"></td> <td style="width: 10%;"></td> <td style="width: 10%;"></td> <td style="width: 10%;"></td> <td style="width: 10%;"></td> <td style="width: 10%;"></td> </tr> <tr> <td></td> <td></td> <td colspan="8" style="text-align: center;"> <table border="1" style="width: 100%; border-collapse: collapse; text-align: center;"> <tr> <td style="width: 10%;"></td> <td style="width: 10%;"></td> <td style="width: 10%;"></td> <td style="width: 10%;"></td> <td style="width: 10%;"></td> <td style="width: 10%;"></td> <td style="width: 10%;"></td> <td style="width: 10%;"></td> <td style="width: 10%;"></td> <td style="width: 10%;"></td> </tr> <tr> <td></td> <td></td> <td colspan="8" style="text-align: center;"> <table border="1" style="width: 100%; border-collapse: collapse; text-align: center;"> <tr> <td style="width: 10%;"></td> <td style="width: 10%;"></td> <td style="width: 10%;"></td> <td style="width: 10%;"></td> <td style="width: 10%;"></td> <td style="width: 10%;"></td> <td
style="width: 10%;"></td> <td style="width: 10%;"></td> <td style="width: 10%;"></td> <td style="width: 10%;"></td> </tr> <tr> <td></td> <td></td> <td colspan="8" style="text-align: center;"> <table border="1" style="width: 100%; border-collapse: collapse; text-align: center;"> <tr> <td style="width: 10%;"></td> <td style="width: 10%;"></td> <td style="width: 10%;"></td> <td style="width: 10%;"></td> <td style="width: 10%;"></td> <td style="width: 10%;"></td> <td style="width: 10%;"></td> <td style="width: 10%;"></td> <td style="width: 10%;"></td> <td style="width: 10%;"></td> </tr> <tr> <td></td> <td></td> <td colspan="8" style="text-align: center;"> <table border="1" style="width: 100%; border-collapse: collapse; text-align: center;"> <tr> <td style="width: 10%;"></td> <td style="width: 10%;"></td> <td style="width: 10%;"></td> <td style="width: 10%;"></td> <td style="width: 10%;"></td> <td style="width: 10%;"></td> <td style="width: 10%;"></td> <td style="width: 10%;"></td> <td style="width: 10%;"></td> <td style="width: 10%;"></td> </tr> <tr> <td></td> <td></td> <td colspan="8" style="text-align: center;"> <table border="1" style="width: 100%; border-collapse: collapse; text-align: center;"> <tr> <td style="width: 10%;"></td> <td style="width: 10%;"></td> <td style="width: 10%;"></td> <td style="width: 10%;"></td> <td style="width: 10%;"></td> <td style="width: 10%;"></td> <td style="width: 10%;"></td> <td style="width: 10%;"></td> <td style="width: 10%;"></td> <td style="width: 10%;"></td> </tr> <tr> <td></td> <td></td> <td colspan="8" style="text-align: center;"> <table border="1" style="width: 100%; border-collapse: collapse; text-align: center;"> <tr> <td style="width: 10%;"></td> <td style="width: 10%;"></td> <td style="width: 10%;"></td> <td style="width: 10%;"></td> <td style="width: 10%;"></td> <td style="width: 10%;"></td> <td style="width: 10%;"></td> <td style="width: 10%;"></td> <td style="width: 10%;"></td> <td style="width: 10%;"></td> </tr> <tr> <td></td> <td></td> <td colspan="8" style="text-align: center;"> <table border="1" style="width: 100%; border-collapse: collapse; text-align: center;"> <tr> <td style="width: 10%;"></td> <td style="width: 10%;"></td> <td style="width: 10%;"></td> <td style="width: 10%;"></td> <td style="width: 10%;"></td> <td style="width: 10%;"></td> <td style="width: 10%;"></td> <td style="width: 10%;"></td> <td style="width: 10%;"></td> <td style="width: 10%;"></td> </tr> <tr> <td></td> <td></td> <td colspan="8" style="text-align: center;"> <table border="1" style="width: 100%; border-collapse: collapse; text-align: center;"> <tr> <td style="width: 10%;"></td> <td style="width: 10%;"></td> <td style="width: 10%;"></td> <td style="width: 10%;"></td> <td style="width: 10%;"></td> <td style="width: 10%;"></td> <td style="width: 10%;"></td> <td style="width: 10%;"></td> <td style="width: 10%;"></td> <td style="width: 10%;"></td> </tr> <tr> <td></td> <td></td> <td colspan="8" style="text-align: center;"> <table border="1" style="width: 100%; border-collapse: collapse; text-align: center;"> <tr> <td style="width: 10%;"></td> <td style="width: 10%;"></td> <td style="width: 10%;"></td> <td style="width: 10%;"></td> <td style="width: 10%;"></td> <td style="width: 10%;"></td> <td style="width: 10%;"></td> <td style="width: 10%;"></td> <td style="width: 10%;"></td> <td style="width: 10%;"></td> </tr> <tr> <td></td> <td></td> <td colspan="8" style="text-align: center;"> <table border="1" style="width: 100%; border-collapse: collapse; text-align: center;"> <tr> <td style="width: 10%;"></td> <td style="width: 10%;"></td> <td style="width: 10%;"></td> <td style="width: 10%;"></td> <td style="width: 10%;"></td> <td style="width: 10%;"></td> <td style="width: 10%;"></td> <td style="width: 10%;"></td> <td style="width: 10%;"></td> <td style="width: 10%;"></td> </tr> <tr> <td></td> <td></td> <td colspan="8" style="text-align: center;"> <table border="1" style="width: 100%; border-collapse: collapse; text-align: center;"> <tr> <td style="width: 10%;"></td> <td style="width: 10%;"></td> <td style="width: 10%;"></td> <td style="width: 10%;"></td> <td style="width: 10%;"></td> <td style="width: 10%;"></td> <td style="width: 10%;"></td> <td style="width: 10%;"></td> <td style="width: 10%;"></td> <td style="width: 10%;"></td> </tr> <tr> <td></td> <td></td> <td colspan="8" style="text-align: center;"> <table border="1" style="width: 100%; border-collapse: collapse; text-align: center;"> <tr> <td style="width: 10%;"></td> <td style="width: 10%;"></td> <td style="width: 10%;"></td> <td style="width: 10%;"></td> <td style="width: 10%;"></td> <td style="width: 10%;"></td> <td style="width: 10%;"></td> <td style="width: 10%;"></td> <td style="width: 10%;"></td> <td style="width: 10%;"></td> </tr> <tr> <td></td> <td></td> <td colspan="8" style="text-align: center;"> <table border="1" style="width: 100%; border-collapse: collapse; text-align: center;"> <tr> <td style="width: 10%;"></td> <td style="width: 10%;"></td> <td style="width: 10%;"></td> <td style="width: 10%;"></td> <td style="width: 10%;"></td> <td style="width: 10%;"></td> <td style="width: 10%;"></td> <td style="width: 10%;"></td> <td style="width: 10%;"></td> <td style="width: 10%;"></td> </tr> <tr> <td></td> <td></td> <td colspan="8" style="text-align: center;"> <table border="1" style="width: 100%; border-collapse: collapse; text-align: center;"> <tr> <td style="width: 10%;"></td> <td style="width: 10%;"></td> <td style="width: 10%;"></td> <td style="width: 10%;"></td> <td style="width: 10%;"></td> <td style="width: 10%;"></td> <td style="width: 10%;"></td> <td style="width: 10%;"></td> <td style="width: 10%;"></td> <td style="width: 10%;"></td> </tr> <tr> <td></td> <td></td> <td colspan="8" style="text-align: center;"> <table border="1" style="width: 100%; border-collapse: collapse; text-align: center;"> <tr> <td style="width: 10%;"></td> <td style="width: 10%;"></td> <td style="width: 10%;"></td> <td style="width: 10%;"></td> <td style="width: 10%;"></td> <td style="width: 10%;"></td> <td style="width: 10%;"></td> <td style="width: 10%;"></td> <td style="width: 10%;"></td> <td style="width: 10%;"></td> </tr> <tr> <td></td> <td></td> <td colspan="8" style="text-align: center;"> <table border="1" style="width: 100%; border-collapse: collapse; text-align: center;"> <tr> <td style="width: 10%;"></td> <td style="width: 10%;"></td> <td style="width: 10%;"></td> <td style="width: 10%;"></td> <td style="width: 10%;"></td> <td style="width: 10%;"></td> <td style="width: 10%;"></td> <td style="width: 10%;"></td> <td style="width: 10%;"></td> <td style="width: 10%;"></td> </tr> <tr> <td></td> <td></td> <td colspan="8" style="text-align: center;"> <table border="1" style="width: 100%; border-collapse: collapse; text-align: center;"> <tr> <td style="width: 10%;"></td> <td style="width: 10%;"></td> <td style="width: 10%;"></td> <td style="width: 10%;"></td> <td style="width: 10%;"></td> <td style="width: 10%;"></td> <td style="width: 10%;"></td> <td style="width: 10%;"></td> <td style="width: 10%;"></td> <td style="width: 10%;"></td> </tr> <tr> <td></td> <td></td> <td colspan="8" style="text-align: center;"> <table border="1" style="width: 100%; border-collapse: collapse; text-align: center;"> <tr> <td style="width: 10%;"></td> <td style="width: 10%;"></td> <td style="width: 10%;"></td> <td style="width: 10%;"></td> <td style="width: 10%;"></td> <td style="width: 10%;"></td> <td style="width: 10%;"></td> <td style="width: 10%;"></td> <td style="width: 10%;"></td> <td style="width: 10%;"></td> </tr> <tr> <td></td> <td></td> <td colspan="8" style="text-align: center;"> <table border="1" style="width: 100%; border-collapse: collapse; text-align: center;"> <tr> <td style="width: 10%;"></td> <td style="width: 10%;"></td> <td style="width: 10%;"></td> <td style="width: 10%;"></td> <td style="width: 10%;"></td> <td style="width: 10%;"></td> <td style="width: 10%;"></td> <td style="width: 10%;"></td> <td style="width: 10%;"></td> <td style="width: 10%;"></td> </tr> <tr> <td></td> <td></td> <td colspan="8" style="text-align: center;"> <table border="1" style="width: 100%; border-collapse: collapse; text-align: center;"> <tr> <td style="width: 10%;"></td> <td style="width: 10%;"></td> <td style="width: 10%;"></td> <td style="width: 10%;"></td> <td style="width: 10%;"></td> <td style="width: 10%;"></td> <td style="width: 10%;"></td> <td style="width: 10%;"></td> <td style="width: 10%;"></td> <td style="width: 10%;"></td> </tr> <tr> <td></td> <td></td> <td colspan="8" style="text-align: center;"> <table border="1" style="width: 100%; border-collapse: collapse; text-align: center;"> <tr> <td style="width: 10%;"></td> <td style="width: 10%;"></td> <td style="width: 10%;"></td> <td style="width: 10%;"></td> <td style="width: 10%;"></td> <td style="width: 10%;"></td> <td style="width: 10%;"></td> <td style="width: 10%;"></td> <td style="width: 10%;"></td> <td style="width: 10%;"></td> </tr> <tr> <td></td> <td></td> <td colspan="8" style="text-align: center;"> <table border="1" style="width: 100%; border-collapse: collapse; text-align: center;"> <tr> <td style="width: 10%;"></td> <td style="width: 10%;"></td> <td style="width: 10%;"></td> <td style="width: 10%;"></td> <td style="width: 10%;"></td> <td style="width: 10%;"></td> <td style="width: 10%;"></td> <td style="width: 10%;"></td> <td style="width: 10%;"></td> <td style="width: 10%;"></td> </tr> <tr> <td></td> <td></td> <td colspan="8" style="text-align: center;"> <table border="1" style="width: 100%; border-collapse: collapse; text-align: center;"> <tr> <td style="width: 10%;"></td> <td style="width: 10%;"></td> <td style="width: 10%;"></td> <td style="width: 10%;"></td> <td style="width: 10%;"></td> <td style="width: 10%;"></td> <td style="width: 10%;"></td> <td style="width: 10%;"></td> <td style="width: 10%;"></td> <td style="width: 10%;"></td> </tr> <tr> <td></td> <td></td> <td colspan="8"
style="text-align: center;"> <table border="1" style="width: 100%; border-collapse: collapse; text-align: center;"> <tr> <td style="width: 10%;"></td> <td style="width: 10%;"></td> <td style="width: 10%;"></td> <td style="width: 10%;"></td> <td style="width: 10%;"></td> <td style="width: 10%;"></td> <td style="width: 10%;"></td> <td style="width: 10%;"></td> <td style="width: 10%;"></td> <td style="width: 10%;"></td> </tr> <tr> <td></td> <td></td> <td colspan="8" style="text-align: center;"> <table border="1" style="width: 100%; border-collapse: collapse; text-align: center;"> <tr> <td style="width: 10%;"></td> <td style="width: 10%;"></td> <td style="width: 10%;"></td> <td style="width: 10%;"></td> <td style="width: 10%;"></td> <td style="width: 10%;"></td> <td style="width: 10%;"></td> <td style="width: 10%;"></td> <td style="width: 10%;"></td> <td style="width: 10%;"></td> </tr> <tr> <td></td> <td></td> <td colspan="8" style="text-align: center;"> <table border="1" style="width: 100%; border-collapse: collapse; text-align: center;"> <tr> <td style="width: 10%;"></td> <td style="width: 10%;"></td> <td style="width: 10%;"></td> <td style="width: 10%;"></td> <td style="width: 10%;"></td> <td style="width: 10%;"></td> <td style="width: 10%;"></td> <td style="width: 10%;"></td> <td style="width: 10%;"></td> <td style="width: 10%;"></td> </tr> <tr> <td></td> <td></td> <td colspan="8" style="text-align: center;"> <table border="1" style="width: 100%; border-collapse: collapse; text-align: center;"> <tr> <td style="width: 10%;"></td> <td style="width: 10%;"></td> <td style="width: 10%;"></td> <td style="width: 10%;"></td> <td style="width: 10%;"></td> <td style="width: 10%;"></td> <td style="width: 10%;"></td> <td style="width: 10%;"></td> <td style="width: 10%;"></td> <td style="width: 10%;"></td> </tr> <tr> <td></td> <td></td> <td colspan="8" style="text-align: center;"> <table border="1" style="width: 100%; border-collapse: collapse; text-align: center;"> <tr> <td style="width: 10%;"></td> <td style="width: 10%;"></td> <td style="width: 10%;"></td> <td style="width: 10%;"></td> <td style="width: 10%;"></td> <td style="width: 10%;"></td> <td style="width: 10%;"></td> <td style="width: 10%;"></td> <td style="width: 10%;"></td> <td style="width: 10%;"></td> </tr> <tr> <td></td> <td></td> <td colspan="8" style="text-align: center;"> <table border="1" style="width: 100%; border-collapse: collapse; text-align: center;"> <tr> <td style="width: 10%;"></td> <td style="width: 10%;"></td> <td style="width: 10%;"></td> <td style="width: 10%;"></td> <td style="width: 10%;"></td> <td style="width: 10%;"></td> <td style="width: 10%;"></td> <td style="width: 10%;"></td> <td style="width: 10%;"></td> <td style="width: 10%;"></td> </tr> <tr> <td></td> <td></td> <td colspan="8" style="text-align: center;"> <table border="1" style="width: 100%; border-collapse: collapse; text-align: center;"> <tr> <td style="width: 10%;"></td> <td style="width: 10%;"></td> <td style="width: 10%;"></td> <td style="width: 10%;"></td> <td style="width: 10%;"></td> <td style="width: 10%;"></td> <td style="width: 10%;"></td> <td style="width: 10%;"></td> <td style="width: 10%;"></td> <td style="width: 10%;"></td> </tr> <tr> <td></td> <td></td> <td colspan="8" style="text-align: center;"> <table border="1" style="width: 100%; border-collapse: collapse; text-align: center;"> <tr> <td style="width: 10%;"></td> <td style="width: 10%;"></td> <td style="width: 10%;"></td> <td style="width: 10%;"></td> <td style="width: 10%;"></td> <td style="width: 10%;"></td> <td style="width: 10%;"></td> <td style="width: 10%;"></td> <td style="width: 10%;"></td> <td style="width: 10%;"></td> </tr> <tr> <td></td> <td></td> <td colspan="8" style="text-align: center;"> <table border="1" style="width: 100%; border-collapse: collapse; text-align: center;"> <tr> <td style="width: 10%;"></td> <td style="width: 10%;"></td> <td style="width: 10%;"></td> <td style="width: 10%;"></td> <td style="width: 10%;"></td> <td style="width: 10%;"></td> <td style="width: 10%;"></td> <td style="width: 10%;"></td> <td style="width: 10%;"></td> <td style="width: 10%;"></td> </tr> <tr> <td></td> <td></td> <td colspan="8" style="text-align: center;"> <table border="1" style="width: 100%; border-collapse: collapse; text-align: center;"> <tr> <td style="width: 10%;"></td> <td style="width: 10%;"></td> <td style="width: 10%;"></td> <td style="width: 10%;"></td> <td style="width: 10%;"></td> <td style="width: 10%;"></td> <td style="width: 10%;"></td> <td style="width: 10%;"></td> <td style="width: 10%;"></td> <td style="width: 10%;"></td> </tr> <tr> <td></td> <td></td> <td colspan="8" style="text-align: center;"> <table border="1" style="width: 100%; border-collapse: collapse; text-align: center;"> <tr> <td style="width: 10%;"></td> <td style="width: 10%;"></td> <td style="width: 10%;"></td> <td style="width: 10%;"></td> <td style="width: 10%;"></td> <td style="width: 10%;"></td> <td style="width: 10%;"></td> <td style="width: 10%;"></td> <td style="width: 10%;"></td> <td style="width: 10%;"></td> </tr> <tr> <td></td> <td></td> <td colspan="8" style="text-align: center;"> <table border="1" style="width: 100%; border-collapse: collapse; text-align: center;"> <tr> <td style="width: 10%;"></td> <td style="width: 10%;"></td> <td style="width: 10%;"></td> <td style="width: 10%;"></td> <td style="width: 10%;"></td> <td style="width: 10%;"></td> <td style="width: 10%;"></td> <td style="width: 10%;"></td> <td style="width: 10%;"></td> <td style="width: 10%;"></td> </tr> <tr> <td></td> <td></td> <td colspan="8" style="text-align: center;"> <table border="1" style="width: 100%; border-collapse: collapse; text-align: center;"> <tr> <td style="width: 10%;"></td> <td style="width: 10%;"></td> <td style="width: 10%;"></td> <td style="width: 10%;"></td> <td style="width: 10%;"></td> <td style="width: 10%;"></td> <td style="width: 10%;"></td> <td style="width: 10%;"></td> <td style="width: 10%;"></td> <td style="width: 10%;"></td> </tr> <tr> <td></td> <td></td> <td colspan="8" style="text-align: center;"> <table border="1" style="width: 100%; border-collapse: collapse; text-align: center;"> <tr> <td style="width: 10%;"></td> <td style="width: 10%;"></td> <td style="width: 10%;"></td> <td style="width: 10%;"></td> <td style="width: 10%;"></td> <td style="width: 10%;"></td> <td style="width: 10%;"></td> <td style="width: 10%;"></td> <td style="width: 10%;"></td> <td style="width: 10%;"></td> </tr> <tr> <td></td> <td></td> <td colspan="8" style="text-align: center;"> <table border="1" style="width: 100%; border-collapse: collapse; text-align: center;"> <tr> <td style="width: 10%;"></td> <td style="width: 10%;"></td> <td style="width: 10%;"></td> <td style="width: 10%;"></td> <td style="width: 10%;"></td> <td style="width: 10%;"></td> <td style="width: 10%;"></td> <td style="width: 10%;"></td> <td style="width: 10%;"></td> <td style="width: 10%;"></td> </tr> <tr> <td></td> <td></td> <td colspan="8" style="text-align: center;"> <table border="1" style="width: 100%; border-collapse: collapse; text-align: center;"> <tr> <td style="width: 10%;"></td> <td style="width: 10%;"></td> <td style="width: 10%;"></td> <td style="width: 10%;"></td> <td style="width: 10%;"></td> <td style="width: 10%;"></td> <td style="width: 10%;"></td> <td style="width: 10%;"></td> <td style="width: 10%;"></td> <td style="width: 10%;"></td> </tr> <tr> <td></td> <td></td> <td colspan="8" style="text-align: center;"> <table border="1" style="width: 100%; border-collapse: collapse; text-align: center;"> <tr> <td style="width: 10%;"></td> <td style="width: 10%;"></td> <td style="width: 10%;"></td> <td style="width: 10%;"></td> <td style="width: 10%;"></td> <td style="width: 10%;"></td> <td style="width: 10%;"></td> <td style="width: 10%;"></td> <td style="width: 10%;"></td> <td style="width: 10%;"></td> </tr> <tr> <td></td> <td></td> <td colspan="8" style="text-align: center;"> <table border="1" style="width: 100%; border-collapse: collapse; text-align: center;"> <tr> <td style="width: 10%;"></td> <td style="width: 10%;"></td> <td style="width: 10%;"></td> <td style="width: 10%;"></td> <td style="width: 10%;"></td> <td style="width: 10%;"></td> <td style="width: 10%;"></td> <td style="width: 10%;"></td> <td style="width: 10%;"></td> <td style="width: 10%;"></td> </tr> <tr> <td></td> <td></td> <td colspan="8" style="text-align: center;"> <table border="1" style="width: 100%; border-collapse: collapse; text-align: center;"> <tr> <td style="width: 10%;"></td> <td style="width: 10%;"></td> <td style="width: 10%;"></td> <td style="width: 10%;"></td> <td style="width: 10%;"></td> <td style="width: 10%;"></td> <td style="width: 10%;"></td> <td style="width: 10%;"></td> <td style="width: 10%;"></td> <td style="width: 10%;"></td> </tr> <tr> <td></td> <td></td> <td colspan="8" style="text-align: center;"> <table border="1" style="width: 100%; border-collapse: collapse; text-align: center;"> <tr> <td style="width: 10%;"></td> <td style="width: 10%;"></td> <td style="width: 10%;"></td> <td style="width: 10%;"></td> <td style="width: 10%;"></td> <td style="width: 10%;"></td> <td style="width: 10%;"></td> <td style="width: 10%;"></td> <td style="width: 10%;"></td> <td style="width: 10%;"></td> </tr> <tr> <td></td> <td></td> <td colspan="8" style="text-align: center;"> <table border="1" style="width: 100%; border-collapse: collapse; text-align: center;"> <tr>
</tr></table></td></tr></table></td></tr></table></td></tr></table></td></tr></table></td></tr></table></td></tr></table></td></tr></table></td></tr></table></td></tr></table></td></tr></table></td></tr></table></td></tr></table></td></tr></table></td></tr></table></td></tr></table></td></tr></table></td></tr></table></td></tr></table></td></tr></table></td></tr></table></td></tr></table></td></tr></table></td></tr></table></td></tr></table></td></tr></table></td></tr></table></td></tr></table></td></tr></table></td></tr></table></td></tr></table></td></tr></table></td></tr></table></td></tr></table></td></tr></table></td></tr></table></td></tr></table></td></tr></table></td></tr></table></td></tr></table></td></tr></table></td></tr></table></td></tr></table></td></tr></table></td></tr></table> | | | | | | | | | | | | | | | | | | | | <table border="1" style="width: 100%; border-collapse: collapse; text-align: center;"> <tr> <td style="width: 10%;"></td> <td style="width: 10%;"></td> <td style="width: 10%;"></td> <td style="width: 10%;"></td> <td style="width: 10%;"></td> <td style="width: 10%;"></td> <td style="width: 10%;"></td> <td style="width: 10%;"></td> <td style="width: 10%;"></td> <td style="width: 10%;"></td> </tr> <tr> <td></td> <td></td> <td colspan="8" style="text-align: center;"> <table border="1" style="width: 100%; border-collapse: collapse; text-align: center;"> <tr> <td style="width: 10%;"></td> <td style="width: 10%;"></td> <td style="width: 10%;"></td> <td style="width: 10%;"></td> <td style="width: 10%;"></td> <td style="width: 10%;"></td> <td style="width: 10%;"></td> <td style="width: 10%;"></td> <td style="width: 10%;"></td> <td style="width: 10%;"></td> </tr> <tr> <td></td> <td></td> <td colspan="8" style="text-align: center;"> <table border="1" style="width: 100%; border-collapse: collapse; text-align: center;"> <tr> <td style="width: 10%;"></td> <td style="width: 10%;"></td> <td style="width: 10%;"></td> <td style="width: 10%;"></td> <td style="width: 10%;"></td> <td style="width: 10%;"></td> <td style="width: 10%;"></td> <td style="width: 10%;"></td> <td style="width: 10%;"></td> <td style="width: 10%;"></td> </tr> <tr> <td></td> <td></td> <td colspan="8" style="text-align: center;"> <table border="1" style="width: 100%; border-collapse: collapse; text-align: center;"> <tr> <td style="width: 10%;"></td> <td style="width: 10%;"></td> <td style="width: 10%;"></td> <td style="width: 10%;"></td> <td style="width: 10%;"></td> <td style="width: 10%;"></td> <td style="width: 10%;"></td> <td style="width: 10%;"></td> <td style="width: 10%;"></td> <td style="width: 10%;"></td> </tr> <tr> <td></td> <td></td> <td colspan="8" style="text-align: center;"> <table border="1" style="width: 100%; border-collapse: collapse; text-align: center;"> <tr> <td style="width: 10%;"></td> <td style="width: 10%;"></td> <td style="width: 10%;"></td> <td style="width: 10%;"></td> <td style="width: 10%;"></td> <td style="width: 10%;"></td> <td style="width: 10%;"></td> <td style="width: 10%;"></td> <td style="width: 10%;"></td> <td style="width: 10%;"></td> </tr> <tr> <td></td> <td></td> <td colspan="8" style="text-align: center;"> <table border="1" style="width: 100%; border-collapse: collapse; text-align: center;"> <tr> <td style="width: 10%;"></td> <td style="width: 10%;"></td> <td style="width: 10%;"></td> <td style="width: 10%;"></td> <td style="width: 10%;"></td> <td style="width: 10%;"></td> <td style="width: 10%;"></td> <td style="width: 10%;"></td> <td style="width: 10%;"></td> <td style="width: 10%;"></td> </tr> <tr> <td></td> <td></td> <td colspan="8" style="text-align: center;"> <table
border="1" style="width: 100%; border-collapse: collapse; text-align: center;"> <tr> <td style="width: 10%;"></td> <td style="width: 10%;"></td> <td style="width: 10%;"></td> <td style="width: 10%;"></td> <td style="width: 10%;"></td> <td style="width: 10%;"></td> <td style="width: 10%;"></td> <td style="width: 10%;"></td> <td style="width: 10%;"></td> <td style="width: 10%;"></td> </tr> <tr> <td></td> <td></td> <td colspan="8" style="text-align: center;"> <table border="1" style="width: 100%; border-collapse: collapse; text-align: center;"> <tr> <td style="width: 10%;"></td> <td style="width: 10%;"></td> <td style="width: 10%;"></td> <td style="width: 10%;"></td> <td style="width: 10%;"></td> <td style="width: 10%;"></td> <td style="width: 10%;"></td> <td style="width: 10%;"></td> <td style="width: 10%;"></td> <td style="width: 10%;"></td> </tr> <tr> <td></td> <td></td> <td colspan="8" style="text-align: center;"> <table border="1" style="width: 100%; border-collapse: collapse; text-align: center;"> <tr> <td style="width: 10%;"></td> <td style="width: 10%;"></td> <td style="width: 10%;"></td> <td style="width: 10%;"></td> <td style="width: 10%;"></td> <td style="width: 10%;"></td> <td style="width: 10%;"></td> <td style="width: 10%;"></td> <td style="width: 10%;"></td> <td style="width: 10%;"></td> </tr> <tr> <td></td> <td></td> <td colspan="8" style="text-align: center;"> <table border="1" style="width: 100%; border-collapse: collapse; text-align: center;"> <tr> <td style="width: 10%;"></td> <td style="width: 10%;"></td> <td style="width: 10%;"></td> <td style="width: 10%;"></td> <td style="width: 10%;"></td> <td style="width: 10%;"></td> <td style="width: 10%;"></td> <td style="width: 10%;"></td> <td style="width: 10%;"></td> <td style="width: 10%;"></td> </tr> <tr> <td></td> <td></td> <td colspan="8" style="text-align: center;"> <table border="1" style="width: 100%; border-collapse: collapse; text-align: center;"> <tr> <td style="width: 10%;"></td> <td style="width: 10%;"></td> <td style="width: 10%;"></td> <td style="width: 10%;"></td> <td style="width: 10%;"></td> <td style="width: 10%;"></td> <td style="width: 10%;"></td> <td style="width: 10%;"></td> <td style="width: 10%;"></td> <td style="width: 10%;"></td> </tr> <tr> <td></td> <td></td> <td colspan="8" style="text-align: center;"> <table border="1" style="width: 100%; border-collapse: collapse; text-align: center;"> <tr> <td style="width: 10%;"></td> <td style="width: 10%;"></td> <td style="width: 10%;"></td> <td style="width: 10%;"></td> <td style="width: 10%;"></td> <td style="width: 10%;"></td> <td style="width: 10%;"></td> <td style="width: 10%;"></td> <td style="width: 10%;"></td> <td style="width: 10%;"></td> </tr> <tr> <td></td> <td></td> <td colspan="8" style="text-align: center;"> <table border="1" style="width: 100%; border-collapse: collapse; text-align: center;"> <tr> <td style="width: 10%;"></td> <td style="width: 10%;"></td> <td style="width: 10%;"></td> <td style="width: 10%;"></td> <td style="width: 10%;"></td> <td style="width: 10%;"></td> <td style="width: 10%;"></td> <td style="width: 10%;"></td> <td style="width: 10%;"></td> <td style="width: 10%;"></td> </tr> <tr> <td></td> <td></td> <td colspan="8" style="text-align: center;"> <table border="1" style="width: 100%; border-collapse: collapse; text-align: center;"> <tr> <td style="width: 10%;"></td> <td style="width: 10%;"></td> <td style="width: 10%;"></td> <td style="width: 10%;"></td> <td style="width: 10%;"></td> <td style="width: 10%;"></td> <td style="width: 10%;"></td> <td style="width: 10%;"></td> <td style="width: 10%;"></td> <td style="width: 10%;"></td> </tr> <tr> <td></td> <td></td> <td colspan="8" style="text-align: center;"> <table border="1" style="width: 100%; border-collapse: collapse; text-align: center;"> <tr> <td style="width: 10%;"></td> <td style="width: 10%;"></td> <td style="width: 10%;"></td> <td style="width: 10%;"></td> <td style="width: 10%;"></td> <td style="width: 10%;"></td> <td style="width: 10%;"></td> <td style="width: 10%;"></td> <td style="width: 10%;"></td> <td style="width: 10%;"></td> </tr> <tr> <td></td> <td></td> <td colspan="8" style="text-align: center;"> <table border="1" style="width: 100%; border-collapse: collapse; text-align: center;"> <tr> <td style="width: 10%;"></td> <td style="width: 10%;"></td> <td style="width: 10%;"></td> <td style="width: 10%;"></td> <td style="width: 10%;"></td> <td style="width: 10%;"></td> <td style="width: 10%;"></td> <td style="width: 10%;"></td> <td style="width: 10%;"></td> <td style="width: 10%;"></td> </tr> <tr> <td></td> <td></td> <td colspan="8" style="text-align: center;"> <table border="1" style="width: 100%; border-collapse: collapse; text-align: center;"> <tr> <td style="width: 10%;"></td> <td style="width: 10%;"></td> <td style="width: 10%;"></td> <td style="width: 10%;"></td> <td style="width: 10%;"></td> <td style="width: 10%;"></td> <td style="width: 10%;"></td> <td style="width: 10%;"></td> <td style="width: 10%;"></td> <td style="width: 10%;"></td> </tr> <tr> <td></td> <td></td> <td colspan="8" style="text-align: center;"> <table border="1" style="width: 100%; border-collapse: collapse; text-align: center;"> <tr> <td style="width: 10%;"></td> <td style="width: 10%;"></td> <td style="width: 10%;"></td> <td style="width: 10%;"></td> <td style="width: 10%;"></td> <td style="width: 10%;"></td> <td style="width: 10%;"></td> <td style="width: 10%;"></td> <td style="width: 10%;"></td> <td style="width: 10%;"></td> </tr> <tr> <td></td> <td></td> <td colspan="8" style="text-align: center;"> <table border="1" style="width: 100%; border-collapse: collapse; text-align: center;"> <tr> <td style="width: 10%;"></td> <td style="width: 10%;"></td> <td style="width: 10%;"></td> <td style="width: 10%;"></td> <td style="width: 10%;"></td> <td style="width: 10%;"></td> <td style="width: 10%;"></td> <td style="width: 10%;"></td> <td style="width: 10%;"></td> <td style="width: 10%;"></td> </tr> <tr> <td></td> <td></td> <td colspan="8" style="text-align: center;"> <table border="1" style="width: 100%; border-collapse: collapse; text-align: center;"> <tr> <td style="width: 10%;"></td> <td style="width: 10%;"></td> <td style="width: 10%;"></td> <td style="width: 10%;"></td> <td style="width: 10%;"></td> <td style="width: 10%;"></td> <td style="width: 10%;"></td> <td style="width: 10%;"></td> <td style="width: 10%;"></td> <td style="width: 10%;"></td> </tr> <tr> <td></td> <td></td> <td colspan="8" style="text-align: center;"> <table border="1" style="width: 100%; border-collapse: collapse; text-align: center;"> <tr> <td style="width: 10%;"></td> <td style="width: 10%;"></td> <td style="width: 10%;"></td> <td style="width: 10%;"></td> <td style="width: 10%;"></td> <td style="width: 10%;"></td> <td style="width: 10%;"></td> <td style="width: 10%;"></td> <td style="width: 10%;"></td> <td style="width: 10%;"></td> </tr> <tr> <td></td> <td></td> <td colspan="8" style="text-align: center;"> <table border="1" style="width: 100%; border-collapse: collapse; text-align: center;"> <tr> <td style="width: 10%;"></td> <td style="width: 10%;"></td> <td style="width: 10%;"></td> <td style="width: 10%;"></td> <td style="width: 10%;"></td> <td style="width: 10%;"></td> <td style="width: 10%;"></td> <td style="width: 10%;"></td> <td style="width: 10%;"></td> <td style="width: 10%;"></td> </tr> <tr> <td></td> <td></td> <td colspan="8" style="text-align: center;"> <table border="1" style="width: 100%; border-collapse: collapse; text-align: center;"> <tr> <td style="width: 10%;"></td> <td style="width: 10%;"></td> <td style="width: 10%;"></td> <td style="width: 10%;"></td> <td style="width: 10%;"></td> <td style="width: 10%;"></td> <td style="width: 10%;"></td> <td style="width: 10%;"></td> <td style="width: 10%;"></td> <td style="width: 10%;"></td> </tr> <tr> <td></td> <td></td> <td colspan="8" style="text-align: center;"> <table border="1" style="width: 100%; border-collapse: collapse; text-align: center;"> <tr> <td style="width: 10%;"></td> <td style="width: 10%;"></td> <td style="width: 10%;"></td> <td style="width: 10%;"></td> <td style="width: 10%;"></td> <td style="width: 10%;"></td> <td style="width: 10%;"></td> <td style="width: 10%;"></td> <td style="width: 10%;"></td> <td style="width: 10%;"></td> </tr> <tr> <td></td> <td></td> <td colspan="8" style="text-align: center;"> <table border="1" style="width: 100%; border-collapse: collapse; text-align: center;"> <tr> <td style="width: 10%;"></td> <td style="width: 10%;"></td> <td style="width: 10%;"></td> <td style="width: 10%;"></td> <td style="width: 10%;"></td> <td style="width: 10%;"></td> <td style="width: 10%;"></td> <td style="width: 10%;"></td> <td style="width: 10%;"></td> <td style="width: 10%;"></td> </tr> <tr> <td></td> <td></td> <td colspan="8" style="text-align: center;"> <table border="1" style="width: 100%; border-collapse: collapse; text-align: center;"> <tr> <td style="width: 10%;"></td> <td style="width: 10%;"></td> <td style="width: 10%;"></td> <td style="width: 10%;"></td> <td style="width: 10%;"></td> <td style="width: 10%;"></td> <td style="width: 10%;"></td> <td style="width: 10%;"></td> <td style="width: 10%;"></td> <td style="width: 10%;"></td> </tr> <tr> <td></td> <td></td> <td colspan="8" style="text-align: center;"> <table border="1" style="width: 100%; border-collapse: collapse; text-align: center;"> <tr> <td style="width: 10%;"></td> <td style="width: 10%;"></td> <td style="width: 10%;"></td> <td style="width: 10%;"></td> <td style="width: 10%;"></td> <td style="width: 10%;"></td> <td style="width: 10%;"></td> <td style="width: 10%;"></td> <td style="width: 10%;"></td> <td style="width: 10%;"></td> </tr> <tr> <td></td> <td></td> <td colspan="8" style="text-align: center;"> <table border="1" style="width: 100%; border-collapse: collapse; text-align: center;"> <tr> <td style="width: 10%;"></td> <td style="width: 10%;"></td> <td style="width:
10%;"></td> <td style="width: 10%;"></td> <td style="width: 10%;"></td> <td style="width: 10%;"></td> <td style="width: 10%;"></td> <td style="width: 10%;"></td> <td style="width: 10%;"></td> <td style="width: 10%;"></td> </tr> <tr> <td></td> <td></td> <td colspan="8" style="text-align: center;"> <table border="1" style="width: 100%; border-collapse: collapse; text-align: center;"> <tr> <td style="width: 10%;"></td> <td style="width: 10%;"></td> <td style="width: 10%;"></td> <td style="width: 10%;"></td> <td style="width: 10%;"></td> <td style="width: 10%;"></td> <td style="width: 10%;"></td> <td style="width: 10%;"></td> <td style="width: 10%;"></td> <td style="width: 10%;"></td> </tr> <tr> <td></td> <td></td> <td colspan="8" style="text-align: center;"> <table border="1" style="width: 100%; border-collapse: collapse; text-align: center;"> <tr> <td style="width: 10%;"></td> <td style="width: 10%;"></td> <td style="width: 10%;"></td> <td style="width: 10%;"></td> <td style="width: 10%;"></td> <td style="width: 10%;"></td> <td style="width: 10%;"></td> <td style="width: 10%;"></td> <td style="width: 10%;"></td> <td style="width: 10%;"></td> </tr> <tr> <td></td> <td></td> <td colspan="8" style="text-align: center;"> <table border="1" style="width: 100%; border-collapse: collapse; text-align: center;"> <tr> <td style="width: 10%;"></td> <td style="width: 10%;"></td> <td style="width: 10%;"></td> <td style="width: 10%;"></td> <td style="width: 10%;"></td> <td style="width: 10%;"></td> <td style="width: 10%;"></td> <td style="width: 10%;"></td> <td style="width: 10%;"></td> <td style="width: 10%;"></td> </tr> <tr> <td></td> <td></td> <td colspan="8" style="text-align: center;"> <table border="1" style="width: 100%; border-collapse: collapse; text-align: center;"> <tr> <td style="width: 10%;"></td> <td style="width: 10%;"></td> <td style="width: 10%;"></td> <td style="width: 10%;"></td> <td style="width: 10%;"></td> <td style="width: 10%;"></td> <td style="width: 10%;"></td> <td style="width: 10%;"></td> <td style="width: 10%;"></td> <td style="width: 10%;"></td> </tr> <tr> <td></td> <td></td> <td colspan="8" style="text-align: center;"> <table border="1" style="width: 100%; border-collapse: collapse; text-align: center;"> <tr> <td style="width: 10%;"></td> <td style="width: 10%;"></td> <td style="width: 10%;"></td> <td style="width: 10%;"></td> <td style="width: 10%;"></td> <td style="width: 10%;"></td> <td style="width: 10%;"></td> <td style="width: 10%;"></td> <td style="width: 10%;"></td> <td style="width: 10%;"></td> </tr> <tr> <td></td> <td></td> <td colspan="8" style="text-align: center;"> <table border="1" style="width: 100%; border-collapse: collapse; text-align: center;"> <tr> <td style="width: 10%;"></td> <td style="width: 10%;"></td> <td style="width: 10%;"></td> <td style="width: 10%;"></td> <td style="width: 10%;"></td> <td style="width: 10%;"></td> <td style="width: 10%;"></td> <td style="width: 10%;"></td> <td style="width: 10%;"></td> <td style="width: 10%;"></td> </tr> <tr> <td></td> <td></td> <td colspan="8" style="text-align: center;"> <table border="1" style="width: 100%; border-collapse: collapse; text-align: center;"> <tr> <td style="width: 10%;"></td> <td style="width: 10%;"></td> <td style="width: 10%;"></td> <td style="width: 10%;"></td> <td style="width: 10%;"></td> <td style="width: 10%;"></td> <td style="width: 10%;"></td> <td style="width: 10%;"></td> <td style="width: 10%;"></td> <td style="width: 10%;"></td> </tr> <tr> <td></td> <td></td> <td colspan="8" style="text-align: center;"> <table border="1" style="width: 100%; border-collapse: collapse; text-align: center;"> <tr> <td style="width: 10%;"></td> <td style="width: 10%;"></td> <td style="width: 10%;"></td> <td style="width: 10%;"></td> <td style="width: 10%;"></td> <td style="width: 10%;"></td> <td style="width: 10%;"></td> <td style="width: 10%;"></td> <td style="width: 10%;"></td> <td style="width: 10%;"></td> </tr> <tr> <td></td> <td></td> <td colspan="8" style="text-align: center;"> <table border="1" style="width: 100%; border-collapse: collapse; text-align: center;"> <tr> <td style="width: 10%;"></td> <td style="width: 10%;"></td> <td style="width: 10%;"></td> <td style="width: 10%;"></td> <td style="width: 10%;"></td> <td style="width: 10%;"></td> <td style="width: 10%;"></td> <td style="width: 10%;"></td> <td style="width: 10%;"></td> <td style="width: 10%;"></td> </tr> <tr> <td></td> <td></td> <td colspan="8" style="text-align: center;"> <table border="1" style="width: 100%; border-collapse: collapse; text-align: center;"> <tr> <td style="width: 10%;"></td> <td style="width: 10%;"></td> <td style="width: 10%;"></td> <td style="width: 10%;"></td> <td style="width: 10%;"></td> <td style="width: 10%;"></td> <td style="width: 10%;"></td> <td style="width: 10%;"></td> <td style="width: 10%;"></td> <td style="width: 10%;"></td> </tr> <tr> <td></td> <td></td> <td colspan="8" style="text-align: center;"> <table border="1" style="width: 100%; border-collapse: collapse; text-align: center;"> <tr> <td style="width: 10%;"></td> <td style="width: 10%;"></td> <td style="width: 10%;"></td> <td style="width: 10%;"></td> <td style="width: 10%;"></td> <td style="width: 10%;"></td> <td style="width: 10%;"></td> <td style="width: 10%;"></td> <td style="width: 10%;"></td> <td style="width: 10%;"></td> </tr> <tr> <td></td> <td></td> <td colspan="8" style="text-align: center;"> <table border="1" style="width: 100%; border-collapse: collapse; text-align: center;"> <tr> <td style="width: 10%;"></td> <td style="width: 10%;"></td> <td style="width: 10%;"></td> <td style="width: 10%;"></td> <td style="width: 10%;"></td> <td style="width: 10%;"></td> <td style="width: 10%;"></td> <td style="width: 10%;"></td> <td style="width: 10%;"></td> <td style="width: 10%;"></td> </tr> <tr> <td></td> <td></td> <td colspan="8" style="text-align: center;"> <table border="1" style="width: 100%; border-collapse: collapse; text-align: center;"> <tr> <td style="width: 10%;"></td> <td style="width: 10%;"></td> <td style="width: 10%;"></td> <td style="width: 10%;"></td> <td style="width: 10%;"></td> <td style="width: 10%;"></td> <td style="width: 10%;"></td> <td style="width: 10%;"></td> <td style="width: 10%;"></td> <td style="width: 10%;"></td> </tr> <tr> <td></td> <td></td> <td colspan="8" style="text-align: center;"> <table border="1" style="width: 100%; border-collapse: collapse; text-align: center;"> <tr> <td style="width: 10%;"></td> <td style="width: 10%;"></td> <td style="width: 10%;"></td> <td style="width: 10%;"></td> <td style="width: 10%;"></td> <td style="width: 10%;"></td> <td style="width: 10%;"></td> <td style="width: 10%;"></td> <td style="width: 10%;"></td> <td style="width: 10%;"></td> </tr> <tr> <td></td> <td></td> <td colspan="8" style="text-align: center;"> <table border="1" style="width: 100%; border-collapse: collapse; text-align: center;"> <tr> <td style="width: 10%;"></td> <td style="width: 10%;"></td> <td style="width: 10%;"></td> <td style="width: 10%;"></td> <td style="width: 10%;"></td> <td style="width: 10%;"></td> <td style="width: 10%;"></td> <td style="width: 10%;"></td> <td style="width: 10%;"></td> <td style="width: 10%;"></td> </tr> <tr> <td></td> <td></td> <td colspan="8" style="text-align: center;"> <table border="1" style="width: 100%; border-collapse: collapse; text-align: center;"> <tr> </tr></table></td></tr></table></td></tr></table></td></tr></table></td></tr></table></td></tr></table></td></tr></table></td></tr></table></td></tr></table></td></tr></table></td></tr></table></td></tr></table></td></tr></table></td></tr></table></td></tr></table></td></tr></table></td></tr></table></td></tr></table></td></tr></table></td></tr></table></td></tr></table></td></tr></table></td></tr></table></td></tr></table></td></tr></table></td></tr></table></td></tr></table></td></tr></table></td></tr></table></td></tr></table></td></tr></table></td></tr></table></td></tr></table></td></tr></table></td></tr></table></td></tr></table></td></tr></table></td></tr></table></td></tr></table></td></tr></table></td></tr></table></td></tr></table></td></tr></table></td></tr></table>
 | | | | | | | | | | | | | | | | | | | | <table border="1" style="width: 100%; border-collapse: collapse; text-align: center;"> <tr> <td style="width: 10%;"></td> <td style="width: 10%;"></td> <td style="width: 10%;"></td> <td style="width: 10%;"></td> <td style="width: 10%;"></td> <td style="width: 10%;"></td> <td style="width: 10%;"></td> <td style="width: 10%;"></td> <td style="width: 10%;"></td> <td style="width: 10%;"></td> </tr> <tr> <td></td> <td></td> <td colspan="8" style="text-align: center;"> <table border="1" style="width: 100%; border-collapse: collapse; text-align: center;"> <tr> <td style="width: 10%;"></td> <td style="width: 10%;"></td> <td style="width: 10%;"></td> <td style="width: 10%;"></td> <td style="width: 10%;"></td> <td style="width: 10%;"></td> <td style="width: 10%;"></td> <td style="width: 10%;"></td> <td style="width: 10%;"></td> <td style="width: 10%;"></td> </tr> <tr> <td></td> <td></td> <td colspan="8" style="text-align: center;"> <table border="1" style="width: 100%; border-collapse: collapse; text-align: center;"> <tr> <td style="width: 10%;"></td> <td style="width: 10%;"></td> <td style="width: 10%;"></td> <td style="width: 10%;"></td> <td style="width: 10%;"></td> <td style="width: 10%;"></td> <td style="width: 10%;"></td> <td style="width: 10%;"></td> <td style="width: 10%;"></td> <td style="width: 10%;"></td> </tr> <tr> <td></td> <td></td> <td colspan="8" style="text-align: center;"> <table border="1" style="width: 100%; border-collapse: collapse; text-align: center;"> <tr> <td style="width: 10%;"></td> <td style="width: 10%;"></td> <td style="width: 10%;"></td> <td style="width: 10%;"></td> <td style="width: 10%;"></td> <td style="width: 10%;"></td> <td style="width: 10%;"></td> <td style="width: 10%;"></td> <td style="width: 10%;"></td> <td style="width: 10%;"></td> </tr> <tr> <td></td> <td></td> <td colspan="8" style="text-align: center;"> <table border="1" style="width: 100%; border-collapse: collapse; text-align: center;"> <tr> <td style="width: 10%;"></td> <td style="width: 10%;"></td> <td style="width: 10%;"></td> <td style="width: 10%;"></td> <td style="width: 10%;"></td> <td style="width: 10%;"></td> <td style="width: 10%;"></td> <td style="width: 10%;"></td> <td style="width: 10%;"></td> <td style="width: 10%;"></td> </tr> <tr> <td></td> <td></td> <td colspan="8" style="text-align: center;"> <table border="1" style="width: 100%; border-collapse: collapse; text-align: center;"> <tr> <td style="width: 10%;"></td> <td style="width: 10%;"></td> <td style="width: 10%;"></td> <td style="width: 10%;"></td> <td style="width: 10%;"></td> <td style="width: 10%;"></td> <td style="width: 10%;"></td> <td style="width: 10%;"></td> <td style="width: 10%;"></td> <td style="width: 10%;"></td> </tr> <tr> <td></td> <td></td> <td colspan="8" style="text-align: center;"> <table border="1" style="width: 100%; border-collapse: collapse; text-align: center;"> <tr> <td style="width: 10%;"></td> <td style="width: 10%;"></td> <td style="width: 10%;"></td> <td style="width: 10%;"></td> <td style="width: 10%;"></td> <td style="width: 10%;"></td> <td style="width: 10%;"></td> <td style="width: 10%;"></td> <td style="width: 10%;"></td> <td style="width: 10%;"></td> </tr> <tr> <td></td> <td></td> <td colspan="8" style="text-align: center;"> <table border="1" style="width: 100%; border-collapse: collapse; text-align: center;"> <tr> <td style="width: 10%;"></td> <td style="width: 10%;"></td> <td style="width: 10%;"></td> <td style="width: 10%;"></td> <td style="width: 10%;"></td> <td style="width: 10%;"></td> <td style="width: 10%;"></td> <td style="width: 10%;"></td> <td style="width: 10%;"></td> <td style="width: 10%;"></td> </tr> <tr> <td></td> <td></td> <td colspan="8" style="text-align: center;"> <table border="1" style="width: 100%; border-collapse: collapse; text-align: center;"> <tr> <td style="width: 10%;"></td> <td style="width: 10%;"></td> <td style="width: 10%;"></td> <td style="width: 10%;"></td> <td style="width: 10%;"></td> <td style="width: 10%;"></td> <td style="width: 10%;"></td> <td style="width: 10%;"></td> <td style="width: 10%;"></td> <td style="width: 10%;"></td> </tr> <tr> <td></td> <td></td> <td colspan="8" style="text-align: center;"> <table border="1" style="width: 100%; border-collapse: collapse; text-align: center;"> <tr> <td style="width: 10%;"></td> <td style="width: 10%;"></td> <td style="width: 10%;"></td> <td style="width: 10%;"></td> <td style="width: 10%;"></td> <td style="width: 10%;"></td> <td style="width: 10%;"></td> <td style="width: 10%;"></td> <td style="width: 10%;"></td> <td style="width: 10%;"></td> </tr> <tr> <td></td> <td></td> <td colspan="8" style="text-align: center;"> <table border="1" style="width: 100%; border-collapse: collapse; text-align: center;"> <tr> <td style="width: 10%;"></td> <td style="width: 10%;"></td> <td style="width: 10%;"></td> <td style="width: 10%;"></td> <td style="width: 10%;"></td> <td style="width: 10%;"></td> <td style="width: 10%;"></td> <td style="width: 10%;"></td> <td style="width: 10%;"></td> <td style="width: 10%;"></td> </tr> <tr> <td></td> <td></td> <td colspan="8" style="text-align: center;"> <table border="1" style="width: 100%; border-collapse: collapse; text-align: center;"> <tr> <td style="width: 10%;"></td> <td style="width: 10%;"></td> <td style="width: 10%;"></td> <td style="width: 10%;"></td> <td style="width: 10%;"></td> <td style="width: 10%;"></td> <td
style="width: 10%;"></td> <td style="width: 10%;"></td> <td style="width: 10%;"></td> <td style="width: 10%;"></td> </tr> <tr> <td></td> <td></td> <td colspan="8" style="text-align: center;"> <table border="1" style="width: 100%; border-collapse: collapse; text-align: center;"> <tr> <td style="width: 10%;"></td> <td style="width: 10%;"></td> <td style="width: 10%;"></td> <td style="width: 10%;"></td> <td style="width: 10%;"></td> <td style="width: 10%;"></td> <td style="width: 10%;"></td> <td style="width: 10%;"></td> <td style="width: 10%;"></td> <td style="width: 10%;"></td> </tr> <tr> <td></td> <td></td> <td colspan="8" style="text-align: center;"> <table border="1" style="width: 100%; border-collapse: collapse; text-align: center;"> <tr> <td style="width: 10%;"></td> <td style="width: 10%;"></td> <td style="width: 10%;"></td> <td style="width: 10%;"></td> <td style="width: 10%;"></td> <td style="width: 10%;"></td> <td style="width: 10%;"></td> <td style="width: 10%;"></td> <td style="width: 10%;"></td> <td style="width: 10%;"></td> </tr> <tr> <td></td> <td></td> <td colspan="8" style="text-align: center;"> <table border="1" style="width: 100%; border-collapse: collapse; text-align: center;"> <tr> <td style="width: 10%;"></td> <td style="width: 10%;"></td> <td style="width: 10%;"></td> <td style="width: 10%;"></td> <td style="width: 10%;"></td> <td style="width: 10%;"></td> <td style="width: 10%;"></td> <td style="width: 10%;"></td> <td style="width: 10%;"></td> <td style="width: 10%;"></td> </tr> <tr> <td></td> <td></td> <td colspan="8" style="text-align: center;"> <table border="1" style="width: 100%; border-collapse: collapse; text-align: center;"> <tr> <td style="width: 10%;"></td> <td style="width: 10%;"></td> <td style="width: 10%;"></td> <td style="width: 10%;"></td> <td style="width: 10%;"></td> <td style="width: 10%;"></td> <td style="width: 10%;"></td> <td style="width: 10%;"></td> <td style="width: 10%;"></td> <td style="width: 10%;"></td> </tr> <tr> <td></td> <td></td> <td colspan="8" style="text-align: center;"> <table border="1" style="width: 100%; border-collapse: collapse; text-align: center;"> <tr> <td style="width: 10%;"></td> <td style="width: 10%;"></td> <td style="width: 10%;"></td> <td style="width: 10%;"></td> <td style="width: 10%;"></td> <td style="width: 10%;"></td> <td style="width: 10%;"></td> <td style="width: 10%;"></td> <td style="width: 10%;"></td> <td style="width: 10%;"></td> </tr> <tr> <td></td> <td></td> <td colspan="8" style="text-align: center;"> <table border="1" style="width: 100%; border-collapse: collapse; text-align: center;"> <tr> <td style="width: 10%;"></td> <td style="width: 10%;"></td> <td style="width: 10%;"></td> <td style="width: 10%;"></td> <td style="width: 10%;"></td> <td style="width: 10%;"></td> <td style="width: 10%;"></td> <td style="width: 10%;"></td> <td style="width: 10%;"></td> <td style="width: 10%;"></td> </tr> <tr> <td></td> <td></td> <td colspan="8" style="text-align: center;"> <table border="1" style="width: 100%; border-collapse: collapse; text-align: center;"> <tr> <td style="width: 10%;"></td> <td style="width: 10%;"></td> <td style="width: 10%;"></td> <td style="width: 10%;"></td> <td style="width: 10%;"></td> <td style="width: 10%;"></td> <td style="width: 10%;"></td> <td style="width: 10%;"></td> <td style="width: 10%;"></td> <td style="width: 10%;"></td> </tr> <tr> <td></td> <td></td> <td colspan="8" style="text-align: center;"> <table border="1" style="width: 100%; border-collapse: collapse; text-align: center;"> <tr> <td style="width: 10%;"></td> <td style="width: 10%;"></td> <td style="width: 10%;"></td> <td style="width: 10%;"></td> <td style="width: 10%;"></td> <td style="width: 10%;"></td> <td style="width: 10%;"></td> <td style="width: 10%;"></td> <td style="width: 10%;"></td> <td style="width: 10%;"></td> </tr> <tr> <td></td> <td></td> <td colspan="8" style="text-align: center;"> <table border="1" style="width: 100%; border-collapse: collapse; text-align: center;"> <tr> <td style="width: 10%;"></td> <td style="width: 10%;"></td> <td style="width: 10%;"></td> <td style="width: 10%;"></td> <td style="width: 10%;"></td> <td style="width: 10%;"></td> <td style="width: 10%;"></td> <td style="width: 10%;"></td> <td style="width: 10%;"></td> <td style="width: 10%;"></td> </tr> <tr> <td></td> <td></td> <td colspan="8" style="text-align: center;"> <table border="1" style="width: 100%; border-collapse: collapse; text-align: center;"> <tr> <td style="width: 10%;"></td> <td style="width: 10%;"></td> <td style="width: 10%;"></td> <td style="width: 10%;"></td> <td style="width: 10%;"></td> <td style="width: 10%;"></td> <td style="width: 10%;"></td> <td style="width: 10%;"></td> <td style="width: 10%;"></td> <td style="width: 10%;"></td> </tr> <tr> <td></td> <td></td> <td colspan="8" style="text-align: center;"> <table border="1" style="width: 100%; border-collapse: collapse; text-align: center;"> <tr> <td style="width: 10%;"></td> <td style="width: 10%;"></td> <td style="width: 10%;"></td> <td style="width: 10%;"></td> <td style="width: 10%;"></td> <td style="width: 10%;"></td> <td style="width: 10%;"></td> <td style="width: 10%;"></td> <td style="width: 10%;"></td> <td style="width: 10%;"></td> </tr> <tr> <td></td> <td></td> <td colspan="8" style="text-align: center;"> <table border="1" style="width: 100%; border-collapse: collapse; text-align: center;"> <tr> <td style="width: 10%;"></td> <td style="width: 10%;"></td> <td style="width: 10%;"></td> <td style="width: 10%;"></td> <td style="width: 10%;"></td> <td style="width: 10%;"></td> <td style="width: 10%;"></td> <td style="width: 10%;"></td> <td style="width: 10%;"></td> <td style="width: 10%;"></td> </tr> <tr> <td></td> <td></td> <td colspan="8" style="text-align: center;"> <table border="1" style="width: 100%; border-collapse: collapse; text-align: center;"> <tr> <td style="width: 10%;"></td> <td style="width: 10%;"></td> <td style="width: 10%;"></td> <td style="width: 10%;"></td> <td style="width: 10%;"></td> <td style="width: 10%;"></td> <td style="width: 10%;"></td> <td style="width: 10%;"></td> <td style="width: 10%;"></td> <td style="width: 10%;"></td> </tr> <tr> <td></td> <td></td> <td colspan="8" style="text-align: center;"> <table border="1" style="width: 100%; border-collapse: collapse; text-align: center;"> <tr> <td style="width: 10%;"></td> <td style="width: 10%;"></td> <td style="width: 10%;"></td> <td style="width: 10%;"></td> <td style="width: 10%;"></td> <td style="width: 10%;"></td> <td style="width: 10%;"></td> <td style="width: 10%;"></td> <td style="width: 10%;"></td> <td style="width: 10%;"></td> </tr> <tr> <td></td> <td></td> <td colspan="8" style="text-align: center;"> <table border="1" style="width: 100%; border-collapse: collapse; text-align: center;"> <tr> <td style="width: 10%;"></td> <td style="width: 10%;"></td> <td style="width: 10%;"></td> <td style="width: 10%;"></td> <td style="width: 10%;"></td> <td style="width: 10%;"></td> <td style="width: 10%;"></td> <td style="width: 10%;"></td> <td style="width: 10%;"></td> <td style="width: 10%;"></td> </tr> <tr> <td></td> <td></td> <td colspan="8" style="text-align: center;"> <table border="1" style="width: 100%; border-collapse: collapse; text-align: center;"> <tr> <td style="width: 10%;"></td> <td style="width: 10%;"></td> <td style="width: 10%;"></td> <td style="width: 10%;"></td> <td style="width: 10%;"></td> <td style="width: 10%;"></td> <td style="width: 10%;"></td> <td style="width: 10%;"></td> <td style="width: 10%;"></td> <td style="width: 10%;"></td> </tr> <tr> <td></td> <td></td> <td colspan="8" style="text-align: center;"> <table border="1" style="width: 100%; border-collapse: collapse; text-align: center;"> <tr> <td style="width: 10%;"></td> <td style="width: 10%;"></td> <td style="width: 10%;"></td> <td style="width: 10%;"></td> <td style="width: 10%;"></td> <td style="width: 10%;"></td> <td style="width: 10%;"></td> <td style="width: 10%;"></td> <td style="width: 10%;"></td> <td style="width: 10%;"></td> </tr> <tr> <td></td> <td></td> <td colspan="8" style="text-align: center;"> <table border="1" style="width: 100%; border-collapse: collapse; text-align: center;"> <tr> <td style="width: 10%;"></td> <td style="width: 10%;"></td> <td style="width: 10%;"></td> <td style="width: 10%;"></td> <td style="width: 10%;"></td> <td style="width: 10%;"></td> <td style="width: 10%;"></td> <td style="width: 10%;"></td> <td style="width: 10%;"></td> <td style="width: 10%;"></td> </tr> <tr> <td></td> <td></td> <td colspan="8" style="text-align: center;"> <table border="1" style="width: 100%; border-collapse: collapse; text-align: center;"> <tr> <td style="width: 10%;"></td> <td style="width: 10%;"></td> <td style="width: 10%;"></td> <td style="width: 10%;"></td> <td style="width: 10%;"></td> <td style="width: 10%;"></td> <td style="width: 10%;"></td> <td style="width: 10%;"></td> <td style="width: 10%;"></td> <td style="width: 10%;"></td> </tr> <tr> <td></td> <td></td> <td colspan="8" style="text-align: center;"> <table border="1" style="width: 100%; border-collapse: collapse; text-align: center;"> <tr> <td style="width: 10%;"></td> <td style="width: 10%;"></td> <td style="width: 10%;"></td> <td style="width: 10%;"></td> <td style="width: 10%;"></td> <td style="width: 10%;"></td> <td style="width: 10%;"></td> <td style="width: 10%;"></td> <td style="width: 10%;"></td> <td style="width: 10%;"></td> </tr> <tr> <td></td> <td></td> <td colspan="8" style="text-align: center;"> <table border="1" style="width: 100%; border-collapse: collapse; text-align: center;"> <tr> <td style="width: 10%;"></td> <td style="width: 10%;"></td> <td style="width: 10%;"></td> <td style="width: 10%;"></td> <td style="width: 10%;"></td> <td style="width: 10%;"></td> <td style="width: 10%;"></td> <td style="width: 10%;"></td> <td style="width: 10%;"></td> <td style="width: 10%;"></td> </tr> <tr> <td></td> <td></td> <td colspan="8"
style="text-align: center;"> <table border="1" style="width: 100%; border-collapse: collapse; text-align: center;"> <tr> <td style="width: 10%;"></td> <td style="width: 10%;"></td> <td style="width: 10%;"></td> <td style="width: 10%;"></td> <td style="width: 10%;"></td> <td style="width: 10%;"></td> <td style="width: 10%;"></td> <td style="width: 10%;"></td> <td style="width: 10%;"></td> <td style="width: 10%;"></td> </tr> <tr> <td></td> <td></td> <td colspan="8" style="text-align: center;"> <table border="1" style="width: 100%; border-collapse: collapse; text-align: center;"> <tr> <td style="width: 10%;"></td> <td style="width: 10%;"></td> <td style="width: 10%;"></td> <td style="width: 10%;"></td> <td style="width: 10%;"></td> <td style="width: 10%;"></td> <td style="width: 10%;"></td> <td style="width: 10%;"></td> <td style="width: 10%;"></td> <td style="width: 10%;"></td> </tr> <tr> <td></td> <td></td> <td colspan="8" style="text-align: center;"> <table border="1" style="width: 100%; border-collapse: collapse; text-align: center;"> <tr> <td style="width: 10%;"></td> <td style="width: 10%;"></td> <td style="width: 10%;"></td> <td style="width: 10%;"></td> <td style="width: 10%;"></td> <td style="width: 10%;"></td> <td style="width: 10%;"></td> <td style="width: 10%;"></td> <td style="width: 10%;"></td> <td style="width: 10%;"></td> </tr> <tr> <td></td> <td></td> <td colspan="8" style="text-align: center;"> <table border="1" style="width: 100%; border-collapse: collapse; text-align: center;"> <tr> <td style="width: 10%;"></td> <td style="width: 10%;"></td> <td style="width: 10%;"></td> <td style="width: 10%;"></td> <td style="width: 10%;"></td> <td style="width: 10%;"></td> <td style="width: 10%;"></td> <td style="width: 10%;"></td> <td style="width: 10%;"></td> <td style="width: 10%;"></td> </tr> <tr> <td></td> <td></td> <td colspan="8" style="text-align: center;"> <table border="1" style="width: 100%; border-collapse: collapse; text-align: center;"> <tr> <td style="width: 10%;"></td> <td style="width: 10%;"></td> <td style="width: 10%;"></td> <td style="width: 10%;"></td> <td style="width: 10%;"></td> <td style="width: 10%;"></td> <td style="width: 10%;"></td> <td style="width: 10%;"></td> <td style="width: 10%;"></td> <td style="width: 10%;"></td> </tr> <tr> <td></td> <td></td> <td colspan="8" style="text-align: center;"> <table border="1" style="width: 100%; border-collapse: collapse; text-align: center;"> <tr> <td style="width: 10%;"></td> <td style="width: 10%;"></td> <td style="width: 10%;"></td> <td style="width: 10%;"></td> <td style="width: 10%;"></td> <td style="width: 10%;"></td> <td style="width: 10%;"></td> <td style="width: 10%;"></td> <td style="width: 10%;"></td> <td style="width: 10%;"></td> </tr> <tr> <td></td> <td></td> <td colspan="8" style="text-align: center;"> <table border="1" style="width: 100%; border-collapse: collapse; text-align: center;"> <tr> <td style="width: 10%;"></td> <td style="width: 10%;"></td> <td style="width: 10%;"></td> <td style="width: 10%;"></td> <td style="width: 10%;"></td> <td style="width: 10%;"></td> <td style="width: 10%;"></td> <td style="width: 10%;"></td> <td style="width: 10%;"></td> <td style="width: 10%;"></td> </tr> <tr> <td></td> <td></td> <td colspan="8" style="text-align: center;"> <table border="1" style="width: 100%; border-collapse: collapse; text-align: center;"> <tr> <td style="width: 10%;"></td> <td style="width: 10%;"></td> <td style="width: 10%;"></td> <td style="width: 10%;"></td> <td style="width: 10%;"></td> <td style="width: 10%;"></td> <td style="width: 10%;"></td> <td style="width: 10%;"></td> <td style="width: 10%;"></td> <td style="width: 10%;"></td> </tr> <tr> <td></td> <td></td> <td colspan="8" style="text-align: center;"> <table border="1" style="width: 100%; border-collapse: collapse; text-align: center;"> <tr> <td style="width: 10%;"></td> <td style="width: 10%;"></td> <td style="width: 10%;"></td> <td style="width: 10%;"></td> <td style="width: 10%;"></td> <td style="width: 10%;"></td> <td style="width: 10%;"></td> <td style="width: 10%;"></td> <td style="width: 10%;"></td> <td style="width: 10%;"></td> </tr> <tr> <td></td> <td></td> <td colspan="8" style="text-align: center;"> <table border="1" style="width: 100%; border-collapse: collapse; text-align: center;"> <tr> </tr></table></td></tr></table></td></tr></table></td></tr></table></td></tr></table></td></tr></table></td></tr></table></td></tr></table></td></tr></table></td></tr></table></td></tr></table></td></tr></table></td></tr></table></td></tr></table></td></tr></table></td></tr></table></td></tr></table></td></tr></table></td></tr></table></td></tr></table></td></tr></table></td></tr></table></td></tr></table></td></tr></table></td></tr></table></td></tr></table></td></tr></table></td></tr></table></td></tr></table></td></tr></table></td></tr></table></td></tr></table></td></tr></table></td></tr></table></td></tr></table></td></tr></table></td></tr></table></td></tr></table></td></tr></table></td></tr></table></td></tr></table></td></tr></table></td></tr></table>
 | | | | | | | | | | | | | | | | | | | | <table border="1" style="width: 100%; border-collapse: collapse; text-align: center;"> <tr> <td style="width: 10%;"></td> <td style="width: 10%;"></td> <td style="width: 10%;"></td> <td style="width: 10%;"></td> <td style="width: 10%;"></td> <td style="width: 10%;"></td> <td style="width: 10%;"></td> <td style="width: 10%;"></td> <td style="width: 10%;"></td> <td style="width: 10%;"></td> </tr> <tr> <td></td> <td></td> <td colspan="8" style="text-align: center;"> <table border="1" style="width: 100%; border-collapse: collapse; text-align: center;"> <tr> <td style="width: 10%;"></td> <td style="width: 10%;"></td> <td style="width: 10%;"></td> <td style="width: 10%;"></td> <td style="width: 10%;"></td> <td style="width: 10%;"></td> <td style="width: 10%;"></td> <td style="width: 10%;"></td> <td style="width: 10%;"></td> <td style="width: 10%;"></td> </tr> <tr> <td></td> <td></td> <td colspan="8" style="text-align: center;"> <table border="1" style="width: 100%; border-collapse: collapse; text-align: center;"> <tr> <td style="width: 10%;"></td> <td style="width: 10%;"></td> <td style="width: 10%;"></td> <td style="width: 10%;"></td> <td style="width: 10%;"></td> <td style="width: 10%;"></td> <td style="width: 10%;"></td> <td style="width: 10%;"></td> <td style="width: 10%;"></td> <td style="width: 10%;"></td> </tr> <tr> <td></td> <td></td> <td colspan="8" style="text-align: center;"> <table border="1" style="width: 100%; border-collapse: collapse; text-align: center;"> <tr> <td style="width: 10%;"></td> <td style="width: 10%;"></td> <td style="width: 10%;"></td> <td style="width: 10%;"></td> <td style="width: 10%;"></td> <td style="width: 10%;"></td> <td style="width: 10%;"></td> <td style="width: 10%;"></td> <td style="width: 10%;"></td> <td style="width: 10%;"></td> </tr> <tr> <td></td> <td></td> <td colspan="8" style="text-align: center;"> <table border="1" style="width: 100%; border-collapse: collapse; text-align: center;"> <tr> <td style="width: 10%;"></td> <td style="width: 10%;"></td> <td style="width: 10%;"></td> <td style="width: 10%;"></td> <td style="width: 10%;"></td> <td style="width: 10%;"></td> <td style="width: 10%;"></td> <td style="width: 10%;"></td> <td style="width: 10%;"></td> <td style="width: 10%;"></td> </tr> <tr> <td></td> <td></td> <td colspan="8" style="text-align: center;"> <table border="1" style="width: 100%; border-collapse: collapse; text-align: center;"> <tr> <td style="width: 10%;"></td> <td style="width: 10%;"></td> <td style="width: 10%;"></td> <td style="width: 10%;"></td> <td style="width: 10%;"></td> <td style="width: 10%;"></td> <td style="width: 10%;"></td> <td style="width: 10%;"></td> <td style="width: 10%;"></td> <td style="width: 10%;"></td> </tr> <tr> <td></td> <td></td> <td colspan="8" style="text-align: center;"> <table border="1" style="width: 100%; border-collapse: collapse; text-align: center;"> <tr> <td style="width: 10%;"></td> <td style="width: 10%;"></td> <td style="width: 10%;"></td> <td style="width: 10%;"></td> <td style="width: 10%;"></td> <td style="width: 10%;"></td> <td style="width: 10%;"></td> <td style="width: 10%;"></td> <td style="width: 10%;"></td> <td style="width: 10%;"></td> </tr> <tr> <td></td> <td></td> <td colspan="8" style="text-align: center;"> <table border="1" style="width: 100%; border-collapse: collapse; text-align: center;"> <tr> <td style="width: 10%;"></td> <td style="width: 10%;"></td> <td style="width: 10%;"></td> <td style="width: 10%;"></td> <td style="width: 10%;"></td> <td style="width: 10%;"></td> <td style="width: 10%;"></td> <td style="width: 10%;"></td> <td style="width: 10%;"></td> <td style="width: 10%;"></td> </tr> <tr> <td></td> <td></td> <td colspan="8" style="text-align: center;"> <table border="1" style="width: 100%; border-collapse: collapse; text-align: center;"> <tr> <td style="width: 10%;"></td> <td style="width: 10%;"></td> <td style="width: 10%;"></td> <td style="width: 10%;"></td> <td style="width: 10%;"></td> <td style="width: 10%;"></td> <td style="width: 10%;"></td> <td style="width: 10%;"></td> <td style="width: 10%;"></td> <td style="width: 10%;"></td> </tr> <tr> <td></td> <td></td> <td colspan="8" style="text-align: center;"> <table border="1" style="width: 100%; border-collapse: collapse; text-align: center;"> <tr> <td style="width: 10%;"></td> <td style="width: 10%;"></td> <td style="width: 10%;"></td> <td style="width: 10%;"></td> <td style="width: 10%;"></td> <td style="width: 10%;"></td> <td style="width: 10%;"></td> <td style="width: 10%;"></td> <td style="width: 10%;"></td> <td style="width: 10%;"></td> </tr> <tr> <td></td> <td></td> <td colspan="8" style="text-align: center;"> <table border="1" style="width: 100%; border-collapse: collapse; text-align: center;"> <tr> <td style="width: 10%;"></td> <td style="width: 10%;"></td> <td style="width: 10%;"></td> <td style="width: 10%;"></td> <td style="width: 10%;"></td> <td style="width: 10%;"></td> <td style="width: 10%;"></td> <td style="width: 10%;"></td> <td style="width: 10%;"></td> <td style="width: 10%;"></td> </tr> <tr> <td></td> <td></td> <td colspan="8" style="text-align: center;"> <table border="1" style="width: 100%; border-collapse: collapse; text-align: center;"> <tr> <td style="width: 10%;"></td> <td style="width: 10%;"></td> <td style="width: 10%;"></td> <td style="width: 10%;"></td> <td style="width: 10%;"></td> <td style="width: 10%;"></td> <td style="width: 10%;"></td> <td style="width: 10%;"></td> <td style="width: 10%;"></td> <td style="width: 10%;"></td> </tr> <tr> <td></td> <td></td> <td colspan="8" style="text-align: center;"> <table border="1" style="width: 100%; border-collapse: collapse; text-align: center;"> <tr> <td style="width: 10%;"></td> <td style="width: 10%;"></td> <td style="width: 10%;"></td> <td style="width: 10%;"></td> <td style="width: 10%;"></td> <td style="width: 10%;"></td> <td style="width: 10%;"></td> <td style="width: 10%;"></td> <td style="width: 10%;"></td> <td style="width: 10%;"></td> </tr> <tr> <td></td> <td></td> <td colspan="8" style="text-align: center;"> <table border="1" style="width: 100%; border-collapse: collapse; text-align: center;"> <tr> <td style="width: 10%;"></td> <td style="width: 10%;"></td> <td style="width: 10%;"></td> <td style="width: 10%;"></td> <td style="width: 10%;"></td> <td style="width: 10%;"></td> <td style="width: 10%;"></td> <td style="width: 10%;"></td> <td style="width: 10%;"></td> <td style="width: 10%;"></td> </tr> <tr> <td></td> <td></td> <td colspan="8" style="text-align: center;"> <table border="1" style="width: 100%; border-collapse: collapse; text-align: center;"> <tr> <td style="width: 10%;"></td> <td style="width: 10%;"></td> <td style="width: 10%;"></td> <td style="width: 10%;"></td> <td style="width: 10%;"></td> <td style="width: 10%;"></td> <td style="width: 10%;"></td> <td style="width: 10%;"></td> <td style="width: 10%;"></td> <td style="width: 10%;"></td> </tr> <tr> <td></td> <td></td> <td colspan="8" style="text-align: center;"> <table border="1" style="width: 100%; border-collapse: collapse; text-align: center;"> <tr> <td style="width: 10%;"></td> <td style="width: 10%;"></td> <td style="width: 10%;"></td> <td style="width: 10%;"></td> <td style="width: 10%;"></td> <td style="width: 10%;"></td> <td style="width: 10%;"></td> <td style="width: 10%;"></td> <td style="width: 10%;"></td> <td style="width: 10%;"></td> </tr> <tr> <td></td> <td></td> <td colspan="8" style="text-align: center;"> <table border="1" style="width: 100%; border-collapse: collapse; text-align: center;"> <tr> <td style="width: 10%;"></td> <td style="width: 10%;"></td> <td style="width: 10%;"></td> <td style="width: 10%;"></td> <td style="width: 10%;"></td> <td style="width: 10%;"></td> <td style="width: 10%;"></td> <td style="width: 10%;"></td> <td style="width: 10%;"></td> <td style="width: 10%;"></td> </tr> <tr> <td></td> <td></td> <td colspan="8" style="text-align: center;"> <table border="1" style="width: 100%; border-collapse: collapse; text-align: center;"> <tr> <td style="width: 10%;"></td> <td style="width: 10%;"></td> <td style="width: 10%;"></td> <td style="width: 10%;"></td> <td style="width: 10%;"></td> <td style="width: 10%;"></td> <td style="width: 10%;"></td> <td style="width: 10%;"></td> <td style="width: 10%;"></td> <td style="width: 10%;"></td> </tr> <tr> <td></td> <td></td> <td colspan="8" style="text-align: center;"> <table border="1" style="width: 100%; border-collapse: collapse; text-align: center;"> <tr> <td
style="width: 10%;"></td> <td style="width: 10%;"></td> <td style="width: 10%;"></td> <td style="width: 10%;"></td> <td style="width: 10%;"></td> <td style="width: 10%;"></td> <td style="width: 10%;"></td> <td style="width: 10%;"></td> <td style="width: 10%;"></td> <td style="width: 10%;"></td> </tr> <tr> <td></td> <td></td> <td colspan="8" style="text-align: center;"> <table border="1" style="width: 100%; border-collapse: collapse; text-align: center;"> <tr> <td style="width: 10%;"></td> <td style="width: 10%;"></td> <td style="width: 10%;"></td> <td style="width: 10%;"></td> <td style="width: 10%;"></td> <td style="width: 10%;"></td> <td style="width: 10%;"></td> <td style="width: 10%;"></td> <td style="width: 10%;"></td> <td style="width: 10%;"></td> </tr> <tr> <td></td> <td></td> <td colspan="8" style="text-align: center;"> <table border="1" style="width: 100%; border-collapse: collapse; text-align: center;"> <tr> <td style="width: 10%;"></td> <td style="width: 10%;"></td> <td style="width: 10%;"></td> <td style="width: 10%;"></td> <td style="width: 10%;"></td> <td style="width: 10%;"></td> <td style="width: 10%;"></td> <td style="width: 10%;"></td> <td style="width: 10%;"></td> <td style="width: 10%;"></td> </tr> <tr> <td></td> <td></td> <td colspan="8" style="text-align: center;"> <table border="1" style="width: 100%; border-collapse: collapse; text-align: center;"> <tr> <td style="width: 10%;"></td> <td style="width: 10%;"></td> <td style="width: 10%;"></td> <td style="width: 10%;"></td> <td style="width: 10%;"></td> <td style="width: 10%;"></td> <td style="width: 10%;"></td> <td style="width: 10%;"></td> <td style="width: 10%;"></td> <td style="width: 10%;"></td> </tr> <tr> <td></td> <td></td> <td colspan="8" style="text-align: center;"> <table border="1" style="width: 100%; border-collapse: collapse; text-align: center;"> <tr> <td style="width: 10%;"></td> <td style="width: 10%;"></td> <td style="width: 10%;"></td> <td style="width: 10%;"></td> <td style="width: 10%;"></td> <td style="width: 10%;"></td> <td style="width: 10%;"></td> <td style="width: 10%;"></td> <td style="width: 10%;"></td> <td style="width: 10%;"></td> </tr> <tr> <td></td> <td></td> <td colspan="8" style="text-align: center;"> <table border="1" style="width: 100%; border-collapse: collapse; text-align: center;"> <tr> <td style="width: 10%;"></td> <td style="width: 10%;"></td> <td style="width: 10%;"></td> <td style="width: 10%;"></td> <td style="width: 10%;"></td> <td style="width: 10%;"></td> <td style="width: 10%;"></td> <td style="width: 10%;"></td> <td style="width: 10%;"></td> <td style="width: 10%;"></td> </tr> <tr> <td></td> <td></td> <td colspan="8" style="text-align: center;"> <table border="1" style="width: 100%; border-collapse: collapse; text-align: center;"> <tr> <td style="width: 10%;"></td> <td style="width: 10%;"></td> <td style="width: 10%;"></td> <td style="width: 10%;"></td> <td style="width: 10%;"></td> <td style="width: 10%;"></td> <td style="width: 10%;"></td> <td style="width: 10%;"></td> <td style="width: 10%;"></td> <td style="width: 10%;"></td> </tr> <tr> <td></td> <td></td> <td colspan="8" style="text-align: center;"> <table border="1" style="width: 100%; border-collapse: collapse; text-align: center;"> <tr> <td style="width: 10%;"></td> <td style="width: 10%;"></td> <td style="width: 10%;"></td> <td style="width: 10%;"></td> <td style="width: 10%;"></td> <td style="width: 10%;"></td> <td style="width: 10%;"></td> <td style="width: 10%;"></td> <td style="width: 10%;"></td> <td style="width: 10%;"></td> </tr> <tr> <td></td> <td></td> <td colspan="8" style="text-align: center;"> <table border="1" style="width: 100%; border-collapse: collapse; text-align: center;"> <tr> <td style="width: 10%;"></td> <td style="width: 10%;"></td> <td style="width: 10%;"></td> <td style="width: 10%;"></td> <td style="width: 10%;"></td> <td style="width: 10%;"></td> <td style="width: 10%;"></td> <td style="width: 10%;"></td> <td style="width: 10%;"></td> <td style="width: 10%;"></td> </tr> <tr> <td></td> <td></td> <td colspan="8" style="text-align: center;"> <table border="1" style="width: 100%; border-collapse: collapse; text-align: center;"> <tr> <td style="width: 10%;"></td> <td style="width: 10%;"></td> <td style="width: 10%;"></td> <td style="width: 10%;"></td> <td style="width: 10%;"></td> <td style="width: 10%;"></td> <td style="width: 10%;"></td> <td style="width: 10%;"></td> <td style="width: 10%;"></td> <td style="width: 10%;"></td> </tr> <tr> <td></td> <td></td> <td colspan="8" style="text-align: center;"> <table border="1" style="width: 100%; border-collapse: collapse; text-align: center;"> <tr> <td style="width: 10%;"></td> <td style="width: 10%;"></td> <td style="width: 10%;"></td> <td style="width: 10%;"></td> <td style="width: 10%;"></td> <td style="width: 10%;"></td> <td style="width: 10%;"></td> <td style="width: 10%;"></td> <td style="width: 10%;"></td> <td style="width: 10%;"></td> </tr> <tr> <td></td> <td></td> <td colspan="8" style="text-align: center;"> <table border="1" style="width: 100%; border-collapse: collapse; text-align: center;"> <tr> <td style="width: 10%;"></td> <td style="width: 10%;"></td> <td style="width: 10%;"></td> <td style="width: 10%;"></td> <td style="width: 10%;"></td> <td style="width: 10%;"></td> <td style="width: 10%;"></td> <td style="width: 10%;"></td> <td style="width: 10%;"></td> <td style="width: 10%;"></td> </tr> <tr> <td></td> <td></td> <td colspan="8" style="text-align: center;"> <table border="1" style="width: 100%; border-collapse: collapse; text-align: center;"> <tr> <td style="width: 10%;"></td> <td style="width: 10%;"></td> <td style="width: 10%;"></td> <td style="width: 10%;"></td> <td style="width: 10%;"></td> <td style="width: 10%;"></td> <td style="width: 10%;"></td> <td style="width: 10%;"></td> <td style="width: 10%;"></td> <td style="width: 10%;"></td> </tr> <tr> <td></td> <td></td> <td colspan="8" style="text-align: center;"> <table border="1" style="width: 100%; border-collapse: collapse; text-align: center;"> <tr> <td style="width: 10%;"></td> <td style="width: 10%;"></td> <td style="width: 10%;"></td> <td style="width: 10%;"></td> <td style="width: 10%;"></td> <td style="width: 10%;"></td> <td style="width: 10%;"></td> <td style="width: 10%;"></td> <td style="width: 10%;"></td> <td style="width: 10%;"></td> </tr> <tr> <td></td> <td></td> <td colspan="8" style="text-align: center;"> <table border="1" style="width: 100%; border-collapse: collapse; text-align: center;"> <tr> <td style="width: 10%;"></td> <td style="width: 10%;"></td> <td style="width: 10%;"></td> <td style="width: 10%;"></td> <td style="width: 10%;"></td> <td style="width: 10%;"></td> <td style="width: 10%;"></td> <td style="width: 10%;"></td> <td style="width: 10%;"></td> <td style="width: 10%;"></td> </tr> <tr> <td></td> <td></td> <td colspan="8" style="text-align: center;"> <table border="1" style="width: 100%; border-collapse: collapse; text-align: center;"> <tr> <td style="width: 10%;"></td> <td style="width: 10%;"></td> <td style="width: 10%;"></td> <td style="width: 10%;"></td> <td style="width: 10%;"></td> <td style="width: 10%;"></td> <td style="width: 10%;"></td> <td style="width: 10%;"></td> <td style="width: 10%;"></td> <td style="width: 10%;"></td> </tr> <tr> <td></td> <td></td> <td colspan="8" style="text-align: center;"> <table border="1" style="width: 100%; border-collapse: collapse; text-align: center;"> <tr> <td style="width: 10%;"></td> <td style="width: 10%;"></td> <td style="width: 10%;"></td> <td style="width: 10%;"></td> <td style="width: 10%;"></td> <td style="width: 10%;"></td> <td style="width: 10%;"></td> <td style="width: 10%;"></td> <td style="width: 10%;"></td> <td style="width: 10%;"></td> </tr> <tr> <td></td> <td></td> <td colspan="8" style="text-align: center;"> <table border="1" style="width: 100%; border-collapse: collapse; text-align: center;"> <tr> <td style="width: 10%;"></td> <td style="width: 10%;"></td> <td style="width: 10%;"></td> <td style="width: 10%;"></td> <td style="width: 10%;"></td> <td style="width: 10%;"></td> <td style="width: 10%;"></td> <td style="width: 10%;"></td> <td style="width: 10%;"></td> <td style="width: 10%;"></td> </tr> <tr> <td></td> <td></td> <td colspan="8" style="text-align: center;"> <table border="1" style="width: 100%; border-collapse: collapse; text-align: center;"> <tr> <td style="width: 10%;"></td> <td style="width: 10%;"></td> <td style="width: 10%;"></td> <td style="width: 10%;"></td> <td style="width: 10%;"></td> <td style="width: 10%;"></td> <td style="width: 10%;"></td> <td style="width: 10%;"></td> <td style="width: 10%;"></td> <td style="width: 10%;"></td> </tr> <tr> <td></td> <td></td> <td colspan="8" style="text-align: center;"> <table border="1" style="width: 100%; border-collapse: collapse; text-align: center;"> <tr> <td style="width: 10%;"></td> <td style="width: 10%;"></td> <td style="width: 10%;"></td> <td style="width: 10%;"></td> <td style="width: 10%;"></td> <td style="width: 10%;"></td> <td style="width: 10%;"></td> <td style="width: 10%;"></td> <td style="width: 10%;"></td> <td style="width: 10%;"></td> </tr> <tr> <td></td> <td></td> <td colspan="8" style="text-align: center;"> <table border="1" style="width: 100%; border-collapse: collapse; text-align: center;"> <tr> <td style="width: 10%;"></td> <td style="width: 10%;"></td> <td style="width: 10%;"></td> <td style="width: 10%;"></td> <td style="width: 10%;"></td> <td style="width: 10%;"></td> <td style="width: 10%;"></td> <td style="width: 10%;"></td> <td style="width: 10%;"></td> <td style="width: 10%;"></td> </tr> <tr> <td></td> <td></td> <td colspan="8" style="text-align: center;"> <table border="1" style="width: 100%; border-collapse: collapse; text-align: center;"> <tr> <td style="width: 10%;"></td> <td style="width: 10%;"></td> <td style="width: 10%;"></td> <td style="width: 10%;"></td> <td style="width: 10%;"></td> <td style="width:
10%;"></td> <td style="width: 10%;"></td> <td style="width: 10%;"></td> <td style="width: 10%;"></td> <td style="width: 10%;"></td> </tr> <tr> <td></td> <td></td> <td colspan="8" style="text-align: center;"> <table border="1" style="width: 100%; border-collapse: collapse; text-align: center;"> <tr> <td style="width: 10%;"></td> <td style="width: 10%;"></td> <td style="width: 10%;"></td> <td style="width: 10%;"></td> <td style="width: 10%;"></td> <td style="width: 10%;"></td> <td style="width: 10%;"></td> <td style="width: 10%;"></td> <td style="width: 10%;"></td> <td style="width: 10%;"></td> </tr> <tr> <td></td> <td></td> <td colspan="8" style="text-align: center;"> <table border="1" style="width: 100%; border-collapse: collapse; text-align: center;"> <tr> </tr></table></td></tr></table></td></tr></table></td></tr></table></td></tr></table></td></tr></table></td></tr></table></td></tr></table></td></tr></table></td></tr></table></td></tr></table></td></tr></table></td></tr></table></td></tr></table></td></tr></table></td></tr></table></td></tr></table></td></tr></table></td></tr></table></td></tr></table></td></tr></table></td></tr></table></td></tr></table></td></tr></table></td></tr></table></td></tr></table></td></tr></table></td></tr></table></td></tr></table></td></tr></table></td></tr></table></td></tr></table></td></tr></table></td></tr></table></td></tr></table></td></tr></table></td></tr></table></td></tr></table></td></tr></table></td></tr></table></td></tr></table></td></tr></table> | | | | | | | | | | | | | | | | | | | | <table border="1" style="width: 100%; border-collapse: collapse; text-align: center;"> <tr> <td style="width: 10%;"></td> <td style="width: 10%;"></td> <td style="width: 10%;"></td> <td style="width: 10%;"></td> <td style="width: 10%;"></td> <td style="width: 10%;"></td> <td style="width: 10%;"></td> <td style="width: 10%;"></td> <td style="width: 10%;"></td> <td style="width: 10%;"></td> </tr> <tr> <td></td> <td></td> <td colspan="8" style="text-align: center;"> <table border="1" style="width: 100%; border-collapse: collapse; text-align: center;"> <tr> <td style="width: 10%;"></td> <td style="width: 10%;"></td> <td style="width: 10%;"></td> <td style="width: 10%;"></td> <td style="width: 10%;"></td> <td style="width: 10%;"></td> <td style="width: 10%;"></td> <td style="width: 10%;"></td> <td style="width: 10%;"></td> <td style="width: 10%;"></td> </tr> <tr> <td></td> <td></td> <td colspan="8" style="text-align: center;"> <table border="1" style="width: 100%; border-collapse: collapse; text-align: center;"> <tr> <td style="width: 10%;"></td> <td style="width: 10%;"></td> <td style="width: 10%;"></td> <td style="width: 10%;"></td> <td style="width: 10%;"></td> <td style="width: 10%;"></td> <td style="width: 10%;"></td> <td style="width: 10%;"></td> <td style="width: 10%;"></td> <td style="width: 10%;"></td> </tr> <tr> <td></td> <td></td> <td colspan="8" style="text-align: center;"> <table border="1" style="width: 100%; border-collapse: collapse; text-align: center;"> <tr> <td style="width: 10%;"></td> <td style="width: 10%;"></td> <td style="width: 10%;"></td> <td style="width: 10%;"></td> <td style="width: 10%;"></td> <td style="width: 10%;"></td> <td style="width: 10%;"></td> <td style="width: 10%;"></td> <td style="width: 10%;"></td> <td style="width: 10%;"></td> </tr> <tr> <td></td> <td></td> <td colspan="8" style="text-align: center;"> <table border="1" style="width: 100%; border-collapse: collapse; text-align: center;"> <tr> <td style="width: 10%;"></td> <td style="width: 10%;"></td> <td style="width: 10%;"></td> <td style="width: 10%;"></td> <td style="width:
10%;"></td> <td style="width: 10%;"></td> <td style="width: 10%;"></td> <td style="width: 10%;"></td> <td style="width: 10%;"></td> <td style="width: 10%;"></td> </tr> <tr> <td></td> <td></td> <td colspan="8" style="text-align: center;"> <table border="1" style="width: 100%; border-collapse: collapse; text-align: center;"> <tr> <td style="width: 10%;"></td> <td style="width: 10%;"></td> <td style="width: 10%;"></td> <td style="width: 10%;"></td> <td style="width: 10%;"></td> <td style="width: 10%;"></td> <td style="width: 10%;"></td> <td style="width: 10%;"></td> <td style="width: 10%;"></td> <td style="width: 10%;"></td> </tr> <tr> <td></td> <td></td> <td colspan="8" style="text-align: center;"> <table border="1" style="width: 100%; border-collapse: collapse; text-align: center;"> <tr> <td style="width: 10%;"></td> <td style="width: 10%;"></td> <td style="width: 10%;"></td> <td style="width: 10%;"></td> <td style="width: 10%;"></td> <td style="width: 10%;"></td> <td style="width: 10%;"></td> <td style="width: 10%;"></td> <td style="width: 10%;"></td> <td style="width: 10%;"></td> </tr> <tr> <td></td> <td></td> <td colspan="8" style="text-align: center;"> <table border="1" style="width: 100%; border-collapse: collapse; text-align: center;"> <tr> <td style="width: 10%;"></td> <td style="width: 10%;"></td> <td style="width: 10%;"></td> <td style="width: 10%;"></td> <td style="width: 10%;"></td> <td style="width: 10%;"></td> <td style="width: 10%;"></td> <td style="width: 10%;"></td> <td style="width: 10%;"></td> <td style="width: 10%;"></td> </tr> <tr> <td></td> <td></td> <td colspan="8" style="text-align: center;"> <table border="1" style="width: 100%; border-collapse: collapse; text-align: center;"> <tr> <td style="width: 10%;"></td> <td style="width: 10%;"></td> <td style="width: 10%;"></td> <td style="width: 10%;"></td> <td style="width: 10%;"></td> <td style="width: 10%;"></td> <td style="width: 10%;"></td> <td style="width: 10%;"></td> <td style="width: 10%;"></td> <td style="width: 10%;"></td> </tr> <tr> <td></td> <td></td> <td colspan="8" style="text-align: center;"> <table border="1" style="width: 100%; border-collapse: collapse; text-align: center;"> <tr> <td style="width: 10%;"></td> <td style="width: 10%;"></td> <td style="width: 10%;"></td> <td style="width: 10%;"></td> <td style="width: 10%;"></td> <td style="width: 10%;"></td> <td style="width: 10%;"></td> <td style="width: 10%;"></td> <td style="width: 10%;"></td> <td style="width: 10%;"></td> </tr> <tr> <td></td> <td></td> <td colspan="8" style="text-align: center;"> <table border="1" style="width: 100%; border-collapse: collapse; text-align: center;"> <tr> <td style="width: 10%;"></td> <td style="width: 10%;"></td> <td style="width: 10%;"></td> <td style="width: 10%;"></td> <td style="width: 10%;"></td> <td style="width: 10%;"></td> <td style="width: 10%;"></td> <td style="width: 10%;"></td> <td style="width: 10%;"></td> <td style="width: 10%;"></td> </tr> <tr> <td></td> <td></td> <td colspan="8" style="text-align: center;"> <table border="1" style="width: 100%; border-collapse: collapse; text-align: center;"> <tr> <td style="width: 10%;"></td> <td style="width: 10%;"></td> <td style="width: 10%;"></td> <td style="width: 10%;"></td> <td style="width: 10%;"></td> <td style="width: 10%;"></td> <td style="width: 10%;"></td> <td style="width: 10%;"></td> <td style="width: 10%;"></td> <td style="width: 10%;"></td> </tr> <tr> <td></td> <td></td> <td colspan="8" style="text-align: center;"> <table border="1" style="width: 100%; border-collapse: collapse; text-align: center;"> <tr> <td style="width: 10%;"></td> <td style="width: 10%;"></td> <td style="width: 10%;"></td> <td style="width: 10%;"></td> <td style="width: 10%;"></td> <td style="width: 10%;"></td> <td style="width: 10%;"></td> <td style="width: 10%;"></td> <td style="width: 10%;"></td> <td style="width: 10%;"></td> </tr> <tr> <td></td> <td></td> <td colspan="8" style="text-align: center;"> <table border="1" style="width: 100%; border-collapse: collapse; text-align: center;"> <tr> <td style="width: 10%;"></td> <td style="width: 10%;"></td> <td style="width: 10%;"></td> <td style="width: 10%;"></td> <td style="width: 10%;"></td> <td style="width: 10%;"></td> <td style="width: 10%;"></td> <td style="width: 10%;"></td> <td style="width: 10%;"></td> <td style="width: 10%;"></td> </tr> <tr> <td></td> <td></td> <td colspan="8" style="text-align: center;"> <table border="1" style="width: 100%; border-collapse: collapse; text-align: center;"> <tr> <td style="width: 10%;"></td> <td style="width: 10%;"></td> <td style="width: 10%;"></td> <td style="width: 10%;"></td> <td style="width: 10%;"></td> <td style="width: 10%;"></td> <td style="width: 10%;"></td> <td style="width: 10%;"></td> <td style="width: 10%;"></td> <td style="width: 10%;"></td> </tr> <tr> <td></td> <td></td> <td colspan="8" style="text-align: center;"> <table border="1" style="width: 100%; border-collapse: collapse; text-align: center;"> <tr> <td style="width: 10%;"></td> <td style="width: 10%;"></td> <td style="width: 10%;"></td> <td style="width: 10%;"></td> <td style="width: 10%;"></td> <td style="width: 10%;"></td> <td style="width: 10%;"></td> <td style="width: 10%;"></td> <td style="width: 10%;"></td> <td style="width: 10%;"></td> </tr> <tr> <td></td> <td></td> <td colspan="8" style="text-align: center;"> <table border="1" style="width: 100%; border-collapse: collapse; text-align: center;"> <tr> <td style="width: 10%;"></td> <td style="width: 10%;"></td> <td style="width: 10%;"></td> <td style="width: 10%;"></td> <td style="width: 10%;"></td> <td style="width: 10%;"></td> <td style="width: 10%;"></td> <td style="width: 10%;"></td> <td style="width: 10%;"></td> <td style="width: 10%;"></td> </tr> <tr> <td></td> <td></td> <td colspan="8" style="text-align: center;"> <table border="1" style="width: 100%; border-collapse: collapse; text-align: center;"> <tr> <td style="width: 10%;"></td> <td style="width: 10%;"></td> <td style="width: 10%;"></td> <td style="width: 10%;"></td> <td style="width: 10%;"></td> <td style="width: 10%;"></td> <td style="width: 10%;"></td> <td style="width: 10%;"></td> <td style="width: 10%;"></td> <td style="width: 10%;"></td> </tr> <tr> <td></td> <td></td> <td colspan="8" style="text-align: center;"> <table border="1" style="width: 100%; border-collapse: collapse; text-align: center;"> <tr> <td style="width: 10%;"></td> <td style="width: 10%;"></td> <td style="width: 10%;"></td> <td style="width: 10%;"></td> <td style="width: 10%;"></td> <td style="width: 10%;"></td> <td style="width: 10%;"></td> <td style="width: 10%;"></td> <td style="width: 10%;"></td> <td style="width: 10%;"></td> </tr> <tr> <td></td> <td></td> <td colspan="8" style="text-align: center;"> <table border="1" style="width: 100%; border-collapse: collapse; text-align: center;"> <tr> <td style="width: 10%;"></td> <td style="width: 10%;"></td> <td style="width: 10%;"></td> <td style="width: 10%;"></td> <td style="width: 10%;"></td> <td style="width: 10%;"></td> <td style="width: 10%;"></td> <td style="width: 10%;"></td> <td style="width: 10%;"></td> <td style="width: 10%;"></td> </tr> <tr> <td></td> <td></td> <td colspan="8" style="text-align: center;"> <table border="1" style="width: 100%; border-collapse: collapse; text-align: center;"> <tr> <td style="width: 10%;"></td> <td style="width: 10%;"></td> <td style="width: 10%;"></td> <td style="width: 10%;"></td> <td style="width: 10%;"></td> <td style="width: 10%;"></td> <td style="width: 10%;"></td> <td style="width: 10%;"></td> <td style="width: 10%;"></td> <td style="width: 10%;"></td> </tr> <tr> <td></td> <td></td> <td colspan="8" style="text-align: center;"> <table border="1" style="width: 100%; border-collapse: collapse; text-align: center;"> <tr> <td style="width: 10%;"></td> <td style="width: 10%;"></td> <td style="width: 10%;"></td> <td style="width: 10%;"></td> <td style="width: 10%;"></td> <td style="width: 10%;"></td> <td style="width: 10%;"></td> <td style="width: 10%;"></td> <td style="width: 10%;"></td> <td style="width: 10%;"></td> </tr> <tr> <td></td> <td></td> <td colspan="8" style="text-align: center;"> <table border="1" style="width: 100%; border-collapse: collapse; text-align: center;"> <tr> <td style="width: 10%;"></td> <td style="width: 10%;"></td> <td style="width: 10%;"></td> <td style="width: 10%;"></td> <td style="width: 10%;"></td> <td style="width: 10%;"></td> <td style="width: 10%;"></td> <td style="width: 10%;"></td> <td style="width: 10%;"></td> <td style="width: 10%;"></td> </tr> <tr> <td></td> <td></td> <td colspan="8" style="text-align: center;"> <table border="1" style="width: 100%; border-collapse: collapse; text-align: center;"> <tr> <td style="width: 10%;"></td> <td style="width: 10%;"></td> <td style="width: 10%;"></td> <td style="width: 10%;"></td> <td style="width: 10%;"></td> <td style="width: 10%;"></td> <td style="width: 10%;"></td> <td style="width: 10%;"></td> <td style="width: 10%;"></td> <td style="width: 10%;"></td> </tr> <tr> <td></td> <td></td> <td colspan="8" style="text-align: center;"> <table border="1" style="width: 100%; border-collapse: collapse; text-align: center;"> <tr> <td style="width: 10%;"></td> <td style="width: 10%;"></td> <td style="width: 10%;"></td> <td style="width: 10%;"></td> <td style="width: 10%;"></td> <td style="width: 10%;"></td> <td style="width: 10%;"></td> <td style="width: 10%;"></td> <td style="width: 10%;"></td> <td style="width: 10%;"></td> </tr> <tr> <td></td> <td></td> <td colspan="8" style="text-align: center;"> <table border="1" style="width: 100%; border-collapse: collapse; text-align: center;"> <tr> <td style="width: 10%;"></td> <td style="width: 10%;"></td> <td style="width: 10%;"></td> <td style="width: 10%;"></td> <td style="width: 10%;"></td> <td style="width: 10%;"></td> <td style="width: 10%;"></td> <td style="width: 10%;"></td> <td style="width: 10%;"></td> <td style="width: 10%;"></td> </tr>
<tr> <td></td> <td></td> <td colspan="8" style="text-align: center;"> <table border="1" style="width: 100%; border-collapse: collapse; text-align: center;"> <tr> <td style="width: 10%;"></td> <td style="width: 10%;"></td> <td style="width: 10%;"></td> <td style="width: 10%;"></td> <td style="width: 10%;"></td> <td style="width: 10%;"></td> <td style="width: 10%;"></td> <td style="width: 10%;"></td> <td style="width: 10%;"></td> <td style="width: 10%;"></td> </tr> <tr> <td></td> <td></td> <td colspan="8" style="text-align: center;"> <table border="1" style="width: 100%; border-collapse: collapse; text-align: center;"> <tr> <td style="width: 10%;"></td> <td style="width: 10%;"></td> <td style="width: 10%;"></td> <td style="width: 10%;"></td> <td style="width: 10%;"></td> <td style="width: 10%;"></td> <td style="width: 10%;"></td> <td style="width: 10%;"></td> <td style="width: 10%;"></td> <td style="width: 10%;"></td> </tr> <tr> <td></td> <td></td> <td colspan="8" style="text-align: center;"> <table border="1" style="width: 100%; border-collapse: collapse; text-align: center;"> <tr> <td style="width: 10%;"></td> <td style="width: 10%;"></td> <td style="width: 10%;"></td> <td style="width: 10%;"></td> <td style="width: 10%;"></td> <td style="width: 10%;"></td> <td style="width: 10%;"></td> <td style="width: 10%;"></td> <td style="width: 10%;"></td> <td style="width: 10%;"></td> </tr> <tr> <td></td> <td></td> <td colspan="8" style="text-align: center;"> <table border="1" style="width: 100%; border-collapse: collapse; text-align: center;"> <tr> <td style="width: 10%;"></td> <td style="width: 10%;"></td> <td style="width: 10%;"></td> <td style="width: 10%;"></td> <td style="width: 10%;"></td> <td style="width: 10%;"></td> <td style="width: 10%;"></td> <td style="width: 10%;"></td> <td style="width: 10%;"></td> <td style="width: 10%;"></td> </tr> <tr> <td></td> <td></td> <td colspan="8" style="text-align: center;"> <table border="1" style="width: 100%; border-collapse: collapse; text-align: center;"> <tr> <td style="width: 10%;"></td> <td style="width: 10%;"></td> <td style="width: 10%;"></td> <td style="width: 10%;"></td> <td style="width: 10%;"></td> <td style="width: 10%;"></td> <td style="width: 10%;"></td> <td style="width: 10%;"></td> <td style="width: 10%;"></td> <td style="width: 10%;"></td> </tr> <tr> <td></td> <td></td> <td colspan="8" style="text-align: center;"> <table border="1" style="width: 100%; border-collapse: collapse; text-align: center;"> <tr> <td style="width: 10%;"></td> <td style="width: 10%;"></td> <td style="width: 10%;"></td> <td style="width: 10%;"></td> <td style="width: 10%;"></td> <td style="width: 10%;"></td> <td style="width: 10%;"></td> <td style="width: 10%;"></td> <td style="width: 10%;"></td> <td style="width: 10%;"></td> </tr> <tr> <td></td> <td></td> <td colspan="8" style="text-align: center;"> <table border="1" style="width: 100%; border-collapse: collapse; text-align: center;"> <tr> <td style="width: 10%;"></td> <td style="width: 10%;"></td> <td style="width: 10%;"></td> <td style="width: 10%;"></td> <td style="width: 10%;"></td> <td style="width: 10%;"></td> <td style="width: 10%;"></td> <td style="width: 10%;"></td> <td style="width: 10%;"></td> <td style="width: 10%;"></td> </tr> <tr> <td></td> <td></td> <td colspan="8" style="text-align: center;"> <table border="1" style="width: 100%; border-collapse: collapse; text-align: center;"> <tr> <td style="width: 10%;"></td> <td style="width: 10%;"></td> <td style="width: 10%;"></td> <td style="width: 10%;"></td> <td style="width: 10%;"></td> <td style="width: 10%;"></td> <td style="width: 10%;"></td> <td style="width: 10%;"></td> <td style="width: 10%;"></td> <td style="width: 10%;"></td> </tr> <tr> <td></td> <td></td> <td colspan="8" style="text-align: center;"> <table border="1" style="width: 100%; border-collapse: collapse; text-align: center;"> <tr> <td style="width: 10%;"></td> <td style="width: 10%;"></td> <td style="width: 10%;"></td> <td style="width: 10%;"></td> <td style="width: 10%;"></td> <td style="width: 10%;"></td> <td style="width: 10%;"></td> <td style="width: 10%;"></td> <td style="width: 10%;"></td> <td style="width: 10%;"></td> </tr> <tr> <td></td> <td></td> <td colspan="8" style="text-align: center;"> <table border="1" style="width: 100%; border-collapse: collapse; text-align: center;"> <tr> <td style="width: 10%;"></td> <td style="width: 10%;"></td> <td style="width: 10%;"></td> <td style="width: 10%;"></td> <td style="width: 10%;"></td> <td style="width: 10%;"></td> <td style="width: 10%;"></td> <td style="width: 10%;"></td> <td style="width: 10%;"></td> <td style="width: 10%;"></td> </tr> <tr> <td></td> <td></td> <td colspan="8" style="text-align: center;"> <table border="1" style="width: 100%; border-collapse: collapse; text-align: center;"> <tr> <td style="width: 10%;"></td> <td style="width: 10%;"></td> <td style="width: 10%;"></td> <td style="width: 10%;"></td> <td style="width: 10%;"></td> <td style="width: 10%;"></td> <td style="width: 10%;"></td> <td style="width: 10%;"></td> <td style="width: 10%;"></td> <td style="width: 10%;"></td> </tr> <tr> <td></td> <td></td> <td colspan="8" style="text-align: center;"> <table border="1" style="width: 100%; border-collapse: collapse; text-align: center;"> <tr> <td style="width: 10%;"></td> <td style="width: 10%;"></td> <td style="width: 10%;"></td> <td style="width: 10%;"></td> <td style="width: 10%;"></td> <td style="width: 10%;"></td> <td style="width: 10%;"></td> <td style="width: 10%;"></td> <td style="width: 10%;"></td> <td style="width: 10%;"></td> </tr> <tr> <td></td> <td></td> <td colspan="8" style="text-align: center;"> <table border="1" style="width: 100%; border-collapse: collapse; text-align: center;"> <tr> <td style="width: 10%;"></td> <td style="width: 10%;"></td> <td style="width: 10%;"></td> <td style="width: 10%;"></td> <td style="width: 10%;"></td> <td style="width: 10%;"></td> <td style="width: 10%;"></td> <td style="width: 10%;"></td> <td style="width: 10%;"></td> <td style="width: 10%;"></td> </tr> <tr> <td></td> <td></td> <td colspan="8" style="text-align: center;"> <table border="1" style="width: 100%; border-collapse: collapse; text-align: center;"> <tr> <td style="width: 10%;"></td> <td style="width: 10%;"></td> <td style="width: 10%;"></td> <td style="width: 10%;"></td> <td style="width: 10%;"></td> <td style="width: 10%;"></td> <td style="width: 10%;"></td> <td style="width: 10%;"></td> <td style="width: 10%;"></td> <td style="width: 10%;"></td> </tr> <tr> <td></td> <td></td> <td colspan="8" style="text-align: center;"> <table border="1" style="width: 100%; border-collapse: collapse; text-align: center;"> <tr> </tr></table></td></tr></table></td></tr></table></td></tr></table></td></tr></table></td></tr></table></td></tr></table></td></tr></table></td></tr></table></td></tr></table></td></tr></table></td></tr></table></td></tr></table></td></tr></table></td></tr></table></td></tr></table></td></tr></table></td></tr></table></td></tr></table></td></tr></table></td></tr></table></td></tr></table></td></tr></table></td></tr></table></td></tr></table></td></tr></table></td></tr></table></td></tr></table></td></tr></table></td></tr></table></td></tr></table></td></tr></table></td></tr></table></td></tr></table></td></tr></table></td></tr></table></td></tr></table></td></tr></table></td></tr></table></td></tr></table></td></tr></table>
 | | | | | | | | | | | | | | | | | | | | <table border="1" style="width: 100%; border-collapse: collapse; text-align: center;"> <tr> <td style="width: 10%;"></td> <td style="width: 10%;"></td> <td style="width: 10%;"></td> <td style="width: 10%;"></td> <td style="width: 10%;"></td> <td style="width: 10%;"></td> <td style="width: 10%;"></td> <td style="width: 10%;"></td> <td style="width: 10%;"></td> <td style="width: 10%;"></td> </tr> <tr> <td></td> <td></td> <td colspan="8" style="text-align: center;"> <table border="1" style="width: 100%; border-collapse: collapse; text-align: center;"> <tr> <td style="width: 10%;"></td> <td style="width: 10%;"></td> <td style="width: 10%;"></td> <td style="width: 10%;"></td> <td style="width: 10%;"></td> <td style="width: 10%;"></td> <td style="width: 10%;"></td> <td style="width: 10%;"></td> <td style="width: 10%;"></td> <td style="width: 10%;"></td> </tr> <tr> <td></td> <td></td> <td colspan="8" style="text-align: center;"> <table border="1" style="width: 100%; border-collapse: collapse; text-align: center;"> <tr> <td style="width: 10%;"></td> <td style="width: 10%;"></td> <td style="width: 10%;"></td> <td style="width: 10%;"></td> <td style="width: 10%;"></td> <td style="width: 10%;"></td> <td style="width: 10%;"></td> <td style="width: 10%;"></td> <td style="width: 10%;"></td> <td style="width: 10%;"></td> </tr> <tr> <td></td> <td></td> <td colspan="8" style="text-align: center;"> <table border="1" style="width: 100%; border-collapse: collapse; text-align: center;"> <tr> <td style="width: 10%;"></td> <td style="width: 10%;"></td> <td style="width: 10%;"></td> <td style="width: 10%;"></td> <td style="width: 10%;"></td> <td style="width: 10%;"></td> <td style="width: 10%;"></td> <td style="width: 10%;"></td> <td style="width: 10%;"></td> <td style="width: 10%;"></td> </tr> <tr> <td></td> <td></td> <td colspan="8" style="text-align: center;"> <table border="1" style="width: 100%; border-collapse: collapse; text-align: center;"> <tr> <td style="width: 10%;"></td> <td style="width: 10%;"></td> <td style="width: 10%;"></td> <td style="width: 10%;"></td> <td style="width: 10%;"></td> <td style="width: 10%;"></td> <td style="width: 10%;"></td> <td style="width: 10%;"></td> <td style="width: 10%;"></td> <td style="width: 10%;"></td> </tr> <tr> <td></td> <td></td> <td colspan="8" style="text-align: center;"> <table border="1" style="width: 100%; border-collapse: collapse; text-align: center;"> <tr> <td style="width: 10%;"></td> <td style="width: 10%;"></td> <td style="width: 10%;"></td> <td style="width: 10%;"></td> <td style="width: 10%;"></td> <td style="width: 10%;"></td> <td style="width: 10%;"></td> <td style="width: 10%;"></td> <td style="width: 10%;"></td> <td style="width: 10%;"></td> </tr> <tr> <td></td> <td></td> <td colspan="8" style="text-align: center;"> <table border="1" style="width: 100%; border-collapse: collapse; text-align: center;"> <tr> <td style="width: 10%;"></td> <td style="width: 10%;"></td> <td style="width: 10%;"></td> <td style="width: 10%;"></td> <td style="width: 10%;"></td> <td style="width: 10%;"></td> <td style="width: 10%;"></td> <td style="width: 10%;"></td> <td style="width: 10%;"></td> <td style="width: 10%;"></td> </tr> <tr> <td></td> <td></td> <td colspan="8" style="text-align: center;"> <table border="1" style="width: 100%; border-collapse: collapse; text-align: center;"> <tr> <td style="width: 10%;"></td> <td style="width: 10%;"></td> <td style="width: 10%;"></td> <td style="width: 10%;"></td> <td style="width: 10%;"></td> <td style="width: 10%;"></td> <td style="width: 10%;"></td> <td style="width: 10%;"></td> <td style="width: 10%;"></td> <td style="width: 10%;"></td> </tr> <tr> <td></td> <td></td> <td colspan="8" style="text-align: center;"> <table border="1" style="width: 100%; border-collapse: collapse; text-align: center;"> <tr> <td style="width: 10%;"></td> <td style="width: 10%;"></td> <td style="width: 10%;"></td> <td style="width: 10%;"></td> <td style="width: 10%;"></td> <td style="width: 10%;"></td> <td style="width: 10%;"></td> <td style="width: 10%;"></td> <td style="width: 10%;"></td> <td style="width: 10%;"></td> </tr> <tr> <td></td> <td></td> <td colspan="8" style="text-align: center;"> <table border="1" style="width: 100%; border-collapse: collapse; text-align: center;"> <tr> <td style="width: 10%;"></td> <td style="width: 10%;"></td> <td style="width: 10%;"></td> <td style="width: 10%;"></td> <td style="width: 10%;"></td> <td style="width: 10%;"></td> <td style="width: 10%;"></td> <td style="width: 10%;"></td> <td style="width: 10%;"></td> <td style="width: 10%;"></td> </tr> <tr> <td></td> <td></td> <td colspan="8" style="text-align: center;"> <table border="1" style="width: 100%; border-collapse: collapse; text-align: center;"> <tr> <td style="width: 10%;"></td> <td style="width: 10%;"></td> <td style="width: 10%;"></td> <td style="width: 10%;"></td> <td style="width: 10%;"></td> <td style="width: 10%;"></td> <td style="width: 10%;"></td> <td style="width: 10%;"></td> <td style="width: 10%;"></td> <td style="width: 10%;"></td> </tr> <tr> <td></td> <td></td> <td colspan="8" style="text-align: center;"> <table border="1" style="width: 100%; border-collapse: collapse; text-align: center;"> <tr> <td style="width: 10%;"></td> <td style="width: 10%;"></td> <td style="width: 10%;"></td> <td style="width: 10%;"></td> <td style="width: 10%;"></td> <td style="width: 10%;"></td> <td style="width: 10%;"></td> <td style="width: 10%;"></td> <td style="width: 10%;"></td> <td style="width: 10%;"></td> </tr> <tr> <td></td> <td></td> <td colspan="8" style="text-align: center;"> <table border="1" style="width: 100%; border-collapse: collapse; text-align: center;"> <tr> <td style="width: 10%;"></td> <td style="width: 10%;"></td> <td style="width: 10%;"></td> <td style="width: 10%;"></td> <td style="width: 10%;"></td> <td style="width: 10%;"></td> <td style="width: 10%;"></td> <td style="width: 10%;"></td> <td style="width: 10%;"></td> <td style="width: 10%;"></td> </tr> <tr> <td></td> <td></td> <td colspan="8" style="text-align: center;"> <table border="1" style="width: 100%; border-collapse: collapse; text-align: center;">
<tr> <td style="width: 10%;"></td> <td style="width: 10%;"></td> <td style="width: 10%;"></td> <td style="width: 10%;"></td> <td style="width: 10%;"></td> <td style="width: 10%;"></td> <td style="width: 10%;"></td> <td style="width: 10%;"></td> <td style="width: 10%;"></td> <td style="width: 10%;"></td> </tr> <tr> <td></td> <td></td> <td colspan="8" style="text-align: center;"> <table border="1" style="width: 100%; border-collapse: collapse; text-align: center;"> <tr> <td style="width: 10%;"></td> <td style="width: 10%;"></td> <td style="width: 10%;"></td> <td style="width: 10%;"></td> <td style="width: 10%;"></td> <td style="width: 10%;"></td> <td style="width: 10%;"></td> <td style="width: 10%;"></td> <td style="width: 10%;"></td> <td style="width: 10%;"></td> </tr> <tr> <td></td> <td></td> <td colspan="8" style="text-align: center;"> <table border="1" style="width: 100%; border-collapse: collapse; text-align: center;"> <tr> <td style="width: 10%;"></td> <td style="width: 10%;"></td> <td style="width: 10%;"></td> <td style="width: 10%;"></td> <td style="width: 10%;"></td> <td style="width: 10%;"></td> <td style="width: 10%;"></td> <td style="width: 10%;"></td> <td style="width: 10%;"></td> <td style="width: 10%;"></td> </tr> <tr> <td></td> <td></td> <td colspan="8" style="text-align: center;"> <table border="1" style="width: 100%; border-collapse: collapse; text-align: center;"> <tr> <td style="width: 10%;"></td> <td style="width: 10%;"></td> <td style="width: 10%;"></td> <td style="width: 10%;"></td> <td style="width: 10%;"></td> <td style="width: 10%;"></td> <td style="width: 10%;"></td> <td style="width: 10%;"></td> <td style="width: 10%;"></td> <td style="width: 10%;"></td> </tr> <tr> <td></td> <td></td> <td colspan="8" style="text-align: center;"> <table border="1" style="width: 100%; border-collapse: collapse; text-align: center;"> <tr> <td style="width: 10%;"></td> <td style="width: 10%;"></td> <td style="width: 10%;"></td> <td style="width: 10%;"></td> <td style="width: 10%;"></td> <td style="width: 10%;"></td> <td style="width: 10%;"></td> <td style="width: 10%;"></td> <td style="width: 10%;"></td> <td style="width: 10%;"></td> </tr> <tr> <td></td> <td></td> <td colspan="8" style="text-align: center;"> <table border="1" style="width: 100%; border-collapse: collapse; text-align: center;"> <tr> <td style="width: 10%;"></td> <td style="width: 10%;"></td> <td style="width: 10%;"></td> <td style="width: 10%;"></td> <td style="width: 10%;"></td> <td style="width: 10%;"></td> <td style="width: 10%;"></td> <td style="width: 10%;"></td> <td style="width: 10%;"></td> <td style="width: 10%;"></td> </tr> <tr> <td></td> <td></td> <td colspan="8" style="text-align: center;"> <table border="1" style="width: 100%; border-collapse: collapse; text-align: center;"> <tr> <td style="width: 10%;"></td> <td style="width: 10%;"></td> <td style="width: 10%;"></td> <td style="width: 10%;"></td> <td style="width: 10%;"></td> <td style="width: 10%;"></td> <td style="width: 10%;"></td> <td style="width: 10%;"></td> <td style="width: 10%;"></td> <td style="width: 10%;"></td> </tr> <tr> <td></td> <td></td> <td colspan="8" style="text-align: center;"> <table border="1" style="width: 100%; border-collapse: collapse; text-align: center;"> <tr> <td style="width: 10%;"></td> <td style="width: 10%;"></td> <td style="width: 10%;"></td> <td style="width: 10%;"></td> <td style="width: 10%;"></td> <td style="width: 10%;"></td> <td style="width: 10%;"></td> <td style="width: 10%;"></td> <td style="width: 10%;"></td> <td style="width: 10%;"></td> </tr> <tr> <td></td> <td></td> <td colspan="8" style="text-align: center;"> <table border="1" style="width: 100%; border-collapse: collapse; text-align: center;"> <tr> <td style="width: 10%;"></td> <td style="width: 10%;"></td> <td style="width: 10%;"></td> <td style="width: 10%;"></td> <td style="width: 10%;"></td> <td style="width: 10%;"></td> <td style="width: 10%;"></td> <td style="width: 10%;"></td> <td style="width: 10%;"></td> <td style="width: 10%;"></td> </tr> <tr> <td></td> <td></td> <td colspan="8" style="text-align: center;"> <table border="1" style="width: 100%; border-collapse: collapse; text-align: center;"> <tr> <td style="width: 10%;"></td> <td style="width: 10%;"></td> <td style="width: 10%;"></td> <td style="width: 10%;"></td> <td style="width: 10%;"></td> <td style="width: 10%;"></td> <td style="width: 10%;"></td> <td style="width: 10%;"></td> <td style="width: 10%;"></td> <td style="width: 10%;"></td> </tr> <tr> <td></td> <td></td> <td colspan="8" style="text-align: center;"> <table border="1" style="width: 100%; border-collapse: collapse; text-align: center;"> <tr> <td style="width: 10%;"></td> <td style="width: 10%;"></td> <td style="width: 10%;"></td> <td style="width: 10%;"></td> <td style="width: 10%;"></td> <td style="width: 10%;"></td> <td style="width: 10%;"></td> <td style="width: 10%;"></td> <td style="width: 10%;"></td> <td style="width: 10%;"></td> </tr> <tr> <td></td> <td></td> <td colspan="8" style="text-align: center;"> <table border="1" style="width: 100%; border-collapse: collapse; text-align: center;"> <tr> <td style="width: 10%;"></td> <td style="width: 10%;"></td> <td style="width: 10%;"></td> <td style="width: 10%;"></td> <td style="width: 10%;"></td> <td style="width: 10%;"></td> <td style="width: 10%;"></td> <td style="width: 10%;"></td> <td style="width: 10%;"></td> <td style="width: 10%;"></td> </tr> <tr> <td></td> <td></td> <td colspan="8" style="text-align: center;"> <table border="1" style="width: 100%; border-collapse: collapse; text-align: center;"> <tr> <td style="width: 10%;"></td> <td style="width: 10%;"></td> <td style="width: 10%;"></td> <td style="width: 10%;"></td> <td style="width: 10%;"></td> <td style="width: 10%;"></td> <td style="width: 10%;"></td> <td style="width: 10%;"></td> <td style="width: 10%;"></td> <td style="width: 10%;"></td> </tr> <tr> <td></td> <td></td> <td colspan="8" style="text-align: center;"> <table border="1" style="width: 100%; border-collapse: collapse; text-align: center;"> <tr> <td style="width: 10%;"></td> <td style="width: 10%;"></td> <td style="width: 10%;"></td> <td style="width: 10%;"></td> <td style="width: 10%;"></td> <td style="width: 10%;"></td> <td style="width: 10%;"></td> <td style="width: 10%;"></td> <td style="width: 10%;"></td> <td style="width: 10%;"></td> </tr> <tr> <td></td> <td></td> <td colspan="8" style="text-align: center;"> <table border="1" style="width: 100%; border-collapse: collapse; text-align: center;"> <tr> <td style="width: 10%;"></td> <td style="width: 10%;"></td> <td style="width: 10%;"></td> <td style="width: 10%;"></td> <td style="width: 10%;"></td> <td style="width: 10%;"></td> <td style="width: 10%;"></td> <td style="width: 10%;"></td> <td style="width: 10%;"></td> <td style="width: 10%;"></td> </tr> <tr> <td></td> <td></td> <td colspan="8" style="text-align: center;"> <table border="1" style="width: 100%; border-collapse: collapse; text-align: center;"> <tr> <td style="width: 10%;"></td> <td style="width: 10%;"></td> <td style="width: 10%;"></td> <td style="width: 10%;"></td> <td style="width: 10%;"></td> <td style="width: 10%;"></td> <td style="width: 10%;"></td> <td style="width: 10%;"></td> <td style="width: 10%;"></td> <td style="width: 10%;"></td> </tr> <tr> <td></td> <td></td> <td colspan="8" style="text-align: center;"> <table border="1" style="width: 100%; border-collapse: collapse; text-align: center;"> <tr> <td style="width: 10%;"></td> <td style="width: 10%;"></td> <td style="width: 10%;"></td> <td style="width: 10%;"></td> <td style="width: 10%;"></td> <td style="width: 10%;"></td> <td style="width: 10%;"></td> <td style="width: 10%;"></td> <td style="width: 10%;"></td> <td style="width: 10%;"></td> </tr> <tr> <td></td> <td></td> <td colspan="8" style="text-align: center;"> <table border="1" style="width: 100%; border-collapse: collapse; text-align: center;"> <tr> <td style="width: 10%;"></td> <td style="width: 10%;"></td> <td style="width: 10%;"></td> <td style="width: 10%;"></td> <td style="width: 10%;"></td> <td style="width: 10%;"></td> <td style="width: 10%;"></td> <td style="width: 10%;"></td> <td style="width: 10%;"></td> <td style="width: 10%;"></td> </tr> <tr> <td></td> <td></td> <td colspan="8" style="text-align: center;"> <table border="1" style="width: 100%; border-collapse: collapse; text-align: center;"> <tr> <td style="width: 10%;"></td> <td style="width: 10%;"></td> <td style="width: 10%;"></td> <td style="width: 10%;"></td> <td style="width: 10%;"></td> <td style="width: 10%;"></td> <td style="width: 10%;"></td> <td style="width: 10%;"></td> <td style="width: 10%;"></td> <td style="width: 10%;"></td> </tr> <tr> <td></td> <td></td> <td colspan="8" style="text-align: center;"> <table border="1" style="width: 100%; border-collapse: collapse; text-align: center;"> <tr> <td style="width: 10%;"></td> <td style="width: 10%;"></td> <td style="width: 10%;"></td> <td style="width: 10%;"></td> <td style="width: 10%;"></td> <td style="width: 10%;"></td> <td style="width: 10%;"></td> <td style="width: 10%;"></td> <td style="width: 10%;"></td> <td style="width: 10%;"></td> </tr> <tr> <td></td> <td></td> <td colspan="8" style="text-align: center;"> <table border="1" style="width: 100%; border-collapse: collapse; text-align: center;"> <tr> <td style="width: 10%;"></td> <td style="width: 10%;"></td> <td style="width: 10%;"></td> <td style="width: 10%;"></td> <td style="width: 10%;"></td> <td style="width: 10%;"></td> <td style="width: 10%;"></td> <td style="width: 10%;"></td> <td style="width: 10%;"></td> <td style="width: 10%;"></td> </tr> <tr> <td></td> <td></td> <td colspan="8" style="text-align: center;"> <table border="1" style="width: 100%; border-collapse: collapse; text-align: center;"> <tr> <td style="width: 10%;"></td> <td style="width: 10%;"></td> <td style="width: 10%;"></td> <td style="width: 10%;"></td> <td style="width: 10%;"></td> <td
style="width: 10%;"></td> <td style="width: 10%;"></td> <td style="width: 10%;"></td> <td style="width: 10%;"></td> <td style="width: 10%;"></td> </tr> <tr> <td></td> <td></td> <td colspan="8" style="text-align: center;"> <table border="1" style="width: 100%; border-collapse: collapse; text-align: center;"> <tr> <td style="width: 10%;"></td> <td style="width: 10%;"></td> <td style="width: 10%;"></td> <td style="width: 10%;"></td> <td style="width: 10%;"></td> <td style="width: 10%;"></td> <td style="width: 10%;"></td> <td style="width: 10%;"></td> <td style="width: 10%;"></td> <td style="width: 10%;"></td> </tr> <tr> <td></td> <td></td> <td colspan="8" style="text-align: center;"> <table border="1" style="width: 100%; border-collapse: collapse; text-align: center;"> <tr> <td style="width: 10%;"></td> <td style="width: 10%;"></td> <td style="width: 10%;"></td> <td style="width: 10%;"></td> <td style="width: 10%;"></td> <td style="width: 10%;"></td> <td style="width: 10%;"></td> <td style="width: 10%;"></td> <td style="width: 10%;"></td> <td style="width: 10%;"></td> </tr> <tr> <td></td> <td></td> <td colspan="8" style="text-align: center;"> <table border="1" style="width: 100%; border-collapse: collapse; text-align: center;"> <tr> <td style="width: 10%;"></td> <td style="width: 10%;"></td> <td style="width: 10%;"></td> <td style="width: 10%;"></td> <td style="width: 10%;"></td> <td style="width: 10%;"></td> <td style="width: 10%;"></td> <td style="width: 10%;"></td> <td style="width: 10%;"></td> <td style="width: 10%;"></td> </tr> <tr> <td></td> <td></td> <td colspan="8" style="text-align: center;"> <table border="1" style="width: 100%; border-collapse: collapse; text-align: center;"> <tr> <td style="width: 10%;"></td> <td style="width: 10%;"></td> <td style="width: 10%;"></td> <td style="width: 10%;"></td> <td style="width: 10%;"></td> <td style="width: 10%;"></td> <td style="width: 10%;"></td> <td style="width: 10%;"></td> <td style="width: 10%;"></td> <td style="width: 10%;"></td> </tr> <tr> <td></td> <td></td> <td colspan="8" style="text-align: center;"> <table border="1" style="width: 100%; border-collapse: collapse; text-align: center;"> <tr> </tr></table></td></tr></table></td></tr></table></td></tr></table></td></tr></table></td></tr></table></td></tr></table></td></tr></table></td></tr></table></td></tr></table></td></tr></table></td></tr></table></td></tr></table></td></tr></table></td></tr></table></td></tr></table></td></tr></table></td></tr></table></td></tr></table></td></tr></table></td></tr></table></td></tr></table></td></tr></table></td></tr></table></td></tr></table></td></tr></table></td></tr></table></td></tr></table></td></tr></table></td></tr></table></td></tr></table></td></tr></table></td></tr></table></td></tr></table></td></tr></table></td></tr></table></td></tr></table></td></tr></table></td></tr></table></td></tr></table> | | | | | | | | | | | | | | | | | | | | <table border="1" style="width: 100%; border-collapse: collapse; text-align: center;"> <tr> <td style="width: 10%;"></td> <td style="width: 10%;"></td> <td style="width: 10%;"></td> <td style="width: 10%;"></td> <td style="width: 10%;"></td> <td style="width: 10%;"></td> <td style="width: 10%;"></td> <td style="width: 10%;"></td> <td style="width: 10%;"></td> <td style="width: 10%;"></td> </tr> <tr> <td></td> <td></td> <td colspan="8" style="text-align: center;"> <table border="1" style="width: 100%; border-collapse: collapse; text-align: center;"> <tr> <td style="width: 10%;"></td> <td style="width: 10%;"></td> <td style="width: 10%;"></td> <td style="width: 10%;"></td> <td style="width: 10%;"></td> <td
style="width: 10%;"></td> <td style="width: 10%;"></td> <td style="width: 10%;"></td> <td style="width: 10%;"></td> <td style="width: 10%;"></td> </tr> <tr> <td></td> <td></td> <td colspan="8" style="text-align: center;"> <table border="1" style="width: 100%; border-collapse: collapse; text-align: center;"> <tr> <td style="width: 10%;"></td> <td style="width: 10%;"></td> <td style="width: 10%;"></td> <td style="width: 10%;"></td> <td style="width: 10%;"></td> <td style="width: 10%;"></td> <td style="width: 10%;"></td> <td style="width: 10%;"></td> <td style="width: 10%;"></td> <td style="width: 10%;"></td> </tr> <tr> <td></td> <td></td> <td colspan="8" style="text-align: center;"> <table border="1" style="width: 100%; border-collapse: collapse; text-align: center;"> <tr> <td style="width: 10%;"></td> <td style="width: 10%;"></td> <td style="width: 10%;"></td> <td style="width: 10%;"></td> <td style="width: 10%;"></td> <td style="width: 10%;"></td> <td style="width: 10%;"></td> <td style="width: 10%;"></td> <td style="width: 10%;"></td> <td style="width: 10%;"></td> </tr> <tr> <td></td> <td></td> <td colspan="8" style="text-align: center;"> <table border="1" style="width: 100%; border-collapse: collapse; text-align: center;"> <tr> <td style="width: 10%;"></td> <td style="width: 10%;"></td> <td style="width: 10%;"></td> <td style="width: 10%;"></td> <td style="width: 10%;"></td> <td style="width: 10%;"></td> <td style="width: 10%;"></td> <td style="width: 10%;"></td> <td style="width: 10%;"></td> <td style="width: 10%;"></td> </tr> <tr> <td></td> <td></td> <td colspan="8" style="text-align: center;"> <table border="1" style="width: 100%; border-collapse: collapse; text-align: center;"> <tr> <td style="width: 10%;"></td> <td style="width: 10%;"></td> <td style="width: 10%;"></td> <td style="width: 10%;"></td> <td style="width: 10%;"></td> <td style="width: 10%;"></td> <td style="width: 10%;"></td> <td style="width: 10%;"></td> <td style="width: 10%;"></td> <td style="width: 10%;"></td> </tr> <tr> <td></td> <td></td> <td colspan="8" style="text-align: center;"> <table border="1" style="width: 100%; border-collapse: collapse; text-align: center;"> <tr> <td style="width: 10%;"></td> <td style="width: 10%;"></td> <td style="width: 10%;"></td> <td style="width: 10%;"></td> <td style="width: 10%;"></td> <td style="width: 10%;"></td> <td style="width: 10%;"></td> <td style="width: 10%;"></td> <td style="width: 10%;"></td> <td style="width: 10%;"></td> </tr> <tr> <td></td> <td></td> <td colspan="8" style="text-align: center;"> <table border="1" style="width: 100%; border-collapse: collapse; text-align: center;"> <tr> <td style="width: 10%;"></td> <td style="width: 10%;"></td> <td style="width: 10%;"></td> <td style="width: 10%;"></td> <td style="width: 10%;"></td> <td style="width: 10%;"></td> <td style="width: 10%;"></td> <td style="width: 10%;"></td> <td style="width: 10%;"></td> <td style="width: 10%;"></td> </tr> <tr> <td></td> <td></td> <td colspan="8" style="text-align: center;"> <table border="1" style="width: 100%; border-collapse: collapse; text-align: center;"> <tr> <td style="width: 10%;"></td> <td style="width: 10%;"></td> <td style="width: 10%;"></td> <td style="width: 10%;"></td> <td style="width: 10%;"></td> <td style="width: 10%;"></td> <td style="width: 10%;"></td> <td style="width: 10%;"></td> <td style="width: 10%;"></td> <td style="width: 10%;"></td> </tr> <tr> <td></td> <td></td> <td colspan="8" style="text-align: center;"> <table border="1" style="width: 100%; border-collapse: collapse; text-align: center;"> <tr> <td style="width: 10%;"></td> <td style="width: 10%;"></td> <td style="width: 10%;"></td> <td style="width: 10%;"></td> <td style="width: 10%;"></td> <td style="width: 10%;"></td> <td style="width: 10%;"></td> <td style="width: 10%;"></td> <td style="width: 10%;"></td> <td style="width: 10%;"></td> </tr> <tr> <td></td> <td></td> <td colspan="8" style="text-align: center;"> <table border="1" style="width: 100%; border-collapse: collapse; text-align: center;"> <tr> <td style="width: 10%;"></td> <td style="width: 10%;"></td> <td style="width: 10%;"></td> <td style="width: 10%;"></td> <td style="width: 10%;"></td> <td style="width: 10%;"></td> <td style="width: 10%;"></td> <td style="width: 10%;"></td> <td style="width: 10%;"></td> <td style="width: 10%;"></td> </tr> <tr> <td></td> <td></td> <td colspan="8" style="text-align: center;"> <table border="1" style="width: 100%; border-collapse: collapse; text-align: center;"> <tr> <td style="width: 10%;"></td> <td style="width: 10%;"></td> <td style="width: 10%;"></td> <td style="width: 10%;"></td> <td style="width: 10%;"></td> <td style="width: 10%;"></td> <td style="width: 10%;"></td> <td style="width: 10%;"></td> <td style="width: 10%;"></td> <td style="width: 10%;"></td> </tr> <tr> <td></td> <td></td> <td colspan="8" style="text-align: center;"> <table border="1" style="width: 100%; border-collapse: collapse; text-align: center;"> <tr> <td style="width: 10%;"></td> <td style="width: 10%;"></td> <td style="width: 10%;"></td> <td style="width: 10%;"></td> <td style="width: 10%;"></td> <td style="width: 10%;"></td> <td style="width: 10%;"></td> <td style="width: 10%;"></td> <td style="width: 10%;"></td> <td style="width: 10%;"></td> </tr> <tr> <td></td> <td></td> <td colspan="8" style="text-align: center;"> <table border="1" style="width: 100%; border-collapse: collapse; text-align: center;"> <tr> <td style="width: 10%;"></td> <td style="width: 10%;"></td> <td style="width: 10%;"></td> <td style="width: 10%;"></td> <td style="width: 10%;"></td> <td style="width: 10%;"></td> <td style="width: 10%;"></td> <td style="width: 10%;"></td> <td style="width: 10%;"></td> <td style="width: 10%;"></td> </tr> <tr> <td></td> <td></td> <td colspan="8" style="text-align: center;"> <table border="1" style="width: 100%; border-collapse: collapse; text-align: center;"> <tr> <td style="width: 10%;"></td> <td style="width: 10%;"></td> <td style="width: 10%;"></td> <td style="width: 10%;"></td> <td style="width: 10%;"></td> <td style="width: 10%;"></td> <td style="width: 10%;"></td> <td style="width: 10%;"></td> <td style="width: 10%;"></td> <td style="width: 10%;"></td> </tr> <tr> <td></td> <td></td> <td colspan="8" style="text-align: center;"> <table border="1" style="width: 100%; border-collapse: collapse; text-align: center;"> <tr> <td style="width: 10%;"></td> <td style="width: 10%;"></td> <td style="width: 10%;"></td> <td style="width: 10%;"></td> <td style="width: 10%;"></td> <td style="width: 10%;"></td> <td style="width: 10%;"></td> <td style="width: 10%;"></td> <td style="width: 10%;"></td> <td style="width: 10%;"></td> </tr> <tr> <td></td> <td></td> <td colspan="8" style="text-align: center;"> <table border="1" style="width: 100%; border-collapse: collapse; text-align: center;"> <tr> <td style="width: 10%;"></td> <td style="width: 10%;"></td> <td style="width: 10%;"></td> <td style="width: 10%;"></td> <td style="width: 10%;"></td> <td style="width: 10%;"></td> <td style="width: 10%;"></td> <td style="width: 10%;"></td> <td style="width: 10%;"></td> <td style="width: 10%;"></td> </tr> <tr> <td></td> <td></td> <td colspan="8" style="text-align: center;"> <table border="1" style="width: 100%; border-collapse: collapse; text-align: center;"> <tr> <td style="width: 10%;"></td> <td style="width: 10%;"></td> <td style="width: 10%;"></td> <td style="width: 10%;"></td> <td style="width: 10%;"></td> <td style="width: 10%;"></td> <td style="width: 10%;"></td> <td style="width: 10%;"></td> <td style="width: 10%;"></td> <td style="width: 10%;"></td> </tr> <tr> <td></td> <td></td> <td colspan="8" style="text-align: center;"> <table border="1" style="width: 100%; border-collapse: collapse; text-align: center;"> <tr> <td style="width: 10%;"></td> <td style="width: 10%;"></td> <td style="width: 10%;"></td> <td style="width: 10%;"></td> <td style="width: 10%;"></td> <td style="width: 10%;"></td> <td style="width: 10%;"></td> <td style="width: 10%;"></td> <td style="width: 10%;"></td> <td style="width: 10%;"></td> </tr> <tr> <td></td> <td></td> <td colspan="8" style="text-align: center;"> <table border="1" style="width: 100%; border-collapse: collapse; text-align: center;"> <tr> <td style="width: 10%;"></td> <td style="width: 10%;"></td> <td style="width: 10%;"></td> <td style="width: 10%;"></td> <td style="width: 10%;"></td> <td style="width: 10%;"></td> <td style="width: 10%;"></td> <td style="width: 10%;"></td> <td style="width: 10%;"></td> <td style="width: 10%;"></td> </tr> <tr> <td></td> <td></td> <td colspan="8" style="text-align: center;"> <table border="1" style="width: 100%; border-collapse: collapse; text-align: center;"> <tr> <td style="width: 10%;"></td> <td style="width: 10%;"></td> <td style="width: 10%;"></td> <td style="width: 10%;"></td> <td style="width: 10%;"></td> <td style="width: 10%;"></td> <td style="width: 10%;"></td> <td style="width: 10%;"></td> <td style="width: 10%;"></td> <td style="width: 10%;"></td> </tr> <tr> <td></td> <td></td> <td colspan="8" style="text-align: center;"> <table border="1" style="width: 100%; border-collapse: collapse; text-align: center;"> <tr> <td style="width: 10%;"></td> <td style="width: 10%;"></td> <td style="width: 10%;"></td> <td style="width: 10%;"></td> <td style="width: 10%;"></td> <td style="width: 10%;"></td> <td style="width: 10%;"></td> <td style="width: 10%;"></td> <td style="width: 10%;"></td> <td style="width: 10%;"></td> </tr> <tr> <td></td> <td></td> <td colspan="8" style="text-align: center;"> <table border="1" style="width: 100%; border-collapse: collapse; text-align: center;"> <tr> <td style="width: 10%;"></td> <td style="width: 10%;"></td> <td style="width: 10%;"></td> <td style="width: 10%;"></td> <td style="width: 10%;"></td> <td style="width: 10%;"></td> <td style="width: 10%;"></td> <td style="width: 10%;"></td> <td style="width: 10%;"></td> <td style="width: 10%;"></td> </tr> <tr> <td></td>
<td></td> <td colspan="8" style="text-align: center;"> <table border="1" style="width: 100%; border-collapse: collapse; text-align: center;"> <tr> <td style="width: 10%;"></td> <td style="width: 10%;"></td> <td style="width: 10%;"></td> <td style="width: 10%;"></td> <td style="width: 10%;"></td> <td style="width: 10%;"></td> <td style="width: 10%;"></td> <td style="width: 10%;"></td> <td style="width: 10%;"></td> <td style="width: 10%;"></td> </tr> <tr> <td></td> <td></td> <td colspan="8" style="text-align: center;"> <table border="1" style="width: 100%; border-collapse: collapse; text-align: center;"> <tr> <td style="width: 10%;"></td> <td style="width: 10%;"></td> <td style="width: 10%;"></td> <td style="width: 10%;"></td> <td style="width: 10%;"></td> <td style="width: 10%;"></td> <td style="width: 10%;"></td> <td style="width: 10%;"></td> <td style="width: 10%;"></td> <td style="width: 10%;"></td> </tr> <tr> <td></td> <td></td> <td colspan="8" style="text-align: center;"> <table border="1" style="width: 100%; border-collapse: collapse; text-align: center;"> <tr> <td style="width: 10%;"></td> <td style="width: 10%;"></td> <td style="width: 10%;"></td> <td style="width: 10%;"></td> <td style="width: 10%;"></td> <td style="width: 10%;"></td> <td style="width: 10%;"></td> <td style="width: 10%;"></td> <td style="width: 10%;"></td> <td style="width: 10%;"></td> </tr> <tr> <td></td> <td></td> <td colspan="8" style="text-align: center;"> <table border="1" style="width: 100%; border-collapse: collapse; text-align: center;"> <tr> <td style="width: 10%;"></td> <td style="width: 10%;"></td> <td style="width: 10%;"></td> <td style="width: 10%;"></td> <td style="width: 10%;"></td> <td style="width: 10%;"></td> <td style="width: 10%;"></td> <td style="width: 10%;"></td> <td style="width: 10%;"></td> <td style="width: 10%;"></td> </tr> <tr> <td></td> <td></td> <td colspan="8" style="text-align: center;"> <table border="1" style="width: 100%; border-collapse: collapse; text-align: center;"> <tr> <td style="width: 10%;"></td> <td style="width: 10%;"></td> <td style="width: 10%;"></td> <td style="width: 10%;"></td> <td style="width: 10%;"></td> <td style="width: 10%;"></td> <td style="width: 10%;"></td> <td style="width: 10%;"></td> <td style="width: 10%;"></td> <td style="width: 10%;"></td> </tr> <tr> <td></td> <td></td> <td colspan="8" style="text-align: center;"> <table border="1" style="width: 100%; border-collapse: collapse; text-align: center;"> <tr> <td style="width: 10%;"></td> <td style="width: 10%;"></td> <td style="width: 10%;"></td> <td style="width: 10%;"></td> <td style="width: 10%;"></td> <td style="width: 10%;"></td> <td style="width: 10%;"></td> <td style="width: 10%;"></td> <td style="width: 10%;"></td> <td style="width: 10%;"></td> </tr> <tr> <td></td> <td></td> <td colspan="8" style="text-align: center;"> <table border="1" style="width: 100%; border-collapse: collapse; text-align: center;"> <tr> <td style="width: 10%;"></td> <td style="width: 10%;"></td> <td style="width: 10%;"></td> <td style="width: 10%;"></td> <td style="width: 10%;"></td> <td style="width: 10%;"></td> <td style="width: 10%;"></td> <td style="width: 10%;"></td> <td style="width: 10%;"></td> <td style="width: 10%;"></td> </tr> <tr> <td></td> <td></td> <td colspan="8" style="text-align: center;"> <table border="1" style="width: 100%; border-collapse: collapse; text-align: center;"> <tr> <td style="width: 10%;"></td> <td style="width: 10%;"></td> <td style="width: 10%;"></td> <td style="width: 10%;"></td> <td style="width: 10%;"></td> <td style="width: 10%;"></td> <td style="width: 10%;"></td> <td style="width: 10%;"></td> <td style="width: 10%;"></td> <td style="width: 10%;"></td> </tr> <tr> <td></td> <td></td> <td colspan="8" style="text-align: center;"> <table border="1" style="width: 100%; border-collapse: collapse; text-align: center;"> <tr> <td style="width: 10%;"></td> <td style="width: 10%;"></td> <td style="width: 10%;"></td> <td style="width: 10%;"></td> <td style="width: 10%;"></td> <td style="width: 10%;"></td> <td style="width: 10%;"></td> <td style="width: 10%;"></td> <td style="width: 10%;"></td> <td style="width: 10%;"></td> </tr> <tr> <td></td> <td></td> <td colspan="8" style="text-align: center;"> <table border="1" style="width: 100%; border-collapse: collapse; text-align: center;"> <tr> <td style="width: 10%;"></td> <td style="width: 10%;"></td> <td style="width: 10%;"></td> <td style="width: 10%;"></td> <td style="width: 10%;"></td> <td style="width: 10%;"></td> <td style="width: 10%;"></td> <td style="width: 10%;"></td> <td style="width: 10%;"></td> <td style="width: 10%;"></td> </tr> <tr> <td></td> <td></td> <td colspan="8" style="text-align: center;"> <table border="1" style="width: 100%; border-collapse: collapse; text-align: center;"> <tr> <td style="width: 10%;"></td> <td style="width: 10%;"></td> <td style="width: 10%;"></td> <td style="width: 10%;"></td> <td style="width: 10%;"></td> <td style="width: 10%;"></td> <td style="width: 10%;"></td> <td style="width: 10%;"></td> <td style="width: 10%;"></td> <td style="width: 10%;"></td> </tr> <tr> <td></td> <td></td> <td colspan="8" style="text-align: center;"> <table border="1" style="width: 100%; border-collapse: collapse; text-align: center;"> <tr> <td style="width: 10%;"></td> <td style="width: 10%;"></td> <td style="width: 10%;"></td> <td style="width: 10%;"></td> <td style="width: 10%;"></td> <td style="width: 10%;"></td> <td style="width: 10%;"></td> <td style="width: 10%;"></td> <td style="width: 10%;"></td> <td style="width: 10%;"></td> </tr> <tr> <td></td> <td></td> <td colspan="8" style="text-align: center;"> <table border="1" style="width: 100%; border-collapse: collapse; text-align: center;"> <tr> <td style="width: 10%;"></td> <td style="width: 10%;"></td> <td style="width: 10%;"></td> <td style="width: 10%;"></td> <td style="width: 10%;"></td> <td style="width: 10%;"></td> <td style="width: 10%;"></td> <td style="width: 10%;"></td> <td style="width: 10%;"></td> <td style="width: 10%;"></td> </tr> <tr> <td></td> <td></td> <td colspan="8" style="text-align: center;"> <table border="1" style="width: 100%; border-collapse: collapse; text-align: center;"> <tr> <td style="width: 10%;"></td> <td style="width: 10%;"></td> <td style="width: 10%;"></td> <td style="width: 10%;"></td> <td style="width: 10%;"></td> <td style="width: 10%;"></td> <td style="width: 10%;"></td> <td style="width: 10%;"></td> <td style="width: 10%;"></td> <td style="width: 10%;"></td> </tr> <tr> <td></td> <td></td> <td colspan="8" style="text-align: center;"> <table border="1" style="width: 100%; border-collapse: collapse; text-align: center;"> <tr> <td style="width: 10%;"></td> <td style="width: 10%;"></td> <td style="width: 10%;"></td> <td style="width: 10%;"></td> <td style="width: 10%;"></td> <td style="width: 10%;"></td> <td style="width: 10%;"></td> <td style="width: 10%;"></td> <td style="width: 10%;"></td> <td style="width: 10%;"></td> </tr> <tr> <td></td> <td></td> <td colspan="8" style="text-align: center;"> <table border="1" style="width: 100%; border-collapse: collapse; text-align: center;"> <tr> </tr></table></td></tr></table></td></tr></table></td></tr></table></td></tr></table></td></tr></table></td></tr></table></td></tr></table></td></tr></table></td></tr></table></td></tr></table></td></tr></table></td></tr></table></td></tr></table></td></tr></table></td></tr></table></td></tr></table></td></tr></table></td></tr></table></td></tr></table></td></tr></table></td></tr></table></td></tr></table></td></tr></table></td></tr></table></td></tr></table></td></tr></table></td></tr></table></td></tr></table></td></tr></table></td></tr></table></td></tr></table></td></tr></table></td></tr></table></td></tr></table></td></tr></table></td></tr></table></td></tr></table></td></tr></table>
 | | | | | | | | | | | | | | | | | | | | <table border="1" style="width: 100%; border-collapse: collapse; text-align: center;"> <tr> <td style="width: 10%;"></td> <td style="width: 10%;"></td> <td style="width: 10%;"></td> <td style="width: 10%;"></td> <td style="width: 10%;"></td> <td style="width: 10%;"></td> <td style="width: 10%;"></td> <td style="width: 10%;"></td> <td style="width: 10%;"></td> <td style="width: 10%;"></td> </tr> <tr> <td></td> <td></td> <td colspan="8" style="text-align: center;"> <table border="1" style="width: 100%; border-collapse: collapse; text-align: center;"> <tr> <td style="width: 10%;"></td> <td style="width: 10%;"></td> <td style="width: 10%;"></td> <td style="width: 10%;"></td> <td style="width: 10%;"></td> <td style="width: 10%;"></td> <td style="width: 10%;"></td> <td style="width: 10%;"></td> <td style="width: 10%;"></td> <td style="width: 10%;"></td> </tr> <tr> <td></td> <td></td> <td colspan="8" style="text-align: center;"> <table border="1" style="width: 100%; border-collapse: collapse; text-align: center;"> <tr> <td style="width: 10%;"></td> <td style="width: 10%;"></td> <td style="width: 10%;"></td> <td style="width: 10%;"></td> <td style="width: 10%;"></td> <td style="width: 10%;"></td> <td style="width: 10%;"></td> <td style="width: 10%;"></td> <td style="width: 10%;"></td> <td style="width: 10%;"></td> </tr> <tr> <td></td> <td></td> <td colspan="8" style="text-align: center;"> <table border="1" style="width: 100%; border-collapse: collapse; text-align: center;"> <tr> <td style="width: 10%;"></td> <td style="width: 10%;"></td> <td style="width: 10%;"></td> <td style="width: 10%;"></td> <td style="width: 10%;"></td> <td style="width: 10%;"></td> <td style="width: 10%;"></td> <td style="width: 10%;"></td> <td style="width: 10%;"></td> <td style="width: 10%;"></td> </tr> <tr> <td></td> <td></td> <td colspan="8" style="text-align: center;"> <table border="1" style="width: 100%; border-collapse: collapse; text-align: center;"> <tr> <td style="width: 10%;"></td> <td style="width: 10%;"></td> <td style="width: 10%;"></td> <td style="width: 10%;"></td> <td style="width: 10%;"></td> <td style="width: 10%;"></td> <td style="width: 10%;"></td> <td style="width: 10%;"></td> <td style="width: 10%;"></td> <td style="width: 10%;"></td> </tr> <tr> <td></td> <td></td> <td colspan="8" style="text-align: center;"> <table border="1" style="width: 100%; border-collapse: collapse; text-align: center;"> <tr> <td style="width: 10%;"></td> <td style="width: 10%;"></td> <td style="width: 10%;"></td> <td style="width: 10%;"></td> <td style="width: 10%;"></td> <td style="width: 10%;"></td> <td style="width: 10%;"></td> <td style="width: 10%;"></td> <td style="width: 10%;"></td> <td style="width: 10%;"></td> </tr> <tr> <td></td> <td></td> <td colspan="8" style="text-align: center;"> <table border="1" style="width: 100%; border-collapse: collapse; text-align: center;"> <tr> <td style="width: 10%;"></td> <td style="width: 10%;"></td> <td style="width: 10%;"></td> <td style="width: 10%;"></td> <td style="width: 10%;"></td> <td style="width: 10%;"></td> <td style="width: 10%;"></td> <td style="width: 10%;"></td> <td style="width: 10%;"></td> <td style="width: 10%;"></td> </tr> <tr> <td></td> <td></td> <td colspan="8" style="text-align: center;"> <table border="1" style="width: 100%; border-collapse: collapse; text-align: center;"> <tr> <td style="width: 10%;"></td> <td style="width: 10%;"></td> <td style="width: 10%;"></td> <td style="width: 10%;"></td> <td style="width: 10%;"></td> <td style="width: 10%;"></td> <td style="width: 10%;"></td> <td style="width: 10%;"></td> <td style="width: 10%;"></td> <td style="width: 10%;"></td> </tr> <tr> <td></td> <td></td> <td colspan="8" style="text-align: center;"> <table border="1" style="width: 100%; border-collapse: collapse; text-align: center;"> <tr> <td style="width: 10%;"></td> <td style="width: 10%;"></td> <td style="width: 10%;"></td> <td style="width: 10%;"></td> <td style="width: 10%;"></td> <td style="width: 10%;"></td> <td style="width: 10%;"></td> <td style="width: 10%;"></td> <td style="width: 10%;"></td> <td style="width: 10%;"></td> </tr> <tr> <td></td> <td></td> <td colspan="8" style="text-align: center;"> <table border="1" style="width: 100%; border-collapse: collapse; text-align: center;"> <tr> <td style="width: 10%;"></td> <td style="width: 10%;"></td> <td style="width: 10%;"></td> <td style="width: 10%;"></td> <td style="width: 10%;"></td> <td style="width: 10%;"></td> <td style="width: 10%;"></td> <td style="width: 10%;"></td> <td style="width: 10%;"></td> <td style="width: 10%;"></td> </tr> <tr> <td></td> <td></td> <td colspan="8" style="text-align: center;"> <table border="1" style="width: 100%; border-collapse: collapse; text-align: center;"> <tr> <td style="width: 10%;"></td> <td style="width: 10%;"></td> <td style="width: 10%;"></td> <td style="width: 10%;"></td> <td style="width: 10%;"></td> <td style="width: 10%;"></td> <td style="width: 10%;"></td> <td style="width: 10%;"></td> <td style="width: 10%;"></td> <td style="width: 10%;"></td> </tr> <tr> <td></td> <td></td> <td colspan="8" style="text-align: center;"> <table border="1" style="width: 100%; border-collapse: collapse; text-align: center;"> <tr> <td style="width: 10%;"></td> <td style="width: 10%;"></td> <td style="width: 10%;"></td> <td style="width: 10%;"></td> <td style="width: 10%;"></td> <td style="width: 10%;"></td> <td style="width: 10%;"></td> <td style="width: 10%;"></td> <td style="width: 10%;"></td> <td style="width: 10%;"></td> </tr> <tr> <td></td> <td></td> <td colspan="8" style="text-align: center;"> <table border="1" style="width: 100%; border-collapse: collapse; text-align: center;"> <tr> <td style="width: 10%;"></td> <td style="width:
10%;"></td> <td style="width: 10%;"></td> <td style="width: 10%;"></td> <td style="width: 10%;"></td> <td style="width: 10%;"></td> <td style="width: 10%;"></td> <td style="width: 10%;"></td> <td style="width: 10%;"></td> <td style="width: 10%;"></td> </tr> <tr> <td></td> <td></td> <td colspan="8" style="text-align: center;"> <table border="1" style="width: 100%; border-collapse: collapse; text-align: center;"> <tr> <td style="width: 10%;"></td> <td style="width: 10%;"></td> <td style="width: 10%;"></td> <td style="width: 10%;"></td> <td style="width: 10%;"></td> <td style="width: 10%;"></td> <td style="width: 10%;"></td> <td style="width: 10%;"></td> <td style="width: 10%;"></td> <td style="width: 10%;"></td> </tr> <tr> <td></td> <td></td> <td colspan="8" style="text-align: center;"> <table border="1" style="width: 100%; border-collapse: collapse; text-align: center;"> <tr> <td style="width: 10%;"></td> <td style="width: 10%;"></td> <td style="width: 10%;"></td> <td style="width: 10%;"></td> <td style="width: 10%;"></td> <td style="width: 10%;"></td> <td style="width: 10%;"></td> <td style="width: 10%;"></td> <td style="width: 10%;"></td> <td style="width: 10%;"></td> </tr> <tr> <td></td> <td></td> <td colspan="8" style="text-align: center;"> <table border="1" style="width: 100%; border-collapse: collapse; text-align: center;"> <tr> <td style="width: 10%;"></td> <td style="width: 10%;"></td> <td style="width: 10%;"></td> <td style="width: 10%;"></td> <td style="width: 10%;"></td> <td style="width: 10%;"></td> <td style="width: 10%;"></td> <td style="width: 10%;"></td> <td style="width: 10%;"></td> <td style="width: 10%;"></td> </tr> <tr> <td></td> <td></td> <td colspan="8" style="text-align: center;"> <table border="1" style="width: 100%; border-collapse: collapse; text-align: center;"> <tr> <td style="width: 10%;"></td> <td style="width: 10%;"></td> <td style="width: 10%;"></td> <td style="width: 10%;"></td> <td style="width: 10%;"></td> <td style="width: 10%;"></td> <td style="width: 10%;"></td> <td style="width: 10%;"></td> <td style="width: 10%;"></td> <td style="width: 10%;"></td> </tr> <tr> <td></td> <td></td> <td colspan="8" style="text-align: center;"> <table border="1" style="width: 100%; border-collapse: collapse; text-align: center;"> <tr> <td style="width: 10%;"></td> <td style="width: 10%;"></td> <td style="width: 10%;"></td> <td style="width: 10%;"></td> <td style="width: 10%;"></td> <td style="width: 10%;"></td> <td style="width: 10%;"></td> <td style="width: 10%;"></td> <td style="width: 10%;"></td> <td style="width: 10%;"></td> </tr> <tr> <td></td> <td></td> <td colspan="8" style="text-align: center;"> <table border="1" style="width: 100%; border-collapse: collapse; text-align: center;"> <tr> <td style="width: 10%;"></td> <td style="width: 10%;"></td> <td style="width: 10%;"></td> <td style="width: 10%;"></td> <td style="width: 10%;"></td> <td style="width: 10%;"></td> <td style="width: 10%;"></td> <td style="width: 10%;"></td> <td style="width: 10%;"></td> <td style="width: 10%;"></td> </tr> <tr> <td></td> <td></td> <td colspan="8" style="text-align: center;"> <table border="1" style="width: 100%; border-collapse: collapse; text-align: center;"> <tr> <td style="width: 10%;"></td> <td style="width: 10%;"></td> <td style="width: 10%;"></td> <td style="width: 10%;"></td> <td style="width: 10%;"></td> <td style="width: 10%;"></td> <td style="width: 10%;"></td> <td style="width: 10%;"></td> <td style="width: 10%;"></td> <td style="width: 10%;"></td> </tr> <tr> <td></td> <td></td> <td colspan="8" style="text-align: center;"> <table border="1" style="width: 100%; border-collapse: collapse; text-align: center;"> <tr> <td style="width: 10%;"></td> <td style="width: 10%;"></td> <td style="width: 10%;"></td> <td style="width: 10%;"></td> <td style="width: 10%;"></td> <td style="width: 10%;"></td> <td style="width: 10%;"></td> <td style="width: 10%;"></td> <td style="width: 10%;"></td> <td style="width: 10%;"></td> </tr> <tr> <td></td> <td></td> <td colspan="8" style="text-align: center;"> <table border="1" style="width: 100%; border-collapse: collapse; text-align: center;"> <tr> <td style="width: 10%;"></td> <td style="width: 10%;"></td> <td style="width: 10%;"></td> <td style="width: 10%;"></td> <td style="width: 10%;"></td> <td style="width: 10%;"></td> <td style="width: 10%;"></td> <td style="width: 10%;"></td> <td style="width: 10%;"></td> <td style="width: 10%;"></td> </tr> <tr> <td></td> <td></td> <td colspan="8" style="text-align: center;"> <table border="1" style="width: 100%; border-collapse: collapse; text-align: center;"> <tr> <td style="width: 10%;"></td> <td style="width: 10%;"></td> <td style="width: 10%;"></td> <td style="width: 10%;"></td> <td style="width: 10%;"></td> <td style="width: 10%;"></td> <td style="width: 10%;"></td> <td style="width: 10%;"></td> <td style="width: 10%;"></td> <td style="width: 10%;"></td> </tr> <tr> <td></td> <td></td> <td colspan="8" style="text-align: center;"> <table border="1" style="width: 100%; border-collapse: collapse; text-align: center;"> <tr> <td style="width: 10%;"></td> <td style="width: 10%;"></td> <td style="width: 10%;"></td> <td style="width: 10%;"></td> <td style="width: 10%;"></td> <td style="width: 10%;"></td> <td style="width: 10%;"></td> <td style="width: 10%;"></td> <td style="width: 10%;"></td> <td style="width: 10%;"></td> </tr> <tr> <td></td> <td></td> <td colspan="8" style="text-align: center;"> <table border="1" style="width: 100%; border-collapse: collapse; text-align: center;"> <tr> <td style="width: 10%;"></td> <td style="width: 10%;"></td> <td style="width: 10%;"></td> <td style="width: 10%;"></td> <td style="width: 10%;"></td> <td style="width: 10%;"></td> <td style="width: 10%;"></td> <td style="width: 10%;"></td> <td style="width: 10%;"></td> <td style="width: 10%;"></td> </tr> <tr> <td></td> <td></td> <td colspan="8" style="text-align: center;"> <table border="1" style="width: 100%; border-collapse: collapse; text-align: center;"> <tr> <td style="width: 10%;"></td> <td style="width: 10%;"></td> <td style="width: 10%;"></td> <td style="width: 10%;"></td> <td style="width: 10%;"></td> <td style="width: 10%;"></td> <td style="width: 10%;"></td> <td style="width: 10%;"></td> <td style="width: 10%;"></td> <td style="width: 10%;"></td> </tr> <tr> <td></td> <td></td> <td colspan="8" style="text-align: center;"> <table border="1" style="width: 100%; border-collapse: collapse; text-align: center;"> <tr> <td style="width: 10%;"></td> <td style="width: 10%;"></td> <td style="width: 10%;"></td> <td style="width: 10%;"></td> <td style="width: 10%;"></td> <td style="width: 10%;"></td> <td style="width: 10%;"></td> <td style="width: 10%;"></td> <td style="width: 10%;"></td> <td style="width: 10%;"></td> </tr> <tr> <td></td> <td></td> <td colspan="8" style="text-align: center;"> <table border="1" style="width: 100%; border-collapse: collapse; text-align: center;"> <tr> <td style="width: 10%;"></td> <td style="width: 10%;"></td> <td style="width: 10%;"></td> <td style="width: 10%;"></td> <td style="width: 10%;"></td> <td style="width: 10%;"></td> <td style="width: 10%;"></td> <td style="width: 10%;"></td> <td style="width: 10%;"></td> <td style="width: 10%;"></td> </tr> <tr> <td></td> <td></td> <td colspan="8" style="text-align: center;"> <table border="1" style="width: 100%; border-collapse: collapse; text-align: center;"> <tr> <td style="width: 10%;"></td> <td style="width: 10%;"></td> <td style="width: 10%;"></td> <td style="width: 10%;"></td> <td style="width: 10%;"></td> <td style="width: 10%;"></td> <td style="width: 10%;"></td> <td style="width: 10%;"></td> <td style="width: 10%;"></td> <td style="width: 10%;"></td> </tr> <tr> <td></td> <td></td> <td colspan="8" style="text-align: center;"> <table border="1" style="width: 100%; border-collapse: collapse; text-align: center;"> <tr> <td style="width: 10%;"></td> <td style="width: 10%;"></td> <td style="width: 10%;"></td> <td style="width: 10%;"></td> <td style="width: 10%;"></td> <td style="width: 10%;"></td> <td style="width: 10%;"></td> <td style="width: 10%;"></td> <td style="width: 10%;"></td> <td style="width: 10%;"></td> </tr> <tr> <td></td> <td></td> <td colspan="8" style="text-align: center;"> <table border="1" style="width: 100%; border-collapse: collapse; text-align: center;"> <tr> <td style="width: 10%;"></td> <td style="width: 10%;"></td> <td style="width: 10%;"></td> <td style="width: 10%;"></td> <td style="width: 10%;"></td> <td style="width: 10%;"></td> <td style="width: 10%;"></td> <td style="width: 10%;"></td> <td style="width: 10%;"></td> <td style="width: 10%;"></td> </tr> <tr> <td></td> <td></td> <td colspan="8" style="text-align: center;"> <table border="1" style="width: 100%; border-collapse: collapse; text-align: center;"> <tr> <td style="width: 10%;"></td> <td style="width: 10%;"></td> <td style="width: 10%;"></td> <td style="width: 10%;"></td> <td style="width: 10%;"></td> <td style="width: 10%;"></td> <td style="width: 10%;"></td> <td style="width: 10%;"></td> <td style="width: 10%;"></td> <td style="width: 10%;"></td> </tr> <tr> <td></td> <td></td> <td colspan="8" style="text-align: center;"> <table border="1" style="width: 100%; border-collapse: collapse; text-align: center;"> <tr> <td style="width: 10%;"></td> <td style="width: 10%;"></td> <td style="width: 10%;"></td> <td style="width: 10%;"></td> <td style="width: 10%;"></td> <td style="width: 10%;"></td> <td style="width: 10%;"></td> <td style="width: 10%;"></td> <td style="width: 10%;"></td> <td style="width: 10%;"></td> </tr> <tr> <td></td> <td></td> <td colspan="8" style="text-align: center;"> <table border="1" style="width: 100%; border-collapse: collapse; text-align: center;"> <tr> <td style="width: 10%;"></td> <td style="width: 10%;"></td> <td style="width: 10%;"></td> <td style="width: 10%;"></td> <td style="width: 10%;"></td> <td style="width: 10%;"></td> <td style="width: 10%;"></td> <td
style="width: 10%;"></td> <td style="width: 10%;"></td> <td style="width: 10%;"></td> </tr> <tr> <td></td> <td></td> <td colspan="8" style="text-align: center;"> <table border="1" style="width: 100%; border-collapse: collapse; text-align: center;"> <tr> <td style="width: 10%;"></td> <td style="width: 10%;"></td> <td style="width: 10%;"></td> <td style="width: 10%;"></td> <td style="width: 10%;"></td> <td style="width: 10%;"></td> <td style="width: 10%;"></td> <td style="width: 10%;"></td> <td style="width: 10%;"></td> <td style="width: 10%;"></td> </tr> <tr> <td></td> <td></td> <td colspan="8" style="text-align: center;"> <table border="1" style="width: 100%; border-collapse: collapse; text-align: center;"> <tr> <td style="width: 10%;"></td> <td style="width: 10%;"></td> <td style="width: 10%;"></td> <td style="width: 10%;"></td> <td style="width: 10%;"></td> <td style="width: 10%;"></td> <td style="width: 10%;"></td> <td style="width: 10%;"></td> <td style="width: 10%;"></td> <td style="width: 10%;"></td> </tr> <tr> <td></td> <td></td> <td colspan="8" style="text-align: center;"> <table border="1" style="width: 100%; border-collapse: collapse; text-align: center;"> <tr> <td style="width: 10%;"></td> <td style="width: 10%;"></td> <td style="width: 10%;"></td> <td style="width: 10%;"></td> <td style="width: 10%;"></td> <td style="width: 10%;"></td> <td style="width: 10%;"></td> <td style="width: 10%;"></td> <td style="width: 10%;"></td> <td style="width: 10%;"></td> </tr> <tr> <td></td> <td></td> <td colspan="8" style="text-align: center;"> <table border="1" style="width: 100%; border-collapse: collapse; text-align: center;"> <tr> </tr></table></td></tr></table></td></tr></table></td></tr></table></td></tr></table></td></tr></table></td></tr></table></td></tr></table></td></tr></table></td></tr></table></td></tr></table></td></tr></table></td></tr></table></td></tr></table></td></tr></table></td></tr></table></td></tr></table></td></tr></table></td></tr></table></td></tr></table></td></tr></table></td></tr></table></td></tr></table></td></tr></table></td></tr></table></td></tr></table></td></tr></table></td></tr></table></td></tr></table></td></tr></table></td></tr></table></td></tr></table></td></tr></table></td></tr></table></td></tr></table></td></tr></table></td></tr></table></td></tr></table> | | | | | | | | | | | | | | | | | | | | <table border="1" style="width: 100%; border-collapse: collapse; text-align: center;"> <tr> <td style="width: 10%;"></td> <td style="width: 10%;"></td> <td style="width: 10%;"></td> <td style="width: 10%;"></td> <td style="width: 10%;"></td> <td style="width: 10%;"></td> <td style="width: 10%;"></td> <td style="width: 10%;"></td> <td style="width: 10%;"></td> <td style="width: 10%;"></td> </tr> <tr> <td></td> <td></td> <td colspan="8" style="text-align: center;"> <table border="1" style="width: 100%; border-collapse: collapse; text-align: center;"> <tr> <td style="width: 10%;"></td> <td style="width: 10%;"></td> <td style="width: 10%;"></td> <td style="width: 10%;"></td> <td style="width: 10%;"></td> <td style="width: 10%;"></td> <td style="width: 10%;"></td> <td style="width: 10%;"></td> <td style="width: 10%;"></td> <td style="width: 10%;"></td> </tr> <tr> <td></td> <td></td> <td colspan="8" style="text-align: center;"> <table border="1" style="width: 100%; border-collapse: collapse; text-align: center;"> <tr> <td style="width: 10%;"></td> <td style="width: 10%;"></td> <td style="width: 10%;"></td> <td style="width: 10%;"></td> <td style="width: 10%;"></td> <td style="width: 10%;"></td> <td style="width: 10%;"></td> <td style="width: 10%;"></td> <td
style="width: 10%;"></td> <td style="width: 10%;"></td> </tr> <tr> <td></td> <td></td> <td colspan="8" style="text-align: center;"> <table border="1" style="width: 100%; border-collapse: collapse; text-align: center;"> <tr> <td style="width: 10%;"></td> <td style="width: 10%;"></td> <td style="width: 10%;"></td> <td style="width: 10%;"></td> <td style="width: 10%;"></td> <td style="width: 10%;"></td> <td style="width: 10%;"></td> <td style="width: 10%;"></td> <td style="width: 10%;"></td> <td style="width: 10%;"></td> </tr> <tr> <td></td> <td></td> <td colspan="8" style="text-align: center;"> <table border="1" style="width: 100%; border-collapse: collapse; text-align: center;"> <tr> <td style="width: 10%;"></td> <td style="width: 10%;"></td> <td style="width: 10%;"></td> <td style="width: 10%;"></td> <td style="width: 10%;"></td> <td style="width: 10%;"></td> <td style="width: 10%;"></td> <td style="width: 10%;"></td> <td style="width: 10%;"></td> <td style="width: 10%;"></td> </tr> <tr> <td></td> <td></td> <td colspan="8" style="text-align: center;"> <table border="1" style="width: 100%; border-collapse: collapse; text-align: center;"> <tr> <td style="width: 10%;"></td> <td style="width: 10%;"></td> <td style="width: 10%;"></td> <td style="width: 10%;"></td> <td style="width: 10%;"></td> <td style="width: 10%;"></td> <td style="width: 10%;"></td> <td style="width: 10%;"></td> <td style="width: 10%;"></td> <td style="width: 10%;"></td> </tr> <tr> <td></td> <td></td> <td colspan="8" style="text-align: center;"> <table border="1" style="width: 100%; border-collapse: collapse; text-align: center;"> <tr> <td style="width: 10%;"></td> <td style="width: 10%;"></td> <td style="width: 10%;"></td> <td style="width: 10%;"></td> <td style="width: 10%;"></td> <td style="width: 10%;"></td> <td style="width: 10%;"></td> <td style="width: 10%;"></td> <td style="width: 10%;"></td> <td style="width: 10%;"></td> </tr> <tr> <td></td> <td></td> <td colspan="8" style="text-align: center;"> <table border="1" style="width: 100%; border-collapse: collapse; text-align: center;"> <tr> <td style="width: 10%;"></td> <td style="width: 10%;"></td> <td style="width: 10%;"></td> <td style="width: 10%;"></td> <td style="width: 10%;"></td> <td style="width: 10%;"></td> <td style="width: 10%;"></td> <td style="width: 10%;"></td> <td style="width: 10%;"></td> <td style="width: 10%;"></td> </tr> <tr> <td></td> <td></td> <td colspan="8" style="text-align: center;"> <table border="1" style="width: 100%; border-collapse: collapse; text-align: center;"> <tr> <td style="width: 10%;"></td> <td style="width: 10%;"></td> <td style="width: 10%;"></td> <td style="width: 10%;"></td> <td style="width: 10%;"></td> <td style="width: 10%;"></td> <td style="width: 10%;"></td> <td style="width: 10%;"></td> <td style="width: 10%;"></td> <td style="width: 10%;"></td> </tr> <tr> <td></td> <td></td> <td colspan="8" style="text-align: center;"> <table border="1" style="width: 100%; border-collapse: collapse; text-align: center;"> <tr> <td style="width: 10%;"></td> <td style="width: 10%;"></td> <td style="width: 10%;"></td> <td style="width: 10%;"></td> <td style="width: 10%;"></td> <td style="width: 10%;"></td> <td style="width: 10%;"></td> <td style="width: 10%;"></td> <td style="width: 10%;"></td> <td style="width: 10%;"></td> </tr> <tr> <td></td> <td></td> <td colspan="8" style="text-align: center;"> <table border="1" style="width: 100%; border-collapse: collapse; text-align: center;"> <tr> <td style="width: 10%;"></td> <td style="width: 10%;"></td> <td style="width: 10%;"></td> <td style="width: 10%;"></td> <td style="width: 10%;"></td> <td style="width: 10%;"></td> <td style="width: 10%;"></td> <td style="width: 10%;"></td> <td style="width: 10%;"></td> <td style="width: 10%;"></td> </tr> <tr> <td></td> <td></td> <td colspan="8" style="text-align: center;"> <table border="1" style="width: 100%; border-collapse: collapse; text-align: center;"> <tr> <td style="width: 10%;"></td> <td style="width: 10%;"></td> <td style="width: 10%;"></td> <td style="width: 10%;"></td> <td style="width: 10%;"></td> <td style="width: 10%;"></td> <td style="width: 10%;"></td> <td style="width: 10%;"></td> <td style="width: 10%;"></td> <td style="width: 10%;"></td> </tr> <tr> <td></td> <td></td> <td colspan="8" style="text-align: center;"> <table border="1" style="width: 100%; border-collapse: collapse; text-align: center;"> <tr> <td style="width: 10%;"></td> <td style="width: 10%;"></td> <td style="width: 10%;"></td> <td style="width: 10%;"></td> <td style="width: 10%;"></td> <td style="width: 10%;"></td> <td style="width: 10%;"></td> <td style="width: 10%;"></td> <td style="width: 10%;"></td> <td style="width: 10%;"></td> </tr> <tr> <td></td> <td></td> <td colspan="8" style="text-align: center;"> <table border="1" style="width: 100%; border-collapse: collapse; text-align: center;"> <tr> <td style="width: 10%;"></td> <td style="width: 10%;"></td> <td style="width: 10%;"></td> <td style="width: 10%;"></td> <td style="width: 10%;"></td> <td style="width: 10%;"></td> <td style="width: 10%;"></td> <td style="width: 10%;"></td> <td style="width: 10%;"></td> <td style="width: 10%;"></td> </tr> <tr> <td></td> <td></td> <td colspan="8" style="text-align: center;"> <table border="1" style="width: 100%; border-collapse: collapse; text-align: center;"> <tr> <td style="width: 10%;"></td> <td style="width: 10%;"></td> <td style="width: 10%;"></td> <td style="width: 10%;"></td> <td style="width: 10%;"></td> <td style="width: 10%;"></td> <td style="width: 10%;"></td> <td style="width: 10%;"></td> <td style="width: 10%;"></td> <td style="width: 10%;"></td> </tr> <tr> <td></td> <td></td> <td colspan="8" style="text-align: center;"> <table border="1" style="width: 100%; border-collapse: collapse; text-align: center;"> <tr> <td style="width: 10%;"></td> <td style="width: 10%;"></td> <td style="width: 10%;"></td> <td style="width: 10%;"></td> <td style="width: 10%;"></td> <td style="width: 10%;"></td> <td style="width: 10%;"></td> <td style="width: 10%;"></td> <td style="width: 10%;"></td> <td style="width: 10%;"></td> </tr> <tr> <td></td> <td></td> <td colspan="8" style="text-align: center;"> <table border="1" style="width: 100%; border-collapse: collapse; text-align: center;"> <tr> <td style="width: 10%;"></td> <td style="width: 10%;"></td> <td style="width: 10%;"></td> <td style="width: 10%;"></td> <td style="width: 10%;"></td> <td style="width: 10%;"></td> <td style="width: 10%;"></td> <td style="width: 10%;"></td> <td style="width: 10%;"></td> <td style="width: 10%;"></td> </tr> <tr> <td></td> <td></td> <td colspan="8" style="text-align: center;"> <table border="1" style="width: 100%; border-collapse: collapse; text-align: center;"> <tr> <td style="width: 10%;"></td> <td style="width: 10%;"></td> <td style="width: 10%;"></td> <td style="width: 10%;"></td> <td style="width: 10%;"></td> <td style="width: 10%;"></td> <td style="width: 10%;"></td> <td style="width: 10%;"></td> <td style="width: 10%;"></td> <td style="width: 10%;"></td> </tr> <tr> <td></td> <td></td> <td colspan="8" style="text-align: center;"> <table border="1" style="width: 100%; border-collapse: collapse; text-align: center;"> <tr> <td style="width: 10%;"></td> <td style="width: 10%;"></td> <td style="width: 10%;"></td> <td style="width: 10%;"></td> <td style="width: 10%;"></td> <td style="width: 10%;"></td> <td style="width: 10%;"></td> <td style="width: 10%;"></td> <td style="width: 10%;"></td> <td style="width: 10%;"></td> </tr> <tr> <td></td> <td></td> <td colspan="8" style="text-align: center;"> <table border="1" style="width: 100%; border-collapse: collapse; text-align: center;"> <tr> <td style="width: 10%;"></td> <td style="width: 10%;"></td> <td style="width: 10%;"></td> <td style="width: 10%;"></td> <td style="width: 10%;"></td> <td style="width: 10%;"></td> <td style="width: 10%;"></td> <td style="width: 10%;"></td> <td style="width: 10%;"></td> <td style="width: 10%;"></td> </tr> <tr> <td></td> <td></td> <td colspan="8" style="text-align: center;"> <table border="1" style="width: 100%; border-collapse: collapse; text-align: center;"> <tr> <td style="width: 10%;"></td> <td style="width: 10%;"></td> <td style="width: 10%;"></td> <td style="width: 10%;"></td> <td style="width: 10%;"></td> <td style="width: 10%;"></td> <td style="width: 10%;"></td> <td style="width: 10%;"></td> <td style="width: 10%;"></td> <td style="width: 10%;"></td> </tr> <tr> <td></td> <td></td> <td colspan="8" style="text-align: center;"> <table border="1" style="width: 100%; border-collapse: collapse; text-align: center;"> <tr> <td style="width: 10%;"></td> <td style="width: 10%;"></td> <td style="width: 10%;"></td> <td style="width: 10%;"></td> <td style="width: 10%;"></td> <td style="width: 10%;"></td> <td style="width: 10%;"></td> <td style="width: 10%;"></td> <td style="width: 10%;"></td> <td style="width: 10%;"></td> </tr> <tr> <td></td> <td></td> <td colspan="8" style="text-align: center;"> <table border="1" style="width: 100%; border-collapse: collapse; text-align: center;"> <tr> <td style="width: 10%;"></td> <td style="width: 10%;"></td> <td style="width: 10%;"></td> <td style="width: 10%;"></td> <td style="width: 10%;"></td> <td style="width: 10%;"></td> <td style="width: 10%;"></td> <td style="width: 10%;"></td> <td style="width: 10%;"></td> <td style="width: 10%;"></td> </tr> <tr> <td></td> <td></td> <td colspan="8" style="text-align: center;"> <table border="1" style="width: 100%; border-collapse: collapse; text-align: center;"> <tr> <td style="width: 10%;"></td> <td style="width: 10%;"></td> <td style="width: 10%;"></td> <td style="width: 10%;"></td> <td style="width: 10%;"></td> <td style="width: 10%;"></td> <td style="width: 10%;"></td> <td style="width: 10%;"></td> <td style="width: 10%;"></td> <td style="width: 10%;"></td> </tr> <tr> <td></td> <td></td> <td colspan="8" style="text-align: center;"> <table border="1" style="width: 100%;
border-collapse: collapse; text-align: center;"> <tr> <td style="width: 10%;"></td> <td style="width: 10%;"></td> <td style="width: 10%;"></td> <td style="width: 10%;"></td> <td style="width: 10%;"></td> <td style="width: 10%;"></td> <td style="width: 10%;"></td> <td style="width: 10%;"></td> <td style="width: 10%;"></td> <td style="width: 10%;"></td> </tr> <tr> <td></td> <td></td> <td colspan="8" style="text-align: center;"> <table border="1" style="width: 100%; border-collapse: collapse; text-align: center;"> <tr> <td style="width: 10%;"></td> <td style="width: 10%;"></td> <td style="width: 10%;"></td> <td style="width: 10%;"></td> <td style="width: 10%;"></td> <td style="width: 10%;"></td> <td style="width: 10%;"></td> <td style="width: 10%;"></td> <td style="width: 10%;"></td> <td style="width: 10%;"></td> </tr> <tr> <td></td> <td></td> <td colspan="8" style="text-align: center;"> <table border="1" style="width: 100%; border-collapse: collapse; text-align: center;"> <tr> <td style="width: 10%;"></td> <td style="width: 10%;"></td> <td style="width: 10%;"></td> <td style="width: 10%;"></td> <td style="width: 10%;"></td> <td style="width: 10%;"></td> <td style="width: 10%;"></td> <td style="width: 10%;"></td> <td style="width: 10%;"></td> <td style="width: 10%;"></td> </tr> <tr> <td></td> <td></td> <td colspan="8" style="text-align: center;"> <table border="1" style="width: 100%; border-collapse: collapse; text-align: center;"> <tr> <td style="width: 10%;"></td> <td style="width: 10%;"></td> <td style="width: 10%;"></td> <td style="width: 10%;"></td> <td style="width: 10%;"></td> <td style="width: 10%;"></td> <td style="width: 10%;"></td> <td style="width: 10%;"></td> <td style="width: 10%;"></td> <td style="width: 10%;"></td> </tr> <tr> <td></td> <td></td> <td colspan="8" style="text-align: center;"> <table border="1" style="width: 100%; border-collapse: collapse; text-align: center;"> <tr> <td style="width: 10%;"></td> <td style="width: 10%;"></td> <td style="width: 10%;"></td> <td style="width: 10%;"></td> <td style="width: 10%;"></td> <td style="width: 10%;"></td> <td style="width: 10%;"></td> <td style="width: 10%;"></td> <td style="width: 10%;"></td> <td style="width: 10%;"></td> </tr> <tr> <td></td> <td></td> <td colspan="8" style="text-align: center;"> <table border="1" style="width: 100%; border-collapse: collapse; text-align: center;"> <tr> <td style="width: 10%;"></td> <td style="width: 10%;"></td> <td style="width: 10%;"></td> <td style="width: 10%;"></td> <td style="width: 10%;"></td> <td style="width: 10%;"></td> <td style="width: 10%;"></td> <td style="width: 10%;"></td> <td style="width: 10%;"></td> <td style="width: 10%;"></td> </tr> <tr> <td></td> <td></td> <td colspan="8" style="text-align: center;"> <table border="1" style="width: 100%; border-collapse: collapse; text-align: center;"> <tr> <td style="width: 10%;"></td> <td style="width: 10%;"></td> <td style="width: 10%;"></td> <td style="width: 10%;"></td> <td style="width: 10%;"></td> <td style="width: 10%;"></td> <td style="width: 10%;"></td> <td style="width: 10%;"></td> <td style="width: 10%;"></td> <td style="width: 10%;"></td> </tr> <tr> <td></td> <td></td> <td colspan="8" style="text-align: center;"> <table border="1" style="width: 100%; border-collapse: collapse; text-align: center;"> <tr> <td style="width: 10%;"></td> <td style="width: 10%;"></td> <td style="width: 10%;"></td> <td style="width: 10%;"></td> <td style="width: 10%;"></td> <td style="width: 10%;"></td> <td style="width: 10%;"></td> <td style="width: 10%;"></td> <td style="width: 10%;"></td> <td style="width: 10%;"></td> </tr> <tr> <td></td> <td></td> <td colspan="8" style="text-align: center;"> <table border="1" style="width: 100%; border-collapse: collapse; text-align: center;"> <tr> <td style="width: 10%;"></td> <td style="width: 10%;"></td> <td style="width: 10%;"></td> <td style="width: 10%;"></td> <td style="width: 10%;"></td> <td style="width: 10%;"></td> <td style="width: 10%;"></td> <td style="width: 10%;"></td> <td style="width: 10%;"></td> <td style="width: 10%;"></td> </tr> <tr> <td></td> <td></td> <td colspan="8" style="text-align: center;"> <table border="1" style="width: 100%; border-collapse: collapse; text-align: center;"> <tr> <td style="width: 10%;"></td> <td style="width: 10%;"></td> <td style="width: 10%;"></td> <td style="width: 10%;"></td> <td style="width: 10%;"></td> <td style="width: 10%;"></td> <td style="width: 10%;"></td> <td style="width: 10%;"></td> <td style="width: 10%;"></td> <td style="width: 10%;"></td> </tr> <tr> <td></td> <td></td> <td colspan="8" style="text-align: center;"> <table border="1" style="width: 100%; border-collapse: collapse; text-align: center;"> <tr> <td style="width: 10%;"></td> <td style="width: 10%;"></td> <td style="width: 10%;"></td> <td style="width: 10%;"></td> <td style="width: 10%;"></td> <td style="width: 10%;"></td> <td style="width: 10%;"></td> <td style="width: 10%;"></td> <td style="width: 10%;"></td> <td style="width: 10%;"></td> </tr> <tr> <td></td> <td></td> <td colspan="8" style="text-align: center;"> <table border="1" style="width: 100%; border-collapse: collapse; text-align: center;"> <tr> <td style="width: 10%;"></td> <td style="width: 10%;"></td> <td style="width: 10%;"></td> <td style="width: 10%;"></td> <td style="width: 10%;"></td> <td style="width: 10%;"></td> <td style="width: 10%;"></td> <td style="width: 10%;"></td> <td style="width: 10%;"></td> <td style="width: 10%;"></td> </tr> <tr> <td></td> <td></td> <td colspan="8" style="text-align: center;"> <table border="1" style="width: 100%; border-collapse: collapse; text-align: center;"> <tr> </tr></table></td></tr></table></td></tr></table></td></tr></table></td></tr></table></td></tr></table></td></tr></table></td></tr></table></td></tr></table></td></tr></table></td></tr></table></td></tr></table></td></tr></table></td></tr></table></td></tr></table></td></tr></table></td></tr></table></td></tr></table></td></tr></table></td></tr></table></td></tr></table></td></tr></table></td></tr></table></td></tr></table></td></tr></table></td></tr></table></td></tr></table></td></tr></table></td></tr></table></td></tr></table></td></tr></table></td></tr></table></td></tr></table></td></tr></table></td></tr></table></td></tr></table></td></tr></table>
 | | | | | | | | | | | | | | | | | | | | <table border="1" style="width: 100%; border-collapse: collapse; text-align: center;"> <tr> <td style="width: 10%;"></td> <td style="width: 10%;"></td> <td style="width: 10%;"></td> <td style="width: 10%;"></td> <td style="width: 10%;"></td> <td style="width: 10%;"></td> <td style="width: 10%;"></td> <td style="width: 10%;"></td> <td style="width: 10%;"></td> <td style="width: 10%;"></td> </tr> <tr> <td></td> <td></td> <td colspan="8" style="text-align: center;"> <table border="1" style="width: 100%; border-collapse: collapse; text-align: center;"> <tr> <td style="width: 10%;"></td> <td style="width: 10%;"></td> <td style="width: 10%;"></td> <td style="width: 10%;"></td> <td style="width: 10%;"></td> <td style="width: 10%;"></td> <td style="width: 10%;"></td> <td style="width: 10%;"></td> <td style="width: 10%;"></td> <td style="width: 10%;"></td> </tr> <tr> <td></td> <td></td> <td colspan="8" style="text-align: center;"> <table border="1" style="width: 100%; border-collapse: collapse; text-align: center;"> <tr> <td style="width: 10%;"></td> <td style="width: 10%;"></td> <td style="width: 10%;"></td> <td style="width: 10%;"></td> <td style="width: 10%;"></td> <td style="width: 10%;"></td> <td style="width: 10%;"></td> <td style="width: 10%;"></td> <td style="width: 10%;"></td> <td style="width: 10%;"></td> </tr> <tr> <td></td> <td></td> <td colspan="8" style="text-align: center;"> <table border="1" style="width: 100%; border-collapse: collapse; text-align: center;"> <tr> <td style="width: 10%;"></td> <td style="width: 10%;"></td> <td style="width: 10%;"></td> <td style="width: 10%;"></td> <td style="width: 10%;"></td> <td style="width: 10%;"></td> <td style="width: 10%;"></td> <td style="width: 10%;"></td> <td style="width: 10%;"></td> <td style="width: 10%;"></td> </tr> <tr> <td></td> <td></td> <td colspan="8" style="text-align: center;"> <table border="1" style="width: 100%; border-collapse: collapse; text-align: center;"> <tr> <td style="width: 10%;"></td> <td style="width: 10%;"></td> <td style="width: 10%;"></td> <td style="width: 10%;"></td> <td style="width: 10%;"></td> <td style="width: 10%;"></td> <td style="width: 10%;"></td> <td style="width: 10%;"></td> <td style="width: 10%;"></td> <td style="width: 10%;"></td> </tr> <tr> <td></td> <td></td> <td colspan="8" style="text-align: center;"> <table border="1" style="width: 100%; border-collapse: collapse; text-align: center;"> <tr> <td style="width: 10%;"></td> <td style="width: 10%;"></td> <td style="width: 10%;"></td> <td style="width: 10%;"></td> <td style="width: 10%;"></td> <td style="width: 10%;"></td> <td style="width: 10%;"></td> <td style="width: 10%;"></td> <td style="width: 10%;"></td> <td style="width: 10%;"></td> </tr> <tr> <td></td> <td></td> <td colspan="8" style="text-align: center;"> <table border="1" style="width: 100%; border-collapse: collapse; text-align: center;"> <tr> <td style="width: 10%;"></td> <td style="width: 10%;"></td> <td style="width: 10%;"></td> <td style="width: 10%;"></td> <td style="width: 10%;"></td> <td style="width: 10%;"></td> <td style="width: 10%;"></td> <td style="width: 10%;"></td> <td style="width: 10%;"></td> <td style="width: 10%;"></td> </tr> <tr> <td></td> <td></td> <td colspan="8" style="text-align: center;"> <table border="1" style="width: 100%; border-collapse: collapse; text-align: center;"> <tr> <td style="width: 10%;"></td> <td style="width: 10%;"></td> <td style="width: 10%;"></td> <td style="width: 10%;"></td> <td style="width: 10%;"></td> <td style="width: 10%;"></td> <td style="width: 10%;"></td> <td style="width: 10%;"></td> <td style="width: 10%;"></td> <td style="width: 10%;"></td> </tr> <tr> <td></td> <td></td> <td colspan="8" style="text-align: center;"> <table border="1" style="width: 100%; border-collapse: collapse; text-align: center;"> <tr> <td style="width: 10%;"></td> <td style="width: 10%;"></td> <td style="width: 10%;"></td> <td style="width: 10%;"></td> <td style="width: 10%;"></td> <td style="width: 10%;"></td> <td style="width: 10%;"></td> <td style="width: 10%;"></td> <td style="width: 10%;"></td> <td style="width: 10%;"></td> </tr> <tr> <td></td> <td></td> <td colspan="8" style="text-align: center;"> <table border="1" style="width: 100%; border-collapse: collapse; text-align: center;"> <tr> <td style="width: 10%;"></td> <td style="width: 10%;"></td> <td style="width: 10%;"></td> <td style="width: 10%;"></td> <td style="width: 10%;"></td> <td style="width: 10%;"></td> <td style="width: 10%;"></td> <td style="width: 10%;"></td> <td style="width: 10%;"></td> <td style="width: 10%;"></td> </tr> <tr> <td></td> <td></td> <td colspan="8" style="text-align: center;"> <table border="1" style="width: 100%; border-collapse: collapse; text-align: center;"> <tr> <td style="width: 10%;"></td> <td style="width: 10%;"></td> <td style="width: 10%;"></td> <td style="width: 10%;"></td> <td style="width: 10%;"></td> <td style="width: 10%;"></td> <td style="width: 10%;"></td> <td style="width: 10%;"></td> <td style="width: 10%;"></td> <td style="width: 10%;"></td> </tr> <tr> <td></td> <td></td> <td colspan="8" style="text-align: center;"> <table border="1" style="width: 100%; border-collapse: collapse; text-align: center;"> <tr> <td style="width: 10%;"></td> <td style="width: 10%;"></td> <td style="width: 10%;"></td> <td style="width: 10%;"></td> <td style="width: 10%;"></td> <td style="width: 10%;"></td> <td style="width: 10%;"></td> <td style="width: 10%;"></td> <td style="width: 10%;"></td> <td style="width: 10%;"></td> </tr> <tr> <td></td> <td></td> <td colspan="8" style="text-align: center;"> <table border="1" style="width: 100%; border-collapse: collapse; text-align: center;"> <tr> <td style="width: 10%;"></td> <td style="width: 10%;"></td> <td style="width: 10%;"></td> <td style="width: 10%;"></td> <td style="width: 10%;"></td> <td style="width: 10%;"></td> <td style="width: 10%;"></td> <td style="width: 10%;"></td> <td style="width: 10%;"></td> <td style="width: 10%;"></td> </tr> <tr> <td></td> <td></td> <td colspan="8" style="text-align: center;"> <table border="1" style="width: 100%; border-collapse: collapse; text-align: center;"> <tr> <td style="width: 10%;"></td> <td style="width: 10%;"></td> <td style="width: 10%;"></td> <td style="width: 10%;"></td> <td style="width: 10%;"></td> <td style="width: 10%;"></td> <td style="width: 10%;"></td> <td style="width: 10%;"></td> <td style="width: 10%;"></td> <td style="width: 10%;"></td> </tr> <tr> <td></td> <td></td> <td colspan="8" style="text-align: center;"> <table border="1" style="width: 100%; border-collapse: collapse; text-align: center;"> <tr> <td style="width: 10%;"></td> <td style="width: 10%;"></td> <td style="width: 10%;"></td> <td style="width: 10%;"></td> <td style="width: 10%;"></td> <td style="width: 10%;"></td> <td style="width: 10%;"></td> <td style="width: 10%;"></td> <td style="width: 10%;"></td> <td style="width: 10%;"></td> </tr> <tr> <td></td> <td></td> <td colspan="8" style="text-align: center;"> <table border="1" style="width: 100%; border-collapse: collapse; text-align: center;"> <tr> <td style="width: 10%;"></td> <td style="width: 10%;"></td> <td style="width: 10%;"></td> <td style="width: 10%;"></td> <td style="width: 10%;"></td> <td style="width:
10%;"></td> <td style="width: 10%;"></td> <td style="width: 10%;"></td> <td style="width: 10%;"></td> <td style="width: 10%;"></td> </tr> <tr> <td></td> <td></td> <td colspan="8" style="text-align: center;"> <table border="1" style="width: 100%; border-collapse: collapse; text-align: center;"> <tr> <td style="width: 10%;"></td> <td style="width: 10%;"></td> <td style="width: 10%;"></td> <td style="width: 10%;"></td> <td style="width: 10%;"></td> <td style="width: 10%;"></td> <td style="width: 10%;"></td> <td style="width: 10%;"></td> <td style="width: 10%;"></td> <td style="width: 10%;"></td> </tr> <tr> <td></td> <td></td> <td colspan="8" style="text-align: center;"> <table border="1" style="width: 100%; border-collapse: collapse; text-align: center;"> <tr> <td style="width: 10%;"></td> <td style="width: 10%;"></td> <td style="width: 10%;"></td> <td style="width: 10%;"></td> <td style="width: 10%;"></td> <td style="width: 10%;"></td> <td style="width: 10%;"></td> <td style="width: 10%;"></td> <td style="width: 10%;"></td> <td style="width: 10%;"></td> </tr> <tr> <td></td> <td></td> <td colspan="8" style="text-align: center;"> <table border="1" style="width: 100%; border-collapse: collapse; text-align: center;"> <tr> <td style="width: 10%;"></td> <td style="width: 10%;"></td> <td style="width: 10%;"></td> <td style="width: 10%;"></td> <td style="width: 10%;"></td> <td style="width: 10%;"></td> <td style="width: 10%;"></td> <td style="width: 10%;"></td> <td style="width: 10%;"></td> <td style="width: 10%;"></td> </tr> <tr> <td></td> <td></td> <td colspan="8" style="text-align: center;"> <table border="1" style="width: 100%; border-collapse: collapse; text-align: center;"> <tr> <td style="width: 10%;"></td> <td style="width: 10%;"></td> <td style="width: 10%;"></td> <td style="width: 10%;"></td> <td style="width: 10%;"></td> <td style="width: 10%;"></td> <td style="width: 10%;"></td> <td style="width: 10%;"></td> <td style="width: 10%;"></td> <td style="width: 10%;"></td> </tr> <tr> <td></td> <td></td> <td colspan="8" style="text-align: center;"> <table border="1" style="width: 100%; border-collapse: collapse; text-align: center;"> <tr> <td style="width: 10%;"></td> <td style="width: 10%;"></td> <td style="width: 10%;"></td> <td style="width: 10%;"></td> <td style="width: 10%;"></td> <td style="width: 10%;"></td> <td style="width: 10%;"></td> <td style="width: 10%;"></td> <td style="width: 10%;"></td> <td style="width: 10%;"></td> </tr> <tr> <td></td> <td></td> <td colspan="8" style="text-align: center;"> <table border="1" style="width: 100%; border-collapse: collapse; text-align: center;"> <tr> <td style="width: 10%;"></td> <td style="width: 10%;"></td> <td style="width: 10%;"></td> <td style="width: 10%;"></td> <td style="width: 10%;"></td> <td style="width: 10%;"></td> <td style="width: 10%;"></td> <td style="width: 10%;"></td> <td style="width: 10%;"></td> <td style="width: 10%;"></td> </tr> <tr> <td></td> <td></td> <td colspan="8" style="text-align: center;"> <table border="1" style="width: 100%; border-collapse: collapse; text-align: center;"> <tr> <td style="width: 10%;"></td> <td style="width: 10%;"></td> <td style="width: 10%;"></td> <td style="width: 10%;"></td> <td style="width: 10%;"></td> <td style="width: 10%;"></td> <td style="width: 10%;"></td> <td style="width: 10%;"></td> <td style="width: 10%;"></td> <td style="width: 10%;"></td> </tr> <tr> <td></td> <td></td> <td colspan="8" style="text-align: center;"> <table border="1" style="width: 100%; border-collapse: collapse; text-align: center;"> <tr> <td style="width: 10%;"></td> <td style="width: 10%;"></td> <td style="width: 10%;"></td> <td style="width: 10%;"></td> <td style="width: 10%;"></td> <td style="width: 10%;"></td> <td style="width: 10%;"></td> <td style="width: 10%;"></td> <td style="width: 10%;"></td> <td style="width: 10%;"></td> </tr> <tr> <td></td> <td></td> <td colspan="8" style="text-align: center;"> <table border="1" style="width: 100%; border-collapse: collapse; text-align: center;"> <tr> <td style="width: 10%;"></td> <td style="width: 10%;"></td> <td style="width: 10%;"></td> <td style="width: 10%;"></td> <td style="width: 10%;"></td> <td style="width: 10%;"></td> <td style="width: 10%;"></td> <td style="width: 10%;"></td> <td style="width: 10%;"></td> <td style="width: 10%;"></td> </tr> <tr> <td></td> <td></td> <td colspan="8" style="text-align: center;"> <table border="1" style="width: 100%; border-collapse: collapse; text-align: center;"> <tr> <td style="width: 10%;"></td> <td style="width: 10%;"></td> <td style="width: 10%;"></td> <td style="width: 10%;"></td> <td style="width: 10%;"></td> <td style="width: 10%;"></td> <td style="width: 10%;"></td> <td style="width: 10%;"></td> <td style="width: 10%;"></td> <td style="width: 10%;"></td> </tr> <tr> <td></td> <td></td> <td colspan="8" style="text-align: center;"> <table border="1" style="width: 100%; border-collapse: collapse; text-align: center;"> <tr> <td style="width: 10%;"></td> <td style="width: 10%;"></td> <td style="width: 10%;"></td> <td style="width: 10%;"></td> <td style="width: 10%;"></td> <td style="width: 10%;"></td> <td style="width: 10%;"></td> <td style="width: 10%;"></td> <td style="width: 10%;"></td> <td style="width: 10%;"></td> </tr> <tr> <td></td> <td></td> <td colspan="8" style="text-align: center;"> <table border="1" style="width: 100%; border-collapse: collapse; text-align: center;"> <tr> <td style="width: 10%;"></td> <td style="width: 10%;"></td> <td style="width: 10%;"></td> <td style="width: 10%;"></td> <td style="width: 10%;"></td> <td style="width: 10%;"></td> <td style="width: 10%;"></td> <td style="width: 10%;"></td> <td style="width: 10%;"></td> <td style="width: 10%;"></td> </tr> <tr> <td></td> <td></td> <td colspan="8" style="text-align: center;"> <table border="1" style="width: 100%; border-collapse: collapse; text-align: center;"> <tr> <td style="width: 10%;"></td> <td style="width: 10%;"></td> <td style="width: 10%;"></td> <td style="width: 10%;"></td> <td style="width: 10%;"></td> <td style="width: 10%;"></td> <td style="width: 10%;"></td> <td style="width: 10%;"></td> <td style="width: 10%;"></td> <td style="width: 10%;"></td> </tr> <tr> <td></td> <td></td> <td colspan="8" style="text-align: center;"> <table border="1" style="width: 100%; border-collapse: collapse; text-align: center;"> <tr> <td style="width: 10%;"></td> <td style="width: 10%;"></td> <td style="width: 10%;"></td> <td style="width: 10%;"></td> <td style="width: 10%;"></td> <td style="width: 10%;"></td> <td style="width: 10%;"></td> <td style="width: 10%;"></td> <td style="width: 10%;"></td> <td style="width: 10%;"></td> </tr> <tr> <td></td> <td></td> <td colspan="8" style="text-align: center;"> <table border="1" style="width: 100%; border-collapse: collapse; text-align: center;"> <tr> <td style="width: 10%;"></td> <td style="width: 10%;"></td> <td style="width: 10%;"></td> <td style="width: 10%;"></td> <td style="width: 10%;"></td> <td style="width: 10%;"></td> <td style="width: 10%;"></td> <td style="width: 10%;"></td> <td style="width: 10%;"></td> <td style="width: 10%;"></td> </tr> <tr> <td></td> <td></td> <td colspan="8" style="text-align: center;"> <table border="1" style="width: 100%; border-collapse: collapse; text-align: center;"> <tr> <td style="width: 10%;"></td> <td style="width: 10%;"></td> <td style="width: 10%;"></td> <td style="width: 10%;"></td> <td style="width: 10%;"></td> <td style="width: 10%;"></td> <td style="width: 10%;"></td> <td style="width: 10%;"></td> <td style="width: 10%;"></td> <td style="width: 10%;"></td> </tr> <tr> <td></td> <td></td> <td colspan="8" style="text-align: center;"> <table border="1" style="width: 100%; border-collapse: collapse; text-align: center;"> <tr> <td style="width: 10%;"></td> <td style="width: 10%;"></td> <td style="width: 10%;"></td> <td style="width: 10%;"></td> <td style="width: 10%;"></td> <td style="width: 10%;"></td> <td style="width: 10%;"></td> <td style="width: 10%;"></td> <td style="width: 10%;"></td> <td style="width: 10%;"></td> </tr> <tr> <td></td> <td></td> <td colspan="8" style="text-align: center;"> <table border="1" style="width: 100%; border-collapse: collapse; text-align: center;"> <tr> <td style="width: 10%;"></td> <td style="width: 10%;"></td> <td style="width: 10%;"></td> <td style="width: 10%;"></td> <td style="width: 10%;"></td> <td style="width: 10%;"></td> <td style="width: 10%;"></td> <td style="width: 10%;"></td> <td style="width: 10%;"></td> <td style="width: 10%;"></td> </tr> <tr> <td></td> <td></td> <td colspan="8" style="text-align: center;"> <table border="1" style="width: 100%; border-collapse: collapse; text-align: center;"> <tr> <td style="width: 10%;"></td> <td style="width: 10%;"></td> <td style="width: 10%;"></td> <td style="width: 10%;"></td> <td style="width: 10%;"></td> <td style="width: 10%;"></td> <td style="width: 10%;"></td> <td style="width: 10%;"></td> <td style="width: 10%;"></td> <td style="width: 10%;"></td> </tr> <tr> <td></td> <td></td> <td colspan="8" style="text-align: center;"> <table border="1" style="width: 100%; border-collapse: collapse; text-align: center;"> <tr> </tr></table></td></tr></table></td></tr></table></td></tr></table></td></tr></table></td></tr></table></td></tr></table></td></tr></table></td></tr></table></td></tr></table></td></tr></table></td></tr></table></td></tr></table></td></tr></table></td></tr></table></td></tr></table></td></tr></table></td></tr></table></td></tr></table></td></tr></table></td></tr></table></td></tr></table></td></tr></table></td></tr></table></td></tr></table></td></tr></table></td></tr></table></td></tr></table></td></tr></table></td></tr></table></td></tr></table></td></tr></table></td></tr></table></td></tr></table></td></tr></table></td></tr></table>
 | | | | | | | | | | | | | | | | | | | | <table border="1" style="width: 100%; border-collapse: collapse; text-align: center;"> <tr> <td style="width: 10%;"></td> <td style="width: 10%;"></td> <td style="width: 10%;"></td> <td style="width: 10%;"></td> <td style="width: 10%;"></td> <td style="width: 10%;"></td> <td style="width: 10%;"></td> <td style="width: 10%;"></td> <td style="width: 10%;"></td> <td style="width: 10%;"></td> </tr> <tr> <td></td> <td></td> <td colspan="8" style="text-align: center;"> <table border="1" style="width: 100%; border-collapse: collapse; text-align: center;"> <tr> <td style="width: 10%;"></td> <td style="width: 10%;"></td> <td style="width: 10%;"></td> <td style="width: 10%;"></td> <td style="width: 10%;"></td> <td style="width: 10%;"></td> <td style="width: 10%;"></td> <td style="width: 10%;"></td> <td style="width: 10%;"></td> <td style="width: 10%;"></td> </tr> <tr> <td></td> <td></td> <td colspan="8" style="text-align: center;"> <table border="1" style="width: 100%; border-collapse: collapse; text-align: center;"> <tr> <td style="width: 10%;"></td> <td style="width: 10%;"></td> <td style="width: 10%;"></td> <td style="width: 10%;"></td> <td style="width: 10%;"></td> <td style="width: 10%;"></td> <td style="width: 10%;"></td> <td style="width: 10%;"></td> <td style="width: 10%;"></td> <td style="width: 10%;"></td> </tr> <tr> <td></td> <td></td> <td colspan="8" style="text-align: center;"> <table border="1" style="width: 100%; border-collapse: collapse; text-align: center;"> <tr> <td style="width: 10%;"></td> <td style="width: 10%;"></td> <td style="width: 10%;"></td> <td style="width: 10%;"></td> <td style="width: 10%;"></td> <td style="width: 10%;"></td> <td style="width: 10%;"></td> <td style="width: 10%;"></td> <td style="width: 10%;"></td> <td style="width: 10%;"></td> </tr> <tr> <td></td> <td></td> <td colspan="8" style="text-align: center;"> <table border="1" style="width: 100%; border-collapse: collapse; text-align: center;"> <tr> <td style="width: 10%;"></td> <td style="width: 10%;"></td> <td style="width: 10%;"></td> <td style="width: 10%;"></td> <td style="width: 10%;"></td> <td style="width: 10%;"></td> <td style="width: 10%;"></td> <td style="width: 10%;"></td> <td style="width: 10%;"></td> <td style="width: 10%;"></td> </tr> <tr> <td></td> <td></td> <td colspan="8" style="text-align: center;"> <table border="1" style="width: 100%; border-collapse: collapse; text-align: center;"> <tr> <td style="width: 10%;"></td> <td style="width: 10%;"></td> <td style="width: 10%;"></td> <td style="width: 10%;"></td> <td style="width: 10%;"></td> <td style="width: 10%;"></td> <td style="width: 10%;"></td> <td style="width: 10%;"></td> <td style="width: 10%;"></td> <td style="width: 10%;"></td> </tr> <tr> <td></td> <td></td> <td colspan="8" style="text-align: center;"> <table border="1" style="width: 100%; border-collapse: collapse; text-align: center;"> <tr> <td style="width: 10%;"></td> <td style="width: 10%;"></td> <td style="width: 10%;"></td> <td style="width: 10%;"></td> <td style="width: 10%;"></td> <td style="width: 10%;"></td> <td style="width: 10%;"></td> <td style="width: 10%;"></td> <td style="width: 10%;"></td> <td style="width: 10%;"></td> </tr> <tr> <td></td> <td></td> <td colspan="8" style="text-align: center;"> <table border="1" style="width: 100%; border-collapse: collapse; text-align: center;"> <tr> <td style="width: 10%;"></td> <td style="width: 10%;"></td> <td style="width: 10%;"></td> <td style="width: 10%;"></td> <td style="width: 10%;"></td> <td style="width: 10%;"></td> <td style="width: 10%;"></td> <td style="width: 10%;"></td> <td style="width: 10%;"></td> <td style="width: 10%;"></td> </tr> <tr> <td></td> <td></td> <td colspan="8" style="text-align: center;"> <table border="1" style="width: 100%;
border-collapse: collapse; text-align: center;"> <tr> <td style="width: 10%;"></td> <td style="width: 10%;"></td> <td style="width: 10%;"></td> <td style="width: 10%;"></td> <td style="width: 10%;"></td> <td style="width: 10%;"></td> <td style="width: 10%;"></td> <td style="width: 10%;"></td> <td style="width: 10%;"></td> <td style="width: 10%;"></td> </tr> <tr> <td></td> <td></td> <td colspan="8" style="text-align: center;"> <table border="1" style="width: 100%; border-collapse: collapse; text-align: center;"> <tr> <td style="width: 10%;"></td> <td style="width: 10%;"></td> <td style="width: 10%;"></td> <td style="width: 10%;"></td> <td style="width: 10%;"></td> <td style="width: 10%;"></td> <td style="width: 10%;"></td> <td style="width: 10%;"></td> <td style="width: 10%;"></td> <td style="width: 10%;"></td> </tr> <tr> <td></td> <td></td> <td colspan="8" style="text-align: center;"> <table border="1" style="width: 100%; border-collapse: collapse; text-align: center;"> <tr> <td style="width: 10%;"></td> <td style="width: 10%;"></td> <td style="width: 10%;"></td> <td style="width: 10%;"></td> <td style="width: 10%;"></td> <td style="width: 10%;"></td> <td style="width: 10%;"></td> <td style="width: 10%;"></td> <td style="width: 10%;"></td> <td style="width: 10%;"></td> </tr> <tr> <td></td> <td></td> <td colspan="8" style="text-align: center;"> <table border="1" style="width: 100%; border-collapse: collapse; text-align: center;"> <tr> <td style="width: 10%;"></td> <td style="width: 10%;"></td> <td style="width: 10%;"></td> <td style="width: 10%;"></td> <td style="width: 10%;"></td> <td style="width: 10%;"></td> <td style="width: 10%;"></td> <td style="width: 10%;"></td> <td style="width: 10%;"></td> <td style="width: 10%;"></td> </tr> <tr> <td></td> <td></td> <td colspan="8" style="text-align: center;"> <table border="1" style="width: 100%; border-collapse: collapse; text-align: center;"> <tr> <td style="width: 10%;"></td> <td style="width: 10%;"></td> <td style="width: 10%;"></td> <td style="width: 10%;"></td> <td style="width: 10%;"></td> <td style="width: 10%;"></td> <td style="width: 10%;"></td> <td style="width: 10%;"></td> <td style="width: 10%;"></td> <td style="width: 10%;"></td> </tr> <tr> <td></td> <td></td> <td colspan="8" style="text-align: center;"> <table border="1" style="width: 100%; border-collapse: collapse; text-align: center;"> <tr> <td style="width: 10%;"></td> <td style="width: 10%;"></td> <td style="width: 10%;"></td> <td style="width: 10%;"></td> <td style="width: 10%;"></td> <td style="width: 10%;"></td> <td style="width: 10%;"></td> <td style="width: 10%;"></td> <td style="width: 10%;"></td> <td style="width: 10%;"></td> </tr> <tr> <td></td> <td></td> <td colspan="8" style="text-align: center;"> <table border="1" style="width: 100%; border-collapse: collapse; text-align: center;"> <tr> <td style="width: 10%;"></td> <td style="width: 10%;"></td> <td style="width: 10%;"></td> <td style="width: 10%;"></td> <td style="width: 10%;"></td> <td style="width: 10%;"></td> <td style="width: 10%;"></td> <td style="width: 10%;"></td> <td style="width: 10%;"></td> <td style="width: 10%;"></td> </tr> <tr> <td></td> <td></td> <td colspan="8" style="text-align: center;"> <table border="1" style="width: 100%; border-collapse: collapse; text-align: center;"> <tr> <td style="width: 10%;"></td> <td style="width: 10%;"></td> <td style="width: 10%;"></td> <td style="width: 10%;"></td> <td style="width: 10%;"></td> <td style="width: 10%;"></td> <td style="width: 10%;"></td> <td style="width: 10%;"></td> <td style="width: 10%;"></td> <td style="width: 10%;"></td> </tr> <tr> <td></td> <td></td> <td colspan="8" style="text-align: center;"> <table border="1" style="width: 100%; border-collapse: collapse; text-align: center;"> <tr> <td style="width: 10%;"></td> <td style="width: 10%;"></td> <td style="width: 10%;"></td> <td style="width: 10%;"></td> <td style="width: 10%;"></td> <td style="width: 10%;"></td> <td style="width: 10%;"></td> <td style="width: 10%;"></td> <td style="width: 10%;"></td> <td style="width: 10%;"></td> </tr> <tr> <td></td> <td></td> <td colspan="8" style="text-align: center;"> <table border="1" style="width: 100%; border-collapse: collapse; text-align: center;"> <tr> <td style="width: 10%;"></td> <td style="width: 10%;"></td> <td style="width: 10%;"></td> <td style="width: 10%;"></td> <td style="width: 10%;"></td> <td style="width: 10%;"></td> <td style="width: 10%;"></td> <td style="width: 10%;"></td> <td style="width: 10%;"></td> <td style="width: 10%;"></td> </tr> <tr> <td></td> <td></td> <td colspan="8" style="text-align: center;"> <table border="1" style="width: 100%; border-collapse: collapse; text-align: center;"> <tr> <td style="width: 10%;"></td> <td style="width: 10%;"></td> <td style="width: 10%;"></td> <td style="width: 10%;"></td> <td style="width: 10%;"></td> <td style="width: 10%;"></td> <td style="width: 10%;"></td> <td style="width: 10%;"></td> <td style="width: 10%;"></td> <td style="width: 10%;"></td> </tr> <tr> <td></td> <td></td> <td colspan="8" style="text-align: center;"> <table border="1" style="width: 100%; border-collapse: collapse; text-align: center;"> <tr> <td style="width: 10%;"></td> <td style="width: 10%;"></td> <td style="width: 10%;"></td> <td style="width: 10%;"></td> <td style="width: 10%;"></td> <td style="width: 10%;"></td> <td style="width: 10%;"></td> <td style="width: 10%;"></td> <td style="width: 10%;"></td> <td style="width: 10%;"></td> </tr> <tr> <td></td> <td></td> <td colspan="8" style="text-align: center;"> <table border="1" style="width: 100%; border-collapse: collapse; text-align: center;"> <tr> <td style="width: 10%;"></td> <td style="width: 10%;"></td> <td style="width: 10%;"></td> <td style="width: 10%;"></td> <td style="width: 10%;"></td> <td style="width: 10%;"></td> <td style="width: 10%;"></td> <td style="width: 10%;"></td> <td style="width: 10%;"></td> <td style="width: 10%;"></td> </tr> <tr> <td></td> <td></td> <td colspan="8" style="text-align: center;"> <table border="1" style="width: 100%; border-collapse: collapse; text-align: center;"> <tr> <td style="width: 10%;"></td> <td style="width: 10%;"></td> <td style="width: 10%;"></td> <td style="width: 10%;"></td> <td style="width: 10%;"></td> <td style="width: 10%;"></td> <td style="width: 10%;"></td> <td style="width: 10%;"></td> <td style="width: 10%;"></td> <td style="width: 10%;"></td> </tr> <tr> <td></td> <td></td> <td colspan="8" style="text-align: center;"> <table border="1" style="width: 100%; border-collapse: collapse; text-align: center;"> <tr> <td style="width: 10%;"></td> <td style="width: 10%;"></td> <td style="width: 10%;"></td> <td style="width: 10%;"></td> <td style="width: 10%;"></td> <td style="width: 10%;"></td> <td style="width: 10%;"></td> <td style="width: 10%;"></td> <td style="width: 10%;"></td> <td style="width: 10%;"></td> </tr> <tr> <td></td> <td></td> <td colspan="8" style="text-align: center;"> <table border="1" style="width: 100%; border-collapse: collapse; text-align: center;"> <tr> <td style="width: 10%;"></td> <td style="width: 10%;"></td> <td style="width: 10%;"></td> <td style="width: 10%;"></td> <td style="width: 10%;"></td> <td style="width: 10%;"></td> <td style="width: 10%;"></td> <td style="width: 10%;"></td> <td style="width: 10%;"></td> <td style="width: 10%;"></td> </tr> <tr> <td></td> <td></td> <td colspan="8" style="text-align: center;"> <table border="1" style="width: 100%; border-collapse: collapse; text-align: center;"> <tr> <td style="width: 10%;"></td> <td style="width: 10%;"></td> <td style="width: 10%;"></td> <td style="width: 10%;"></td> <td style="width: 10%;"></td> <td style="width: 10%;"></td> <td style="width: 10%;"></td> <td style="width: 10%;"></td> <td style="width: 10%;"></td> <td style="width: 10%;"></td> </tr> <tr> <td></td> <td></td> <td colspan="8" style="text-align: center;"> <table border="1" style="width: 100%; border-collapse: collapse; text-align: center;"> <tr> <td style="width: 10%;"></td> <td style="width: 10%;"></td> <td style="width: 10%;"></td> <td style="width: 10%;"></td> <td style="width: 10%;"></td> <td style="width: 10%;"></td> <td style="width: 10%;"></td> <td style="width: 10%;"></td> <td style="width: 10%;"></td> <td style="width: 10%;"></td> </tr> <tr> <td></td> <td></td> <td colspan="8" style="text-align: center;"> <table border="1" style="width: 100%; border-collapse: collapse; text-align: center;"> <tr> <td style="width: 10%;"></td> <td style="width: 10%;"></td> <td style="width: 10%;"></td> <td style="width: 10%;"></td> <td style="width: 10%;"></td> <td style="width: 10%;"></td> <td style="width: 10%;"></td> <td style="width: 10%;"></td> <td style="width: 10%;"></td> <td style="width: 10%;"></td> </tr> <tr> <td></td> <td></td> <td colspan="8" style="text-align: center;"> <table border="1" style="width: 100%; border-collapse: collapse; text-align: center;"> <tr> <td style="width: 10%;"></td> <td style="width: 10%;"></td> <td style="width: 10%;"></td> <td style="width: 10%;"></td> <td style="width: 10%;"></td> <td style="width: 10%;"></td> <td style="width: 10%;"></td> <td style="width: 10%;"></td> <td style="width: 10%;"></td> <td style="width: 10%;"></td> </tr> <tr> <td></td> <td></td> <td colspan="8" style="text-align: center;"> <table border="1" style="width: 100%; border-collapse: collapse; text-align: center;"> <tr> <td style="width: 10%;"></td> <td style="width: 10%;"></td> <td style="width: 10%;"></td> <td style="width: 10%;"></td> <td style="width: 10%;"></td> <td style="width: 10%;"></td> <td style="width: 10%;"></td> <td style="width: 10%;"></td> <td style="width: 10%;"></td> <td style="width: 10%;"></td> </tr> <tr> <td></td> <td></td> <td colspan="8" style="text-align: center;"> <table border="1" style="width: 100%; border-collapse: collapse; text-align: center;"> <tr> <td style="width: 10%;"></td> <td style="width: 10%;"></td> <td style="width: 10%;"></td> <td style="width:
10%;"></td> <td style="width: 10%;"></td> <td style="width: 10%;"></td> <td style="width: 10%;"></td> <td style="width: 10%;"></td> <td style="width: 10%;"></td> <td style="width: 10%;"></td> </tr> <tr> <td></td> <td></td> <td colspan="8" style="text-align: center;"> <table border="1" style="width: 100%; border-collapse: collapse; text-align: center;"> <tr> <td style="width: 10%;"></td> <td style="width: 10%;"></td> <td style="width: 10%;"></td> <td style="width: 10%;"></td> <td style="width: 10%;"></td> <td style="width: 10%;"></td> <td style="width: 10%;"></td> <td style="width: 10%;"></td> <td style="width: 10%;"></td> <td style="width: 10%;"></td> </tr> <tr> <td></td> <td></td> <td colspan="8" style="text-align: center;"> <table border="1" style="width: 100%; border-collapse: collapse; text-align: center;"> <tr> <td style="width: 10%;"></td> <td style="width: 10%;"></td> <td style="width: 10%;"></td> <td style="width: 10%;"></td> <td style="width: 10%;"></td> <td style="width: 10%;"></td> <td style="width: 10%;"></td> <td style="width: 10%;"></td> <td style="width: 10%;"></td> <td style="width: 10%;"></td> </tr> <tr> <td></td> <td></td> <td colspan="8" style="text-align: center;"> <table border="1" style="width: 100%; border-collapse: collapse; text-align: center;"> <tr> <td style="width: 10%;"></td> <td style="width: 10%;"></td> <td style="width: 10%;"></td> <td style="width: 10%;"></td> <td style="width: 10%;"></td> <td style="width: 10%;"></td> <td style="width: 10%;"></td> <td style="width: 10%;"></td> <td style="width: 10%;"></td> <td style="width: 10%;"></td> </tr> <tr> <td></td> <td></td> <td colspan="8" style="text-align: center;"> <table border="1" style="width: 100%; border-collapse: collapse; text-align: center;"> <tr> <td style="width: 10%;"></td> <td style="width: 10%;"></td> <td style="width: 10%;"></td> <td style="width: 10%;"></td> <td style="width: 10%;"></td> <td style="width: 10%;"></td> <td style="width: 10%;"></td> <td style="width: 10%;"></td> <td style="width: 10%;"></td> <td style="width: 10%;"></td> </tr> <tr> <td></td> <td></td> <td colspan="8" style="text-align: center;"> <table border="1" style="width: 100%; border-collapse: collapse; text-align: center;"> <tr> </tr></table></td></tr></table></td></tr></table></td></tr></table></td></tr></table></td></tr></table></td></tr></table></td></tr></table></td></tr></table></td></tr></table></td></tr></table></td></tr></table></td></tr></table></td></tr></table></td></tr></table></td></tr></table></td></tr></table></td></tr></table></td></tr></table></td></tr></table></td></tr></table></td></tr></table></td></tr></table></td></tr></table></td></tr></table></td></tr></table></td></tr></table></td></tr></table></td></tr></table></td></tr></table></td></tr></table></td></tr></table></td></tr></table></td></tr></table></td></tr></table> | | | | | | | | | | | | | | | | | | | | <table border="1" style="width: 100%; border-collapse: collapse; text-align: center;"> <tr> <td style="width: 10%;"></td> <td style="width: 10%;"></td> <td style="width: 10%;"></td> <td style="width: 10%;"></td> <td style="width: 10%;"></td> <td style="width: 10%;"></td> <td style="width: 10%;"></td> <td style="width: 10%;"></td> <td style="width: 10%;"></td> <td style="width: 10%;"></td> </tr> <tr> <td></td> <td></td> <td colspan="8" style="text-align: center;"> <table border="1" style="width: 100%; border-collapse: collapse; text-align: center;"> <tr> <td style="width: 10%;"></td> <td style="width: 10%;"></td> <td style="width: 10%;"></td> <td style="width: 10%;"></td> <td style="width: 10%;"></td> <td style="width: 10%;"></td> <td style="width:
10%;"></td> <td style="width: 10%;"></td> <td style="width: 10%;"></td> <td style="width: 10%;"></td> </tr> <tr> <td></td> <td></td> <td colspan="8" style="text-align: center;"> <table border="1" style="width: 100%; border-collapse: collapse; text-align: center;"> <tr> <td style="width: 10%;"></td> <td style="width: 10%;"></td> <td style="width: 10%;"></td> <td style="width: 10%;"></td> <td style="width: 10%;"></td> <td style="width: 10%;"></td> <td style="width: 10%;"></td> <td style="width: 10%;"></td> <td style="width: 10%;"></td> <td style="width: 10%;"></td> </tr> <tr> <td></td> <td></td> <td colspan="8" style="text-align: center;"> <table border="1" style="width: 100%; border-collapse: collapse; text-align: center;"> <tr> <td style="width: 10%;"></td> <td style="width: 10%;"></td> <td style="width: 10%;"></td> <td style="width: 10%;"></td> <td style="width: 10%;"></td> <td style="width: 10%;"></td> <td style="width: 10%;"></td> <td style="width: 10%;"></td> <td style="width: 10%;"></td> <td style="width: 10%;"></td> </tr> <tr> <td></td> <td></td> <td colspan="8" style="text-align: center;"> <table border="1" style="width: 100%; border-collapse: collapse; text-align: center;"> <tr> <td style="width: 10%;"></td> <td style="width: 10%;"></td> <td style="width: 10%;"></td> <td style="width: 10%;"></td> <td style="width: 10%;"></td> <td style="width: 10%;"></td> <td style="width: 10%;"></td> <td style="width: 10%;"></td> <td style="width: 10%;"></td> <td style="width: 10%;"></td> </tr> <tr> <td></td> <td></td> <td colspan="8" style="text-align: center;"> <table border="1" style="width: 100%; border-collapse: collapse; text-align: center;"> <tr> <td style="width: 10%;"></td> <td style="width: 10%;"></td> <td style="width: 10%;"></td> <td style="width: 10%;"></td> <td style="width: 10%;"></td> <td style="width: 10%;"></td> <td style="width: 10%;"></td> <td style="width: 10%;"></td> <td style="width: 10%;"></td> <td style="width: 10%;"></td> </tr> <tr> <td></td> <td></td> <td colspan="8" style="text-align: center;"> <table border="1" style="width: 100%; border-collapse: collapse; text-align: center;"> <tr> <td style="width: 10%;"></td> <td style="width: 10%;"></td> <td style="width: 10%;"></td> <td style="width: 10%;"></td> <td style="width: 10%;"></td> <td style="width: 10%;"></td> <td style="width: 10%;"></td> <td style="width: 10%;"></td> <td style="width: 10%;"></td> <td style="width: 10%;"></td> </tr> <tr> <td></td> <td></td> <td colspan="8" style="text-align: center;"> <table border="1" style="width: 100%; border-collapse: collapse; text-align: center;"> <tr> <td style="width: 10%;"></td> <td style="width: 10%;"></td> <td style="width: 10%;"></td> <td style="width: 10%;"></td> <td style="width: 10%;"></td> <td style="width: 10%;"></td> <td style="width: 10%;"></td> <td style="width: 10%;"></td> <td style="width: 10%;"></td> <td style="width: 10%;"></td> </tr> <tr> <td></td> <td></td> <td colspan="8" style="text-align: center;"> <table border="1" style="width: 100%; border-collapse: collapse; text-align: center;"> <tr> <td style="width: 10%;"></td> <td style="width: 10%;"></td> <td style="width: 10%;"></td> <td style="width: 10%;"></td> <td style="width: 10%;"></td> <td style="width: 10%;"></td> <td style="width: 10%;"></td> <td style="width: 10%;"></td> <td style="width: 10%;"></td> <td style="width: 10%;"></td> </tr> <tr> <td></td> <td></td> <td colspan="8" style="text-align: center;"> <table border="1" style="width: 100%; border-collapse: collapse; text-align: center;"> <tr> <td style="width: 10%;"></td> <td style="width: 10%;"></td> <td style="width: 10%;"></td> <td style="width: 10%;"></td> <td style="width: 10%;"></td> <td style="width: 10%;"></td> <td style="width: 10%;"></td> <td style="width: 10%;"></td> <td style="width: 10%;"></td> <td style="width: 10%;"></td> </tr> <tr> <td></td> <td></td> <td colspan="8" style="text-align: center;"> <table border="1" style="width: 100%; border-collapse: collapse; text-align: center;"> <tr> <td style="width: 10%;"></td> <td style="width: 10%;"></td> <td style="width: 10%;"></td> <td style="width: 10%;"></td> <td style="width: 10%;"></td> <td style="width: 10%;"></td> <td style="width: 10%;"></td> <td style="width: 10%;"></td> <td style="width: 10%;"></td> <td style="width: 10%;"></td> </tr> <tr> <td></td> <td></td> <td colspan="8" style="text-align: center;"> <table border="1" style="width: 100%; border-collapse: collapse; text-align: center;"> <tr> <td style="width: 10%;"></td> <td style="width: 10%;"></td> <td style="width: 10%;"></td> <td style="width: 10%;"></td> <td style="width: 10%;"></td> <td style="width: 10%;"></td> <td style="width: 10%;"></td> <td style="width: 10%;"></td> <td style="width: 10%;"></td> <td style="width: 10%;"></td> </tr> <tr> <td></td> <td></td> <td colspan="8" style="text-align: center;"> <table border="1" style="width: 100%; border-collapse: collapse; text-align: center;"> <tr> <td style="width: 10%;"></td> <td style="width: 10%;"></td> <td style="width: 10%;"></td> <td style="width: 10%;"></td> <td style="width: 10%;"></td> <td style="width: 10%;"></td> <td style="width: 10%;"></td> <td style="width: 10%;"></td> <td style="width: 10%;"></td> <td style="width: 10%;"></td> </tr> <tr> <td></td> <td></td> <td colspan="8" style="text-align: center;"> <table border="1" style="width: 100%; border-collapse: collapse; text-align: center;"> <tr> <td style="width: 10%;"></td> <td style="width: 10%;"></td> <td style="width: 10%;"></td> <td style="width: 10%;"></td> <td style="width: 10%;"></td> <td style="width: 10%;"></td> <td style="width: 10%;"></td> <td style="width: 10%;"></td> <td style="width: 10%;"></td> <td style="width: 10%;"></td> </tr> <tr> <td></td> <td></td> <td colspan="8" style="text-align: center;"> <table border="1" style="width: 100%; border-collapse: collapse; text-align: center;"> <tr> <td style="width: 10%;"></td> <td style="width: 10%;"></td> <td style="width: 10%;"></td> <td style="width: 10%;"></td> <td style="width: 10%;"></td> <td style="width: 10%;"></td> <td style="width: 10%;"></td> <td style="width: 10%;"></td> <td style="width: 10%;"></td> <td style="width: 10%;"></td> </tr> <tr> <td></td> <td></td> <td colspan="8" style="text-align: center;"> <table border="1" style="width: 100%; border-collapse: collapse; text-align: center;"> <tr> <td style="width: 10%;"></td> <td style="width: 10%;"></td> <td style="width: 10%;"></td> <td style="width: 10%;"></td> <td style="width: 10%;"></td> <td style="width: 10%;"></td> <td style="width: 10%;"></td> <td style="width: 10%;"></td> <td style="width: 10%;"></td> <td style="width: 10%;"></td> </tr> <tr> <td></td> <td></td> <td colspan="8" style="text-align: center;"> <table border="1" style="width: 100%; border-collapse: collapse; text-align: center;"> <tr> <td style="width: 10%;"></td> <td style="width: 10%;"></td> <td style="width: 10%;"></td> <td style="width: 10%;"></td> <td style="width: 10%;"></td> <td style="width: 10%;"></td> <td style="width: 10%;"></td> <td style="width: 10%;"></td> <td style="width: 10%;"></td> <td style="width: 10%;"></td> </tr> <tr> <td></td> <td></td> <td colspan="8" style="text-align: center;"> <table border="1" style="width: 100%; border-collapse: collapse; text-align: center;"> <tr> <td style="width: 10%;"></td> <td style="width: 10%;"></td> <td style="width: 10%;"></td> <td style="width: 10%;"></td> <td style="width: 10%;"></td> <td style="width: 10%;"></td> <td style="width: 10%;"></td> <td style="width: 10%;"></td> <td style="width: 10%;"></td> <td style="width: 10%;"></td> </tr> <tr> <td></td> <td></td> <td colspan="8" style="text-align: center;"> <table border="1" style="width: 100%; border-collapse: collapse; text-align: center;"> <tr> <td style="width: 10%;"></td> <td style="width: 10%;"></td> <td style="width: 10%;"></td> <td style="width: 10%;"></td> <td style="width: 10%;"></td> <td style="width: 10%;"></td> <td style="width: 10%;"></td> <td style="width: 10%;"></td> <td style="width: 10%;"></td> <td style="width: 10%;"></td> </tr> <tr> <td></td> <td></td> <td colspan="8" style="text-align: center;"> <table border="1" style="width: 100%; border-collapse: collapse; text-align: center;"> <tr> <td style="width: 10%;"></td> <td style="width: 10%;"></td> <td style="width: 10%;"></td> <td style="width: 10%;"></td> <td style="width: 10%;"></td> <td style="width: 10%;"></td> <td style="width: 10%;"></td> <td style="width: 10%;"></td> <td style="width: 10%;"></td> <td style="width: 10%;"></td> </tr> <tr> <td></td> <td></td> <td colspan="8" style="text-align: center;"> <table border="1" style="width: 100%; border-collapse: collapse; text-align: center;"> <tr> <td style="width: 10%;"></td> <td style="width: 10%;"></td> <td style="width: 10%;"></td> <td style="width: 10%;"></td> <td style="width: 10%;"></td> <td style="width: 10%;"></td> <td style="width: 10%;"></td> <td style="width: 10%;"></td> <td style="width: 10%;"></td> <td style="width: 10%;"></td> </tr> <tr> <td></td> <td></td> <td colspan="8" style="text-align: center;"> <table border="1" style="width: 100%; border-collapse: collapse; text-align: center;"> <tr> <td style="width: 10%;"></td> <td style="width: 10%;"></td> <td style="width: 10%;"></td> <td style="width: 10%;"></td> <td style="width: 10%;"></td> <td style="width: 10%;"></td> <td style="width: 10%;"></td> <td style="width: 10%;"></td> <td style="width: 10%;"></td> <td style="width: 10%;"></td> </tr> <tr> <td></td> <td></td> <td colspan="8" style="text-align: center;"> <table border="1" style="width: 100%; border-collapse: collapse; text-align: center;"> <tr> <td style="width: 10%;"></td> <td style="width: 10%;"></td> <td style="width: 10%;"></td> <td style="width: 10%;"></td> <td style="width: 10%;"></td> <td style="width: 10%;"></td> <td style="width: 10%;"></td> <td style="width: 10%;"></td> <td style="width: 10%;"></td> <td style="width: 10%;"></td> </tr> <tr> <td></td> <td></td> <td colspan="8" style="text-align:
center;"> <table border="1" style="width: 100%; border-collapse: collapse; text-align: center;"> <tr> <td style="width: 10%;"></td> <td style="width: 10%;"></td> <td style="width: 10%;"></td> <td style="width: 10%;"></td> <td style="width: 10%;"></td> <td style="width: 10%;"></td> <td style="width: 10%;"></td> <td style="width: 10%;"></td> <td style="width: 10%;"></td> <td style="width: 10%;"></td> </tr> <tr> <td></td> <td></td> <td colspan="8" style="text-align: center;"> <table border="1" style="width: 100%; border-collapse: collapse; text-align: center;"> <tr> <td style="width: 10%;"></td> <td style="width: 10%;"></td> <td style="width: 10%;"></td> <td style="width: 10%;"></td> <td style="width: 10%;"></td> <td style="width: 10%;"></td> <td style="width: 10%;"></td> <td style="width: 10%;"></td> <td style="width: 10%;"></td> <td style="width: 10%;"></td> </tr> <tr> <td></td> <td></td> <td colspan="8" style="text-align: center;"> <table border="1" style="width: 100%; border-collapse: collapse; text-align: center;"> <tr> <td style="width: 10%;"></td> <td style="width: 10%;"></td> <td style="width: 10%;"></td> <td style="width: 10%;"></td> <td style="width: 10%;"></td> <td style="width: 10%;"></td> <td style="width: 10%;"></td> <td style="width: 10%;"></td> <td style="width: 10%;"></td> <td style="width: 10%;"></td> </tr> <tr> <td></td> <td></td> <td colspan="8" style="text-align: center;"> <table border="1" style="width: 100%; border-collapse: collapse; text-align: center;"> <tr> <td style="width: 10%;"></td> <td style="width: 10%;"></td> <td style="width: 10%;"></td> <td style="width: 10%;"></td> <td style="width: 10%;"></td> <td style="width: 10%;"></td> <td style="width: 10%;"></td> <td style="width: 10%;"></td> <td style="width: 10%;"></td> <td style="width: 10%;"></td> </tr> <tr> <td></td> <td></td> <td colspan="8" style="text-align: center;"> <table border="1" style="width: 100%; border-collapse: collapse; text-align: center;"> <tr> <td style="width: 10%;"></td> <td style="width: 10%;"></td> <td style="width: 10%;"></td> <td style="width: 10%;"></td> <td style="width: 10%;"></td> <td style="width: 10%;"></td> <td style="width: 10%;"></td> <td style="width: 10%;"></td> <td style="width: 10%;"></td> <td style="width: 10%;"></td> </tr> <tr> <td></td> <td></td> <td colspan="8" style="text-align: center;"> <table border="1" style="width: 100%; border-collapse: collapse; text-align: center;"> <tr> <td style="width: 10%;"></td> <td style="width: 10%;"></td> <td style="width: 10%;"></td> <td style="width: 10%;"></td> <td style="width: 10%;"></td> <td style="width: 10%;"></td> <td style="width: 10%;"></td> <td style="width: 10%;"></td> <td style="width: 10%;"></td> <td style="width: 10%;"></td> </tr> <tr> <td></td> <td></td> <td colspan="8" style="text-align: center;"> <table border="1" style="width: 100%; border-collapse: collapse; text-align: center;"> <tr> <td style="width: 10%;"></td> <td style="width: 10%;"></td> <td style="width: 10%;"></td> <td style="width: 10%;"></td> <td style="width: 10%;"></td> <td style="width: 10%;"></td> <td style="width: 10%;"></td> <td style="width: 10%;"></td> <td style="width: 10%;"></td> <td style="width: 10%;"></td> </tr> <tr> <td></td> <td></td> <td colspan="8" style="text-align: center;"> <table border="1" style="width: 100%; border-collapse: collapse; text-align: center;"> <tr> <td style="width: 10%;"></td> <td style="width: 10%;"></td> <td style="width: 10%;"></td> <td style="width: 10%;"></td> <td style="width: 10%;"></td> <td style="width: 10%;"></td> <td style="width: 10%;"></td> <td style="width: 10%;"></td> <td style="width: 10%;"></td> <td style="width: 10%;"></td> </tr> <tr> <td></td> <td></td> <td colspan="8" style="text-align: center;"> <table border="1" style="width: 100%; border-collapse: collapse; text-align: center;"> <tr> <td style="width: 10%;"></td> <td style="width: 10%;"></td> <td style="width: 10%;"></td> <td style="width: 10%;"></td> <td style="width: 10%;"></td> <td style="width: 10%;"></td> <td style="width: 10%;"></td> <td style="width: 10%;"></td> <td style="width: 10%;"></td> <td style="width: 10%;"></td> </tr> <tr> <td></td> <td></td> <td colspan="8" style="text-align: center;"> <table border="1" style="width: 100%; border-collapse: collapse; text-align: center;"> <tr> <td style="width: 10%;"></td> <td style="width: 10%;"></td> <td style="width: 10%;"></td> <td style="width: 10%;"></td> <td style="width: 10%;"></td> <td style="width: 10%;"></td> <td style="width: 10%;"></td> <td style="width: 10%;"></td> <td style="width: 10%;"></td> <td style="width: 10%;"></td> </tr> <tr> <td></td> <td></td> <td colspan="8" style="text-align: center;"> <table border="1" style="width: 100%; border-collapse: collapse; text-align: center;"> <tr> </tr></table></td></tr></table></td></tr></table></td></tr></table></td></tr></table></td></tr></table></td></tr></table></td></tr></table></td></tr></table></td></tr></table></td></tr></table></td></tr></table></td></tr></table></td></tr></table></td></tr></table></td></tr></table></td></tr></table></td></tr></table></td></tr></table></td></tr></table></td></tr></table></td></tr></table></td></tr></table></td></tr></table></td></tr></table></td></tr></table></td></tr></table></td></tr></table></td></tr></table></td></tr></table></td></tr></table></td></tr></table></td></tr></table></td></tr></table>
 | | | | | | | | | | | | | | | | | | | | <table border="1" style="width: 100%; border-collapse: collapse; text-align: center;"> <tr> <td style="width: 10%;"></td> <td style="width: 10%;"></td> <td style="width: 10%;"></td> <td style="width: 10%;"></td> <td style="width: 10%;"></td> <td style="width: 10%;"></td> <td style="width: 10%;"></td> <td style="width: 10%;"></td> <td style="width: 10%;"></td> <td style="width: 10%;"></td> </tr> <tr> <td></td> <td></td> <td colspan="8" style="text-align: center;"> <table border="1" style="width: 100%; border-collapse: collapse; text-align: center;"> <tr> <td style="width: 10%;"></td> <td style="width: 10%;"></td> <td style="width: 10%;"></td> <td style="width: 10%;"></td> <td style="width: 10%;"></td> <td style="width: 10%;"></td> <td style="width: 10%;"></td> <td style="width: 10%;"></td> <td style="width: 10%;"></td> <td style="width: 10%;"></td> </tr> <tr> <td></td> <td></td> <td colspan="8" style="text-align: center;"> <table border="1" style="width: 100%; border-collapse: collapse; text-align: center;"> <tr> <td style="width: 10%;"></td> <td style="width: 10%;"></td> <td style="width: 10%;"></td> <td style="width: 10%;"></td> <td style="width: 10%;"></td> <td style="width: 10%;"></td> <td style="width: 10%;"></td> <td style="width: 10%;"></td> <td style="width: 10%;"></td> <td style="width: 10%;"></td> </tr> <tr> <td></td> <td></td> <td colspan="8" style="text-align: center;"> <table border="1" style="width: 100%; border-collapse: collapse; text-align: center;"> <tr> <td style="width: 10%;"></td> <td style="width: 10%;"></td> <td style="width: 10%;"></td> <td style="width: 10%;"></td> <td style="width: 10%;"></td> <td style="width: 10%;"></td> <td style="width: 10%;"></td> <td style="width: 10%;"></td> <td style="width: 10%;"></td> <td style="width: 10%;"></td> </tr> <tr> <td></td> <td></td> <td colspan="8" style="text-align: center;"> <table border="1" style="width: 100%; border-collapse: collapse; text-align: center;"> <tr> <td style="width: 10%;"></td> <td style="width: 10%;"></td> <td style="width: 10%;"></td> <td style="width: 10%;"></td> <td style="width: 10%;"></td> <td style="width: 10%;"></td> <td style="width: 10%;"></td> <td style="width: 10%;"></td> <td style="width: 10%;"></td> <td style="width: 10%;"></td> </tr> <tr> <td></td> <td></td> <td colspan="8" style="text-align: center;"> <table border="1" style="width: 100%; border-collapse: collapse; text-align: center;"> <tr> <td style="width: 10%;"></td> <td style="width: 10%;"></td> <td style="width: 10%;"></td> <td style="width: 10%;"></td> <td style="width: 10%;"></td> <td style="width: 10%;"></td> <td style="width: 10%;"></td> <td style="width: 10%;"></td> <td style="width: 10%;"></td> <td style="width: 10%;"></td> </tr> <tr> <td></td> <td></td> <td colspan="8" style="text-align: center;"> <table border="1" style="width: 100%; border-collapse: collapse; text-align: center;"> <tr> <td style="width: 10%;"></td> <td style="width: 10%;"></td> <td style="width: 10%;"></td> <td style="width: 10%;"></td> <td style="width: 10%;"></td> <td style="width: 10%;"></td> <td style="width: 10%;"></td> <td style="width: 10%;"></td> <td style="width: 10%;"></td> <td style="width: 10%;"></td> </tr> <tr> <td></td> <td></td> <td colspan="8" style="text-align: center;"> <table border="1" style="width: 100%; border-collapse: collapse; text-align: center;"> <tr> <td style="width: 10%;"></td> <td style="width: 10%;"></td> <td style="width: 10%;"></td> <td style="width: 10%;"></td> <td style="width: 10%;"></td> <td style="width: 10%;"></td> <td style="width: 10%;"></td> <td style="width: 10%;"></td> <td style="width: 10%;"></td> <td style="width: 10%;"></td> </tr> <tr> <td></td> <td></td> <td colspan="8" style="text-align: center;"> <table border="1" style="width: 100%; border-collapse: collapse; text-align: center;"> <tr> <td style="width: 10%;"></td> <td style="width: 10%;"></td> <td style="width: 10%;"></td> <td style="width: 10%;"></td> <td style="width: 10%;"></td> <td style="width: 10%;"></td> <td style="width: 10%;"></td> <td style="width: 10%;"></td> <td style="width: 10%;"></td> <td style="width: 10%;"></td> </tr> <tr> <td></td> <td></td> <td colspan="8" style="text-align: center;"> <table border="1" style="width: 100%; border-collapse: collapse; text-align: center;"> <tr> <td style="width: 10%;"></td> <td style="width: 10%;"></td> <td style="width: 10%;"></td> <td style="width: 10%;"></td> <td style="width: 10%;"></td> <td style="width: 10%;"></td> <td style="width: 10%;"></td> <td style="width: 10%;"></td> <td style="width: 10%;"></td> <td style="width: 10%;"></td> </tr> <tr> <td></td> <td></td> <td colspan="8" style="text-align: center;"> <table border="1" style="width: 100%; border-collapse: collapse; text-align: center;"> <tr> <td style="width: 10%;"></td> <td style="width: 10%;"></td> <td style="width: 10%;"></td> <td style="width: 10%;"></td> <td style="width: 10%;"></td> <td style="width: 10%;"></td> <td style="width: 10%;"></td> <td style="width: 10%;"></td> <td style="width: 10%;"></td> <td style="width: 10%;"></td> </tr> <tr> <td></td> <td></td> <td colspan="8" style="text-align: center;"> <table border="1" style="width: 100%; border-collapse: collapse; text-align: center;"> <tr> <td style="width: 10%;"></td> <td style="width: 10%;"></td> <td style="width: 10%;"></td> <td style="width: 10%;"></td> <td style="width: 10%;"></td> <td style="width: 10%;"></td> <td style="width: 10%;"></td> <td style="width: 10%;"></td> <td style="width: 10%;"></td> <td style="width: 10%;"></td> </tr> <tr> <td></td> <td></td> <td colspan="8" style="text-align: center;"> <table border="1" style="width: 100%; border-collapse: collapse; text-align: center;"> <tr> <td style="width: 10%;"></td> <td style="width: 10%;"></td> <td style="width: 10%;"></td> <td style="width: 10%;"></td> <td style="width: 10%;"></td> <td style="width: 10%;"></td> <td style="width: 10%;"></td> <td style="width: 10%;"></td> <td style="width: 10%;"></td> <td style="width: 10%;"></td> </tr> <tr> <td></td> <td></td> <td colspan="8" style="text-align: center;"> <table border="1" style="width: 100%; border-collapse: collapse; text-align: center;"> <tr> <td style="width: 10%;"></td> <td style="width: 10%;"></td> <td style="width: 10%;"></td> <td style="width: 10%;"></td> <td style="width: 10%;"></td> <td style="width: 10%;"></td> <td style="width: 10%;"></td> <td style="width: 10%;"></td> <td style="width: 10%;"></td> <td style="width: 10%;"></td> </tr> <tr> <td></td> <td></td> <td colspan="8" style="text-align: center;"> <table border="1" style="width: 100%; border-collapse: collapse; text-align: center;"> <tr> <td style="width: 10%;"></td> <td style="width: 10%;"></td> <td style="width: 10%;"></td> <td style="width: 10%;"></td> <td style="width: 10%;"></td> <td style="width: 10%;"></td> <td style="width: 10%;"></td> <td style="width: 10%;"></td> <td style="width: 10%;"></td> <td style="width: 10%;"></td> </tr> <tr> <td></td> <td></td> <td colspan="8" style="text-align: center;"> <table border="1" style="width: 100%; border-collapse: collapse; text-align: center;"> <tr> <td style="width: 10%;"></td> <td style="width: 10%;"></td> <td style="width: 10%;"></td> <td style="width: 10%;"></td> <td style="width: 10%;"></td> <td style="width: 10%;"></td> <td style="width: 10%;"></td> <td style="width: 10%;"></td> <td style="width: 10%;"></td> <td style="width: 10%;"></td> </tr> <tr> <td></td> <td></td> <td colspan="8" style="text-align: center;"> <table border="1" style="width: 100%; border-collapse: collapse; text-align: center;"> <tr> <td style="width: 10%;"></td> <td style="width: 10%;"></td> <td style="width: 10%;"></td> <td style="width: 10%;"></td> <td style="width: 10%;"></td> <td style="width: 10%;"></td> <td style="width: 10%;"></td> <td style="width: 10%;"></td> <td style="width: 10%;"></td> <td style="width: 10%;"></td> </tr> <tr> <td></td> <td></td> <td colspan="8" style="text-align: center;"> <table border="1" style="width: 100%; border-collapse: collapse; text-align: center;"> <tr> <td style="width: 10%;"></td> <td style="width: 10%;"></td> <td style="width: 10%;"></td> <td style="width: 10%;"></td> <td style="width: 10%;"></td> <td style="width: 10%;"></td> <td
style="width: 10%;"></td> <td style="width: 10%;"></td> <td style="width: 10%;"></td> <td style="width: 10%;"></td> </tr> <tr> <td></td> <td></td> <td colspan="8" style="text-align: center;"> <table border="1" style="width: 100%; border-collapse: collapse; text-align: center;"> <tr> <td style="width: 10%;"></td> <td style="width: 10%;"></td> <td style="width: 10%;"></td> <td style="width: 10%;"></td> <td style="width: 10%;"></td> <td style="width: 10%;"></td> <td style="width: 10%;"></td> <td style="width: 10%;"></td> <td style="width: 10%;"></td> <td style="width: 10%;"></td> </tr> <tr> <td></td> <td></td> <td colspan="8" style="text-align: center;"> <table border="1" style="width: 100%; border-collapse: collapse; text-align: center;"> <tr> <td style="width: 10%;"></td> <td style="width: 10%;"></td> <td style="width: 10%;"></td> <td style="width: 10%;"></td> <td style="width: 10%;"></td> <td style="width: 10%;"></td> <td style="width: 10%;"></td> <td style="width: 10%;"></td> <td style="width: 10%;"></td> <td style="width: 10%;"></td> </tr> <tr> <td></td> <td></td> <td colspan="8" style="text-align: center;"> <table border="1" style="width: 100%; border-collapse: collapse; text-align: center;"> <tr> <td style="width: 10%;"></td> <td style="width: 10%;"></td> <td style="width: 10%;"></td> <td style="width: 10%;"></td> <td style="width: 10%;"></td> <td style="width: 10%;"></td> <td style="width: 10%;"></td> <td style="width: 10%;"></td> <td style="width: 10%;"></td> <td style="width: 10%;"></td> </tr> <tr> <td></td> <td></td> <td colspan="8" style="text-align: center;"> <table border="1" style="width: 100%; border-collapse: collapse; text-align: center;"> <tr> <td style="width: 10%;"></td> <td style="width: 10%;"></td> <td style="width: 10%;"></td> <td style="width: 10%;"></td> <td style="width: 10%;"></td> <td style="width: 10%;"></td> <td style="width: 10%;"></td> <td style="width: 10%;"></td> <td style="width: 10%;"></td> <td style="width: 10%;"></td> </tr> <tr> <td></td> <td></td> <td colspan="8" style="text-align: center;"> <table border="1" style="width: 100%; border-collapse: collapse; text-align: center;"> <tr> <td style="width: 10%;"></td> <td style="width: 10%;"></td> <td style="width: 10%;"></td> <td style="width: 10%;"></td> <td style="width: 10%;"></td> <td style="width: 10%;"></td> <td style="width: 10%;"></td> <td style="width: 10%;"></td> <td style="width: 10%;"></td> <td style="width: 10%;"></td> </tr> <tr> <td></td> <td></td> <td colspan="8" style="text-align: center;"> <table border="1" style="width: 100%; border-collapse: collapse; text-align: center;"> <tr> <td style="width: 10%;"></td> <td style="width: 10%;"></td> <td style="width: 10%;"></td> <td style="width: 10%;"></td> <td style="width: 10%;"></td> <td style="width: 10%;"></td> <td style="width: 10%;"></td> <td style="width: 10%;"></td> <td style="width: 10%;"></td> <td style="width: 10%;"></td> </tr> <tr> <td></td> <td></td> <td colspan="8" style="text-align: center;"> <table border="1" style="width: 100%; border-collapse: collapse; text-align: center;"> <tr> <td style="width: 10%;"></td> <td style="width: 10%;"></td> <td style="width: 10%;"></td> <td style="width: 10%;"></td> <td style="width: 10%;"></td> <td style="width: 10%;"></td> <td style="width: 10%;"></td> <td style="width: 10%;"></td> <td style="width: 10%;"></td> <td style="width: 10%;"></td> </tr> <tr> <td></td> <td></td> <td colspan="8" style="text-align: center;"> <table border="1" style="width: 100%; border-collapse: collapse; text-align: center;"> <tr> <td style="width: 10%;"></td> <td style="width: 10%;"></td> <td style="width: 10%;"></td> <td style="width: 10%;"></td> <td style="width: 10%;"></td> <td style="width: 10%;"></td> <td style="width: 10%;"></td> <td style="width: 10%;"></td> <td style="width: 10%;"></td> <td style="width: 10%;"></td> </tr> <tr> <td></td> <td></td> <td colspan="8" style="text-align: center;"> <table border="1" style="width: 100%; border-collapse: collapse; text-align: center;"> <tr> <td style="width: 10%;"></td> <td style="width: 10%;"></td> <td style="width: 10%;"></td> <td style="width: 10%;"></td> <td style="width: 10%;"></td> <td style="width: 10%;"></td> <td style="width: 10%;"></td> <td style="width: 10%;"></td> <td style="width: 10%;"></td> <td style="width: 10%;"></td> </tr> <tr> <td></td> <td></td> <td colspan="8" style="text-align: center;"> <table border="1" style="width: 100%; border-collapse: collapse; text-align: center;"> <tr> <td style="width: 10%;"></td> <td style="width: 10%;"></td> <td style="width: 10%;"></td> <td style="width: 10%;"></td> <td style="width: 10%;"></td> <td style="width: 10%;"></td> <td style="width: 10%;"></td> <td style="width: 10%;"></td> <td style="width: 10%;"></td> <td style="width: 10%;"></td> </tr> <tr> <td></td> <td></td> <td colspan="8" style="text-align: center;"> <table border="1" style="width: 100%; border-collapse: collapse; text-align: center;"> <tr> <td style="width: 10%;"></td> <td style="width: 10%;"></td> <td style="width: 10%;"></td> <td style="width: 10%;"></td> <td style="width: 10%;"></td> <td style="width: 10%;"></td> <td style="width: 10%;"></td> <td style="width: 10%;"></td> <td style="width: 10%;"></td> <td style="width: 10%;"></td> </tr> <tr> <td></td> <td></td> <td colspan="8" style="text-align: center;"> <table border="1" style="width: 100%; border-collapse: collapse; text-align: center;"> <tr> <td style="width: 10%;"></td> <td style="width: 10%;"></td> <td style="width: 10%;"></td> <td style="width: 10%;"></td> <td style="width: 10%;"></td> <td style="width: 10%;"></td> <td style="width: 10%;"></td> <td style="width: 10%;"></td> <td style="width: 10%;"></td> <td style="width: 10%;"></td> </tr> <tr> <td></td> <td></td> <td colspan="8" style="text-align: center;"> <table border="1" style="width: 100%; border-collapse: collapse; text-align: center;"> <tr> <td style="width: 10%;"></td> <td style="width: 10%;"></td> <td style="width: 10%;"></td> <td style="width: 10%;"></td> <td style="width: 10%;"></td> <td style="width: 10%;"></td> <td style="width: 10%;"></td> <td style="width: 10%;"></td> <td style="width: 10%;"></td> <td style="width: 10%;"></td> </tr> <tr> <td></td> <td></td> <td colspan="8" style="text-align: center;"> <table border="1" style="width: 100%; border-collapse: collapse; text-align: center;"> <tr> <td style="width: 10%;"></td> <td style="width: 10%;"></td> <td style="width: 10%;"></td> <td style="width: 10%;"></td> <td style="width: 10%;"></td> <td style="width: 10%;"></td> <td style="width: 10%;"></td> <td style="width: 10%;"></td> <td style="width: 10%;"></td> <td style="width: 10%;"></td> </tr> <tr> <td></td> <td></td> <td colspan="8" style="text-align: center;"> <table border="1" style="width: 100%; border-collapse: collapse; text-align: center;"> <tr> </tr></table></td></tr></table></td></tr></table></td></tr></table></td></tr></table></td></tr></table></td></tr></table></td></tr></table></td></tr></table></td></tr></table></td></tr></table></td></tr></table></td></tr></table></td></tr></table></td></tr></table></td></tr></table></td></tr></table></td></tr></table></td></tr></table></td></tr></table></td></tr></table></td></tr></table></td></tr></table></td></tr></table></td></tr></table></td></tr></table></td></tr></table></td></tr></table></td></tr></table></td></tr></table></td></tr></table></td></tr></table></td></tr></table>
 | | | | | | | | | | | | | | | | | | | | <table border="1" style="width: 100%; border-collapse: collapse; text-align: center;"> <tr> <td style="width: 10%;"></td> <td style="width: 10%;"></td> <td style="width: 10%;"></td> <td style="width: 10%;"></td> <td style="width: 10%;"></td> <td style="width: 10%;"></td> <td style="width: 10%;"></td> <td style="width: 10%;"></td> <td style="width: 10%;"></td> <td style="width: 10%;"></td> </tr> <tr> <td></td> <td></td> <td colspan="8" style="text-align: center;"> <table border="1" style="width: 100%; border-collapse: collapse; text-align: center;"> <tr> <td style="width: 10%;"></td> <td style="width: 10%;"></td> <td style="width: 10%;"></td> <td style="width: 10%;"></td> <td style="width: 10%;"></td> <td style="width: 10%;"></td> <td style="width: 10%;"></td> <td style="width: 10%;"></td> <td style="width: 10%;"></td> <td style="width: 10%;"></td> </tr> <tr> <td></td> <td></td> <td colspan="8" style="text-align: center;"> <table border="1" style="width: 100%; border-collapse: collapse; text-align: center;"> <tr> <td style="width: 10%;"></td> <td style="width: 10%;"></td> <td style="width: 10%;"></td> <td style="width: 10%;"></td> <td style="width: 10%;"></td> <td style="width: 10%;"></td> <td style="width: 10%;"></td> <td style="width: 10%;"></td> <td style="width: 10%;"></td> <td style="width: 10%;"></td> </tr> <tr> <td></td> <td></td> <td colspan="8" style="text-align: center;"> <table border="1" style="width: 100%; border-collapse: collapse; text-align: center;"> <tr> <td style="width: 10%;"></td> <td style="width: 10%;"></td> <td style="width: 10%;"></td> <td style="width: 10%;"></td> <td style="width: 10%;"></td> <td style="width: 10%;"></td> <td style="width: 10%;"></td> <td style="width: 10%;"></td> <td style="width: 10%;"></td> <td style="width: 10%;"></td> </tr> <tr> <td></td> <td></td> <td colspan="8" style="text-align: center;"> <table border="1" style="width: 100%; border-collapse: collapse; text-align: center;"> <tr> <td style="width: 10%;"></td> <td style="width: 10%;"></td> <td style="width: 10%;"></td> <td style="width: 10%;"></td> <td style="width: 10%;"></td> <td style="width: 10%;"></td> <td style="width: 10%;"></td> <td style="width: 10%;"></td> <td style="width: 10%;"></td> <td style="width: 10%;"></td> </tr> <tr> <td></td> <td></td> <td colspan="8" style="text-align: center;"> <table border="1" style="width: 100%; border-collapse: collapse; text-align: center;"> <tr> <td style="width: 10%;"></td> <td style="width: 10%;"></td> <td style="width: 10%;"></td> <td style="width: 10%;"></td> <td style="width: 10%;"></td> <td style="width: 10%;"></td> <td style="width: 10%;"></td> <td style="width: 10%;"></td> <td style="width: 10%;"></td> <td style="width: 10%;"></td> </tr> <tr> <td></td> <td></td> <td colspan="8" style="text-align: center;"> <table border="1" style="width: 100%; border-collapse: collapse; text-align: center;"> <tr> <td style="width: 10%;"></td> <td style="width: 10%;"></td> <td style="width: 10%;"></td> <td style="width: 10%;"></td> <td style="width: 10%;"></td> <td style="width: 10%;"></td> <td style="width: 10%;"></td> <td style="width: 10%;"></td> <td style="width: 10%;"></td> <td style="width: 10%;"></td> </tr> <tr> <td></td> <td></td> <td colspan="8" style="text-align: center;"> <table border="1" style="width: 100%; border-collapse: collapse; text-align: center;"> <tr> <td style="width: 10%;"></td> <td style="width: 10%;"></td> <td style="width: 10%;"></td> <td style="width: 10%;"></td> <td style="width: 10%;"></td> <td style="width: 10%;"></td> <td style="width: 10%;"></td> <td style="width: 10%;"></td> <td style="width: 10%;"></td> <td style="width: 10%;"></td> </tr> <tr> <td></td> <td></td> <td colspan="8" style="text-align: center;"> <table border="1" style="width: 100%; border-collapse: collapse; text-align: center;"> <tr> <td style="width: 10%;"></td> <td style="width: 10%;"></td> <td style="width: 10%;"></td> <td style="width: 10%;"></td> <td style="width: 10%;"></td> <td style="width: 10%;"></td> <td style="width: 10%;"></td> <td style="width: 10%;"></td> <td style="width: 10%;"></td> <td style="width: 10%;"></td> </tr> <tr> <td></td> <td></td> <td colspan="8" style="text-align: center;"> <table border="1" style="width: 100%; border-collapse: collapse; text-align: center;"> <tr> <td style="width: 10%;"></td> <td style="width: 10%;"></td> <td style="width: 10%;"></td> <td style="width: 10%;"></td> <td style="width: 10%;"></td> <td style="width: 10%;"></td> <td style="width: 10%;"></td> <td style="width: 10%;"></td> <td style="width: 10%;"></td> <td style="width: 10%;"></td> </tr> <tr> <td></td> <td></td> <td colspan="8" style="text-align: center;"> <table border="1" style="width: 100%; border-collapse: collapse; text-align: center;"> <tr> <td style="width: 10%;"></td> <td style="width: 10%;"></td> <td style="width: 10%;"></td> <td style="width: 10%;"></td> <td style="width: 10%;"></td> <td style="width: 10%;"></td> <td style="width: 10%;"></td> <td style="width: 10%;"></td> <td style="width: 10%;"></td> <td style="width: 10%;"></td> </tr> <tr> <td></td> <td></td> <td colspan="8" style="text-align: center;"> <table border="1" style="width: 100%; border-collapse: collapse; text-align: center;"> <tr> <td style="width: 10%;"></td> <td style="width: 10%;"></td> <td style="width: 10%;"></td> <td style="width: 10%;"></td> <td style="width: 10%;"></td> <td style="width: 10%;"></td> <td style="width: 10%;"></td> <td style="width: 10%;"></td> <td style="width: 10%;"></td> <td style="width: 10%;"></td> </tr> <tr> <td></td> <td></td> <td colspan="8" style="text-align: center;"> <table border="1" style="width: 100%; border-collapse: collapse; text-align: center;"> <tr> <td style="width: 10%;"></td> <td style="width: 10%;"></td> <td style="width: 10%;"></td> <td style="width: 10%;"></td> <td style="width: 10%;"></td> <td style="width: 10%;"></td> <td style="width: 10%;"></td> <td style="width: 10%;"></td> <td style="width: 10%;"></td> <td style="width: 10%;"></td> </tr> <tr> <td></td> <td></td> <td colspan="8" style="text-align: center;"> <table border="1" style="width: 100%; border-collapse: collapse; text-align: center;"> <tr> <td style="width:
10%;"></td> <td style="width: 10%;"></td> <td style="width: 10%;"></td> <td style="width: 10%;"></td> <td style="width: 10%;"></td> <td style="width: 10%;"></td> <td style="width: 10%;"></td> <td style="width: 10%;"></td> <td style="width: 10%;"></td> <td style="width: 10%;"></td> </tr> <tr> <td></td> <td></td> <td colspan="8" style="text-align: center;"> <table border="1" style="width: 100%; border-collapse: collapse; text-align: center;"> <tr> <td style="width: 10%;"></td> <td style="width: 10%;"></td> <td style="width: 10%;"></td> <td style="width: 10%;"></td> <td style="width: 10%;"></td> <td style="width: 10%;"></td> <td style="width: 10%;"></td> <td style="width: 10%;"></td> <td style="width: 10%;"></td> <td style="width: 10%;"></td> </tr> <tr> <td></td> <td></td> <td colspan="8" style="text-align: center;"> <table border="1" style="width: 100%; border-collapse: collapse; text-align: center;"> <tr> <td style="width: 10%;"></td> <td style="width: 10%;"></td> <td style="width: 10%;"></td> <td style="width: 10%;"></td> <td style="width: 10%;"></td> <td style="width: 10%;"></td> <td style="width: 10%;"></td> <td style="width: 10%;"></td> <td style="width: 10%;"></td> <td style="width: 10%;"></td> </tr> <tr> <td></td> <td></td> <td colspan="8" style="text-align: center;"> <table border="1" style="width: 100%; border-collapse: collapse; text-align: center;"> <tr> <td style="width: 10%;"></td> <td style="width: 10%;"></td> <td style="width: 10%;"></td> <td style="width: 10%;"></td> <td style="width: 10%;"></td> <td style="width: 10%;"></td> <td style="width: 10%;"></td> <td style="width: 10%;"></td> <td style="width: 10%;"></td> <td style="width: 10%;"></td> </tr> <tr> <td></td> <td></td> <td colspan="8" style="text-align: center;"> <table border="1" style="width: 100%; border-collapse: collapse; text-align: center;"> <tr> <td style="width: 10%;"></td> <td style="width: 10%;"></td> <td style="width: 10%;"></td> <td style="width: 10%;"></td> <td style="width: 10%;"></td> <td style="width: 10%;"></td> <td style="width: 10%;"></td> <td style="width: 10%;"></td> <td style="width: 10%;"></td> <td style="width: 10%;"></td> </tr> <tr> <td></td> <td></td> <td colspan="8" style="text-align: center;"> <table border="1" style="width: 100%; border-collapse: collapse; text-align: center;"> <tr> <td style="width: 10%;"></td> <td style="width: 10%;"></td> <td style="width: 10%;"></td> <td style="width: 10%;"></td> <td style="width: 10%;"></td> <td style="width: 10%;"></td> <td style="width: 10%;"></td> <td style="width: 10%;"></td> <td style="width: 10%;"></td> <td style="width: 10%;"></td> </tr> <tr> <td></td> <td></td> <td colspan="8" style="text-align: center;"> <table border="1" style="width: 100%; border-collapse: collapse; text-align: center;"> <tr> <td style="width: 10%;"></td> <td style="width: 10%;"></td> <td style="width: 10%;"></td> <td style="width: 10%;"></td> <td style="width: 10%;"></td> <td style="width: 10%;"></td> <td style="width: 10%;"></td> <td style="width: 10%;"></td> <td style="width: 10%;"></td> <td style="width: 10%;"></td> </tr> <tr> <td></td> <td></td> <td colspan="8" style="text-align: center;"> <table border="1" style="width: 100%; border-collapse: collapse; text-align: center;"> <tr> <td style="width: 10%;"></td> <td style="width: 10%;"></td> <td style="width: 10%;"></td> <td style="width: 10%;"></td> <td style="width: 10%;"></td> <td style="width: 10%;"></td> <td style="width: 10%;"></td> <td style="width: 10%;"></td> <td style="width: 10%;"></td> <td style="width: 10%;"></td> </tr> <tr> <td></td> <td></td> <td colspan="8" style="text-align: center;"> <table border="1" style="width: 100%; border-collapse: collapse; text-align: center;"> <tr> <td style="width: 10%;"></td> <td style="width: 10%;"></td> <td style="width: 10%;"></td> <td style="width: 10%;"></td> <td style="width: 10%;"></td> <td style="width: 10%;"></td> <td style="width: 10%;"></td> <td style="width: 10%;"></td> <td style="width: 10%;"></td> <td style="width: 10%;"></td> </tr> <tr> <td></td> <td></td> <td colspan="8" style="text-align: center;"> <table border="1" style="width: 100%; border-collapse: collapse; text-align: center;"> <tr> <td style="width: 10%;"></td> <td style="width: 10%;"></td> <td style="width: 10%;"></td> <td style="width: 10%;"></td> <td style="width: 10%;"></td> <td style="width: 10%;"></td> <td style="width: 10%;"></td> <td style="width: 10%;"></td> <td style="width: 10%;"></td> <td style="width: 10%;"></td> </tr> <tr> <td></td> <td></td> <td colspan="8" style="text-align: center;"> <table border="1" style="width: 100%; border-collapse: collapse; text-align: center;"> <tr> <td style="width: 10%;"></td> <td style="width: 10%;"></td> <td style="width: 10%;"></td> <td style="width: 10%;"></td> <td style="width: 10%;"></td> <td style="width: 10%;"></td> <td style="width: 10%;"></td> <td style="width: 10%;"></td> <td style="width: 10%;"></td> <td style="width: 10%;"></td> </tr> <tr> <td></td> <td></td> <td colspan="8" style="text-align: center;"> <table border="1" style="width: 100%; border-collapse: collapse; text-align: center;"> <tr> <td style="width: 10%;"></td> <td style="width: 10%;"></td> <td style="width: 10%;"></td> <td style="width: 10%;"></td> <td style="width: 10%;"></td> <td style="width: 10%;"></td> <td style="width: 10%;"></td> <td style="width: 10%;"></td> <td style="width: 10%;"></td> <td style="width: 10%;"></td> </tr> <tr> <td></td> <td></td> <td colspan="8" style="text-align: center;"> <table border="1" style="width: 100%; border-collapse: collapse; text-align: center;"> <tr> <td style="width: 10%;"></td> <td style="width: 10%;"></td> <td style="width: 10%;"></td> <td style="width: 10%;"></td> <td style="width: 10%;"></td> <td style="width: 10%;"></td> <td style="width: 10%;"></td> <td style="width: 10%;"></td> <td style="width: 10%;"></td> <td style="width: 10%;"></td> </tr> <tr> <td></td> <td></td> <td colspan="8" style="text-align: center;"> <table border="1" style="width: 100%; border-collapse: collapse; text-align: center;"> <tr> <td style="width: 10%;"></td> <td style="width: 10%;"></td> <td style="width: 10%;"></td> <td style="width: 10%;"></td> <td style="width: 10%;"></td> <td style="width: 10%;"></td> <td style="width: 10%;"></td> <td style="width: 10%;"></td> <td style="width: 10%;"></td> <td style="width: 10%;"></td> </tr> <tr> <td></td> <td></td> <td colspan="8" style="text-align: center;"> <table border="1" style="width: 100%; border-collapse: collapse; text-align: center;"> <tr> <td style="width: 10%;"></td> <td style="width: 10%;"></td> <td style="width: 10%;"></td> <td style="width: 10%;"></td> <td style="width: 10%;"></td> <td style="width: 10%;"></td> <td style="width: 10%;"></td> <td style="width: 10%;"></td> <td style="width: 10%;"></td> <td style="width: 10%;"></td> </tr> <tr> <td></td> <td></td> <td colspan="8" style="text-align: center;"> <table border="1" style="width: 100%; border-collapse: collapse; text-align: center;"> <tr> <td style="width: 10%;"></td> <td style="width: 10%;"></td> <td style="width: 10%;"></td> <td style="width: 10%;"></td> <td style="width: 10%;"></td> <td style="width: 10%;"></td> <td style="width: 10%;"></td> <td style="width: 10%;"></td> <td style="width: 10%;"></td> <td style="width: 10%;"></td> </tr> <tr> <td></td> <td></td> <td colspan="8" style="text-align: center;"> <table border="1" style="width: 100%; border-collapse: collapse; text-align: center;"> <tr> <td style="width: 10%;"></td> <td style="width: 10%;"></td> <td style="width: 10%;"></td> <td style="width: 10%;"></td> <td style="width: 10%;"></td> <td style="width: 10%;"></td> <td style="width: 10%;"></td> <td style="width: 10%;"></td> <td style="width: 10%;"></td> <td style="width: 10%;"></td> </tr> <tr> <td></td> <td></td> <td colspan="8" style="text-align: center;"> <table border="1" style="width: 100%; border-collapse: collapse; text-align: center;"> <tr> <td style="width: 10%;"></td> <td style="width: 10%;"></td> <td style="width: 10%;"></td> <td style="width: 10%;"></td> <td style="width: 10%;"></td> <td style="width: 10%;"></td> <td style="width: 10%;"></td> <td style="width: 10%;"></td> <td style="width: 10%;"></td> <td style="width: 10%;"></td> </tr> <tr> <td></td> <td></td> <td colspan="8" style="text-align: center;"> <table border="1" style="width: 100%; border-collapse: collapse; text-align: center;"> <tr> </tr></table></td></tr></table></td></tr></table></td></tr></table></td></tr></table></td></tr></table></td></tr></table></td></tr></table></td></tr></table></td></tr></table></td></tr></table></td></tr></table></td></tr></table></td></tr></table></td></tr></table></td></tr></table></td></tr></table></td></tr></table></td></tr></table></td></tr></table></td></tr></table></td></tr></table></td></tr></table></td></tr></table></td></tr></table></td></tr></table></td></tr></table></td></tr></table></td></tr></table></td></tr></table></td></tr></table></td></tr></table>
 | | | | | | | | | | | | | | | | | | | | <table border="1" style="width: 100%; border-collapse: collapse; text-align: center;"> <tr> <td style="width: 10%;"></td> <td style="width: 10%;"></td> <td style="width: 10%;"></td> <td style="width: 10%;"></td> <td style="width: 10%;"></td> <td style="width: 10%;"></td> <td style="width: 10%;"></td> <td style="width: 10%;"></td> <td style="width: 10%;"></td> <td style="width: 10%;"></td> </tr> <tr> <td></td> <td></td> <td colspan="8" style="text-align: center;"> <table border="1" style="width: 100%; border-collapse: collapse; text-align: center;"> <tr> <td style="width: 10%;"></td> <td style="width: 10%;"></td> <td style="width: 10%;"></td> <td style="width: 10%;"></td> <td style="width: 10%;"></td> <td style="width: 10%;"></td> <td style="width: 10%;"></td> <td style="width: 10%;"></td> <td style="width: 10%;"></td> <td style="width: 10%;"></td> </tr> <tr> <td></td> <td></td> <td colspan="8" style="text-align: center;"> <table border="1" style="width: 100%; border-collapse: collapse; text-align: center;"> <tr> <td style="width: 10%;"></td> <td style="width: 10%;"></td> <td style="width: 10%;"></td> <td style="width: 10%;"></td> <td style="width: 10%;"></td> <td style="width: 10%;"></td> <td style="width: 10%;"></td> <td style="width: 10%;"></td> <td style="width: 10%;"></td> <td style="width: 10%;"></td> </tr> <tr> <td></td> <td></td> <td colspan="8" style="text-align: center;"> <table border="1" style="width: 100%; border-collapse: collapse; text-align: center;"> <tr> <td style="width: 10%;"></td> <td style="width: 10%;"></td> <td style="width: 10%;"></td> <td style="width: 10%;"></td> <td style="width: 10%;"></td> <td style="width: 10%;"></td> <td style="width: 10%;"></td> <td style="width: 10%;"></td> <td style="width: 10%;"></td> <td style="width: 10%;"></td> </tr> <tr> <td></td> <td></td> <td colspan="8" style="text-align: center;"> <table border="1" style="width: 100%; border-collapse: collapse; text-align: center;"> <tr> <td style="width: 10%;"></td> <td style="width: 10%;"></td> <td style="width: 10%;"></td> <td style="width: 10%;"></td> <td style="width: 10%;"></td> <td style="width: 10%;"></td> <td style="width: 10%;"></td> <td style="width: 10%;"></td> <td style="width: 10%;"></td> <td style="width: 10%;"></td> </tr> <tr> <td></td> <td></td> <td colspan="8" style="text-align: center;"> <table border="1" style="width: 100%; border-collapse: collapse; text-align: center;"> <tr> <td style="width: 10%;"></td> <td style="width: 10%;"></td> <td style="width: 10%;"></td> <td style="width: 10%;"></td> <td style="width: 10%;"></td> <td style="width: 10%;"></td> <td style="width: 10%;"></td> <td style="width: 10%;"></td> <td style="width: 10%;"></td> <td style="width: 10%;"></td> </tr> <tr> <td></td> <td></td> <td colspan="8" style="text-align: center;"> <table border="1" style="width: 100%; border-collapse: collapse; text-align: center;"> <tr> <td style="width: 10%;"></td> <td style="width: 10%;"></td> <td style="width: 10%;"></td> <td style="width: 10%;"></td> <td style="width: 10%;"></td> <td style="width: 10%;"></td> <td style="width: 10%;"></td> <td style="width: 10%;"></td> <td style="width: 10%;"></td> <td style="width: 10%;"></td> </tr> <tr> <td></td> <td></td> <td colspan="8" style="text-align: center;"> <table border="1" style="width: 100%; border-collapse: collapse; text-align: center;"> <tr> <td style="width: 10%;"></td> <td style="width: 10%;"></td> <td style="width: 10%;"></td> <td style="width: 10%;"></td> <td style="width: 10%;"></td> <td style="width: 10%;"></td> <td style="width: 10%;"></td> <td style="width: 10%;"></td> <td style="width: 10%;"></td> <td style="width: 10%;"></td> </tr> <tr> <td></td> <td></td> <td colspan="8" style="text-align: center;"> <table border="1" style="width: 100%; border-collapse: collapse; text-align: center;"> <tr> <td style="width: 10%;"></td> <td style="width: 10%;"></td> <td style="width: 10%;"></td> <td style="width: 10%;"></td> <td style="width: 10%;"></td> <td style="width: 10%;"></td> <td style="width: 10%;"></td> <td style="width: 10%;"></td> <td style="width: 10%;"></td> <td style="width: 10%;"></td> </tr> <tr> <td></td> <td></td> <td colspan="8" style="text-align: center;"> <table border="1" style="width: 100%; border-collapse: collapse; text-align: center;"> <tr> <td style="width: 10%;"></td> <td style="width: 10%;"></td> <td style="width: 10%;"></td> <td style="width: 10%;"></td> <td style="width: 10%;"></td> <td style="width: 10%;"></td> <td style="width: 10%;"></td> <td style="width: 10%;"></td> <td style="width: 10%;"></td> <td style="width: 10%;"></td> </tr> <tr> <td></td> <td></td> <td
colspan="8" style="text-align: center;"> <table border="1" style="width: 100%; border-collapse: collapse; text-align: center;"> <tr> <td style="width: 10%;"></td> <td style="width: 10%;"></td> <td style="width: 10%;"></td> <td style="width: 10%;"></td> <td style="width: 10%;"></td> <td style="width: 10%;"></td> <td style="width: 10%;"></td> <td style="width: 10%;"></td> <td style="width: 10%;"></td> <td style="width: 10%;"></td> </tr> <tr> <td></td> <td></td> <td colspan="8" style="text-align: center;"> <table border="1" style="width: 100%; border-collapse: collapse; text-align: center;"> <tr> <td style="width: 10%;"></td> <td style="width: 10%;"></td> <td style="width: 10%;"></td> <td style="width: 10%;"></td> <td style="width: 10%;"></td> <td style="width: 10%;"></td> <td style="width: 10%;"></td> <td style="width: 10%;"></td> <td style="width: 10%;"></td> <td style="width: 10%;"></td> </tr> <tr> <td></td> <td></td> <td colspan="8" style="text-align: center;"> <table border="1" style="width: 100%; border-collapse: collapse; text-align: center;"> <tr> <td style="width: 10%;"></td> <td style="width: 10%;"></td> <td style="width: 10%;"></td> <td style="width: 10%;"></td> <td style="width: 10%;"></td> <td style="width: 10%;"></td> <td style="width: 10%;"></td> <td style="width: 10%;"></td> <td style="width: 10%;"></td> <td style="width: 10%;"></td> </tr> <tr> <td></td> <td></td> <td colspan="8" style="text-align: center;"> <table border="1" style="width: 100%; border-collapse: collapse; text-align: center;"> <tr> <td style="width: 10%;"></td> <td style="width: 10%;"></td> <td style="width: 10%;"></td> <td style="width: 10%;"></td> <td style="width: 10%;"></td> <td style="width: 10%;"></td> <td style="width: 10%;"></td> <td style="width: 10%;"></td> <td style="width: 10%;"></td> <td style="width: 10%;"></td> </tr> <tr> <td></td> <td></td> <td colspan="8" style="text-align: center;"> <table border="1" style="width: 100%; border-collapse: collapse; text-align: center;"> <tr> <td style="width: 10%;"></td> <td style="width: 10%;"></td> <td style="width: 10%;"></td> <td style="width: 10%;"></td> <td style="width: 10%;"></td> <td style="width: 10%;"></td> <td style="width: 10%;"></td> <td style="width: 10%;"></td> <td style="width: 10%;"></td> <td style="width: 10%;"></td> </tr> <tr> <td></td> <td></td> <td colspan="8" style="text-align: center;"> <table border="1" style="width: 100%; border-collapse: collapse; text-align: center;"> <tr> <td style="width: 10%;"></td> <td style="width: 10%;"></td> <td style="width: 10%;"></td> <td style="width: 10%;"></td> <td style="width: 10%;"></td> <td style="width: 10%;"></td> <td style="width: 10%;"></td> <td style="width: 10%;"></td> <td style="width: 10%;"></td> <td style="width: 10%;"></td> </tr> <tr> <td></td> <td></td> <td colspan="8" style="text-align: center;"> <table border="1" style="width: 100%; border-collapse: collapse; text-align: center;"> <tr> <td style="width: 10%;"></td> <td style="width: 10%;"></td> <td style="width: 10%;"></td> <td style="width: 10%;"></td> <td style="width: 10%;"></td> <td style="width: 10%;"></td> <td style="width: 10%;"></td> <td style="width: 10%;"></td> <td style="width: 10%;"></td> <td style="width: 10%;"></td> </tr> <tr> <td></td> <td></td> <td colspan="8" style="text-align: center;"> <table border="1" style="width: 100%; border-collapse: collapse; text-align: center;"> <tr> <td style="width: 10%;"></td> <td style="width: 10%;"></td> <td style="width: 10%;"></td> <td style="width: 10%;"></td> <td style="width: 10%;"></td> <td style="width: 10%;"></td> <td style="width: 10%;"></td> <td style="width: 10%;"></td> <td style="width: 10%;"></td> <td style="width: 10%;"></td> </tr> <tr> <td></td> <td></td> <td colspan="8" style="text-align: center;"> <table border="1" style="width: 100%; border-collapse: collapse; text-align: center;"> <tr> <td style="width: 10%;"></td> <td style="width: 10%;"></td> <td style="width: 10%;"></td> <td style="width: 10%;"></td> <td style="width: 10%;"></td> <td style="width: 10%;"></td> <td style="width: 10%;"></td> <td style="width: 10%;"></td> <td style="width: 10%;"></td> <td style="width: 10%;"></td> </tr> <tr> <td></td> <td></td> <td colspan="8" style="text-align: center;"> <table border="1" style="width: 100%; border-collapse: collapse; text-align: center;"> <tr> <td style="width: 10%;"></td> <td style="width: 10%;"></td> <td style="width: 10%;"></td> <td style="width: 10%;"></td> <td style="width: 10%;"></td> <td style="width: 10%;"></td> <td style="width: 10%;"></td> <td style="width: 10%;"></td> <td style="width: 10%;"></td> <td style="width: 10%;"></td> </tr> <tr> <td></td> <td></td> <td colspan="8" style="text-align: center;"> <table border="1" style="width: 100%; border-collapse: collapse; text-align: center;"> <tr> <td style="width: 10%;"></td> <td style="width: 10%;"></td> <td style="width: 10%;"></td> <td style="width: 10%;"></td> <td style="width: 10%;"></td> <td style="width: 10%;"></td> <td style="width: 10%;"></td> <td style="width: 10%;"></td> <td style="width: 10%;"></td> <td style="width: 10%;"></td> </tr> <tr> <td></td> <td></td> <td colspan="8" style="text-align: center;"> <table border="1" style="width: 100%; border-collapse: collapse; text-align: center;"> <tr> <td style="width: 10%;"></td> <td style="width: 10%;"></td> <td style="width: 10%;"></td> <td style="width: 10%;"></td> <td style="width: 10%;"></td> <td style="width: 10%;"></td> <td style="width: 10%;"></td> <td style="width: 10%;"></td> <td style="width: 10%;"></td> <td style="width: 10%;"></td> </tr> <tr> <td></td> <td></td> <td colspan="8" style="text-align: center;"> <table border="1" style="width: 100%; border-collapse: collapse; text-align: center;"> <tr> <td style="width: 10%;"></td> <td style="width: 10%;"></td> <td style="width: 10%;"></td> <td style="width: 10%;"></td> <td style="width: 10%;"></td> <td style="width: 10%;"></td> <td style="width: 10%;"></td> <td style="width: 10%;"></td> <td style="width: 10%;"></td> <td style="width: 10%;"></td> </tr> <tr> <td></td> <td></td> <td colspan="8" style="text-align: center;"> <table border="1" style="width: 100%; border-collapse: collapse; text-align: center;"> <tr> <td style="width: 10%;"></td> <td style="width: 10%;"></td> <td style="width: 10%;"></td> <td style="width: 10%;"></td> <td style="width: 10%;"></td> <td style="width: 10%;"></td> <td style="width: 10%;"></td> <td style="width: 10%;"></td> <td style="width: 10%;"></td> <td style="width: 10%;"></td> </tr> <tr> <td></td> <td></td> <td colspan="8" style="text-align: center;"> <table border="1" style="width: 100%; border-collapse: collapse; text-align: center;"> <tr> <td style="width: 10%;"></td> <td style="width: 10%;"></td> <td style="width: 10%;"></td> <td style="width: 10%;"></td> <td style="width: 10%;"></td> <td style="width: 10%;"></td> <td style="width: 10%;"></td> <td style="width: 10%;"></td> <td style="width: 10%;"></td> <td style="width: 10%;"></td> </tr> <tr> <td></td> <td></td> <td colspan="8" style="text-align: center;"> <table border="1" style="width: 100%; border-collapse: collapse; text-align: center;"> <tr> <td style="width: 10%;"></td> <td style="width: 10%;"></td> <td style="width: 10%;"></td> <td style="width: 10%;"></td> <td style="width: 10%;"></td> <td style="width: 10%;"></td> <td style="width: 10%;"></td> <td style="width: 10%;"></td> <td style="width: 10%;"></td> <td style="width: 10%;"></td> </tr> <tr> <td></td> <td></td> <td colspan="8" style="text-align: center;"> <table border="1" style="width: 100%; border-collapse: collapse; text-align: center;"> <tr> <td style="width: 10%;"></td> <td style="width: 10%;"></td> <td style="width: 10%;"></td> <td style="width: 10%;"></td> <td style="width: 10%;"></td> <td style="width: 10%;"></td> <td style="width: 10%;"></td> <td style="width: 10%;"></td> <td style="width: 10%;"></td> <td style="width: 10%;"></td> </tr> <tr> <td></td> <td></td> <td colspan="8" style="text-align: center;"> <table border="1" style="width: 100%; border-collapse: collapse; text-align: center;"> <tr> <td style="width: 10%;"></td> <td style="width: 10%;"></td> <td style="width: 10%;"></td> <td style="width: 10%;"></td> <td style="width: 10%;"></td> <td style="width: 10%;"></td> <td style="width: 10%;"></td> <td style="width: 10%;"></td> <td style="width: 10%;"></td> <td style="width: 10%;"></td> </tr> <tr> <td></td> <td></td> <td colspan="8" style="text-align: center;"> <table border="1" style="width: 100%; border-collapse: collapse; text-align: center;"> <tr> <td style="width: 10%;"></td> <td style="width: 10%;"></td> <td style="width: 10%;"></td> <td style="width: 10%;"></td> <td style="width: 10%;"></td> <td style="width: 10%;"></td> <td style="width: 10%;"></td> <td style="width: 10%;"></td> <td style="width: 10%;"></td> <td style="width: 10%;"></td> </tr> <tr> <td></td> <td></td> <td colspan="8" style="text-align: center;"> <table border="1" style="width: 100%; border-collapse: collapse; text-align: center;"> <tr> <td style="width: 10%;"></td> <td style="width: 10%;"></td> <td style="width: 10%;"></td> <td style="width: 10%;"></td> <td style="width: 10%;"></td> <td style="width: 10%;"></td> <td style="width: 10%;"></td> <td style="width: 10%;"></td> <td style="width: 10%;"></td> <td style="width: 10%;"></td> </tr> <tr> <td></td> <td></td> <td colspan="8" style="text-align: center;"> <table border="1" style="width: 100%; border-collapse: collapse; text-align: center;"> <tr>
</tr></table></td></tr></table></td></tr></table></td></tr></table></td></tr></table></td></tr></table></td></tr></table></td></tr></table></td></tr></table></td></tr></table></td></tr></table></td></tr></table></td></tr></table></td></tr></table></td></tr></table></td></tr></table></td></tr></table></td></tr></table></td></tr></table></td></tr></table></td></tr></table></td></tr></table></td></tr></table></td></tr></table></td></tr></table></td></tr></table></td></tr></table></td></tr></table></td></tr></table></td></tr></table></td></tr></table> | | | | | | | | | | | | | | | | | | | | <table border="1" style="width: 100%; border-collapse: collapse; text-align: center;"> <tr> <td style="width: 10%;"></td> <td style="width: 10%;"></td> <td style="width: 10%;"></td> <td style="width: 10%;"></td> <td style="width: 10%;"></td> <td style="width: 10%;"></td> <td style="width: 10%;"></td> <td style="width: 10%;"></td> <td style="width: 10%;"></td> <td style="width: 10%;"></td> </tr> <tr> <td></td> <td></td> <td colspan="8" style="text-align: center;"> <table border="1" style="width: 100%; border-collapse: collapse; text-align: center;"> <tr> <td style="width: 10%;"></td> <td style="width: 10%;"></td> <td style="width: 10%;"></td> <td style="width: 10%;"></td> <td style="width: 10%;"></td> <td style="width: 10%;"></td> <td style="width: 10%;"></td> <td style="width: 10%;"></td> <td style="width: 10%;"></td> <td style="width: 10%;"></td> </tr> <tr> <td></td> <td></td> <td colspan="8" style="text-align: center;"> <table border="1" style="width: 100%; border-collapse: collapse; text-align: center;"> <tr> <td style="width: 10%;"></td> <td style="width: 10%;"></td> <td style="width: 10%;"></td> <td style="width: 10%;"></td> <td style="width: 10%;"></td> <td style="width: 10%;"></td> <td style="width: 10%;"></td> <td style="width: 10%;"></td> <td style="width: 10%;"></td> <td style="width: 10%;"></td> </tr> <tr> <td></td> <td></td> <td colspan="8" style="text-align: center;"> <table border="1" style="width: 100%; border-collapse: collapse; text-align: center;"> <tr> <td style="width: 10%;"></td> <td style="width: 10%;"></td> <td style="width: 10%;"></td> <td style="width: 10%;"></td> <td style="width: 10%;"></td> <td style="width: 10%;"></td> <td style="width: 10%;"></td> <td style="width: 10%;"></td> <td style="width: 10%;"></td> <td style="width: 10%;"></td> </tr> <tr> <td></td> <td></td> <td colspan="8" style="text-align: center;"> <table border="1" style="width: 100%; border-collapse: collapse; text-align: center;"> <tr> <td style="width: 10%;"></td> <td style="width: 10%;"></td> <td style="width: 10%;"></td> <td style="width: 10%;"></td> <td style="width: 10%;"></td> <td style="width: 10%;"></td> <td style="width: 10%;"></td> <td style="width: 10%;"></td> <td style="width: 10%;"></td> <td style="width: 10%;"></td> </tr> <tr> <td></td> <td></td> <td colspan="8" style="text-align: center;"> <table border="1" style="width: 100%; border-collapse: collapse; text-align: center;"> <tr> <td style="width: 10%;"></td> <td style="width: 10%;"></td> <td style="width: 10%;"></td> <td style="width: 10%;"></td> <td style="width: 10%;"></td> <td style="width: 10%;"></td> <td style="width: 10%;"></td> <td style="width: 10%;"></td> <td style="width: 10%;"></td> <td style="width: 10%;"></td> </tr> <tr> <td></td> <td></td> <td colspan="8" style="text-align: center;"> <table border="1" style="width: 100%; border-collapse: collapse; text-align: center;"> <tr> <td style="width: 10%;"></td> <td style="width: 10%;"></td> <td style="width: 10%;"></td> <td style="width: 10%;"></td> <td style="width: 10%;"></td> <td style="width:
10%;"></td> <td style="width: 10%;"></td> <td style="width: 10%;"></td> <td style="width: 10%;"></td> <td style="width: 10%;"></td> </tr> <tr> <td></td> <td></td> <td colspan="8" style="text-align: center;"> <table border="1" style="width: 100%; border-collapse: collapse; text-align: center;"> <tr> <td style="width: 10%;"></td> <td style="width: 10%;"></td> <td style="width: 10%;"></td> <td style="width: 10%;"></td> <td style="width: 10%;"></td> <td style="width: 10%;"></td> <td style="width: 10%;"></td> <td style="width: 10%;"></td> <td style="width: 10%;"></td> <td style="width: 10%;"></td> </tr> <tr> <td></td> <td></td> <td colspan="8" style="text-align: center;"> <table border="1" style="width: 100%; border-collapse: collapse; text-align: center;"> <tr> <td style="width: 10%;"></td> <td style="width: 10%;"></td> <td style="width: 10%;"></td> <td style="width: 10%;"></td> <td style="width: 10%;"></td> <td style="width: 10%;"></td> <td style="width: 10%;"></td> <td style="width: 10%;"></td> <td style="width: 10%;"></td> <td style="width: 10%;"></td> </tr> <tr> <td></td> <td></td> <td colspan="8" style="text-align: center;"> <table border="1" style="width: 100%; border-collapse: collapse; text-align: center;"> <tr> <td style="width: 10%;"></td> <td style="width: 10%;"></td> <td style="width: 10%;"></td> <td style="width: 10%;"></td> <td style="width: 10%;"></td> <td style="width: 10%;"></td> <td style="width: 10%;"></td> <td style="width: 10%;"></td> <td style="width: 10%;"></td> <td style="width: 10%;"></td> </tr> <tr> <td></td> <td></td> <td colspan="8" style="text-align: center;"> <table border="1" style="width: 100%; border-collapse: collapse; text-align: center;"> <tr> <td style="width: 10%;"></td> <td style="width: 10%;"></td> <td style="width: 10%;"></td> <td style="width: 10%;"></td> <td style="width: 10%;"></td> <td style="width: 10%;"></td> <td style="width: 10%;"></td> <td style="width: 10%;"></td> <td style="width: 10%;"></td> <td style="width: 10%;"></td> </tr> <tr> <td></td> <td></td> <td colspan="8" style="text-align: center;"> <table border="1" style="width: 100%; border-collapse: collapse; text-align: center;"> <tr> <td style="width: 10%;"></td> <td style="width: 10%;"></td> <td style="width: 10%;"></td> <td style="width: 10%;"></td> <td style="width: 10%;"></td> <td style="width: 10%;"></td> <td style="width: 10%;"></td> <td style="width: 10%;"></td> <td style="width: 10%;"></td> <td style="width: 10%;"></td> </tr> <tr> <td></td> <td></td> <td colspan="8" style="text-align: center;"> <table border="1" style="width: 100%; border-collapse: collapse; text-align: center;"> <tr> <td style="width: 10%;"></td> <td style="width: 10%;"></td> <td style="width: 10%;"></td> <td style="width: 10%;"></td> <td style="width: 10%;"></td> <td style="width: 10%;"></td> <td style="width: 10%;"></td> <td style="width: 10%;"></td> <td style="width: 10%;"></td> <td style="width: 10%;"></td> </tr> <tr> <td></td> <td></td> <td colspan="8" style="text-align: center;"> <table border="1" style="width: 100%; border-collapse: collapse; text-align: center;"> <tr> <td style="width: 10%;"></td> <td style="width: 10%;"></td> <td style="width: 10%;"></td> <td style="width: 10%;"></td> <td style="width: 10%;"></td> <td style="width: 10%;"></td> <td style="width: 10%;"></td> <td style="width: 10%;"></td> <td style="width: 10%;"></td> <td style="width: 10%;"></td> </tr> <tr> <td></td> <td></td> <td colspan="8" style="text-align: center;"> <table border="1" style="width: 100%; border-collapse: collapse; text-align: center;"> <tr> <td style="width: 10%;"></td> <td style="width: 10%;"></td> <td style="width: 10%;"></td> <td style="width: 10%;"></td> <td style="width: 10%;"></td> <td style="width: 10%;"></td> <td style="width: 10%;"></td> <td style="width: 10%;"></td> <td style="width: 10%;"></td> <td style="width: 10%;"></td> </tr> <tr> <td></td> <td></td> <td colspan="8" style="text-align: center;"> <table border="1" style="width: 100%; border-collapse: collapse; text-align: center;"> <tr> <td style="width: 10%;"></td> <td style="width: 10%;"></td> <td style="width: 10%;"></td> <td style="width: 10%;"></td> <td style="width: 10%;"></td> <td style="width: 10%;"></td> <td style="width: 10%;"></td> <td style="width: 10%;"></td> <td style="width: 10%;"></td> <td style="width: 10%;"></td> </tr> <tr> <td></td> <td></td> <td colspan="8" style="text-align: center;"> <table border="1" style="width: 100%; border-collapse: collapse; text-align: center;"> <tr> <td style="width: 10%;"></td> <td style="width: 10%;"></td> <td style="width: 10%;"></td> <td style="width: 10%;"></td> <td style="width: 10%;"></td> <td style="width: 10%;"></td> <td style="width: 10%;"></td> <td style="width: 10%;"></td> <td style="width: 10%;"></td> <td style="width: 10%;"></td> </tr> <tr> <td></td> <td></td> <td colspan="8" style="text-align: center;"> <table border="1" style="width: 100%; border-collapse: collapse; text-align: center;"> <tr> <td style="width: 10%;"></td> <td style="width: 10%;"></td> <td style="width: 10%;"></td> <td style="width: 10%;"></td> <td style="width: 10%;"></td> <td style="width: 10%;"></td> <td style="width: 10%;"></td> <td style="width: 10%;"></td> <td style="width: 10%;"></td> <td style="width: 10%;"></td> </tr> <tr> <td></td> <td></td> <td colspan="8" style="text-align: center;"> <table border="1" style="width: 100%; border-collapse: collapse; text-align: center;"> <tr> <td style="width: 10%;"></td> <td style="width: 10%;"></td> <td style="width: 10%;"></td> <td style="width: 10%;"></td> <td style="width: 10%;"></td> <td style="width: 10%;"></td> <td style="width: 10%;"></td> <td style="width: 10%;"></td> <td style="width: 10%;"></td> <td style="width: 10%;"></td> </tr> <tr> <td></td> <td></td> <td colspan="8" style="text-align: center;"> <table border="1" style="width: 100%; border-collapse: collapse; text-align: center;"> <tr> <td style="width: 10%;"></td> <td style="width: 10%;"></td> <td style="width: 10%;"></td> <td style="width: 10%;"></td> <td style="width: 10%;"></td> <td style="width: 10%;"></td> <td style="width: 10%;"></td> <td style="width: 10%;"></td> <td style="width: 10%;"></td> <td style="width: 10%;"></td> </tr> <tr> <td></td> <td></td> <td colspan="8" style="text-align: center;"> <table border="1" style="width: 100%; border-collapse: collapse; text-align: center;"> <tr> <td style="width: 10%;"></td> <td style="width: 10%;"></td> <td style="width: 10%;"></td> <td style="width: 10%;"></td> <td style="width: 10%;"></td> <td style="width: 10%;"></td> <td style="width: 10%;"></td> <td style="width: 10%;"></td> <td style="width: 10%;"></td> <td style="width: 10%;"></td> </tr> <tr> <td></td> <td></td> <td colspan="8" style="text-align: center;"> <table border="1" style="width: 100%; border-collapse: collapse; text-align: center;"> <tr> <td style="width: 10%;"></td> <td style="width: 10%;"></td> <td style="width: 10%;"></td> <td style="width: 10%;"></td> <td style="width: 10%;"></td> <td style="width: 10%;"></td> <td style="width: 10%;"></td> <td style="width: 10%;"></td> <td style="width: 10%;"></td> <td style="width: 10%;"></td> </tr> <tr> <td></td> <td></td> <td colspan="8" style="text-align: center;"> <table border="1" style="width: 100%; border-collapse: collapse; text-align: center;"> <tr> <td style="width: 10%;"></td> <td style="width: 10%;"></td> <td style="width: 10%;"></td> <td style="width: 10%;"></td> <td style="width: 10%;"></td> <td style="width: 10%;"></td> <td style="width: 10%;"></td> <td style="width: 10%;"></td> <td style="width: 10%;"></td> <td style="width: 10%;"></td> </tr> <tr> <td></td> <td></td> <td colspan="8" style="text-align: center;"> <table border="1" style="width: 100%; border-collapse: collapse; text-align: center;"> <tr> <td style="width: 10%;"></td> <td style="width: 10%;"></td> <td style="width: 10%;"></td> <td style="width: 10%;"></td> <td style="width: 10%;"></td> <td style="width: 10%;"></td> <td style="width: 10%;"></td> <td style="width: 10%;"></td> <td style="width: 10%;"></td> <td style="width: 10%;"></td> </tr> <tr> <td></td> <td></td> <td colspan="8" style="text-align: center;"> <table border="1" style="width: 100%; border-collapse: collapse; text-align: center;"> <tr> <td style="width: 10%;"></td> <td style="width: 10%;"></td> <td style="width: 10%;"></td> <td style="width: 10%;"></td> <td style="width: 10%;"></td> <td style="width: 10%;"></td> <td style="width: 10%;"></td> <td style="width: 10%;"></td> <td style="width: 10%;"></td> <td style="width: 10%;"></td> </tr> <tr> <td></td> <td></td> <td colspan="8" style="text-align: center;"> <table border="1" style="width: 100%; border-collapse: collapse; text-align: center;"> <tr> <td style="width: 10%;"></td> <td style="width: 10%;"></td> <td style="width: 10%;"></td> <td style="width: 10%;"></td> <td style="width: 10%;"></td> <td style="width: 10%;"></td> <td style="width: 10%;"></td> <td style="width: 10%;"></td> <td style="width: 10%;"></td> <td style="width: 10%;"></td> </tr> <tr> <td></td> <td></td> <td colspan="8" style="text-align: center;"> <table border="1" style="width: 100%; border-collapse: collapse; text-align: center;"> <tr> <td style="width: 10%;"></td> <td style="width: 10%;"></td> <td style="width: 10%;"></td> <td style="width: 10%;"></td> <td style="width: 10%;"></td> <td style="width: 10%;"></td> <td style="width: 10%;"></td> <td style="width: 10%;"></td> <td style="width: 10%;"></td> <td style="width: 10%;"></td> </tr> <tr> <td></td> <td></td> <td colspan="8" style="text-align: center;"> <table border="1" style="width: 100%; border-collapse: collapse; text-align: center;"> <tr> <td style="width: 10%;"></td> <td style="width: 10%;"></td> <td style="width: 10%;"></td> <td style="width: 10%;"></td> <td style="width: 10%;"></td> <td style="width: 10%;"></td> <td style="width: 10%;"></td> <td style="width: 10%;"></td> <td style="width: 10%;"></td> <td style="width: 10%;"></td> </tr> <tr> <td></td> <td></td> <td
colspan="8" style="text-align: center;"> <table border="1" style="width: 100%; border-collapse: collapse; text-align: center;"> <tr> <td style="width: 10%;"></td> <td style="width: 10%;"></td> <td style="width: 10%;"></td> <td style="width: 10%;"></td> <td style="width: 10%;"></td> <td style="width: 10%;"></td> <td style="width: 10%;"></td> <td style="width: 10%;"></td> <td style="width: 10%;"></td> <td style="width: 10%;"></td> </tr> <tr> <td></td> <td></td> <td colspan="8" style="text-align: center;"> <table border="1" style="width: 100%; border-collapse: collapse; text-align: center;"> <tr> </tr></table></td></tr></table></td></tr></table></td></tr></table></td></tr></table></td></tr></table></td></tr></table></td></tr></table></td></tr></table></td></tr></table></td></tr></table></td></tr></table></td></tr></table></td></tr></table></td></tr></table></td></tr></table></td></tr></table></td></tr></table></td></tr></table></td></tr></table></td></tr></table></td></tr></table></td></tr></table></td></tr></table></td></tr></table></td></tr></table></td></tr></table></td></tr></table></td></tr></table></td></tr></table> | | | | | | | | | | | | | | | | | | | | <table border="1" style="width: 100%; border-collapse: collapse; text-align: center;"> <tr> <td style="width: 10%;"></td> <td style="width: 10%;"></td> <td style="width: 10%;"></td> <td style="width: 10%;"></td> <td style="width: 10%;"></td> <td style="width: 10%;"></td> <td style="width: 10%;"></td> <td style="width: 10%;"></td> <td style="width: 10%;"></td> <td style="width: 10%;"></td> </tr> <tr> <td></td> <td></td> <td colspan="8" style="text-align: center;"> <table border="1" style="width: 100%; border-collapse: collapse; text-align: center;"> <tr> <td style="width: 10%;"></td> <td style="width: 10%;"></td> <td style="width: 10%;"></td> <td style="width: 10%;"></td> <td style="width: 10%;"></td> <td style="width: 10%;"></td> <td style="width: 10%;"></td> <td style="width: 10%;"></td> <td style="width: 10%;"></td> <td style="width: 10%;"></td> </tr> <tr> <td></td> <td></td> <td colspan="8" style="text-align: center;"> <table border="1" style="width: 100%; border-collapse: collapse; text-align: center;"> <tr> <td style="width: 10%;"></td> <td style="width: 10%;"></td> <td style="width: 10%;"></td> <td style="width: 10%;"></td> <td style="width: 10%;"></td> <td style="width: 10%;"></td> <td style="width: 10%;"></td> <td style="width: 10%;"></td> <td style="width: 10%;"></td> <td style="width: 10%;"></td> </tr> <tr> <td></td> <td></td> <td colspan="8" style="text-align: center;"> <table border="1" style="width: 100%; border-collapse: collapse; text-align: center;"> <tr> <td style="width: 10%;"></td> <td style="width: 10%;"></td> <td style="width: 10%;"></td> <td style="width: 10%;"></td> <td style="width: 10%;"></td> <td style="width: 10%;"></td> <td style="width: 10%;"></td> <td style="width: 10%;"></td> <td style="width: 10%;"></td> <td style="width: 10%;"></td> </tr> <tr> <td></td> <td></td> <td colspan="8" style="text-align: center;"> <table border="1" style="width: 100%; border-collapse: collapse; text-align: center;"> <tr> <td style="width: 10%;"></td> <td style="width: 10%;"></td> <td style="width: 10%;"></td> <td style="width: 10%;"></td> <td style="width: 10%;"></td> <td style="width: 10%;"></td> <td style="width: 10%;"></td> <td style="width: 10%;"></td> <td style="width: 10%;"></td> <td style="width: 10%;"></td> </tr> <tr> <td></td> <td></td> <td colspan="8" style="text-align: center;"> <table border="1" style="width: 100%; border-collapse: collapse; text-align: center;"> <tr> <td style="width: 10%;"></td> <td style="width:
10%;"></td> <td style="width: 10%;"></td> <td style="width: 10%;"></td> <td style="width: 10%;"></td> <td style="width: 10%;"></td> <td style="width: 10%;"></td> <td style="width: 10%;"></td> <td style="width: 10%;"></td> <td style="width: 10%;"></td> </tr> <tr> <td></td> <td></td> <td colspan="8" style="text-align: center;"> <table border="1" style="width: 100%; border-collapse: collapse; text-align: center;"> <tr> <td style="width: 10%;"></td> <td style="width: 10%;"></td> <td style="width: 10%;"></td> <td style="width: 10%;"></td> <td style="width: 10%;"></td> <td style="width: 10%;"></td> <td style="width: 10%;"></td> <td style="width: 10%;"></td> <td style="width: 10%;"></td> <td style="width: 10%;"></td> </tr> <tr> <td></td> <td></td> <td colspan="8" style="text-align: center;"> <table border="1" style="width: 100%; border-collapse: collapse; text-align: center;"> <tr> <td style="width: 10%;"></td> <td style="width: 10%;"></td> <td style="width: 10%;"></td> <td style="width: 10%;"></td> <td style="width: 10%;"></td> <td style="width: 10%;"></td> <td style="width: 10%;"></td> <td style="width: 10%;"></td> <td style="width: 10%;"></td> <td style="width: 10%;"></td> </tr> <tr> <td></td> <td></td> <td colspan="8" style="text-align: center;"> <table border="1" style="width: 100%; border-collapse: collapse; text-align: center;"> <tr> <td style="width: 10%;"></td> <td style="width: 10%;"></td> <td style="width: 10%;"></td> <td style="width: 10%;"></td> <td style="width: 10%;"></td> <td style="width: 10%;"></td> <td style="width: 10%;"></td> <td style="width: 10%;"></td> <td style="width: 10%;"></td> <td style="width: 10%;"></td> </tr> <tr> <td></td> <td></td> <td colspan="8" style="text-align: center;"> <table border="1" style="width: 100%; border-collapse: collapse; text-align: center;"> <tr> <td style="width: 10%;"></td> <td style="width: 10%;"></td> <td style="width: 10%;"></td> <td style="width: 10%;"></td> <td style="width: 10%;"></td> <td style="width: 10%;"></td> <td style="width: 10%;"></td> <td style="width: 10%;"></td> <td style="width: 10%;"></td> <td style="width: 10%;"></td> </tr> <tr> <td></td> <td></td> <td colspan="8" style="text-align: center;"> <table border="1" style="width: 100%; border-collapse: collapse; text-align: center;"> <tr> <td style="width: 10%;"></td> <td style="width: 10%;"></td> <td style="width: 10%;"></td> <td style="width: 10%;"></td> <td style="width: 10%;"></td> <td style="width: 10%;"></td> <td style="width: 10%;"></td> <td style="width: 10%;"></td> <td style="width: 10%;"></td> <td style="width: 10%;"></td> </tr> <tr> <td></td> <td></td> <td colspan="8" style="text-align: center;"> <table border="1" style="width: 100%; border-collapse: collapse; text-align: center;"> <tr> <td style="width: 10%;"></td> <td style="width: 10%;"></td> <td style="width: 10%;"></td> <td style="width: 10%;"></td> <td style="width: 10%;"></td> <td style="width: 10%;"></td> <td style="width: 10%;"></td> <td style="width: 10%;"></td> <td style="width: 10%;"></td> <td style="width: 10%;"></td> </tr> <tr> <td></td> <td></td> <td colspan="8" style="text-align: center;"> <table border="1" style="width: 100%; border-collapse: collapse; text-align: center;"> <tr> <td style="width: 10%;"></td> <td style="width: 10%;"></td> <td style="width: 10%;"></td> <td style="width: 10%;"></td> <td style="width: 10%;"></td> <td style="width: 10%;"></td> <td style="width: 10%;"></td> <td style="width: 10%;"></td> <td style="width: 10%;"></td> <td style="width: 10%;"></td> </tr> <tr> <td></td> <td></td> <td colspan="8" style="text-align: center;"> <table border="1" style="width: 100%; border-collapse: collapse; text-align: center;"> <tr> <td style="width: 10%;"></td> <td style="width: 10%;"></td> <td style="width: 10%;"></td> <td style="width: 10%;"></td> <td style="width: 10%;"></td> <td style="width: 10%;"></td> <td style="width: 10%;"></td> <td style="width: 10%;"></td> <td style="width: 10%;"></td> <td style="width: 10%;"></td> </tr> <tr> <td></td> <td></td> <td colspan="8" style="text-align: center;"> <table border="1" style="width: 100%; border-collapse: collapse; text-align: center;"> <tr> <td style="width: 10%;"></td> <td style="width: 10%;"></td> <td style="width: 10%;"></td> <td style="width: 10%;"></td> <td style="width: 10%;"></td> <td style="width: 10%;"></td> <td style="width: 10%;"></td> <td style="width: 10%;"></td> <td style="width: 10%;"></td> <td style="width: 10%;"></td> </tr> <tr> <td></td> <td></td> <td colspan="8" style="text-align: center;"> <table border="1" style="width: 100%; border-collapse: collapse; text-align: center;"> <tr> <td style="width: 10%;"></td> <td style="width: 10%;"></td> <td style="width: 10%;"></td> <td style="width: 10%;"></td> <td style="width: 10%;"></td> <td style="width: 10%;"></td> <td style="width: 10%;"></td> <td style="width: 10%;"></td> <td style="width: 10%;"></td> <td style="width: 10%;"></td> </tr> <tr> <td></td> <td></td> <td colspan="8" style="text-align: center;"> <table border="1" style="width: 100%; border-collapse: collapse; text-align: center;"> <tr> <td style="width: 10%;"></td> <td style="width: 10%;"></td> <td style="width: 10%;"></td> <td style="width: 10%;"></td> <td style="width: 10%;"></td> <td style="width: 10%;"></td> <td style="width: 10%;"></td> <td style="width: 10%;"></td> <td style="width: 10%;"></td> <td style="width: 10%;"></td> </tr> <tr> <td></td> <td></td> <td colspan="8" style="text-align: center;"> <table border="1" style="width: 100%; border-collapse: collapse; text-align: center;"> <tr> <td style="width: 10%;"></td> <td style="width: 10%;"></td> <td style="width: 10%;"></td> <td style="width: 10%;"></td> <td style="width: 10%;"></td> <td style="width: 10%;"></td> <td style="width: 10%;"></td> <td style="width: 10%;"></td> <td style="width: 10%;"></td> <td style="width: 10%;"></td> </tr> <tr> <td></td> <td></td> <td colspan="8" style="text-align: center;"> <table border="1" style="width: 100%; border-collapse: collapse; text-align: center;"> <tr> <td style="width: 10%;"></td> <td style="width: 10%;"></td> <td style="width: 10%;"></td> <td style="width: 10%;"></td> <td style="width: 10%;"></td> <td style="width: 10%;"></td> <td style="width: 10%;"></td> <td style="width: 10%;"></td> <td style="width: 10%;"></td> <td style="width: 10%;"></td> </tr> <tr> <td></td> <td></td> <td colspan="8" style="text-align: center;"> <table border="1" style="width: 100%; border-collapse: collapse; text-align: center;"> <tr> <td style="width: 10%;"></td> <td style="width: 10%;"></td> <td style="width: 10%;"></td> <td style="width: 10%;"></td> <td style="width: 10%;"></td> <td style="width: 10%;"></td> <td style="width: 10%;"></td> <td style="width: 10%;"></td> <td style="width: 10%;"></td> <td style="width: 10%;"></td> </tr> <tr> <td></td> <td></td> <td colspan="8" style="text-align: center;"> <table border="1" style="width: 100%; border-collapse: collapse; text-align: center;"> <tr> <td style="width: 10%;"></td> <td style="width: 10%;"></td> <td style="width: 10%;"></td> <td style="width: 10%;"></td> <td style="width: 10%;"></td> <td style="width: 10%;"></td> <td style="width: 10%;"></td> <td style="width: 10%;"></td> <td style="width: 10%;"></td> <td style="width: 10%;"></td> </tr> <tr> <td></td> <td></td> <td colspan="8" style="text-align: center;"> <table border="1" style="width: 100%; border-collapse: collapse; text-align: center;"> <tr> <td style="width: 10%;"></td> <td style="width: 10%;"></td> <td style="width: 10%;"></td> <td style="width: 10%;"></td> <td style="width: 10%;"></td> <td style="width: 10%;"></td> <td style="width: 10%;"></td> <td style="width: 10%;"></td> <td style="width: 10%;"></td> <td style="width: 10%;"></td> </tr> <tr> <td></td> <td></td> <td colspan="8" style="text-align: center;"> <table border="1" style="width: 100%; border-collapse: collapse; text-align: center;"> <tr> <td style="width: 10%;"></td> <td style="width: 10%;"></td> <td style="width: 10%;"></td> <td style="width: 10%;"></td> <td style="width: 10%;"></td> <td style="width: 10%;"></td> <td style="width: 10%;"></td> <td style="width: 10%;"></td> <td style="width: 10%;"></td> <td style="width: 10%;"></td> </tr> <tr> <td></td> <td></td> <td colspan="8" style="text-align: center;"> <table border="1" style="width: 100%; border-collapse: collapse; text-align: center;"> <tr> <td style="width: 10%;"></td> <td style="width: 10%;"></td> <td style="width: 10%;"></td> <td style="width: 10%;"></td> <td style="width: 10%;"></td> <td style="width: 10%;"></td> <td style="width: 10%;"></td> <td style="width: 10%;"></td> <td style="width: 10%;"></td> <td style="width: 10%;"></td> </tr> <tr> <td></td> <td></td> <td colspan="8" style="text-align: center;"> <table border="1" style="width: 100%; border-collapse: collapse; text-align: center;"> <tr> <td style="width: 10%;"></td> <td style="width: 10%;"></td> <td style="width: 10%;"></td> <td style="width: 10%;"></td> <td style="width: 10%;"></td> <td style="width: 10%;"></td> <td style="width: 10%;"></td> <td style="width: 10%;"></td> <td style="width: 10%;"></td> <td style="width: 10%;"></td> </tr> <tr> <td></td> <td></td> <td colspan="8" style="text-align: center;"> <table border="1" style="width: 100%; border-collapse: collapse; text-align: center;"> <tr> <td style="width: 10%;"></td> <td style="width: 10%;"></td> <td style="width: 10%;"></td> <td style="width: 10%;"></td> <td style="width: 10%;"></td> <td style="width: 10%;"></td> <td style="width: 10%;"></td> <td style="width: 10%;"></td> <td style="width: 10%;"></td> <td style="width: 10%;"></td> </tr> <tr> <td></td> <td></td> <td colspan="8" style="text-align: center;"> <table border="1" style="width: 100%; border-collapse: collapse; text-align: center;"> <tr> <td style="width: 10%;"></td> <td style="width: 10%;"></td> <td style="width: 10%;"></td> <td style="width: 10%;"></td> <td style="width: 10%;"></td> <td style="width: 10%;"></td> <td style="width: 10%;"></td> <td
style="width: 10%;"></td> <td style="width: 10%;"></td> <td style="width: 10%;"></td> </tr> <tr> <td></td> <td></td> <td colspan="8" style="text-align: center;"> <table border="1" style="width: 100%; border-collapse: collapse; text-align: center;"> <tr> <td style="width: 10%;"></td> <td style="width: 10%;"></td> <td style="width: 10%;"></td> <td style="width: 10%;"></td> <td style="width: 10%;"></td> <td style="width: 10%;"></td> <td style="width: 10%;"></td> <td style="width: 10%;"></td> <td style="width: 10%;"></td> <td style="width: 10%;"></td> </tr> <tr> <td></td> <td></td> <td colspan="8" style="text-align: center;"> <table border="1" style="width: 100%; border-collapse: collapse; text-align: center;"> <tr> </tr></table></td></tr></table></td></tr></table></td></tr></table></td></tr></table></td></tr></table></td></tr></table></td></tr></table></td></tr></table></td></tr></table></td></tr></table></td></tr></table></td></tr></table></td></tr></table></td></tr></table></td></tr></table></td></tr></table></td></tr></table></td></tr></table></td></tr></table></td></tr></table></td></tr></table></td></tr></table></td></tr></table></td></tr></table></td></tr></table></td></tr></table></td></tr></table></td></tr></table> | | | | | | | | | | | | | | | | | | | | <table border="1" style="width: 100%; border-collapse: collapse; text-align: center;"> <tr> <td style="width: 10%;"></td> <td style="width: 10%;"></td> <td style="width: 10%;"></td> <td style="width: 10%;"></td> <td style="width: 10%;"></td> <td style="width: 10%;"></td> <td style="width: 10%;"></td> <td style="width: 10%;"></td> <td style="width: 10%;"></td> <td style="width: 10%;"></td> </tr> <tr> <td></td> <td></td> <td colspan="8" style="text-align: center;"> <table border="1" style="width: 100%; border-collapse: collapse; text-align: center;"> <tr> <td style="width: 10%;"></td> <td style="width: 10%;"></td> <td style="width: 10%;"></td> <td style="width: 10%;"></td> <td style="width: 10%;"></td> <td style="width: 10%;"></td> <td style="width: 10%;"></td> <td style="width: 10%;"></td> <td style="width: 10%;"></td> <td style="width: 10%;"></td> </tr> <tr> <td></td> <td></td> <td colspan="8" style="text-align: center;"> <table border="1" style="width: 100%; border-collapse: collapse; text-align: center;"> <tr> <td style="width: 10%;"></td> <td style="width: 10%;"></td> <td style="width: 10%;"></td> <td style="width: 10%;"></td> <td style="width: 10%;"></td> <td style="width: 10%;"></td> <td style="width: 10%;"></td> <td style="width: 10%;"></td> <td style="width: 10%;"></td> <td style="width: 10%;"></td> </tr> <tr> <td></td> <td></td> <td colspan="8" style="text-align: center;"> <table border="1" style="width: 100%; border-collapse: collapse; text-align: center;"> <tr> <td style="width: 10%;"></td> <td style="width: 10%;"></td> <td style="width: 10%;"></td> <td style="width: 10%;"></td> <td style="width: 10%;"></td> <td style="width: 10%;"></td> <td style="width: 10%;"></td> <td style="width: 10%;"></td> <td style="width: 10%;"></td> <td style="width: 10%;"></td> </tr> <tr> <td></td> <td></td> <td colspan="8" style="text-align: center;"> <table border="1" style="width: 100%; border-collapse: collapse; text-align: center;"> <tr> <td style="width: 10%;"></td> <td style="width: 10%;"></td> <td style="width: 10%;"></td> <td style="width: 10%;"></td> <td style="width: 10%;"></td> <td style="width: 10%;"></td> <td style="width: 10%;"></td> <td style="width: 10%;"></td> <td style="width: 10%;"></td> <td style="width: 10%;"></td> </tr> <tr> <td></td> <td></td> <td colspan="8" style="text-align: center;"> <table border="1" style="width: 100%;
border-collapse: collapse; text-align: center;"> <tr> <td style="width: 10%;"></td> <td style="width: 10%;"></td> <td style="width: 10%;"></td> <td style="width: 10%;"></td> <td style="width: 10%;"></td> <td style="width: 10%;"></td> <td style="width: 10%;"></td> <td style="width: 10%;"></td> <td style="width: 10%;"></td> <td style="width: 10%;"></td> </tr> <tr> <td></td> <td></td> <td colspan="8" style="text-align: center;"> <table border="1" style="width: 100%; border-collapse: collapse; text-align: center;"> <tr> <td style="width: 10%;"></td> <td style="width: 10%;"></td> <td style="width: 10%;"></td> <td style="width: 10%;"></td> <td style="width: 10%;"></td> <td style="width: 10%;"></td> <td style="width: 10%;"></td> <td style="width: 10%;"></td> <td style="width: 10%;"></td> <td style="width: 10%;"></td> </tr> <tr> <td></td> <td></td> <td colspan="8" style="text-align: center;"> <table border="1" style="width: 100%; border-collapse: collapse; text-align: center;"> <tr> <td style="width: 10%;"></td> <td style="width: 10%;"></td> <td style="width: 10%;"></td> <td style="width: 10%;"></td> <td style="width: 10%;"></td> <td style="width: 10%;"></td> <td style="width: 10%;"></td> <td style="width: 10%;"></td> <td style="width: 10%;"></td> <td style="width: 10%;"></td> </tr> <tr> <td></td> <td></td> <td colspan="8" style="text-align: center;"> <table border="1" style="width: 100%; border-collapse: collapse; text-align: center;"> <tr> <td style="width: 10%;"></td> <td style="width: 10%;"></td> <td style="width: 10%;"></td> <td style="width: 10%;"></td> <td style="width: 10%;"></td> <td style="width: 10%;"></td> <td style="width: 10%;"></td> <td style="width: 10%;"></td> <td style="width: 10%;"></td> <td style="width: 10%;"></td> </tr> <tr> <td></td> <td></td> <td colspan="8" style="text-align: center;"> <table border="1" style="width: 100%; border-collapse: collapse; text-align: center;"> <tr> <td style="width: 10%;"></td> <td style="width: 10%;"></td> <td style="width: 10%;"></td> <td style="width: 10%;"></td> <td style="width: 10%;"></td> <td style="width: 10%;"></td> <td style="width: 10%;"></td> <td style="width: 10%;"></td> <td style="width: 10%;"></td> <td style="width: 10%;"></td> </tr> <tr> <td></td> <td></td> <td colspan="8" style="text-align: center;"> <table border="1" style="width: 100%; border-collapse: collapse; text-align: center;"> <tr> <td style="width: 10%;"></td> <td style="width: 10%;"></td> <td style="width: 10%;"></td> <td style="width: 10%;"></td> <td style="width: 10%;"></td> <td style="width: 10%;"></td> <td style="width: 10%;"></td> <td style="width: 10%;"></td> <td style="width: 10%;"></td> <td style="width: 10%;"></td> </tr> <tr> <td></td> <td></td> <td colspan="8" style="text-align: center;"> <table border="1" style="width: 100%; border-collapse: collapse; text-align: center;"> <tr> <td style="width: 10%;"></td> <td style="width: 10%;"></td> <td style="width: 10%;"></td> <td style="width: 10%;"></td> <td style="width: 10%;"></td> <td style="width: 10%;"></td> <td style="width: 10%;"></td> <td style="width: 10%;"></td> <td style="width: 10%;"></td> <td style="width: 10%;"></td> </tr> <tr> <td></td> <td></td> <td colspan="8" style="text-align: center;"> <table border="1" style="width: 100%; border-collapse: collapse; text-align: center;"> <tr> <td style="width: 10%;"></td> <td style="width: 10%;"></td> <td style="width: 10%;"></td> <td style="width: 10%;"></td> <td style="width: 10%;"></td> <td style="width: 10%;"></td> <td style="width: 10%;"></td> <td style="width: 10%;"></td> <td style="width: 10%;"></td> <td style="width: 10%;"></td> </tr> <tr> <td></td> <td></td> <td colspan="8" style="text-align: center;"> <table border="1" style="width: 100%; border-collapse: collapse; text-align: center;"> <tr> <td style="width: 10%;"></td> <td style="width: 10%;"></td> <td style="width: 10%;"></td> <td style="width: 10%;"></td> <td style="width: 10%;"></td> <td style="width: 10%;"></td> <td style="width: 10%;"></td> <td style="width: 10%;"></td> <td style="width: 10%;"></td> <td style="width: 10%;"></td> </tr> <tr> <td></td> <td></td> <td colspan="8" style="text-align: center;"> <table border="1" style="width: 100%; border-collapse: collapse; text-align: center;"> <tr> <td style="width: 10%;"></td> <td style="width: 10%;"></td> <td style="width: 10%;"></td> <td style="width: 10%;"></td> <td style="width: 10%;"></td> <td style="width: 10%;"></td> <td style="width: 10%;"></td> <td style="width: 10%;"></td> <td style="width: 10%;"></td> <td style="width: 10%;"></td> </tr> <tr> <td></td> <td></td> <td colspan="8" style="text-align: center;"> <table border="1" style="width: 100%; border-collapse: collapse; text-align: center;"> <tr> <td style="width: 10%;"></td> <td style="width: 10%;"></td> <td style="width: 10%;"></td> <td style="width: 10%;"></td> <td style="width: 10%;"></td> <td style="width: 10%;"></td> <td style="width: 10%;"></td> <td style="width: 10%;"></td> <td style="width: 10%;"></td> <td style="width: 10%;"></td> </tr> <tr> <td></td> <td></td> <td colspan="8" style="text-align: center;"> <table border="1" style="width: 100%; border-collapse: collapse; text-align: center;"> <tr> <td style="width: 10%;"></td> <td style="width: 10%;"></td> <td style="width: 10%;"></td> <td style="width: 10%;"></td> <td style="width: 10%;"></td> <td style="width: 10%;"></td> <td style="width: 10%;"></td> <td style="width: 10%;"></td> <td style="width: 10%;"></td> <td style="width: 10%;"></td> </tr> <tr> <td></td> <td></td> <td colspan="8" style="text-align: center;"> <table border="1" style="width: 100%; border-collapse: collapse; text-align: center;"> <tr> <td style="width: 10%;"></td> <td style="width: 10%;"></td> <td style="width: 10%;"></td> <td style="width: 10%;"></td> <td style="width: 10%;"></td> <td style="width: 10%;"></td> <td style="width: 10%;"></td> <td style="width: 10%;"></td> <td style="width: 10%;"></td> <td style="width: 10%;"></td> </tr> <tr> <td></td> <td></td> <td colspan="8" style="text-align: center;"> <table border="1" style="width: 100%; border-collapse: collapse; text-align: center;"> <tr> <td style="width: 10%;"></td> <td style="width: 10%;"></td> <td style="width: 10%;"></td> <td style="width: 10%;"></td> <td style="width: 10%;"></td> <td style="width: 10%;"></td> <td style="width: 10%;"></td> <td style="width: 10%;"></td> <td style="width: 10%;"></td> <td style="width: 10%;"></td> </tr> <tr> <td></td> <td></td> <td colspan="8" style="text-align: center;"> <table border="1" style="width: 100%; border-collapse: collapse; text-align: center;"> <tr> <td style="width: 10%;"></td> <td style="width: 10%;"></td> <td style="width: 10%;"></td> <td style="width: 10%;"></td> <td style="width: 10%;"></td> <td style="width: 10%;"></td> <td style="width: 10%;"></td> <td style="width: 10%;"></td> <td style="width: 10%;"></td> <td style="width: 10%;"></td> </tr> <tr> <td></td> <td></td> <td colspan="8" style="text-align: center;"> <table border="1" style="width: 100%; border-collapse: collapse; text-align: center;"> <tr> <td style="width: 10%;"></td> <td style="width: 10%;"></td> <td style="width: 10%;"></td> <td style="width: 10%;"></td> <td style="width: 10%;"></td> <td style="width: 10%;"></td> <td style="width: 10%;"></td> <td style="width: 10%;"></td> <td style="width: 10%;"></td> <td style="width: 10%;"></td> </tr> <tr> <td></td> <td></td> <td colspan="8" style="text-align: center;"> <table border="1" style="width: 100%; border-collapse: collapse; text-align: center;"> <tr> <td style="width: 10%;"></td> <td style="width: 10%;"></td> <td style="width: 10%;"></td> <td style="width: 10%;"></td> <td style="width: 10%;"></td> <td style="width: 10%;"></td> <td style="width: 10%;"></td> <td style="width: 10%;"></td> <td style="width: 10%;"></td> <td style="width: 10%;"></td> </tr> <tr> <td></td> <td></td> <td colspan="8" style="text-align: center;"> <table border="1" style="width: 100%; border-collapse: collapse; text-align: center;"> <tr> <td style="width: 10%;"></td> <td style="width: 10%;"></td> <td style="width: 10%;"></td> <td style="width: 10%;"></td> <td style="width: 10%;"></td> <td style="width: 10%;"></td> <td style="width: 10%;"></td> <td style="width: 10%;"></td> <td style="width: 10%;"></td> <td style="width: 10%;"></td> </tr> <tr> <td></td> <td></td> <td colspan="8" style="text-align: center;"> <table border="1" style="width: 100%; border-collapse: collapse; text-align: center;"> <tr> <td style="width: 10%;"></td> <td style="width: 10%;"></td> <td style="width: 10%;"></td> <td style="width: 10%;"></td> <td style="width: 10%;"></td> <td style="width: 10%;"></td> <td style="width: 10%;"></td> <td style="width: 10%;"></td> <td style="width: 10%;"></td> <td style="width: 10%;"></td> </tr> <tr> <td></td> <td></td> <td colspan="8" style="text-align: center;"> <table border="1" style="width: 100%; border-collapse: collapse; text-align: center;"> <tr> <td style="width: 10%;"></td> <td style="width: 10%;"></td> <td style="width: 10%;"></td> <td style="width: 10%;"></td> <td style="width: 10%;"></td> <td style="width: 10%;"></td> <td style="width: 10%;"></td> <td style="width: 10%;"></td> <td style="width: 10%;"></td> <td style="width: 10%;"></td> </tr> <tr> <td></td> <td></td> <td colspan="8" style="text-align: center;"> <table border="1" style="width: 100%; border-collapse: collapse; text-align: center;"> <tr> <td style="width: 10%;"></td> <td style="width: 10%;"></td> <td style="width: 10%;"></td> <td style="width: 10%;"></td> <td style="width: 10%;"></td> <td style="width: 10%;"></td> <td style="width: 10%;"></td> <td style="width: 10%;"></td> <td style="width: 10%;"></td> <td style="width: 10%;"></td> </tr> <tr> <td></td> <td></td> <td colspan="8" style="text-align: center;"> <table border="1" style="width: 100%; border-collapse: collapse; text-align: center;"> <tr> <td style="width: 10%;"></td> <td style="width: 10%;"></td> <td style="width: 10%;"></td> <td style="width:
10%;"></td> <td style="width: 10%;"></td> <td style="width: 10%;"></td> <td style="width: 10%;"></td> <td style="width: 10%;"></td> <td style="width: 10%;"></td> <td style="width: 10%;"></td> </tr> <tr> <td></td> <td></td> <td colspan="8" style="text-align: center;"> <table border="1" style="width: 100%; border-collapse: collapse; text-align: center;"> <tr> </tr></table></td></tr></table></td></tr></table></td></tr></table></td></tr></table></td></tr></table></td></tr></table></td></tr></table></td></tr></table></td></tr></table></td></tr></table></td></tr></table></td></tr></table></td></tr></table></td></tr></table></td></tr></table></td></tr></table></td></tr></table></td></tr></table></td></tr></table></td></tr></table></td></tr></table></td></tr></table></td></tr></table></td></tr></table></td></tr></table></td></tr></table></td></tr></table> | | | | | | | | | | | | | | | | | | | | <table border="1" style="width: 100%; border-collapse: collapse; text-align: center;"> <tr> <td style="width: 10%;"></td> <td style="width: 10%;"></td> <td style="width: 10%;"></td> <td style="width: 10%;"></td> <td style="width: 10%;"></td> <td style="width: 10%;"></td> <td style="width: 10%;"></td> <td style="width: 10%;"></td> <td style="width: 10%;"></td> <td style="width: 10%;"></td> </tr> <tr> <td></td> <td></td> <td colspan="8" style="text-align: center;"> <table border="1" style="width: 100%; border-collapse: collapse; text-align: center;"> <tr> <td style="width: 10%;"></td> <td style="width: 10%;"></td> <td style="width: 10%;"></td> <td style="width: 10%;"></td> <td style="width: 10%;"></td> <td style="width: 10%;"></td> <td style="width: 10%;"></td> <td style="width: 10%;"></td> <td style="width: 10%;"></td> <td style="width: 10%;"></td> </tr> <tr> <td></td> <td></td> <td colspan="8" style="text-align: center;"> <table border="1" style="width: 100%; border-collapse: collapse; text-align: center;"> <tr> <td style="width: 10%;"></td> <td style="width: 10%;"></td> <td style="width: 10%;"></td> <td style="width: 10%;"></td> <td style="width: 10%;"></td> <td style="width: 10%;"></td> <td style="width: 10%;"></td> <td style="width: 10%;"></td> <td style="width: 10%;"></td> <td style="width: 10%;"></td> </tr> <tr> <td></td> <td></td> <td colspan="8" style="text-align: center;"> <table border="1" style="width: 100%; border-collapse: collapse; text-align: center;"> <tr> <td style="width: 10%;"></td> <td style="width: 10%;"></td> <td style="width: 10%;"></td> <td style="width: 10%;"></td> <td style="width: 10%;"></td> <td style="width: 10%;"></td> <td style="width: 10%;"></td> <td style="width: 10%;"></td> <td style="width: 10%;"></td> <td style="width: 10%;"></td> </tr> <tr> <td></td> <td></td> <td colspan="8" style="text-align: center;"> <table border="1" style="width: 100%; border-collapse: collapse; text-align: center;"> <tr> <td style="width: 10%;"></td> <td style="width: 10%;"></td> <td style="width: 10%;"></td> <td style="width: 10%;"></td> <td style="width: 10%;"></td> <td style="width: 10%;"></td> <td style="width: 10%;"></td> <td style="width: 10%;"></td> <td style="width: 10%;"></td> <td style="width: 10%;"></td> </tr> <tr> <td></td> <td></td> <td colspan="8" style="text-align: center;"> <table border="1" style="width: 100%; border-collapse: collapse; text-align: center;"> <tr> <td style="width: 10%;"></td> <td style="width: 10%;"></td> <td style="width: 10%;"></td> <td style="width: 10%;"></td> <td style="width: 10%;"></td> <td style="width: 10%;"></td> <td style="width: 10%;"></td> <td style="width: 10%;"></td> <td style="width: 10%;"></td> <td style="width: 10%;"></td> </tr> <tr> <td></td> <td></td>
<td colspan="8" style="text-align: center;"> <table border="1" style="width: 100%; border-collapse: collapse; text-align: center;"> <tr> <td style="width: 10%;"></td> <td style="width: 10%;"></td> <td style="width: 10%;"></td> <td style="width: 10%;"></td> <td style="width: 10%;"></td> <td style="width: 10%;"></td> <td style="width: 10%;"></td> <td style="width: 10%;"></td> <td style="width: 10%;"></td> <td style="width: 10%;"></td> </tr> <tr> <td></td> <td></td> <td colspan="8" style="text-align: center;"> <table border="1" style="width: 100%; border-collapse: collapse; text-align: center;"> <tr> <td style="width: 10%;"></td> <td style="width: 10%;"></td> <td style="width: 10%;"></td> <td style="width: 10%;"></td> <td style="width: 10%;"></td> <td style="width: 10%;"></td> <td style="width: 10%;"></td> <td style="width: 10%;"></td> <td style="width: 10%;"></td> <td style="width: 10%;"></td> </tr> <tr> <td></td> <td></td> <td colspan="8" style="text-align: center;"> <table border="1" style="width: 100%; border-collapse: collapse; text-align: center;"> <tr> <td style="width: 10%;"></td> <td style="width: 10%;"></td> <td style="width: 10%;"></td> <td style="width: 10%;"></td> <td style="width: 10%;"></td> <td style="width: 10%;"></td> <td style="width: 10%;"></td> <td style="width: 10%;"></td> <td style="width: 10%;"></td> <td style="width: 10%;"></td> </tr> <tr> <td></td> <td></td> <td colspan="8" style="text-align: center;"> <table border="1" style="width: 100%; border-collapse: collapse; text-align: center;"> <tr> <td style="width: 10%;"></td> <td style="width: 10%;"></td> <td style="width: 10%;"></td> <td style="width: 10%;"></td> <td style="width: 10%;"></td> <td style="width: 10%;"></td> <td style="width: 10%;"></td> <td style="width: 10%;"></td> <td style="width: 10%;"></td> <td style="width: 10%;"></td> </tr> <tr> <td></td> <td></td> <td colspan="8" style="text-align: center;"> <table border="1" style="width: 100%; border-collapse: collapse; text-align: center;"> <tr> <td style="width: 10%;"></td> <td style="width: 10%;"></td> <td style="width: 10%;"></td> <td style="width: 10%;"></td> <td style="width: 10%;"></td> <td style="width: 10%;"></td> <td style="width: 10%;"></td> <td style="width: 10%;"></td> <td style="width: 10%;"></td> <td style="width: 10%;"></td> </tr> <tr> <td></td> <td></td> <td colspan="8" style="text-align: center;"> <table border="1" style="width: 100%; border-collapse: collapse; text-align: center;"> <tr> <td style="width: 10%;"></td> <td style="width: 10%;"></td> <td style="width: 10%;"></td> <td style="width: 10%;"></td> <td style="width: 10%;"></td> <td style="width: 10%;"></td> <td style="width: 10%;"></td> <td style="width: 10%;"></td> <td style="width: 10%;"></td> <td style="width: 10%;"></td> </tr> <tr> <td></td> <td></td> <td colspan="8" style="text-align: center;"> <table border="1" style="width: 100%; border-collapse: collapse; text-align: center;"> <tr> <td style="width: 10%;"></td> <td style="width: 10%;"></td> <td style="width: 10%;"></td> <td style="width: 10%;"></td> <td style="width: 10%;"></td> <td style="width: 10%;"></td> <td style="width: 10%;"></td> <td style="width: 10%;"></td> <td style="width: 10%;"></td> <td style="width: 10%;"></td> </tr> <tr> <td></td> <td></td> <td colspan="8" style="text-align: center;"> <table border="1" style="width: 100%; border-collapse: collapse; text-align: center;"> <tr> <td style="width: 10%;"></td> <td style="width: 10%;"></td> <td style="width: 10%;"></td> <td style="width: 10%;"></td> <td style="width: 10%;"></td> <td style="width: 10%;"></td> <td style="width: 10%;"></td> <td style="width: 10%;"></td> <td style="width: 10%;"></td> <td style="width: 10%;"></td> </tr> <tr> <td></td> <td></td> <td colspan="8" style="text-align: center;"> <table border="1" style="width: 100%; border-collapse: collapse; text-align: center;"> <tr> <td style="width: 10%;"></td> <td style="width: 10%;"></td> <td style="width: 10%;"></td> <td style="width: 10%;"></td> <td style="width: 10%;"></td> <td style="width: 10%;"></td> <td style="width: 10%;"></td> <td style="width: 10%;"></td> <td style="width: 10%;"></td> <td style="width: 10%;"></td> </tr> <tr> <td></td> <td></td> <td colspan="8" style="text-align: center;"> <table border="1" style="width: 100%; border-collapse: collapse; text-align: center;"> <tr> <td style="width: 10%;"></td> <td style="width: 10%;"></td> <td style="width: 10%;"></td> <td style="width: 10%;"></td> <td style="width: 10%;"></td> <td style="width: 10%;"></td> <td style="width: 10%;"></td> <td style="width: 10%;"></td> <td style="width: 10%;"></td> <td style="width: 10%;"></td> </tr> <tr> <td></td> <td></td> <td colspan="8" style="text-align: center;"> <table border="1" style="width: 100%; border-collapse: collapse; text-align: center;"> <tr> <td style="width: 10%;"></td> <td style="width: 10%;"></td> <td style="width: 10%;"></td> <td style="width: 10%;"></td> <td style="width: 10%;"></td> <td style="width: 10%;"></td> <td style="width: 10%;"></td> <td style="width: 10%;"></td> <td style="width: 10%;"></td> <td style="width: 10%;"></td> </tr> <tr> <td></td> <td></td> <td colspan="8" style="text-align: center;"> <table border="1" style="width: 100%; border-collapse: collapse; text-align: center;"> <tr> <td style="width: 10%;"></td> <td style="width: 10%;"></td> <td style="width: 10%;"></td> <td style="width: 10%;"></td> <td style="width: 10%;"></td> <td style="width: 10%;"></td> <td style="width: 10%;"></td> <td style="width: 10%;"></td> <td style="width: 10%;"></td> <td style="width: 10%;"></td> </tr> <tr> <td></td> <td></td> <td colspan="8" style="text-align: center;"> <table border="1" style="width: 100%; border-collapse: collapse; text-align: center;"> <tr> <td style="width: 10%;"></td> <td style="width: 10%;"></td> <td style="width: 10%;"></td> <td style="width: 10%;"></td> <td style="width: 10%;"></td> <td style="width: 10%;"></td> <td style="width: 10%;"></td> <td style="width: 10%;"></td> <td style="width: 10%;"></td> <td style="width: 10%;"></td> </tr> <tr> <td></td> <td></td> <td colspan="8" style="text-align: center;"> <table border="1" style="width: 100%; border-collapse: collapse; text-align: center;"> <tr> <td style="width: 10%;"></td> <td style="width: 10%;"></td> <td style="width: 10%;"></td> <td style="width: 10%;"></td> <td style="width: 10%;"></td> <td style="width: 10%;"></td> <td style="width: 10%;"></td> <td style="width: 10%;"></td> <td style="width: 10%;"></td> <td style="width: 10%;"></td> </tr> <tr> <td></td> <td></td> <td colspan="8" style="text-align: center;"> <table border="1" style="width: 100%; border-collapse: collapse; text-align: center;"> <tr> <td style="width: 10%;"></td> <td style="width: 10%;"></td> <td style="width: 10%;"></td> <td style="width: 10%;"></td> <td style="width: 10%;"></td> <td style="width: 10%;"></td> <td style="width: 10%;"></td> <td style="width: 10%;"></td> <td style="width: 10%;"></td> <td style="width: 10%;"></td> </tr> <tr> <td></td> <td></td> <td colspan="8" style="text-align: center;"> <table border="1" style="width: 100%; border-collapse: collapse; text-align: center;"> <tr> <td style="width: 10%;"></td> <td style="width: 10%;"></td> <td style="width: 10%;"></td> <td style="width: 10%;"></td> <td style="width: 10%;"></td> <td style="width: 10%;"></td> <td style="width: 10%;"></td> <td style="width: 10%;"></td> <td style="width: 10%;"></td> <td style="width: 10%;"></td> </tr> <tr> <td></td> <td></td> <td colspan="8" style="text-align: center;"> <table border="1" style="width: 100%; border-collapse: collapse; text-align: center;"> <tr> <td style="width: 10%;"></td> <td style="width: 10%;"></td> <td style="width: 10%;"></td> <td style="width: 10%;"></td> <td style="width: 10%;"></td> <td style="width: 10%;"></td> <td style="width: 10%;"></td> <td style="width: 10%;"></td> <td style="width: 10%;"></td> <td style="width: 10%;"></td> </tr> <tr> <td></td> <td></td> <td colspan="8" style="text-align: center;"> <table border="1" style="width: 100%; border-collapse: collapse; text-align: center;"> <tr> <td style="width: 10%;"></td> <td style="width: 10%;"></td> <td style="width: 10%;"></td> <td style="width: 10%;"></td> <td style="width: 10%;"></td> <td style="width: 10%;"></td> <td style="width: 10%;"></td> <td style="width: 10%;"></td> <td style="width: 10%;"></td> <td style="width: 10%;"></td> </tr> <tr> <td></td> <td></td> <td colspan="8" style="text-align: center;"> <table border="1" style="width: 100%; border-collapse: collapse; text-align: center;"> <tr> <td style="width: 10%;"></td> <td style="width: 10%;"></td> <td style="width: 10%;"></td> <td style="width: 10%;"></td> <td style="width: 10%;"></td> <td style="width: 10%;"></td> <td style="width: 10%;"></td> <td style="width: 10%;"></td> <td style="width: 10%;"></td> <td style="width: 10%;"></td> </tr> <tr> <td></td> <td></td> <td colspan="8" style="text-align: center;"> <table border="1" style="width: 100%; border-collapse: collapse; text-align: center;"> <tr> <td style="width: 10%;"></td> <td style="width: 10%;"></td> <td style="width: 10%;"></td> <td style="width: 10%;"></td> <td style="width: 10%;"></td> <td style="width: 10%;"></td> <td style="width: 10%;"></td> <td style="width: 10%;"></td> <td style="width: 10%;"></td> <td style="width: 10%;"></td> </tr> <tr> <td></td> <td></td> <td colspan="8" style="text-align: center;"> <table border="1" style="width: 100%; border-collapse: collapse; text-align: center;"> <tr> </tr></table></td></tr></table></td></tr></table></td></tr></table></td></tr></table></td></tr></table></td></tr></table></td></tr></table></td></tr></table></td></tr></table></td></tr></table></td></tr></table></td></tr></table></td></tr></table></td></tr></table></td></tr></table></td></tr></table></td></tr></table></td></tr></table></td></tr></table></td></tr></table></td></tr></table></td></tr></table></td></tr></table></td></tr></table></td></tr></table></td></tr></table>
 | | | | | | | | | | | | | | | | | | | | <table border="1" style="width: 100%; border-collapse: collapse; text-align: center;"> <tr> <td style="width: 10%;"></td> <td style="width: 10%;"></td> <td style="width: 10%;"></td> <td style="width: 10%;"></td> <td style="width: 10%;"></td> <td style="width: 10%;"></td> <td style="width: 10%;"></td> <td style="width: 10%;"></td> <td style="width: 10%;"></td> <td style="width: 10%;"></td> </tr> <tr> <td></td> <td></td> <td colspan="8" style="text-align: center;"> <table border="1" style="width: 100%; border-collapse: collapse; text-align: center;"> <tr> <td style="width: 10%;"></td> <td style="width: 10%;"></td> <td style="width: 10%;"></td> <td style="width: 10%;"></td> <td style="width: 10%;"></td> <td style="width: 10%;"></td> <td style="width: 10%;"></td> <td style="width: 10%;"></td> <td style="width: 10%;"></td> <td style="width: 10%;"></td> </tr> <tr> <td></td> <td></td> <td colspan="8" style="text-align: center;"> <table border="1" style="width: 100%; border-collapse: collapse; text-align: center;"> <tr> <td style="width: 10%;"></td> <td style="width: 10%;"></td> <td style="width: 10%;"></td> <td style="width: 10%;"></td> <td style="width: 10%;"></td> <td style="width: 10%;"></td> <td style="width: 10%;"></td> <td style="width: 10%;"></td> <td style="width: 10%;"></td> <td style="width: 10%;"></td> </tr> <tr> <td></td> <td></td> <td colspan="8" style="text-align: center;"> <table border="1" style="width: 100%; border-collapse: collapse; text-align: center;"> <tr> <td style="width: 10%;"></td> <td style="width: 10%;"></td> <td style="width: 10%;"></td> <td style="width: 10%;"></td> <td style="width: 10%;"></td> <td style="width: 10%;"></td> <td style="width: 10%;"></td> <td style="width: 10%;"></td> <td style="width: 10%;"></td> <td style="width: 10%;"></td> </tr> <tr> <td></td> <td></td> <td colspan="8" style="text-align: center;"> <table border="1" style="width: 100%; border-collapse: collapse; text-align: center;"> <tr> <td style="width: 10%;"></td> <td style="width: 10%;"></td> <td style="width: 10%;"></td> <td style="width: 10%;"></td> <td style="width: 10%;"></td> <td style="width: 10%;"></td> <td style="width: 10%;"></td> <td style="width: 10%;"></td> <td style="width: 10%;"></td> <td style="width: 10%;"></td> </tr> <tr> <td></td> <td></td> <td colspan="8" style="text-align: center;"> <table border="1" style="width: 100%; border-collapse: collapse; text-align: center;"> <tr> <td style="width: 10%;"></td> <td style="width: 10%;"></td> <td style="width: 10%;"></td> <td style="width: 10%;"></td> <td style="width: 10%;"></td> <td style="width: 10%;"></td> <td style="width: 10%;"></td> <td style="width: 10%;"></td> <td style="width: 10%;"></td> <td style="width: 10%;"></td> </tr> <tr> <td></td> <td></td> <td colspan="8" style="text-align: center;"> <table border="1" style="width: 100%; border-collapse: collapse; text-align: center;"> <tr> <td style="width: 10%;"></td> <td style="width: 10%;"></td> <td style="width: 10%;"></td> <td style="width: 10%;"></td> <td style="width: 10%;"></td> <td style="width: 10%;"></td> <td style="width: 10%;"></td> <td style="width: 10%;"></td> <td style="width: 10%;"></td> <td style="width: 10%;"></td> </tr> <tr> <td></td> <td></td> <td colspan="8" style="text-align: center;"> <table border="1" style="width: 100%; border-collapse: collapse; text-align: center;"> <tr> <td style="width: 10%;"></td> <td style="width: 10%;"></td> <td style="width: 10%;"></td> <td style="width: 10%;"></td> <td style="width: 10%;"></td> <td style="width: 10%;"></td> <td style="width: 10%;"></td> <td style="width: 10%;"></td> <td style="width: 10%;"></td> <td
style="width: 10%;"></td> </tr> <tr> <td></td> <td></td> <td colspan="8" style="text-align: center;"> <table border="1" style="width: 100%; border-collapse: collapse; text-align: center;"> <tr> <td style="width: 10%;"></td> <td style="width: 10%;"></td> <td style="width: 10%;"></td> <td style="width: 10%;"></td> <td style="width: 10%;"></td> <td style="width: 10%;"></td> <td style="width: 10%;"></td> <td style="width: 10%;"></td> <td style="width: 10%;"></td> <td style="width: 10%;"></td> </tr> <tr> <td></td> <td></td> <td colspan="8" style="text-align: center;"> <table border="1" style="width: 100%; border-collapse: collapse; text-align: center;"> <tr> <td style="width: 10%;"></td> <td style="width: 10%;"></td> <td style="width: 10%;"></td> <td style="width: 10%;"></td> <td style="width: 10%;"></td> <td style="width: 10%;"></td> <td style="width: 10%;"></td> <td style="width: 10%;"></td> <td style="width: 10%;"></td> <td style="width: 10%;"></td> </tr> <tr> <td></td> <td></td> <td colspan="8" style="text-align: center;"> <table border="1" style="width: 100%; border-collapse: collapse; text-align: center;"> <tr> <td style="width: 10%;"></td> <td style="width: 10%;"></td> <td style="width: 10%;"></td> <td style="width: 10%;"></td> <td style="width: 10%;"></td> <td style="width: 10%;"></td> <td style="width: 10%;"></td> <td style="width: 10%;"></td> <td style="width: 10%;"></td> <td style="width: 10%;"></td> </tr> <tr> <td></td> <td></td> <td colspan="8" style="text-align: center;"> <table border="1" style="width: 100%; border-collapse: collapse; text-align: center;"> <tr> <td style="width: 10%;"></td> <td style="width: 10%;"></td> <td style="width: 10%;"></td> <td style="width: 10%;"></td> <td style="width: 10%;"></td> <td style="width: 10%;"></td> <td style="width: 10%;"></td> <td style="width: 10%;"></td> <td style="width: 10%;"></td> <td style="width: 10%;"></td> </tr> <tr> <td></td> <td></td> <td colspan="8" style="text-align: center;"> <table border="1" style="width: 100%; border-collapse: collapse; text-align: center;"> <tr> <td style="width: 10%;"></td> <td style="width: 10%;"></td> <td style="width: 10%;"></td> <td style="width: 10%;"></td> <td style="width: 10%;"></td> <td style="width: 10%;"></td> <td style="width: 10%;"></td> <td style="width: 10%;"></td> <td style="width: 10%;"></td> <td style="width: 10%;"></td> </tr> <tr> <td></td> <td></td> <td colspan="8" style="text-align: center;"> <table border="1" style="width: 100%; border-collapse: collapse; text-align: center;"> <tr> <td style="width: 10%;"></td> <td style="width: 10%;"></td> <td style="width: 10%;"></td> <td style="width: 10%;"></td> <td style="width: 10%;"></td> <td style="width: 10%;"></td> <td style="width: 10%;"></td> <td style="width: 10%;"></td> <td style="width: 10%;"></td> <td style="width: 10%;"></td> </tr> <tr> <td></td> <td></td> <td colspan="8" style="text-align: center;"> <table border="1" style="width: 100%; border-collapse: collapse; text-align: center;"> <tr> <td style="width: 10%;"></td> <td style="width: 10%;"></td> <td style="width: 10%;"></td> <td style="width: 10%;"></td> <td style="width: 10%;"></td> <td style="width: 10%;"></td> <td style="width: 10%;"></td> <td style="width: 10%;"></td> <td style="width: 10%;"></td> <td style="width: 10%;"></td> </tr> <tr> <td></td> <td></td> <td colspan="8" style="text-align: center;"> <table border="1" style="width: 100%; border-collapse: collapse; text-align: center;"> <tr> <td style="width: 10%;"></td> <td style="width: 10%;"></td> <td style="width: 10%;"></td> <td style="width: 10%;"></td> <td style="width: 10%;"></td> <td style="width: 10%;"></td> <td style="width: 10%;"></td> <td style="width: 10%;"></td> <td style="width: 10%;"></td> <td style="width: 10%;"></td> </tr> <tr> <td></td> <td></td> <td colspan="8" style="text-align: center;"> <table border="1" style="width: 100%; border-collapse: collapse; text-align: center;"> <tr> <td style="width: 10%;"></td> <td style="width: 10%;"></td> <td style="width: 10%;"></td> <td style="width: 10%;"></td> <td style="width: 10%;"></td> <td style="width: 10%;"></td> <td style="width: 10%;"></td> <td style="width: 10%;"></td> <td style="width: 10%;"></td> <td style="width: 10%;"></td> </tr> <tr> <td></td> <td></td> <td colspan="8" style="text-align: center;"> <table border="1" style="width: 100%; border-collapse: collapse; text-align: center;"> <tr> <td style="width: 10%;"></td> <td style="width: 10%;"></td> <td style="width: 10%;"></td> <td style="width: 10%;"></td> <td style="width: 10%;"></td> <td style="width: 10%;"></td> <td style="width: 10%;"></td> <td style="width: 10%;"></td> <td style="width: 10%;"></td> <td style="width: 10%;"></td> </tr> <tr> <td></td> <td></td> <td colspan="8" style="text-align: center;"> <table border="1" style="width: 100%; border-collapse: collapse; text-align: center;"> <tr> <td style="width: 10%;"></td> <td style="width: 10%;"></td> <td style="width: 10%;"></td> <td style="width: 10%;"></td> <td style="width: 10%;"></td> <td style="width: 10%;"></td> <td style="width: 10%;"></td> <td style="width: 10%;"></td> <td style="width: 10%;"></td> <td style="width: 10%;"></td> </tr> <tr> <td></td> <td></td> <td colspan="8" style="text-align: center;"> <table border="1" style="width: 100%; border-collapse: collapse; text-align: center;"> <tr> <td style="width: 10%;"></td> <td style="width: 10%;"></td> <td style="width: 10%;"></td> <td style="width: 10%;"></td> <td style="width: 10%;"></td> <td style="width: 10%;"></td> <td style="width: 10%;"></td> <td style="width: 10%;"></td> <td style="width: 10%;"></td> <td style="width: 10%;"></td> </tr> <tr> <td></td> <td></td> <td colspan="8" style="text-align: center;"> <table border="1" style="width: 100%; border-collapse: collapse; text-align: center;"> <tr> <td style="width: 10%;"></td> <td style="width: 10%;"></td> <td style="width: 10%;"></td> <td style="width: 10%;"></td> <td style="width: 10%;"></td> <td style="width: 10%;"></td> <td style="width: 10%;"></td> <td style="width: 10%;"></td> <td style="width: 10%;"></td> <td style="width: 10%;"></td> </tr> <tr> <td></td> <td></td> <td colspan="8" style="text-align: center;"> <table border="1" style="width: 100%; border-collapse: collapse; text-align: center;"> <tr> <td style="width: 10%;"></td> <td style="width: 10%;"></td> <td style="width: 10%;"></td> <td style="width: 10%;"></td> <td style="width: 10%;"></td> <td style="width: 10%;"></td> <td style="width: 10%;"></td> <td style="width: 10%;"></td> <td style="width: 10%;"></td> <td style="width: 10%;"></td> </tr> <tr> <td></td> <td></td> <td colspan="8" style="text-align: center;"> <table border="1" style="width: 100%; border-collapse: collapse; text-align: center;"> <tr> <td style="width: 10%;"></td> <td style="width: 10%;"></td> <td style="width: 10%;"></td> <td style="width: 10%;"></td> <td style="width: 10%;"></td> <td style="width: 10%;"></td> <td style="width: 10%;"></td> <td style="width: 10%;"></td> <td style="width: 10%;"></td> <td style="width: 10%;"></td> </tr> <tr> <td></td> <td></td> <td colspan="8" style="text-align: center;"> <table border="1" style="width: 100%; border-collapse: collapse; text-align: center;"> <tr> <td style="width: 10%;"></td> <td style="width: 10%;"></td> <td style="width: 10%;"></td> <td style="width: 10%;"></td> <td style="width: 10%;"></td> <td style="width: 10%;"></td> <td style="width: 10%;"></td> <td style="width: 10%;"></td> <td style="width: 10%;"></td> <td style="width: 10%;"></td> </tr> <tr> <td></td> <td></td> <td colspan="8" style="text-align: center;"> <table border="1" style="width: 100%; border-collapse: collapse; text-align: center;"> <tr> <td style="width: 10%;"></td> <td style="width: 10%;"></td> <td style="width: 10%;"></td> <td style="width: 10%;"></td> <td style="width: 10%;"></td> <td style="width: 10%;"></td> <td style="width: 10%;"></td> <td style="width: 10%;"></td> <td style="width: 10%;"></td> <td style="width: 10%;"></td> </tr> <tr> <td></td> <td></td> <td colspan="8" style="text-align: center;"> <table border="1" style="width: 100%; border-collapse: collapse; text-align: center;"> <tr> </tr></table></td></tr></table></td></tr></table></td></tr></table></td></tr></table></td></tr></table></td></tr></table></td></tr></table></td></tr></table></td></tr></table></td></tr></table></td></tr></table></td></tr></table></td></tr></table></td></tr></table></td></tr></table></td></tr></table></td></tr></table></td></tr></table></td></tr></table></td></tr></table></td></tr></table></td></tr></table></td></tr></table></td></tr></table></td></tr></table>
 | | | | | | | | | | | | | | | | | | | | <table border="1" style="width: 100%; border-collapse: collapse; text-align: center;"> <tr> <td style="width: 10%;"></td> <td style="width: 10%;"></td> <td style="width: 10%;"></td> <td style="width: 10%;"></td> <td style="width: 10%;"></td> <td style="width: 10%;"></td> <td style="width: 10%;"></td> <td style="width: 10%;"></td> <td style="width: 10%;"></td> <td style="width: 10%;"></td> </tr> <tr> <td></td> <td></td> <td colspan="8" style="text-align: center;"> <table border="1" style="width: 100%; border-collapse: collapse; text-align: center;"> <tr> <td style="width: 10%;"></td> <td style="width: 10%;"></td> <td style="width: 10%;"></td> <td style="width: 10%;"></td> <td style="width: 10%;"></td> <td style="width: 10%;"></td> <td style="width: 10%;"></td> <td style="width: 10%;"></td> <td style="width: 10%;"></td> <td style="width: 10%;"></td> </tr> <tr> <td></td> <td></td> <td colspan="8" style="text-align: center;"> <table border="1" style="width: 100%; border-collapse: collapse; text-align: center;"> <tr> <td style="width: 10%;"></td> <td style="width: 10%;"></td> <td style="width: 10%;"></td> <td style="width: 10%;"></td> <td style="width: 10%;"></td> <td style="width: 10%;"></td> <td style="width: 10%;"></td> <td style="width: 10%;"></td> <td style="width: 10%;"></td> <td style="width: 10%;"></td> </tr> <tr> <td></td> <td></td> <td colspan="8" style="text-align: center;"> <table border="1" style="width: 100%; border-collapse: collapse; text-align: center;"> <tr> <td style="width: 10%;"></td> <td style="width: 10%;"></td> <td style="width: 10%;"></td> <td style="width: 10%;"></td> <td style="width: 10%;"></td> <td style="width: 10%;"></td> <td style="width: 10%;"></td> <td style="width: 10%;"></td> <td style="width: 10%;"></td> <td style="width: 10%;"></td> </tr> <tr> <td></td> <td></td> <td colspan="8" style="text-align: center;"> <table border="1" style="width: 100%; border-collapse: collapse; text-align: center;"> <tr> <td style="width: 10%;"></td> <td style="width: 10%;"></td> <td style="width: 10%;"></td> <td style="width: 10%;"></td> <td style="width: 10%;"></td> <td style="width: 10%;"></td> <td style="width: 10%;"></td> <td style="width: 10%;"></td> <td style="width: 10%;"></td> <td style="width: 10%;"></td> </tr> <tr> <td></td> <td></td> <td colspan="8" style="text-align: center;"> <table border="1" style="width: 100%; border-collapse: collapse; text-align: center;"> <tr> <td style="width: 10%;"></td> <td style="width: 10%;"></td> <td style="width: 10%;"></td> <td style="width: 10%;"></td> <td style="width: 10%;"></td> <td style="width: 10%;"></td> <td style="width: 10%;"></td> <td style="width: 10%;"></td> <td style="width: 10%;"></td> <td style="width: 10%;"></td> </tr> <tr> <td></td> <td></td> <td colspan="8" style="text-align: center;"> <table border="1" style="width: 100%; border-collapse: collapse; text-align: center;"> <tr> <td style="width: 10%;"></td> <td style="width: 10%;"></td> <td style="width: 10%;"></td> <td style="width: 10%;"></td> <td style="width: 10%;"></td> <td style="width: 10%;"></td> <td style="width: 10%;"></td> <td style="width: 10%;"></td> <td style="width: 10%;"></td> <td style="width: 10%;"></td> </tr> <tr> <td></td> <td></td> <td colspan="8" style="text-align: center;"> <table border="1" style="width: 100%; border-collapse: collapse; text-align: center;"> <tr> <td style="width: 10%;"></td> <td style="width: 10%;"></td> <td style="width: 10%;"></td> <td style="width: 10%;"></td> <td style="width: 10%;"></td> <td style="width: 10%;"></td> <td style="width: 10%;"></td> <td style="width: 10%;"></td> <td style="width: 10%;"></td> <td style="width: 10%;"></td> </tr> <tr> <td></td> <td></td> <td colspan="8" style="text-align: center;"> <table border="1" style="width: 100%; border-collapse: collapse; text-align: center;"> <tr> <td style="width: 10%;"></td> <td style="width: 10%;"></td> <td style="width: 10%;"></td> <td style="width: 10%;"></td> <td style="width: 10%;"></td> <td style="width: 10%;"></td> <td style="width: 10%;"></td> <td style="width: 10%;"></td> <td style="width: 10%;"></td> <td style="width: 10%;"></td> </tr> <tr> <td></td> <td></td> <td colspan="8" style="text-align: center;"> <table border="1" style="width: 100%; border-collapse: collapse; text-align: center;"> <tr> <td style="width: 10%;"></td> <td style="width: 10%;"></td> <td style="width: 10%;"></td> <td style="width: 10%;"></td> <td style="width: 10%;"></td> <td style="width: 10%;"></td> <td style="width: 10%;"></td> <td style="width: 10%;"></td> <td style="width: 10%;"></td> <td style="width: 10%;"></td> </tr> <tr> <td></td> <td></td> <td colspan="8" style="text-align: center;"> <table border="1" style="width: 100%; border-collapse: collapse; text-align: center;"> <tr> <td style="width: 10%;"></td> <td style="width: 10%;"></td> <td style="width: 10%;"></td> <td style="width: 10%;"></td> <td style="width: 10%;"></td> <td style="width: 10%;"></td> <td style="width: 10%;"></td> <td style="width:
10%;"></td> <td style="width: 10%;"></td> <td style="width: 10%;"></td> </tr> <tr> <td></td> <td></td> <td colspan="8" style="text-align: center;"> <table border="1" style="width: 100%; border-collapse: collapse; text-align: center;"> <tr> <td style="width: 10%;"></td> <td style="width: 10%;"></td> <td style="width: 10%;"></td> <td style="width: 10%;"></td> <td style="width: 10%;"></td> <td style="width: 10%;"></td> <td style="width: 10%;"></td> <td style="width: 10%;"></td> <td style="width: 10%;"></td> <td style="width: 10%;"></td> </tr> <tr> <td></td> <td></td> <td colspan="8" style="text-align: center;"> <table border="1" style="width: 100%; border-collapse: collapse; text-align: center;"> <tr> <td style="width: 10%;"></td> <td style="width: 10%;"></td> <td style="width: 10%;"></td> <td style="width: 10%;"></td> <td style="width: 10%;"></td> <td style="width: 10%;"></td> <td style="width: 10%;"></td> <td style="width: 10%;"></td> <td style="width: 10%;"></td> <td style="width: 10%;"></td> </tr> <tr> <td></td> <td></td> <td colspan="8" style="text-align: center;"> <table border="1" style="width: 100%; border-collapse: collapse; text-align: center;"> <tr> <td style="width: 10%;"></td> <td style="width: 10%;"></td> <td style="width: 10%;"></td> <td style="width: 10%;"></td> <td style="width: 10%;"></td> <td style="width: 10%;"></td> <td style="width: 10%;"></td> <td style="width: 10%;"></td> <td style="width: 10%;"></td> <td style="width: 10%;"></td> </tr> <tr> <td></td> <td></td> <td colspan="8" style="text-align: center;"> <table border="1" style="width: 100%; border-collapse: collapse; text-align: center;"> <tr> <td style="width: 10%;"></td> <td style="width: 10%;"></td> <td style="width: 10%;"></td> <td style="width: 10%;"></td> <td style="width: 10%;"></td> <td style="width: 10%;"></td> <td style="width: 10%;"></td> <td style="width: 10%;"></td> <td style="width: 10%;"></td> <td style="width: 10%;"></td> </tr> <tr> <td></td> <td></td> <td colspan="8" style="text-align: center;"> <table border="1" style="width: 100%; border-collapse: collapse; text-align: center;"> <tr> <td style="width: 10%;"></td> <td style="width: 10%;"></td> <td style="width: 10%;"></td> <td style="width: 10%;"></td> <td style="width: 10%;"></td> <td style="width: 10%;"></td> <td style="width: 10%;"></td> <td style="width: 10%;"></td> <td style="width: 10%;"></td> <td style="width: 10%;"></td> </tr> <tr> <td></td> <td></td> <td colspan="8" style="text-align: center;"> <table border="1" style="width: 100%; border-collapse: collapse; text-align: center;"> <tr> <td style="width: 10%;"></td> <td style="width: 10%;"></td> <td style="width: 10%;"></td> <td style="width: 10%;"></td> <td style="width: 10%;"></td> <td style="width: 10%;"></td> <td style="width: 10%;"></td> <td style="width: 10%;"></td> <td style="width: 10%;"></td> <td style="width: 10%;"></td> </tr> <tr> <td></td> <td></td> <td colspan="8" style="text-align: center;"> <table border="1" style="width: 100%; border-collapse: collapse; text-align: center;"> <tr> <td style="width: 10%;"></td> <td style="width: 10%;"></td> <td style="width: 10%;"></td> <td style="width: 10%;"></td> <td style="width: 10%;"></td> <td style="width: 10%;"></td> <td style="width: 10%;"></td> <td style="width: 10%;"></td> <td style="width: 10%;"></td> <td style="width: 10%;"></td> </tr> <tr> <td></td> <td></td> <td colspan="8" style="text-align: center;"> <table border="1" style="width: 100%; border-collapse: collapse; text-align: center;"> <tr> <td style="width: 10%;"></td> <td style="width: 10%;"></td> <td style="width: 10%;"></td> <td style="width: 10%;"></td> <td style="width: 10%;"></td> <td style="width: 10%;"></td> <td style="width: 10%;"></td> <td style="width: 10%;"></td> <td style="width: 10%;"></td> <td style="width: 10%;"></td> </tr> <tr> <td></td> <td></td> <td colspan="8" style="text-align: center;"> <table border="1" style="width: 100%; border-collapse: collapse; text-align: center;"> <tr> <td style="width: 10%;"></td> <td style="width: 10%;"></td> <td style="width: 10%;"></td> <td style="width: 10%;"></td> <td style="width: 10%;"></td> <td style="width: 10%;"></td> <td style="width: 10%;"></td> <td style="width: 10%;"></td> <td style="width: 10%;"></td> <td style="width: 10%;"></td> </tr> <tr> <td></td> <td></td> <td colspan="8" style="text-align: center;"> <table border="1" style="width: 100%; border-collapse: collapse; text-align: center;"> <tr> <td style="width: 10%;"></td> <td style="width: 10%;"></td> <td style="width: 10%;"></td> <td style="width: 10%;"></td> <td style="width: 10%;"></td> <td style="width: 10%;"></td> <td style="width: 10%;"></td> <td style="width: 10%;"></td> <td style="width: 10%;"></td> <td style="width: 10%;"></td> </tr> <tr> <td></td> <td></td> <td colspan="8" style="text-align: center;"> <table border="1" style="width: 100%; border-collapse: collapse; text-align: center;"> <tr> <td style="width: 10%;"></td> <td style="width: 10%;"></td> <td style="width: 10%;"></td> <td style="width: 10%;"></td> <td style="width: 10%;"></td> <td style="width: 10%;"></td> <td style="width: 10%;"></td> <td style="width: 10%;"></td> <td style="width: 10%;"></td> <td style="width: 10%;"></td> </tr> <tr> <td></td> <td></td> <td colspan="8" style="text-align: center;"> <table border="1" style="width: 100%; border-collapse: collapse; text-align: center;"> <tr> <td style="width: 10%;"></td> <td style="width: 10%;"></td> <td style="width: 10%;"></td> <td style="width: 10%;"></td> <td style="width: 10%;"></td> <td style="width: 10%;"></td> <td style="width: 10%;"></td> <td style="width: 10%;"></td> <td style="width: 10%;"></td> <td style="width: 10%;"></td> </tr> <tr> <td></td> <td></td> <td colspan="8" style="text-align: center;"> <table border="1" style="width: 100%; border-collapse: collapse; text-align: center;"> <tr> <td style="width: 10%;"></td> <td style="width: 10%;"></td> <td style="width: 10%;"></td> <td style="width: 10%;"></td> <td style="width: 10%;"></td> <td style="width: 10%;"></td> <td style="width: 10%;"></td> <td style="width: 10%;"></td> <td style="width: 10%;"></td> <td style="width: 10%;"></td> </tr> <tr> <td></td> <td></td> <td colspan="8" style="text-align: center;"> <table border="1" style="width: 100%; border-collapse: collapse; text-align: center;"> <tr> </tr></table></td></tr></table></td></tr></table></td></tr></table></td></tr></table></td></tr></table></td></tr></table></td></tr></table></td></tr></table></td></tr></table></td></tr></table></td></tr></table></td></tr></table></td></tr></table></td></tr></table></td></tr></table></td></tr></table></td></tr></table></td></tr></table></td></tr></table></td></tr></table></td></tr></table></td></tr></table></td></tr></table></td></tr></table>
 | | | | | | | | | | | | | | | | | | | | <table border="1" style="width: 100%; border-collapse: collapse; text-align: center;"> <tr> <td style="width: 10%;"></td> <td style="width: 10%;"></td> <td style="width: 10%;"></td> <td style="width: 10%;"></td> <td style="width: 10%;"></td> <td style="width: 10%;"></td> <td style="width: 10%;"></td> <td style="width: 10%;"></td> <td style="width: 10%;"></td> <td style="width: 10%;"></td> </tr> <tr> <td></td> <td></td> <td colspan="8" style="text-align: center;"> <table border="1" style="width: 100%; border-collapse: collapse; text-align: center;"> <tr> <td style="width: 10%;"></td> <td style="width: 10%;"></td> <td style="width: 10%;"></td> <td style="width: 10%;"></td> <td style="width: 10%;"></td> <td style="width: 10%;"></td> <td style="width: 10%;"></td> <td style="width: 10%;"></td> <td style="width: 10%;"></td> <td style="width: 10%;"></td> </tr> <tr> <td></td> <td></td> <td colspan="8" style="text-align: center;"> <table border="1" style="width: 100%; border-collapse: collapse; text-align: center;"> <tr> <td style="width: 10%;"></td> <td style="width: 10%;"></td> <td style="width: 10%;"></td> <td style="width: 10%;"></td> <td style="width: 10%;"></td> <td style="width: 10%;"></td> <td style="width: 10%;"></td> <td style="width: 10%;"></td> <td style="width: 10%;"></td> <td style="width: 10%;"></td> </tr> <tr> <td></td> <td></td> <td colspan="8" style="text-align: center;"> <table border="1" style="width: 100%; border-collapse: collapse; text-align: center;"> <tr> <td style="width: 10%;"></td> <td style="width: 10%;"></td> <td style="width: 10%;"></td> <td style="width: 10%;"></td> <td style="width: 10%;"></td> <td style="width: 10%;"></td> <td style="width: 10%;"></td> <td style="width: 10%;"></td> <td style="width: 10%;"></td> <td style="width: 10%;"></td> </tr> <tr> <td></td> <td></td> <td colspan="8" style="text-align: center;"> <table border="1" style="width: 100%; border-collapse: collapse; text-align: center;"> <tr> <td style="width: 10%;"></td> <td style="width: 10%;"></td> <td style="width: 10%;"></td> <td style="width: 10%;"></td> <td style="width: 10%;"></td> <td style="width: 10%;"></td> <td style="width: 10%;"></td> <td style="width: 10%;"></td> <td style="width: 10%;"></td> <td style="width: 10%;"></td> </tr> <tr> <td></td> <td></td> <td colspan="8" style="text-align: center;"> <table border="1" style="width: 100%; border-collapse: collapse; text-align: center;"> <tr> <td style="width: 10%;"></td> <td style="width: 10%;"></td> <td style="width: 10%;"></td> <td style="width: 10%;"></td> <td style="width: 10%;"></td> <td style="width: 10%;"></td> <td style="width: 10%;"></td> <td style="width: 10%;"></td> <td style="width: 10%;"></td> <td style="width: 10%;"></td> </tr> <tr> <td></td> <td></td> <td colspan="8" style="text-align: center;"> <table border="1" style="width: 100%; border-collapse: collapse; text-align: center;"> <tr> <td style="width: 10%;"></td> <td style="width: 10%;"></td> <td style="width: 10%;"></td> <td style="width: 10%;"></td> <td style="width: 10%;"></td> <td style="width: 10%;"></td> <td style="width: 10%;"></td> <td style="width: 10%;"></td> <td style="width: 10%;"></td> <td style="width: 10%;"></td> </tr> <tr> <td></td> <td></td> <td colspan="8" style="text-align: center;"> <table border="1" style="width: 100%; border-collapse: collapse; text-align: center;"> <tr> <td style="width: 10%;"></td> <td style="width: 10%;"></td> <td style="width: 10%;"></td> <td style="width: 10%;"></td> <td style="width: 10%;"></td> <td style="width: 10%;"></td> <td style="width: 10%;"></td> <td style="width: 10%;"></td> <td style="width: 10%;"></td> <td style="width: 10%;"></td> </tr> <tr> <td></td> <td></td> <td colspan="8" style="text-align: center;"> <table border="1" style="width: 100%; border-collapse: collapse; text-align: center;"> <tr> <td style="width: 10%;"></td> <td style="width: 10%;"></td> <td style="width: 10%;"></td> <td style="width: 10%;"></td> <td style="width: 10%;"></td> <td style="width: 10%;"></td> <td style="width: 10%;"></td> <td style="width: 10%;"></td> <td style="width: 10%;"></td> <td style="width: 10%;"></td> </tr> <tr> <td></td> <td></td> <td colspan="8" style="text-align: center;"> <table border="1" style="width: 100%; border-collapse: collapse; text-align: center;"> <tr> <td style="width: 10%;"></td> <td style="width: 10%;"></td> <td style="width: 10%;"></td> <td style="width: 10%;"></td> <td style="width: 10%;"></td> <td style="width: 10%;"></td> <td style="width: 10%;"></td> <td style="width: 10%;"></td> <td style="width: 10%;"></td> <td style="width: 10%;"></td> </tr> <tr> <td></td> <td></td> <td colspan="8" style="text-align: center;"> <table border="1" style="width: 100%; border-collapse: collapse; text-align: center;"> <tr> <td style="width: 10%;"></td> <td style="width: 10%;"></td> <td style="width: 10%;"></td> <td style="width: 10%;"></td> <td style="width: 10%;"></td> <td style="width: 10%;"></td> <td style="width: 10%;"></td> <td style="width: 10%;"></td> <td style="width: 10%;"></td> <td style="width: 10%;"></td> </tr> <tr> <td></td> <td></td> <td colspan="8" style="text-align: center;"> <table border="1" style="width: 100%; border-collapse: collapse; text-align: center;"> <tr> <td style="width: 10%;"></td> <td style="width: 10%;"></td> <td style="width: 10%;"></td> <td style="width: 10%;"></td> <td style="width: 10%;"></td> <td style="width: 10%;"></td> <td style="width: 10%;"></td> <td style="width: 10%;"></td> <td style="width: 10%;"></td> <td style="width: 10%;"></td> </tr> <tr> <td></td> <td></td> <td colspan="8" style="text-align: center;"> <table border="1" style="width: 100%; border-collapse: collapse; text-align: center;"> <tr> <td style="width: 10%;"></td> <td style="width: 10%;"></td> <td style="width: 10%;"></td> <td style="width: 10%;"></td> <td style="width: 10%;"></td> <td style="width: 10%;"></td> <td style="width: 10%;"></td> <td style="width: 10%;"></td> <td style="width: 10%;"></td> <td style="width: 10%;"></td> </tr> <tr> <td></td> <td></td> <td colspan="8" style="text-align: center;"> <table border="1" style="width: 100%; border-collapse: collapse; text-align: center;"> <tr> <td style="width: 10%;"></td> <td style="width: 10%;"></td> <td style="width: 10%;"></td> <td style="width: 10%;"></td> <td style="width: 10%;"></td> <td style="width: 10%;"></td> <td style="width: 10%;"></td> <td style="width: 10%;"></td> <td style="width: 10%;"></td> <td style="width: 10%;"></td> </tr> <tr> <td></td> <td></td> <td colspan="8" style="text-align: center;"> <table border="1" style="width: 100%; border-collapse: collapse; text-align: center;"> <tr> <td style="width: 10%;"></td> <td style="width: 10%;"></td> <td style="width: 10%;"></td> <td style="width: 10%;"></td> <td style="width: 10%;"></td> <td style="width: 10%;"></td> <td style="width:
10%;"></td> <td style="width: 10%;"></td> <td style="width: 10%;"></td> <td style="width: 10%;"></td> </tr> <tr> <td></td> <td></td> <td colspan="8" style="text-align: center;"> <table border="1" style="width: 100%; border-collapse: collapse; text-align: center;"> <tr> <td style="width: 10%;"></td> <td style="width: 10%;"></td> <td style="width: 10%;"></td> <td style="width: 10%;"></td> <td style="width: 10%;"></td> <td style="width: 10%;"></td> <td style="width: 10%;"></td> <td style="width: 10%;"></td> <td style="width: 10%;"></td> <td style="width: 10%;"></td> </tr> <tr> <td></td> <td></td> <td colspan="8" style="text-align: center;"> <table border="1" style="width: 100%; border-collapse: collapse; text-align: center;"> <tr> <td style="width: 10%;"></td> <td style="width: 10%;"></td> <td style="width: 10%;"></td> <td style="width: 10%;"></td> <td style="width: 10%;"></td> <td style="width: 10%;"></td> <td style="width: 10%;"></td> <td style="width: 10%;"></td> <td style="width: 10%;"></td> <td style="width: 10%;"></td> </tr> <tr> <td></td> <td></td> <td colspan="8" style="text-align: center;"> <table border="1" style="width: 100%; border-collapse: collapse; text-align: center;"> <tr> <td style="width: 10%;"></td> <td style="width: 10%;"></td> <td style="width: 10%;"></td> <td style="width: 10%;"></td> <td style="width: 10%;"></td> <td style="width: 10%;"></td> <td style="width: 10%;"></td> <td style="width: 10%;"></td> <td style="width: 10%;"></td> <td style="width: 10%;"></td> </tr> <tr> <td></td> <td></td> <td colspan="8" style="text-align: center;"> <table border="1" style="width: 100%; border-collapse: collapse; text-align: center;"> <tr> <td style="width: 10%;"></td> <td style="width: 10%;"></td> <td style="width: 10%;"></td> <td style="width: 10%;"></td> <td style="width: 10%;"></td> <td style="width: 10%;"></td> <td style="width: 10%;"></td> <td style="width: 10%;"></td> <td style="width: 10%;"></td> <td style="width: 10%;"></td> </tr> <tr> <td></td> <td></td> <td colspan="8" style="text-align: center;"> <table border="1" style="width: 100%; border-collapse: collapse; text-align: center;"> <tr> <td style="width: 10%;"></td> <td style="width: 10%;"></td> <td style="width: 10%;"></td> <td style="width: 10%;"></td> <td style="width: 10%;"></td> <td style="width: 10%;"></td> <td style="width: 10%;"></td> <td style="width: 10%;"></td> <td style="width: 10%;"></td> <td style="width: 10%;"></td> </tr> <tr> <td></td> <td></td> <td colspan="8" style="text-align: center;"> <table border="1" style="width: 100%; border-collapse: collapse; text-align: center;"> <tr> <td style="width: 10%;"></td> <td style="width: 10%;"></td> <td style="width: 10%;"></td> <td style="width: 10%;"></td> <td style="width: 10%;"></td> <td style="width: 10%;"></td> <td style="width: 10%;"></td> <td style="width: 10%;"></td> <td style="width: 10%;"></td> <td style="width: 10%;"></td> </tr> <tr> <td></td> <td></td> <td colspan="8" style="text-align: center;"> <table border="1" style="width: 100%; border-collapse: collapse; text-align: center;"> <tr> <td style="width: 10%;"></td> <td style="width: 10%;"></td> <td style="width: 10%;"></td> <td style="width: 10%;"></td> <td style="width: 10%;"></td> <td style="width: 10%;"></td> <td style="width: 10%;"></td> <td style="width: 10%;"></td> <td style="width: 10%;"></td> <td style="width: 10%;"></td> </tr> <tr> <td></td> <td></td> <td colspan="8" style="text-align: center;"> <table border="1" style="width: 100%; border-collapse: collapse; text-align: center;"> <tr> <td style="width: 10%;"></td> <td style="width: 10%;"></td> <td style="width: 10%;"></td> <td style="width: 10%;"></td> <td style="width: 10%;"></td> <td style="width: 10%;"></td> <td style="width: 10%;"></td> <td style="width: 10%;"></td> <td style="width: 10%;"></td> <td style="width: 10%;"></td> </tr> <tr> <td></td> <td></td> <td colspan="8" style="text-align: center;"> <table border="1" style="width: 100%; border-collapse: collapse; text-align: center;"> <tr> </tr></table></td></tr></table></td></tr></table></td></tr></table></td></tr></table></td></tr></table></td></tr></table></td></tr></table></td></tr></table></td></tr></table></td></tr></table></td></tr></table></td></tr></table></td></tr></table></td></tr></table></td></tr></table></td></tr></table></td></tr></table></td></tr></table></td></tr></table></td></tr></table></td></tr></table></td></tr></table></td></tr></table>
 | | | | | | | | | | | | | | | | | | | | <table border="1" style="width: 100%; border-collapse: collapse; text-align: center;"> <tr> <td style="width: 10%;"></td> <td style="width: 10%;"></td> <td style="width: 10%;"></td> <td style="width: 10%;"></td> <td style="width: 10%;"></td> <td style="width: 10%;"></td> <td style="width: 10%;"></td> <td style="width: 10%;"></td> <td style="width: 10%;"></td> <td style="width: 10%;"></td> </tr> <tr> <td></td> <td></td> <td colspan="8" style="text-align: center;"> <table border="1" style="width: 100%; border-collapse: collapse; text-align: center;"> <tr> <td style="width: 10%;"></td> <td style="width: 10%;"></td> <td style="width: 10%;"></td> <td style="width: 10%;"></td> <td style="width: 10%;"></td> <td style="width: 10%;"></td> <td style="width: 10%;"></td> <td style="width: 10%;"></td> <td style="width: 10%;"></td> <td style="width: 10%;"></td> </tr> <tr> <td></td> <td></td> <td colspan="8" style="text-align: center;"> <table border="1" style="width: 100%; border-collapse: collapse; text-align: center;"> <tr> <td style="width: 10%;"></td> <td style="width: 10%;"></td> <td style="width: 10%;"></td> <td style="width: 10%;"></td> <td style="width: 10%;"></td> <td style="width: 10%;"></td> <td style="width: 10%;"></td> <td style="width: 10%;"></td> <td style="width: 10%;"></td> <td style="width: 10%;"></td> </tr> <tr> <td></td> <td></td> <td colspan="8" style="text-align: center;"> <table border="1" style="width: 100%; border-collapse: collapse; text-align: center;"> <tr> <td style="width: 10%;"></td> <td style="width: 10%;"></td> <td style="width: 10%;"></td> <td style="width: 10%;"></td> <td style="width: 10%;"></td> <td style="width: 10%;"></td> <td style="width: 10%;"></td> <td style="width: 10%;"></td> <td style="width: 10%;"></td> <td style="width: 10%;"></td> </tr> <tr> <td></td> <td></td> <td colspan="8" style="text-align: center;"> <table border="1" style="width: 100%; border-collapse: collapse; text-align: center;"> <tr> <td style="width: 10%;"></td> <td style="width: 10%;"></td> <td style="width: 10%;"></td> <td style="width: 10%;"></td> <td style="width: 10%;"></td> <td style="width: 10%;"></td> <td style="width: 10%;"></td> <td style="width: 10%;"></td> <td style="width: 10%;"></td> <td style="width: 10%;"></td> </tr> <tr> <td></td> <td></td> <td colspan="8" style="text-align: center;"> <table border="1" style="width: 100%; border-collapse: collapse; text-align: center;"> <tr> <td style="width: 10%;"></td> <td style="width: 10%;"></td> <td style="width: 10%;"></td> <td style="width: 10%;"></td> <td style="width: 10%;"></td> <td style="width: 10%;"></td> <td style="width: 10%;"></td> <td style="width: 10%;"></td> <td style="width: 10%;"></td> <td style="width: 10%;"></td> </tr> <tr> <td></td> <td></td> <td colspan="8" style="text-align: center;"> <table border="1" style="width: 100%; border-collapse: collapse; text-align: center;"> <tr> <td style="width: 10%;"></td> <td style="width: 10%;"></td> <td style="width: 10%;"></td> <td style="width: 10%;"></td> <td style="width: 10%;"></td> <td style="width: 10%;"></td> <td style="width: 10%;"></td> <td style="width: 10%;"></td> <td style="width: 10%;"></td> <td style="width: 10%;"></td> </tr> <tr> <td></td> <td></td> <td colspan="8" style="text-align: center;"> <table border="1" style="width: 100%; border-collapse: collapse; text-align: center;"> <tr> <td style="width: 10%;"></td> <td style="width: 10%;"></td> <td style="width: 10%;"></td> <td style="width: 10%;"></td> <td style="width: 10%;"></td> <td style="width: 10%;"></td> <td style="width: 10%;"></td> <td style="width: 10%;"></td> <td style="width: 10%;"></td> <td style="width: 10%;"></td> </tr> <tr> <td></td> <td></td> <td colspan="8" style="text-align: center;"> <table border="1" style="width: 100%; border-collapse: collapse; text-align: center;"> <tr> <td style="width: 10%;"></td> <td style="width: 10%;"></td> <td style="width: 10%;"></td> <td style="width: 10%;"></td> <td style="width: 10%;"></td> <td style="width: 10%;"></td> <td style="width: 10%;"></td> <td style="width: 10%;"></td> <td style="width: 10%;"></td> <td style="width: 10%;"></td> </tr> <tr> <td></td> <td></td> <td colspan="8" style="text-align: center;"> <table border="1" style="width: 100%; border-collapse: collapse; text-align: center;"> <tr> <td style="width: 10%;"></td> <td style="width: 10%;"></td> <td style="width: 10%;"></td> <td style="width: 10%;"></td> <td style="width: 10%;"></td> <td style="width: 10%;"></td> <td style="width: 10%;"></td> <td style="width: 10%;"></td> <td style="width: 10%;"></td> <td style="width: 10%;"></td> </tr> <tr> <td></td> <td></td> <td colspan="8" style="text-align: center;"> <table border="1" style="width: 100%; border-collapse: collapse; text-align: center;"> <tr> <td style="width: 10%;"></td> <td style="width: 10%;"></td> <td style="width: 10%;"></td> <td style="width: 10%;"></td> <td style="width: 10%;"></td> <td style="width: 10%;"></td> <td style="width: 10%;"></td> <td style="width: 10%;"></td> <td style="width: 10%;"></td> <td style="width: 10%;"></td> </tr> <tr> <td></td> <td></td> <td colspan="8" style="text-align: center;"> <table border="1" style="width: 100%; border-collapse: collapse; text-align: center;"> <tr> <td style="width: 10%;"></td> <td style="width: 10%;"></td> <td style="width: 10%;"></td> <td style="width: 10%;"></td> <td style="width: 10%;"></td> <td style="width: 10%;"></td> <td style="width: 10%;"></td> <td style="width: 10%;"></td> <td style="width: 10%;"></td> <td style="width: 10%;"></td> </tr> <tr> <td></td> <td></td> <td colspan="8" style="text-align: center;"> <table border="1" style="width: 100%; border-collapse: collapse; text-align: center;"> <tr> <td style="width: 10%;"></td> <td style="width: 10%;"></td> <td style="width: 10%;"></td> <td style="width: 10%;"></td> <td style="width: 10%;"></td> <td style="width: 10%;"></td> <td style="width: 10%;"></td> <td style="width: 10%;"></td> <td style="width: 10%;"></td> <td style="width: 10%;"></td> </tr> <tr> <td></td> <td></td> <td colspan="8" style="text-align: center;"> <table border="1" style="width: 100%; border-collapse: collapse; text-align: center;"> <tr> <td style="width: 10%;"></td> <td style="width: 10%;"></td> <td style="width: 10%;"></td> <td style="width: 10%;"></td> <td style="width: 10%;"></td> <td style="width: 10%;"></td> <td style="width: 10%;"></td> <td style="width: 10%;"></td> <td style="width: 10%;"></td> <td style="width: 10%;"></td> </tr> <tr> <td></td> <td></td> <td colspan="8" style="text-align: center;"> <table border="1" style="width: 100%; border-collapse: collapse; text-align: center;"> <tr> <td style="width: 10%;"></td> <td style="width: 10%;"></td> <td style="width: 10%;"></td> <td style="width: 10%;"></td> <td style="width: 10%;"></td> <td style="width: 10%;"></td> <td style="width: 10%;"></td> <td style="width: 10%;"></td> <td style="width: 10%;"></td> <td style="width: 10%;"></td> </tr> <tr> <td></td> <td></td> <td colspan="8" style="text-align: center;"> <table border="1" style="width: 100%; border-collapse: collapse; text-align: center;"> <tr> <td style="width: 10%;"></td> <td style="width: 10%;"></td> <td style="width: 10%;"></td> <td style="width: 10%;"></td> <td style="width: 10%;"></td> <td style="width: 10%;"></td> <td style="width: 10%;"></td> <td style="width: 10%;"></td> <td style="width: 10%;"></td> <td style="width: 10%;"></td> </tr> <tr> <td></td> <td></td> <td colspan="8" style="text-align: center;"> <table border="1" style="width: 100%; border-collapse: collapse; text-align: center;"> <tr> <td style="width: 10%;"></td> <td style="width: 10%;"></td> <td style="width: 10%;"></td> <td style="width: 10%;"></td> <td style="width: 10%;"></td> <td style="width: 10%;"></td> <td style="width: 10%;"></td> <td style="width: 10%;"></td> <td style="width: 10%;"></td> <td style="width: 10%;"></td> </tr> <tr> <td></td> <td></td> <td colspan="8" style="text-align: center;"> <table border="1" style="width: 100%; border-collapse: collapse; text-align: center;"> <tr> <td style="width: 10%;"></td> <td style="width: 10%;"></td> <td style="width: 10%;"></td> <td style="width: 10%;"></td> <td style="width: 10%;"></td> <td style="width: 10%;"></td> <td style="width: 10%;"></td> <td style="width: 10%;"></td> <td style="width: 10%;"></td> <td style="width: 10%;"></td> </tr> <tr> <td></td> <td></td> <td colspan="8" style="text-align: center;"> <table border="1" style="width: 100%; border-collapse: collapse; text-align: center;"> <tr> <td style="width: 10%;"></td> <td style="width: 10%;"></td> <td style="width: 10%;"></td> <td style="width: 10%;"></td> <td style="width: 10%;"></td> <td style="width: 10%;"></td> <td style="width: 10%;"></td> <td style="width: 10%;"></td> <td style="width: 10%;"></td> <td style="width: 10%;"></td> </tr> <tr> <td></td> <td></td> <td colspan="8" style="text-align: center;"> <table border="1" style="width: 100%; border-collapse: collapse; text-align: center;"> <tr> <td style="width: 10%;"></td> <td style="width: 10%;"></td> <td style="width: 10%;"></td> <td style="width: 10%;"></td> <td style="width: 10%;"></td> <td style="width: 10%;"></td> <td
style="width: 10%;"></td> <td style="width: 10%;"></td> <td style="width: 10%;"></td> <td style="width: 10%;"></td> </tr> <tr> <td></td> <td></td> <td colspan="8" style="text-align: center;"> <table border="1" style="width: 100%; border-collapse: collapse; text-align: center;"> <tr> <td style="width: 10%;"></td> <td style="width: 10%;"></td> <td style="width: 10%;"></td> <td style="width: 10%;"></td> <td style="width: 10%;"></td> <td style="width: 10%;"></td> <td style="width: 10%;"></td> <td style="width: 10%;"></td> <td style="width: 10%;"></td> <td style="width: 10%;"></td> </tr> <tr> <td></td> <td></td> <td colspan="8" style="text-align: center;"> <table border="1" style="width: 100%; border-collapse: collapse; text-align: center;"> <tr> <td style="width: 10%;"></td> <td style="width: 10%;"></td> <td style="width: 10%;"></td> <td style="width: 10%;"></td> <td style="width: 10%;"></td> <td style="width: 10%;"></td> <td style="width: 10%;"></td> <td style="width: 10%;"></td> <td style="width: 10%;"></td> <td style="width: 10%;"></td> </tr> <tr> <td></td> <td></td> <td colspan="8" style="text-align: center;"> <table border="1" style="width: 100%; border-collapse: collapse; text-align: center;"> <tr> </tr></table></td></tr></table></td></tr></table></td></tr></table></td></tr></table></td></tr></table></td></tr></table></td></tr></table></td></tr></table></td></tr></table></td></tr></table></td></tr></table></td></tr></table></td></tr></table></td></tr></table></td></tr></table></td></tr></table></td></tr></table></td></tr></table></td></tr></table></td></tr></table></td></tr></table></td></tr></table> | | | | | | | | | | | | | | | | | | | | <table border="1" style="width: 100%; border-collapse: collapse; text-align: center;"> <tr> <td style="width: 10%;"></td> <td style="width: 10%;"></td> <td style="width: 10%;"></td> <td style="width: 10%;"></td> <td style="width: 10%;"></td> <td style="width: 10%;"></td> <td style="width: 10%;"></td> <td style="width: 10%;"></td> <td style="width: 10%;"></td> <td style="width: 10%;"></td> </tr> <tr> <td></td> <td></td> <td colspan="8" style="text-align: center;"> <table border="1" style="width: 100%; border-collapse: collapse; text-align: center;"> <tr> <td style="width: 10%;"></td> <td style="width: 10%;"></td> <td style="width: 10%;"></td> <td style="width: 10%;"></td> <td style="width: 10%;"></td> <td style="width: 10%;"></td> <td style="width: 10%;"></td> <td style="width: 10%;"></td> <td style="width: 10%;"></td> <td style="width: 10%;"></td> </tr> <tr> <td></td> <td></td> <td colspan="8" style="text-align: center;"> <table border="1" style="width: 100%; border-collapse: collapse; text-align: center;"> <tr> <td style="width: 10%;"></td> <td style="width: 10%;"></td> <td style="width: 10%;"></td> <td style="width: 10%;"></td> <td style="width: 10%;"></td> <td style="width: 10%;"></td> <td style="width: 10%;"></td> <td style="width: 10%;"></td> <td style="width: 10%;"></td> <td style="width: 10%;"></td> </tr> <tr> <td></td> <td></td> <td colspan="8" style="text-align: center;"> <table border="1" style="width: 100%; border-collapse: collapse; text-align: center;"> <tr> <td style="width: 10%;"></td> <td style="width: 10%;"></td> <td style="width: 10%;"></td> <td style="width: 10%;"></td> <td style="width: 10%;"></td> <td style="width: 10%;"></td> <td style="width: 10%;"></td> <td style="width: 10%;"></td> <td style="width: 10%;"></td> <td style="width: 10%;"></td> </tr> <tr> <td></td> <td></td> <td colspan="8" style="text-align: center;"> <table border="1" style="width: 100%; border-collapse: collapse; text-align: center;"> <tr> <td style="width:
10%;"></td> <td style="width: 10%;"></td> <td style="width: 10%;"></td> <td style="width: 10%;"></td> <td style="width: 10%;"></td> <td style="width: 10%;"></td> <td style="width: 10%;"></td> <td style="width: 10%;"></td> <td style="width: 10%;"></td> <td style="width: 10%;"></td> </tr> <tr> <td></td> <td></td> <td colspan="8" style="text-align: center;"> <table border="1" style="width: 100%; border-collapse: collapse; text-align: center;"> <tr> <td style="width: 10%;"></td> <td style="width: 10%;"></td> <td style="width: 10%;"></td> <td style="width: 10%;"></td> <td style="width: 10%;"></td> <td style="width: 10%;"></td> <td style="width: 10%;"></td> <td style="width: 10%;"></td> <td style="width: 10%;"></td> <td style="width: 10%;"></td> </tr> <tr> <td></td> <td></td> <td colspan="8" style="text-align: center;"> <table border="1" style="width: 100%; border-collapse: collapse; text-align: center;"> <tr> <td style="width: 10%;"></td> <td style="width: 10%;"></td> <td style="width: 10%;"></td> <td style="width: 10%;"></td> <td style="width: 10%;"></td> <td style="width: 10%;"></td> <td style="width: 10%;"></td> <td style="width: 10%;"></td> <td style="width: 10%;"></td> <td style="width: 10%;"></td> </tr> <tr> <td></td> <td></td> <td colspan="8" style="text-align: center;"> <table border="1" style="width: 100%; border-collapse: collapse; text-align: center;"> <tr> <td style="width: 10%;"></td> <td style="width: 10%;"></td> <td style="width: 10%;"></td> <td style="width: 10%;"></td> <td style="width: 10%;"></td> <td style="width: 10%;"></td> <td style="width: 10%;"></td> <td style="width: 10%;"></td> <td style="width: 10%;"></td> <td style="width: 10%;"></td> </tr> <tr> <td></td> <td></td> <td colspan="8" style="text-align: center;"> <table border="1" style="width: 100%; border-collapse: collapse; text-align: center;"> <tr> <td style="width: 10%;"></td> <td style="width: 10%;"></td> <td style="width: 10%;"></td> <td style="width: 10%;"></td> <td style="width: 10%;"></td> <td style="width: 10%;"></td> <td style="width: 10%;"></td> <td style="width: 10%;"></td> <td style="width: 10%;"></td> <td style="width: 10%;"></td> </tr> <tr> <td></td> <td></td> <td colspan="8" style="text-align: center;"> <table border="1" style="width: 100%; border-collapse: collapse; text-align: center;"> <tr> <td style="width: 10%;"></td> <td style="width: 10%;"></td> <td style="width: 10%;"></td> <td style="width: 10%;"></td> <td style="width: 10%;"></td> <td style="width: 10%;"></td> <td style="width: 10%;"></td> <td style="width: 10%;"></td> <td style="width: 10%;"></td> <td style="width: 10%;"></td> </tr> <tr> <td></td> <td></td> <td colspan="8" style="text-align: center;"> <table border="1" style="width: 100%; border-collapse: collapse; text-align: center;"> <tr> <td style="width: 10%;"></td> <td style="width: 10%;"></td> <td style="width: 10%;"></td> <td style="width: 10%;"></td> <td style="width: 10%;"></td> <td style="width: 10%;"></td> <td style="width: 10%;"></td> <td style="width: 10%;"></td> <td style="width: 10%;"></td> <td style="width: 10%;"></td> </tr> <tr> <td></td> <td></td> <td colspan="8" style="text-align: center;"> <table border="1" style="width: 100%; border-collapse: collapse; text-align: center;"> <tr> <td style="width: 10%;"></td> <td style="width: 10%;"></td> <td style="width: 10%;"></td> <td style="width: 10%;"></td> <td style="width: 10%;"></td> <td style="width: 10%;"></td> <td style="width: 10%;"></td> <td style="width: 10%;"></td> <td style="width: 10%;"></td> <td style="width: 10%;"></td> </tr> <tr> <td></td> <td></td> <td colspan="8" style="text-align: center;"> <table border="1" style="width: 100%; border-collapse: collapse; text-align: center;"> <tr> <td style="width: 10%;"></td> <td style="width: 10%;"></td> <td style="width: 10%;"></td> <td style="width: 10%;"></td> <td style="width: 10%;"></td> <td style="width: 10%;"></td> <td style="width: 10%;"></td> <td style="width: 10%;"></td> <td style="width: 10%;"></td> <td style="width: 10%;"></td> </tr> <tr> <td></td> <td></td> <td colspan="8" style="text-align: center;"> <table border="1" style="width: 100%; border-collapse: collapse; text-align: center;"> <tr> <td style="width: 10%;"></td> <td style="width: 10%;"></td> <td style="width: 10%;"></td> <td style="width: 10%;"></td> <td style="width: 10%;"></td> <td style="width: 10%;"></td> <td style="width: 10%;"></td> <td style="width: 10%;"></td> <td style="width: 10%;"></td> <td style="width: 10%;"></td> </tr> <tr> <td></td> <td></td> <td colspan="8" style="text-align: center;"> <table border="1" style="width: 100%; border-collapse: collapse; text-align: center;"> <tr> <td style="width: 10%;"></td> <td style="width: 10%;"></td> <td style="width: 10%;"></td> <td style="width: 10%;"></td> <td style="width: 10%;"></td> <td style="width: 10%;"></td> <td style="width: 10%;"></td> <td style="width: 10%;"></td> <td style="width: 10%;"></td> <td style="width: 10%;"></td> </tr> <tr> <td></td> <td></td> <td colspan="8" style="text-align: center;"> <table border="1" style="width: 100%; border-collapse: collapse; text-align: center;"> <tr> <td style="width: 10%;"></td> <td style="width: 10%;"></td> <td style="width: 10%;"></td> <td style="width: 10%;"></td> <td style="width: 10%;"></td> <td style="width: 10%;"></td> <td style="width: 10%;"></td> <td style="width: 10%;"></td> <td style="width: 10%;"></td> <td style="width: 10%;"></td> </tr> <tr> <td></td> <td></td> <td colspan="8" style="text-align: center;"> <table border="1" style="width: 100%; border-collapse: collapse; text-align: center;"> <tr> <td style="width: 10%;"></td> <td style="width: 10%;"></td> <td style="width: 10%;"></td> <td style="width: 10%;"></td> <td style="width: 10%;"></td> <td style="width: 10%;"></td> <td style="width: 10%;"></td> <td style="width: 10%;"></td> <td style="width: 10%;"></td> <td style="width: 10%;"></td> </tr> <tr> <td></td> <td></td> <td colspan="8" style="text-align: center;"> <table border="1" style="width: 100%; border-collapse: collapse; text-align: center;"> <tr> <td style="width: 10%;"></td> <td style="width: 10%;"></td> <td style="width: 10%;"></td> <td style="width: 10%;"></td> <td style="width: 10%;"></td> <td style="width: 10%;"></td> <td style="width: 10%;"></td> <td style="width: 10%;"></td> <td style="width: 10%;"></td> <td style="width: 10%;"></td> </tr> <tr> <td></td> <td></td> <td colspan="8" style="text-align: center;"> <table border="1" style="width: 100%; border-collapse: collapse; text-align: center;"> <tr> <td style="width: 10%;"></td> <td style="width: 10%;"></td> <td style="width: 10%;"></td> <td style="width: 10%;"></td> <td style="width: 10%;"></td> <td style="width: 10%;"></td> <td style="width: 10%;"></td> <td style="width: 10%;"></td> <td style="width: 10%;"></td> <td style="width: 10%;"></td> </tr> <tr> <td></td> <td></td> <td colspan="8" style="text-align: center;"> <table border="1" style="width: 100%; border-collapse: collapse; text-align: center;"> <tr> <td style="width: 10%;"></td> <td style="width: 10%;"></td> <td style="width: 10%;"></td> <td style="width: 10%;"></td> <td style="width: 10%;"></td> <td style="width: 10%;"></td> <td style="width: 10%;"></td> <td style="width: 10%;"></td> <td style="width: 10%;"></td> <td style="width: 10%;"></td> </tr> <tr> <td></td> <td></td> <td colspan="8" style="text-align: center;"> <table border="1" style="width: 100%; border-collapse: collapse; text-align: center;"> <tr> <td style="width: 10%;"></td> <td style="width: 10%;"></td> <td style="width: 10%;"></td> <td style="width: 10%;"></td> <td style="width: 10%;"></td> <td style="width: 10%;"></td> <td style="width: 10%;"></td> <td style="width: 10%;"></td> <td style="width: 10%;"></td> <td style="width: 10%;"></td> </tr> <tr> <td></td> <td></td> <td colspan="8" style="text-align: center;"> <table border="1" style="width: 100%; border-collapse: collapse; text-align: center;"> <tr> </tr></table></td></tr></table></td></tr></table></td></tr></table></td></tr></table></td></tr></table></td></tr></table></td></tr></table></td></tr></table></td></tr></table></td></tr></table></td></tr></table></td></tr></table></td></tr></table></td></tr></table></td></tr></table></td></tr></table></td></tr></table></td></tr></table></td></tr></table></td></tr></table></td></tr></table>
 | | | | | | | | | | | | | | | | | | | | <table border="1" style="width: 100%; border-collapse: collapse; text-align: center;"> <tr> <td style="width: 10%;"></td> <td style="width: 10%;"></td> <td style="width: 10%;"></td> <td style="width: 10%;"></td> <td style="width: 10%;"></td> <td style="width: 10%;"></td> <td style="width: 10%;"></td> <td style="width: 10%;"></td> <td style="width: 10%;"></td> <td style="width: 10%;"></td> </tr> <tr> <td></td> <td></td> <td colspan="8" style="text-align: center;"> <table border="1" style="width: 100%; border-collapse: collapse; text-align: center;"> <tr> <td style="width: 10%;"></td> <td style="width: 10%;"></td> <td style="width: 10%;"></td> <td style="width: 10%;"></td> <td style="width: 10%;"></td> <td style="width: 10%;"></td> <td style="width: 10%;"></td> <td style="width: 10%;"></td> <td style="width: 10%;"></td> <td style="width: 10%;"></td> </tr> <tr> <td></td> <td></td> <td colspan="8" style="text-align: center;"> <table border="1" style="width: 100%; border-collapse: collapse; text-align: center;"> <tr> <td style="width: 10%;"></td> <td style="width: 10%;"></td> <td style="width: 10%;"></td> <td style="width: 10%;"></td> <td style="width: 10%;"></td> <td style="width: 10%;"></td> <td style="width: 10%;"></td> <td style="width: 10%;"></td> <td style="width: 10%;"></td> <td style="width: 10%;"></td> </tr> <tr> <td></td> <td></td> <td colspan="8" style="text-align: center;"> <table border="1" style="width: 100%; border-collapse: collapse; text-align: center;"> <tr> <td style="width: 10%;"></td> <td style="width: 10%;"></td> <td style="width: 10%;"></td> <td style="width: 10%;"></td> <td style="width: 10%;"></td> <td style="width: 10%;"></td> <td style="width: 10%;"></td> <td style="width: 10%;"></td> <td style="width: 10%;"></td> <td style="width: 10%;"></td> </tr> <tr> <td></td> <td></td> <td colspan="8" style="text-align: center;"> <table border="1" style="width: 100%; border-collapse: collapse; text-align: center;"> <tr> <td style="width: 10%;"></td> <td style="width: 10%;"></td> <td style="width: 10%;"></td> <td style="width: 10%;"></td> <td style="width: 10%;"></td> <td style="width: 10%;"></td> <td style="width: 10%;"></td> <td style="width: 10%;"></td> <td style="width: 10%;"></td> <td style="width: 10%;"></td> </tr> <tr> <td></td> <td></td> <td colspan="8" style="text-align: center;"> <table border="1" style="width: 100%; border-collapse: collapse; text-align: center;"> <tr> <td style="width: 10%;"></td> <td style="width: 10%;"></td> <td style="width: 10%;"></td> <td style="width: 10%;"></td> <td style="width: 10%;"></td> <td style="width: 10%;"></td> <td style="width: 10%;"></td> <td style="width: 10%;"></td> <td style="width: 10%;"></td> <td style="width: 10%;"></td> </tr> <tr> <td></td> <td></td> <td colspan="8" style="text-align: center;"> <table border="1" style="width: 100%; border-collapse: collapse; text-align: center;"> <tr> <td style="width: 10%;"></td> <td style="width: 10%;"></td> <td style="width: 10%;"></td> <td style="width: 10%;"></td> <td style="width: 10%;"></td> <td style="width: 10%;"></td> <td style="width: 10%;"></td> <td style="width: 10%;"></td> <td style="width: 10%;"></td> <td style="width: 10%;"></td> </tr> <tr> <td></td> <td></td> <td colspan="8" style="text-align: center;"> <table border="1" style="width: 100%; border-collapse: collapse; text-align: center;"> <tr> <td style="width: 10%;"></td> <td style="width: 10%;"></td> <td style="width: 10%;"></td> <td style="width: 10%;"></td> <td style="width: 10%;"></td> <td style="width: 10%;"></td> <td style="width: 10%;"></td> <td style="width: 10%;"></td> <td style="width: 10%;"></td> <td style="width: 10%;"></td> </tr> <tr> <td></td> <td></td> <td colspan="8" style="text-align: center;"> <table border="1" style="width: 100%; border-collapse: collapse; text-align: center;"> <tr> <td style="width: 10%;"></td> <td style="width: 10%;"></td> <td style="width: 10%;"></td> <td style="width: 10%;"></td> <td style="width: 10%;"></td> <td style="width: 10%;"></td> <td style="width: 10%;"></td> <td style="width: 10%;"></td> <td style="width: 10%;"></td> <td style="width: 10%;"></td> </tr> <tr> <td></td> <td></td> <td colspan="8" style="text-align: center;"> <table border="1" style="width: 100%; border-collapse: collapse; text-align: center;"> <tr> <td style="width: 10%;"></td> <td style="width: 10%;"></td> <td style="width: 10%;"></td> <td style="width: 10%;"></td> <td style="width: 10%;"></td> <td style="width: 10%;"></td> <td style="width: 10%;"></td> <td style="width: 10%;"></td> <td style="width: 10%;"></td> <td style="width: 10%;"></td> </tr> <tr> <td></td> <td></td> <td colspan="8" style="text-align: center;"> <table border="1" style="width: 100%; border-collapse: collapse; text-align: center;"> <tr> <td style="width: 10%;"></td> <td style="width: 10%;"></td> <td style="width: 10%;"></td> <td style="width: 10%;"></td> <td style="width: 10%;"></td> <td style="width: 10%;"></td> <td style="width: 10%;"></td> <td style="width: 10%;"></td> <td style="width: 10%;"></td> <td style="width: 10%;"></td> </tr> <tr> <td></td> <td></td> <td colspan="8" style="text-align: center;"> <table border="1" style="width: 100%; border-collapse: collapse; text-align: center;"> <tr> <td style="width: 10%;"></td> <td style="width:
10%;"></td> <td style="width: 10%;"></td> <td style="width: 10%;"></td> <td style="width: 10%;"></td> <td style="width: 10%;"></td> <td style="width: 10%;"></td> <td style="width: 10%;"></td> <td style="width: 10%;"></td> <td style="width: 10%;"></td> </tr> <tr> <td></td> <td></td> <td colspan="8" style="text-align: center;"> <table border="1" style="width: 100%; border-collapse: collapse; text-align: center;"> <tr> <td style="width: 10%;"></td> <td style="width: 10%;"></td> <td style="width: 10%;"></td> <td style="width: 10%;"></td> <td style="width: 10%;"></td> <td style="width: 10%;"></td> <td style="width: 10%;"></td> <td style="width: 10%;"></td> <td style="width: 10%;"></td> <td style="width: 10%;"></td> </tr> <tr> <td></td> <td></td> <td colspan="8" style="text-align: center;"> <table border="1" style="width: 100%; border-collapse: collapse; text-align: center;"> <tr> <td style="width: 10%;"></td> <td style="width: 10%;"></td> <td style="width: 10%;"></td> <td style="width: 10%;"></td> <td style="width: 10%;"></td> <td style="width: 10%;"></td> <td style="width: 10%;"></td> <td style="width: 10%;"></td> <td style="width: 10%;"></td> <td style="width: 10%;"></td> </tr> <tr> <td></td> <td></td> <td colspan="8" style="text-align: center;"> <table border="1" style="width: 100%; border-collapse: collapse; text-align: center;"> <tr> <td style="width: 10%;"></td> <td style="width: 10%;"></td> <td style="width: 10%;"></td> <td style="width: 10%;"></td> <td style="width: 10%;"></td> <td style="width: 10%;"></td> <td style="width: 10%;"></td> <td style="width: 10%;"></td> <td style="width: 10%;"></td> <td style="width: 10%;"></td> </tr> <tr> <td></td> <td></td> <td colspan="8" style="text-align: center;"> <table border="1" style="width: 100%; border-collapse: collapse; text-align: center;"> <tr> <td style="width: 10%;"></td> <td style="width: 10%;"></td> <td style="width: 10%;"></td> <td style="width: 10%;"></td> <td style="width: 10%;"></td> <td style="width: 10%;"></td> <td style="width: 10%;"></td> <td style="width: 10%;"></td> <td style="width: 10%;"></td> <td style="width: 10%;"></td> </tr> <tr> <td></td> <td></td> <td colspan="8" style="text-align: center;"> <table border="1" style="width: 100%; border-collapse: collapse; text-align: center;"> <tr> <td style="width: 10%;"></td> <td style="width: 10%;"></td> <td style="width: 10%;"></td> <td style="width: 10%;"></td> <td style="width: 10%;"></td> <td style="width: 10%;"></td> <td style="width: 10%;"></td> <td style="width: 10%;"></td> <td style="width: 10%;"></td> <td style="width: 10%;"></td> </tr> <tr> <td></td> <td></td> <td colspan="8" style="text-align: center;"> <table border="1" style="width: 100%; border-collapse: collapse; text-align: center;"> <tr> <td style="width: 10%;"></td> <td style="width: 10%;"></td> <td style="width: 10%;"></td> <td style="width: 10%;"></td> <td style="width: 10%;"></td> <td style="width: 10%;"></td> <td style="width: 10%;"></td> <td style="width: 10%;"></td> <td style="width: 10%;"></td> <td style="width: 10%;"></td> </tr> <tr> <td></td> <td></td> <td colspan="8" style="text-align: center;"> <table border="1" style="width: 100%; border-collapse: collapse; text-align: center;"> <tr> <td style="width: 10%;"></td> <td style="width: 10%;"></td> <td style="width: 10%;"></td> <td style="width: 10%;"></td> <td style="width: 10%;"></td> <td style="width: 10%;"></td> <td style="width: 10%;"></td> <td style="width: 10%;"></td> <td style="width: 10%;"></td> <td style="width: 10%;"></td> </tr> <tr> <td></td> <td></td> <td colspan="8" style="text-align: center;"> <table border="1" style="width: 100%; border-collapse: collapse; text-align: center;"> <tr> <td style="width: 10%;"></td> <td style="width: 10%;"></td> <td style="width: 10%;"></td> <td style="width: 10%;"></td> <td style="width: 10%;"></td> <td style="width: 10%;"></td> <td style="width: 10%;"></td> <td style="width: 10%;"></td> <td style="width: 10%;"></td> <td style="width: 10%;"></td> </tr> <tr> <td></td> <td></td> <td colspan="8" style="text-align: center;"> <table border="1" style="width: 100%; border-collapse: collapse; text-align: center;"> <tr> </tr></table></td></tr></table></td></tr></table></td></tr></table></td></tr></table></td></tr></table></td></tr></table></td></tr></table></td></tr></table></td></tr></table></td></tr></table></td></tr></table></td></tr></table></td></tr></table></td></tr></table></td></tr></table></td></tr></table></td></tr></table></td></tr></table></td></tr></table></td></tr></table>
 | | | | | | | | | | | | | | | | | | | | <table border="1" style="width: 100%; border-collapse: collapse; text-align: center;"> <tr> <td style="width: 10%;"></td> <td style="width: 10%;"></td> <td style="width: 10%;"></td> <td style="width: 10%;"></td> <td style="width: 10%;"></td> <td style="width: 10%;"></td> <td style="width: 10%;"></td> <td style="width: 10%;"></td> <td style="width: 10%;"></td> <td style="width: 10%;"></td> </tr> <tr> <td></td> <td></td> <td colspan="8" style="text-align: center;"> <table border="1" style="width: 100%; border-collapse: collapse; text-align: center;"> <tr> <td style="width: 10%;"></td> <td style="width: 10%;"></td> <td style="width: 10%;"></td> <td style="width: 10%;"></td> <td style="width: 10%;"></td> <td style="width: 10%;"></td> <td style="width: 10%;"></td> <td style="width: 10%;"></td> <td style="width: 10%;"></td> <td style="width: 10%;"></td> </tr> <tr> <td></td> <td></td> <td colspan="8" style="text-align: center;"> <table border="1" style="width: 100%; border-collapse: collapse; text-align: center;"> <tr> <td style="width: 10%;"></td> <td style="width: 10%;"></td> <td style="width: 10%;"></td> <td style="width: 10%;"></td> <td style="width: 10%;"></td> <td style="width: 10%;"></td> <td style="width: 10%;"></td> <td style="width: 10%;"></td> <td style="width: 10%;"></td> <td style="width: 10%;"></td> </tr> <tr> <td></td> <td></td> <td colspan="8" style="text-align: center;"> <table border="1" style="width: 100%; border-collapse: collapse; text-align: center;"> <tr> <td style="width: 10%;"></td> <td style="width: 10%;"></td> <td style="width: 10%;"></td> <td style="width: 10%;"></td> <td style="width: 10%;"></td> <td style="width: 10%;"></td> <td style="width: 10%;"></td> <td style="width: 10%;"></td> <td style="width: 10%;"></td> <td style="width: 10%;"></td> </tr> <tr> <td></td> <td></td> <td colspan="8" style="text-align: center;"> <table border="1" style="width: 100%; border-collapse: collapse; text-align: center;"> <tr> <td style="width: 10%;"></td> <td style="width: 10%;"></td> <td style="width: 10%;"></td> <td style="width: 10%;"></td> <td style="width: 10%;"></td> <td style="width: 10%;"></td> <td style="width: 10%;"></td> <td style="width: 10%;"></td> <td style="width: 10%;"></td> <td style="width: 10%;"></td> </tr> <tr> <td></td> <td></td> <td colspan="8" style="text-align: center;"> <table border="1" style="width: 100%; border-collapse: collapse; text-align: center;"> <tr> <td style="width: 10%;"></td> <td style="width: 10%;"></td> <td style="width: 10%;"></td> <td style="width: 10%;"></td> <td style="width: 10%;"></td> <td style="width: 10%;"></td> <td style="width: 10%;"></td> <td style="width: 10%;"></td> <td style="width: 10%;"></td> <td style="width: 10%;"></td> </tr> <tr> <td></td> <td></td> <td colspan="8" style="text-align: center;"> <table border="1" style="width: 100%; border-collapse: collapse; text-align: center;"> <tr> <td style="width: 10%;"></td> <td style="width: 10%;"></td> <td style="width: 10%;"></td> <td style="width: 10%;"></td> <td style="width: 10%;"></td> <td style="width: 10%;"></td> <td style="width: 10%;"></td> <td style="width: 10%;"></td> <td style="width: 10%;"></td> <td style="width: 10%;"></td> </tr> <tr> <td></td> <td></td> <td colspan="8" style="text-align: center;"> <table border="1" style="width: 100%; border-collapse: collapse; text-align: center;"> <tr> <td style="width: 10%;"></td> <td style="width: 10%;"></td> <td style="width: 10%;"></td> <td style="width: 10%;"></td> <td style="width: 10%;"></td> <td style="width: 10%;"></td> <td style="width: 10%;"></td> <td style="width: 10%;"></td> <td style="width: 10%;"></td> <td style="width: 10%;"></td> </tr> <tr> <td></td> <td></td> <td colspan="8" style="text-align: center;"> <table border="1" style="width: 100%; border-collapse: collapse; text-align: center;"> <tr> <td style="width: 10%;"></td> <td style="width: 10%;"></td> <td style="width: 10%;"></td> <td style="width: 10%;"></td> <td style="width: 10%;"></td> <td style="width: 10%;"></td> <td style="width: 10%;"></td> <td style="width: 10%;"></td> <td style="width: 10%;"></td> <td style="width: 10%;"></td> </tr> <tr> <td></td> <td></td> <td colspan="8" style="text-align: center;"> <table border="1" style="width: 100%; border-collapse: collapse; text-align: center;"> <tr> <td style="width: 10%;"></td> <td style="width: 10%;"></td> <td style="width: 10%;"></td> <td style="width: 10%;"></td> <td style="width: 10%;"></td> <td style="width: 10%;"></td> <td style="width: 10%;"></td> <td style="width: 10%;"></td> <td style="width: 10%;"></td> <td style="width: 10%;"></td> </tr> <tr> <td></td> <td></td> <td colspan="8" style="text-align: center;"> <table border="1" style="width: 100%; border-collapse: collapse; text-align: center;"> <tr> <td style="width: 10%;"></td> <td style="width: 10%;"></td> <td style="width: 10%;"></td> <td style="width: 10%;"></td> <td style="width: 10%;"></td> <td style="width: 10%;"></td> <td style="width: 10%;"></td> <td style="width: 10%;"></td> <td style="width: 10%;"></td> <td style="width: 10%;"></td> </tr> <tr> <td></td> <td></td> <td colspan="8" style="text-align: center;"> <table border="1" style="width: 100%; border-collapse: collapse; text-align: center;"> <tr> <td style="width: 10%;"></td> <td style="width: 10%;"></td> <td style="width: 10%;"></td> <td style="width: 10%;"></td> <td style="width: 10%;"></td> <td style="width: 10%;"></td> <td style="width: 10%;"></td> <td style="width: 10%;"></td> <td style="width: 10%;"></td> <td style="width: 10%;"></td> </tr> <tr> <td></td> <td></td> <td colspan="8" style="text-align: center;"> <table border="1" style="width: 100%; border-collapse: collapse; text-align: center;"> <tr> <td style="width: 10%;"></td> <td style="width: 10%;"></td> <td style="width: 10%;"></td> <td style="width: 10%;"></td> <td style="width: 10%;"></td> <td style="width: 10%;"></td> <td style="width: 10%;"></td> <td style="width: 10%;"></td> <td style="width: 10%;"></td> <td style="width: 10%;"></td> </tr> <tr> <td></td> <td></td> <td colspan="8" style="text-align: center;"> <table border="1" style="width: 100%; border-collapse: collapse; text-align: center;"> <tr> <td style="width: 10%;"></td> <td style="width: 10%;"></td> <td style="width: 10%;"></td> <td style="width: 10%;"></td> <td style="width: 10%;"></td> <td style="width: 10%;"></td> <td style="width: 10%;"></td> <td style="width: 10%;"></td> <td style="width: 10%;"></td> <td style="width: 10%;"></td> </tr> <tr> <td></td> <td></td> <td colspan="8" style="text-align: center;"> <table border="1" style="width: 100%; border-collapse: collapse; text-align: center;"> <tr> <td style="width: 10%;"></td> <td style="width: 10%;"></td> <td style="width: 10%;"></td> <td style="width: 10%;"></td> <td style="width: 10%;"></td> <td style="width: 10%;"></td> <td style="width: 10%;"></td> <td style="width: 10%;"></td> <td style="width: 10%;"></td> <td style="width: 10%;"></td> </tr> <tr> <td></td> <td></td> <td colspan="8" style="text-align: center;"> <table border="1" style="width: 100%; border-collapse: collapse; text-align: center;"> <tr> <td style="width: 10%;"></td> <td style="width: 10%;"></td> <td style="width: 10%;"></td> <td style="width: 10%;"></td> <td style="width: 10%;"></td> <td style="width: 10%;"></td> <td style="width: 10%;"></td> <td style="width: 10%;"></td> <td style="width: 10%;"></td> <td style="width: 10%;"></td> </tr> <tr> <td></td> <td></td> <td colspan="8" style="text-align: center;"> <table border="1" style="width: 100%; border-collapse: collapse; text-align: center;"> <tr> <td style="width: 10%;"></td> <td style="width: 10%;"></td> <td style="width: 10%;"></td> <td style="width: 10%;"></td> <td style="width: 10%;"></td> <td style="width: 10%;"></td> <td style="width: 10%;"></td> <td style="width: 10%;"></td> <td style="width: 10%;"></td> <td style="width: 10%;"></td> </tr> <tr> <td></td> <td></td> <td colspan="8" style="text-align: center;"> <table border="1" style="width: 100%; border-collapse: collapse; text-align: center;"> <tr> <td style="width: 10%;"></td> <td style="width: 10%;"></td> <td style="width: 10%;"></td> <td style="width: 10%;"></td> <td style="width: 10%;"></td> <td style="width: 10%;"></td> <td style="width: 10%;"></td> <td style="width: 10%;"></td> <td style="width: 10%;"></td> <td style="width: 10%;"></td> </tr> <tr> <td></td> <td></td> <td colspan="8" style="text-align: center;"> <table border="1" style="width: 100%; border-collapse: collapse; text-align: center;"> <tr> <td style="width: 10%;"></td> <td style="width: 10%;"></td> <td style="width: 10%;"></td> <td style="width: 10%;"></td> <td style="width: 10%;"></td> <td style="width: 10%;"></td> <td style="width: 10%;"></td> <td style="width: 10%;"></td> <td style="width: 10%;"></td> <td style="width: 10%;"></td> </tr> <tr> <td></td> <td></td> <td colspan="8" style="text-align: center;"> <table border="1" style="width: 100%; border-collapse: collapse; text-align: center;"> <tr>
</tr></table></td></tr></table></td></tr></table></td></tr></table></td></tr></table></td></tr></table></td></tr></table></td></tr></table></td></tr></table></td></tr></table></td></tr></table></td></tr></table></td></tr></table></td></tr></table></td></tr></table></td></tr></table></td></tr></table></td></tr></table></td></tr></table></td></tr></table> | | | | | | | | | | | | | | | | | | | | <table border="1" style="width: 100%; border-collapse: collapse; text-align: center;"> <tr> <td style="width: 10%;"></td> <td style="width: 10%;"></td> <td style="width: 10%;"></td> <td style="width: 10%;"></td> <td style="width: 10%;"></td> <td style="width: 10%;"></td> <td style="width: 10%;"></td> <td style="width: 10%;"></td> <td style="width: 10%;"></td> <td style="width: 10%;"></td> </tr> <tr> <td></td> <td></td> <td colspan="8" style="text-align: center;"> <table border="1" style="width: 100%; border-collapse: collapse; text-align: center;"> <tr> <td style="width: 10%;"></td> <td style="width: 10%;"></td> <td style="width: 10%;"></td> <td style="width: 10%;"></td> <td style="width: 10%;"></td> <td style="width: 10%;"></td> <td style="width: 10%;"></td> <td style="width: 10%;"></td> <td style="width: 10%;"></td> <td style="width: 10%;"></td> </tr> <tr> <td></td> <td></td> <td colspan="8" style="text-align: center;"> <table border="1" style="width: 100%; border-collapse: collapse; text-align: center;"> <tr> <td style="width: 10%;"></td> <td style="width: 10%;"></td> <td style="width: 10%;"></td> <td style="width: 10%;"></td> <td style="width: 10%;"></td> <td style="width: 10%;"></td> <td style="width: 10%;"></td> <td style="width: 10%;"></td> <td style="width: 10%;"></td> <td style="width: 10%;"></td> </tr> <tr> <td></td> <td></td> <td colspan="8" style="text-align: center;"> <table border="1" style="width: 100%; border-collapse: collapse; text-align: center;"> <tr> <td style="width: 10%;"></td> <td style="width: 10%;"></td> <td style="width: 10%;"></td> <td style="width: 10%;"></td> <td style="width: 10%;"></td> <td style="width: 10%;"></td> <td style="width: 10%;"></td> <td style="width: 10%;"></td> <td style="width: 10%;"></td> <td style="width: 10%;"></td> </tr> <tr> <td></td> <td></td> <td colspan="8" style="text-align: center;"> <table border="1" style="width: 100%; border-collapse: collapse; text-align: center;"> <tr> <td style="width: 10%;"></td> <td style="width: 10%;"></td> <td style="width: 10%;"></td> <td style="width: 10%;"></td> <td style="width: 10%;"></td> <td style="width: 10%;"></td> <td style="width: 10%;"></td> <td style="width: 10%;"></td> <td style="width: 10%;"></td> <td style="width: 10%;"></td> </tr> <tr> <td></td> <td></td> <td colspan="8" style="text-align: center;"> <table border="1" style="width: 100%; border-collapse: collapse; text-align: center;"> <tr> <td style="width: 10%;"></td> <td style="width: 10%;"></td> <td style="width: 10%;"></td> <td style="width: 10%;"></td> <td style="width: 10%;"></td> <td style="width: 10%;"></td> <td style="width: 10%;"></td> <td style="width: 10%;"></td> <td style="width: 10%;"></td> <td style="width: 10%;"></td> </tr> <tr> <td></td> <td></td> <td colspan="8" style="text-align: center;"> <table border="1" style="width: 100%; border-collapse: collapse; text-align: center;"> <tr> <td style="width: 10%;"></td> <td style="width: 10%;"></td> <td style="width: 10%;"></td> <td style="width: 10%;"></td> <td style="width: 10%;"></td> <td style="width: 10%;"></td> <td style="width: 10%;"></td> <td style="width: 10%;"></td> <td style="width: 10%;"></td> <td style="width: 10%;"></td> </tr> <tr> <td></td> <td></td> <td colspan="8" style="text-align:
center;"> <table border="1" style="width: 100%; border-collapse: collapse; text-align: center;"> <tr> <td style="width: 10%;"></td> <td style="width: 10%;"></td> <td style="width: 10%;"></td> <td style="width: 10%;"></td> <td style="width: 10%;"></td> <td style="width: 10%;"></td> <td style="width: 10%;"></td> <td style="width: 10%;"></td> <td style="width: 10%;"></td> <td style="width: 10%;"></td> </tr> <tr> <td></td> <td></td> <td colspan="8" style="text-align: center;"> <table border="1" style="width: 100%; border-collapse: collapse; text-align: center;"> <tr> <td style="width: 10%;"></td> <td style="width: 10%;"></td> <td style="width: 10%;"></td> <td style="width: 10%;"></td> <td style="width: 10%;"></td> <td style="width: 10%;"></td> <td style="width: 10%;"></td> <td style="width: 10%;"></td> <td style="width: 10%;"></td> <td style="width: 10%;"></td> </tr> <tr> <td></td> <td></td> <td colspan="8" style="text-align: center;"> <table border="1" style="width: 100%; border-collapse: collapse; text-align: center;"> <tr> <td style="width: 10%;"></td> <td style="width: 10%;"></td> <td style="width: 10%;"></td> <td style="width: 10%;"></td> <td style="width: 10%;"></td> <td style="width: 10%;"></td> <td style="width: 10%;"></td> <td style="width: 10%;"></td> <td style="width: 10%;"></td> <td style="width: 10%;"></td> </tr> <tr> <td></td> <td></td> <td colspan="8" style="text-align: center;"> <table border="1" style="width: 100%; border-collapse: collapse; text-align: center;"> <tr> <td style="width: 10%;"></td> <td style="width: 10%;"></td> <td style="width: 10%;"></td> <td style="width: 10%;"></td> <td style="width: 10%;"></td> <td style="width: 10%;"></td> <td style="width: 10%;"></td> <td style="width: 10%;"></td> <td style="width: 10%;"></td> <td style="width: 10%;"></td> </tr> <tr> <td></td> <td></td> <td colspan="8" style="text-align: center;"> <table border="1" style="width: 100%; border-collapse: collapse; text-align: center;"> <tr> <td style="width: 10%;"></td> <td style="width: 10%;"></td> <td style="width: 10%;"></td> <td style="width: 10%;"></td> <td style="width: 10%;"></td> <td style="width: 10%;"></td> <td style="width: 10%;"></td> <td style="width: 10%;"></td> <td style="width: 10%;"></td> <td style="width: 10%;"></td> </tr> <tr> <td></td> <td></td> <td colspan="8" style="text-align: center;"> <table border="1" style="width: 100%; border-collapse: collapse; text-align: center;"> <tr> <td style="width: 10%;"></td> <td style="width: 10%;"></td> <td style="width: 10%;"></td> <td style="width: 10%;"></td> <td style="width: 10%;"></td> <td style="width: 10%;"></td> <td style="width: 10%;"></td> <td style="width: 10%;"></td> <td style="width: 10%;"></td> <td style="width: 10%;"></td> </tr> <tr> <td></td> <td></td> <td colspan="8" style="text-align: center;"> <table border="1" style="width: 100%; border-collapse: collapse; text-align: center;"> <tr> <td style="width: 10%;"></td> <td style="width: 10%;"></td> <td style="width: 10%;"></td> <td style="width: 10%;"></td> <td style="width: 10%;"></td> <td style="width: 10%;"></td> <td style="width: 10%;"></td> <td style="width: 10%;"></td> <td style="width: 10%;"></td> <td style="width: 10%;"></td> </tr> <tr> <td></td> <td></td> <td colspan="8" style="text-align: center;"> <table border="1" style="width: 100%; border-collapse: collapse; text-align: center;"> <tr> <td style="width: 10%;"></td> <td style="width: 10%;"></td> <td style="width: 10%;"></td> <td style="width: 10%;"></td> <td style="width: 10%;"></td> <td style="width: 10%;"></td> <td style="width: 10%;"></td> <td style="width: 10%;"></td> <td style="width: 10%;"></td> <td style="width: 10%;"></td> </tr> <tr> <td></td> <td></td> <td colspan="8" style="text-align: center;"> <table border="1" style="width: 100%; border-collapse: collapse; text-align: center;"> <tr> <td style="width: 10%;"></td> <td style="width: 10%;"></td> <td style="width: 10%;"></td> <td style="width: 10%;"></td> <td style="width: 10%;"></td> <td style="width: 10%;"></td> <td style="width: 10%;"></td> <td style="width: 10%;"></td> <td style="width: 10%;"></td> <td style="width: 10%;"></td> </tr> <tr> <td></td> <td></td> <td colspan="8" style="text-align: center;"> <table border="1" style="width: 100%; border-collapse: collapse; text-align: center;"> <tr> <td style="width: 10%;"></td> <td style="width: 10%;"></td> <td style="width: 10%;"></td> <td style="width: 10%;"></td> <td style="width: 10%;"></td> <td style="width: 10%;"></td> <td style="width: 10%;"></td> <td style="width: 10%;"></td> <td style="width: 10%;"></td> <td style="width: 10%;"></td> </tr> <tr> <td></td> <td></td> <td colspan="8" style="text-align: center;"> <table border="1" style="width: 100%; border-collapse: collapse; text-align: center;"> <tr> <td style="width: 10%;"></td> <td style="width: 10%;"></td> <td style="width: 10%;"></td> <td style="width: 10%;"></td> <td style="width: 10%;"></td> <td style="width: 10%;"></td> <td style="width: 10%;"></td> <td style="width: 10%;"></td> <td style="width: 10%;"></td> <td style="width: 10%;"></td> </tr> <tr> <td></td> <td></td> <td colspan="8" style="text-align: center;"> <table border="1" style="width: 100%; border-collapse: collapse; text-align: center;"> <tr> </tr></table></td></tr></table></td></tr></table></td></tr></table></td></tr></table></td></tr></table></td></tr></table></td></tr></table></td></tr></table></td></tr></table></td></tr></table></td></tr></table></td></tr></table></td></tr></table></td></tr></table></td></tr></table></td></tr></table></td></tr></table></td></tr></table>
 | | | | | | | | | | | | | | | | | | | | <table border="1" style="width: 100%; border-collapse: collapse; text-align: center;"> <tr> <td style="width: 10%;"></td> <td style="width: 10%;"></td> <td style="width: 10%;"></td> <td style="width: 10%;"></td> <td style="width: 10%;"></td> <td style="width: 10%;"></td> <td style="width: 10%;"></td> <td style="width: 10%;"></td> <td style="width: 10%;"></td> <td style="width: 10%;"></td> </tr> <tr> <td></td> <td></td> <td colspan="8" style="text-align: center;"> <table border="1" style="width: 100%; border-collapse: collapse; text-align: center;"> <tr> <td style="width: 10%;"></td> <td style="width: 10%;"></td> <td style="width: 10%;"></td> <td style="width: 10%;"></td> <td style="width: 10%;"></td> <td style="width: 10%;"></td> <td style="width: 10%;"></td> <td style="width: 10%;"></td> <td style="width: 10%;"></td> <td style="width: 10%;"></td> </tr> <tr> <td></td> <td></td> <td colspan="8" style="text-align: center;"> <table border="1" style="width: 100%; border-collapse: collapse; text-align: center;"> <tr> <td style="width: 10%;"></td> <td style="width: 10%;"></td> <td style="width: 10%;"></td> <td style="width: 10%;"></td> <td style="width: 10%;"></td> <td style="width: 10%;"></td> <td style="width: 10%;"></td> <td style="width: 10%;"></td> <td style="width: 10%;"></td> <td style="width: 10%;"></td> </tr> <tr> <td></td> <td></td> <td colspan="8" style="text-align: center;"> <table border="1" style="width: 100%; border-collapse: collapse; text-align: center;"> <tr> <td style="width: 10%;"></td> <td style="width: 10%;"></td> <td style="width: 10%;"></td> <td style="width: 10%;"></td> <td style="width: 10%;"></td> <td style="width: 10%;"></td> <td style="width: 10%;"></td> <td style="width: 10%;"></td> <td style="width: 10%;"></td> <td style="width: 10%;"></td> </tr> <tr> <td></td> <td></td> <td colspan="8" style="text-align: center;"> <table border="1" style="width: 100%; border-collapse: collapse; text-align: center;"> <tr> <td style="width: 10%;"></td> <td style="width: 10%;"></td> <td style="width: 10%;"></td> <td style="width: 10%;"></td> <td style="width: 10%;"></td> <td style="width: 10%;"></td> <td style="width: 10%;"></td> <td style="width: 10%;"></td> <td style="width: 10%;"></td> <td style="width: 10%;"></td> </tr> <tr> <td></td> <td></td> <td colspan="8" style="text-align: center;"> <table border="1" style="width: 100%; border-collapse: collapse; text-align: center;"> <tr> <td style="width: 10%;"></td> <td style="width: 10%;"></td> <td style="width: 10%;"></td> <td style="width: 10%;"></td> <td style="width: 10%;"></td> <td style="width: 10%;"></td> <td style="width: 10%;"></td> <td style="width: 10%;"></td> <td style="width: 10%;"></td> <td style="width: 10%;"></td> </tr> <tr> <td></td> <td></td> <td colspan="8" style="text-align: center;"> <table border="1" style="width: 100%; border-collapse: collapse; text-align: center;"> <tr> <td style="width: 10%;"></td> <td style="width: 10%;"></td> <td style="width: 10%;"></td> <td style="width: 10%;"></td> <td style="width: 10%;"></td> <td style="width: 10%;"></td> <td style="width: 10%;"></td> <td style="width: 10%;"></td> <td style="width: 10%;"></td> <td style="width: 10%;"></td> </tr> <tr> <td></td> <td></td> <td colspan="8" style="text-align: center;"> <table border="1" style="width: 100%; border-collapse: collapse; text-align: center;"> <tr> <td style="width: 10%;"></td> <td style="width: 10%;"></td> <td style="width: 10%;"></td> <td style="width: 10%;"></td> <td style="width: 10%;"></td> <td style="width: 10%;"></td> <td style="width: 10%;"></td> <td style="width: 10%;"></td> <td style="width: 10%;"></td> <td style="width: 10%;"></td> </tr> <tr> <td></td> <td></td> <td colspan="8" style="text-align: center;"> <table border="1" style="width: 100%; border-collapse: collapse; text-align: center;"> <tr> <td style="width: 10%;"></td> <td style="width: 10%;"></td> <td style="width: 10%;"></td> <td style="width: 10%;"></td> <td style="width: 10%;"></td> <td style="width: 10%;"></td> <td style="width: 10%;"></td> <td style="width: 10%;"></td> <td style="width: 10%;"></td> <td style="width: 10%;"></td> </tr> <tr> <td></td> <td></td> <td colspan="8" style="text-align: center;"> <table border="1" style="width: 100%; border-collapse: collapse; text-align: center;"> <tr> <td style="width: 10%;"></td> <td style="width: 10%;"></td> <td style="width: 10%;"></td> <td style="width: 10%;"></td> <td style="width: 10%;"></td> <td style="width: 10%;"></td> <td style="width: 10%;"></td> <td style="width: 10%;"></td> <td style="width: 10%;"></td> <td style="width: 10%;"></td> </tr> <tr> <td></td> <td></td> <td colspan="8" style="text-align: center;"> <table border="1" style="width: 100%; border-collapse: collapse; text-align: center;"> <tr> <td style="width: 10%;"></td> <td style="width: 10%;"></td> <td style="width: 10%;"></td> <td style="width: 10%;"></td> <td style="width: 10%;"></td> <td style="width: 10%;"></td> <td style="width: 10%;"></td> <td style="width: 10%;"></td> <td style="width: 10%;"></td> <td style="width: 10%;"></td> </tr> <tr> <td></td> <td></td> <td colspan="8" style="text-align: center;"> <table border="1" style="width: 100%; border-collapse: collapse; text-align: center;"> <tr> <td style="width: 10%;"></td> <td style="width: 10%;"></td> <td style="width: 10%;"></td> <td style="width: 10%;"></td> <td style="width: 10%;"></td> <td style="width: 10%;"></td> <td style="width: 10%;"></td> <td style="width: 10%;"></td> <td style="width: 10%;"></td> <td style="width: 10%;"></td> </tr> <tr> <td></td> <td></td> <td colspan="8" style="text-align: center;"> <table border="1" style="width: 100%; border-collapse: collapse; text-align: center;"> <tr> <td style="width: 10%;"></td> <td style="width: 10%;"></td> <td style="width: 10%;"></td> <td style="width: 10%;"></td> <td style="width: 10%;"></td> <td style="width: 10%;"></td> <td style="width: 10%;"></td> <td style="width: 10%;"></td> <td style="width: 10%;"></td> <td style="width: 10%;"></td> </tr> <tr> <td></td> <td></td> <td colspan="8" style="text-align: center;"> <table border="1" style="width: 100%; border-collapse: collapse; text-align: center;"> <tr> <td style="width: 10%;"></td> <td style="width: 10%;"></td> <td style="width: 10%;"></td> <td style="width: 10%;"></td> <td style="width: 10%;"></td> <td style="width: 10%;"></td> <td style="width: 10%;"></td> <td style="width: 10%;"></td> <td style="width: 10%;"></td> <td style="width: 10%;"></td> </tr> <tr> <td></td> <td></td> <td colspan="8" style="text-align: center;"> <table border="1" style="width: 100%; border-collapse: collapse; text-align: center;"> <tr> <td style="width: 10%;"></td> <td style="width: 10%;"></td> <td style="width: 10%;"></td> <td style="width: 10%;"></td> <td style="width: 10%;"></td> <td style="width: 10%;"></td> <td style="width: 10%;"></td> <td style="width: 10%;"></td> <td style="width: 10%;"></td> <td style="width: 10%;"></td> </tr> <tr> <td></td> <td></td> <td colspan="8" style="text-align: center;"> <table border="1" style="width: 100%; border-collapse: collapse; text-align: center;"> <tr> <td style="width: 10%;"></td> <td style="width: 10%;"></td> <td style="width: 10%;"></td> <td style="width: 10%;"></td> <td style="width: 10%;"></td> <td style="width: 10%;"></td> <td style="width: 10%;"></td> <td style="width: 10%;"></td> <td style="width: 10%;"></td> <td style="width: 10%;"></td> </tr> <tr> <td></td> <td></td> <td colspan="8" style="text-align: center;"> <table border="1" style="width: 100%; border-collapse: collapse; text-align: center;"> <tr> <td style="width: 10%;"></td> <td style="width: 10%;"></td> <td style="width: 10%;"></td> <td style="width: 10%;"></td> <td style="width: 10%;"></td> <td style="width: 10%;"></td> <td style="width: 10%;"></td> <td style="width: 10%;"></td> <td style="width: 10%;"></td> <td style="width: 10%;"></td> </tr> <tr> <td></td> <td></td> <td colspan="8" style="text-align: center;"> <table border="1" style="width: 100%; border-collapse: collapse; text-align:
center;"> <tr> </tr></table></td></tr></table></td></tr></table></td></tr></table></td></tr></table></td></tr></table></td></tr></table></td></tr></table></td></tr></table></td></tr></table></td></tr></table></td></tr></table></td></tr></table></td></tr></table></td></tr></table></td></tr></table></td></tr></table></td></tr></table> | | | | | | | | | | | | | | | | | | | | <table border="1" style="width: 100%; border-collapse: collapse; text-align: center;"> <tr> <td style="width: 10%;"></td> <td style="width: 10%;"></td> <td style="width: 10%;"></td> <td style="width: 10%;"></td> <td style="width: 10%;"></td> <td style="width: 10%;"></td> <td style="width: 10%;"></td> <td style="width: 10%;"></td> <td style="width: 10%;"></td> <td style="width: 10%;"></td> </tr> <tr> <td></td> <td></td> <td colspan="8" style="text-align: center;"> <table border="1" style="width: 100%; border-collapse: collapse; text-align: center;"> <tr> <td style="width: 10%;"></td> <td style="width: 10%;"></td> <td style="width: 10%;"></td> <td style="width: 10%;"></td> <td style="width: 10%;"></td> <td style="width: 10%;"></td> <td style="width: 10%;"></td> <td style="width: 10%;"></td> <td style="width: 10%;"></td> <td style="width: 10%;"></td> </tr> <tr> <td></td> <td></td> <td colspan="8" style="text-align: center;"> <table border="1" style="width: 100%; border-collapse: collapse; text-align: center;"> <tr> <td style="width: 10%;"></td> <td style="width: 10%;"></td> <td style="width: 10%;"></td> <td style="width: 10%;"></td> <td style="width: 10%;"></td> <td style="width: 10%;"></td> <td style="width: 10%;"></td> <td style="width: 10%;"></td> <td style="width: 10%;"></td> <td style="width: 10%;"></td> </tr> <tr> <td></td> <td></td> <td colspan="8" style="text-align: center;"> <table border="1" style="width: 100%; border-collapse: collapse; text-align: center;"> <tr> <td style="width: 10%;"></td> <td style="width: 10%;"></td> <td style="width: 10%;"></td> <td style="width: 10%;"></td> <td style="width: 10%;"></td> <td style="width: 10%;"></td> <td style="width: 10%;"></td> <td style="width: 10%;"></td> <td style="width: 10%;"></td> <td style="width: 10%;"></td> </tr> <tr> <td></td> <td></td> <td colspan="8" style="text-align: center;"> <table border="1" style="width: 100%; border-collapse: collapse; text-align: center;"> <tr> <td style="width: 10%;"></td> <td style="width: 10%;"></td> <td style="width: 10%;"></td> <td style="width: 10%;"></td> <td style="width: 10%;"></td> <td style="width: 10%;"></td> <td style="width: 10%;"></td> <td style="width: 10%;"></td> <td style="width: 10%;"></td> <td style="width: 10%;"></td> </tr> <tr> <td></td> <td></td> <td colspan="8" style="text-align: center;"> <table border="1" style="width: 100%; border-collapse: collapse; text-align: center;"> <tr> <td style="width: 10%;"></td> <td style="width: 10%;"></td> <td style="width: 10%;"></td> <td style="width: 10%;"></td> <td style="width: 10%;"></td> <td style="width: 10%;"></td> <td style="width: 10%;"></td> <td style="width: 10%;"></td> <td style="width: 10%;"></td> <td style="width: 10%;"></td> </tr> <tr> <td></td> <td></td> <td colspan="8" style="text-align: center;"> <table border="1" style="width: 100%; border-collapse: collapse; text-align: center;"> <tr> <td style="width: 10%;"></td> <td style="width: 10%;"></td> <td style="width: 10%;"></td> <td style="width: 10%;"></td> <td style="width: 10%;"></td> <td style="width: 10%;"></td> <td style="width: 10%;"></td> <td style="width: 10%;"></td> <td style="width: 10%;"></td> <td style="width: 10%;"></td> </tr> <tr> <td></td> <td></td> <td colspan="8" style="text-align: center;"> <table
border="1" style="width: 100%; border-collapse: collapse; text-align: center;"> <tr> <td style="width: 10%;"></td> <td style="width: 10%;"></td> <td style="width: 10%;"></td> <td style="width: 10%;"></td> <td style="width: 10%;"></td> <td style="width: 10%;"></td> <td style="width: 10%;"></td> <td style="width: 10%;"></td> <td style="width: 10%;"></td> <td style="width: 10%;"></td> </tr> <tr> <td></td> <td></td> <td colspan="8" style="text-align: center;"> <table border="1" style="width: 100%; border-collapse: collapse; text-align: center;"> <tr> <td style="width: 10%;"></td> <td style="width: 10%;"></td> <td style="width: 10%;"></td> <td style="width: 10%;"></td> <td style="width: 10%;"></td> <td style="width: 10%;"></td> <td style="width: 10%;"></td> <td style="width: 10%;"></td> <td style="width: 10%;"></td> <td style="width: 10%;"></td> </tr> <tr> <td></td> <td></td> <td colspan="8" style="text-align: center;"> <table border="1" style="width: 100%; border-collapse: collapse; text-align: center;"> <tr> <td style="width: 10%;"></td> <td style="width: 10%;"></td> <td style="width: 10%;"></td> <td style="width: 10%;"></td> <td style="width: 10%;"></td> <td style="width: 10%;"></td> <td style="width: 10%;"></td> <td style="width: 10%;"></td> <td style="width: 10%;"></td> <td style="width: 10%;"></td> </tr> <tr> <td></td> <td></td> <td colspan="8" style="text-align: center;"> <table border="1" style="width: 100%; border-collapse: collapse; text-align: center;"> <tr> <td style="width: 10%;"></td> <td style="width: 10%;"></td> <td style="width: 10%;"></td> <td style="width: 10%;"></td> <td style="width: 10%;"></td> <td style="width: 10%;"></td> <td style="width: 10%;"></td> <td style="width: 10%;"></td> <td style="width: 10%;"></td> <td style="width: 10%;"></td> </tr> <tr> <td></td> <td></td> <td colspan="8" style="text-align: center;"> <table border="1" style="width: 100%; border-collapse: collapse; text-align: center;"> <tr> <td style="width: 10%;"></td> <td style="width: 10%;"></td> <td style="width: 10%;"></td> <td style="width: 10%;"></td> <td style="width: 10%;"></td> <td style="width: 10%;"></td> <td style="width: 10%;"></td> <td style="width: 10%;"></td> <td style="width: 10%;"></td> <td style="width: 10%;"></td> </tr> <tr> <td></td> <td></td> <td colspan="8" style="text-align: center;"> <table border="1" style="width: 100%; border-collapse: collapse; text-align: center;"> <tr> <td style="width: 10%;"></td> <td style="width: 10%;"></td> <td style="width: 10%;"></td> <td style="width: 10%;"></td> <td style="width: 10%;"></td> <td style="width: 10%;"></td> <td style="width: 10%;"></td> <td style="width: 10%;"></td> <td style="width: 10%;"></td> <td style="width: 10%;"></td> </tr> <tr> <td></td> <td></td> <td colspan="8" style="text-align: center;"> <table border="1" style="width: 100%; border-collapse: collapse; text-align: center;"> <tr> <td style="width: 10%;"></td> <td style="width: 10%;"></td> <td style="width: 10%;"></td> <td style="width: 10%;"></td> <td style="width: 10%;"></td> <td style="width: 10%;"></td> <td style="width: 10%;"></td> <td style="width: 10%;"></td> <td style="width: 10%;"></td> <td style="width: 10%;"></td> </tr> <tr> <td></td> <td></td> <td colspan="8" style="text-align: center;"> <table border="1" style="width: 100%; border-collapse: collapse; text-align: center;"> <tr> <td style="width: 10%;"></td> <td style="width: 10%;"></td> <td style="width: 10%;"></td> <td style="width: 10%;"></td> <td style="width: 10%;"></td> <td style="width: 10%;"></td> <td style="width: 10%;"></td> <td style="width: 10%;"></td> <td style="width: 10%;"></td> <td style="width: 10%;"></td> </tr> <tr> <td></td> <td></td> <td colspan="8" style="text-align: center;"> <table border="1" style="width: 100%; border-collapse: collapse; text-align: center;"> <tr> <td style="width: 10%;"></td> <td style="width: 10%;"></td> <td style="width: 10%;"></td> <td style="width: 10%;"></td> <td style="width: 10%;"></td> <td style="width: 10%;"></td> <td style="width: 10%;"></td> <td style="width: 10%;"></td> <td style="width: 10%;"></td> <td style="width: 10%;"></td> </tr> <tr> <td></td> <td></td> <td colspan="8" style="text-align: center;"> <table border="1" style="width: 100%; border-collapse: collapse; text-align: center;"> <tr> </tr></table></td></tr></table></td></tr></table></td></tr></table></td></tr></table></td></tr></table></td></tr></table></td></tr></table></td></tr></table></td></tr></table></td></tr></table></td></tr></table></td></tr></table></td></tr></table></td></tr></table></td></tr></table></td></tr></table>
 | | | | | | | | | | | | | | | | | | | | <table border="1" style="width: 100%; border-collapse: collapse; text-align: center;"> <tr> <td style="width: 10%;"></td> <td style="width: 10%;"></td> <td style="width: 10%;"></td> <td style="width: 10%;"></td> <td style="width: 10%;"></td> <td style="width: 10%;"></td> <td style="width: 10%;"></td> <td style="width: 10%;"></td> <td style="width: 10%;"></td> <td style="width: 10%;"></td> </tr> <tr> <td></td> <td></td> <td colspan="8" style="text-align: center;"> <table border="1" style="width: 100%; border-collapse: collapse; text-align: center;"> <tr> <td style="width: 10%;"></td> <td style="width: 10%;"></td> <td style="width: 10%;"></td> <td style="width: 10%;"></td> <td style="width: 10%;"></td> <td style="width: 10%;"></td> <td style="width: 10%;"></td> <td style="width: 10%;"></td> <td style="width: 10%;"></td> <td style="width: 10%;"></td> </tr> <tr> <td></td> <td></td> <td colspan="8" style="text-align: center;"> <table border="1" style="width: 100%; border-collapse: collapse; text-align: center;"> <tr> <td style="width: 10%;"></td> <td style="width: 10%;"></td> <td style="width: 10%;"></td> <td style="width: 10%;"></td> <td style="width: 10%;"></td> <td style="width: 10%;"></td> <td style="width: 10%;"></td> <td style="width: 10%;"></td> <td style="width: 10%;"></td> <td style="width: 10%;"></td> </tr> <tr> <td></td> <td></td> <td colspan="8" style="text-align: center;"> <table border="1" style="width: 100%; border-collapse: collapse; text-align: center;"> <tr> <td style="width: 10%;"></td> <td style="width: 10%;"></td> <td style="width: 10%;"></td> <td style="width: 10%;"></td> <td style="width: 10%;"></td> <td style="width: 10%;"></td> <td style="width: 10%;"></td> <td style="width: 10%;"></td> <td style="width: 10%;"></td> <td style="width: 10%;"></td> </tr> <tr> <td></td> <td></td> <td colspan="8" style="text-align: center;"> <table border="1" style="width: 100%; border-collapse: collapse; text-align: center;"> <tr> <td style="width: 10%;"></td> <td style="width: 10%;"></td> <td style="width: 10%;"></td> <td style="width: 10%;"></td> <td style="width: 10%;"></td> <td style="width: 10%;"></td> <td style="width: 10%;"></td> <td style="width: 10%;"></td> <td style="width: 10%;"></td> <td style="width: 10%;"></td> </tr> <tr> <td></td> <td></td> <td colspan="8" style="text-align: center;"> <table border="1" style="width: 100%; border-collapse: collapse; text-align: center;"> <tr> <td style="width: 10%;"></td> <td style="width: 10%;"></td> <td style="width: 10%;"></td> <td style="width: 10%;"></td> <td style="width: 10%;"></td> <td style="width: 10%;"></td> <td style="width: 10%;"></td> <td style="width: 10%;"></td> <td style="width: 10%;"></td> <td style="width: 10%;"></td> </tr> <tr> <td></td> <td></td> <td colspan="8" style="text-align: center;"> <table border="1" style="width: 100%; border-collapse: collapse; text-align: center;"> <tr> <td style="width: 10%;"></td> <td style="width: 10%;"></td> <td style="width: 10%;"></td> <td style="width: 10%;"></td> <td style="width: 10%;"></td> <td style="width: 10%;"></td> <td style="width: 10%;"></td> <td style="width: 10%;"></td> <td style="width: 10%;"></td> <td style="width: 10%;"></td> </tr> <tr> <td></td> <td></td> <td colspan="8" style="text-align: center;"> <table border="1" style="width: 100%; border-collapse: collapse; text-align: center;"> <tr> <td style="width: 10%;"></td> <td style="width: 10%;"></td> <td style="width: 10%;"></td> <td style="width: 10%;"></td> <td style="width: 10%;"></td> <td style="width: 10%;"></td> <td style="width: 10%;"></td> <td style="width: 10%;"></td> <td style="width: 10%;"></td> <td style="width: 10%;"></td> </tr> <tr> <td></td> <td></td> <td colspan="8" style="text-align: center;"> <table border="1" style="width: 100%; border-collapse: collapse; text-align: center;"> <tr> <td style="width: 10%;"></td> <td style="width: 10%;"></td> <td style="width: 10%;"></td> <td style="width: 10%;"></td> <td style="width: 10%;"></td> <td style="width: 10%;"></td> <td style="width: 10%;"></td> <td style="width: 10%;"></td> <td style="width: 10%;"></td> <td style="width: 10%;"></td> </tr> <tr> <td></td> <td></td> <td colspan="8" style="text-align: center;"> <table border="1" style="width: 100%; border-collapse: collapse; text-align: center;"> <tr> <td style="width: 10%;"></td> <td style="width: 10%;"></td> <td style="width: 10%;"></td> <td style="width: 10%;"></td> <td style="width: 10%;"></td> <td style="width: 10%;"></td> <td style="width: 10%;"></td> <td style="width: 10%;"></td> <td style="width: 10%;"></td> <td style="width: 10%;"></td> </tr> <tr> <td></td> <td></td> <td colspan="8" style="text-align: center;"> <table border="1" style="width: 100%; border-collapse: collapse; text-align: center;"> <tr> <td style="width: 10%;"></td> <td style="width: 10%;"></td> <td style="width: 10%;"></td> <td style="width: 10%;"></td> <td style="width: 10%;"></td> <td style="width: 10%;"></td> <td style="width: 10%;"></td> <td style="width: 10%;"></td> <td style="width: 10%;"></td> <td style="width: 10%;"></td> </tr> <tr> <td></td> <td></td> <td colspan="8" style="text-align: center;"> <table border="1" style="width: 100%; border-collapse: collapse; text-align: center;"> <tr> <td style="width: 10%;"></td> <td style="width: 10%;"></td> <td style="width: 10%;"></td> <td style="width: 10%;"></td> <td style="width: 10%;"></td> <td style="width: 10%;"></td> <td style="width: 10%;"></td> <td style="width: 10%;"></td> <td style="width: 10%;"></td> <td style="width: 10%;"></td> </tr> <tr> <td></td> <td></td> <td colspan="8" style="text-align: center;"> <table border="1" style="width: 100%; border-collapse: collapse; text-align: center;"> <tr> <td style="width: 10%;"></td> <td style="width: 10%;"></td> <td style="width: 10%;"></td> <td style="width: 10%;"></td> <td style="width: 10%;"></td> <td style="width: 10%;"></td> <td style="width: 10%;"></td> <td style="width: 10%;"></td> <td style="width: 10%;"></td> <td style="width: 10%;"></td> </tr> <tr> <td></td> <td></td> <td colspan="8" style="text-align: center;"> <table border="1" style="width: 100%; border-collapse: collapse; text-align: center;"> <tr> <td style="width: 10%;"></td> <td style="width: 10%;"></td> <td style="width: 10%;"></td> <td style="width: 10%;"></td> <td style="width: 10%;"></td> <td style="width: 10%;"></td> <td style="width: 10%;"></td> <td style="width: 10%;"></td> <td style="width: 10%;"></td> <td style="width: 10%;"></td> </tr> <tr> <td></td> <td></td> <td colspan="8" style="text-align: center;"> <table border="1" style="width: 100%; border-collapse: collapse; text-align: center;"> <tr> <td style="width: 10%;"></td> <td style="width: 10%;"></td> <td style="width: 10%;"></td> <td style="width: 10%;"></td> <td style="width: 10%;"></td> <td style="width: 10%;"></td> <td style="width: 10%;"></td> <td style="width: 10%;"></td> <td style="width: 10%;"></td> <td style="width: 10%;"></td> </tr> <tr> <td></td> <td></td> <td colspan="8" style="text-align: center;"> <table border="1" style="width: 100%; border-collapse: collapse; text-align: center;"> <tr> </tr></table></td></tr></table></td></tr></table></td></tr></table></td></tr></table></td></tr></table></td></tr></table></td></tr></table></td></tr></table></td></tr></table></td></tr></table></td></tr></table></td></tr></table></td></tr></table></td></tr></table></td></tr></table>
 | | | | | | | | | | | | | | | | | | | | <table border="1" style="width: 100%; border-collapse: collapse; text-align: center;"> <tr> <td style="width: 10%;"></td> <td style="width: 10%;"></td> <td style="width: 10%;"></td> <td style="width: 10%;"></td> <td style="width: 10%;"></td> <td style="width: 10%;"></td> <td style="width: 10%;"></td> <td style="width: 10%;"></td> <td style="width: 10%;"></td> <td style="width: 10%;"></td> </tr> <tr> <td></td> <td></td> <td colspan="8" style="text-align: center;"> <table border="1" style="width: 100%; border-collapse: collapse; text-align: center;"> <tr> <td style="width: 10%;"></td> <td style="width: 10%;"></td> <td style="width: 10%;"></td> <td style="width: 10%;"></td> <td style="width: 10%;"></td> <td style="width: 10%;"></td> <td style="width: 10%;"></td> <td style="width: 10%;"></td> <td style="width: 10%;"></td> <td style="width: 10%;"></td> </tr> <tr> <td></td> <td></td> <td colspan="8" style="text-align: center;"> <table border="1" style="width: 100%; border-collapse: collapse; text-align: center;"> <tr> <td style="width: 10%;"></td> <td style="width: 10%;"></td> <td style="width: 10%;"></td> <td style="width: 10%;"></td> <td style="width: 10%;"></td> <td style="width: 10%;"></td> <td style="width: 10%;"></td> <td style="width: 10%;"></td> <td style="width: 10%;"></td> <td style="width: 10%;"></td> </tr> <tr> <td></td> <td></td> <td colspan="8" style="text-align: center;"> <table border="1" style="width: 100%; border-collapse: collapse; text-align: center;"> <tr> <td style="width: 10%;"></td> <td style="width: 10%;"></td> <td style="width: 10%;"></td> <td style="width: 10%;"></td> <td style="width: 10%;"></td> <td style="width: 10%;"></td> <td style="width: 10%;"></td> <td style="width: 10%;"></td> <td style="width: 10%;"></td> <td style="width: 10%;"></td> </tr> <tr> <td></td> <td></td> <td colspan="8" style="text-align: center;"> <table border="1" style="width: 100%; border-collapse: collapse; text-align: center;"> <tr> <td style="width: 10%;"></td> <td style="width: 10%;"></td> <td style="width: 10%;"></td> <td style="width: 10%;"></td> <td style="width: 10%;"></td> <td style="width: 10%;"></td> <td style="width: 10%;"></td> <td style="width: 10%;"></td> <td style="width: 10%;"></td> <td style="width: 10%;"></td> </tr> <tr> <td></td> <td></td> <td colspan="8" style="text-align: center;"> <table border="1" style="width: 100%; border-collapse: collapse; text-align: center;"> <tr> <td style="width: 10%;"></td> <td style="width: 10%;"></td> <td style="width: 10%;"></td> <td style="width: 10%;"></td> <td style="width: 10%;"></td> <td style="width: 10%;"></td> <td style="width: 10%;"></td> <td style="width: 10%;"></td> <td style="width: 10%;"></td> <td style="width: 10%;"></td> </tr> <tr> <td></td> <td></td> <td colspan="8" style="text-align: center;"> <table border="1" style="width: 100%; border-collapse: collapse; text-align: center;"> <tr> <td style="width: 10%;"></td> <td style="width: 10%;"></td> <td style="width: 10%;"></td> <td style="width: 10%;"></td> <td style="width: 10%;"></td> <td style="width: 10%;"></td> <td style="width: 10%;"></td> <td style="width: 10%;"></td> <td style="width: 10%;"></td> <td style="width: 10%;"></td> </tr> <tr> <td></td> <td></td> <td colspan="8" style="text-align: center;"> <table border="1" style="width: 100%; border-collapse: collapse; text-align: center;"> <tr> <td style="width: 10%;"></td> <td style="width: 10%;"></td> <td style="width: 10%;"></td> <td style="width: 10%;"></td> <td style="width: 10%;"></td> <td style="width: 10%;"></td> <td style="width: 10%;"></td> <td style="width: 10%;"></td> <td style="width: 10%;"></td> <td style="width: 10%;"></td> </tr> <tr> <td></td> <td></td> <td colspan="8" style="text-align: center;"> <table border="1" style="width: 100%; border-collapse: collapse; text-align: center;"> <tr> <td style="width: 10%;"></td> <td style="width: 10%;"></td> <td style="width: 10%;"></td> <td style="width: 10%;"></td> <td style="width: 10%;"></td> <td style="width: 10%;"></td> <td style="width: 10%;"></td> <td style="width: 10%;"></td> <td style="width: 10%;"></td> <td style="width: 10%;"></td> </tr> <tr> <td></td> <td></td> <td colspan="8" style="text-align: center;"> <table border="1" style="width: 100%; border-collapse: collapse; text-align: center;"> <tr> <td style="width: 10%;"></td> <td style="width: 10%;"></td> <td style="width: 10%;"></td> <td style="width: 10%;"></td> <td style="width: 10%;"></td> <td style="width: 10%;"></td> <td style="width: 10%;"></td> <td style="width: 10%;"></td> <td style="width: 10%;"></td> <td style="width: 10%;"></td> </tr> <tr> <td></td> <td></td> <td colspan="8" style="text-align: center;"> <table border="1" style="width: 100%; border-collapse: collapse; text-align: center;"> <tr> <td style="width: 10%;"></td> <td style="width: 10%;"></td> <td style="width: 10%;"></td> <td style="width: 10%;"></td> <td style="width: 10%;"></td> <td style="width: 10%;"></td> <td style="width: 10%;"></td> <td style="width: 10%;"></td> <td style="width: 10%;"></td> <td style="width: 10%;"></td> </tr> <tr> <td></td> <td></td> <td colspan="8" style="text-align: center;"> <table border="1" style="width: 100%; border-collapse: collapse; text-align: center;"> <tr> <td
style="width: 10%;"></td> <td style="width: 10%;"></td> <td style="width: 10%;"></td> <td style="width: 10%;"></td> <td style="width: 10%;"></td> <td style="width: 10%;"></td> <td style="width: 10%;"></td> <td style="width: 10%;"></td> <td style="width: 10%;"></td> <td style="width: 10%;"></td> </tr> <tr> <td></td> <td></td> <td colspan="8" style="text-align: center;"> <table border="1" style="width: 100%; border-collapse: collapse; text-align: center;"> <tr> <td style="width: 10%;"></td> <td style="width: 10%;"></td> <td style="width: 10%;"></td> <td style="width: 10%;"></td> <td style="width: 10%;"></td> <td style="width: 10%;"></td> <td style="width: 10%;"></td> <td style="width: 10%;"></td> <td style="width: 10%;"></td> <td style="width: 10%;"></td> </tr> <tr> <td></td> <td></td> <td colspan="8" style="text-align: center;"> <table border="1" style="width: 100%; border-collapse: collapse; text-align: center;"> <tr> <td style="width: 10%;"></td> <td style="width: 10%;"></td> <td style="width: 10%;"></td> <td style="width: 10%;"></td> <td style="width: 10%;"></td> <td style="width: 10%;"></td> <td style="width: 10%;"></td> <td style="width: 10%;"></td> <td style="width: 10%;"></td> <td style="width: 10%;"></td> </tr> <tr> <td></td> <td></td> <td colspan="8" style="text-align: center;"> <table border="1" style="width: 100%; border-collapse: collapse; text-align: center;"> <tr> </tr></table></td></tr></table></td></tr></table></td></tr></table></td></tr></table></td></tr></table></td></tr></table></td></tr></table></td></tr></table></td></tr></table></td></tr></table></td></tr></table></td></tr></table></td></tr></table></td></tr></table> | | | | | | | | | | | | | | | | | | | | <table border="1" style="width: 100%; border-collapse: collapse; text-align: center;"> <tr> <td style="width: 10%;"></td> <td style="width: 10%;"></td> <td style="width: 10%;"></td> <td style="width: 10%;"></td> <td style="width: 10%;"></td> <td style="width: 10%;"></td> <td style="width: 10%;"></td> <td style="width: 10%;"></td> <td style="width: 10%;"></td> <td style="width: 10%;"></td> </tr> <tr> <td></td> <td></td> <td colspan="8" style="text-align: center;"> <table border="1" style="width: 100%; border-collapse: collapse; text-align: center;"> <tr> <td style="width: 10%;"></td> <td style="width: 10%;"></td> <td style="width: 10%;"></td> <td style="width: 10%;"></td> <td style="width: 10%;"></td> <td style="width: 10%;"></td> <td style="width: 10%;"></td> <td style="width: 10%;"></td> <td style="width: 10%;"></td> <td style="width: 10%;"></td> </tr> <tr> <td></td> <td></td> <td colspan="8" style="text-align: center;"> <table border="1" style="width: 100%; border-collapse: collapse; text-align: center;"> <tr> <td style="width: 10%;"></td> <td style="width: 10%;"></td> <td style="width: 10%;"></td> <td style="width: 10%;"></td> <td style="width: 10%;"></td> <td style="width: 10%;"></td> <td style="width: 10%;"></td> <td style="width: 10%;"></td> <td style="width: 10%;"></td> <td style="width: 10%;"></td> </tr> <tr> <td></td> <td></td> <td colspan="8" style="text-align: center;"> <table border="1" style="width: 100%; border-collapse: collapse; text-align: center;"> <tr> <td style="width: 10%;"></td> <td style="width: 10%;"></td> <td style="width: 10%;"></td> <td style="width: 10%;"></td> <td style="width: 10%;"></td> <td style="width: 10%;"></td> <td style="width: 10%;"></td> <td style="width: 10%;"></td> <td style="width: 10%;"></td> <td style="width: 10%;"></td> </tr> <tr> <td></td> <td></td> <td colspan="8" style="text-align: center;"> <table border="1" style="width: 100%; border-collapse: collapse; text-align:
center;"> <tr> <td style="width: 10%;"></td> <td style="width: 10%;"></td> <td style="width: 10%;"></td> <td style="width: 10%;"></td> <td style="width: 10%;"></td> <td style="width: 10%;"></td> <td style="width: 10%;"></td> <td style="width: 10%;"></td> <td style="width: 10%;"></td> <td style="width: 10%;"></td> </tr> <tr> <td></td> <td></td> <td colspan="8" style="text-align: center;"> <table border="1" style="width: 100%; border-collapse: collapse; text-align: center;"> <tr> <td style="width: 10%;"></td> <td style="width: 10%;"></td> <td style="width: 10%;"></td> <td style="width: 10%;"></td> <td style="width: 10%;"></td> <td style="width: 10%;"></td> <td style="width: 10%;"></td> <td style="width: 10%;"></td> <td style="width: 10%;"></td> <td style="width: 10%;"></td> </tr> <tr> <td></td> <td></td> <td colspan="8" style="text-align: center;"> <table border="1" style="width: 100%; border-collapse: collapse; text-align: center;"> <tr> <td style="width: 10%;"></td> <td style="width: 10%;"></td> <td style="width: 10%;"></td> <td style="width: 10%;"></td> <td style="width: 10%;"></td> <td style="width: 10%;"></td> <td style="width: 10%;"></td> <td style="width: 10%;"></td> <td style="width: 10%;"></td> <td style="width: 10%;"></td> </tr> <tr> <td></td> <td></td> <td colspan="8" style="text-align: center;"> <table border="1" style="width: 100%; border-collapse: collapse; text-align: center;"> <tr> <td style="width: 10%;"></td> <td style="width: 10%;"></td> <td style="width: 10%;"></td> <td style="width: 10%;"></td> <td style="width: 10%;"></td> <td style="width: 10%;"></td> <td style="width: 10%;"></td> <td style="width: 10%;"></td> <td style="width: 10%;"></td> <td style="width: 10%;"></td> </tr> <tr> <td></td> <td></td> <td colspan="8" style="text-align: center;"> <table border="1" style="width: 100%; border-collapse: collapse; text-align: center;"> <tr> <td style="width: 10%;"></td> <td style="width: 10%;"></td> <td style="width: 10%;"></td> <td style="width: 10%;"></td> <td style="width: 10%;"></td> <td style="width: 10%;"></td> <td style="width: 10%;"></td> <td style="width: 10%;"></td> <td style="width: 10%;"></td> <td style="width: 10%;"></td> </tr> <tr> <td></td> <td></td> <td colspan="8" style="text-align: center;"> <table border="1" style="width: 100%; border-collapse: collapse; text-align: center;"> <tr> <td style="width: 10%;"></td> <td style="width: 10%;"></td> <td style="width: 10%;"></td> <td style="width: 10%;"></td> <td style="width: 10%;"></td> <td style="width: 10%;"></td> <td style="width: 10%;"></td> <td style="width: 10%;"></td> <td style="width: 10%;"></td> <td style="width: 10%;"></td> </tr> <tr> <td></td> <td></td> <td colspan="8" style="text-align: center;"> <table border="1" style="width: 100%; border-collapse: collapse; text-align: center;"> <tr> <td style="width: 10%;"></td> <td style="width: 10%;"></td> <td style="width: 10%;"></td> <td style="width: 10%;"></td> <td style="width: 10%;"></td> <td style="width: 10%;"></td> <td style="width: 10%;"></td> <td style="width: 10%;"></td> <td style="width: 10%;"></td> <td style="width: 10%;"></td> </tr> <tr> <td></td> <td></td> <td colspan="8" style="text-align: center;"> <table border="1" style="width: 100%; border-collapse: collapse; text-align: center;"> <tr> <td style="width: 10%;"></td> <td style="width: 10%;"></td> <td style="width: 10%;"></td> <td style="width: 10%;"></td> <td style="width: 10%;"></td> <td style="width: 10%;"></td> <td style="width: 10%;"></td> <td style="width: 10%;"></td> <td style="width: 10%;"></td> <td style="width: 10%;"></td> </tr> <tr> <td></td> <td></td> <td colspan="8" style="text-align: center;"> <table border="1" style="width: 100%; border-collapse: collapse; text-align: center;"> <tr> <td style="width: 10%;"></td> <td style="width: 10%;"></td> <td style="width: 10%;"></td> <td style="width: 10%;"></td> <td style="width: 10%;"></td> <td style="width: 10%;"></td> <td style="width: 10%;"></td> <td style="width: 10%;"></td> <td style="width: 10%;"></td> <td style="width: 10%;"></td> </tr> <tr> <td></td> <td></td> <td colspan="8" style="text-align: center;"> <table border="1" style="width: 100%; border-collapse: collapse; text-align: center;"> <tr> </tr></table></td></tr></table></td></tr></table></td></tr></table></td></tr></table></td></tr></table></td></tr></table></td></tr></table></td></tr></table></td></tr></table></td></tr></table></td></tr></table></td></tr></table></td></tr></table>
 | | | | | | | | | | | | | | | | | | | | <table border="1" style="width: 100%; border-collapse: collapse; text-align: center;"> <tr> <td style="width: 10%;"></td> <td style="width: 10%;"></td> <td style="width: 10%;"></td> <td style="width: 10%;"></td> <td style="width: 10%;"></td> <td style="width: 10%;"></td> <td style="width: 10%;"></td> <td style="width: 10%;"></td> <td style="width: 10%;"></td> <td style="width: 10%;"></td> </tr> <tr> <td></td> <td></td> <td colspan="8" style="text-align: center;"> <table border="1" style="width: 100%; border-collapse: collapse; text-align: center;"> <tr> <td style="width: 10%;"></td> <td style="width: 10%;"></td> <td style="width: 10%;"></td> <td style="width: 10%;"></td> <td style="width: 10%;"></td> <td style="width: 10%;"></td> <td style="width: 10%;"></td> <td style="width: 10%;"></td> <td style="width: 10%;"></td> <td style="width: 10%;"></td> </tr> <tr> <td></td> <td></td> <td colspan="8" style="text-align: center;"> <table border="1" style="width: 100%; border-collapse: collapse; text-align: center;"> <tr> <td style="width: 10%;"></td> <td style="width: 10%;"></td> <td style="width: 10%;"></td> <td style="width: 10%;"></td> <td style="width: 10%;"></td> <td style="width: 10%;"></td> <td style="width: 10%;"></td> <td style="width: 10%;"></td> <td style="width: 10%;"></td> <td style="width: 10%;"></td> </tr> <tr> <td></td> <td></td> <td colspan="8" style="text-align: center;"> <table border="1" style="width: 100%; border-collapse: collapse; text-align: center;"> <tr> <td style="width: 10%;"></td> <td style="width: 10%;"></td> <td style="width: 10%;"></td> <td style="width: 10%;"></td> <td style="width: 10%;"></td> <td style="width: 10%;"></td> <td style="width: 10%;"></td> <td style="width: 10%;"></td> <td style="width: 10%;"></td> <td style="width: 10%;"></td> </tr> <tr> <td></td> <td></td> <td colspan="8" style="text-align: center;"> <table border="1" style="width: 100%; border-collapse: collapse; text-align: center;"> <tr> <td style="width: 10%;"></td> <td style="width: 10%;"></td> <td style="width: 10%;"></td> <td style="width: 10%;"></td> <td style="width: 10%;"></td> <td style="width: 10%;"></td> <td style="width: 10%;"></td> <td style="width: 10%;"></td> <td style="width: 10%;"></td> <td style="width: 10%;"></td> </tr> <tr> <td></td> <td></td> <td colspan="8" style="text-align: center;"> <table border="1" style="width: 100%; border-collapse: collapse; text-align: center;"> <tr> <td style="width: 10%;"></td> <td style="width: 10%;"></td> <td style="width: 10%;"></td> <td style="width: 10%;"></td> <td style="width: 10%;"></td> <td style="width: 10%;"></td> <td style="width: 10%;"></td> <td style="width: 10%;"></td> <td style="width: 10%;"></td> <td style="width: 10%;"></td> </tr> <tr> <td></td> <td></td> <td colspan="8" style="text-align: center;"> <table border="1" style="width: 100%; border-collapse: collapse; text-align: center;"> <tr> <td style="width: 10%;"></td> <td style="width: 10%;"></td> <td style="width: 10%;"></td> <td style="width: 10%;"></td> <td style="width: 10%;"></td> <td style="width: 10%;"></td> <td style="width: 10%;"></td> <td style="width: 10%;"></td> <td style="width: 10%;"></td> <td style="width: 10%;"></td> </tr> <tr> <td></td> <td></td> <td colspan="8" style="text-align: center;"> <table border="1" style="width: 100%; border-collapse: collapse; text-align: center;"> <tr> <td style="width: 10%;"></td> <td style="width: 10%;"></td> <td style="width: 10%;"></td> <td style="width: 10%;"></td> <td style="width: 10%;"></td> <td style="width: 10%;"></td> <td style="width: 10%;"></td> <td style="width: 10%;"></td> <td style="width: 10%;"></td> <td style="width: 10%;"></td> </tr> <tr> <td></td> <td></td> <td colspan="8" style="text-align: center;"> <table border="1" style="width: 100%; border-collapse: collapse; text-align: center;"> <tr> <td style="width: 10%;"></td> <td style="width: 10%;"></td> <td style="width: 10%;"></td> <td style="width: 10%;"></td> <td style="width: 10%;"></td> <td style="width: 10%;"></td> <td style="width: 10%;"></td> <td style="width: 10%;"></td> <td style="width: 10%;"></td> <td style="width: 10%;"></td> </tr> <tr> <td></td> <td></td> <td colspan="8" style="text-align: center;"> <table border="1" style="width: 100%; border-collapse: collapse; text-align: center;"> <tr> <td style="width: 10%;"></td> <td style="width: 10%;"></td> <td style="width: 10%;"></td> <td style="width: 10%;"></td> <td style="width: 10%;"></td> <td style="width: 10%;"></td> <td style="width: 10%;"></td> <td style="width: 10%;"></td> <td style="width: 10%;"></td> <td style="width: 10%;"></td> </tr> <tr> <td></td> <td></td> <td colspan="8" style="text-align: center;"> <table border="1" style="width: 100%; border-collapse: collapse; text-align: center;"> <tr> <td style="width: 10%;"></td> <td style="width: 10%;"></td> <td style="width: 10%;"></td> <td style="width: 10%;"></td> <td style="width: 10%;"></td> <td style="width: 10%;"></td> <td style="width: 10%;"></td> <td style="width: 10%;"></td> <td style="width: 10%;"></td> <td style="width: 10%;"></td> </tr> <tr> <td></td> <td></td> <td colspan="8" style="text-align: center;"> <table border="1" style="width: 100%; border-collapse: collapse; text-align: center;"> <tr> <td style="width: 10%;"></td> <td style="width: 10%;"></td> <td style="width: 10%;"></td> <td style="width: 10%;"></td> <td style="width: 10%;"></td> <td style="width: 10%;"></td> <td style="width: 10%;"></td> <td style="width: 10%;"></td> <td style="width: 10%;"></td> <td style="width: 10%;"></td> </tr> <tr> <td></td> <td></td> <td colspan="8" style="text-align: center;"> <table border="1" style="width: 100%; border-collapse: collapse; text-align: center;"> <tr> </tr></table></td></tr></table></td></tr></table></td></tr></table></td></tr></table></td></tr></table></td></tr></table></td></tr></table></td></tr></table></td></tr></table></td></tr></table></td></tr></table></td></tr></table>
 | | | | | | | | | | | | | | | | | | | | <table border="1" style="width: 100%; border-collapse: collapse; text-align: center;"> <tr> <td style="width: 10%;"></td> <td style="width: 10%;"></td> <td style="width: 10%;"></td> <td style="width: 10%;"></td> <td style="width: 10%;"></td> <td style="width: 10%;"></td> <td style="width: 10%;"></td> <td style="width: 10%;"></td> <td style="width: 10%;"></td> <td style="width: 10%;"></td> </tr> <tr> <td></td> <td></td> <td colspan="8" style="text-align: center;"> <table border="1" style="width: 100%; border-collapse: collapse; text-align: center;"> <tr> <td style="width: 10%;"></td> <td style="width: 10%;"></td> <td style="width: 10%;"></td> <td style="width: 10%;"></td> <td style="width: 10%;"></td> <td style="width: 10%;"></td> <td style="width: 10%;"></td> <td style="width: 10%;"></td> <td style="width: 10%;"></td> <td style="width: 10%;"></td> </tr> <tr> <td></td> <td></td> <td colspan="8" style="text-align: center;"> <table border="1" style="width: 100%; border-collapse: collapse; text-align: center;"> <tr> <td style="width: 10%;"></td> <td style="width: 10%;"></td> <td style="width: 10%;"></td> <td style="width: 10%;"></td> <td style="width: 10%;"></td> <td style="width: 10%;"></td> <td style="width: 10%;"></td> <td style="width: 10%;"></td> <td style="width: 10%;"></td> <td style="width: 10%;"></td> </tr> <tr> <td></td> <td></td> <td colspan="8" style="text-align: center;"> <table border="1" style="width: 100%; border-collapse: collapse; text-align: center;"> <tr> <td style="width: 10%;"></td> <td style="width: 10%;"></td> <td style="width: 10%;"></td> <td style="width: 10%;"></td> <td style="width: 10%;"></td> <td style="width: 10%;"></td> <td style="width: 10%;"></td> <td style="width: 10%;"></td> <td style="width: 10%;"></td> <td style="width: 10%;"></td> </tr> <tr> <td></td> <td></td> <td colspan="8" style="text-align: center;"> <table border="1" style="width: 100%; border-collapse: collapse; text-align: center;"> <tr> <td style="width: 10%;"></td> <td style="width: 10%;"></td> <td style="width: 10%;"></td> <td style="width: 10%;"></td> <td style="width: 10%;"></td> <td style="width: 10%;"></td> <td style="width: 10%;"></td> <td style="width: 10%;"></td> <td style="width: 10%;"></td> <td style="width: 10%;"></td> </tr> <tr> <td></td> <td></td> <td colspan="8" style="text-align: center;"> <table border="1" style="width: 100%; border-collapse: collapse; text-align: center;"> <tr> <td style="width: 10%;"></td> <td style="width: 10%;"></td> <td style="width: 10%;"></td> <td style="width: 10%;"></td> <td style="width: 10%;"></td> <td style="width: 10%;"></td> <td style="width: 10%;"></td> <td style="width: 10%;"></td> <td style="width: 10%;"></td> <td style="width: 10%;"></td> </tr> <tr> <td></td> <td></td> <td colspan="8" style="text-align: center;"> <table border="1" style="width: 100%; border-collapse: collapse; text-align: center;"> <tr> <td style="width: 10%;"></td> <td style="width: 10%;"></td> <td style="width: 10%;"></td> <td style="width: 10%;"></td> <td style="width: 10%;"></td> <td style="width: 10%;"></td> <td style="width: 10%;"></td> <td style="width: 10%;"></td> <td style="width: 10%;"></td> <td style="width: 10%;"></td> </tr> <tr> <td></td> <td></td> <td colspan="8" style="text-align: center;"> <table border="1" style="width: 100%; border-collapse: collapse; text-align: center;"> <tr> <td style="width: 10%;"></td> <td style="width: 10%;"></td> <td style="width: 10%;"></td> <td style="width: 10%;"></td> <td style="width: 10%;"></td> <td style="width: 10%;"></td> <td style="width: 10%;"></td> <td style="width: 10%;"></td> <td style="width: 10%;"></td> <td style="width: 10%;"></td> </tr> <tr> <td></td> <td></td> <td colspan="8" style="text-align: center;"> <table border="1" style="width: 100%; border-collapse: collapse; text-align: center;"> <tr> <td style="width: 10%;"></td> <td style="width: 10%;"></td> <td style="width: 10%;"></td> <td style="width: 10%;"></td> <td style="width: 10%;"></td> <td style="width: 10%;"></td> <td style="width: 10%;"></td> <td style="width: 10%;"></td> <td style="width: 10%;"></td> <td style="width: 10%;"></td> </tr> <tr> <td></td> <td></td> <td colspan="8" style="text-align: center;"> <table border="1" style="width: 100%; border-collapse: collapse; text-align: center;"> <tr> <td style="width: 10%;"></td> <td style="width: 10%;"></td> <td style="width: 10%;"></td> <td style="width: 10%;"></td> <td style="width: 10%;"></td> <td style="width: 10%;"></td> <td style="width: 10%;"></td> <td style="width: 10%;"></td> <td style="width: 10%;"></td> <td style="width: 10%;"></td> </tr> <tr> <td></td> <td></td> <td colspan="8" style="text-align: center;"> <table border="1" style="width: 100%; border-collapse: collapse; text-align: center;"> <tr> <td style="width: 10%;"></td> <td style="width: 10%;"></td> <td style="width: 10%;"></td> <td style="width: 10%;"></td> <td style="width: 10%;"></td> <td style="width: 10%;"></td> <td style="width: 10%;"></td> <td style="width: 10%;"></td> <td style="width: 10%;"></td> <td style="width: 10%;"></td> </tr> <tr> <td></td> <td></td> <td colspan="8" style="text-align: center;"> <table border="1" style="width: 100%; border-collapse: collapse; text-align: center;"> <tr> </tr></table></td></tr></table></td></tr></table></td></tr></table></td></tr></table></td></tr></table></td></tr></table></td></tr></table></td></tr></table></td></tr></table></td></tr></table></td></tr></table>
 | | | | | | | | | | | | | | | | | | | | <table border="1" style="width: 100%; border-collapse: collapse; text-align: center;"> <tr> <td style="width: 10%;"></td> <td style="width: 10%;"></td> <td style="width: 10%;"></td> <td style="width: 10%;"></td> <td style="width: 10%;"></td> <td style="width: 10%;"></td> <td style="width: 10%;"></td> <td style="width: 10%;"></td> <td style="width: 10%;"></td> <td style="width: 10%;"></td> </tr> <tr> <td></td> <td></td> <td colspan="8" style="text-align: center;"> <table border="1" style="width: 100%; border-collapse: collapse; text-align: center;"> <tr> <td style="width: 10%;"></td> <td style="width: 10%;"></td> <td style="width: 10%;"></td> <td style="width: 10%;"></td> <td style="width: 10%;"></td> <td style="width: 10%;"></td> <td style="width: 10%;"></td> <td style="width: 10%;"></td> <td style="width: 10%;"></td> <td style="width: 10%;"></td> </tr> <tr> <td></td> <td></td> <td colspan="8" style="text-align: center;"> <table border="1" style="width: 100%; border-collapse: collapse; text-align: center;"> <tr> <td style="width: 10%;"></td> <td style="width: 10%;"></td> <td style="width: 10%;"></td> <td style="width: 10%;"></td> <td style="width: 10%;"></td> <td style="width: 10%;"></td> <td style="width: 10%;"></td> <td style="width: 10%;"></td> <td style="width: 10%;"></td> <td style="width: 10%;"></td> </tr> <tr> <td></td> <td></td> <td colspan="8" style="text-align: center;"> <table border="1" style="width: 100%; border-collapse: collapse; text-align: center;"> <tr> <td style="width: 10%;"></td> <td style="width: 10%;"></td> <td style="width: 10%;"></td> <td style="width: 10%;"></td> <td style="width: 10%;"></td> <td style="width: 10%;"></td> <td style="width: 10%;"></td> <td style="width: 10%;"></td> <td style="width: 10%;"></td> <td style="width: 10%;"></td> </tr> <tr> <td></td> <td></td> <td colspan="8" style="text-align: center;"> <table border="1" style="width: 100%; border-collapse: collapse; text-align: center;"> <tr> <td style="width: 10%;"></td> <td style="width: 10%;"></td> <td style="width: 10%;"></td> <td style="width: 10%;"></td> <td style="width: 10%;"></td> <td style="width: 10%;"></td> <td style="width: 10%;"></td> <td style="width: 10%;"></td> <td style="width: 10%;"></td> <td style="width: 10%;"></td> </tr> <tr> <td></td> <td></td> <td colspan="8" style="text-align: center;"> <table border="1" style="width: 100%; border-collapse: collapse; text-align: center;"> <tr> <td style="width: 10%;"></td> <td style="width: 10%;"></td> <td style="width: 10%;"></td> <td style="width: 10%;"></td> <td style="width: 10%;"></td> <td style="width: 10%;"></td> <td style="width: 10%;"></td> <td style="width: 10%;"></td> <td style="width: 10%;"></td> <td style="width: 10%;"></td> </tr> <tr> <td></td> <td></td> <td colspan="8" style="text-align: center;"> <table border="1" style="width: 100%; border-collapse: collapse; text-align: center;"> <tr> <td style="width: 10%;"></td> <td style="width: 10%;"></td> <td style="width: 10%;"></td> <td style="width: 10%;"></td> <td style="width: 10%;"></td> <td style="width: 10%;"></td> <td style="width: 10%;"></td> <td style="width: 10%;"></td> <td style="width: 10%;"></td> <td style="width: 10%;"></td> </tr> <tr> <td></td> <td></td> <td colspan="8" style="text-align: center;"> <table border="1" style="width: 100%; border-collapse: collapse; text-align: center;"> <tr> <td style="width: 10%;"></td> <td style="width: 10%;"></td> <td style="width: 10%;"></td> <td style="width: 10%;"></td> <td style="width: 10%;"></td> <td style="width: 10%;"></td> <td style="width: 10%;"></td> <td style="width: 10%;"></td> <td style="width: 10%;"></td> <td style="width: 10%;"></td> </tr> <tr> <td></td> <td></td> <td colspan="8" style="text-align: center;"> <table border="1" style="width: 100%; border-collapse: collapse; text-align: center;"> <tr> <td style="width: 10%;"></td> <td style="width: 10%;"></td> <td style="width: 10%;"></td> <td style="width: 10%;"></td> <td style="width: 10%;"></td> <td style="width: 10%;"></td> <td style="width: 10%;"></td> <td style="width: 10%;"></td> <td style="width: 10%;"></td> <td style="width: 10%;"></td> </tr> <tr> <td></td> <td></td> <td colspan="8" style="text-align: center;"> <table border="1" style="width: 100%; border-collapse: collapse; text-align: center;"> <tr> <td style="width: 10%;"></td> <td style="width: 10%;"></td> <td style="width: 10%;"></td> <td style="width: 10%;"></td> <td style="width: 10%;"></td> <td style="width: 10%;"></td> <td style="width: 10%;"></td> <td style="width: 10%;"></td> <td style="width: 10%;"></td> <td style="width: 10%;"></td> </tr> <tr> <td></td> <td></td> <td colspan="8" style="text-align: center;"> <table border="1" style="width: 100%; border-collapse: collapse; text-align: center;"> <tr> </tr></table></td></tr></table></td></tr></table></td></tr></table></td></tr></table></td></tr></table></td></tr></table></td></tr></table></td></tr></table></td></tr></table></td></tr></table>
 | | | | | | | | | | | | | | | | | | | | <table border="1" style="width: 100%; border-collapse: collapse; text-align: center;"> <tr> <td style="width: 10%;"></td> <td style="width: 10%;"></td> <td style="width: 10%;"></td> <td style="width: 10%;"></td> <td style="width: 10%;"></td> <td style="width: 10%;"></td> <td style="width: 10%;"></td> <td style="width: 10%;"></td> <td style="width: 10%;"></td> <td style="width: 10%;"></td> </tr> <tr> <td></td> <td></td> <td colspan="8" style="text-align: center;"> <table border="1" style="width: 100%; border-collapse: collapse; text-align: center;"> <tr> <td style="width: 10%;"></td> <td style="width: 10%;"></td> <td style="width: 10%;"></td> <td style="width: 10%;"></td> <td style="width: 10%;"></td> <td style="width: 10%;"></td> <td style="width: 10%;"></td> <td style="width: 10%;"></td> <td style="width: 10%;"></td> <td style="width: 10%;"></td> </tr> <tr> <td></td> <td></td> <td colspan="8" style="text-align: center;"> <table border="1" style="width: 100%; border-collapse: collapse; text-align: center;"> <tr> <td style="width: 10%;"></td> <td style="width: 10%;"></td> <td style="width: 10%;"></td> <td style="width: 10%;"></td> <td style="width: 10%;"></td> <td style="width: 10%;"></td> <td style="width: 10%;"></td> <td style="width: 10%;"></td> <td style="width: 10%;"></td> <td style="width: 10%;"></td> </tr> <tr> <td></td> <td></td> <td colspan="8" style="text-align: center;"> <table border="1" style="width: 100%; border-collapse: collapse; text-align: center;"> <tr> <td style="width: 10%;"></td> <td style="width: 10%;"></td> <td style="width: 10%;"></td> <td style="width: 10%;"></td> <td style="width: 10%;"></td> <td style="width: 10%;"></td> <td style="width: 10%;"></td> <td style="width: 10%;"></td> <td style="width: 10%;"></td> <td style="width: 10%;"></td> </tr> <tr> <td></td> <td></td> <td colspan="8" style="text-align: center;"> <table border="1" style="width: 100%; border-collapse: collapse; text-align: center;"> <tr> <td style="width: 10%;"></td> <td style="width: 10%;"></td> <td style="width: 10%;"></td> <td style="width: 10%;"></td> <td style="width: 10%;"></td> <td style="width: 10%;"></td> <td style="width: 10%;"></td> <td style="width: 10%;"></td> <td style="width: 10%;"></td> <td style="width: 10%;"></td> </tr> <tr> <td></td> <td></td> <td colspan="8" style="text-align: center;"> <table border="1" style="width: 100%; border-collapse: collapse; text-align: center;"> <tr> <td style="width: 10%;"></td> <td style="width: 10%;"></td> <td style="width: 10%;"></td> <td style="width: 10%;"></td> <td style="width: 10%;"></td> <td style="width: 10%;"></td> <td style="width: 10%;"></td> <td style="width: 10%;"></td> <td style="width: 10%;"></td> <td style="width: 10%;"></td> </tr> <tr> <td></td> <td></td> <td colspan="8" style="text-align: center;"> <table border="1" style="width: 100%; border-collapse: collapse; text-align: center;"> <tr> <td style="width: 10%;"></td> <td style="width: 10%;"></td> <td style="width: 10%;"></td> <td style="width: 10%;"></td> <td style="width: 10%;"></td> <td style="width: 10%;"></td> <td style="width: 10%;"></td> <td style="width: 10%;"></td> <td style="width: 10%;"></td> <td style="width: 10%;"></td> </tr> <tr> <td></td> <td></td> <td colspan="8" style="text-align: center;"> <table border="1" style="width: 100%; border-collapse: collapse; text-align: center;"> <tr> <td style="width: 10%;"></td> <td style="width: 10%;"></td> <td style="width: 10%;"></td> <td style="width: 10%;"></td> <td style="width: 10%;"></td> <td style="width: 10%;"></td> <td style="width: 10%;"></td> <td style="width: 10%;"></td> <td style="width: 10%;"></td> <td style="width:
10%;"></td> </tr> <tr> <td></td> <td></td> <td colspan="8" style="text-align: center;"> <table border="1" style="width: 100%; border-collapse: collapse; text-align: center;"> <tr> <td style="width: 10%;"></td> <td style="width: 10%;"></td> <td style="width: 10%;"></td> <td style="width: 10%;"></td> <td style="width: 10%;"></td> <td style="width: 10%;"></td> <td style="width: 10%;"></td> <td style="width: 10%;"></td> <td style="width: 10%;"></td> <td style="width: 10%;"></td> </tr> <tr> <td></td> <td></td> <td colspan="8" style="text-align: center;"> <table border="1" style="width: 100%; border-collapse: collapse; text-align: center;"> <tr> </tr></table></td></tr></table></td></tr></table></td></tr></table></td></tr></table></td></tr></table></td></tr></table></td></tr></table></td></tr></table></td></tr></table> | | | | | | | | | | | | | | | | | | | | <table border="1" style="width: 100%; border-collapse: collapse; text-align: center;"> <tr> <td style="width: 10%;"></td> <td style="width: 10%;"></td> <td style="width: 10%;"></td> <td style="width: 10%;"></td> <td style="width: 10%;"></td> <td style="width: 10%;"></td> <td style="width: 10%;"></td> <td style="width: 10%;"></td> <td style="width: 10%;"></td> <td style="width: 10%;"></td> </tr> <tr> <td></td> <td></td> <td colspan="8" style="text-align: center;"> <table border="1" style="width: 100%; border-collapse: collapse; text-align: center;"> <tr> <td style="width: 10%;"></td> <td style="width: 10%;"></td> <td style="width: 10%;"></td> <td style="width: 10%;"></td> <td style="width: 10%;"></td> <td style="width: 10%;"></td> <td style="width: 10%;"></td> <td style="width: 10%;"></td> <td style="width: 10%;"></td> <td style="width: 10%;"></td> </tr> <tr> <td></td> <td></td> <td colspan="8" style="text-align: center;"> <table border="1" style="width: 100%; border-collapse: collapse; text-align: center;"> <tr> <td style="width: 10%;"></td> <td style="width: 10%;"></td> <td style="width: 10%;"></td> <td style="width: 10%;"></td> <td style="width: 10%;"></td> <td style="width: 10%;"></td> <td style="width: 10%;"></td> <td style="width: 10%;"></td> <td style="width: 10%;"></td> <td style="width: 10%;"></td> </tr> <tr> <td></td> <td></td> <td colspan="8" style="text-align: center;"> <table border="1" style="width: 100%; border-collapse: collapse; text-align: center;"> <tr> <td style="width: 10%;"></td> <td style="width: 10%;"></td> <td style="width: 10%;"></td> <td style="width: 10%;"></td> <td style="width: 10%;"></td> <td style="width: 10%;"></td> <td style="width: 10%;"></td> <td style="width: 10%;"></td> <td style="width: 10%;"></td> <td style="width: 10%;"></td> </tr> <tr> <td></td> <td></td> <td colspan="8" style="text-align: center;"> <table border="1" style="width: 100%; border-collapse: collapse; text-align: center;"> <tr> <td style="width: 10%;"></td> <td style="width: 10%;"></td> <td style="width: 10%;"></td> <td style="width: 10%;"></td> <td style="width: 10%;"></td> <td style="width: 10%;"></td> <td style="width: 10%;"></td> <td style="width: 10%;"></td> <td style="width: 10%;"></td> <td style="width: 10%;"></td> </tr> <tr> <td></td> <td></td> <td colspan="8" style="text-align: center;"> <table border="1" style="width: 100%; border-collapse: collapse; text-align: center;"> <tr> <td style="width: 10%;"></td> <td style="width: 10%;"></td> <td style="width: 10%;"></td> <td style="width: 10%;"></td> <td style="width: 10%;"></td> <td style="width: 10%;"></td> <td style="width: 10%;"></td> <td style="width: 10%;"></td> <td style="width: 10%;"></td> <td style="width: 10%;"></td> </tr> <tr> <td></td> <td></td> <td colspan="8" style="text-align:
center;"> <table border="1" style="width: 100%; border-collapse: collapse; text-align: center;"> <tr> <td style="width: 10%;"></td> <td style="width: 10%;"></td> <td style="width: 10%;"></td> <td style="width: 10%;"></td> <td style="width: 10%;"></td> <td style="width: 10%;"></td> <td style="width: 10%;"></td> <td style="width: 10%;"></td> <td style="width: 10%;"></td> <td style="width: 10%;"></td> </tr> <tr> <td></td> <td></td> <td colspan="8" style="text-align: center;"> <table border="1" style="width: 100%; border-collapse: collapse; text-align: center;"> <tr> <td style="width: 10%;"></td> <td style="width: 10%;"></td> <td style="width: 10%;"></td> <td style="width: 10%;"></td> <td style="width: 10%;"></td> <td style="width: 10%;"></td> <td style="width: 10%;"></td> <td style="width: 10%;"></td> <td style="width: 10%;"></td> <td style="width: 10%;"></td> </tr> <tr> <td></td> <td></td> <td colspan="8" style="text-align: center;"> <table border="1" style="width: 100%; border-collapse: collapse; text-align: center;"> <tr> </tr></table></td></tr></table></td></tr></table></td></tr></table></td></tr></table></td></tr></table></td></tr></table></td></tr></table></td></tr></table> | | | | | | | | | | | | | | | | | | | | <table border="1" style="width: 100%; border-collapse: collapse; text-align: center;"> <tr> <td style="width: 10%;"></td> <td style="width: 10%;"></td> <td style="width: 10%;"></td> <td style="width: 10%;"></td> <td style="width: 10%;"></td> <td style="width: 10%;"></td> <td style="width: 10%;"></td> <td style="width: 10%;"></td> <td style="width: 10%;"></td> <td style="width: 10%;"></td> </tr> <tr> <td></td> <td></td> <td colspan="8" style="text-align: center;"> <table border="1" style="width: 100%; border-collapse: collapse; text-align: center;"> <tr> <td style="width: 10%;"></td> <td style="width: 10%;"></td> <td style="width: 10%;"></td> <td style="width: 10%;"></td> <td style="width: 10%;"></td> <td style="width: 10%;"></td> <td style="width: 10%;"></td> <td style="width: 10%;"></td> <td style="width: 10%;"></td> <td style="width: 10%;"></td> </tr> <tr> <td></td> <td></td> <td colspan="8" style="text-align: center;"> <table border="1" style="width: 100%; border-collapse: collapse; text-align: center;"> <tr> <td style="width: 10%;"></td> <td style="width: 10%;"></td> <td style="width: 10%;"></td> <td style="width: 10%;"></td> <td style="width: 10%;"></td> <td style="width: 10%;"></td> <td style="width: 10%;"></td> <td style="width: 10%;"></td> <td style="width: 10%;"></td> <td style="width: 10%;"></td> </tr> <tr> <td></td> <td></td> <td colspan="8" style="text-align: center;"> <table border="1" style="width: 100%; border-collapse: collapse; text-align: center;"> <tr> <td style="width: 10%;"></td> <td style="width: 10%;"></td> <td style="width: 10%;"></td> <td style="width: 10%;"></td> <td style="width: 10%;"></td> <td style="width: 10%;"></td> <td style="width: 10%;"></td> <td style="width: 10%;"></td> <td style="width: 10%;"></td> <td style="width: 10%;"></td> </tr> <tr> <td></td> <td></td> <td colspan="8" style="text-align: center;"> <table border="1" style="width: 100%; border-collapse: collapse; text-align: center;"> <tr> <td style="width: 10%;"></td> <td style="width: 10%;"></td> <td style="width: 10%;"></td> <td style="width: 10%;"></td> <td style="width: 10%;"></td> <td style="width: 10%;"></td> <td style="width: 10%;"></td> <td style="width: 10%;"></td> <td style="width: 10%;"></td> <td style="width: 10%;"></td> </tr> <tr> <td></td> <td></td> <td colspan="8" style="text-align: center;"> <table border="1" style="width: 100%; border-collapse: collapse; text-align: center;">
<tr> <td style="width: 10%;"></td> <td style="width: 10%;"></td> <td style="width: 10%;"></td> <td style="width: 10%;"></td> <td style="width: 10%;"></td> <td style="width: 10%;"></td> <td style="width: 10%;"></td> <td style="width: 10%;"></td> <td style="width: 10%;"></td> <td style="width: 10%;"></td> </tr> <tr> <td></td> <td></td> <td colspan="8" style="text-align: center;"> <table border="1" style="width: 100%; border-collapse: collapse; text-align: center;"> <tr> <td style="width: 10%;"></td> <td style="width: 10%;"></td> <td style="width: 10%;"></td> <td style="width: 10%;"></td> <td style="width: 10%;"></td> <td style="width: 10%;"></td> <td style="width: 10%;"></td> <td style="width: 10%;"></td> <td style="width: 10%;"></td> <td style="width: 10%;"></td> </tr> <tr> <td></td> <td></td> <td colspan="8" style="text-align: center;"> <table border="1" style="width: 100%; border-collapse: collapse; text-align: center;"> <tr> </tr></table></td></tr></table></td></tr></table></td></tr></table></td></tr></table></td></tr></table></td></tr></table></td></tr></table> | | | | | | | | | | | | | | | | | | | | <table border="1" style="width: 100%; border-collapse: collapse; text-align: center;"> <tr> <td style="width: 10%;"></td> <td style="width: 10%;"></td> <td style="width: 10%;"></td> <td style="width: 10%;"></td> <td style="width: 10%;"></td> <td style="width: 10%;"></td> <td style="width: 10%;"></td> <td style="width: 10%;"></td> <td style="width: 10%;"></td> <td style="width: 10%;"></td> </tr> <tr> <td></td> <td></td> <td colspan="8" style="text-align: center;"> <table border="1" style="width: 100%; border-collapse: collapse; text-align: center;"> <tr> <td style="width: 10%;"></td> <td style="width: 10%;"></td> <td style="width: 10%;"></td> <td style="width: 10%;"></td> <td style="width: 10%;"></td> <td style="width: 10%;"></td> <td style="width: 10%;"></td> <td style="width: 10%;"></td> <td style="width: 10%;"></td> <td style="width: 10%;"></td> </tr> <tr> <td></td> <td></td> <td colspan="8" style="text-align: center;"> <table border="1" style="width: 100%; border-collapse: collapse; text-align: center;"> <tr> <td style="width: 10%;"></td> <td style="width: 10%;"></td> <td style="width: 10%;"></td> <td style="width: 10%;"></td> <td style="width: 10%;"></td> <td style="width: 10%;"></td> <td style="width: 10%;"></td> <td style="width: 10%;"></td> <td style="width: 10%;"></td> <td style="width: 10%;"></td> </tr> <tr> <td></td> <td></td> <td colspan="8" style="text-align: center;"> <table border="1" style="width: 100%; border-collapse: collapse; text-align: center;"> <tr> <td style="width: 10%;"></td> <td style="width: 10%;"></td> <td style="width: 10%;"></td> <td style="width: 10%;"></td> <td style="width: 10%;"></td> <td style="width: 10%;"></td> <td style="width: 10%;"></td> <td style="width: 10%;"></td> <td style="width: 10%;"></td> <td style="width: 10%;"></td> </tr> <tr> <td></td> <td></td> <td colspan="8" style="text-align: center;"> <table border="1" style="width: 100%; border-collapse: collapse; text-align: center;"> <tr> <td style="width: 10%;"></td> <td style="width: 10%;"></td> <td style="width: 10%;"></td> <td style="width: 10%;"></td> <td style="width: 10%;"></td> <td style="width: 10%;"></td> <td style="width: 10%;"></td> <td style="width: 10%;"></td> <td style="width: 10%;"></td> <td style="width: 10%;"></td> </tr> <tr> <td></td> <td></td> <td colspan="8" style="text-align: center;"> <table border="1" style="width: 100%; border-collapse: collapse; text-align: center;"> <tr> <td style="width: 10%;"></td> <td style="width: 10%;"></td> <td style="width: 10%;"></td> <td style="width:
10%;"></td> <td style="width: 10%;"></td> <td style="width: 10%;"></td> <td style="width: 10%;"></td> <td style="width: 10%;"></td> <td style="width: 10%;"></td> <td style="width: 10%;"></td> </tr> <tr> <td></td> <td></td> <td colspan="8" style="text-align: center;"> <table border="1" style="width: 100%; border-collapse: collapse; text-align: center;"> <tr> </tr></table></td></tr></table></td></tr></table></td></tr></table></td></tr></table></td></tr></table></td></tr></table> | | | | | | | | | | | | | | | | | | | | <table border="1" style="width: 100%; border-collapse: collapse; text-align: center;"> <tr> <td style="width: 10%;"></td> <td style="width: 10%;"></td> <td style="width: 10%;"></td> <td style="width: 10%;"></td> <td style="width: 10%;"></td> <td style="width: 10%;"></td> <td style="width: 10%;"></td> <td style="width: 10%;"></td> <td style="width: 10%;"></td> <td style="width: 10%;"></td> </tr> <tr> <td></td> <td></td> <td colspan="8" style="text-align: center;"> <table border="1" style="width: 100%; border-collapse: collapse; text-align: center;"> <tr> <td style="width: 10%;"></td> <td style="width: 10%;"></td> <td style="width: 10%;"></td> <td style="width: 10%;"></td> <td style="width: 10%;"></td> <td style="width: 10%;"></td> <td style="width: 10%;"></td> <td style="width: 10%;"></td> <td style="width: 10%;"></td> <td style="width: 10%;"></td> </tr> <tr> <td></td> <td></td> <td colspan="8" style="text-align: center;"> <table border="1" style="width: 100%; border-collapse: collapse; text-align: center;"> <tr> <td style="width: 10%;"></td> <td style="width: 10%;"></td> <td style="width: 10%;"></td> <td style="width: 10%;"></td> <td style="width: 10%;"></td> <td style="width: 10%;"></td> <td style="width: 10%;"></td> <td style="width: 10%;"></td> <td style="width: 10%;"></td> <td style="width: 10%;"></td> </tr> <tr> <td></td> <td></td> <td colspan="8" style="text-align: center;"> <table border="1" style="width: 100%; border-collapse: collapse; text-align: center;"> <tr> <td style="width: 10%;"></td> <td style="width: 10%;"></td> <td style="width: 10%;"></td> <td style="width: 10%;"></td> <td style="width: 10%;"></td> <td style="width: 10%;"></td> <td style="width: 10%;"></td> <td style="width: 10%;"></td> <td style="width: 10%;"></td> <td style="width: 10%;"></td> </tr> <tr> <td></td> <td></td> <td colspan="8" style="text-align: center;"> <table border="1" style="width: 100%; border-collapse: collapse; text-align: center;"> <tr> <td style="width: 10%;"></td> <td style="width: 10%;"></td> <td style="width: 10%;"></td> <td style="width: 10%;"></td> <td style="width: 10%;"></td> <td style="width: 10%;"></td> <td style="width: 10%;"></td> <td style="width: 10%;"></td> <td style="width: 10%;"></td> <td style="width: 10%;"></td> </tr> <tr> <td></td> <td></td> <td colspan="8" style="text-align: center;"> <table border="1" style="width: 100%; border-collapse: collapse; text-align: center;"> <tr> </tr></table></td></tr></table></td></tr></table></td></tr></table></td></tr></table></td></tr></table>
 | | | | | | | | | | | | | | | | | | | | <table border="1" style="width: 100%; border-collapse: collapse; text-align: center;"> <tr> <td style="width: 10%;"></td> <td style="width: 10%;"></td> <td style="width: 10%;"></td> <td style="width: 10%;"></td> <td style="width: 10%;"></td> <td style="width: 10%;"></td> <td style="width: 10%;"></td> <td style="width: 10%;"></td> <td style="width: 10%;"></td> <td style="width: 10%;"></td> </tr> <tr> <td></td> <td></td> <td colspan="8" style="text-align: center;"> <table border="1" style="width: 100%; border-collapse: collapse; text-align: center;"> <tr> <td style="width: 10%;"></td> <td style="width: 10%;"></td> <td style="width: 10%;"></td> <td style="width: 10%;"></td> <td style="width: 10%;"></td> <td style="width: 10%;"></td> <td style="width: 10%;"></td> <td style="width: 10%;"></td> <td style="width: 10%;"></td> <td style="width: 10%;"></td> </tr> <tr> <td></td> <td></td> <td colspan="8" style="text-align: center;"> <table border="1" style="width: 100%; border-collapse: collapse; text-align: center;"> <tr> <td style="width: 10%;"></td> <td style="width: 10%;"></td> <td style="width: 10%;"></td> <td style="width: 10%;"></td> <td style="width: 10%;"></td> <td style="width: 10%;"></td> <td style="width: 10%;"></td> <td style="width: 10%;"></td> <td style="width: 10%;"></td> <td style="width: 10%;"></td> </tr> <tr> <td></td> <td></td> <td colspan="8" style="text-align: center;"> <table border="1" style="width: 100%; border-collapse: collapse; text-align: center;"> <tr> <td style="width: 10%;"></td> <td style="width: 10%;"></td> <td style="width: 10%;"></td> <td style="width: 10%;"></td> <td style="width: 10%;"></td> <td style="width: 10%;"></td> <td style="width: 10%;"></td> <td style="width: 10%;"></td> <td style="width: 10%;"></td> <td style="width: 10%;"></td> </tr> <tr> <td></td> <td></td> <td colspan="8" style="text-align: center;"> <table border="1" style="width: 100%; border-collapse: collapse; text-align: center;"> <tr> </tr></table></td></tr></table></td></tr></table></td></tr></table></td></tr></table>
 | | | | | | | | | | | | | | | | | | | | <table border="1" style="width: 100%; border-collapse: collapse; text-align: center;"> <tr> <td style="width: 10%;"></td> <td style="width: 10%;"></td> <td style="width: 10%;"></td> <td style="width: 10%;"></td> <td style="width: 10%;"></td> <td style="width: 10%;"></td> <td style="width: 10%;"></td> <td style="width: 10%;"></td> <td style="width: 10%;"></td> <td style="width: 10%;"></td> </tr> <tr> <td></td> <td></td> <td colspan="8" style="text-align: center;"> <table border="1" style="width: 100%; border-collapse: collapse; text-align: center;"> <tr> <td style="width: 10%;"></td> <td style="width: 10%;"></td> <td style="width: 10%;"></td> <td style="width: 10%;"></td> <td style="width: 10%;"></td> <td style="width: 10%;"></td> <td style="width: 10%;"></td> <td style="width: 10%;"></td> <td style="width: 10%;"></td> <td style="width: 10%;"></td> </tr> <tr> <td></td> <td></td> <td colspan="8" style="text-align: center;"> <table border="1" style="width: 100%; border-collapse: collapse; text-align: center;"> <tr> <td style="width: 10%;"></td> <td style="width: 10%;"></td> <td style="width: 10%;"></td> <td style="width: 10%;"></td> <td style="width: 10%;"></td> <td style="width: 10%;"></td> <td style="width: 10%;"></td> <td style="width: 10%;"></td> <td style="width: 10%;"></td> <td style="width: 10%;"></td> </tr> <tr> <td></td> <td></td> <td colspan="8" style="text-align: center;"> <table border="1" style="width: 100%; border-collapse: collapse; text-align: center;"> <tr> </tr></table></td></tr></table></td></tr></table></td></tr></table>
 | | | | | | | | | | | | | | | | | | | | <table border="1" style="width: 100%; border-collapse: collapse; text-align: center;"> <tr> <td style="width: 10%;"></td> <td style="width: 10%;"></td> <td style="width: 10%;"></td> <td style="width: 10%;"></td> <td style="width: 10%;"></td> <td style="width: 10%;"></td> <td style="width: 10%;"></td> <td style="width: 10%;"></td> <td style="width: 10%;"></td> <td style="width: 10%;"></td> </tr> <tr> <td></td> <td></td> <td colspan="8" style="text-align: center;"> <table border="1" style="width: 100%; border-collapse: collapse; text-align: center;"> <tr> <td style="width: 10%;"></td> <td style="width: 10%;"></td> <td style="width: 10%;"></td> <td style="width: 10%;"></td> <td style="width: 10%;"></td> <td style="width: 10%;"></td> <td style="width: 10%;"></td> <td style="width: 10%;"></td> <td style="width: 10%;"></td> <td style="width: 10%;"></td> </tr> <tr> <td></td> <td></td> <td colspan="8" style="text-align: center;"> <table border="1" style="width: 100%; border-collapse: collapse; text-align: center;"> <tr> </tr></table></td></tr></table></td></tr></table> | | | | | | | | | | | | | | | | | | | | <table border="1" style="width: 100%; border-collapse: collapse; text-align: center;"> <tr> <td style="width: 10%;"></td> <td style="width: 10%;"></td> <td style="width: 10%;"></td> <td style="width: 10%;"></td> <td style="width: 10%;"></td> <td style="width: 10%;"></td> <td style="width: 10%;"></td> <td style="width: 10%;"></td> <td style="width: 10%;"></td> <td style="width: 10%;"></td> </tr> <tr>
<td></td> <td></td> <td colspan="8" style="text-align: center;"> <table border="1" style="width: 100%; border-collapse: collapse; text-align: center;"> <tr> </tr></table></td></tr></table> | | | | | | | | | | | | | | | | | | | | <table border="1" style="width: 100%; border-collapse: collapse; text-align: center;"> <tr> </tr></table>
 | | | | | | | | | | | | | | | | | | | | | | | | | | | | | | | | | | | | | | | | | | | | | | | | | | | | | | | | | | | | | | | | | | | | | | | | | | | | | | | |
 | | | | | | | | | | | | | | | | | | | | | | | | | | | | | | | | | | | | | | | |
 | | | | | | | | | | | | | | | | | | | | | | | | | | | | | | | | | | | | | | | |
 | | | | | | | | | | | | | | | | | | | | | | | | | | | | | | | | | | | | | | | | | | | | | | | | | | | | | | | | | | | | | | | | | | | | | | | | | | | | | | | |
 | | | | | | | | | | | | | | | | | | | | | | | | | | | | | | | | | | | | | | | | | | | | | | | | | | | | | | | | | | | | | | | | | | | |
| | |

 | | | | | | | | | | | | | | | | | | | |

 | | | | | | | | | | | | | | | | | | | |

 | | | | | | | | | | | | | | | | | | | |

 | | | | | | | | | | | | | | | | | | | |

 | | | | | | | | | | | | | | | | | | | |

 | | | | | | | | | | | | | | | | | | | |

 | | | | | | | | | | | | | | | | | | | |

 | | | | | | | | | | | | | | | | | | | |

 | | | | | | | | | | | | | | | | | | | |

 | | | | | | | | | | | | | | | | | | | |

 | | | | | | | | | | | | | | | | | | | |

 | | | | | | | | | | | | | | | | | | | |

 | | | | | | | | | | | | | | | | | | | |

 | | | | | | | | | | | | | | | | | | | |

 | | | | | | | | | | | | | | | | | | | |

 | | | | | | | | | | | | | | | | | | | |

 | | | | | | | | | | | | | | | | | | | |

 | | | | | | | | | | | | | | | | | | | |

 | | | | | | | | | | | | | | | | | | | |

 | | | | | | | | | | | | | | | | | | | |

 | | | | | | | | | | | | | | | | | | | |

 | | | | | | | | | | | | | | | | | | | |

 | | | | | | | | | | | | | | | | | | | |

 | | | | | | | | | | | | | | | | | | | |

 | | | | | | | | | | | | | | | | | | | |

 | | | | | | | | | | | | | | | | | | | |

 | | | | | | | | | | | | | | | | | | | |

 | | | | | | | | | | | | | | | | | | | |
 | | | | | | | | | | | | | | | | | | | |

 | | | | | | | | | | | | | | | | | | | |

 | | | | | | | | | | | | | | | | | | | |
 | | | | | | | | | | | | | | | | | | | |

 | | | | | | | | | | | | | | | | | | | |

 | | | | | | | | | | | | | | | | | | | |
 | | | | | | | | | | | | | | | | | | | |
 | | | | | | | | | | | | | | | | | | | |

 | | | | | | | | | | | | | | | | | | | |
 | | | | | | | | | | | | | | | | | | | |
 | | | | | | | | | | | | | | | | | | | |

 | | | | | | | | | | | | | | | | | | | | | | | | | | | | | | | | | | | | | | | | | | | | | | | | | | | | | | | | | | | | | | | | | | | | | | | | | | | | | | | | | | | | | | | | | | | | | | | | | | | |
 | | | | | | | | | | | | | | | | | | | |
 | | | | | | | | | | | | | | | | | | | |
 | | | | | | | | | | | | | | | | | | | |
 | | | | | | | | | | | | | | | | | | | |
 | | | | | | | | | | | | | | | | | | | |
 | | | | | | | | | | | | | | | | | | | |
 | | | | | | | | | | | | | | | | | | | |
 | | | | | | | | | | | | | | | | | | | |
 | | | | | | | | | | | | | | | | | | | | | | | | | | | | | | | | | | | | | | | |
 | | | | | | | | | | | | | | | | | | | |
 | | | | | | | | | | | | | | | | | | | | | | | | | | | | | | | | | | | | | | | |
 | | | | | | | | | | | | | | | | | | | | | | | | | | | | | | | | | | | | | | | |
 | | | | | | | | | | | | | | | | | | | | | | | | | | | | | | | | | | | | | | | |
 | | | | | | | | | | | | | | | | | | | | | | | | | | | | | | | | | | | | | | | | | | | | | | | | | | | | | | | | | | | | | | | | | | | | | | | | | | | | | | | | | | | | | | | | | | | | | | | | | | | |
 | | | | | | | | | | | | | | | | | | | | | | | | | | | | | | | | | | | | | | | | | | | | | | | |
| | | <table border="1" style="width: 100%; border-collapse: collapse; text-align: center;"> <tr> <td style="width: 10%;"></td> <td style="width: 10%;"></td> <td style="width: 10%;"></td> <td style="width: 10%;"></td> <td style="width: 10%;"></td> <td style="width: 10%;"></td> <td style="width: 10%;"></td> <td style="width: 10%;"></td> <td style="width: 10%;"></td> <td style="width: 10%;"></td> </tr> <tr> <td></td> <td></td> <td colspan="8" style="text-align: center;"> <table border="1" style="width: 100%; border-collapse: collapse; text-align: center;"> <tr> <td style="width: 10%;"></td> <td style="width: 10%;"></td> <td style="width: 10%;"></td> <td style="width: 10%;"></td> <td style="width: 10%;"></td> <td style="width: 10%;"></td> <td style="width: 10%;"></td> <td style="width: 10%;"></td> <td style="width: 10%;"></td> <td style="width: 10%;"></td> </tr> <tr> <td></td> <td></td> <td colspan="8" style="text-align: center;"> <table border="1" style="width: 100%; border-collapse: collapse; text-align: center;"> <tr> <td style="width: 10%;"></td> <td style="width: 10%;"></td> <td style="width: 10%;"></td> <td style="width: 10%;"></td> <td style="width: 10%;"></td> <td style="width: 10%;"></td> <td style="width: 10%;"></td> <td style="width: 10%;"></td> <td style="width: 10%;"></td> <td style="width: 10%;"></td> </tr> <tr> <td></td> <td></td> <td colspan="8" style="text-align: center;"> <table border="1" style="width: 100%; border-collapse: collapse; text-align: center;"> <tr> <td style="width: 10%;"></td> <td style="width: 10%;"></td> <td style="width: 10%;"></td> <td style="width: 10%;"></td> <td style="width: 10%;"></td> <td style="width: 10%;"></td> <td style="width: 10%;"></td> <td style="width: 10%;"></td> <td style="width: 10%;"></td> <td style="width: 10%;"></td> </tr> <tr> <td></td> <td></td> <td colspan="8" style="text-align: center;"> <table border="1" style="width: 100%; border-collapse: collapse; text-align: center;"> <tr> <td style="width: 10%;"></td> <td style="width: 10%;"></td> <td style="width: 10%;"></td> <td style="width: 10%;"></td> <td style="width: 10%;"></td> <td style="width: 10%;"></td> <td style="width: 10%;"></td> <td style="width: 10%;"></td> <td style="width: 10%;"></td> <td style="width: 10%;"></td> </tr> <tr> <td></td> <td></td> <td colspan="8" style="text-align: center;"> <table border="1" style="width: 100%; border-collapse: collapse; text-align: center;"> <tr> <td style="width: 10%;"></td> <td style="width: 10%;"></td> <td style="width: 10%;"></td> <td style="width: 10%;"></td> <td style="width: 10%;"></td> <td style="width: 10%;"></td> <td style="width: 10%;"></td> <td style="width: 10%;"></td> <td style="width: 10%;"></td> <td style="width: 10%;"></td> </tr> <tr> <td></td> <td></td> <td colspan="8" style="text-align: center;"> <table border="1" style="width: 100%; border-collapse: collapse; text-align: center;"> <tr> <td style="width: 10%;"></td> <td style="width: 10%;"></td> <td style="width: 10%;"></td> <td style="width: 10%;"></td> <td style="width: 10%;"></td> <td style="width: 10%;"></td> <td style="width: 10%;"></td> <td style="width: 10%;"></td> <td style="width: 10%;"></td> <td style="width: 10%;"></td> </tr> <tr> <td></td> <td></td> <td colspan="8" style="text-align: center;"> <table border="1" style="width: 100%; border-collapse: collapse; text-align: center;"> <tr> <td style="width: 10%;"></td> <td style="width: 10%;"></td> <td style="width: 10%;"></td> <td style="width: 10%;"></td> <td style="width: 10%;"></td> <td style="width: 10%;"></td> <td style="width: 10%;"></td> <td style="width: 10%;"></td> <td style="width: 10%;"></td> <td style="width: 10%;"></td> </tr> <tr> <td></td> <td></td> <td colspan="8" style="text-align: center;"> <table border="1" style="width: 100%; border-collapse: collapse; text-align: center;"> <tr> <td style="width: 10%;"></td> <td style="width: 10%;"></td> <td style="width: 10%;"></td> <td style="width: 10%;"></td> <td style="width: 10%;"></td> <td style="width: 10%;"></td> <td style="width: 10%;"></td> <td style="width: 10%;"></td> <td style="width: 10%;"></td> <td style="width: 10%;"></td> </tr> <tr> <td></td> <td></td> <td colspan="8" style="text-align: center;"> <table border="1" style="width: 100%; border-collapse: collapse; text-align: center;"> <tr> <td style="width: 10%;"></td> <td style="width: 10%;"></td> <td style="width: 10%;"></td> <td style="width: 10%;"></td> <td style="width: 10%;"></td> <td style="width: 10%;"></td> <td style="width: 10%;"></td> <td style="width: 10%;"></td> <td style="width: 10%;"></td> <td style="width: 10%;"></td> </tr> <tr> <td></td> <td></td> <td colspan="8" style="text-align: center;"> <table border="1" style="width: 100%; border-collapse: collapse; text-align: center;"> <tr> <td style="width: 10%;"></td> <td style="width: 10%;"></td> <td style="width: 10%;"></td> <td style="width: 10%;"></td> <td style="width: 10%;"></td> <td style="width: 10%;"></td> <td style="width: 10%;"></td> <td style="width: 10%;"></td> <td style="width: 10%;"></td> <td style="width: 10%;"></td> </tr> <tr> <td></td> <td></td> <td colspan="8" style="text-align: center;"> <table border="1" style="width: 100%; border-collapse: collapse; text-align: center;"> <tr> <td style="width: 10%;"></td> <td style="width: 10%;"></td> <td style="width: 10%;"></td> <td style="width: 10%;"></td> <td style="width: 10%;"></td> <td style="width: 10%;"></td> <td style="width: 10%;"></td> <td style="width: 10%;"></td> <td style="width: 10%;"></td> <td style="width: 10%;"></td> </tr> <tr> <td></td> <td></td> <td colspan="8" style="text-align: center;"> <table border="1" style="width: 100%; border-collapse: collapse; text-align: center;"> <tr> <td style="width: 10%;"></td> <td style="width: 10%;"></td> <td style="width: 10%;"></td> <td style="width: 10%;"></td> <td style="width: 10%;"></td> <td style="width: 10%;"></td> <td style="width: 10%;"></td> <td style="width: 10%;"></td> <td style="width: 10%;"></td> <td style="width: 10%;"></td> </tr> <tr> <td></td> <td></td> <td colspan="8" style="text-align: center;"> <table border="1" style="width: 100%; border-collapse: collapse; text-align: center;"> <tr> <td style="width: 10%;"></td> <td style="width: 10%;"></td> <td style="width: 10%;"></td> <td style="width: 10%;"></td> <td style="width: 10%;"></td> <td style="width: 10%;"></td> <td style="width: 10%;"></td> <td style="width: 10%;"></td> <td style="width: 10%;"></td> <td style="width: 10%;"></td> </tr> <tr> <td></td> <td></td> <td colspan="8" style="text-align: center;"> <table border="1" style="width: 100%; border-collapse: collapse; text-align: center;"> <tr> <td style="width: 10%;"></td> <td style="width: 10%;"></td> <td style="width: 10%;"></td> <td style="width: 10%;"></td> <td style="width: 10%;"></td> <td style="width: 10%;"></td> <td style="width: 10%;"></td> <td style="width: 10%;"></td> <td style="width: 10%;"></td> <td style="width: 10%;"></td> </tr> <tr> <td></td> <td></td> <td colspan="8" style="text-align: center;"> <table border="1" style="width: 100%; border-collapse: collapse; text-align: center;"> <tr> <td style="width: 10%;"></td> <td style="width: 10%;"></td> <td style="width: 10%;"></td> <td style="width: 10%;"></td> <td style="width: 10%;"></td> <td style="width: 10%;"></td> <td style="width: 10%;"></td> <td style="width: 10%;"></td> <td style="width: 10%;"></td> <td style="width: 10%;"></td> </tr> <tr> <td></td> <td></td> <td colspan="8" style="text-align: center;"> <table border="1" style="width: 100%; border-collapse: collapse; text-align: center;"> <tr> <td style="width: 10%;"></td> <td style="width: 10%;"></td> <td style="width: 10%;"></td> <td style="width: 10%;"></td> <td style="width: 10%;"></td> <td style="width: 10%;"></td> <td style="width: 10%;"></td> <td style="width: 10%;"></td> <td style="width: 10%;"></td> <td style="width: 10%;"></td> </tr> <tr> <td></td> <td></td> <td colspan="8" style="text-align: center;"> <table border="1" style="width: 100%; border-collapse: collapse; text-align: center;"> <tr> <td style="width: 10%;"></td> <td style="width: 10%;"></td> <td style="width: 10%;"></td> <td style="width: 10%;"></td> <td style="width: 10%;"></td> <td style="width: 10%;"></td> <td style="width: 10%;"></td> <td style="width: 10%;"></td> <td style="width: 10%;"></td> <td style="width: 10%;"></td> </tr> <tr> <td></td> <td></td> <td colspan="8" style="text-align: center;"> <table border="1" style="width: 100%; border-collapse: collapse; text-align: center;"> <tr> <td style="width: 10%;"></td> <td style="width: 10%;"></td> <td style="width: 10%;"></td> <td style="width: 10%;"></td> <td style="width: 10%;"></td> <td style="width: 10%;"></td> <td style="width: 10%;"></td> <td style="width: 10%;"></td> <td style="width: 10%;"></td> <td style="width: 10%;"></td> </tr> <tr> <td></td> <td></td> <td colspan="8" style="text-align: center;"> <table border="1" style="width: 100%; border-collapse: collapse; text-align: center;"> <tr> <td style="width: 10%;"></td> <td style="width: 10%;"></td> <td style="width: 10%;"></td> <td style="width: 10%;"></td> <td style="width: 10%;"></td> <td style="width: 10%;"></td> <td style="width: 10%;"></td> <td style="width: 10%;"></td> <td style="width: 10%;"></td> <td style="width: 10%;"></td> </tr> <tr> <td></td> <td></td> <td colspan="8" style="text-align: center;"> <table border="1" style="width: 100%; border-collapse: collapse; text-align: center;"> <tr> <td style="width: 10%;"></td> <td style="width: 10%;"></td> <td style="width: 10%;"></td> <td style="width: 10%;"></td> <td style="width: 10%;"></td> <td style="width: 10%;"></td> <td style="width: 10%;"></td> <td style="width: 10%;"></td> <td style="width: 10%;"></td> <td style="width: 10%;"></td> </tr> <tr> <td></td> <td></td> <td colspan="8" style="text-align: center;"> <table border="1" style="width: 100%; border-collapse: collapse; text-align: center;"> <tr> <td style="width: 10%;"></td> <td style="width: 10%;"></td> <td
style="width: 10%;"></td> <td style="width: 10%;"></td> <td style="width: 10%;"></td> <td style="width: 10%;"></td> <td style="width: 10%;"></td> <td style="width: 10%;"></td> <td style="width: 10%;"></td> <td style="width: 10%;"></td> </tr> <tr> <td></td> <td></td> <td colspan="8" style="text-align: center;"> <table border="1" style="width: 100%; border-collapse: collapse; text-align: center;"> <tr> <td style="width: 10%;"></td> <td style="width: 10%;"></td> <td style="width: 10%;"></td> <td style="width: 10%;"></td> <td style="width: 10%;"></td> <td style="width: 10%;"></td> <td style="width: 10%;"></td> <td style="width: 10%;"></td> <td style="width: 10%;"></td> <td style="width: 10%;"></td> </tr> <tr> <td></td> <td></td> <td colspan="8" style="text-align: center;"> <table border="1" style="width: 100%; border-collapse: collapse; text-align: center;"> <tr> <td style="width: 10%;"></td> <td style="width: 10%;"></td> <td style="width: 10%;"></td> <td style="width: 10%;"></td> <td style="width: 10%;"></td> <td style="width: 10%;"></td> <td style="width: 10%;"></td> <td style="width: 10%;"></td> <td style="width: 10%;"></td> <td style="width: 10%;"></td> </tr> <tr> <td></td> <td></td> <td colspan="8" style="text-align: center;"> <table border="1" style="width: 100%; border-collapse: collapse; text-align: center;"> <tr> <td style="width: 10%;"></td> <td style="width: 10%;"></td> <td style="width: 10%;"></td> <td style="width: 10%;"></td> <td style="width: 10%;"></td> <td style="width: 10%;"></td> <td style="width: 10%;"></td> <td style="width: 10%;"></td> <td style="width: 10%;"></td> <td style="width: 10%;"></td> </tr> <tr> <td></td> <td></td> <td colspan="8" style="text-align: center;"> <table border="1" style="width: 100%; border-collapse: collapse; text-align: center;"> <tr> <td style="width: 10%;"></td> <td style="width: 10%;"></td> <td style="width: 10%;"></td> <td style="width: 10%;"></td> <td style="width: 10%;"></td> <td style="width: 10%;"></td> <td style="width: 10%;"></td> <td style="width: 10%;"></td> <td style="width: 10%;"></td> <td style="width: 10%;"></td> </tr> <tr> <td></td> <td></td> <td colspan="8" style="text-align: center;"> <table border="1" style="width: 100%; border-collapse: collapse; text-align: center;"> <tr> <td style="width: 10%;"></td> <td style="width: 10%;"></td> <td style="width: 10%;"></td> <td style="width: 10%;"></td> <td style="width: 10%;"></td> <td style="width: 10%;"></td> <td style="width: 10%;"></td> <td style="width: 10%;"></td> <td style="width: 10%;"></td> <td style="width: 10%;"></td> </tr> <tr> <td></td> <td></td> <td colspan="8" style="text-align: center;"> <table border="1" style="width: 100%; border-collapse: collapse; text-align: center;"> <tr> <td style="width: 10%;"></td> <td style="width: 10%;"></td> <td style="width: 10%;"></td> <td style="width: 10%;"></td> <td style="width: 10%;"></td> <td style="width: 10%;"></td> <td style="width: 10%;"></td> <td style="width: 10%;"></td> <td style="width: 10%;"></td> <td style="width: 10%;"></td> </tr> <tr> <td></td> <td></td> <td colspan="8" style="text-align: center;"> <table border="1" style="width: 100%; border-collapse: collapse; text-align: center;"> <tr> <td style="width: 10%;"></td> <td style="width: 10%;"></td> <td style="width: 10%;"></td> <td style="width: 10%;"></td> <td style="width: 10%;"></td> <td style="width: 10%;"></td> <td style="width: 10%;"></td> <td style="width: 10%;"></td> <td style="width: 10%;"></td> <td style="width: 10%;"></td> </tr> <tr> <td></td> <td></td> <td colspan="8" style="text-align: center;"> <table border="1" style="width: 100%; border-collapse: collapse; text-align: center;"> <tr> <td style="width: 10%;"></td> <td style="width: 10%;"></td> <td style="width: 10%;"></td> <td style="width: 10%;"></td> <td style="width: 10%;"></td> <td style="width: 10%;"></td> <td style="width: 10%;"></td> <td style="width: 10%;"></td> <td style="width: 10%;"></td> <td style="width: 10%;"></td> </tr> <tr> <td></td> <td></td> <td colspan="8" style="text-align: center;"> <table border="1" style="width: 100%; border-collapse: collapse; text-align: center;"> <tr> <td style="width: 10%;"></td> <td style="width: 10%;"></td> <td style="width: 10%;"></td> <td style="width: 10%;"></td> <td style="width: 10%;"></td> <td style="width: 10%;"></td> <td style="width: 10%;"></td> <td style="width: 10%;"></td> <td style="width: 10%;"></td> <td style="width: 10%;"></td> </tr> <tr> <td></td> <td></td> <td colspan="8" style="text-align: center;"> <table border="1" style="width: 100%; border-collapse: collapse; text-align: center;"> <tr> <td style="width: 10%;"></td> <td style="width: 10%;"></td> <td style="width: 10%;"></td> <td style="width: 10%;"></td> <td style="width: 10%;"></td> <td style="width: 10%;"></td> <td style="width: 10%;"></td> <td style="width: 10%;"></td> <td style="width: 10%;"></td> <td style="width: 10%;"></td> </tr> <tr> <td></td> <td></td> <td colspan="8" style="text-align: center;"> <table border="1" style="width: 100%; border-collapse: collapse; text-align: center;"> <tr> <td style="width: 10%;"></td> <td style="width: 10%;"></td> <td style="width: 10%;"></td> <td style="width: 10%;"></td> <td style="width: 10%;"></td> <td style="width: 10%;"></td> <td style="width: 10%;"></td> <td style="width: 10%;"></td> <td style="width: 10%;"></td> <td style="width: 10%;"></td> </tr> <tr> <td></td> <td></td> <td colspan="8" style="text-align: center;"> <table border="1" style="width: 100%; border-collapse: collapse; text-align: center;"> <tr> <td style="width: 10%;"></td> <td style="width: 10%;"></td> <td style="width: 10%;"></td> <td style="width: 10%;"></td> <td style="width: 10%;"></td> <td style="width: 10%;"></td> <td style="width: 10%;"></td> <td style="width: 10%;"></td> <td style="width: 10%;"></td> <td style="width: 10%;"></td> </tr> <tr> <td></td> <td></td> <td colspan="8" style="text-align: center;"> <table border="1" style="width: 100%; border-collapse: collapse; text-align: center;"> <tr> <td style="width: 10%;"></td> <td style="width: 10%;"></td> <td style="width: 10%;"></td> <td style="width: 10%;"></td> <td style="width: 10%;"></td> <td style="width: 10%;"></td> <td style="width: 10%;"></td> <td style="width: 10%;"></td> <td style="width: 10%;"></td> <td style="width: 10%;"></td> </tr> <tr> <td></td> <td></td> <td colspan="8" style="text-align: center;"> <table border="1" style="width: 100%; border-collapse: collapse; text-align: center;"> <tr> <td style="width: 10%;"></td> <td style="width: 10%;"></td> <td style="width: 10%;"></td> <td style="width: 10%;"></td> <td style="width: 10%;"></td> <td style="width: 10%;"></td> <td style="width: 10%;"></td> <td style="width: 10%;"></td> <td style="width: 10%;"></td> <td style="width: 10%;"></td> </tr> <tr> <td></td> <td></td> <td colspan="8" style="text-align: center;"> <table border="1" style="width: 100%; border-collapse: collapse; text-align: center;"> <tr> <td style="width: 10%;"></td> <td style="width: 10%;"></td> <td style="width: 10%;"></td> <td style="width: 10%;"></td> <td style="width: 10%;"></td> <td style="width: 10%;"></td> <td style="width: 10%;"></td> <td style="width: 10%;"></td> <td style="width: 10%;"></td> <td style="width: 10%;"></td> </tr> <tr> <td></td> <td></td> <td colspan="8" style="text-align: center;"> <table border="1" style="width: 100%; border-collapse: collapse; text-align: center;"> <tr> <td style="width: 10%;"></td> <td style="width: 10%;"></td> <td style="width: 10%;"></td> <td style="width: 10%;"></td> <td style="width: 10%;"></td> <td style="width: 10%;"></td> <td style="width: 10%;"></td> <td style="width: 10%;"></td> <td style="width: 10%;"></td> <td style="width: 10%;"></td> </tr> <tr> <td></td> <td></td> <td colspan="8" style="text-align: center;"> <table border="1" style="width: 100%; border-collapse: collapse; text-align: center;"> <tr> <td style="width: 10%;"></td> <td style="width: 10%;"></td> <td style="width: 10%;"></td> <td style="width: 10%;"></td> <td style="width: 10%;"></td> <td style="width: 10%;"></td> <td style="width: 10%;"></td> <td style="width: 10%;"></td> <td style="width: 10%;"></td> <td style="width: 10%;"></td> </tr> <tr> <td></td> <td></td> <td colspan="8" style="text-align: center;"> <table border="1" style="width: 100%; border-collapse: collapse; text-align: center;"> <tr> <td style="width: 10%;"></td> <td style="width: 10%;"></td> <td style="width: 10%;"></td> <td style="width: 10%;"></td> <td style="width: 10%;"></td> <td style="width: 10%;"></td> <td style="width: 10%;"></td> <td style="width: 10%;"></td> <td style="width: 10%;"></td> <td style="width: 10%;"></td> </tr> <tr> <td></td> <td></td> <td colspan="8" style="text-align: center;"> <table border="1" style="width: 100%; border-collapse: collapse; text-align: center;"> <tr> <td style="width: 10%;"></td> <td style="width: 10%;"></td> <td style="width: 10%;"></td> <td style="width: 10%;"></td> <td style="width: 10%;"></td> <td style="width: 10%;"></td> <td style="width: 10%;"></td> <td style="width: 10%;"></td> <td style="width: 10%;"></td> <td style="width: 10%;"></td> </tr> <tr> <td></td> <td></td> <td colspan="8" style="text-align: center;"> <table border="1" style="width: 100%; border-collapse: collapse; text-align: center;"> <tr> <td style="width: 10%;"></td> <td style="width: 10%;"></td> <td style="width: 10%;"></td> <td style="width: 10%;"></td> <td style="width: 10%;"></td> <td style="width: 10%;"></td> <td style="width: 10%;"></td> <td style="width: 10%;"></td> <td style="width: 10%;"></td> <td style="width: 10%;"></td> </tr> <tr> <td></td> <td></td> <td colspan="8" style="text-align: center;"> <table border="1" style="width: 100%; border-collapse: collapse; text-align: center;"> <tr> <td style="width: 10%;"></td> <td style="width: 10%;"></td> <td style="width: 10%;"></td> <td style="width: 10%;"></td> <td style="width: 10%;"></td> <td style="width: 10%;"></td> <td style="width: 10%;"></td> <td style="width:
10%;"></td> <td style="width: 10%;"></td> <td style="width: 10%;"></td> </tr> <tr> <td></td> <td></td> <td colspan="8" style="text-align: center;"> <table border="1" style="width: 100%; border-collapse: collapse; text-align: center;"> <tr> <td style="width: 10%;"></td> <td style="width: 10%;"></td> <td style="width: 10%;"></td> <td style="width: 10%;"></td> <td style="width: 10%;"></td> <td style="width: 10%;"></td> <td style="width: 10%;"></td> <td style="width: 10%;"></td> <td style="width: 10%;"></td> <td style="width: 10%;"></td> </tr> <tr> <td></td> <td></td> <td colspan="8" style="text-align: center;"> <table border="1" style="width: 100%; border-collapse: collapse; text-align: center;"> <tr> <td style="width: 10%;"></td> <td style="width: 10%;"></td> <td style="width: 10%;"></td> <td style="width: 10%;"></td> <td style="width: 10%;"></td> <td style="width: 10%;"></td> <td style="width: 10%;"></td> <td style="width: 10%;"></td> <td style="width: 10%;"></td> <td style="width: 10%;"></td> </tr> <tr> <td></td> <td></td> <td colspan="8" style="text-align: center;"> <table border="1" style="width: 100%; border-collapse: collapse; text-align: center;"> <tr> <td style="width: 10%;"></td> <td style="width: 10%;"></td> <td style="width: 10%;"></td> <td style="width: 10%;"></td> <td style="width: 10%;"></td> <td style="width: 10%;"></td> <td style="width: 10%;"></td> <td style="width: 10%;"></td> <td style="width: 10%;"></td> <td style="width: 10%;"></td> </tr> <tr> <td></td> <td></td> <td colspan="8" style="text-align: center;"> <table border="1" style="width: 100%; border-collapse: collapse; text-align: center;"> <tr> <td style="width: 10%;"></td> <td style="width: 10%;"></td> <td style="width: 10%;"></td> <td style="width: 10%;"></td> <td style="width: 10%;"></td> <td style="width: 10%;"></td> <td style="width: 10%;"></td> <td style="width: 10%;"></td> <td style="width: 10%;"></td> <td style="width: 10%;"></td> </tr> <tr> <td></td> <td></td> <td colspan="8" style="text-align: center;"> <table border="1" style="width: 100%; border-collapse: collapse; text-align: center;"> <tr> <td style="width: 10%;"></td> <td style="width: 10%;"></td> <td style="width: 10%;"></td> <td style="width: 10%;"></td> <td style="width: 10%;"></td> <td style="width: 10%;"></td> <td style="width: 10%;"></td> <td style="width: 10%;"></td> <td style="width: 10%;"></td> <td style="width: 10%;"></td> </tr> <tr> <td></td> <td></td> <td colspan="8" style="text-align: center;"> <table border="1" style="width: 100%; border-collapse: collapse; text-align: center;"> <tr> <td style="width: 10%;"></td> <td style="width: 10%;"></td> <td style="width: 10%;"></td> <td style="width: 10%;"></td> <td style="width: 10%;"></td> <td style="width: 10%;"></td> <td style="width: 10%;"></td> <td style="width: 10%;"></td> <td style="width: 10%;"></td> <td style="width: 10%;"></td> </tr> <tr> <td></td> <td></td> <td colspan="8" style="text-align: center;"> <table border="1" style="width: 100%; border-collapse: collapse; text-align: center;"> <tr> <td style="width: 10%;"></td> <td style="width: 10%;"></td> <td style="width: 10%;"></td> <td style="width: 10%;"></td> <td style="width: 10%;"></td> <td style="width: 10%;"></td> <td style="width: 10%;"></td> <td style="width: 10%;"></td> <td style="width: 10%;"></td> <td style="width: 10%;"></td> </tr> <tr> <td></td> <td></td> <td colspan="8" style="text-align: center;"> <table border="1" style="width: 100%; border-collapse: collapse; text-align: center;"> <tr> </tr></table></td></tr></table></td></tr></table></td></tr></table></td></tr></table></td></tr></table></td></tr></table></td></tr></table></td></tr></table></td></tr></table></td></tr></table></td></tr></table></td></tr></table></td></tr></table></td></tr></table></td></tr></table></td></tr></table></td></tr></table></td></tr></table></td></tr></table></td></tr></table></td></tr></table></td></tr></table></td></tr></table></td></tr></table></td></tr></table></td></tr></table></td></tr></table></td></tr></table></td></tr></table></td></tr></table></td></tr></table></td></tr></table></td></tr></table></td></tr></table></td></tr></table></td></tr></table></td></tr></table></td></tr></table></td></tr></table></td></tr></table></td></tr></table></td></tr></table></td></tr></table></td></tr></table></td></tr></table></td></tr></table></td></tr></table></td></tr></table></td></tr></table></td></tr></table>
 | | | | | | | | | | | | | | | | | | | | <table border="1" style="width: 100%; border-collapse: collapse; text-align: center;"> <tr> <td style="width: 10%;"></td> <td style="width: 10%;"></td> <td style="width: 10%;"></td> <td style="width: 10%;"></td> <td style="width: 10%;"></td> <td style="width: 10%;"></td> <td style="width: 10%;"></td> <td style="width: 10%;"></td> <td style="width: 10%;"></td> <td style="width: 10%;"></td> </tr> <tr> <td></td> <td></td> <td colspan="8" style="text-align: center;"> <table border="1" style="width: 100%; border-collapse: collapse; text-align: center;"> <tr> <td style="width: 10%;"></td> <td style="width: 10%;"></td> <td style="width: 10%;"></td> <td style="width: 10%;"></td> <td style="width: 10%;"></td> <td style="width: 10%;"></td> <td style="width: 10%;"></td> <td style="width: 10%;"></td> <td style="width: 10%;"></td> <td style="width: 10%;"></td> </tr> <tr> <td></td> <td></td> <td colspan="8" style="text-align: center;"> <table border="1" style="width: 100%; border-collapse: collapse; text-align: center;"> <tr> <td style="width: 10%;"></td> <td style="width: 10%;"></td> <td style="width: 10%;"></td> <td style="width: 10%;"></td> <td style="width: 10%;"></td> <td style="width: 10%;"></td> <td style="width: 10%;"></td> <td style="width: 10%;"></td> <td style="width: 10%;"></td> <td style="width: 10%;"></td> </tr> <tr> <td></td> <td></td> <td colspan="8" style="text-align: center;"> <table border="1" style="width: 100%; border-collapse: collapse; text-align: center;"> <tr> <td style="width: 10%;"></td> <td style="width: 10%;"></td> <td style="width: 10%;"></td> <td style="width: 10%;"></td> <td style="width: 10%;"></td> <td style="width: 10%;"></td> <td style="width: 10%;"></td> <td style="width: 10%;"></td> <td style="width: 10%;"></td> <td style="width: 10%;"></td> </tr> <tr> <td></td> <td></td> <td colspan="8" style="text-align: center;"> <table border="1" style="width: 100%; border-collapse: collapse; text-align: center;"> <tr> <td style="width: 10%;"></td> <td style="width: 10%;"></td> <td style="width: 10%;"></td> <td style="width: 10%;"></td> <td style="width: 10%;"></td> <td style="width: 10%;"></td> <td style="width: 10%;"></td> <td style="width: 10%;"></td> <td style="width: 10%;"></td> <td style="width: 10%;"></td> </tr> <tr> <td></td> <td></td> <td colspan="8" style="text-align: center;"> <table border="1" style="width: 100%; border-collapse: collapse; text-align: center;"> <tr> <td style="width: 10%;"></td> <td style="width: 10%;"></td> <td style="width: 10%;"></td> <td style="width: 10%;"></td> <td style="width: 10%;"></td> <td style="width: 10%;"></td> <td style="width: 10%;"></td> <td style="width: 10%;"></td> <td style="width: 10%;"></td> <td style="width: 10%;"></td> </tr> <tr> <td></td> <td></td> <td colspan="8" style="text-align: center;"> <table border="1" style="width: 100%; border-collapse: collapse; text-align: center;"> <tr> <td style="width: 10%;"></td> <td style="width: 10%;"></td> <td style="width: 10%;"></td> <td style="width: 10%;"></td> <td style="width: 10%;"></td> <td style="width: 10%;"></td> <td style="width: 10%;"></td> <td style="width: 10%;"></td> <td style="width: 10%;"></td> <td style="width: 10%;"></td> </tr> <tr> <td></td> <td></td> <td colspan="8" style="text-align: center;"> <table border="1" style="width: 100%; border-collapse: collapse; text-align: center;"> <tr> <td style="width: 10%;"></td> <td style="width: 10%;"></td> <td style="width: 10%;"></td> <td style="width: 10%;"></td> <td style="width: 10%;"></td> <td style="width: 10%;"></td> <td style="width: 10%;"></td> <td style="width: 10%;"></td> <td style="width: 10%;"></td> <td style="width: 10%;"></td> </tr> <tr> <td></td> <td></td> <td colspan="8" style="text-align: center;"> <table border="1" style="width: 100%; border-collapse: collapse; text-align: center;"> <tr> <td style="width: 10%;"></td> <td style="width: 10%;"></td> <td style="width: 10%;"></td> <td style="width: 10%;"></td> <td style="width: 10%;"></td> <td style="width: 10%;"></td> <td style="width: 10%;"></td> <td style="width: 10%;"></td> <td style="width: 10%;"></td> <td style="width: 10%;"></td> </tr> <tr> <td></td> <td></td> <td colspan="8" style="text-align: center;"> <table border="1" style="width: 100%; border-collapse: collapse; text-align: center;"> <tr> <td style="width: 10%;"></td> <td style="width: 10%;"></td> <td style="width: 10%;"></td> <td style="width: 10%;"></td> <td style="width: 10%;"></td> <td style="width: 10%;"></td> <td style="width: 10%;"></td> <td style="width: 10%;"></td> <td style="width: 10%;"></td> <td style="width: 10%;"></td> </tr> <tr> <td></td> <td></td> <td colspan="8" style="text-align: center;"> <table border="1" style="width: 100%; border-collapse: collapse; text-align: center;"> <tr> <td style="width: 10%;"></td> <td style="width: 10%;"></td> <td style="width: 10%;"></td> <td style="width: 10%;"></td> <td style="width: 10%;"></td> <td style="width: 10%;"></td> <td style="width: 10%;"></td> <td style="width: 10%;"></td> <td style="width: 10%;"></td> <td style="width: 10%;"></td> </tr> <tr> <td></td> <td></td> <td colspan="8" style="text-align: center;"> <table border="1" style="width: 100%; border-collapse: collapse; text-align: center;"> <tr> <td style="width: 10%;"></td> <td style="width: 10%;"></td> <td style="width: 10%;"></td> <td style="width: 10%;"></td> <td style="width: 10%;"></td> <td style="width: 10%;"></td> <td style="width: 10%;"></td> <td style="width: 10%;"></td> <td style="width: 10%;"></td> <td style="width: 10%;"></td> </tr> <tr> <td></td> <td></td> <td colspan="8" style="text-align: center;"> <table border="1" style="width: 100%; border-collapse: collapse; text-align: center;"> <tr> <td style="width: 10%;"></td> <td style="width: 10%;"></td> <td style="width: 10%;"></td> <td style="width: 10%;"></td> <td style="width: 10%;"></td> <td style="width: 10%;"></td> <td style="width: 10%;"></td> <td style="width: 10%;"></td> <td style="width: 10%;"></td> <td style="width: 10%;"></td> </tr> <tr> <td></td> <td></td> <td colspan="8" style="text-align: center;"> <table border="1" style="width: 100%; border-collapse: collapse; text-align: center;"> <tr> <td style="width: 10%;"></td> <td style="width: 10%;"></td> <td style="width: 10%;"></td> <td style="width: 10%;"></td> <td style="width: 10%;"></td> <td style="width: 10%;"></td> <td style="width: 10%;"></td> <td style="width: 10%;"></td> <td style="width: 10%;"></td> <td style="width: 10%;"></td> </tr> <tr> <td></td> <td></td> <td colspan="8" style="text-align: center;"> <table border="1" style="width: 100%; border-collapse: collapse; text-align: center;"> <tr> <td style="width: 10%;"></td> <td style="width: 10%;"></td> <td style="width: 10%;"></td> <td style="width: 10%;"></td> <td style="width: 10%;"></td> <td style="width: 10%;"></td> <td style="width: 10%;"></td> <td style="width: 10%;"></td> <td style="width: 10%;"></td> <td style="width: 10%;"></td> </tr> <tr> <td></td> <td></td> <td colspan="8" style="text-align: center;"> <table border="1" style="width: 100%; border-collapse: collapse; text-align: center;"> <tr> <td style="width: 10%;"></td> <td style="width: 10%;"></td> <td style="width: 10%;"></td> <td style="width: 10%;"></td> <td style="width: 10%;"></td> <td style="width: 10%;"></td> <td style="width: 10%;"></td> <td style="width: 10%;"></td> <td style="width: 10%;"></td> <td style="width: 10%;"></td> </tr> <tr> <td></td> <td></td> <td colspan="8" style="text-align: center;"> <table border="1" style="width: 100%; border-collapse: collapse; text-align: center;"> <tr> <td style="width: 10%;"></td> <td style="width: 10%;"></td> <td style="width: 10%;"></td> <td style="width: 10%;"></td> <td style="width: 10%;"></td> <td style="width: 10%;"></td> <td style="width: 10%;"></td> <td style="width: 10%;"></td> <td style="width: 10%;"></td> <td style="width: 10%;"></td> </tr> <tr> <td></td> <td></td> <td colspan="8" style="text-align: center;"> <table border="1" style="width: 100%; border-collapse: collapse; text-align: center;"> <tr> <td style="width: 10%;"></td> <td style="width: 10%;"></td> <td style="width: 10%;"></td> <td style="width: 10%;"></td> <td style="width: 10%;"></td> <td style="width: 10%;"></td> <td style="width: 10%;"></td> <td style="width: 10%;"></td> <td style="width: 10%;"></td> <td style="width: 10%;"></td> </tr> <tr> <td></td> <td></td> <td colspan="8" style="text-align: center;"> <table border="1" style="width: 100%; border-collapse: collapse; text-align: center;"> <tr> <td style="width: 10%;"></td> <td style="width: 10%;"></td> <td style="width: 10%;"></td> <td style="width: 10%;"></td> <td style="width: 10%;"></td> <td style="width:
10%;"></td> <td style="width: 10%;"></td> <td style="width: 10%;"></td> <td style="width: 10%;"></td> <td style="width: 10%;"></td> </tr> <tr> <td></td> <td></td> <td colspan="8" style="text-align: center;"> <table border="1" style="width: 100%; border-collapse: collapse; text-align: center;"> <tr> <td style="width: 10%;"></td> <td style="width: 10%;"></td> <td style="width: 10%;"></td> <td style="width: 10%;"></td> <td style="width: 10%;"></td> <td style="width: 10%;"></td> <td style="width: 10%;"></td> <td style="width: 10%;"></td> <td style="width: 10%;"></td> <td style="width: 10%;"></td> </tr> <tr> <td></td> <td></td> <td colspan="8" style="text-align: center;"> <table border="1" style="width: 100%; border-collapse: collapse; text-align: center;"> <tr> <td style="width: 10%;"></td> <td style="width: 10%;"></td> <td style="width: 10%;"></td> <td style="width: 10%;"></td> <td style="width: 10%;"></td> <td style="width: 10%;"></td> <td style="width: 10%;"></td> <td style="width: 10%;"></td> <td style="width: 10%;"></td> <td style="width: 10%;"></td> </tr> <tr> <td></td> <td></td> <td colspan="8" style="text-align: center;"> <table border="1" style="width: 100%; border-collapse: collapse; text-align: center;"> <tr> <td style="width: 10%;"></td> <td style="width: 10%;"></td> <td style="width: 10%;"></td> <td style="width: 10%;"></td> <td style="width: 10%;"></td> <td style="width: 10%;"></td> <td style="width: 10%;"></td> <td style="width: 10%;"></td> <td style="width: 10%;"></td> <td style="width: 10%;"></td> </tr> <tr> <td></td> <td></td> <td colspan="8" style="text-align: center;"> <table border="1" style="width: 100%; border-collapse: collapse; text-align: center;"> <tr> <td style="width: 10%;"></td> <td style="width: 10%;"></td> <td style="width: 10%;"></td> <td style="width: 10%;"></td> <td style="width: 10%;"></td> <td style="width: 10%;"></td> <td style="width: 10%;"></td> <td style="width: 10%;"></td> <td style="width: 10%;"></td> <td style="width: 10%;"></td> </tr> <tr> <td></td> <td></td> <td colspan="8" style="text-align: center;"> <table border="1" style="width: 100%; border-collapse: collapse; text-align: center;"> <tr> <td style="width: 10%;"></td> <td style="width: 10%;"></td> <td style="width: 10%;"></td> <td style="width: 10%;"></td> <td style="width: 10%;"></td> <td style="width: 10%;"></td> <td style="width: 10%;"></td> <td style="width: 10%;"></td> <td style="width: 10%;"></td> <td style="width: 10%;"></td> </tr> <tr> <td></td> <td></td> <td colspan="8" style="text-align: center;"> <table border="1" style="width: 100%; border-collapse: collapse; text-align: center;"> <tr> <td style="width: 10%;"></td> <td style="width: 10%;"></td> <td style="width: 10%;"></td> <td style="width: 10%;"></td> <td style="width: 10%;"></td> <td style="width: 10%;"></td> <td style="width: 10%;"></td> <td style="width: 10%;"></td> <td style="width: 10%;"></td> <td style="width: 10%;"></td> </tr> <tr> <td></td> <td></td> <td colspan="8" style="text-align: center;"> <table border="1" style="width: 100%; border-collapse: collapse; text-align: center;"> <tr> <td style="width: 10%;"></td> <td style="width: 10%;"></td> <td style="width: 10%;"></td> <td style="width: 10%;"></td> <td style="width: 10%;"></td> <td style="width: 10%;"></td> <td style="width: 10%;"></td> <td style="width: 10%;"></td> <td style="width: 10%;"></td> <td style="width: 10%;"></td> </tr> <tr> <td></td> <td></td> <td colspan="8" style="text-align: center;"> <table border="1" style="width: 100%; border-collapse: collapse; text-align: center;"> <tr> <td style="width: 10%;"></td> <td style="width: 10%;"></td> <td style="width: 10%;"></td> <td style="width: 10%;"></td> <td style="width: 10%;"></td> <td style="width: 10%;"></td> <td style="width: 10%;"></td> <td style="width: 10%;"></td> <td style="width: 10%;"></td> <td style="width: 10%;"></td> </tr> <tr> <td></td> <td></td> <td colspan="8" style="text-align: center;"> <table border="1" style="width: 100%; border-collapse: collapse; text-align: center;"> <tr> <td style="width: 10%;"></td> <td style="width: 10%;"></td> <td style="width: 10%;"></td> <td style="width: 10%;"></td> <td style="width: 10%;"></td> <td style="width: 10%;"></td> <td style="width: 10%;"></td> <td style="width: 10%;"></td> <td style="width: 10%;"></td> <td style="width: 10%;"></td> </tr> <tr> <td></td> <td></td> <td colspan="8" style="text-align: center;"> <table border="1" style="width: 100%; border-collapse: collapse; text-align: center;"> <tr> <td style="width: 10%;"></td> <td style="width: 10%;"></td> <td style="width: 10%;"></td> <td style="width: 10%;"></td> <td style="width: 10%;"></td> <td style="width: 10%;"></td> <td style="width: 10%;"></td> <td style="width: 10%;"></td> <td style="width: 10%;"></td> <td style="width: 10%;"></td> </tr> <tr> <td></td> <td></td> <td colspan="8" style="text-align: center;"> <table border="1" style="width: 100%; border-collapse: collapse; text-align: center;"> <tr> <td style="width: 10%;"></td> <td style="width: 10%;"></td> <td style="width: 10%;"></td> <td style="width: 10%;"></td> <td style="width: 10%;"></td> <td style="width: 10%;"></td> <td style="width: 10%;"></td> <td style="width: 10%;"></td> <td style="width: 10%;"></td> <td style="width: 10%;"></td> </tr> <tr> <td></td> <td></td> <td colspan="8" style="text-align: center;"> <table border="1" style="width: 100%; border-collapse: collapse; text-align: center;"> <tr> <td style="width: 10%;"></td> <td style="width: 10%;"></td> <td style="width: 10%;"></td> <td style="width: 10%;"></td> <td style="width: 10%;"></td> <td style="width: 10%;"></td> <td style="width: 10%;"></td> <td style="width: 10%;"></td> <td style="width: 10%;"></td> <td style="width: 10%;"></td> </tr> <tr> <td></td> <td></td> <td colspan="8" style="text-align: center;"> <table border="1" style="width: 100%; border-collapse: collapse; text-align: center;"> <tr> <td style="width: 10%;"></td> <td style="width: 10%;"></td> <td style="width: 10%;"></td> <td style="width: 10%;"></td> <td style="width: 10%;"></td> <td style="width: 10%;"></td> <td style="width: 10%;"></td> <td style="width: 10%;"></td> <td style="width: 10%;"></td> <td style="width: 10%;"></td> </tr> <tr> <td></td> <td></td> <td colspan="8" style="text-align: center;"> <table border="1" style="width: 100%; border-collapse: collapse; text-align: center;"> <tr> <td style="width: 10%;"></td> <td style="width: 10%;"></td> <td style="width: 10%;"></td> <td style="width: 10%;"></td> <td style="width: 10%;"></td> <td style="width: 10%;"></td> <td style="width: 10%;"></td> <td style="width: 10%;"></td> <td style="width: 10%;"></td> <td style="width: 10%;"></td> </tr> <tr> <td></td> <td></td> <td colspan="8" style="text-align: center;"> <table border="1" style="width: 100%; border-collapse: collapse; text-align: center;"> <tr> <td style="width: 10%;"></td> <td style="width: 10%;"></td> <td style="width: 10%;"></td> <td style="width: 10%;"></td> <td style="width: 10%;"></td> <td style="width: 10%;"></td> <td style="width: 10%;"></td> <td style="width: 10%;"></td> <td style="width: 10%;"></td> <td style="width: 10%;"></td> </tr> <tr> <td></td> <td></td> <td colspan="8" style="text-align: center;"> <table border="1" style="width: 100%; border-collapse: collapse; text-align: center;"> <tr> <td style="width: 10%;"></td> <td style="width: 10%;"></td> <td style="width: 10%;"></td> <td style="width: 10%;"></td> <td style="width: 10%;"></td> <td style="width: 10%;"></td> <td style="width: 10%;"></td> <td style="width: 10%;"></td> <td style="width: 10%;"></td> <td style="width: 10%;"></td> </tr> <tr> <td></td> <td></td> <td colspan="8" style="text-align: center;"> <table border="1" style="width: 100%; border-collapse: collapse; text-align: center;"> <tr> <td style="width: 10%;"></td> <td style="width: 10%;"></td> <td style="width: 10%;"></td> <td style="width: 10%;"></td> <td style="width: 10%;"></td> <td style="width: 10%;"></td> <td style="width: 10%;"></td> <td style="width: 10%;"></td> <td style="width: 10%;"></td> <td style="width: 10%;"></td> </tr> <tr> <td></td> <td></td> <td colspan="8" style="text-align: center;"> <table border="1" style="width: 100%; border-collapse: collapse; text-align: center;"> <tr> <td style="width: 10%;"></td> <td style="width: 10%;"></td> <td style="width: 10%;"></td> <td style="width: 10%;"></td> <td style="width: 10%;"></td> <td style="width: 10%;"></td> <td style="width: 10%;"></td> <td style="width: 10%;"></td> <td style="width: 10%;"></td> <td style="width: 10%;"></td> </tr> <tr> <td></td> <td></td> <td colspan="8" style="text-align: center;"> <table border="1" style="width: 100%; border-collapse: collapse; text-align: center;"> <tr> <td style="width: 10%;"></td> <td style="width: 10%;"></td> <td style="width: 10%;"></td> <td style="width: 10%;"></td> <td style="width: 10%;"></td> <td style="width: 10%;"></td> <td style="width: 10%;"></td> <td style="width: 10%;"></td> <td style="width: 10%;"></td> <td style="width: 10%;"></td> </tr> <tr> <td></td> <td></td> <td colspan="8" style="text-align: center;"> <table border="1" style="width: 100%; border-collapse: collapse; text-align: center;"> <tr> <td style="width: 10%;"></td> <td style="width: 10%;"></td> <td style="width: 10%;"></td> <td style="width: 10%;"></td> <td style="width: 10%;"></td> <td style="width: 10%;"></td> <td style="width: 10%;"></td> <td style="width: 10%;"></td> <td style="width: 10%;"></td> <td style="width: 10%;"></td> </tr> <tr> <td></td> <td></td> <td colspan="8" style="text-align: center;"> <table border="1" style="width: 100%; border-collapse: collapse; text-align: center;"> <tr> <td style="width: 10%;"></td> <td style="width: 10%;"></td> <td style="width: 10%;"></td> <td style="width: 10%;"></td> <td style="width: 10%;"></td> <td style="width: 10%;"></td> <td style="width: 10%;"></td> <td style="width: 10%;"></td> <td style="width: 10%;"></td> <td style="width: 10%;"></td> </tr> <tr> <td></td> <td></td> <td
colspan="8" style="text-align: center;"> <table border="1" style="width: 100%; border-collapse: collapse; text-align: center;"> <tr> <td style="width: 10%;"></td> <td style="width: 10%;"></td> <td style="width: 10%;"></td> <td style="width: 10%;"></td> <td style="width: 10%;"></td> <td style="width: 10%;"></td> <td style="width: 10%;"></td> <td style="width: 10%;"></td> <td style="width: 10%;"></td> <td style="width: 10%;"></td> </tr> <tr> <td></td> <td></td> <td colspan="8" style="text-align: center;"> <table border="1" style="width: 100%; border-collapse: collapse; text-align: center;"> <tr> <td style="width: 10%;"></td> <td style="width: 10%;"></td> <td style="width: 10%;"></td> <td style="width: 10%;"></td> <td style="width: 10%;"></td> <td style="width: 10%;"></td> <td style="width: 10%;"></td> <td style="width: 10%;"></td> <td style="width: 10%;"></td> <td style="width: 10%;"></td> </tr> <tr> <td></td> <td></td> <td colspan="8" style="text-align: center;"> <table border="1" style="width: 100%; border-collapse: collapse; text-align: center;"> <tr> <td style="width: 10%;"></td> <td style="width: 10%;"></td> <td style="width: 10%;"></td> <td style="width: 10%;"></td> <td style="width: 10%;"></td> <td style="width: 10%;"></td> <td style="width: 10%;"></td> <td style="width: 10%;"></td> <td style="width: 10%;"></td> <td style="width: 10%;"></td> </tr> <tr> <td></td> <td></td> <td colspan="8" style="text-align: center;"> <table border="1" style="width: 100%; border-collapse: collapse; text-align: center;"> <tr> <td style="width: 10%;"></td> <td style="width: 10%;"></td> <td style="width: 10%;"></td> <td style="width: 10%;"></td> <td style="width: 10%;"></td> <td style="width: 10%;"></td> <td style="width: 10%;"></td> <td style="width: 10%;"></td> <td style="width: 10%;"></td> <td style="width: 10%;"></td> </tr> <tr> <td></td> <td></td> <td colspan="8" style="text-align: center;"> <table border="1" style="width: 100%; border-collapse: collapse; text-align: center;"> <tr> <td style="width: 10%;"></td> <td style="width: 10%;"></td> <td style="width: 10%;"></td> <td style="width: 10%;"></td> <td style="width: 10%;"></td> <td style="width: 10%;"></td> <td style="width: 10%;"></td> <td style="width: 10%;"></td> <td style="width: 10%;"></td> <td style="width: 10%;"></td> </tr> <tr> <td></td> <td></td> <td colspan="8" style="text-align: center;"> <table border="1" style="width: 100%; border-collapse: collapse; text-align: center;"> <tr> <td style="width: 10%;"></td> <td style="width: 10%;"></td> <td style="width: 10%;"></td> <td style="width: 10%;"></td> <td style="width: 10%;"></td> <td style="width: 10%;"></td> <td style="width: 10%;"></td> <td style="width: 10%;"></td> <td style="width: 10%;"></td> <td style="width: 10%;"></td> </tr> <tr> <td></td> <td></td> <td colspan="8" style="text-align: center;"> <table border="1" style="width: 100%; border-collapse: collapse; text-align: center;"> <tr> <td style="width: 10%;"></td> <td style="width: 10%;"></td> <td style="width: 10%;"></td> <td style="width: 10%;"></td> <td style="width: 10%;"></td> <td style="width: 10%;"></td> <td style="width: 10%;"></td> <td style="width: 10%;"></td> <td style="width: 10%;"></td> <td style="width: 10%;"></td> </tr> <tr> <td></td> <td></td> <td colspan="8" style="text-align: center;"> <table border="1" style="width: 100%; border-collapse: collapse; text-align: center;"> <tr> <td style="width: 10%;"></td> <td style="width: 10%;"></td> <td style="width: 10%;"></td> <td style="width: 10%;"></td> <td style="width: 10%;"></td> <td style="width: 10%;"></td> <td style="width: 10%;"></td> <td style="width: 10%;"></td> <td style="width: 10%;"></td> <td style="width: 10%;"></td> </tr> <tr> <td></td> <td></td> <td colspan="8" style="text-align: center;"> <table border="1" style="width: 100%; border-collapse: collapse; text-align: center;"> <tr> <td style="width: 10%;"></td> <td style="width: 10%;"></td> <td style="width: 10%;"></td> <td style="width: 10%;"></td> <td style="width: 10%;"></td> <td style="width: 10%;"></td> <td style="width: 10%;"></td> <td style="width: 10%;"></td> <td style="width: 10%;"></td> <td style="width: 10%;"></td> </tr> <tr> <td></td> <td></td> <td colspan="8" style="text-align: center;"> <table border="1" style="width: 100%; border-collapse: collapse; text-align: center;"> <tr> </tr></table></td></tr></table></td></tr></table></td></tr></table></td></tr></table></td></tr></table></td></tr></table></td></tr></table></td></tr></table></td></tr></table></td></tr></table></td></tr></table></td></tr></table></td></tr></table></td></tr></table></td></tr></table></td></tr></table></td></tr></table></td></tr></table></td></tr></table></td></tr></table></td></tr></table></td></tr></table></td></tr></table></td></tr></table></td></tr></table></td></tr></table></td></tr></table></td></tr></table></td></tr></table></td></tr></table></td></tr></table></td></tr></table></td></tr></table></td></tr></table></td></tr></table></td></tr></table></td></tr></table></td></tr></table></td></tr></table></td></tr></table></td></tr></table></td></tr></table></td></tr></table></td></tr></table></td></tr></table></td></tr></table></td></tr></table></td></tr></table></td></tr></table>
 | | | | | | | | | | | | | | | | | | | | <table border="1" style="width: 100%; border-collapse: collapse; text-align: center;"> <tr> <td style="width: 10%;"></td> <td style="width: 10%;"></td> <td style="width: 10%;"></td> <td style="width: 10%;"></td> <td style="width: 10%;"></td> <td style="width: 10%;"></td> <td style="width: 10%;"></td> <td style="width: 10%;"></td> <td style="width: 10%;"></td> <td style="width: 10%;"></td> </tr> <tr> <td></td> <td></td> <td colspan="8" style="text-align: center;"> <table border="1" style="width: 100%; border-collapse: collapse; text-align: center;"> <tr> <td style="width: 10%;"></td> <td style="width: 10%;"></td> <td style="width: 10%;"></td> <td style="width: 10%;"></td> <td style="width: 10%;"></td> <td style="width: 10%;"></td> <td style="width: 10%;"></td> <td style="width: 10%;"></td> <td style="width: 10%;"></td> <td style="width: 10%;"></td> </tr> <tr> <td></td> <td></td> <td colspan="8" style="text-align: center;"> <table border="1" style="width: 100%; border-collapse: collapse; text-align: center;"> <tr> <td style="width: 10%;"></td> <td style="width: 10%;"></td> <td style="width: 10%;"></td> <td style="width: 10%;"></td> <td style="width: 10%;"></td> <td style="width: 10%;"></td> <td style="width: 10%;"></td> <td style="width: 10%;"></td> <td style="width: 10%;"></td> <td style="width: 10%;"></td> </tr> <tr> <td></td> <td></td> <td colspan="8" style="text-align: center;"> <table border="1" style="width: 100%; border-collapse: collapse; text-align: center;"> <tr> <td style="width: 10%;"></td> <td style="width: 10%;"></td> <td style="width: 10%;"></td> <td style="width: 10%;"></td> <td style="width: 10%;"></td> <td style="width: 10%;"></td> <td style="width: 10%;"></td> <td style="width: 10%;"></td> <td style="width: 10%;"></td> <td style="width: 10%;"></td> </tr> <tr> <td></td> <td></td> <td colspan="8" style="text-align: center;"> <table border="1" style="width: 100%; border-collapse: collapse; text-align: center;"> <tr> <td style="width: 10%;"></td> <td style="width: 10%;"></td> <td style="width: 10%;"></td> <td style="width: 10%;"></td> <td style="width: 10%;"></td> <td style="width: 10%;"></td> <td style="width: 10%;"></td> <td style="width: 10%;"></td> <td style="width: 10%;"></td> <td style="width: 10%;"></td> </tr> <tr> <td></td> <td></td> <td colspan="8" style="text-align: center;"> <table border="1" style="width: 100%; border-collapse: collapse; text-align: center;"> <tr> <td style="width: 10%;"></td> <td style="width: 10%;"></td> <td style="width: 10%;"></td> <td style="width: 10%;"></td> <td style="width: 10%;"></td> <td style="width: 10%;"></td> <td style="width: 10%;"></td> <td style="width: 10%;"></td> <td style="width: 10%;"></td> <td style="width: 10%;"></td> </tr> <tr> <td></td> <td></td> <td colspan="8" style="text-align: center;"> <table border="1" style="width: 100%; border-collapse: collapse; text-align: center;"> <tr> <td style="width: 10%;"></td> <td style="width: 10%;"></td> <td style="width: 10%;"></td> <td style="width: 10%;"></td> <td style="width: 10%;"></td> <td style="width: 10%;"></td> <td style="width: 10%;"></td> <td style="width: 10%;"></td> <td style="width: 10%;"></td> <td style="width: 10%;"></td> </tr> <tr> <td></td> <td></td> <td colspan="8" style="text-align: center;"> <table border="1" style="width: 100%; border-collapse: collapse; text-align: center;"> <tr> <td style="width: 10%;"></td> <td style="width: 10%;"></td> <td style="width: 10%;"></td> <td style="width: 10%;"></td> <td style="width: 10%;"></td> <td style="width: 10%;"></td> <td style="width: 10%;"></td> <td style="width: 10%;"></td> <td style="width: 10%;"></td> <td style="width: 10%;"></td> </tr> <tr> <td></td> <td></td> <td colspan="8" style="text-align: center;"> <table border="1" style="width: 100%; border-collapse: collapse; text-align: center;"> <tr> <td style="width: 10%;"></td> <td style="width: 10%;"></td> <td style="width: 10%;"></td> <td style="width: 10%;"></td> <td style="width: 10%;"></td> <td style="width: 10%;"></td> <td style="width: 10%;"></td> <td style="width: 10%;"></td> <td style="width: 10%;"></td> <td style="width: 10%;"></td> </tr> <tr> <td></td> <td></td> <td colspan="8" style="text-align: center;"> <table border="1" style="width: 100%; border-collapse: collapse; text-align: center;"> <tr> <td style="width: 10%;"></td> <td style="width: 10%;"></td> <td style="width: 10%;"></td> <td style="width: 10%;"></td> <td style="width: 10%;"></td> <td style="width: 10%;"></td> <td style="width: 10%;"></td> <td style="width: 10%;"></td> <td style="width: 10%;"></td> <td style="width: 10%;"></td> </tr> <tr> <td></td> <td></td> <td colspan="8" style="text-align: center;"> <table border="1" style="width: 100%; border-collapse: collapse; text-align: center;"> <tr> <td style="width: 10%;"></td> <td style="width: 10%;"></td> <td style="width: 10%;"></td> <td style="width: 10%;"></td> <td style="width: 10%;"></td> <td style="width: 10%;"></td> <td style="width: 10%;"></td> <td style="width: 10%;"></td> <td style="width: 10%;"></td> <td style="width: 10%;"></td> </tr> <tr> <td></td> <td></td> <td colspan="8" style="text-align: center;"> <table border="1" style="width: 100%; border-collapse: collapse; text-align: center;"> <tr> <td style="width: 10%;"></td> <td style="width: 10%;"></td> <td style="width: 10%;"></td> <td style="width: 10%;"></td> <td style="width: 10%;"></td> <td style="width: 10%;"></td> <td style="width: 10%;"></td> <td style="width: 10%;"></td> <td style="width: 10%;"></td> <td style="width: 10%;"></td> </tr> <tr> <td></td> <td></td> <td colspan="8" style="text-align: center;"> <table border="1" style="width: 100%; border-collapse: collapse; text-align: center;"> <tr> <td style="width: 10%;"></td> <td style="width: 10%;"></td> <td style="width: 10%;"></td> <td style="width: 10%;"></td> <td style="width: 10%;"></td> <td style="width: 10%;"></td> <td style="width: 10%;"></td> <td style="width: 10%;"></td> <td style="width: 10%;"></td> <td style="width: 10%;"></td> </tr> <tr> <td></td> <td></td> <td colspan="8" style="text-align: center;"> <table border="1" style="width: 100%; border-collapse: collapse; text-align: center;"> <tr> <td style="width: 10%;"></td> <td style="width: 10%;"></td> <td style="width: 10%;"></td> <td style="width: 10%;"></td> <td style="width: 10%;"></td> <td style="width: 10%;"></td> <td style="width: 10%;"></td> <td style="width: 10%;"></td> <td style="width: 10%;"></td> <td style="width: 10%;"></td> </tr> <tr> <td></td> <td></td> <td colspan="8" style="text-align: center;"> <table border="1" style="width: 100%; border-collapse: collapse; text-align: center;"> <tr> <td style="width: 10%;"></td> <td style="width: 10%;"></td> <td style="width: 10%;"></td> <td style="width: 10%;"></td> <td style="width: 10%;"></td> <td style="width: 10%;"></td> <td style="width: 10%;"></td> <td style="width: 10%;"></td> <td style="width: 10%;"></td> <td style="width: 10%;"></td> </tr> <tr> <td></td> <td></td> <td colspan="8" style="text-align: center;"> <table border="1" style="width: 100%; border-collapse: collapse; text-align: center;"> <tr> <td style="width: 10%;"></td> <td style="width: 10%;"></td> <td style="width: 10%;"></td> <td style="width: 10%;"></td> <td style="width: 10%;"></td> <td style="width: 10%;"></td> <td style="width: 10%;"></td> <td style="width: 10%;"></td> <td style="width: 10%;"></td> <td style="width: 10%;"></td> </tr> <tr> <td></td> <td></td> <td colspan="8" style="text-align: center;"> <table border="1" style="width: 100%; border-collapse: collapse; text-align: center;"> <tr> <td style="width: 10%;"></td> <td style="width: 10%;"></td> <td style="width: 10%;"></td> <td style="width: 10%;"></td> <td style="width: 10%;"></td> <td style="width: 10%;"></td> <td style="width: 10%;"></td> <td style="width: 10%;"></td> <td style="width: 10%;"></td> <td style="width: 10%;"></td> </tr> <tr>
<td></td> <td></td> <td colspan="8" style="text-align: center;"> <table border="1" style="width: 100%; border-collapse: collapse; text-align: center;"> <tr> <td style="width: 10%;"></td> <td style="width: 10%;"></td> <td style="width: 10%;"></td> <td style="width: 10%;"></td> <td style="width: 10%;"></td> <td style="width: 10%;"></td> <td style="width: 10%;"></td> <td style="width: 10%;"></td> <td style="width: 10%;"></td> <td style="width: 10%;"></td> </tr> <tr> <td></td> <td></td> <td colspan="8" style="text-align: center;"> <table border="1" style="width: 100%; border-collapse: collapse; text-align: center;"> <tr> <td style="width: 10%;"></td> <td style="width: 10%;"></td> <td style="width: 10%;"></td> <td style="width: 10%;"></td> <td style="width: 10%;"></td> <td style="width: 10%;"></td> <td style="width: 10%;"></td> <td style="width: 10%;"></td> <td style="width: 10%;"></td> <td style="width: 10%;"></td> </tr> <tr> <td></td> <td></td> <td colspan="8" style="text-align: center;"> <table border="1" style="width: 100%; border-collapse: collapse; text-align: center;"> <tr> <td style="width: 10%;"></td> <td style="width: 10%;"></td> <td style="width: 10%;"></td> <td style="width: 10%;"></td> <td style="width: 10%;"></td> <td style="width: 10%;"></td> <td style="width: 10%;"></td> <td style="width: 10%;"></td> <td style="width: 10%;"></td> <td style="width: 10%;"></td> </tr> <tr> <td></td> <td></td> <td colspan="8" style="text-align: center;"> <table border="1" style="width: 100%; border-collapse: collapse; text-align: center;"> <tr> <td style="width: 10%;"></td> <td style="width: 10%;"></td> <td style="width: 10%;"></td> <td style="width: 10%;"></td> <td style="width: 10%;"></td> <td style="width: 10%;"></td> <td style="width: 10%;"></td> <td style="width: 10%;"></td> <td style="width: 10%;"></td> <td style="width: 10%;"></td> </tr> <tr> <td></td> <td></td> <td colspan="8" style="text-align: center;"> <table border="1" style="width: 100%; border-collapse: collapse; text-align: center;"> <tr> <td style="width: 10%;"></td> <td style="width: 10%;"></td> <td style="width: 10%;"></td> <td style="width: 10%;"></td> <td style="width: 10%;"></td> <td style="width: 10%;"></td> <td style="width: 10%;"></td> <td style="width: 10%;"></td> <td style="width: 10%;"></td> <td style="width: 10%;"></td> </tr> <tr> <td></td> <td></td> <td colspan="8" style="text-align: center;"> <table border="1" style="width: 100%; border-collapse: collapse; text-align: center;"> <tr> <td style="width: 10%;"></td> <td style="width: 10%;"></td> <td style="width: 10%;"></td> <td style="width: 10%;"></td> <td style="width: 10%;"></td> <td style="width: 10%;"></td> <td style="width: 10%;"></td> <td style="width: 10%;"></td> <td style="width: 10%;"></td> <td style="width: 10%;"></td> </tr> <tr> <td></td> <td></td> <td colspan="8" style="text-align: center;"> <table border="1" style="width: 100%; border-collapse: collapse; text-align: center;"> <tr> <td style="width: 10%;"></td> <td style="width: 10%;"></td> <td style="width: 10%;"></td> <td style="width: 10%;"></td> <td style="width: 10%;"></td> <td style="width: 10%;"></td> <td style="width: 10%;"></td> <td style="width: 10%;"></td> <td style="width: 10%;"></td> <td style="width: 10%;"></td> </tr> <tr> <td></td> <td></td> <td colspan="8" style="text-align: center;"> <table border="1" style="width: 100%; border-collapse: collapse; text-align: center;"> <tr> <td style="width: 10%;"></td> <td style="width: 10%;"></td> <td style="width: 10%;"></td> <td style="width: 10%;"></td> <td style="width: 10%;"></td> <td style="width: 10%;"></td> <td style="width: 10%;"></td> <td style="width: 10%;"></td> <td style="width: 10%;"></td> <td style="width: 10%;"></td> </tr> <tr> <td></td> <td></td> <td colspan="8" style="text-align: center;"> <table border="1" style="width: 100%; border-collapse: collapse; text-align: center;"> <tr> <td style="width: 10%;"></td> <td style="width: 10%;"></td> <td style="width: 10%;"></td> <td style="width: 10%;"></td> <td style="width: 10%;"></td> <td style="width: 10%;"></td> <td style="width: 10%;"></td> <td style="width: 10%;"></td> <td style="width: 10%;"></td> <td style="width: 10%;"></td> </tr> <tr> <td></td> <td></td> <td colspan="8" style="text-align: center;"> <table border="1" style="width: 100%; border-collapse: collapse; text-align: center;"> <tr> <td style="width: 10%;"></td> <td style="width: 10%;"></td> <td style="width: 10%;"></td> <td style="width: 10%;"></td> <td style="width: 10%;"></td> <td style="width: 10%;"></td> <td style="width: 10%;"></td> <td style="width: 10%;"></td> <td style="width: 10%;"></td> <td style="width: 10%;"></td> </tr> <tr> <td></td> <td></td> <td colspan="8" style="text-align: center;"> <table border="1" style="width: 100%; border-collapse: collapse; text-align: center;"> <tr> <td style="width: 10%;"></td> <td style="width: 10%;"></td> <td style="width: 10%;"></td> <td style="width: 10%;"></td> <td style="width: 10%;"></td> <td style="width: 10%;"></td> <td style="width: 10%;"></td> <td style="width: 10%;"></td> <td style="width: 10%;"></td> <td style="width: 10%;"></td> </tr> <tr> <td></td> <td></td> <td colspan="8" style="text-align: center;"> <table border="1" style="width: 100%; border-collapse: collapse; text-align: center;"> <tr> <td style="width: 10%;"></td> <td style="width: 10%;"></td> <td style="width: 10%;"></td> <td style="width: 10%;"></td> <td style="width: 10%;"></td> <td style="width: 10%;"></td> <td style="width: 10%;"></td> <td style="width: 10%;"></td> <td style="width: 10%;"></td> <td style="width: 10%;"></td> </tr> <tr> <td></td> <td></td> <td colspan="8" style="text-align: center;"> <table border="1" style="width: 100%; border-collapse: collapse; text-align: center;"> <tr> <td style="width: 10%;"></td> <td style="width: 10%;"></td> <td style="width: 10%;"></td> <td style="width: 10%;"></td> <td style="width: 10%;"></td> <td style="width: 10%;"></td> <td style="width: 10%;"></td> <td style="width: 10%;"></td> <td style="width: 10%;"></td> <td style="width: 10%;"></td> </tr> <tr> <td></td> <td></td> <td colspan="8" style="text-align: center;"> <table border="1" style="width: 100%; border-collapse: collapse; text-align: center;"> <tr> <td style="width: 10%;"></td> <td style="width: 10%;"></td> <td style="width: 10%;"></td> <td style="width: 10%;"></td> <td style="width: 10%;"></td> <td style="width: 10%;"></td> <td style="width: 10%;"></td> <td style="width: 10%;"></td> <td style="width: 10%;"></td> <td style="width: 10%;"></td> </tr> <tr> <td></td> <td></td> <td colspan="8" style="text-align: center;"> <table border="1" style="width: 100%; border-collapse: collapse; text-align: center;"> <tr> <td style="width: 10%;"></td> <td style="width: 10%;"></td> <td style="width: 10%;"></td> <td style="width: 10%;"></td> <td style="width: 10%;"></td> <td style="width: 10%;"></td> <td style="width: 10%;"></td> <td style="width: 10%;"></td> <td style="width: 10%;"></td> <td style="width: 10%;"></td> </tr> <tr> <td></td> <td></td> <td colspan="8" style="text-align: center;"> <table border="1" style="width: 100%; border-collapse: collapse; text-align: center;"> <tr> <td style="width: 10%;"></td> <td style="width: 10%;"></td> <td style="width: 10%;"></td> <td style="width: 10%;"></td> <td style="width: 10%;"></td> <td style="width: 10%;"></td> <td style="width: 10%;"></td> <td style="width: 10%;"></td> <td style="width: 10%;"></td> <td style="width: 10%;"></td> </tr> <tr> <td></td> <td></td> <td colspan="8" style="text-align: center;"> <table border="1" style="width: 100%; border-collapse: collapse; text-align: center;"> <tr> <td style="width: 10%;"></td> <td style="width: 10%;"></td> <td style="width: 10%;"></td> <td style="width: 10%;"></td> <td style="width: 10%;"></td> <td style="width: 10%;"></td> <td style="width: 10%;"></td> <td style="width: 10%;"></td> <td style="width: 10%;"></td> <td style="width: 10%;"></td> </tr> <tr> <td></td> <td></td> <td colspan="8" style="text-align: center;"> <table border="1" style="width: 100%; border-collapse: collapse; text-align: center;"> <tr> <td style="width: 10%;"></td> <td style="width: 10%;"></td> <td style="width: 10%;"></td> <td style="width: 10%;"></td> <td style="width: 10%;"></td> <td style="width: 10%;"></td> <td style="width: 10%;"></td> <td style="width: 10%;"></td> <td style="width: 10%;"></td> <td style="width: 10%;"></td> </tr> <tr> <td></td> <td></td> <td colspan="8" style="text-align: center;"> <table border="1" style="width: 100%; border-collapse: collapse; text-align: center;"> <tr> <td style="width: 10%;"></td> <td style="width: 10%;"></td> <td style="width: 10%;"></td> <td style="width: 10%;"></td> <td style="width: 10%;"></td> <td style="width: 10%;"></td> <td style="width: 10%;"></td> <td style="width: 10%;"></td> <td style="width: 10%;"></td> <td style="width: 10%;"></td> </tr> <tr> <td></td> <td></td> <td colspan="8" style="text-align: center;"> <table border="1" style="width: 100%; border-collapse: collapse; text-align: center;"> <tr> <td style="width: 10%;"></td> <td style="width: 10%;"></td> <td style="width: 10%;"></td> <td style="width: 10%;"></td> <td style="width: 10%;"></td> <td style="width: 10%;"></td> <td style="width: 10%;"></td> <td style="width: 10%;"></td> <td style="width: 10%;"></td> <td style="width: 10%;"></td> </tr> <tr> <td></td> <td></td> <td colspan="8" style="text-align: center;"> <table border="1" style="width: 100%; border-collapse: collapse; text-align: center;"> <tr> <td style="width: 10%;"></td> <td style="width: 10%;"></td> <td style="width: 10%;"></td> <td style="width: 10%;"></td> <td style="width: 10%;"></td> <td style="width: 10%;"></td> <td style="width: 10%;"></td> <td style="width: 10%;"></td> <td style="width: 10%;"></td> <td style="width: 10%;"></td> </tr> <tr> <td></td> <td></td> <td colspan="8" style="text-align: center;"> <table border="1" style="width: 100%; border-collapse: collapse; text-align: center;"> <tr> <td
style="width: 10%;"></td> <td style="width: 10%;"></td> <td style="width: 10%;"></td> <td style="width: 10%;"></td> <td style="width: 10%;"></td> <td style="width: 10%;"></td> <td style="width: 10%;"></td> <td style="width: 10%;"></td> <td style="width: 10%;"></td> <td style="width: 10%;"></td> </tr> <tr> <td></td> <td></td> <td colspan="8" style="text-align: center;"> <table border="1" style="width: 100%; border-collapse: collapse; text-align: center;"> <tr> <td style="width: 10%;"></td> <td style="width: 10%;"></td> <td style="width: 10%;"></td> <td style="width: 10%;"></td> <td style="width: 10%;"></td> <td style="width: 10%;"></td> <td style="width: 10%;"></td> <td style="width: 10%;"></td> <td style="width: 10%;"></td> <td style="width: 10%;"></td> </tr> <tr> <td></td> <td></td> <td colspan="8" style="text-align: center;"> <table border="1" style="width: 100%; border-collapse: collapse; text-align: center;"> <tr> <td style="width: 10%;"></td> <td style="width: 10%;"></td> <td style="width: 10%;"></td> <td style="width: 10%;"></td> <td style="width: 10%;"></td> <td style="width: 10%;"></td> <td style="width: 10%;"></td> <td style="width: 10%;"></td> <td style="width: 10%;"></td> <td style="width: 10%;"></td> </tr> <tr> <td></td> <td></td> <td colspan="8" style="text-align: center;"> <table border="1" style="width: 100%; border-collapse: collapse; text-align: center;"> <tr> <td style="width: 10%;"></td> <td style="width: 10%;"></td> <td style="width: 10%;"></td> <td style="width: 10%;"></td> <td style="width: 10%;"></td> <td style="width: 10%;"></td> <td style="width: 10%;"></td> <td style="width: 10%;"></td> <td style="width: 10%;"></td> <td style="width: 10%;"></td> </tr> <tr> <td></td> <td></td> <td colspan="8" style="text-align: center;"> <table border="1" style="width: 100%; border-collapse: collapse; text-align: center;"> <tr> <td style="width: 10%;"></td> <td style="width: 10%;"></td> <td style="width: 10%;"></td> <td style="width: 10%;"></td> <td style="width: 10%;"></td> <td style="width: 10%;"></td> <td style="width: 10%;"></td> <td style="width: 10%;"></td> <td style="width: 10%;"></td> <td style="width: 10%;"></td> </tr> <tr> <td></td> <td></td> <td colspan="8" style="text-align: center;"> <table border="1" style="width: 100%; border-collapse: collapse; text-align: center;"> <tr> <td style="width: 10%;"></td> <td style="width: 10%;"></td> <td style="width: 10%;"></td> <td style="width: 10%;"></td> <td style="width: 10%;"></td> <td style="width: 10%;"></td> <td style="width: 10%;"></td> <td style="width: 10%;"></td> <td style="width: 10%;"></td> <td style="width: 10%;"></td> </tr> <tr> <td></td> <td></td> <td colspan="8" style="text-align: center;"> <table border="1" style="width: 100%; border-collapse: collapse; text-align: center;"> <tr> <td style="width: 10%;"></td> <td style="width: 10%;"></td> <td style="width: 10%;"></td> <td style="width: 10%;"></td> <td style="width: 10%;"></td> <td style="width: 10%;"></td> <td style="width: 10%;"></td> <td style="width: 10%;"></td> <td style="width: 10%;"></td> <td style="width: 10%;"></td> </tr> <tr> <td></td> <td></td> <td colspan="8" style="text-align: center;"> <table border="1" style="width: 100%; border-collapse: collapse; text-align: center;"> <tr> <td style="width: 10%;"></td> <td style="width: 10%;"></td> <td style="width: 10%;"></td> <td style="width: 10%;"></td> <td style="width: 10%;"></td> <td style="width: 10%;"></td> <td style="width: 10%;"></td> <td style="width: 10%;"></td> <td style="width: 10%;"></td> <td style="width: 10%;"></td> </tr> <tr> <td></td> <td></td> <td colspan="8" style="text-align: center;"> <table border="1" style="width: 100%; border-collapse: collapse; text-align: center;"> <tr> <td style="width: 10%;"></td> <td style="width: 10%;"></td> <td style="width: 10%;"></td> <td style="width: 10%;"></td> <td style="width: 10%;"></td> <td style="width: 10%;"></td> <td style="width: 10%;"></td> <td style="width: 10%;"></td> <td style="width: 10%;"></td> <td style="width: 10%;"></td> </tr> <tr> <td></td> <td></td> <td colspan="8" style="text-align: center;"> <table border="1" style="width: 100%; border-collapse: collapse; text-align: center;"> <tr> <td style="width: 10%;"></td> <td style="width: 10%;"></td> <td style="width: 10%;"></td> <td style="width: 10%;"></td> <td style="width: 10%;"></td> <td style="width: 10%;"></td> <td style="width: 10%;"></td> <td style="width: 10%;"></td> <td style="width: 10%;"></td> <td style="width: 10%;"></td> </tr> <tr> <td></td> <td></td> <td colspan="8" style="text-align: center;"> <table border="1" style="width: 100%; border-collapse: collapse; text-align: center;"> <tr> </tr></table></td></tr></table></td></tr></table></td></tr></table></td></tr></table></td></tr></table></td></tr></table></td></tr></table></td></tr></table></td></tr></table></td></tr></table></td></tr></table></td></tr></table></td></tr></table></td></tr></table></td></tr></table></td></tr></table></td></tr></table></td></tr></table></td></tr></table></td></tr></table></td></tr></table></td></tr></table></td></tr></table></td></tr></table></td></tr></table></td></tr></table></td></tr></table></td></tr></table></td></tr></table></td></tr></table></td></tr></table></td></tr></table></td></tr></table></td></tr></table></td></tr></table></td></tr></table></td></tr></table></td></tr></table></td></tr></table></td></tr></table></td></tr></table></td></tr></table></td></tr></table></td></tr></table></td></tr></table></td></tr></table></td></tr></table></td></tr></table>
 | | | | | | | | | | | | | | | | | | | | <table border="1" style="width: 100%; border-collapse: collapse; text-align: center;"> <tr> <td style="width: 10%;"></td> <td style="width: 10%;"></td> <td style="width: 10%;"></td> <td style="width: 10%;"></td> <td style="width: 10%;"></td> <td style="width: 10%;"></td> <td style="width: 10%;"></td> <td style="width: 10%;"></td> <td style="width: 10%;"></td> <td style="width: 10%;"></td> </tr> <tr> <td></td> <td></td> <td colspan="8" style="text-align: center;"> <table border="1" style="width: 100%; border-collapse: collapse; text-align: center;"> <tr> <td style="width: 10%;"></td> <td style="width: 10%;"></td> <td style="width: 10%;"></td> <td style="width: 10%;"></td> <td style="width: 10%;"></td> <td style="width: 10%;"></td> <td style="width: 10%;"></td> <td style="width: 10%;"></td> <td style="width: 10%;"></td> <td style="width: 10%;"></td> </tr> <tr> <td></td> <td></td> <td colspan="8" style="text-align: center;"> <table border="1" style="width: 100%; border-collapse: collapse; text-align: center;"> <tr> <td style="width: 10%;"></td> <td style="width: 10%;"></td> <td style="width: 10%;"></td> <td style="width: 10%;"></td> <td style="width: 10%;"></td> <td style="width: 10%;"></td> <td style="width: 10%;"></td> <td style="width: 10%;"></td> <td style="width: 10%;"></td> <td style="width: 10%;"></td> </tr> <tr> <td></td> <td></td> <td colspan="8" style="text-align: center;"> <table border="1" style="width: 100%; border-collapse: collapse; text-align: center;"> <tr> <td style="width: 10%;"></td> <td style="width: 10%;"></td> <td style="width: 10%;"></td> <td style="width: 10%;"></td> <td style="width: 10%;"></td> <td style="width: 10%;"></td> <td style="width: 10%;"></td> <td style="width: 10%;"></td> <td style="width: 10%;"></td> <td style="width: 10%;"></td> </tr> <tr> <td></td> <td></td> <td colspan="8" style="text-align: center;"> <table border="1" style="width: 100%; border-collapse: collapse; text-align: center;"> <tr> <td style="width: 10%;"></td> <td style="width: 10%;"></td> <td style="width: 10%;"></td> <td style="width: 10%;"></td> <td style="width: 10%;"></td> <td style="width: 10%;"></td> <td style="width: 10%;"></td> <td style="width: 10%;"></td> <td style="width: 10%;"></td> <td style="width: 10%;"></td> </tr> <tr> <td></td> <td></td> <td colspan="8" style="text-align: center;"> <table border="1" style="width: 100%; border-collapse: collapse; text-align: center;"> <tr> <td style="width: 10%;"></td> <td style="width: 10%;"></td> <td style="width: 10%;"></td> <td style="width: 10%;"></td> <td style="width: 10%;"></td> <td style="width: 10%;"></td> <td style="width: 10%;"></td> <td style="width: 10%;"></td> <td style="width: 10%;"></td> <td style="width: 10%;"></td> </tr> <tr> <td></td> <td></td> <td colspan="8" style="text-align: center;"> <table border="1" style="width: 100%; border-collapse: collapse; text-align: center;"> <tr> <td style="width: 10%;"></td> <td style="width: 10%;"></td> <td style="width: 10%;"></td> <td style="width: 10%;"></td> <td style="width: 10%;"></td> <td style="width: 10%;"></td> <td style="width: 10%;"></td> <td style="width: 10%;"></td> <td style="width: 10%;"></td> <td style="width: 10%;"></td> </tr> <tr> <td></td> <td></td> <td colspan="8" style="text-align: center;"> <table border="1" style="width: 100%; border-collapse: collapse; text-align: center;"> <tr> <td style="width: 10%;"></td> <td style="width: 10%;"></td> <td style="width: 10%;"></td> <td style="width: 10%;"></td> <td style="width: 10%;"></td> <td style="width: 10%;"></td> <td style="width: 10%;"></td> <td style="width: 10%;"></td> <td style="width: 10%;"></td> <td style="width: 10%;"></td> </tr> <tr> <td></td> <td></td> <td colspan="8" style="text-align: center;"> <table border="1" style="width: 100%; border-collapse: collapse; text-align: center;"> <tr> <td style="width: 10%;"></td> <td style="width: 10%;"></td> <td style="width: 10%;"></td> <td style="width: 10%;"></td> <td style="width: 10%;"></td> <td style="width: 10%;"></td> <td style="width: 10%;"></td> <td style="width: 10%;"></td> <td style="width: 10%;"></td> <td style="width: 10%;"></td> </tr> <tr> <td></td> <td></td> <td colspan="8" style="text-align: center;"> <table border="1" style="width: 100%; border-collapse: collapse; text-align: center;"> <tr> <td style="width: 10%;"></td> <td style="width: 10%;"></td> <td style="width: 10%;"></td> <td style="width: 10%;"></td> <td style="width: 10%;"></td> <td style="width: 10%;"></td> <td style="width: 10%;"></td> <td style="width: 10%;"></td> <td style="width: 10%;"></td> <td style="width: 10%;"></td> </tr> <tr> <td></td> <td></td> <td colspan="8" style="text-align: center;"> <table border="1" style="width: 100%; border-collapse: collapse; text-align: center;"> <tr> <td style="width: 10%;"></td> <td style="width: 10%;"></td> <td style="width: 10%;"></td> <td style="width: 10%;"></td> <td style="width: 10%;"></td> <td style="width: 10%;"></td> <td style="width: 10%;"></td> <td style="width: 10%;"></td> <td style="width: 10%;"></td> <td style="width: 10%;"></td> </tr> <tr> <td></td> <td></td> <td colspan="8" style="text-align: center;"> <table border="1" style="width: 100%; border-collapse: collapse; text-align: center;"> <tr> <td style="width: 10%;"></td> <td style="width: 10%;"></td> <td style="width: 10%;"></td> <td style="width: 10%;"></td> <td style="width: 10%;"></td> <td style="width: 10%;"></td> <td style="width: 10%;"></td> <td style="width: 10%;"></td> <td style="width: 10%;"></td> <td style="width: 10%;"></td> </tr> <tr> <td></td> <td></td> <td colspan="8" style="text-align: center;"> <table border="1" style="width: 100%; border-collapse: collapse; text-align: center;"> <tr> <td style="width: 10%;"></td> <td style="width: 10%;"></td> <td style="width: 10%;"></td> <td style="width: 10%;"></td> <td style="width: 10%;"></td> <td style="width: 10%;"></td> <td style="width: 10%;"></td> <td style="width: 10%;"></td> <td style="width: 10%;"></td> <td style="width: 10%;"></td> </tr> <tr> <td></td> <td></td> <td colspan="8" style="text-align: center;"> <table border="1" style="width: 100%; border-collapse: collapse; text-align: center;"> <tr> <td style="width: 10%;"></td> <td style="width: 10%;"></td> <td style="width: 10%;"></td> <td style="width: 10%;"></td> <td style="width: 10%;"></td> <td style="width: 10%;"></td> <td style="width: 10%;"></td> <td style="width: 10%;"></td> <td style="width: 10%;"></td> <td style="width: 10%;"></td> </tr> <tr> <td></td> <td></td> <td colspan="8" style="text-align: center;"> <table border="1" style="width: 100%; border-collapse: collapse; text-align: center;"> <tr> <td style="width: 10%;"></td> <td style="width: 10%;"></td> <td style="width: 10%;"></td> <td style="width: 10%;"></td> <td style="width: 10%;"></td> <td style="width: 10%;"></td> <td style="width: 10%;"></td> <td style="width: 10%;"></td> <td style="width: 10%;"></td> <td style="width: 10%;"></td> </tr> <tr> <td></td> <td></td> <td colspan="8" style="text-align: center;"> <table border="1" style="width: 100%; border-collapse: collapse; text-align: center;"> <tr> <td style="width: 10%;"></td> <td style="width: 10%;"></td> <td style="width: 10%;"></td> <td style="width: 10%;"></td> <td style="width: 10%;"></td> <td style="width: 10%;"></td> <td style="width: 10%;"></td> <td style="width: 10%;"></td> <td style="width: 10%;"></td> <td style="width: 10%;"></td> </tr> <tr> <td></td> <td></td> <td colspan="8" style="text-align: center;"> <table border="1" style="width: 100%; border-collapse: collapse; text-align: center;"> <tr>
<td style="width: 10%;"></td> <td style="width: 10%;"></td> <td style="width: 10%;"></td> <td style="width: 10%;"></td> <td style="width: 10%;"></td> <td style="width: 10%;"></td> <td style="width: 10%;"></td> <td style="width: 10%;"></td> <td style="width: 10%;"></td> <td style="width: 10%;"></td> </tr> <tr> <td></td> <td></td> <td colspan="8" style="text-align: center;"> <table border="1" style="width: 100%; border-collapse: collapse; text-align: center;"> <tr> <td style="width: 10%;"></td> <td style="width: 10%;"></td> <td style="width: 10%;"></td> <td style="width: 10%;"></td> <td style="width: 10%;"></td> <td style="width: 10%;"></td> <td style="width: 10%;"></td> <td style="width: 10%;"></td> <td style="width: 10%;"></td> <td style="width: 10%;"></td> </tr> <tr> <td></td> <td></td> <td colspan="8" style="text-align: center;"> <table border="1" style="width: 100%; border-collapse: collapse; text-align: center;"> <tr> <td style="width: 10%;"></td> <td style="width: 10%;"></td> <td style="width: 10%;"></td> <td style="width: 10%;"></td> <td style="width: 10%;"></td> <td style="width: 10%;"></td> <td style="width: 10%;"></td> <td style="width: 10%;"></td> <td style="width: 10%;"></td> <td style="width: 10%;"></td> </tr> <tr> <td></td> <td></td> <td colspan="8" style="text-align: center;"> <table border="1" style="width: 100%; border-collapse: collapse; text-align: center;"> <tr> <td style="width: 10%;"></td> <td style="width: 10%;"></td> <td style="width: 10%;"></td> <td style="width: 10%;"></td> <td style="width: 10%;"></td> <td style="width: 10%;"></td> <td style="width: 10%;"></td> <td style="width: 10%;"></td> <td style="width: 10%;"></td> <td style="width: 10%;"></td> </tr> <tr> <td></td> <td></td> <td colspan="8" style="text-align: center;"> <table border="1" style="width: 100%; border-collapse: collapse; text-align: center;"> <tr> <td style="width: 10%;"></td> <td style="width: 10%;"></td> <td style="width: 10%;"></td> <td style="width: 10%;"></td> <td style="width: 10%;"></td> <td style="width: 10%;"></td> <td style="width: 10%;"></td> <td style="width: 10%;"></td> <td style="width: 10%;"></td> <td style="width: 10%;"></td> </tr> <tr> <td></td> <td></td> <td colspan="8" style="text-align: center;"> <table border="1" style="width: 100%; border-collapse: collapse; text-align: center;"> <tr> <td style="width: 10%;"></td> <td style="width: 10%;"></td> <td style="width: 10%;"></td> <td style="width: 10%;"></td> <td style="width: 10%;"></td> <td style="width: 10%;"></td> <td style="width: 10%;"></td> <td style="width: 10%;"></td> <td style="width: 10%;"></td> <td style="width: 10%;"></td> </tr> <tr> <td></td> <td></td> <td colspan="8" style="text-align: center;"> <table border="1" style="width: 100%; border-collapse: collapse; text-align: center;"> <tr> <td style="width: 10%;"></td> <td style="width: 10%;"></td> <td style="width: 10%;"></td> <td style="width: 10%;"></td> <td style="width: 10%;"></td> <td style="width: 10%;"></td> <td style="width: 10%;"></td> <td style="width: 10%;"></td> <td style="width: 10%;"></td> <td style="width: 10%;"></td> </tr> <tr> <td></td> <td></td> <td colspan="8" style="text-align: center;"> <table border="1" style="width: 100%; border-collapse: collapse; text-align: center;"> <tr> <td style="width: 10%;"></td> <td style="width: 10%;"></td> <td style="width: 10%;"></td> <td style="width: 10%;"></td> <td style="width: 10%;"></td> <td style="width: 10%;"></td> <td style="width: 10%;"></td> <td style="width: 10%;"></td> <td style="width: 10%;"></td> <td style="width: 10%;"></td> </tr> <tr> <td></td> <td></td> <td colspan="8" style="text-align: center;"> <table border="1" style="width: 100%; border-collapse: collapse; text-align: center;"> <tr> <td style="width: 10%;"></td> <td style="width: 10%;"></td> <td style="width: 10%;"></td> <td style="width: 10%;"></td> <td style="width: 10%;"></td> <td style="width: 10%;"></td> <td style="width: 10%;"></td> <td style="width: 10%;"></td> <td style="width: 10%;"></td> <td style="width: 10%;"></td> </tr> <tr> <td></td> <td></td> <td colspan="8" style="text-align: center;"> <table border="1" style="width: 100%; border-collapse: collapse; text-align: center;"> <tr> <td style="width: 10%;"></td> <td style="width: 10%;"></td> <td style="width: 10%;"></td> <td style="width: 10%;"></td> <td style="width: 10%;"></td> <td style="width: 10%;"></td> <td style="width: 10%;"></td> <td style="width: 10%;"></td> <td style="width: 10%;"></td> <td style="width: 10%;"></td> </tr> <tr> <td></td> <td></td> <td colspan="8" style="text-align: center;"> <table border="1" style="width: 100%; border-collapse: collapse; text-align: center;"> <tr> <td style="width: 10%;"></td> <td style="width: 10%;"></td> <td style="width: 10%;"></td> <td style="width: 10%;"></td> <td style="width: 10%;"></td> <td style="width: 10%;"></td> <td style="width: 10%;"></td> <td style="width: 10%;"></td> <td style="width: 10%;"></td> <td style="width: 10%;"></td> </tr> <tr> <td></td> <td></td> <td colspan="8" style="text-align: center;"> <table border="1" style="width: 100%; border-collapse: collapse; text-align: center;"> <tr> <td style="width: 10%;"></td> <td style="width: 10%;"></td> <td style="width: 10%;"></td> <td style="width: 10%;"></td> <td style="width: 10%;"></td> <td style="width: 10%;"></td> <td style="width: 10%;"></td> <td style="width: 10%;"></td> <td style="width: 10%;"></td> <td style="width: 10%;"></td> </tr> <tr> <td></td> <td></td> <td colspan="8" style="text-align: center;"> <table border="1" style="width: 100%; border-collapse: collapse; text-align: center;"> <tr> <td style="width: 10%;"></td> <td style="width: 10%;"></td> <td style="width: 10%;"></td> <td style="width: 10%;"></td> <td style="width: 10%;"></td> <td style="width: 10%;"></td> <td style="width: 10%;"></td> <td style="width: 10%;"></td> <td style="width: 10%;"></td> <td style="width: 10%;"></td> </tr> <tr> <td></td> <td></td> <td colspan="8" style="text-align: center;"> <table border="1" style="width: 100%; border-collapse: collapse; text-align: center;"> <tr> <td style="width: 10%;"></td> <td style="width: 10%;"></td> <td style="width: 10%;"></td> <td style="width: 10%;"></td> <td style="width: 10%;"></td> <td style="width: 10%;"></td> <td style="width: 10%;"></td> <td style="width: 10%;"></td> <td style="width: 10%;"></td> <td style="width: 10%;"></td> </tr> <tr> <td></td> <td></td> <td colspan="8" style="text-align: center;"> <table border="1" style="width: 100%; border-collapse: collapse; text-align: center;"> <tr> <td style="width: 10%;"></td> <td style="width: 10%;"></td> <td style="width: 10%;"></td> <td style="width: 10%;"></td> <td style="width: 10%;"></td> <td style="width: 10%;"></td> <td style="width: 10%;"></td> <td style="width: 10%;"></td> <td style="width: 10%;"></td> <td style="width: 10%;"></td> </tr> <tr> <td></td> <td></td> <td colspan="8" style="text-align: center;"> <table border="1" style="width: 100%; border-collapse: collapse; text-align: center;"> <tr> <td style="width: 10%;"></td> <td style="width: 10%;"></td> <td style="width: 10%;"></td> <td style="width: 10%;"></td> <td style="width: 10%;"></td> <td style="width: 10%;"></td> <td style="width: 10%;"></td> <td style="width: 10%;"></td> <td style="width: 10%;"></td> <td style="width: 10%;"></td> </tr> <tr> <td></td> <td></td> <td colspan="8" style="text-align: center;"> <table border="1" style="width: 100%; border-collapse: collapse; text-align: center;"> <tr> <td style="width: 10%;"></td> <td style="width: 10%;"></td> <td style="width: 10%;"></td> <td style="width: 10%;"></td> <td style="width: 10%;"></td> <td style="width: 10%;"></td> <td style="width: 10%;"></td> <td style="width: 10%;"></td> <td style="width: 10%;"></td> <td style="width: 10%;"></td> </tr> <tr> <td></td> <td></td> <td colspan="8" style="text-align: center;"> <table border="1" style="width: 100%; border-collapse: collapse; text-align: center;"> <tr> <td style="width: 10%;"></td> <td style="width: 10%;"></td> <td style="width: 10%;"></td> <td style="width: 10%;"></td> <td style="width: 10%;"></td> <td style="width: 10%;"></td> <td style="width: 10%;"></td> <td style="width: 10%;"></td> <td style="width: 10%;"></td> <td style="width: 10%;"></td> </tr> <tr> <td></td> <td></td> <td colspan="8" style="text-align: center;"> <table border="1" style="width: 100%; border-collapse: collapse; text-align: center;"> <tr> <td style="width: 10%;"></td> <td style="width: 10%;"></td> <td style="width: 10%;"></td> <td style="width: 10%;"></td> <td style="width: 10%;"></td> <td style="width: 10%;"></td> <td style="width: 10%;"></td> <td style="width: 10%;"></td> <td style="width: 10%;"></td> <td style="width: 10%;"></td> </tr> <tr> <td></td> <td></td> <td colspan="8" style="text-align: center;"> <table border="1" style="width: 100%; border-collapse: collapse; text-align: center;"> <tr> <td style="width: 10%;"></td> <td style="width: 10%;"></td> <td style="width: 10%;"></td> <td style="width: 10%;"></td> <td style="width: 10%;"></td> <td style="width: 10%;"></td> <td style="width: 10%;"></td> <td style="width: 10%;"></td> <td style="width: 10%;"></td> <td style="width: 10%;"></td> </tr> <tr> <td></td> <td></td> <td colspan="8" style="text-align: center;"> <table border="1" style="width: 100%; border-collapse: collapse; text-align: center;"> <tr> <td style="width: 10%;"></td> <td style="width: 10%;"></td> <td style="width: 10%;"></td> <td style="width: 10%;"></td> <td style="width: 10%;"></td> <td style="width: 10%;"></td> <td style="width: 10%;"></td> <td style="width: 10%;"></td> <td style="width: 10%;"></td> <td style="width: 10%;"></td> </tr> <tr> <td></td> <td></td> <td colspan="8" style="text-align: center;"> <table border="1" style="width: 100%; border-collapse: collapse; text-align: center;"> <tr> <td style="width: 10%;"></td> <td style="width: 10%;"></td> <td style="width: 10%;"></td> <td style="width: 10%;"></td> <td style="width: 10%;"></td> <td style="width:
10%;"></td> <td style="width: 10%;"></td> <td style="width: 10%;"></td> <td style="width: 10%;"></td> <td style="width: 10%;"></td> </tr> <tr> <td></td> <td></td> <td colspan="8" style="text-align: center;"> <table border="1" style="width: 100%; border-collapse: collapse; text-align: center;"> <tr> <td style="width: 10%;"></td> <td style="width: 10%;"></td> <td style="width: 10%;"></td> <td style="width: 10%;"></td> <td style="width: 10%;"></td> <td style="width: 10%;"></td> <td style="width: 10%;"></td> <td style="width: 10%;"></td> <td style="width: 10%;"></td> <td style="width: 10%;"></td> </tr> <tr> <td></td> <td></td> <td colspan="8" style="text-align: center;"> <table border="1" style="width: 100%; border-collapse: collapse; text-align: center;"> <tr> <td style="width: 10%;"></td> <td style="width: 10%;"></td> <td style="width: 10%;"></td> <td style="width: 10%;"></td> <td style="width: 10%;"></td> <td style="width: 10%;"></td> <td style="width: 10%;"></td> <td style="width: 10%;"></td> <td style="width: 10%;"></td> <td style="width: 10%;"></td> </tr> <tr> <td></td> <td></td> <td colspan="8" style="text-align: center;"> <table border="1" style="width: 100%; border-collapse: collapse; text-align: center;"> <tr> <td style="width: 10%;"></td> <td style="width: 10%;"></td> <td style="width: 10%;"></td> <td style="width: 10%;"></td> <td style="width: 10%;"></td> <td style="width: 10%;"></td> <td style="width: 10%;"></td> <td style="width: 10%;"></td> <td style="width: 10%;"></td> <td style="width: 10%;"></td> </tr> <tr> <td></td> <td></td> <td colspan="8" style="text-align: center;"> <table border="1" style="width: 100%; border-collapse: collapse; text-align: center;"> <tr> <td style="width: 10%;"></td> <td style="width: 10%;"></td> <td style="width: 10%;"></td> <td style="width: 10%;"></td> <td style="width: 10%;"></td> <td style="width: 10%;"></td> <td style="width: 10%;"></td> <td style="width: 10%;"></td> <td style="width: 10%;"></td> <td style="width: 10%;"></td> </tr> <tr> <td></td> <td></td> <td colspan="8" style="text-align: center;"> <table border="1" style="width: 100%; border-collapse: collapse; text-align: center;"> <tr> <td style="width: 10%;"></td> <td style="width: 10%;"></td> <td style="width: 10%;"></td> <td style="width: 10%;"></td> <td style="width: 10%;"></td> <td style="width: 10%;"></td> <td style="width: 10%;"></td> <td style="width: 10%;"></td> <td style="width: 10%;"></td> <td style="width: 10%;"></td> </tr> <tr> <td></td> <td></td> <td colspan="8" style="text-align: center;"> <table border="1" style="width: 100%; border-collapse: collapse; text-align: center;"> <tr> <td style="width: 10%;"></td> <td style="width: 10%;"></td> <td style="width: 10%;"></td> <td style="width: 10%;"></td> <td style="width: 10%;"></td> <td style="width: 10%;"></td> <td style="width: 10%;"></td> <td style="width: 10%;"></td> <td style="width: 10%;"></td> <td style="width: 10%;"></td> </tr> <tr> <td></td> <td></td> <td colspan="8" style="text-align: center;"> <table border="1" style="width: 100%; border-collapse: collapse; text-align: center;"> <tr> <td style="width: 10%;"></td> <td style="width: 10%;"></td> <td style="width: 10%;"></td> <td style="width: 10%;"></td> <td style="width: 10%;"></td> <td style="width: 10%;"></td> <td style="width: 10%;"></td> <td style="width: 10%;"></td> <td style="width: 10%;"></td> <td style="width: 10%;"></td> </tr> <tr> <td></td> <td></td> <td colspan="8" style="text-align: center;"> <table border="1" style="width: 100%; border-collapse: collapse; text-align: center;"> <tr> <td style="width: 10%;"></td> <td style="width: 10%;"></td> <td style="width: 10%;"></td> <td style="width: 10%;"></td> <td style="width: 10%;"></td> <td style="width: 10%;"></td> <td style="width: 10%;"></td> <td style="width: 10%;"></td> <td style="width: 10%;"></td> <td style="width: 10%;"></td> </tr> <tr> <td></td> <td></td> <td colspan="8" style="text-align: center;"> <table border="1" style="width: 100%; border-collapse: collapse; text-align: center;"> <tr> <td style="width: 10%;"></td> <td style="width: 10%;"></td> <td style="width: 10%;"></td> <td style="width: 10%;"></td> <td style="width: 10%;"></td> <td style="width: 10%;"></td> <td style="width: 10%;"></td> <td style="width: 10%;"></td> <td style="width: 10%;"></td> <td style="width: 10%;"></td> </tr> <tr> <td></td> <td></td> <td colspan="8" style="text-align: center;"> <table border="1" style="width: 100%; border-collapse: collapse; text-align: center;"> <tr> </tr></table></td></tr></table></td></tr></table></td></tr></table></td></tr></table></td></tr></table></td></tr></table></td></tr></table></td></tr></table></td></tr></table></td></tr></table></td></tr></table></td></tr></table></td></tr></table></td></tr></table></td></tr></table></td></tr></table></td></tr></table></td></tr></table></td></tr></table></td></tr></table></td></tr></table></td></tr></table></td></tr></table></td></tr></table></td></tr></table></td></tr></table></td></tr></table></td></tr></table></td></tr></table></td></tr></table></td></tr></table></td></tr></table></td></tr></table></td></tr></table></td></tr></table></td></tr></table></td></tr></table></td></tr></table></td></tr></table></td></tr></table></td></tr></table></td></tr></table></td></tr></table></td></tr></table></td></tr></table></td></tr></table></td></tr></table>
 | | | | | | | | | | | | | | | | | | | | <table border="1" style="width: 100%; border-collapse: collapse; text-align: center;"> <tr> <td style="width: 10%;"></td> <td style="width: 10%;"></td> <td style="width: 10%;"></td> <td style="width: 10%;"></td> <td style="width: 10%;"></td> <td style="width: 10%;"></td> <td style="width: 10%;"></td> <td style="width: 10%;"></td> <td style="width: 10%;"></td> <td style="width: 10%;"></td> </tr> <tr> <td></td> <td></td> <td colspan="8" style="text-align: center;"> <table border="1" style="width: 100%; border-collapse: collapse; text-align: center;"> <tr> <td style="width: 10%;"></td> <td style="width: 10%;"></td> <td style="width: 10%;"></td> <td style="width: 10%;"></td> <td style="width: 10%;"></td> <td style="width: 10%;"></td> <td style="width: 10%;"></td> <td style="width: 10%;"></td> <td style="width: 10%;"></td> <td style="width: 10%;"></td> </tr> <tr> <td></td> <td></td> <td colspan="8" style="text-align: center;"> <table border="1" style="width: 100%; border-collapse: collapse; text-align: center;"> <tr> <td style="width: 10%;"></td> <td style="width: 10%;"></td> <td style="width: 10%;"></td> <td style="width: 10%;"></td> <td style="width: 10%;"></td> <td style="width: 10%;"></td> <td style="width: 10%;"></td> <td style="width: 10%;"></td> <td style="width: 10%;"></td> <td style="width: 10%;"></td> </tr> <tr> <td></td> <td></td> <td colspan="8" style="text-align: center;"> <table border="1" style="width: 100%; border-collapse: collapse; text-align: center;"> <tr> <td style="width: 10%;"></td> <td style="width: 10%;"></td> <td style="width: 10%;"></td> <td style="width: 10%;"></td> <td style="width: 10%;"></td> <td style="width: 10%;"></td> <td style="width: 10%;"></td> <td style="width: 10%;"></td> <td style="width: 10%;"></td> <td style="width: 10%;"></td> </tr> <tr> <td></td> <td></td> <td colspan="8" style="text-align: center;"> <table border="1" style="width: 100%; border-collapse: collapse; text-align: center;"> <tr> <td style="width: 10%;"></td> <td style="width: 10%;"></td> <td style="width: 10%;"></td> <td style="width: 10%;"></td> <td style="width: 10%;"></td> <td style="width: 10%;"></td> <td style="width: 10%;"></td> <td style="width: 10%;"></td> <td style="width: 10%;"></td> <td style="width: 10%;"></td> </tr> <tr> <td></td> <td></td> <td colspan="8" style="text-align: center;"> <table border="1" style="width: 100%; border-collapse: collapse; text-align: center;"> <tr> <td style="width: 10%;"></td> <td style="width: 10%;"></td> <td style="width: 10%;"></td> <td style="width: 10%;"></td> <td style="width: 10%;"></td> <td style="width: 10%;"></td> <td style="width: 10%;"></td> <td style="width: 10%;"></td> <td style="width: 10%;"></td> <td style="width: 10%;"></td> </tr> <tr> <td></td> <td></td> <td colspan="8" style="text-align: center;"> <table border="1" style="width: 100%; border-collapse: collapse; text-align: center;"> <tr> <td style="width: 10%;"></td> <td style="width: 10%;"></td> <td style="width: 10%;"></td> <td style="width: 10%;"></td> <td style="width: 10%;"></td> <td style="width: 10%;"></td> <td style="width: 10%;"></td> <td style="width: 10%;"></td> <td style="width: 10%;"></td> <td style="width: 10%;"></td> </tr> <tr> <td></td> <td></td> <td colspan="8" style="text-align: center;"> <table border="1" style="width: 100%; border-collapse: collapse; text-align: center;"> <tr> <td style="width: 10%;"></td> <td style="width: 10%;"></td> <td style="width: 10%;"></td> <td style="width: 10%;"></td> <td style="width: 10%;"></td> <td style="width: 10%;"></td> <td style="width: 10%;"></td> <td style="width: 10%;"></td> <td style="width: 10%;"></td> <td style="width: 10%;"></td> </tr> <tr> <td></td> <td></td> <td colspan="8" style="text-align: center;"> <table border="1" style="width: 100%; border-collapse: collapse; text-align: center;"> <tr> <td style="width: 10%;"></td> <td style="width: 10%;"></td> <td style="width: 10%;"></td> <td style="width: 10%;"></td> <td style="width: 10%;"></td> <td style="width: 10%;"></td> <td style="width: 10%;"></td> <td style="width: 10%;"></td> <td style="width: 10%;"></td> <td style="width: 10%;"></td> </tr> <tr> <td></td> <td></td> <td colspan="8" style="text-align: center;"> <table border="1" style="width: 100%; border-collapse: collapse; text-align: center;"> <tr> <td style="width: 10%;"></td> <td style="width: 10%;"></td> <td style="width: 10%;"></td> <td style="width: 10%;"></td> <td style="width: 10%;"></td> <td style="width: 10%;"></td> <td style="width: 10%;"></td> <td style="width: 10%;"></td> <td style="width: 10%;"></td> <td style="width: 10%;"></td> </tr> <tr> <td></td> <td></td> <td colspan="8" style="text-align: center;"> <table border="1" style="width: 100%; border-collapse: collapse; text-align: center;"> <tr> <td style="width: 10%;"></td> <td style="width: 10%;"></td> <td style="width: 10%;"></td> <td style="width: 10%;"></td> <td style="width: 10%;"></td> <td style="width: 10%;"></td> <td style="width: 10%;"></td> <td style="width: 10%;"></td> <td style="width: 10%;"></td> <td style="width: 10%;"></td> </tr> <tr> <td></td> <td></td> <td colspan="8" style="text-align: center;"> <table border="1" style="width: 100%; border-collapse: collapse; text-align: center;"> <tr> <td style="width: 10%;"></td> <td style="width: 10%;"></td> <td style="width: 10%;"></td> <td style="width: 10%;"></td> <td style="width: 10%;"></td> <td style="width: 10%;"></td> <td style="width: 10%;"></td> <td style="width: 10%;"></td> <td style="width: 10%;"></td> <td style="width: 10%;"></td> </tr> <tr> <td></td> <td></td> <td colspan="8" style="text-align: center;"> <table border="1" style="width: 100%; border-collapse: collapse; text-align: center;"> <tr> <td style="width: 10%;"></td> <td style="width: 10%;"></td> <td style="width: 10%;"></td> <td style="width: 10%;"></td> <td style="width: 10%;"></td> <td style="width: 10%;"></td> <td style="width: 10%;"></td> <td style="width: 10%;"></td> <td style="width: 10%;"></td> <td style="width: 10%;"></td> </tr> <tr> <td></td> <td></td> <td colspan="8" style="text-align: center;"> <table border="1" style="width: 100%; border-collapse: collapse; text-align: center;"> <tr> <td style="width: 10%;"></td> <td style="width: 10%;"></td> <td style="width: 10%;"></td> <td style="width: 10%;"></td> <td style="width: 10%;"></td> <td style="width: 10%;"></td> <td style="width: 10%;"></td> <td style="width: 10%;"></td> <td style="width: 10%;"></td> <td style="width: 10%;"></td> </tr> <tr> <td></td> <td></td> <td colspan="8" style="text-align: center;"> <table border="1" style="width: 100%; border-collapse: collapse; text-align: center;"> <tr> <td style="width: 10%;"></td> <td style="width: 10%;"></td> <td style="width: 10%;"></td> <td style="width: 10%;"></td> <td style="width: 10%;"></td> <td style="width: 10%;"></td> <td style="width: 10%;"></td> <td style="width: 10%;"></td> <td style="width: 10%;"></td> <td style="width: 10%;"></td> </tr> <tr> <td></td> <td></td> <td colspan="8" style="text-align: center;"> <table border="1" style="width: 100%; border-collapse: collapse; text-align: center;"> <tr> <td style="width: 10%;"></td> <td style="width: 10%;"></td> <td style="width: 10%;"></td> <td style="width: 10%;"></td> <td style="width: 10%;"></td> <td style="width: 10%;"></td> <td style="width: 10%;"></td> <td style="width: 10%;"></td> <td style="width: 10%;"></td> <td style="width: 10%;"></td> </tr> <tr> <td></td> <td></td> <td colspan="8" style="text-align: center;"> <table border="1" style="width: 100%; border-collapse: collapse; text-align: center;"> <tr> <td style="width: 10%;"></td> <td style="width: 10%;"></td> <td style="width: 10%;"></td> <td style="width: 10%;"></td> <td style="width: 10%;"></td> <td style="width: 10%;"></td> <td
style="width: 10%;"></td> <td style="width: 10%;"></td> <td style="width: 10%;"></td> <td style="width: 10%;"></td> </tr> <tr> <td></td> <td></td> <td colspan="8" style="text-align: center;"> <table border="1" style="width: 100%; border-collapse: collapse; text-align: center;"> <tr> <td style="width: 10%;"></td> <td style="width: 10%;"></td> <td style="width: 10%;"></td> <td style="width: 10%;"></td> <td style="width: 10%;"></td> <td style="width: 10%;"></td> <td style="width: 10%;"></td> <td style="width: 10%;"></td> <td style="width: 10%;"></td> <td style="width: 10%;"></td> </tr> <tr> <td></td> <td></td> <td colspan="8" style="text-align: center;"> <table border="1" style="width: 100%; border-collapse: collapse; text-align: center;"> <tr> <td style="width: 10%;"></td> <td style="width: 10%;"></td> <td style="width: 10%;"></td> <td style="width: 10%;"></td> <td style="width: 10%;"></td> <td style="width: 10%;"></td> <td style="width: 10%;"></td> <td style="width: 10%;"></td> <td style="width: 10%;"></td> <td style="width: 10%;"></td> </tr> <tr> <td></td> <td></td> <td colspan="8" style="text-align: center;"> <table border="1" style="width: 100%; border-collapse: collapse; text-align: center;"> <tr> <td style="width: 10%;"></td> <td style="width: 10%;"></td> <td style="width: 10%;"></td> <td style="width: 10%;"></td> <td style="width: 10%;"></td> <td style="width: 10%;"></td> <td style="width: 10%;"></td> <td style="width: 10%;"></td> <td style="width: 10%;"></td> <td style="width: 10%;"></td> </tr> <tr> <td></td> <td></td> <td colspan="8" style="text-align: center;"> <table border="1" style="width: 100%; border-collapse: collapse; text-align: center;"> <tr> <td style="width: 10%;"></td> <td style="width: 10%;"></td> <td style="width: 10%;"></td> <td style="width: 10%;"></td> <td style="width: 10%;"></td> <td style="width: 10%;"></td> <td style="width: 10%;"></td> <td style="width: 10%;"></td> <td style="width: 10%;"></td> <td style="width: 10%;"></td> </tr> <tr> <td></td> <td></td> <td colspan="8" style="text-align: center;"> <table border="1" style="width: 100%; border-collapse: collapse; text-align: center;"> <tr> <td style="width: 10%;"></td> <td style="width: 10%;"></td> <td style="width: 10%;"></td> <td style="width: 10%;"></td> <td style="width: 10%;"></td> <td style="width: 10%;"></td> <td style="width: 10%;"></td> <td style="width: 10%;"></td> <td style="width: 10%;"></td> <td style="width: 10%;"></td> </tr> <tr> <td></td> <td></td> <td colspan="8" style="text-align: center;"> <table border="1" style="width: 100%; border-collapse: collapse; text-align: center;"> <tr> <td style="width: 10%;"></td> <td style="width: 10%;"></td> <td style="width: 10%;"></td> <td style="width: 10%;"></td> <td style="width: 10%;"></td> <td style="width: 10%;"></td> <td style="width: 10%;"></td> <td style="width: 10%;"></td> <td style="width: 10%;"></td> <td style="width: 10%;"></td> </tr> <tr> <td></td> <td></td> <td colspan="8" style="text-align: center;"> <table border="1" style="width: 100%; border-collapse: collapse; text-align: center;"> <tr> <td style="width: 10%;"></td> <td style="width: 10%;"></td> <td style="width: 10%;"></td> <td style="width: 10%;"></td> <td style="width: 10%;"></td> <td style="width: 10%;"></td> <td style="width: 10%;"></td> <td style="width: 10%;"></td> <td style="width: 10%;"></td> <td style="width: 10%;"></td> </tr> <tr> <td></td> <td></td> <td colspan="8" style="text-align: center;"> <table border="1" style="width: 100%; border-collapse: collapse; text-align: center;"> <tr> <td style="width: 10%;"></td> <td style="width: 10%;"></td> <td style="width: 10%;"></td> <td style="width: 10%;"></td> <td style="width: 10%;"></td> <td style="width: 10%;"></td> <td style="width: 10%;"></td> <td style="width: 10%;"></td> <td style="width: 10%;"></td> <td style="width: 10%;"></td> </tr> <tr> <td></td> <td></td> <td colspan="8" style="text-align: center;"> <table border="1" style="width: 100%; border-collapse: collapse; text-align: center;"> <tr> <td style="width: 10%;"></td> <td style="width: 10%;"></td> <td style="width: 10%;"></td> <td style="width: 10%;"></td> <td style="width: 10%;"></td> <td style="width: 10%;"></td> <td style="width: 10%;"></td> <td style="width: 10%;"></td> <td style="width: 10%;"></td> <td style="width: 10%;"></td> </tr> <tr> <td></td> <td></td> <td colspan="8" style="text-align: center;"> <table border="1" style="width: 100%; border-collapse: collapse; text-align: center;"> <tr> <td style="width: 10%;"></td> <td style="width: 10%;"></td> <td style="width: 10%;"></td> <td style="width: 10%;"></td> <td style="width: 10%;"></td> <td style="width: 10%;"></td> <td style="width: 10%;"></td> <td style="width: 10%;"></td> <td style="width: 10%;"></td> <td style="width: 10%;"></td> </tr> <tr> <td></td> <td></td> <td colspan="8" style="text-align: center;"> <table border="1" style="width: 100%; border-collapse: collapse; text-align: center;"> <tr> <td style="width: 10%;"></td> <td style="width: 10%;"></td> <td style="width: 10%;"></td> <td style="width: 10%;"></td> <td style="width: 10%;"></td> <td style="width: 10%;"></td> <td style="width: 10%;"></td> <td style="width: 10%;"></td> <td style="width: 10%;"></td> <td style="width: 10%;"></td> </tr> <tr> <td></td> <td></td> <td colspan="8" style="text-align: center;"> <table border="1" style="width: 100%; border-collapse: collapse; text-align: center;"> <tr> <td style="width: 10%;"></td> <td style="width: 10%;"></td> <td style="width: 10%;"></td> <td style="width: 10%;"></td> <td style="width: 10%;"></td> <td style="width: 10%;"></td> <td style="width: 10%;"></td> <td style="width: 10%;"></td> <td style="width: 10%;"></td> <td style="width: 10%;"></td> </tr> <tr> <td></td> <td></td> <td colspan="8" style="text-align: center;"> <table border="1" style="width: 100%; border-collapse: collapse; text-align: center;"> <tr> <td style="width: 10%;"></td> <td style="width: 10%;"></td> <td style="width: 10%;"></td> <td style="width: 10%;"></td> <td style="width: 10%;"></td> <td style="width: 10%;"></td> <td style="width: 10%;"></td> <td style="width: 10%;"></td> <td style="width: 10%;"></td> <td style="width: 10%;"></td> </tr> <tr> <td></td> <td></td> <td colspan="8" style="text-align: center;"> <table border="1" style="width: 100%; border-collapse: collapse; text-align: center;"> <tr> <td style="width: 10%;"></td> <td style="width: 10%;"></td> <td style="width: 10%;"></td> <td style="width: 10%;"></td> <td style="width: 10%;"></td> <td style="width: 10%;"></td> <td style="width: 10%;"></td> <td style="width: 10%;"></td> <td style="width: 10%;"></td> <td style="width: 10%;"></td> </tr> <tr> <td></td> <td></td> <td colspan="8" style="text-align: center;"> <table border="1" style="width: 100%; border-collapse: collapse; text-align: center;"> <tr> <td style="width: 10%;"></td> <td style="width: 10%;"></td> <td style="width: 10%;"></td> <td style="width: 10%;"></td> <td style="width: 10%;"></td> <td style="width: 10%;"></td> <td style="width: 10%;"></td> <td style="width: 10%;"></td> <td style="width: 10%;"></td> <td style="width: 10%;"></td> </tr> <tr> <td></td> <td></td> <td colspan="8" style="text-align: center;"> <table border="1" style="width: 100%; border-collapse: collapse; text-align: center;"> <tr> <td style="width: 10%;"></td> <td style="width: 10%;"></td> <td style="width: 10%;"></td> <td style="width: 10%;"></td> <td style="width: 10%;"></td> <td style="width: 10%;"></td> <td style="width: 10%;"></td> <td style="width: 10%;"></td> <td style="width: 10%;"></td> <td style="width: 10%;"></td> </tr> <tr> <td></td> <td></td> <td colspan="8" style="text-align: center;"> <table border="1" style="width: 100%; border-collapse: collapse; text-align: center;"> <tr> <td style="width: 10%;"></td> <td style="width: 10%;"></td> <td style="width: 10%;"></td> <td style="width: 10%;"></td> <td style="width: 10%;"></td> <td style="width: 10%;"></td> <td style="width: 10%;"></td> <td style="width: 10%;"></td> <td style="width: 10%;"></td> <td style="width: 10%;"></td> </tr> <tr> <td></td> <td></td> <td colspan="8" style="text-align: center;"> <table border="1" style="width: 100%; border-collapse: collapse; text-align: center;"> <tr> <td style="width: 10%;"></td> <td style="width: 10%;"></td> <td style="width: 10%;"></td> <td style="width: 10%;"></td> <td style="width: 10%;"></td> <td style="width: 10%;"></td> <td style="width: 10%;"></td> <td style="width: 10%;"></td> <td style="width: 10%;"></td> <td style="width: 10%;"></td> </tr> <tr> <td></td> <td></td> <td colspan="8" style="text-align: center;"> <table border="1" style="width: 100%; border-collapse: collapse; text-align: center;"> <tr> <td style="width: 10%;"></td> <td style="width: 10%;"></td> <td style="width: 10%;"></td> <td style="width: 10%;"></td> <td style="width: 10%;"></td> <td style="width: 10%;"></td> <td style="width: 10%;"></td> <td style="width: 10%;"></td> <td style="width: 10%;"></td> <td style="width: 10%;"></td> </tr> <tr> <td></td> <td></td> <td colspan="8" style="text-align: center;"> <table border="1" style="width: 100%; border-collapse: collapse; text-align: center;"> <tr> <td style="width: 10%;"></td> <td style="width: 10%;"></td> <td style="width: 10%;"></td> <td style="width: 10%;"></td> <td style="width: 10%;"></td> <td style="width: 10%;"></td> <td style="width: 10%;"></td> <td style="width: 10%;"></td> <td style="width: 10%;"></td> <td style="width: 10%;"></td> </tr> <tr> <td></td> <td></td> <td colspan="8" style="text-align: center;"> <table border="1" style="width: 100%; border-collapse: collapse; text-align: center;"> <tr> <td style="width: 10%;"></td> <td style="width: 10%;"></td> <td style="width: 10%;"></td> <td style="width: 10%;"></td> <td style="width: 10%;"></td> <td style="width: 10%;"></td> <td style="width: 10%;"></td> <td style="width: 10%;"></td> <td style="width: 10%;"></td> <td style="width: 10%;"></td> </tr> <tr> <td></td> <td></td> <td colspan="8"
style="text-align: center;"> <table border="1" style="width: 100%; border-collapse: collapse; text-align: center;"> <tr> <td style="width: 10%;"></td> <td style="width: 10%;"></td> <td style="width: 10%;"></td> <td style="width: 10%;"></td> <td style="width: 10%;"></td> <td style="width: 10%;"></td> <td style="width: 10%;"></td> <td style="width: 10%;"></td> <td style="width: 10%;"></td> <td style="width: 10%;"></td> </tr> <tr> <td></td> <td></td> <td colspan="8" style="text-align: center;"> <table border="1" style="width: 100%; border-collapse: collapse; text-align: center;"> <tr> <td style="width: 10%;"></td> <td style="width: 10%;"></td> <td style="width: 10%;"></td> <td style="width: 10%;"></td> <td style="width: 10%;"></td> <td style="width: 10%;"></td> <td style="width: 10%;"></td> <td style="width: 10%;"></td> <td style="width: 10%;"></td> <td style="width: 10%;"></td> </tr> <tr> <td></td> <td></td> <td colspan="8" style="text-align: center;"> <table border="1" style="width: 100%; border-collapse: collapse; text-align: center;"> <tr> <td style="width: 10%;"></td> <td style="width: 10%;"></td> <td style="width: 10%;"></td> <td style="width: 10%;"></td> <td style="width: 10%;"></td> <td style="width: 10%;"></td> <td style="width: 10%;"></td> <td style="width: 10%;"></td> <td style="width: 10%;"></td> <td style="width: 10%;"></td> </tr> <tr> <td></td> <td></td> <td colspan="8" style="text-align: center;"> <table border="1" style="width: 100%; border-collapse: collapse; text-align: center;"> <tr> <td style="width: 10%;"></td> <td style="width: 10%;"></td> <td style="width: 10%;"></td> <td style="width: 10%;"></td> <td style="width: 10%;"></td> <td style="width: 10%;"></td> <td style="width: 10%;"></td> <td style="width: 10%;"></td> <td style="width: 10%;"></td> <td style="width: 10%;"></td> </tr> <tr> <td></td> <td></td> <td colspan="8" style="text-align: center;"> <table border="1" style="width: 100%; border-collapse: collapse; text-align: center;"> <tr> <td style="width: 10%;"></td> <td style="width: 10%;"></td> <td style="width: 10%;"></td> <td style="width: 10%;"></td> <td style="width: 10%;"></td> <td style="width: 10%;"></td> <td style="width: 10%;"></td> <td style="width: 10%;"></td> <td style="width: 10%;"></td> <td style="width: 10%;"></td> </tr> <tr> <td></td> <td></td> <td colspan="8" style="text-align: center;"> <table border="1" style="width: 100%; border-collapse: collapse; text-align: center;"> <tr> <td style="width: 10%;"></td> <td style="width: 10%;"></td> <td style="width: 10%;"></td> <td style="width: 10%;"></td> <td style="width: 10%;"></td> <td style="width: 10%;"></td> <td style="width: 10%;"></td> <td style="width: 10%;"></td> <td style="width: 10%;"></td> <td style="width: 10%;"></td> </tr> <tr> <td></td> <td></td> <td colspan="8" style="text-align: center;"> <table border="1" style="width: 100%; border-collapse: collapse; text-align: center;"> <tr> <td style="width: 10%;"></td> <td style="width: 10%;"></td> <td style="width: 10%;"></td> <td style="width: 10%;"></td> <td style="width: 10%;"></td> <td style="width: 10%;"></td> <td style="width: 10%;"></td> <td style="width: 10%;"></td> <td style="width: 10%;"></td> <td style="width: 10%;"></td> </tr> <tr> <td></td> <td></td> <td colspan="8" style="text-align: center;"> <table border="1" style="width: 100%; border-collapse: collapse; text-align: center;"> <tr> <td style="width: 10%;"></td> <td style="width: 10%;"></td> <td style="width: 10%;"></td> <td style="width: 10%;"></td> <td style="width: 10%;"></td> <td style="width: 10%;"></td> <td style="width: 10%;"></td> <td style="width: 10%;"></td> <td style="width: 10%;"></td> <td style="width: 10%;"></td> </tr> <tr> <td></td> <td></td> <td colspan="8" style="text-align: center;"> <table border="1" style="width: 100%; border-collapse: collapse; text-align: center;"> <tr> </tr></table></td></tr></table></td></tr></table></td></tr></table></td></tr></table></td></tr></table></td></tr></table></td></tr></table></td></tr></table></td></tr></table></td></tr></table></td></tr></table></td></tr></table></td></tr></table></td></tr></table></td></tr></table></td></tr></table></td></tr></table></td></tr></table></td></tr></table></td></tr></table></td></tr></table></td></tr></table></td></tr></table></td></tr></table></td></tr></table></td></tr></table></td></tr></table></td></tr></table></td></tr></table></td></tr></table></td></tr></table></td></tr></table></td></tr></table></td></tr></table></td></tr></table></td></tr></table></td></tr></table></td></tr></table></td></tr></table></td></tr></table></td></tr></table></td></tr></table></td></tr></table></td></tr></table></td></tr></table></td></tr></table>
 | | | | | | | | | | | | | | | | | | | | <table border="1" style="width: 100%; border-collapse: collapse; text-align: center;"> <tr> <td style="width: 10%;"></td> <td style="width: 10%;"></td> <td style="width: 10%;"></td> <td style="width: 10%;"></td> <td style="width: 10%;"></td> <td style="width: 10%;"></td> <td style="width: 10%;"></td> <td style="width: 10%;"></td> <td style="width: 10%;"></td> <td style="width: 10%;"></td> </tr> <tr> <td></td> <td></td> <td colspan="8" style="text-align: center;"> <table border="1" style="width: 100%; border-collapse: collapse; text-align: center;"> <tr> <td style="width: 10%;"></td> <td style="width: 10%;"></td> <td style="width: 10%;"></td> <td style="width: 10%;"></td> <td style="width: 10%;"></td> <td style="width: 10%;"></td> <td style="width: 10%;"></td> <td style="width: 10%;"></td> <td style="width: 10%;"></td> <td style="width: 10%;"></td> </tr> <tr> <td></td> <td></td> <td colspan="8" style="text-align: center;"> <table border="1" style="width: 100%; border-collapse: collapse; text-align: center;"> <tr> <td style="width: 10%;"></td> <td style="width: 10%;"></td> <td style="width: 10%;"></td> <td style="width: 10%;"></td> <td style="width: 10%;"></td> <td style="width: 10%;"></td> <td style="width: 10%;"></td> <td style="width: 10%;"></td> <td style="width: 10%;"></td> <td style="width: 10%;"></td> </tr> <tr> <td></td> <td></td> <td colspan="8" style="text-align: center;"> <table border="1" style="width: 100%; border-collapse: collapse; text-align: center;"> <tr> <td style="width: 10%;"></td> <td style="width: 10%;"></td> <td style="width: 10%;"></td> <td style="width: 10%;"></td> <td style="width: 10%;"></td> <td style="width: 10%;"></td> <td style="width: 10%;"></td> <td style="width: 10%;"></td> <td style="width: 10%;"></td> <td style="width: 10%;"></td> </tr> <tr> <td></td> <td></td> <td colspan="8" style="text-align: center;"> <table border="1" style="width: 100%; border-collapse: collapse; text-align: center;"> <tr> <td style="width: 10%;"></td> <td style="width: 10%;"></td> <td style="width: 10%;"></td> <td style="width: 10%;"></td> <td style="width: 10%;"></td> <td style="width: 10%;"></td> <td style="width: 10%;"></td> <td style="width: 10%;"></td> <td style="width: 10%;"></td> <td style="width: 10%;"></td> </tr> <tr> <td></td> <td></td> <td colspan="8" style="text-align: center;"> <table border="1" style="width: 100%; border-collapse: collapse; text-align: center;"> <tr> <td style="width: 10%;"></td> <td style="width: 10%;"></td> <td style="width: 10%;"></td> <td style="width: 10%;"></td> <td style="width: 10%;"></td> <td style="width: 10%;"></td> <td style="width: 10%;"></td> <td style="width: 10%;"></td> <td style="width: 10%;"></td> <td style="width: 10%;"></td> </tr> <tr> <td></td> <td></td> <td colspan="8" style="text-align: center;"> <table border="1" style="width: 100%; border-collapse: collapse; text-align: center;"> <tr> <td style="width: 10%;"></td> <td style="width: 10%;"></td> <td style="width: 10%;"></td> <td style="width: 10%;"></td> <td style="width: 10%;"></td> <td style="width: 10%;"></td> <td style="width: 10%;"></td> <td style="width: 10%;"></td> <td style="width: 10%;"></td> <td style="width: 10%;"></td> </tr> <tr> <td></td> <td></td> <td colspan="8" style="text-align: center;"> <table border="1" style="width: 100%; border-collapse: collapse; text-align: center;"> <tr> <td style="width: 10%;"></td> <td style="width: 10%;"></td> <td style="width: 10%;"></td> <td style="width: 10%;"></td> <td style="width: 10%;"></td> <td style="width: 10%;"></td> <td style="width: 10%;"></td> <td style="width: 10%;"></td> <td style="width: 10%;"></td> <td style="width: 10%;"></td> </tr> <tr> <td></td> <td></td> <td colspan="8" style="text-align: center;"> <table border="1" style="width: 100%; border-collapse: collapse; text-align: center;"> <tr> <td style="width: 10%;"></td> <td style="width: 10%;"></td> <td style="width: 10%;"></td> <td style="width: 10%;"></td> <td style="width: 10%;"></td> <td style="width: 10%;"></td> <td style="width: 10%;"></td> <td style="width: 10%;"></td> <td style="width: 10%;"></td> <td style="width: 10%;"></td> </tr> <tr> <td></td> <td></td> <td colspan="8" style="text-align: center;"> <table border="1" style="width: 100%; border-collapse: collapse; text-align: center;"> <tr> <td style="width: 10%;"></td> <td style="width: 10%;"></td> <td style="width: 10%;"></td> <td style="width: 10%;"></td> <td style="width: 10%;"></td> <td style="width: 10%;"></td> <td style="width: 10%;"></td> <td style="width: 10%;"></td> <td style="width: 10%;"></td> <td style="width: 10%;"></td> </tr> <tr> <td></td> <td></td> <td colspan="8" style="text-align: center;"> <table border="1" style="width: 100%; border-collapse: collapse; text-align: center;"> <tr> <td style="width: 10%;"></td> <td style="width: 10%;"></td> <td style="width: 10%;"></td> <td style="width: 10%;"></td> <td style="width: 10%;"></td> <td style="width: 10%;"></td> <td style="width: 10%;"></td> <td style="width: 10%;"></td> <td style="width: 10%;"></td> <td style="width: 10%;"></td> </tr> <tr> <td></td> <td></td> <td colspan="8" style="text-align: center;"> <table border="1" style="width: 100%; border-collapse: collapse; text-align: center;"> <tr> <td style="width: 10%;"></td> <td style="width: 10%;"></td> <td style="width: 10%;"></td> <td style="width: 10%;"></td> <td style="width: 10%;"></td> <td style="width: 10%;"></td> <td style="width: 10%;"></td> <td style="width: 10%;"></td> <td style="width: 10%;"></td> <td style="width: 10%;"></td> </tr> <tr> <td></td> <td></td> <td colspan="8" style="text-align: center;"> <table border="1" style="width: 100%; border-collapse: collapse; text-align: center;"> <tr> <td style="width: 10%;"></td> <td style="width: 10%;"></td> <td style="width: 10%;"></td> <td style="width: 10%;"></td> <td style="width: 10%;"></td> <td style="width: 10%;"></td> <td style="width: 10%;"></td> <td style="width: 10%;"></td> <td style="width: 10%;"></td> <td style="width: 10%;"></td> </tr> <tr> <td></td> <td></td> <td colspan="8" style="text-align: center;"> <table border="1" style="width: 100%; border-collapse: collapse; text-align: center;"> <tr> <td style="width: 10%;"></td> <td style="width: 10%;"></td> <td style="width: 10%;"></td> <td style="width: 10%;"></td> <td style="width: 10%;"></td> <td style="width: 10%;"></td> <td style="width: 10%;"></td> <td style="width: 10%;"></td> <td style="width: 10%;"></td> <td style="width: 10%;"></td> </tr> <tr> <td></td> <td></td> <td colspan="8" style="text-align: center;"> <table border="1" style="width: 100%; border-collapse: collapse; text-align: center;"> <tr> <td style="width: 10%;"></td> <td style="width: 10%;"></td> <td style="width: 10%;"></td> <td style="width: 10%;"></td> <td style="width: 10%;"></td> <td style="width: 10%;"></td> <td style="width: 10%;"></td> <td style="width: 10%;"></td> <td style="width: 10%;"></td> <td style="width: 10%;"></td> </tr> <tr> <td></td> <td></td> <td colspan="8" style="text-align: center;"> <table border="1" style="width: 100%; border-collapse: collapse; text-align: center;"> <tr> <td style="width: 10%;"></td> <td style="width: 10%;"></td> <td style="width: 10%;"></td> <td style="width: 10%;"></td> <td style="width: 10%;"></td> <td style="width: 10%;"></td> <td style="width: 10%;"></td> <td style="width: 10%;"></td> <td style="width: 10%;"></td> <td style="width: 10%;"></td> </tr> <tr> <td></td> <td></td> <td colspan="8" style="text-align: center;"> <table border="1" style="width: 100%; border-collapse: collapse; text-align: center;"> <tr> <td style="width: 10%;"></td> <td style="width: 10%;"></td> <td style="width: 10%;"></td> <td style="width: 10%;"></td> <td style="width: 10%;"></td> <td style="width: 10%;"></td> <td style="width: 10%;"></td> <td style="width: 10%;"></td> <td style="width: 10%;"></td> <td style="width: 10%;"></td> </tr> <tr> <td></td> <td></td> <td colspan="8" style="text-align: center;"> <table border="1" style="width: 100%; border-collapse: collapse; text-align: center;"> <tr> <td style="width: 10%;"></td> <td style="width: 10%;"></td> <td style="width: 10%;"></td> <td style="width: 10%;"></td> <td style="width: 10%;"></td> <td style="width: 10%;"></td> <td style="width: 10%;"></td> <td style="width: 10%;"></td> <td style="width: 10%;"></td> <td style="width: 10%;"></td> </tr> <tr> <td></td> <td></td> <td colspan="8" style="text-align: center;">
<table border="1" style="width: 100%; border-collapse: collapse; text-align: center;"> <tr> <td style="width: 10%;"></td> <td style="width: 10%;"></td> <td style="width: 10%;"></td> <td style="width: 10%;"></td> <td style="width: 10%;"></td> <td style="width: 10%;"></td> <td style="width: 10%;"></td> <td style="width: 10%;"></td> <td style="width: 10%;"></td> <td style="width: 10%;"></td> </tr> <tr> <td></td> <td></td> <td colspan="8" style="text-align: center;"> <table border="1" style="width: 100%; border-collapse: collapse; text-align: center;"> <tr> <td style="width: 10%;"></td> <td style="width: 10%;"></td> <td style="width: 10%;"></td> <td style="width: 10%;"></td> <td style="width: 10%;"></td> <td style="width: 10%;"></td> <td style="width: 10%;"></td> <td style="width: 10%;"></td> <td style="width: 10%;"></td> <td style="width: 10%;"></td> </tr> <tr> <td></td> <td></td> <td colspan="8" style="text-align: center;"> <table border="1" style="width: 100%; border-collapse: collapse; text-align: center;"> <tr> <td style="width: 10%;"></td> <td style="width: 10%;"></td> <td style="width: 10%;"></td> <td style="width: 10%;"></td> <td style="width: 10%;"></td> <td style="width: 10%;"></td> <td style="width: 10%;"></td> <td style="width: 10%;"></td> <td style="width: 10%;"></td> <td style="width: 10%;"></td> </tr> <tr> <td></td> <td></td> <td colspan="8" style="text-align: center;"> <table border="1" style="width: 100%; border-collapse: collapse; text-align: center;"> <tr> <td style="width: 10%;"></td> <td style="width: 10%;"></td> <td style="width: 10%;"></td> <td style="width: 10%;"></td> <td style="width: 10%;"></td> <td style="width: 10%;"></td> <td style="width: 10%;"></td> <td style="width: 10%;"></td> <td style="width: 10%;"></td> <td style="width: 10%;"></td> </tr> <tr> <td></td> <td></td> <td colspan="8" style="text-align: center;"> <table border="1" style="width: 100%; border-collapse: collapse; text-align: center;"> <tr> <td style="width: 10%;"></td> <td style="width: 10%;"></td> <td style="width: 10%;"></td> <td style="width: 10%;"></td> <td style="width: 10%;"></td> <td style="width: 10%;"></td> <td style="width: 10%;"></td> <td style="width: 10%;"></td> <td style="width: 10%;"></td> <td style="width: 10%;"></td> </tr> <tr> <td></td> <td></td> <td colspan="8" style="text-align: center;"> <table border="1" style="width: 100%; border-collapse: collapse; text-align: center;"> <tr> <td style="width: 10%;"></td> <td style="width: 10%;"></td> <td style="width: 10%;"></td> <td style="width: 10%;"></td> <td style="width: 10%;"></td> <td style="width: 10%;"></td> <td style="width: 10%;"></td> <td style="width: 10%;"></td> <td style="width: 10%;"></td> <td style="width: 10%;"></td> </tr> <tr> <td></td> <td></td> <td colspan="8" style="text-align: center;"> <table border="1" style="width: 100%; border-collapse: collapse; text-align: center;"> <tr> <td style="width: 10%;"></td> <td style="width: 10%;"></td> <td style="width: 10%;"></td> <td style="width: 10%;"></td> <td style="width: 10%;"></td> <td style="width: 10%;"></td> <td style="width: 10%;"></td> <td style="width: 10%;"></td> <td style="width: 10%;"></td> <td style="width: 10%;"></td> </tr> <tr> <td></td> <td></td> <td colspan="8" style="text-align: center;"> <table border="1" style="width: 100%; border-collapse: collapse; text-align: center;"> <tr> <td style="width: 10%;"></td> <td style="width: 10%;"></td> <td style="width: 10%;"></td> <td style="width: 10%;"></td> <td style="width: 10%;"></td> <td style="width: 10%;"></td> <td style="width: 10%;"></td> <td style="width: 10%;"></td> <td style="width: 10%;"></td> <td style="width: 10%;"></td> </tr> <tr> <td></td> <td></td> <td colspan="8" style="text-align: center;"> <table border="1" style="width: 100%; border-collapse: collapse; text-align: center;"> <tr> <td style="width: 10%;"></td> <td style="width: 10%;"></td> <td style="width: 10%;"></td> <td style="width: 10%;"></td> <td style="width: 10%;"></td> <td style="width: 10%;"></td> <td style="width: 10%;"></td> <td style="width: 10%;"></td> <td style="width: 10%;"></td> <td style="width: 10%;"></td> </tr> <tr> <td></td> <td></td> <td colspan="8" style="text-align: center;"> <table border="1" style="width: 100%; border-collapse: collapse; text-align: center;"> <tr> <td style="width: 10%;"></td> <td style="width: 10%;"></td> <td style="width: 10%;"></td> <td style="width: 10%;"></td> <td style="width: 10%;"></td> <td style="width: 10%;"></td> <td style="width: 10%;"></td> <td style="width: 10%;"></td> <td style="width: 10%;"></td> <td style="width: 10%;"></td> </tr> <tr> <td></td> <td></td> <td colspan="8" style="text-align: center;"> <table border="1" style="width: 100%; border-collapse: collapse; text-align: center;"> <tr> <td style="width: 10%;"></td> <td style="width: 10%;"></td> <td style="width: 10%;"></td> <td style="width: 10%;"></td> <td style="width: 10%;"></td> <td style="width: 10%;"></td> <td style="width: 10%;"></td> <td style="width: 10%;"></td> <td style="width: 10%;"></td> <td style="width: 10%;"></td> </tr> <tr> <td></td> <td></td> <td colspan="8" style="text-align: center;"> <table border="1" style="width: 100%; border-collapse: collapse; text-align: center;"> <tr> <td style="width: 10%;"></td> <td style="width: 10%;"></td> <td style="width: 10%;"></td> <td style="width: 10%;"></td> <td style="width: 10%;"></td> <td style="width: 10%;"></td> <td style="width: 10%;"></td> <td style="width: 10%;"></td> <td style="width: 10%;"></td> <td style="width: 10%;"></td> </tr> <tr> <td></td> <td></td> <td colspan="8" style="text-align: center;"> <table border="1" style="width: 100%; border-collapse: collapse; text-align: center;"> <tr> <td style="width: 10%;"></td> <td style="width: 10%;"></td> <td style="width: 10%;"></td> <td style="width: 10%;"></td> <td style="width: 10%;"></td> <td style="width: 10%;"></td> <td style="width: 10%;"></td> <td style="width: 10%;"></td> <td style="width: 10%;"></td> <td style="width: 10%;"></td> </tr> <tr> <td></td> <td></td> <td colspan="8" style="text-align: center;"> <table border="1" style="width: 100%; border-collapse: collapse; text-align: center;"> <tr> <td style="width: 10%;"></td> <td style="width: 10%;"></td> <td style="width: 10%;"></td> <td style="width: 10%;"></td> <td style="width: 10%;"></td> <td style="width: 10%;"></td> <td style="width: 10%;"></td> <td style="width: 10%;"></td> <td style="width: 10%;"></td> <td style="width: 10%;"></td> </tr> <tr> <td></td> <td></td> <td colspan="8" style="text-align: center;"> <table border="1" style="width: 100%; border-collapse: collapse; text-align: center;"> <tr> <td style="width: 10%;"></td> <td style="width: 10%;"></td> <td style="width: 10%;"></td> <td style="width: 10%;"></td> <td style="width: 10%;"></td> <td style="width: 10%;"></td> <td style="width: 10%;"></td> <td style="width: 10%;"></td> <td style="width: 10%;"></td> <td style="width: 10%;"></td> </tr> <tr> <td></td> <td></td> <td colspan="8" style="text-align: center;"> <table border="1" style="width: 100%; border-collapse: collapse; text-align: center;"> <tr> <td style="width: 10%;"></td> <td style="width: 10%;"></td> <td style="width: 10%;"></td> <td style="width: 10%;"></td> <td style="width: 10%;"></td> <td style="width: 10%;"></td> <td style="width: 10%;"></td> <td style="width: 10%;"></td> <td style="width: 10%;"></td> <td style="width: 10%;"></td> </tr> <tr> <td></td> <td></td> <td colspan="8" style="text-align: center;"> <table border="1" style="width: 100%; border-collapse: collapse; text-align: center;"> <tr> <td style="width: 10%;"></td> <td style="width: 10%;"></td> <td style="width: 10%;"></td> <td style="width: 10%;"></td> <td style="width: 10%;"></td> <td style="width: 10%;"></td> <td style="width: 10%;"></td> <td style="width: 10%;"></td> <td style="width: 10%;"></td> <td style="width: 10%;"></td> </tr> <tr> <td></td> <td></td> <td colspan="8" style="text-align: center;"> <table border="1" style="width: 100%; border-collapse: collapse; text-align: center;"> <tr> <td style="width: 10%;"></td> <td style="width: 10%;"></td> <td style="width: 10%;"></td> <td style="width: 10%;"></td> <td style="width: 10%;"></td> <td style="width: 10%;"></td> <td style="width: 10%;"></td> <td style="width: 10%;"></td> <td style="width: 10%;"></td> <td style="width: 10%;"></td> </tr> <tr> <td></td> <td></td> <td colspan="8" style="text-align: center;"> <table border="1" style="width: 100%; border-collapse: collapse; text-align: center;"> <tr> <td style="width: 10%;"></td> <td style="width: 10%;"></td> <td style="width: 10%;"></td> <td style="width: 10%;"></td> <td style="width: 10%;"></td> <td style="width: 10%;"></td> <td style="width: 10%;"></td> <td style="width: 10%;"></td> <td style="width: 10%;"></td> <td style="width: 10%;"></td> </tr> <tr> <td></td> <td></td> <td colspan="8" style="text-align: center;"> <table border="1" style="width: 100%; border-collapse: collapse; text-align: center;"> <tr> <td style="width: 10%;"></td> <td style="width: 10%;"></td> <td style="width: 10%;"></td> <td style="width: 10%;"></td> <td style="width: 10%;"></td> <td style="width: 10%;"></td> <td style="width: 10%;"></td> <td style="width: 10%;"></td> <td style="width: 10%;"></td> <td style="width: 10%;"></td> </tr> <tr> <td></td> <td></td> <td colspan="8" style="text-align: center;"> <table border="1" style="width: 100%; border-collapse: collapse; text-align: center;"> <tr> <td style="width: 10%;"></td> <td style="width: 10%;"></td> <td style="width: 10%;"></td> <td style="width: 10%;"></td> <td style="width: 10%;"></td> <td style="width: 10%;"></td> <td style="width: 10%;"></td> <td style="width: 10%;"></td> <td style="width: 10%;"></td> <td style="width: 10%;"></td> </tr> <tr> <td></td> <td></td> <td colspan="8" style="text-align: center;"> <table border="1" style="width: 100%; border-collapse: collapse; text-align: center;"> <tr> <td style="width: 10%;"></td> <td style="width: 10%;"></td> <td style="width:
10%;"></td> <td style="width: 10%;"></td> <td style="width: 10%;"></td> <td style="width: 10%;"></td> <td style="width: 10%;"></td> <td style="width: 10%;"></td> <td style="width: 10%;"></td> <td style="width: 10%;"></td> </tr> <tr> <td></td> <td></td> <td colspan="8" style="text-align: center;"> <table border="1" style="width: 100%; border-collapse: collapse; text-align: center;"> <tr> <td style="width: 10%;"></td> <td style="width: 10%;"></td> <td style="width: 10%;"></td> <td style="width: 10%;"></td> <td style="width: 10%;"></td> <td style="width: 10%;"></td> <td style="width: 10%;"></td> <td style="width: 10%;"></td> <td style="width: 10%;"></td> <td style="width: 10%;"></td> </tr> <tr> <td></td> <td></td> <td colspan="8" style="text-align: center;"> <table border="1" style="width: 100%; border-collapse: collapse; text-align: center;"> <tr> <td style="width: 10%;"></td> <td style="width: 10%;"></td> <td style="width: 10%;"></td> <td style="width: 10%;"></td> <td style="width: 10%;"></td> <td style="width: 10%;"></td> <td style="width: 10%;"></td> <td style="width: 10%;"></td> <td style="width: 10%;"></td> <td style="width: 10%;"></td> </tr> <tr> <td></td> <td></td> <td colspan="8" style="text-align: center;"> <table border="1" style="width: 100%; border-collapse: collapse; text-align: center;"> <tr> <td style="width: 10%;"></td> <td style="width: 10%;"></td> <td style="width: 10%;"></td> <td style="width: 10%;"></td> <td style="width: 10%;"></td> <td style="width: 10%;"></td> <td style="width: 10%;"></td> <td style="width: 10%;"></td> <td style="width: 10%;"></td> <td style="width: 10%;"></td> </tr> <tr> <td></td> <td></td> <td colspan="8" style="text-align: center;"> <table border="1" style="width: 100%; border-collapse: collapse; text-align: center;"> <tr> <td style="width: 10%;"></td> <td style="width: 10%;"></td> <td style="width: 10%;"></td> <td style="width: 10%;"></td> <td style="width: 10%;"></td> <td style="width: 10%;"></td> <td style="width: 10%;"></td> <td style="width: 10%;"></td> <td style="width: 10%;"></td> <td style="width: 10%;"></td> </tr> <tr> <td></td> <td></td> <td colspan="8" style="text-align: center;"> <table border="1" style="width: 100%; border-collapse: collapse; text-align: center;"> <tr> <td style="width: 10%;"></td> <td style="width: 10%;"></td> <td style="width: 10%;"></td> <td style="width: 10%;"></td> <td style="width: 10%;"></td> <td style="width: 10%;"></td> <td style="width: 10%;"></td> <td style="width: 10%;"></td> <td style="width: 10%;"></td> <td style="width: 10%;"></td> </tr> <tr> <td></td> <td></td> <td colspan="8" style="text-align: center;"> <table border="1" style="width: 100%; border-collapse: collapse; text-align: center;"> <tr> </tr></table></td></tr></table></td></tr></table></td></tr></table></td></tr></table></td></tr></table></td></tr></table></td></tr></table></td></tr></table></td></tr></table></td></tr></table></td></tr></table></td></tr></table></td></tr></table></td></tr></table></td></tr></table></td></tr></table></td></tr></table></td></tr></table></td></tr></table></td></tr></table></td></tr></table></td></tr></table></td></tr></table></td></tr></table></td></tr></table></td></tr></table></td></tr></table></td></tr></table></td></tr></table></td></tr></table></td></tr></table></td></tr></table></td></tr></table></td></tr></table></td></tr></table></td></tr></table></td></tr></table></td></tr></table></td></tr></table></td></tr></table></td></tr></table></td></tr></table></td></tr></table></td></tr></table></td></tr></table>
 | | | | | | | | | | | | | | | | | | | | <table border="1" style="width: 100%; border-collapse: collapse; text-align: center;"> <tr> <td style="width: 10%;"></td> <td style="width: 10%;"></td> <td style="width: 10%;"></td> <td style="width: 10%;"></td> <td style="width: 10%;"></td> <td style="width: 10%;"></td> <td style="width: 10%;"></td> <td style="width: 10%;"></td> <td style="width: 10%;"></td> <td style="width: 10%;"></td> </tr> <tr> <td></td> <td></td> <td colspan="8" style="text-align: center;"> <table border="1" style="width: 100%; border-collapse: collapse; text-align: center;"> <tr> <td style="width: 10%;"></td> <td style="width: 10%;"></td> <td style="width: 10%;"></td> <td style="width: 10%;"></td> <td style="width: 10%;"></td> <td style="width: 10%;"></td> <td style="width: 10%;"></td> <td style="width: 10%;"></td> <td style="width: 10%;"></td> <td style="width: 10%;"></td> </tr> <tr> <td></td> <td></td> <td colspan="8" style="text-align: center;"> <table border="1" style="width: 100%; border-collapse: collapse; text-align: center;"> <tr> <td style="width: 10%;"></td> <td style="width: 10%;"></td> <td style="width: 10%;"></td> <td style="width: 10%;"></td> <td style="width: 10%;"></td> <td style="width: 10%;"></td> <td style="width: 10%;"></td> <td style="width: 10%;"></td> <td style="width: 10%;"></td> <td style="width: 10%;"></td> </tr> <tr> <td></td> <td></td> <td colspan="8" style="text-align: center;"> <table border="1" style="width: 100%; border-collapse: collapse; text-align: center;"> <tr> <td style="width: 10%;"></td> <td style="width: 10%;"></td> <td style="width: 10%;"></td> <td style="width: 10%;"></td> <td style="width: 10%;"></td> <td style="width: 10%;"></td> <td style="width: 10%;"></td> <td style="width: 10%;"></td> <td style="width: 10%;"></td> <td style="width: 10%;"></td> </tr> <tr> <td></td> <td></td> <td colspan="8" style="text-align: center;"> <table border="1" style="width: 100%; border-collapse: collapse; text-align: center;"> <tr> <td style="width: 10%;"></td> <td style="width: 10%;"></td> <td style="width: 10%;"></td> <td style="width: 10%;"></td> <td style="width: 10%;"></td> <td style="width: 10%;"></td> <td style="width: 10%;"></td> <td style="width: 10%;"></td> <td style="width: 10%;"></td> <td style="width: 10%;"></td> </tr> <tr> <td></td> <td></td> <td colspan="8" style="text-align: center;"> <table border="1" style="width: 100%; border-collapse: collapse; text-align: center;"> <tr> <td style="width: 10%;"></td> <td style="width: 10%;"></td> <td style="width: 10%;"></td> <td style="width: 10%;"></td> <td style="width: 10%;"></td> <td style="width: 10%;"></td> <td style="width: 10%;"></td> <td style="width: 10%;"></td> <td style="width: 10%;"></td> <td style="width: 10%;"></td> </tr> <tr> <td></td> <td></td> <td colspan="8" style="text-align: center;"> <table border="1" style="width: 100%; border-collapse: collapse; text-align: center;"> <tr> <td style="width: 10%;"></td> <td style="width: 10%;"></td> <td style="width: 10%;"></td> <td style="width: 10%;"></td> <td style="width: 10%;"></td> <td style="width: 10%;"></td> <td style="width: 10%;"></td> <td style="width: 10%;"></td> <td style="width: 10%;"></td> <td style="width: 10%;"></td> </tr> <tr> <td></td> <td></td> <td colspan="8" style="text-align: center;"> <table border="1" style="width: 100%; border-collapse: collapse; text-align: center;"> <tr> <td style="width: 10%;"></td> <td style="width: 10%;"></td> <td style="width: 10%;"></td> <td style="width: 10%;"></td> <td style="width: 10%;"></td> <td style="width: 10%;"></td> <td style="width: 10%;"></td> <td style="width: 10%;"></td> <td style="width: 10%;"></td> <td style="width: 10%;"></td> </tr> <tr> <td></td> <td></td> <td colspan="8" style="text-align: center;"> <table border="1" style="width: 100%; border-collapse: collapse; text-align: center;"> <tr> <td style="width: 10%;"></td> <td style="width: 10%;"></td> <td style="width: 10%;"></td> <td style="width: 10%;"></td> <td style="width: 10%;"></td> <td style="width: 10%;"></td> <td style="width: 10%;"></td> <td style="width: 10%;"></td> <td style="width: 10%;"></td> <td style="width: 10%;"></td> </tr> <tr> <td></td> <td></td> <td colspan="8" style="text-align: center;"> <table border="1" style="width: 100%; border-collapse: collapse; text-align: center;"> <tr> <td style="width: 10%;"></td> <td style="width: 10%;"></td> <td style="width: 10%;"></td> <td style="width: 10%;"></td> <td style="width: 10%;"></td> <td style="width: 10%;"></td> <td style="width: 10%;"></td> <td style="width: 10%;"></td> <td style="width: 10%;"></td> <td style="width: 10%;"></td> </tr> <tr> <td></td> <td></td> <td colspan="8" style="text-align: center;"> <table border="1" style="width: 100%; border-collapse: collapse; text-align: center;"> <tr> <td style="width: 10%;"></td> <td style="width: 10%;"></td> <td style="width: 10%;"></td> <td style="width: 10%;"></td> <td style="width: 10%;"></td> <td style="width: 10%;"></td> <td style="width: 10%;"></td> <td style="width: 10%;"></td> <td style="width: 10%;"></td> <td style="width: 10%;"></td> </tr> <tr> <td></td> <td></td> <td colspan="8" style="text-align: center;"> <table border="1" style="width: 100%; border-collapse: collapse; text-align: center;"> <tr> <td style="width: 10%;"></td> <td style="width: 10%;"></td> <td style="width: 10%;"></td> <td style="width: 10%;"></td> <td style="width: 10%;"></td> <td style="width: 10%;"></td> <td style="width: 10%;"></td> <td style="width: 10%;"></td> <td style="width: 10%;"></td> <td style="width: 10%;"></td> </tr> <tr> <td></td> <td></td> <td colspan="8" style="text-align: center;"> <table border="1" style="width: 100%; border-collapse: collapse; text-align: center;"> <tr> <td style="width: 10%;"></td> <td style="width: 10%;"></td> <td style="width: 10%;"></td> <td style="width: 10%;"></td> <td style="width: 10%;"></td> <td style="width: 10%;"></td> <td style="width: 10%;"></td> <td style="width: 10%;"></td> <td style="width: 10%;"></td> <td style="width: 10%;"></td> </tr> <tr> <td></td> <td></td> <td colspan="8" style="text-align: center;"> <table border="1" style="width: 100%; border-collapse: collapse; text-align: center;"> <tr> <td style="width: 10%;"></td> <td style="width: 10%;"></td> <td style="width: 10%;"></td> <td style="width: 10%;"></td> <td style="width: 10%;"></td> <td style="width: 10%;"></td> <td style="width: 10%;"></td> <td style="width: 10%;"></td> <td style="width: 10%;"></td> <td style="width: 10%;"></td> </tr> <tr> <td></td> <td></td> <td colspan="8" style="text-align: center;"> <table border="1" style="width: 100%; border-collapse: collapse; text-align: center;"> <tr> <td style="width: 10%;"></td> <td style="width: 10%;"></td> <td style="width: 10%;"></td> <td style="width: 10%;"></td> <td style="width: 10%;"></td> <td style="width: 10%;"></td> <td style="width: 10%;"></td> <td style="width: 10%;"></td> <td style="width: 10%;"></td> <td style="width: 10%;"></td> </tr> <tr> <td></td> <td></td> <td colspan="8" style="text-align: center;"> <table border="1" style="width: 100%; border-collapse: collapse; text-align: center;"> <tr> <td style="width: 10%;"></td> <td style="width: 10%;"></td> <td style="width: 10%;"></td> <td style="width: 10%;"></td> <td style="width: 10%;"></td> <td style="width: 10%;"></td> <td style="width: 10%;"></td> <td style="width: 10%;"></td> <td style="width: 10%;"></td> <td style="width: 10%;"></td> </tr> <tr> <td></td> <td></td> <td colspan="8" style="text-align: center;"> <table border="1" style="width: 100%; border-collapse: collapse; text-align: center;"> <tr> <td style="width: 10%;"></td> <td style="width: 10%;"></td> <td style="width: 10%;"></td> <td style="width: 10%;"></td> <td style="width: 10%;"></td> <td style="width: 10%;"></td> <td style="width: 10%;"></td> <td style="width: 10%;"></td> <td style="width: 10%;"></td> <td style="width: 10%;"></td> </tr> <tr> <td></td> <td></td> <td colspan="8" style="text-align: center;"> <table border="1" style="width: 100%; border-collapse: collapse; text-align: center;"> <tr> <td style="width: 10%;"></td> <td style="width: 10%;"></td> <td style="width: 10%;"></td> <td style="width: 10%;"></td> <td style="width: 10%;"></td> <td style="width: 10%;"></td> <td style="width: 10%;"></td> <td style="width: 10%;"></td> <td style="width: 10%;"></td> <td style="width: 10%;"></td> </tr> <tr> <td></td> <td></td> <td colspan="8" style="text-align: center;"> <table border="1" style="width: 100%; border-collapse: collapse; text-align: center;"> <tr> <td style="width: 10%;"></td> <td style="width: 10%;"></td> <td style="width: 10%;"></td> <td style="width: 10%;"></td> <td style="width: 10%;"></td> <td style="width: 10%;"></td> <td style="width: 10%;"></td> <td style="width: 10%;"></td> <td style="width: 10%;"></td> <td style="width: 10%;"></td> </tr> <tr> <td></td> <td></td> <td colspan="8" style="text-align: center;"> <table border="1" style="width: 100%; border-collapse: collapse; text-align: center;"> <tr> <td style="width: 10%;"></td> <td style="width: 10%;"></td> <td style="width: 10%;"></td> <td style="width: 10%;"></td> <td style="width: 10%;"></td> <td style="width: 10%;"></td> <td style="width: 10%;"></td> <td style="width: 10%;"></td> <td style="width: 10%;"></td> <td style="width: 10%;"></td> </tr> <tr> <td></td> <td></td> <td colspan="8" style="text-align: center;"> <table border="1" style="width: 100%; border-collapse: collapse; text-align: center;"> <tr> <td style="width: 10%;"></td> <td style="width: 10%;"></td> <td style="width: 10%;"></td> <td style="width: 10%;"></td> <td
style="width: 10%;"></td> <td style="width: 10%;"></td> <td style="width: 10%;"></td> <td style="width: 10%;"></td> <td style="width: 10%;"></td> <td style="width: 10%;"></td> </tr> <tr> <td></td> <td></td> <td colspan="8" style="text-align: center;"> <table border="1" style="width: 100%; border-collapse: collapse; text-align: center;"> <tr> <td style="width: 10%;"></td> <td style="width: 10%;"></td> <td style="width: 10%;"></td> <td style="width: 10%;"></td> <td style="width: 10%;"></td> <td style="width: 10%;"></td> <td style="width: 10%;"></td> <td style="width: 10%;"></td> <td style="width: 10%;"></td> <td style="width: 10%;"></td> </tr> <tr> <td></td> <td></td> <td colspan="8" style="text-align: center;"> <table border="1" style="width: 100%; border-collapse: collapse; text-align: center;"> <tr> <td style="width: 10%;"></td> <td style="width: 10%;"></td> <td style="width: 10%;"></td> <td style="width: 10%;"></td> <td style="width: 10%;"></td> <td style="width: 10%;"></td> <td style="width: 10%;"></td> <td style="width: 10%;"></td> <td style="width: 10%;"></td> <td style="width: 10%;"></td> </tr> <tr> <td></td> <td></td> <td colspan="8" style="text-align: center;"> <table border="1" style="width: 100%; border-collapse: collapse; text-align: center;"> <tr> <td style="width: 10%;"></td> <td style="width: 10%;"></td> <td style="width: 10%;"></td> <td style="width: 10%;"></td> <td style="width: 10%;"></td> <td style="width: 10%;"></td> <td style="width: 10%;"></td> <td style="width: 10%;"></td> <td style="width: 10%;"></td> <td style="width: 10%;"></td> </tr> <tr> <td></td> <td></td> <td colspan="8" style="text-align: center;"> <table border="1" style="width: 100%; border-collapse: collapse; text-align: center;"> <tr> <td style="width: 10%;"></td> <td style="width: 10%;"></td> <td style="width: 10%;"></td> <td style="width: 10%;"></td> <td style="width: 10%;"></td> <td style="width: 10%;"></td> <td style="width: 10%;"></td> <td style="width: 10%;"></td> <td style="width: 10%;"></td> <td style="width: 10%;"></td> </tr> <tr> <td></td> <td></td> <td colspan="8" style="text-align: center;"> <table border="1" style="width: 100%; border-collapse: collapse; text-align: center;"> <tr> <td style="width: 10%;"></td> <td style="width: 10%;"></td> <td style="width: 10%;"></td> <td style="width: 10%;"></td> <td style="width: 10%;"></td> <td style="width: 10%;"></td> <td style="width: 10%;"></td> <td style="width: 10%;"></td> <td style="width: 10%;"></td> <td style="width: 10%;"></td> </tr> <tr> <td></td> <td></td> <td colspan="8" style="text-align: center;"> <table border="1" style="width: 100%; border-collapse: collapse; text-align: center;"> <tr> <td style="width: 10%;"></td> <td style="width: 10%;"></td> <td style="width: 10%;"></td> <td style="width: 10%;"></td> <td style="width: 10%;"></td> <td style="width: 10%;"></td> <td style="width: 10%;"></td> <td style="width: 10%;"></td> <td style="width: 10%;"></td> <td style="width: 10%;"></td> </tr> <tr> <td></td> <td></td> <td colspan="8" style="text-align: center;"> <table border="1" style="width: 100%; border-collapse: collapse; text-align: center;"> <tr> <td style="width: 10%;"></td> <td style="width: 10%;"></td> <td style="width: 10%;"></td> <td style="width: 10%;"></td> <td style="width: 10%;"></td> <td style="width: 10%;"></td> <td style="width: 10%;"></td> <td style="width: 10%;"></td> <td style="width: 10%;"></td> <td style="width: 10%;"></td> </tr> <tr> <td></td> <td></td> <td colspan="8" style="text-align: center;"> <table border="1" style="width: 100%; border-collapse: collapse; text-align: center;"> <tr> <td style="width: 10%;"></td> <td style="width: 10%;"></td> <td style="width: 10%;"></td> <td style="width: 10%;"></td> <td style="width: 10%;"></td> <td style="width: 10%;"></td> <td style="width: 10%;"></td> <td style="width: 10%;"></td> <td style="width: 10%;"></td> <td style="width: 10%;"></td> </tr> <tr> <td></td> <td></td> <td colspan="8" style="text-align: center;"> <table border="1" style="width: 100%; border-collapse: collapse; text-align: center;"> <tr> <td style="width: 10%;"></td> <td style="width: 10%;"></td> <td style="width: 10%;"></td> <td style="width: 10%;"></td> <td style="width: 10%;"></td> <td style="width: 10%;"></td> <td style="width: 10%;"></td> <td style="width: 10%;"></td> <td style="width: 10%;"></td> <td style="width: 10%;"></td> </tr> <tr> <td></td> <td></td> <td colspan="8" style="text-align: center;"> <table border="1" style="width: 100%; border-collapse: collapse; text-align: center;"> <tr> <td style="width: 10%;"></td> <td style="width: 10%;"></td> <td style="width: 10%;"></td> <td style="width: 10%;"></td> <td style="width: 10%;"></td> <td style="width: 10%;"></td> <td style="width: 10%;"></td> <td style="width: 10%;"></td> <td style="width: 10%;"></td> <td style="width: 10%;"></td> </tr> <tr> <td></td> <td></td> <td colspan="8" style="text-align: center;"> <table border="1" style="width: 100%; border-collapse: collapse; text-align: center;"> <tr> <td style="width: 10%;"></td> <td style="width: 10%;"></td> <td style="width: 10%;"></td> <td style="width: 10%;"></td> <td style="width: 10%;"></td> <td style="width: 10%;"></td> <td style="width: 10%;"></td> <td style="width: 10%;"></td> <td style="width: 10%;"></td> <td style="width: 10%;"></td> </tr> <tr> <td></td> <td></td> <td colspan="8" style="text-align: center;"> <table border="1" style="width: 100%; border-collapse: collapse; text-align: center;"> <tr> <td style="width: 10%;"></td> <td style="width: 10%;"></td> <td style="width: 10%;"></td> <td style="width: 10%;"></td> <td style="width: 10%;"></td> <td style="width: 10%;"></td> <td style="width: 10%;"></td> <td style="width: 10%;"></td> <td style="width: 10%;"></td> <td style="width: 10%;"></td> </tr> <tr> <td></td> <td></td> <td colspan="8" style="text-align: center;"> <table border="1" style="width: 100%; border-collapse: collapse; text-align: center;"> <tr> <td style="width: 10%;"></td> <td style="width: 10%;"></td> <td style="width: 10%;"></td> <td style="width: 10%;"></td> <td style="width: 10%;"></td> <td style="width: 10%;"></td> <td style="width: 10%;"></td> <td style="width: 10%;"></td> <td style="width: 10%;"></td> <td style="width: 10%;"></td> </tr> <tr> <td></td> <td></td> <td colspan="8" style="text-align: center;"> <table border="1" style="width: 100%; border-collapse: collapse; text-align: center;"> <tr> <td style="width: 10%;"></td> <td style="width: 10%;"></td> <td style="width: 10%;"></td> <td style="width: 10%;"></td> <td style="width: 10%;"></td> <td style="width: 10%;"></td> <td style="width: 10%;"></td> <td style="width: 10%;"></td> <td style="width: 10%;"></td> <td style="width: 10%;"></td> </tr> <tr> <td></td> <td></td> <td colspan="8" style="text-align: center;"> <table border="1" style="width: 100%; border-collapse: collapse; text-align: center;"> <tr> <td style="width: 10%;"></td> <td style="width: 10%;"></td> <td style="width: 10%;"></td> <td style="width: 10%;"></td> <td style="width: 10%;"></td> <td style="width: 10%;"></td> <td style="width: 10%;"></td> <td style="width: 10%;"></td> <td style="width: 10%;"></td> <td style="width: 10%;"></td> </tr> <tr> <td></td> <td></td> <td colspan="8" style="text-align: center;"> <table border="1" style="width: 100%; border-collapse: collapse; text-align: center;"> <tr> <td style="width: 10%;"></td> <td style="width: 10%;"></td> <td style="width: 10%;"></td> <td style="width: 10%;"></td> <td style="width: 10%;"></td> <td style="width: 10%;"></td> <td style="width: 10%;"></td> <td style="width: 10%;"></td> <td style="width: 10%;"></td> <td style="width: 10%;"></td> </tr> <tr> <td></td> <td></td> <td colspan="8" style="text-align: center;"> <table border="1" style="width: 100%; border-collapse: collapse; text-align: center;"> <tr> <td style="width: 10%;"></td> <td style="width: 10%;"></td> <td style="width: 10%;"></td> <td style="width: 10%;"></td> <td style="width: 10%;"></td> <td style="width: 10%;"></td> <td style="width: 10%;"></td> <td style="width: 10%;"></td> <td style="width: 10%;"></td> <td style="width: 10%;"></td> </tr> <tr> <td></td> <td></td> <td colspan="8" style="text-align: center;"> <table border="1" style="width: 100%; border-collapse: collapse; text-align: center;"> <tr> <td style="width: 10%;"></td> <td style="width: 10%;"></td> <td style="width: 10%;"></td> <td style="width: 10%;"></td> <td style="width: 10%;"></td> <td style="width: 10%;"></td> <td style="width: 10%;"></td> <td style="width: 10%;"></td> <td style="width: 10%;"></td> <td style="width: 10%;"></td> </tr> <tr> <td></td> <td></td> <td colspan="8" style="text-align: center;"> <table border="1" style="width: 100%; border-collapse: collapse; text-align: center;"> <tr> <td style="width: 10%;"></td> <td style="width: 10%;"></td> <td style="width: 10%;"></td> <td style="width: 10%;"></td> <td style="width: 10%;"></td> <td style="width: 10%;"></td> <td style="width: 10%;"></td> <td style="width: 10%;"></td> <td style="width: 10%;"></td> <td style="width: 10%;"></td> </tr> <tr> <td></td> <td></td> <td colspan="8" style="text-align: center;"> <table border="1" style="width: 100%; border-collapse: collapse; text-align: center;"> <tr> <td style="width: 10%;"></td> <td style="width: 10%;"></td> <td style="width: 10%;"></td> <td style="width: 10%;"></td> <td style="width: 10%;"></td> <td style="width: 10%;"></td> <td style="width: 10%;"></td> <td style="width: 10%;"></td> <td style="width: 10%;"></td> <td style="width: 10%;"></td> </tr> <tr> <td></td> <td></td> <td colspan="8" style="text-align: center;"> <table border="1" style="width: 100%; border-collapse: collapse; text-align: center;"> <tr> <td style="width: 10%;"></td> <td style="width: 10%;"></td> <td style="width: 10%;"></td> <td style="width: 10%;"></td> <td style="width: 10%;"></td> <td style="width: 10%;"></td> <td style="width: 10%;"></td> <td style="width: 10%;"></td> <td style="width: 10%;"></td> <td style="width:
10%;"></td> </tr> <tr> <td></td> <td></td> <td colspan="8" style="text-align: center;"> <table border="1" style="width: 100%; border-collapse: collapse; text-align: center;"> <tr> <td style="width: 10%;"></td> <td style="width: 10%;"></td> <td style="width: 10%;"></td> <td style="width: 10%;"></td> <td style="width: 10%;"></td> <td style="width: 10%;"></td> <td style="width: 10%;"></td> <td style="width: 10%;"></td> <td style="width: 10%;"></td> <td style="width: 10%;"></td> </tr> <tr> <td></td> <td></td> <td colspan="8" style="text-align: center;"> <table border="1" style="width: 100%; border-collapse: collapse; text-align: center;"> <tr> <td style="width: 10%;"></td> <td style="width: 10%;"></td> <td style="width: 10%;"></td> <td style="width: 10%;"></td> <td style="width: 10%;"></td> <td style="width: 10%;"></td> <td style="width: 10%;"></td> <td style="width: 10%;"></td> <td style="width: 10%;"></td> <td style="width: 10%;"></td> </tr> <tr> <td></td> <td></td> <td colspan="8" style="text-align: center;"> <table border="1" style="width: 100%; border-collapse: collapse; text-align: center;"> <tr> </tr></table></td></tr></table></td></tr></table></td></tr></table></td></tr></table></td></tr></table></td></tr></table></td></tr></table></td></tr></table></td></tr></table></td></tr></table></td></tr></table></td></tr></table></td></tr></table></td></tr></table></td></tr></table></td></tr></table></td></tr></table></td></tr></table></td></tr></table></td></tr></table></td></tr></table></td></tr></table></td></tr></table></td></tr></table></td></tr></table></td></tr></table></td></tr></table></td></tr></table></td></tr></table></td></tr></table></td></tr></table></td></tr></table></td></tr></table></td></tr></table></td></tr></table></td></tr></table></td></tr></table></td></tr></table></td></tr></table></td></tr></table></td></tr></table></td></tr></table></td></tr></table></td></tr></table> | | | | | | | | | | | | | | | | | | | | <table border="1" style="width: 100%; border-collapse: collapse; text-align: center;"> <tr> <td style="width: 10%;"></td> <td style="width: 10%;"></td> <td style="width: 10%;"></td> <td style="width: 10%;"></td> <td style="width: 10%;"></td> <td style="width: 10%;"></td> <td style="width: 10%;"></td> <td style="width: 10%;"></td> <td style="width: 10%;"></td> <td style="width: 10%;"></td> </tr> <tr> <td></td> <td></td> <td colspan="8" style="text-align: center;"> <table border="1" style="width: 100%; border-collapse: collapse; text-align: center;"> <tr> <td style="width: 10%;"></td> <td style="width: 10%;"></td> <td style="width: 10%;"></td> <td style="width: 10%;"></td> <td style="width: 10%;"></td> <td style="width: 10%;"></td> <td style="width: 10%;"></td> <td style="width: 10%;"></td> <td style="width: 10%;"></td> <td style="width: 10%;"></td> </tr> <tr> <td></td> <td></td> <td colspan="8" style="text-align: center;"> <table border="1" style="width: 100%; border-collapse: collapse; text-align: center;"> <tr> <td style="width: 10%;"></td> <td style="width: 10%;"></td> <td style="width: 10%;"></td> <td style="width: 10%;"></td> <td style="width: 10%;"></td> <td style="width: 10%;"></td> <td
style="width: 10%;"></td> <td style="width: 10%;"></td> <td style="width: 10%;"></td> <td style="width: 10%;"></td> </tr> <tr> <td></td> <td></td> <td colspan="8" style="text-align: center;"> <table border="1" style="width: 100%; border-collapse: collapse; text-align: center;"> <tr> <td style="width: 10%;"></td> <td style="width: 10%;"></td> <td style="width: 10%;"></td> <td style="width: 10%;"></td> <td style="width: 10%;"></td> <td style="width: 10%;"></td> <td style="width: 10%;"></td> <td style="width: 10%;"></td> <td style="width: 10%;"></td> <td style="width: 10%;"></td> </tr> <tr> <td></td> <td></td> <td colspan="8" style="text-align: center;"> <table border="1" style="width: 100%; border-collapse: collapse; text-align: center;"> <tr> <td style="width: 10%;"></td> <td style="width: 10%;"></td> <td style="width: 10%;"></td> <td style="width: 10%;"></td> <td style="width: 10%;"></td> <td style="width: 10%;"></td> <td style="width: 10%;"></td> <td style="width: 10%;"></td> <td style="width: 10%;"></td> <td style="width: 10%;"></td> </tr> <tr> <td></td> <td></td> <td colspan="8" style="text-align: center;"> <table border="1" style="width: 100%; border-collapse: collapse; text-align: center;"> <tr> <td style="width: 10%;"></td> <td style="width: 10%;"></td> <td style="width: 10%;"></td> <td style="width: 10%;"></td> <td style="width: 10%;"></td> <td style="width: 10%;"></td> <td style="width: 10%;"></td> <td style="width: 10%;"></td> <td style="width: 10%;"></td> <td style="width: 10%;"></td> </tr> <tr> <td></td> <td></td> <td colspan="8" style="text-align: center;"> <table border="1" style="width: 100%; border-collapse: collapse; text-align: center;"> <tr> <td style="width: 10%;"></td> <td style="width: 10%;"></td> <td style="width: 10%;"></td> <td style="width: 10%;"></td> <td style="width: 10%;"></td> <td style="width: 10%;"></td> <td style="width: 10%;"></td> <td style="width: 10%;"></td> <td style="width: 10%;"></td> <td style="width: 10%;"></td> </tr> <tr> <td></td> <td></td> <td colspan="8" style="text-align: center;"> <table border="1" style="width: 100%; border-collapse: collapse; text-align: center;"> <tr> <td style="width: 10%;"></td> <td style="width: 10%;"></td> <td style="width: 10%;"></td> <td style="width: 10%;"></td> <td style="width: 10%;"></td> <td style="width: 10%;"></td> <td style="width: 10%;"></td> <td style="width: 10%;"></td> <td style="width: 10%;"></td> <td style="width: 10%;"></td> </tr> <tr> <td></td> <td></td> <td colspan="8" style="text-align: center;"> <table border="1" style="width: 100%; border-collapse: collapse; text-align: center;"> <tr> <td style="width: 10%;"></td> <td style="width: 10%;"></td> <td style="width: 10%;"></td> <td style="width: 10%;"></td> <td style="width: 10%;"></td> <td style="width: 10%;"></td> <td style="width: 10%;"></td> <td style="width: 10%;"></td> <td style="width: 10%;"></td> <td style="width: 10%;"></td> </tr> <tr> <td></td> <td></td> <td colspan="8" style="text-align: center;"> <table border="1" style="width: 100%; border-collapse: collapse; text-align: center;"> <tr> <td style="width: 10%;"></td> <td style="width: 10%;"></td> <td style="width: 10%;"></td> <td style="width: 10%;"></td> <td style="width: 10%;"></td> <td style="width: 10%;"></td> <td style="width: 10%;"></td> <td style="width: 10%;"></td> <td style="width: 10%;"></td> <td style="width: 10%;"></td> </tr> <tr> <td></td> <td></td> <td colspan="8" style="text-align: center;"> <table border="1" style="width: 100%; border-collapse: collapse; text-align: center;"> <tr> <td style="width: 10%;"></td> <td style="width: 10%;"></td> <td style="width: 10%;"></td> <td style="width: 10%;"></td> <td style="width: 10%;"></td> <td style="width: 10%;"></td> <td style="width: 10%;"></td> <td style="width: 10%;"></td> <td style="width: 10%;"></td> <td style="width: 10%;"></td> </tr> <tr> <td></td> <td></td> <td colspan="8" style="text-align: center;"> <table border="1" style="width: 100%; border-collapse: collapse; text-align: center;"> <tr> <td style="width: 10%;"></td> <td style="width: 10%;"></td> <td style="width: 10%;"></td> <td style="width: 10%;"></td> <td style="width: 10%;"></td> <td style="width: 10%;"></td> <td style="width: 10%;"></td> <td style="width: 10%;"></td> <td style="width: 10%;"></td> <td style="width: 10%;"></td> </tr> <tr> <td></td> <td></td> <td colspan="8" style="text-align: center;"> <table border="1" style="width: 100%; border-collapse: collapse; text-align: center;"> <tr> <td style="width: 10%;"></td> <td style="width: 10%;"></td> <td style="width: 10%;"></td> <td style="width: 10%;"></td> <td style="width: 10%;"></td> <td style="width: 10%;"></td> <td style="width: 10%;"></td> <td style="width: 10%;"></td> <td style="width: 10%;"></td> <td style="width: 10%;"></td> </tr> <tr> <td></td> <td></td> <td colspan="8" style="text-align: center;"> <table border="1" style="width: 100%; border-collapse: collapse; text-align: center;"> <tr> <td style="width: 10%;"></td> <td style="width: 10%;"></td> <td style="width: 10%;"></td> <td style="width: 10%;"></td> <td style="width: 10%;"></td> <td style="width: 10%;"></td> <td style="width: 10%;"></td> <td style="width: 10%;"></td> <td style="width: 10%;"></td> <td style="width: 10%;"></td> </tr> <tr> <td></td> <td></td> <td colspan="8" style="text-align: center;"> <table border="1" style="width: 100%; border-collapse: collapse; text-align: center;"> <tr> <td style="width: 10%;"></td> <td style="width: 10%;"></td> <td style="width: 10%;"></td> <td style="width: 10%;"></td> <td style="width: 10%;"></td> <td style="width: 10%;"></td> <td style="width: 10%;"></td> <td style="width: 10%;"></td> <td style="width: 10%;"></td> <td style="width: 10%;"></td> </tr> <tr> <td></td> <td></td> <td colspan="8" style="text-align: center;"> <table border="1" style="width: 100%; border-collapse: collapse; text-align: center;"> <tr> <td style="width: 10%;"></td> <td style="width: 10%;"></td> <td style="width: 10%;"></td> <td style="width: 10%;"></td> <td style="width: 10%;"></td> <td style="width: 10%;"></td> <td style="width: 10%;"></td> <td style="width: 10%;"></td> <td style="width: 10%;"></td> <td style="width: 10%;"></td> </tr> <tr> <td></td> <td></td> <td colspan="8" style="text-align: center;"> <table border="1" style="width: 100%; border-collapse: collapse; text-align: center;"> <tr> <td style="width: 10%;"></td> <td style="width: 10%;"></td> <td style="width: 10%;"></td> <td style="width: 10%;"></td> <td style="width: 10%;"></td> <td style="width: 10%;"></td> <td style="width: 10%;"></td> <td style="width: 10%;"></td> <td style="width: 10%;"></td> <td style="width: 10%;"></td> </tr> <tr> <td></td> <td></td> <td colspan="8" style="text-align: center;"> <table border="1" style="width: 100%; border-collapse: collapse; text-align: center;"> <tr> <td style="width: 10%;"></td> <td style="width: 10%;"></td> <td style="width: 10%;"></td> <td style="width: 10%;"></td> <td style="width: 10%;"></td> <td style="width: 10%;"></td> <td style="width: 10%;"></td> <td style="width: 10%;"></td> <td style="width: 10%;"></td> <td style="width: 10%;"></td> </tr> <tr> <td></td> <td></td> <td colspan="8" style="text-align: center;"> <table border="1" style="width: 100%; border-collapse: collapse; text-align: center;"> <tr> <td style="width: 10%;"></td> <td style="width: 10%;"></td> <td style="width: 10%;"></td> <td style="width: 10%;"></td> <td style="width: 10%;"></td> <td style="width: 10%;"></td> <td style="width: 10%;"></td> <td style="width: 10%;"></td> <td style="width: 10%;"></td> <td style="width: 10%;"></td> </tr> <tr> <td></td> <td></td> <td colspan="8" style="text-align: center;"> <table border="1" style="width: 100%; border-collapse: collapse; text-align: center;"> <tr> <td style="width: 10%;"></td> <td style="width: 10%;"></td> <td style="width: 10%;"></td> <td style="width: 10%;"></td> <td style="width: 10%;"></td> <td style="width: 10%;"></td> <td style="width: 10%;"></td> <td style="width: 10%;"></td> <td style="width: 10%;"></td> <td style="width: 10%;"></td> </tr> <tr> <td></td> <td></td> <td colspan="8" style="text-align: center;"> <table border="1" style="width: 100%; border-collapse: collapse; text-align: center;"> <tr> <td style="width: 10%;"></td> <td style="width: 10%;"></td> <td style="width: 10%;"></td> <td style="width: 10%;"></td> <td style="width: 10%;"></td> <td style="width: 10%;"></td> <td style="width: 10%;"></td> <td style="width: 10%;"></td> <td style="width: 10%;"></td> <td style="width: 10%;"></td> </tr> <tr> <td></td> <td></td> <td colspan="8" style="text-align: center;"> <table border="1" style="width: 100%; border-collapse: collapse; text-align: center;"> <tr> <td style="width: 10%;"></td> <td style="width: 10%;"></td> <td style="width: 10%;"></td> <td style="width: 10%;"></td> <td style="width: 10%;"></td> <td style="width: 10%;"></td> <td style="width: 10%;"></td> <td style="width: 10%;"></td> <td style="width: 10%;"></td> <td style="width: 10%;"></td> </tr> <tr> <td></td> <td></td> <td colspan="8" style="text-align: center;"> <table border="1" style="width: 100%; border-collapse: collapse; text-align: center;"> <tr> <td style="width: 10%;"></td> <td style="width: 10%;"></td> <td style="width: 10%;"></td> <td style="width: 10%;"></td> <td style="width: 10%;"></td> <td style="width: 10%;"></td> <td style="width: 10%;"></td> <td style="width: 10%;"></td> <td style="width: 10%;"></td> <td style="width: 10%;"></td> </tr> <tr> <td></td> <td></td> <td colspan="8" style="text-align: center;"> <table border="1" style="width: 100%; border-collapse: collapse; text-align: center;"> <tr> <td style="width: 10%;"></td> <td style="width: 10%;"></td> <td style="width: 10%;"></td> <td style="width: 10%;"></td> <td style="width: 10%;"></td> <td style="width: 10%;"></td> <td style="width: 10%;"></td> <td style="width: 10%;"></td> <td style="width: 10%;"></td> <td style="width: 10%;"></td> </tr> <tr> <td></td> <td></td> <td colspan="8"
style="text-align: center;"> <table border="1" style="width: 100%; border-collapse: collapse; text-align: center;"> <tr> <td style="width: 10%;"></td> <td style="width: 10%;"></td> <td style="width: 10%;"></td> <td style="width: 10%;"></td> <td style="width: 10%;"></td> <td style="width: 10%;"></td> <td style="width: 10%;"></td> <td style="width: 10%;"></td> <td style="width: 10%;"></td> <td style="width: 10%;"></td> </tr> <tr> <td></td> <td></td> <td colspan="8" style="text-align: center;"> <table border="1" style="width: 100%; border-collapse: collapse; text-align: center;"> <tr> <td style="width: 10%;"></td> <td style="width: 10%;"></td> <td style="width: 10%;"></td> <td style="width: 10%;"></td> <td style="width: 10%;"></td> <td style="width: 10%;"></td> <td style="width: 10%;"></td> <td style="width: 10%;"></td> <td style="width: 10%;"></td> <td style="width: 10%;"></td> </tr> <tr> <td></td> <td></td> <td colspan="8" style="text-align: center;"> <table border="1" style="width: 100%; border-collapse: collapse; text-align: center;"> <tr> <td style="width: 10%;"></td> <td style="width: 10%;"></td> <td style="width: 10%;"></td> <td style="width: 10%;"></td> <td style="width: 10%;"></td> <td style="width: 10%;"></td> <td style="width: 10%;"></td> <td style="width: 10%;"></td> <td style="width: 10%;"></td> <td style="width: 10%;"></td> </tr> <tr> <td></td> <td></td> <td colspan="8" style="text-align: center;"> <table border="1" style="width: 100%; border-collapse: collapse; text-align: center;"> <tr> <td style="width: 10%;"></td> <td style="width: 10%;"></td> <td style="width: 10%;"></td> <td style="width: 10%;"></td> <td style="width: 10%;"></td> <td style="width: 10%;"></td> <td style="width: 10%;"></td> <td style="width: 10%;"></td> <td style="width: 10%;"></td> <td style="width: 10%;"></td> </tr> <tr> <td></td> <td></td> <td colspan="8" style="text-align: center;"> <table border="1" style="width: 100%; border-collapse: collapse; text-align: center;"> <tr> <td style="width: 10%;"></td> <td style="width: 10%;"></td> <td style="width: 10%;"></td> <td style="width: 10%;"></td> <td style="width: 10%;"></td> <td style="width: 10%;"></td> <td style="width: 10%;"></td> <td style="width: 10%;"></td> <td style="width: 10%;"></td> <td style="width: 10%;"></td> </tr> <tr> <td></td> <td></td> <td colspan="8" style="text-align: center;"> <table border="1" style="width: 100%; border-collapse: collapse; text-align: center;"> <tr> <td style="width: 10%;"></td> <td style="width: 10%;"></td> <td style="width: 10%;"></td> <td style="width: 10%;"></td> <td style="width: 10%;"></td> <td style="width: 10%;"></td> <td style="width: 10%;"></td> <td style="width: 10%;"></td> <td style="width: 10%;"></td> <td style="width: 10%;"></td> </tr> <tr> <td></td> <td></td> <td colspan="8" style="text-align: center;"> <table border="1" style="width: 100%; border-collapse: collapse; text-align: center;"> <tr> <td style="width: 10%;"></td> <td style="width: 10%;"></td> <td style="width: 10%;"></td> <td style="width: 10%;"></td> <td style="width: 10%;"></td> <td style="width: 10%;"></td> <td style="width: 10%;"></td> <td style="width: 10%;"></td> <td style="width: 10%;"></td> <td style="width: 10%;"></td> </tr> <tr> <td></td> <td></td> <td colspan="8" style="text-align: center;"> <table border="1" style="width: 100%; border-collapse: collapse; text-align: center;"> <tr> <td style="width: 10%;"></td> <td style="width: 10%;"></td> <td style="width: 10%;"></td> <td style="width: 10%;"></td> <td style="width: 10%;"></td> <td style="width: 10%;"></td> <td style="width: 10%;"></td> <td style="width: 10%;"></td> <td style="width: 10%;"></td> <td style="width: 10%;"></td> </tr> <tr> <td></td> <td></td> <td colspan="8" style="text-align: center;"> <table border="1" style="width: 100%; border-collapse: collapse; text-align: center;"> <tr> <td style="width: 10%;"></td> <td style="width: 10%;"></td> <td style="width: 10%;"></td> <td style="width: 10%;"></td> <td style="width: 10%;"></td> <td style="width: 10%;"></td> <td style="width: 10%;"></td> <td style="width: 10%;"></td> <td style="width: 10%;"></td> <td style="width: 10%;"></td> </tr> <tr> <td></td> <td></td> <td colspan="8" style="text-align: center;"> <table border="1" style="width: 100%; border-collapse: collapse; text-align: center;"> <tr> <td style="width: 10%;"></td> <td style="width: 10%;"></td> <td style="width: 10%;"></td> <td style="width: 10%;"></td> <td style="width: 10%;"></td> <td style="width: 10%;"></td> <td style="width: 10%;"></td> <td style="width: 10%;"></td> <td style="width: 10%;"></td> <td style="width: 10%;"></td> </tr> <tr> <td></td> <td></td> <td colspan="8" style="text-align: center;"> <table border="1" style="width: 100%; border-collapse: collapse; text-align: center;"> <tr> <td style="width: 10%;"></td> <td style="width: 10%;"></td> <td style="width: 10%;"></td> <td style="width: 10%;"></td> <td style="width: 10%;"></td> <td style="width: 10%;"></td> <td style="width: 10%;"></td> <td style="width: 10%;"></td> <td style="width: 10%;"></td> <td style="width: 10%;"></td> </tr> <tr> <td></td> <td></td> <td colspan="8" style="text-align: center;"> <table border="1" style="width: 100%; border-collapse: collapse; text-align: center;"> <tr> <td style="width: 10%;"></td> <td style="width: 10%;"></td> <td style="width: 10%;"></td> <td style="width: 10%;"></td> <td style="width: 10%;"></td> <td style="width: 10%;"></td> <td style="width: 10%;"></td> <td style="width: 10%;"></td> <td style="width: 10%;"></td> <td style="width: 10%;"></td> </tr> <tr> <td></td> <td></td> <td colspan="8" style="text-align: center;"> <table border="1" style="width: 100%; border-collapse: collapse; text-align: center;"> <tr> <td style="width: 10%;"></td> <td style="width: 10%;"></td> <td style="width: 10%;"></td> <td style="width: 10%;"></td> <td style="width: 10%;"></td> <td style="width: 10%;"></td> <td style="width: 10%;"></td> <td style="width: 10%;"></td> <td style="width: 10%;"></td> <td style="width: 10%;"></td> </tr> <tr> <td></td> <td></td> <td colspan="8" style="text-align: center;"> <table border="1" style="width: 100%; border-collapse: collapse; text-align: center;"> <tr> <td style="width: 10%;"></td> <td style="width: 10%;"></td> <td style="width: 10%;"></td> <td style="width: 10%;"></td> <td style="width: 10%;"></td> <td style="width: 10%;"></td> <td style="width: 10%;"></td> <td style="width: 10%;"></td> <td style="width: 10%;"></td> <td style="width: 10%;"></td> </tr> <tr> <td></td> <td></td> <td colspan="8" style="text-align: center;"> <table border="1" style="width: 100%; border-collapse: collapse; text-align: center;"> <tr> <td style="width: 10%;"></td> <td style="width: 10%;"></td> <td style="width: 10%;"></td> <td style="width: 10%;"></td> <td style="width: 10%;"></td> <td style="width: 10%;"></td> <td style="width: 10%;"></td> <td style="width: 10%;"></td> <td style="width: 10%;"></td> <td style="width: 10%;"></td> </tr> <tr> <td></td> <td></td> <td colspan="8" style="text-align: center;"> <table border="1" style="width: 100%; border-collapse: collapse; text-align: center;"> <tr> <td style="width: 10%;"></td> <td style="width: 10%;"></td> <td style="width: 10%;"></td> <td style="width: 10%;"></td> <td style="width: 10%;"></td> <td style="width: 10%;"></td> <td style="width: 10%;"></td> <td style="width: 10%;"></td> <td style="width: 10%;"></td> <td style="width: 10%;"></td> </tr> <tr> <td></td> <td></td> <td colspan="8" style="text-align: center;"> <table border="1" style="width: 100%; border-collapse: collapse; text-align: center;"> <tr> <td style="width: 10%;"></td> <td style="width: 10%;"></td> <td style="width: 10%;"></td> <td style="width: 10%;"></td> <td style="width: 10%;"></td> <td style="width: 10%;"></td> <td style="width: 10%;"></td> <td style="width: 10%;"></td> <td style="width: 10%;"></td> <td style="width: 10%;"></td> </tr> <tr> <td></td> <td></td> <td colspan="8" style="text-align: center;"> <table border="1" style="width: 100%; border-collapse: collapse; text-align: center;"> <tr> <td style="width: 10%;"></td> <td style="width: 10%;"></td> <td style="width: 10%;"></td> <td style="width: 10%;"></td> <td style="width: 10%;"></td> <td style="width: 10%;"></td> <td style="width: 10%;"></td> <td style="width: 10%;"></td> <td style="width: 10%;"></td> <td style="width: 10%;"></td> </tr> <tr> <td></td> <td></td> <td colspan="8" style="text-align: center;"> <table border="1" style="width: 100%; border-collapse: collapse; text-align: center;"> <tr> <td style="width: 10%;"></td> <td style="width: 10%;"></td> <td style="width: 10%;"></td> <td style="width: 10%;"></td> <td style="width: 10%;"></td> <td style="width: 10%;"></td> <td style="width: 10%;"></td> <td style="width: 10%;"></td> <td style="width: 10%;"></td> <td style="width: 10%;"></td> </tr> <tr> <td></td> <td></td> <td colspan="8" style="text-align: center;"> <table border="1" style="width: 100%; border-collapse: collapse; text-align: center;"> <tr> </tr></table></td></tr></table></td></tr></table></td></tr></table></td></tr></table></td></tr></table></td></tr></table></td></tr></table></td></tr></table></td></tr></table></td></tr></table></td></tr></table></td></tr></table></td></tr></table></td></tr></table></td></tr></table></td></tr></table></td></tr></table></td></tr></table></td></tr></table></td></tr></table></td></tr></table></td></tr></table></td></tr></table></td></tr></table></td></tr></table></td></tr></table></td></tr></table></td></tr></table></td></tr></table></td></tr></table></td></tr></table></td></tr></table></td></tr></table></td></tr></table></td></tr></table></td></tr></table></td></tr></table></td></tr></table></td></tr></table></td></tr></table></td></tr></table></td></tr></table></td></tr></table>
 | | | | | | | | | | | | | | | | | | | | <table border="1" style="width: 100%; border-collapse: collapse; text-align: center;"> <tr> <td style="width: 10%;"></td> <td style="width: 10%;"></td> <td style="width: 10%;"></td> <td style="width: 10%;"></td> <td style="width: 10%;"></td> <td style="width: 10%;"></td> <td style="width: 10%;"></td> <td style="width: 10%;"></td> <td style="width: 10%;"></td> <td style="width: 10%;"></td> </tr> <tr> <td></td> <td></td> <td colspan="8" style="text-align: center;"> <table border="1" style="width: 100%; border-collapse: collapse; text-align: center;"> <tr> <td style="width: 10%;"></td> <td style="width: 10%;"></td> <td style="width: 10%;"></td> <td style="width: 10%;"></td> <td style="width: 10%;"></td> <td style="width: 10%;"></td> <td style="width: 10%;"></td> <td style="width: 10%;"></td> <td style="width: 10%;"></td> <td style="width: 10%;"></td> </tr> <tr> <td></td> <td></td> <td colspan="8" style="text-align: center;"> <table border="1" style="width: 100%; border-collapse: collapse; text-align: center;"> <tr> <td style="width: 10%;"></td> <td style="width: 10%;"></td> <td style="width: 10%;"></td> <td style="width: 10%;"></td> <td style="width: 10%;"></td> <td style="width: 10%;"></td> <td style="width: 10%;"></td> <td style="width: 10%;"></td> <td style="width: 10%;"></td> <td style="width: 10%;"></td> </tr> <tr> <td></td> <td></td> <td colspan="8" style="text-align: center;"> <table border="1" style="width: 100%; border-collapse: collapse; text-align: center;"> <tr> <td style="width: 10%;"></td> <td style="width: 10%;"></td> <td style="width: 10%;"></td> <td style="width: 10%;"></td> <td style="width: 10%;"></td> <td style="width: 10%;"></td> <td style="width: 10%;"></td> <td style="width: 10%;"></td> <td style="width: 10%;"></td> <td style="width: 10%;"></td> </tr> <tr> <td></td> <td></td> <td colspan="8" style="text-align: center;"> <table border="1" style="width: 100%; border-collapse: collapse; text-align: center;"> <tr> <td style="width: 10%;"></td> <td style="width: 10%;"></td> <td style="width: 10%;"></td> <td style="width: 10%;"></td> <td style="width: 10%;"></td> <td style="width: 10%;"></td> <td style="width: 10%;"></td> <td style="width: 10%;"></td> <td style="width: 10%;"></td> <td style="width: 10%;"></td> </tr> <tr> <td></td> <td></td> <td colspan="8" style="text-align: center;"> <table border="1" style="width: 100%; border-collapse: collapse; text-align: center;"> <tr> <td style="width: 10%;"></td> <td style="width: 10%;"></td> <td style="width: 10%;"></td> <td style="width: 10%;"></td> <td style="width: 10%;"></td> <td style="width: 10%;"></td> <td style="width: 10%;"></td> <td style="width: 10%;"></td> <td style="width: 10%;"></td> <td style="width: 10%;"></td> </tr> <tr> <td></td> <td></td> <td colspan="8" style="text-align: center;"> <table border="1" style="width: 100%; border-collapse: collapse; text-align: center;"> <tr> <td style="width: 10%;"></td> <td style="width: 10%;"></td> <td style="width: 10%;"></td> <td style="width: 10%;"></td> <td style="width: 10%;"></td> <td style="width: 10%;"></td> <td style="width: 10%;"></td> <td style="width: 10%;"></td> <td style="width: 10%;"></td> <td style="width: 10%;"></td> </tr> <tr> <td></td> <td></td> <td colspan="8" style="text-align: center;"> <table border="1" style="width: 100%; border-collapse:
collapse; text-align: center;"> <tr> <td style="width: 10%;"></td> <td style="width: 10%;"></td> <td style="width: 10%;"></td> <td style="width: 10%;"></td> <td style="width: 10%;"></td> <td style="width: 10%;"></td> <td style="width: 10%;"></td> <td style="width: 10%;"></td> <td style="width: 10%;"></td> <td style="width: 10%;"></td> </tr> <tr> <td></td> <td></td> <td colspan="8" style="text-align: center;"> <table border="1" style="width: 100%; border-collapse: collapse; text-align: center;"> <tr> <td style="width: 10%;"></td> <td style="width: 10%;"></td> <td style="width: 10%;"></td> <td style="width: 10%;"></td> <td style="width: 10%;"></td> <td style="width: 10%;"></td> <td style="width: 10%;"></td> <td style="width: 10%;"></td> <td style="width: 10%;"></td> <td style="width: 10%;"></td> </tr> <tr> <td></td> <td></td> <td colspan="8" style="text-align: center;"> <table border="1" style="width: 100%; border-collapse: collapse; text-align: center;"> <tr> <td style="width: 10%;"></td> <td style="width: 10%;"></td> <td style="width: 10%;"></td> <td style="width: 10%;"></td> <td style="width: 10%;"></td> <td style="width: 10%;"></td> <td style="width: 10%;"></td> <td style="width: 10%;"></td> <td style="width: 10%;"></td> <td style="width: 10%;"></td> </tr> <tr> <td></td> <td></td> <td colspan="8" style="text-align: center;"> <table border="1" style="width: 100%; border-collapse: collapse; text-align: center;"> <tr> <td style="width: 10%;"></td> <td style="width: 10%;"></td> <td style="width: 10%;"></td> <td style="width: 10%;"></td> <td style="width: 10%;"></td> <td style="width: 10%;"></td> <td style="width: 10%;"></td> <td style="width: 10%;"></td> <td style="width: 10%;"></td> <td style="width: 10%;"></td> </tr> <tr> <td></td> <td></td> <td colspan="8" style="text-align: center;"> <table border="1" style="width: 100%; border-collapse: collapse; text-align: center;"> <tr> <td style="width: 10%;"></td> <td style="width: 10%;"></td> <td style="width: 10%;"></td> <td style="width: 10%;"></td> <td style="width: 10%;"></td> <td style="width: 10%;"></td> <td style="width: 10%;"></td> <td style="width: 10%;"></td> <td style="width: 10%;"></td> <td style="width: 10%;"></td> </tr> <tr> <td></td> <td></td> <td colspan="8" style="text-align: center;"> <table border="1" style="width: 100%; border-collapse: collapse; text-align: center;"> <tr> <td style="width: 10%;"></td> <td style="width: 10%;"></td> <td style="width: 10%;"></td> <td style="width: 10%;"></td> <td style="width: 10%;"></td> <td style="width: 10%;"></td> <td style="width: 10%;"></td> <td style="width: 10%;"></td> <td style="width: 10%;"></td> <td style="width: 10%;"></td> </tr> <tr> <td></td> <td></td> <td colspan="8" style="text-align: center;"> <table border="1" style="width: 100%; border-collapse: collapse; text-align: center;"> <tr> <td style="width: 10%;"></td> <td style="width: 10%;"></td> <td style="width: 10%;"></td> <td style="width: 10%;"></td> <td style="width: 10%;"></td> <td style="width: 10%;"></td> <td style="width: 10%;"></td> <td style="width: 10%;"></td> <td style="width: 10%;"></td> <td style="width: 10%;"></td> </tr> <tr> <td></td> <td></td> <td colspan="8" style="text-align: center;"> <table border="1" style="width: 100%; border-collapse: collapse; text-align: center;"> <tr> <td style="width: 10%;"></td> <td style="width: 10%;"></td> <td style="width: 10%;"></td> <td style="width: 10%;"></td> <td style="width: 10%;"></td> <td style="width: 10%;"></td> <td style="width: 10%;"></td> <td style="width: 10%;"></td> <td style="width: 10%;"></td> <td style="width: 10%;"></td> </tr> <tr> <td></td> <td></td> <td colspan="8" style="text-align: center;"> <table border="1" style="width: 100%; border-collapse: collapse; text-align: center;"> <tr> <td style="width: 10%;"></td> <td style="width: 10%;"></td> <td style="width: 10%;"></td> <td style="width: 10%;"></td> <td style="width: 10%;"></td> <td style="width: 10%;"></td> <td style="width: 10%;"></td> <td style="width: 10%;"></td> <td style="width: 10%;"></td> <td style="width: 10%;"></td> </tr> <tr> <td></td> <td></td> <td colspan="8" style="text-align: center;"> <table border="1" style="width: 100%; border-collapse: collapse; text-align: center;"> <tr> <td style="width: 10%;"></td> <td style="width: 10%;"></td> <td style="width: 10%;"></td> <td style="width: 10%;"></td> <td style="width: 10%;"></td> <td style="width: 10%;"></td> <td style="width: 10%;"></td> <td style="width: 10%;"></td> <td style="width: 10%;"></td> <td style="width: 10%;"></td> </tr> <tr> <td></td> <td></td> <td colspan="8" style="text-align: center;"> <table border="1" style="width: 100%; border-collapse: collapse; text-align: center;"> <tr> <td style="width: 10%;"></td> <td style="width: 10%;"></td> <td style="width: 10%;"></td> <td style="width: 10%;"></td> <td style="width: 10%;"></td> <td style="width: 10%;"></td> <td style="width: 10%;"></td> <td style="width: 10%;"></td> <td style="width: 10%;"></td> <td style="width: 10%;"></td> </tr> <tr> <td></td> <td></td> <td colspan="8" style="text-align: center;"> <table border="1" style="width: 100%; border-collapse: collapse; text-align: center;"> <tr> <td style="width: 10%;"></td> <td style="width: 10%;"></td> <td style="width: 10%;"></td> <td style="width: 10%;"></td> <td style="width: 10%;"></td> <td style="width: 10%;"></td> <td style="width: 10%;"></td> <td style="width: 10%;"></td> <td style="width: 10%;"></td> <td style="width: 10%;"></td> </tr> <tr> <td></td> <td></td> <td colspan="8" style="text-align: center;"> <table border="1" style="width: 100%; border-collapse: collapse; text-align: center;"> <tr> <td style="width: 10%;"></td> <td style="width: 10%;"></td> <td style="width: 10%;"></td> <td style="width: 10%;"></td> <td style="width: 10%;"></td> <td style="width: 10%;"></td> <td style="width: 10%;"></td> <td style="width: 10%;"></td> <td style="width: 10%;"></td> <td style="width: 10%;"></td> </tr> <tr> <td></td> <td></td> <td colspan="8" style="text-align: center;"> <table border="1" style="width: 100%; border-collapse: collapse; text-align: center;"> <tr> <td style="width: 10%;"></td> <td style="width: 10%;"></td> <td style="width: 10%;"></td> <td style="width: 10%;"></td> <td style="width: 10%;"></td> <td style="width: 10%;"></td> <td style="width: 10%;"></td> <td style="width: 10%;"></td> <td style="width: 10%;"></td> <td style="width: 10%;"></td> </tr> <tr> <td></td> <td></td> <td colspan="8" style="text-align: center;"> <table border="1" style="width: 100%; border-collapse: collapse; text-align: center;"> <tr> <td style="width: 10%;"></td> <td style="width: 10%;"></td> <td style="width: 10%;"></td> <td style="width: 10%;"></td> <td style="width: 10%;"></td> <td style="width: 10%;"></td> <td style="width: 10%;"></td> <td style="width: 10%;"></td> <td style="width: 10%;"></td> <td style="width: 10%;"></td> </tr> <tr> <td></td> <td></td> <td colspan="8" style="text-align: center;"> <table border="1" style="width: 100%; border-collapse: collapse; text-align: center;"> <tr> <td style="width: 10%;"></td> <td style="width: 10%;"></td> <td style="width: 10%;"></td> <td style="width: 10%;"></td> <td style="width: 10%;"></td> <td style="width: 10%;"></td> <td style="width: 10%;"></td> <td style="width: 10%;"></td> <td style="width: 10%;"></td> <td style="width: 10%;"></td> </tr> <tr> <td></td> <td></td> <td colspan="8" style="text-align: center;"> <table border="1" style="width: 100%; border-collapse: collapse; text-align: center;"> <tr> <td style="width: 10%;"></td> <td style="width: 10%;"></td> <td style="width: 10%;"></td> <td style="width: 10%;"></td> <td style="width: 10%;"></td> <td style="width: 10%;"></td> <td style="width: 10%;"></td> <td style="width: 10%;"></td> <td style="width: 10%;"></td> <td style="width: 10%;"></td> </tr> <tr> <td></td> <td></td> <td colspan="8" style="text-align: center;"> <table border="1" style="width: 100%; border-collapse: collapse; text-align: center;"> <tr> <td style="width: 10%;"></td> <td style="width: 10%;"></td> <td style="width: 10%;"></td> <td style="width: 10%;"></td> <td style="width: 10%;"></td> <td style="width: 10%;"></td> <td style="width: 10%;"></td> <td style="width: 10%;"></td> <td style="width: 10%;"></td> <td style="width: 10%;"></td> </tr> <tr> <td></td> <td></td> <td colspan="8" style="text-align: center;"> <table border="1" style="width: 100%; border-collapse: collapse; text-align: center;"> <tr> <td style="width: 10%;"></td> <td style="width: 10%;"></td> <td style="width: 10%;"></td> <td style="width: 10%;"></td> <td style="width: 10%;"></td> <td style="width: 10%;"></td> <td style="width: 10%;"></td> <td style="width: 10%;"></td> <td style="width: 10%;"></td> <td style="width: 10%;"></td> </tr> <tr> <td></td> <td></td> <td colspan="8" style="text-align: center;"> <table border="1" style="width: 100%; border-collapse: collapse; text-align: center;"> <tr> <td style="width: 10%;"></td> <td style="width: 10%;"></td> <td style="width: 10%;"></td> <td style="width: 10%;"></td> <td style="width: 10%;"></td> <td style="width: 10%;"></td> <td style="width: 10%;"></td> <td style="width: 10%;"></td> <td style="width: 10%;"></td> <td style="width: 10%;"></td> </tr> <tr> <td></td> <td></td> <td colspan="8" style="text-align: center;"> <table border="1" style="width: 100%; border-collapse: collapse; text-align: center;"> <tr> <td style="width: 10%;"></td> <td style="width: 10%;"></td> <td style="width: 10%;"></td> <td style="width: 10%;"></td> <td style="width: 10%;"></td> <td style="width: 10%;"></td> <td style="width: 10%;"></td> <td style="width: 10%;"></td> <td style="width: 10%;"></td> <td style="width: 10%;"></td> </tr> <tr> <td></td> <td></td> <td colspan="8" style="text-align: center;"> <table border="1" style="width: 100%; border-collapse: collapse; text-align: center;"> <tr> <td style="width: 10%;"></td> <td style="width: 10%;"></td> <td style="width: 10%;"></td> <td style="width: 10%;"></td> <td
style="width: 10%;"></td> <td style="width: 10%;"></td> <td style="width: 10%;"></td> <td style="width: 10%;"></td> <td style="width: 10%;"></td> <td style="width: 10%;"></td> </tr> <tr> <td></td> <td></td> <td colspan="8" style="text-align: center;"> <table border="1" style="width: 100%; border-collapse: collapse; text-align: center;"> <tr> <td style="width: 10%;"></td> <td style="width: 10%;"></td> <td style="width: 10%;"></td> <td style="width: 10%;"></td> <td style="width: 10%;"></td> <td style="width: 10%;"></td> <td style="width: 10%;"></td> <td style="width: 10%;"></td> <td style="width: 10%;"></td> <td style="width: 10%;"></td> </tr> <tr> <td></td> <td></td> <td colspan="8" style="text-align: center;"> <table border="1" style="width: 100%; border-collapse: collapse; text-align: center;"> <tr> <td style="width: 10%;"></td> <td style="width: 10%;"></td> <td style="width: 10%;"></td> <td style="width: 10%;"></td> <td style="width: 10%;"></td> <td style="width: 10%;"></td> <td style="width: 10%;"></td> <td style="width: 10%;"></td> <td style="width: 10%;"></td> <td style="width: 10%;"></td> </tr> <tr> <td></td> <td></td> <td colspan="8" style="text-align: center;"> <table border="1" style="width: 100%; border-collapse: collapse; text-align: center;"> <tr> <td style="width: 10%;"></td> <td style="width: 10%;"></td> <td style="width: 10%;"></td> <td style="width: 10%;"></td> <td style="width: 10%;"></td> <td style="width: 10%;"></td> <td style="width: 10%;"></td> <td style="width: 10%;"></td> <td style="width: 10%;"></td> <td style="width: 10%;"></td> </tr> <tr> <td></td> <td></td> <td colspan="8" style="text-align: center;"> <table border="1" style="width: 100%; border-collapse: collapse; text-align: center;"> <tr> <td style="width: 10%;"></td> <td style="width: 10%;"></td> <td style="width: 10%;"></td> <td style="width: 10%;"></td> <td style="width: 10%;"></td> <td style="width: 10%;"></td> <td style="width: 10%;"></td> <td style="width: 10%;"></td> <td style="width: 10%;"></td> <td style="width: 10%;"></td> </tr> <tr> <td></td> <td></td> <td colspan="8" style="text-align: center;"> <table border="1" style="width: 100%; border-collapse: collapse; text-align: center;"> <tr> <td style="width: 10%;"></td> <td style="width: 10%;"></td> <td style="width: 10%;"></td> <td style="width: 10%;"></td> <td style="width: 10%;"></td> <td style="width: 10%;"></td> <td style="width: 10%;"></td> <td style="width: 10%;"></td> <td style="width: 10%;"></td> <td style="width: 10%;"></td> </tr> <tr> <td></td> <td></td> <td colspan="8" style="text-align: center;"> <table border="1" style="width: 100%; border-collapse: collapse; text-align: center;"> <tr> <td style="width: 10%;"></td> <td style="width: 10%;"></td> <td style="width: 10%;"></td> <td style="width: 10%;"></td> <td style="width: 10%;"></td> <td style="width: 10%;"></td> <td style="width: 10%;"></td> <td style="width: 10%;"></td> <td style="width: 10%;"></td> <td style="width: 10%;"></td> </tr> <tr> <td></td> <td></td> <td colspan="8" style="text-align: center;"> <table border="1" style="width: 100%; border-collapse: collapse; text-align: center;"> <tr> <td style="width: 10%;"></td> <td style="width: 10%;"></td> <td style="width: 10%;"></td> <td style="width: 10%;"></td> <td style="width: 10%;"></td> <td style="width: 10%;"></td> <td style="width: 10%;"></td> <td style="width: 10%;"></td> <td style="width: 10%;"></td> <td style="width: 10%;"></td> </tr> <tr> <td></td> <td></td> <td colspan="8" style="text-align: center;"> <table border="1" style="width: 100%; border-collapse: collapse; text-align: center;"> <tr> <td style="width: 10%;"></td> <td style="width: 10%;"></td> <td style="width: 10%;"></td> <td style="width: 10%;"></td> <td style="width: 10%;"></td> <td style="width: 10%;"></td> <td style="width: 10%;"></td> <td style="width: 10%;"></td> <td style="width: 10%;"></td> <td style="width: 10%;"></td> </tr> <tr> <td></td> <td></td> <td colspan="8" style="text-align: center;"> <table border="1" style="width: 100%; border-collapse: collapse; text-align: center;"> <tr> <td style="width: 10%;"></td> <td style="width: 10%;"></td> <td style="width: 10%;"></td> <td style="width: 10%;"></td> <td style="width: 10%;"></td> <td style="width: 10%;"></td> <td style="width: 10%;"></td> <td style="width: 10%;"></td> <td style="width: 10%;"></td> <td style="width: 10%;"></td> </tr> <tr> <td></td> <td></td> <td colspan="8" style="text-align: center;"> <table border="1" style="width: 100%; border-collapse: collapse; text-align: center;"> <tr> <td style="width: 10%;"></td> <td style="width: 10%;"></td> <td style="width: 10%;"></td> <td style="width: 10%;"></td> <td style="width: 10%;"></td> <td style="width: 10%;"></td> <td style="width: 10%;"></td> <td style="width: 10%;"></td> <td style="width: 10%;"></td> <td style="width: 10%;"></td> </tr> <tr> <td></td> <td></td> <td colspan="8" style="text-align: center;"> <table border="1" style="width: 100%; border-collapse: collapse; text-align: center;"> <tr> <td style="width: 10%;"></td> <td style="width: 10%;"></td> <td style="width: 10%;"></td> <td style="width: 10%;"></td> <td style="width: 10%;"></td> <td style="width: 10%;"></td> <td style="width: 10%;"></td> <td style="width: 10%;"></td> <td style="width: 10%;"></td> <td style="width: 10%;"></td> </tr> <tr> <td></td> <td></td> <td colspan="8" style="text-align: center;"> <table border="1" style="width: 100%; border-collapse: collapse; text-align: center;"> <tr> <td style="width: 10%;"></td> <td style="width: 10%;"></td> <td style="width: 10%;"></td> <td style="width: 10%;"></td> <td style="width: 10%;"></td> <td style="width: 10%;"></td> <td style="width: 10%;"></td> <td style="width: 10%;"></td> <td style="width: 10%;"></td> <td style="width: 10%;"></td> </tr> <tr> <td></td> <td></td> <td colspan="8" style="text-align: center;"> <table border="1" style="width: 100%; border-collapse: collapse; text-align: center;"> <tr> <td style="width: 10%;"></td> <td style="width: 10%;"></td> <td style="width: 10%;"></td> <td style="width: 10%;"></td> <td style="width: 10%;"></td> <td style="width: 10%;"></td> <td style="width: 10%;"></td> <td style="width: 10%;"></td> <td style="width: 10%;"></td> <td style="width: 10%;"></td> </tr> <tr> <td></td> <td></td> <td colspan="8" style="text-align: center;"> <table border="1" style="width: 100%; border-collapse: collapse; text-align: center;"> <tr> </tr></table></td></tr></table></td></tr></table></td></tr></table></td></tr></table></td></tr></table></td></tr></table></td></tr></table></td></tr></table></td></tr></table></td></tr></table></td></tr></table></td></tr></table></td></tr></table></td></tr></table></td></tr></table></td></tr></table></td></tr></table></td></tr></table></td></tr></table></td></tr></table></td></tr></table></td></tr></table></td></tr></table></td></tr></table></td></tr></table></td></tr></table></td></tr></table></td></tr></table></td></tr></table></td></tr></table></td></tr></table></td></tr></table></td></tr></table></td></tr></table></td></tr></table></td></tr></table></td></tr></table></td></tr></table></td></tr></table></td></tr></table></td></tr></table></td></tr></table>
 | | | | | | | | | | | | | | | | | | | | <table border="1" style="width: 100%; border-collapse: collapse; text-align: center;"> <tr> <td style="width: 10%;"></td> <td style="width: 10%;"></td> <td style="width: 10%;"></td> <td style="width: 10%;"></td> <td style="width: 10%;"></td> <td style="width: 10%;"></td> <td style="width: 10%;"></td> <td style="width: 10%;"></td> <td style="width: 10%;"></td> <td style="width: 10%;"></td> </tr> <tr> <td></td> <td></td> <td colspan="8" style="text-align: center;"> <table border="1" style="width: 100%; border-collapse: collapse; text-align: center;"> <tr> <td style="width: 10%;"></td> <td style="width: 10%;"></td> <td style="width: 10%;"></td> <td style="width: 10%;"></td> <td style="width: 10%;"></td> <td style="width: 10%;"></td> <td style="width: 10%;"></td> <td style="width: 10%;"></td> <td style="width: 10%;"></td> <td style="width: 10%;"></td> </tr> <tr> <td></td> <td></td> <td colspan="8" style="text-align: center;"> <table border="1" style="width: 100%; border-collapse: collapse; text-align: center;"> <tr> <td style="width: 10%;"></td> <td style="width: 10%;"></td> <td style="width: 10%;"></td> <td style="width: 10%;"></td> <td style="width: 10%;"></td> <td style="width: 10%;"></td> <td style="width: 10%;"></td> <td style="width: 10%;"></td> <td style="width: 10%;"></td> <td style="width: 10%;"></td> </tr> <tr> <td></td> <td></td> <td colspan="8" style="text-align: center;"> <table border="1" style="width: 100%; border-collapse: collapse; text-align: center;"> <tr> <td style="width: 10%;"></td> <td style="width: 10%;"></td> <td style="width: 10%;"></td> <td style="width: 10%;"></td> <td style="width: 10%;"></td> <td style="width: 10%;"></td> <td style="width: 10%;"></td> <td style="width: 10%;"></td> <td style="width: 10%;"></td> <td style="width: 10%;"></td> </tr> <tr> <td></td> <td></td> <td colspan="8" style="text-align: center;"> <table border="1" style="width: 100%; border-collapse: collapse; text-align: center;"> <tr> <td style="width: 10%;"></td> <td style="width: 10%;"></td> <td style="width: 10%;"></td> <td style="width: 10%;"></td> <td style="width: 10%;"></td> <td style="width: 10%;"></td> <td style="width: 10%;"></td> <td style="width: 10%;"></td> <td style="width: 10%;"></td> <td style="width: 10%;"></td> </tr> <tr> <td></td> <td></td> <td colspan="8" style="text-align: center;"> <table border="1" style="width: 100%; border-collapse: collapse; text-align: center;"> <tr> <td style="width: 10%;"></td> <td style="width: 10%;"></td> <td style="width: 10%;"></td> <td style="width: 10%;"></td> <td style="width: 10%;"></td> <td style="width: 10%;"></td> <td style="width: 10%;"></td> <td style="width: 10%;"></td> <td style="width: 10%;"></td> <td style="width: 10%;"></td> </tr> <tr> <td></td> <td></td> <td colspan="8" style="text-align: center;"> <table border="1" style="width: 100%; border-collapse: collapse; text-align: center;"> <tr> <td style="width: 10%;"></td> <td style="width: 10%;"></td> <td style="width: 10%;"></td> <td style="width: 10%;"></td> <td style="width: 10%;"></td> <td style="width: 10%;"></td> <td style="width: 10%;"></td> <td style="width: 10%;"></td> <td style="width: 10%;"></td> <td style="width: 10%;"></td> </tr> <tr> <td></td> <td></td> <td colspan="8" style="text-align: center;"> <table border="1" style="width: 100%; border-collapse: collapse; text-align: center;"> <tr> <td style="width: 10%;"></td> <td style="width: 10%;"></td> <td style="width: 10%;"></td> <td style="width: 10%;"></td> <td style="width: 10%;"></td> <td style="width: 10%;"></td> <td style="width: 10%;"></td> <td style="width: 10%;"></td> <td style="width: 10%;"></td> <td style="width: 10%;"></td> </tr> <tr> <td></td> <td></td> <td colspan="8" style="text-align: center;"> <table border="1" style="width: 100%; border-collapse: collapse; text-align: center;"> <tr> <td style="width: 10%;"></td> <td style="width: 10%;"></td> <td style="width: 10%;"></td> <td style="width: 10%;"></td> <td style="width: 10%;"></td> <td style="width: 10%;"></td> <td style="width: 10%;"></td> <td style="width: 10%;"></td> <td style="width: 10%;"></td> <td style="width: 10%;"></td> </tr> <tr> <td></td> <td></td> <td colspan="8" style="text-align: center;"> <table border="1" style="width: 100%; border-collapse: collapse; text-align: center;"> <tr> <td style="width: 10%;"></td> <td style="width: 10%;"></td> <td style="width: 10%;"></td> <td style="width: 10%;"></td> <td style="width: 10%;"></td> <td style="width: 10%;"></td> <td style="width: 10%;"></td> <td style="width: 10%;"></td> <td style="width: 10%;"></td> <td style="width: 10%;"></td> </tr> <tr> <td></td> <td></td> <td colspan="8" style="text-align: center;"> <table border="1" style="width: 100%; border-collapse: collapse; text-align: center;"> <tr> <td style="width: 10%;"></td> <td style="width: 10%;"></td> <td style="width: 10%;"></td> <td style="width: 10%;"></td> <td style="width: 10%;"></td> <td style="width: 10%;"></td> <td style="width: 10%;"></td> <td style="width: 10%;"></td> <td style="width: 10%;"></td> <td style="width: 10%;"></td> </tr> <tr> <td></td> <td></td> <td colspan="8" style="text-align: center;"> <table border="1" style="width: 100%; border-collapse: collapse; text-align: center;"> <tr> <td style="width: 10%;"></td> <td style="width: 10%;"></td> <td style="width: 10%;"></td> <td style="width: 10%;"></td> <td style="width: 10%;"></td> <td style="width: 10%;"></td> <td style="width: 10%;"></td> <td style="width: 10%;"></td> <td style="width: 10%;"></td> <td style="width: 10%;"></td> </tr> <tr> <td></td> <td></td> <td colspan="8" style="text-align: center;"> <table border="1" style="width: 100%; border-collapse: collapse; text-align: center;"> <tr> <td style="width: 10%;"></td> <td style="width: 10%;"></td> <td style="width: 10%;"></td> <td style="width: 10%;"></td> <td style="width: 10%;"></td> <td style="width: 10%;"></td> <td style="width: 10%;"></td> <td style="width:
10%;"></td> <td style="width: 10%;"></td> <td style="width: 10%;"></td> </tr> <tr> <td></td> <td></td> <td colspan="8" style="text-align: center;"> <table border="1" style="width: 100%; border-collapse: collapse; text-align: center;"> <tr> <td style="width: 10%;"></td> <td style="width: 10%;"></td> <td style="width: 10%;"></td> <td style="width: 10%;"></td> <td style="width: 10%;"></td> <td style="width: 10%;"></td> <td style="width: 10%;"></td> <td style="width: 10%;"></td> <td style="width: 10%;"></td> <td style="width: 10%;"></td> </tr> <tr> <td></td> <td></td> <td colspan="8" style="text-align: center;"> <table border="1" style="width: 100%; border-collapse: collapse; text-align: center;"> <tr> <td style="width: 10%;"></td> <td style="width: 10%;"></td> <td style="width: 10%;"></td> <td style="width: 10%;"></td> <td style="width: 10%;"></td> <td style="width: 10%;"></td> <td style="width: 10%;"></td> <td style="width: 10%;"></td> <td style="width: 10%;"></td> <td style="width: 10%;"></td> </tr> <tr> <td></td> <td></td> <td colspan="8" style="text-align: center;"> <table border="1" style="width: 100%; border-collapse: collapse; text-align: center;"> <tr> <td style="width: 10%;"></td> <td style="width: 10%;"></td> <td style="width: 10%;"></td> <td style="width: 10%;"></td> <td style="width: 10%;"></td> <td style="width: 10%;"></td> <td style="width: 10%;"></td> <td style="width: 10%;"></td> <td style="width: 10%;"></td> <td style="width: 10%;"></td> </tr> <tr> <td></td> <td></td> <td colspan="8" style="text-align: center;"> <table border="1" style="width: 100%; border-collapse: collapse; text-align: center;"> <tr> <td style="width: 10%;"></td> <td style="width: 10%;"></td> <td style="width: 10%;"></td> <td style="width: 10%;"></td> <td style="width: 10%;"></td> <td style="width: 10%;"></td> <td style="width: 10%;"></td> <td style="width: 10%;"></td> <td style="width: 10%;"></td> <td style="width: 10%;"></td> </tr> <tr> <td></td> <td></td> <td colspan="8" style="text-align: center;"> <table border="1" style="width: 100%; border-collapse: collapse; text-align: center;"> <tr> <td style="width: 10%;"></td> <td style="width: 10%;"></td> <td style="width: 10%;"></td> <td style="width: 10%;"></td> <td style="width: 10%;"></td> <td style="width: 10%;"></td> <td style="width: 10%;"></td> <td style="width: 10%;"></td> <td style="width: 10%;"></td> <td style="width: 10%;"></td> </tr> <tr> <td></td> <td></td> <td colspan="8" style="text-align: center;"> <table border="1" style="width: 100%; border-collapse: collapse; text-align: center;"> <tr> <td style="width: 10%;"></td> <td style="width: 10%;"></td> <td style="width: 10%;"></td> <td style="width: 10%;"></td> <td style="width: 10%;"></td> <td style="width: 10%;"></td> <td style="width: 10%;"></td> <td style="width: 10%;"></td> <td style="width: 10%;"></td> <td style="width: 10%;"></td> </tr> <tr> <td></td> <td></td> <td colspan="8" style="text-align: center;"> <table border="1" style="width: 100%; border-collapse: collapse; text-align: center;"> <tr> <td style="width: 10%;"></td> <td style="width: 10%;"></td> <td style="width: 10%;"></td> <td style="width: 10%;"></td> <td style="width: 10%;"></td> <td style="width: 10%;"></td> <td style="width: 10%;"></td> <td style="width: 10%;"></td> <td style="width: 10%;"></td> <td style="width: 10%;"></td> </tr> <tr> <td></td> <td></td> <td colspan="8" style="text-align: center;"> <table border="1" style="width: 100%; border-collapse: collapse; text-align: center;"> <tr> <td style="width: 10%;"></td> <td style="width: 10%;"></td> <td style="width: 10%;"></td> <td style="width: 10%;"></td> <td style="width: 10%;"></td> <td style="width: 10%;"></td> <td style="width: 10%;"></td> <td style="width: 10%;"></td> <td style="width: 10%;"></td> <td style="width: 10%;"></td> </tr> <tr> <td></td> <td></td> <td colspan="8" style="text-align: center;"> <table border="1" style="width: 100%; border-collapse: collapse; text-align: center;"> <tr> <td style="width: 10%;"></td> <td style="width: 10%;"></td> <td style="width: 10%;"></td> <td style="width: 10%;"></td> <td style="width: 10%;"></td> <td style="width: 10%;"></td> <td style="width: 10%;"></td> <td style="width: 10%;"></td> <td style="width: 10%;"></td> <td style="width: 10%;"></td> </tr> <tr> <td></td> <td></td> <td colspan="8" style="text-align: center;"> <table border="1" style="width: 100%; border-collapse: collapse; text-align: center;"> <tr> <td style="width: 10%;"></td> <td style="width: 10%;"></td> <td style="width: 10%;"></td> <td style="width: 10%;"></td> <td style="width: 10%;"></td> <td style="width: 10%;"></td> <td style="width: 10%;"></td> <td style="width: 10%;"></td> <td style="width: 10%;"></td> <td style="width: 10%;"></td> </tr> <tr> <td></td> <td></td> <td colspan="8" style="text-align: center;"> <table border="1" style="width: 100%; border-collapse: collapse; text-align: center;"> <tr> <td style="width: 10%;"></td> <td style="width: 10%;"></td> <td style="width: 10%;"></td> <td style="width: 10%;"></td> <td style="width: 10%;"></td> <td style="width: 10%;"></td> <td style="width: 10%;"></td> <td style="width: 10%;"></td> <td style="width: 10%;"></td> <td style="width: 10%;"></td> </tr> <tr> <td></td> <td></td> <td colspan="8" style="text-align: center;"> <table border="1" style="width: 100%; border-collapse: collapse; text-align: center;"> <tr> <td style="width: 10%;"></td> <td style="width: 10%;"></td> <td style="width: 10%;"></td> <td style="width: 10%;"></td> <td style="width: 10%;"></td> <td style="width: 10%;"></td> <td style="width: 10%;"></td> <td style="width: 10%;"></td> <td style="width: 10%;"></td> <td style="width: 10%;"></td> </tr> <tr> <td></td> <td></td> <td colspan="8" style="text-align: center;"> <table border="1" style="width: 100%; border-collapse: collapse; text-align: center;"> <tr> <td style="width: 10%;"></td> <td style="width: 10%;"></td> <td style="width: 10%;"></td> <td style="width: 10%;"></td> <td style="width: 10%;"></td> <td style="width: 10%;"></td> <td style="width: 10%;"></td> <td style="width: 10%;"></td> <td style="width: 10%;"></td> <td style="width: 10%;"></td> </tr> <tr> <td></td> <td></td> <td colspan="8" style="text-align: center;"> <table border="1" style="width: 100%; border-collapse: collapse; text-align: center;"> <tr> <td style="width: 10%;"></td> <td style="width: 10%;"></td> <td style="width: 10%;"></td> <td style="width: 10%;"></td> <td style="width: 10%;"></td> <td style="width: 10%;"></td> <td style="width: 10%;"></td> <td style="width: 10%;"></td> <td style="width: 10%;"></td> <td style="width: 10%;"></td> </tr> <tr> <td></td> <td></td> <td colspan="8" style="text-align: center;"> <table border="1" style="width: 100%; border-collapse: collapse; text-align: center;"> <tr> <td style="width: 10%;"></td> <td style="width: 10%;"></td> <td style="width: 10%;"></td> <td style="width: 10%;"></td> <td style="width: 10%;"></td> <td style="width: 10%;"></td> <td style="width: 10%;"></td> <td style="width: 10%;"></td> <td style="width: 10%;"></td> <td style="width: 10%;"></td> </tr> <tr> <td></td> <td></td> <td colspan="8" style="text-align: center;"> <table border="1" style="width: 100%; border-collapse: collapse; text-align: center;"> <tr> <td style="width: 10%;"></td> <td style="width: 10%;"></td> <td style="width: 10%;"></td> <td style="width: 10%;"></td> <td style="width: 10%;"></td> <td style="width: 10%;"></td> <td style="width: 10%;"></td> <td style="width: 10%;"></td> <td style="width: 10%;"></td> <td style="width: 10%;"></td> </tr> <tr> <td></td> <td></td> <td colspan="8" style="text-align: center;"> <table border="1" style="width: 100%; border-collapse: collapse; text-align: center;"> <tr> <td style="width: 10%;"></td> <td style="width: 10%;"></td> <td style="width: 10%;"></td> <td style="width: 10%;"></td> <td style="width: 10%;"></td> <td style="width: 10%;"></td> <td style="width: 10%;"></td> <td style="width: 10%;"></td> <td style="width: 10%;"></td> <td style="width: 10%;"></td> </tr> <tr> <td></td> <td></td> <td colspan="8" style="text-align: center;"> <table border="1" style="width: 100%; border-collapse: collapse; text-align: center;"> <tr> <td style="width: 10%;"></td> <td style="width: 10%;"></td> <td style="width: 10%;"></td> <td style="width: 10%;"></td> <td style="width: 10%;"></td> <td style="width: 10%;"></td> <td style="width: 10%;"></td> <td style="width: 10%;"></td> <td style="width: 10%;"></td> <td style="width: 10%;"></td> </tr> <tr> <td></td> <td></td> <td colspan="8" style="text-align: center;"> <table border="1" style="width: 100%; border-collapse: collapse; text-align: center;"> <tr> <td style="width: 10%;"></td> <td style="width: 10%;"></td> <td style="width: 10%;"></td> <td style="width: 10%;"></td> <td style="width: 10%;"></td> <td style="width: 10%;"></td> <td style="width: 10%;"></td> <td style="width: 10%;"></td> <td style="width: 10%;"></td> <td style="width: 10%;"></td> </tr> <tr> <td></td> <td></td> <td colspan="8" style="text-align: center;"> <table border="1" style="width: 100%; border-collapse: collapse; text-align: center;"> <tr> <td style="width: 10%;"></td> <td style="width: 10%;"></td> <td style="width: 10%;"></td> <td style="width: 10%;"></td> <td style="width: 10%;"></td> <td style="width: 10%;"></td> <td style="width: 10%;"></td> <td style="width: 10%;"></td> <td style="width: 10%;"></td> <td style="width: 10%;"></td> </tr> <tr> <td></td> <td></td> <td colspan="8" style="text-align: center;"> <table border="1" style="width: 100%; border-collapse: collapse; text-align: center;"> <tr> <td style="width: 10%;"></td> <td style="width: 10%;"></td> <td style="width: 10%;"></td> <td style="width: 10%;"></td> <td style="width: 10%;"></td> <td style="width: 10%;"></td> <td style="width: 10%;"></td> <td style="width: 10%;"></td> <td style="width: 10%;"></td> <td style="width: 10%;"></td> </tr> <tr> <td></td> <td></td> <td colspan="8" style="text-align: center;"> <table border="1"
style="width: 100%; border-collapse: collapse; text-align: center;"> <tr> <td style="width: 10%;"></td> <td style="width: 10%;"></td> <td style="width: 10%;"></td> <td style="width: 10%;"></td> <td style="width: 10%;"></td> <td style="width: 10%;"></td> <td style="width: 10%;"></td> <td style="width: 10%;"></td> <td style="width: 10%;"></td> <td style="width: 10%;"></td> </tr> <tr> <td></td> <td></td> <td colspan="8" style="text-align: center;"> <table border="1" style="width: 100%; border-collapse: collapse; text-align: center;"> <tr> <td style="width: 10%;"></td> <td style="width: 10%;"></td> <td style="width: 10%;"></td> <td style="width: 10%;"></td> <td style="width: 10%;"></td> <td style="width: 10%;"></td> <td style="width: 10%;"></td> <td style="width: 10%;"></td> <td style="width: 10%;"></td> <td style="width: 10%;"></td> </tr> <tr> <td></td> <td></td> <td colspan="8" style="text-align: center;"> <table border="1" style="width: 100%; border-collapse: collapse; text-align: center;"> <tr> <td style="width: 10%;"></td> <td style="width: 10%;"></td> <td style="width: 10%;"></td> <td style="width: 10%;"></td> <td style="width: 10%;"></td> <td style="width: 10%;"></td> <td style="width: 10%;"></td> <td style="width: 10%;"></td> <td style="width: 10%;"></td> <td style="width: 10%;"></td> </tr> <tr> <td></td> <td></td> <td colspan="8" style="text-align: center;"> <table border="1" style="width: 100%; border-collapse: collapse; text-align: center;"> <tr> <td style="width: 10%;"></td> <td style="width: 10%;"></td> <td style="width: 10%;"></td> <td style="width: 10%;"></td> <td style="width: 10%;"></td> <td style="width: 10%;"></td> <td style="width: 10%;"></td> <td style="width: 10%;"></td> <td style="width: 10%;"></td> <td style="width: 10%;"></td> </tr> <tr> <td></td> <td></td> <td colspan="8" style="text-align: center;"> <table border="1" style="width: 100%; border-collapse: collapse; text-align: center;"> <tr> <td style="width: 10%;"></td> <td style="width: 10%;"></td> <td style="width: 10%;"></td> <td style="width: 10%;"></td> <td style="width: 10%;"></td> <td style="width: 10%;"></td> <td style="width: 10%;"></td> <td style="width: 10%;"></td> <td style="width: 10%;"></td> <td style="width: 10%;"></td> </tr> <tr> <td></td> <td></td> <td colspan="8" style="text-align: center;"> <table border="1" style="width: 100%; border-collapse: collapse; text-align: center;"> <tr> <td style="width: 10%;"></td> <td style="width: 10%;"></td> <td style="width: 10%;"></td> <td style="width: 10%;"></td> <td style="width: 10%;"></td> <td style="width: 10%;"></td> <td style="width: 10%;"></td> <td style="width: 10%;"></td> <td style="width: 10%;"></td> <td style="width: 10%;"></td> </tr> <tr> <td></td> <td></td> <td colspan="8" style="text-align: center;"> <table border="1" style="width: 100%; border-collapse: collapse; text-align: center;"> <tr> <td style="width: 10%;"></td> <td style="width: 10%;"></td> <td style="width: 10%;"></td> <td style="width: 10%;"></td> <td style="width: 10%;"></td> <td style="width: 10%;"></td> <td style="width: 10%;"></td> <td style="width: 10%;"></td> <td style="width: 10%;"></td> <td style="width: 10%;"></td> </tr> <tr> <td></td> <td></td> <td colspan="8" style="text-align: center;"> <table border="1" style="width: 100%; border-collapse: collapse; text-align: center;"> <tr> </tr></table></td></tr></table></td></tr></table></td></tr></table></td></tr></table></td></tr></table></td></tr></table></td></tr></table></td></tr></table></td></tr></table></td></tr></table></td></tr></table></td></tr></table></td></tr></table></td></tr></table></td></tr></table></td></tr></table></td></tr></table></td></tr></table></td></tr></table></td></tr></table></td></tr></table></td></tr></table></td></tr></table></td></tr></table></td></tr></table></td></tr></table></td></tr></table></td></tr></table></td></tr></table></td></tr></table></td></tr></table></td></tr></table></td></tr></table></td></tr></table></td></tr></table></td></tr></table></td></tr></table></td></tr></table></td></tr></table></td></tr></table></td></tr></table>
 | | | | | | | | | | | | | | | | | | | | <table border="1" style="width: 100%; border-collapse: collapse; text-align: center;"> <tr> <td style="width: 10%;"></td> <td style="width: 10%;"></td> <td style="width: 10%;"></td> <td style="width: 10%;"></td> <td style="width: 10%;"></td> <td style="width: 10%;"></td> <td style="width: 10%;"></td> <td style="width: 10%;"></td> <td style="width: 10%;"></td> <td style="width: 10%;"></td> </tr> <tr> <td></td> <td></td> <td colspan="8" style="text-align: center;"> <table border="1" style="width: 100%; border-collapse: collapse; text-align: center;"> <tr> <td style="width: 10%;"></td> <td style="width: 10%;"></td> <td style="width: 10%;"></td> <td style="width: 10%;"></td> <td style="width: 10%;"></td> <td style="width: 10%;"></td> <td style="width: 10%;"></td> <td style="width: 10%;"></td> <td style="width: 10%;"></td> <td style="width: 10%;"></td> </tr> <tr> <td></td> <td></td> <td colspan="8" style="text-align: center;"> <table border="1" style="width: 100%; border-collapse: collapse; text-align: center;"> <tr> <td style="width: 10%;"></td> <td style="width: 10%;"></td> <td style="width: 10%;"></td> <td style="width: 10%;"></td> <td style="width: 10%;"></td> <td style="width: 10%;"></td> <td style="width: 10%;"></td> <td style="width: 10%;"></td> <td style="width: 10%;"></td> <td style="width: 10%;"></td> </tr> <tr> <td></td> <td></td> <td colspan="8" style="text-align: center;"> <table border="1" style="width: 100%; border-collapse: collapse; text-align: center;"> <tr> <td style="width: 10%;"></td> <td style="width: 10%;"></td> <td style="width: 10%;"></td> <td style="width: 10%;"></td> <td style="width: 10%;"></td> <td style="width: 10%;"></td> <td style="width: 10%;"></td> <td style="width: 10%;"></td> <td style="width: 10%;"></td> <td style="width: 10%;"></td> </tr> <tr> <td></td> <td></td> <td colspan="8" style="text-align: center;"> <table border="1" style="width: 100%; border-collapse: collapse; text-align: center;"> <tr> <td style="width: 10%;"></td> <td style="width: 10%;"></td> <td style="width: 10%;"></td> <td style="width: 10%;"></td> <td style="width: 10%;"></td> <td style="width: 10%;"></td> <td style="width: 10%;"></td> <td style="width: 10%;"></td> <td style="width: 10%;"></td> <td style="width: 10%;"></td> </tr> <tr> <td></td> <td></td> <td colspan="8" style="text-align: center;"> <table border="1" style="width: 100%; border-collapse: collapse; text-align: center;"> <tr> <td style="width: 10%;"></td> <td style="width: 10%;"></td> <td style="width: 10%;"></td> <td style="width: 10%;"></td> <td style="width: 10%;"></td> <td style="width: 10%;"></td> <td style="width: 10%;"></td> <td style="width: 10%;"></td> <td style="width: 10%;"></td> <td style="width: 10%;"></td> </tr> <tr> <td></td> <td></td> <td colspan="8" style="text-align: center;"> <table border="1" style="width: 100%; border-collapse: collapse; text-align: center;"> <tr> <td style="width: 10%;"></td> <td style="width: 10%;"></td> <td style="width: 10%;"></td> <td style="width: 10%;"></td> <td style="width: 10%;"></td> <td style="width: 10%;"></td> <td style="width: 10%;"></td> <td style="width: 10%;"></td> <td style="width: 10%;"></td> <td style="width: 10%;"></td> </tr> <tr> <td></td> <td></td> <td colspan="8" style="text-align: center;"> <table border="1" style="width: 100%; border-collapse: collapse; text-align: center;"> <tr> <td style="width: 10%;"></td> <td style="width: 10%;"></td> <td style="width: 10%;"></td> <td style="width: 10%;"></td> <td style="width: 10%;"></td> <td style="width: 10%;"></td> <td style="width: 10%;"></td> <td style="width: 10%;"></td> <td style="width: 10%;"></td> <td style="width: 10%;"></td> </tr> <tr> <td></td> <td></td> <td colspan="8" style="text-align: center;"> <table border="1" style="width: 100%; border-collapse: collapse; text-align: center;"> <tr> <td style="width: 10%;"></td> <td style="width: 10%;"></td> <td style="width: 10%;"></td> <td style="width: 10%;"></td> <td style="width: 10%;"></td> <td style="width: 10%;"></td> <td style="width: 10%;"></td> <td style="width: 10%;"></td> <td style="width: 10%;"></td> <td style="width: 10%;"></td> </tr> <tr> <td></td> <td></td> <td colspan="8" style="text-align: center;"> <table border="1" style="width: 100%; border-collapse: collapse; text-align: center;"> <tr> <td style="width: 10%;"></td> <td style="width: 10%;"></td> <td style="width: 10%;"></td> <td style="width: 10%;"></td> <td style="width: 10%;"></td> <td style="width: 10%;"></td> <td style="width: 10%;"></td> <td style="width: 10%;"></td> <td style="width: 10%;"></td> <td style="width: 10%;"></td> </tr> <tr> <td></td> <td></td> <td colspan="8" style="text-align: center;"> <table border="1" style="width: 100%; border-collapse: collapse; text-align: center;"> <tr> <td style="width: 10%;"></td> <td style="width: 10%;"></td> <td style="width: 10%;"></td> <td style="width: 10%;"></td> <td style="width: 10%;"></td> <td style="width: 10%;"></td> <td style="width: 10%;"></td> <td style="width: 10%;"></td> <td style="width: 10%;"></td> <td style="width: 10%;"></td> </tr> <tr> <td></td> <td></td> <td colspan="8" style="text-align: center;"> <table border="1" style="width: 100%; border-collapse: collapse; text-align: center;"> <tr> <td style="width: 10%;"></td> <td style="width: 10%;"></td> <td style="width: 10%;"></td> <td style="width: 10%;"></td> <td style="width: 10%;"></td> <td style="width: 10%;"></td> <td style="width: 10%;"></td> <td style="width: 10%;"></td> <td style="width: 10%;"></td> <td style="width: 10%;"></td> </tr> <tr> <td></td> <td></td> <td colspan="8" style="text-align: center;"> <table border="1" style="width: 100%; border-collapse: collapse; text-align: center;"> <tr> <td style="width: 10%;"></td> <td style="width: 10%;"></td> <td style="width: 10%;"></td> <td style="width: 10%;"></td> <td style="width: 10%;"></td> <td style="width: 10%;"></td> <td style="width: 10%;"></td> <td style="width: 10%;"></td> <td style="width: 10%;"></td> <td style="width: 10%;"></td> </tr> <tr> <td></td> <td></td> <td colspan="8" style="text-align: center;"> <table border="1" style="width: 100%; border-collapse: collapse; text-align: center;"> <tr> <td style="width: 10%;"></td> <td style="width: 10%;"></td> <td style="width: 10%;"></td> <td style="width: 10%;"></td> <td style="width: 10%;"></td> <td style="width: 10%;"></td> <td style="width: 10%;"></td> <td style="width: 10%;"></td> <td style="width: 10%;"></td> <td style="width: 10%;"></td> </tr> <tr> <td></td> <td></td> <td colspan="8" style="text-align: center;"> <table border="1" style="width: 100%; border-collapse: collapse; text-align: center;"> <tr> <td style="width: 10%;"></td> <td style="width: 10%;"></td> <td style="width: 10%;"></td> <td style="width: 10%;"></td> <td style="width: 10%;"></td> <td style="width: 10%;"></td> <td style="width: 10%;"></td> <td style="width: 10%;"></td> <td style="width: 10%;"></td> <td style="width: 10%;"></td> </tr> <tr> <td></td> <td></td> <td colspan="8" style="text-align: center;"> <table border="1" style="width: 100%; border-collapse: collapse; text-align: center;"> <tr> <td style="width: 10%;"></td> <td style="width: 10%;"></td> <td style="width: 10%;"></td> <td style="width: 10%;"></td> <td style="width: 10%;"></td> <td style="width: 10%;"></td> <td style="width: 10%;"></td> <td style="width: 10%;"></td> <td style="width: 10%;"></td> <td style="width: 10%;"></td> </tr> <tr> <td></td> <td></td> <td colspan="8" style="text-align: center;"> <table border="1" style="width: 100%; border-collapse: collapse; text-align: center;"> <tr> <td style="width: 10%;"></td> <td style="width: 10%;"></td> <td style="width: 10%;"></td> <td style="width: 10%;"></td> <td style="width: 10%;"></td> <td style="width: 10%;"></td> <td style="width: 10%;"></td> <td style="width: 10%;"></td> <td style="width: 10%;"></td> <td style="width: 10%;"></td> </tr> <tr> <td></td> <td></td> <td colspan="8" style="text-align: center;"> <table border="1" style="width: 100%; border-collapse: collapse; text-align: center;"> <tr> <td style="width: 10%;"></td> <td style="width: 10%;"></td> <td style="width: 10%;"></td> <td style="width: 10%;"></td> <td style="width: 10%;"></td> <td style="width: 10%;"></td> <td style="width: 10%;"></td> <td style="width: 10%;"></td> <td style="width: 10%;"></td> <td style="width: 10%;"></td> </tr> <tr> <td></td> <td></td> <td colspan="8" style="text-align: center;"> <table border="1" style="width: 100%; border-collapse: collapse; text-align: center;"> <tr> <td style="width: 10%;"></td> <td style="width: 10%;"></td> <td style="width: 10%;"></td> <td style="width: 10%;"></td> <td style="width: 10%;"></td> <td style="width: 10%;"></td> <td style="width: 10%;"></td> <td style="width: 10%;"></td> <td style="width: 10%;"></td> <td style="width: 10%;"></td> </tr> <tr> <td></td> <td></td> <td colspan="8" style="text-align: center;"> <table border="1" style="width: 100%; border-collapse: collapse; text-align: center;"> <tr> <td style="width: 10%;"></td> <td style="width:
10%;"></td> <td style="width: 10%;"></td> <td style="width: 10%;"></td> <td style="width: 10%;"></td> <td style="width: 10%;"></td> <td style="width: 10%;"></td> <td style="width: 10%;"></td> <td style="width: 10%;"></td> <td style="width: 10%;"></td> </tr> <tr> <td></td> <td></td> <td colspan="8" style="text-align: center;"> <table border="1" style="width: 100%; border-collapse: collapse; text-align: center;"> <tr> <td style="width: 10%;"></td> <td style="width: 10%;"></td> <td style="width: 10%;"></td> <td style="width: 10%;"></td> <td style="width: 10%;"></td> <td style="width: 10%;"></td> <td style="width: 10%;"></td> <td style="width: 10%;"></td> <td style="width: 10%;"></td> <td style="width: 10%;"></td> </tr> <tr> <td></td> <td></td> <td colspan="8" style="text-align: center;"> <table border="1" style="width: 100%; border-collapse: collapse; text-align: center;"> <tr> <td style="width: 10%;"></td> <td style="width: 10%;"></td> <td style="width: 10%;"></td> <td style="width: 10%;"></td> <td style="width: 10%;"></td> <td style="width: 10%;"></td> <td style="width: 10%;"></td> <td style="width: 10%;"></td> <td style="width: 10%;"></td> <td style="width: 10%;"></td> </tr> <tr> <td></td> <td></td> <td colspan="8" style="text-align: center;"> <table border="1" style="width: 100%; border-collapse: collapse; text-align: center;"> <tr> <td style="width: 10%;"></td> <td style="width: 10%;"></td> <td style="width: 10%;"></td> <td style="width: 10%;"></td> <td style="width: 10%;"></td> <td style="width: 10%;"></td> <td style="width: 10%;"></td> <td style="width: 10%;"></td> <td style="width: 10%;"></td> <td style="width: 10%;"></td> </tr> <tr> <td></td> <td></td> <td colspan="8" style="text-align: center;"> <table border="1" style="width: 100%; border-collapse: collapse; text-align: center;"> <tr> <td style="width: 10%;"></td> <td style="width: 10%;"></td> <td style="width: 10%;"></td> <td style="width: 10%;"></td> <td style="width: 10%;"></td> <td style="width: 10%;"></td> <td style="width: 10%;"></td> <td style="width: 10%;"></td> <td style="width: 10%;"></td> <td style="width: 10%;"></td> </tr> <tr> <td></td> <td></td> <td colspan="8" style="text-align: center;"> <table border="1" style="width: 100%; border-collapse: collapse; text-align: center;"> <tr> <td style="width: 10%;"></td> <td style="width: 10%;"></td> <td style="width: 10%;"></td> <td style="width: 10%;"></td> <td style="width: 10%;"></td> <td style="width: 10%;"></td> <td style="width: 10%;"></td> <td style="width: 10%;"></td> <td style="width: 10%;"></td> <td style="width: 10%;"></td> </tr> <tr> <td></td> <td></td> <td colspan="8" style="text-align: center;"> <table border="1" style="width: 100%; border-collapse: collapse; text-align: center;"> <tr> <td style="width: 10%;"></td> <td style="width: 10%;"></td> <td style="width: 10%;"></td> <td style="width: 10%;"></td> <td style="width: 10%;"></td> <td style="width: 10%;"></td> <td style="width: 10%;"></td> <td style="width: 10%;"></td> <td style="width: 10%;"></td> <td style="width: 10%;"></td> </tr> <tr> <td></td> <td></td> <td colspan="8" style="text-align: center;"> <table border="1" style="width: 100%; border-collapse: collapse; text-align: center;"> <tr> <td style="width: 10%;"></td> <td style="width: 10%;"></td> <td style="width: 10%;"></td> <td style="width: 10%;"></td> <td style="width: 10%;"></td> <td style="width: 10%;"></td> <td style="width: 10%;"></td> <td style="width: 10%;"></td> <td style="width: 10%;"></td> <td style="width: 10%;"></td> </tr> <tr> <td></td> <td></td> <td colspan="8" style="text-align: center;"> <table border="1" style="width: 100%; border-collapse: collapse; text-align: center;"> <tr> <td style="width: 10%;"></td> <td style="width: 10%;"></td> <td style="width: 10%;"></td> <td style="width: 10%;"></td> <td style="width: 10%;"></td> <td style="width: 10%;"></td> <td style="width: 10%;"></td> <td style="width: 10%;"></td> <td style="width: 10%;"></td> <td style="width: 10%;"></td> </tr> <tr> <td></td> <td></td> <td colspan="8" style="text-align: center;"> <table border="1" style="width: 100%; border-collapse: collapse; text-align: center;"> <tr> <td style="width: 10%;"></td> <td style="width: 10%;"></td> <td style="width: 10%;"></td> <td style="width: 10%;"></td> <td style="width: 10%;"></td> <td style="width: 10%;"></td> <td style="width: 10%;"></td> <td style="width: 10%;"></td> <td style="width: 10%;"></td> <td style="width: 10%;"></td> </tr> <tr> <td></td> <td></td> <td colspan="8" style="text-align: center;"> <table border="1" style="width: 100%; border-collapse: collapse; text-align: center;"> <tr> <td style="width: 10%;"></td> <td style="width: 10%;"></td> <td style="width: 10%;"></td> <td style="width: 10%;"></td> <td style="width: 10%;"></td> <td style="width: 10%;"></td> <td style="width: 10%;"></td> <td style="width: 10%;"></td> <td style="width: 10%;"></td> <td style="width: 10%;"></td> </tr> <tr> <td></td> <td></td> <td colspan="8" style="text-align: center;"> <table border="1" style="width: 100%; border-collapse: collapse; text-align: center;"> <tr> <td style="width: 10%;"></td> <td style="width: 10%;"></td> <td style="width: 10%;"></td> <td style="width: 10%;"></td> <td style="width: 10%;"></td> <td style="width: 10%;"></td> <td style="width: 10%;"></td> <td style="width: 10%;"></td> <td style="width: 10%;"></td> <td style="width: 10%;"></td> </tr> <tr> <td></td> <td></td> <td colspan="8" style="text-align: center;"> <table border="1" style="width: 100%; border-collapse: collapse; text-align: center;"> <tr> <td style="width: 10%;"></td> <td style="width: 10%;"></td> <td style="width: 10%;"></td> <td style="width: 10%;"></td> <td style="width: 10%;"></td> <td style="width: 10%;"></td> <td style="width: 10%;"></td> <td style="width: 10%;"></td> <td style="width: 10%;"></td> <td style="width: 10%;"></td> </tr> <tr> <td></td> <td></td> <td colspan="8" style="text-align: center;"> <table border="1" style="width: 100%; border-collapse: collapse; text-align: center;"> <tr> <td style="width: 10%;"></td> <td style="width: 10%;"></td> <td style="width: 10%;"></td> <td style="width: 10%;"></td> <td style="width: 10%;"></td> <td style="width: 10%;"></td> <td style="width: 10%;"></td> <td style="width: 10%;"></td> <td style="width: 10%;"></td> <td style="width: 10%;"></td> </tr> <tr> <td></td> <td></td> <td colspan="8" style="text-align: center;"> <table border="1" style="width: 100%; border-collapse: collapse; text-align: center;"> <tr> <td style="width: 10%;"></td> <td style="width: 10%;"></td> <td style="width: 10%;"></td> <td style="width: 10%;"></td> <td style="width: 10%;"></td> <td style="width: 10%;"></td> <td style="width: 10%;"></td> <td style="width: 10%;"></td> <td style="width: 10%;"></td> <td style="width: 10%;"></td> </tr> <tr> <td></td> <td></td> <td colspan="8" style="text-align: center;"> <table border="1" style="width: 100%; border-collapse: collapse; text-align: center;"> <tr> <td style="width: 10%;"></td> <td style="width: 10%;"></td> <td style="width: 10%;"></td> <td style="width: 10%;"></td> <td style="width: 10%;"></td> <td style="width: 10%;"></td> <td style="width: 10%;"></td> <td style="width: 10%;"></td> <td style="width: 10%;"></td> <td style="width: 10%;"></td> </tr> <tr> <td></td> <td></td> <td colspan="8" style="text-align: center;"> <table border="1" style="width: 100%; border-collapse: collapse; text-align: center;"> <tr> <td style="width: 10%;"></td> <td style="width: 10%;"></td> <td style="width: 10%;"></td> <td style="width: 10%;"></td> <td style="width: 10%;"></td> <td style="width: 10%;"></td> <td style="width: 10%;"></td> <td style="width: 10%;"></td> <td style="width: 10%;"></td> <td style="width: 10%;"></td> </tr> <tr> <td></td> <td></td> <td colspan="8" style="text-align: center;"> <table border="1" style="width: 100%; border-collapse: collapse; text-align: center;"> <tr> <td style="width: 10%;"></td> <td style="width: 10%;"></td> <td style="width: 10%;"></td> <td style="width: 10%;"></td> <td style="width: 10%;"></td> <td style="width: 10%;"></td> <td style="width: 10%;"></td> <td style="width: 10%;"></td> <td style="width: 10%;"></td> <td style="width: 10%;"></td> </tr> <tr> <td></td> <td></td> <td colspan="8" style="text-align: center;"> <table border="1" style="width: 100%; border-collapse: collapse; text-align: center;"> <tr> <td style="width: 10%;"></td> <td style="width: 10%;"></td> <td style="width: 10%;"></td> <td style="width: 10%;"></td> <td style="width: 10%;"></td> <td style="width: 10%;"></td> <td style="width: 10%;"></td> <td style="width: 10%;"></td> <td style="width: 10%;"></td> <td style="width: 10%;"></td> </tr> <tr> <td></td> <td></td> <td colspan="8" style="text-align: center;"> <table border="1" style="width: 100%; border-collapse: collapse; text-align: center;"> <tr> <td style="width: 10%;"></td> <td style="width: 10%;"></td> <td style="width: 10%;"></td> <td style="width: 10%;"></td> <td style="width: 10%;"></td> <td style="width: 10%;"></td> <td style="width: 10%;"></td> <td style="width: 10%;"></td> <td style="width: 10%;"></td> <td style="width: 10%;"></td> </tr> <tr> <td></td> <td></td> <td colspan="8" style="text-align: center;"> <table border="1" style="width: 100%; border-collapse: collapse; text-align: center;"> <tr> <td style="width: 10%;"></td> <td style="width: 10%;"></td> <td style="width: 10%;"></td> <td style="width: 10%;"></td> <td style="width: 10%;"></td> <td style="width: 10%;"></td> <td style="width: 10%;"></td> <td style="width: 10%;"></td> <td style="width: 10%;"></td> <td style="width: 10%;"></td> </tr> <tr> <td></td> <td></td> <td colspan="8" style="text-align: center;"> <table border="1" style="width: 100%; border-collapse: collapse; text-align: center;"> <tr>
</tr></table></td></tr></table></td></tr></table></td></tr></table></td></tr></table></td></tr></table></td></tr></table></td></tr></table></td></tr></table></td></tr></table></td></tr></table></td></tr></table></td></tr></table></td></tr></table></td></tr></table></td></tr></table></td></tr></table></td></tr></table></td></tr></table></td></tr></table></td></tr></table></td></tr></table></td></tr></table></td></tr></table></td></tr></table></td></tr></table></td></tr></table></td></tr></table></td></tr></table></td></tr></table></td></tr></table></td></tr></table></td></tr></table></td></tr></table></td></tr></table></td></tr></table></td></tr></table></td></tr></table></td></tr></table></td></tr></table></td></tr></table> | | | | | | | | | | | | | | | | | | | | <table border="1" style="width: 100%; border-collapse: collapse; text-align: center;"> <tr> <td style="width: 10%;"></td> <td style="width: 10%;"></td> <td style="width: 10%;"></td> <td style="width: 10%;"></td> <td style="width: 10%;"></td> <td style="width: 10%;"></td> <td style="width: 10%;"></td> <td style="width: 10%;"></td> <td style="width: 10%;"></td> <td style="width: 10%;"></td> </tr> <tr> <td></td> <td></td> <td colspan="8" style="text-align: center;"> <table border="1" style="width: 100%; border-collapse: collapse; text-align: center;"> <tr> <td style="width: 10%;"></td> <td style="width: 10%;"></td> <td style="width: 10%;"></td> <td style="width: 10%;"></td> <td style="width: 10%;"></td> <td style="width: 10%;"></td> <td style="width: 10%;"></td> <td style="width: 10%;"></td> <td style="width: 10%;"></td> <td style="width: 10%;"></td> </tr> <tr> <td></td> <td></td> <td colspan="8" style="text-align: center;"> <table border="1" style="width: 100%; border-collapse: collapse; text-align: center;"> <tr> <td style="width: 10%;"></td> <td style="width: 10%;"></td> <td style="width: 10%;"></td> <td style="width: 10%;"></td> <td style="width: 10%;"></td> <td style="width: 10%;"></td> <td style="width: 10%;"></td> <td style="width: 10%;"></td> <td style="width: 10%;"></td> <td style="width: 10%;"></td> </tr> <tr> <td></td> <td></td> <td colspan="8" style="text-align: center;"> <table border="1" style="width: 100%; border-collapse: collapse; text-align: center;"> <tr> <td style="width: 10%;"></td> <td style="width: 10%;"></td> <td style="width: 10%;"></td> <td style="width: 10%;"></td> <td style="width: 10%;"></td> <td style="width: 10%;"></td> <td style="width: 10%;"></td> <td style="width: 10%;"></td> <td style="width: 10%;"></td> <td style="width: 10%;"></td> </tr> <tr> <td></td> <td></td> <td colspan="8" style="text-align: center;"> <table border="1" style="width: 100%; border-collapse: collapse; text-align: center;"> <tr> <td style="width: 10%;"></td> <td style="width: 10%;"></td> <td style="width: 10%;"></td> <td style="width: 10%;"></td> <td style="width: 10%;"></td> <td style="width: 10%;"></td> <td style="width: 10%;"></td> <td style="width: 10%;"></td> <td style="width: 10%;"></td> <td style="width: 10%;"></td> </tr> <tr> <td></td> <td></td> <td colspan="8" style="text-align: center;"> <table border="1" style="width: 100%; border-collapse:
collapse; text-align: center;"> <tr> <td style="width: 10%;"></td> <td style="width: 10%;"></td> <td style="width: 10%;"></td> <td style="width: 10%;"></td> <td style="width: 10%;"></td> <td style="width: 10%;"></td> <td style="width: 10%;"></td> <td style="width: 10%;"></td> <td style="width: 10%;"></td> <td style="width: 10%;"></td> </tr> <tr> <td></td> <td></td> <td colspan="8" style="text-align: center;"> <table border="1" style="width: 100%; border-collapse: collapse; text-align: center;"> <tr> <td style="width: 10%;"></td> <td style="width: 10%;"></td> <td style="width: 10%;"></td> <td style="width: 10%;"></td> <td style="width: 10%;"></td> <td style="width: 10%;"></td> <td style="width: 10%;"></td> <td style="width: 10%;"></td> <td style="width: 10%;"></td> <td style="width: 10%;"></td> </tr> <tr> <td></td> <td></td> <td colspan="8" style="text-align: center;"> <table border="1" style="width: 100%; border-collapse: collapse; text-align: center;"> <tr> <td style="width: 10%;"></td> <td style="width: 10%;"></td> <td style="width: 10%;"></td> <td style="width: 10%;"></td> <td style="width: 10%;"></td> <td style="width: 10%;"></td> <td style="width: 10%;"></td> <td style="width: 10%;"></td> <td style="width: 10%;"></td> <td style="width: 10%;"></td> </tr> <tr> <td></td> <td></td> <td colspan="8" style="text-align: center;"> <table border="1" style="width: 100%; border-collapse: collapse; text-align: center;"> <tr> <td style="width: 10%;"></td> <td style="width: 10%;"></td> <td style="width: 10%;"></td> <td style="width: 10%;"></td> <td style="width: 10%;"></td> <td style="width: 10%;"></td> <td style="width: 10%;"></td> <td style="width: 10%;"></td> <td style="width: 10%;"></td> <td style="width: 10%;"></td> </tr> <tr> <td></td> <td></td> <td colspan="8" style="text-align: center;"> <table border="1" style="width: 100%; border-collapse: collapse; text-align: center;"> <tr> <td style="width: 10%;"></td> <td style="width: 10%;"></td> <td style="width: 10%;"></td> <td style="width: 10%;"></td> <td style="width: 10%;"></td> <td style="width: 10%;"></td> <td style="width: 10%;"></td> <td style="width: 10%;"></td> <td style="width: 10%;"></td> <td style="width: 10%;"></td> </tr> <tr> <td></td> <td></td> <td colspan="8" style="text-align: center;"> <table border="1" style="width: 100%; border-collapse: collapse; text-align: center;"> <tr> <td style="width: 10%;"></td> <td style="width: 10%;"></td> <td style="width: 10%;"></td> <td style="width: 10%;"></td> <td style="width: 10%;"></td> <td style="width: 10%;"></td> <td style="width: 10%;"></td> <td style="width: 10%;"></td> <td style="width: 10%;"></td> <td style="width: 10%;"></td> </tr> <tr> <td></td> <td></td> <td colspan="8" style="text-align: center;"> <table border="1" style="width: 100%; border-collapse: collapse; text-align: center;"> <tr> <td style="width: 10%;"></td> <td style="width: 10%;"></td> <td style="width: 10%;"></td> <td style="width: 10%;"></td> <td style="width: 10%;"></td> <td style="width: 10%;"></td> <td style="width: 10%;"></td> <td style="width: 10%;"></td> <td style="width: 10%;"></td> <td style="width: 10%;"></td> </tr> <tr> <td></td> <td></td> <td colspan="8" style="text-align: center;"> <table border="1" style="width: 100%; border-collapse: collapse; text-align: center;"> <tr> <td style="width: 10%;"></td> <td style="width: 10%;"></td> <td style="width: 10%;"></td> <td style="width: 10%;"></td> <td style="width: 10%;"></td> <td style="width: 10%;"></td> <td style="width: 10%;"></td> <td style="width: 10%;"></td> <td style="width: 10%;"></td> <td style="width: 10%;"></td> </tr> <tr> <td></td> <td></td> <td colspan="8" style="text-align: center;"> <table border="1" style="width: 100%; border-collapse: collapse; text-align: center;"> <tr> <td style="width: 10%;"></td> <td style="width: 10%;"></td> <td style="width: 10%;"></td> <td style="width: 10%;"></td> <td style="width: 10%;"></td> <td style="width: 10%;"></td> <td style="width: 10%;"></td> <td style="width: 10%;"></td> <td style="width: 10%;"></td> <td style="width: 10%;"></td> </tr> <tr> <td></td> <td></td> <td colspan="8" style="text-align: center;"> <table border="1" style="width: 100%; border-collapse: collapse; text-align: center;"> <tr> <td style="width: 10%;"></td> <td style="width: 10%;"></td> <td style="width: 10%;"></td> <td style="width: 10%;"></td> <td style="width: 10%;"></td> <td style="width: 10%;"></td> <td style="width: 10%;"></td> <td style="width: 10%;"></td> <td style="width: 10%;"></td> <td style="width: 10%;"></td> </tr> <tr> <td></td> <td></td> <td colspan="8" style="text-align: center;"> <table border="1" style="width: 100%; border-collapse: collapse; text-align: center;"> <tr> <td style="width: 10%;"></td> <td style="width: 10%;"></td> <td style="width: 10%;"></td> <td style="width: 10%;"></td> <td style="width: 10%;"></td> <td style="width: 10%;"></td> <td style="width: 10%;"></td> <td style="width: 10%;"></td> <td style="width: 10%;"></td> <td style="width: 10%;"></td> </tr> <tr> <td></td> <td></td> <td colspan="8" style="text-align: center;"> <table border="1" style="width: 100%; border-collapse: collapse; text-align: center;"> <tr> <td style="width: 10%;"></td> <td style="width: 10%;"></td> <td style="width: 10%;"></td> <td style="width: 10%;"></td> <td style="width: 10%;"></td> <td style="width: 10%;"></td> <td style="width: 10%;"></td> <td style="width: 10%;"></td> <td style="width: 10%;"></td> <td style="width: 10%;"></td> </tr> <tr> <td></td> <td></td> <td colspan="8" style="text-align: center;"> <table border="1" style="width: 100%; border-collapse: collapse; text-align: center;"> <tr> <td style="width: 10%;"></td> <td style="width: 10%;"></td> <td style="width: 10%;"></td> <td style="width: 10%;"></td> <td style="width: 10%;"></td> <td style="width: 10%;"></td> <td style="width: 10%;"></td> <td style="width: 10%;"></td> <td style="width: 10%;"></td> <td style="width: 10%;"></td> </tr> <tr> <td></td> <td></td> <td colspan="8" style="text-align: center;"> <table border="1" style="width: 100%; border-collapse: collapse; text-align: center;"> <tr> <td style="width: 10%;"></td> <td style="width: 10%;"></td> <td style="width: 10%;"></td> <td style="width: 10%;"></td> <td style="width: 10%;"></td> <td style="width: 10%;"></td> <td style="width: 10%;"></td> <td style="width: 10%;"></td> <td style="width: 10%;"></td> <td style="width: 10%;"></td> </tr> <tr> <td></td> <td></td> <td colspan="8" style="text-align: center;"> <table border="1" style="width: 100%; border-collapse: collapse; text-align: center;"> <tr> <td style="width: 10%;"></td> <td style="width: 10%;"></td> <td style="width: 10%;"></td> <td style="width: 10%;"></td> <td style="width: 10%;"></td> <td style="width: 10%;"></td> <td style="width: 10%;"></td> <td style="width: 10%;"></td> <td style="width: 10%;"></td> <td style="width: 10%;"></td> </tr> <tr> <td></td> <td></td> <td colspan="8" style="text-align: center;"> <table border="1" style="width: 100%; border-collapse: collapse; text-align: center;"> <tr> <td style="width: 10%;"></td> <td style="width: 10%;"></td> <td style="width: 10%;"></td> <td style="width: 10%;"></td> <td style="width: 10%;"></td> <td style="width: 10%;"></td> <td style="width: 10%;"></td> <td style="width: 10%;"></td> <td style="width: 10%;"></td> <td style="width: 10%;"></td> </tr> <tr> <td></td> <td></td> <td colspan="8" style="text-align: center;"> <table border="1" style="width: 100%; border-collapse: collapse; text-align: center;"> <tr> <td style="width: 10%;"></td> <td style="width: 10%;"></td> <td style="width: 10%;"></td> <td style="width: 10%;"></td> <td style="width: 10%;"></td> <td style="width: 10%;"></td> <td style="width: 10%;"></td> <td style="width: 10%;"></td> <td style="width: 10%;"></td> <td style="width: 10%;"></td> </tr> <tr> <td></td> <td></td> <td colspan="8" style="text-align: center;"> <table border="1" style="width: 100%; border-collapse: collapse; text-align: center;"> <tr> <td style="width: 10%;"></td> <td style="width: 10%;"></td> <td style="width: 10%;"></td> <td style="width: 10%;"></td> <td style="width: 10%;"></td> <td style="width: 10%;"></td> <td style="width: 10%;"></td> <td style="width: 10%;"></td> <td style="width: 10%;"></td> <td style="width: 10%;"></td> </tr> <tr> <td></td> <td></td> <td colspan="8" style="text-align: center;"> <table border="1" style="width: 100%; border-collapse: collapse; text-align: center;"> <tr> <td style="width: 10%;"></td> <td style="width: 10%;"></td> <td style="width: 10%;"></td> <td style="width: 10%;"></td> <td style="width: 10%;"></td> <td style="width: 10%;"></td> <td style="width: 10%;"></td> <td style="width: 10%;"></td> <td style="width: 10%;"></td> <td style="width: 10%;"></td> </tr> <tr> <td></td> <td></td> <td colspan="8" style="text-align: center;"> <table border="1" style="width: 100%; border-collapse: collapse; text-align: center;"> <tr> <td style="width: 10%;"></td> <td style="width: 10%;"></td> <td style="width: 10%;"></td> <td style="width: 10%;"></td> <td style="width: 10%;"></td> <td style="width: 10%;"></td> <td style="width: 10%;"></td> <td style="width: 10%;"></td> <td style="width: 10%;"></td> <td style="width: 10%;"></td> </tr> <tr> <td></td> <td></td> <td colspan="8" style="text-align: center;"> <table border="1" style="width: 100%; border-collapse: collapse; text-align: center;"> <tr> <td style="width: 10%;"></td> <td style="width: 10%;"></td> <td style="width: 10%;"></td> <td style="width: 10%;"></td> <td style="width: 10%;"></td> <td style="width: 10%;"></td> <td style="width: 10%;"></td> <td style="width: 10%;"></td> <td style="width: 10%;"></td> <td style="width: 10%;"></td> </tr> <tr> <td></td> <td></td> <td colspan="8" style="text-align: center;"> <table border="1" style="width: 100%; border-collapse: collapse; text-align: center;"> <tr> <td style="width: 10%;"></td> <td style="width: 10%;"></td> <td style="width: 10%;"></td> <td style="width: 10%;"></td> <td
style="width: 10%;"></td> <td style="width: 10%;"></td> <td style="width: 10%;"></td> <td style="width: 10%;"></td> <td style="width: 10%;"></td> <td style="width: 10%;"></td> </tr> <tr> <td></td> <td></td> <td colspan="8" style="text-align: center;"> <table border="1" style="width: 100%; border-collapse: collapse; text-align: center;"> <tr> <td style="width: 10%;"></td> <td style="width: 10%;"></td> <td style="width: 10%;"></td> <td style="width: 10%;"></td> <td style="width: 10%;"></td> <td style="width: 10%;"></td> <td style="width: 10%;"></td> <td style="width: 10%;"></td> <td style="width: 10%;"></td> <td style="width: 10%;"></td> </tr> <tr> <td></td> <td></td> <td colspan="8" style="text-align: center;"> <table border="1" style="width: 100%; border-collapse: collapse; text-align: center;"> <tr> <td style="width: 10%;"></td> <td style="width: 10%;"></td> <td style="width: 10%;"></td> <td style="width: 10%;"></td> <td style="width: 10%;"></td> <td style="width: 10%;"></td> <td style="width: 10%;"></td> <td style="width: 10%;"></td> <td style="width: 10%;"></td> <td style="width: 10%;"></td> </tr> <tr> <td></td> <td></td> <td colspan="8" style="text-align: center;"> <table border="1" style="width: 100%; border-collapse: collapse; text-align: center;"> <tr> <td style="width: 10%;"></td> <td style="width: 10%;"></td> <td style="width: 10%;"></td> <td style="width: 10%;"></td> <td style="width: 10%;"></td> <td style="width: 10%;"></td> <td style="width: 10%;"></td> <td style="width: 10%;"></td> <td style="width: 10%;"></td> <td style="width: 10%;"></td> </tr> <tr> <td></td> <td></td> <td colspan="8" style="text-align: center;"> <table border="1" style="width: 100%; border-collapse: collapse; text-align: center;"> <tr> <td style="width: 10%;"></td> <td style="width: 10%;"></td> <td style="width: 10%;"></td> <td style="width: 10%;"></td> <td style="width: 10%;"></td> <td style="width: 10%;"></td> <td style="width: 10%;"></td> <td style="width: 10%;"></td> <td style="width: 10%;"></td> <td style="width: 10%;"></td> </tr> <tr> <td></td> <td></td> <td colspan="8" style="text-align: center;"> <table border="1" style="width: 100%; border-collapse: collapse; text-align: center;"> <tr> <td style="width: 10%;"></td> <td style="width: 10%;"></td> <td style="width: 10%;"></td> <td style="width: 10%;"></td> <td style="width: 10%;"></td> <td style="width: 10%;"></td> <td style="width: 10%;"></td> <td style="width: 10%;"></td> <td style="width: 10%;"></td> <td style="width: 10%;"></td> </tr> <tr> <td></td> <td></td> <td colspan="8" style="text-align: center;"> <table border="1" style="width: 100%; border-collapse: collapse; text-align: center;"> <tr> <td style="width: 10%;"></td> <td style="width: 10%;"></td> <td style="width: 10%;"></td> <td style="width: 10%;"></td> <td style="width: 10%;"></td> <td style="width: 10%;"></td> <td style="width: 10%;"></td> <td style="width: 10%;"></td> <td style="width: 10%;"></td> <td style="width: 10%;"></td> </tr> <tr> <td></td> <td></td> <td colspan="8" style="text-align: center;"> <table border="1" style="width: 100%; border-collapse: collapse; text-align: center;"> <tr> <td style="width: 10%;"></td> <td style="width: 10%;"></td> <td style="width: 10%;"></td> <td style="width: 10%;"></td> <td style="width: 10%;"></td> <td style="width: 10%;"></td> <td style="width: 10%;"></td> <td style="width: 10%;"></td> <td style="width: 10%;"></td> <td style="width: 10%;"></td> </tr> <tr> <td></td> <td></td> <td colspan="8" style="text-align: center;"> <table border="1" style="width: 100%; border-collapse: collapse; text-align: center;"> <tr> <td style="width: 10%;"></td> <td style="width: 10%;"></td> <td style="width: 10%;"></td> <td style="width: 10%;"></td> <td style="width: 10%;"></td> <td style="width: 10%;"></td> <td style="width: 10%;"></td> <td style="width: 10%;"></td> <td style="width: 10%;"></td> <td style="width: 10%;"></td> </tr> <tr> <td></td> <td></td> <td colspan="8" style="text-align: center;"> <table border="1" style="width: 100%; border-collapse: collapse; text-align: center;"> <tr> <td style="width: 10%;"></td> <td style="width: 10%;"></td> <td style="width: 10%;"></td> <td style="width: 10%;"></td> <td style="width: 10%;"></td> <td style="width: 10%;"></td> <td style="width: 10%;"></td> <td style="width: 10%;"></td> <td style="width: 10%;"></td> <td style="width: 10%;"></td> </tr> <tr> <td></td> <td></td> <td colspan="8" style="text-align: center;"> <table border="1" style="width: 100%; border-collapse: collapse; text-align: center;"> <tr> <td style="width: 10%;"></td> <td style="width: 10%;"></td> <td style="width: 10%;"></td> <td style="width: 10%;"></td> <td style="width: 10%;"></td> <td style="width: 10%;"></td> <td style="width: 10%;"></td> <td style="width: 10%;"></td> <td style="width: 10%;"></td> <td style="width: 10%;"></td> </tr> <tr> <td></td> <td></td> <td colspan="8" style="text-align: center;"> <table border="1" style="width: 100%; border-collapse: collapse; text-align: center;"> <tr> <td style="width: 10%;"></td> <td style="width: 10%;"></td> <td style="width: 10%;"></td> <td style="width: 10%;"></td> <td style="width: 10%;"></td> <td style="width: 10%;"></td> <td style="width: 10%;"></td> <td style="width: 10%;"></td> <td style="width: 10%;"></td> <td style="width: 10%;"></td> </tr> <tr> <td></td> <td></td> <td colspan="8" style="text-align: center;"> <table border="1" style="width: 100%; border-collapse: collapse; text-align: center;"> <tr> <td style="width: 10%;"></td> <td style="width: 10%;"></td> <td style="width: 10%;"></td> <td style="width: 10%;"></td> <td style="width: 10%;"></td> <td style="width: 10%;"></td> <td style="width: 10%;"></td> <td style="width: 10%;"></td> <td style="width: 10%;"></td> <td style="width: 10%;"></td> </tr> <tr> <td></td> <td></td> <td colspan="8" style="text-align: center;"> <table border="1" style="width: 100%; border-collapse: collapse; text-align: center;"> <tr> </tr></table></td></tr></table></td></tr></table></td></tr></table></td></tr></table></td></tr></table></td></tr></table></td></tr></table></td></tr></table></td></tr></table></td></tr></table></td></tr></table></td></tr></table></td></tr></table></td></tr></table></td></tr></table></td></tr></table></td></tr></table></td></tr></table></td></tr></table></td></tr></table></td></tr></table></td></tr></table></td></tr></table></td></tr></table></td></tr></table></td></tr></table></td></tr></table></td></tr></table></td></tr></table></td></tr></table></td></tr></table></td></tr></table></td></tr></table></td></tr></table></td></tr></table></td></tr></table></td></tr></table></td></tr></table></td></tr></table>
 | | | | | | | | | | | | | | | | | | | | <table border="1" style="width: 100%; border-collapse: collapse; text-align: center;"> <tr> <td style="width: 10%;"></td> <td style="width: 10%;"></td> <td style="width: 10%;"></td> <td style="width: 10%;"></td> <td style="width: 10%;"></td> <td style="width: 10%;"></td> <td style="width: 10%;"></td> <td style="width: 10%;"></td> <td style="width: 10%;"></td> <td style="width: 10%;"></td> </tr> <tr> <td></td> <td></td> <td colspan="8" style="text-align: center;"> <table border="1" style="width: 100%; border-collapse: collapse; text-align: center;"> <tr> <td style="width: 10%;"></td> <td style="width: 10%;"></td> <td style="width: 10%;"></td> <td style="width: 10%;"></td> <td style="width: 10%;"></td> <td style="width: 10%;"></td> <td style="width: 10%;"></td> <td style="width: 10%;"></td> <td style="width: 10%;"></td> <td style="width: 10%;"></td> </tr> <tr> <td></td> <td></td> <td colspan="8" style="text-align: center;"> <table border="1" style="width: 100%; border-collapse: collapse; text-align: center;"> <tr> <td style="width: 10%;"></td> <td style="width: 10%;"></td> <td style="width: 10%;"></td> <td style="width: 10%;"></td> <td style="width: 10%;"></td> <td style="width: 10%;"></td> <td style="width: 10%;"></td> <td style="width: 10%;"></td> <td style="width: 10%;"></td> <td style="width: 10%;"></td> </tr> <tr> <td></td> <td></td> <td colspan="8" style="text-align: center;"> <table border="1" style="width: 100%; border-collapse: collapse; text-align: center;"> <tr> <td style="width: 10%;"></td> <td style="width: 10%;"></td> <td style="width: 10%;"></td> <td style="width: 10%;"></td> <td style="width: 10%;"></td> <td style="width: 10%;"></td> <td style="width: 10%;"></td> <td style="width: 10%;"></td> <td style="width: 10%;"></td> <td style="width: 10%;"></td> </tr> <tr> <td></td> <td></td> <td colspan="8" style="text-align: center;"> <table border="1" style="width: 100%; border-collapse: collapse; text-align: center;"> <tr> <td style="width: 10%;"></td> <td style="width: 10%;"></td> <td style="width: 10%;"></td> <td style="width: 10%;"></td> <td style="width: 10%;"></td> <td style="width: 10%;"></td> <td style="width: 10%;"></td> <td style="width: 10%;"></td> <td style="width: 10%;"></td> <td style="width: 10%;"></td> </tr> <tr> <td></td> <td></td> <td colspan="8" style="text-align: center;"> <table border="1" style="width: 100%; border-collapse: collapse; text-align: center;"> <tr> <td style="width: 10%;"></td> <td style="width: 10%;"></td> <td style="width: 10%;"></td> <td style="width: 10%;"></td> <td style="width: 10%;"></td> <td style="width: 10%;"></td> <td style="width: 10%;"></td> <td style="width: 10%;"></td> <td style="width: 10%;"></td> <td style="width: 10%;"></td> </tr> <tr> <td></td> <td></td> <td colspan="8" style="text-align: center;"> <table border="1" style="width: 100%; border-collapse: collapse; text-align: center;"> <tr> <td style="width: 10%;"></td> <td style="width: 10%;"></td> <td style="width: 10%;"></td> <td style="width: 10%;"></td> <td style="width: 10%;"></td> <td style="width: 10%;"></td> <td style="width: 10%;"></td> <td style="width: 10%;"></td> <td style="width: 10%;"></td> <td style="width: 10%;"></td> </tr> <tr> <td></td> <td></td> <td colspan="8" style="text-align: center;"> <table border="1" style="width: 100%; border-collapse: collapse; text-align: center;"> <tr> <td style="width: 10%;"></td> <td style="width: 10%;"></td> <td style="width: 10%;"></td> <td style="width: 10%;"></td> <td style="width: 10%;"></td> <td style="width: 10%;"></td> <td style="width: 10%;"></td> <td style="width: 10%;"></td> <td style="width: 10%;"></td> <td style="width: 10%;"></td> </tr> <tr> <td></td> <td></td> <td colspan="8" style="text-align: center;"> <table border="1" style="width: 100%; border-collapse: collapse; text-align: center;"> <tr> <td style="width: 10%;"></td> <td style="width: 10%;"></td> <td style="width: 10%;"></td> <td style="width: 10%;"></td> <td style="width: 10%;"></td> <td style="width: 10%;"></td> <td style="width: 10%;"></td> <td style="width: 10%;"></td> <td style="width: 10%;"></td> <td style="width: 10%;"></td> </tr> <tr> <td></td> <td></td> <td colspan="8" style="text-align: center;"> <table border="1" style="width: 100%; border-collapse: collapse; text-align: center;"> <tr> <td style="width: 10%;"></td> <td style="width: 10%;"></td> <td style="width: 10%;"></td> <td style="width: 10%;"></td> <td style="width: 10%;"></td> <td style="width: 10%;"></td> <td style="width: 10%;"></td> <td style="width: 10%;"></td> <td style="width: 10%;"></td> <td style="width: 10%;"></td> </tr> <tr> <td></td> <td></td> <td colspan="8" style="text-align: center;"> <table border="1" style="width: 100%; border-collapse: collapse; text-align: center;"> <tr> <td style="width: 10%;"></td> <td style="width: 10%;"></td> <td style="width: 10%;"></td> <td style="width: 10%;"></td> <td style="width: 10%;"></td> <td style="width: 10%;"></td> <td style="width: 10%;"></td> <td style="width: 10%;"></td> <td style="width: 10%;"></td> <td style="width: 10%;"></td> </tr> <tr> <td></td> <td></td> <td colspan="8" style="text-align: center;"> <table border="1" style="width: 100%; border-collapse: collapse; text-align: center;"> <tr> <td style="width: 10%;"></td> <td style="width: 10%;"></td> <td style="width: 10%;"></td> <td style="width: 10%;"></td> <td style="width: 10%;"></td> <td style="width: 10%;"></td> <td style="width: 10%;"></td> <td style="width: 10%;"></td> <td style="width: 10%;"></td> <td style="width: 10%;"></td> </tr> <tr> <td></td> <td></td> <td colspan="8" style="text-align: center;"> <table border="1" style="width: 100%; border-collapse: collapse; text-align: center;"> <tr> <td style="width: 10%;"></td> <td style="width: 10%;"></td> <td style="width: 10%;"></td> <td style="width: 10%;"></td> <td style="width: 10%;"></td> <td style="width: 10%;"></td> <td style="width: 10%;"></td> <td style="width: 10%;"></td> <td style="width: 10%;"></td> <td style="width: 10%;"></td> </tr> <tr> <td></td> <td></td> <td colspan="8" style="text-align: center;"> <table border="1" style="width: 100%; border-collapse: collapse; text-align: center;"> <tr> <td style="width: 10%;"></td> <td style="width: 10%;"></td> <td style="width: 10%;"></td> <td style="width: 10%;"></td> <td style="width: 10%;"></td> <td style="width: 10%;"></td> <td style="width: 10%;"></td> <td style="width: 10%;"></td> <td style="width: 10%;"></td> <td
style="width: 10%;"></td> </tr> <tr> <td></td> <td></td> <td colspan="8" style="text-align: center;"> <table border="1" style="width: 100%; border-collapse: collapse; text-align: center;"> <tr> <td style="width: 10%;"></td> <td style="width: 10%;"></td> <td style="width: 10%;"></td> <td style="width: 10%;"></td> <td style="width: 10%;"></td> <td style="width: 10%;"></td> <td style="width: 10%;"></td> <td style="width: 10%;"></td> <td style="width: 10%;"></td> <td style="width: 10%;"></td> </tr> <tr> <td></td> <td></td> <td colspan="8" style="text-align: center;"> <table border="1" style="width: 100%; border-collapse: collapse; text-align: center;"> <tr> <td style="width: 10%;"></td> <td style="width: 10%;"></td> <td style="width: 10%;"></td> <td style="width: 10%;"></td> <td style="width: 10%;"></td> <td style="width: 10%;"></td> <td style="width: 10%;"></td> <td style="width: 10%;"></td> <td style="width: 10%;"></td> <td style="width: 10%;"></td> </tr> <tr> <td></td> <td></td> <td colspan="8" style="text-align: center;"> <table border="1" style="width: 100%; border-collapse: collapse; text-align: center;"> <tr> <td style="width: 10%;"></td> <td style="width: 10%;"></td> <td style="width: 10%;"></td> <td style="width: 10%;"></td> <td style="width: 10%;"></td> <td style="width: 10%;"></td> <td style="width: 10%;"></td> <td style="width: 10%;"></td> <td style="width: 10%;"></td> <td style="width: 10%;"></td> </tr> <tr> <td></td> <td></td> <td colspan="8" style="text-align: center;"> <table border="1" style="width: 100%; border-collapse: collapse; text-align: center;"> <tr> <td style="width: 10%;"></td> <td style="width: 10%;"></td> <td style="width: 10%;"></td> <td style="width: 10%;"></td> <td style="width: 10%;"></td> <td style="width: 10%;"></td> <td style="width: 10%;"></td> <td style="width: 10%;"></td> <td style="width: 10%;"></td> <td style="width: 10%;"></td> </tr> <tr> <td></td> <td></td> <td colspan="8" style="text-align: center;"> <table border="1" style="width: 100%; border-collapse: collapse; text-align: center;"> <tr> <td style="width: 10%;"></td> <td style="width: 10%;"></td> <td style="width: 10%;"></td> <td style="width: 10%;"></td> <td style="width: 10%;"></td> <td style="width: 10%;"></td> <td style="width: 10%;"></td> <td style="width: 10%;"></td> <td style="width: 10%;"></td> <td style="width: 10%;"></td> </tr> <tr> <td></td> <td></td> <td colspan="8" style="text-align: center;"> <table border="1" style="width: 100%; border-collapse: collapse; text-align: center;"> <tr> <td style="width: 10%;"></td> <td style="width: 10%;"></td> <td style="width: 10%;"></td> <td style="width: 10%;"></td> <td style="width: 10%;"></td> <td style="width: 10%;"></td> <td style="width: 10%;"></td> <td style="width: 10%;"></td> <td style="width: 10%;"></td> <td style="width: 10%;"></td> </tr> <tr> <td></td> <td></td> <td colspan="8" style="text-align: center;"> <table border="1" style="width: 100%; border-collapse: collapse; text-align: center;"> <tr> <td style="width: 10%;"></td> <td style="width: 10%;"></td> <td style="width: 10%;"></td> <td style="width: 10%;"></td> <td style="width: 10%;"></td> <td style="width: 10%;"></td> <td style="width: 10%;"></td> <td style="width: 10%;"></td> <td style="width: 10%;"></td> <td style="width: 10%;"></td> </tr> <tr> <td></td> <td></td> <td colspan="8" style="text-align: center;"> <table border="1" style="width: 100%; border-collapse: collapse; text-align: center;"> <tr> <td style="width: 10%;"></td> <td style="width: 10%;"></td> <td style="width: 10%;"></td> <td style="width: 10%;"></td> <td style="width: 10%;"></td> <td style="width: 10%;"></td> <td style="width: 10%;"></td> <td style="width: 10%;"></td> <td style="width: 10%;"></td> <td style="width: 10%;"></td> </tr> <tr> <td></td> <td></td> <td colspan="8" style="text-align: center;"> <table border="1" style="width: 100%; border-collapse: collapse; text-align: center;"> <tr> <td style="width: 10%;"></td> <td style="width: 10%;"></td> <td style="width: 10%;"></td> <td style="width: 10%;"></td> <td style="width: 10%;"></td> <td style="width: 10%;"></td> <td style="width: 10%;"></td> <td style="width: 10%;"></td> <td style="width: 10%;"></td> <td style="width: 10%;"></td> </tr> <tr> <td></td> <td></td> <td colspan="8" style="text-align: center;"> <table border="1" style="width: 100%; border-collapse: collapse; text-align: center;"> <tr> <td style="width: 10%;"></td> <td style="width: 10%;"></td> <td style="width: 10%;"></td> <td style="width: 10%;"></td> <td style="width: 10%;"></td> <td style="width: 10%;"></td> <td style="width: 10%;"></td> <td style="width: 10%;"></td> <td style="width: 10%;"></td> <td style="width: 10%;"></td> </tr> <tr> <td></td> <td></td> <td colspan="8" style="text-align: center;"> <table border="1" style="width: 100%; border-collapse: collapse; text-align: center;"> <tr> <td style="width: 10%;"></td> <td style="width: 10%;"></td> <td style="width: 10%;"></td> <td style="width: 10%;"></td> <td style="width: 10%;"></td> <td style="width: 10%;"></td> <td style="width: 10%;"></td> <td style="width: 10%;"></td> <td style="width: 10%;"></td> <td style="width: 10%;"></td> </tr> <tr> <td></td> <td></td> <td colspan="8" style="text-align: center;"> <table border="1" style="width: 100%; border-collapse: collapse; text-align: center;"> <tr> <td style="width: 10%;"></td> <td style="width: 10%;"></td> <td style="width: 10%;"></td> <td style="width: 10%;"></td> <td style="width: 10%;"></td> <td style="width: 10%;"></td> <td style="width: 10%;"></td> <td style="width: 10%;"></td> <td style="width: 10%;"></td> <td style="width: 10%;"></td> </tr> <tr> <td></td> <td></td> <td colspan="8" style="text-align: center;"> <table border="1" style="width: 100%; border-collapse: collapse; text-align: center;"> <tr> <td style="width: 10%;"></td> <td style="width: 10%;"></td> <td style="width: 10%;"></td> <td style="width: 10%;"></td> <td style="width: 10%;"></td> <td style="width: 10%;"></td> <td style="width: 10%;"></td> <td style="width: 10%;"></td> <td style="width: 10%;"></td> <td style="width: 10%;"></td> </tr> <tr> <td></td> <td></td> <td colspan="8" style="text-align: center;"> <table border="1" style="width: 100%; border-collapse: collapse; text-align: center;"> <tr> <td style="width: 10%;"></td> <td style="width: 10%;"></td> <td style="width: 10%;"></td> <td style="width: 10%;"></td> <td style="width: 10%;"></td> <td style="width: 10%;"></td> <td style="width: 10%;"></td> <td style="width: 10%;"></td> <td style="width: 10%;"></td> <td style="width: 10%;"></td> </tr> <tr> <td></td> <td></td> <td colspan="8" style="text-align: center;"> <table border="1" style="width: 100%; border-collapse: collapse; text-align: center;"> <tr> <td style="width: 10%;"></td> <td style="width: 10%;"></td> <td style="width: 10%;"></td> <td style="width: 10%;"></td> <td style="width: 10%;"></td> <td style="width: 10%;"></td> <td style="width: 10%;"></td> <td style="width: 10%;"></td> <td style="width: 10%;"></td> <td style="width: 10%;"></td> </tr> <tr> <td></td> <td></td> <td colspan="8" style="text-align: center;"> <table border="1" style="width: 100%; border-collapse: collapse; text-align: center;"> <tr> <td style="width: 10%;"></td> <td style="width: 10%;"></td> <td style="width: 10%;"></td> <td style="width: 10%;"></td> <td style="width: 10%;"></td> <td style="width: 10%;"></td> <td style="width: 10%;"></td> <td style="width: 10%;"></td> <td style="width: 10%;"></td> <td style="width: 10%;"></td> </tr> <tr> <td></td> <td></td> <td colspan="8" style="text-align: center;"> <table border="1" style="width: 100%; border-collapse: collapse; text-align: center;"> <tr> <td style="width: 10%;"></td> <td style="width: 10%;"></td> <td style="width: 10%;"></td> <td style="width: 10%;"></td> <td style="width: 10%;"></td> <td style="width: 10%;"></td> <td style="width: 10%;"></td> <td style="width: 10%;"></td> <td style="width: 10%;"></td> <td style="width: 10%;"></td> </tr> <tr> <td></td> <td></td> <td colspan="8" style="text-align: center;"> <table border="1" style="width: 100%; border-collapse: collapse; text-align: center;"> <tr> <td style="width: 10%;"></td> <td style="width: 10%;"></td> <td style="width: 10%;"></td> <td style="width: 10%;"></td> <td style="width: 10%;"></td> <td style="width: 10%;"></td> <td style="width: 10%;"></td> <td style="width: 10%;"></td> <td style="width: 10%;"></td> <td style="width: 10%;"></td> </tr> <tr> <td></td> <td></td> <td colspan="8" style="text-align: center;"> <table border="1" style="width: 100%; border-collapse: collapse; text-align: center;"> <tr> <td style="width: 10%;"></td> <td style="width: 10%;"></td> <td style="width: 10%;"></td> <td style="width: 10%;"></td> <td style="width: 10%;"></td> <td style="width: 10%;"></td> <td style="width: 10%;"></td> <td style="width: 10%;"></td> <td style="width: 10%;"></td> <td style="width: 10%;"></td> </tr> <tr> <td></td> <td></td> <td colspan="8" style="text-align: center;"> <table border="1" style="width: 100%; border-collapse: collapse; text-align: center;"> <tr> <td style="width: 10%;"></td> <td style="width: 10%;"></td> <td style="width: 10%;"></td> <td style="width: 10%;"></td> <td style="width: 10%;"></td> <td style="width: 10%;"></td> <td style="width: 10%;"></td> <td style="width: 10%;"></td> <td style="width: 10%;"></td> <td style="width: 10%;"></td> </tr> <tr> <td></td> <td></td> <td colspan="8" style="text-align: center;"> <table border="1" style="width: 100%; border-collapse: collapse; text-align: center;"> <tr> <td style="width: 10%;"></td> <td style="width: 10%;"></td> <td style="width: 10%;"></td> <td style="width: 10%;"></td> <td style="width: 10%;"></td> <td style="width: 10%;"></td> <td style="width: 10%;"></td> <td style="width: 10%;"></td> <td style="width: 10%;"></td> <td style="width: 10%;"></td> </tr> <tr> <td></td> <td></td> <td colspan="8" style="text-align: center;"> <table border="1" style="width: 100%; border-collapse: collapse;
text-align: center;"> <tr> <td style="width: 10%;"></td> <td style="width: 10%;"></td> <td style="width: 10%;"></td> <td style="width: 10%;"></td> <td style="width: 10%;"></td> <td style="width: 10%;"></td> <td style="width: 10%;"></td> <td style="width: 10%;"></td> <td style="width: 10%;"></td> <td style="width: 10%;"></td> </tr> <tr> <td></td> <td></td> <td colspan="8" style="text-align: center;"> <table border="1" style="width: 100%; border-collapse: collapse; text-align: center;"> <tr> <td style="width: 10%;"></td> <td style="width: 10%;"></td> <td style="width: 10%;"></td> <td style="width: 10%;"></td> <td style="width: 10%;"></td> <td style="width: 10%;"></td> <td style="width: 10%;"></td> <td style="width: 10%;"></td> <td style="width: 10%;"></td> <td style="width: 10%;"></td> </tr> <tr> <td></td> <td></td> <td colspan="8" style="text-align: center;"> <table border="1" style="width: 100%; border-collapse: collapse; text-align: center;"> <tr> <td style="width: 10%;"></td> <td style="width: 10%;"></td> <td style="width: 10%;"></td> <td style="width: 10%;"></td> <td style="width: 10%;"></td> <td style="width: 10%;"></td> <td style="width: 10%;"></td> <td style="width: 10%;"></td> <td style="width: 10%;"></td> <td style="width: 10%;"></td> </tr> <tr> <td></td> <td></td> <td colspan="8" style="text-align: center;"> <table border="1" style="width: 100%; border-collapse: collapse; text-align: center;"> <tr> </tr></table></td></tr></table></td></tr></table></td></tr></table></td></tr></table></td></tr></table></td></tr></table></td></tr></table></td></tr></table></td></tr></table></td></tr></table></td></tr></table></td></tr></table></td></tr></table></td></tr></table></td></tr></table></td></tr></table></td></tr></table></td></tr></table></td></tr></table></td></tr></table></td></tr></table></td></tr></table></td></tr></table></td></tr></table></td></tr></table></td></tr></table></td></tr></table></td></tr></table></td></tr></table></td></tr></table></td></tr></table></td></tr></table></td></tr></table></td></tr></table></td></tr></table></td></tr></table></td></tr></table></td></tr></table> | | | | | | | | | | | | | | | | | | | | <table border="1" style="width: 100%; border-collapse: collapse; text-align: center;"> <tr> <td style="width: 10%;"></td> <td style="width: 10%;"></td> <td style="width: 10%;"></td> <td style="width: 10%;"></td> <td style="width: 10%;"></td> <td style="width: 10%;"></td> <td style="width: 10%;"></td> <td style="width: 10%;"></td> <td style="width: 10%;"></td> <td style="width: 10%;"></td> </tr> <tr> <td></td> <td></td> <td colspan="8" style="text-align: center;"> <table border="1" style="width: 100%; border-collapse: collapse; text-align: center;"> <tr> <td style="width: 10%;"></td> <td style="width: 10%;"></td> <td style="width: 10%;"></td> <td style="width: 10%;"></td> <td style="width: 10%;"></td> <td style="width: 10%;"></td> <td style="width: 10%;"></td> <td style="width: 10%;"></td> <td style="width: 10%;"></td> <td style="width: 10%;"></td> </tr> <tr> <td></td> <td></td> <td colspan="8" style="text-align: center;"> <table border="1" style="width: 100%; border-collapse: collapse;
text-align: center;"> <tr> <td style="width: 10%;"></td> <td style="width: 10%;"></td> <td style="width: 10%;"></td> <td style="width: 10%;"></td> <td style="width: 10%;"></td> <td style="width: 10%;"></td> <td style="width: 10%;"></td> <td style="width: 10%;"></td> <td style="width: 10%;"></td> <td style="width: 10%;"></td> </tr> <tr> <td></td> <td></td> <td colspan="8" style="text-align: center;"> <table border="1" style="width: 100%; border-collapse: collapse; text-align: center;"> <tr> <td style="width: 10%;"></td> <td style="width: 10%;"></td> <td style="width: 10%;"></td> <td style="width: 10%;"></td> <td style="width: 10%;"></td> <td style="width: 10%;"></td> <td style="width: 10%;"></td> <td style="width: 10%;"></td> <td style="width: 10%;"></td> <td style="width: 10%;"></td> </tr> <tr> <td></td> <td></td> <td colspan="8" style="text-align: center;"> <table border="1" style="width: 100%; border-collapse: collapse; text-align: center;"> <tr> <td style="width: 10%;"></td> <td style="width: 10%;"></td> <td style="width: 10%;"></td> <td style="width: 10%;"></td> <td style="width: 10%;"></td> <td style="width: 10%;"></td> <td style="width: 10%;"></td> <td style="width: 10%;"></td> <td style="width: 10%;"></td> <td style="width: 10%;"></td> </tr> <tr> <td></td> <td></td> <td colspan="8" style="text-align: center;"> <table border="1" style="width: 100%; border-collapse: collapse; text-align: center;"> <tr> <td style="width: 10%;"></td> <td style="width: 10%;"></td> <td style="width: 10%;"></td> <td style="width: 10%;"></td> <td style="width: 10%;"></td> <td style="width: 10%;"></td> <td style="width: 10%;"></td> <td style="width: 10%;"></td> <td style="width: 10%;"></td> <td style="width: 10%;"></td> </tr> <tr> <td></td> <td></td> <td colspan="8" style="text-align: center;"> <table border="1" style="width: 100%; border-collapse: collapse; text-align: center;"> <tr> <td style="width: 10%;"></td> <td style="width: 10%;"></td> <td style="width: 10%;"></td> <td style="width: 10%;"></td> <td style="width: 10%;"></td> <td style="width: 10%;"></td> <td style="width: 10%;"></td> <td style="width: 10%;"></td> <td style="width: 10%;"></td> <td style="width: 10%;"></td> </tr> <tr> <td></td> <td></td> <td colspan="8" style="text-align: center;"> <table border="1" style="width: 100%; border-collapse: collapse; text-align: center;"> <tr> <td style="width: 10%;"></td> <td style="width: 10%;"></td> <td style="width: 10%;"></td> <td style="width: 10%;"></td> <td style="width: 10%;"></td> <td style="width: 10%;"></td> <td style="width: 10%;"></td> <td style="width: 10%;"></td> <td style="width: 10%;"></td> <td style="width: 10%;"></td> </tr> <tr> <td></td> <td></td> <td colspan="8" style="text-align: center;"> <table border="1" style="width: 100%; border-collapse: collapse; text-align: center;"> <tr> <td style="width: 10%;"></td> <td style="width: 10%;"></td> <td style="width: 10%;"></td> <td style="width: 10%;"></td> <td style="width: 10%;"></td> <td style="width: 10%;"></td> <td style="width: 10%;"></td> <td style="width: 10%;"></td> <td style="width: 10%;"></td> <td style="width: 10%;"></td> </tr> <tr> <td></td> <td></td> <td colspan="8" style="text-align: center;"> <table border="1" style="width: 100%; border-collapse: collapse; text-align: center;"> <tr> <td style="width: 10%;"></td> <td style="width: 10%;"></td> <td style="width: 10%;"></td> <td style="width: 10%;"></td> <td style="width: 10%;"></td> <td style="width: 10%;"></td> <td style="width: 10%;"></td> <td style="width: 10%;"></td> <td style="width: 10%;"></td> <td style="width: 10%;"></td> </tr> <tr> <td></td> <td></td> <td colspan="8" style="text-align: center;"> <table border="1" style="width: 100%; border-collapse: collapse; text-align: center;"> <tr> <td style="width: 10%;"></td> <td style="width: 10%;"></td> <td style="width: 10%;"></td> <td style="width: 10%;"></td> <td style="width: 10%;"></td> <td style="width: 10%;"></td> <td style="width: 10%;"></td> <td style="width: 10%;"></td> <td style="width: 10%;"></td> <td style="width: 10%;"></td> </tr> <tr> <td></td> <td></td> <td colspan="8" style="text-align: center;"> <table border="1" style="width: 100%; border-collapse: collapse; text-align: center;"> <tr> <td style="width: 10%;"></td> <td style="width: 10%;"></td> <td style="width: 10%;"></td> <td style="width: 10%;"></td> <td style="width: 10%;"></td> <td style="width: 10%;"></td> <td style="width: 10%;"></td> <td style="width: 10%;"></td> <td style="width: 10%;"></td> <td style="width: 10%;"></td> </tr> <tr> <td></td> <td></td> <td colspan="8" style="text-align: center;"> <table border="1" style="width: 100%; border-collapse: collapse; text-align: center;"> <tr> <td style="width: 10%;"></td> <td style="width: 10%;"></td> <td style="width: 10%;"></td> <td style="width: 10%;"></td> <td style="width: 10%;"></td> <td style="width: 10%;"></td> <td style="width: 10%;"></td> <td style="width: 10%;"></td> <td style="width: 10%;"></td> <td style="width: 10%;"></td> </tr> <tr> <td></td> <td></td> <td colspan="8" style="text-align: center;"> <table border="1" style="width: 100%; border-collapse: collapse; text-align: center;"> <tr> <td style="width: 10%;"></td> <td style="width: 10%;"></td> <td style="width: 10%;"></td> <td style="width: 10%;"></td> <td style="width: 10%;"></td> <td style="width: 10%;"></td> <td style="width: 10%;"></td> <td style="width: 10%;"></td> <td style="width: 10%;"></td> <td style="width: 10%;"></td> </tr> <tr> <td></td> <td></td> <td colspan="8" style="text-align: center;"> <table border="1" style="width: 100%; border-collapse: collapse; text-align: center;"> <tr> <td style="width: 10%;"></td> <td style="width: 10%;"></td> <td style="width: 10%;"></td> <td style="width: 10%;"></td> <td style="width: 10%;"></td> <td style="width: 10%;"></td> <td style="width: 10%;"></td> <td style="width: 10%;"></td> <td style="width: 10%;"></td> <td style="width: 10%;"></td> </tr> <tr> <td></td> <td></td> <td colspan="8" style="text-align: center;"> <table border="1" style="width: 100%; border-collapse: collapse; text-align: center;"> <tr> <td style="width: 10%;"></td> <td style="width: 10%;"></td> <td style="width: 10%;"></td> <td style="width: 10%;"></td> <td style="width: 10%;"></td> <td style="width: 10%;"></td> <td style="width: 10%;"></td> <td style="width: 10%;"></td> <td style="width: 10%;"></td> <td style="width: 10%;"></td> </tr> <tr> <td></td> <td></td> <td colspan="8" style="text-align: center;"> <table border="1" style="width: 100%; border-collapse: collapse; text-align: center;"> <tr> <td style="width: 10%;"></td> <td style="width: 10%;"></td> <td style="width: 10%;"></td> <td style="width: 10%;"></td> <td style="width: 10%;"></td> <td style="width: 10%;"></td> <td style="width: 10%;"></td> <td style="width: 10%;"></td> <td style="width: 10%;"></td> <td style="width: 10%;"></td> </tr> <tr> <td></td> <td></td> <td colspan="8" style="text-align: center;"> <table border="1" style="width: 100%; border-collapse: collapse; text-align: center;"> <tr> <td style="width: 10%;"></td> <td style="width: 10%;"></td> <td style="width: 10%;"></td> <td style="width: 10%;"></td> <td style="width: 10%;"></td> <td style="width: 10%;"></td> <td style="width: 10%;"></td> <td style="width: 10%;"></td> <td style="width: 10%;"></td> <td style="width: 10%;"></td> </tr> <tr> <td></td> <td></td> <td colspan="8" style="text-align: center;"> <table border="1" style="width: 100%; border-collapse: collapse; text-align: center;"> <tr> <td style="width: 10%;"></td> <td style="width: 10%;"></td> <td style="width: 10%;"></td> <td style="width: 10%;"></td> <td style="width: 10%;"></td> <td style="width: 10%;"></td> <td style="width: 10%;"></td> <td style="width: 10%;"></td> <td style="width: 10%;"></td> <td style="width: 10%;"></td> </tr> <tr> <td></td> <td></td> <td colspan="8" style="text-align: center;"> <table border="1" style="width: 100%; border-collapse: collapse; text-align: center;"> <tr> <td style="width: 10%;"></td> <td style="width: 10%;"></td> <td style="width: 10%;"></td> <td style="width: 10%;"></td> <td style="width: 10%;"></td> <td style="width: 10%;"></td> <td style="width: 10%;"></td> <td style="width: 10%;"></td> <td style="width: 10%;"></td> <td style="width: 10%;"></td> </tr> <tr> <td></td> <td></td> <td colspan="8" style="text-align: center;"> <table border="1" style="width: 100%; border-collapse: collapse; text-align: center;"> <tr> <td style="width: 10%;"></td> <td style="width: 10%;"></td> <td style="width: 10%;"></td> <td style="width: 10%;"></td> <td style="width: 10%;"></td> <td style="width: 10%;"></td> <td style="width: 10%;"></td> <td style="width: 10%;"></td> <td style="width: 10%;"></td> <td style="width: 10%;"></td> </tr> <tr> <td></td> <td></td> <td colspan="8" style="text-align: center;"> <table border="1" style="width: 100%; border-collapse: collapse; text-align: center;"> <tr> <td style="width: 10%;"></td> <td style="width: 10%;"></td> <td style="width: 10%;"></td> <td style="width: 10%;"></td> <td style="width: 10%;"></td> <td style="width: 10%;"></td> <td style="width: 10%;"></td> <td style="width: 10%;"></td> <td style="width: 10%;"></td> <td style="width: 10%;"></td> </tr> <tr> <td></td> <td></td> <td colspan="8" style="text-align: center;"> <table border="1" style="width: 100%; border-collapse: collapse; text-align: center;"> <tr> <td style="width: 10%;"></td> <td style="width: 10%;"></td> <td style="width: 10%;"></td> <td style="width: 10%;"></td> <td style="width: 10%;"></td> <td style="width: 10%;"></td> <td style="width: 10%;"></td> <td style="width: 10%;"></td> <td style="width: 10%;"></td> <td style="width: 10%;"></td> </tr> <tr> <td></td> <td></td> <td colspan="8" style="text-align: center;"> <table border="1" style="width: 100%; border-collapse: collapse; text-align: center;"> <tr> <td style="width: 10%;"></td> <td style="width: 10%;"></td> <td style="width: 10%;"></td> <td style="width: 10%;"></td> <td style="width:
10%;"></td> <td style="width: 10%;"></td> <td style="width: 10%;"></td> <td style="width: 10%;"></td> <td style="width: 10%;"></td> <td style="width: 10%;"></td> </tr> <tr> <td></td> <td></td> <td colspan="8" style="text-align: center;"> <table border="1" style="width: 100%; border-collapse: collapse; text-align: center;"> <tr> <td style="width: 10%;"></td> <td style="width: 10%;"></td> <td style="width: 10%;"></td> <td style="width: 10%;"></td> <td style="width: 10%;"></td> <td style="width: 10%;"></td> <td style="width: 10%;"></td> <td style="width: 10%;"></td> <td style="width: 10%;"></td> <td style="width: 10%;"></td> </tr> <tr> <td></td> <td></td> <td colspan="8" style="text-align: center;"> <table border="1" style="width: 100%; border-collapse: collapse; text-align: center;"> <tr> <td style="width: 10%;"></td> <td style="width: 10%;"></td> <td style="width: 10%;"></td> <td style="width: 10%;"></td> <td style="width: 10%;"></td> <td style="width: 10%;"></td> <td style="width: 10%;"></td> <td style="width: 10%;"></td> <td style="width: 10%;"></td> <td style="width: 10%;"></td> </tr> <tr> <td></td> <td></td> <td colspan="8" style="text-align: center;"> <table border="1" style="width: 100%; border-collapse: collapse; text-align: center;"> <tr> <td style="width: 10%;"></td> <td style="width: 10%;"></td> <td style="width: 10%;"></td> <td style="width: 10%;"></td> <td style="width: 10%;"></td> <td style="width: 10%;"></td> <td style="width: 10%;"></td> <td style="width: 10%;"></td> <td style="width: 10%;"></td> <td style="width: 10%;"></td> </tr> <tr> <td></td> <td></td> <td colspan="8" style="text-align: center;"> <table border="1" style="width: 100%; border-collapse: collapse; text-align: center;"> <tr> <td style="width: 10%;"></td> <td style="width: 10%;"></td> <td style="width: 10%;"></td> <td style="width: 10%;"></td> <td style="width: 10%;"></td> <td style="width: 10%;"></td> <td style="width: 10%;"></td> <td style="width: 10%;"></td> <td style="width: 10%;"></td> <td style="width: 10%;"></td> </tr> <tr> <td></td> <td></td> <td colspan="8" style="text-align: center;"> <table border="1" style="width: 100%; border-collapse: collapse; text-align: center;"> <tr> <td style="width: 10%;"></td> <td style="width: 10%;"></td> <td style="width: 10%;"></td> <td style="width: 10%;"></td> <td style="width: 10%;"></td> <td style="width: 10%;"></td> <td style="width: 10%;"></td> <td style="width: 10%;"></td> <td style="width: 10%;"></td> <td style="width: 10%;"></td> </tr> <tr> <td></td> <td></td> <td colspan="8" style="text-align: center;"> <table border="1" style="width: 100%; border-collapse: collapse; text-align: center;"> <tr> <td style="width: 10%;"></td> <td style="width: 10%;"></td> <td style="width: 10%;"></td> <td style="width: 10%;"></td> <td style="width: 10%;"></td> <td style="width: 10%;"></td> <td style="width: 10%;"></td> <td style="width: 10%;"></td> <td style="width: 10%;"></td> <td style="width: 10%;"></td> </tr> <tr> <td></td> <td></td> <td colspan="8" style="text-align: center;"> <table border="1" style="width: 100%; border-collapse: collapse; text-align: center;"> <tr> <td style="width: 10%;"></td> <td style="width: 10%;"></td> <td style="width: 10%;"></td> <td style="width: 10%;"></td> <td style="width: 10%;"></td> <td style="width: 10%;"></td> <td style="width: 10%;"></td> <td style="width: 10%;"></td> <td style="width: 10%;"></td> <td style="width: 10%;"></td> </tr> <tr> <td></td> <td></td> <td colspan="8" style="text-align: center;"> <table border="1" style="width: 100%; border-collapse: collapse; text-align: center;"> <tr> <td style="width: 10%;"></td> <td style="width: 10%;"></td> <td style="width: 10%;"></td> <td style="width: 10%;"></td> <td style="width: 10%;"></td> <td style="width: 10%;"></td> <td style="width: 10%;"></td> <td style="width: 10%;"></td> <td style="width: 10%;"></td> <td style="width: 10%;"></td> </tr> <tr> <td></td> <td></td> <td colspan="8" style="text-align: center;"> <table border="1" style="width: 100%; border-collapse: collapse; text-align: center;"> <tr> <td style="width: 10%;"></td> <td style="width: 10%;"></td> <td style="width: 10%;"></td> <td style="width: 10%;"></td> <td style="width: 10%;"></td> <td style="width: 10%;"></td> <td style="width: 10%;"></td> <td style="width: 10%;"></td> <td style="width: 10%;"></td> <td style="width: 10%;"></td> </tr> <tr> <td></td> <td></td> <td colspan="8" style="text-align: center;"> <table border="1" style="width: 100%; border-collapse: collapse; text-align: center;"> <tr> <td style="width: 10%;"></td> <td style="width: 10%;"></td> <td style="width: 10%;"></td> <td style="width: 10%;"></td> <td style="width: 10%;"></td> <td style="width: 10%;"></td> <td style="width: 10%;"></td> <td style="width: 10%;"></td> <td style="width: 10%;"></td> <td style="width: 10%;"></td> </tr> <tr> <td></td> <td></td> <td colspan="8" style="text-align: center;"> <table border="1" style="width: 100%; border-collapse: collapse; text-align: center;"> <tr> <td style="width: 10%;"></td> <td style="width: 10%;"></td> <td style="width: 10%;"></td> <td style="width: 10%;"></td> <td style="width: 10%;"></td> <td style="width: 10%;"></td> <td style="width: 10%;"></td> <td style="width: 10%;"></td> <td style="width: 10%;"></td> <td style="width: 10%;"></td> </tr> <tr> <td></td> <td></td> <td colspan="8" style="text-align: center;"> <table border="1" style="width: 100%; border-collapse: collapse; text-align: center;"> <tr> <td style="width: 10%;"></td> <td style="width: 10%;"></td> <td style="width: 10%;"></td> <td style="width: 10%;"></td> <td style="width: 10%;"></td> <td style="width: 10%;"></td> <td style="width: 10%;"></td> <td style="width: 10%;"></td> <td style="width: 10%;"></td> <td style="width: 10%;"></td> </tr> <tr> <td></td> <td></td> <td colspan="8" style="text-align: center;"> <table border="1" style="width: 100%; border-collapse: collapse; text-align: center;"> <tr> <td style="width: 10%;"></td> <td style="width: 10%;"></td> <td style="width: 10%;"></td> <td style="width: 10%;"></td> <td style="width: 10%;"></td> <td style="width: 10%;"></td> <td style="width: 10%;"></td> <td style="width: 10%;"></td> <td style="width: 10%;"></td> <td style="width: 10%;"></td> </tr> <tr> <td></td> <td></td> <td colspan="8" style="text-align: center;"> <table border="1" style="width: 100%; border-collapse: collapse; text-align: center;"> <tr> </tr></table></td></tr></table></td></tr></table></td></tr></table></td></tr></table></td></tr></table></td></tr></table></td></tr></table></td></tr></table></td></tr></table></td></tr></table></td></tr></table></td></tr></table></td></tr></table></td></tr></table></td></tr></table></td></tr></table></td></tr></table></td></tr></table></td></tr></table></td></tr></table></td></tr></table></td></tr></table></td></tr></table></td></tr></table></td></tr></table></td></tr></table></td></tr></table></td></tr></table></td></tr></table></td></tr></table></td></tr></table></td></tr></table></td></tr></table></td></tr></table></td></tr></table></td></tr></table></td></tr></table>
 | | | | | | | | | | | | | | | | | | | | <table border="1" style="width: 100%; border-collapse: collapse; text-align: center;"> <tr> <td style="width: 10%;"></td> <td style="width: 10%;"></td> <td style="width: 10%;"></td> <td style="width: 10%;"></td> <td style="width: 10%;"></td> <td style="width: 10%;"></td> <td style="width: 10%;"></td> <td style="width: 10%;"></td> <td style="width: 10%;"></td> <td style="width: 10%;"></td> </tr> <tr> <td></td> <td></td> <td colspan="8" style="text-align: center;"> <table border="1" style="width: 100%; border-collapse: collapse; text-align: center;"> <tr> <td style="width: 10%;"></td> <td style="width: 10%;"></td> <td style="width: 10%;"></td> <td style="width: 10%;"></td> <td style="width: 10%;"></td> <td style="width: 10%;"></td> <td style="width: 10%;"></td> <td style="width: 10%;"></td> <td style="width: 10%;"></td> <td style="width: 10%;"></td> </tr> <tr> <td></td> <td></td> <td colspan="8" style="text-align: center;"> <table border="1" style="width: 100%; border-collapse: collapse; text-align: center;"> <tr> <td style="width: 10%;"></td> <td style="width: 10%;"></td> <td style="width: 10%;"></td> <td style="width: 10%;"></td> <td style="width: 10%;"></td> <td style="width: 10%;"></td> <td style="width: 10%;"></td> <td style="width: 10%;"></td> <td style="width: 10%;"></td> <td style="width: 10%;"></td> </tr> <tr> <td></td> <td></td> <td colspan="8" style="text-align: center;"> <table border="1" style="width: 100%; border-collapse: collapse; text-align: center;"> <tr> <td style="width: 10%;"></td> <td style="width: 10%;"></td> <td style="width: 10%;"></td> <td style="width: 10%;"></td> <td style="width: 10%;"></td> <td style="width: 10%;"></td> <td style="width: 10%;"></td> <td style="width: 10%;"></td> <td style="width: 10%;"></td> <td style="width: 10%;"></td> </tr> <tr> <td></td> <td></td> <td colspan="8" style="text-align: center;"> <table border="1" style="width: 100%; border-collapse: collapse; text-align: center;"> <tr> <td style="width: 10%;"></td> <td style="width: 10%;"></td> <td style="width: 10%;"></td> <td style="width: 10%;"></td> <td style="width: 10%;"></td> <td style="width: 10%;"></td> <td style="width: 10%;"></td> <td style="width: 10%;"></td> <td style="width: 10%;"></td> <td style="width: 10%;"></td> </tr> <tr> <td></td> <td></td> <td colspan="8" style="text-align: center;"> <table border="1" style="width: 100%; border-collapse: collapse; text-align: center;"> <tr> <td style="width: 10%;"></td> <td style="width: 10%;"></td> <td style="width: 10%;"></td> <td style="width: 10%;"></td> <td style="width: 10%;"></td> <td style="width: 10%;"></td> <td style="width: 10%;"></td> <td style="width: 10%;"></td> <td style="width: 10%;"></td> <td style="width: 10%;"></td> </tr> <tr> <td></td> <td></td> <td colspan="8" style="text-align: center;"> <table border="1" style="width: 100%; border-collapse: collapse; text-align: center;"> <tr> <td style="width: 10%;"></td> <td style="width: 10%;"></td> <td style="width: 10%;"></td> <td style="width: 10%;"></td> <td style="width: 10%;"></td> <td style="width: 10%;"></td> <td style="width: 10%;"></td> <td style="width: 10%;"></td> <td style="width: 10%;"></td> <td style="width: 10%;"></td> </tr> <tr> <td></td> <td></td> <td colspan="8" style="text-align: center;"> <table border="1" style="width: 100%; border-collapse: collapse; text-align: center;"> <tr> <td style="width: 10%;"></td> <td style="width: 10%;"></td> <td style="width: 10%;"></td> <td style="width: 10%;"></td> <td style="width: 10%;"></td> <td style="width: 10%;"></td> <td style="width: 10%;"></td> <td style="width: 10%;"></td> <td style="width: 10%;"></td> <td style="width: 10%;"></td> </tr> <tr> <td></td> <td></td> <td colspan="8" style="text-align: center;"> <table border="1" style="width: 100%; border-collapse: collapse; text-align: center;"> <tr> <td style="width: 10%;"></td> <td style="width: 10%;"></td> <td style="width: 10%;"></td> <td style="width: 10%;"></td> <td style="width: 10%;"></td> <td style="width: 10%;"></td> <td style="width: 10%;"></td> <td style="width: 10%;"></td> <td style="width: 10%;"></td> <td style="width: 10%;"></td> </tr> <tr> <td></td> <td></td> <td colspan="8" style="text-align: center;"> <table border="1" style="width: 100%; border-collapse: collapse; text-align: center;"> <tr> <td style="width: 10%;"></td> <td style="width: 10%;"></td> <td style="width: 10%;"></td> <td style="width: 10%;"></td> <td style="width: 10%;"></td> <td style="width: 10%;"></td> <td style="width: 10%;"></td> <td style="width: 10%;"></td> <td style="width: 10%;"></td> <td style="width: 10%;"></td> </tr> <tr> <td></td> <td></td> <td colspan="8" style="text-align: center;"> <table border="1" style="width: 100%; border-collapse: collapse; text-align: center;"> <tr> <td style="width: 10%;"></td> <td style="width: 10%;"></td> <td style="width: 10%;"></td> <td style="width: 10%;"></td> <td style="width: 10%;"></td> <td style="width: 10%;"></td> <td style="width: 10%;"></td> <td style="width: 10%;"></td> <td style="width: 10%;"></td> <td style="width: 10%;"></td> </tr> <tr> <td></td> <td></td> <td colspan="8" style="text-align: center;"> <table border="1" style="width: 100%; border-collapse: collapse; text-align: center;"> <tr> <td style="width: 10%;"></td> <td style="width: 10%;"></td> <td style="width: 10%;"></td> <td style="width: 10%;"></td> <td style="width: 10%;"></td> <td style="width: 10%;"></td> <td style="width: 10%;"></td> <td style="width: 10%;"></td> <td style="width: 10%;"></td> <td style="width: 10%;"></td> </tr> <tr> <td></td> <td></td> <td colspan="8" style="text-align: center;"> <table border="1" style="width: 100%; border-collapse: collapse; text-align: center;"> <tr> <td style="width: 10%;"></td> <td style="width: 10%;"></td> <td style="width: 10%;"></td> <td style="width: 10%;"></td> <td style="width: 10%;"></td> <td style="width: 10%;"></td> <td style="width: 10%;"></td> <td style="width: 10%;"></td> <td style="width: 10%;"></td> <td style="width: 10%;"></td> </tr> <tr> <td></td> <td></td> <td
colspan="8" style="text-align: center;"> <table border="1" style="width: 100%; border-collapse: collapse; text-align: center;"> <tr> <td style="width: 10%;"></td> <td style="width: 10%;"></td> <td style="width: 10%;"></td> <td style="width: 10%;"></td> <td style="width: 10%;"></td> <td style="width: 10%;"></td> <td style="width: 10%;"></td> <td style="width: 10%;"></td> <td style="width: 10%;"></td> <td style="width: 10%;"></td> </tr> <tr> <td></td> <td></td> <td colspan="8" style="text-align: center;"> <table border="1" style="width: 100%; border-collapse: collapse; text-align: center;"> <tr> <td style="width: 10%;"></td> <td style="width: 10%;"></td> <td style="width: 10%;"></td> <td style="width: 10%;"></td> <td style="width: 10%;"></td> <td style="width: 10%;"></td> <td style="width: 10%;"></td> <td style="width: 10%;"></td> <td style="width: 10%;"></td> <td style="width: 10%;"></td> </tr> <tr> <td></td> <td></td> <td colspan="8" style="text-align: center;"> <table border="1" style="width: 100%; border-collapse: collapse; text-align: center;"> <tr> <td style="width: 10%;"></td> <td style="width: 10%;"></td> <td style="width: 10%;"></td> <td style="width: 10%;"></td> <td style="width: 10%;"></td> <td style="width: 10%;"></td> <td style="width: 10%;"></td> <td style="width: 10%;"></td> <td style="width: 10%;"></td> <td style="width: 10%;"></td> </tr> <tr> <td></td> <td></td> <td colspan="8" style="text-align: center;"> <table border="1" style="width: 100%; border-collapse: collapse; text-align: center;"> <tr> <td style="width: 10%;"></td> <td style="width: 10%;"></td> <td style="width: 10%;"></td> <td style="width: 10%;"></td> <td style="width: 10%;"></td> <td style="width: 10%;"></td> <td style="width: 10%;"></td> <td style="width: 10%;"></td> <td style="width: 10%;"></td> <td style="width: 10%;"></td> </tr> <tr> <td></td> <td></td> <td colspan="8" style="text-align: center;"> <table border="1" style="width: 100%; border-collapse: collapse; text-align: center;"> <tr> <td style="width: 10%;"></td> <td style="width: 10%;"></td> <td style="width: 10%;"></td> <td style="width: 10%;"></td> <td style="width: 10%;"></td> <td style="width: 10%;"></td> <td style="width: 10%;"></td> <td style="width: 10%;"></td> <td style="width: 10%;"></td> <td style="width: 10%;"></td> </tr> <tr> <td></td> <td></td> <td colspan="8" style="text-align: center;"> <table border="1" style="width: 100%; border-collapse: collapse; text-align: center;"> <tr> <td style="width: 10%;"></td> <td style="width: 10%;"></td> <td style="width: 10%;"></td> <td style="width: 10%;"></td> <td style="width: 10%;"></td> <td style="width: 10%;"></td> <td style="width: 10%;"></td> <td style="width: 10%;"></td> <td style="width: 10%;"></td> <td style="width: 10%;"></td> </tr> <tr> <td></td> <td></td> <td colspan="8" style="text-align: center;"> <table border="1" style="width: 100%; border-collapse: collapse; text-align: center;"> <tr> <td style="width: 10%;"></td> <td style="width: 10%;"></td> <td style="width: 10%;"></td> <td style="width: 10%;"></td> <td style="width: 10%;"></td> <td style="width: 10%;"></td> <td style="width: 10%;"></td> <td style="width: 10%;"></td> <td style="width: 10%;"></td> <td style="width: 10%;"></td> </tr> <tr> <td></td> <td></td> <td colspan="8" style="text-align: center;"> <table border="1" style="width: 100%; border-collapse: collapse; text-align: center;"> <tr> <td style="width: 10%;"></td> <td style="width: 10%;"></td> <td style="width: 10%;"></td> <td style="width: 10%;"></td> <td style="width: 10%;"></td> <td style="width: 10%;"></td> <td style="width: 10%;"></td> <td style="width: 10%;"></td> <td style="width: 10%;"></td> <td style="width: 10%;"></td> </tr> <tr> <td></td> <td></td> <td colspan="8" style="text-align: center;"> <table border="1" style="width: 100%; border-collapse: collapse; text-align: center;"> <tr> <td style="width: 10%;"></td> <td style="width: 10%;"></td> <td style="width: 10%;"></td> <td style="width: 10%;"></td> <td style="width: 10%;"></td> <td style="width: 10%;"></td> <td style="width: 10%;"></td> <td style="width: 10%;"></td> <td style="width: 10%;"></td> <td style="width: 10%;"></td> </tr> <tr> <td></td> <td></td> <td colspan="8" style="text-align: center;"> <table border="1" style="width: 100%; border-collapse: collapse; text-align: center;"> <tr> <td style="width: 10%;"></td> <td style="width: 10%;"></td> <td style="width: 10%;"></td> <td style="width: 10%;"></td> <td style="width: 10%;"></td> <td style="width: 10%;"></td> <td style="width: 10%;"></td> <td style="width: 10%;"></td> <td style="width: 10%;"></td> <td style="width: 10%;"></td> </tr> <tr> <td></td> <td></td> <td colspan="8" style="text-align: center;"> <table border="1" style="width: 100%; border-collapse: collapse; text-align: center;"> <tr> <td style="width: 10%;"></td> <td style="width: 10%;"></td> <td style="width: 10%;"></td> <td style="width: 10%;"></td> <td style="width: 10%;"></td> <td style="width: 10%;"></td> <td style="width: 10%;"></td> <td style="width: 10%;"></td> <td style="width: 10%;"></td> <td style="width: 10%;"></td> </tr> <tr> <td></td> <td></td> <td colspan="8" style="text-align: center;"> <table border="1" style="width: 100%; border-collapse: collapse; text-align: center;"> <tr> <td style="width: 10%;"></td> <td style="width: 10%;"></td> <td style="width: 10%;"></td> <td style="width: 10%;"></td> <td style="width: 10%;"></td> <td style="width: 10%;"></td> <td style="width: 10%;"></td> <td style="width: 10%;"></td> <td style="width: 10%;"></td> <td style="width: 10%;"></td> </tr> <tr> <td></td> <td></td> <td colspan="8" style="text-align: center;"> <table border="1" style="width: 100%; border-collapse: collapse; text-align: center;"> <tr> <td style="width: 10%;"></td> <td style="width: 10%;"></td> <td style="width: 10%;"></td> <td style="width: 10%;"></td> <td style="width: 10%;"></td> <td style="width: 10%;"></td> <td style="width: 10%;"></td> <td style="width: 10%;"></td> <td style="width: 10%;"></td> <td style="width: 10%;"></td> </tr> <tr> <td></td> <td></td> <td colspan="8" style="text-align: center;"> <table border="1" style="width: 100%; border-collapse: collapse; text-align: center;"> <tr> <td style="width: 10%;"></td> <td style="width: 10%;"></td> <td style="width: 10%;"></td> <td style="width: 10%;"></td> <td style="width: 10%;"></td> <td style="width: 10%;"></td> <td style="width: 10%;"></td> <td style="width: 10%;"></td> <td style="width: 10%;"></td> <td style="width: 10%;"></td> </tr> <tr> <td></td> <td></td> <td colspan="8" style="text-align: center;"> <table border="1" style="width: 100%; border-collapse: collapse; text-align: center;"> <tr> <td style="width: 10%;"></td> <td style="width: 10%;"></td> <td style="width: 10%;"></td> <td style="width: 10%;"></td> <td style="width: 10%;"></td> <td style="width: 10%;"></td> <td style="width: 10%;"></td> <td style="width: 10%;"></td> <td style="width: 10%;"></td> <td style="width: 10%;"></td> </tr> <tr> <td></td> <td></td> <td colspan="8" style="text-align: center;"> <table border="1" style="width: 100%; border-collapse: collapse; text-align: center;"> <tr> <td style="width: 10%;"></td> <td style="width: 10%;"></td> <td style="width: 10%;"></td> <td style="width: 10%;"></td> <td style="width: 10%;"></td> <td style="width: 10%;"></td> <td style="width: 10%;"></td> <td style="width: 10%;"></td> <td style="width: 10%;"></td> <td style="width: 10%;"></td> </tr> <tr> <td></td> <td></td> <td colspan="8" style="text-align: center;"> <table border="1" style="width: 100%; border-collapse: collapse; text-align: center;"> <tr> <td style="width: 10%;"></td> <td style="width: 10%;"></td> <td style="width: 10%;"></td> <td style="width: 10%;"></td> <td style="width: 10%;"></td> <td style="width: 10%;"></td> <td style="width: 10%;"></td> <td style="width: 10%;"></td> <td style="width: 10%;"></td> <td style="width: 10%;"></td> </tr> <tr> <td></td> <td></td> <td colspan="8" style="text-align: center;"> <table border="1" style="width: 100%; border-collapse: collapse; text-align: center;"> <tr> <td style="width: 10%;"></td> <td style="width: 10%;"></td> <td style="width: 10%;"></td> <td style="width: 10%;"></td> <td style="width: 10%;"></td> <td style="width: 10%;"></td> <td style="width: 10%;"></td> <td style="width: 10%;"></td> <td style="width: 10%;"></td> <td style="width: 10%;"></td> </tr> <tr> <td></td> <td></td> <td colspan="8" style="text-align: center;"> <table border="1" style="width: 100%; border-collapse: collapse; text-align: center;"> <tr> <td style="width: 10%;"></td> <td style="width: 10%;"></td> <td style="width: 10%;"></td> <td style="width: 10%;"></td> <td style="width: 10%;"></td> <td style="width: 10%;"></td> <td style="width: 10%;"></td> <td style="width: 10%;"></td> <td style="width: 10%;"></td> <td style="width: 10%;"></td> </tr> <tr> <td></td> <td></td> <td colspan="8" style="text-align: center;"> <table border="1" style="width: 100%; border-collapse: collapse; text-align: center;"> <tr> <td style="width: 10%;"></td> <td style="width: 10%;"></td> <td style="width: 10%;"></td> <td style="width: 10%;"></td> <td style="width: 10%;"></td> <td style="width: 10%;"></td> <td style="width: 10%;"></td> <td style="width: 10%;"></td> <td style="width: 10%;"></td> <td style="width: 10%;"></td> </tr> <tr> <td></td> <td></td> <td colspan="8" style="text-align: center;"> <table border="1" style="width: 100%; border-collapse: collapse; text-align: center;"> <tr> <td style="width: 10%;"></td> <td style="width: 10%;"></td> <td style="width: 10%;"></td> <td style="width: 10%;"></td> <td style="width: 10%;"></td> <td style="width: 10%;"></td> <td style="width: 10%;"></td> <td style="width: 10%;"></td> <td style="width: 10%;"></td> <td style="width: 10%;"></td> </tr> <tr> <td></td> <td></td> <td colspan="8" style="text-align: center;"> <table border="1" style="width: 100%; border-collapse: collapse; text-align: center;"> <tr> <td style="width: 10%;"></td> <td
style="width: 10%;"></td> <td style="width: 10%;"></td> <td style="width: 10%;"></td> <td style="width: 10%;"></td> <td style="width: 10%;"></td> <td style="width: 10%;"></td> <td style="width: 10%;"></td> <td style="width: 10%;"></td> <td style="width: 10%;"></td> </tr> <tr> <td></td> <td></td> <td colspan="8" style="text-align: center;"> <table border="1" style="width: 100%; border-collapse: collapse; text-align: center;"> <tr> <td style="width: 10%;"></td> <td style="width: 10%;"></td> <td style="width: 10%;"></td> <td style="width: 10%;"></td> <td style="width: 10%;"></td> <td style="width: 10%;"></td> <td style="width: 10%;"></td> <td style="width: 10%;"></td> <td style="width: 10%;"></td> <td style="width: 10%;"></td> </tr> <tr> <td></td> <td></td> <td colspan="8" style="text-align: center;"> <table border="1" style="width: 100%; border-collapse: collapse; text-align: center;"> <tr> </tr></table></td></tr></table></td></tr></table></td></tr></table></td></tr></table></td></tr></table></td></tr></table></td></tr></table></td></tr></table></td></tr></table></td></tr></table></td></tr></table></td></tr></table></td></tr></table></td></tr></table></td></tr></table></td></tr></table></td></tr></table></td></tr></table></td></tr></table></td></tr></table></td></tr></table></td></tr></table></td></tr></table></td></tr></table></td></tr></table></td></tr></table></td></tr></table></td></tr></table></td></tr></table></td></tr></table></td></tr></table></td></tr></table></td></tr></table></td></tr></table></td></tr></table></td></tr></table> | | | | | | | | | | | | | | | | | | | | <table border="1" style="width: 100%; border-collapse: collapse; text-align: center;"> <tr> <td style="width: 10%;"></td> <td style="width: 10%;"></td> <td style="width: 10%;"></td> <td style="width: 10%;"></td> <td style="width: 10%;"></td> <td style="width: 10%;"></td> <td style="width: 10%;"></td> <td style="width: 10%;"></td> <td style="width: 10%;"></td> <td style="width: 10%;"></td> </tr> <tr> <td></td> <td></td> <td colspan="8" style="text-align: center;"> <table border="1" style="width: 100%; border-collapse: collapse; text-align: center;"> <tr> <td style="width: 10%;"></td> <td style="width: 10%;"></td> <td style="width: 10%;"></td> <td style="width: 10%;"></td> <td style="width: 10%;"></td> <td style="width: 10%;"></td> <td style="width: 10%;"></td> <td style="width: 10%;"></td> <td style="width: 10%;"></td> <td style="width: 10%;"></td> </tr> <tr> <td></td> <td></td> <td colspan="8" style="text-align: center;"> <table border="1" style="width: 100%; border-collapse: collapse; text-align: center;"> <tr> <td style="width: 10%;"></td> <td style="width: 10%;"></td> <td style="width: 10%;"></td> <td style="width: 10%;"></td> <td style="width: 10%;"></td> <td style="width: 10%;"></td> <td style="width: 10%;"></td> <td style="width: 10%;"></td> <td style="width: 10%;"></td> <td style="width: 10%;"></td> </tr> <tr> <td></td> <td></td> <td colspan="8" style="text-align: center;"> <table border="1" style="width: 100%; border-collapse: collapse; text-align: center;"> <tr> <td style="width: 10%;"></td> <td style="width: 10%;"></td> <td
style="width: 10%;"></td> <td style="width: 10%;"></td> <td style="width: 10%;"></td> <td style="width: 10%;"></td> <td style="width: 10%;"></td> <td style="width: 10%;"></td> <td style="width: 10%;"></td> <td style="width: 10%;"></td> </tr> <tr> <td></td> <td></td> <td colspan="8" style="text-align: center;"> <table border="1" style="width: 100%; border-collapse: collapse; text-align: center;"> <tr> <td style="width: 10%;"></td> <td style="width: 10%;"></td> <td style="width: 10%;"></td> <td style="width: 10%;"></td> <td style="width: 10%;"></td> <td style="width: 10%;"></td> <td style="width: 10%;"></td> <td style="width: 10%;"></td> <td style="width: 10%;"></td> <td style="width: 10%;"></td> </tr> <tr> <td></td> <td></td> <td colspan="8" style="text-align: center;"> <table border="1" style="width: 100%; border-collapse: collapse; text-align: center;"> <tr> <td style="width: 10%;"></td> <td style="width: 10%;"></td> <td style="width: 10%;"></td> <td style="width: 10%;"></td> <td style="width: 10%;"></td> <td style="width: 10%;"></td> <td style="width: 10%;"></td> <td style="width: 10%;"></td> <td style="width: 10%;"></td> <td style="width: 10%;"></td> </tr> <tr> <td></td> <td></td> <td colspan="8" style="text-align: center;"> <table border="1" style="width: 100%; border-collapse: collapse; text-align: center;"> <tr> <td style="width: 10%;"></td> <td style="width: 10%;"></td> <td style="width: 10%;"></td> <td style="width: 10%;"></td> <td style="width: 10%;"></td> <td style="width: 10%;"></td> <td style="width: 10%;"></td> <td style="width: 10%;"></td> <td style="width: 10%;"></td> <td style="width: 10%;"></td> </tr> <tr> <td></td> <td></td> <td colspan="8" style="text-align: center;"> <table border="1" style="width: 100%; border-collapse: collapse; text-align: center;"> <tr> <td style="width: 10%;"></td> <td style="width: 10%;"></td> <td style="width: 10%;"></td> <td style="width: 10%;"></td> <td style="width: 10%;"></td> <td style="width: 10%;"></td> <td style="width: 10%;"></td> <td style="width: 10%;"></td> <td style="width: 10%;"></td> <td style="width: 10%;"></td> </tr> <tr> <td></td> <td></td> <td colspan="8" style="text-align: center;"> <table border="1" style="width: 100%; border-collapse: collapse; text-align: center;"> <tr> <td style="width: 10%;"></td> <td style="width: 10%;"></td> <td style="width: 10%;"></td> <td style="width: 10%;"></td> <td style="width: 10%;"></td> <td style="width: 10%;"></td> <td style="width: 10%;"></td> <td style="width: 10%;"></td> <td style="width: 10%;"></td> <td style="width: 10%;"></td> </tr> <tr> <td></td> <td></td> <td colspan="8" style="text-align: center;"> <table border="1" style="width: 100%; border-collapse: collapse; text-align: center;"> <tr> <td style="width: 10%;"></td> <td style="width: 10%;"></td> <td style="width: 10%;"></td> <td style="width: 10%;"></td> <td style="width: 10%;"></td> <td style="width: 10%;"></td> <td style="width: 10%;"></td> <td style="width: 10%;"></td> <td style="width: 10%;"></td> <td style="width: 10%;"></td> </tr> <tr> <td></td> <td></td> <td colspan="8" style="text-align: center;"> <table border="1" style="width: 100%; border-collapse: collapse; text-align: center;"> <tr> <td style="width: 10%;"></td> <td style="width: 10%;"></td> <td style="width: 10%;"></td> <td style="width: 10%;"></td> <td style="width: 10%;"></td> <td style="width: 10%;"></td> <td style="width: 10%;"></td> <td style="width: 10%;"></td> <td style="width: 10%;"></td> <td style="width: 10%;"></td> </tr> <tr> <td></td> <td></td> <td colspan="8" style="text-align: center;"> <table border="1" style="width: 100%; border-collapse: collapse; text-align: center;"> <tr> <td style="width: 10%;"></td> <td style="width: 10%;"></td> <td style="width: 10%;"></td> <td style="width: 10%;"></td> <td style="width: 10%;"></td> <td style="width: 10%;"></td> <td style="width: 10%;"></td> <td style="width: 10%;"></td> <td style="width: 10%;"></td> <td style="width: 10%;"></td> </tr> <tr> <td></td> <td></td> <td colspan="8" style="text-align: center;"> <table border="1" style="width: 100%; border-collapse: collapse; text-align: center;"> <tr> <td style="width: 10%;"></td> <td style="width: 10%;"></td> <td style="width: 10%;"></td> <td style="width: 10%;"></td> <td style="width: 10%;"></td> <td style="width: 10%;"></td> <td style="width: 10%;"></td> <td style="width: 10%;"></td> <td style="width: 10%;"></td> <td style="width: 10%;"></td> </tr> <tr> <td></td> <td></td> <td colspan="8" style="text-align: center;"> <table border="1" style="width: 100%; border-collapse: collapse; text-align: center;"> <tr> <td style="width: 10%;"></td> <td style="width: 10%;"></td> <td style="width: 10%;"></td> <td style="width: 10%;"></td> <td style="width: 10%;"></td> <td style="width: 10%;"></td> <td style="width: 10%;"></td> <td style="width: 10%;"></td> <td style="width: 10%;"></td> <td style="width: 10%;"></td> </tr> <tr> <td></td> <td></td> <td colspan="8" style="text-align: center;"> <table border="1" style="width: 100%; border-collapse: collapse; text-align: center;"> <tr> <td style="width: 10%;"></td> <td style="width: 10%;"></td> <td style="width: 10%;"></td> <td style="width: 10%;"></td> <td style="width: 10%;"></td> <td style="width: 10%;"></td> <td style="width: 10%;"></td> <td style="width: 10%;"></td> <td style="width: 10%;"></td> <td style="width: 10%;"></td> </tr> <tr> <td></td> <td></td> <td colspan="8" style="text-align: center;"> <table border="1" style="width: 100%; border-collapse: collapse; text-align: center;"> <tr> <td style="width: 10%;"></td> <td style="width: 10%;"></td> <td style="width: 10%;"></td> <td style="width: 10%;"></td> <td style="width: 10%;"></td> <td style="width: 10%;"></td> <td style="width: 10%;"></td> <td style="width: 10%;"></td> <td style="width: 10%;"></td> <td style="width: 10%;"></td> </tr> <tr> <td></td> <td></td> <td colspan="8" style="text-align: center;"> <table border="1" style="width: 100%; border-collapse: collapse; text-align: center;"> <tr> <td style="width: 10%;"></td> <td style="width: 10%;"></td> <td style="width: 10%;"></td> <td style="width: 10%;"></td> <td style="width: 10%;"></td> <td style="width: 10%;"></td> <td style="width: 10%;"></td> <td style="width: 10%;"></td> <td style="width: 10%;"></td> <td style="width: 10%;"></td> </tr> <tr> <td></td> <td></td> <td colspan="8" style="text-align: center;"> <table border="1" style="width: 100%; border-collapse: collapse; text-align: center;"> <tr> <td style="width: 10%;"></td> <td style="width: 10%;"></td> <td style="width: 10%;"></td> <td style="width: 10%;"></td> <td style="width: 10%;"></td> <td style="width: 10%;"></td> <td style="width: 10%;"></td> <td style="width: 10%;"></td> <td style="width: 10%;"></td> <td style="width: 10%;"></td> </tr> <tr> <td></td> <td></td> <td colspan="8" style="text-align: center;"> <table border="1" style="width: 100%; border-collapse: collapse; text-align: center;"> <tr> <td style="width: 10%;"></td> <td style="width: 10%;"></td> <td style="width: 10%;"></td> <td style="width: 10%;"></td> <td style="width: 10%;"></td> <td style="width: 10%;"></td> <td style="width: 10%;"></td> <td style="width: 10%;"></td> <td style="width: 10%;"></td> <td style="width: 10%;"></td> </tr> <tr> <td></td> <td></td> <td colspan="8" style="text-align: center;"> <table border="1" style="width: 100%; border-collapse: collapse; text-align: center;"> <tr> <td style="width: 10%;"></td> <td style="width: 10%;"></td> <td style="width: 10%;"></td> <td style="width: 10%;"></td> <td style="width: 10%;"></td> <td style="width: 10%;"></td> <td style="width: 10%;"></td> <td style="width: 10%;"></td> <td style="width: 10%;"></td> <td style="width: 10%;"></td> </tr> <tr> <td></td> <td></td> <td colspan="8" style="text-align: center;"> <table border="1" style="width: 100%; border-collapse: collapse; text-align: center;"> <tr> <td style="width: 10%;"></td> <td style="width: 10%;"></td> <td style="width: 10%;"></td> <td style="width: 10%;"></td> <td style="width: 10%;"></td> <td style="width: 10%;"></td> <td style="width: 10%;"></td> <td style="width: 10%;"></td> <td style="width: 10%;"></td> <td style="width: 10%;"></td> </tr> <tr> <td></td> <td></td> <td colspan="8" style="text-align: center;"> <table border="1" style="width: 100%; border-collapse: collapse; text-align: center;"> <tr> <td style="width: 10%;"></td> <td style="width: 10%;"></td> <td style="width: 10%;"></td> <td style="width: 10%;"></td> <td style="width: 10%;"></td> <td style="width: 10%;"></td> <td style="width: 10%;"></td> <td style="width: 10%;"></td> <td style="width: 10%;"></td> <td style="width: 10%;"></td> </tr> <tr> <td></td> <td></td> <td colspan="8" style="text-align: center;"> <table border="1" style="width: 100%; border-collapse: collapse; text-align: center;"> <tr> <td style="width: 10%;"></td> <td style="width: 10%;"></td> <td style="width: 10%;"></td> <td style="width: 10%;"></td> <td style="width: 10%;"></td> <td style="width: 10%;"></td> <td style="width: 10%;"></td> <td style="width: 10%;"></td> <td style="width: 10%;"></td> <td style="width: 10%;"></td> </tr> <tr> <td></td> <td></td> <td colspan="8" style="text-align: center;"> <table border="1" style="width: 100%; border-collapse: collapse; text-align: center;"> <tr> <td style="width: 10%;"></td> <td style="width: 10%;"></td> <td style="width: 10%;"></td> <td style="width: 10%;"></td> <td style="width: 10%;"></td> <td style="width: 10%;"></td> <td style="width: 10%;"></td> <td style="width: 10%;"></td> <td style="width: 10%;"></td> <td style="width: 10%;"></td> </tr> <tr> <td></td> <td></td> <td colspan="8" style="text-align: center;"> <table border="1" style="width: 100%; border-collapse: collapse; text-align: center;"> <tr> <td style="width: 10%;"></td> <td style="width: 10%;"></td> <td style="width: 10%;"></td> <td style="width: 10%;"></td> <td style="width: 10%;"></td> <td style="width: 10%;"></td> <td style="width: 10%;"></td> <td style="width:
10%;"></td> <td style="width: 10%;"></td> <td style="width: 10%;"></td> </tr> <tr> <td></td> <td></td> <td colspan="8" style="text-align: center;"> <table border="1" style="width: 100%; border-collapse: collapse; text-align: center;"> <tr> <td style="width: 10%;"></td> <td style="width: 10%;"></td> <td style="width: 10%;"></td> <td style="width: 10%;"></td> <td style="width: 10%;"></td> <td style="width: 10%;"></td> <td style="width: 10%;"></td> <td style="width: 10%;"></td> <td style="width: 10%;"></td> <td style="width: 10%;"></td> </tr> <tr> <td></td> <td></td> <td colspan="8" style="text-align: center;"> <table border="1" style="width: 100%; border-collapse: collapse; text-align: center;"> <tr> <td style="width: 10%;"></td> <td style="width: 10%;"></td> <td style="width: 10%;"></td> <td style="width: 10%;"></td> <td style="width: 10%;"></td> <td style="width: 10%;"></td> <td style="width: 10%;"></td> <td style="width: 10%;"></td> <td style="width: 10%;"></td> <td style="width: 10%;"></td> </tr> <tr> <td></td> <td></td> <td colspan="8" style="text-align: center;"> <table border="1" style="width: 100%; border-collapse: collapse; text-align: center;"> <tr> <td style="width: 10%;"></td> <td style="width: 10%;"></td> <td style="width: 10%;"></td> <td style="width: 10%;"></td> <td style="width: 10%;"></td> <td style="width: 10%;"></td> <td style="width: 10%;"></td> <td style="width: 10%;"></td> <td style="width: 10%;"></td> <td style="width: 10%;"></td> </tr> <tr> <td></td> <td></td> <td colspan="8" style="text-align: center;"> <table border="1" style="width: 100%; border-collapse: collapse; text-align: center;"> <tr> <td style="width: 10%;"></td> <td style="width: 10%;"></td> <td style="width: 10%;"></td> <td style="width: 10%;"></td> <td style="width: 10%;"></td> <td style="width: 10%;"></td> <td style="width: 10%;"></td> <td style="width: 10%;"></td> <td style="width: 10%;"></td> <td style="width: 10%;"></td> </tr> <tr> <td></td> <td></td> <td colspan="8" style="text-align: center;"> <table border="1" style="width: 100%; border-collapse: collapse; text-align: center;"> <tr> <td style="width: 10%;"></td> <td style="width: 10%;"></td> <td style="width: 10%;"></td> <td style="width: 10%;"></td> <td style="width: 10%;"></td> <td style="width: 10%;"></td> <td style="width: 10%;"></td> <td style="width: 10%;"></td> <td style="width: 10%;"></td> <td style="width: 10%;"></td> </tr> <tr> <td></td> <td></td> <td colspan="8" style="text-align: center;"> <table border="1" style="width: 100%; border-collapse: collapse; text-align: center;"> <tr> <td style="width: 10%;"></td> <td style="width: 10%;"></td> <td style="width: 10%;"></td> <td style="width: 10%;"></td> <td style="width: 10%;"></td> <td style="width: 10%;"></td> <td style="width: 10%;"></td> <td style="width: 10%;"></td> <td style="width: 10%;"></td> <td style="width: 10%;"></td> </tr> <tr> <td></td> <td></td> <td colspan="8" style="text-align: center;"> <table border="1" style="width: 100%; border-collapse: collapse; text-align: center;"> <tr> <td style="width: 10%;"></td> <td style="width: 10%;"></td> <td style="width: 10%;"></td> <td style="width: 10%;"></td> <td style="width: 10%;"></td> <td style="width: 10%;"></td> <td style="width: 10%;"></td> <td style="width: 10%;"></td> <td style="width: 10%;"></td> <td style="width: 10%;"></td> </tr> <tr> <td></td> <td></td> <td colspan="8" style="text-align: center;"> <table border="1" style="width: 100%; border-collapse: collapse; text-align: center;"> <tr> <td style="width: 10%;"></td> <td style="width: 10%;"></td> <td style="width: 10%;"></td> <td style="width: 10%;"></td> <td style="width: 10%;"></td> <td style="width: 10%;"></td> <td style="width: 10%;"></td> <td style="width: 10%;"></td> <td style="width: 10%;"></td> <td style="width: 10%;"></td> </tr> <tr> <td></td> <td></td> <td colspan="8" style="text-align: center;"> <table border="1" style="width: 100%; border-collapse: collapse; text-align: center;"> <tr> <td style="width: 10%;"></td> <td style="width: 10%;"></td> <td style="width: 10%;"></td> <td style="width: 10%;"></td> <td style="width: 10%;"></td> <td style="width: 10%;"></td> <td style="width: 10%;"></td> <td style="width: 10%;"></td> <td style="width: 10%;"></td> <td style="width: 10%;"></td> </tr> <tr> <td></td> <td></td> <td colspan="8" style="text-align: center;"> <table border="1" style="width: 100%; border-collapse: collapse; text-align: center;"> <tr> <td style="width: 10%;"></td> <td style="width: 10%;"></td> <td style="width: 10%;"></td> <td style="width: 10%;"></td> <td style="width: 10%;"></td> <td style="width: 10%;"></td> <td style="width: 10%;"></td> <td style="width: 10%;"></td> <td style="width: 10%;"></td> <td style="width: 10%;"></td> </tr> <tr> <td></td> <td></td> <td colspan="8" style="text-align: center;"> <table border="1" style="width: 100%; border-collapse: collapse; text-align: center;"> <tr> </tr></table></td></tr></table></td></tr></table></td></tr></table></td></tr></table></td></tr></table></td></tr></table></td></tr></table></td></tr></table></td></tr></table></td></tr></table></td></tr></table></td></tr></table></td></tr></table></td></tr></table></td></tr></table></td></tr></table></td></tr></table></td></tr></table></td></tr></table></td></tr></table></td></tr></table></td></tr></table></td></tr></table></td></tr></table></td></tr></table></td></tr></table></td></tr></table></td></tr></table></td></tr></table></td></tr></table></td></tr></table></td></tr></table></td></tr></table></td></tr></table></td></tr></table>
 | | | | | | | | | | | | | | | | | | | | <table border="1" style="width: 100%; border-collapse: collapse; text-align: center;"> <tr> <td style="width: 10%;"></td> <td style="width: 10%;"></td> <td style="width: 10%;"></td> <td style="width: 10%;"></td> <td style="width: 10%;"></td> <td style="width: 10%;"></td> <td style="width: 10%;"></td> <td style="width: 10%;"></td> <td style="width: 10%;"></td> <td style="width: 10%;"></td> </tr> <tr> <td></td> <td></td> <td colspan="8" style="text-align: center;"> <table border="1" style="width: 100%; border-collapse: collapse; text-align: center;"> <tr> <td style="width: 10%;"></td> <td style="width: 10%;"></td> <td style="width: 10%;"></td> <td style="width: 10%;"></td> <td style="width: 10%;"></td> <td style="width: 10%;"></td> <td style="width: 10%;"></td> <td style="width: 10%;"></td> <td style="width: 10%;"></td> <td style="width: 10%;"></td> </tr> <tr> <td></td> <td></td> <td colspan="8" style="text-align: center;"> <table border="1" style="width: 100%; border-collapse: collapse; text-align: center;"> <tr> <td style="width: 10%;"></td> <td style="width: 10%;"></td> <td style="width: 10%;"></td> <td style="width: 10%;"></td> <td style="width: 10%;"></td> <td style="width: 10%;"></td> <td style="width: 10%;"></td> <td style="width: 10%;"></td> <td style="width: 10%;"></td> <td style="width: 10%;"></td> </tr> <tr> <td></td> <td></td> <td colspan="8" style="text-align: center;"> <table border="1" style="width: 100%; border-collapse: collapse; text-align: center;"> <tr> <td style="width: 10%;"></td> <td style="width: 10%;"></td> <td style="width: 10%;"></td> <td style="width: 10%;"></td> <td style="width: 10%;"></td> <td style="width: 10%;"></td> <td style="width: 10%;"></td> <td style="width: 10%;"></td> <td style="width: 10%;"></td> <td style="width: 10%;"></td> </tr> <tr> <td></td> <td></td> <td colspan="8" style="text-align: center;"> <table border="1" style="width: 100%; border-collapse: collapse; text-align: center;"> <tr> <td style="width: 10%;"></td> <td style="width: 10%;"></td> <td style="width: 10%;"></td> <td style="width: 10%;"></td> <td style="width: 10%;"></td> <td style="width: 10%;"></td> <td style="width: 10%;"></td> <td style="width: 10%;"></td> <td style="width: 10%;"></td> <td style="width: 10%;"></td> </tr> <tr> <td></td> <td></td> <td colspan="8" style="text-align: center;"> <table border="1" style="width: 100%; border-collapse: collapse; text-align: center;"> <tr> <td style="width: 10%;"></td> <td style="width: 10%;"></td> <td style="width: 10%;"></td> <td style="width: 10%;"></td> <td style="width: 10%;"></td> <td style="width: 10%;"></td> <td style="width: 10%;"></td> <td style="width: 10%;"></td> <td style="width: 10%;"></td> <td style="width: 10%;"></td> </tr> <tr> <td></td> <td></td> <td colspan="8" style="text-align: center;"> <table border="1" style="width: 100%; border-collapse: collapse; text-align: center;"> <tr> <td style="width: 10%;"></td> <td style="width: 10%;"></td> <td style="width: 10%;"></td> <td style="width: 10%;"></td> <td style="width: 10%;"></td> <td style="width: 10%;"></td> <td style="width: 10%;"></td> <td style="width: 10%;"></td> <td style="width: 10%;"></td> <td style="width: 10%;"></td> </tr> <tr> <td></td> <td></td> <td colspan="8" style="text-align: center;"> <table border="1" style="width: 100%; border-collapse: collapse; text-align: center;"> <tr> <td style="width: 10%;"></td> <td style="width: 10%;"></td> <td style="width: 10%;"></td> <td style="width: 10%;"></td> <td style="width: 10%;"></td> <td style="width: 10%;"></td> <td style="width: 10%;"></td> <td style="width: 10%;"></td> <td style="width: 10%;"></td> <td style="width: 10%;"></td> </tr> <tr> <td></td> <td></td> <td colspan="8" style="text-align: center;"> <table border="1" style="width: 100%; border-collapse: collapse; text-align: center;"> <tr> <td style="width: 10%;"></td> <td style="width: 10%;"></td> <td style="width: 10%;"></td> <td style="width: 10%;"></td> <td style="width: 10%;"></td> <td style="width: 10%;"></td> <td style="width: 10%;"></td> <td style="width: 10%;"></td> <td style="width: 10%;"></td> <td style="width: 10%;"></td> </tr> <tr> <td></td> <td></td> <td colspan="8" style="text-align: center;"> <table border="1" style="width: 100%; border-collapse: collapse; text-align: center;"> <tr> <td style="width: 10%;"></td> <td style="width: 10%;"></td> <td style="width: 10%;"></td> <td style="width: 10%;"></td> <td style="width: 10%;"></td> <td style="width: 10%;"></td> <td style="width: 10%;"></td> <td style="width: 10%;"></td> <td style="width: 10%;"></td> <td style="width: 10%;"></td> </tr> <tr> <td></td> <td></td> <td colspan="8" style="text-align: center;"> <table border="1" style="width: 100%; border-collapse: collapse; text-align: center;"> <tr> <td style="width: 10%;"></td> <td style="width: 10%;"></td> <td style="width: 10%;"></td> <td style="width: 10%;"></td> <td style="width: 10%;"></td> <td style="width: 10%;"></td> <td style="width: 10%;"></td> <td style="width: 10%;"></td> <td style="width: 10%;"></td> <td style="width: 10%;"></td> </tr> <tr> <td></td> <td></td> <td colspan="8" style="text-align: center;"> <table border="1" style="width: 100%; border-collapse: collapse; text-align: center;"> <tr> <td style="width: 10%;"></td> <td style="width: 10%;"></td> <td style="width: 10%;"></td> <td style="width: 10%;"></td> <td style="width: 10%;"></td> <td style="width: 10%;"></td> <td style="width: 10%;"></td> <td style="width: 10%;"></td> <td style="width: 10%;"></td> <td style="width: 10%;"></td> </tr> <tr> <td></td> <td></td> <td colspan="8" style="text-align: center;"> <table border="1" style="width: 100%; border-collapse: collapse; text-align: center;"> <tr> <td style="width: 10%;"></td> <td style="width: 10%;"></td> <td style="width: 10%;"></td> <td style="width: 10%;"></td> <td style="width: 10%;"></td> <td style="width: 10%;"></td> <td style="width: 10%;"></td> <td style="width: 10%;"></td> <td style="width: 10%;"></td> <td style="width: 10%;"></td> </tr> <tr> <td></td> <td></td> <td colspan="8" style="text-align: center;"> <table border="1" style="width: 100%; border-collapse: collapse; text-align: center;"> <tr> <td style="width: 10%;"></td> <td style="width: 10%;"></td> <td style="width: 10%;"></td> <td style="width: 10%;"></td> <td style="width: 10%;"></td> <td style="width: 10%;"></td> <td style="width: 10%;"></td> <td style="width: 10%;"></td> <td style="width: 10%;"></td> <td style="width: 10%;"></td> </tr> <tr> <td></td> <td></td> <td colspan="8" style="text-align: center;"> <table border="1" style="width: 100%; border-collapse: collapse; text-align: center;"> <tr> <td style="width: 10%;"></td> <td style="width: 10%;"></td> <td style="width: 10%;"></td> <td style="width: 10%;"></td> <td style="width: 10%;"></td> <td style="width: 10%;"></td> <td style="width: 10%;"></td> <td style="width: 10%;"></td> <td style="width: 10%;"></td> <td style="width: 10%;"></td> </tr> <tr> <td></td> <td></td> <td colspan="8" style="text-align: center;"> <table border="1" style="width: 100%; border-collapse: collapse; text-align: center;"> <tr> <td style="width: 10%;"></td> <td style="width: 10%;"></td> <td style="width: 10%;"></td> <td style="width: 10%;"></td> <td style="width: 10%;"></td> <td style="width: 10%;"></td> <td style="width: 10%;"></td> <td style="width: 10%;"></td> <td style="width: 10%;"></td> <td style="width: 10%;"></td> </tr> <tr> <td></td> <td></td> <td colspan="8" style="text-align: center;"> <table border="1" style="width: 100%; border-collapse: collapse; text-align:
center;"> <tr> <td style="width: 10%;"></td> <td style="width: 10%;"></td> <td style="width: 10%;"></td> <td style="width: 10%;"></td> <td style="width: 10%;"></td> <td style="width: 10%;"></td> <td style="width: 10%;"></td> <td style="width: 10%;"></td> <td style="width: 10%;"></td> <td style="width: 10%;"></td> </tr> <tr> <td></td> <td></td> <td colspan="8" style="text-align: center;"> <table border="1" style="width: 100%; border-collapse: collapse; text-align: center;"> <tr> <td style="width: 10%;"></td> <td style="width: 10%;"></td> <td style="width: 10%;"></td> <td style="width: 10%;"></td> <td style="width: 10%;"></td> <td style="width: 10%;"></td> <td style="width: 10%;"></td> <td style="width: 10%;"></td> <td style="width: 10%;"></td> <td style="width: 10%;"></td> </tr> <tr> <td></td> <td></td> <td colspan="8" style="text-align: center;"> <table border="1" style="width: 100%; border-collapse: collapse; text-align: center;"> <tr> <td style="width: 10%;"></td> <td style="width: 10%;"></td> <td style="width: 10%;"></td> <td style="width: 10%;"></td> <td style="width: 10%;"></td> <td style="width: 10%;"></td> <td style="width: 10%;"></td> <td style="width: 10%;"></td> <td style="width: 10%;"></td> <td style="width: 10%;"></td> </tr> <tr> <td></td> <td></td> <td colspan="8" style="text-align: center;"> <table border="1" style="width: 100%; border-collapse: collapse; text-align: center;"> <tr> <td style="width: 10%;"></td> <td style="width: 10%;"></td> <td style="width: 10%;"></td> <td style="width: 10%;"></td> <td style="width: 10%;"></td> <td style="width: 10%;"></td> <td style="width: 10%;"></td> <td style="width: 10%;"></td> <td style="width: 10%;"></td> <td style="width: 10%;"></td> </tr> <tr> <td></td> <td></td> <td colspan="8" style="text-align: center;"> <table border="1" style="width: 100%; border-collapse: collapse; text-align: center;"> <tr> <td style="width: 10%;"></td> <td style="width: 10%;"></td> <td style="width: 10%;"></td> <td style="width: 10%;"></td> <td style="width: 10%;"></td> <td style="width: 10%;"></td> <td style="width: 10%;"></td> <td style="width: 10%;"></td> <td style="width: 10%;"></td> <td style="width: 10%;"></td> </tr> <tr> <td></td> <td></td> <td colspan="8" style="text-align: center;"> <table border="1" style="width: 100%; border-collapse: collapse; text-align: center;"> <tr> <td style="width: 10%;"></td> <td style="width: 10%;"></td> <td style="width: 10%;"></td> <td style="width: 10%;"></td> <td style="width: 10%;"></td> <td style="width: 10%;"></td> <td style="width: 10%;"></td> <td style="width: 10%;"></td> <td style="width: 10%;"></td> <td style="width: 10%;"></td> </tr> <tr> <td></td> <td></td> <td colspan="8" style="text-align: center;"> <table border="1" style="width: 100%; border-collapse: collapse; text-align: center;"> <tr> <td style="width: 10%;"></td> <td style="width: 10%;"></td> <td style="width: 10%;"></td> <td style="width: 10%;"></td> <td style="width: 10%;"></td> <td style="width: 10%;"></td> <td style="width: 10%;"></td> <td style="width: 10%;"></td> <td style="width: 10%;"></td> <td style="width: 10%;"></td> </tr> <tr> <td></td> <td></td> <td colspan="8" style="text-align: center;"> <table border="1" style="width: 100%; border-collapse: collapse; text-align: center;"> <tr> <td style="width: 10%;"></td> <td style="width: 10%;"></td> <td style="width: 10%;"></td> <td style="width: 10%;"></td> <td style="width: 10%;"></td> <td style="width: 10%;"></td> <td style="width: 10%;"></td> <td style="width: 10%;"></td> <td style="width: 10%;"></td> <td style="width: 10%;"></td> </tr> <tr> <td></td> <td></td> <td colspan="8" style="text-align: center;"> <table border="1" style="width: 100%; border-collapse: collapse; text-align: center;"> <tr> <td style="width: 10%;"></td> <td style="width: 10%;"></td> <td style="width: 10%;"></td> <td style="width: 10%;"></td> <td style="width: 10%;"></td> <td style="width: 10%;"></td> <td style="width: 10%;"></td> <td style="width: 10%;"></td> <td style="width: 10%;"></td> <td style="width: 10%;"></td> </tr> <tr> <td></td> <td></td> <td colspan="8" style="text-align: center;"> <table border="1" style="width: 100%; border-collapse: collapse; text-align: center;"> <tr> <td style="width: 10%;"></td> <td style="width: 10%;"></td> <td style="width: 10%;"></td> <td style="width: 10%;"></td> <td style="width: 10%;"></td> <td style="width: 10%;"></td> <td style="width: 10%;"></td> <td style="width: 10%;"></td> <td style="width: 10%;"></td> <td style="width: 10%;"></td> </tr> <tr> <td></td> <td></td> <td colspan="8" style="text-align: center;"> <table border="1" style="width: 100%; border-collapse: collapse; text-align: center;"> <tr> <td style="width: 10%;"></td> <td style="width: 10%;"></td> <td style="width: 10%;"></td> <td style="width: 10%;"></td> <td style="width: 10%;"></td> <td style="width: 10%;"></td> <td style="width: 10%;"></td> <td style="width: 10%;"></td> <td style="width: 10%;"></td> <td style="width: 10%;"></td> </tr> <tr> <td></td> <td></td> <td colspan="8" style="text-align: center;"> <table border="1" style="width: 100%; border-collapse: collapse; text-align: center;"> <tr> <td style="width: 10%;"></td> <td style="width: 10%;"></td> <td style="width: 10%;"></td> <td style="width: 10%;"></td> <td style="width: 10%;"></td> <td style="width: 10%;"></td> <td style="width: 10%;"></td> <td style="width: 10%;"></td> <td style="width: 10%;"></td> <td style="width: 10%;"></td> </tr> <tr> <td></td> <td></td> <td colspan="8" style="text-align: center;"> <table border="1" style="width: 100%; border-collapse: collapse; text-align: center;"> <tr> <td style="width: 10%;"></td> <td style="width: 10%;"></td> <td style="width: 10%;"></td> <td style="width: 10%;"></td> <td style="width: 10%;"></td> <td style="width: 10%;"></td> <td style="width: 10%;"></td> <td style="width: 10%;"></td> <td style="width: 10%;"></td> <td style="width: 10%;"></td> </tr> <tr> <td></td> <td></td> <td colspan="8" style="text-align: center;"> <table border="1" style="width: 100%; border-collapse: collapse; text-align: center;"> <tr> <td style="width: 10%;"></td> <td style="width: 10%;"></td> <td style="width: 10%;"></td> <td style="width: 10%;"></td> <td style="width: 10%;"></td> <td style="width: 10%;"></td> <td style="width: 10%;"></td> <td style="width: 10%;"></td> <td style="width: 10%;"></td> <td style="width: 10%;"></td> </tr> <tr> <td></td> <td></td> <td colspan="8" style="text-align: center;"> <table border="1" style="width: 100%; border-collapse: collapse; text-align: center;"> <tr> <td style="width: 10%;"></td> <td style="width: 10%;"></td> <td style="width: 10%;"></td> <td style="width: 10%;"></td> <td style="width: 10%;"></td> <td style="width: 10%;"></td> <td style="width: 10%;"></td> <td style="width: 10%;"></td> <td style="width: 10%;"></td> <td style="width: 10%;"></td> </tr> <tr> <td></td> <td></td> <td colspan="8" style="text-align: center;"> <table border="1" style="width: 100%; border-collapse: collapse; text-align: center;"> <tr> <td style="width: 10%;"></td> <td style="width: 10%;"></td> <td style="width: 10%;"></td> <td style="width: 10%;"></td> <td style="width: 10%;"></td> <td style="width: 10%;"></td> <td style="width: 10%;"></td> <td style="width: 10%;"></td> <td style="width: 10%;"></td> <td style="width: 10%;"></td> </tr> <tr> <td></td> <td></td> <td colspan="8" style="text-align: center;"> <table border="1" style="width: 100%; border-collapse: collapse; text-align: center;"> <tr> <td style="width: 10%;"></td> <td style="width: 10%;"></td> <td style="width: 10%;"></td> <td style="width: 10%;"></td> <td style="width: 10%;"></td> <td style="width: 10%;"></td> <td style="width: 10%;"></td> <td style="width: 10%;"></td> <td style="width: 10%;"></td> <td style="width: 10%;"></td> </tr> <tr> <td></td> <td></td> <td colspan="8" style="text-align: center;"> <table border="1" style="width: 100%; border-collapse: collapse; text-align: center;"> <tr> <td style="width: 10%;"></td> <td style="width: 10%;"></td> <td style="width: 10%;"></td> <td style="width: 10%;"></td> <td style="width: 10%;"></td> <td style="width: 10%;"></td> <td style="width: 10%;"></td> <td style="width: 10%;"></td> <td style="width: 10%;"></td> <td style="width: 10%;"></td> </tr> <tr> <td></td> <td></td> <td colspan="8" style="text-align: center;"> <table border="1" style="width: 100%; border-collapse: collapse; text-align: center;"> <tr> </tr></table></td></tr></table></td></tr></table></td></tr></table></td></tr></table></td></tr></table></td></tr></table></td></tr></table></td></tr></table></td></tr></table></td></tr></table></td></tr></table></td></tr></table></td></tr></table></td></tr></table></td></tr></table></td></tr></table></td></tr></table></td></tr></table></td></tr></table></td></tr></table></td></tr></table></td></tr></table></td></tr></table></td></tr></table></td></tr></table></td></tr></table></td></tr></table></td></tr></table></td></tr></table></td></tr></table></td></tr></table></td></tr></table></td></tr></table></td></tr></table>
 | | | | | | | | | | | | | | | | | | | | <table border="1" style="width: 100%; border-collapse: collapse; text-align: center;"> <tr> <td style="width: 10%;"></td> <td style="width: 10%;"></td> <td style="width: 10%;"></td> <td style="width: 10%;"></td> <td style="width: 10%;"></td> <td style="width: 10%;"></td> <td style="width: 10%;"></td> <td style="width: 10%;"></td> <td style="width: 10%;"></td> <td style="width: 10%;"></td> </tr> <tr> <td></td> <td></td> <td colspan="8" style="text-align: center;"> <table border="1" style="width: 100%; border-collapse: collapse; text-align: center;"> <tr> <td style="width: 10%;"></td> <td style="width: 10%;"></td> <td style="width: 10%;"></td> <td style="width: 10%;"></td> <td style="width: 10%;"></td> <td style="width: 10%;"></td> <td style="width: 10%;"></td> <td style="width: 10%;"></td> <td style="width: 10%;"></td> <td style="width: 10%;"></td> </tr> <tr> <td></td> <td></td> <td colspan="8" style="text-align: center;"> <table border="1" style="width: 100%; border-collapse: collapse; text-align: center;"> <tr> <td style="width: 10%;"></td> <td style="width: 10%;"></td> <td style="width: 10%;"></td> <td style="width: 10%;"></td> <td style="width: 10%;"></td> <td style="width: 10%;"></td> <td style="width: 10%;"></td> <td style="width: 10%;"></td> <td style="width: 10%;"></td> <td style="width: 10%;"></td> </tr> <tr> <td></td> <td></td> <td colspan="8" style="text-align: center;"> <table border="1" style="width: 100%; border-collapse: collapse; text-align: center;"> <tr> <td style="width: 10%;"></td> <td style="width: 10%;"></td> <td style="width: 10%;"></td> <td style="width: 10%;"></td> <td style="width: 10%;"></td> <td style="width: 10%;"></td> <td style="width: 10%;"></td> <td style="width: 10%;"></td> <td style="width: 10%;"></td> <td style="width: 10%;"></td> </tr> <tr> <td></td> <td></td> <td colspan="8" style="text-align: center;"> <table border="1" style="width: 100%; border-collapse: collapse; text-align: center;"> <tr> <td style="width: 10%;"></td> <td style="width: 10%;"></td> <td style="width: 10%;"></td> <td style="width: 10%;"></td> <td style="width: 10%;"></td> <td style="width: 10%;"></td> <td style="width: 10%;"></td> <td style="width: 10%;"></td> <td style="width: 10%;"></td> <td style="width: 10%;"></td> </tr> <tr> <td></td> <td></td> <td colspan="8" style="text-align: center;"> <table border="1" style="width: 100%; border-collapse: collapse; text-align: center;"> <tr> <td style="width: 10%;"></td> <td style="width: 10%;"></td> <td style="width: 10%;"></td> <td style="width: 10%;"></td> <td style="width: 10%;"></td> <td style="width: 10%;"></td> <td style="width: 10%;"></td> <td style="width: 10%;"></td> <td style="width: 10%;"></td> <td style="width: 10%;"></td> </tr> <tr> <td></td> <td></td> <td colspan="8" style="text-align: center;"> <table border="1" style="width: 100%; border-collapse: collapse; text-align: center;"> <tr> <td style="width: 10%;"></td> <td style="width: 10%;"></td> <td style="width: 10%;"></td> <td style="width: 10%;"></td> <td style="width: 10%;"></td> <td style="width: 10%;"></td> <td style="width: 10%;"></td> <td style="width: 10%;"></td> <td style="width: 10%;"></td> <td style="width: 10%;"></td> </tr> <tr> <td></td> <td></td> <td colspan="8" style="text-align: center;"> <table border="1" style="width: 100%; border-collapse: collapse; text-align: center;"> <tr> <td style="width: 10%;"></td> <td style="width: 10%;"></td> <td style="width: 10%;"></td> <td style="width: 10%;"></td> <td style="width: 10%;"></td> <td style="width: 10%;"></td> <td style="width: 10%;"></td> <td style="width: 10%;"></td> <td style="width: 10%;"></td> <td style="width: 10%;"></td> </tr> <tr> <td></td> <td></td> <td colspan="8" style="text-align: center;"> <table border="1" style="width: 100%; border-collapse: collapse; text-align: center;"> <tr> <td style="width: 10%;"></td> <td style="width: 10%;"></td> <td style="width: 10%;"></td> <td style="width: 10%;"></td> <td style="width: 10%;"></td> <td style="width: 10%;"></td> <td style="width: 10%;"></td> <td style="width:
10%;"></td> <td style="width: 10%;"></td> <td style="width: 10%;"></td> </tr> <tr> <td></td> <td></td> <td colspan="8" style="text-align: center;"> <table border="1" style="width: 100%; border-collapse: collapse; text-align: center;"> <tr> <td style="width: 10%;"></td> <td style="width: 10%;"></td> <td style="width: 10%;"></td> <td style="width: 10%;"></td> <td style="width: 10%;"></td> <td style="width: 10%;"></td> <td style="width: 10%;"></td> <td style="width: 10%;"></td> <td style="width: 10%;"></td> <td style="width: 10%;"></td> </tr> <tr> <td></td> <td></td> <td colspan="8" style="text-align: center;"> <table border="1" style="width: 100%; border-collapse: collapse; text-align: center;"> <tr> <td style="width: 10%;"></td> <td style="width: 10%;"></td> <td style="width: 10%;"></td> <td style="width: 10%;"></td> <td style="width: 10%;"></td> <td style="width: 10%;"></td> <td style="width: 10%;"></td> <td style="width: 10%;"></td> <td style="width: 10%;"></td> <td style="width: 10%;"></td> </tr> <tr> <td></td> <td></td> <td colspan="8" style="text-align: center;"> <table border="1" style="width: 100%; border-collapse: collapse; text-align: center;"> <tr> <td style="width: 10%;"></td> <td style="width: 10%;"></td> <td style="width: 10%;"></td> <td style="width: 10%;"></td> <td style="width: 10%;"></td> <td style="width: 10%;"></td> <td style="width: 10%;"></td> <td style="width: 10%;"></td> <td style="width: 10%;"></td> <td style="width: 10%;"></td> </tr> <tr> <td></td> <td></td> <td colspan="8" style="text-align: center;"> <table border="1" style="width: 100%; border-collapse: collapse; text-align: center;"> <tr> <td style="width: 10%;"></td> <td style="width: 10%;"></td> <td style="width: 10%;"></td> <td style="width: 10%;"></td> <td style="width: 10%;"></td> <td style="width: 10%;"></td> <td style="width: 10%;"></td> <td style="width: 10%;"></td> <td style="width: 10%;"></td> <td style="width: 10%;"></td> </tr> <tr> <td></td> <td></td> <td colspan="8" style="text-align: center;"> <table border="1" style="width: 100%; border-collapse: collapse; text-align: center;"> <tr> <td style="width: 10%;"></td> <td style="width: 10%;"></td> <td style="width: 10%;"></td> <td style="width: 10%;"></td> <td style="width: 10%;"></td> <td style="width: 10%;"></td> <td style="width: 10%;"></td> <td style="width: 10%;"></td> <td style="width: 10%;"></td> <td style="width: 10%;"></td> </tr> <tr> <td></td> <td></td> <td colspan="8" style="text-align: center;"> <table border="1" style="width: 100%; border-collapse: collapse; text-align: center;"> <tr> <td style="width: 10%;"></td> <td style="width: 10%;"></td> <td style="width: 10%;"></td> <td style="width: 10%;"></td> <td style="width: 10%;"></td> <td style="width: 10%;"></td> <td style="width: 10%;"></td> <td style="width: 10%;"></td> <td style="width: 10%;"></td> <td style="width: 10%;"></td> </tr> <tr> <td></td> <td></td> <td colspan="8" style="text-align: center;"> <table border="1" style="width: 100%; border-collapse: collapse; text-align: center;"> <tr> <td style="width: 10%;"></td> <td style="width: 10%;"></td> <td style="width: 10%;"></td> <td style="width: 10%;"></td> <td style="width: 10%;"></td> <td style="width: 10%;"></td> <td style="width: 10%;"></td> <td style="width: 10%;"></td> <td style="width: 10%;"></td> <td style="width: 10%;"></td> </tr> <tr> <td></td> <td></td> <td colspan="8" style="text-align: center;"> <table border="1" style="width: 100%; border-collapse: collapse; text-align: center;"> <tr> <td style="width: 10%;"></td> <td style="width: 10%;"></td> <td style="width: 10%;"></td> <td style="width: 10%;"></td> <td style="width: 10%;"></td> <td style="width: 10%;"></td> <td style="width: 10%;"></td> <td style="width: 10%;"></td> <td style="width: 10%;"></td> <td style="width: 10%;"></td> </tr> <tr> <td></td> <td></td> <td colspan="8" style="text-align: center;"> <table border="1" style="width: 100%; border-collapse: collapse; text-align: center;"> <tr> <td style="width: 10%;"></td> <td style="width: 10%;"></td> <td style="width: 10%;"></td> <td style="width: 10%;"></td> <td style="width: 10%;"></td> <td style="width: 10%;"></td> <td style="width: 10%;"></td> <td style="width: 10%;"></td> <td style="width: 10%;"></td> <td style="width: 10%;"></td> </tr> <tr> <td></td> <td></td> <td colspan="8" style="text-align: center;"> <table border="1" style="width: 100%; border-collapse: collapse; text-align: center;"> <tr> <td style="width: 10%;"></td> <td style="width: 10%;"></td> <td style="width: 10%;"></td> <td style="width: 10%;"></td> <td style="width: 10%;"></td> <td style="width: 10%;"></td> <td style="width: 10%;"></td> <td style="width: 10%;"></td> <td style="width: 10%;"></td> <td style="width: 10%;"></td> </tr> <tr> <td></td> <td></td> <td colspan="8" style="text-align: center;"> <table border="1" style="width: 100%; border-collapse: collapse; text-align: center;"> <tr> <td style="width: 10%;"></td> <td style="width: 10%;"></td> <td style="width: 10%;"></td> <td style="width: 10%;"></td> <td style="width: 10%;"></td> <td style="width: 10%;"></td> <td style="width: 10%;"></td> <td style="width: 10%;"></td> <td style="width: 10%;"></td> <td style="width: 10%;"></td> </tr> <tr> <td></td> <td></td> <td colspan="8" style="text-align: center;"> <table border="1" style="width: 100%; border-collapse: collapse; text-align: center;"> <tr> <td style="width: 10%;"></td> <td style="width: 10%;"></td> <td style="width: 10%;"></td> <td style="width: 10%;"></td> <td style="width: 10%;"></td> <td style="width: 10%;"></td> <td style="width: 10%;"></td> <td style="width: 10%;"></td> <td style="width: 10%;"></td> <td style="width: 10%;"></td> </tr> <tr> <td></td> <td></td> <td colspan="8" style="text-align: center;"> <table border="1" style="width: 100%; border-collapse: collapse; text-align: center;"> <tr> <td style="width: 10%;"></td> <td style="width: 10%;"></td> <td style="width: 10%;"></td> <td style="width: 10%;"></td> <td style="width: 10%;"></td> <td style="width: 10%;"></td> <td style="width: 10%;"></td> <td style="width: 10%;"></td> <td style="width: 10%;"></td> <td style="width: 10%;"></td> </tr> <tr> <td></td> <td></td> <td colspan="8" style="text-align: center;"> <table border="1" style="width: 100%; border-collapse: collapse; text-align: center;"> <tr> <td style="width: 10%;"></td> <td style="width: 10%;"></td> <td style="width: 10%;"></td> <td style="width: 10%;"></td> <td style="width: 10%;"></td> <td style="width: 10%;"></td> <td style="width: 10%;"></td> <td style="width: 10%;"></td> <td style="width: 10%;"></td> <td style="width: 10%;"></td> </tr> <tr> <td></td> <td></td> <td colspan="8" style="text-align: center;"> <table border="1" style="width: 100%; border-collapse: collapse; text-align: center;"> <tr> <td style="width: 10%;"></td> <td style="width: 10%;"></td> <td style="width: 10%;"></td> <td style="width: 10%;"></td> <td style="width: 10%;"></td> <td style="width: 10%;"></td> <td style="width: 10%;"></td> <td style="width: 10%;"></td> <td style="width: 10%;"></td> <td style="width: 10%;"></td> </tr> <tr> <td></td> <td></td> <td colspan="8" style="text-align: center;"> <table border="1" style="width: 100%; border-collapse: collapse; text-align: center;"> <tr> <td style="width: 10%;"></td> <td style="width: 10%;"></td> <td style="width: 10%;"></td> <td style="width: 10%;"></td> <td style="width: 10%;"></td> <td style="width: 10%;"></td> <td style="width: 10%;"></td> <td style="width: 10%;"></td> <td style="width: 10%;"></td> <td style="width: 10%;"></td> </tr> <tr> <td></td> <td></td> <td colspan="8" style="text-align: center;"> <table border="1" style="width: 100%; border-collapse: collapse; text-align: center;"> <tr> <td style="width: 10%;"></td> <td style="width: 10%;"></td> <td style="width: 10%;"></td> <td style="width: 10%;"></td> <td style="width: 10%;"></td> <td style="width: 10%;"></td> <td style="width: 10%;"></td> <td style="width: 10%;"></td> <td style="width: 10%;"></td> <td style="width: 10%;"></td> </tr> <tr> <td></td> <td></td> <td colspan="8" style="text-align: center;"> <table border="1" style="width: 100%; border-collapse: collapse; text-align: center;"> <tr> <td style="width: 10%;"></td> <td style="width: 10%;"></td> <td style="width: 10%;"></td> <td style="width: 10%;"></td> <td style="width: 10%;"></td> <td style="width: 10%;"></td> <td style="width: 10%;"></td> <td style="width: 10%;"></td> <td style="width: 10%;"></td> <td style="width: 10%;"></td> </tr> <tr> <td></td> <td></td> <td colspan="8" style="text-align: center;"> <table border="1" style="width: 100%; border-collapse: collapse; text-align: center;"> <tr> <td style="width: 10%;"></td> <td style="width: 10%;"></td> <td style="width: 10%;"></td> <td style="width: 10%;"></td> <td style="width: 10%;"></td> <td style="width: 10%;"></td> <td style="width: 10%;"></td> <td style="width: 10%;"></td> <td style="width: 10%;"></td> <td style="width: 10%;"></td> </tr> <tr> <td></td> <td></td> <td colspan="8" style="text-align: center;"> <table border="1" style="width: 100%; border-collapse: collapse; text-align: center;"> <tr> <td style="width: 10%;"></td> <td style="width: 10%;"></td> <td style="width: 10%;"></td> <td style="width: 10%;"></td> <td style="width: 10%;"></td> <td style="width: 10%;"></td> <td style="width: 10%;"></td> <td style="width: 10%;"></td> <td style="width: 10%;"></td> <td style="width: 10%;"></td> </tr> <tr> <td></td> <td></td> <td colspan="8" style="text-align: center;"> <table border="1" style="width: 100%; border-collapse: collapse; text-align: center;"> <tr> <td style="width: 10%;"></td> <td style="width: 10%;"></td> <td style="width: 10%;"></td> <td style="width: 10%;"></td> <td style="width: 10%;"></td> <td style="width: 10%;"></td> <td style="width: 10%;"></td> <td style="width: 10%;"></td> <td style="width: 10%;"></td> <td style="width: 10%;"></td> </tr> <tr> <td></td> <td></td> <td colspan="8" style="text-align: center;"> <table border="1"
style="width: 100%; border-collapse: collapse; text-align: center;"> <tr> <td style="width: 10%;"></td> <td style="width: 10%;"></td> <td style="width: 10%;"></td> <td style="width: 10%;"></td> <td style="width: 10%;"></td> <td style="width: 10%;"></td> <td style="width: 10%;"></td> <td style="width: 10%;"></td> <td style="width: 10%;"></td> <td style="width: 10%;"></td> </tr> <tr> <td></td> <td></td> <td colspan="8" style="text-align: center;"> <table border="1" style="width: 100%; border-collapse: collapse; text-align: center;"> <tr> <td style="width: 10%;"></td> <td style="width: 10%;"></td> <td style="width: 10%;"></td> <td style="width: 10%;"></td> <td style="width: 10%;"></td> <td style="width: 10%;"></td> <td style="width: 10%;"></td> <td style="width: 10%;"></td> <td style="width: 10%;"></td> <td style="width: 10%;"></td> </tr> <tr> <td></td> <td></td> <td colspan="8" style="text-align: center;"> <table border="1" style="width: 100%; border-collapse: collapse; text-align: center;"> <tr> <td style="width: 10%;"></td> <td style="width: 10%;"></td> <td style="width: 10%;"></td> <td style="width: 10%;"></td> <td style="width: 10%;"></td> <td style="width: 10%;"></td> <td style="width: 10%;"></td> <td style="width: 10%;"></td> <td style="width: 10%;"></td> <td style="width: 10%;"></td> </tr> <tr> <td></td> <td></td> <td colspan="8" style="text-align: center;"> <table border="1" style="width: 100%; border-collapse: collapse; text-align: center;"> <tr> </tr></table></td></tr></table></td></tr></table></td></tr></table></td></tr></table></td></tr></table></td></tr></table></td></tr></table></td></tr></table></td></tr></table></td></tr></table></td></tr></table></td></tr></table></td></tr></table></td></tr></table></td></tr></table></td></tr></table></td></tr></table></td></tr></table></td></tr></table></td></tr></table></td></tr></table></td></tr></table></td></tr></table></td></tr></table></td></tr></table></td></tr></table></td></tr></table></td></tr></table></td></tr></table></td></tr></table></td></tr></table></td></tr></table></td></tr></table> | | | | | | | | | | | | | | | | | | | | <table border="1" style="width: 100%; border-collapse: collapse; text-align: center;"> <tr> <td style="width: 10%;"></td> <td style="width: 10%;"></td> <td style="width: 10%;"></td> <td style="width: 10%;"></td> <td style="width: 10%;"></td> <td style="width: 10%;"></td> <td style="width: 10%;"></td> <td style="width: 10%;"></td> <td style="width: 10%;"></td> <td style="width: 10%;"></td> </tr> <tr> <td></td> <td></td> <td colspan="8" style="text-align: center;"> <table border="1" style="width: 100%; border-collapse: collapse; text-align: center;"> <tr> <td style="width: 10%;"></td> <td style="width: 10%;"></td> <td style="width: 10%;"></td> <td style="width: 10%;"></td> <td style="width: 10%;"></td> <td style="width: 10%;"></td> <td style="width: 10%;"></td> <td style="width: 10%;"></td> <td style="width: 10%;"></td> <td style="width: 10%;"></td> </tr> <tr> <td></td> <td></td> <td colspan="8" style="text-align: center;"> <table border="1" style="width: 100%; border-collapse: collapse; text-align: center;"> <tr> <td style="width:
10%;"></td> <td style="width: 10%;"></td> <td style="width: 10%;"></td> <td style="width: 10%;"></td> <td style="width: 10%;"></td> <td style="width: 10%;"></td> <td style="width: 10%;"></td> <td style="width: 10%;"></td> <td style="width: 10%;"></td> <td style="width: 10%;"></td> </tr> <tr> <td></td> <td></td> <td colspan="8" style="text-align: center;"> <table border="1" style="width: 100%; border-collapse: collapse; text-align: center;"> <tr> <td style="width: 10%;"></td> <td style="width: 10%;"></td> <td style="width: 10%;"></td> <td style="width: 10%;"></td> <td style="width: 10%;"></td> <td style="width: 10%;"></td> <td style="width: 10%;"></td> <td style="width: 10%;"></td> <td style="width: 10%;"></td> <td style="width: 10%;"></td> </tr> <tr> <td></td> <td></td> <td colspan="8" style="text-align: center;"> <table border="1" style="width: 100%; border-collapse: collapse; text-align: center;"> <tr> <td style="width: 10%;"></td> <td style="width: 10%;"></td> <td style="width: 10%;"></td> <td style="width: 10%;"></td> <td style="width: 10%;"></td> <td style="width: 10%;"></td> <td style="width: 10%;"></td> <td style="width: 10%;"></td> <td style="width: 10%;"></td> <td style="width: 10%;"></td> </tr> <tr> <td></td> <td></td> <td colspan="8" style="text-align: center;"> <table border="1" style="width: 100%; border-collapse: collapse; text-align: center;"> <tr> <td style="width: 10%;"></td> <td style="width: 10%;"></td> <td style="width: 10%;"></td> <td style="width: 10%;"></td> <td style="width: 10%;"></td> <td style="width: 10%;"></td> <td style="width: 10%;"></td> <td style="width: 10%;"></td> <td style="width: 10%;"></td> <td style="width: 10%;"></td> </tr> <tr> <td></td> <td></td> <td colspan="8" style="text-align: center;"> <table border="1" style="width: 100%; border-collapse: collapse; text-align: center;"> <tr> <td style="width: 10%;"></td> <td style="width: 10%;"></td> <td style="width: 10%;"></td> <td style="width: 10%;"></td> <td style="width: 10%;"></td> <td style="width: 10%;"></td> <td style="width: 10%;"></td> <td style="width: 10%;"></td> <td style="width: 10%;"></td> <td style="width: 10%;"></td> </tr> <tr> <td></td> <td></td> <td colspan="8" style="text-align: center;"> <table border="1" style="width: 100%; border-collapse: collapse; text-align: center;"> <tr> <td style="width: 10%;"></td> <td style="width: 10%;"></td> <td style="width: 10%;"></td> <td style="width: 10%;"></td> <td style="width: 10%;"></td> <td style="width: 10%;"></td> <td style="width: 10%;"></td> <td style="width: 10%;"></td> <td style="width: 10%;"></td> <td style="width: 10%;"></td> </tr> <tr> <td></td> <td></td> <td colspan="8" style="text-align: center;"> <table border="1" style="width: 100%; border-collapse: collapse; text-align: center;"> <tr> <td style="width: 10%;"></td> <td style="width: 10%;"></td> <td style="width: 10%;"></td> <td style="width: 10%;"></td> <td style="width: 10%;"></td> <td style="width: 10%;"></td> <td style="width: 10%;"></td> <td style="width: 10%;"></td> <td style="width: 10%;"></td> <td style="width: 10%;"></td> </tr> <tr> <td></td> <td></td> <td colspan="8" style="text-align: center;"> <table border="1" style="width: 100%; border-collapse: collapse; text-align: center;"> <tr> <td style="width: 10%;"></td> <td style="width: 10%;"></td> <td style="width: 10%;"></td> <td style="width: 10%;"></td> <td style="width: 10%;"></td> <td style="width: 10%;"></td> <td style="width: 10%;"></td> <td style="width: 10%;"></td> <td style="width: 10%;"></td> <td style="width: 10%;"></td> </tr> <tr> <td></td> <td></td> <td colspan="8" style="text-align: center;"> <table border="1" style="width: 100%; border-collapse: collapse; text-align: center;"> <tr> <td style="width: 10%;"></td> <td style="width: 10%;"></td> <td style="width: 10%;"></td> <td style="width: 10%;"></td> <td style="width: 10%;"></td> <td style="width: 10%;"></td> <td style="width: 10%;"></td> <td style="width: 10%;"></td> <td style="width: 10%;"></td> <td style="width: 10%;"></td> </tr> <tr> <td></td> <td></td> <td colspan="8" style="text-align: center;"> <table border="1" style="width: 100%; border-collapse: collapse; text-align: center;"> <tr> <td style="width: 10%;"></td> <td style="width: 10%;"></td> <td style="width: 10%;"></td> <td style="width: 10%;"></td> <td style="width: 10%;"></td> <td style="width: 10%;"></td> <td style="width: 10%;"></td> <td style="width: 10%;"></td> <td style="width: 10%;"></td> <td style="width: 10%;"></td> </tr> <tr> <td></td> <td></td> <td colspan="8" style="text-align: center;"> <table border="1" style="width: 100%; border-collapse: collapse; text-align: center;"> <tr> <td style="width: 10%;"></td> <td style="width: 10%;"></td> <td style="width: 10%;"></td> <td style="width: 10%;"></td> <td style="width: 10%;"></td> <td style="width: 10%;"></td> <td style="width: 10%;"></td> <td style="width: 10%;"></td> <td style="width: 10%;"></td> <td style="width: 10%;"></td> </tr> <tr> <td></td> <td></td> <td colspan="8" style="text-align: center;"> <table border="1" style="width: 100%; border-collapse: collapse; text-align: center;"> <tr> <td style="width: 10%;"></td> <td style="width: 10%;"></td> <td style="width: 10%;"></td> <td style="width: 10%;"></td> <td style="width: 10%;"></td> <td style="width: 10%;"></td> <td style="width: 10%;"></td> <td style="width: 10%;"></td> <td style="width: 10%;"></td> <td style="width: 10%;"></td> </tr> <tr> <td></td> <td></td> <td colspan="8" style="text-align: center;"> <table border="1" style="width: 100%; border-collapse: collapse; text-align: center;"> <tr> <td style="width: 10%;"></td> <td style="width: 10%;"></td> <td style="width: 10%;"></td> <td style="width: 10%;"></td> <td style="width: 10%;"></td> <td style="width: 10%;"></td> <td style="width: 10%;"></td> <td style="width: 10%;"></td> <td style="width: 10%;"></td> <td style="width: 10%;"></td> </tr> <tr> <td></td> <td></td> <td colspan="8" style="text-align: center;"> <table border="1" style="width: 100%; border-collapse: collapse; text-align: center;"> <tr> <td style="width: 10%;"></td> <td style="width: 10%;"></td> <td style="width: 10%;"></td> <td style="width: 10%;"></td> <td style="width: 10%;"></td> <td style="width: 10%;"></td> <td style="width: 10%;"></td> <td style="width: 10%;"></td> <td style="width: 10%;"></td> <td style="width: 10%;"></td> </tr> <tr> <td></td> <td></td> <td colspan="8" style="text-align: center;"> <table border="1" style="width: 100%; border-collapse: collapse; text-align: center;"> <tr> <td style="width: 10%;"></td> <td style="width: 10%;"></td> <td style="width: 10%;"></td> <td style="width: 10%;"></td> <td style="width: 10%;"></td> <td style="width: 10%;"></td> <td style="width: 10%;"></td> <td style="width: 10%;"></td> <td style="width: 10%;"></td> <td style="width: 10%;"></td> </tr> <tr> <td></td> <td></td> <td colspan="8" style="text-align: center;"> <table border="1" style="width: 100%; border-collapse: collapse; text-align: center;"> <tr> <td style="width: 10%;"></td> <td style="width: 10%;"></td> <td style="width: 10%;"></td> <td style="width: 10%;"></td> <td style="width: 10%;"></td> <td style="width: 10%;"></td> <td style="width: 10%;"></td> <td style="width: 10%;"></td> <td style="width: 10%;"></td> <td style="width: 10%;"></td> </tr> <tr> <td></td> <td></td> <td colspan="8" style="text-align: center;"> <table border="1" style="width: 100%; border-collapse: collapse; text-align: center;"> <tr> <td style="width: 10%;"></td> <td style="width: 10%;"></td> <td style="width: 10%;"></td> <td style="width: 10%;"></td> <td style="width: 10%;"></td> <td style="width: 10%;"></td> <td style="width: 10%;"></td> <td style="width: 10%;"></td> <td style="width: 10%;"></td> <td style="width: 10%;"></td> </tr> <tr> <td></td> <td></td> <td colspan="8" style="text-align: center;"> <table border="1" style="width: 100%; border-collapse: collapse; text-align: center;"> <tr> <td style="width: 10%;"></td> <td style="width: 10%;"></td> <td style="width: 10%;"></td> <td style="width: 10%;"></td> <td style="width: 10%;"></td> <td style="width: 10%;"></td> <td style="width: 10%;"></td> <td style="width: 10%;"></td> <td style="width: 10%;"></td> <td style="width: 10%;"></td> </tr> <tr> <td></td> <td></td> <td colspan="8" style="text-align: center;"> <table border="1" style="width: 100%; border-collapse: collapse; text-align: center;"> <tr> <td style="width: 10%;"></td> <td style="width: 10%;"></td> <td style="width: 10%;"></td> <td style="width: 10%;"></td> <td style="width: 10%;"></td> <td style="width: 10%;"></td> <td style="width: 10%;"></td> <td style="width: 10%;"></td> <td style="width: 10%;"></td> <td style="width: 10%;"></td> </tr> <tr> <td></td> <td></td> <td colspan="8" style="text-align: center;"> <table border="1" style="width: 100%; border-collapse: collapse; text-align: center;"> <tr> <td style="width: 10%;"></td> <td style="width: 10%;"></td> <td style="width: 10%;"></td> <td style="width: 10%;"></td> <td style="width: 10%;"></td> <td style="width: 10%;"></td> <td style="width: 10%;"></td> <td style="width: 10%;"></td> <td style="width: 10%;"></td> <td style="width: 10%;"></td> </tr> <tr> <td></td> <td></td> <td colspan="8" style="text-align: center;"> <table border="1" style="width: 100%; border-collapse: collapse; text-align: center;"> <tr> <td style="width: 10%;"></td> <td style="width: 10%;"></td> <td style="width: 10%;"></td> <td style="width: 10%;"></td> <td style="width: 10%;"></td> <td style="width: 10%;"></td> <td style="width: 10%;"></td> <td style="width: 10%;"></td> <td style="width: 10%;"></td> <td style="width: 10%;"></td> </tr> <tr> <td></td> <td></td> <td colspan="8" style="text-align: center;"> <table border="1" style="width: 100%; border-collapse: collapse; text-align: center;"> <tr> <td style="width: 10%;"></td> <td style="width: 10%;"></td> <td style="width: 10%;"></td> <td style="width: 10%;"></td> <td style="width: 10%;"></td> <td style="width: 10%;"></td> <td
style="width: 10%;"></td> <td style="width: 10%;"></td> <td style="width: 10%;"></td> <td style="width: 10%;"></td> </tr> <tr> <td></td> <td></td> <td colspan="8" style="text-align: center;"> <table border="1" style="width: 100%; border-collapse: collapse; text-align: center;"> <tr> <td style="width: 10%;"></td> <td style="width: 10%;"></td> <td style="width: 10%;"></td> <td style="width: 10%;"></td> <td style="width: 10%;"></td> <td style="width: 10%;"></td> <td style="width: 10%;"></td> <td style="width: 10%;"></td> <td style="width: 10%;"></td> <td style="width: 10%;"></td> </tr> <tr> <td></td> <td></td> <td colspan="8" style="text-align: center;"> <table border="1" style="width: 100%; border-collapse: collapse; text-align: center;"> <tr> <td style="width: 10%;"></td> <td style="width: 10%;"></td> <td style="width: 10%;"></td> <td style="width: 10%;"></td> <td style="width: 10%;"></td> <td style="width: 10%;"></td> <td style="width: 10%;"></td> <td style="width: 10%;"></td> <td style="width: 10%;"></td> <td style="width: 10%;"></td> </tr> <tr> <td></td> <td></td> <td colspan="8" style="text-align: center;"> <table border="1" style="width: 100%; border-collapse: collapse; text-align: center;"> <tr> <td style="width: 10%;"></td> <td style="width: 10%;"></td> <td style="width: 10%;"></td> <td style="width: 10%;"></td> <td style="width: 10%;"></td> <td style="width: 10%;"></td> <td style="width: 10%;"></td> <td style="width: 10%;"></td> <td style="width: 10%;"></td> <td style="width: 10%;"></td> </tr> <tr> <td></td> <td></td> <td colspan="8" style="text-align: center;"> <table border="1" style="width: 100%; border-collapse: collapse; text-align: center;"> <tr> <td style="width: 10%;"></td> <td style="width: 10%;"></td> <td style="width: 10%;"></td> <td style="width: 10%;"></td> <td style="width: 10%;"></td> <td style="width: 10%;"></td> <td style="width: 10%;"></td> <td style="width: 10%;"></td> <td style="width: 10%;"></td> <td style="width: 10%;"></td> </tr> <tr> <td></td> <td></td> <td colspan="8" style="text-align: center;"> <table border="1" style="width: 100%; border-collapse: collapse; text-align: center;"> <tr> <td style="width: 10%;"></td> <td style="width: 10%;"></td> <td style="width: 10%;"></td> <td style="width: 10%;"></td> <td style="width: 10%;"></td> <td style="width: 10%;"></td> <td style="width: 10%;"></td> <td style="width: 10%;"></td> <td style="width: 10%;"></td> <td style="width: 10%;"></td> </tr> <tr> <td></td> <td></td> <td colspan="8" style="text-align: center;"> <table border="1" style="width: 100%; border-collapse: collapse; text-align: center;"> <tr> <td style="width: 10%;"></td> <td style="width: 10%;"></td> <td style="width: 10%;"></td> <td style="width: 10%;"></td> <td style="width: 10%;"></td> <td style="width: 10%;"></td> <td style="width: 10%;"></td> <td style="width: 10%;"></td> <td style="width: 10%;"></td> <td style="width: 10%;"></td> </tr> <tr> <td></td> <td></td> <td colspan="8" style="text-align: center;"> <table border="1" style="width: 100%; border-collapse: collapse; text-align: center;"> <tr> <td style="width: 10%;"></td> <td style="width: 10%;"></td> <td style="width: 10%;"></td> <td style="width: 10%;"></td> <td style="width: 10%;"></td> <td style="width: 10%;"></td> <td style="width: 10%;"></td> <td style="width: 10%;"></td> <td style="width: 10%;"></td> <td style="width: 10%;"></td> </tr> <tr> <td></td> <td></td> <td colspan="8" style="text-align: center;"> <table border="1" style="width: 100%; border-collapse: collapse; text-align: center;"> <tr> <td style="width: 10%;"></td> <td style="width: 10%;"></td> <td style="width: 10%;"></td> <td style="width: 10%;"></td> <td style="width: 10%;"></td> <td style="width: 10%;"></td> <td style="width: 10%;"></td> <td style="width: 10%;"></td> <td style="width: 10%;"></td> <td style="width: 10%;"></td> </tr> <tr> <td></td> <td></td> <td colspan="8" style="text-align: center;"> <table border="1" style="width: 100%; border-collapse: collapse; text-align: center;"> <tr> </tr></table></td></tr></table></td></tr></table></td></tr></table></td></tr></table></td></tr></table></td></tr></table></td></tr></table></td></tr></table></td></tr></table></td></tr></table></td></tr></table></td></tr></table></td></tr></table></td></tr></table></td></tr></table></td></tr></table></td></tr></table></td></tr></table></td></tr></table></td></tr></table></td></tr></table></td></tr></table></td></tr></table></td></tr></table></td></tr></table></td></tr></table></td></tr></table></td></tr></table></td></tr></table></td></tr></table></td></tr></table></td></tr></table>
 | | | | | | | | | | | | | | | | | | | | <table border="1" style="width: 100%; border-collapse: collapse; text-align: center;"> <tr> <td style="width: 10%;"></td> <td style="width: 10%;"></td> <td style="width: 10%;"></td> <td style="width: 10%;"></td> <td style="width: 10%;"></td> <td style="width: 10%;"></td> <td style="width: 10%;"></td> <td style="width: 10%;"></td> <td style="width: 10%;"></td> <td style="width: 10%;"></td> </tr> <tr> <td></td> <td></td> <td colspan="8" style="text-align: center;"> <table border="1" style="width: 100%; border-collapse: collapse; text-align: center;"> <tr> <td style="width: 10%;"></td> <td style="width: 10%;"></td> <td style="width: 10%;"></td> <td style="width: 10%;"></td> <td style="width: 10%;"></td> <td style="width: 10%;"></td> <td style="width: 10%;"></td> <td style="width: 10%;"></td> <td style="width: 10%;"></td> <td style="width: 10%;"></td> </tr> <tr> <td></td> <td></td> <td colspan="8" style="text-align: center;"> <table border="1" style="width: 100%; border-collapse: collapse; text-align: center;"> <tr> <td style="width: 10%;"></td> <td style="width: 10%;"></td> <td style="width: 10%;"></td> <td style="width: 10%;"></td> <td style="width: 10%;"></td> <td style="width: 10%;"></td> <td style="width: 10%;"></td> <td style="width: 10%;"></td> <td style="width: 10%;"></td> <td style="width: 10%;"></td> </tr> <tr> <td></td> <td></td> <td colspan="8" style="text-align: center;"> <table border="1" style="width: 100%; border-collapse: collapse; text-align: center;"> <tr> <td style="width: 10%;"></td> <td style="width: 10%;"></td> <td style="width: 10%;"></td> <td style="width: 10%;"></td> <td style="width: 10%;"></td> <td style="width: 10%;"></td> <td style="width: 10%;"></td> <td style="width: 10%;"></td> <td style="width: 10%;"></td> <td style="width: 10%;"></td> </tr> <tr> <td></td> <td></td> <td colspan="8" style="text-align: center;"> <table border="1" style="width: 100%; border-collapse: collapse; text-align: center;"> <tr> <td style="width: 10%;"></td> <td style="width: 10%;"></td> <td style="width: 10%;"></td> <td style="width: 10%;"></td> <td style="width: 10%;"></td> <td style="width: 10%;"></td> <td style="width: 10%;"></td> <td style="width: 10%;"></td> <td style="width: 10%;"></td> <td style="width: 10%;"></td> </tr> <tr> <td></td> <td></td> <td colspan="8" style="text-align: center;"> <table border="1" style="width: 100%; border-collapse: collapse; text-align: center;"> <tr> <td style="width: 10%;"></td> <td style="width: 10%;"></td> <td style="width: 10%;"></td> <td style="width: 10%;"></td> <td style="width: 10%;"></td> <td style="width: 10%;"></td> <td style="width: 10%;"></td> <td style="width: 10%;"></td> <td style="width: 10%;"></td> <td style="width: 10%;"></td> </tr> <tr> <td></td> <td></td> <td colspan="8" style="text-align: center;"> <table border="1" style="width: 100%; border-collapse: collapse; text-align: center;"> <tr> <td style="width: 10%;"></td> <td style="width: 10%;"></td> <td style="width: 10%;"></td> <td style="width: 10%;"></td> <td style="width: 10%;"></td> <td style="width: 10%;"></td> <td style="width: 10%;"></td> <td style="width: 10%;"></td> <td style="width: 10%;"></td> <td style="width: 10%;"></td> </tr> <tr> <td></td> <td></td> <td colspan="8" style="text-align: center;"> <table border="1" style="width: 100%; border-collapse: collapse; text-align: center;"> <tr> <td style="width: 10%;"></td> <td style="width: 10%;"></td> <td style="width: 10%;"></td> <td style="width: 10%;"></td> <td style="width: 10%;"></td> <td style="width: 10%;"></td> <td style="width: 10%;"></td> <td style="width: 10%;"></td> <td style="width: 10%;"></td> <td style="width: 10%;"></td> </tr> <tr> <td></td> <td></td> <td colspan="8" style="text-align: center;"> <table border="1" style="width: 100%; border-collapse: collapse; text-align: center;"> <tr> <td style="width: 10%;"></td> <td style="width: 10%;"></td> <td style="width: 10%;"></td> <td style="width: 10%;"></td> <td style="width: 10%;"></td> <td style="width: 10%;"></td> <td style="width: 10%;"></td> <td style="width: 10%;"></td> <td style="width: 10%;"></td> <td style="width: 10%;"></td> </tr> <tr> <td></td> <td></td> <td colspan="8" style="text-align: center;"> <table border="1" style="width: 100%; border-collapse: collapse; text-align: center;"> <tr> <td style="width: 10%;"></td> <td style="width: 10%;"></td> <td style="width: 10%;"></td> <td style="width: 10%;"></td> <td style="width: 10%;"></td> <td style="width: 10%;"></td> <td style="width: 10%;"></td> <td style="width: 10%;"></td> <td style="width: 10%;"></td> <td style="width: 10%;"></td> </tr> <tr> <td></td> <td></td> <td colspan="8" style="text-align: center;"> <table border="1" style="width: 100%; border-collapse: collapse; text-align: center;"> <tr> <td style="width: 10%;"></td> <td style="width: 10%;"></td> <td style="width: 10%;"></td> <td style="width: 10%;"></td> <td style="width: 10%;"></td> <td style="width: 10%;"></td> <td style="width: 10%;"></td> <td style="width: 10%;"></td> <td style="width: 10%;"></td> <td style="width: 10%;"></td> </tr> <tr> <td></td> <td></td> <td colspan="8" style="text-align: center;"> <table border="1" style="width: 100%; border-collapse: collapse; text-align: center;"> <tr> <td style="width: 10%;"></td> <td style="width: 10%;"></td> <td style="width: 10%;"></td> <td style="width: 10%;"></td> <td style="width: 10%;"></td> <td style="width: 10%;"></td> <td style="width: 10%;"></td> <td style="width: 10%;"></td> <td style="width: 10%;"></td> <td style="width: 10%;"></td> </tr> <tr> <td></td> <td></td> <td colspan="8" style="text-align: center;"> <table border="1" style="width: 100%; border-collapse: collapse; text-align: center;"> <tr> <td style="width: 10%;"></td> <td style="width: 10%;"></td> <td style="width: 10%;"></td> <td style="width: 10%;"></td> <td style="width: 10%;"></td> <td style="width: 10%;"></td> <td style="width: 10%;"></td> <td style="width: 10%;"></td> <td style="width: 10%;"></td> <td style="width: 10%;"></td> </tr> <tr> <td></td> <td></td> <td colspan="8" style="text-align: center;"> <table border="1" style="width: 100%; border-collapse: collapse; text-align: center;"> <tr> <td style="width: 10%;"></td> <td style="width: 10%;"></td> <td style="width: 10%;"></td> <td style="width: 10%;"></td> <td style="width: 10%;"></td> <td style="width: 10%;"></td> <td style="width: 10%;"></td> <td style="width: 10%;"></td> <td style="width: 10%;"></td> <td style="width: 10%;"></td> </tr> <tr> <td></td> <td></td> <td colspan="8" style="text-align: center;"> <table border="1" style="width: 100%; border-collapse: collapse; text-align: center;"> <tr> <td style="width: 10%;"></td> <td style="width: 10%;"></td> <td style="width: 10%;"></td> <td style="width: 10%;"></td> <td style="width: 10%;"></td> <td style="width: 10%;"></td> <td style="width: 10%;"></td> <td style="width: 10%;"></td> <td style="width: 10%;"></td> <td style="width: 10%;"></td> </tr> <tr> <td></td> <td></td> <td colspan="8" style="text-align: center;"> <table border="1" style="width: 100%; border-collapse: collapse; text-align: center;"> <tr> <td style="width: 10%;"></td> <td style="width: 10%;"></td> <td style="width: 10%;"></td> <td style="width: 10%;"></td> <td style="width: 10%;"></td> <td style="width: 10%;"></td> <td style="width: 10%;"></td> <td style="width: 10%;"></td> <td style="width: 10%;"></td> <td style="width: 10%;"></td> </tr> <tr> <td></td> <td></td> <td colspan="8" style="text-align: center;"> <table border="1" style="width: 100%; border-collapse: collapse; text-align: center;"> <tr> <td style="width: 10%;"></td> <td style="width: 10%;"></td> <td style="width: 10%;"></td> <td style="width: 10%;"></td> <td style="width: 10%;"></td> <td style="width: 10%;"></td> <td style="width: 10%;"></td> <td style="width: 10%;"></td> <td style="width: 10%;"></td> <td style="width: 10%;"></td> </tr> <tr> <td></td> <td></td> <td colspan="8" style="text-align: center;"> <table border="1" style="width: 100%; border-collapse: collapse; text-align: center;"> <tr> <td style="width: 10%;"></td> <td style="width: 10%;"></td> <td style="width: 10%;"></td> <td style="width: 10%;"></td> <td style="width: 10%;"></td> <td style="width: 10%;"></td> <td style="width: 10%;"></td> <td style="width: 10%;"></td> <td style="width: 10%;"></td> <td style="width: 10%;"></td> </tr> <tr> <td></td> <td></td> <td colspan="8" style="text-align: center;"> <table border="1" style="width: 100%; border-collapse: collapse; text-align: center;"> <tr>
<td style="width: 10%;"></td> <td style="width: 10%;"></td> <td style="width: 10%;"></td> <td style="width: 10%;"></td> <td style="width: 10%;"></td> <td style="width: 10%;"></td> <td style="width: 10%;"></td> <td style="width: 10%;"></td> <td style="width: 10%;"></td> <td style="width: 10%;"></td> </tr> <tr> <td></td> <td></td> <td colspan="8" style="text-align: center;"> <table border="1" style="width: 100%; border-collapse: collapse; text-align: center;"> <tr> <td style="width: 10%;"></td> <td style="width: 10%;"></td> <td style="width: 10%;"></td> <td style="width: 10%;"></td> <td style="width: 10%;"></td> <td style="width: 10%;"></td> <td style="width: 10%;"></td> <td style="width: 10%;"></td> <td style="width: 10%;"></td> <td style="width: 10%;"></td> </tr> <tr> <td></td> <td></td> <td colspan="8" style="text-align: center;"> <table border="1" style="width: 100%; border-collapse: collapse; text-align: center;"> <tr> <td style="width: 10%;"></td> <td style="width: 10%;"></td> <td style="width: 10%;"></td> <td style="width: 10%;"></td> <td style="width: 10%;"></td> <td style="width: 10%;"></td> <td style="width: 10%;"></td> <td style="width: 10%;"></td> <td style="width: 10%;"></td> <td style="width: 10%;"></td> </tr> <tr> <td></td> <td></td> <td colspan="8" style="text-align: center;"> <table border="1" style="width: 100%; border-collapse: collapse; text-align: center;"> <tr> <td style="width: 10%;"></td> <td style="width: 10%;"></td> <td style="width: 10%;"></td> <td style="width: 10%;"></td> <td style="width: 10%;"></td> <td style="width: 10%;"></td> <td style="width: 10%;"></td> <td style="width: 10%;"></td> <td style="width: 10%;"></td> <td style="width: 10%;"></td> </tr> <tr> <td></td> <td></td> <td colspan="8" style="text-align: center;"> <table border="1" style="width: 100%; border-collapse: collapse; text-align: center;"> <tr> <td style="width: 10%;"></td> <td style="width: 10%;"></td> <td style="width: 10%;"></td> <td style="width: 10%;"></td> <td style="width: 10%;"></td> <td style="width: 10%;"></td> <td style="width: 10%;"></td> <td style="width: 10%;"></td> <td style="width: 10%;"></td> <td style="width: 10%;"></td> </tr> <tr> <td></td> <td></td> <td colspan="8" style="text-align: center;"> <table border="1" style="width: 100%; border-collapse: collapse; text-align: center;"> <tr> <td style="width: 10%;"></td> <td style="width: 10%;"></td> <td style="width: 10%;"></td> <td style="width: 10%;"></td> <td style="width: 10%;"></td> <td style="width: 10%;"></td> <td style="width: 10%;"></td> <td style="width: 10%;"></td> <td style="width: 10%;"></td> <td style="width: 10%;"></td> </tr> <tr> <td></td> <td></td> <td colspan="8" style="text-align: center;"> <table border="1" style="width: 100%; border-collapse: collapse; text-align: center;"> <tr> <td style="width: 10%;"></td> <td style="width: 10%;"></td> <td style="width: 10%;"></td> <td style="width: 10%;"></td> <td style="width: 10%;"></td> <td style="width: 10%;"></td> <td style="width: 10%;"></td> <td style="width: 10%;"></td> <td style="width: 10%;"></td> <td style="width: 10%;"></td> </tr> <tr> <td></td> <td></td> <td colspan="8" style="text-align: center;"> <table border="1" style="width: 100%; border-collapse: collapse; text-align: center;"> <tr> <td style="width: 10%;"></td> <td style="width: 10%;"></td> <td style="width: 10%;"></td> <td style="width: 10%;"></td> <td style="width: 10%;"></td> <td style="width: 10%;"></td> <td style="width: 10%;"></td> <td style="width: 10%;"></td> <td style="width: 10%;"></td> <td style="width: 10%;"></td> </tr> <tr> <td></td> <td></td> <td colspan="8" style="text-align: center;"> <table border="1" style="width: 100%; border-collapse: collapse; text-align: center;"> <tr> <td style="width: 10%;"></td> <td style="width: 10%;"></td> <td style="width: 10%;"></td> <td style="width: 10%;"></td> <td style="width: 10%;"></td> <td style="width: 10%;"></td> <td style="width: 10%;"></td> <td style="width: 10%;"></td> <td style="width: 10%;"></td> <td style="width: 10%;"></td> </tr> <tr> <td></td> <td></td> <td colspan="8" style="text-align: center;"> <table border="1" style="width: 100%; border-collapse: collapse; text-align: center;"> <tr> <td style="width: 10%;"></td> <td style="width: 10%;"></td> <td style="width: 10%;"></td> <td style="width: 10%;"></td> <td style="width: 10%;"></td> <td style="width: 10%;"></td> <td style="width: 10%;"></td> <td style="width: 10%;"></td> <td style="width: 10%;"></td> <td style="width: 10%;"></td> </tr> <tr> <td></td> <td></td> <td colspan="8" style="text-align: center;"> <table border="1" style="width: 100%; border-collapse: collapse; text-align: center;"> <tr> <td style="width: 10%;"></td> <td style="width: 10%;"></td> <td style="width: 10%;"></td> <td style="width: 10%;"></td> <td style="width: 10%;"></td> <td style="width: 10%;"></td> <td style="width: 10%;"></td> <td style="width: 10%;"></td> <td style="width: 10%;"></td> <td style="width: 10%;"></td> </tr> <tr> <td></td> <td></td> <td colspan="8" style="text-align: center;"> <table border="1" style="width: 100%; border-collapse: collapse; text-align: center;"> <tr> <td style="width: 10%;"></td> <td style="width: 10%;"></td> <td style="width: 10%;"></td> <td style="width: 10%;"></td> <td style="width: 10%;"></td> <td style="width: 10%;"></td> <td style="width: 10%;"></td> <td style="width: 10%;"></td> <td style="width: 10%;"></td> <td style="width: 10%;"></td> </tr> <tr> <td></td> <td></td> <td colspan="8" style="text-align: center;"> <table border="1" style="width: 100%; border-collapse: collapse; text-align: center;"> <tr> <td style="width: 10%;"></td> <td style="width: 10%;"></td> <td style="width: 10%;"></td> <td style="width: 10%;"></td> <td style="width: 10%;"></td> <td style="width: 10%;"></td> <td style="width: 10%;"></td> <td style="width: 10%;"></td> <td style="width: 10%;"></td> <td style="width: 10%;"></td> </tr> <tr> <td></td> <td></td> <td colspan="8" style="text-align: center;"> <table border="1" style="width: 100%; border-collapse: collapse; text-align: center;"> <tr> </tr></table></td></tr></table></td></tr></table></td></tr></table></td></tr></table></td></tr></table></td></tr></table></td></tr></table></td></tr></table></td></tr></table></td></tr></table></td></tr></table></td></tr></table></td></tr></table></td></tr></table></td></tr></table></td></tr></table></td></tr></table></td></tr></table></td></tr></table></td></tr></table></td></tr></table></td></tr></table></td></tr></table></td></tr></table></td></tr></table></td></tr></table></td></tr></table></td></tr></table></td></tr></table></td></tr></table></td></tr></table>
 | | | | | | | | | | | | | | | | | | | | <table border="1" style="width: 100%; border-collapse: collapse; text-align: center;"> <tr> <td style="width: 10%;"></td> <td style="width: 10%;"></td> <td style="width: 10%;"></td> <td style="width: 10%;"></td> <td style="width: 10%;"></td> <td style="width: 10%;"></td> <td style="width: 10%;"></td> <td style="width: 10%;"></td> <td style="width: 10%;"></td> <td style="width: 10%;"></td> </tr> <tr> <td></td> <td></td> <td colspan="8" style="text-align: center;"> <table border="1" style="width: 100%; border-collapse: collapse; text-align: center;"> <tr> <td style="width: 10%;"></td> <td style="width: 10%;"></td> <td style="width: 10%;"></td> <td style="width: 10%;"></td> <td style="width: 10%;"></td> <td style="width: 10%;"></td> <td style="width: 10%;"></td> <td style="width: 10%;"></td> <td style="width: 10%;"></td> <td style="width: 10%;"></td> </tr> <tr> <td></td> <td></td> <td colspan="8" style="text-align: center;"> <table border="1" style="width: 100%; border-collapse: collapse; text-align: center;"> <tr> <td style="width: 10%;"></td> <td style="width: 10%;"></td> <td style="width: 10%;"></td> <td style="width: 10%;"></td> <td style="width: 10%;"></td> <td style="width: 10%;"></td> <td style="width: 10%;"></td> <td style="width: 10%;"></td> <td style="width: 10%;"></td> <td style="width: 10%;"></td> </tr> <tr> <td></td> <td></td> <td colspan="8" style="text-align: center;"> <table border="1" style="width: 100%; border-collapse: collapse; text-align: center;"> <tr> <td style="width: 10%;"></td> <td style="width: 10%;"></td> <td style="width: 10%;"></td> <td style="width: 10%;"></td> <td style="width: 10%;"></td> <td style="width: 10%;"></td> <td style="width: 10%;"></td> <td style="width: 10%;"></td> <td style="width: 10%;"></td> <td style="width: 10%;"></td> </tr> <tr> <td></td> <td></td> <td colspan="8" style="text-align: center;"> <table border="1" style="width: 100%; border-collapse: collapse; text-align: center;"> <tr> <td style="width: 10%;"></td> <td style="width: 10%;"></td> <td style="width: 10%;"></td> <td style="width: 10%;"></td> <td style="width: 10%;"></td> <td style="width: 10%;"></td> <td style="width: 10%;"></td> <td style="width: 10%;"></td> <td style="width: 10%;"></td> <td style="width: 10%;"></td> </tr> <tr> <td></td> <td></td> <td colspan="8" style="text-align: center;"> <table border="1" style="width: 100%; border-collapse: collapse; text-align: center;"> <tr> <td style="width: 10%;"></td> <td style="width: 10%;"></td> <td style="width: 10%;"></td> <td style="width: 10%;"></td> <td style="width: 10%;"></td> <td style="width: 10%;"></td> <td style="width: 10%;"></td> <td style="width: 10%;"></td> <td style="width: 10%;"></td> <td style="width: 10%;"></td> </tr> <tr> <td></td> <td></td> <td colspan="8" style="text-align: center;"> <table border="1" style="width: 100%; border-collapse: collapse; text-align: center;"> <tr> <td style="width: 10%;"></td> <td style="width: 10%;"></td> <td style="width: 10%;"></td> <td style="width: 10%;"></td> <td style="width: 10%;"></td> <td style="width: 10%;"></td> <td style="width: 10%;"></td> <td style="width: 10%;"></td> <td style="width: 10%;"></td> <td style="width: 10%;"></td> </tr> <tr> <td></td> <td></td> <td colspan="8" style="text-align: center;"> <table border="1" style="width: 100%; border-collapse: collapse; text-align: center;"> <tr> <td style="width: 10%;"></td> <td style="width: 10%;"></td> <td style="width: 10%;"></td> <td style="width: 10%;"></td> <td style="width: 10%;"></td> <td style="width: 10%;"></td> <td style="width: 10%;"></td> <td style="width: 10%;"></td> <td style="width: 10%;"></td> <td style="width: 10%;"></td> </tr> <tr> <td></td> <td></td> <td colspan="8" style="text-align: center;"> <table border="1" style="width: 100%; border-collapse: collapse; text-align: center;"> <tr> <td style="width: 10%;"></td> <td style="width: 10%;"></td> <td style="width: 10%;"></td> <td style="width: 10%;"></td> <td style="width: 10%;"></td> <td style="width: 10%;"></td> <td style="width: 10%;"></td> <td style="width: 10%;"></td> <td style="width: 10%;"></td> <td style="width: 10%;"></td> </tr> <tr> <td></td> <td></td> <td colspan="8" style="text-align: center;"> <table border="1" style="width: 100%; border-collapse: collapse; text-align: center;"> <tr> <td style="width: 10%;"></td> <td style="width: 10%;"></td> <td style="width: 10%;"></td> <td style="width: 10%;"></td> <td style="width: 10%;"></td> <td style="width: 10%;"></td> <td style="width: 10%;"></td> <td style="width: 10%;"></td> <td style="width: 10%;"></td> <td style="width: 10%;"></td> </tr> <tr> <td></td> <td></td> <td colspan="8" style="text-align: center;"> <table border="1" style="width: 100%; border-collapse: collapse; text-align: center;"> <tr> <td style="width: 10%;"></td> <td style="width: 10%;"></td> <td style="width: 10%;"></td> <td style="width: 10%;"></td> <td style="width: 10%;"></td> <td style="width: 10%;"></td> <td style="width: 10%;"></td> <td style="width: 10%;"></td> <td style="width: 10%;"></td> <td style="width: 10%;"></td> </tr> <tr> <td></td> <td></td> <td colspan="8" style="text-align: center;"> <table border="1" style="width: 100%; border-collapse: collapse; text-align: center;"> <tr> <td style="width: 10%;"></td> <td style="width: 10%;"></td> <td style="width: 10%;"></td> <td style="width: 10%;"></td> <td style="width: 10%;"></td> <td style="width: 10%;"></td> <td style="width: 10%;"></td> <td style="width: 10%;"></td> <td style="width: 10%;"></td> <td style="width: 10%;"></td> </tr> <tr> <td></td> <td></td> <td colspan="8" style="text-align: center;"> <table border="1" style="width: 100%; border-collapse: collapse; text-align: center;"> <tr> <td style="width: 10%;"></td> <td style="width: 10%;"></td> <td style="width: 10%;"></td> <td style="width: 10%;"></td> <td style="width: 10%;"></td> <td style="width: 10%;"></td> <td style="width: 10%;"></td> <td style="width: 10%;"></td> <td style="width: 10%;"></td> <td style="width: 10%;"></td> </tr> <tr> <td></td> <td></td> <td colspan="8" style="text-align: center;"> <table border="1" style="width: 100%; border-collapse: collapse; text-align: center;"> <tr> <td style="width: 10%;"></td> <td style="width: 10%;"></td> <td style="width: 10%;"></td> <td style="width: 10%;"></td> <td style="width: 10%;"></td> <td style="width: 10%;"></td> <td style="width: 10%;"></td> <td style="width: 10%;"></td> <td style="width: 10%;"></td> <td style="width: 10%;"></td>
</tr> <tr> <td></td> <td></td> <td colspan="8" style="text-align: center;"> <table border="1" style="width: 100%; border-collapse: collapse; text-align: center;"> <tr> <td style="width: 10%;"></td> <td style="width: 10%;"></td> <td style="width: 10%;"></td> <td style="width: 10%;"></td> <td style="width: 10%;"></td> <td style="width: 10%;"></td> <td style="width: 10%;"></td> <td style="width: 10%;"></td> <td style="width: 10%;"></td> <td style="width: 10%;"></td> </tr> <tr> <td></td> <td></td> <td colspan="8" style="text-align: center;"> <table border="1" style="width: 100%; border-collapse: collapse; text-align: center;"> <tr> <td style="width: 10%;"></td> <td style="width: 10%;"></td> <td style="width: 10%;"></td> <td style="width: 10%;"></td> <td style="width: 10%;"></td> <td style="width: 10%;"></td> <td style="width: 10%;"></td> <td style="width: 10%;"></td> <td style="width: 10%;"></td> <td style="width: 10%;"></td> </tr> <tr> <td></td> <td></td> <td colspan="8" style="text-align: center;"> <table border="1" style="width: 100%; border-collapse: collapse; text-align: center;"> <tr> <td style="width: 10%;"></td> <td style="width: 10%;"></td> <td style="width: 10%;"></td> <td style="width: 10%;"></td> <td style="width: 10%;"></td> <td style="width: 10%;"></td> <td style="width: 10%;"></td> <td style="width: 10%;"></td> <td style="width: 10%;"></td> <td style="width: 10%;"></td> </tr> <tr> <td></td> <td></td> <td colspan="8" style="text-align: center;"> <table border="1" style="width: 100%; border-collapse: collapse; text-align: center;"> <tr> <td style="width: 10%;"></td> <td style="width: 10%;"></td> <td style="width: 10%;"></td> <td style="width: 10%;"></td> <td style="width: 10%;"></td> <td style="width: 10%;"></td> <td style="width: 10%;"></td> <td style="width: 10%;"></td> <td style="width: 10%;"></td> <td style="width: 10%;"></td> </tr> <tr> <td></td> <td></td> <td colspan="8" style="text-align: center;"> <table border="1" style="width: 100%; border-collapse: collapse; text-align: center;"> <tr> <td style="width: 10%;"></td> <td style="width: 10%;"></td> <td style="width: 10%;"></td> <td style="width: 10%;"></td> <td style="width: 10%;"></td> <td style="width: 10%;"></td> <td style="width: 10%;"></td> <td style="width: 10%;"></td> <td style="width: 10%;"></td> <td style="width: 10%;"></td> </tr> <tr> <td></td> <td></td> <td colspan="8" style="text-align: center;"> <table border="1" style="width: 100%; border-collapse: collapse; text-align: center;"> <tr> <td style="width: 10%;"></td> <td style="width: 10%;"></td> <td style="width: 10%;"></td> <td style="width: 10%;"></td> <td style="width: 10%;"></td> <td style="width: 10%;"></td> <td style="width: 10%;"></td> <td style="width: 10%;"></td> <td style="width: 10%;"></td> <td style="width: 10%;"></td> </tr> <tr> <td></td> <td></td> <td colspan="8" style="text-align: center;"> <table border="1" style="width: 100%; border-collapse: collapse; text-align: center;"> <tr> <td style="width: 10%;"></td> <td style="width: 10%;"></td> <td style="width: 10%;"></td> <td style="width: 10%;"></td> <td style="width: 10%;"></td> <td style="width: 10%;"></td> <td style="width: 10%;"></td> <td style="width: 10%;"></td> <td style="width: 10%;"></td> <td style="width: 10%;"></td> </tr> <tr> <td></td> <td></td> <td colspan="8" style="text-align: center;"> <table border="1" style="width: 100%; border-collapse: collapse; text-align: center;"> <tr> <td style="width: 10%;"></td> <td style="width: 10%;"></td> <td style="width: 10%;"></td> <td style="width: 10%;"></td> <td style="width: 10%;"></td> <td style="width: 10%;"></td> <td style="width: 10%;"></td> <td style="width: 10%;"></td> <td style="width: 10%;"></td> <td style="width: 10%;"></td> </tr> <tr> <td></td> <td></td> <td colspan="8" style="text-align: center;"> <table border="1" style="width: 100%; border-collapse: collapse; text-align: center;"> <tr> <td style="width: 10%;"></td> <td style="width: 10%;"></td> <td style="width: 10%;"></td> <td style="width: 10%;"></td> <td style="width: 10%;"></td> <td style="width: 10%;"></td> <td style="width: 10%;"></td> <td style="width: 10%;"></td> <td style="width: 10%;"></td> <td style="width: 10%;"></td> </tr> <tr> <td></td> <td></td> <td colspan="8" style="text-align: center;"> <table border="1" style="width: 100%; border-collapse: collapse; text-align: center;"> <tr> <td style="width: 10%;"></td> <td style="width: 10%;"></td> <td style="width: 10%;"></td> <td style="width: 10%;"></td> <td style="width: 10%;"></td> <td style="width: 10%;"></td> <td style="width: 10%;"></td> <td style="width: 10%;"></td> <td style="width: 10%;"></td> <td style="width: 10%;"></td> </tr> <tr> <td></td> <td></td> <td colspan="8" style="text-align: center;"> <table border="1" style="width: 100%; border-collapse: collapse; text-align: center;"> <tr> <td style="width: 10%;"></td> <td style="width: 10%;"></td> <td style="width: 10%;"></td> <td style="width: 10%;"></td> <td style="width: 10%;"></td> <td style="width: 10%;"></td> <td style="width: 10%;"></td> <td style="width: 10%;"></td> <td style="width: 10%;"></td> <td style="width: 10%;"></td> </tr> <tr> <td></td> <td></td> <td colspan="8" style="text-align: center;"> <table border="1" style="width: 100%; border-collapse: collapse; text-align: center;"> <tr> <td style="width: 10%;"></td> <td style="width: 10%;"></td> <td style="width: 10%;"></td> <td style="width: 10%;"></td> <td style="width: 10%;"></td> <td style="width: 10%;"></td> <td style="width: 10%;"></td> <td style="width: 10%;"></td> <td style="width: 10%;"></td> <td style="width: 10%;"></td> </tr> <tr> <td></td> <td></td> <td colspan="8" style="text-align: center;"> <table border="1" style="width: 100%; border-collapse: collapse; text-align: center;"> <tr> <td style="width: 10%;"></td> <td style="width: 10%;"></td> <td style="width: 10%;"></td> <td style="width: 10%;"></td> <td style="width: 10%;"></td> <td style="width: 10%;"></td> <td style="width: 10%;"></td> <td style="width: 10%;"></td> <td style="width: 10%;"></td> <td style="width: 10%;"></td> </tr> <tr> <td></td> <td></td> <td colspan="8" style="text-align: center;"> <table border="1" style="width: 100%; border-collapse: collapse; text-align: center;"> <tr> <td style="width: 10%;"></td> <td style="width: 10%;"></td> <td style="width: 10%;"></td> <td style="width: 10%;"></td> <td style="width: 10%;"></td> <td style="width: 10%;"></td> <td style="width: 10%;"></td> <td style="width: 10%;"></td> <td style="width: 10%;"></td> <td style="width: 10%;"></td> </tr> <tr> <td></td> <td></td> <td colspan="8" style="text-align: center;"> <table border="1" style="width: 100%; border-collapse: collapse; text-align: center;"> <tr> <td style="width: 10%;"></td> <td style="width: 10%;"></td> <td style="width: 10%;"></td> <td style="width: 10%;"></td> <td style="width: 10%;"></td> <td style="width: 10%;"></td> <td style="width: 10%;"></td> <td style="width: 10%;"></td> <td style="width: 10%;"></td> <td style="width: 10%;"></td> </tr> <tr> <td></td> <td></td> <td colspan="8" style="text-align: center;"> <table border="1" style="width: 100%; border-collapse: collapse; text-align: center;"> <tr> <td style="width: 10%;"></td> <td style="width: 10%;"></td> <td style="width: 10%;"></td> <td style="width: 10%;"></td> <td style="width: 10%;"></td> <td style="width: 10%;"></td> <td style="width: 10%;"></td> <td style="width: 10%;"></td> <td style="width: 10%;"></td> <td style="width: 10%;"></td> </tr> <tr> <td></td> <td></td> <td colspan="8" style="text-align: center;"> <table border="1" style="width: 100%; border-collapse: collapse; text-align: center;"> <tr> </tr></table></td></tr></table></td></tr></table></td></tr></table></td></tr></table></td></tr></table></td></tr></table></td></tr></table></td></tr></table></td></tr></table></td></tr></table></td></tr></table></td></tr></table></td></tr></table></td></tr></table></td></tr></table></td></tr></table></td></tr></table></td></tr></table></td></tr></table></td></tr></table></td></tr></table></td></tr></table></td></tr></table></td></tr></table></td></tr></table></td></tr></table></td></tr></table></td></tr></table></td></tr></table></td></tr></table>
 | | | | | | | | | | | | | | | | | | | | <table border="1" style="width: 100%; border-collapse: collapse; text-align: center;"> <tr> <td style="width: 10%;"></td> <td style="width: 10%;"></td> <td style="width: 10%;"></td> <td style="width: 10%;"></td> <td style="width: 10%;"></td> <td style="width: 10%;"></td> <td style="width: 10%;"></td> <td style="width: 10%;"></td> <td style="width: 10%;"></td> <td style="width: 10%;"></td> </tr> <tr> <td></td> <td></td> <td colspan="8" style="text-align: center;"> <table border="1" style="width: 100%; border-collapse: collapse; text-align: center;"> <tr> <td style="width: 10%;"></td> <td style="width: 10%;"></td> <td style="width: 10%;"></td> <td style="width: 10%;"></td> <td style="width: 10%;"></td> <td style="width: 10%;"></td> <td style="width: 10%;"></td> <td style="width: 10%;"></td> <td style="width: 10%;"></td> <td style="width: 10%;"></td> </tr> <tr> <td></td> <td></td> <td colspan="8" style="text-align: center;"> <table border="1" style="width: 100%; border-collapse: collapse; text-align: center;"> <tr> <td style="width: 10%;"></td> <td style="width: 10%;"></td> <td style="width: 10%;"></td> <td style="width: 10%;"></td> <td style="width: 10%;"></td> <td style="width: 10%;"></td> <td style="width: 10%;"></td> <td style="width: 10%;"></td> <td style="width: 10%;"></td> <td style="width: 10%;"></td> </tr> <tr> <td></td> <td></td> <td colspan="8" style="text-align: center;"> <table border="1" style="width: 100%; border-collapse: collapse; text-align: center;"> <tr> <td style="width: 10%;"></td> <td style="width: 10%;"></td> <td style="width: 10%;"></td> <td style="width: 10%;"></td> <td style="width: 10%;"></td> <td style="width: 10%;"></td> <td style="width: 10%;"></td> <td style="width: 10%;"></td> <td style="width: 10%;"></td> <td style="width: 10%;"></td> </tr> <tr> <td></td> <td></td> <td colspan="8" style="text-align: center;"> <table border="1" style="width: 100%; border-collapse: collapse; text-align: center;"> <tr> <td style="width: 10%;"></td> <td style="width: 10%;"></td> <td style="width: 10%;"></td> <td style="width: 10%;"></td> <td style="width: 10%;"></td> <td style="width: 10%;"></td> <td style="width: 10%;"></td> <td style="width: 10%;"></td> <td style="width: 10%;"></td> <td style="width: 10%;"></td> </tr> <tr> <td></td> <td></td> <td colspan="8" style="text-align: center;"> <table border="1" style="width: 100%; border-collapse: collapse; text-align: center;"> <tr> <td style="width: 10%;"></td> <td style="width: 10%;"></td> <td style="width: 10%;"></td> <td style="width: 10%;"></td> <td style="width: 10%;"></td> <td style="width: 10%;"></td> <td style="width: 10%;"></td> <td style="width: 10%;"></td> <td style="width: 10%;"></td> <td style="width: 10%;"></td> </tr> <tr> <td></td> <td></td> <td colspan="8" style="text-align: center;"> <table border="1" style="width: 100%; border-collapse: collapse; text-align: center;"> <tr> <td style="width: 10%;"></td> <td style="width: 10%;"></td> <td style="width: 10%;"></td> <td style="width: 10%;"></td> <td style="width: 10%;"></td> <td style="width: 10%;"></td> <td style="width: 10%;"></td> <td style="width: 10%;"></td> <td style="width: 10%;"></td> <td style="width: 10%;"></td> </tr> <tr> <td></td> <td></td> <td colspan="8" style="text-align: center;"> <table border="1" style="width: 100%; border-collapse: collapse; text-align: center;"> <tr> <td style="width: 10%;"></td> <td style="width: 10%;"></td> <td style="width: 10%;"></td> <td style="width: 10%;"></td> <td style="width: 10%;"></td> <td style="width: 10%;"></td> <td style="width: 10%;"></td> <td style="width: 10%;"></td> <td style="width: 10%;"></td> <td style="width: 10%;"></td> </tr> <tr> <td></td> <td></td> <td colspan="8" style="text-align: center;"> <table border="1" style="width: 100%; border-collapse: collapse; text-align: center;"> <tr> <td style="width: 10%;"></td> <td style="width: 10%;"></td> <td style="width: 10%;"></td> <td style="width: 10%;"></td> <td style="width: 10%;"></td> <td style="width: 10%;"></td> <td style="width: 10%;"></td> <td style="width: 10%;"></td> <td style="width: 10%;"></td> <td style="width: 10%;"></td> </tr> <tr> <td></td> <td></td> <td colspan="8" style="text-align: center;"> <table border="1" style="width: 100%; border-collapse: collapse; text-align: center;"> <tr> <td style="width: 10%;"></td> <td style="width: 10%;"></td> <td style="width: 10%;"></td> <td style="width: 10%;"></td> <td style="width: 10%;"></td> <td style="width: 10%;"></td> <td style="width: 10%;"></td> <td style="width: 10%;"></td> <td style="width: 10%;"></td> <td style="width: 10%;"></td> </tr> <tr> <td></td> <td></td> <td colspan="8" style="text-align: center;"> <table border="1" style="width: 100%; border-collapse: collapse; text-align: center;"> <tr> <td style="width: 10%;"></td> <td style="width: 10%;"></td> <td style="width: 10%;"></td> <td style="width: 10%;"></td> <td style="width: 10%;"></td> <td
style="width: 10%;"></td> <td style="width: 10%;"></td> <td style="width: 10%;"></td> <td style="width: 10%;"></td> <td style="width: 10%;"></td> </tr> <tr> <td></td> <td></td> <td colspan="8" style="text-align: center;"> <table border="1" style="width: 100%; border-collapse: collapse; text-align: center;"> <tr> <td style="width: 10%;"></td> <td style="width: 10%;"></td> <td style="width: 10%;"></td> <td style="width: 10%;"></td> <td style="width: 10%;"></td> <td style="width: 10%;"></td> <td style="width: 10%;"></td> <td style="width: 10%;"></td> <td style="width: 10%;"></td> <td style="width: 10%;"></td> </tr> <tr> <td></td> <td></td> <td colspan="8" style="text-align: center;"> <table border="1" style="width: 100%; border-collapse: collapse; text-align: center;"> <tr> <td style="width: 10%;"></td> <td style="width: 10%;"></td> <td style="width: 10%;"></td> <td style="width: 10%;"></td> <td style="width: 10%;"></td> <td style="width: 10%;"></td> <td style="width: 10%;"></td> <td style="width: 10%;"></td> <td style="width: 10%;"></td> <td style="width: 10%;"></td> </tr> <tr> <td></td> <td></td> <td colspan="8" style="text-align: center;"> <table border="1" style="width: 100%; border-collapse: collapse; text-align: center;"> <tr> <td style="width: 10%;"></td> <td style="width: 10%;"></td> <td style="width: 10%;"></td> <td style="width: 10%;"></td> <td style="width: 10%;"></td> <td style="width: 10%;"></td> <td style="width: 10%;"></td> <td style="width: 10%;"></td> <td style="width: 10%;"></td> <td style="width: 10%;"></td> </tr> <tr> <td></td> <td></td> <td colspan="8" style="text-align: center;"> <table border="1" style="width: 100%; border-collapse: collapse; text-align: center;"> <tr> <td style="width: 10%;"></td> <td style="width: 10%;"></td> <td style="width: 10%;"></td> <td style="width: 10%;"></td> <td style="width: 10%;"></td> <td style="width: 10%;"></td> <td style="width: 10%;"></td> <td style="width: 10%;"></td> <td style="width: 10%;"></td> <td style="width: 10%;"></td> </tr> <tr> <td></td> <td></td> <td colspan="8" style="text-align: center;"> <table border="1" style="width: 100%; border-collapse: collapse; text-align: center;"> <tr> <td style="width: 10%;"></td> <td style="width: 10%;"></td> <td style="width: 10%;"></td> <td style="width: 10%;"></td> <td style="width: 10%;"></td> <td style="width: 10%;"></td> <td style="width: 10%;"></td> <td style="width: 10%;"></td> <td style="width: 10%;"></td> <td style="width: 10%;"></td> </tr> <tr> <td></td> <td></td> <td colspan="8" style="text-align: center;"> <table border="1" style="width: 100%; border-collapse: collapse; text-align: center;"> <tr> <td style="width: 10%;"></td> <td style="width: 10%;"></td> <td style="width: 10%;"></td> <td style="width: 10%;"></td> <td style="width: 10%;"></td> <td style="width: 10%;"></td> <td style="width: 10%;"></td> <td style="width: 10%;"></td> <td style="width: 10%;"></td> <td style="width: 10%;"></td> </tr> <tr> <td></td> <td></td> <td colspan="8" style="text-align: center;"> <table border="1" style="width: 100%; border-collapse: collapse; text-align: center;"> <tr> <td style="width: 10%;"></td> <td style="width: 10%;"></td> <td style="width: 10%;"></td> <td style="width: 10%;"></td> <td style="width: 10%;"></td> <td style="width: 10%;"></td> <td style="width: 10%;"></td> <td style="width: 10%;"></td> <td style="width: 10%;"></td> <td style="width: 10%;"></td> </tr> <tr> <td></td> <td></td> <td colspan="8" style="text-align: center;"> <table border="1" style="width: 100%; border-collapse: collapse; text-align: center;"> <tr> <td style="width: 10%;"></td> <td style="width: 10%;"></td> <td style="width: 10%;"></td> <td style="width: 10%;"></td> <td style="width: 10%;"></td> <td style="width: 10%;"></td> <td style="width: 10%;"></td> <td style="width: 10%;"></td> <td style="width: 10%;"></td> <td style="width: 10%;"></td> </tr> <tr> <td></td> <td></td> <td colspan="8" style="text-align: center;"> <table border="1" style="width: 100%; border-collapse: collapse; text-align: center;"> <tr> <td style="width: 10%;"></td> <td style="width: 10%;"></td> <td style="width: 10%;"></td> <td style="width: 10%;"></td> <td style="width: 10%;"></td> <td style="width: 10%;"></td> <td style="width: 10%;"></td> <td style="width: 10%;"></td> <td style="width: 10%;"></td> <td style="width: 10%;"></td> </tr> <tr> <td></td> <td></td> <td colspan="8" style="text-align: center;"> <table border="1" style="width: 100%; border-collapse: collapse; text-align: center;"> <tr> <td style="width: 10%;"></td> <td style="width: 10%;"></td> <td style="width: 10%;"></td> <td style="width: 10%;"></td> <td style="width: 10%;"></td> <td style="width: 10%;"></td> <td style="width: 10%;"></td> <td style="width: 10%;"></td> <td style="width: 10%;"></td> <td style="width: 10%;"></td> </tr> <tr> <td></td> <td></td> <td colspan="8" style="text-align: center;"> <table border="1" style="width: 100%; border-collapse: collapse; text-align: center;"> <tr> <td style="width: 10%;"></td> <td style="width: 10%;"></td> <td style="width: 10%;"></td> <td style="width: 10%;"></td> <td style="width: 10%;"></td> <td style="width: 10%;"></td> <td style="width: 10%;"></td> <td style="width: 10%;"></td> <td style="width: 10%;"></td> <td style="width: 10%;"></td> </tr> <tr> <td></td> <td></td> <td colspan="8" style="text-align: center;"> <table border="1" style="width: 100%; border-collapse: collapse; text-align: center;"> <tr> <td style="width: 10%;"></td> <td style="width: 10%;"></td> <td style="width: 10%;"></td> <td style="width: 10%;"></td> <td style="width: 10%;"></td> <td style="width: 10%;"></td> <td style="width: 10%;"></td> <td style="width: 10%;"></td> <td style="width: 10%;"></td> <td style="width: 10%;"></td> </tr> <tr> <td></td> <td></td> <td colspan="8" style="text-align: center;"> <table border="1" style="width: 100%; border-collapse: collapse; text-align: center;"> <tr> <td style="width: 10%;"></td> <td style="width: 10%;"></td> <td style="width: 10%;"></td> <td style="width: 10%;"></td> <td style="width: 10%;"></td> <td style="width: 10%;"></td> <td style="width: 10%;"></td> <td style="width: 10%;"></td> <td style="width: 10%;"></td> <td style="width: 10%;"></td> </tr> <tr> <td></td> <td></td> <td colspan="8" style="text-align: center;"> <table border="1" style="width: 100%; border-collapse: collapse; text-align: center;"> <tr> <td style="width: 10%;"></td> <td style="width: 10%;"></td> <td style="width: 10%;"></td> <td style="width: 10%;"></td> <td style="width: 10%;"></td> <td style="width: 10%;"></td> <td style="width: 10%;"></td> <td style="width: 10%;"></td> <td style="width: 10%;"></td> <td style="width: 10%;"></td> </tr> <tr> <td></td> <td></td> <td colspan="8" style="text-align: center;"> <table border="1" style="width: 100%; border-collapse: collapse; text-align: center;"> <tr> <td style="width: 10%;"></td> <td style="width: 10%;"></td> <td style="width: 10%;"></td> <td style="width: 10%;"></td> <td style="width: 10%;"></td> <td style="width: 10%;"></td> <td style="width: 10%;"></td> <td style="width: 10%;"></td> <td style="width: 10%;"></td> <td style="width: 10%;"></td> </tr> <tr> <td></td> <td></td> <td colspan="8" style="text-align: center;"> <table border="1" style="width: 100%; border-collapse: collapse; text-align: center;"> <tr> <td style="width: 10%;"></td> <td style="width: 10%;"></td> <td style="width: 10%;"></td> <td style="width: 10%;"></td> <td style="width: 10%;"></td> <td style="width: 10%;"></td> <td style="width: 10%;"></td> <td style="width: 10%;"></td> <td style="width: 10%;"></td> <td style="width: 10%;"></td> </tr> <tr> <td></td> <td></td> <td colspan="8" style="text-align: center;"> <table border="1" style="width: 100%; border-collapse: collapse; text-align: center;"> <tr> <td style="width: 10%;"></td> <td style="width: 10%;"></td> <td style="width: 10%;"></td> <td style="width: 10%;"></td> <td style="width: 10%;"></td> <td style="width: 10%;"></td> <td style="width: 10%;"></td> <td style="width: 10%;"></td> <td style="width: 10%;"></td> <td style="width: 10%;"></td> </tr> <tr> <td></td> <td></td> <td colspan="8" style="text-align: center;"> <table border="1" style="width: 100%; border-collapse: collapse; text-align: center;"> <tr> <td style="width: 10%;"></td> <td style="width: 10%;"></td> <td style="width: 10%;"></td> <td style="width: 10%;"></td> <td style="width: 10%;"></td> <td style="width: 10%;"></td> <td style="width: 10%;"></td> <td style="width: 10%;"></td> <td style="width: 10%;"></td> <td style="width: 10%;"></td> </tr> <tr> <td></td> <td></td> <td colspan="8" style="text-align: center;"> <table border="1" style="width: 100%; border-collapse: collapse; text-align: center;"> <tr> </tr></table></td></tr></table></td></tr></table></td></tr></table></td></tr></table></td></tr></table></td></tr></table></td></tr></table></td></tr></table></td></tr></table></td></tr></table></td></tr></table></td></tr></table></td></tr></table></td></tr></table></td></tr></table></td></tr></table></td></tr></table></td></tr></table></td></tr></table></td></tr></table></td></tr></table></td></tr></table></td></tr></table></td></tr></table></td></tr></table></td></tr></table></td></tr></table></td></tr></table></td></tr></table>
 | | | | | | | | | | | | | | | | | | | | <table border="1" style="width: 100%; border-collapse: collapse; text-align: center;"> <tr> <td style="width: 10%;"></td> <td style="width: 10%;"></td> <td style="width: 10%;"></td> <td style="width: 10%;"></td> <td style="width: 10%;"></td> <td style="width: 10%;"></td> <td style="width: 10%;"></td> <td style="width: 10%;"></td> <td style="width: 10%;"></td> <td style="width: 10%;"></td> </tr> <tr> <td></td> <td></td> <td colspan="8" style="text-align: center;"> <table border="1" style="width: 100%; border-collapse: collapse; text-align: center;"> <tr> <td style="width: 10%;"></td> <td style="width: 10%;"></td> <td style="width: 10%;"></td> <td style="width: 10%;"></td> <td style="width: 10%;"></td> <td style="width: 10%;"></td> <td style="width: 10%;"></td> <td style="width: 10%;"></td> <td style="width: 10%;"></td> <td style="width: 10%;"></td> </tr> <tr> <td></td> <td></td> <td colspan="8" style="text-align: center;"> <table border="1" style="width: 100%; border-collapse: collapse; text-align: center;"> <tr> <td style="width: 10%;"></td> <td style="width: 10%;"></td> <td style="width: 10%;"></td> <td style="width: 10%;"></td> <td style="width: 10%;"></td> <td style="width: 10%;"></td> <td style="width: 10%;"></td> <td style="width: 10%;"></td> <td style="width: 10%;"></td> <td style="width: 10%;"></td> </tr> <tr> <td></td> <td></td> <td colspan="8" style="text-align: center;"> <table border="1" style="width: 100%; border-collapse: collapse; text-align: center;"> <tr> <td style="width: 10%;"></td> <td style="width: 10%;"></td> <td style="width: 10%;"></td> <td style="width: 10%;"></td> <td style="width: 10%;"></td> <td style="width: 10%;"></td> <td style="width: 10%;"></td> <td style="width: 10%;"></td> <td style="width: 10%;"></td> <td style="width: 10%;"></td> </tr> <tr> <td></td> <td></td> <td colspan="8" style="text-align: center;"> <table border="1" style="width: 100%; border-collapse: collapse; text-align: center;"> <tr> <td style="width: 10%;"></td> <td style="width: 10%;"></td> <td style="width: 10%;"></td> <td style="width: 10%;"></td> <td style="width: 10%;"></td> <td style="width: 10%;"></td> <td style="width: 10%;"></td> <td style="width: 10%;"></td> <td style="width: 10%;"></td> <td style="width: 10%;"></td> </tr> <tr> <td></td> <td></td> <td colspan="8" style="text-align: center;"> <table border="1" style="width: 100%; border-collapse: collapse; text-align: center;"> <tr> <td style="width: 10%;"></td> <td style="width: 10%;"></td> <td style="width: 10%;"></td> <td style="width: 10%;"></td> <td style="width: 10%;"></td> <td style="width: 10%;"></td> <td style="width: 10%;"></td> <td style="width: 10%;"></td> <td style="width: 10%;"></td> <td style="width: 10%;"></td> </tr> <tr> <td></td> <td></td> <td colspan="8" style="text-align: center;"> <table border="1" style="width: 100%; border-collapse: collapse; text-align: center;"> <tr> <td style="width: 10%;"></td> <td style="width: 10%;"></td> <td style="width: 10%;"></td> <td style="width: 10%;"></td> <td style="width: 10%;"></td> <td style="width: 10%;"></td> <td style="width: 10%;"></td> <td style="width: 10%;"></td> <td style="width: 10%;"></td> <td style="width: 10%;"></td> </tr> <tr> <td></td> <td></td> <td colspan="8" style="text-align: center;"> <table border="1" style="width: 100%; border-collapse: collapse; text-align: center;"> <tr> <td style="width: 10%;"></td> <td style="width: 10%;"></td> <td style="width: 10%;"></td> <td style="width: 10%;"></td> <td style="width: 10%;"></td> <td style="width: 10%;"></td> <td style="width: 10%;"></td> <td style="width: 10%;"></td> <td style="width: 10%;"></td> <td style="width: 10%;"></td> </tr> <tr> <td></td> <td></td> <td colspan="8" style="text-align: center;"> <table border="1" style="width: 100%; border-collapse: collapse; text-align: center;"> <tr> <td style="width:
10%;"></td> <td style="width: 10%;"></td> <td style="width: 10%;"></td> <td style="width: 10%;"></td> <td style="width: 10%;"></td> <td style="width: 10%;"></td> <td style="width: 10%;"></td> <td style="width: 10%;"></td> <td style="width: 10%;"></td> <td style="width: 10%;"></td> </tr> <tr> <td></td> <td></td> <td colspan="8" style="text-align: center;"> <table border="1" style="width: 100%; border-collapse: collapse; text-align: center;"> <tr> <td style="width: 10%;"></td> <td style="width: 10%;"></td> <td style="width: 10%;"></td> <td style="width: 10%;"></td> <td style="width: 10%;"></td> <td style="width: 10%;"></td> <td style="width: 10%;"></td> <td style="width: 10%;"></td> <td style="width: 10%;"></td> <td style="width: 10%;"></td> </tr> <tr> <td></td> <td></td> <td colspan="8" style="text-align: center;"> <table border="1" style="width: 100%; border-collapse: collapse; text-align: center;"> <tr> <td style="width: 10%;"></td> <td style="width: 10%;"></td> <td style="width: 10%;"></td> <td style="width: 10%;"></td> <td style="width: 10%;"></td> <td style="width: 10%;"></td> <td style="width: 10%;"></td> <td style="width: 10%;"></td> <td style="width: 10%;"></td> <td style="width: 10%;"></td> </tr> <tr> <td></td> <td></td> <td colspan="8" style="text-align: center;"> <table border="1" style="width: 100%; border-collapse: collapse; text-align: center;"> <tr> <td style="width: 10%;"></td> <td style="width: 10%;"></td> <td style="width: 10%;"></td> <td style="width: 10%;"></td> <td style="width: 10%;"></td> <td style="width: 10%;"></td> <td style="width: 10%;"></td> <td style="width: 10%;"></td> <td style="width: 10%;"></td> <td style="width: 10%;"></td> </tr> <tr> <td></td> <td></td> <td colspan="8" style="text-align: center;"> <table border="1" style="width: 100%; border-collapse: collapse; text-align: center;"> <tr> <td style="width: 10%;"></td> <td style="width: 10%;"></td> <td style="width: 10%;"></td> <td style="width: 10%;"></td> <td style="width: 10%;"></td> <td style="width: 10%;"></td> <td style="width: 10%;"></td> <td style="width: 10%;"></td> <td style="width: 10%;"></td> <td style="width: 10%;"></td> </tr> <tr> <td></td> <td></td> <td colspan="8" style="text-align: center;"> <table border="1" style="width: 100%; border-collapse: collapse; text-align: center;"> <tr> <td style="width: 10%;"></td> <td style="width: 10%;"></td> <td style="width: 10%;"></td> <td style="width: 10%;"></td> <td style="width: 10%;"></td> <td style="width: 10%;"></td> <td style="width: 10%;"></td> <td style="width: 10%;"></td> <td style="width: 10%;"></td> <td style="width: 10%;"></td> </tr> <tr> <td></td> <td></td> <td colspan="8" style="text-align: center;"> <table border="1" style="width: 100%; border-collapse: collapse; text-align: center;"> <tr> <td style="width: 10%;"></td> <td style="width: 10%;"></td> <td style="width: 10%;"></td> <td style="width: 10%;"></td> <td style="width: 10%;"></td> <td style="width: 10%;"></td> <td style="width: 10%;"></td> <td style="width: 10%;"></td> <td style="width: 10%;"></td> <td style="width: 10%;"></td> </tr> <tr> <td></td> <td></td> <td colspan="8" style="text-align: center;"> <table border="1" style="width: 100%; border-collapse: collapse; text-align: center;"> <tr> <td style="width: 10%;"></td> <td style="width: 10%;"></td> <td style="width: 10%;"></td> <td style="width: 10%;"></td> <td style="width: 10%;"></td> <td style="width: 10%;"></td> <td style="width: 10%;"></td> <td style="width: 10%;"></td> <td style="width: 10%;"></td> <td style="width: 10%;"></td> </tr> <tr> <td></td> <td></td> <td colspan="8" style="text-align: center;"> <table border="1" style="width: 100%; border-collapse: collapse; text-align: center;"> <tr> <td style="width: 10%;"></td> <td style="width: 10%;"></td> <td style="width: 10%;"></td> <td style="width: 10%;"></td> <td style="width: 10%;"></td> <td style="width: 10%;"></td> <td style="width: 10%;"></td> <td style="width: 10%;"></td> <td style="width: 10%;"></td> <td style="width: 10%;"></td> </tr> <tr> <td></td> <td></td> <td colspan="8" style="text-align: center;"> <table border="1" style="width: 100%; border-collapse: collapse; text-align: center;"> <tr> <td style="width: 10%;"></td> <td style="width: 10%;"></td> <td style="width: 10%;"></td> <td style="width: 10%;"></td> <td style="width: 10%;"></td> <td style="width: 10%;"></td> <td style="width: 10%;"></td> <td style="width: 10%;"></td> <td style="width: 10%;"></td> <td style="width: 10%;"></td> </tr> <tr> <td></td> <td></td> <td colspan="8" style="text-align: center;"> <table border="1" style="width: 100%; border-collapse: collapse; text-align: center;"> <tr> <td style="width: 10%;"></td> <td style="width: 10%;"></td> <td style="width: 10%;"></td> <td style="width: 10%;"></td> <td style="width: 10%;"></td> <td style="width: 10%;"></td> <td style="width: 10%;"></td> <td style="width: 10%;"></td> <td style="width: 10%;"></td> <td style="width: 10%;"></td> </tr> <tr> <td></td> <td></td> <td colspan="8" style="text-align: center;"> <table border="1" style="width: 100%; border-collapse: collapse; text-align: center;"> <tr> <td style="width: 10%;"></td> <td style="width: 10%;"></td> <td style="width: 10%;"></td> <td style="width: 10%;"></td> <td style="width: 10%;"></td> <td style="width: 10%;"></td> <td style="width: 10%;"></td> <td style="width: 10%;"></td> <td style="width: 10%;"></td> <td style="width: 10%;"></td> </tr> <tr> <td></td> <td></td> <td colspan="8" style="text-align: center;"> <table border="1" style="width: 100%; border-collapse: collapse; text-align: center;"> <tr> <td style="width: 10%;"></td> <td style="width: 10%;"></td> <td style="width: 10%;"></td> <td style="width: 10%;"></td> <td style="width: 10%;"></td> <td style="width: 10%;"></td> <td style="width: 10%;"></td> <td style="width: 10%;"></td> <td style="width: 10%;"></td> <td style="width: 10%;"></td> </tr> <tr> <td></td> <td></td> <td colspan="8" style="text-align: center;"> <table border="1" style="width: 100%; border-collapse: collapse; text-align: center;"> <tr> <td style="width: 10%;"></td> <td style="width: 10%;"></td> <td style="width: 10%;"></td> <td style="width: 10%;"></td> <td style="width: 10%;"></td> <td style="width: 10%;"></td> <td style="width: 10%;"></td> <td style="width: 10%;"></td> <td style="width: 10%;"></td> <td style="width: 10%;"></td> </tr> <tr> <td></td> <td></td> <td colspan="8" style="text-align: center;"> <table border="1" style="width: 100%; border-collapse: collapse; text-align: center;"> <tr> <td style="width: 10%;"></td> <td style="width: 10%;"></td> <td style="width: 10%;"></td> <td style="width: 10%;"></td> <td style="width: 10%;"></td> <td style="width: 10%;"></td> <td style="width: 10%;"></td> <td style="width: 10%;"></td> <td style="width: 10%;"></td> <td style="width: 10%;"></td> </tr> <tr> <td></td> <td></td> <td colspan="8" style="text-align: center;"> <table border="1" style="width: 100%; border-collapse: collapse; text-align: center;"> <tr> <td style="width: 10%;"></td> <td style="width: 10%;"></td> <td style="width: 10%;"></td> <td style="width: 10%;"></td> <td style="width: 10%;"></td> <td style="width: 10%;"></td> <td style="width: 10%;"></td> <td style="width: 10%;"></td> <td style="width: 10%;"></td> <td style="width: 10%;"></td> </tr> <tr> <td></td> <td></td> <td colspan="8" style="text-align: center;"> <table border="1" style="width: 100%; border-collapse: collapse; text-align: center;"> <tr> <td style="width: 10%;"></td> <td style="width: 10%;"></td> <td style="width: 10%;"></td> <td style="width: 10%;"></td> <td style="width: 10%;"></td> <td style="width: 10%;"></td> <td style="width: 10%;"></td> <td style="width: 10%;"></td> <td style="width: 10%;"></td> <td style="width: 10%;"></td> </tr> <tr> <td></td> <td></td> <td colspan="8" style="text-align: center;"> <table border="1" style="width: 100%; border-collapse: collapse; text-align: center;"> <tr> <td style="width: 10%;"></td> <td style="width: 10%;"></td> <td style="width: 10%;"></td> <td style="width: 10%;"></td> <td style="width: 10%;"></td> <td style="width: 10%;"></td> <td style="width: 10%;"></td> <td style="width: 10%;"></td> <td style="width: 10%;"></td> <td style="width: 10%;"></td> </tr> <tr> <td></td> <td></td> <td colspan="8" style="text-align: center;"> <table border="1" style="width: 100%; border-collapse: collapse; text-align: center;"> <tr> <td style="width: 10%;"></td> <td style="width: 10%;"></td> <td style="width: 10%;"></td> <td style="width: 10%;"></td> <td style="width: 10%;"></td> <td style="width: 10%;"></td> <td style="width: 10%;"></td> <td style="width: 10%;"></td> <td style="width: 10%;"></td> <td style="width: 10%;"></td> </tr> <tr> <td></td> <td></td> <td colspan="8" style="text-align: center;"> <table border="1" style="width: 100%; border-collapse: collapse; text-align: center;"> <tr> <td style="width: 10%;"></td> <td style="width: 10%;"></td> <td style="width: 10%;"></td> <td style="width: 10%;"></td> <td style="width: 10%;"></td> <td style="width: 10%;"></td> <td style="width: 10%;"></td> <td style="width: 10%;"></td> <td style="width: 10%;"></td> <td style="width: 10%;"></td> </tr> <tr> <td></td> <td></td> <td colspan="8" style="text-align: center;"> <table border="1" style="width: 100%; border-collapse: collapse; text-align: center;"> <tr> </tr></table></td></tr></table></td></tr></table></td></tr></table></td></tr></table></td></tr></table></td></tr></table></td></tr></table></td></tr></table></td></tr></table></td></tr></table></td></tr></table></td></tr></table></td></tr></table></td></tr></table></td></tr></table></td></tr></table></td></tr></table></td></tr></table></td></tr></table></td></tr></table></td></tr></table></td></tr></table></td></tr></table></td></tr></table></td></tr></table></td></tr></table></td></tr></table></td></tr></table>
 | | | | | | | | | | | | | | | | | | | | <table border="1" style="width: 100%; border-collapse: collapse; text-align: center;"> <tr> <td style="width: 10%;"></td> <td style="width: 10%;"></td> <td style="width: 10%;"></td> <td style="width: 10%;"></td> <td style="width: 10%;"></td> <td style="width: 10%;"></td> <td style="width: 10%;"></td> <td style="width: 10%;"></td> <td style="width: 10%;"></td> <td style="width: 10%;"></td> </tr> <tr> <td></td> <td></td> <td colspan="8" style="text-align: center;"> <table border="1" style="width: 100%; border-collapse: collapse; text-align: center;"> <tr> <td style="width: 10%;"></td> <td style="width: 10%;"></td> <td style="width: 10%;"></td> <td style="width: 10%;"></td> <td style="width: 10%;"></td> <td style="width: 10%;"></td> <td style="width: 10%;"></td> <td style="width: 10%;"></td> <td style="width: 10%;"></td> <td style="width: 10%;"></td> </tr> <tr> <td></td> <td></td> <td colspan="8" style="text-align: center;"> <table border="1" style="width: 100%; border-collapse: collapse; text-align: center;"> <tr> <td style="width: 10%;"></td> <td style="width: 10%;"></td> <td style="width: 10%;"></td> <td style="width: 10%;"></td> <td style="width: 10%;"></td> <td style="width: 10%;"></td> <td style="width: 10%;"></td> <td style="width: 10%;"></td> <td style="width: 10%;"></td> <td style="width: 10%;"></td> </tr> <tr> <td></td> <td></td> <td colspan="8" style="text-align: center;"> <table border="1" style="width: 100%; border-collapse: collapse; text-align: center;"> <tr> <td style="width: 10%;"></td> <td style="width: 10%;"></td> <td style="width: 10%;"></td> <td style="width: 10%;"></td> <td style="width: 10%;"></td> <td style="width: 10%;"></td> <td style="width: 10%;"></td> <td style="width: 10%;"></td> <td style="width: 10%;"></td> <td style="width: 10%;"></td> </tr> <tr> <td></td> <td></td> <td colspan="8" style="text-align: center;"> <table border="1" style="width: 100%; border-collapse: collapse; text-align: center;"> <tr> <td style="width: 10%;"></td> <td style="width: 10%;"></td> <td style="width: 10%;"></td> <td style="width: 10%;"></td> <td style="width: 10%;"></td> <td style="width: 10%;"></td> <td style="width: 10%;"></td> <td style="width: 10%;"></td> <td style="width: 10%;"></td> <td style="width: 10%;"></td> </tr> <tr> <td></td> <td></td> <td colspan="8" style="text-align: center;"> <table border="1" style="width: 100%; border-collapse: collapse; text-align: center;"> <tr> <td style="width: 10%;"></td> <td style="width: 10%;"></td> <td style="width: 10%;"></td> <td style="width: 10%;"></td> <td style="width: 10%;"></td> <td style="width: 10%;"></td> <td style="width: 10%;"></td> <td style="width: 10%;"></td> <td style="width: 10%;"></td> <td style="width: 10%;"></td> </tr> <tr> <td></td> <td></td> <td colspan="8" style="text-align: center;"> <table border="1" style="width: 100%; border-collapse: collapse; text-align: center;"> <tr> <td style="width: 10%;"></td> <td style="width: 10%;"></td> <td style="width: 10%;"></td> <td style="width: 10%;"></td> <td style="width: 10%;"></td> <td style="width: 10%;"></td> <td style="width: 10%;"></td> <td style="width: 10%;"></td> <td style="width: 10%;"></td> <td style="width: 10%;"></td> </tr> <tr> <td></td> <td></td> <td colspan="8" style="text-align: center;">
<table border="1" style="width: 100%; border-collapse: collapse; text-align: center;"> <tr> <td style="width: 10%;"></td> <td style="width: 10%;"></td> <td style="width: 10%;"></td> <td style="width: 10%;"></td> <td style="width: 10%;"></td> <td style="width: 10%;"></td> <td style="width: 10%;"></td> <td style="width: 10%;"></td> <td style="width: 10%;"></td> <td style="width: 10%;"></td> </tr> <tr> <td></td> <td></td> <td colspan="8" style="text-align: center;"> <table border="1" style="width: 100%; border-collapse: collapse; text-align: center;"> <tr> <td style="width: 10%;"></td> <td style="width: 10%;"></td> <td style="width: 10%;"></td> <td style="width: 10%;"></td> <td style="width: 10%;"></td> <td style="width: 10%;"></td> <td style="width: 10%;"></td> <td style="width: 10%;"></td> <td style="width: 10%;"></td> <td style="width: 10%;"></td> </tr> <tr> <td></td> <td></td> <td colspan="8" style="text-align: center;"> <table border="1" style="width: 100%; border-collapse: collapse; text-align: center;"> <tr> <td style="width: 10%;"></td> <td style="width: 10%;"></td> <td style="width: 10%;"></td> <td style="width: 10%;"></td> <td style="width: 10%;"></td> <td style="width: 10%;"></td> <td style="width: 10%;"></td> <td style="width: 10%;"></td> <td style="width: 10%;"></td> <td style="width: 10%;"></td> </tr> <tr> <td></td> <td></td> <td colspan="8" style="text-align: center;"> <table border="1" style="width: 100%; border-collapse: collapse; text-align: center;"> <tr> <td style="width: 10%;"></td> <td style="width: 10%;"></td> <td style="width: 10%;"></td> <td style="width: 10%;"></td> <td style="width: 10%;"></td> <td style="width: 10%;"></td> <td style="width: 10%;"></td> <td style="width: 10%;"></td> <td style="width: 10%;"></td> <td style="width: 10%;"></td> </tr> <tr> <td></td> <td></td> <td colspan="8" style="text-align: center;"> <table border="1" style="width: 100%; border-collapse: collapse; text-align: center;"> <tr> <td style="width: 10%;"></td> <td style="width: 10%;"></td> <td style="width: 10%;"></td> <td style="width: 10%;"></td> <td style="width: 10%;"></td> <td style="width: 10%;"></td> <td style="width: 10%;"></td> <td style="width: 10%;"></td> <td style="width: 10%;"></td> <td style="width: 10%;"></td> </tr> <tr> <td></td> <td></td> <td colspan="8" style="text-align: center;"> <table border="1" style="width: 100%; border-collapse: collapse; text-align: center;"> <tr> <td style="width: 10%;"></td> <td style="width: 10%;"></td> <td style="width: 10%;"></td> <td style="width: 10%;"></td> <td style="width: 10%;"></td> <td style="width: 10%;"></td> <td style="width: 10%;"></td> <td style="width: 10%;"></td> <td style="width: 10%;"></td> <td style="width: 10%;"></td> </tr> <tr> <td></td> <td></td> <td colspan="8" style="text-align: center;"> <table border="1" style="width: 100%; border-collapse: collapse; text-align: center;"> <tr> <td style="width: 10%;"></td> <td style="width: 10%;"></td> <td style="width: 10%;"></td> <td style="width: 10%;"></td> <td style="width: 10%;"></td> <td style="width: 10%;"></td> <td style="width: 10%;"></td> <td style="width: 10%;"></td> <td style="width: 10%;"></td> <td style="width: 10%;"></td> </tr> <tr> <td></td> <td></td> <td colspan="8" style="text-align: center;"> <table border="1" style="width: 100%; border-collapse: collapse; text-align: center;"> <tr> <td style="width: 10%;"></td> <td style="width: 10%;"></td> <td style="width: 10%;"></td> <td style="width: 10%;"></td> <td style="width: 10%;"></td> <td style="width: 10%;"></td> <td style="width: 10%;"></td> <td style="width: 10%;"></td> <td style="width: 10%;"></td> <td style="width: 10%;"></td> </tr> <tr> <td></td> <td></td> <td colspan="8" style="text-align: center;"> <table border="1" style="width: 100%; border-collapse: collapse; text-align: center;"> <tr> <td style="width: 10%;"></td> <td style="width: 10%;"></td> <td style="width: 10%;"></td> <td style="width: 10%;"></td> <td style="width: 10%;"></td> <td style="width: 10%;"></td> <td style="width: 10%;"></td> <td style="width: 10%;"></td> <td style="width: 10%;"></td> <td style="width: 10%;"></td> </tr> <tr> <td></td> <td></td> <td colspan="8" style="text-align: center;"> <table border="1" style="width: 100%; border-collapse: collapse; text-align: center;"> <tr> <td style="width: 10%;"></td> <td style="width: 10%;"></td> <td style="width: 10%;"></td> <td style="width: 10%;"></td> <td style="width: 10%;"></td> <td style="width: 10%;"></td> <td style="width: 10%;"></td> <td style="width: 10%;"></td> <td style="width: 10%;"></td> <td style="width: 10%;"></td> </tr> <tr> <td></td> <td></td> <td colspan="8" style="text-align: center;"> <table border="1" style="width: 100%; border-collapse: collapse; text-align: center;"> <tr> <td style="width: 10%;"></td> <td style="width: 10%;"></td> <td style="width: 10%;"></td> <td style="width: 10%;"></td> <td style="width: 10%;"></td> <td style="width: 10%;"></td> <td style="width: 10%;"></td> <td style="width: 10%;"></td> <td style="width: 10%;"></td> <td style="width: 10%;"></td> </tr> <tr> <td></td> <td></td> <td colspan="8" style="text-align: center;"> <table border="1" style="width: 100%; border-collapse: collapse; text-align: center;"> <tr> <td style="width: 10%;"></td> <td style="width: 10%;"></td> <td style="width: 10%;"></td> <td style="width: 10%;"></td> <td style="width: 10%;"></td> <td style="width: 10%;"></td> <td style="width: 10%;"></td> <td style="width: 10%;"></td> <td style="width: 10%;"></td> <td style="width: 10%;"></td> </tr> <tr> <td></td> <td></td> <td colspan="8" style="text-align: center;"> <table border="1" style="width: 100%; border-collapse: collapse; text-align: center;"> <tr> <td style="width: 10%;"></td> <td style="width: 10%;"></td> <td style="width: 10%;"></td> <td style="width: 10%;"></td> <td style="width: 10%;"></td> <td style="width: 10%;"></td> <td style="width: 10%;"></td> <td style="width: 10%;"></td> <td style="width: 10%;"></td> <td style="width: 10%;"></td> </tr> <tr> <td></td> <td></td> <td colspan="8" style="text-align: center;"> <table border="1" style="width: 100%; border-collapse: collapse; text-align: center;"> <tr> <td style="width: 10%;"></td> <td style="width: 10%;"></td> <td style="width: 10%;"></td> <td style="width: 10%;"></td> <td style="width: 10%;"></td> <td style="width: 10%;"></td> <td style="width: 10%;"></td> <td style="width: 10%;"></td> <td style="width: 10%;"></td> <td style="width: 10%;"></td> </tr> <tr> <td></td> <td></td> <td colspan="8" style="text-align: center;"> <table border="1" style="width: 100%; border-collapse: collapse; text-align: center;"> <tr> <td style="width: 10%;"></td> <td style="width: 10%;"></td> <td style="width: 10%;"></td> <td style="width: 10%;"></td> <td style="width: 10%;"></td> <td style="width: 10%;"></td> <td style="width: 10%;"></td> <td style="width: 10%;"></td> <td style="width: 10%;"></td> <td style="width: 10%;"></td> </tr> <tr> <td></td> <td></td> <td colspan="8" style="text-align: center;"> <table border="1" style="width: 100%; border-collapse: collapse; text-align: center;"> <tr> <td style="width: 10%;"></td> <td style="width: 10%;"></td> <td style="width: 10%;"></td> <td style="width: 10%;"></td> <td style="width: 10%;"></td> <td style="width: 10%;"></td> <td style="width: 10%;"></td> <td style="width: 10%;"></td> <td style="width: 10%;"></td> <td style="width: 10%;"></td> </tr> <tr> <td></td> <td></td> <td colspan="8" style="text-align: center;"> <table border="1" style="width: 100%; border-collapse: collapse; text-align: center;"> <tr> <td style="width: 10%;"></td> <td style="width: 10%;"></td> <td style="width: 10%;"></td> <td style="width: 10%;"></td> <td style="width: 10%;"></td> <td style="width: 10%;"></td> <td style="width: 10%;"></td> <td style="width: 10%;"></td> <td style="width: 10%;"></td> <td style="width: 10%;"></td> </tr> <tr> <td></td> <td></td> <td colspan="8" style="text-align: center;"> <table border="1" style="width: 100%; border-collapse: collapse; text-align: center;"> <tr> <td style="width: 10%;"></td> <td style="width: 10%;"></td> <td style="width: 10%;"></td> <td style="width: 10%;"></td> <td style="width: 10%;"></td> <td style="width: 10%;"></td> <td style="width: 10%;"></td> <td style="width: 10%;"></td> <td style="width: 10%;"></td> <td style="width: 10%;"></td> </tr> <tr> <td></td> <td></td> <td colspan="8" style="text-align: center;"> <table border="1" style="width: 100%; border-collapse: collapse; text-align: center;"> <tr> <td style="width: 10%;"></td> <td style="width: 10%;"></td> <td style="width: 10%;"></td> <td style="width: 10%;"></td> <td style="width: 10%;"></td> <td style="width: 10%;"></td> <td style="width: 10%;"></td> <td style="width: 10%;"></td> <td style="width: 10%;"></td> <td style="width: 10%;"></td> </tr> <tr> <td></td> <td></td> <td colspan="8" style="text-align: center;"> <table border="1" style="width: 100%; border-collapse: collapse; text-align: center;"> <tr> <td style="width: 10%;"></td> <td style="width: 10%;"></td> <td style="width: 10%;"></td> <td style="width: 10%;"></td> <td style="width: 10%;"></td> <td style="width: 10%;"></td> <td style="width: 10%;"></td> <td style="width: 10%;"></td> <td style="width: 10%;"></td> <td style="width: 10%;"></td> </tr> <tr> <td></td> <td></td> <td colspan="8" style="text-align: center;"> <table border="1" style="width: 100%; border-collapse: collapse; text-align: center;"> <tr> </tr></table></td></tr></table></td></tr></table></td></tr></table></td></tr></table></td></tr></table></td></tr></table></td></tr></table></td></tr></table></td></tr></table></td></tr></table></td></tr></table></td></tr></table></td></tr></table></td></tr></table></td></tr></table></td></tr></table></td></tr></table></td></tr></table></td></tr></table></td></tr></table></td></tr></table></td></tr></table></td></tr></table></td></tr></table></td></tr></table></td></tr></table></td></tr></table>
 | | | | | | | | | | | | | | | | | | | | <table border="1" style="width: 100%; border-collapse: collapse; text-align: center;"> <tr> <td style="width: 10%;"></td> <td style="width: 10%;"></td> <td style="width: 10%;"></td> <td style="width: 10%;"></td> <td style="width: 10%;"></td> <td style="width: 10%;"></td> <td style="width: 10%;"></td> <td style="width: 10%;"></td> <td style="width: 10%;"></td> <td style="width: 10%;"></td> </tr> <tr> <td></td> <td></td> <td colspan="8" style="text-align: center;"> <table border="1" style="width: 100%; border-collapse: collapse; text-align: center;"> <tr> <td style="width: 10%;"></td> <td style="width: 10%;"></td> <td style="width: 10%;"></td> <td style="width: 10%;"></td> <td style="width: 10%;"></td> <td style="width: 10%;"></td> <td style="width: 10%;"></td> <td style="width: 10%;"></td> <td style="width: 10%;"></td> <td style="width: 10%;"></td> </tr> <tr> <td></td> <td></td> <td colspan="8" style="text-align: center;"> <table border="1" style="width: 100%; border-collapse: collapse; text-align: center;"> <tr> <td style="width: 10%;"></td> <td style="width: 10%;"></td> <td style="width: 10%;"></td> <td style="width: 10%;"></td> <td style="width: 10%;"></td> <td style="width: 10%;"></td> <td style="width: 10%;"></td> <td style="width: 10%;"></td> <td style="width: 10%;"></td> <td style="width: 10%;"></td> </tr> <tr> <td></td> <td></td> <td colspan="8" style="text-align: center;"> <table border="1" style="width: 100%; border-collapse: collapse; text-align: center;"> <tr> <td style="width: 10%;"></td> <td style="width: 10%;"></td> <td style="width: 10%;"></td> <td style="width: 10%;"></td> <td style="width: 10%;"></td> <td style="width: 10%;"></td> <td style="width: 10%;"></td> <td style="width: 10%;"></td> <td style="width: 10%;"></td> <td style="width: 10%;"></td> </tr> <tr> <td></td> <td></td> <td colspan="8" style="text-align: center;"> <table border="1" style="width: 100%; border-collapse: collapse; text-align: center;"> <tr> <td style="width: 10%;"></td> <td style="width: 10%;"></td> <td style="width: 10%;"></td> <td style="width: 10%;"></td> <td style="width: 10%;"></td> <td style="width: 10%;"></td> <td style="width: 10%;"></td> <td style="width: 10%;"></td> <td style="width: 10%;"></td> <td style="width: 10%;"></td> </tr> <tr> <td></td> <td></td> <td colspan="8" style="text-align: center;"> <table border="1" style="width: 100%; border-collapse: collapse; text-align: center;"> <tr> <td style="width: 10%;"></td> <td style="width: 10%;"></td> <td style="width: 10%;"></td> <td style="width: 10%;"></td> <td style="width: 10%;"></td> <td style="width: 10%;"></td> <td style="width: 10%;"></td> <td style="width: 10%;"></td> <td style="width: 10%;"></td> <td style="width: 10%;"></td> </tr> <tr> <td></td> <td></td> <td colspan="8" style="text-align: center;"> <table border="1" style="width: 100%; border-collapse: collapse; text-align: center;"> <tr> <td style="width: 10%;"></td> <td style="width: 10%;"></td> <td style="width: 10%;"></td> <td style="width: 10%;"></td> <td style="width: 10%;"></td> <td style="width: 10%;"></td> <td style="width: 10%;"></td> <td style="width: 10%;"></td> <td style="width: 10%;"></td> <td
style="width: 10%;"></td> </tr> <tr> <td></td> <td></td> <td colspan="8" style="text-align: center;"> <table border="1" style="width: 100%; border-collapse: collapse; text-align: center;"> <tr> <td style="width: 10%;"></td> <td style="width: 10%;"></td> <td style="width: 10%;"></td> <td style="width: 10%;"></td> <td style="width: 10%;"></td> <td style="width: 10%;"></td> <td style="width: 10%;"></td> <td style="width: 10%;"></td> <td style="width: 10%;"></td> <td style="width: 10%;"></td> </tr> <tr> <td></td> <td></td> <td colspan="8" style="text-align: center;"> <table border="1" style="width: 100%; border-collapse: collapse; text-align: center;"> <tr> <td style="width: 10%;"></td> <td style="width: 10%;"></td> <td style="width: 10%;"></td> <td style="width: 10%;"></td> <td style="width: 10%;"></td> <td style="width: 10%;"></td> <td style="width: 10%;"></td> <td style="width: 10%;"></td> <td style="width: 10%;"></td> <td style="width: 10%;"></td> </tr> <tr> <td></td> <td></td> <td colspan="8" style="text-align: center;"> <table border="1" style="width: 100%; border-collapse: collapse; text-align: center;"> <tr> <td style="width: 10%;"></td> <td style="width: 10%;"></td> <td style="width: 10%;"></td> <td style="width: 10%;"></td> <td style="width: 10%;"></td> <td style="width: 10%;"></td> <td style="width: 10%;"></td> <td style="width: 10%;"></td> <td style="width: 10%;"></td> <td style="width: 10%;"></td> </tr> <tr> <td></td> <td></td> <td colspan="8" style="text-align: center;"> <table border="1" style="width: 100%; border-collapse: collapse; text-align: center;"> <tr> <td style="width: 10%;"></td> <td style="width: 10%;"></td> <td style="width: 10%;"></td> <td style="width: 10%;"></td> <td style="width: 10%;"></td> <td style="width: 10%;"></td> <td style="width: 10%;"></td> <td style="width: 10%;"></td> <td style="width: 10%;"></td> <td style="width: 10%;"></td> </tr> <tr> <td></td> <td></td> <td colspan="8" style="text-align: center;"> <table border="1" style="width: 100%; border-collapse: collapse; text-align: center;"> <tr> <td style="width: 10%;"></td> <td style="width: 10%;"></td> <td style="width: 10%;"></td> <td style="width: 10%;"></td> <td style="width: 10%;"></td> <td style="width: 10%;"></td> <td style="width: 10%;"></td> <td style="width: 10%;"></td> <td style="width: 10%;"></td> <td style="width: 10%;"></td> </tr> <tr> <td></td> <td></td> <td colspan="8" style="text-align: center;"> <table border="1" style="width: 100%; border-collapse: collapse; text-align: center;"> <tr> <td style="width: 10%;"></td> <td style="width: 10%;"></td> <td style="width: 10%;"></td> <td style="width: 10%;"></td> <td style="width: 10%;"></td> <td style="width: 10%;"></td> <td style="width: 10%;"></td> <td style="width: 10%;"></td> <td style="width: 10%;"></td> <td style="width: 10%;"></td> </tr> <tr> <td></td> <td></td> <td colspan="8" style="text-align: center;"> <table border="1" style="width: 100%; border-collapse: collapse; text-align: center;"> <tr> <td style="width: 10%;"></td> <td style="width: 10%;"></td> <td style="width: 10%;"></td> <td style="width: 10%;"></td> <td style="width: 10%;"></td> <td style="width: 10%;"></td> <td style="width: 10%;"></td> <td style="width: 10%;"></td> <td style="width: 10%;"></td> <td style="width: 10%;"></td> </tr> <tr> <td></td> <td></td> <td colspan="8" style="text-align: center;"> <table border="1" style="width: 100%; border-collapse: collapse; text-align: center;"> <tr> <td style="width: 10%;"></td> <td style="width: 10%;"></td> <td style="width: 10%;"></td> <td style="width: 10%;"></td> <td style="width: 10%;"></td> <td style="width: 10%;"></td> <td style="width: 10%;"></td> <td style="width: 10%;"></td> <td style="width: 10%;"></td> <td style="width: 10%;"></td> </tr> <tr> <td></td> <td></td> <td colspan="8" style="text-align: center;"> <table border="1" style="width: 100%; border-collapse: collapse; text-align: center;"> <tr> <td style="width: 10%;"></td> <td style="width: 10%;"></td> <td style="width: 10%;"></td> <td style="width: 10%;"></td> <td style="width: 10%;"></td> <td style="width: 10%;"></td> <td style="width: 10%;"></td> <td style="width: 10%;"></td> <td style="width: 10%;"></td> <td style="width: 10%;"></td> </tr> <tr> <td></td> <td></td> <td colspan="8" style="text-align: center;"> <table border="1" style="width: 100%; border-collapse: collapse; text-align: center;"> <tr> <td style="width: 10%;"></td> <td style="width: 10%;"></td> <td style="width: 10%;"></td> <td style="width: 10%;"></td> <td style="width: 10%;"></td> <td style="width: 10%;"></td> <td style="width: 10%;"></td> <td style="width: 10%;"></td> <td style="width: 10%;"></td> <td style="width: 10%;"></td> </tr> <tr> <td></td> <td></td> <td colspan="8" style="text-align: center;"> <table border="1" style="width: 100%; border-collapse: collapse; text-align: center;"> <tr> <td style="width: 10%;"></td> <td style="width: 10%;"></td> <td style="width: 10%;"></td> <td style="width: 10%;"></td> <td style="width: 10%;"></td> <td style="width: 10%;"></td> <td style="width: 10%;"></td> <td style="width: 10%;"></td> <td style="width: 10%;"></td> <td style="width: 10%;"></td> </tr> <tr> <td></td> <td></td> <td colspan="8" style="text-align: center;"> <table border="1" style="width: 100%; border-collapse: collapse; text-align: center;"> <tr> <td style="width: 10%;"></td> <td style="width: 10%;"></td> <td style="width: 10%;"></td> <td style="width: 10%;"></td> <td style="width: 10%;"></td> <td style="width: 10%;"></td> <td style="width: 10%;"></td> <td style="width: 10%;"></td> <td style="width: 10%;"></td> <td style="width: 10%;"></td> </tr> <tr> <td></td> <td></td> <td colspan="8" style="text-align: center;"> <table border="1" style="width: 100%; border-collapse: collapse; text-align: center;"> <tr> <td style="width: 10%;"></td> <td style="width: 10%;"></td> <td style="width: 10%;"></td> <td style="width: 10%;"></td> <td style="width: 10%;"></td> <td style="width: 10%;"></td> <td style="width: 10%;"></td> <td style="width: 10%;"></td> <td style="width: 10%;"></td> <td style="width: 10%;"></td> </tr> <tr> <td></td> <td></td> <td colspan="8" style="text-align: center;"> <table border="1" style="width: 100%; border-collapse: collapse; text-align: center;"> <tr> <td style="width: 10%;"></td> <td style="width: 10%;"></td> <td style="width: 10%;"></td> <td style="width: 10%;"></td> <td style="width: 10%;"></td> <td style="width: 10%;"></td> <td style="width: 10%;"></td> <td style="width: 10%;"></td> <td style="width: 10%;"></td> <td style="width: 10%;"></td> </tr> <tr> <td></td> <td></td> <td colspan="8" style="text-align: center;"> <table border="1" style="width: 100%; border-collapse: collapse; text-align: center;"> <tr> <td style="width: 10%;"></td> <td style="width: 10%;"></td> <td style="width: 10%;"></td> <td style="width: 10%;"></td> <td style="width: 10%;"></td> <td style="width: 10%;"></td> <td style="width: 10%;"></td> <td style="width: 10%;"></td> <td style="width: 10%;"></td> <td style="width: 10%;"></td> </tr> <tr> <td></td> <td></td> <td colspan="8" style="text-align: center;"> <table border="1" style="width: 100%; border-collapse: collapse; text-align: center;"> <tr> <td style="width: 10%;"></td> <td style="width: 10%;"></td> <td style="width: 10%;"></td> <td style="width: 10%;"></td> <td style="width: 10%;"></td> <td style="width: 10%;"></td> <td style="width: 10%;"></td> <td style="width: 10%;"></td> <td style="width: 10%;"></td> <td style="width: 10%;"></td> </tr> <tr> <td></td> <td></td> <td colspan="8" style="text-align: center;"> <table border="1" style="width: 100%; border-collapse: collapse; text-align: center;"> <tr> <td style="width: 10%;"></td> <td style="width: 10%;"></td> <td style="width: 10%;"></td> <td style="width: 10%;"></td> <td style="width: 10%;"></td> <td style="width: 10%;"></td> <td style="width: 10%;"></td> <td style="width: 10%;"></td> <td style="width: 10%;"></td> <td style="width: 10%;"></td> </tr> <tr> <td></td> <td></td> <td colspan="8" style="text-align: center;"> <table border="1" style="width: 100%; border-collapse: collapse; text-align: center;"> <tr> <td style="width: 10%;"></td> <td style="width: 10%;"></td> <td style="width: 10%;"></td> <td style="width: 10%;"></td> <td style="width: 10%;"></td> <td style="width: 10%;"></td> <td style="width: 10%;"></td> <td style="width: 10%;"></td> <td style="width: 10%;"></td> <td style="width: 10%;"></td> </tr> <tr> <td></td> <td></td> <td colspan="8" style="text-align: center;"> <table border="1" style="width: 100%; border-collapse: collapse; text-align: center;"> <tr> <td style="width: 10%;"></td> <td style="width: 10%;"></td> <td style="width: 10%;"></td> <td style="width: 10%;"></td> <td style="width: 10%;"></td> <td style="width: 10%;"></td> <td style="width: 10%;"></td> <td style="width: 10%;"></td> <td style="width: 10%;"></td> <td style="width: 10%;"></td> </tr> <tr> <td></td> <td></td> <td colspan="8" style="text-align: center;"> <table border="1" style="width: 100%; border-collapse: collapse; text-align: center;"> <tr> </tr></table></td></tr></table></td></tr></table></td></tr></table></td></tr></table></td></tr></table></td></tr></table></td></tr></table></td></tr></table></td></tr></table></td></tr></table></td></tr></table></td></tr></table></td></tr></table></td></tr></table></td></tr></table></td></tr></table></td></tr></table></td></tr></table></td></tr></table></td></tr></table></td></tr></table></td></tr></table></td></tr></table></td></tr></table></td></tr></table></td></tr></table>
 | | | | | | | | | | | | | | | | | | | | <table border="1" style="width: 100%; border-collapse: collapse; text-align: center;"> <tr> <td style="width: 10%;"></td> <td style="width: 10%;"></td> <td style="width: 10%;"></td> <td style="width: 10%;"></td> <td style="width: 10%;"></td> <td style="width: 10%;"></td> <td style="width: 10%;"></td> <td style="width: 10%;"></td> <td style="width: 10%;"></td> <td style="width: 10%;"></td> </tr> <tr> <td></td> <td></td> <td colspan="8" style="text-align: center;"> <table border="1" style="width: 100%; border-collapse: collapse; text-align: center;"> <tr> <td style="width: 10%;"></td> <td style="width: 10%;"></td> <td style="width: 10%;"></td> <td style="width: 10%;"></td> <td style="width: 10%;"></td> <td style="width: 10%;"></td> <td style="width: 10%;"></td> <td style="width: 10%;"></td> <td style="width: 10%;"></td> <td style="width: 10%;"></td> </tr> <tr> <td></td> <td></td> <td colspan="8" style="text-align: center;"> <table border="1" style="width: 100%; border-collapse: collapse; text-align: center;"> <tr> <td style="width: 10%;"></td> <td style="width: 10%;"></td> <td style="width: 10%;"></td> <td style="width: 10%;"></td> <td style="width: 10%;"></td> <td style="width: 10%;"></td> <td style="width: 10%;"></td> <td style="width: 10%;"></td> <td style="width: 10%;"></td> <td style="width: 10%;"></td> </tr> <tr> <td></td> <td></td> <td colspan="8" style="text-align: center;"> <table border="1" style="width: 100%; border-collapse: collapse; text-align: center;"> <tr> <td style="width: 10%;"></td> <td style="width: 10%;"></td> <td style="width: 10%;"></td> <td style="width: 10%;"></td> <td style="width: 10%;"></td> <td style="width: 10%;"></td> <td style="width: 10%;"></td> <td style="width: 10%;"></td> <td style="width: 10%;"></td> <td style="width: 10%;"></td> </tr> <tr> <td></td> <td></td> <td colspan="8" style="text-align: center;"> <table border="1" style="width: 100%; border-collapse: collapse; text-align: center;"> <tr> <td style="width: 10%;"></td> <td style="width: 10%;"></td> <td style="width: 10%;"></td> <td style="width: 10%;"></td> <td style="width: 10%;"></td> <td style="width: 10%;"></td> <td style="width: 10%;"></td> <td style="width: 10%;"></td> <td style="width: 10%;"></td> <td style="width: 10%;"></td> </tr> <tr> <td></td> <td></td> <td colspan="8" style="text-align: center;"> <table border="1" style="width: 100%; border-collapse: collapse; text-align: center;"> <tr> <td style="width: 10%;"></td> <td style="width: 10%;"></td> <td style="width: 10%;"></td> <td style="width: 10%;"></td> <td style="width: 10%;"></td> <td style="width: 10%;"></td> <td style="width: 10%;"></td> <td style="width: 10%;"></td> <td style="width: 10%;"></td> <td style="width: 10%;"></td> </tr> <tr> <td></td> <td></td> <td colspan="8" style="text-align: center;"> <table border="1" style="width: 100%; border-collapse: collapse; text-align: center;"> <tr> <td style="width: 10%;"></td> <td style="width: 10%;"></td> <td style="width: 10%;"></td> <td style="width: 10%;"></td> <td style="width: 10%;"></td> <td style="width: 10%;"></td> <td style="width: 10%;"></td> <td style="width: 10%;"></td> <td style="width: 10%;"></td> <td style="width: 10%;"></td> </tr> <tr> <td></td> <td></td> <td colspan="8" style="text-align: center;"> <table border="1" style="width: 100%; border-collapse: collapse; text-align: center;"> <tr> <td style="width: 10%;"></td> <td style="width: 10%;"></td> <td style="width: 10%;"></td> <td style="width: 10%;"></td> <td style="width: 10%;"></td> <td style="width: 10%;"></td> <td style="width:
10%;"></td> <td style="width: 10%;"></td> <td style="width: 10%;"></td> <td style="width: 10%;"></td> </tr> <tr> <td></td> <td></td> <td colspan="8" style="text-align: center;"> <table border="1" style="width: 100%; border-collapse: collapse; text-align: center;"> <tr> <td style="width: 10%;"></td> <td style="width: 10%;"></td> <td style="width: 10%;"></td> <td style="width: 10%;"></td> <td style="width: 10%;"></td> <td style="width: 10%;"></td> <td style="width: 10%;"></td> <td style="width: 10%;"></td> <td style="width: 10%;"></td> <td style="width: 10%;"></td> </tr> <tr> <td></td> <td></td> <td colspan="8" style="text-align: center;"> <table border="1" style="width: 100%; border-collapse: collapse; text-align: center;"> <tr> <td style="width: 10%;"></td> <td style="width: 10%;"></td> <td style="width: 10%;"></td> <td style="width: 10%;"></td> <td style="width: 10%;"></td> <td style="width: 10%;"></td> <td style="width: 10%;"></td> <td style="width: 10%;"></td> <td style="width: 10%;"></td> <td style="width: 10%;"></td> </tr> <tr> <td></td> <td></td> <td colspan="8" style="text-align: center;"> <table border="1" style="width: 100%; border-collapse: collapse; text-align: center;"> <tr> <td style="width: 10%;"></td> <td style="width: 10%;"></td> <td style="width: 10%;"></td> <td style="width: 10%;"></td> <td style="width: 10%;"></td> <td style="width: 10%;"></td> <td style="width: 10%;"></td> <td style="width: 10%;"></td> <td style="width: 10%;"></td> <td style="width: 10%;"></td> </tr> <tr> <td></td> <td></td> <td colspan="8" style="text-align: center;"> <table border="1" style="width: 100%; border-collapse: collapse; text-align: center;"> <tr> <td style="width: 10%;"></td> <td style="width: 10%;"></td> <td style="width: 10%;"></td> <td style="width: 10%;"></td> <td style="width: 10%;"></td> <td style="width: 10%;"></td> <td style="width: 10%;"></td> <td style="width: 10%;"></td> <td style="width: 10%;"></td> <td style="width: 10%;"></td> </tr> <tr> <td></td> <td></td> <td colspan="8" style="text-align: center;"> <table border="1" style="width: 100%; border-collapse: collapse; text-align: center;"> <tr> <td style="width: 10%;"></td> <td style="width: 10%;"></td> <td style="width: 10%;"></td> <td style="width: 10%;"></td> <td style="width: 10%;"></td> <td style="width: 10%;"></td> <td style="width: 10%;"></td> <td style="width: 10%;"></td> <td style="width: 10%;"></td> <td style="width: 10%;"></td> </tr> <tr> <td></td> <td></td> <td colspan="8" style="text-align: center;"> <table border="1" style="width: 100%; border-collapse: collapse; text-align: center;"> <tr> <td style="width: 10%;"></td> <td style="width: 10%;"></td> <td style="width: 10%;"></td> <td style="width: 10%;"></td> <td style="width: 10%;"></td> <td style="width: 10%;"></td> <td style="width: 10%;"></td> <td style="width: 10%;"></td> <td style="width: 10%;"></td> <td style="width: 10%;"></td> </tr> <tr> <td></td> <td></td> <td colspan="8" style="text-align: center;"> <table border="1" style="width: 100%; border-collapse: collapse; text-align: center;"> <tr> <td style="width: 10%;"></td> <td style="width: 10%;"></td> <td style="width: 10%;"></td> <td style="width: 10%;"></td> <td style="width: 10%;"></td> <td style="width: 10%;"></td> <td style="width: 10%;"></td> <td style="width: 10%;"></td> <td style="width: 10%;"></td> <td style="width: 10%;"></td> </tr> <tr> <td></td> <td></td> <td colspan="8" style="text-align: center;"> <table border="1" style="width: 100%; border-collapse: collapse; text-align: center;"> <tr> <td style="width: 10%;"></td> <td style="width: 10%;"></td> <td style="width: 10%;"></td> <td style="width: 10%;"></td> <td style="width: 10%;"></td> <td style="width: 10%;"></td> <td style="width: 10%;"></td> <td style="width: 10%;"></td> <td style="width: 10%;"></td> <td style="width: 10%;"></td> </tr> <tr> <td></td> <td></td> <td colspan="8" style="text-align: center;"> <table border="1" style="width: 100%; border-collapse: collapse; text-align: center;"> <tr> <td style="width: 10%;"></td> <td style="width: 10%;"></td> <td style="width: 10%;"></td> <td style="width: 10%;"></td> <td style="width: 10%;"></td> <td style="width: 10%;"></td> <td style="width: 10%;"></td> <td style="width: 10%;"></td> <td style="width: 10%;"></td> <td style="width: 10%;"></td> </tr> <tr> <td></td> <td></td> <td colspan="8" style="text-align: center;"> <table border="1" style="width: 100%; border-collapse: collapse; text-align: center;"> <tr> <td style="width: 10%;"></td> <td style="width: 10%;"></td> <td style="width: 10%;"></td> <td style="width: 10%;"></td> <td style="width: 10%;"></td> <td style="width: 10%;"></td> <td style="width: 10%;"></td> <td style="width: 10%;"></td> <td style="width: 10%;"></td> <td style="width: 10%;"></td> </tr> <tr> <td></td> <td></td> <td colspan="8" style="text-align: center;"> <table border="1" style="width: 100%; border-collapse: collapse; text-align: center;"> <tr> <td style="width: 10%;"></td> <td style="width: 10%;"></td> <td style="width: 10%;"></td> <td style="width: 10%;"></td> <td style="width: 10%;"></td> <td style="width: 10%;"></td> <td style="width: 10%;"></td> <td style="width: 10%;"></td> <td style="width: 10%;"></td> <td style="width: 10%;"></td> </tr> <tr> <td></td> <td></td> <td colspan="8" style="text-align: center;"> <table border="1" style="width: 100%; border-collapse: collapse; text-align: center;"> <tr> <td style="width: 10%;"></td> <td style="width: 10%;"></td> <td style="width: 10%;"></td> <td style="width: 10%;"></td> <td style="width: 10%;"></td> <td style="width: 10%;"></td> <td style="width: 10%;"></td> <td style="width: 10%;"></td> <td style="width: 10%;"></td> <td style="width: 10%;"></td> </tr> <tr> <td></td> <td></td> <td colspan="8" style="text-align: center;"> <table border="1" style="width: 100%; border-collapse: collapse; text-align: center;"> <tr> <td style="width: 10%;"></td> <td style="width: 10%;"></td> <td style="width: 10%;"></td> <td style="width: 10%;"></td> <td style="width: 10%;"></td> <td style="width: 10%;"></td> <td style="width: 10%;"></td> <td style="width: 10%;"></td> <td style="width: 10%;"></td> <td style="width: 10%;"></td> </tr> <tr> <td></td> <td></td> <td colspan="8" style="text-align: center;"> <table border="1" style="width: 100%; border-collapse: collapse; text-align: center;"> <tr> <td style="width: 10%;"></td> <td style="width: 10%;"></td> <td style="width: 10%;"></td> <td style="width: 10%;"></td> <td style="width: 10%;"></td> <td style="width: 10%;"></td> <td style="width: 10%;"></td> <td style="width: 10%;"></td> <td style="width: 10%;"></td> <td style="width: 10%;"></td> </tr> <tr> <td></td> <td></td> <td colspan="8" style="text-align: center;"> <table border="1" style="width: 100%; border-collapse: collapse; text-align: center;"> <tr> <td style="width: 10%;"></td> <td style="width: 10%;"></td> <td style="width: 10%;"></td> <td style="width: 10%;"></td> <td style="width: 10%;"></td> <td style="width: 10%;"></td> <td style="width: 10%;"></td> <td style="width: 10%;"></td> <td style="width: 10%;"></td> <td style="width: 10%;"></td> </tr> <tr> <td></td> <td></td> <td colspan="8" style="text-align: center;"> <table border="1" style="width: 100%; border-collapse: collapse; text-align: center;"> <tr> <td style="width: 10%;"></td> <td style="width: 10%;"></td> <td style="width: 10%;"></td> <td style="width: 10%;"></td> <td style="width: 10%;"></td> <td style="width: 10%;"></td> <td style="width: 10%;"></td> <td style="width: 10%;"></td> <td style="width: 10%;"></td> <td style="width: 10%;"></td> </tr> <tr> <td></td> <td></td> <td colspan="8" style="text-align: center;"> <table border="1" style="width: 100%; border-collapse: collapse; text-align: center;"> <tr> <td style="width: 10%;"></td> <td style="width: 10%;"></td> <td style="width: 10%;"></td> <td style="width: 10%;"></td> <td style="width: 10%;"></td> <td style="width: 10%;"></td> <td style="width: 10%;"></td> <td style="width: 10%;"></td> <td style="width: 10%;"></td> <td style="width: 10%;"></td> </tr> <tr> <td></td> <td></td> <td colspan="8" style="text-align: center;"> <table border="1" style="width: 100%; border-collapse: collapse; text-align: center;"> <tr> </tr></table></td></tr></table></td></tr></table></td></tr></table></td></tr></table></td></tr></table></td></tr></table></td></tr></table></td></tr></table></td></tr></table></td></tr></table></td></tr></table></td></tr></table></td></tr></table></td></tr></table></td></tr></table></td></tr></table></td></tr></table></td></tr></table></td></tr></table></td></tr></table></td></tr></table></td></tr></table></td></tr></table></td></tr></table></td></tr></table>
 | | | | | | | | | | | | | | | | | | | | <table border="1" style="width: 100%; border-collapse: collapse; text-align: center;"> <tr> <td style="width: 10%;"></td> <td style="width: 10%;"></td> <td style="width: 10%;"></td> <td style="width: 10%;"></td> <td style="width: 10%;"></td> <td style="width: 10%;"></td> <td style="width: 10%;"></td> <td style="width: 10%;"></td> <td style="width: 10%;"></td> <td style="width: 10%;"></td> </tr> <tr> <td></td> <td></td> <td colspan="8" style="text-align: center;"> <table border="1" style="width: 100%; border-collapse: collapse; text-align: center;"> <tr> <td style="width: 10%;"></td> <td style="width: 10%;"></td> <td style="width: 10%;"></td> <td style="width: 10%;"></td> <td style="width: 10%;"></td> <td style="width: 10%;"></td> <td style="width: 10%;"></td> <td style="width: 10%;"></td> <td style="width: 10%;"></td> <td style="width: 10%;"></td> </tr> <tr> <td></td> <td></td> <td colspan="8" style="text-align: center;"> <table border="1" style="width: 100%; border-collapse: collapse; text-align: center;"> <tr> <td style="width: 10%;"></td> <td style="width: 10%;"></td> <td style="width: 10%;"></td> <td style="width: 10%;"></td> <td style="width: 10%;"></td> <td style="width: 10%;"></td> <td style="width: 10%;"></td> <td style="width: 10%;"></td> <td style="width: 10%;"></td> <td style="width: 10%;"></td> </tr> <tr> <td></td> <td></td> <td colspan="8" style="text-align: center;"> <table border="1" style="width: 100%; border-collapse: collapse; text-align: center;"> <tr> <td style="width: 10%;"></td> <td style="width: 10%;"></td> <td style="width: 10%;"></td> <td style="width: 10%;"></td> <td style="width: 10%;"></td> <td style="width: 10%;"></td> <td style="width: 10%;"></td> <td style="width: 10%;"></td> <td style="width: 10%;"></td> <td style="width: 10%;"></td> </tr> <tr> <td></td> <td></td> <td colspan="8" style="text-align: center;"> <table border="1" style="width: 100%; border-collapse: collapse; text-align: center;"> <tr> <td style="width: 10%;"></td> <td style="width: 10%;"></td> <td style="width: 10%;"></td> <td style="width: 10%;"></td> <td style="width: 10%;"></td> <td style="width: 10%;"></td> <td style="width: 10%;"></td> <td style="width: 10%;"></td> <td style="width: 10%;"></td> <td style="width: 10%;"></td> </tr> <tr> <td></td> <td></td> <td colspan="8" style="text-align: center;"> <table border="1" style="width: 100%; border-collapse: collapse; text-align: center;"> <tr> <td style="width: 10%;"></td> <td style="width: 10%;"></td> <td style="width: 10%;"></td> <td style="width: 10%;"></td> <td style="width: 10%;"></td> <td style="width: 10%;"></td> <td style="width: 10%;"></td> <td style="width: 10%;"></td> <td style="width: 10%;"></td> <td style="width: 10%;"></td> </tr> <tr> <td></td> <td></td> <td colspan="8" style="text-align: center;"> <table border="1" style="width: 100%; border-collapse: collapse; text-align: center;"> <tr> <td style="width: 10%;"></td> <td style="width: 10%;"></td> <td style="width: 10%;"></td> <td style="width: 10%;"></td> <td style="width: 10%;"></td> <td style="width: 10%;"></td> <td style="width: 10%;"></td> <td style="width: 10%;"></td> <td style="width: 10%;"></td> <td style="width: 10%;"></td> </tr> <tr> <td></td> <td></td> <td colspan="8" style="text-align: center;"> <table border="1" style="width: 100%; border-collapse: collapse; text-align: center;"> <tr> <td style="width: 10%;"></td> <td style="width: 10%;"></td> <td style="width: 10%;"></td> <td style="width: 10%;"></td> <td style="width: 10%;"></td> <td style="width: 10%;"></td> <td style="width: 10%;"></td> <td style="width: 10%;"></td> <td style="width: 10%;"></td> <td style="width: 10%;"></td> </tr> <tr> <td></td> <td></td> <td colspan="8" style="text-align: center;"> <table border="1" style="width: 100%; border-collapse: collapse; text-align: center;"> <tr> <td style="width: 10%;"></td> <td style="width: 10%;"></td> <td style="width: 10%;"></td> <td style="width: 10%;"></td> <td style="width: 10%;"></td> <td style="width: 10%;"></td> <td style="width: 10%;"></td> <td style="width: 10%;"></td> <td style="width: 10%;"></td> <td style="width: 10%;"></td> </tr> <tr> <td></td> <td></td> <td colspan="8" style="text-align: center;"> <table border="1" style="width: 100%; border-collapse: collapse; text-align: center;"> <tr> <td style="width: 10%;"></td> <td style="width: 10%;"></td> <td style="width: 10%;"></td> <td style="width: 10%;"></td> <td style="width:
10%;"></td> <td style="width: 10%;"></td> <td style="width: 10%;"></td> <td style="width: 10%;"></td> <td style="width: 10%;"></td> <td style="width: 10%;"></td> </tr> <tr> <td></td> <td></td> <td colspan="8" style="text-align: center;"> <table border="1" style="width: 100%; border-collapse: collapse; text-align: center;"> <tr> <td style="width: 10%;"></td> <td style="width: 10%;"></td> <td style="width: 10%;"></td> <td style="width: 10%;"></td> <td style="width: 10%;"></td> <td style="width: 10%;"></td> <td style="width: 10%;"></td> <td style="width: 10%;"></td> <td style="width: 10%;"></td> <td style="width: 10%;"></td> </tr> <tr> <td></td> <td></td> <td colspan="8" style="text-align: center;"> <table border="1" style="width: 100%; border-collapse: collapse; text-align: center;"> <tr> <td style="width: 10%;"></td> <td style="width: 10%;"></td> <td style="width: 10%;"></td> <td style="width: 10%;"></td> <td style="width: 10%;"></td> <td style="width: 10%;"></td> <td style="width: 10%;"></td> <td style="width: 10%;"></td> <td style="width: 10%;"></td> <td style="width: 10%;"></td> </tr> <tr> <td></td> <td></td> <td colspan="8" style="text-align: center;"> <table border="1" style="width: 100%; border-collapse: collapse; text-align: center;"> <tr> <td style="width: 10%;"></td> <td style="width: 10%;"></td> <td style="width: 10%;"></td> <td style="width: 10%;"></td> <td style="width: 10%;"></td> <td style="width: 10%;"></td> <td style="width: 10%;"></td> <td style="width: 10%;"></td> <td style="width: 10%;"></td> <td style="width: 10%;"></td> </tr> <tr> <td></td> <td></td> <td colspan="8" style="text-align: center;"> <table border="1" style="width: 100%; border-collapse: collapse; text-align: center;"> <tr> <td style="width: 10%;"></td> <td style="width: 10%;"></td> <td style="width: 10%;"></td> <td style="width: 10%;"></td> <td style="width: 10%;"></td> <td style="width: 10%;"></td> <td style="width: 10%;"></td> <td style="width: 10%;"></td> <td style="width: 10%;"></td> <td style="width: 10%;"></td> </tr> <tr> <td></td> <td></td> <td colspan="8" style="text-align: center;"> <table border="1" style="width: 100%; border-collapse: collapse; text-align: center;"> <tr> <td style="width: 10%;"></td> <td style="width: 10%;"></td> <td style="width: 10%;"></td> <td style="width: 10%;"></td> <td style="width: 10%;"></td> <td style="width: 10%;"></td> <td style="width: 10%;"></td> <td style="width: 10%;"></td> <td style="width: 10%;"></td> <td style="width: 10%;"></td> </tr> <tr> <td></td> <td></td> <td colspan="8" style="text-align: center;"> <table border="1" style="width: 100%; border-collapse: collapse; text-align: center;"> <tr> <td style="width: 10%;"></td> <td style="width: 10%;"></td> <td style="width: 10%;"></td> <td style="width: 10%;"></td> <td style="width: 10%;"></td> <td style="width: 10%;"></td> <td style="width: 10%;"></td> <td style="width: 10%;"></td> <td style="width: 10%;"></td> <td style="width: 10%;"></td> </tr> <tr> <td></td> <td></td> <td colspan="8" style="text-align: center;"> <table border="1" style="width: 100%; border-collapse: collapse; text-align: center;"> <tr> <td style="width: 10%;"></td> <td style="width: 10%;"></td> <td style="width: 10%;"></td> <td style="width: 10%;"></td> <td style="width: 10%;"></td> <td style="width: 10%;"></td> <td style="width: 10%;"></td> <td style="width: 10%;"></td> <td style="width: 10%;"></td> <td style="width: 10%;"></td> </tr> <tr> <td></td> <td></td> <td colspan="8" style="text-align: center;"> <table border="1" style="width: 100%; border-collapse: collapse; text-align: center;"> <tr> <td style="width: 10%;"></td> <td style="width: 10%;"></td> <td style="width: 10%;"></td> <td style="width: 10%;"></td> <td style="width: 10%;"></td> <td style="width: 10%;"></td> <td style="width: 10%;"></td> <td style="width: 10%;"></td> <td style="width: 10%;"></td> <td style="width: 10%;"></td> </tr> <tr> <td></td> <td></td> <td colspan="8" style="text-align: center;"> <table border="1" style="width: 100%; border-collapse: collapse; text-align: center;"> <tr> <td style="width: 10%;"></td> <td style="width: 10%;"></td> <td style="width: 10%;"></td> <td style="width: 10%;"></td> <td style="width: 10%;"></td> <td style="width: 10%;"></td> <td style="width: 10%;"></td> <td style="width: 10%;"></td> <td style="width: 10%;"></td> <td style="width: 10%;"></td> </tr> <tr> <td></td> <td></td> <td colspan="8" style="text-align: center;"> <table border="1" style="width: 100%; border-collapse: collapse; text-align: center;"> <tr> <td style="width: 10%;"></td> <td style="width: 10%;"></td> <td style="width: 10%;"></td> <td style="width: 10%;"></td> <td style="width: 10%;"></td> <td style="width: 10%;"></td> <td style="width: 10%;"></td> <td style="width: 10%;"></td> <td style="width: 10%;"></td> <td style="width: 10%;"></td> </tr> <tr> <td></td> <td></td> <td colspan="8" style="text-align: center;"> <table border="1" style="width: 100%; border-collapse: collapse; text-align: center;"> <tr> <td style="width: 10%;"></td> <td style="width: 10%;"></td> <td style="width: 10%;"></td> <td style="width: 10%;"></td> <td style="width: 10%;"></td> <td style="width: 10%;"></td> <td style="width: 10%;"></td> <td style="width: 10%;"></td> <td style="width: 10%;"></td> <td style="width: 10%;"></td> </tr> <tr> <td></td> <td></td> <td colspan="8" style="text-align: center;"> <table border="1" style="width: 100%; border-collapse: collapse; text-align: center;"> <tr> <td style="width: 10%;"></td> <td style="width: 10%;"></td> <td style="width: 10%;"></td> <td style="width: 10%;"></td> <td style="width: 10%;"></td> <td style="width: 10%;"></td> <td style="width: 10%;"></td> <td style="width: 10%;"></td> <td style="width: 10%;"></td> <td style="width: 10%;"></td> </tr> <tr> <td></td> <td></td> <td colspan="8" style="text-align: center;"> <table border="1" style="width: 100%; border-collapse: collapse; text-align: center;"> <tr> <td style="width: 10%;"></td> <td style="width: 10%;"></td> <td style="width: 10%;"></td> <td style="width: 10%;"></td> <td style="width: 10%;"></td> <td style="width: 10%;"></td> <td style="width: 10%;"></td> <td style="width: 10%;"></td> <td style="width: 10%;"></td> <td style="width: 10%;"></td> </tr> <tr> <td></td> <td></td> <td colspan="8" style="text-align: center;"> <table border="1" style="width: 100%; border-collapse: collapse; text-align: center;"> <tr> <td style="width: 10%;"></td> <td style="width: 10%;"></td> <td style="width: 10%;"></td> <td style="width: 10%;"></td> <td style="width: 10%;"></td> <td style="width: 10%;"></td> <td style="width: 10%;"></td> <td style="width: 10%;"></td> <td style="width: 10%;"></td> <td style="width: 10%;"></td> </tr> <tr> <td></td> <td></td> <td colspan="8" style="text-align: center;"> <table border="1" style="width: 100%; border-collapse: collapse; text-align: center;"> <tr> </tr></table></td></tr></table></td></tr></table></td></tr></table></td></tr></table></td></tr></table></td></tr></table></td></tr></table></td></tr></table></td></tr></table></td></tr></table></td></tr></table></td></tr></table></td></tr></table></td></tr></table></td></tr></table></td></tr></table></td></tr></table></td></tr></table></td></tr></table></td></tr></table></td></tr></table></td></tr></table></td></tr></table></td></tr></table>
 | | | | | | | | | | | | | | | | | | | | <table border="1" style="width: 100%; border-collapse: collapse; text-align: center;"> <tr> <td style="width: 10%;"></td> <td style="width: 10%;"></td> <td style="width: 10%;"></td> <td style="width: 10%;"></td> <td style="width: 10%;"></td> <td style="width: 10%;"></td> <td style="width: 10%;"></td> <td style="width: 10%;"></td> <td style="width: 10%;"></td> <td style="width: 10%;"></td> </tr> <tr> <td></td> <td></td> <td colspan="8" style="text-align: center;"> <table border="1" style="width: 100%; border-collapse: collapse; text-align: center;"> <tr> <td style="width: 10%;"></td> <td style="width: 10%;"></td> <td style="width: 10%;"></td> <td style="width: 10%;"></td> <td style="width: 10%;"></td> <td style="width: 10%;"></td> <td style="width: 10%;"></td> <td style="width: 10%;"></td> <td style="width: 10%;"></td> <td style="width: 10%;"></td> </tr> <tr> <td></td> <td></td> <td colspan="8" style="text-align: center;"> <table border="1" style="width: 100%; border-collapse: collapse; text-align: center;"> <tr> <td style="width: 10%;"></td> <td style="width: 10%;"></td> <td style="width: 10%;"></td> <td style="width: 10%;"></td> <td style="width: 10%;"></td> <td style="width: 10%;"></td> <td style="width: 10%;"></td> <td style="width: 10%;"></td> <td style="width: 10%;"></td> <td style="width: 10%;"></td> </tr> <tr> <td></td> <td></td> <td colspan="8" style="text-align: center;"> <table border="1" style="width: 100%; border-collapse: collapse; text-align: center;"> <tr> <td style="width: 10%;"></td> <td style="width: 10%;"></td> <td style="width: 10%;"></td> <td style="width: 10%;"></td> <td style="width: 10%;"></td> <td style="width: 10%;"></td> <td style="width: 10%;"></td> <td style="width: 10%;"></td> <td style="width: 10%;"></td> <td style="width: 10%;"></td> </tr> <tr> <td></td> <td></td> <td colspan="8" style="text-align: center;"> <table border="1" style="width: 100%; border-collapse: collapse; text-align: center;"> <tr> <td style="width: 10%;"></td> <td style="width: 10%;"></td> <td style="width: 10%;"></td> <td style="width: 10%;"></td> <td style="width: 10%;"></td> <td style="width: 10%;"></td> <td style="width: 10%;"></td> <td style="width: 10%;"></td> <td style="width: 10%;"></td> <td style="width: 10%;"></td> </tr> <tr> <td></td> <td></td> <td colspan="8" style="text-align: center;"> <table border="1" style="width: 100%; border-collapse: collapse; text-align: center;"> <tr> <td style="width: 10%;"></td> <td style="width: 10%;"></td> <td style="width: 10%;"></td> <td style="width: 10%;"></td> <td style="width: 10%;"></td> <td style="width: 10%;"></td> <td style="width: 10%;"></td> <td style="width: 10%;"></td> <td style="width: 10%;"></td> <td style="width: 10%;"></td> </tr> <tr> <td></td> <td></td> <td colspan="8" style="text-align: center;"> <table border="1" style="width: 100%; border-collapse: collapse; text-align: center;"> <tr> <td style="width: 10%;"></td> <td style="width: 10%;"></td> <td style="width: 10%;"></td> <td style="width: 10%;"></td> <td style="width: 10%;"></td> <td style="width: 10%;"></td> <td style="width: 10%;"></td> <td style="width: 10%;"></td> <td style="width: 10%;"></td> <td style="width: 10%;"></td> </tr> <tr> <td></td> <td></td> <td colspan="8" style="text-align: center;"> <table border="1" style="width: 100%; border-collapse: collapse; text-align: center;"> <tr> <td style="width: 10%;"></td> <td style="width: 10%;"></td> <td style="width: 10%;"></td> <td style="width: 10%;"></td> <td style="width: 10%;"></td> <td style="width: 10%;"></td> <td style="width: 10%;"></td> <td style="width: 10%;"></td> <td style="width: 10%;"></td> <td style="width: 10%;"></td> </tr> <tr> <td></td> <td></td> <td colspan="8" style="text-align: center;"> <table border="1" style="width: 100%; border-collapse: collapse; text-align: center;"> <tr> <td style="width: 10%;"></td> <td style="width: 10%;"></td> <td style="width: 10%;"></td> <td style="width: 10%;"></td> <td style="width: 10%;"></td> <td style="width: 10%;"></td> <td style="width: 10%;"></td> <td style="width: 10%;"></td> <td style="width: 10%;"></td> <td style="width: 10%;"></td> </tr> <tr> <td></td> <td></td> <td colspan="8" style="text-align: center;"> <table border="1" style="width: 100%; border-collapse: collapse; text-align: center;"> <tr> <td style="width: 10%;"></td> <td style="width: 10%;"></td> <td style="width: 10%;"></td> <td style="width: 10%;"></td> <td style="width: 10%;"></td> <td style="width: 10%;"></td> <td style="width: 10%;"></td> <td style="width: 10%;"></td> <td style="width: 10%;"></td> <td style="width: 10%;"></td> </tr> <tr> <td></td> <td></td> <td colspan="8" style="text-align: center;"> <table border="1" style="width: 100%; border-collapse: collapse; text-align: center;"> <tr> <td style="width: 10%;"></td> <td style="width: 10%;"></td> <td style="width: 10%;"></td> <td style="width: 10%;"></td> <td style="width: 10%;"></td> <td style="width: 10%;"></td> <td style="width: 10%;"></td> <td style="width: 10%;"></td> <td style="width: 10%;"></td> <td style="width: 10%;"></td> </tr> <tr> <td></td> <td></td> <td colspan="8" style="text-align: center;"> <table border="1" style="width: 100%; border-collapse: collapse; text-align: center;"> <tr> <td style="width: 10%;"></td> <td style="width: 10%;"></td> <td style="width: 10%;"></td> <td style="width: 10%;"></td> <td style="width: 10%;"></td> <td style="width: 10%;"></td> <td style="width: 10%;"></td> <td style="width: 10%;"></td> <td style="width: 10%;"></td> <td style="width: 10%;"></td> </tr> <tr> <td></td> <td></td> <td colspan="8" style="text-align: center;"> <table border="1" style="width: 100%; border-collapse: collapse; text-align: center;"> <tr> <td style="width: 10%;"></td> <td style="width: 10%;"></td> <td style="width: 10%;"></td> <td
style="width: 10%;"></td> <td style="width: 10%;"></td> <td style="width: 10%;"></td> <td style="width: 10%;"></td> <td style="width: 10%;"></td> <td style="width: 10%;"></td> <td style="width: 10%;"></td> </tr> <tr> <td></td> <td></td> <td colspan="8" style="text-align: center;"> <table border="1" style="width: 100%; border-collapse: collapse; text-align: center;"> <tr> <td style="width: 10%;"></td> <td style="width: 10%;"></td> <td style="width: 10%;"></td> <td style="width: 10%;"></td> <td style="width: 10%;"></td> <td style="width: 10%;"></td> <td style="width: 10%;"></td> <td style="width: 10%;"></td> <td style="width: 10%;"></td> <td style="width: 10%;"></td> </tr> <tr> <td></td> <td></td> <td colspan="8" style="text-align: center;"> <table border="1" style="width: 100%; border-collapse: collapse; text-align: center;"> <tr> <td style="width: 10%;"></td> <td style="width: 10%;"></td> <td style="width: 10%;"></td> <td style="width: 10%;"></td> <td style="width: 10%;"></td> <td style="width: 10%;"></td> <td style="width: 10%;"></td> <td style="width: 10%;"></td> <td style="width: 10%;"></td> <td style="width: 10%;"></td> </tr> <tr> <td></td> <td></td> <td colspan="8" style="text-align: center;"> <table border="1" style="width: 100%; border-collapse: collapse; text-align: center;"> <tr> <td style="width: 10%;"></td> <td style="width: 10%;"></td> <td style="width: 10%;"></td> <td style="width: 10%;"></td> <td style="width: 10%;"></td> <td style="width: 10%;"></td> <td style="width: 10%;"></td> <td style="width: 10%;"></td> <td style="width: 10%;"></td> <td style="width: 10%;"></td> </tr> <tr> <td></td> <td></td> <td colspan="8" style="text-align: center;"> <table border="1" style="width: 100%; border-collapse: collapse; text-align: center;"> <tr> <td style="width: 10%;"></td> <td style="width: 10%;"></td> <td style="width: 10%;"></td> <td style="width: 10%;"></td> <td style="width: 10%;"></td> <td style="width: 10%;"></td> <td style="width: 10%;"></td> <td style="width: 10%;"></td> <td style="width: 10%;"></td> <td style="width: 10%;"></td> </tr> <tr> <td></td> <td></td> <td colspan="8" style="text-align: center;"> <table border="1" style="width: 100%; border-collapse: collapse; text-align: center;"> <tr> <td style="width: 10%;"></td> <td style="width: 10%;"></td> <td style="width: 10%;"></td> <td style="width: 10%;"></td> <td style="width: 10%;"></td> <td style="width: 10%;"></td> <td style="width: 10%;"></td> <td style="width: 10%;"></td> <td style="width: 10%;"></td> <td style="width: 10%;"></td> </tr> <tr> <td></td> <td></td> <td colspan="8" style="text-align: center;"> <table border="1" style="width: 100%; border-collapse: collapse; text-align: center;"> <tr> <td style="width: 10%;"></td> <td style="width: 10%;"></td> <td style="width: 10%;"></td> <td style="width: 10%;"></td> <td style="width: 10%;"></td> <td style="width: 10%;"></td> <td style="width: 10%;"></td> <td style="width: 10%;"></td> <td style="width: 10%;"></td> <td style="width: 10%;"></td> </tr> <tr> <td></td> <td></td> <td colspan="8" style="text-align: center;"> <table border="1" style="width: 100%; border-collapse: collapse; text-align: center;"> <tr> <td style="width: 10%;"></td> <td style="width: 10%;"></td> <td style="width: 10%;"></td> <td style="width: 10%;"></td> <td style="width: 10%;"></td> <td style="width: 10%;"></td> <td style="width: 10%;"></td> <td style="width: 10%;"></td> <td style="width: 10%;"></td> <td style="width: 10%;"></td> </tr> <tr> <td></td> <td></td> <td colspan="8" style="text-align: center;"> <table border="1" style="width: 100%; border-collapse: collapse; text-align: center;"> <tr> <td style="width: 10%;"></td> <td style="width: 10%;"></td> <td style="width: 10%;"></td> <td style="width: 10%;"></td> <td style="width: 10%;"></td> <td style="width: 10%;"></td> <td style="width: 10%;"></td> <td style="width: 10%;"></td> <td style="width: 10%;"></td> <td style="width: 10%;"></td> </tr> <tr> <td></td> <td></td> <td colspan="8" style="text-align: center;"> <table border="1" style="width: 100%; border-collapse: collapse; text-align: center;"> <tr> <td style="width: 10%;"></td> <td style="width: 10%;"></td> <td style="width: 10%;"></td> <td style="width: 10%;"></td> <td style="width: 10%;"></td> <td style="width: 10%;"></td> <td style="width: 10%;"></td> <td style="width: 10%;"></td> <td style="width: 10%;"></td> <td style="width: 10%;"></td> </tr> <tr> <td></td> <td></td> <td colspan="8" style="text-align: center;"> <table border="1" style="width: 100%; border-collapse: collapse; text-align: center;"> <tr> <td style="width: 10%;"></td> <td style="width: 10%;"></td> <td style="width: 10%;"></td> <td style="width: 10%;"></td> <td style="width: 10%;"></td> <td style="width: 10%;"></td> <td style="width: 10%;"></td> <td style="width: 10%;"></td> <td style="width: 10%;"></td> <td style="width: 10%;"></td> </tr> <tr> <td></td> <td></td> <td colspan="8" style="text-align: center;"> <table border="1" style="width: 100%; border-collapse: collapse; text-align: center;"> <tr> </tr></table></td></tr></table></td></tr></table></td></tr></table></td></tr></table></td></tr></table></td></tr></table></td></tr></table></td></tr></table></td></tr></table></td></tr></table></td></tr></table></td></tr></table></td></tr></table></td></tr></table></td></tr></table></td></tr></table></td></tr></table></td></tr></table></td></tr></table></td></tr></table></td></tr></table></td></tr></table></td></tr></table>
 | | | | | | | | | | | | | | | | | | | | <table border="1" style="width: 100%; border-collapse: collapse; text-align: center;"> <tr> <td style="width: 10%;"></td> <td style="width: 10%;"></td> <td style="width: 10%;"></td> <td style="width: 10%;"></td> <td style="width: 10%;"></td> <td style="width: 10%;"></td> <td style="width: 10%;"></td> <td style="width: 10%;"></td> <td style="width: 10%;"></td> <td style="width: 10%;"></td> </tr> <tr> <td></td> <td></td> <td colspan="8" style="text-align: center;"> <table border="1" style="width: 100%; border-collapse: collapse; text-align: center;"> <tr> <td style="width: 10%;"></td> <td style="width: 10%;"></td> <td style="width: 10%;"></td> <td style="width: 10%;"></td> <td style="width: 10%;"></td> <td style="width: 10%;"></td> <td style="width: 10%;"></td> <td style="width: 10%;"></td> <td style="width: 10%;"></td> <td style="width: 10%;"></td> </tr> <tr> <td></td> <td></td> <td colspan="8" style="text-align: center;"> <table border="1" style="width: 100%; border-collapse: collapse; text-align: center;"> <tr> <td style="width: 10%;"></td> <td style="width: 10%;"></td> <td style="width: 10%;"></td> <td style="width: 10%;"></td> <td style="width: 10%;"></td> <td style="width: 10%;"></td> <td style="width: 10%;"></td> <td style="width: 10%;"></td> <td style="width: 10%;"></td> <td style="width: 10%;"></td> </tr> <tr> <td></td> <td></td> <td colspan="8" style="text-align: center;"> <table border="1" style="width: 100%; border-collapse: collapse; text-align: center;"> <tr> <td style="width: 10%;"></td> <td style="width: 10%;"></td> <td style="width: 10%;"></td> <td style="width: 10%;"></td> <td style="width: 10%;"></td> <td style="width: 10%;"></td> <td style="width: 10%;"></td> <td style="width: 10%;"></td> <td style="width: 10%;"></td> <td style="width: 10%;"></td> </tr> <tr> <td></td> <td></td> <td colspan="8" style="text-align: center;"> <table border="1" style="width: 100%; border-collapse: collapse; text-align: center;"> <tr> <td style="width: 10%;"></td> <td style="width: 10%;"></td> <td style="width: 10%;"></td> <td style="width: 10%;"></td> <td style="width: 10%;"></td> <td style="width: 10%;"></td> <td style="width: 10%;"></td> <td style="width: 10%;"></td> <td style="width: 10%;"></td> <td style="width: 10%;"></td> </tr> <tr> <td></td> <td></td> <td colspan="8" style="text-align: center;"> <table border="1" style="width: 100%; border-collapse: collapse; text-align: center;"> <tr> <td style="width: 10%;"></td> <td style="width: 10%;"></td> <td style="width: 10%;"></td> <td style="width: 10%;"></td> <td style="width: 10%;"></td> <td style="width: 10%;"></td> <td style="width: 10%;"></td> <td style="width: 10%;"></td> <td style="width: 10%;"></td> <td style="width: 10%;"></td> </tr> <tr> <td></td> <td></td> <td colspan="8" style="text-align: center;"> <table border="1" style="width: 100%; border-collapse: collapse; text-align: center;"> <tr> <td style="width: 10%;"></td> <td style="width: 10%;"></td> <td style="width: 10%;"></td> <td style="width: 10%;"></td> <td style="width: 10%;"></td> <td style="width: 10%;"></td> <td style="width: 10%;"></td> <td style="width: 10%;"></td> <td style="width: 10%;"></td> <td style="width: 10%;"></td> </tr> <tr> <td></td> <td></td> <td colspan="8" style="text-align: center;"> <table border="1" style="width: 100%; border-collapse: collapse; text-align: center;"> <tr> <td style="width: 10%;"></td> <td style="width: 10%;"></td> <td style="width: 10%;"></td> <td style="width: 10%;"></td> <td style="width: 10%;"></td> <td style="width: 10%;"></td> <td style="width: 10%;"></td> <td style="width: 10%;"></td> <td style="width: 10%;"></td> <td style="width: 10%;"></td> </tr> <tr> <td></td> <td></td> <td colspan="8" style="text-align: center;"> <table border="1" style="width: 100%; border-collapse: collapse; text-align: center;"> <tr> <td style="width: 10%;"></td> <td style="width: 10%;"></td> <td style="width: 10%;"></td> <td style="width: 10%;"></td> <td style="width: 10%;"></td> <td style="width: 10%;"></td> <td style="width: 10%;"></td> <td style="width: 10%;"></td> <td style="width: 10%;"></td> <td style="width: 10%;"></td> </tr> <tr> <td></td> <td></td> <td colspan="8" style="text-align: center;"> <table border="1" style="width: 100%; border-collapse: collapse; text-align: center;"> <tr> <td style="width: 10%;"></td> <td style="width: 10%;"></td> <td style="width: 10%;"></td> <td style="width: 10%;"></td> <td style="width: 10%;"></td> <td style="width: 10%;"></td> <td style="width: 10%;"></td> <td style="width: 10%;"></td> <td style="width: 10%;"></td> <td style="width: 10%;"></td> </tr> <tr> <td></td> <td></td> <td colspan="8" style="text-align: center;"> <table border="1" style="width: 100%; border-collapse: collapse; text-align: center;"> <tr> <td style="width: 10%;"></td> <td style="width: 10%;"></td> <td style="width: 10%;"></td> <td style="width: 10%;"></td> <td style="width: 10%;"></td> <td style="width: 10%;"></td> <td style="width: 10%;"></td> <td style="width: 10%;"></td> <td style="width: 10%;"></td> <td style="width: 10%;"></td> </tr> <tr> <td></td> <td></td> <td colspan="8" style="text-align: center;"> <table border="1" style="width: 100%; border-collapse: collapse; text-align: center;"> <tr> <td style="width: 10%;"></td> <td style="width: 10%;"></td> <td style="width: 10%;"></td> <td style="width: 10%;"></td> <td style="width: 10%;"></td> <td style="width: 10%;"></td> <td style="width: 10%;"></td> <td style="width: 10%;"></td> <td style="width: 10%;"></td> <td style="width: 10%;"></td> </tr> <tr> <td></td> <td></td> <td colspan="8" style="text-align: center;"> <table border="1" style="width: 100%; border-collapse: collapse; text-align: center;"> <tr> <td style="width: 10%;"></td> <td style="width: 10%;"></td> <td style="width: 10%;"></td> <td style="width: 10%;"></td> <td style="width: 10%;"></td> <td style="width: 10%;"></td> <td style="width: 10%;"></td> <td style="width: 10%;"></td> <td style="width: 10%;"></td> <td style="width: 10%;"></td> </tr> <tr> <td></td> <td></td> <td colspan="8" style="text-align: center;"> <table border="1" style="width: 100%; border-collapse: collapse; text-align: center;"> <tr> <td style="width: 10%;"></td> <td style="width: 10%;"></td> <td style="width: 10%;"></td> <td style="width: 10%;"></td> <td style="width: 10%;"></td> <td style="width: 10%;"></td> <td style="width: 10%;"></td> <td style="width: 10%;"></td> <td style="width: 10%;"></td> <td style="width: 10%;"></td> </tr> <tr> <td></td> <td></td> <td colspan="8" style="text-align: center;"> <table border="1" style="width: 100%; border-collapse: collapse; text-align: center;"> <tr> <td style="width: 10%;"></td> <td style="width: 10%;"></td> <td style="width: 10%;"></td> <td style="width: 10%;"></td> <td style="width: 10%;"></td> <td style="width: 10%;"></td> <td style="width: 10%;"></td> <td style="width: 10%;"></td> <td style="width: 10%;"></td> <td style="width: 10%;"></td> </tr> <tr> <td></td> <td></td> <td colspan="8" style="text-align: center;"> <table border="1" style="width: 100%; border-collapse: collapse; text-align: center;"> <tr> <td style="width: 10%;"></td> <td style="width: 10%;"></td> <td style="width: 10%;"></td> <td style="width: 10%;"></td> <td style="width: 10%;"></td> <td style="width: 10%;"></td> <td style="width: 10%;"></td> <td style="width: 10%;"></td> <td style="width: 10%;"></td> <td style="width: 10%;"></td> </tr> <tr> <td></td> <td></td> <td colspan="8" style="text-align: center;"> <table border="1" style="width: 100%; border-collapse: collapse; text-align: center;"> <tr> <td style="width: 10%;"></td> <td style="width: 10%;"></td> <td
style="width: 10%;"></td> <td style="width: 10%;"></td> <td style="width: 10%;"></td> <td style="width: 10%;"></td> <td style="width: 10%;"></td> <td style="width: 10%;"></td> <td style="width: 10%;"></td> <td style="width: 10%;"></td> </tr> <tr> <td></td> <td></td> <td colspan="8" style="text-align: center;"> <table border="1" style="width: 100%; border-collapse: collapse; text-align: center;"> <tr> <td style="width: 10%;"></td> <td style="width: 10%;"></td> <td style="width: 10%;"></td> <td style="width: 10%;"></td> <td style="width: 10%;"></td> <td style="width: 10%;"></td> <td style="width: 10%;"></td> <td style="width: 10%;"></td> <td style="width: 10%;"></td> <td style="width: 10%;"></td> </tr> <tr> <td></td> <td></td> <td colspan="8" style="text-align: center;"> <table border="1" style="width: 100%; border-collapse: collapse; text-align: center;"> <tr> <td style="width: 10%;"></td> <td style="width: 10%;"></td> <td style="width: 10%;"></td> <td style="width: 10%;"></td> <td style="width: 10%;"></td> <td style="width: 10%;"></td> <td style="width: 10%;"></td> <td style="width: 10%;"></td> <td style="width: 10%;"></td> <td style="width: 10%;"></td> </tr> <tr> <td></td> <td></td> <td colspan="8" style="text-align: center;"> <table border="1" style="width: 100%; border-collapse: collapse; text-align: center;"> <tr> <td style="width: 10%;"></td> <td style="width: 10%;"></td> <td style="width: 10%;"></td> <td style="width: 10%;"></td> <td style="width: 10%;"></td> <td style="width: 10%;"></td> <td style="width: 10%;"></td> <td style="width: 10%;"></td> <td style="width: 10%;"></td> <td style="width: 10%;"></td> </tr> <tr> <td></td> <td></td> <td colspan="8" style="text-align: center;"> <table border="1" style="width: 100%; border-collapse: collapse; text-align: center;"> <tr> <td style="width: 10%;"></td> <td style="width: 10%;"></td> <td style="width: 10%;"></td> <td style="width: 10%;"></td> <td style="width: 10%;"></td> <td style="width: 10%;"></td> <td style="width: 10%;"></td> <td style="width: 10%;"></td> <td style="width: 10%;"></td> <td style="width: 10%;"></td> </tr> <tr> <td></td> <td></td> <td colspan="8" style="text-align: center;"> <table border="1" style="width: 100%; border-collapse: collapse; text-align: center;"> <tr> <td style="width: 10%;"></td> <td style="width: 10%;"></td> <td style="width: 10%;"></td> <td style="width: 10%;"></td> <td style="width: 10%;"></td> <td style="width: 10%;"></td> <td style="width: 10%;"></td> <td style="width: 10%;"></td> <td style="width: 10%;"></td> <td style="width: 10%;"></td> </tr> <tr> <td></td> <td></td> <td colspan="8" style="text-align: center;"> <table border="1" style="width: 100%; border-collapse: collapse; text-align: center;"> <tr> </tr></table></td></tr></table></td></tr></table></td></tr></table></td></tr></table></td></tr></table></td></tr></table></td></tr></table></td></tr></table></td></tr></table></td></tr></table></td></tr></table></td></tr></table></td></tr></table></td></tr></table></td></tr></table></td></tr></table></td></tr></table></td></tr></table></td></tr></table></td></tr></table></td></tr></table></td></tr></table> | | | | | | | | | | | | | |
| | | | | | <table border="1" style="width: 100%; border-collapse: collapse; text-align: center;"> <tr> <td style="width: 10%;"></td> <td style="width: 10%;"></td> <td style="width: 10%;"></td> <td style="width: 10%;"></td> <td style="width: 10%;"></td> <td style="width: 10%;"></td> <td style="width: 10%;"></td> <td style="width: 10%;"></td> <td style="width: 10%;"></td> <td style="width: 10%;"></td> </tr> <tr> <td></td> <td></td> <td colspan="8" style="text-align: center;"> <table border="1" style="width: 100%; border-collapse: collapse; text-align: center;"> <tr> <td style="width: 10%;"></td> <td style="width: 10%;"></td> <td style="width: 10%;"></td> <td style="width: 10%;"></td> <td style="width: 10%;"></td> <td style="width: 10%;"></td> <td style="width: 10%;"></td> <td style="width: 10%;"></td> <td style="width: 10%;"></td> <td style="width: 10%;"></td> </tr> <tr> <td></td> <td></td> <td colspan="8" style="text-align: center;"> <table border="1" style="width: 100%; border-collapse: collapse; text-align: center;"> <tr> <td style="width: 10%;"></td> <td style="width: 10%;"></td> <td style="width: 10%;"></td> <td style="width: 10%;"></td> <td style="width: 10%;"></td> <td style="width: 10%;"></td> <td style="width: 10%;"></td> <td style="width: 10%;"></td> <td style="width: 10%;"></td> <td style="width: 10%;"></td> </tr> <tr> <td></td> <td></td> <td colspan="8" style="text-align: center;"> <table border="1" style="width: 100%; border-collapse: collapse; text-align: center;"> <tr> <td style="width: 10%;"></td> <td style="width: 10%;"></td> <td style="width: 10%;"></td> <td style="width: 10%;"></td> <td style="width: 10%;"></td> <td style="width: 10%;"></td> <td style="width: 10%;"></td> <td style="width: 10%;"></td> <td style="width: 10%;"></td> <td style="width: 10%;"></td> </tr> <tr> <td></td> <td></td> <td colspan="8" style="text-align: center;"> <table border="1" style="width: 100%; border-collapse: collapse; text-align: center;"> <tr> <td style="width: 10%;"></td> <td style="width: 10%;"></td> <td style="width: 10%;"></td> <td style="width: 10%;"></td> <td style="width: 10%;"></td> <td style="width: 10%;"></td> <td style="width: 10%;"></td> <td style="width: 10%;"></td> <td style="width: 10%;"></td> <td style="width: 10%;"></td> </tr> <tr> <td></td> <td></td> <td colspan="8" style="text-align: center;"> <table border="1" style="width: 100%; border-collapse: collapse; text-align: center;"> <tr> <td style="width: 10%;"></td> <td style="width: 10%;"></td> <td style="width: 10%;"></td> <td style="width: 10%;"></td> <td style="width: 10%;"></td> <td style="width: 10%;"></td> <td style="width: 10%;"></td> <td style="width: 10%;"></td> <td style="width: 10%;"></td> <td style="width: 10%;"></td> </tr> <tr> <td></td> <td></td> <td colspan="8" style="text-align: center;"> <table border="1" style="width: 100%; border-collapse: collapse; text-align: center;"> <tr> <td style="width: 10%;"></td> <td style="width: 10%;"></td> <td style="width: 10%;"></td> <td style="width: 10%;"></td> <td style="width: 10%;"></td> <td style="width: 10%;"></td> <td style="width: 10%;"></td> <td style="width: 10%;"></td> <td style="width: 10%;"></td> <td style="width: 10%;"></td> </tr> <tr> <td></td> <td></td> <td colspan="8" style="text-align: center;"> <table border="1" style="width: 100%; border-collapse: collapse; text-align: center;"> <tr> <td style="width: 10%;"></td> <td style="width: 10%;"></td> <td style="width: 10%;"></td> <td style="width: 10%;"></td> <td style="width: 10%;"></td> <td style="width: 10%;"></td> <td style="width: 10%;"></td> <td style="width: 10%;"></td> <td style="width: 10%;"></td> <td style="width: 10%;"></td> </tr> <tr> <td></td> <td></td> <td colspan="8" style="text-align: center;"> <table border="1" style="width: 100%; border-collapse: collapse; text-align: center;"> <tr> <td style="width: 10%;"></td> <td style="width: 10%;"></td> <td style="width: 10%;"></td> <td style="width: 10%;"></td> <td style="width: 10%;"></td> <td style="width: 10%;"></td> <td style="width: 10%;"></td> <td style="width: 10%;"></td> <td style="width: 10%;"></td> <td style="width: 10%;"></td> </tr> <tr> <td></td> <td></td> <td colspan="8" style="text-align: center;"> <table border="1" style="width: 100%; border-collapse: collapse; text-align: center;"> <tr> <td style="width: 10%;"></td> <td style="width: 10%;"></td> <td style="width: 10%;"></td> <td style="width: 10%;"></td> <td style="width: 10%;"></td> <td style="width: 10%;"></td> <td style="width: 10%;"></td> <td style="width: 10%;"></td> <td style="width: 10%;"></td> <td style="width: 10%;"></td> </tr> <tr> <td></td> <td></td> <td colspan="8" style="text-align: center;"> <table border="1" style="width: 100%; border-collapse: collapse; text-align: center;"> <tr> <td style="width: 10%;"></td> <td style="width: 10%;"></td> <td style="width: 10%;"></td> <td style="width: 10%;"></td> <td style="width: 10%;"></td> <td style="width: 10%;"></td> <td style="width: 10%;"></td> <td style="width: 10%;"></td> <td style="width: 10%;"></td> <td style="width: 10%;"></td> </tr> <tr> <td></td> <td></td> <td colspan="8" style="text-align: center;"> <table border="1" style="width: 100%; border-collapse: collapse; text-align: center;"> <tr> <td style="width: 10%;"></td> <td style="width: 10%;"></td> <td style="width: 10%;"></td> <td style="width: 10%;"></td> <td style="width: 10%;"></td> <td style="width: 10%;"></td> <td style="width: 10%;"></td> <td style="width: 10%;"></td> <td style="width: 10%;"></td> <td style="width: 10%;"></td> </tr> <tr> <td></td> <td></td> <td colspan="8" style="text-align: center;"> <table border="1" style="width: 100%; border-collapse: collapse; text-align: center;"> <tr> <td style="width: 10%;"></td> <td style="width: 10%;"></td> <td style="width: 10%;"></td> <td style="width: 10%;"></td> <td style="width: 10%;"></td> <td style="width: 10%;"></td> <td style="width: 10%;"></td> <td style="width: 10%;"></td> <td style="width: 10%;"></td> <td style="width: 10%;"></td> </tr> <tr> <td></td> <td></td> <td colspan="8" style="text-align: center;"> <table border="1" style="width: 100%; border-collapse: collapse; text-align: center;"> <tr> <td style="width: 10%;"></td> <td style="width: 10%;"></td> <td style="width: 10%;"></td> <td style="width: 10%;"></td> <td style="width: 10%;"></td> <td style="width: 10%;"></td> <td style="width: 10%;"></td> <td style="width: 10%;"></td> <td style="width: 10%;"></td> <td style="width: 10%;"></td> </tr> <tr> <td></td> <td></td> <td colspan="8" style="text-align: center;"> <table border="1" style="width: 100%; border-collapse: collapse; text-align: center;"> <tr> <td style="width: 10%;"></td> <td style="width: 10%;"></td> <td style="width: 10%;"></td> <td style="width: 10%;"></td> <td style="width: 10%;"></td> <td style="width: 10%;"></td> <td style="width: 10%;"></td> <td style="width: 10%;"></td> <td style="width: 10%;"></td> <td style="width: 10%;"></td> </tr> <tr> <td></td> <td></td> <td colspan="8" style="text-align: center;"> <table border="1" style="width: 100%; border-collapse: collapse; text-align: center;"> <tr> <td style="width: 10%;"></td> <td style="width: 10%;"></td> <td style="width: 10%;"></td> <td style="width: 10%;"></td> <td style="width: 10%;"></td> <td style="width: 10%;"></td> <td style="width: 10%;"></td> <td style="width: 10%;"></td> <td style="width: 10%;"></td> <td style="width: 10%;"></td> </tr> <tr> <td></td> <td></td> <td colspan="8" style="text-align: center;"> <table border="1" style="width: 100%; border-collapse: collapse; text-align: center;"> <tr> <td style="width: 10%;"></td> <td style="width: 10%;"></td> <td style="width: 10%;"></td> <td style="width: 10%;"></td> <td style="width: 10%;"></td> <td style="width: 10%;"></td> <td style="width: 10%;"></td> <td style="width: 10%;"></td> <td style="width: 10%;"></td> <td style="width: 10%;"></td> </tr> <tr> <td></td> <td></td> <td colspan="8" style="text-align: center;"> <table border="1" style="width: 100%; border-collapse: collapse; text-align: center;"> <tr> <td style="width: 10%;"></td> <td style="width: 10%;"></td> <td style="width: 10%;"></td> <td style="width: 10%;"></td> <td style="width: 10%;"></td> <td style="width: 10%;"></td> <td style="width: 10%;"></td> <td style="width: 10%;"></td> <td style="width: 10%;"></td> <td style="width: 10%;"></td> </tr> <tr> <td></td> <td></td> <td colspan="8" style="text-align: center;"> <table border="1" style="width: 100%; border-collapse: collapse; text-align: center;"> <tr> <td style="width: 10%;"></td> <td style="width: 10%;"></td> <td style="width: 10%;"></td> <td style="width: 10%;"></td> <td style="width: 10%;"></td> <td style="width: 10%;"></td> <td style="width: 10%;"></td> <td style="width: 10%;"></td> <td style="width: 10%;"></td> <td style="width: 10%;"></td> </tr> <tr> <td></td> <td></td> <td colspan="8" style="text-align: center;"> <table border="1" style="width: 100%; border-collapse: collapse; text-align: center;"> <tr> <td style="width: 10%;"></td> <td style="width: 10%;"></td> <td style="width: 10%;"></td> <td style="width: 10%;"></td> <td style="width: 10%;"></td> <td style="width: 10%;"></td> <td style="width: 10%;"></td> <td style="width: 10%;"></td> <td style="width: 10%;"></td> <td style="width: 10%;"></td> </tr> <tr> <td></td> <td></td> <td colspan="8" style="text-align: center;"> <table border="1" style="width: 100%; border-collapse: collapse; text-align: center;"> <tr> <td style="width: 10%;"></td> <td style="width: 10%;"></td> <td style="width: 10%;"></td> <td style="width: 10%;"></td> <td style="width: 10%;"></td> <td style="width: 10%;"></td> <td style="width: 10%;"></td> <td style="width: 10%;"></td> <td style="width: 10%;"></td> <td style="width: 10%;"></td> </tr> <tr> <td></td> <td></td> <td colspan="8" style="text-align: center;"> <table border="1" style="width: 100%; border-collapse: collapse; text-align: center;"> <tr>
</tr></table></td></tr></table></td></tr></table></td></tr></table></td></tr></table></td></tr></table></td></tr></table></td></tr></table></td></tr></table></td></tr></table></td></tr></table></td></tr></table></td></tr></table></td></tr></table></td></tr></table></td></tr></table></td></tr></table></td></tr></table></td></tr></table></td></tr></table></td></tr></table></td></tr></table> | | | | | | | | | | | | | | | | | | | | <table border="1" style="width: 100%; border-collapse: collapse; text-align: center;"> <tr> <td style="width: 10%;"></td> <td style="width: 10%;"></td> <td style="width: 10%;"></td> <td style="width: 10%;"></td> <td style="width: 10%;"></td> <td style="width: 10%;"></td> <td style="width: 10%;"></td> <td style="width: 10%;"></td> <td style="width: 10%;"></td> <td style="width: 10%;"></td> </tr> <tr> <td></td> <td></td> <td colspan="8" style="text-align: center;"> <table border="1" style="width: 100%; border-collapse: collapse; text-align: center;"> <tr> <td style="width: 10%;"></td> <td style="width: 10%;"></td> <td style="width: 10%;"></td> <td style="width: 10%;"></td> <td style="width: 10%;"></td> <td style="width: 10%;"></td> <td style="width: 10%;"></td> <td style="width: 10%;"></td> <td style="width: 10%;"></td> <td style="width: 10%;"></td> </tr> <tr> <td></td> <td></td> <td colspan="8" style="text-align: center;"> <table border="1" style="width: 100%; border-collapse: collapse; text-align: center;"> <tr> <td style="width: 10%;"></td> <td style="width: 10%;"></td> <td style="width: 10%;"></td> <td style="width: 10%;"></td> <td style="width: 10%;"></td> <td style="width: 10%;"></td> <td style="width: 10%;"></td> <td style="width: 10%;"></td> <td style="width: 10%;"></td> <td style="width: 10%;"></td> </tr> <tr> <td></td> <td></td> <td colspan="8" style="text-align: center;"> <table border="1" style="width: 100%; border-collapse: collapse; text-align: center;"> <tr> <td style="width: 10%;"></td> <td style="width: 10%;"></td> <td style="width: 10%;"></td> <td style="width: 10%;"></td> <td style="width: 10%;"></td> <td style="width: 10%;"></td> <td style="width: 10%;"></td> <td style="width: 10%;"></td> <td style="width: 10%;"></td> <td style="width: 10%;"></td> </tr> <tr> <td></td> <td></td> <td colspan="8" style="text-align: center;"> <table border="1" style="width: 100%; border-collapse: collapse; text-align: center;"> <tr> <td style="width: 10%;"></td> <td style="width: 10%;"></td> <td style="width: 10%;"></td> <td style="width: 10%;"></td> <td style="width: 10%;"></td> <td style="width: 10%;"></td> <td style="width: 10%;"></td> <td style="width: 10%;"></td> <td style="width: 10%;"></td> <td style="width: 10%;"></td> </tr> <tr> <td></td> <td></td> <td colspan="8" style="text-align: center;"> <table border="1" style="width: 100%; border-collapse: collapse; text-align: center;"> <tr> <td style="width: 10%;"></td> <td style="width: 10%;"></td> <td style="width: 10%;"></td> <td style="width: 10%;"></td> <td style="width: 10%;"></td> <td style="width: 10%;"></td> <td style="width: 10%;"></td> <td style="width: 10%;"></td> <td style="width: 10%;"></td> <td style="width: 10%;"></td> </tr> <tr>
<td></td> <td></td> <td colspan="8" style="text-align: center;"> <table border="1" style="width: 100%; border-collapse: collapse; text-align: center;"> <tr> <td style="width: 10%;"></td> <td style="width: 10%;"></td> <td style="width: 10%;"></td> <td style="width: 10%;"></td> <td style="width: 10%;"></td> <td style="width: 10%;"></td> <td style="width: 10%;"></td> <td style="width: 10%;"></td> <td style="width: 10%;"></td> <td style="width: 10%;"></td> </tr> <tr> <td></td> <td></td> <td colspan="8" style="text-align: center;"> <table border="1" style="width: 100%; border-collapse: collapse; text-align: center;"> <tr> <td style="width: 10%;"></td> <td style="width: 10%;"></td> <td style="width: 10%;"></td> <td style="width: 10%;"></td> <td style="width: 10%;"></td> <td style="width: 10%;"></td> <td style="width: 10%;"></td> <td style="width: 10%;"></td> <td style="width: 10%;"></td> <td style="width: 10%;"></td> </tr> <tr> <td></td> <td></td> <td colspan="8" style="text-align: center;"> <table border="1" style="width: 100%; border-collapse: collapse; text-align: center;"> <tr> <td style="width: 10%;"></td> <td style="width: 10%;"></td> <td style="width: 10%;"></td> <td style="width: 10%;"></td> <td style="width: 10%;"></td> <td style="width: 10%;"></td> <td style="width: 10%;"></td> <td style="width: 10%;"></td> <td style="width: 10%;"></td> <td style="width: 10%;"></td> </tr> <tr> <td></td> <td></td> <td colspan="8" style="text-align: center;"> <table border="1" style="width: 100%; border-collapse: collapse; text-align: center;"> <tr> <td style="width: 10%;"></td> <td style="width: 10%;"></td> <td style="width: 10%;"></td> <td style="width: 10%;"></td> <td style="width: 10%;"></td> <td style="width: 10%;"></td> <td style="width: 10%;"></td> <td style="width: 10%;"></td> <td style="width: 10%;"></td> <td style="width: 10%;"></td> </tr> <tr> <td></td> <td></td> <td colspan="8" style="text-align: center;"> <table border="1" style="width: 100%; border-collapse: collapse; text-align: center;"> <tr> <td style="width: 10%;"></td> <td style="width: 10%;"></td> <td style="width: 10%;"></td> <td style="width: 10%;"></td> <td style="width: 10%;"></td> <td style="width: 10%;"></td> <td style="width: 10%;"></td> <td style="width: 10%;"></td> <td style="width: 10%;"></td> <td style="width: 10%;"></td> </tr> <tr> <td></td> <td></td> <td colspan="8" style="text-align: center;"> <table border="1" style="width: 100%; border-collapse: collapse; text-align: center;"> <tr> <td style="width: 10%;"></td> <td style="width: 10%;"></td> <td style="width: 10%;"></td> <td style="width: 10%;"></td> <td style="width: 10%;"></td> <td style="width: 10%;"></td> <td style="width: 10%;"></td> <td style="width: 10%;"></td> <td style="width: 10%;"></td> <td style="width: 10%;"></td> </tr> <tr> <td></td> <td></td> <td colspan="8" style="text-align: center;"> <table border="1" style="width: 100%; border-collapse: collapse; text-align: center;"> <tr> <td style="width: 10%;"></td> <td style="width: 10%;"></td> <td style="width: 10%;"></td> <td style="width: 10%;"></td> <td style="width: 10%;"></td> <td style="width: 10%;"></td> <td style="width: 10%;"></td> <td style="width: 10%;"></td> <td style="width: 10%;"></td> <td style="width: 10%;"></td> </tr> <tr> <td></td> <td></td> <td colspan="8" style="text-align: center;"> <table border="1" style="width: 100%; border-collapse: collapse; text-align: center;"> <tr> <td style="width: 10%;"></td> <td style="width: 10%;"></td> <td style="width: 10%;"></td> <td style="width: 10%;"></td> <td style="width: 10%;"></td> <td style="width: 10%;"></td> <td style="width: 10%;"></td> <td style="width: 10%;"></td> <td style="width: 10%;"></td> <td style="width: 10%;"></td> </tr> <tr> <td></td> <td></td> <td colspan="8" style="text-align: center;"> <table border="1" style="width: 100%; border-collapse: collapse; text-align: center;"> <tr> <td style="width: 10%;"></td> <td style="width: 10%;"></td> <td style="width: 10%;"></td> <td style="width: 10%;"></td> <td style="width: 10%;"></td> <td style="width: 10%;"></td> <td style="width: 10%;"></td> <td style="width: 10%;"></td> <td style="width: 10%;"></td> <td style="width: 10%;"></td> </tr> <tr> <td></td> <td></td> <td colspan="8" style="text-align: center;"> <table border="1" style="width: 100%; border-collapse: collapse; text-align: center;"> <tr> <td style="width: 10%;"></td> <td style="width: 10%;"></td> <td style="width: 10%;"></td> <td style="width: 10%;"></td> <td style="width: 10%;"></td> <td style="width: 10%;"></td> <td style="width: 10%;"></td> <td style="width: 10%;"></td> <td style="width: 10%;"></td> <td style="width: 10%;"></td> </tr> <tr> <td></td> <td></td> <td colspan="8" style="text-align: center;"> <table border="1" style="width: 100%; border-collapse: collapse; text-align: center;"> <tr> <td style="width: 10%;"></td> <td style="width: 10%;"></td> <td style="width: 10%;"></td> <td style="width: 10%;"></td> <td style="width: 10%;"></td> <td style="width: 10%;"></td> <td style="width: 10%;"></td> <td style="width: 10%;"></td> <td style="width: 10%;"></td> <td style="width: 10%;"></td> </tr> <tr> <td></td> <td></td> <td colspan="8" style="text-align: center;"> <table border="1" style="width: 100%; border-collapse: collapse; text-align: center;"> <tr> <td style="width: 10%;"></td> <td style="width: 10%;"></td> <td style="width: 10%;"></td> <td style="width: 10%;"></td> <td style="width: 10%;"></td> <td style="width: 10%;"></td> <td style="width: 10%;"></td> <td style="width: 10%;"></td> <td style="width: 10%;"></td> <td style="width: 10%;"></td> </tr> <tr> <td></td> <td></td> <td colspan="8" style="text-align: center;"> <table border="1" style="width: 100%; border-collapse: collapse; text-align: center;"> <tr> <td style="width: 10%;"></td> <td style="width: 10%;"></td> <td style="width: 10%;"></td> <td style="width: 10%;"></td> <td style="width: 10%;"></td> <td style="width: 10%;"></td> <td style="width: 10%;"></td> <td style="width: 10%;"></td> <td style="width: 10%;"></td> <td style="width: 10%;"></td> </tr> <tr> <td></td> <td></td> <td colspan="8" style="text-align: center;"> <table border="1" style="width: 100%; border-collapse: collapse; text-align: center;"> <tr> <td style="width: 10%;"></td> <td style="width: 10%;"></td> <td style="width: 10%;"></td> <td style="width: 10%;"></td> <td style="width: 10%;"></td> <td style="width: 10%;"></td> <td style="width: 10%;"></td> <td style="width: 10%;"></td> <td style="width: 10%;"></td> <td style="width: 10%;"></td> </tr> <tr> <td></td> <td></td> <td colspan="8" style="text-align: center;"> <table border="1" style="width: 100%; border-collapse: collapse; text-align: center;"> <tr> </tr></table></td></tr></table></td></tr></table></td></tr></table></td></tr></table></td></tr></table></td></tr></table></td></tr></table></td></tr></table></td></tr></table></td></tr></table></td></tr></table></td></tr></table></td></tr></table></td></tr></table></td></tr></table></td></tr></table></td></tr></table></td></tr></table></td></tr></table></td></tr></table>
 | | | | | | | | | | | | | | | | | | | | <table border="1" style="width: 100%; border-collapse: collapse; text-align: center;"> <tr> <td style="width: 10%;"></td> <td style="width: 10%;"></td> <td style="width: 10%;"></td> <td style="width: 10%;"></td> <td style="width: 10%;"></td> <td style="width: 10%;"></td> <td style="width: 10%;"></td> <td style="width: 10%;"></td> <td style="width: 10%;"></td> <td style="width: 10%;"></td> </tr> <tr> <td></td> <td></td> <td colspan="8" style="text-align: center;"> <table border="1" style="width: 100%; border-collapse: collapse; text-align: center;"> <tr> <td style="width: 10%;"></td> <td style="width: 10%;"></td> <td style="width: 10%;"></td> <td style="width: 10%;"></td> <td style="width: 10%;"></td> <td style="width: 10%;"></td> <td style="width: 10%;"></td> <td style="width: 10%;"></td> <td style="width: 10%;"></td> <td style="width: 10%;"></td> </tr> <tr> <td></td> <td></td> <td colspan="8" style="text-align: center;"> <table border="1" style="width: 100%; border-collapse: collapse; text-align: center;"> <tr> <td style="width: 10%;"></td> <td style="width: 10%;"></td> <td style="width: 10%;"></td> <td style="width: 10%;"></td> <td style="width: 10%;"></td> <td style="width: 10%;"></td> <td style="width: 10%;"></td> <td style="width: 10%;"></td> <td style="width: 10%;"></td> <td style="width: 10%;"></td> </tr> <tr> <td></td> <td></td> <td colspan="8" style="text-align: center;"> <table border="1" style="width: 100%; border-collapse: collapse; text-align: center;"> <tr> <td style="width: 10%;"></td> <td style="width: 10%;"></td> <td style="width: 10%;"></td> <td style="width: 10%;"></td> <td style="width: 10%;"></td> <td style="width: 10%;"></td> <td style="width: 10%;"></td> <td style="width: 10%;"></td> <td style="width: 10%;"></td> <td style="width: 10%;"></td> </tr> <tr> <td></td> <td></td> <td colspan="8" style="text-align: center;"> <table border="1" style="width: 100%; border-collapse: collapse; text-align: center;"> <tr> <td style="width: 10%;"></td> <td style="width: 10%;"></td> <td style="width: 10%;"></td> <td style="width: 10%;"></td> <td style="width: 10%;"></td> <td style="width: 10%;"></td> <td style="width: 10%;"></td> <td style="width: 10%;"></td> <td style="width: 10%;"></td> <td style="width: 10%;"></td> </tr> <tr> <td></td> <td></td> <td colspan="8" style="text-align: center;"> <table border="1" style="width: 100%; border-collapse: collapse; text-align: center;"> <tr> <td style="width: 10%;"></td> <td style="width: 10%;"></td> <td style="width: 10%;"></td> <td style="width: 10%;"></td> <td style="width: 10%;"></td> <td style="width: 10%;"></td> <td style="width: 10%;"></td> <td style="width: 10%;"></td> <td style="width: 10%;"></td> <td style="width: 10%;"></td> </tr> <tr> <td></td> <td></td> <td colspan="8" style="text-align: center;"> <table border="1" style="width: 100%; border-collapse: collapse; text-align: center;"> <tr> <td style="width: 10%;"></td> <td style="width: 10%;"></td> <td style="width: 10%;"></td> <td style="width: 10%;"></td> <td style="width: 10%;"></td> <td style="width: 10%;"></td> <td style="width: 10%;"></td> <td style="width: 10%;"></td> <td style="width: 10%;"></td> <td style="width: 10%;"></td> </tr> <tr> <td></td> <td></td> <td colspan="8" style="text-align: center;"> <table border="1" style="width: 100%; border-collapse: collapse; text-align: center;"> <tr> <td style="width: 10%;"></td> <td style="width: 10%;"></td> <td style="width: 10%;"></td> <td style="width: 10%;"></td> <td style="width: 10%;"></td> <td style="width: 10%;"></td> <td style="width: 10%;"></td> <td style="width: 10%;"></td> <td style="width: 10%;"></td> <td style="width: 10%;"></td> </tr> <tr> <td></td> <td></td> <td colspan="8" style="text-align: center;"> <table border="1" style="width: 100%; border-collapse: collapse; text-align: center;"> <tr> <td style="width: 10%;"></td> <td style="width: 10%;"></td> <td style="width: 10%;"></td> <td style="width: 10%;"></td> <td style="width: 10%;"></td> <td style="width: 10%;"></td> <td style="width: 10%;"></td> <td style="width: 10%;"></td> <td style="width: 10%;"></td> <td style="width: 10%;"></td> </tr> <tr> <td></td> <td></td> <td colspan="8" style="text-align: center;"> <table border="1" style="width: 100%; border-collapse: collapse; text-align: center;"> <tr> <td style="width: 10%;"></td> <td style="width: 10%;"></td> <td style="width: 10%;"></td> <td style="width: 10%;"></td> <td style="width: 10%;"></td> <td style="width: 10%;"></td> <td style="width: 10%;"></td> <td style="width: 10%;"></td> <td style="width: 10%;"></td> <td style="width: 10%;"></td> </tr> <tr> <td></td> <td></td> <td colspan="8" style="text-align: center;"> <table border="1" style="width: 100%; border-collapse: collapse; text-align: center;"> <tr> <td style="width: 10%;"></td> <td style="width: 10%;"></td> <td style="width: 10%;"></td> <td style="width: 10%;"></td> <td style="width: 10%;"></td> <td style="width: 10%;"></td> <td style="width: 10%;"></td> <td style="width: 10%;"></td> <td style="width: 10%;"></td> <td style="width: 10%;"></td> </tr> <tr> <td></td> <td></td> <td colspan="8" style="text-align: center;"> <table border="1" style="width: 100%; border-collapse: collapse; text-align: center;"> <tr> <td style="width: 10%;"></td> <td style="width: 10%;"></td> <td style="width: 10%;"></td> <td style="width: 10%;"></td> <td style="width: 10%;"></td> <td style="width: 10%;"></td> <td style="width: 10%;"></td> <td style="width: 10%;"></td> <td style="width: 10%;"></td> <td style="width: 10%;"></td> </tr> <tr> <td></td> <td></td> <td colspan="8" style="text-align: center;"> <table border="1" style="width: 100%; border-collapse: collapse; text-align: center;"> <tr> <td style="width: 10%;"></td> <td style="width: 10%;"></td> <td style="width: 10%;"></td> <td style="width: 10%;"></td> <td style="width: 10%;"></td> <td style="width: 10%;"></td> <td style="width: 10%;"></td> <td style="width: 10%;"></td> <td style="width: 10%;"></td> <td style="width: 10%;"></td> </tr> <tr> <td></td> <td></td> <td
colspan="8" style="text-align: center;"> <table border="1" style="width: 100%; border-collapse: collapse; text-align: center;"> <tr> <td style="width: 10%;"></td> <td style="width: 10%;"></td> <td style="width: 10%;"></td> <td style="width: 10%;"></td> <td style="width: 10%;"></td> <td style="width: 10%;"></td> <td style="width: 10%;"></td> <td style="width: 10%;"></td> <td style="width: 10%;"></td> <td style="width: 10%;"></td> </tr> <tr> <td></td> <td></td> <td colspan="8" style="text-align: center;"> <table border="1" style="width: 100%; border-collapse: collapse; text-align: center;"> <tr> <td style="width: 10%;"></td> <td style="width: 10%;"></td> <td style="width: 10%;"></td> <td style="width: 10%;"></td> <td style="width: 10%;"></td> <td style="width: 10%;"></td> <td style="width: 10%;"></td> <td style="width: 10%;"></td> <td style="width: 10%;"></td> <td style="width: 10%;"></td> </tr> <tr> <td></td> <td></td> <td colspan="8" style="text-align: center;"> <table border="1" style="width: 100%; border-collapse: collapse; text-align: center;"> <tr> <td style="width: 10%;"></td> <td style="width: 10%;"></td> <td style="width: 10%;"></td> <td style="width: 10%;"></td> <td style="width: 10%;"></td> <td style="width: 10%;"></td> <td style="width: 10%;"></td> <td style="width: 10%;"></td> <td style="width: 10%;"></td> <td style="width: 10%;"></td> </tr> <tr> <td></td> <td></td> <td colspan="8" style="text-align: center;"> <table border="1" style="width: 100%; border-collapse: collapse; text-align: center;"> <tr> <td style="width: 10%;"></td> <td style="width: 10%;"></td> <td style="width: 10%;"></td> <td style="width: 10%;"></td> <td style="width: 10%;"></td> <td style="width: 10%;"></td> <td style="width: 10%;"></td> <td style="width: 10%;"></td> <td style="width: 10%;"></td> <td style="width: 10%;"></td> </tr> <tr> <td></td> <td></td> <td colspan="8" style="text-align: center;"> <table border="1" style="width: 100%; border-collapse: collapse; text-align: center;"> <tr> <td style="width: 10%;"></td> <td style="width: 10%;"></td> <td style="width: 10%;"></td> <td style="width: 10%;"></td> <td style="width: 10%;"></td> <td style="width: 10%;"></td> <td style="width: 10%;"></td> <td style="width: 10%;"></td> <td style="width: 10%;"></td> <td style="width: 10%;"></td> </tr> <tr> <td></td> <td></td> <td colspan="8" style="text-align: center;"> <table border="1" style="width: 100%; border-collapse: collapse; text-align: center;"> <tr> <td style="width: 10%;"></td> <td style="width: 10%;"></td> <td style="width: 10%;"></td> <td style="width: 10%;"></td> <td style="width: 10%;"></td> <td style="width: 10%;"></td> <td style="width: 10%;"></td> <td style="width: 10%;"></td> <td style="width: 10%;"></td> <td style="width: 10%;"></td> </tr> <tr> <td></td> <td></td> <td colspan="8" style="text-align: center;"> <table border="1" style="width: 100%; border-collapse: collapse; text-align: center;"> <tr> </tr></table></td></tr></table></td></tr></table></td></tr></table></td></tr></table></td></tr></table></td></tr></table></td></tr></table></td></tr></table></td></tr></table></td></tr></table></td></tr></table></td></tr></table></td></tr></table></td></tr></table></td></tr></table></td></tr></table></td></tr></table></td></tr></table></td></tr></table>
 | | | | | | | | | | | | | | | | | | | | <table border="1" style="width: 100%; border-collapse: collapse; text-align: center;"> <tr> <td style="width: 10%;"></td> <td style="width: 10%;"></td> <td style="width: 10%;"></td> <td style="width: 10%;"></td> <td style="width: 10%;"></td> <td style="width: 10%;"></td> <td style="width: 10%;"></td> <td style="width: 10%;"></td> <td style="width: 10%;"></td> <td style="width: 10%;"></td> </tr> <tr> <td></td> <td></td> <td colspan="8" style="text-align: center;"> <table border="1" style="width: 100%; border-collapse: collapse; text-align: center;"> <tr> <td style="width: 10%;"></td> <td style="width: 10%;"></td> <td style="width: 10%;"></td> <td style="width: 10%;"></td> <td style="width: 10%;"></td> <td style="width: 10%;"></td> <td style="width: 10%;"></td> <td style="width: 10%;"></td> <td style="width: 10%;"></td> <td style="width: 10%;"></td> </tr> <tr> <td></td> <td></td> <td colspan="8" style="text-align: center;"> <table border="1" style="width: 100%; border-collapse: collapse; text-align: center;"> <tr> <td style="width: 10%;"></td> <td style="width: 10%;"></td> <td style="width: 10%;"></td> <td style="width: 10%;"></td> <td style="width: 10%;"></td> <td style="width: 10%;"></td> <td style="width: 10%;"></td> <td style="width: 10%;"></td> <td style="width: 10%;"></td> <td style="width: 10%;"></td> </tr> <tr> <td></td> <td></td> <td colspan="8" style="text-align: center;"> <table border="1" style="width: 100%; border-collapse: collapse; text-align: center;"> <tr> <td style="width: 10%;"></td> <td style="width: 10%;"></td> <td style="width: 10%;"></td> <td style="width: 10%;"></td> <td style="width: 10%;"></td> <td style="width: 10%;"></td> <td style="width: 10%;"></td> <td style="width: 10%;"></td> <td style="width: 10%;"></td> <td style="width: 10%;"></td> </tr> <tr> <td></td> <td></td> <td colspan="8" style="text-align: center;"> <table border="1" style="width: 100%; border-collapse: collapse; text-align: center;"> <tr> <td style="width: 10%;"></td> <td style="width: 10%;"></td> <td style="width: 10%;"></td> <td style="width: 10%;"></td> <td style="width: 10%;"></td> <td style="width: 10%;"></td> <td style="width: 10%;"></td> <td style="width: 10%;"></td> <td style="width: 10%;"></td> <td style="width: 10%;"></td> </tr> <tr> <td></td> <td></td> <td colspan="8" style="text-align: center;"> <table border="1" style="width: 100%; border-collapse: collapse; text-align: center;"> <tr> <td style="width: 10%;"></td> <td style="width: 10%;"></td> <td style="width: 10%;"></td> <td style="width: 10%;"></td> <td style="width: 10%;"></td> <td style="width: 10%;"></td> <td style="width: 10%;"></td> <td style="width: 10%;"></td> <td style="width: 10%;"></td> <td style="width: 10%;"></td> </tr> <tr> <td></td> <td></td> <td colspan="8" style="text-align: center;"> <table border="1" style="width: 100%; border-collapse: collapse; text-align: center;"> <tr> <td style="width: 10%;"></td> <td style="width: 10%;"></td> <td style="width: 10%;"></td> <td style="width: 10%;"></td> <td style="width: 10%;"></td> <td style="width: 10%;"></td> <td style="width: 10%;"></td> <td style="width: 10%;"></td> <td style="width: 10%;"></td> <td style="width: 10%;"></td> </tr> <tr> <td></td> <td></td> <td colspan="8" style="text-align: center;"> <table border="1" style="width: 100%; border-collapse: collapse; text-align: center;"> <tr> <td style="width: 10%;"></td> <td style="width: 10%;"></td> <td style="width: 10%;"></td> <td style="width: 10%;"></td> <td style="width: 10%;"></td> <td style="width: 10%;"></td> <td style="width: 10%;"></td> <td style="width: 10%;"></td> <td style="width: 10%;"></td> <td style="width: 10%;"></td> </tr> <tr> <td></td> <td></td> <td colspan="8" style="text-align: center;"> <table border="1" style="width: 100%; border-collapse: collapse; text-align: center;"> <tr> <td style="width: 10%;"></td> <td style="width: 10%;"></td> <td style="width: 10%;"></td> <td style="width: 10%;"></td> <td style="width: 10%;"></td> <td style="width: 10%;"></td> <td style="width: 10%;"></td> <td style="width: 10%;"></td> <td style="width: 10%;"></td> <td style="width: 10%;"></td> </tr> <tr> <td></td> <td></td> <td colspan="8" style="text-align: center;"> <table border="1" style="width: 100%; border-collapse: collapse; text-align: center;"> <tr> <td style="width: 10%;"></td> <td style="width: 10%;"></td> <td style="width: 10%;"></td> <td style="width: 10%;"></td> <td style="width: 10%;"></td> <td style="width: 10%;"></td> <td style="width: 10%;"></td> <td style="width: 10%;"></td> <td style="width: 10%;"></td> <td style="width: 10%;"></td> </tr> <tr> <td></td> <td></td> <td colspan="8" style="text-align: center;"> <table border="1" style="width: 100%; border-collapse: collapse; text-align: center;"> <tr> <td style="width: 10%;"></td> <td style="width: 10%;"></td> <td style="width: 10%;"></td> <td style="width: 10%;"></td> <td style="width: 10%;"></td> <td style="width: 10%;"></td> <td style="width: 10%;"></td> <td style="width: 10%;"></td> <td style="width: 10%;"></td> <td style="width: 10%;"></td> </tr> <tr> <td></td> <td></td> <td colspan="8" style="text-align: center;"> <table border="1" style="width: 100%; border-collapse: collapse; text-align: center;"> <tr> <td style="width: 10%;"></td> <td style="width: 10%;"></td> <td style="width: 10%;"></td> <td style="width: 10%;"></td> <td style="width: 10%;"></td> <td style="width: 10%;"></td> <td style="width: 10%;"></td> <td style="width: 10%;"></td> <td style="width: 10%;"></td> <td style="width: 10%;"></td> </tr> <tr> <td></td> <td></td> <td colspan="8" style="text-align: center;"> <table border="1" style="width: 100%; border-collapse: collapse; text-align: center;"> <tr> <td style="width: 10%;"></td> <td style="width: 10%;"></td> <td style="width: 10%;"></td> <td style="width: 10%;"></td> <td style="width: 10%;"></td> <td style="width: 10%;"></td> <td style="width: 10%;"></td> <td style="width: 10%;"></td> <td style="width: 10%;"></td> <td style="width: 10%;"></td> </tr> <tr> <td></td> <td></td> <td colspan="8" style="text-align: center;"> <table border="1" style="width: 100%; border-collapse: collapse; text-align: center;"> <tr> <td style="width: 10%;"></td> <td style="width: 10%;"></td> <td style="width: 10%;"></td> <td style="width: 10%;"></td> <td style="width: 10%;"></td> <td style="width: 10%;"></td> <td style="width: 10%;"></td> <td style="width: 10%;"></td> <td style="width: 10%;"></td> <td style="width: 10%;"></td> </tr> <tr> <td></td> <td></td> <td colspan="8" style="text-align: center;"> <table border="1" style="width: 100%; border-collapse: collapse; text-align: center;"> <tr> <td style="width: 10%;"></td> <td style="width: 10%;"></td> <td style="width: 10%;"></td> <td style="width: 10%;"></td> <td style="width: 10%;"></td> <td style="width: 10%;"></td> <td style="width: 10%;"></td> <td style="width: 10%;"></td> <td style="width: 10%;"></td> <td style="width: 10%;"></td> </tr> <tr> <td></td> <td></td> <td colspan="8" style="text-align: center;"> <table border="1" style="width: 100%; border-collapse: collapse; text-align: center;"> <tr> <td style="width: 10%;"></td> <td style="width: 10%;"></td> <td style="width: 10%;"></td> <td style="width: 10%;"></td> <td style="width: 10%;"></td> <td style="width: 10%;"></td> <td style="width: 10%;"></td> <td style="width: 10%;"></td> <td style="width: 10%;"></td> <td style="width: 10%;"></td> </tr> <tr> <td></td> <td></td> <td colspan="8" style="text-align: center;"> <table border="1" style="width: 100%; border-collapse: collapse; text-align: center;"> <tr> <td style="width: 10%;"></td> <td style="width: 10%;"></td> <td style="width: 10%;"></td> <td style="width: 10%;"></td> <td style="width: 10%;"></td> <td style="width: 10%;"></td> <td style="width: 10%;"></td> <td style="width: 10%;"></td> <td style="width: 10%;"></td> <td style="width: 10%;"></td> </tr> <tr> <td></td> <td></td> <td colspan="8" style="text-align: center;"> <table border="1" style="width: 100%; border-collapse: collapse; text-align: center;"> <tr> <td style="width: 10%;"></td> <td style="width: 10%;"></td> <td style="width: 10%;"></td> <td style="width: 10%;"></td> <td style="width: 10%;"></td> <td style="width: 10%;"></td> <td style="width: 10%;"></td> <td style="width: 10%;"></td> <td style="width: 10%;"></td> <td style="width: 10%;"></td> </tr> <tr> <td></td> <td></td> <td colspan="8" style="text-align: center;"> <table border="1" style="width: 100%; border-collapse: collapse; text-align: center;"> <tr> </tr></table></td></tr></table></td></tr></table></td></tr></table></td></tr></table></td></tr></table></td></tr></table></td></tr></table></td></tr></table></td></tr></table></td></tr></table></td></tr></table></td></tr></table></td></tr></table></td></tr></table></td></tr></table></td></tr></table></td></tr></table></td></tr></table>
 | | | | | | | | | | | | | | | | | | | | <table border="1" style="width: 100%; border-collapse: collapse; text-align: center;"> <tr> <td style="width: 10%;"></td> <td style="width: 10%;"></td> <td style="width: 10%;"></td> <td style="width: 10%;"></td> <td style="width: 10%;"></td> <td style="width: 10%;"></td> <td style="width: 10%;"></td> <td style="width: 10%;"></td> <td style="width: 10%;"></td> <td style="width: 10%;"></td> </tr> <tr> <td></td> <td></td> <td colspan="8" style="text-align: center;"> <table border="1" style="width: 100%; border-collapse: collapse; text-align: center;"> <tr> <td style="width: 10%;"></td> <td style="width: 10%;"></td> <td style="width: 10%;"></td> <td style="width: 10%;"></td> <td style="width: 10%;"></td> <td style="width: 10%;"></td> <td style="width: 10%;"></td> <td style="width: 10%;"></td> <td style="width: 10%;"></td> <td style="width: 10%;"></td> </tr> <tr> <td></td> <td></td> <td colspan="8" style="text-align: center;"> <table border="1" style="width: 100%; border-collapse: collapse; text-align: center;"> <tr> <td style="width: 10%;"></td> <td style="width: 10%;"></td> <td style="width: 10%;"></td> <td style="width: 10%;"></td> <td style="width: 10%;"></td> <td style="width: 10%;"></td> <td style="width: 10%;"></td> <td style="width: 10%;"></td> <td style="width: 10%;"></td> <td style="width: 10%;"></td> </tr> <tr> <td></td> <td></td> <td colspan="8" style="text-align: center;"> <table border="1" style="width: 100%; border-collapse: collapse; text-align: center;"> <tr> <td style="width: 10%;"></td> <td style="width: 10%;"></td> <td style="width: 10%;"></td> <td style="width: 10%;"></td> <td style="width: 10%;"></td> <td style="width: 10%;"></td> <td style="width: 10%;"></td> <td style="width: 10%;"></td> <td style="width: 10%;"></td> <td style="width: 10%;"></td> </tr> <tr> <td></td> <td></td> <td colspan="8" style="text-align: center;"> <table border="1" style="width: 100%; border-collapse: collapse; text-align: center;"> <tr> <td style="width: 10%;"></td> <td style="width: 10%;"></td> <td style="width: 10%;"></td> <td style="width: 10%;"></td> <td style="width: 10%;"></td> <td style="width: 10%;"></td> <td style="width: 10%;"></td> <td style="width: 10%;"></td> <td style="width: 10%;"></td> <td style="width: 10%;"></td> </tr> <tr> <td></td> <td></td> <td colspan="8" style="text-align: center;"> <table border="1" style="width: 100%; border-collapse: collapse; text-align: center;"> <tr> <td style="width: 10%;"></td> <td style="width: 10%;"></td> <td style="width: 10%;"></td> <td style="width: 10%;"></td> <td style="width: 10%;"></td> <td style="width: 10%;"></td> <td style="width: 10%;"></td> <td style="width: 10%;"></td> <td style="width: 10%;"></td> <td style="width: 10%;"></td> </tr> <tr> <td></td> <td></td> <td colspan="8" style="text-align: center;"> <table border="1" style="width: 100%; border-collapse: collapse; text-align: center;"> <tr> <td style="width: 10%;"></td> <td style="width: 10%;"></td> <td style="width: 10%;"></td> <td style="width: 10%;"></td> <td style="width: 10%;"></td> <td style="width: 10%;"></td> <td style="width: 10%;"></td> <td style="width: 10%;"></td> <td style="width: 10%;"></td> <td style="width: 10%;"></td> </tr> <tr> <td></td> <td></td> <td colspan="8" style="text-align: center;"> <table border="1" style="width: 100%; border-collapse: collapse; text-align: center;"> <tr> <td style="width: 10%;"></td> <td style="width: 10%;"></td> <td style="width: 10%;"></td> <td style="width: 10%;"></td> <td style="width: 10%;"></td> <td style="width: 10%;"></td> <td style="width: 10%;"></td> <td style="width: 10%;"></td> <td style="width: 10%;"></td> <td style="width: 10%;"></td> </tr> <tr> <td></td> <td></td> <td colspan="8" style="text-align: center;"> <table border="1" style="width: 100%; border-collapse: collapse; text-align: center;"> <tr> <td style="width: 10%;"></td> <td style="width: 10%;"></td> <td style="width: 10%;"></td> <td style="width: 10%;"></td> <td style="width: 10%;"></td> <td style="width: 10%;"></td> <td style="width: 10%;"></td> <td style="width: 10%;"></td> <td style="width: 10%;"></td> <td
style="width: 10%;"></td> </tr> <tr> <td></td> <td></td> <td colspan="8" style="text-align: center;"> <table border="1" style="width: 100%; border-collapse: collapse; text-align: center;"> <tr> <td style="width: 10%;"></td> <td style="width: 10%;"></td> <td style="width: 10%;"></td> <td style="width: 10%;"></td> <td style="width: 10%;"></td> <td style="width: 10%;"></td> <td style="width: 10%;"></td> <td style="width: 10%;"></td> <td style="width: 10%;"></td> <td style="width: 10%;"></td> </tr> <tr> <td></td> <td></td> <td colspan="8" style="text-align: center;"> <table border="1" style="width: 100%; border-collapse: collapse; text-align: center;"> <tr> <td style="width: 10%;"></td> <td style="width: 10%;"></td> <td style="width: 10%;"></td> <td style="width: 10%;"></td> <td style="width: 10%;"></td> <td style="width: 10%;"></td> <td style="width: 10%;"></td> <td style="width: 10%;"></td> <td style="width: 10%;"></td> <td style="width: 10%;"></td> </tr> <tr> <td></td> <td></td> <td colspan="8" style="text-align: center;"> <table border="1" style="width: 100%; border-collapse: collapse; text-align: center;"> <tr> <td style="width: 10%;"></td> <td style="width: 10%;"></td> <td style="width: 10%;"></td> <td style="width: 10%;"></td> <td style="width: 10%;"></td> <td style="width: 10%;"></td> <td style="width: 10%;"></td> <td style="width: 10%;"></td> <td style="width: 10%;"></td> <td style="width: 10%;"></td> </tr> <tr> <td></td> <td></td> <td colspan="8" style="text-align: center;"> <table border="1" style="width: 100%; border-collapse: collapse; text-align: center;"> <tr> <td style="width: 10%;"></td> <td style="width: 10%;"></td> <td style="width: 10%;"></td> <td style="width: 10%;"></td> <td style="width: 10%;"></td> <td style="width: 10%;"></td> <td style="width: 10%;"></td> <td style="width: 10%;"></td> <td style="width: 10%;"></td> <td style="width: 10%;"></td> </tr> <tr> <td></td> <td></td> <td colspan="8" style="text-align: center;"> <table border="1" style="width: 100%; border-collapse: collapse; text-align: center;"> <tr> <td style="width: 10%;"></td> <td style="width: 10%;"></td> <td style="width: 10%;"></td> <td style="width: 10%;"></td> <td style="width: 10%;"></td> <td style="width: 10%;"></td> <td style="width: 10%;"></td> <td style="width: 10%;"></td> <td style="width: 10%;"></td> <td style="width: 10%;"></td> </tr> <tr> <td></td> <td></td> <td colspan="8" style="text-align: center;"> <table border="1" style="width: 100%; border-collapse: collapse; text-align: center;"> <tr> <td style="width: 10%;"></td> <td style="width: 10%;"></td> <td style="width: 10%;"></td> <td style="width: 10%;"></td> <td style="width: 10%;"></td> <td style="width: 10%;"></td> <td style="width: 10%;"></td> <td style="width: 10%;"></td> <td style="width: 10%;"></td> <td style="width: 10%;"></td> </tr> <tr> <td></td> <td></td> <td colspan="8" style="text-align: center;"> <table border="1" style="width: 100%; border-collapse: collapse; text-align: center;"> <tr> <td style="width: 10%;"></td> <td style="width: 10%;"></td> <td style="width: 10%;"></td> <td style="width: 10%;"></td> <td style="width: 10%;"></td> <td style="width: 10%;"></td> <td style="width: 10%;"></td> <td style="width: 10%;"></td> <td style="width: 10%;"></td> <td style="width: 10%;"></td> </tr> <tr> <td></td> <td></td> <td colspan="8" style="text-align: center;"> <table border="1" style="width: 100%; border-collapse: collapse; text-align: center;"> <tr> <td style="width: 10%;"></td> <td style="width: 10%;"></td> <td style="width: 10%;"></td> <td style="width: 10%;"></td> <td style="width: 10%;"></td> <td style="width: 10%;"></td> <td style="width: 10%;"></td> <td style="width: 10%;"></td> <td style="width: 10%;"></td> <td style="width: 10%;"></td> </tr> <tr> <td></td> <td></td> <td colspan="8" style="text-align: center;"> <table border="1" style="width: 100%; border-collapse: collapse; text-align: center;"> <tr> </tr></table></td></tr></table></td></tr></table></td></tr></table></td></tr></table></td></tr></table></td></tr></table></td></tr></table></td></tr></table></td></tr></table></td></tr></table></td></tr></table></td></tr></table></td></tr></table></td></tr></table></td></tr></table></td></tr></table></td></tr></table>
 | | | | | | | | | | | | | | | | | | | | <table border="1" style="width: 100%; border-collapse: collapse; text-align: center;"> <tr> <td style="width: 10%;"></td> <td style="width: 10%;"></td> <td style="width: 10%;"></td> <td style="width: 10%;"></td> <td style="width: 10%;"></td> <td style="width: 10%;"></td> <td style="width: 10%;"></td> <td style="width: 10%;"></td> <td style="width: 10%;"></td> <td style="width: 10%;"></td> </tr> <tr> <td></td> <td></td> <td colspan="8" style="text-align: center;"> <table border="1" style="width: 100%; border-collapse: collapse; text-align: center;"> <tr> <td style="width: 10%;"></td> <td style="width: 10%;"></td> <td style="width: 10%;"></td> <td style="width: 10%;"></td> <td style="width: 10%;"></td> <td style="width: 10%;"></td> <td style="width: 10%;"></td> <td style="width: 10%;"></td> <td style="width: 10%;"></td> <td style="width: 10%;"></td> </tr> <tr> <td></td> <td></td> <td colspan="8" style="text-align: center;"> <table border="1" style="width: 100%; border-collapse: collapse; text-align: center;"> <tr> <td style="width: 10%;"></td> <td style="width: 10%;"></td> <td style="width: 10%;"></td> <td style="width: 10%;"></td> <td style="width: 10%;"></td> <td style="width: 10%;"></td> <td style="width: 10%;"></td> <td style="width: 10%;"></td> <td style="width: 10%;"></td> <td style="width: 10%;"></td> </tr> <tr> <td></td> <td></td> <td colspan="8" style="text-align: center;"> <table border="1" style="width: 100%; border-collapse: collapse; text-align: center;"> <tr> <td style="width: 10%;"></td> <td style="width: 10%;"></td> <td style="width: 10%;"></td> <td style="width: 10%;"></td> <td style="width: 10%;"></td> <td style="width: 10%;"></td> <td style="width: 10%;"></td> <td style="width: 10%;"></td> <td style="width: 10%;"></td> <td style="width: 10%;"></td> </tr> <tr> <td></td> <td></td> <td colspan="8" style="text-align: center;"> <table border="1" style="width: 100%; border-collapse: collapse; text-align: center;"> <tr> <td style="width: 10%;"></td> <td style="width: 10%;"></td> <td style="width: 10%;"></td> <td style="width: 10%;"></td> <td style="width: 10%;"></td> <td style="width: 10%;"></td> <td style="width: 10%;"></td> <td style="width: 10%;"></td> <td style="width: 10%;"></td> <td style="width: 10%;"></td> </tr> <tr> <td></td> <td></td> <td colspan="8" style="text-align: center;"> <table border="1" style="width: 100%; border-collapse: collapse; text-align: center;"> <tr> <td style="width: 10%;"></td> <td style="width: 10%;"></td> <td style="width: 10%;"></td> <td style="width: 10%;"></td> <td style="width: 10%;"></td> <td style="width: 10%;"></td> <td style="width: 10%;"></td> <td style="width: 10%;"></td> <td style="width: 10%;"></td> <td style="width: 10%;"></td> </tr> <tr> <td></td> <td></td> <td colspan="8" style="text-align: center;"> <table border="1" style="width: 100%; border-collapse: collapse; text-align: center;"> <tr> <td style="width: 10%;"></td> <td style="width: 10%;"></td> <td style="width: 10%;"></td> <td style="width: 10%;"></td> <td style="width: 10%;"></td> <td style="width: 10%;"></td> <td style="width: 10%;"></td> <td style="width: 10%;"></td> <td style="width: 10%;"></td> <td style="width: 10%;"></td> </tr> <tr> <td></td> <td></td> <td colspan="8" style="text-align: center;"> <table border="1" style="width: 100%; border-collapse: collapse; text-align: center;"> <tr> <td style="width: 10%;"></td> <td style="width: 10%;"></td> <td style="width: 10%;"></td> <td style="width: 10%;"></td> <td style="width: 10%;"></td> <td style="width: 10%;"></td> <td style="width: 10%;"></td> <td style="width: 10%;"></td> <td style="width: 10%;"></td> <td style="width: 10%;"></td> </tr> <tr> <td></td> <td></td> <td colspan="8" style="text-align: center;"> <table border="1" style="width: 100%; border-collapse: collapse; text-align: center;"> <tr> <td style="width: 10%;"></td> <td style="width: 10%;"></td> <td style="width: 10%;"></td> <td style="width: 10%;"></td> <td style="width: 10%;"></td> <td style="width: 10%;"></td> <td style="width: 10%;"></td> <td style="width: 10%;"></td> <td style="width: 10%;"></td> <td style="width: 10%;"></td> </tr> <tr> <td></td> <td></td> <td colspan="8" style="text-align: center;"> <table border="1" style="width: 100%; border-collapse: collapse; text-align: center;"> <tr> <td style="width: 10%;"></td> <td style="width: 10%;"></td> <td style="width: 10%;"></td> <td style="width: 10%;"></td> <td style="width: 10%;"></td> <td style="width: 10%;"></td> <td style="width: 10%;"></td> <td style="width: 10%;"></td> <td style="width: 10%;"></td> <td style="width: 10%;"></td> </tr> <tr> <td></td> <td></td> <td colspan="8" style="text-align: center;"> <table border="1" style="width: 100%; border-collapse: collapse; text-align: center;"> <tr> <td style="width: 10%;"></td> <td style="width: 10%;"></td> <td style="width: 10%;"></td> <td style="width: 10%;"></td> <td style="width: 10%;"></td> <td style="width: 10%;"></td> <td style="width: 10%;"></td> <td style="width: 10%;"></td> <td style="width: 10%;"></td> <td style="width: 10%;"></td> </tr> <tr> <td></td> <td></td> <td colspan="8" style="text-align: center;"> <table border="1" style="width: 100%; border-collapse: collapse; text-align: center;"> <tr> <td style="width: 10%;"></td> <td style="width: 10%;"></td> <td style="width: 10%;"></td> <td style="width: 10%;"></td> <td style="width: 10%;"></td> <td style="width: 10%;"></td> <td style="width: 10%;"></td> <td style="width: 10%;"></td> <td style="width: 10%;"></td> <td style="width: 10%;"></td> </tr> <tr> <td></td> <td></td> <td colspan="8" style="text-align: center;"> <table border="1" style="width: 100%; border-collapse: collapse; text-align: center;"> <tr> <td style="width: 10%;"></td> <td style="width: 10%;"></td> <td style="width: 10%;"></td> <td style="width: 10%;"></td> <td style="width: 10%;"></td> <td style="width: 10%;"></td> <td style="width: 10%;"></td> <td style="width: 10%;"></td> <td style="width: 10%;"></td> <td style="width: 10%;"></td> </tr> <tr> <td></td> <td></td> <td colspan="8" style="text-align: center;"> <table border="1" style="width: 100%; border-collapse: collapse; text-align: center;"> <tr> <td style="width: 10%;"></td> <td style="width: 10%;"></td> <td style="width: 10%;"></td> <td style="width: 10%;"></td> <td style="width: 10%;"></td> <td style="width: 10%;"></td> <td style="width: 10%;"></td> <td style="width: 10%;"></td> <td style="width: 10%;"></td> <td style="width: 10%;"></td> </tr> <tr> <td></td> <td></td> <td colspan="8" style="text-align: center;"> <table border="1" style="width: 100%; border-collapse: collapse; text-align: center;"> <tr> <td style="width: 10%;"></td> <td style="width: 10%;"></td> <td style="width: 10%;"></td> <td style="width: 10%;"></td> <td style="width: 10%;"></td> <td style="width: 10%;"></td> <td style="width: 10%;"></td> <td style="width: 10%;"></td> <td style="width: 10%;"></td> <td style="width: 10%;"></td> </tr> <tr> <td></td> <td></td> <td colspan="8" style="text-align: center;"> <table border="1" style="width: 100%; border-collapse: collapse; text-align: center;"> <tr> <td style="width: 10%;"></td> <td style="width: 10%;"></td> <td style="width: 10%;"></td> <td style="width: 10%;"></td> <td style="width: 10%;"></td> <td style="width: 10%;"></td> <td style="width: 10%;"></td> <td style="width: 10%;"></td> <td style="width: 10%;"></td> <td style="width: 10%;"></td> </tr> <tr> <td></td> <td></td> <td colspan="8" style="text-align: center;"> <table border="1" style="width: 100%; border-collapse: collapse; text-align: center;"> <tr> </tr></table></td></tr></table></td></tr></table></td></tr></table></td></tr></table></td></tr></table></td></tr></table></td></tr></table></td></tr></table></td></tr></table></td></tr></table></td></tr></table></td></tr></table></td></tr></table></td></tr></table></td></tr></table></td></tr></table>
 | | | | | | | | | | | | | | | | | | | | <table border="1" style="width: 100%; border-collapse: collapse; text-align: center;"> <tr> <td style="width: 10%;"></td> <td style="width: 10%;"></td> <td style="width: 10%;"></td> <td style="width: 10%;"></td> <td style="width: 10%;"></td> <td style="width: 10%;"></td> <td style="width: 10%;"></td> <td style="width: 10%;"></td> <td style="width: 10%;"></td> <td style="width: 10%;"></td> </tr> <tr> <td></td> <td></td> <td colspan="8" style="text-align: center;"> <table border="1" style="width: 100%; border-collapse: collapse; text-align: center;"> <tr> <td style="width: 10%;"></td> <td style="width: 10%;"></td> <td style="width: 10%;"></td> <td style="width: 10%;"></td> <td style="width: 10%;"></td> <td style="width: 10%;"></td> <td style="width: 10%;"></td> <td style="width: 10%;"></td> <td style="width: 10%;"></td> <td style="width: 10%;"></td> </tr> <tr> <td></td> <td></td> <td colspan="8" style="text-align: center;"> <table border="1" style="width: 100%; border-collapse: collapse; text-align: center;"> <tr> <td style="width: 10%;"></td> <td style="width: 10%;"></td> <td style="width: 10%;"></td> <td style="width: 10%;"></td> <td style="width: 10%;"></td> <td style="width: 10%;"></td> <td style="width: 10%;"></td> <td style="width: 10%;"></td> <td style="width: 10%;"></td> <td style="width: 10%;"></td> </tr> <tr> <td></td> <td></td> <td colspan="8" style="text-align: center;"> <table border="1" style="width: 100%; border-collapse: collapse; text-align: center;"> <tr> <td style="width: 10%;"></td> <td style="width: 10%;"></td> <td style="width: 10%;"></td> <td style="width: 10%;"></td> <td style="width: 10%;"></td> <td style="width: 10%;"></td> <td style="width: 10%;"></td> <td style="width: 10%;"></td> <td style="width: 10%;"></td> <td style="width: 10%;"></td> </tr> <tr> <td></td> <td></td> <td colspan="8" style="text-align: center;"> <table border="1" style="width: 100%; border-collapse: collapse; text-align: center;"> <tr> <td style="width: 10%;"></td> <td style="width: 10%;"></td> <td style="width: 10%;"></td> <td style="width: 10%;"></td> <td style="width: 10%;"></td> <td style="width: 10%;"></td> <td style="width: 10%;"></td> <td style="width: 10%;"></td> <td style="width: 10%;"></td> <td style="width: 10%;"></td> </tr> <tr> <td></td> <td></td> <td colspan="8" style="text-align: center;"> <table border="1" style="width: 100%; border-collapse: collapse; text-align: center;"> <tr> <td style="width: 10%;"></td> <td style="width: 10%;"></td> <td style="width: 10%;"></td> <td style="width: 10%;"></td> <td style="width: 10%;"></td> <td style="width: 10%;"></td> <td style="width: 10%;"></td> <td style="width: 10%;"></td> <td style="width: 10%;"></td> <td style="width: 10%;"></td> </tr> <tr> <td></td> <td></td> <td colspan="8" style="text-align: center;"> <table border="1" style="width: 100%; border-collapse: collapse; text-align: center;"> <tr> <td style="width: 10%;"></td> <td style="width: 10%;"></td> <td style="width: 10%;"></td> <td style="width: 10%;"></td> <td style="width: 10%;"></td> <td style="width: 10%;"></td> <td style="width: 10%;"></td> <td style="width: 10%;"></td> <td style="width: 10%;"></td> <td style="width: 10%;"></td> </tr> <tr> <td></td> <td></td> <td colspan="8" style="text-align: center;"> <table border="1" style="width: 100%; border-collapse: collapse; text-align: center;"> <tr> <td style="width: 10%;"></td> <td style="width: 10%;"></td> <td style="width: 10%;"></td> <td style="width: 10%;"></td> <td style="width: 10%;"></td> <td style="width: 10%;"></td> <td style="width: 10%;"></td> <td style="width: 10%;"></td> <td style="width: 10%;"></td> <td style="width: 10%;"></td> </tr> <tr> <td></td> <td></td> <td colspan="8" style="text-align: center;"> <table border="1" style="width: 100%; border-collapse: collapse; text-align: center;"> <tr> <td style="width: 10%;"></td> <td style="width: 10%;"></td> <td style="width: 10%;"></td> <td style="width: 10%;"></td> <td style="width: 10%;"></td> <td style="width: 10%;"></td> <td style="width: 10%;"></td> <td style="width: 10%;"></td> <td style="width: 10%;"></td> <td style="width:
10%;"></td> </tr> <tr> <td></td> <td></td> <td colspan="8" style="text-align: center;"> <table border="1" style="width: 100%; border-collapse: collapse; text-align: center;"> <tr> <td style="width: 10%;"></td> <td style="width: 10%;"></td> <td style="width: 10%;"></td> <td style="width: 10%;"></td> <td style="width: 10%;"></td> <td style="width: 10%;"></td> <td style="width: 10%;"></td> <td style="width: 10%;"></td> <td style="width: 10%;"></td> <td style="width: 10%;"></td> </tr> <tr> <td></td> <td></td> <td colspan="8" style="text-align: center;"> <table border="1" style="width: 100%; border-collapse: collapse; text-align: center;"> <tr> <td style="width: 10%;"></td> <td style="width: 10%;"></td> <td style="width: 10%;"></td> <td style="width: 10%;"></td> <td style="width: 10%;"></td> <td style="width: 10%;"></td> <td style="width: 10%;"></td> <td style="width: 10%;"></td> <td style="width: 10%;"></td> <td style="width: 10%;"></td> </tr> <tr> <td></td> <td></td> <td colspan="8" style="text-align: center;"> <table border="1" style="width: 100%; border-collapse: collapse; text-align: center;"> <tr> <td style="width: 10%;"></td> <td style="width: 10%;"></td> <td style="width: 10%;"></td> <td style="width: 10%;"></td> <td style="width: 10%;"></td> <td style="width: 10%;"></td> <td style="width: 10%;"></td> <td style="width: 10%;"></td> <td style="width: 10%;"></td> <td style="width: 10%;"></td> </tr> <tr> <td></td> <td></td> <td colspan="8" style="text-align: center;"> <table border="1" style="width: 100%; border-collapse: collapse; text-align: center;"> <tr> <td style="width: 10%;"></td> <td style="width: 10%;"></td> <td style="width: 10%;"></td> <td style="width: 10%;"></td> <td style="width: 10%;"></td> <td style="width: 10%;"></td> <td style="width: 10%;"></td> <td style="width: 10%;"></td> <td style="width: 10%;"></td> <td style="width: 10%;"></td> </tr> <tr> <td></td> <td></td> <td colspan="8" style="text-align: center;"> <table border="1" style="width: 100%; border-collapse: collapse; text-align: center;"> <tr> <td style="width: 10%;"></td> <td style="width: 10%;"></td> <td style="width: 10%;"></td> <td style="width: 10%;"></td> <td style="width: 10%;"></td> <td style="width: 10%;"></td> <td style="width: 10%;"></td> <td style="width: 10%;"></td> <td style="width: 10%;"></td> <td style="width: 10%;"></td> </tr> <tr> <td></td> <td></td> <td colspan="8" style="text-align: center;"> <table border="1" style="width: 100%; border-collapse: collapse; text-align: center;"> <tr> <td style="width: 10%;"></td> <td style="width: 10%;"></td> <td style="width: 10%;"></td> <td style="width: 10%;"></td> <td style="width: 10%;"></td> <td style="width: 10%;"></td> <td style="width: 10%;"></td> <td style="width: 10%;"></td> <td style="width: 10%;"></td> <td style="width: 10%;"></td> </tr> <tr> <td></td> <td></td> <td colspan="8" style="text-align: center;"> <table border="1" style="width: 100%; border-collapse: collapse; text-align: center;"> <tr> </tr></table></td></tr></table></td></tr></table></td></tr></table></td></tr></table></td></tr></table></td></tr></table></td></tr></table></td></tr></table></td></tr></table></td></tr></table></td></tr></table></td></tr></table></td></tr></table></td></tr></table></td></tr></table>
 | | | | | | | | | | | | | | | | | | | | <table border="1" style="width: 100%; border-collapse: collapse; text-align: center;"> <tr> <td style="width: 10%;"></td> <td style="width: 10%;"></td> <td style="width: 10%;"></td> <td style="width: 10%;"></td> <td style="width: 10%;"></td> <td style="width: 10%;"></td> <td style="width: 10%;"></td> <td style="width: 10%;"></td> <td style="width: 10%;"></td> <td style="width: 10%;"></td> </tr> <tr> <td></td> <td></td> <td colspan="8" style="text-align: center;"> <table border="1" style="width: 100%; border-collapse: collapse; text-align: center;"> <tr> <td style="width: 10%;"></td> <td style="width: 10%;"></td> <td style="width: 10%;"></td> <td style="width: 10%;"></td> <td style="width: 10%;"></td> <td style="width: 10%;"></td> <td style="width: 10%;"></td> <td style="width: 10%;"></td> <td style="width: 10%;"></td> <td style="width: 10%;"></td> </tr> <tr> <td></td> <td></td> <td colspan="8" style="text-align: center;"> <table border="1" style="width: 100%; border-collapse: collapse; text-align: center;"> <tr> <td style="width: 10%;"></td> <td style="width: 10%;"></td> <td style="width: 10%;"></td> <td style="width: 10%;"></td> <td style="width: 10%;"></td> <td style="width: 10%;"></td> <td style="width: 10%;"></td> <td style="width: 10%;"></td> <td style="width: 10%;"></td> <td style="width: 10%;"></td> </tr> <tr> <td></td> <td></td> <td colspan="8" style="text-align: center;"> <table border="1" style="width: 100%; border-collapse: collapse; text-align: center;"> <tr> <td style="width: 10%;"></td> <td style="width: 10%;"></td> <td style="width: 10%;"></td> <td style="width: 10%;"></td> <td style="width: 10%;"></td> <td style="width: 10%;"></td> <td style="width: 10%;"></td> <td style="width: 10%;"></td> <td style="width: 10%;"></td> <td style="width: 10%;"></td> </tr> <tr> <td></td> <td></td> <td colspan="8" style="text-align: center;"> <table border="1" style="width: 100%; border-collapse: collapse; text-align: center;"> <tr> <td style="width: 10%;"></td> <td style="width: 10%;"></td> <td style="width: 10%;"></td> <td style="width: 10%;"></td> <td style="width: 10%;"></td> <td style="width: 10%;"></td> <td style="width: 10%;"></td> <td style="width: 10%;"></td> <td style="width: 10%;"></td> <td style="width: 10%;"></td> </tr> <tr> <td></td> <td></td> <td colspan="8" style="text-align: center;"> <table border="1" style="width: 100%; border-collapse: collapse; text-align: center;"> <tr> <td style="width: 10%;"></td> <td style="width: 10%;"></td> <td style="width: 10%;"></td> <td style="width: 10%;"></td> <td style="width: 10%;"></td> <td style="width: 10%;"></td> <td style="width: 10%;"></td> <td style="width: 10%;"></td> <td style="width: 10%;"></td> <td style="width: 10%;"></td> </tr> <tr> <td></td> <td></td> <td colspan="8" style="text-align: center;"> <table border="1" style="width: 100%; border-collapse: collapse; text-align: center;"> <tr> <td style="width: 10%;"></td> <td style="width: 10%;"></td> <td style="width: 10%;"></td> <td style="width: 10%;"></td> <td style="width: 10%;"></td> <td style="width: 10%;"></td> <td style="width: 10%;"></td> <td style="width: 10%;"></td> <td style="width: 10%;"></td> <td style="width: 10%;"></td> </tr> <tr> <td></td> <td></td> <td colspan="8" style="text-align: center;"> <table border="1" style="width: 100%; border-collapse: collapse; text-align: center;"> <tr> <td style="width: 10%;"></td> <td style="width: 10%;"></td> <td style="width: 10%;"></td> <td style="width: 10%;"></td> <td style="width: 10%;"></td> <td style="width: 10%;"></td> <td style="width: 10%;"></td> <td style="width: 10%;"></td> <td style="width: 10%;"></td> <td style="width: 10%;"></td> </tr> <tr> <td></td> <td></td> <td colspan="8" style="text-align: center;"> <table border="1" style="width: 100%; border-collapse: collapse; text-align: center;"> <tr> <td style="width: 10%;"></td> <td style="width: 10%;"></td> <td style="width: 10%;"></td> <td style="width: 10%;"></td> <td style="width: 10%;"></td> <td style="width: 10%;"></td> <td style="width: 10%;"></td> <td style="width: 10%;"></td> <td style="width: 10%;"></td> <td style="width: 10%;"></td> </tr> <tr> <td></td> <td></td> <td colspan="8" style="text-align: center;"> <table border="1" style="width: 100%; border-collapse: collapse; text-align: center;"> <tr> <td style="width: 10%;"></td> <td style="width: 10%;"></td> <td style="width: 10%;"></td> <td style="width: 10%;"></td> <td style="width: 10%;"></td> <td style="width: 10%;"></td> <td style="width: 10%;"></td> <td style="width: 10%;"></td> <td style="width: 10%;"></td> <td style="width: 10%;"></td> </tr> <tr> <td></td> <td></td> <td colspan="8" style="text-align: center;"> <table border="1" style="width: 100%; border-collapse: collapse; text-align: center;"> <tr> <td style="width: 10%;"></td> <td style="width: 10%;"></td> <td style="width: 10%;"></td> <td style="width: 10%;"></td> <td style="width: 10%;"></td> <td style="width: 10%;"></td> <td style="width: 10%;"></td> <td style="width: 10%;"></td> <td style="width: 10%;"></td> <td style="width: 10%;"></td> </tr> <tr> <td></td> <td></td> <td colspan="8" style="text-align: center;"> <table border="1" style="width: 100%; border-collapse: collapse; text-align: center;"> <tr> <td style="width: 10%;"></td> <td style="width: 10%;"></td> <td style="width: 10%;"></td> <td style="width: 10%;"></td> <td style="width: 10%;"></td> <td style="width: 10%;"></td> <td style="width: 10%;"></td> <td style="width: 10%;"></td> <td style="width: 10%;"></td> <td style="width: 10%;"></td> </tr> <tr> <td></td> <td></td> <td colspan="8" style="text-align: center;"> <table border="1" style="width: 100%; border-collapse: collapse; text-align: center;"> <tr> <td style="width: 10%;"></td> <td style="width: 10%;"></td> <td style="width: 10%;"></td> <td style="width: 10%;"></td> <td style="width: 10%;"></td> <td style="width: 10%;"></td> <td style="width: 10%;"></td> <td style="width: 10%;"></td> <td style="width: 10%;"></td> <td style="width: 10%;"></td> </tr> <tr> <td></td> <td></td> <td colspan="8" style="text-align: center;"> <table border="1" style="width: 100%; border-collapse: collapse; text-align: center;"> <tr> <td style="width: 10%;"></td> <td style="width: 10%;"></td> <td style="width: 10%;"></td> <td style="width: 10%;"></td> <td style="width: 10%;"></td> <td style="width: 10%;"></td> <td style="width: 10%;"></td> <td style="width: 10%;"></td> <td style="width: 10%;"></td> <td style="width: 10%;"></td> </tr> <tr> <td></td> <td></td> <td colspan="8" style="text-align: center;"> <table border="1" style="width: 100%; border-collapse: collapse; text-align: center;"> <tr> </tr></table></td></tr></table></td></tr></table></td></tr></table></td></tr></table></td></tr></table></td></tr></table></td></tr></table></td></tr></table></td></tr></table></td></tr></table></td></tr></table></td></tr></table></td></tr></table></td></tr></table>
 | | | | | | | | | | | | | | | | | | | | <table border="1" style="width: 100%; border-collapse: collapse; text-align: center;"> <tr> <td style="width: 10%;"></td> <td style="width: 10%;"></td> <td style="width: 10%;"></td> <td style="width: 10%;"></td> <td style="width: 10%;"></td> <td style="width: 10%;"></td> <td style="width: 10%;"></td> <td style="width: 10%;"></td> <td style="width: 10%;"></td> <td style="width: 10%;"></td> </tr> <tr> <td></td> <td></td> <td colspan="8" style="text-align: center;"> <table border="1" style="width: 100%; border-collapse: collapse; text-align: center;"> <tr> <td style="width: 10%;"></td> <td style="width: 10%;"></td> <td style="width: 10%;"></td> <td style="width: 10%;"></td> <td style="width: 10%;"></td> <td style="width: 10%;"></td> <td style="width: 10%;"></td> <td style="width: 10%;"></td> <td style="width: 10%;"></td> <td style="width: 10%;"></td> </tr> <tr> <td></td> <td></td> <td colspan="8" style="text-align: center;"> <table border="1" style="width: 100%; border-collapse: collapse; text-align: center;"> <tr> <td style="width: 10%;"></td> <td style="width: 10%;"></td> <td style="width: 10%;"></td> <td style="width: 10%;"></td> <td style="width: 10%;"></td> <td style="width: 10%;"></td> <td style="width: 10%;"></td> <td style="width: 10%;"></td> <td style="width: 10%;"></td> <td style="width: 10%;"></td> </tr> <tr> <td></td> <td></td> <td colspan="8" style="text-align: center;"> <table border="1" style="width: 100%; border-collapse: collapse; text-align: center;"> <tr> <td style="width: 10%;"></td> <td style="width: 10%;"></td> <td style="width: 10%;"></td> <td style="width: 10%;"></td> <td style="width: 10%;"></td> <td style="width: 10%;"></td> <td style="width: 10%;"></td> <td style="width: 10%;"></td> <td style="width: 10%;"></td> <td style="width: 10%;"></td> </tr> <tr> <td></td> <td></td> <td colspan="8" style="text-align: center;"> <table border="1" style="width: 100%; border-collapse: collapse; text-align: center;"> <tr> <td style="width: 10%;"></td> <td style="width: 10%;"></td> <td style="width: 10%;"></td> <td style="width: 10%;"></td> <td style="width: 10%;"></td> <td style="width: 10%;"></td> <td style="width: 10%;"></td> <td style="width: 10%;"></td> <td style="width: 10%;"></td> <td style="width: 10%;"></td> </tr> <tr> <td></td> <td></td> <td colspan="8" style="text-align: center;"> <table border="1" style="width: 100%; border-collapse: collapse; text-align: center;"> <tr> <td style="width: 10%;"></td> <td style="width: 10%;"></td> <td style="width: 10%;"></td> <td style="width: 10%;"></td> <td style="width: 10%;"></td> <td style="width: 10%;"></td> <td style="width: 10%;"></td> <td style="width: 10%;"></td> <td style="width: 10%;"></td> <td style="width: 10%;"></td> </tr> <tr> <td></td> <td></td> <td colspan="8" style="text-align: center;"> <table border="1" style="width: 100%; border-collapse: collapse; text-align: center;"> <tr> <td style="width: 10%;"></td> <td style="width: 10%;"></td> <td style="width: 10%;"></td> <td style="width: 10%;"></td> <td style="width: 10%;"></td> <td style="width: 10%;"></td> <td style="width: 10%;"></td> <td style="width: 10%;"></td> <td style="width: 10%;"></td> <td style="width: 10%;"></td> </tr> <tr> <td></td> <td></td> <td colspan="8" style="text-align: center;"> <table border="1" style="width: 100%; border-collapse: collapse; text-align: center;"> <tr> <td style="width: 10%;"></td> <td style="width: 10%;"></td> <td style="width: 10%;"></td> <td style="width: 10%;"></td> <td style="width: 10%;"></td> <td style="width: 10%;"></td> <td style="width: 10%;"></td> <td style="width: 10%;"></td> <td style="width: 10%;"></td> <td style="width: 10%;"></td> </tr> <tr> <td></td> <td></td> <td colspan="8" style="text-align: center;"> <table border="1" style="width: 100%; border-collapse: collapse; text-align: center;"> <tr> <td style="width: 10%;"></td> <td style="width: 10%;"></td> <td style="width: 10%;"></td> <td style="width: 10%;"></td> <td style="width: 10%;"></td> <td style="width: 10%;"></td> <td style="width: 10%;"></td> <td style="width: 10%;"></td> <td style="width: 10%;"></td> <td style="width: 10%;"></td> </tr> <tr> <td></td> <td></td> <td colspan="8" style="text-align: center;"> <table border="1" style="width: 100%; border-collapse: collapse; text-align: center;"> <tr> <td style="width: 10%;"></td> <td style="width: 10%;"></td> <td style="width: 10%;"></td> <td style="width: 10%;"></td> <td style="width: 10%;"></td> <td style="width: 10%;"></td> <td style="width: 10%;"></td> <td style="width: 10%;"></td> <td style="width: 10%;"></td> <td style="width: 10%;"></td> </tr> <tr> <td></td> <td></td> <td colspan="8" style="text-align: center;"> <table border="1" style="width: 100%; border-collapse: collapse; text-align: center;"> <tr> <td style="width: 10%;"></td> <td style="width: 10%;"></td> <td style="width: 10%;"></td> <td style="width: 10%;"></td> <td style="width: 10%;"></td> <td style="width: 10%;"></td> <td style="width: 10%;"></td> <td style="width: 10%;"></td> <td style="width: 10%;"></td> <td style="width: 10%;"></td> </tr> <tr> <td></td> <td></td> <td colspan="8" style="text-align: center;"> <table border="1" style="width: 100%; border-collapse: collapse; text-align: center;"> <tr> <td style="width: 10%;"></td> <td style="width: 10%;"></td> <td style="width: 10%;"></td> <td style="width: 10%;"></td> <td style="width: 10%;"></td> <td style="width: 10%;"></td> <td style="width: 10%;"></td> <td style="width: 10%;"></td> <td style="width: 10%;"></td> <td style="width: 10%;"></td> </tr> <tr> <td></td> <td></td> <td colspan="8" style="text-align: center;"> <table border="1" style="width: 100%; border-collapse: collapse; text-align: center;"> <tr> <td style="width: 10%;"></td> <td style="width: 10%;"></td> <td style="width: 10%;"></td> <td style="width: 10%;"></td> <td style="width: 10%;"></td> <td style="width: 10%;"></td> <td style="width: 10%;"></td> <td style="width: 10%;"></td> <td style="width: 10%;"></td> <td style="width: 10%;"></td> </tr> <tr> <td></td> <td></td> <td colspan="8" style="text-align: center;"> <table
border="1" style="width: 100%; border-collapse: collapse; text-align: center;"> <tr> </tr></table></td></tr></table></td></tr></table></td></tr></table></td></tr></table></td></tr></table></td></tr></table></td></tr></table></td></tr></table></td></tr></table></td></tr></table></td></tr></table></td></tr></table></td></tr></table> | | | | | | | | | | | | | | | | | | | | <table border="1" style="width: 100%; border-collapse: collapse; text-align: center;"> <tr> <td style="width: 10%;"></td> <td style="width: 10%;"></td> <td style="width: 10%;"></td> <td style="width: 10%;"></td> <td style="width: 10%;"></td> <td style="width: 10%;"></td> <td style="width: 10%;"></td> <td style="width: 10%;"></td> <td style="width: 10%;"></td> <td style="width: 10%;"></td> </tr> <tr> <td></td> <td></td> <td colspan="8" style="text-align: center;"> <table border="1" style="width: 100%; border-collapse: collapse; text-align: center;"> <tr> <td style="width: 10%;"></td> <td style="width: 10%;"></td> <td style="width: 10%;"></td> <td style="width: 10%;"></td> <td style="width: 10%;"></td> <td style="width: 10%;"></td> <td style="width: 10%;"></td> <td style="width: 10%;"></td> <td style="width: 10%;"></td> <td style="width: 10%;"></td> </tr> <tr> <td></td> <td></td> <td colspan="8" style="text-align: center;"> <table border="1" style="width: 100%; border-collapse: collapse; text-align: center;"> <tr> <td style="width: 10%;"></td> <td style="width: 10%;"></td> <td style="width: 10%;"></td> <td style="width: 10%;"></td> <td style="width: 10%;"></td> <td style="width: 10%;"></td> <td style="width: 10%;"></td> <td style="width: 10%;"></td> <td style="width: 10%;"></td> <td style="width: 10%;"></td> </tr> <tr> <td></td> <td></td> <td colspan="8" style="text-align: center;"> <table border="1" style="width: 100%; border-collapse: collapse; text-align: center;"> <tr> <td style="width: 10%;"></td> <td style="width: 10%;"></td> <td style="width: 10%;"></td> <td style="width: 10%;"></td> <td style="width: 10%;"></td> <td style="width: 10%;"></td> <td style="width: 10%;"></td> <td style="width: 10%;"></td> <td style="width: 10%;"></td> <td style="width: 10%;"></td> </tr> <tr> <td></td> <td></td> <td colspan="8" style="text-align: center;"> <table border="1" style="width: 100%; border-collapse: collapse; text-align: center;"> <tr> <td style="width: 10%;"></td> <td style="width: 10%;"></td> <td style="width: 10%;"></td> <td style="width: 10%;"></td> <td style="width: 10%;"></td> <td style="width: 10%;"></td> <td style="width: 10%;"></td> <td style="width: 10%;"></td> <td style="width: 10%;"></td> <td style="width: 10%;"></td> </tr> <tr> <td></td> <td></td> <td colspan="8" style="text-align: center;"> <table border="1" style="width: 100%; border-collapse: collapse; text-align: center;"> <tr> <td style="width: 10%;"></td> <td style="width: 10%;"></td> <td style="width: 10%;"></td> <td style="width: 10%;"></td> <td style="width: 10%;"></td> <td style="width: 10%;"></td> <td style="width: 10%;"></td> <td style="width: 10%;"></td> <td style="width: 10%;"></td> <td style="width: 10%;"></td> </tr> <tr> <td></td> <td></td> <td colspan="8" style="text-align:
center;"> <table border="1" style="width: 100%; border-collapse: collapse; text-align: center;"> <tr> <td style="width: 10%;"></td> <td style="width: 10%;"></td> <td style="width: 10%;"></td> <td style="width: 10%;"></td> <td style="width: 10%;"></td> <td style="width: 10%;"></td> <td style="width: 10%;"></td> <td style="width: 10%;"></td> <td style="width: 10%;"></td> <td style="width: 10%;"></td> </tr> <tr> <td></td> <td></td> <td colspan="8" style="text-align: center;"> <table border="1" style="width: 100%; border-collapse: collapse; text-align: center;"> <tr> <td style="width: 10%;"></td> <td style="width: 10%;"></td> <td style="width: 10%;"></td> <td style="width: 10%;"></td> <td style="width: 10%;"></td> <td style="width: 10%;"></td> <td style="width: 10%;"></td> <td style="width: 10%;"></td> <td style="width: 10%;"></td> <td style="width: 10%;"></td> </tr> <tr> <td></td> <td></td> <td colspan="8" style="text-align: center;"> <table border="1" style="width: 100%; border-collapse: collapse; text-align: center;"> <tr> <td style="width: 10%;"></td> <td style="width: 10%;"></td> <td style="width: 10%;"></td> <td style="width: 10%;"></td> <td style="width: 10%;"></td> <td style="width: 10%;"></td> <td style="width: 10%;"></td> <td style="width: 10%;"></td> <td style="width: 10%;"></td> <td style="width: 10%;"></td> </tr> <tr> <td></td> <td></td> <td colspan="8" style="text-align: center;"> <table border="1" style="width: 100%; border-collapse: collapse; text-align: center;"> <tr> <td style="width: 10%;"></td> <td style="width: 10%;"></td> <td style="width: 10%;"></td> <td style="width: 10%;"></td> <td style="width: 10%;"></td> <td style="width: 10%;"></td> <td style="width: 10%;"></td> <td style="width: 10%;"></td> <td style="width: 10%;"></td> <td style="width: 10%;"></td> </tr> <tr> <td></td> <td></td> <td colspan="8" style="text-align: center;"> <table border="1" style="width: 100%; border-collapse: collapse; text-align: center;"> <tr> <td style="width: 10%;"></td> <td style="width: 10%;"></td> <td style="width: 10%;"></td> <td style="width: 10%;"></td> <td style="width: 10%;"></td> <td style="width: 10%;"></td> <td style="width: 10%;"></td> <td style="width: 10%;"></td> <td style="width: 10%;"></td> <td style="width: 10%;"></td> </tr> <tr> <td></td> <td></td> <td colspan="8" style="text-align: center;"> <table border="1" style="width: 100%; border-collapse: collapse; text-align: center;"> <tr> <td style="width: 10%;"></td> <td style="width: 10%;"></td> <td style="width: 10%;"></td> <td style="width: 10%;"></td> <td style="width: 10%;"></td> <td style="width: 10%;"></td> <td style="width: 10%;"></td> <td style="width: 10%;"></td> <td style="width: 10%;"></td> <td style="width: 10%;"></td> </tr> <tr> <td></td> <td></td> <td colspan="8" style="text-align: center;"> <table border="1" style="width: 100%; border-collapse: collapse; text-align: center;"> <tr> </tr></table></td></tr></table></td></tr></table></td></tr></table></td></tr></table></td></tr></table></td></tr></table></td></tr></table></td></tr></table></td></tr></table></td></tr></table></td></tr></table></td></tr></table> | | | | | | | | | | | | | | | | | | |
 | <table border="1" style="width: 100%; border-collapse: collapse; text-align: center;"> <tr> <td style="width: 10%;"></td> <td style="width: 10%;"></td> <td style="width: 10%;"></td> <td style="width: 10%;"></td> <td style="width: 10%;"></td> <td style="width: 10%;"></td> <td style="width: 10%;"></td> <td style="width: 10%;"></td> <td style="width: 10%;"></td> <td style="width: 10%;"></td> </tr> <tr> <td></td> <td></td> <td colspan="8" style="text-align: center;"> <table border="1" style="width: 100%; border-collapse: collapse; text-align: center;"> <tr> <td style="width: 10%;"></td> <td style="width: 10%;"></td> <td style="width: 10%;"></td> <td style="width: 10%;"></td> <td style="width: 10%;"></td> <td style="width: 10%;"></td> <td style="width: 10%;"></td> <td style="width: 10%;"></td> <td style="width: 10%;"></td> <td style="width: 10%;"></td> </tr> <tr> <td></td> <td></td> <td colspan="8" style="text-align: center;"> <table border="1" style="width: 100%; border-collapse: collapse; text-align: center;"> <tr> <td style="width: 10%;"></td> <td style="width: 10%;"></td> <td style="width: 10%;"></td> <td style="width: 10%;"></td> <td style="width: 10%;"></td> <td style="width: 10%;"></td> <td style="width: 10%;"></td> <td style="width: 10%;"></td> <td style="width: 10%;"></td> <td style="width: 10%;"></td> </tr> <tr> <td></td> <td></td> <td colspan="8" style="text-align: center;"> <table border="1" style="width: 100%; border-collapse: collapse; text-align: center;"> <tr> <td style="width: 10%;"></td> <td style="width: 10%;"></td> <td style="width: 10%;"></td> <td style="width: 10%;"></td> <td style="width: 10%;"></td> <td style="width: 10%;"></td> <td style="width: 10%;"></td> <td style="width: 10%;"></td> <td style="width: 10%;"></td> <td style="width: 10%;"></td> </tr> <tr> <td></td> <td></td> <td colspan="8" style="text-align: center;"> <table border="1" style="width: 100%; border-collapse: collapse; text-align: center;"> <tr> <td style="width: 10%;"></td> <td style="width: 10%;"></td> <td style="width: 10%;"></td> <td style="width: 10%;"></td> <td style="width: 10%;"></td> <td style="width: 10%;"></td> <td style="width: 10%;"></td> <td style="width: 10%;"></td> <td style="width: 10%;"></td> <td style="width: 10%;"></td> </tr> <tr> <td></td> <td></td> <td colspan="8" style="text-align: center;"> <table border="1" style="width: 100%; border-collapse: collapse; text-align: center;"> <tr> <td style="width: 10%;"></td> <td style="width: 10%;"></td> <td style="width: 10%;"></td> <td style="width: 10%;"></td> <td style="width: 10%;"></td> <td style="width: 10%;"></td> <td style="width: 10%;"></td> <td style="width: 10%;"></td> <td style="width: 10%;"></td> <td style="width: 10%;"></td> </tr> <tr> <td></td> <td></td> <td colspan="8" style="text-align: center;"> <table border="1" style="width: 100%; border-collapse: collapse; text-align: center;"> <tr> <td style="width: 10%;"></td> <td style="width: 10%;"></td> <td style="width: 10%;"></td> <td style="width: 10%;"></td> <td style="width: 10%;"></td> <td style="width: 10%;"></td> <td style="width: 10%;"></td> <td style="width: 10%;"></td> <td style="width: 10%;"></td> <td style="width: 10%;"></td> </tr> <tr> <td></td> <td></td> <td colspan="8" style="text-align: center;"> <table border="1" style="width: 100%; border-collapse: collapse; text-align: center;"> <tr> <td style="width: 10%;"></td> <td style="width: 10%;"></td> <td style="width: 10%;"></td> <td style="width: 10%;"></td> <td style="width: 10%;"></td> <td style="width: 10%;"></td> <td style="width: 10%;"></td> <td style="width: 10%;"></td> <td style="width: 10%;"></td> <td style="width: 10%;"></td> </tr> <tr> <td></td> <td></td> <td colspan="8" style="text-align: center;"> <table border="1" style="width: 100%; border-collapse: collapse; text-align: center;"> <tr> <td style="width: 10%;"></td> <td style="width: 10%;"></td> <td style="width: 10%;"></td> <td style="width: 10%;"></td> <td style="width: 10%;"></td> <td style="width: 10%;"></td> <td style="width: 10%;"></td> <td style="width: 10%;"></td> <td style="width: 10%;"></td> <td style="width: 10%;"></td> </tr> <tr> <td></td> <td></td> <td colspan="8" style="text-align: center;"> <table border="1" style="width: 100%; border-collapse: collapse; text-align: center;"> <tr> <td style="width: 10%;"></td> <td style="width: 10%;"></td> <td style="width: 10%;"></td> <td style="width: 10%;"></td> <td style="width: 10%;"></td> <td style="width: 10%;"></td> <td style="width: 10%;"></td> <td style="width: 10%;"></td> <td style="width: 10%;"></td> <td style="width: 10%;"></td> </tr> <tr> <td></td> <td></td> <td colspan="8" style="text-align: center;"> <table border="1" style="width: 100%; border-collapse: collapse; text-align: center;"> <tr> <td style="width: 10%;"></td> <td style="width: 10%;"></td> <td style="width: 10%;"></td> <td style="width: 10%;"></td> <td style="width: 10%;"></td> <td style="width: 10%;"></td> <td style="width: 10%;"></td> <td style="width: 10%;"></td> <td style="width: 10%;"></td> <td style="width: 10%;"></td> </tr> <tr> <td></td> <td></td> <td colspan="8" style="text-align: center;"> <table border="1" style="width: 100%; border-collapse: collapse; text-align: center;"> <tr> </tr></table></td></tr></table></td></tr></table></td></tr></table></td></tr></table></td></tr></table></td></tr></table></td></tr></table></td></tr></table></td></tr></table></td></tr></table></td></tr></table>
 | | | | | | | | | | | | | | | | | | | | <table border="1" style="width: 100%; border-collapse: collapse; text-align: center;"> <tr> <td style="width: 10%;"></td> <td style="width: 10%;"></td> <td style="width: 10%;"></td> <td style="width: 10%;"></td> <td style="width: 10%;"></td> <td style="width: 10%;"></td> <td style="width: 10%;"></td> <td style="width: 10%;"></td> <td style="width: 10%;"></td> <td style="width: 10%;"></td> </tr> <tr> <td></td> <td></td> <td colspan="8" style="text-align: center;"> <table border="1" style="width: 100%; border-collapse: collapse; text-align: center;"> <tr> <td style="width: 10%;"></td> <td style="width: 10%;"></td> <td style="width: 10%;"></td> <td style="width: 10%;"></td> <td style="width: 10%;"></td> <td style="width: 10%;"></td> <td style="width: 10%;"></td> <td style="width: 10%;"></td> <td style="width: 10%;"></td> <td style="width: 10%;"></td> </tr> <tr> <td></td> <td></td> <td colspan="8" style="text-align: center;"> <table border="1" style="width: 100%; border-collapse: collapse; text-align: center;"> <tr> <td style="width: 10%;"></td> <td style="width: 10%;"></td> <td style="width: 10%;"></td> <td style="width: 10%;"></td> <td style="width: 10%;"></td> <td style="width: 10%;"></td> <td style="width: 10%;"></td> <td style="width: 10%;"></td> <td style="width: 10%;"></td> <td style="width: 10%;"></td> </tr> <tr> <td></td> <td></td> <td colspan="8" style="text-align: center;"> <table border="1" style="width: 100%; border-collapse: collapse; text-align: center;"> <tr> <td style="width: 10%;"></td> <td style="width: 10%;"></td> <td style="width: 10%;"></td> <td style="width: 10%;"></td> <td style="width: 10%;"></td> <td style="width: 10%;"></td> <td style="width: 10%;"></td> <td style="width: 10%;"></td> <td style="width: 10%;"></td> <td style="width: 10%;"></td> </tr> <tr> <td></td> <td></td> <td colspan="8" style="text-align: center;"> <table border="1" style="width: 100%; border-collapse: collapse; text-align: center;"> <tr> <td style="width: 10%;"></td> <td style="width: 10%;"></td> <td style="width: 10%;"></td> <td style="width: 10%;"></td> <td style="width: 10%;"></td> <td style="width: 10%;"></td> <td style="width: 10%;"></td> <td style="width: 10%;"></td> <td style="width: 10%;"></td> <td style="width: 10%;"></td> </tr> <tr> <td></td> <td></td> <td colspan="8" style="text-align: center;"> <table border="1" style="width: 100%; border-collapse: collapse; text-align: center;"> <tr> <td style="width: 10%;"></td> <td style="width: 10%;"></td> <td style="width: 10%;"></td> <td style="width: 10%;"></td> <td style="width: 10%;"></td> <td style="width: 10%;"></td> <td style="width: 10%;"></td> <td style="width: 10%;"></td> <td style="width: 10%;"></td> <td style="width: 10%;"></td> </tr> <tr> <td></td> <td></td> <td colspan="8" style="text-align: center;"> <table border="1" style="width: 100%; border-collapse: collapse; text-align: center;"> <tr> <td style="width: 10%;"></td> <td style="width: 10%;"></td> <td style="width: 10%;"></td> <td style="width: 10%;"></td> <td style="width: 10%;"></td> <td style="width: 10%;"></td> <td style="width: 10%;"></td> <td style="width: 10%;"></td> <td style="width: 10%;"></td> <td style="width: 10%;"></td> </tr> <tr> <td></td> <td></td> <td colspan="8" style="text-align: center;"> <table border="1" style="width: 100%; border-collapse: collapse; text-align: center;"> <tr> <td style="width: 10%;"></td> <td style="width: 10%;"></td> <td style="width: 10%;"></td> <td style="width: 10%;"></td> <td style="width: 10%;"></td> <td style="width: 10%;"></td> <td style="width: 10%;"></td> <td style="width: 10%;"></td> <td style="width: 10%;"></td> <td style="width: 10%;"></td> </tr> <tr> <td></td> <td></td> <td colspan="8" style="text-align: center;"> <table border="1" style="width: 100%; border-collapse: collapse; text-align: center;"> <tr> <td style="width: 10%;"></td> <td style="width: 10%;"></td> <td style="width: 10%;"></td> <td style="width: 10%;"></td> <td style="width: 10%;"></td> <td style="width: 10%;"></td> <td style="width: 10%;"></td> <td style="width: 10%;"></td> <td style="width: 10%;"></td> <td style="width: 10%;"></td> </tr> <tr> <td></td> <td></td> <td colspan="8" style="text-align: center;"> <table border="1" style="width: 100%; border-collapse: collapse; text-align: center;"> <tr> <td style="width: 10%;"></td> <td style="width: 10%;"></td> <td style="width: 10%;"></td> <td style="width: 10%;"></td> <td style="width: 10%;"></td> <td style="width: 10%;"></td> <td style="width: 10%;"></td> <td style="width: 10%;"></td> <td style="width: 10%;"></td> <td style="width: 10%;"></td> </tr> <tr> <td></td> <td></td> <td colspan="8" style="text-align: center;"> <table border="1" style="width: 100%; border-collapse: collapse; text-align: center;"> <tr> </tr></table></td></tr></table></td></tr></table></td></tr></table></td></tr></table></td></tr></table></td></tr></table></td></tr></table></td></tr></table></td></tr></table></td></tr></table>
 | | | | | | | | | | | | | | | | | | | | <table border="1" style="width: 100%; border-collapse: collapse; text-align: center;"> <tr> <td style="width: 10%;"></td> <td style="width: 10%;"></td> <td style="width: 10%;"></td> <td style="width: 10%;"></td> <td style="width: 10%;"></td> <td style="width: 10%;"></td> <td style="width: 10%;"></td> <td style="width: 10%;"></td> <td style="width: 10%;"></td> <td style="width: 10%;"></td> </tr> <tr> <td></td> <td></td> <td colspan="8" style="text-align: center;"> <table border="1" style="width: 100%; border-collapse: collapse; text-align: center;"> <tr> <td style="width: 10%;"></td> <td style="width: 10%;"></td> <td style="width: 10%;"></td> <td style="width: 10%;"></td> <td style="width: 10%;"></td> <td style="width: 10%;"></td> <td style="width: 10%;"></td> <td style="width: 10%;"></td> <td style="width: 10%;"></td> <td style="width: 10%;"></td> </tr> <tr> <td></td> <td></td> <td colspan="8" style="text-align: center;"> <table border="1" style="width: 100%; border-collapse: collapse; text-align: center;"> <tr> <td style="width: 10%;"></td> <td style="width: 10%;"></td> <td style="width: 10%;"></td> <td style="width: 10%;"></td> <td style="width: 10%;"></td> <td style="width: 10%;"></td> <td style="width: 10%;"></td> <td style="width: 10%;"></td> <td style="width: 10%;"></td> <td style="width: 10%;"></td> </tr> <tr> <td></td> <td></td> <td colspan="8" style="text-align: center;"> <table border="1" style="width: 100%; border-collapse: collapse; text-align: center;"> <tr> <td style="width: 10%;"></td> <td style="width: 10%;"></td> <td style="width: 10%;"></td> <td style="width: 10%;"></td> <td style="width: 10%;"></td> <td style="width: 10%;"></td> <td style="width: 10%;"></td> <td style="width: 10%;"></td> <td style="width: 10%;"></td> <td style="width: 10%;"></td> </tr> <tr> <td></td> <td></td> <td colspan="8" style="text-align: center;"> <table border="1" style="width: 100%; border-collapse: collapse; text-align: center;"> <tr> <td style="width: 10%;"></td> <td style="width: 10%;"></td> <td style="width: 10%;"></td> <td style="width: 10%;"></td> <td style="width: 10%;"></td> <td style="width: 10%;"></td> <td style="width: 10%;"></td> <td style="width: 10%;"></td> <td style="width: 10%;"></td> <td style="width: 10%;"></td> </tr> <tr> <td></td> <td></td> <td colspan="8" style="text-align: center;"> <table border="1" style="width: 100%; border-collapse: collapse; text-align: center;"> <tr> <td style="width: 10%;"></td> <td style="width: 10%;"></td> <td style="width: 10%;"></td> <td style="width: 10%;"></td> <td style="width: 10%;"></td> <td style="width: 10%;"></td> <td style="width: 10%;"></td> <td style="width: 10%;"></td> <td style="width: 10%;"></td> <td style="width: 10%;"></td> </tr> <tr> <td></td> <td></td> <td colspan="8" style="text-align: center;"> <table border="1" style="width: 100%; border-collapse: collapse; text-align: center;"> <tr> <td style="width: 10%;"></td> <td style="width: 10%;"></td> <td style="width: 10%;"></td> <td style="width: 10%;"></td> <td style="width: 10%;"></td> <td style="width: 10%;"></td> <td style="width: 10%;"></td> <td style="width: 10%;"></td> <td style="width: 10%;"></td> <td style="width: 10%;"></td> </tr> <tr> <td></td> <td></td> <td colspan="8" style="text-align: center;"> <table border="1" style="width: 100%; border-collapse: collapse; text-align: center;"> <tr> <td style="width: 10%;"></td> <td style="width: 10%;"></td> <td style="width: 10%;"></td> <td style="width: 10%;"></td> <td style="width: 10%;"></td> <td style="width: 10%;"></td> <td style="width: 10%;"></td> <td style="width: 10%;"></td> <td style="width: 10%;"></td> <td style="width: 10%;"></td> </tr> <tr> <td></td> <td></td> <td colspan="8" style="text-align: center;"> <table border="1" style="width: 100%; border-collapse: collapse; text-align: center;"> <tr> <td style="width: 10%;"></td> <td style="width: 10%;"></td> <td style="width: 10%;"></td> <td style="width: 10%;"></td> <td style="width: 10%;"></td> <td style="width: 10%;"></td> <td style="width: 10%;"></td> <td style="width: 10%;"></td> <td style="width: 10%;"></td> <td style="width: 10%;"></td> </tr> <tr> <td></td> <td></td> <td colspan="8" style="text-align: center;"> <table border="1" style="width: 100%; border-collapse: collapse; text-align: center;"> <tr> </tr></table></td></tr></table></td></tr></table></td></tr></table></td></tr></table></td></tr></table></td></tr></table></td></tr></table></td></tr></table></td></tr></table>
 | | | | | | | | | | | | | | | | | | | | <table border="1" style="width: 100%; border-collapse: collapse; text-align: center;"> <tr> <td style="width: 10%;"></td> <td style="width: 10%;"></td> <td style="width: 10%;"></td> <td style="width: 10%;"></td> <td style="width: 10%;"></td> <td style="width: 10%;"></td> <td style="width: 10%;"></td> <td style="width: 10%;"></td> <td style="width: 10%;"></td> <td style="width: 10%;"></td> </tr> <tr> <td></td> <td></td> <td colspan="8" style="text-align: center;"> <table border="1" style="width: 100%; border-collapse: collapse; text-align: center;"> <tr> <td style="width: 10%;"></td> <td style="width: 10%;"></td> <td style="width: 10%;"></td> <td style="width: 10%;"></td> <td style="width: 10%;"></td> <td style="width: 10%;"></td> <td style="width: 10%;"></td> <td style="width: 10%;"></td> <td style="width: 10%;"></td> <td style="width: 10%;"></td> </tr> <tr> <td></td> <td></td> <td colspan="8" style="text-align: center;"> <table border="1" style="width: 100%; border-collapse: collapse; text-align: center;"> <tr> <td style="width: 10%;"></td> <td style="width: 10%;"></td> <td style="width: 10%;"></td> <td style="width: 10%;"></td> <td style="width: 10%;"></td> <td style="width: 10%;"></td> <td style="width: 10%;"></td> <td style="width: 10%;"></td> <td style="width: 10%;"></td> <td style="width: 10%;"></td> </tr> <tr> <td></td> <td></td> <td colspan="8" style="text-align: center;"> <table border="1" style="width: 100%; border-collapse: collapse; text-align: center;"> <tr> <td style="width: 10%;"></td> <td style="width: 10%;"></td> <td style="width: 10%;"></td> <td style="width: 10%;"></td> <td style="width: 10%;"></td> <td style="width: 10%;"></td> <td style="width: 10%;"></td> <td style="width: 10%;"></td> <td style="width: 10%;"></td> <td style="width: 10%;"></td> </tr> <tr> <td></td> <td></td> <td colspan="8" style="text-align: center;"> <table border="1" style="width: 100%; border-collapse: collapse; text-align: center;"> <tr> <td style="width: 10%;"></td> <td style="width: 10%;"></td> <td style="width: 10%;"></td> <td style="width: 10%;"></td> <td style="width: 10%;"></td> <td style="width: 10%;"></td> <td style="width: 10%;"></td> <td style="width: 10%;"></td> <td style="width: 10%;"></td> <td style="width: 10%;"></td> </tr> <tr> <td></td> <td></td> <td colspan="8" style="text-align: center;"> <table border="1" style="width: 100%; border-collapse: collapse; text-align: center;"> <tr> <td style="width: 10%;"></td> <td style="width: 10%;"></td> <td style="width: 10%;"></td> <td style="width: 10%;"></td> <td style="width: 10%;"></td> <td style="width: 10%;"></td> <td style="width: 10%;"></td> <td style="width: 10%;"></td> <td style="width: 10%;"></td> <td style="width: 10%;"></td> </tr> <tr> <td></td> <td></td> <td colspan="8" style="text-align: center;"> <table border="1" style="width: 100%; border-collapse: collapse; text-align: center;"> <tr> <td style="width: 10%;"></td> <td style="width: 10%;"></td> <td style="width: 10%;"></td> <td style="width: 10%;"></td> <td style="width: 10%;"></td> <td style="width: 10%;"></td> <td style="width: 10%;"></td> <td style="width: 10%;"></td> <td style="width: 10%;"></td> <td style="width: 10%;"></td> </tr> <tr> <td></td> <td></td> <td colspan="8" style="text-align: center;"> <table border="1" style="width: 100%; border-collapse: collapse; text-align: center;"> <tr> <td style="width: 10%;"></td> <td style="width: 10%;"></td> <td style="width: 10%;"></td> <td style="width: 10%;"></td> <td style="width: 10%;"></td> <td style="width: 10%;"></td> <td style="width: 10%;"></td> <td style="width: 10%;"></td> <td style="width: 10%;"></td> <td style="width: 10%;"></td> </tr> <tr> <td></td> <td></td> <td colspan="8" style="text-align: center;"> <table border="1" style="width: 100%; border-collapse: collapse; text-align: center;"> <tr> </tr></table></td></tr></table></td></tr></table></td></tr></table></td></tr></table></td></tr></table></td></tr></table></td></tr></table></td></tr></table>
 | | | | | | | | | | | | | | | | | | | | <table border="1" style="width: 100%; border-collapse: collapse; text-align: center;"> <tr> <td style="width: 10%;"></td> <td style="width: 10%;"></td> <td style="width: 10%;"></td> <td style="width: 10%;"></td> <td style="width: 10%;"></td> <td style="width: 10%;"></td> <td style="width: 10%;"></td> <td style="width: 10%;"></td> <td style="width: 10%;"></td> <td style="width: 10%;"></td> </tr> <tr> <td></td> <td></td> <td colspan="8" style="text-align: center;"> <table border="1" style="width: 100%; border-collapse: collapse; text-align: center;"> <tr> <td style="width: 10%;"></td> <td style="width: 10%;"></td> <td style="width: 10%;"></td> <td style="width: 10%;"></td> <td style="width: 10%;"></td> <td style="width: 10%;"></td> <td style="width: 10%;"></td> <td style="width: 10%;"></td> <td style="width: 10%;"></td> <td style="width: 10%;"></td> </tr> <tr> <td></td> <td></td> <td colspan="8" style="text-align: center;"> <table border="1" style="width: 100%; border-collapse: collapse; text-align: center;"> <tr> <td style="width: 10%;"></td> <td style="width: 10%;"></td> <td style="width: 10%;"></td> <td style="width: 10%;"></td> <td style="width: 10%;"></td> <td style="width: 10%;"></td> <td style="width: 10%;"></td> <td style="width: 10%;"></td> <td style="width: 10%;"></td> <td style="width: 10%;"></td> </tr> <tr> <td></td> <td></td> <td colspan="8" style="text-align: center;"> <table border="1" style="width: 100%; border-collapse: collapse; text-align: center;"> <tr> <td style="width: 10%;"></td> <td style="width: 10%;"></td> <td style="width: 10%;"></td> <td style="width: 10%;"></td> <td style="width: 10%;"></td> <td style="width: 10%;"></td> <td style="width: 10%;"></td> <td style="width: 10%;"></td> <td style="width: 10%;"></td> <td style="width: 10%;"></td> </tr> <tr> <td></td> <td></td> <td colspan="8" style="text-align: center;"> <table border="1" style="width: 100%; border-collapse: collapse; text-align: center;"> <tr> <td style="width: 10%;"></td> <td style="width: 10%;"></td> <td style="width: 10%;"></td> <td style="width: 10%;"></td> <td style="width: 10%;"></td> <td style="width: 10%;"></td> <td style="width: 10%;"></td> <td style="width: 10%;"></td> <td style="width: 10%;"></td> <td style="width: 10%;"></td> </tr> <tr> <td></td> <td></td> <td colspan="8" style="text-align: center;"> <table border="1" style="width: 100%; border-collapse: collapse; text-align: center;"> <tr> <td style="width: 10%;"></td> <td style="width: 10%;"></td> <td style="width: 10%;"></td> <td style="width: 10%;"></td> <td style="width: 10%;"></td> <td style="width: 10%;"></td> <td style="width: 10%;"></td> <td style="width: 10%;"></td> <td style="width: 10%;"></td> <td style="width: 10%;"></td> </tr> <tr> <td></td> <td></td> <td colspan="8" style="text-align: center;"> <table border="1" style="width: 100%; border-collapse: collapse; text-align: center;"> <tr> <td style="width: 10%;"></td> <td style="width: 10%;"></td> <td style="width: 10%;"></td> <td style="width: 10%;"></td> <td style="width: 10%;"></td> <td style="width: 10%;"></td> <td style="width: 10%;"></td> <td style="width: 10%;"></td> <td style="width: 10%;"></td> <td style="width: 10%;"></td> </tr> <tr> <td></td> <td></td> <td colspan="8" style="text-align: center;"> <table border="1" style="width: 100%; border-collapse: collapse; text-align: center;"> <tr> </tr></table></td></tr></table></td></tr></table></td></tr></table></td></tr></table></td></tr></table></td></tr></table></td></tr></table>
 | | | | | | | | | | | | | | | | | | | | <table border="1" style="width: 100%; border-collapse: collapse; text-align: center;"> <tr> <td style="width: 10%;"></td> <td style="width: 10%;"></td> <td style="width: 10%;"></td> <td style="width: 10%;"></td> <td style="width: 10%;"></td> <td style="width: 10%;"></td> <td style="width: 10%;"></td> <td style="width: 10%;"></td> <td style="width: 10%;"></td> <td style="width: 10%;"></td> </tr> <tr> <td></td> <td></td> <td colspan="8" style="text-align: center;"> <table border="1" style="width: 100%; border-collapse: collapse; text-align: center;"> <tr> <td style="width: 10%;"></td> <td style="width: 10%;"></td> <td style="width: 10%;"></td> <td style="width: 10%;"></td> <td style="width: 10%;"></td> <td style="width: 10%;"></td> <td style="width: 10%;"></td> <td style="width: 10%;"></td> <td style="width: 10%;"></td> <td style="width: 10%;"></td> </tr> <tr> <td></td> <td></td> <td colspan="8" style="text-align: center;"> <table border="1" style="width: 100%; border-collapse: collapse; text-align: center;"> <tr> <td style="width: 10%;"></td> <td style="width: 10%;"></td> <td style="width: 10%;"></td> <td style="width: 10%;"></td> <td style="width: 10%;"></td> <td style="width: 10%;"></td> <td style="width: 10%;"></td> <td style="width: 10%;"></td> <td style="width: 10%;"></td> <td style="width: 10%;"></td> </tr> <tr> <td></td> <td></td> <td colspan="8" style="text-align: center;"> <table border="1" style="width: 100%; border-collapse: collapse; text-align: center;"> <tr> <td style="width: 10%;"></td> <td style="width: 10%;"></td> <td style="width: 10%;"></td> <td style="width: 10%;"></td> <td style="width: 10%;"></td> <td style="width: 10%;"></td> <td style="width: 10%;"></td> <td style="width: 10%;"></td> <td style="width: 10%;"></td> <td style="width: 10%;"></td> </tr> <tr> <td></td> <td></td> <td colspan="8" style="text-align: center;"> <table border="1" style="width: 100%; border-collapse: collapse; text-align: center;"> <tr> <td style="width: 10%;"></td> <td style="width: 10%;"></td> <td style="width: 10%;"></td> <td style="width: 10%;"></td> <td style="width: 10%;"></td> <td style="width: 10%;"></td> <td style="width: 10%;"></td> <td style="width: 10%;"></td> <td style="width: 10%;"></td> <td style="width: 10%;"></td> </tr> <tr> <td></td> <td></td> <td colspan="8" style="text-align: center;"> <table border="1" style="width: 100%; border-collapse: collapse; text-align: center;"> <tr> <td style="width: 10%;"></td> <td style="width: 10%;"></td> <td style="width: 10%;"></td> <td style="width: 10%;"></td> <td style="width: 10%;"></td> <td style="width: 10%;"></td> <td style="width: 10%;"></td> <td style="width: 10%;"></td> <td style="width: 10%;"></td> <td style="width: 10%;"></td> </tr> <tr> <td></td> <td></td> <td colspan="8" style="text-align: center;"> <table border="1" style="width: 100%; border-collapse: collapse; text-align: center;"> <tr> </tr></table></td></tr></table></td></tr></table></td></tr></table></td></tr></table></td></tr></table></td></tr></table>
 | | | | | | | | | | | | | | | | | | | | <table border="1" style="width: 100%; border-collapse: collapse; text-align: center;"> <tr> <td style="width: 10%;"></td> <td style="width: 10%;"></td> <td style="width: 10%;"></td> <td style="width: 10%;"></td> <td style="width: 10%;"></td> <td style="width: 10%;"></td> <td style="width: 10%;"></td> <td style="width: 10%;"></td> <td style="width: 10%;"></td> <td style="width: 10%;"></td> </tr> <tr> <td></td> <td></td> <td colspan="8" style="text-align: center;"> <table border="1" style="width: 100%; border-collapse: collapse; text-align: center;"> <tr> <td style="width: 10%;"></td> <td style="width: 10%;"></td> <td style="width: 10%;"></td> <td style="width: 10%;"></td> <td style="width: 10%;"></td> <td style="width: 10%;"></td> <td style="width: 10%;"></td> <td style="width: 10%;"></td> <td style="width: 10%;"></td> <td style="width: 10%;"></td> </tr> <tr> <td></td> <td></td> <td colspan="8" style="text-align: center;"> <table border="1" style="width: 100%; border-collapse: collapse; text-align: center;"> <tr> <td style="width: 10%;"></td> <td style="width: 10%;"></td> <td style="width: 10%;"></td> <td style="width: 10%;"></td> <td style="width: 10%;"></td> <td style="width: 10%;"></td> <td style="width: 10%;"></td> <td style="width: 10%;"></td> <td style="width: 10%;"></td> <td style="width: 10%;"></td> </tr> <tr> <td></td> <td></td> <td colspan="8" style="text-align: center;"> <table border="1" style="width: 100%; border-collapse: collapse; text-align: center;"> <tr> <td style="width: 10%;"></td> <td style="width: 10%;"></td> <td style="width: 10%;"></td> <td style="width: 10%;"></td> <td style="width: 10%;"></td> <td style="width: 10%;"></td> <td style="width: 10%;"></td> <td style="width: 10%;"></td> <td style="width: 10%;"></td> <td style="width: 10%;"></td> </tr> <tr> <td></td> <td></td> <td colspan="8" style="text-align: center;"> <table border="1" style="width: 100%; border-collapse: collapse; text-align: center;"> <tr> <td style="width: 10%;"></td> <td style="width: 10%;"></td> <td style="width: 10%;"></td> <td style="width: 10%;"></td> <td style="width: 10%;"></td> <td style="width: 10%;"></td> <td style="width: 10%;"></td> <td style="width: 10%;"></td> <td style="width: 10%;"></td> <td style="width: 10%;"></td> </tr> <tr> <td></td> <td></td> <td colspan="8" style="text-align: center;"> <table border="1" style="width: 100%; border-collapse: collapse; text-align: center;"> <tr> </tr></table></td></tr></table></td></tr></table></td></tr></table></td></tr></table></td></tr></table>
 | | | | | | | | | | | | | | | | | | | | <table border="1" style="width: 100%; border-collapse: collapse; text-align: center;"> <tr> <td style="width: 10%;"></td> <td style="width: 10%;"></td> <td style="width: 10%;"></td> <td style="width: 10%;"></td> <td style="width: 10%;"></td> <td style="width: 10%;"></td> <td style="width: 10%;"></td> <td style="width: 10%;"></td> <td style="width: 10%;"></td> <td style="width: 10%;"></td> </tr> <tr> <td></td> <td></td> <td colspan="8" style="text-align: center;"> <table border="1" style="width: 100%; border-collapse: collapse; text-align: center;"> <tr> <td style="width: 10%;"></td> <td style="width: 10%;"></td> <td style="width: 10%;"></td> <td style="width: 10%;"></td> <td style="width: 10%;"></td> <td style="width: 10%;"></td> <td style="width: 10%;"></td> <td style="width: 10%;"></td> <td style="width: 10%;"></td> <td style="width: 10%;"></td> </tr> <tr> <td></td> <td></td> <td colspan="8" style="text-align: center;"> <table border="1" style="width: 100%; border-collapse: collapse; text-align: center;"> <tr> <td style="width: 10%;"></td> <td style="width: 10%;"></td> <td style="width: 10%;"></td> <td style="width: 10%;"></td> <td style="width: 10%;"></td> <td style="width: 10%;"></td> <td style="width: 10%;"></td> <td style="width: 10%;"></td> <td style="width: 10%;"></td> <td style="width: 10%;"></td> </tr> <tr> <td></td> <td></td> <td colspan="8" style="text-align: center;"> <table border="1" style="width: 100%; border-collapse: collapse; text-align: center;"> <tr> <td style="width: 10%;"></td> <td style="width: 10%;"></td> <td style="width: 10%;"></td> <td style="width: 10%;"></td> <td style="width: 10%;"></td> <td style="width: 10%;"></td> <td style="width: 10%;"></td> <td style="width: 10%;"></td> <td style="width: 10%;"></td> <td style="width: 10%;"></td> </tr> <tr> <td></td> <td></td> <td colspan="8" style="text-align: center;"> <table border="1" style="width: 100%; border-collapse: collapse; text-align: center;"> <tr> </tr></table></td></tr></table></td></tr></table></td></tr></table></td></tr></table>
 | | | | | | | | | | | | | | | | | | | | <table border="1" style="width: 100%; border-collapse: collapse; text-align: center;"> <tr> <td style="width: 10%;"></td> <td style="width: 10%;"></td> <td style="width: 10%;"></td> <td style="width: 10%;"></td> <td style="width: 10%;"></td> <td style="width: 10%;"></td> <td style="width: 10%;"></td> <td style="width: 10%;"></td> <td style="width: 10%;"></td> <td style="width: 10%;"></td> </tr> <tr> <td></td> <td></td> <td colspan="8" style="text-align: center;"> <table border="1" style="width: 100%; border-collapse: collapse; text-align: center;"> <tr> <td style="width: 10%;"></td> <td style="width: 10%;"></td> <td style="width: 10%;"></td> <td style="width: 10%;"></td> <td style="width: 10%;"></td> <td style="width: 10%;"></td> <td style="width: 10%;"></td> <td style="width: 10%;"></td> <td style="width: 10%;"></td> <td style="width: 10%;"></td> </tr> <tr> <td></td> <td></td> <td colspan="8" style="text-align: center;"> <table border="1" style="width: 100%; border-collapse: collapse; text-align: center;"> <tr> <td style="width: 10%;"></td> <td style="width: 10%;"></td> <td style="width: 10%;"></td> <td style="width: 10%;"></td> <td style="width: 10%;"></td> <td style="width: 10%;"></td> <td style="width: 10%;"></td> <td style="width: 10%;"></td> <td style="width: 10%;"></td> <td style="width: 10%;"></td> </tr> <tr> <td></td> <td></td> <td colspan="8" style="text-align: center;"> <table border="1" style="width: 100%; border-collapse: collapse; text-align: center;"> <tr> </tr></table></td></tr></table></td></tr></table></td></tr></table>
 | | | | | | | | | | | | | | | | | | | | <table border="1" style="width: 100%; border-collapse: collapse; text-align: center;"> <tr> <td style="width: 10%;"></td> <td style="width: 10%;"></td> <td style="width: 10%;"></td> <td style="width: 10%;"></td> <td style="width: 10%;"></td> <td style="width: 10%;"></td> <td style="width: 10%;"></td> <td style="width: 10%;"></td> <td style="width: 10%;"></td> <td style="width: 10%;"></td> </tr> <tr> <td></td> <td></td> <td colspan="8" style="text-align: center;"> <table border="1" style="width: 100%; border-collapse: collapse; text-align: center;"> <tr> <td style="width: 10%;"></td> <td style="width: 10%;"></td> <td style="width: 10%;"></td> <td style="width: 10%;"></td> <td style="width: 10%;"></td> <td style="width: 10%;"></td> <td style="width: 10%;"></td> <td style="width: 10%;"></td> <td style="width: 10%;"></td> <td style="width: 10%;"></td> </tr> <tr> <td></td> <td></td> <td colspan="8" style="text-align: center;"> <table border="1" style="width: 100%; border-collapse: collapse; text-align: center;"> <tr> </tr></table></td></tr></table></td></tr></table>
 | | | | | | | | | | | | | | | | | | | | <table border="1" style="width: 100%; border-collapse: collapse; text-align: center;"> <tr> <td style="width: 10%;"></td> <td style="width: 10%;"></td> <td style="width: 10%;"></td> <td style="width: 10%;"></td> <td style="width: 10%;"></td> <td style="width: 10%;"></td> <td style="width: 10%;"></td> <td style="width: 10%;"></td> <td style="width: 10%;"></td> <td style="width: 10%;"></td> </tr> <tr> <td></td> <td></td> <td colspan="8" style="text-align: center;"> <table border="1" style="width: 100%; border-collapse: collapse; text-align: center;"> <tr> </tr></table></td></tr></table> | | | | | | | | | | | | | | | | | | | | <table border="1" style="width: 100%; border-collapse: collapse; text-align: center;"> <tr> </tr></table>
 | | | | | | | | | | | | | | | | | | | | | | | | | | | | | | | | | | | | | | | | | | | | | | | | | | | | | | | | | | | | | | | | | | | | | | | | | | | | | | | |
 | | | | | | | | | | | | | | | | | | | | | | | | | | | | | | | | | | | | | | | |
 | | | | | | | | | | | | | | | | | | | | | | | | | | | | | | | | | | | | | | | |
 | | | | | | | | | | | | | | | | | | | | | | | | | | | | | | | | | | | | | | | |
 | | | | | | | | | | | | | | | | | | | | | | | | | | | | | | | | | | | | | | | | | | | | | | | | | | | | | | | | | | | | | | | | | | | | | | | | | | | | | | | |
 | | | | | | | | | | | | | | | | | | | | | | | | | | | | | | | | | | | | | | | | | | | | | | | | | | | | | | | | | | | | | | | | | | | |
| | |

 | | | | | | | | | | | | | | | | | | | |

 | | | | | | | | | | | | | | | | | | | |

 | | | | | | | | | | | | | | | | | | | |

 | | | | | | | | | | | | | | | | | | | |

 | | | | | | | | | | | | | | | | | | | |

 | | | | | | | | | | | | | | | | | | | |

 | | | | | | | | | | | | | | | | | | | |

 | | | | | | | | | | | | | | | | | | | |

 | | | | | | | | | | | | | | | | | | | |

 | | | | | | | | | | | | | | | | | | | |

 | | | | | | | | | | | | | | | | | | | |

 | | | | | | | | | | | | | | | | | | | |

 | | | | | | | | | | | | | | | | | | | |

 | | | | | | | | | | | | | | | | | | | |

 | | | | | | | | | | | | | | | | | | | |

 | | | | | | | | | | | | | | | | | | | |

 | | | | | | | | | | | | | | | | | | | |

 | | | | | | | | | | | | | | | | | | | |

 | | | | | | | | | | | | | | | | | | | |

 | | | | | | | | | | | | | | | | | | | |

 | | | | | | | | | | | | | | | | | | | |

 | | | | | | | | | | | | | | | | | | | |

 | | | | | | | | | | | | | | | | | | | |

 | | | | | | | | | | | | | | | | | | | |

 | | | | | | | | | | | | | | | | | | | |

 | | | | | | | | | | | | | | | | | | | |

 | | | | | | | | | | | | | | | | | | | |

 | | | | | | | | | | | | | | | | | | | |
 | | | | | | | | | | | | | | | | | | | |

 | | | | | | | | | | | | | | | | | | | |

 | | | | | | | | | | | | | | | | | | | |
 | | | | | | | | | | | | | | | | | | | |

 | | | | | | | | | | | | | | | | | | | |

 | | | | | | | | | | | | | | | | | | | |
 | | | | | | | | | | | | | | | | | | | |
 | | | | | | | | | | | | | | | | | | | |

 | | | | | | | | | | | | | | | | | | | |
 | | | | | | | | | | | | | | | | | | | |
 | | | | | | | | | | | | | | | | | | | |

 | | | | | | | | | | | | | | | | | | | | | | | | | | | | | | | | | | | | | | | | | | | | | | | | | | | | | | | | | | | | | | | | | | | | | | | | | | | | | | | | | | | | | | | | | | | | | | | | | | | |
 | | | | | | | | | | | | | | | | | | | |
 | | | | | | | | | | | | | | | | | | | |
 | | | | | | | | | | | | | | | | | | | |
 | | | | | | | | | | | | | | | | | | | |
 | | | | | | | | | | | | | | | | | | | |
 | | | | | | | | | | | | | | | | | | | |
 | | | | | | | | | | | | | | | | | | | |
 | | | | | | | | | | | | | | | | | | | |
 | | | | | | | | | | | | | | | | | | | | | | | | | | | | | | | | | | | | | | | |
 | | | | | | | | | | | | | | | | | | | |
 | | | | | | | | | | | | | | | | | | | | | | | | | | | | | | | | | | | | | | | |
 | | | | | | | | | | | | | | | | | | | | | | | | | | | | | | | | | | | | | | | |
 | | | | | | | | | | | | | | | | | | | | | | | | | | | | | | | | | | | | | | | |
 | | | | | | | | | | | | | | | | | | | | | | | | | | | | | | | | | | | | | | | | | | | | | | | | | | | | | | | | | | | | | | | | | | | | | | | | | | | | | | | | | | | | | | | | | | | | | | | | | | | |
 | | | | | | | | | | | | | | | | | | | | | | | | | | | | | | | | | | | | | | | | | | | | | | | |
| | | <table border="1" style="width: 100%; border-collapse: collapse; text-align: center;"> <tr> <td style="width: 10%;"></td> <td style="width: 10%;"></td> <td style="width: 10%;"></td> <td style="width: 10%;"></td> <td style="width: 10%;"></td> <td style="width: 10%;"></td> <td style="width: 10%;"></td> <td style="width: 10%;"></td> <td style="width: 10%;"></td> <td style="width: 10%;"></td> </tr> <tr> <td></td> <td></td> <td colspan="8" style="text-align: center;"> <table border="1" style="width: 100%; border-collapse: collapse; text-align: center;"> <tr> <td style="width: 10%;"></td> <td style="width: 10%;"></td> <td style="width: 10%;"></td> <td style="width: 10%;"></td> <td style="width: 10%;"></td> <td style="width: 10%;"></td> <td style="width: 10%;"></td> <td style="width: 10%;"></td> <td style="width: 10%;"></td> <td style="width: 10%;"></td> </tr> <tr> <td></td> <td></td> <td colspan="8" style="text-align: center;"> <table border="1" style="width: 100%; border-collapse: collapse; text-align: center;"> <tr> <td style="width: 10%;"></td> <td style="width: 10%;"></td> <td style="width: 10%;"></td> <td style="width: 10%;"></td> <td style="width: 10%;"></td> <td style="width: 10%;"></td> <td style="width: 10%;"></td> <td style="width: 10%;"></td> <td style="width: 10%;"></td> <td style="width: 10%;"></td> </tr> <tr> <td></td> <td></td> <td colspan="8" style="text-align: center;"> <table border="1" style="width: 100%; border-collapse: collapse; text-align: center;"> <tr> <td style="width: 10%;"></td> <td style="width: 10%;"></td> <td style="width: 10%;"></td> <td style="width: 10%;"></td> <td style="width: 10%;"></td> <td style="width: 10%;"></td> <td style="width: 10%;"></td> <td style="width: 10%;"></td> <td style="width: 10%;"></td> <td style="width: 10%;"></td> </tr> <tr> <td></td> <td></td> <td colspan="8" style="text-align: center;"> <table border="1" style="width: 100%; border-collapse: collapse; text-align: center;"> <tr> <td style="width: 10%;"></td> <td style="width: 10%;"></td> <td style="width: 10%;"></td> <td style="width: 10%;"></td> <td style="width: 10%;"></td> <td style="width: 10%;"></td> <td style="width: 10%;"></td> <td style="width: 10%;"></td> <td style="width: 10%;"></td> <td style="width: 10%;"></td> </tr> <tr> <td></td> <td></td> <td colspan="8" style="text-align: center;"> <table border="1" style="width: 100%; border-collapse: collapse; text-align: center;"> <tr> <td style="width: 10%;"></td> <td style="width: 10%;"></td> <td style="width: 10%;"></td> <td style="width: 10%;"></td> <td style="width: 10%;"></td> <td style="width: 10%;"></td> <td style="width: 10%;"></td> <td style="width: 10%;"></td> <td style="width: 10%;"></td> <td style="width: 10%;"></td> </tr> <tr> <td></td> <td></td> <td colspan="8" style="text-align: center;"> <table border="1" style="width: 100%; border-collapse: collapse; text-align: center;"> <tr> <td style="width: 10%;"></td> <td style="width: 10%;"></td> <td style="width: 10%;"></td> <td style="width: 10%;"></td> <td style="width: 10%;"></td> <td style="width: 10%;"></td> <td style="width: 10%;"></td> <td style="width: 10%;"></td> <td style="width: 10%;"></td> <td style="width: 10%;"></td> </tr> <tr> <td></td> <td></td> <td colspan="8" style="text-align: center;"> <table border="1" style="width: 100%; border-collapse: collapse; text-align: center;"> <tr> <td style="width: 10%;"></td> <td style="width: 10%;"></td> <td style="width: 10%;"></td> <td style="width: 10%;"></td> <td style="width: 10%;"></td> <td style="width: 10%;"></td> <td style="width: 10%;"></td> <td style="width: 10%;"></td> <td style="width: 10%;"></td> <td style="width: 10%;"></td> </tr> <tr> <td></td> <td></td> <td colspan="8" style="text-align: center;"> <table border="1" style="width: 100%; border-collapse: collapse; text-align: center;"> <tr> <td style="width: 10%;"></td> <td style="width: 10%;"></td> <td style="width: 10%;"></td> <td style="width: 10%;"></td> <td style="width: 10%;"></td> <td style="width: 10%;"></td> <td style="width: 10%;"></td> <td style="width: 10%;"></td> <td style="width: 10%;"></td> <td style="width: 10%;"></td> </tr> <tr> <td></td> <td></td> <td colspan="8" style="text-align: center;"> <table border="1" style="width: 100%; border-collapse: collapse; text-align: center;"> <tr> <td style="width: 10%;"></td> <td style="width: 10%;"></td> <td style="width: 10%;"></td> <td style="width: 10%;"></td> <td style="width: 10%;"></td> <td style="width: 10%;"></td> <td style="width: 10%;"></td> <td style="width: 10%;"></td> <td style="width: 10%;"></td> <td style="width: 10%;"></td> </tr> <tr> <td></td> <td></td> <td colspan="8" style="text-align: center;"> <table border="1" style="width: 100%; border-collapse: collapse; text-align: center;"> <tr> <td style="width: 10%;"></td> <td style="width: 10%;"></td> <td style="width: 10%;"></td> <td style="width: 10%;"></td> <td style="width: 10%;"></td> <td style="width: 10%;"></td> <td style="width: 10%;"></td> <td style="width: 10%;"></td> <td style="width: 10%;"></td> <td style="width: 10%;"></td> </tr> <tr> <td></td> <td></td> <td colspan="8" style="text-align: center;"> <table border="1" style="width: 100%; border-collapse: collapse; text-align: center;"> <tr> <td style="width: 10%;"></td> <td style="width: 10%;"></td> <td style="width: 10%;"></td> <td style="width: 10%;"></td> <td style="width: 10%;"></td> <td style="width: 10%;"></td> <td style="width: 10%;"></td> <td style="width: 10%;"></td> <td style="width: 10%;"></td> <td style="width: 10%;"></td> </tr> <tr> <td></td> <td></td> <td colspan="8" style="text-align: center;"> <table border="1" style="width: 100%; border-collapse: collapse; text-align: center;"> <tr> <td style="width: 10%;"></td> <td style="width: 10%;"></td> <td style="width: 10%;"></td> <td style="width: 10%;"></td> <td style="width: 10%;"></td> <td style="width: 10%;"></td> <td style="width: 10%;"></td> <td style="width: 10%;"></td> <td style="width: 10%;"></td> <td style="width: 10%;"></td> </tr> <tr> <td></td> <td></td> <td colspan="8" style="text-align: center;"> <table border="1" style="width: 100%; border-collapse: collapse; text-align: center;"> <tr> <td style="width: 10%;"></td> <td style="width: 10%;"></td> <td style="width: 10%;"></td> <td style="width: 10%;"></td> <td style="width: 10%;"></td> <td style="width: 10%;"></td> <td style="width: 10%;"></td> <td style="width: 10%;"></td> <td style="width: 10%;"></td> <td style="width: 10%;"></td> </tr> <tr> <td></td> <td></td> <td colspan="8" style="text-align: center;"> <table border="1" style="width: 100%; border-collapse: collapse; text-align: center;"> <tr> <td style="width: 10%;"></td> <td style="width: 10%;"></td> <td style="width: 10%;"></td> <td style="width: 10%;"></td> <td style="width: 10%;"></td> <td style="width: 10%;"></td> <td style="width: 10%;"></td> <td style="width: 10%;"></td> <td style="width: 10%;"></td> <td style="width: 10%;"></td> </tr> <tr> <td></td> <td></td> <td colspan="8" style="text-align: center;"> <table border="1" style="width: 100%; border-collapse: collapse; text-align: center;"> <tr> <td style="width: 10%;"></td> <td style="width: 10%;"></td> <td style="width: 10%;"></td> <td style="width: 10%;"></td> <td style="width: 10%;"></td> <td style="width: 10%;"></td> <td style="width: 10%;"></td> <td style="width: 10%;"></td> <td style="width: 10%;"></td> <td style="width: 10%;"></td> </tr> <tr> <td></td> <td></td> <td colspan="8" style="text-align: center;"> <table border="1" style="width: 100%; border-collapse: collapse; text-align: center;"> <tr> <td style="width: 10%;"></td> <td style="width: 10%;"></td> <td style="width: 10%;"></td> <td style="width: 10%;"></td> <td style="width: 10%;"></td> <td style="width: 10%;"></td> <td style="width: 10%;"></td> <td style="width: 10%;"></td> <td style="width: 10%;"></td> <td style="width: 10%;"></td> </tr> <tr> <td></td> <td></td> <td colspan="8" style="text-align: center;"> <table border="1" style="width: 100%; border-collapse: collapse; text-align: center;"> <tr> <td style="width: 10%;"></td> <td style="width: 10%;"></td> <td style="width: 10%;"></td> <td style="width: 10%;"></td> <td style="width: 10%;"></td> <td style="width: 10%;"></td> <td style="width: 10%;"></td> <td style="width: 10%;"></td> <td style="width: 10%;"></td> <td style="width: 10%;"></td> </tr> <tr> <td></td> <td></td> <td colspan="8" style="text-align: center;"> <table border="1" style="width: 100%; border-collapse: collapse; text-align: center;"> <tr> <td style="width: 10%;"></td> <td style="width: 10%;"></td> <td style="width: 10%;"></td> <td style="width: 10%;"></td> <td style="width: 10%;"></td> <td style="width: 10%;"></td> <td style="width: 10%;"></td> <td style="width: 10%;"></td> <td style="width: 10%;"></td> <td style="width: 10%;"></td> </tr> <tr> <td></td> <td></td> <td colspan="8" style="text-align: center;"> <table border="1" style="width: 100%; border-collapse: collapse; text-align: center;"> <tr> <td style="width: 10%;"></td> <td style="width: 10%;"></td> <td style="width: 10%;"></td> <td style="width: 10%;"></td> <td style="width: 10%;"></td> <td style="width: 10%;"></td> <td style="width: 10%;"></td> <td style="width: 10%;"></td> <td style="width: 10%;"></td> <td style="width: 10%;"></td> </tr> <tr> <td></td> <td></td> <td colspan="8" style="text-align: center;"> <table border="1" style="width: 100%; border-collapse: collapse; text-align: center;"> <tr> <td style="width: 10%;"></td> <td style="width: 10%;"></td> <td style="width: 10%;"></td> <td style="width: 10%;"></td> <td style="width: 10%;"></td> <td style="width: 10%;"></td> <td style="width: 10%;"></td> <td style="width: 10%;"></td> <td style="width: 10%;"></td> <td style="width: 10%;"></td> </tr> <tr> <td></td> <td></td> <td colspan="8" style="text-align: center;"> <table border="1" style="width: 100%; border-collapse: collapse; text-align: center;"> <tr> <td style="width: 10%;"></td> <td style="width: 10%;"></td> <td
style="width: 10%;"></td> <td style="width: 10%;"></td> <td style="width: 10%;"></td> <td style="width: 10%;"></td> <td style="width: 10%;"></td> <td style="width: 10%;"></td> <td style="width: 10%;"></td> <td style="width: 10%;"></td> </tr> <tr> <td></td> <td></td> <td colspan="8" style="text-align: center;"> <table border="1" style="width: 100%; border-collapse: collapse; text-align: center;"> <tr> <td style="width: 10%;"></td> <td style="width: 10%;"></td> <td style="width: 10%;"></td> <td style="width: 10%;"></td> <td style="width: 10%;"></td> <td style="width: 10%;"></td> <td style="width: 10%;"></td> <td style="width: 10%;"></td> <td style="width: 10%;"></td> <td style="width: 10%;"></td> </tr> <tr> <td></td> <td></td> <td colspan="8" style="text-align: center;"> <table border="1" style="width: 100%; border-collapse: collapse; text-align: center;"> <tr> <td style="width: 10%;"></td> <td style="width: 10%;"></td> <td style="width: 10%;"></td> <td style="width: 10%;"></td> <td style="width: 10%;"></td> <td style="width: 10%;"></td> <td style="width: 10%;"></td> <td style="width: 10%;"></td> <td style="width: 10%;"></td> <td style="width: 10%;"></td> </tr> <tr> <td></td> <td></td> <td colspan="8" style="text-align: center;"> <table border="1" style="width: 100%; border-collapse: collapse; text-align: center;"> <tr> <td style="width: 10%;"></td> <td style="width: 10%;"></td> <td style="width: 10%;"></td> <td style="width: 10%;"></td> <td style="width: 10%;"></td> <td style="width: 10%;"></td> <td style="width: 10%;"></td> <td style="width: 10%;"></td> <td style="width: 10%;"></td> <td style="width: 10%;"></td> </tr> <tr> <td></td> <td></td> <td colspan="8" style="text-align: center;"> <table border="1" style="width: 100%; border-collapse: collapse; text-align: center;"> <tr> <td style="width: 10%;"></td> <td style="width: 10%;"></td> <td style="width: 10%;"></td> <td style="width: 10%;"></td> <td style="width: 10%;"></td> <td style="width: 10%;"></td> <td style="width: 10%;"></td> <td style="width: 10%;"></td> <td style="width: 10%;"></td> <td style="width: 10%;"></td> </tr> <tr> <td></td> <td></td> <td colspan="8" style="text-align: center;"> <table border="1" style="width: 100%; border-collapse: collapse; text-align: center;"> <tr> <td style="width: 10%;"></td> <td style="width: 10%;"></td> <td style="width: 10%;"></td> <td style="width: 10%;"></td> <td style="width: 10%;"></td> <td style="width: 10%;"></td> <td style="width: 10%;"></td> <td style="width: 10%;"></td> <td style="width: 10%;"></td> <td style="width: 10%;"></td> </tr> <tr> <td></td> <td></td> <td colspan="8" style="text-align: center;"> <table border="1" style="width: 100%; border-collapse: collapse; text-align: center;"> <tr> <td style="width: 10%;"></td> <td style="width: 10%;"></td> <td style="width: 10%;"></td> <td style="width: 10%;"></td> <td style="width: 10%;"></td> <td style="width: 10%;"></td> <td style="width: 10%;"></td> <td style="width: 10%;"></td> <td style="width: 10%;"></td> <td style="width: 10%;"></td> </tr> <tr> <td></td> <td></td> <td colspan="8" style="text-align: center;"> <table border="1" style="width: 100%; border-collapse: collapse; text-align: center;"> <tr> <td style="width: 10%;"></td> <td style="width: 10%;"></td> <td style="width: 10%;"></td> <td style="width: 10%;"></td> <td style="width: 10%;"></td> <td style="width: 10%;"></td> <td style="width: 10%;"></td> <td style="width: 10%;"></td> <td style="width: 10%;"></td> <td style="width: 10%;"></td> </tr> <tr> <td></td> <td></td> <td colspan="8" style="text-align: center;"> <table border="1" style="width: 100%; border-collapse: collapse; text-align: center;"> <tr> <td style="width: 10%;"></td> <td style="width: 10%;"></td> <td style="width: 10%;"></td> <td style="width: 10%;"></td> <td style="width: 10%;"></td> <td style="width: 10%;"></td> <td style="width: 10%;"></td> <td style="width: 10%;"></td> <td style="width: 10%;"></td> <td style="width: 10%;"></td> </tr> <tr> <td></td> <td></td> <td colspan="8" style="text-align: center;"> <table border="1" style="width: 100%; border-collapse: collapse; text-align: center;"> <tr> <td style="width: 10%;"></td> <td style="width: 10%;"></td> <td style="width: 10%;"></td> <td style="width: 10%;"></td> <td style="width: 10%;"></td> <td style="width: 10%;"></td> <td style="width: 10%;"></td> <td style="width: 10%;"></td> <td style="width: 10%;"></td> <td style="width: 10%;"></td> </tr> <tr> <td></td> <td></td> <td colspan="8" style="text-align: center;"> <table border="1" style="width: 100%; border-collapse: collapse; text-align: center;"> <tr> <td style="width: 10%;"></td> <td style="width: 10%;"></td> <td style="width: 10%;"></td> <td style="width: 10%;"></td> <td style="width: 10%;"></td> <td style="width: 10%;"></td> <td style="width: 10%;"></td> <td style="width: 10%;"></td> <td style="width: 10%;"></td> <td style="width: 10%;"></td> </tr> <tr> <td></td> <td></td> <td colspan="8" style="text-align: center;"> <table border="1" style="width: 100%; border-collapse: collapse; text-align: center;"> <tr> <td style="width: 10%;"></td> <td style="width: 10%;"></td> <td style="width: 10%;"></td> <td style="width: 10%;"></td> <td style="width: 10%;"></td> <td style="width: 10%;"></td> <td style="width: 10%;"></td> <td style="width: 10%;"></td> <td style="width: 10%;"></td> <td style="width: 10%;"></td> </tr> <tr> <td></td> <td></td> <td colspan="8" style="text-align: center;"> <table border="1" style="width: 100%; border-collapse: collapse; text-align: center;"> <tr> <td style="width: 10%;"></td> <td style="width: 10%;"></td> <td style="width: 10%;"></td> <td style="width: 10%;"></td> <td style="width: 10%;"></td> <td style="width: 10%;"></td> <td style="width: 10%;"></td> <td style="width: 10%;"></td> <td style="width: 10%;"></td> <td style="width: 10%;"></td> </tr> <tr> <td></td> <td></td> <td colspan="8" style="text-align: center;"> <table border="1" style="width: 100%; border-collapse: collapse; text-align: center;"> <tr> <td style="width: 10%;"></td> <td style="width: 10%;"></td> <td style="width: 10%;"></td> <td style="width: 10%;"></td> <td style="width: 10%;"></td> <td style="width: 10%;"></td> <td style="width: 10%;"></td> <td style="width: 10%;"></td> <td style="width: 10%;"></td> <td style="width: 10%;"></td> </tr> <tr> <td></td> <td></td> <td colspan="8" style="text-align: center;"> <table border="1" style="width: 100%; border-collapse: collapse; text-align: center;"> <tr> <td style="width: 10%;"></td> <td style="width: 10%;"></td> <td style="width: 10%;"></td> <td style="width: 10%;"></td> <td style="width: 10%;"></td> <td style="width: 10%;"></td> <td style="width: 10%;"></td> <td style="width: 10%;"></td> <td style="width: 10%;"></td> <td style="width: 10%;"></td> </tr> <tr> <td></td> <td></td> <td colspan="8" style="text-align: center;"> <table border="1" style="width: 100%; border-collapse: collapse; text-align: center;"> <tr> <td style="width: 10%;"></td> <td style="width: 10%;"></td> <td style="width: 10%;"></td> <td style="width: 10%;"></td> <td style="width: 10%;"></td> <td style="width: 10%;"></td> <td style="width: 10%;"></td> <td style="width: 10%;"></td> <td style="width: 10%;"></td> <td style="width: 10%;"></td> </tr> <tr> <td></td> <td></td> <td colspan="8" style="text-align: center;"> <table border="1" style="width: 100%; border-collapse: collapse; text-align: center;"> <tr> <td style="width: 10%;"></td> <td style="width: 10%;"></td> <td style="width: 10%;"></td> <td style="width: 10%;"></td> <td style="width: 10%;"></td> <td style="width: 10%;"></td> <td style="width: 10%;"></td> <td style="width: 10%;"></td> <td style="width: 10%;"></td> <td style="width: 10%;"></td> </tr> <tr> <td></td> <td></td> <td colspan="8" style="text-align: center;"> <table border="1" style="width: 100%; border-collapse: collapse; text-align: center;"> <tr> <td style="width: 10%;"></td> <td style="width: 10%;"></td> <td style="width: 10%;"></td> <td style="width: 10%;"></td> <td style="width: 10%;"></td> <td style="width: 10%;"></td> <td style="width: 10%;"></td> <td style="width: 10%;"></td> <td style="width: 10%;"></td> <td style="width: 10%;"></td> </tr> <tr> <td></td> <td></td> <td colspan="8" style="text-align: center;"> <table border="1" style="width: 100%; border-collapse: collapse; text-align: center;"> <tr> <td style="width: 10%;"></td> <td style="width: 10%;"></td> <td style="width: 10%;"></td> <td style="width: 10%;"></td> <td style="width: 10%;"></td> <td style="width: 10%;"></td> <td style="width: 10%;"></td> <td style="width: 10%;"></td> <td style="width: 10%;"></td> <td style="width: 10%;"></td> </tr> <tr> <td></td> <td></td> <td colspan="8" style="text-align: center;"> <table border="1" style="width: 100%; border-collapse: collapse; text-align: center;"> <tr> <td style="width: 10%;"></td> <td style="width: 10%;"></td> <td style="width: 10%;"></td> <td style="width: 10%;"></td> <td style="width: 10%;"></td> <td style="width: 10%;"></td> <td style="width: 10%;"></td> <td style="width: 10%;"></td> <td style="width: 10%;"></td> <td style="width: 10%;"></td> </tr> <tr> <td></td> <td></td> <td colspan="8" style="text-align: center;"> <table border="1" style="width: 100%; border-collapse: collapse; text-align: center;"> <tr> <td style="width: 10%;"></td> <td style="width: 10%;"></td> <td style="width: 10%;"></td> <td style="width: 10%;"></td> <td style="width: 10%;"></td> <td style="width: 10%;"></td> <td style="width: 10%;"></td> <td style="width: 10%;"></td> <td style="width: 10%;"></td> <td style="width: 10%;"></td> </tr> <tr> <td></td> <td></td> <td colspan="8" style="text-align: center;"> <table border="1" style="width: 100%; border-collapse: collapse; text-align: center;"> <tr> <td style="width: 10%;"></td> <td style="width: 10%;"></td> <td style="width: 10%;"></td> <td style="width: 10%;"></td> <td style="width: 10%;"></td> <td style="width: 10%;"></td> <td style="width: 10%;"></td> <td style="width:
10%;"></td> <td style="width: 10%;"></td> <td style="width: 10%;"></td> </tr> <tr> <td></td> <td></td> <td colspan="8" style="text-align: center;"> <table border="1" style="width: 100%; border-collapse: collapse; text-align: center;"> <tr> <td style="width: 10%;"></td> <td style="width: 10%;"></td> <td style="width: 10%;"></td> <td style="width: 10%;"></td> <td style="width: 10%;"></td> <td style="width: 10%;"></td> <td style="width: 10%;"></td> <td style="width: 10%;"></td> <td style="width: 10%;"></td> <td style="width: 10%;"></td> </tr> <tr> <td></td> <td></td> <td colspan="8" style="text-align: center;"> <table border="1" style="width: 100%; border-collapse: collapse; text-align: center;"> <tr> <td style="width: 10%;"></td> <td style="width: 10%;"></td> <td style="width: 10%;"></td> <td style="width: 10%;"></td> <td style="width: 10%;"></td> <td style="width: 10%;"></td> <td style="width: 10%;"></td> <td style="width: 10%;"></td> <td style="width: 10%;"></td> <td style="width: 10%;"></td> </tr> <tr> <td></td> <td></td> <td colspan="8" style="text-align: center;"> <table border="1" style="width: 100%; border-collapse: collapse; text-align: center;"> <tr> <td style="width: 10%;"></td> <td style="width: 10%;"></td> <td style="width: 10%;"></td> <td style="width: 10%;"></td> <td style="width: 10%;"></td> <td style="width: 10%;"></td> <td style="width: 10%;"></td> <td style="width: 10%;"></td> <td style="width: 10%;"></td> <td style="width: 10%;"></td> </tr> <tr> <td></td> <td></td> <td colspan="8" style="text-align: center;"> <table border="1" style="width: 100%; border-collapse: collapse; text-align: center;"> <tr> <td style="width: 10%;"></td> <td style="width: 10%;"></td> <td style="width: 10%;"></td> <td style="width: 10%;"></td> <td style="width: 10%;"></td> <td style="width: 10%;"></td> <td style="width: 10%;"></td> <td style="width: 10%;"></td> <td style="width: 10%;"></td> <td style="width: 10%;"></td> </tr> <tr> <td></td> <td></td> <td colspan="8" style="text-align: center;"> <table border="1" style="width: 100%; border-collapse: collapse; text-align: center;"> <tr> <td style="width: 10%;"></td> <td style="width: 10%;"></td> <td style="width: 10%;"></td> <td style="width: 10%;"></td> <td style="width: 10%;"></td> <td style="width: 10%;"></td> <td style="width: 10%;"></td> <td style="width: 10%;"></td> <td style="width: 10%;"></td> <td style="width: 10%;"></td> </tr> <tr> <td></td> <td></td> <td colspan="8" style="text-align: center;"> <table border="1" style="width: 100%; border-collapse: collapse; text-align: center;"> <tr> <td style="width: 10%;"></td> <td style="width: 10%;"></td> <td style="width: 10%;"></td> <td style="width: 10%;"></td> <td style="width: 10%;"></td> <td style="width: 10%;"></td> <td style="width: 10%;"></td> <td style="width: 10%;"></td> <td style="width: 10%;"></td> <td style="width: 10%;"></td> </tr> <tr> <td></td> <td></td> <td colspan="8" style="text-align: center;"> <table border="1" style="width: 100%; border-collapse: collapse; text-align: center;"> <tr> </tr></table></td></tr></table></td></tr></table></td></tr></table></td></tr></table></td></tr></table></td></tr></table></td></tr></table></td></tr></table></td></tr></table></td></tr></table></td></tr></table></td></tr></table></td></tr></table></td></tr></table></td></tr></table></td></tr></table></td></tr></table></td></tr></table></td></tr></table></td></tr></table></td></tr></table></td></tr></table></td></tr></table></td></tr></table></td></tr></table></td></tr></table></td></tr></table></td></tr></table></td></tr></table></td></tr></table></td></tr></table></td></tr></table></td></tr></table></td></tr></table></td></tr></table></td></tr></table></td></tr></table></td></tr></table></td></tr></table></td></tr></table></td></tr></table></td></tr></table></td></tr></table></td></tr></table></td></tr></table></td></tr></table></td></tr></table></td></tr></table></td></tr></table>
 | | | | | | | | | | | | | | | | | | | | <table border="1" style="width: 100%; border-collapse: collapse; text-align: center;"> <tr> <td style="width: 10%;"></td> <td style="width: 10%;"></td> <td style="width: 10%;"></td> <td style="width: 10%;"></td> <td style="width: 10%;"></td> <td style="width: 10%;"></td> <td style="width: 10%;"></td> <td style="width: 10%;"></td> <td style="width: 10%;"></td> <td style="width: 10%;"></td> </tr> <tr> <td></td> <td></td> <td colspan="8" style="text-align: center;"> <table border="1" style="width: 100%; border-collapse: collapse; text-align: center;"> <tr> <td style="width: 10%;"></td> <td style="width: 10%;"></td> <td style="width: 10%;"></td> <td style="width: 10%;"></td> <td style="width: 10%;"></td> <td style="width: 10%;"></td> <td style="width: 10%;"></td> <td style="width: 10%;"></td> <td style="width: 10%;"></td> <td style="width: 10%;"></td> </tr> <tr> <td></td> <td></td> <td colspan="8" style="text-align: center;"> <table border="1" style="width: 100%; border-collapse: collapse; text-align: center;"> <tr> <td style="width: 10%;"></td> <td style="width: 10%;"></td> <td style="width: 10%;"></td> <td style="width: 10%;"></td> <td style="width: 10%;"></td> <td style="width: 10%;"></td> <td style="width: 10%;"></td> <td style="width: 10%;"></td> <td style="width: 10%;"></td> <td style="width: 10%;"></td> </tr> <tr> <td></td> <td></td> <td colspan="8" style="text-align: center;"> <table border="1" style="width: 100%; border-collapse: collapse; text-align: center;"> <tr> <td style="width: 10%;"></td> <td style="width: 10%;"></td> <td style="width: 10%;"></td> <td style="width: 10%;"></td> <td style="width: 10%;"></td> <td style="width: 10%;"></td> <td style="width: 10%;"></td> <td style="width: 10%;"></td> <td style="width: 10%;"></td> <td style="width: 10%;"></td> </tr> <tr> <td></td> <td></td> <td colspan="8" style="text-align: center;"> <table border="1" style="width: 100%; border-collapse: collapse; text-align: center;"> <tr> <td style="width: 10%;"></td> <td style="width: 10%;"></td> <td style="width: 10%;"></td> <td style="width: 10%;"></td> <td style="width: 10%;"></td> <td style="width: 10%;"></td> <td style="width: 10%;"></td> <td style="width: 10%;"></td> <td style="width: 10%;"></td> <td style="width: 10%;"></td> </tr> <tr> <td></td> <td></td> <td colspan="8" style="text-align: center;"> <table border="1" style="width: 100%; border-collapse: collapse; text-align: center;"> <tr> <td style="width: 10%;"></td> <td style="width: 10%;"></td> <td style="width: 10%;"></td> <td style="width: 10%;"></td> <td style="width: 10%;"></td> <td style="width: 10%;"></td> <td style="width: 10%;"></td> <td style="width: 10%;"></td> <td style="width: 10%;"></td> <td style="width: 10%;"></td> </tr> <tr> <td></td> <td></td> <td colspan="8" style="text-align: center;"> <table border="1" style="width: 100%; border-collapse: collapse; text-align: center;"> <tr> <td style="width: 10%;"></td> <td style="width: 10%;"></td> <td style="width: 10%;"></td> <td style="width: 10%;"></td> <td style="width: 10%;"></td> <td style="width: 10%;"></td> <td style="width: 10%;"></td> <td style="width: 10%;"></td> <td style="width: 10%;"></td> <td style="width: 10%;"></td> </tr> <tr> <td></td> <td></td> <td colspan="8" style="text-align: center;"> <table border="1" style="width: 100%; border-collapse: collapse; text-align: center;"> <tr> <td style="width: 10%;"></td> <td style="width: 10%;"></td> <td style="width: 10%;"></td> <td style="width: 10%;"></td> <td style="width: 10%;"></td> <td style="width: 10%;"></td> <td style="width: 10%;"></td> <td style="width: 10%;"></td> <td style="width: 10%;"></td> <td style="width: 10%;"></td> </tr> <tr> <td></td> <td></td> <td colspan="8" style="text-align: center;"> <table border="1" style="width: 100%; border-collapse: collapse; text-align: center;"> <tr> <td style="width: 10%;"></td> <td style="width: 10%;"></td> <td style="width: 10%;"></td> <td style="width: 10%;"></td> <td style="width: 10%;"></td> <td style="width: 10%;"></td> <td style="width: 10%;"></td> <td style="width: 10%;"></td> <td style="width: 10%;"></td> <td style="width: 10%;"></td> </tr> <tr> <td></td> <td></td> <td colspan="8" style="text-align: center;"> <table border="1" style="width: 100%; border-collapse: collapse; text-align: center;"> <tr> <td style="width: 10%;"></td> <td style="width: 10%;"></td> <td style="width: 10%;"></td> <td style="width: 10%;"></td> <td style="width: 10%;"></td> <td style="width: 10%;"></td> <td style="width: 10%;"></td> <td style="width: 10%;"></td> <td style="width: 10%;"></td> <td style="width: 10%;"></td> </tr> <tr> <td></td> <td></td> <td colspan="8" style="text-align: center;"> <table border="1" style="width: 100%; border-collapse: collapse; text-align: center;"> <tr> <td style="width: 10%;"></td> <td style="width: 10%;"></td> <td style="width: 10%;"></td> <td style="width: 10%;"></td> <td style="width: 10%;"></td> <td style="width: 10%;"></td> <td style="width: 10%;"></td> <td style="width: 10%;"></td> <td style="width: 10%;"></td> <td style="width: 10%;"></td> </tr> <tr> <td></td> <td></td> <td colspan="8" style="text-align: center;"> <table border="1" style="width: 100%; border-collapse: collapse; text-align: center;"> <tr> <td style="width: 10%;"></td> <td style="width: 10%;"></td> <td style="width: 10%;"></td> <td style="width: 10%;"></td> <td style="width: 10%;"></td> <td style="width: 10%;"></td> <td style="width: 10%;"></td> <td style="width: 10%;"></td> <td style="width: 10%;"></td> <td style="width: 10%;"></td> </tr> <tr> <td></td> <td></td> <td colspan="8" style="text-align: center;"> <table border="1" style="width: 100%; border-collapse: collapse; text-align: center;"> <tr> <td style="width: 10%;"></td> <td style="width: 10%;"></td> <td style="width: 10%;"></td> <td style="width: 10%;"></td> <td style="width: 10%;"></td> <td style="width: 10%;"></td> <td style="width: 10%;"></td> <td style="width: 10%;"></td> <td style="width: 10%;"></td> <td style="width: 10%;"></td> </tr> <tr> <td></td> <td></td> <td colspan="8" style="text-align: center;"> <table border="1" style="width: 100%; border-collapse: collapse; text-align: center;"> <tr> <td style="width: 10%;"></td> <td style="width: 10%;"></td> <td style="width: 10%;"></td> <td style="width: 10%;"></td> <td style="width: 10%;"></td> <td style="width: 10%;"></td> <td style="width: 10%;"></td> <td style="width: 10%;"></td> <td style="width: 10%;"></td> <td style="width: 10%;"></td> </tr> <tr> <td></td> <td></td> <td colspan="8" style="text-align: center;"> <table border="1" style="width: 100%; border-collapse: collapse; text-align: center;"> <tr> <td style="width: 10%;"></td> <td style="width: 10%;"></td> <td style="width: 10%;"></td> <td style="width: 10%;"></td> <td style="width: 10%;"></td> <td style="width: 10%;"></td> <td style="width: 10%;"></td> <td style="width: 10%;"></td> <td style="width: 10%;"></td> <td style="width: 10%;"></td> </tr> <tr> <td></td> <td></td> <td colspan="8" style="text-align: center;"> <table border="1" style="width: 100%; border-collapse: collapse; text-align: center;"> <tr> <td style="width: 10%;"></td> <td style="width: 10%;"></td> <td style="width: 10%;"></td> <td style="width: 10%;"></td> <td style="width: 10%;"></td> <td style="width: 10%;"></td> <td style="width: 10%;"></td> <td style="width: 10%;"></td> <td style="width: 10%;"></td> <td style="width: 10%;"></td> </tr> <tr> <td></td> <td></td> <td colspan="8" style="text-align: center;"> <table border="1" style="width: 100%; border-collapse: collapse; text-align: center;"> <tr> <td style="width: 10%;"></td> <td style="width: 10%;"></td> <td style="width: 10%;"></td> <td style="width: 10%;"></td> <td style="width: 10%;"></td> <td style="width: 10%;"></td> <td style="width: 10%;"></td> <td style="width: 10%;"></td> <td style="width: 10%;"></td> <td style="width: 10%;"></td> </tr> <tr> <td></td> <td></td> <td colspan="8" style="text-align: center;"> <table border="1" style="width: 100%; border-collapse: collapse; text-align: center;"> <tr> <td style="width: 10%;"></td> <td style="width: 10%;"></td> <td style="width: 10%;"></td> <td style="width: 10%;"></td> <td style="width: 10%;"></td> <td style="width: 10%;"></td> <td style="width: 10%;"></td> <td style="width: 10%;"></td> <td style="width: 10%;"></td> <td style="width: 10%;"></td> </tr> <tr> <td></td> <td></td> <td colspan="8" style="text-align: center;"> <table border="1" style="width: 100%; border-collapse: collapse; text-align: center;"> <tr> <td style="width: 10%;"></td> <td style="width: 10%;"></td> <td style="width: 10%;"></td> <td style="width: 10%;"></td> <td style="width: 10%;"></td> <td style="width:
10%;"></td> <td style="width: 10%;"></td> <td style="width: 10%;"></td> <td style="width: 10%;"></td> <td style="width: 10%;"></td> </tr> <tr> <td></td> <td></td> <td colspan="8" style="text-align: center;"> <table border="1" style="width: 100%; border-collapse: collapse; text-align: center;"> <tr> <td style="width: 10%;"></td> <td style="width: 10%;"></td> <td style="width: 10%;"></td> <td style="width: 10%;"></td> <td style="width: 10%;"></td> <td style="width: 10%;"></td> <td style="width: 10%;"></td> <td style="width: 10%;"></td> <td style="width: 10%;"></td> <td style="width: 10%;"></td> </tr> <tr> <td></td> <td></td> <td colspan="8" style="text-align: center;"> <table border="1" style="width: 100%; border-collapse: collapse; text-align: center;"> <tr> <td style="width: 10%;"></td> <td style="width: 10%;"></td> <td style="width: 10%;"></td> <td style="width: 10%;"></td> <td style="width: 10%;"></td> <td style="width: 10%;"></td> <td style="width: 10%;"></td> <td style="width: 10%;"></td> <td style="width: 10%;"></td> <td style="width: 10%;"></td> </tr> <tr> <td></td> <td></td> <td colspan="8" style="text-align: center;"> <table border="1" style="width: 100%; border-collapse: collapse; text-align: center;"> <tr> <td style="width: 10%;"></td> <td style="width: 10%;"></td> <td style="width: 10%;"></td> <td style="width: 10%;"></td> <td style="width: 10%;"></td> <td style="width: 10%;"></td> <td style="width: 10%;"></td> <td style="width: 10%;"></td> <td style="width: 10%;"></td> <td style="width: 10%;"></td> </tr> <tr> <td></td> <td></td> <td colspan="8" style="text-align: center;"> <table border="1" style="width: 100%; border-collapse: collapse; text-align: center;"> <tr> <td style="width: 10%;"></td> <td style="width: 10%;"></td> <td style="width: 10%;"></td> <td style="width: 10%;"></td> <td style="width: 10%;"></td> <td style="width: 10%;"></td> <td style="width: 10%;"></td> <td style="width: 10%;"></td> <td style="width: 10%;"></td> <td style="width: 10%;"></td> </tr> <tr> <td></td> <td></td> <td colspan="8" style="text-align: center;"> <table border="1" style="width: 100%; border-collapse: collapse; text-align: center;"> <tr> <td style="width: 10%;"></td> <td style="width: 10%;"></td> <td style="width: 10%;"></td> <td style="width: 10%;"></td> <td style="width: 10%;"></td> <td style="width: 10%;"></td> <td style="width: 10%;"></td> <td style="width: 10%;"></td> <td style="width: 10%;"></td> <td style="width: 10%;"></td> </tr> <tr> <td></td> <td></td> <td colspan="8" style="text-align: center;"> <table border="1" style="width: 100%; border-collapse: collapse; text-align: center;"> <tr> <td style="width: 10%;"></td> <td style="width: 10%;"></td> <td style="width: 10%;"></td> <td style="width: 10%;"></td> <td style="width: 10%;"></td> <td style="width: 10%;"></td> <td style="width: 10%;"></td> <td style="width: 10%;"></td> <td style="width: 10%;"></td> <td style="width: 10%;"></td> </tr> <tr> <td></td> <td></td> <td colspan="8" style="text-align: center;"> <table border="1" style="width: 100%; border-collapse: collapse; text-align: center;"> <tr> <td style="width: 10%;"></td> <td style="width: 10%;"></td> <td style="width: 10%;"></td> <td style="width: 10%;"></td> <td style="width: 10%;"></td> <td style="width: 10%;"></td> <td style="width: 10%;"></td> <td style="width: 10%;"></td> <td style="width: 10%;"></td> <td style="width: 10%;"></td> </tr> <tr> <td></td> <td></td> <td colspan="8" style="text-align: center;"> <table border="1" style="width: 100%; border-collapse: collapse; text-align: center;"> <tr> <td style="width: 10%;"></td> <td style="width: 10%;"></td> <td style="width: 10%;"></td> <td style="width: 10%;"></td> <td style="width: 10%;"></td> <td style="width: 10%;"></td> <td style="width: 10%;"></td> <td style="width: 10%;"></td> <td style="width: 10%;"></td> <td style="width: 10%;"></td> </tr> <tr> <td></td> <td></td> <td colspan="8" style="text-align: center;"> <table border="1" style="width: 100%; border-collapse: collapse; text-align: center;"> <tr> <td style="width: 10%;"></td> <td style="width: 10%;"></td> <td style="width: 10%;"></td> <td style="width: 10%;"></td> <td style="width: 10%;"></td> <td style="width: 10%;"></td> <td style="width: 10%;"></td> <td style="width: 10%;"></td> <td style="width: 10%;"></td> <td style="width: 10%;"></td> </tr> <tr> <td></td> <td></td> <td colspan="8" style="text-align: center;"> <table border="1" style="width: 100%; border-collapse: collapse; text-align: center;"> <tr> <td style="width: 10%;"></td> <td style="width: 10%;"></td> <td style="width: 10%;"></td> <td style="width: 10%;"></td> <td style="width: 10%;"></td> <td style="width: 10%;"></td> <td style="width: 10%;"></td> <td style="width: 10%;"></td> <td style="width: 10%;"></td> <td style="width: 10%;"></td> </tr> <tr> <td></td> <td></td> <td colspan="8" style="text-align: center;"> <table border="1" style="width: 100%; border-collapse: collapse; text-align: center;"> <tr> <td style="width: 10%;"></td> <td style="width: 10%;"></td> <td style="width: 10%;"></td> <td style="width: 10%;"></td> <td style="width: 10%;"></td> <td style="width: 10%;"></td> <td style="width: 10%;"></td> <td style="width: 10%;"></td> <td style="width: 10%;"></td> <td style="width: 10%;"></td> </tr> <tr> <td></td> <td></td> <td colspan="8" style="text-align: center;"> <table border="1" style="width: 100%; border-collapse: collapse; text-align: center;"> <tr> <td style="width: 10%;"></td> <td style="width: 10%;"></td> <td style="width: 10%;"></td> <td style="width: 10%;"></td> <td style="width: 10%;"></td> <td style="width: 10%;"></td> <td style="width: 10%;"></td> <td style="width: 10%;"></td> <td style="width: 10%;"></td> <td style="width: 10%;"></td> </tr> <tr> <td></td> <td></td> <td colspan="8" style="text-align: center;"> <table border="1" style="width: 100%; border-collapse: collapse; text-align: center;"> <tr> <td style="width: 10%;"></td> <td style="width: 10%;"></td> <td style="width: 10%;"></td> <td style="width: 10%;"></td> <td style="width: 10%;"></td> <td style="width: 10%;"></td> <td style="width: 10%;"></td> <td style="width: 10%;"></td> <td style="width: 10%;"></td> <td style="width: 10%;"></td> </tr> <tr> <td></td> <td></td> <td colspan="8" style="text-align: center;"> <table border="1" style="width: 100%; border-collapse: collapse; text-align: center;"> <tr> <td style="width: 10%;"></td> <td style="width: 10%;"></td> <td style="width: 10%;"></td> <td style="width: 10%;"></td> <td style="width: 10%;"></td> <td style="width: 10%;"></td> <td style="width: 10%;"></td> <td style="width: 10%;"></td> <td style="width: 10%;"></td> <td style="width: 10%;"></td> </tr> <tr> <td></td> <td></td> <td colspan="8" style="text-align: center;"> <table border="1" style="width: 100%; border-collapse: collapse; text-align: center;"> <tr> <td style="width: 10%;"></td> <td style="width: 10%;"></td> <td style="width: 10%;"></td> <td style="width: 10%;"></td> <td style="width: 10%;"></td> <td style="width: 10%;"></td> <td style="width: 10%;"></td> <td style="width: 10%;"></td> <td style="width: 10%;"></td> <td style="width: 10%;"></td> </tr> <tr> <td></td> <td></td> <td colspan="8" style="text-align: center;"> <table border="1" style="width: 100%; border-collapse: collapse; text-align: center;"> <tr> <td style="width: 10%;"></td> <td style="width: 10%;"></td> <td style="width: 10%;"></td> <td style="width: 10%;"></td> <td style="width: 10%;"></td> <td style="width: 10%;"></td> <td style="width: 10%;"></td> <td style="width: 10%;"></td> <td style="width: 10%;"></td> <td style="width: 10%;"></td> </tr> <tr> <td></td> <td></td> <td colspan="8" style="text-align: center;"> <table border="1" style="width: 100%; border-collapse: collapse; text-align: center;"> <tr> <td style="width: 10%;"></td> <td style="width: 10%;"></td> <td style="width: 10%;"></td> <td style="width: 10%;"></td> <td style="width: 10%;"></td> <td style="width: 10%;"></td> <td style="width: 10%;"></td> <td style="width: 10%;"></td> <td style="width: 10%;"></td> <td style="width: 10%;"></td> </tr> <tr> <td></td> <td></td> <td colspan="8" style="text-align: center;"> <table border="1" style="width: 100%; border-collapse: collapse; text-align: center;"> <tr> <td style="width: 10%;"></td> <td style="width: 10%;"></td> <td style="width: 10%;"></td> <td style="width: 10%;"></td> <td style="width: 10%;"></td> <td style="width: 10%;"></td> <td style="width: 10%;"></td> <td style="width: 10%;"></td> <td style="width: 10%;"></td> <td style="width: 10%;"></td> </tr> <tr> <td></td> <td></td> <td colspan="8" style="text-align: center;"> <table border="1" style="width: 100%; border-collapse: collapse; text-align: center;"> <tr> <td style="width: 10%;"></td> <td style="width: 10%;"></td> <td style="width: 10%;"></td> <td style="width: 10%;"></td> <td style="width: 10%;"></td> <td style="width: 10%;"></td> <td style="width: 10%;"></td> <td style="width: 10%;"></td> <td style="width: 10%;"></td> <td style="width: 10%;"></td> </tr> <tr> <td></td> <td></td> <td colspan="8" style="text-align: center;"> <table border="1" style="width: 100%; border-collapse: collapse; text-align: center;"> <tr> <td style="width: 10%;"></td> <td style="width: 10%;"></td> <td style="width: 10%;"></td> <td style="width: 10%;"></td> <td style="width: 10%;"></td> <td style="width: 10%;"></td> <td style="width: 10%;"></td> <td style="width: 10%;"></td> <td style="width: 10%;"></td> <td style="width: 10%;"></td> </tr> <tr> <td></td> <td></td> <td colspan="8" style="text-align: center;"> <table border="1" style="width: 100%; border-collapse: collapse; text-align: center;"> <tr> <td style="width: 10%;"></td> <td style="width: 10%;"></td> <td style="width: 10%;"></td> <td style="width: 10%;"></td> <td style="width: 10%;"></td> <td style="width: 10%;"></td> <td style="width: 10%;"></td> <td style="width: 10%;"></td> <td style="width: 10%;"></td> <td style="width: 10%;"></td> </tr> <tr> <td></td> <td></td> <td
colspan="8" style="text-align: center;"> <table border="1" style="width: 100%; border-collapse: collapse; text-align: center;"> <tr> <td style="width: 10%;"></td> <td style="width: 10%;"></td> <td style="width: 10%;"></td> <td style="width: 10%;"></td> <td style="width: 10%;"></td> <td style="width: 10%;"></td> <td style="width: 10%;"></td> <td style="width: 10%;"></td> <td style="width: 10%;"></td> <td style="width: 10%;"></td> </tr> <tr> <td></td> <td></td> <td colspan="8" style="text-align: center;"> <table border="1" style="width: 100%; border-collapse: collapse; text-align: center;"> <tr> <td style="width: 10%;"></td> <td style="width: 10%;"></td> <td style="width: 10%;"></td> <td style="width: 10%;"></td> <td style="width: 10%;"></td> <td style="width: 10%;"></td> <td style="width: 10%;"></td> <td style="width: 10%;"></td> <td style="width: 10%;"></td> <td style="width: 10%;"></td> </tr> <tr> <td></td> <td></td> <td colspan="8" style="text-align: center;"> <table border="1" style="width: 100%; border-collapse: collapse; text-align: center;"> <tr> <td style="width: 10%;"></td> <td style="width: 10%;"></td> <td style="width: 10%;"></td> <td style="width: 10%;"></td> <td style="width: 10%;"></td> <td style="width: 10%;"></td> <td style="width: 10%;"></td> <td style="width: 10%;"></td> <td style="width: 10%;"></td> <td style="width: 10%;"></td> </tr> <tr> <td></td> <td></td> <td colspan="8" style="text-align: center;"> <table border="1" style="width: 100%; border-collapse: collapse; text-align: center;"> <tr> <td style="width: 10%;"></td> <td style="width: 10%;"></td> <td style="width: 10%;"></td> <td style="width: 10%;"></td> <td style="width: 10%;"></td> <td style="width: 10%;"></td> <td style="width: 10%;"></td> <td style="width: 10%;"></td> <td style="width: 10%;"></td> <td style="width: 10%;"></td> </tr> <tr> <td></td> <td></td> <td colspan="8" style="text-align: center;"> <table border="1" style="width: 100%; border-collapse: collapse; text-align: center;"> <tr> <td style="width: 10%;"></td> <td style="width: 10%;"></td> <td style="width: 10%;"></td> <td style="width: 10%;"></td> <td style="width: 10%;"></td> <td style="width: 10%;"></td> <td style="width: 10%;"></td> <td style="width: 10%;"></td> <td style="width: 10%;"></td> <td style="width: 10%;"></td> </tr> <tr> <td></td> <td></td> <td colspan="8" style="text-align: center;"> <table border="1" style="width: 100%; border-collapse: collapse; text-align: center;"> <tr> <td style="width: 10%;"></td> <td style="width: 10%;"></td> <td style="width: 10%;"></td> <td style="width: 10%;"></td> <td style="width: 10%;"></td> <td style="width: 10%;"></td> <td style="width: 10%;"></td> <td style="width: 10%;"></td> <td style="width: 10%;"></td> <td style="width: 10%;"></td> </tr> <tr> <td></td> <td></td> <td colspan="8" style="text-align: center;"> <table border="1" style="width: 100%; border-collapse: collapse; text-align: center;"> <tr> <td style="width: 10%;"></td> <td style="width: 10%;"></td> <td style="width: 10%;"></td> <td style="width: 10%;"></td> <td style="width: 10%;"></td> <td style="width: 10%;"></td> <td style="width: 10%;"></td> <td style="width: 10%;"></td> <td style="width: 10%;"></td> <td style="width: 10%;"></td> </tr> <tr> <td></td> <td></td> <td colspan="8" style="text-align: center;"> <table border="1" style="width: 100%; border-collapse: collapse; text-align: center;"> <tr> <td style="width: 10%;"></td> <td style="width: 10%;"></td> <td style="width: 10%;"></td> <td style="width: 10%;"></td> <td style="width: 10%;"></td> <td style="width: 10%;"></td> <td style="width: 10%;"></td> <td style="width: 10%;"></td> <td style="width: 10%;"></td> <td style="width: 10%;"></td> </tr> <tr> <td></td> <td></td> <td colspan="8" style="text-align: center;"> <table border="1" style="width: 100%; border-collapse: collapse; text-align: center;"> <tr> </tr></table></td></tr></table></td></tr></table></td></tr></table></td></tr></table></td></tr></table></td></tr></table></td></tr></table></td></tr></table></td></tr></table></td></tr></table></td></tr></table></td></tr></table></td></tr></table></td></tr></table></td></tr></table></td></tr></table></td></tr></table></td></tr></table></td></tr></table></td></tr></table></td></tr></table></td></tr></table></td></tr></table></td></tr></table></td></tr></table></td></tr></table></td></tr></table></td></tr></table></td></tr></table></td></tr></table></td></tr></table></td></tr></table></td></tr></table></td></tr></table></td></tr></table></td></tr></table></td></tr></table></td></tr></table></td></tr></table></td></tr></table></td></tr></table></td></tr></table></td></tr></table></td></tr></table></td></tr></table></td></tr></table></td></tr></table></td></tr></table>
 | | | | | | | | | | | | | | | | | | | | <table border="1" style="width: 100%; border-collapse: collapse; text-align: center;"> <tr> <td style="width: 10%;"></td> <td style="width: 10%;"></td> <td style="width: 10%;"></td> <td style="width: 10%;"></td> <td style="width: 10%;"></td> <td style="width: 10%;"></td> <td style="width: 10%;"></td> <td style="width: 10%;"></td> <td style="width: 10%;"></td> <td style="width: 10%;"></td> </tr> <tr> <td></td> <td></td> <td colspan="8" style="text-align: center;"> <table border="1" style="width: 100%; border-collapse: collapse; text-align: center;"> <tr> <td style="width: 10%;"></td> <td style="width: 10%;"></td> <td style="width: 10%;"></td> <td style="width: 10%;"></td> <td style="width: 10%;"></td> <td style="width: 10%;"></td> <td style="width: 10%;"></td> <td style="width: 10%;"></td> <td style="width: 10%;"></td> <td style="width: 10%;"></td> </tr> <tr> <td></td> <td></td> <td colspan="8" style="text-align: center;"> <table border="1" style="width: 100%; border-collapse: collapse; text-align: center;"> <tr> <td style="width: 10%;"></td> <td style="width: 10%;"></td> <td style="width: 10%;"></td> <td style="width: 10%;"></td> <td style="width: 10%;"></td> <td style="width: 10%;"></td> <td style="width: 10%;"></td> <td style="width: 10%;"></td> <td style="width: 10%;"></td> <td style="width: 10%;"></td> </tr> <tr> <td></td> <td></td> <td colspan="8" style="text-align: center;"> <table border="1" style="width: 100%; border-collapse: collapse; text-align: center;"> <tr> <td style="width: 10%;"></td> <td style="width: 10%;"></td> <td style="width: 10%;"></td> <td style="width: 10%;"></td> <td style="width: 10%;"></td> <td style="width: 10%;"></td> <td style="width: 10%;"></td> <td style="width: 10%;"></td> <td style="width: 10%;"></td> <td style="width: 10%;"></td> </tr> <tr> <td></td> <td></td> <td colspan="8" style="text-align: center;"> <table border="1" style="width: 100%; border-collapse: collapse; text-align: center;"> <tr> <td style="width: 10%;"></td> <td style="width: 10%;"></td> <td style="width: 10%;"></td> <td style="width: 10%;"></td> <td style="width: 10%;"></td> <td style="width: 10%;"></td> <td style="width: 10%;"></td> <td style="width: 10%;"></td> <td style="width: 10%;"></td> <td style="width: 10%;"></td> </tr> <tr> <td></td> <td></td> <td colspan="8" style="text-align: center;"> <table border="1" style="width: 100%; border-collapse: collapse; text-align: center;"> <tr> <td style="width: 10%;"></td> <td style="width: 10%;"></td> <td style="width: 10%;"></td> <td style="width: 10%;"></td> <td style="width: 10%;"></td> <td style="width: 10%;"></td> <td style="width: 10%;"></td> <td style="width: 10%;"></td> <td style="width: 10%;"></td> <td style="width: 10%;"></td> </tr> <tr> <td></td> <td></td> <td colspan="8" style="text-align: center;"> <table border="1" style="width: 100%; border-collapse: collapse; text-align: center;"> <tr> <td style="width: 10%;"></td> <td style="width: 10%;"></td> <td style="width: 10%;"></td> <td style="width: 10%;"></td> <td style="width: 10%;"></td> <td style="width: 10%;"></td> <td style="width: 10%;"></td> <td style="width: 10%;"></td> <td style="width: 10%;"></td> <td style="width: 10%;"></td> </tr> <tr> <td></td> <td></td> <td colspan="8" style="text-align: center;"> <table border="1" style="width: 100%; border-collapse: collapse; text-align: center;"> <tr> <td style="width: 10%;"></td> <td style="width: 10%;"></td> <td style="width: 10%;"></td> <td style="width: 10%;"></td> <td style="width: 10%;"></td> <td style="width: 10%;"></td> <td style="width: 10%;"></td> <td style="width: 10%;"></td> <td style="width: 10%;"></td> <td style="width: 10%;"></td> </tr> <tr> <td></td> <td></td> <td colspan="8" style="text-align: center;"> <table border="1" style="width: 100%; border-collapse: collapse; text-align: center;"> <tr> <td style="width: 10%;"></td> <td style="width: 10%;"></td> <td style="width: 10%;"></td> <td style="width: 10%;"></td> <td style="width: 10%;"></td> <td style="width: 10%;"></td> <td style="width: 10%;"></td> <td style="width: 10%;"></td> <td style="width: 10%;"></td> <td style="width: 10%;"></td> </tr> <tr> <td></td> <td></td> <td colspan="8" style="text-align: center;"> <table border="1" style="width: 100%; border-collapse: collapse; text-align: center;"> <tr> <td style="width: 10%;"></td> <td style="width: 10%;"></td> <td style="width: 10%;"></td> <td style="width: 10%;"></td> <td style="width: 10%;"></td> <td style="width: 10%;"></td> <td style="width: 10%;"></td> <td style="width: 10%;"></td> <td style="width: 10%;"></td> <td style="width: 10%;"></td> </tr> <tr> <td></td> <td></td> <td colspan="8" style="text-align: center;"> <table border="1" style="width: 100%; border-collapse: collapse; text-align: center;"> <tr> <td style="width: 10%;"></td> <td style="width: 10%;"></td> <td style="width: 10%;"></td> <td style="width: 10%;"></td> <td style="width: 10%;"></td> <td style="width: 10%;"></td> <td style="width: 10%;"></td> <td style="width: 10%;"></td> <td style="width: 10%;"></td> <td style="width: 10%;"></td> </tr> <tr> <td></td> <td></td> <td colspan="8" style="text-align: center;"> <table border="1" style="width: 100%; border-collapse: collapse; text-align: center;"> <tr> <td style="width: 10%;"></td> <td style="width: 10%;"></td> <td style="width: 10%;"></td> <td style="width: 10%;"></td> <td style="width: 10%;"></td> <td style="width: 10%;"></td> <td style="width: 10%;"></td> <td style="width: 10%;"></td> <td style="width: 10%;"></td> <td style="width: 10%;"></td> </tr> <tr> <td></td> <td></td> <td colspan="8" style="text-align: center;"> <table border="1" style="width: 100%; border-collapse: collapse; text-align: center;"> <tr> <td style="width: 10%;"></td> <td style="width: 10%;"></td> <td style="width: 10%;"></td> <td style="width: 10%;"></td> <td style="width: 10%;"></td> <td style="width: 10%;"></td> <td style="width: 10%;"></td> <td style="width: 10%;"></td> <td style="width: 10%;"></td> <td style="width: 10%;"></td> </tr> <tr> <td></td> <td></td> <td colspan="8" style="text-align: center;"> <table border="1" style="width: 100%; border-collapse: collapse; text-align: center;"> <tr> <td style="width: 10%;"></td> <td style="width: 10%;"></td> <td style="width: 10%;"></td> <td style="width: 10%;"></td> <td style="width: 10%;"></td> <td style="width: 10%;"></td> <td style="width: 10%;"></td> <td style="width: 10%;"></td> <td style="width: 10%;"></td> <td style="width: 10%;"></td> </tr> <tr> <td></td> <td></td> <td colspan="8" style="text-align: center;"> <table border="1" style="width: 100%; border-collapse: collapse; text-align: center;"> <tr> <td style="width: 10%;"></td> <td style="width: 10%;"></td> <td style="width: 10%;"></td> <td style="width: 10%;"></td> <td style="width: 10%;"></td> <td style="width: 10%;"></td> <td style="width: 10%;"></td> <td style="width: 10%;"></td> <td style="width: 10%;"></td> <td style="width: 10%;"></td> </tr> <tr> <td></td> <td></td> <td colspan="8" style="text-align: center;"> <table border="1" style="width: 100%; border-collapse: collapse; text-align: center;"> <tr> <td style="width: 10%;"></td> <td style="width: 10%;"></td> <td style="width: 10%;"></td> <td style="width: 10%;"></td> <td style="width: 10%;"></td> <td style="width: 10%;"></td> <td style="width: 10%;"></td> <td style="width: 10%;"></td> <td style="width: 10%;"></td> <td style="width: 10%;"></td> </tr> <tr> <td></td> <td></td> <td colspan="8" style="text-align: center;"> <table border="1" style="width: 100%; border-collapse: collapse; text-align: center;"> <tr> <td style="width: 10%;"></td> <td style="width: 10%;"></td> <td style="width: 10%;"></td> <td style="width: 10%;"></td> <td style="width: 10%;"></td> <td style="width: 10%;"></td> <td style="width: 10%;"></td> <td style="width: 10%;"></td> <td style="width: 10%;"></td> <td style="width: 10%;"></td> </tr> <tr>
<td></td> <td></td> <td colspan="8" style="text-align: center;"> <table border="1" style="width: 100%; border-collapse: collapse; text-align: center;"> <tr> <td style="width: 10%;"></td> <td style="width: 10%;"></td> <td style="width: 10%;"></td> <td style="width: 10%;"></td> <td style="width: 10%;"></td> <td style="width: 10%;"></td> <td style="width: 10%;"></td> <td style="width: 10%;"></td> <td style="width: 10%;"></td> <td style="width: 10%;"></td> </tr> <tr> <td></td> <td></td> <td colspan="8" style="text-align: center;"> <table border="1" style="width: 100%; border-collapse: collapse; text-align: center;"> <tr> <td style="width: 10%;"></td> <td style="width: 10%;"></td> <td style="width: 10%;"></td> <td style="width: 10%;"></td> <td style="width: 10%;"></td> <td style="width: 10%;"></td> <td style="width: 10%;"></td> <td style="width: 10%;"></td> <td style="width: 10%;"></td> <td style="width: 10%;"></td> </tr> <tr> <td></td> <td></td> <td colspan="8" style="text-align: center;"> <table border="1" style="width: 100%; border-collapse: collapse; text-align: center;"> <tr> <td style="width: 10%;"></td> <td style="width: 10%;"></td> <td style="width: 10%;"></td> <td style="width: 10%;"></td> <td style="width: 10%;"></td> <td style="width: 10%;"></td> <td style="width: 10%;"></td> <td style="width: 10%;"></td> <td style="width: 10%;"></td> <td style="width: 10%;"></td> </tr> <tr> <td></td> <td></td> <td colspan="8" style="text-align: center;"> <table border="1" style="width: 100%; border-collapse: collapse; text-align: center;"> <tr> <td style="width: 10%;"></td> <td style="width: 10%;"></td> <td style="width: 10%;"></td> <td style="width: 10%;"></td> <td style="width: 10%;"></td> <td style="width: 10%;"></td> <td style="width: 10%;"></td> <td style="width: 10%;"></td> <td style="width: 10%;"></td> <td style="width: 10%;"></td> </tr> <tr> <td></td> <td></td> <td colspan="8" style="text-align: center;"> <table border="1" style="width: 100%; border-collapse: collapse; text-align: center;"> <tr> <td style="width: 10%;"></td> <td style="width: 10%;"></td> <td style="width: 10%;"></td> <td style="width: 10%;"></td> <td style="width: 10%;"></td> <td style="width: 10%;"></td> <td style="width: 10%;"></td> <td style="width: 10%;"></td> <td style="width: 10%;"></td> <td style="width: 10%;"></td> </tr> <tr> <td></td> <td></td> <td colspan="8" style="text-align: center;"> <table border="1" style="width: 100%; border-collapse: collapse; text-align: center;"> <tr> <td style="width: 10%;"></td> <td style="width: 10%;"></td> <td style="width: 10%;"></td> <td style="width: 10%;"></td> <td style="width: 10%;"></td> <td style="width: 10%;"></td> <td style="width: 10%;"></td> <td style="width: 10%;"></td> <td style="width: 10%;"></td> <td style="width: 10%;"></td> </tr> <tr> <td></td> <td></td> <td colspan="8" style="text-align: center;"> <table border="1" style="width: 100%; border-collapse: collapse; text-align: center;"> <tr> <td style="width: 10%;"></td> <td style="width: 10%;"></td> <td style="width: 10%;"></td> <td style="width: 10%;"></td> <td style="width: 10%;"></td> <td style="width: 10%;"></td> <td style="width: 10%;"></td> <td style="width: 10%;"></td> <td style="width: 10%;"></td> <td style="width: 10%;"></td> </tr> <tr> <td></td> <td></td> <td colspan="8" style="text-align: center;"> <table border="1" style="width: 100%; border-collapse: collapse; text-align: center;"> <tr> <td style="width: 10%;"></td> <td style="width: 10%;"></td> <td style="width: 10%;"></td> <td style="width: 10%;"></td> <td style="width: 10%;"></td> <td style="width: 10%;"></td> <td style="width: 10%;"></td> <td style="width: 10%;"></td> <td style="width: 10%;"></td> <td style="width: 10%;"></td> </tr> <tr> <td></td> <td></td> <td colspan="8" style="text-align: center;"> <table border="1" style="width: 100%; border-collapse: collapse; text-align: center;"> <tr> <td style="width: 10%;"></td> <td style="width: 10%;"></td> <td style="width: 10%;"></td> <td style="width: 10%;"></td> <td style="width: 10%;"></td> <td style="width: 10%;"></td> <td style="width: 10%;"></td> <td style="width: 10%;"></td> <td style="width: 10%;"></td> <td style="width: 10%;"></td> </tr> <tr> <td></td> <td></td> <td colspan="8" style="text-align: center;"> <table border="1" style="width: 100%; border-collapse: collapse; text-align: center;"> <tr> <td style="width: 10%;"></td> <td style="width: 10%;"></td> <td style="width: 10%;"></td> <td style="width: 10%;"></td> <td style="width: 10%;"></td> <td style="width: 10%;"></td> <td style="width: 10%;"></td> <td style="width: 10%;"></td> <td style="width: 10%;"></td> <td style="width: 10%;"></td> </tr> <tr> <td></td> <td></td> <td colspan="8" style="text-align: center;"> <table border="1" style="width: 100%; border-collapse: collapse; text-align: center;"> <tr> <td style="width: 10%;"></td> <td style="width: 10%;"></td> <td style="width: 10%;"></td> <td style="width: 10%;"></td> <td style="width: 10%;"></td> <td style="width: 10%;"></td> <td style="width: 10%;"></td> <td style="width: 10%;"></td> <td style="width: 10%;"></td> <td style="width: 10%;"></td> </tr> <tr> <td></td> <td></td> <td colspan="8" style="text-align: center;"> <table border="1" style="width: 100%; border-collapse: collapse; text-align: center;"> <tr> <td style="width: 10%;"></td> <td style="width: 10%;"></td> <td style="width: 10%;"></td> <td style="width: 10%;"></td> <td style="width: 10%;"></td> <td style="width: 10%;"></td> <td style="width: 10%;"></td> <td style="width: 10%;"></td> <td style="width: 10%;"></td> <td style="width: 10%;"></td> </tr> <tr> <td></td> <td></td> <td colspan="8" style="text-align: center;"> <table border="1" style="width: 100%; border-collapse: collapse; text-align: center;"> <tr> <td style="width: 10%;"></td> <td style="width: 10%;"></td> <td style="width: 10%;"></td> <td style="width: 10%;"></td> <td style="width: 10%;"></td> <td style="width: 10%;"></td> <td style="width: 10%;"></td> <td style="width: 10%;"></td> <td style="width: 10%;"></td> <td style="width: 10%;"></td> </tr> <tr> <td></td> <td></td> <td colspan="8" style="text-align: center;"> <table border="1" style="width: 100%; border-collapse: collapse; text-align: center;"> <tr> <td style="width: 10%;"></td> <td style="width: 10%;"></td> <td style="width: 10%;"></td> <td style="width: 10%;"></td> <td style="width: 10%;"></td> <td style="width: 10%;"></td> <td style="width: 10%;"></td> <td style="width: 10%;"></td> <td style="width: 10%;"></td> <td style="width: 10%;"></td> </tr> <tr> <td></td> <td></td> <td colspan="8" style="text-align: center;"> <table border="1" style="width: 100%; border-collapse: collapse; text-align: center;"> <tr> <td style="width: 10%;"></td> <td style="width: 10%;"></td> <td style="width: 10%;"></td> <td style="width: 10%;"></td> <td style="width: 10%;"></td> <td style="width: 10%;"></td> <td style="width: 10%;"></td> <td style="width: 10%;"></td> <td style="width: 10%;"></td> <td style="width: 10%;"></td> </tr> <tr> <td></td> <td></td> <td colspan="8" style="text-align: center;"> <table border="1" style="width: 100%; border-collapse: collapse; text-align: center;"> <tr> <td style="width: 10%;"></td> <td style="width: 10%;"></td> <td style="width: 10%;"></td> <td style="width: 10%;"></td> <td style="width: 10%;"></td> <td style="width: 10%;"></td> <td style="width: 10%;"></td> <td style="width: 10%;"></td> <td style="width: 10%;"></td> <td style="width: 10%;"></td> </tr> <tr> <td></td> <td></td> <td colspan="8" style="text-align: center;"> <table border="1" style="width: 100%; border-collapse: collapse; text-align: center;"> <tr> <td style="width: 10%;"></td> <td style="width: 10%;"></td> <td style="width: 10%;"></td> <td style="width: 10%;"></td> <td style="width: 10%;"></td> <td style="width: 10%;"></td> <td style="width: 10%;"></td> <td style="width: 10%;"></td> <td style="width: 10%;"></td> <td style="width: 10%;"></td> </tr> <tr> <td></td> <td></td> <td colspan="8" style="text-align: center;"> <table border="1" style="width: 100%; border-collapse: collapse; text-align: center;"> <tr> <td style="width: 10%;"></td> <td style="width: 10%;"></td> <td style="width: 10%;"></td> <td style="width: 10%;"></td> <td style="width: 10%;"></td> <td style="width: 10%;"></td> <td style="width: 10%;"></td> <td style="width: 10%;"></td> <td style="width: 10%;"></td> <td style="width: 10%;"></td> </tr> <tr> <td></td> <td></td> <td colspan="8" style="text-align: center;"> <table border="1" style="width: 100%; border-collapse: collapse; text-align: center;"> <tr> <td style="width: 10%;"></td> <td style="width: 10%;"></td> <td style="width: 10%;"></td> <td style="width: 10%;"></td> <td style="width: 10%;"></td> <td style="width: 10%;"></td> <td style="width: 10%;"></td> <td style="width: 10%;"></td> <td style="width: 10%;"></td> <td style="width: 10%;"></td> </tr> <tr> <td></td> <td></td> <td colspan="8" style="text-align: center;"> <table border="1" style="width: 100%; border-collapse: collapse; text-align: center;"> <tr> <td style="width: 10%;"></td> <td style="width: 10%;"></td> <td style="width: 10%;"></td> <td style="width: 10%;"></td> <td style="width: 10%;"></td> <td style="width: 10%;"></td> <td style="width: 10%;"></td> <td style="width: 10%;"></td> <td style="width: 10%;"></td> <td style="width: 10%;"></td> </tr> <tr> <td></td> <td></td> <td colspan="8" style="text-align: center;"> <table border="1" style="width: 100%; border-collapse: collapse; text-align: center;"> <tr> <td style="width: 10%;"></td> <td style="width: 10%;"></td> <td style="width: 10%;"></td> <td style="width: 10%;"></td> <td style="width: 10%;"></td> <td style="width: 10%;"></td> <td style="width: 10%;"></td> <td style="width: 10%;"></td> <td style="width: 10%;"></td> <td style="width: 10%;"></td> </tr> <tr> <td></td> <td></td> <td colspan="8" style="text-align: center;"> <table border="1" style="width: 100%; border-collapse: collapse; text-align: center;"> <tr> <td
style="width: 10%;"></td> <td style="width: 10%;"></td> <td style="width: 10%;"></td> <td style="width: 10%;"></td> <td style="width: 10%;"></td> <td style="width: 10%;"></td> <td style="width: 10%;"></td> <td style="width: 10%;"></td> <td style="width: 10%;"></td> <td style="width: 10%;"></td> </tr> <tr> <td></td> <td></td> <td colspan="8" style="text-align: center;"> <table border="1" style="width: 100%; border-collapse: collapse; text-align: center;"> <tr> <td style="width: 10%;"></td> <td style="width: 10%;"></td> <td style="width: 10%;"></td> <td style="width: 10%;"></td> <td style="width: 10%;"></td> <td style="width: 10%;"></td> <td style="width: 10%;"></td> <td style="width: 10%;"></td> <td style="width: 10%;"></td> <td style="width: 10%;"></td> </tr> <tr> <td></td> <td></td> <td colspan="8" style="text-align: center;"> <table border="1" style="width: 100%; border-collapse: collapse; text-align: center;"> <tr> <td style="width: 10%;"></td> <td style="width: 10%;"></td> <td style="width: 10%;"></td> <td style="width: 10%;"></td> <td style="width: 10%;"></td> <td style="width: 10%;"></td> <td style="width: 10%;"></td> <td style="width: 10%;"></td> <td style="width: 10%;"></td> <td style="width: 10%;"></td> </tr> <tr> <td></td> <td></td> <td colspan="8" style="text-align: center;"> <table border="1" style="width: 100%; border-collapse: collapse; text-align: center;"> <tr> <td style="width: 10%;"></td> <td style="width: 10%;"></td> <td style="width: 10%;"></td> <td style="width: 10%;"></td> <td style="width: 10%;"></td> <td style="width: 10%;"></td> <td style="width: 10%;"></td> <td style="width: 10%;"></td> <td style="width: 10%;"></td> <td style="width: 10%;"></td> </tr> <tr> <td></td> <td></td> <td colspan="8" style="text-align: center;"> <table border="1" style="width: 100%; border-collapse: collapse; text-align: center;"> <tr> <td style="width: 10%;"></td> <td style="width: 10%;"></td> <td style="width: 10%;"></td> <td style="width: 10%;"></td> <td style="width: 10%;"></td> <td style="width: 10%;"></td> <td style="width: 10%;"></td> <td style="width: 10%;"></td> <td style="width: 10%;"></td> <td style="width: 10%;"></td> </tr> <tr> <td></td> <td></td> <td colspan="8" style="text-align: center;"> <table border="1" style="width: 100%; border-collapse: collapse; text-align: center;"> <tr> <td style="width: 10%;"></td> <td style="width: 10%;"></td> <td style="width: 10%;"></td> <td style="width: 10%;"></td> <td style="width: 10%;"></td> <td style="width: 10%;"></td> <td style="width: 10%;"></td> <td style="width: 10%;"></td> <td style="width: 10%;"></td> <td style="width: 10%;"></td> </tr> <tr> <td></td> <td></td> <td colspan="8" style="text-align: center;"> <table border="1" style="width: 100%; border-collapse: collapse; text-align: center;"> <tr> <td style="width: 10%;"></td> <td style="width: 10%;"></td> <td style="width: 10%;"></td> <td style="width: 10%;"></td> <td style="width: 10%;"></td> <td style="width: 10%;"></td> <td style="width: 10%;"></td> <td style="width: 10%;"></td> <td style="width: 10%;"></td> <td style="width: 10%;"></td> </tr> <tr> <td></td> <td></td> <td colspan="8" style="text-align: center;"> <table border="1" style="width: 100%; border-collapse: collapse; text-align: center;"> <tr> <td style="width: 10%;"></td> <td style="width: 10%;"></td> <td style="width: 10%;"></td> <td style="width: 10%;"></td> <td style="width: 10%;"></td> <td style="width: 10%;"></td> <td style="width: 10%;"></td> <td style="width: 10%;"></td> <td style="width: 10%;"></td> <td style="width: 10%;"></td> </tr> <tr> <td></td> <td></td> <td colspan="8" style="text-align: center;"> <table border="1" style="width: 100%; border-collapse: collapse; text-align: center;"> <tr> <td style="width: 10%;"></td> <td style="width: 10%;"></td> <td style="width: 10%;"></td> <td style="width: 10%;"></td> <td style="width: 10%;"></td> <td style="width: 10%;"></td> <td style="width: 10%;"></td> <td style="width: 10%;"></td> <td style="width: 10%;"></td> <td style="width: 10%;"></td> </tr> <tr> <td></td> <td></td> <td colspan="8" style="text-align: center;"> <table border="1" style="width: 100%; border-collapse: collapse; text-align: center;"> <tr> </tr></table></td></tr></table></td></tr></table></td></tr></table></td></tr></table></td></tr></table></td></tr></table></td></tr></table></td></tr></table></td></tr></table></td></tr></table></td></tr></table></td></tr></table></td></tr></table></td></tr></table></td></tr></table></td></tr></table></td></tr></table></td></tr></table></td></tr></table></td></tr></table></td></tr></table></td></tr></table></td></tr></table></td></tr></table></td></tr></table></td></tr></table></td></tr></table></td></tr></table></td></tr></table></td></tr></table></td></tr></table></td></tr></table></td></tr></table></td></tr></table></td></tr></table></td></tr></table></td></tr></table></td></tr></table></td></tr></table></td></tr></table></td></tr></table></td></tr></table></td></tr></table></td></tr></table></td></tr></table></td></tr></table></td></tr></table>
 | | | | | | | | | | | | | | | | | | | | <table border="1" style="width: 100%; border-collapse: collapse; text-align: center;"> <tr> <td style="width: 10%;"></td> <td style="width: 10%;"></td> <td style="width: 10%;"></td> <td style="width: 10%;"></td> <td style="width: 10%;"></td> <td style="width: 10%;"></td> <td style="width: 10%;"></td> <td style="width: 10%;"></td> <td style="width: 10%;"></td> <td style="width: 10%;"></td> </tr> <tr> <td></td> <td></td> <td colspan="8" style="text-align: center;"> <table border="1" style="width: 100%; border-collapse: collapse; text-align: center;"> <tr> <td style="width: 10%;"></td> <td style="width: 10%;"></td> <td style="width: 10%;"></td> <td style="width: 10%;"></td> <td style="width: 10%;"></td> <td style="width: 10%;"></td> <td style="width: 10%;"></td> <td style="width: 10%;"></td> <td style="width: 10%;"></td> <td style="width: 10%;"></td> </tr> <tr> <td></td> <td></td> <td colspan="8" style="text-align: center;"> <table border="1" style="width: 100%; border-collapse: collapse; text-align: center;"> <tr> <td style="width: 10%;"></td> <td style="width: 10%;"></td> <td style="width: 10%;"></td> <td style="width: 10%;"></td> <td style="width: 10%;"></td> <td style="width: 10%;"></td> <td style="width: 10%;"></td> <td style="width: 10%;"></td> <td style="width: 10%;"></td> <td style="width: 10%;"></td> </tr> <tr> <td></td> <td></td> <td colspan="8" style="text-align: center;"> <table border="1" style="width: 100%; border-collapse: collapse; text-align: center;"> <tr> <td style="width: 10%;"></td> <td style="width: 10%;"></td> <td style="width: 10%;"></td> <td style="width: 10%;"></td> <td style="width: 10%;"></td> <td style="width: 10%;"></td> <td style="width: 10%;"></td> <td style="width: 10%;"></td> <td style="width: 10%;"></td> <td style="width: 10%;"></td> </tr> <tr> <td></td> <td></td> <td colspan="8" style="text-align: center;"> <table border="1" style="width: 100%; border-collapse: collapse; text-align: center;"> <tr> <td style="width: 10%;"></td> <td style="width: 10%;"></td> <td style="width: 10%;"></td> <td style="width: 10%;"></td> <td style="width: 10%;"></td> <td style="width: 10%;"></td> <td style="width: 10%;"></td> <td style="width: 10%;"></td> <td style="width: 10%;"></td> <td style="width: 10%;"></td> </tr> <tr> <td></td> <td></td> <td colspan="8" style="text-align: center;"> <table border="1" style="width: 100%; border-collapse: collapse; text-align: center;"> <tr> <td style="width: 10%;"></td> <td style="width: 10%;"></td> <td style="width: 10%;"></td> <td style="width: 10%;"></td> <td style="width: 10%;"></td> <td style="width: 10%;"></td> <td style="width: 10%;"></td> <td style="width: 10%;"></td> <td style="width: 10%;"></td> <td style="width: 10%;"></td> </tr> <tr> <td></td> <td></td> <td colspan="8" style="text-align: center;"> <table border="1" style="width: 100%; border-collapse: collapse; text-align: center;"> <tr> <td style="width: 10%;"></td> <td style="width: 10%;"></td> <td style="width: 10%;"></td> <td style="width: 10%;"></td> <td style="width: 10%;"></td> <td style="width: 10%;"></td> <td style="width: 10%;"></td> <td style="width: 10%;"></td> <td style="width: 10%;"></td> <td style="width: 10%;"></td> </tr> <tr> <td></td> <td></td> <td colspan="8" style="text-align: center;"> <table border="1" style="width: 100%; border-collapse: collapse; text-align: center;"> <tr> <td style="width: 10%;"></td> <td style="width: 10%;"></td> <td style="width: 10%;"></td> <td style="width: 10%;"></td> <td style="width: 10%;"></td> <td style="width: 10%;"></td> <td style="width: 10%;"></td> <td style="width: 10%;"></td> <td style="width: 10%;"></td> <td style="width: 10%;"></td> </tr> <tr> <td></td> <td></td> <td colspan="8" style="text-align: center;"> <table border="1" style="width: 100%; border-collapse: collapse; text-align: center;"> <tr> <td style="width: 10%;"></td> <td style="width: 10%;"></td> <td style="width: 10%;"></td> <td style="width: 10%;"></td> <td style="width: 10%;"></td> <td style="width: 10%;"></td> <td style="width: 10%;"></td> <td style="width: 10%;"></td> <td style="width: 10%;"></td> <td style="width: 10%;"></td> </tr> <tr> <td></td> <td></td> <td colspan="8" style="text-align: center;"> <table border="1" style="width: 100%; border-collapse: collapse; text-align: center;"> <tr> <td style="width: 10%;"></td> <td style="width: 10%;"></td> <td style="width: 10%;"></td> <td style="width: 10%;"></td> <td style="width: 10%;"></td> <td style="width: 10%;"></td> <td style="width: 10%;"></td> <td style="width: 10%;"></td> <td style="width: 10%;"></td> <td style="width: 10%;"></td> </tr> <tr> <td></td> <td></td> <td colspan="8" style="text-align: center;"> <table border="1" style="width: 100%; border-collapse: collapse; text-align: center;"> <tr> <td style="width: 10%;"></td> <td style="width: 10%;"></td> <td style="width: 10%;"></td> <td style="width: 10%;"></td> <td style="width: 10%;"></td> <td style="width: 10%;"></td> <td style="width: 10%;"></td> <td style="width: 10%;"></td> <td style="width: 10%;"></td> <td style="width: 10%;"></td> </tr> <tr> <td></td> <td></td> <td colspan="8" style="text-align: center;"> <table border="1" style="width: 100%; border-collapse: collapse; text-align: center;"> <tr> <td style="width: 10%;"></td> <td style="width: 10%;"></td> <td style="width: 10%;"></td> <td style="width: 10%;"></td> <td style="width: 10%;"></td> <td style="width: 10%;"></td> <td style="width: 10%;"></td> <td style="width: 10%;"></td> <td style="width: 10%;"></td> <td style="width: 10%;"></td> </tr> <tr> <td></td> <td></td> <td colspan="8" style="text-align: center;"> <table border="1" style="width: 100%; border-collapse: collapse; text-align: center;"> <tr> <td style="width: 10%;"></td> <td style="width: 10%;"></td> <td style="width: 10%;"></td> <td style="width: 10%;"></td> <td style="width: 10%;"></td> <td style="width: 10%;"></td> <td style="width: 10%;"></td> <td style="width: 10%;"></td> <td style="width: 10%;"></td> <td style="width: 10%;"></td> </tr> <tr> <td></td> <td></td> <td colspan="8" style="text-align: center;"> <table border="1" style="width: 100%; border-collapse: collapse; text-align: center;"> <tr> <td style="width: 10%;"></td> <td style="width: 10%;"></td> <td style="width: 10%;"></td> <td style="width: 10%;"></td> <td style="width: 10%;"></td> <td style="width: 10%;"></td> <td style="width: 10%;"></td> <td style="width: 10%;"></td> <td style="width: 10%;"></td> <td style="width: 10%;"></td> </tr> <tr> <td></td> <td></td> <td colspan="8" style="text-align: center;"> <table border="1" style="width: 100%; border-collapse: collapse; text-align: center;"> <tr> <td style="width: 10%;"></td> <td style="width: 10%;"></td> <td style="width: 10%;"></td> <td style="width: 10%;"></td> <td style="width: 10%;"></td> <td style="width: 10%;"></td> <td style="width: 10%;"></td> <td style="width: 10%;"></td> <td style="width: 10%;"></td> <td style="width: 10%;"></td> </tr> <tr> <td></td> <td></td> <td colspan="8" style="text-align: center;"> <table border="1" style="width: 100%; border-collapse: collapse; text-align: center;"> <tr> <td style="width: 10%;"></td> <td style="width: 10%;"></td> <td style="width: 10%;"></td> <td style="width: 10%;"></td> <td style="width: 10%;"></td> <td style="width: 10%;"></td> <td style="width: 10%;"></td> <td style="width: 10%;"></td> <td style="width: 10%;"></td> <td style="width: 10%;"></td> </tr> <tr> <td></td> <td></td> <td colspan="8" style="text-align: center;"> <table border="1" style="width: 100%; border-collapse: collapse; text-align: center;"> <tr>
<td style="width: 10%;"></td> <td style="width: 10%;"></td> <td style="width: 10%;"></td> <td style="width: 10%;"></td> <td style="width: 10%;"></td> <td style="width: 10%;"></td> <td style="width: 10%;"></td> <td style="width: 10%;"></td> <td style="width: 10%;"></td> <td style="width: 10%;"></td> </tr> <tr> <td></td> <td></td> <td colspan="8" style="text-align: center;"> <table border="1" style="width: 100%; border-collapse: collapse; text-align: center;"> <tr> <td style="width: 10%;"></td> <td style="width: 10%;"></td> <td style="width: 10%;"></td> <td style="width: 10%;"></td> <td style="width: 10%;"></td> <td style="width: 10%;"></td> <td style="width: 10%;"></td> <td style="width: 10%;"></td> <td style="width: 10%;"></td> <td style="width: 10%;"></td> </tr> <tr> <td></td> <td></td> <td colspan="8" style="text-align: center;"> <table border="1" style="width: 100%; border-collapse: collapse; text-align: center;"> <tr> <td style="width: 10%;"></td> <td style="width: 10%;"></td> <td style="width: 10%;"></td> <td style="width: 10%;"></td> <td style="width: 10%;"></td> <td style="width: 10%;"></td> <td style="width: 10%;"></td> <td style="width: 10%;"></td> <td style="width: 10%;"></td> <td style="width: 10%;"></td> </tr> <tr> <td></td> <td></td> <td colspan="8" style="text-align: center;"> <table border="1" style="width: 100%; border-collapse: collapse; text-align: center;"> <tr> <td style="width: 10%;"></td> <td style="width: 10%;"></td> <td style="width: 10%;"></td> <td style="width: 10%;"></td> <td style="width: 10%;"></td> <td style="width: 10%;"></td> <td style="width: 10%;"></td> <td style="width: 10%;"></td> <td style="width: 10%;"></td> <td style="width: 10%;"></td> </tr> <tr> <td></td> <td></td> <td colspan="8" style="text-align: center;"> <table border="1" style="width: 100%; border-collapse: collapse; text-align: center;"> <tr> <td style="width: 10%;"></td> <td style="width: 10%;"></td> <td style="width: 10%;"></td> <td style="width: 10%;"></td> <td style="width: 10%;"></td> <td style="width: 10%;"></td> <td style="width: 10%;"></td> <td style="width: 10%;"></td> <td style="width: 10%;"></td> <td style="width: 10%;"></td> </tr> <tr> <td></td> <td></td> <td colspan="8" style="text-align: center;"> <table border="1" style="width: 100%; border-collapse: collapse; text-align: center;"> <tr> <td style="width: 10%;"></td> <td style="width: 10%;"></td> <td style="width: 10%;"></td> <td style="width: 10%;"></td> <td style="width: 10%;"></td> <td style="width: 10%;"></td> <td style="width: 10%;"></td> <td style="width: 10%;"></td> <td style="width: 10%;"></td> <td style="width: 10%;"></td> </tr> <tr> <td></td> <td></td> <td colspan="8" style="text-align: center;"> <table border="1" style="width: 100%; border-collapse: collapse; text-align: center;"> <tr> <td style="width: 10%;"></td> <td style="width: 10%;"></td> <td style="width: 10%;"></td> <td style="width: 10%;"></td> <td style="width: 10%;"></td> <td style="width: 10%;"></td> <td style="width: 10%;"></td> <td style="width: 10%;"></td> <td style="width: 10%;"></td> <td style="width: 10%;"></td> </tr> <tr> <td></td> <td></td> <td colspan="8" style="text-align: center;"> <table border="1" style="width: 100%; border-collapse: collapse; text-align: center;"> <tr> <td style="width: 10%;"></td> <td style="width: 10%;"></td> <td style="width: 10%;"></td> <td style="width: 10%;"></td> <td style="width: 10%;"></td> <td style="width: 10%;"></td> <td style="width: 10%;"></td> <td style="width: 10%;"></td> <td style="width: 10%;"></td> <td style="width: 10%;"></td> </tr> <tr> <td></td> <td></td> <td colspan="8" style="text-align: center;"> <table border="1" style="width: 100%; border-collapse: collapse; text-align: center;"> <tr> <td style="width: 10%;"></td> <td style="width: 10%;"></td> <td style="width: 10%;"></td> <td style="width: 10%;"></td> <td style="width: 10%;"></td> <td style="width: 10%;"></td> <td style="width: 10%;"></td> <td style="width: 10%;"></td> <td style="width: 10%;"></td> <td style="width: 10%;"></td> </tr> <tr> <td></td> <td></td> <td colspan="8" style="text-align: center;"> <table border="1" style="width: 100%; border-collapse: collapse; text-align: center;"> <tr> <td style="width: 10%;"></td> <td style="width: 10%;"></td> <td style="width: 10%;"></td> <td style="width: 10%;"></td> <td style="width: 10%;"></td> <td style="width: 10%;"></td> <td style="width: 10%;"></td> <td style="width: 10%;"></td> <td style="width: 10%;"></td> <td style="width: 10%;"></td> </tr> <tr> <td></td> <td></td> <td colspan="8" style="text-align: center;"> <table border="1" style="width: 100%; border-collapse: collapse; text-align: center;"> <tr> <td style="width: 10%;"></td> <td style="width: 10%;"></td> <td style="width: 10%;"></td> <td style="width: 10%;"></td> <td style="width: 10%;"></td> <td style="width: 10%;"></td> <td style="width: 10%;"></td> <td style="width: 10%;"></td> <td style="width: 10%;"></td> <td style="width: 10%;"></td> </tr> <tr> <td></td> <td></td> <td colspan="8" style="text-align: center;"> <table border="1" style="width: 100%; border-collapse: collapse; text-align: center;"> <tr> <td style="width: 10%;"></td> <td style="width: 10%;"></td> <td style="width: 10%;"></td> <td style="width: 10%;"></td> <td style="width: 10%;"></td> <td style="width: 10%;"></td> <td style="width: 10%;"></td> <td style="width: 10%;"></td> <td style="width: 10%;"></td> <td style="width: 10%;"></td> </tr> <tr> <td></td> <td></td> <td colspan="8" style="text-align: center;"> <table border="1" style="width: 100%; border-collapse: collapse; text-align: center;"> <tr> <td style="width: 10%;"></td> <td style="width: 10%;"></td> <td style="width: 10%;"></td> <td style="width: 10%;"></td> <td style="width: 10%;"></td> <td style="width: 10%;"></td> <td style="width: 10%;"></td> <td style="width: 10%;"></td> <td style="width: 10%;"></td> <td style="width: 10%;"></td> </tr> <tr> <td></td> <td></td> <td colspan="8" style="text-align: center;"> <table border="1" style="width: 100%; border-collapse: collapse; text-align: center;"> <tr> <td style="width: 10%;"></td> <td style="width: 10%;"></td> <td style="width: 10%;"></td> <td style="width: 10%;"></td> <td style="width: 10%;"></td> <td style="width: 10%;"></td> <td style="width: 10%;"></td> <td style="width: 10%;"></td> <td style="width: 10%;"></td> <td style="width: 10%;"></td> </tr> <tr> <td></td> <td></td> <td colspan="8" style="text-align: center;"> <table border="1" style="width: 100%; border-collapse: collapse; text-align: center;"> <tr> <td style="width: 10%;"></td> <td style="width: 10%;"></td> <td style="width: 10%;"></td> <td style="width: 10%;"></td> <td style="width: 10%;"></td> <td style="width: 10%;"></td> <td style="width: 10%;"></td> <td style="width: 10%;"></td> <td style="width: 10%;"></td> <td style="width: 10%;"></td> </tr> <tr> <td></td> <td></td> <td colspan="8" style="text-align: center;"> <table border="1" style="width: 100%; border-collapse: collapse; text-align: center;"> <tr> <td style="width: 10%;"></td> <td style="width: 10%;"></td> <td style="width: 10%;"></td> <td style="width: 10%;"></td> <td style="width: 10%;"></td> <td style="width: 10%;"></td> <td style="width: 10%;"></td> <td style="width: 10%;"></td> <td style="width: 10%;"></td> <td style="width: 10%;"></td> </tr> <tr> <td></td> <td></td> <td colspan="8" style="text-align: center;"> <table border="1" style="width: 100%; border-collapse: collapse; text-align: center;"> <tr> <td style="width: 10%;"></td> <td style="width: 10%;"></td> <td style="width: 10%;"></td> <td style="width: 10%;"></td> <td style="width: 10%;"></td> <td style="width: 10%;"></td> <td style="width: 10%;"></td> <td style="width: 10%;"></td> <td style="width: 10%;"></td> <td style="width: 10%;"></td> </tr> <tr> <td></td> <td></td> <td colspan="8" style="text-align: center;"> <table border="1" style="width: 100%; border-collapse: collapse; text-align: center;"> <tr> <td style="width: 10%;"></td> <td style="width: 10%;"></td> <td style="width: 10%;"></td> <td style="width: 10%;"></td> <td style="width: 10%;"></td> <td style="width: 10%;"></td> <td style="width: 10%;"></td> <td style="width: 10%;"></td> <td style="width: 10%;"></td> <td style="width: 10%;"></td> </tr> <tr> <td></td> <td></td> <td colspan="8" style="text-align: center;"> <table border="1" style="width: 100%; border-collapse: collapse; text-align: center;"> <tr> <td style="width: 10%;"></td> <td style="width: 10%;"></td> <td style="width: 10%;"></td> <td style="width: 10%;"></td> <td style="width: 10%;"></td> <td style="width: 10%;"></td> <td style="width: 10%;"></td> <td style="width: 10%;"></td> <td style="width: 10%;"></td> <td style="width: 10%;"></td> </tr> <tr> <td></td> <td></td> <td colspan="8" style="text-align: center;"> <table border="1" style="width: 100%; border-collapse: collapse; text-align: center;"> <tr> <td style="width: 10%;"></td> <td style="width: 10%;"></td> <td style="width: 10%;"></td> <td style="width: 10%;"></td> <td style="width: 10%;"></td> <td style="width: 10%;"></td> <td style="width: 10%;"></td> <td style="width: 10%;"></td> <td style="width: 10%;"></td> <td style="width: 10%;"></td> </tr> <tr> <td></td> <td></td> <td colspan="8" style="text-align: center;"> <table border="1" style="width: 100%; border-collapse: collapse; text-align: center;"> <tr> <td style="width: 10%;"></td> <td style="width: 10%;"></td> <td style="width: 10%;"></td> <td style="width: 10%;"></td> <td style="width: 10%;"></td> <td style="width: 10%;"></td> <td style="width: 10%;"></td> <td style="width: 10%;"></td> <td style="width: 10%;"></td> <td style="width: 10%;"></td> </tr> <tr> <td></td> <td></td> <td colspan="8" style="text-align: center;"> <table border="1" style="width: 100%; border-collapse: collapse; text-align: center;"> <tr> <td style="width: 10%;"></td> <td style="width: 10%;"></td> <td style="width: 10%;"></td> <td style="width: 10%;"></td> <td style="width: 10%;"></td> <td style="width:
10%;"></td> <td style="width: 10%;"></td> <td style="width: 10%;"></td> <td style="width: 10%;"></td> <td style="width: 10%;"></td> </tr> <tr> <td></td> <td></td> <td colspan="8" style="text-align: center;"> <table border="1" style="width: 100%; border-collapse: collapse; text-align: center;"> <tr> <td style="width: 10%;"></td> <td style="width: 10%;"></td> <td style="width: 10%;"></td> <td style="width: 10%;"></td> <td style="width: 10%;"></td> <td style="width: 10%;"></td> <td style="width: 10%;"></td> <td style="width: 10%;"></td> <td style="width: 10%;"></td> <td style="width: 10%;"></td> </tr> <tr> <td></td> <td></td> <td colspan="8" style="text-align: center;"> <table border="1" style="width: 100%; border-collapse: collapse; text-align: center;"> <tr> <td style="width: 10%;"></td> <td style="width: 10%;"></td> <td style="width: 10%;"></td> <td style="width: 10%;"></td> <td style="width: 10%;"></td> <td style="width: 10%;"></td> <td style="width: 10%;"></td> <td style="width: 10%;"></td> <td style="width: 10%;"></td> <td style="width: 10%;"></td> </tr> <tr> <td></td> <td></td> <td colspan="8" style="text-align: center;"> <table border="1" style="width: 100%; border-collapse: collapse; text-align: center;"> <tr> <td style="width: 10%;"></td> <td style="width: 10%;"></td> <td style="width: 10%;"></td> <td style="width: 10%;"></td> <td style="width: 10%;"></td> <td style="width: 10%;"></td> <td style="width: 10%;"></td> <td style="width: 10%;"></td> <td style="width: 10%;"></td> <td style="width: 10%;"></td> </tr> <tr> <td></td> <td></td> <td colspan="8" style="text-align: center;"> <table border="1" style="width: 100%; border-collapse: collapse; text-align: center;"> <tr> <td style="width: 10%;"></td> <td style="width: 10%;"></td> <td style="width: 10%;"></td> <td style="width: 10%;"></td> <td style="width: 10%;"></td> <td style="width: 10%;"></td> <td style="width: 10%;"></td> <td style="width: 10%;"></td> <td style="width: 10%;"></td> <td style="width: 10%;"></td> </tr> <tr> <td></td> <td></td> <td colspan="8" style="text-align: center;"> <table border="1" style="width: 100%; border-collapse: collapse; text-align: center;"> <tr> <td style="width: 10%;"></td> <td style="width: 10%;"></td> <td style="width: 10%;"></td> <td style="width: 10%;"></td> <td style="width: 10%;"></td> <td style="width: 10%;"></td> <td style="width: 10%;"></td> <td style="width: 10%;"></td> <td style="width: 10%;"></td> <td style="width: 10%;"></td> </tr> <tr> <td></td> <td></td> <td colspan="8" style="text-align: center;"> <table border="1" style="width: 100%; border-collapse: collapse; text-align: center;"> <tr> <td style="width: 10%;"></td> <td style="width: 10%;"></td> <td style="width: 10%;"></td> <td style="width: 10%;"></td> <td style="width: 10%;"></td> <td style="width: 10%;"></td> <td style="width: 10%;"></td> <td style="width: 10%;"></td> <td style="width: 10%;"></td> <td style="width: 10%;"></td> </tr> <tr> <td></td> <td></td> <td colspan="8" style="text-align: center;"> <table border="1" style="width: 100%; border-collapse: collapse; text-align: center;"> <tr> <td style="width: 10%;"></td> <td style="width: 10%;"></td> <td style="width: 10%;"></td> <td style="width: 10%;"></td> <td style="width: 10%;"></td> <td style="width: 10%;"></td> <td style="width: 10%;"></td> <td style="width: 10%;"></td> <td style="width: 10%;"></td> <td style="width: 10%;"></td> </tr> <tr> <td></td> <td></td> <td colspan="8" style="text-align: center;"> <table border="1" style="width: 100%; border-collapse: collapse; text-align: center;"> <tr> <td style="width: 10%;"></td> <td style="width: 10%;"></td> <td style="width: 10%;"></td> <td style="width: 10%;"></td> <td style="width: 10%;"></td> <td style="width: 10%;"></td> <td style="width: 10%;"></td> <td style="width: 10%;"></td> <td style="width: 10%;"></td> <td style="width: 10%;"></td> </tr> <tr> <td></td> <td></td> <td colspan="8" style="text-align: center;"> <table border="1" style="width: 100%; border-collapse: collapse; text-align: center;"> <tr> </tr></table></td></tr></table></td></tr></table></td></tr></table></td></tr></table></td></tr></table></td></tr></table></td></tr></table></td></tr></table></td></tr></table></td></tr></table></td></tr></table></td></tr></table></td></tr></table></td></tr></table></td></tr></table></td></tr></table></td></tr></table></td></tr></table></td></tr></table></td></tr></table></td></tr></table></td></tr></table></td></tr></table></td></tr></table></td></tr></table></td></tr></table></td></tr></table></td></tr></table></td></tr></table></td></tr></table></td></tr></table></td></tr></table></td></tr></table></td></tr></table></td></tr></table></td></tr></table></td></tr></table></td></tr></table></td></tr></table></td></tr></table></td></tr></table></td></tr></table></td></tr></table></td></tr></table></td></tr></table></td></tr></table>
 | | | | | | | | | | | | | | | | | | | | <table border="1" style="width: 100%; border-collapse: collapse; text-align: center;"> <tr> <td style="width: 10%;"></td> <td style="width: 10%;"></td> <td style="width: 10%;"></td> <td style="width: 10%;"></td> <td style="width: 10%;"></td> <td style="width: 10%;"></td> <td style="width: 10%;"></td> <td style="width: 10%;"></td> <td style="width: 10%;"></td> <td style="width: 10%;"></td> </tr> <tr> <td></td> <td></td> <td colspan="8" style="text-align: center;"> <table border="1" style="width: 100%; border-collapse: collapse; text-align: center;"> <tr> <td style="width: 10%;"></td> <td style="width: 10%;"></td> <td style="width: 10%;"></td> <td style="width: 10%;"></td> <td style="width: 10%;"></td> <td style="width: 10%;"></td> <td style="width: 10%;"></td> <td style="width: 10%;"></td> <td style="width: 10%;"></td> <td style="width: 10%;"></td> </tr> <tr> <td></td> <td></td> <td colspan="8" style="text-align: center;"> <table border="1" style="width: 100%; border-collapse: collapse; text-align: center;"> <tr> <td style="width: 10%;"></td> <td style="width: 10%;"></td> <td style="width: 10%;"></td> <td style="width: 10%;"></td> <td style="width: 10%;"></td> <td style="width: 10%;"></td> <td style="width: 10%;"></td> <td style="width: 10%;"></td> <td style="width: 10%;"></td> <td style="width: 10%;"></td> </tr> <tr> <td></td> <td></td> <td colspan="8" style="text-align: center;"> <table border="1" style="width: 100%; border-collapse: collapse; text-align: center;"> <tr> <td style="width: 10%;"></td> <td style="width: 10%;"></td> <td style="width: 10%;"></td> <td style="width: 10%;"></td> <td style="width: 10%;"></td> <td style="width: 10%;"></td> <td style="width: 10%;"></td> <td style="width: 10%;"></td> <td style="width: 10%;"></td> <td style="width: 10%;"></td> </tr> <tr> <td></td> <td></td> <td colspan="8" style="text-align: center;"> <table border="1" style="width: 100%; border-collapse: collapse; text-align: center;"> <tr> <td style="width: 10%;"></td> <td style="width: 10%;"></td> <td style="width: 10%;"></td> <td style="width: 10%;"></td> <td style="width: 10%;"></td> <td style="width: 10%;"></td> <td style="width: 10%;"></td> <td style="width: 10%;"></td> <td style="width: 10%;"></td> <td style="width: 10%;"></td> </tr> <tr> <td></td> <td></td> <td colspan="8" style="text-align: center;"> <table border="1" style="width: 100%; border-collapse: collapse; text-align: center;"> <tr> <td style="width: 10%;"></td> <td style="width: 10%;"></td> <td style="width: 10%;"></td> <td style="width: 10%;"></td> <td style="width: 10%;"></td> <td style="width: 10%;"></td> <td style="width: 10%;"></td> <td style="width: 10%;"></td> <td style="width: 10%;"></td> <td style="width: 10%;"></td> </tr> <tr> <td></td> <td></td> <td colspan="8" style="text-align: center;"> <table border="1" style="width: 100%; border-collapse: collapse; text-align: center;"> <tr> <td style="width: 10%;"></td> <td style="width: 10%;"></td> <td style="width: 10%;"></td> <td style="width: 10%;"></td> <td style="width: 10%;"></td> <td style="width: 10%;"></td> <td style="width: 10%;"></td> <td style="width: 10%;"></td> <td style="width: 10%;"></td> <td style="width: 10%;"></td> </tr> <tr> <td></td> <td></td> <td colspan="8" style="text-align: center;"> <table border="1" style="width: 100%; border-collapse: collapse; text-align: center;"> <tr> <td style="width: 10%;"></td> <td style="width: 10%;"></td> <td style="width: 10%;"></td> <td style="width: 10%;"></td> <td style="width: 10%;"></td> <td style="width: 10%;"></td> <td style="width: 10%;"></td> <td style="width: 10%;"></td> <td style="width: 10%;"></td> <td style="width: 10%;"></td> </tr> <tr> <td></td> <td></td> <td colspan="8" style="text-align: center;"> <table border="1" style="width: 100%; border-collapse: collapse; text-align: center;"> <tr> <td style="width: 10%;"></td> <td style="width: 10%;"></td> <td style="width: 10%;"></td> <td style="width: 10%;"></td> <td style="width: 10%;"></td> <td style="width: 10%;"></td> <td style="width: 10%;"></td> <td style="width: 10%;"></td> <td style="width: 10%;"></td> <td style="width: 10%;"></td> </tr> <tr> <td></td> <td></td> <td colspan="8" style="text-align: center;"> <table border="1" style="width: 100%; border-collapse: collapse; text-align: center;"> <tr> <td style="width: 10%;"></td> <td style="width: 10%;"></td> <td style="width: 10%;"></td> <td style="width: 10%;"></td> <td style="width: 10%;"></td> <td style="width: 10%;"></td> <td style="width: 10%;"></td> <td style="width: 10%;"></td> <td style="width: 10%;"></td> <td style="width: 10%;"></td> </tr> <tr> <td></td> <td></td> <td colspan="8" style="text-align: center;"> <table border="1" style="width: 100%; border-collapse: collapse; text-align: center;"> <tr> <td style="width: 10%;"></td> <td style="width: 10%;"></td> <td style="width: 10%;"></td> <td style="width: 10%;"></td> <td style="width: 10%;"></td> <td style="width: 10%;"></td> <td style="width: 10%;"></td> <td style="width: 10%;"></td> <td style="width: 10%;"></td> <td style="width: 10%;"></td> </tr> <tr> <td></td> <td></td> <td colspan="8" style="text-align: center;"> <table border="1" style="width: 100%; border-collapse: collapse; text-align: center;"> <tr> <td style="width: 10%;"></td> <td style="width: 10%;"></td> <td style="width: 10%;"></td> <td style="width: 10%;"></td> <td style="width: 10%;"></td> <td style="width: 10%;"></td> <td style="width: 10%;"></td> <td style="width: 10%;"></td> <td style="width: 10%;"></td> <td style="width: 10%;"></td> </tr> <tr> <td></td> <td></td> <td colspan="8" style="text-align: center;"> <table border="1" style="width: 100%; border-collapse: collapse; text-align: center;"> <tr> <td style="width: 10%;"></td> <td style="width: 10%;"></td> <td style="width: 10%;"></td> <td style="width: 10%;"></td> <td style="width: 10%;"></td> <td style="width: 10%;"></td> <td style="width: 10%;"></td> <td style="width: 10%;"></td> <td style="width: 10%;"></td> <td style="width: 10%;"></td> </tr> <tr> <td></td> <td></td> <td colspan="8" style="text-align: center;"> <table border="1" style="width: 100%; border-collapse: collapse; text-align: center;"> <tr> <td style="width: 10%;"></td> <td style="width: 10%;"></td> <td style="width: 10%;"></td> <td style="width: 10%;"></td> <td style="width: 10%;"></td> <td style="width: 10%;"></td> <td style="width: 10%;"></td> <td style="width: 10%;"></td> <td style="width: 10%;"></td> <td style="width: 10%;"></td> </tr> <tr> <td></td> <td></td> <td colspan="8" style="text-align: center;"> <table border="1" style="width: 100%; border-collapse: collapse; text-align: center;"> <tr> <td style="width: 10%;"></td> <td style="width: 10%;"></td> <td style="width: 10%;"></td> <td style="width: 10%;"></td> <td style="width: 10%;"></td> <td style="width: 10%;"></td> <td style="width: 10%;"></td> <td style="width: 10%;"></td> <td style="width: 10%;"></td> <td style="width: 10%;"></td> </tr> <tr> <td></td> <td></td> <td colspan="8" style="text-align: center;"> <table border="1" style="width: 100%; border-collapse: collapse; text-align: center;"> <tr> <td style="width: 10%;"></td> <td style="width: 10%;"></td> <td style="width: 10%;"></td> <td style="width: 10%;"></td> <td style="width: 10%;"></td> <td style="width: 10%;"></td> <td style="width: 10%;"></td> <td style="width: 10%;"></td> <td style="width: 10%;"></td> <td style="width: 10%;"></td> </tr> <tr> <td></td> <td></td> <td colspan="8" style="text-align: center;"> <table border="1" style="width: 100%; border-collapse: collapse; text-align: center;"> <tr> <td style="width: 10%;"></td> <td style="width: 10%;"></td> <td style="width: 10%;"></td> <td style="width: 10%;"></td> <td style="width: 10%;"></td> <td style="width: 10%;"></td> <td
style="width: 10%;"></td> <td style="width: 10%;"></td> <td style="width: 10%;"></td> <td style="width: 10%;"></td> </tr> <tr> <td></td> <td></td> <td colspan="8" style="text-align: center;"> <table border="1" style="width: 100%; border-collapse: collapse; text-align: center;"> <tr> <td style="width: 10%;"></td> <td style="width: 10%;"></td> <td style="width: 10%;"></td> <td style="width: 10%;"></td> <td style="width: 10%;"></td> <td style="width: 10%;"></td> <td style="width: 10%;"></td> <td style="width: 10%;"></td> <td style="width: 10%;"></td> <td style="width: 10%;"></td> </tr> <tr> <td></td> <td></td> <td colspan="8" style="text-align: center;"> <table border="1" style="width: 100%; border-collapse: collapse; text-align: center;"> <tr> <td style="width: 10%;"></td> <td style="width: 10%;"></td> <td style="width: 10%;"></td> <td style="width: 10%;"></td> <td style="width: 10%;"></td> <td style="width: 10%;"></td> <td style="width: 10%;"></td> <td style="width: 10%;"></td> <td style="width: 10%;"></td> <td style="width: 10%;"></td> </tr> <tr> <td></td> <td></td> <td colspan="8" style="text-align: center;"> <table border="1" style="width: 100%; border-collapse: collapse; text-align: center;"> <tr> <td style="width: 10%;"></td> <td style="width: 10%;"></td> <td style="width: 10%;"></td> <td style="width: 10%;"></td> <td style="width: 10%;"></td> <td style="width: 10%;"></td> <td style="width: 10%;"></td> <td style="width: 10%;"></td> <td style="width: 10%;"></td> <td style="width: 10%;"></td> </tr> <tr> <td></td> <td></td> <td colspan="8" style="text-align: center;"> <table border="1" style="width: 100%; border-collapse: collapse; text-align: center;"> <tr> <td style="width: 10%;"></td> <td style="width: 10%;"></td> <td style="width: 10%;"></td> <td style="width: 10%;"></td> <td style="width: 10%;"></td> <td style="width: 10%;"></td> <td style="width: 10%;"></td> <td style="width: 10%;"></td> <td style="width: 10%;"></td> <td style="width: 10%;"></td> </tr> <tr> <td></td> <td></td> <td colspan="8" style="text-align: center;"> <table border="1" style="width: 100%; border-collapse: collapse; text-align: center;"> <tr> <td style="width: 10%;"></td> <td style="width: 10%;"></td> <td style="width: 10%;"></td> <td style="width: 10%;"></td> <td style="width: 10%;"></td> <td style="width: 10%;"></td> <td style="width: 10%;"></td> <td style="width: 10%;"></td> <td style="width: 10%;"></td> <td style="width: 10%;"></td> </tr> <tr> <td></td> <td></td> <td colspan="8" style="text-align: center;"> <table border="1" style="width: 100%; border-collapse: collapse; text-align: center;"> <tr> <td style="width: 10%;"></td> <td style="width: 10%;"></td> <td style="width: 10%;"></td> <td style="width: 10%;"></td> <td style="width: 10%;"></td> <td style="width: 10%;"></td> <td style="width: 10%;"></td> <td style="width: 10%;"></td> <td style="width: 10%;"></td> <td style="width: 10%;"></td> </tr> <tr> <td></td> <td></td> <td colspan="8" style="text-align: center;"> <table border="1" style="width: 100%; border-collapse: collapse; text-align: center;"> <tr> <td style="width: 10%;"></td> <td style="width: 10%;"></td> <td style="width: 10%;"></td> <td style="width: 10%;"></td> <td style="width: 10%;"></td> <td style="width: 10%;"></td> <td style="width: 10%;"></td> <td style="width: 10%;"></td> <td style="width: 10%;"></td> <td style="width: 10%;"></td> </tr> <tr> <td></td> <td></td> <td colspan="8" style="text-align: center;"> <table border="1" style="width: 100%; border-collapse: collapse; text-align: center;"> <tr> <td style="width: 10%;"></td> <td style="width: 10%;"></td> <td style="width: 10%;"></td> <td style="width: 10%;"></td> <td style="width: 10%;"></td> <td style="width: 10%;"></td> <td style="width: 10%;"></td> <td style="width: 10%;"></td> <td style="width: 10%;"></td> <td style="width: 10%;"></td> </tr> <tr> <td></td> <td></td> <td colspan="8" style="text-align: center;"> <table border="1" style="width: 100%; border-collapse: collapse; text-align: center;"> <tr> <td style="width: 10%;"></td> <td style="width: 10%;"></td> <td style="width: 10%;"></td> <td style="width: 10%;"></td> <td style="width: 10%;"></td> <td style="width: 10%;"></td> <td style="width: 10%;"></td> <td style="width: 10%;"></td> <td style="width: 10%;"></td> <td style="width: 10%;"></td> </tr> <tr> <td></td> <td></td> <td colspan="8" style="text-align: center;"> <table border="1" style="width: 100%; border-collapse: collapse; text-align: center;"> <tr> <td style="width: 10%;"></td> <td style="width: 10%;"></td> <td style="width: 10%;"></td> <td style="width: 10%;"></td> <td style="width: 10%;"></td> <td style="width: 10%;"></td> <td style="width: 10%;"></td> <td style="width: 10%;"></td> <td style="width: 10%;"></td> <td style="width: 10%;"></td> </tr> <tr> <td></td> <td></td> <td colspan="8" style="text-align: center;"> <table border="1" style="width: 100%; border-collapse: collapse; text-align: center;"> <tr> <td style="width: 10%;"></td> <td style="width: 10%;"></td> <td style="width: 10%;"></td> <td style="width: 10%;"></td> <td style="width: 10%;"></td> <td style="width: 10%;"></td> <td style="width: 10%;"></td> <td style="width: 10%;"></td> <td style="width: 10%;"></td> <td style="width: 10%;"></td> </tr> <tr> <td></td> <td></td> <td colspan="8" style="text-align: center;"> <table border="1" style="width: 100%; border-collapse: collapse; text-align: center;"> <tr> <td style="width: 10%;"></td> <td style="width: 10%;"></td> <td style="width: 10%;"></td> <td style="width: 10%;"></td> <td style="width: 10%;"></td> <td style="width: 10%;"></td> <td style="width: 10%;"></td> <td style="width: 10%;"></td> <td style="width: 10%;"></td> <td style="width: 10%;"></td> </tr> <tr> <td></td> <td></td> <td colspan="8" style="text-align: center;"> <table border="1" style="width: 100%; border-collapse: collapse; text-align: center;"> <tr> <td style="width: 10%;"></td> <td style="width: 10%;"></td> <td style="width: 10%;"></td> <td style="width: 10%;"></td> <td style="width: 10%;"></td> <td style="width: 10%;"></td> <td style="width: 10%;"></td> <td style="width: 10%;"></td> <td style="width: 10%;"></td> <td style="width: 10%;"></td> </tr> <tr> <td></td> <td></td> <td colspan="8" style="text-align: center;"> <table border="1" style="width: 100%; border-collapse: collapse; text-align: center;"> <tr> <td style="width: 10%;"></td> <td style="width: 10%;"></td> <td style="width: 10%;"></td> <td style="width: 10%;"></td> <td style="width: 10%;"></td> <td style="width: 10%;"></td> <td style="width: 10%;"></td> <td style="width: 10%;"></td> <td style="width: 10%;"></td> <td style="width: 10%;"></td> </tr> <tr> <td></td> <td></td> <td colspan="8" style="text-align: center;"> <table border="1" style="width: 100%; border-collapse: collapse; text-align: center;"> <tr> <td style="width: 10%;"></td> <td style="width: 10%;"></td> <td style="width: 10%;"></td> <td style="width: 10%;"></td> <td style="width: 10%;"></td> <td style="width: 10%;"></td> <td style="width: 10%;"></td> <td style="width: 10%;"></td> <td style="width: 10%;"></td> <td style="width: 10%;"></td> </tr> <tr> <td></td> <td></td> <td colspan="8" style="text-align: center;"> <table border="1" style="width: 100%; border-collapse: collapse; text-align: center;"> <tr> <td style="width: 10%;"></td> <td style="width: 10%;"></td> <td style="width: 10%;"></td> <td style="width: 10%;"></td> <td style="width: 10%;"></td> <td style="width: 10%;"></td> <td style="width: 10%;"></td> <td style="width: 10%;"></td> <td style="width: 10%;"></td> <td style="width: 10%;"></td> </tr> <tr> <td></td> <td></td> <td colspan="8" style="text-align: center;"> <table border="1" style="width: 100%; border-collapse: collapse; text-align: center;"> <tr> <td style="width: 10%;"></td> <td style="width: 10%;"></td> <td style="width: 10%;"></td> <td style="width: 10%;"></td> <td style="width: 10%;"></td> <td style="width: 10%;"></td> <td style="width: 10%;"></td> <td style="width: 10%;"></td> <td style="width: 10%;"></td> <td style="width: 10%;"></td> </tr> <tr> <td></td> <td></td> <td colspan="8" style="text-align: center;"> <table border="1" style="width: 100%; border-collapse: collapse; text-align: center;"> <tr> <td style="width: 10%;"></td> <td style="width: 10%;"></td> <td style="width: 10%;"></td> <td style="width: 10%;"></td> <td style="width: 10%;"></td> <td style="width: 10%;"></td> <td style="width: 10%;"></td> <td style="width: 10%;"></td> <td style="width: 10%;"></td> <td style="width: 10%;"></td> </tr> <tr> <td></td> <td></td> <td colspan="8" style="text-align: center;"> <table border="1" style="width: 100%; border-collapse: collapse; text-align: center;"> <tr> <td style="width: 10%;"></td> <td style="width: 10%;"></td> <td style="width: 10%;"></td> <td style="width: 10%;"></td> <td style="width: 10%;"></td> <td style="width: 10%;"></td> <td style="width: 10%;"></td> <td style="width: 10%;"></td> <td style="width: 10%;"></td> <td style="width: 10%;"></td> </tr> <tr> <td></td> <td></td> <td colspan="8" style="text-align: center;"> <table border="1" style="width: 100%; border-collapse: collapse; text-align: center;"> <tr> <td style="width: 10%;"></td> <td style="width: 10%;"></td> <td style="width: 10%;"></td> <td style="width: 10%;"></td> <td style="width: 10%;"></td> <td style="width: 10%;"></td> <td style="width: 10%;"></td> <td style="width: 10%;"></td> <td style="width: 10%;"></td> <td style="width: 10%;"></td> </tr> <tr> <td></td> <td></td> <td colspan="8" style="text-align: center;"> <table border="1" style="width: 100%; border-collapse: collapse; text-align: center;"> <tr> <td style="width: 10%;"></td> <td style="width: 10%;"></td> <td style="width: 10%;"></td> <td style="width: 10%;"></td> <td style="width: 10%;"></td> <td style="width: 10%;"></td> <td style="width: 10%;"></td> <td style="width: 10%;"></td> <td style="width: 10%;"></td> <td style="width: 10%;"></td> </tr> <tr> <td></td> <td></td> <td colspan="8"
style="text-align: center;"> <table border="1" style="width: 100%; border-collapse: collapse; text-align: center;"> <tr> <td style="width: 10%;"></td> <td style="width: 10%;"></td> <td style="width: 10%;"></td> <td style="width: 10%;"></td> <td style="width: 10%;"></td> <td style="width: 10%;"></td> <td style="width: 10%;"></td> <td style="width: 10%;"></td> <td style="width: 10%;"></td> <td style="width: 10%;"></td> </tr> <tr> <td></td> <td></td> <td colspan="8" style="text-align: center;"> <table border="1" style="width: 100%; border-collapse: collapse; text-align: center;"> <tr> <td style="width: 10%;"></td> <td style="width: 10%;"></td> <td style="width: 10%;"></td> <td style="width: 10%;"></td> <td style="width: 10%;"></td> <td style="width: 10%;"></td> <td style="width: 10%;"></td> <td style="width: 10%;"></td> <td style="width: 10%;"></td> <td style="width: 10%;"></td> </tr> <tr> <td></td> <td></td> <td colspan="8" style="text-align: center;"> <table border="1" style="width: 100%; border-collapse: collapse; text-align: center;"> <tr> <td style="width: 10%;"></td> <td style="width: 10%;"></td> <td style="width: 10%;"></td> <td style="width: 10%;"></td> <td style="width: 10%;"></td> <td style="width: 10%;"></td> <td style="width: 10%;"></td> <td style="width: 10%;"></td> <td style="width: 10%;"></td> <td style="width: 10%;"></td> </tr> <tr> <td></td> <td></td> <td colspan="8" style="text-align: center;"> <table border="1" style="width: 100%; border-collapse: collapse; text-align: center;"> <tr> <td style="width: 10%;"></td> <td style="width: 10%;"></td> <td style="width: 10%;"></td> <td style="width: 10%;"></td> <td style="width: 10%;"></td> <td style="width: 10%;"></td> <td style="width: 10%;"></td> <td style="width: 10%;"></td> <td style="width: 10%;"></td> <td style="width: 10%;"></td> </tr> <tr> <td></td> <td></td> <td colspan="8" style="text-align: center;"> <table border="1" style="width: 100%; border-collapse: collapse; text-align: center;"> <tr> <td style="width: 10%;"></td> <td style="width: 10%;"></td> <td style="width: 10%;"></td> <td style="width: 10%;"></td> <td style="width: 10%;"></td> <td style="width: 10%;"></td> <td style="width: 10%;"></td> <td style="width: 10%;"></td> <td style="width: 10%;"></td> <td style="width: 10%;"></td> </tr> <tr> <td></td> <td></td> <td colspan="8" style="text-align: center;"> <table border="1" style="width: 100%; border-collapse: collapse; text-align: center;"> <tr> <td style="width: 10%;"></td> <td style="width: 10%;"></td> <td style="width: 10%;"></td> <td style="width: 10%;"></td> <td style="width: 10%;"></td> <td style="width: 10%;"></td> <td style="width: 10%;"></td> <td style="width: 10%;"></td> <td style="width: 10%;"></td> <td style="width: 10%;"></td> </tr> <tr> <td></td> <td></td> <td colspan="8" style="text-align: center;"> <table border="1" style="width: 100%; border-collapse: collapse; text-align: center;"> <tr> <td style="width: 10%;"></td> <td style="width: 10%;"></td> <td style="width: 10%;"></td> <td style="width: 10%;"></td> <td style="width: 10%;"></td> <td style="width: 10%;"></td> <td style="width: 10%;"></td> <td style="width: 10%;"></td> <td style="width: 10%;"></td> <td style="width: 10%;"></td> </tr> <tr> <td></td> <td></td> <td colspan="8" style="text-align: center;"> <table border="1" style="width: 100%; border-collapse: collapse; text-align: center;"> <tr> </tr></table></td></tr></table></td></tr></table></td></tr></table></td></tr></table></td></tr></table></td></tr></table></td></tr></table></td></tr></table></td></tr></table></td></tr></table></td></tr></table></td></tr></table></td></tr></table></td></tr></table></td></tr></table></td></tr></table></td></tr></table></td></tr></table></td></tr></table></td></tr></table></td></tr></table></td></tr></table></td></tr></table></td></tr></table></td></tr></table></td></tr></table></td></tr></table></td></tr></table></td></tr></table></td></tr></table></td></tr></table></td></tr></table></td></tr></table></td></tr></table></td></tr></table></td></tr></table></td></tr></table></td></tr></table></td></tr></table></td></tr></table></td></tr></table></td></tr></table></td></tr></table></td></tr></table></td></tr></table>
 | | | | | | | | | | | | | | | | | | | | <table border="1" style="width: 100%; border-collapse: collapse; text-align: center;"> <tr> <td style="width: 10%;"></td> <td style="width: 10%;"></td> <td style="width: 10%;"></td> <td style="width: 10%;"></td> <td style="width: 10%;"></td> <td style="width: 10%;"></td> <td style="width: 10%;"></td> <td style="width: 10%;"></td> <td style="width: 10%;"></td> <td style="width: 10%;"></td> </tr> <tr> <td></td> <td></td> <td colspan="8" style="text-align: center;"> <table border="1" style="width: 100%; border-collapse: collapse; text-align: center;"> <tr> <td style="width: 10%;"></td> <td style="width: 10%;"></td> <td style="width: 10%;"></td> <td style="width: 10%;"></td> <td style="width: 10%;"></td> <td style="width: 10%;"></td> <td style="width: 10%;"></td> <td style="width: 10%;"></td> <td style="width: 10%;"></td> <td style="width: 10%;"></td> </tr> <tr> <td></td> <td></td> <td colspan="8" style="text-align: center;"> <table border="1" style="width: 100%; border-collapse: collapse; text-align: center;"> <tr> <td style="width: 10%;"></td> <td style="width: 10%;"></td> <td style="width: 10%;"></td> <td style="width: 10%;"></td> <td style="width: 10%;"></td> <td style="width: 10%;"></td> <td style="width: 10%;"></td> <td style="width: 10%;"></td> <td style="width: 10%;"></td> <td style="width: 10%;"></td> </tr> <tr> <td></td> <td></td> <td colspan="8" style="text-align: center;"> <table border="1" style="width: 100%; border-collapse: collapse; text-align: center;"> <tr> <td style="width: 10%;"></td> <td style="width: 10%;"></td> <td style="width: 10%;"></td> <td style="width: 10%;"></td> <td style="width: 10%;"></td> <td style="width: 10%;"></td> <td style="width: 10%;"></td> <td style="width: 10%;"></td> <td style="width: 10%;"></td> <td style="width: 10%;"></td> </tr> <tr> <td></td> <td></td> <td colspan="8" style="text-align: center;"> <table border="1" style="width: 100%; border-collapse: collapse; text-align: center;"> <tr> <td style="width: 10%;"></td> <td style="width: 10%;"></td> <td style="width: 10%;"></td> <td style="width: 10%;"></td> <td style="width: 10%;"></td> <td style="width: 10%;"></td> <td style="width: 10%;"></td> <td style="width: 10%;"></td> <td style="width: 10%;"></td> <td style="width: 10%;"></td> </tr> <tr> <td></td> <td></td> <td colspan="8" style="text-align: center;"> <table border="1" style="width: 100%; border-collapse: collapse; text-align: center;"> <tr> <td style="width: 10%;"></td> <td style="width: 10%;"></td> <td style="width: 10%;"></td> <td style="width: 10%;"></td> <td style="width: 10%;"></td> <td style="width: 10%;"></td> <td style="width: 10%;"></td> <td style="width: 10%;"></td> <td style="width: 10%;"></td> <td style="width: 10%;"></td> </tr> <tr> <td></td> <td></td> <td colspan="8" style="text-align: center;"> <table border="1" style="width: 100%; border-collapse: collapse; text-align: center;"> <tr> <td style="width: 10%;"></td> <td style="width: 10%;"></td> <td style="width: 10%;"></td> <td style="width: 10%;"></td> <td style="width: 10%;"></td> <td style="width: 10%;"></td> <td style="width: 10%;"></td> <td style="width: 10%;"></td> <td style="width: 10%;"></td> <td style="width: 10%;"></td> </tr> <tr> <td></td> <td></td> <td colspan="8" style="text-align: center;"> <table border="1" style="width: 100%; border-collapse: collapse; text-align: center;"> <tr> <td style="width: 10%;"></td> <td style="width: 10%;"></td> <td style="width: 10%;"></td> <td style="width: 10%;"></td> <td style="width: 10%;"></td> <td style="width: 10%;"></td> <td style="width: 10%;"></td> <td style="width: 10%;"></td> <td style="width: 10%;"></td> <td style="width: 10%;"></td> </tr> <tr> <td></td> <td></td> <td colspan="8" style="text-align: center;"> <table border="1" style="width: 100%; border-collapse: collapse; text-align: center;"> <tr> <td style="width: 10%;"></td> <td style="width: 10%;"></td> <td style="width: 10%;"></td> <td style="width: 10%;"></td> <td style="width: 10%;"></td> <td style="width: 10%;"></td> <td style="width: 10%;"></td> <td style="width: 10%;"></td> <td style="width: 10%;"></td> <td style="width: 10%;"></td> </tr> <tr> <td></td> <td></td> <td colspan="8" style="text-align: center;"> <table border="1" style="width: 100%; border-collapse: collapse; text-align: center;"> <tr> <td style="width: 10%;"></td> <td style="width: 10%;"></td> <td style="width: 10%;"></td> <td style="width: 10%;"></td> <td style="width: 10%;"></td> <td style="width: 10%;"></td> <td style="width: 10%;"></td> <td style="width: 10%;"></td> <td style="width: 10%;"></td> <td style="width: 10%;"></td> </tr> <tr> <td></td> <td></td> <td colspan="8" style="text-align: center;"> <table border="1" style="width: 100%; border-collapse: collapse; text-align: center;"> <tr> <td style="width: 10%;"></td> <td style="width: 10%;"></td> <td style="width: 10%;"></td> <td style="width: 10%;"></td> <td style="width: 10%;"></td> <td style="width: 10%;"></td> <td style="width: 10%;"></td> <td style="width: 10%;"></td> <td style="width: 10%;"></td> <td style="width: 10%;"></td> </tr> <tr> <td></td> <td></td> <td colspan="8" style="text-align: center;"> <table border="1" style="width: 100%; border-collapse: collapse; text-align: center;"> <tr> <td style="width: 10%;"></td> <td style="width: 10%;"></td> <td style="width: 10%;"></td> <td style="width: 10%;"></td> <td style="width: 10%;"></td> <td style="width: 10%;"></td> <td style="width: 10%;"></td> <td style="width: 10%;"></td> <td style="width: 10%;"></td> <td style="width: 10%;"></td> </tr> <tr> <td></td> <td></td> <td colspan="8" style="text-align: center;"> <table border="1" style="width: 100%; border-collapse: collapse; text-align: center;"> <tr> <td style="width: 10%;"></td> <td style="width: 10%;"></td> <td style="width: 10%;"></td> <td style="width: 10%;"></td> <td style="width: 10%;"></td> <td style="width: 10%;"></td> <td style="width: 10%;"></td> <td style="width: 10%;"></td> <td style="width: 10%;"></td> <td style="width: 10%;"></td> </tr> <tr> <td></td> <td></td> <td colspan="8" style="text-align: center;"> <table border="1" style="width: 100%; border-collapse: collapse; text-align: center;"> <tr> <td style="width: 10%;"></td> <td style="width: 10%;"></td> <td style="width: 10%;"></td> <td style="width: 10%;"></td> <td style="width: 10%;"></td> <td style="width: 10%;"></td> <td style="width: 10%;"></td> <td style="width: 10%;"></td> <td style="width: 10%;"></td> <td style="width: 10%;"></td> </tr> <tr> <td></td> <td></td> <td colspan="8" style="text-align: center;"> <table border="1" style="width: 100%; border-collapse: collapse; text-align: center;"> <tr> <td style="width: 10%;"></td> <td style="width: 10%;"></td> <td style="width: 10%;"></td> <td style="width: 10%;"></td> <td style="width: 10%;"></td> <td style="width: 10%;"></td> <td style="width: 10%;"></td> <td style="width: 10%;"></td> <td style="width: 10%;"></td> <td style="width: 10%;"></td> </tr> <tr> <td></td> <td></td> <td colspan="8" style="text-align: center;"> <table border="1" style="width: 100%; border-collapse: collapse; text-align: center;"> <tr> <td style="width: 10%;"></td> <td style="width: 10%;"></td> <td style="width: 10%;"></td> <td style="width: 10%;"></td> <td style="width: 10%;"></td> <td style="width: 10%;"></td> <td style="width: 10%;"></td> <td style="width: 10%;"></td> <td style="width: 10%;"></td> <td style="width: 10%;"></td> </tr> <tr> <td></td> <td></td> <td colspan="8" style="text-align: center;"> <table border="1" style="width: 100%; border-collapse: collapse; text-align: center;"> <tr> <td style="width: 10%;"></td> <td style="width: 10%;"></td> <td style="width: 10%;"></td> <td style="width: 10%;"></td> <td style="width: 10%;"></td> <td style="width: 10%;"></td> <td style="width: 10%;"></td> <td style="width: 10%;"></td> <td style="width: 10%;"></td> <td style="width: 10%;"></td> </tr> <tr> <td></td> <td></td> <td colspan="8" style="text-align: center;"> <table border="1" style="width: 100%; border-collapse: collapse; text-align: center;"> <tr> <td style="width: 10%;"></td> <td style="width: 10%;"></td> <td style="width: 10%;"></td> <td style="width: 10%;"></td> <td style="width: 10%;"></td> <td style="width: 10%;"></td> <td style="width: 10%;"></td> <td style="width: 10%;"></td> <td style="width: 10%;"></td> <td style="width: 10%;"></td> </tr> <tr> <td></td> <td></td> <td colspan="8" style="text-align: center;">
<table border="1" style="width: 100%; border-collapse: collapse; text-align: center;"> <tr> <td style="width: 10%;"></td> <td style="width: 10%;"></td> <td style="width: 10%;"></td> <td style="width: 10%;"></td> <td style="width: 10%;"></td> <td style="width: 10%;"></td> <td style="width: 10%;"></td> <td style="width: 10%;"></td> <td style="width: 10%;"></td> <td style="width: 10%;"></td> </tr> <tr> <td></td> <td></td> <td colspan="8" style="text-align: center;"> <table border="1" style="width: 100%; border-collapse: collapse; text-align: center;"> <tr> <td style="width: 10%;"></td> <td style="width: 10%;"></td> <td style="width: 10%;"></td> <td style="width: 10%;"></td> <td style="width: 10%;"></td> <td style="width: 10%;"></td> <td style="width: 10%;"></td> <td style="width: 10%;"></td> <td style="width: 10%;"></td> <td style="width: 10%;"></td> </tr> <tr> <td></td> <td></td> <td colspan="8" style="text-align: center;"> <table border="1" style="width: 100%; border-collapse: collapse; text-align: center;"> <tr> <td style="width: 10%;"></td> <td style="width: 10%;"></td> <td style="width: 10%;"></td> <td style="width: 10%;"></td> <td style="width: 10%;"></td> <td style="width: 10%;"></td> <td style="width: 10%;"></td> <td style="width: 10%;"></td> <td style="width: 10%;"></td> <td style="width: 10%;"></td> </tr> <tr> <td></td> <td></td> <td colspan="8" style="text-align: center;"> <table border="1" style="width: 100%; border-collapse: collapse; text-align: center;"> <tr> <td style="width: 10%;"></td> <td style="width: 10%;"></td> <td style="width: 10%;"></td> <td style="width: 10%;"></td> <td style="width: 10%;"></td> <td style="width: 10%;"></td> <td style="width: 10%;"></td> <td style="width: 10%;"></td> <td style="width: 10%;"></td> <td style="width: 10%;"></td> </tr> <tr> <td></td> <td></td> <td colspan="8" style="text-align: center;"> <table border="1" style="width: 100%; border-collapse: collapse; text-align: center;"> <tr> <td style="width: 10%;"></td> <td style="width: 10%;"></td> <td style="width: 10%;"></td> <td style="width: 10%;"></td> <td style="width: 10%;"></td> <td style="width: 10%;"></td> <td style="width: 10%;"></td> <td style="width: 10%;"></td> <td style="width: 10%;"></td> <td style="width: 10%;"></td> </tr> <tr> <td></td> <td></td> <td colspan="8" style="text-align: center;"> <table border="1" style="width: 100%; border-collapse: collapse; text-align: center;"> <tr> <td style="width: 10%;"></td> <td style="width: 10%;"></td> <td style="width: 10%;"></td> <td style="width: 10%;"></td> <td style="width: 10%;"></td> <td style="width: 10%;"></td> <td style="width: 10%;"></td> <td style="width: 10%;"></td> <td style="width: 10%;"></td> <td style="width: 10%;"></td> </tr> <tr> <td></td> <td></td> <td colspan="8" style="text-align: center;"> <table border="1" style="width: 100%; border-collapse: collapse; text-align: center;"> <tr> <td style="width: 10%;"></td> <td style="width: 10%;"></td> <td style="width: 10%;"></td> <td style="width: 10%;"></td> <td style="width: 10%;"></td> <td style="width: 10%;"></td> <td style="width: 10%;"></td> <td style="width: 10%;"></td> <td style="width: 10%;"></td> <td style="width: 10%;"></td> </tr> <tr> <td></td> <td></td> <td colspan="8" style="text-align: center;"> <table border="1" style="width: 100%; border-collapse: collapse; text-align: center;"> <tr> <td style="width: 10%;"></td> <td style="width: 10%;"></td> <td style="width: 10%;"></td> <td style="width: 10%;"></td> <td style="width: 10%;"></td> <td style="width: 10%;"></td> <td style="width: 10%;"></td> <td style="width: 10%;"></td> <td style="width: 10%;"></td> <td style="width: 10%;"></td> </tr> <tr> <td></td> <td></td> <td colspan="8" style="text-align: center;"> <table border="1" style="width: 100%; border-collapse: collapse; text-align: center;"> <tr> <td style="width: 10%;"></td> <td style="width: 10%;"></td> <td style="width: 10%;"></td> <td style="width: 10%;"></td> <td style="width: 10%;"></td> <td style="width: 10%;"></td> <td style="width: 10%;"></td> <td style="width: 10%;"></td> <td style="width: 10%;"></td> <td style="width: 10%;"></td> </tr> <tr> <td></td> <td></td> <td colspan="8" style="text-align: center;"> <table border="1" style="width: 100%; border-collapse: collapse; text-align: center;"> <tr> <td style="width: 10%;"></td> <td style="width: 10%;"></td> <td style="width: 10%;"></td> <td style="width: 10%;"></td> <td style="width: 10%;"></td> <td style="width: 10%;"></td> <td style="width: 10%;"></td> <td style="width: 10%;"></td> <td style="width: 10%;"></td> <td style="width: 10%;"></td> </tr> <tr> <td></td> <td></td> <td colspan="8" style="text-align: center;"> <table border="1" style="width: 100%; border-collapse: collapse; text-align: center;"> <tr> <td style="width: 10%;"></td> <td style="width: 10%;"></td> <td style="width: 10%;"></td> <td style="width: 10%;"></td> <td style="width: 10%;"></td> <td style="width: 10%;"></td> <td style="width: 10%;"></td> <td style="width: 10%;"></td> <td style="width: 10%;"></td> <td style="width: 10%;"></td> </tr> <tr> <td></td> <td></td> <td colspan="8" style="text-align: center;"> <table border="1" style="width: 100%; border-collapse: collapse; text-align: center;"> <tr> <td style="width: 10%;"></td> <td style="width: 10%;"></td> <td style="width: 10%;"></td> <td style="width: 10%;"></td> <td style="width: 10%;"></td> <td style="width: 10%;"></td> <td style="width: 10%;"></td> <td style="width: 10%;"></td> <td style="width: 10%;"></td> <td style="width: 10%;"></td> </tr> <tr> <td></td> <td></td> <td colspan="8" style="text-align: center;"> <table border="1" style="width: 100%; border-collapse: collapse; text-align: center;"> <tr> <td style="width: 10%;"></td> <td style="width: 10%;"></td> <td style="width: 10%;"></td> <td style="width: 10%;"></td> <td style="width: 10%;"></td> <td style="width: 10%;"></td> <td style="width: 10%;"></td> <td style="width: 10%;"></td> <td style="width: 10%;"></td> <td style="width: 10%;"></td> </tr> <tr> <td></td> <td></td> <td colspan="8" style="text-align: center;"> <table border="1" style="width: 100%; border-collapse: collapse; text-align: center;"> <tr> <td style="width: 10%;"></td> <td style="width: 10%;"></td> <td style="width: 10%;"></td> <td style="width: 10%;"></td> <td style="width: 10%;"></td> <td style="width: 10%;"></td> <td style="width: 10%;"></td> <td style="width: 10%;"></td> <td style="width: 10%;"></td> <td style="width: 10%;"></td> </tr> <tr> <td></td> <td></td> <td colspan="8" style="text-align: center;"> <table border="1" style="width: 100%; border-collapse: collapse; text-align: center;"> <tr> <td style="width: 10%;"></td> <td style="width: 10%;"></td> <td style="width: 10%;"></td> <td style="width: 10%;"></td> <td style="width: 10%;"></td> <td style="width: 10%;"></td> <td style="width: 10%;"></td> <td style="width: 10%;"></td> <td style="width: 10%;"></td> <td style="width: 10%;"></td> </tr> <tr> <td></td> <td></td> <td colspan="8" style="text-align: center;"> <table border="1" style="width: 100%; border-collapse: collapse; text-align: center;"> <tr> <td style="width: 10%;"></td> <td style="width: 10%;"></td> <td style="width: 10%;"></td> <td style="width: 10%;"></td> <td style="width: 10%;"></td> <td style="width: 10%;"></td> <td style="width: 10%;"></td> <td style="width: 10%;"></td> <td style="width: 10%;"></td> <td style="width: 10%;"></td> </tr> <tr> <td></td> <td></td> <td colspan="8" style="text-align: center;"> <table border="1" style="width: 100%; border-collapse: collapse; text-align: center;"> <tr> <td style="width: 10%;"></td> <td style="width: 10%;"></td> <td style="width: 10%;"></td> <td style="width: 10%;"></td> <td style="width: 10%;"></td> <td style="width: 10%;"></td> <td style="width: 10%;"></td> <td style="width: 10%;"></td> <td style="width: 10%;"></td> <td style="width: 10%;"></td> </tr> <tr> <td></td> <td></td> <td colspan="8" style="text-align: center;"> <table border="1" style="width: 100%; border-collapse: collapse; text-align: center;"> <tr> <td style="width: 10%;"></td> <td style="width: 10%;"></td> <td style="width: 10%;"></td> <td style="width: 10%;"></td> <td style="width: 10%;"></td> <td style="width: 10%;"></td> <td style="width: 10%;"></td> <td style="width: 10%;"></td> <td style="width: 10%;"></td> <td style="width: 10%;"></td> </tr> <tr> <td></td> <td></td> <td colspan="8" style="text-align: center;"> <table border="1" style="width: 100%; border-collapse: collapse; text-align: center;"> <tr> <td style="width: 10%;"></td> <td style="width: 10%;"></td> <td style="width: 10%;"></td> <td style="width: 10%;"></td> <td style="width: 10%;"></td> <td style="width: 10%;"></td> <td style="width: 10%;"></td> <td style="width: 10%;"></td> <td style="width: 10%;"></td> <td style="width: 10%;"></td> </tr> <tr> <td></td> <td></td> <td colspan="8" style="text-align: center;"> <table border="1" style="width: 100%; border-collapse: collapse; text-align: center;"> <tr> <td style="width: 10%;"></td> <td style="width: 10%;"></td> <td style="width: 10%;"></td> <td style="width: 10%;"></td> <td style="width: 10%;"></td> <td style="width: 10%;"></td> <td style="width: 10%;"></td> <td style="width: 10%;"></td> <td style="width: 10%;"></td> <td style="width: 10%;"></td> </tr> <tr> <td></td> <td></td> <td colspan="8" style="text-align: center;"> <table border="1" style="width: 100%; border-collapse: collapse; text-align: center;"> <tr> <td style="width: 10%;"></td> <td style="width: 10%;"></td> <td style="width: 10%;"></td> <td style="width: 10%;"></td> <td style="width: 10%;"></td> <td style="width: 10%;"></td> <td style="width: 10%;"></td> <td style="width: 10%;"></td> <td style="width: 10%;"></td> <td style="width: 10%;"></td> </tr> <tr> <td></td> <td></td> <td colspan="8" style="text-align: center;"> <table border="1" style="width: 100%; border-collapse: collapse; text-align: center;"> <tr> <td style="width: 10%;"></td> <td style="width: 10%;"></td> <td style="width:
10%;"></td> <td style="width: 10%;"></td> <td style="width: 10%;"></td> <td style="width: 10%;"></td> <td style="width: 10%;"></td> <td style="width: 10%;"></td> <td style="width: 10%;"></td> <td style="width: 10%;"></td> </tr> <tr> <td></td> <td></td> <td colspan="8" style="text-align: center;"> <table border="1" style="width: 100%; border-collapse: collapse; text-align: center;"> <tr> <td style="width: 10%;"></td> <td style="width: 10%;"></td> <td style="width: 10%;"></td> <td style="width: 10%;"></td> <td style="width: 10%;"></td> <td style="width: 10%;"></td> <td style="width: 10%;"></td> <td style="width: 10%;"></td> <td style="width: 10%;"></td> <td style="width: 10%;"></td> </tr> <tr> <td></td> <td></td> <td colspan="8" style="text-align: center;"> <table border="1" style="width: 100%; border-collapse: collapse; text-align: center;"> <tr> <td style="width: 10%;"></td> <td style="width: 10%;"></td> <td style="width: 10%;"></td> <td style="width: 10%;"></td> <td style="width: 10%;"></td> <td style="width: 10%;"></td> <td style="width: 10%;"></td> <td style="width: 10%;"></td> <td style="width: 10%;"></td> <td style="width: 10%;"></td> </tr> <tr> <td></td> <td></td> <td colspan="8" style="text-align: center;"> <table border="1" style="width: 100%; border-collapse: collapse; text-align: center;"> <tr> <td style="width: 10%;"></td> <td style="width: 10%;"></td> <td style="width: 10%;"></td> <td style="width: 10%;"></td> <td style="width: 10%;"></td> <td style="width: 10%;"></td> <td style="width: 10%;"></td> <td style="width: 10%;"></td> <td style="width: 10%;"></td> <td style="width: 10%;"></td> </tr> <tr> <td></td> <td></td> <td colspan="8" style="text-align: center;"> <table border="1" style="width: 100%; border-collapse: collapse; text-align: center;"> <tr> <td style="width: 10%;"></td> <td style="width: 10%;"></td> <td style="width: 10%;"></td> <td style="width: 10%;"></td> <td style="width: 10%;"></td> <td style="width: 10%;"></td> <td style="width: 10%;"></td> <td style="width: 10%;"></td> <td style="width: 10%;"></td> <td style="width: 10%;"></td> </tr> <tr> <td></td> <td></td> <td colspan="8" style="text-align: center;"> <table border="1" style="width: 100%; border-collapse: collapse; text-align: center;"> <tr> </tr></table></td></tr></table></td></tr></table></td></tr></table></td></tr></table></td></tr></table></td></tr></table></td></tr></table></td></tr></table></td></tr></table></td></tr></table></td></tr></table></td></tr></table></td></tr></table></td></tr></table></td></tr></table></td></tr></table></td></tr></table></td></tr></table></td></tr></table></td></tr></table></td></tr></table></td></tr></table></td></tr></table></td></tr></table></td></tr></table></td></tr></table></td></tr></table></td></tr></table></td></tr></table></td></tr></table></td></tr></table></td></tr></table></td></tr></table></td></tr></table></td></tr></table></td></tr></table></td></tr></table></td></tr></table></td></tr></table></td></tr></table></td></tr></table></td></tr></table></td></tr></table></td></tr></table>
 | | | | | | | | | | | | | | | | | | | | <table border="1" style="width: 100%; border-collapse: collapse; text-align: center;"> <tr> <td style="width: 10%;"></td> <td style="width: 10%;"></td> <td style="width: 10%;"></td> <td style="width: 10%;"></td> <td style="width: 10%;"></td> <td style="width: 10%;"></td> <td style="width: 10%;"></td> <td style="width: 10%;"></td> <td style="width: 10%;"></td> <td style="width: 10%;"></td> </tr> <tr> <td></td> <td></td> <td colspan="8" style="text-align: center;"> <table border="1" style="width: 100%; border-collapse: collapse; text-align: center;"> <tr> <td style="width: 10%;"></td> <td style="width: 10%;"></td> <td style="width: 10%;"></td> <td style="width: 10%;"></td> <td style="width: 10%;"></td> <td style="width: 10%;"></td> <td style="width: 10%;"></td> <td style="width: 10%;"></td> <td style="width: 10%;"></td> <td style="width: 10%;"></td> </tr> <tr> <td></td> <td></td> <td colspan="8" style="text-align: center;"> <table border="1" style="width: 100%; border-collapse: collapse; text-align: center;"> <tr> <td style="width: 10%;"></td> <td style="width: 10%;"></td> <td style="width: 10%;"></td> <td style="width: 10%;"></td> <td style="width: 10%;"></td> <td style="width: 10%;"></td> <td style="width: 10%;"></td> <td style="width: 10%;"></td> <td style="width: 10%;"></td> <td style="width: 10%;"></td> </tr> <tr> <td></td> <td></td> <td colspan="8" style="text-align: center;"> <table border="1" style="width: 100%; border-collapse: collapse; text-align: center;"> <tr> <td style="width: 10%;"></td> <td style="width: 10%;"></td> <td style="width: 10%;"></td> <td style="width: 10%;"></td> <td style="width: 10%;"></td> <td style="width: 10%;"></td> <td style="width: 10%;"></td> <td style="width: 10%;"></td> <td style="width: 10%;"></td> <td style="width: 10%;"></td> </tr> <tr> <td></td> <td></td> <td colspan="8" style="text-align: center;"> <table border="1" style="width: 100%; border-collapse: collapse; text-align: center;"> <tr> <td style="width: 10%;"></td> <td style="width: 10%;"></td> <td style="width: 10%;"></td> <td style="width: 10%;"></td> <td style="width: 10%;"></td> <td style="width: 10%;"></td> <td style="width: 10%;"></td> <td style="width: 10%;"></td> <td style="width: 10%;"></td> <td style="width: 10%;"></td> </tr> <tr> <td></td> <td></td> <td colspan="8" style="text-align: center;"> <table border="1" style="width: 100%; border-collapse: collapse; text-align: center;"> <tr> <td style="width: 10%;"></td> <td style="width: 10%;"></td> <td style="width: 10%;"></td> <td style="width: 10%;"></td> <td style="width: 10%;"></td> <td style="width: 10%;"></td> <td style="width: 10%;"></td> <td style="width: 10%;"></td> <td style="width: 10%;"></td> <td style="width: 10%;"></td> </tr> <tr> <td></td> <td></td> <td colspan="8" style="text-align: center;"> <table border="1" style="width: 100%; border-collapse: collapse; text-align: center;"> <tr> <td style="width: 10%;"></td> <td style="width: 10%;"></td> <td style="width: 10%;"></td> <td style="width: 10%;"></td> <td style="width: 10%;"></td> <td style="width: 10%;"></td> <td style="width: 10%;"></td> <td style="width: 10%;"></td> <td style="width: 10%;"></td> <td style="width: 10%;"></td> </tr> <tr> <td></td> <td></td> <td colspan="8" style="text-align: center;"> <table border="1" style="width: 100%; border-collapse: collapse; text-align: center;"> <tr> <td style="width: 10%;"></td> <td style="width: 10%;"></td> <td style="width: 10%;"></td> <td style="width: 10%;"></td> <td style="width: 10%;"></td> <td style="width: 10%;"></td> <td style="width: 10%;"></td> <td style="width: 10%;"></td> <td style="width: 10%;"></td> <td style="width: 10%;"></td> </tr> <tr> <td></td> <td></td> <td colspan="8" style="text-align: center;"> <table border="1" style="width: 100%; border-collapse: collapse; text-align: center;"> <tr> <td style="width: 10%;"></td> <td style="width: 10%;"></td> <td style="width: 10%;"></td> <td style="width: 10%;"></td> <td style="width: 10%;"></td> <td style="width: 10%;"></td> <td style="width: 10%;"></td> <td style="width: 10%;"></td> <td style="width: 10%;"></td> <td style="width: 10%;"></td> </tr> <tr> <td></td> <td></td> <td colspan="8" style="text-align: center;"> <table border="1" style="width: 100%; border-collapse: collapse; text-align: center;"> <tr> <td style="width: 10%;"></td> <td style="width: 10%;"></td> <td style="width: 10%;"></td> <td style="width: 10%;"></td> <td style="width: 10%;"></td> <td style="width: 10%;"></td> <td style="width: 10%;"></td> <td style="width: 10%;"></td> <td style="width: 10%;"></td> <td style="width: 10%;"></td> </tr> <tr> <td></td> <td></td> <td colspan="8" style="text-align: center;"> <table border="1" style="width: 100%; border-collapse: collapse; text-align: center;"> <tr> <td style="width: 10%;"></td> <td style="width: 10%;"></td> <td style="width: 10%;"></td> <td style="width: 10%;"></td> <td style="width: 10%;"></td> <td style="width: 10%;"></td> <td style="width: 10%;"></td> <td style="width: 10%;"></td> <td style="width: 10%;"></td> <td style="width: 10%;"></td> </tr> <tr> <td></td> <td></td> <td colspan="8" style="text-align: center;"> <table border="1" style="width: 100%; border-collapse: collapse; text-align: center;"> <tr> <td style="width: 10%;"></td> <td style="width: 10%;"></td> <td style="width: 10%;"></td> <td style="width: 10%;"></td> <td style="width: 10%;"></td> <td style="width: 10%;"></td> <td style="width: 10%;"></td> <td style="width: 10%;"></td> <td style="width: 10%;"></td> <td style="width: 10%;"></td> </tr> <tr> <td></td> <td></td> <td colspan="8" style="text-align: center;"> <table border="1" style="width: 100%; border-collapse: collapse; text-align: center;"> <tr> <td style="width: 10%;"></td> <td style="width: 10%;"></td> <td style="width: 10%;"></td> <td style="width: 10%;"></td> <td style="width: 10%;"></td> <td style="width: 10%;"></td> <td style="width: 10%;"></td> <td style="width: 10%;"></td> <td style="width: 10%;"></td> <td style="width: 10%;"></td> </tr> <tr> <td></td> <td></td> <td colspan="8" style="text-align: center;"> <table border="1" style="width: 100%; border-collapse: collapse; text-align: center;"> <tr> <td style="width: 10%;"></td> <td style="width: 10%;"></td> <td style="width: 10%;"></td> <td style="width: 10%;"></td> <td style="width: 10%;"></td> <td style="width: 10%;"></td> <td style="width: 10%;"></td> <td style="width: 10%;"></td> <td style="width: 10%;"></td> <td style="width: 10%;"></td> </tr> <tr> <td></td> <td></td> <td colspan="8" style="text-align: center;"> <table border="1" style="width: 100%; border-collapse: collapse; text-align: center;"> <tr> <td style="width: 10%;"></td> <td style="width: 10%;"></td> <td style="width: 10%;"></td> <td style="width: 10%;"></td> <td style="width: 10%;"></td> <td style="width: 10%;"></td> <td style="width: 10%;"></td> <td style="width: 10%;"></td> <td style="width: 10%;"></td> <td style="width: 10%;"></td> </tr> <tr> <td></td> <td></td> <td colspan="8" style="text-align: center;"> <table border="1" style="width: 100%; border-collapse: collapse; text-align: center;"> <tr> <td style="width: 10%;"></td> <td style="width: 10%;"></td> <td style="width: 10%;"></td> <td style="width: 10%;"></td> <td style="width: 10%;"></td> <td style="width: 10%;"></td> <td style="width: 10%;"></td> <td style="width: 10%;"></td> <td style="width: 10%;"></td> <td style="width: 10%;"></td> </tr> <tr> <td></td> <td></td> <td colspan="8" style="text-align: center;"> <table border="1" style="width: 100%; border-collapse: collapse; text-align: center;"> <tr> <td style="width: 10%;"></td> <td style="width: 10%;"></td> <td style="width: 10%;"></td> <td style="width: 10%;"></td> <td style="width: 10%;"></td> <td style="width: 10%;"></td> <td style="width: 10%;"></td> <td style="width: 10%;"></td> <td style="width: 10%;"></td> <td style="width: 10%;"></td> </tr> <tr> <td></td> <td></td> <td colspan="8" style="text-align: center;"> <table border="1" style="width: 100%; border-collapse: collapse; text-align: center;"> <tr> <td style="width: 10%;"></td> <td style="width: 10%;"></td> <td style="width: 10%;"></td> <td style="width: 10%;"></td> <td style="width: 10%;"></td> <td style="width: 10%;"></td> <td style="width: 10%;"></td> <td style="width: 10%;"></td> <td style="width: 10%;"></td> <td style="width: 10%;"></td> </tr> <tr> <td></td> <td></td> <td colspan="8" style="text-align: center;"> <table border="1" style="width: 100%; border-collapse: collapse; text-align: center;"> <tr> <td style="width: 10%;"></td> <td style="width: 10%;"></td> <td style="width: 10%;"></td> <td style="width: 10%;"></td> <td style="width: 10%;"></td> <td style="width: 10%;"></td> <td style="width: 10%;"></td> <td style="width: 10%;"></td> <td style="width: 10%;"></td> <td style="width: 10%;"></td> </tr> <tr> <td></td> <td></td> <td colspan="8" style="text-align: center;"> <table border="1" style="width: 100%; border-collapse: collapse; text-align: center;"> <tr> <td style="width: 10%;"></td> <td style="width: 10%;"></td> <td style="width: 10%;"></td> <td style="width: 10%;"></td> <td style="width: 10%;"></td> <td style="width: 10%;"></td> <td style="width: 10%;"></td> <td style="width: 10%;"></td> <td style="width: 10%;"></td> <td style="width: 10%;"></td> </tr> <tr> <td></td> <td></td> <td colspan="8" style="text-align: center;"> <table border="1" style="width: 100%; border-collapse: collapse; text-align: center;"> <tr> <td style="width: 10%;"></td> <td style="width: 10%;"></td> <td style="width: 10%;"></td> <td style="width: 10%;"></td> <td
style="width: 10%;"></td> <td style="width: 10%;"></td> <td style="width: 10%;"></td> <td style="width: 10%;"></td> <td style="width: 10%;"></td> <td style="width: 10%;"></td> </tr> <tr> <td></td> <td></td> <td colspan="8" style="text-align: center;"> <table border="1" style="width: 100%; border-collapse: collapse; text-align: center;"> <tr> <td style="width: 10%;"></td> <td style="width: 10%;"></td> <td style="width: 10%;"></td> <td style="width: 10%;"></td> <td style="width: 10%;"></td> <td style="width: 10%;"></td> <td style="width: 10%;"></td> <td style="width: 10%;"></td> <td style="width: 10%;"></td> <td style="width: 10%;"></td> </tr> <tr> <td></td> <td></td> <td colspan="8" style="text-align: center;"> <table border="1" style="width: 100%; border-collapse: collapse; text-align: center;"> <tr> <td style="width: 10%;"></td> <td style="width: 10%;"></td> <td style="width: 10%;"></td> <td style="width: 10%;"></td> <td style="width: 10%;"></td> <td style="width: 10%;"></td> <td style="width: 10%;"></td> <td style="width: 10%;"></td> <td style="width: 10%;"></td> <td style="width: 10%;"></td> </tr> <tr> <td></td> <td></td> <td colspan="8" style="text-align: center;"> <table border="1" style="width: 100%; border-collapse: collapse; text-align: center;"> <tr> <td style="width: 10%;"></td> <td style="width: 10%;"></td> <td style="width: 10%;"></td> <td style="width: 10%;"></td> <td style="width: 10%;"></td> <td style="width: 10%;"></td> <td style="width: 10%;"></td> <td style="width: 10%;"></td> <td style="width: 10%;"></td> <td style="width: 10%;"></td> </tr> <tr> <td></td> <td></td> <td colspan="8" style="text-align: center;"> <table border="1" style="width: 100%; border-collapse: collapse; text-align: center;"> <tr> <td style="width: 10%;"></td> <td style="width: 10%;"></td> <td style="width: 10%;"></td> <td style="width: 10%;"></td> <td style="width: 10%;"></td> <td style="width: 10%;"></td> <td style="width: 10%;"></td> <td style="width: 10%;"></td> <td style="width: 10%;"></td> <td style="width: 10%;"></td> </tr> <tr> <td></td> <td></td> <td colspan="8" style="text-align: center;"> <table border="1" style="width: 100%; border-collapse: collapse; text-align: center;"> <tr> <td style="width: 10%;"></td> <td style="width: 10%;"></td> <td style="width: 10%;"></td> <td style="width: 10%;"></td> <td style="width: 10%;"></td> <td style="width: 10%;"></td> <td style="width: 10%;"></td> <td style="width: 10%;"></td> <td style="width: 10%;"></td> <td style="width: 10%;"></td> </tr> <tr> <td></td> <td></td> <td colspan="8" style="text-align: center;"> <table border="1" style="width: 100%; border-collapse: collapse; text-align: center;"> <tr> <td style="width: 10%;"></td> <td style="width: 10%;"></td> <td style="width: 10%;"></td> <td style="width: 10%;"></td> <td style="width: 10%;"></td> <td style="width: 10%;"></td> <td style="width: 10%;"></td> <td style="width: 10%;"></td> <td style="width: 10%;"></td> <td style="width: 10%;"></td> </tr> <tr> <td></td> <td></td> <td colspan="8" style="text-align: center;"> <table border="1" style="width: 100%; border-collapse: collapse; text-align: center;"> <tr> <td style="width: 10%;"></td> <td style="width: 10%;"></td> <td style="width: 10%;"></td> <td style="width: 10%;"></td> <td style="width: 10%;"></td> <td style="width: 10%;"></td> <td style="width: 10%;"></td> <td style="width: 10%;"></td> <td style="width: 10%;"></td> <td style="width: 10%;"></td> </tr> <tr> <td></td> <td></td> <td colspan="8" style="text-align: center;"> <table border="1" style="width: 100%; border-collapse: collapse; text-align: center;"> <tr> <td style="width: 10%;"></td> <td style="width: 10%;"></td> <td style="width: 10%;"></td> <td style="width: 10%;"></td> <td style="width: 10%;"></td> <td style="width: 10%;"></td> <td style="width: 10%;"></td> <td style="width: 10%;"></td> <td style="width: 10%;"></td> <td style="width: 10%;"></td> </tr> <tr> <td></td> <td></td> <td colspan="8" style="text-align: center;"> <table border="1" style="width: 100%; border-collapse: collapse; text-align: center;"> <tr> <td style="width: 10%;"></td> <td style="width: 10%;"></td> <td style="width: 10%;"></td> <td style="width: 10%;"></td> <td style="width: 10%;"></td> <td style="width: 10%;"></td> <td style="width: 10%;"></td> <td style="width: 10%;"></td> <td style="width: 10%;"></td> <td style="width: 10%;"></td> </tr> <tr> <td></td> <td></td> <td colspan="8" style="text-align: center;"> <table border="1" style="width: 100%; border-collapse: collapse; text-align: center;"> <tr> <td style="width: 10%;"></td> <td style="width: 10%;"></td> <td style="width: 10%;"></td> <td style="width: 10%;"></td> <td style="width: 10%;"></td> <td style="width: 10%;"></td> <td style="width: 10%;"></td> <td style="width: 10%;"></td> <td style="width: 10%;"></td> <td style="width: 10%;"></td> </tr> <tr> <td></td> <td></td> <td colspan="8" style="text-align: center;"> <table border="1" style="width: 100%; border-collapse: collapse; text-align: center;"> <tr> <td style="width: 10%;"></td> <td style="width: 10%;"></td> <td style="width: 10%;"></td> <td style="width: 10%;"></td> <td style="width: 10%;"></td> <td style="width: 10%;"></td> <td style="width: 10%;"></td> <td style="width: 10%;"></td> <td style="width: 10%;"></td> <td style="width: 10%;"></td> </tr> <tr> <td></td> <td></td> <td colspan="8" style="text-align: center;"> <table border="1" style="width: 100%; border-collapse: collapse; text-align: center;"> <tr> <td style="width: 10%;"></td> <td style="width: 10%;"></td> <td style="width: 10%;"></td> <td style="width: 10%;"></td> <td style="width: 10%;"></td> <td style="width: 10%;"></td> <td style="width: 10%;"></td> <td style="width: 10%;"></td> <td style="width: 10%;"></td> <td style="width: 10%;"></td> </tr> <tr> <td></td> <td></td> <td colspan="8" style="text-align: center;"> <table border="1" style="width: 100%; border-collapse: collapse; text-align: center;"> <tr> <td style="width: 10%;"></td> <td style="width: 10%;"></td> <td style="width: 10%;"></td> <td style="width: 10%;"></td> <td style="width: 10%;"></td> <td style="width: 10%;"></td> <td style="width: 10%;"></td> <td style="width: 10%;"></td> <td style="width: 10%;"></td> <td style="width: 10%;"></td> </tr> <tr> <td></td> <td></td> <td colspan="8" style="text-align: center;"> <table border="1" style="width: 100%; border-collapse: collapse; text-align: center;"> <tr> <td style="width: 10%;"></td> <td style="width: 10%;"></td> <td style="width: 10%;"></td> <td style="width: 10%;"></td> <td style="width: 10%;"></td> <td style="width: 10%;"></td> <td style="width: 10%;"></td> <td style="width: 10%;"></td> <td style="width: 10%;"></td> <td style="width: 10%;"></td> </tr> <tr> <td></td> <td></td> <td colspan="8" style="text-align: center;"> <table border="1" style="width: 100%; border-collapse: collapse; text-align: center;"> <tr> <td style="width: 10%;"></td> <td style="width: 10%;"></td> <td style="width: 10%;"></td> <td style="width: 10%;"></td> <td style="width: 10%;"></td> <td style="width: 10%;"></td> <td style="width: 10%;"></td> <td style="width: 10%;"></td> <td style="width: 10%;"></td> <td style="width: 10%;"></td> </tr> <tr> <td></td> <td></td> <td colspan="8" style="text-align: center;"> <table border="1" style="width: 100%; border-collapse: collapse; text-align: center;"> <tr> <td style="width: 10%;"></td> <td style="width: 10%;"></td> <td style="width: 10%;"></td> <td style="width: 10%;"></td> <td style="width: 10%;"></td> <td style="width: 10%;"></td> <td style="width: 10%;"></td> <td style="width: 10%;"></td> <td style="width: 10%;"></td> <td style="width: 10%;"></td> </tr> <tr> <td></td> <td></td> <td colspan="8" style="text-align: center;"> <table border="1" style="width: 100%; border-collapse: collapse; text-align: center;"> <tr> <td style="width: 10%;"></td> <td style="width: 10%;"></td> <td style="width: 10%;"></td> <td style="width: 10%;"></td> <td style="width: 10%;"></td> <td style="width: 10%;"></td> <td style="width: 10%;"></td> <td style="width: 10%;"></td> <td style="width: 10%;"></td> <td style="width: 10%;"></td> </tr> <tr> <td></td> <td></td> <td colspan="8" style="text-align: center;"> <table border="1" style="width: 100%; border-collapse: collapse; text-align: center;"> <tr> <td style="width: 10%;"></td> <td style="width: 10%;"></td> <td style="width: 10%;"></td> <td style="width: 10%;"></td> <td style="width: 10%;"></td> <td style="width: 10%;"></td> <td style="width: 10%;"></td> <td style="width: 10%;"></td> <td style="width: 10%;"></td> <td style="width: 10%;"></td> </tr> <tr> <td></td> <td></td> <td colspan="8" style="text-align: center;"> <table border="1" style="width: 100%; border-collapse: collapse; text-align: center;"> <tr> <td style="width: 10%;"></td> <td style="width: 10%;"></td> <td style="width: 10%;"></td> <td style="width: 10%;"></td> <td style="width: 10%;"></td> <td style="width: 10%;"></td> <td style="width: 10%;"></td> <td style="width: 10%;"></td> <td style="width: 10%;"></td> <td style="width: 10%;"></td> </tr> <tr> <td></td> <td></td> <td colspan="8" style="text-align: center;"> <table border="1" style="width: 100%; border-collapse: collapse; text-align: center;"> <tr> <td style="width: 10%;"></td> <td style="width: 10%;"></td> <td style="width: 10%;"></td> <td style="width: 10%;"></td> <td style="width: 10%;"></td> <td style="width: 10%;"></td> <td style="width: 10%;"></td> <td style="width: 10%;"></td> <td style="width: 10%;"></td> <td style="width: 10%;"></td> </tr> <tr> <td></td> <td></td> <td colspan="8" style="text-align: center;"> <table border="1" style="width: 100%; border-collapse: collapse; text-align: center;"> <tr> <td style="width: 10%;"></td> <td style="width: 10%;"></td> <td style="width: 10%;"></td> <td style="width: 10%;"></td> <td style="width: 10%;"></td> <td style="width: 10%;"></td> <td style="width: 10%;"></td> <td style="width: 10%;"></td> <td style="width: 10%;"></td> <td style="width:
10%;"></td> </tr> <tr> <td></td> <td></td> <td colspan="8" style="text-align: center;"> <table border="1" style="width: 100%; border-collapse: collapse; text-align: center;"> <tr> <td style="width: 10%;"></td> <td style="width: 10%;"></td> <td style="width: 10%;"></td> <td style="width: 10%;"></td> <td style="width: 10%;"></td> <td style="width: 10%;"></td> <td style="width: 10%;"></td> <td style="width: 10%;"></td> <td style="width: 10%;"></td> <td style="width: 10%;"></td> </tr> <tr> <td></td> <td></td> <td colspan="8" style="text-align: center;"> <table border="1" style="width: 100%; border-collapse: collapse; text-align: center;"> <tr> </tr></table></td></tr></table></td></tr></table></td></tr></table></td></tr></table></td></tr></table></td></tr></table></td></tr></table></td></tr></table></td></tr></table></td></tr></table></td></tr></table></td></tr></table></td></tr></table></td></tr></table></td></tr></table></td></tr></table></td></tr></table></td></tr></table></td></tr></table></td></tr></table></td></tr></table></td></tr></table></td></tr></table></td></tr></table></td></tr></table></td></tr></table></td></tr></table></td></tr></table></td></tr></table></td></tr></table></td></tr></table></td></tr></table></td></tr></table></td></tr></table></td></tr></table></td></tr></table></td></tr></table></td></tr></table></td></tr></table></td></tr></table></td></tr></table></td></tr></table></td></tr></table> | | | | | | | | | | | | | | | | | | | | <table border="1" style="width: 100%; border-collapse: collapse; text-align: center;"> <tr> <td style="width: 10%;"></td> <td style="width: 10%;"></td> <td style="width: 10%;"></td> <td style="width: 10%;"></td> <td style="width: 10%;"></td> <td style="width: 10%;"></td> <td style="width: 10%;"></td> <td style="width: 10%;"></td> <td style="width: 10%;"></td> <td style="width: 10%;"></td> </tr> <tr> <td></td> <td></td> <td colspan="8" style="text-align: center;"> <table border="1" style="width: 100%; border-collapse: collapse; text-align: center;"> <tr> <td style="width: 10%;"></td> <td style="width: 10%;"></td> <td style="width: 10%;"></td> <td style="width: 10%;"></td> <td style="width: 10%;"></td> <td style="width: 10%;"></td> <td style="width: 10%;"></td> <td style="width: 10%;"></td> <td style="width: 10%;"></td> <td style="width: 10%;"></td> </tr> <tr> <td></td> <td></td> <td colspan="8" style="text-align: center;"> <table border="1" style="width: 100%; border-collapse: collapse; text-align: center;"> <tr> <td style="width: 10%;"></td> <td style="width: 10%;"></td> <td style="width: 10%;"></td> <td style="width: 10%;"></td> <td style="width: 10%;"></td> <td style="width: 10%;"></td> <td
style="width: 10%;"></td> <td style="width: 10%;"></td> <td style="width: 10%;"></td> <td style="width: 10%;"></td> </tr> <tr> <td></td> <td></td> <td colspan="8" style="text-align: center;"> <table border="1" style="width: 100%; border-collapse: collapse; text-align: center;"> <tr> <td style="width: 10%;"></td> <td style="width: 10%;"></td> <td style="width: 10%;"></td> <td style="width: 10%;"></td> <td style="width: 10%;"></td> <td style="width: 10%;"></td> <td style="width: 10%;"></td> <td style="width: 10%;"></td> <td style="width: 10%;"></td> <td style="width: 10%;"></td> </tr> <tr> <td></td> <td></td> <td colspan="8" style="text-align: center;"> <table border="1" style="width: 100%; border-collapse: collapse; text-align: center;"> <tr> <td style="width: 10%;"></td> <td style="width: 10%;"></td> <td style="width: 10%;"></td> <td style="width: 10%;"></td> <td style="width: 10%;"></td> <td style="width: 10%;"></td> <td style="width: 10%;"></td> <td style="width: 10%;"></td> <td style="width: 10%;"></td> <td style="width: 10%;"></td> </tr> <tr> <td></td> <td></td> <td colspan="8" style="text-align: center;"> <table border="1" style="width: 100%; border-collapse: collapse; text-align: center;"> <tr> <td style="width: 10%;"></td> <td style="width: 10%;"></td> <td style="width: 10%;"></td> <td style="width: 10%;"></td> <td style="width: 10%;"></td> <td style="width: 10%;"></td> <td style="width: 10%;"></td> <td style="width: 10%;"></td> <td style="width: 10%;"></td> <td style="width: 10%;"></td> </tr> <tr> <td></td> <td></td> <td colspan="8" style="text-align: center;"> <table border="1" style="width: 100%; border-collapse: collapse; text-align: center;"> <tr> <td style="width: 10%;"></td> <td style="width: 10%;"></td> <td style="width: 10%;"></td> <td style="width: 10%;"></td> <td style="width: 10%;"></td> <td style="width: 10%;"></td> <td style="width: 10%;"></td> <td style="width: 10%;"></td> <td style="width: 10%;"></td> <td style="width: 10%;"></td> </tr> <tr> <td></td> <td></td> <td colspan="8" style="text-align: center;"> <table border="1" style="width: 100%; border-collapse: collapse; text-align: center;"> <tr> <td style="width: 10%;"></td> <td style="width: 10%;"></td> <td style="width: 10%;"></td> <td style="width: 10%;"></td> <td style="width: 10%;"></td> <td style="width: 10%;"></td> <td style="width: 10%;"></td> <td style="width: 10%;"></td> <td style="width: 10%;"></td> <td style="width: 10%;"></td> </tr> <tr> <td></td> <td></td> <td colspan="8" style="text-align: center;"> <table border="1" style="width: 100%; border-collapse: collapse; text-align: center;"> <tr> <td style="width: 10%;"></td> <td style="width: 10%;"></td> <td style="width: 10%;"></td> <td style="width: 10%;"></td> <td style="width: 10%;"></td> <td style="width: 10%;"></td> <td style="width: 10%;"></td> <td style="width: 10%;"></td> <td style="width: 10%;"></td> <td style="width: 10%;"></td> </tr> <tr> <td></td> <td></td> <td colspan="8" style="text-align: center;"> <table border="1" style="width: 100%; border-collapse: collapse; text-align: center;"> <tr> <td style="width: 10%;"></td> <td style="width: 10%;"></td> <td style="width: 10%;"></td> <td style="width: 10%;"></td> <td style="width: 10%;"></td> <td style="width: 10%;"></td> <td style="width: 10%;"></td> <td style="width: 10%;"></td> <td style="width: 10%;"></td> <td style="width: 10%;"></td> </tr> <tr> <td></td> <td></td> <td colspan="8" style="text-align: center;"> <table border="1" style="width: 100%; border-collapse: collapse; text-align: center;"> <tr> <td style="width: 10%;"></td> <td style="width: 10%;"></td> <td style="width: 10%;"></td> <td style="width: 10%;"></td> <td style="width: 10%;"></td> <td style="width: 10%;"></td> <td style="width: 10%;"></td> <td style="width: 10%;"></td> <td style="width: 10%;"></td> <td style="width: 10%;"></td> </tr> <tr> <td></td> <td></td> <td colspan="8" style="text-align: center;"> <table border="1" style="width: 100%; border-collapse: collapse; text-align: center;"> <tr> <td style="width: 10%;"></td> <td style="width: 10%;"></td> <td style="width: 10%;"></td> <td style="width: 10%;"></td> <td style="width: 10%;"></td> <td style="width: 10%;"></td> <td style="width: 10%;"></td> <td style="width: 10%;"></td> <td style="width: 10%;"></td> <td style="width: 10%;"></td> </tr> <tr> <td></td> <td></td> <td colspan="8" style="text-align: center;"> <table border="1" style="width: 100%; border-collapse: collapse; text-align: center;"> <tr> <td style="width: 10%;"></td> <td style="width: 10%;"></td> <td style="width: 10%;"></td> <td style="width: 10%;"></td> <td style="width: 10%;"></td> <td style="width: 10%;"></td> <td style="width: 10%;"></td> <td style="width: 10%;"></td> <td style="width: 10%;"></td> <td style="width: 10%;"></td> </tr> <tr> <td></td> <td></td> <td colspan="8" style="text-align: center;"> <table border="1" style="width: 100%; border-collapse: collapse; text-align: center;"> <tr> <td style="width: 10%;"></td> <td style="width: 10%;"></td> <td style="width: 10%;"></td> <td style="width: 10%;"></td> <td style="width: 10%;"></td> <td style="width: 10%;"></td> <td style="width: 10%;"></td> <td style="width: 10%;"></td> <td style="width: 10%;"></td> <td style="width: 10%;"></td> </tr> <tr> <td></td> <td></td> <td colspan="8" style="text-align: center;"> <table border="1" style="width: 100%; border-collapse: collapse; text-align: center;"> <tr> <td style="width: 10%;"></td> <td style="width: 10%;"></td> <td style="width: 10%;"></td> <td style="width: 10%;"></td> <td style="width: 10%;"></td> <td style="width: 10%;"></td> <td style="width: 10%;"></td> <td style="width: 10%;"></td> <td style="width: 10%;"></td> <td style="width: 10%;"></td> </tr> <tr> <td></td> <td></td> <td colspan="8" style="text-align: center;"> <table border="1" style="width: 100%; border-collapse: collapse; text-align: center;"> <tr> <td style="width: 10%;"></td> <td style="width: 10%;"></td> <td style="width: 10%;"></td> <td style="width: 10%;"></td> <td style="width: 10%;"></td> <td style="width: 10%;"></td> <td style="width: 10%;"></td> <td style="width: 10%;"></td> <td style="width: 10%;"></td> <td style="width: 10%;"></td> </tr> <tr> <td></td> <td></td> <td colspan="8" style="text-align: center;"> <table border="1" style="width: 100%; border-collapse: collapse; text-align: center;"> <tr> <td style="width: 10%;"></td> <td style="width: 10%;"></td> <td style="width: 10%;"></td> <td style="width: 10%;"></td> <td style="width: 10%;"></td> <td style="width: 10%;"></td> <td style="width: 10%;"></td> <td style="width: 10%;"></td> <td style="width: 10%;"></td> <td style="width: 10%;"></td> </tr> <tr> <td></td> <td></td> <td colspan="8" style="text-align: center;"> <table border="1" style="width: 100%; border-collapse: collapse; text-align: center;"> <tr> <td style="width: 10%;"></td> <td style="width: 10%;"></td> <td style="width: 10%;"></td> <td style="width: 10%;"></td> <td style="width: 10%;"></td> <td style="width: 10%;"></td> <td style="width: 10%;"></td> <td style="width: 10%;"></td> <td style="width: 10%;"></td> <td style="width: 10%;"></td> </tr> <tr> <td></td> <td></td> <td colspan="8" style="text-align: center;"> <table border="1" style="width: 100%; border-collapse: collapse; text-align: center;"> <tr> <td style="width: 10%;"></td> <td style="width: 10%;"></td> <td style="width: 10%;"></td> <td style="width: 10%;"></td> <td style="width: 10%;"></td> <td style="width: 10%;"></td> <td style="width: 10%;"></td> <td style="width: 10%;"></td> <td style="width: 10%;"></td> <td style="width: 10%;"></td> </tr> <tr> <td></td> <td></td> <td colspan="8" style="text-align: center;"> <table border="1" style="width: 100%; border-collapse: collapse; text-align: center;"> <tr> <td style="width: 10%;"></td> <td style="width: 10%;"></td> <td style="width: 10%;"></td> <td style="width: 10%;"></td> <td style="width: 10%;"></td> <td style="width: 10%;"></td> <td style="width: 10%;"></td> <td style="width: 10%;"></td> <td style="width: 10%;"></td> <td style="width: 10%;"></td> </tr> <tr> <td></td> <td></td> <td colspan="8" style="text-align: center;"> <table border="1" style="width: 100%; border-collapse: collapse; text-align: center;"> <tr> <td style="width: 10%;"></td> <td style="width: 10%;"></td> <td style="width: 10%;"></td> <td style="width: 10%;"></td> <td style="width: 10%;"></td> <td style="width: 10%;"></td> <td style="width: 10%;"></td> <td style="width: 10%;"></td> <td style="width: 10%;"></td> <td style="width: 10%;"></td> </tr> <tr> <td></td> <td></td> <td colspan="8" style="text-align: center;"> <table border="1" style="width: 100%; border-collapse: collapse; text-align: center;"> <tr> <td style="width: 10%;"></td> <td style="width: 10%;"></td> <td style="width: 10%;"></td> <td style="width: 10%;"></td> <td style="width: 10%;"></td> <td style="width: 10%;"></td> <td style="width: 10%;"></td> <td style="width: 10%;"></td> <td style="width: 10%;"></td> <td style="width: 10%;"></td> </tr> <tr> <td></td> <td></td> <td colspan="8" style="text-align: center;"> <table border="1" style="width: 100%; border-collapse: collapse; text-align: center;"> <tr> <td style="width: 10%;"></td> <td style="width: 10%;"></td> <td style="width: 10%;"></td> <td style="width: 10%;"></td> <td style="width: 10%;"></td> <td style="width: 10%;"></td> <td style="width: 10%;"></td> <td style="width: 10%;"></td> <td style="width: 10%;"></td> <td style="width: 10%;"></td> </tr> <tr> <td></td> <td></td> <td colspan="8" style="text-align: center;"> <table border="1" style="width: 100%; border-collapse: collapse; text-align: center;"> <tr> <td style="width: 10%;"></td> <td style="width: 10%;"></td> <td style="width: 10%;"></td> <td style="width: 10%;"></td> <td style="width: 10%;"></td> <td style="width: 10%;"></td> <td style="width: 10%;"></td> <td style="width: 10%;"></td> <td style="width: 10%;"></td> <td style="width: 10%;"></td> </tr> <tr> <td></td> <td></td> <td colspan="8"
style="text-align: center;"> <table border="1" style="width: 100%; border-collapse: collapse; text-align: center;"> <tr> <td style="width: 10%;"></td> <td style="width: 10%;"></td> <td style="width: 10%;"></td> <td style="width: 10%;"></td> <td style="width: 10%;"></td> <td style="width: 10%;"></td> <td style="width: 10%;"></td> <td style="width: 10%;"></td> <td style="width: 10%;"></td> <td style="width: 10%;"></td> </tr> <tr> <td></td> <td></td> <td colspan="8" style="text-align: center;"> <table border="1" style="width: 100%; border-collapse: collapse; text-align: center;"> <tr> <td style="width: 10%;"></td> <td style="width: 10%;"></td> <td style="width: 10%;"></td> <td style="width: 10%;"></td> <td style="width: 10%;"></td> <td style="width: 10%;"></td> <td style="width: 10%;"></td> <td style="width: 10%;"></td> <td style="width: 10%;"></td> <td style="width: 10%;"></td> </tr> <tr> <td></td> <td></td> <td colspan="8" style="text-align: center;"> <table border="1" style="width: 100%; border-collapse: collapse; text-align: center;"> <tr> <td style="width: 10%;"></td> <td style="width: 10%;"></td> <td style="width: 10%;"></td> <td style="width: 10%;"></td> <td style="width: 10%;"></td> <td style="width: 10%;"></td> <td style="width: 10%;"></td> <td style="width: 10%;"></td> <td style="width: 10%;"></td> <td style="width: 10%;"></td> </tr> <tr> <td></td> <td></td> <td colspan="8" style="text-align: center;"> <table border="1" style="width: 100%; border-collapse: collapse; text-align: center;"> <tr> <td style="width: 10%;"></td> <td style="width: 10%;"></td> <td style="width: 10%;"></td> <td style="width: 10%;"></td> <td style="width: 10%;"></td> <td style="width: 10%;"></td> <td style="width: 10%;"></td> <td style="width: 10%;"></td> <td style="width: 10%;"></td> <td style="width: 10%;"></td> </tr> <tr> <td></td> <td></td> <td colspan="8" style="text-align: center;"> <table border="1" style="width: 100%; border-collapse: collapse; text-align: center;"> <tr> <td style="width: 10%;"></td> <td style="width: 10%;"></td> <td style="width: 10%;"></td> <td style="width: 10%;"></td> <td style="width: 10%;"></td> <td style="width: 10%;"></td> <td style="width: 10%;"></td> <td style="width: 10%;"></td> <td style="width: 10%;"></td> <td style="width: 10%;"></td> </tr> <tr> <td></td> <td></td> <td colspan="8" style="text-align: center;"> <table border="1" style="width: 100%; border-collapse: collapse; text-align: center;"> <tr> <td style="width: 10%;"></td> <td style="width: 10%;"></td> <td style="width: 10%;"></td> <td style="width: 10%;"></td> <td style="width: 10%;"></td> <td style="width: 10%;"></td> <td style="width: 10%;"></td> <td style="width: 10%;"></td> <td style="width: 10%;"></td> <td style="width: 10%;"></td> </tr> <tr> <td></td> <td></td> <td colspan="8" style="text-align: center;"> <table border="1" style="width: 100%; border-collapse: collapse; text-align: center;"> <tr> <td style="width: 10%;"></td> <td style="width: 10%;"></td> <td style="width: 10%;"></td> <td style="width: 10%;"></td> <td style="width: 10%;"></td> <td style="width: 10%;"></td> <td style="width: 10%;"></td> <td style="width: 10%;"></td> <td style="width: 10%;"></td> <td style="width: 10%;"></td> </tr> <tr> <td></td> <td></td> <td colspan="8" style="text-align: center;"> <table border="1" style="width: 100%; border-collapse: collapse; text-align: center;"> <tr> <td style="width: 10%;"></td> <td style="width: 10%;"></td> <td style="width: 10%;"></td> <td style="width: 10%;"></td> <td style="width: 10%;"></td> <td style="width: 10%;"></td> <td style="width: 10%;"></td> <td style="width: 10%;"></td> <td style="width: 10%;"></td> <td style="width: 10%;"></td> </tr> <tr> <td></td> <td></td> <td colspan="8" style="text-align: center;"> <table border="1" style="width: 100%; border-collapse: collapse; text-align: center;"> <tr> <td style="width: 10%;"></td> <td style="width: 10%;"></td> <td style="width: 10%;"></td> <td style="width: 10%;"></td> <td style="width: 10%;"></td> <td style="width: 10%;"></td> <td style="width: 10%;"></td> <td style="width: 10%;"></td> <td style="width: 10%;"></td> <td style="width: 10%;"></td> </tr> <tr> <td></td> <td></td> <td colspan="8" style="text-align: center;"> <table border="1" style="width: 100%; border-collapse: collapse; text-align: center;"> <tr> <td style="width: 10%;"></td> <td style="width: 10%;"></td> <td style="width: 10%;"></td> <td style="width: 10%;"></td> <td style="width: 10%;"></td> <td style="width: 10%;"></td> <td style="width: 10%;"></td> <td style="width: 10%;"></td> <td style="width: 10%;"></td> <td style="width: 10%;"></td> </tr> <tr> <td></td> <td></td> <td colspan="8" style="text-align: center;"> <table border="1" style="width: 100%; border-collapse: collapse; text-align: center;"> <tr> <td style="width: 10%;"></td> <td style="width: 10%;"></td> <td style="width: 10%;"></td> <td style="width: 10%;"></td> <td style="width: 10%;"></td> <td style="width: 10%;"></td> <td style="width: 10%;"></td> <td style="width: 10%;"></td> <td style="width: 10%;"></td> <td style="width: 10%;"></td> </tr> <tr> <td></td> <td></td> <td colspan="8" style="text-align: center;"> <table border="1" style="width: 100%; border-collapse: collapse; text-align: center;"> <tr> <td style="width: 10%;"></td> <td style="width: 10%;"></td> <td style="width: 10%;"></td> <td style="width: 10%;"></td> <td style="width: 10%;"></td> <td style="width: 10%;"></td> <td style="width: 10%;"></td> <td style="width: 10%;"></td> <td style="width: 10%;"></td> <td style="width: 10%;"></td> </tr> <tr> <td></td> <td></td> <td colspan="8" style="text-align: center;"> <table border="1" style="width: 100%; border-collapse: collapse; text-align: center;"> <tr> <td style="width: 10%;"></td> <td style="width: 10%;"></td> <td style="width: 10%;"></td> <td style="width: 10%;"></td> <td style="width: 10%;"></td> <td style="width: 10%;"></td> <td style="width: 10%;"></td> <td style="width: 10%;"></td> <td style="width: 10%;"></td> <td style="width: 10%;"></td> </tr> <tr> <td></td> <td></td> <td colspan="8" style="text-align: center;"> <table border="1" style="width: 100%; border-collapse: collapse; text-align: center;"> <tr> <td style="width: 10%;"></td> <td style="width: 10%;"></td> <td style="width: 10%;"></td> <td style="width: 10%;"></td> <td style="width: 10%;"></td> <td style="width: 10%;"></td> <td style="width: 10%;"></td> <td style="width: 10%;"></td> <td style="width: 10%;"></td> <td style="width: 10%;"></td> </tr> <tr> <td></td> <td></td> <td colspan="8" style="text-align: center;"> <table border="1" style="width: 100%; border-collapse: collapse; text-align: center;"> <tr> <td style="width: 10%;"></td> <td style="width: 10%;"></td> <td style="width: 10%;"></td> <td style="width: 10%;"></td> <td style="width: 10%;"></td> <td style="width: 10%;"></td> <td style="width: 10%;"></td> <td style="width: 10%;"></td> <td style="width: 10%;"></td> <td style="width: 10%;"></td> </tr> <tr> <td></td> <td></td> <td colspan="8" style="text-align: center;"> <table border="1" style="width: 100%; border-collapse: collapse; text-align: center;"> <tr> <td style="width: 10%;"></td> <td style="width: 10%;"></td> <td style="width: 10%;"></td> <td style="width: 10%;"></td> <td style="width: 10%;"></td> <td style="width: 10%;"></td> <td style="width: 10%;"></td> <td style="width: 10%;"></td> <td style="width: 10%;"></td> <td style="width: 10%;"></td> </tr> <tr> <td></td> <td></td> <td colspan="8" style="text-align: center;"> <table border="1" style="width: 100%; border-collapse: collapse; text-align: center;"> <tr> <td style="width: 10%;"></td> <td style="width: 10%;"></td> <td style="width: 10%;"></td> <td style="width: 10%;"></td> <td style="width: 10%;"></td> <td style="width: 10%;"></td> <td style="width: 10%;"></td> <td style="width: 10%;"></td> <td style="width: 10%;"></td> <td style="width: 10%;"></td> </tr> <tr> <td></td> <td></td> <td colspan="8" style="text-align: center;"> <table border="1" style="width: 100%; border-collapse: collapse; text-align: center;"> <tr> <td style="width: 10%;"></td> <td style="width: 10%;"></td> <td style="width: 10%;"></td> <td style="width: 10%;"></td> <td style="width: 10%;"></td> <td style="width: 10%;"></td> <td style="width: 10%;"></td> <td style="width: 10%;"></td> <td style="width: 10%;"></td> <td style="width: 10%;"></td> </tr> <tr> <td></td> <td></td> <td colspan="8" style="text-align: center;"> <table border="1" style="width: 100%; border-collapse: collapse; text-align: center;"> <tr> </tr></table></td></tr></table></td></tr></table></td></tr></table></td></tr></table></td></tr></table></td></tr></table></td></tr></table></td></tr></table></td></tr></table></td></tr></table></td></tr></table></td></tr></table></td></tr></table></td></tr></table></td></tr></table></td></tr></table></td></tr></table></td></tr></table></td></tr></table></td></tr></table></td></tr></table></td></tr></table></td></tr></table></td></tr></table></td></tr></table></td></tr></table></td></tr></table></td></tr></table></td></tr></table></td></tr></table></td></tr></table></td></tr></table></td></tr></table></td></tr></table></td></tr></table></td></tr></table></td></tr></table></td></tr></table></td></tr></table></td></tr></table></td></tr></table></td></tr></table>
 | | | | | | | | | | | | | | | | | | | | <table border="1" style="width: 100%; border-collapse: collapse; text-align: center;"> <tr> <td style="width: 10%;"></td> <td style="width: 10%;"></td> <td style="width: 10%;"></td> <td style="width: 10%;"></td> <td style="width: 10%;"></td> <td style="width: 10%;"></td> <td style="width: 10%;"></td> <td style="width: 10%;"></td> <td style="width: 10%;"></td> <td style="width: 10%;"></td> </tr> <tr> <td></td> <td></td> <td colspan="8" style="text-align: center;"> <table border="1" style="width: 100%; border-collapse: collapse; text-align: center;"> <tr> <td style="width: 10%;"></td> <td style="width: 10%;"></td> <td style="width: 10%;"></td> <td style="width: 10%;"></td> <td style="width: 10%;"></td> <td style="width: 10%;"></td> <td style="width: 10%;"></td> <td style="width: 10%;"></td> <td style="width: 10%;"></td> <td style="width: 10%;"></td> </tr> <tr> <td></td> <td></td> <td colspan="8" style="text-align: center;"> <table border="1" style="width: 100%; border-collapse: collapse; text-align: center;"> <tr> <td style="width: 10%;"></td> <td style="width: 10%;"></td> <td style="width: 10%;"></td> <td style="width: 10%;"></td> <td style="width: 10%;"></td> <td style="width: 10%;"></td> <td style="width: 10%;"></td> <td style="width: 10%;"></td> <td style="width: 10%;"></td> <td style="width: 10%;"></td> </tr> <tr> <td></td> <td></td> <td colspan="8" style="text-align: center;"> <table border="1" style="width: 100%; border-collapse: collapse; text-align: center;"> <tr> <td style="width: 10%;"></td> <td style="width: 10%;"></td> <td style="width: 10%;"></td> <td style="width: 10%;"></td> <td style="width: 10%;"></td> <td style="width: 10%;"></td> <td style="width: 10%;"></td> <td style="width: 10%;"></td> <td style="width: 10%;"></td> <td style="width: 10%;"></td> </tr> <tr> <td></td> <td></td> <td colspan="8" style="text-align: center;"> <table border="1" style="width: 100%; border-collapse: collapse; text-align: center;"> <tr> <td style="width: 10%;"></td> <td style="width: 10%;"></td> <td style="width: 10%;"></td> <td style="width: 10%;"></td> <td style="width: 10%;"></td> <td style="width: 10%;"></td> <td style="width: 10%;"></td> <td style="width: 10%;"></td> <td style="width: 10%;"></td> <td style="width: 10%;"></td> </tr> <tr> <td></td> <td></td> <td colspan="8" style="text-align: center;"> <table border="1" style="width: 100%; border-collapse: collapse; text-align: center;"> <tr> <td style="width: 10%;"></td> <td style="width: 10%;"></td> <td style="width: 10%;"></td> <td style="width: 10%;"></td> <td style="width: 10%;"></td> <td style="width: 10%;"></td> <td style="width: 10%;"></td> <td style="width: 10%;"></td> <td style="width: 10%;"></td> <td style="width: 10%;"></td> </tr> <tr> <td></td> <td></td> <td colspan="8" style="text-align: center;"> <table border="1" style="width: 100%; border-collapse: collapse; text-align: center;"> <tr> <td style="width: 10%;"></td> <td style="width: 10%;"></td> <td style="width: 10%;"></td> <td style="width: 10%;"></td> <td style="width: 10%;"></td> <td style="width: 10%;"></td> <td style="width: 10%;"></td> <td style="width: 10%;"></td> <td style="width: 10%;"></td> <td style="width: 10%;"></td> </tr> <tr> <td></td> <td></td> <td colspan="8" style="text-align: center;"> <table border="1" style="width: 100%; border-collapse:
collapse; text-align: center;"> <tr> <td style="width: 10%;"></td> <td style="width: 10%;"></td> <td style="width: 10%;"></td> <td style="width: 10%;"></td> <td style="width: 10%;"></td> <td style="width: 10%;"></td> <td style="width: 10%;"></td> <td style="width: 10%;"></td> <td style="width: 10%;"></td> <td style="width: 10%;"></td> </tr> <tr> <td></td> <td></td> <td colspan="8" style="text-align: center;"> <table border="1" style="width: 100%; border-collapse: collapse; text-align: center;"> <tr> <td style="width: 10%;"></td> <td style="width: 10%;"></td> <td style="width: 10%;"></td> <td style="width: 10%;"></td> <td style="width: 10%;"></td> <td style="width: 10%;"></td> <td style="width: 10%;"></td> <td style="width: 10%;"></td> <td style="width: 10%;"></td> <td style="width: 10%;"></td> </tr> <tr> <td></td> <td></td> <td colspan="8" style="text-align: center;"> <table border="1" style="width: 100%; border-collapse: collapse; text-align: center;"> <tr> <td style="width: 10%;"></td> <td style="width: 10%;"></td> <td style="width: 10%;"></td> <td style="width: 10%;"></td> <td style="width: 10%;"></td> <td style="width: 10%;"></td> <td style="width: 10%;"></td> <td style="width: 10%;"></td> <td style="width: 10%;"></td> <td style="width: 10%;"></td> </tr> <tr> <td></td> <td></td> <td colspan="8" style="text-align: center;"> <table border="1" style="width: 100%; border-collapse: collapse; text-align: center;"> <tr> <td style="width: 10%;"></td> <td style="width: 10%;"></td> <td style="width: 10%;"></td> <td style="width: 10%;"></td> <td style="width: 10%;"></td> <td style="width: 10%;"></td> <td style="width: 10%;"></td> <td style="width: 10%;"></td> <td style="width: 10%;"></td> <td style="width: 10%;"></td> </tr> <tr> <td></td> <td></td> <td colspan="8" style="text-align: center;"> <table border="1" style="width: 100%; border-collapse: collapse; text-align: center;"> <tr> <td style="width: 10%;"></td> <td style="width: 10%;"></td> <td style="width: 10%;"></td> <td style="width: 10%;"></td> <td style="width: 10%;"></td> <td style="width: 10%;"></td> <td style="width: 10%;"></td> <td style="width: 10%;"></td> <td style="width: 10%;"></td> <td style="width: 10%;"></td> </tr> <tr> <td></td> <td></td> <td colspan="8" style="text-align: center;"> <table border="1" style="width: 100%; border-collapse: collapse; text-align: center;"> <tr> <td style="width: 10%;"></td> <td style="width: 10%;"></td> <td style="width: 10%;"></td> <td style="width: 10%;"></td> <td style="width: 10%;"></td> <td style="width: 10%;"></td> <td style="width: 10%;"></td> <td style="width: 10%;"></td> <td style="width: 10%;"></td> <td style="width: 10%;"></td> </tr> <tr> <td></td> <td></td> <td colspan="8" style="text-align: center;"> <table border="1" style="width: 100%; border-collapse: collapse; text-align: center;"> <tr> <td style="width: 10%;"></td> <td style="width: 10%;"></td> <td style="width: 10%;"></td> <td style="width: 10%;"></td> <td style="width: 10%;"></td> <td style="width: 10%;"></td> <td style="width: 10%;"></td> <td style="width: 10%;"></td> <td style="width: 10%;"></td> <td style="width: 10%;"></td> </tr> <tr> <td></td> <td></td> <td colspan="8" style="text-align: center;"> <table border="1" style="width: 100%; border-collapse: collapse; text-align: center;"> <tr> <td style="width: 10%;"></td> <td style="width: 10%;"></td> <td style="width: 10%;"></td> <td style="width: 10%;"></td> <td style="width: 10%;"></td> <td style="width: 10%;"></td> <td style="width: 10%;"></td> <td style="width: 10%;"></td> <td style="width: 10%;"></td> <td style="width: 10%;"></td> </tr> <tr> <td></td> <td></td> <td colspan="8" style="text-align: center;"> <table border="1" style="width: 100%; border-collapse: collapse; text-align: center;"> <tr> <td style="width: 10%;"></td> <td style="width: 10%;"></td> <td style="width: 10%;"></td> <td style="width: 10%;"></td> <td style="width: 10%;"></td> <td style="width: 10%;"></td> <td style="width: 10%;"></td> <td style="width: 10%;"></td> <td style="width: 10%;"></td> <td style="width: 10%;"></td> </tr> <tr> <td></td> <td></td> <td colspan="8" style="text-align: center;"> <table border="1" style="width: 100%; border-collapse: collapse; text-align: center;"> <tr> <td style="width: 10%;"></td> <td style="width: 10%;"></td> <td style="width: 10%;"></td> <td style="width: 10%;"></td> <td style="width: 10%;"></td> <td style="width: 10%;"></td> <td style="width: 10%;"></td> <td style="width: 10%;"></td> <td style="width: 10%;"></td> <td style="width: 10%;"></td> </tr> <tr> <td></td> <td></td> <td colspan="8" style="text-align: center;"> <table border="1" style="width: 100%; border-collapse: collapse; text-align: center;"> <tr> <td style="width: 10%;"></td> <td style="width: 10%;"></td> <td style="width: 10%;"></td> <td style="width: 10%;"></td> <td style="width: 10%;"></td> <td style="width: 10%;"></td> <td style="width: 10%;"></td> <td style="width: 10%;"></td> <td style="width: 10%;"></td> <td style="width: 10%;"></td> </tr> <tr> <td></td> <td></td> <td colspan="8" style="text-align: center;"> <table border="1" style="width: 100%; border-collapse: collapse; text-align: center;"> <tr> <td style="width: 10%;"></td> <td style="width: 10%;"></td> <td style="width: 10%;"></td> <td style="width: 10%;"></td> <td style="width: 10%;"></td> <td style="width: 10%;"></td> <td style="width: 10%;"></td> <td style="width: 10%;"></td> <td style="width: 10%;"></td> <td style="width: 10%;"></td> </tr> <tr> <td></td> <td></td> <td colspan="8" style="text-align: center;"> <table border="1" style="width: 100%; border-collapse: collapse; text-align: center;"> <tr> <td style="width: 10%;"></td> <td style="width: 10%;"></td> <td style="width: 10%;"></td> <td style="width: 10%;"></td> <td style="width: 10%;"></td> <td style="width: 10%;"></td> <td style="width: 10%;"></td> <td style="width: 10%;"></td> <td style="width: 10%;"></td> <td style="width: 10%;"></td> </tr> <tr> <td></td> <td></td> <td colspan="8" style="text-align: center;"> <table border="1" style="width: 100%; border-collapse: collapse; text-align: center;"> <tr> <td style="width: 10%;"></td> <td style="width: 10%;"></td> <td style="width: 10%;"></td> <td style="width: 10%;"></td> <td style="width: 10%;"></td> <td style="width: 10%;"></td> <td style="width: 10%;"></td> <td style="width: 10%;"></td> <td style="width: 10%;"></td> <td style="width: 10%;"></td> </tr> <tr> <td></td> <td></td> <td colspan="8" style="text-align: center;"> <table border="1" style="width: 100%; border-collapse: collapse; text-align: center;"> <tr> <td style="width: 10%;"></td> <td style="width: 10%;"></td> <td style="width: 10%;"></td> <td style="width: 10%;"></td> <td style="width: 10%;"></td> <td style="width: 10%;"></td> <td style="width: 10%;"></td> <td style="width: 10%;"></td> <td style="width: 10%;"></td> <td style="width: 10%;"></td> </tr> <tr> <td></td> <td></td> <td colspan="8" style="text-align: center;"> <table border="1" style="width: 100%; border-collapse: collapse; text-align: center;"> <tr> <td style="width: 10%;"></td> <td style="width: 10%;"></td> <td style="width: 10%;"></td> <td style="width: 10%;"></td> <td style="width: 10%;"></td> <td style="width: 10%;"></td> <td style="width: 10%;"></td> <td style="width: 10%;"></td> <td style="width: 10%;"></td> <td style="width: 10%;"></td> </tr> <tr> <td></td> <td></td> <td colspan="8" style="text-align: center;"> <table border="1" style="width: 100%; border-collapse: collapse; text-align: center;"> <tr> <td style="width: 10%;"></td> <td style="width: 10%;"></td> <td style="width: 10%;"></td> <td style="width: 10%;"></td> <td style="width: 10%;"></td> <td style="width: 10%;"></td> <td style="width: 10%;"></td> <td style="width: 10%;"></td> <td style="width: 10%;"></td> <td style="width: 10%;"></td> </tr> <tr> <td></td> <td></td> <td colspan="8" style="text-align: center;"> <table border="1" style="width: 100%; border-collapse: collapse; text-align: center;"> <tr> <td style="width: 10%;"></td> <td style="width: 10%;"></td> <td style="width: 10%;"></td> <td style="width: 10%;"></td> <td style="width: 10%;"></td> <td style="width: 10%;"></td> <td style="width: 10%;"></td> <td style="width: 10%;"></td> <td style="width: 10%;"></td> <td style="width: 10%;"></td> </tr> <tr> <td></td> <td></td> <td colspan="8" style="text-align: center;"> <table border="1" style="width: 100%; border-collapse: collapse; text-align: center;"> <tr> <td style="width: 10%;"></td> <td style="width: 10%;"></td> <td style="width: 10%;"></td> <td style="width: 10%;"></td> <td style="width: 10%;"></td> <td style="width: 10%;"></td> <td style="width: 10%;"></td> <td style="width: 10%;"></td> <td style="width: 10%;"></td> <td style="width: 10%;"></td> </tr> <tr> <td></td> <td></td> <td colspan="8" style="text-align: center;"> <table border="1" style="width: 100%; border-collapse: collapse; text-align: center;"> <tr> <td style="width: 10%;"></td> <td style="width: 10%;"></td> <td style="width: 10%;"></td> <td style="width: 10%;"></td> <td style="width: 10%;"></td> <td style="width: 10%;"></td> <td style="width: 10%;"></td> <td style="width: 10%;"></td> <td style="width: 10%;"></td> <td style="width: 10%;"></td> </tr> <tr> <td></td> <td></td> <td colspan="8" style="text-align: center;"> <table border="1" style="width: 100%; border-collapse: collapse; text-align: center;"> <tr> <td style="width: 10%;"></td> <td style="width: 10%;"></td> <td style="width: 10%;"></td> <td style="width: 10%;"></td> <td style="width: 10%;"></td> <td style="width: 10%;"></td> <td style="width: 10%;"></td> <td style="width: 10%;"></td> <td style="width: 10%;"></td> <td style="width: 10%;"></td> </tr> <tr> <td></td> <td></td> <td colspan="8" style="text-align: center;"> <table border="1" style="width: 100%; border-collapse: collapse; text-align: center;"> <tr> <td style="width: 10%;"></td> <td style="width: 10%;"></td> <td style="width: 10%;"></td> <td style="width: 10%;"></td> <td
style="width: 10%;"></td> <td style="width: 10%;"></td> <td style="width: 10%;"></td> <td style="width: 10%;"></td> <td style="width: 10%;"></td> <td style="width: 10%;"></td> </tr> <tr> <td></td> <td></td> <td colspan="8" style="text-align: center;"> <table border="1" style="width: 100%; border-collapse: collapse; text-align: center;"> <tr> <td style="width: 10%;"></td> <td style="width: 10%;"></td> <td style="width: 10%;"></td> <td style="width: 10%;"></td> <td style="width: 10%;"></td> <td style="width: 10%;"></td> <td style="width: 10%;"></td> <td style="width: 10%;"></td> <td style="width: 10%;"></td> <td style="width: 10%;"></td> </tr> <tr> <td></td> <td></td> <td colspan="8" style="text-align: center;"> <table border="1" style="width: 100%; border-collapse: collapse; text-align: center;"> <tr> <td style="width: 10%;"></td> <td style="width: 10%;"></td> <td style="width: 10%;"></td> <td style="width: 10%;"></td> <td style="width: 10%;"></td> <td style="width: 10%;"></td> <td style="width: 10%;"></td> <td style="width: 10%;"></td> <td style="width: 10%;"></td> <td style="width: 10%;"></td> </tr> <tr> <td></td> <td></td> <td colspan="8" style="text-align: center;"> <table border="1" style="width: 100%; border-collapse: collapse; text-align: center;"> <tr> <td style="width: 10%;"></td> <td style="width: 10%;"></td> <td style="width: 10%;"></td> <td style="width: 10%;"></td> <td style="width: 10%;"></td> <td style="width: 10%;"></td> <td style="width: 10%;"></td> <td style="width: 10%;"></td> <td style="width: 10%;"></td> <td style="width: 10%;"></td> </tr> <tr> <td></td> <td></td> <td colspan="8" style="text-align: center;"> <table border="1" style="width: 100%; border-collapse: collapse; text-align: center;"> <tr> <td style="width: 10%;"></td> <td style="width: 10%;"></td> <td style="width: 10%;"></td> <td style="width: 10%;"></td> <td style="width: 10%;"></td> <td style="width: 10%;"></td> <td style="width: 10%;"></td> <td style="width: 10%;"></td> <td style="width: 10%;"></td> <td style="width: 10%;"></td> </tr> <tr> <td></td> <td></td> <td colspan="8" style="text-align: center;"> <table border="1" style="width: 100%; border-collapse: collapse; text-align: center;"> <tr> <td style="width: 10%;"></td> <td style="width: 10%;"></td> <td style="width: 10%;"></td> <td style="width: 10%;"></td> <td style="width: 10%;"></td> <td style="width: 10%;"></td> <td style="width: 10%;"></td> <td style="width: 10%;"></td> <td style="width: 10%;"></td> <td style="width: 10%;"></td> </tr> <tr> <td></td> <td></td> <td colspan="8" style="text-align: center;"> <table border="1" style="width: 100%; border-collapse: collapse; text-align: center;"> <tr> <td style="width: 10%;"></td> <td style="width: 10%;"></td> <td style="width: 10%;"></td> <td style="width: 10%;"></td> <td style="width: 10%;"></td> <td style="width: 10%;"></td> <td style="width: 10%;"></td> <td style="width: 10%;"></td> <td style="width: 10%;"></td> <td style="width: 10%;"></td> </tr> <tr> <td></td> <td></td> <td colspan="8" style="text-align: center;"> <table border="1" style="width: 100%; border-collapse: collapse; text-align: center;"> <tr> <td style="width: 10%;"></td> <td style="width: 10%;"></td> <td style="width: 10%;"></td> <td style="width: 10%;"></td> <td style="width: 10%;"></td> <td style="width: 10%;"></td> <td style="width: 10%;"></td> <td style="width: 10%;"></td> <td style="width: 10%;"></td> <td style="width: 10%;"></td> </tr> <tr> <td></td> <td></td> <td colspan="8" style="text-align: center;"> <table border="1" style="width: 100%; border-collapse: collapse; text-align: center;"> <tr> <td style="width: 10%;"></td> <td style="width: 10%;"></td> <td style="width: 10%;"></td> <td style="width: 10%;"></td> <td style="width: 10%;"></td> <td style="width: 10%;"></td> <td style="width: 10%;"></td> <td style="width: 10%;"></td> <td style="width: 10%;"></td> <td style="width: 10%;"></td> </tr> <tr> <td></td> <td></td> <td colspan="8" style="text-align: center;"> <table border="1" style="width: 100%; border-collapse: collapse; text-align: center;"> <tr> <td style="width: 10%;"></td> <td style="width: 10%;"></td> <td style="width: 10%;"></td> <td style="width: 10%;"></td> <td style="width: 10%;"></td> <td style="width: 10%;"></td> <td style="width: 10%;"></td> <td style="width: 10%;"></td> <td style="width: 10%;"></td> <td style="width: 10%;"></td> </tr> <tr> <td></td> <td></td> <td colspan="8" style="text-align: center;"> <table border="1" style="width: 100%; border-collapse: collapse; text-align: center;"> <tr> <td style="width: 10%;"></td> <td style="width: 10%;"></td> <td style="width: 10%;"></td> <td style="width: 10%;"></td> <td style="width: 10%;"></td> <td style="width: 10%;"></td> <td style="width: 10%;"></td> <td style="width: 10%;"></td> <td style="width: 10%;"></td> <td style="width: 10%;"></td> </tr> <tr> <td></td> <td></td> <td colspan="8" style="text-align: center;"> <table border="1" style="width: 100%; border-collapse: collapse; text-align: center;"> <tr> <td style="width: 10%;"></td> <td style="width: 10%;"></td> <td style="width: 10%;"></td> <td style="width: 10%;"></td> <td style="width: 10%;"></td> <td style="width: 10%;"></td> <td style="width: 10%;"></td> <td style="width: 10%;"></td> <td style="width: 10%;"></td> <td style="width: 10%;"></td> </tr> <tr> <td></td> <td></td> <td colspan="8" style="text-align: center;"> <table border="1" style="width: 100%; border-collapse: collapse; text-align: center;"> <tr> <td style="width: 10%;"></td> <td style="width: 10%;"></td> <td style="width: 10%;"></td> <td style="width: 10%;"></td> <td style="width: 10%;"></td> <td style="width: 10%;"></td> <td style="width: 10%;"></td> <td style="width: 10%;"></td> <td style="width: 10%;"></td> <td style="width: 10%;"></td> </tr> <tr> <td></td> <td></td> <td colspan="8" style="text-align: center;"> <table border="1" style="width: 100%; border-collapse: collapse; text-align: center;"> <tr> </tr></table></td></tr></table></td></tr></table></td></tr></table></td></tr></table></td></tr></table></td></tr></table></td></tr></table></td></tr></table></td></tr></table></td></tr></table></td></tr></table></td></tr></table></td></tr></table></td></tr></table></td></tr></table></td></tr></table></td></tr></table></td></tr></table></td></tr></table></td></tr></table></td></tr></table></td></tr></table></td></tr></table></td></tr></table></td></tr></table></td></tr></table></td></tr></table></td></tr></table></td></tr></table></td></tr></table></td></tr></table></td></tr></table></td></tr></table></td></tr></table></td></tr></table></td></tr></table></td></tr></table></td></tr></table></td></tr></table></td></tr></table></td></tr></table>
 | | | | | | | | | | | | | | | | | | | | <table border="1" style="width: 100%; border-collapse: collapse; text-align: center;"> <tr> <td style="width: 10%;"></td> <td style="width: 10%;"></td> <td style="width: 10%;"></td> <td style="width: 10%;"></td> <td style="width: 10%;"></td> <td style="width: 10%;"></td> <td style="width: 10%;"></td> <td style="width: 10%;"></td> <td style="width: 10%;"></td> <td style="width: 10%;"></td> </tr> <tr> <td></td> <td></td> <td colspan="8" style="text-align: center;"> <table border="1" style="width: 100%; border-collapse: collapse; text-align: center;"> <tr> <td style="width: 10%;"></td> <td style="width: 10%;"></td> <td style="width: 10%;"></td> <td style="width: 10%;"></td> <td style="width: 10%;"></td> <td style="width: 10%;"></td> <td style="width: 10%;"></td> <td style="width: 10%;"></td> <td style="width: 10%;"></td> <td style="width: 10%;"></td> </tr> <tr> <td></td> <td></td> <td colspan="8" style="text-align: center;"> <table border="1" style="width: 100%; border-collapse: collapse; text-align: center;"> <tr> <td style="width: 10%;"></td> <td style="width: 10%;"></td> <td style="width: 10%;"></td> <td style="width: 10%;"></td> <td style="width: 10%;"></td> <td style="width: 10%;"></td> <td style="width: 10%;"></td> <td style="width: 10%;"></td> <td style="width: 10%;"></td> <td style="width: 10%;"></td> </tr> <tr> <td></td> <td></td> <td colspan="8" style="text-align: center;"> <table border="1" style="width: 100%; border-collapse: collapse; text-align: center;"> <tr> <td style="width: 10%;"></td> <td style="width: 10%;"></td> <td style="width: 10%;"></td> <td style="width: 10%;"></td> <td style="width: 10%;"></td> <td style="width: 10%;"></td> <td style="width: 10%;"></td> <td style="width: 10%;"></td> <td style="width: 10%;"></td> <td style="width: 10%;"></td> </tr> <tr> <td></td> <td></td> <td colspan="8" style="text-align: center;"> <table border="1" style="width: 100%; border-collapse: collapse; text-align: center;"> <tr> <td style="width: 10%;"></td> <td style="width: 10%;"></td> <td style="width: 10%;"></td> <td style="width: 10%;"></td> <td style="width: 10%;"></td> <td style="width: 10%;"></td> <td style="width: 10%;"></td> <td style="width: 10%;"></td> <td style="width: 10%;"></td> <td style="width: 10%;"></td> </tr> <tr> <td></td> <td></td> <td colspan="8" style="text-align: center;"> <table border="1" style="width: 100%; border-collapse: collapse; text-align: center;"> <tr> <td style="width: 10%;"></td> <td style="width: 10%;"></td> <td style="width: 10%;"></td> <td style="width: 10%;"></td> <td style="width: 10%;"></td> <td style="width: 10%;"></td> <td style="width: 10%;"></td> <td style="width: 10%;"></td> <td style="width: 10%;"></td> <td style="width: 10%;"></td> </tr> <tr> <td></td> <td></td> <td colspan="8" style="text-align: center;"> <table border="1" style="width: 100%; border-collapse: collapse; text-align: center;"> <tr> <td style="width: 10%;"></td> <td style="width: 10%;"></td> <td style="width: 10%;"></td> <td style="width: 10%;"></td> <td style="width: 10%;"></td> <td style="width: 10%;"></td> <td style="width: 10%;"></td> <td style="width: 10%;"></td> <td style="width: 10%;"></td> <td style="width: 10%;"></td> </tr> <tr> <td></td> <td></td> <td colspan="8" style="text-align: center;"> <table border="1" style="width: 100%; border-collapse: collapse; text-align: center;"> <tr> <td style="width: 10%;"></td> <td style="width: 10%;"></td> <td style="width: 10%;"></td> <td style="width: 10%;"></td> <td style="width: 10%;"></td> <td style="width: 10%;"></td> <td style="width: 10%;"></td> <td style="width: 10%;"></td> <td style="width: 10%;"></td> <td style="width: 10%;"></td> </tr> <tr> <td></td> <td></td> <td colspan="8" style="text-align: center;"> <table border="1" style="width: 100%; border-collapse: collapse; text-align: center;"> <tr> <td style="width: 10%;"></td> <td style="width: 10%;"></td> <td style="width: 10%;"></td> <td style="width: 10%;"></td> <td style="width: 10%;"></td> <td style="width: 10%;"></td> <td style="width: 10%;"></td> <td style="width: 10%;"></td> <td style="width: 10%;"></td> <td style="width: 10%;"></td> </tr> <tr> <td></td> <td></td> <td colspan="8" style="text-align: center;"> <table border="1" style="width: 100%; border-collapse: collapse; text-align: center;"> <tr> <td style="width: 10%;"></td> <td style="width: 10%;"></td> <td style="width: 10%;"></td> <td style="width: 10%;"></td> <td style="width: 10%;"></td> <td style="width: 10%;"></td> <td style="width: 10%;"></td> <td style="width: 10%;"></td> <td style="width: 10%;"></td> <td style="width: 10%;"></td> </tr> <tr> <td></td> <td></td> <td colspan="8" style="text-align: center;"> <table border="1" style="width: 100%; border-collapse: collapse; text-align: center;"> <tr> <td style="width: 10%;"></td> <td style="width: 10%;"></td> <td style="width: 10%;"></td> <td style="width: 10%;"></td> <td style="width: 10%;"></td> <td style="width: 10%;"></td> <td style="width: 10%;"></td> <td style="width: 10%;"></td> <td style="width: 10%;"></td> <td style="width: 10%;"></td> </tr> <tr> <td></td> <td></td> <td colspan="8" style="text-align: center;"> <table border="1" style="width: 100%; border-collapse: collapse; text-align: center;"> <tr> <td style="width: 10%;"></td> <td style="width: 10%;"></td> <td style="width: 10%;"></td> <td style="width: 10%;"></td> <td style="width: 10%;"></td> <td style="width: 10%;"></td> <td style="width: 10%;"></td> <td style="width: 10%;"></td> <td style="width: 10%;"></td> <td style="width: 10%;"></td> </tr> <tr> <td></td> <td></td> <td colspan="8" style="text-align: center;"> <table border="1" style="width: 100%; border-collapse: collapse; text-align: center;"> <tr> <td style="width: 10%;"></td> <td style="width: 10%;"></td> <td style="width: 10%;"></td> <td style="width: 10%;"></td> <td style="width: 10%;"></td> <td style="width: 10%;"></td> <td style="width: 10%;"></td> <td style="width:
10%;"></td> <td style="width: 10%;"></td> <td style="width: 10%;"></td> </tr> <tr> <td></td> <td></td> <td colspan="8" style="text-align: center;"> <table border="1" style="width: 100%; border-collapse: collapse; text-align: center;"> <tr> <td style="width: 10%;"></td> <td style="width: 10%;"></td> <td style="width: 10%;"></td> <td style="width: 10%;"></td> <td style="width: 10%;"></td> <td style="width: 10%;"></td> <td style="width: 10%;"></td> <td style="width: 10%;"></td> <td style="width: 10%;"></td> <td style="width: 10%;"></td> </tr> <tr> <td></td> <td></td> <td colspan="8" style="text-align: center;"> <table border="1" style="width: 100%; border-collapse: collapse; text-align: center;"> <tr> <td style="width: 10%;"></td> <td style="width: 10%;"></td> <td style="width: 10%;"></td> <td style="width: 10%;"></td> <td style="width: 10%;"></td> <td style="width: 10%;"></td> <td style="width: 10%;"></td> <td style="width: 10%;"></td> <td style="width: 10%;"></td> <td style="width: 10%;"></td> </tr> <tr> <td></td> <td></td> <td colspan="8" style="text-align: center;"> <table border="1" style="width: 100%; border-collapse: collapse; text-align: center;"> <tr> <td style="width: 10%;"></td> <td style="width: 10%;"></td> <td style="width: 10%;"></td> <td style="width: 10%;"></td> <td style="width: 10%;"></td> <td style="width: 10%;"></td> <td style="width: 10%;"></td> <td style="width: 10%;"></td> <td style="width: 10%;"></td> <td style="width: 10%;"></td> </tr> <tr> <td></td> <td></td> <td colspan="8" style="text-align: center;"> <table border="1" style="width: 100%; border-collapse: collapse; text-align: center;"> <tr> <td style="width: 10%;"></td> <td style="width: 10%;"></td> <td style="width: 10%;"></td> <td style="width: 10%;"></td> <td style="width: 10%;"></td> <td style="width: 10%;"></td> <td style="width: 10%;"></td> <td style="width: 10%;"></td> <td style="width: 10%;"></td> <td style="width: 10%;"></td> </tr> <tr> <td></td> <td></td> <td colspan="8" style="text-align: center;"> <table border="1" style="width: 100%; border-collapse: collapse; text-align: center;"> <tr> <td style="width: 10%;"></td> <td style="width: 10%;"></td> <td style="width: 10%;"></td> <td style="width: 10%;"></td> <td style="width: 10%;"></td> <td style="width: 10%;"></td> <td style="width: 10%;"></td> <td style="width: 10%;"></td> <td style="width: 10%;"></td> <td style="width: 10%;"></td> </tr> <tr> <td></td> <td></td> <td colspan="8" style="text-align: center;"> <table border="1" style="width: 100%; border-collapse: collapse; text-align: center;"> <tr> <td style="width: 10%;"></td> <td style="width: 10%;"></td> <td style="width: 10%;"></td> <td style="width: 10%;"></td> <td style="width: 10%;"></td> <td style="width: 10%;"></td> <td style="width: 10%;"></td> <td style="width: 10%;"></td> <td style="width: 10%;"></td> <td style="width: 10%;"></td> </tr> <tr> <td></td> <td></td> <td colspan="8" style="text-align: center;"> <table border="1" style="width: 100%; border-collapse: collapse; text-align: center;"> <tr> <td style="width: 10%;"></td> <td style="width: 10%;"></td> <td style="width: 10%;"></td> <td style="width: 10%;"></td> <td style="width: 10%;"></td> <td style="width: 10%;"></td> <td style="width: 10%;"></td> <td style="width: 10%;"></td> <td style="width: 10%;"></td> <td style="width: 10%;"></td> </tr> <tr> <td></td> <td></td> <td colspan="8" style="text-align: center;"> <table border="1" style="width: 100%; border-collapse: collapse; text-align: center;"> <tr> <td style="width: 10%;"></td> <td style="width: 10%;"></td> <td style="width: 10%;"></td> <td style="width: 10%;"></td> <td style="width: 10%;"></td> <td style="width: 10%;"></td> <td style="width: 10%;"></td> <td style="width: 10%;"></td> <td style="width: 10%;"></td> <td style="width: 10%;"></td> </tr> <tr> <td></td> <td></td> <td colspan="8" style="text-align: center;"> <table border="1" style="width: 100%; border-collapse: collapse; text-align: center;"> <tr> <td style="width: 10%;"></td> <td style="width: 10%;"></td> <td style="width: 10%;"></td> <td style="width: 10%;"></td> <td style="width: 10%;"></td> <td style="width: 10%;"></td> <td style="width: 10%;"></td> <td style="width: 10%;"></td> <td style="width: 10%;"></td> <td style="width: 10%;"></td> </tr> <tr> <td></td> <td></td> <td colspan="8" style="text-align: center;"> <table border="1" style="width: 100%; border-collapse: collapse; text-align: center;"> <tr> <td style="width: 10%;"></td> <td style="width: 10%;"></td> <td style="width: 10%;"></td> <td style="width: 10%;"></td> <td style="width: 10%;"></td> <td style="width: 10%;"></td> <td style="width: 10%;"></td> <td style="width: 10%;"></td> <td style="width: 10%;"></td> <td style="width: 10%;"></td> </tr> <tr> <td></td> <td></td> <td colspan="8" style="text-align: center;"> <table border="1" style="width: 100%; border-collapse: collapse; text-align: center;"> <tr> <td style="width: 10%;"></td> <td style="width: 10%;"></td> <td style="width: 10%;"></td> <td style="width: 10%;"></td> <td style="width: 10%;"></td> <td style="width: 10%;"></td> <td style="width: 10%;"></td> <td style="width: 10%;"></td> <td style="width: 10%;"></td> <td style="width: 10%;"></td> </tr> <tr> <td></td> <td></td> <td colspan="8" style="text-align: center;"> <table border="1" style="width: 100%; border-collapse: collapse; text-align: center;"> <tr> <td style="width: 10%;"></td> <td style="width: 10%;"></td> <td style="width: 10%;"></td> <td style="width: 10%;"></td> <td style="width: 10%;"></td> <td style="width: 10%;"></td> <td style="width: 10%;"></td> <td style="width: 10%;"></td> <td style="width: 10%;"></td> <td style="width: 10%;"></td> </tr> <tr> <td></td> <td></td> <td colspan="8" style="text-align: center;"> <table border="1" style="width: 100%; border-collapse: collapse; text-align: center;"> <tr> <td style="width: 10%;"></td> <td style="width: 10%;"></td> <td style="width: 10%;"></td> <td style="width: 10%;"></td> <td style="width: 10%;"></td> <td style="width: 10%;"></td> <td style="width: 10%;"></td> <td style="width: 10%;"></td> <td style="width: 10%;"></td> <td style="width: 10%;"></td> </tr> <tr> <td></td> <td></td> <td colspan="8" style="text-align: center;"> <table border="1" style="width: 100%; border-collapse: collapse; text-align: center;"> <tr> <td style="width: 10%;"></td> <td style="width: 10%;"></td> <td style="width: 10%;"></td> <td style="width: 10%;"></td> <td style="width: 10%;"></td> <td style="width: 10%;"></td> <td style="width: 10%;"></td> <td style="width: 10%;"></td> <td style="width: 10%;"></td> <td style="width: 10%;"></td> </tr> <tr> <td></td> <td></td> <td colspan="8" style="text-align: center;"> <table border="1" style="width: 100%; border-collapse: collapse; text-align: center;"> <tr> <td style="width: 10%;"></td> <td style="width: 10%;"></td> <td style="width: 10%;"></td> <td style="width: 10%;"></td> <td style="width: 10%;"></td> <td style="width: 10%;"></td> <td style="width: 10%;"></td> <td style="width: 10%;"></td> <td style="width: 10%;"></td> <td style="width: 10%;"></td> </tr> <tr> <td></td> <td></td> <td colspan="8" style="text-align: center;"> <table border="1" style="width: 100%; border-collapse: collapse; text-align: center;"> <tr> <td style="width: 10%;"></td> <td style="width: 10%;"></td> <td style="width: 10%;"></td> <td style="width: 10%;"></td> <td style="width: 10%;"></td> <td style="width: 10%;"></td> <td style="width: 10%;"></td> <td style="width: 10%;"></td> <td style="width: 10%;"></td> <td style="width: 10%;"></td> </tr> <tr> <td></td> <td></td> <td colspan="8" style="text-align: center;"> <table border="1" style="width: 100%; border-collapse: collapse; text-align: center;"> <tr> <td style="width: 10%;"></td> <td style="width: 10%;"></td> <td style="width: 10%;"></td> <td style="width: 10%;"></td> <td style="width: 10%;"></td> <td style="width: 10%;"></td> <td style="width: 10%;"></td> <td style="width: 10%;"></td> <td style="width: 10%;"></td> <td style="width: 10%;"></td> </tr> <tr> <td></td> <td></td> <td colspan="8" style="text-align: center;"> <table border="1" style="width: 100%; border-collapse: collapse; text-align: center;"> <tr> <td style="width: 10%;"></td> <td style="width: 10%;"></td> <td style="width: 10%;"></td> <td style="width: 10%;"></td> <td style="width: 10%;"></td> <td style="width: 10%;"></td> <td style="width: 10%;"></td> <td style="width: 10%;"></td> <td style="width: 10%;"></td> <td style="width: 10%;"></td> </tr> <tr> <td></td> <td></td> <td colspan="8" style="text-align: center;"> <table border="1" style="width: 100%; border-collapse: collapse; text-align: center;"> <tr> <td style="width: 10%;"></td> <td style="width: 10%;"></td> <td style="width: 10%;"></td> <td style="width: 10%;"></td> <td style="width: 10%;"></td> <td style="width: 10%;"></td> <td style="width: 10%;"></td> <td style="width: 10%;"></td> <td style="width: 10%;"></td> <td style="width: 10%;"></td> </tr> <tr> <td></td> <td></td> <td colspan="8" style="text-align: center;"> <table border="1" style="width: 100%; border-collapse: collapse; text-align: center;"> <tr> <td style="width: 10%;"></td> <td style="width: 10%;"></td> <td style="width: 10%;"></td> <td style="width: 10%;"></td> <td style="width: 10%;"></td> <td style="width: 10%;"></td> <td style="width: 10%;"></td> <td style="width: 10%;"></td> <td style="width: 10%;"></td> <td style="width: 10%;"></td> </tr> <tr> <td></td> <td></td> <td colspan="8" style="text-align: center;"> <table border="1" style="width: 100%; border-collapse: collapse; text-align: center;"> <tr> <td style="width: 10%;"></td> <td style="width: 10%;"></td> <td style="width: 10%;"></td> <td style="width: 10%;"></td> <td style="width: 10%;"></td> <td style="width: 10%;"></td> <td style="width: 10%;"></td> <td style="width: 10%;"></td> <td style="width: 10%;"></td> <td style="width: 10%;"></td> </tr> <tr> <td></td> <td></td> <td colspan="8" style="text-align: center;"> <table border="1"
style="width: 100%; border-collapse: collapse; text-align: center;"> <tr> <td style="width: 10%;"></td> <td style="width: 10%;"></td> <td style="width: 10%;"></td> <td style="width: 10%;"></td> <td style="width: 10%;"></td> <td style="width: 10%;"></td> <td style="width: 10%;"></td> <td style="width: 10%;"></td> <td style="width: 10%;"></td> <td style="width: 10%;"></td> </tr> <tr> <td></td> <td></td> <td colspan="8" style="text-align: center;"> <table border="1" style="width: 100%; border-collapse: collapse; text-align: center;"> <tr> <td style="width: 10%;"></td> <td style="width: 10%;"></td> <td style="width: 10%;"></td> <td style="width: 10%;"></td> <td style="width: 10%;"></td> <td style="width: 10%;"></td> <td style="width: 10%;"></td> <td style="width: 10%;"></td> <td style="width: 10%;"></td> <td style="width: 10%;"></td> </tr> <tr> <td></td> <td></td> <td colspan="8" style="text-align: center;"> <table border="1" style="width: 100%; border-collapse: collapse; text-align: center;"> <tr> <td style="width: 10%;"></td> <td style="width: 10%;"></td> <td style="width: 10%;"></td> <td style="width: 10%;"></td> <td style="width: 10%;"></td> <td style="width: 10%;"></td> <td style="width: 10%;"></td> <td style="width: 10%;"></td> <td style="width: 10%;"></td> <td style="width: 10%;"></td> </tr> <tr> <td></td> <td></td> <td colspan="8" style="text-align: center;"> <table border="1" style="width: 100%; border-collapse: collapse; text-align: center;"> <tr> <td style="width: 10%;"></td> <td style="width: 10%;"></td> <td style="width: 10%;"></td> <td style="width: 10%;"></td> <td style="width: 10%;"></td> <td style="width: 10%;"></td> <td style="width: 10%;"></td> <td style="width: 10%;"></td> <td style="width: 10%;"></td> <td style="width: 10%;"></td> </tr> <tr> <td></td> <td></td> <td colspan="8" style="text-align: center;"> <table border="1" style="width: 100%; border-collapse: collapse; text-align: center;"> <tr> <td style="width: 10%;"></td> <td style="width: 10%;"></td> <td style="width: 10%;"></td> <td style="width: 10%;"></td> <td style="width: 10%;"></td> <td style="width: 10%;"></td> <td style="width: 10%;"></td> <td style="width: 10%;"></td> <td style="width: 10%;"></td> <td style="width: 10%;"></td> </tr> <tr> <td></td> <td></td> <td colspan="8" style="text-align: center;"> <table border="1" style="width: 100%; border-collapse: collapse; text-align: center;"> <tr> <td style="width: 10%;"></td> <td style="width: 10%;"></td> <td style="width: 10%;"></td> <td style="width: 10%;"></td> <td style="width: 10%;"></td> <td style="width: 10%;"></td> <td style="width: 10%;"></td> <td style="width: 10%;"></td> <td style="width: 10%;"></td> <td style="width: 10%;"></td> </tr> <tr> <td></td> <td></td> <td colspan="8" style="text-align: center;"> <table border="1" style="width: 100%; border-collapse: collapse; text-align: center;"> <tr> </tr></table></td></tr></table></td></tr></table></td></tr></table></td></tr></table></td></tr></table></td></tr></table></td></tr></table></td></tr></table></td></tr></table></td></tr></table></td></tr></table></td></tr></table></td></tr></table></td></tr></table></td></tr></table></td></tr></table></td></tr></table></td></tr></table></td></tr></table></td></tr></table></td></tr></table></td></tr></table></td></tr></table></td></tr></table></td></tr></table></td></tr></table></td></tr></table></td></tr></table></td></tr></table></td></tr></table></td></tr></table></td></tr></table></td></tr></table></td></tr></table></td></tr></table></td></tr></table></td></tr></table></td></tr></table></td></tr></table></td></tr></table>
 | | | | | | | | | | | | | | | | | | | | <table border="1" style="width: 100%; border-collapse: collapse; text-align: center;"> <tr> <td style="width: 10%;"></td> <td style="width: 10%;"></td> <td style="width: 10%;"></td> <td style="width: 10%;"></td> <td style="width: 10%;"></td> <td style="width: 10%;"></td> <td style="width: 10%;"></td> <td style="width: 10%;"></td> <td style="width: 10%;"></td> <td style="width: 10%;"></td> </tr> <tr> <td></td> <td></td> <td colspan="8" style="text-align: center;"> <table border="1" style="width: 100%; border-collapse: collapse; text-align: center;"> <tr> <td style="width: 10%;"></td> <td style="width: 10%;"></td> <td style="width: 10%;"></td> <td style="width: 10%;"></td> <td style="width: 10%;"></td> <td style="width: 10%;"></td> <td style="width: 10%;"></td> <td style="width: 10%;"></td> <td style="width: 10%;"></td> <td style="width: 10%;"></td> </tr> <tr> <td></td> <td></td> <td colspan="8" style="text-align: center;"> <table border="1" style="width: 100%; border-collapse: collapse; text-align: center;"> <tr> <td style="width: 10%;"></td> <td style="width: 10%;"></td> <td style="width: 10%;"></td> <td style="width: 10%;"></td> <td style="width: 10%;"></td> <td style="width: 10%;"></td> <td style="width: 10%;"></td> <td style="width: 10%;"></td> <td style="width: 10%;"></td> <td style="width: 10%;"></td> </tr> <tr> <td></td> <td></td> <td colspan="8" style="text-align: center;"> <table border="1" style="width: 100%; border-collapse: collapse; text-align: center;"> <tr> <td style="width: 10%;"></td> <td style="width: 10%;"></td> <td style="width: 10%;"></td> <td style="width: 10%;"></td> <td style="width: 10%;"></td> <td style="width: 10%;"></td> <td style="width: 10%;"></td> <td style="width: 10%;"></td> <td style="width: 10%;"></td> <td style="width: 10%;"></td> </tr> <tr> <td></td> <td></td> <td colspan="8" style="text-align: center;"> <table border="1" style="width: 100%; border-collapse: collapse; text-align: center;"> <tr> <td style="width: 10%;"></td> <td style="width: 10%;"></td> <td style="width: 10%;"></td> <td style="width: 10%;"></td> <td style="width: 10%;"></td> <td style="width: 10%;"></td> <td style="width: 10%;"></td> <td style="width: 10%;"></td> <td style="width: 10%;"></td> <td style="width: 10%;"></td> </tr> <tr> <td></td> <td></td> <td colspan="8" style="text-align: center;"> <table border="1" style="width: 100%; border-collapse: collapse; text-align: center;"> <tr> <td style="width: 10%;"></td> <td style="width: 10%;"></td> <td style="width: 10%;"></td> <td style="width: 10%;"></td> <td style="width: 10%;"></td> <td style="width: 10%;"></td> <td style="width: 10%;"></td> <td style="width: 10%;"></td> <td style="width: 10%;"></td> <td style="width: 10%;"></td> </tr> <tr> <td></td> <td></td> <td colspan="8" style="text-align: center;"> <table border="1" style="width: 100%; border-collapse: collapse; text-align: center;"> <tr> <td style="width: 10%;"></td> <td style="width: 10%;"></td> <td style="width: 10%;"></td> <td style="width: 10%;"></td> <td style="width: 10%;"></td> <td style="width: 10%;"></td> <td style="width: 10%;"></td> <td style="width: 10%;"></td> <td style="width: 10%;"></td> <td style="width: 10%;"></td> </tr> <tr> <td></td> <td></td> <td colspan="8" style="text-align: center;"> <table border="1" style="width: 100%; border-collapse: collapse; text-align: center;"> <tr> <td style="width: 10%;"></td> <td style="width: 10%;"></td> <td style="width: 10%;"></td> <td style="width: 10%;"></td> <td style="width: 10%;"></td> <td style="width: 10%;"></td> <td style="width: 10%;"></td> <td style="width: 10%;"></td> <td style="width: 10%;"></td> <td style="width: 10%;"></td> </tr> <tr> <td></td> <td></td> <td colspan="8" style="text-align: center;"> <table border="1" style="width: 100%; border-collapse: collapse; text-align: center;"> <tr> <td style="width: 10%;"></td> <td style="width: 10%;"></td> <td style="width: 10%;"></td> <td style="width: 10%;"></td> <td style="width: 10%;"></td> <td style="width: 10%;"></td> <td style="width: 10%;"></td> <td style="width: 10%;"></td> <td style="width: 10%;"></td> <td style="width: 10%;"></td> </tr> <tr> <td></td> <td></td> <td colspan="8" style="text-align: center;"> <table border="1" style="width: 100%; border-collapse: collapse; text-align: center;"> <tr> <td style="width: 10%;"></td> <td style="width: 10%;"></td> <td style="width: 10%;"></td> <td style="width: 10%;"></td> <td style="width: 10%;"></td> <td style="width: 10%;"></td> <td style="width: 10%;"></td> <td style="width: 10%;"></td> <td style="width: 10%;"></td> <td style="width: 10%;"></td> </tr> <tr> <td></td> <td></td> <td colspan="8" style="text-align: center;"> <table border="1" style="width: 100%; border-collapse: collapse; text-align: center;"> <tr> <td style="width: 10%;"></td> <td style="width: 10%;"></td> <td style="width: 10%;"></td> <td style="width: 10%;"></td> <td style="width: 10%;"></td> <td style="width: 10%;"></td> <td style="width: 10%;"></td> <td style="width: 10%;"></td> <td style="width: 10%;"></td> <td style="width: 10%;"></td> </tr> <tr> <td></td> <td></td> <td colspan="8" style="text-align: center;"> <table border="1" style="width: 100%; border-collapse: collapse; text-align: center;"> <tr> <td style="width: 10%;"></td> <td style="width: 10%;"></td> <td style="width: 10%;"></td> <td style="width: 10%;"></td> <td style="width: 10%;"></td> <td style="width: 10%;"></td> <td style="width: 10%;"></td> <td style="width: 10%;"></td> <td style="width: 10%;"></td> <td style="width: 10%;"></td> </tr> <tr> <td></td> <td></td> <td colspan="8" style="text-align: center;"> <table border="1" style="width: 100%; border-collapse: collapse; text-align: center;"> <tr> <td style="width: 10%;"></td> <td style="width: 10%;"></td> <td style="width: 10%;"></td> <td style="width: 10%;"></td> <td style="width: 10%;"></td> <td style="width: 10%;"></td> <td style="width: 10%;"></td> <td style="width: 10%;"></td> <td style="width: 10%;"></td> <td style="width: 10%;"></td> </tr> <tr> <td></td> <td></td> <td colspan="8" style="text-align: center;"> <table border="1" style="width: 100%; border-collapse: collapse; text-align: center;"> <tr> <td style="width: 10%;"></td> <td style="width: 10%;"></td> <td style="width: 10%;"></td> <td style="width: 10%;"></td> <td style="width: 10%;"></td> <td style="width: 10%;"></td> <td style="width: 10%;"></td> <td style="width: 10%;"></td> <td style="width: 10%;"></td> <td style="width: 10%;"></td> </tr> <tr> <td></td> <td></td> <td colspan="8" style="text-align: center;"> <table border="1" style="width: 100%; border-collapse: collapse; text-align: center;"> <tr> <td style="width: 10%;"></td> <td style="width: 10%;"></td> <td style="width: 10%;"></td> <td style="width: 10%;"></td> <td style="width: 10%;"></td> <td style="width: 10%;"></td> <td style="width: 10%;"></td> <td style="width: 10%;"></td> <td style="width: 10%;"></td> <td style="width: 10%;"></td> </tr> <tr> <td></td> <td></td> <td colspan="8" style="text-align: center;"> <table border="1" style="width: 100%; border-collapse: collapse; text-align: center;"> <tr> <td style="width: 10%;"></td> <td style="width: 10%;"></td> <td style="width: 10%;"></td> <td style="width: 10%;"></td> <td style="width: 10%;"></td> <td style="width: 10%;"></td> <td style="width: 10%;"></td> <td style="width: 10%;"></td> <td style="width: 10%;"></td> <td style="width: 10%;"></td> </tr> <tr> <td></td> <td></td> <td colspan="8" style="text-align: center;"> <table border="1" style="width: 100%; border-collapse: collapse; text-align: center;"> <tr> <td style="width: 10%;"></td> <td style="width: 10%;"></td> <td style="width: 10%;"></td> <td style="width: 10%;"></td> <td style="width: 10%;"></td> <td style="width: 10%;"></td> <td style="width: 10%;"></td> <td style="width: 10%;"></td> <td style="width: 10%;"></td> <td style="width: 10%;"></td> </tr> <tr> <td></td> <td></td> <td colspan="8" style="text-align: center;"> <table border="1" style="width: 100%; border-collapse: collapse; text-align: center;"> <tr> <td style="width: 10%;"></td> <td style="width: 10%;"></td> <td style="width: 10%;"></td> <td style="width: 10%;"></td> <td style="width: 10%;"></td> <td style="width: 10%;"></td> <td style="width: 10%;"></td> <td style="width: 10%;"></td> <td style="width: 10%;"></td> <td style="width: 10%;"></td> </tr> <tr> <td></td> <td></td> <td colspan="8" style="text-align: center;"> <table border="1" style="width: 100%; border-collapse: collapse; text-align: center;"> <tr> <td style="width: 10%;"></td> <td style="width: 10%;"></td> <td style="width: 10%;"></td> <td style="width: 10%;"></td> <td style="width: 10%;"></td> <td style="width: 10%;"></td> <td style="width: 10%;"></td> <td style="width: 10%;"></td> <td style="width: 10%;"></td> <td style="width: 10%;"></td> </tr> <tr> <td></td> <td></td> <td colspan="8" style="text-align: center;"> <table border="1" style="width: 100%; border-collapse: collapse; text-align: center;"> <tr> <td style="width: 10%;"></td> <td style="width:
10%;"></td> <td style="width: 10%;"></td> <td style="width: 10%;"></td> <td style="width: 10%;"></td> <td style="width: 10%;"></td> <td style="width: 10%;"></td> <td style="width: 10%;"></td> <td style="width: 10%;"></td> <td style="width: 10%;"></td> </tr> <tr> <td></td> <td></td> <td colspan="8" style="text-align: center;"> <table border="1" style="width: 100%; border-collapse: collapse; text-align: center;"> <tr> <td style="width: 10%;"></td> <td style="width: 10%;"></td> <td style="width: 10%;"></td> <td style="width: 10%;"></td> <td style="width: 10%;"></td> <td style="width: 10%;"></td> <td style="width: 10%;"></td> <td style="width: 10%;"></td> <td style="width: 10%;"></td> <td style="width: 10%;"></td> </tr> <tr> <td></td> <td></td> <td colspan="8" style="text-align: center;"> <table border="1" style="width: 100%; border-collapse: collapse; text-align: center;"> <tr> <td style="width: 10%;"></td> <td style="width: 10%;"></td> <td style="width: 10%;"></td> <td style="width: 10%;"></td> <td style="width: 10%;"></td> <td style="width: 10%;"></td> <td style="width: 10%;"></td> <td style="width: 10%;"></td> <td style="width: 10%;"></td> <td style="width: 10%;"></td> </tr> <tr> <td></td> <td></td> <td colspan="8" style="text-align: center;"> <table border="1" style="width: 100%; border-collapse: collapse; text-align: center;"> <tr> <td style="width: 10%;"></td> <td style="width: 10%;"></td> <td style="width: 10%;"></td> <td style="width: 10%;"></td> <td style="width: 10%;"></td> <td style="width: 10%;"></td> <td style="width: 10%;"></td> <td style="width: 10%;"></td> <td style="width: 10%;"></td> <td style="width: 10%;"></td> </tr> <tr> <td></td> <td></td> <td colspan="8" style="text-align: center;"> <table border="1" style="width: 100%; border-collapse: collapse; text-align: center;"> <tr> <td style="width: 10%;"></td> <td style="width: 10%;"></td> <td style="width: 10%;"></td> <td style="width: 10%;"></td> <td style="width: 10%;"></td> <td style="width: 10%;"></td> <td style="width: 10%;"></td> <td style="width: 10%;"></td> <td style="width: 10%;"></td> <td style="width: 10%;"></td> </tr> <tr> <td></td> <td></td> <td colspan="8" style="text-align: center;"> <table border="1" style="width: 100%; border-collapse: collapse; text-align: center;"> <tr> <td style="width: 10%;"></td> <td style="width: 10%;"></td> <td style="width: 10%;"></td> <td style="width: 10%;"></td> <td style="width: 10%;"></td> <td style="width: 10%;"></td> <td style="width: 10%;"></td> <td style="width: 10%;"></td> <td style="width: 10%;"></td> <td style="width: 10%;"></td> </tr> <tr> <td></td> <td></td> <td colspan="8" style="text-align: center;"> <table border="1" style="width: 100%; border-collapse: collapse; text-align: center;"> <tr> <td style="width: 10%;"></td> <td style="width: 10%;"></td> <td style="width: 10%;"></td> <td style="width: 10%;"></td> <td style="width: 10%;"></td> <td style="width: 10%;"></td> <td style="width: 10%;"></td> <td style="width: 10%;"></td> <td style="width: 10%;"></td> <td style="width: 10%;"></td> </tr> <tr> <td></td> <td></td> <td colspan="8" style="text-align: center;"> <table border="1" style="width: 100%; border-collapse: collapse; text-align: center;"> <tr> <td style="width: 10%;"></td> <td style="width: 10%;"></td> <td style="width: 10%;"></td> <td style="width: 10%;"></td> <td style="width: 10%;"></td> <td style="width: 10%;"></td> <td style="width: 10%;"></td> <td style="width: 10%;"></td> <td style="width: 10%;"></td> <td style="width: 10%;"></td> </tr> <tr> <td></td> <td></td> <td colspan="8" style="text-align: center;"> <table border="1" style="width: 100%; border-collapse: collapse; text-align: center;"> <tr> <td style="width: 10%;"></td> <td style="width: 10%;"></td> <td style="width: 10%;"></td> <td style="width: 10%;"></td> <td style="width: 10%;"></td> <td style="width: 10%;"></td> <td style="width: 10%;"></td> <td style="width: 10%;"></td> <td style="width: 10%;"></td> <td style="width: 10%;"></td> </tr> <tr> <td></td> <td></td> <td colspan="8" style="text-align: center;"> <table border="1" style="width: 100%; border-collapse: collapse; text-align: center;"> <tr> <td style="width: 10%;"></td> <td style="width: 10%;"></td> <td style="width: 10%;"></td> <td style="width: 10%;"></td> <td style="width: 10%;"></td> <td style="width: 10%;"></td> <td style="width: 10%;"></td> <td style="width: 10%;"></td> <td style="width: 10%;"></td> <td style="width: 10%;"></td> </tr> <tr> <td></td> <td></td> <td colspan="8" style="text-align: center;"> <table border="1" style="width: 100%; border-collapse: collapse; text-align: center;"> <tr> <td style="width: 10%;"></td> <td style="width: 10%;"></td> <td style="width: 10%;"></td> <td style="width: 10%;"></td> <td style="width: 10%;"></td> <td style="width: 10%;"></td> <td style="width: 10%;"></td> <td style="width: 10%;"></td> <td style="width: 10%;"></td> <td style="width: 10%;"></td> </tr> <tr> <td></td> <td></td> <td colspan="8" style="text-align: center;"> <table border="1" style="width: 100%; border-collapse: collapse; text-align: center;"> <tr> <td style="width: 10%;"></td> <td style="width: 10%;"></td> <td style="width: 10%;"></td> <td style="width: 10%;"></td> <td style="width: 10%;"></td> <td style="width: 10%;"></td> <td style="width: 10%;"></td> <td style="width: 10%;"></td> <td style="width: 10%;"></td> <td style="width: 10%;"></td> </tr> <tr> <td></td> <td></td> <td colspan="8" style="text-align: center;"> <table border="1" style="width: 100%; border-collapse: collapse; text-align: center;"> <tr> <td style="width: 10%;"></td> <td style="width: 10%;"></td> <td style="width: 10%;"></td> <td style="width: 10%;"></td> <td style="width: 10%;"></td> <td style="width: 10%;"></td> <td style="width: 10%;"></td> <td style="width: 10%;"></td> <td style="width: 10%;"></td> <td style="width: 10%;"></td> </tr> <tr> <td></td> <td></td> <td colspan="8" style="text-align: center;"> <table border="1" style="width: 100%; border-collapse: collapse; text-align: center;"> <tr> <td style="width: 10%;"></td> <td style="width: 10%;"></td> <td style="width: 10%;"></td> <td style="width: 10%;"></td> <td style="width: 10%;"></td> <td style="width: 10%;"></td> <td style="width: 10%;"></td> <td style="width: 10%;"></td> <td style="width: 10%;"></td> <td style="width: 10%;"></td> </tr> <tr> <td></td> <td></td> <td colspan="8" style="text-align: center;"> <table border="1" style="width: 100%; border-collapse: collapse; text-align: center;"> <tr> <td style="width: 10%;"></td> <td style="width: 10%;"></td> <td style="width: 10%;"></td> <td style="width: 10%;"></td> <td style="width: 10%;"></td> <td style="width: 10%;"></td> <td style="width: 10%;"></td> <td style="width: 10%;"></td> <td style="width: 10%;"></td> <td style="width: 10%;"></td> </tr> <tr> <td></td> <td></td> <td colspan="8" style="text-align: center;"> <table border="1" style="width: 100%; border-collapse: collapse; text-align: center;"> <tr> <td style="width: 10%;"></td> <td style="width: 10%;"></td> <td style="width: 10%;"></td> <td style="width: 10%;"></td> <td style="width: 10%;"></td> <td style="width: 10%;"></td> <td style="width: 10%;"></td> <td style="width: 10%;"></td> <td style="width: 10%;"></td> <td style="width: 10%;"></td> </tr> <tr> <td></td> <td></td> <td colspan="8" style="text-align: center;"> <table border="1" style="width: 100%; border-collapse: collapse; text-align: center;"> <tr> <td style="width: 10%;"></td> <td style="width: 10%;"></td> <td style="width: 10%;"></td> <td style="width: 10%;"></td> <td style="width: 10%;"></td> <td style="width: 10%;"></td> <td style="width: 10%;"></td> <td style="width: 10%;"></td> <td style="width: 10%;"></td> <td style="width: 10%;"></td> </tr> <tr> <td></td> <td></td> <td colspan="8" style="text-align: center;"> <table border="1" style="width: 100%; border-collapse: collapse; text-align: center;"> <tr> <td style="width: 10%;"></td> <td style="width: 10%;"></td> <td style="width: 10%;"></td> <td style="width: 10%;"></td> <td style="width: 10%;"></td> <td style="width: 10%;"></td> <td style="width: 10%;"></td> <td style="width: 10%;"></td> <td style="width: 10%;"></td> <td style="width: 10%;"></td> </tr> <tr> <td></td> <td></td> <td colspan="8" style="text-align: center;"> <table border="1" style="width: 100%; border-collapse: collapse; text-align: center;"> <tr> <td style="width: 10%;"></td> <td style="width: 10%;"></td> <td style="width: 10%;"></td> <td style="width: 10%;"></td> <td style="width: 10%;"></td> <td style="width: 10%;"></td> <td style="width: 10%;"></td> <td style="width: 10%;"></td> <td style="width: 10%;"></td> <td style="width: 10%;"></td> </tr> <tr> <td></td> <td></td> <td colspan="8" style="text-align: center;"> <table border="1" style="width: 100%; border-collapse: collapse; text-align: center;"> <tr> <td style="width: 10%;"></td> <td style="width: 10%;"></td> <td style="width: 10%;"></td> <td style="width: 10%;"></td> <td style="width: 10%;"></td> <td style="width: 10%;"></td> <td style="width: 10%;"></td> <td style="width: 10%;"></td> <td style="width: 10%;"></td> <td style="width: 10%;"></td> </tr> <tr> <td></td> <td></td> <td colspan="8" style="text-align: center;"> <table border="1" style="width: 100%; border-collapse: collapse; text-align: center;"> <tr>
</tr></table></td></tr></table></td></tr></table></td></tr></table></td></tr></table></td></tr></table></td></tr></table></td></tr></table></td></tr></table></td></tr></table></td></tr></table></td></tr></table></td></tr></table></td></tr></table></td></tr></table></td></tr></table></td></tr></table></td></tr></table></td></tr></table></td></tr></table></td></tr></table></td></tr></table></td></tr></table></td></tr></table></td></tr></table></td></tr></table></td></tr></table></td></tr></table></td></tr></table></td></tr></table></td></tr></table></td></tr></table></td></tr></table></td></tr></table></td></tr></table></td></tr></table></td></tr></table></td></tr></table></td></tr></table></td></tr></table> | | | | | | | | | | | | | | | | | | | | <table border="1" style="width: 100%; border-collapse: collapse; text-align: center;"> <tr> <td style="width: 10%;"></td> <td style="width: 10%;"></td> <td style="width: 10%;"></td> <td style="width: 10%;"></td> <td style="width: 10%;"></td> <td style="width: 10%;"></td> <td style="width: 10%;"></td> <td style="width: 10%;"></td> <td style="width: 10%;"></td> <td style="width: 10%;"></td> </tr> <tr> <td></td> <td></td> <td colspan="8" style="text-align: center;"> <table border="1" style="width: 100%; border-collapse: collapse; text-align: center;"> <tr> <td style="width: 10%;"></td> <td style="width: 10%;"></td> <td style="width: 10%;"></td> <td style="width: 10%;"></td> <td style="width: 10%;"></td> <td style="width: 10%;"></td> <td style="width: 10%;"></td> <td style="width: 10%;"></td> <td style="width: 10%;"></td> <td style="width: 10%;"></td> </tr> <tr> <td></td> <td></td> <td colspan="8" style="text-align: center;"> <table border="1" style="width: 100%; border-collapse: collapse; text-align: center;"> <tr> <td style="width: 10%;"></td> <td style="width: 10%;"></td> <td style="width: 10%;"></td> <td style="width: 10%;"></td> <td style="width: 10%;"></td> <td style="width: 10%;"></td> <td style="width: 10%;"></td> <td style="width: 10%;"></td> <td style="width: 10%;"></td> <td style="width: 10%;"></td> </tr> <tr> <td></td> <td></td> <td colspan="8" style="text-align: center;"> <table border="1" style="width: 100%; border-collapse: collapse; text-align: center;"> <tr> <td style="width: 10%;"></td> <td style="width: 10%;"></td> <td style="width: 10%;"></td> <td style="width: 10%;"></td> <td style="width: 10%;"></td> <td style="width: 10%;"></td> <td style="width: 10%;"></td> <td style="width: 10%;"></td> <td style="width: 10%;"></td> <td style="width: 10%;"></td> </tr> <tr> <td></td> <td></td> <td colspan="8" style="text-align: center;"> <table border="1" style="width: 100%; border-collapse:
collapse; text-align: center;"> <tr> <td style="width: 10%;"></td> <td style="width: 10%;"></td> <td style="width: 10%;"></td> <td style="width: 10%;"></td> <td style="width: 10%;"></td> <td style="width: 10%;"></td> <td style="width: 10%;"></td> <td style="width: 10%;"></td> <td style="width: 10%;"></td> <td style="width: 10%;"></td> </tr> <tr> <td></td> <td></td> <td colspan="8" style="text-align: center;"> <table border="1" style="width: 100%; border-collapse: collapse; text-align: center;"> <tr> <td style="width: 10%;"></td> <td style="width: 10%;"></td> <td style="width: 10%;"></td> <td style="width: 10%;"></td> <td style="width: 10%;"></td> <td style="width: 10%;"></td> <td style="width: 10%;"></td> <td style="width: 10%;"></td> <td style="width: 10%;"></td> <td style="width: 10%;"></td> </tr> <tr> <td></td> <td></td> <td colspan="8" style="text-align: center;"> <table border="1" style="width: 100%; border-collapse: collapse; text-align: center;"> <tr> <td style="width: 10%;"></td> <td style="width: 10%;"></td> <td style="width: 10%;"></td> <td style="width: 10%;"></td> <td style="width: 10%;"></td> <td style="width: 10%;"></td> <td style="width: 10%;"></td> <td style="width: 10%;"></td> <td style="width: 10%;"></td> <td style="width: 10%;"></td> </tr> <tr> <td></td> <td></td> <td colspan="8" style="text-align: center;"> <table border="1" style="width: 100%; border-collapse: collapse; text-align: center;"> <tr> <td style="width: 10%;"></td> <td style="width: 10%;"></td> <td style="width: 10%;"></td> <td style="width: 10%;"></td> <td style="width: 10%;"></td> <td style="width: 10%;"></td> <td style="width: 10%;"></td> <td style="width: 10%;"></td> <td style="width: 10%;"></td> <td style="width: 10%;"></td> </tr> <tr> <td></td> <td></td> <td colspan="8" style="text-align: center;"> <table border="1" style="width: 100%; border-collapse: collapse; text-align: center;"> <tr> <td style="width: 10%;"></td> <td style="width: 10%;"></td> <td style="width: 10%;"></td> <td style="width: 10%;"></td> <td style="width: 10%;"></td> <td style="width: 10%;"></td> <td style="width: 10%;"></td> <td style="width: 10%;"></td> <td style="width: 10%;"></td> <td style="width: 10%;"></td> </tr> <tr> <td></td> <td></td> <td colspan="8" style="text-align: center;"> <table border="1" style="width: 100%; border-collapse: collapse; text-align: center;"> <tr> <td style="width: 10%;"></td> <td style="width: 10%;"></td> <td style="width: 10%;"></td> <td style="width: 10%;"></td> <td style="width: 10%;"></td> <td style="width: 10%;"></td> <td style="width: 10%;"></td> <td style="width: 10%;"></td> <td style="width: 10%;"></td> <td style="width: 10%;"></td> </tr> <tr> <td></td> <td></td> <td colspan="8" style="text-align: center;"> <table border="1" style="width: 100%; border-collapse: collapse; text-align: center;"> <tr> <td style="width: 10%;"></td> <td style="width: 10%;"></td> <td style="width: 10%;"></td> <td style="width: 10%;"></td> <td style="width: 10%;"></td> <td style="width: 10%;"></td> <td style="width: 10%;"></td> <td style="width: 10%;"></td> <td style="width: 10%;"></td> <td style="width: 10%;"></td> </tr> <tr> <td></td> <td></td> <td colspan="8" style="text-align: center;"> <table border="1" style="width: 100%; border-collapse: collapse; text-align: center;"> <tr> <td style="width: 10%;"></td> <td style="width: 10%;"></td> <td style="width: 10%;"></td> <td style="width: 10%;"></td> <td style="width: 10%;"></td> <td style="width: 10%;"></td> <td style="width: 10%;"></td> <td style="width: 10%;"></td> <td style="width: 10%;"></td> <td style="width: 10%;"></td> </tr> <tr> <td></td> <td></td> <td colspan="8" style="text-align: center;"> <table border="1" style="width: 100%; border-collapse: collapse; text-align: center;"> <tr> <td style="width: 10%;"></td> <td style="width: 10%;"></td> <td style="width: 10%;"></td> <td style="width: 10%;"></td> <td style="width: 10%;"></td> <td style="width: 10%;"></td> <td style="width: 10%;"></td> <td style="width: 10%;"></td> <td style="width: 10%;"></td> <td style="width: 10%;"></td> </tr> <tr> <td></td> <td></td> <td colspan="8" style="text-align: center;"> <table border="1" style="width: 100%; border-collapse: collapse; text-align: center;"> <tr> <td style="width: 10%;"></td> <td style="width: 10%;"></td> <td style="width: 10%;"></td> <td style="width: 10%;"></td> <td style="width: 10%;"></td> <td style="width: 10%;"></td> <td style="width: 10%;"></td> <td style="width: 10%;"></td> <td style="width: 10%;"></td> <td style="width: 10%;"></td> </tr> <tr> <td></td> <td></td> <td colspan="8" style="text-align: center;"> <table border="1" style="width: 100%; border-collapse: collapse; text-align: center;"> <tr> <td style="width: 10%;"></td> <td style="width: 10%;"></td> <td style="width: 10%;"></td> <td style="width: 10%;"></td> <td style="width: 10%;"></td> <td style="width: 10%;"></td> <td style="width: 10%;"></td> <td style="width: 10%;"></td> <td style="width: 10%;"></td> <td style="width: 10%;"></td> </tr> <tr> <td></td> <td></td> <td colspan="8" style="text-align: center;"> <table border="1" style="width: 100%; border-collapse: collapse; text-align: center;"> <tr> <td style="width: 10%;"></td> <td style="width: 10%;"></td> <td style="width: 10%;"></td> <td style="width: 10%;"></td> <td style="width: 10%;"></td> <td style="width: 10%;"></td> <td style="width: 10%;"></td> <td style="width: 10%;"></td> <td style="width: 10%;"></td> <td style="width: 10%;"></td> </tr> <tr> <td></td> <td></td> <td colspan="8" style="text-align: center;"> <table border="1" style="width: 100%; border-collapse: collapse; text-align: center;"> <tr> <td style="width: 10%;"></td> <td style="width: 10%;"></td> <td style="width: 10%;"></td> <td style="width: 10%;"></td> <td style="width: 10%;"></td> <td style="width: 10%;"></td> <td style="width: 10%;"></td> <td style="width: 10%;"></td> <td style="width: 10%;"></td> <td style="width: 10%;"></td> </tr> <tr> <td></td> <td></td> <td colspan="8" style="text-align: center;"> <table border="1" style="width: 100%; border-collapse: collapse; text-align: center;"> <tr> <td style="width: 10%;"></td> <td style="width: 10%;"></td> <td style="width: 10%;"></td> <td style="width: 10%;"></td> <td style="width: 10%;"></td> <td style="width: 10%;"></td> <td style="width: 10%;"></td> <td style="width: 10%;"></td> <td style="width: 10%;"></td> <td style="width: 10%;"></td> </tr> <tr> <td></td> <td></td> <td colspan="8" style="text-align: center;"> <table border="1" style="width: 100%; border-collapse: collapse; text-align: center;"> <tr> <td style="width: 10%;"></td> <td style="width: 10%;"></td> <td style="width: 10%;"></td> <td style="width: 10%;"></td> <td style="width: 10%;"></td> <td style="width: 10%;"></td> <td style="width: 10%;"></td> <td style="width: 10%;"></td> <td style="width: 10%;"></td> <td style="width: 10%;"></td> </tr> <tr> <td></td> <td></td> <td colspan="8" style="text-align: center;"> <table border="1" style="width: 100%; border-collapse: collapse; text-align: center;"> <tr> <td style="width: 10%;"></td> <td style="width: 10%;"></td> <td style="width: 10%;"></td> <td style="width: 10%;"></td> <td style="width: 10%;"></td> <td style="width: 10%;"></td> <td style="width: 10%;"></td> <td style="width: 10%;"></td> <td style="width: 10%;"></td> <td style="width: 10%;"></td> </tr> <tr> <td></td> <td></td> <td colspan="8" style="text-align: center;"> <table border="1" style="width: 100%; border-collapse: collapse; text-align: center;"> <tr> <td style="width: 10%;"></td> <td style="width: 10%;"></td> <td style="width: 10%;"></td> <td style="width: 10%;"></td> <td style="width: 10%;"></td> <td style="width: 10%;"></td> <td style="width: 10%;"></td> <td style="width: 10%;"></td> <td style="width: 10%;"></td> <td style="width: 10%;"></td> </tr> <tr> <td></td> <td></td> <td colspan="8" style="text-align: center;"> <table border="1" style="width: 100%; border-collapse: collapse; text-align: center;"> <tr> <td style="width: 10%;"></td> <td style="width: 10%;"></td> <td style="width: 10%;"></td> <td style="width: 10%;"></td> <td style="width: 10%;"></td> <td style="width: 10%;"></td> <td style="width: 10%;"></td> <td style="width: 10%;"></td> <td style="width: 10%;"></td> <td style="width: 10%;"></td> </tr> <tr> <td></td> <td></td> <td colspan="8" style="text-align: center;"> <table border="1" style="width: 100%; border-collapse: collapse; text-align: center;"> <tr> <td style="width: 10%;"></td> <td style="width: 10%;"></td> <td style="width: 10%;"></td> <td style="width: 10%;"></td> <td style="width: 10%;"></td> <td style="width: 10%;"></td> <td style="width: 10%;"></td> <td style="width: 10%;"></td> <td style="width: 10%;"></td> <td style="width: 10%;"></td> </tr> <tr> <td></td> <td></td> <td colspan="8" style="text-align: center;"> <table border="1" style="width: 100%; border-collapse: collapse; text-align: center;"> <tr> <td style="width: 10%;"></td> <td style="width: 10%;"></td> <td style="width: 10%;"></td> <td style="width: 10%;"></td> <td style="width: 10%;"></td> <td style="width: 10%;"></td> <td style="width: 10%;"></td> <td style="width: 10%;"></td> <td style="width: 10%;"></td> <td style="width: 10%;"></td> </tr> <tr> <td></td> <td></td> <td colspan="8" style="text-align: center;"> <table border="1" style="width: 100%; border-collapse: collapse; text-align: center;"> <tr> <td style="width: 10%;"></td> <td style="width: 10%;"></td> <td style="width: 10%;"></td> <td style="width: 10%;"></td> <td style="width: 10%;"></td> <td style="width: 10%;"></td> <td style="width: 10%;"></td> <td style="width: 10%;"></td> <td style="width: 10%;"></td> <td style="width: 10%;"></td> </tr> <tr> <td></td> <td></td> <td colspan="8" style="text-align: center;"> <table border="1" style="width: 100%; border-collapse: collapse; text-align: center;"> <tr> <td style="width: 10%;"></td> <td style="width: 10%;"></td> <td style="width: 10%;"></td> <td style="width: 10%;"></td> <td
style="width: 10%;"></td> <td style="width: 10%;"></td> <td style="width: 10%;"></td> <td style="width: 10%;"></td> <td style="width: 10%;"></td> <td style="width: 10%;"></td> </tr> <tr> <td></td> <td></td> <td colspan="8" style="text-align: center;"> <table border="1" style="width: 100%; border-collapse: collapse; text-align: center;"> <tr> <td style="width: 10%;"></td> <td style="width: 10%;"></td> <td style="width: 10%;"></td> <td style="width: 10%;"></td> <td style="width: 10%;"></td> <td style="width: 10%;"></td> <td style="width: 10%;"></td> <td style="width: 10%;"></td> <td style="width: 10%;"></td> <td style="width: 10%;"></td> </tr> <tr> <td></td> <td></td> <td colspan="8" style="text-align: center;"> <table border="1" style="width: 100%; border-collapse: collapse; text-align: center;"> <tr> <td style="width: 10%;"></td> <td style="width: 10%;"></td> <td style="width: 10%;"></td> <td style="width: 10%;"></td> <td style="width: 10%;"></td> <td style="width: 10%;"></td> <td style="width: 10%;"></td> <td style="width: 10%;"></td> <td style="width: 10%;"></td> <td style="width: 10%;"></td> </tr> <tr> <td></td> <td></td> <td colspan="8" style="text-align: center;"> <table border="1" style="width: 100%; border-collapse: collapse; text-align: center;"> <tr> <td style="width: 10%;"></td> <td style="width: 10%;"></td> <td style="width: 10%;"></td> <td style="width: 10%;"></td> <td style="width: 10%;"></td> <td style="width: 10%;"></td> <td style="width: 10%;"></td> <td style="width: 10%;"></td> <td style="width: 10%;"></td> <td style="width: 10%;"></td> </tr> <tr> <td></td> <td></td> <td colspan="8" style="text-align: center;"> <table border="1" style="width: 100%; border-collapse: collapse; text-align: center;"> <tr> <td style="width: 10%;"></td> <td style="width: 10%;"></td> <td style="width: 10%;"></td> <td style="width: 10%;"></td> <td style="width: 10%;"></td> <td style="width: 10%;"></td> <td style="width: 10%;"></td> <td style="width: 10%;"></td> <td style="width: 10%;"></td> <td style="width: 10%;"></td> </tr> <tr> <td></td> <td></td> <td colspan="8" style="text-align: center;"> <table border="1" style="width: 100%; border-collapse: collapse; text-align: center;"> <tr> <td style="width: 10%;"></td> <td style="width: 10%;"></td> <td style="width: 10%;"></td> <td style="width: 10%;"></td> <td style="width: 10%;"></td> <td style="width: 10%;"></td> <td style="width: 10%;"></td> <td style="width: 10%;"></td> <td style="width: 10%;"></td> <td style="width: 10%;"></td> </tr> <tr> <td></td> <td></td> <td colspan="8" style="text-align: center;"> <table border="1" style="width: 100%; border-collapse: collapse; text-align: center;"> <tr> <td style="width: 10%;"></td> <td style="width: 10%;"></td> <td style="width: 10%;"></td> <td style="width: 10%;"></td> <td style="width: 10%;"></td> <td style="width: 10%;"></td> <td style="width: 10%;"></td> <td style="width: 10%;"></td> <td style="width: 10%;"></td> <td style="width: 10%;"></td> </tr> <tr> <td></td> <td></td> <td colspan="8" style="text-align: center;"> <table border="1" style="width: 100%; border-collapse: collapse; text-align: center;"> <tr> <td style="width: 10%;"></td> <td style="width: 10%;"></td> <td style="width: 10%;"></td> <td style="width: 10%;"></td> <td style="width: 10%;"></td> <td style="width: 10%;"></td> <td style="width: 10%;"></td> <td style="width: 10%;"></td> <td style="width: 10%;"></td> <td style="width: 10%;"></td> </tr> <tr> <td></td> <td></td> <td colspan="8" style="text-align: center;"> <table border="1" style="width: 100%; border-collapse: collapse; text-align: center;"> <tr> <td style="width: 10%;"></td> <td style="width: 10%;"></td> <td style="width: 10%;"></td> <td style="width: 10%;"></td> <td style="width: 10%;"></td> <td style="width: 10%;"></td> <td style="width: 10%;"></td> <td style="width: 10%;"></td> <td style="width: 10%;"></td> <td style="width: 10%;"></td> </tr> <tr> <td></td> <td></td> <td colspan="8" style="text-align: center;"> <table border="1" style="width: 100%; border-collapse: collapse; text-align: center;"> <tr> <td style="width: 10%;"></td> <td style="width: 10%;"></td> <td style="width: 10%;"></td> <td style="width: 10%;"></td> <td style="width: 10%;"></td> <td style="width: 10%;"></td> <td style="width: 10%;"></td> <td style="width: 10%;"></td> <td style="width: 10%;"></td> <td style="width: 10%;"></td> </tr> <tr> <td></td> <td></td> <td colspan="8" style="text-align: center;"> <table border="1" style="width: 100%; border-collapse: collapse; text-align: center;"> <tr> <td style="width: 10%;"></td> <td style="width: 10%;"></td> <td style="width: 10%;"></td> <td style="width: 10%;"></td> <td style="width: 10%;"></td> <td style="width: 10%;"></td> <td style="width: 10%;"></td> <td style="width: 10%;"></td> <td style="width: 10%;"></td> <td style="width: 10%;"></td> </tr> <tr> <td></td> <td></td> <td colspan="8" style="text-align: center;"> <table border="1" style="width: 100%; border-collapse: collapse; text-align: center;"> <tr> <td style="width: 10%;"></td> <td style="width: 10%;"></td> <td style="width: 10%;"></td> <td style="width: 10%;"></td> <td style="width: 10%;"></td> <td style="width: 10%;"></td> <td style="width: 10%;"></td> <td style="width: 10%;"></td> <td style="width: 10%;"></td> <td style="width: 10%;"></td> </tr> <tr> <td></td> <td></td> <td colspan="8" style="text-align: center;"> <table border="1" style="width: 100%; border-collapse: collapse; text-align: center;"> <tr> <td style="width: 10%;"></td> <td style="width: 10%;"></td> <td style="width: 10%;"></td> <td style="width: 10%;"></td> <td style="width: 10%;"></td> <td style="width: 10%;"></td> <td style="width: 10%;"></td> <td style="width: 10%;"></td> <td style="width: 10%;"></td> <td style="width: 10%;"></td> </tr> <tr> <td></td> <td></td> <td colspan="8" style="text-align: center;"> <table border="1" style="width: 100%; border-collapse: collapse; text-align: center;"> <tr> </tr></table></td></tr></table></td></tr></table></td></tr></table></td></tr></table></td></tr></table></td></tr></table></td></tr></table></td></tr></table></td></tr></table></td></tr></table></td></tr></table></td></tr></table></td></tr></table></td></tr></table></td></tr></table></td></tr></table></td></tr></table></td></tr></table></td></tr></table></td></tr></table></td></tr></table></td></tr></table></td></tr></table></td></tr></table></td></tr></table></td></tr></table></td></tr></table></td></tr></table></td></tr></table></td></tr></table></td></tr></table></td></tr></table></td></tr></table></td></tr></table></td></tr></table></td></tr></table></td></tr></table></td></tr></table>
 | | | | | | | | | | | | | | | | | | | | <table border="1" style="width: 100%; border-collapse: collapse; text-align: center;"> <tr> <td style="width: 10%;"></td> <td style="width: 10%;"></td> <td style="width: 10%;"></td> <td style="width: 10%;"></td> <td style="width: 10%;"></td> <td style="width: 10%;"></td> <td style="width: 10%;"></td> <td style="width: 10%;"></td> <td style="width: 10%;"></td> <td style="width: 10%;"></td> </tr> <tr> <td></td> <td></td> <td colspan="8" style="text-align: center;"> <table border="1" style="width: 100%; border-collapse: collapse; text-align: center;"> <tr> <td style="width: 10%;"></td> <td style="width: 10%;"></td> <td style="width: 10%;"></td> <td style="width: 10%;"></td> <td style="width: 10%;"></td> <td style="width: 10%;"></td> <td style="width: 10%;"></td> <td style="width: 10%;"></td> <td style="width: 10%;"></td> <td style="width: 10%;"></td> </tr> <tr> <td></td> <td></td> <td colspan="8" style="text-align: center;"> <table border="1" style="width: 100%; border-collapse: collapse; text-align: center;"> <tr> <td style="width: 10%;"></td> <td style="width: 10%;"></td> <td style="width: 10%;"></td> <td style="width: 10%;"></td> <td style="width: 10%;"></td> <td style="width: 10%;"></td> <td style="width: 10%;"></td> <td style="width: 10%;"></td> <td style="width: 10%;"></td> <td style="width: 10%;"></td> </tr> <tr> <td></td> <td></td> <td colspan="8" style="text-align: center;"> <table border="1" style="width: 100%; border-collapse: collapse; text-align: center;"> <tr> <td style="width: 10%;"></td> <td style="width: 10%;"></td> <td style="width: 10%;"></td> <td style="width: 10%;"></td> <td style="width: 10%;"></td> <td style="width: 10%;"></td> <td style="width: 10%;"></td> <td style="width: 10%;"></td> <td style="width: 10%;"></td> <td style="width: 10%;"></td> </tr> <tr> <td></td> <td></td> <td colspan="8" style="text-align: center;"> <table border="1" style="width: 100%; border-collapse: collapse; text-align: center;"> <tr> <td style="width: 10%;"></td> <td style="width: 10%;"></td> <td style="width: 10%;"></td> <td style="width: 10%;"></td> <td style="width: 10%;"></td> <td style="width: 10%;"></td> <td style="width: 10%;"></td> <td style="width: 10%;"></td> <td style="width: 10%;"></td> <td style="width: 10%;"></td> </tr> <tr> <td></td> <td></td> <td colspan="8" style="text-align: center;"> <table border="1" style="width: 100%; border-collapse: collapse; text-align: center;"> <tr> <td style="width: 10%;"></td> <td style="width: 10%;"></td> <td style="width: 10%;"></td> <td style="width: 10%;"></td> <td style="width: 10%;"></td> <td style="width: 10%;"></td> <td style="width: 10%;"></td> <td style="width: 10%;"></td> <td style="width: 10%;"></td> <td style="width: 10%;"></td> </tr> <tr> <td></td> <td></td> <td colspan="8" style="text-align: center;"> <table border="1" style="width: 100%; border-collapse: collapse; text-align: center;"> <tr> <td style="width: 10%;"></td> <td style="width: 10%;"></td> <td style="width: 10%;"></td> <td style="width: 10%;"></td> <td style="width: 10%;"></td> <td style="width: 10%;"></td> <td style="width: 10%;"></td> <td style="width: 10%;"></td> <td style="width: 10%;"></td> <td style="width: 10%;"></td> </tr> <tr> <td></td> <td></td> <td colspan="8" style="text-align: center;"> <table border="1" style="width: 100%; border-collapse: collapse; text-align: center;"> <tr> <td style="width: 10%;"></td> <td style="width: 10%;"></td> <td style="width: 10%;"></td> <td style="width: 10%;"></td> <td style="width: 10%;"></td> <td style="width: 10%;"></td> <td style="width: 10%;"></td> <td style="width: 10%;"></td> <td style="width: 10%;"></td> <td style="width: 10%;"></td> </tr> <tr> <td></td> <td></td> <td colspan="8" style="text-align: center;"> <table border="1" style="width: 100%; border-collapse: collapse; text-align: center;"> <tr> <td style="width: 10%;"></td> <td style="width: 10%;"></td> <td style="width: 10%;"></td> <td style="width: 10%;"></td> <td style="width: 10%;"></td> <td style="width: 10%;"></td> <td style="width: 10%;"></td> <td style="width: 10%;"></td> <td style="width: 10%;"></td> <td style="width: 10%;"></td> </tr> <tr> <td></td> <td></td> <td colspan="8" style="text-align: center;"> <table border="1" style="width: 100%; border-collapse: collapse; text-align: center;"> <tr> <td style="width: 10%;"></td> <td style="width: 10%;"></td> <td style="width: 10%;"></td> <td style="width: 10%;"></td> <td style="width: 10%;"></td> <td style="width: 10%;"></td> <td style="width: 10%;"></td> <td style="width: 10%;"></td> <td style="width: 10%;"></td> <td style="width: 10%;"></td> </tr> <tr> <td></td> <td></td> <td colspan="8" style="text-align: center;"> <table border="1" style="width: 100%; border-collapse: collapse; text-align: center;"> <tr> <td style="width: 10%;"></td> <td style="width: 10%;"></td> <td style="width: 10%;"></td> <td style="width: 10%;"></td> <td style="width: 10%;"></td> <td style="width: 10%;"></td> <td style="width: 10%;"></td> <td style="width: 10%;"></td> <td style="width: 10%;"></td> <td style="width: 10%;"></td> </tr> <tr> <td></td> <td></td> <td colspan="8" style="text-align: center;"> <table border="1" style="width: 100%; border-collapse: collapse; text-align: center;"> <tr> <td style="width: 10%;"></td> <td style="width: 10%;"></td> <td style="width: 10%;"></td> <td style="width: 10%;"></td> <td style="width: 10%;"></td> <td style="width: 10%;"></td> <td style="width: 10%;"></td> <td style="width: 10%;"></td> <td style="width: 10%;"></td> <td style="width: 10%;"></td> </tr> <tr> <td></td> <td></td> <td colspan="8" style="text-align: center;"> <table border="1" style="width: 100%; border-collapse: collapse; text-align: center;"> <tr> <td style="width: 10%;"></td> <td style="width: 10%;"></td> <td style="width: 10%;"></td> <td style="width: 10%;"></td> <td style="width: 10%;"></td> <td style="width: 10%;"></td> <td style="width: 10%;"></td> <td style="width: 10%;"></td> <td style="width: 10%;"></td> <td
style="width: 10%;"></td> </tr> <tr> <td></td> <td></td> <td colspan="8" style="text-align: center;"> <table border="1" style="width: 100%; border-collapse: collapse; text-align: center;"> <tr> <td style="width: 10%;"></td> <td style="width: 10%;"></td> <td style="width: 10%;"></td> <td style="width: 10%;"></td> <td style="width: 10%;"></td> <td style="width: 10%;"></td> <td style="width: 10%;"></td> <td style="width: 10%;"></td> <td style="width: 10%;"></td> <td style="width: 10%;"></td> </tr> <tr> <td></td> <td></td> <td colspan="8" style="text-align: center;"> <table border="1" style="width: 100%; border-collapse: collapse; text-align: center;"> <tr> <td style="width: 10%;"></td> <td style="width: 10%;"></td> <td style="width: 10%;"></td> <td style="width: 10%;"></td> <td style="width: 10%;"></td> <td style="width: 10%;"></td> <td style="width: 10%;"></td> <td style="width: 10%;"></td> <td style="width: 10%;"></td> <td style="width: 10%;"></td> </tr> <tr> <td></td> <td></td> <td colspan="8" style="text-align: center;"> <table border="1" style="width: 100%; border-collapse: collapse; text-align: center;"> <tr> <td style="width: 10%;"></td> <td style="width: 10%;"></td> <td style="width: 10%;"></td> <td style="width: 10%;"></td> <td style="width: 10%;"></td> <td style="width: 10%;"></td> <td style="width: 10%;"></td> <td style="width: 10%;"></td> <td style="width: 10%;"></td> <td style="width: 10%;"></td> </tr> <tr> <td></td> <td></td> <td colspan="8" style="text-align: center;"> <table border="1" style="width: 100%; border-collapse: collapse; text-align: center;"> <tr> <td style="width: 10%;"></td> <td style="width: 10%;"></td> <td style="width: 10%;"></td> <td style="width: 10%;"></td> <td style="width: 10%;"></td> <td style="width: 10%;"></td> <td style="width: 10%;"></td> <td style="width: 10%;"></td> <td style="width: 10%;"></td> <td style="width: 10%;"></td> </tr> <tr> <td></td> <td></td> <td colspan="8" style="text-align: center;"> <table border="1" style="width: 100%; border-collapse: collapse; text-align: center;"> <tr> <td style="width: 10%;"></td> <td style="width: 10%;"></td> <td style="width: 10%;"></td> <td style="width: 10%;"></td> <td style="width: 10%;"></td> <td style="width: 10%;"></td> <td style="width: 10%;"></td> <td style="width: 10%;"></td> <td style="width: 10%;"></td> <td style="width: 10%;"></td> </tr> <tr> <td></td> <td></td> <td colspan="8" style="text-align: center;"> <table border="1" style="width: 100%; border-collapse: collapse; text-align: center;"> <tr> <td style="width: 10%;"></td> <td style="width: 10%;"></td> <td style="width: 10%;"></td> <td style="width: 10%;"></td> <td style="width: 10%;"></td> <td style="width: 10%;"></td> <td style="width: 10%;"></td> <td style="width: 10%;"></td> <td style="width: 10%;"></td> <td style="width: 10%;"></td> </tr> <tr> <td></td> <td></td> <td colspan="8" style="text-align: center;"> <table border="1" style="width: 100%; border-collapse: collapse; text-align: center;"> <tr> <td style="width: 10%;"></td> <td style="width: 10%;"></td> <td style="width: 10%;"></td> <td style="width: 10%;"></td> <td style="width: 10%;"></td> <td style="width: 10%;"></td> <td style="width: 10%;"></td> <td style="width: 10%;"></td> <td style="width: 10%;"></td> <td style="width: 10%;"></td> </tr> <tr> <td></td> <td></td> <td colspan="8" style="text-align: center;"> <table border="1" style="width: 100%; border-collapse: collapse; text-align: center;"> <tr> <td style="width: 10%;"></td> <td style="width: 10%;"></td> <td style="width: 10%;"></td> <td style="width: 10%;"></td> <td style="width: 10%;"></td> <td style="width: 10%;"></td> <td style="width: 10%;"></td> <td style="width: 10%;"></td> <td style="width: 10%;"></td> <td style="width: 10%;"></td> </tr> <tr> <td></td> <td></td> <td colspan="8" style="text-align: center;"> <table border="1" style="width: 100%; border-collapse: collapse; text-align: center;"> <tr> <td style="width: 10%;"></td> <td style="width: 10%;"></td> <td style="width: 10%;"></td> <td style="width: 10%;"></td> <td style="width: 10%;"></td> <td style="width: 10%;"></td> <td style="width: 10%;"></td> <td style="width: 10%;"></td> <td style="width: 10%;"></td> <td style="width: 10%;"></td> </tr> <tr> <td></td> <td></td> <td colspan="8" style="text-align: center;"> <table border="1" style="width: 100%; border-collapse: collapse; text-align: center;"> <tr> <td style="width: 10%;"></td> <td style="width: 10%;"></td> <td style="width: 10%;"></td> <td style="width: 10%;"></td> <td style="width: 10%;"></td> <td style="width: 10%;"></td> <td style="width: 10%;"></td> <td style="width: 10%;"></td> <td style="width: 10%;"></td> <td style="width: 10%;"></td> </tr> <tr> <td></td> <td></td> <td colspan="8" style="text-align: center;"> <table border="1" style="width: 100%; border-collapse: collapse; text-align: center;"> <tr> <td style="width: 10%;"></td> <td style="width: 10%;"></td> <td style="width: 10%;"></td> <td style="width: 10%;"></td> <td style="width: 10%;"></td> <td style="width: 10%;"></td> <td style="width: 10%;"></td> <td style="width: 10%;"></td> <td style="width: 10%;"></td> <td style="width: 10%;"></td> </tr> <tr> <td></td> <td></td> <td colspan="8" style="text-align: center;"> <table border="1" style="width: 100%; border-collapse: collapse; text-align: center;"> <tr> <td style="width: 10%;"></td> <td style="width: 10%;"></td> <td style="width: 10%;"></td> <td style="width: 10%;"></td> <td style="width: 10%;"></td> <td style="width: 10%;"></td> <td style="width: 10%;"></td> <td style="width: 10%;"></td> <td style="width: 10%;"></td> <td style="width: 10%;"></td> </tr> <tr> <td></td> <td></td> <td colspan="8" style="text-align: center;"> <table border="1" style="width: 100%; border-collapse: collapse; text-align: center;"> <tr> <td style="width: 10%;"></td> <td style="width: 10%;"></td> <td style="width: 10%;"></td> <td style="width: 10%;"></td> <td style="width: 10%;"></td> <td style="width: 10%;"></td> <td style="width: 10%;"></td> <td style="width: 10%;"></td> <td style="width: 10%;"></td> <td style="width: 10%;"></td> </tr> <tr> <td></td> <td></td> <td colspan="8" style="text-align: center;"> <table border="1" style="width: 100%; border-collapse: collapse; text-align: center;"> <tr> <td style="width: 10%;"></td> <td style="width: 10%;"></td> <td style="width: 10%;"></td> <td style="width: 10%;"></td> <td style="width: 10%;"></td> <td style="width: 10%;"></td> <td style="width: 10%;"></td> <td style="width: 10%;"></td> <td style="width: 10%;"></td> <td style="width: 10%;"></td> </tr> <tr> <td></td> <td></td> <td colspan="8" style="text-align: center;"> <table border="1" style="width: 100%; border-collapse: collapse; text-align: center;"> <tr> <td style="width: 10%;"></td> <td style="width: 10%;"></td> <td style="width: 10%;"></td> <td style="width: 10%;"></td> <td style="width: 10%;"></td> <td style="width: 10%;"></td> <td style="width: 10%;"></td> <td style="width: 10%;"></td> <td style="width: 10%;"></td> <td style="width: 10%;"></td> </tr> <tr> <td></td> <td></td> <td colspan="8" style="text-align: center;"> <table border="1" style="width: 100%; border-collapse: collapse; text-align: center;"> <tr> <td style="width: 10%;"></td> <td style="width: 10%;"></td> <td style="width: 10%;"></td> <td style="width: 10%;"></td> <td style="width: 10%;"></td> <td style="width: 10%;"></td> <td style="width: 10%;"></td> <td style="width: 10%;"></td> <td style="width: 10%;"></td> <td style="width: 10%;"></td> </tr> <tr> <td></td> <td></td> <td colspan="8" style="text-align: center;"> <table border="1" style="width: 100%; border-collapse: collapse; text-align: center;"> <tr> <td style="width: 10%;"></td> <td style="width: 10%;"></td> <td style="width: 10%;"></td> <td style="width: 10%;"></td> <td style="width: 10%;"></td> <td style="width: 10%;"></td> <td style="width: 10%;"></td> <td style="width: 10%;"></td> <td style="width: 10%;"></td> <td style="width: 10%;"></td> </tr> <tr> <td></td> <td></td> <td colspan="8" style="text-align: center;"> <table border="1" style="width: 100%; border-collapse: collapse; text-align: center;"> <tr> <td style="width: 10%;"></td> <td style="width: 10%;"></td> <td style="width: 10%;"></td> <td style="width: 10%;"></td> <td style="width: 10%;"></td> <td style="width: 10%;"></td> <td style="width: 10%;"></td> <td style="width: 10%;"></td> <td style="width: 10%;"></td> <td style="width: 10%;"></td> </tr> <tr> <td></td> <td></td> <td colspan="8" style="text-align: center;"> <table border="1" style="width: 100%; border-collapse: collapse; text-align: center;"> <tr> <td style="width: 10%;"></td> <td style="width: 10%;"></td> <td style="width: 10%;"></td> <td style="width: 10%;"></td> <td style="width: 10%;"></td> <td style="width: 10%;"></td> <td style="width: 10%;"></td> <td style="width: 10%;"></td> <td style="width: 10%;"></td> <td style="width: 10%;"></td> </tr> <tr> <td></td> <td></td> <td colspan="8" style="text-align: center;"> <table border="1" style="width: 100%; border-collapse: collapse; text-align: center;"> <tr> <td style="width: 10%;"></td> <td style="width: 10%;"></td> <td style="width: 10%;"></td> <td style="width: 10%;"></td> <td style="width: 10%;"></td> <td style="width: 10%;"></td> <td style="width: 10%;"></td> <td style="width: 10%;"></td> <td style="width: 10%;"></td> <td style="width: 10%;"></td> </tr> <tr> <td></td> <td></td> <td colspan="8" style="text-align: center;"> <table border="1" style="width: 100%; border-collapse: collapse; text-align: center;"> <tr> <td style="width: 10%;"></td> <td style="width: 10%;"></td> <td style="width: 10%;"></td> <td style="width: 10%;"></td> <td style="width: 10%;"></td> <td style="width: 10%;"></td> <td style="width: 10%;"></td> <td style="width: 10%;"></td> <td style="width: 10%;"></td> <td style="width: 10%;"></td> </tr> <tr> <td></td> <td></td> <td colspan="8" style="text-align: center;"> <table border="1" style="width: 100%; border-collapse: collapse;
text-align: center;"> <tr> <td style="width: 10%;"></td> <td style="width: 10%;"></td> <td style="width: 10%;"></td> <td style="width: 10%;"></td> <td style="width: 10%;"></td> <td style="width: 10%;"></td> <td style="width: 10%;"></td> <td style="width: 10%;"></td> <td style="width: 10%;"></td> <td style="width: 10%;"></td> </tr> <tr> <td></td> <td></td> <td colspan="8" style="text-align: center;"> <table border="1" style="width: 100%; border-collapse: collapse; text-align: center;"> <tr> <td style="width: 10%;"></td> <td style="width: 10%;"></td> <td style="width: 10%;"></td> <td style="width: 10%;"></td> <td style="width: 10%;"></td> <td style="width: 10%;"></td> <td style="width: 10%;"></td> <td style="width: 10%;"></td> <td style="width: 10%;"></td> <td style="width: 10%;"></td> </tr> <tr> <td></td> <td></td> <td colspan="8" style="text-align: center;"> <table border="1" style="width: 100%; border-collapse: collapse; text-align: center;"> <tr> <td style="width: 10%;"></td> <td style="width: 10%;"></td> <td style="width: 10%;"></td> <td style="width: 10%;"></td> <td style="width: 10%;"></td> <td style="width: 10%;"></td> <td style="width: 10%;"></td> <td style="width: 10%;"></td> <td style="width: 10%;"></td> <td style="width: 10%;"></td> </tr> <tr> <td></td> <td></td> <td colspan="8" style="text-align: center;"> <table border="1" style="width: 100%; border-collapse: collapse; text-align: center;"> <tr> </tr></table></td></tr></table></td></tr></table></td></tr></table></td></tr></table></td></tr></table></td></tr></table></td></tr></table></td></tr></table></td></tr></table></td></tr></table></td></tr></table></td></tr></table></td></tr></table></td></tr></table></td></tr></table></td></tr></table></td></tr></table></td></tr></table></td></tr></table></td></tr></table></td></tr></table></td></tr></table></td></tr></table></td></tr></table></td></tr></table></td></tr></table></td></tr></table></td></tr></table></td></tr></table></td></tr></table></td></tr></table></td></tr></table></td></tr></table></td></tr></table></td></tr></table></td></tr></table></td></tr></table> | | | | | | | | | | | | | | | | | | | | <table border="1" style="width: 100%; border-collapse: collapse; text-align: center;"> <tr> <td style="width: 10%;"></td> <td style="width: 10%;"></td> <td style="width: 10%;"></td> <td style="width: 10%;"></td> <td style="width: 10%;"></td> <td style="width: 10%;"></td> <td style="width: 10%;"></td> <td style="width: 10%;"></td> <td style="width: 10%;"></td> <td style="width: 10%;"></td> </tr> <tr> <td></td> <td></td> <td colspan="8" style="text-align: center;"> <table border="1" style="width: 100%; border-collapse: collapse;
text-align: center;"> <tr> <td style="width: 10%;"></td> <td style="width: 10%;"></td> <td style="width: 10%;"></td> <td style="width: 10%;"></td> <td style="width: 10%;"></td> <td style="width: 10%;"></td> <td style="width: 10%;"></td> <td style="width: 10%;"></td> <td style="width: 10%;"></td> <td style="width: 10%;"></td> </tr> <tr> <td></td> <td></td> <td colspan="8" style="text-align: center;"> <table border="1" style="width: 100%; border-collapse: collapse; text-align: center;"> <tr> <td style="width: 10%;"></td> <td style="width: 10%;"></td> <td style="width: 10%;"></td> <td style="width: 10%;"></td> <td style="width: 10%;"></td> <td style="width: 10%;"></td> <td style="width: 10%;"></td> <td style="width: 10%;"></td> <td style="width: 10%;"></td> <td style="width: 10%;"></td> </tr> <tr> <td></td> <td></td> <td colspan="8" style="text-align: center;"> <table border="1" style="width: 100%; border-collapse: collapse; text-align: center;"> <tr> <td style="width: 10%;"></td> <td style="width: 10%;"></td> <td style="width: 10%;"></td> <td style="width: 10%;"></td> <td style="width: 10%;"></td> <td style="width: 10%;"></td> <td style="width: 10%;"></td> <td style="width: 10%;"></td> <td style="width: 10%;"></td> <td style="width: 10%;"></td> </tr> <tr> <td></td> <td></td> <td colspan="8" style="text-align: center;"> <table border="1" style="width: 100%; border-collapse: collapse; text-align: center;"> <tr> <td style="width: 10%;"></td> <td style="width: 10%;"></td> <td style="width: 10%;"></td> <td style="width: 10%;"></td> <td style="width: 10%;"></td> <td style="width: 10%;"></td> <td style="width: 10%;"></td> <td style="width: 10%;"></td> <td style="width: 10%;"></td> <td style="width: 10%;"></td> </tr> <tr> <td></td> <td></td> <td colspan="8" style="text-align: center;"> <table border="1" style="width: 100%; border-collapse: collapse; text-align: center;"> <tr> <td style="width: 10%;"></td> <td style="width: 10%;"></td> <td style="width: 10%;"></td> <td style="width: 10%;"></td> <td style="width: 10%;"></td> <td style="width: 10%;"></td> <td style="width: 10%;"></td> <td style="width: 10%;"></td> <td style="width: 10%;"></td> <td style="width: 10%;"></td> </tr> <tr> <td></td> <td></td> <td colspan="8" style="text-align: center;"> <table border="1" style="width: 100%; border-collapse: collapse; text-align: center;"> <tr> <td style="width: 10%;"></td> <td style="width: 10%;"></td> <td style="width: 10%;"></td> <td style="width: 10%;"></td> <td style="width: 10%;"></td> <td style="width: 10%;"></td> <td style="width: 10%;"></td> <td style="width: 10%;"></td> <td style="width: 10%;"></td> <td style="width: 10%;"></td> </tr> <tr> <td></td> <td></td> <td colspan="8" style="text-align: center;"> <table border="1" style="width: 100%; border-collapse: collapse; text-align: center;"> <tr> <td style="width: 10%;"></td> <td style="width: 10%;"></td> <td style="width: 10%;"></td> <td style="width: 10%;"></td> <td style="width: 10%;"></td> <td style="width: 10%;"></td> <td style="width: 10%;"></td> <td style="width: 10%;"></td> <td style="width: 10%;"></td> <td style="width: 10%;"></td> </tr> <tr> <td></td> <td></td> <td colspan="8" style="text-align: center;"> <table border="1" style="width: 100%; border-collapse: collapse; text-align: center;"> <tr> <td style="width: 10%;"></td> <td style="width: 10%;"></td> <td style="width: 10%;"></td> <td style="width: 10%;"></td> <td style="width: 10%;"></td> <td style="width: 10%;"></td> <td style="width: 10%;"></td> <td style="width: 10%;"></td> <td style="width: 10%;"></td> <td style="width: 10%;"></td> </tr> <tr> <td></td> <td></td> <td colspan="8" style="text-align: center;"> <table border="1" style="width: 100%; border-collapse: collapse; text-align: center;"> <tr> <td style="width: 10%;"></td> <td style="width: 10%;"></td> <td style="width: 10%;"></td> <td style="width: 10%;"></td> <td style="width: 10%;"></td> <td style="width: 10%;"></td> <td style="width: 10%;"></td> <td style="width: 10%;"></td> <td style="width: 10%;"></td> <td style="width: 10%;"></td> </tr> <tr> <td></td> <td></td> <td colspan="8" style="text-align: center;"> <table border="1" style="width: 100%; border-collapse: collapse; text-align: center;"> <tr> <td style="width: 10%;"></td> <td style="width: 10%;"></td> <td style="width: 10%;"></td> <td style="width: 10%;"></td> <td style="width: 10%;"></td> <td style="width: 10%;"></td> <td style="width: 10%;"></td> <td style="width: 10%;"></td> <td style="width: 10%;"></td> <td style="width: 10%;"></td> </tr> <tr> <td></td> <td></td> <td colspan="8" style="text-align: center;"> <table border="1" style="width: 100%; border-collapse: collapse; text-align: center;"> <tr> <td style="width: 10%;"></td> <td style="width: 10%;"></td> <td style="width: 10%;"></td> <td style="width: 10%;"></td> <td style="width: 10%;"></td> <td style="width: 10%;"></td> <td style="width: 10%;"></td> <td style="width: 10%;"></td> <td style="width: 10%;"></td> <td style="width: 10%;"></td> </tr> <tr> <td></td> <td></td> <td colspan="8" style="text-align: center;"> <table border="1" style="width: 100%; border-collapse: collapse; text-align: center;"> <tr> <td style="width: 10%;"></td> <td style="width: 10%;"></td> <td style="width: 10%;"></td> <td style="width: 10%;"></td> <td style="width: 10%;"></td> <td style="width: 10%;"></td> <td style="width: 10%;"></td> <td style="width: 10%;"></td> <td style="width: 10%;"></td> <td style="width: 10%;"></td> </tr> <tr> <td></td> <td></td> <td colspan="8" style="text-align: center;"> <table border="1" style="width: 100%; border-collapse: collapse; text-align: center;"> <tr> <td style="width: 10%;"></td> <td style="width: 10%;"></td> <td style="width: 10%;"></td> <td style="width: 10%;"></td> <td style="width: 10%;"></td> <td style="width: 10%;"></td> <td style="width: 10%;"></td> <td style="width: 10%;"></td> <td style="width: 10%;"></td> <td style="width: 10%;"></td> </tr> <tr> <td></td> <td></td> <td colspan="8" style="text-align: center;"> <table border="1" style="width: 100%; border-collapse: collapse; text-align: center;"> <tr> <td style="width: 10%;"></td> <td style="width: 10%;"></td> <td style="width: 10%;"></td> <td style="width: 10%;"></td> <td style="width: 10%;"></td> <td style="width: 10%;"></td> <td style="width: 10%;"></td> <td style="width: 10%;"></td> <td style="width: 10%;"></td> <td style="width: 10%;"></td> </tr> <tr> <td></td> <td></td> <td colspan="8" style="text-align: center;"> <table border="1" style="width: 100%; border-collapse: collapse; text-align: center;"> <tr> <td style="width: 10%;"></td> <td style="width: 10%;"></td> <td style="width: 10%;"></td> <td style="width: 10%;"></td> <td style="width: 10%;"></td> <td style="width: 10%;"></td> <td style="width: 10%;"></td> <td style="width: 10%;"></td> <td style="width: 10%;"></td> <td style="width: 10%;"></td> </tr> <tr> <td></td> <td></td> <td colspan="8" style="text-align: center;"> <table border="1" style="width: 100%; border-collapse: collapse; text-align: center;"> <tr> <td style="width: 10%;"></td> <td style="width: 10%;"></td> <td style="width: 10%;"></td> <td style="width: 10%;"></td> <td style="width: 10%;"></td> <td style="width: 10%;"></td> <td style="width: 10%;"></td> <td style="width: 10%;"></td> <td style="width: 10%;"></td> <td style="width: 10%;"></td> </tr> <tr> <td></td> <td></td> <td colspan="8" style="text-align: center;"> <table border="1" style="width: 100%; border-collapse: collapse; text-align: center;"> <tr> <td style="width: 10%;"></td> <td style="width: 10%;"></td> <td style="width: 10%;"></td> <td style="width: 10%;"></td> <td style="width: 10%;"></td> <td style="width: 10%;"></td> <td style="width: 10%;"></td> <td style="width: 10%;"></td> <td style="width: 10%;"></td> <td style="width: 10%;"></td> </tr> <tr> <td></td> <td></td> <td colspan="8" style="text-align: center;"> <table border="1" style="width: 100%; border-collapse: collapse; text-align: center;"> <tr> <td style="width: 10%;"></td> <td style="width: 10%;"></td> <td style="width: 10%;"></td> <td style="width: 10%;"></td> <td style="width: 10%;"></td> <td style="width: 10%;"></td> <td style="width: 10%;"></td> <td style="width: 10%;"></td> <td style="width: 10%;"></td> <td style="width: 10%;"></td> </tr> <tr> <td></td> <td></td> <td colspan="8" style="text-align: center;"> <table border="1" style="width: 100%; border-collapse: collapse; text-align: center;"> <tr> <td style="width: 10%;"></td> <td style="width: 10%;"></td> <td style="width: 10%;"></td> <td style="width: 10%;"></td> <td style="width: 10%;"></td> <td style="width: 10%;"></td> <td style="width: 10%;"></td> <td style="width: 10%;"></td> <td style="width: 10%;"></td> <td style="width: 10%;"></td> </tr> <tr> <td></td> <td></td> <td colspan="8" style="text-align: center;"> <table border="1" style="width: 100%; border-collapse: collapse; text-align: center;"> <tr> <td style="width: 10%;"></td> <td style="width: 10%;"></td> <td style="width: 10%;"></td> <td style="width: 10%;"></td> <td style="width: 10%;"></td> <td style="width: 10%;"></td> <td style="width: 10%;"></td> <td style="width: 10%;"></td> <td style="width: 10%;"></td> <td style="width: 10%;"></td> </tr> <tr> <td></td> <td></td> <td colspan="8" style="text-align: center;"> <table border="1" style="width: 100%; border-collapse: collapse; text-align: center;"> <tr> <td style="width: 10%;"></td> <td style="width: 10%;"></td> <td style="width: 10%;"></td> <td style="width: 10%;"></td> <td style="width: 10%;"></td> <td style="width: 10%;"></td> <td style="width: 10%;"></td> <td style="width: 10%;"></td> <td style="width: 10%;"></td> <td style="width: 10%;"></td> </tr> <tr> <td></td> <td></td> <td colspan="8" style="text-align: center;"> <table border="1" style="width: 100%; border-collapse: collapse; text-align: center;"> <tr> <td style="width: 10%;"></td> <td style="width: 10%;"></td> <td style="width: 10%;"></td> <td style="width: 10%;"></td> <td style="width:
10%;"></td> <td style="width: 10%;"></td> <td style="width: 10%;"></td> <td style="width: 10%;"></td> <td style="width: 10%;"></td> <td style="width: 10%;"></td> </tr> <tr> <td></td> <td></td> <td colspan="8" style="text-align: center;"> <table border="1" style="width: 100%; border-collapse: collapse; text-align: center;"> <tr> <td style="width: 10%;"></td> <td style="width: 10%;"></td> <td style="width: 10%;"></td> <td style="width: 10%;"></td> <td style="width: 10%;"></td> <td style="width: 10%;"></td> <td style="width: 10%;"></td> <td style="width: 10%;"></td> <td style="width: 10%;"></td> <td style="width: 10%;"></td> </tr> <tr> <td></td> <td></td> <td colspan="8" style="text-align: center;"> <table border="1" style="width: 100%; border-collapse: collapse; text-align: center;"> <tr> <td style="width: 10%;"></td> <td style="width: 10%;"></td> <td style="width: 10%;"></td> <td style="width: 10%;"></td> <td style="width: 10%;"></td> <td style="width: 10%;"></td> <td style="width: 10%;"></td> <td style="width: 10%;"></td> <td style="width: 10%;"></td> <td style="width: 10%;"></td> </tr> <tr> <td></td> <td></td> <td colspan="8" style="text-align: center;"> <table border="1" style="width: 100%; border-collapse: collapse; text-align: center;"> <tr> <td style="width: 10%;"></td> <td style="width: 10%;"></td> <td style="width: 10%;"></td> <td style="width: 10%;"></td> <td style="width: 10%;"></td> <td style="width: 10%;"></td> <td style="width: 10%;"></td> <td style="width: 10%;"></td> <td style="width: 10%;"></td> <td style="width: 10%;"></td> </tr> <tr> <td></td> <td></td> <td colspan="8" style="text-align: center;"> <table border="1" style="width: 100%; border-collapse: collapse; text-align: center;"> <tr> <td style="width: 10%;"></td> <td style="width: 10%;"></td> <td style="width: 10%;"></td> <td style="width: 10%;"></td> <td style="width: 10%;"></td> <td style="width: 10%;"></td> <td style="width: 10%;"></td> <td style="width: 10%;"></td> <td style="width: 10%;"></td> <td style="width: 10%;"></td> </tr> <tr> <td></td> <td></td> <td colspan="8" style="text-align: center;"> <table border="1" style="width: 100%; border-collapse: collapse; text-align: center;"> <tr> <td style="width: 10%;"></td> <td style="width: 10%;"></td> <td style="width: 10%;"></td> <td style="width: 10%;"></td> <td style="width: 10%;"></td> <td style="width: 10%;"></td> <td style="width: 10%;"></td> <td style="width: 10%;"></td> <td style="width: 10%;"></td> <td style="width: 10%;"></td> </tr> <tr> <td></td> <td></td> <td colspan="8" style="text-align: center;"> <table border="1" style="width: 100%; border-collapse: collapse; text-align: center;"> <tr> <td style="width: 10%;"></td> <td style="width: 10%;"></td> <td style="width: 10%;"></td> <td style="width: 10%;"></td> <td style="width: 10%;"></td> <td style="width: 10%;"></td> <td style="width: 10%;"></td> <td style="width: 10%;"></td> <td style="width: 10%;"></td> <td style="width: 10%;"></td> </tr> <tr> <td></td> <td></td> <td colspan="8" style="text-align: center;"> <table border="1" style="width: 100%; border-collapse: collapse; text-align: center;"> <tr> <td style="width: 10%;"></td> <td style="width: 10%;"></td> <td style="width: 10%;"></td> <td style="width: 10%;"></td> <td style="width: 10%;"></td> <td style="width: 10%;"></td> <td style="width: 10%;"></td> <td style="width: 10%;"></td> <td style="width: 10%;"></td> <td style="width: 10%;"></td> </tr> <tr> <td></td> <td></td> <td colspan="8" style="text-align: center;"> <table border="1" style="width: 100%; border-collapse: collapse; text-align: center;"> <tr> <td style="width: 10%;"></td> <td style="width: 10%;"></td> <td style="width: 10%;"></td> <td style="width: 10%;"></td> <td style="width: 10%;"></td> <td style="width: 10%;"></td> <td style="width: 10%;"></td> <td style="width: 10%;"></td> <td style="width: 10%;"></td> <td style="width: 10%;"></td> </tr> <tr> <td></td> <td></td> <td colspan="8" style="text-align: center;"> <table border="1" style="width: 100%; border-collapse: collapse; text-align: center;"> <tr> <td style="width: 10%;"></td> <td style="width: 10%;"></td> <td style="width: 10%;"></td> <td style="width: 10%;"></td> <td style="width: 10%;"></td> <td style="width: 10%;"></td> <td style="width: 10%;"></td> <td style="width: 10%;"></td> <td style="width: 10%;"></td> <td style="width: 10%;"></td> </tr> <tr> <td></td> <td></td> <td colspan="8" style="text-align: center;"> <table border="1" style="width: 100%; border-collapse: collapse; text-align: center;"> <tr> <td style="width: 10%;"></td> <td style="width: 10%;"></td> <td style="width: 10%;"></td> <td style="width: 10%;"></td> <td style="width: 10%;"></td> <td style="width: 10%;"></td> <td style="width: 10%;"></td> <td style="width: 10%;"></td> <td style="width: 10%;"></td> <td style="width: 10%;"></td> </tr> <tr> <td></td> <td></td> <td colspan="8" style="text-align: center;"> <table border="1" style="width: 100%; border-collapse: collapse; text-align: center;"> <tr> <td style="width: 10%;"></td> <td style="width: 10%;"></td> <td style="width: 10%;"></td> <td style="width: 10%;"></td> <td style="width: 10%;"></td> <td style="width: 10%;"></td> <td style="width: 10%;"></td> <td style="width: 10%;"></td> <td style="width: 10%;"></td> <td style="width: 10%;"></td> </tr> <tr> <td></td> <td></td> <td colspan="8" style="text-align: center;"> <table border="1" style="width: 100%; border-collapse: collapse; text-align: center;"> <tr> <td style="width: 10%;"></td> <td style="width: 10%;"></td> <td style="width: 10%;"></td> <td style="width: 10%;"></td> <td style="width: 10%;"></td> <td style="width: 10%;"></td> <td style="width: 10%;"></td> <td style="width: 10%;"></td> <td style="width: 10%;"></td> <td style="width: 10%;"></td> </tr> <tr> <td></td> <td></td> <td colspan="8" style="text-align: center;"> <table border="1" style="width: 100%; border-collapse: collapse; text-align: center;"> <tr> <td style="width: 10%;"></td> <td style="width: 10%;"></td> <td style="width: 10%;"></td> <td style="width: 10%;"></td> <td style="width: 10%;"></td> <td style="width: 10%;"></td> <td style="width: 10%;"></td> <td style="width: 10%;"></td> <td style="width: 10%;"></td> <td style="width: 10%;"></td> </tr> <tr> <td></td> <td></td> <td colspan="8" style="text-align: center;"> <table border="1" style="width: 100%; border-collapse: collapse; text-align: center;"> <tr> </tr></table></td></tr></table></td></tr></table></td></tr></table></td></tr></table></td></tr></table></td></tr></table></td></tr></table></td></tr></table></td></tr></table></td></tr></table></td></tr></table></td></tr></table></td></tr></table></td></tr></table></td></tr></table></td></tr></table></td></tr></table></td></tr></table></td></tr></table></td></tr></table></td></tr></table></td></tr></table></td></tr></table></td></tr></table></td></tr></table></td></tr></table></td></tr></table></td></tr></table></td></tr></table></td></tr></table></td></tr></table></td></tr></table></td></tr></table></td></tr></table></td></tr></table></td></tr></table>
 | | | | | | | | | | | | | | | | | | | | <table border="1" style="width: 100%; border-collapse: collapse; text-align: center;"> <tr> <td style="width: 10%;"></td> <td style="width: 10%;"></td> <td style="width: 10%;"></td> <td style="width: 10%;"></td> <td style="width: 10%;"></td> <td style="width: 10%;"></td> <td style="width: 10%;"></td> <td style="width: 10%;"></td> <td style="width: 10%;"></td> <td style="width: 10%;"></td> </tr> <tr> <td></td> <td></td> <td colspan="8" style="text-align: center;"> <table border="1" style="width: 100%; border-collapse: collapse; text-align: center;"> <tr> <td style="width: 10%;"></td> <td style="width: 10%;"></td> <td style="width: 10%;"></td> <td style="width: 10%;"></td> <td style="width: 10%;"></td> <td style="width: 10%;"></td> <td style="width: 10%;"></td> <td style="width: 10%;"></td> <td style="width: 10%;"></td> <td style="width: 10%;"></td> </tr> <tr> <td></td> <td></td> <td colspan="8" style="text-align: center;"> <table border="1" style="width: 100%; border-collapse: collapse; text-align: center;"> <tr> <td style="width: 10%;"></td> <td style="width: 10%;"></td> <td style="width: 10%;"></td> <td style="width: 10%;"></td> <td style="width: 10%;"></td> <td style="width: 10%;"></td> <td style="width: 10%;"></td> <td style="width: 10%;"></td> <td style="width: 10%;"></td> <td style="width: 10%;"></td> </tr> <tr> <td></td> <td></td> <td colspan="8" style="text-align: center;"> <table border="1" style="width: 100%; border-collapse: collapse; text-align: center;"> <tr> <td style="width: 10%;"></td> <td style="width: 10%;"></td> <td style="width: 10%;"></td> <td style="width: 10%;"></td> <td style="width: 10%;"></td> <td style="width: 10%;"></td> <td style="width: 10%;"></td> <td style="width: 10%;"></td> <td style="width: 10%;"></td> <td style="width: 10%;"></td> </tr> <tr> <td></td> <td></td> <td colspan="8" style="text-align: center;"> <table border="1" style="width: 100%; border-collapse: collapse; text-align: center;"> <tr> <td style="width: 10%;"></td> <td style="width: 10%;"></td> <td style="width: 10%;"></td> <td style="width: 10%;"></td> <td style="width: 10%;"></td> <td style="width: 10%;"></td> <td style="width: 10%;"></td> <td style="width: 10%;"></td> <td style="width: 10%;"></td> <td style="width: 10%;"></td> </tr> <tr> <td></td> <td></td> <td colspan="8" style="text-align: center;"> <table border="1" style="width: 100%; border-collapse: collapse; text-align: center;"> <tr> <td style="width: 10%;"></td> <td style="width: 10%;"></td> <td style="width: 10%;"></td> <td style="width: 10%;"></td> <td style="width: 10%;"></td> <td style="width: 10%;"></td> <td style="width: 10%;"></td> <td style="width: 10%;"></td> <td style="width: 10%;"></td> <td style="width: 10%;"></td> </tr> <tr> <td></td> <td></td> <td colspan="8" style="text-align: center;"> <table border="1" style="width: 100%; border-collapse: collapse; text-align: center;"> <tr> <td style="width: 10%;"></td> <td style="width: 10%;"></td> <td style="width: 10%;"></td> <td style="width: 10%;"></td> <td style="width: 10%;"></td> <td style="width: 10%;"></td> <td style="width: 10%;"></td> <td style="width: 10%;"></td> <td style="width: 10%;"></td> <td style="width: 10%;"></td> </tr> <tr> <td></td> <td></td> <td colspan="8" style="text-align: center;"> <table border="1" style="width: 100%; border-collapse: collapse; text-align: center;"> <tr> <td style="width: 10%;"></td> <td style="width: 10%;"></td> <td style="width: 10%;"></td> <td style="width: 10%;"></td> <td style="width: 10%;"></td> <td style="width: 10%;"></td> <td style="width: 10%;"></td> <td style="width: 10%;"></td> <td style="width: 10%;"></td> <td style="width: 10%;"></td> </tr> <tr> <td></td> <td></td> <td colspan="8" style="text-align: center;"> <table border="1" style="width: 100%; border-collapse: collapse; text-align: center;"> <tr> <td style="width: 10%;"></td> <td style="width: 10%;"></td> <td style="width: 10%;"></td> <td style="width: 10%;"></td> <td style="width: 10%;"></td> <td style="width: 10%;"></td> <td style="width: 10%;"></td> <td style="width: 10%;"></td> <td style="width: 10%;"></td> <td style="width: 10%;"></td> </tr> <tr> <td></td> <td></td> <td colspan="8" style="text-align: center;"> <table border="1" style="width: 100%; border-collapse: collapse; text-align: center;"> <tr> <td style="width: 10%;"></td> <td style="width: 10%;"></td> <td style="width: 10%;"></td> <td style="width: 10%;"></td> <td style="width: 10%;"></td> <td style="width: 10%;"></td> <td style="width: 10%;"></td> <td style="width: 10%;"></td> <td style="width: 10%;"></td> <td style="width: 10%;"></td> </tr> <tr> <td></td> <td></td> <td colspan="8" style="text-align: center;"> <table border="1" style="width: 100%; border-collapse: collapse; text-align: center;"> <tr> <td style="width: 10%;"></td> <td style="width: 10%;"></td> <td style="width: 10%;"></td> <td style="width: 10%;"></td> <td style="width: 10%;"></td> <td style="width: 10%;"></td> <td style="width: 10%;"></td> <td style="width: 10%;"></td> <td style="width: 10%;"></td> <td style="width: 10%;"></td> </tr> <tr> <td></td> <td></td> <td colspan="8" style="text-align: center;"> <table border="1" style="width: 100%; border-collapse: collapse; text-align: center;"> <tr> <td style="width: 10%;"></td> <td style="width: 10%;"></td> <td style="width: 10%;"></td> <td style="width: 10%;"></td> <td style="width: 10%;"></td> <td style="width: 10%;"></td> <td style="width: 10%;"></td> <td style="width: 10%;"></td> <td style="width: 10%;"></td> <td style="width: 10%;"></td> </tr> <tr> <td></td> <td></td> <td
colspan="8" style="text-align: center;"> <table border="1" style="width: 100%; border-collapse: collapse; text-align: center;"> <tr> <td style="width: 10%;"></td> <td style="width: 10%;"></td> <td style="width: 10%;"></td> <td style="width: 10%;"></td> <td style="width: 10%;"></td> <td style="width: 10%;"></td> <td style="width: 10%;"></td> <td style="width: 10%;"></td> <td style="width: 10%;"></td> <td style="width: 10%;"></td> </tr> <tr> <td></td> <td></td> <td colspan="8" style="text-align: center;"> <table border="1" style="width: 100%; border-collapse: collapse; text-align: center;"> <tr> <td style="width: 10%;"></td> <td style="width: 10%;"></td> <td style="width: 10%;"></td> <td style="width: 10%;"></td> <td style="width: 10%;"></td> <td style="width: 10%;"></td> <td style="width: 10%;"></td> <td style="width: 10%;"></td> <td style="width: 10%;"></td> <td style="width: 10%;"></td> </tr> <tr> <td></td> <td></td> <td colspan="8" style="text-align: center;"> <table border="1" style="width: 100%; border-collapse: collapse; text-align: center;"> <tr> <td style="width: 10%;"></td> <td style="width: 10%;"></td> <td style="width: 10%;"></td> <td style="width: 10%;"></td> <td style="width: 10%;"></td> <td style="width: 10%;"></td> <td style="width: 10%;"></td> <td style="width: 10%;"></td> <td style="width: 10%;"></td> <td style="width: 10%;"></td> </tr> <tr> <td></td> <td></td> <td colspan="8" style="text-align: center;"> <table border="1" style="width: 100%; border-collapse: collapse; text-align: center;"> <tr> <td style="width: 10%;"></td> <td style="width: 10%;"></td> <td style="width: 10%;"></td> <td style="width: 10%;"></td> <td style="width: 10%;"></td> <td style="width: 10%;"></td> <td style="width: 10%;"></td> <td style="width: 10%;"></td> <td style="width: 10%;"></td> <td style="width: 10%;"></td> </tr> <tr> <td></td> <td></td> <td colspan="8" style="text-align: center;"> <table border="1" style="width: 100%; border-collapse: collapse; text-align: center;"> <tr> <td style="width: 10%;"></td> <td style="width: 10%;"></td> <td style="width: 10%;"></td> <td style="width: 10%;"></td> <td style="width: 10%;"></td> <td style="width: 10%;"></td> <td style="width: 10%;"></td> <td style="width: 10%;"></td> <td style="width: 10%;"></td> <td style="width: 10%;"></td> </tr> <tr> <td></td> <td></td> <td colspan="8" style="text-align: center;"> <table border="1" style="width: 100%; border-collapse: collapse; text-align: center;"> <tr> <td style="width: 10%;"></td> <td style="width: 10%;"></td> <td style="width: 10%;"></td> <td style="width: 10%;"></td> <td style="width: 10%;"></td> <td style="width: 10%;"></td> <td style="width: 10%;"></td> <td style="width: 10%;"></td> <td style="width: 10%;"></td> <td style="width: 10%;"></td> </tr> <tr> <td></td> <td></td> <td colspan="8" style="text-align: center;"> <table border="1" style="width: 100%; border-collapse: collapse; text-align: center;"> <tr> <td style="width: 10%;"></td> <td style="width: 10%;"></td> <td style="width: 10%;"></td> <td style="width: 10%;"></td> <td style="width: 10%;"></td> <td style="width: 10%;"></td> <td style="width: 10%;"></td> <td style="width: 10%;"></td> <td style="width: 10%;"></td> <td style="width: 10%;"></td> </tr> <tr> <td></td> <td></td> <td colspan="8" style="text-align: center;"> <table border="1" style="width: 100%; border-collapse: collapse; text-align: center;"> <tr> <td style="width: 10%;"></td> <td style="width: 10%;"></td> <td style="width: 10%;"></td> <td style="width: 10%;"></td> <td style="width: 10%;"></td> <td style="width: 10%;"></td> <td style="width: 10%;"></td> <td style="width: 10%;"></td> <td style="width: 10%;"></td> <td style="width: 10%;"></td> </tr> <tr> <td></td> <td></td> <td colspan="8" style="text-align: center;"> <table border="1" style="width: 100%; border-collapse: collapse; text-align: center;"> <tr> <td style="width: 10%;"></td> <td style="width: 10%;"></td> <td style="width: 10%;"></td> <td style="width: 10%;"></td> <td style="width: 10%;"></td> <td style="width: 10%;"></td> <td style="width: 10%;"></td> <td style="width: 10%;"></td> <td style="width: 10%;"></td> <td style="width: 10%;"></td> </tr> <tr> <td></td> <td></td> <td colspan="8" style="text-align: center;"> <table border="1" style="width: 100%; border-collapse: collapse; text-align: center;"> <tr> <td style="width: 10%;"></td> <td style="width: 10%;"></td> <td style="width: 10%;"></td> <td style="width: 10%;"></td> <td style="width: 10%;"></td> <td style="width: 10%;"></td> <td style="width: 10%;"></td> <td style="width: 10%;"></td> <td style="width: 10%;"></td> <td style="width: 10%;"></td> </tr> <tr> <td></td> <td></td> <td colspan="8" style="text-align: center;"> <table border="1" style="width: 100%; border-collapse: collapse; text-align: center;"> <tr> <td style="width: 10%;"></td> <td style="width: 10%;"></td> <td style="width: 10%;"></td> <td style="width: 10%;"></td> <td style="width: 10%;"></td> <td style="width: 10%;"></td> <td style="width: 10%;"></td> <td style="width: 10%;"></td> <td style="width: 10%;"></td> <td style="width: 10%;"></td> </tr> <tr> <td></td> <td></td> <td colspan="8" style="text-align: center;"> <table border="1" style="width: 100%; border-collapse: collapse; text-align: center;"> <tr> <td style="width: 10%;"></td> <td style="width: 10%;"></td> <td style="width: 10%;"></td> <td style="width: 10%;"></td> <td style="width: 10%;"></td> <td style="width: 10%;"></td> <td style="width: 10%;"></td> <td style="width: 10%;"></td> <td style="width: 10%;"></td> <td style="width: 10%;"></td> </tr> <tr> <td></td> <td></td> <td colspan="8" style="text-align: center;"> <table border="1" style="width: 100%; border-collapse: collapse; text-align: center;"> <tr> <td style="width: 10%;"></td> <td style="width: 10%;"></td> <td style="width: 10%;"></td> <td style="width: 10%;"></td> <td style="width: 10%;"></td> <td style="width: 10%;"></td> <td style="width: 10%;"></td> <td style="width: 10%;"></td> <td style="width: 10%;"></td> <td style="width: 10%;"></td> </tr> <tr> <td></td> <td></td> <td colspan="8" style="text-align: center;"> <table border="1" style="width: 100%; border-collapse: collapse; text-align: center;"> <tr> <td style="width: 10%;"></td> <td style="width: 10%;"></td> <td style="width: 10%;"></td> <td style="width: 10%;"></td> <td style="width: 10%;"></td> <td style="width: 10%;"></td> <td style="width: 10%;"></td> <td style="width: 10%;"></td> <td style="width: 10%;"></td> <td style="width: 10%;"></td> </tr> <tr> <td></td> <td></td> <td colspan="8" style="text-align: center;"> <table border="1" style="width: 100%; border-collapse: collapse; text-align: center;"> <tr> <td style="width: 10%;"></td> <td style="width: 10%;"></td> <td style="width: 10%;"></td> <td style="width: 10%;"></td> <td style="width: 10%;"></td> <td style="width: 10%;"></td> <td style="width: 10%;"></td> <td style="width: 10%;"></td> <td style="width: 10%;"></td> <td style="width: 10%;"></td> </tr> <tr> <td></td> <td></td> <td colspan="8" style="text-align: center;"> <table border="1" style="width: 100%; border-collapse: collapse; text-align: center;"> <tr> <td style="width: 10%;"></td> <td style="width: 10%;"></td> <td style="width: 10%;"></td> <td style="width: 10%;"></td> <td style="width: 10%;"></td> <td style="width: 10%;"></td> <td style="width: 10%;"></td> <td style="width: 10%;"></td> <td style="width: 10%;"></td> <td style="width: 10%;"></td> </tr> <tr> <td></td> <td></td> <td colspan="8" style="text-align: center;"> <table border="1" style="width: 100%; border-collapse: collapse; text-align: center;"> <tr> <td style="width: 10%;"></td> <td style="width: 10%;"></td> <td style="width: 10%;"></td> <td style="width: 10%;"></td> <td style="width: 10%;"></td> <td style="width: 10%;"></td> <td style="width: 10%;"></td> <td style="width: 10%;"></td> <td style="width: 10%;"></td> <td style="width: 10%;"></td> </tr> <tr> <td></td> <td></td> <td colspan="8" style="text-align: center;"> <table border="1" style="width: 100%; border-collapse: collapse; text-align: center;"> <tr> <td style="width: 10%;"></td> <td style="width: 10%;"></td> <td style="width: 10%;"></td> <td style="width: 10%;"></td> <td style="width: 10%;"></td> <td style="width: 10%;"></td> <td style="width: 10%;"></td> <td style="width: 10%;"></td> <td style="width: 10%;"></td> <td style="width: 10%;"></td> </tr> <tr> <td></td> <td></td> <td colspan="8" style="text-align: center;"> <table border="1" style="width: 100%; border-collapse: collapse; text-align: center;"> <tr> <td style="width: 10%;"></td> <td style="width: 10%;"></td> <td style="width: 10%;"></td> <td style="width: 10%;"></td> <td style="width: 10%;"></td> <td style="width: 10%;"></td> <td style="width: 10%;"></td> <td style="width: 10%;"></td> <td style="width: 10%;"></td> <td style="width: 10%;"></td> </tr> <tr> <td></td> <td></td> <td colspan="8" style="text-align: center;"> <table border="1" style="width: 100%; border-collapse: collapse; text-align: center;"> <tr> <td style="width: 10%;"></td> <td style="width: 10%;"></td> <td style="width: 10%;"></td> <td style="width: 10%;"></td> <td style="width: 10%;"></td> <td style="width: 10%;"></td> <td style="width: 10%;"></td> <td style="width: 10%;"></td> <td style="width: 10%;"></td> <td style="width: 10%;"></td> </tr> <tr> <td></td> <td></td> <td colspan="8" style="text-align: center;"> <table border="1" style="width: 100%; border-collapse: collapse; text-align: center;"> <tr> <td style="width: 10%;"></td> <td style="width: 10%;"></td> <td style="width: 10%;"></td> <td style="width: 10%;"></td> <td style="width: 10%;"></td> <td style="width: 10%;"></td> <td style="width: 10%;"></td> <td style="width: 10%;"></td> <td style="width: 10%;"></td> <td style="width: 10%;"></td> </tr> <tr> <td></td> <td></td> <td colspan="8" style="text-align: center;"> <table border="1" style="width: 100%; border-collapse: collapse; text-align: center;"> <tr> <td style="width: 10%;"></td> <td
style="width: 10%;"></td> <td style="width: 10%;"></td> <td style="width: 10%;"></td> <td style="width: 10%;"></td> <td style="width: 10%;"></td> <td style="width: 10%;"></td> <td style="width: 10%;"></td> <td style="width: 10%;"></td> <td style="width: 10%;"></td> </tr> <tr> <td></td> <td></td> <td colspan="8" style="text-align: center;"> <table border="1" style="width: 100%; border-collapse: collapse; text-align: center;"> <tr> <td style="width: 10%;"></td> <td style="width: 10%;"></td> <td style="width: 10%;"></td> <td style="width: 10%;"></td> <td style="width: 10%;"></td> <td style="width: 10%;"></td> <td style="width: 10%;"></td> <td style="width: 10%;"></td> <td style="width: 10%;"></td> <td style="width: 10%;"></td> </tr> <tr> <td></td> <td></td> <td colspan="8" style="text-align: center;"> <table border="1" style="width: 100%; border-collapse: collapse; text-align: center;"> <tr> </tr></table></td></tr></table></td></tr></table></td></tr></table></td></tr></table></td></tr></table></td></tr></table></td></tr></table></td></tr></table></td></tr></table></td></tr></table></td></tr></table></td></tr></table></td></tr></table></td></tr></table></td></tr></table></td></tr></table></td></tr></table></td></tr></table></td></tr></table></td></tr></table></td></tr></table></td></tr></table></td></tr></table></td></tr></table></td></tr></table></td></tr></table></td></tr></table></td></tr></table></td></tr></table></td></tr></table></td></tr></table></td></tr></table></td></tr></table></td></tr></table></td></tr></table> | | | | | | | | | | | | | | | | | | | | <table border="1" style="width: 100%; border-collapse: collapse; text-align: center;"> <tr> <td style="width: 10%;"></td> <td style="width: 10%;"></td> <td style="width: 10%;"></td> <td style="width: 10%;"></td> <td style="width: 10%;"></td> <td style="width: 10%;"></td> <td style="width: 10%;"></td> <td style="width: 10%;"></td> <td style="width: 10%;"></td> <td style="width: 10%;"></td> </tr> <tr> <td></td> <td></td> <td colspan="8" style="text-align: center;"> <table border="1" style="width: 100%; border-collapse: collapse; text-align: center;"> <tr> <td style="width: 10%;"></td> <td style="width: 10%;"></td> <td style="width: 10%;"></td> <td style="width: 10%;"></td> <td style="width: 10%;"></td> <td style="width: 10%;"></td> <td style="width: 10%;"></td> <td style="width: 10%;"></td> <td style="width: 10%;"></td> <td style="width: 10%;"></td> </tr> <tr> <td></td> <td></td> <td colspan="8" style="text-align: center;"> <table border="1" style="width: 100%; border-collapse: collapse; text-align: center;"> <tr> <td style="width: 10%;"></td> <td style="width: 10%;"></td> <td
style="width: 10%;"></td> <td style="width: 10%;"></td> <td style="width: 10%;"></td> <td style="width: 10%;"></td> <td style="width: 10%;"></td> <td style="width: 10%;"></td> <td style="width: 10%;"></td> <td style="width: 10%;"></td> </tr> <tr> <td></td> <td></td> <td colspan="8" style="text-align: center;"> <table border="1" style="width: 100%; border-collapse: collapse; text-align: center;"> <tr> <td style="width: 10%;"></td> <td style="width: 10%;"></td> <td style="width: 10%;"></td> <td style="width: 10%;"></td> <td style="width: 10%;"></td> <td style="width: 10%;"></td> <td style="width: 10%;"></td> <td style="width: 10%;"></td> <td style="width: 10%;"></td> <td style="width: 10%;"></td> </tr> <tr> <td></td> <td></td> <td colspan="8" style="text-align: center;"> <table border="1" style="width: 100%; border-collapse: collapse; text-align: center;"> <tr> <td style="width: 10%;"></td> <td style="width: 10%;"></td> <td style="width: 10%;"></td> <td style="width: 10%;"></td> <td style="width: 10%;"></td> <td style="width: 10%;"></td> <td style="width: 10%;"></td> <td style="width: 10%;"></td> <td style="width: 10%;"></td> <td style="width: 10%;"></td> </tr> <tr> <td></td> <td></td> <td colspan="8" style="text-align: center;"> <table border="1" style="width: 100%; border-collapse: collapse; text-align: center;"> <tr> <td style="width: 10%;"></td> <td style="width: 10%;"></td> <td style="width: 10%;"></td> <td style="width: 10%;"></td> <td style="width: 10%;"></td> <td style="width: 10%;"></td> <td style="width: 10%;"></td> <td style="width: 10%;"></td> <td style="width: 10%;"></td> <td style="width: 10%;"></td> </tr> <tr> <td></td> <td></td> <td colspan="8" style="text-align: center;"> <table border="1" style="width: 100%; border-collapse: collapse; text-align: center;"> <tr> <td style="width: 10%;"></td> <td style="width: 10%;"></td> <td style="width: 10%;"></td> <td style="width: 10%;"></td> <td style="width: 10%;"></td> <td style="width: 10%;"></td> <td style="width: 10%;"></td> <td style="width: 10%;"></td> <td style="width: 10%;"></td> <td style="width: 10%;"></td> </tr> <tr> <td></td> <td></td> <td colspan="8" style="text-align: center;"> <table border="1" style="width: 100%; border-collapse: collapse; text-align: center;"> <tr> <td style="width: 10%;"></td> <td style="width: 10%;"></td> <td style="width: 10%;"></td> <td style="width: 10%;"></td> <td style="width: 10%;"></td> <td style="width: 10%;"></td> <td style="width: 10%;"></td> <td style="width: 10%;"></td> <td style="width: 10%;"></td> <td style="width: 10%;"></td> </tr> <tr> <td></td> <td></td> <td colspan="8" style="text-align: center;"> <table border="1" style="width: 100%; border-collapse: collapse; text-align: center;"> <tr> <td style="width: 10%;"></td> <td style="width: 10%;"></td> <td style="width: 10%;"></td> <td style="width: 10%;"></td> <td style="width: 10%;"></td> <td style="width: 10%;"></td> <td style="width: 10%;"></td> <td style="width: 10%;"></td> <td style="width: 10%;"></td> <td style="width: 10%;"></td> </tr> <tr> <td></td> <td></td> <td colspan="8" style="text-align: center;"> <table border="1" style="width: 100%; border-collapse: collapse; text-align: center;"> <tr> <td style="width: 10%;"></td> <td style="width: 10%;"></td> <td style="width: 10%;"></td> <td style="width: 10%;"></td> <td style="width: 10%;"></td> <td style="width: 10%;"></td> <td style="width: 10%;"></td> <td style="width: 10%;"></td> <td style="width: 10%;"></td> <td style="width: 10%;"></td> </tr> <tr> <td></td> <td></td> <td colspan="8" style="text-align: center;"> <table border="1" style="width: 100%; border-collapse: collapse; text-align: center;"> <tr> <td style="width: 10%;"></td> <td style="width: 10%;"></td> <td style="width: 10%;"></td> <td style="width: 10%;"></td> <td style="width: 10%;"></td> <td style="width: 10%;"></td> <td style="width: 10%;"></td> <td style="width: 10%;"></td> <td style="width: 10%;"></td> <td style="width: 10%;"></td> </tr> <tr> <td></td> <td></td> <td colspan="8" style="text-align: center;"> <table border="1" style="width: 100%; border-collapse: collapse; text-align: center;"> <tr> <td style="width: 10%;"></td> <td style="width: 10%;"></td> <td style="width: 10%;"></td> <td style="width: 10%;"></td> <td style="width: 10%;"></td> <td style="width: 10%;"></td> <td style="width: 10%;"></td> <td style="width: 10%;"></td> <td style="width: 10%;"></td> <td style="width: 10%;"></td> </tr> <tr> <td></td> <td></td> <td colspan="8" style="text-align: center;"> <table border="1" style="width: 100%; border-collapse: collapse; text-align: center;"> <tr> <td style="width: 10%;"></td> <td style="width: 10%;"></td> <td style="width: 10%;"></td> <td style="width: 10%;"></td> <td style="width: 10%;"></td> <td style="width: 10%;"></td> <td style="width: 10%;"></td> <td style="width: 10%;"></td> <td style="width: 10%;"></td> <td style="width: 10%;"></td> </tr> <tr> <td></td> <td></td> <td colspan="8" style="text-align: center;"> <table border="1" style="width: 100%; border-collapse: collapse; text-align: center;"> <tr> <td style="width: 10%;"></td> <td style="width: 10%;"></td> <td style="width: 10%;"></td> <td style="width: 10%;"></td> <td style="width: 10%;"></td> <td style="width: 10%;"></td> <td style="width: 10%;"></td> <td style="width: 10%;"></td> <td style="width: 10%;"></td> <td style="width: 10%;"></td> </tr> <tr> <td></td> <td></td> <td colspan="8" style="text-align: center;"> <table border="1" style="width: 100%; border-collapse: collapse; text-align: center;"> <tr> <td style="width: 10%;"></td> <td style="width: 10%;"></td> <td style="width: 10%;"></td> <td style="width: 10%;"></td> <td style="width: 10%;"></td> <td style="width: 10%;"></td> <td style="width: 10%;"></td> <td style="width: 10%;"></td> <td style="width: 10%;"></td> <td style="width: 10%;"></td> </tr> <tr> <td></td> <td></td> <td colspan="8" style="text-align: center;"> <table border="1" style="width: 100%; border-collapse: collapse; text-align: center;"> <tr> <td style="width: 10%;"></td> <td style="width: 10%;"></td> <td style="width: 10%;"></td> <td style="width: 10%;"></td> <td style="width: 10%;"></td> <td style="width: 10%;"></td> <td style="width: 10%;"></td> <td style="width: 10%;"></td> <td style="width: 10%;"></td> <td style="width: 10%;"></td> </tr> <tr> <td></td> <td></td> <td colspan="8" style="text-align: center;"> <table border="1" style="width: 100%; border-collapse: collapse; text-align: center;"> <tr> <td style="width: 10%;"></td> <td style="width: 10%;"></td> <td style="width: 10%;"></td> <td style="width: 10%;"></td> <td style="width: 10%;"></td> <td style="width: 10%;"></td> <td style="width: 10%;"></td> <td style="width: 10%;"></td> <td style="width: 10%;"></td> <td style="width: 10%;"></td> </tr> <tr> <td></td> <td></td> <td colspan="8" style="text-align: center;"> <table border="1" style="width: 100%; border-collapse: collapse; text-align: center;"> <tr> <td style="width: 10%;"></td> <td style="width: 10%;"></td> <td style="width: 10%;"></td> <td style="width: 10%;"></td> <td style="width: 10%;"></td> <td style="width: 10%;"></td> <td style="width: 10%;"></td> <td style="width: 10%;"></td> <td style="width: 10%;"></td> <td style="width: 10%;"></td> </tr> <tr> <td></td> <td></td> <td colspan="8" style="text-align: center;"> <table border="1" style="width: 100%; border-collapse: collapse; text-align: center;"> <tr> <td style="width: 10%;"></td> <td style="width: 10%;"></td> <td style="width: 10%;"></td> <td style="width: 10%;"></td> <td style="width: 10%;"></td> <td style="width: 10%;"></td> <td style="width: 10%;"></td> <td style="width: 10%;"></td> <td style="width: 10%;"></td> <td style="width: 10%;"></td> </tr> <tr> <td></td> <td></td> <td colspan="8" style="text-align: center;"> <table border="1" style="width: 100%; border-collapse: collapse; text-align: center;"> <tr> <td style="width: 10%;"></td> <td style="width: 10%;"></td> <td style="width: 10%;"></td> <td style="width: 10%;"></td> <td style="width: 10%;"></td> <td style="width: 10%;"></td> <td style="width: 10%;"></td> <td style="width: 10%;"></td> <td style="width: 10%;"></td> <td style="width: 10%;"></td> </tr> <tr> <td></td> <td></td> <td colspan="8" style="text-align: center;"> <table border="1" style="width: 100%; border-collapse: collapse; text-align: center;"> <tr> <td style="width: 10%;"></td> <td style="width: 10%;"></td> <td style="width: 10%;"></td> <td style="width: 10%;"></td> <td style="width: 10%;"></td> <td style="width: 10%;"></td> <td style="width: 10%;"></td> <td style="width: 10%;"></td> <td style="width: 10%;"></td> <td style="width: 10%;"></td> </tr> <tr> <td></td> <td></td> <td colspan="8" style="text-align: center;"> <table border="1" style="width: 100%; border-collapse: collapse; text-align: center;"> <tr> <td style="width: 10%;"></td> <td style="width: 10%;"></td> <td style="width: 10%;"></td> <td style="width: 10%;"></td> <td style="width: 10%;"></td> <td style="width: 10%;"></td> <td style="width: 10%;"></td> <td style="width: 10%;"></td> <td style="width: 10%;"></td> <td style="width: 10%;"></td> </tr> <tr> <td></td> <td></td> <td colspan="8" style="text-align: center;"> <table border="1" style="width: 100%; border-collapse: collapse; text-align: center;"> <tr> <td style="width: 10%;"></td> <td style="width: 10%;"></td> <td style="width: 10%;"></td> <td style="width: 10%;"></td> <td style="width: 10%;"></td> <td style="width: 10%;"></td> <td style="width: 10%;"></td> <td style="width: 10%;"></td> <td style="width: 10%;"></td> <td style="width: 10%;"></td> </tr> <tr> <td></td> <td></td> <td colspan="8" style="text-align: center;"> <table border="1" style="width: 100%; border-collapse: collapse; text-align: center;"> <tr> <td style="width: 10%;"></td> <td style="width: 10%;"></td> <td style="width: 10%;"></td> <td style="width: 10%;"></td> <td style="width: 10%;"></td> <td style="width: 10%;"></td> <td style="width: 10%;"></td> <td style="width:
10%;"></td> <td style="width: 10%;"></td> <td style="width: 10%;"></td> </tr> <tr> <td></td> <td></td> <td colspan="8" style="text-align: center;"> <table border="1" style="width: 100%; border-collapse: collapse; text-align: center;"> <tr> <td style="width: 10%;"></td> <td style="width: 10%;"></td> <td style="width: 10%;"></td> <td style="width: 10%;"></td> <td style="width: 10%;"></td> <td style="width: 10%;"></td> <td style="width: 10%;"></td> <td style="width: 10%;"></td> <td style="width: 10%;"></td> <td style="width: 10%;"></td> </tr> <tr> <td></td> <td></td> <td colspan="8" style="text-align: center;"> <table border="1" style="width: 100%; border-collapse: collapse; text-align: center;"> <tr> <td style="width: 10%;"></td> <td style="width: 10%;"></td> <td style="width: 10%;"></td> <td style="width: 10%;"></td> <td style="width: 10%;"></td> <td style="width: 10%;"></td> <td style="width: 10%;"></td> <td style="width: 10%;"></td> <td style="width: 10%;"></td> <td style="width: 10%;"></td> </tr> <tr> <td></td> <td></td> <td colspan="8" style="text-align: center;"> <table border="1" style="width: 100%; border-collapse: collapse; text-align: center;"> <tr> <td style="width: 10%;"></td> <td style="width: 10%;"></td> <td style="width: 10%;"></td> <td style="width: 10%;"></td> <td style="width: 10%;"></td> <td style="width: 10%;"></td> <td style="width: 10%;"></td> <td style="width: 10%;"></td> <td style="width: 10%;"></td> <td style="width: 10%;"></td> </tr> <tr> <td></td> <td></td> <td colspan="8" style="text-align: center;"> <table border="1" style="width: 100%; border-collapse: collapse; text-align: center;"> <tr> <td style="width: 10%;"></td> <td style="width: 10%;"></td> <td style="width: 10%;"></td> <td style="width: 10%;"></td> <td style="width: 10%;"></td> <td style="width: 10%;"></td> <td style="width: 10%;"></td> <td style="width: 10%;"></td> <td style="width: 10%;"></td> <td style="width: 10%;"></td> </tr> <tr> <td></td> <td></td> <td colspan="8" style="text-align: center;"> <table border="1" style="width: 100%; border-collapse: collapse; text-align: center;"> <tr> <td style="width: 10%;"></td> <td style="width: 10%;"></td> <td style="width: 10%;"></td> <td style="width: 10%;"></td> <td style="width: 10%;"></td> <td style="width: 10%;"></td> <td style="width: 10%;"></td> <td style="width: 10%;"></td> <td style="width: 10%;"></td> <td style="width: 10%;"></td> </tr> <tr> <td></td> <td></td> <td colspan="8" style="text-align: center;"> <table border="1" style="width: 100%; border-collapse: collapse; text-align: center;"> <tr> <td style="width: 10%;"></td> <td style="width: 10%;"></td> <td style="width: 10%;"></td> <td style="width: 10%;"></td> <td style="width: 10%;"></td> <td style="width: 10%;"></td> <td style="width: 10%;"></td> <td style="width: 10%;"></td> <td style="width: 10%;"></td> <td style="width: 10%;"></td> </tr> <tr> <td></td> <td></td> <td colspan="8" style="text-align: center;"> <table border="1" style="width: 100%; border-collapse: collapse; text-align: center;"> <tr> <td style="width: 10%;"></td> <td style="width: 10%;"></td> <td style="width: 10%;"></td> <td style="width: 10%;"></td> <td style="width: 10%;"></td> <td style="width: 10%;"></td> <td style="width: 10%;"></td> <td style="width: 10%;"></td> <td style="width: 10%;"></td> <td style="width: 10%;"></td> </tr> <tr> <td></td> <td></td> <td colspan="8" style="text-align: center;"> <table border="1" style="width: 100%; border-collapse: collapse; text-align: center;"> <tr> <td style="width: 10%;"></td> <td style="width: 10%;"></td> <td style="width: 10%;"></td> <td style="width: 10%;"></td> <td style="width: 10%;"></td> <td style="width: 10%;"></td> <td style="width: 10%;"></td> <td style="width: 10%;"></td> <td style="width: 10%;"></td> <td style="width: 10%;"></td> </tr> <tr> <td></td> <td></td> <td colspan="8" style="text-align: center;"> <table border="1" style="width: 100%; border-collapse: collapse; text-align: center;"> <tr> <td style="width: 10%;"></td> <td style="width: 10%;"></td> <td style="width: 10%;"></td> <td style="width: 10%;"></td> <td style="width: 10%;"></td> <td style="width: 10%;"></td> <td style="width: 10%;"></td> <td style="width: 10%;"></td> <td style="width: 10%;"></td> <td style="width: 10%;"></td> </tr> <tr> <td></td> <td></td> <td colspan="8" style="text-align: center;"> <table border="1" style="width: 100%; border-collapse: collapse; text-align: center;"> <tr> <td style="width: 10%;"></td> <td style="width: 10%;"></td> <td style="width: 10%;"></td> <td style="width: 10%;"></td> <td style="width: 10%;"></td> <td style="width: 10%;"></td> <td style="width: 10%;"></td> <td style="width: 10%;"></td> <td style="width: 10%;"></td> <td style="width: 10%;"></td> </tr> <tr> <td></td> <td></td> <td colspan="8" style="text-align: center;"> <table border="1" style="width: 100%; border-collapse: collapse; text-align: center;"> <tr> </tr></table></td></tr></table></td></tr></table></td></tr></table></td></tr></table></td></tr></table></td></tr></table></td></tr></table></td></tr></table></td></tr></table></td></tr></table></td></tr></table></td></tr></table></td></tr></table></td></tr></table></td></tr></table></td></tr></table></td></tr></table></td></tr></table></td></tr></table></td></tr></table></td></tr></table></td></tr></table></td></tr></table></td></tr></table></td></tr></table></td></tr></table></td></tr></table></td></tr></table></td></tr></table></td></tr></table></td></tr></table></td></tr></table></td></tr></table></td></tr></table>
 | | | | | | | | | | | | | | | | | | | | <table border="1" style="width: 100%; border-collapse: collapse; text-align: center;"> <tr> <td style="width: 10%;"></td> <td style="width: 10%;"></td> <td style="width: 10%;"></td> <td style="width: 10%;"></td> <td style="width: 10%;"></td> <td style="width: 10%;"></td> <td style="width: 10%;"></td> <td style="width: 10%;"></td> <td style="width: 10%;"></td> <td style="width: 10%;"></td> </tr> <tr> <td></td> <td></td> <td colspan="8" style="text-align: center;"> <table border="1" style="width: 100%; border-collapse: collapse; text-align: center;"> <tr> <td style="width: 10%;"></td> <td style="width: 10%;"></td> <td style="width: 10%;"></td> <td style="width: 10%;"></td> <td style="width: 10%;"></td> <td style="width: 10%;"></td> <td style="width: 10%;"></td> <td style="width: 10%;"></td> <td style="width: 10%;"></td> <td style="width: 10%;"></td> </tr> <tr> <td></td> <td></td> <td colspan="8" style="text-align: center;"> <table border="1" style="width: 100%; border-collapse: collapse; text-align: center;"> <tr> <td style="width: 10%;"></td> <td style="width: 10%;"></td> <td style="width: 10%;"></td> <td style="width: 10%;"></td> <td style="width: 10%;"></td> <td style="width: 10%;"></td> <td style="width: 10%;"></td> <td style="width: 10%;"></td> <td style="width: 10%;"></td> <td style="width: 10%;"></td> </tr> <tr> <td></td> <td></td> <td colspan="8" style="text-align: center;"> <table border="1" style="width: 100%; border-collapse: collapse; text-align: center;"> <tr> <td style="width: 10%;"></td> <td style="width: 10%;"></td> <td style="width: 10%;"></td> <td style="width: 10%;"></td> <td style="width: 10%;"></td> <td style="width: 10%;"></td> <td style="width: 10%;"></td> <td style="width: 10%;"></td> <td style="width: 10%;"></td> <td style="width: 10%;"></td> </tr> <tr> <td></td> <td></td> <td colspan="8" style="text-align: center;"> <table border="1" style="width: 100%; border-collapse: collapse; text-align: center;"> <tr> <td style="width: 10%;"></td> <td style="width: 10%;"></td> <td style="width: 10%;"></td> <td style="width: 10%;"></td> <td style="width: 10%;"></td> <td style="width: 10%;"></td> <td style="width: 10%;"></td> <td style="width: 10%;"></td> <td style="width: 10%;"></td> <td style="width: 10%;"></td> </tr> <tr> <td></td> <td></td> <td colspan="8" style="text-align: center;"> <table border="1" style="width: 100%; border-collapse: collapse; text-align: center;"> <tr> <td style="width: 10%;"></td> <td style="width: 10%;"></td> <td style="width: 10%;"></td> <td style="width: 10%;"></td> <td style="width: 10%;"></td> <td style="width: 10%;"></td> <td style="width: 10%;"></td> <td style="width: 10%;"></td> <td style="width: 10%;"></td> <td style="width: 10%;"></td> </tr> <tr> <td></td> <td></td> <td colspan="8" style="text-align: center;"> <table border="1" style="width: 100%; border-collapse: collapse; text-align: center;"> <tr> <td style="width: 10%;"></td> <td style="width: 10%;"></td> <td style="width: 10%;"></td> <td style="width: 10%;"></td> <td style="width: 10%;"></td> <td style="width: 10%;"></td> <td style="width: 10%;"></td> <td style="width: 10%;"></td> <td style="width: 10%;"></td> <td style="width: 10%;"></td> </tr> <tr> <td></td> <td></td> <td colspan="8" style="text-align: center;"> <table border="1" style="width: 100%; border-collapse: collapse; text-align: center;"> <tr> <td style="width: 10%;"></td> <td style="width: 10%;"></td> <td style="width: 10%;"></td> <td style="width: 10%;"></td> <td style="width: 10%;"></td> <td style="width: 10%;"></td> <td style="width: 10%;"></td> <td style="width: 10%;"></td> <td style="width: 10%;"></td> <td style="width: 10%;"></td> </tr> <tr> <td></td> <td></td> <td colspan="8" style="text-align: center;"> <table border="1" style="width: 100%; border-collapse: collapse; text-align: center;"> <tr> <td style="width: 10%;"></td> <td style="width: 10%;"></td> <td style="width: 10%;"></td> <td style="width: 10%;"></td> <td style="width: 10%;"></td> <td style="width: 10%;"></td> <td style="width: 10%;"></td> <td style="width: 10%;"></td> <td style="width: 10%;"></td> <td style="width: 10%;"></td> </tr> <tr> <td></td> <td></td> <td colspan="8" style="text-align: center;"> <table border="1" style="width: 100%; border-collapse: collapse; text-align: center;"> <tr> <td style="width: 10%;"></td> <td style="width: 10%;"></td> <td style="width: 10%;"></td> <td style="width: 10%;"></td> <td style="width: 10%;"></td> <td style="width: 10%;"></td> <td style="width: 10%;"></td> <td style="width: 10%;"></td> <td style="width: 10%;"></td> <td style="width: 10%;"></td> </tr> <tr> <td></td> <td></td> <td colspan="8" style="text-align: center;"> <table border="1" style="width: 100%; border-collapse: collapse; text-align: center;"> <tr> <td style="width: 10%;"></td> <td style="width: 10%;"></td> <td style="width: 10%;"></td> <td style="width: 10%;"></td> <td style="width: 10%;"></td> <td style="width: 10%;"></td> <td style="width: 10%;"></td> <td style="width: 10%;"></td> <td style="width: 10%;"></td> <td style="width: 10%;"></td> </tr> <tr> <td></td> <td></td> <td colspan="8" style="text-align: center;"> <table border="1" style="width: 100%; border-collapse: collapse; text-align: center;"> <tr> <td style="width: 10%;"></td> <td style="width: 10%;"></td> <td style="width: 10%;"></td> <td style="width: 10%;"></td> <td style="width: 10%;"></td> <td style="width: 10%;"></td> <td style="width: 10%;"></td> <td style="width: 10%;"></td> <td style="width: 10%;"></td> <td style="width: 10%;"></td> </tr> <tr> <td></td> <td></td> <td colspan="8" style="text-align: center;"> <table border="1" style="width: 100%; border-collapse: collapse; text-align: center;"> <tr> <td style="width: 10%;"></td> <td style="width: 10%;"></td> <td style="width: 10%;"></td> <td style="width: 10%;"></td> <td style="width: 10%;"></td> <td style="width: 10%;"></td> <td style="width: 10%;"></td> <td style="width: 10%;"></td> <td style="width: 10%;"></td> <td style="width: 10%;"></td> </tr> <tr> <td></td> <td></td> <td colspan="8" style="text-align: center;"> <table border="1" style="width: 100%; border-collapse: collapse; text-align: center;"> <tr> <td style="width: 10%;"></td> <td style="width: 10%;"></td> <td style="width: 10%;"></td> <td style="width: 10%;"></td> <td style="width: 10%;"></td> <td style="width: 10%;"></td> <td style="width: 10%;"></td> <td style="width: 10%;"></td> <td style="width: 10%;"></td> <td style="width: 10%;"></td> </tr> <tr> <td></td> <td></td> <td colspan="8" style="text-align: center;"> <table border="1" style="width: 100%; border-collapse: collapse; text-align: center;"> <tr> <td style="width: 10%;"></td> <td style="width: 10%;"></td> <td style="width: 10%;"></td> <td style="width: 10%;"></td> <td style="width: 10%;"></td> <td style="width: 10%;"></td> <td style="width: 10%;"></td> <td style="width: 10%;"></td> <td style="width: 10%;"></td> <td style="width: 10%;"></td> </tr> <tr> <td></td> <td></td> <td colspan="8" style="text-align: center;"> <table border="1" style="width: 100%; border-collapse: collapse; text-align:
center;"> <tr> <td style="width: 10%;"></td> <td style="width: 10%;"></td> <td style="width: 10%;"></td> <td style="width: 10%;"></td> <td style="width: 10%;"></td> <td style="width: 10%;"></td> <td style="width: 10%;"></td> <td style="width: 10%;"></td> <td style="width: 10%;"></td> <td style="width: 10%;"></td> </tr> <tr> <td></td> <td></td> <td colspan="8" style="text-align: center;"> <table border="1" style="width: 100%; border-collapse: collapse; text-align: center;"> <tr> <td style="width: 10%;"></td> <td style="width: 10%;"></td> <td style="width: 10%;"></td> <td style="width: 10%;"></td> <td style="width: 10%;"></td> <td style="width: 10%;"></td> <td style="width: 10%;"></td> <td style="width: 10%;"></td> <td style="width: 10%;"></td> <td style="width: 10%;"></td> </tr> <tr> <td></td> <td></td> <td colspan="8" style="text-align: center;"> <table border="1" style="width: 100%; border-collapse: collapse; text-align: center;"> <tr> <td style="width: 10%;"></td> <td style="width: 10%;"></td> <td style="width: 10%;"></td> <td style="width: 10%;"></td> <td style="width: 10%;"></td> <td style="width: 10%;"></td> <td style="width: 10%;"></td> <td style="width: 10%;"></td> <td style="width: 10%;"></td> <td style="width: 10%;"></td> </tr> <tr> <td></td> <td></td> <td colspan="8" style="text-align: center;"> <table border="1" style="width: 100%; border-collapse: collapse; text-align: center;"> <tr> <td style="width: 10%;"></td> <td style="width: 10%;"></td> <td style="width: 10%;"></td> <td style="width: 10%;"></td> <td style="width: 10%;"></td> <td style="width: 10%;"></td> <td style="width: 10%;"></td> <td style="width: 10%;"></td> <td style="width: 10%;"></td> <td style="width: 10%;"></td> </tr> <tr> <td></td> <td></td> <td colspan="8" style="text-align: center;"> <table border="1" style="width: 100%; border-collapse: collapse; text-align: center;"> <tr> <td style="width: 10%;"></td> <td style="width: 10%;"></td> <td style="width: 10%;"></td> <td style="width: 10%;"></td> <td style="width: 10%;"></td> <td style="width: 10%;"></td> <td style="width: 10%;"></td> <td style="width: 10%;"></td> <td style="width: 10%;"></td> <td style="width: 10%;"></td> </tr> <tr> <td></td> <td></td> <td colspan="8" style="text-align: center;"> <table border="1" style="width: 100%; border-collapse: collapse; text-align: center;"> <tr> <td style="width: 10%;"></td> <td style="width: 10%;"></td> <td style="width: 10%;"></td> <td style="width: 10%;"></td> <td style="width: 10%;"></td> <td style="width: 10%;"></td> <td style="width: 10%;"></td> <td style="width: 10%;"></td> <td style="width: 10%;"></td> <td style="width: 10%;"></td> </tr> <tr> <td></td> <td></td> <td colspan="8" style="text-align: center;"> <table border="1" style="width: 100%; border-collapse: collapse; text-align: center;"> <tr> <td style="width: 10%;"></td> <td style="width: 10%;"></td> <td style="width: 10%;"></td> <td style="width: 10%;"></td> <td style="width: 10%;"></td> <td style="width: 10%;"></td> <td style="width: 10%;"></td> <td style="width: 10%;"></td> <td style="width: 10%;"></td> <td style="width: 10%;"></td> </tr> <tr> <td></td> <td></td> <td colspan="8" style="text-align: center;"> <table border="1" style="width: 100%; border-collapse: collapse; text-align: center;"> <tr> <td style="width: 10%;"></td> <td style="width: 10%;"></td> <td style="width: 10%;"></td> <td style="width: 10%;"></td> <td style="width: 10%;"></td> <td style="width: 10%;"></td> <td style="width: 10%;"></td> <td style="width: 10%;"></td> <td style="width: 10%;"></td> <td style="width: 10%;"></td> </tr> <tr> <td></td> <td></td> <td colspan="8" style="text-align: center;"> <table border="1" style="width: 100%; border-collapse: collapse; text-align: center;"> <tr> <td style="width: 10%;"></td> <td style="width: 10%;"></td> <td style="width: 10%;"></td> <td style="width: 10%;"></td> <td style="width: 10%;"></td> <td style="width: 10%;"></td> <td style="width: 10%;"></td> <td style="width: 10%;"></td> <td style="width: 10%;"></td> <td style="width: 10%;"></td> </tr> <tr> <td></td> <td></td> <td colspan="8" style="text-align: center;"> <table border="1" style="width: 100%; border-collapse: collapse; text-align: center;"> <tr> <td style="width: 10%;"></td> <td style="width: 10%;"></td> <td style="width: 10%;"></td> <td style="width: 10%;"></td> <td style="width: 10%;"></td> <td style="width: 10%;"></td> <td style="width: 10%;"></td> <td style="width: 10%;"></td> <td style="width: 10%;"></td> <td style="width: 10%;"></td> </tr> <tr> <td></td> <td></td> <td colspan="8" style="text-align: center;"> <table border="1" style="width: 100%; border-collapse: collapse; text-align: center;"> <tr> <td style="width: 10%;"></td> <td style="width: 10%;"></td> <td style="width: 10%;"></td> <td style="width: 10%;"></td> <td style="width: 10%;"></td> <td style="width: 10%;"></td> <td style="width: 10%;"></td> <td style="width: 10%;"></td> <td style="width: 10%;"></td> <td style="width: 10%;"></td> </tr> <tr> <td></td> <td></td> <td colspan="8" style="text-align: center;"> <table border="1" style="width: 100%; border-collapse: collapse; text-align: center;"> <tr> <td style="width: 10%;"></td> <td style="width: 10%;"></td> <td style="width: 10%;"></td> <td style="width: 10%;"></td> <td style="width: 10%;"></td> <td style="width: 10%;"></td> <td style="width: 10%;"></td> <td style="width: 10%;"></td> <td style="width: 10%;"></td> <td style="width: 10%;"></td> </tr> <tr> <td></td> <td></td> <td colspan="8" style="text-align: center;"> <table border="1" style="width: 100%; border-collapse: collapse; text-align: center;"> <tr> <td style="width: 10%;"></td> <td style="width: 10%;"></td> <td style="width: 10%;"></td> <td style="width: 10%;"></td> <td style="width: 10%;"></td> <td style="width: 10%;"></td> <td style="width: 10%;"></td> <td style="width: 10%;"></td> <td style="width: 10%;"></td> <td style="width: 10%;"></td> </tr> <tr> <td></td> <td></td> <td colspan="8" style="text-align: center;"> <table border="1" style="width: 100%; border-collapse: collapse; text-align: center;"> <tr> <td style="width: 10%;"></td> <td style="width: 10%;"></td> <td style="width: 10%;"></td> <td style="width: 10%;"></td> <td style="width: 10%;"></td> <td style="width: 10%;"></td> <td style="width: 10%;"></td> <td style="width: 10%;"></td> <td style="width: 10%;"></td> <td style="width: 10%;"></td> </tr> <tr> <td></td> <td></td> <td colspan="8" style="text-align: center;"> <table border="1" style="width: 100%; border-collapse: collapse; text-align: center;"> <tr> <td style="width: 10%;"></td> <td style="width: 10%;"></td> <td style="width: 10%;"></td> <td style="width: 10%;"></td> <td style="width: 10%;"></td> <td style="width: 10%;"></td> <td style="width: 10%;"></td> <td style="width: 10%;"></td> <td style="width: 10%;"></td> <td style="width: 10%;"></td> </tr> <tr> <td></td> <td></td> <td colspan="8" style="text-align: center;"> <table border="1" style="width: 100%; border-collapse: collapse; text-align: center;"> <tr> <td style="width: 10%;"></td> <td style="width: 10%;"></td> <td style="width: 10%;"></td> <td style="width: 10%;"></td> <td style="width: 10%;"></td> <td style="width: 10%;"></td> <td style="width: 10%;"></td> <td style="width: 10%;"></td> <td style="width: 10%;"></td> <td style="width: 10%;"></td> </tr> <tr> <td></td> <td></td> <td colspan="8" style="text-align: center;"> <table border="1" style="width: 100%; border-collapse: collapse; text-align: center;"> <tr> <td style="width: 10%;"></td> <td style="width: 10%;"></td> <td style="width: 10%;"></td> <td style="width: 10%;"></td> <td style="width: 10%;"></td> <td style="width: 10%;"></td> <td style="width: 10%;"></td> <td style="width: 10%;"></td> <td style="width: 10%;"></td> <td style="width: 10%;"></td> </tr> <tr> <td></td> <td></td> <td colspan="8" style="text-align: center;"> <table border="1" style="width: 100%; border-collapse: collapse; text-align: center;"> <tr> <td style="width: 10%;"></td> <td style="width: 10%;"></td> <td style="width: 10%;"></td> <td style="width: 10%;"></td> <td style="width: 10%;"></td> <td style="width: 10%;"></td> <td style="width: 10%;"></td> <td style="width: 10%;"></td> <td style="width: 10%;"></td> <td style="width: 10%;"></td> </tr> <tr> <td></td> <td></td> <td colspan="8" style="text-align: center;"> <table border="1" style="width: 100%; border-collapse: collapse; text-align: center;"> <tr> </tr></table></td></tr></table></td></tr></table></td></tr></table></td></tr></table></td></tr></table></td></tr></table></td></tr></table></td></tr></table></td></tr></table></td></tr></table></td></tr></table></td></tr></table></td></tr></table></td></tr></table></td></tr></table></td></tr></table></td></tr></table></td></tr></table></td></tr></table></td></tr></table></td></tr></table></td></tr></table></td></tr></table></td></tr></table></td></tr></table></td></tr></table></td></tr></table></td></tr></table></td></tr></table></td></tr></table></td></tr></table></td></tr></table></td></tr></table>
 | | | | | | | | | | | | | | | | | | | | <table border="1" style="width: 100%; border-collapse: collapse; text-align: center;"> <tr> <td style="width: 10%;"></td> <td style="width: 10%;"></td> <td style="width: 10%;"></td> <td style="width: 10%;"></td> <td style="width: 10%;"></td> <td style="width: 10%;"></td> <td style="width: 10%;"></td> <td style="width: 10%;"></td> <td style="width: 10%;"></td> <td style="width: 10%;"></td> </tr> <tr> <td></td> <td></td> <td colspan="8" style="text-align: center;"> <table border="1" style="width: 100%; border-collapse: collapse; text-align: center;"> <tr> <td style="width: 10%;"></td> <td style="width: 10%;"></td> <td style="width: 10%;"></td> <td style="width: 10%;"></td> <td style="width: 10%;"></td> <td style="width: 10%;"></td> <td style="width: 10%;"></td> <td style="width: 10%;"></td> <td style="width: 10%;"></td> <td style="width: 10%;"></td> </tr> <tr> <td></td> <td></td> <td colspan="8" style="text-align: center;"> <table border="1" style="width: 100%; border-collapse: collapse; text-align: center;"> <tr> <td style="width: 10%;"></td> <td style="width: 10%;"></td> <td style="width: 10%;"></td> <td style="width: 10%;"></td> <td style="width: 10%;"></td> <td style="width: 10%;"></td> <td style="width: 10%;"></td> <td style="width: 10%;"></td> <td style="width: 10%;"></td> <td style="width: 10%;"></td> </tr> <tr> <td></td> <td></td> <td colspan="8" style="text-align: center;"> <table border="1" style="width: 100%; border-collapse: collapse; text-align: center;"> <tr> <td style="width: 10%;"></td> <td style="width: 10%;"></td> <td style="width: 10%;"></td> <td style="width: 10%;"></td> <td style="width: 10%;"></td> <td style="width: 10%;"></td> <td style="width: 10%;"></td> <td style="width: 10%;"></td> <td style="width: 10%;"></td> <td style="width: 10%;"></td> </tr> <tr> <td></td> <td></td> <td colspan="8" style="text-align: center;"> <table border="1" style="width: 100%; border-collapse: collapse; text-align: center;"> <tr> <td style="width: 10%;"></td> <td style="width: 10%;"></td> <td style="width: 10%;"></td> <td style="width: 10%;"></td> <td style="width: 10%;"></td> <td style="width: 10%;"></td> <td style="width: 10%;"></td> <td style="width: 10%;"></td> <td style="width: 10%;"></td> <td style="width: 10%;"></td> </tr> <tr> <td></td> <td></td> <td colspan="8" style="text-align: center;"> <table border="1" style="width: 100%; border-collapse: collapse; text-align: center;"> <tr> <td style="width: 10%;"></td> <td style="width: 10%;"></td> <td style="width: 10%;"></td> <td style="width: 10%;"></td> <td style="width: 10%;"></td> <td style="width: 10%;"></td> <td style="width: 10%;"></td> <td style="width: 10%;"></td> <td style="width: 10%;"></td> <td style="width: 10%;"></td> </tr> <tr> <td></td> <td></td> <td colspan="8" style="text-align: center;"> <table border="1" style="width: 100%; border-collapse: collapse; text-align: center;"> <tr> <td style="width: 10%;"></td> <td style="width: 10%;"></td> <td style="width: 10%;"></td> <td style="width: 10%;"></td> <td style="width: 10%;"></td> <td style="width: 10%;"></td> <td style="width: 10%;"></td> <td style="width: 10%;"></td> <td style="width: 10%;"></td> <td style="width: 10%;"></td> </tr> <tr> <td></td> <td></td> <td colspan="8" style="text-align: center;"> <table border="1" style="width: 100%; border-collapse: collapse; text-align: center;"> <tr> <td style="width: 10%;"></td> <td style="width: 10%;"></td> <td style="width: 10%;"></td> <td style="width: 10%;"></td> <td style="width: 10%;"></td> <td style="width: 10%;"></td> <td style="width: 10%;"></td> <td style="width:
10%;"></td> <td style="width: 10%;"></td> <td style="width: 10%;"></td> </tr> <tr> <td></td> <td></td> <td colspan="8" style="text-align: center;"> <table border="1" style="width: 100%; border-collapse: collapse; text-align: center;"> <tr> <td style="width: 10%;"></td> <td style="width: 10%;"></td> <td style="width: 10%;"></td> <td style="width: 10%;"></td> <td style="width: 10%;"></td> <td style="width: 10%;"></td> <td style="width: 10%;"></td> <td style="width: 10%;"></td> <td style="width: 10%;"></td> <td style="width: 10%;"></td> </tr> <tr> <td></td> <td></td> <td colspan="8" style="text-align: center;"> <table border="1" style="width: 100%; border-collapse: collapse; text-align: center;"> <tr> <td style="width: 10%;"></td> <td style="width: 10%;"></td> <td style="width: 10%;"></td> <td style="width: 10%;"></td> <td style="width: 10%;"></td> <td style="width: 10%;"></td> <td style="width: 10%;"></td> <td style="width: 10%;"></td> <td style="width: 10%;"></td> <td style="width: 10%;"></td> </tr> <tr> <td></td> <td></td> <td colspan="8" style="text-align: center;"> <table border="1" style="width: 100%; border-collapse: collapse; text-align: center;"> <tr> <td style="width: 10%;"></td> <td style="width: 10%;"></td> <td style="width: 10%;"></td> <td style="width: 10%;"></td> <td style="width: 10%;"></td> <td style="width: 10%;"></td> <td style="width: 10%;"></td> <td style="width: 10%;"></td> <td style="width: 10%;"></td> <td style="width: 10%;"></td> </tr> <tr> <td></td> <td></td> <td colspan="8" style="text-align: center;"> <table border="1" style="width: 100%; border-collapse: collapse; text-align: center;"> <tr> <td style="width: 10%;"></td> <td style="width: 10%;"></td> <td style="width: 10%;"></td> <td style="width: 10%;"></td> <td style="width: 10%;"></td> <td style="width: 10%;"></td> <td style="width: 10%;"></td> <td style="width: 10%;"></td> <td style="width: 10%;"></td> <td style="width: 10%;"></td> </tr> <tr> <td></td> <td></td> <td colspan="8" style="text-align: center;"> <table border="1" style="width: 100%; border-collapse: collapse; text-align: center;"> <tr> <td style="width: 10%;"></td> <td style="width: 10%;"></td> <td style="width: 10%;"></td> <td style="width: 10%;"></td> <td style="width: 10%;"></td> <td style="width: 10%;"></td> <td style="width: 10%;"></td> <td style="width: 10%;"></td> <td style="width: 10%;"></td> <td style="width: 10%;"></td> </tr> <tr> <td></td> <td></td> <td colspan="8" style="text-align: center;"> <table border="1" style="width: 100%; border-collapse: collapse; text-align: center;"> <tr> <td style="width: 10%;"></td> <td style="width: 10%;"></td> <td style="width: 10%;"></td> <td style="width: 10%;"></td> <td style="width: 10%;"></td> <td style="width: 10%;"></td> <td style="width: 10%;"></td> <td style="width: 10%;"></td> <td style="width: 10%;"></td> <td style="width: 10%;"></td> </tr> <tr> <td></td> <td></td> <td colspan="8" style="text-align: center;"> <table border="1" style="width: 100%; border-collapse: collapse; text-align: center;"> <tr> <td style="width: 10%;"></td> <td style="width: 10%;"></td> <td style="width: 10%;"></td> <td style="width: 10%;"></td> <td style="width: 10%;"></td> <td style="width: 10%;"></td> <td style="width: 10%;"></td> <td style="width: 10%;"></td> <td style="width: 10%;"></td> <td style="width: 10%;"></td> </tr> <tr> <td></td> <td></td> <td colspan="8" style="text-align: center;"> <table border="1" style="width: 100%; border-collapse: collapse; text-align: center;"> <tr> <td style="width: 10%;"></td> <td style="width: 10%;"></td> <td style="width: 10%;"></td> <td style="width: 10%;"></td> <td style="width: 10%;"></td> <td style="width: 10%;"></td> <td style="width: 10%;"></td> <td style="width: 10%;"></td> <td style="width: 10%;"></td> <td style="width: 10%;"></td> </tr> <tr> <td></td> <td></td> <td colspan="8" style="text-align: center;"> <table border="1" style="width: 100%; border-collapse: collapse; text-align: center;"> <tr> <td style="width: 10%;"></td> <td style="width: 10%;"></td> <td style="width: 10%;"></td> <td style="width: 10%;"></td> <td style="width: 10%;"></td> <td style="width: 10%;"></td> <td style="width: 10%;"></td> <td style="width: 10%;"></td> <td style="width: 10%;"></td> <td style="width: 10%;"></td> </tr> <tr> <td></td> <td></td> <td colspan="8" style="text-align: center;"> <table border="1" style="width: 100%; border-collapse: collapse; text-align: center;"> <tr> <td style="width: 10%;"></td> <td style="width: 10%;"></td> <td style="width: 10%;"></td> <td style="width: 10%;"></td> <td style="width: 10%;"></td> <td style="width: 10%;"></td> <td style="width: 10%;"></td> <td style="width: 10%;"></td> <td style="width: 10%;"></td> <td style="width: 10%;"></td> </tr> <tr> <td></td> <td></td> <td colspan="8" style="text-align: center;"> <table border="1" style="width: 100%; border-collapse: collapse; text-align: center;"> <tr> <td style="width: 10%;"></td> <td style="width: 10%;"></td> <td style="width: 10%;"></td> <td style="width: 10%;"></td> <td style="width: 10%;"></td> <td style="width: 10%;"></td> <td style="width: 10%;"></td> <td style="width: 10%;"></td> <td style="width: 10%;"></td> <td style="width: 10%;"></td> </tr> <tr> <td></td> <td></td> <td colspan="8" style="text-align: center;"> <table border="1" style="width: 100%; border-collapse: collapse; text-align: center;"> <tr> <td style="width: 10%;"></td> <td style="width: 10%;"></td> <td style="width: 10%;"></td> <td style="width: 10%;"></td> <td style="width: 10%;"></td> <td style="width: 10%;"></td> <td style="width: 10%;"></td> <td style="width: 10%;"></td> <td style="width: 10%;"></td> <td style="width: 10%;"></td> </tr> <tr> <td></td> <td></td> <td colspan="8" style="text-align: center;"> <table border="1" style="width: 100%; border-collapse: collapse; text-align: center;"> <tr> <td style="width: 10%;"></td> <td style="width: 10%;"></td> <td style="width: 10%;"></td> <td style="width: 10%;"></td> <td style="width: 10%;"></td> <td style="width: 10%;"></td> <td style="width: 10%;"></td> <td style="width: 10%;"></td> <td style="width: 10%;"></td> <td style="width: 10%;"></td> </tr> <tr> <td></td> <td></td> <td colspan="8" style="text-align: center;"> <table border="1" style="width: 100%; border-collapse: collapse; text-align: center;"> <tr> <td style="width: 10%;"></td> <td style="width: 10%;"></td> <td style="width: 10%;"></td> <td style="width: 10%;"></td> <td style="width: 10%;"></td> <td style="width: 10%;"></td> <td style="width: 10%;"></td> <td style="width: 10%;"></td> <td style="width: 10%;"></td> <td style="width: 10%;"></td> </tr> <tr> <td></td> <td></td> <td colspan="8" style="text-align: center;"> <table border="1" style="width: 100%; border-collapse: collapse; text-align: center;"> <tr> <td style="width: 10%;"></td> <td style="width: 10%;"></td> <td style="width: 10%;"></td> <td style="width: 10%;"></td> <td style="width: 10%;"></td> <td style="width: 10%;"></td> <td style="width: 10%;"></td> <td style="width: 10%;"></td> <td style="width: 10%;"></td> <td style="width: 10%;"></td> </tr> <tr> <td></td> <td></td> <td colspan="8" style="text-align: center;"> <table border="1" style="width: 100%; border-collapse: collapse; text-align: center;"> <tr> <td style="width: 10%;"></td> <td style="width: 10%;"></td> <td style="width: 10%;"></td> <td style="width: 10%;"></td> <td style="width: 10%;"></td> <td style="width: 10%;"></td> <td style="width: 10%;"></td> <td style="width: 10%;"></td> <td style="width: 10%;"></td> <td style="width: 10%;"></td> </tr> <tr> <td></td> <td></td> <td colspan="8" style="text-align: center;"> <table border="1" style="width: 100%; border-collapse: collapse; text-align: center;"> <tr> <td style="width: 10%;"></td> <td style="width: 10%;"></td> <td style="width: 10%;"></td> <td style="width: 10%;"></td> <td style="width: 10%;"></td> <td style="width: 10%;"></td> <td style="width: 10%;"></td> <td style="width: 10%;"></td> <td style="width: 10%;"></td> <td style="width: 10%;"></td> </tr> <tr> <td></td> <td></td> <td colspan="8" style="text-align: center;"> <table border="1" style="width: 100%; border-collapse: collapse; text-align: center;"> <tr> <td style="width: 10%;"></td> <td style="width: 10%;"></td> <td style="width: 10%;"></td> <td style="width: 10%;"></td> <td style="width: 10%;"></td> <td style="width: 10%;"></td> <td style="width: 10%;"></td> <td style="width: 10%;"></td> <td style="width: 10%;"></td> <td style="width: 10%;"></td> </tr> <tr> <td></td> <td></td> <td colspan="8" style="text-align: center;"> <table border="1" style="width: 100%; border-collapse: collapse; text-align: center;"> <tr> <td style="width: 10%;"></td> <td style="width: 10%;"></td> <td style="width: 10%;"></td> <td style="width: 10%;"></td> <td style="width: 10%;"></td> <td style="width: 10%;"></td> <td style="width: 10%;"></td> <td style="width: 10%;"></td> <td style="width: 10%;"></td> <td style="width: 10%;"></td> </tr> <tr> <td></td> <td></td> <td colspan="8" style="text-align: center;"> <table border="1" style="width: 100%; border-collapse: collapse; text-align: center;"> <tr> <td style="width: 10%;"></td> <td style="width: 10%;"></td> <td style="width: 10%;"></td> <td style="width: 10%;"></td> <td style="width: 10%;"></td> <td style="width: 10%;"></td> <td style="width: 10%;"></td> <td style="width: 10%;"></td> <td style="width: 10%;"></td> <td style="width: 10%;"></td> </tr> <tr> <td></td> <td></td> <td colspan="8" style="text-align: center;"> <table border="1" style="width: 100%; border-collapse: collapse; text-align: center;"> <tr> <td style="width: 10%;"></td> <td style="width: 10%;"></td> <td style="width: 10%;"></td> <td style="width: 10%;"></td> <td style="width: 10%;"></td> <td style="width: 10%;"></td> <td style="width: 10%;"></td> <td style="width: 10%;"></td> <td style="width: 10%;"></td> <td style="width: 10%;"></td> </tr> <tr> <td></td> <td></td> <td colspan="8" style="text-align: center;"> <table border="1"
style="width: 100%; border-collapse: collapse; text-align: center;"> <tr> <td style="width: 10%;"></td> <td style="width: 10%;"></td> <td style="width: 10%;"></td> <td style="width: 10%;"></td> <td style="width: 10%;"></td> <td style="width: 10%;"></td> <td style="width: 10%;"></td> <td style="width: 10%;"></td> <td style="width: 10%;"></td> <td style="width: 10%;"></td> </tr> <tr> <td></td> <td></td> <td colspan="8" style="text-align: center;"> <table border="1" style="width: 100%; border-collapse: collapse; text-align: center;"> <tr> <td style="width: 10%;"></td> <td style="width: 10%;"></td> <td style="width: 10%;"></td> <td style="width: 10%;"></td> <td style="width: 10%;"></td> <td style="width: 10%;"></td> <td style="width: 10%;"></td> <td style="width: 10%;"></td> <td style="width: 10%;"></td> <td style="width: 10%;"></td> </tr> <tr> <td></td> <td></td> <td colspan="8" style="text-align: center;"> <table border="1" style="width: 100%; border-collapse: collapse; text-align: center;"> <tr> <td style="width: 10%;"></td> <td style="width: 10%;"></td> <td style="width: 10%;"></td> <td style="width: 10%;"></td> <td style="width: 10%;"></td> <td style="width: 10%;"></td> <td style="width: 10%;"></td> <td style="width: 10%;"></td> <td style="width: 10%;"></td> <td style="width: 10%;"></td> </tr> <tr> <td></td> <td></td> <td colspan="8" style="text-align: center;"> <table border="1" style="width: 100%; border-collapse: collapse; text-align: center;"> <tr> </tr></table></td></tr></table></td></tr></table></td></tr></table></td></tr></table></td></tr></table></td></tr></table></td></tr></table></td></tr></table></td></tr></table></td></tr></table></td></tr></table></td></tr></table></td></tr></table></td></tr></table></td></tr></table></td></tr></table></td></tr></table></td></tr></table></td></tr></table></td></tr></table></td></tr></table></td></tr></table></td></tr></table></td></tr></table></td></tr></table></td></tr></table></td></tr></table></td></tr></table></td></tr></table></td></tr></table></td></tr></table></td></tr></table> | | | | | | | | | | | | | | | | | | | | <table border="1" style="width: 100%; border-collapse: collapse; text-align: center;"> <tr> <td style="width: 10%;"></td> <td style="width: 10%;"></td> <td style="width: 10%;"></td> <td style="width: 10%;"></td> <td style="width: 10%;"></td> <td style="width: 10%;"></td> <td style="width: 10%;"></td> <td style="width: 10%;"></td> <td style="width: 10%;"></td> <td style="width: 10%;"></td> </tr> <tr> <td></td> <td></td> <td colspan="8" style="text-align: center;"> <table border="1" style="width: 100%; border-collapse: collapse; text-align: center;"> <tr> <td style="width:
10%;"></td> <td style="width: 10%;"></td> <td style="width: 10%;"></td> <td style="width: 10%;"></td> <td style="width: 10%;"></td> <td style="width: 10%;"></td> <td style="width: 10%;"></td> <td style="width: 10%;"></td> <td style="width: 10%;"></td> <td style="width: 10%;"></td> </tr> <tr> <td></td> <td></td> <td colspan="8" style="text-align: center;"> <table border="1" style="width: 100%; border-collapse: collapse; text-align: center;"> <tr> <td style="width: 10%;"></td> <td style="width: 10%;"></td> <td style="width: 10%;"></td> <td style="width: 10%;"></td> <td style="width: 10%;"></td> <td style="width: 10%;"></td> <td style="width: 10%;"></td> <td style="width: 10%;"></td> <td style="width: 10%;"></td> <td style="width: 10%;"></td> </tr> <tr> <td></td> <td></td> <td colspan="8" style="text-align: center;"> <table border="1" style="width: 100%; border-collapse: collapse; text-align: center;"> <tr> <td style="width: 10%;"></td> <td style="width: 10%;"></td> <td style="width: 10%;"></td> <td style="width: 10%;"></td> <td style="width: 10%;"></td> <td style="width: 10%;"></td> <td style="width: 10%;"></td> <td style="width: 10%;"></td> <td style="width: 10%;"></td> <td style="width: 10%;"></td> </tr> <tr> <td></td> <td></td> <td colspan="8" style="text-align: center;"> <table border="1" style="width: 100%; border-collapse: collapse; text-align: center;"> <tr> <td style="width: 10%;"></td> <td style="width: 10%;"></td> <td style="width: 10%;"></td> <td style="width: 10%;"></td> <td style="width: 10%;"></td> <td style="width: 10%;"></td> <td style="width: 10%;"></td> <td style="width: 10%;"></td> <td style="width: 10%;"></td> <td style="width: 10%;"></td> </tr> <tr> <td></td> <td></td> <td colspan="8" style="text-align: center;"> <table border="1" style="width: 100%; border-collapse: collapse; text-align: center;"> <tr> <td style="width: 10%;"></td> <td style="width: 10%;"></td> <td style="width: 10%;"></td> <td style="width: 10%;"></td> <td style="width: 10%;"></td> <td style="width: 10%;"></td> <td style="width: 10%;"></td> <td style="width: 10%;"></td> <td style="width: 10%;"></td> <td style="width: 10%;"></td> </tr> <tr> <td></td> <td></td> <td colspan="8" style="text-align: center;"> <table border="1" style="width: 100%; border-collapse: collapse; text-align: center;"> <tr> <td style="width: 10%;"></td> <td style="width: 10%;"></td> <td style="width: 10%;"></td> <td style="width: 10%;"></td> <td style="width: 10%;"></td> <td style="width: 10%;"></td> <td style="width: 10%;"></td> <td style="width: 10%;"></td> <td style="width: 10%;"></td> <td style="width: 10%;"></td> </tr> <tr> <td></td> <td></td> <td colspan="8" style="text-align: center;"> <table border="1" style="width: 100%; border-collapse: collapse; text-align: center;"> <tr> <td style="width: 10%;"></td> <td style="width: 10%;"></td> <td style="width: 10%;"></td> <td style="width: 10%;"></td> <td style="width: 10%;"></td> <td style="width: 10%;"></td> <td style="width: 10%;"></td> <td style="width: 10%;"></td> <td style="width: 10%;"></td> <td style="width: 10%;"></td> </tr> <tr> <td></td> <td></td> <td colspan="8" style="text-align: center;"> <table border="1" style="width: 100%; border-collapse: collapse; text-align: center;"> <tr> <td style="width: 10%;"></td> <td style="width: 10%;"></td> <td style="width: 10%;"></td> <td style="width: 10%;"></td> <td style="width: 10%;"></td> <td style="width: 10%;"></td> <td style="width: 10%;"></td> <td style="width: 10%;"></td> <td style="width: 10%;"></td> <td style="width: 10%;"></td> </tr> <tr> <td></td> <td></td> <td colspan="8" style="text-align: center;"> <table border="1" style="width: 100%; border-collapse: collapse; text-align: center;"> <tr> <td style="width: 10%;"></td> <td style="width: 10%;"></td> <td style="width: 10%;"></td> <td style="width: 10%;"></td> <td style="width: 10%;"></td> <td style="width: 10%;"></td> <td style="width: 10%;"></td> <td style="width: 10%;"></td> <td style="width: 10%;"></td> <td style="width: 10%;"></td> </tr> <tr> <td></td> <td></td> <td colspan="8" style="text-align: center;"> <table border="1" style="width: 100%; border-collapse: collapse; text-align: center;"> <tr> <td style="width: 10%;"></td> <td style="width: 10%;"></td> <td style="width: 10%;"></td> <td style="width: 10%;"></td> <td style="width: 10%;"></td> <td style="width: 10%;"></td> <td style="width: 10%;"></td> <td style="width: 10%;"></td> <td style="width: 10%;"></td> <td style="width: 10%;"></td> </tr> <tr> <td></td> <td></td> <td colspan="8" style="text-align: center;"> <table border="1" style="width: 100%; border-collapse: collapse; text-align: center;"> <tr> <td style="width: 10%;"></td> <td style="width: 10%;"></td> <td style="width: 10%;"></td> <td style="width: 10%;"></td> <td style="width: 10%;"></td> <td style="width: 10%;"></td> <td style="width: 10%;"></td> <td style="width: 10%;"></td> <td style="width: 10%;"></td> <td style="width: 10%;"></td> </tr> <tr> <td></td> <td></td> <td colspan="8" style="text-align: center;"> <table border="1" style="width: 100%; border-collapse: collapse; text-align: center;"> <tr> <td style="width: 10%;"></td> <td style="width: 10%;"></td> <td style="width: 10%;"></td> <td style="width: 10%;"></td> <td style="width: 10%;"></td> <td style="width: 10%;"></td> <td style="width: 10%;"></td> <td style="width: 10%;"></td> <td style="width: 10%;"></td> <td style="width: 10%;"></td> </tr> <tr> <td></td> <td></td> <td colspan="8" style="text-align: center;"> <table border="1" style="width: 100%; border-collapse: collapse; text-align: center;"> <tr> <td style="width: 10%;"></td> <td style="width: 10%;"></td> <td style="width: 10%;"></td> <td style="width: 10%;"></td> <td style="width: 10%;"></td> <td style="width: 10%;"></td> <td style="width: 10%;"></td> <td style="width: 10%;"></td> <td style="width: 10%;"></td> <td style="width: 10%;"></td> </tr> <tr> <td></td> <td></td> <td colspan="8" style="text-align: center;"> <table border="1" style="width: 100%; border-collapse: collapse; text-align: center;"> <tr> <td style="width: 10%;"></td> <td style="width: 10%;"></td> <td style="width: 10%;"></td> <td style="width: 10%;"></td> <td style="width: 10%;"></td> <td style="width: 10%;"></td> <td style="width: 10%;"></td> <td style="width: 10%;"></td> <td style="width: 10%;"></td> <td style="width: 10%;"></td> </tr> <tr> <td></td> <td></td> <td colspan="8" style="text-align: center;"> <table border="1" style="width: 100%; border-collapse: collapse; text-align: center;"> <tr> <td style="width: 10%;"></td> <td style="width: 10%;"></td> <td style="width: 10%;"></td> <td style="width: 10%;"></td> <td style="width: 10%;"></td> <td style="width: 10%;"></td> <td style="width: 10%;"></td> <td style="width: 10%;"></td> <td style="width: 10%;"></td> <td style="width: 10%;"></td> </tr> <tr> <td></td> <td></td> <td colspan="8" style="text-align: center;"> <table border="1" style="width: 100%; border-collapse: collapse; text-align: center;"> <tr> <td style="width: 10%;"></td> <td style="width: 10%;"></td> <td style="width: 10%;"></td> <td style="width: 10%;"></td> <td style="width: 10%;"></td> <td style="width: 10%;"></td> <td style="width: 10%;"></td> <td style="width: 10%;"></td> <td style="width: 10%;"></td> <td style="width: 10%;"></td> </tr> <tr> <td></td> <td></td> <td colspan="8" style="text-align: center;"> <table border="1" style="width: 100%; border-collapse: collapse; text-align: center;"> <tr> <td style="width: 10%;"></td> <td style="width: 10%;"></td> <td style="width: 10%;"></td> <td style="width: 10%;"></td> <td style="width: 10%;"></td> <td style="width: 10%;"></td> <td style="width: 10%;"></td> <td style="width: 10%;"></td> <td style="width: 10%;"></td> <td style="width: 10%;"></td> </tr> <tr> <td></td> <td></td> <td colspan="8" style="text-align: center;"> <table border="1" style="width: 100%; border-collapse: collapse; text-align: center;"> <tr> <td style="width: 10%;"></td> <td style="width: 10%;"></td> <td style="width: 10%;"></td> <td style="width: 10%;"></td> <td style="width: 10%;"></td> <td style="width: 10%;"></td> <td style="width: 10%;"></td> <td style="width: 10%;"></td> <td style="width: 10%;"></td> <td style="width: 10%;"></td> </tr> <tr> <td></td> <td></td> <td colspan="8" style="text-align: center;"> <table border="1" style="width: 100%; border-collapse: collapse; text-align: center;"> <tr> <td style="width: 10%;"></td> <td style="width: 10%;"></td> <td style="width: 10%;"></td> <td style="width: 10%;"></td> <td style="width: 10%;"></td> <td style="width: 10%;"></td> <td style="width: 10%;"></td> <td style="width: 10%;"></td> <td style="width: 10%;"></td> <td style="width: 10%;"></td> </tr> <tr> <td></td> <td></td> <td colspan="8" style="text-align: center;"> <table border="1" style="width: 100%; border-collapse: collapse; text-align: center;"> <tr> <td style="width: 10%;"></td> <td style="width: 10%;"></td> <td style="width: 10%;"></td> <td style="width: 10%;"></td> <td style="width: 10%;"></td> <td style="width: 10%;"></td> <td style="width: 10%;"></td> <td style="width: 10%;"></td> <td style="width: 10%;"></td> <td style="width: 10%;"></td> </tr> <tr> <td></td> <td></td> <td colspan="8" style="text-align: center;"> <table border="1" style="width: 100%; border-collapse: collapse; text-align: center;"> <tr> <td style="width: 10%;"></td> <td style="width: 10%;"></td> <td style="width: 10%;"></td> <td style="width: 10%;"></td> <td style="width: 10%;"></td> <td style="width: 10%;"></td> <td style="width: 10%;"></td> <td style="width: 10%;"></td> <td style="width: 10%;"></td> <td style="width: 10%;"></td> </tr> <tr> <td></td> <td></td> <td colspan="8" style="text-align: center;"> <table border="1" style="width: 100%; border-collapse: collapse; text-align: center;"> <tr> <td style="width: 10%;"></td> <td style="width: 10%;"></td> <td style="width: 10%;"></td> <td style="width: 10%;"></td> <td style="width: 10%;"></td> <td style="width: 10%;"></td> <td
style="width: 10%;"></td> <td style="width: 10%;"></td> <td style="width: 10%;"></td> <td style="width: 10%;"></td> </tr> <tr> <td></td> <td></td> <td colspan="8" style="text-align: center;"> <table border="1" style="width: 100%; border-collapse: collapse; text-align: center;"> <tr> <td style="width: 10%;"></td> <td style="width: 10%;"></td> <td style="width: 10%;"></td> <td style="width: 10%;"></td> <td style="width: 10%;"></td> <td style="width: 10%;"></td> <td style="width: 10%;"></td> <td style="width: 10%;"></td> <td style="width: 10%;"></td> <td style="width: 10%;"></td> </tr> <tr> <td></td> <td></td> <td colspan="8" style="text-align: center;"> <table border="1" style="width: 100%; border-collapse: collapse; text-align: center;"> <tr> <td style="width: 10%;"></td> <td style="width: 10%;"></td> <td style="width: 10%;"></td> <td style="width: 10%;"></td> <td style="width: 10%;"></td> <td style="width: 10%;"></td> <td style="width: 10%;"></td> <td style="width: 10%;"></td> <td style="width: 10%;"></td> <td style="width: 10%;"></td> </tr> <tr> <td></td> <td></td> <td colspan="8" style="text-align: center;"> <table border="1" style="width: 100%; border-collapse: collapse; text-align: center;"> <tr> <td style="width: 10%;"></td> <td style="width: 10%;"></td> <td style="width: 10%;"></td> <td style="width: 10%;"></td> <td style="width: 10%;"></td> <td style="width: 10%;"></td> <td style="width: 10%;"></td> <td style="width: 10%;"></td> <td style="width: 10%;"></td> <td style="width: 10%;"></td> </tr> <tr> <td></td> <td></td> <td colspan="8" style="text-align: center;"> <table border="1" style="width: 100%; border-collapse: collapse; text-align: center;"> <tr> <td style="width: 10%;"></td> <td style="width: 10%;"></td> <td style="width: 10%;"></td> <td style="width: 10%;"></td> <td style="width: 10%;"></td> <td style="width: 10%;"></td> <td style="width: 10%;"></td> <td style="width: 10%;"></td> <td style="width: 10%;"></td> <td style="width: 10%;"></td> </tr> <tr> <td></td> <td></td> <td colspan="8" style="text-align: center;"> <table border="1" style="width: 100%; border-collapse: collapse; text-align: center;"> <tr> <td style="width: 10%;"></td> <td style="width: 10%;"></td> <td style="width: 10%;"></td> <td style="width: 10%;"></td> <td style="width: 10%;"></td> <td style="width: 10%;"></td> <td style="width: 10%;"></td> <td style="width: 10%;"></td> <td style="width: 10%;"></td> <td style="width: 10%;"></td> </tr> <tr> <td></td> <td></td> <td colspan="8" style="text-align: center;"> <table border="1" style="width: 100%; border-collapse: collapse; text-align: center;"> <tr> <td style="width: 10%;"></td> <td style="width: 10%;"></td> <td style="width: 10%;"></td> <td style="width: 10%;"></td> <td style="width: 10%;"></td> <td style="width: 10%;"></td> <td style="width: 10%;"></td> <td style="width: 10%;"></td> <td style="width: 10%;"></td> <td style="width: 10%;"></td> </tr> <tr> <td></td> <td></td> <td colspan="8" style="text-align: center;"> <table border="1" style="width: 100%; border-collapse: collapse; text-align: center;"> <tr> <td style="width: 10%;"></td> <td style="width: 10%;"></td> <td style="width: 10%;"></td> <td style="width: 10%;"></td> <td style="width: 10%;"></td> <td style="width: 10%;"></td> <td style="width: 10%;"></td> <td style="width: 10%;"></td> <td style="width: 10%;"></td> <td style="width: 10%;"></td> </tr> <tr> <td></td> <td></td> <td colspan="8" style="text-align: center;"> <table border="1" style="width: 100%; border-collapse: collapse; text-align: center;"> <tr> <td style="width: 10%;"></td> <td style="width: 10%;"></td> <td style="width: 10%;"></td> <td style="width: 10%;"></td> <td style="width: 10%;"></td> <td style="width: 10%;"></td> <td style="width: 10%;"></td> <td style="width: 10%;"></td> <td style="width: 10%;"></td> <td style="width: 10%;"></td> </tr> <tr> <td></td> <td></td> <td colspan="8" style="text-align: center;"> <table border="1" style="width: 100%; border-collapse: collapse; text-align: center;"> <tr> </tr></table></td></tr></table></td></tr></table></td></tr></table></td></tr></table></td></tr></table></td></tr></table></td></tr></table></td></tr></table></td></tr></table></td></tr></table></td></tr></table></td></tr></table></td></tr></table></td></tr></table></td></tr></table></td></tr></table></td></tr></table></td></tr></table></td></tr></table></td></tr></table></td></tr></table></td></tr></table></td></tr></table></td></tr></table></td></tr></table></td></tr></table></td></tr></table></td></tr></table></td></tr></table></td></tr></table></td></tr></table>
 | | | | | | | | | | | | | | | | | | | | <table border="1" style="width: 100%; border-collapse: collapse; text-align: center;"> <tr> <td style="width: 10%;"></td> <td style="width: 10%;"></td> <td style="width: 10%;"></td> <td style="width: 10%;"></td> <td style="width: 10%;"></td> <td style="width: 10%;"></td> <td style="width: 10%;"></td> <td style="width: 10%;"></td> <td style="width: 10%;"></td> <td style="width: 10%;"></td> </tr> <tr> <td></td> <td></td> <td colspan="8" style="text-align: center;"> <table border="1" style="width: 100%; border-collapse: collapse; text-align: center;"> <tr> <td style="width: 10%;"></td> <td style="width: 10%;"></td> <td style="width: 10%;"></td> <td style="width: 10%;"></td> <td style="width: 10%;"></td> <td style="width: 10%;"></td> <td style="width: 10%;"></td> <td style="width: 10%;"></td> <td style="width: 10%;"></td> <td style="width: 10%;"></td> </tr> <tr> <td></td> <td></td> <td colspan="8" style="text-align: center;"> <table border="1" style="width: 100%; border-collapse: collapse; text-align: center;"> <tr> <td style="width: 10%;"></td> <td style="width: 10%;"></td> <td style="width: 10%;"></td> <td style="width: 10%;"></td> <td style="width: 10%;"></td> <td style="width: 10%;"></td> <td style="width: 10%;"></td> <td style="width: 10%;"></td> <td style="width: 10%;"></td> <td style="width: 10%;"></td> </tr> <tr> <td></td> <td></td> <td colspan="8" style="text-align: center;"> <table border="1" style="width: 100%; border-collapse: collapse; text-align: center;"> <tr> <td style="width: 10%;"></td> <td style="width: 10%;"></td> <td style="width: 10%;"></td> <td style="width: 10%;"></td> <td style="width: 10%;"></td> <td style="width: 10%;"></td> <td style="width: 10%;"></td> <td style="width: 10%;"></td> <td style="width: 10%;"></td> <td style="width: 10%;"></td> </tr> <tr> <td></td> <td></td> <td colspan="8" style="text-align: center;"> <table border="1" style="width: 100%; border-collapse: collapse; text-align: center;"> <tr> <td style="width: 10%;"></td> <td style="width: 10%;"></td> <td style="width: 10%;"></td> <td style="width: 10%;"></td> <td style="width: 10%;"></td> <td style="width: 10%;"></td> <td style="width: 10%;"></td> <td style="width: 10%;"></td> <td style="width: 10%;"></td> <td style="width: 10%;"></td> </tr> <tr> <td></td> <td></td> <td colspan="8" style="text-align: center;"> <table border="1" style="width: 100%; border-collapse: collapse; text-align: center;"> <tr> <td style="width: 10%;"></td> <td style="width: 10%;"></td> <td style="width: 10%;"></td> <td style="width: 10%;"></td> <td style="width: 10%;"></td> <td style="width: 10%;"></td> <td style="width: 10%;"></td> <td style="width: 10%;"></td> <td style="width: 10%;"></td> <td style="width: 10%;"></td> </tr> <tr> <td></td> <td></td> <td colspan="8" style="text-align: center;"> <table border="1" style="width: 100%; border-collapse: collapse; text-align: center;"> <tr> <td style="width: 10%;"></td> <td style="width: 10%;"></td> <td style="width: 10%;"></td> <td style="width: 10%;"></td> <td style="width: 10%;"></td> <td style="width: 10%;"></td> <td style="width: 10%;"></td> <td style="width: 10%;"></td> <td style="width: 10%;"></td> <td style="width: 10%;"></td> </tr> <tr> <td></td> <td></td> <td colspan="8" style="text-align: center;"> <table border="1" style="width: 100%; border-collapse: collapse; text-align: center;"> <tr> <td style="width: 10%;"></td> <td style="width: 10%;"></td> <td style="width: 10%;"></td> <td style="width: 10%;"></td> <td style="width: 10%;"></td> <td style="width: 10%;"></td> <td style="width: 10%;"></td> <td style="width: 10%;"></td> <td style="width: 10%;"></td> <td style="width: 10%;"></td> </tr> <tr> <td></td> <td></td> <td colspan="8" style="text-align: center;"> <table border="1" style="width: 100%; border-collapse: collapse; text-align: center;"> <tr> <td style="width: 10%;"></td> <td style="width: 10%;"></td> <td style="width: 10%;"></td> <td style="width: 10%;"></td> <td style="width: 10%;"></td> <td style="width: 10%;"></td> <td style="width: 10%;"></td> <td style="width: 10%;"></td> <td style="width: 10%;"></td> <td style="width: 10%;"></td> </tr> <tr> <td></td> <td></td> <td colspan="8" style="text-align: center;"> <table border="1" style="width: 100%; border-collapse: collapse; text-align: center;"> <tr> <td style="width: 10%;"></td> <td style="width: 10%;"></td> <td style="width: 10%;"></td> <td style="width: 10%;"></td> <td style="width: 10%;"></td> <td style="width: 10%;"></td> <td style="width: 10%;"></td> <td style="width: 10%;"></td> <td style="width: 10%;"></td> <td style="width: 10%;"></td> </tr> <tr> <td></td> <td></td> <td colspan="8" style="text-align: center;"> <table border="1" style="width: 100%; border-collapse: collapse; text-align: center;"> <tr> <td style="width: 10%;"></td> <td style="width: 10%;"></td> <td style="width: 10%;"></td> <td style="width: 10%;"></td> <td style="width: 10%;"></td> <td style="width: 10%;"></td> <td style="width: 10%;"></td> <td style="width: 10%;"></td> <td style="width: 10%;"></td> <td style="width: 10%;"></td> </tr> <tr> <td></td> <td></td> <td colspan="8" style="text-align: center;"> <table border="1" style="width: 100%; border-collapse: collapse; text-align: center;"> <tr> <td style="width: 10%;"></td> <td style="width: 10%;"></td> <td style="width: 10%;"></td> <td style="width: 10%;"></td> <td style="width: 10%;"></td> <td style="width: 10%;"></td> <td style="width: 10%;"></td> <td style="width: 10%;"></td> <td style="width: 10%;"></td> <td style="width: 10%;"></td> </tr> <tr> <td></td> <td></td> <td colspan="8" style="text-align: center;"> <table border="1" style="width: 100%; border-collapse: collapse; text-align: center;"> <tr> <td style="width: 10%;"></td> <td style="width: 10%;"></td> <td style="width: 10%;"></td> <td style="width: 10%;"></td> <td style="width: 10%;"></td> <td style="width: 10%;"></td> <td style="width: 10%;"></td> <td style="width: 10%;"></td> <td style="width: 10%;"></td> <td style="width: 10%;"></td> </tr> <tr> <td></td> <td></td> <td colspan="8" style="text-align: center;"> <table border="1" style="width: 100%; border-collapse: collapse; text-align: center;"> <tr> <td style="width: 10%;"></td> <td style="width: 10%;"></td> <td style="width: 10%;"></td> <td style="width: 10%;"></td> <td style="width: 10%;"></td> <td style="width: 10%;"></td> <td style="width: 10%;"></td> <td style="width: 10%;"></td> <td style="width: 10%;"></td> <td style="width: 10%;"></td> </tr> <tr> <td></td> <td></td> <td colspan="8" style="text-align: center;"> <table border="1" style="width: 100%; border-collapse: collapse; text-align: center;"> <tr> <td style="width: 10%;"></td> <td style="width: 10%;"></td> <td style="width: 10%;"></td> <td style="width: 10%;"></td> <td style="width: 10%;"></td> <td style="width: 10%;"></td> <td style="width: 10%;"></td> <td style="width: 10%;"></td> <td style="width: 10%;"></td> <td style="width: 10%;"></td> </tr> <tr> <td></td> <td></td> <td colspan="8" style="text-align: center;"> <table border="1" style="width: 100%; border-collapse: collapse; text-align: center;"> <tr> <td style="width: 10%;"></td> <td style="width: 10%;"></td> <td style="width: 10%;"></td> <td style="width: 10%;"></td> <td style="width: 10%;"></td> <td style="width: 10%;"></td> <td style="width: 10%;"></td> <td style="width: 10%;"></td> <td style="width: 10%;"></td> <td style="width: 10%;"></td> </tr> <tr> <td></td> <td></td> <td colspan="8" style="text-align: center;"> <table border="1" style="width: 100%; border-collapse: collapse; text-align: center;"> <tr> <td style="width: 10%;"></td> <td style="width: 10%;"></td> <td style="width: 10%;"></td> <td style="width: 10%;"></td> <td style="width: 10%;"></td> <td style="width: 10%;"></td> <td style="width: 10%;"></td> <td style="width: 10%;"></td> <td style="width: 10%;"></td> <td style="width: 10%;"></td> </tr> <tr> <td></td> <td></td> <td colspan="8" style="text-align: center;"> <table border="1" style="width: 100%; border-collapse: collapse; text-align: center;"> <tr>
<td style="width: 10%;"></td> <td style="width: 10%;"></td> <td style="width: 10%;"></td> <td style="width: 10%;"></td> <td style="width: 10%;"></td> <td style="width: 10%;"></td> <td style="width: 10%;"></td> <td style="width: 10%;"></td> <td style="width: 10%;"></td> <td style="width: 10%;"></td> </tr> <tr> <td></td> <td></td> <td colspan="8" style="text-align: center;"> <table border="1" style="width: 100%; border-collapse: collapse; text-align: center;"> <tr> <td style="width: 10%;"></td> <td style="width: 10%;"></td> <td style="width: 10%;"></td> <td style="width: 10%;"></td> <td style="width: 10%;"></td> <td style="width: 10%;"></td> <td style="width: 10%;"></td> <td style="width: 10%;"></td> <td style="width: 10%;"></td> <td style="width: 10%;"></td> </tr> <tr> <td></td> <td></td> <td colspan="8" style="text-align: center;"> <table border="1" style="width: 100%; border-collapse: collapse; text-align: center;"> <tr> <td style="width: 10%;"></td> <td style="width: 10%;"></td> <td style="width: 10%;"></td> <td style="width: 10%;"></td> <td style="width: 10%;"></td> <td style="width: 10%;"></td> <td style="width: 10%;"></td> <td style="width: 10%;"></td> <td style="width: 10%;"></td> <td style="width: 10%;"></td> </tr> <tr> <td></td> <td></td> <td colspan="8" style="text-align: center;"> <table border="1" style="width: 100%; border-collapse: collapse; text-align: center;"> <tr> <td style="width: 10%;"></td> <td style="width: 10%;"></td> <td style="width: 10%;"></td> <td style="width: 10%;"></td> <td style="width: 10%;"></td> <td style="width: 10%;"></td> <td style="width: 10%;"></td> <td style="width: 10%;"></td> <td style="width: 10%;"></td> <td style="width: 10%;"></td> </tr> <tr> <td></td> <td></td> <td colspan="8" style="text-align: center;"> <table border="1" style="width: 100%; border-collapse: collapse; text-align: center;"> <tr> <td style="width: 10%;"></td> <td style="width: 10%;"></td> <td style="width: 10%;"></td> <td style="width: 10%;"></td> <td style="width: 10%;"></td> <td style="width: 10%;"></td> <td style="width: 10%;"></td> <td style="width: 10%;"></td> <td style="width: 10%;"></td> <td style="width: 10%;"></td> </tr> <tr> <td></td> <td></td> <td colspan="8" style="text-align: center;"> <table border="1" style="width: 100%; border-collapse: collapse; text-align: center;"> <tr> <td style="width: 10%;"></td> <td style="width: 10%;"></td> <td style="width: 10%;"></td> <td style="width: 10%;"></td> <td style="width: 10%;"></td> <td style="width: 10%;"></td> <td style="width: 10%;"></td> <td style="width: 10%;"></td> <td style="width: 10%;"></td> <td style="width: 10%;"></td> </tr> <tr> <td></td> <td></td> <td colspan="8" style="text-align: center;"> <table border="1" style="width: 100%; border-collapse: collapse; text-align: center;"> <tr> <td style="width: 10%;"></td> <td style="width: 10%;"></td> <td style="width: 10%;"></td> <td style="width: 10%;"></td> <td style="width: 10%;"></td> <td style="width: 10%;"></td> <td style="width: 10%;"></td> <td style="width: 10%;"></td> <td style="width: 10%;"></td> <td style="width: 10%;"></td> </tr> <tr> <td></td> <td></td> <td colspan="8" style="text-align: center;"> <table border="1" style="width: 100%; border-collapse: collapse; text-align: center;"> <tr> <td style="width: 10%;"></td> <td style="width: 10%;"></td> <td style="width: 10%;"></td> <td style="width: 10%;"></td> <td style="width: 10%;"></td> <td style="width: 10%;"></td> <td style="width: 10%;"></td> <td style="width: 10%;"></td> <td style="width: 10%;"></td> <td style="width: 10%;"></td> </tr> <tr> <td></td> <td></td> <td colspan="8" style="text-align: center;"> <table border="1" style="width: 100%; border-collapse: collapse; text-align: center;"> <tr> <td style="width: 10%;"></td> <td style="width: 10%;"></td> <td style="width: 10%;"></td> <td style="width: 10%;"></td> <td style="width: 10%;"></td> <td style="width: 10%;"></td> <td style="width: 10%;"></td> <td style="width: 10%;"></td> <td style="width: 10%;"></td> <td style="width: 10%;"></td> </tr> <tr> <td></td> <td></td> <td colspan="8" style="text-align: center;"> <table border="1" style="width: 100%; border-collapse: collapse; text-align: center;"> <tr> <td style="width: 10%;"></td> <td style="width: 10%;"></td> <td style="width: 10%;"></td> <td style="width: 10%;"></td> <td style="width: 10%;"></td> <td style="width: 10%;"></td> <td style="width: 10%;"></td> <td style="width: 10%;"></td> <td style="width: 10%;"></td> <td style="width: 10%;"></td> </tr> <tr> <td></td> <td></td> <td colspan="8" style="text-align: center;"> <table border="1" style="width: 100%; border-collapse: collapse; text-align: center;"> <tr> <td style="width: 10%;"></td> <td style="width: 10%;"></td> <td style="width: 10%;"></td> <td style="width: 10%;"></td> <td style="width: 10%;"></td> <td style="width: 10%;"></td> <td style="width: 10%;"></td> <td style="width: 10%;"></td> <td style="width: 10%;"></td> <td style="width: 10%;"></td> </tr> <tr> <td></td> <td></td> <td colspan="8" style="text-align: center;"> <table border="1" style="width: 100%; border-collapse: collapse; text-align: center;"> <tr> <td style="width: 10%;"></td> <td style="width: 10%;"></td> <td style="width: 10%;"></td> <td style="width: 10%;"></td> <td style="width: 10%;"></td> <td style="width: 10%;"></td> <td style="width: 10%;"></td> <td style="width: 10%;"></td> <td style="width: 10%;"></td> <td style="width: 10%;"></td> </tr> <tr> <td></td> <td></td> <td colspan="8" style="text-align: center;"> <table border="1" style="width: 100%; border-collapse: collapse; text-align: center;"> <tr> <td style="width: 10%;"></td> <td style="width: 10%;"></td> <td style="width: 10%;"></td> <td style="width: 10%;"></td> <td style="width: 10%;"></td> <td style="width: 10%;"></td> <td style="width: 10%;"></td> <td style="width: 10%;"></td> <td style="width: 10%;"></td> <td style="width: 10%;"></td> </tr> <tr> <td></td> <td></td> <td colspan="8" style="text-align: center;"> <table border="1" style="width: 100%; border-collapse: collapse; text-align: center;"> <tr> </tr></table></td></tr></table></td></tr></table></td></tr></table></td></tr></table></td></tr></table></td></tr></table></td></tr></table></td></tr></table></td></tr></table></td></tr></table></td></tr></table></td></tr></table></td></tr></table></td></tr></table></td></tr></table></td></tr></table></td></tr></table></td></tr></table></td></tr></table></td></tr></table></td></tr></table></td></tr></table></td></tr></table></td></tr></table></td></tr></table></td></tr></table></td></tr></table></td></tr></table></td></tr></table></td></tr></table>
 | | | | | | | | | | | | | | | | | | | | <table border="1" style="width: 100%; border-collapse: collapse; text-align: center;"> <tr> <td style="width: 10%;"></td> <td style="width: 10%;"></td> <td style="width: 10%;"></td> <td style="width: 10%;"></td> <td style="width: 10%;"></td> <td style="width: 10%;"></td> <td style="width: 10%;"></td> <td style="width: 10%;"></td> <td style="width: 10%;"></td> <td style="width: 10%;"></td> </tr> <tr> <td></td> <td></td> <td colspan="8" style="text-align: center;"> <table border="1" style="width: 100%; border-collapse: collapse; text-align: center;"> <tr> <td style="width: 10%;"></td> <td style="width: 10%;"></td> <td style="width: 10%;"></td> <td style="width: 10%;"></td> <td style="width: 10%;"></td> <td style="width: 10%;"></td> <td style="width: 10%;"></td> <td style="width: 10%;"></td> <td style="width: 10%;"></td> <td style="width: 10%;"></td> </tr> <tr> <td></td> <td></td> <td colspan="8" style="text-align: center;"> <table border="1" style="width: 100%; border-collapse: collapse; text-align: center;"> <tr> <td style="width: 10%;"></td> <td style="width: 10%;"></td> <td style="width: 10%;"></td> <td style="width: 10%;"></td> <td style="width: 10%;"></td> <td style="width: 10%;"></td> <td style="width: 10%;"></td> <td style="width: 10%;"></td> <td style="width: 10%;"></td> <td style="width: 10%;"></td> </tr> <tr> <td></td> <td></td> <td colspan="8" style="text-align: center;"> <table border="1" style="width: 100%; border-collapse: collapse; text-align: center;"> <tr> <td style="width: 10%;"></td> <td style="width: 10%;"></td> <td style="width: 10%;"></td> <td style="width: 10%;"></td> <td style="width: 10%;"></td> <td style="width: 10%;"></td> <td style="width: 10%;"></td> <td style="width: 10%;"></td> <td style="width: 10%;"></td> <td style="width: 10%;"></td> </tr> <tr> <td></td> <td></td> <td colspan="8" style="text-align: center;"> <table border="1" style="width: 100%; border-collapse: collapse; text-align: center;"> <tr> <td style="width: 10%;"></td> <td style="width: 10%;"></td> <td style="width: 10%;"></td> <td style="width: 10%;"></td> <td style="width: 10%;"></td> <td style="width: 10%;"></td> <td style="width: 10%;"></td> <td style="width: 10%;"></td> <td style="width: 10%;"></td> <td style="width: 10%;"></td> </tr> <tr> <td></td> <td></td> <td colspan="8" style="text-align: center;"> <table border="1" style="width: 100%; border-collapse: collapse; text-align: center;"> <tr> <td style="width: 10%;"></td> <td style="width: 10%;"></td> <td style="width: 10%;"></td> <td style="width: 10%;"></td> <td style="width: 10%;"></td> <td style="width: 10%;"></td> <td style="width: 10%;"></td> <td style="width: 10%;"></td> <td style="width: 10%;"></td> <td style="width: 10%;"></td> </tr> <tr> <td></td> <td></td> <td colspan="8" style="text-align: center;"> <table border="1" style="width: 100%; border-collapse: collapse; text-align: center;"> <tr> <td style="width: 10%;"></td> <td style="width: 10%;"></td> <td style="width: 10%;"></td> <td style="width: 10%;"></td> <td style="width: 10%;"></td> <td style="width: 10%;"></td> <td style="width: 10%;"></td> <td style="width: 10%;"></td> <td style="width: 10%;"></td> <td style="width: 10%;"></td> </tr> <tr> <td></td> <td></td> <td colspan="8" style="text-align: center;"> <table border="1" style="width: 100%; border-collapse: collapse; text-align: center;"> <tr> <td style="width: 10%;"></td> <td style="width: 10%;"></td> <td style="width: 10%;"></td> <td style="width: 10%;"></td> <td style="width: 10%;"></td> <td style="width: 10%;"></td> <td style="width: 10%;"></td> <td style="width: 10%;"></td> <td style="width: 10%;"></td> <td style="width: 10%;"></td> </tr> <tr> <td></td> <td></td> <td colspan="8" style="text-align: center;"> <table border="1" style="width: 100%; border-collapse: collapse; text-align: center;"> <tr> <td style="width: 10%;"></td> <td style="width: 10%;"></td> <td style="width: 10%;"></td> <td style="width: 10%;"></td> <td style="width: 10%;"></td> <td style="width: 10%;"></td> <td style="width: 10%;"></td> <td style="width: 10%;"></td> <td style="width: 10%;"></td> <td style="width: 10%;"></td> </tr> <tr> <td></td> <td></td> <td colspan="8" style="text-align: center;"> <table border="1" style="width: 100%; border-collapse: collapse; text-align: center;"> <tr> <td style="width: 10%;"></td> <td style="width: 10%;"></td> <td style="width: 10%;"></td> <td style="width: 10%;"></td> <td style="width: 10%;"></td> <td style="width: 10%;"></td> <td style="width: 10%;"></td> <td style="width: 10%;"></td> <td style="width: 10%;"></td> <td style="width: 10%;"></td> </tr> <tr> <td></td> <td></td> <td colspan="8" style="text-align: center;"> <table border="1" style="width: 100%; border-collapse: collapse; text-align: center;"> <tr> <td style="width: 10%;"></td> <td style="width: 10%;"></td> <td style="width: 10%;"></td> <td style="width: 10%;"></td> <td style="width: 10%;"></td> <td style="width: 10%;"></td> <td style="width: 10%;"></td> <td style="width: 10%;"></td> <td style="width: 10%;"></td> <td style="width: 10%;"></td> </tr> <tr> <td></td> <td></td> <td colspan="8" style="text-align: center;"> <table border="1" style="width: 100%; border-collapse: collapse; text-align: center;"> <tr> <td style="width: 10%;"></td> <td style="width: 10%;"></td> <td style="width: 10%;"></td> <td style="width: 10%;"></td> <td style="width: 10%;"></td> <td style="width: 10%;"></td> <td style="width: 10%;"></td> <td style="width: 10%;"></td> <td style="width: 10%;"></td> <td style="width: 10%;"></td> </tr> <tr> <td></td> <td></td> <td colspan="8" style="text-align: center;"> <table border="1" style="width: 100%; border-collapse: collapse; text-align: center;"> <tr> <td style="width: 10%;"></td> <td style="width: 10%;"></td> <td style="width: 10%;"></td> <td style="width: 10%;"></td> <td style="width: 10%;"></td> <td style="width: 10%;"></td> <td style="width: 10%;"></td> <td style="width: 10%;"></td> <td style="width: 10%;"></td> <td style="width: 10%;"></td>
</tr> <tr> <td></td> <td></td> <td colspan="8" style="text-align: center;"> <table border="1" style="width: 100%; border-collapse: collapse; text-align: center;"> <tr> <td style="width: 10%;"></td> <td style="width: 10%;"></td> <td style="width: 10%;"></td> <td style="width: 10%;"></td> <td style="width: 10%;"></td> <td style="width: 10%;"></td> <td style="width: 10%;"></td> <td style="width: 10%;"></td> <td style="width: 10%;"></td> <td style="width: 10%;"></td> </tr> <tr> <td></td> <td></td> <td colspan="8" style="text-align: center;"> <table border="1" style="width: 100%; border-collapse: collapse; text-align: center;"> <tr> <td style="width: 10%;"></td> <td style="width: 10%;"></td> <td style="width: 10%;"></td> <td style="width: 10%;"></td> <td style="width: 10%;"></td> <td style="width: 10%;"></td> <td style="width: 10%;"></td> <td style="width: 10%;"></td> <td style="width: 10%;"></td> <td style="width: 10%;"></td> </tr> <tr> <td></td> <td></td> <td colspan="8" style="text-align: center;"> <table border="1" style="width: 100%; border-collapse: collapse; text-align: center;"> <tr> <td style="width: 10%;"></td> <td style="width: 10%;"></td> <td style="width: 10%;"></td> <td style="width: 10%;"></td> <td style="width: 10%;"></td> <td style="width: 10%;"></td> <td style="width: 10%;"></td> <td style="width: 10%;"></td> <td style="width: 10%;"></td> <td style="width: 10%;"></td> </tr> <tr> <td></td> <td></td> <td colspan="8" style="text-align: center;"> <table border="1" style="width: 100%; border-collapse: collapse; text-align: center;"> <tr> <td style="width: 10%;"></td> <td style="width: 10%;"></td> <td style="width: 10%;"></td> <td style="width: 10%;"></td> <td style="width: 10%;"></td> <td style="width: 10%;"></td> <td style="width: 10%;"></td> <td style="width: 10%;"></td> <td style="width: 10%;"></td> <td style="width: 10%;"></td> </tr> <tr> <td></td> <td></td> <td colspan="8" style="text-align: center;"> <table border="1" style="width: 100%; border-collapse: collapse; text-align: center;"> <tr> <td style="width: 10%;"></td> <td style="width: 10%;"></td> <td style="width: 10%;"></td> <td style="width: 10%;"></td> <td style="width: 10%;"></td> <td style="width: 10%;"></td> <td style="width: 10%;"></td> <td style="width: 10%;"></td> <td style="width: 10%;"></td> <td style="width: 10%;"></td> </tr> <tr> <td></td> <td></td> <td colspan="8" style="text-align: center;"> <table border="1" style="width: 100%; border-collapse: collapse; text-align: center;"> <tr> <td style="width: 10%;"></td> <td style="width: 10%;"></td> <td style="width: 10%;"></td> <td style="width: 10%;"></td> <td style="width: 10%;"></td> <td style="width: 10%;"></td> <td style="width: 10%;"></td> <td style="width: 10%;"></td> <td style="width: 10%;"></td> <td style="width: 10%;"></td> </tr> <tr> <td></td> <td></td> <td colspan="8" style="text-align: center;"> <table border="1" style="width: 100%; border-collapse: collapse; text-align: center;"> <tr> <td style="width: 10%;"></td> <td style="width: 10%;"></td> <td style="width: 10%;"></td> <td style="width: 10%;"></td> <td style="width: 10%;"></td> <td style="width: 10%;"></td> <td style="width: 10%;"></td> <td style="width: 10%;"></td> <td style="width: 10%;"></td> <td style="width: 10%;"></td> </tr> <tr> <td></td> <td></td> <td colspan="8" style="text-align: center;"> <table border="1" style="width: 100%; border-collapse: collapse; text-align: center;"> <tr> <td style="width: 10%;"></td> <td style="width: 10%;"></td> <td style="width: 10%;"></td> <td style="width: 10%;"></td> <td style="width: 10%;"></td> <td style="width: 10%;"></td> <td style="width: 10%;"></td> <td style="width: 10%;"></td> <td style="width: 10%;"></td> <td style="width: 10%;"></td> </tr> <tr> <td></td> <td></td> <td colspan="8" style="text-align: center;"> <table border="1" style="width: 100%; border-collapse: collapse; text-align: center;"> <tr> <td style="width: 10%;"></td> <td style="width: 10%;"></td> <td style="width: 10%;"></td> <td style="width: 10%;"></td> <td style="width: 10%;"></td> <td style="width: 10%;"></td> <td style="width: 10%;"></td> <td style="width: 10%;"></td> <td style="width: 10%;"></td> <td style="width: 10%;"></td> </tr> <tr> <td></td> <td></td> <td colspan="8" style="text-align: center;"> <table border="1" style="width: 100%; border-collapse: collapse; text-align: center;"> <tr> <td style="width: 10%;"></td> <td style="width: 10%;"></td> <td style="width: 10%;"></td> <td style="width: 10%;"></td> <td style="width: 10%;"></td> <td style="width: 10%;"></td> <td style="width: 10%;"></td> <td style="width: 10%;"></td> <td style="width: 10%;"></td> <td style="width: 10%;"></td> </tr> <tr> <td></td> <td></td> <td colspan="8" style="text-align: center;"> <table border="1" style="width: 100%; border-collapse: collapse; text-align: center;"> <tr> <td style="width: 10%;"></td> <td style="width: 10%;"></td> <td style="width: 10%;"></td> <td style="width: 10%;"></td> <td style="width: 10%;"></td> <td style="width: 10%;"></td> <td style="width: 10%;"></td> <td style="width: 10%;"></td> <td style="width: 10%;"></td> <td style="width: 10%;"></td> </tr> <tr> <td></td> <td></td> <td colspan="8" style="text-align: center;"> <table border="1" style="width: 100%; border-collapse: collapse; text-align: center;"> <tr> <td style="width: 10%;"></td> <td style="width: 10%;"></td> <td style="width: 10%;"></td> <td style="width: 10%;"></td> <td style="width: 10%;"></td> <td style="width: 10%;"></td> <td style="width: 10%;"></td> <td style="width: 10%;"></td> <td style="width: 10%;"></td> <td style="width: 10%;"></td> </tr> <tr> <td></td> <td></td> <td colspan="8" style="text-align: center;"> <table border="1" style="width: 100%; border-collapse: collapse; text-align: center;"> <tr> <td style="width: 10%;"></td> <td style="width: 10%;"></td> <td style="width: 10%;"></td> <td style="width: 10%;"></td> <td style="width: 10%;"></td> <td style="width: 10%;"></td> <td style="width: 10%;"></td> <td style="width: 10%;"></td> <td style="width: 10%;"></td> <td style="width: 10%;"></td> </tr> <tr> <td></td> <td></td> <td colspan="8" style="text-align: center;"> <table border="1" style="width: 100%; border-collapse: collapse; text-align: center;"> <tr> <td style="width: 10%;"></td> <td style="width: 10%;"></td> <td style="width: 10%;"></td> <td style="width: 10%;"></td> <td style="width: 10%;"></td> <td style="width: 10%;"></td> <td style="width: 10%;"></td> <td style="width: 10%;"></td> <td style="width: 10%;"></td> <td style="width: 10%;"></td> </tr> <tr> <td></td> <td></td> <td colspan="8" style="text-align: center;"> <table border="1" style="width: 100%; border-collapse: collapse; text-align: center;"> <tr> <td style="width: 10%;"></td> <td style="width: 10%;"></td> <td style="width: 10%;"></td> <td style="width: 10%;"></td> <td style="width: 10%;"></td> <td style="width: 10%;"></td> <td style="width: 10%;"></td> <td style="width: 10%;"></td> <td style="width: 10%;"></td> <td style="width: 10%;"></td> </tr> <tr> <td></td> <td></td> <td colspan="8" style="text-align: center;"> <table border="1" style="width: 100%; border-collapse: collapse; text-align: center;"> <tr> <td style="width: 10%;"></td> <td style="width: 10%;"></td> <td style="width: 10%;"></td> <td style="width: 10%;"></td> <td style="width: 10%;"></td> <td style="width: 10%;"></td> <td style="width: 10%;"></td> <td style="width: 10%;"></td> <td style="width: 10%;"></td> <td style="width: 10%;"></td> </tr> <tr> <td></td> <td></td> <td colspan="8" style="text-align: center;"> <table border="1" style="width: 100%; border-collapse: collapse; text-align: center;"> <tr> </tr></table></td></tr></table></td></tr></table></td></tr></table></td></tr></table></td></tr></table></td></tr></table></td></tr></table></td></tr></table></td></tr></table></td></tr></table></td></tr></table></td></tr></table></td></tr></table></td></tr></table></td></tr></table></td></tr></table></td></tr></table></td></tr></table></td></tr></table></td></tr></table></td></tr></table></td></tr></table></td></tr></table></td></tr></table></td></tr></table></td></tr></table></td></tr></table></td></tr></table></td></tr></table>
 | | | | | | | | | | | | | | | | | | | | <table border="1" style="width: 100%; border-collapse: collapse; text-align: center;"> <tr> <td style="width: 10%;"></td> <td style="width: 10%;"></td> <td style="width: 10%;"></td> <td style="width: 10%;"></td> <td style="width: 10%;"></td> <td style="width: 10%;"></td> <td style="width: 10%;"></td> <td style="width: 10%;"></td> <td style="width: 10%;"></td> <td style="width: 10%;"></td> </tr> <tr> <td></td> <td></td> <td colspan="8" style="text-align: center;"> <table border="1" style="width: 100%; border-collapse: collapse; text-align: center;"> <tr> <td style="width: 10%;"></td> <td style="width: 10%;"></td> <td style="width: 10%;"></td> <td style="width: 10%;"></td> <td style="width: 10%;"></td> <td style="width: 10%;"></td> <td style="width: 10%;"></td> <td style="width: 10%;"></td> <td style="width: 10%;"></td> <td style="width: 10%;"></td> </tr> <tr> <td></td> <td></td> <td colspan="8" style="text-align: center;"> <table border="1" style="width: 100%; border-collapse: collapse; text-align: center;"> <tr> <td style="width: 10%;"></td> <td style="width: 10%;"></td> <td style="width: 10%;"></td> <td style="width: 10%;"></td> <td style="width: 10%;"></td> <td style="width: 10%;"></td> <td style="width: 10%;"></td> <td style="width: 10%;"></td> <td style="width: 10%;"></td> <td style="width: 10%;"></td> </tr> <tr> <td></td> <td></td> <td colspan="8" style="text-align: center;"> <table border="1" style="width: 100%; border-collapse: collapse; text-align: center;"> <tr> <td style="width: 10%;"></td> <td style="width: 10%;"></td> <td style="width: 10%;"></td> <td style="width: 10%;"></td> <td style="width: 10%;"></td> <td style="width: 10%;"></td> <td style="width: 10%;"></td> <td style="width: 10%;"></td> <td style="width: 10%;"></td> <td style="width: 10%;"></td> </tr> <tr> <td></td> <td></td> <td colspan="8" style="text-align: center;"> <table border="1" style="width: 100%; border-collapse: collapse; text-align: center;"> <tr> <td style="width: 10%;"></td> <td style="width: 10%;"></td> <td style="width: 10%;"></td> <td style="width: 10%;"></td> <td style="width: 10%;"></td> <td style="width: 10%;"></td> <td style="width: 10%;"></td> <td style="width: 10%;"></td> <td style="width: 10%;"></td> <td style="width: 10%;"></td> </tr> <tr> <td></td> <td></td> <td colspan="8" style="text-align: center;"> <table border="1" style="width: 100%; border-collapse: collapse; text-align: center;"> <tr> <td style="width: 10%;"></td> <td style="width: 10%;"></td> <td style="width: 10%;"></td> <td style="width: 10%;"></td> <td style="width: 10%;"></td> <td style="width: 10%;"></td> <td style="width: 10%;"></td> <td style="width: 10%;"></td> <td style="width: 10%;"></td> <td style="width: 10%;"></td> </tr> <tr> <td></td> <td></td> <td colspan="8" style="text-align: center;"> <table border="1" style="width: 100%; border-collapse: collapse; text-align: center;"> <tr> <td style="width: 10%;"></td> <td style="width: 10%;"></td> <td style="width: 10%;"></td> <td style="width: 10%;"></td> <td style="width: 10%;"></td> <td style="width: 10%;"></td> <td style="width: 10%;"></td> <td style="width: 10%;"></td> <td style="width: 10%;"></td> <td style="width: 10%;"></td> </tr> <tr> <td></td> <td></td> <td colspan="8" style="text-align: center;"> <table border="1" style="width: 100%; border-collapse: collapse; text-align: center;"> <tr> <td style="width: 10%;"></td> <td style="width: 10%;"></td> <td style="width: 10%;"></td> <td style="width: 10%;"></td> <td style="width: 10%;"></td> <td style="width: 10%;"></td> <td style="width: 10%;"></td> <td style="width: 10%;"></td> <td style="width: 10%;"></td> <td style="width: 10%;"></td> </tr> <tr> <td></td> <td></td> <td colspan="8" style="text-align: center;"> <table border="1" style="width: 100%; border-collapse: collapse; text-align: center;"> <tr> <td style="width: 10%;"></td> <td style="width: 10%;"></td> <td style="width: 10%;"></td> <td style="width: 10%;"></td> <td style="width: 10%;"></td> <td style="width: 10%;"></td> <td style="width: 10%;"></td> <td style="width: 10%;"></td> <td style="width: 10%;"></td> <td style="width: 10%;"></td> </tr> <tr> <td></td> <td></td> <td colspan="8" style="text-align: center;"> <table border="1" style="width: 100%; border-collapse: collapse; text-align: center;"> <tr> <td style="width: 10%;"></td> <td style="width: 10%;"></td> <td style="width: 10%;"></td> <td style="width: 10%;"></td> <td style="width: 10%;"></td> <td
style="width: 10%;"></td> <td style="width: 10%;"></td> <td style="width: 10%;"></td> <td style="width: 10%;"></td> <td style="width: 10%;"></td> </tr> <tr> <td></td> <td></td> <td colspan="8" style="text-align: center;"> <table border="1" style="width: 100%; border-collapse: collapse; text-align: center;"> <tr> <td style="width: 10%;"></td> <td style="width: 10%;"></td> <td style="width: 10%;"></td> <td style="width: 10%;"></td> <td style="width: 10%;"></td> <td style="width: 10%;"></td> <td style="width: 10%;"></td> <td style="width: 10%;"></td> <td style="width: 10%;"></td> <td style="width: 10%;"></td> </tr> <tr> <td></td> <td></td> <td colspan="8" style="text-align: center;"> <table border="1" style="width: 100%; border-collapse: collapse; text-align: center;"> <tr> <td style="width: 10%;"></td> <td style="width: 10%;"></td> <td style="width: 10%;"></td> <td style="width: 10%;"></td> <td style="width: 10%;"></td> <td style="width: 10%;"></td> <td style="width: 10%;"></td> <td style="width: 10%;"></td> <td style="width: 10%;"></td> <td style="width: 10%;"></td> </tr> <tr> <td></td> <td></td> <td colspan="8" style="text-align: center;"> <table border="1" style="width: 100%; border-collapse: collapse; text-align: center;"> <tr> <td style="width: 10%;"></td> <td style="width: 10%;"></td> <td style="width: 10%;"></td> <td style="width: 10%;"></td> <td style="width: 10%;"></td> <td style="width: 10%;"></td> <td style="width: 10%;"></td> <td style="width: 10%;"></td> <td style="width: 10%;"></td> <td style="width: 10%;"></td> </tr> <tr> <td></td> <td></td> <td colspan="8" style="text-align: center;"> <table border="1" style="width: 100%; border-collapse: collapse; text-align: center;"> <tr> <td style="width: 10%;"></td> <td style="width: 10%;"></td> <td style="width: 10%;"></td> <td style="width: 10%;"></td> <td style="width: 10%;"></td> <td style="width: 10%;"></td> <td style="width: 10%;"></td> <td style="width: 10%;"></td> <td style="width: 10%;"></td> <td style="width: 10%;"></td> </tr> <tr> <td></td> <td></td> <td colspan="8" style="text-align: center;"> <table border="1" style="width: 100%; border-collapse: collapse; text-align: center;"> <tr> <td style="width: 10%;"></td> <td style="width: 10%;"></td> <td style="width: 10%;"></td> <td style="width: 10%;"></td> <td style="width: 10%;"></td> <td style="width: 10%;"></td> <td style="width: 10%;"></td> <td style="width: 10%;"></td> <td style="width: 10%;"></td> <td style="width: 10%;"></td> </tr> <tr> <td></td> <td></td> <td colspan="8" style="text-align: center;"> <table border="1" style="width: 100%; border-collapse: collapse; text-align: center;"> <tr> <td style="width: 10%;"></td> <td style="width: 10%;"></td> <td style="width: 10%;"></td> <td style="width: 10%;"></td> <td style="width: 10%;"></td> <td style="width: 10%;"></td> <td style="width: 10%;"></td> <td style="width: 10%;"></td> <td style="width: 10%;"></td> <td style="width: 10%;"></td> </tr> <tr> <td></td> <td></td> <td colspan="8" style="text-align: center;"> <table border="1" style="width: 100%; border-collapse: collapse; text-align: center;"> <tr> <td style="width: 10%;"></td> <td style="width: 10%;"></td> <td style="width: 10%;"></td> <td style="width: 10%;"></td> <td style="width: 10%;"></td> <td style="width: 10%;"></td> <td style="width: 10%;"></td> <td style="width: 10%;"></td> <td style="width: 10%;"></td> <td style="width: 10%;"></td> </tr> <tr> <td></td> <td></td> <td colspan="8" style="text-align: center;"> <table border="1" style="width: 100%; border-collapse: collapse; text-align: center;"> <tr> <td style="width: 10%;"></td> <td style="width: 10%;"></td> <td style="width: 10%;"></td> <td style="width: 10%;"></td> <td style="width: 10%;"></td> <td style="width: 10%;"></td> <td style="width: 10%;"></td> <td style="width: 10%;"></td> <td style="width: 10%;"></td> <td style="width: 10%;"></td> </tr> <tr> <td></td> <td></td> <td colspan="8" style="text-align: center;"> <table border="1" style="width: 100%; border-collapse: collapse; text-align: center;"> <tr> <td style="width: 10%;"></td> <td style="width: 10%;"></td> <td style="width: 10%;"></td> <td style="width: 10%;"></td> <td style="width: 10%;"></td> <td style="width: 10%;"></td> <td style="width: 10%;"></td> <td style="width: 10%;"></td> <td style="width: 10%;"></td> <td style="width: 10%;"></td> </tr> <tr> <td></td> <td></td> <td colspan="8" style="text-align: center;"> <table border="1" style="width: 100%; border-collapse: collapse; text-align: center;"> <tr> <td style="width: 10%;"></td> <td style="width: 10%;"></td> <td style="width: 10%;"></td> <td style="width: 10%;"></td> <td style="width: 10%;"></td> <td style="width: 10%;"></td> <td style="width: 10%;"></td> <td style="width: 10%;"></td> <td style="width: 10%;"></td> <td style="width: 10%;"></td> </tr> <tr> <td></td> <td></td> <td colspan="8" style="text-align: center;"> <table border="1" style="width: 100%; border-collapse: collapse; text-align: center;"> <tr> <td style="width: 10%;"></td> <td style="width: 10%;"></td> <td style="width: 10%;"></td> <td style="width: 10%;"></td> <td style="width: 10%;"></td> <td style="width: 10%;"></td> <td style="width: 10%;"></td> <td style="width: 10%;"></td> <td style="width: 10%;"></td> <td style="width: 10%;"></td> </tr> <tr> <td></td> <td></td> <td colspan="8" style="text-align: center;"> <table border="1" style="width: 100%; border-collapse: collapse; text-align: center;"> <tr> <td style="width: 10%;"></td> <td style="width: 10%;"></td> <td style="width: 10%;"></td> <td style="width: 10%;"></td> <td style="width: 10%;"></td> <td style="width: 10%;"></td> <td style="width: 10%;"></td> <td style="width: 10%;"></td> <td style="width: 10%;"></td> <td style="width: 10%;"></td> </tr> <tr> <td></td> <td></td> <td colspan="8" style="text-align: center;"> <table border="1" style="width: 100%; border-collapse: collapse; text-align: center;"> <tr> <td style="width: 10%;"></td> <td style="width: 10%;"></td> <td style="width: 10%;"></td> <td style="width: 10%;"></td> <td style="width: 10%;"></td> <td style="width: 10%;"></td> <td style="width: 10%;"></td> <td style="width: 10%;"></td> <td style="width: 10%;"></td> <td style="width: 10%;"></td> </tr> <tr> <td></td> <td></td> <td colspan="8" style="text-align: center;"> <table border="1" style="width: 100%; border-collapse: collapse; text-align: center;"> <tr> <td style="width: 10%;"></td> <td style="width: 10%;"></td> <td style="width: 10%;"></td> <td style="width: 10%;"></td> <td style="width: 10%;"></td> <td style="width: 10%;"></td> <td style="width: 10%;"></td> <td style="width: 10%;"></td> <td style="width: 10%;"></td> <td style="width: 10%;"></td> </tr> <tr> <td></td> <td></td> <td colspan="8" style="text-align: center;"> <table border="1" style="width: 100%; border-collapse: collapse; text-align: center;"> <tr> <td style="width: 10%;"></td> <td style="width: 10%;"></td> <td style="width: 10%;"></td> <td style="width: 10%;"></td> <td style="width: 10%;"></td> <td style="width: 10%;"></td> <td style="width: 10%;"></td> <td style="width: 10%;"></td> <td style="width: 10%;"></td> <td style="width: 10%;"></td> </tr> <tr> <td></td> <td></td> <td colspan="8" style="text-align: center;"> <table border="1" style="width: 100%; border-collapse: collapse; text-align: center;"> <tr> <td style="width: 10%;"></td> <td style="width: 10%;"></td> <td style="width: 10%;"></td> <td style="width: 10%;"></td> <td style="width: 10%;"></td> <td style="width: 10%;"></td> <td style="width: 10%;"></td> <td style="width: 10%;"></td> <td style="width: 10%;"></td> <td style="width: 10%;"></td> </tr> <tr> <td></td> <td></td> <td colspan="8" style="text-align: center;"> <table border="1" style="width: 100%; border-collapse: collapse; text-align: center;"> <tr> <td style="width: 10%;"></td> <td style="width: 10%;"></td> <td style="width: 10%;"></td> <td style="width: 10%;"></td> <td style="width: 10%;"></td> <td style="width: 10%;"></td> <td style="width: 10%;"></td> <td style="width: 10%;"></td> <td style="width: 10%;"></td> <td style="width: 10%;"></td> </tr> <tr> <td></td> <td></td> <td colspan="8" style="text-align: center;"> <table border="1" style="width: 100%; border-collapse: collapse; text-align: center;"> <tr> <td style="width: 10%;"></td> <td style="width: 10%;"></td> <td style="width: 10%;"></td> <td style="width: 10%;"></td> <td style="width: 10%;"></td> <td style="width: 10%;"></td> <td style="width: 10%;"></td> <td style="width: 10%;"></td> <td style="width: 10%;"></td> <td style="width: 10%;"></td> </tr> <tr> <td></td> <td></td> <td colspan="8" style="text-align: center;"> <table border="1" style="width: 100%; border-collapse: collapse; text-align: center;"> <tr> </tr></table></td></tr></table></td></tr></table></td></tr></table></td></tr></table></td></tr></table></td></tr></table></td></tr></table></td></tr></table></td></tr></table></td></tr></table></td></tr></table></td></tr></table></td></tr></table></td></tr></table></td></tr></table></td></tr></table></td></tr></table></td></tr></table></td></tr></table></td></tr></table></td></tr></table></td></tr></table></td></tr></table></td></tr></table></td></tr></table></td></tr></table></td></tr></table></td></tr></table>
 | | | | | | | | | | | | | | | | | | | | <table border="1" style="width: 100%; border-collapse: collapse; text-align: center;"> <tr> <td style="width: 10%;"></td> <td style="width: 10%;"></td> <td style="width: 10%;"></td> <td style="width: 10%;"></td> <td style="width: 10%;"></td> <td style="width: 10%;"></td> <td style="width: 10%;"></td> <td style="width: 10%;"></td> <td style="width: 10%;"></td> <td style="width: 10%;"></td> </tr> <tr> <td></td> <td></td> <td colspan="8" style="text-align: center;"> <table border="1" style="width: 100%; border-collapse: collapse; text-align: center;"> <tr> <td style="width: 10%;"></td> <td style="width: 10%;"></td> <td style="width: 10%;"></td> <td style="width: 10%;"></td> <td style="width: 10%;"></td> <td style="width: 10%;"></td> <td style="width: 10%;"></td> <td style="width: 10%;"></td> <td style="width: 10%;"></td> <td style="width: 10%;"></td> </tr> <tr> <td></td> <td></td> <td colspan="8" style="text-align: center;"> <table border="1" style="width: 100%; border-collapse: collapse; text-align: center;"> <tr> <td style="width: 10%;"></td> <td style="width: 10%;"></td> <td style="width: 10%;"></td> <td style="width: 10%;"></td> <td style="width: 10%;"></td> <td style="width: 10%;"></td> <td style="width: 10%;"></td> <td style="width: 10%;"></td> <td style="width: 10%;"></td> <td style="width: 10%;"></td> </tr> <tr> <td></td> <td></td> <td colspan="8" style="text-align: center;"> <table border="1" style="width: 100%; border-collapse: collapse; text-align: center;"> <tr> <td style="width: 10%;"></td> <td style="width: 10%;"></td> <td style="width: 10%;"></td> <td style="width: 10%;"></td> <td style="width: 10%;"></td> <td style="width: 10%;"></td> <td style="width: 10%;"></td> <td style="width: 10%;"></td> <td style="width: 10%;"></td> <td style="width: 10%;"></td> </tr> <tr> <td></td> <td></td> <td colspan="8" style="text-align: center;"> <table border="1" style="width: 100%; border-collapse: collapse; text-align: center;"> <tr> <td style="width: 10%;"></td> <td style="width: 10%;"></td> <td style="width: 10%;"></td> <td style="width: 10%;"></td> <td style="width: 10%;"></td> <td style="width: 10%;"></td> <td style="width: 10%;"></td> <td style="width: 10%;"></td> <td style="width: 10%;"></td> <td style="width: 10%;"></td> </tr> <tr> <td></td> <td></td> <td colspan="8" style="text-align: center;"> <table border="1" style="width: 100%; border-collapse: collapse; text-align: center;"> <tr> <td style="width: 10%;"></td> <td style="width: 10%;"></td> <td style="width: 10%;"></td> <td style="width: 10%;"></td> <td style="width: 10%;"></td> <td style="width: 10%;"></td> <td style="width: 10%;"></td> <td style="width: 10%;"></td> <td style="width: 10%;"></td> <td style="width: 10%;"></td> </tr> <tr> <td></td> <td></td> <td colspan="8" style="text-align: center;"> <table border="1" style="width: 100%; border-collapse: collapse; text-align: center;"> <tr> <td style="width: 10%;"></td> <td style="width: 10%;"></td> <td style="width: 10%;"></td> <td style="width: 10%;"></td> <td style="width: 10%;"></td> <td style="width: 10%;"></td> <td style="width: 10%;"></td> <td style="width: 10%;"></td> <td style="width: 10%;"></td> <td style="width: 10%;"></td> </tr> <tr> <td></td> <td></td> <td colspan="8" style="text-align: center;"> <table border="1" style="width: 100%; border-collapse: collapse; text-align: center;"> <tr> <td style="width:
10%;"></td> <td style="width: 10%;"></td> <td style="width: 10%;"></td> <td style="width: 10%;"></td> <td style="width: 10%;"></td> <td style="width: 10%;"></td> <td style="width: 10%;"></td> <td style="width: 10%;"></td> <td style="width: 10%;"></td> <td style="width: 10%;"></td> </tr> <tr> <td></td> <td></td> <td colspan="8" style="text-align: center;"> <table border="1" style="width: 100%; border-collapse: collapse; text-align: center;"> <tr> <td style="width: 10%;"></td> <td style="width: 10%;"></td> <td style="width: 10%;"></td> <td style="width: 10%;"></td> <td style="width: 10%;"></td> <td style="width: 10%;"></td> <td style="width: 10%;"></td> <td style="width: 10%;"></td> <td style="width: 10%;"></td> <td style="width: 10%;"></td> </tr> <tr> <td></td> <td></td> <td colspan="8" style="text-align: center;"> <table border="1" style="width: 100%; border-collapse: collapse; text-align: center;"> <tr> <td style="width: 10%;"></td> <td style="width: 10%;"></td> <td style="width: 10%;"></td> <td style="width: 10%;"></td> <td style="width: 10%;"></td> <td style="width: 10%;"></td> <td style="width: 10%;"></td> <td style="width: 10%;"></td> <td style="width: 10%;"></td> <td style="width: 10%;"></td> </tr> <tr> <td></td> <td></td> <td colspan="8" style="text-align: center;"> <table border="1" style="width: 100%; border-collapse: collapse; text-align: center;"> <tr> <td style="width: 10%;"></td> <td style="width: 10%;"></td> <td style="width: 10%;"></td> <td style="width: 10%;"></td> <td style="width: 10%;"></td> <td style="width: 10%;"></td> <td style="width: 10%;"></td> <td style="width: 10%;"></td> <td style="width: 10%;"></td> <td style="width: 10%;"></td> </tr> <tr> <td></td> <td></td> <td colspan="8" style="text-align: center;"> <table border="1" style="width: 100%; border-collapse: collapse; text-align: center;"> <tr> <td style="width: 10%;"></td> <td style="width: 10%;"></td> <td style="width: 10%;"></td> <td style="width: 10%;"></td> <td style="width: 10%;"></td> <td style="width: 10%;"></td> <td style="width: 10%;"></td> <td style="width: 10%;"></td> <td style="width: 10%;"></td> <td style="width: 10%;"></td> </tr> <tr> <td></td> <td></td> <td colspan="8" style="text-align: center;"> <table border="1" style="width: 100%; border-collapse: collapse; text-align: center;"> <tr> <td style="width: 10%;"></td> <td style="width: 10%;"></td> <td style="width: 10%;"></td> <td style="width: 10%;"></td> <td style="width: 10%;"></td> <td style="width: 10%;"></td> <td style="width: 10%;"></td> <td style="width: 10%;"></td> <td style="width: 10%;"></td> <td style="width: 10%;"></td> </tr> <tr> <td></td> <td></td> <td colspan="8" style="text-align: center;"> <table border="1" style="width: 100%; border-collapse: collapse; text-align: center;"> <tr> <td style="width: 10%;"></td> <td style="width: 10%;"></td> <td style="width: 10%;"></td> <td style="width: 10%;"></td> <td style="width: 10%;"></td> <td style="width: 10%;"></td> <td style="width: 10%;"></td> <td style="width: 10%;"></td> <td style="width: 10%;"></td> <td style="width: 10%;"></td> </tr> <tr> <td></td> <td></td> <td colspan="8" style="text-align: center;"> <table border="1" style="width: 100%; border-collapse: collapse; text-align: center;"> <tr> <td style="width: 10%;"></td> <td style="width: 10%;"></td> <td style="width: 10%;"></td> <td style="width: 10%;"></td> <td style="width: 10%;"></td> <td style="width: 10%;"></td> <td style="width: 10%;"></td> <td style="width: 10%;"></td> <td style="width: 10%;"></td> <td style="width: 10%;"></td> </tr> <tr> <td></td> <td></td> <td colspan="8" style="text-align: center;"> <table border="1" style="width: 100%; border-collapse: collapse; text-align: center;"> <tr> <td style="width: 10%;"></td> <td style="width: 10%;"></td> <td style="width: 10%;"></td> <td style="width: 10%;"></td> <td style="width: 10%;"></td> <td style="width: 10%;"></td> <td style="width: 10%;"></td> <td style="width: 10%;"></td> <td style="width: 10%;"></td> <td style="width: 10%;"></td> </tr> <tr> <td></td> <td></td> <td colspan="8" style="text-align: center;"> <table border="1" style="width: 100%; border-collapse: collapse; text-align: center;"> <tr> <td style="width: 10%;"></td> <td style="width: 10%;"></td> <td style="width: 10%;"></td> <td style="width: 10%;"></td> <td style="width: 10%;"></td> <td style="width: 10%;"></td> <td style="width: 10%;"></td> <td style="width: 10%;"></td> <td style="width: 10%;"></td> <td style="width: 10%;"></td> </tr> <tr> <td></td> <td></td> <td colspan="8" style="text-align: center;"> <table border="1" style="width: 100%; border-collapse: collapse; text-align: center;"> <tr> <td style="width: 10%;"></td> <td style="width: 10%;"></td> <td style="width: 10%;"></td> <td style="width: 10%;"></td> <td style="width: 10%;"></td> <td style="width: 10%;"></td> <td style="width: 10%;"></td> <td style="width: 10%;"></td> <td style="width: 10%;"></td> <td style="width: 10%;"></td> </tr> <tr> <td></td> <td></td> <td colspan="8" style="text-align: center;"> <table border="1" style="width: 100%; border-collapse: collapse; text-align: center;"> <tr> <td style="width: 10%;"></td> <td style="width: 10%;"></td> <td style="width: 10%;"></td> <td style="width: 10%;"></td> <td style="width: 10%;"></td> <td style="width: 10%;"></td> <td style="width: 10%;"></td> <td style="width: 10%;"></td> <td style="width: 10%;"></td> <td style="width: 10%;"></td> </tr> <tr> <td></td> <td></td> <td colspan="8" style="text-align: center;"> <table border="1" style="width: 100%; border-collapse: collapse; text-align: center;"> <tr> <td style="width: 10%;"></td> <td style="width: 10%;"></td> <td style="width: 10%;"></td> <td style="width: 10%;"></td> <td style="width: 10%;"></td> <td style="width: 10%;"></td> <td style="width: 10%;"></td> <td style="width: 10%;"></td> <td style="width: 10%;"></td> <td style="width: 10%;"></td> </tr> <tr> <td></td> <td></td> <td colspan="8" style="text-align: center;"> <table border="1" style="width: 100%; border-collapse: collapse; text-align: center;"> <tr> <td style="width: 10%;"></td> <td style="width: 10%;"></td> <td style="width: 10%;"></td> <td style="width: 10%;"></td> <td style="width: 10%;"></td> <td style="width: 10%;"></td> <td style="width: 10%;"></td> <td style="width: 10%;"></td> <td style="width: 10%;"></td> <td style="width: 10%;"></td> </tr> <tr> <td></td> <td></td> <td colspan="8" style="text-align: center;"> <table border="1" style="width: 100%; border-collapse: collapse; text-align: center;"> <tr> <td style="width: 10%;"></td> <td style="width: 10%;"></td> <td style="width: 10%;"></td> <td style="width: 10%;"></td> <td style="width: 10%;"></td> <td style="width: 10%;"></td> <td style="width: 10%;"></td> <td style="width: 10%;"></td> <td style="width: 10%;"></td> <td style="width: 10%;"></td> </tr> <tr> <td></td> <td></td> <td colspan="8" style="text-align: center;"> <table border="1" style="width: 100%; border-collapse: collapse; text-align: center;"> <tr> <td style="width: 10%;"></td> <td style="width: 10%;"></td> <td style="width: 10%;"></td> <td style="width: 10%;"></td> <td style="width: 10%;"></td> <td style="width: 10%;"></td> <td style="width: 10%;"></td> <td style="width: 10%;"></td> <td style="width: 10%;"></td> <td style="width: 10%;"></td> </tr> <tr> <td></td> <td></td> <td colspan="8" style="text-align: center;"> <table border="1" style="width: 100%; border-collapse: collapse; text-align: center;"> <tr> <td style="width: 10%;"></td> <td style="width: 10%;"></td> <td style="width: 10%;"></td> <td style="width: 10%;"></td> <td style="width: 10%;"></td> <td style="width: 10%;"></td> <td style="width: 10%;"></td> <td style="width: 10%;"></td> <td style="width: 10%;"></td> <td style="width: 10%;"></td> </tr> <tr> <td></td> <td></td> <td colspan="8" style="text-align: center;"> <table border="1" style="width: 100%; border-collapse: collapse; text-align: center;"> <tr> <td style="width: 10%;"></td> <td style="width: 10%;"></td> <td style="width: 10%;"></td> <td style="width: 10%;"></td> <td style="width: 10%;"></td> <td style="width: 10%;"></td> <td style="width: 10%;"></td> <td style="width: 10%;"></td> <td style="width: 10%;"></td> <td style="width: 10%;"></td> </tr> <tr> <td></td> <td></td> <td colspan="8" style="text-align: center;"> <table border="1" style="width: 100%; border-collapse: collapse; text-align: center;"> <tr> <td style="width: 10%;"></td> <td style="width: 10%;"></td> <td style="width: 10%;"></td> <td style="width: 10%;"></td> <td style="width: 10%;"></td> <td style="width: 10%;"></td> <td style="width: 10%;"></td> <td style="width: 10%;"></td> <td style="width: 10%;"></td> <td style="width: 10%;"></td> </tr> <tr> <td></td> <td></td> <td colspan="8" style="text-align: center;"> <table border="1" style="width: 100%; border-collapse: collapse; text-align: center;"> <tr> <td style="width: 10%;"></td> <td style="width: 10%;"></td> <td style="width: 10%;"></td> <td style="width: 10%;"></td> <td style="width: 10%;"></td> <td style="width: 10%;"></td> <td style="width: 10%;"></td> <td style="width: 10%;"></td> <td style="width: 10%;"></td> <td style="width: 10%;"></td> </tr> <tr> <td></td> <td></td> <td colspan="8" style="text-align: center;"> <table border="1" style="width: 100%; border-collapse: collapse; text-align: center;"> <tr> </tr></table></td></tr></table></td></tr></table></td></tr></table></td></tr></table></td></tr></table></td></tr></table></td></tr></table></td></tr></table></td></tr></table></td></tr></table></td></tr></table></td></tr></table></td></tr></table></td></tr></table></td></tr></table></td></tr></table></td></tr></table></td></tr></table></td></tr></table></td></tr></table></td></tr></table></td></tr></table></td></tr></table></td></tr></table></td></tr></table></td></tr></table></td></tr></table>
 | | | | | | | | | | | | | | | | | | | | <table border="1" style="width: 100%; border-collapse: collapse; text-align: center;"> <tr> <td style="width: 10%;"></td> <td style="width: 10%;"></td> <td style="width: 10%;"></td> <td style="width: 10%;"></td> <td style="width: 10%;"></td> <td style="width: 10%;"></td> <td style="width: 10%;"></td> <td style="width: 10%;"></td> <td style="width: 10%;"></td> <td style="width: 10%;"></td> </tr> <tr> <td></td> <td></td> <td colspan="8" style="text-align: center;"> <table border="1" style="width: 100%; border-collapse: collapse; text-align: center;"> <tr> <td style="width: 10%;"></td> <td style="width: 10%;"></td> <td style="width: 10%;"></td> <td style="width: 10%;"></td> <td style="width: 10%;"></td> <td style="width: 10%;"></td> <td style="width: 10%;"></td> <td style="width: 10%;"></td> <td style="width: 10%;"></td> <td style="width: 10%;"></td> </tr> <tr> <td></td> <td></td> <td colspan="8" style="text-align: center;"> <table border="1" style="width: 100%; border-collapse: collapse; text-align: center;"> <tr> <td style="width: 10%;"></td> <td style="width: 10%;"></td> <td style="width: 10%;"></td> <td style="width: 10%;"></td> <td style="width: 10%;"></td> <td style="width: 10%;"></td> <td style="width: 10%;"></td> <td style="width: 10%;"></td> <td style="width: 10%;"></td> <td style="width: 10%;"></td> </tr> <tr> <td></td> <td></td> <td colspan="8" style="text-align: center;"> <table border="1" style="width: 100%; border-collapse: collapse; text-align: center;"> <tr> <td style="width: 10%;"></td> <td style="width: 10%;"></td> <td style="width: 10%;"></td> <td style="width: 10%;"></td> <td style="width: 10%;"></td> <td style="width: 10%;"></td> <td style="width: 10%;"></td> <td style="width: 10%;"></td> <td style="width: 10%;"></td> <td style="width: 10%;"></td> </tr> <tr> <td></td> <td></td> <td colspan="8" style="text-align: center;"> <table border="1" style="width: 100%; border-collapse: collapse; text-align: center;"> <tr> <td style="width: 10%;"></td> <td style="width: 10%;"></td> <td style="width: 10%;"></td> <td style="width: 10%;"></td> <td style="width: 10%;"></td> <td style="width: 10%;"></td> <td style="width: 10%;"></td> <td style="width: 10%;"></td> <td style="width: 10%;"></td> <td style="width: 10%;"></td> </tr> <tr> <td></td> <td></td> <td colspan="8" style="text-align: center;"> <table border="1" style="width: 100%; border-collapse: collapse; text-align: center;"> <tr> <td style="width: 10%;"></td> <td style="width: 10%;"></td> <td style="width: 10%;"></td> <td style="width: 10%;"></td> <td style="width: 10%;"></td> <td style="width: 10%;"></td> <td style="width: 10%;"></td> <td style="width: 10%;"></td> <td style="width: 10%;"></td> <td style="width: 10%;"></td> </tr> <tr> <td></td> <td></td> <td colspan="8" style="text-align: center;">
<table border="1" style="width: 100%; border-collapse: collapse; text-align: center;"> <tr> <td style="width: 10%;"></td> <td style="width: 10%;"></td> <td style="width: 10%;"></td> <td style="width: 10%;"></td> <td style="width: 10%;"></td> <td style="width: 10%;"></td> <td style="width: 10%;"></td> <td style="width: 10%;"></td> <td style="width: 10%;"></td> <td style="width: 10%;"></td> </tr> <tr> <td></td> <td></td> <td colspan="8" style="text-align: center;"> <table border="1" style="width: 100%; border-collapse: collapse; text-align: center;"> <tr> <td style="width: 10%;"></td> <td style="width: 10%;"></td> <td style="width: 10%;"></td> <td style="width: 10%;"></td> <td style="width: 10%;"></td> <td style="width: 10%;"></td> <td style="width: 10%;"></td> <td style="width: 10%;"></td> <td style="width: 10%;"></td> <td style="width: 10%;"></td> </tr> <tr> <td></td> <td></td> <td colspan="8" style="text-align: center;"> <table border="1" style="width: 100%; border-collapse: collapse; text-align: center;"> <tr> <td style="width: 10%;"></td> <td style="width: 10%;"></td> <td style="width: 10%;"></td> <td style="width: 10%;"></td> <td style="width: 10%;"></td> <td style="width: 10%;"></td> <td style="width: 10%;"></td> <td style="width: 10%;"></td> <td style="width: 10%;"></td> <td style="width: 10%;"></td> </tr> <tr> <td></td> <td></td> <td colspan="8" style="text-align: center;"> <table border="1" style="width: 100%; border-collapse: collapse; text-align: center;"> <tr> <td style="width: 10%;"></td> <td style="width: 10%;"></td> <td style="width: 10%;"></td> <td style="width: 10%;"></td> <td style="width: 10%;"></td> <td style="width: 10%;"></td> <td style="width: 10%;"></td> <td style="width: 10%;"></td> <td style="width: 10%;"></td> <td style="width: 10%;"></td> </tr> <tr> <td></td> <td></td> <td colspan="8" style="text-align: center;"> <table border="1" style="width: 100%; border-collapse: collapse; text-align: center;"> <tr> <td style="width: 10%;"></td> <td style="width: 10%;"></td> <td style="width: 10%;"></td> <td style="width: 10%;"></td> <td style="width: 10%;"></td> <td style="width: 10%;"></td> <td style="width: 10%;"></td> <td style="width: 10%;"></td> <td style="width: 10%;"></td> <td style="width: 10%;"></td> </tr> <tr> <td></td> <td></td> <td colspan="8" style="text-align: center;"> <table border="1" style="width: 100%; border-collapse: collapse; text-align: center;"> <tr> <td style="width: 10%;"></td> <td style="width: 10%;"></td> <td style="width: 10%;"></td> <td style="width: 10%;"></td> <td style="width: 10%;"></td> <td style="width: 10%;"></td> <td style="width: 10%;"></td> <td style="width: 10%;"></td> <td style="width: 10%;"></td> <td style="width: 10%;"></td> </tr> <tr> <td></td> <td></td> <td colspan="8" style="text-align: center;"> <table border="1" style="width: 100%; border-collapse: collapse; text-align: center;"> <tr> <td style="width: 10%;"></td> <td style="width: 10%;"></td> <td style="width: 10%;"></td> <td style="width: 10%;"></td> <td style="width: 10%;"></td> <td style="width: 10%;"></td> <td style="width: 10%;"></td> <td style="width: 10%;"></td> <td style="width: 10%;"></td> <td style="width: 10%;"></td> </tr> <tr> <td></td> <td></td> <td colspan="8" style="text-align: center;"> <table border="1" style="width: 100%; border-collapse: collapse; text-align: center;"> <tr> <td style="width: 10%;"></td> <td style="width: 10%;"></td> <td style="width: 10%;"></td> <td style="width: 10%;"></td> <td style="width: 10%;"></td> <td style="width: 10%;"></td> <td style="width: 10%;"></td> <td style="width: 10%;"></td> <td style="width: 10%;"></td> <td style="width: 10%;"></td> </tr> <tr> <td></td> <td></td> <td colspan="8" style="text-align: center;"> <table border="1" style="width: 100%; border-collapse: collapse; text-align: center;"> <tr> <td style="width: 10%;"></td> <td style="width: 10%;"></td> <td style="width: 10%;"></td> <td style="width: 10%;"></td> <td style="width: 10%;"></td> <td style="width: 10%;"></td> <td style="width: 10%;"></td> <td style="width: 10%;"></td> <td style="width: 10%;"></td> <td style="width: 10%;"></td> </tr> <tr> <td></td> <td></td> <td colspan="8" style="text-align: center;"> <table border="1" style="width: 100%; border-collapse: collapse; text-align: center;"> <tr> <td style="width: 10%;"></td> <td style="width: 10%;"></td> <td style="width: 10%;"></td> <td style="width: 10%;"></td> <td style="width: 10%;"></td> <td style="width: 10%;"></td> <td style="width: 10%;"></td> <td style="width: 10%;"></td> <td style="width: 10%;"></td> <td style="width: 10%;"></td> </tr> <tr> <td></td> <td></td> <td colspan="8" style="text-align: center;"> <table border="1" style="width: 100%; border-collapse: collapse; text-align: center;"> <tr> <td style="width: 10%;"></td> <td style="width: 10%;"></td> <td style="width: 10%;"></td> <td style="width: 10%;"></td> <td style="width: 10%;"></td> <td style="width: 10%;"></td> <td style="width: 10%;"></td> <td style="width: 10%;"></td> <td style="width: 10%;"></td> <td style="width: 10%;"></td> </tr> <tr> <td></td> <td></td> <td colspan="8" style="text-align: center;"> <table border="1" style="width: 100%; border-collapse: collapse; text-align: center;"> <tr> <td style="width: 10%;"></td> <td style="width: 10%;"></td> <td style="width: 10%;"></td> <td style="width: 10%;"></td> <td style="width: 10%;"></td> <td style="width: 10%;"></td> <td style="width: 10%;"></td> <td style="width: 10%;"></td> <td style="width: 10%;"></td> <td style="width: 10%;"></td> </tr> <tr> <td></td> <td></td> <td colspan="8" style="text-align: center;"> <table border="1" style="width: 100%; border-collapse: collapse; text-align: center;"> <tr> <td style="width: 10%;"></td> <td style="width: 10%;"></td> <td style="width: 10%;"></td> <td style="width: 10%;"></td> <td style="width: 10%;"></td> <td style="width: 10%;"></td> <td style="width: 10%;"></td> <td style="width: 10%;"></td> <td style="width: 10%;"></td> <td style="width: 10%;"></td> </tr> <tr> <td></td> <td></td> <td colspan="8" style="text-align: center;"> <table border="1" style="width: 100%; border-collapse: collapse; text-align: center;"> <tr> <td style="width: 10%;"></td> <td style="width: 10%;"></td> <td style="width: 10%;"></td> <td style="width: 10%;"></td> <td style="width: 10%;"></td> <td style="width: 10%;"></td> <td style="width: 10%;"></td> <td style="width: 10%;"></td> <td style="width: 10%;"></td> <td style="width: 10%;"></td> </tr> <tr> <td></td> <td></td> <td colspan="8" style="text-align: center;"> <table border="1" style="width: 100%; border-collapse: collapse; text-align: center;"> <tr> <td style="width: 10%;"></td> <td style="width: 10%;"></td> <td style="width: 10%;"></td> <td style="width: 10%;"></td> <td style="width: 10%;"></td> <td style="width: 10%;"></td> <td style="width: 10%;"></td> <td style="width: 10%;"></td> <td style="width: 10%;"></td> <td style="width: 10%;"></td> </tr> <tr> <td></td> <td></td> <td colspan="8" style="text-align: center;"> <table border="1" style="width: 100%; border-collapse: collapse; text-align: center;"> <tr> <td style="width: 10%;"></td> <td style="width: 10%;"></td> <td style="width: 10%;"></td> <td style="width: 10%;"></td> <td style="width: 10%;"></td> <td style="width: 10%;"></td> <td style="width: 10%;"></td> <td style="width: 10%;"></td> <td style="width: 10%;"></td> <td style="width: 10%;"></td> </tr> <tr> <td></td> <td></td> <td colspan="8" style="text-align: center;"> <table border="1" style="width: 100%; border-collapse: collapse; text-align: center;"> <tr> <td style="width: 10%;"></td> <td style="width: 10%;"></td> <td style="width: 10%;"></td> <td style="width: 10%;"></td> <td style="width: 10%;"></td> <td style="width: 10%;"></td> <td style="width: 10%;"></td> <td style="width: 10%;"></td> <td style="width: 10%;"></td> <td style="width: 10%;"></td> </tr> <tr> <td></td> <td></td> <td colspan="8" style="text-align: center;"> <table border="1" style="width: 100%; border-collapse: collapse; text-align: center;"> <tr> <td style="width: 10%;"></td> <td style="width: 10%;"></td> <td style="width: 10%;"></td> <td style="width: 10%;"></td> <td style="width: 10%;"></td> <td style="width: 10%;"></td> <td style="width: 10%;"></td> <td style="width: 10%;"></td> <td style="width: 10%;"></td> <td style="width: 10%;"></td> </tr> <tr> <td></td> <td></td> <td colspan="8" style="text-align: center;"> <table border="1" style="width: 100%; border-collapse: collapse; text-align: center;"> <tr> <td style="width: 10%;"></td> <td style="width: 10%;"></td> <td style="width: 10%;"></td> <td style="width: 10%;"></td> <td style="width: 10%;"></td> <td style="width: 10%;"></td> <td style="width: 10%;"></td> <td style="width: 10%;"></td> <td style="width: 10%;"></td> <td style="width: 10%;"></td> </tr> <tr> <td></td> <td></td> <td colspan="8" style="text-align: center;"> <table border="1" style="width: 100%; border-collapse: collapse; text-align: center;"> <tr> <td style="width: 10%;"></td> <td style="width: 10%;"></td> <td style="width: 10%;"></td> <td style="width: 10%;"></td> <td style="width: 10%;"></td> <td style="width: 10%;"></td> <td style="width: 10%;"></td> <td style="width: 10%;"></td> <td style="width: 10%;"></td> <td style="width: 10%;"></td> </tr> <tr> <td></td> <td></td> <td colspan="8" style="text-align: center;"> <table border="1" style="width: 100%; border-collapse: collapse; text-align: center;"> <tr> </tr></table></td></tr></table></td></tr></table></td></tr></table></td></tr></table></td></tr></table></td></tr></table></td></tr></table></td></tr></table></td></tr></table></td></tr></table></td></tr></table></td></tr></table></td></tr></table></td></tr></table></td></tr></table></td></tr></table></td></tr></table></td></tr></table></td></tr></table></td></tr></table></td></tr></table></td></tr></table></td></tr></table></td></tr></table></td></tr></table></td></tr></table>
 | | | | | | | | | | | | | | | | | | | | <table border="1" style="width: 100%; border-collapse: collapse; text-align: center;"> <tr> <td style="width: 10%;"></td> <td style="width: 10%;"></td> <td style="width: 10%;"></td> <td style="width: 10%;"></td> <td style="width: 10%;"></td> <td style="width: 10%;"></td> <td style="width: 10%;"></td> <td style="width: 10%;"></td> <td style="width: 10%;"></td> <td style="width: 10%;"></td> </tr> <tr> <td></td> <td></td> <td colspan="8" style="text-align: center;"> <table border="1" style="width: 100%; border-collapse: collapse; text-align: center;"> <tr> <td style="width: 10%;"></td> <td style="width: 10%;"></td> <td style="width: 10%;"></td> <td style="width: 10%;"></td> <td style="width: 10%;"></td> <td style="width: 10%;"></td> <td style="width: 10%;"></td> <td style="width: 10%;"></td> <td style="width: 10%;"></td> <td style="width: 10%;"></td> </tr> <tr> <td></td> <td></td> <td colspan="8" style="text-align: center;"> <table border="1" style="width: 100%; border-collapse: collapse; text-align: center;"> <tr> <td style="width: 10%;"></td> <td style="width: 10%;"></td> <td style="width: 10%;"></td> <td style="width: 10%;"></td> <td style="width: 10%;"></td> <td style="width: 10%;"></td> <td style="width: 10%;"></td> <td style="width: 10%;"></td> <td style="width: 10%;"></td> <td style="width: 10%;"></td> </tr> <tr> <td></td> <td></td> <td colspan="8" style="text-align: center;"> <table border="1" style="width: 100%; border-collapse: collapse; text-align: center;"> <tr> <td style="width: 10%;"></td> <td style="width: 10%;"></td> <td style="width: 10%;"></td> <td style="width: 10%;"></td> <td style="width: 10%;"></td> <td style="width: 10%;"></td> <td style="width: 10%;"></td> <td style="width: 10%;"></td> <td style="width: 10%;"></td> <td style="width: 10%;"></td> </tr> <tr> <td></td> <td></td> <td colspan="8" style="text-align: center;"> <table border="1" style="width: 100%; border-collapse: collapse; text-align: center;"> <tr> <td style="width: 10%;"></td> <td style="width: 10%;"></td> <td style="width: 10%;"></td> <td style="width: 10%;"></td> <td style="width: 10%;"></td> <td style="width: 10%;"></td> <td style="width: 10%;"></td> <td style="width: 10%;"></td> <td style="width: 10%;"></td> <td style="width: 10%;"></td> </tr> <tr> <td></td> <td></td> <td colspan="8" style="text-align: center;"> <table border="1" style="width: 100%; border-collapse: collapse; text-align: center;"> <tr> <td style="width: 10%;"></td> <td style="width: 10%;"></td> <td style="width: 10%;"></td> <td style="width: 10%;"></td> <td style="width: 10%;"></td> <td style="width: 10%;"></td> <td style="width: 10%;"></td> <td style="width: 10%;"></td> <td style="width: 10%;"></td> <td
style="width: 10%;"></td> </tr> <tr> <td></td> <td></td> <td colspan="8" style="text-align: center;"> <table border="1" style="width: 100%; border-collapse: collapse; text-align: center;"> <tr> <td style="width: 10%;"></td> <td style="width: 10%;"></td> <td style="width: 10%;"></td> <td style="width: 10%;"></td> <td style="width: 10%;"></td> <td style="width: 10%;"></td> <td style="width: 10%;"></td> <td style="width: 10%;"></td> <td style="width: 10%;"></td> <td style="width: 10%;"></td> </tr> <tr> <td></td> <td></td> <td colspan="8" style="text-align: center;"> <table border="1" style="width: 100%; border-collapse: collapse; text-align: center;"> <tr> <td style="width: 10%;"></td> <td style="width: 10%;"></td> <td style="width: 10%;"></td> <td style="width: 10%;"></td> <td style="width: 10%;"></td> <td style="width: 10%;"></td> <td style="width: 10%;"></td> <td style="width: 10%;"></td> <td style="width: 10%;"></td> <td style="width: 10%;"></td> </tr> <tr> <td></td> <td></td> <td colspan="8" style="text-align: center;"> <table border="1" style="width: 100%; border-collapse: collapse; text-align: center;"> <tr> <td style="width: 10%;"></td> <td style="width: 10%;"></td> <td style="width: 10%;"></td> <td style="width: 10%;"></td> <td style="width: 10%;"></td> <td style="width: 10%;"></td> <td style="width: 10%;"></td> <td style="width: 10%;"></td> <td style="width: 10%;"></td> <td style="width: 10%;"></td> </tr> <tr> <td></td> <td></td> <td colspan="8" style="text-align: center;"> <table border="1" style="width: 100%; border-collapse: collapse; text-align: center;"> <tr> <td style="width: 10%;"></td> <td style="width: 10%;"></td> <td style="width: 10%;"></td> <td style="width: 10%;"></td> <td style="width: 10%;"></td> <td style="width: 10%;"></td> <td style="width: 10%;"></td> <td style="width: 10%;"></td> <td style="width: 10%;"></td> <td style="width: 10%;"></td> </tr> <tr> <td></td> <td></td> <td colspan="8" style="text-align: center;"> <table border="1" style="width: 100%; border-collapse: collapse; text-align: center;"> <tr> <td style="width: 10%;"></td> <td style="width: 10%;"></td> <td style="width: 10%;"></td> <td style="width: 10%;"></td> <td style="width: 10%;"></td> <td style="width: 10%;"></td> <td style="width: 10%;"></td> <td style="width: 10%;"></td> <td style="width: 10%;"></td> <td style="width: 10%;"></td> </tr> <tr> <td></td> <td></td> <td colspan="8" style="text-align: center;"> <table border="1" style="width: 100%; border-collapse: collapse; text-align: center;"> <tr> <td style="width: 10%;"></td> <td style="width: 10%;"></td> <td style="width: 10%;"></td> <td style="width: 10%;"></td> <td style="width: 10%;"></td> <td style="width: 10%;"></td> <td style="width: 10%;"></td> <td style="width: 10%;"></td> <td style="width: 10%;"></td> <td style="width: 10%;"></td> </tr> <tr> <td></td> <td></td> <td colspan="8" style="text-align: center;"> <table border="1" style="width: 100%; border-collapse: collapse; text-align: center;"> <tr> <td style="width: 10%;"></td> <td style="width: 10%;"></td> <td style="width: 10%;"></td> <td style="width: 10%;"></td> <td style="width: 10%;"></td> <td style="width: 10%;"></td> <td style="width: 10%;"></td> <td style="width: 10%;"></td> <td style="width: 10%;"></td> <td style="width: 10%;"></td> </tr> <tr> <td></td> <td></td> <td colspan="8" style="text-align: center;"> <table border="1" style="width: 100%; border-collapse: collapse; text-align: center;"> <tr> <td style="width: 10%;"></td> <td style="width: 10%;"></td> <td style="width: 10%;"></td> <td style="width: 10%;"></td> <td style="width: 10%;"></td> <td style="width: 10%;"></td> <td style="width: 10%;"></td> <td style="width: 10%;"></td> <td style="width: 10%;"></td> <td style="width: 10%;"></td> </tr> <tr> <td></td> <td></td> <td colspan="8" style="text-align: center;"> <table border="1" style="width: 100%; border-collapse: collapse; text-align: center;"> <tr> <td style="width: 10%;"></td> <td style="width: 10%;"></td> <td style="width: 10%;"></td> <td style="width: 10%;"></td> <td style="width: 10%;"></td> <td style="width: 10%;"></td> <td style="width: 10%;"></td> <td style="width: 10%;"></td> <td style="width: 10%;"></td> <td style="width: 10%;"></td> </tr> <tr> <td></td> <td></td> <td colspan="8" style="text-align: center;"> <table border="1" style="width: 100%; border-collapse: collapse; text-align: center;"> <tr> <td style="width: 10%;"></td> <td style="width: 10%;"></td> <td style="width: 10%;"></td> <td style="width: 10%;"></td> <td style="width: 10%;"></td> <td style="width: 10%;"></td> <td style="width: 10%;"></td> <td style="width: 10%;"></td> <td style="width: 10%;"></td> <td style="width: 10%;"></td> </tr> <tr> <td></td> <td></td> <td colspan="8" style="text-align: center;"> <table border="1" style="width: 100%; border-collapse: collapse; text-align: center;"> <tr> <td style="width: 10%;"></td> <td style="width: 10%;"></td> <td style="width: 10%;"></td> <td style="width: 10%;"></td> <td style="width: 10%;"></td> <td style="width: 10%;"></td> <td style="width: 10%;"></td> <td style="width: 10%;"></td> <td style="width: 10%;"></td> <td style="width: 10%;"></td> </tr> <tr> <td></td> <td></td> <td colspan="8" style="text-align: center;"> <table border="1" style="width: 100%; border-collapse: collapse; text-align: center;"> <tr> <td style="width: 10%;"></td> <td style="width: 10%;"></td> <td style="width: 10%;"></td> <td style="width: 10%;"></td> <td style="width: 10%;"></td> <td style="width: 10%;"></td> <td style="width: 10%;"></td> <td style="width: 10%;"></td> <td style="width: 10%;"></td> <td style="width: 10%;"></td> </tr> <tr> <td></td> <td></td> <td colspan="8" style="text-align: center;"> <table border="1" style="width: 100%; border-collapse: collapse; text-align: center;"> <tr> <td style="width: 10%;"></td> <td style="width: 10%;"></td> <td style="width: 10%;"></td> <td style="width: 10%;"></td> <td style="width: 10%;"></td> <td style="width: 10%;"></td> <td style="width: 10%;"></td> <td style="width: 10%;"></td> <td style="width: 10%;"></td> <td style="width: 10%;"></td> </tr> <tr> <td></td> <td></td> <td colspan="8" style="text-align: center;"> <table border="1" style="width: 100%; border-collapse: collapse; text-align: center;"> <tr> <td style="width: 10%;"></td> <td style="width: 10%;"></td> <td style="width: 10%;"></td> <td style="width: 10%;"></td> <td style="width: 10%;"></td> <td style="width: 10%;"></td> <td style="width: 10%;"></td> <td style="width: 10%;"></td> <td style="width: 10%;"></td> <td style="width: 10%;"></td> </tr> <tr> <td></td> <td></td> <td colspan="8" style="text-align: center;"> <table border="1" style="width: 100%; border-collapse: collapse; text-align: center;"> <tr> <td style="width: 10%;"></td> <td style="width: 10%;"></td> <td style="width: 10%;"></td> <td style="width: 10%;"></td> <td style="width: 10%;"></td> <td style="width: 10%;"></td> <td style="width: 10%;"></td> <td style="width: 10%;"></td> <td style="width: 10%;"></td> <td style="width: 10%;"></td> </tr> <tr> <td></td> <td></td> <td colspan="8" style="text-align: center;"> <table border="1" style="width: 100%; border-collapse: collapse; text-align: center;"> <tr> <td style="width: 10%;"></td> <td style="width: 10%;"></td> <td style="width: 10%;"></td> <td style="width: 10%;"></td> <td style="width: 10%;"></td> <td style="width: 10%;"></td> <td style="width: 10%;"></td> <td style="width: 10%;"></td> <td style="width: 10%;"></td> <td style="width: 10%;"></td> </tr> <tr> <td></td> <td></td> <td colspan="8" style="text-align: center;"> <table border="1" style="width: 100%; border-collapse: collapse; text-align: center;"> <tr> <td style="width: 10%;"></td> <td style="width: 10%;"></td> <td style="width: 10%;"></td> <td style="width: 10%;"></td> <td style="width: 10%;"></td> <td style="width: 10%;"></td> <td style="width: 10%;"></td> <td style="width: 10%;"></td> <td style="width: 10%;"></td> <td style="width: 10%;"></td> </tr> <tr> <td></td> <td></td> <td colspan="8" style="text-align: center;"> <table border="1" style="width: 100%; border-collapse: collapse; text-align: center;"> <tr> <td style="width: 10%;"></td> <td style="width: 10%;"></td> <td style="width: 10%;"></td> <td style="width: 10%;"></td> <td style="width: 10%;"></td> <td style="width: 10%;"></td> <td style="width: 10%;"></td> <td style="width: 10%;"></td> <td style="width: 10%;"></td> <td style="width: 10%;"></td> </tr> <tr> <td></td> <td></td> <td colspan="8" style="text-align: center;"> <table border="1" style="width: 100%; border-collapse: collapse; text-align: center;"> <tr> <td style="width: 10%;"></td> <td style="width: 10%;"></td> <td style="width: 10%;"></td> <td style="width: 10%;"></td> <td style="width: 10%;"></td> <td style="width: 10%;"></td> <td style="width: 10%;"></td> <td style="width: 10%;"></td> <td style="width: 10%;"></td> <td style="width: 10%;"></td> </tr> <tr> <td></td> <td></td> <td colspan="8" style="text-align: center;"> <table border="1" style="width: 100%; border-collapse: collapse; text-align: center;"> <tr> </tr></table></td></tr></table></td></tr></table></td></tr></table></td></tr></table></td></tr></table></td></tr></table></td></tr></table></td></tr></table></td></tr></table></td></tr></table></td></tr></table></td></tr></table></td></tr></table></td></tr></table></td></tr></table></td></tr></table></td></tr></table></td></tr></table></td></tr></table></td></tr></table></td></tr></table></td></tr></table></td></tr></table></td></tr></table></td></tr></table>
 | | | | | | | | | | | | | | | | | | | | <table border="1" style="width: 100%; border-collapse: collapse; text-align: center;"> <tr> <td style="width: 10%;"></td> <td style="width: 10%;"></td> <td style="width: 10%;"></td> <td style="width: 10%;"></td> <td style="width: 10%;"></td> <td style="width: 10%;"></td> <td style="width: 10%;"></td> <td style="width: 10%;"></td> <td style="width: 10%;"></td> <td style="width: 10%;"></td> </tr> <tr> <td></td> <td></td> <td colspan="8" style="text-align: center;"> <table border="1" style="width: 100%; border-collapse: collapse; text-align: center;"> <tr> <td style="width: 10%;"></td> <td style="width: 10%;"></td> <td style="width: 10%;"></td> <td style="width: 10%;"></td> <td style="width: 10%;"></td> <td style="width: 10%;"></td> <td style="width: 10%;"></td> <td style="width: 10%;"></td> <td style="width: 10%;"></td> <td style="width: 10%;"></td> </tr> <tr> <td></td> <td></td> <td colspan="8" style="text-align: center;"> <table border="1" style="width: 100%; border-collapse: collapse; text-align: center;"> <tr> <td style="width: 10%;"></td> <td style="width: 10%;"></td> <td style="width: 10%;"></td> <td style="width: 10%;"></td> <td style="width: 10%;"></td> <td style="width: 10%;"></td> <td style="width: 10%;"></td> <td style="width: 10%;"></td> <td style="width: 10%;"></td> <td style="width: 10%;"></td> </tr> <tr> <td></td> <td></td> <td colspan="8" style="text-align: center;"> <table border="1" style="width: 100%; border-collapse: collapse; text-align: center;"> <tr> <td style="width: 10%;"></td> <td style="width: 10%;"></td> <td style="width: 10%;"></td> <td style="width: 10%;"></td> <td style="width: 10%;"></td> <td style="width: 10%;"></td> <td style="width: 10%;"></td> <td style="width: 10%;"></td> <td style="width: 10%;"></td> <td style="width: 10%;"></td> </tr> <tr> <td></td> <td></td> <td colspan="8" style="text-align: center;"> <table border="1" style="width: 100%; border-collapse: collapse; text-align: center;"> <tr> <td style="width: 10%;"></td> <td style="width: 10%;"></td> <td style="width: 10%;"></td> <td style="width: 10%;"></td> <td style="width: 10%;"></td> <td style="width: 10%;"></td> <td style="width: 10%;"></td> <td style="width: 10%;"></td> <td style="width: 10%;"></td> <td style="width: 10%;"></td> </tr> <tr> <td></td> <td></td> <td colspan="8" style="text-align: center;"> <table border="1" style="width: 100%; border-collapse: collapse; text-align: center;"> <tr> <td style="width: 10%;"></td> <td style="width: 10%;"></td> <td style="width: 10%;"></td> <td style="width: 10%;"></td> <td style="width: 10%;"></td> <td style="width: 10%;"></td> <td style="width: 10%;"></td> <td style="width: 10%;"></td> <td style="width: 10%;"></td> <td style="width: 10%;"></td> </tr> <tr> <td></td> <td></td> <td colspan="8" style="text-align: center;"> <table border="1" style="width: 100%; border-collapse: collapse; text-align: center;"> <tr> <td style="width: 10%;"></td> <td style="width: 10%;"></td> <td style="width: 10%;"></td> <td style="width: 10%;"></td> <td style="width: 10%;"></td> <td style="width: 10%;"></td> <td style="width:
10%;"></td> <td style="width: 10%;"></td> <td style="width: 10%;"></td> <td style="width: 10%;"></td> </tr> <tr> <td></td> <td></td> <td colspan="8" style="text-align: center;"> <table border="1" style="width: 100%; border-collapse: collapse; text-align: center;"> <tr> <td style="width: 10%;"></td> <td style="width: 10%;"></td> <td style="width: 10%;"></td> <td style="width: 10%;"></td> <td style="width: 10%;"></td> <td style="width: 10%;"></td> <td style="width: 10%;"></td> <td style="width: 10%;"></td> <td style="width: 10%;"></td> <td style="width: 10%;"></td> </tr> <tr> <td></td> <td></td> <td colspan="8" style="text-align: center;"> <table border="1" style="width: 100%; border-collapse: collapse; text-align: center;"> <tr> <td style="width: 10%;"></td> <td style="width: 10%;"></td> <td style="width: 10%;"></td> <td style="width: 10%;"></td> <td style="width: 10%;"></td> <td style="width: 10%;"></td> <td style="width: 10%;"></td> <td style="width: 10%;"></td> <td style="width: 10%;"></td> <td style="width: 10%;"></td> </tr> <tr> <td></td> <td></td> <td colspan="8" style="text-align: center;"> <table border="1" style="width: 100%; border-collapse: collapse; text-align: center;"> <tr> <td style="width: 10%;"></td> <td style="width: 10%;"></td> <td style="width: 10%;"></td> <td style="width: 10%;"></td> <td style="width: 10%;"></td> <td style="width: 10%;"></td> <td style="width: 10%;"></td> <td style="width: 10%;"></td> <td style="width: 10%;"></td> <td style="width: 10%;"></td> </tr> <tr> <td></td> <td></td> <td colspan="8" style="text-align: center;"> <table border="1" style="width: 100%; border-collapse: collapse; text-align: center;"> <tr> <td style="width: 10%;"></td> <td style="width: 10%;"></td> <td style="width: 10%;"></td> <td style="width: 10%;"></td> <td style="width: 10%;"></td> <td style="width: 10%;"></td> <td style="width: 10%;"></td> <td style="width: 10%;"></td> <td style="width: 10%;"></td> <td style="width: 10%;"></td> </tr> <tr> <td></td> <td></td> <td colspan="8" style="text-align: center;"> <table border="1" style="width: 100%; border-collapse: collapse; text-align: center;"> <tr> <td style="width: 10%;"></td> <td style="width: 10%;"></td> <td style="width: 10%;"></td> <td style="width: 10%;"></td> <td style="width: 10%;"></td> <td style="width: 10%;"></td> <td style="width: 10%;"></td> <td style="width: 10%;"></td> <td style="width: 10%;"></td> <td style="width: 10%;"></td> </tr> <tr> <td></td> <td></td> <td colspan="8" style="text-align: center;"> <table border="1" style="width: 100%; border-collapse: collapse; text-align: center;"> <tr> <td style="width: 10%;"></td> <td style="width: 10%;"></td> <td style="width: 10%;"></td> <td style="width: 10%;"></td> <td style="width: 10%;"></td> <td style="width: 10%;"></td> <td style="width: 10%;"></td> <td style="width: 10%;"></td> <td style="width: 10%;"></td> <td style="width: 10%;"></td> </tr> <tr> <td></td> <td></td> <td colspan="8" style="text-align: center;"> <table border="1" style="width: 100%; border-collapse: collapse; text-align: center;"> <tr> <td style="width: 10%;"></td> <td style="width: 10%;"></td> <td style="width: 10%;"></td> <td style="width: 10%;"></td> <td style="width: 10%;"></td> <td style="width: 10%;"></td> <td style="width: 10%;"></td> <td style="width: 10%;"></td> <td style="width: 10%;"></td> <td style="width: 10%;"></td> </tr> <tr> <td></td> <td></td> <td colspan="8" style="text-align: center;"> <table border="1" style="width: 100%; border-collapse: collapse; text-align: center;"> <tr> <td style="width: 10%;"></td> <td style="width: 10%;"></td> <td style="width: 10%;"></td> <td style="width: 10%;"></td> <td style="width: 10%;"></td> <td style="width: 10%;"></td> <td style="width: 10%;"></td> <td style="width: 10%;"></td> <td style="width: 10%;"></td> <td style="width: 10%;"></td> </tr> <tr> <td></td> <td></td> <td colspan="8" style="text-align: center;"> <table border="1" style="width: 100%; border-collapse: collapse; text-align: center;"> <tr> <td style="width: 10%;"></td> <td style="width: 10%;"></td> <td style="width: 10%;"></td> <td style="width: 10%;"></td> <td style="width: 10%;"></td> <td style="width: 10%;"></td> <td style="width: 10%;"></td> <td style="width: 10%;"></td> <td style="width: 10%;"></td> <td style="width: 10%;"></td> </tr> <tr> <td></td> <td></td> <td colspan="8" style="text-align: center;"> <table border="1" style="width: 100%; border-collapse: collapse; text-align: center;"> <tr> <td style="width: 10%;"></td> <td style="width: 10%;"></td> <td style="width: 10%;"></td> <td style="width: 10%;"></td> <td style="width: 10%;"></td> <td style="width: 10%;"></td> <td style="width: 10%;"></td> <td style="width: 10%;"></td> <td style="width: 10%;"></td> <td style="width: 10%;"></td> </tr> <tr> <td></td> <td></td> <td colspan="8" style="text-align: center;"> <table border="1" style="width: 100%; border-collapse: collapse; text-align: center;"> <tr> <td style="width: 10%;"></td> <td style="width: 10%;"></td> <td style="width: 10%;"></td> <td style="width: 10%;"></td> <td style="width: 10%;"></td> <td style="width: 10%;"></td> <td style="width: 10%;"></td> <td style="width: 10%;"></td> <td style="width: 10%;"></td> <td style="width: 10%;"></td> </tr> <tr> <td></td> <td></td> <td colspan="8" style="text-align: center;"> <table border="1" style="width: 100%; border-collapse: collapse; text-align: center;"> <tr> <td style="width: 10%;"></td> <td style="width: 10%;"></td> <td style="width: 10%;"></td> <td style="width: 10%;"></td> <td style="width: 10%;"></td> <td style="width: 10%;"></td> <td style="width: 10%;"></td> <td style="width: 10%;"></td> <td style="width: 10%;"></td> <td style="width: 10%;"></td> </tr> <tr> <td></td> <td></td> <td colspan="8" style="text-align: center;"> <table border="1" style="width: 100%; border-collapse: collapse; text-align: center;"> <tr> <td style="width: 10%;"></td> <td style="width: 10%;"></td> <td style="width: 10%;"></td> <td style="width: 10%;"></td> <td style="width: 10%;"></td> <td style="width: 10%;"></td> <td style="width: 10%;"></td> <td style="width: 10%;"></td> <td style="width: 10%;"></td> <td style="width: 10%;"></td> </tr> <tr> <td></td> <td></td> <td colspan="8" style="text-align: center;"> <table border="1" style="width: 100%; border-collapse: collapse; text-align: center;"> <tr> <td style="width: 10%;"></td> <td style="width: 10%;"></td> <td style="width: 10%;"></td> <td style="width: 10%;"></td> <td style="width: 10%;"></td> <td style="width: 10%;"></td> <td style="width: 10%;"></td> <td style="width: 10%;"></td> <td style="width: 10%;"></td> <td style="width: 10%;"></td> </tr> <tr> <td></td> <td></td> <td colspan="8" style="text-align: center;"> <table border="1" style="width: 100%; border-collapse: collapse; text-align: center;"> <tr> <td style="width: 10%;"></td> <td style="width: 10%;"></td> <td style="width: 10%;"></td> <td style="width: 10%;"></td> <td style="width: 10%;"></td> <td style="width: 10%;"></td> <td style="width: 10%;"></td> <td style="width: 10%;"></td> <td style="width: 10%;"></td> <td style="width: 10%;"></td> </tr> <tr> <td></td> <td></td> <td colspan="8" style="text-align: center;"> <table border="1" style="width: 100%; border-collapse: collapse; text-align: center;"> <tr> <td style="width: 10%;"></td> <td style="width: 10%;"></td> <td style="width: 10%;"></td> <td style="width: 10%;"></td> <td style="width: 10%;"></td> <td style="width: 10%;"></td> <td style="width: 10%;"></td> <td style="width: 10%;"></td> <td style="width: 10%;"></td> <td style="width: 10%;"></td> </tr> <tr> <td></td> <td></td> <td colspan="8" style="text-align: center;"> <table border="1" style="width: 100%; border-collapse: collapse; text-align: center;"> <tr> <td style="width: 10%;"></td> <td style="width: 10%;"></td> <td style="width: 10%;"></td> <td style="width: 10%;"></td> <td style="width: 10%;"></td> <td style="width: 10%;"></td> <td style="width: 10%;"></td> <td style="width: 10%;"></td> <td style="width: 10%;"></td> <td style="width: 10%;"></td> </tr> <tr> <td></td> <td></td> <td colspan="8" style="text-align: center;"> <table border="1" style="width: 100%; border-collapse: collapse; text-align: center;"> <tr> </tr></table></td></tr></table></td></tr></table></td></tr></table></td></tr></table></td></tr></table></td></tr></table></td></tr></table></td></tr></table></td></tr></table></td></tr></table></td></tr></table></td></tr></table></td></tr></table></td></tr></table></td></tr></table></td></tr></table></td></tr></table></td></tr></table></td></tr></table></td></tr></table></td></tr></table></td></tr></table></td></tr></table></td></tr></table>
 | | | | | | | | | | | | | | | | | | | | <table border="1" style="width: 100%; border-collapse: collapse; text-align: center;"> <tr> <td style="width: 10%;"></td> <td style="width: 10%;"></td> <td style="width: 10%;"></td> <td style="width: 10%;"></td> <td style="width: 10%;"></td> <td style="width: 10%;"></td> <td style="width: 10%;"></td> <td style="width: 10%;"></td> <td style="width: 10%;"></td> <td style="width: 10%;"></td> </tr> <tr> <td></td> <td></td> <td colspan="8" style="text-align: center;"> <table border="1" style="width: 100%; border-collapse: collapse; text-align: center;"> <tr> <td style="width: 10%;"></td> <td style="width: 10%;"></td> <td style="width: 10%;"></td> <td style="width: 10%;"></td> <td style="width: 10%;"></td> <td style="width: 10%;"></td> <td style="width: 10%;"></td> <td style="width: 10%;"></td> <td style="width: 10%;"></td> <td style="width: 10%;"></td> </tr> <tr> <td></td> <td></td> <td colspan="8" style="text-align: center;"> <table border="1" style="width: 100%; border-collapse: collapse; text-align: center;"> <tr> <td style="width: 10%;"></td> <td style="width: 10%;"></td> <td style="width: 10%;"></td> <td style="width: 10%;"></td> <td style="width: 10%;"></td> <td style="width: 10%;"></td> <td style="width: 10%;"></td> <td style="width: 10%;"></td> <td style="width: 10%;"></td> <td style="width: 10%;"></td> </tr> <tr> <td></td> <td></td> <td colspan="8" style="text-align: center;"> <table border="1" style="width: 100%; border-collapse: collapse; text-align: center;"> <tr> <td style="width: 10%;"></td> <td style="width: 10%;"></td> <td style="width: 10%;"></td> <td style="width: 10%;"></td> <td style="width: 10%;"></td> <td style="width: 10%;"></td> <td style="width: 10%;"></td> <td style="width: 10%;"></td> <td style="width: 10%;"></td> <td style="width: 10%;"></td> </tr> <tr> <td></td> <td></td> <td colspan="8" style="text-align: center;"> <table border="1" style="width: 100%; border-collapse: collapse; text-align: center;"> <tr> <td style="width: 10%;"></td> <td style="width: 10%;"></td> <td style="width: 10%;"></td> <td style="width: 10%;"></td> <td style="width: 10%;"></td> <td style="width: 10%;"></td> <td style="width: 10%;"></td> <td style="width: 10%;"></td> <td style="width: 10%;"></td> <td style="width: 10%;"></td> </tr> <tr> <td></td> <td></td> <td colspan="8" style="text-align: center;"> <table border="1" style="width: 100%; border-collapse: collapse; text-align: center;"> <tr> <td style="width: 10%;"></td> <td style="width: 10%;"></td> <td style="width: 10%;"></td> <td style="width: 10%;"></td> <td style="width: 10%;"></td> <td style="width: 10%;"></td> <td style="width: 10%;"></td> <td style="width: 10%;"></td> <td style="width: 10%;"></td> <td style="width: 10%;"></td> </tr> <tr> <td></td> <td></td> <td colspan="8" style="text-align: center;"> <table border="1" style="width: 100%; border-collapse: collapse; text-align: center;"> <tr> <td style="width: 10%;"></td> <td style="width: 10%;"></td> <td style="width: 10%;"></td> <td style="width: 10%;"></td> <td style="width: 10%;"></td> <td style="width: 10%;"></td> <td style="width: 10%;"></td> <td style="width: 10%;"></td> <td style="width: 10%;"></td> <td style="width: 10%;"></td> </tr> <tr> <td></td> <td></td> <td colspan="8" style="text-align: center;"> <table border="1" style="width: 100%; border-collapse: collapse; text-align: center;"> <tr> <td style="width: 10%;"></td> <td style="width: 10%;"></td> <td style="width: 10%;"></td> <td style="width: 10%;"></td> <td style="width: 10%;"></td> <td style="width: 10%;"></td> <td style="width: 10%;"></td> <td style="width: 10%;"></td> <td style="width: 10%;"></td> <td style="width: 10%;"></td> </tr> <tr> <td></td> <td></td> <td colspan="8" style="text-align: center;"> <table border="1" style="width: 100%; border-collapse: collapse; text-align: center;"> <tr> <td style="width: 10%;"></td> <td style="width: 10%;"></td> <td style="width: 10%;"></td> <td style="width: 10%;"></td> <td style="width:
10%;"></td> <td style="width: 10%;"></td> <td style="width: 10%;"></td> <td style="width: 10%;"></td> <td style="width: 10%;"></td> <td style="width: 10%;"></td> </tr> <tr> <td></td> <td></td> <td colspan="8" style="text-align: center;"> <table border="1" style="width: 100%; border-collapse: collapse; text-align: center;"> <tr> <td style="width: 10%;"></td> <td style="width: 10%;"></td> <td style="width: 10%;"></td> <td style="width: 10%;"></td> <td style="width: 10%;"></td> <td style="width: 10%;"></td> <td style="width: 10%;"></td> <td style="width: 10%;"></td> <td style="width: 10%;"></td> <td style="width: 10%;"></td> </tr> <tr> <td></td> <td></td> <td colspan="8" style="text-align: center;"> <table border="1" style="width: 100%; border-collapse: collapse; text-align: center;"> <tr> <td style="width: 10%;"></td> <td style="width: 10%;"></td> <td style="width: 10%;"></td> <td style="width: 10%;"></td> <td style="width: 10%;"></td> <td style="width: 10%;"></td> <td style="width: 10%;"></td> <td style="width: 10%;"></td> <td style="width: 10%;"></td> <td style="width: 10%;"></td> </tr> <tr> <td></td> <td></td> <td colspan="8" style="text-align: center;"> <table border="1" style="width: 100%; border-collapse: collapse; text-align: center;"> <tr> <td style="width: 10%;"></td> <td style="width: 10%;"></td> <td style="width: 10%;"></td> <td style="width: 10%;"></td> <td style="width: 10%;"></td> <td style="width: 10%;"></td> <td style="width: 10%;"></td> <td style="width: 10%;"></td> <td style="width: 10%;"></td> <td style="width: 10%;"></td> </tr> <tr> <td></td> <td></td> <td colspan="8" style="text-align: center;"> <table border="1" style="width: 100%; border-collapse: collapse; text-align: center;"> <tr> <td style="width: 10%;"></td> <td style="width: 10%;"></td> <td style="width: 10%;"></td> <td style="width: 10%;"></td> <td style="width: 10%;"></td> <td style="width: 10%;"></td> <td style="width: 10%;"></td> <td style="width: 10%;"></td> <td style="width: 10%;"></td> <td style="width: 10%;"></td> </tr> <tr> <td></td> <td></td> <td colspan="8" style="text-align: center;"> <table border="1" style="width: 100%; border-collapse: collapse; text-align: center;"> <tr> <td style="width: 10%;"></td> <td style="width: 10%;"></td> <td style="width: 10%;"></td> <td style="width: 10%;"></td> <td style="width: 10%;"></td> <td style="width: 10%;"></td> <td style="width: 10%;"></td> <td style="width: 10%;"></td> <td style="width: 10%;"></td> <td style="width: 10%;"></td> </tr> <tr> <td></td> <td></td> <td colspan="8" style="text-align: center;"> <table border="1" style="width: 100%; border-collapse: collapse; text-align: center;"> <tr> <td style="width: 10%;"></td> <td style="width: 10%;"></td> <td style="width: 10%;"></td> <td style="width: 10%;"></td> <td style="width: 10%;"></td> <td style="width: 10%;"></td> <td style="width: 10%;"></td> <td style="width: 10%;"></td> <td style="width: 10%;"></td> <td style="width: 10%;"></td> </tr> <tr> <td></td> <td></td> <td colspan="8" style="text-align: center;"> <table border="1" style="width: 100%; border-collapse: collapse; text-align: center;"> <tr> <td style="width: 10%;"></td> <td style="width: 10%;"></td> <td style="width: 10%;"></td> <td style="width: 10%;"></td> <td style="width: 10%;"></td> <td style="width: 10%;"></td> <td style="width: 10%;"></td> <td style="width: 10%;"></td> <td style="width: 10%;"></td> <td style="width: 10%;"></td> </tr> <tr> <td></td> <td></td> <td colspan="8" style="text-align: center;"> <table border="1" style="width: 100%; border-collapse: collapse; text-align: center;"> <tr> <td style="width: 10%;"></td> <td style="width: 10%;"></td> <td style="width: 10%;"></td> <td style="width: 10%;"></td> <td style="width: 10%;"></td> <td style="width: 10%;"></td> <td style="width: 10%;"></td> <td style="width: 10%;"></td> <td style="width: 10%;"></td> <td style="width: 10%;"></td> </tr> <tr> <td></td> <td></td> <td colspan="8" style="text-align: center;"> <table border="1" style="width: 100%; border-collapse: collapse; text-align: center;"> <tr> <td style="width: 10%;"></td> <td style="width: 10%;"></td> <td style="width: 10%;"></td> <td style="width: 10%;"></td> <td style="width: 10%;"></td> <td style="width: 10%;"></td> <td style="width: 10%;"></td> <td style="width: 10%;"></td> <td style="width: 10%;"></td> <td style="width: 10%;"></td> </tr> <tr> <td></td> <td></td> <td colspan="8" style="text-align: center;"> <table border="1" style="width: 100%; border-collapse: collapse; text-align: center;"> <tr> <td style="width: 10%;"></td> <td style="width: 10%;"></td> <td style="width: 10%;"></td> <td style="width: 10%;"></td> <td style="width: 10%;"></td> <td style="width: 10%;"></td> <td style="width: 10%;"></td> <td style="width: 10%;"></td> <td style="width: 10%;"></td> <td style="width: 10%;"></td> </tr> <tr> <td></td> <td></td> <td colspan="8" style="text-align: center;"> <table border="1" style="width: 100%; border-collapse: collapse; text-align: center;"> <tr> <td style="width: 10%;"></td> <td style="width: 10%;"></td> <td style="width: 10%;"></td> <td style="width: 10%;"></td> <td style="width: 10%;"></td> <td style="width: 10%;"></td> <td style="width: 10%;"></td> <td style="width: 10%;"></td> <td style="width: 10%;"></td> <td style="width: 10%;"></td> </tr> <tr> <td></td> <td></td> <td colspan="8" style="text-align: center;"> <table border="1" style="width: 100%; border-collapse: collapse; text-align: center;"> <tr> <td style="width: 10%;"></td> <td style="width: 10%;"></td> <td style="width: 10%;"></td> <td style="width: 10%;"></td> <td style="width: 10%;"></td> <td style="width: 10%;"></td> <td style="width: 10%;"></td> <td style="width: 10%;"></td> <td style="width: 10%;"></td> <td style="width: 10%;"></td> </tr> <tr> <td></td> <td></td> <td colspan="8" style="text-align: center;"> <table border="1" style="width: 100%; border-collapse: collapse; text-align: center;"> <tr> <td style="width: 10%;"></td> <td style="width: 10%;"></td> <td style="width: 10%;"></td> <td style="width: 10%;"></td> <td style="width: 10%;"></td> <td style="width: 10%;"></td> <td style="width: 10%;"></td> <td style="width: 10%;"></td> <td style="width: 10%;"></td> <td style="width: 10%;"></td> </tr> <tr> <td></td> <td></td> <td colspan="8" style="text-align: center;"> <table border="1" style="width: 100%; border-collapse: collapse; text-align: center;"> <tr> <td style="width: 10%;"></td> <td style="width: 10%;"></td> <td style="width: 10%;"></td> <td style="width: 10%;"></td> <td style="width: 10%;"></td> <td style="width: 10%;"></td> <td style="width: 10%;"></td> <td style="width: 10%;"></td> <td style="width: 10%;"></td> <td style="width: 10%;"></td> </tr> <tr> <td></td> <td></td> <td colspan="8" style="text-align: center;"> <table border="1" style="width: 100%; border-collapse: collapse; text-align: center;"> <tr> </tr></table></td></tr></table></td></tr></table></td></tr></table></td></tr></table></td></tr></table></td></tr></table></td></tr></table></td></tr></table></td></tr></table></td></tr></table></td></tr></table></td></tr></table></td></tr></table></td></tr></table></td></tr></table></td></tr></table></td></tr></table></td></tr></table></td></tr></table></td></tr></table></td></tr></table></td></tr></table></td></tr></table>
 | | | | | | | | | | | | | | | | | | | | <table border="1" style="width: 100%; border-collapse: collapse; text-align: center;"> <tr> <td style="width: 10%;"></td> <td style="width: 10%;"></td> <td style="width: 10%;"></td> <td style="width: 10%;"></td> <td style="width: 10%;"></td> <td style="width: 10%;"></td> <td style="width: 10%;"></td> <td style="width: 10%;"></td> <td style="width: 10%;"></td> <td style="width: 10%;"></td> </tr> <tr> <td></td> <td></td> <td colspan="8" style="text-align: center;"> <table border="1" style="width: 100%; border-collapse: collapse; text-align: center;"> <tr> <td style="width: 10%;"></td> <td style="width: 10%;"></td> <td style="width: 10%;"></td> <td style="width: 10%;"></td> <td style="width: 10%;"></td> <td style="width: 10%;"></td> <td style="width: 10%;"></td> <td style="width: 10%;"></td> <td style="width: 10%;"></td> <td style="width: 10%;"></td> </tr> <tr> <td></td> <td></td> <td colspan="8" style="text-align: center;"> <table border="1" style="width: 100%; border-collapse: collapse; text-align: center;"> <tr> <td style="width: 10%;"></td> <td style="width: 10%;"></td> <td style="width: 10%;"></td> <td style="width: 10%;"></td> <td style="width: 10%;"></td> <td style="width: 10%;"></td> <td style="width: 10%;"></td> <td style="width: 10%;"></td> <td style="width: 10%;"></td> <td style="width: 10%;"></td> </tr> <tr> <td></td> <td></td> <td colspan="8" style="text-align: center;"> <table border="1" style="width: 100%; border-collapse: collapse; text-align: center;"> <tr> <td style="width: 10%;"></td> <td style="width: 10%;"></td> <td style="width: 10%;"></td> <td style="width: 10%;"></td> <td style="width: 10%;"></td> <td style="width: 10%;"></td> <td style="width: 10%;"></td> <td style="width: 10%;"></td> <td style="width: 10%;"></td> <td style="width: 10%;"></td> </tr> <tr> <td></td> <td></td> <td colspan="8" style="text-align: center;"> <table border="1" style="width: 100%; border-collapse: collapse; text-align: center;"> <tr> <td style="width: 10%;"></td> <td style="width: 10%;"></td> <td style="width: 10%;"></td> <td style="width: 10%;"></td> <td style="width: 10%;"></td> <td style="width: 10%;"></td> <td style="width: 10%;"></td> <td style="width: 10%;"></td> <td style="width: 10%;"></td> <td style="width: 10%;"></td> </tr> <tr> <td></td> <td></td> <td colspan="8" style="text-align: center;"> <table border="1" style="width: 100%; border-collapse: collapse; text-align: center;"> <tr> <td style="width: 10%;"></td> <td style="width: 10%;"></td> <td style="width: 10%;"></td> <td style="width: 10%;"></td> <td style="width: 10%;"></td> <td style="width: 10%;"></td> <td style="width: 10%;"></td> <td style="width: 10%;"></td> <td style="width: 10%;"></td> <td style="width: 10%;"></td> </tr> <tr> <td></td> <td></td> <td colspan="8" style="text-align: center;"> <table border="1" style="width: 100%; border-collapse: collapse; text-align: center;"> <tr> <td style="width: 10%;"></td> <td style="width: 10%;"></td> <td style="width: 10%;"></td> <td style="width: 10%;"></td> <td style="width: 10%;"></td> <td style="width: 10%;"></td> <td style="width: 10%;"></td> <td style="width: 10%;"></td> <td style="width: 10%;"></td> <td style="width: 10%;"></td> </tr> <tr> <td></td> <td></td> <td colspan="8" style="text-align: center;"> <table border="1" style="width: 100%; border-collapse: collapse; text-align: center;"> <tr> <td style="width: 10%;"></td> <td style="width: 10%;"></td> <td style="width: 10%;"></td> <td style="width: 10%;"></td> <td style="width: 10%;"></td> <td style="width: 10%;"></td> <td style="width: 10%;"></td> <td style="width: 10%;"></td> <td style="width: 10%;"></td> <td style="width: 10%;"></td> </tr> <tr> <td></td> <td></td> <td colspan="8" style="text-align: center;"> <table border="1" style="width: 100%; border-collapse: collapse; text-align: center;"> <tr> <td style="width: 10%;"></td> <td style="width: 10%;"></td> <td style="width: 10%;"></td> <td style="width: 10%;"></td> <td style="width: 10%;"></td> <td style="width: 10%;"></td> <td style="width: 10%;"></td> <td style="width: 10%;"></td> <td style="width: 10%;"></td> <td style="width: 10%;"></td> </tr> <tr> <td></td> <td></td> <td colspan="8" style="text-align: center;"> <table border="1" style="width: 100%; border-collapse: collapse; text-align: center;"> <tr> <td style="width: 10%;"></td> <td style="width: 10%;"></td> <td style="width: 10%;"></td> <td style="width: 10%;"></td> <td style="width: 10%;"></td> <td style="width: 10%;"></td> <td style="width: 10%;"></td> <td style="width: 10%;"></td> <td style="width: 10%;"></td> <td style="width: 10%;"></td> </tr> <tr> <td></td> <td></td> <td colspan="8" style="text-align: center;"> <table border="1" style="width: 100%; border-collapse: collapse; text-align: center;"> <tr> <td style="width: 10%;"></td> <td style="width: 10%;"></td> <td style="width: 10%;"></td> <td style="width: 10%;"></td> <td style="width: 10%;"></td> <td style="width: 10%;"></td> <td style="width: 10%;"></td> <td style="width: 10%;"></td> <td style="width: 10%;"></td> <td style="width: 10%;"></td> </tr> <tr> <td></td> <td></td> <td colspan="8" style="text-align: center;"> <table border="1" style="width: 100%; border-collapse: collapse; text-align: center;"> <tr> <td style="width: 10%;"></td> <td style="width: 10%;"></td> <td style="width: 10%;"></td> <td
style="width: 10%;"></td> <td style="width: 10%;"></td> <td style="width: 10%;"></td> <td style="width: 10%;"></td> <td style="width: 10%;"></td> <td style="width: 10%;"></td> <td style="width: 10%;"></td> </tr> <tr> <td></td> <td></td> <td colspan="8" style="text-align: center;"> <table border="1" style="width: 100%; border-collapse: collapse; text-align: center;"> <tr> <td style="width: 10%;"></td> <td style="width: 10%;"></td> <td style="width: 10%;"></td> <td style="width: 10%;"></td> <td style="width: 10%;"></td> <td style="width: 10%;"></td> <td style="width: 10%;"></td> <td style="width: 10%;"></td> <td style="width: 10%;"></td> <td style="width: 10%;"></td> </tr> <tr> <td></td> <td></td> <td colspan="8" style="text-align: center;"> <table border="1" style="width: 100%; border-collapse: collapse; text-align: center;"> <tr> <td style="width: 10%;"></td> <td style="width: 10%;"></td> <td style="width: 10%;"></td> <td style="width: 10%;"></td> <td style="width: 10%;"></td> <td style="width: 10%;"></td> <td style="width: 10%;"></td> <td style="width: 10%;"></td> <td style="width: 10%;"></td> <td style="width: 10%;"></td> </tr> <tr> <td></td> <td></td> <td colspan="8" style="text-align: center;"> <table border="1" style="width: 100%; border-collapse: collapse; text-align: center;"> <tr> <td style="width: 10%;"></td> <td style="width: 10%;"></td> <td style="width: 10%;"></td> <td style="width: 10%;"></td> <td style="width: 10%;"></td> <td style="width: 10%;"></td> <td style="width: 10%;"></td> <td style="width: 10%;"></td> <td style="width: 10%;"></td> <td style="width: 10%;"></td> </tr> <tr> <td></td> <td></td> <td colspan="8" style="text-align: center;"> <table border="1" style="width: 100%; border-collapse: collapse; text-align: center;"> <tr> <td style="width: 10%;"></td> <td style="width: 10%;"></td> <td style="width: 10%;"></td> <td style="width: 10%;"></td> <td style="width: 10%;"></td> <td style="width: 10%;"></td> <td style="width: 10%;"></td> <td style="width: 10%;"></td> <td style="width: 10%;"></td> <td style="width: 10%;"></td> </tr> <tr> <td></td> <td></td> <td colspan="8" style="text-align: center;"> <table border="1" style="width: 100%; border-collapse: collapse; text-align: center;"> <tr> <td style="width: 10%;"></td> <td style="width: 10%;"></td> <td style="width: 10%;"></td> <td style="width: 10%;"></td> <td style="width: 10%;"></td> <td style="width: 10%;"></td> <td style="width: 10%;"></td> <td style="width: 10%;"></td> <td style="width: 10%;"></td> <td style="width: 10%;"></td> </tr> <tr> <td></td> <td></td> <td colspan="8" style="text-align: center;"> <table border="1" style="width: 100%; border-collapse: collapse; text-align: center;"> <tr> <td style="width: 10%;"></td> <td style="width: 10%;"></td> <td style="width: 10%;"></td> <td style="width: 10%;"></td> <td style="width: 10%;"></td> <td style="width: 10%;"></td> <td style="width: 10%;"></td> <td style="width: 10%;"></td> <td style="width: 10%;"></td> <td style="width: 10%;"></td> </tr> <tr> <td></td> <td></td> <td colspan="8" style="text-align: center;"> <table border="1" style="width: 100%; border-collapse: collapse; text-align: center;"> <tr> <td style="width: 10%;"></td> <td style="width: 10%;"></td> <td style="width: 10%;"></td> <td style="width: 10%;"></td> <td style="width: 10%;"></td> <td style="width: 10%;"></td> <td style="width: 10%;"></td> <td style="width: 10%;"></td> <td style="width: 10%;"></td> <td style="width: 10%;"></td> </tr> <tr> <td></td> <td></td> <td colspan="8" style="text-align: center;"> <table border="1" style="width: 100%; border-collapse: collapse; text-align: center;"> <tr> <td style="width: 10%;"></td> <td style="width: 10%;"></td> <td style="width: 10%;"></td> <td style="width: 10%;"></td> <td style="width: 10%;"></td> <td style="width: 10%;"></td> <td style="width: 10%;"></td> <td style="width: 10%;"></td> <td style="width: 10%;"></td> <td style="width: 10%;"></td> </tr> <tr> <td></td> <td></td> <td colspan="8" style="text-align: center;"> <table border="1" style="width: 100%; border-collapse: collapse; text-align: center;"> <tr> <td style="width: 10%;"></td> <td style="width: 10%;"></td> <td style="width: 10%;"></td> <td style="width: 10%;"></td> <td style="width: 10%;"></td> <td style="width: 10%;"></td> <td style="width: 10%;"></td> <td style="width: 10%;"></td> <td style="width: 10%;"></td> <td style="width: 10%;"></td> </tr> <tr> <td></td> <td></td> <td colspan="8" style="text-align: center;"> <table border="1" style="width: 100%; border-collapse: collapse; text-align: center;"> <tr> <td style="width: 10%;"></td> <td style="width: 10%;"></td> <td style="width: 10%;"></td> <td style="width: 10%;"></td> <td style="width: 10%;"></td> <td style="width: 10%;"></td> <td style="width: 10%;"></td> <td style="width: 10%;"></td> <td style="width: 10%;"></td> <td style="width: 10%;"></td> </tr> <tr> <td></td> <td></td> <td colspan="8" style="text-align: center;"> <table border="1" style="width: 100%; border-collapse: collapse; text-align: center;"> <tr> </tr></table></td></tr></table></td></tr></table></td></tr></table></td></tr></table></td></tr></table></td></tr></table></td></tr></table></td></tr></table></td></tr></table></td></tr></table></td></tr></table></td></tr></table></td></tr></table></td></tr></table></td></tr></table></td></tr></table></td></tr></table></td></tr></table></td></tr></table></td></tr></table></td></tr></table></td></tr></table>
 | | | | | | | | | | | | | | | | | | | | <table border="1" style="width: 100%; border-collapse: collapse; text-align: center;"> <tr> <td style="width: 10%;"></td> <td style="width: 10%;"></td> <td style="width: 10%;"></td> <td style="width: 10%;"></td> <td style="width: 10%;"></td> <td style="width: 10%;"></td> <td style="width: 10%;"></td> <td style="width: 10%;"></td> <td style="width: 10%;"></td> <td style="width: 10%;"></td> </tr> <tr> <td></td> <td></td> <td colspan="8" style="text-align: center;"> <table border="1" style="width: 100%; border-collapse: collapse; text-align: center;"> <tr> <td style="width: 10%;"></td> <td style="width: 10%;"></td> <td style="width: 10%;"></td> <td style="width: 10%;"></td> <td style="width: 10%;"></td> <td style="width: 10%;"></td> <td style="width: 10%;"></td> <td style="width: 10%;"></td> <td style="width: 10%;"></td> <td style="width: 10%;"></td> </tr> <tr> <td></td> <td></td> <td colspan="8" style="text-align: center;"> <table border="1" style="width: 100%; border-collapse: collapse; text-align: center;"> <tr> <td style="width: 10%;"></td> <td style="width: 10%;"></td> <td style="width: 10%;"></td> <td style="width: 10%;"></td> <td style="width: 10%;"></td> <td style="width: 10%;"></td> <td style="width: 10%;"></td> <td style="width: 10%;"></td> <td style="width: 10%;"></td> <td style="width: 10%;"></td> </tr> <tr> <td></td> <td></td> <td colspan="8" style="text-align: center;"> <table border="1" style="width: 100%; border-collapse: collapse; text-align: center;"> <tr> <td style="width: 10%;"></td> <td style="width: 10%;"></td> <td style="width: 10%;"></td> <td style="width: 10%;"></td> <td style="width: 10%;"></td> <td style="width: 10%;"></td> <td style="width: 10%;"></td> <td style="width: 10%;"></td> <td style="width: 10%;"></td> <td style="width: 10%;"></td> </tr> <tr> <td></td> <td></td> <td colspan="8" style="text-align: center;"> <table border="1" style="width: 100%; border-collapse: collapse; text-align: center;"> <tr> <td style="width: 10%;"></td> <td style="width: 10%;"></td> <td style="width: 10%;"></td> <td style="width: 10%;"></td> <td style="width: 10%;"></td> <td style="width: 10%;"></td> <td style="width: 10%;"></td> <td style="width: 10%;"></td> <td style="width: 10%;"></td> <td style="width: 10%;"></td> </tr> <tr> <td></td> <td></td> <td colspan="8" style="text-align: center;"> <table border="1" style="width: 100%; border-collapse: collapse; text-align: center;"> <tr> <td style="width: 10%;"></td> <td style="width: 10%;"></td> <td style="width: 10%;"></td> <td style="width: 10%;"></td> <td style="width: 10%;"></td> <td style="width: 10%;"></td> <td style="width: 10%;"></td> <td style="width: 10%;"></td> <td style="width: 10%;"></td> <td style="width: 10%;"></td> </tr> <tr> <td></td> <td></td> <td colspan="8" style="text-align: center;"> <table border="1" style="width: 100%; border-collapse: collapse; text-align: center;"> <tr> <td style="width: 10%;"></td> <td style="width: 10%;"></td> <td style="width: 10%;"></td> <td style="width: 10%;"></td> <td style="width: 10%;"></td> <td style="width: 10%;"></td> <td style="width: 10%;"></td> <td style="width: 10%;"></td> <td style="width: 10%;"></td> <td style="width: 10%;"></td> </tr> <tr> <td></td> <td></td> <td colspan="8" style="text-align: center;"> <table border="1" style="width: 100%; border-collapse: collapse; text-align: center;"> <tr> <td style="width: 10%;"></td> <td style="width: 10%;"></td> <td style="width: 10%;"></td> <td style="width: 10%;"></td> <td style="width: 10%;"></td> <td style="width: 10%;"></td> <td style="width: 10%;"></td> <td style="width: 10%;"></td> <td style="width: 10%;"></td> <td style="width: 10%;"></td> </tr> <tr> <td></td> <td></td> <td colspan="8" style="text-align: center;"> <table border="1" style="width: 100%; border-collapse: collapse; text-align: center;"> <tr> <td style="width: 10%;"></td> <td style="width: 10%;"></td> <td style="width: 10%;"></td> <td style="width: 10%;"></td> <td style="width: 10%;"></td> <td style="width: 10%;"></td> <td style="width: 10%;"></td> <td style="width: 10%;"></td> <td style="width: 10%;"></td> <td style="width: 10%;"></td> </tr> <tr> <td></td> <td></td> <td colspan="8" style="text-align: center;"> <table border="1" style="width: 100%; border-collapse: collapse; text-align: center;"> <tr> <td style="width: 10%;"></td> <td style="width: 10%;"></td> <td style="width: 10%;"></td> <td style="width: 10%;"></td> <td style="width: 10%;"></td> <td style="width: 10%;"></td> <td style="width: 10%;"></td> <td style="width: 10%;"></td> <td style="width: 10%;"></td> <td style="width: 10%;"></td> </tr> <tr> <td></td> <td></td> <td colspan="8" style="text-align: center;"> <table border="1" style="width: 100%; border-collapse: collapse; text-align: center;"> <tr> <td style="width: 10%;"></td> <td style="width: 10%;"></td> <td style="width: 10%;"></td> <td style="width: 10%;"></td> <td style="width: 10%;"></td> <td style="width: 10%;"></td> <td style="width: 10%;"></td> <td style="width: 10%;"></td> <td style="width: 10%;"></td> <td style="width: 10%;"></td> </tr> <tr> <td></td> <td></td> <td colspan="8" style="text-align: center;"> <table border="1" style="width: 100%; border-collapse: collapse; text-align: center;"> <tr> <td style="width: 10%;"></td> <td style="width: 10%;"></td> <td style="width: 10%;"></td> <td style="width: 10%;"></td> <td style="width: 10%;"></td> <td style="width: 10%;"></td> <td style="width: 10%;"></td> <td style="width: 10%;"></td> <td style="width: 10%;"></td> <td style="width: 10%;"></td> </tr> <tr> <td></td> <td></td> <td colspan="8" style="text-align: center;"> <table border="1" style="width: 100%; border-collapse: collapse; text-align: center;"> <tr> <td style="width: 10%;"></td> <td style="width: 10%;"></td> <td style="width: 10%;"></td> <td style="width: 10%;"></td> <td style="width: 10%;"></td> <td style="width: 10%;"></td> <td style="width: 10%;"></td> <td style="width: 10%;"></td> <td style="width: 10%;"></td> <td style="width: 10%;"></td> </tr> <tr> <td></td> <td></td> <td colspan="8" style="text-align: center;"> <table border="1" style="width: 100%; border-collapse: collapse; text-align: center;"> <tr> <td style="width: 10%;"></td> <td style="width: 10%;"></td> <td style="width: 10%;"></td> <td style="width: 10%;"></td> <td style="width: 10%;"></td> <td style="width: 10%;"></td> <td style="width: 10%;"></td> <td style="width: 10%;"></td> <td style="width: 10%;"></td> <td style="width: 10%;"></td> </tr> <tr> <td></td> <td></td> <td colspan="8" style="text-align: center;"> <table border="1" style="width: 100%; border-collapse: collapse; text-align: center;"> <tr> <td style="width: 10%;"></td> <td style="width: 10%;"></td> <td style="width: 10%;"></td> <td style="width: 10%;"></td> <td style="width: 10%;"></td> <td style="width: 10%;"></td> <td style="width: 10%;"></td> <td style="width: 10%;"></td> <td style="width: 10%;"></td> <td style="width: 10%;"></td> </tr> <tr> <td></td> <td></td> <td colspan="8" style="text-align: center;"> <table border="1" style="width: 100%; border-collapse: collapse; text-align: center;"> <tr> <td style="width: 10%;"></td> <td style="width: 10%;"></td> <td
style="width: 10%;"></td> <td style="width: 10%;"></td> <td style="width: 10%;"></td> <td style="width: 10%;"></td> <td style="width: 10%;"></td> <td style="width: 10%;"></td> <td style="width: 10%;"></td> <td style="width: 10%;"></td> </tr> <tr> <td></td> <td></td> <td colspan="8" style="text-align: center;"> <table border="1" style="width: 100%; border-collapse: collapse; text-align: center;"> <tr> <td style="width: 10%;"></td> <td style="width: 10%;"></td> <td style="width: 10%;"></td> <td style="width: 10%;"></td> <td style="width: 10%;"></td> <td style="width: 10%;"></td> <td style="width: 10%;"></td> <td style="width: 10%;"></td> <td style="width: 10%;"></td> <td style="width: 10%;"></td> </tr> <tr> <td></td> <td></td> <td colspan="8" style="text-align: center;"> <table border="1" style="width: 100%; border-collapse: collapse; text-align: center;"> <tr> <td style="width: 10%;"></td> <td style="width: 10%;"></td> <td style="width: 10%;"></td> <td style="width: 10%;"></td> <td style="width: 10%;"></td> <td style="width: 10%;"></td> <td style="width: 10%;"></td> <td style="width: 10%;"></td> <td style="width: 10%;"></td> <td style="width: 10%;"></td> </tr> <tr> <td></td> <td></td> <td colspan="8" style="text-align: center;"> <table border="1" style="width: 100%; border-collapse: collapse; text-align: center;"> <tr> <td style="width: 10%;"></td> <td style="width: 10%;"></td> <td style="width: 10%;"></td> <td style="width: 10%;"></td> <td style="width: 10%;"></td> <td style="width: 10%;"></td> <td style="width: 10%;"></td> <td style="width: 10%;"></td> <td style="width: 10%;"></td> <td style="width: 10%;"></td> </tr> <tr> <td></td> <td></td> <td colspan="8" style="text-align: center;"> <table border="1" style="width: 100%; border-collapse: collapse; text-align: center;"> <tr> <td style="width: 10%;"></td> <td style="width: 10%;"></td> <td style="width: 10%;"></td> <td style="width: 10%;"></td> <td style="width: 10%;"></td> <td style="width: 10%;"></td> <td style="width: 10%;"></td> <td style="width: 10%;"></td> <td style="width: 10%;"></td> <td style="width: 10%;"></td> </tr> <tr> <td></td> <td></td> <td colspan="8" style="text-align: center;"> <table border="1" style="width: 100%; border-collapse: collapse; text-align: center;"> <tr> <td style="width: 10%;"></td> <td style="width: 10%;"></td> <td style="width: 10%;"></td> <td style="width: 10%;"></td> <td style="width: 10%;"></td> <td style="width: 10%;"></td> <td style="width: 10%;"></td> <td style="width: 10%;"></td> <td style="width: 10%;"></td> <td style="width: 10%;"></td> </tr> <tr> <td></td> <td></td> <td colspan="8" style="text-align: center;"> <table border="1" style="width: 100%; border-collapse: collapse; text-align: center;"> <tr> </tr></table></td></tr></table></td></tr></table></td></tr></table></td></tr></table></td></tr></table></td></tr></table></td></tr></table></td></tr></table></td></tr></table></td></tr></table></td></tr></table></td></tr></table></td></tr></table></td></tr></table></td></tr></table></td></tr></table></td></tr></table></td></tr></table></td></tr></table></td></tr></table></td></tr></table>
 | | | | | | | | | | | | | | | | | | | | <table border="1" style="width: 100%; border-collapse: collapse; text-align: center;"> <tr> <td style="width: 10%;"></td> <td style="width: 10%;"></td> <td style="width: 10%;"></td> <td style="width: 10%;"></td> <td style="width: 10%;"></td> <td style="width: 10%;"></td> <td style="width: 10%;"></td> <td style="width: 10%;"></td> <td style="width: 10%;"></td> <td style="width: 10%;"></td> </tr> <tr> <td></td> <td></td> <td colspan="8" style="text-align: center;"> <table border="1" style="width: 100%; border-collapse: collapse; text-align: center;"> <tr> <td style="width: 10%;"></td> <td style="width: 10%;"></td> <td style="width: 10%;"></td> <td style="width: 10%;"></td> <td style="width: 10%;"></td> <td style="width: 10%;"></td> <td style="width: 10%;"></td> <td style="width: 10%;"></td> <td style="width: 10%;"></td> <td style="width: 10%;"></td> </tr> <tr> <td></td> <td></td> <td colspan="8" style="text-align: center;"> <table border="1" style="width: 100%; border-collapse: collapse; text-align: center;"> <tr> <td style="width: 10%;"></td> <td style="width: 10%;"></td> <td style="width: 10%;"></td> <td style="width: 10%;"></td> <td style="width: 10%;"></td> <td style="width: 10%;"></td> <td style="width: 10%;"></td> <td style="width: 10%;"></td> <td style="width: 10%;"></td> <td style="width: 10%;"></td> </tr> <tr> <td></td> <td></td> <td colspan="8" style="text-align: center;"> <table border="1" style="width: 100%; border-collapse: collapse; text-align: center;"> <tr> <td style="width: 10%;"></td> <td style="width: 10%;"></td> <td style="width: 10%;"></td> <td style="width: 10%;"></td> <td style="width: 10%;"></td> <td style="width: 10%;"></td> <td style="width: 10%;"></td> <td style="width: 10%;"></td> <td style="width: 10%;"></td> <td style="width: 10%;"></td> </tr> <tr> <td></td> <td></td> <td colspan="8" style="text-align: center;"> <table border="1" style="width: 100%; border-collapse: collapse; text-align: center;"> <tr> <td style="width: 10%;"></td> <td style="width: 10%;"></td> <td style="width: 10%;"></td> <td style="width: 10%;"></td> <td style="width: 10%;"></td> <td style="width: 10%;"></td> <td style="width: 10%;"></td> <td style="width: 10%;"></td> <td style="width: 10%;"></td> <td style="width: 10%;"></td> </tr> <tr> <td></td> <td></td> <td colspan="8" style="text-align: center;"> <table border="1" style="width: 100%; border-collapse: collapse; text-align: center;"> <tr> <td style="width: 10%;"></td> <td style="width: 10%;"></td> <td style="width: 10%;"></td> <td style="width: 10%;"></td> <td style="width: 10%;"></td> <td style="width: 10%;"></td> <td style="width: 10%;"></td> <td style="width: 10%;"></td> <td style="width: 10%;"></td> <td style="width: 10%;"></td> </tr> <tr> <td></td> <td></td> <td colspan="8" style="text-align: center;"> <table border="1" style="width: 100%; border-collapse: collapse; text-align: center;"> <tr> <td style="width: 10%;"></td> <td style="width: 10%;"></td> <td style="width: 10%;"></td> <td style="width: 10%;"></td> <td style="width: 10%;"></td> <td style="width: 10%;"></td> <td style="width: 10%;"></td> <td style="width: 10%;"></td> <td style="width: 10%;"></td> <td style="width: 10%;"></td> </tr> <tr> <td></td> <td></td> <td colspan="8" style="text-align: center;"> <table border="1" style="width: 100%; border-collapse: collapse; text-align: center;"> <tr> <td style="width: 10%;"></td> <td style="width: 10%;"></td> <td style="width: 10%;"></td> <td style="width: 10%;"></td> <td style="width: 10%;"></td> <td style="width: 10%;"></td> <td style="width: 10%;"></td> <td style="width: 10%;"></td> <td style="width: 10%;"></td> <td style="width: 10%;"></td> </tr> <tr> <td></td> <td></td> <td colspan="8" style="text-align: center;"> <table border="1" style="width: 100%; border-collapse: collapse; text-align: center;"> <tr> <td style="width: 10%;"></td> <td style="width: 10%;"></td> <td style="width: 10%;"></td> <td style="width: 10%;"></td> <td style="width: 10%;"></td> <td style="width: 10%;"></td> <td style="width: 10%;"></td> <td style="width: 10%;"></td> <td style="width: 10%;"></td> <td style="width: 10%;"></td> </tr> <tr> <td></td> <td></td> <td colspan="8" style="text-align: center;"> <table border="1" style="width: 100%; border-collapse: collapse; text-align: center;"> <tr> <td style="width: 10%;"></td> <td style="width: 10%;"></td> <td style="width: 10%;"></td> <td style="width: 10%;"></td> <td style="width: 10%;"></td> <td style="width: 10%;"></td> <td style="width: 10%;"></td> <td style="width: 10%;"></td> <td style="width: 10%;"></td> <td style="width: 10%;"></td> </tr> <tr> <td></td> <td></td> <td colspan="8" style="text-align: center;"> <table border="1" style="width: 100%; border-collapse: collapse; text-align: center;"> <tr> <td style="width: 10%;"></td> <td style="width: 10%;"></td> <td style="width: 10%;"></td> <td style="width: 10%;"></td> <td style="width: 10%;"></td> <td style="width: 10%;"></td> <td style="width: 10%;"></td> <td style="width: 10%;"></td> <td style="width: 10%;"></td> <td style="width: 10%;"></td> </tr> <tr> <td></td> <td></td> <td colspan="8" style="text-align: center;"> <table border="1" style="width: 100%; border-collapse: collapse; text-align: center;"> <tr> <td style="width: 10%;"></td> <td style="width: 10%;"></td> <td style="width: 10%;"></td> <td style="width: 10%;"></td> <td style="width: 10%;"></td> <td style="width: 10%;"></td> <td style="width: 10%;"></td> <td style="width: 10%;"></td> <td style="width: 10%;"></td> <td style="width: 10%;"></td> </tr> <tr> <td></td> <td></td> <td colspan="8" style="text-align: center;"> <table border="1" style="width: 100%; border-collapse: collapse; text-align: center;"> <tr> <td style="width: 10%;"></td> <td style="width: 10%;"></td> <td style="width: 10%;"></td> <td style="width: 10%;"></td> <td style="width: 10%;"></td> <td style="width: 10%;"></td> <td style="width: 10%;"></td> <td style="width: 10%;"></td> <td style="width: 10%;"></td> <td style="width: 10%;"></td> </tr> <tr> <td></td> <td></td> <td colspan="8" style="text-align: center;"> <table border="1" style="width: 100%; border-collapse: collapse; text-align: center;"> <tr> <td style="width: 10%;"></td> <td style="width: 10%;"></td> <td style="width: 10%;"></td> <td style="width: 10%;"></td> <td style="width: 10%;"></td> <td style="width: 10%;"></td> <td style="width: 10%;"></td> <td style="width: 10%;"></td> <td style="width: 10%;"></td> <td style="width: 10%;"></td> </tr> <tr> <td></td> <td></td> <td colspan="8" style="text-align: center;"> <table border="1" style="width: 100%; border-collapse: collapse; text-align: center;"> <tr> <td style="width: 10%;"></td> <td style="width: 10%;"></td> <td style="width: 10%;"></td> <td style="width: 10%;"></td> <td style="width: 10%;"></td> <td style="width: 10%;"></td> <td style="width: 10%;"></td> <td style="width: 10%;"></td> <td style="width: 10%;"></td> <td style="width: 10%;"></td> </tr> <tr> <td></td> <td></td> <td colspan="8" style="text-align: center;"> <table border="1" style="width: 100%; border-collapse: collapse; text-align: center;"> <tr> <td style="width: 10%;"></td> <td style="width: 10%;"></td> <td style="width: 10%;"></td> <td style="width: 10%;"></td> <td style="width: 10%;"></td> <td style="width: 10%;"></td> <td style="width: 10%;"></td> <td style="width: 10%;"></td> <td style="width: 10%;"></td> <td style="width: 10%;"></td> </tr> <tr> <td></td> <td></td> <td colspan="8" style="text-align: center;"> <table border="1" style="width: 100%; border-collapse: collapse; text-align: center;"> <tr> <td style="width: 10%;"></td> <td style="width: 10%;"></td> <td style="width: 10%;"></td> <td style="width: 10%;"></td> <td style="width: 10%;"></td> <td style="width: 10%;"></td> <td style="width: 10%;"></td> <td style="width: 10%;"></td> <td style="width: 10%;"></td> <td style="width: 10%;"></td> </tr> <tr> <td></td> <td></td> <td colspan="8" style="text-align: center;"> <table border="1" style="width: 100%; border-collapse: collapse; text-align: center;"> <tr> <td style="width: 10%;"></td> <td style="width: 10%;"></td> <td style="width: 10%;"></td> <td style="width: 10%;"></td> <td style="width: 10%;"></td> <td style="width: 10%;"></td> <td style="width: 10%;"></td> <td style="width: 10%;"></td> <td style="width: 10%;"></td> <td style="width: 10%;"></td> </tr> <tr> <td></td> <td></td> <td colspan="8" style="text-align: center;"> <table border="1" style="width: 100%; border-collapse: collapse; text-align: center;"> <tr> <td style="width: 10%;"></td> <td style="width: 10%;"></td> <td style="width: 10%;"></td> <td style="width: 10%;"></td> <td style="width: 10%;"></td> <td style="width: 10%;"></td> <td style="width: 10%;"></td> <td style="width: 10%;"></td> <td style="width: 10%;"></td> <td style="width: 10%;"></td> </tr> <tr> <td></td> <td></td> <td colspan="8" style="text-align: center;"> <table border="1" style="width: 100%; border-collapse: collapse; text-align: center;"> <tr> <td style="width: 10%;"></td> <td style="width: 10%;"></td> <td style="width: 10%;"></td> <td style="width: 10%;"></td> <td style="width: 10%;"></td> <td style="width: 10%;"></td> <td style="width: 10%;"></td> <td style="width: 10%;"></td> <td style="width: 10%;"></td> <td style="width: 10%;"></td> </tr> <tr> <td></td> <td></td> <td colspan="8" style="text-align: center;"> <table border="1" style="width: 100%; border-collapse: collapse; text-align: center;"> <tr>
</tr></table></td></tr></table></td></tr></table></td></tr></table></td></tr></table></td></tr></table></td></tr></table></td></tr></table></td></tr></table></td></tr></table></td></tr></table></td></tr></table></td></tr></table></td></tr></table></td></tr></table></td></tr></table></td></tr></table></td></tr></table></td></tr></table></td></tr></table></td></tr></table> | | | | | | | | | | | | | | | | | | | | <table border="1" style="width: 100%; border-collapse: collapse; text-align: center;"> <tr> <td style="width: 10%;"></td> <td style="width: 10%;"></td> <td style="width: 10%;"></td> <td style="width: 10%;"></td> <td style="width: 10%;"></td> <td style="width: 10%;"></td> <td style="width: 10%;"></td> <td style="width: 10%;"></td> <td style="width: 10%;"></td> <td style="width: 10%;"></td> </tr> <tr> <td></td> <td></td> <td colspan="8" style="text-align: center;"> <table border="1" style="width: 100%; border-collapse: collapse; text-align: center;"> <tr> <td style="width: 10%;"></td> <td style="width: 10%;"></td> <td style="width: 10%;"></td> <td style="width: 10%;"></td> <td style="width: 10%;"></td> <td style="width: 10%;"></td> <td style="width: 10%;"></td> <td style="width: 10%;"></td> <td style="width: 10%;"></td> <td style="width: 10%;"></td> </tr> <tr> <td></td> <td></td> <td colspan="8" style="text-align: center;"> <table border="1" style="width: 100%; border-collapse: collapse; text-align: center;"> <tr> <td style="width: 10%;"></td> <td style="width: 10%;"></td> <td style="width: 10%;"></td> <td style="width: 10%;"></td> <td style="width: 10%;"></td> <td style="width: 10%;"></td> <td style="width: 10%;"></td> <td style="width: 10%;"></td> <td style="width: 10%;"></td> <td style="width: 10%;"></td> </tr> <tr> <td></td> <td></td> <td colspan="8" style="text-align: center;"> <table border="1" style="width: 100%; border-collapse: collapse; text-align: center;"> <tr> <td style="width: 10%;"></td> <td style="width: 10%;"></td> <td style="width: 10%;"></td> <td style="width: 10%;"></td> <td style="width: 10%;"></td> <td style="width: 10%;"></td> <td style="width: 10%;"></td> <td style="width: 10%;"></td> <td style="width: 10%;"></td> <td style="width: 10%;"></td> </tr> <tr> <td></td> <td></td> <td colspan="8" style="text-align: center;"> <table border="1" style="width: 100%; border-collapse: collapse; text-align: center;"> <tr> <td style="width: 10%;"></td> <td style="width: 10%;"></td> <td style="width: 10%;"></td> <td style="width: 10%;"></td> <td style="width: 10%;"></td> <td style="width: 10%;"></td> <td style="width: 10%;"></td> <td style="width: 10%;"></td> <td style="width: 10%;"></td> <td style="width: 10%;"></td> </tr> <tr>
<td></td> <td></td> <td colspan="8" style="text-align: center;"> <table border="1" style="width: 100%; border-collapse: collapse; text-align: center;"> <tr> <td style="width: 10%;"></td> <td style="width: 10%;"></td> <td style="width: 10%;"></td> <td style="width: 10%;"></td> <td style="width: 10%;"></td> <td style="width: 10%;"></td> <td style="width: 10%;"></td> <td style="width: 10%;"></td> <td style="width: 10%;"></td> <td style="width: 10%;"></td> </tr> <tr> <td></td> <td></td> <td colspan="8" style="text-align: center;"> <table border="1" style="width: 100%; border-collapse: collapse; text-align: center;"> <tr> <td style="width: 10%;"></td> <td style="width: 10%;"></td> <td style="width: 10%;"></td> <td style="width: 10%;"></td> <td style="width: 10%;"></td> <td style="width: 10%;"></td> <td style="width: 10%;"></td> <td style="width: 10%;"></td> <td style="width: 10%;"></td> <td style="width: 10%;"></td> </tr> <tr> <td></td> <td></td> <td colspan="8" style="text-align: center;"> <table border="1" style="width: 100%; border-collapse: collapse; text-align: center;"> <tr> <td style="width: 10%;"></td> <td style="width: 10%;"></td> <td style="width: 10%;"></td> <td style="width: 10%;"></td> <td style="width: 10%;"></td> <td style="width: 10%;"></td> <td style="width: 10%;"></td> <td style="width: 10%;"></td> <td style="width: 10%;"></td> <td style="width: 10%;"></td> </tr> <tr> <td></td> <td></td> <td colspan="8" style="text-align: center;"> <table border="1" style="width: 100%; border-collapse: collapse; text-align: center;"> <tr> <td style="width: 10%;"></td> <td style="width: 10%;"></td> <td style="width: 10%;"></td> <td style="width: 10%;"></td> <td style="width: 10%;"></td> <td style="width: 10%;"></td> <td style="width: 10%;"></td> <td style="width: 10%;"></td> <td style="width: 10%;"></td> <td style="width: 10%;"></td> </tr> <tr> <td></td> <td></td> <td colspan="8" style="text-align: center;"> <table border="1" style="width: 100%; border-collapse: collapse; text-align: center;"> <tr> <td style="width: 10%;"></td> <td style="width: 10%;"></td> <td style="width: 10%;"></td> <td style="width: 10%;"></td> <td style="width: 10%;"></td> <td style="width: 10%;"></td> <td style="width: 10%;"></td> <td style="width: 10%;"></td> <td style="width: 10%;"></td> <td style="width: 10%;"></td> </tr> <tr> <td></td> <td></td> <td colspan="8" style="text-align: center;"> <table border="1" style="width: 100%; border-collapse: collapse; text-align: center;"> <tr> <td style="width: 10%;"></td> <td style="width: 10%;"></td> <td style="width: 10%;"></td> <td style="width: 10%;"></td> <td style="width: 10%;"></td> <td style="width: 10%;"></td> <td style="width: 10%;"></td> <td style="width: 10%;"></td> <td style="width: 10%;"></td> <td style="width: 10%;"></td> </tr> <tr> <td></td> <td></td> <td colspan="8" style="text-align: center;"> <table border="1" style="width: 100%; border-collapse: collapse; text-align: center;"> <tr> <td style="width: 10%;"></td> <td style="width: 10%;"></td> <td style="width: 10%;"></td> <td style="width: 10%;"></td> <td style="width: 10%;"></td> <td style="width: 10%;"></td> <td style="width: 10%;"></td> <td style="width: 10%;"></td> <td style="width: 10%;"></td> <td style="width: 10%;"></td> </tr> <tr> <td></td> <td></td> <td colspan="8" style="text-align: center;"> <table border="1" style="width: 100%; border-collapse: collapse; text-align: center;"> <tr> <td style="width: 10%;"></td> <td style="width: 10%;"></td> <td style="width: 10%;"></td> <td style="width: 10%;"></td> <td style="width: 10%;"></td> <td style="width: 10%;"></td> <td style="width: 10%;"></td> <td style="width: 10%;"></td> <td style="width: 10%;"></td> <td style="width: 10%;"></td> </tr> <tr> <td></td> <td></td> <td colspan="8" style="text-align: center;"> <table border="1" style="width: 100%; border-collapse: collapse; text-align: center;"> <tr> <td style="width: 10%;"></td> <td style="width: 10%;"></td> <td style="width: 10%;"></td> <td style="width: 10%;"></td> <td style="width: 10%;"></td> <td style="width: 10%;"></td> <td style="width: 10%;"></td> <td style="width: 10%;"></td> <td style="width: 10%;"></td> <td style="width: 10%;"></td> </tr> <tr> <td></td> <td></td> <td colspan="8" style="text-align: center;"> <table border="1" style="width: 100%; border-collapse: collapse; text-align: center;"> <tr> <td style="width: 10%;"></td> <td style="width: 10%;"></td> <td style="width: 10%;"></td> <td style="width: 10%;"></td> <td style="width: 10%;"></td> <td style="width: 10%;"></td> <td style="width: 10%;"></td> <td style="width: 10%;"></td> <td style="width: 10%;"></td> <td style="width: 10%;"></td> </tr> <tr> <td></td> <td></td> <td colspan="8" style="text-align: center;"> <table border="1" style="width: 100%; border-collapse: collapse; text-align: center;"> <tr> <td style="width: 10%;"></td> <td style="width: 10%;"></td> <td style="width: 10%;"></td> <td style="width: 10%;"></td> <td style="width: 10%;"></td> <td style="width: 10%;"></td> <td style="width: 10%;"></td> <td style="width: 10%;"></td> <td style="width: 10%;"></td> <td style="width: 10%;"></td> </tr> <tr> <td></td> <td></td> <td colspan="8" style="text-align: center;"> <table border="1" style="width: 100%; border-collapse: collapse; text-align: center;"> <tr> <td style="width: 10%;"></td> <td style="width: 10%;"></td> <td style="width: 10%;"></td> <td style="width: 10%;"></td> <td style="width: 10%;"></td> <td style="width: 10%;"></td> <td style="width: 10%;"></td> <td style="width: 10%;"></td> <td style="width: 10%;"></td> <td style="width: 10%;"></td> </tr> <tr> <td></td> <td></td> <td colspan="8" style="text-align: center;"> <table border="1" style="width: 100%; border-collapse: collapse; text-align: center;"> <tr> <td style="width: 10%;"></td> <td style="width: 10%;"></td> <td style="width: 10%;"></td> <td style="width: 10%;"></td> <td style="width: 10%;"></td> <td style="width: 10%;"></td> <td style="width: 10%;"></td> <td style="width: 10%;"></td> <td style="width: 10%;"></td> <td style="width: 10%;"></td> </tr> <tr> <td></td> <td></td> <td colspan="8" style="text-align: center;"> <table border="1" style="width: 100%; border-collapse: collapse; text-align: center;"> <tr> <td style="width: 10%;"></td> <td style="width: 10%;"></td> <td style="width: 10%;"></td> <td style="width: 10%;"></td> <td style="width: 10%;"></td> <td style="width: 10%;"></td> <td style="width: 10%;"></td> <td style="width: 10%;"></td> <td style="width: 10%;"></td> <td style="width: 10%;"></td> </tr> <tr> <td></td> <td></td> <td colspan="8" style="text-align: center;"> <table border="1" style="width: 100%; border-collapse: collapse; text-align: center;"> <tr> </tr></table></td></tr></table></td></tr></table></td></tr></table></td></tr></table></td></tr></table></td></tr></table></td></tr></table></td></tr></table></td></tr></table></td></tr></table></td></tr></table></td></tr></table></td></tr></table></td></tr></table></td></tr></table></td></tr></table></td></tr></table></td></tr></table></td></tr></table>
 | | | | | | | | | | | | | | | | | | | | <table border="1" style="width: 100%; border-collapse: collapse; text-align: center;"> <tr> <td style="width: 10%;"></td> <td style="width: 10%;"></td> <td style="width: 10%;"></td> <td style="width: 10%;"></td> <td style="width: 10%;"></td> <td style="width: 10%;"></td> <td style="width: 10%;"></td> <td style="width: 10%;"></td> <td style="width: 10%;"></td> <td style="width: 10%;"></td> </tr> <tr> <td></td> <td></td> <td colspan="8" style="text-align: center;"> <table border="1" style="width: 100%; border-collapse: collapse; text-align: center;"> <tr> <td style="width: 10%;"></td> <td style="width: 10%;"></td> <td style="width: 10%;"></td> <td style="width: 10%;"></td> <td style="width: 10%;"></td> <td style="width: 10%;"></td> <td style="width: 10%;"></td> <td style="width: 10%;"></td> <td style="width: 10%;"></td> <td style="width: 10%;"></td> </tr> <tr> <td></td> <td></td> <td colspan="8" style="text-align: center;"> <table border="1" style="width: 100%; border-collapse: collapse; text-align: center;"> <tr> <td style="width: 10%;"></td> <td style="width: 10%;"></td> <td style="width: 10%;"></td> <td style="width: 10%;"></td> <td style="width: 10%;"></td> <td style="width: 10%;"></td> <td style="width: 10%;"></td> <td style="width: 10%;"></td> <td style="width: 10%;"></td> <td style="width: 10%;"></td> </tr> <tr> <td></td> <td></td> <td colspan="8" style="text-align: center;"> <table border="1" style="width: 100%; border-collapse: collapse; text-align: center;"> <tr> <td style="width: 10%;"></td> <td style="width: 10%;"></td> <td style="width: 10%;"></td> <td style="width: 10%;"></td> <td style="width: 10%;"></td> <td style="width: 10%;"></td> <td style="width: 10%;"></td> <td style="width: 10%;"></td> <td style="width: 10%;"></td> <td style="width: 10%;"></td> </tr> <tr> <td></td> <td></td> <td colspan="8" style="text-align: center;"> <table border="1" style="width: 100%; border-collapse: collapse; text-align: center;"> <tr> <td style="width: 10%;"></td> <td style="width: 10%;"></td> <td style="width: 10%;"></td> <td style="width: 10%;"></td> <td style="width: 10%;"></td> <td style="width: 10%;"></td> <td style="width: 10%;"></td> <td style="width: 10%;"></td> <td style="width: 10%;"></td> <td style="width: 10%;"></td> </tr> <tr> <td></td> <td></td> <td colspan="8" style="text-align: center;"> <table border="1" style="width: 100%; border-collapse: collapse; text-align: center;"> <tr> <td style="width: 10%;"></td> <td style="width: 10%;"></td> <td style="width: 10%;"></td> <td style="width: 10%;"></td> <td style="width: 10%;"></td> <td style="width: 10%;"></td> <td style="width: 10%;"></td> <td style="width: 10%;"></td> <td style="width: 10%;"></td> <td style="width: 10%;"></td> </tr> <tr> <td></td> <td></td> <td colspan="8" style="text-align: center;"> <table border="1" style="width: 100%; border-collapse: collapse; text-align: center;"> <tr> <td style="width: 10%;"></td> <td style="width: 10%;"></td> <td style="width: 10%;"></td> <td style="width: 10%;"></td> <td style="width: 10%;"></td> <td style="width: 10%;"></td> <td style="width: 10%;"></td> <td style="width: 10%;"></td> <td style="width: 10%;"></td> <td style="width: 10%;"></td> </tr> <tr> <td></td> <td></td> <td colspan="8" style="text-align: center;"> <table border="1" style="width: 100%; border-collapse: collapse; text-align: center;"> <tr> <td style="width: 10%;"></td> <td style="width: 10%;"></td> <td style="width: 10%;"></td> <td style="width: 10%;"></td> <td style="width: 10%;"></td> <td style="width: 10%;"></td> <td style="width: 10%;"></td> <td style="width: 10%;"></td> <td style="width: 10%;"></td> <td style="width: 10%;"></td> </tr> <tr> <td></td> <td></td> <td colspan="8" style="text-align: center;"> <table border="1" style="width: 100%; border-collapse: collapse; text-align: center;"> <tr> <td style="width: 10%;"></td> <td style="width: 10%;"></td> <td style="width: 10%;"></td> <td style="width: 10%;"></td> <td style="width: 10%;"></td> <td style="width: 10%;"></td> <td style="width: 10%;"></td> <td style="width: 10%;"></td> <td style="width: 10%;"></td> <td style="width: 10%;"></td> </tr> <tr> <td></td> <td></td> <td colspan="8" style="text-align: center;"> <table border="1" style="width: 100%; border-collapse: collapse; text-align: center;"> <tr> <td style="width: 10%;"></td> <td style="width: 10%;"></td> <td style="width: 10%;"></td> <td style="width: 10%;"></td> <td style="width: 10%;"></td> <td style="width: 10%;"></td> <td style="width: 10%;"></td> <td style="width: 10%;"></td> <td style="width: 10%;"></td> <td style="width: 10%;"></td> </tr> <tr> <td></td> <td></td> <td colspan="8" style="text-align: center;"> <table border="1" style="width: 100%; border-collapse: collapse; text-align: center;"> <tr> <td style="width: 10%;"></td> <td style="width: 10%;"></td> <td style="width: 10%;"></td> <td style="width: 10%;"></td> <td style="width: 10%;"></td> <td style="width: 10%;"></td> <td style="width: 10%;"></td> <td style="width: 10%;"></td> <td style="width: 10%;"></td> <td style="width: 10%;"></td> </tr> <tr> <td></td> <td></td> <td colspan="8" style="text-align: center;"> <table border="1" style="width: 100%; border-collapse: collapse; text-align: center;"> <tr> <td style="width: 10%;"></td> <td style="width: 10%;"></td> <td style="width: 10%;"></td> <td style="width: 10%;"></td> <td style="width: 10%;"></td> <td style="width: 10%;"></td> <td style="width: 10%;"></td> <td style="width: 10%;"></td> <td style="width: 10%;"></td> <td style="width: 10%;"></td> </tr> <tr> <td></td> <td></td> <td
colspan="8" style="text-align: center;"> <table border="1" style="width: 100%; border-collapse: collapse; text-align: center;"> <tr> <td style="width: 10%;"></td> <td style="width: 10%;"></td> <td style="width: 10%;"></td> <td style="width: 10%;"></td> <td style="width: 10%;"></td> <td style="width: 10%;"></td> <td style="width: 10%;"></td> <td style="width: 10%;"></td> <td style="width: 10%;"></td> <td style="width: 10%;"></td> </tr> <tr> <td></td> <td></td> <td colspan="8" style="text-align: center;"> <table border="1" style="width: 100%; border-collapse: collapse; text-align: center;"> <tr> <td style="width: 10%;"></td> <td style="width: 10%;"></td> <td style="width: 10%;"></td> <td style="width: 10%;"></td> <td style="width: 10%;"></td> <td style="width: 10%;"></td> <td style="width: 10%;"></td> <td style="width: 10%;"></td> <td style="width: 10%;"></td> <td style="width: 10%;"></td> </tr> <tr> <td></td> <td></td> <td colspan="8" style="text-align: center;"> <table border="1" style="width: 100%; border-collapse: collapse; text-align: center;"> <tr> <td style="width: 10%;"></td> <td style="width: 10%;"></td> <td style="width: 10%;"></td> <td style="width: 10%;"></td> <td style="width: 10%;"></td> <td style="width: 10%;"></td> <td style="width: 10%;"></td> <td style="width: 10%;"></td> <td style="width: 10%;"></td> <td style="width: 10%;"></td> </tr> <tr> <td></td> <td></td> <td colspan="8" style="text-align: center;"> <table border="1" style="width: 100%; border-collapse: collapse; text-align: center;"> <tr> <td style="width: 10%;"></td> <td style="width: 10%;"></td> <td style="width: 10%;"></td> <td style="width: 10%;"></td> <td style="width: 10%;"></td> <td style="width: 10%;"></td> <td style="width: 10%;"></td> <td style="width: 10%;"></td> <td style="width: 10%;"></td> <td style="width: 10%;"></td> </tr> <tr> <td></td> <td></td> <td colspan="8" style="text-align: center;"> <table border="1" style="width: 100%; border-collapse: collapse; text-align: center;"> <tr> <td style="width: 10%;"></td> <td style="width: 10%;"></td> <td style="width: 10%;"></td> <td style="width: 10%;"></td> <td style="width: 10%;"></td> <td style="width: 10%;"></td> <td style="width: 10%;"></td> <td style="width: 10%;"></td> <td style="width: 10%;"></td> <td style="width: 10%;"></td> </tr> <tr> <td></td> <td></td> <td colspan="8" style="text-align: center;"> <table border="1" style="width: 100%; border-collapse: collapse; text-align: center;"> <tr> <td style="width: 10%;"></td> <td style="width: 10%;"></td> <td style="width: 10%;"></td> <td style="width: 10%;"></td> <td style="width: 10%;"></td> <td style="width: 10%;"></td> <td style="width: 10%;"></td> <td style="width: 10%;"></td> <td style="width: 10%;"></td> <td style="width: 10%;"></td> </tr> <tr> <td></td> <td></td> <td colspan="8" style="text-align: center;"> <table border="1" style="width: 100%; border-collapse: collapse; text-align: center;"> <tr> </tr></table></td></tr></table></td></tr></table></td></tr></table></td></tr></table></td></tr></table></td></tr></table></td></tr></table></td></tr></table></td></tr></table></td></tr></table></td></tr></table></td></tr></table></td></tr></table></td></tr></table></td></tr></table></td></tr></table></td></tr></table></td></tr></table>
 | | | | | | | | | | | | | | | | | | | | <table border="1" style="width: 100%; border-collapse: collapse; text-align: center;"> <tr> <td style="width: 10%;"></td> <td style="width: 10%;"></td> <td style="width: 10%;"></td> <td style="width: 10%;"></td> <td style="width: 10%;"></td> <td style="width: 10%;"></td> <td style="width: 10%;"></td> <td style="width: 10%;"></td> <td style="width: 10%;"></td> <td style="width: 10%;"></td> </tr> <tr> <td></td> <td></td> <td colspan="8" style="text-align: center;"> <table border="1" style="width: 100%; border-collapse: collapse; text-align: center;"> <tr> <td style="width: 10%;"></td> <td style="width: 10%;"></td> <td style="width: 10%;"></td> <td style="width: 10%;"></td> <td style="width: 10%;"></td> <td style="width: 10%;"></td> <td style="width: 10%;"></td> <td style="width: 10%;"></td> <td style="width: 10%;"></td> <td style="width: 10%;"></td> </tr> <tr> <td></td> <td></td> <td colspan="8" style="text-align: center;"> <table border="1" style="width: 100%; border-collapse: collapse; text-align: center;"> <tr> <td style="width: 10%;"></td> <td style="width: 10%;"></td> <td style="width: 10%;"></td> <td style="width: 10%;"></td> <td style="width: 10%;"></td> <td style="width: 10%;"></td> <td style="width: 10%;"></td> <td style="width: 10%;"></td> <td style="width: 10%;"></td> <td style="width: 10%;"></td> </tr> <tr> <td></td> <td></td> <td colspan="8" style="text-align: center;"> <table border="1" style="width: 100%; border-collapse: collapse; text-align: center;"> <tr> <td style="width: 10%;"></td> <td style="width: 10%;"></td> <td style="width: 10%;"></td> <td style="width: 10%;"></td> <td style="width: 10%;"></td> <td style="width: 10%;"></td> <td style="width: 10%;"></td> <td style="width: 10%;"></td> <td style="width: 10%;"></td> <td style="width: 10%;"></td> </tr> <tr> <td></td> <td></td> <td colspan="8" style="text-align: center;"> <table border="1" style="width: 100%; border-collapse: collapse; text-align: center;"> <tr> <td style="width: 10%;"></td> <td style="width: 10%;"></td> <td style="width: 10%;"></td> <td style="width: 10%;"></td> <td style="width: 10%;"></td> <td style="width: 10%;"></td> <td style="width: 10%;"></td> <td style="width: 10%;"></td> <td style="width: 10%;"></td> <td style="width: 10%;"></td> </tr> <tr> <td></td> <td></td> <td colspan="8" style="text-align: center;"> <table border="1" style="width: 100%; border-collapse: collapse; text-align: center;"> <tr> <td style="width: 10%;"></td> <td style="width: 10%;"></td> <td style="width: 10%;"></td> <td style="width: 10%;"></td> <td style="width: 10%;"></td> <td style="width: 10%;"></td> <td style="width: 10%;"></td> <td style="width: 10%;"></td> <td style="width: 10%;"></td> <td style="width: 10%;"></td> </tr> <tr> <td></td> <td></td> <td colspan="8" style="text-align: center;"> <table border="1" style="width: 100%; border-collapse: collapse; text-align: center;"> <tr> <td style="width: 10%;"></td> <td style="width: 10%;"></td> <td style="width: 10%;"></td> <td style="width: 10%;"></td> <td style="width: 10%;"></td> <td style="width: 10%;"></td> <td style="width: 10%;"></td> <td style="width: 10%;"></td> <td style="width: 10%;"></td> <td style="width: 10%;"></td> </tr> <tr> <td></td> <td></td> <td colspan="8" style="text-align: center;"> <table border="1" style="width: 100%; border-collapse: collapse; text-align: center;"> <tr> <td style="width: 10%;"></td> <td style="width: 10%;"></td> <td style="width: 10%;"></td> <td style="width: 10%;"></td> <td style="width: 10%;"></td> <td style="width: 10%;"></td> <td style="width: 10%;"></td> <td style="width: 10%;"></td> <td style="width: 10%;"></td> <td style="width: 10%;"></td> </tr> <tr> <td></td> <td></td> <td colspan="8" style="text-align: center;"> <table border="1" style="width: 100%; border-collapse: collapse; text-align: center;"> <tr> <td style="width: 10%;"></td> <td style="width: 10%;"></td> <td style="width: 10%;"></td> <td style="width: 10%;"></td> <td style="width: 10%;"></td> <td style="width: 10%;"></td> <td style="width: 10%;"></td> <td style="width: 10%;"></td> <td style="width: 10%;"></td> <td style="width: 10%;"></td> </tr> <tr> <td></td> <td></td> <td colspan="8" style="text-align: center;"> <table border="1" style="width: 100%; border-collapse: collapse; text-align: center;"> <tr> <td style="width: 10%;"></td> <td style="width: 10%;"></td> <td style="width: 10%;"></td> <td style="width: 10%;"></td> <td style="width: 10%;"></td> <td style="width: 10%;"></td> <td style="width: 10%;"></td> <td style="width: 10%;"></td> <td style="width: 10%;"></td> <td style="width: 10%;"></td> </tr> <tr> <td></td> <td></td> <td colspan="8" style="text-align: center;"> <table border="1" style="width: 100%; border-collapse: collapse; text-align: center;"> <tr> <td style="width: 10%;"></td> <td style="width: 10%;"></td> <td style="width: 10%;"></td> <td style="width: 10%;"></td> <td style="width: 10%;"></td> <td style="width: 10%;"></td> <td style="width: 10%;"></td> <td style="width: 10%;"></td> <td style="width: 10%;"></td> <td style="width: 10%;"></td> </tr> <tr> <td></td> <td></td> <td colspan="8" style="text-align: center;"> <table border="1" style="width: 100%; border-collapse: collapse; text-align: center;"> <tr> <td style="width: 10%;"></td> <td style="width: 10%;"></td> <td style="width: 10%;"></td> <td style="width: 10%;"></td> <td style="width: 10%;"></td> <td style="width: 10%;"></td> <td style="width: 10%;"></td> <td style="width: 10%;"></td> <td style="width: 10%;"></td> <td style="width: 10%;"></td> </tr> <tr> <td></td> <td></td> <td colspan="8" style="text-align: center;"> <table border="1" style="width: 100%; border-collapse: collapse; text-align: center;"> <tr> <td style="width: 10%;"></td> <td style="width: 10%;"></td> <td style="width: 10%;"></td> <td style="width: 10%;"></td> <td style="width: 10%;"></td> <td style="width: 10%;"></td> <td style="width: 10%;"></td> <td style="width: 10%;"></td> <td style="width: 10%;"></td> <td style="width: 10%;"></td> </tr> <tr> <td></td> <td></td> <td colspan="8" style="text-align: center;"> <table border="1" style="width: 100%; border-collapse: collapse; text-align: center;"> <tr> <td style="width: 10%;"></td> <td style="width: 10%;"></td> <td style="width: 10%;"></td> <td style="width: 10%;"></td> <td style="width: 10%;"></td> <td style="width: 10%;"></td> <td style="width: 10%;"></td> <td style="width: 10%;"></td> <td style="width: 10%;"></td> <td style="width: 10%;"></td> </tr> <tr> <td></td> <td></td> <td colspan="8" style="text-align: center;"> <table border="1" style="width: 100%; border-collapse: collapse; text-align: center;"> <tr> <td style="width: 10%;"></td> <td style="width: 10%;"></td> <td style="width: 10%;"></td> <td style="width: 10%;"></td> <td style="width: 10%;"></td> <td style="width: 10%;"></td> <td style="width: 10%;"></td> <td style="width: 10%;"></td> <td style="width: 10%;"></td> <td style="width: 10%;"></td> </tr> <tr> <td></td> <td></td> <td colspan="8" style="text-align: center;"> <table border="1" style="width: 100%; border-collapse: collapse; text-align: center;"> <tr> <td style="width: 10%;"></td> <td style="width: 10%;"></td> <td style="width: 10%;"></td> <td style="width: 10%;"></td> <td style="width: 10%;"></td> <td style="width: 10%;"></td> <td style="width: 10%;"></td> <td style="width: 10%;"></td> <td style="width: 10%;"></td> <td style="width: 10%;"></td> </tr> <tr> <td></td> <td></td> <td colspan="8" style="text-align: center;"> <table border="1" style="width: 100%; border-collapse: collapse; text-align: center;"> <tr> <td style="width: 10%;"></td> <td style="width: 10%;"></td> <td style="width: 10%;"></td> <td style="width: 10%;"></td> <td style="width: 10%;"></td> <td style="width: 10%;"></td> <td style="width: 10%;"></td> <td style="width: 10%;"></td> <td style="width: 10%;"></td> <td style="width: 10%;"></td> </tr> <tr> <td></td> <td></td> <td colspan="8" style="text-align: center;"> <table border="1" style="width: 100%; border-collapse: collapse; text-align: center;"> <tr> </tr></table></td></tr></table></td></tr></table></td></tr></table></td></tr></table></td></tr></table></td></tr></table></td></tr></table></td></tr></table></td></tr></table></td></tr></table></td></tr></table></td></tr></table></td></tr></table></td></tr></table></td></tr></table></td></tr></table></td></tr></table>
 | | | | | | | | | | | | | | | | | | | | <table border="1" style="width: 100%; border-collapse: collapse; text-align: center;"> <tr> <td style="width: 10%;"></td> <td style="width: 10%;"></td> <td style="width: 10%;"></td> <td style="width: 10%;"></td> <td style="width: 10%;"></td> <td style="width: 10%;"></td> <td style="width: 10%;"></td> <td style="width: 10%;"></td> <td style="width: 10%;"></td> <td style="width: 10%;"></td> </tr> <tr> <td></td> <td></td> <td colspan="8" style="text-align: center;"> <table border="1" style="width: 100%; border-collapse: collapse; text-align: center;"> <tr> <td style="width: 10%;"></td> <td style="width: 10%;"></td> <td style="width: 10%;"></td> <td style="width: 10%;"></td> <td style="width: 10%;"></td> <td style="width: 10%;"></td> <td style="width: 10%;"></td> <td style="width: 10%;"></td> <td style="width: 10%;"></td> <td style="width: 10%;"></td> </tr> <tr> <td></td> <td></td> <td colspan="8" style="text-align: center;"> <table border="1" style="width: 100%; border-collapse: collapse; text-align: center;"> <tr> <td style="width: 10%;"></td> <td style="width: 10%;"></td> <td style="width: 10%;"></td> <td style="width: 10%;"></td> <td style="width: 10%;"></td> <td style="width: 10%;"></td> <td style="width: 10%;"></td> <td style="width: 10%;"></td> <td style="width: 10%;"></td> <td style="width: 10%;"></td> </tr> <tr> <td></td> <td></td> <td colspan="8" style="text-align: center;"> <table border="1" style="width: 100%; border-collapse: collapse; text-align: center;"> <tr> <td style="width: 10%;"></td> <td style="width: 10%;"></td> <td style="width: 10%;"></td> <td style="width: 10%;"></td> <td style="width: 10%;"></td> <td style="width: 10%;"></td> <td style="width: 10%;"></td> <td style="width: 10%;"></td> <td style="width: 10%;"></td> <td style="width: 10%;"></td> </tr> <tr> <td></td> <td></td> <td colspan="8" style="text-align: center;"> <table border="1" style="width: 100%; border-collapse: collapse; text-align: center;"> <tr> <td style="width: 10%;"></td> <td style="width: 10%;"></td> <td style="width: 10%;"></td> <td style="width: 10%;"></td> <td style="width: 10%;"></td> <td style="width: 10%;"></td> <td style="width: 10%;"></td> <td style="width: 10%;"></td> <td style="width: 10%;"></td> <td style="width: 10%;"></td> </tr> <tr> <td></td> <td></td> <td colspan="8" style="text-align: center;"> <table border="1" style="width: 100%; border-collapse: collapse; text-align: center;"> <tr> <td style="width: 10%;"></td> <td style="width: 10%;"></td> <td style="width: 10%;"></td> <td style="width: 10%;"></td> <td style="width: 10%;"></td> <td style="width: 10%;"></td> <td style="width: 10%;"></td> <td style="width: 10%;"></td> <td style="width: 10%;"></td> <td style="width: 10%;"></td> </tr> <tr> <td></td> <td></td> <td colspan="8" style="text-align: center;"> <table border="1" style="width: 100%; border-collapse: collapse; text-align: center;"> <tr> <td style="width: 10%;"></td> <td style="width: 10%;"></td> <td style="width: 10%;"></td> <td style="width: 10%;"></td> <td style="width: 10%;"></td> <td style="width: 10%;"></td> <td style="width: 10%;"></td> <td style="width: 10%;"></td> <td style="width: 10%;"></td> <td style="width: 10%;"></td> </tr> <tr> <td></td> <td></td> <td colspan="8" style="text-align: center;"> <table border="1" style="width: 100%; border-collapse: collapse; text-align: center;"> <tr> <td style="width: 10%;"></td> <td style="width: 10%;"></td> <td style="width: 10%;"></td> <td style="width: 10%;"></td> <td style="width: 10%;"></td> <td style="width: 10%;"></td> <td style="width: 10%;"></td> <td style="width: 10%;"></td> <td style="width: 10%;"></td> <td
style="width: 10%;"></td> </tr> <tr> <td></td> <td></td> <td colspan="8" style="text-align: center;"> <table border="1" style="width: 100%; border-collapse: collapse; text-align: center;"> <tr> <td style="width: 10%;"></td> <td style="width: 10%;"></td> <td style="width: 10%;"></td> <td style="width: 10%;"></td> <td style="width: 10%;"></td> <td style="width: 10%;"></td> <td style="width: 10%;"></td> <td style="width: 10%;"></td> <td style="width: 10%;"></td> <td style="width: 10%;"></td> </tr> <tr> <td></td> <td></td> <td colspan="8" style="text-align: center;"> <table border="1" style="width: 100%; border-collapse: collapse; text-align: center;"> <tr> <td style="width: 10%;"></td> <td style="width: 10%;"></td> <td style="width: 10%;"></td> <td style="width: 10%;"></td> <td style="width: 10%;"></td> <td style="width: 10%;"></td> <td style="width: 10%;"></td> <td style="width: 10%;"></td> <td style="width: 10%;"></td> <td style="width: 10%;"></td> </tr> <tr> <td></td> <td></td> <td colspan="8" style="text-align: center;"> <table border="1" style="width: 100%; border-collapse: collapse; text-align: center;"> <tr> <td style="width: 10%;"></td> <td style="width: 10%;"></td> <td style="width: 10%;"></td> <td style="width: 10%;"></td> <td style="width: 10%;"></td> <td style="width: 10%;"></td> <td style="width: 10%;"></td> <td style="width: 10%;"></td> <td style="width: 10%;"></td> <td style="width: 10%;"></td> </tr> <tr> <td></td> <td></td> <td colspan="8" style="text-align: center;"> <table border="1" style="width: 100%; border-collapse: collapse; text-align: center;"> <tr> <td style="width: 10%;"></td> <td style="width: 10%;"></td> <td style="width: 10%;"></td> <td style="width: 10%;"></td> <td style="width: 10%;"></td> <td style="width: 10%;"></td> <td style="width: 10%;"></td> <td style="width: 10%;"></td> <td style="width: 10%;"></td> <td style="width: 10%;"></td> </tr> <tr> <td></td> <td></td> <td colspan="8" style="text-align: center;"> <table border="1" style="width: 100%; border-collapse: collapse; text-align: center;"> <tr> <td style="width: 10%;"></td> <td style="width: 10%;"></td> <td style="width: 10%;"></td> <td style="width: 10%;"></td> <td style="width: 10%;"></td> <td style="width: 10%;"></td> <td style="width: 10%;"></td> <td style="width: 10%;"></td> <td style="width: 10%;"></td> <td style="width: 10%;"></td> </tr> <tr> <td></td> <td></td> <td colspan="8" style="text-align: center;"> <table border="1" style="width: 100%; border-collapse: collapse; text-align: center;"> <tr> <td style="width: 10%;"></td> <td style="width: 10%;"></td> <td style="width: 10%;"></td> <td style="width: 10%;"></td> <td style="width: 10%;"></td> <td style="width: 10%;"></td> <td style="width: 10%;"></td> <td style="width: 10%;"></td> <td style="width: 10%;"></td> <td style="width: 10%;"></td> </tr> <tr> <td></td> <td></td> <td colspan="8" style="text-align: center;"> <table border="1" style="width: 100%; border-collapse: collapse; text-align: center;"> <tr> <td style="width: 10%;"></td> <td style="width: 10%;"></td> <td style="width: 10%;"></td> <td style="width: 10%;"></td> <td style="width: 10%;"></td> <td style="width: 10%;"></td> <td style="width: 10%;"></td> <td style="width: 10%;"></td> <td style="width: 10%;"></td> <td style="width: 10%;"></td> </tr> <tr> <td></td> <td></td> <td colspan="8" style="text-align: center;"> <table border="1" style="width: 100%; border-collapse: collapse; text-align: center;"> <tr> <td style="width: 10%;"></td> <td style="width: 10%;"></td> <td style="width: 10%;"></td> <td style="width: 10%;"></td> <td style="width: 10%;"></td> <td style="width: 10%;"></td> <td style="width: 10%;"></td> <td style="width: 10%;"></td> <td style="width: 10%;"></td> <td style="width: 10%;"></td> </tr> <tr> <td></td> <td></td> <td colspan="8" style="text-align: center;"> <table border="1" style="width: 100%; border-collapse: collapse; text-align: center;"> <tr> </tr></table></td></tr></table></td></tr></table></td></tr></table></td></tr></table></td></tr></table></td></tr></table></td></tr></table></td></tr></table></td></tr></table></td></tr></table></td></tr></table></td></tr></table></td></tr></table></td></tr></table></td></tr></table></td></tr></table>
 | | | | | | | | | | | | | | | | | | | | <table border="1" style="width: 100%; border-collapse: collapse; text-align: center;"> <tr> <td style="width: 10%;"></td> <td style="width: 10%;"></td> <td style="width: 10%;"></td> <td style="width: 10%;"></td> <td style="width: 10%;"></td> <td style="width: 10%;"></td> <td style="width: 10%;"></td> <td style="width: 10%;"></td> <td style="width: 10%;"></td> <td style="width: 10%;"></td> </tr> <tr> <td></td> <td></td> <td colspan="8" style="text-align: center;"> <table border="1" style="width: 100%; border-collapse: collapse; text-align: center;"> <tr> <td style="width: 10%;"></td> <td style="width: 10%;"></td> <td style="width: 10%;"></td> <td style="width: 10%;"></td> <td style="width: 10%;"></td> <td style="width: 10%;"></td> <td style="width: 10%;"></td> <td style="width: 10%;"></td> <td style="width: 10%;"></td> <td style="width: 10%;"></td> </tr> <tr> <td></td> <td></td> <td colspan="8" style="text-align: center;"> <table border="1" style="width: 100%; border-collapse: collapse; text-align: center;"> <tr> <td style="width: 10%;"></td> <td style="width: 10%;"></td> <td style="width: 10%;"></td> <td style="width: 10%;"></td> <td style="width: 10%;"></td> <td style="width: 10%;"></td> <td style="width: 10%;"></td> <td style="width: 10%;"></td> <td style="width: 10%;"></td> <td style="width: 10%;"></td> </tr> <tr> <td></td> <td></td> <td colspan="8" style="text-align: center;"> <table border="1" style="width: 100%; border-collapse: collapse; text-align: center;"> <tr> <td style="width: 10%;"></td> <td style="width: 10%;"></td> <td style="width: 10%;"></td> <td style="width: 10%;"></td> <td style="width: 10%;"></td> <td style="width: 10%;"></td> <td style="width: 10%;"></td> <td style="width: 10%;"></td> <td style="width: 10%;"></td> <td style="width: 10%;"></td> </tr> <tr> <td></td> <td></td> <td colspan="8" style="text-align: center;"> <table border="1" style="width: 100%; border-collapse: collapse; text-align: center;"> <tr> <td style="width: 10%;"></td> <td style="width: 10%;"></td> <td style="width: 10%;"></td> <td style="width: 10%;"></td> <td style="width: 10%;"></td> <td style="width: 10%;"></td> <td style="width: 10%;"></td> <td style="width: 10%;"></td> <td style="width: 10%;"></td> <td style="width: 10%;"></td> </tr> <tr> <td></td> <td></td> <td colspan="8" style="text-align: center;"> <table border="1" style="width: 100%; border-collapse: collapse; text-align: center;"> <tr> <td style="width: 10%;"></td> <td style="width: 10%;"></td> <td style="width: 10%;"></td> <td style="width: 10%;"></td> <td style="width: 10%;"></td> <td style="width: 10%;"></td> <td style="width: 10%;"></td> <td style="width: 10%;"></td> <td style="width: 10%;"></td> <td style="width: 10%;"></td> </tr> <tr> <td></td> <td></td> <td colspan="8" style="text-align: center;"> <table border="1" style="width: 100%; border-collapse: collapse; text-align: center;"> <tr> <td style="width: 10%;"></td> <td style="width: 10%;"></td> <td style="width: 10%;"></td> <td style="width: 10%;"></td> <td style="width: 10%;"></td> <td style="width: 10%;"></td> <td style="width: 10%;"></td> <td style="width: 10%;"></td> <td style="width: 10%;"></td> <td style="width: 10%;"></td> </tr> <tr> <td></td> <td></td> <td colspan="8" style="text-align: center;"> <table border="1" style="width: 100%; border-collapse: collapse; text-align: center;"> <tr> <td style="width: 10%;"></td> <td style="width: 10%;"></td> <td style="width: 10%;"></td> <td style="width: 10%;"></td> <td style="width: 10%;"></td> <td style="width: 10%;"></td> <td style="width: 10%;"></td> <td style="width: 10%;"></td> <td style="width: 10%;"></td> <td style="width: 10%;"></td> </tr> <tr> <td></td> <td></td> <td colspan="8" style="text-align: center;"> <table border="1" style="width: 100%; border-collapse: collapse; text-align: center;"> <tr> <td style="width: 10%;"></td> <td style="width: 10%;"></td> <td style="width: 10%;"></td> <td style="width: 10%;"></td> <td style="width: 10%;"></td> <td style="width: 10%;"></td> <td style="width: 10%;"></td> <td style="width: 10%;"></td> <td style="width: 10%;"></td> <td style="width: 10%;"></td> </tr> <tr> <td></td> <td></td> <td colspan="8" style="text-align: center;"> <table border="1" style="width: 100%; border-collapse: collapse; text-align: center;"> <tr> <td style="width: 10%;"></td> <td style="width: 10%;"></td> <td style="width: 10%;"></td> <td style="width: 10%;"></td> <td style="width: 10%;"></td> <td style="width: 10%;"></td> <td style="width: 10%;"></td> <td style="width: 10%;"></td> <td style="width: 10%;"></td> <td style="width: 10%;"></td> </tr> <tr> <td></td> <td></td> <td colspan="8" style="text-align: center;"> <table border="1" style="width: 100%; border-collapse: collapse; text-align: center;"> <tr> <td style="width: 10%;"></td> <td style="width: 10%;"></td> <td style="width: 10%;"></td> <td style="width: 10%;"></td> <td style="width: 10%;"></td> <td style="width: 10%;"></td> <td style="width: 10%;"></td> <td style="width: 10%;"></td> <td style="width: 10%;"></td> <td style="width: 10%;"></td> </tr> <tr> <td></td> <td></td> <td colspan="8" style="text-align: center;"> <table border="1" style="width: 100%; border-collapse: collapse; text-align: center;"> <tr> <td style="width: 10%;"></td> <td style="width: 10%;"></td> <td style="width: 10%;"></td> <td style="width: 10%;"></td> <td style="width: 10%;"></td> <td style="width: 10%;"></td> <td style="width: 10%;"></td> <td style="width: 10%;"></td> <td style="width: 10%;"></td> <td style="width: 10%;"></td> </tr> <tr> <td></td> <td></td> <td colspan="8" style="text-align: center;"> <table border="1" style="width: 100%; border-collapse: collapse; text-align: center;"> <tr> <td style="width: 10%;"></td> <td style="width: 10%;"></td> <td style="width: 10%;"></td> <td style="width: 10%;"></td> <td style="width: 10%;"></td> <td style="width: 10%;"></td> <td style="width: 10%;"></td> <td style="width: 10%;"></td> <td style="width: 10%;"></td> <td style="width: 10%;"></td> </tr> <tr> <td></td> <td></td> <td colspan="8" style="text-align: center;"> <table border="1" style="width: 100%; border-collapse: collapse; text-align: center;"> <tr> <td style="width: 10%;"></td> <td style="width: 10%;"></td> <td style="width: 10%;"></td> <td style="width: 10%;"></td> <td style="width: 10%;"></td> <td style="width: 10%;"></td> <td style="width: 10%;"></td> <td style="width: 10%;"></td> <td style="width: 10%;"></td> <td style="width: 10%;"></td> </tr> <tr> <td></td> <td></td> <td colspan="8" style="text-align: center;"> <table border="1" style="width: 100%; border-collapse: collapse; text-align: center;"> <tr> <td style="width: 10%;"></td> <td style="width: 10%;"></td> <td style="width: 10%;"></td> <td style="width: 10%;"></td> <td style="width: 10%;"></td> <td style="width: 10%;"></td> <td style="width: 10%;"></td> <td style="width: 10%;"></td> <td style="width: 10%;"></td> <td style="width: 10%;"></td> </tr> <tr> <td></td> <td></td> <td colspan="8" style="text-align: center;"> <table border="1" style="width: 100%; border-collapse: collapse; text-align: center;"> <tr> </tr></table></td></tr></table></td></tr></table></td></tr></table></td></tr></table></td></tr></table></td></tr></table></td></tr></table></td></tr></table></td></tr></table></td></tr></table></td></tr></table></td></tr></table></td></tr></table></td></tr></table></td></tr></table>
 | | | | | | | | | | | | | | | | | | | | <table border="1" style="width: 100%; border-collapse: collapse; text-align: center;"> <tr> <td style="width: 10%;"></td> <td style="width: 10%;"></td> <td style="width: 10%;"></td> <td style="width: 10%;"></td> <td style="width: 10%;"></td> <td style="width: 10%;"></td> <td style="width: 10%;"></td> <td style="width: 10%;"></td> <td style="width: 10%;"></td> <td style="width: 10%;"></td> </tr> <tr> <td></td> <td></td> <td colspan="8" style="text-align: center;"> <table border="1" style="width: 100%; border-collapse: collapse; text-align: center;"> <tr> <td style="width: 10%;"></td> <td style="width: 10%;"></td> <td style="width: 10%;"></td> <td style="width: 10%;"></td> <td style="width: 10%;"></td> <td style="width: 10%;"></td> <td style="width: 10%;"></td> <td style="width: 10%;"></td> <td style="width: 10%;"></td> <td style="width: 10%;"></td> </tr> <tr> <td></td> <td></td> <td colspan="8" style="text-align: center;"> <table border="1" style="width: 100%; border-collapse: collapse; text-align: center;"> <tr> <td style="width: 10%;"></td> <td style="width: 10%;"></td> <td style="width: 10%;"></td> <td style="width: 10%;"></td> <td style="width: 10%;"></td> <td style="width: 10%;"></td> <td style="width: 10%;"></td> <td style="width: 10%;"></td> <td style="width: 10%;"></td> <td style="width: 10%;"></td> </tr> <tr> <td></td> <td></td> <td colspan="8" style="text-align: center;"> <table border="1" style="width: 100%; border-collapse: collapse; text-align: center;"> <tr> <td style="width: 10%;"></td> <td style="width: 10%;"></td> <td style="width: 10%;"></td> <td style="width: 10%;"></td> <td style="width: 10%;"></td> <td style="width: 10%;"></td> <td style="width: 10%;"></td> <td style="width: 10%;"></td> <td style="width: 10%;"></td> <td style="width: 10%;"></td> </tr> <tr> <td></td> <td></td> <td colspan="8" style="text-align: center;"> <table border="1" style="width: 100%; border-collapse: collapse; text-align: center;"> <tr> <td style="width: 10%;"></td> <td style="width: 10%;"></td> <td style="width: 10%;"></td> <td style="width: 10%;"></td> <td style="width: 10%;"></td> <td style="width: 10%;"></td> <td style="width: 10%;"></td> <td style="width: 10%;"></td> <td style="width: 10%;"></td> <td style="width: 10%;"></td> </tr> <tr> <td></td> <td></td> <td colspan="8" style="text-align: center;"> <table border="1" style="width: 100%; border-collapse: collapse; text-align: center;"> <tr> <td style="width: 10%;"></td> <td style="width: 10%;"></td> <td style="width: 10%;"></td> <td style="width: 10%;"></td> <td style="width: 10%;"></td> <td style="width: 10%;"></td> <td style="width: 10%;"></td> <td style="width: 10%;"></td> <td style="width: 10%;"></td> <td style="width: 10%;"></td> </tr> <tr> <td></td> <td></td> <td colspan="8" style="text-align: center;"> <table border="1" style="width: 100%; border-collapse: collapse; text-align: center;"> <tr> <td style="width: 10%;"></td> <td style="width: 10%;"></td> <td style="width: 10%;"></td> <td style="width: 10%;"></td> <td style="width: 10%;"></td> <td style="width: 10%;"></td> <td style="width: 10%;"></td> <td style="width: 10%;"></td> <td style="width: 10%;"></td> <td style="width: 10%;"></td> </tr> <tr> <td></td> <td></td> <td colspan="8" style="text-align: center;"> <table border="1" style="width: 100%; border-collapse: collapse; text-align: center;"> <tr> <td style="width: 10%;"></td> <td style="width: 10%;"></td> <td style="width: 10%;"></td> <td style="width: 10%;"></td> <td style="width: 10%;"></td> <td style="width: 10%;"></td> <td style="width: 10%;"></td> <td style="width: 10%;"></td> <td style="width: 10%;"></td> <td style="width:
10%;"></td> </tr> <tr> <td></td> <td></td> <td colspan="8" style="text-align: center;"> <table border="1" style="width: 100%; border-collapse: collapse; text-align: center;"> <tr> <td style="width: 10%;"></td> <td style="width: 10%;"></td> <td style="width: 10%;"></td> <td style="width: 10%;"></td> <td style="width: 10%;"></td> <td style="width: 10%;"></td> <td style="width: 10%;"></td> <td style="width: 10%;"></td> <td style="width: 10%;"></td> <td style="width: 10%;"></td> </tr> <tr> <td></td> <td></td> <td colspan="8" style="text-align: center;"> <table border="1" style="width: 100%; border-collapse: collapse; text-align: center;"> <tr> <td style="width: 10%;"></td> <td style="width: 10%;"></td> <td style="width: 10%;"></td> <td style="width: 10%;"></td> <td style="width: 10%;"></td> <td style="width: 10%;"></td> <td style="width: 10%;"></td> <td style="width: 10%;"></td> <td style="width: 10%;"></td> <td style="width: 10%;"></td> </tr> <tr> <td></td> <td></td> <td colspan="8" style="text-align: center;"> <table border="1" style="width: 100%; border-collapse: collapse; text-align: center;"> <tr> <td style="width: 10%;"></td> <td style="width: 10%;"></td> <td style="width: 10%;"></td> <td style="width: 10%;"></td> <td style="width: 10%;"></td> <td style="width: 10%;"></td> <td style="width: 10%;"></td> <td style="width: 10%;"></td> <td style="width: 10%;"></td> <td style="width: 10%;"></td> </tr> <tr> <td></td> <td></td> <td colspan="8" style="text-align: center;"> <table border="1" style="width: 100%; border-collapse: collapse; text-align: center;"> <tr> <td style="width: 10%;"></td> <td style="width: 10%;"></td> <td style="width: 10%;"></td> <td style="width: 10%;"></td> <td style="width: 10%;"></td> <td style="width: 10%;"></td> <td style="width: 10%;"></td> <td style="width: 10%;"></td> <td style="width: 10%;"></td> <td style="width: 10%;"></td> </tr> <tr> <td></td> <td></td> <td colspan="8" style="text-align: center;"> <table border="1" style="width: 100%; border-collapse: collapse; text-align: center;"> <tr> <td style="width: 10%;"></td> <td style="width: 10%;"></td> <td style="width: 10%;"></td> <td style="width: 10%;"></td> <td style="width: 10%;"></td> <td style="width: 10%;"></td> <td style="width: 10%;"></td> <td style="width: 10%;"></td> <td style="width: 10%;"></td> <td style="width: 10%;"></td> </tr> <tr> <td></td> <td></td> <td colspan="8" style="text-align: center;"> <table border="1" style="width: 100%; border-collapse: collapse; text-align: center;"> <tr> <td style="width: 10%;"></td> <td style="width: 10%;"></td> <td style="width: 10%;"></td> <td style="width: 10%;"></td> <td style="width: 10%;"></td> <td style="width: 10%;"></td> <td style="width: 10%;"></td> <td style="width: 10%;"></td> <td style="width: 10%;"></td> <td style="width: 10%;"></td> </tr> <tr> <td></td> <td></td> <td colspan="8" style="text-align: center;"> <table border="1" style="width: 100%; border-collapse: collapse; text-align: center;"> <tr> </tr></table></td></tr></table></td></tr></table></td></tr></table></td></tr></table></td></tr></table></td></tr></table></td></tr></table></td></tr></table></td></tr></table></td></tr></table></td></tr></table></td></tr></table></td></tr></table></td></tr></table>
 | | | | | | | | | | | | | | | | | | | | <table border="1" style="width: 100%; border-collapse: collapse; text-align: center;"> <tr> <td style="width: 10%;"></td> <td style="width: 10%;"></td> <td style="width: 10%;"></td> <td style="width: 10%;"></td> <td style="width: 10%;"></td> <td style="width: 10%;"></td> <td style="width: 10%;"></td> <td style="width: 10%;"></td> <td style="width: 10%;"></td> <td style="width: 10%;"></td> </tr> <tr> <td></td> <td></td> <td colspan="8" style="text-align: center;"> <table border="1" style="width: 100%; border-collapse: collapse; text-align: center;"> <tr> <td style="width: 10%;"></td> <td style="width: 10%;"></td> <td style="width: 10%;"></td> <td style="width: 10%;"></td> <td style="width: 10%;"></td> <td style="width: 10%;"></td> <td style="width: 10%;"></td> <td style="width: 10%;"></td> <td style="width: 10%;"></td> <td style="width: 10%;"></td> </tr> <tr> <td></td> <td></td> <td colspan="8" style="text-align: center;"> <table border="1" style="width: 100%; border-collapse: collapse; text-align: center;"> <tr> <td style="width: 10%;"></td> <td style="width: 10%;"></td> <td style="width: 10%;"></td> <td style="width: 10%;"></td> <td style="width: 10%;"></td> <td style="width: 10%;"></td> <td style="width: 10%;"></td> <td style="width: 10%;"></td> <td style="width: 10%;"></td> <td style="width: 10%;"></td> </tr> <tr> <td></td> <td></td> <td colspan="8" style="text-align: center;"> <table border="1" style="width: 100%; border-collapse: collapse; text-align: center;"> <tr> <td style="width: 10%;"></td> <td style="width: 10%;"></td> <td style="width: 10%;"></td> <td style="width: 10%;"></td> <td style="width: 10%;"></td> <td style="width: 10%;"></td> <td style="width: 10%;"></td> <td style="width: 10%;"></td> <td style="width: 10%;"></td> <td style="width: 10%;"></td> </tr> <tr> <td></td> <td></td> <td colspan="8" style="text-align: center;"> <table border="1" style="width: 100%; border-collapse: collapse; text-align: center;"> <tr> <td style="width: 10%;"></td> <td style="width: 10%;"></td> <td style="width: 10%;"></td> <td style="width: 10%;"></td> <td style="width: 10%;"></td> <td style="width: 10%;"></td> <td style="width: 10%;"></td> <td style="width: 10%;"></td> <td style="width: 10%;"></td> <td style="width: 10%;"></td> </tr> <tr> <td></td> <td></td> <td colspan="8" style="text-align: center;"> <table border="1" style="width: 100%; border-collapse: collapse; text-align: center;"> <tr> <td style="width: 10%;"></td> <td style="width: 10%;"></td> <td style="width: 10%;"></td> <td style="width: 10%;"></td> <td style="width: 10%;"></td> <td style="width: 10%;"></td> <td style="width: 10%;"></td> <td style="width: 10%;"></td> <td style="width: 10%;"></td> <td style="width: 10%;"></td> </tr> <tr> <td></td> <td></td> <td colspan="8" style="text-align: center;"> <table border="1" style="width: 100%; border-collapse: collapse; text-align: center;"> <tr> <td style="width: 10%;"></td> <td style="width: 10%;"></td> <td style="width: 10%;"></td> <td style="width: 10%;"></td> <td style="width: 10%;"></td> <td style="width: 10%;"></td> <td style="width: 10%;"></td> <td style="width: 10%;"></td> <td style="width: 10%;"></td> <td style="width: 10%;"></td> </tr> <tr> <td></td> <td></td> <td colspan="8" style="text-align: center;"> <table border="1" style="width: 100%; border-collapse: collapse; text-align: center;"> <tr> <td style="width: 10%;"></td> <td style="width: 10%;"></td> <td style="width: 10%;"></td> <td style="width: 10%;"></td> <td style="width: 10%;"></td> <td style="width: 10%;"></td> <td style="width: 10%;"></td> <td style="width: 10%;"></td> <td style="width: 10%;"></td> <td style="width: 10%;"></td> </tr> <tr> <td></td> <td></td> <td colspan="8" style="text-align: center;"> <table border="1" style="width: 100%; border-collapse: collapse; text-align: center;"> <tr> <td style="width: 10%;"></td> <td style="width: 10%;"></td> <td style="width: 10%;"></td> <td style="width: 10%;"></td> <td style="width: 10%;"></td> <td style="width: 10%;"></td> <td style="width: 10%;"></td> <td style="width: 10%;"></td> <td style="width: 10%;"></td> <td style="width: 10%;"></td> </tr> <tr> <td></td> <td></td> <td colspan="8" style="text-align: center;"> <table border="1" style="width: 100%; border-collapse: collapse; text-align: center;"> <tr> <td style="width: 10%;"></td> <td style="width: 10%;"></td> <td style="width: 10%;"></td> <td style="width: 10%;"></td> <td style="width: 10%;"></td> <td style="width: 10%;"></td> <td style="width: 10%;"></td> <td style="width: 10%;"></td> <td style="width: 10%;"></td> <td style="width: 10%;"></td> </tr> <tr> <td></td> <td></td> <td colspan="8" style="text-align: center;"> <table border="1" style="width: 100%; border-collapse: collapse; text-align: center;"> <tr> <td style="width: 10%;"></td> <td style="width: 10%;"></td> <td style="width: 10%;"></td> <td style="width: 10%;"></td> <td style="width: 10%;"></td> <td style="width: 10%;"></td> <td style="width: 10%;"></td> <td style="width: 10%;"></td> <td style="width: 10%;"></td> <td style="width: 10%;"></td> </tr> <tr> <td></td> <td></td> <td colspan="8" style="text-align: center;"> <table border="1" style="width: 100%; border-collapse: collapse; text-align: center;"> <tr> <td style="width: 10%;"></td> <td style="width: 10%;"></td> <td style="width: 10%;"></td> <td style="width: 10%;"></td> <td style="width: 10%;"></td> <td style="width: 10%;"></td> <td style="width: 10%;"></td> <td style="width: 10%;"></td> <td style="width: 10%;"></td> <td style="width: 10%;"></td> </tr> <tr> <td></td> <td></td> <td colspan="8" style="text-align: center;"> <table border="1" style="width: 100%; border-collapse: collapse; text-align: center;"> <tr> <td style="width: 10%;"></td> <td style="width: 10%;"></td> <td style="width: 10%;"></td> <td style="width: 10%;"></td> <td style="width: 10%;"></td> <td style="width: 10%;"></td> <td style="width: 10%;"></td> <td style="width: 10%;"></td> <td style="width: 10%;"></td> <td style="width: 10%;"></td> </tr> <tr> <td></td> <td></td> <td colspan="8" style="text-align: center;"> <table border="1" style="width: 100%; border-collapse: collapse; text-align: center;"> <tr> </tr></table></td></tr></table></td></tr></table></td></tr></table></td></tr></table></td></tr></table></td></tr></table></td></tr></table></td></tr></table></td></tr></table></td></tr></table></td></tr></table></td></tr></table></td></tr></table>
 | | | | | | | | | | | | | | | | | | | | <table border="1" style="width: 100%; border-collapse: collapse; text-align: center;"> <tr> <td style="width: 10%;"></td> <td style="width: 10%;"></td> <td style="width: 10%;"></td> <td style="width: 10%;"></td> <td style="width: 10%;"></td> <td style="width: 10%;"></td> <td style="width: 10%;"></td> <td style="width: 10%;"></td> <td style="width: 10%;"></td> <td style="width: 10%;"></td> </tr> <tr> <td></td> <td></td> <td colspan="8" style="text-align: center;"> <table border="1" style="width: 100%; border-collapse: collapse; text-align: center;"> <tr> <td style="width: 10%;"></td> <td style="width: 10%;"></td> <td style="width: 10%;"></td> <td style="width: 10%;"></td> <td style="width: 10%;"></td> <td style="width: 10%;"></td> <td style="width: 10%;"></td> <td style="width: 10%;"></td> <td style="width: 10%;"></td> <td style="width: 10%;"></td> </tr> <tr> <td></td> <td></td> <td colspan="8" style="text-align: center;"> <table border="1" style="width: 100%; border-collapse: collapse; text-align: center;"> <tr> <td style="width: 10%;"></td> <td style="width: 10%;"></td> <td style="width: 10%;"></td> <td style="width: 10%;"></td> <td style="width: 10%;"></td> <td style="width: 10%;"></td> <td style="width: 10%;"></td> <td style="width: 10%;"></td> <td style="width: 10%;"></td> <td style="width: 10%;"></td> </tr> <tr> <td></td> <td></td> <td colspan="8" style="text-align: center;"> <table border="1" style="width: 100%; border-collapse: collapse; text-align: center;"> <tr> <td style="width: 10%;"></td> <td style="width: 10%;"></td> <td style="width: 10%;"></td> <td style="width: 10%;"></td> <td style="width: 10%;"></td> <td style="width: 10%;"></td> <td style="width: 10%;"></td> <td style="width: 10%;"></td> <td style="width: 10%;"></td> <td style="width: 10%;"></td> </tr> <tr> <td></td> <td></td> <td colspan="8" style="text-align: center;"> <table border="1" style="width: 100%; border-collapse: collapse; text-align: center;"> <tr> <td style="width: 10%;"></td> <td style="width: 10%;"></td> <td style="width: 10%;"></td> <td style="width: 10%;"></td> <td style="width: 10%;"></td> <td style="width: 10%;"></td> <td style="width: 10%;"></td> <td style="width: 10%;"></td> <td style="width: 10%;"></td> <td style="width: 10%;"></td> </tr> <tr> <td></td> <td></td> <td colspan="8" style="text-align: center;"> <table border="1" style="width: 100%; border-collapse: collapse; text-align: center;"> <tr> <td style="width: 10%;"></td> <td style="width: 10%;"></td> <td style="width: 10%;"></td> <td style="width: 10%;"></td> <td style="width: 10%;"></td> <td style="width: 10%;"></td> <td style="width: 10%;"></td> <td style="width: 10%;"></td> <td style="width: 10%;"></td> <td style="width: 10%;"></td> </tr> <tr> <td></td> <td></td> <td colspan="8" style="text-align: center;"> <table border="1" style="width: 100%; border-collapse: collapse; text-align: center;"> <tr> <td style="width: 10%;"></td> <td style="width: 10%;"></td> <td style="width: 10%;"></td> <td style="width: 10%;"></td> <td style="width: 10%;"></td> <td style="width: 10%;"></td> <td style="width: 10%;"></td> <td style="width: 10%;"></td> <td style="width: 10%;"></td> <td style="width: 10%;"></td> </tr> <tr> <td></td> <td></td> <td colspan="8" style="text-align: center;"> <table border="1" style="width: 100%; border-collapse: collapse; text-align: center;"> <tr> <td style="width: 10%;"></td> <td style="width: 10%;"></td> <td style="width: 10%;"></td> <td style="width: 10%;"></td> <td style="width: 10%;"></td> <td style="width: 10%;"></td> <td style="width: 10%;"></td> <td style="width: 10%;"></td> <td style="width: 10%;"></td> <td style="width: 10%;"></td> </tr> <tr> <td></td> <td></td> <td colspan="8" style="text-align: center;"> <table border="1" style="width: 100%; border-collapse: collapse; text-align: center;"> <tr> <td style="width: 10%;"></td> <td style="width: 10%;"></td> <td style="width: 10%;"></td> <td style="width: 10%;"></td> <td style="width: 10%;"></td> <td style="width: 10%;"></td> <td style="width: 10%;"></td> <td style="width: 10%;"></td> <td style="width: 10%;"></td> <td style="width: 10%;"></td> </tr> <tr> <td></td> <td></td> <td colspan="8" style="text-align: center;"> <table border="1" style="width: 100%; border-collapse: collapse; text-align: center;"> <tr> <td style="width: 10%;"></td> <td style="width: 10%;"></td> <td style="width: 10%;"></td> <td style="width: 10%;"></td> <td style="width: 10%;"></td> <td style="width: 10%;"></td> <td style="width: 10%;"></td> <td style="width: 10%;"></td> <td style="width: 10%;"></td> <td style="width: 10%;"></td> </tr> <tr> <td></td> <td></td> <td colspan="8" style="text-align: center;"> <table border="1" style="width: 100%; border-collapse: collapse; text-align: center;"> <tr> <td style="width: 10%;"></td> <td style="width: 10%;"></td> <td style="width: 10%;"></td> <td style="width: 10%;"></td> <td style="width: 10%;"></td> <td style="width: 10%;"></td> <td style="width: 10%;"></td> <td style="width: 10%;"></td> <td style="width: 10%;"></td> <td style="width: 10%;"></td> </tr> <tr> <td></td> <td></td> <td colspan="8" style="text-align: center;"> <table border="1" style="width: 100%; border-collapse: collapse; text-align: center;"> <tr> <td style="width: 10%;"></td> <td style="width: 10%;"></td> <td style="width: 10%;"></td> <td style="width: 10%;"></td> <td style="width: 10%;"></td> <td style="width: 10%;"></td> <td style="width: 10%;"></td> <td style="width: 10%;"></td> <td style="width: 10%;"></td> <td style="width: 10%;"></td> </tr> <tr> <td></td> <td></td> <td colspan="8" style="text-align: center;"> <table
border="1" style="width: 100%; border-collapse: collapse; text-align: center;"> <tr> </tr></table></td></tr></table></td></tr></table></td></tr></table></td></tr></table></td></tr></table></td></tr></table></td></tr></table></td></tr></table></td></tr></table></td></tr></table></td></tr></table></td></tr></table> | | | | | | | | | | | | | | | | | | | | <table border="1" style="width: 100%; border-collapse: collapse; text-align: center;"> <tr> <td style="width: 10%;"></td> <td style="width: 10%;"></td> <td style="width: 10%;"></td> <td style="width: 10%;"></td> <td style="width: 10%;"></td> <td style="width: 10%;"></td> <td style="width: 10%;"></td> <td style="width: 10%;"></td> <td style="width: 10%;"></td> <td style="width: 10%;"></td> </tr> <tr> <td></td> <td></td> <td colspan="8" style="text-align: center;"> <table border="1" style="width: 100%; border-collapse: collapse; text-align: center;"> <tr> <td style="width: 10%;"></td> <td style="width: 10%;"></td> <td style="width: 10%;"></td> <td style="width: 10%;"></td> <td style="width: 10%;"></td> <td style="width: 10%;"></td> <td style="width: 10%;"></td> <td style="width: 10%;"></td> <td style="width: 10%;"></td> <td style="width: 10%;"></td> </tr> <tr> <td></td> <td></td> <td colspan="8" style="text-align: center;"> <table border="1" style="width: 100%; border-collapse: collapse; text-align: center;"> <tr> <td style="width: 10%;"></td> <td style="width: 10%;"></td> <td style="width: 10%;"></td> <td style="width: 10%;"></td> <td style="width: 10%;"></td> <td style="width: 10%;"></td> <td style="width: 10%;"></td> <td style="width: 10%;"></td> <td style="width: 10%;"></td> <td style="width: 10%;"></td> </tr> <tr> <td></td> <td></td> <td colspan="8" style="text-align: center;"> <table border="1" style="width: 100%; border-collapse: collapse; text-align: center;"> <tr> <td style="width: 10%;"></td> <td style="width: 10%;"></td> <td style="width: 10%;"></td> <td style="width: 10%;"></td> <td style="width: 10%;"></td> <td style="width: 10%;"></td> <td style="width: 10%;"></td> <td style="width: 10%;"></td> <td style="width: 10%;"></td> <td style="width: 10%;"></td> </tr> <tr> <td></td> <td></td> <td colspan="8" style="text-align: center;"> <table border="1" style="width: 100%; border-collapse: collapse; text-align: center;"> <tr> <td style="width: 10%;"></td> <td style="width: 10%;"></td> <td style="width: 10%;"></td> <td style="width: 10%;"></td> <td style="width: 10%;"></td> <td style="width: 10%;"></td> <td style="width: 10%;"></td> <td style="width: 10%;"></td> <td style="width: 10%;"></td> <td style="width: 10%;"></td> </tr> <tr> <td></td> <td></td> <td colspan="8" style="text-align:
center;"> <table border="1" style="width: 100%; border-collapse: collapse; text-align: center;"> <tr> <td style="width: 10%;"></td> <td style="width: 10%;"></td> <td style="width: 10%;"></td> <td style="width: 10%;"></td> <td style="width: 10%;"></td> <td style="width: 10%;"></td> <td style="width: 10%;"></td> <td style="width: 10%;"></td> <td style="width: 10%;"></td> <td style="width: 10%;"></td> </tr> <tr> <td></td> <td></td> <td colspan="8" style="text-align: center;"> <table border="1" style="width: 100%; border-collapse: collapse; text-align: center;"> <tr> <td style="width: 10%;"></td> <td style="width: 10%;"></td> <td style="width: 10%;"></td> <td style="width: 10%;"></td> <td style="width: 10%;"></td> <td style="width: 10%;"></td> <td style="width: 10%;"></td> <td style="width: 10%;"></td> <td style="width: 10%;"></td> <td style="width: 10%;"></td> </tr> <tr> <td></td> <td></td> <td colspan="8" style="text-align: center;"> <table border="1" style="width: 100%; border-collapse: collapse; text-align: center;"> <tr> <td style="width: 10%;"></td> <td style="width: 10%;"></td> <td style="width: 10%;"></td> <td style="width: 10%;"></td> <td style="width: 10%;"></td> <td style="width: 10%;"></td> <td style="width: 10%;"></td> <td style="width: 10%;"></td> <td style="width: 10%;"></td> <td style="width: 10%;"></td> </tr> <tr> <td></td> <td></td> <td colspan="8" style="text-align: center;"> <table border="1" style="width: 100%; border-collapse: collapse; text-align: center;"> <tr> <td style="width: 10%;"></td> <td style="width: 10%;"></td> <td style="width: 10%;"></td> <td style="width: 10%;"></td> <td style="width: 10%;"></td> <td style="width: 10%;"></td> <td style="width: 10%;"></td> <td style="width: 10%;"></td> <td style="width: 10%;"></td> <td style="width: 10%;"></td> </tr> <tr> <td></td> <td></td> <td colspan="8" style="text-align: center;"> <table border="1" style="width: 100%; border-collapse: collapse; text-align: center;"> <tr> <td style="width: 10%;"></td> <td style="width: 10%;"></td> <td style="width: 10%;"></td> <td style="width: 10%;"></td> <td style="width: 10%;"></td> <td style="width: 10%;"></td> <td style="width: 10%;"></td> <td style="width: 10%;"></td> <td style="width: 10%;"></td> <td style="width: 10%;"></td> </tr> <tr> <td></td> <td></td> <td colspan="8" style="text-align: center;"> <table border="1" style="width: 100%; border-collapse: collapse; text-align: center;"> <tr> <td style="width: 10%;"></td> <td style="width: 10%;"></td> <td style="width: 10%;"></td> <td style="width: 10%;"></td> <td style="width: 10%;"></td> <td style="width: 10%;"></td> <td style="width: 10%;"></td> <td style="width: 10%;"></td> <td style="width: 10%;"></td> <td style="width: 10%;"></td> </tr> <tr> <td></td> <td></td> <td colspan="8" style="text-align: center;"> <table border="1" style="width: 100%; border-collapse: collapse; text-align: center;"> <tr> </tr></table></td></tr></table></td></tr></table></td></tr></table></td></tr></table></td></tr></table></td></tr></table></td></tr></table></td></tr></table></td></tr></table></td></tr></table></td></tr></table>
 | | | | | | | | | | | | | | | | | | | | <table border="1" style="width: 100%; border-collapse: collapse; text-align: center;"> <tr> <td style="width: 10%;"></td> <td style="width: 10%;"></td> <td style="width: 10%;"></td> <td style="width: 10%;"></td> <td style="width: 10%;"></td> <td style="width: 10%;"></td> <td style="width: 10%;"></td> <td style="width: 10%;"></td> <td style="width: 10%;"></td> <td style="width: 10%;"></td> </tr> <tr> <td></td> <td></td> <td colspan="8" style="text-align: center;"> <table border="1" style="width: 100%; border-collapse: collapse; text-align: center;"> <tr> <td style="width: 10%;"></td> <td style="width: 10%;"></td> <td style="width: 10%;"></td> <td style="width: 10%;"></td> <td style="width: 10%;"></td> <td style="width: 10%;"></td> <td style="width: 10%;"></td> <td style="width: 10%;"></td> <td style="width: 10%;"></td> <td style="width: 10%;"></td> </tr> <tr> <td></td> <td></td> <td colspan="8" style="text-align: center;"> <table border="1" style="width: 100%; border-collapse: collapse; text-align: center;"> <tr> <td style="width: 10%;"></td> <td style="width: 10%;"></td> <td style="width: 10%;"></td> <td style="width: 10%;"></td> <td style="width: 10%;"></td> <td style="width: 10%;"></td> <td style="width: 10%;"></td> <td style="width: 10%;"></td> <td style="width: 10%;"></td> <td style="width: 10%;"></td> </tr> <tr> <td></td> <td></td> <td colspan="8" style="text-align: center;"> <table border="1" style="width: 100%; border-collapse: collapse; text-align: center;"> <tr> <td style="width: 10%;"></td> <td style="width: 10%;"></td> <td style="width: 10%;"></td> <td style="width: 10%;"></td> <td style="width: 10%;"></td> <td style="width: 10%;"></td> <td style="width: 10%;"></td> <td style="width: 10%;"></td> <td style="width: 10%;"></td> <td style="width: 10%;"></td> </tr> <tr> <td></td> <td></td> <td colspan="8" style="text-align: center;"> <table border="1" style="width: 100%; border-collapse: collapse; text-align: center;"> <tr> <td style="width: 10%;"></td> <td style="width: 10%;"></td> <td style="width: 10%;"></td> <td style="width: 10%;"></td> <td style="width: 10%;"></td> <td style="width: 10%;"></td> <td style="width: 10%;"></td> <td style="width: 10%;"></td> <td style="width: 10%;"></td> <td style="width: 10%;"></td> </tr> <tr> <td></td> <td></td> <td colspan="8" style="text-align: center;"> <table border="1" style="width: 100%; border-collapse: collapse; text-align: center;"> <tr> <td style="width: 10%;"></td> <td style="width: 10%;"></td> <td style="width: 10%;"></td> <td style="width: 10%;"></td> <td style="width: 10%;"></td> <td style="width: 10%;"></td> <td style="width: 10%;"></td> <td style="width: 10%;"></td> <td style="width: 10%;"></td> <td style="width: 10%;"></td> </tr> <tr> <td></td> <td></td> <td colspan="8" style="text-align: center;"> <table border="1" style="width: 100%; border-collapse: collapse; text-align: center;"> <tr> <td style="width: 10%;"></td> <td style="width: 10%;"></td> <td style="width: 10%;"></td> <td style="width: 10%;"></td> <td style="width: 10%;"></td> <td style="width: 10%;"></td> <td style="width: 10%;"></td> <td style="width: 10%;"></td> <td style="width: 10%;"></td> <td style="width: 10%;"></td> </tr> <tr> <td></td> <td></td> <td colspan="8" style="text-align: center;"> <table border="1" style="width: 100%; border-collapse: collapse; text-align: center;"> <tr> <td style="width: 10%;"></td> <td style="width: 10%;"></td> <td style="width: 10%;"></td> <td style="width: 10%;"></td> <td style="width: 10%;"></td> <td style="width: 10%;"></td> <td style="width: 10%;"></td> <td style="width: 10%;"></td> <td style="width: 10%;"></td> <td style="width: 10%;"></td> </tr> <tr> <td></td> <td></td> <td colspan="8" style="text-align: center;"> <table border="1" style="width: 100%; border-collapse: collapse; text-align: center;"> <tr> <td style="width: 10%;"></td> <td style="width: 10%;"></td> <td style="width: 10%;"></td> <td style="width: 10%;"></td> <td style="width: 10%;"></td> <td style="width: 10%;"></td> <td style="width: 10%;"></td> <td style="width: 10%;"></td> <td style="width: 10%;"></td> <td style="width: 10%;"></td> </tr> <tr> <td></td> <td></td> <td colspan="8" style="text-align: center;"> <table border="1" style="width: 100%; border-collapse: collapse; text-align: center;"> <tr> <td style="width: 10%;"></td> <td style="width: 10%;"></td> <td style="width: 10%;"></td> <td style="width: 10%;"></td> <td style="width: 10%;"></td> <td style="width: 10%;"></td> <td style="width: 10%;"></td> <td style="width: 10%;"></td> <td style="width: 10%;"></td> <td style="width: 10%;"></td> </tr> <tr> <td></td> <td></td> <td colspan="8" style="text-align: center;"> <table border="1" style="width: 100%; border-collapse: collapse; text-align: center;"> <tr> </tr></table></td></tr></table></td></tr></table></td></tr></table></td></tr></table></td></tr></table></td></tr></table></td></tr></table></td></tr></table></td></tr></table></td></tr></table>
 | | | | | | | | | | | | | | | | | | | | <table border="1" style="width: 100%; border-collapse: collapse; text-align: center;"> <tr> <td style="width: 10%;"></td> <td style="width: 10%;"></td> <td style="width: 10%;"></td> <td style="width: 10%;"></td> <td style="width: 10%;"></td> <td style="width: 10%;"></td> <td style="width: 10%;"></td> <td style="width: 10%;"></td> <td style="width: 10%;"></td> <td style="width: 10%;"></td> </tr> <tr> <td></td> <td></td> <td colspan="8" style="text-align: center;"> <table border="1" style="width: 100%; border-collapse: collapse; text-align: center;"> <tr> <td style="width: 10%;"></td> <td style="width: 10%;"></td> <td style="width: 10%;"></td> <td style="width: 10%;"></td> <td style="width: 10%;"></td> <td style="width: 10%;"></td> <td style="width: 10%;"></td> <td style="width: 10%;"></td> <td style="width: 10%;"></td> <td style="width: 10%;"></td> </tr> <tr> <td></td> <td></td> <td colspan="8" style="text-align: center;"> <table border="1" style="width: 100%; border-collapse: collapse; text-align: center;"> <tr> <td style="width: 10%;"></td> <td style="width: 10%;"></td> <td style="width: 10%;"></td> <td style="width: 10%;"></td> <td style="width: 10%;"></td> <td style="width: 10%;"></td> <td style="width: 10%;"></td> <td style="width: 10%;"></td> <td style="width: 10%;"></td> <td style="width: 10%;"></td> </tr> <tr> <td></td> <td></td> <td colspan="8" style="text-align: center;"> <table border="1" style="width: 100%; border-collapse: collapse; text-align: center;"> <tr> <td style="width: 10%;"></td> <td style="width: 10%;"></td> <td style="width: 10%;"></td> <td style="width: 10%;"></td> <td style="width: 10%;"></td> <td style="width: 10%;"></td> <td style="width: 10%;"></td> <td style="width: 10%;"></td> <td style="width: 10%;"></td> <td style="width: 10%;"></td> </tr> <tr> <td></td> <td></td> <td colspan="8" style="text-align: center;"> <table border="1" style="width: 100%; border-collapse: collapse; text-align: center;"> <tr> <td style="width: 10%;"></td> <td style="width: 10%;"></td> <td style="width: 10%;"></td> <td style="width: 10%;"></td> <td style="width: 10%;"></td> <td style="width: 10%;"></td> <td style="width: 10%;"></td> <td style="width: 10%;"></td> <td style="width: 10%;"></td> <td style="width: 10%;"></td> </tr> <tr> <td></td> <td></td> <td colspan="8" style="text-align: center;"> <table border="1" style="width: 100%; border-collapse: collapse; text-align: center;"> <tr> <td style="width: 10%;"></td> <td style="width: 10%;"></td> <td style="width: 10%;"></td> <td style="width: 10%;"></td> <td style="width: 10%;"></td> <td style="width: 10%;"></td> <td style="width: 10%;"></td> <td style="width: 10%;"></td> <td style="width: 10%;"></td> <td style="width: 10%;"></td> </tr> <tr> <td></td> <td></td> <td colspan="8" style="text-align: center;"> <table border="1" style="width: 100%; border-collapse: collapse; text-align: center;"> <tr> <td style="width: 10%;"></td> <td style="width: 10%;"></td> <td style="width: 10%;"></td> <td style="width: 10%;"></td> <td style="width: 10%;"></td> <td style="width: 10%;"></td> <td style="width: 10%;"></td> <td style="width: 10%;"></td> <td style="width: 10%;"></td> <td style="width: 10%;"></td> </tr> <tr> <td></td> <td></td> <td colspan="8" style="text-align: center;"> <table border="1" style="width: 100%; border-collapse: collapse; text-align: center;"> <tr> <td style="width: 10%;"></td> <td style="width: 10%;"></td> <td style="width: 10%;"></td> <td style="width: 10%;"></td> <td style="width: 10%;"></td> <td style="width: 10%;"></td> <td style="width: 10%;"></td> <td style="width: 10%;"></td> <td style="width: 10%;"></td> <td style="width: 10%;"></td> </tr> <tr> <td></td> <td></td> <td colspan="8" style="text-align: center;"> <table border="1" style="width: 100%; border-collapse: collapse; text-align: center;"> <tr> <td style="width: 10%;"></td> <td style="width: 10%;"></td> <td style="width: 10%;"></td> <td style="width: 10%;"></td> <td style="width: 10%;"></td> <td style="width: 10%;"></td> <td style="width: 10%;"></td> <td style="width: 10%;"></td> <td style="width: 10%;"></td> <td style="width: 10%;"></td> </tr> <tr> <td></td> <td></td> <td colspan="8" style="text-align: center;"> <table border="1" style="width: 100%; border-collapse: collapse; text-align: center;"> <tr> </tr></table></td></tr></table></td></tr></table></td></tr></table></td></tr></table></td></tr></table></td></tr></table></td></tr></table></td></tr></table></td></tr></table>
 | | | | | | | | | | | | | | | | | | | | <table border="1" style="width: 100%; border-collapse: collapse; text-align: center;"> <tr> <td style="width: 10%;"></td> <td style="width: 10%;"></td> <td style="width: 10%;"></td> <td style="width: 10%;"></td> <td style="width: 10%;"></td> <td style="width: 10%;"></td> <td style="width: 10%;"></td> <td style="width: 10%;"></td> <td style="width: 10%;"></td> <td style="width: 10%;"></td> </tr> <tr> <td></td> <td></td> <td colspan="8" style="text-align: center;"> <table border="1" style="width: 100%; border-collapse: collapse; text-align: center;"> <tr> <td style="width: 10%;"></td> <td style="width: 10%;"></td> <td style="width: 10%;"></td> <td style="width: 10%;"></td> <td style="width: 10%;"></td> <td style="width: 10%;"></td> <td style="width: 10%;"></td> <td style="width: 10%;"></td> <td style="width: 10%;"></td> <td style="width: 10%;"></td> </tr> <tr> <td></td> <td></td> <td colspan="8" style="text-align: center;"> <table border="1" style="width: 100%; border-collapse: collapse; text-align: center;"> <tr> <td style="width: 10%;"></td> <td style="width: 10%;"></td> <td style="width: 10%;"></td> <td style="width: 10%;"></td> <td style="width: 10%;"></td> <td style="width: 10%;"></td> <td style="width: 10%;"></td> <td style="width: 10%;"></td> <td style="width: 10%;"></td> <td style="width: 10%;"></td> </tr> <tr> <td></td> <td></td> <td colspan="8" style="text-align: center;"> <table border="1" style="width: 100%; border-collapse: collapse; text-align: center;"> <tr> <td style="width: 10%;"></td> <td style="width: 10%;"></td> <td style="width: 10%;"></td> <td style="width: 10%;"></td> <td style="width: 10%;"></td> <td style="width: 10%;"></td> <td style="width: 10%;"></td> <td style="width: 10%;"></td> <td style="width: 10%;"></td> <td style="width: 10%;"></td> </tr> <tr> <td></td> <td></td> <td colspan="8" style="text-align: center;"> <table border="1" style="width: 100%; border-collapse: collapse; text-align: center;"> <tr> <td style="width: 10%;"></td> <td style="width: 10%;"></td> <td style="width: 10%;"></td> <td style="width: 10%;"></td> <td style="width: 10%;"></td> <td style="width: 10%;"></td> <td style="width: 10%;"></td> <td style="width: 10%;"></td> <td style="width: 10%;"></td> <td style="width: 10%;"></td> </tr> <tr> <td></td> <td></td> <td colspan="8" style="text-align: center;"> <table border="1" style="width: 100%; border-collapse: collapse; text-align: center;"> <tr> <td style="width: 10%;"></td> <td style="width: 10%;"></td> <td style="width: 10%;"></td> <td style="width: 10%;"></td> <td style="width: 10%;"></td> <td style="width: 10%;"></td> <td style="width: 10%;"></td> <td style="width: 10%;"></td> <td style="width: 10%;"></td> <td style="width: 10%;"></td> </tr> <tr> <td></td> <td></td> <td colspan="8" style="text-align: center;"> <table border="1" style="width: 100%; border-collapse: collapse; text-align: center;"> <tr> <td style="width: 10%;"></td> <td style="width: 10%;"></td> <td style="width: 10%;"></td> <td style="width: 10%;"></td> <td style="width: 10%;"></td> <td style="width: 10%;"></td> <td style="width: 10%;"></td> <td style="width: 10%;"></td> <td style="width: 10%;"></td> <td style="width: 10%;"></td> </tr> <tr> <td></td> <td></td> <td colspan="8" style="text-align: center;"> <table border="1" style="width: 100%; border-collapse: collapse; text-align: center;"> <tr> <td style="width: 10%;"></td> <td style="width: 10%;"></td> <td style="width: 10%;"></td> <td style="width: 10%;"></td> <td style="width: 10%;"></td> <td style="width: 10%;"></td> <td style="width: 10%;"></td> <td style="width: 10%;"></td> <td style="width: 10%;"></td> <td style="width: 10%;"></td> </tr> <tr> <td></td> <td></td> <td colspan="8" style="text-align: center;"> <table border="1" style="width: 100%; border-collapse: collapse; text-align: center;"> <tr> </tr></table></td></tr></table></td></tr></table></td></tr></table></td></tr></table></td></tr></table></td></tr></table></td></tr></table></td></tr></table>
 | | | | | | | | | | | | | | | | | | | | <table border="1" style="width: 100%; border-collapse: collapse; text-align: center;"> <tr> <td style="width: 10%;"></td> <td style="width: 10%;"></td> <td style="width: 10%;"></td> <td style="width: 10%;"></td> <td style="width: 10%;"></td> <td style="width: 10%;"></td> <td style="width: 10%;"></td> <td style="width: 10%;"></td> <td style="width: 10%;"></td> <td style="width: 10%;"></td> </tr> <tr> <td></td> <td></td> <td colspan="8" style="text-align: center;"> <table border="1" style="width: 100%; border-collapse: collapse; text-align: center;"> <tr> <td style="width: 10%;"></td> <td style="width: 10%;"></td> <td style="width: 10%;"></td> <td style="width: 10%;"></td> <td style="width: 10%;"></td> <td style="width: 10%;"></td> <td style="width: 10%;"></td> <td style="width: 10%;"></td> <td style="width: 10%;"></td> <td style="width: 10%;"></td> </tr> <tr> <td></td> <td></td> <td colspan="8" style="text-align: center;"> <table border="1" style="width: 100%; border-collapse: collapse; text-align: center;"> <tr> <td style="width: 10%;"></td> <td style="width: 10%;"></td> <td style="width: 10%;"></td> <td style="width: 10%;"></td> <td style="width: 10%;"></td> <td style="width: 10%;"></td> <td style="width: 10%;"></td> <td style="width: 10%;"></td> <td style="width: 10%;"></td> <td style="width: 10%;"></td> </tr> <tr> <td></td> <td></td> <td colspan="8" style="text-align: center;"> <table border="1" style="width: 100%; border-collapse: collapse; text-align: center;"> <tr> <td style="width: 10%;"></td> <td style="width: 10%;"></td> <td style="width: 10%;"></td> <td style="width: 10%;"></td> <td style="width: 10%;"></td> <td style="width: 10%;"></td> <td style="width: 10%;"></td> <td style="width: 10%;"></td> <td style="width: 10%;"></td> <td style="width: 10%;"></td> </tr> <tr> <td></td> <td></td> <td colspan="8" style="text-align: center;"> <table border="1" style="width: 100%; border-collapse: collapse; text-align: center;"> <tr> <td style="width: 10%;"></td> <td style="width: 10%;"></td> <td style="width: 10%;"></td> <td style="width: 10%;"></td> <td style="width: 10%;"></td> <td style="width: 10%;"></td> <td style="width: 10%;"></td> <td style="width: 10%;"></td> <td style="width: 10%;"></td> <td style="width: 10%;"></td> </tr> <tr> <td></td> <td></td> <td colspan="8" style="text-align: center;"> <table border="1" style="width: 100%; border-collapse: collapse; text-align: center;"> <tr> <td style="width: 10%;"></td> <td style="width: 10%;"></td> <td style="width: 10%;"></td> <td style="width: 10%;"></td> <td style="width: 10%;"></td> <td style="width: 10%;"></td> <td style="width: 10%;"></td> <td style="width: 10%;"></td> <td style="width: 10%;"></td> <td style="width: 10%;"></td> </tr> <tr> <td></td> <td></td> <td colspan="8" style="text-align: center;"> <table border="1" style="width: 100%; border-collapse: collapse; text-align: center;"> <tr> <td style="width: 10%;"></td> <td style="width: 10%;"></td> <td style="width: 10%;"></td> <td style="width: 10%;"></td> <td style="width: 10%;"></td> <td style="width: 10%;"></td> <td style="width: 10%;"></td> <td style="width: 10%;"></td> <td style="width: 10%;"></td> <td style="width: 10%;"></td> </tr> <tr> <td></td> <td></td> <td colspan="8" style="text-align: center;"> <table border="1" style="width: 100%; border-collapse: collapse; text-align: center;"> <tr> </tr></table></td></tr></table></td></tr></table></td></tr></table></td></tr></table></td></tr></table></td></tr></table></td></tr></table>
 | | | | | | | | | | | | | | | | | | | | <table border="1" style="width: 100%; border-collapse: collapse; text-align: center;"> <tr> <td style="width: 10%;"></td> <td style="width: 10%;"></td> <td style="width: 10%;"></td> <td style="width: 10%;"></td> <td style="width: 10%;"></td> <td style="width: 10%;"></td> <td style="width: 10%;"></td> <td style="width: 10%;"></td> <td style="width: 10%;"></td> <td style="width: 10%;"></td> </tr> <tr> <td></td> <td></td> <td colspan="8" style="text-align: center;"> <table border="1" style="width: 100%; border-collapse: collapse; text-align: center;"> <tr> <td style="width: 10%;"></td> <td style="width: 10%;"></td> <td style="width: 10%;"></td> <td style="width: 10%;"></td> <td style="width: 10%;"></td> <td style="width: 10%;"></td> <td style="width: 10%;"></td> <td style="width: 10%;"></td> <td style="width: 10%;"></td> <td style="width: 10%;"></td> </tr> <tr> <td></td> <td></td> <td colspan="8" style="text-align: center;"> <table border="1" style="width: 100%; border-collapse: collapse; text-align: center;"> <tr> <td style="width: 10%;"></td> <td style="width: 10%;"></td> <td style="width: 10%;"></td> <td style="width: 10%;"></td> <td style="width: 10%;"></td> <td style="width: 10%;"></td> <td style="width: 10%;"></td> <td style="width: 10%;"></td> <td style="width: 10%;"></td> <td style="width: 10%;"></td> </tr> <tr> <td></td> <td></td> <td colspan="8" style="text-align: center;"> <table border="1" style="width: 100%; border-collapse: collapse; text-align: center;"> <tr> <td style="width: 10%;"></td> <td style="width: 10%;"></td> <td style="width: 10%;"></td> <td style="width: 10%;"></td> <td style="width: 10%;"></td> <td style="width: 10%;"></td> <td style="width: 10%;"></td> <td style="width: 10%;"></td> <td style="width: 10%;"></td> <td style="width: 10%;"></td> </tr> <tr> <td></td> <td></td> <td colspan="8" style="text-align: center;"> <table border="1" style="width: 100%; border-collapse: collapse; text-align: center;"> <tr> <td style="width: 10%;"></td> <td style="width: 10%;"></td> <td style="width: 10%;"></td> <td style="width: 10%;"></td> <td style="width: 10%;"></td> <td style="width: 10%;"></td> <td style="width: 10%;"></td> <td style="width: 10%;"></td> <td style="width: 10%;"></td> <td style="width: 10%;"></td> </tr> <tr> <td></td> <td></td> <td colspan="8" style="text-align: center;"> <table border="1" style="width: 100%; border-collapse: collapse; text-align: center;"> <tr> <td style="width: 10%;"></td> <td style="width: 10%;"></td> <td style="width: 10%;"></td> <td style="width: 10%;"></td> <td style="width: 10%;"></td> <td style="width: 10%;"></td> <td style="width: 10%;"></td> <td style="width: 10%;"></td> <td style="width: 10%;"></td> <td style="width: 10%;"></td> </tr> <tr> <td></td> <td></td> <td colspan="8" style="text-align: center;"> <table border="1" style="width: 100%; border-collapse: collapse; text-align: center;"> <tr> </tr></table></td></tr></table></td></tr></table></td></tr></table></td></tr></table></td></tr></table></td></tr></table>
 | | | | | | | | | | | | | | | | | | | | <table border="1" style="width: 100%; border-collapse: collapse; text-align: center;"> <tr> <td style="width: 10%;"></td> <td style="width: 10%;"></td> <td style="width: 10%;"></td> <td style="width: 10%;"></td> <td style="width: 10%;"></td> <td style="width: 10%;"></td> <td style="width: 10%;"></td> <td style="width: 10%;"></td> <td style="width: 10%;"></td> <td style="width: 10%;"></td> </tr> <tr> <td></td> <td></td> <td colspan="8" style="text-align: center;"> <table border="1" style="width: 100%; border-collapse: collapse; text-align: center;"> <tr> <td style="width: 10%;"></td> <td style="width: 10%;"></td> <td style="width: 10%;"></td> <td style="width: 10%;"></td> <td style="width: 10%;"></td> <td style="width: 10%;"></td> <td style="width: 10%;"></td> <td style="width: 10%;"></td> <td style="width: 10%;"></td> <td style="width: 10%;"></td> </tr> <tr> <td></td> <td></td> <td colspan="8" style="text-align: center;"> <table border="1" style="width: 100%; border-collapse: collapse; text-align: center;"> <tr> <td style="width: 10%;"></td> <td style="width: 10%;"></td> <td style="width: 10%;"></td> <td style="width: 10%;"></td> <td style="width: 10%;"></td> <td style="width: 10%;"></td> <td style="width: 10%;"></td> <td style="width: 10%;"></td> <td style="width: 10%;"></td> <td style="width: 10%;"></td> </tr> <tr> <td></td> <td></td> <td colspan="8" style="text-align: center;"> <table border="1" style="width: 100%; border-collapse: collapse; text-align: center;"> <tr> <td style="width: 10%;"></td> <td style="width: 10%;"></td> <td style="width: 10%;"></td> <td style="width: 10%;"></td> <td style="width: 10%;"></td> <td style="width: 10%;"></td> <td style="width: 10%;"></td> <td style="width: 10%;"></td> <td style="width: 10%;"></td> <td style="width: 10%;"></td> </tr> <tr> <td></td> <td></td> <td colspan="8" style="text-align: center;"> <table border="1" style="width: 100%; border-collapse: collapse; text-align: center;"> <tr> <td style="width: 10%;"></td> <td style="width: 10%;"></td> <td style="width: 10%;"></td> <td style="width: 10%;"></td> <td style="width: 10%;"></td> <td style="width: 10%;"></td> <td style="width: 10%;"></td> <td style="width: 10%;"></td> <td style="width: 10%;"></td> <td style="width: 10%;"></td> </tr> <tr> <td></td> <td></td> <td colspan="8" style="text-align: center;"> <table border="1" style="width: 100%; border-collapse: collapse; text-align: center;"> <tr> </tr></table></td></tr></table></td></tr></table></td></tr></table></td></tr></table></td></tr></table>
 | | | | | | | | | | | | | | | | | | | | <table border="1" style="width: 100%; border-collapse: collapse; text-align: center;"> <tr> <td style="width: 10%;"></td> <td style="width: 10%;"></td> <td style="width: 10%;"></td> <td style="width: 10%;"></td> <td style="width: 10%;"></td> <td style="width: 10%;"></td> <td style="width: 10%;"></td> <td style="width: 10%;"></td> <td style="width: 10%;"></td> <td style="width: 10%;"></td> </tr> <tr> <td></td> <td></td> <td colspan="8" style="text-align: center;"> <table border="1" style="width: 100%; border-collapse: collapse; text-align: center;"> <tr> <td style="width: 10%;"></td> <td style="width: 10%;"></td> <td style="width: 10%;"></td> <td style="width: 10%;"></td> <td style="width: 10%;"></td> <td style="width: 10%;"></td> <td style="width: 10%;"></td> <td style="width: 10%;"></td> <td style="width: 10%;"></td> <td style="width: 10%;"></td> </tr> <tr> <td></td> <td></td> <td colspan="8" style="text-align: center;"> <table border="1" style="width: 100%; border-collapse: collapse; text-align: center;"> <tr> <td style="width: 10%;"></td> <td style="width: 10%;"></td> <td style="width: 10%;"></td> <td style="width: 10%;"></td> <td style="width: 10%;"></td> <td style="width: 10%;"></td> <td style="width: 10%;"></td> <td style="width: 10%;"></td> <td style="width: 10%;"></td> <td style="width: 10%;"></td> </tr> <tr> <td></td> <td></td> <td colspan="8" style="text-align: center;"> <table border="1" style="width: 100%; border-collapse: collapse; text-align: center;"> <tr> <td style="width: 10%;"></td> <td style="width: 10%;"></td> <td style="width: 10%;"></td> <td style="width: 10%;"></td> <td style="width: 10%;"></td> <td style="width: 10%;"></td> <td style="width: 10%;"></td> <td style="width: 10%;"></td> <td style="width: 10%;"></td> <td style="width: 10%;"></td> </tr> <tr> <td></td> <td></td> <td colspan="8" style="text-align: center;"> <table border="1" style="width: 100%; border-collapse: collapse; text-align: center;"> <tr> </tr></table></td></tr></table></td></tr></table></td></tr></table></td></tr></table>
 | | | | | | | | | | | | | | | | | | | | <table border="1" style="width: 100%; border-collapse: collapse; text-align: center;"> <tr> <td style="width: 10%;"></td> <td style="width: 10%;"></td> <td style="width: 10%;"></td> <td style="width: 10%;"></td> <td style="width: 10%;"></td> <td style="width: 10%;"></td> <td style="width: 10%;"></td> <td style="width: 10%;"></td> <td style="width: 10%;"></td> <td style="width: 10%;"></td> </tr> <tr> <td></td> <td></td> <td colspan="8" style="text-align: center;"> <table border="1" style="width: 100%; border-collapse: collapse; text-align: center;"> <tr> <td style="width: 10%;"></td> <td style="width: 10%;"></td> <td style="width: 10%;"></td> <td style="width: 10%;"></td> <td style="width: 10%;"></td> <td style="width: 10%;"></td> <td style="width: 10%;"></td> <td style="width: 10%;"></td> <td style="width: 10%;"></td> <td style="width: 10%;"></td> </tr> <tr> <td></td> <td></td> <td colspan="8" style="text-align: center;"> <table border="1" style="width: 100%; border-collapse: collapse; text-align: center;"> <tr> <td style="width: 10%;"></td> <td style="width: 10%;"></td> <td style="width: 10%;"></td> <td style="width: 10%;"></td> <td style="width: 10%;"></td> <td style="width: 10%;"></td> <td style="width: 10%;"></td> <td style="width: 10%;"></td> <td style="width: 10%;"></td> <td style="width: 10%;"></td> </tr> <tr> <td></td> <td></td> <td colspan="8" style="text-align: center;"> <table border="1" style="width: 100%; border-collapse: collapse; text-align: center;"> <tr> </tr></table></td></tr></table></td></tr></table></td></tr></table>
 | | | | | | | | | | | | | | | | | | | | <table border="1" style="width: 100%; border-collapse: collapse; text-align: center;"> <tr> <td style="width: 10%;"></td> <td style="width: 10%;"></td> <td style="width: 10%;"></td> <td style="width: 10%;"></td> <td style="width: 10%;"></td> <td style="width: 10%;"></td> <td style="width: 10%;"></td> <td style="width: 10%;"></td> <td style="width: 10%;"></td> <td style="width: 10%;"></td> </tr> <tr> <td></td> <td></td> <td colspan="8" style="text-align: center;"> <table border="1" style="width: 100%; border-collapse: collapse; text-align: center;"> <tr> <td style="width: 10%;"></td> <td style="width: 10%;"></td> <td style="width: 10%;"></td> <td style="width: 10%;"></td> <td style="width: 10%;"></td> <td style="width: 10%;"></td> <td style="width: 10%;"></td> <td style="width: 10%;"></td> <td style="width: 10%;"></td> <td style="width: 10%;"></td> </tr> <tr> <td></td> <td></td> <td colspan="8" style="text-align: center;"> <table border="1" style="width: 100%; border-collapse: collapse; text-align: center;"> <tr> </tr></table></td></tr></table></td></tr></table>
 | | | | | | | | | | | | | | | | | | | | <table border="1" style="width: 100%; border-collapse: collapse; text-align: center;"> <tr> <td style="width: 10%;"></td> <td style="width: 10%;"></td> <td style="width: 10%;"></td> <td style="width: 10%;"></td> <td style="width: 10%;"></td> <td style="width: 10%;"></td> <td style="width: 10%;"></td> <td style="width: 10%;"></td> <td style="width: 10%;"></td> <td style="width: 10%;"></td> </tr> <tr> <td></td> <td></td> <td colspan="8" style="text-align: center;"> <table border="1" style="width: 100%; border-collapse: collapse; text-align: center;"> <tr> </tr></table></td></tr></table>
 | | | | | | | | | | | | | | | | | | | | <table border="1" style="width: 100%; border-collapse: collapse; text-align: center;"> <tr> </tr></table> | | | | | | | | | | | | | | | | | | | | | | | | | | | | | | | | | | | | | | | | | | | | | | | | | | | | | | | | | | | |
 | | | | | | | | | | | | | | | | | | | |
 | | | | | | | | | | | | | | | | | | | | | | | | | | | | | | | | | | | | | | | |
 | | | | | | | | | | | | | | | | | | | | | | | | | | | | | | | | | | | | | | | |
 | | | | | | | | | | | | | | | | | | | | | | | | | | | | | | | | | | | | | | | |
 | | | | | | | | | | | | | | | | | | | | | | | | | | | | | | | | | | | | | | | | | | | | | | | | | | | | | | | | | | | | | | | | | | | | | | | | | | | | | | | |
 | | | | | | | | | | | | | | | | | | | | | | | | | | | | | | | | | | | | | | | | | | | | | | | | | | | | | | | | | | | | | | | | | | | |
| | |

 | | | | | | | | | | | | | | | | | | | |

 | | | | | | | | | | | | | | | | | | | |

 | | | | | | | | | | | | | | | | | | | |

 | | | | | | | | | | | | | | | | | | | |

 | | | | | | | | | | | | | | | | | | | |

 | | | | | | | | | | | | | | | | | | | |

 | | | | | | | | | | | | | | | | | | | |

 | | | | | | | | | | | | | | | | | | | |

 | | | | | | | | | | | | | | | | | | | |

 | | | | | | | | | | | | | | | | | | | |

 | | | | | | | | | | | | | | | | | | | |

 | | | | | | | | | | | | | | | | | | | |

 | | | | | | | | | | | | | | | | | | | |

 | | | | | | | | | | | | | | | | | | | |

 | | | | | | | | | | | | | | | | | | | |

 | | | | | | | | | | | | | | | | | | | |

 | | | | | | | | | | | | | | | | | | | |

 | | | | | | | | | | | | | | | | | | | |

 | | | | | | | | | | | | | | | | | | | |

 | | | | | | | | | | | | | | | | | | | |

 | | | | | | | | | | | | | | | | | | | |

 | | | | | | | | | | | | | | | | | | | |

 | | | | | | | | | | | | | | | | | | | |

 | | | | | | | | | | | | | | | | | | | |

 | | | | | | | | | | | | | | | | | | | |

 | | | | | | | | | | | | | | | | | | | |

 | | | | | | | | | | | | | | | | | | | |

 | | | | | | | | | | | | | | | | | | | |
 | | | | | | | | | | | | | | | | | | | |

 | | | | | | | | | | | | | | | | | | | |

 | | | | | | | | | | | | | | | | | | | |
 | | | | | | | | | | | | | | | | | | | |

 | | | | | | | | | | | | | | | | | | | |

 | | | | | | | | | | | | | | | | | | | |
 | | | | | | | | | | | | | | | | | | | |
 | | | | | | | | | | | | | | | | | | | |

 | | | | | | | | | | | | | | | | | | | |
 | | | | | | | | | | | | | | | | | | | |
 | | | | | | | | | | | | | | | | | | | |

 | | | | | | | | | | | | | | | | | | | | | | | | | | | | | | | | | | | | | | | | | | | | | | | | | | | | | | | | | | | | | | | | | | | | | | | | | | | | | | | | | | | | | | | | | | | | | | | | | | | |
 | | | | | | | | | | | | | | | | | | | |
 | | | | | | | | | | | | | | | | | | | |
 | | | | | | | | | | | | | | | | | | | |
 | | | | | | | | | | | | | | | | | | | |
 | | | | | | | | | | | | | | | | | | | |
 | | | | | | | | | | | | | | | | | | | |
 | | | | | | | | | | | | | | | | | | | |
 | | | | | | | | | | | | | | | | | | | |
 | | | | | | | | | | | | | | | | | | | | | | | | | | | | | | | | | | | | | | | |
 | | | | | | | | | | | | | | | | | | | |
 | | | | | | | | | | | | | | | | | | | | | | | | | | | | | | | | | | | | | | | |
 | | | | | | | | | | | | | | | | | | | | | | | | | | | | | | | | | | | | | | | |
 | | | | | | | | | | | | | | | | | | | | | | | | | | | | | | | | | | | | | | | |
 | | | | | | | | | | | | | | | | | | | | | | | | | | | | | | | | | | | | | | | | | | | | | | | | | | | | | | | | | | | | | | | | | | | | | | | | | | | | | | | | | | | | | | | | | | | | | | | | | | | |
 | | | | | | | | | | | | | | | | | | | | | | | | | | | | | | | | | | | | | | | | | | | | | | | |
| | | <table border="1" style="width: 100%; border-collapse: collapse; text-align: center;"> <tr> <td style="width: 10%;"></td> <td style="width: 10%;"></td> <td style="width: 10%;"></td> <td style="width: 10%;"></td> <td style="width: 10%;"></td> <td style="width: 10%;"></td> <td style="width: 10%;"></td> <td style="width: 10%;"></td> <td style="width: 10%;"></td> <td style="width: 10%;"></td> </tr> <tr> <td></td> <td></td> <td colspan="8" style="text-align: center;"> <table border="1" style="width: 100%; border-collapse: collapse; text-align: center;"> <tr> <td style="width: 10%;"></td> <td style="width: 10%;"></td> <td style="width: 10%;"></td> <td style="width: 10%;"></td> <td style="width: 10%;"></td> <td style="width: 10%;"></td> <td style="width: 10%;"></td> <td style="width: 10%;"></td> <td style="width: 10%;"></td> <td style="width: 10%;"></td> </tr> <tr> <td></td> <td></td> <td colspan="8" style="text-align: center;"> <table border="1" style="width: 100%; border-collapse: collapse; text-align: center;"> <tr> <td style="width: 10%;"></td> <td style="width: 10%;"></td> <td style="width: 10%;"></td> <td style="width: 10%;"></td> <td style="width: 10%;"></td> <td style="width: 10%;"></td> <td style="width: 10%;"></td> <td style="width: 10%;"></td> <td style="width: 10%;"></td> <td style="width: 10%;"></td> </tr> <tr> <td></td> <td></td> <td colspan="8" style="text-align: center;"> <table border="1" style="width: 100%; border-collapse: collapse; text-align: center;"> <tr> <td style="width: 10%;"></td> <td style="width: 10%;"></td> <td style="width: 10%;"></td> <td style="width: 10%;"></td> <td style="width: 10%;"></td> <td style="width: 10%;"></td> <td style="width: 10%;"></td> <td style="width: 10%;"></td> <td style="width: 10%;"></td> <td style="width: 10%;"></td> </tr> <tr> <td></td> <td></td> <td colspan="8" style="text-align: center;"> <table border="1" style="width: 100%; border-collapse: collapse; text-align: center;"> <tr> <td style="width: 10%;"></td> <td style="width: 10%;"></td> <td style="width: 10%;"></td> <td style="width: 10%;"></td> <td style="width: 10%;"></td> <td style="width: 10%;"></td> <td style="width: 10%;"></td> <td style="width: 10%;"></td> <td style="width: 10%;"></td> <td style="width: 10%;"></td> </tr> <tr> <td></td> <td></td> <td colspan="8" style="text-align: center;"> <table border="1" style="width: 100%; border-collapse: collapse; text-align: center;"> <tr> <td style="width: 10%;"></td> <td style="width: 10%;"></td> <td style="width: 10%;"></td> <td style="width: 10%;"></td> <td style="width: 10%;"></td> <td style="width: 10%;"></td> <td style="width: 10%;"></td> <td style="width: 10%;"></td> <td style="width: 10%;"></td> <td style="width: 10%;"></td> </tr> <tr> <td></td> <td></td> <td colspan="8" style="text-align: center;"> <table border="1" style="width: 100%; border-collapse: collapse; text-align: center;"> <tr> <td style="width: 10%;"></td> <td style="width: 10%;"></td> <td style="width: 10%;"></td> <td style="width: 10%;"></td> <td style="width: 10%;"></td> <td style="width: 10%;"></td> <td style="width: 10%;"></td> <td style="width: 10%;"></td> <td style="width: 10%;"></td> <td style="width: 10%;"></td> </tr> <tr> <td></td> <td></td> <td colspan="8" style="text-align: center;"> <table border="1" style="width: 100%; border-collapse: collapse; text-align: center;"> <tr> <td style="width: 10%;"></td> <td style="width: 10%;"></td> <td style="width: 10%;"></td> <td style="width: 10%;"></td> <td style="width: 10%;"></td> <td style="width: 10%;"></td> <td style="width: 10%;"></td> <td style="width: 10%;"></td> <td style="width: 10%;"></td> <td style="width: 10%;"></td> </tr> <tr> <td></td> <td></td> <td colspan="8" style="text-align: center;"> <table border="1" style="width: 100%; border-collapse: collapse; text-align: center;"> <tr> <td style="width: 10%;"></td> <td style="width: 10%;"></td> <td style="width: 10%;"></td> <td style="width: 10%;"></td> <td style="width: 10%;"></td> <td style="width: 10%;"></td> <td style="width: 10%;"></td> <td style="width: 10%;"></td> <td style="width: 10%;"></td> <td style="width: 10%;"></td> </tr> <tr> <td></td> <td></td> <td colspan="8" style="text-align: center;"> <table border="1" style="width: 100%; border-collapse: collapse; text-align: center;"> <tr> <td style="width: 10%;"></td> <td style="width: 10%;"></td> <td style="width: 10%;"></td> <td style="width: 10%;"></td> <td style="width: 10%;"></td> <td style="width: 10%;"></td> <td style="width: 10%;"></td> <td style="width: 10%;"></td> <td style="width: 10%;"></td> <td style="width: 10%;"></td> </tr> <tr> <td></td> <td></td> <td colspan="8" style="text-align: center;"> <table border="1" style="width: 100%; border-collapse: collapse; text-align: center;"> <tr> <td style="width: 10%;"></td> <td style="width: 10%;"></td> <td style="width: 10%;"></td> <td style="width: 10%;"></td> <td style="width: 10%;"></td> <td style="width: 10%;"></td> <td style="width: 10%;"></td> <td style="width: 10%;"></td> <td style="width: 10%;"></td> <td style="width: 10%;"></td> </tr> <tr> <td></td> <td></td> <td colspan="8" style="text-align: center;"> <table border="1" style="width: 100%; border-collapse: collapse; text-align: center;"> <tr> <td style="width: 10%;"></td> <td style="width: 10%;"></td> <td style="width: 10%;"></td> <td style="width: 10%;"></td> <td style="width: 10%;"></td> <td style="width: 10%;"></td> <td style="width: 10%;"></td> <td style="width: 10%;"></td> <td style="width: 10%;"></td> <td style="width: 10%;"></td> </tr> <tr> <td></td> <td></td> <td colspan="8" style="text-align: center;"> <table border="1" style="width: 100%; border-collapse: collapse; text-align: center;"> <tr> <td style="width: 10%;"></td> <td style="width: 10%;"></td> <td style="width: 10%;"></td> <td style="width: 10%;"></td> <td style="width: 10%;"></td> <td style="width: 10%;"></td> <td style="width: 10%;"></td> <td style="width: 10%;"></td> <td style="width: 10%;"></td> <td style="width: 10%;"></td> </tr> <tr> <td></td> <td></td> <td colspan="8" style="text-align: center;"> <table border="1" style="width: 100%; border-collapse: collapse; text-align: center;"> <tr> <td style="width: 10%;"></td> <td style="width: 10%;"></td> <td style="width: 10%;"></td> <td style="width: 10%;"></td> <td style="width: 10%;"></td> <td style="width: 10%;"></td> <td style="width: 10%;"></td> <td style="width: 10%;"></td> <td style="width: 10%;"></td> <td style="width: 10%;"></td> </tr> <tr> <td></td> <td></td> <td colspan="8" style="text-align: center;"> <table border="1" style="width: 100%; border-collapse: collapse; text-align: center;"> <tr> <td style="width: 10%;"></td> <td style="width: 10%;"></td> <td style="width: 10%;"></td> <td style="width: 10%;"></td> <td style="width: 10%;"></td> <td style="width: 10%;"></td> <td style="width: 10%;"></td> <td style="width: 10%;"></td> <td style="width: 10%;"></td> <td style="width: 10%;"></td> </tr> <tr> <td></td> <td></td> <td colspan="8" style="text-align: center;"> <table border="1" style="width: 100%; border-collapse: collapse; text-align: center;"> <tr> <td style="width: 10%;"></td> <td style="width: 10%;"></td> <td style="width: 10%;"></td> <td style="width: 10%;"></td> <td style="width: 10%;"></td> <td style="width: 10%;"></td> <td style="width: 10%;"></td> <td style="width: 10%;"></td> <td style="width: 10%;"></td> <td style="width: 10%;"></td> </tr> <tr> <td></td> <td></td> <td colspan="8" style="text-align: center;"> <table border="1" style="width: 100%; border-collapse: collapse; text-align: center;"> <tr> <td style="width: 10%;"></td> <td style="width: 10%;"></td> <td style="width: 10%;"></td> <td style="width: 10%;"></td> <td style="width: 10%;"></td> <td style="width: 10%;"></td> <td style="width: 10%;"></td> <td style="width: 10%;"></td> <td style="width: 10%;"></td> <td style="width: 10%;"></td> </tr> <tr> <td></td> <td></td> <td colspan="8" style="text-align: center;"> <table border="1" style="width: 100%; border-collapse: collapse; text-align: center;"> <tr> <td style="width: 10%;"></td> <td style="width: 10%;"></td> <td style="width: 10%;"></td> <td style="width: 10%;"></td> <td style="width: 10%;"></td> <td style="width: 10%;"></td> <td style="width: 10%;"></td> <td style="width: 10%;"></td> <td style="width: 10%;"></td> <td style="width: 10%;"></td> </tr> <tr> <td></td> <td></td> <td colspan="8" style="text-align: center;"> <table border="1" style="width: 100%; border-collapse: collapse; text-align: center;"> <tr> <td style="width: 10%;"></td> <td style="width: 10%;"></td> <td style="width: 10%;"></td> <td style="width: 10%;"></td> <td style="width: 10%;"></td> <td style="width: 10%;"></td> <td style="width: 10%;"></td> <td style="width: 10%;"></td> <td style="width: 10%;"></td> <td style="width: 10%;"></td> </tr> <tr> <td></td> <td></td> <td colspan="8" style="text-align: center;"> <table border="1" style="width: 100%; border-collapse: collapse; text-align: center;"> <tr> <td style="width: 10%;"></td> <td style="width: 10%;"></td> <td style="width: 10%;"></td> <td style="width: 10%;"></td> <td style="width: 10%;"></td> <td style="width: 10%;"></td> <td style="width: 10%;"></td> <td style="width: 10%;"></td> <td style="width: 10%;"></td> <td style="width: 10%;"></td> </tr> <tr> <td></td> <td></td> <td colspan="8" style="text-align: center;"> <table border="1" style="width: 100%; border-collapse: collapse; text-align: center;"> <tr> <td style="width: 10%;"></td> <td style="width: 10%;"></td> <td style="width: 10%;"></td> <td style="width: 10%;"></td> <td style="width: 10%;"></td> <td style="width: 10%;"></td> <td style="width: 10%;"></td> <td style="width: 10%;"></td> <td style="width: 10%;"></td> <td style="width: 10%;"></td> </tr> <tr> <td></td> <td></td> <td colspan="8" style="text-align: center;"> <table border="1" style="width: 100%; border-collapse: collapse; text-align: center;"> <tr> <td style="width: 10%;"></td> <td style="width: 10%;"></td> <td
style="width: 10%;"></td> <td style="width: 10%;"></td> <td style="width: 10%;"></td> <td style="width: 10%;"></td> <td style="width: 10%;"></td> <td style="width: 10%;"></td> <td style="width: 10%;"></td> <td style="width: 10%;"></td> </tr> <tr> <td></td> <td></td> <td colspan="8" style="text-align: center;"> <table border="1" style="width: 100%; border-collapse: collapse; text-align: center;"> <tr> <td style="width: 10%;"></td> <td style="width: 10%;"></td> <td style="width: 10%;"></td> <td style="width: 10%;"></td> <td style="width: 10%;"></td> <td style="width: 10%;"></td> <td style="width: 10%;"></td> <td style="width: 10%;"></td> <td style="width: 10%;"></td> <td style="width: 10%;"></td> </tr> <tr> <td></td> <td></td> <td colspan="8" style="text-align: center;"> <table border="1" style="width: 100%; border-collapse: collapse; text-align: center;"> <tr> <td style="width: 10%;"></td> <td style="width: 10%;"></td> <td style="width: 10%;"></td> <td style="width: 10%;"></td> <td style="width: 10%;"></td> <td style="width: 10%;"></td> <td style="width: 10%;"></td> <td style="width: 10%;"></td> <td style="width: 10%;"></td> <td style="width: 10%;"></td> </tr> <tr> <td></td> <td></td> <td colspan="8" style="text-align: center;"> <table border="1" style="width: 100%; border-collapse: collapse; text-align: center;"> <tr> <td style="width: 10%;"></td> <td style="width: 10%;"></td> <td style="width: 10%;"></td> <td style="width: 10%;"></td> <td style="width: 10%;"></td> <td style="width: 10%;"></td> <td style="width: 10%;"></td> <td style="width: 10%;"></td> <td style="width: 10%;"></td> <td style="width: 10%;"></td> </tr> <tr> <td></td> <td></td> <td colspan="8" style="text-align: center;"> <table border="1" style="width: 100%; border-collapse: collapse; text-align: center;"> <tr> <td style="width: 10%;"></td> <td style="width: 10%;"></td> <td style="width: 10%;"></td> <td style="width: 10%;"></td> <td style="width: 10%;"></td> <td style="width: 10%;"></td> <td style="width: 10%;"></td> <td style="width: 10%;"></td> <td style="width: 10%;"></td> <td style="width: 10%;"></td> </tr> <tr> <td></td> <td></td> <td colspan="8" style="text-align: center;"> <table border="1" style="width: 100%; border-collapse: collapse; text-align: center;"> <tr> <td style="width: 10%;"></td> <td style="width: 10%;"></td> <td style="width: 10%;"></td> <td style="width: 10%;"></td> <td style="width: 10%;"></td> <td style="width: 10%;"></td> <td style="width: 10%;"></td> <td style="width: 10%;"></td> <td style="width: 10%;"></td> <td style="width: 10%;"></td> </tr> <tr> <td></td> <td></td> <td colspan="8" style="text-align: center;"> <table border="1" style="width: 100%; border-collapse: collapse; text-align: center;"> <tr> <td style="width: 10%;"></td> <td style="width: 10%;"></td> <td style="width: 10%;"></td> <td style="width: 10%;"></td> <td style="width: 10%;"></td> <td style="width: 10%;"></td> <td style="width: 10%;"></td> <td style="width: 10%;"></td> <td style="width: 10%;"></td> <td style="width: 10%;"></td> </tr> <tr> <td></td> <td></td> <td colspan="8" style="text-align: center;"> <table border="1" style="width: 100%; border-collapse: collapse; text-align: center;"> <tr> <td style="width: 10%;"></td> <td style="width: 10%;"></td> <td style="width: 10%;"></td> <td style="width: 10%;"></td> <td style="width: 10%;"></td> <td style="width: 10%;"></td> <td style="width: 10%;"></td> <td style="width: 10%;"></td> <td style="width: 10%;"></td> <td style="width: 10%;"></td> </tr> <tr> <td></td> <td></td> <td colspan="8" style="text-align: center;"> <table border="1" style="width: 100%; border-collapse: collapse; text-align: center;"> <tr> <td style="width: 10%;"></td> <td style="width: 10%;"></td> <td style="width: 10%;"></td> <td style="width: 10%;"></td> <td style="width: 10%;"></td> <td style="width: 10%;"></td> <td style="width: 10%;"></td> <td style="width: 10%;"></td> <td style="width: 10%;"></td> <td style="width: 10%;"></td> </tr> <tr> <td></td> <td></td> <td colspan="8" style="text-align: center;"> <table border="1" style="width: 100%; border-collapse: collapse; text-align: center;"> <tr> <td style="width: 10%;"></td> <td style="width: 10%;"></td> <td style="width: 10%;"></td> <td style="width: 10%;"></td> <td style="width: 10%;"></td> <td style="width: 10%;"></td> <td style="width: 10%;"></td> <td style="width: 10%;"></td> <td style="width: 10%;"></td> <td style="width: 10%;"></td> </tr> <tr> <td></td> <td></td> <td colspan="8" style="text-align: center;"> <table border="1" style="width: 100%; border-collapse: collapse; text-align: center;"> <tr> <td style="width: 10%;"></td> <td style="width: 10%;"></td> <td style="width: 10%;"></td> <td style="width: 10%;"></td> <td style="width: 10%;"></td> <td style="width: 10%;"></td> <td style="width: 10%;"></td> <td style="width: 10%;"></td> <td style="width: 10%;"></td> <td style="width: 10%;"></td> </tr> <tr> <td></td> <td></td> <td colspan="8" style="text-align: center;"> <table border="1" style="width: 100%; border-collapse: collapse; text-align: center;"> <tr> <td style="width: 10%;"></td> <td style="width: 10%;"></td> <td style="width: 10%;"></td> <td style="width: 10%;"></td> <td style="width: 10%;"></td> <td style="width: 10%;"></td> <td style="width: 10%;"></td> <td style="width: 10%;"></td> <td style="width: 10%;"></td> <td style="width: 10%;"></td> </tr> <tr> <td></td> <td></td> <td colspan="8" style="text-align: center;"> <table border="1" style="width: 100%; border-collapse: collapse; text-align: center;"> <tr> <td style="width: 10%;"></td> <td style="width: 10%;"></td> <td style="width: 10%;"></td> <td style="width: 10%;"></td> <td style="width: 10%;"></td> <td style="width: 10%;"></td> <td style="width: 10%;"></td> <td style="width: 10%;"></td> <td style="width: 10%;"></td> <td style="width: 10%;"></td> </tr> <tr> <td></td> <td></td> <td colspan="8" style="text-align: center;"> <table border="1" style="width: 100%; border-collapse: collapse; text-align: center;"> <tr> <td style="width: 10%;"></td> <td style="width: 10%;"></td> <td style="width: 10%;"></td> <td style="width: 10%;"></td> <td style="width: 10%;"></td> <td style="width: 10%;"></td> <td style="width: 10%;"></td> <td style="width: 10%;"></td> <td style="width: 10%;"></td> <td style="width: 10%;"></td> </tr> <tr> <td></td> <td></td> <td colspan="8" style="text-align: center;"> <table border="1" style="width: 100%; border-collapse: collapse; text-align: center;"> <tr> <td style="width: 10%;"></td> <td style="width: 10%;"></td> <td style="width: 10%;"></td> <td style="width: 10%;"></td> <td style="width: 10%;"></td> <td style="width: 10%;"></td> <td style="width: 10%;"></td> <td style="width: 10%;"></td> <td style="width: 10%;"></td> <td style="width: 10%;"></td> </tr> <tr> <td></td> <td></td> <td colspan="8" style="text-align: center;"> <table border="1" style="width: 100%; border-collapse: collapse; text-align: center;"> <tr> <td style="width: 10%;"></td> <td style="width: 10%;"></td> <td style="width: 10%;"></td> <td style="width: 10%;"></td> <td style="width: 10%;"></td> <td style="width: 10%;"></td> <td style="width: 10%;"></td> <td style="width: 10%;"></td> <td style="width: 10%;"></td> <td style="width: 10%;"></td> </tr> <tr> <td></td> <td></td> <td colspan="8" style="text-align: center;"> <table border="1" style="width: 100%; border-collapse: collapse; text-align: center;"> <tr> <td style="width: 10%;"></td> <td style="width: 10%;"></td> <td style="width: 10%;"></td> <td style="width: 10%;"></td> <td style="width: 10%;"></td> <td style="width: 10%;"></td> <td style="width: 10%;"></td> <td style="width: 10%;"></td> <td style="width: 10%;"></td> <td style="width: 10%;"></td> </tr> <tr> <td></td> <td></td> <td colspan="8" style="text-align: center;"> <table border="1" style="width: 100%; border-collapse: collapse; text-align: center;"> <tr> <td style="width: 10%;"></td> <td style="width: 10%;"></td> <td style="width: 10%;"></td> <td style="width: 10%;"></td> <td style="width: 10%;"></td> <td style="width: 10%;"></td> <td style="width: 10%;"></td> <td style="width: 10%;"></td> <td style="width: 10%;"></td> <td style="width: 10%;"></td> </tr> <tr> <td></td> <td></td> <td colspan="8" style="text-align: center;"> <table border="1" style="width: 100%; border-collapse: collapse; text-align: center;"> <tr> <td style="width: 10%;"></td> <td style="width: 10%;"></td> <td style="width: 10%;"></td> <td style="width: 10%;"></td> <td style="width: 10%;"></td> <td style="width: 10%;"></td> <td style="width: 10%;"></td> <td style="width: 10%;"></td> <td style="width: 10%;"></td> <td style="width: 10%;"></td> </tr> <tr> <td></td> <td></td> <td colspan="8" style="text-align: center;"> <table border="1" style="width: 100%; border-collapse: collapse; text-align: center;"> <tr> <td style="width: 10%;"></td> <td style="width: 10%;"></td> <td style="width: 10%;"></td> <td style="width: 10%;"></td> <td style="width: 10%;"></td> <td style="width: 10%;"></td> <td style="width: 10%;"></td> <td style="width: 10%;"></td> <td style="width: 10%;"></td> <td style="width: 10%;"></td> </tr> <tr> <td></td> <td></td> <td colspan="8" style="text-align: center;"> <table border="1" style="width: 100%; border-collapse: collapse; text-align: center;"> <tr> <td style="width: 10%;"></td> <td style="width: 10%;"></td> <td style="width: 10%;"></td> <td style="width: 10%;"></td> <td style="width: 10%;"></td> <td style="width: 10%;"></td> <td style="width: 10%;"></td> <td style="width: 10%;"></td> <td style="width: 10%;"></td> <td style="width: 10%;"></td> </tr> <tr> <td></td> <td></td> <td colspan="8" style="text-align: center;"> <table border="1" style="width: 100%; border-collapse: collapse; text-align: center;"> <tr> <td style="width: 10%;"></td> <td style="width: 10%;"></td> <td style="width: 10%;"></td> <td style="width: 10%;"></td> <td style="width: 10%;"></td> <td style="width: 10%;"></td> <td style="width: 10%;"></td> <td style="width:
10%;"></td> <td style="width: 10%;"></td> <td style="width: 10%;"></td> </tr> <tr> <td></td> <td></td> <td colspan="8" style="text-align: center;"> <table border="1" style="width: 100%; border-collapse: collapse; text-align: center;"> <tr> <td style="width: 10%;"></td> <td style="width: 10%;"></td> <td style="width: 10%;"></td> <td style="width: 10%;"></td> <td style="width: 10%;"></td> <td style="width: 10%;"></td> <td style="width: 10%;"></td> <td style="width: 10%;"></td> <td style="width: 10%;"></td> <td style="width: 10%;"></td> </tr> <tr> <td></td> <td></td> <td colspan="8" style="text-align: center;"> <table border="1" style="width: 100%; border-collapse: collapse; text-align: center;"> <tr> <td style="width: 10%;"></td> <td style="width: 10%;"></td> <td style="width: 10%;"></td> <td style="width: 10%;"></td> <td style="width: 10%;"></td> <td style="width: 10%;"></td> <td style="width: 10%;"></td> <td style="width: 10%;"></td> <td style="width: 10%;"></td> <td style="width: 10%;"></td> </tr> <tr> <td></td> <td></td> <td colspan="8" style="text-align: center;"> <table border="1" style="width: 100%; border-collapse: collapse; text-align: center;"> <tr> <td style="width: 10%;"></td> <td style="width: 10%;"></td> <td style="width: 10%;"></td> <td style="width: 10%;"></td> <td style="width: 10%;"></td> <td style="width: 10%;"></td> <td style="width: 10%;"></td> <td style="width: 10%;"></td> <td style="width: 10%;"></td> <td style="width: 10%;"></td> </tr> <tr> <td></td> <td></td> <td colspan="8" style="text-align: center;"> <table border="1" style="width: 100%; border-collapse: collapse; text-align: center;"> <tr> <td style="width: 10%;"></td> <td style="width: 10%;"></td> <td style="width: 10%;"></td> <td style="width: 10%;"></td> <td style="width: 10%;"></td> <td style="width: 10%;"></td> <td style="width: 10%;"></td> <td style="width: 10%;"></td> <td style="width: 10%;"></td> <td style="width: 10%;"></td> </tr> <tr> <td></td> <td></td> <td colspan="8" style="text-align: center;"> <table border="1" style="width: 100%; border-collapse: collapse; text-align: center;"> <tr> <td style="width: 10%;"></td> <td style="width: 10%;"></td> <td style="width: 10%;"></td> <td style="width: 10%;"></td> <td style="width: 10%;"></td> <td style="width: 10%;"></td> <td style="width: 10%;"></td> <td style="width: 10%;"></td> <td style="width: 10%;"></td> <td style="width: 10%;"></td> </tr> <tr> <td></td> <td></td> <td colspan="8" style="text-align: center;"> <table border="1" style="width: 100%; border-collapse: collapse; text-align: center;"> <tr> </tr></table></td></tr></table></td></tr></table></td></tr></table></td></tr></table></td></tr></table></td></tr></table></td></tr></table></td></tr></table></td></tr></table></td></tr></table></td></tr></table></td></tr></table></td></tr></table></td></tr></table></td></tr></table></td></tr></table></td></tr></table></td></tr></table></td></tr></table></td></tr></table></td></tr></table></td></tr></table></td></tr></table></td></tr></table></td></tr></table></td></tr></table></td></tr></table></td></tr></table></td></tr></table></td></tr></table></td></tr></table></td></tr></table></td></tr></table></td></tr></table></td></tr></table></td></tr></table></td></tr></table></td></tr></table></td></tr></table></td></tr></table></td></tr></table></td></tr></table></td></tr></table></td></tr></table></td></tr></table></td></tr></table></td></tr></table></td></tr></table>
 | | | | | | | | | | | | | | | | | | | | <table border="1" style="width: 100%; border-collapse: collapse; text-align: center;"> <tr> <td style="width: 10%;"></td> <td style="width: 10%;"></td> <td style="width: 10%;"></td> <td style="width: 10%;"></td> <td style="width: 10%;"></td> <td style="width: 10%;"></td> <td style="width: 10%;"></td> <td style="width: 10%;"></td> <td style="width: 10%;"></td> <td style="width: 10%;"></td> </tr> <tr> <td></td> <td></td> <td colspan="8" style="text-align: center;"> <table border="1" style="width: 100%; border-collapse: collapse; text-align: center;"> <tr> <td style="width: 10%;"></td> <td style="width: 10%;"></td> <td style="width: 10%;"></td> <td style="width: 10%;"></td> <td style="width: 10%;"></td> <td style="width: 10%;"></td> <td style="width: 10%;"></td> <td style="width: 10%;"></td> <td style="width: 10%;"></td> <td style="width: 10%;"></td> </tr> <tr> <td></td> <td></td> <td colspan="8" style="text-align: center;"> <table border="1" style="width: 100%; border-collapse: collapse; text-align: center;"> <tr> <td style="width: 10%;"></td> <td style="width: 10%;"></td> <td style="width: 10%;"></td> <td style="width: 10%;"></td> <td style="width: 10%;"></td> <td style="width: 10%;"></td> <td style="width: 10%;"></td> <td style="width: 10%;"></td> <td style="width: 10%;"></td> <td style="width: 10%;"></td> </tr> <tr> <td></td> <td></td> <td colspan="8" style="text-align: center;"> <table border="1" style="width: 100%; border-collapse: collapse; text-align: center;"> <tr> <td style="width: 10%;"></td> <td style="width: 10%;"></td> <td style="width: 10%;"></td> <td style="width: 10%;"></td> <td style="width: 10%;"></td> <td style="width: 10%;"></td> <td style="width: 10%;"></td> <td style="width: 10%;"></td> <td style="width: 10%;"></td> <td style="width: 10%;"></td> </tr> <tr> <td></td> <td></td> <td colspan="8" style="text-align: center;"> <table border="1" style="width: 100%; border-collapse: collapse; text-align: center;"> <tr> <td style="width: 10%;"></td> <td style="width: 10%;"></td> <td style="width: 10%;"></td> <td style="width: 10%;"></td> <td style="width: 10%;"></td> <td style="width: 10%;"></td> <td style="width: 10%;"></td> <td style="width: 10%;"></td> <td style="width: 10%;"></td> <td style="width: 10%;"></td> </tr> <tr> <td></td> <td></td> <td colspan="8" style="text-align: center;"> <table border="1" style="width: 100%; border-collapse: collapse; text-align: center;"> <tr> <td style="width: 10%;"></td> <td style="width: 10%;"></td> <td style="width: 10%;"></td> <td style="width: 10%;"></td> <td style="width: 10%;"></td> <td style="width: 10%;"></td> <td style="width: 10%;"></td> <td style="width: 10%;"></td> <td style="width: 10%;"></td> <td style="width: 10%;"></td> </tr> <tr> <td></td> <td></td> <td colspan="8" style="text-align: center;"> <table border="1" style="width: 100%; border-collapse: collapse; text-align: center;"> <tr> <td style="width: 10%;"></td> <td style="width: 10%;"></td> <td style="width: 10%;"></td> <td style="width: 10%;"></td> <td style="width: 10%;"></td> <td style="width: 10%;"></td> <td style="width: 10%;"></td> <td style="width: 10%;"></td> <td style="width: 10%;"></td> <td style="width: 10%;"></td> </tr> <tr> <td></td> <td></td> <td colspan="8" style="text-align: center;"> <table border="1" style="width: 100%; border-collapse: collapse; text-align: center;"> <tr> <td style="width: 10%;"></td> <td style="width: 10%;"></td> <td style="width: 10%;"></td> <td style="width: 10%;"></td> <td style="width: 10%;"></td> <td style="width: 10%;"></td> <td style="width: 10%;"></td> <td style="width: 10%;"></td> <td style="width: 10%;"></td> <td style="width: 10%;"></td> </tr> <tr> <td></td> <td></td> <td colspan="8" style="text-align: center;"> <table border="1" style="width: 100%; border-collapse: collapse; text-align: center;"> <tr> <td style="width: 10%;"></td> <td style="width: 10%;"></td> <td style="width: 10%;"></td> <td style="width: 10%;"></td> <td style="width: 10%;"></td> <td style="width: 10%;"></td> <td style="width: 10%;"></td> <td style="width: 10%;"></td> <td style="width: 10%;"></td> <td style="width: 10%;"></td> </tr> <tr> <td></td> <td></td> <td colspan="8" style="text-align: center;"> <table border="1" style="width: 100%; border-collapse: collapse; text-align: center;"> <tr> <td style="width: 10%;"></td> <td style="width: 10%;"></td> <td style="width: 10%;"></td> <td style="width: 10%;"></td> <td style="width: 10%;"></td> <td style="width: 10%;"></td> <td style="width: 10%;"></td> <td style="width: 10%;"></td> <td style="width: 10%;"></td> <td style="width: 10%;"></td> </tr> <tr> <td></td> <td></td> <td colspan="8" style="text-align: center;"> <table border="1" style="width: 100%; border-collapse: collapse; text-align: center;"> <tr> <td style="width: 10%;"></td> <td style="width: 10%;"></td> <td style="width: 10%;"></td> <td style="width: 10%;"></td> <td style="width: 10%;"></td> <td style="width: 10%;"></td> <td style="width: 10%;"></td> <td style="width: 10%;"></td> <td style="width: 10%;"></td> <td style="width: 10%;"></td> </tr> <tr> <td></td> <td></td> <td colspan="8" style="text-align: center;"> <table border="1" style="width: 100%; border-collapse: collapse; text-align: center;"> <tr> <td style="width: 10%;"></td> <td style="width: 10%;"></td> <td style="width: 10%;"></td> <td style="width: 10%;"></td> <td style="width: 10%;"></td> <td style="width: 10%;"></td> <td style="width: 10%;"></td> <td style="width: 10%;"></td> <td style="width: 10%;"></td> <td style="width: 10%;"></td> </tr> <tr> <td></td> <td></td> <td colspan="8" style="text-align: center;"> <table border="1" style="width: 100%; border-collapse: collapse; text-align: center;"> <tr> <td style="width: 10%;"></td> <td style="width: 10%;"></td> <td style="width: 10%;"></td> <td style="width: 10%;"></td> <td style="width: 10%;"></td> <td style="width: 10%;"></td> <td style="width: 10%;"></td> <td style="width: 10%;"></td> <td style="width: 10%;"></td> <td style="width: 10%;"></td> </tr> <tr> <td></td> <td></td> <td colspan="8" style="text-align: center;"> <table border="1" style="width: 100%; border-collapse: collapse; text-align: center;"> <tr> <td style="width: 10%;"></td> <td style="width: 10%;"></td> <td style="width: 10%;"></td> <td style="width: 10%;"></td> <td style="width: 10%;"></td> <td style="width: 10%;"></td> <td style="width: 10%;"></td> <td style="width: 10%;"></td> <td style="width: 10%;"></td> <td style="width: 10%;"></td> </tr> <tr> <td></td> <td></td> <td colspan="8" style="text-align: center;"> <table border="1" style="width: 100%; border-collapse: collapse; text-align: center;"> <tr> <td style="width: 10%;"></td> <td style="width: 10%;"></td> <td style="width: 10%;"></td> <td style="width: 10%;"></td> <td style="width: 10%;"></td> <td style="width: 10%;"></td> <td style="width: 10%;"></td> <td style="width: 10%;"></td> <td style="width: 10%;"></td> <td style="width: 10%;"></td> </tr> <tr> <td></td> <td></td> <td colspan="8" style="text-align: center;"> <table border="1" style="width: 100%; border-collapse: collapse; text-align: center;"> <tr> <td style="width: 10%;"></td> <td style="width: 10%;"></td> <td style="width: 10%;"></td> <td style="width: 10%;"></td> <td style="width: 10%;"></td> <td style="width: 10%;"></td> <td style="width: 10%;"></td> <td style="width: 10%;"></td> <td style="width: 10%;"></td> <td style="width: 10%;"></td> </tr> <tr> <td></td> <td></td> <td colspan="8" style="text-align: center;"> <table border="1" style="width: 100%; border-collapse: collapse; text-align: center;"> <tr> <td style="width: 10%;"></td> <td style="width: 10%;"></td> <td style="width: 10%;"></td> <td style="width: 10%;"></td> <td style="width: 10%;"></td> <td style="width: 10%;"></td> <td style="width: 10%;"></td> <td style="width: 10%;"></td> <td style="width: 10%;"></td> <td style="width: 10%;"></td> </tr> <tr> <td></td> <td></td> <td colspan="8" style="text-align: center;"> <table border="1" style="width: 100%; border-collapse: collapse; text-align: center;"> <tr> <td style="width: 10%;"></td> <td style="width: 10%;"></td> <td style="width: 10%;"></td> <td style="width: 10%;"></td> <td style="width: 10%;"></td> <td style="width: 10%;"></td> <td style="width: 10%;"></td> <td style="width: 10%;"></td> <td style="width: 10%;"></td> <td style="width: 10%;"></td> </tr> <tr> <td></td> <td></td> <td colspan="8" style="text-align: center;"> <table border="1" style="width: 100%; border-collapse: collapse; text-align: center;"> <tr> <td style="width: 10%;"></td> <td style="width: 10%;"></td> <td style="width: 10%;"></td> <td style="width: 10%;"></td> <td style="width: 10%;"></td> <td style="width:
10%;"></td> <td style="width: 10%;"></td> <td style="width: 10%;"></td> <td style="width: 10%;"></td> <td style="width: 10%;"></td> </tr> <tr> <td></td> <td></td> <td colspan="8" style="text-align: center;"> <table border="1" style="width: 100%; border-collapse: collapse; text-align: center;"> <tr> <td style="width: 10%;"></td> <td style="width: 10%;"></td> <td style="width: 10%;"></td> <td style="width: 10%;"></td> <td style="width: 10%;"></td> <td style="width: 10%;"></td> <td style="width: 10%;"></td> <td style="width: 10%;"></td> <td style="width: 10%;"></td> <td style="width: 10%;"></td> </tr> <tr> <td></td> <td></td> <td colspan="8" style="text-align: center;"> <table border="1" style="width: 100%; border-collapse: collapse; text-align: center;"> <tr> <td style="width: 10%;"></td> <td style="width: 10%;"></td> <td style="width: 10%;"></td> <td style="width: 10%;"></td> <td style="width: 10%;"></td> <td style="width: 10%;"></td> <td style="width: 10%;"></td> <td style="width: 10%;"></td> <td style="width: 10%;"></td> <td style="width: 10%;"></td> </tr> <tr> <td></td> <td></td> <td colspan="8" style="text-align: center;"> <table border="1" style="width: 100%; border-collapse: collapse; text-align: center;"> <tr> <td style="width: 10%;"></td> <td style="width: 10%;"></td> <td style="width: 10%;"></td> <td style="width: 10%;"></td> <td style="width: 10%;"></td> <td style="width: 10%;"></td> <td style="width: 10%;"></td> <td style="width: 10%;"></td> <td style="width: 10%;"></td> <td style="width: 10%;"></td> </tr> <tr> <td></td> <td></td> <td colspan="8" style="text-align: center;"> <table border="1" style="width: 100%; border-collapse: collapse; text-align: center;"> <tr> <td style="width: 10%;"></td> <td style="width: 10%;"></td> <td style="width: 10%;"></td> <td style="width: 10%;"></td> <td style="width: 10%;"></td> <td style="width: 10%;"></td> <td style="width: 10%;"></td> <td style="width: 10%;"></td> <td style="width: 10%;"></td> <td style="width: 10%;"></td> </tr> <tr> <td></td> <td></td> <td colspan="8" style="text-align: center;"> <table border="1" style="width: 100%; border-collapse: collapse; text-align: center;"> <tr> <td style="width: 10%;"></td> <td style="width: 10%;"></td> <td style="width: 10%;"></td> <td style="width: 10%;"></td> <td style="width: 10%;"></td> <td style="width: 10%;"></td> <td style="width: 10%;"></td> <td style="width: 10%;"></td> <td style="width: 10%;"></td> <td style="width: 10%;"></td> </tr> <tr> <td></td> <td></td> <td colspan="8" style="text-align: center;"> <table border="1" style="width: 100%; border-collapse: collapse; text-align: center;"> <tr> <td style="width: 10%;"></td> <td style="width: 10%;"></td> <td style="width: 10%;"></td> <td style="width: 10%;"></td> <td style="width: 10%;"></td> <td style="width: 10%;"></td> <td style="width: 10%;"></td> <td style="width: 10%;"></td> <td style="width: 10%;"></td> <td style="width: 10%;"></td> </tr> <tr> <td></td> <td></td> <td colspan="8" style="text-align: center;"> <table border="1" style="width: 100%; border-collapse: collapse; text-align: center;"> <tr> <td style="width: 10%;"></td> <td style="width: 10%;"></td> <td style="width: 10%;"></td> <td style="width: 10%;"></td> <td style="width: 10%;"></td> <td style="width: 10%;"></td> <td style="width: 10%;"></td> <td style="width: 10%;"></td> <td style="width: 10%;"></td> <td style="width: 10%;"></td> </tr> <tr> <td></td> <td></td> <td colspan="8" style="text-align: center;"> <table border="1" style="width: 100%; border-collapse: collapse; text-align: center;"> <tr> <td style="width: 10%;"></td> <td style="width: 10%;"></td> <td style="width: 10%;"></td> <td style="width: 10%;"></td> <td style="width: 10%;"></td> <td style="width: 10%;"></td> <td style="width: 10%;"></td> <td style="width: 10%;"></td> <td style="width: 10%;"></td> <td style="width: 10%;"></td> </tr> <tr> <td></td> <td></td> <td colspan="8" style="text-align: center;"> <table border="1" style="width: 100%; border-collapse: collapse; text-align: center;"> <tr> <td style="width: 10%;"></td> <td style="width: 10%;"></td> <td style="width: 10%;"></td> <td style="width: 10%;"></td> <td style="width: 10%;"></td> <td style="width: 10%;"></td> <td style="width: 10%;"></td> <td style="width: 10%;"></td> <td style="width: 10%;"></td> <td style="width: 10%;"></td> </tr> <tr> <td></td> <td></td> <td colspan="8" style="text-align: center;"> <table border="1" style="width: 100%; border-collapse: collapse; text-align: center;"> <tr> <td style="width: 10%;"></td> <td style="width: 10%;"></td> <td style="width: 10%;"></td> <td style="width: 10%;"></td> <td style="width: 10%;"></td> <td style="width: 10%;"></td> <td style="width: 10%;"></td> <td style="width: 10%;"></td> <td style="width: 10%;"></td> <td style="width: 10%;"></td> </tr> <tr> <td></td> <td></td> <td colspan="8" style="text-align: center;"> <table border="1" style="width: 100%; border-collapse: collapse; text-align: center;"> <tr> <td style="width: 10%;"></td> <td style="width: 10%;"></td> <td style="width: 10%;"></td> <td style="width: 10%;"></td> <td style="width: 10%;"></td> <td style="width: 10%;"></td> <td style="width: 10%;"></td> <td style="width: 10%;"></td> <td style="width: 10%;"></td> <td style="width: 10%;"></td> </tr> <tr> <td></td> <td></td> <td colspan="8" style="text-align: center;"> <table border="1" style="width: 100%; border-collapse: collapse; text-align: center;"> <tr> <td style="width: 10%;"></td> <td style="width: 10%;"></td> <td style="width: 10%;"></td> <td style="width: 10%;"></td> <td style="width: 10%;"></td> <td style="width: 10%;"></td> <td style="width: 10%;"></td> <td style="width: 10%;"></td> <td style="width: 10%;"></td> <td style="width: 10%;"></td> </tr> <tr> <td></td> <td></td> <td colspan="8" style="text-align: center;"> <table border="1" style="width: 100%; border-collapse: collapse; text-align: center;"> <tr> <td style="width: 10%;"></td> <td style="width: 10%;"></td> <td style="width: 10%;"></td> <td style="width: 10%;"></td> <td style="width: 10%;"></td> <td style="width: 10%;"></td> <td style="width: 10%;"></td> <td style="width: 10%;"></td> <td style="width: 10%;"></td> <td style="width: 10%;"></td> </tr> <tr> <td></td> <td></td> <td colspan="8" style="text-align: center;"> <table border="1" style="width: 100%; border-collapse: collapse; text-align: center;"> <tr> <td style="width: 10%;"></td> <td style="width: 10%;"></td> <td style="width: 10%;"></td> <td style="width: 10%;"></td> <td style="width: 10%;"></td> <td style="width: 10%;"></td> <td style="width: 10%;"></td> <td style="width: 10%;"></td> <td style="width: 10%;"></td> <td style="width: 10%;"></td> </tr> <tr> <td></td> <td></td> <td colspan="8" style="text-align: center;"> <table border="1" style="width: 100%; border-collapse: collapse; text-align: center;"> <tr> <td style="width: 10%;"></td> <td style="width: 10%;"></td> <td style="width: 10%;"></td> <td style="width: 10%;"></td> <td style="width: 10%;"></td> <td style="width: 10%;"></td> <td style="width: 10%;"></td> <td style="width: 10%;"></td> <td style="width: 10%;"></td> <td style="width: 10%;"></td> </tr> <tr> <td></td> <td></td> <td colspan="8" style="text-align: center;"> <table border="1" style="width: 100%; border-collapse: collapse; text-align: center;"> <tr> <td style="width: 10%;"></td> <td style="width: 10%;"></td> <td style="width: 10%;"></td> <td style="width: 10%;"></td> <td style="width: 10%;"></td> <td style="width: 10%;"></td> <td style="width: 10%;"></td> <td style="width: 10%;"></td> <td style="width: 10%;"></td> <td style="width: 10%;"></td> </tr> <tr> <td></td> <td></td> <td colspan="8" style="text-align: center;"> <table border="1" style="width: 100%; border-collapse: collapse; text-align: center;"> <tr> <td style="width: 10%;"></td> <td style="width: 10%;"></td> <td style="width: 10%;"></td> <td style="width: 10%;"></td> <td style="width: 10%;"></td> <td style="width: 10%;"></td> <td style="width: 10%;"></td> <td style="width: 10%;"></td> <td style="width: 10%;"></td> <td style="width: 10%;"></td> </tr> <tr> <td></td> <td></td> <td colspan="8" style="text-align: center;"> <table border="1" style="width: 100%; border-collapse: collapse; text-align: center;"> <tr> <td style="width: 10%;"></td> <td style="width: 10%;"></td> <td style="width: 10%;"></td> <td style="width: 10%;"></td> <td style="width: 10%;"></td> <td style="width: 10%;"></td> <td style="width: 10%;"></td> <td style="width: 10%;"></td> <td style="width: 10%;"></td> <td style="width: 10%;"></td> </tr> <tr> <td></td> <td></td> <td colspan="8" style="text-align: center;"> <table border="1" style="width: 100%; border-collapse: collapse; text-align: center;"> <tr> <td style="width: 10%;"></td> <td style="width: 10%;"></td> <td style="width: 10%;"></td> <td style="width: 10%;"></td> <td style="width: 10%;"></td> <td style="width: 10%;"></td> <td style="width: 10%;"></td> <td style="width: 10%;"></td> <td style="width: 10%;"></td> <td style="width: 10%;"></td> </tr> <tr> <td></td> <td></td> <td colspan="8" style="text-align: center;"> <table border="1" style="width: 100%; border-collapse: collapse; text-align: center;"> <tr> <td style="width: 10%;"></td> <td style="width: 10%;"></td> <td style="width: 10%;"></td> <td style="width: 10%;"></td> <td style="width: 10%;"></td> <td style="width: 10%;"></td> <td style="width: 10%;"></td> <td style="width: 10%;"></td> <td style="width: 10%;"></td> <td style="width: 10%;"></td> </tr> <tr> <td></td> <td></td> <td colspan="8" style="text-align: center;"> <table border="1" style="width: 100%; border-collapse: collapse; text-align: center;"> <tr> <td style="width: 10%;"></td> <td style="width: 10%;"></td> <td style="width: 10%;"></td> <td style="width: 10%;"></td> <td style="width: 10%;"></td> <td style="width: 10%;"></td> <td style="width: 10%;"></td> <td style="width: 10%;"></td> <td style="width: 10%;"></td> <td style="width: 10%;"></td> </tr> <tr> <td></td> <td></td> <td
colspan="8" style="text-align: center;"> <table border="1" style="width: 100%; border-collapse: collapse; text-align: center;"> <tr> <td style="width: 10%;"></td> <td style="width: 10%;"></td> <td style="width: 10%;"></td> <td style="width: 10%;"></td> <td style="width: 10%;"></td> <td style="width: 10%;"></td> <td style="width: 10%;"></td> <td style="width: 10%;"></td> <td style="width: 10%;"></td> <td style="width: 10%;"></td> </tr> <tr> <td></td> <td></td> <td colspan="8" style="text-align: center;"> <table border="1" style="width: 100%; border-collapse: collapse; text-align: center;"> <tr> <td style="width: 10%;"></td> <td style="width: 10%;"></td> <td style="width: 10%;"></td> <td style="width: 10%;"></td> <td style="width: 10%;"></td> <td style="width: 10%;"></td> <td style="width: 10%;"></td> <td style="width: 10%;"></td> <td style="width: 10%;"></td> <td style="width: 10%;"></td> </tr> <tr> <td></td> <td></td> <td colspan="8" style="text-align: center;"> <table border="1" style="width: 100%; border-collapse: collapse; text-align: center;"> <tr> <td style="width: 10%;"></td> <td style="width: 10%;"></td> <td style="width: 10%;"></td> <td style="width: 10%;"></td> <td style="width: 10%;"></td> <td style="width: 10%;"></td> <td style="width: 10%;"></td> <td style="width: 10%;"></td> <td style="width: 10%;"></td> <td style="width: 10%;"></td> </tr> <tr> <td></td> <td></td> <td colspan="8" style="text-align: center;"> <table border="1" style="width: 100%; border-collapse: collapse; text-align: center;"> <tr> <td style="width: 10%;"></td> <td style="width: 10%;"></td> <td style="width: 10%;"></td> <td style="width: 10%;"></td> <td style="width: 10%;"></td> <td style="width: 10%;"></td> <td style="width: 10%;"></td> <td style="width: 10%;"></td> <td style="width: 10%;"></td> <td style="width: 10%;"></td> </tr> <tr> <td></td> <td></td> <td colspan="8" style="text-align: center;"> <table border="1" style="width: 100%; border-collapse: collapse; text-align: center;"> <tr> <td style="width: 10%;"></td> <td style="width: 10%;"></td> <td style="width: 10%;"></td> <td style="width: 10%;"></td> <td style="width: 10%;"></td> <td style="width: 10%;"></td> <td style="width: 10%;"></td> <td style="width: 10%;"></td> <td style="width: 10%;"></td> <td style="width: 10%;"></td> </tr> <tr> <td></td> <td></td> <td colspan="8" style="text-align: center;"> <table border="1" style="width: 100%; border-collapse: collapse; text-align: center;"> <tr> <td style="width: 10%;"></td> <td style="width: 10%;"></td> <td style="width: 10%;"></td> <td style="width: 10%;"></td> <td style="width: 10%;"></td> <td style="width: 10%;"></td> <td style="width: 10%;"></td> <td style="width: 10%;"></td> <td style="width: 10%;"></td> <td style="width: 10%;"></td> </tr> <tr> <td></td> <td></td> <td colspan="8" style="text-align: center;"> <table border="1" style="width: 100%; border-collapse: collapse; text-align: center;"> <tr> <td style="width: 10%;"></td> <td style="width: 10%;"></td> <td style="width: 10%;"></td> <td style="width: 10%;"></td> <td style="width: 10%;"></td> <td style="width: 10%;"></td> <td style="width: 10%;"></td> <td style="width: 10%;"></td> <td style="width: 10%;"></td> <td style="width: 10%;"></td> </tr> <tr> <td></td> <td></td> <td colspan="8" style="text-align: center;"> <table border="1" style="width: 100%; border-collapse: collapse; text-align: center;"> <tr> </tr></table></td></tr></table></td></tr></table></td></tr></table></td></tr></table></td></tr></table></td></tr></table></td></tr></table></td></tr></table></td></tr></table></td></tr></table></td></tr></table></td></tr></table></td></tr></table></td></tr></table></td></tr></table></td></tr></table></td></tr></table></td></tr></table></td></tr></table></td></tr></table></td></tr></table></td></tr></table></td></tr></table></td></tr></table></td></tr></table></td></tr></table></td></tr></table></td></tr></table></td></tr></table></td></tr></table></td></tr></table></td></tr></table></td></tr></table></td></tr></table></td></tr></table></td></tr></table></td></tr></table></td></tr></table></td></tr></table></td></tr></table></td></tr></table></td></tr></table></td></tr></table></td></tr></table></td></tr></table></td></tr></table></td></tr></table>
 | | | | | | | | | | | | | | | | | | | | <table border="1" style="width: 100%; border-collapse: collapse; text-align: center;"> <tr> <td style="width: 10%;"></td> <td style="width: 10%;"></td> <td style="width: 10%;"></td> <td style="width: 10%;"></td> <td style="width: 10%;"></td> <td style="width: 10%;"></td> <td style="width: 10%;"></td> <td style="width: 10%;"></td> <td style="width: 10%;"></td> <td style="width: 10%;"></td> </tr> <tr> <td></td> <td></td> <td colspan="8" style="text-align: center;"> <table border="1" style="width: 100%; border-collapse: collapse; text-align: center;"> <tr> <td style="width: 10%;"></td> <td style="width: 10%;"></td> <td style="width: 10%;"></td> <td style="width: 10%;"></td> <td style="width: 10%;"></td> <td style="width: 10%;"></td> <td style="width: 10%;"></td> <td style="width: 10%;"></td> <td style="width: 10%;"></td> <td style="width: 10%;"></td> </tr> <tr> <td></td> <td></td> <td colspan="8" style="text-align: center;"> <table border="1" style="width: 100%; border-collapse: collapse; text-align: center;"> <tr> <td style="width: 10%;"></td> <td style="width: 10%;"></td> <td style="width: 10%;"></td> <td style="width: 10%;"></td> <td style="width: 10%;"></td> <td style="width: 10%;"></td> <td style="width: 10%;"></td> <td style="width: 10%;"></td> <td style="width: 10%;"></td> <td style="width: 10%;"></td> </tr> <tr> <td></td> <td></td> <td colspan="8" style="text-align: center;"> <table border="1" style="width: 100%; border-collapse: collapse; text-align: center;"> <tr> <td style="width: 10%;"></td> <td style="width: 10%;"></td> <td style="width: 10%;"></td> <td style="width: 10%;"></td> <td style="width: 10%;"></td> <td style="width: 10%;"></td> <td style="width: 10%;"></td> <td style="width: 10%;"></td> <td style="width: 10%;"></td> <td style="width: 10%;"></td> </tr> <tr> <td></td> <td></td> <td colspan="8" style="text-align: center;"> <table border="1" style="width: 100%; border-collapse: collapse; text-align: center;"> <tr> <td style="width: 10%;"></td> <td style="width: 10%;"></td> <td style="width: 10%;"></td> <td style="width: 10%;"></td> <td style="width: 10%;"></td> <td style="width: 10%;"></td> <td style="width: 10%;"></td> <td style="width: 10%;"></td> <td style="width: 10%;"></td> <td style="width: 10%;"></td> </tr> <tr> <td></td> <td></td> <td colspan="8" style="text-align: center;"> <table border="1" style="width: 100%; border-collapse: collapse; text-align: center;"> <tr> <td style="width: 10%;"></td> <td style="width: 10%;"></td> <td style="width: 10%;"></td> <td style="width: 10%;"></td> <td style="width: 10%;"></td> <td style="width: 10%;"></td> <td style="width: 10%;"></td> <td style="width: 10%;"></td> <td style="width: 10%;"></td> <td style="width: 10%;"></td> </tr> <tr> <td></td> <td></td> <td colspan="8" style="text-align: center;"> <table border="1" style="width: 100%; border-collapse: collapse; text-align: center;"> <tr> <td style="width: 10%;"></td> <td style="width: 10%;"></td> <td style="width: 10%;"></td> <td style="width: 10%;"></td> <td style="width: 10%;"></td> <td style="width: 10%;"></td> <td style="width: 10%;"></td> <td style="width: 10%;"></td> <td style="width: 10%;"></td> <td style="width: 10%;"></td> </tr> <tr> <td></td> <td></td> <td colspan="8" style="text-align: center;"> <table border="1" style="width: 100%; border-collapse: collapse; text-align: center;"> <tr> <td style="width: 10%;"></td> <td style="width: 10%;"></td> <td style="width: 10%;"></td> <td style="width: 10%;"></td> <td style="width: 10%;"></td> <td style="width: 10%;"></td> <td style="width: 10%;"></td> <td style="width: 10%;"></td> <td style="width: 10%;"></td> <td style="width: 10%;"></td> </tr> <tr> <td></td> <td></td> <td colspan="8" style="text-align: center;"> <table border="1" style="width: 100%; border-collapse: collapse; text-align: center;"> <tr> <td style="width: 10%;"></td> <td style="width: 10%;"></td> <td style="width: 10%;"></td> <td style="width: 10%;"></td> <td style="width: 10%;"></td> <td style="width: 10%;"></td> <td style="width: 10%;"></td> <td style="width: 10%;"></td> <td style="width: 10%;"></td> <td style="width: 10%;"></td> </tr> <tr> <td></td> <td></td> <td colspan="8" style="text-align: center;"> <table border="1" style="width: 100%; border-collapse: collapse; text-align: center;"> <tr> <td style="width: 10%;"></td> <td style="width: 10%;"></td> <td style="width: 10%;"></td> <td style="width: 10%;"></td> <td style="width: 10%;"></td> <td style="width: 10%;"></td> <td style="width: 10%;"></td> <td style="width: 10%;"></td> <td style="width: 10%;"></td> <td style="width: 10%;"></td> </tr> <tr> <td></td> <td></td> <td colspan="8" style="text-align: center;"> <table border="1" style="width: 100%; border-collapse: collapse; text-align: center;"> <tr> <td style="width: 10%;"></td> <td style="width: 10%;"></td> <td style="width: 10%;"></td> <td style="width: 10%;"></td> <td style="width: 10%;"></td> <td style="width: 10%;"></td> <td style="width: 10%;"></td> <td style="width: 10%;"></td> <td style="width: 10%;"></td> <td style="width: 10%;"></td> </tr> <tr> <td></td> <td></td> <td colspan="8" style="text-align: center;"> <table border="1" style="width: 100%; border-collapse: collapse; text-align: center;"> <tr> <td style="width: 10%;"></td> <td style="width: 10%;"></td> <td style="width: 10%;"></td> <td style="width: 10%;"></td> <td style="width: 10%;"></td> <td style="width: 10%;"></td> <td style="width: 10%;"></td> <td style="width: 10%;"></td> <td style="width: 10%;"></td> <td style="width: 10%;"></td> </tr> <tr> <td></td> <td></td> <td colspan="8" style="text-align: center;"> <table border="1" style="width: 100%; border-collapse: collapse; text-align: center;"> <tr> <td style="width: 10%;"></td> <td style="width: 10%;"></td> <td style="width: 10%;"></td> <td style="width: 10%;"></td> <td style="width: 10%;"></td> <td style="width: 10%;"></td> <td style="width: 10%;"></td> <td style="width: 10%;"></td> <td style="width: 10%;"></td> <td style="width: 10%;"></td> </tr> <tr> <td></td> <td></td> <td colspan="8" style="text-align: center;"> <table border="1" style="width: 100%; border-collapse: collapse; text-align: center;"> <tr> <td style="width: 10%;"></td> <td style="width: 10%;"></td> <td style="width: 10%;"></td> <td style="width: 10%;"></td> <td style="width: 10%;"></td> <td style="width: 10%;"></td> <td style="width: 10%;"></td> <td style="width: 10%;"></td> <td style="width: 10%;"></td> <td style="width: 10%;"></td> </tr> <tr> <td></td> <td></td> <td colspan="8" style="text-align: center;"> <table border="1" style="width: 100%; border-collapse: collapse; text-align: center;"> <tr> <td style="width: 10%;"></td> <td style="width: 10%;"></td> <td style="width: 10%;"></td> <td style="width: 10%;"></td> <td style="width: 10%;"></td> <td style="width: 10%;"></td> <td style="width: 10%;"></td> <td style="width: 10%;"></td> <td style="width: 10%;"></td> <td style="width: 10%;"></td> </tr> <tr> <td></td> <td></td> <td colspan="8" style="text-align: center;"> <table border="1" style="width: 100%; border-collapse: collapse; text-align: center;"> <tr> <td style="width: 10%;"></td> <td style="width: 10%;"></td> <td style="width: 10%;"></td> <td style="width: 10%;"></td> <td style="width: 10%;"></td> <td style="width: 10%;"></td> <td style="width: 10%;"></td> <td style="width: 10%;"></td> <td style="width: 10%;"></td> <td style="width: 10%;"></td> </tr> <tr> <td></td> <td></td> <td colspan="8" style="text-align: center;"> <table border="1" style="width: 100%; border-collapse: collapse; text-align: center;"> <tr> <td style="width: 10%;"></td> <td style="width: 10%;"></td> <td style="width: 10%;"></td> <td style="width: 10%;"></td> <td style="width: 10%;"></td> <td style="width: 10%;"></td> <td style="width: 10%;"></td> <td style="width: 10%;"></td> <td style="width: 10%;"></td> <td style="width: 10%;"></td> </tr> <tr>
<td></td> <td></td> <td colspan="8" style="text-align: center;"> <table border="1" style="width: 100%; border-collapse: collapse; text-align: center;"> <tr> <td style="width: 10%;"></td> <td style="width: 10%;"></td> <td style="width: 10%;"></td> <td style="width: 10%;"></td> <td style="width: 10%;"></td> <td style="width: 10%;"></td> <td style="width: 10%;"></td> <td style="width: 10%;"></td> <td style="width: 10%;"></td> <td style="width: 10%;"></td> </tr> <tr> <td></td> <td></td> <td colspan="8" style="text-align: center;"> <table border="1" style="width: 100%; border-collapse: collapse; text-align: center;"> <tr> <td style="width: 10%;"></td> <td style="width: 10%;"></td> <td style="width: 10%;"></td> <td style="width: 10%;"></td> <td style="width: 10%;"></td> <td style="width: 10%;"></td> <td style="width: 10%;"></td> <td style="width: 10%;"></td> <td style="width: 10%;"></td> <td style="width: 10%;"></td> </tr> <tr> <td></td> <td></td> <td colspan="8" style="text-align: center;"> <table border="1" style="width: 100%; border-collapse: collapse; text-align: center;"> <tr> <td style="width: 10%;"></td> <td style="width: 10%;"></td> <td style="width: 10%;"></td> <td style="width: 10%;"></td> <td style="width: 10%;"></td> <td style="width: 10%;"></td> <td style="width: 10%;"></td> <td style="width: 10%;"></td> <td style="width: 10%;"></td> <td style="width: 10%;"></td> </tr> <tr> <td></td> <td></td> <td colspan="8" style="text-align: center;"> <table border="1" style="width: 100%; border-collapse: collapse; text-align: center;"> <tr> <td style="width: 10%;"></td> <td style="width: 10%;"></td> <td style="width: 10%;"></td> <td style="width: 10%;"></td> <td style="width: 10%;"></td> <td style="width: 10%;"></td> <td style="width: 10%;"></td> <td style="width: 10%;"></td> <td style="width: 10%;"></td> <td style="width: 10%;"></td> </tr> <tr> <td></td> <td></td> <td colspan="8" style="text-align: center;"> <table border="1" style="width: 100%; border-collapse: collapse; text-align: center;"> <tr> <td style="width: 10%;"></td> <td style="width: 10%;"></td> <td style="width: 10%;"></td> <td style="width: 10%;"></td> <td style="width: 10%;"></td> <td style="width: 10%;"></td> <td style="width: 10%;"></td> <td style="width: 10%;"></td> <td style="width: 10%;"></td> <td style="width: 10%;"></td> </tr> <tr> <td></td> <td></td> <td colspan="8" style="text-align: center;"> <table border="1" style="width: 100%; border-collapse: collapse; text-align: center;"> <tr> <td style="width: 10%;"></td> <td style="width: 10%;"></td> <td style="width: 10%;"></td> <td style="width: 10%;"></td> <td style="width: 10%;"></td> <td style="width: 10%;"></td> <td style="width: 10%;"></td> <td style="width: 10%;"></td> <td style="width: 10%;"></td> <td style="width: 10%;"></td> </tr> <tr> <td></td> <td></td> <td colspan="8" style="text-align: center;"> <table border="1" style="width: 100%; border-collapse: collapse; text-align: center;"> <tr> <td style="width: 10%;"></td> <td style="width: 10%;"></td> <td style="width: 10%;"></td> <td style="width: 10%;"></td> <td style="width: 10%;"></td> <td style="width: 10%;"></td> <td style="width: 10%;"></td> <td style="width: 10%;"></td> <td style="width: 10%;"></td> <td style="width: 10%;"></td> </tr> <tr> <td></td> <td></td> <td colspan="8" style="text-align: center;"> <table border="1" style="width: 100%; border-collapse: collapse; text-align: center;"> <tr> <td style="width: 10%;"></td> <td style="width: 10%;"></td> <td style="width: 10%;"></td> <td style="width: 10%;"></td> <td style="width: 10%;"></td> <td style="width: 10%;"></td> <td style="width: 10%;"></td> <td style="width: 10%;"></td> <td style="width: 10%;"></td> <td style="width: 10%;"></td> </tr> <tr> <td></td> <td></td> <td colspan="8" style="text-align: center;"> <table border="1" style="width: 100%; border-collapse: collapse; text-align: center;"> <tr> <td style="width: 10%;"></td> <td style="width: 10%;"></td> <td style="width: 10%;"></td> <td style="width: 10%;"></td> <td style="width: 10%;"></td> <td style="width: 10%;"></td> <td style="width: 10%;"></td> <td style="width: 10%;"></td> <td style="width: 10%;"></td> <td style="width: 10%;"></td> </tr> <tr> <td></td> <td></td> <td colspan="8" style="text-align: center;"> <table border="1" style="width: 100%; border-collapse: collapse; text-align: center;"> <tr> <td style="width: 10%;"></td> <td style="width: 10%;"></td> <td style="width: 10%;"></td> <td style="width: 10%;"></td> <td style="width: 10%;"></td> <td style="width: 10%;"></td> <td style="width: 10%;"></td> <td style="width: 10%;"></td> <td style="width: 10%;"></td> <td style="width: 10%;"></td> </tr> <tr> <td></td> <td></td> <td colspan="8" style="text-align: center;"> <table border="1" style="width: 100%; border-collapse: collapse; text-align: center;"> <tr> <td style="width: 10%;"></td> <td style="width: 10%;"></td> <td style="width: 10%;"></td> <td style="width: 10%;"></td> <td style="width: 10%;"></td> <td style="width: 10%;"></td> <td style="width: 10%;"></td> <td style="width: 10%;"></td> <td style="width: 10%;"></td> <td style="width: 10%;"></td> </tr> <tr> <td></td> <td></td> <td colspan="8" style="text-align: center;"> <table border="1" style="width: 100%; border-collapse: collapse; text-align: center;"> <tr> <td style="width: 10%;"></td> <td style="width: 10%;"></td> <td style="width: 10%;"></td> <td style="width: 10%;"></td> <td style="width: 10%;"></td> <td style="width: 10%;"></td> <td style="width: 10%;"></td> <td style="width: 10%;"></td> <td style="width: 10%;"></td> <td style="width: 10%;"></td> </tr> <tr> <td></td> <td></td> <td colspan="8" style="text-align: center;"> <table border="1" style="width: 100%; border-collapse: collapse; text-align: center;"> <tr> <td style="width: 10%;"></td> <td style="width: 10%;"></td> <td style="width: 10%;"></td> <td style="width: 10%;"></td> <td style="width: 10%;"></td> <td style="width: 10%;"></td> <td style="width: 10%;"></td> <td style="width: 10%;"></td> <td style="width: 10%;"></td> <td style="width: 10%;"></td> </tr> <tr> <td></td> <td></td> <td colspan="8" style="text-align: center;"> <table border="1" style="width: 100%; border-collapse: collapse; text-align: center;"> <tr> <td style="width: 10%;"></td> <td style="width: 10%;"></td> <td style="width: 10%;"></td> <td style="width: 10%;"></td> <td style="width: 10%;"></td> <td style="width: 10%;"></td> <td style="width: 10%;"></td> <td style="width: 10%;"></td> <td style="width: 10%;"></td> <td style="width: 10%;"></td> </tr> <tr> <td></td> <td></td> <td colspan="8" style="text-align: center;"> <table border="1" style="width: 100%; border-collapse: collapse; text-align: center;"> <tr> <td style="width: 10%;"></td> <td style="width: 10%;"></td> <td style="width: 10%;"></td> <td style="width: 10%;"></td> <td style="width: 10%;"></td> <td style="width: 10%;"></td> <td style="width: 10%;"></td> <td style="width: 10%;"></td> <td style="width: 10%;"></td> <td style="width: 10%;"></td> </tr> <tr> <td></td> <td></td> <td colspan="8" style="text-align: center;"> <table border="1" style="width: 100%; border-collapse: collapse; text-align: center;"> <tr> <td style="width: 10%;"></td> <td style="width: 10%;"></td> <td style="width: 10%;"></td> <td style="width: 10%;"></td> <td style="width: 10%;"></td> <td style="width: 10%;"></td> <td style="width: 10%;"></td> <td style="width: 10%;"></td> <td style="width: 10%;"></td> <td style="width: 10%;"></td> </tr> <tr> <td></td> <td></td> <td colspan="8" style="text-align: center;"> <table border="1" style="width: 100%; border-collapse: collapse; text-align: center;"> <tr> <td style="width: 10%;"></td> <td style="width: 10%;"></td> <td style="width: 10%;"></td> <td style="width: 10%;"></td> <td style="width: 10%;"></td> <td style="width: 10%;"></td> <td style="width: 10%;"></td> <td style="width: 10%;"></td> <td style="width: 10%;"></td> <td style="width: 10%;"></td> </tr> <tr> <td></td> <td></td> <td colspan="8" style="text-align: center;"> <table border="1" style="width: 100%; border-collapse: collapse; text-align: center;"> <tr> <td style="width: 10%;"></td> <td style="width: 10%;"></td> <td style="width: 10%;"></td> <td style="width: 10%;"></td> <td style="width: 10%;"></td> <td style="width: 10%;"></td> <td style="width: 10%;"></td> <td style="width: 10%;"></td> <td style="width: 10%;"></td> <td style="width: 10%;"></td> </tr> <tr> <td></td> <td></td> <td colspan="8" style="text-align: center;"> <table border="1" style="width: 100%; border-collapse: collapse; text-align: center;"> <tr> <td style="width: 10%;"></td> <td style="width: 10%;"></td> <td style="width: 10%;"></td> <td style="width: 10%;"></td> <td style="width: 10%;"></td> <td style="width: 10%;"></td> <td style="width: 10%;"></td> <td style="width: 10%;"></td> <td style="width: 10%;"></td> <td style="width: 10%;"></td> </tr> <tr> <td></td> <td></td> <td colspan="8" style="text-align: center;"> <table border="1" style="width: 100%; border-collapse: collapse; text-align: center;"> <tr> <td style="width: 10%;"></td> <td style="width: 10%;"></td> <td style="width: 10%;"></td> <td style="width: 10%;"></td> <td style="width: 10%;"></td> <td style="width: 10%;"></td> <td style="width: 10%;"></td> <td style="width: 10%;"></td> <td style="width: 10%;"></td> <td style="width: 10%;"></td> </tr> <tr> <td></td> <td></td> <td colspan="8" style="text-align: center;"> <table border="1" style="width: 100%; border-collapse: collapse; text-align: center;"> <tr> <td style="width: 10%;"></td> <td style="width: 10%;"></td> <td style="width: 10%;"></td> <td style="width: 10%;"></td> <td style="width: 10%;"></td> <td style="width: 10%;"></td> <td style="width: 10%;"></td> <td style="width: 10%;"></td> <td style="width: 10%;"></td> <td style="width: 10%;"></td> </tr> <tr> <td></td> <td></td> <td colspan="8" style="text-align: center;"> <table border="1" style="width: 100%; border-collapse: collapse; text-align: center;"> <tr> <td
style="width: 10%;"></td> <td style="width: 10%;"></td> <td style="width: 10%;"></td> <td style="width: 10%;"></td> <td style="width: 10%;"></td> <td style="width: 10%;"></td> <td style="width: 10%;"></td> <td style="width: 10%;"></td> <td style="width: 10%;"></td> <td style="width: 10%;"></td> </tr> <tr> <td></td> <td></td> <td colspan="8" style="text-align: center;"> <table border="1" style="width: 100%; border-collapse: collapse; text-align: center;"> <tr> <td style="width: 10%;"></td> <td style="width: 10%;"></td> <td style="width: 10%;"></td> <td style="width: 10%;"></td> <td style="width: 10%;"></td> <td style="width: 10%;"></td> <td style="width: 10%;"></td> <td style="width: 10%;"></td> <td style="width: 10%;"></td> <td style="width: 10%;"></td> </tr> <tr> <td></td> <td></td> <td colspan="8" style="text-align: center;"> <table border="1" style="width: 100%; border-collapse: collapse; text-align: center;"> <tr> <td style="width: 10%;"></td> <td style="width: 10%;"></td> <td style="width: 10%;"></td> <td style="width: 10%;"></td> <td style="width: 10%;"></td> <td style="width: 10%;"></td> <td style="width: 10%;"></td> <td style="width: 10%;"></td> <td style="width: 10%;"></td> <td style="width: 10%;"></td> </tr> <tr> <td></td> <td></td> <td colspan="8" style="text-align: center;"> <table border="1" style="width: 100%; border-collapse: collapse; text-align: center;"> <tr> <td style="width: 10%;"></td> <td style="width: 10%;"></td> <td style="width: 10%;"></td> <td style="width: 10%;"></td> <td style="width: 10%;"></td> <td style="width: 10%;"></td> <td style="width: 10%;"></td> <td style="width: 10%;"></td> <td style="width: 10%;"></td> <td style="width: 10%;"></td> </tr> <tr> <td></td> <td></td> <td colspan="8" style="text-align: center;"> <table border="1" style="width: 100%; border-collapse: collapse; text-align: center;"> <tr> <td style="width: 10%;"></td> <td style="width: 10%;"></td> <td style="width: 10%;"></td> <td style="width: 10%;"></td> <td style="width: 10%;"></td> <td style="width: 10%;"></td> <td style="width: 10%;"></td> <td style="width: 10%;"></td> <td style="width: 10%;"></td> <td style="width: 10%;"></td> </tr> <tr> <td></td> <td></td> <td colspan="8" style="text-align: center;"> <table border="1" style="width: 100%; border-collapse: collapse; text-align: center;"> <tr> <td style="width: 10%;"></td> <td style="width: 10%;"></td> <td style="width: 10%;"></td> <td style="width: 10%;"></td> <td style="width: 10%;"></td> <td style="width: 10%;"></td> <td style="width: 10%;"></td> <td style="width: 10%;"></td> <td style="width: 10%;"></td> <td style="width: 10%;"></td> </tr> <tr> <td></td> <td></td> <td colspan="8" style="text-align: center;"> <table border="1" style="width: 100%; border-collapse: collapse; text-align: center;"> <tr> <td style="width: 10%;"></td> <td style="width: 10%;"></td> <td style="width: 10%;"></td> <td style="width: 10%;"></td> <td style="width: 10%;"></td> <td style="width: 10%;"></td> <td style="width: 10%;"></td> <td style="width: 10%;"></td> <td style="width: 10%;"></td> <td style="width: 10%;"></td> </tr> <tr> <td></td> <td></td> <td colspan="8" style="text-align: center;"> <table border="1" style="width: 100%; border-collapse: collapse; text-align: center;"> <tr> <td style="width: 10%;"></td> <td style="width: 10%;"></td> <td style="width: 10%;"></td> <td style="width: 10%;"></td> <td style="width: 10%;"></td> <td style="width: 10%;"></td> <td style="width: 10%;"></td> <td style="width: 10%;"></td> <td style="width: 10%;"></td> <td style="width: 10%;"></td> </tr> <tr> <td></td> <td></td> <td colspan="8" style="text-align: center;"> <table border="1" style="width: 100%; border-collapse: collapse; text-align: center;"> <tr> </tr></table></td></tr></table></td></tr></table></td></tr></table></td></tr></table></td></tr></table></td></tr></table></td></tr></table></td></tr></table></td></tr></table></td></tr></table></td></tr></table></td></tr></table></td></tr></table></td></tr></table></td></tr></table></td></tr></table></td></tr></table></td></tr></table></td></tr></table></td></tr></table></td></tr></table></td></tr></table></td></tr></table></td></tr></table></td></tr></table></td></tr></table></td></tr></table></td></tr></table></td></tr></table></td></tr></table></td></tr></table></td></tr></table></td></tr></table></td></tr></table></td></tr></table></td></tr></table></td></tr></table></td></tr></table></td></tr></table></td></tr></table></td></tr></table></td></tr></table></td></tr></table></td></tr></table></td></tr></table></td></tr></table>
 | | | | | | | | | | | | | | | | | | | | <table border="1" style="width: 100%; border-collapse: collapse; text-align: center;"> <tr> <td style="width: 10%;"></td> <td style="width: 10%;"></td> <td style="width: 10%;"></td> <td style="width: 10%;"></td> <td style="width: 10%;"></td> <td style="width: 10%;"></td> <td style="width: 10%;"></td> <td style="width: 10%;"></td> <td style="width: 10%;"></td> <td style="width: 10%;"></td> </tr> <tr> <td></td> <td></td> <td colspan="8" style="text-align: center;"> <table border="1" style="width: 100%; border-collapse: collapse; text-align: center;"> <tr> <td style="width: 10%;"></td> <td style="width: 10%;"></td> <td style="width: 10%;"></td> <td style="width: 10%;"></td> <td style="width: 10%;"></td> <td style="width: 10%;"></td> <td style="width: 10%;"></td> <td style="width: 10%;"></td> <td style="width: 10%;"></td> <td style="width: 10%;"></td> </tr> <tr> <td></td> <td></td> <td colspan="8" style="text-align: center;"> <table border="1" style="width: 100%; border-collapse: collapse; text-align: center;"> <tr> <td style="width: 10%;"></td> <td style="width: 10%;"></td> <td style="width: 10%;"></td> <td style="width: 10%;"></td> <td style="width: 10%;"></td> <td style="width: 10%;"></td> <td style="width: 10%;"></td> <td style="width: 10%;"></td> <td style="width: 10%;"></td> <td style="width: 10%;"></td> </tr> <tr> <td></td> <td></td> <td colspan="8" style="text-align: center;"> <table border="1" style="width: 100%; border-collapse: collapse; text-align: center;"> <tr> <td style="width: 10%;"></td> <td style="width: 10%;"></td> <td style="width: 10%;"></td> <td style="width: 10%;"></td> <td style="width: 10%;"></td> <td style="width: 10%;"></td> <td style="width: 10%;"></td> <td style="width: 10%;"></td> <td style="width: 10%;"></td> <td style="width: 10%;"></td> </tr> <tr> <td></td> <td></td> <td colspan="8" style="text-align: center;"> <table border="1" style="width: 100%; border-collapse: collapse; text-align: center;"> <tr> <td style="width: 10%;"></td> <td style="width: 10%;"></td> <td style="width: 10%;"></td> <td style="width: 10%;"></td> <td style="width: 10%;"></td> <td style="width: 10%;"></td> <td style="width: 10%;"></td> <td style="width: 10%;"></td> <td style="width: 10%;"></td> <td style="width: 10%;"></td> </tr> <tr> <td></td> <td></td> <td colspan="8" style="text-align: center;"> <table border="1" style="width: 100%; border-collapse: collapse; text-align: center;"> <tr> <td style="width: 10%;"></td> <td style="width: 10%;"></td> <td style="width: 10%;"></td> <td style="width: 10%;"></td> <td style="width: 10%;"></td> <td style="width: 10%;"></td> <td style="width: 10%;"></td> <td style="width: 10%;"></td> <td style="width: 10%;"></td> <td style="width: 10%;"></td> </tr> <tr> <td></td> <td></td> <td colspan="8" style="text-align: center;"> <table border="1" style="width: 100%; border-collapse: collapse; text-align: center;"> <tr> <td style="width: 10%;"></td> <td style="width: 10%;"></td> <td style="width: 10%;"></td> <td style="width: 10%;"></td> <td style="width: 10%;"></td> <td style="width: 10%;"></td> <td style="width: 10%;"></td> <td style="width: 10%;"></td> <td style="width: 10%;"></td> <td style="width: 10%;"></td> </tr> <tr> <td></td> <td></td> <td colspan="8" style="text-align: center;"> <table border="1" style="width: 100%; border-collapse: collapse; text-align: center;"> <tr> <td style="width: 10%;"></td> <td style="width: 10%;"></td> <td style="width: 10%;"></td> <td style="width: 10%;"></td> <td style="width: 10%;"></td> <td style="width: 10%;"></td> <td style="width: 10%;"></td> <td style="width: 10%;"></td> <td style="width: 10%;"></td> <td style="width: 10%;"></td> </tr> <tr> <td></td> <td></td> <td colspan="8" style="text-align: center;"> <table border="1" style="width: 100%; border-collapse: collapse; text-align: center;"> <tr> <td style="width: 10%;"></td> <td style="width: 10%;"></td> <td style="width: 10%;"></td> <td style="width: 10%;"></td> <td style="width: 10%;"></td> <td style="width: 10%;"></td> <td style="width: 10%;"></td> <td style="width: 10%;"></td> <td style="width: 10%;"></td> <td style="width: 10%;"></td> </tr> <tr> <td></td> <td></td> <td colspan="8" style="text-align: center;"> <table border="1" style="width: 100%; border-collapse: collapse; text-align: center;"> <tr> <td style="width: 10%;"></td> <td style="width: 10%;"></td> <td style="width: 10%;"></td> <td style="width: 10%;"></td> <td style="width: 10%;"></td> <td style="width: 10%;"></td> <td style="width: 10%;"></td> <td style="width: 10%;"></td> <td style="width: 10%;"></td> <td style="width: 10%;"></td> </tr> <tr> <td></td> <td></td> <td colspan="8" style="text-align: center;"> <table border="1" style="width: 100%; border-collapse: collapse; text-align: center;"> <tr> <td style="width: 10%;"></td> <td style="width: 10%;"></td> <td style="width: 10%;"></td> <td style="width: 10%;"></td> <td style="width: 10%;"></td> <td style="width: 10%;"></td> <td style="width: 10%;"></td> <td style="width: 10%;"></td> <td style="width: 10%;"></td> <td style="width: 10%;"></td> </tr> <tr> <td></td> <td></td> <td colspan="8" style="text-align: center;"> <table border="1" style="width: 100%; border-collapse: collapse; text-align: center;"> <tr> <td style="width: 10%;"></td> <td style="width: 10%;"></td> <td style="width: 10%;"></td> <td style="width: 10%;"></td> <td style="width: 10%;"></td> <td style="width: 10%;"></td> <td style="width: 10%;"></td> <td style="width: 10%;"></td> <td style="width: 10%;"></td> <td style="width: 10%;"></td> </tr> <tr> <td></td> <td></td> <td colspan="8" style="text-align: center;"> <table border="1" style="width: 100%; border-collapse: collapse; text-align: center;"> <tr> <td style="width: 10%;"></td> <td style="width: 10%;"></td> <td style="width: 10%;"></td> <td style="width: 10%;"></td> <td style="width: 10%;"></td> <td style="width: 10%;"></td> <td style="width: 10%;"></td> <td style="width: 10%;"></td> <td style="width: 10%;"></td> <td style="width: 10%;"></td> </tr> <tr> <td></td> <td></td> <td colspan="8" style="text-align: center;"> <table border="1" style="width: 100%; border-collapse: collapse; text-align: center;"> <tr> <td style="width: 10%;"></td> <td style="width: 10%;"></td> <td style="width: 10%;"></td> <td style="width: 10%;"></td> <td style="width: 10%;"></td> <td style="width: 10%;"></td> <td style="width: 10%;"></td> <td style="width: 10%;"></td> <td style="width: 10%;"></td> <td style="width: 10%;"></td> </tr> <tr> <td></td> <td></td> <td colspan="8" style="text-align: center;"> <table border="1" style="width: 100%; border-collapse: collapse; text-align: center;"> <tr> <td style="width: 10%;"></td> <td style="width: 10%;"></td> <td style="width: 10%;"></td> <td style="width: 10%;"></td> <td style="width: 10%;"></td> <td style="width: 10%;"></td> <td style="width: 10%;"></td> <td style="width: 10%;"></td> <td style="width: 10%;"></td> <td style="width: 10%;"></td> </tr> <tr> <td></td> <td></td> <td colspan="8" style="text-align: center;"> <table border="1" style="width: 100%; border-collapse: collapse; text-align: center;"> <tr> <td style="width: 10%;"></td> <td style="width: 10%;"></td> <td style="width: 10%;"></td> <td style="width: 10%;"></td> <td style="width: 10%;"></td> <td style="width: 10%;"></td> <td style="width: 10%;"></td> <td style="width: 10%;"></td> <td style="width: 10%;"></td> <td style="width: 10%;"></td> </tr> <tr> <td></td> <td></td> <td colspan="8" style="text-align: center;"> <table border="1" style="width: 100%; border-collapse: collapse; text-align: center;"> <tr>
<td style="width: 10%;"></td> <td style="width: 10%;"></td> <td style="width: 10%;"></td> <td style="width: 10%;"></td> <td style="width: 10%;"></td> <td style="width: 10%;"></td> <td style="width: 10%;"></td> <td style="width: 10%;"></td> <td style="width: 10%;"></td> <td style="width: 10%;"></td> </tr> <tr> <td></td> <td></td> <td colspan="8" style="text-align: center;"> <table border="1" style="width: 100%; border-collapse: collapse; text-align: center;"> <tr> <td style="width: 10%;"></td> <td style="width: 10%;"></td> <td style="width: 10%;"></td> <td style="width: 10%;"></td> <td style="width: 10%;"></td> <td style="width: 10%;"></td> <td style="width: 10%;"></td> <td style="width: 10%;"></td> <td style="width: 10%;"></td> <td style="width: 10%;"></td> </tr> <tr> <td></td> <td></td> <td colspan="8" style="text-align: center;"> <table border="1" style="width: 100%; border-collapse: collapse; text-align: center;"> <tr> <td style="width: 10%;"></td> <td style="width: 10%;"></td> <td style="width: 10%;"></td> <td style="width: 10%;"></td> <td style="width: 10%;"></td> <td style="width: 10%;"></td> <td style="width: 10%;"></td> <td style="width: 10%;"></td> <td style="width: 10%;"></td> <td style="width: 10%;"></td> </tr> <tr> <td></td> <td></td> <td colspan="8" style="text-align: center;"> <table border="1" style="width: 100%; border-collapse: collapse; text-align: center;"> <tr> <td style="width: 10%;"></td> <td style="width: 10%;"></td> <td style="width: 10%;"></td> <td style="width: 10%;"></td> <td style="width: 10%;"></td> <td style="width: 10%;"></td> <td style="width: 10%;"></td> <td style="width: 10%;"></td> <td style="width: 10%;"></td> <td style="width: 10%;"></td> </tr> <tr> <td></td> <td></td> <td colspan="8" style="text-align: center;"> <table border="1" style="width: 100%; border-collapse: collapse; text-align: center;"> <tr> <td style="width: 10%;"></td> <td style="width: 10%;"></td> <td style="width: 10%;"></td> <td style="width: 10%;"></td> <td style="width: 10%;"></td> <td style="width: 10%;"></td> <td style="width: 10%;"></td> <td style="width: 10%;"></td> <td style="width: 10%;"></td> <td style="width: 10%;"></td> </tr> <tr> <td></td> <td></td> <td colspan="8" style="text-align: center;"> <table border="1" style="width: 100%; border-collapse: collapse; text-align: center;"> <tr> <td style="width: 10%;"></td> <td style="width: 10%;"></td> <td style="width: 10%;"></td> <td style="width: 10%;"></td> <td style="width: 10%;"></td> <td style="width: 10%;"></td> <td style="width: 10%;"></td> <td style="width: 10%;"></td> <td style="width: 10%;"></td> <td style="width: 10%;"></td> </tr> <tr> <td></td> <td></td> <td colspan="8" style="text-align: center;"> <table border="1" style="width: 100%; border-collapse: collapse; text-align: center;"> <tr> <td style="width: 10%;"></td> <td style="width: 10%;"></td> <td style="width: 10%;"></td> <td style="width: 10%;"></td> <td style="width: 10%;"></td> <td style="width: 10%;"></td> <td style="width: 10%;"></td> <td style="width: 10%;"></td> <td style="width: 10%;"></td> <td style="width: 10%;"></td> </tr> <tr> <td></td> <td></td> <td colspan="8" style="text-align: center;"> <table border="1" style="width: 100%; border-collapse: collapse; text-align: center;"> <tr> <td style="width: 10%;"></td> <td style="width: 10%;"></td> <td style="width: 10%;"></td> <td style="width: 10%;"></td> <td style="width: 10%;"></td> <td style="width: 10%;"></td> <td style="width: 10%;"></td> <td style="width: 10%;"></td> <td style="width: 10%;"></td> <td style="width: 10%;"></td> </tr> <tr> <td></td> <td></td> <td colspan="8" style="text-align: center;"> <table border="1" style="width: 100%; border-collapse: collapse; text-align: center;"> <tr> <td style="width: 10%;"></td> <td style="width: 10%;"></td> <td style="width: 10%;"></td> <td style="width: 10%;"></td> <td style="width: 10%;"></td> <td style="width: 10%;"></td> <td style="width: 10%;"></td> <td style="width: 10%;"></td> <td style="width: 10%;"></td> <td style="width: 10%;"></td> </tr> <tr> <td></td> <td></td> <td colspan="8" style="text-align: center;"> <table border="1" style="width: 100%; border-collapse: collapse; text-align: center;"> <tr> <td style="width: 10%;"></td> <td style="width: 10%;"></td> <td style="width: 10%;"></td> <td style="width: 10%;"></td> <td style="width: 10%;"></td> <td style="width: 10%;"></td> <td style="width: 10%;"></td> <td style="width: 10%;"></td> <td style="width: 10%;"></td> <td style="width: 10%;"></td> </tr> <tr> <td></td> <td></td> <td colspan="8" style="text-align: center;"> <table border="1" style="width: 100%; border-collapse: collapse; text-align: center;"> <tr> <td style="width: 10%;"></td> <td style="width: 10%;"></td> <td style="width: 10%;"></td> <td style="width: 10%;"></td> <td style="width: 10%;"></td> <td style="width: 10%;"></td> <td style="width: 10%;"></td> <td style="width: 10%;"></td> <td style="width: 10%;"></td> <td style="width: 10%;"></td> </tr> <tr> <td></td> <td></td> <td colspan="8" style="text-align: center;"> <table border="1" style="width: 100%; border-collapse: collapse; text-align: center;"> <tr> <td style="width: 10%;"></td> <td style="width: 10%;"></td> <td style="width: 10%;"></td> <td style="width: 10%;"></td> <td style="width: 10%;"></td> <td style="width: 10%;"></td> <td style="width: 10%;"></td> <td style="width: 10%;"></td> <td style="width: 10%;"></td> <td style="width: 10%;"></td> </tr> <tr> <td></td> <td></td> <td colspan="8" style="text-align: center;"> <table border="1" style="width: 100%; border-collapse: collapse; text-align: center;"> <tr> <td style="width: 10%;"></td> <td style="width: 10%;"></td> <td style="width: 10%;"></td> <td style="width: 10%;"></td> <td style="width: 10%;"></td> <td style="width: 10%;"></td> <td style="width: 10%;"></td> <td style="width: 10%;"></td> <td style="width: 10%;"></td> <td style="width: 10%;"></td> </tr> <tr> <td></td> <td></td> <td colspan="8" style="text-align: center;"> <table border="1" style="width: 100%; border-collapse: collapse; text-align: center;"> <tr> <td style="width: 10%;"></td> <td style="width: 10%;"></td> <td style="width: 10%;"></td> <td style="width: 10%;"></td> <td style="width: 10%;"></td> <td style="width: 10%;"></td> <td style="width: 10%;"></td> <td style="width: 10%;"></td> <td style="width: 10%;"></td> <td style="width: 10%;"></td> </tr> <tr> <td></td> <td></td> <td colspan="8" style="text-align: center;"> <table border="1" style="width: 100%; border-collapse: collapse; text-align: center;"> <tr> <td style="width: 10%;"></td> <td style="width: 10%;"></td> <td style="width: 10%;"></td> <td style="width: 10%;"></td> <td style="width: 10%;"></td> <td style="width: 10%;"></td> <td style="width: 10%;"></td> <td style="width: 10%;"></td> <td style="width: 10%;"></td> <td style="width: 10%;"></td> </tr> <tr> <td></td> <td></td> <td colspan="8" style="text-align: center;"> <table border="1" style="width: 100%; border-collapse: collapse; text-align: center;"> <tr> <td style="width: 10%;"></td> <td style="width: 10%;"></td> <td style="width: 10%;"></td> <td style="width: 10%;"></td> <td style="width: 10%;"></td> <td style="width: 10%;"></td> <td style="width: 10%;"></td> <td style="width: 10%;"></td> <td style="width: 10%;"></td> <td style="width: 10%;"></td> </tr> <tr> <td></td> <td></td> <td colspan="8" style="text-align: center;"> <table border="1" style="width: 100%; border-collapse: collapse; text-align: center;"> <tr> <td style="width: 10%;"></td> <td style="width: 10%;"></td> <td style="width: 10%;"></td> <td style="width: 10%;"></td> <td style="width: 10%;"></td> <td style="width: 10%;"></td> <td style="width: 10%;"></td> <td style="width: 10%;"></td> <td style="width: 10%;"></td> <td style="width: 10%;"></td> </tr> <tr> <td></td> <td></td> <td colspan="8" style="text-align: center;"> <table border="1" style="width: 100%; border-collapse: collapse; text-align: center;"> <tr> <td style="width: 10%;"></td> <td style="width: 10%;"></td> <td style="width: 10%;"></td> <td style="width: 10%;"></td> <td style="width: 10%;"></td> <td style="width: 10%;"></td> <td style="width: 10%;"></td> <td style="width: 10%;"></td> <td style="width: 10%;"></td> <td style="width: 10%;"></td> </tr> <tr> <td></td> <td></td> <td colspan="8" style="text-align: center;"> <table border="1" style="width: 100%; border-collapse: collapse; text-align: center;"> <tr> <td style="width: 10%;"></td> <td style="width: 10%;"></td> <td style="width: 10%;"></td> <td style="width: 10%;"></td> <td style="width: 10%;"></td> <td style="width: 10%;"></td> <td style="width: 10%;"></td> <td style="width: 10%;"></td> <td style="width: 10%;"></td> <td style="width: 10%;"></td> </tr> <tr> <td></td> <td></td> <td colspan="8" style="text-align: center;"> <table border="1" style="width: 100%; border-collapse: collapse; text-align: center;"> <tr> <td style="width: 10%;"></td> <td style="width: 10%;"></td> <td style="width: 10%;"></td> <td style="width: 10%;"></td> <td style="width: 10%;"></td> <td style="width: 10%;"></td> <td style="width: 10%;"></td> <td style="width: 10%;"></td> <td style="width: 10%;"></td> <td style="width: 10%;"></td> </tr> <tr> <td></td> <td></td> <td colspan="8" style="text-align: center;"> <table border="1" style="width: 100%; border-collapse: collapse; text-align: center;"> <tr> <td style="width: 10%;"></td> <td style="width: 10%;"></td> <td style="width: 10%;"></td> <td style="width: 10%;"></td> <td style="width: 10%;"></td> <td style="width: 10%;"></td> <td style="width: 10%;"></td> <td style="width: 10%;"></td> <td style="width: 10%;"></td> <td style="width: 10%;"></td> </tr> <tr> <td></td> <td></td> <td colspan="8" style="text-align: center;"> <table border="1" style="width: 100%; border-collapse: collapse; text-align: center;"> <tr> <td style="width: 10%;"></td> <td style="width: 10%;"></td> <td style="width: 10%;"></td> <td style="width: 10%;"></td> <td style="width: 10%;"></td> <td style="width:
10%;"></td> <td style="width: 10%;"></td> <td style="width: 10%;"></td> <td style="width: 10%;"></td> <td style="width: 10%;"></td> </tr> <tr> <td></td> <td></td> <td colspan="8" style="text-align: center;"> <table border="1" style="width: 100%; border-collapse: collapse; text-align: center;"> <tr> <td style="width: 10%;"></td> <td style="width: 10%;"></td> <td style="width: 10%;"></td> <td style="width: 10%;"></td> <td style="width: 10%;"></td> <td style="width: 10%;"></td> <td style="width: 10%;"></td> <td style="width: 10%;"></td> <td style="width: 10%;"></td> <td style="width: 10%;"></td> </tr> <tr> <td></td> <td></td> <td colspan="8" style="text-align: center;"> <table border="1" style="width: 100%; border-collapse: collapse; text-align: center;"> <tr> <td style="width: 10%;"></td> <td style="width: 10%;"></td> <td style="width: 10%;"></td> <td style="width: 10%;"></td> <td style="width: 10%;"></td> <td style="width: 10%;"></td> <td style="width: 10%;"></td> <td style="width: 10%;"></td> <td style="width: 10%;"></td> <td style="width: 10%;"></td> </tr> <tr> <td></td> <td></td> <td colspan="8" style="text-align: center;"> <table border="1" style="width: 100%; border-collapse: collapse; text-align: center;"> <tr> <td style="width: 10%;"></td> <td style="width: 10%;"></td> <td style="width: 10%;"></td> <td style="width: 10%;"></td> <td style="width: 10%;"></td> <td style="width: 10%;"></td> <td style="width: 10%;"></td> <td style="width: 10%;"></td> <td style="width: 10%;"></td> <td style="width: 10%;"></td> </tr> <tr> <td></td> <td></td> <td colspan="8" style="text-align: center;"> <table border="1" style="width: 100%; border-collapse: collapse; text-align: center;"> <tr> <td style="width: 10%;"></td> <td style="width: 10%;"></td> <td style="width: 10%;"></td> <td style="width: 10%;"></td> <td style="width: 10%;"></td> <td style="width: 10%;"></td> <td style="width: 10%;"></td> <td style="width: 10%;"></td> <td style="width: 10%;"></td> <td style="width: 10%;"></td> </tr> <tr> <td></td> <td></td> <td colspan="8" style="text-align: center;"> <table border="1" style="width: 100%; border-collapse: collapse; text-align: center;"> <tr> <td style="width: 10%;"></td> <td style="width: 10%;"></td> <td style="width: 10%;"></td> <td style="width: 10%;"></td> <td style="width: 10%;"></td> <td style="width: 10%;"></td> <td style="width: 10%;"></td> <td style="width: 10%;"></td> <td style="width: 10%;"></td> <td style="width: 10%;"></td> </tr> <tr> <td></td> <td></td> <td colspan="8" style="text-align: center;"> <table border="1" style="width: 100%; border-collapse: collapse; text-align: center;"> <tr> <td style="width: 10%;"></td> <td style="width: 10%;"></td> <td style="width: 10%;"></td> <td style="width: 10%;"></td> <td style="width: 10%;"></td> <td style="width: 10%;"></td> <td style="width: 10%;"></td> <td style="width: 10%;"></td> <td style="width: 10%;"></td> <td style="width: 10%;"></td> </tr> <tr> <td></td> <td></td> <td colspan="8" style="text-align: center;"> <table border="1" style="width: 100%; border-collapse: collapse; text-align: center;"> <tr> <td style="width: 10%;"></td> <td style="width: 10%;"></td> <td style="width: 10%;"></td> <td style="width: 10%;"></td> <td style="width: 10%;"></td> <td style="width: 10%;"></td> <td style="width: 10%;"></td> <td style="width: 10%;"></td> <td style="width: 10%;"></td> <td style="width: 10%;"></td> </tr> <tr> <td></td> <td></td> <td colspan="8" style="text-align: center;"> <table border="1" style="width: 100%; border-collapse: collapse; text-align: center;"> <tr> </tr></table></td></tr></table></td></tr></table></td></tr></table></td></tr></table></td></tr></table></td></tr></table></td></tr></table></td></tr></table></td></tr></table></td></tr></table></td></tr></table></td></tr></table></td></tr></table></td></tr></table></td></tr></table></td></tr></table></td></tr></table></td></tr></table></td></tr></table></td></tr></table></td></tr></table></td></tr></table></td></tr></table></td></tr></table></td></tr></table></td></tr></table></td></tr></table></td></tr></table></td></tr></table></td></tr></table></td></tr></table></td></tr></table></td></tr></table></td></tr></table></td></tr></table></td></tr></table></td></tr></table></td></tr></table></td></tr></table></td></tr></table></td></tr></table></td></tr></table></td></tr></table></td></tr></table></td></tr></table>
 | | | | | | | | | | | | | | | | | | | | <table border="1" style="width: 100%; border-collapse: collapse; text-align: center;"> <tr> <td style="width: 10%;"></td> <td style="width: 10%;"></td> <td style="width: 10%;"></td> <td style="width: 10%;"></td> <td style="width: 10%;"></td> <td style="width: 10%;"></td> <td style="width: 10%;"></td> <td style="width: 10%;"></td> <td style="width: 10%;"></td> <td style="width: 10%;"></td> </tr> <tr> <td></td> <td></td> <td colspan="8" style="text-align: center;"> <table border="1" style="width: 100%; border-collapse: collapse; text-align: center;"> <tr> <td style="width: 10%;"></td> <td style="width: 10%;"></td> <td style="width: 10%;"></td> <td style="width: 10%;"></td> <td style="width: 10%;"></td> <td style="width: 10%;"></td> <td style="width: 10%;"></td> <td style="width: 10%;"></td> <td style="width: 10%;"></td> <td style="width: 10%;"></td> </tr> <tr> <td></td> <td></td> <td colspan="8" style="text-align: center;"> <table border="1" style="width: 100%; border-collapse: collapse; text-align: center;"> <tr> <td style="width: 10%;"></td> <td style="width: 10%;"></td> <td style="width: 10%;"></td> <td style="width: 10%;"></td> <td style="width: 10%;"></td> <td style="width: 10%;"></td> <td style="width: 10%;"></td> <td style="width: 10%;"></td> <td style="width: 10%;"></td> <td style="width: 10%;"></td> </tr> <tr> <td></td> <td></td> <td colspan="8" style="text-align: center;"> <table border="1" style="width: 100%; border-collapse: collapse; text-align: center;"> <tr> <td style="width: 10%;"></td> <td style="width: 10%;"></td> <td style="width: 10%;"></td> <td style="width: 10%;"></td> <td style="width: 10%;"></td> <td style="width: 10%;"></td> <td style="width: 10%;"></td> <td style="width: 10%;"></td> <td style="width: 10%;"></td> <td style="width: 10%;"></td> </tr> <tr> <td></td> <td></td> <td colspan="8" style="text-align: center;"> <table border="1" style="width: 100%; border-collapse: collapse; text-align: center;"> <tr> <td style="width: 10%;"></td> <td style="width: 10%;"></td> <td style="width: 10%;"></td> <td style="width: 10%;"></td> <td style="width: 10%;"></td> <td style="width: 10%;"></td> <td style="width: 10%;"></td> <td style="width: 10%;"></td> <td style="width: 10%;"></td> <td style="width: 10%;"></td> </tr> <tr> <td></td> <td></td> <td colspan="8" style="text-align: center;"> <table border="1" style="width: 100%; border-collapse: collapse; text-align: center;"> <tr> <td style="width: 10%;"></td> <td style="width: 10%;"></td> <td style="width: 10%;"></td> <td style="width: 10%;"></td> <td style="width: 10%;"></td> <td style="width: 10%;"></td> <td style="width: 10%;"></td> <td style="width: 10%;"></td> <td style="width: 10%;"></td> <td style="width: 10%;"></td> </tr> <tr> <td></td> <td></td> <td colspan="8" style="text-align: center;"> <table border="1" style="width: 100%; border-collapse: collapse; text-align: center;"> <tr> <td style="width: 10%;"></td> <td style="width: 10%;"></td> <td style="width: 10%;"></td> <td style="width: 10%;"></td> <td style="width: 10%;"></td> <td style="width: 10%;"></td> <td style="width: 10%;"></td> <td style="width: 10%;"></td> <td style="width: 10%;"></td> <td style="width: 10%;"></td> </tr> <tr> <td></td> <td></td> <td colspan="8" style="text-align: center;"> <table border="1" style="width: 100%; border-collapse: collapse; text-align: center;"> <tr> <td style="width: 10%;"></td> <td style="width: 10%;"></td> <td style="width: 10%;"></td> <td style="width: 10%;"></td> <td style="width: 10%;"></td> <td style="width: 10%;"></td> <td style="width: 10%;"></td> <td style="width: 10%;"></td> <td style="width: 10%;"></td> <td style="width: 10%;"></td> </tr> <tr> <td></td> <td></td> <td colspan="8" style="text-align: center;"> <table border="1" style="width: 100%; border-collapse: collapse; text-align: center;"> <tr> <td style="width: 10%;"></td> <td style="width: 10%;"></td> <td style="width: 10%;"></td> <td style="width: 10%;"></td> <td style="width: 10%;"></td> <td style="width: 10%;"></td> <td style="width: 10%;"></td> <td style="width: 10%;"></td> <td style="width: 10%;"></td> <td style="width: 10%;"></td> </tr> <tr> <td></td> <td></td> <td colspan="8" style="text-align: center;"> <table border="1" style="width: 100%; border-collapse: collapse; text-align: center;"> <tr> <td style="width: 10%;"></td> <td style="width: 10%;"></td> <td style="width: 10%;"></td> <td style="width: 10%;"></td> <td style="width: 10%;"></td> <td style="width: 10%;"></td> <td style="width: 10%;"></td> <td style="width: 10%;"></td> <td style="width: 10%;"></td> <td style="width: 10%;"></td> </tr> <tr> <td></td> <td></td> <td colspan="8" style="text-align: center;"> <table border="1" style="width: 100%; border-collapse: collapse; text-align: center;"> <tr> <td style="width: 10%;"></td> <td style="width: 10%;"></td> <td style="width: 10%;"></td> <td style="width: 10%;"></td> <td style="width: 10%;"></td> <td style="width: 10%;"></td> <td style="width: 10%;"></td> <td style="width: 10%;"></td> <td style="width: 10%;"></td> <td style="width: 10%;"></td> </tr> <tr> <td></td> <td></td> <td colspan="8" style="text-align: center;"> <table border="1" style="width: 100%; border-collapse: collapse; text-align: center;"> <tr> <td style="width: 10%;"></td> <td style="width: 10%;"></td> <td style="width: 10%;"></td> <td style="width: 10%;"></td> <td style="width: 10%;"></td> <td style="width: 10%;"></td> <td style="width: 10%;"></td> <td style="width: 10%;"></td> <td style="width: 10%;"></td> <td style="width: 10%;"></td> </tr> <tr> <td></td> <td></td> <td colspan="8" style="text-align: center;"> <table border="1" style="width: 100%; border-collapse: collapse; text-align: center;"> <tr> <td style="width: 10%;"></td> <td style="width: 10%;"></td> <td style="width: 10%;"></td> <td style="width: 10%;"></td> <td style="width: 10%;"></td> <td style="width: 10%;"></td> <td style="width: 10%;"></td> <td style="width: 10%;"></td> <td style="width: 10%;"></td> <td style="width: 10%;"></td> </tr> <tr> <td></td> <td></td> <td colspan="8" style="text-align: center;"> <table border="1" style="width: 100%; border-collapse: collapse; text-align: center;"> <tr> <td style="width: 10%;"></td> <td style="width: 10%;"></td> <td style="width: 10%;"></td> <td style="width: 10%;"></td> <td style="width: 10%;"></td> <td style="width: 10%;"></td> <td style="width: 10%;"></td> <td style="width: 10%;"></td> <td style="width: 10%;"></td> <td style="width: 10%;"></td> </tr> <tr> <td></td> <td></td> <td colspan="8" style="text-align: center;"> <table border="1" style="width: 100%; border-collapse: collapse; text-align: center;"> <tr> <td style="width: 10%;"></td> <td style="width: 10%;"></td> <td style="width: 10%;"></td> <td style="width: 10%;"></td> <td style="width: 10%;"></td> <td style="width: 10%;"></td> <td style="width: 10%;"></td> <td style="width: 10%;"></td> <td style="width: 10%;"></td> <td style="width: 10%;"></td> </tr> <tr> <td></td> <td></td> <td colspan="8" style="text-align: center;"> <table border="1" style="width: 100%; border-collapse: collapse; text-align: center;"> <tr> <td style="width: 10%;"></td> <td style="width: 10%;"></td> <td style="width: 10%;"></td> <td style="width: 10%;"></td> <td style="width: 10%;"></td> <td style="width: 10%;"></td> <td style="width: 10%;"></td> <td style="width: 10%;"></td> <td style="width: 10%;"></td> <td style="width: 10%;"></td> </tr> <tr> <td></td> <td></td> <td colspan="8" style="text-align: center;"> <table border="1" style="width: 100%; border-collapse: collapse; text-align: center;"> <tr> <td style="width: 10%;"></td> <td style="width: 10%;"></td> <td style="width: 10%;"></td> <td style="width: 10%;"></td> <td style="width: 10%;"></td> <td style="width: 10%;"></td> <td
style="width: 10%;"></td> <td style="width: 10%;"></td> <td style="width: 10%;"></td> <td style="width: 10%;"></td> </tr> <tr> <td></td> <td></td> <td colspan="8" style="text-align: center;"> <table border="1" style="width: 100%; border-collapse: collapse; text-align: center;"> <tr> <td style="width: 10%;"></td> <td style="width: 10%;"></td> <td style="width: 10%;"></td> <td style="width: 10%;"></td> <td style="width: 10%;"></td> <td style="width: 10%;"></td> <td style="width: 10%;"></td> <td style="width: 10%;"></td> <td style="width: 10%;"></td> <td style="width: 10%;"></td> </tr> <tr> <td></td> <td></td> <td colspan="8" style="text-align: center;"> <table border="1" style="width: 100%; border-collapse: collapse; text-align: center;"> <tr> <td style="width: 10%;"></td> <td style="width: 10%;"></td> <td style="width: 10%;"></td> <td style="width: 10%;"></td> <td style="width: 10%;"></td> <td style="width: 10%;"></td> <td style="width: 10%;"></td> <td style="width: 10%;"></td> <td style="width: 10%;"></td> <td style="width: 10%;"></td> </tr> <tr> <td></td> <td></td> <td colspan="8" style="text-align: center;"> <table border="1" style="width: 100%; border-collapse: collapse; text-align: center;"> <tr> <td style="width: 10%;"></td> <td style="width: 10%;"></td> <td style="width: 10%;"></td> <td style="width: 10%;"></td> <td style="width: 10%;"></td> <td style="width: 10%;"></td> <td style="width: 10%;"></td> <td style="width: 10%;"></td> <td style="width: 10%;"></td> <td style="width: 10%;"></td> </tr> <tr> <td></td> <td></td> <td colspan="8" style="text-align: center;"> <table border="1" style="width: 100%; border-collapse: collapse; text-align: center;"> <tr> <td style="width: 10%;"></td> <td style="width: 10%;"></td> <td style="width: 10%;"></td> <td style="width: 10%;"></td> <td style="width: 10%;"></td> <td style="width: 10%;"></td> <td style="width: 10%;"></td> <td style="width: 10%;"></td> <td style="width: 10%;"></td> <td style="width: 10%;"></td> </tr> <tr> <td></td> <td></td> <td colspan="8" style="text-align: center;"> <table border="1" style="width: 100%; border-collapse: collapse; text-align: center;"> <tr> <td style="width: 10%;"></td> <td style="width: 10%;"></td> <td style="width: 10%;"></td> <td style="width: 10%;"></td> <td style="width: 10%;"></td> <td style="width: 10%;"></td> <td style="width: 10%;"></td> <td style="width: 10%;"></td> <td style="width: 10%;"></td> <td style="width: 10%;"></td> </tr> <tr> <td></td> <td></td> <td colspan="8" style="text-align: center;"> <table border="1" style="width: 100%; border-collapse: collapse; text-align: center;"> <tr> <td style="width: 10%;"></td> <td style="width: 10%;"></td> <td style="width: 10%;"></td> <td style="width: 10%;"></td> <td style="width: 10%;"></td> <td style="width: 10%;"></td> <td style="width: 10%;"></td> <td style="width: 10%;"></td> <td style="width: 10%;"></td> <td style="width: 10%;"></td> </tr> <tr> <td></td> <td></td> <td colspan="8" style="text-align: center;"> <table border="1" style="width: 100%; border-collapse: collapse; text-align: center;"> <tr> <td style="width: 10%;"></td> <td style="width: 10%;"></td> <td style="width: 10%;"></td> <td style="width: 10%;"></td> <td style="width: 10%;"></td> <td style="width: 10%;"></td> <td style="width: 10%;"></td> <td style="width: 10%;"></td> <td style="width: 10%;"></td> <td style="width: 10%;"></td> </tr> <tr> <td></td> <td></td> <td colspan="8" style="text-align: center;"> <table border="1" style="width: 100%; border-collapse: collapse; text-align: center;"> <tr> <td style="width: 10%;"></td> <td style="width: 10%;"></td> <td style="width: 10%;"></td> <td style="width: 10%;"></td> <td style="width: 10%;"></td> <td style="width: 10%;"></td> <td style="width: 10%;"></td> <td style="width: 10%;"></td> <td style="width: 10%;"></td> <td style="width: 10%;"></td> </tr> <tr> <td></td> <td></td> <td colspan="8" style="text-align: center;"> <table border="1" style="width: 100%; border-collapse: collapse; text-align: center;"> <tr> <td style="width: 10%;"></td> <td style="width: 10%;"></td> <td style="width: 10%;"></td> <td style="width: 10%;"></td> <td style="width: 10%;"></td> <td style="width: 10%;"></td> <td style="width: 10%;"></td> <td style="width: 10%;"></td> <td style="width: 10%;"></td> <td style="width: 10%;"></td> </tr> <tr> <td></td> <td></td> <td colspan="8" style="text-align: center;"> <table border="1" style="width: 100%; border-collapse: collapse; text-align: center;"> <tr> <td style="width: 10%;"></td> <td style="width: 10%;"></td> <td style="width: 10%;"></td> <td style="width: 10%;"></td> <td style="width: 10%;"></td> <td style="width: 10%;"></td> <td style="width: 10%;"></td> <td style="width: 10%;"></td> <td style="width: 10%;"></td> <td style="width: 10%;"></td> </tr> <tr> <td></td> <td></td> <td colspan="8" style="text-align: center;"> <table border="1" style="width: 100%; border-collapse: collapse; text-align: center;"> <tr> <td style="width: 10%;"></td> <td style="width: 10%;"></td> <td style="width: 10%;"></td> <td style="width: 10%;"></td> <td style="width: 10%;"></td> <td style="width: 10%;"></td> <td style="width: 10%;"></td> <td style="width: 10%;"></td> <td style="width: 10%;"></td> <td style="width: 10%;"></td> </tr> <tr> <td></td> <td></td> <td colspan="8" style="text-align: center;"> <table border="1" style="width: 100%; border-collapse: collapse; text-align: center;"> <tr> <td style="width: 10%;"></td> <td style="width: 10%;"></td> <td style="width: 10%;"></td> <td style="width: 10%;"></td> <td style="width: 10%;"></td> <td style="width: 10%;"></td> <td style="width: 10%;"></td> <td style="width: 10%;"></td> <td style="width: 10%;"></td> <td style="width: 10%;"></td> </tr> <tr> <td></td> <td></td> <td colspan="8" style="text-align: center;"> <table border="1" style="width: 100%; border-collapse: collapse; text-align: center;"> <tr> <td style="width: 10%;"></td> <td style="width: 10%;"></td> <td style="width: 10%;"></td> <td style="width: 10%;"></td> <td style="width: 10%;"></td> <td style="width: 10%;"></td> <td style="width: 10%;"></td> <td style="width: 10%;"></td> <td style="width: 10%;"></td> <td style="width: 10%;"></td> </tr> <tr> <td></td> <td></td> <td colspan="8" style="text-align: center;"> <table border="1" style="width: 100%; border-collapse: collapse; text-align: center;"> <tr> <td style="width: 10%;"></td> <td style="width: 10%;"></td> <td style="width: 10%;"></td> <td style="width: 10%;"></td> <td style="width: 10%;"></td> <td style="width: 10%;"></td> <td style="width: 10%;"></td> <td style="width: 10%;"></td> <td style="width: 10%;"></td> <td style="width: 10%;"></td> </tr> <tr> <td></td> <td></td> <td colspan="8" style="text-align: center;"> <table border="1" style="width: 100%; border-collapse: collapse; text-align: center;"> <tr> <td style="width: 10%;"></td> <td style="width: 10%;"></td> <td style="width: 10%;"></td> <td style="width: 10%;"></td> <td style="width: 10%;"></td> <td style="width: 10%;"></td> <td style="width: 10%;"></td> <td style="width: 10%;"></td> <td style="width: 10%;"></td> <td style="width: 10%;"></td> </tr> <tr> <td></td> <td></td> <td colspan="8" style="text-align: center;"> <table border="1" style="width: 100%; border-collapse: collapse; text-align: center;"> <tr> <td style="width: 10%;"></td> <td style="width: 10%;"></td> <td style="width: 10%;"></td> <td style="width: 10%;"></td> <td style="width: 10%;"></td> <td style="width: 10%;"></td> <td style="width: 10%;"></td> <td style="width: 10%;"></td> <td style="width: 10%;"></td> <td style="width: 10%;"></td> </tr> <tr> <td></td> <td></td> <td colspan="8" style="text-align: center;"> <table border="1" style="width: 100%; border-collapse: collapse; text-align: center;"> <tr> <td style="width: 10%;"></td> <td style="width: 10%;"></td> <td style="width: 10%;"></td> <td style="width: 10%;"></td> <td style="width: 10%;"></td> <td style="width: 10%;"></td> <td style="width: 10%;"></td> <td style="width: 10%;"></td> <td style="width: 10%;"></td> <td style="width: 10%;"></td> </tr> <tr> <td></td> <td></td> <td colspan="8" style="text-align: center;"> <table border="1" style="width: 100%; border-collapse: collapse; text-align: center;"> <tr> <td style="width: 10%;"></td> <td style="width: 10%;"></td> <td style="width: 10%;"></td> <td style="width: 10%;"></td> <td style="width: 10%;"></td> <td style="width: 10%;"></td> <td style="width: 10%;"></td> <td style="width: 10%;"></td> <td style="width: 10%;"></td> <td style="width: 10%;"></td> </tr> <tr> <td></td> <td></td> <td colspan="8" style="text-align: center;"> <table border="1" style="width: 100%; border-collapse: collapse; text-align: center;"> <tr> <td style="width: 10%;"></td> <td style="width: 10%;"></td> <td style="width: 10%;"></td> <td style="width: 10%;"></td> <td style="width: 10%;"></td> <td style="width: 10%;"></td> <td style="width: 10%;"></td> <td style="width: 10%;"></td> <td style="width: 10%;"></td> <td style="width: 10%;"></td> </tr> <tr> <td></td> <td></td> <td colspan="8" style="text-align: center;"> <table border="1" style="width: 100%; border-collapse: collapse; text-align: center;"> <tr> <td style="width: 10%;"></td> <td style="width: 10%;"></td> <td style="width: 10%;"></td> <td style="width: 10%;"></td> <td style="width: 10%;"></td> <td style="width: 10%;"></td> <td style="width: 10%;"></td> <td style="width: 10%;"></td> <td style="width: 10%;"></td> <td style="width: 10%;"></td> </tr> <tr> <td></td> <td></td> <td colspan="8" style="text-align: center;"> <table border="1" style="width: 100%; border-collapse: collapse; text-align: center;"> <tr> <td style="width: 10%;"></td> <td style="width: 10%;"></td> <td style="width: 10%;"></td> <td style="width: 10%;"></td> <td style="width: 10%;"></td> <td style="width: 10%;"></td> <td style="width: 10%;"></td> <td style="width: 10%;"></td> <td style="width: 10%;"></td> <td style="width: 10%;"></td> </tr> <tr> <td></td> <td></td> <td colspan="8"
style="text-align: center;"> <table border="1" style="width: 100%; border-collapse: collapse; text-align: center;"> <tr> <td style="width: 10%;"></td> <td style="width: 10%;"></td> <td style="width: 10%;"></td> <td style="width: 10%;"></td> <td style="width: 10%;"></td> <td style="width: 10%;"></td> <td style="width: 10%;"></td> <td style="width: 10%;"></td> <td style="width: 10%;"></td> <td style="width: 10%;"></td> </tr> <tr> <td></td> <td></td> <td colspan="8" style="text-align: center;"> <table border="1" style="width: 100%; border-collapse: collapse; text-align: center;"> <tr> <td style="width: 10%;"></td> <td style="width: 10%;"></td> <td style="width: 10%;"></td> <td style="width: 10%;"></td> <td style="width: 10%;"></td> <td style="width: 10%;"></td> <td style="width: 10%;"></td> <td style="width: 10%;"></td> <td style="width: 10%;"></td> <td style="width: 10%;"></td> </tr> <tr> <td></td> <td></td> <td colspan="8" style="text-align: center;"> <table border="1" style="width: 100%; border-collapse: collapse; text-align: center;"> <tr> <td style="width: 10%;"></td> <td style="width: 10%;"></td> <td style="width: 10%;"></td> <td style="width: 10%;"></td> <td style="width: 10%;"></td> <td style="width: 10%;"></td> <td style="width: 10%;"></td> <td style="width: 10%;"></td> <td style="width: 10%;"></td> <td style="width: 10%;"></td> </tr> <tr> <td></td> <td></td> <td colspan="8" style="text-align: center;"> <table border="1" style="width: 100%; border-collapse: collapse; text-align: center;"> <tr> <td style="width: 10%;"></td> <td style="width: 10%;"></td> <td style="width: 10%;"></td> <td style="width: 10%;"></td> <td style="width: 10%;"></td> <td style="width: 10%;"></td> <td style="width: 10%;"></td> <td style="width: 10%;"></td> <td style="width: 10%;"></td> <td style="width: 10%;"></td> </tr> <tr> <td></td> <td></td> <td colspan="8" style="text-align: center;"> <table border="1" style="width: 100%; border-collapse: collapse; text-align: center;"> <tr> <td style="width: 10%;"></td> <td style="width: 10%;"></td> <td style="width: 10%;"></td> <td style="width: 10%;"></td> <td style="width: 10%;"></td> <td style="width: 10%;"></td> <td style="width: 10%;"></td> <td style="width: 10%;"></td> <td style="width: 10%;"></td> <td style="width: 10%;"></td> </tr> <tr> <td></td> <td></td> <td colspan="8" style="text-align: center;"> <table border="1" style="width: 100%; border-collapse: collapse; text-align: center;"> <tr> <td style="width: 10%;"></td> <td style="width: 10%;"></td> <td style="width: 10%;"></td> <td style="width: 10%;"></td> <td style="width: 10%;"></td> <td style="width: 10%;"></td> <td style="width: 10%;"></td> <td style="width: 10%;"></td> <td style="width: 10%;"></td> <td style="width: 10%;"></td> </tr> <tr> <td></td> <td></td> <td colspan="8" style="text-align: center;"> <table border="1" style="width: 100%; border-collapse: collapse; text-align: center;"> <tr> </tr></table></td></tr></table></td></tr></table></td></tr></table></td></tr></table></td></tr></table></td></tr></table></td></tr></table></td></tr></table></td></tr></table></td></tr></table></td></tr></table></td></tr></table></td></tr></table></td></tr></table></td></tr></table></td></tr></table></td></tr></table></td></tr></table></td></tr></table></td></tr></table></td></tr></table></td></tr></table></td></tr></table></td></tr></table></td></tr></table></td></tr></table></td></tr></table></td></tr></table></td></tr></table></td></tr></table></td></tr></table></td></tr></table></td></tr></table></td></tr></table></td></tr></table></td></tr></table></td></tr></table></td></tr></table></td></tr></table></td></tr></table></td></tr></table></td></tr></table></td></tr></table></td></tr></table>
 | | | | | | | | | | | | | | | | | | | | <table border="1" style="width: 100%; border-collapse: collapse; text-align: center;"> <tr> <td style="width: 10%;"></td> <td style="width: 10%;"></td> <td style="width: 10%;"></td> <td style="width: 10%;"></td> <td style="width: 10%;"></td> <td style="width: 10%;"></td> <td style="width: 10%;"></td> <td style="width: 10%;"></td> <td style="width: 10%;"></td> <td style="width: 10%;"></td> </tr> <tr> <td></td> <td></td> <td colspan="8" style="text-align: center;"> <table border="1" style="width: 100%; border-collapse: collapse; text-align: center;"> <tr> <td style="width: 10%;"></td> <td style="width: 10%;"></td> <td style="width: 10%;"></td> <td style="width: 10%;"></td> <td style="width: 10%;"></td> <td style="width: 10%;"></td> <td style="width: 10%;"></td> <td style="width: 10%;"></td> <td style="width: 10%;"></td> <td style="width: 10%;"></td> </tr> <tr> <td></td> <td></td> <td colspan="8" style="text-align: center;"> <table border="1" style="width: 100%; border-collapse: collapse; text-align: center;"> <tr> <td style="width: 10%;"></td> <td style="width: 10%;"></td> <td style="width: 10%;"></td> <td style="width: 10%;"></td> <td style="width: 10%;"></td> <td style="width: 10%;"></td> <td style="width: 10%;"></td> <td style="width: 10%;"></td> <td style="width: 10%;"></td> <td style="width: 10%;"></td> </tr> <tr> <td></td> <td></td> <td colspan="8" style="text-align: center;"> <table border="1" style="width: 100%; border-collapse: collapse; text-align: center;"> <tr> <td style="width: 10%;"></td> <td style="width: 10%;"></td> <td style="width: 10%;"></td> <td style="width: 10%;"></td> <td style="width: 10%;"></td> <td style="width: 10%;"></td> <td style="width: 10%;"></td> <td style="width: 10%;"></td> <td style="width: 10%;"></td> <td style="width: 10%;"></td> </tr> <tr> <td></td> <td></td> <td colspan="8" style="text-align: center;"> <table border="1" style="width: 100%; border-collapse: collapse; text-align: center;"> <tr> <td style="width: 10%;"></td> <td style="width: 10%;"></td> <td style="width: 10%;"></td> <td style="width: 10%;"></td> <td style="width: 10%;"></td> <td style="width: 10%;"></td> <td style="width: 10%;"></td> <td style="width: 10%;"></td> <td style="width: 10%;"></td> <td style="width: 10%;"></td> </tr> <tr> <td></td> <td></td> <td colspan="8" style="text-align: center;"> <table border="1" style="width: 100%; border-collapse: collapse; text-align: center;"> <tr> <td style="width: 10%;"></td> <td style="width: 10%;"></td> <td style="width: 10%;"></td> <td style="width: 10%;"></td> <td style="width: 10%;"></td> <td style="width: 10%;"></td> <td style="width: 10%;"></td> <td style="width: 10%;"></td> <td style="width: 10%;"></td> <td style="width: 10%;"></td> </tr> <tr> <td></td> <td></td> <td colspan="8" style="text-align: center;"> <table border="1" style="width: 100%; border-collapse: collapse; text-align: center;"> <tr> <td style="width: 10%;"></td> <td style="width: 10%;"></td> <td style="width: 10%;"></td> <td style="width: 10%;"></td> <td style="width: 10%;"></td> <td style="width: 10%;"></td> <td style="width: 10%;"></td> <td style="width: 10%;"></td> <td style="width: 10%;"></td> <td style="width: 10%;"></td> </tr> <tr> <td></td> <td></td> <td colspan="8" style="text-align: center;"> <table border="1" style="width: 100%; border-collapse: collapse; text-align: center;"> <tr> <td style="width: 10%;"></td> <td style="width: 10%;"></td> <td style="width: 10%;"></td> <td style="width: 10%;"></td> <td style="width: 10%;"></td> <td style="width: 10%;"></td> <td style="width: 10%;"></td> <td style="width: 10%;"></td> <td style="width: 10%;"></td> <td style="width: 10%;"></td> </tr> <tr> <td></td> <td></td> <td colspan="8" style="text-align: center;"> <table border="1" style="width: 100%; border-collapse: collapse; text-align: center;"> <tr> <td style="width: 10%;"></td> <td style="width: 10%;"></td> <td style="width: 10%;"></td> <td style="width: 10%;"></td> <td style="width: 10%;"></td> <td style="width: 10%;"></td> <td style="width: 10%;"></td> <td style="width: 10%;"></td> <td style="width: 10%;"></td> <td style="width: 10%;"></td> </tr> <tr> <td></td> <td></td> <td colspan="8" style="text-align: center;"> <table border="1" style="width: 100%; border-collapse: collapse; text-align: center;"> <tr> <td style="width: 10%;"></td> <td style="width: 10%;"></td> <td style="width: 10%;"></td> <td style="width: 10%;"></td> <td style="width: 10%;"></td> <td style="width: 10%;"></td> <td style="width: 10%;"></td> <td style="width: 10%;"></td> <td style="width: 10%;"></td> <td style="width: 10%;"></td> </tr> <tr> <td></td> <td></td> <td colspan="8" style="text-align: center;"> <table border="1" style="width: 100%; border-collapse: collapse; text-align: center;"> <tr> <td style="width: 10%;"></td> <td style="width: 10%;"></td> <td style="width: 10%;"></td> <td style="width: 10%;"></td> <td style="width: 10%;"></td> <td style="width: 10%;"></td> <td style="width: 10%;"></td> <td style="width: 10%;"></td> <td style="width: 10%;"></td> <td style="width: 10%;"></td> </tr> <tr> <td></td> <td></td> <td colspan="8" style="text-align: center;"> <table border="1" style="width: 100%; border-collapse: collapse; text-align: center;"> <tr> <td style="width: 10%;"></td> <td style="width: 10%;"></td> <td style="width: 10%;"></td> <td style="width: 10%;"></td> <td style="width: 10%;"></td> <td style="width: 10%;"></td> <td style="width: 10%;"></td> <td style="width: 10%;"></td> <td style="width: 10%;"></td> <td style="width: 10%;"></td> </tr> <tr> <td></td> <td></td> <td colspan="8" style="text-align: center;"> <table border="1" style="width: 100%; border-collapse: collapse; text-align: center;"> <tr> <td style="width: 10%;"></td> <td style="width: 10%;"></td> <td style="width: 10%;"></td> <td style="width: 10%;"></td> <td style="width: 10%;"></td> <td style="width: 10%;"></td> <td style="width: 10%;"></td> <td style="width: 10%;"></td> <td style="width: 10%;"></td> <td style="width: 10%;"></td> </tr> <tr> <td></td> <td></td> <td colspan="8" style="text-align: center;"> <table border="1" style="width: 100%; border-collapse: collapse; text-align: center;"> <tr> <td style="width: 10%;"></td> <td style="width: 10%;"></td> <td style="width: 10%;"></td> <td style="width: 10%;"></td> <td style="width: 10%;"></td> <td style="width: 10%;"></td> <td style="width: 10%;"></td> <td style="width: 10%;"></td> <td style="width: 10%;"></td> <td style="width: 10%;"></td> </tr> <tr> <td></td> <td></td> <td colspan="8" style="text-align: center;"> <table border="1" style="width: 100%; border-collapse: collapse; text-align: center;"> <tr> <td style="width: 10%;"></td> <td style="width: 10%;"></td> <td style="width: 10%;"></td> <td style="width: 10%;"></td> <td style="width: 10%;"></td> <td style="width: 10%;"></td> <td style="width: 10%;"></td> <td style="width: 10%;"></td> <td style="width: 10%;"></td> <td style="width: 10%;"></td> </tr> <tr> <td></td> <td></td> <td colspan="8" style="text-align: center;"> <table border="1" style="width: 100%; border-collapse: collapse; text-align: center;"> <tr> <td style="width: 10%;"></td> <td style="width: 10%;"></td> <td style="width: 10%;"></td> <td style="width: 10%;"></td> <td style="width: 10%;"></td> <td style="width: 10%;"></td> <td style="width: 10%;"></td> <td style="width: 10%;"></td> <td style="width: 10%;"></td> <td style="width: 10%;"></td> </tr> <tr> <td></td> <td></td> <td colspan="8" style="text-align: center;"> <table border="1" style="width: 100%; border-collapse: collapse; text-align: center;"> <tr> <td style="width: 10%;"></td> <td style="width: 10%;"></td> <td style="width: 10%;"></td> <td style="width: 10%;"></td> <td style="width: 10%;"></td> <td style="width: 10%;"></td> <td style="width: 10%;"></td> <td style="width: 10%;"></td> <td style="width: 10%;"></td> <td style="width: 10%;"></td> </tr> <tr> <td></td> <td></td> <td colspan="8" style="text-align: center;"> <table border="1" style="width: 100%; border-collapse: collapse; text-align: center;"> <tr> <td style="width: 10%;"></td> <td style="width: 10%;"></td> <td style="width: 10%;"></td> <td style="width: 10%;"></td> <td style="width: 10%;"></td> <td style="width: 10%;"></td> <td style="width: 10%;"></td> <td style="width: 10%;"></td> <td style="width: 10%;"></td> <td style="width: 10%;"></td> </tr> <tr> <td></td> <td></td> <td colspan="8" style="text-align: center;">
<table border="1" style="width: 100%; border-collapse: collapse; text-align: center;"> <tr> <td style="width: 10%;"></td> <td style="width: 10%;"></td> <td style="width: 10%;"></td> <td style="width: 10%;"></td> <td style="width: 10%;"></td> <td style="width: 10%;"></td> <td style="width: 10%;"></td> <td style="width: 10%;"></td> <td style="width: 10%;"></td> <td style="width: 10%;"></td> </tr> <tr> <td></td> <td></td> <td colspan="8" style="text-align: center;"> <table border="1" style="width: 100%; border-collapse: collapse; text-align: center;"> <tr> <td style="width: 10%;"></td> <td style="width: 10%;"></td> <td style="width: 10%;"></td> <td style="width: 10%;"></td> <td style="width: 10%;"></td> <td style="width: 10%;"></td> <td style="width: 10%;"></td> <td style="width: 10%;"></td> <td style="width: 10%;"></td> <td style="width: 10%;"></td> </tr> <tr> <td></td> <td></td> <td colspan="8" style="text-align: center;"> <table border="1" style="width: 100%; border-collapse: collapse; text-align: center;"> <tr> <td style="width: 10%;"></td> <td style="width: 10%;"></td> <td style="width: 10%;"></td> <td style="width: 10%;"></td> <td style="width: 10%;"></td> <td style="width: 10%;"></td> <td style="width: 10%;"></td> <td style="width: 10%;"></td> <td style="width: 10%;"></td> <td style="width: 10%;"></td> </tr> <tr> <td></td> <td></td> <td colspan="8" style="text-align: center;"> <table border="1" style="width: 100%; border-collapse: collapse; text-align: center;"> <tr> <td style="width: 10%;"></td> <td style="width: 10%;"></td> <td style="width: 10%;"></td> <td style="width: 10%;"></td> <td style="width: 10%;"></td> <td style="width: 10%;"></td> <td style="width: 10%;"></td> <td style="width: 10%;"></td> <td style="width: 10%;"></td> <td style="width: 10%;"></td> </tr> <tr> <td></td> <td></td> <td colspan="8" style="text-align: center;"> <table border="1" style="width: 100%; border-collapse: collapse; text-align: center;"> <tr> <td style="width: 10%;"></td> <td style="width: 10%;"></td> <td style="width: 10%;"></td> <td style="width: 10%;"></td> <td style="width: 10%;"></td> <td style="width: 10%;"></td> <td style="width: 10%;"></td> <td style="width: 10%;"></td> <td style="width: 10%;"></td> <td style="width: 10%;"></td> </tr> <tr> <td></td> <td></td> <td colspan="8" style="text-align: center;"> <table border="1" style="width: 100%; border-collapse: collapse; text-align: center;"> <tr> <td style="width: 10%;"></td> <td style="width: 10%;"></td> <td style="width: 10%;"></td> <td style="width: 10%;"></td> <td style="width: 10%;"></td> <td style="width: 10%;"></td> <td style="width: 10%;"></td> <td style="width: 10%;"></td> <td style="width: 10%;"></td> <td style="width: 10%;"></td> </tr> <tr> <td></td> <td></td> <td colspan="8" style="text-align: center;"> <table border="1" style="width: 100%; border-collapse: collapse; text-align: center;"> <tr> <td style="width: 10%;"></td> <td style="width: 10%;"></td> <td style="width: 10%;"></td> <td style="width: 10%;"></td> <td style="width: 10%;"></td> <td style="width: 10%;"></td> <td style="width: 10%;"></td> <td style="width: 10%;"></td> <td style="width: 10%;"></td> <td style="width: 10%;"></td> </tr> <tr> <td></td> <td></td> <td colspan="8" style="text-align: center;"> <table border="1" style="width: 100%; border-collapse: collapse; text-align: center;"> <tr> <td style="width: 10%;"></td> <td style="width: 10%;"></td> <td style="width: 10%;"></td> <td style="width: 10%;"></td> <td style="width: 10%;"></td> <td style="width: 10%;"></td> <td style="width: 10%;"></td> <td style="width: 10%;"></td> <td style="width: 10%;"></td> <td style="width: 10%;"></td> </tr> <tr> <td></td> <td></td> <td colspan="8" style="text-align: center;"> <table border="1" style="width: 100%; border-collapse: collapse; text-align: center;"> <tr> <td style="width: 10%;"></td> <td style="width: 10%;"></td> <td style="width: 10%;"></td> <td style="width: 10%;"></td> <td style="width: 10%;"></td> <td style="width: 10%;"></td> <td style="width: 10%;"></td> <td style="width: 10%;"></td> <td style="width: 10%;"></td> <td style="width: 10%;"></td> </tr> <tr> <td></td> <td></td> <td colspan="8" style="text-align: center;"> <table border="1" style="width: 100%; border-collapse: collapse; text-align: center;"> <tr> <td style="width: 10%;"></td> <td style="width: 10%;"></td> <td style="width: 10%;"></td> <td style="width: 10%;"></td> <td style="width: 10%;"></td> <td style="width: 10%;"></td> <td style="width: 10%;"></td> <td style="width: 10%;"></td> <td style="width: 10%;"></td> <td style="width: 10%;"></td> </tr> <tr> <td></td> <td></td> <td colspan="8" style="text-align: center;"> <table border="1" style="width: 100%; border-collapse: collapse; text-align: center;"> <tr> <td style="width: 10%;"></td> <td style="width: 10%;"></td> <td style="width: 10%;"></td> <td style="width: 10%;"></td> <td style="width: 10%;"></td> <td style="width: 10%;"></td> <td style="width: 10%;"></td> <td style="width: 10%;"></td> <td style="width: 10%;"></td> <td style="width: 10%;"></td> </tr> <tr> <td></td> <td></td> <td colspan="8" style="text-align: center;"> <table border="1" style="width: 100%; border-collapse: collapse; text-align: center;"> <tr> <td style="width: 10%;"></td> <td style="width: 10%;"></td> <td style="width: 10%;"></td> <td style="width: 10%;"></td> <td style="width: 10%;"></td> <td style="width: 10%;"></td> <td style="width: 10%;"></td> <td style="width: 10%;"></td> <td style="width: 10%;"></td> <td style="width: 10%;"></td> </tr> <tr> <td></td> <td></td> <td colspan="8" style="text-align: center;"> <table border="1" style="width: 100%; border-collapse: collapse; text-align: center;"> <tr> <td style="width: 10%;"></td> <td style="width: 10%;"></td> <td style="width: 10%;"></td> <td style="width: 10%;"></td> <td style="width: 10%;"></td> <td style="width: 10%;"></td> <td style="width: 10%;"></td> <td style="width: 10%;"></td> <td style="width: 10%;"></td> <td style="width: 10%;"></td> </tr> <tr> <td></td> <td></td> <td colspan="8" style="text-align: center;"> <table border="1" style="width: 100%; border-collapse: collapse; text-align: center;"> <tr> <td style="width: 10%;"></td> <td style="width: 10%;"></td> <td style="width: 10%;"></td> <td style="width: 10%;"></td> <td style="width: 10%;"></td> <td style="width: 10%;"></td> <td style="width: 10%;"></td> <td style="width: 10%;"></td> <td style="width: 10%;"></td> <td style="width: 10%;"></td> </tr> <tr> <td></td> <td></td> <td colspan="8" style="text-align: center;"> <table border="1" style="width: 100%; border-collapse: collapse; text-align: center;"> <tr> <td style="width: 10%;"></td> <td style="width: 10%;"></td> <td style="width: 10%;"></td> <td style="width: 10%;"></td> <td style="width: 10%;"></td> <td style="width: 10%;"></td> <td style="width: 10%;"></td> <td style="width: 10%;"></td> <td style="width: 10%;"></td> <td style="width: 10%;"></td> </tr> <tr> <td></td> <td></td> <td colspan="8" style="text-align: center;"> <table border="1" style="width: 100%; border-collapse: collapse; text-align: center;"> <tr> <td style="width: 10%;"></td> <td style="width: 10%;"></td> <td style="width: 10%;"></td> <td style="width: 10%;"></td> <td style="width: 10%;"></td> <td style="width: 10%;"></td> <td style="width: 10%;"></td> <td style="width: 10%;"></td> <td style="width: 10%;"></td> <td style="width: 10%;"></td> </tr> <tr> <td></td> <td></td> <td colspan="8" style="text-align: center;"> <table border="1" style="width: 100%; border-collapse: collapse; text-align: center;"> <tr> <td style="width: 10%;"></td> <td style="width: 10%;"></td> <td style="width: 10%;"></td> <td style="width: 10%;"></td> <td style="width: 10%;"></td> <td style="width: 10%;"></td> <td style="width: 10%;"></td> <td style="width: 10%;"></td> <td style="width: 10%;"></td> <td style="width: 10%;"></td> </tr> <tr> <td></td> <td></td> <td colspan="8" style="text-align: center;"> <table border="1" style="width: 100%; border-collapse: collapse; text-align: center;"> <tr> <td style="width: 10%;"></td> <td style="width: 10%;"></td> <td style="width: 10%;"></td> <td style="width: 10%;"></td> <td style="width: 10%;"></td> <td style="width: 10%;"></td> <td style="width: 10%;"></td> <td style="width: 10%;"></td> <td style="width: 10%;"></td> <td style="width: 10%;"></td> </tr> <tr> <td></td> <td></td> <td colspan="8" style="text-align: center;"> <table border="1" style="width: 100%; border-collapse: collapse; text-align: center;"> <tr> <td style="width: 10%;"></td> <td style="width: 10%;"></td> <td style="width: 10%;"></td> <td style="width: 10%;"></td> <td style="width: 10%;"></td> <td style="width: 10%;"></td> <td style="width: 10%;"></td> <td style="width: 10%;"></td> <td style="width: 10%;"></td> <td style="width: 10%;"></td> </tr> <tr> <td></td> <td></td> <td colspan="8" style="text-align: center;"> <table border="1" style="width: 100%; border-collapse: collapse; text-align: center;"> <tr> <td style="width: 10%;"></td> <td style="width: 10%;"></td> <td style="width: 10%;"></td> <td style="width: 10%;"></td> <td style="width: 10%;"></td> <td style="width: 10%;"></td> <td style="width: 10%;"></td> <td style="width: 10%;"></td> <td style="width: 10%;"></td> <td style="width: 10%;"></td> </tr> <tr> <td></td> <td></td> <td colspan="8" style="text-align: center;"> <table border="1" style="width: 100%; border-collapse: collapse; text-align: center;"> <tr> <td style="width: 10%;"></td> <td style="width: 10%;"></td> <td style="width: 10%;"></td> <td style="width: 10%;"></td> <td style="width: 10%;"></td> <td style="width: 10%;"></td> <td style="width: 10%;"></td> <td style="width: 10%;"></td> <td style="width: 10%;"></td> <td style="width: 10%;"></td> </tr> <tr> <td></td> <td></td> <td colspan="8" style="text-align: center;"> <table border="1" style="width: 100%; border-collapse: collapse; text-align: center;"> <tr> <td style="width: 10%;"></td> <td style="width: 10%;"></td> <td style="width:
10%;"></td> <td style="width: 10%;"></td> <td style="width: 10%;"></td> <td style="width: 10%;"></td> <td style="width: 10%;"></td> <td style="width: 10%;"></td> <td style="width: 10%;"></td> <td style="width: 10%;"></td> </tr> <tr> <td></td> <td></td> <td colspan="8" style="text-align: center;"> <table border="1" style="width: 100%; border-collapse: collapse; text-align: center;"> <tr> <td style="width: 10%;"></td> <td style="width: 10%;"></td> <td style="width: 10%;"></td> <td style="width: 10%;"></td> <td style="width: 10%;"></td> <td style="width: 10%;"></td> <td style="width: 10%;"></td> <td style="width: 10%;"></td> <td style="width: 10%;"></td> <td style="width: 10%;"></td> </tr> <tr> <td></td> <td></td> <td colspan="8" style="text-align: center;"> <table border="1" style="width: 100%; border-collapse: collapse; text-align: center;"> <tr> <td style="width: 10%;"></td> <td style="width: 10%;"></td> <td style="width: 10%;"></td> <td style="width: 10%;"></td> <td style="width: 10%;"></td> <td style="width: 10%;"></td> <td style="width: 10%;"></td> <td style="width: 10%;"></td> <td style="width: 10%;"></td> <td style="width: 10%;"></td> </tr> <tr> <td></td> <td></td> <td colspan="8" style="text-align: center;"> <table border="1" style="width: 100%; border-collapse: collapse; text-align: center;"> <tr> <td style="width: 10%;"></td> <td style="width: 10%;"></td> <td style="width: 10%;"></td> <td style="width: 10%;"></td> <td style="width: 10%;"></td> <td style="width: 10%;"></td> <td style="width: 10%;"></td> <td style="width: 10%;"></td> <td style="width: 10%;"></td> <td style="width: 10%;"></td> </tr> <tr> <td></td> <td></td> <td colspan="8" style="text-align: center;"> <table border="1" style="width: 100%; border-collapse: collapse; text-align: center;"> <tr> </tr></table></td></tr></table></td></tr></table></td></tr></table></td></tr></table></td></tr></table></td></tr></table></td></tr></table></td></tr></table></td></tr></table></td></tr></table></td></tr></table></td></tr></table></td></tr></table></td></tr></table></td></tr></table></td></tr></table></td></tr></table></td></tr></table></td></tr></table></td></tr></table></td></tr></table></td></tr></table></td></tr></table></td></tr></table></td></tr></table></td></tr></table></td></tr></table></td></tr></table></td></tr></table></td></tr></table></td></tr></table></td></tr></table></td></tr></table></td></tr></table></td></tr></table></td></tr></table></td></tr></table></td></tr></table></td></tr></table></td></tr></table></td></tr></table></td></tr></table></td></tr></table>
 | | | | | | | | | | | | | | | | | | | | <table border="1" style="width: 100%; border-collapse: collapse; text-align: center;"> <tr> <td style="width: 10%;"></td> <td style="width: 10%;"></td> <td style="width: 10%;"></td> <td style="width: 10%;"></td> <td style="width: 10%;"></td> <td style="width: 10%;"></td> <td style="width: 10%;"></td> <td style="width: 10%;"></td> <td style="width: 10%;"></td> <td style="width: 10%;"></td> </tr> <tr> <td></td> <td></td> <td colspan="8" style="text-align: center;"> <table border="1" style="width: 100%; border-collapse: collapse; text-align: center;"> <tr> <td style="width: 10%;"></td> <td style="width: 10%;"></td> <td style="width: 10%;"></td> <td style="width: 10%;"></td> <td style="width: 10%;"></td> <td style="width: 10%;"></td> <td style="width: 10%;"></td> <td style="width: 10%;"></td> <td style="width: 10%;"></td> <td style="width: 10%;"></td> </tr> <tr> <td></td> <td></td> <td colspan="8" style="text-align: center;"> <table border="1" style="width: 100%; border-collapse: collapse; text-align: center;"> <tr> <td style="width: 10%;"></td> <td style="width: 10%;"></td> <td style="width: 10%;"></td> <td style="width: 10%;"></td> <td style="width: 10%;"></td> <td style="width: 10%;"></td> <td style="width: 10%;"></td> <td style="width: 10%;"></td> <td style="width: 10%;"></td> <td style="width: 10%;"></td> </tr> <tr> <td></td> <td></td> <td colspan="8" style="text-align: center;"> <table border="1" style="width: 100%; border-collapse: collapse; text-align: center;"> <tr> <td style="width: 10%;"></td> <td style="width: 10%;"></td> <td style="width: 10%;"></td> <td style="width: 10%;"></td> <td style="width: 10%;"></td> <td style="width: 10%;"></td> <td style="width: 10%;"></td> <td style="width: 10%;"></td> <td style="width: 10%;"></td> <td style="width: 10%;"></td> </tr> <tr> <td></td> <td></td> <td colspan="8" style="text-align: center;"> <table border="1" style="width: 100%; border-collapse: collapse; text-align: center;"> <tr> <td style="width: 10%;"></td> <td style="width: 10%;"></td> <td style="width: 10%;"></td> <td style="width: 10%;"></td> <td style="width: 10%;"></td> <td style="width: 10%;"></td> <td style="width: 10%;"></td> <td style="width: 10%;"></td> <td style="width: 10%;"></td> <td style="width: 10%;"></td> </tr> <tr> <td></td> <td></td> <td colspan="8" style="text-align: center;"> <table border="1" style="width: 100%; border-collapse: collapse; text-align: center;"> <tr> <td style="width: 10%;"></td> <td style="width: 10%;"></td> <td style="width: 10%;"></td> <td style="width: 10%;"></td> <td style="width: 10%;"></td> <td style="width: 10%;"></td> <td style="width: 10%;"></td> <td style="width: 10%;"></td> <td style="width: 10%;"></td> <td style="width: 10%;"></td> </tr> <tr> <td></td> <td></td> <td colspan="8" style="text-align: center;"> <table border="1" style="width: 100%; border-collapse: collapse; text-align: center;"> <tr> <td style="width: 10%;"></td> <td style="width: 10%;"></td> <td style="width: 10%;"></td> <td style="width: 10%;"></td> <td style="width: 10%;"></td> <td style="width: 10%;"></td> <td style="width: 10%;"></td> <td style="width: 10%;"></td> <td style="width: 10%;"></td> <td style="width: 10%;"></td> </tr> <tr> <td></td> <td></td> <td colspan="8" style="text-align: center;"> <table border="1" style="width: 100%; border-collapse: collapse; text-align: center;"> <tr> <td style="width: 10%;"></td> <td style="width: 10%;"></td> <td style="width: 10%;"></td> <td style="width: 10%;"></td> <td style="width: 10%;"></td> <td style="width: 10%;"></td> <td style="width: 10%;"></td> <td style="width: 10%;"></td> <td style="width: 10%;"></td> <td style="width: 10%;"></td> </tr> <tr> <td></td> <td></td> <td colspan="8" style="text-align: center;"> <table border="1" style="width: 100%; border-collapse: collapse; text-align: center;"> <tr> <td style="width: 10%;"></td> <td style="width: 10%;"></td> <td style="width: 10%;"></td> <td style="width: 10%;"></td> <td style="width: 10%;"></td> <td style="width: 10%;"></td> <td style="width: 10%;"></td> <td style="width: 10%;"></td> <td style="width: 10%;"></td> <td style="width: 10%;"></td> </tr> <tr> <td></td> <td></td> <td colspan="8" style="text-align: center;"> <table border="1" style="width: 100%; border-collapse: collapse; text-align: center;"> <tr> <td style="width: 10%;"></td> <td style="width: 10%;"></td> <td style="width: 10%;"></td> <td style="width: 10%;"></td> <td style="width: 10%;"></td> <td style="width: 10%;"></td> <td style="width: 10%;"></td> <td style="width: 10%;"></td> <td style="width: 10%;"></td> <td style="width: 10%;"></td> </tr> <tr> <td></td> <td></td> <td colspan="8" style="text-align: center;"> <table border="1" style="width: 100%; border-collapse: collapse; text-align: center;"> <tr> <td style="width: 10%;"></td> <td style="width: 10%;"></td> <td style="width: 10%;"></td> <td style="width: 10%;"></td> <td style="width: 10%;"></td> <td style="width: 10%;"></td> <td style="width: 10%;"></td> <td style="width: 10%;"></td> <td style="width: 10%;"></td> <td style="width: 10%;"></td> </tr> <tr> <td></td> <td></td> <td colspan="8" style="text-align: center;"> <table border="1" style="width: 100%; border-collapse: collapse; text-align: center;"> <tr> <td style="width: 10%;"></td> <td style="width: 10%;"></td> <td style="width: 10%;"></td> <td style="width: 10%;"></td> <td style="width: 10%;"></td> <td style="width: 10%;"></td> <td style="width: 10%;"></td> <td style="width: 10%;"></td> <td style="width: 10%;"></td> <td style="width: 10%;"></td> </tr> <tr> <td></td> <td></td> <td colspan="8" style="text-align: center;"> <table border="1" style="width: 100%; border-collapse: collapse; text-align: center;"> <tr> <td style="width: 10%;"></td> <td style="width: 10%;"></td> <td style="width: 10%;"></td> <td style="width: 10%;"></td> <td style="width: 10%;"></td> <td style="width: 10%;"></td> <td style="width: 10%;"></td> <td style="width: 10%;"></td> <td style="width: 10%;"></td> <td style="width: 10%;"></td> </tr> <tr> <td></td> <td></td> <td colspan="8" style="text-align: center;"> <table border="1" style="width: 100%; border-collapse: collapse; text-align: center;"> <tr> <td style="width: 10%;"></td> <td style="width: 10%;"></td> <td style="width: 10%;"></td> <td style="width: 10%;"></td> <td style="width: 10%;"></td> <td style="width: 10%;"></td> <td style="width: 10%;"></td> <td style="width: 10%;"></td> <td style="width: 10%;"></td> <td style="width: 10%;"></td> </tr> <tr> <td></td> <td></td> <td colspan="8" style="text-align: center;"> <table border="1" style="width: 100%; border-collapse: collapse; text-align: center;"> <tr> <td style="width: 10%;"></td> <td style="width: 10%;"></td> <td style="width: 10%;"></td> <td style="width: 10%;"></td> <td style="width: 10%;"></td> <td style="width: 10%;"></td> <td style="width: 10%;"></td> <td style="width: 10%;"></td> <td style="width: 10%;"></td> <td style="width: 10%;"></td> </tr> <tr> <td></td> <td></td> <td colspan="8" style="text-align: center;"> <table border="1" style="width: 100%; border-collapse: collapse; text-align: center;"> <tr> <td style="width: 10%;"></td> <td style="width: 10%;"></td> <td style="width: 10%;"></td> <td style="width: 10%;"></td> <td style="width: 10%;"></td> <td style="width: 10%;"></td> <td style="width: 10%;"></td> <td style="width: 10%;"></td> <td style="width: 10%;"></td> <td style="width: 10%;"></td> </tr> <tr> <td></td> <td></td> <td colspan="8" style="text-align: center;"> <table border="1" style="width: 100%; border-collapse: collapse; text-align: center;"> <tr> <td style="width: 10%;"></td> <td style="width: 10%;"></td> <td style="width: 10%;"></td> <td style="width: 10%;"></td> <td style="width: 10%;"></td> <td style="width: 10%;"></td> <td style="width: 10%;"></td> <td style="width: 10%;"></td> <td style="width: 10%;"></td> <td style="width: 10%;"></td> </tr> <tr> <td></td> <td></td> <td colspan="8" style="text-align: center;"> <table border="1" style="width: 100%; border-collapse: collapse; text-align: center;"> <tr> <td style="width: 10%;"></td> <td style="width: 10%;"></td> <td style="width: 10%;"></td> <td style="width: 10%;"></td> <td style="width: 10%;"></td> <td style="width: 10%;"></td> <td style="width: 10%;"></td> <td style="width: 10%;"></td> <td style="width: 10%;"></td> <td style="width: 10%;"></td> </tr> <tr> <td></td> <td></td> <td colspan="8" style="text-align: center;"> <table border="1" style="width: 100%; border-collapse: collapse; text-align: center;"> <tr> <td style="width: 10%;"></td> <td style="width: 10%;"></td> <td style="width: 10%;"></td> <td style="width: 10%;"></td> <td style="width: 10%;"></td> <td style="width: 10%;"></td> <td style="width: 10%;"></td> <td style="width: 10%;"></td> <td style="width: 10%;"></td> <td style="width: 10%;"></td> </tr> <tr> <td></td> <td></td> <td colspan="8" style="text-align: center;"> <table border="1" style="width: 100%; border-collapse: collapse; text-align: center;"> <tr> <td style="width: 10%;"></td> <td style="width: 10%;"></td> <td style="width: 10%;"></td> <td style="width: 10%;"></td> <td style="width: 10%;"></td> <td style="width: 10%;"></td> <td style="width: 10%;"></td> <td style="width: 10%;"></td> <td style="width: 10%;"></td> <td style="width: 10%;"></td> </tr> <tr> <td></td> <td></td> <td colspan="8" style="text-align: center;"> <table border="1" style="width: 100%; border-collapse: collapse; text-align: center;"> <tr> <td style="width: 10%;"></td> <td style="width: 10%;"></td> <td style="width: 10%;"></td> <td style="width: 10%;"></td> <td
style="width: 10%;"></td> <td style="width: 10%;"></td> <td style="width: 10%;"></td> <td style="width: 10%;"></td> <td style="width: 10%;"></td> <td style="width: 10%;"></td> </tr> <tr> <td></td> <td></td> <td colspan="8" style="text-align: center;"> <table border="1" style="width: 100%; border-collapse: collapse; text-align: center;"> <tr> <td style="width: 10%;"></td> <td style="width: 10%;"></td> <td style="width: 10%;"></td> <td style="width: 10%;"></td> <td style="width: 10%;"></td> <td style="width: 10%;"></td> <td style="width: 10%;"></td> <td style="width: 10%;"></td> <td style="width: 10%;"></td> <td style="width: 10%;"></td> </tr> <tr> <td></td> <td></td> <td colspan="8" style="text-align: center;"> <table border="1" style="width: 100%; border-collapse: collapse; text-align: center;"> <tr> <td style="width: 10%;"></td> <td style="width: 10%;"></td> <td style="width: 10%;"></td> <td style="width: 10%;"></td> <td style="width: 10%;"></td> <td style="width: 10%;"></td> <td style="width: 10%;"></td> <td style="width: 10%;"></td> <td style="width: 10%;"></td> <td style="width: 10%;"></td> </tr> <tr> <td></td> <td></td> <td colspan="8" style="text-align: center;"> <table border="1" style="width: 100%; border-collapse: collapse; text-align: center;"> <tr> <td style="width: 10%;"></td> <td style="width: 10%;"></td> <td style="width: 10%;"></td> <td style="width: 10%;"></td> <td style="width: 10%;"></td> <td style="width: 10%;"></td> <td style="width: 10%;"></td> <td style="width: 10%;"></td> <td style="width: 10%;"></td> <td style="width: 10%;"></td> </tr> <tr> <td></td> <td></td> <td colspan="8" style="text-align: center;"> <table border="1" style="width: 100%; border-collapse: collapse; text-align: center;"> <tr> <td style="width: 10%;"></td> <td style="width: 10%;"></td> <td style="width: 10%;"></td> <td style="width: 10%;"></td> <td style="width: 10%;"></td> <td style="width: 10%;"></td> <td style="width: 10%;"></td> <td style="width: 10%;"></td> <td style="width: 10%;"></td> <td style="width: 10%;"></td> </tr> <tr> <td></td> <td></td> <td colspan="8" style="text-align: center;"> <table border="1" style="width: 100%; border-collapse: collapse; text-align: center;"> <tr> <td style="width: 10%;"></td> <td style="width: 10%;"></td> <td style="width: 10%;"></td> <td style="width: 10%;"></td> <td style="width: 10%;"></td> <td style="width: 10%;"></td> <td style="width: 10%;"></td> <td style="width: 10%;"></td> <td style="width: 10%;"></td> <td style="width: 10%;"></td> </tr> <tr> <td></td> <td></td> <td colspan="8" style="text-align: center;"> <table border="1" style="width: 100%; border-collapse: collapse; text-align: center;"> <tr> <td style="width: 10%;"></td> <td style="width: 10%;"></td> <td style="width: 10%;"></td> <td style="width: 10%;"></td> <td style="width: 10%;"></td> <td style="width: 10%;"></td> <td style="width: 10%;"></td> <td style="width: 10%;"></td> <td style="width: 10%;"></td> <td style="width: 10%;"></td> </tr> <tr> <td></td> <td></td> <td colspan="8" style="text-align: center;"> <table border="1" style="width: 100%; border-collapse: collapse; text-align: center;"> <tr> <td style="width: 10%;"></td> <td style="width: 10%;"></td> <td style="width: 10%;"></td> <td style="width: 10%;"></td> <td style="width: 10%;"></td> <td style="width: 10%;"></td> <td style="width: 10%;"></td> <td style="width: 10%;"></td> <td style="width: 10%;"></td> <td style="width: 10%;"></td> </tr> <tr> <td></td> <td></td> <td colspan="8" style="text-align: center;"> <table border="1" style="width: 100%; border-collapse: collapse; text-align: center;"> <tr> <td style="width: 10%;"></td> <td style="width: 10%;"></td> <td style="width: 10%;"></td> <td style="width: 10%;"></td> <td style="width: 10%;"></td> <td style="width: 10%;"></td> <td style="width: 10%;"></td> <td style="width: 10%;"></td> <td style="width: 10%;"></td> <td style="width: 10%;"></td> </tr> <tr> <td></td> <td></td> <td colspan="8" style="text-align: center;"> <table border="1" style="width: 100%; border-collapse: collapse; text-align: center;"> <tr> <td style="width: 10%;"></td> <td style="width: 10%;"></td> <td style="width: 10%;"></td> <td style="width: 10%;"></td> <td style="width: 10%;"></td> <td style="width: 10%;"></td> <td style="width: 10%;"></td> <td style="width: 10%;"></td> <td style="width: 10%;"></td> <td style="width: 10%;"></td> </tr> <tr> <td></td> <td></td> <td colspan="8" style="text-align: center;"> <table border="1" style="width: 100%; border-collapse: collapse; text-align: center;"> <tr> <td style="width: 10%;"></td> <td style="width: 10%;"></td> <td style="width: 10%;"></td> <td style="width: 10%;"></td> <td style="width: 10%;"></td> <td style="width: 10%;"></td> <td style="width: 10%;"></td> <td style="width: 10%;"></td> <td style="width: 10%;"></td> <td style="width: 10%;"></td> </tr> <tr> <td></td> <td></td> <td colspan="8" style="text-align: center;"> <table border="1" style="width: 100%; border-collapse: collapse; text-align: center;"> <tr> <td style="width: 10%;"></td> <td style="width: 10%;"></td> <td style="width: 10%;"></td> <td style="width: 10%;"></td> <td style="width: 10%;"></td> <td style="width: 10%;"></td> <td style="width: 10%;"></td> <td style="width: 10%;"></td> <td style="width: 10%;"></td> <td style="width: 10%;"></td> </tr> <tr> <td></td> <td></td> <td colspan="8" style="text-align: center;"> <table border="1" style="width: 100%; border-collapse: collapse; text-align: center;"> <tr> <td style="width: 10%;"></td> <td style="width: 10%;"></td> <td style="width: 10%;"></td> <td style="width: 10%;"></td> <td style="width: 10%;"></td> <td style="width: 10%;"></td> <td style="width: 10%;"></td> <td style="width: 10%;"></td> <td style="width: 10%;"></td> <td style="width: 10%;"></td> </tr> <tr> <td></td> <td></td> <td colspan="8" style="text-align: center;"> <table border="1" style="width: 100%; border-collapse: collapse; text-align: center;"> <tr> <td style="width: 10%;"></td> <td style="width: 10%;"></td> <td style="width: 10%;"></td> <td style="width: 10%;"></td> <td style="width: 10%;"></td> <td style="width: 10%;"></td> <td style="width: 10%;"></td> <td style="width: 10%;"></td> <td style="width: 10%;"></td> <td style="width: 10%;"></td> </tr> <tr> <td></td> <td></td> <td colspan="8" style="text-align: center;"> <table border="1" style="width: 100%; border-collapse: collapse; text-align: center;"> <tr> <td style="width: 10%;"></td> <td style="width: 10%;"></td> <td style="width: 10%;"></td> <td style="width: 10%;"></td> <td style="width: 10%;"></td> <td style="width: 10%;"></td> <td style="width: 10%;"></td> <td style="width: 10%;"></td> <td style="width: 10%;"></td> <td style="width: 10%;"></td> </tr> <tr> <td></td> <td></td> <td colspan="8" style="text-align: center;"> <table border="1" style="width: 100%; border-collapse: collapse; text-align: center;"> <tr> <td style="width: 10%;"></td> <td style="width: 10%;"></td> <td style="width: 10%;"></td> <td style="width: 10%;"></td> <td style="width: 10%;"></td> <td style="width: 10%;"></td> <td style="width: 10%;"></td> <td style="width: 10%;"></td> <td style="width: 10%;"></td> <td style="width: 10%;"></td> </tr> <tr> <td></td> <td></td> <td colspan="8" style="text-align: center;"> <table border="1" style="width: 100%; border-collapse: collapse; text-align: center;"> <tr> <td style="width: 10%;"></td> <td style="width: 10%;"></td> <td style="width: 10%;"></td> <td style="width: 10%;"></td> <td style="width: 10%;"></td> <td style="width: 10%;"></td> <td style="width: 10%;"></td> <td style="width: 10%;"></td> <td style="width: 10%;"></td> <td style="width: 10%;"></td> </tr> <tr> <td></td> <td></td> <td colspan="8" style="text-align: center;"> <table border="1" style="width: 100%; border-collapse: collapse; text-align: center;"> <tr> <td style="width: 10%;"></td> <td style="width: 10%;"></td> <td style="width: 10%;"></td> <td style="width: 10%;"></td> <td style="width: 10%;"></td> <td style="width: 10%;"></td> <td style="width: 10%;"></td> <td style="width: 10%;"></td> <td style="width: 10%;"></td> <td style="width: 10%;"></td> </tr> <tr> <td></td> <td></td> <td colspan="8" style="text-align: center;"> <table border="1" style="width: 100%; border-collapse: collapse; text-align: center;"> <tr> <td style="width: 10%;"></td> <td style="width: 10%;"></td> <td style="width: 10%;"></td> <td style="width: 10%;"></td> <td style="width: 10%;"></td> <td style="width: 10%;"></td> <td style="width: 10%;"></td> <td style="width: 10%;"></td> <td style="width: 10%;"></td> <td style="width: 10%;"></td> </tr> <tr> <td></td> <td></td> <td colspan="8" style="text-align: center;"> <table border="1" style="width: 100%; border-collapse: collapse; text-align: center;"> <tr> <td style="width: 10%;"></td> <td style="width: 10%;"></td> <td style="width: 10%;"></td> <td style="width: 10%;"></td> <td style="width: 10%;"></td> <td style="width: 10%;"></td> <td style="width: 10%;"></td> <td style="width: 10%;"></td> <td style="width: 10%;"></td> <td style="width: 10%;"></td> </tr> <tr> <td></td> <td></td> <td colspan="8" style="text-align: center;"> <table border="1" style="width: 100%; border-collapse: collapse; text-align: center;"> <tr> <td style="width: 10%;"></td> <td style="width: 10%;"></td> <td style="width: 10%;"></td> <td style="width: 10%;"></td> <td style="width: 10%;"></td> <td style="width: 10%;"></td> <td style="width: 10%;"></td> <td style="width: 10%;"></td> <td style="width: 10%;"></td> <td style="width: 10%;"></td> </tr> <tr> <td></td> <td></td> <td colspan="8" style="text-align: center;"> <table border="1" style="width: 100%; border-collapse: collapse; text-align: center;"> <tr> <td style="width: 10%;"></td> <td style="width: 10%;"></td> <td style="width: 10%;"></td> <td style="width: 10%;"></td> <td style="width: 10%;"></td> <td style="width: 10%;"></td> <td style="width: 10%;"></td> <td style="width: 10%;"></td> <td style="width: 10%;"></td> <td style="width:
10%;"></td> </tr> <tr> <td></td> <td></td> <td colspan="8" style="text-align: center;"> <table border="1" style="width: 100%; border-collapse: collapse; text-align: center;"> <tr> </tr></table></td></tr></table></td></tr></table></td></tr></table></td></tr></table></td></tr></table></td></tr></table></td></tr></table></td></tr></table></td></tr></table></td></tr></table></td></tr></table></td></tr></table></td></tr></table></td></tr></table></td></tr></table></td></tr></table></td></tr></table></td></tr></table></td></tr></table></td></tr></table></td></tr></table></td></tr></table></td></tr></table></td></tr></table></td></tr></table></td></tr></table></td></tr></table></td></tr></table></td></tr></table></td></tr></table></td></tr></table></td></tr></table></td></tr></table></td></tr></table></td></tr></table></td></tr></table></td></tr></table></td></tr></table></td></tr></table></td></tr></table></td></tr></table></td></tr></table> | | | | | | | | | | | | | | | | | | | | <table border="1" style="width: 100%; border-collapse: collapse; text-align: center;"> <tr> <td style="width: 10%;"></td> <td style="width: 10%;"></td> <td style="width: 10%;"></td> <td style="width: 10%;"></td> <td style="width: 10%;"></td> <td style="width: 10%;"></td> <td style="width: 10%;"></td> <td style="width: 10%;"></td> <td style="width: 10%;"></td> <td style="width: 10%;"></td> </tr> <tr> <td></td> <td></td> <td colspan="8" style="text-align: center;"> <table border="1" style="width: 100%; border-collapse: collapse; text-align: center;"> <tr> <td style="width: 10%;"></td> <td style="width: 10%;"></td> <td style="width: 10%;"></td> <td style="width: 10%;"></td> <td style="width: 10%;"></td> <td style="width: 10%;"></td> <td style="width: 10%;"></td> <td style="width: 10%;"></td> <td style="width: 10%;"></td> <td style="width: 10%;"></td> </tr> <tr> <td></td> <td></td> <td colspan="8" style="text-align: center;"> <table border="1" style="width: 100%; border-collapse: collapse; text-align: center;"> <tr> <td style="width: 10%;"></td> <td style="width: 10%;"></td> <td style="width: 10%;"></td> <td style="width: 10%;"></td> <td style="width: 10%;"></td> <td style="width: 10%;"></td> <td
style="width: 10%;"></td> <td style="width: 10%;"></td> <td style="width: 10%;"></td> <td style="width: 10%;"></td> </tr> <tr> <td></td> <td></td> <td colspan="8" style="text-align: center;"> <table border="1" style="width: 100%; border-collapse: collapse; text-align: center;"> <tr> <td style="width: 10%;"></td> <td style="width: 10%;"></td> <td style="width: 10%;"></td> <td style="width: 10%;"></td> <td style="width: 10%;"></td> <td style="width: 10%;"></td> <td style="width: 10%;"></td> <td style="width: 10%;"></td> <td style="width: 10%;"></td> <td style="width: 10%;"></td> </tr> <tr> <td></td> <td></td> <td colspan="8" style="text-align: center;"> <table border="1" style="width: 100%; border-collapse: collapse; text-align: center;"> <tr> <td style="width: 10%;"></td> <td style="width: 10%;"></td> <td style="width: 10%;"></td> <td style="width: 10%;"></td> <td style="width: 10%;"></td> <td style="width: 10%;"></td> <td style="width: 10%;"></td> <td style="width: 10%;"></td> <td style="width: 10%;"></td> <td style="width: 10%;"></td> </tr> <tr> <td></td> <td></td> <td colspan="8" style="text-align: center;"> <table border="1" style="width: 100%; border-collapse: collapse; text-align: center;"> <tr> <td style="width: 10%;"></td> <td style="width: 10%;"></td> <td style="width: 10%;"></td> <td style="width: 10%;"></td> <td style="width: 10%;"></td> <td style="width: 10%;"></td> <td style="width: 10%;"></td> <td style="width: 10%;"></td> <td style="width: 10%;"></td> <td style="width: 10%;"></td> </tr> <tr> <td></td> <td></td> <td colspan="8" style="text-align: center;"> <table border="1" style="width: 100%; border-collapse: collapse; text-align: center;"> <tr> <td style="width: 10%;"></td> <td style="width: 10%;"></td> <td style="width: 10%;"></td> <td style="width: 10%;"></td> <td style="width: 10%;"></td> <td style="width: 10%;"></td> <td style="width: 10%;"></td> <td style="width: 10%;"></td> <td style="width: 10%;"></td> <td style="width: 10%;"></td> </tr> <tr> <td></td> <td></td> <td colspan="8" style="text-align: center;"> <table border="1" style="width: 100%; border-collapse: collapse; text-align: center;"> <tr> <td style="width: 10%;"></td> <td style="width: 10%;"></td> <td style="width: 10%;"></td> <td style="width: 10%;"></td> <td style="width: 10%;"></td> <td style="width: 10%;"></td> <td style="width: 10%;"></td> <td style="width: 10%;"></td> <td style="width: 10%;"></td> <td style="width: 10%;"></td> </tr> <tr> <td></td> <td></td> <td colspan="8" style="text-align: center;"> <table border="1" style="width: 100%; border-collapse: collapse; text-align: center;"> <tr> <td style="width: 10%;"></td> <td style="width: 10%;"></td> <td style="width: 10%;"></td> <td style="width: 10%;"></td> <td style="width: 10%;"></td> <td style="width: 10%;"></td> <td style="width: 10%;"></td> <td style="width: 10%;"></td> <td style="width: 10%;"></td> <td style="width: 10%;"></td> </tr> <tr> <td></td> <td></td> <td colspan="8" style="text-align: center;"> <table border="1" style="width: 100%; border-collapse: collapse; text-align: center;"> <tr> <td style="width: 10%;"></td> <td style="width: 10%;"></td> <td style="width: 10%;"></td> <td style="width: 10%;"></td> <td style="width: 10%;"></td> <td style="width: 10%;"></td> <td style="width: 10%;"></td> <td style="width: 10%;"></td> <td style="width: 10%;"></td> <td style="width: 10%;"></td> </tr> <tr> <td></td> <td></td> <td colspan="8" style="text-align: center;"> <table border="1" style="width: 100%; border-collapse: collapse; text-align: center;"> <tr> <td style="width: 10%;"></td> <td style="width: 10%;"></td> <td style="width: 10%;"></td> <td style="width: 10%;"></td> <td style="width: 10%;"></td> <td style="width: 10%;"></td> <td style="width: 10%;"></td> <td style="width: 10%;"></td> <td style="width: 10%;"></td> <td style="width: 10%;"></td> </tr> <tr> <td></td> <td></td> <td colspan="8" style="text-align: center;"> <table border="1" style="width: 100%; border-collapse: collapse; text-align: center;"> <tr> <td style="width: 10%;"></td> <td style="width: 10%;"></td> <td style="width: 10%;"></td> <td style="width: 10%;"></td> <td style="width: 10%;"></td> <td style="width: 10%;"></td> <td style="width: 10%;"></td> <td style="width: 10%;"></td> <td style="width: 10%;"></td> <td style="width: 10%;"></td> </tr> <tr> <td></td> <td></td> <td colspan="8" style="text-align: center;"> <table border="1" style="width: 100%; border-collapse: collapse; text-align: center;"> <tr> <td style="width: 10%;"></td> <td style="width: 10%;"></td> <td style="width: 10%;"></td> <td style="width: 10%;"></td> <td style="width: 10%;"></td> <td style="width: 10%;"></td> <td style="width: 10%;"></td> <td style="width: 10%;"></td> <td style="width: 10%;"></td> <td style="width: 10%;"></td> </tr> <tr> <td></td> <td></td> <td colspan="8" style="text-align: center;"> <table border="1" style="width: 100%; border-collapse: collapse; text-align: center;"> <tr> <td style="width: 10%;"></td> <td style="width: 10%;"></td> <td style="width: 10%;"></td> <td style="width: 10%;"></td> <td style="width: 10%;"></td> <td style="width: 10%;"></td> <td style="width: 10%;"></td> <td style="width: 10%;"></td> <td style="width: 10%;"></td> <td style="width: 10%;"></td> </tr> <tr> <td></td> <td></td> <td colspan="8" style="text-align: center;"> <table border="1" style="width: 100%; border-collapse: collapse; text-align: center;"> <tr> <td style="width: 10%;"></td> <td style="width: 10%;"></td> <td style="width: 10%;"></td> <td style="width: 10%;"></td> <td style="width: 10%;"></td> <td style="width: 10%;"></td> <td style="width: 10%;"></td> <td style="width: 10%;"></td> <td style="width: 10%;"></td> <td style="width: 10%;"></td> </tr> <tr> <td></td> <td></td> <td colspan="8" style="text-align: center;"> <table border="1" style="width: 100%; border-collapse: collapse; text-align: center;"> <tr> <td style="width: 10%;"></td> <td style="width: 10%;"></td> <td style="width: 10%;"></td> <td style="width: 10%;"></td> <td style="width: 10%;"></td> <td style="width: 10%;"></td> <td style="width: 10%;"></td> <td style="width: 10%;"></td> <td style="width: 10%;"></td> <td style="width: 10%;"></td> </tr> <tr> <td></td> <td></td> <td colspan="8" style="text-align: center;"> <table border="1" style="width: 100%; border-collapse: collapse; text-align: center;"> <tr> <td style="width: 10%;"></td> <td style="width: 10%;"></td> <td style="width: 10%;"></td> <td style="width: 10%;"></td> <td style="width: 10%;"></td> <td style="width: 10%;"></td> <td style="width: 10%;"></td> <td style="width: 10%;"></td> <td style="width: 10%;"></td> <td style="width: 10%;"></td> </tr> <tr> <td></td> <td></td> <td colspan="8" style="text-align: center;"> <table border="1" style="width: 100%; border-collapse: collapse; text-align: center;"> <tr> <td style="width: 10%;"></td> <td style="width: 10%;"></td> <td style="width: 10%;"></td> <td style="width: 10%;"></td> <td style="width: 10%;"></td> <td style="width: 10%;"></td> <td style="width: 10%;"></td> <td style="width: 10%;"></td> <td style="width: 10%;"></td> <td style="width: 10%;"></td> </tr> <tr> <td></td> <td></td> <td colspan="8" style="text-align: center;"> <table border="1" style="width: 100%; border-collapse: collapse; text-align: center;"> <tr> <td style="width: 10%;"></td> <td style="width: 10%;"></td> <td style="width: 10%;"></td> <td style="width: 10%;"></td> <td style="width: 10%;"></td> <td style="width: 10%;"></td> <td style="width: 10%;"></td> <td style="width: 10%;"></td> <td style="width: 10%;"></td> <td style="width: 10%;"></td> </tr> <tr> <td></td> <td></td> <td colspan="8" style="text-align: center;"> <table border="1" style="width: 100%; border-collapse: collapse; text-align: center;"> <tr> <td style="width: 10%;"></td> <td style="width: 10%;"></td> <td style="width: 10%;"></td> <td style="width: 10%;"></td> <td style="width: 10%;"></td> <td style="width: 10%;"></td> <td style="width: 10%;"></td> <td style="width: 10%;"></td> <td style="width: 10%;"></td> <td style="width: 10%;"></td> </tr> <tr> <td></td> <td></td> <td colspan="8" style="text-align: center;"> <table border="1" style="width: 100%; border-collapse: collapse; text-align: center;"> <tr> <td style="width: 10%;"></td> <td style="width: 10%;"></td> <td style="width: 10%;"></td> <td style="width: 10%;"></td> <td style="width: 10%;"></td> <td style="width: 10%;"></td> <td style="width: 10%;"></td> <td style="width: 10%;"></td> <td style="width: 10%;"></td> <td style="width: 10%;"></td> </tr> <tr> <td></td> <td></td> <td colspan="8" style="text-align: center;"> <table border="1" style="width: 100%; border-collapse: collapse; text-align: center;"> <tr> <td style="width: 10%;"></td> <td style="width: 10%;"></td> <td style="width: 10%;"></td> <td style="width: 10%;"></td> <td style="width: 10%;"></td> <td style="width: 10%;"></td> <td style="width: 10%;"></td> <td style="width: 10%;"></td> <td style="width: 10%;"></td> <td style="width: 10%;"></td> </tr> <tr> <td></td> <td></td> <td colspan="8" style="text-align: center;"> <table border="1" style="width: 100%; border-collapse: collapse; text-align: center;"> <tr> <td style="width: 10%;"></td> <td style="width: 10%;"></td> <td style="width: 10%;"></td> <td style="width: 10%;"></td> <td style="width: 10%;"></td> <td style="width: 10%;"></td> <td style="width: 10%;"></td> <td style="width: 10%;"></td> <td style="width: 10%;"></td> <td style="width: 10%;"></td> </tr> <tr> <td></td> <td></td> <td colspan="8" style="text-align: center;"> <table border="1" style="width: 100%; border-collapse: collapse; text-align: center;"> <tr> <td style="width: 10%;"></td> <td style="width: 10%;"></td> <td style="width: 10%;"></td> <td style="width: 10%;"></td> <td style="width: 10%;"></td> <td style="width: 10%;"></td> <td style="width: 10%;"></td> <td style="width: 10%;"></td> <td style="width: 10%;"></td> <td style="width: 10%;"></td> </tr> <tr> <td></td> <td></td> <td colspan="8"
style="text-align: center;"> <table border="1" style="width: 100%; border-collapse: collapse; text-align: center;"> <tr> <td style="width: 10%;"></td> <td style="width: 10%;"></td> <td style="width: 10%;"></td> <td style="width: 10%;"></td> <td style="width: 10%;"></td> <td style="width: 10%;"></td> <td style="width: 10%;"></td> <td style="width: 10%;"></td> <td style="width: 10%;"></td> <td style="width: 10%;"></td> </tr> <tr> <td></td> <td></td> <td colspan="8" style="text-align: center;"> <table border="1" style="width: 100%; border-collapse: collapse; text-align: center;"> <tr> <td style="width: 10%;"></td> <td style="width: 10%;"></td> <td style="width: 10%;"></td> <td style="width: 10%;"></td> <td style="width: 10%;"></td> <td style="width: 10%;"></td> <td style="width: 10%;"></td> <td style="width: 10%;"></td> <td style="width: 10%;"></td> <td style="width: 10%;"></td> </tr> <tr> <td></td> <td></td> <td colspan="8" style="text-align: center;"> <table border="1" style="width: 100%; border-collapse: collapse; text-align: center;"> <tr> <td style="width: 10%;"></td> <td style="width: 10%;"></td> <td style="width: 10%;"></td> <td style="width: 10%;"></td> <td style="width: 10%;"></td> <td style="width: 10%;"></td> <td style="width: 10%;"></td> <td style="width: 10%;"></td> <td style="width: 10%;"></td> <td style="width: 10%;"></td> </tr> <tr> <td></td> <td></td> <td colspan="8" style="text-align: center;"> <table border="1" style="width: 100%; border-collapse: collapse; text-align: center;"> <tr> <td style="width: 10%;"></td> <td style="width: 10%;"></td> <td style="width: 10%;"></td> <td style="width: 10%;"></td> <td style="width: 10%;"></td> <td style="width: 10%;"></td> <td style="width: 10%;"></td> <td style="width: 10%;"></td> <td style="width: 10%;"></td> <td style="width: 10%;"></td> </tr> <tr> <td></td> <td></td> <td colspan="8" style="text-align: center;"> <table border="1" style="width: 100%; border-collapse: collapse; text-align: center;"> <tr> <td style="width: 10%;"></td> <td style="width: 10%;"></td> <td style="width: 10%;"></td> <td style="width: 10%;"></td> <td style="width: 10%;"></td> <td style="width: 10%;"></td> <td style="width: 10%;"></td> <td style="width: 10%;"></td> <td style="width: 10%;"></td> <td style="width: 10%;"></td> </tr> <tr> <td></td> <td></td> <td colspan="8" style="text-align: center;"> <table border="1" style="width: 100%; border-collapse: collapse; text-align: center;"> <tr> <td style="width: 10%;"></td> <td style="width: 10%;"></td> <td style="width: 10%;"></td> <td style="width: 10%;"></td> <td style="width: 10%;"></td> <td style="width: 10%;"></td> <td style="width: 10%;"></td> <td style="width: 10%;"></td> <td style="width: 10%;"></td> <td style="width: 10%;"></td> </tr> <tr> <td></td> <td></td> <td colspan="8" style="text-align: center;"> <table border="1" style="width: 100%; border-collapse: collapse; text-align: center;"> <tr> <td style="width: 10%;"></td> <td style="width: 10%;"></td> <td style="width: 10%;"></td> <td style="width: 10%;"></td> <td style="width: 10%;"></td> <td style="width: 10%;"></td> <td style="width: 10%;"></td> <td style="width: 10%;"></td> <td style="width: 10%;"></td> <td style="width: 10%;"></td> </tr> <tr> <td></td> <td></td> <td colspan="8" style="text-align: center;"> <table border="1" style="width: 100%; border-collapse: collapse; text-align: center;"> <tr> <td style="width: 10%;"></td> <td style="width: 10%;"></td> <td style="width: 10%;"></td> <td style="width: 10%;"></td> <td style="width: 10%;"></td> <td style="width: 10%;"></td> <td style="width: 10%;"></td> <td style="width: 10%;"></td> <td style="width: 10%;"></td> <td style="width: 10%;"></td> </tr> <tr> <td></td> <td></td> <td colspan="8" style="text-align: center;"> <table border="1" style="width: 100%; border-collapse: collapse; text-align: center;"> <tr> <td style="width: 10%;"></td> <td style="width: 10%;"></td> <td style="width: 10%;"></td> <td style="width: 10%;"></td> <td style="width: 10%;"></td> <td style="width: 10%;"></td> <td style="width: 10%;"></td> <td style="width: 10%;"></td> <td style="width: 10%;"></td> <td style="width: 10%;"></td> </tr> <tr> <td></td> <td></td> <td colspan="8" style="text-align: center;"> <table border="1" style="width: 100%; border-collapse: collapse; text-align: center;"> <tr> <td style="width: 10%;"></td> <td style="width: 10%;"></td> <td style="width: 10%;"></td> <td style="width: 10%;"></td> <td style="width: 10%;"></td> <td style="width: 10%;"></td> <td style="width: 10%;"></td> <td style="width: 10%;"></td> <td style="width: 10%;"></td> <td style="width: 10%;"></td> </tr> <tr> <td></td> <td></td> <td colspan="8" style="text-align: center;"> <table border="1" style="width: 100%; border-collapse: collapse; text-align: center;"> <tr> <td style="width: 10%;"></td> <td style="width: 10%;"></td> <td style="width: 10%;"></td> <td style="width: 10%;"></td> <td style="width: 10%;"></td> <td style="width: 10%;"></td> <td style="width: 10%;"></td> <td style="width: 10%;"></td> <td style="width: 10%;"></td> <td style="width: 10%;"></td> </tr> <tr> <td></td> <td></td> <td colspan="8" style="text-align: center;"> <table border="1" style="width: 100%; border-collapse: collapse; text-align: center;"> <tr> <td style="width: 10%;"></td> <td style="width: 10%;"></td> <td style="width: 10%;"></td> <td style="width: 10%;"></td> <td style="width: 10%;"></td> <td style="width: 10%;"></td> <td style="width: 10%;"></td> <td style="width: 10%;"></td> <td style="width: 10%;"></td> <td style="width: 10%;"></td> </tr> <tr> <td></td> <td></td> <td colspan="8" style="text-align: center;"> <table border="1" style="width: 100%; border-collapse: collapse; text-align: center;"> <tr> <td style="width: 10%;"></td> <td style="width: 10%;"></td> <td style="width: 10%;"></td> <td style="width: 10%;"></td> <td style="width: 10%;"></td> <td style="width: 10%;"></td> <td style="width: 10%;"></td> <td style="width: 10%;"></td> <td style="width: 10%;"></td> <td style="width: 10%;"></td> </tr> <tr> <td></td> <td></td> <td colspan="8" style="text-align: center;"> <table border="1" style="width: 100%; border-collapse: collapse; text-align: center;"> <tr> <td style="width: 10%;"></td> <td style="width: 10%;"></td> <td style="width: 10%;"></td> <td style="width: 10%;"></td> <td style="width: 10%;"></td> <td style="width: 10%;"></td> <td style="width: 10%;"></td> <td style="width: 10%;"></td> <td style="width: 10%;"></td> <td style="width: 10%;"></td> </tr> <tr> <td></td> <td></td> <td colspan="8" style="text-align: center;"> <table border="1" style="width: 100%; border-collapse: collapse; text-align: center;"> <tr> <td style="width: 10%;"></td> <td style="width: 10%;"></td> <td style="width: 10%;"></td> <td style="width: 10%;"></td> <td style="width: 10%;"></td> <td style="width: 10%;"></td> <td style="width: 10%;"></td> <td style="width: 10%;"></td> <td style="width: 10%;"></td> <td style="width: 10%;"></td> </tr> <tr> <td></td> <td></td> <td colspan="8" style="text-align: center;"> <table border="1" style="width: 100%; border-collapse: collapse; text-align: center;"> <tr> <td style="width: 10%;"></td> <td style="width: 10%;"></td> <td style="width: 10%;"></td> <td style="width: 10%;"></td> <td style="width: 10%;"></td> <td style="width: 10%;"></td> <td style="width: 10%;"></td> <td style="width: 10%;"></td> <td style="width: 10%;"></td> <td style="width: 10%;"></td> </tr> <tr> <td></td> <td></td> <td colspan="8" style="text-align: center;"> <table border="1" style="width: 100%; border-collapse: collapse; text-align: center;"> <tr> <td style="width: 10%;"></td> <td style="width: 10%;"></td> <td style="width: 10%;"></td> <td style="width: 10%;"></td> <td style="width: 10%;"></td> <td style="width: 10%;"></td> <td style="width: 10%;"></td> <td style="width: 10%;"></td> <td style="width: 10%;"></td> <td style="width: 10%;"></td> </tr> <tr> <td></td> <td></td> <td colspan="8" style="text-align: center;"> <table border="1" style="width: 100%; border-collapse: collapse; text-align: center;"> <tr> </tr></table></td></tr></table></td></tr></table></td></tr></table></td></tr></table></td></tr></table></td></tr></table></td></tr></table></td></tr></table></td></tr></table></td></tr></table></td></tr></table></td></tr></table></td></tr></table></td></tr></table></td></tr></table></td></tr></table></td></tr></table></td></tr></table></td></tr></table></td></tr></table></td></tr></table></td></tr></table></td></tr></table></td></tr></table></td></tr></table></td></tr></table></td></tr></table></td></tr></table></td></tr></table></td></tr></table></td></tr></table></td></tr></table></td></tr></table></td></tr></table></td></tr></table></td></tr></table></td></tr></table></td></tr></table></td></tr></table></td></tr></table></td></tr></table>
 | | | | | | | | | | | | | | | | | | | | <table border="1" style="width: 100%; border-collapse: collapse; text-align: center;"> <tr> <td style="width: 10%;"></td> <td style="width: 10%;"></td> <td style="width: 10%;"></td> <td style="width: 10%;"></td> <td style="width: 10%;"></td> <td style="width: 10%;"></td> <td style="width: 10%;"></td> <td style="width: 10%;"></td> <td style="width: 10%;"></td> <td style="width: 10%;"></td> </tr> <tr> <td></td> <td></td> <td colspan="8" style="text-align: center;"> <table border="1" style="width: 100%; border-collapse: collapse; text-align: center;"> <tr> <td style="width: 10%;"></td> <td style="width: 10%;"></td> <td style="width: 10%;"></td> <td style="width: 10%;"></td> <td style="width: 10%;"></td> <td style="width: 10%;"></td> <td style="width: 10%;"></td> <td style="width: 10%;"></td> <td style="width: 10%;"></td> <td style="width: 10%;"></td> </tr> <tr> <td></td> <td></td> <td colspan="8" style="text-align: center;"> <table border="1" style="width: 100%; border-collapse: collapse; text-align: center;"> <tr> <td style="width: 10%;"></td> <td style="width: 10%;"></td> <td style="width: 10%;"></td> <td style="width: 10%;"></td> <td style="width: 10%;"></td> <td style="width: 10%;"></td> <td style="width: 10%;"></td> <td style="width: 10%;"></td> <td style="width: 10%;"></td> <td style="width: 10%;"></td> </tr> <tr> <td></td> <td></td> <td colspan="8" style="text-align: center;"> <table border="1" style="width: 100%; border-collapse: collapse; text-align: center;"> <tr> <td style="width: 10%;"></td> <td style="width: 10%;"></td> <td style="width: 10%;"></td> <td style="width: 10%;"></td> <td style="width: 10%;"></td> <td style="width: 10%;"></td> <td style="width: 10%;"></td> <td style="width: 10%;"></td> <td style="width: 10%;"></td> <td style="width: 10%;"></td> </tr> <tr> <td></td> <td></td> <td colspan="8" style="text-align: center;"> <table border="1" style="width: 100%; border-collapse: collapse; text-align: center;"> <tr> <td style="width: 10%;"></td> <td style="width: 10%;"></td> <td style="width: 10%;"></td> <td style="width: 10%;"></td> <td style="width: 10%;"></td> <td style="width: 10%;"></td> <td style="width: 10%;"></td> <td style="width: 10%;"></td> <td style="width: 10%;"></td> <td style="width: 10%;"></td> </tr> <tr> <td></td> <td></td> <td colspan="8" style="text-align: center;"> <table border="1" style="width: 100%; border-collapse: collapse; text-align: center;"> <tr> <td style="width: 10%;"></td> <td style="width: 10%;"></td> <td style="width: 10%;"></td> <td style="width: 10%;"></td> <td style="width: 10%;"></td> <td style="width: 10%;"></td> <td style="width: 10%;"></td> <td style="width: 10%;"></td> <td style="width: 10%;"></td> <td style="width: 10%;"></td> </tr> <tr> <td></td> <td></td> <td colspan="8" style="text-align: center;"> <table border="1" style="width: 100%; border-collapse: collapse; text-align: center;"> <tr> <td style="width: 10%;"></td> <td style="width: 10%;"></td> <td style="width: 10%;"></td> <td style="width: 10%;"></td> <td style="width: 10%;"></td> <td style="width: 10%;"></td> <td style="width: 10%;"></td> <td style="width: 10%;"></td> <td style="width: 10%;"></td> <td style="width: 10%;"></td> </tr> <tr> <td></td> <td></td> <td colspan="8" style="text-align: center;"> <table border="1" style="width: 100%; border-collapse:
collapse; text-align: center;"> <tr> <td style="width: 10%;"></td> <td style="width: 10%;"></td> <td style="width: 10%;"></td> <td style="width: 10%;"></td> <td style="width: 10%;"></td> <td style="width: 10%;"></td> <td style="width: 10%;"></td> <td style="width: 10%;"></td> <td style="width: 10%;"></td> <td style="width: 10%;"></td> </tr> <tr> <td></td> <td></td> <td colspan="8" style="text-align: center;"> <table border="1" style="width: 100%; border-collapse: collapse; text-align: center;"> <tr> <td style="width: 10%;"></td> <td style="width: 10%;"></td> <td style="width: 10%;"></td> <td style="width: 10%;"></td> <td style="width: 10%;"></td> <td style="width: 10%;"></td> <td style="width: 10%;"></td> <td style="width: 10%;"></td> <td style="width: 10%;"></td> <td style="width: 10%;"></td> </tr> <tr> <td></td> <td></td> <td colspan="8" style="text-align: center;"> <table border="1" style="width: 100%; border-collapse: collapse; text-align: center;"> <tr> <td style="width: 10%;"></td> <td style="width: 10%;"></td> <td style="width: 10%;"></td> <td style="width: 10%;"></td> <td style="width: 10%;"></td> <td style="width: 10%;"></td> <td style="width: 10%;"></td> <td style="width: 10%;"></td> <td style="width: 10%;"></td> <td style="width: 10%;"></td> </tr> <tr> <td></td> <td></td> <td colspan="8" style="text-align: center;"> <table border="1" style="width: 100%; border-collapse: collapse; text-align: center;"> <tr> <td style="width: 10%;"></td> <td style="width: 10%;"></td> <td style="width: 10%;"></td> <td style="width: 10%;"></td> <td style="width: 10%;"></td> <td style="width: 10%;"></td> <td style="width: 10%;"></td> <td style="width: 10%;"></td> <td style="width: 10%;"></td> <td style="width: 10%;"></td> </tr> <tr> <td></td> <td></td> <td colspan="8" style="text-align: center;"> <table border="1" style="width: 100%; border-collapse: collapse; text-align: center;"> <tr> <td style="width: 10%;"></td> <td style="width: 10%;"></td> <td style="width: 10%;"></td> <td style="width: 10%;"></td> <td style="width: 10%;"></td> <td style="width: 10%;"></td> <td style="width: 10%;"></td> <td style="width: 10%;"></td> <td style="width: 10%;"></td> <td style="width: 10%;"></td> </tr> <tr> <td></td> <td></td> <td colspan="8" style="text-align: center;"> <table border="1" style="width: 100%; border-collapse: collapse; text-align: center;"> <tr> <td style="width: 10%;"></td> <td style="width: 10%;"></td> <td style="width: 10%;"></td> <td style="width: 10%;"></td> <td style="width: 10%;"></td> <td style="width: 10%;"></td> <td style="width: 10%;"></td> <td style="width: 10%;"></td> <td style="width: 10%;"></td> <td style="width: 10%;"></td> </tr> <tr> <td></td> <td></td> <td colspan="8" style="text-align: center;"> <table border="1" style="width: 100%; border-collapse: collapse; text-align: center;"> <tr> <td style="width: 10%;"></td> <td style="width: 10%;"></td> <td style="width: 10%;"></td> <td style="width: 10%;"></td> <td style="width: 10%;"></td> <td style="width: 10%;"></td> <td style="width: 10%;"></td> <td style="width: 10%;"></td> <td style="width: 10%;"></td> <td style="width: 10%;"></td> </tr> <tr> <td></td> <td></td> <td colspan="8" style="text-align: center;"> <table border="1" style="width: 100%; border-collapse: collapse; text-align: center;"> <tr> <td style="width: 10%;"></td> <td style="width: 10%;"></td> <td style="width: 10%;"></td> <td style="width: 10%;"></td> <td style="width: 10%;"></td> <td style="width: 10%;"></td> <td style="width: 10%;"></td> <td style="width: 10%;"></td> <td style="width: 10%;"></td> <td style="width: 10%;"></td> </tr> <tr> <td></td> <td></td> <td colspan="8" style="text-align: center;"> <table border="1" style="width: 100%; border-collapse: collapse; text-align: center;"> <tr> <td style="width: 10%;"></td> <td style="width: 10%;"></td> <td style="width: 10%;"></td> <td style="width: 10%;"></td> <td style="width: 10%;"></td> <td style="width: 10%;"></td> <td style="width: 10%;"></td> <td style="width: 10%;"></td> <td style="width: 10%;"></td> <td style="width: 10%;"></td> </tr> <tr> <td></td> <td></td> <td colspan="8" style="text-align: center;"> <table border="1" style="width: 100%; border-collapse: collapse; text-align: center;"> <tr> <td style="width: 10%;"></td> <td style="width: 10%;"></td> <td style="width: 10%;"></td> <td style="width: 10%;"></td> <td style="width: 10%;"></td> <td style="width: 10%;"></td> <td style="width: 10%;"></td> <td style="width: 10%;"></td> <td style="width: 10%;"></td> <td style="width: 10%;"></td> </tr> <tr> <td></td> <td></td> <td colspan="8" style="text-align: center;"> <table border="1" style="width: 100%; border-collapse: collapse; text-align: center;"> <tr> <td style="width: 10%;"></td> <td style="width: 10%;"></td> <td style="width: 10%;"></td> <td style="width: 10%;"></td> <td style="width: 10%;"></td> <td style="width: 10%;"></td> <td style="width: 10%;"></td> <td style="width: 10%;"></td> <td style="width: 10%;"></td> <td style="width: 10%;"></td> </tr> <tr> <td></td> <td></td> <td colspan="8" style="text-align: center;"> <table border="1" style="width: 100%; border-collapse: collapse; text-align: center;"> <tr> <td style="width: 10%;"></td> <td style="width: 10%;"></td> <td style="width: 10%;"></td> <td style="width: 10%;"></td> <td style="width: 10%;"></td> <td style="width: 10%;"></td> <td style="width: 10%;"></td> <td style="width: 10%;"></td> <td style="width: 10%;"></td> <td style="width: 10%;"></td> </tr> <tr> <td></td> <td></td> <td colspan="8" style="text-align: center;"> <table border="1" style="width: 100%; border-collapse: collapse; text-align: center;"> <tr> <td style="width: 10%;"></td> <td style="width: 10%;"></td> <td style="width: 10%;"></td> <td style="width: 10%;"></td> <td style="width: 10%;"></td> <td style="width: 10%;"></td> <td style="width: 10%;"></td> <td style="width: 10%;"></td> <td style="width: 10%;"></td> <td style="width: 10%;"></td> </tr> <tr> <td></td> <td></td> <td colspan="8" style="text-align: center;"> <table border="1" style="width: 100%; border-collapse: collapse; text-align: center;"> <tr> <td style="width: 10%;"></td> <td style="width: 10%;"></td> <td style="width: 10%;"></td> <td style="width: 10%;"></td> <td style="width: 10%;"></td> <td style="width: 10%;"></td> <td style="width: 10%;"></td> <td style="width: 10%;"></td> <td style="width: 10%;"></td> <td style="width: 10%;"></td> </tr> <tr> <td></td> <td></td> <td colspan="8" style="text-align: center;"> <table border="1" style="width: 100%; border-collapse: collapse; text-align: center;"> <tr> <td style="width: 10%;"></td> <td style="width: 10%;"></td> <td style="width: 10%;"></td> <td style="width: 10%;"></td> <td style="width: 10%;"></td> <td style="width: 10%;"></td> <td style="width: 10%;"></td> <td style="width: 10%;"></td> <td style="width: 10%;"></td> <td style="width: 10%;"></td> </tr> <tr> <td></td> <td></td> <td colspan="8" style="text-align: center;"> <table border="1" style="width: 100%; border-collapse: collapse; text-align: center;"> <tr> <td style="width: 10%;"></td> <td style="width: 10%;"></td> <td style="width: 10%;"></td> <td style="width: 10%;"></td> <td style="width: 10%;"></td> <td style="width: 10%;"></td> <td style="width: 10%;"></td> <td style="width: 10%;"></td> <td style="width: 10%;"></td> <td style="width: 10%;"></td> </tr> <tr> <td></td> <td></td> <td colspan="8" style="text-align: center;"> <table border="1" style="width: 100%; border-collapse: collapse; text-align: center;"> <tr> <td style="width: 10%;"></td> <td style="width: 10%;"></td> <td style="width: 10%;"></td> <td style="width: 10%;"></td> <td style="width: 10%;"></td> <td style="width: 10%;"></td> <td style="width: 10%;"></td> <td style="width: 10%;"></td> <td style="width: 10%;"></td> <td style="width: 10%;"></td> </tr> <tr> <td></td> <td></td> <td colspan="8" style="text-align: center;"> <table border="1" style="width: 100%; border-collapse: collapse; text-align: center;"> <tr> <td style="width: 10%;"></td> <td style="width: 10%;"></td> <td style="width: 10%;"></td> <td style="width: 10%;"></td> <td style="width: 10%;"></td> <td style="width: 10%;"></td> <td style="width: 10%;"></td> <td style="width: 10%;"></td> <td style="width: 10%;"></td> <td style="width: 10%;"></td> </tr> <tr> <td></td> <td></td> <td colspan="8" style="text-align: center;"> <table border="1" style="width: 100%; border-collapse: collapse; text-align: center;"> <tr> <td style="width: 10%;"></td> <td style="width: 10%;"></td> <td style="width: 10%;"></td> <td style="width: 10%;"></td> <td style="width: 10%;"></td> <td style="width: 10%;"></td> <td style="width: 10%;"></td> <td style="width: 10%;"></td> <td style="width: 10%;"></td> <td style="width: 10%;"></td> </tr> <tr> <td></td> <td></td> <td colspan="8" style="text-align: center;"> <table border="1" style="width: 100%; border-collapse: collapse; text-align: center;"> <tr> <td style="width: 10%;"></td> <td style="width: 10%;"></td> <td style="width: 10%;"></td> <td style="width: 10%;"></td> <td style="width: 10%;"></td> <td style="width: 10%;"></td> <td style="width: 10%;"></td> <td style="width: 10%;"></td> <td style="width: 10%;"></td> <td style="width: 10%;"></td> </tr> <tr> <td></td> <td></td> <td colspan="8" style="text-align: center;"> <table border="1" style="width: 100%; border-collapse: collapse; text-align: center;"> <tr> <td style="width: 10%;"></td> <td style="width: 10%;"></td> <td style="width: 10%;"></td> <td style="width: 10%;"></td> <td style="width: 10%;"></td> <td style="width: 10%;"></td> <td style="width: 10%;"></td> <td style="width: 10%;"></td> <td style="width: 10%;"></td> <td style="width: 10%;"></td> </tr> <tr> <td></td> <td></td> <td colspan="8" style="text-align: center;"> <table border="1" style="width: 100%; border-collapse: collapse; text-align: center;"> <tr> <td style="width: 10%;"></td> <td style="width: 10%;"></td> <td style="width: 10%;"></td> <td style="width: 10%;"></td> <td
style="width: 10%;"></td> <td style="width: 10%;"></td> <td style="width: 10%;"></td> <td style="width: 10%;"></td> <td style="width: 10%;"></td> <td style="width: 10%;"></td> </tr> <tr> <td></td> <td></td> <td colspan="8" style="text-align: center;"> <table border="1" style="width: 100%; border-collapse: collapse; text-align: center;"> <tr> <td style="width: 10%;"></td> <td style="width: 10%;"></td> <td style="width: 10%;"></td> <td style="width: 10%;"></td> <td style="width: 10%;"></td> <td style="width: 10%;"></td> <td style="width: 10%;"></td> <td style="width: 10%;"></td> <td style="width: 10%;"></td> <td style="width: 10%;"></td> </tr> <tr> <td></td> <td></td> <td colspan="8" style="text-align: center;"> <table border="1" style="width: 100%; border-collapse: collapse; text-align: center;"> <tr> <td style="width: 10%;"></td> <td style="width: 10%;"></td> <td style="width: 10%;"></td> <td style="width: 10%;"></td> <td style="width: 10%;"></td> <td style="width: 10%;"></td> <td style="width: 10%;"></td> <td style="width: 10%;"></td> <td style="width: 10%;"></td> <td style="width: 10%;"></td> </tr> <tr> <td></td> <td></td> <td colspan="8" style="text-align: center;"> <table border="1" style="width: 100%; border-collapse: collapse; text-align: center;"> <tr> <td style="width: 10%;"></td> <td style="width: 10%;"></td> <td style="width: 10%;"></td> <td style="width: 10%;"></td> <td style="width: 10%;"></td> <td style="width: 10%;"></td> <td style="width: 10%;"></td> <td style="width: 10%;"></td> <td style="width: 10%;"></td> <td style="width: 10%;"></td> </tr> <tr> <td></td> <td></td> <td colspan="8" style="text-align: center;"> <table border="1" style="width: 100%; border-collapse: collapse; text-align: center;"> <tr> <td style="width: 10%;"></td> <td style="width: 10%;"></td> <td style="width: 10%;"></td> <td style="width: 10%;"></td> <td style="width: 10%;"></td> <td style="width: 10%;"></td> <td style="width: 10%;"></td> <td style="width: 10%;"></td> <td style="width: 10%;"></td> <td style="width: 10%;"></td> </tr> <tr> <td></td> <td></td> <td colspan="8" style="text-align: center;"> <table border="1" style="width: 100%; border-collapse: collapse; text-align: center;"> <tr> <td style="width: 10%;"></td> <td style="width: 10%;"></td> <td style="width: 10%;"></td> <td style="width: 10%;"></td> <td style="width: 10%;"></td> <td style="width: 10%;"></td> <td style="width: 10%;"></td> <td style="width: 10%;"></td> <td style="width: 10%;"></td> <td style="width: 10%;"></td> </tr> <tr> <td></td> <td></td> <td colspan="8" style="text-align: center;"> <table border="1" style="width: 100%; border-collapse: collapse; text-align: center;"> <tr> <td style="width: 10%;"></td> <td style="width: 10%;"></td> <td style="width: 10%;"></td> <td style="width: 10%;"></td> <td style="width: 10%;"></td> <td style="width: 10%;"></td> <td style="width: 10%;"></td> <td style="width: 10%;"></td> <td style="width: 10%;"></td> <td style="width: 10%;"></td> </tr> <tr> <td></td> <td></td> <td colspan="8" style="text-align: center;"> <table border="1" style="width: 100%; border-collapse: collapse; text-align: center;"> <tr> <td style="width: 10%;"></td> <td style="width: 10%;"></td> <td style="width: 10%;"></td> <td style="width: 10%;"></td> <td style="width: 10%;"></td> <td style="width: 10%;"></td> <td style="width: 10%;"></td> <td style="width: 10%;"></td> <td style="width: 10%;"></td> <td style="width: 10%;"></td> </tr> <tr> <td></td> <td></td> <td colspan="8" style="text-align: center;"> <table border="1" style="width: 100%; border-collapse: collapse; text-align: center;"> <tr> <td style="width: 10%;"></td> <td style="width: 10%;"></td> <td style="width: 10%;"></td> <td style="width: 10%;"></td> <td style="width: 10%;"></td> <td style="width: 10%;"></td> <td style="width: 10%;"></td> <td style="width: 10%;"></td> <td style="width: 10%;"></td> <td style="width: 10%;"></td> </tr> <tr> <td></td> <td></td> <td colspan="8" style="text-align: center;"> <table border="1" style="width: 100%; border-collapse: collapse; text-align: center;"> <tr> <td style="width: 10%;"></td> <td style="width: 10%;"></td> <td style="width: 10%;"></td> <td style="width: 10%;"></td> <td style="width: 10%;"></td> <td style="width: 10%;"></td> <td style="width: 10%;"></td> <td style="width: 10%;"></td> <td style="width: 10%;"></td> <td style="width: 10%;"></td> </tr> <tr> <td></td> <td></td> <td colspan="8" style="text-align: center;"> <table border="1" style="width: 100%; border-collapse: collapse; text-align: center;"> <tr> <td style="width: 10%;"></td> <td style="width: 10%;"></td> <td style="width: 10%;"></td> <td style="width: 10%;"></td> <td style="width: 10%;"></td> <td style="width: 10%;"></td> <td style="width: 10%;"></td> <td style="width: 10%;"></td> <td style="width: 10%;"></td> <td style="width: 10%;"></td> </tr> <tr> <td></td> <td></td> <td colspan="8" style="text-align: center;"> <table border="1" style="width: 100%; border-collapse: collapse; text-align: center;"> <tr> <td style="width: 10%;"></td> <td style="width: 10%;"></td> <td style="width: 10%;"></td> <td style="width: 10%;"></td> <td style="width: 10%;"></td> <td style="width: 10%;"></td> <td style="width: 10%;"></td> <td style="width: 10%;"></td> <td style="width: 10%;"></td> <td style="width: 10%;"></td> </tr> <tr> <td></td> <td></td> <td colspan="8" style="text-align: center;"> <table border="1" style="width: 100%; border-collapse: collapse; text-align: center;"> <tr> </tr></table></td></tr></table></td></tr></table></td></tr></table></td></tr></table></td></tr></table></td></tr></table></td></tr></table></td></tr></table></td></tr></table></td></tr></table></td></tr></table></td></tr></table></td></tr></table></td></tr></table></td></tr></table></td></tr></table></td></tr></table></td></tr></table></td></tr></table></td></tr></table></td></tr></table></td></tr></table></td></tr></table></td></tr></table></td></tr></table></td></tr></table></td></tr></table></td></tr></table></td></tr></table></td></tr></table></td></tr></table></td></tr></table></td></tr></table></td></tr></table></td></tr></table></td></tr></table></td></tr></table></td></tr></table></td></tr></table></td></tr></table>
 | | | | | | | | | | | | | | | | | | | | <table border="1" style="width: 100%; border-collapse: collapse; text-align: center;"> <tr> <td style="width: 10%;"></td> <td style="width: 10%;"></td> <td style="width: 10%;"></td> <td style="width: 10%;"></td> <td style="width: 10%;"></td> <td style="width: 10%;"></td> <td style="width: 10%;"></td> <td style="width: 10%;"></td> <td style="width: 10%;"></td> <td style="width: 10%;"></td> </tr> <tr> <td></td> <td></td> <td colspan="8" style="text-align: center;"> <table border="1" style="width: 100%; border-collapse: collapse; text-align: center;"> <tr> <td style="width: 10%;"></td> <td style="width: 10%;"></td> <td style="width: 10%;"></td> <td style="width: 10%;"></td> <td style="width: 10%;"></td> <td style="width: 10%;"></td> <td style="width: 10%;"></td> <td style="width: 10%;"></td> <td style="width: 10%;"></td> <td style="width: 10%;"></td> </tr> <tr> <td></td> <td></td> <td colspan="8" style="text-align: center;"> <table border="1" style="width: 100%; border-collapse: collapse; text-align: center;"> <tr> <td style="width: 10%;"></td> <td style="width: 10%;"></td> <td style="width: 10%;"></td> <td style="width: 10%;"></td> <td style="width: 10%;"></td> <td style="width: 10%;"></td> <td style="width: 10%;"></td> <td style="width: 10%;"></td> <td style="width: 10%;"></td> <td style="width: 10%;"></td> </tr> <tr> <td></td> <td></td> <td colspan="8" style="text-align: center;"> <table border="1" style="width: 100%; border-collapse: collapse; text-align: center;"> <tr> <td style="width: 10%;"></td> <td style="width: 10%;"></td> <td style="width: 10%;"></td> <td style="width: 10%;"></td> <td style="width: 10%;"></td> <td style="width: 10%;"></td> <td style="width: 10%;"></td> <td style="width: 10%;"></td> <td style="width: 10%;"></td> <td style="width: 10%;"></td> </tr> <tr> <td></td> <td></td> <td colspan="8" style="text-align: center;"> <table border="1" style="width: 100%; border-collapse: collapse; text-align: center;"> <tr> <td style="width: 10%;"></td> <td style="width: 10%;"></td> <td style="width: 10%;"></td> <td style="width: 10%;"></td> <td style="width: 10%;"></td> <td style="width: 10%;"></td> <td style="width: 10%;"></td> <td style="width: 10%;"></td> <td style="width: 10%;"></td> <td style="width: 10%;"></td> </tr> <tr> <td></td> <td></td> <td colspan="8" style="text-align: center;"> <table border="1" style="width: 100%; border-collapse: collapse; text-align: center;"> <tr> <td style="width: 10%;"></td> <td style="width: 10%;"></td> <td style="width: 10%;"></td> <td style="width: 10%;"></td> <td style="width: 10%;"></td> <td style="width: 10%;"></td> <td style="width: 10%;"></td> <td style="width: 10%;"></td> <td style="width: 10%;"></td> <td style="width: 10%;"></td> </tr> <tr> <td></td> <td></td> <td colspan="8" style="text-align: center;"> <table border="1" style="width: 100%; border-collapse: collapse; text-align: center;"> <tr> <td style="width: 10%;"></td> <td style="width: 10%;"></td> <td style="width: 10%;"></td> <td style="width: 10%;"></td> <td style="width: 10%;"></td> <td style="width: 10%;"></td> <td style="width: 10%;"></td> <td style="width: 10%;"></td> <td style="width: 10%;"></td> <td style="width: 10%;"></td> </tr> <tr> <td></td> <td></td> <td colspan="8" style="text-align: center;"> <table border="1" style="width: 100%; border-collapse: collapse; text-align: center;"> <tr> <td style="width: 10%;"></td> <td style="width: 10%;"></td> <td style="width: 10%;"></td> <td style="width: 10%;"></td> <td style="width: 10%;"></td> <td style="width: 10%;"></td> <td style="width: 10%;"></td> <td style="width: 10%;"></td> <td style="width: 10%;"></td> <td style="width: 10%;"></td> </tr> <tr> <td></td> <td></td> <td colspan="8" style="text-align: center;"> <table border="1" style="width: 100%; border-collapse: collapse; text-align: center;"> <tr> <td style="width: 10%;"></td> <td style="width: 10%;"></td> <td style="width: 10%;"></td> <td style="width: 10%;"></td> <td style="width: 10%;"></td> <td style="width: 10%;"></td> <td style="width: 10%;"></td> <td style="width: 10%;"></td> <td style="width: 10%;"></td> <td style="width: 10%;"></td> </tr> <tr> <td></td> <td></td> <td colspan="8" style="text-align: center;"> <table border="1" style="width: 100%; border-collapse: collapse; text-align: center;"> <tr> <td style="width: 10%;"></td> <td style="width: 10%;"></td> <td style="width: 10%;"></td> <td style="width: 10%;"></td> <td style="width: 10%;"></td> <td style="width: 10%;"></td> <td style="width: 10%;"></td> <td style="width: 10%;"></td> <td style="width: 10%;"></td> <td style="width: 10%;"></td> </tr> <tr> <td></td> <td></td> <td colspan="8" style="text-align: center;"> <table border="1" style="width: 100%; border-collapse: collapse; text-align: center;"> <tr> <td style="width: 10%;"></td> <td style="width: 10%;"></td> <td style="width: 10%;"></td> <td style="width: 10%;"></td> <td style="width: 10%;"></td> <td style="width: 10%;"></td> <td style="width: 10%;"></td> <td style="width: 10%;"></td> <td style="width: 10%;"></td> <td style="width: 10%;"></td> </tr> <tr> <td></td> <td></td> <td colspan="8" style="text-align: center;"> <table border="1" style="width: 100%; border-collapse: collapse; text-align: center;"> <tr> <td style="width: 10%;"></td> <td style="width: 10%;"></td> <td style="width: 10%;"></td> <td style="width: 10%;"></td> <td style="width: 10%;"></td> <td style="width: 10%;"></td> <td style="width: 10%;"></td> <td style="width: 10%;"></td> <td style="width: 10%;"></td> <td style="width: 10%;"></td> </tr> <tr> <td></td> <td></td> <td colspan="8" style="text-align: center;"> <table border="1" style="width: 100%; border-collapse: collapse; text-align: center;"> <tr> <td style="width: 10%;"></td> <td style="width: 10%;"></td> <td style="width: 10%;"></td> <td style="width: 10%;"></td> <td style="width: 10%;"></td> <td style="width: 10%;"></td> <td style="width: 10%;"></td> <td style="width:
10%;"></td> <td style="width: 10%;"></td> <td style="width: 10%;"></td> </tr> <tr> <td></td> <td></td> <td colspan="8" style="text-align: center;"> <table border="1" style="width: 100%; border-collapse: collapse; text-align: center;"> <tr> <td style="width: 10%;"></td> <td style="width: 10%;"></td> <td style="width: 10%;"></td> <td style="width: 10%;"></td> <td style="width: 10%;"></td> <td style="width: 10%;"></td> <td style="width: 10%;"></td> <td style="width: 10%;"></td> <td style="width: 10%;"></td> <td style="width: 10%;"></td> </tr> <tr> <td></td> <td></td> <td colspan="8" style="text-align: center;"> <table border="1" style="width: 100%; border-collapse: collapse; text-align: center;"> <tr> <td style="width: 10%;"></td> <td style="width: 10%;"></td> <td style="width: 10%;"></td> <td style="width: 10%;"></td> <td style="width: 10%;"></td> <td style="width: 10%;"></td> <td style="width: 10%;"></td> <td style="width: 10%;"></td> <td style="width: 10%;"></td> <td style="width: 10%;"></td> </tr> <tr> <td></td> <td></td> <td colspan="8" style="text-align: center;"> <table border="1" style="width: 100%; border-collapse: collapse; text-align: center;"> <tr> <td style="width: 10%;"></td> <td style="width: 10%;"></td> <td style="width: 10%;"></td> <td style="width: 10%;"></td> <td style="width: 10%;"></td> <td style="width: 10%;"></td> <td style="width: 10%;"></td> <td style="width: 10%;"></td> <td style="width: 10%;"></td> <td style="width: 10%;"></td> </tr> <tr> <td></td> <td></td> <td colspan="8" style="text-align: center;"> <table border="1" style="width: 100%; border-collapse: collapse; text-align: center;"> <tr> <td style="width: 10%;"></td> <td style="width: 10%;"></td> <td style="width: 10%;"></td> <td style="width: 10%;"></td> <td style="width: 10%;"></td> <td style="width: 10%;"></td> <td style="width: 10%;"></td> <td style="width: 10%;"></td> <td style="width: 10%;"></td> <td style="width: 10%;"></td> </tr> <tr> <td></td> <td></td> <td colspan="8" style="text-align: center;"> <table border="1" style="width: 100%; border-collapse: collapse; text-align: center;"> <tr> <td style="width: 10%;"></td> <td style="width: 10%;"></td> <td style="width: 10%;"></td> <td style="width: 10%;"></td> <td style="width: 10%;"></td> <td style="width: 10%;"></td> <td style="width: 10%;"></td> <td style="width: 10%;"></td> <td style="width: 10%;"></td> <td style="width: 10%;"></td> </tr> <tr> <td></td> <td></td> <td colspan="8" style="text-align: center;"> <table border="1" style="width: 100%; border-collapse: collapse; text-align: center;"> <tr> <td style="width: 10%;"></td> <td style="width: 10%;"></td> <td style="width: 10%;"></td> <td style="width: 10%;"></td> <td style="width: 10%;"></td> <td style="width: 10%;"></td> <td style="width: 10%;"></td> <td style="width: 10%;"></td> <td style="width: 10%;"></td> <td style="width: 10%;"></td> </tr> <tr> <td></td> <td></td> <td colspan="8" style="text-align: center;"> <table border="1" style="width: 100%; border-collapse: collapse; text-align: center;"> <tr> <td style="width: 10%;"></td> <td style="width: 10%;"></td> <td style="width: 10%;"></td> <td style="width: 10%;"></td> <td style="width: 10%;"></td> <td style="width: 10%;"></td> <td style="width: 10%;"></td> <td style="width: 10%;"></td> <td style="width: 10%;"></td> <td style="width: 10%;"></td> </tr> <tr> <td></td> <td></td> <td colspan="8" style="text-align: center;"> <table border="1" style="width: 100%; border-collapse: collapse; text-align: center;"> <tr> <td style="width: 10%;"></td> <td style="width: 10%;"></td> <td style="width: 10%;"></td> <td style="width: 10%;"></td> <td style="width: 10%;"></td> <td style="width: 10%;"></td> <td style="width: 10%;"></td> <td style="width: 10%;"></td> <td style="width: 10%;"></td> <td style="width: 10%;"></td> </tr> <tr> <td></td> <td></td> <td colspan="8" style="text-align: center;"> <table border="1" style="width: 100%; border-collapse: collapse; text-align: center;"> <tr> <td style="width: 10%;"></td> <td style="width: 10%;"></td> <td style="width: 10%;"></td> <td style="width: 10%;"></td> <td style="width: 10%;"></td> <td style="width: 10%;"></td> <td style="width: 10%;"></td> <td style="width: 10%;"></td> <td style="width: 10%;"></td> <td style="width: 10%;"></td> </tr> <tr> <td></td> <td></td> <td colspan="8" style="text-align: center;"> <table border="1" style="width: 100%; border-collapse: collapse; text-align: center;"> <tr> <td style="width: 10%;"></td> <td style="width: 10%;"></td> <td style="width: 10%;"></td> <td style="width: 10%;"></td> <td style="width: 10%;"></td> <td style="width: 10%;"></td> <td style="width: 10%;"></td> <td style="width: 10%;"></td> <td style="width: 10%;"></td> <td style="width: 10%;"></td> </tr> <tr> <td></td> <td></td> <td colspan="8" style="text-align: center;"> <table border="1" style="width: 100%; border-collapse: collapse; text-align: center;"> <tr> <td style="width: 10%;"></td> <td style="width: 10%;"></td> <td style="width: 10%;"></td> <td style="width: 10%;"></td> <td style="width: 10%;"></td> <td style="width: 10%;"></td> <td style="width: 10%;"></td> <td style="width: 10%;"></td> <td style="width: 10%;"></td> <td style="width: 10%;"></td> </tr> <tr> <td></td> <td></td> <td colspan="8" style="text-align: center;"> <table border="1" style="width: 100%; border-collapse: collapse; text-align: center;"> <tr> <td style="width: 10%;"></td> <td style="width: 10%;"></td> <td style="width: 10%;"></td> <td style="width: 10%;"></td> <td style="width: 10%;"></td> <td style="width: 10%;"></td> <td style="width: 10%;"></td> <td style="width: 10%;"></td> <td style="width: 10%;"></td> <td style="width: 10%;"></td> </tr> <tr> <td></td> <td></td> <td colspan="8" style="text-align: center;"> <table border="1" style="width: 100%; border-collapse: collapse; text-align: center;"> <tr> <td style="width: 10%;"></td> <td style="width: 10%;"></td> <td style="width: 10%;"></td> <td style="width: 10%;"></td> <td style="width: 10%;"></td> <td style="width: 10%;"></td> <td style="width: 10%;"></td> <td style="width: 10%;"></td> <td style="width: 10%;"></td> <td style="width: 10%;"></td> </tr> <tr> <td></td> <td></td> <td colspan="8" style="text-align: center;"> <table border="1" style="width: 100%; border-collapse: collapse; text-align: center;"> <tr> <td style="width: 10%;"></td> <td style="width: 10%;"></td> <td style="width: 10%;"></td> <td style="width: 10%;"></td> <td style="width: 10%;"></td> <td style="width: 10%;"></td> <td style="width: 10%;"></td> <td style="width: 10%;"></td> <td style="width: 10%;"></td> <td style="width: 10%;"></td> </tr> <tr> <td></td> <td></td> <td colspan="8" style="text-align: center;"> <table border="1" style="width: 100%; border-collapse: collapse; text-align: center;"> <tr> <td style="width: 10%;"></td> <td style="width: 10%;"></td> <td style="width: 10%;"></td> <td style="width: 10%;"></td> <td style="width: 10%;"></td> <td style="width: 10%;"></td> <td style="width: 10%;"></td> <td style="width: 10%;"></td> <td style="width: 10%;"></td> <td style="width: 10%;"></td> </tr> <tr> <td></td> <td></td> <td colspan="8" style="text-align: center;"> <table border="1" style="width: 100%; border-collapse: collapse; text-align: center;"> <tr> <td style="width: 10%;"></td> <td style="width: 10%;"></td> <td style="width: 10%;"></td> <td style="width: 10%;"></td> <td style="width: 10%;"></td> <td style="width: 10%;"></td> <td style="width: 10%;"></td> <td style="width: 10%;"></td> <td style="width: 10%;"></td> <td style="width: 10%;"></td> </tr> <tr> <td></td> <td></td> <td colspan="8" style="text-align: center;"> <table border="1" style="width: 100%; border-collapse: collapse; text-align: center;"> <tr> <td style="width: 10%;"></td> <td style="width: 10%;"></td> <td style="width: 10%;"></td> <td style="width: 10%;"></td> <td style="width: 10%;"></td> <td style="width: 10%;"></td> <td style="width: 10%;"></td> <td style="width: 10%;"></td> <td style="width: 10%;"></td> <td style="width: 10%;"></td> </tr> <tr> <td></td> <td></td> <td colspan="8" style="text-align: center;"> <table border="1" style="width: 100%; border-collapse: collapse; text-align: center;"> <tr> <td style="width: 10%;"></td> <td style="width: 10%;"></td> <td style="width: 10%;"></td> <td style="width: 10%;"></td> <td style="width: 10%;"></td> <td style="width: 10%;"></td> <td style="width: 10%;"></td> <td style="width: 10%;"></td> <td style="width: 10%;"></td> <td style="width: 10%;"></td> </tr> <tr> <td></td> <td></td> <td colspan="8" style="text-align: center;"> <table border="1" style="width: 100%; border-collapse: collapse; text-align: center;"> <tr> <td style="width: 10%;"></td> <td style="width: 10%;"></td> <td style="width: 10%;"></td> <td style="width: 10%;"></td> <td style="width: 10%;"></td> <td style="width: 10%;"></td> <td style="width: 10%;"></td> <td style="width: 10%;"></td> <td style="width: 10%;"></td> <td style="width: 10%;"></td> </tr> <tr> <td></td> <td></td> <td colspan="8" style="text-align: center;"> <table border="1" style="width: 100%; border-collapse: collapse; text-align: center;"> <tr> <td style="width: 10%;"></td> <td style="width: 10%;"></td> <td style="width: 10%;"></td> <td style="width: 10%;"></td> <td style="width: 10%;"></td> <td style="width: 10%;"></td> <td style="width: 10%;"></td> <td style="width: 10%;"></td> <td style="width: 10%;"></td> <td style="width: 10%;"></td> </tr> <tr> <td></td> <td></td> <td colspan="8" style="text-align: center;"> <table border="1" style="width: 100%; border-collapse: collapse; text-align: center;"> <tr> <td style="width: 10%;"></td> <td style="width: 10%;"></td> <td style="width: 10%;"></td> <td style="width: 10%;"></td> <td style="width: 10%;"></td> <td style="width: 10%;"></td> <td style="width: 10%;"></td> <td style="width: 10%;"></td> <td style="width: 10%;"></td> <td style="width: 10%;"></td> </tr> <tr> <td></td> <td></td> <td colspan="8" style="text-align: center;"> <table border="1"
style="width: 100%; border-collapse: collapse; text-align: center;"> <tr> <td style="width: 10%;"></td> <td style="width: 10%;"></td> <td style="width: 10%;"></td> <td style="width: 10%;"></td> <td style="width: 10%;"></td> <td style="width: 10%;"></td> <td style="width: 10%;"></td> <td style="width: 10%;"></td> <td style="width: 10%;"></td> <td style="width: 10%;"></td> </tr> <tr> <td></td> <td></td> <td colspan="8" style="text-align: center;"> <table border="1" style="width: 100%; border-collapse: collapse; text-align: center;"> <tr> <td style="width: 10%;"></td> <td style="width: 10%;"></td> <td style="width: 10%;"></td> <td style="width: 10%;"></td> <td style="width: 10%;"></td> <td style="width: 10%;"></td> <td style="width: 10%;"></td> <td style="width: 10%;"></td> <td style="width: 10%;"></td> <td style="width: 10%;"></td> </tr> <tr> <td></td> <td></td> <td colspan="8" style="text-align: center;"> <table border="1" style="width: 100%; border-collapse: collapse; text-align: center;"> <tr> <td style="width: 10%;"></td> <td style="width: 10%;"></td> <td style="width: 10%;"></td> <td style="width: 10%;"></td> <td style="width: 10%;"></td> <td style="width: 10%;"></td> <td style="width: 10%;"></td> <td style="width: 10%;"></td> <td style="width: 10%;"></td> <td style="width: 10%;"></td> </tr> <tr> <td></td> <td></td> <td colspan="8" style="text-align: center;"> <table border="1" style="width: 100%; border-collapse: collapse; text-align: center;"> <tr> <td style="width: 10%;"></td> <td style="width: 10%;"></td> <td style="width: 10%;"></td> <td style="width: 10%;"></td> <td style="width: 10%;"></td> <td style="width: 10%;"></td> <td style="width: 10%;"></td> <td style="width: 10%;"></td> <td style="width: 10%;"></td> <td style="width: 10%;"></td> </tr> <tr> <td></td> <td></td> <td colspan="8" style="text-align: center;"> <table border="1" style="width: 100%; border-collapse: collapse; text-align: center;"> <tr> <td style="width: 10%;"></td> <td style="width: 10%;"></td> <td style="width: 10%;"></td> <td style="width: 10%;"></td> <td style="width: 10%;"></td> <td style="width: 10%;"></td> <td style="width: 10%;"></td> <td style="width: 10%;"></td> <td style="width: 10%;"></td> <td style="width: 10%;"></td> </tr> <tr> <td></td> <td></td> <td colspan="8" style="text-align: center;"> <table border="1" style="width: 100%; border-collapse: collapse; text-align: center;"> <tr> </tr></table></td></tr></table></td></tr></table></td></tr></table></td></tr></table></td></tr></table></td></tr></table></td></tr></table></td></tr></table></td></tr></table></td></tr></table></td></tr></table></td></tr></table></td></tr></table></td></tr></table></td></tr></table></td></tr></table></td></tr></table></td></tr></table></td></tr></table></td></tr></table></td></tr></table></td></tr></table></td></tr></table></td></tr></table></td></tr></table></td></tr></table></td></tr></table></td></tr></table></td></tr></table></td></tr></table></td></tr></table></td></tr></table></td></tr></table></td></tr></table></td></tr></table></td></tr></table></td></tr></table></td></tr></table></td></tr></table>
 | | | | | | | | | | | | | | | | | | | | <table border="1" style="width: 100%; border-collapse: collapse; text-align: center;"> <tr> <td style="width: 10%;"></td> <td style="width: 10%;"></td> <td style="width: 10%;"></td> <td style="width: 10%;"></td> <td style="width: 10%;"></td> <td style="width: 10%;"></td> <td style="width: 10%;"></td> <td style="width: 10%;"></td> <td style="width: 10%;"></td> <td style="width: 10%;"></td> </tr> <tr> <td></td> <td></td> <td colspan="8" style="text-align: center;"> <table border="1" style="width: 100%; border-collapse: collapse; text-align: center;"> <tr> <td style="width: 10%;"></td> <td style="width: 10%;"></td> <td style="width: 10%;"></td> <td style="width: 10%;"></td> <td style="width: 10%;"></td> <td style="width: 10%;"></td> <td style="width: 10%;"></td> <td style="width: 10%;"></td> <td style="width: 10%;"></td> <td style="width: 10%;"></td> </tr> <tr> <td></td> <td></td> <td colspan="8" style="text-align: center;"> <table border="1" style="width: 100%; border-collapse: collapse; text-align: center;"> <tr> <td style="width: 10%;"></td> <td style="width: 10%;"></td> <td style="width: 10%;"></td> <td style="width: 10%;"></td> <td style="width: 10%;"></td> <td style="width: 10%;"></td> <td style="width: 10%;"></td> <td style="width: 10%;"></td> <td style="width: 10%;"></td> <td style="width: 10%;"></td> </tr> <tr> <td></td> <td></td> <td colspan="8" style="text-align: center;"> <table border="1" style="width: 100%; border-collapse: collapse; text-align: center;"> <tr> <td style="width: 10%;"></td> <td style="width: 10%;"></td> <td style="width: 10%;"></td> <td style="width: 10%;"></td> <td style="width: 10%;"></td> <td style="width: 10%;"></td> <td style="width: 10%;"></td> <td style="width: 10%;"></td> <td style="width: 10%;"></td> <td style="width: 10%;"></td> </tr> <tr> <td></td> <td></td> <td colspan="8" style="text-align: center;"> <table border="1" style="width: 100%; border-collapse: collapse; text-align: center;"> <tr> <td style="width: 10%;"></td> <td style="width: 10%;"></td> <td style="width: 10%;"></td> <td style="width: 10%;"></td> <td style="width: 10%;"></td> <td style="width: 10%;"></td> <td style="width: 10%;"></td> <td style="width: 10%;"></td> <td style="width: 10%;"></td> <td style="width: 10%;"></td> </tr> <tr> <td></td> <td></td> <td colspan="8" style="text-align: center;"> <table border="1" style="width: 100%; border-collapse: collapse; text-align: center;"> <tr> <td style="width: 10%;"></td> <td style="width: 10%;"></td> <td style="width: 10%;"></td> <td style="width: 10%;"></td> <td style="width: 10%;"></td> <td style="width: 10%;"></td> <td style="width: 10%;"></td> <td style="width: 10%;"></td> <td style="width: 10%;"></td> <td style="width: 10%;"></td> </tr> <tr> <td></td> <td></td> <td colspan="8" style="text-align: center;"> <table border="1" style="width: 100%; border-collapse: collapse; text-align: center;"> <tr> <td style="width: 10%;"></td> <td style="width: 10%;"></td> <td style="width: 10%;"></td> <td style="width: 10%;"></td> <td style="width: 10%;"></td> <td style="width: 10%;"></td> <td style="width: 10%;"></td> <td style="width: 10%;"></td> <td style="width: 10%;"></td> <td style="width: 10%;"></td> </tr> <tr> <td></td> <td></td> <td colspan="8" style="text-align: center;"> <table border="1" style="width: 100%; border-collapse: collapse; text-align: center;"> <tr> <td style="width: 10%;"></td> <td style="width: 10%;"></td> <td style="width: 10%;"></td> <td style="width: 10%;"></td> <td style="width: 10%;"></td> <td style="width: 10%;"></td> <td style="width: 10%;"></td> <td style="width: 10%;"></td> <td style="width: 10%;"></td> <td style="width: 10%;"></td> </tr> <tr> <td></td> <td></td> <td colspan="8" style="text-align: center;"> <table border="1" style="width: 100%; border-collapse: collapse; text-align: center;"> <tr> <td style="width: 10%;"></td> <td style="width: 10%;"></td> <td style="width: 10%;"></td> <td style="width: 10%;"></td> <td style="width: 10%;"></td> <td style="width: 10%;"></td> <td style="width: 10%;"></td> <td style="width: 10%;"></td> <td style="width: 10%;"></td> <td style="width: 10%;"></td> </tr> <tr> <td></td> <td></td> <td colspan="8" style="text-align: center;"> <table border="1" style="width: 100%; border-collapse: collapse; text-align: center;"> <tr> <td style="width: 10%;"></td> <td style="width: 10%;"></td> <td style="width: 10%;"></td> <td style="width: 10%;"></td> <td style="width: 10%;"></td> <td style="width: 10%;"></td> <td style="width: 10%;"></td> <td style="width: 10%;"></td> <td style="width: 10%;"></td> <td style="width: 10%;"></td> </tr> <tr> <td></td> <td></td> <td colspan="8" style="text-align: center;"> <table border="1" style="width: 100%; border-collapse: collapse; text-align: center;"> <tr> <td style="width: 10%;"></td> <td style="width: 10%;"></td> <td style="width: 10%;"></td> <td style="width: 10%;"></td> <td style="width: 10%;"></td> <td style="width: 10%;"></td> <td style="width: 10%;"></td> <td style="width: 10%;"></td> <td style="width: 10%;"></td> <td style="width: 10%;"></td> </tr> <tr> <td></td> <td></td> <td colspan="8" style="text-align: center;"> <table border="1" style="width: 100%; border-collapse: collapse; text-align: center;"> <tr> <td style="width: 10%;"></td> <td style="width: 10%;"></td> <td style="width: 10%;"></td> <td style="width: 10%;"></td> <td style="width: 10%;"></td> <td style="width: 10%;"></td> <td style="width: 10%;"></td> <td style="width: 10%;"></td> <td style="width: 10%;"></td> <td style="width: 10%;"></td> </tr> <tr> <td></td> <td></td> <td colspan="8" style="text-align: center;"> <table border="1" style="width: 100%; border-collapse: collapse; text-align: center;"> <tr> <td style="width: 10%;"></td> <td style="width: 10%;"></td> <td style="width: 10%;"></td> <td style="width: 10%;"></td> <td style="width: 10%;"></td> <td style="width: 10%;"></td> <td style="width: 10%;"></td> <td style="width: 10%;"></td> <td style="width: 10%;"></td> <td style="width: 10%;"></td> </tr> <tr> <td></td> <td></td> <td colspan="8" style="text-align: center;"> <table border="1" style="width: 100%; border-collapse: collapse; text-align: center;"> <tr> <td style="width: 10%;"></td> <td style="width: 10%;"></td> <td style="width: 10%;"></td> <td style="width: 10%;"></td> <td style="width: 10%;"></td> <td style="width: 10%;"></td> <td style="width: 10%;"></td> <td style="width: 10%;"></td> <td style="width: 10%;"></td> <td style="width: 10%;"></td> </tr> <tr> <td></td> <td></td> <td colspan="8" style="text-align: center;"> <table border="1" style="width: 100%; border-collapse: collapse; text-align: center;"> <tr> <td style="width: 10%;"></td> <td style="width: 10%;"></td> <td style="width: 10%;"></td> <td style="width: 10%;"></td> <td style="width: 10%;"></td> <td style="width: 10%;"></td> <td style="width: 10%;"></td> <td style="width: 10%;"></td> <td style="width: 10%;"></td> <td style="width: 10%;"></td> </tr> <tr> <td></td> <td></td> <td colspan="8" style="text-align: center;"> <table border="1" style="width: 100%; border-collapse: collapse; text-align: center;"> <tr> <td style="width: 10%;"></td> <td style="width: 10%;"></td> <td style="width: 10%;"></td> <td style="width: 10%;"></td> <td style="width: 10%;"></td> <td style="width: 10%;"></td> <td style="width: 10%;"></td> <td style="width: 10%;"></td> <td style="width: 10%;"></td> <td style="width: 10%;"></td> </tr> <tr> <td></td> <td></td> <td colspan="8" style="text-align: center;"> <table border="1" style="width: 100%; border-collapse: collapse; text-align: center;"> <tr> <td style="width: 10%;"></td> <td style="width: 10%;"></td> <td style="width: 10%;"></td> <td style="width: 10%;"></td> <td style="width: 10%;"></td> <td style="width: 10%;"></td> <td style="width: 10%;"></td> <td style="width: 10%;"></td> <td style="width: 10%;"></td> <td style="width: 10%;"></td> </tr> <tr> <td></td> <td></td> <td colspan="8" style="text-align: center;"> <table border="1" style="width: 100%; border-collapse: collapse; text-align: center;"> <tr> <td style="width: 10%;"></td> <td style="width: 10%;"></td> <td style="width: 10%;"></td> <td style="width: 10%;"></td> <td style="width: 10%;"></td> <td style="width: 10%;"></td> <td style="width: 10%;"></td> <td style="width: 10%;"></td> <td style="width: 10%;"></td> <td style="width: 10%;"></td> </tr> <tr> <td></td> <td></td> <td colspan="8" style="text-align: center;"> <table border="1" style="width: 100%; border-collapse: collapse; text-align: center;"> <tr> <td style="width: 10%;"></td> <td style="width: 10%;"></td> <td style="width: 10%;"></td> <td style="width: 10%;"></td> <td style="width: 10%;"></td> <td style="width: 10%;"></td> <td style="width: 10%;"></td> <td style="width: 10%;"></td> <td style="width: 10%;"></td> <td style="width: 10%;"></td> </tr> <tr> <td></td> <td></td> <td colspan="8" style="text-align: center;"> <table border="1" style="width: 100%; border-collapse: collapse; text-align: center;"> <tr> <td style="width: 10%;"></td> <td style="width:
10%;"></td> <td style="width: 10%;"></td> <td style="width: 10%;"></td> <td style="width: 10%;"></td> <td style="width: 10%;"></td> <td style="width: 10%;"></td> <td style="width: 10%;"></td> <td style="width: 10%;"></td> <td style="width: 10%;"></td> </tr> <tr> <td></td> <td></td> <td colspan="8" style="text-align: center;"> <table border="1" style="width: 100%; border-collapse: collapse; text-align: center;"> <tr> <td style="width: 10%;"></td> <td style="width: 10%;"></td> <td style="width: 10%;"></td> <td style="width: 10%;"></td> <td style="width: 10%;"></td> <td style="width: 10%;"></td> <td style="width: 10%;"></td> <td style="width: 10%;"></td> <td style="width: 10%;"></td> <td style="width: 10%;"></td> </tr> <tr> <td></td> <td></td> <td colspan="8" style="text-align: center;"> <table border="1" style="width: 100%; border-collapse: collapse; text-align: center;"> <tr> <td style="width: 10%;"></td> <td style="width: 10%;"></td> <td style="width: 10%;"></td> <td style="width: 10%;"></td> <td style="width: 10%;"></td> <td style="width: 10%;"></td> <td style="width: 10%;"></td> <td style="width: 10%;"></td> <td style="width: 10%;"></td> <td style="width: 10%;"></td> </tr> <tr> <td></td> <td></td> <td colspan="8" style="text-align: center;"> <table border="1" style="width: 100%; border-collapse: collapse; text-align: center;"> <tr> <td style="width: 10%;"></td> <td style="width: 10%;"></td> <td style="width: 10%;"></td> <td style="width: 10%;"></td> <td style="width: 10%;"></td> <td style="width: 10%;"></td> <td style="width: 10%;"></td> <td style="width: 10%;"></td> <td style="width: 10%;"></td> <td style="width: 10%;"></td> </tr> <tr> <td></td> <td></td> <td colspan="8" style="text-align: center;"> <table border="1" style="width: 100%; border-collapse: collapse; text-align: center;"> <tr> <td style="width: 10%;"></td> <td style="width: 10%;"></td> <td style="width: 10%;"></td> <td style="width: 10%;"></td> <td style="width: 10%;"></td> <td style="width: 10%;"></td> <td style="width: 10%;"></td> <td style="width: 10%;"></td> <td style="width: 10%;"></td> <td style="width: 10%;"></td> </tr> <tr> <td></td> <td></td> <td colspan="8" style="text-align: center;"> <table border="1" style="width: 100%; border-collapse: collapse; text-align: center;"> <tr> <td style="width: 10%;"></td> <td style="width: 10%;"></td> <td style="width: 10%;"></td> <td style="width: 10%;"></td> <td style="width: 10%;"></td> <td style="width: 10%;"></td> <td style="width: 10%;"></td> <td style="width: 10%;"></td> <td style="width: 10%;"></td> <td style="width: 10%;"></td> </tr> <tr> <td></td> <td></td> <td colspan="8" style="text-align: center;"> <table border="1" style="width: 100%; border-collapse: collapse; text-align: center;"> <tr> <td style="width: 10%;"></td> <td style="width: 10%;"></td> <td style="width: 10%;"></td> <td style="width: 10%;"></td> <td style="width: 10%;"></td> <td style="width: 10%;"></td> <td style="width: 10%;"></td> <td style="width: 10%;"></td> <td style="width: 10%;"></td> <td style="width: 10%;"></td> </tr> <tr> <td></td> <td></td> <td colspan="8" style="text-align: center;"> <table border="1" style="width: 100%; border-collapse: collapse; text-align: center;"> <tr> <td style="width: 10%;"></td> <td style="width: 10%;"></td> <td style="width: 10%;"></td> <td style="width: 10%;"></td> <td style="width: 10%;"></td> <td style="width: 10%;"></td> <td style="width: 10%;"></td> <td style="width: 10%;"></td> <td style="width: 10%;"></td> <td style="width: 10%;"></td> </tr> <tr> <td></td> <td></td> <td colspan="8" style="text-align: center;"> <table border="1" style="width: 100%; border-collapse: collapse; text-align: center;"> <tr> <td style="width: 10%;"></td> <td style="width: 10%;"></td> <td style="width: 10%;"></td> <td style="width: 10%;"></td> <td style="width: 10%;"></td> <td style="width: 10%;"></td> <td style="width: 10%;"></td> <td style="width: 10%;"></td> <td style="width: 10%;"></td> <td style="width: 10%;"></td> </tr> <tr> <td></td> <td></td> <td colspan="8" style="text-align: center;"> <table border="1" style="width: 100%; border-collapse: collapse; text-align: center;"> <tr> <td style="width: 10%;"></td> <td style="width: 10%;"></td> <td style="width: 10%;"></td> <td style="width: 10%;"></td> <td style="width: 10%;"></td> <td style="width: 10%;"></td> <td style="width: 10%;"></td> <td style="width: 10%;"></td> <td style="width: 10%;"></td> <td style="width: 10%;"></td> </tr> <tr> <td></td> <td></td> <td colspan="8" style="text-align: center;"> <table border="1" style="width: 100%; border-collapse: collapse; text-align: center;"> <tr> <td style="width: 10%;"></td> <td style="width: 10%;"></td> <td style="width: 10%;"></td> <td style="width: 10%;"></td> <td style="width: 10%;"></td> <td style="width: 10%;"></td> <td style="width: 10%;"></td> <td style="width: 10%;"></td> <td style="width: 10%;"></td> <td style="width: 10%;"></td> </tr> <tr> <td></td> <td></td> <td colspan="8" style="text-align: center;"> <table border="1" style="width: 100%; border-collapse: collapse; text-align: center;"> <tr> <td style="width: 10%;"></td> <td style="width: 10%;"></td> <td style="width: 10%;"></td> <td style="width: 10%;"></td> <td style="width: 10%;"></td> <td style="width: 10%;"></td> <td style="width: 10%;"></td> <td style="width: 10%;"></td> <td style="width: 10%;"></td> <td style="width: 10%;"></td> </tr> <tr> <td></td> <td></td> <td colspan="8" style="text-align: center;"> <table border="1" style="width: 100%; border-collapse: collapse; text-align: center;"> <tr> <td style="width: 10%;"></td> <td style="width: 10%;"></td> <td style="width: 10%;"></td> <td style="width: 10%;"></td> <td style="width: 10%;"></td> <td style="width: 10%;"></td> <td style="width: 10%;"></td> <td style="width: 10%;"></td> <td style="width: 10%;"></td> <td style="width: 10%;"></td> </tr> <tr> <td></td> <td></td> <td colspan="8" style="text-align: center;"> <table border="1" style="width: 100%; border-collapse: collapse; text-align: center;"> <tr> <td style="width: 10%;"></td> <td style="width: 10%;"></td> <td style="width: 10%;"></td> <td style="width: 10%;"></td> <td style="width: 10%;"></td> <td style="width: 10%;"></td> <td style="width: 10%;"></td> <td style="width: 10%;"></td> <td style="width: 10%;"></td> <td style="width: 10%;"></td> </tr> <tr> <td></td> <td></td> <td colspan="8" style="text-align: center;"> <table border="1" style="width: 100%; border-collapse: collapse; text-align: center;"> <tr> <td style="width: 10%;"></td> <td style="width: 10%;"></td> <td style="width: 10%;"></td> <td style="width: 10%;"></td> <td style="width: 10%;"></td> <td style="width: 10%;"></td> <td style="width: 10%;"></td> <td style="width: 10%;"></td> <td style="width: 10%;"></td> <td style="width: 10%;"></td> </tr> <tr> <td></td> <td></td> <td colspan="8" style="text-align: center;"> <table border="1" style="width: 100%; border-collapse: collapse; text-align: center;"> <tr> <td style="width: 10%;"></td> <td style="width: 10%;"></td> <td style="width: 10%;"></td> <td style="width: 10%;"></td> <td style="width: 10%;"></td> <td style="width: 10%;"></td> <td style="width: 10%;"></td> <td style="width: 10%;"></td> <td style="width: 10%;"></td> <td style="width: 10%;"></td> </tr> <tr> <td></td> <td></td> <td colspan="8" style="text-align: center;"> <table border="1" style="width: 100%; border-collapse: collapse; text-align: center;"> <tr> <td style="width: 10%;"></td> <td style="width: 10%;"></td> <td style="width: 10%;"></td> <td style="width: 10%;"></td> <td style="width: 10%;"></td> <td style="width: 10%;"></td> <td style="width: 10%;"></td> <td style="width: 10%;"></td> <td style="width: 10%;"></td> <td style="width: 10%;"></td> </tr> <tr> <td></td> <td></td> <td colspan="8" style="text-align: center;"> <table border="1" style="width: 100%; border-collapse: collapse; text-align: center;"> <tr> <td style="width: 10%;"></td> <td style="width: 10%;"></td> <td style="width: 10%;"></td> <td style="width: 10%;"></td> <td style="width: 10%;"></td> <td style="width: 10%;"></td> <td style="width: 10%;"></td> <td style="width: 10%;"></td> <td style="width: 10%;"></td> <td style="width: 10%;"></td> </tr> <tr> <td></td> <td></td> <td colspan="8" style="text-align: center;"> <table border="1" style="width: 100%; border-collapse: collapse; text-align: center;"> <tr> <td style="width: 10%;"></td> <td style="width: 10%;"></td> <td style="width: 10%;"></td> <td style="width: 10%;"></td> <td style="width: 10%;"></td> <td style="width: 10%;"></td> <td style="width: 10%;"></td> <td style="width: 10%;"></td> <td style="width: 10%;"></td> <td style="width: 10%;"></td> </tr> <tr> <td></td> <td></td> <td colspan="8" style="text-align: center;"> <table border="1" style="width: 100%; border-collapse: collapse; text-align: center;"> <tr> </tr></table></td></tr></table></td></tr></table></td></tr></table></td></tr></table></td></tr></table></td></tr></table></td></tr></table></td></tr></table></td></tr></table></td></tr></table></td></tr></table></td></tr></table></td></tr></table></td></tr></table></td></tr></table></td></tr></table></td></tr></table></td></tr></table></td></tr></table></td></tr></table></td></tr></table></td></tr></table></td></tr></table></td></tr></table></td></tr></table></td></tr></table></td></tr></table></td></tr></table></td></tr></table></td></tr></table></td></tr></table></td></tr></table></td></tr></table></td></tr></table></td></tr></table></td></tr></table></td></tr></table></td></tr></table>
 | | | | | | | | | | | | | | | | | | | | <table border="1" style="width: 100%; border-collapse: collapse; text-align: center;"> <tr> <td style="width: 10%;"></td> <td style="width: 10%;"></td> <td style="width: 10%;"></td> <td style="width: 10%;"></td> <td style="width: 10%;"></td> <td style="width: 10%;"></td> <td style="width: 10%;"></td> <td style="width: 10%;"></td> <td style="width: 10%;"></td> <td style="width: 10%;"></td> </tr> <tr> <td></td> <td></td> <td colspan="8" style="text-align: center;"> <table border="1" style="width: 100%; border-collapse: collapse; text-align: center;"> <tr> <td style="width: 10%;"></td> <td style="width: 10%;"></td> <td style="width: 10%;"></td> <td style="width: 10%;"></td> <td style="width: 10%;"></td> <td style="width: 10%;"></td> <td style="width: 10%;"></td> <td style="width: 10%;"></td> <td style="width: 10%;"></td> <td style="width: 10%;"></td> </tr> <tr> <td></td> <td></td> <td colspan="8" style="text-align: center;"> <table border="1" style="width: 100%; border-collapse: collapse; text-align: center;"> <tr> <td style="width: 10%;"></td> <td style="width: 10%;"></td> <td style="width: 10%;"></td> <td style="width: 10%;"></td> <td style="width: 10%;"></td> <td style="width: 10%;"></td> <td style="width: 10%;"></td> <td style="width: 10%;"></td> <td style="width: 10%;"></td> <td style="width: 10%;"></td> </tr> <tr> <td></td> <td></td> <td colspan="8" style="text-align: center;"> <table border="1" style="width: 100%; border-collapse: collapse; text-align: center;"> <tr> <td style="width: 10%;"></td> <td style="width: 10%;"></td> <td style="width: 10%;"></td> <td style="width: 10%;"></td> <td style="width: 10%;"></td> <td style="width: 10%;"></td> <td style="width: 10%;"></td> <td style="width: 10%;"></td> <td style="width: 10%;"></td> <td style="width: 10%;"></td> </tr> <tr> <td></td> <td></td> <td colspan="8" style="text-align: center;"> <table border="1" style="width: 100%; border-collapse: collapse; text-align: center;"> <tr> <td style="width: 10%;"></td> <td style="width: 10%;"></td> <td style="width: 10%;"></td> <td style="width: 10%;"></td> <td style="width: 10%;"></td> <td style="width: 10%;"></td> <td style="width: 10%;"></td> <td style="width: 10%;"></td> <td style="width: 10%;"></td> <td style="width: 10%;"></td> </tr> <tr> <td></td> <td></td> <td colspan="8" style="text-align: center;"> <table border="1" style="width: 100%; border-collapse: collapse; text-align: center;"> <tr> <td style="width: 10%;"></td> <td style="width: 10%;"></td> <td style="width: 10%;"></td> <td style="width: 10%;"></td> <td style="width: 10%;"></td> <td style="width: 10%;"></td> <td
style="width: 10%;"></td> <td style="width: 10%;"></td> <td style="width: 10%;"></td> <td style="width: 10%;"></td> </tr> <tr> <td></td> <td></td> <td colspan="8" style="text-align: center;"> <table border="1" style="width: 100%; border-collapse: collapse; text-align: center;"> <tr> <td style="width: 10%;"></td> <td style="width: 10%;"></td> <td style="width: 10%;"></td> <td style="width: 10%;"></td> <td style="width: 10%;"></td> <td style="width: 10%;"></td> <td style="width: 10%;"></td> <td style="width: 10%;"></td> <td style="width: 10%;"></td> <td style="width: 10%;"></td> </tr> <tr> <td></td> <td></td> <td colspan="8" style="text-align: center;"> <table border="1" style="width: 100%; border-collapse: collapse; text-align: center;"> <tr> <td style="width: 10%;"></td> <td style="width: 10%;"></td> <td style="width: 10%;"></td> <td style="width: 10%;"></td> <td style="width: 10%;"></td> <td style="width: 10%;"></td> <td style="width: 10%;"></td> <td style="width: 10%;"></td> <td style="width: 10%;"></td> <td style="width: 10%;"></td> </tr> <tr> <td></td> <td></td> <td colspan="8" style="text-align: center;"> <table border="1" style="width: 100%; border-collapse: collapse; text-align: center;"> <tr> <td style="width: 10%;"></td> <td style="width: 10%;"></td> <td style="width: 10%;"></td> <td style="width: 10%;"></td> <td style="width: 10%;"></td> <td style="width: 10%;"></td> <td style="width: 10%;"></td> <td style="width: 10%;"></td> <td style="width: 10%;"></td> <td style="width: 10%;"></td> </tr> <tr> <td></td> <td></td> <td colspan="8" style="text-align: center;"> <table border="1" style="width: 100%; border-collapse: collapse; text-align: center;"> <tr> <td style="width: 10%;"></td> <td style="width: 10%;"></td> <td style="width: 10%;"></td> <td style="width: 10%;"></td> <td style="width: 10%;"></td> <td style="width: 10%;"></td> <td style="width: 10%;"></td> <td style="width: 10%;"></td> <td style="width: 10%;"></td> <td style="width: 10%;"></td> </tr> <tr> <td></td> <td></td> <td colspan="8" style="text-align: center;"> <table border="1" style="width: 100%; border-collapse: collapse; text-align: center;"> <tr> <td style="width: 10%;"></td> <td style="width: 10%;"></td> <td style="width: 10%;"></td> <td style="width: 10%;"></td> <td style="width: 10%;"></td> <td style="width: 10%;"></td> <td style="width: 10%;"></td> <td style="width: 10%;"></td> <td style="width: 10%;"></td> <td style="width: 10%;"></td> </tr> <tr> <td></td> <td></td> <td colspan="8" style="text-align: center;"> <table border="1" style="width: 100%; border-collapse: collapse; text-align: center;"> <tr> <td style="width: 10%;"></td> <td style="width: 10%;"></td> <td style="width: 10%;"></td> <td style="width: 10%;"></td> <td style="width: 10%;"></td> <td style="width: 10%;"></td> <td style="width: 10%;"></td> <td style="width: 10%;"></td> <td style="width: 10%;"></td> <td style="width: 10%;"></td> </tr> <tr> <td></td> <td></td> <td colspan="8" style="text-align: center;"> <table border="1" style="width: 100%; border-collapse: collapse; text-align: center;"> <tr> <td style="width: 10%;"></td> <td style="width: 10%;"></td> <td style="width: 10%;"></td> <td style="width: 10%;"></td> <td style="width: 10%;"></td> <td style="width: 10%;"></td> <td style="width: 10%;"></td> <td style="width: 10%;"></td> <td style="width: 10%;"></td> <td style="width: 10%;"></td> </tr> <tr> <td></td> <td></td> <td colspan="8" style="text-align: center;"> <table border="1" style="width: 100%; border-collapse: collapse; text-align: center;"> <tr> <td style="width: 10%;"></td> <td style="width: 10%;"></td> <td style="width: 10%;"></td> <td style="width: 10%;"></td> <td style="width: 10%;"></td> <td style="width: 10%;"></td> <td style="width: 10%;"></td> <td style="width: 10%;"></td> <td style="width: 10%;"></td> <td style="width: 10%;"></td> </tr> <tr> <td></td> <td></td> <td colspan="8" style="text-align: center;"> <table border="1" style="width: 100%; border-collapse: collapse; text-align: center;"> <tr> <td style="width: 10%;"></td> <td style="width: 10%;"></td> <td style="width: 10%;"></td> <td style="width: 10%;"></td> <td style="width: 10%;"></td> <td style="width: 10%;"></td> <td style="width: 10%;"></td> <td style="width: 10%;"></td> <td style="width: 10%;"></td> <td style="width: 10%;"></td> </tr> <tr> <td></td> <td></td> <td colspan="8" style="text-align: center;"> <table border="1" style="width: 100%; border-collapse: collapse; text-align: center;"> <tr> <td style="width: 10%;"></td> <td style="width: 10%;"></td> <td style="width: 10%;"></td> <td style="width: 10%;"></td> <td style="width: 10%;"></td> <td style="width: 10%;"></td> <td style="width: 10%;"></td> <td style="width: 10%;"></td> <td style="width: 10%;"></td> <td style="width: 10%;"></td> </tr> <tr> <td></td> <td></td> <td colspan="8" style="text-align: center;"> <table border="1" style="width: 100%; border-collapse: collapse; text-align: center;"> <tr> <td style="width: 10%;"></td> <td style="width: 10%;"></td> <td style="width: 10%;"></td> <td style="width: 10%;"></td> <td style="width: 10%;"></td> <td style="width: 10%;"></td> <td style="width: 10%;"></td> <td style="width: 10%;"></td> <td style="width: 10%;"></td> <td style="width: 10%;"></td> </tr> <tr> <td></td> <td></td> <td colspan="8" style="text-align: center;"> <table border="1" style="width: 100%; border-collapse: collapse; text-align: center;"> <tr> <td style="width: 10%;"></td> <td style="width: 10%;"></td> <td style="width: 10%;"></td> <td style="width: 10%;"></td> <td style="width: 10%;"></td> <td style="width: 10%;"></td> <td style="width: 10%;"></td> <td style="width: 10%;"></td> <td style="width: 10%;"></td> <td style="width: 10%;"></td> </tr> <tr> <td></td> <td></td> <td colspan="8" style="text-align: center;"> <table border="1" style="width: 100%; border-collapse: collapse; text-align: center;"> <tr> <td style="width: 10%;"></td> <td style="width: 10%;"></td> <td style="width: 10%;"></td> <td style="width: 10%;"></td> <td style="width: 10%;"></td> <td style="width: 10%;"></td> <td style="width: 10%;"></td> <td style="width: 10%;"></td> <td style="width: 10%;"></td> <td style="width: 10%;"></td> </tr> <tr> <td></td> <td></td> <td colspan="8" style="text-align: center;"> <table border="1" style="width: 100%; border-collapse: collapse; text-align: center;"> <tr> <td style="width: 10%;"></td> <td style="width: 10%;"></td> <td style="width: 10%;"></td> <td style="width: 10%;"></td> <td style="width: 10%;"></td> <td style="width: 10%;"></td> <td style="width: 10%;"></td> <td style="width: 10%;"></td> <td style="width: 10%;"></td> <td style="width: 10%;"></td> </tr> <tr> <td></td> <td></td> <td colspan="8" style="text-align: center;"> <table border="1" style="width: 100%; border-collapse: collapse; text-align: center;"> <tr> <td style="width: 10%;"></td> <td style="width: 10%;"></td> <td style="width: 10%;"></td> <td style="width: 10%;"></td> <td style="width: 10%;"></td> <td style="width: 10%;"></td> <td style="width: 10%;"></td> <td style="width: 10%;"></td> <td style="width: 10%;"></td> <td style="width: 10%;"></td> </tr> <tr> <td></td> <td></td> <td colspan="8" style="text-align: center;"> <table border="1" style="width: 100%; border-collapse: collapse; text-align: center;"> <tr> <td style="width: 10%;"></td> <td style="width: 10%;"></td> <td style="width: 10%;"></td> <td style="width: 10%;"></td> <td style="width: 10%;"></td> <td style="width: 10%;"></td> <td style="width: 10%;"></td> <td style="width: 10%;"></td> <td style="width: 10%;"></td> <td style="width: 10%;"></td> </tr> <tr> <td></td> <td></td> <td colspan="8" style="text-align: center;"> <table border="1" style="width: 100%; border-collapse: collapse; text-align: center;"> <tr> <td style="width: 10%;"></td> <td style="width: 10%;"></td> <td style="width: 10%;"></td> <td style="width: 10%;"></td> <td style="width: 10%;"></td> <td style="width: 10%;"></td> <td style="width: 10%;"></td> <td style="width: 10%;"></td> <td style="width: 10%;"></td> <td style="width: 10%;"></td> </tr> <tr> <td></td> <td></td> <td colspan="8" style="text-align: center;"> <table border="1" style="width: 100%; border-collapse: collapse; text-align: center;"> <tr> <td style="width: 10%;"></td> <td style="width: 10%;"></td> <td style="width: 10%;"></td> <td style="width: 10%;"></td> <td style="width: 10%;"></td> <td style="width: 10%;"></td> <td style="width: 10%;"></td> <td style="width: 10%;"></td> <td style="width: 10%;"></td> <td style="width: 10%;"></td> </tr> <tr> <td></td> <td></td> <td colspan="8" style="text-align: center;"> <table border="1" style="width: 100%; border-collapse: collapse; text-align: center;"> <tr> <td style="width: 10%;"></td> <td style="width: 10%;"></td> <td style="width: 10%;"></td> <td style="width: 10%;"></td> <td style="width: 10%;"></td> <td style="width: 10%;"></td> <td style="width: 10%;"></td> <td style="width: 10%;"></td> <td style="width: 10%;"></td> <td style="width: 10%;"></td> </tr> <tr> <td></td> <td></td> <td colspan="8" style="text-align: center;"> <table border="1" style="width: 100%; border-collapse: collapse; text-align: center;"> <tr> <td style="width: 10%;"></td> <td style="width: 10%;"></td> <td style="width: 10%;"></td> <td style="width: 10%;"></td> <td style="width: 10%;"></td> <td style="width: 10%;"></td> <td style="width: 10%;"></td> <td style="width: 10%;"></td> <td style="width: 10%;"></td> <td style="width: 10%;"></td> </tr> <tr> <td></td> <td></td> <td colspan="8" style="text-align: center;"> <table border="1" style="width: 100%; border-collapse: collapse; text-align: center;"> <tr> <td style="width: 10%;"></td> <td style="width: 10%;"></td> <td style="width: 10%;"></td> <td style="width: 10%;"></td> <td style="width: 10%;"></td> <td style="width: 10%;"></td> <td style="width: 10%;"></td> <td style="width: 10%;"></td> <td style="width: 10%;"></td> <td style="width: 10%;"></td> </tr> <tr> <td></td> <td></td> <td colspan="8"
style="text-align: center;"> <table border="1" style="width: 100%; border-collapse: collapse; text-align: center;"> <tr> <td style="width: 10%;"></td> <td style="width: 10%;"></td> <td style="width: 10%;"></td> <td style="width: 10%;"></td> <td style="width: 10%;"></td> <td style="width: 10%;"></td> <td style="width: 10%;"></td> <td style="width: 10%;"></td> <td style="width: 10%;"></td> <td style="width: 10%;"></td> </tr> <tr> <td></td> <td></td> <td colspan="8" style="text-align: center;"> <table border="1" style="width: 100%; border-collapse: collapse; text-align: center;"> <tr> <td style="width: 10%;"></td> <td style="width: 10%;"></td> <td style="width: 10%;"></td> <td style="width: 10%;"></td> <td style="width: 10%;"></td> <td style="width: 10%;"></td> <td style="width: 10%;"></td> <td style="width: 10%;"></td> <td style="width: 10%;"></td> <td style="width: 10%;"></td> </tr> <tr> <td></td> <td></td> <td colspan="8" style="text-align: center;"> <table border="1" style="width: 100%; border-collapse: collapse; text-align: center;"> <tr> <td style="width: 10%;"></td> <td style="width: 10%;"></td> <td style="width: 10%;"></td> <td style="width: 10%;"></td> <td style="width: 10%;"></td> <td style="width: 10%;"></td> <td style="width: 10%;"></td> <td style="width: 10%;"></td> <td style="width: 10%;"></td> <td style="width: 10%;"></td> </tr> <tr> <td></td> <td></td> <td colspan="8" style="text-align: center;"> <table border="1" style="width: 100%; border-collapse: collapse; text-align: center;"> <tr> <td style="width: 10%;"></td> <td style="width: 10%;"></td> <td style="width: 10%;"></td> <td style="width: 10%;"></td> <td style="width: 10%;"></td> <td style="width: 10%;"></td> <td style="width: 10%;"></td> <td style="width: 10%;"></td> <td style="width: 10%;"></td> <td style="width: 10%;"></td> </tr> <tr> <td></td> <td></td> <td colspan="8" style="text-align: center;"> <table border="1" style="width: 100%; border-collapse: collapse; text-align: center;"> <tr> <td style="width: 10%;"></td> <td style="width: 10%;"></td> <td style="width: 10%;"></td> <td style="width: 10%;"></td> <td style="width: 10%;"></td> <td style="width: 10%;"></td> <td style="width: 10%;"></td> <td style="width: 10%;"></td> <td style="width: 10%;"></td> <td style="width: 10%;"></td> </tr> <tr> <td></td> <td></td> <td colspan="8" style="text-align: center;"> <table border="1" style="width: 100%; border-collapse: collapse; text-align: center;"> <tr> <td style="width: 10%;"></td> <td style="width: 10%;"></td> <td style="width: 10%;"></td> <td style="width: 10%;"></td> <td style="width: 10%;"></td> <td style="width: 10%;"></td> <td style="width: 10%;"></td> <td style="width: 10%;"></td> <td style="width: 10%;"></td> <td style="width: 10%;"></td> </tr> <tr> <td></td> <td></td> <td colspan="8" style="text-align: center;"> <table border="1" style="width: 100%; border-collapse: collapse; text-align: center;"> <tr> <td style="width: 10%;"></td> <td style="width: 10%;"></td> <td style="width: 10%;"></td> <td style="width: 10%;"></td> <td style="width: 10%;"></td> <td style="width: 10%;"></td> <td style="width: 10%;"></td> <td style="width: 10%;"></td> <td style="width: 10%;"></td> <td style="width: 10%;"></td> </tr> <tr> <td></td> <td></td> <td colspan="8" style="text-align: center;"> <table border="1" style="width: 100%; border-collapse: collapse; text-align: center;"> <tr> <td style="width: 10%;"></td> <td style="width: 10%;"></td> <td style="width: 10%;"></td> <td style="width: 10%;"></td> <td style="width: 10%;"></td> <td style="width: 10%;"></td> <td style="width: 10%;"></td> <td style="width: 10%;"></td> <td style="width: 10%;"></td> <td style="width: 10%;"></td> </tr> <tr> <td></td> <td></td> <td colspan="8" style="text-align: center;"> <table border="1" style="width: 100%; border-collapse: collapse; text-align: center;"> <tr> <td style="width: 10%;"></td> <td style="width: 10%;"></td> <td style="width: 10%;"></td> <td style="width: 10%;"></td> <td style="width: 10%;"></td> <td style="width: 10%;"></td> <td style="width: 10%;"></td> <td style="width: 10%;"></td> <td style="width: 10%;"></td> <td style="width: 10%;"></td> </tr> <tr> <td></td> <td></td> <td colspan="8" style="text-align: center;"> <table border="1" style="width: 100%; border-collapse: collapse; text-align: center;"> <tr> <td style="width: 10%;"></td> <td style="width: 10%;"></td> <td style="width: 10%;"></td> <td style="width: 10%;"></td> <td style="width: 10%;"></td> <td style="width: 10%;"></td> <td style="width: 10%;"></td> <td style="width: 10%;"></td> <td style="width: 10%;"></td> <td style="width: 10%;"></td> </tr> <tr> <td></td> <td></td> <td colspan="8" style="text-align: center;"> <table border="1" style="width: 100%; border-collapse: collapse; text-align: center;"> <tr> </tr></table></td></tr></table></td></tr></table></td></tr></table></td></tr></table></td></tr></table></td></tr></table></td></tr></table></td></tr></table></td></tr></table></td></tr></table></td></tr></table></td></tr></table></td></tr></table></td></tr></table></td></tr></table></td></tr></table></td></tr></table></td></tr></table></td></tr></table></td></tr></table></td></tr></table></td></tr></table></td></tr></table></td></tr></table></td></tr></table></td></tr></table></td></tr></table></td></tr></table></td></tr></table></td></tr></table></td></tr></table></td></tr></table></td></tr></table></td></tr></table></td></tr></table></td></tr></table></td></tr></table>
 | | | | | | | | | | | | | | | | | | | | <table border="1" style="width: 100%; border-collapse: collapse; text-align: center;"> <tr> <td style="width: 10%;"></td> <td style="width: 10%;"></td> <td style="width: 10%;"></td> <td style="width: 10%;"></td> <td style="width: 10%;"></td> <td style="width: 10%;"></td> <td style="width: 10%;"></td> <td style="width: 10%;"></td> <td style="width: 10%;"></td> <td style="width: 10%;"></td> </tr> <tr> <td></td> <td></td> <td colspan="8" style="text-align: center;"> <table border="1" style="width: 100%; border-collapse: collapse; text-align: center;"> <tr> <td style="width: 10%;"></td> <td style="width: 10%;"></td> <td style="width: 10%;"></td> <td style="width: 10%;"></td> <td style="width: 10%;"></td> <td style="width: 10%;"></td> <td style="width: 10%;"></td> <td style="width: 10%;"></td> <td style="width: 10%;"></td> <td style="width: 10%;"></td> </tr> <tr> <td></td> <td></td> <td colspan="8" style="text-align: center;"> <table border="1" style="width: 100%; border-collapse: collapse; text-align: center;"> <tr> <td style="width: 10%;"></td> <td style="width: 10%;"></td> <td style="width: 10%;"></td> <td style="width: 10%;"></td> <td style="width: 10%;"></td> <td style="width: 10%;"></td> <td style="width: 10%;"></td> <td style="width: 10%;"></td> <td style="width: 10%;"></td> <td style="width: 10%;"></td> </tr> <tr> <td></td> <td></td> <td colspan="8" style="text-align: center;"> <table border="1" style="width: 100%; border-collapse: collapse; text-align: center;"> <tr> <td style="width: 10%;"></td> <td style="width: 10%;"></td> <td style="width: 10%;"></td> <td style="width: 10%;"></td> <td style="width: 10%;"></td> <td style="width: 10%;"></td> <td style="width: 10%;"></td> <td style="width: 10%;"></td> <td style="width: 10%;"></td> <td style="width: 10%;"></td> </tr> <tr> <td></td> <td></td> <td colspan="8" style="text-align: center;"> <table border="1" style="width: 100%; border-collapse: collapse; text-align: center;"> <tr> <td style="width: 10%;"></td> <td style="width: 10%;"></td> <td style="width: 10%;"></td> <td style="width: 10%;"></td> <td style="width: 10%;"></td> <td style="width: 10%;"></td> <td style="width: 10%;"></td> <td style="width: 10%;"></td> <td style="width: 10%;"></td> <td style="width: 10%;"></td> </tr> <tr> <td></td> <td></td> <td colspan="8" style="text-align: center;"> <table border="1" style="width: 100%; border-collapse: collapse; text-align: center;"> <tr> <td style="width: 10%;"></td> <td style="width: 10%;"></td> <td style="width: 10%;"></td> <td style="width: 10%;"></td> <td style="width: 10%;"></td> <td style="width: 10%;"></td> <td style="width: 10%;"></td> <td style="width: 10%;"></td> <td style="width: 10%;"></td> <td style="width: 10%;"></td> </tr> <tr> <td></td> <td></td> <td colspan="8" style="text-align: center;"> <table border="1" style="width: 100%; border-collapse: collapse; text-align: center;"> <tr> <td style="width: 10%;"></td> <td style="width: 10%;"></td> <td style="width: 10%;"></td> <td style="width: 10%;"></td> <td style="width: 10%;"></td> <td style="width: 10%;"></td> <td style="width: 10%;"></td> <td style="width: 10%;"></td> <td style="width: 10%;"></td> <td style="width: 10%;"></td> </tr> <tr> <td></td> <td></td> <td colspan="8" style="text-align: center;"> <table border="1" style="width: 100%; border-collapse: collapse; text-align: center;"> <tr> <td style="width: 10%;"></td> <td style="width: 10%;"></td> <td style="width: 10%;"></td> <td style="width: 10%;"></td> <td style="width: 10%;"></td> <td style="width: 10%;"></td> <td style="width: 10%;"></td> <td style="width: 10%;"></td> <td style="width: 10%;"></td> <td style="width: 10%;"></td> </tr> <tr> <td></td> <td></td> <td colspan="8" style="text-align: center;"> <table border="1" style="width: 100%; border-collapse: collapse; text-align: center;"> <tr> <td style="width: 10%;"></td> <td style="width: 10%;"></td> <td style="width: 10%;"></td> <td style="width: 10%;"></td> <td style="width: 10%;"></td> <td style="width: 10%;"></td> <td style="width: 10%;"></td> <td style="width: 10%;"></td> <td style="width: 10%;"></td> <td style="width: 10%;"></td> </tr> <tr> <td></td> <td></td> <td colspan="8" style="text-align: center;"> <table border="1" style="width: 100%; border-collapse: collapse; text-align: center;"> <tr> <td style="width: 10%;"></td> <td style="width: 10%;"></td> <td style="width: 10%;"></td> <td style="width: 10%;"></td> <td style="width: 10%;"></td> <td style="width: 10%;"></td> <td style="width: 10%;"></td> <td style="width: 10%;"></td> <td style="width: 10%;"></td> <td style="width: 10%;"></td> </tr> <tr> <td></td> <td></td> <td colspan="8" style="text-align: center;"> <table border="1" style="width: 100%; border-collapse: collapse; text-align: center;"> <tr> <td style="width: 10%;"></td> <td style="width: 10%;"></td> <td style="width: 10%;"></td> <td style="width: 10%;"></td> <td style="width: 10%;"></td> <td style="width: 10%;"></td> <td style="width: 10%;"></td> <td style="width: 10%;"></td> <td style="width: 10%;"></td> <td style="width: 10%;"></td> </tr> <tr> <td></td> <td></td> <td colspan="8" style="text-align: center;"> <table border="1" style="width: 100%; border-collapse: collapse; text-align: center;"> <tr> <td style="width: 10%;"></td> <td style="width: 10%;"></td> <td style="width: 10%;"></td> <td style="width: 10%;"></td> <td style="width: 10%;"></td> <td style="width: 10%;"></td> <td style="width: 10%;"></td> <td style="width: 10%;"></td> <td style="width: 10%;"></td> <td style="width: 10%;"></td> </tr> <tr> <td></td> <td></td> <td colspan="8" style="text-align: center;"> <table border="1" style="width: 100%; border-collapse: collapse; text-align: center;"> <tr> <td style="width: 10%;"></td> <td style="width: 10%;"></td> <td style="width: 10%;"></td> <td style="width: 10%;"></td> <td style="width: 10%;"></td> <td style="width: 10%;"></td> <td style="width: 10%;"></td> <td style="width: 10%;"></td> <td style="width: 10%;"></td> <td style="width: 10%;"></td> </tr> <tr> <td></td> <td></td> <td colspan="8" style="text-align: center;"> <table border="1" style="width: 100%; border-collapse: collapse; text-align: center;"> <tr> <td style="width: 10%;"></td> <td style="width: 10%;"></td> <td style="width: 10%;"></td> <td style="width: 10%;"></td> <td style="width: 10%;"></td> <td style="width: 10%;"></td> <td style="width: 10%;"></td> <td style="width: 10%;"></td> <td style="width: 10%;"></td> <td style="width: 10%;"></td> </tr> <tr> <td></td> <td></td> <td colspan="8" style="text-align: center;"> <table border="1" style="width: 100%; border-collapse: collapse; text-align: center;"> <tr> <td style="width: 10%;"></td> <td
style="width: 10%;"></td> <td style="width: 10%;"></td> <td style="width: 10%;"></td> <td style="width: 10%;"></td> <td style="width: 10%;"></td> <td style="width: 10%;"></td> <td style="width: 10%;"></td> <td style="width: 10%;"></td> <td style="width: 10%;"></td> </tr> <tr> <td></td> <td></td> <td colspan="8" style="text-align: center;"> <table border="1" style="width: 100%; border-collapse: collapse; text-align: center;"> <tr> <td style="width: 10%;"></td> <td style="width: 10%;"></td> <td style="width: 10%;"></td> <td style="width: 10%;"></td> <td style="width: 10%;"></td> <td style="width: 10%;"></td> <td style="width: 10%;"></td> <td style="width: 10%;"></td> <td style="width: 10%;"></td> <td style="width: 10%;"></td> </tr> <tr> <td></td> <td></td> <td colspan="8" style="text-align: center;"> <table border="1" style="width: 100%; border-collapse: collapse; text-align: center;"> <tr> <td style="width: 10%;"></td> <td style="width: 10%;"></td> <td style="width: 10%;"></td> <td style="width: 10%;"></td> <td style="width: 10%;"></td> <td style="width: 10%;"></td> <td style="width: 10%;"></td> <td style="width: 10%;"></td> <td style="width: 10%;"></td> <td style="width: 10%;"></td> </tr> <tr> <td></td> <td></td> <td colspan="8" style="text-align: center;"> <table border="1" style="width: 100%; border-collapse: collapse; text-align: center;"> <tr> <td style="width: 10%;"></td> <td style="width: 10%;"></td> <td style="width: 10%;"></td> <td style="width: 10%;"></td> <td style="width: 10%;"></td> <td style="width: 10%;"></td> <td style="width: 10%;"></td> <td style="width: 10%;"></td> <td style="width: 10%;"></td> <td style="width: 10%;"></td> </tr> <tr> <td></td> <td></td> <td colspan="8" style="text-align: center;"> <table border="1" style="width: 100%; border-collapse: collapse; text-align: center;"> <tr> <td style="width: 10%;"></td> <td style="width: 10%;"></td> <td style="width: 10%;"></td> <td style="width: 10%;"></td> <td style="width: 10%;"></td> <td style="width: 10%;"></td> <td style="width: 10%;"></td> <td style="width: 10%;"></td> <td style="width: 10%;"></td> <td style="width: 10%;"></td> </tr> <tr> <td></td> <td></td> <td colspan="8" style="text-align: center;"> <table border="1" style="width: 100%; border-collapse: collapse; text-align: center;"> <tr> <td style="width: 10%;"></td> <td style="width: 10%;"></td> <td style="width: 10%;"></td> <td style="width: 10%;"></td> <td style="width: 10%;"></td> <td style="width: 10%;"></td> <td style="width: 10%;"></td> <td style="width: 10%;"></td> <td style="width: 10%;"></td> <td style="width: 10%;"></td> </tr> <tr> <td></td> <td></td> <td colspan="8" style="text-align: center;"> <table border="1" style="width: 100%; border-collapse: collapse; text-align: center;"> <tr> <td style="width: 10%;"></td> <td style="width: 10%;"></td> <td style="width: 10%;"></td> <td style="width: 10%;"></td> <td style="width: 10%;"></td> <td style="width: 10%;"></td> <td style="width: 10%;"></td> <td style="width: 10%;"></td> <td style="width: 10%;"></td> <td style="width: 10%;"></td> </tr> <tr> <td></td> <td></td> <td colspan="8" style="text-align: center;"> <table border="1" style="width: 100%; border-collapse: collapse; text-align: center;"> <tr> <td style="width: 10%;"></td> <td style="width: 10%;"></td> <td style="width: 10%;"></td> <td style="width: 10%;"></td> <td style="width: 10%;"></td> <td style="width: 10%;"></td> <td style="width: 10%;"></td> <td style="width: 10%;"></td> <td style="width: 10%;"></td> <td style="width: 10%;"></td> </tr> <tr> <td></td> <td></td> <td colspan="8" style="text-align: center;"> <table border="1" style="width: 100%; border-collapse: collapse; text-align: center;"> <tr> <td style="width: 10%;"></td> <td style="width: 10%;"></td> <td style="width: 10%;"></td> <td style="width: 10%;"></td> <td style="width: 10%;"></td> <td style="width: 10%;"></td> <td style="width: 10%;"></td> <td style="width: 10%;"></td> <td style="width: 10%;"></td> <td style="width: 10%;"></td> </tr> <tr> <td></td> <td></td> <td colspan="8" style="text-align: center;"> <table border="1" style="width: 100%; border-collapse: collapse; text-align: center;"> <tr> <td style="width: 10%;"></td> <td style="width: 10%;"></td> <td style="width: 10%;"></td> <td style="width: 10%;"></td> <td style="width: 10%;"></td> <td style="width: 10%;"></td> <td style="width: 10%;"></td> <td style="width: 10%;"></td> <td style="width: 10%;"></td> <td style="width: 10%;"></td> </tr> <tr> <td></td> <td></td> <td colspan="8" style="text-align: center;"> <table border="1" style="width: 100%; border-collapse: collapse; text-align: center;"> <tr> <td style="width: 10%;"></td> <td style="width: 10%;"></td> <td style="width: 10%;"></td> <td style="width: 10%;"></td> <td style="width: 10%;"></td> <td style="width: 10%;"></td> <td style="width: 10%;"></td> <td style="width: 10%;"></td> <td style="width: 10%;"></td> <td style="width: 10%;"></td> </tr> <tr> <td></td> <td></td> <td colspan="8" style="text-align: center;"> <table border="1" style="width: 100%; border-collapse: collapse; text-align: center;"> <tr> <td style="width: 10%;"></td> <td style="width: 10%;"></td> <td style="width: 10%;"></td> <td style="width: 10%;"></td> <td style="width: 10%;"></td> <td style="width: 10%;"></td> <td style="width: 10%;"></td> <td style="width: 10%;"></td> <td style="width: 10%;"></td> <td style="width: 10%;"></td> </tr> <tr> <td></td> <td></td> <td colspan="8" style="text-align: center;"> <table border="1" style="width: 100%; border-collapse: collapse; text-align: center;"> <tr> <td style="width: 10%;"></td> <td style="width: 10%;"></td> <td style="width: 10%;"></td> <td style="width: 10%;"></td> <td style="width: 10%;"></td> <td style="width: 10%;"></td> <td style="width: 10%;"></td> <td style="width: 10%;"></td> <td style="width: 10%;"></td> <td style="width: 10%;"></td> </tr> <tr> <td></td> <td></td> <td colspan="8" style="text-align: center;"> <table border="1" style="width: 100%; border-collapse: collapse; text-align: center;"> <tr> <td style="width: 10%;"></td> <td style="width: 10%;"></td> <td style="width: 10%;"></td> <td style="width: 10%;"></td> <td style="width: 10%;"></td> <td style="width: 10%;"></td> <td style="width: 10%;"></td> <td style="width: 10%;"></td> <td style="width: 10%;"></td> <td style="width: 10%;"></td> </tr> <tr> <td></td> <td></td> <td colspan="8" style="text-align: center;"> <table border="1" style="width: 100%; border-collapse: collapse; text-align: center;"> <tr> <td style="width: 10%;"></td> <td style="width: 10%;"></td> <td style="width: 10%;"></td> <td style="width: 10%;"></td> <td style="width: 10%;"></td> <td style="width: 10%;"></td> <td style="width: 10%;"></td> <td style="width: 10%;"></td> <td style="width: 10%;"></td> <td style="width: 10%;"></td> </tr> <tr> <td></td> <td></td> <td colspan="8" style="text-align: center;"> <table border="1" style="width: 100%; border-collapse: collapse; text-align: center;"> <tr> <td style="width: 10%;"></td> <td style="width: 10%;"></td> <td style="width: 10%;"></td> <td style="width: 10%;"></td> <td style="width: 10%;"></td> <td style="width: 10%;"></td> <td style="width: 10%;"></td> <td style="width: 10%;"></td> <td style="width: 10%;"></td> <td style="width: 10%;"></td> </tr> <tr> <td></td> <td></td> <td colspan="8" style="text-align: center;"> <table border="1" style="width: 100%; border-collapse: collapse; text-align: center;"> <tr> <td style="width: 10%;"></td> <td style="width: 10%;"></td> <td style="width: 10%;"></td> <td style="width: 10%;"></td> <td style="width: 10%;"></td> <td style="width: 10%;"></td> <td style="width: 10%;"></td> <td style="width: 10%;"></td> <td style="width: 10%;"></td> <td style="width: 10%;"></td> </tr> <tr> <td></td> <td></td> <td colspan="8" style="text-align: center;"> <table border="1" style="width: 100%; border-collapse: collapse; text-align: center;"> <tr> <td style="width: 10%;"></td> <td style="width: 10%;"></td> <td style="width: 10%;"></td> <td style="width: 10%;"></td> <td style="width: 10%;"></td> <td style="width: 10%;"></td> <td style="width: 10%;"></td> <td style="width: 10%;"></td> <td style="width: 10%;"></td> <td style="width: 10%;"></td> </tr> <tr> <td></td> <td></td> <td colspan="8" style="text-align: center;"> <table border="1" style="width: 100%; border-collapse: collapse; text-align: center;"> <tr> <td style="width: 10%;"></td> <td style="width: 10%;"></td> <td style="width: 10%;"></td> <td style="width: 10%;"></td> <td style="width: 10%;"></td> <td style="width: 10%;"></td> <td style="width: 10%;"></td> <td style="width: 10%;"></td> <td style="width: 10%;"></td> <td style="width: 10%;"></td> </tr> <tr> <td></td> <td></td> <td colspan="8" style="text-align: center;"> <table border="1" style="width: 100%; border-collapse: collapse; text-align: center;"> <tr> <td style="width: 10%;"></td> <td style="width: 10%;"></td> <td style="width: 10%;"></td> <td style="width: 10%;"></td> <td style="width: 10%;"></td> <td style="width: 10%;"></td> <td style="width: 10%;"></td> <td style="width: 10%;"></td> <td style="width: 10%;"></td> <td style="width: 10%;"></td> </tr> <tr> <td></td> <td></td> <td colspan="8" style="text-align: center;"> <table border="1" style="width: 100%; border-collapse: collapse; text-align: center;"> <tr> <td style="width: 10%;"></td> <td style="width: 10%;"></td> <td style="width: 10%;"></td> <td style="width: 10%;"></td> <td style="width: 10%;"></td> <td style="width: 10%;"></td> <td style="width: 10%;"></td> <td style="width: 10%;"></td> <td style="width: 10%;"></td> <td style="width: 10%;"></td> </tr> <tr> <td></td> <td></td> <td colspan="8" style="text-align: center;"> <table border="1" style="width: 100%; border-collapse: collapse; text-align: center;"> <tr> <td style="width: 10%;"></td> <td style="width: 10%;"></td> <td style="width: 10%;"></td> <td style="width: 10%;"></td> <td style="width: 10%;"></td> <td style="width: 10%;"></td> <td style="width:
10%;"></td> <td style="width: 10%;"></td> <td style="width: 10%;"></td> <td style="width: 10%;"></td> </tr> <tr> <td></td> <td></td> <td colspan="8" style="text-align: center;"> <table border="1" style="width: 100%; border-collapse: collapse; text-align: center;"> <tr> </tr></table></td></tr></table></td></tr></table></td></tr></table></td></tr></table></td></tr></table></td></tr></table></td></tr></table></td></tr></table></td></tr></table></td></tr></table></td></tr></table></td></tr></table></td></tr></table></td></tr></table></td></tr></table></td></tr></table></td></tr></table></td></tr></table></td></tr></table></td></tr></table></td></tr></table></td></tr></table></td></tr></table></td></tr></table></td></tr></table></td></tr></table></td></tr></table></td></tr></table></td></tr></table></td></tr></table></td></tr></table></td></tr></table></td></tr></table></td></tr></table></td></tr></table></td></tr></table> | | | | | | | | | | | | | | | | | | | | <table border="1" style="width: 100%; border-collapse: collapse; text-align: center;"> <tr> <td style="width: 10%;"></td> <td style="width: 10%;"></td> <td style="width: 10%;"></td> <td style="width: 10%;"></td> <td style="width: 10%;"></td> <td style="width: 10%;"></td> <td style="width: 10%;"></td> <td style="width: 10%;"></td> <td style="width: 10%;"></td> <td style="width: 10%;"></td> </tr> <tr> <td></td> <td></td> <td colspan="8" style="text-align: center;"> <table border="1" style="width: 100%; border-collapse: collapse; text-align: center;"> <tr> <td style="width: 10%;"></td> <td style="width: 10%;"></td> <td style="width: 10%;"></td> <td style="width: 10%;"></td> <td style="width: 10%;"></td> <td style="width: 10%;"></td> <td style="width: 10%;"></td> <td style="width: 10%;"></td> <td style="width: 10%;"></td> <td style="width: 10%;"></td> </tr> <tr> <td></td> <td></td> <td colspan="8" style="text-align: center;"> <table border="1" style="width: 100%; border-collapse: collapse; text-align: center;"> <tr> <td style="width: 10%;"></td> <td style="width: 10%;"></td> <td style="width: 10%;"></td> <td style="width: 10%;"></td> <td style="width: 10%;"></td> <td style="width: 10%;"></td> <td style="width:
10%;"></td> <td style="width: 10%;"></td> <td style="width: 10%;"></td> <td style="width: 10%;"></td> </tr> <tr> <td></td> <td></td> <td colspan="8" style="text-align: center;"> <table border="1" style="width: 100%; border-collapse: collapse; text-align: center;"> <tr> <td style="width: 10%;"></td> <td style="width: 10%;"></td> <td style="width: 10%;"></td> <td style="width: 10%;"></td> <td style="width: 10%;"></td> <td style="width: 10%;"></td> <td style="width: 10%;"></td> <td style="width: 10%;"></td> <td style="width: 10%;"></td> <td style="width: 10%;"></td> </tr> <tr> <td></td> <td></td> <td colspan="8" style="text-align: center;"> <table border="1" style="width: 100%; border-collapse: collapse; text-align: center;"> <tr> <td style="width: 10%;"></td> <td style="width: 10%;"></td> <td style="width: 10%;"></td> <td style="width: 10%;"></td> <td style="width: 10%;"></td> <td style="width: 10%;"></td> <td style="width: 10%;"></td> <td style="width: 10%;"></td> <td style="width: 10%;"></td> <td style="width: 10%;"></td> </tr> <tr> <td></td> <td></td> <td colspan="8" style="text-align: center;"> <table border="1" style="width: 100%; border-collapse: collapse; text-align: center;"> <tr> <td style="width: 10%;"></td> <td style="width: 10%;"></td> <td style="width: 10%;"></td> <td style="width: 10%;"></td> <td style="width: 10%;"></td> <td style="width: 10%;"></td> <td style="width: 10%;"></td> <td style="width: 10%;"></td> <td style="width: 10%;"></td> <td style="width: 10%;"></td> </tr> <tr> <td></td> <td></td> <td colspan="8" style="text-align: center;"> <table border="1" style="width: 100%; border-collapse: collapse; text-align: center;"> <tr> <td style="width: 10%;"></td> <td style="width: 10%;"></td> <td style="width: 10%;"></td> <td style="width: 10%;"></td> <td style="width: 10%;"></td> <td style="width: 10%;"></td> <td style="width: 10%;"></td> <td style="width: 10%;"></td> <td style="width: 10%;"></td> <td style="width: 10%;"></td> </tr> <tr> <td></td> <td></td> <td colspan="8" style="text-align: center;"> <table border="1" style="width: 100%; border-collapse: collapse; text-align: center;"> <tr> <td style="width: 10%;"></td> <td style="width: 10%;"></td> <td style="width: 10%;"></td> <td style="width: 10%;"></td> <td style="width: 10%;"></td> <td style="width: 10%;"></td> <td style="width: 10%;"></td> <td style="width: 10%;"></td> <td style="width: 10%;"></td> <td style="width: 10%;"></td> </tr> <tr> <td></td> <td></td> <td colspan="8" style="text-align: center;"> <table border="1" style="width: 100%; border-collapse: collapse; text-align: center;"> <tr> <td style="width: 10%;"></td> <td style="width: 10%;"></td> <td style="width: 10%;"></td> <td style="width: 10%;"></td> <td style="width: 10%;"></td> <td style="width: 10%;"></td> <td style="width: 10%;"></td> <td style="width: 10%;"></td> <td style="width: 10%;"></td> <td style="width: 10%;"></td> </tr> <tr> <td></td> <td></td> <td colspan="8" style="text-align: center;"> <table border="1" style="width: 100%; border-collapse: collapse; text-align: center;"> <tr> <td style="width: 10%;"></td> <td style="width: 10%;"></td> <td style="width: 10%;"></td> <td style="width: 10%;"></td> <td style="width: 10%;"></td> <td style="width: 10%;"></td> <td style="width: 10%;"></td> <td style="width: 10%;"></td> <td style="width: 10%;"></td> <td style="width: 10%;"></td> </tr> <tr> <td></td> <td></td> <td colspan="8" style="text-align: center;"> <table border="1" style="width: 100%; border-collapse: collapse; text-align: center;"> <tr> <td style="width: 10%;"></td> <td style="width: 10%;"></td> <td style="width: 10%;"></td> <td style="width: 10%;"></td> <td style="width: 10%;"></td> <td style="width: 10%;"></td> <td style="width: 10%;"></td> <td style="width: 10%;"></td> <td style="width: 10%;"></td> <td style="width: 10%;"></td> </tr> <tr> <td></td> <td></td> <td colspan="8" style="text-align: center;"> <table border="1" style="width: 100%; border-collapse: collapse; text-align: center;"> <tr> <td style="width: 10%;"></td> <td style="width: 10%;"></td> <td style="width: 10%;"></td> <td style="width: 10%;"></td> <td style="width: 10%;"></td> <td style="width: 10%;"></td> <td style="width: 10%;"></td> <td style="width: 10%;"></td> <td style="width: 10%;"></td> <td style="width: 10%;"></td> </tr> <tr> <td></td> <td></td> <td colspan="8" style="text-align: center;"> <table border="1" style="width: 100%; border-collapse: collapse; text-align: center;"> <tr> <td style="width: 10%;"></td> <td style="width: 10%;"></td> <td style="width: 10%;"></td> <td style="width: 10%;"></td> <td style="width: 10%;"></td> <td style="width: 10%;"></td> <td style="width: 10%;"></td> <td style="width: 10%;"></td> <td style="width: 10%;"></td> <td style="width: 10%;"></td> </tr> <tr> <td></td> <td></td> <td colspan="8" style="text-align: center;"> <table border="1" style="width: 100%; border-collapse: collapse; text-align: center;"> <tr> <td style="width: 10%;"></td> <td style="width: 10%;"></td> <td style="width: 10%;"></td> <td style="width: 10%;"></td> <td style="width: 10%;"></td> <td style="width: 10%;"></td> <td style="width: 10%;"></td> <td style="width: 10%;"></td> <td style="width: 10%;"></td> <td style="width: 10%;"></td> </tr> <tr> <td></td> <td></td> <td colspan="8" style="text-align: center;"> <table border="1" style="width: 100%; border-collapse: collapse; text-align: center;"> <tr> <td style="width: 10%;"></td> <td style="width: 10%;"></td> <td style="width: 10%;"></td> <td style="width: 10%;"></td> <td style="width: 10%;"></td> <td style="width: 10%;"></td> <td style="width: 10%;"></td> <td style="width: 10%;"></td> <td style="width: 10%;"></td> <td style="width: 10%;"></td> </tr> <tr> <td></td> <td></td> <td colspan="8" style="text-align: center;"> <table border="1" style="width: 100%; border-collapse: collapse; text-align: center;"> <tr> <td style="width: 10%;"></td> <td style="width: 10%;"></td> <td style="width: 10%;"></td> <td style="width: 10%;"></td> <td style="width: 10%;"></td> <td style="width: 10%;"></td> <td style="width: 10%;"></td> <td style="width: 10%;"></td> <td style="width: 10%;"></td> <td style="width: 10%;"></td> </tr> <tr> <td></td> <td></td> <td colspan="8" style="text-align: center;"> <table border="1" style="width: 100%; border-collapse: collapse; text-align: center;"> <tr> <td style="width: 10%;"></td> <td style="width: 10%;"></td> <td style="width: 10%;"></td> <td style="width: 10%;"></td> <td style="width: 10%;"></td> <td style="width: 10%;"></td> <td style="width: 10%;"></td> <td style="width: 10%;"></td> <td style="width: 10%;"></td> <td style="width: 10%;"></td> </tr> <tr> <td></td> <td></td> <td colspan="8" style="text-align: center;"> <table border="1" style="width: 100%; border-collapse: collapse; text-align: center;"> <tr> <td style="width: 10%;"></td> <td style="width: 10%;"></td> <td style="width: 10%;"></td> <td style="width: 10%;"></td> <td style="width: 10%;"></td> <td style="width: 10%;"></td> <td style="width: 10%;"></td> <td style="width: 10%;"></td> <td style="width: 10%;"></td> <td style="width: 10%;"></td> </tr> <tr> <td></td> <td></td> <td colspan="8" style="text-align: center;"> <table border="1" style="width: 100%; border-collapse: collapse; text-align: center;"> <tr> <td style="width: 10%;"></td> <td style="width: 10%;"></td> <td style="width: 10%;"></td> <td style="width: 10%;"></td> <td style="width: 10%;"></td> <td style="width: 10%;"></td> <td style="width: 10%;"></td> <td style="width: 10%;"></td> <td style="width: 10%;"></td> <td style="width: 10%;"></td> </tr> <tr> <td></td> <td></td> <td colspan="8" style="text-align: center;"> <table border="1" style="width: 100%; border-collapse: collapse; text-align: center;"> <tr> <td style="width: 10%;"></td> <td style="width: 10%;"></td> <td style="width: 10%;"></td> <td style="width: 10%;"></td> <td style="width: 10%;"></td> <td style="width: 10%;"></td> <td style="width: 10%;"></td> <td style="width: 10%;"></td> <td style="width: 10%;"></td> <td style="width: 10%;"></td> </tr> <tr> <td></td> <td></td> <td colspan="8" style="text-align: center;"> <table border="1" style="width: 100%; border-collapse: collapse; text-align: center;"> <tr> <td style="width: 10%;"></td> <td style="width: 10%;"></td> <td style="width: 10%;"></td> <td style="width: 10%;"></td> <td style="width: 10%;"></td> <td style="width: 10%;"></td> <td style="width: 10%;"></td> <td style="width: 10%;"></td> <td style="width: 10%;"></td> <td style="width: 10%;"></td> </tr> <tr> <td></td> <td></td> <td colspan="8" style="text-align: center;"> <table border="1" style="width: 100%; border-collapse: collapse; text-align: center;"> <tr> <td style="width: 10%;"></td> <td style="width: 10%;"></td> <td style="width: 10%;"></td> <td style="width: 10%;"></td> <td style="width: 10%;"></td> <td style="width: 10%;"></td> <td style="width: 10%;"></td> <td style="width: 10%;"></td> <td style="width: 10%;"></td> <td style="width: 10%;"></td> </tr> <tr> <td></td> <td></td> <td colspan="8" style="text-align: center;"> <table border="1" style="width: 100%; border-collapse: collapse; text-align: center;"> <tr> <td style="width: 10%;"></td> <td style="width: 10%;"></td> <td style="width: 10%;"></td> <td style="width: 10%;"></td> <td style="width: 10%;"></td> <td style="width: 10%;"></td> <td style="width: 10%;"></td> <td style="width: 10%;"></td> <td style="width: 10%;"></td> <td style="width: 10%;"></td> </tr> <tr> <td></td> <td></td> <td colspan="8" style="text-align: center;"> <table border="1" style="width: 100%; border-collapse: collapse; text-align: center;"> <tr> <td style="width: 10%;"></td> <td style="width: 10%;"></td> <td style="width: 10%;"></td> <td style="width: 10%;"></td> <td style="width: 10%;"></td> <td style="width: 10%;"></td> <td style="width: 10%;"></td> <td style="width: 10%;"></td> <td style="width: 10%;"></td> <td style="width: 10%;"></td> </tr> <tr> <td></td> <td></td> <td colspan="8" style="text-align:
center;"> <table border="1" style="width: 100%; border-collapse: collapse; text-align: center;"> <tr> <td style="width: 10%;"></td> <td style="width: 10%;"></td> <td style="width: 10%;"></td> <td style="width: 10%;"></td> <td style="width: 10%;"></td> <td style="width: 10%;"></td> <td style="width: 10%;"></td> <td style="width: 10%;"></td> <td style="width: 10%;"></td> <td style="width: 10%;"></td> </tr> <tr> <td></td> <td></td> <td colspan="8" style="text-align: center;"> <table border="1" style="width: 100%; border-collapse: collapse; text-align: center;"> <tr> <td style="width: 10%;"></td> <td style="width: 10%;"></td> <td style="width: 10%;"></td> <td style="width: 10%;"></td> <td style="width: 10%;"></td> <td style="width: 10%;"></td> <td style="width: 10%;"></td> <td style="width: 10%;"></td> <td style="width: 10%;"></td> <td style="width: 10%;"></td> </tr> <tr> <td></td> <td></td> <td colspan="8" style="text-align: center;"> <table border="1" style="width: 100%; border-collapse: collapse; text-align: center;"> <tr> <td style="width: 10%;"></td> <td style="width: 10%;"></td> <td style="width: 10%;"></td> <td style="width: 10%;"></td> <td style="width: 10%;"></td> <td style="width: 10%;"></td> <td style="width: 10%;"></td> <td style="width: 10%;"></td> <td style="width: 10%;"></td> <td style="width: 10%;"></td> </tr> <tr> <td></td> <td></td> <td colspan="8" style="text-align: center;"> <table border="1" style="width: 100%; border-collapse: collapse; text-align: center;"> <tr> <td style="width: 10%;"></td> <td style="width: 10%;"></td> <td style="width: 10%;"></td> <td style="width: 10%;"></td> <td style="width: 10%;"></td> <td style="width: 10%;"></td> <td style="width: 10%;"></td> <td style="width: 10%;"></td> <td style="width: 10%;"></td> <td style="width: 10%;"></td> </tr> <tr> <td></td> <td></td> <td colspan="8" style="text-align: center;"> <table border="1" style="width: 100%; border-collapse: collapse; text-align: center;"> <tr> <td style="width: 10%;"></td> <td style="width: 10%;"></td> <td style="width: 10%;"></td> <td style="width: 10%;"></td> <td style="width: 10%;"></td> <td style="width: 10%;"></td> <td style="width: 10%;"></td> <td style="width: 10%;"></td> <td style="width: 10%;"></td> <td style="width: 10%;"></td> </tr> <tr> <td></td> <td></td> <td colspan="8" style="text-align: center;"> <table border="1" style="width: 100%; border-collapse: collapse; text-align: center;"> <tr> <td style="width: 10%;"></td> <td style="width: 10%;"></td> <td style="width: 10%;"></td> <td style="width: 10%;"></td> <td style="width: 10%;"></td> <td style="width: 10%;"></td> <td style="width: 10%;"></td> <td style="width: 10%;"></td> <td style="width: 10%;"></td> <td style="width: 10%;"></td> </tr> <tr> <td></td> <td></td> <td colspan="8" style="text-align: center;"> <table border="1" style="width: 100%; border-collapse: collapse; text-align: center;"> <tr> <td style="width: 10%;"></td> <td style="width: 10%;"></td> <td style="width: 10%;"></td> <td style="width: 10%;"></td> <td style="width: 10%;"></td> <td style="width: 10%;"></td> <td style="width: 10%;"></td> <td style="width: 10%;"></td> <td style="width: 10%;"></td> <td style="width: 10%;"></td> </tr> <tr> <td></td> <td></td> <td colspan="8" style="text-align: center;"> <table border="1" style="width: 100%; border-collapse: collapse; text-align: center;"> <tr> <td style="width: 10%;"></td> <td style="width: 10%;"></td> <td style="width: 10%;"></td> <td style="width: 10%;"></td> <td style="width: 10%;"></td> <td style="width: 10%;"></td> <td style="width: 10%;"></td> <td style="width: 10%;"></td> <td style="width: 10%;"></td> <td style="width: 10%;"></td> </tr> <tr> <td></td> <td></td> <td colspan="8" style="text-align: center;"> <table border="1" style="width: 100%; border-collapse: collapse; text-align: center;"> <tr> <td style="width: 10%;"></td> <td style="width: 10%;"></td> <td style="width: 10%;"></td> <td style="width: 10%;"></td> <td style="width: 10%;"></td> <td style="width: 10%;"></td> <td style="width: 10%;"></td> <td style="width: 10%;"></td> <td style="width: 10%;"></td> <td style="width: 10%;"></td> </tr> <tr> <td></td> <td></td> <td colspan="8" style="text-align: center;"> <table border="1" style="width: 100%; border-collapse: collapse; text-align: center;"> <tr> <td style="width: 10%;"></td> <td style="width: 10%;"></td> <td style="width: 10%;"></td> <td style="width: 10%;"></td> <td style="width: 10%;"></td> <td style="width: 10%;"></td> <td style="width: 10%;"></td> <td style="width: 10%;"></td> <td style="width: 10%;"></td> <td style="width: 10%;"></td> </tr> <tr> <td></td> <td></td> <td colspan="8" style="text-align: center;"> <table border="1" style="width: 100%; border-collapse: collapse; text-align: center;"> <tr> <td style="width: 10%;"></td> <td style="width: 10%;"></td> <td style="width: 10%;"></td> <td style="width: 10%;"></td> <td style="width: 10%;"></td> <td style="width: 10%;"></td> <td style="width: 10%;"></td> <td style="width: 10%;"></td> <td style="width: 10%;"></td> <td style="width: 10%;"></td> </tr> <tr> <td></td> <td></td> <td colspan="8" style="text-align: center;"> <table border="1" style="width: 100%; border-collapse: collapse; text-align: center;"> <tr> </tr></table></td></tr></table></td></tr></table></td></tr></table></td></tr></table></td></tr></table></td></tr></table></td></tr></table></td></tr></table></td></tr></table></td></tr></table></td></tr></table></td></tr></table></td></tr></table></td></tr></table></td></tr></table></td></tr></table></td></tr></table></td></tr></table></td></tr></table></td></tr></table></td></tr></table></td></tr></table></td></tr></table></td></tr></table></td></tr></table></td></tr></table></td></tr></table></td></tr></table></td></tr></table></td></tr></table></td></tr></table></td></tr></table></td></tr></table></td></tr></table></td></tr></table>
 | | | | | | | | | | | | | | | | | | | | <table border="1" style="width: 100%; border-collapse: collapse; text-align: center;"> <tr> <td style="width: 10%;"></td> <td style="width: 10%;"></td> <td style="width: 10%;"></td> <td style="width: 10%;"></td> <td style="width: 10%;"></td> <td style="width: 10%;"></td> <td style="width: 10%;"></td> <td style="width: 10%;"></td> <td style="width: 10%;"></td> <td style="width: 10%;"></td> </tr> <tr> <td></td> <td></td> <td colspan="8" style="text-align: center;"> <table border="1" style="width: 100%; border-collapse: collapse; text-align: center;"> <tr> <td style="width: 10%;"></td> <td style="width: 10%;"></td> <td style="width: 10%;"></td> <td style="width: 10%;"></td> <td style="width: 10%;"></td> <td style="width: 10%;"></td> <td style="width: 10%;"></td> <td style="width: 10%;"></td> <td style="width: 10%;"></td> <td style="width: 10%;"></td> </tr> <tr> <td></td> <td></td> <td colspan="8" style="text-align: center;"> <table border="1" style="width: 100%; border-collapse: collapse; text-align: center;"> <tr> <td style="width: 10%;"></td> <td style="width: 10%;"></td> <td style="width: 10%;"></td> <td style="width: 10%;"></td> <td style="width: 10%;"></td> <td style="width: 10%;"></td> <td style="width: 10%;"></td> <td style="width: 10%;"></td> <td style="width: 10%;"></td> <td style="width: 10%;"></td> </tr> <tr> <td></td> <td></td> <td colspan="8" style="text-align: center;"> <table border="1" style="width: 100%; border-collapse: collapse; text-align: center;"> <tr> <td style="width: 10%;"></td> <td style="width: 10%;"></td> <td style="width: 10%;"></td> <td style="width: 10%;"></td> <td style="width: 10%;"></td> <td style="width: 10%;"></td> <td style="width: 10%;"></td> <td style="width: 10%;"></td> <td style="width: 10%;"></td> <td style="width: 10%;"></td> </tr> <tr> <td></td> <td></td> <td colspan="8" style="text-align: center;"> <table border="1" style="width: 100%; border-collapse: collapse; text-align: center;"> <tr> <td style="width: 10%;"></td> <td style="width: 10%;"></td> <td style="width: 10%;"></td> <td style="width: 10%;"></td> <td style="width: 10%;"></td> <td style="width: 10%;"></td> <td style="width: 10%;"></td> <td style="width: 10%;"></td> <td style="width: 10%;"></td> <td style="width: 10%;"></td> </tr> <tr> <td></td> <td></td> <td colspan="8" style="text-align: center;"> <table border="1" style="width: 100%; border-collapse: collapse; text-align: center;"> <tr> <td style="width: 10%;"></td> <td style="width: 10%;"></td> <td style="width: 10%;"></td> <td style="width: 10%;"></td> <td style="width: 10%;"></td> <td style="width: 10%;"></td> <td style="width: 10%;"></td> <td style="width: 10%;"></td> <td style="width: 10%;"></td> <td style="width: 10%;"></td> </tr> <tr> <td></td> <td></td> <td colspan="8" style="text-align: center;"> <table border="1" style="width: 100%; border-collapse: collapse; text-align: center;"> <tr> <td style="width: 10%;"></td> <td style="width: 10%;"></td> <td style="width: 10%;"></td> <td style="width: 10%;"></td> <td style="width: 10%;"></td> <td style="width: 10%;"></td> <td style="width: 10%;"></td> <td style="width: 10%;"></td> <td style="width: 10%;"></td> <td style="width: 10%;"></td> </tr> <tr> <td></td> <td></td> <td colspan="8" style="text-align: center;"> <table border="1" style="width: 100%; border-collapse: collapse; text-align: center;"> <tr> <td style="width: 10%;"></td> <td style="width: 10%;"></td> <td style="width: 10%;"></td> <td style="width: 10%;"></td> <td style="width: 10%;"></td> <td style="width: 10%;"></td> <td style="width: 10%;"></td> <td style="width: 10%;"></td> <td style="width: 10%;"></td> <td style="width: 10%;"></td> </tr> <tr> <td></td> <td></td> <td colspan="8" style="text-align: center;"> <table border="1" style="width: 100%; border-collapse: collapse; text-align: center;"> <tr> <td style="width: 10%;"></td> <td style="width: 10%;"></td> <td style="width: 10%;"></td> <td style="width: 10%;"></td> <td style="width: 10%;"></td> <td style="width: 10%;"></td> <td style="width: 10%;"></td> <td style="width: 10%;"></td> <td style="width: 10%;"></td> <td style="width: 10%;"></td> </tr> <tr> <td></td> <td></td> <td colspan="8" style="text-align: center;"> <table border="1" style="width: 100%; border-collapse: collapse; text-align: center;"> <tr> <td style="width: 10%;"></td> <td style="width: 10%;"></td> <td style="width: 10%;"></td> <td style="width: 10%;"></td> <td style="width: 10%;"></td> <td style="width: 10%;"></td> <td style="width: 10%;"></td> <td style="width: 10%;"></td> <td style="width: 10%;"></td> <td style="width: 10%;"></td> </tr> <tr> <td></td> <td></td> <td colspan="8" style="text-align: center;"> <table border="1" style="width: 100%; border-collapse: collapse; text-align: center;"> <tr> <td style="width: 10%;"></td> <td style="width: 10%;"></td> <td style="width: 10%;"></td> <td style="width: 10%;"></td> <td style="width: 10%;"></td> <td style="width: 10%;"></td> <td style="width: 10%;"></td> <td style="width: 10%;"></td> <td style="width: 10%;"></td> <td style="width: 10%;"></td> </tr> <tr> <td></td> <td></td> <td colspan="8" style="text-align: center;"> <table border="1" style="width: 100%; border-collapse: collapse; text-align: center;"> <tr> <td style="width: 10%;"></td> <td style="width: 10%;"></td> <td style="width: 10%;"></td> <td style="width: 10%;"></td> <td style="width: 10%;"></td> <td style="width: 10%;"></td> <td style="width: 10%;"></td> <td style="width: 10%;"></td> <td style="width: 10%;"></td> <td style="width: 10%;"></td> </tr> <tr> <td></td> <td></td> <td colspan="8" style="text-align: center;"> <table border="1" style="width: 100%; border-collapse: collapse; text-align: center;"> <tr> <td style="width: 10%;"></td> <td style="width: 10%;"></td> <td style="width: 10%;"></td> <td style="width: 10%;"></td> <td style="width: 10%;"></td> <td style="width: 10%;"></td> <td style="width: 10%;"></td> <td style="width: 10%;"></td> <td style="width: 10%;"></td> <td style="width: 10%;"></td> </tr> <tr> <td></td> <td></td> <td colspan="8" style="text-align: center;"> <table border="1" style="width: 100%; border-collapse: collapse; text-align: center;"> <tr> <td style="width: 10%;"></td> <td style="width: 10%;"></td> <td style="width: 10%;"></td> <td
style="width: 10%;"></td> <td style="width: 10%;"></td> <td style="width: 10%;"></td> <td style="width: 10%;"></td> <td style="width: 10%;"></td> <td style="width: 10%;"></td> <td style="width: 10%;"></td> </tr> <tr> <td></td> <td></td> <td colspan="8" style="text-align: center;"> <table border="1" style="width: 100%; border-collapse: collapse; text-align: center;"> <tr> <td style="width: 10%;"></td> <td style="width: 10%;"></td> <td style="width: 10%;"></td> <td style="width: 10%;"></td> <td style="width: 10%;"></td> <td style="width: 10%;"></td> <td style="width: 10%;"></td> <td style="width: 10%;"></td> <td style="width: 10%;"></td> <td style="width: 10%;"></td> </tr> <tr> <td></td> <td></td> <td colspan="8" style="text-align: center;"> <table border="1" style="width: 100%; border-collapse: collapse; text-align: center;"> <tr> <td style="width: 10%;"></td> <td style="width: 10%;"></td> <td style="width: 10%;"></td> <td style="width: 10%;"></td> <td style="width: 10%;"></td> <td style="width: 10%;"></td> <td style="width: 10%;"></td> <td style="width: 10%;"></td> <td style="width: 10%;"></td> <td style="width: 10%;"></td> </tr> <tr> <td></td> <td></td> <td colspan="8" style="text-align: center;"> <table border="1" style="width: 100%; border-collapse: collapse; text-align: center;"> <tr> <td style="width: 10%;"></td> <td style="width: 10%;"></td> <td style="width: 10%;"></td> <td style="width: 10%;"></td> <td style="width: 10%;"></td> <td style="width: 10%;"></td> <td style="width: 10%;"></td> <td style="width: 10%;"></td> <td style="width: 10%;"></td> <td style="width: 10%;"></td> </tr> <tr> <td></td> <td></td> <td colspan="8" style="text-align: center;"> <table border="1" style="width: 100%; border-collapse: collapse; text-align: center;"> <tr> <td style="width: 10%;"></td> <td style="width: 10%;"></td> <td style="width: 10%;"></td> <td style="width: 10%;"></td> <td style="width: 10%;"></td> <td style="width: 10%;"></td> <td style="width: 10%;"></td> <td style="width: 10%;"></td> <td style="width: 10%;"></td> <td style="width: 10%;"></td> </tr> <tr> <td></td> <td></td> <td colspan="8" style="text-align: center;"> <table border="1" style="width: 100%; border-collapse: collapse; text-align: center;"> <tr> <td style="width: 10%;"></td> <td style="width: 10%;"></td> <td style="width: 10%;"></td> <td style="width: 10%;"></td> <td style="width: 10%;"></td> <td style="width: 10%;"></td> <td style="width: 10%;"></td> <td style="width: 10%;"></td> <td style="width: 10%;"></td> <td style="width: 10%;"></td> </tr> <tr> <td></td> <td></td> <td colspan="8" style="text-align: center;"> <table border="1" style="width: 100%; border-collapse: collapse; text-align: center;"> <tr> <td style="width: 10%;"></td> <td style="width: 10%;"></td> <td style="width: 10%;"></td> <td style="width: 10%;"></td> <td style="width: 10%;"></td> <td style="width: 10%;"></td> <td style="width: 10%;"></td> <td style="width: 10%;"></td> <td style="width: 10%;"></td> <td style="width: 10%;"></td> </tr> <tr> <td></td> <td></td> <td colspan="8" style="text-align: center;"> <table border="1" style="width: 100%; border-collapse: collapse; text-align: center;"> <tr> <td style="width: 10%;"></td> <td style="width: 10%;"></td> <td style="width: 10%;"></td> <td style="width: 10%;"></td> <td style="width: 10%;"></td> <td style="width: 10%;"></td> <td style="width: 10%;"></td> <td style="width: 10%;"></td> <td style="width: 10%;"></td> <td style="width: 10%;"></td> </tr> <tr> <td></td> <td></td> <td colspan="8" style="text-align: center;"> <table border="1" style="width: 100%; border-collapse: collapse; text-align: center;"> <tr> <td style="width: 10%;"></td> <td style="width: 10%;"></td> <td style="width: 10%;"></td> <td style="width: 10%;"></td> <td style="width: 10%;"></td> <td style="width: 10%;"></td> <td style="width: 10%;"></td> <td style="width: 10%;"></td> <td style="width: 10%;"></td> <td style="width: 10%;"></td> </tr> <tr> <td></td> <td></td> <td colspan="8" style="text-align: center;"> <table border="1" style="width: 100%; border-collapse: collapse; text-align: center;"> <tr> <td style="width: 10%;"></td> <td style="width: 10%;"></td> <td style="width: 10%;"></td> <td style="width: 10%;"></td> <td style="width: 10%;"></td> <td style="width: 10%;"></td> <td style="width: 10%;"></td> <td style="width: 10%;"></td> <td style="width: 10%;"></td> <td style="width: 10%;"></td> </tr> <tr> <td></td> <td></td> <td colspan="8" style="text-align: center;"> <table border="1" style="width: 100%; border-collapse: collapse; text-align: center;"> <tr> <td style="width: 10%;"></td> <td style="width: 10%;"></td> <td style="width: 10%;"></td> <td style="width: 10%;"></td> <td style="width: 10%;"></td> <td style="width: 10%;"></td> <td style="width: 10%;"></td> <td style="width: 10%;"></td> <td style="width: 10%;"></td> <td style="width: 10%;"></td> </tr> <tr> <td></td> <td></td> <td colspan="8" style="text-align: center;"> <table border="1" style="width: 100%; border-collapse: collapse; text-align: center;"> <tr> <td style="width: 10%;"></td> <td style="width: 10%;"></td> <td style="width: 10%;"></td> <td style="width: 10%;"></td> <td style="width: 10%;"></td> <td style="width: 10%;"></td> <td style="width: 10%;"></td> <td style="width: 10%;"></td> <td style="width: 10%;"></td> <td style="width: 10%;"></td> </tr> <tr> <td></td> <td></td> <td colspan="8" style="text-align: center;"> <table border="1" style="width: 100%; border-collapse: collapse; text-align: center;"> <tr> <td style="width: 10%;"></td> <td style="width: 10%;"></td> <td style="width: 10%;"></td> <td style="width: 10%;"></td> <td style="width: 10%;"></td> <td style="width: 10%;"></td> <td style="width: 10%;"></td> <td style="width: 10%;"></td> <td style="width: 10%;"></td> <td style="width: 10%;"></td> </tr> <tr> <td></td> <td></td> <td colspan="8" style="text-align: center;"> <table border="1" style="width: 100%; border-collapse: collapse; text-align: center;"> <tr> <td style="width: 10%;"></td> <td style="width: 10%;"></td> <td style="width: 10%;"></td> <td style="width: 10%;"></td> <td style="width: 10%;"></td> <td style="width: 10%;"></td> <td style="width: 10%;"></td> <td style="width: 10%;"></td> <td style="width: 10%;"></td> <td style="width: 10%;"></td> </tr> <tr> <td></td> <td></td> <td colspan="8" style="text-align: center;"> <table border="1" style="width: 100%; border-collapse: collapse; text-align: center;"> <tr> <td style="width: 10%;"></td> <td style="width: 10%;"></td> <td style="width: 10%;"></td> <td style="width: 10%;"></td> <td style="width: 10%;"></td> <td style="width: 10%;"></td> <td style="width: 10%;"></td> <td style="width: 10%;"></td> <td style="width: 10%;"></td> <td style="width: 10%;"></td> </tr> <tr> <td></td> <td></td> <td colspan="8" style="text-align: center;"> <table border="1" style="width: 100%; border-collapse: collapse; text-align: center;"> <tr> <td style="width: 10%;"></td> <td style="width: 10%;"></td> <td style="width: 10%;"></td> <td style="width: 10%;"></td> <td style="width: 10%;"></td> <td style="width: 10%;"></td> <td style="width: 10%;"></td> <td style="width: 10%;"></td> <td style="width: 10%;"></td> <td style="width: 10%;"></td> </tr> <tr> <td></td> <td></td> <td colspan="8" style="text-align: center;"> <table border="1" style="width: 100%; border-collapse: collapse; text-align: center;"> <tr> <td style="width: 10%;"></td> <td style="width: 10%;"></td> <td style="width: 10%;"></td> <td style="width: 10%;"></td> <td style="width: 10%;"></td> <td style="width: 10%;"></td> <td style="width: 10%;"></td> <td style="width: 10%;"></td> <td style="width: 10%;"></td> <td style="width: 10%;"></td> </tr> <tr> <td></td> <td></td> <td colspan="8" style="text-align: center;"> <table border="1" style="width: 100%; border-collapse: collapse; text-align: center;"> <tr> <td style="width: 10%;"></td> <td style="width: 10%;"></td> <td style="width: 10%;"></td> <td style="width: 10%;"></td> <td style="width: 10%;"></td> <td style="width: 10%;"></td> <td style="width: 10%;"></td> <td style="width: 10%;"></td> <td style="width: 10%;"></td> <td style="width: 10%;"></td> </tr> <tr> <td></td> <td></td> <td colspan="8" style="text-align: center;"> <table border="1" style="width: 100%; border-collapse: collapse; text-align: center;"> <tr> <td style="width: 10%;"></td> <td style="width: 10%;"></td> <td style="width: 10%;"></td> <td style="width: 10%;"></td> <td style="width: 10%;"></td> <td style="width: 10%;"></td> <td style="width: 10%;"></td> <td style="width: 10%;"></td> <td style="width: 10%;"></td> <td style="width: 10%;"></td> </tr> <tr> <td></td> <td></td> <td colspan="8" style="text-align: center;"> <table border="1" style="width: 100%; border-collapse: collapse; text-align: center;"> <tr> <td style="width: 10%;"></td> <td style="width: 10%;"></td> <td style="width: 10%;"></td> <td style="width: 10%;"></td> <td style="width: 10%;"></td> <td style="width: 10%;"></td> <td style="width: 10%;"></td> <td style="width: 10%;"></td> <td style="width: 10%;"></td> <td style="width: 10%;"></td> </tr> <tr> <td></td> <td></td> <td colspan="8" style="text-align: center;"> <table border="1" style="width: 100%; border-collapse: collapse; text-align: center;"> <tr> <td style="width: 10%;"></td> <td style="width: 10%;"></td> <td style="width: 10%;"></td> <td style="width: 10%;"></td> <td style="width: 10%;"></td> <td style="width: 10%;"></td> <td style="width: 10%;"></td> <td style="width: 10%;"></td> <td style="width: 10%;"></td> <td style="width: 10%;"></td> </tr> <tr> <td></td> <td></td> <td colspan="8" style="text-align: center;"> <table border="1" style="width: 100%; border-collapse: collapse; text-align: center;"> <tr>
</tr></table></td></tr></table></td></tr></table></td></tr></table></td></tr></table></td></tr></table></td></tr></table></td></tr></table></td></tr></table></td></tr></table></td></tr></table></td></tr></table></td></tr></table></td></tr></table></td></tr></table></td></tr></table></td></tr></table></td></tr></table></td></tr></table></td></tr></table></td></tr></table></td></tr></table></td></tr></table></td></tr></table></td></tr></table></td></tr></table></td></tr></table></td></tr></table></td></tr></table></td></tr></table></td></tr></table></td></tr></table></td></tr></table></td></tr></table></td></tr></table> | | | | | | | | | | | | | | | | | | | | <table border="1" style="width: 100%; border-collapse: collapse; text-align: center;"> <tr> <td style="width: 10%;"></td> <td style="width: 10%;"></td> <td style="width: 10%;"></td> <td style="width: 10%;"></td> <td style="width: 10%;"></td> <td style="width: 10%;"></td> <td style="width: 10%;"></td> <td style="width: 10%;"></td> <td style="width: 10%;"></td> <td style="width: 10%;"></td> </tr> <tr> <td></td> <td></td> <td colspan="8" style="text-align: center;"> <table border="1" style="width: 100%; border-collapse: collapse; text-align: center;"> <tr> <td style="width: 10%;"></td> <td style="width: 10%;"></td> <td style="width: 10%;"></td> <td style="width: 10%;"></td> <td style="width: 10%;"></td> <td style="width: 10%;"></td> <td style="width: 10%;"></td> <td style="width: 10%;"></td> <td style="width: 10%;"></td> <td style="width: 10%;"></td> </tr> <tr> <td></td> <td></td> <td colspan="8" style="text-align: center;"> <table border="1" style="width: 100%; border-collapse: collapse; text-align: center;"> <tr> <td style="width: 10%;"></td> <td style="width: 10%;"></td> <td style="width: 10%;"></td> <td style="width: 10%;"></td> <td style="width: 10%;"></td> <td style="width: 10%;"></td> <td style="width: 10%;"></td> <td style="width: 10%;"></td> <td style="width: 10%;"></td> <td style="width: 10%;"></td> </tr> <tr> <td></td> <td></td> <td colspan="8" style="text-align: center;"> <table border="1" style="width: 100%; border-collapse: collapse; text-align: center;"> <tr> <td style="width: 10%;"></td> <td
style="width: 10%;"></td> <td style="width: 10%;"></td> <td style="width: 10%;"></td> <td style="width: 10%;"></td> <td style="width: 10%;"></td> <td style="width: 10%;"></td> <td style="width: 10%;"></td> <td style="width: 10%;"></td> <td style="width: 10%;"></td> </tr> <tr> <td></td> <td></td> <td colspan="8" style="text-align: center;"> <table border="1" style="width: 100%; border-collapse: collapse; text-align: center;"> <tr> <td style="width: 10%;"></td> <td style="width: 10%;"></td> <td style="width: 10%;"></td> <td style="width: 10%;"></td> <td style="width: 10%;"></td> <td style="width: 10%;"></td> <td style="width: 10%;"></td> <td style="width: 10%;"></td> <td style="width: 10%;"></td> <td style="width: 10%;"></td> </tr> <tr> <td></td> <td></td> <td colspan="8" style="text-align: center;"> <table border="1" style="width: 100%; border-collapse: collapse; text-align: center;"> <tr> <td style="width: 10%;"></td> <td style="width: 10%;"></td> <td style="width: 10%;"></td> <td style="width: 10%;"></td> <td style="width: 10%;"></td> <td style="width: 10%;"></td> <td style="width: 10%;"></td> <td style="width: 10%;"></td> <td style="width: 10%;"></td> <td style="width: 10%;"></td> </tr> <tr> <td></td> <td></td> <td colspan="8" style="text-align: center;"> <table border="1" style="width: 100%; border-collapse: collapse; text-align: center;"> <tr> <td style="width: 10%;"></td> <td style="width: 10%;"></td> <td style="width: 10%;"></td> <td style="width: 10%;"></td> <td style="width: 10%;"></td> <td style="width: 10%;"></td> <td style="width: 10%;"></td> <td style="width: 10%;"></td> <td style="width: 10%;"></td> <td style="width: 10%;"></td> </tr> <tr> <td></td> <td></td> <td colspan="8" style="text-align: center;"> <table border="1" style="width: 100%; border-collapse: collapse; text-align: center;"> <tr> <td style="width: 10%;"></td> <td style="width: 10%;"></td> <td style="width: 10%;"></td> <td style="width: 10%;"></td> <td style="width: 10%;"></td> <td style="width: 10%;"></td> <td style="width: 10%;"></td> <td style="width: 10%;"></td> <td style="width: 10%;"></td> <td style="width: 10%;"></td> </tr> <tr> <td></td> <td></td> <td colspan="8" style="text-align: center;"> <table border="1" style="width: 100%; border-collapse: collapse; text-align: center;"> <tr> <td style="width: 10%;"></td> <td style="width: 10%;"></td> <td style="width: 10%;"></td> <td style="width: 10%;"></td> <td style="width: 10%;"></td> <td style="width: 10%;"></td> <td style="width: 10%;"></td> <td style="width: 10%;"></td> <td style="width: 10%;"></td> <td style="width: 10%;"></td> </tr> <tr> <td></td> <td></td> <td colspan="8" style="text-align: center;"> <table border="1" style="width: 100%; border-collapse: collapse; text-align: center;"> <tr> <td style="width: 10%;"></td> <td style="width: 10%;"></td> <td style="width: 10%;"></td> <td style="width: 10%;"></td> <td style="width: 10%;"></td> <td style="width: 10%;"></td> <td style="width: 10%;"></td> <td style="width: 10%;"></td> <td style="width: 10%;"></td> <td style="width: 10%;"></td> </tr> <tr> <td></td> <td></td> <td colspan="8" style="text-align: center;"> <table border="1" style="width: 100%; border-collapse: collapse; text-align: center;"> <tr> <td style="width: 10%;"></td> <td style="width: 10%;"></td> <td style="width: 10%;"></td> <td style="width: 10%;"></td> <td style="width: 10%;"></td> <td style="width: 10%;"></td> <td style="width: 10%;"></td> <td style="width: 10%;"></td> <td style="width: 10%;"></td> <td style="width: 10%;"></td> </tr> <tr> <td></td> <td></td> <td colspan="8" style="text-align: center;"> <table border="1" style="width: 100%; border-collapse: collapse; text-align: center;"> <tr> <td style="width: 10%;"></td> <td style="width: 10%;"></td> <td style="width: 10%;"></td> <td style="width: 10%;"></td> <td style="width: 10%;"></td> <td style="width: 10%;"></td> <td style="width: 10%;"></td> <td style="width: 10%;"></td> <td style="width: 10%;"></td> <td style="width: 10%;"></td> </tr> <tr> <td></td> <td></td> <td colspan="8" style="text-align: center;"> <table border="1" style="width: 100%; border-collapse: collapse; text-align: center;"> <tr> <td style="width: 10%;"></td> <td style="width: 10%;"></td> <td style="width: 10%;"></td> <td style="width: 10%;"></td> <td style="width: 10%;"></td> <td style="width: 10%;"></td> <td style="width: 10%;"></td> <td style="width: 10%;"></td> <td style="width: 10%;"></td> <td style="width: 10%;"></td> </tr> <tr> <td></td> <td></td> <td colspan="8" style="text-align: center;"> <table border="1" style="width: 100%; border-collapse: collapse; text-align: center;"> <tr> <td style="width: 10%;"></td> <td style="width: 10%;"></td> <td style="width: 10%;"></td> <td style="width: 10%;"></td> <td style="width: 10%;"></td> <td style="width: 10%;"></td> <td style="width: 10%;"></td> <td style="width: 10%;"></td> <td style="width: 10%;"></td> <td style="width: 10%;"></td> </tr> <tr> <td></td> <td></td> <td colspan="8" style="text-align: center;"> <table border="1" style="width: 100%; border-collapse: collapse; text-align: center;"> <tr> <td style="width: 10%;"></td> <td style="width: 10%;"></td> <td style="width: 10%;"></td> <td style="width: 10%;"></td> <td style="width: 10%;"></td> <td style="width: 10%;"></td> <td style="width: 10%;"></td> <td style="width: 10%;"></td> <td style="width: 10%;"></td> <td style="width: 10%;"></td> </tr> <tr> <td></td> <td></td> <td colspan="8" style="text-align: center;"> <table border="1" style="width: 100%; border-collapse: collapse; text-align: center;"> <tr> <td style="width: 10%;"></td> <td style="width: 10%;"></td> <td style="width: 10%;"></td> <td style="width: 10%;"></td> <td style="width: 10%;"></td> <td style="width: 10%;"></td> <td style="width: 10%;"></td> <td style="width: 10%;"></td> <td style="width: 10%;"></td> <td style="width: 10%;"></td> </tr> <tr> <td></td> <td></td> <td colspan="8" style="text-align: center;"> <table border="1" style="width: 100%; border-collapse: collapse; text-align: center;"> <tr> <td style="width: 10%;"></td> <td style="width: 10%;"></td> <td style="width: 10%;"></td> <td style="width: 10%;"></td> <td style="width: 10%;"></td> <td style="width: 10%;"></td> <td style="width: 10%;"></td> <td style="width: 10%;"></td> <td style="width: 10%;"></td> <td style="width: 10%;"></td> </tr> <tr> <td></td> <td></td> <td colspan="8" style="text-align: center;"> <table border="1" style="width: 100%; border-collapse: collapse; text-align: center;"> <tr> <td style="width: 10%;"></td> <td style="width: 10%;"></td> <td style="width: 10%;"></td> <td style="width: 10%;"></td> <td style="width: 10%;"></td> <td style="width: 10%;"></td> <td style="width: 10%;"></td> <td style="width: 10%;"></td> <td style="width: 10%;"></td> <td style="width: 10%;"></td> </tr> <tr> <td></td> <td></td> <td colspan="8" style="text-align: center;"> <table border="1" style="width: 100%; border-collapse: collapse; text-align: center;"> <tr> <td style="width: 10%;"></td> <td style="width: 10%;"></td> <td style="width: 10%;"></td> <td style="width: 10%;"></td> <td style="width: 10%;"></td> <td style="width: 10%;"></td> <td style="width: 10%;"></td> <td style="width: 10%;"></td> <td style="width: 10%;"></td> <td style="width: 10%;"></td> </tr> <tr> <td></td> <td></td> <td colspan="8" style="text-align: center;"> <table border="1" style="width: 100%; border-collapse: collapse; text-align: center;"> <tr> <td style="width: 10%;"></td> <td style="width: 10%;"></td> <td style="width: 10%;"></td> <td style="width: 10%;"></td> <td style="width: 10%;"></td> <td style="width: 10%;"></td> <td style="width: 10%;"></td> <td style="width: 10%;"></td> <td style="width: 10%;"></td> <td style="width: 10%;"></td> </tr> <tr> <td></td> <td></td> <td colspan="8" style="text-align: center;"> <table border="1" style="width: 100%; border-collapse: collapse; text-align: center;"> <tr> <td style="width: 10%;"></td> <td style="width: 10%;"></td> <td style="width: 10%;"></td> <td style="width: 10%;"></td> <td style="width: 10%;"></td> <td style="width: 10%;"></td> <td style="width: 10%;"></td> <td style="width: 10%;"></td> <td style="width: 10%;"></td> <td style="width: 10%;"></td> </tr> <tr> <td></td> <td></td> <td colspan="8" style="text-align: center;"> <table border="1" style="width: 100%; border-collapse: collapse; text-align: center;"> <tr> <td style="width: 10%;"></td> <td style="width: 10%;"></td> <td style="width: 10%;"></td> <td style="width: 10%;"></td> <td style="width: 10%;"></td> <td style="width: 10%;"></td> <td style="width: 10%;"></td> <td style="width: 10%;"></td> <td style="width: 10%;"></td> <td style="width: 10%;"></td> </tr> <tr> <td></td> <td></td> <td colspan="8" style="text-align: center;"> <table border="1" style="width: 100%; border-collapse: collapse; text-align: center;"> <tr> <td style="width: 10%;"></td> <td style="width: 10%;"></td> <td style="width: 10%;"></td> <td style="width: 10%;"></td> <td style="width: 10%;"></td> <td style="width: 10%;"></td> <td style="width: 10%;"></td> <td style="width: 10%;"></td> <td style="width: 10%;"></td> <td style="width: 10%;"></td> </tr> <tr> <td></td> <td></td> <td colspan="8" style="text-align: center;"> <table border="1" style="width: 100%; border-collapse: collapse; text-align: center;"> <tr> <td style="width: 10%;"></td> <td style="width: 10%;"></td> <td style="width: 10%;"></td> <td style="width: 10%;"></td> <td style="width: 10%;"></td> <td style="width: 10%;"></td> <td style="width: 10%;"></td> <td style="width: 10%;"></td> <td style="width: 10%;"></td> <td style="width: 10%;"></td> </tr> <tr> <td></td> <td></td> <td colspan="8" style="text-align: center;"> <table border="1" style="width: 100%; border-collapse: collapse; text-align: center;"> <tr> <td style="width: 10%;"></td> <td style="width: 10%;"></td> <td style="width: 10%;"></td> <td style="width: 10%;"></td> <td style="width: 10%;"></td> <td style="width: 10%;"></td> <td style="width:
10%;"></td> <td style="width: 10%;"></td> <td style="width: 10%;"></td> <td style="width: 10%;"></td> </tr> <tr> <td></td> <td></td> <td colspan="8" style="text-align: center;"> <table border="1" style="width: 100%; border-collapse: collapse; text-align: center;"> <tr> <td style="width: 10%;"></td> <td style="width: 10%;"></td> <td style="width: 10%;"></td> <td style="width: 10%;"></td> <td style="width: 10%;"></td> <td style="width: 10%;"></td> <td style="width: 10%;"></td> <td style="width: 10%;"></td> <td style="width: 10%;"></td> <td style="width: 10%;"></td> </tr> <tr> <td></td> <td></td> <td colspan="8" style="text-align: center;"> <table border="1" style="width: 100%; border-collapse: collapse; text-align: center;"> <tr> <td style="width: 10%;"></td> <td style="width: 10%;"></td> <td style="width: 10%;"></td> <td style="width: 10%;"></td> <td style="width: 10%;"></td> <td style="width: 10%;"></td> <td style="width: 10%;"></td> <td style="width: 10%;"></td> <td style="width: 10%;"></td> <td style="width: 10%;"></td> </tr> <tr> <td></td> <td></td> <td colspan="8" style="text-align: center;"> <table border="1" style="width: 100%; border-collapse: collapse; text-align: center;"> <tr> <td style="width: 10%;"></td> <td style="width: 10%;"></td> <td style="width: 10%;"></td> <td style="width: 10%;"></td> <td style="width: 10%;"></td> <td style="width: 10%;"></td> <td style="width: 10%;"></td> <td style="width: 10%;"></td> <td style="width: 10%;"></td> <td style="width: 10%;"></td> </tr> <tr> <td></td> <td></td> <td colspan="8" style="text-align: center;"> <table border="1" style="width: 100%; border-collapse: collapse; text-align: center;"> <tr> <td style="width: 10%;"></td> <td style="width: 10%;"></td> <td style="width: 10%;"></td> <td style="width: 10%;"></td> <td style="width: 10%;"></td> <td style="width: 10%;"></td> <td style="width: 10%;"></td> <td style="width: 10%;"></td> <td style="width: 10%;"></td> <td style="width: 10%;"></td> </tr> <tr> <td></td> <td></td> <td colspan="8" style="text-align: center;"> <table border="1" style="width: 100%; border-collapse: collapse; text-align: center;"> <tr> <td style="width: 10%;"></td> <td style="width: 10%;"></td> <td style="width: 10%;"></td> <td style="width: 10%;"></td> <td style="width: 10%;"></td> <td style="width: 10%;"></td> <td style="width: 10%;"></td> <td style="width: 10%;"></td> <td style="width: 10%;"></td> <td style="width: 10%;"></td> </tr> <tr> <td></td> <td></td> <td colspan="8" style="text-align: center;"> <table border="1" style="width: 100%; border-collapse: collapse; text-align: center;"> <tr> <td style="width: 10%;"></td> <td style="width: 10%;"></td> <td style="width: 10%;"></td> <td style="width: 10%;"></td> <td style="width: 10%;"></td> <td style="width: 10%;"></td> <td style="width: 10%;"></td> <td style="width: 10%;"></td> <td style="width: 10%;"></td> <td style="width: 10%;"></td> </tr> <tr> <td></td> <td></td> <td colspan="8" style="text-align: center;"> <table border="1" style="width: 100%; border-collapse: collapse; text-align: center;"> <tr> <td style="width: 10%;"></td> <td style="width: 10%;"></td> <td style="width: 10%;"></td> <td style="width: 10%;"></td> <td style="width: 10%;"></td> <td style="width: 10%;"></td> <td style="width: 10%;"></td> <td style="width: 10%;"></td> <td style="width: 10%;"></td> <td style="width: 10%;"></td> </tr> <tr> <td></td> <td></td> <td colspan="8" style="text-align: center;"> <table border="1" style="width: 100%; border-collapse: collapse; text-align: center;"> <tr> <td style="width: 10%;"></td> <td style="width: 10%;"></td> <td style="width: 10%;"></td> <td style="width: 10%;"></td> <td style="width: 10%;"></td> <td style="width: 10%;"></td> <td style="width: 10%;"></td> <td style="width: 10%;"></td> <td style="width: 10%;"></td> <td style="width: 10%;"></td> </tr> <tr> <td></td> <td></td> <td colspan="8" style="text-align: center;"> <table border="1" style="width: 100%; border-collapse: collapse; text-align: center;"> <tr> </tr></table></td></tr></table></td></tr></table></td></tr></table></td></tr></table></td></tr></table></td></tr></table></td></tr></table></td></tr></table></td></tr></table></td></tr></table></td></tr></table></td></tr></table></td></tr></table></td></tr></table></td></tr></table></td></tr></table></td></tr></table></td></tr></table></td></tr></table></td></tr></table></td></tr></table></td></tr></table></td></tr></table></td></tr></table></td></tr></table></td></tr></table></td></tr></table></td></tr></table></td></tr></table></td></tr></table></td></tr></table></td></tr></table></td></tr></table>
 | | | | | | | | | | | | | | | | | | | | <table border="1" style="width: 100%; border-collapse: collapse; text-align: center;"> <tr> <td style="width: 10%;"></td> <td style="width: 10%;"></td> <td style="width: 10%;"></td> <td style="width: 10%;"></td> <td style="width: 10%;"></td> <td style="width: 10%;"></td> <td style="width: 10%;"></td> <td style="width: 10%;"></td> <td style="width: 10%;"></td> <td style="width: 10%;"></td> </tr> <tr> <td></td> <td></td> <td colspan="8" style="text-align: center;"> <table border="1" style="width: 100%; border-collapse: collapse; text-align: center;"> <tr> <td style="width: 10%;"></td> <td style="width: 10%;"></td> <td style="width: 10%;"></td> <td style="width: 10%;"></td> <td style="width: 10%;"></td> <td style="width: 10%;"></td> <td style="width: 10%;"></td> <td style="width: 10%;"></td> <td style="width: 10%;"></td> <td style="width: 10%;"></td> </tr> <tr> <td></td> <td></td> <td colspan="8" style="text-align: center;"> <table border="1" style="width: 100%; border-collapse: collapse; text-align: center;"> <tr> <td style="width: 10%;"></td> <td style="width: 10%;"></td> <td style="width: 10%;"></td> <td style="width: 10%;"></td> <td style="width: 10%;"></td> <td style="width: 10%;"></td> <td style="width: 10%;"></td> <td style="width: 10%;"></td> <td style="width: 10%;"></td> <td style="width: 10%;"></td> </tr> <tr> <td></td> <td></td> <td colspan="8" style="text-align: center;"> <table border="1" style="width: 100%; border-collapse: collapse; text-align: center;"> <tr> <td style="width: 10%;"></td> <td style="width: 10%;"></td> <td style="width: 10%;"></td> <td style="width: 10%;"></td> <td style="width: 10%;"></td> <td style="width: 10%;"></td> <td style="width: 10%;"></td> <td style="width: 10%;"></td> <td style="width: 10%;"></td> <td style="width: 10%;"></td> </tr> <tr> <td></td> <td></td> <td colspan="8" style="text-align: center;"> <table border="1" style="width: 100%; border-collapse: collapse; text-align: center;"> <tr> <td style="width: 10%;"></td> <td style="width: 10%;"></td> <td style="width: 10%;"></td> <td style="width: 10%;"></td> <td style="width: 10%;"></td> <td style="width: 10%;"></td> <td style="width: 10%;"></td> <td style="width: 10%;"></td> <td style="width: 10%;"></td> <td style="width: 10%;"></td> </tr> <tr> <td></td> <td></td> <td colspan="8" style="text-align: center;"> <table border="1" style="width: 100%; border-collapse: collapse; text-align: center;"> <tr> <td style="width: 10%;"></td> <td style="width: 10%;"></td> <td style="width: 10%;"></td> <td style="width: 10%;"></td> <td style="width: 10%;"></td> <td style="width: 10%;"></td> <td style="width: 10%;"></td> <td style="width: 10%;"></td> <td style="width: 10%;"></td> <td style="width: 10%;"></td> </tr> <tr> <td></td> <td></td> <td colspan="8" style="text-align: center;"> <table border="1" style="width: 100%; border-collapse: collapse; text-align: center;"> <tr> <td style="width: 10%;"></td> <td style="width: 10%;"></td> <td style="width: 10%;"></td> <td style="width: 10%;"></td> <td style="width: 10%;"></td> <td style="width: 10%;"></td> <td style="width: 10%;"></td> <td style="width: 10%;"></td> <td style="width: 10%;"></td> <td style="width: 10%;"></td> </tr> <tr> <td></td> <td></td> <td colspan="8" style="text-align: center;"> <table border="1" style="width: 100%; border-collapse: collapse; text-align: center;"> <tr> <td style="width: 10%;"></td> <td style="width: 10%;"></td> <td style="width: 10%;"></td> <td style="width: 10%;"></td> <td style="width: 10%;"></td> <td style="width: 10%;"></td> <td style="width: 10%;"></td> <td style="width: 10%;"></td> <td style="width: 10%;"></td> <td style="width: 10%;"></td> </tr> <tr> <td></td> <td></td> <td colspan="8" style="text-align: center;"> <table border="1" style="width: 100%; border-collapse: collapse; text-align: center;"> <tr> <td style="width: 10%;"></td> <td style="width: 10%;"></td> <td style="width: 10%;"></td> <td style="width: 10%;"></td> <td style="width: 10%;"></td> <td style="width: 10%;"></td> <td style="width: 10%;"></td> <td style="width: 10%;"></td> <td style="width: 10%;"></td> <td style="width: 10%;"></td> </tr> <tr> <td></td> <td></td> <td colspan="8" style="text-align: center;"> <table border="1" style="width: 100%; border-collapse: collapse; text-align: center;"> <tr> <td style="width: 10%;"></td> <td style="width: 10%;"></td> <td style="width: 10%;"></td> <td style="width: 10%;"></td> <td style="width: 10%;"></td> <td style="width: 10%;"></td> <td style="width: 10%;"></td> <td style="width: 10%;"></td> <td style="width: 10%;"></td> <td style="width: 10%;"></td> </tr> <tr> <td></td> <td></td> <td colspan="8" style="text-align: center;"> <table border="1" style="width: 100%; border-collapse: collapse; text-align: center;"> <tr> <td style="width: 10%;"></td> <td style="width: 10%;"></td> <td style="width: 10%;"></td> <td style="width: 10%;"></td> <td style="width: 10%;"></td> <td style="width: 10%;"></td> <td style="width: 10%;"></td> <td style="width: 10%;"></td> <td style="width: 10%;"></td> <td style="width: 10%;"></td> </tr> <tr> <td></td> <td></td> <td colspan="8" style="text-align: center;"> <table border="1" style="width: 100%; border-collapse: collapse; text-align: center;"> <tr> <td style="width: 10%;"></td> <td style="width: 10%;"></td> <td style="width: 10%;"></td> <td style="width: 10%;"></td> <td style="width: 10%;"></td> <td style="width: 10%;"></td> <td style="width: 10%;"></td> <td style="width: 10%;"></td> <td style="width: 10%;"></td> <td style="width: 10%;"></td> </tr> <tr> <td></td> <td></td> <td colspan="8" style="text-align: center;"> <table border="1" style="width: 100%; border-collapse: collapse; text-align: center;"> <tr> <td style="width: 10%;"></td> <td style="width: 10%;"></td> <td style="width: 10%;"></td> <td style="width: 10%;"></td> <td style="width: 10%;"></td> <td style="width: 10%;"></td> <td style="width: 10%;"></td> <td style="width: 10%;"></td> <td style="width: 10%;"></td> <td style="width: 10%;"></td> </tr> <tr> <td></td> <td></td> <td colspan="8" style="text-align: center;"> <table border="1" style="width: 100%; border-collapse: collapse; text-align: center;"> <tr> <td style="width: 10%;"></td> <td style="width: 10%;"></td> <td style="width: 10%;"></td> <td style="width: 10%;"></td> <td style="width: 10%;"></td> <td style="width: 10%;"></td> <td style="width: 10%;"></td> <td style="width: 10%;"></td> <td style="width: 10%;"></td> <td style="width: 10%;"></td> </tr> <tr> <td></td> <td></td> <td colspan="8" style="text-align: center;"> <table border="1" style="width: 100%; border-collapse: collapse; text-align: center;"> <tr> <td style="width: 10%;"></td> <td style="width: 10%;"></td> <td style="width: 10%;"></td> <td style="width: 10%;"></td> <td style="width: 10%;"></td> <td style="width: 10%;"></td> <td style="width: 10%;"></td> <td style="width: 10%;"></td> <td style="width: 10%;"></td> <td style="width: 10%;"></td> </tr> <tr> <td></td> <td></td> <td colspan="8" style="text-align: center;"> <table border="1" style="width: 100%; border-collapse: collapse; text-align: center;"> <tr> <td style="width: 10%;"></td> <td style="width: 10%;"></td> <td style="width: 10%;"></td> <td style="width: 10%;"></td> <td style="width: 10%;"></td> <td style="width: 10%;"></td> <td style="width: 10%;"></td> <td style="width: 10%;"></td> <td style="width: 10%;"></td> <td style="width: 10%;"></td> </tr> <tr> <td></td> <td></td> <td colspan="8" style="text-align: center;"> <table border="1" style="width: 100%; border-collapse:
collapse; text-align: center;"> <tr> <td style="width: 10%;"></td> <td style="width: 10%;"></td> <td style="width: 10%;"></td> <td style="width: 10%;"></td> <td style="width: 10%;"></td> <td style="width: 10%;"></td> <td style="width: 10%;"></td> <td style="width: 10%;"></td> <td style="width: 10%;"></td> <td style="width: 10%;"></td> </tr> <tr> <td></td> <td></td> <td colspan="8" style="text-align: center;"> <table border="1" style="width: 100%; border-collapse: collapse; text-align: center;"> <tr> <td style="width: 10%;"></td> <td style="width: 10%;"></td> <td style="width: 10%;"></td> <td style="width: 10%;"></td> <td style="width: 10%;"></td> <td style="width: 10%;"></td> <td style="width: 10%;"></td> <td style="width: 10%;"></td> <td style="width: 10%;"></td> <td style="width: 10%;"></td> </tr> <tr> <td></td> <td></td> <td colspan="8" style="text-align: center;"> <table border="1" style="width: 100%; border-collapse: collapse; text-align: center;"> <tr> <td style="width: 10%;"></td> <td style="width: 10%;"></td> <td style="width: 10%;"></td> <td style="width: 10%;"></td> <td style="width: 10%;"></td> <td style="width: 10%;"></td> <td style="width: 10%;"></td> <td style="width: 10%;"></td> <td style="width: 10%;"></td> <td style="width: 10%;"></td> </tr> <tr> <td></td> <td></td> <td colspan="8" style="text-align: center;"> <table border="1" style="width: 100%; border-collapse: collapse; text-align: center;"> <tr> <td style="width: 10%;"></td> <td style="width: 10%;"></td> <td style="width: 10%;"></td> <td style="width: 10%;"></td> <td style="width: 10%;"></td> <td style="width: 10%;"></td> <td style="width: 10%;"></td> <td style="width: 10%;"></td> <td style="width: 10%;"></td> <td style="width: 10%;"></td> </tr> <tr> <td></td> <td></td> <td colspan="8" style="text-align: center;"> <table border="1" style="width: 100%; border-collapse: collapse; text-align: center;"> <tr> <td style="width: 10%;"></td> <td style="width: 10%;"></td> <td style="width: 10%;"></td> <td style="width: 10%;"></td> <td style="width: 10%;"></td> <td style="width: 10%;"></td> <td style="width: 10%;"></td> <td style="width: 10%;"></td> <td style="width: 10%;"></td> <td style="width: 10%;"></td> </tr> <tr> <td></td> <td></td> <td colspan="8" style="text-align: center;"> <table border="1" style="width: 100%; border-collapse: collapse; text-align: center;"> <tr> <td style="width: 10%;"></td> <td style="width: 10%;"></td> <td style="width: 10%;"></td> <td style="width: 10%;"></td> <td style="width: 10%;"></td> <td style="width: 10%;"></td> <td style="width: 10%;"></td> <td style="width: 10%;"></td> <td style="width: 10%;"></td> <td style="width: 10%;"></td> </tr> <tr> <td></td> <td></td> <td colspan="8" style="text-align: center;"> <table border="1" style="width: 100%; border-collapse: collapse; text-align: center;"> <tr> <td style="width: 10%;"></td> <td style="width: 10%;"></td> <td style="width: 10%;"></td> <td style="width: 10%;"></td> <td style="width: 10%;"></td> <td style="width: 10%;"></td> <td style="width: 10%;"></td> <td style="width: 10%;"></td> <td style="width: 10%;"></td> <td style="width: 10%;"></td> </tr> <tr> <td></td> <td></td> <td colspan="8" style="text-align: center;"> <table border="1" style="width: 100%; border-collapse: collapse; text-align: center;"> <tr> <td style="width: 10%;"></td> <td style="width: 10%;"></td> <td style="width: 10%;"></td> <td style="width: 10%;"></td> <td style="width: 10%;"></td> <td style="width: 10%;"></td> <td style="width: 10%;"></td> <td style="width: 10%;"></td> <td style="width: 10%;"></td> <td style="width: 10%;"></td> </tr> <tr> <td></td> <td></td> <td colspan="8" style="text-align: center;"> <table border="1" style="width: 100%; border-collapse: collapse; text-align: center;"> <tr> <td style="width: 10%;"></td> <td style="width: 10%;"></td> <td style="width: 10%;"></td> <td style="width: 10%;"></td> <td style="width: 10%;"></td> <td style="width: 10%;"></td> <td style="width: 10%;"></td> <td style="width: 10%;"></td> <td style="width: 10%;"></td> <td style="width: 10%;"></td> </tr> <tr> <td></td> <td></td> <td colspan="8" style="text-align: center;"> <table border="1" style="width: 100%; border-collapse: collapse; text-align: center;"> <tr> <td style="width: 10%;"></td> <td style="width: 10%;"></td> <td style="width: 10%;"></td> <td style="width: 10%;"></td> <td style="width: 10%;"></td> <td style="width: 10%;"></td> <td style="width: 10%;"></td> <td style="width: 10%;"></td> <td style="width: 10%;"></td> <td style="width: 10%;"></td> </tr> <tr> <td></td> <td></td> <td colspan="8" style="text-align: center;"> <table border="1" style="width: 100%; border-collapse: collapse; text-align: center;"> <tr> <td style="width: 10%;"></td> <td style="width: 10%;"></td> <td style="width: 10%;"></td> <td style="width: 10%;"></td> <td style="width: 10%;"></td> <td style="width: 10%;"></td> <td style="width: 10%;"></td> <td style="width: 10%;"></td> <td style="width: 10%;"></td> <td style="width: 10%;"></td> </tr> <tr> <td></td> <td></td> <td colspan="8" style="text-align: center;"> <table border="1" style="width: 100%; border-collapse: collapse; text-align: center;"> <tr> <td style="width: 10%;"></td> <td style="width: 10%;"></td> <td style="width: 10%;"></td> <td style="width: 10%;"></td> <td style="width: 10%;"></td> <td style="width: 10%;"></td> <td style="width: 10%;"></td> <td style="width: 10%;"></td> <td style="width: 10%;"></td> <td style="width: 10%;"></td> </tr> <tr> <td></td> <td></td> <td colspan="8" style="text-align: center;"> <table border="1" style="width: 100%; border-collapse: collapse; text-align: center;"> <tr> <td style="width: 10%;"></td> <td style="width: 10%;"></td> <td style="width: 10%;"></td> <td style="width: 10%;"></td> <td style="width: 10%;"></td> <td style="width: 10%;"></td> <td style="width: 10%;"></td> <td style="width: 10%;"></td> <td style="width: 10%;"></td> <td style="width: 10%;"></td> </tr> <tr> <td></td> <td></td> <td colspan="8" style="text-align: center;"> <table border="1" style="width: 100%; border-collapse: collapse; text-align: center;"> <tr> <td style="width: 10%;"></td> <td style="width: 10%;"></td> <td style="width: 10%;"></td> <td style="width: 10%;"></td> <td style="width: 10%;"></td> <td style="width: 10%;"></td> <td style="width: 10%;"></td> <td style="width: 10%;"></td> <td style="width: 10%;"></td> <td style="width: 10%;"></td> </tr> <tr> <td></td> <td></td> <td colspan="8" style="text-align: center;"> <table border="1" style="width: 100%; border-collapse: collapse; text-align: center;"> <tr> <td style="width: 10%;"></td> <td style="width: 10%;"></td> <td style="width: 10%;"></td> <td style="width: 10%;"></td> <td style="width: 10%;"></td> <td style="width: 10%;"></td> <td style="width: 10%;"></td> <td style="width: 10%;"></td> <td style="width: 10%;"></td> <td style="width: 10%;"></td> </tr> <tr> <td></td> <td></td> <td colspan="8" style="text-align: center;"> <table border="1" style="width: 100%; border-collapse: collapse; text-align: center;"> <tr> <td style="width: 10%;"></td> <td style="width: 10%;"></td> <td style="width: 10%;"></td> <td style="width: 10%;"></td> <td style="width: 10%;"></td> <td style="width: 10%;"></td> <td style="width: 10%;"></td> <td style="width: 10%;"></td> <td style="width: 10%;"></td> <td style="width: 10%;"></td> </tr> <tr> <td></td> <td></td> <td colspan="8" style="text-align: center;"> <table border="1" style="width: 100%; border-collapse: collapse; text-align: center;"> <tr> </tr></table></td></tr></table></td></tr></table></td></tr></table></td></tr></table></td></tr></table></td></tr></table></td></tr></table></td></tr></table></td></tr></table></td></tr></table></td></tr></table></td></tr></table></td></tr></table></td></tr></table></td></tr></table></td></tr></table></td></tr></table></td></tr></table></td></tr></table></td></tr></table></td></tr></table></td></tr></table></td></tr></table></td></tr></table></td></tr></table></td></tr></table></td></tr></table></td></tr></table></td></tr></table></td></tr></table></td></tr></table></td></tr></table>
 | | | | | | | | | | | | | | | | | | | | <table border="1" style="width: 100%; border-collapse: collapse; text-align: center;"> <tr> <td style="width: 10%;"></td> <td style="width: 10%;"></td> <td style="width: 10%;"></td> <td style="width: 10%;"></td> <td style="width: 10%;"></td> <td style="width: 10%;"></td> <td style="width: 10%;"></td> <td style="width: 10%;"></td> <td style="width: 10%;"></td> <td style="width: 10%;"></td> </tr> <tr> <td></td> <td></td> <td colspan="8" style="text-align: center;"> <table border="1" style="width: 100%; border-collapse: collapse; text-align: center;"> <tr> <td style="width: 10%;"></td> <td style="width: 10%;"></td> <td style="width: 10%;"></td> <td style="width: 10%;"></td> <td style="width: 10%;"></td> <td style="width: 10%;"></td> <td style="width: 10%;"></td> <td style="width: 10%;"></td> <td style="width: 10%;"></td> <td style="width: 10%;"></td> </tr> <tr> <td></td> <td></td> <td colspan="8" style="text-align: center;"> <table border="1" style="width: 100%; border-collapse: collapse; text-align: center;"> <tr> <td style="width: 10%;"></td> <td style="width: 10%;"></td> <td style="width: 10%;"></td> <td style="width: 10%;"></td> <td style="width: 10%;"></td> <td style="width: 10%;"></td> <td style="width: 10%;"></td> <td style="width: 10%;"></td> <td style="width: 10%;"></td> <td style="width: 10%;"></td> </tr> <tr> <td></td> <td></td> <td colspan="8" style="text-align: center;"> <table border="1" style="width: 100%; border-collapse: collapse; text-align: center;"> <tr> <td style="width: 10%;"></td> <td style="width: 10%;"></td> <td style="width: 10%;"></td> <td style="width: 10%;"></td> <td style="width: 10%;"></td> <td style="width: 10%;"></td> <td style="width: 10%;"></td> <td style="width: 10%;"></td> <td style="width: 10%;"></td> <td style="width: 10%;"></td> </tr> <tr> <td></td> <td></td> <td colspan="8" style="text-align: center;"> <table border="1" style="width: 100%; border-collapse: collapse; text-align: center;"> <tr> <td style="width: 10%;"></td> <td style="width: 10%;"></td> <td style="width: 10%;"></td> <td style="width: 10%;"></td> <td style="width: 10%;"></td> <td style="width: 10%;"></td> <td style="width: 10%;"></td> <td style="width: 10%;"></td> <td style="width: 10%;"></td> <td style="width: 10%;"></td> </tr> <tr> <td></td> <td></td> <td colspan="8" style="text-align: center;"> <table border="1" style="width: 100%; border-collapse: collapse; text-align: center;"> <tr> <td style="width: 10%;"></td> <td style="width: 10%;"></td> <td style="width: 10%;"></td> <td style="width: 10%;"></td> <td style="width: 10%;"></td> <td style="width: 10%;"></td> <td style="width: 10%;"></td> <td style="width: 10%;"></td> <td style="width: 10%;"></td> <td style="width: 10%;"></td> </tr> <tr> <td></td> <td></td> <td colspan="8" style="text-align: center;"> <table border="1" style="width: 100%; border-collapse: collapse; text-align: center;"> <tr> <td style="width: 10%;"></td> <td style="width: 10%;"></td> <td style="width: 10%;"></td> <td style="width: 10%;"></td> <td style="width: 10%;"></td> <td style="width: 10%;"></td> <td style="width: 10%;"></td> <td style="width: 10%;"></td> <td style="width: 10%;"></td> <td style="width: 10%;"></td> </tr> <tr> <td></td> <td></td> <td colspan="8" style="text-align: center;"> <table border="1" style="width: 100%; border-collapse: collapse; text-align: center;"> <tr> <td style="width: 10%;"></td> <td style="width: 10%;"></td> <td style="width: 10%;"></td> <td style="width: 10%;"></td> <td style="width: 10%;"></td> <td style="width: 10%;"></td> <td style="width: 10%;"></td> <td style="width: 10%;"></td> <td style="width: 10%;"></td> <td style="width: 10%;"></td> </tr> <tr> <td></td> <td></td> <td colspan="8" style="text-align: center;"> <table border="1" style="width: 100%; border-collapse: collapse; text-align: center;"> <tr> <td style="width: 10%;"></td> <td style="width: 10%;"></td> <td style="width: 10%;"></td> <td style="width: 10%;"></td> <td style="width: 10%;"></td> <td style="width: 10%;"></td> <td style="width: 10%;"></td> <td
style="width: 10%;"></td> <td style="width: 10%;"></td> <td style="width: 10%;"></td> </tr> <tr> <td></td> <td></td> <td colspan="8" style="text-align: center;"> <table border="1" style="width: 100%; border-collapse: collapse; text-align: center;"> <tr> <td style="width: 10%;"></td> <td style="width: 10%;"></td> <td style="width: 10%;"></td> <td style="width: 10%;"></td> <td style="width: 10%;"></td> <td style="width: 10%;"></td> <td style="width: 10%;"></td> <td style="width: 10%;"></td> <td style="width: 10%;"></td> <td style="width: 10%;"></td> </tr> <tr> <td></td> <td></td> <td colspan="8" style="text-align: center;"> <table border="1" style="width: 100%; border-collapse: collapse; text-align: center;"> <tr> <td style="width: 10%;"></td> <td style="width: 10%;"></td> <td style="width: 10%;"></td> <td style="width: 10%;"></td> <td style="width: 10%;"></td> <td style="width: 10%;"></td> <td style="width: 10%;"></td> <td style="width: 10%;"></td> <td style="width: 10%;"></td> <td style="width: 10%;"></td> </tr> <tr> <td></td> <td></td> <td colspan="8" style="text-align: center;"> <table border="1" style="width: 100%; border-collapse: collapse; text-align: center;"> <tr> <td style="width: 10%;"></td> <td style="width: 10%;"></td> <td style="width: 10%;"></td> <td style="width: 10%;"></td> <td style="width: 10%;"></td> <td style="width: 10%;"></td> <td style="width: 10%;"></td> <td style="width: 10%;"></td> <td style="width: 10%;"></td> <td style="width: 10%;"></td> </tr> <tr> <td></td> <td></td> <td colspan="8" style="text-align: center;"> <table border="1" style="width: 100%; border-collapse: collapse; text-align: center;"> <tr> <td style="width: 10%;"></td> <td style="width: 10%;"></td> <td style="width: 10%;"></td> <td style="width: 10%;"></td> <td style="width: 10%;"></td> <td style="width: 10%;"></td> <td style="width: 10%;"></td> <td style="width: 10%;"></td> <td style="width: 10%;"></td> <td style="width: 10%;"></td> </tr> <tr> <td></td> <td></td> <td colspan="8" style="text-align: center;"> <table border="1" style="width: 100%; border-collapse: collapse; text-align: center;"> <tr> <td style="width: 10%;"></td> <td style="width: 10%;"></td> <td style="width: 10%;"></td> <td style="width: 10%;"></td> <td style="width: 10%;"></td> <td style="width: 10%;"></td> <td style="width: 10%;"></td> <td style="width: 10%;"></td> <td style="width: 10%;"></td> <td style="width: 10%;"></td> </tr> <tr> <td></td> <td></td> <td colspan="8" style="text-align: center;"> <table border="1" style="width: 100%; border-collapse: collapse; text-align: center;"> <tr> <td style="width: 10%;"></td> <td style="width: 10%;"></td> <td style="width: 10%;"></td> <td style="width: 10%;"></td> <td style="width: 10%;"></td> <td style="width: 10%;"></td> <td style="width: 10%;"></td> <td style="width: 10%;"></td> <td style="width: 10%;"></td> <td style="width: 10%;"></td> </tr> <tr> <td></td> <td></td> <td colspan="8" style="text-align: center;"> <table border="1" style="width: 100%; border-collapse: collapse; text-align: center;"> <tr> <td style="width: 10%;"></td> <td style="width: 10%;"></td> <td style="width: 10%;"></td> <td style="width: 10%;"></td> <td style="width: 10%;"></td> <td style="width: 10%;"></td> <td style="width: 10%;"></td> <td style="width: 10%;"></td> <td style="width: 10%;"></td> <td style="width: 10%;"></td> </tr> <tr> <td></td> <td></td> <td colspan="8" style="text-align: center;"> <table border="1" style="width: 100%; border-collapse: collapse; text-align: center;"> <tr> <td style="width: 10%;"></td> <td style="width: 10%;"></td> <td style="width: 10%;"></td> <td style="width: 10%;"></td> <td style="width: 10%;"></td> <td style="width: 10%;"></td> <td style="width: 10%;"></td> <td style="width: 10%;"></td> <td style="width: 10%;"></td> <td style="width: 10%;"></td> </tr> <tr> <td></td> <td></td> <td colspan="8" style="text-align: center;"> <table border="1" style="width: 100%; border-collapse: collapse; text-align: center;"> <tr> <td style="width: 10%;"></td> <td style="width: 10%;"></td> <td style="width: 10%;"></td> <td style="width: 10%;"></td> <td style="width: 10%;"></td> <td style="width: 10%;"></td> <td style="width: 10%;"></td> <td style="width: 10%;"></td> <td style="width: 10%;"></td> <td style="width: 10%;"></td> </tr> <tr> <td></td> <td></td> <td colspan="8" style="text-align: center;"> <table border="1" style="width: 100%; border-collapse: collapse; text-align: center;"> <tr> <td style="width: 10%;"></td> <td style="width: 10%;"></td> <td style="width: 10%;"></td> <td style="width: 10%;"></td> <td style="width: 10%;"></td> <td style="width: 10%;"></td> <td style="width: 10%;"></td> <td style="width: 10%;"></td> <td style="width: 10%;"></td> <td style="width: 10%;"></td> </tr> <tr> <td></td> <td></td> <td colspan="8" style="text-align: center;"> <table border="1" style="width: 100%; border-collapse: collapse; text-align: center;"> <tr> <td style="width: 10%;"></td> <td style="width: 10%;"></td> <td style="width: 10%;"></td> <td style="width: 10%;"></td> <td style="width: 10%;"></td> <td style="width: 10%;"></td> <td style="width: 10%;"></td> <td style="width: 10%;"></td> <td style="width: 10%;"></td> <td style="width: 10%;"></td> </tr> <tr> <td></td> <td></td> <td colspan="8" style="text-align: center;"> <table border="1" style="width: 100%; border-collapse: collapse; text-align: center;"> <tr> <td style="width: 10%;"></td> <td style="width: 10%;"></td> <td style="width: 10%;"></td> <td style="width: 10%;"></td> <td style="width: 10%;"></td> <td style="width: 10%;"></td> <td style="width: 10%;"></td> <td style="width: 10%;"></td> <td style="width: 10%;"></td> <td style="width: 10%;"></td> </tr> <tr> <td></td> <td></td> <td colspan="8" style="text-align: center;"> <table border="1" style="width: 100%; border-collapse: collapse; text-align: center;"> <tr> <td style="width: 10%;"></td> <td style="width: 10%;"></td> <td style="width: 10%;"></td> <td style="width: 10%;"></td> <td style="width: 10%;"></td> <td style="width: 10%;"></td> <td style="width: 10%;"></td> <td style="width: 10%;"></td> <td style="width: 10%;"></td> <td style="width: 10%;"></td> </tr> <tr> <td></td> <td></td> <td colspan="8" style="text-align: center;"> <table border="1" style="width: 100%; border-collapse: collapse; text-align: center;"> <tr> <td style="width: 10%;"></td> <td style="width: 10%;"></td> <td style="width: 10%;"></td> <td style="width: 10%;"></td> <td style="width: 10%;"></td> <td style="width: 10%;"></td> <td style="width: 10%;"></td> <td style="width: 10%;"></td> <td style="width: 10%;"></td> <td style="width: 10%;"></td> </tr> <tr> <td></td> <td></td> <td colspan="8" style="text-align: center;"> <table border="1" style="width: 100%; border-collapse: collapse; text-align: center;"> <tr> <td style="width: 10%;"></td> <td style="width: 10%;"></td> <td style="width: 10%;"></td> <td style="width: 10%;"></td> <td style="width: 10%;"></td> <td style="width: 10%;"></td> <td style="width: 10%;"></td> <td style="width: 10%;"></td> <td style="width: 10%;"></td> <td style="width: 10%;"></td> </tr> <tr> <td></td> <td></td> <td colspan="8" style="text-align: center;"> <table border="1" style="width: 100%; border-collapse: collapse; text-align: center;"> <tr> <td style="width: 10%;"></td> <td style="width: 10%;"></td> <td style="width: 10%;"></td> <td style="width: 10%;"></td> <td style="width: 10%;"></td> <td style="width: 10%;"></td> <td style="width: 10%;"></td> <td style="width: 10%;"></td> <td style="width: 10%;"></td> <td style="width: 10%;"></td> </tr> <tr> <td></td> <td></td> <td colspan="8" style="text-align: center;"> <table border="1" style="width: 100%; border-collapse: collapse; text-align: center;"> <tr> <td style="width: 10%;"></td> <td style="width: 10%;"></td> <td style="width: 10%;"></td> <td style="width: 10%;"></td> <td style="width: 10%;"></td> <td style="width: 10%;"></td> <td style="width: 10%;"></td> <td style="width: 10%;"></td> <td style="width: 10%;"></td> <td style="width: 10%;"></td> </tr> <tr> <td></td> <td></td> <td colspan="8" style="text-align: center;"> <table border="1" style="width: 100%; border-collapse: collapse; text-align: center;"> <tr> <td style="width: 10%;"></td> <td style="width: 10%;"></td> <td style="width: 10%;"></td> <td style="width: 10%;"></td> <td style="width: 10%;"></td> <td style="width: 10%;"></td> <td style="width: 10%;"></td> <td style="width: 10%;"></td> <td style="width: 10%;"></td> <td style="width: 10%;"></td> </tr> <tr> <td></td> <td></td> <td colspan="8" style="text-align: center;"> <table border="1" style="width: 100%; border-collapse: collapse; text-align: center;"> <tr> <td style="width: 10%;"></td> <td style="width: 10%;"></td> <td style="width: 10%;"></td> <td style="width: 10%;"></td> <td style="width: 10%;"></td> <td style="width: 10%;"></td> <td style="width: 10%;"></td> <td style="width: 10%;"></td> <td style="width: 10%;"></td> <td style="width: 10%;"></td> </tr> <tr> <td></td> <td></td> <td colspan="8" style="text-align: center;"> <table border="1" style="width: 100%; border-collapse: collapse; text-align: center;"> <tr> <td style="width: 10%;"></td> <td style="width: 10%;"></td> <td style="width: 10%;"></td> <td style="width: 10%;"></td> <td style="width: 10%;"></td> <td style="width: 10%;"></td> <td style="width: 10%;"></td> <td style="width: 10%;"></td> <td style="width: 10%;"></td> <td style="width: 10%;"></td> </tr> <tr> <td></td> <td></td> <td colspan="8" style="text-align: center;"> <table border="1" style="width: 100%; border-collapse: collapse; text-align: center;"> <tr> <td style="width: 10%;"></td> <td style="width: 10%;"></td> <td style="width: 10%;"></td> <td style="width: 10%;"></td> <td style="width: 10%;"></td> <td style="width: 10%;"></td> <td style="width: 10%;"></td> <td style="width: 10%;"></td> <td style="width: 10%;"></td> <td style="width: 10%;"></td> </tr> <tr> <td></td> <td></td> <td colspan="8" style="text-align: center;"> <table
border="1" style="width: 100%; border-collapse: collapse; text-align: center;"> <tr> <td style="width: 10%;"></td> <td style="width: 10%;"></td> <td style="width: 10%;"></td> <td style="width: 10%;"></td> <td style="width: 10%;"></td> <td style="width: 10%;"></td> <td style="width: 10%;"></td> <td style="width: 10%;"></td> <td style="width: 10%;"></td> <td style="width: 10%;"></td> </tr> <tr> <td></td> <td></td> <td colspan="8" style="text-align: center;"> <table border="1" style="width: 100%; border-collapse: collapse; text-align: center;"> <tr> </tr></table></td></tr></table></td></tr></table></td></tr></table></td></tr></table></td></tr></table></td></tr></table></td></tr></table></td></tr></table></td></tr></table></td></tr></table></td></tr></table></td></tr></table></td></tr></table></td></tr></table></td></tr></table></td></tr></table></td></tr></table></td></tr></table></td></tr></table></td></tr></table></td></tr></table></td></tr></table></td></tr></table></td></tr></table></td></tr></table></td></tr></table></td></tr></table></td></tr></table></td></tr></table></td></tr></table></td></tr></table> | | | | | | | | | | | | | | | | | | | | <table border="1" style="width: 100%; border-collapse: collapse; text-align: center;"> <tr> <td style="width: 10%;"></td> <td style="width: 10%;"></td> <td style="width: 10%;"></td> <td style="width: 10%;"></td> <td style="width: 10%;"></td> <td style="width: 10%;"></td> <td style="width: 10%;"></td> <td style="width: 10%;"></td> <td style="width: 10%;"></td> <td style="width: 10%;"></td> </tr> <tr> <td></td> <td></td> <td colspan="8" style="text-align: center;"> <table border="1" style="width: 100%; border-collapse: collapse; text-align: center;"> <tr> <td style="width: 10%;"></td> <td style="width: 10%;"></td> <td style="width: 10%;"></td> <td style="width: 10%;"></td> <td style="width: 10%;"></td> <td style="width: 10%;"></td> <td style="width: 10%;"></td> <td style="width: 10%;"></td> <td style="width: 10%;"></td> <td style="width: 10%;"></td> </tr> <tr> <td></td> <td></td> <td colspan="8" style="text-align: center;"> <table border="1" style="width: 100%; border-collapse: collapse; text-align: center;"> <tr> <td
style="width: 10%;"></td> <td style="width: 10%;"></td> <td style="width: 10%;"></td> <td style="width: 10%;"></td> <td style="width: 10%;"></td> <td style="width: 10%;"></td> <td style="width: 10%;"></td> <td style="width: 10%;"></td> <td style="width: 10%;"></td> <td style="width: 10%;"></td> </tr> <tr> <td></td> <td></td> <td colspan="8" style="text-align: center;"> <table border="1" style="width: 100%; border-collapse: collapse; text-align: center;"> <tr> <td style="width: 10%;"></td> <td style="width: 10%;"></td> <td style="width: 10%;"></td> <td style="width: 10%;"></td> <td style="width: 10%;"></td> <td style="width: 10%;"></td> <td style="width: 10%;"></td> <td style="width: 10%;"></td> <td style="width: 10%;"></td> <td style="width: 10%;"></td> </tr> <tr> <td></td> <td></td> <td colspan="8" style="text-align: center;"> <table border="1" style="width: 100%; border-collapse: collapse; text-align: center;"> <tr> <td style="width: 10%;"></td> <td style="width: 10%;"></td> <td style="width: 10%;"></td> <td style="width: 10%;"></td> <td style="width: 10%;"></td> <td style="width: 10%;"></td> <td style="width: 10%;"></td> <td style="width: 10%;"></td> <td style="width: 10%;"></td> <td style="width: 10%;"></td> </tr> <tr> <td></td> <td></td> <td colspan="8" style="text-align: center;"> <table border="1" style="width: 100%; border-collapse: collapse; text-align: center;"> <tr> <td style="width: 10%;"></td> <td style="width: 10%;"></td> <td style="width: 10%;"></td> <td style="width: 10%;"></td> <td style="width: 10%;"></td> <td style="width: 10%;"></td> <td style="width: 10%;"></td> <td style="width: 10%;"></td> <td style="width: 10%;"></td> <td style="width: 10%;"></td> </tr> <tr> <td></td> <td></td> <td colspan="8" style="text-align: center;"> <table border="1" style="width: 100%; border-collapse: collapse; text-align: center;"> <tr> <td style="width: 10%;"></td> <td style="width: 10%;"></td> <td style="width: 10%;"></td> <td style="width: 10%;"></td> <td style="width: 10%;"></td> <td style="width: 10%;"></td> <td style="width: 10%;"></td> <td style="width: 10%;"></td> <td style="width: 10%;"></td> <td style="width: 10%;"></td> </tr> <tr> <td></td> <td></td> <td colspan="8" style="text-align: center;"> <table border="1" style="width: 100%; border-collapse: collapse; text-align: center;"> <tr> <td style="width: 10%;"></td> <td style="width: 10%;"></td> <td style="width: 10%;"></td> <td style="width: 10%;"></td> <td style="width: 10%;"></td> <td style="width: 10%;"></td> <td style="width: 10%;"></td> <td style="width: 10%;"></td> <td style="width: 10%;"></td> <td style="width: 10%;"></td> </tr> <tr> <td></td> <td></td> <td colspan="8" style="text-align: center;"> <table border="1" style="width: 100%; border-collapse: collapse; text-align: center;"> <tr> <td style="width: 10%;"></td> <td style="width: 10%;"></td> <td style="width: 10%;"></td> <td style="width: 10%;"></td> <td style="width: 10%;"></td> <td style="width: 10%;"></td> <td style="width: 10%;"></td> <td style="width: 10%;"></td> <td style="width: 10%;"></td> <td style="width: 10%;"></td> </tr> <tr> <td></td> <td></td> <td colspan="8" style="text-align: center;"> <table border="1" style="width: 100%; border-collapse: collapse; text-align: center;"> <tr> <td style="width: 10%;"></td> <td style="width: 10%;"></td> <td style="width: 10%;"></td> <td style="width: 10%;"></td> <td style="width: 10%;"></td> <td style="width: 10%;"></td> <td style="width: 10%;"></td> <td style="width: 10%;"></td> <td style="width: 10%;"></td> <td style="width: 10%;"></td> </tr> <tr> <td></td> <td></td> <td colspan="8" style="text-align: center;"> <table border="1" style="width: 100%; border-collapse: collapse; text-align: center;"> <tr> <td style="width: 10%;"></td> <td style="width: 10%;"></td> <td style="width: 10%;"></td> <td style="width: 10%;"></td> <td style="width: 10%;"></td> <td style="width: 10%;"></td> <td style="width: 10%;"></td> <td style="width: 10%;"></td> <td style="width: 10%;"></td> <td style="width: 10%;"></td> </tr> <tr> <td></td> <td></td> <td colspan="8" style="text-align: center;"> <table border="1" style="width: 100%; border-collapse: collapse; text-align: center;"> <tr> <td style="width: 10%;"></td> <td style="width: 10%;"></td> <td style="width: 10%;"></td> <td style="width: 10%;"></td> <td style="width: 10%;"></td> <td style="width: 10%;"></td> <td style="width: 10%;"></td> <td style="width: 10%;"></td> <td style="width: 10%;"></td> <td style="width: 10%;"></td> </tr> <tr> <td></td> <td></td> <td colspan="8" style="text-align: center;"> <table border="1" style="width: 100%; border-collapse: collapse; text-align: center;"> <tr> <td style="width: 10%;"></td> <td style="width: 10%;"></td> <td style="width: 10%;"></td> <td style="width: 10%;"></td> <td style="width: 10%;"></td> <td style="width: 10%;"></td> <td style="width: 10%;"></td> <td style="width: 10%;"></td> <td style="width: 10%;"></td> <td style="width: 10%;"></td> </tr> <tr> <td></td> <td></td> <td colspan="8" style="text-align: center;"> <table border="1" style="width: 100%; border-collapse: collapse; text-align: center;"> <tr> <td style="width: 10%;"></td> <td style="width: 10%;"></td> <td style="width: 10%;"></td> <td style="width: 10%;"></td> <td style="width: 10%;"></td> <td style="width: 10%;"></td> <td style="width: 10%;"></td> <td style="width: 10%;"></td> <td style="width: 10%;"></td> <td style="width: 10%;"></td> </tr> <tr> <td></td> <td></td> <td colspan="8" style="text-align: center;"> <table border="1" style="width: 100%; border-collapse: collapse; text-align: center;"> <tr> <td style="width: 10%;"></td> <td style="width: 10%;"></td> <td style="width: 10%;"></td> <td style="width: 10%;"></td> <td style="width: 10%;"></td> <td style="width: 10%;"></td> <td style="width: 10%;"></td> <td style="width: 10%;"></td> <td style="width: 10%;"></td> <td style="width: 10%;"></td> </tr> <tr> <td></td> <td></td> <td colspan="8" style="text-align: center;"> <table border="1" style="width: 100%; border-collapse: collapse; text-align: center;"> <tr> <td style="width: 10%;"></td> <td style="width: 10%;"></td> <td style="width: 10%;"></td> <td style="width: 10%;"></td> <td style="width: 10%;"></td> <td style="width: 10%;"></td> <td style="width: 10%;"></td> <td style="width: 10%;"></td> <td style="width: 10%;"></td> <td style="width: 10%;"></td> </tr> <tr> <td></td> <td></td> <td colspan="8" style="text-align: center;"> <table border="1" style="width: 100%; border-collapse: collapse; text-align: center;"> <tr> <td style="width: 10%;"></td> <td style="width: 10%;"></td> <td style="width: 10%;"></td> <td style="width: 10%;"></td> <td style="width: 10%;"></td> <td style="width: 10%;"></td> <td style="width: 10%;"></td> <td style="width: 10%;"></td> <td style="width: 10%;"></td> <td style="width: 10%;"></td> </tr> <tr> <td></td> <td></td> <td colspan="8" style="text-align: center;"> <table border="1" style="width: 100%; border-collapse: collapse; text-align: center;"> <tr> <td style="width: 10%;"></td> <td style="width: 10%;"></td> <td style="width: 10%;"></td> <td style="width: 10%;"></td> <td style="width: 10%;"></td> <td style="width: 10%;"></td> <td style="width: 10%;"></td> <td style="width: 10%;"></td> <td style="width: 10%;"></td> <td style="width: 10%;"></td> </tr> <tr> <td></td> <td></td> <td colspan="8" style="text-align: center;"> <table border="1" style="width: 100%; border-collapse: collapse; text-align: center;"> <tr> <td style="width: 10%;"></td> <td style="width: 10%;"></td> <td style="width: 10%;"></td> <td style="width: 10%;"></td> <td style="width: 10%;"></td> <td style="width: 10%;"></td> <td style="width: 10%;"></td> <td style="width: 10%;"></td> <td style="width: 10%;"></td> <td style="width: 10%;"></td> </tr> <tr> <td></td> <td></td> <td colspan="8" style="text-align: center;"> <table border="1" style="width: 100%; border-collapse: collapse; text-align: center;"> <tr> <td style="width: 10%;"></td> <td style="width: 10%;"></td> <td style="width: 10%;"></td> <td style="width: 10%;"></td> <td style="width: 10%;"></td> <td style="width: 10%;"></td> <td style="width: 10%;"></td> <td style="width: 10%;"></td> <td style="width: 10%;"></td> <td style="width: 10%;"></td> </tr> <tr> <td></td> <td></td> <td colspan="8" style="text-align: center;"> <table border="1" style="width: 100%; border-collapse: collapse; text-align: center;"> <tr> <td style="width: 10%;"></td> <td style="width: 10%;"></td> <td style="width: 10%;"></td> <td style="width: 10%;"></td> <td style="width: 10%;"></td> <td style="width: 10%;"></td> <td style="width: 10%;"></td> <td style="width: 10%;"></td> <td style="width: 10%;"></td> <td style="width: 10%;"></td> </tr> <tr> <td></td> <td></td> <td colspan="8" style="text-align: center;"> <table border="1" style="width: 100%; border-collapse: collapse; text-align: center;"> <tr> <td style="width: 10%;"></td> <td style="width: 10%;"></td> <td style="width: 10%;"></td> <td style="width: 10%;"></td> <td style="width: 10%;"></td> <td style="width: 10%;"></td> <td style="width: 10%;"></td> <td style="width: 10%;"></td> <td style="width: 10%;"></td> <td style="width: 10%;"></td> </tr> <tr> <td></td> <td></td> <td colspan="8" style="text-align: center;"> <table border="1" style="width: 100%; border-collapse: collapse; text-align: center;"> <tr> <td style="width: 10%;"></td> <td style="width: 10%;"></td> <td style="width: 10%;"></td> <td style="width: 10%;"></td> <td style="width: 10%;"></td> <td style="width: 10%;"></td> <td style="width: 10%;"></td> <td style="width: 10%;"></td> <td style="width: 10%;"></td> <td style="width: 10%;"></td> </tr> <tr> <td></td> <td></td> <td colspan="8" style="text-align: center;"> <table border="1" style="width: 100%; border-collapse: collapse; text-align: center;"> <tr> <td style="width: 10%;"></td> <td style="width: 10%;"></td> <td style="width: 10%;"></td> <td style="width: 10%;"></td> <td style="width: 10%;"></td> <td style="width:
10%;"></td> <td style="width: 10%;"></td> <td style="width: 10%;"></td> <td style="width: 10%;"></td> <td style="width: 10%;"></td> </tr> <tr> <td></td> <td></td> <td colspan="8" style="text-align: center;"> <table border="1" style="width: 100%; border-collapse: collapse; text-align: center;"> <tr> <td style="width: 10%;"></td> <td style="width: 10%;"></td> <td style="width: 10%;"></td> <td style="width: 10%;"></td> <td style="width: 10%;"></td> <td style="width: 10%;"></td> <td style="width: 10%;"></td> <td style="width: 10%;"></td> <td style="width: 10%;"></td> <td style="width: 10%;"></td> </tr> <tr> <td></td> <td></td> <td colspan="8" style="text-align: center;"> <table border="1" style="width: 100%; border-collapse: collapse; text-align: center;"> <tr> <td style="width: 10%;"></td> <td style="width: 10%;"></td> <td style="width: 10%;"></td> <td style="width: 10%;"></td> <td style="width: 10%;"></td> <td style="width: 10%;"></td> <td style="width: 10%;"></td> <td style="width: 10%;"></td> <td style="width: 10%;"></td> <td style="width: 10%;"></td> </tr> <tr> <td></td> <td></td> <td colspan="8" style="text-align: center;"> <table border="1" style="width: 100%; border-collapse: collapse; text-align: center;"> <tr> <td style="width: 10%;"></td> <td style="width: 10%;"></td> <td style="width: 10%;"></td> <td style="width: 10%;"></td> <td style="width: 10%;"></td> <td style="width: 10%;"></td> <td style="width: 10%;"></td> <td style="width: 10%;"></td> <td style="width: 10%;"></td> <td style="width: 10%;"></td> </tr> <tr> <td></td> <td></td> <td colspan="8" style="text-align: center;"> <table border="1" style="width: 100%; border-collapse: collapse; text-align: center;"> <tr> <td style="width: 10%;"></td> <td style="width: 10%;"></td> <td style="width: 10%;"></td> <td style="width: 10%;"></td> <td style="width: 10%;"></td> <td style="width: 10%;"></td> <td style="width: 10%;"></td> <td style="width: 10%;"></td> <td style="width: 10%;"></td> <td style="width: 10%;"></td> </tr> <tr> <td></td> <td></td> <td colspan="8" style="text-align: center;"> <table border="1" style="width: 100%; border-collapse: collapse; text-align: center;"> <tr> <td style="width: 10%;"></td> <td style="width: 10%;"></td> <td style="width: 10%;"></td> <td style="width: 10%;"></td> <td style="width: 10%;"></td> <td style="width: 10%;"></td> <td style="width: 10%;"></td> <td style="width: 10%;"></td> <td style="width: 10%;"></td> <td style="width: 10%;"></td> </tr> <tr> <td></td> <td></td> <td colspan="8" style="text-align: center;"> <table border="1" style="width: 100%; border-collapse: collapse; text-align: center;"> <tr> <td style="width: 10%;"></td> <td style="width: 10%;"></td> <td style="width: 10%;"></td> <td style="width: 10%;"></td> <td style="width: 10%;"></td> <td style="width: 10%;"></td> <td style="width: 10%;"></td> <td style="width: 10%;"></td> <td style="width: 10%;"></td> <td style="width: 10%;"></td> </tr> <tr> <td></td> <td></td> <td colspan="8" style="text-align: center;"> <table border="1" style="width: 100%; border-collapse: collapse; text-align: center;"> <tr> </tr></table></td></tr></table></td></tr></table></td></tr></table></td></tr></table></td></tr></table></td></tr></table></td></tr></table></td></tr></table></td></tr></table></td></tr></table></td></tr></table></td></tr></table></td></tr></table></td></tr></table></td></tr></table></td></tr></table></td></tr></table></td></tr></table></td></tr></table></td></tr></table></td></tr></table></td></tr></table></td></tr></table></td></tr></table></td></tr></table></td></tr></table></td></tr></table></td></tr></table></td></tr></table></td></tr></table>
 | | | | | | | | | | | | | | | | | | | | <table border="1" style="width: 100%; border-collapse: collapse; text-align: center;"> <tr> <td style="width: 10%;"></td> <td style="width: 10%;"></td> <td style="width: 10%;"></td> <td style="width: 10%;"></td> <td style="width: 10%;"></td> <td style="width: 10%;"></td> <td style="width: 10%;"></td> <td style="width: 10%;"></td> <td style="width: 10%;"></td> <td style="width: 10%;"></td> </tr> <tr> <td></td> <td></td> <td colspan="8" style="text-align: center;"> <table border="1" style="width: 100%; border-collapse: collapse; text-align: center;"> <tr> <td style="width: 10%;"></td> <td style="width: 10%;"></td> <td style="width: 10%;"></td> <td style="width: 10%;"></td> <td style="width: 10%;"></td> <td style="width: 10%;"></td> <td style="width: 10%;"></td> <td style="width: 10%;"></td> <td style="width: 10%;"></td> <td style="width: 10%;"></td> </tr> <tr> <td></td> <td></td> <td colspan="8" style="text-align: center;"> <table border="1" style="width: 100%; border-collapse: collapse; text-align: center;"> <tr> <td style="width: 10%;"></td> <td style="width: 10%;"></td> <td style="width: 10%;"></td> <td style="width: 10%;"></td> <td style="width: 10%;"></td> <td style="width: 10%;"></td> <td style="width: 10%;"></td> <td style="width: 10%;"></td> <td style="width: 10%;"></td> <td style="width: 10%;"></td> </tr> <tr> <td></td> <td></td> <td colspan="8" style="text-align: center;"> <table border="1" style="width: 100%; border-collapse: collapse; text-align: center;"> <tr> <td style="width: 10%;"></td> <td style="width: 10%;"></td> <td style="width: 10%;"></td> <td style="width: 10%;"></td> <td style="width: 10%;"></td> <td style="width: 10%;"></td> <td style="width: 10%;"></td> <td style="width: 10%;"></td> <td style="width: 10%;"></td> <td style="width: 10%;"></td> </tr> <tr> <td></td> <td></td> <td colspan="8" style="text-align: center;"> <table border="1" style="width: 100%; border-collapse: collapse; text-align: center;"> <tr> <td style="width: 10%;"></td> <td style="width: 10%;"></td> <td style="width: 10%;"></td> <td style="width: 10%;"></td> <td style="width: 10%;"></td> <td style="width: 10%;"></td> <td style="width: 10%;"></td> <td style="width: 10%;"></td> <td style="width: 10%;"></td> <td style="width: 10%;"></td> </tr> <tr> <td></td> <td></td> <td colspan="8" style="text-align: center;"> <table border="1" style="width: 100%; border-collapse: collapse; text-align: center;"> <tr> <td style="width: 10%;"></td> <td style="width: 10%;"></td> <td style="width: 10%;"></td> <td style="width: 10%;"></td> <td style="width: 10%;"></td> <td style="width: 10%;"></td> <td style="width: 10%;"></td> <td style="width: 10%;"></td> <td style="width: 10%;"></td> <td style="width: 10%;"></td> </tr> <tr> <td></td> <td></td> <td colspan="8" style="text-align: center;"> <table border="1" style="width: 100%; border-collapse: collapse; text-align: center;"> <tr> <td style="width: 10%;"></td> <td style="width: 10%;"></td> <td style="width: 10%;"></td> <td style="width: 10%;"></td> <td style="width: 10%;"></td> <td style="width: 10%;"></td> <td style="width: 10%;"></td> <td style="width: 10%;"></td> <td style="width: 10%;"></td> <td style="width: 10%;"></td> </tr> <tr> <td></td> <td></td> <td colspan="8" style="text-align: center;"> <table border="1" style="width: 100%; border-collapse: collapse; text-align: center;"> <tr> <td style="width: 10%;"></td> <td style="width: 10%;"></td> <td style="width: 10%;"></td> <td style="width: 10%;"></td> <td style="width: 10%;"></td> <td style="width: 10%;"></td> <td style="width: 10%;"></td> <td style="width: 10%;"></td> <td style="width: 10%;"></td> <td style="width: 10%;"></td> </tr> <tr> <td></td> <td></td> <td colspan="8" style="text-align: center;"> <table border="1" style="width: 100%; border-collapse: collapse; text-align: center;"> <tr> <td style="width: 10%;"></td> <td style="width: 10%;"></td> <td style="width: 10%;"></td> <td style="width: 10%;"></td> <td style="width: 10%;"></td> <td style="width: 10%;"></td> <td style="width: 10%;"></td> <td style="width: 10%;"></td> <td style="width: 10%;"></td> <td style="width: 10%;"></td> </tr> <tr> <td></td> <td></td> <td colspan="8" style="text-align: center;"> <table border="1" style="width: 100%; border-collapse: collapse; text-align: center;"> <tr> <td style="width: 10%;"></td> <td style="width: 10%;"></td> <td style="width: 10%;"></td> <td style="width: 10%;"></td> <td style="width: 10%;"></td> <td style="width: 10%;"></td> <td style="width: 10%;"></td> <td style="width: 10%;"></td> <td style="width: 10%;"></td> <td style="width: 10%;"></td> </tr> <tr> <td></td> <td></td> <td colspan="8" style="text-align: center;"> <table border="1" style="width: 100%; border-collapse: collapse; text-align: center;"> <tr> <td style="width: 10%;"></td> <td style="width: 10%;"></td> <td style="width: 10%;"></td> <td style="width: 10%;"></td> <td style="width: 10%;"></td> <td style="width: 10%;"></td> <td style="width: 10%;"></td> <td style="width: 10%;"></td> <td style="width: 10%;"></td> <td style="width: 10%;"></td> </tr> <tr> <td></td> <td></td> <td colspan="8" style="text-align: center;"> <table border="1" style="width: 100%; border-collapse: collapse; text-align: center;"> <tr> <td style="width: 10%;"></td> <td style="width: 10%;"></td> <td style="width: 10%;"></td> <td style="width: 10%;"></td> <td style="width: 10%;"></td> <td style="width: 10%;"></td> <td style="width: 10%;"></td> <td style="width: 10%;"></td> <td style="width: 10%;"></td> <td style="width: 10%;"></td> </tr> <tr> <td></td> <td></td> <td colspan="8" style="text-align: center;"> <table border="1" style="width: 100%; border-collapse: collapse; text-align: center;"> <tr> <td style="width: 10%;"></td> <td style="width: 10%;"></td> <td style="width: 10%;"></td> <td style="width: 10%;"></td> <td style="width: 10%;"></td> <td style="width: 10%;"></td> <td style="width: 10%;"></td> <td style="width: 10%;"></td> <td style="width: 10%;"></td> <td style="width: 10%;"></td> </tr> <tr> <td></td> <td></td> <td colspan="8" style="text-align: center;"> <table border="1" style="width: 100%; border-collapse: collapse; text-align: center;"> <tr> <td style="width: 10%;"></td> <td style="width: 10%;"></td> <td style="width: 10%;"></td> <td style="width: 10%;"></td> <td style="width: 10%;"></td> <td style="width: 10%;"></td> <td style="width: 10%;"></td> <td style="width: 10%;"></td> <td style="width: 10%;"></td> <td style="width: 10%;"></td> </tr> <tr> <td></td> <td></td> <td colspan="8" style="text-align: center;"> <table border="1" style="width: 100%; border-collapse: collapse; text-align: center;"> <tr> <td style="width: 10%;"></td> <td style="width: 10%;"></td> <td style="width: 10%;"></td> <td style="width: 10%;"></td> <td style="width: 10%;"></td> <td style="width: 10%;"></td> <td style="width: 10%;"></td> <td style="width: 10%;"></td> <td style="width: 10%;"></td> <td style="width: 10%;"></td> </tr> <tr> <td></td> <td></td> <td colspan="8" style="text-align: center;"> <table border="1" style="width: 100%; border-collapse: collapse; text-align: center;"> <tr> <td style="width: 10%;"></td> <td style="width: 10%;"></td> <td style="width: 10%;"></td> <td style="width: 10%;"></td> <td style="width: 10%;"></td> <td style="width: 10%;"></td> <td style="width: 10%;"></td> <td style="width: 10%;"></td> <td style="width: 10%;"></td> <td style="width: 10%;"></td> </tr> <tr> <td></td> <td></td> <td colspan="8" style="text-align: center;"> <table border="1" style="width: 100%; border-collapse: collapse; text-align: center;"> <tr> <td style="width: 10%;"></td> <td style="width: 10%;"></td> <td style="width: 10%;"></td> <td style="width: 10%;"></td> <td style="width: 10%;"></td> <td style="width: 10%;"></td> <td style="width: 10%;"></td> <td style="width: 10%;"></td> <td style="width: 10%;"></td> <td style="width: 10%;"></td> </tr> <tr> <td></td> <td></td> <td colspan="8" style="text-align: center;"> <table border="1" style="width: 100%; border-collapse: collapse; text-align: center;"> <tr> <td style="width: 10%;"></td> <td style="width: 10%;"></td> <td style="width: 10%;"></td> <td style="width: 10%;"></td> <td style="width: 10%;"></td> <td style="width: 10%;"></td> <td style="width: 10%;"></td> <td style="width: 10%;"></td> <td style="width: 10%;"></td> <td style="width: 10%;"></td> </tr> <tr> <td></td> <td></td> <td colspan="8" style="text-align: center;"> <table border="1" style="width: 100%; border-collapse: collapse; text-align:
center;"> <tr> <td style="width: 10%;"></td> <td style="width: 10%;"></td> <td style="width: 10%;"></td> <td style="width: 10%;"></td> <td style="width: 10%;"></td> <td style="width: 10%;"></td> <td style="width: 10%;"></td> <td style="width: 10%;"></td> <td style="width: 10%;"></td> <td style="width: 10%;"></td> </tr> <tr> <td></td> <td></td> <td colspan="8" style="text-align: center;"> <table border="1" style="width: 100%; border-collapse: collapse; text-align: center;"> <tr> <td style="width: 10%;"></td> <td style="width: 10%;"></td> <td style="width: 10%;"></td> <td style="width: 10%;"></td> <td style="width: 10%;"></td> <td style="width: 10%;"></td> <td style="width: 10%;"></td> <td style="width: 10%;"></td> <td style="width: 10%;"></td> <td style="width: 10%;"></td> </tr> <tr> <td></td> <td></td> <td colspan="8" style="text-align: center;"> <table border="1" style="width: 100%; border-collapse: collapse; text-align: center;"> <tr> <td style="width: 10%;"></td> <td style="width: 10%;"></td> <td style="width: 10%;"></td> <td style="width: 10%;"></td> <td style="width: 10%;"></td> <td style="width: 10%;"></td> <td style="width: 10%;"></td> <td style="width: 10%;"></td> <td style="width: 10%;"></td> <td style="width: 10%;"></td> </tr> <tr> <td></td> <td></td> <td colspan="8" style="text-align: center;"> <table border="1" style="width: 100%; border-collapse: collapse; text-align: center;"> <tr> <td style="width: 10%;"></td> <td style="width: 10%;"></td> <td style="width: 10%;"></td> <td style="width: 10%;"></td> <td style="width: 10%;"></td> <td style="width: 10%;"></td> <td style="width: 10%;"></td> <td style="width: 10%;"></td> <td style="width: 10%;"></td> <td style="width: 10%;"></td> </tr> <tr> <td></td> <td></td> <td colspan="8" style="text-align: center;"> <table border="1" style="width: 100%; border-collapse: collapse; text-align: center;"> <tr> <td style="width: 10%;"></td> <td style="width: 10%;"></td> <td style="width: 10%;"></td> <td style="width: 10%;"></td> <td style="width: 10%;"></td> <td style="width: 10%;"></td> <td style="width: 10%;"></td> <td style="width: 10%;"></td> <td style="width: 10%;"></td> <td style="width: 10%;"></td> </tr> <tr> <td></td> <td></td> <td colspan="8" style="text-align: center;"> <table border="1" style="width: 100%; border-collapse: collapse; text-align: center;"> <tr> <td style="width: 10%;"></td> <td style="width: 10%;"></td> <td style="width: 10%;"></td> <td style="width: 10%;"></td> <td style="width: 10%;"></td> <td style="width: 10%;"></td> <td style="width: 10%;"></td> <td style="width: 10%;"></td> <td style="width: 10%;"></td> <td style="width: 10%;"></td> </tr> <tr> <td></td> <td></td> <td colspan="8" style="text-align: center;"> <table border="1" style="width: 100%; border-collapse: collapse; text-align: center;"> <tr> <td style="width: 10%;"></td> <td style="width: 10%;"></td> <td style="width: 10%;"></td> <td style="width: 10%;"></td> <td style="width: 10%;"></td> <td style="width: 10%;"></td> <td style="width: 10%;"></td> <td style="width: 10%;"></td> <td style="width: 10%;"></td> <td style="width: 10%;"></td> </tr> <tr> <td></td> <td></td> <td colspan="8" style="text-align: center;"> <table border="1" style="width: 100%; border-collapse: collapse; text-align: center;"> <tr> <td style="width: 10%;"></td> <td style="width: 10%;"></td> <td style="width: 10%;"></td> <td style="width: 10%;"></td> <td style="width: 10%;"></td> <td style="width: 10%;"></td> <td style="width: 10%;"></td> <td style="width: 10%;"></td> <td style="width: 10%;"></td> <td style="width: 10%;"></td> </tr> <tr> <td></td> <td></td> <td colspan="8" style="text-align: center;"> <table border="1" style="width: 100%; border-collapse: collapse; text-align: center;"> <tr> <td style="width: 10%;"></td> <td style="width: 10%;"></td> <td style="width: 10%;"></td> <td style="width: 10%;"></td> <td style="width: 10%;"></td> <td style="width: 10%;"></td> <td style="width: 10%;"></td> <td style="width: 10%;"></td> <td style="width: 10%;"></td> <td style="width: 10%;"></td> </tr> <tr> <td></td> <td></td> <td colspan="8" style="text-align: center;"> <table border="1" style="width: 100%; border-collapse: collapse; text-align: center;"> <tr> <td style="width: 10%;"></td> <td style="width: 10%;"></td> <td style="width: 10%;"></td> <td style="width: 10%;"></td> <td style="width: 10%;"></td> <td style="width: 10%;"></td> <td style="width: 10%;"></td> <td style="width: 10%;"></td> <td style="width: 10%;"></td> <td style="width: 10%;"></td> </tr> <tr> <td></td> <td></td> <td colspan="8" style="text-align: center;"> <table border="1" style="width: 100%; border-collapse: collapse; text-align: center;"> <tr> <td style="width: 10%;"></td> <td style="width: 10%;"></td> <td style="width: 10%;"></td> <td style="width: 10%;"></td> <td style="width: 10%;"></td> <td style="width: 10%;"></td> <td style="width: 10%;"></td> <td style="width: 10%;"></td> <td style="width: 10%;"></td> <td style="width: 10%;"></td> </tr> <tr> <td></td> <td></td> <td colspan="8" style="text-align: center;"> <table border="1" style="width: 100%; border-collapse: collapse; text-align: center;"> <tr> </tr></table></td></tr></table></td></tr></table></td></tr></table></td></tr></table></td></tr></table></td></tr></table></td></tr></table></td></tr></table></td></tr></table></td></tr></table></td></tr></table></td></tr></table></td></tr></table></td></tr></table></td></tr></table></td></tr></table></td></tr></table></td></tr></table></td></tr></table></td></tr></table></td></tr></table></td></tr></table></td></tr></table></td></tr></table></td></tr></table></td></tr></table></td></tr></table></td></tr></table></td></tr></table>
 | | | | | | | | | | | | | | | | | | | | <table border="1" style="width: 100%; border-collapse: collapse; text-align: center;"> <tr> <td style="width: 10%;"></td> <td style="width: 10%;"></td> <td style="width: 10%;"></td> <td style="width: 10%;"></td> <td style="width: 10%;"></td> <td style="width: 10%;"></td> <td style="width: 10%;"></td> <td style="width: 10%;"></td> <td style="width: 10%;"></td> <td style="width: 10%;"></td> </tr> <tr> <td></td> <td></td> <td colspan="8" style="text-align: center;"> <table border="1" style="width: 100%; border-collapse: collapse; text-align: center;"> <tr> <td style="width: 10%;"></td> <td style="width: 10%;"></td> <td style="width: 10%;"></td> <td style="width: 10%;"></td> <td style="width: 10%;"></td> <td style="width: 10%;"></td> <td style="width: 10%;"></td> <td style="width: 10%;"></td> <td style="width: 10%;"></td> <td style="width: 10%;"></td> </tr> <tr> <td></td> <td></td> <td colspan="8" style="text-align: center;"> <table border="1" style="width: 100%; border-collapse: collapse; text-align: center;"> <tr> <td style="width: 10%;"></td> <td style="width: 10%;"></td> <td style="width: 10%;"></td> <td style="width: 10%;"></td> <td style="width: 10%;"></td> <td style="width: 10%;"></td> <td style="width: 10%;"></td> <td style="width: 10%;"></td> <td style="width: 10%;"></td> <td style="width: 10%;"></td> </tr> <tr> <td></td> <td></td> <td colspan="8" style="text-align: center;"> <table border="1" style="width: 100%; border-collapse: collapse; text-align: center;"> <tr> <td style="width: 10%;"></td> <td style="width: 10%;"></td> <td style="width: 10%;"></td> <td style="width: 10%;"></td> <td style="width: 10%;"></td> <td style="width: 10%;"></td> <td style="width: 10%;"></td> <td style="width: 10%;"></td> <td style="width: 10%;"></td> <td style="width: 10%;"></td> </tr> <tr> <td></td> <td></td> <td colspan="8" style="text-align: center;"> <table border="1" style="width: 100%; border-collapse: collapse; text-align: center;"> <tr> <td style="width: 10%;"></td> <td style="width: 10%;"></td> <td style="width: 10%;"></td> <td style="width: 10%;"></td> <td style="width: 10%;"></td> <td style="width: 10%;"></td> <td style="width: 10%;"></td> <td style="width: 10%;"></td> <td style="width: 10%;"></td> <td style="width: 10%;"></td> </tr> <tr> <td></td> <td></td> <td colspan="8" style="text-align: center;"> <table border="1" style="width: 100%; border-collapse: collapse; text-align: center;"> <tr> <td style="width: 10%;"></td> <td style="width: 10%;"></td> <td style="width: 10%;"></td> <td style="width: 10%;"></td> <td style="width: 10%;"></td> <td style="width: 10%;"></td> <td style="width: 10%;"></td> <td style="width: 10%;"></td> <td style="width: 10%;"></td> <td style="width: 10%;"></td> </tr> <tr> <td></td> <td></td> <td colspan="8" style="text-align: center;"> <table border="1" style="width: 100%; border-collapse: collapse; text-align: center;"> <tr> <td style="width: 10%;"></td> <td style="width: 10%;"></td> <td style="width: 10%;"></td> <td style="width: 10%;"></td> <td style="width: 10%;"></td> <td style="width: 10%;"></td> <td style="width: 10%;"></td> <td style="width: 10%;"></td> <td style="width: 10%;"></td> <td style="width: 10%;"></td> </tr> <tr> <td></td> <td></td> <td colspan="8" style="text-align: center;"> <table border="1" style="width: 100%; border-collapse: collapse; text-align: center;"> <tr> <td style="width: 10%;"></td> <td style="width: 10%;"></td> <td style="width: 10%;"></td> <td style="width: 10%;"></td> <td style="width: 10%;"></td> <td style="width: 10%;"></td> <td style="width: 10%;"></td> <td style="width: 10%;"></td> <td style="width: 10%;"></td> <td style="width: 10%;"></td> </tr> <tr> <td></td> <td></td> <td colspan="8" style="text-align: center;"> <table border="1" style="width: 100%; border-collapse: collapse; text-align: center;"> <tr> <td style="width: 10%;"></td> <td style="width: 10%;"></td> <td style="width: 10%;"></td> <td style="width: 10%;"></td> <td style="width: 10%;"></td> <td style="width: 10%;"></td> <td style="width: 10%;"></td> <td style="width: 10%;"></td> <td style="width: 10%;"></td> <td style="width: 10%;"></td> </tr> <tr> <td></td> <td></td> <td colspan="8" style="text-align: center;"> <table border="1" style="width: 100%; border-collapse: collapse; text-align: center;"> <tr> <td style="width: 10%;"></td> <td style="width: 10%;"></td> <td style="width: 10%;"></td> <td style="width: 10%;"></td> <td style="width: 10%;"></td> <td style="width: 10%;"></td> <td style="width: 10%;"></td> <td style="width: 10%;"></td> <td style="width: 10%;"></td> <td style="width: 10%;"></td> </tr> <tr> <td></td> <td></td> <td colspan="8" style="text-align: center;"> <table border="1" style="width: 100%; border-collapse: collapse; text-align: center;"> <tr> <td style="width: 10%;"></td> <td style="width: 10%;"></td> <td style="width: 10%;"></td> <td style="width: 10%;"></td> <td style="width: 10%;"></td> <td style="width: 10%;"></td> <td style="width: 10%;"></td> <td style="width: 10%;"></td> <td style="width: 10%;"></td> <td style="width: 10%;"></td> </tr> <tr> <td></td> <td></td> <td colspan="8" style="text-align: center;"> <table border="1" style="width: 100%; border-collapse: collapse; text-align: center;"> <tr> <td style="width: 10%;"></td> <td style="width: 10%;"></td> <td style="width: 10%;"></td> <td style="width: 10%;"></td> <td style="width: 10%;"></td> <td style="width: 10%;"></td> <td style="width: 10%;"></td> <td style="width: 10%;"></td> <td style="width: 10%;"></td> <td style="width: 10%;"></td> </tr> <tr> <td></td> <td></td> <td colspan="8" style="text-align: center;"> <table border="1" style="width: 100%; border-collapse: collapse; text-align: center;"> <tr> <td style="width: 10%;"></td> <td style="width: 10%;"></td> <td style="width: 10%;"></td> <td style="width: 10%;"></td> <td style="width: 10%;"></td> <td style="width: 10%;"></td> <td style="width: 10%;"></td> <td style="width: 10%;"></td> <td style="width: 10%;"></td> <td style="width: 10%;"></td> </tr> <tr> <td></td> <td></td> <td colspan="8" style="text-align: center;"> <table border="1" style="width: 100%; border-collapse: collapse; text-align: center;"> <tr> <td style="width: 10%;"></td> <td style="width: 10%;"></td> <td style="width: 10%;"></td> <td style="width: 10%;"></td> <td style="width: 10%;"></td> <td style="width: 10%;"></td> <td style="width: 10%;"></td> <td style="width: 10%;"></td> <td style="width: 10%;"></td> <td style="width:
10%;"></td> </tr> <tr> <td></td> <td></td> <td colspan="8" style="text-align: center;"> <table border="1" style="width: 100%; border-collapse: collapse; text-align: center;"> <tr> <td style="width: 10%;"></td> <td style="width: 10%;"></td> <td style="width: 10%;"></td> <td style="width: 10%;"></td> <td style="width: 10%;"></td> <td style="width: 10%;"></td> <td style="width: 10%;"></td> <td style="width: 10%;"></td> <td style="width: 10%;"></td> <td style="width: 10%;"></td> </tr> <tr> <td></td> <td></td> <td colspan="8" style="text-align: center;"> <table border="1" style="width: 100%; border-collapse: collapse; text-align: center;"> <tr> <td style="width: 10%;"></td> <td style="width: 10%;"></td> <td style="width: 10%;"></td> <td style="width: 10%;"></td> <td style="width: 10%;"></td> <td style="width: 10%;"></td> <td style="width: 10%;"></td> <td style="width: 10%;"></td> <td style="width: 10%;"></td> <td style="width: 10%;"></td> </tr> <tr> <td></td> <td></td> <td colspan="8" style="text-align: center;"> <table border="1" style="width: 100%; border-collapse: collapse; text-align: center;"> <tr> <td style="width: 10%;"></td> <td style="width: 10%;"></td> <td style="width: 10%;"></td> <td style="width: 10%;"></td> <td style="width: 10%;"></td> <td style="width: 10%;"></td> <td style="width: 10%;"></td> <td style="width: 10%;"></td> <td style="width: 10%;"></td> <td style="width: 10%;"></td> </tr> <tr> <td></td> <td></td> <td colspan="8" style="text-align: center;"> <table border="1" style="width: 100%; border-collapse: collapse; text-align: center;"> <tr> <td style="width: 10%;"></td> <td style="width: 10%;"></td> <td style="width: 10%;"></td> <td style="width: 10%;"></td> <td style="width: 10%;"></td> <td style="width: 10%;"></td> <td style="width: 10%;"></td> <td style="width: 10%;"></td> <td style="width: 10%;"></td> <td style="width: 10%;"></td> </tr> <tr> <td></td> <td></td> <td colspan="8" style="text-align: center;"> <table border="1" style="width: 100%; border-collapse: collapse; text-align: center;"> <tr> <td style="width: 10%;"></td> <td style="width: 10%;"></td> <td style="width: 10%;"></td> <td style="width: 10%;"></td> <td style="width: 10%;"></td> <td style="width: 10%;"></td> <td style="width: 10%;"></td> <td style="width: 10%;"></td> <td style="width: 10%;"></td> <td style="width: 10%;"></td> </tr> <tr> <td></td> <td></td> <td colspan="8" style="text-align: center;"> <table border="1" style="width: 100%; border-collapse: collapse; text-align: center;"> <tr> <td style="width: 10%;"></td> <td style="width: 10%;"></td> <td style="width: 10%;"></td> <td style="width: 10%;"></td> <td style="width: 10%;"></td> <td style="width: 10%;"></td> <td style="width: 10%;"></td> <td style="width: 10%;"></td> <td style="width: 10%;"></td> <td style="width: 10%;"></td> </tr> <tr> <td></td> <td></td> <td colspan="8" style="text-align: center;"> <table border="1" style="width: 100%; border-collapse: collapse; text-align: center;"> <tr> <td style="width: 10%;"></td> <td style="width: 10%;"></td> <td style="width: 10%;"></td> <td style="width: 10%;"></td> <td style="width: 10%;"></td> <td style="width: 10%;"></td> <td style="width: 10%;"></td> <td style="width: 10%;"></td> <td style="width: 10%;"></td> <td style="width: 10%;"></td> </tr> <tr> <td></td> <td></td> <td colspan="8" style="text-align: center;"> <table border="1" style="width: 100%; border-collapse: collapse; text-align: center;"> <tr> <td style="width: 10%;"></td> <td style="width: 10%;"></td> <td style="width: 10%;"></td> <td style="width: 10%;"></td> <td style="width: 10%;"></td> <td style="width: 10%;"></td> <td style="width: 10%;"></td> <td style="width: 10%;"></td> <td style="width: 10%;"></td> <td style="width: 10%;"></td> </tr> <tr> <td></td> <td></td> <td colspan="8" style="text-align: center;"> <table border="1" style="width: 100%; border-collapse: collapse; text-align: center;"> <tr> <td style="width: 10%;"></td> <td style="width: 10%;"></td> <td style="width: 10%;"></td> <td style="width: 10%;"></td> <td style="width: 10%;"></td> <td style="width: 10%;"></td> <td style="width: 10%;"></td> <td style="width: 10%;"></td> <td style="width: 10%;"></td> <td style="width: 10%;"></td> </tr> <tr> <td></td> <td></td> <td colspan="8" style="text-align: center;"> <table border="1" style="width: 100%; border-collapse: collapse; text-align: center;"> <tr> <td style="width: 10%;"></td> <td style="width: 10%;"></td> <td style="width: 10%;"></td> <td style="width: 10%;"></td> <td style="width: 10%;"></td> <td style="width: 10%;"></td> <td style="width: 10%;"></td> <td style="width: 10%;"></td> <td style="width: 10%;"></td> <td style="width: 10%;"></td> </tr> <tr> <td></td> <td></td> <td colspan="8" style="text-align: center;"> <table border="1" style="width: 100%; border-collapse: collapse; text-align: center;"> <tr> <td style="width: 10%;"></td> <td style="width: 10%;"></td> <td style="width: 10%;"></td> <td style="width: 10%;"></td> <td style="width: 10%;"></td> <td style="width: 10%;"></td> <td style="width: 10%;"></td> <td style="width: 10%;"></td> <td style="width: 10%;"></td> <td style="width: 10%;"></td> </tr> <tr> <td></td> <td></td> <td colspan="8" style="text-align: center;"> <table border="1" style="width: 100%; border-collapse: collapse; text-align: center;"> <tr> <td style="width: 10%;"></td> <td style="width: 10%;"></td> <td style="width: 10%;"></td> <td style="width: 10%;"></td> <td style="width: 10%;"></td> <td style="width: 10%;"></td> <td style="width: 10%;"></td> <td style="width: 10%;"></td> <td style="width: 10%;"></td> <td style="width: 10%;"></td> </tr> <tr> <td></td> <td></td> <td colspan="8" style="text-align: center;"> <table border="1" style="width: 100%; border-collapse: collapse; text-align: center;"> <tr> <td style="width: 10%;"></td> <td style="width: 10%;"></td> <td style="width: 10%;"></td> <td style="width: 10%;"></td> <td style="width: 10%;"></td> <td style="width: 10%;"></td> <td style="width: 10%;"></td> <td style="width: 10%;"></td> <td style="width: 10%;"></td> <td style="width: 10%;"></td> </tr> <tr> <td></td> <td></td> <td colspan="8" style="text-align: center;"> <table border="1" style="width: 100%; border-collapse: collapse; text-align: center;"> <tr> <td style="width: 10%;"></td> <td style="width: 10%;"></td> <td style="width: 10%;"></td> <td style="width: 10%;"></td> <td style="width: 10%;"></td> <td style="width: 10%;"></td> <td style="width: 10%;"></td> <td style="width: 10%;"></td> <td style="width: 10%;"></td> <td style="width: 10%;"></td> </tr> <tr> <td></td> <td></td> <td colspan="8" style="text-align: center;"> <table border="1" style="width: 100%; border-collapse: collapse; text-align: center;"> <tr> </tr></table></td></tr></table></td></tr></table></td></tr></table></td></tr></table></td></tr></table></td></tr></table></td></tr></table></td></tr></table></td></tr></table></td></tr></table></td></tr></table></td></tr></table></td></tr></table></td></tr></table></td></tr></table></td></tr></table></td></tr></table></td></tr></table></td></tr></table></td></tr></table></td></tr></table></td></tr></table></td></tr></table></td></tr></table></td></tr></table></td></tr></table></td></tr></table></td></tr></table>
 | | | | | | | | | | | | | | | | | | | | <table border="1" style="width: 100%; border-collapse: collapse; text-align: center;"> <tr> <td style="width: 10%;"></td> <td style="width: 10%;"></td> <td style="width: 10%;"></td> <td style="width: 10%;"></td> <td style="width: 10%;"></td> <td style="width: 10%;"></td> <td style="width: 10%;"></td> <td style="width: 10%;"></td> <td style="width: 10%;"></td> <td style="width: 10%;"></td> </tr> <tr> <td></td> <td></td> <td colspan="8" style="text-align: center;"> <table border="1" style="width: 100%; border-collapse: collapse; text-align: center;"> <tr> <td style="width: 10%;"></td> <td style="width: 10%;"></td> <td style="width: 10%;"></td> <td style="width: 10%;"></td> <td style="width: 10%;"></td> <td style="width: 10%;"></td> <td style="width: 10%;"></td> <td style="width: 10%;"></td> <td style="width: 10%;"></td> <td style="width: 10%;"></td> </tr> <tr> <td></td> <td></td> <td colspan="8" style="text-align: center;"> <table border="1" style="width: 100%; border-collapse: collapse; text-align: center;"> <tr> <td style="width: 10%;"></td> <td style="width: 10%;"></td> <td style="width: 10%;"></td> <td style="width: 10%;"></td> <td style="width: 10%;"></td> <td style="width: 10%;"></td> <td style="width: 10%;"></td> <td style="width: 10%;"></td> <td style="width: 10%;"></td> <td style="width: 10%;"></td> </tr> <tr> <td></td> <td></td> <td colspan="8" style="text-align: center;"> <table border="1" style="width: 100%; border-collapse: collapse; text-align: center;"> <tr> <td style="width: 10%;"></td> <td style="width: 10%;"></td> <td style="width: 10%;"></td> <td style="width: 10%;"></td> <td style="width: 10%;"></td> <td style="width: 10%;"></td> <td style="width: 10%;"></td> <td style="width: 10%;"></td> <td style="width: 10%;"></td> <td style="width: 10%;"></td> </tr> <tr> <td></td> <td></td> <td colspan="8" style="text-align: center;"> <table border="1" style="width: 100%; border-collapse: collapse; text-align: center;"> <tr> <td style="width: 10%;"></td> <td style="width: 10%;"></td> <td style="width: 10%;"></td> <td style="width: 10%;"></td> <td style="width: 10%;"></td> <td style="width: 10%;"></td> <td style="width: 10%;"></td> <td style="width: 10%;"></td> <td style="width: 10%;"></td> <td style="width: 10%;"></td> </tr> <tr> <td></td> <td></td> <td colspan="8" style="text-align: center;"> <table border="1" style="width: 100%; border-collapse: collapse; text-align: center;"> <tr> <td style="width: 10%;"></td> <td style="width: 10%;"></td> <td style="width: 10%;"></td> <td style="width: 10%;"></td> <td style="width: 10%;"></td> <td style="width: 10%;"></td> <td style="width: 10%;"></td> <td style="width: 10%;"></td> <td style="width: 10%;"></td> <td style="width: 10%;"></td> </tr> <tr> <td></td> <td></td> <td colspan="8" style="text-align: center;"> <table border="1" style="width: 100%; border-collapse: collapse; text-align: center;"> <tr> <td style="width: 10%;"></td> <td style="width: 10%;"></td> <td style="width: 10%;"></td> <td style="width: 10%;"></td> <td style="width: 10%;"></td> <td style="width: 10%;"></td> <td style="width: 10%;"></td> <td style="width: 10%;"></td> <td style="width: 10%;"></td> <td style="width: 10%;"></td> </tr> <tr> <td></td> <td></td> <td colspan="8" style="text-align: center;"> <table border="1" style="width: 100%; border-collapse: collapse; text-align: center;"> <tr> <td style="width: 10%;"></td> <td style="width: 10%;"></td> <td style="width: 10%;"></td> <td style="width: 10%;"></td> <td style="width: 10%;"></td> <td style="width: 10%;"></td> <td style="width: 10%;"></td> <td style="width: 10%;"></td> <td style="width: 10%;"></td> <td style="width: 10%;"></td> </tr> <tr> <td></td> <td></td> <td colspan="8" style="text-align: center;"> <table border="1" style="width: 100%; border-collapse: collapse; text-align: center;"> <tr> <td style="width: 10%;"></td> <td style="width: 10%;"></td> <td style="width: 10%;"></td> <td style="width: 10%;"></td> <td style="width: 10%;"></td> <td style="width: 10%;"></td> <td style="width: 10%;"></td> <td style="width: 10%;"></td> <td style="width: 10%;"></td> <td style="width: 10%;"></td> </tr> <tr> <td></td> <td></td> <td colspan="8" style="text-align: center;"> <table border="1" style="width: 100%; border-collapse: collapse; text-align: center;"> <tr> <td style="width: 10%;"></td> <td style="width: 10%;"></td> <td style="width: 10%;"></td> <td style="width: 10%;"></td> <td style="width: 10%;"></td> <td style="width: 10%;"></td> <td style="width: 10%;"></td> <td style="width: 10%;"></td> <td style="width: 10%;"></td> <td style="width: 10%;"></td> </tr> <tr> <td></td> <td></td> <td colspan="8" style="text-align: center;"> <table border="1" style="width: 100%; border-collapse: collapse; text-align: center;"> <tr> <td style="width: 10%;"></td> <td style="width: 10%;"></td> <td style="width: 10%;"></td> <td style="width: 10%;"></td> <td style="width:
10%;"></td> <td style="width: 10%;"></td> <td style="width: 10%;"></td> <td style="width: 10%;"></td> <td style="width: 10%;"></td> <td style="width: 10%;"></td> </tr> <tr> <td></td> <td></td> <td colspan="8" style="text-align: center;"> <table border="1" style="width: 100%; border-collapse: collapse; text-align: center;"> <tr> <td style="width: 10%;"></td> <td style="width: 10%;"></td> <td style="width: 10%;"></td> <td style="width: 10%;"></td> <td style="width: 10%;"></td> <td style="width: 10%;"></td> <td style="width: 10%;"></td> <td style="width: 10%;"></td> <td style="width: 10%;"></td> <td style="width: 10%;"></td> </tr> <tr> <td></td> <td></td> <td colspan="8" style="text-align: center;"> <table border="1" style="width: 100%; border-collapse: collapse; text-align: center;"> <tr> <td style="width: 10%;"></td> <td style="width: 10%;"></td> <td style="width: 10%;"></td> <td style="width: 10%;"></td> <td style="width: 10%;"></td> <td style="width: 10%;"></td> <td style="width: 10%;"></td> <td style="width: 10%;"></td> <td style="width: 10%;"></td> <td style="width: 10%;"></td> </tr> <tr> <td></td> <td></td> <td colspan="8" style="text-align: center;"> <table border="1" style="width: 100%; border-collapse: collapse; text-align: center;"> <tr> <td style="width: 10%;"></td> <td style="width: 10%;"></td> <td style="width: 10%;"></td> <td style="width: 10%;"></td> <td style="width: 10%;"></td> <td style="width: 10%;"></td> <td style="width: 10%;"></td> <td style="width: 10%;"></td> <td style="width: 10%;"></td> <td style="width: 10%;"></td> </tr> <tr> <td></td> <td></td> <td colspan="8" style="text-align: center;"> <table border="1" style="width: 100%; border-collapse: collapse; text-align: center;"> <tr> <td style="width: 10%;"></td> <td style="width: 10%;"></td> <td style="width: 10%;"></td> <td style="width: 10%;"></td> <td style="width: 10%;"></td> <td style="width: 10%;"></td> <td style="width: 10%;"></td> <td style="width: 10%;"></td> <td style="width: 10%;"></td> <td style="width: 10%;"></td> </tr> <tr> <td></td> <td></td> <td colspan="8" style="text-align: center;"> <table border="1" style="width: 100%; border-collapse: collapse; text-align: center;"> <tr> <td style="width: 10%;"></td> <td style="width: 10%;"></td> <td style="width: 10%;"></td> <td style="width: 10%;"></td> <td style="width: 10%;"></td> <td style="width: 10%;"></td> <td style="width: 10%;"></td> <td style="width: 10%;"></td> <td style="width: 10%;"></td> <td style="width: 10%;"></td> </tr> <tr> <td></td> <td></td> <td colspan="8" style="text-align: center;"> <table border="1" style="width: 100%; border-collapse: collapse; text-align: center;"> <tr> <td style="width: 10%;"></td> <td style="width: 10%;"></td> <td style="width: 10%;"></td> <td style="width: 10%;"></td> <td style="width: 10%;"></td> <td style="width: 10%;"></td> <td style="width: 10%;"></td> <td style="width: 10%;"></td> <td style="width: 10%;"></td> <td style="width: 10%;"></td> </tr> <tr> <td></td> <td></td> <td colspan="8" style="text-align: center;"> <table border="1" style="width: 100%; border-collapse: collapse; text-align: center;"> <tr> <td style="width: 10%;"></td> <td style="width: 10%;"></td> <td style="width: 10%;"></td> <td style="width: 10%;"></td> <td style="width: 10%;"></td> <td style="width: 10%;"></td> <td style="width: 10%;"></td> <td style="width: 10%;"></td> <td style="width: 10%;"></td> <td style="width: 10%;"></td> </tr> <tr> <td></td> <td></td> <td colspan="8" style="text-align: center;"> <table border="1" style="width: 100%; border-collapse: collapse; text-align: center;"> <tr> <td style="width: 10%;"></td> <td style="width: 10%;"></td> <td style="width: 10%;"></td> <td style="width: 10%;"></td> <td style="width: 10%;"></td> <td style="width: 10%;"></td> <td style="width: 10%;"></td> <td style="width: 10%;"></td> <td style="width: 10%;"></td> <td style="width: 10%;"></td> </tr> <tr> <td></td> <td></td> <td colspan="8" style="text-align: center;"> <table border="1" style="width: 100%; border-collapse: collapse; text-align: center;"> <tr> <td style="width: 10%;"></td> <td style="width: 10%;"></td> <td style="width: 10%;"></td> <td style="width: 10%;"></td> <td style="width: 10%;"></td> <td style="width: 10%;"></td> <td style="width: 10%;"></td> <td style="width: 10%;"></td> <td style="width: 10%;"></td> <td style="width: 10%;"></td> </tr> <tr> <td></td> <td></td> <td colspan="8" style="text-align: center;"> <table border="1" style="width: 100%; border-collapse: collapse; text-align: center;"> <tr> <td style="width: 10%;"></td> <td style="width: 10%;"></td> <td style="width: 10%;"></td> <td style="width: 10%;"></td> <td style="width: 10%;"></td> <td style="width: 10%;"></td> <td style="width: 10%;"></td> <td style="width: 10%;"></td> <td style="width: 10%;"></td> <td style="width: 10%;"></td> </tr> <tr> <td></td> <td></td> <td colspan="8" style="text-align: center;"> <table border="1" style="width: 100%; border-collapse: collapse; text-align: center;"> <tr> <td style="width: 10%;"></td> <td style="width: 10%;"></td> <td style="width: 10%;"></td> <td style="width: 10%;"></td> <td style="width: 10%;"></td> <td style="width: 10%;"></td> <td style="width: 10%;"></td> <td style="width: 10%;"></td> <td style="width: 10%;"></td> <td style="width: 10%;"></td> </tr> <tr> <td></td> <td></td> <td colspan="8" style="text-align: center;"> <table border="1" style="width: 100%; border-collapse: collapse; text-align: center;"> <tr> <td style="width: 10%;"></td> <td style="width: 10%;"></td> <td style="width: 10%;"></td> <td style="width: 10%;"></td> <td style="width: 10%;"></td> <td style="width: 10%;"></td> <td style="width: 10%;"></td> <td style="width: 10%;"></td> <td style="width: 10%;"></td> <td style="width: 10%;"></td> </tr> <tr> <td></td> <td></td> <td colspan="8" style="text-align: center;"> <table border="1" style="width: 100%; border-collapse: collapse; text-align: center;"> <tr> <td style="width: 10%;"></td> <td style="width: 10%;"></td> <td style="width: 10%;"></td> <td style="width: 10%;"></td> <td style="width: 10%;"></td> <td style="width: 10%;"></td> <td style="width: 10%;"></td> <td style="width: 10%;"></td> <td style="width: 10%;"></td> <td style="width: 10%;"></td> </tr> <tr> <td></td> <td></td> <td colspan="8" style="text-align: center;"> <table border="1" style="width: 100%; border-collapse: collapse; text-align: center;"> <tr> <td style="width: 10%;"></td> <td style="width: 10%;"></td> <td style="width: 10%;"></td> <td style="width: 10%;"></td> <td style="width: 10%;"></td> <td style="width: 10%;"></td> <td style="width: 10%;"></td> <td style="width: 10%;"></td> <td style="width: 10%;"></td> <td style="width: 10%;"></td> </tr> <tr> <td></td> <td></td> <td colspan="8" style="text-align: center;"> <table border="1" style="width: 100%; border-collapse: collapse; text-align: center;"> <tr> <td style="width: 10%;"></td> <td style="width: 10%;"></td> <td style="width: 10%;"></td> <td style="width: 10%;"></td> <td style="width: 10%;"></td> <td style="width: 10%;"></td> <td style="width: 10%;"></td> <td style="width: 10%;"></td> <td style="width: 10%;"></td> <td style="width: 10%;"></td> </tr> <tr> <td></td> <td></td> <td colspan="8" style="text-align: center;"> <table border="1" style="width: 100%; border-collapse: collapse; text-align: center;"> <tr> <td style="width: 10%;"></td> <td style="width: 10%;"></td> <td style="width: 10%;"></td> <td style="width: 10%;"></td> <td style="width: 10%;"></td> <td style="width: 10%;"></td> <td style="width: 10%;"></td> <td style="width: 10%;"></td> <td style="width: 10%;"></td> <td style="width: 10%;"></td> </tr> <tr> <td></td> <td></td> <td colspan="8" style="text-align: center;"> <table border="1" style="width: 100%; border-collapse: collapse; text-align: center;"> <tr> </tr></table></td></tr></table></td></tr></table></td></tr></table></td></tr></table></td></tr></table></td></tr></table></td></tr></table></td></tr></table></td></tr></table></td></tr></table></td></tr></table></td></tr></table></td></tr></table></td></tr></table></td></tr></table></td></tr></table></td></tr></table></td></tr></table></td></tr></table></td></tr></table></td></tr></table></td></tr></table></td></tr></table></td></tr></table></td></tr></table></td></tr></table></td></tr></table>
 | | | | | | | | | | | | | | | | | | | | <table border="1" style="width: 100%; border-collapse: collapse; text-align: center;"> <tr> <td style="width: 10%;"></td> <td style="width: 10%;"></td> <td style="width: 10%;"></td> <td style="width: 10%;"></td> <td style="width: 10%;"></td> <td style="width: 10%;"></td> <td style="width: 10%;"></td> <td style="width: 10%;"></td> <td style="width: 10%;"></td> <td style="width: 10%;"></td> </tr> <tr> <td></td> <td></td> <td colspan="8" style="text-align: center;"> <table border="1" style="width: 100%; border-collapse: collapse; text-align: center;"> <tr> <td style="width: 10%;"></td> <td style="width: 10%;"></td> <td style="width: 10%;"></td> <td style="width: 10%;"></td> <td style="width: 10%;"></td> <td style="width: 10%;"></td> <td style="width: 10%;"></td> <td style="width: 10%;"></td> <td style="width: 10%;"></td> <td style="width: 10%;"></td> </tr> <tr> <td></td> <td></td> <td colspan="8" style="text-align: center;"> <table border="1" style="width: 100%; border-collapse: collapse; text-align: center;"> <tr> <td style="width: 10%;"></td> <td style="width: 10%;"></td> <td style="width: 10%;"></td> <td style="width: 10%;"></td> <td style="width: 10%;"></td> <td style="width: 10%;"></td> <td style="width: 10%;"></td> <td style="width: 10%;"></td> <td style="width: 10%;"></td> <td style="width: 10%;"></td> </tr> <tr> <td></td> <td></td> <td colspan="8" style="text-align: center;"> <table border="1" style="width: 100%; border-collapse: collapse; text-align: center;"> <tr> <td style="width: 10%;"></td> <td style="width: 10%;"></td> <td style="width: 10%;"></td> <td style="width: 10%;"></td> <td style="width: 10%;"></td> <td style="width: 10%;"></td> <td style="width: 10%;"></td> <td style="width: 10%;"></td> <td style="width: 10%;"></td> <td style="width: 10%;"></td> </tr> <tr> <td></td> <td></td> <td colspan="8" style="text-align: center;"> <table border="1" style="width: 100%; border-collapse: collapse; text-align: center;"> <tr> <td style="width: 10%;"></td> <td style="width: 10%;"></td> <td style="width: 10%;"></td> <td style="width: 10%;"></td> <td style="width: 10%;"></td> <td style="width: 10%;"></td> <td style="width: 10%;"></td> <td style="width: 10%;"></td> <td style="width: 10%;"></td> <td style="width: 10%;"></td> </tr> <tr> <td></td> <td></td> <td colspan="8" style="text-align: center;"> <table border="1" style="width: 100%; border-collapse: collapse; text-align: center;"> <tr> <td style="width: 10%;"></td> <td style="width: 10%;"></td> <td style="width: 10%;"></td> <td style="width: 10%;"></td> <td style="width: 10%;"></td> <td style="width: 10%;"></td> <td style="width: 10%;"></td> <td style="width: 10%;"></td> <td style="width: 10%;"></td> <td style="width: 10%;"></td> </tr> <tr> <td></td> <td></td> <td colspan="8" style="text-align: center;"> <table border="1" style="width: 100%; border-collapse: collapse; text-align: center;"> <tr> <td style="width: 10%;"></td> <td style="width: 10%;"></td> <td style="width: 10%;"></td> <td style="width: 10%;"></td> <td style="width: 10%;"></td> <td style="width: 10%;"></td> <td style="width: 10%;"></td> <td style="width: 10%;"></td> <td style="width: 10%;"></td> <td style="width: 10%;"></td> </tr> <tr> <td></td> <td></td> <td colspan="8" style="text-align: center;"> <table border="1" style="width: 100%; border-collapse: collapse; text-align: center;"> <tr> <td style="width: 10%;"></td> <td style="width: 10%;"></td> <td style="width: 10%;"></td> <td style="width: 10%;"></td> <td style="width: 10%;"></td> <td style="width: 10%;"></td> <td style="width: 10%;"></td> <td style="width: 10%;"></td> <td style="width: 10%;"></td> <td style="width: 10%;"></td> </tr> <tr> <td></td> <td></td> <td colspan="8" style="text-align: center;"> <table border="1" style="width: 100%; border-collapse: collapse; text-align: center;"> <tr> <td
style="width: 10%;"></td> <td style="width: 10%;"></td> <td style="width: 10%;"></td> <td style="width: 10%;"></td> <td style="width: 10%;"></td> <td style="width: 10%;"></td> <td style="width: 10%;"></td> <td style="width: 10%;"></td> <td style="width: 10%;"></td> <td style="width: 10%;"></td> </tr> <tr> <td></td> <td></td> <td colspan="8" style="text-align: center;"> <table border="1" style="width: 100%; border-collapse: collapse; text-align: center;"> <tr> <td style="width: 10%;"></td> <td style="width: 10%;"></td> <td style="width: 10%;"></td> <td style="width: 10%;"></td> <td style="width: 10%;"></td> <td style="width: 10%;"></td> <td style="width: 10%;"></td> <td style="width: 10%;"></td> <td style="width: 10%;"></td> <td style="width: 10%;"></td> </tr> <tr> <td></td> <td></td> <td colspan="8" style="text-align: center;"> <table border="1" style="width: 100%; border-collapse: collapse; text-align: center;"> <tr> <td style="width: 10%;"></td> <td style="width: 10%;"></td> <td style="width: 10%;"></td> <td style="width: 10%;"></td> <td style="width: 10%;"></td> <td style="width: 10%;"></td> <td style="width: 10%;"></td> <td style="width: 10%;"></td> <td style="width: 10%;"></td> <td style="width: 10%;"></td> </tr> <tr> <td></td> <td></td> <td colspan="8" style="text-align: center;"> <table border="1" style="width: 100%; border-collapse: collapse; text-align: center;"> <tr> <td style="width: 10%;"></td> <td style="width: 10%;"></td> <td style="width: 10%;"></td> <td style="width: 10%;"></td> <td style="width: 10%;"></td> <td style="width: 10%;"></td> <td style="width: 10%;"></td> <td style="width: 10%;"></td> <td style="width: 10%;"></td> <td style="width: 10%;"></td> </tr> <tr> <td></td> <td></td> <td colspan="8" style="text-align: center;"> <table border="1" style="width: 100%; border-collapse: collapse; text-align: center;"> <tr> <td style="width: 10%;"></td> <td style="width: 10%;"></td> <td style="width: 10%;"></td> <td style="width: 10%;"></td> <td style="width: 10%;"></td> <td style="width: 10%;"></td> <td style="width: 10%;"></td> <td style="width: 10%;"></td> <td style="width: 10%;"></td> <td style="width: 10%;"></td> </tr> <tr> <td></td> <td></td> <td colspan="8" style="text-align: center;"> <table border="1" style="width: 100%; border-collapse: collapse; text-align: center;"> <tr> <td style="width: 10%;"></td> <td style="width: 10%;"></td> <td style="width: 10%;"></td> <td style="width: 10%;"></td> <td style="width: 10%;"></td> <td style="width: 10%;"></td> <td style="width: 10%;"></td> <td style="width: 10%;"></td> <td style="width: 10%;"></td> <td style="width: 10%;"></td> </tr> <tr> <td></td> <td></td> <td colspan="8" style="text-align: center;"> <table border="1" style="width: 100%; border-collapse: collapse; text-align: center;"> <tr> <td style="width: 10%;"></td> <td style="width: 10%;"></td> <td style="width: 10%;"></td> <td style="width: 10%;"></td> <td style="width: 10%;"></td> <td style="width: 10%;"></td> <td style="width: 10%;"></td> <td style="width: 10%;"></td> <td style="width: 10%;"></td> <td style="width: 10%;"></td> </tr> <tr> <td></td> <td></td> <td colspan="8" style="text-align: center;"> <table border="1" style="width: 100%; border-collapse: collapse; text-align: center;"> <tr> <td style="width: 10%;"></td> <td style="width: 10%;"></td> <td style="width: 10%;"></td> <td style="width: 10%;"></td> <td style="width: 10%;"></td> <td style="width: 10%;"></td> <td style="width: 10%;"></td> <td style="width: 10%;"></td> <td style="width: 10%;"></td> <td style="width: 10%;"></td> </tr> <tr> <td></td> <td></td> <td colspan="8" style="text-align: center;"> <table border="1" style="width: 100%; border-collapse: collapse; text-align: center;"> <tr> <td style="width: 10%;"></td> <td style="width: 10%;"></td> <td style="width: 10%;"></td> <td style="width: 10%;"></td> <td style="width: 10%;"></td> <td style="width: 10%;"></td> <td style="width: 10%;"></td> <td style="width: 10%;"></td> <td style="width: 10%;"></td> <td style="width: 10%;"></td> </tr> <tr> <td></td> <td></td> <td colspan="8" style="text-align: center;"> <table border="1" style="width: 100%; border-collapse: collapse; text-align: center;"> <tr> <td style="width: 10%;"></td> <td style="width: 10%;"></td> <td style="width: 10%;"></td> <td style="width: 10%;"></td> <td style="width: 10%;"></td> <td style="width: 10%;"></td> <td style="width: 10%;"></td> <td style="width: 10%;"></td> <td style="width: 10%;"></td> <td style="width: 10%;"></td> </tr> <tr> <td></td> <td></td> <td colspan="8" style="text-align: center;"> <table border="1" style="width: 100%; border-collapse: collapse; text-align: center;"> <tr> <td style="width: 10%;"></td> <td style="width: 10%;"></td> <td style="width: 10%;"></td> <td style="width: 10%;"></td> <td style="width: 10%;"></td> <td style="width: 10%;"></td> <td style="width: 10%;"></td> <td style="width: 10%;"></td> <td style="width: 10%;"></td> <td style="width: 10%;"></td> </tr> <tr> <td></td> <td></td> <td colspan="8" style="text-align: center;"> <table border="1" style="width: 100%; border-collapse: collapse; text-align: center;"> <tr> <td style="width: 10%;"></td> <td style="width: 10%;"></td> <td style="width: 10%;"></td> <td style="width: 10%;"></td> <td style="width: 10%;"></td> <td style="width: 10%;"></td> <td style="width: 10%;"></td> <td style="width: 10%;"></td> <td style="width: 10%;"></td> <td style="width: 10%;"></td> </tr> <tr> <td></td> <td></td> <td colspan="8" style="text-align: center;"> <table border="1" style="width: 100%; border-collapse: collapse; text-align: center;"> <tr> <td style="width: 10%;"></td> <td style="width: 10%;"></td> <td style="width: 10%;"></td> <td style="width: 10%;"></td> <td style="width: 10%;"></td> <td style="width: 10%;"></td> <td style="width: 10%;"></td> <td style="width: 10%;"></td> <td style="width: 10%;"></td> <td style="width: 10%;"></td> </tr> <tr> <td></td> <td></td> <td colspan="8" style="text-align: center;"> <table border="1" style="width: 100%; border-collapse: collapse; text-align: center;"> <tr> <td style="width: 10%;"></td> <td style="width: 10%;"></td> <td style="width: 10%;"></td> <td style="width: 10%;"></td> <td style="width: 10%;"></td> <td style="width: 10%;"></td> <td style="width: 10%;"></td> <td style="width: 10%;"></td> <td style="width: 10%;"></td> <td style="width: 10%;"></td> </tr> <tr> <td></td> <td></td> <td colspan="8" style="text-align: center;"> <table border="1" style="width: 100%; border-collapse: collapse; text-align: center;"> <tr> <td style="width: 10%;"></td> <td style="width: 10%;"></td> <td style="width: 10%;"></td> <td style="width: 10%;"></td> <td style="width: 10%;"></td> <td style="width: 10%;"></td> <td style="width: 10%;"></td> <td style="width: 10%;"></td> <td style="width: 10%;"></td> <td style="width: 10%;"></td> </tr> <tr> <td></td> <td></td> <td colspan="8" style="text-align: center;"> <table border="1" style="width: 100%; border-collapse: collapse; text-align: center;"> <tr> <td style="width: 10%;"></td> <td style="width: 10%;"></td> <td style="width: 10%;"></td> <td style="width: 10%;"></td> <td style="width: 10%;"></td> <td style="width: 10%;"></td> <td style="width: 10%;"></td> <td style="width: 10%;"></td> <td style="width: 10%;"></td> <td style="width: 10%;"></td> </tr> <tr> <td></td> <td></td> <td colspan="8" style="text-align: center;"> <table border="1" style="width: 100%; border-collapse: collapse; text-align: center;"> <tr> <td style="width: 10%;"></td> <td style="width: 10%;"></td> <td style="width: 10%;"></td> <td style="width: 10%;"></td> <td style="width: 10%;"></td> <td style="width: 10%;"></td> <td style="width: 10%;"></td> <td style="width: 10%;"></td> <td style="width: 10%;"></td> <td style="width: 10%;"></td> </tr> <tr> <td></td> <td></td> <td colspan="8" style="text-align: center;"> <table border="1" style="width: 100%; border-collapse: collapse; text-align: center;"> <tr> <td style="width: 10%;"></td> <td style="width: 10%;"></td> <td style="width: 10%;"></td> <td style="width: 10%;"></td> <td style="width: 10%;"></td> <td style="width: 10%;"></td> <td style="width: 10%;"></td> <td style="width: 10%;"></td> <td style="width: 10%;"></td> <td style="width: 10%;"></td> </tr> <tr> <td></td> <td></td> <td colspan="8" style="text-align: center;"> <table border="1" style="width: 100%; border-collapse: collapse; text-align: center;"> <tr> </tr></table></td></tr></table></td></tr></table></td></tr></table></td></tr></table></td></tr></table></td></tr></table></td></tr></table></td></tr></table></td></tr></table></td></tr></table></td></tr></table></td></tr></table></td></tr></table></td></tr></table></td></tr></table></td></tr></table></td></tr></table></td></tr></table></td></tr></table></td></tr></table></td></tr></table></td></tr></table></td></tr></table></td></tr></table></td></tr></table></td></tr></table>
 | | | | | | | | | | | | | | | | | | | | <table border="1" style="width: 100%; border-collapse: collapse; text-align: center;"> <tr> <td style="width: 10%;"></td> <td style="width: 10%;"></td> <td style="width: 10%;"></td> <td style="width: 10%;"></td> <td style="width: 10%;"></td> <td style="width: 10%;"></td> <td style="width: 10%;"></td> <td style="width: 10%;"></td> <td style="width: 10%;"></td> <td style="width: 10%;"></td> </tr> <tr> <td></td> <td></td> <td colspan="8" style="text-align: center;"> <table border="1" style="width: 100%; border-collapse: collapse; text-align: center;"> <tr> <td style="width: 10%;"></td> <td style="width: 10%;"></td> <td style="width: 10%;"></td> <td style="width: 10%;"></td> <td style="width: 10%;"></td> <td style="width: 10%;"></td> <td style="width: 10%;"></td> <td style="width: 10%;"></td> <td style="width: 10%;"></td> <td style="width: 10%;"></td> </tr> <tr> <td></td> <td></td> <td colspan="8" style="text-align: center;"> <table border="1" style="width: 100%; border-collapse: collapse; text-align: center;"> <tr> <td style="width: 10%;"></td> <td style="width: 10%;"></td> <td style="width: 10%;"></td> <td style="width: 10%;"></td> <td style="width: 10%;"></td> <td style="width: 10%;"></td> <td style="width: 10%;"></td> <td style="width: 10%;"></td> <td style="width: 10%;"></td> <td style="width: 10%;"></td> </tr> <tr> <td></td> <td></td> <td colspan="8" style="text-align: center;"> <table border="1" style="width: 100%; border-collapse: collapse; text-align: center;"> <tr> <td style="width: 10%;"></td> <td style="width: 10%;"></td> <td style="width: 10%;"></td> <td style="width: 10%;"></td> <td style="width: 10%;"></td> <td style="width: 10%;"></td> <td style="width: 10%;"></td> <td style="width: 10%;"></td> <td style="width: 10%;"></td> <td style="width: 10%;"></td> </tr> <tr> <td></td> <td></td> <td colspan="8" style="text-align: center;"> <table border="1" style="width: 100%; border-collapse: collapse; text-align: center;"> <tr> <td style="width: 10%;"></td> <td style="width: 10%;"></td> <td style="width: 10%;"></td> <td style="width: 10%;"></td> <td style="width: 10%;"></td> <td style="width: 10%;"></td> <td style="width: 10%;"></td> <td style="width: 10%;"></td> <td style="width: 10%;"></td> <td style="width: 10%;"></td> </tr> <tr> <td></td> <td></td> <td colspan="8" style="text-align: center;"> <table border="1" style="width: 100%; border-collapse: collapse; text-align: center;"> <tr> <td style="width: 10%;"></td> <td style="width: 10%;"></td> <td style="width: 10%;"></td> <td style="width: 10%;"></td> <td style="width: 10%;"></td> <td style="width: 10%;"></td> <td style="width: 10%;"></td> <td style="width: 10%;"></td> <td style="width: 10%;"></td> <td style="width: 10%;"></td> </tr> <tr> <td></td> <td></td> <td colspan="8" style="text-align: center;"> <table border="1" style="width: 100%; border-collapse: collapse; text-align: center;"> <tr> <td style="width: 10%;"></td> <td style="width: 10%;"></td> <td style="width: 10%;"></td> <td style="width: 10%;"></td> <td style="width: 10%;"></td> <td style="width: 10%;"></td> <td style="width: 10%;"></td> <td style="width: 10%;"></td> <td style="width: 10%;"></td> <td style="width: 10%;"></td> </tr> <tr> <td></td> <td></td> <td colspan="8"
style="text-align: center;"> <table border="1" style="width: 100%; border-collapse: collapse; text-align: center;"> <tr> <td style="width: 10%;"></td> <td style="width: 10%;"></td> <td style="width: 10%;"></td> <td style="width: 10%;"></td> <td style="width: 10%;"></td> <td style="width: 10%;"></td> <td style="width: 10%;"></td> <td style="width: 10%;"></td> <td style="width: 10%;"></td> <td style="width: 10%;"></td> </tr> <tr> <td></td> <td></td> <td colspan="8" style="text-align: center;"> <table border="1" style="width: 100%; border-collapse: collapse; text-align: center;"> <tr> <td style="width: 10%;"></td> <td style="width: 10%;"></td> <td style="width: 10%;"></td> <td style="width: 10%;"></td> <td style="width: 10%;"></td> <td style="width: 10%;"></td> <td style="width: 10%;"></td> <td style="width: 10%;"></td> <td style="width: 10%;"></td> <td style="width: 10%;"></td> </tr> <tr> <td></td> <td></td> <td colspan="8" style="text-align: center;"> <table border="1" style="width: 100%; border-collapse: collapse; text-align: center;"> <tr> <td style="width: 10%;"></td> <td style="width: 10%;"></td> <td style="width: 10%;"></td> <td style="width: 10%;"></td> <td style="width: 10%;"></td> <td style="width: 10%;"></td> <td style="width: 10%;"></td> <td style="width: 10%;"></td> <td style="width: 10%;"></td> <td style="width: 10%;"></td> </tr> <tr> <td></td> <td></td> <td colspan="8" style="text-align: center;"> <table border="1" style="width: 100%; border-collapse: collapse; text-align: center;"> <tr> <td style="width: 10%;"></td> <td style="width: 10%;"></td> <td style="width: 10%;"></td> <td style="width: 10%;"></td> <td style="width: 10%;"></td> <td style="width: 10%;"></td> <td style="width: 10%;"></td> <td style="width: 10%;"></td> <td style="width: 10%;"></td> <td style="width: 10%;"></td> </tr> <tr> <td></td> <td></td> <td colspan="8" style="text-align: center;"> <table border="1" style="width: 100%; border-collapse: collapse; text-align: center;"> <tr> <td style="width: 10%;"></td> <td style="width: 10%;"></td> <td style="width: 10%;"></td> <td style="width: 10%;"></td> <td style="width: 10%;"></td> <td style="width: 10%;"></td> <td style="width: 10%;"></td> <td style="width: 10%;"></td> <td style="width: 10%;"></td> <td style="width: 10%;"></td> </tr> <tr> <td></td> <td></td> <td colspan="8" style="text-align: center;"> <table border="1" style="width: 100%; border-collapse: collapse; text-align: center;"> <tr> <td style="width: 10%;"></td> <td style="width: 10%;"></td> <td style="width: 10%;"></td> <td style="width: 10%;"></td> <td style="width: 10%;"></td> <td style="width: 10%;"></td> <td style="width: 10%;"></td> <td style="width: 10%;"></td> <td style="width: 10%;"></td> <td style="width: 10%;"></td> </tr> <tr> <td></td> <td></td> <td colspan="8" style="text-align: center;"> <table border="1" style="width: 100%; border-collapse: collapse; text-align: center;"> <tr> <td style="width: 10%;"></td> <td style="width: 10%;"></td> <td style="width: 10%;"></td> <td style="width: 10%;"></td> <td style="width: 10%;"></td> <td style="width: 10%;"></td> <td style="width: 10%;"></td> <td style="width: 10%;"></td> <td style="width: 10%;"></td> <td style="width: 10%;"></td> </tr> <tr> <td></td> <td></td> <td colspan="8" style="text-align: center;"> <table border="1" style="width: 100%; border-collapse: collapse; text-align: center;"> <tr> <td style="width: 10%;"></td> <td style="width: 10%;"></td> <td style="width: 10%;"></td> <td style="width: 10%;"></td> <td style="width: 10%;"></td> <td style="width: 10%;"></td> <td style="width: 10%;"></td> <td style="width: 10%;"></td> <td style="width: 10%;"></td> <td style="width: 10%;"></td> </tr> <tr> <td></td> <td></td> <td colspan="8" style="text-align: center;"> <table border="1" style="width: 100%; border-collapse: collapse; text-align: center;"> <tr> <td style="width: 10%;"></td> <td style="width: 10%;"></td> <td style="width: 10%;"></td> <td style="width: 10%;"></td> <td style="width: 10%;"></td> <td style="width: 10%;"></td> <td style="width: 10%;"></td> <td style="width: 10%;"></td> <td style="width: 10%;"></td> <td style="width: 10%;"></td> </tr> <tr> <td></td> <td></td> <td colspan="8" style="text-align: center;"> <table border="1" style="width: 100%; border-collapse: collapse; text-align: center;"> <tr> <td style="width: 10%;"></td> <td style="width: 10%;"></td> <td style="width: 10%;"></td> <td style="width: 10%;"></td> <td style="width: 10%;"></td> <td style="width: 10%;"></td> <td style="width: 10%;"></td> <td style="width: 10%;"></td> <td style="width: 10%;"></td> <td style="width: 10%;"></td> </tr> <tr> <td></td> <td></td> <td colspan="8" style="text-align: center;"> <table border="1" style="width: 100%; border-collapse: collapse; text-align: center;"> <tr> <td style="width: 10%;"></td> <td style="width: 10%;"></td> <td style="width: 10%;"></td> <td style="width: 10%;"></td> <td style="width: 10%;"></td> <td style="width: 10%;"></td> <td style="width: 10%;"></td> <td style="width: 10%;"></td> <td style="width: 10%;"></td> <td style="width: 10%;"></td> </tr> <tr> <td></td> <td></td> <td colspan="8" style="text-align: center;"> <table border="1" style="width: 100%; border-collapse: collapse; text-align: center;"> <tr> <td style="width: 10%;"></td> <td style="width: 10%;"></td> <td style="width: 10%;"></td> <td style="width: 10%;"></td> <td style="width: 10%;"></td> <td style="width: 10%;"></td> <td style="width: 10%;"></td> <td style="width: 10%;"></td> <td style="width: 10%;"></td> <td style="width: 10%;"></td> </tr> <tr> <td></td> <td></td> <td colspan="8" style="text-align: center;"> <table border="1" style="width: 100%; border-collapse: collapse; text-align: center;"> <tr> <td style="width: 10%;"></td> <td style="width: 10%;"></td> <td style="width: 10%;"></td> <td style="width: 10%;"></td> <td style="width: 10%;"></td> <td style="width: 10%;"></td> <td style="width: 10%;"></td> <td style="width: 10%;"></td> <td style="width: 10%;"></td> <td style="width: 10%;"></td> </tr> <tr> <td></td> <td></td> <td colspan="8" style="text-align: center;"> <table border="1" style="width: 100%; border-collapse: collapse; text-align: center;"> <tr> <td style="width: 10%;"></td> <td style="width: 10%;"></td> <td style="width: 10%;"></td> <td style="width: 10%;"></td> <td style="width: 10%;"></td> <td style="width: 10%;"></td> <td style="width: 10%;"></td> <td style="width: 10%;"></td> <td style="width: 10%;"></td> <td style="width: 10%;"></td> </tr> <tr> <td></td> <td></td> <td colspan="8" style="text-align: center;"> <table border="1" style="width: 100%; border-collapse: collapse; text-align: center;"> <tr> <td style="width: 10%;"></td> <td style="width: 10%;"></td> <td style="width: 10%;"></td> <td style="width: 10%;"></td> <td style="width: 10%;"></td> <td style="width: 10%;"></td> <td style="width: 10%;"></td> <td style="width: 10%;"></td> <td style="width: 10%;"></td> <td style="width: 10%;"></td> </tr> <tr> <td></td> <td></td> <td colspan="8" style="text-align: center;"> <table border="1" style="width: 100%; border-collapse: collapse; text-align: center;"> <tr> <td style="width: 10%;"></td> <td style="width: 10%;"></td> <td style="width: 10%;"></td> <td style="width: 10%;"></td> <td style="width: 10%;"></td> <td style="width: 10%;"></td> <td style="width: 10%;"></td> <td style="width: 10%;"></td> <td style="width: 10%;"></td> <td style="width: 10%;"></td> </tr> <tr> <td></td> <td></td> <td colspan="8" style="text-align: center;"> <table border="1" style="width: 100%; border-collapse: collapse; text-align: center;"> <tr> <td style="width: 10%;"></td> <td style="width: 10%;"></td> <td style="width: 10%;"></td> <td style="width: 10%;"></td> <td style="width: 10%;"></td> <td style="width: 10%;"></td> <td style="width: 10%;"></td> <td style="width: 10%;"></td> <td style="width: 10%;"></td> <td style="width: 10%;"></td> </tr> <tr> <td></td> <td></td> <td colspan="8" style="text-align: center;"> <table border="1" style="width: 100%; border-collapse: collapse; text-align: center;"> <tr> <td style="width: 10%;"></td> <td style="width: 10%;"></td> <td style="width: 10%;"></td> <td style="width: 10%;"></td> <td style="width: 10%;"></td> <td style="width: 10%;"></td> <td style="width: 10%;"></td> <td style="width: 10%;"></td> <td style="width: 10%;"></td> <td style="width: 10%;"></td> </tr> <tr> <td></td> <td></td> <td colspan="8" style="text-align: center;"> <table border="1" style="width: 100%; border-collapse: collapse; text-align: center;"> <tr> </tr></table></td></tr></table></td></tr></table></td></tr></table></td></tr></table></td></tr></table></td></tr></table></td></tr></table></td></tr></table></td></tr></table></td></tr></table></td></tr></table></td></tr></table></td></tr></table></td></tr></table></td></tr></table></td></tr></table></td></tr></table></td></tr></table></td></tr></table></td></tr></table></td></tr></table></td></tr></table></td></tr></table></td></tr></table></td></tr></table>
 | | | | | | | | | | | | | | | | | | | | <table border="1" style="width: 100%; border-collapse: collapse; text-align: center;"> <tr> <td style="width: 10%;"></td> <td style="width: 10%;"></td> <td style="width: 10%;"></td> <td style="width: 10%;"></td> <td style="width: 10%;"></td> <td style="width: 10%;"></td> <td style="width: 10%;"></td> <td style="width: 10%;"></td> <td style="width: 10%;"></td> <td style="width: 10%;"></td> </tr> <tr> <td></td> <td></td> <td colspan="8" style="text-align: center;"> <table border="1" style="width: 100%; border-collapse: collapse; text-align: center;"> <tr> <td style="width: 10%;"></td> <td style="width: 10%;"></td> <td style="width: 10%;"></td> <td style="width: 10%;"></td> <td style="width: 10%;"></td> <td style="width: 10%;"></td> <td style="width: 10%;"></td> <td style="width: 10%;"></td> <td style="width: 10%;"></td> <td style="width: 10%;"></td> </tr> <tr> <td></td> <td></td> <td colspan="8" style="text-align: center;"> <table border="1" style="width: 100%; border-collapse: collapse; text-align: center;"> <tr> <td style="width: 10%;"></td> <td style="width: 10%;"></td> <td style="width: 10%;"></td> <td style="width: 10%;"></td> <td style="width: 10%;"></td> <td style="width: 10%;"></td> <td style="width: 10%;"></td> <td style="width: 10%;"></td> <td style="width: 10%;"></td> <td style="width: 10%;"></td> </tr> <tr> <td></td> <td></td> <td colspan="8" style="text-align: center;"> <table border="1" style="width: 100%; border-collapse: collapse; text-align: center;"> <tr> <td style="width: 10%;"></td> <td style="width: 10%;"></td> <td style="width: 10%;"></td> <td style="width: 10%;"></td> <td style="width: 10%;"></td> <td style="width: 10%;"></td> <td style="width: 10%;"></td> <td style="width: 10%;"></td> <td style="width: 10%;"></td> <td style="width: 10%;"></td> </tr> <tr> <td></td> <td></td> <td colspan="8" style="text-align: center;"> <table border="1" style="width: 100%; border-collapse: collapse; text-align: center;"> <tr> <td style="width: 10%;"></td> <td style="width: 10%;"></td> <td style="width: 10%;"></td> <td style="width: 10%;"></td> <td style="width: 10%;"></td> <td style="width: 10%;"></td> <td style="width: 10%;"></td> <td style="width: 10%;"></td> <td style="width: 10%;"></td> <td style="width: 10%;"></td> </tr> <tr> <td></td> <td></td> <td colspan="8" style="text-align: center;"> <table border="1" style="width: 100%; border-collapse: collapse; text-align: center;"> <tr> <td style="width: 10%;"></td> <td style="width: 10%;"></td> <td style="width: 10%;"></td> <td style="width: 10%;"></td> <td style="width: 10%;"></td> <td style="width: 10%;"></td> <td style="width: 10%;"></td> <td style="width: 10%;"></td> <td style="width: 10%;"></td> <td style="width: 10%;"></td> </tr> <tr> <td></td> <td></td> <td colspan="8" style="text-align: center;"> <table border="1" style="width: 100%; border-collapse: collapse; text-align: center;"> <tr> <td style="width: 10%;"></td> <td style="width: 10%;"></td> <td style="width: 10%;"></td> <td style="width: 10%;"></td> <td style="width: 10%;"></td> <td style="width: 10%;"></td> <td style="width: 10%;"></td> <td style="width: 10%;"></td> <td
style="width: 10%;"></td> <td style="width: 10%;"></td> </tr> <tr> <td></td> <td></td> <td colspan="8" style="text-align: center;"> <table border="1" style="width: 100%; border-collapse: collapse; text-align: center;"> <tr> <td style="width: 10%;"></td> <td style="width: 10%;"></td> <td style="width: 10%;"></td> <td style="width: 10%;"></td> <td style="width: 10%;"></td> <td style="width: 10%;"></td> <td style="width: 10%;"></td> <td style="width: 10%;"></td> <td style="width: 10%;"></td> <td style="width: 10%;"></td> </tr> <tr> <td></td> <td></td> <td colspan="8" style="text-align: center;"> <table border="1" style="width: 100%; border-collapse: collapse; text-align: center;"> <tr> <td style="width: 10%;"></td> <td style="width: 10%;"></td> <td style="width: 10%;"></td> <td style="width: 10%;"></td> <td style="width: 10%;"></td> <td style="width: 10%;"></td> <td style="width: 10%;"></td> <td style="width: 10%;"></td> <td style="width: 10%;"></td> <td style="width: 10%;"></td> </tr> <tr> <td></td> <td></td> <td colspan="8" style="text-align: center;"> <table border="1" style="width: 100%; border-collapse: collapse; text-align: center;"> <tr> <td style="width: 10%;"></td> <td style="width: 10%;"></td> <td style="width: 10%;"></td> <td style="width: 10%;"></td> <td style="width: 10%;"></td> <td style="width: 10%;"></td> <td style="width: 10%;"></td> <td style="width: 10%;"></td> <td style="width: 10%;"></td> <td style="width: 10%;"></td> </tr> <tr> <td></td> <td></td> <td colspan="8" style="text-align: center;"> <table border="1" style="width: 100%; border-collapse: collapse; text-align: center;"> <tr> <td style="width: 10%;"></td> <td style="width: 10%;"></td> <td style="width: 10%;"></td> <td style="width: 10%;"></td> <td style="width: 10%;"></td> <td style="width: 10%;"></td> <td style="width: 10%;"></td> <td style="width: 10%;"></td> <td style="width: 10%;"></td> <td style="width: 10%;"></td> </tr> <tr> <td></td> <td></td> <td colspan="8" style="text-align: center;"> <table border="1" style="width: 100%; border-collapse: collapse; text-align: center;"> <tr> <td style="width: 10%;"></td> <td style="width: 10%;"></td> <td style="width: 10%;"></td> <td style="width: 10%;"></td> <td style="width: 10%;"></td> <td style="width: 10%;"></td> <td style="width: 10%;"></td> <td style="width: 10%;"></td> <td style="width: 10%;"></td> <td style="width: 10%;"></td> </tr> <tr> <td></td> <td></td> <td colspan="8" style="text-align: center;"> <table border="1" style="width: 100%; border-collapse: collapse; text-align: center;"> <tr> <td style="width: 10%;"></td> <td style="width: 10%;"></td> <td style="width: 10%;"></td> <td style="width: 10%;"></td> <td style="width: 10%;"></td> <td style="width: 10%;"></td> <td style="width: 10%;"></td> <td style="width: 10%;"></td> <td style="width: 10%;"></td> <td style="width: 10%;"></td> </tr> <tr> <td></td> <td></td> <td colspan="8" style="text-align: center;"> <table border="1" style="width: 100%; border-collapse: collapse; text-align: center;"> <tr> <td style="width: 10%;"></td> <td style="width: 10%;"></td> <td style="width: 10%;"></td> <td style="width: 10%;"></td> <td style="width: 10%;"></td> <td style="width: 10%;"></td> <td style="width: 10%;"></td> <td style="width: 10%;"></td> <td style="width: 10%;"></td> <td style="width: 10%;"></td> </tr> <tr> <td></td> <td></td> <td colspan="8" style="text-align: center;"> <table border="1" style="width: 100%; border-collapse: collapse; text-align: center;"> <tr> <td style="width: 10%;"></td> <td style="width: 10%;"></td> <td style="width: 10%;"></td> <td style="width: 10%;"></td> <td style="width: 10%;"></td> <td style="width: 10%;"></td> <td style="width: 10%;"></td> <td style="width: 10%;"></td> <td style="width: 10%;"></td> <td style="width: 10%;"></td> </tr> <tr> <td></td> <td></td> <td colspan="8" style="text-align: center;"> <table border="1" style="width: 100%; border-collapse: collapse; text-align: center;"> <tr> <td style="width: 10%;"></td> <td style="width: 10%;"></td> <td style="width: 10%;"></td> <td style="width: 10%;"></td> <td style="width: 10%;"></td> <td style="width: 10%;"></td> <td style="width: 10%;"></td> <td style="width: 10%;"></td> <td style="width: 10%;"></td> <td style="width: 10%;"></td> </tr> <tr> <td></td> <td></td> <td colspan="8" style="text-align: center;"> <table border="1" style="width: 100%; border-collapse: collapse; text-align: center;"> <tr> <td style="width: 10%;"></td> <td style="width: 10%;"></td> <td style="width: 10%;"></td> <td style="width: 10%;"></td> <td style="width: 10%;"></td> <td style="width: 10%;"></td> <td style="width: 10%;"></td> <td style="width: 10%;"></td> <td style="width: 10%;"></td> <td style="width: 10%;"></td> </tr> <tr> <td></td> <td></td> <td colspan="8" style="text-align: center;"> <table border="1" style="width: 100%; border-collapse: collapse; text-align: center;"> <tr> <td style="width: 10%;"></td> <td style="width: 10%;"></td> <td style="width: 10%;"></td> <td style="width: 10%;"></td> <td style="width: 10%;"></td> <td style="width: 10%;"></td> <td style="width: 10%;"></td> <td style="width: 10%;"></td> <td style="width: 10%;"></td> <td style="width: 10%;"></td> </tr> <tr> <td></td> <td></td> <td colspan="8" style="text-align: center;"> <table border="1" style="width: 100%; border-collapse: collapse; text-align: center;"> <tr> <td style="width: 10%;"></td> <td style="width: 10%;"></td> <td style="width: 10%;"></td> <td style="width: 10%;"></td> <td style="width: 10%;"></td> <td style="width: 10%;"></td> <td style="width: 10%;"></td> <td style="width: 10%;"></td> <td style="width: 10%;"></td> <td style="width: 10%;"></td> </tr> <tr> <td></td> <td></td> <td colspan="8" style="text-align: center;"> <table border="1" style="width: 100%; border-collapse: collapse; text-align: center;"> <tr> <td style="width: 10%;"></td> <td style="width: 10%;"></td> <td style="width: 10%;"></td> <td style="width: 10%;"></td> <td style="width: 10%;"></td> <td style="width: 10%;"></td> <td style="width: 10%;"></td> <td style="width: 10%;"></td> <td style="width: 10%;"></td> <td style="width: 10%;"></td> </tr> <tr> <td></td> <td></td> <td colspan="8" style="text-align: center;"> <table border="1" style="width: 100%; border-collapse: collapse; text-align: center;"> <tr> <td style="width: 10%;"></td> <td style="width: 10%;"></td> <td style="width: 10%;"></td> <td style="width: 10%;"></td> <td style="width: 10%;"></td> <td style="width: 10%;"></td> <td style="width: 10%;"></td> <td style="width: 10%;"></td> <td style="width: 10%;"></td> <td style="width: 10%;"></td> </tr> <tr> <td></td> <td></td> <td colspan="8" style="text-align: center;"> <table border="1" style="width: 100%; border-collapse: collapse; text-align: center;"> <tr> <td style="width: 10%;"></td> <td style="width: 10%;"></td> <td style="width: 10%;"></td> <td style="width: 10%;"></td> <td style="width: 10%;"></td> <td style="width: 10%;"></td> <td style="width: 10%;"></td> <td style="width: 10%;"></td> <td style="width: 10%;"></td> <td style="width: 10%;"></td> </tr> <tr> <td></td> <td></td> <td colspan="8" style="text-align: center;"> <table border="1" style="width: 100%; border-collapse: collapse; text-align: center;"> <tr> <td style="width: 10%;"></td> <td style="width: 10%;"></td> <td style="width: 10%;"></td> <td style="width: 10%;"></td> <td style="width: 10%;"></td> <td style="width: 10%;"></td> <td style="width: 10%;"></td> <td style="width: 10%;"></td> <td style="width: 10%;"></td> <td style="width: 10%;"></td> </tr> <tr> <td></td> <td></td> <td colspan="8" style="text-align: center;"> <table border="1" style="width: 100%; border-collapse: collapse; text-align: center;"> <tr> <td style="width: 10%;"></td> <td style="width: 10%;"></td> <td style="width: 10%;"></td> <td style="width: 10%;"></td> <td style="width: 10%;"></td> <td style="width: 10%;"></td> <td style="width: 10%;"></td> <td style="width: 10%;"></td> <td style="width: 10%;"></td> <td style="width: 10%;"></td> </tr> <tr> <td></td> <td></td> <td colspan="8" style="text-align: center;"> <table border="1" style="width: 100%; border-collapse: collapse; text-align: center;"> <tr> </tr></table></td></tr></table></td></tr></table></td></tr></table></td></tr></table></td></tr></table></td></tr></table></td></tr></table></td></tr></table></td></tr></table></td></tr></table></td></tr></table></td></tr></table></td></tr></table></td></tr></table></td></tr></table></td></tr></table></td></tr></table></td></tr></table></td></tr></table></td></tr></table></td></tr></table></td></tr></table></td></tr></table></td></tr></table>
 | | | | | | | | | | | | | | | | | | | | <table border="1" style="width: 100%; border-collapse: collapse; text-align: center;"> <tr> <td style="width: 10%;"></td> <td style="width: 10%;"></td> <td style="width: 10%;"></td> <td style="width: 10%;"></td> <td style="width: 10%;"></td> <td style="width: 10%;"></td> <td style="width: 10%;"></td> <td style="width: 10%;"></td> <td style="width: 10%;"></td> <td style="width: 10%;"></td> </tr> <tr> <td></td> <td></td> <td colspan="8" style="text-align: center;"> <table border="1" style="width: 100%; border-collapse: collapse; text-align: center;"> <tr> <td style="width: 10%;"></td> <td style="width: 10%;"></td> <td style="width: 10%;"></td> <td style="width: 10%;"></td> <td style="width: 10%;"></td> <td style="width: 10%;"></td> <td style="width: 10%;"></td> <td style="width: 10%;"></td> <td style="width: 10%;"></td> <td style="width: 10%;"></td> </tr> <tr> <td></td> <td></td> <td colspan="8" style="text-align: center;"> <table border="1" style="width: 100%; border-collapse: collapse; text-align: center;"> <tr> <td style="width: 10%;"></td> <td style="width: 10%;"></td> <td style="width: 10%;"></td> <td style="width: 10%;"></td> <td style="width: 10%;"></td> <td style="width: 10%;"></td> <td style="width: 10%;"></td> <td style="width: 10%;"></td> <td style="width: 10%;"></td> <td style="width: 10%;"></td> </tr> <tr> <td></td> <td></td> <td colspan="8" style="text-align: center;"> <table border="1" style="width: 100%; border-collapse: collapse; text-align: center;"> <tr> <td style="width: 10%;"></td> <td style="width: 10%;"></td> <td style="width: 10%;"></td> <td style="width: 10%;"></td> <td style="width: 10%;"></td> <td style="width: 10%;"></td> <td style="width: 10%;"></td> <td style="width: 10%;"></td> <td style="width: 10%;"></td> <td style="width: 10%;"></td> </tr> <tr> <td></td> <td></td> <td colspan="8" style="text-align: center;"> <table border="1" style="width: 100%; border-collapse: collapse; text-align: center;"> <tr> <td style="width: 10%;"></td> <td style="width: 10%;"></td> <td style="width: 10%;"></td> <td style="width: 10%;"></td> <td style="width: 10%;"></td> <td style="width: 10%;"></td> <td style="width: 10%;"></td> <td style="width: 10%;"></td> <td style="width: 10%;"></td> <td style="width: 10%;"></td> </tr> <tr> <td></td> <td></td> <td colspan="8" style="text-align: center;"> <table border="1" style="width: 100%; border-collapse: collapse; text-align: center;"> <tr> <td style="width: 10%;"></td> <td style="width: 10%;"></td> <td style="width: 10%;"></td> <td style="width: 10%;"></td> <td style="width: 10%;"></td> <td style="width: 10%;"></td> <td style="width: 10%;"></td> <td style="width: 10%;"></td> <td style="width: 10%;"></td> <td style="width: 10%;"></td> </tr> <tr> <td></td> <td></td> <td colspan="8" style="text-align: center;"> <table border="1" style="width: 100%; border-collapse: collapse; text-align: center;"> <tr> <td style="width: 10%;"></td> <td style="width: 10%;"></td> <td style="width: 10%;"></td> <td style="width: 10%;"></td> <td style="width: 10%;"></td> <td style="width: 10%;"></td> <td style="width: 10%;"></td> <td style="width: 10%;"></td> <td style="width: 10%;"></td> <td style="width: 10%;"></td> </tr> <tr> <td></td> <td></td> <td colspan="8" style="text-align: center;"> <table border="1" style="width: 100%; border-collapse: collapse; text-align: center;"> <tr> <td style="width: 10%;"></td> <td style="width: 10%;"></td> <td style="width: 10%;"></td> <td style="width: 10%;"></td> <td style="width: 10%;"></td> <td style="width:
10%;"></td> <td style="width: 10%;"></td> <td style="width: 10%;"></td> <td style="width: 10%;"></td> <td style="width: 10%;"></td> </tr> <tr> <td></td> <td></td> <td colspan="8" style="text-align: center;"> <table border="1" style="width: 100%; border-collapse: collapse; text-align: center;"> <tr> <td style="width: 10%;"></td> <td style="width: 10%;"></td> <td style="width: 10%;"></td> <td style="width: 10%;"></td> <td style="width: 10%;"></td> <td style="width: 10%;"></td> <td style="width: 10%;"></td> <td style="width: 10%;"></td> <td style="width: 10%;"></td> <td style="width: 10%;"></td> </tr> <tr> <td></td> <td></td> <td colspan="8" style="text-align: center;"> <table border="1" style="width: 100%; border-collapse: collapse; text-align: center;"> <tr> <td style="width: 10%;"></td> <td style="width: 10%;"></td> <td style="width: 10%;"></td> <td style="width: 10%;"></td> <td style="width: 10%;"></td> <td style="width: 10%;"></td> <td style="width: 10%;"></td> <td style="width: 10%;"></td> <td style="width: 10%;"></td> <td style="width: 10%;"></td> </tr> <tr> <td></td> <td></td> <td colspan="8" style="text-align: center;"> <table border="1" style="width: 100%; border-collapse: collapse; text-align: center;"> <tr> <td style="width: 10%;"></td> <td style="width: 10%;"></td> <td style="width: 10%;"></td> <td style="width: 10%;"></td> <td style="width: 10%;"></td> <td style="width: 10%;"></td> <td style="width: 10%;"></td> <td style="width: 10%;"></td> <td style="width: 10%;"></td> <td style="width: 10%;"></td> </tr> <tr> <td></td> <td></td> <td colspan="8" style="text-align: center;"> <table border="1" style="width: 100%; border-collapse: collapse; text-align: center;"> <tr> <td style="width: 10%;"></td> <td style="width: 10%;"></td> <td style="width: 10%;"></td> <td style="width: 10%;"></td> <td style="width: 10%;"></td> <td style="width: 10%;"></td> <td style="width: 10%;"></td> <td style="width: 10%;"></td> <td style="width: 10%;"></td> <td style="width: 10%;"></td> </tr> <tr> <td></td> <td></td> <td colspan="8" style="text-align: center;"> <table border="1" style="width: 100%; border-collapse: collapse; text-align: center;"> <tr> <td style="width: 10%;"></td> <td style="width: 10%;"></td> <td style="width: 10%;"></td> <td style="width: 10%;"></td> <td style="width: 10%;"></td> <td style="width: 10%;"></td> <td style="width: 10%;"></td> <td style="width: 10%;"></td> <td style="width: 10%;"></td> <td style="width: 10%;"></td> </tr> <tr> <td></td> <td></td> <td colspan="8" style="text-align: center;"> <table border="1" style="width: 100%; border-collapse: collapse; text-align: center;"> <tr> <td style="width: 10%;"></td> <td style="width: 10%;"></td> <td style="width: 10%;"></td> <td style="width: 10%;"></td> <td style="width: 10%;"></td> <td style="width: 10%;"></td> <td style="width: 10%;"></td> <td style="width: 10%;"></td> <td style="width: 10%;"></td> <td style="width: 10%;"></td> </tr> <tr> <td></td> <td></td> <td colspan="8" style="text-align: center;"> <table border="1" style="width: 100%; border-collapse: collapse; text-align: center;"> <tr> <td style="width: 10%;"></td> <td style="width: 10%;"></td> <td style="width: 10%;"></td> <td style="width: 10%;"></td> <td style="width: 10%;"></td> <td style="width: 10%;"></td> <td style="width: 10%;"></td> <td style="width: 10%;"></td> <td style="width: 10%;"></td> <td style="width: 10%;"></td> </tr> <tr> <td></td> <td></td> <td colspan="8" style="text-align: center;"> <table border="1" style="width: 100%; border-collapse: collapse; text-align: center;"> <tr> <td style="width: 10%;"></td> <td style="width: 10%;"></td> <td style="width: 10%;"></td> <td style="width: 10%;"></td> <td style="width: 10%;"></td> <td style="width: 10%;"></td> <td style="width: 10%;"></td> <td style="width: 10%;"></td> <td style="width: 10%;"></td> <td style="width: 10%;"></td> </tr> <tr> <td></td> <td></td> <td colspan="8" style="text-align: center;"> <table border="1" style="width: 100%; border-collapse: collapse; text-align: center;"> <tr> <td style="width: 10%;"></td> <td style="width: 10%;"></td> <td style="width: 10%;"></td> <td style="width: 10%;"></td> <td style="width: 10%;"></td> <td style="width: 10%;"></td> <td style="width: 10%;"></td> <td style="width: 10%;"></td> <td style="width: 10%;"></td> <td style="width: 10%;"></td> </tr> <tr> <td></td> <td></td> <td colspan="8" style="text-align: center;"> <table border="1" style="width: 100%; border-collapse: collapse; text-align: center;"> <tr> <td style="width: 10%;"></td> <td style="width: 10%;"></td> <td style="width: 10%;"></td> <td style="width: 10%;"></td> <td style="width: 10%;"></td> <td style="width: 10%;"></td> <td style="width: 10%;"></td> <td style="width: 10%;"></td> <td style="width: 10%;"></td> <td style="width: 10%;"></td> </tr> <tr> <td></td> <td></td> <td colspan="8" style="text-align: center;"> <table border="1" style="width: 100%; border-collapse: collapse; text-align: center;"> <tr> <td style="width: 10%;"></td> <td style="width: 10%;"></td> <td style="width: 10%;"></td> <td style="width: 10%;"></td> <td style="width: 10%;"></td> <td style="width: 10%;"></td> <td style="width: 10%;"></td> <td style="width: 10%;"></td> <td style="width: 10%;"></td> <td style="width: 10%;"></td> </tr> <tr> <td></td> <td></td> <td colspan="8" style="text-align: center;"> <table border="1" style="width: 100%; border-collapse: collapse; text-align: center;"> <tr> <td style="width: 10%;"></td> <td style="width: 10%;"></td> <td style="width: 10%;"></td> <td style="width: 10%;"></td> <td style="width: 10%;"></td> <td style="width: 10%;"></td> <td style="width: 10%;"></td> <td style="width: 10%;"></td> <td style="width: 10%;"></td> <td style="width: 10%;"></td> </tr> <tr> <td></td> <td></td> <td colspan="8" style="text-align: center;"> <table border="1" style="width: 100%; border-collapse: collapse; text-align: center;"> <tr> <td style="width: 10%;"></td> <td style="width: 10%;"></td> <td style="width: 10%;"></td> <td style="width: 10%;"></td> <td style="width: 10%;"></td> <td style="width: 10%;"></td> <td style="width: 10%;"></td> <td style="width: 10%;"></td> <td style="width: 10%;"></td> <td style="width: 10%;"></td> </tr> <tr> <td></td> <td></td> <td colspan="8" style="text-align: center;"> <table border="1" style="width: 100%; border-collapse: collapse; text-align: center;"> <tr> <td style="width: 10%;"></td> <td style="width: 10%;"></td> <td style="width: 10%;"></td> <td style="width: 10%;"></td> <td style="width: 10%;"></td> <td style="width: 10%;"></td> <td style="width: 10%;"></td> <td style="width: 10%;"></td> <td style="width: 10%;"></td> <td style="width: 10%;"></td> </tr> <tr> <td></td> <td></td> <td colspan="8" style="text-align: center;"> <table border="1" style="width: 100%; border-collapse: collapse; text-align: center;"> <tr> <td style="width: 10%;"></td> <td style="width: 10%;"></td> <td style="width: 10%;"></td> <td style="width: 10%;"></td> <td style="width: 10%;"></td> <td style="width: 10%;"></td> <td style="width: 10%;"></td> <td style="width: 10%;"></td> <td style="width: 10%;"></td> <td style="width: 10%;"></td> </tr> <tr> <td></td> <td></td> <td colspan="8" style="text-align: center;"> <table border="1" style="width: 100%; border-collapse: collapse; text-align: center;"> <tr> </tr></table></td></tr></table></td></tr></table></td></tr></table></td></tr></table></td></tr></table></td></tr></table></td></tr></table></td></tr></table></td></tr></table></td></tr></table></td></tr></table></td></tr></table></td></tr></table></td></tr></table></td></tr></table></td></tr></table></td></tr></table></td></tr></table></td></tr></table></td></tr></table></td></tr></table></td></tr></table></td></tr></table>
 | | | | | | | | | | | | | | | | | | | | <table border="1" style="width: 100%; border-collapse: collapse; text-align: center;"> <tr> <td style="width: 10%;"></td> <td style="width: 10%;"></td> <td style="width: 10%;"></td> <td style="width: 10%;"></td> <td style="width: 10%;"></td> <td style="width: 10%;"></td> <td style="width: 10%;"></td> <td style="width: 10%;"></td> <td style="width: 10%;"></td> <td style="width: 10%;"></td> </tr> <tr> <td></td> <td></td> <td colspan="8" style="text-align: center;"> <table border="1" style="width: 100%; border-collapse: collapse; text-align: center;"> <tr> <td style="width: 10%;"></td> <td style="width: 10%;"></td> <td style="width: 10%;"></td> <td style="width: 10%;"></td> <td style="width: 10%;"></td> <td style="width: 10%;"></td> <td style="width: 10%;"></td> <td style="width: 10%;"></td> <td style="width: 10%;"></td> <td style="width: 10%;"></td> </tr> <tr> <td></td> <td></td> <td colspan="8" style="text-align: center;"> <table border="1" style="width: 100%; border-collapse: collapse; text-align: center;"> <tr> <td style="width: 10%;"></td> <td style="width: 10%;"></td> <td style="width: 10%;"></td> <td style="width: 10%;"></td> <td style="width: 10%;"></td> <td style="width: 10%;"></td> <td style="width: 10%;"></td> <td style="width: 10%;"></td> <td style="width: 10%;"></td> <td style="width: 10%;"></td> </tr> <tr> <td></td> <td></td> <td colspan="8" style="text-align: center;"> <table border="1" style="width: 100%; border-collapse: collapse; text-align: center;"> <tr> <td style="width: 10%;"></td> <td style="width: 10%;"></td> <td style="width: 10%;"></td> <td style="width: 10%;"></td> <td style="width: 10%;"></td> <td style="width: 10%;"></td> <td style="width: 10%;"></td> <td style="width: 10%;"></td> <td style="width: 10%;"></td> <td style="width: 10%;"></td> </tr> <tr> <td></td> <td></td> <td colspan="8" style="text-align: center;"> <table border="1" style="width: 100%; border-collapse: collapse; text-align: center;"> <tr> <td style="width: 10%;"></td> <td style="width: 10%;"></td> <td style="width: 10%;"></td> <td style="width: 10%;"></td> <td style="width: 10%;"></td> <td style="width: 10%;"></td> <td style="width: 10%;"></td> <td style="width: 10%;"></td> <td style="width: 10%;"></td> <td style="width: 10%;"></td> </tr> <tr> <td></td> <td></td> <td colspan="8" style="text-align: center;"> <table border="1" style="width: 100%; border-collapse: collapse; text-align: center;"> <tr> <td style="width: 10%;"></td> <td style="width: 10%;"></td> <td style="width: 10%;"></td> <td style="width: 10%;"></td> <td style="width: 10%;"></td> <td style="width: 10%;"></td> <td style="width: 10%;"></td> <td style="width: 10%;"></td> <td style="width: 10%;"></td> <td style="width: 10%;"></td> </tr> <tr> <td></td> <td></td> <td colspan="8" style="text-align: center;"> <table border="1" style="width: 100%; border-collapse: collapse; text-align: center;"> <tr> <td style="width: 10%;"></td> <td style="width: 10%;"></td> <td style="width: 10%;"></td> <td style="width: 10%;"></td> <td style="width: 10%;"></td> <td style="width: 10%;"></td> <td style="width: 10%;"></td> <td style="width: 10%;"></td> <td style="width: 10%;"></td> <td style="width: 10%;"></td> </tr> <tr> <td></td> <td></td> <td colspan="8" style="text-align: center;"> <table border="1" style="width: 100%; border-collapse: collapse; text-align: center;"> <tr> <td style="width: 10%;"></td> <td style="width: 10%;"></td> <td style="width: 10%;"></td> <td style="width: 10%;"></td> <td style="width: 10%;"></td> <td style="width: 10%;"></td> <td style="width: 10%;"></td> <td style="width: 10%;"></td> <td style="width: 10%;"></td> <td style="width: 10%;"></td> </tr> <tr> <td></td> <td></td> <td colspan="8" style="text-align: center;"> <table border="1" style="width: 100%; border-collapse: collapse; text-align: center;"> <tr> <td style="width: 10%;"></td> <td style="width: 10%;"></td> <td style="width: 10%;"></td> <td style="width: 10%;"></td> <td style="width: 10%;"></td> <td style="width: 10%;"></td> <td style="width: 10%;"></td> <td style="width: 10%;"></td> <td style="width: 10%;"></td> <td style="width: 10%;"></td> </tr> <tr> <td></td> <td></td> <td colspan="8" style="text-align: center;"> <table border="1" style="width: 100%; border-collapse: collapse; text-align: center;"> <tr> <td style="width: 10%;"></td> <td style="width: 10%;"></td> <td style="width: 10%;"></td> <td style="width:
10%;"></td> <td style="width: 10%;"></td> <td style="width: 10%;"></td> <td style="width: 10%;"></td> <td style="width: 10%;"></td> <td style="width: 10%;"></td> <td style="width: 10%;"></td> </tr> <tr> <td></td> <td></td> <td colspan="8" style="text-align: center;"> <table border="1" style="width: 100%; border-collapse: collapse; text-align: center;"> <tr> <td style="width: 10%;"></td> <td style="width: 10%;"></td> <td style="width: 10%;"></td> <td style="width: 10%;"></td> <td style="width: 10%;"></td> <td style="width: 10%;"></td> <td style="width: 10%;"></td> <td style="width: 10%;"></td> <td style="width: 10%;"></td> <td style="width: 10%;"></td> </tr> <tr> <td></td> <td></td> <td colspan="8" style="text-align: center;"> <table border="1" style="width: 100%; border-collapse: collapse; text-align: center;"> <tr> <td style="width: 10%;"></td> <td style="width: 10%;"></td> <td style="width: 10%;"></td> <td style="width: 10%;"></td> <td style="width: 10%;"></td> <td style="width: 10%;"></td> <td style="width: 10%;"></td> <td style="width: 10%;"></td> <td style="width: 10%;"></td> <td style="width: 10%;"></td> </tr> <tr> <td></td> <td></td> <td colspan="8" style="text-align: center;"> <table border="1" style="width: 100%; border-collapse: collapse; text-align: center;"> <tr> <td style="width: 10%;"></td> <td style="width: 10%;"></td> <td style="width: 10%;"></td> <td style="width: 10%;"></td> <td style="width: 10%;"></td> <td style="width: 10%;"></td> <td style="width: 10%;"></td> <td style="width: 10%;"></td> <td style="width: 10%;"></td> <td style="width: 10%;"></td> </tr> <tr> <td></td> <td></td> <td colspan="8" style="text-align: center;"> <table border="1" style="width: 100%; border-collapse: collapse; text-align: center;"> <tr> <td style="width: 10%;"></td> <td style="width: 10%;"></td> <td style="width: 10%;"></td> <td style="width: 10%;"></td> <td style="width: 10%;"></td> <td style="width: 10%;"></td> <td style="width: 10%;"></td> <td style="width: 10%;"></td> <td style="width: 10%;"></td> <td style="width: 10%;"></td> </tr> <tr> <td></td> <td></td> <td colspan="8" style="text-align: center;"> <table border="1" style="width: 100%; border-collapse: collapse; text-align: center;"> <tr> <td style="width: 10%;"></td> <td style="width: 10%;"></td> <td style="width: 10%;"></td> <td style="width: 10%;"></td> <td style="width: 10%;"></td> <td style="width: 10%;"></td> <td style="width: 10%;"></td> <td style="width: 10%;"></td> <td style="width: 10%;"></td> <td style="width: 10%;"></td> </tr> <tr> <td></td> <td></td> <td colspan="8" style="text-align: center;"> <table border="1" style="width: 100%; border-collapse: collapse; text-align: center;"> <tr> <td style="width: 10%;"></td> <td style="width: 10%;"></td> <td style="width: 10%;"></td> <td style="width: 10%;"></td> <td style="width: 10%;"></td> <td style="width: 10%;"></td> <td style="width: 10%;"></td> <td style="width: 10%;"></td> <td style="width: 10%;"></td> <td style="width: 10%;"></td> </tr> <tr> <td></td> <td></td> <td colspan="8" style="text-align: center;"> <table border="1" style="width: 100%; border-collapse: collapse; text-align: center;"> <tr> <td style="width: 10%;"></td> <td style="width: 10%;"></td> <td style="width: 10%;"></td> <td style="width: 10%;"></td> <td style="width: 10%;"></td> <td style="width: 10%;"></td> <td style="width: 10%;"></td> <td style="width: 10%;"></td> <td style="width: 10%;"></td> <td style="width: 10%;"></td> </tr> <tr> <td></td> <td></td> <td colspan="8" style="text-align: center;"> <table border="1" style="width: 100%; border-collapse: collapse; text-align: center;"> <tr> <td style="width: 10%;"></td> <td style="width: 10%;"></td> <td style="width: 10%;"></td> <td style="width: 10%;"></td> <td style="width: 10%;"></td> <td style="width: 10%;"></td> <td style="width: 10%;"></td> <td style="width: 10%;"></td> <td style="width: 10%;"></td> <td style="width: 10%;"></td> </tr> <tr> <td></td> <td></td> <td colspan="8" style="text-align: center;"> <table border="1" style="width: 100%; border-collapse: collapse; text-align: center;"> <tr> <td style="width: 10%;"></td> <td style="width: 10%;"></td> <td style="width: 10%;"></td> <td style="width: 10%;"></td> <td style="width: 10%;"></td> <td style="width: 10%;"></td> <td style="width: 10%;"></td> <td style="width: 10%;"></td> <td style="width: 10%;"></td> <td style="width: 10%;"></td> </tr> <tr> <td></td> <td></td> <td colspan="8" style="text-align: center;"> <table border="1" style="width: 100%; border-collapse: collapse; text-align: center;"> <tr> <td style="width: 10%;"></td> <td style="width: 10%;"></td> <td style="width: 10%;"></td> <td style="width: 10%;"></td> <td style="width: 10%;"></td> <td style="width: 10%;"></td> <td style="width: 10%;"></td> <td style="width: 10%;"></td> <td style="width: 10%;"></td> <td style="width: 10%;"></td> </tr> <tr> <td></td> <td></td> <td colspan="8" style="text-align: center;"> <table border="1" style="width: 100%; border-collapse: collapse; text-align: center;"> <tr> <td style="width: 10%;"></td> <td style="width: 10%;"></td> <td style="width: 10%;"></td> <td style="width: 10%;"></td> <td style="width: 10%;"></td> <td style="width: 10%;"></td> <td style="width: 10%;"></td> <td style="width: 10%;"></td> <td style="width: 10%;"></td> <td style="width: 10%;"></td> </tr> <tr> <td></td> <td></td> <td colspan="8" style="text-align: center;"> <table border="1" style="width: 100%; border-collapse: collapse; text-align: center;"> <tr> <td style="width: 10%;"></td> <td style="width: 10%;"></td> <td style="width: 10%;"></td> <td style="width: 10%;"></td> <td style="width: 10%;"></td> <td style="width: 10%;"></td> <td style="width: 10%;"></td> <td style="width: 10%;"></td> <td style="width: 10%;"></td> <td style="width: 10%;"></td> </tr> <tr> <td></td> <td></td> <td colspan="8" style="text-align: center;"> <table border="1" style="width: 100%; border-collapse: collapse; text-align: center;"> <tr> </tr></table></td></tr></table></td></tr></table></td></tr></table></td></tr></table></td></tr></table></td></tr></table></td></tr></table></td></tr></table></td></tr></table></td></tr></table></td></tr></table></td></tr></table></td></tr></table></td></tr></table></td></tr></table></td></tr></table></td></tr></table></td></tr></table></td></tr></table></td></tr></table></td></tr></table></td></tr></table>
 | | | | | | | | | | | | | | | | | | | | <table border="1" style="width: 100%; border-collapse: collapse; text-align: center;"> <tr> <td style="width: 10%;"></td> <td style="width: 10%;"></td> <td style="width: 10%;"></td> <td style="width: 10%;"></td> <td style="width: 10%;"></td> <td style="width: 10%;"></td> <td style="width: 10%;"></td> <td style="width: 10%;"></td> <td style="width: 10%;"></td> <td style="width: 10%;"></td> </tr> <tr> <td></td> <td></td> <td colspan="8" style="text-align: center;"> <table border="1" style="width: 100%; border-collapse: collapse; text-align: center;"> <tr> <td style="width: 10%;"></td> <td style="width: 10%;"></td> <td style="width: 10%;"></td> <td style="width: 10%;"></td> <td style="width: 10%;"></td> <td style="width: 10%;"></td> <td style="width: 10%;"></td> <td style="width: 10%;"></td> <td style="width: 10%;"></td> <td style="width: 10%;"></td> </tr> <tr> <td></td> <td></td> <td colspan="8" style="text-align: center;"> <table border="1" style="width: 100%; border-collapse: collapse; text-align: center;"> <tr> <td style="width: 10%;"></td> <td style="width: 10%;"></td> <td style="width: 10%;"></td> <td style="width: 10%;"></td> <td style="width: 10%;"></td> <td style="width: 10%;"></td> <td style="width: 10%;"></td> <td style="width: 10%;"></td> <td style="width: 10%;"></td> <td style="width: 10%;"></td> </tr> <tr> <td></td> <td></td> <td colspan="8" style="text-align: center;"> <table border="1" style="width: 100%; border-collapse: collapse; text-align: center;"> <tr> <td style="width: 10%;"></td> <td style="width: 10%;"></td> <td style="width: 10%;"></td> <td style="width: 10%;"></td> <td style="width: 10%;"></td> <td style="width: 10%;"></td> <td style="width: 10%;"></td> <td style="width: 10%;"></td> <td style="width: 10%;"></td> <td style="width: 10%;"></td> </tr> <tr> <td></td> <td></td> <td colspan="8" style="text-align: center;"> <table border="1" style="width: 100%; border-collapse: collapse; text-align: center;"> <tr> <td style="width: 10%;"></td> <td style="width: 10%;"></td> <td style="width: 10%;"></td> <td style="width: 10%;"></td> <td style="width: 10%;"></td> <td style="width: 10%;"></td> <td style="width: 10%;"></td> <td style="width: 10%;"></td> <td style="width: 10%;"></td> <td style="width: 10%;"></td> </tr> <tr> <td></td> <td></td> <td colspan="8" style="text-align: center;"> <table border="1" style="width: 100%; border-collapse: collapse; text-align: center;"> <tr> <td style="width: 10%;"></td> <td style="width: 10%;"></td> <td style="width: 10%;"></td> <td style="width: 10%;"></td> <td style="width: 10%;"></td> <td style="width: 10%;"></td> <td style="width: 10%;"></td> <td style="width: 10%;"></td> <td style="width: 10%;"></td> <td style="width: 10%;"></td> </tr> <tr> <td></td> <td></td> <td colspan="8" style="text-align: center;"> <table border="1" style="width: 100%; border-collapse: collapse; text-align: center;"> <tr> <td style="width: 10%;"></td> <td style="width: 10%;"></td> <td style="width: 10%;"></td> <td style="width: 10%;"></td> <td style="width: 10%;"></td> <td style="width: 10%;"></td> <td style="width: 10%;"></td> <td style="width: 10%;"></td> <td style="width: 10%;"></td> <td style="width: 10%;"></td> </tr> <tr> <td></td> <td></td> <td colspan="8" style="text-align: center;"> <table border="1" style="width: 100%; border-collapse: collapse; text-align: center;"> <tr> <td style="width: 10%;"></td> <td style="width: 10%;"></td> <td style="width: 10%;"></td> <td style="width: 10%;"></td> <td style="width: 10%;"></td> <td style="width: 10%;"></td> <td style="width: 10%;"></td> <td style="width: 10%;"></td> <td style="width: 10%;"></td> <td style="width: 10%;"></td> </tr> <tr> <td></td> <td></td> <td colspan="8" style="text-align: center;"> <table border="1" style="width: 100%; border-collapse: collapse; text-align: center;"> <tr> <td style="width: 10%;"></td> <td style="width: 10%;"></td> <td style="width: 10%;"></td> <td style="width: 10%;"></td> <td style="width: 10%;"></td> <td style="width: 10%;"></td> <td style="width: 10%;"></td> <td style="width: 10%;"></td> <td style="width: 10%;"></td> <td style="width: 10%;"></td> </tr> <tr> <td></td> <td></td> <td colspan="8" style="text-align: center;"> <table border="1" style="width: 100%; border-collapse: collapse; text-align: center;"> <tr> <td style="width: 10%;"></td> <td style="width: 10%;"></td> <td style="width: 10%;"></td> <td style="width: 10%;"></td> <td style="width: 10%;"></td> <td style="width: 10%;"></td> <td style="width: 10%;"></td> <td style="width: 10%;"></td> <td style="width: 10%;"></td> <td style="width: 10%;"></td> </tr> <tr> <td></td> <td></td> <td colspan="8" style="text-align: center;"> <table border="1" style="width: 100%; border-collapse: collapse; text-align: center;"> <tr> <td style="width: 10%;"></td> <td style="width: 10%;"></td> <td style="width: 10%;"></td> <td style="width: 10%;"></td> <td style="width: 10%;"></td> <td style="width: 10%;"></td> <td style="width: 10%;"></td> <td style="width: 10%;"></td> <td style="width: 10%;"></td> <td style="width: 10%;"></td> </tr> <tr> <td></td> <td></td> <td colspan="8" style="text-align: center;"> <table border="1" style="width: 100%; border-collapse: collapse; text-align: center;"> <tr> <td style="width: 10%;"></td> <td style="width: 10%;"></td> <td style="width: 10%;"></td> <td style="width: 10%;"></td> <td style="width: 10%;"></td> <td style="width: 10%;"></td> <td style="width: 10%;"></td> <td style="width: 10%;"></td> <td style="width: 10%;"></td> <td style="width: 10%;"></td> </tr> <tr> <td></td> <td></td> <td colspan="8" style="text-align: center;"> <table border="1" style="width: 100%; border-collapse: collapse; text-align: center;"> <tr> <td style="width: 10%;"></td> <td style="width: 10%;"></td> <td
style="width: 10%;"></td> <td style="width: 10%;"></td> <td style="width: 10%;"></td> <td style="width: 10%;"></td> <td style="width: 10%;"></td> <td style="width: 10%;"></td> <td style="width: 10%;"></td> <td style="width: 10%;"></td> </tr> <tr> <td></td> <td></td> <td colspan="8" style="text-align: center;"> <table border="1" style="width: 100%; border-collapse: collapse; text-align: center;"> <tr> <td style="width: 10%;"></td> <td style="width: 10%;"></td> <td style="width: 10%;"></td> <td style="width: 10%;"></td> <td style="width: 10%;"></td> <td style="width: 10%;"></td> <td style="width: 10%;"></td> <td style="width: 10%;"></td> <td style="width: 10%;"></td> <td style="width: 10%;"></td> </tr> <tr> <td></td> <td></td> <td colspan="8" style="text-align: center;"> <table border="1" style="width: 100%; border-collapse: collapse; text-align: center;"> <tr> <td style="width: 10%;"></td> <td style="width: 10%;"></td> <td style="width: 10%;"></td> <td style="width: 10%;"></td> <td style="width: 10%;"></td> <td style="width: 10%;"></td> <td style="width: 10%;"></td> <td style="width: 10%;"></td> <td style="width: 10%;"></td> <td style="width: 10%;"></td> </tr> <tr> <td></td> <td></td> <td colspan="8" style="text-align: center;"> <table border="1" style="width: 100%; border-collapse: collapse; text-align: center;"> <tr> <td style="width: 10%;"></td> <td style="width: 10%;"></td> <td style="width: 10%;"></td> <td style="width: 10%;"></td> <td style="width: 10%;"></td> <td style="width: 10%;"></td> <td style="width: 10%;"></td> <td style="width: 10%;"></td> <td style="width: 10%;"></td> <td style="width: 10%;"></td> </tr> <tr> <td></td> <td></td> <td colspan="8" style="text-align: center;"> <table border="1" style="width: 100%; border-collapse: collapse; text-align: center;"> <tr> <td style="width: 10%;"></td> <td style="width: 10%;"></td> <td style="width: 10%;"></td> <td style="width: 10%;"></td> <td style="width: 10%;"></td> <td style="width: 10%;"></td> <td style="width: 10%;"></td> <td style="width: 10%;"></td> <td style="width: 10%;"></td> <td style="width: 10%;"></td> </tr> <tr> <td></td> <td></td> <td colspan="8" style="text-align: center;"> <table border="1" style="width: 100%; border-collapse: collapse; text-align: center;"> <tr> <td style="width: 10%;"></td> <td style="width: 10%;"></td> <td style="width: 10%;"></td> <td style="width: 10%;"></td> <td style="width: 10%;"></td> <td style="width: 10%;"></td> <td style="width: 10%;"></td> <td style="width: 10%;"></td> <td style="width: 10%;"></td> <td style="width: 10%;"></td> </tr> <tr> <td></td> <td></td> <td colspan="8" style="text-align: center;"> <table border="1" style="width: 100%; border-collapse: collapse; text-align: center;"> <tr> <td style="width: 10%;"></td> <td style="width: 10%;"></td> <td style="width: 10%;"></td> <td style="width: 10%;"></td> <td style="width: 10%;"></td> <td style="width: 10%;"></td> <td style="width: 10%;"></td> <td style="width: 10%;"></td> <td style="width: 10%;"></td> <td style="width: 10%;"></td> </tr> <tr> <td></td> <td></td> <td colspan="8" style="text-align: center;"> <table border="1" style="width: 100%; border-collapse: collapse; text-align: center;"> <tr> <td style="width: 10%;"></td> <td style="width: 10%;"></td> <td style="width: 10%;"></td> <td style="width: 10%;"></td> <td style="width: 10%;"></td> <td style="width: 10%;"></td> <td style="width: 10%;"></td> <td style="width: 10%;"></td> <td style="width: 10%;"></td> <td style="width: 10%;"></td> </tr> <tr> <td></td> <td></td> <td colspan="8" style="text-align: center;"> <table border="1" style="width: 100%; border-collapse: collapse; text-align: center;"> <tr> <td style="width: 10%;"></td> <td style="width: 10%;"></td> <td style="width: 10%;"></td> <td style="width: 10%;"></td> <td style="width: 10%;"></td> <td style="width: 10%;"></td> <td style="width: 10%;"></td> <td style="width: 10%;"></td> <td style="width: 10%;"></td> <td style="width: 10%;"></td> </tr> <tr> <td></td> <td></td> <td colspan="8" style="text-align: center;"> <table border="1" style="width: 100%; border-collapse: collapse; text-align: center;"> <tr> </tr></table></td></tr></table></td></tr></table></td></tr></table></td></tr></table></td></tr></table></td></tr></table></td></tr></table></td></tr></table></td></tr></table></td></tr></table></td></tr></table></td></tr></table></td></tr></table></td></tr></table></td></tr></table></td></tr></table></td></tr></table></td></tr></table></td></tr></table></td></tr></table></td></tr></table>
 | | | | | | | | | | | | | | | | | | | | <table border="1" style="width: 100%; border-collapse: collapse; text-align: center;"> <tr> <td style="width: 10%;"></td> <td style="width: 10%;"></td> <td style="width: 10%;"></td> <td style="width: 10%;"></td> <td style="width: 10%;"></td> <td style="width: 10%;"></td> <td style="width: 10%;"></td> <td style="width: 10%;"></td> <td style="width: 10%;"></td> <td style="width: 10%;"></td> </tr> <tr> <td></td> <td></td> <td colspan="8" style="text-align: center;"> <table border="1" style="width: 100%; border-collapse: collapse; text-align: center;"> <tr> <td style="width: 10%;"></td> <td style="width: 10%;"></td> <td style="width: 10%;"></td> <td style="width: 10%;"></td> <td style="width: 10%;"></td> <td style="width: 10%;"></td> <td style="width: 10%;"></td> <td style="width: 10%;"></td> <td style="width: 10%;"></td> <td style="width: 10%;"></td> </tr> <tr> <td></td> <td></td> <td colspan="8" style="text-align: center;"> <table border="1" style="width: 100%; border-collapse: collapse; text-align: center;"> <tr> <td style="width: 10%;"></td> <td style="width: 10%;"></td> <td style="width: 10%;"></td> <td style="width: 10%;"></td> <td style="width: 10%;"></td> <td style="width: 10%;"></td> <td style="width: 10%;"></td> <td style="width: 10%;"></td> <td style="width: 10%;"></td> <td style="width: 10%;"></td> </tr> <tr> <td></td> <td></td> <td colspan="8" style="text-align: center;"> <table border="1" style="width: 100%; border-collapse: collapse; text-align: center;"> <tr> <td style="width: 10%;"></td> <td style="width: 10%;"></td> <td style="width: 10%;"></td> <td style="width: 10%;"></td> <td style="width: 10%;"></td> <td style="width: 10%;"></td> <td style="width: 10%;"></td> <td style="width: 10%;"></td> <td style="width: 10%;"></td> <td style="width: 10%;"></td> </tr> <tr> <td></td> <td></td> <td colspan="8" style="text-align: center;"> <table border="1" style="width: 100%; border-collapse: collapse; text-align: center;"> <tr> <td style="width: 10%;"></td> <td style="width: 10%;"></td> <td style="width: 10%;"></td> <td style="width: 10%;"></td> <td style="width: 10%;"></td> <td style="width: 10%;"></td> <td style="width: 10%;"></td> <td style="width: 10%;"></td> <td style="width: 10%;"></td> <td style="width: 10%;"></td> </tr> <tr> <td></td> <td></td> <td colspan="8" style="text-align: center;"> <table border="1" style="width: 100%; border-collapse: collapse; text-align: center;"> <tr> <td style="width: 10%;"></td> <td style="width: 10%;"></td> <td style="width: 10%;"></td> <td style="width: 10%;"></td> <td style="width: 10%;"></td> <td style="width: 10%;"></td> <td style="width: 10%;"></td> <td style="width: 10%;"></td> <td style="width: 10%;"></td> <td style="width: 10%;"></td> </tr> <tr> <td></td> <td></td> <td colspan="8" style="text-align: center;"> <table border="1" style="width: 100%; border-collapse: collapse; text-align: center;"> <tr> <td style="width: 10%;"></td> <td style="width: 10%;"></td> <td style="width: 10%;"></td> <td style="width: 10%;"></td> <td style="width: 10%;"></td> <td style="width: 10%;"></td> <td style="width: 10%;"></td> <td style="width: 10%;"></td> <td style="width: 10%;"></td> <td style="width: 10%;"></td> </tr> <tr> <td></td> <td></td> <td colspan="8" style="text-align: center;"> <table border="1" style="width: 100%; border-collapse: collapse; text-align: center;"> <tr> <td style="width: 10%;"></td> <td style="width: 10%;"></td> <td style="width: 10%;"></td> <td style="width: 10%;"></td> <td style="width: 10%;"></td> <td style="width: 10%;"></td> <td style="width: 10%;"></td> <td style="width: 10%;"></td> <td style="width: 10%;"></td> <td style="width: 10%;"></td> </tr> <tr> <td></td> <td></td> <td colspan="8" style="text-align: center;"> <table border="1" style="width: 100%; border-collapse: collapse; text-align: center;"> <tr> <td style="width: 10%;"></td> <td style="width: 10%;"></td> <td style="width: 10%;"></td> <td style="width: 10%;"></td> <td style="width: 10%;"></td> <td style="width: 10%;"></td> <td style="width: 10%;"></td> <td style="width: 10%;"></td> <td style="width: 10%;"></td> <td style="width: 10%;"></td> </tr> <tr> <td></td> <td></td> <td colspan="8" style="text-align: center;"> <table border="1" style="width: 100%; border-collapse: collapse; text-align: center;"> <tr> <td style="width: 10%;"></td> <td style="width: 10%;"></td> <td style="width: 10%;"></td> <td style="width: 10%;"></td> <td style="width: 10%;"></td> <td style="width: 10%;"></td> <td style="width: 10%;"></td> <td style="width: 10%;"></td> <td style="width: 10%;"></td> <td style="width: 10%;"></td> </tr> <tr> <td></td> <td></td> <td colspan="8" style="text-align: center;"> <table border="1" style="width: 100%; border-collapse: collapse; text-align: center;"> <tr> <td style="width: 10%;"></td> <td style="width: 10%;"></td> <td style="width: 10%;"></td> <td style="width: 10%;"></td> <td style="width: 10%;"></td> <td style="width: 10%;"></td> <td style="width: 10%;"></td> <td style="width: 10%;"></td> <td style="width: 10%;"></td> <td style="width: 10%;"></td> </tr> <tr> <td></td> <td></td> <td colspan="8" style="text-align: center;"> <table border="1" style="width: 100%; border-collapse: collapse; text-align: center;"> <tr> <td style="width: 10%;"></td> <td style="width: 10%;"></td> <td style="width: 10%;"></td> <td style="width: 10%;"></td> <td style="width: 10%;"></td> <td style="width: 10%;"></td> <td style="width: 10%;"></td> <td style="width: 10%;"></td> <td style="width: 10%;"></td> <td style="width: 10%;"></td> </tr> <tr> <td></td> <td></td> <td colspan="8" style="text-align: center;"> <table border="1" style="width: 100%; border-collapse: collapse; text-align: center;"> <tr> <td style="width: 10%;"></td> <td style="width: 10%;"></td> <td style="width: 10%;"></td> <td style="width: 10%;"></td> <td style="width: 10%;"></td> <td style="width: 10%;"></td> <td style="width: 10%;"></td> <td style="width: 10%;"></td> <td style="width: 10%;"></td> <td style="width: 10%;"></td> </tr> <tr> <td></td> <td></td> <td colspan="8" style="text-align: center;"> <table border="1" style="width: 100%; border-collapse: collapse; text-align: center;"> <tr> <td style="width: 10%;"></td> <td style="width: 10%;"></td> <td style="width: 10%;"></td> <td style="width: 10%;"></td> <td style="width: 10%;"></td> <td style="width: 10%;"></td> <td style="width: 10%;"></td> <td style="width: 10%;"></td> <td style="width: 10%;"></td> <td style="width: 10%;"></td> </tr> <tr> <td></td> <td></td> <td colspan="8" style="text-align: center;"> <table border="1" style="width: 100%; border-collapse: collapse; text-align: center;"> <tr> <td style="width: 10%;"></td> <td style="width: 10%;"></td> <td style="width: 10%;"></td> <td style="width: 10%;"></td> <td style="width: 10%;"></td> <td style="width: 10%;"></td> <td style="width: 10%;"></td> <td style="width: 10%;"></td> <td style="width: 10%;"></td> <td style="width: 10%;"></td> </tr> <tr> <td></td> <td></td> <td colspan="8" style="text-align: center;"> <table border="1" style="width: 100%; border-collapse: collapse; text-align: center;"> <tr> <td style="width: 10%;"></td> <td style="width: 10%;"></td> <td style="width: 10%;"></td> <td style="width: 10%;"></td> <td style="width: 10%;"></td> <td style="width: 10%;"></td> <td style="width: 10%;"></td> <td style="width: 10%;"></td> <td style="width: 10%;"></td> <td style="width: 10%;"></td> </tr> <tr> <td></td> <td></td> <td colspan="8" style="text-align: center;"> <table border="1" style="width: 100%; border-collapse: collapse; text-align: center;"> <tr> <td style="width: 10%;"></td> <td
style="width: 10%;"></td> <td style="width: 10%;"></td> <td style="width: 10%;"></td> <td style="width: 10%;"></td> <td style="width: 10%;"></td> <td style="width: 10%;"></td> <td style="width: 10%;"></td> <td style="width: 10%;"></td> <td style="width: 10%;"></td> </tr> <tr> <td></td> <td></td> <td colspan="8" style="text-align: center;"> <table border="1" style="width: 100%; border-collapse: collapse; text-align: center;"> <tr> <td style="width: 10%;"></td> <td style="width: 10%;"></td> <td style="width: 10%;"></td> <td style="width: 10%;"></td> <td style="width: 10%;"></td> <td style="width: 10%;"></td> <td style="width: 10%;"></td> <td style="width: 10%;"></td> <td style="width: 10%;"></td> <td style="width: 10%;"></td> </tr> <tr> <td></td> <td></td> <td colspan="8" style="text-align: center;"> <table border="1" style="width: 100%; border-collapse: collapse; text-align: center;"> <tr> <td style="width: 10%;"></td> <td style="width: 10%;"></td> <td style="width: 10%;"></td> <td style="width: 10%;"></td> <td style="width: 10%;"></td> <td style="width: 10%;"></td> <td style="width: 10%;"></td> <td style="width: 10%;"></td> <td style="width: 10%;"></td> <td style="width: 10%;"></td> </tr> <tr> <td></td> <td></td> <td colspan="8" style="text-align: center;"> <table border="1" style="width: 100%; border-collapse: collapse; text-align: center;"> <tr> <td style="width: 10%;"></td> <td style="width: 10%;"></td> <td style="width: 10%;"></td> <td style="width: 10%;"></td> <td style="width: 10%;"></td> <td style="width: 10%;"></td> <td style="width: 10%;"></td> <td style="width: 10%;"></td> <td style="width: 10%;"></td> <td style="width: 10%;"></td> </tr> <tr> <td></td> <td></td> <td colspan="8" style="text-align: center;"> <table border="1" style="width: 100%; border-collapse: collapse; text-align: center;"> <tr> </tr></table></td></tr></table></td></tr></table></td></tr></table></td></tr></table></td></tr></table></td></tr></table></td></tr></table></td></tr></table></td></tr></table></td></tr></table></td></tr></table></td></tr></table></td></tr></table></td></tr></table></td></tr></table></td></tr></table></td></tr></table></td></tr></table></td></tr></table></td></tr></table> | | | |
| | | | | | | | | | | | | | | | <table border="1" style="width: 100%; border-collapse: collapse; text-align: center;"> <tr> <td style="width: 10%;"></td> <td style="width: 10%;"></td> <td style="width: 10%;"></td> <td style="width: 10%;"></td> <td style="width: 10%;"></td> <td style="width: 10%;"></td> <td style="width: 10%;"></td> <td style="width: 10%;"></td> <td style="width: 10%;"></td> <td style="width: 10%;"></td> </tr> <tr> <td></td> <td></td> <td colspan="8" style="text-align: center;"> <table border="1" style="width: 100%; border-collapse: collapse; text-align: center;"> <tr> <td style="width: 10%;"></td> <td style="width: 10%;"></td> <td style="width: 10%;"></td> <td style="width: 10%;"></td> <td style="width: 10%;"></td> <td style="width: 10%;"></td> <td style="width: 10%;"></td> <td style="width: 10%;"></td> <td style="width: 10%;"></td> <td style="width: 10%;"></td> </tr> <tr> <td></td> <td></td> <td colspan="8" style="text-align: center;"> <table border="1" style="width: 100%; border-collapse: collapse; text-align: center;"> <tr> <td style="width: 10%;"></td> <td style="width: 10%;"></td> <td style="width: 10%;"></td> <td style="width: 10%;"></td> <td style="width: 10%;"></td> <td style="width: 10%;"></td> <td style="width: 10%;"></td> <td style="width: 10%;"></td> <td style="width: 10%;"></td> <td style="width: 10%;"></td> </tr> <tr> <td></td> <td></td> <td colspan="8" style="text-align: center;"> <table border="1" style="width: 100%; border-collapse: collapse; text-align: center;"> <tr> <td style="width: 10%;"></td> <td style="width: 10%;"></td> <td style="width: 10%;"></td> <td style="width: 10%;"></td> <td style="width: 10%;"></td> <td style="width: 10%;"></td> <td style="width: 10%;"></td> <td style="width: 10%;"></td> <td style="width: 10%;"></td> <td style="width: 10%;"></td> </tr> <tr> <td></td> <td></td> <td colspan="8" style="text-align: center;"> <table border="1" style="width: 100%; border-collapse: collapse; text-align: center;"> <tr> <td style="width: 10%;"></td> <td style="width: 10%;"></td> <td style="width: 10%;"></td> <td style="width: 10%;"></td> <td style="width: 10%;"></td> <td style="width: 10%;"></td> <td style="width: 10%;"></td> <td style="width: 10%;"></td> <td style="width: 10%;"></td> <td style="width: 10%;"></td> </tr> <tr> <td></td> <td></td> <td colspan="8" style="text-align: center;"> <table border="1" style="width: 100%; border-collapse: collapse; text-align: center;"> <tr> <td style="width: 10%;"></td> <td style="width: 10%;"></td> <td style="width: 10%;"></td> <td style="width: 10%;"></td> <td style="width: 10%;"></td> <td style="width: 10%;"></td> <td style="width: 10%;"></td> <td style="width: 10%;"></td> <td style="width: 10%;"></td> <td style="width: 10%;"></td> </tr> <tr> <td></td> <td></td> <td colspan="8" style="text-align: center;"> <table border="1" style="width: 100%; border-collapse: collapse; text-align: center;"> <tr> <td style="width: 10%;"></td> <td style="width: 10%;"></td> <td style="width: 10%;"></td> <td style="width: 10%;"></td> <td style="width: 10%;"></td> <td style="width: 10%;"></td> <td style="width: 10%;"></td> <td style="width: 10%;"></td> <td style="width: 10%;"></td> <td style="width: 10%;"></td> </tr> <tr> <td></td> <td></td> <td colspan="8" style="text-align: center;"> <table border="1" style="width: 100%; border-collapse: collapse; text-align: center;"> <tr> <td style="width: 10%;"></td> <td style="width: 10%;"></td> <td style="width: 10%;"></td> <td style="width: 10%;"></td> <td style="width: 10%;"></td> <td style="width: 10%;"></td> <td style="width: 10%;"></td> <td style="width: 10%;"></td> <td style="width: 10%;"></td> <td style="width: 10%;"></td> </tr> <tr> <td></td> <td></td> <td colspan="8" style="text-align: center;"> <table border="1" style="width: 100%; border-collapse: collapse; text-align: center;"> <tr> <td style="width: 10%;"></td> <td style="width: 10%;"></td> <td style="width: 10%;"></td> <td style="width: 10%;"></td> <td style="width: 10%;"></td> <td style="width: 10%;"></td> <td style="width: 10%;"></td> <td style="width: 10%;"></td> <td style="width: 10%;"></td> <td style="width: 10%;"></td> </tr> <tr> <td></td> <td></td> <td colspan="8" style="text-align: center;"> <table border="1" style="width: 100%; border-collapse: collapse; text-align: center;"> <tr> <td style="width: 10%;"></td> <td style="width: 10%;"></td> <td style="width: 10%;"></td> <td style="width: 10%;"></td> <td style="width: 10%;"></td> <td style="width: 10%;"></td> <td style="width: 10%;"></td> <td style="width: 10%;"></td> <td style="width: 10%;"></td> <td style="width: 10%;"></td> </tr> <tr> <td></td> <td></td> <td colspan="8" style="text-align: center;"> <table border="1" style="width: 100%; border-collapse: collapse; text-align: center;"> <tr> <td style="width: 10%;"></td> <td style="width: 10%;"></td> <td style="width: 10%;"></td> <td style="width: 10%;"></td> <td style="width: 10%;"></td> <td style="width: 10%;"></td> <td style="width: 10%;"></td> <td style="width: 10%;"></td> <td style="width: 10%;"></td> <td style="width: 10%;"></td> </tr> <tr> <td></td> <td></td> <td colspan="8" style="text-align: center;"> <table border="1" style="width: 100%; border-collapse: collapse; text-align: center;"> <tr> <td style="width: 10%;"></td> <td style="width: 10%;"></td> <td style="width: 10%;"></td> <td style="width: 10%;"></td> <td style="width: 10%;"></td> <td style="width: 10%;"></td> <td style="width: 10%;"></td> <td style="width: 10%;"></td> <td style="width: 10%;"></td> <td style="width: 10%;"></td> </tr> <tr> <td></td> <td></td> <td colspan="8" style="text-align: center;"> <table border="1" style="width: 100%; border-collapse: collapse; text-align: center;"> <tr> <td style="width: 10%;"></td> <td style="width: 10%;"></td> <td style="width: 10%;"></td> <td style="width: 10%;"></td> <td style="width: 10%;"></td> <td style="width: 10%;"></td> <td style="width: 10%;"></td> <td style="width: 10%;"></td> <td style="width: 10%;"></td> <td style="width: 10%;"></td> </tr> <tr> <td></td> <td></td> <td colspan="8" style="text-align: center;"> <table border="1" style="width: 100%; border-collapse: collapse; text-align: center;"> <tr> <td style="width: 10%;"></td> <td style="width: 10%;"></td> <td style="width: 10%;"></td> <td style="width: 10%;"></td> <td style="width: 10%;"></td> <td style="width: 10%;"></td> <td style="width: 10%;"></td> <td style="width: 10%;"></td> <td style="width: 10%;"></td> <td style="width: 10%;"></td> </tr> <tr> <td></td> <td></td> <td colspan="8" style="text-align: center;"> <table border="1" style="width: 100%; border-collapse: collapse; text-align: center;"> <tr> <td style="width: 10%;"></td> <td style="width: 10%;"></td> <td style="width: 10%;"></td> <td style="width: 10%;"></td> <td style="width: 10%;"></td> <td style="width: 10%;"></td> <td style="width: 10%;"></td> <td style="width: 10%;"></td> <td style="width: 10%;"></td> <td style="width: 10%;"></td> </tr> <tr> <td></td> <td></td> <td colspan="8" style="text-align: center;"> <table border="1" style="width: 100%; border-collapse: collapse; text-align: center;"> <tr> <td style="width: 10%;"></td> <td style="width: 10%;"></td> <td style="width: 10%;"></td> <td style="width: 10%;"></td> <td style="width: 10%;"></td> <td style="width: 10%;"></td> <td style="width: 10%;"></td> <td style="width: 10%;"></td> <td style="width: 10%;"></td> <td style="width: 10%;"></td> </tr> <tr> <td></td> <td></td> <td colspan="8" style="text-align: center;"> <table border="1" style="width: 100%; border-collapse: collapse; text-align: center;"> <tr> <td style="width: 10%;"></td> <td style="width: 10%;"></td> <td style="width: 10%;"></td> <td style="width: 10%;"></td> <td style="width: 10%;"></td> <td style="width: 10%;"></td> <td style="width: 10%;"></td> <td style="width: 10%;"></td> <td style="width: 10%;"></td> <td style="width: 10%;"></td> </tr> <tr> <td></td> <td></td> <td colspan="8" style="text-align: center;"> <table border="1" style="width: 100%; border-collapse: collapse; text-align: center;"> <tr> <td style="width: 10%;"></td> <td style="width: 10%;"></td> <td style="width: 10%;"></td> <td style="width: 10%;"></td> <td style="width: 10%;"></td> <td style="width: 10%;"></td> <td style="width: 10%;"></td> <td style="width: 10%;"></td> <td style="width: 10%;"></td> <td style="width: 10%;"></td> </tr> <tr> <td></td> <td></td> <td colspan="8" style="text-align: center;"> <table border="1" style="width: 100%; border-collapse: collapse; text-align: center;"> <tr> <td style="width: 10%;"></td> <td style="width: 10%;"></td> <td style="width: 10%;"></td> <td style="width: 10%;"></td> <td style="width: 10%;"></td> <td style="width: 10%;"></td> <td style="width: 10%;"></td> <td style="width: 10%;"></td> <td style="width: 10%;"></td> <td style="width: 10%;"></td> </tr> <tr> <td></td> <td></td> <td colspan="8" style="text-align: center;"> <table border="1" style="width: 100%; border-collapse: collapse; text-align: center;"> <tr> </tr></table></td></tr></table></td></tr></table></td></tr></table></td></tr></table></td></tr></table></td></tr></table></td></tr></table></td></tr></table></td></tr></table></td></tr></table></td></tr></table></td></tr></table></td></tr></table></td></tr></table></td></tr></table></td></tr></table></td></tr></table></td></tr></table></td></tr></table>
 | | | | | | | | | | | | | | | | | | | | <table border="1" style="width: 100%; border-collapse: collapse; text-align: center;"> <tr> <td style="width: 10%;"></td> <td style="width: 10%;"></td> <td style="width: 10%;"></td> <td style="width: 10%;"></td> <td style="width: 10%;"></td> <td style="width: 10%;"></td> <td style="width: 10%;"></td> <td style="width: 10%;"></td> <td style="width: 10%;"></td> <td style="width: 10%;"></td> </tr> <tr> <td></td> <td></td> <td colspan="8" style="text-align: center;"> <table border="1" style="width: 100%; border-collapse: collapse; text-align: center;"> <tr> <td style="width: 10%;"></td> <td style="width: 10%;"></td> <td style="width: 10%;"></td> <td style="width: 10%;"></td> <td style="width: 10%;"></td> <td style="width: 10%;"></td> <td style="width: 10%;"></td> <td style="width: 10%;"></td> <td style="width: 10%;"></td> <td style="width: 10%;"></td> </tr> <tr> <td></td> <td></td> <td colspan="8" style="text-align: center;"> <table border="1" style="width: 100%; border-collapse: collapse; text-align: center;"> <tr> <td style="width: 10%;"></td> <td style="width: 10%;"></td> <td style="width: 10%;"></td> <td style="width: 10%;"></td> <td style="width: 10%;"></td> <td style="width: 10%;"></td> <td style="width: 10%;"></td> <td style="width: 10%;"></td> <td style="width: 10%;"></td> <td style="width: 10%;"></td> </tr> <tr> <td></td> <td></td> <td colspan="8" style="text-align: center;"> <table border="1" style="width: 100%; border-collapse: collapse; text-align: center;"> <tr> <td style="width: 10%;"></td> <td style="width: 10%;"></td> <td style="width: 10%;"></td> <td style="width: 10%;"></td> <td style="width: 10%;"></td> <td style="width: 10%;"></td> <td style="width: 10%;"></td> <td style="width: 10%;"></td> <td style="width: 10%;"></td> <td style="width: 10%;"></td> </tr> <tr> <td></td> <td></td> <td colspan="8" style="text-align: center;"> <table border="1" style="width: 100%; border-collapse: collapse; text-align: center;"> <tr> <td style="width: 10%;"></td> <td style="width: 10%;"></td> <td style="width: 10%;"></td> <td style="width: 10%;"></td> <td style="width: 10%;"></td> <td style="width: 10%;"></td> <td style="width: 10%;"></td> <td style="width: 10%;"></td> <td style="width: 10%;"></td> <td style="width: 10%;"></td> </tr> <tr> <td></td> <td></td> <td colspan="8" style="text-align: center;"> <table border="1" style="width: 100%; border-collapse: collapse; text-align: center;"> <tr> <td style="width: 10%;"></td> <td style="width: 10%;"></td> <td style="width: 10%;"></td> <td style="width: 10%;"></td> <td style="width: 10%;"></td> <td style="width: 10%;"></td> <td style="width: 10%;"></td> <td style="width: 10%;"></td> <td style="width: 10%;"></td> <td style="width: 10%;"></td> </tr> <tr> <td></td> <td></td> <td
colspan="8" style="text-align: center;"> <table border="1" style="width: 100%; border-collapse: collapse; text-align: center;"> <tr> <td style="width: 10%;"></td> <td style="width: 10%;"></td> <td style="width: 10%;"></td> <td style="width: 10%;"></td> <td style="width: 10%;"></td> <td style="width: 10%;"></td> <td style="width: 10%;"></td> <td style="width: 10%;"></td> <td style="width: 10%;"></td> <td style="width: 10%;"></td> </tr> <tr> <td></td> <td></td> <td colspan="8" style="text-align: center;"> <table border="1" style="width: 100%; border-collapse: collapse; text-align: center;"> <tr> <td style="width: 10%;"></td> <td style="width: 10%;"></td> <td style="width: 10%;"></td> <td style="width: 10%;"></td> <td style="width: 10%;"></td> <td style="width: 10%;"></td> <td style="width: 10%;"></td> <td style="width: 10%;"></td> <td style="width: 10%;"></td> <td style="width: 10%;"></td> </tr> <tr> <td></td> <td></td> <td colspan="8" style="text-align: center;"> <table border="1" style="width: 100%; border-collapse: collapse; text-align: center;"> <tr> <td style="width: 10%;"></td> <td style="width: 10%;"></td> <td style="width: 10%;"></td> <td style="width: 10%;"></td> <td style="width: 10%;"></td> <td style="width: 10%;"></td> <td style="width: 10%;"></td> <td style="width: 10%;"></td> <td style="width: 10%;"></td> <td style="width: 10%;"></td> </tr> <tr> <td></td> <td></td> <td colspan="8" style="text-align: center;"> <table border="1" style="width: 100%; border-collapse: collapse; text-align: center;"> <tr> <td style="width: 10%;"></td> <td style="width: 10%;"></td> <td style="width: 10%;"></td> <td style="width: 10%;"></td> <td style="width: 10%;"></td> <td style="width: 10%;"></td> <td style="width: 10%;"></td> <td style="width: 10%;"></td> <td style="width: 10%;"></td> <td style="width: 10%;"></td> </tr> <tr> <td></td> <td></td> <td colspan="8" style="text-align: center;"> <table border="1" style="width: 100%; border-collapse: collapse; text-align: center;"> <tr> <td style="width: 10%;"></td> <td style="width: 10%;"></td> <td style="width: 10%;"></td> <td style="width: 10%;"></td> <td style="width: 10%;"></td> <td style="width: 10%;"></td> <td style="width: 10%;"></td> <td style="width: 10%;"></td> <td style="width: 10%;"></td> <td style="width: 10%;"></td> </tr> <tr> <td></td> <td></td> <td colspan="8" style="text-align: center;"> <table border="1" style="width: 100%; border-collapse: collapse; text-align: center;"> <tr> <td style="width: 10%;"></td> <td style="width: 10%;"></td> <td style="width: 10%;"></td> <td style="width: 10%;"></td> <td style="width: 10%;"></td> <td style="width: 10%;"></td> <td style="width: 10%;"></td> <td style="width: 10%;"></td> <td style="width: 10%;"></td> <td style="width: 10%;"></td> </tr> <tr> <td></td> <td></td> <td colspan="8" style="text-align: center;"> <table border="1" style="width: 100%; border-collapse: collapse; text-align: center;"> <tr> <td style="width: 10%;"></td> <td style="width: 10%;"></td> <td style="width: 10%;"></td> <td style="width: 10%;"></td> <td style="width: 10%;"></td> <td style="width: 10%;"></td> <td style="width: 10%;"></td> <td style="width: 10%;"></td> <td style="width: 10%;"></td> <td style="width: 10%;"></td> </tr> <tr> <td></td> <td></td> <td colspan="8" style="text-align: center;"> <table border="1" style="width: 100%; border-collapse: collapse; text-align: center;"> <tr> <td style="width: 10%;"></td> <td style="width: 10%;"></td> <td style="width: 10%;"></td> <td style="width: 10%;"></td> <td style="width: 10%;"></td> <td style="width: 10%;"></td> <td style="width: 10%;"></td> <td style="width: 10%;"></td> <td style="width: 10%;"></td> <td style="width: 10%;"></td> </tr> <tr> <td></td> <td></td> <td colspan="8" style="text-align: center;"> <table border="1" style="width: 100%; border-collapse: collapse; text-align: center;"> <tr> <td style="width: 10%;"></td> <td style="width: 10%;"></td> <td style="width: 10%;"></td> <td style="width: 10%;"></td> <td style="width: 10%;"></td> <td style="width: 10%;"></td> <td style="width: 10%;"></td> <td style="width: 10%;"></td> <td style="width: 10%;"></td> <td style="width: 10%;"></td> </tr> <tr> <td></td> <td></td> <td colspan="8" style="text-align: center;"> <table border="1" style="width: 100%; border-collapse: collapse; text-align: center;"> <tr> <td style="width: 10%;"></td> <td style="width: 10%;"></td> <td style="width: 10%;"></td> <td style="width: 10%;"></td> <td style="width: 10%;"></td> <td style="width: 10%;"></td> <td style="width: 10%;"></td> <td style="width: 10%;"></td> <td style="width: 10%;"></td> <td style="width: 10%;"></td> </tr> <tr> <td></td> <td></td> <td colspan="8" style="text-align: center;"> <table border="1" style="width: 100%; border-collapse: collapse; text-align: center;"> <tr> <td style="width: 10%;"></td> <td style="width: 10%;"></td> <td style="width: 10%;"></td> <td style="width: 10%;"></td> <td style="width: 10%;"></td> <td style="width: 10%;"></td> <td style="width: 10%;"></td> <td style="width: 10%;"></td> <td style="width: 10%;"></td> <td style="width: 10%;"></td> </tr> <tr> <td></td> <td></td> <td colspan="8" style="text-align: center;"> <table border="1" style="width: 100%; border-collapse: collapse; text-align: center;"> <tr> <td style="width: 10%;"></td> <td style="width: 10%;"></td> <td style="width: 10%;"></td> <td style="width: 10%;"></td> <td style="width: 10%;"></td> <td style="width: 10%;"></td> <td style="width: 10%;"></td> <td style="width: 10%;"></td> <td style="width: 10%;"></td> <td style="width: 10%;"></td> </tr> <tr> <td></td> <td></td> <td colspan="8" style="text-align: center;"> <table border="1" style="width: 100%; border-collapse: collapse; text-align: center;"> <tr> </tr></table></td></tr></table></td></tr></table></td></tr></table></td></tr></table></td></tr></table></td></tr></table></td></tr></table></td></tr></table></td></tr></table></td></tr></table></td></tr></table></td></tr></table></td></tr></table></td></tr></table></td></tr></table></td></tr></table></td></tr></table></td></tr></table>
 | | | | | | | | | | | | | | | | | | | | <table border="1" style="width: 100%; border-collapse: collapse; text-align: center;"> <tr> <td style="width: 10%;"></td> <td style="width: 10%;"></td> <td style="width: 10%;"></td> <td style="width: 10%;"></td> <td style="width: 10%;"></td> <td style="width: 10%;"></td> <td style="width: 10%;"></td> <td style="width: 10%;"></td> <td style="width: 10%;"></td> <td style="width: 10%;"></td> </tr> <tr> <td></td> <td></td> <td colspan="8" style="text-align: center;"> <table border="1" style="width: 100%; border-collapse: collapse; text-align: center;"> <tr> <td style="width: 10%;"></td> <td style="width: 10%;"></td> <td style="width: 10%;"></td> <td style="width: 10%;"></td> <td style="width: 10%;"></td> <td style="width: 10%;"></td> <td style="width: 10%;"></td> <td style="width: 10%;"></td> <td style="width: 10%;"></td> <td style="width: 10%;"></td> </tr> <tr> <td></td> <td></td> <td colspan="8" style="text-align: center;"> <table border="1" style="width: 100%; border-collapse: collapse; text-align: center;"> <tr> <td style="width: 10%;"></td> <td style="width: 10%;"></td> <td style="width: 10%;"></td> <td style="width: 10%;"></td> <td style="width: 10%;"></td> <td style="width: 10%;"></td> <td style="width: 10%;"></td> <td style="width: 10%;"></td> <td style="width: 10%;"></td> <td style="width: 10%;"></td> </tr> <tr> <td></td> <td></td> <td colspan="8" style="text-align: center;"> <table border="1" style="width: 100%; border-collapse: collapse; text-align: center;"> <tr> <td style="width: 10%;"></td> <td style="width: 10%;"></td> <td style="width: 10%;"></td> <td style="width: 10%;"></td> <td style="width: 10%;"></td> <td style="width: 10%;"></td> <td style="width: 10%;"></td> <td style="width: 10%;"></td> <td style="width: 10%;"></td> <td style="width: 10%;"></td> </tr> <tr> <td></td> <td></td> <td colspan="8" style="text-align: center;"> <table border="1" style="width: 100%; border-collapse: collapse; text-align: center;"> <tr> <td style="width: 10%;"></td> <td style="width: 10%;"></td> <td style="width: 10%;"></td> <td style="width: 10%;"></td> <td style="width: 10%;"></td> <td style="width: 10%;"></td> <td style="width: 10%;"></td> <td style="width: 10%;"></td> <td style="width: 10%;"></td> <td style="width: 10%;"></td> </tr> <tr> <td></td> <td></td> <td colspan="8" style="text-align: center;"> <table border="1" style="width: 100%; border-collapse: collapse; text-align: center;"> <tr> <td style="width: 10%;"></td> <td style="width: 10%;"></td> <td style="width: 10%;"></td> <td style="width: 10%;"></td> <td style="width: 10%;"></td> <td style="width: 10%;"></td> <td style="width: 10%;"></td> <td style="width: 10%;"></td> <td style="width: 10%;"></td> <td style="width: 10%;"></td> </tr> <tr> <td></td> <td></td> <td colspan="8" style="text-align: center;"> <table border="1" style="width: 100%; border-collapse: collapse; text-align: center;"> <tr> <td style="width: 10%;"></td> <td style="width: 10%;"></td> <td style="width: 10%;"></td> <td style="width: 10%;"></td> <td style="width: 10%;"></td> <td style="width: 10%;"></td> <td style="width: 10%;"></td> <td style="width: 10%;"></td> <td style="width: 10%;"></td> <td style="width: 10%;"></td> </tr> <tr> <td></td> <td></td> <td colspan="8" style="text-align: center;"> <table border="1" style="width: 100%; border-collapse: collapse; text-align: center;"> <tr> <td style="width: 10%;"></td> <td style="width: 10%;"></td> <td style="width: 10%;"></td> <td style="width: 10%;"></td> <td style="width: 10%;"></td> <td style="width: 10%;"></td> <td style="width: 10%;"></td> <td style="width: 10%;"></td> <td style="width: 10%;"></td> <td style="width: 10%;"></td> </tr> <tr> <td></td> <td></td> <td colspan="8" style="text-align: center;"> <table border="1" style="width: 100%; border-collapse: collapse; text-align: center;"> <tr> <td style="width: 10%;"></td> <td style="width: 10%;"></td> <td style="width: 10%;"></td> <td style="width: 10%;"></td> <td style="width: 10%;"></td> <td style="width: 10%;"></td> <td style="width: 10%;"></td> <td style="width: 10%;"></td> <td style="width: 10%;"></td> <td style="width: 10%;"></td> </tr> <tr> <td></td> <td></td> <td colspan="8" style="text-align: center;"> <table border="1" style="width: 100%; border-collapse: collapse; text-align: center;"> <tr> <td style="width: 10%;"></td> <td style="width: 10%;"></td> <td style="width: 10%;"></td> <td style="width: 10%;"></td> <td style="width: 10%;"></td> <td style="width: 10%;"></td> <td style="width: 10%;"></td> <td style="width: 10%;"></td> <td style="width: 10%;"></td> <td style="width: 10%;"></td> </tr> <tr> <td></td> <td></td> <td colspan="8" style="text-align: center;"> <table border="1" style="width: 100%; border-collapse: collapse; text-align: center;"> <tr> <td style="width: 10%;"></td> <td style="width: 10%;"></td> <td style="width: 10%;"></td> <td style="width: 10%;"></td> <td style="width: 10%;"></td> <td style="width: 10%;"></td> <td style="width: 10%;"></td> <td style="width: 10%;"></td> <td style="width: 10%;"></td> <td style="width: 10%;"></td> </tr> <tr> <td></td> <td></td> <td colspan="8" style="text-align: center;"> <table border="1" style="width: 100%; border-collapse: collapse; text-align: center;"> <tr> <td style="width: 10%;"></td> <td style="width: 10%;"></td> <td style="width: 10%;"></td> <td style="width: 10%;"></td> <td style="width: 10%;"></td> <td style="width: 10%;"></td> <td style="width: 10%;"></td> <td style="width: 10%;"></td> <td style="width: 10%;"></td> <td style="width: 10%;"></td> </tr> <tr> <td></td> <td></td> <td colspan="8" style="text-align: center;"> <table border="1" style="width: 100%; border-collapse: collapse; text-align: center;"> <tr> <td style="width: 10%;"></td> <td style="width: 10%;"></td> <td style="width: 10%;"></td> <td style="width: 10%;"></td> <td style="width: 10%;"></td> <td style="width: 10%;"></td> <td style="width: 10%;"></td> <td style="width: 10%;"></td> <td style="width: 10%;"></td> <td style="width: 10%;"></td> </tr> <tr> <td></td> <td></td> <td colspan="8" style="text-align:
center;"> <table border="1" style="width: 100%; border-collapse: collapse; text-align: center;"> <tr> <td style="width: 10%;"></td> <td style="width: 10%;"></td> <td style="width: 10%;"></td> <td style="width: 10%;"></td> <td style="width: 10%;"></td> <td style="width: 10%;"></td> <td style="width: 10%;"></td> <td style="width: 10%;"></td> <td style="width: 10%;"></td> <td style="width: 10%;"></td> </tr> <tr> <td></td> <td></td> <td colspan="8" style="text-align: center;"> <table border="1" style="width: 100%; border-collapse: collapse; text-align: center;"> <tr> <td style="width: 10%;"></td> <td style="width: 10%;"></td> <td style="width: 10%;"></td> <td style="width: 10%;"></td> <td style="width: 10%;"></td> <td style="width: 10%;"></td> <td style="width: 10%;"></td> <td style="width: 10%;"></td> <td style="width: 10%;"></td> <td style="width: 10%;"></td> </tr> <tr> <td></td> <td></td> <td colspan="8" style="text-align: center;"> <table border="1" style="width: 100%; border-collapse: collapse; text-align: center;"> <tr> <td style="width: 10%;"></td> <td style="width: 10%;"></td> <td style="width: 10%;"></td> <td style="width: 10%;"></td> <td style="width: 10%;"></td> <td style="width: 10%;"></td> <td style="width: 10%;"></td> <td style="width: 10%;"></td> <td style="width: 10%;"></td> <td style="width: 10%;"></td> </tr> <tr> <td></td> <td></td> <td colspan="8" style="text-align: center;"> <table border="1" style="width: 100%; border-collapse: collapse; text-align: center;"> <tr> <td style="width: 10%;"></td> <td style="width: 10%;"></td> <td style="width: 10%;"></td> <td style="width: 10%;"></td> <td style="width: 10%;"></td> <td style="width: 10%;"></td> <td style="width: 10%;"></td> <td style="width: 10%;"></td> <td style="width: 10%;"></td> <td style="width: 10%;"></td> </tr> <tr> <td></td> <td></td> <td colspan="8" style="text-align: center;"> <table border="1" style="width: 100%; border-collapse: collapse; text-align: center;"> <tr> </tr></table></td></tr></table></td></tr></table></td></tr></table></td></tr></table></td></tr></table></td></tr></table></td></tr></table></td></tr></table></td></tr></table></td></tr></table></td></tr></table></td></tr></table></td></tr></table></td></tr></table></td></tr></table></td></tr></table></td></tr></table>
 | | | | | | | | | | | | | | | | | | | | <table border="1" style="width: 100%; border-collapse: collapse; text-align: center;"> <tr> <td style="width: 10%;"></td> <td style="width: 10%;"></td> <td style="width: 10%;"></td> <td style="width: 10%;"></td> <td style="width: 10%;"></td> <td style="width: 10%;"></td> <td style="width: 10%;"></td> <td style="width: 10%;"></td> <td style="width: 10%;"></td> <td style="width: 10%;"></td> </tr> <tr> <td></td> <td></td> <td colspan="8" style="text-align: center;"> <table border="1" style="width: 100%; border-collapse: collapse; text-align: center;"> <tr> <td style="width: 10%;"></td> <td style="width: 10%;"></td> <td style="width: 10%;"></td> <td style="width: 10%;"></td> <td style="width: 10%;"></td> <td style="width: 10%;"></td> <td style="width: 10%;"></td> <td style="width: 10%;"></td> <td style="width: 10%;"></td> <td style="width: 10%;"></td> </tr> <tr> <td></td> <td></td> <td colspan="8" style="text-align: center;"> <table border="1" style="width: 100%; border-collapse: collapse; text-align: center;"> <tr> <td style="width: 10%;"></td> <td style="width: 10%;"></td> <td style="width: 10%;"></td> <td style="width: 10%;"></td> <td style="width: 10%;"></td> <td style="width: 10%;"></td> <td style="width: 10%;"></td> <td style="width: 10%;"></td> <td style="width: 10%;"></td> <td style="width: 10%;"></td> </tr> <tr> <td></td> <td></td> <td colspan="8" style="text-align: center;"> <table border="1" style="width: 100%; border-collapse: collapse; text-align: center;"> <tr> <td style="width: 10%;"></td> <td style="width: 10%;"></td> <td style="width: 10%;"></td> <td style="width: 10%;"></td> <td style="width: 10%;"></td> <td style="width: 10%;"></td> <td style="width: 10%;"></td> <td style="width: 10%;"></td> <td style="width: 10%;"></td> <td style="width: 10%;"></td> </tr> <tr> <td></td> <td></td> <td colspan="8" style="text-align: center;"> <table border="1" style="width: 100%; border-collapse: collapse; text-align: center;"> <tr> <td style="width: 10%;"></td> <td style="width: 10%;"></td> <td style="width: 10%;"></td> <td style="width: 10%;"></td> <td style="width: 10%;"></td> <td style="width: 10%;"></td> <td style="width: 10%;"></td> <td style="width: 10%;"></td> <td style="width: 10%;"></td> <td style="width: 10%;"></td> </tr> <tr> <td></td> <td></td> <td colspan="8" style="text-align: center;"> <table border="1" style="width: 100%; border-collapse: collapse; text-align: center;"> <tr> <td style="width: 10%;"></td> <td style="width: 10%;"></td> <td style="width: 10%;"></td> <td style="width: 10%;"></td> <td style="width: 10%;"></td> <td style="width: 10%;"></td> <td style="width: 10%;"></td> <td style="width: 10%;"></td> <td style="width: 10%;"></td> <td style="width: 10%;"></td> </tr> <tr> <td></td> <td></td> <td colspan="8" style="text-align: center;"> <table border="1" style="width: 100%; border-collapse: collapse; text-align: center;"> <tr> <td style="width: 10%;"></td> <td style="width: 10%;"></td> <td style="width: 10%;"></td> <td style="width: 10%;"></td> <td style="width: 10%;"></td> <td style="width: 10%;"></td> <td style="width: 10%;"></td> <td style="width: 10%;"></td> <td style="width: 10%;"></td> <td style="width: 10%;"></td> </tr> <tr> <td></td> <td></td> <td colspan="8" style="text-align: center;"> <table border="1" style="width: 100%; border-collapse: collapse; text-align: center;"> <tr> <td style="width: 10%;"></td> <td style="width: 10%;"></td> <td style="width: 10%;"></td> <td style="width: 10%;"></td> <td style="width: 10%;"></td> <td style="width: 10%;"></td> <td style="width: 10%;"></td> <td style="width: 10%;"></td> <td style="width: 10%;"></td> <td style="width: 10%;"></td> </tr> <tr> <td></td> <td></td> <td colspan="8" style="text-align: center;"> <table border="1" style="width: 100%; border-collapse: collapse; text-align: center;"> <tr> <td style="width: 10%;"></td> <td style="width: 10%;"></td> <td style="width: 10%;"></td> <td style="width: 10%;"></td> <td style="width: 10%;"></td> <td style="width: 10%;"></td> <td style="width: 10%;"></td> <td style="width: 10%;"></td> <td style="width: 10%;"></td> <td style="width: 10%;"></td> </tr> <tr> <td></td> <td></td> <td colspan="8" style="text-align: center;"> <table border="1" style="width: 100%; border-collapse: collapse; text-align: center;"> <tr> <td style="width: 10%;"></td> <td style="width: 10%;"></td> <td style="width: 10%;"></td> <td style="width: 10%;"></td> <td style="width: 10%;"></td> <td style="width: 10%;"></td> <td style="width: 10%;"></td> <td style="width: 10%;"></td> <td style="width: 10%;"></td> <td style="width: 10%;"></td> </tr> <tr> <td></td> <td></td> <td colspan="8" style="text-align: center;"> <table border="1" style="width: 100%; border-collapse: collapse; text-align: center;"> <tr> <td style="width: 10%;"></td> <td style="width: 10%;"></td> <td style="width: 10%;"></td> <td style="width: 10%;"></td> <td style="width: 10%;"></td> <td style="width: 10%;"></td> <td style="width: 10%;"></td> <td style="width: 10%;"></td> <td style="width: 10%;"></td> <td style="width: 10%;"></td> </tr> <tr> <td></td> <td></td> <td colspan="8" style="text-align: center;"> <table border="1" style="width: 100%; border-collapse: collapse; text-align: center;"> <tr> <td style="width: 10%;"></td> <td style="width: 10%;"></td> <td style="width: 10%;"></td> <td style="width: 10%;"></td> <td style="width: 10%;"></td> <td style="width: 10%;"></td> <td style="width: 10%;"></td> <td style="width: 10%;"></td> <td style="width: 10%;"></td> <td style="width: 10%;"></td> </tr> <tr> <td></td> <td></td> <td colspan="8" style="text-align: center;"> <table border="1" style="width: 100%; border-collapse: collapse; text-align: center;"> <tr> <td style="width: 10%;"></td> <td style="width: 10%;"></td> <td style="width: 10%;"></td> <td style="width: 10%;"></td> <td style="width: 10%;"></td> <td style="width: 10%;"></td> <td style="width: 10%;"></td> <td style="width: 10%;"></td> <td style="width: 10%;"></td> <td style="width: 10%;"></td> </tr> <tr> <td></td> <td></td> <td colspan="8" style="text-align: center;"> <table border="1" style="width: 100%; border-collapse: collapse; text-align: center;"> <tr> <td style="width: 10%;"></td> <td style="width: 10%;"></td> <td style="width: 10%;"></td> <td style="width: 10%;"></td> <td style="width: 10%;"></td> <td style="width: 10%;"></td> <td style="width: 10%;"></td> <td style="width: 10%;"></td> <td style="width: 10%;"></td> <td style="width: 10%;"></td> </tr> <tr> <td></td> <td></td> <td colspan="8" style="text-align: center;"> <table border="1" style="width: 100%; border-collapse: collapse; text-align: center;"> <tr> <td style="width: 10%;"></td> <td style="width: 10%;"></td> <td style="width: 10%;"></td> <td style="width: 10%;"></td> <td style="width: 10%;"></td> <td style="width: 10%;"></td> <td style="width: 10%;"></td> <td style="width: 10%;"></td> <td style="width: 10%;"></td> <td style="width: 10%;"></td> </tr> <tr> <td></td> <td></td> <td colspan="8" style="text-align: center;"> <table border="1" style="width: 100%; border-collapse: collapse; text-align: center;"> <tr> <td style="width: 10%;"></td> <td style="width: 10%;"></td> <td style="width: 10%;"></td> <td style="width: 10%;"></td> <td style="width: 10%;"></td> <td style="width: 10%;"></td> <td style="width: 10%;"></td> <td style="width: 10%;"></td> <td style="width: 10%;"></td> <td style="width: 10%;"></td> </tr> <tr> <td></td> <td></td> <td colspan="8" style="text-align: center;"> <table border="1" style="width: 100%; border-collapse: collapse; text-align: center;"> <tr> </tr></table></td></tr></table></td></tr></table></td></tr></table></td></tr></table></td></tr></table></td></tr></table></td></tr></table></td></tr></table></td></tr></table></td></tr></table></td></tr></table></td></tr></table></td></tr></table></td></tr></table></td></tr></table></td></tr></table>
 | | | | | | | | | | | | | | | | | | | | <table border="1" style="width: 100%; border-collapse: collapse; text-align: center;"> <tr> <td style="width: 10%;"></td> <td style="width: 10%;"></td> <td style="width: 10%;"></td> <td style="width: 10%;"></td> <td style="width: 10%;"></td> <td style="width: 10%;"></td> <td style="width: 10%;"></td> <td style="width: 10%;"></td> <td style="width: 10%;"></td> <td style="width: 10%;"></td> </tr> <tr> <td></td> <td></td> <td colspan="8" style="text-align: center;"> <table border="1" style="width: 100%; border-collapse: collapse; text-align: center;"> <tr> <td style="width: 10%;"></td> <td style="width: 10%;"></td> <td style="width: 10%;"></td> <td style="width: 10%;"></td> <td style="width: 10%;"></td> <td style="width: 10%;"></td> <td style="width: 10%;"></td> <td style="width: 10%;"></td> <td style="width: 10%;"></td> <td style="width: 10%;"></td> </tr> <tr> <td></td> <td></td> <td colspan="8" style="text-align: center;"> <table border="1" style="width: 100%; border-collapse: collapse; text-align: center;"> <tr> <td style="width: 10%;"></td> <td style="width: 10%;"></td> <td style="width: 10%;"></td> <td style="width: 10%;"></td> <td style="width: 10%;"></td> <td style="width: 10%;"></td> <td style="width: 10%;"></td> <td style="width: 10%;"></td> <td style="width: 10%;"></td> <td style="width: 10%;"></td> </tr> <tr> <td></td> <td></td> <td colspan="8" style="text-align: center;"> <table border="1" style="width: 100%; border-collapse: collapse; text-align: center;"> <tr> <td style="width: 10%;"></td> <td style="width: 10%;"></td> <td style="width: 10%;"></td> <td style="width: 10%;"></td> <td style="width: 10%;"></td> <td style="width: 10%;"></td> <td style="width: 10%;"></td> <td style="width: 10%;"></td> <td style="width: 10%;"></td> <td style="width: 10%;"></td> </tr> <tr> <td></td> <td></td> <td colspan="8" style="text-align: center;"> <table border="1" style="width: 100%; border-collapse: collapse; text-align: center;"> <tr> <td style="width: 10%;"></td> <td style="width: 10%;"></td> <td style="width: 10%;"></td> <td style="width: 10%;"></td> <td style="width: 10%;"></td> <td style="width: 10%;"></td> <td style="width: 10%;"></td> <td style="width: 10%;"></td> <td style="width: 10%;"></td> <td style="width: 10%;"></td> </tr> <tr> <td></td> <td></td> <td colspan="8" style="text-align: center;"> <table border="1" style="width: 100%; border-collapse: collapse; text-align: center;"> <tr> <td style="width: 10%;"></td> <td style="width: 10%;"></td> <td style="width: 10%;"></td> <td style="width: 10%;"></td> <td style="width: 10%;"></td> <td style="width: 10%;"></td> <td style="width: 10%;"></td> <td style="width: 10%;"></td> <td style="width: 10%;"></td> <td style="width: 10%;"></td> </tr> <tr> <td></td> <td></td> <td colspan="8" style="text-align: center;"> <table border="1" style="width: 100%; border-collapse: collapse; text-align: center;"> <tr> <td style="width: 10%;"></td> <td style="width: 10%;"></td> <td style="width: 10%;"></td> <td style="width: 10%;"></td> <td style="width: 10%;"></td> <td style="width: 10%;"></td> <td style="width: 10%;"></td> <td style="width: 10%;"></td> <td style="width: 10%;"></td> <td style="width: 10%;"></td> </tr> <tr> <td></td> <td></td> <td colspan="8" style="text-align: center;"> <table border="1" style="width: 100%; border-collapse: collapse; text-align: center;"> <tr> <td style="width: 10%;"></td> <td style="width: 10%;"></td> <td style="width: 10%;"></td> <td style="width: 10%;"></td> <td style="width: 10%;"></td> <td style="width: 10%;"></td> <td style="width: 10%;"></td> <td style="width: 10%;"></td> <td style="width: 10%;"></td> <td style="width: 10%;"></td> </tr> <tr> <td></td> <td></td> <td colspan="8" style="text-align: center;"> <table border="1" style="width: 100%; border-collapse: collapse; text-align: center;"> <tr> <td style="width: 10%;"></td> <td style="width: 10%;"></td> <td style="width: 10%;"></td> <td style="width: 10%;"></td> <td style="width: 10%;"></td> <td style="width: 10%;"></td> <td style="width: 10%;"></td> <td style="width: 10%;"></td> <td style="width: 10%;"></td> <td style="width: 10%;"></td> </tr> <tr>
<td></td> <td></td> <td colspan="8" style="text-align: center;"> <table border="1" style="width: 100%; border-collapse: collapse; text-align: center;"> <tr> <td style="width: 10%;"></td> <td style="width: 10%;"></td> <td style="width: 10%;"></td> <td style="width: 10%;"></td> <td style="width: 10%;"></td> <td style="width: 10%;"></td> <td style="width: 10%;"></td> <td style="width: 10%;"></td> <td style="width: 10%;"></td> <td style="width: 10%;"></td> </tr> <tr> <td></td> <td></td> <td colspan="8" style="text-align: center;"> <table border="1" style="width: 100%; border-collapse: collapse; text-align: center;"> <tr> <td style="width: 10%;"></td> <td style="width: 10%;"></td> <td style="width: 10%;"></td> <td style="width: 10%;"></td> <td style="width: 10%;"></td> <td style="width: 10%;"></td> <td style="width: 10%;"></td> <td style="width: 10%;"></td> <td style="width: 10%;"></td> <td style="width: 10%;"></td> </tr> <tr> <td></td> <td></td> <td colspan="8" style="text-align: center;"> <table border="1" style="width: 100%; border-collapse: collapse; text-align: center;"> <tr> <td style="width: 10%;"></td> <td style="width: 10%;"></td> <td style="width: 10%;"></td> <td style="width: 10%;"></td> <td style="width: 10%;"></td> <td style="width: 10%;"></td> <td style="width: 10%;"></td> <td style="width: 10%;"></td> <td style="width: 10%;"></td> <td style="width: 10%;"></td> </tr> <tr> <td></td> <td></td> <td colspan="8" style="text-align: center;"> <table border="1" style="width: 100%; border-collapse: collapse; text-align: center;"> <tr> <td style="width: 10%;"></td> <td style="width: 10%;"></td> <td style="width: 10%;"></td> <td style="width: 10%;"></td> <td style="width: 10%;"></td> <td style="width: 10%;"></td> <td style="width: 10%;"></td> <td style="width: 10%;"></td> <td style="width: 10%;"></td> <td style="width: 10%;"></td> </tr> <tr> <td></td> <td></td> <td colspan="8" style="text-align: center;"> <table border="1" style="width: 100%; border-collapse: collapse; text-align: center;"> <tr> <td style="width: 10%;"></td> <td style="width: 10%;"></td> <td style="width: 10%;"></td> <td style="width: 10%;"></td> <td style="width: 10%;"></td> <td style="width: 10%;"></td> <td style="width: 10%;"></td> <td style="width: 10%;"></td> <td style="width: 10%;"></td> <td style="width: 10%;"></td> </tr> <tr> <td></td> <td></td> <td colspan="8" style="text-align: center;"> <table border="1" style="width: 100%; border-collapse: collapse; text-align: center;"> <tr> <td style="width: 10%;"></td> <td style="width: 10%;"></td> <td style="width: 10%;"></td> <td style="width: 10%;"></td> <td style="width: 10%;"></td> <td style="width: 10%;"></td> <td style="width: 10%;"></td> <td style="width: 10%;"></td> <td style="width: 10%;"></td> <td style="width: 10%;"></td> </tr> <tr> <td></td> <td></td> <td colspan="8" style="text-align: center;"> <table border="1" style="width: 100%; border-collapse: collapse; text-align: center;"> <tr> </tr></table></td></tr></table></td></tr></table></td></tr></table></td></tr></table></td></tr></table></td></tr></table></td></tr></table></td></tr></table></td></tr></table></td></tr></table></td></tr></table></td></tr></table></td></tr></table></td></tr></table></td></tr></table>
 | | | | | | | | | | | | | | | | | | | | <table border="1" style="width: 100%; border-collapse: collapse; text-align: center;"> <tr> <td style="width: 10%;"></td> <td style="width: 10%;"></td> <td style="width: 10%;"></td> <td style="width: 10%;"></td> <td style="width: 10%;"></td> <td style="width: 10%;"></td> <td style="width: 10%;"></td> <td style="width: 10%;"></td> <td style="width: 10%;"></td> <td style="width: 10%;"></td> </tr> <tr> <td></td> <td></td> <td colspan="8" style="text-align: center;"> <table border="1" style="width: 100%; border-collapse: collapse; text-align: center;"> <tr> <td style="width: 10%;"></td> <td style="width: 10%;"></td> <td style="width: 10%;"></td> <td style="width: 10%;"></td> <td style="width: 10%;"></td> <td style="width: 10%;"></td> <td style="width: 10%;"></td> <td style="width: 10%;"></td> <td style="width: 10%;"></td> <td style="width: 10%;"></td> </tr> <tr> <td></td> <td></td> <td colspan="8" style="text-align: center;"> <table border="1" style="width: 100%; border-collapse: collapse; text-align: center;"> <tr> <td style="width: 10%;"></td> <td style="width: 10%;"></td> <td style="width: 10%;"></td> <td style="width: 10%;"></td> <td style="width: 10%;"></td> <td style="width: 10%;"></td> <td style="width: 10%;"></td> <td style="width: 10%;"></td> <td style="width: 10%;"></td> <td style="width: 10%;"></td> </tr> <tr> <td></td> <td></td> <td colspan="8" style="text-align: center;"> <table border="1" style="width: 100%; border-collapse: collapse; text-align: center;"> <tr> <td style="width: 10%;"></td> <td style="width: 10%;"></td> <td style="width: 10%;"></td> <td style="width: 10%;"></td> <td style="width: 10%;"></td> <td style="width: 10%;"></td> <td style="width: 10%;"></td> <td style="width: 10%;"></td> <td style="width: 10%;"></td> <td style="width: 10%;"></td> </tr> <tr> <td></td> <td></td> <td colspan="8" style="text-align: center;"> <table border="1" style="width: 100%; border-collapse: collapse; text-align: center;"> <tr> <td style="width: 10%;"></td> <td style="width: 10%;"></td> <td style="width: 10%;"></td> <td style="width: 10%;"></td> <td style="width: 10%;"></td> <td style="width: 10%;"></td> <td style="width: 10%;"></td> <td style="width: 10%;"></td> <td style="width: 10%;"></td> <td style="width: 10%;"></td> </tr> <tr> <td></td> <td></td> <td colspan="8" style="text-align: center;"> <table border="1" style="width: 100%; border-collapse: collapse; text-align: center;"> <tr> <td style="width: 10%;"></td> <td style="width: 10%;"></td> <td style="width: 10%;"></td> <td style="width: 10%;"></td> <td style="width: 10%;"></td> <td style="width: 10%;"></td> <td style="width: 10%;"></td> <td style="width: 10%;"></td> <td style="width: 10%;"></td> <td style="width: 10%;"></td> </tr> <tr> <td></td> <td></td> <td colspan="8" style="text-align: center;"> <table border="1" style="width: 100%; border-collapse: collapse; text-align: center;"> <tr> <td style="width: 10%;"></td> <td style="width: 10%;"></td> <td style="width: 10%;"></td> <td style="width: 10%;"></td> <td style="width: 10%;"></td> <td style="width: 10%;"></td> <td style="width: 10%;"></td> <td style="width: 10%;"></td> <td style="width: 10%;"></td> <td style="width: 10%;"></td> </tr> <tr> <td></td> <td></td> <td colspan="8" style="text-align: center;"> <table border="1" style="width: 100%; border-collapse: collapse; text-align: center;"> <tr> <td style="width: 10%;"></td> <td style="width: 10%;"></td> <td style="width: 10%;"></td> <td style="width: 10%;"></td> <td style="width: 10%;"></td> <td style="width: 10%;"></td> <td style="width: 10%;"></td> <td style="width: 10%;"></td> <td style="width: 10%;"></td> <td style="width: 10%;"></td> </tr> <tr> <td></td> <td></td> <td colspan="8" style="text-align: center;"> <table border="1" style="width: 100%; border-collapse: collapse; text-align: center;"> <tr> <td style="width: 10%;"></td> <td style="width: 10%;"></td> <td style="width: 10%;"></td> <td style="width: 10%;"></td> <td style="width: 10%;"></td> <td style="width: 10%;"></td> <td style="width: 10%;"></td> <td style="width: 10%;"></td> <td style="width: 10%;"></td> <td style="width: 10%;"></td> </tr> <tr> <td></td> <td></td> <td colspan="8" style="text-align: center;"> <table border="1" style="width: 100%; border-collapse: collapse; text-align: center;"> <tr> <td style="width: 10%;"></td> <td style="width: 10%;"></td> <td style="width: 10%;"></td> <td style="width: 10%;"></td> <td style="width: 10%;"></td> <td style="width: 10%;"></td> <td style="width: 10%;"></td> <td style="width: 10%;"></td> <td style="width: 10%;"></td> <td style="width: 10%;"></td> </tr> <tr> <td></td> <td></td> <td colspan="8" style="text-align: center;"> <table border="1" style="width: 100%; border-collapse: collapse; text-align: center;"> <tr> <td style="width: 10%;"></td> <td style="width: 10%;"></td> <td style="width: 10%;"></td> <td style="width: 10%;"></td> <td style="width: 10%;"></td> <td style="width: 10%;"></td> <td style="width: 10%;"></td> <td style="width: 10%;"></td> <td style="width: 10%;"></td> <td style="width: 10%;"></td> </tr> <tr> <td></td> <td></td> <td colspan="8" style="text-align: center;"> <table border="1" style="width: 100%; border-collapse: collapse; text-align: center;"> <tr> <td style="width: 10%;"></td> <td style="width: 10%;"></td> <td style="width: 10%;"></td> <td style="width: 10%;"></td> <td style="width: 10%;"></td> <td style="width: 10%;"></td> <td style="width: 10%;"></td> <td style="width: 10%;"></td> <td style="width: 10%;"></td> <td style="width: 10%;"></td> </tr> <tr> <td></td> <td></td> <td colspan="8" style="text-align: center;"> <table border="1" style="width: 100%; border-collapse: collapse; text-align: center;"> <tr> <td style="width: 10%;"></td> <td style="width: 10%;"></td> <td style="width: 10%;"></td> <td style="width: 10%;"></td> <td style="width: 10%;"></td> <td style="width: 10%;"></td> <td style="width: 10%;"></td> <td style="width: 10%;"></td> <td style="width: 10%;"></td> <td style="width: 10%;"></td> </tr> <tr> <td></td> <td></td> <td colspan="8" style="text-align: center;"> <table border="1" style="width: 100%; border-collapse: collapse; text-align: center;"> <tr> <td style="width: 10%;"></td> <td style="width: 10%;"></td> <td style="width: 10%;"></td> <td style="width: 10%;"></td> <td style="width: 10%;"></td> <td style="width: 10%;"></td> <td style="width: 10%;"></td> <td style="width: 10%;"></td> <td style="width: 10%;"></td> <td style="width: 10%;"></td> </tr> <tr> <td></td> <td></td> <td colspan="8" style="text-align: center;"> <table border="1" style="width: 100%; border-collapse: collapse; text-align: center;"> <tr> </tr></table></td></tr></table></td></tr></table></td></tr></table></td></tr></table></td></tr></table></td></tr></table></td></tr></table></td></tr></table></td></tr></table></td></tr></table></td></tr></table></td></tr></table></td></tr></table></td></tr></table>
 | | | | | | | | | | | | | | | | | | | | <table border="1" style="width: 100%; border-collapse: collapse; text-align: center;"> <tr> <td style="width: 10%;"></td> <td style="width: 10%;"></td> <td style="width: 10%;"></td> <td style="width: 10%;"></td> <td style="width: 10%;"></td> <td style="width: 10%;"></td> <td style="width: 10%;"></td> <td style="width: 10%;"></td> <td style="width: 10%;"></td> <td style="width: 10%;"></td> </tr> <tr> <td></td> <td></td> <td colspan="8" style="text-align: center;"> <table border="1" style="width: 100%; border-collapse: collapse; text-align: center;"> <tr> <td style="width: 10%;"></td> <td style="width: 10%;"></td> <td style="width: 10%;"></td> <td style="width: 10%;"></td> <td style="width: 10%;"></td> <td style="width: 10%;"></td> <td style="width: 10%;"></td> <td style="width: 10%;"></td> <td style="width: 10%;"></td> <td style="width: 10%;"></td> </tr> <tr> <td></td> <td></td> <td colspan="8" style="text-align: center;"> <table border="1" style="width: 100%; border-collapse: collapse; text-align: center;"> <tr> <td style="width: 10%;"></td> <td style="width: 10%;"></td> <td style="width: 10%;"></td> <td style="width: 10%;"></td> <td style="width: 10%;"></td> <td style="width: 10%;"></td> <td style="width: 10%;"></td> <td style="width: 10%;"></td> <td style="width: 10%;"></td> <td style="width: 10%;"></td> </tr> <tr> <td></td> <td></td> <td colspan="8" style="text-align: center;"> <table border="1" style="width: 100%; border-collapse: collapse; text-align: center;"> <tr> <td style="width: 10%;"></td> <td style="width: 10%;"></td> <td style="width: 10%;"></td> <td style="width: 10%;"></td> <td style="width: 10%;"></td> <td style="width: 10%;"></td> <td style="width: 10%;"></td> <td style="width: 10%;"></td> <td style="width: 10%;"></td> <td style="width: 10%;"></td> </tr> <tr> <td></td> <td></td> <td colspan="8" style="text-align: center;"> <table border="1" style="width: 100%; border-collapse: collapse; text-align: center;"> <tr> <td style="width: 10%;"></td> <td style="width: 10%;"></td> <td style="width: 10%;"></td> <td style="width: 10%;"></td> <td style="width: 10%;"></td> <td style="width: 10%;"></td> <td style="width: 10%;"></td> <td style="width: 10%;"></td> <td style="width: 10%;"></td> <td style="width: 10%;"></td> </tr> <tr> <td></td> <td></td> <td colspan="8" style="text-align: center;"> <table border="1" style="width: 100%; border-collapse: collapse; text-align: center;"> <tr> <td style="width: 10%;"></td> <td style="width: 10%;"></td> <td style="width: 10%;"></td> <td style="width: 10%;"></td> <td style="width: 10%;"></td> <td style="width: 10%;"></td> <td style="width: 10%;"></td> <td style="width: 10%;"></td> <td style="width: 10%;"></td> <td style="width: 10%;"></td> </tr> <tr> <td></td> <td></td> <td colspan="8" style="text-align: center;"> <table border="1" style="width: 100%; border-collapse: collapse; text-align: center;"> <tr> <td style="width: 10%;"></td> <td style="width: 10%;"></td> <td style="width: 10%;"></td> <td style="width: 10%;"></td> <td style="width: 10%;"></td> <td style="width: 10%;"></td> <td style="width: 10%;"></td> <td style="width: 10%;"></td> <td style="width: 10%;"></td> <td style="width: 10%;"></td> </tr> <tr> <td></td> <td></td> <td colspan="8" style="text-align: center;"> <table border="1" style="width: 100%; border-collapse: collapse; text-align: center;"> <tr> <td style="width: 10%;"></td> <td style="width: 10%;"></td> <td style="width: 10%;"></td> <td style="width: 10%;"></td> <td style="width: 10%;"></td> <td style="width: 10%;"></td> <td style="width: 10%;"></td> <td style="width: 10%;"></td> <td style="width: 10%;"></td> <td style="width: 10%;"></td> </tr> <tr> <td></td> <td></td> <td colspan="8" style="text-align: center;"> <table border="1" style="width: 100%; border-collapse: collapse; text-align: center;"> <tr> <td style="width: 10%;"></td> <td style="width: 10%;"></td> <td style="width: 10%;"></td> <td style="width: 10%;"></td> <td style="width: 10%;"></td> <td style="width: 10%;"></td> <td style="width: 10%;"></td> <td style="width: 10%;"></td> <td style="width: 10%;"></td> <td style="width: 10%;"></td> </tr> <tr> <td></td> <td></td> <td
colspan="8" style="text-align: center;"> <table border="1" style="width: 100%; border-collapse: collapse; text-align: center;"> <tr> <td style="width: 10%;"></td> <td style="width: 10%;"></td> <td style="width: 10%;"></td> <td style="width: 10%;"></td> <td style="width: 10%;"></td> <td style="width: 10%;"></td> <td style="width: 10%;"></td> <td style="width: 10%;"></td> <td style="width: 10%;"></td> <td style="width: 10%;"></td> </tr> <tr> <td></td> <td></td> <td colspan="8" style="text-align: center;"> <table border="1" style="width: 100%; border-collapse: collapse; text-align: center;"> <tr> <td style="width: 10%;"></td> <td style="width: 10%;"></td> <td style="width: 10%;"></td> <td style="width: 10%;"></td> <td style="width: 10%;"></td> <td style="width: 10%;"></td> <td style="width: 10%;"></td> <td style="width: 10%;"></td> <td style="width: 10%;"></td> <td style="width: 10%;"></td> </tr> <tr> <td></td> <td></td> <td colspan="8" style="text-align: center;"> <table border="1" style="width: 100%; border-collapse: collapse; text-align: center;"> <tr> <td style="width: 10%;"></td> <td style="width: 10%;"></td> <td style="width: 10%;"></td> <td style="width: 10%;"></td> <td style="width: 10%;"></td> <td style="width: 10%;"></td> <td style="width: 10%;"></td> <td style="width: 10%;"></td> <td style="width: 10%;"></td> <td style="width: 10%;"></td> </tr> <tr> <td></td> <td></td> <td colspan="8" style="text-align: center;"> <table border="1" style="width: 100%; border-collapse: collapse; text-align: center;"> <tr> <td style="width: 10%;"></td> <td style="width: 10%;"></td> <td style="width: 10%;"></td> <td style="width: 10%;"></td> <td style="width: 10%;"></td> <td style="width: 10%;"></td> <td style="width: 10%;"></td> <td style="width: 10%;"></td> <td style="width: 10%;"></td> <td style="width: 10%;"></td> </tr> <tr> <td></td> <td></td> <td colspan="8" style="text-align: center;"> <table border="1" style="width: 100%; border-collapse: collapse; text-align: center;"> <tr> </tr></table></td></tr></table></td></tr></table></td></tr></table></td></tr></table></td></tr></table></td></tr></table></td></tr></table></td></tr></table></td></tr></table></td></tr></table></td></tr></table></td></tr></table></td></tr></table>
 | | | | | | | | | | | | | | | | | | | | <table border="1" style="width: 100%; border-collapse: collapse; text-align: center;"> <tr> <td style="width: 10%;"></td> <td style="width: 10%;"></td> <td style="width: 10%;"></td> <td style="width: 10%;"></td> <td style="width: 10%;"></td> <td style="width: 10%;"></td> <td style="width: 10%;"></td> <td style="width: 10%;"></td> <td style="width: 10%;"></td> <td style="width: 10%;"></td> </tr> <tr> <td></td> <td></td> <td colspan="8" style="text-align: center;"> <table border="1" style="width: 100%; border-collapse: collapse; text-align: center;"> <tr> <td style="width: 10%;"></td> <td style="width: 10%;"></td> <td style="width: 10%;"></td> <td style="width: 10%;"></td> <td style="width: 10%;"></td> <td style="width: 10%;"></td> <td style="width: 10%;"></td> <td style="width: 10%;"></td> <td style="width: 10%;"></td> <td style="width: 10%;"></td> </tr> <tr> <td></td> <td></td> <td colspan="8" style="text-align: center;"> <table border="1" style="width: 100%; border-collapse: collapse; text-align: center;"> <tr> <td style="width: 10%;"></td> <td style="width: 10%;"></td> <td style="width: 10%;"></td> <td style="width: 10%;"></td> <td style="width: 10%;"></td> <td style="width: 10%;"></td> <td style="width: 10%;"></td> <td style="width: 10%;"></td> <td style="width: 10%;"></td> <td style="width: 10%;"></td> </tr> <tr> <td></td> <td></td> <td colspan="8" style="text-align: center;"> <table border="1" style="width: 100%; border-collapse: collapse; text-align: center;"> <tr> <td style="width: 10%;"></td> <td style="width: 10%;"></td> <td style="width: 10%;"></td> <td style="width: 10%;"></td> <td style="width: 10%;"></td> <td style="width: 10%;"></td> <td style="width: 10%;"></td> <td style="width: 10%;"></td> <td style="width: 10%;"></td> <td style="width: 10%;"></td> </tr> <tr> <td></td> <td></td> <td colspan="8" style="text-align: center;"> <table border="1" style="width: 100%; border-collapse: collapse; text-align: center;"> <tr> <td style="width: 10%;"></td> <td style="width: 10%;"></td> <td style="width: 10%;"></td> <td style="width: 10%;"></td> <td style="width: 10%;"></td> <td style="width: 10%;"></td> <td style="width: 10%;"></td> <td style="width: 10%;"></td> <td style="width: 10%;"></td> <td style="width: 10%;"></td> </tr> <tr> <td></td> <td></td> <td colspan="8" style="text-align: center;"> <table border="1" style="width: 100%; border-collapse: collapse; text-align: center;"> <tr> <td style="width: 10%;"></td> <td style="width: 10%;"></td> <td style="width: 10%;"></td> <td style="width: 10%;"></td> <td style="width: 10%;"></td> <td style="width: 10%;"></td> <td style="width: 10%;"></td> <td style="width: 10%;"></td> <td style="width: 10%;"></td> <td style="width: 10%;"></td> </tr> <tr> <td></td> <td></td> <td colspan="8" style="text-align: center;"> <table border="1" style="width: 100%; border-collapse: collapse; text-align: center;"> <tr> <td style="width: 10%;"></td> <td style="width: 10%;"></td> <td style="width: 10%;"></td> <td style="width: 10%;"></td> <td style="width: 10%;"></td> <td style="width: 10%;"></td> <td style="width: 10%;"></td> <td style="width: 10%;"></td> <td style="width: 10%;"></td> <td style="width: 10%;"></td> </tr> <tr> <td></td> <td></td> <td colspan="8" style="text-align: center;"> <table border="1" style="width: 100%; border-collapse: collapse; text-align: center;"> <tr> <td style="width: 10%;"></td> <td style="width: 10%;"></td> <td style="width: 10%;"></td> <td style="width: 10%;"></td> <td style="width: 10%;"></td> <td style="width: 10%;"></td> <td style="width: 10%;"></td> <td style="width: 10%;"></td> <td style="width: 10%;"></td> <td style="width: 10%;"></td> </tr> <tr> <td></td> <td></td> <td colspan="8" style="text-align: center;"> <table border="1" style="width: 100%; border-collapse: collapse; text-align: center;"> <tr> <td style="width: 10%;"></td> <td style="width: 10%;"></td> <td style="width: 10%;"></td> <td style="width: 10%;"></td> <td style="width: 10%;"></td> <td style="width: 10%;"></td> <td style="width: 10%;"></td> <td style="width: 10%;"></td> <td style="width: 10%;"></td> <td style="width: 10%;"></td> </tr> <tr> <td></td> <td></td> <td colspan="8" style="text-align: center;"> <table border="1" style="width: 100%; border-collapse: collapse; text-align: center;"> <tr> <td style="width: 10%;"></td> <td style="width: 10%;"></td> <td style="width: 10%;"></td> <td style="width: 10%;"></td> <td style="width: 10%;"></td> <td style="width: 10%;"></td> <td style="width: 10%;"></td> <td style="width: 10%;"></td> <td style="width: 10%;"></td> <td style="width: 10%;"></td> </tr> <tr> <td></td> <td></td> <td colspan="8" style="text-align: center;"> <table border="1" style="width: 100%; border-collapse: collapse; text-align: center;"> <tr> <td style="width: 10%;"></td> <td style="width: 10%;"></td> <td style="width: 10%;"></td> <td style="width: 10%;"></td> <td style="width: 10%;"></td> <td style="width: 10%;"></td> <td style="width: 10%;"></td> <td style="width: 10%;"></td> <td style="width: 10%;"></td> <td style="width: 10%;"></td> </tr> <tr> <td></td> <td></td> <td colspan="8" style="text-align: center;"> <table border="1" style="width: 100%; border-collapse: collapse; text-align: center;"> <tr> <td style="width: 10%;"></td> <td style="width: 10%;"></td> <td style="width: 10%;"></td> <td style="width: 10%;"></td> <td style="width: 10%;"></td> <td style="width: 10%;"></td> <td style="width: 10%;"></td> <td style="width: 10%;"></td> <td style="width: 10%;"></td> <td style="width: 10%;"></td> </tr> <tr> <td></td> <td></td> <td colspan="8" style="text-align: center;"> <table border="1" style="width: 100%; border-collapse: collapse; text-align: center;"> <tr> </tr></table></td></tr></table></td></tr></table></td></tr></table></td></tr></table></td></tr></table></td></tr></table></td></tr></table></td></tr></table></td></tr></table></td></tr></table></td></tr></table></td></tr></table>
 | | | | | | | | | | | | | | | | | | | | <table border="1" style="width: 100%; border-collapse: collapse; text-align: center;"> <tr> <td style="width: 10%;"></td> <td style="width: 10%;"></td> <td style="width: 10%;"></td> <td style="width: 10%;"></td> <td style="width: 10%;"></td> <td style="width: 10%;"></td> <td style="width: 10%;"></td> <td style="width: 10%;"></td> <td style="width: 10%;"></td> <td style="width: 10%;"></td> </tr> <tr> <td></td> <td></td> <td colspan="8" style="text-align: center;"> <table border="1" style="width: 100%; border-collapse: collapse; text-align: center;"> <tr> <td style="width: 10%;"></td> <td style="width: 10%;"></td> <td style="width: 10%;"></td> <td style="width: 10%;"></td> <td style="width: 10%;"></td> <td style="width: 10%;"></td> <td style="width: 10%;"></td> <td style="width: 10%;"></td> <td style="width: 10%;"></td> <td style="width: 10%;"></td> </tr> <tr> <td></td> <td></td> <td colspan="8" style="text-align: center;"> <table border="1" style="width: 100%; border-collapse: collapse; text-align: center;"> <tr> <td style="width: 10%;"></td> <td style="width: 10%;"></td> <td style="width: 10%;"></td> <td style="width: 10%;"></td> <td style="width: 10%;"></td> <td style="width: 10%;"></td> <td style="width: 10%;"></td> <td style="width: 10%;"></td> <td style="width: 10%;"></td> <td style="width: 10%;"></td> </tr> <tr> <td></td> <td></td> <td colspan="8" style="text-align: center;"> <table border="1" style="width: 100%; border-collapse: collapse; text-align: center;"> <tr> <td style="width: 10%;"></td> <td style="width: 10%;"></td> <td style="width: 10%;"></td> <td style="width: 10%;"></td> <td style="width: 10%;"></td> <td style="width: 10%;"></td> <td style="width: 10%;"></td> <td style="width: 10%;"></td> <td style="width: 10%;"></td> <td style="width: 10%;"></td> </tr> <tr> <td></td> <td></td> <td colspan="8" style="text-align: center;"> <table border="1" style="width: 100%; border-collapse: collapse; text-align: center;"> <tr> <td style="width: 10%;"></td> <td style="width: 10%;"></td> <td style="width: 10%;"></td> <td style="width: 10%;"></td> <td style="width: 10%;"></td> <td style="width: 10%;"></td> <td style="width: 10%;"></td> <td style="width: 10%;"></td> <td style="width: 10%;"></td> <td style="width: 10%;"></td> </tr> <tr> <td></td> <td></td> <td colspan="8" style="text-align: center;"> <table border="1" style="width: 100%; border-collapse: collapse; text-align: center;"> <tr> <td style="width: 10%;"></td> <td style="width: 10%;"></td> <td style="width: 10%;"></td> <td style="width: 10%;"></td> <td style="width: 10%;"></td> <td style="width: 10%;"></td> <td style="width: 10%;"></td> <td style="width: 10%;"></td> <td style="width: 10%;"></td> <td style="width: 10%;"></td> </tr> <tr> <td></td> <td></td> <td colspan="8" style="text-align: center;"> <table border="1" style="width: 100%; border-collapse: collapse; text-align: center;"> <tr> <td style="width: 10%;"></td> <td style="width: 10%;"></td> <td style="width: 10%;"></td> <td style="width: 10%;"></td> <td style="width: 10%;"></td> <td style="width: 10%;"></td> <td style="width: 10%;"></td> <td style="width: 10%;"></td> <td style="width: 10%;"></td> <td style="width: 10%;"></td> </tr> <tr> <td></td> <td></td> <td colspan="8" style="text-align: center;"> <table border="1" style="width: 100%; border-collapse: collapse; text-align: center;"> <tr> <td style="width: 10%;"></td> <td style="width: 10%;"></td> <td style="width: 10%;"></td> <td style="width: 10%;"></td> <td style="width: 10%;"></td> <td style="width: 10%;"></td> <td style="width: 10%;"></td> <td style="width: 10%;"></td> <td style="width: 10%;"></td> <td style="width: 10%;"></td> </tr> <tr> <td></td> <td></td> <td colspan="8" style="text-align: center;"> <table border="1" style="width: 100%; border-collapse: collapse; text-align: center;"> <tr> <td style="width: 10%;"></td> <td style="width: 10%;"></td> <td style="width: 10%;"></td> <td style="width: 10%;"></td> <td style="width: 10%;"></td> <td style="width: 10%;"></td> <td style="width: 10%;"></td> <td style="width: 10%;"></td> <td style="width: 10%;"></td> <td style="width: 10%;"></td> </tr> <tr> <td></td> <td></td> <td colspan="8" style="text-align: center;"> <table border="1" style="width: 100%; border-collapse: collapse; text-align: center;"> <tr> <td style="width: 10%;"></td> <td style="width: 10%;"></td> <td style="width: 10%;"></td> <td style="width: 10%;"></td> <td style="width: 10%;"></td> <td style="width: 10%;"></td> <td style="width: 10%;"></td> <td style="width: 10%;"></td> <td style="width: 10%;"></td> <td style="width: 10%;"></td> </tr> <tr> <td></td> <td></td> <td colspan="8" style="text-align: center;"> <table border="1" style="width: 100%; border-collapse: collapse; text-align: center;"> <tr> <td style="width: 10%;"></td> <td style="width: 10%;"></td> <td style="width: 10%;"></td> <td style="width: 10%;"></td> <td style="width: 10%;"></td> <td style="width: 10%;"></td> <td style="width: 10%;"></td> <td style="width: 10%;"></td> <td style="width: 10%;"></td> <td style="width: 10%;"></td> </tr> <tr> <td></td> <td></td> <td colspan="8" style="text-align: center;"> <table border="1" style="width: 100%; border-collapse: collapse; text-align: center;"> <tr> </tr></table></td></tr></table></td></tr></table></td></tr></table></td></tr></table></td></tr></table></td></tr></table></td></tr></table></td></tr></table></td></tr></table></td></tr></table></td></tr></table>
 | | | | | | | | | | | | | | | | | | | | <table border="1" style="width: 100%; border-collapse: collapse; text-align: center;"> <tr> <td style="width: 10%;"></td> <td style="width: 10%;"></td> <td style="width: 10%;"></td> <td style="width: 10%;"></td> <td style="width: 10%;"></td> <td style="width: 10%;"></td> <td style="width: 10%;"></td> <td style="width: 10%;"></td> <td style="width: 10%;"></td> <td style="width: 10%;"></td> </tr> <tr> <td></td> <td></td> <td colspan="8" style="text-align: center;"> <table border="1" style="width: 100%; border-collapse: collapse; text-align: center;"> <tr> <td style="width: 10%;"></td> <td style="width: 10%;"></td> <td style="width: 10%;"></td> <td style="width: 10%;"></td> <td style="width: 10%;"></td> <td style="width: 10%;"></td> <td style="width: 10%;"></td> <td style="width: 10%;"></td> <td style="width: 10%;"></td> <td style="width: 10%;"></td> </tr> <tr> <td></td> <td></td> <td colspan="8" style="text-align: center;"> <table border="1" style="width: 100%; border-collapse: collapse; text-align: center;"> <tr> <td style="width: 10%;"></td> <td style="width: 10%;"></td> <td style="width: 10%;"></td> <td style="width: 10%;"></td> <td style="width: 10%;"></td> <td style="width: 10%;"></td> <td style="width: 10%;"></td> <td style="width: 10%;"></td> <td style="width: 10%;"></td> <td style="width: 10%;"></td> </tr> <tr> <td></td> <td></td> <td colspan="8" style="text-align: center;"> <table border="1" style="width: 100%; border-collapse: collapse; text-align: center;"> <tr> <td style="width: 10%;"></td> <td style="width: 10%;"></td> <td style="width: 10%;"></td> <td style="width: 10%;"></td> <td style="width: 10%;"></td> <td style="width: 10%;"></td> <td style="width: 10%;"></td> <td style="width: 10%;"></td> <td style="width: 10%;"></td> <td style="width: 10%;"></td> </tr> <tr> <td></td> <td></td> <td colspan="8" style="text-align: center;"> <table border="1" style="width: 100%; border-collapse: collapse; text-align: center;"> <tr> <td style="width: 10%;"></td> <td style="width: 10%;"></td> <td style="width: 10%;"></td> <td style="width: 10%;"></td> <td style="width: 10%;"></td> <td style="width: 10%;"></td> <td style="width: 10%;"></td> <td style="width: 10%;"></td> <td style="width: 10%;"></td> <td style="width: 10%;"></td> </tr> <tr> <td></td> <td></td> <td colspan="8" style="text-align: center;"> <table border="1" style="width: 100%; border-collapse: collapse; text-align: center;"> <tr> <td style="width: 10%;"></td> <td style="width: 10%;"></td> <td style="width: 10%;"></td> <td style="width: 10%;"></td> <td style="width: 10%;"></td> <td style="width: 10%;"></td> <td style="width: 10%;"></td> <td style="width: 10%;"></td> <td style="width: 10%;"></td> <td style="width: 10%;"></td> </tr> <tr> <td></td> <td></td> <td colspan="8" style="text-align: center;"> <table border="1" style="width: 100%;
border-collapse: collapse; text-align: center;"> <tr> <td style="width: 10%;"></td> <td style="width: 10%;"></td> <td style="width: 10%;"></td> <td style="width: 10%;"></td> <td style="width: 10%;"></td> <td style="width: 10%;"></td> <td style="width: 10%;"></td> <td style="width: 10%;"></td> <td style="width: 10%;"></td> <td style="width: 10%;"></td> </tr> <tr> <td></td> <td></td> <td colspan="8" style="text-align: center;"> <table border="1" style="width: 100%; border-collapse: collapse; text-align: center;"> <tr> <td style="width: 10%;"></td> <td style="width: 10%;"></td> <td style="width: 10%;"></td> <td style="width: 10%;"></td> <td style="width: 10%;"></td> <td style="width: 10%;"></td> <td style="width: 10%;"></td> <td style="width: 10%;"></td> <td style="width: 10%;"></td> <td style="width: 10%;"></td> </tr> <tr> <td></td> <td></td> <td colspan="8" style="text-align: center;"> <table border="1" style="width: 100%; border-collapse: collapse; text-align: center;"> <tr> <td style="width: 10%;"></td> <td style="width: 10%;"></td> <td style="width: 10%;"></td> <td style="width: 10%;"></td> <td style="width: 10%;"></td> <td style="width: 10%;"></td> <td style="width: 10%;"></td> <td style="width: 10%;"></td> <td style="width: 10%;"></td> <td style="width: 10%;"></td> </tr> <tr> <td></td> <td></td> <td colspan="8" style="text-align: center;"> <table border="1" style="width: 100%; border-collapse: collapse; text-align: center;"> <tr> <td style="width: 10%;"></td> <td style="width: 10%;"></td> <td style="width: 10%;"></td> <td style="width: 10%;"></td> <td style="width: 10%;"></td> <td style="width: 10%;"></td> <td style="width: 10%;"></td> <td style="width: 10%;"></td> <td style="width: 10%;"></td> <td style="width: 10%;"></td> </tr> <tr> <td></td> <td></td> <td colspan="8" style="text-align: center;"> <table border="1" style="width: 100%; border-collapse: collapse; text-align: center;"> <tr> </tr></table></td></tr></table></td></tr></table></td></tr></table></td></tr></table></td></tr></table></td></tr></table></td></tr></table></td></tr></table></td></tr></table></td></tr></table> | | | | | | | | | | | | | | | | | | | | <table border="1" style="width: 100%;
border-collapse: collapse; text-align: center;"> <tr> <td style="width: 10%;"></td> <td style="width: 10%;"></td> <td style="width: 10%;"></td> <td style="width: 10%;"></td> <td style="width: 10%;"></td> <td style="width: 10%;"></td> <td style="width: 10%;"></td> <td style="width: 10%;"></td> <td style="width: 10%;"></td> <td style="width: 10%;"></td> </tr> <tr> <td></td> <td></td> <td colspan="8" style="text-align: center;"> <table border="1" style="width: 100%; border-collapse: collapse; text-align: center;"> <tr> <td style="width: 10%;"></td> <td style="width: 10%;"></td> <td style="width: 10%;"></td> <td style="width: 10%;"></td> <td style="width: 10%;"></td> <td style="width: 10%;"></td> <td style="width: 10%;"></td> <td style="width: 10%;"></td> <td style="width: 10%;"></td> <td style="width: 10%;"></td> </tr> <tr> <td></td> <td></td> <td colspan="8" style="text-align: center;"> <table border="1" style="width: 100%; border-collapse: collapse; text-align: center;"> <tr> <td style="width: 10%;"></td> <td style="width: 10%;"></td> <td style="width: 10%;"></td> <td style="width: 10%;"></td> <td style="width: 10%;"></td> <td style="width: 10%;"></td> <td style="width: 10%;"></td> <td style="width: 10%;"></td> <td style="width: 10%;"></td> <td style="width: 10%;"></td> </tr> <tr> <td></td> <td></td> <td colspan="8" style="text-align: center;"> <table border="1" style="width: 100%; border-collapse: collapse; text-align: center;"> <tr> <td style="width: 10%;"></td> <td style="width: 10%;"></td> <td style="width: 10%;"></td> <td style="width: 10%;"></td> <td style="width: 10%;"></td> <td style="width: 10%;"></td> <td style="width: 10%;"></td> <td style="width: 10%;"></td> <td style="width: 10%;"></td> <td style="width: 10%;"></td> </tr> <tr> <td></td> <td></td> <td colspan="8" style="text-align: center;"> <table border="1" style="width: 100%; border-collapse: collapse; text-align: center;"> <tr> <td style="width: 10%;"></td> <td style="width: 10%;"></td> <td style="width: 10%;"></td> <td style="width: 10%;"></td> <td style="width: 10%;"></td> <td style="width: 10%;"></td> <td style="width: 10%;"></td> <td style="width: 10%;"></td> <td style="width: 10%;"></td> <td style="width: 10%;"></td> </tr> <tr> <td></td> <td></td> <td colspan="8" style="text-align: center;"> <table border="1" style="width: 100%; border-collapse: collapse; text-align: center;"> <tr> <td style="width: 10%;"></td> <td style="width: 10%;"></td> <td style="width: 10%;"></td> <td style="width: 10%;"></td> <td style="width: 10%;"></td> <td style="width: 10%;"></td> <td style="width: 10%;"></td> <td style="width: 10%;"></td> <td style="width: 10%;"></td> <td style="width: 10%;"></td> </tr> <tr> <td></td> <td></td> <td colspan="8" style="text-align: center;"> <table border="1" style="width: 100%; border-collapse: collapse; text-align: center;"> <tr> <td style="width: 10%;"></td> <td style="width: 10%;"></td> <td style="width: 10%;"></td> <td style="width: 10%;"></td> <td style="width: 10%;"></td> <td style="width: 10%;"></td> <td style="width: 10%;"></td> <td style="width: 10%;"></td> <td style="width: 10%;"></td> <td style="width: 10%;"></td> </tr> <tr> <td></td> <td></td> <td colspan="8" style="text-align: center;"> <table border="1" style="width: 100%; border-collapse: collapse; text-align: center;"> <tr> <td style="width: 10%;"></td> <td style="width: 10%;"></td> <td style="width: 10%;"></td> <td style="width: 10%;"></td> <td style="width: 10%;"></td> <td style="width: 10%;"></td> <td style="width: 10%;"></td> <td style="width: 10%;"></td> <td style="width: 10%;"></td> <td style="width: 10%;"></td> </tr> <tr> <td></td> <td></td> <td colspan="8" style="text-align: center;"> <table border="1" style="width: 100%; border-collapse: collapse; text-align: center;"> <tr> <td style="width: 10%;"></td> <td style="width: 10%;"></td> <td style="width: 10%;"></td> <td style="width: 10%;"></td> <td style="width: 10%;"></td> <td style="width: 10%;"></td> <td style="width: 10%;"></td> <td style="width: 10%;"></td> <td style="width: 10%;"></td> <td style="width: 10%;"></td> </tr> <tr> <td></td> <td></td> <td colspan="8" style="text-align: center;"> <table border="1" style="width: 100%; border-collapse: collapse; text-align: center;"> <tr> </tr></table></td></tr></table></td></tr></table></td></tr></table></td></tr></table></td></tr></table></td></tr></table></td></tr></table></td></tr></table></td></tr></table>
 | | | | | | | | | | | | | | | | | | | | <table border="1" style="width: 100%; border-collapse: collapse; text-align: center;"> <tr> <td style="width: 10%;"></td> <td style="width: 10%;"></td> <td style="width: 10%;"></td> <td style="width: 10%;"></td> <td style="width: 10%;"></td> <td style="width: 10%;"></td> <td style="width: 10%;"></td> <td style="width: 10%;"></td> <td style="width: 10%;"></td> <td style="width: 10%;"></td> </tr> <tr> <td></td> <td></td> <td colspan="8" style="text-align: center;"> <table border="1" style="width: 100%; border-collapse: collapse; text-align: center;"> <tr> <td style="width: 10%;"></td> <td style="width: 10%;"></td> <td style="width: 10%;"></td> <td style="width: 10%;"></td> <td style="width: 10%;"></td> <td style="width: 10%;"></td> <td style="width: 10%;"></td> <td style="width: 10%;"></td> <td style="width: 10%;"></td> <td style="width: 10%;"></td> </tr> <tr> <td></td> <td></td> <td colspan="8" style="text-align: center;"> <table border="1" style="width: 100%; border-collapse: collapse; text-align: center;"> <tr> <td style="width: 10%;"></td> <td style="width: 10%;"></td> <td style="width: 10%;"></td> <td style="width: 10%;"></td> <td style="width: 10%;"></td> <td style="width: 10%;"></td> <td style="width: 10%;"></td> <td style="width: 10%;"></td> <td style="width: 10%;"></td> <td style="width: 10%;"></td> </tr> <tr> <td></td> <td></td> <td colspan="8" style="text-align: center;"> <table border="1" style="width: 100%; border-collapse: collapse; text-align: center;"> <tr> <td style="width: 10%;"></td> <td style="width: 10%;"></td> <td style="width: 10%;"></td> <td style="width: 10%;"></td> <td style="width: 10%;"></td> <td style="width: 10%;"></td> <td style="width: 10%;"></td> <td style="width: 10%;"></td> <td style="width: 10%;"></td> <td style="width: 10%;"></td> </tr> <tr> <td></td> <td></td> <td colspan="8" style="text-align: center;"> <table border="1" style="width: 100%; border-collapse: collapse; text-align: center;"> <tr> <td style="width: 10%;"></td> <td style="width: 10%;"></td> <td style="width: 10%;"></td> <td style="width: 10%;"></td> <td style="width: 10%;"></td> <td style="width: 10%;"></td> <td style="width: 10%;"></td> <td style="width: 10%;"></td> <td style="width: 10%;"></td> <td style="width: 10%;"></td> </tr> <tr> <td></td> <td></td> <td colspan="8" style="text-align: center;"> <table border="1" style="width: 100%; border-collapse: collapse; text-align: center;"> <tr> <td style="width: 10%;"></td> <td style="width: 10%;"></td> <td style="width: 10%;"></td> <td style="width: 10%;"></td> <td style="width: 10%;"></td> <td style="width: 10%;"></td> <td style="width: 10%;"></td> <td style="width: 10%;"></td> <td style="width: 10%;"></td> <td style="width: 10%;"></td> </tr> <tr> <td></td> <td></td> <td colspan="8" style="text-align: center;"> <table border="1" style="width: 100%; border-collapse: collapse; text-align: center;"> <tr> <td style="width: 10%;"></td> <td style="width: 10%;"></td> <td style="width: 10%;"></td> <td style="width: 10%;"></td> <td style="width: 10%;"></td> <td style="width: 10%;"></td> <td style="width: 10%;"></td> <td style="width: 10%;"></td> <td style="width: 10%;"></td> <td style="width: 10%;"></td> </tr> <tr> <td></td> <td></td> <td colspan="8" style="text-align: center;"> <table border="1" style="width: 100%; border-collapse: collapse; text-align: center;"> <tr> <td style="width: 10%;"></td> <td style="width: 10%;"></td> <td style="width: 10%;"></td> <td style="width: 10%;"></td> <td style="width: 10%;"></td> <td style="width: 10%;"></td> <td style="width: 10%;"></td> <td style="width: 10%;"></td> <td style="width: 10%;"></td> <td style="width: 10%;"></td> </tr> <tr> <td></td> <td></td> <td colspan="8" style="text-align: center;"> <table border="1" style="width: 100%; border-collapse: collapse; text-align: center;"> <tr> </tr></table></td></tr></table></td></tr></table></td></tr></table></td></tr></table></td></tr></table></td></tr></table></td></tr></table></td></tr></table>
 | | | | | | | | | | | | | | | | | | | | <table border="1" style="width: 100%; border-collapse: collapse; text-align: center;"> <tr> <td style="width: 10%;"></td> <td style="width: 10%;"></td> <td style="width: 10%;"></td> <td style="width: 10%;"></td> <td style="width: 10%;"></td> <td style="width: 10%;"></td> <td style="width: 10%;"></td> <td style="width: 10%;"></td> <td style="width: 10%;"></td> <td style="width: 10%;"></td> </tr> <tr> <td></td> <td></td> <td colspan="8" style="text-align: center;"> <table border="1" style="width: 100%; border-collapse: collapse; text-align: center;"> <tr> <td style="width: 10%;"></td> <td style="width: 10%;"></td> <td style="width: 10%;"></td> <td style="width: 10%;"></td> <td style="width: 10%;"></td> <td style="width: 10%;"></td> <td style="width: 10%;"></td> <td style="width: 10%;"></td> <td style="width: 10%;"></td> <td style="width: 10%;"></td> </tr> <tr> <td></td> <td></td> <td colspan="8" style="text-align: center;"> <table border="1" style="width: 100%; border-collapse: collapse; text-align: center;"> <tr> <td style="width: 10%;"></td> <td style="width: 10%;"></td> <td style="width: 10%;"></td> <td style="width: 10%;"></td> <td style="width: 10%;"></td> <td style="width: 10%;"></td> <td style="width: 10%;"></td> <td style="width: 10%;"></td> <td style="width: 10%;"></td> <td style="width: 10%;"></td> </tr> <tr> <td></td> <td></td> <td colspan="8" style="text-align: center;"> <table border="1" style="width: 100%; border-collapse: collapse; text-align: center;"> <tr> <td style="width: 10%;"></td> <td style="width: 10%;"></td> <td style="width: 10%;"></td> <td style="width: 10%;"></td> <td style="width: 10%;"></td> <td style="width: 10%;"></td> <td style="width: 10%;"></td> <td style="width: 10%;"></td> <td style="width: 10%;"></td> <td style="width: 10%;"></td> </tr> <tr> <td></td> <td></td> <td colspan="8" style="text-align: center;"> <table border="1" style="width: 100%; border-collapse: collapse; text-align: center;"> <tr> <td style="width: 10%;"></td> <td style="width: 10%;"></td> <td style="width: 10%;"></td> <td style="width: 10%;"></td> <td style="width: 10%;"></td> <td style="width: 10%;"></td> <td style="width: 10%;"></td> <td style="width: 10%;"></td> <td style="width: 10%;"></td> <td style="width: 10%;"></td> </tr> <tr> <td></td> <td></td> <td colspan="8" style="text-align: center;"> <table border="1" style="width: 100%; border-collapse: collapse; text-align: center;"> <tr> <td style="width: 10%;"></td> <td style="width: 10%;"></td> <td style="width: 10%;"></td> <td style="width: 10%;"></td> <td style="width: 10%;"></td> <td style="width: 10%;"></td> <td style="width: 10%;"></td> <td style="width: 10%;"></td> <td style="width: 10%;"></td> <td style="width: 10%;"></td> </tr> <tr> <td></td> <td></td> <td colspan="8" style="text-align: center;"> <table border="1" style="width: 100%; border-collapse: collapse; text-align: center;"> <tr> <td style="width: 10%;"></td> <td style="width: 10%;"></td> <td style="width: 10%;"></td> <td style="width: 10%;"></td> <td style="width: 10%;"></td> <td style="width: 10%;"></td> <td style="width: 10%;"></td> <td style="width: 10%;"></td> <td style="width: 10%;"></td> <td style="width: 10%;"></td> </tr> <tr> <td></td> <td></td> <td colspan="8" style="text-align: center;"> <table border="1" style="width: 100%; border-collapse: collapse; text-align: center;"> <tr> </tr></table></td></tr></table></td></tr></table></td></tr></table></td></tr></table></td></tr></table></td></tr></table></td></tr></table>
 | | | | | | | | | | | | | | | | | | | | <table border="1" style="width: 100%; border-collapse: collapse; text-align: center;"> <tr> <td style="width: 10%;"></td> <td style="width: 10%;"></td> <td style="width: 10%;"></td> <td style="width: 10%;"></td> <td style="width: 10%;"></td> <td style="width: 10%;"></td> <td style="width: 10%;"></td> <td style="width: 10%;"></td> <td style="width: 10%;"></td> <td style="width: 10%;"></td> </tr> <tr> <td></td> <td></td> <td colspan="8" style="text-align: center;"> <table border="1" style="width: 100%; border-collapse: collapse; text-align: center;"> <tr> <td style="width: 10%;"></td> <td style="width: 10%;"></td> <td style="width: 10%;"></td> <td style="width: 10%;"></td> <td style="width: 10%;"></td> <td style="width: 10%;"></td> <td style="width: 10%;"></td> <td style="width: 10%;"></td> <td style="width: 10%;"></td> <td style="width: 10%;"></td> </tr> <tr> <td></td> <td></td> <td colspan="8" style="text-align: center;"> <table border="1" style="width: 100%; border-collapse: collapse; text-align: center;"> <tr> <td style="width: 10%;"></td> <td style="width: 10%;"></td> <td style="width: 10%;"></td> <td style="width: 10%;"></td> <td style="width: 10%;"></td> <td style="width: 10%;"></td> <td style="width: 10%;"></td> <td style="width: 10%;"></td> <td style="width: 10%;"></td> <td style="width: 10%;"></td> </tr> <tr> <td></td> <td></td> <td colspan="8" style="text-align: center;"> <table border="1" style="width: 100%; border-collapse: collapse; text-align: center;"> <tr> <td style="width: 10%;"></td> <td style="width: 10%;"></td> <td style="width: 10%;"></td> <td style="width: 10%;"></td> <td style="width: 10%;"></td> <td style="width: 10%;"></td> <td style="width: 10%;"></td> <td style="width: 10%;"></td> <td style="width: 10%;"></td> <td style="width: 10%;"></td> </tr> <tr> <td></td> <td></td> <td colspan="8" style="text-align: center;"> <table border="1" style="width: 100%; border-collapse: collapse; text-align: center;"> <tr> <td style="width: 10%;"></td> <td style="width: 10%;"></td> <td style="width: 10%;"></td> <td style="width: 10%;"></td> <td style="width: 10%;"></td> <td style="width: 10%;"></td> <td style="width: 10%;"></td> <td style="width: 10%;"></td> <td style="width: 10%;"></td> <td style="width: 10%;"></td> </tr> <tr> <td></td> <td></td> <td colspan="8" style="text-align: center;"> <table border="1" style="width: 100%; border-collapse: collapse; text-align: center;"> <tr> <td style="width: 10%;"></td> <td style="width: 10%;"></td> <td style="width: 10%;"></td> <td style="width: 10%;"></td> <td style="width: 10%;"></td> <td style="width: 10%;"></td> <td style="width: 10%;"></td> <td style="width: 10%;"></td> <td style="width: 10%;"></td> <td style="width: 10%;"></td> </tr> <tr> <td></td> <td></td> <td colspan="8" style="text-align: center;"> <table border="1" style="width: 100%; border-collapse: collapse; text-align: center;"> <tr> </tr></table></td></tr></table></td></tr></table></td></tr></table></td></tr></table></td></tr></table></td></tr></table>
 | | | | | | | | | | | | | | | | | | | | <table border="1" style="width: 100%; border-collapse: collapse; text-align: center;"> <tr> <td style="width: 10%;"></td> <td style="width: 10%;"></td> <td style="width: 10%;"></td> <td style="width: 10%;"></td> <td style="width: 10%;"></td> <td style="width: 10%;"></td> <td style="width: 10%;"></td> <td style="width: 10%;"></td> <td style="width: 10%;"></td> <td style="width: 10%;"></td> </tr> <tr> <td></td> <td></td> <td colspan="8" style="text-align: center;"> <table border="1" style="width: 100%; border-collapse: collapse; text-align: center;"> <tr> <td style="width: 10%;"></td> <td style="width: 10%;"></td> <td style="width: 10%;"></td> <td style="width: 10%;"></td> <td style="width: 10%;"></td> <td style="width: 10%;"></td> <td style="width: 10%;"></td> <td style="width: 10%;"></td> <td style="width: 10%;"></td> <td style="width: 10%;"></td> </tr> <tr> <td></td> <td></td> <td colspan="8" style="text-align: center;"> <table border="1" style="width: 100%; border-collapse: collapse; text-align: center;"> <tr> <td style="width: 10%;"></td> <td style="width: 10%;"></td> <td style="width: 10%;"></td> <td style="width: 10%;"></td> <td style="width: 10%;"></td> <td style="width: 10%;"></td> <td style="width: 10%;"></td> <td style="width: 10%;"></td> <td style="width: 10%;"></td> <td style="width: 10%;"></td> </tr> <tr> <td></td> <td></td> <td colspan="8" style="text-align: center;"> <table border="1" style="width: 100%; border-collapse: collapse; text-align: center;"> <tr> <td style="width: 10%;"></td> <td style="width: 10%;"></td> <td style="width: 10%;"></td> <td style="width: 10%;"></td> <td style="width: 10%;"></td> <td style="width: 10%;"></td> <td style="width: 10%;"></td> <td style="width: 10%;"></td> <td style="width: 10%;"></td> <td style="width: 10%;"></td> </tr> <tr> <td></td> <td></td> <td colspan="8" style="text-align: center;"> <table border="1" style="width: 100%; border-collapse: collapse; text-align: center;"> <tr> <td style="width: 10%;"></td> <td style="width: 10%;"></td> <td style="width: 10%;"></td> <td style="width: 10%;"></td> <td style="width: 10%;"></td> <td style="width: 10%;"></td> <td style="width: 10%;"></td> <td style="width: 10%;"></td> <td style="width: 10%;"></td> <td style="width: 10%;"></td> </tr> <tr> <td></td> <td></td> <td colspan="8" style="text-align: center;"> <table border="1" style="width: 100%; border-collapse: collapse; text-align: center;"> <tr> </tr></table></td></tr></table></td></tr></table></td></tr></table></td></tr></table></td></tr></table>
 | | | | | | | | | | | | | | | | | | | | <table border="1" style="width: 100%; border-collapse: collapse; text-align: center;"> <tr> <td style="width: 10%;"></td> <td style="width: 10%;"></td> <td style="width: 10%;"></td> <td style="width: 10%;"></td> <td style="width: 10%;"></td> <td style="width: 10%;"></td> <td style="width: 10%;"></td> <td style="width: 10%;"></td> <td style="width: 10%;"></td> <td style="width: 10%;"></td> </tr> <tr> <td></td> <td></td> <td colspan="8" style="text-align: center;"> <table border="1" style="width: 100%; border-collapse: collapse; text-align: center;"> <tr> <td style="width: 10%;"></td> <td style="width: 10%;"></td> <td style="width: 10%;"></td> <td style="width: 10%;"></td> <td style="width: 10%;"></td> <td style="width: 10%;"></td> <td style="width: 10%;"></td> <td style="width: 10%;"></td> <td style="width: 10%;"></td> <td style="width: 10%;"></td> </tr> <tr> <td></td> <td></td> <td colspan="8" style="text-align: center;"> <table border="1" style="width: 100%; border-collapse: collapse; text-align: center;"> <tr> <td style="width: 10%;"></td> <td style="width: 10%;"></td> <td style="width: 10%;"></td> <td style="width: 10%;"></td> <td style="width: 10%;"></td> <td style="width: 10%;"></td> <td style="width: 10%;"></td> <td style="width: 10%;"></td> <td style="width: 10%;"></td> <td style="width: 10%;"></td> </tr> <tr> <td></td> <td></td> <td colspan="8" style="text-align: center;"> <table border="1" style="width: 100%; border-collapse: collapse; text-align: center;"> <tr> <td style="width: 10%;"></td> <td style="width: 10%;"></td> <td style="width: 10%;"></td> <td style="width: 10%;"></td> <td style="width: 10%;"></td> <td style="width: 10%;"></td> <td style="width: 10%;"></td> <td style="width: 10%;"></td> <td style="width: 10%;"></td> <td style="width: 10%;"></td> </tr> <tr> <td></td> <td></td> <td colspan="8" style="text-align: center;"> <table border="1" style="width: 100%; border-collapse: collapse; text-align: center;"> <tr> </tr></table></td></tr></table></td></tr></table></td></tr></table></td></tr></table>
 | | | | | | | | | | | | | | | | | | | | <table border="1" style="width: 100%; border-collapse: collapse; text-align: center;"> <tr> <td style="width: 10%;"></td> <td style="width: 10%;"></td> <td style="width: 10%;"></td> <td style="width: 10%;"></td> <td style="width: 10%;"></td> <td style="width: 10%;"></td> <td style="width: 10%;"></td> <td style="width: 10%;"></td> <td style="width: 10%;"></td> <td style="width: 10%;"></td> </tr> <tr> <td></td> <td></td> <td colspan="8" style="text-align: center;"> <table border="1" style="width: 100%; border-collapse: collapse; text-align: center;"> <tr> <td style="width: 10%;"></td> <td style="width: 10%;"></td> <td style="width: 10%;"></td> <td style="width: 10%;"></td> <td style="width: 10%;"></td> <td style="width: 10%;"></td> <td style="width: 10%;"></td> <td style="width: 10%;"></td> <td style="width: 10%;"></td> <td style="width: 10%;"></td> </tr> <tr> <td></td> <td></td> <td colspan="8" style="text-align: center;"> <table border="1" style="width: 100%; border-collapse: collapse; text-align: center;"> <tr> <td style="width: 10%;"></td> <td style="width: 10%;"></td> <td style="width: 10%;"></td> <td style="width: 10%;"></td> <td style="width: 10%;"></td> <td style="width: 10%;"></td> <td style="width: 10%;"></td> <td style="width: 10%;"></td> <td style="width: 10%;"></td> <td style="width: 10%;"></td> </tr> <tr> <td></td> <td></td> <td colspan="8" style="text-align: center;"> <table border="1" style="width: 100%; border-collapse: collapse; text-align: center;"> <tr> </tr></table></td></tr></table></td></tr></table></td></tr></table>
 | | | | | | | | | | | | | | | | | | | | <table border="1" style="width: 100%; border-collapse: collapse; text-align: center;"> <tr> <td style="width: 10%;"></td> <td style="width: 10%;"></td> <td style="width: 10%;"></td> <td style="width: 10%;"></td> <td style="width: 10%;"></td> <td style="width: 10%;"></td> <td style="width: 10%;"></td> <td style="width: 10%;"></td> <td style="width: 10%;"></td> <td style="width: 10%;"></td> </tr> <tr> <td></td> <td></td> <td colspan="8" style="text-align: center;"> <table border="1" style="width: 100%; border-collapse: collapse; text-align: center;"> <tr> <td style="width: 10%;"></td> <td style="width: 10%;"></td> <td style="width: 10%;"></td> <td style="width: 10%;"></td> <td style="width: 10%;"></td> <td style="width: 10%;"></td> <td style="width: 10%;"></td> <td style="width: 10%;"></td> <td style="width: 10%;"></td> <td style="width: 10%;"></td> </tr> <tr> <td></td> <td></td> <td colspan="8" style="text-align: center;"> <table border="1" style="width: 100%; border-collapse: collapse; text-align: center;"> <tr> </tr></table></td></tr></table></td></tr></table>
 | | | | | | | | | | | | | | | | | | | | <table border="1" style="width: 100%; border-collapse: collapse; text-align: center;"> <tr> <td style="width: 10%;"></td> <td style="width: 10%;"></td> <td style="width: 10%;"></td> <td style="width: 10%;"></td> <td style="width: 10%;"></td> <td style="width: 10%;"></td> <td style="width: 10%;"></td> <td style="width: 10%;"></td> <td style="width: 10%;"></td> <td style="width: 10%;"></td> </tr> <tr> <td></td> <td></td> <td colspan="8" style="text-align: center;"> <table border="1" style="width: 100%; border-collapse: collapse; text-align: center;"> <tr> </tr></table></td></tr></table>
 | | | | | | | | | | | | | | | | | | | | <table border="1" style="width: 100%; border-collapse: collapse; text-align: center;"> <tr> </tr></table>
 | | | | | | | | | | | | | | | | | | | | | | | | | | | | | | | | | | | | | | | | | | | | | | | | | | | | | | | | | | | | | | | | | | | | | | | | | | | | | | | |
 | | | | | | | | | | | | | | | | | | | |
 | | | | | | | | | | | | | | | | | | | | | | | | | | | | | | | | | | | | | | | |
 | | | | | | | | | | | | | | | | | | | | | | | | | | | | | | | | | | | | | | | |
 | | | | | | | | | | | | | | | | | | | | | | | | | | | | | | | | | | | | | | | |
 | | | | | | | | | | | | | | | | | | | | | | | | | | | | | | | | | | | | | | | | | | | | | | | | | | | | | | | | | | | | | | | | | | | | | | | | | | | | | | | |
 | | | | | | | | | | | | | | | | | | | | | | | | | | | | | | | | | | | | | | | | | | | | | | | | | | | | | | | | | | | | | | | | | | | |
| | |

 | | | | | | | | | | | | | | | | | | | |

 | | | | | | | | | | | | | | | | | | | |

 | | | | | | | | | | | | | | | | | | | |

 | | | | | | | | | | | | | | | | | | | |

 | | | | | | | | | | | | | | | | | | | |

 | | | | | | | | | | | | | | | | | | | |

 | | | | | | | | | | | | | | | | | | | |

 | | | | | | | | | | | | | | | | | | | |

 | | | | | | | | | | | | | | | | | | | |

 | | | | | | | | | | | | | | | | | | | |

 | | | | | | | | | | | | | | | | | | | |

 | | | | | | | | | | | | | | | | | | | |

 | | | | | | | | | | | | | | | | | | | |

 | | | | | | | | | | | | | | | | | | | |

 | | | | | | | | | | | | | | | | | | | |

 | | | | | | | | | | | | | | | | | | | |

 | | | | | | | | | | | | | | | | | | | |

 | | | | | | | | | | | | | | | | | | | |

 | | | | | | | | | | | | | | | | | | | |

 | | | | | | | | | | | | | | | | | | | |

 | | | | | | | | | | | | | | | | | | | |

 | | | | | | | | | | | | | | | | | | | |

 | | | | | | | | | | | | | | | | | | | |

 | | | | | | | | | | | | | | | | | | | |

 | | | | | | | | | | | | | | | | | | | |

 | | | | | | | | | | | | | | | | | | | |

 | | | | | | | | | | | | | | | | | | | |

 | | | | | | | | | | | | | | | | | | | |
 | | | | | | | | | | | | | | | | | | | |

 | | | | | | | | | | | | | | | | | | | |

 | | | | | | | | | | | | | | | | | | | |
 | | | | | | | | | | | | | | | | | | | |

 | | | | | | | | | | | | | | | | | | | |

 | | | | | | | | | | | | | | | | | | | |
 | | | | | | | | | | | | | | | | | | | |
 | | | | | | | | | | | | | | | | | | | |

 | | | | | | | | | | | | | | | | | | | |
 | | | | | | | | | | | | | | | | | | | |
 | | | | | | | | | | | | | | | | | | | |

 | | | | | | | | | | | | | | | | | | | | | | | | | | | | | | | | | | | | | | | | | | | | | | | | | | | | | | | | | | | | | | | | | | | | | | | | | | | | | | | | | | | | | | | | | | | | | | | | | | | |
 | | | | | | | | | | | | | | | | | | | |
 | | | | | | | | | | | | | | | | | | | |
 | | | | | | | | | | | | | | | | | | | |
 | | | | | | | | | | | | | | | | | | | |
 | | | | | | | | | | | | | | | | | | | |
 | | | | | | | | | | | | | | | | | | | |
 | | | | | | | | | | | | | | | | | | | |
 | | | | | | | | | | | | | | | | | | | |
 | | | | | | | | | | | | | | | | | | | | | | | | | | | | | | | | | | | | | | | |
 | | | | | | | | | | | | | | | | | | | |
 | | | | | | | | | | | | | | | | | | | | | | | | | | | | | | | | | | | | | | | |
 | | | | | | | | | | | | | | | | | | | | | | | | | | | | | | | | | | | | | | | |
 | | | | | | | | | | | | | | | | | | | | | | | | | | | | | | | | | | | | | | | |
 | | | | | | | | | | | | | | | | | | | | | | | | | | | | | | | | | | | | | | | | | | | | | | | | | | | | | | | | | | | | | | | | | | | | | | | | | | | | | | | | | | | | | | | | | | | | | | | | | | | |
 | | | | | | | | | | | | | | | | | | | | | | | | | | | | | | | | | | | | | | | | | | | | | | | |
| | | <table border="1" style="width: 100%; border-collapse: collapse; text-align: center;"> <tr> <td style="width: 10%;"></td> <td style="width: 10%;"></td> <td style="width: 10%;"></td> <td style="width: 10%;"></td> <td style="width: 10%;"></td> <td style="width: 10%;"></td> <td style="width: 10%;"></td> <td style="width: 10%;"></td> <td style="width: 10%;"></td> <td style="width: 10%;"></td> </tr> <tr> <td></td> <td></td> <td colspan="8" style="text-align: center;"> <table border="1" style="width: 100%; border-collapse: collapse; text-align: center;"> <tr> <td style="width: 10%;"></td> <td style="width: 10%;"></td> <td style="width: 10%;"></td> <td style="width: 10%;"></td> <td style="width: 10%;"></td> <td style="width: 10%;"></td> <td style="width: 10%;"></td> <td style="width: 10%;"></td> <td style="width: 10%;"></td> <td style="width: 10%;"></td> </tr> <tr> <td></td> <td></td> <td colspan="8" style="text-align: center;"> <table border="1" style="width: 100%; border-collapse: collapse; text-align: center;"> <tr> <td style="width: 10%;"></td> <td style="width: 10%;"></td> <td style="width: 10%;"></td> <td style="width: 10%;"></td> <td style="width: 10%;"></td> <td style="width: 10%;"></td> <td style="width: 10%;"></td> <td style="width: 10%;"></td> <td style="width: 10%;"></td> <td style="width: 10%;"></td> </tr> <tr> <td></td> <td></td> <td colspan="8" style="text-align: center;"> <table border="1" style="width: 100%; border-collapse: collapse; text-align: center;"> <tr> <td style="width: 10%;"></td> <td style="width: 10%;"></td> <td style="width: 10%;"></td> <td style="width: 10%;"></td> <td style="width: 10%;"></td> <td style="width: 10%;"></td> <td style="width: 10%;"></td> <td style="width: 10%;"></td> <td style="width: 10%;"></td> <td style="width: 10%;"></td> </tr> <tr> <td></td> <td></td> <td colspan="8" style="text-align: center;"> <table border="1" style="width: 100%; border-collapse: collapse; text-align: center;"> <tr> <td style="width: 10%;"></td> <td style="width: 10%;"></td> <td style="width: 10%;"></td> <td style="width: 10%;"></td> <td style="width: 10%;"></td> <td style="width: 10%;"></td> <td style="width: 10%;"></td> <td style="width: 10%;"></td> <td style="width: 10%;"></td> <td style="width: 10%;"></td> </tr> <tr> <td></td> <td></td> <td colspan="8" style="text-align: center;"> <table border="1" style="width: 100%; border-collapse: collapse; text-align: center;"> <tr> <td style="width: 10%;"></td> <td style="width: 10%;"></td> <td style="width: 10%;"></td> <td style="width: 10%;"></td> <td style="width: 10%;"></td> <td style="width: 10%;"></td> <td style="width: 10%;"></td> <td style="width: 10%;"></td> <td style="width: 10%;"></td> <td style="width: 10%;"></td> </tr> <tr> <td></td> <td></td> <td colspan="8" style="text-align: center;"> <table border="1" style="width: 100%; border-collapse: collapse; text-align: center;"> <tr> <td style="width: 10%;"></td> <td style="width: 10%;"></td> <td style="width: 10%;"></td> <td style="width: 10%;"></td> <td style="width: 10%;"></td> <td style="width: 10%;"></td> <td style="width: 10%;"></td> <td style="width: 10%;"></td> <td style="width: 10%;"></td> <td style="width: 10%;"></td> </tr> <tr> <td></td> <td></td> <td colspan="8" style="text-align: center;"> <table border="1" style="width: 100%; border-collapse: collapse; text-align: center;"> <tr> <td style="width: 10%;"></td> <td style="width: 10%;"></td> <td style="width: 10%;"></td> <td style="width: 10%;"></td> <td style="width: 10%;"></td> <td style="width: 10%;"></td> <td style="width: 10%;"></td> <td style="width: 10%;"></td> <td style="width: 10%;"></td> <td style="width: 10%;"></td> </tr> <tr> <td></td> <td></td> <td colspan="8" style="text-align: center;"> <table border="1" style="width: 100%; border-collapse: collapse; text-align: center;"> <tr> <td style="width: 10%;"></td> <td style="width: 10%;"></td> <td style="width: 10%;"></td> <td style="width: 10%;"></td> <td style="width: 10%;"></td> <td style="width: 10%;"></td> <td style="width: 10%;"></td> <td style="width: 10%;"></td> <td style="width: 10%;"></td> <td style="width: 10%;"></td> </tr> <tr> <td></td> <td></td> <td colspan="8" style="text-align: center;"> <table border="1" style="width: 100%; border-collapse: collapse; text-align: center;"> <tr> <td style="width: 10%;"></td> <td style="width: 10%;"></td> <td style="width: 10%;"></td> <td style="width: 10%;"></td> <td style="width: 10%;"></td> <td style="width: 10%;"></td> <td style="width: 10%;"></td> <td style="width: 10%;"></td> <td style="width: 10%;"></td> <td style="width: 10%;"></td> </tr> <tr> <td></td> <td></td> <td colspan="8" style="text-align: center;"> <table border="1" style="width: 100%; border-collapse: collapse; text-align: center;"> <tr> <td style="width: 10%;"></td> <td style="width: 10%;"></td> <td style="width: 10%;"></td> <td style="width: 10%;"></td> <td style="width: 10%;"></td> <td style="width: 10%;"></td> <td style="width: 10%;"></td> <td style="width: 10%;"></td> <td style="width: 10%;"></td> <td style="width: 10%;"></td> </tr> <tr> <td></td> <td></td> <td colspan="8" style="text-align: center;"> <table border="1" style="width: 100%; border-collapse: collapse; text-align: center;"> <tr> <td style="width: 10%;"></td> <td style="width: 10%;"></td> <td style="width: 10%;"></td> <td style="width: 10%;"></td> <td style="width: 10%;"></td> <td style="width: 10%;"></td> <td style="width: 10%;"></td> <td style="width: 10%;"></td> <td style="width: 10%;"></td> <td style="width: 10%;"></td> </tr> <tr> <td></td> <td></td> <td colspan="8" style="text-align: center;"> <table border="1" style="width: 100%; border-collapse: collapse; text-align: center;"> <tr> <td style="width: 10%;"></td> <td style="width: 10%;"></td> <td style="width: 10%;"></td> <td style="width: 10%;"></td> <td style="width: 10%;"></td> <td style="width: 10%;"></td> <td style="width: 10%;"></td> <td style="width: 10%;"></td> <td style="width: 10%;"></td> <td style="width: 10%;"></td> </tr> <tr> <td></td> <td></td> <td colspan="8" style="text-align: center;"> <table border="1" style="width: 100%; border-collapse: collapse; text-align: center;"> <tr> <td style="width: 10%;"></td> <td style="width: 10%;"></td> <td style="width: 10%;"></td> <td style="width: 10%;"></td> <td style="width: 10%;"></td> <td style="width: 10%;"></td> <td style="width: 10%;"></td> <td style="width: 10%;"></td> <td style="width: 10%;"></td> <td style="width: 10%;"></td> </tr> <tr> <td></td> <td></td> <td colspan="8" style="text-align: center;"> <table border="1" style="width: 100%; border-collapse: collapse; text-align: center;"> <tr> <td style="width: 10%;"></td> <td style="width: 10%;"></td> <td style="width: 10%;"></td> <td style="width: 10%;"></td> <td style="width: 10%;"></td> <td style="width: 10%;"></td> <td style="width: 10%;"></td> <td style="width: 10%;"></td> <td style="width: 10%;"></td> <td style="width: 10%;"></td> </tr> <tr> <td></td> <td></td> <td colspan="8" style="text-align: center;"> <table border="1" style="width: 100%; border-collapse: collapse; text-align: center;"> <tr> <td style="width: 10%;"></td> <td style="width: 10%;"></td> <td style="width: 10%;"></td> <td style="width: 10%;"></td> <td style="width: 10%;"></td> <td style="width: 10%;"></td> <td style="width: 10%;"></td> <td style="width: 10%;"></td> <td style="width: 10%;"></td> <td style="width: 10%;"></td> </tr> <tr> <td></td> <td></td> <td colspan="8" style="text-align: center;"> <table border="1" style="width: 100%; border-collapse: collapse; text-align: center;"> <tr> <td style="width: 10%;"></td> <td style="width: 10%;"></td> <td style="width: 10%;"></td> <td style="width: 10%;"></td> <td style="width: 10%;"></td> <td style="width: 10%;"></td> <td style="width: 10%;"></td> <td style="width: 10%;"></td> <td style="width: 10%;"></td> <td style="width: 10%;"></td> </tr> <tr> <td></td> <td></td> <td colspan="8" style="text-align: center;"> <table border="1" style="width: 100%; border-collapse: collapse; text-align: center;"> <tr> <td style="width: 10%;"></td> <td style="width: 10%;"></td> <td style="width: 10%;"></td> <td style="width: 10%;"></td> <td style="width: 10%;"></td> <td style="width: 10%;"></td> <td style="width: 10%;"></td> <td style="width: 10%;"></td> <td style="width: 10%;"></td> <td style="width: 10%;"></td> </tr> <tr> <td></td> <td></td> <td colspan="8" style="text-align: center;"> <table border="1" style="width: 100%; border-collapse: collapse; text-align: center;"> <tr> <td style="width: 10%;"></td> <td style="width: 10%;"></td> <td style="width: 10%;"></td> <td style="width: 10%;"></td> <td style="width: 10%;"></td> <td style="width: 10%;"></td> <td style="width: 10%;"></td> <td style="width: 10%;"></td> <td style="width: 10%;"></td> <td style="width: 10%;"></td> </tr> <tr> <td></td> <td></td> <td colspan="8" style="text-align: center;"> <table border="1" style="width: 100%; border-collapse: collapse; text-align: center;"> <tr> <td style="width: 10%;"></td> <td style="width: 10%;"></td> <td style="width: 10%;"></td> <td style="width: 10%;"></td> <td style="width: 10%;"></td> <td style="width: 10%;"></td> <td style="width: 10%;"></td> <td style="width: 10%;"></td> <td style="width: 10%;"></td> <td style="width: 10%;"></td> </tr> <tr> <td></td> <td></td> <td colspan="8" style="text-align: center;"> <table border="1" style="width: 100%; border-collapse: collapse; text-align: center;"> <tr> <td style="width: 10%;"></td> <td style="width: 10%;"></td> <td style="width: 10%;"></td> <td style="width: 10%;"></td> <td style="width: 10%;"></td> <td style="width: 10%;"></td> <td style="width: 10%;"></td> <td style="width: 10%;"></td> <td style="width: 10%;"></td> <td style="width: 10%;"></td> </tr> <tr> <td></td> <td></td> <td colspan="8" style="text-align: center;"> <table border="1" style="width: 100%; border-collapse: collapse; text-align: center;"> <tr> <td style="width: 10%;"></td> <td style="width: 10%;"></td> <td
style="width: 10%;"></td> <td style="width: 10%;"></td> <td style="width: 10%;"></td> <td style="width: 10%;"></td> <td style="width: 10%;"></td> <td style="width: 10%;"></td> <td style="width: 10%;"></td> <td style="width: 10%;"></td> </tr> <tr> <td></td> <td></td> <td colspan="8" style="text-align: center;"> <table border="1" style="width: 100%; border-collapse: collapse; text-align: center;"> <tr> <td style="width: 10%;"></td> <td style="width: 10%;"></td> <td style="width: 10%;"></td> <td style="width: 10%;"></td> <td style="width: 10%;"></td> <td style="width: 10%;"></td> <td style="width: 10%;"></td> <td style="width: 10%;"></td> <td style="width: 10%;"></td> <td style="width: 10%;"></td> </tr> <tr> <td></td> <td></td> <td colspan="8" style="text-align: center;"> <table border="1" style="width: 100%; border-collapse: collapse; text-align: center;"> <tr> <td style="width: 10%;"></td> <td style="width: 10%;"></td> <td style="width: 10%;"></td> <td style="width: 10%;"></td> <td style="width: 10%;"></td> <td style="width: 10%;"></td> <td style="width: 10%;"></td> <td style="width: 10%;"></td> <td style="width: 10%;"></td> <td style="width: 10%;"></td> </tr> <tr> <td></td> <td></td> <td colspan="8" style="text-align: center;"> <table border="1" style="width: 100%; border-collapse: collapse; text-align: center;"> <tr> <td style="width: 10%;"></td> <td style="width: 10%;"></td> <td style="width: 10%;"></td> <td style="width: 10%;"></td> <td style="width: 10%;"></td> <td style="width: 10%;"></td> <td style="width: 10%;"></td> <td style="width: 10%;"></td> <td style="width: 10%;"></td> <td style="width: 10%;"></td> </tr> <tr> <td></td> <td></td> <td colspan="8" style="text-align: center;"> <table border="1" style="width: 100%; border-collapse: collapse; text-align: center;"> <tr> <td style="width: 10%;"></td> <td style="width: 10%;"></td> <td style="width: 10%;"></td> <td style="width: 10%;"></td> <td style="width: 10%;"></td> <td style="width: 10%;"></td> <td style="width: 10%;"></td> <td style="width: 10%;"></td> <td style="width: 10%;"></td> <td style="width: 10%;"></td> </tr> <tr> <td></td> <td></td> <td colspan="8" style="text-align: center;"> <table border="1" style="width: 100%; border-collapse: collapse; text-align: center;"> <tr> <td style="width: 10%;"></td> <td style="width: 10%;"></td> <td style="width: 10%;"></td> <td style="width: 10%;"></td> <td style="width: 10%;"></td> <td style="width: 10%;"></td> <td style="width: 10%;"></td> <td style="width: 10%;"></td> <td style="width: 10%;"></td> <td style="width: 10%;"></td> </tr> <tr> <td></td> <td></td> <td colspan="8" style="text-align: center;"> <table border="1" style="width: 100%; border-collapse: collapse; text-align: center;"> <tr> <td style="width: 10%;"></td> <td style="width: 10%;"></td> <td style="width: 10%;"></td> <td style="width: 10%;"></td> <td style="width: 10%;"></td> <td style="width: 10%;"></td> <td style="width: 10%;"></td> <td style="width: 10%;"></td> <td style="width: 10%;"></td> <td style="width: 10%;"></td> </tr> <tr> <td></td> <td></td> <td colspan="8" style="text-align: center;"> <table border="1" style="width: 100%; border-collapse: collapse; text-align: center;"> <tr> <td style="width: 10%;"></td> <td style="width: 10%;"></td> <td style="width: 10%;"></td> <td style="width: 10%;"></td> <td style="width: 10%;"></td> <td style="width: 10%;"></td> <td style="width: 10%;"></td> <td style="width: 10%;"></td> <td style="width: 10%;"></td> <td style="width: 10%;"></td> </tr> <tr> <td></td> <td></td> <td colspan="8" style="text-align: center;"> <table border="1" style="width: 100%; border-collapse: collapse; text-align: center;"> <tr> <td style="width: 10%;"></td> <td style="width: 10%;"></td> <td style="width: 10%;"></td> <td style="width: 10%;"></td> <td style="width: 10%;"></td> <td style="width: 10%;"></td> <td style="width: 10%;"></td> <td style="width: 10%;"></td> <td style="width: 10%;"></td> <td style="width: 10%;"></td> </tr> <tr> <td></td> <td></td> <td colspan="8" style="text-align: center;"> <table border="1" style="width: 100%; border-collapse: collapse; text-align: center;"> <tr> <td style="width: 10%;"></td> <td style="width: 10%;"></td> <td style="width: 10%;"></td> <td style="width: 10%;"></td> <td style="width: 10%;"></td> <td style="width: 10%;"></td> <td style="width: 10%;"></td> <td style="width: 10%;"></td> <td style="width: 10%;"></td> <td style="width: 10%;"></td> </tr> <tr> <td></td> <td></td> <td colspan="8" style="text-align: center;"> <table border="1" style="width: 100%; border-collapse: collapse; text-align: center;"> <tr> <td style="width: 10%;"></td> <td style="width: 10%;"></td> <td style="width: 10%;"></td> <td style="width: 10%;"></td> <td style="width: 10%;"></td> <td style="width: 10%;"></td> <td style="width: 10%;"></td> <td style="width: 10%;"></td> <td style="width: 10%;"></td> <td style="width: 10%;"></td> </tr> <tr> <td></td> <td></td> <td colspan="8" style="text-align: center;"> <table border="1" style="width: 100%; border-collapse: collapse; text-align: center;"> <tr> <td style="width: 10%;"></td> <td style="width: 10%;"></td> <td style="width: 10%;"></td> <td style="width: 10%;"></td> <td style="width: 10%;"></td> <td style="width: 10%;"></td> <td style="width: 10%;"></td> <td style="width: 10%;"></td> <td style="width: 10%;"></td> <td style="width: 10%;"></td> </tr> <tr> <td></td> <td></td> <td colspan="8" style="text-align: center;"> <table border="1" style="width: 100%; border-collapse: collapse; text-align: center;"> <tr> <td style="width: 10%;"></td> <td style="width: 10%;"></td> <td style="width: 10%;"></td> <td style="width: 10%;"></td> <td style="width: 10%;"></td> <td style="width: 10%;"></td> <td style="width: 10%;"></td> <td style="width: 10%;"></td> <td style="width: 10%;"></td> <td style="width: 10%;"></td> </tr> <tr> <td></td> <td></td> <td colspan="8" style="text-align: center;"> <table border="1" style="width: 100%; border-collapse: collapse; text-align: center;"> <tr> <td style="width: 10%;"></td> <td style="width: 10%;"></td> <td style="width: 10%;"></td> <td style="width: 10%;"></td> <td style="width: 10%;"></td> <td style="width: 10%;"></td> <td style="width: 10%;"></td> <td style="width: 10%;"></td> <td style="width: 10%;"></td> <td style="width: 10%;"></td> </tr> <tr> <td></td> <td></td> <td colspan="8" style="text-align: center;"> <table border="1" style="width: 100%; border-collapse: collapse; text-align: center;"> <tr> <td style="width: 10%;"></td> <td style="width: 10%;"></td> <td style="width: 10%;"></td> <td style="width: 10%;"></td> <td style="width: 10%;"></td> <td style="width: 10%;"></td> <td style="width: 10%;"></td> <td style="width: 10%;"></td> <td style="width: 10%;"></td> <td style="width: 10%;"></td> </tr> <tr> <td></td> <td></td> <td colspan="8" style="text-align: center;"> <table border="1" style="width: 100%; border-collapse: collapse; text-align: center;"> <tr> <td style="width: 10%;"></td> <td style="width: 10%;"></td> <td style="width: 10%;"></td> <td style="width: 10%;"></td> <td style="width: 10%;"></td> <td style="width: 10%;"></td> <td style="width: 10%;"></td> <td style="width: 10%;"></td> <td style="width: 10%;"></td> <td style="width: 10%;"></td> </tr> <tr> <td></td> <td></td> <td colspan="8" style="text-align: center;"> <table border="1" style="width: 100%; border-collapse: collapse; text-align: center;"> <tr> <td style="width: 10%;"></td> <td style="width: 10%;"></td> <td style="width: 10%;"></td> <td style="width: 10%;"></td> <td style="width: 10%;"></td> <td style="width: 10%;"></td> <td style="width: 10%;"></td> <td style="width: 10%;"></td> <td style="width: 10%;"></td> <td style="width: 10%;"></td> </tr> <tr> <td></td> <td></td> <td colspan="8" style="text-align: center;"> <table border="1" style="width: 100%; border-collapse: collapse; text-align: center;"> <tr> <td style="width: 10%;"></td> <td style="width: 10%;"></td> <td style="width: 10%;"></td> <td style="width: 10%;"></td> <td style="width: 10%;"></td> <td style="width: 10%;"></td> <td style="width: 10%;"></td> <td style="width: 10%;"></td> <td style="width: 10%;"></td> <td style="width: 10%;"></td> </tr> <tr> <td></td> <td></td> <td colspan="8" style="text-align: center;"> <table border="1" style="width: 100%; border-collapse: collapse; text-align: center;"> <tr> <td style="width: 10%;"></td> <td style="width: 10%;"></td> <td style="width: 10%;"></td> <td style="width: 10%;"></td> <td style="width: 10%;"></td> <td style="width: 10%;"></td> <td style="width: 10%;"></td> <td style="width: 10%;"></td> <td style="width: 10%;"></td> <td style="width: 10%;"></td> </tr> <tr> <td></td> <td></td> <td colspan="8" style="text-align: center;"> <table border="1" style="width: 100%; border-collapse: collapse; text-align: center;"> <tr> <td style="width: 10%;"></td> <td style="width: 10%;"></td> <td style="width: 10%;"></td> <td style="width: 10%;"></td> <td style="width: 10%;"></td> <td style="width: 10%;"></td> <td style="width: 10%;"></td> <td style="width: 10%;"></td> <td style="width: 10%;"></td> <td style="width: 10%;"></td> </tr> <tr> <td></td> <td></td> <td colspan="8" style="text-align: center;"> <table border="1" style="width: 100%; border-collapse: collapse; text-align: center;"> <tr> <td style="width: 10%;"></td> <td style="width: 10%;"></td> <td style="width: 10%;"></td> <td style="width: 10%;"></td> <td style="width: 10%;"></td> <td style="width: 10%;"></td> <td style="width: 10%;"></td> <td style="width: 10%;"></td> <td style="width: 10%;"></td> <td style="width: 10%;"></td> </tr> <tr> <td></td> <td></td> <td colspan="8" style="text-align: center;"> <table border="1" style="width: 100%; border-collapse: collapse; text-align: center;"> <tr> <td style="width: 10%;"></td> <td style="width: 10%;"></td> <td style="width: 10%;"></td> <td style="width: 10%;"></td> <td style="width: 10%;"></td> <td style="width: 10%;"></td> <td style="width: 10%;"></td> <td style="width:
10%;"></td> <td style="width: 10%;"></td> <td style="width: 10%;"></td> </tr> <tr> <td></td> <td></td> <td colspan="8" style="text-align: center;"> <table border="1" style="width: 100%; border-collapse: collapse; text-align: center;"> <tr> <td style="width: 10%;"></td> <td style="width: 10%;"></td> <td style="width: 10%;"></td> <td style="width: 10%;"></td> <td style="width: 10%;"></td> <td style="width: 10%;"></td> <td style="width: 10%;"></td> <td style="width: 10%;"></td> <td style="width: 10%;"></td> <td style="width: 10%;"></td> </tr> <tr> <td></td> <td></td> <td colspan="8" style="text-align: center;"> <table border="1" style="width: 100%; border-collapse: collapse; text-align: center;"> <tr> <td style="width: 10%;"></td> <td style="width: 10%;"></td> <td style="width: 10%;"></td> <td style="width: 10%;"></td> <td style="width: 10%;"></td> <td style="width: 10%;"></td> <td style="width: 10%;"></td> <td style="width: 10%;"></td> <td style="width: 10%;"></td> <td style="width: 10%;"></td> </tr> <tr> <td></td> <td></td> <td colspan="8" style="text-align: center;"> <table border="1" style="width: 100%; border-collapse: collapse; text-align: center;"> <tr> <td style="width: 10%;"></td> <td style="width: 10%;"></td> <td style="width: 10%;"></td> <td style="width: 10%;"></td> <td style="width: 10%;"></td> <td style="width: 10%;"></td> <td style="width: 10%;"></td> <td style="width: 10%;"></td> <td style="width: 10%;"></td> <td style="width: 10%;"></td> </tr> <tr> <td></td> <td></td> <td colspan="8" style="text-align: center;"> <table border="1" style="width: 100%; border-collapse: collapse; text-align: center;"> <tr> <td style="width: 10%;"></td> <td style="width: 10%;"></td> <td style="width: 10%;"></td> <td style="width: 10%;"></td> <td style="width: 10%;"></td> <td style="width: 10%;"></td> <td style="width: 10%;"></td> <td style="width: 10%;"></td> <td style="width: 10%;"></td> <td style="width: 10%;"></td> </tr> <tr> <td></td> <td></td> <td colspan="8" style="text-align: center;"> <table border="1" style="width: 100%; border-collapse: collapse; text-align: center;"> <tr> </tr></table></td></tr></table></td></tr></table></td></tr></table></td></tr></table></td></tr></table></td></tr></table></td></tr></table></td></tr></table></td></tr></table></td></tr></table></td></tr></table></td></tr></table></td></tr></table></td></tr></table></td></tr></table></td></tr></table></td></tr></table></td></tr></table></td></tr></table></td></tr></table></td></tr></table></td></tr></table></td></tr></table></td></tr></table></td></tr></table></td></tr></table></td></tr></table></td></tr></table></td></tr></table></td></tr></table></td></tr></table></td></tr></table></td></tr></table></td></tr></table></td></tr></table></td></tr></table></td></tr></table></td></tr></table></td></tr></table></td></tr></table></td></tr></table></td></tr></table></td></tr></table></td></tr></table></td></tr></table></td></tr></table></td></tr></table>
 | | | | | | | | | | | | | | | | | | | | <table border="1" style="width: 100%; border-collapse: collapse; text-align: center;"> <tr> <td style="width: 10%;"></td> <td style="width: 10%;"></td> <td style="width: 10%;"></td> <td style="width: 10%;"></td> <td style="width: 10%;"></td> <td style="width: 10%;"></td> <td style="width: 10%;"></td> <td style="width: 10%;"></td> <td style="width: 10%;"></td> <td style="width: 10%;"></td> </tr> <tr> <td></td> <td></td> <td colspan="8" style="text-align: center;"> <table border="1" style="width: 100%; border-collapse: collapse; text-align: center;"> <tr> <td style="width: 10%;"></td> <td style="width: 10%;"></td> <td style="width: 10%;"></td> <td style="width: 10%;"></td> <td style="width: 10%;"></td> <td style="width: 10%;"></td> <td style="width: 10%;"></td> <td style="width: 10%;"></td> <td style="width: 10%;"></td> <td style="width: 10%;"></td> </tr> <tr> <td></td> <td></td> <td colspan="8" style="text-align: center;"> <table border="1" style="width: 100%; border-collapse: collapse; text-align: center;"> <tr> <td style="width: 10%;"></td> <td style="width: 10%;"></td> <td style="width: 10%;"></td> <td style="width: 10%;"></td> <td style="width: 10%;"></td> <td style="width: 10%;"></td> <td style="width: 10%;"></td> <td style="width: 10%;"></td> <td style="width: 10%;"></td> <td style="width: 10%;"></td> </tr> <tr> <td></td> <td></td> <td colspan="8" style="text-align: center;"> <table border="1" style="width: 100%; border-collapse: collapse; text-align: center;"> <tr> <td style="width: 10%;"></td> <td style="width: 10%;"></td> <td style="width: 10%;"></td> <td style="width: 10%;"></td> <td style="width: 10%;"></td> <td style="width: 10%;"></td> <td style="width: 10%;"></td> <td style="width: 10%;"></td> <td style="width: 10%;"></td> <td style="width: 10%;"></td> </tr> <tr> <td></td> <td></td> <td colspan="8" style="text-align: center;"> <table border="1" style="width: 100%; border-collapse: collapse; text-align: center;"> <tr> <td style="width: 10%;"></td> <td style="width: 10%;"></td> <td style="width: 10%;"></td> <td style="width: 10%;"></td> <td style="width: 10%;"></td> <td style="width: 10%;"></td> <td style="width: 10%;"></td> <td style="width: 10%;"></td> <td style="width: 10%;"></td> <td style="width: 10%;"></td> </tr> <tr> <td></td> <td></td> <td colspan="8" style="text-align: center;"> <table border="1" style="width: 100%; border-collapse: collapse; text-align: center;"> <tr> <td style="width: 10%;"></td> <td style="width: 10%;"></td> <td style="width: 10%;"></td> <td style="width: 10%;"></td> <td style="width: 10%;"></td> <td style="width: 10%;"></td> <td style="width: 10%;"></td> <td style="width: 10%;"></td> <td style="width: 10%;"></td> <td style="width: 10%;"></td> </tr> <tr> <td></td> <td></td> <td colspan="8" style="text-align: center;"> <table border="1" style="width: 100%; border-collapse: collapse; text-align: center;"> <tr> <td style="width: 10%;"></td> <td style="width: 10%;"></td> <td style="width: 10%;"></td> <td style="width: 10%;"></td> <td style="width: 10%;"></td> <td style="width: 10%;"></td> <td style="width: 10%;"></td> <td style="width: 10%;"></td> <td style="width: 10%;"></td> <td style="width: 10%;"></td> </tr> <tr> <td></td> <td></td> <td colspan="8" style="text-align: center;"> <table border="1" style="width: 100%; border-collapse: collapse; text-align: center;"> <tr> <td style="width: 10%;"></td> <td style="width: 10%;"></td> <td style="width: 10%;"></td> <td style="width: 10%;"></td> <td style="width: 10%;"></td> <td style="width: 10%;"></td> <td style="width: 10%;"></td> <td style="width: 10%;"></td> <td style="width: 10%;"></td> <td style="width: 10%;"></td> </tr> <tr> <td></td> <td></td> <td colspan="8" style="text-align: center;"> <table border="1" style="width: 100%; border-collapse: collapse; text-align: center;"> <tr> <td style="width: 10%;"></td> <td style="width: 10%;"></td> <td style="width: 10%;"></td> <td style="width: 10%;"></td> <td style="width: 10%;"></td> <td style="width: 10%;"></td> <td style="width: 10%;"></td> <td style="width: 10%;"></td> <td style="width: 10%;"></td> <td style="width: 10%;"></td> </tr> <tr> <td></td> <td></td> <td colspan="8" style="text-align: center;"> <table border="1" style="width: 100%; border-collapse: collapse; text-align: center;"> <tr> <td style="width: 10%;"></td> <td style="width: 10%;"></td> <td style="width: 10%;"></td> <td style="width: 10%;"></td> <td style="width: 10%;"></td> <td style="width: 10%;"></td> <td style="width: 10%;"></td> <td style="width: 10%;"></td> <td style="width: 10%;"></td> <td style="width: 10%;"></td> </tr> <tr> <td></td> <td></td> <td colspan="8" style="text-align: center;"> <table border="1" style="width: 100%; border-collapse: collapse; text-align: center;"> <tr> <td style="width: 10%;"></td> <td style="width: 10%;"></td> <td style="width: 10%;"></td> <td style="width: 10%;"></td> <td style="width: 10%;"></td> <td style="width: 10%;"></td> <td style="width: 10%;"></td> <td style="width: 10%;"></td> <td style="width: 10%;"></td> <td style="width: 10%;"></td> </tr> <tr> <td></td> <td></td> <td colspan="8" style="text-align: center;"> <table border="1" style="width: 100%; border-collapse: collapse; text-align: center;"> <tr> <td style="width: 10%;"></td> <td style="width: 10%;"></td> <td style="width: 10%;"></td> <td style="width: 10%;"></td> <td style="width: 10%;"></td> <td style="width: 10%;"></td> <td style="width: 10%;"></td> <td style="width: 10%;"></td> <td style="width: 10%;"></td> <td style="width: 10%;"></td> </tr> <tr> <td></td> <td></td> <td colspan="8" style="text-align: center;"> <table border="1" style="width: 100%; border-collapse: collapse; text-align: center;"> <tr> <td style="width: 10%;"></td> <td style="width: 10%;"></td> <td style="width: 10%;"></td> <td style="width: 10%;"></td> <td style="width: 10%;"></td> <td style="width: 10%;"></td> <td style="width: 10%;"></td> <td style="width: 10%;"></td> <td style="width: 10%;"></td> <td style="width: 10%;"></td> </tr> <tr> <td></td> <td></td> <td colspan="8" style="text-align: center;"> <table border="1" style="width: 100%; border-collapse: collapse; text-align: center;"> <tr> <td style="width: 10%;"></td> <td style="width: 10%;"></td> <td style="width: 10%;"></td> <td style="width: 10%;"></td> <td style="width: 10%;"></td> <td style="width: 10%;"></td> <td style="width: 10%;"></td> <td style="width: 10%;"></td> <td style="width: 10%;"></td> <td style="width: 10%;"></td> </tr> <tr> <td></td> <td></td> <td colspan="8" style="text-align: center;"> <table border="1" style="width: 100%; border-collapse: collapse; text-align: center;"> <tr> <td style="width: 10%;"></td> <td style="width: 10%;"></td> <td style="width: 10%;"></td> <td style="width: 10%;"></td> <td style="width: 10%;"></td> <td style="width: 10%;"></td> <td style="width: 10%;"></td> <td style="width: 10%;"></td> <td style="width: 10%;"></td> <td style="width: 10%;"></td> </tr> <tr> <td></td> <td></td> <td colspan="8" style="text-align: center;"> <table border="1" style="width: 100%; border-collapse: collapse; text-align: center;"> <tr> <td style="width: 10%;"></td> <td style="width: 10%;"></td> <td style="width: 10%;"></td> <td style="width: 10%;"></td> <td style="width: 10%;"></td> <td style="width: 10%;"></td> <td style="width: 10%;"></td> <td style="width: 10%;"></td> <td style="width: 10%;"></td> <td style="width: 10%;"></td> </tr> <tr> <td></td> <td></td> <td colspan="8" style="text-align: center;"> <table border="1" style="width: 100%; border-collapse: collapse; text-align: center;"> <tr> <td style="width: 10%;"></td> <td style="width: 10%;"></td> <td style="width: 10%;"></td> <td style="width: 10%;"></td> <td style="width: 10%;"></td> <td style="width: 10%;"></td> <td style="width: 10%;"></td> <td style="width: 10%;"></td> <td style="width: 10%;"></td> <td style="width: 10%;"></td> </tr> <tr> <td></td> <td></td> <td colspan="8" style="text-align: center;"> <table border="1" style="width: 100%; border-collapse: collapse; text-align: center;"> <tr> <td style="width: 10%;"></td> <td style="width: 10%;"></td> <td style="width: 10%;"></td> <td style="width: 10%;"></td> <td style="width: 10%;"></td> <td style="width: 10%;"></td> <td style="width: 10%;"></td> <td style="width: 10%;"></td> <td style="width: 10%;"></td> <td style="width: 10%;"></td> </tr> <tr> <td></td> <td></td> <td colspan="8" style="text-align: center;"> <table border="1" style="width: 100%; border-collapse: collapse; text-align: center;"> <tr> <td style="width: 10%;"></td> <td style="width: 10%;"></td> <td style="width: 10%;"></td> <td style="width: 10%;"></td> <td style="width: 10%;"></td> <td style="width:
10%;"></td> <td style="width: 10%;"></td> <td style="width: 10%;"></td> <td style="width: 10%;"></td> <td style="width: 10%;"></td> </tr> <tr> <td></td> <td></td> <td colspan="8" style="text-align: center;"> <table border="1" style="width: 100%; border-collapse: collapse; text-align: center;"> <tr> <td style="width: 10%;"></td> <td style="width: 10%;"></td> <td style="width: 10%;"></td> <td style="width: 10%;"></td> <td style="width: 10%;"></td> <td style="width: 10%;"></td> <td style="width: 10%;"></td> <td style="width: 10%;"></td> <td style="width: 10%;"></td> <td style="width: 10%;"></td> </tr> <tr> <td></td> <td></td> <td colspan="8" style="text-align: center;"> <table border="1" style="width: 100%; border-collapse: collapse; text-align: center;"> <tr> <td style="width: 10%;"></td> <td style="width: 10%;"></td> <td style="width: 10%;"></td> <td style="width: 10%;"></td> <td style="width: 10%;"></td> <td style="width: 10%;"></td> <td style="width: 10%;"></td> <td style="width: 10%;"></td> <td style="width: 10%;"></td> <td style="width: 10%;"></td> </tr> <tr> <td></td> <td></td> <td colspan="8" style="text-align: center;"> <table border="1" style="width: 100%; border-collapse: collapse; text-align: center;"> <tr> <td style="width: 10%;"></td> <td style="width: 10%;"></td> <td style="width: 10%;"></td> <td style="width: 10%;"></td> <td style="width: 10%;"></td> <td style="width: 10%;"></td> <td style="width: 10%;"></td> <td style="width: 10%;"></td> <td style="width: 10%;"></td> <td style="width: 10%;"></td> </tr> <tr> <td></td> <td></td> <td colspan="8" style="text-align: center;"> <table border="1" style="width: 100%; border-collapse: collapse; text-align: center;"> <tr> <td style="width: 10%;"></td> <td style="width: 10%;"></td> <td style="width: 10%;"></td> <td style="width: 10%;"></td> <td style="width: 10%;"></td> <td style="width: 10%;"></td> <td style="width: 10%;"></td> <td style="width: 10%;"></td> <td style="width: 10%;"></td> <td style="width: 10%;"></td> </tr> <tr> <td></td> <td></td> <td colspan="8" style="text-align: center;"> <table border="1" style="width: 100%; border-collapse: collapse; text-align: center;"> <tr> <td style="width: 10%;"></td> <td style="width: 10%;"></td> <td style="width: 10%;"></td> <td style="width: 10%;"></td> <td style="width: 10%;"></td> <td style="width: 10%;"></td> <td style="width: 10%;"></td> <td style="width: 10%;"></td> <td style="width: 10%;"></td> <td style="width: 10%;"></td> </tr> <tr> <td></td> <td></td> <td colspan="8" style="text-align: center;"> <table border="1" style="width: 100%; border-collapse: collapse; text-align: center;"> <tr> <td style="width: 10%;"></td> <td style="width: 10%;"></td> <td style="width: 10%;"></td> <td style="width: 10%;"></td> <td style="width: 10%;"></td> <td style="width: 10%;"></td> <td style="width: 10%;"></td> <td style="width: 10%;"></td> <td style="width: 10%;"></td> <td style="width: 10%;"></td> </tr> <tr> <td></td> <td></td> <td colspan="8" style="text-align: center;"> <table border="1" style="width: 100%; border-collapse: collapse; text-align: center;"> <tr> <td style="width: 10%;"></td> <td style="width: 10%;"></td> <td style="width: 10%;"></td> <td style="width: 10%;"></td> <td style="width: 10%;"></td> <td style="width: 10%;"></td> <td style="width: 10%;"></td> <td style="width: 10%;"></td> <td style="width: 10%;"></td> <td style="width: 10%;"></td> </tr> <tr> <td></td> <td></td> <td colspan="8" style="text-align: center;"> <table border="1" style="width: 100%; border-collapse: collapse; text-align: center;"> <tr> <td style="width: 10%;"></td> <td style="width: 10%;"></td> <td style="width: 10%;"></td> <td style="width: 10%;"></td> <td style="width: 10%;"></td> <td style="width: 10%;"></td> <td style="width: 10%;"></td> <td style="width: 10%;"></td> <td style="width: 10%;"></td> <td style="width: 10%;"></td> </tr> <tr> <td></td> <td></td> <td colspan="8" style="text-align: center;"> <table border="1" style="width: 100%; border-collapse: collapse; text-align: center;"> <tr> <td style="width: 10%;"></td> <td style="width: 10%;"></td> <td style="width: 10%;"></td> <td style="width: 10%;"></td> <td style="width: 10%;"></td> <td style="width: 10%;"></td> <td style="width: 10%;"></td> <td style="width: 10%;"></td> <td style="width: 10%;"></td> <td style="width: 10%;"></td> </tr> <tr> <td></td> <td></td> <td colspan="8" style="text-align: center;"> <table border="1" style="width: 100%; border-collapse: collapse; text-align: center;"> <tr> <td style="width: 10%;"></td> <td style="width: 10%;"></td> <td style="width: 10%;"></td> <td style="width: 10%;"></td> <td style="width: 10%;"></td> <td style="width: 10%;"></td> <td style="width: 10%;"></td> <td style="width: 10%;"></td> <td style="width: 10%;"></td> <td style="width: 10%;"></td> </tr> <tr> <td></td> <td></td> <td colspan="8" style="text-align: center;"> <table border="1" style="width: 100%; border-collapse: collapse; text-align: center;"> <tr> <td style="width: 10%;"></td> <td style="width: 10%;"></td> <td style="width: 10%;"></td> <td style="width: 10%;"></td> <td style="width: 10%;"></td> <td style="width: 10%;"></td> <td style="width: 10%;"></td> <td style="width: 10%;"></td> <td style="width: 10%;"></td> <td style="width: 10%;"></td> </tr> <tr> <td></td> <td></td> <td colspan="8" style="text-align: center;"> <table border="1" style="width: 100%; border-collapse: collapse; text-align: center;"> <tr> <td style="width: 10%;"></td> <td style="width: 10%;"></td> <td style="width: 10%;"></td> <td style="width: 10%;"></td> <td style="width: 10%;"></td> <td style="width: 10%;"></td> <td style="width: 10%;"></td> <td style="width: 10%;"></td> <td style="width: 10%;"></td> <td style="width: 10%;"></td> </tr> <tr> <td></td> <td></td> <td colspan="8" style="text-align: center;"> <table border="1" style="width: 100%; border-collapse: collapse; text-align: center;"> <tr> <td style="width: 10%;"></td> <td style="width: 10%;"></td> <td style="width: 10%;"></td> <td style="width: 10%;"></td> <td style="width: 10%;"></td> <td style="width: 10%;"></td> <td style="width: 10%;"></td> <td style="width: 10%;"></td> <td style="width: 10%;"></td> <td style="width: 10%;"></td> </tr> <tr> <td></td> <td></td> <td colspan="8" style="text-align: center;"> <table border="1" style="width: 100%; border-collapse: collapse; text-align: center;"> <tr> <td style="width: 10%;"></td> <td style="width: 10%;"></td> <td style="width: 10%;"></td> <td style="width: 10%;"></td> <td style="width: 10%;"></td> <td style="width: 10%;"></td> <td style="width: 10%;"></td> <td style="width: 10%;"></td> <td style="width: 10%;"></td> <td style="width: 10%;"></td> </tr> <tr> <td></td> <td></td> <td colspan="8" style="text-align: center;"> <table border="1" style="width: 100%; border-collapse: collapse; text-align: center;"> <tr> <td style="width: 10%;"></td> <td style="width: 10%;"></td> <td style="width: 10%;"></td> <td style="width: 10%;"></td> <td style="width: 10%;"></td> <td style="width: 10%;"></td> <td style="width: 10%;"></td> <td style="width: 10%;"></td> <td style="width: 10%;"></td> <td style="width: 10%;"></td> </tr> <tr> <td></td> <td></td> <td colspan="8" style="text-align: center;"> <table border="1" style="width: 100%; border-collapse: collapse; text-align: center;"> <tr> <td style="width: 10%;"></td> <td style="width: 10%;"></td> <td style="width: 10%;"></td> <td style="width: 10%;"></td> <td style="width: 10%;"></td> <td style="width: 10%;"></td> <td style="width: 10%;"></td> <td style="width: 10%;"></td> <td style="width: 10%;"></td> <td style="width: 10%;"></td> </tr> <tr> <td></td> <td></td> <td colspan="8" style="text-align: center;"> <table border="1" style="width: 100%; border-collapse: collapse; text-align: center;"> <tr> <td style="width: 10%;"></td> <td style="width: 10%;"></td> <td style="width: 10%;"></td> <td style="width: 10%;"></td> <td style="width: 10%;"></td> <td style="width: 10%;"></td> <td style="width: 10%;"></td> <td style="width: 10%;"></td> <td style="width: 10%;"></td> <td style="width: 10%;"></td> </tr> <tr> <td></td> <td></td> <td colspan="8" style="text-align: center;"> <table border="1" style="width: 100%; border-collapse: collapse; text-align: center;"> <tr> <td style="width: 10%;"></td> <td style="width: 10%;"></td> <td style="width: 10%;"></td> <td style="width: 10%;"></td> <td style="width: 10%;"></td> <td style="width: 10%;"></td> <td style="width: 10%;"></td> <td style="width: 10%;"></td> <td style="width: 10%;"></td> <td style="width: 10%;"></td> </tr> <tr> <td></td> <td></td> <td colspan="8" style="text-align: center;"> <table border="1" style="width: 100%; border-collapse: collapse; text-align: center;"> <tr> <td style="width: 10%;"></td> <td style="width: 10%;"></td> <td style="width: 10%;"></td> <td style="width: 10%;"></td> <td style="width: 10%;"></td> <td style="width: 10%;"></td> <td style="width: 10%;"></td> <td style="width: 10%;"></td> <td style="width: 10%;"></td> <td style="width: 10%;"></td> </tr> <tr> <td></td> <td></td> <td colspan="8" style="text-align: center;"> <table border="1" style="width: 100%; border-collapse: collapse; text-align: center;"> <tr> <td style="width: 10%;"></td> <td style="width: 10%;"></td> <td style="width: 10%;"></td> <td style="width: 10%;"></td> <td style="width: 10%;"></td> <td style="width: 10%;"></td> <td style="width: 10%;"></td> <td style="width: 10%;"></td> <td style="width: 10%;"></td> <td style="width: 10%;"></td> </tr> <tr> <td></td> <td></td> <td colspan="8" style="text-align: center;"> <table border="1" style="width: 100%; border-collapse: collapse; text-align: center;"> <tr> <td style="width: 10%;"></td> <td style="width: 10%;"></td> <td style="width: 10%;"></td> <td style="width: 10%;"></td> <td style="width: 10%;"></td> <td style="width: 10%;"></td> <td style="width: 10%;"></td> <td style="width: 10%;"></td> <td style="width: 10%;"></td> <td style="width: 10%;"></td> </tr> <tr> <td></td> <td></td> <td
colspan="8" style="text-align: center;"> <table border="1" style="width: 100%; border-collapse: collapse; text-align: center;"> <tr> <td style="width: 10%;"></td> <td style="width: 10%;"></td> <td style="width: 10%;"></td> <td style="width: 10%;"></td> <td style="width: 10%;"></td> <td style="width: 10%;"></td> <td style="width: 10%;"></td> <td style="width: 10%;"></td> <td style="width: 10%;"></td> <td style="width: 10%;"></td> </tr> <tr> <td></td> <td></td> <td colspan="8" style="text-align: center;"> <table border="1" style="width: 100%; border-collapse: collapse; text-align: center;"> <tr> <td style="width: 10%;"></td> <td style="width: 10%;"></td> <td style="width: 10%;"></td> <td style="width: 10%;"></td> <td style="width: 10%;"></td> <td style="width: 10%;"></td> <td style="width: 10%;"></td> <td style="width: 10%;"></td> <td style="width: 10%;"></td> <td style="width: 10%;"></td> </tr> <tr> <td></td> <td></td> <td colspan="8" style="text-align: center;"> <table border="1" style="width: 100%; border-collapse: collapse; text-align: center;"> <tr> <td style="width: 10%;"></td> <td style="width: 10%;"></td> <td style="width: 10%;"></td> <td style="width: 10%;"></td> <td style="width: 10%;"></td> <td style="width: 10%;"></td> <td style="width: 10%;"></td> <td style="width: 10%;"></td> <td style="width: 10%;"></td> <td style="width: 10%;"></td> </tr> <tr> <td></td> <td></td> <td colspan="8" style="text-align: center;"> <table border="1" style="width: 100%; border-collapse: collapse; text-align: center;"> <tr> <td style="width: 10%;"></td> <td style="width: 10%;"></td> <td style="width: 10%;"></td> <td style="width: 10%;"></td> <td style="width: 10%;"></td> <td style="width: 10%;"></td> <td style="width: 10%;"></td> <td style="width: 10%;"></td> <td style="width: 10%;"></td> <td style="width: 10%;"></td> </tr> <tr> <td></td> <td></td> <td colspan="8" style="text-align: center;"> <table border="1" style="width: 100%; border-collapse: collapse; text-align: center;"> <tr> <td style="width: 10%;"></td> <td style="width: 10%;"></td> <td style="width: 10%;"></td> <td style="width: 10%;"></td> <td style="width: 10%;"></td> <td style="width: 10%;"></td> <td style="width: 10%;"></td> <td style="width: 10%;"></td> <td style="width: 10%;"></td> <td style="width: 10%;"></td> </tr> <tr> <td></td> <td></td> <td colspan="8" style="text-align: center;"> <table border="1" style="width: 100%; border-collapse: collapse; text-align: center;"> <tr> <td style="width: 10%;"></td> <td style="width: 10%;"></td> <td style="width: 10%;"></td> <td style="width: 10%;"></td> <td style="width: 10%;"></td> <td style="width: 10%;"></td> <td style="width: 10%;"></td> <td style="width: 10%;"></td> <td style="width: 10%;"></td> <td style="width: 10%;"></td> </tr> <tr> <td></td> <td></td> <td colspan="8" style="text-align: center;"> <table border="1" style="width: 100%; border-collapse: collapse; text-align: center;"> <tr> </tr></table></td></tr></table></td></tr></table></td></tr></table></td></tr></table></td></tr></table></td></tr></table></td></tr></table></td></tr></table></td></tr></table></td></tr></table></td></tr></table></td></tr></table></td></tr></table></td></tr></table></td></tr></table></td></tr></table></td></tr></table></td></tr></table></td></tr></table></td></tr></table></td></tr></table></td></tr></table></td></tr></table></td></tr></table></td></tr></table></td></tr></table></td></tr></table></td></tr></table></td></tr></table></td></tr></table></td></tr></table></td></tr></table></td></tr></table></td></tr></table></td></tr></table></td></tr></table></td></tr></table></td></tr></table></td></tr></table></td></tr></table></td></tr></table></td></tr></table></td></tr></table></td></tr></table></td></tr></table></td></tr></table>
 | | | | | | | | | | | | | | | | | | | | <table border="1" style="width: 100%; border-collapse: collapse; text-align: center;"> <tr> <td style="width: 10%;"></td> <td style="width: 10%;"></td> <td style="width: 10%;"></td> <td style="width: 10%;"></td> <td style="width: 10%;"></td> <td style="width: 10%;"></td> <td style="width: 10%;"></td> <td style="width: 10%;"></td> <td style="width: 10%;"></td> <td style="width: 10%;"></td> </tr> <tr> <td></td> <td></td> <td colspan="8" style="text-align: center;"> <table border="1" style="width: 100%; border-collapse: collapse; text-align: center;"> <tr> <td style="width: 10%;"></td> <td style="width: 10%;"></td> <td style="width: 10%;"></td> <td style="width: 10%;"></td> <td style="width: 10%;"></td> <td style="width: 10%;"></td> <td style="width: 10%;"></td> <td style="width: 10%;"></td> <td style="width: 10%;"></td> <td style="width: 10%;"></td> </tr> <tr> <td></td> <td></td> <td colspan="8" style="text-align: center;"> <table border="1" style="width: 100%; border-collapse: collapse; text-align: center;"> <tr> <td style="width: 10%;"></td> <td style="width: 10%;"></td> <td style="width: 10%;"></td> <td style="width: 10%;"></td> <td style="width: 10%;"></td> <td style="width: 10%;"></td> <td style="width: 10%;"></td> <td style="width: 10%;"></td> <td style="width: 10%;"></td> <td style="width: 10%;"></td> </tr> <tr> <td></td> <td></td> <td colspan="8" style="text-align: center;"> <table border="1" style="width: 100%; border-collapse: collapse; text-align: center;"> <tr> <td style="width: 10%;"></td> <td style="width: 10%;"></td> <td style="width: 10%;"></td> <td style="width: 10%;"></td> <td style="width: 10%;"></td> <td style="width: 10%;"></td> <td style="width: 10%;"></td> <td style="width: 10%;"></td> <td style="width: 10%;"></td> <td style="width: 10%;"></td> </tr> <tr> <td></td> <td></td> <td colspan="8" style="text-align: center;"> <table border="1" style="width: 100%; border-collapse: collapse; text-align: center;"> <tr> <td style="width: 10%;"></td> <td style="width: 10%;"></td> <td style="width: 10%;"></td> <td style="width: 10%;"></td> <td style="width: 10%;"></td> <td style="width: 10%;"></td> <td style="width: 10%;"></td> <td style="width: 10%;"></td> <td style="width: 10%;"></td> <td style="width: 10%;"></td> </tr> <tr> <td></td> <td></td> <td colspan="8" style="text-align: center;"> <table border="1" style="width: 100%; border-collapse: collapse; text-align: center;"> <tr> <td style="width: 10%;"></td> <td style="width: 10%;"></td> <td style="width: 10%;"></td> <td style="width: 10%;"></td> <td style="width: 10%;"></td> <td style="width: 10%;"></td> <td style="width: 10%;"></td> <td style="width: 10%;"></td> <td style="width: 10%;"></td> <td style="width: 10%;"></td> </tr> <tr> <td></td> <td></td> <td colspan="8" style="text-align: center;"> <table border="1" style="width: 100%; border-collapse: collapse; text-align: center;"> <tr> <td style="width: 10%;"></td> <td style="width: 10%;"></td> <td style="width: 10%;"></td> <td style="width: 10%;"></td> <td style="width: 10%;"></td> <td style="width: 10%;"></td> <td style="width: 10%;"></td> <td style="width: 10%;"></td> <td style="width: 10%;"></td> <td style="width: 10%;"></td> </tr> <tr> <td></td> <td></td> <td colspan="8" style="text-align: center;"> <table border="1" style="width: 100%; border-collapse: collapse; text-align: center;"> <tr> <td style="width: 10%;"></td> <td style="width: 10%;"></td> <td style="width: 10%;"></td> <td style="width: 10%;"></td> <td style="width: 10%;"></td> <td style="width: 10%;"></td> <td style="width: 10%;"></td> <td style="width: 10%;"></td> <td style="width: 10%;"></td> <td style="width: 10%;"></td> </tr> <tr> <td></td> <td></td> <td colspan="8" style="text-align: center;"> <table border="1" style="width: 100%; border-collapse: collapse; text-align: center;"> <tr> <td style="width: 10%;"></td> <td style="width: 10%;"></td> <td style="width: 10%;"></td> <td style="width: 10%;"></td> <td style="width: 10%;"></td> <td style="width: 10%;"></td> <td style="width: 10%;"></td> <td style="width: 10%;"></td> <td style="width: 10%;"></td> <td style="width: 10%;"></td> </tr> <tr> <td></td> <td></td> <td colspan="8" style="text-align: center;"> <table border="1" style="width: 100%; border-collapse: collapse; text-align: center;"> <tr> <td style="width: 10%;"></td> <td style="width: 10%;"></td> <td style="width: 10%;"></td> <td style="width: 10%;"></td> <td style="width: 10%;"></td> <td style="width: 10%;"></td> <td style="width: 10%;"></td> <td style="width: 10%;"></td> <td style="width: 10%;"></td> <td style="width: 10%;"></td> </tr> <tr> <td></td> <td></td> <td colspan="8" style="text-align: center;"> <table border="1" style="width: 100%; border-collapse: collapse; text-align: center;"> <tr> <td style="width: 10%;"></td> <td style="width: 10%;"></td> <td style="width: 10%;"></td> <td style="width: 10%;"></td> <td style="width: 10%;"></td> <td style="width: 10%;"></td> <td style="width: 10%;"></td> <td style="width: 10%;"></td> <td style="width: 10%;"></td> <td style="width: 10%;"></td> </tr> <tr> <td></td> <td></td> <td colspan="8" style="text-align: center;"> <table border="1" style="width: 100%; border-collapse: collapse; text-align: center;"> <tr> <td style="width: 10%;"></td> <td style="width: 10%;"></td> <td style="width: 10%;"></td> <td style="width: 10%;"></td> <td style="width: 10%;"></td> <td style="width: 10%;"></td> <td style="width: 10%;"></td> <td style="width: 10%;"></td> <td style="width: 10%;"></td> <td style="width: 10%;"></td> </tr> <tr> <td></td> <td></td> <td colspan="8" style="text-align: center;"> <table border="1" style="width: 100%; border-collapse: collapse; text-align: center;"> <tr> <td style="width: 10%;"></td> <td style="width: 10%;"></td> <td style="width: 10%;"></td> <td style="width: 10%;"></td> <td style="width: 10%;"></td> <td style="width: 10%;"></td> <td style="width: 10%;"></td> <td style="width: 10%;"></td> <td style="width: 10%;"></td> <td style="width: 10%;"></td> </tr> <tr> <td></td> <td></td> <td colspan="8" style="text-align: center;"> <table border="1" style="width: 100%; border-collapse: collapse; text-align: center;"> <tr> <td style="width: 10%;"></td> <td style="width: 10%;"></td> <td style="width: 10%;"></td> <td style="width: 10%;"></td> <td style="width: 10%;"></td> <td style="width: 10%;"></td> <td style="width: 10%;"></td> <td style="width: 10%;"></td> <td style="width: 10%;"></td> <td style="width: 10%;"></td> </tr> <tr> <td></td> <td></td> <td colspan="8" style="text-align: center;"> <table border="1" style="width: 100%; border-collapse: collapse; text-align: center;"> <tr> <td style="width: 10%;"></td> <td style="width: 10%;"></td> <td style="width: 10%;"></td> <td style="width: 10%;"></td> <td style="width: 10%;"></td> <td style="width: 10%;"></td> <td style="width: 10%;"></td> <td style="width: 10%;"></td> <td style="width: 10%;"></td> <td style="width: 10%;"></td> </tr> <tr> <td></td> <td></td> <td colspan="8" style="text-align: center;"> <table border="1" style="width: 100%; border-collapse: collapse; text-align: center;"> <tr> <td style="width: 10%;"></td> <td style="width: 10%;"></td> <td style="width: 10%;"></td> <td style="width: 10%;"></td> <td style="width: 10%;"></td> <td style="width: 10%;"></td> <td style="width: 10%;"></td> <td style="width: 10%;"></td> <td style="width: 10%;"></td> <td style="width: 10%;"></td> </tr> <tr> <td></td> <td></td> <td colspan="8" style="text-align: center;"> <table border="1" style="width: 100%; border-collapse: collapse; text-align: center;"> <tr> <td style="width: 10%;"></td> <td style="width: 10%;"></td> <td style="width: 10%;"></td> <td style="width: 10%;"></td> <td style="width: 10%;"></td> <td style="width: 10%;"></td> <td style="width: 10%;"></td> <td style="width: 10%;"></td> <td style="width: 10%;"></td> <td style="width: 10%;"></td> </tr> <tr>
<td></td> <td></td> <td colspan="8" style="text-align: center;"> <table border="1" style="width: 100%; border-collapse: collapse; text-align: center;"> <tr> <td style="width: 10%;"></td> <td style="width: 10%;"></td> <td style="width: 10%;"></td> <td style="width: 10%;"></td> <td style="width: 10%;"></td> <td style="width: 10%;"></td> <td style="width: 10%;"></td> <td style="width: 10%;"></td> <td style="width: 10%;"></td> <td style="width: 10%;"></td> </tr> <tr> <td></td> <td></td> <td colspan="8" style="text-align: center;"> <table border="1" style="width: 100%; border-collapse: collapse; text-align: center;"> <tr> <td style="width: 10%;"></td> <td style="width: 10%;"></td> <td style="width: 10%;"></td> <td style="width: 10%;"></td> <td style="width: 10%;"></td> <td style="width: 10%;"></td> <td style="width: 10%;"></td> <td style="width: 10%;"></td> <td style="width: 10%;"></td> <td style="width: 10%;"></td> </tr> <tr> <td></td> <td></td> <td colspan="8" style="text-align: center;"> <table border="1" style="width: 100%; border-collapse: collapse; text-align: center;"> <tr> <td style="width: 10%;"></td> <td style="width: 10%;"></td> <td style="width: 10%;"></td> <td style="width: 10%;"></td> <td style="width: 10%;"></td> <td style="width: 10%;"></td> <td style="width: 10%;"></td> <td style="width: 10%;"></td> <td style="width: 10%;"></td> <td style="width: 10%;"></td> </tr> <tr> <td></td> <td></td> <td colspan="8" style="text-align: center;"> <table border="1" style="width: 100%; border-collapse: collapse; text-align: center;"> <tr> <td style="width: 10%;"></td> <td style="width: 10%;"></td> <td style="width: 10%;"></td> <td style="width: 10%;"></td> <td style="width: 10%;"></td> <td style="width: 10%;"></td> <td style="width: 10%;"></td> <td style="width: 10%;"></td> <td style="width: 10%;"></td> <td style="width: 10%;"></td> </tr> <tr> <td></td> <td></td> <td colspan="8" style="text-align: center;"> <table border="1" style="width: 100%; border-collapse: collapse; text-align: center;"> <tr> <td style="width: 10%;"></td> <td style="width: 10%;"></td> <td style="width: 10%;"></td> <td style="width: 10%;"></td> <td style="width: 10%;"></td> <td style="width: 10%;"></td> <td style="width: 10%;"></td> <td style="width: 10%;"></td> <td style="width: 10%;"></td> <td style="width: 10%;"></td> </tr> <tr> <td></td> <td></td> <td colspan="8" style="text-align: center;"> <table border="1" style="width: 100%; border-collapse: collapse; text-align: center;"> <tr> <td style="width: 10%;"></td> <td style="width: 10%;"></td> <td style="width: 10%;"></td> <td style="width: 10%;"></td> <td style="width: 10%;"></td> <td style="width: 10%;"></td> <td style="width: 10%;"></td> <td style="width: 10%;"></td> <td style="width: 10%;"></td> <td style="width: 10%;"></td> </tr> <tr> <td></td> <td></td> <td colspan="8" style="text-align: center;"> <table border="1" style="width: 100%; border-collapse: collapse; text-align: center;"> <tr> <td style="width: 10%;"></td> <td style="width: 10%;"></td> <td style="width: 10%;"></td> <td style="width: 10%;"></td> <td style="width: 10%;"></td> <td style="width: 10%;"></td> <td style="width: 10%;"></td> <td style="width: 10%;"></td> <td style="width: 10%;"></td> <td style="width: 10%;"></td> </tr> <tr> <td></td> <td></td> <td colspan="8" style="text-align: center;"> <table border="1" style="width: 100%; border-collapse: collapse; text-align: center;"> <tr> <td style="width: 10%;"></td> <td style="width: 10%;"></td> <td style="width: 10%;"></td> <td style="width: 10%;"></td> <td style="width: 10%;"></td> <td style="width: 10%;"></td> <td style="width: 10%;"></td> <td style="width: 10%;"></td> <td style="width: 10%;"></td> <td style="width: 10%;"></td> </tr> <tr> <td></td> <td></td> <td colspan="8" style="text-align: center;"> <table border="1" style="width: 100%; border-collapse: collapse; text-align: center;"> <tr> <td style="width: 10%;"></td> <td style="width: 10%;"></td> <td style="width: 10%;"></td> <td style="width: 10%;"></td> <td style="width: 10%;"></td> <td style="width: 10%;"></td> <td style="width: 10%;"></td> <td style="width: 10%;"></td> <td style="width: 10%;"></td> <td style="width: 10%;"></td> </tr> <tr> <td></td> <td></td> <td colspan="8" style="text-align: center;"> <table border="1" style="width: 100%; border-collapse: collapse; text-align: center;"> <tr> <td style="width: 10%;"></td> <td style="width: 10%;"></td> <td style="width: 10%;"></td> <td style="width: 10%;"></td> <td style="width: 10%;"></td> <td style="width: 10%;"></td> <td style="width: 10%;"></td> <td style="width: 10%;"></td> <td style="width: 10%;"></td> <td style="width: 10%;"></td> </tr> <tr> <td></td> <td></td> <td colspan="8" style="text-align: center;"> <table border="1" style="width: 100%; border-collapse: collapse; text-align: center;"> <tr> <td style="width: 10%;"></td> <td style="width: 10%;"></td> <td style="width: 10%;"></td> <td style="width: 10%;"></td> <td style="width: 10%;"></td> <td style="width: 10%;"></td> <td style="width: 10%;"></td> <td style="width: 10%;"></td> <td style="width: 10%;"></td> <td style="width: 10%;"></td> </tr> <tr> <td></td> <td></td> <td colspan="8" style="text-align: center;"> <table border="1" style="width: 100%; border-collapse: collapse; text-align: center;"> <tr> <td style="width: 10%;"></td> <td style="width: 10%;"></td> <td style="width: 10%;"></td> <td style="width: 10%;"></td> <td style="width: 10%;"></td> <td style="width: 10%;"></td> <td style="width: 10%;"></td> <td style="width: 10%;"></td> <td style="width: 10%;"></td> <td style="width: 10%;"></td> </tr> <tr> <td></td> <td></td> <td colspan="8" style="text-align: center;"> <table border="1" style="width: 100%; border-collapse: collapse; text-align: center;"> <tr> <td style="width: 10%;"></td> <td style="width: 10%;"></td> <td style="width: 10%;"></td> <td style="width: 10%;"></td> <td style="width: 10%;"></td> <td style="width: 10%;"></td> <td style="width: 10%;"></td> <td style="width: 10%;"></td> <td style="width: 10%;"></td> <td style="width: 10%;"></td> </tr> <tr> <td></td> <td></td> <td colspan="8" style="text-align: center;"> <table border="1" style="width: 100%; border-collapse: collapse; text-align: center;"> <tr> <td style="width: 10%;"></td> <td style="width: 10%;"></td> <td style="width: 10%;"></td> <td style="width: 10%;"></td> <td style="width: 10%;"></td> <td style="width: 10%;"></td> <td style="width: 10%;"></td> <td style="width: 10%;"></td> <td style="width: 10%;"></td> <td style="width: 10%;"></td> </tr> <tr> <td></td> <td></td> <td colspan="8" style="text-align: center;"> <table border="1" style="width: 100%; border-collapse: collapse; text-align: center;"> <tr> <td style="width: 10%;"></td> <td style="width: 10%;"></td> <td style="width: 10%;"></td> <td style="width: 10%;"></td> <td style="width: 10%;"></td> <td style="width: 10%;"></td> <td style="width: 10%;"></td> <td style="width: 10%;"></td> <td style="width: 10%;"></td> <td style="width: 10%;"></td> </tr> <tr> <td></td> <td></td> <td colspan="8" style="text-align: center;"> <table border="1" style="width: 100%; border-collapse: collapse; text-align: center;"> <tr> <td style="width: 10%;"></td> <td style="width: 10%;"></td> <td style="width: 10%;"></td> <td style="width: 10%;"></td> <td style="width: 10%;"></td> <td style="width: 10%;"></td> <td style="width: 10%;"></td> <td style="width: 10%;"></td> <td style="width: 10%;"></td> <td style="width: 10%;"></td> </tr> <tr> <td></td> <td></td> <td colspan="8" style="text-align: center;"> <table border="1" style="width: 100%; border-collapse: collapse; text-align: center;"> <tr> <td style="width: 10%;"></td> <td style="width: 10%;"></td> <td style="width: 10%;"></td> <td style="width: 10%;"></td> <td style="width: 10%;"></td> <td style="width: 10%;"></td> <td style="width: 10%;"></td> <td style="width: 10%;"></td> <td style="width: 10%;"></td> <td style="width: 10%;"></td> </tr> <tr> <td></td> <td></td> <td colspan="8" style="text-align: center;"> <table border="1" style="width: 100%; border-collapse: collapse; text-align: center;"> <tr> <td style="width: 10%;"></td> <td style="width: 10%;"></td> <td style="width: 10%;"></td> <td style="width: 10%;"></td> <td style="width: 10%;"></td> <td style="width: 10%;"></td> <td style="width: 10%;"></td> <td style="width: 10%;"></td> <td style="width: 10%;"></td> <td style="width: 10%;"></td> </tr> <tr> <td></td> <td></td> <td colspan="8" style="text-align: center;"> <table border="1" style="width: 100%; border-collapse: collapse; text-align: center;"> <tr> <td style="width: 10%;"></td> <td style="width: 10%;"></td> <td style="width: 10%;"></td> <td style="width: 10%;"></td> <td style="width: 10%;"></td> <td style="width: 10%;"></td> <td style="width: 10%;"></td> <td style="width: 10%;"></td> <td style="width: 10%;"></td> <td style="width: 10%;"></td> </tr> <tr> <td></td> <td></td> <td colspan="8" style="text-align: center;"> <table border="1" style="width: 100%; border-collapse: collapse; text-align: center;"> <tr> <td style="width: 10%;"></td> <td style="width: 10%;"></td> <td style="width: 10%;"></td> <td style="width: 10%;"></td> <td style="width: 10%;"></td> <td style="width: 10%;"></td> <td style="width: 10%;"></td> <td style="width: 10%;"></td> <td style="width: 10%;"></td> <td style="width: 10%;"></td> </tr> <tr> <td></td> <td></td> <td colspan="8" style="text-align: center;"> <table border="1" style="width: 100%; border-collapse: collapse; text-align: center;"> <tr> <td style="width: 10%;"></td> <td style="width: 10%;"></td> <td style="width: 10%;"></td> <td style="width: 10%;"></td> <td style="width: 10%;"></td> <td style="width: 10%;"></td> <td style="width: 10%;"></td> <td style="width: 10%;"></td> <td style="width: 10%;"></td> <td style="width: 10%;"></td> </tr> <tr> <td></td> <td></td> <td colspan="8" style="text-align: center;"> <table border="1" style="width: 100%; border-collapse: collapse; text-align: center;"> <tr> <td
style="width: 10%;"></td> <td style="width: 10%;"></td> <td style="width: 10%;"></td> <td style="width: 10%;"></td> <td style="width: 10%;"></td> <td style="width: 10%;"></td> <td style="width: 10%;"></td> <td style="width: 10%;"></td> <td style="width: 10%;"></td> <td style="width: 10%;"></td> </tr> <tr> <td></td> <td></td> <td colspan="8" style="text-align: center;"> <table border="1" style="width: 100%; border-collapse: collapse; text-align: center;"> <tr> <td style="width: 10%;"></td> <td style="width: 10%;"></td> <td style="width: 10%;"></td> <td style="width: 10%;"></td> <td style="width: 10%;"></td> <td style="width: 10%;"></td> <td style="width: 10%;"></td> <td style="width: 10%;"></td> <td style="width: 10%;"></td> <td style="width: 10%;"></td> </tr> <tr> <td></td> <td></td> <td colspan="8" style="text-align: center;"> <table border="1" style="width: 100%; border-collapse: collapse; text-align: center;"> <tr> <td style="width: 10%;"></td> <td style="width: 10%;"></td> <td style="width: 10%;"></td> <td style="width: 10%;"></td> <td style="width: 10%;"></td> <td style="width: 10%;"></td> <td style="width: 10%;"></td> <td style="width: 10%;"></td> <td style="width: 10%;"></td> <td style="width: 10%;"></td> </tr> <tr> <td></td> <td></td> <td colspan="8" style="text-align: center;"> <table border="1" style="width: 100%; border-collapse: collapse; text-align: center;"> <tr> <td style="width: 10%;"></td> <td style="width: 10%;"></td> <td style="width: 10%;"></td> <td style="width: 10%;"></td> <td style="width: 10%;"></td> <td style="width: 10%;"></td> <td style="width: 10%;"></td> <td style="width: 10%;"></td> <td style="width: 10%;"></td> <td style="width: 10%;"></td> </tr> <tr> <td></td> <td></td> <td colspan="8" style="text-align: center;"> <table border="1" style="width: 100%; border-collapse: collapse; text-align: center;"> <tr> <td style="width: 10%;"></td> <td style="width: 10%;"></td> <td style="width: 10%;"></td> <td style="width: 10%;"></td> <td style="width: 10%;"></td> <td style="width: 10%;"></td> <td style="width: 10%;"></td> <td style="width: 10%;"></td> <td style="width: 10%;"></td> <td style="width: 10%;"></td> </tr> <tr> <td></td> <td></td> <td colspan="8" style="text-align: center;"> <table border="1" style="width: 100%; border-collapse: collapse; text-align: center;"> <tr> <td style="width: 10%;"></td> <td style="width: 10%;"></td> <td style="width: 10%;"></td> <td style="width: 10%;"></td> <td style="width: 10%;"></td> <td style="width: 10%;"></td> <td style="width: 10%;"></td> <td style="width: 10%;"></td> <td style="width: 10%;"></td> <td style="width: 10%;"></td> </tr> <tr> <td></td> <td></td> <td colspan="8" style="text-align: center;"> <table border="1" style="width: 100%; border-collapse: collapse; text-align: center;"> <tr> <td style="width: 10%;"></td> <td style="width: 10%;"></td> <td style="width: 10%;"></td> <td style="width: 10%;"></td> <td style="width: 10%;"></td> <td style="width: 10%;"></td> <td style="width: 10%;"></td> <td style="width: 10%;"></td> <td style="width: 10%;"></td> <td style="width: 10%;"></td> </tr> <tr> <td></td> <td></td> <td colspan="8" style="text-align: center;"> <table border="1" style="width: 100%; border-collapse: collapse; text-align: center;"> <tr> </tr></table></td></tr></table></td></tr></table></td></tr></table></td></tr></table></td></tr></table></td></tr></table></td></tr></table></td></tr></table></td></tr></table></td></tr></table></td></tr></table></td></tr></table></td></tr></table></td></tr></table></td></tr></table></td></tr></table></td></tr></table></td></tr></table></td></tr></table></td></tr></table></td></tr></table></td></tr></table></td></tr></table></td></tr></table></td></tr></table></td></tr></table></td></tr></table></td></tr></table></td></tr></table></td></tr></table></td></tr></table></td></tr></table></td></tr></table></td></tr></table></td></tr></table></td></tr></table></td></tr></table></td></tr></table></td></tr></table></td></tr></table></td></tr></table></td></tr></table></td></tr></table></td></tr></table></td></tr></table>
 | | | | | | | | | | | | | | | | | | | | <table border="1" style="width: 100%; border-collapse: collapse; text-align: center;"> <tr> <td style="width: 10%;"></td> <td style="width: 10%;"></td> <td style="width: 10%;"></td> <td style="width: 10%;"></td> <td style="width: 10%;"></td> <td style="width: 10%;"></td> <td style="width: 10%;"></td> <td style="width: 10%;"></td> <td style="width: 10%;"></td> <td style="width: 10%;"></td> </tr> <tr> <td></td> <td></td> <td colspan="8" style="text-align: center;"> <table border="1" style="width: 100%; border-collapse: collapse; text-align: center;"> <tr> <td style="width: 10%;"></td> <td style="width: 10%;"></td> <td style="width: 10%;"></td> <td style="width: 10%;"></td> <td style="width: 10%;"></td> <td style="width: 10%;"></td> <td style="width: 10%;"></td> <td style="width: 10%;"></td> <td style="width: 10%;"></td> <td style="width: 10%;"></td> </tr> <tr> <td></td> <td></td> <td colspan="8" style="text-align: center;"> <table border="1" style="width: 100%; border-collapse: collapse; text-align: center;"> <tr> <td style="width: 10%;"></td> <td style="width: 10%;"></td> <td style="width: 10%;"></td> <td style="width: 10%;"></td> <td style="width: 10%;"></td> <td style="width: 10%;"></td> <td style="width: 10%;"></td> <td style="width: 10%;"></td> <td style="width: 10%;"></td> <td style="width: 10%;"></td> </tr> <tr> <td></td> <td></td> <td colspan="8" style="text-align: center;"> <table border="1" style="width: 100%; border-collapse: collapse; text-align: center;"> <tr> <td style="width: 10%;"></td> <td style="width: 10%;"></td> <td style="width: 10%;"></td> <td style="width: 10%;"></td> <td style="width: 10%;"></td> <td style="width: 10%;"></td> <td style="width: 10%;"></td> <td style="width: 10%;"></td> <td style="width: 10%;"></td> <td style="width: 10%;"></td> </tr> <tr> <td></td> <td></td> <td colspan="8" style="text-align: center;"> <table border="1" style="width: 100%; border-collapse: collapse; text-align: center;"> <tr> <td style="width: 10%;"></td> <td style="width: 10%;"></td> <td style="width: 10%;"></td> <td style="width: 10%;"></td> <td style="width: 10%;"></td> <td style="width: 10%;"></td> <td style="width: 10%;"></td> <td style="width: 10%;"></td> <td style="width: 10%;"></td> <td style="width: 10%;"></td> </tr> <tr> <td></td> <td></td> <td colspan="8" style="text-align: center;"> <table border="1" style="width: 100%; border-collapse: collapse; text-align: center;"> <tr> <td style="width: 10%;"></td> <td style="width: 10%;"></td> <td style="width: 10%;"></td> <td style="width: 10%;"></td> <td style="width: 10%;"></td> <td style="width: 10%;"></td> <td style="width: 10%;"></td> <td style="width: 10%;"></td> <td style="width: 10%;"></td> <td style="width: 10%;"></td> </tr> <tr> <td></td> <td></td> <td colspan="8" style="text-align: center;"> <table border="1" style="width: 100%; border-collapse: collapse; text-align: center;"> <tr> <td style="width: 10%;"></td> <td style="width: 10%;"></td> <td style="width: 10%;"></td> <td style="width: 10%;"></td> <td style="width: 10%;"></td> <td style="width: 10%;"></td> <td style="width: 10%;"></td> <td style="width: 10%;"></td> <td style="width: 10%;"></td> <td style="width: 10%;"></td> </tr> <tr> <td></td> <td></td> <td colspan="8" style="text-align: center;"> <table border="1" style="width: 100%; border-collapse: collapse; text-align: center;"> <tr> <td style="width: 10%;"></td> <td style="width: 10%;"></td> <td style="width: 10%;"></td> <td style="width: 10%;"></td> <td style="width: 10%;"></td> <td style="width: 10%;"></td> <td style="width: 10%;"></td> <td style="width: 10%;"></td> <td style="width: 10%;"></td> <td style="width: 10%;"></td> </tr> <tr> <td></td> <td></td> <td colspan="8" style="text-align: center;"> <table border="1" style="width: 100%; border-collapse: collapse; text-align: center;"> <tr> <td style="width: 10%;"></td> <td style="width: 10%;"></td> <td style="width: 10%;"></td> <td style="width: 10%;"></td> <td style="width: 10%;"></td> <td style="width: 10%;"></td> <td style="width: 10%;"></td> <td style="width: 10%;"></td> <td style="width: 10%;"></td> <td style="width: 10%;"></td> </tr> <tr> <td></td> <td></td> <td colspan="8" style="text-align: center;"> <table border="1" style="width: 100%; border-collapse: collapse; text-align: center;"> <tr> <td style="width: 10%;"></td> <td style="width: 10%;"></td> <td style="width: 10%;"></td> <td style="width: 10%;"></td> <td style="width: 10%;"></td> <td style="width: 10%;"></td> <td style="width: 10%;"></td> <td style="width: 10%;"></td> <td style="width: 10%;"></td> <td style="width: 10%;"></td> </tr> <tr> <td></td> <td></td> <td colspan="8" style="text-align: center;"> <table border="1" style="width: 100%; border-collapse: collapse; text-align: center;"> <tr> <td style="width: 10%;"></td> <td style="width: 10%;"></td> <td style="width: 10%;"></td> <td style="width: 10%;"></td> <td style="width: 10%;"></td> <td style="width: 10%;"></td> <td style="width: 10%;"></td> <td style="width: 10%;"></td> <td style="width: 10%;"></td> <td style="width: 10%;"></td> </tr> <tr> <td></td> <td></td> <td colspan="8" style="text-align: center;"> <table border="1" style="width: 100%; border-collapse: collapse; text-align: center;"> <tr> <td style="width: 10%;"></td> <td style="width: 10%;"></td> <td style="width: 10%;"></td> <td style="width: 10%;"></td> <td style="width: 10%;"></td> <td style="width: 10%;"></td> <td style="width: 10%;"></td> <td style="width: 10%;"></td> <td style="width: 10%;"></td> <td style="width: 10%;"></td> </tr> <tr> <td></td> <td></td> <td colspan="8" style="text-align: center;"> <table border="1" style="width: 100%; border-collapse: collapse; text-align: center;"> <tr> <td style="width: 10%;"></td> <td style="width: 10%;"></td> <td style="width: 10%;"></td> <td style="width: 10%;"></td> <td style="width: 10%;"></td> <td style="width: 10%;"></td> <td style="width: 10%;"></td> <td style="width: 10%;"></td> <td style="width: 10%;"></td> <td style="width: 10%;"></td> </tr> <tr> <td></td> <td></td> <td colspan="8" style="text-align: center;"> <table border="1" style="width: 100%; border-collapse: collapse; text-align: center;"> <tr> <td style="width: 10%;"></td> <td style="width: 10%;"></td> <td style="width: 10%;"></td> <td style="width: 10%;"></td> <td style="width: 10%;"></td> <td style="width: 10%;"></td> <td style="width: 10%;"></td> <td style="width: 10%;"></td> <td style="width: 10%;"></td> <td style="width: 10%;"></td> </tr> <tr> <td></td> <td></td> <td colspan="8" style="text-align: center;"> <table border="1" style="width: 100%; border-collapse: collapse; text-align: center;"> <tr> <td style="width: 10%;"></td> <td style="width: 10%;"></td> <td style="width: 10%;"></td> <td style="width: 10%;"></td> <td style="width: 10%;"></td> <td style="width: 10%;"></td> <td style="width: 10%;"></td> <td style="width: 10%;"></td> <td style="width: 10%;"></td> <td style="width: 10%;"></td> </tr> <tr> <td></td> <td></td> <td colspan="8" style="text-align: center;"> <table border="1" style="width: 100%; border-collapse: collapse; text-align: center;"> <tr> <td style="width: 10%;"></td> <td style="width: 10%;"></td> <td style="width: 10%;"></td> <td style="width: 10%;"></td> <td style="width: 10%;"></td> <td style="width: 10%;"></td> <td style="width: 10%;"></td> <td style="width: 10%;"></td> <td style="width: 10%;"></td> <td style="width: 10%;"></td> </tr> <tr> <td></td> <td></td> <td colspan="8" style="text-align: center;"> <table border="1" style="width: 100%; border-collapse: collapse; text-align: center;"> <tr>
<td style="width: 10%;"></td> <td style="width: 10%;"></td> <td style="width: 10%;"></td> <td style="width: 10%;"></td> <td style="width: 10%;"></td> <td style="width: 10%;"></td> <td style="width: 10%;"></td> <td style="width: 10%;"></td> <td style="width: 10%;"></td> <td style="width: 10%;"></td> </tr> <tr> <td></td> <td></td> <td colspan="8" style="text-align: center;"> <table border="1" style="width: 100%; border-collapse: collapse; text-align: center;"> <tr> <td style="width: 10%;"></td> <td style="width: 10%;"></td> <td style="width: 10%;"></td> <td style="width: 10%;"></td> <td style="width: 10%;"></td> <td style="width: 10%;"></td> <td style="width: 10%;"></td> <td style="width: 10%;"></td> <td style="width: 10%;"></td> <td style="width: 10%;"></td> </tr> <tr> <td></td> <td></td> <td colspan="8" style="text-align: center;"> <table border="1" style="width: 100%; border-collapse: collapse; text-align: center;"> <tr> <td style="width: 10%;"></td> <td style="width: 10%;"></td> <td style="width: 10%;"></td> <td style="width: 10%;"></td> <td style="width: 10%;"></td> <td style="width: 10%;"></td> <td style="width: 10%;"></td> <td style="width: 10%;"></td> <td style="width: 10%;"></td> <td style="width: 10%;"></td> </tr> <tr> <td></td> <td></td> <td colspan="8" style="text-align: center;"> <table border="1" style="width: 100%; border-collapse: collapse; text-align: center;"> <tr> <td style="width: 10%;"></td> <td style="width: 10%;"></td> <td style="width: 10%;"></td> <td style="width: 10%;"></td> <td style="width: 10%;"></td> <td style="width: 10%;"></td> <td style="width: 10%;"></td> <td style="width: 10%;"></td> <td style="width: 10%;"></td> <td style="width: 10%;"></td> </tr> <tr> <td></td> <td></td> <td colspan="8" style="text-align: center;"> <table border="1" style="width: 100%; border-collapse: collapse; text-align: center;"> <tr> <td style="width: 10%;"></td> <td style="width: 10%;"></td> <td style="width: 10%;"></td> <td style="width: 10%;"></td> <td style="width: 10%;"></td> <td style="width: 10%;"></td> <td style="width: 10%;"></td> <td style="width: 10%;"></td> <td style="width: 10%;"></td> <td style="width: 10%;"></td> </tr> <tr> <td></td> <td></td> <td colspan="8" style="text-align: center;"> <table border="1" style="width: 100%; border-collapse: collapse; text-align: center;"> <tr> <td style="width: 10%;"></td> <td style="width: 10%;"></td> <td style="width: 10%;"></td> <td style="width: 10%;"></td> <td style="width: 10%;"></td> <td style="width: 10%;"></td> <td style="width: 10%;"></td> <td style="width: 10%;"></td> <td style="width: 10%;"></td> <td style="width: 10%;"></td> </tr> <tr> <td></td> <td></td> <td colspan="8" style="text-align: center;"> <table border="1" style="width: 100%; border-collapse: collapse; text-align: center;"> <tr> <td style="width: 10%;"></td> <td style="width: 10%;"></td> <td style="width: 10%;"></td> <td style="width: 10%;"></td> <td style="width: 10%;"></td> <td style="width: 10%;"></td> <td style="width: 10%;"></td> <td style="width: 10%;"></td> <td style="width: 10%;"></td> <td style="width: 10%;"></td> </tr> <tr> <td></td> <td></td> <td colspan="8" style="text-align: center;"> <table border="1" style="width: 100%; border-collapse: collapse; text-align: center;"> <tr> <td style="width: 10%;"></td> <td style="width: 10%;"></td> <td style="width: 10%;"></td> <td style="width: 10%;"></td> <td style="width: 10%;"></td> <td style="width: 10%;"></td> <td style="width: 10%;"></td> <td style="width: 10%;"></td> <td style="width: 10%;"></td> <td style="width: 10%;"></td> </tr> <tr> <td></td> <td></td> <td colspan="8" style="text-align: center;"> <table border="1" style="width: 100%; border-collapse: collapse; text-align: center;"> <tr> <td style="width: 10%;"></td> <td style="width: 10%;"></td> <td style="width: 10%;"></td> <td style="width: 10%;"></td> <td style="width: 10%;"></td> <td style="width: 10%;"></td> <td style="width: 10%;"></td> <td style="width: 10%;"></td> <td style="width: 10%;"></td> <td style="width: 10%;"></td> </tr> <tr> <td></td> <td></td> <td colspan="8" style="text-align: center;"> <table border="1" style="width: 100%; border-collapse: collapse; text-align: center;"> <tr> <td style="width: 10%;"></td> <td style="width: 10%;"></td> <td style="width: 10%;"></td> <td style="width: 10%;"></td> <td style="width: 10%;"></td> <td style="width: 10%;"></td> <td style="width: 10%;"></td> <td style="width: 10%;"></td> <td style="width: 10%;"></td> <td style="width: 10%;"></td> </tr> <tr> <td></td> <td></td> <td colspan="8" style="text-align: center;"> <table border="1" style="width: 100%; border-collapse: collapse; text-align: center;"> <tr> <td style="width: 10%;"></td> <td style="width: 10%;"></td> <td style="width: 10%;"></td> <td style="width: 10%;"></td> <td style="width: 10%;"></td> <td style="width: 10%;"></td> <td style="width: 10%;"></td> <td style="width: 10%;"></td> <td style="width: 10%;"></td> <td style="width: 10%;"></td> </tr> <tr> <td></td> <td></td> <td colspan="8" style="text-align: center;"> <table border="1" style="width: 100%; border-collapse: collapse; text-align: center;"> <tr> <td style="width: 10%;"></td> <td style="width: 10%;"></td> <td style="width: 10%;"></td> <td style="width: 10%;"></td> <td style="width: 10%;"></td> <td style="width: 10%;"></td> <td style="width: 10%;"></td> <td style="width: 10%;"></td> <td style="width: 10%;"></td> <td style="width: 10%;"></td> </tr> <tr> <td></td> <td></td> <td colspan="8" style="text-align: center;"> <table border="1" style="width: 100%; border-collapse: collapse; text-align: center;"> <tr> <td style="width: 10%;"></td> <td style="width: 10%;"></td> <td style="width: 10%;"></td> <td style="width: 10%;"></td> <td style="width: 10%;"></td> <td style="width: 10%;"></td> <td style="width: 10%;"></td> <td style="width: 10%;"></td> <td style="width: 10%;"></td> <td style="width: 10%;"></td> </tr> <tr> <td></td> <td></td> <td colspan="8" style="text-align: center;"> <table border="1" style="width: 100%; border-collapse: collapse; text-align: center;"> <tr> <td style="width: 10%;"></td> <td style="width: 10%;"></td> <td style="width: 10%;"></td> <td style="width: 10%;"></td> <td style="width: 10%;"></td> <td style="width: 10%;"></td> <td style="width: 10%;"></td> <td style="width: 10%;"></td> <td style="width: 10%;"></td> <td style="width: 10%;"></td> </tr> <tr> <td></td> <td></td> <td colspan="8" style="text-align: center;"> <table border="1" style="width: 100%; border-collapse: collapse; text-align: center;"> <tr> <td style="width: 10%;"></td> <td style="width: 10%;"></td> <td style="width: 10%;"></td> <td style="width: 10%;"></td> <td style="width: 10%;"></td> <td style="width: 10%;"></td> <td style="width: 10%;"></td> <td style="width: 10%;"></td> <td style="width: 10%;"></td> <td style="width: 10%;"></td> </tr> <tr> <td></td> <td></td> <td colspan="8" style="text-align: center;"> <table border="1" style="width: 100%; border-collapse: collapse; text-align: center;"> <tr> <td style="width: 10%;"></td> <td style="width: 10%;"></td> <td style="width: 10%;"></td> <td style="width: 10%;"></td> <td style="width: 10%;"></td> <td style="width: 10%;"></td> <td style="width: 10%;"></td> <td style="width: 10%;"></td> <td style="width: 10%;"></td> <td style="width: 10%;"></td> </tr> <tr> <td></td> <td></td> <td colspan="8" style="text-align: center;"> <table border="1" style="width: 100%; border-collapse: collapse; text-align: center;"> <tr> <td style="width: 10%;"></td> <td style="width: 10%;"></td> <td style="width: 10%;"></td> <td style="width: 10%;"></td> <td style="width: 10%;"></td> <td style="width: 10%;"></td> <td style="width: 10%;"></td> <td style="width: 10%;"></td> <td style="width: 10%;"></td> <td style="width: 10%;"></td> </tr> <tr> <td></td> <td></td> <td colspan="8" style="text-align: center;"> <table border="1" style="width: 100%; border-collapse: collapse; text-align: center;"> <tr> <td style="width: 10%;"></td> <td style="width: 10%;"></td> <td style="width: 10%;"></td> <td style="width: 10%;"></td> <td style="width: 10%;"></td> <td style="width: 10%;"></td> <td style="width: 10%;"></td> <td style="width: 10%;"></td> <td style="width: 10%;"></td> <td style="width: 10%;"></td> </tr> <tr> <td></td> <td></td> <td colspan="8" style="text-align: center;"> <table border="1" style="width: 100%; border-collapse: collapse; text-align: center;"> <tr> <td style="width: 10%;"></td> <td style="width: 10%;"></td> <td style="width: 10%;"></td> <td style="width: 10%;"></td> <td style="width: 10%;"></td> <td style="width: 10%;"></td> <td style="width: 10%;"></td> <td style="width: 10%;"></td> <td style="width: 10%;"></td> <td style="width: 10%;"></td> </tr> <tr> <td></td> <td></td> <td colspan="8" style="text-align: center;"> <table border="1" style="width: 100%; border-collapse: collapse; text-align: center;"> <tr> <td style="width: 10%;"></td> <td style="width: 10%;"></td> <td style="width: 10%;"></td> <td style="width: 10%;"></td> <td style="width: 10%;"></td> <td style="width: 10%;"></td> <td style="width: 10%;"></td> <td style="width: 10%;"></td> <td style="width: 10%;"></td> <td style="width: 10%;"></td> </tr> <tr> <td></td> <td></td> <td colspan="8" style="text-align: center;"> <table border="1" style="width: 100%; border-collapse: collapse; text-align: center;"> <tr> <td style="width: 10%;"></td> <td style="width: 10%;"></td> <td style="width: 10%;"></td> <td style="width: 10%;"></td> <td style="width: 10%;"></td> <td style="width: 10%;"></td> <td style="width: 10%;"></td> <td style="width: 10%;"></td> <td style="width: 10%;"></td> <td style="width: 10%;"></td> </tr> <tr> <td></td> <td></td> <td colspan="8" style="text-align: center;"> <table border="1" style="width: 100%; border-collapse: collapse; text-align: center;"> <tr> <td style="width: 10%;"></td> <td style="width: 10%;"></td> <td style="width: 10%;"></td> <td style="width: 10%;"></td> <td style="width: 10%;"></td> <td style="width:
10%;"></td> <td style="width: 10%;"></td> <td style="width: 10%;"></td> <td style="width: 10%;"></td> <td style="width: 10%;"></td> </tr> <tr> <td></td> <td></td> <td colspan="8" style="text-align: center;"> <table border="1" style="width: 100%; border-collapse: collapse; text-align: center;"> <tr> <td style="width: 10%;"></td> <td style="width: 10%;"></td> <td style="width: 10%;"></td> <td style="width: 10%;"></td> <td style="width: 10%;"></td> <td style="width: 10%;"></td> <td style="width: 10%;"></td> <td style="width: 10%;"></td> <td style="width: 10%;"></td> <td style="width: 10%;"></td> </tr> <tr> <td></td> <td></td> <td colspan="8" style="text-align: center;"> <table border="1" style="width: 100%; border-collapse: collapse; text-align: center;"> <tr> <td style="width: 10%;"></td> <td style="width: 10%;"></td> <td style="width: 10%;"></td> <td style="width: 10%;"></td> <td style="width: 10%;"></td> <td style="width: 10%;"></td> <td style="width: 10%;"></td> <td style="width: 10%;"></td> <td style="width: 10%;"></td> <td style="width: 10%;"></td> </tr> <tr> <td></td> <td></td> <td colspan="8" style="text-align: center;"> <table border="1" style="width: 100%; border-collapse: collapse; text-align: center;"> <tr> <td style="width: 10%;"></td> <td style="width: 10%;"></td> <td style="width: 10%;"></td> <td style="width: 10%;"></td> <td style="width: 10%;"></td> <td style="width: 10%;"></td> <td style="width: 10%;"></td> <td style="width: 10%;"></td> <td style="width: 10%;"></td> <td style="width: 10%;"></td> </tr> <tr> <td></td> <td></td> <td colspan="8" style="text-align: center;"> <table border="1" style="width: 100%; border-collapse: collapse; text-align: center;"> <tr> <td style="width: 10%;"></td> <td style="width: 10%;"></td> <td style="width: 10%;"></td> <td style="width: 10%;"></td> <td style="width: 10%;"></td> <td style="width: 10%;"></td> <td style="width: 10%;"></td> <td style="width: 10%;"></td> <td style="width: 10%;"></td> <td style="width: 10%;"></td> </tr> <tr> <td></td> <td></td> <td colspan="8" style="text-align: center;"> <table border="1" style="width: 100%; border-collapse: collapse; text-align: center;"> <tr> <td style="width: 10%;"></td> <td style="width: 10%;"></td> <td style="width: 10%;"></td> <td style="width: 10%;"></td> <td style="width: 10%;"></td> <td style="width: 10%;"></td> <td style="width: 10%;"></td> <td style="width: 10%;"></td> <td style="width: 10%;"></td> <td style="width: 10%;"></td> </tr> <tr> <td></td> <td></td> <td colspan="8" style="text-align: center;"> <table border="1" style="width: 100%; border-collapse: collapse; text-align: center;"> <tr> <td style="width: 10%;"></td> <td style="width: 10%;"></td> <td style="width: 10%;"></td> <td style="width: 10%;"></td> <td style="width: 10%;"></td> <td style="width: 10%;"></td> <td style="width: 10%;"></td> <td style="width: 10%;"></td> <td style="width: 10%;"></td> <td style="width: 10%;"></td> </tr> <tr> <td></td> <td></td> <td colspan="8" style="text-align: center;"> <table border="1" style="width: 100%; border-collapse: collapse; text-align: center;"> <tr> </tr></table></td></tr></table></td></tr></table></td></tr></table></td></tr></table></td></tr></table></td></tr></table></td></tr></table></td></tr></table></td></tr></table></td></tr></table></td></tr></table></td></tr></table></td></tr></table></td></tr></table></td></tr></table></td></tr></table></td></tr></table></td></tr></table></td></tr></table></td></tr></table></td></tr></table></td></tr></table></td></tr></table></td></tr></table></td></tr></table></td></tr></table></td></tr></table></td></tr></table></td></tr></table></td></tr></table></td></tr></table></td></tr></table></td></tr></table></td></tr></table></td></tr></table></td></tr></table></td></tr></table></td></tr></table></td></tr></table></td></tr></table></td></tr></table></td></tr></table></td></tr></table></td></tr></table>
 | | | | | | | | | | | | | | | | | | | | <table border="1" style="width: 100%; border-collapse: collapse; text-align: center;"> <tr> <td style="width: 10%;"></td> <td style="width: 10%;"></td> <td style="width: 10%;"></td> <td style="width: 10%;"></td> <td style="width: 10%;"></td> <td style="width: 10%;"></td> <td style="width: 10%;"></td> <td style="width: 10%;"></td> <td style="width: 10%;"></td> <td style="width: 10%;"></td> </tr> <tr> <td></td> <td></td> <td colspan="8" style="text-align: center;"> <table border="1" style="width: 100%; border-collapse: collapse; text-align: center;"> <tr> <td style="width: 10%;"></td> <td style="width: 10%;"></td> <td style="width: 10%;"></td> <td style="width: 10%;"></td> <td style="width: 10%;"></td> <td style="width: 10%;"></td> <td style="width: 10%;"></td> <td style="width: 10%;"></td> <td style="width: 10%;"></td> <td style="width: 10%;"></td> </tr> <tr> <td></td> <td></td> <td colspan="8" style="text-align: center;"> <table border="1" style="width: 100%; border-collapse: collapse; text-align: center;"> <tr> <td style="width: 10%;"></td> <td style="width: 10%;"></td> <td style="width: 10%;"></td> <td style="width: 10%;"></td> <td style="width: 10%;"></td> <td style="width: 10%;"></td> <td style="width: 10%;"></td> <td style="width: 10%;"></td> <td style="width: 10%;"></td> <td style="width: 10%;"></td> </tr> <tr> <td></td> <td></td> <td colspan="8" style="text-align: center;"> <table border="1" style="width: 100%; border-collapse: collapse; text-align: center;"> <tr> <td style="width: 10%;"></td> <td style="width: 10%;"></td> <td style="width: 10%;"></td> <td style="width: 10%;"></td> <td style="width: 10%;"></td> <td style="width: 10%;"></td> <td style="width: 10%;"></td> <td style="width: 10%;"></td> <td style="width: 10%;"></td> <td style="width: 10%;"></td> </tr> <tr> <td></td> <td></td> <td colspan="8" style="text-align: center;"> <table border="1" style="width: 100%; border-collapse: collapse; text-align: center;"> <tr> <td style="width: 10%;"></td> <td style="width: 10%;"></td> <td style="width: 10%;"></td> <td style="width: 10%;"></td> <td style="width: 10%;"></td> <td style="width: 10%;"></td> <td style="width: 10%;"></td> <td style="width: 10%;"></td> <td style="width: 10%;"></td> <td style="width: 10%;"></td> </tr> <tr> <td></td> <td></td> <td colspan="8" style="text-align: center;"> <table border="1" style="width: 100%; border-collapse: collapse; text-align: center;"> <tr> <td style="width: 10%;"></td> <td style="width: 10%;"></td> <td style="width: 10%;"></td> <td style="width: 10%;"></td> <td style="width: 10%;"></td> <td style="width: 10%;"></td> <td style="width: 10%;"></td> <td style="width: 10%;"></td> <td style="width: 10%;"></td> <td style="width: 10%;"></td> </tr> <tr> <td></td> <td></td> <td colspan="8" style="text-align: center;"> <table border="1" style="width: 100%; border-collapse: collapse; text-align: center;"> <tr> <td style="width: 10%;"></td> <td style="width: 10%;"></td> <td style="width: 10%;"></td> <td style="width: 10%;"></td> <td style="width: 10%;"></td> <td style="width: 10%;"></td> <td style="width: 10%;"></td> <td style="width: 10%;"></td> <td style="width: 10%;"></td> <td style="width: 10%;"></td> </tr> <tr> <td></td> <td></td> <td colspan="8" style="text-align: center;"> <table border="1" style="width: 100%; border-collapse: collapse; text-align: center;"> <tr> <td style="width: 10%;"></td> <td style="width: 10%;"></td> <td style="width: 10%;"></td> <td style="width: 10%;"></td> <td style="width: 10%;"></td> <td style="width: 10%;"></td> <td style="width: 10%;"></td> <td style="width: 10%;"></td> <td style="width: 10%;"></td> <td style="width: 10%;"></td> </tr> <tr> <td></td> <td></td> <td colspan="8" style="text-align: center;"> <table border="1" style="width: 100%; border-collapse: collapse; text-align: center;"> <tr> <td style="width: 10%;"></td> <td style="width: 10%;"></td> <td style="width: 10%;"></td> <td style="width: 10%;"></td> <td style="width: 10%;"></td> <td style="width: 10%;"></td> <td style="width: 10%;"></td> <td style="width: 10%;"></td> <td style="width: 10%;"></td> <td style="width: 10%;"></td> </tr> <tr> <td></td> <td></td> <td colspan="8" style="text-align: center;"> <table border="1" style="width: 100%; border-collapse: collapse; text-align: center;"> <tr> <td style="width: 10%;"></td> <td style="width: 10%;"></td> <td style="width: 10%;"></td> <td style="width: 10%;"></td> <td style="width: 10%;"></td> <td style="width: 10%;"></td> <td style="width: 10%;"></td> <td style="width: 10%;"></td> <td style="width: 10%;"></td> <td style="width: 10%;"></td> </tr> <tr> <td></td> <td></td> <td colspan="8" style="text-align: center;"> <table border="1" style="width: 100%; border-collapse: collapse; text-align: center;"> <tr> <td style="width: 10%;"></td> <td style="width: 10%;"></td> <td style="width: 10%;"></td> <td style="width: 10%;"></td> <td style="width: 10%;"></td> <td style="width: 10%;"></td> <td style="width: 10%;"></td> <td style="width: 10%;"></td> <td style="width: 10%;"></td> <td style="width: 10%;"></td> </tr> <tr> <td></td> <td></td> <td colspan="8" style="text-align: center;"> <table border="1" style="width: 100%; border-collapse: collapse; text-align: center;"> <tr> <td style="width: 10%;"></td> <td style="width: 10%;"></td> <td style="width: 10%;"></td> <td style="width: 10%;"></td> <td style="width: 10%;"></td> <td style="width: 10%;"></td> <td style="width: 10%;"></td> <td style="width: 10%;"></td> <td style="width: 10%;"></td> <td style="width: 10%;"></td> </tr> <tr> <td></td> <td></td> <td colspan="8" style="text-align: center;"> <table border="1" style="width: 100%; border-collapse: collapse; text-align: center;"> <tr> <td style="width: 10%;"></td> <td style="width: 10%;"></td> <td style="width: 10%;"></td> <td style="width: 10%;"></td> <td style="width: 10%;"></td> <td style="width: 10%;"></td> <td style="width: 10%;"></td> <td style="width: 10%;"></td> <td style="width: 10%;"></td> <td style="width: 10%;"></td> </tr> <tr> <td></td> <td></td> <td colspan="8" style="text-align: center;"> <table border="1" style="width: 100%; border-collapse: collapse; text-align: center;"> <tr> <td style="width: 10%;"></td> <td style="width: 10%;"></td> <td style="width: 10%;"></td> <td style="width: 10%;"></td> <td style="width: 10%;"></td> <td style="width: 10%;"></td> <td style="width: 10%;"></td> <td style="width: 10%;"></td> <td style="width: 10%;"></td> <td style="width: 10%;"></td> </tr> <tr> <td></td> <td></td> <td colspan="8" style="text-align: center;"> <table border="1" style="width: 100%; border-collapse: collapse; text-align: center;"> <tr> <td style="width: 10%;"></td> <td style="width: 10%;"></td> <td style="width: 10%;"></td> <td style="width: 10%;"></td> <td style="width: 10%;"></td> <td style="width: 10%;"></td> <td style="width: 10%;"></td> <td style="width: 10%;"></td> <td style="width: 10%;"></td> <td style="width: 10%;"></td> </tr> <tr> <td></td> <td></td> <td colspan="8" style="text-align: center;"> <table border="1" style="width: 100%; border-collapse: collapse; text-align: center;"> <tr> <td style="width: 10%;"></td> <td style="width: 10%;"></td> <td style="width: 10%;"></td> <td style="width: 10%;"></td> <td style="width: 10%;"></td> <td style="width: 10%;"></td> <td style="width: 10%;"></td> <td style="width: 10%;"></td> <td style="width: 10%;"></td> <td style="width: 10%;"></td> </tr> <tr> <td></td> <td></td> <td colspan="8" style="text-align: center;"> <table border="1" style="width: 100%; border-collapse: collapse; text-align: center;"> <tr> <td style="width: 10%;"></td> <td style="width: 10%;"></td> <td style="width: 10%;"></td> <td style="width: 10%;"></td> <td style="width: 10%;"></td> <td style="width: 10%;"></td> <td
style="width: 10%;"></td> <td style="width: 10%;"></td> <td style="width: 10%;"></td> <td style="width: 10%;"></td> </tr> <tr> <td></td> <td></td> <td colspan="8" style="text-align: center;"> <table border="1" style="width: 100%; border-collapse: collapse; text-align: center;"> <tr> <td style="width: 10%;"></td> <td style="width: 10%;"></td> <td style="width: 10%;"></td> <td style="width: 10%;"></td> <td style="width: 10%;"></td> <td style="width: 10%;"></td> <td style="width: 10%;"></td> <td style="width: 10%;"></td> <td style="width: 10%;"></td> <td style="width: 10%;"></td> </tr> <tr> <td></td> <td></td> <td colspan="8" style="text-align: center;"> <table border="1" style="width: 100%; border-collapse: collapse; text-align: center;"> <tr> <td style="width: 10%;"></td> <td style="width: 10%;"></td> <td style="width: 10%;"></td> <td style="width: 10%;"></td> <td style="width: 10%;"></td> <td style="width: 10%;"></td> <td style="width: 10%;"></td> <td style="width: 10%;"></td> <td style="width: 10%;"></td> <td style="width: 10%;"></td> </tr> <tr> <td></td> <td></td> <td colspan="8" style="text-align: center;"> <table border="1" style="width: 100%; border-collapse: collapse; text-align: center;"> <tr> <td style="width: 10%;"></td> <td style="width: 10%;"></td> <td style="width: 10%;"></td> <td style="width: 10%;"></td> <td style="width: 10%;"></td> <td style="width: 10%;"></td> <td style="width: 10%;"></td> <td style="width: 10%;"></td> <td style="width: 10%;"></td> <td style="width: 10%;"></td> </tr> <tr> <td></td> <td></td> <td colspan="8" style="text-align: center;"> <table border="1" style="width: 100%; border-collapse: collapse; text-align: center;"> <tr> <td style="width: 10%;"></td> <td style="width: 10%;"></td> <td style="width: 10%;"></td> <td style="width: 10%;"></td> <td style="width: 10%;"></td> <td style="width: 10%;"></td> <td style="width: 10%;"></td> <td style="width: 10%;"></td> <td style="width: 10%;"></td> <td style="width: 10%;"></td> </tr> <tr> <td></td> <td></td> <td colspan="8" style="text-align: center;"> <table border="1" style="width: 100%; border-collapse: collapse; text-align: center;"> <tr> <td style="width: 10%;"></td> <td style="width: 10%;"></td> <td style="width: 10%;"></td> <td style="width: 10%;"></td> <td style="width: 10%;"></td> <td style="width: 10%;"></td> <td style="width: 10%;"></td> <td style="width: 10%;"></td> <td style="width: 10%;"></td> <td style="width: 10%;"></td> </tr> <tr> <td></td> <td></td> <td colspan="8" style="text-align: center;"> <table border="1" style="width: 100%; border-collapse: collapse; text-align: center;"> <tr> <td style="width: 10%;"></td> <td style="width: 10%;"></td> <td style="width: 10%;"></td> <td style="width: 10%;"></td> <td style="width: 10%;"></td> <td style="width: 10%;"></td> <td style="width: 10%;"></td> <td style="width: 10%;"></td> <td style="width: 10%;"></td> <td style="width: 10%;"></td> </tr> <tr> <td></td> <td></td> <td colspan="8" style="text-align: center;"> <table border="1" style="width: 100%; border-collapse: collapse; text-align: center;"> <tr> <td style="width: 10%;"></td> <td style="width: 10%;"></td> <td style="width: 10%;"></td> <td style="width: 10%;"></td> <td style="width: 10%;"></td> <td style="width: 10%;"></td> <td style="width: 10%;"></td> <td style="width: 10%;"></td> <td style="width: 10%;"></td> <td style="width: 10%;"></td> </tr> <tr> <td></td> <td></td> <td colspan="8" style="text-align: center;"> <table border="1" style="width: 100%; border-collapse: collapse; text-align: center;"> <tr> <td style="width: 10%;"></td> <td style="width: 10%;"></td> <td style="width: 10%;"></td> <td style="width: 10%;"></td> <td style="width: 10%;"></td> <td style="width: 10%;"></td> <td style="width: 10%;"></td> <td style="width: 10%;"></td> <td style="width: 10%;"></td> <td style="width: 10%;"></td> </tr> <tr> <td></td> <td></td> <td colspan="8" style="text-align: center;"> <table border="1" style="width: 100%; border-collapse: collapse; text-align: center;"> <tr> <td style="width: 10%;"></td> <td style="width: 10%;"></td> <td style="width: 10%;"></td> <td style="width: 10%;"></td> <td style="width: 10%;"></td> <td style="width: 10%;"></td> <td style="width: 10%;"></td> <td style="width: 10%;"></td> <td style="width: 10%;"></td> <td style="width: 10%;"></td> </tr> <tr> <td></td> <td></td> <td colspan="8" style="text-align: center;"> <table border="1" style="width: 100%; border-collapse: collapse; text-align: center;"> <tr> <td style="width: 10%;"></td> <td style="width: 10%;"></td> <td style="width: 10%;"></td> <td style="width: 10%;"></td> <td style="width: 10%;"></td> <td style="width: 10%;"></td> <td style="width: 10%;"></td> <td style="width: 10%;"></td> <td style="width: 10%;"></td> <td style="width: 10%;"></td> </tr> <tr> <td></td> <td></td> <td colspan="8" style="text-align: center;"> <table border="1" style="width: 100%; border-collapse: collapse; text-align: center;"> <tr> <td style="width: 10%;"></td> <td style="width: 10%;"></td> <td style="width: 10%;"></td> <td style="width: 10%;"></td> <td style="width: 10%;"></td> <td style="width: 10%;"></td> <td style="width: 10%;"></td> <td style="width: 10%;"></td> <td style="width: 10%;"></td> <td style="width: 10%;"></td> </tr> <tr> <td></td> <td></td> <td colspan="8" style="text-align: center;"> <table border="1" style="width: 100%; border-collapse: collapse; text-align: center;"> <tr> <td style="width: 10%;"></td> <td style="width: 10%;"></td> <td style="width: 10%;"></td> <td style="width: 10%;"></td> <td style="width: 10%;"></td> <td style="width: 10%;"></td> <td style="width: 10%;"></td> <td style="width: 10%;"></td> <td style="width: 10%;"></td> <td style="width: 10%;"></td> </tr> <tr> <td></td> <td></td> <td colspan="8" style="text-align: center;"> <table border="1" style="width: 100%; border-collapse: collapse; text-align: center;"> <tr> <td style="width: 10%;"></td> <td style="width: 10%;"></td> <td style="width: 10%;"></td> <td style="width: 10%;"></td> <td style="width: 10%;"></td> <td style="width: 10%;"></td> <td style="width: 10%;"></td> <td style="width: 10%;"></td> <td style="width: 10%;"></td> <td style="width: 10%;"></td> </tr> <tr> <td></td> <td></td> <td colspan="8" style="text-align: center;"> <table border="1" style="width: 100%; border-collapse: collapse; text-align: center;"> <tr> <td style="width: 10%;"></td> <td style="width: 10%;"></td> <td style="width: 10%;"></td> <td style="width: 10%;"></td> <td style="width: 10%;"></td> <td style="width: 10%;"></td> <td style="width: 10%;"></td> <td style="width: 10%;"></td> <td style="width: 10%;"></td> <td style="width: 10%;"></td> </tr> <tr> <td></td> <td></td> <td colspan="8" style="text-align: center;"> <table border="1" style="width: 100%; border-collapse: collapse; text-align: center;"> <tr> <td style="width: 10%;"></td> <td style="width: 10%;"></td> <td style="width: 10%;"></td> <td style="width: 10%;"></td> <td style="width: 10%;"></td> <td style="width: 10%;"></td> <td style="width: 10%;"></td> <td style="width: 10%;"></td> <td style="width: 10%;"></td> <td style="width: 10%;"></td> </tr> <tr> <td></td> <td></td> <td colspan="8" style="text-align: center;"> <table border="1" style="width: 100%; border-collapse: collapse; text-align: center;"> <tr> <td style="width: 10%;"></td> <td style="width: 10%;"></td> <td style="width: 10%;"></td> <td style="width: 10%;"></td> <td style="width: 10%;"></td> <td style="width: 10%;"></td> <td style="width: 10%;"></td> <td style="width: 10%;"></td> <td style="width: 10%;"></td> <td style="width: 10%;"></td> </tr> <tr> <td></td> <td></td> <td colspan="8" style="text-align: center;"> <table border="1" style="width: 100%; border-collapse: collapse; text-align: center;"> <tr> <td style="width: 10%;"></td> <td style="width: 10%;"></td> <td style="width: 10%;"></td> <td style="width: 10%;"></td> <td style="width: 10%;"></td> <td style="width: 10%;"></td> <td style="width: 10%;"></td> <td style="width: 10%;"></td> <td style="width: 10%;"></td> <td style="width: 10%;"></td> </tr> <tr> <td></td> <td></td> <td colspan="8" style="text-align: center;"> <table border="1" style="width: 100%; border-collapse: collapse; text-align: center;"> <tr> <td style="width: 10%;"></td> <td style="width: 10%;"></td> <td style="width: 10%;"></td> <td style="width: 10%;"></td> <td style="width: 10%;"></td> <td style="width: 10%;"></td> <td style="width: 10%;"></td> <td style="width: 10%;"></td> <td style="width: 10%;"></td> <td style="width: 10%;"></td> </tr> <tr> <td></td> <td></td> <td colspan="8" style="text-align: center;"> <table border="1" style="width: 100%; border-collapse: collapse; text-align: center;"> <tr> <td style="width: 10%;"></td> <td style="width: 10%;"></td> <td style="width: 10%;"></td> <td style="width: 10%;"></td> <td style="width: 10%;"></td> <td style="width: 10%;"></td> <td style="width: 10%;"></td> <td style="width: 10%;"></td> <td style="width: 10%;"></td> <td style="width: 10%;"></td> </tr> <tr> <td></td> <td></td> <td colspan="8" style="text-align: center;"> <table border="1" style="width: 100%; border-collapse: collapse; text-align: center;"> <tr> <td style="width: 10%;"></td> <td style="width: 10%;"></td> <td style="width: 10%;"></td> <td style="width: 10%;"></td> <td style="width: 10%;"></td> <td style="width: 10%;"></td> <td style="width: 10%;"></td> <td style="width: 10%;"></td> <td style="width: 10%;"></td> <td style="width: 10%;"></td> </tr> <tr> <td></td> <td></td> <td colspan="8" style="text-align: center;"> <table border="1" style="width: 100%; border-collapse: collapse; text-align: center;"> <tr> <td style="width: 10%;"></td> <td style="width: 10%;"></td> <td style="width: 10%;"></td> <td style="width: 10%;"></td> <td style="width: 10%;"></td> <td style="width: 10%;"></td> <td style="width: 10%;"></td> <td style="width: 10%;"></td> <td style="width: 10%;"></td> <td style="width: 10%;"></td> </tr> <tr> <td></td> <td></td> <td colspan="8"
style="text-align: center;"> <table border="1" style="width: 100%; border-collapse: collapse; text-align: center;"> <tr> <td style="width: 10%;"></td> <td style="width: 10%;"></td> <td style="width: 10%;"></td> <td style="width: 10%;"></td> <td style="width: 10%;"></td> <td style="width: 10%;"></td> <td style="width: 10%;"></td> <td style="width: 10%;"></td> <td style="width: 10%;"></td> <td style="width: 10%;"></td> </tr> <tr> <td></td> <td></td> <td colspan="8" style="text-align: center;"> <table border="1" style="width: 100%; border-collapse: collapse; text-align: center;"> <tr> <td style="width: 10%;"></td> <td style="width: 10%;"></td> <td style="width: 10%;"></td> <td style="width: 10%;"></td> <td style="width: 10%;"></td> <td style="width: 10%;"></td> <td style="width: 10%;"></td> <td style="width: 10%;"></td> <td style="width: 10%;"></td> <td style="width: 10%;"></td> </tr> <tr> <td></td> <td></td> <td colspan="8" style="text-align: center;"> <table border="1" style="width: 100%; border-collapse: collapse; text-align: center;"> <tr> <td style="width: 10%;"></td> <td style="width: 10%;"></td> <td style="width: 10%;"></td> <td style="width: 10%;"></td> <td style="width: 10%;"></td> <td style="width: 10%;"></td> <td style="width: 10%;"></td> <td style="width: 10%;"></td> <td style="width: 10%;"></td> <td style="width: 10%;"></td> </tr> <tr> <td></td> <td></td> <td colspan="8" style="text-align: center;"> <table border="1" style="width: 100%; border-collapse: collapse; text-align: center;"> <tr> <td style="width: 10%;"></td> <td style="width: 10%;"></td> <td style="width: 10%;"></td> <td style="width: 10%;"></td> <td style="width: 10%;"></td> <td style="width: 10%;"></td> <td style="width: 10%;"></td> <td style="width: 10%;"></td> <td style="width: 10%;"></td> <td style="width: 10%;"></td> </tr> <tr> <td></td> <td></td> <td colspan="8" style="text-align: center;"> <table border="1" style="width: 100%; border-collapse: collapse; text-align: center;"> <tr> <td style="width: 10%;"></td> <td style="width: 10%;"></td> <td style="width: 10%;"></td> <td style="width: 10%;"></td> <td style="width: 10%;"></td> <td style="width: 10%;"></td> <td style="width: 10%;"></td> <td style="width: 10%;"></td> <td style="width: 10%;"></td> <td style="width: 10%;"></td> </tr> <tr> <td></td> <td></td> <td colspan="8" style="text-align: center;"> <table border="1" style="width: 100%; border-collapse: collapse; text-align: center;"> <tr> </tr></table></td></tr></table></td></tr></table></td></tr></table></td></tr></table></td></tr></table></td></tr></table></td></tr></table></td></tr></table></td></tr></table></td></tr></table></td></tr></table></td></tr></table></td></tr></table></td></tr></table></td></tr></table></td></tr></table></td></tr></table></td></tr></table></td></tr></table></td></tr></table></td></tr></table></td></tr></table></td></tr></table></td></tr></table></td></tr></table></td></tr></table></td></tr></table></td></tr></table></td></tr></table></td></tr></table></td></tr></table></td></tr></table></td></tr></table></td></tr></table></td></tr></table></td></tr></table></td></tr></table></td></tr></table></td></tr></table></td></tr></table></td></tr></table></td></tr></table></td></tr></table>
 | | | | | | | | | | | | | | | | | | | | <table border="1" style="width: 100%; border-collapse: collapse; text-align: center;"> <tr> <td style="width: 10%;"></td> <td style="width: 10%;"></td> <td style="width: 10%;"></td> <td style="width: 10%;"></td> <td style="width: 10%;"></td> <td style="width: 10%;"></td> <td style="width: 10%;"></td> <td style="width: 10%;"></td> <td style="width: 10%;"></td> <td style="width: 10%;"></td> </tr> <tr> <td></td> <td></td> <td colspan="8" style="text-align: center;"> <table border="1" style="width: 100%; border-collapse: collapse; text-align: center;"> <tr> <td style="width: 10%;"></td> <td style="width: 10%;"></td> <td style="width: 10%;"></td> <td style="width: 10%;"></td> <td style="width: 10%;"></td> <td style="width: 10%;"></td> <td style="width: 10%;"></td> <td style="width: 10%;"></td> <td style="width: 10%;"></td> <td style="width: 10%;"></td> </tr> <tr> <td></td> <td></td> <td colspan="8" style="text-align: center;"> <table border="1" style="width: 100%; border-collapse: collapse; text-align: center;"> <tr> <td style="width: 10%;"></td> <td style="width: 10%;"></td> <td style="width: 10%;"></td> <td style="width: 10%;"></td> <td style="width: 10%;"></td> <td style="width: 10%;"></td> <td style="width: 10%;"></td> <td style="width: 10%;"></td> <td style="width: 10%;"></td> <td style="width: 10%;"></td> </tr> <tr> <td></td> <td></td> <td colspan="8" style="text-align: center;"> <table border="1" style="width: 100%; border-collapse: collapse; text-align: center;"> <tr> <td style="width: 10%;"></td> <td style="width: 10%;"></td> <td style="width: 10%;"></td> <td style="width: 10%;"></td> <td style="width: 10%;"></td> <td style="width: 10%;"></td> <td style="width: 10%;"></td> <td style="width: 10%;"></td> <td style="width: 10%;"></td> <td style="width: 10%;"></td> </tr> <tr> <td></td> <td></td> <td colspan="8" style="text-align: center;"> <table border="1" style="width: 100%; border-collapse: collapse; text-align: center;"> <tr> <td style="width: 10%;"></td> <td style="width: 10%;"></td> <td style="width: 10%;"></td> <td style="width: 10%;"></td> <td style="width: 10%;"></td> <td style="width: 10%;"></td> <td style="width: 10%;"></td> <td style="width: 10%;"></td> <td style="width: 10%;"></td> <td style="width: 10%;"></td> </tr> <tr> <td></td> <td></td> <td colspan="8" style="text-align: center;"> <table border="1" style="width: 100%; border-collapse: collapse; text-align: center;"> <tr> <td style="width: 10%;"></td> <td style="width: 10%;"></td> <td style="width: 10%;"></td> <td style="width: 10%;"></td> <td style="width: 10%;"></td> <td style="width: 10%;"></td> <td style="width: 10%;"></td> <td style="width: 10%;"></td> <td style="width: 10%;"></td> <td style="width: 10%;"></td> </tr> <tr> <td></td> <td></td> <td colspan="8" style="text-align: center;"> <table border="1" style="width: 100%; border-collapse: collapse; text-align: center;"> <tr> <td style="width: 10%;"></td> <td style="width: 10%;"></td> <td style="width: 10%;"></td> <td style="width: 10%;"></td> <td style="width: 10%;"></td> <td style="width: 10%;"></td> <td style="width: 10%;"></td> <td style="width: 10%;"></td> <td style="width: 10%;"></td> <td style="width: 10%;"></td> </tr> <tr> <td></td> <td></td> <td colspan="8" style="text-align: center;"> <table border="1" style="width: 100%; border-collapse: collapse; text-align: center;"> <tr> <td style="width: 10%;"></td> <td style="width: 10%;"></td> <td style="width: 10%;"></td> <td style="width: 10%;"></td> <td style="width: 10%;"></td> <td style="width: 10%;"></td> <td style="width: 10%;"></td> <td style="width: 10%;"></td> <td style="width: 10%;"></td> <td style="width: 10%;"></td> </tr> <tr> <td></td> <td></td> <td colspan="8" style="text-align: center;"> <table border="1" style="width: 100%; border-collapse: collapse; text-align: center;"> <tr> <td style="width: 10%;"></td> <td style="width: 10%;"></td> <td style="width: 10%;"></td> <td style="width: 10%;"></td> <td style="width: 10%;"></td> <td style="width: 10%;"></td> <td style="width: 10%;"></td> <td style="width: 10%;"></td> <td style="width: 10%;"></td> <td style="width: 10%;"></td> </tr> <tr> <td></td> <td></td> <td colspan="8" style="text-align: center;"> <table border="1" style="width: 100%; border-collapse: collapse; text-align: center;"> <tr> <td style="width: 10%;"></td> <td style="width: 10%;"></td> <td style="width: 10%;"></td> <td style="width: 10%;"></td> <td style="width: 10%;"></td> <td style="width: 10%;"></td> <td style="width: 10%;"></td> <td style="width: 10%;"></td> <td style="width: 10%;"></td> <td style="width: 10%;"></td> </tr> <tr> <td></td> <td></td> <td colspan="8" style="text-align: center;"> <table border="1" style="width: 100%; border-collapse: collapse; text-align: center;"> <tr> <td style="width: 10%;"></td> <td style="width: 10%;"></td> <td style="width: 10%;"></td> <td style="width: 10%;"></td> <td style="width: 10%;"></td> <td style="width: 10%;"></td> <td style="width: 10%;"></td> <td style="width: 10%;"></td> <td style="width: 10%;"></td> <td style="width: 10%;"></td> </tr> <tr> <td></td> <td></td> <td colspan="8" style="text-align: center;"> <table border="1" style="width: 100%; border-collapse: collapse; text-align: center;"> <tr> <td style="width: 10%;"></td> <td style="width: 10%;"></td> <td style="width: 10%;"></td> <td style="width: 10%;"></td> <td style="width: 10%;"></td> <td style="width: 10%;"></td> <td style="width: 10%;"></td> <td style="width: 10%;"></td> <td style="width: 10%;"></td> <td style="width: 10%;"></td> </tr> <tr> <td></td> <td></td> <td colspan="8" style="text-align: center;"> <table border="1" style="width: 100%; border-collapse: collapse; text-align: center;"> <tr> <td style="width: 10%;"></td> <td style="width: 10%;"></td> <td style="width: 10%;"></td> <td style="width: 10%;"></td> <td style="width: 10%;"></td> <td style="width: 10%;"></td> <td style="width: 10%;"></td> <td style="width: 10%;"></td> <td style="width: 10%;"></td> <td style="width: 10%;"></td> </tr> <tr> <td></td> <td></td> <td colspan="8" style="text-align: center;"> <table border="1" style="width: 100%; border-collapse: collapse; text-align: center;"> <tr> <td style="width: 10%;"></td> <td style="width: 10%;"></td> <td style="width: 10%;"></td> <td style="width: 10%;"></td> <td style="width: 10%;"></td> <td style="width: 10%;"></td> <td style="width: 10%;"></td> <td style="width: 10%;"></td> <td style="width: 10%;"></td> <td style="width: 10%;"></td> </tr> <tr> <td></td> <td></td> <td colspan="8" style="text-align: center;"> <table border="1" style="width: 100%; border-collapse: collapse; text-align: center;"> <tr> <td style="width: 10%;"></td> <td style="width: 10%;"></td> <td style="width: 10%;"></td> <td style="width: 10%;"></td> <td style="width: 10%;"></td> <td style="width: 10%;"></td> <td style="width: 10%;"></td> <td style="width: 10%;"></td> <td style="width: 10%;"></td> <td style="width: 10%;"></td> </tr> <tr> <td></td> <td></td> <td colspan="8" style="text-align: center;"> <table border="1" style="width: 100%; border-collapse: collapse; text-align: center;"> <tr> <td style="width: 10%;"></td> <td style="width: 10%;"></td> <td style="width: 10%;"></td> <td style="width: 10%;"></td> <td style="width: 10%;"></td> <td style="width: 10%;"></td> <td style="width: 10%;"></td> <td style="width: 10%;"></td> <td style="width: 10%;"></td> <td style="width: 10%;"></td> </tr> <tr> <td></td> <td></td> <td colspan="8" style="text-align: center;"> <table border="1" style="width: 100%; border-collapse: collapse; text-align: center;"> <tr> <td style="width: 10%;"></td> <td style="width: 10%;"></td> <td style="width: 10%;"></td> <td style="width: 10%;"></td> <td style="width: 10%;"></td> <td style="width: 10%;"></td> <td style="width: 10%;"></td> <td style="width: 10%;"></td> <td style="width: 10%;"></td> <td style="width: 10%;"></td> </tr> <tr> <td></td> <td></td> <td colspan="8" style="text-align: center;"> <table border="1" style="width: 100%; border-collapse: collapse; text-align: center;"> <tr> <td style="width: 10%;"></td> <td style="width: 10%;"></td> <td style="width: 10%;"></td> <td style="width: 10%;"></td> <td style="width: 10%;"></td> <td style="width: 10%;"></td> <td style="width: 10%;"></td> <td style="width: 10%;"></td> <td style="width: 10%;"></td> <td style="width: 10%;"></td> </tr> <tr> <td></td> <td></td> <td colspan="8" style="text-align: center;">
<table border="1" style="width: 100%; border-collapse: collapse; text-align: center;"> <tr> <td style="width: 10%;"></td> <td style="width: 10%;"></td> <td style="width: 10%;"></td> <td style="width: 10%;"></td> <td style="width: 10%;"></td> <td style="width: 10%;"></td> <td style="width: 10%;"></td> <td style="width: 10%;"></td> <td style="width: 10%;"></td> <td style="width: 10%;"></td> </tr> <tr> <td></td> <td></td> <td colspan="8" style="text-align: center;"> <table border="1" style="width: 100%; border-collapse: collapse; text-align: center;"> <tr> <td style="width: 10%;"></td> <td style="width: 10%;"></td> <td style="width: 10%;"></td> <td style="width: 10%;"></td> <td style="width: 10%;"></td> <td style="width: 10%;"></td> <td style="width: 10%;"></td> <td style="width: 10%;"></td> <td style="width: 10%;"></td> <td style="width: 10%;"></td> </tr> <tr> <td></td> <td></td> <td colspan="8" style="text-align: center;"> <table border="1" style="width: 100%; border-collapse: collapse; text-align: center;"> <tr> <td style="width: 10%;"></td> <td style="width: 10%;"></td> <td style="width: 10%;"></td> <td style="width: 10%;"></td> <td style="width: 10%;"></td> <td style="width: 10%;"></td> <td style="width: 10%;"></td> <td style="width: 10%;"></td> <td style="width: 10%;"></td> <td style="width: 10%;"></td> </tr> <tr> <td></td> <td></td> <td colspan="8" style="text-align: center;"> <table border="1" style="width: 100%; border-collapse: collapse; text-align: center;"> <tr> <td style="width: 10%;"></td> <td style="width: 10%;"></td> <td style="width: 10%;"></td> <td style="width: 10%;"></td> <td style="width: 10%;"></td> <td style="width: 10%;"></td> <td style="width: 10%;"></td> <td style="width: 10%;"></td> <td style="width: 10%;"></td> <td style="width: 10%;"></td> </tr> <tr> <td></td> <td></td> <td colspan="8" style="text-align: center;"> <table border="1" style="width: 100%; border-collapse: collapse; text-align: center;"> <tr> <td style="width: 10%;"></td> <td style="width: 10%;"></td> <td style="width: 10%;"></td> <td style="width: 10%;"></td> <td style="width: 10%;"></td> <td style="width: 10%;"></td> <td style="width: 10%;"></td> <td style="width: 10%;"></td> <td style="width: 10%;"></td> <td style="width: 10%;"></td> </tr> <tr> <td></td> <td></td> <td colspan="8" style="text-align: center;"> <table border="1" style="width: 100%; border-collapse: collapse; text-align: center;"> <tr> <td style="width: 10%;"></td> <td style="width: 10%;"></td> <td style="width: 10%;"></td> <td style="width: 10%;"></td> <td style="width: 10%;"></td> <td style="width: 10%;"></td> <td style="width: 10%;"></td> <td style="width: 10%;"></td> <td style="width: 10%;"></td> <td style="width: 10%;"></td> </tr> <tr> <td></td> <td></td> <td colspan="8" style="text-align: center;"> <table border="1" style="width: 100%; border-collapse: collapse; text-align: center;"> <tr> <td style="width: 10%;"></td> <td style="width: 10%;"></td> <td style="width: 10%;"></td> <td style="width: 10%;"></td> <td style="width: 10%;"></td> <td style="width: 10%;"></td> <td style="width: 10%;"></td> <td style="width: 10%;"></td> <td style="width: 10%;"></td> <td style="width: 10%;"></td> </tr> <tr> <td></td> <td></td> <td colspan="8" style="text-align: center;"> <table border="1" style="width: 100%; border-collapse: collapse; text-align: center;"> <tr> <td style="width: 10%;"></td> <td style="width: 10%;"></td> <td style="width: 10%;"></td> <td style="width: 10%;"></td> <td style="width: 10%;"></td> <td style="width: 10%;"></td> <td style="width: 10%;"></td> <td style="width: 10%;"></td> <td style="width: 10%;"></td> <td style="width: 10%;"></td> </tr> <tr> <td></td> <td></td> <td colspan="8" style="text-align: center;"> <table border="1" style="width: 100%; border-collapse: collapse; text-align: center;"> <tr> <td style="width: 10%;"></td> <td style="width: 10%;"></td> <td style="width: 10%;"></td> <td style="width: 10%;"></td> <td style="width: 10%;"></td> <td style="width: 10%;"></td> <td style="width: 10%;"></td> <td style="width: 10%;"></td> <td style="width: 10%;"></td> <td style="width: 10%;"></td> </tr> <tr> <td></td> <td></td> <td colspan="8" style="text-align: center;"> <table border="1" style="width: 100%; border-collapse: collapse; text-align: center;"> <tr> <td style="width: 10%;"></td> <td style="width: 10%;"></td> <td style="width: 10%;"></td> <td style="width: 10%;"></td> <td style="width: 10%;"></td> <td style="width: 10%;"></td> <td style="width: 10%;"></td> <td style="width: 10%;"></td> <td style="width: 10%;"></td> <td style="width: 10%;"></td> </tr> <tr> <td></td> <td></td> <td colspan="8" style="text-align: center;"> <table border="1" style="width: 100%; border-collapse: collapse; text-align: center;"> <tr> <td style="width: 10%;"></td> <td style="width: 10%;"></td> <td style="width: 10%;"></td> <td style="width: 10%;"></td> <td style="width: 10%;"></td> <td style="width: 10%;"></td> <td style="width: 10%;"></td> <td style="width: 10%;"></td> <td style="width: 10%;"></td> <td style="width: 10%;"></td> </tr> <tr> <td></td> <td></td> <td colspan="8" style="text-align: center;"> <table border="1" style="width: 100%; border-collapse: collapse; text-align: center;"> <tr> <td style="width: 10%;"></td> <td style="width: 10%;"></td> <td style="width: 10%;"></td> <td style="width: 10%;"></td> <td style="width: 10%;"></td> <td style="width: 10%;"></td> <td style="width: 10%;"></td> <td style="width: 10%;"></td> <td style="width: 10%;"></td> <td style="width: 10%;"></td> </tr> <tr> <td></td> <td></td> <td colspan="8" style="text-align: center;"> <table border="1" style="width: 100%; border-collapse: collapse; text-align: center;"> <tr> <td style="width: 10%;"></td> <td style="width: 10%;"></td> <td style="width: 10%;"></td> <td style="width: 10%;"></td> <td style="width: 10%;"></td> <td style="width: 10%;"></td> <td style="width: 10%;"></td> <td style="width: 10%;"></td> <td style="width: 10%;"></td> <td style="width: 10%;"></td> </tr> <tr> <td></td> <td></td> <td colspan="8" style="text-align: center;"> <table border="1" style="width: 100%; border-collapse: collapse; text-align: center;"> <tr> <td style="width: 10%;"></td> <td style="width: 10%;"></td> <td style="width: 10%;"></td> <td style="width: 10%;"></td> <td style="width: 10%;"></td> <td style="width: 10%;"></td> <td style="width: 10%;"></td> <td style="width: 10%;"></td> <td style="width: 10%;"></td> <td style="width: 10%;"></td> </tr> <tr> <td></td> <td></td> <td colspan="8" style="text-align: center;"> <table border="1" style="width: 100%; border-collapse: collapse; text-align: center;"> <tr> <td style="width: 10%;"></td> <td style="width: 10%;"></td> <td style="width: 10%;"></td> <td style="width: 10%;"></td> <td style="width: 10%;"></td> <td style="width: 10%;"></td> <td style="width: 10%;"></td> <td style="width: 10%;"></td> <td style="width: 10%;"></td> <td style="width: 10%;"></td> </tr> <tr> <td></td> <td></td> <td colspan="8" style="text-align: center;"> <table border="1" style="width: 100%; border-collapse: collapse; text-align: center;"> <tr> <td style="width: 10%;"></td> <td style="width: 10%;"></td> <td style="width: 10%;"></td> <td style="width: 10%;"></td> <td style="width: 10%;"></td> <td style="width: 10%;"></td> <td style="width: 10%;"></td> <td style="width: 10%;"></td> <td style="width: 10%;"></td> <td style="width: 10%;"></td> </tr> <tr> <td></td> <td></td> <td colspan="8" style="text-align: center;"> <table border="1" style="width: 100%; border-collapse: collapse; text-align: center;"> <tr> <td style="width: 10%;"></td> <td style="width: 10%;"></td> <td style="width: 10%;"></td> <td style="width: 10%;"></td> <td style="width: 10%;"></td> <td style="width: 10%;"></td> <td style="width: 10%;"></td> <td style="width: 10%;"></td> <td style="width: 10%;"></td> <td style="width: 10%;"></td> </tr> <tr> <td></td> <td></td> <td colspan="8" style="text-align: center;"> <table border="1" style="width: 100%; border-collapse: collapse; text-align: center;"> <tr> <td style="width: 10%;"></td> <td style="width: 10%;"></td> <td style="width: 10%;"></td> <td style="width: 10%;"></td> <td style="width: 10%;"></td> <td style="width: 10%;"></td> <td style="width: 10%;"></td> <td style="width: 10%;"></td> <td style="width: 10%;"></td> <td style="width: 10%;"></td> </tr> <tr> <td></td> <td></td> <td colspan="8" style="text-align: center;"> <table border="1" style="width: 100%; border-collapse: collapse; text-align: center;"> <tr> <td style="width: 10%;"></td> <td style="width: 10%;"></td> <td style="width: 10%;"></td> <td style="width: 10%;"></td> <td style="width: 10%;"></td> <td style="width: 10%;"></td> <td style="width: 10%;"></td> <td style="width: 10%;"></td> <td style="width: 10%;"></td> <td style="width: 10%;"></td> </tr> <tr> <td></td> <td></td> <td colspan="8" style="text-align: center;"> <table border="1" style="width: 100%; border-collapse: collapse; text-align: center;"> <tr> <td style="width: 10%;"></td> <td style="width: 10%;"></td> <td style="width: 10%;"></td> <td style="width: 10%;"></td> <td style="width: 10%;"></td> <td style="width: 10%;"></td> <td style="width: 10%;"></td> <td style="width: 10%;"></td> <td style="width: 10%;"></td> <td style="width: 10%;"></td> </tr> <tr> <td></td> <td></td> <td colspan="8" style="text-align: center;"> <table border="1" style="width: 100%; border-collapse: collapse; text-align: center;"> <tr> <td style="width: 10%;"></td> <td style="width: 10%;"></td> <td style="width: 10%;"></td> <td style="width: 10%;"></td> <td style="width: 10%;"></td> <td style="width: 10%;"></td> <td style="width: 10%;"></td> <td style="width: 10%;"></td> <td style="width: 10%;"></td> <td style="width: 10%;"></td> </tr> <tr> <td></td> <td></td> <td colspan="8" style="text-align: center;"> <table border="1" style="width: 100%; border-collapse: collapse; text-align: center;"> <tr> <td style="width: 10%;"></td> <td style="width: 10%;"></td> <td style="width:
10%;"></td> <td style="width: 10%;"></td> <td style="width: 10%;"></td> <td style="width: 10%;"></td> <td style="width: 10%;"></td> <td style="width: 10%;"></td> <td style="width: 10%;"></td> <td style="width: 10%;"></td> </tr> <tr> <td></td> <td></td> <td colspan="8" style="text-align: center;"> <table border="1" style="width: 100%; border-collapse: collapse; text-align: center;"> <tr> <td style="width: 10%;"></td> <td style="width: 10%;"></td> <td style="width: 10%;"></td> <td style="width: 10%;"></td> <td style="width: 10%;"></td> <td style="width: 10%;"></td> <td style="width: 10%;"></td> <td style="width: 10%;"></td> <td style="width: 10%;"></td> <td style="width: 10%;"></td> </tr> <tr> <td></td> <td></td> <td colspan="8" style="text-align: center;"> <table border="1" style="width: 100%; border-collapse: collapse; text-align: center;"> <tr> <td style="width: 10%;"></td> <td style="width: 10%;"></td> <td style="width: 10%;"></td> <td style="width: 10%;"></td> <td style="width: 10%;"></td> <td style="width: 10%;"></td> <td style="width: 10%;"></td> <td style="width: 10%;"></td> <td style="width: 10%;"></td> <td style="width: 10%;"></td> </tr> <tr> <td></td> <td></td> <td colspan="8" style="text-align: center;"> <table border="1" style="width: 100%; border-collapse: collapse; text-align: center;"> <tr> </tr></table></td></tr></table></td></tr></table></td></tr></table></td></tr></table></td></tr></table></td></tr></table></td></tr></table></td></tr></table></td></tr></table></td></tr></table></td></tr></table></td></tr></table></td></tr></table></td></tr></table></td></tr></table></td></tr></table></td></tr></table></td></tr></table></td></tr></table></td></tr></table></td></tr></table></td></tr></table></td></tr></table></td></tr></table></td></tr></table></td></tr></table></td></tr></table></td></tr></table></td></tr></table></td></tr></table></td></tr></table></td></tr></table></td></tr></table></td></tr></table></td></tr></table></td></tr></table></td></tr></table></td></tr></table></td></tr></table></td></tr></table></td></tr></table></td></tr></table>
 | | | | | | | | | | | | | | | | | | | | <table border="1" style="width: 100%; border-collapse: collapse; text-align: center;"> <tr> <td style="width: 10%;"></td> <td style="width: 10%;"></td> <td style="width: 10%;"></td> <td style="width: 10%;"></td> <td style="width: 10%;"></td> <td style="width: 10%;"></td> <td style="width: 10%;"></td> <td style="width: 10%;"></td> <td style="width: 10%;"></td> <td style="width: 10%;"></td> </tr> <tr> <td></td> <td></td> <td colspan="8" style="text-align: center;"> <table border="1" style="width: 100%; border-collapse: collapse; text-align: center;"> <tr> <td style="width: 10%;"></td> <td style="width: 10%;"></td> <td style="width: 10%;"></td> <td style="width: 10%;"></td> <td style="width: 10%;"></td> <td style="width: 10%;"></td> <td style="width: 10%;"></td> <td style="width: 10%;"></td> <td style="width: 10%;"></td> <td style="width: 10%;"></td> </tr> <tr> <td></td> <td></td> <td colspan="8" style="text-align: center;"> <table border="1" style="width: 100%; border-collapse: collapse; text-align: center;"> <tr> <td style="width: 10%;"></td> <td style="width: 10%;"></td> <td style="width: 10%;"></td> <td style="width: 10%;"></td> <td style="width: 10%;"></td> <td style="width: 10%;"></td> <td style="width: 10%;"></td> <td style="width: 10%;"></td> <td style="width: 10%;"></td> <td style="width: 10%;"></td> </tr> <tr> <td></td> <td></td> <td colspan="8" style="text-align: center;"> <table border="1" style="width: 100%; border-collapse: collapse; text-align: center;"> <tr> <td style="width: 10%;"></td> <td style="width: 10%;"></td> <td style="width: 10%;"></td> <td style="width: 10%;"></td> <td style="width: 10%;"></td> <td style="width: 10%;"></td> <td style="width: 10%;"></td> <td style="width: 10%;"></td> <td style="width: 10%;"></td> <td style="width: 10%;"></td> </tr> <tr> <td></td> <td></td> <td colspan="8" style="text-align: center;"> <table border="1" style="width: 100%; border-collapse: collapse; text-align: center;"> <tr> <td style="width: 10%;"></td> <td style="width: 10%;"></td> <td style="width: 10%;"></td> <td style="width: 10%;"></td> <td style="width: 10%;"></td> <td style="width: 10%;"></td> <td style="width: 10%;"></td> <td style="width: 10%;"></td> <td style="width: 10%;"></td> <td style="width: 10%;"></td> </tr> <tr> <td></td> <td></td> <td colspan="8" style="text-align: center;"> <table border="1" style="width: 100%; border-collapse: collapse; text-align: center;"> <tr> <td style="width: 10%;"></td> <td style="width: 10%;"></td> <td style="width: 10%;"></td> <td style="width: 10%;"></td> <td style="width: 10%;"></td> <td style="width: 10%;"></td> <td style="width: 10%;"></td> <td style="width: 10%;"></td> <td style="width: 10%;"></td> <td style="width: 10%;"></td> </tr> <tr> <td></td> <td></td> <td colspan="8" style="text-align: center;"> <table border="1" style="width: 100%; border-collapse: collapse; text-align: center;"> <tr> <td style="width: 10%;"></td> <td style="width: 10%;"></td> <td style="width: 10%;"></td> <td style="width: 10%;"></td> <td style="width: 10%;"></td> <td style="width: 10%;"></td> <td style="width: 10%;"></td> <td style="width: 10%;"></td> <td style="width: 10%;"></td> <td style="width: 10%;"></td> </tr> <tr> <td></td> <td></td> <td colspan="8" style="text-align: center;"> <table border="1" style="width: 100%; border-collapse: collapse; text-align: center;"> <tr> <td style="width: 10%;"></td> <td style="width: 10%;"></td> <td style="width: 10%;"></td> <td style="width: 10%;"></td> <td style="width: 10%;"></td> <td style="width: 10%;"></td> <td style="width: 10%;"></td> <td style="width: 10%;"></td> <td style="width: 10%;"></td> <td style="width: 10%;"></td> </tr> <tr> <td></td> <td></td> <td colspan="8" style="text-align: center;"> <table border="1" style="width: 100%; border-collapse: collapse; text-align: center;"> <tr> <td style="width: 10%;"></td> <td style="width: 10%;"></td> <td style="width: 10%;"></td> <td style="width: 10%;"></td> <td style="width: 10%;"></td> <td style="width: 10%;"></td> <td style="width: 10%;"></td> <td style="width: 10%;"></td> <td style="width: 10%;"></td> <td style="width: 10%;"></td> </tr> <tr> <td></td> <td></td> <td colspan="8" style="text-align: center;"> <table border="1" style="width: 100%; border-collapse: collapse; text-align: center;"> <tr> <td style="width: 10%;"></td> <td style="width: 10%;"></td> <td style="width: 10%;"></td> <td style="width: 10%;"></td> <td style="width: 10%;"></td> <td style="width: 10%;"></td> <td style="width: 10%;"></td> <td style="width: 10%;"></td> <td style="width: 10%;"></td> <td style="width: 10%;"></td> </tr> <tr> <td></td> <td></td> <td colspan="8" style="text-align: center;"> <table border="1" style="width: 100%; border-collapse: collapse; text-align: center;"> <tr> <td style="width: 10%;"></td> <td style="width: 10%;"></td> <td style="width: 10%;"></td> <td style="width: 10%;"></td> <td style="width: 10%;"></td> <td style="width: 10%;"></td> <td style="width: 10%;"></td> <td style="width: 10%;"></td> <td style="width: 10%;"></td> <td style="width: 10%;"></td> </tr> <tr> <td></td> <td></td> <td colspan="8" style="text-align: center;"> <table border="1" style="width: 100%; border-collapse: collapse; text-align: center;"> <tr> <td style="width: 10%;"></td> <td style="width: 10%;"></td> <td style="width: 10%;"></td> <td style="width: 10%;"></td> <td style="width: 10%;"></td> <td style="width: 10%;"></td> <td style="width: 10%;"></td> <td style="width: 10%;"></td> <td style="width: 10%;"></td> <td style="width: 10%;"></td> </tr> <tr> <td></td> <td></td> <td colspan="8" style="text-align: center;"> <table border="1" style="width: 100%; border-collapse: collapse; text-align: center;"> <tr> <td style="width: 10%;"></td> <td style="width: 10%;"></td> <td style="width: 10%;"></td> <td style="width: 10%;"></td> <td style="width: 10%;"></td> <td style="width: 10%;"></td> <td style="width: 10%;"></td> <td style="width: 10%;"></td> <td style="width: 10%;"></td> <td style="width: 10%;"></td> </tr> <tr> <td></td> <td></td> <td colspan="8" style="text-align: center;"> <table border="1" style="width: 100%; border-collapse: collapse; text-align: center;"> <tr> <td style="width: 10%;"></td> <td style="width: 10%;"></td> <td style="width: 10%;"></td> <td style="width: 10%;"></td> <td style="width: 10%;"></td> <td style="width: 10%;"></td> <td style="width: 10%;"></td> <td style="width: 10%;"></td> <td style="width: 10%;"></td> <td style="width: 10%;"></td> </tr> <tr> <td></td> <td></td> <td colspan="8" style="text-align: center;"> <table border="1" style="width: 100%; border-collapse: collapse; text-align: center;"> <tr> <td style="width: 10%;"></td> <td style="width: 10%;"></td> <td style="width: 10%;"></td> <td style="width: 10%;"></td> <td style="width: 10%;"></td> <td style="width: 10%;"></td> <td style="width: 10%;"></td> <td style="width: 10%;"></td> <td style="width: 10%;"></td> <td style="width: 10%;"></td> </tr> <tr> <td></td> <td></td> <td colspan="8" style="text-align: center;"> <table border="1" style="width: 100%; border-collapse: collapse; text-align: center;"> <tr> <td style="width: 10%;"></td> <td style="width: 10%;"></td> <td style="width: 10%;"></td> <td style="width: 10%;"></td> <td style="width: 10%;"></td> <td style="width: 10%;"></td> <td style="width: 10%;"></td> <td style="width: 10%;"></td> <td style="width: 10%;"></td> <td style="width: 10%;"></td> </tr> <tr> <td></td> <td></td> <td colspan="8" style="text-align: center;"> <table border="1" style="width: 100%; border-collapse: collapse; text-align: center;"> <tr> <td style="width: 10%;"></td> <td style="width: 10%;"></td> <td style="width: 10%;"></td> <td style="width: 10%;"></td> <td style="width: 10%;"></td> <td style="width: 10%;"></td> <td style="width: 10%;"></td> <td style="width: 10%;"></td> <td style="width: 10%;"></td> <td style="width: 10%;"></td> </tr> <tr> <td></td> <td></td> <td colspan="8" style="text-align: center;"> <table border="1" style="width: 100%; border-collapse: collapse; text-align: center;"> <tr> <td style="width: 10%;"></td> <td style="width: 10%;"></td> <td style="width: 10%;"></td> <td style="width: 10%;"></td> <td style="width: 10%;"></td> <td style="width: 10%;"></td> <td style="width: 10%;"></td> <td style="width: 10%;"></td> <td style="width: 10%;"></td> <td style="width: 10%;"></td> </tr> <tr> <td></td> <td></td> <td colspan="8" style="text-align: center;"> <table border="1" style="width: 100%; border-collapse: collapse; text-align: center;"> <tr> <td style="width: 10%;"></td> <td style="width: 10%;"></td> <td style="width: 10%;"></td> <td style="width: 10%;"></td> <td style="width: 10%;"></td> <td style="width: 10%;"></td> <td style="width: 10%;"></td> <td style="width: 10%;"></td> <td style="width: 10%;"></td> <td style="width: 10%;"></td> </tr> <tr> <td></td> <td></td> <td colspan="8" style="text-align: center;"> <table border="1" style="width: 100%; border-collapse: collapse; text-align: center;"> <tr> <td style="width: 10%;"></td> <td style="width: 10%;"></td> <td style="width: 10%;"></td> <td style="width: 10%;"></td> <td style="width: 10%;"></td> <td style="width: 10%;"></td> <td style="width: 10%;"></td> <td style="width: 10%;"></td> <td style="width: 10%;"></td> <td style="width: 10%;"></td> </tr> <tr> <td></td> <td></td> <td colspan="8" style="text-align: center;"> <table border="1" style="width: 100%; border-collapse: collapse; text-align: center;"> <tr> <td style="width: 10%;"></td> <td style="width: 10%;"></td> <td style="width: 10%;"></td> <td style="width: 10%;"></td> <td
style="width: 10%;"></td> <td style="width: 10%;"></td> <td style="width: 10%;"></td> <td style="width: 10%;"></td> <td style="width: 10%;"></td> <td style="width: 10%;"></td> </tr> <tr> <td></td> <td></td> <td colspan="8" style="text-align: center;"> <table border="1" style="width: 100%; border-collapse: collapse; text-align: center;"> <tr> <td style="width: 10%;"></td> <td style="width: 10%;"></td> <td style="width: 10%;"></td> <td style="width: 10%;"></td> <td style="width: 10%;"></td> <td style="width: 10%;"></td> <td style="width: 10%;"></td> <td style="width: 10%;"></td> <td style="width: 10%;"></td> <td style="width: 10%;"></td> </tr> <tr> <td></td> <td></td> <td colspan="8" style="text-align: center;"> <table border="1" style="width: 100%; border-collapse: collapse; text-align: center;"> <tr> <td style="width: 10%;"></td> <td style="width: 10%;"></td> <td style="width: 10%;"></td> <td style="width: 10%;"></td> <td style="width: 10%;"></td> <td style="width: 10%;"></td> <td style="width: 10%;"></td> <td style="width: 10%;"></td> <td style="width: 10%;"></td> <td style="width: 10%;"></td> </tr> <tr> <td></td> <td></td> <td colspan="8" style="text-align: center;"> <table border="1" style="width: 100%; border-collapse: collapse; text-align: center;"> <tr> <td style="width: 10%;"></td> <td style="width: 10%;"></td> <td style="width: 10%;"></td> <td style="width: 10%;"></td> <td style="width: 10%;"></td> <td style="width: 10%;"></td> <td style="width: 10%;"></td> <td style="width: 10%;"></td> <td style="width: 10%;"></td> <td style="width: 10%;"></td> </tr> <tr> <td></td> <td></td> <td colspan="8" style="text-align: center;"> <table border="1" style="width: 100%; border-collapse: collapse; text-align: center;"> <tr> <td style="width: 10%;"></td> <td style="width: 10%;"></td> <td style="width: 10%;"></td> <td style="width: 10%;"></td> <td style="width: 10%;"></td> <td style="width: 10%;"></td> <td style="width: 10%;"></td> <td style="width: 10%;"></td> <td style="width: 10%;"></td> <td style="width: 10%;"></td> </tr> <tr> <td></td> <td></td> <td colspan="8" style="text-align: center;"> <table border="1" style="width: 100%; border-collapse: collapse; text-align: center;"> <tr> <td style="width: 10%;"></td> <td style="width: 10%;"></td> <td style="width: 10%;"></td> <td style="width: 10%;"></td> <td style="width: 10%;"></td> <td style="width: 10%;"></td> <td style="width: 10%;"></td> <td style="width: 10%;"></td> <td style="width: 10%;"></td> <td style="width: 10%;"></td> </tr> <tr> <td></td> <td></td> <td colspan="8" style="text-align: center;"> <table border="1" style="width: 100%; border-collapse: collapse; text-align: center;"> <tr> <td style="width: 10%;"></td> <td style="width: 10%;"></td> <td style="width: 10%;"></td> <td style="width: 10%;"></td> <td style="width: 10%;"></td> <td style="width: 10%;"></td> <td style="width: 10%;"></td> <td style="width: 10%;"></td> <td style="width: 10%;"></td> <td style="width: 10%;"></td> </tr> <tr> <td></td> <td></td> <td colspan="8" style="text-align: center;"> <table border="1" style="width: 100%; border-collapse: collapse; text-align: center;"> <tr> <td style="width: 10%;"></td> <td style="width: 10%;"></td> <td style="width: 10%;"></td> <td style="width: 10%;"></td> <td style="width: 10%;"></td> <td style="width: 10%;"></td> <td style="width: 10%;"></td> <td style="width: 10%;"></td> <td style="width: 10%;"></td> <td style="width: 10%;"></td> </tr> <tr> <td></td> <td></td> <td colspan="8" style="text-align: center;"> <table border="1" style="width: 100%; border-collapse: collapse; text-align: center;"> <tr> <td style="width: 10%;"></td> <td style="width: 10%;"></td> <td style="width: 10%;"></td> <td style="width: 10%;"></td> <td style="width: 10%;"></td> <td style="width: 10%;"></td> <td style="width: 10%;"></td> <td style="width: 10%;"></td> <td style="width: 10%;"></td> <td style="width: 10%;"></td> </tr> <tr> <td></td> <td></td> <td colspan="8" style="text-align: center;"> <table border="1" style="width: 100%; border-collapse: collapse; text-align: center;"> <tr> <td style="width: 10%;"></td> <td style="width: 10%;"></td> <td style="width: 10%;"></td> <td style="width: 10%;"></td> <td style="width: 10%;"></td> <td style="width: 10%;"></td> <td style="width: 10%;"></td> <td style="width: 10%;"></td> <td style="width: 10%;"></td> <td style="width: 10%;"></td> </tr> <tr> <td></td> <td></td> <td colspan="8" style="text-align: center;"> <table border="1" style="width: 100%; border-collapse: collapse; text-align: center;"> <tr> <td style="width: 10%;"></td> <td style="width: 10%;"></td> <td style="width: 10%;"></td> <td style="width: 10%;"></td> <td style="width: 10%;"></td> <td style="width: 10%;"></td> <td style="width: 10%;"></td> <td style="width: 10%;"></td> <td style="width: 10%;"></td> <td style="width: 10%;"></td> </tr> <tr> <td></td> <td></td> <td colspan="8" style="text-align: center;"> <table border="1" style="width: 100%; border-collapse: collapse; text-align: center;"> <tr> <td style="width: 10%;"></td> <td style="width: 10%;"></td> <td style="width: 10%;"></td> <td style="width: 10%;"></td> <td style="width: 10%;"></td> <td style="width: 10%;"></td> <td style="width: 10%;"></td> <td style="width: 10%;"></td> <td style="width: 10%;"></td> <td style="width: 10%;"></td> </tr> <tr> <td></td> <td></td> <td colspan="8" style="text-align: center;"> <table border="1" style="width: 100%; border-collapse: collapse; text-align: center;"> <tr> <td style="width: 10%;"></td> <td style="width: 10%;"></td> <td style="width: 10%;"></td> <td style="width: 10%;"></td> <td style="width: 10%;"></td> <td style="width: 10%;"></td> <td style="width: 10%;"></td> <td style="width: 10%;"></td> <td style="width: 10%;"></td> <td style="width: 10%;"></td> </tr> <tr> <td></td> <td></td> <td colspan="8" style="text-align: center;"> <table border="1" style="width: 100%; border-collapse: collapse; text-align: center;"> <tr> <td style="width: 10%;"></td> <td style="width: 10%;"></td> <td style="width: 10%;"></td> <td style="width: 10%;"></td> <td style="width: 10%;"></td> <td style="width: 10%;"></td> <td style="width: 10%;"></td> <td style="width: 10%;"></td> <td style="width: 10%;"></td> <td style="width: 10%;"></td> </tr> <tr> <td></td> <td></td> <td colspan="8" style="text-align: center;"> <table border="1" style="width: 100%; border-collapse: collapse; text-align: center;"> <tr> <td style="width: 10%;"></td> <td style="width: 10%;"></td> <td style="width: 10%;"></td> <td style="width: 10%;"></td> <td style="width: 10%;"></td> <td style="width: 10%;"></td> <td style="width: 10%;"></td> <td style="width: 10%;"></td> <td style="width: 10%;"></td> <td style="width: 10%;"></td> </tr> <tr> <td></td> <td></td> <td colspan="8" style="text-align: center;"> <table border="1" style="width: 100%; border-collapse: collapse; text-align: center;"> <tr> <td style="width: 10%;"></td> <td style="width: 10%;"></td> <td style="width: 10%;"></td> <td style="width: 10%;"></td> <td style="width: 10%;"></td> <td style="width: 10%;"></td> <td style="width: 10%;"></td> <td style="width: 10%;"></td> <td style="width: 10%;"></td> <td style="width: 10%;"></td> </tr> <tr> <td></td> <td></td> <td colspan="8" style="text-align: center;"> <table border="1" style="width: 100%; border-collapse: collapse; text-align: center;"> <tr> <td style="width: 10%;"></td> <td style="width: 10%;"></td> <td style="width: 10%;"></td> <td style="width: 10%;"></td> <td style="width: 10%;"></td> <td style="width: 10%;"></td> <td style="width: 10%;"></td> <td style="width: 10%;"></td> <td style="width: 10%;"></td> <td style="width: 10%;"></td> </tr> <tr> <td></td> <td></td> <td colspan="8" style="text-align: center;"> <table border="1" style="width: 100%; border-collapse: collapse; text-align: center;"> <tr> <td style="width: 10%;"></td> <td style="width: 10%;"></td> <td style="width: 10%;"></td> <td style="width: 10%;"></td> <td style="width: 10%;"></td> <td style="width: 10%;"></td> <td style="width: 10%;"></td> <td style="width: 10%;"></td> <td style="width: 10%;"></td> <td style="width: 10%;"></td> </tr> <tr> <td></td> <td></td> <td colspan="8" style="text-align: center;"> <table border="1" style="width: 100%; border-collapse: collapse; text-align: center;"> <tr> <td style="width: 10%;"></td> <td style="width: 10%;"></td> <td style="width: 10%;"></td> <td style="width: 10%;"></td> <td style="width: 10%;"></td> <td style="width: 10%;"></td> <td style="width: 10%;"></td> <td style="width: 10%;"></td> <td style="width: 10%;"></td> <td style="width: 10%;"></td> </tr> <tr> <td></td> <td></td> <td colspan="8" style="text-align: center;"> <table border="1" style="width: 100%; border-collapse: collapse; text-align: center;"> <tr> <td style="width: 10%;"></td> <td style="width: 10%;"></td> <td style="width: 10%;"></td> <td style="width: 10%;"></td> <td style="width: 10%;"></td> <td style="width: 10%;"></td> <td style="width: 10%;"></td> <td style="width: 10%;"></td> <td style="width: 10%;"></td> <td style="width: 10%;"></td> </tr> <tr> <td></td> <td></td> <td colspan="8" style="text-align: center;"> <table border="1" style="width: 100%; border-collapse: collapse; text-align: center;"> <tr> <td style="width: 10%;"></td> <td style="width: 10%;"></td> <td style="width: 10%;"></td> <td style="width: 10%;"></td> <td style="width: 10%;"></td> <td style="width: 10%;"></td> <td style="width: 10%;"></td> <td style="width: 10%;"></td> <td style="width: 10%;"></td> <td style="width: 10%;"></td> </tr> <tr> <td></td> <td></td> <td colspan="8" style="text-align: center;"> <table border="1" style="width: 100%; border-collapse: collapse; text-align: center;"> <tr>
</tr></table></td></tr></table></td></tr></table></td></tr></table></td></tr></table></td></tr></table></td></tr></table></td></tr></table></td></tr></table></td></tr></table></td></tr></table></td></tr></table></td></tr></table></td></tr></table></td></tr></table></td></tr></table></td></tr></table></td></tr></table></td></tr></table></td></tr></table></td></tr></table></td></tr></table></td></tr></table></td></tr></table></td></tr></table></td></tr></table></td></tr></table></td></tr></table></td></tr></table></td></tr></table></td></tr></table></td></tr></table></td></tr></table></td></tr></table></td></tr></table></td></tr></table></td></tr></table></td></tr></table></td></tr></table></td></tr></table></td></tr></table></td></tr></table> | | | | | | | | | | | | | | | | | | | | <table border="1" style="width: 100%; border-collapse: collapse; text-align: center;"> <tr> <td style="width: 10%;"></td> <td style="width: 10%;"></td> <td style="width: 10%;"></td> <td style="width: 10%;"></td> <td style="width: 10%;"></td> <td style="width: 10%;"></td> <td style="width: 10%;"></td> <td style="width: 10%;"></td> <td style="width: 10%;"></td> <td style="width: 10%;"></td> </tr> <tr> <td></td> <td></td> <td colspan="8" style="text-align: center;"> <table border="1" style="width: 100%; border-collapse: collapse; text-align: center;"> <tr> <td style="width: 10%;"></td> <td style="width: 10%;"></td> <td style="width: 10%;"></td> <td style="width: 10%;"></td> <td style="width: 10%;"></td> <td style="width: 10%;"></td> <td style="width: 10%;"></td> <td style="width: 10%;"></td> <td style="width: 10%;"></td> <td style="width: 10%;"></td> </tr> <tr> <td></td> <td></td> <td colspan="8" style="text-align:
center;"> <table border="1" style="width: 100%; border-collapse: collapse; text-align: center;"> <tr> <td style="width: 10%;"></td> <td style="width: 10%;"></td> <td style="width: 10%;"></td> <td style="width: 10%;"></td> <td style="width: 10%;"></td> <td style="width: 10%;"></td> <td style="width: 10%;"></td> <td style="width: 10%;"></td> <td style="width: 10%;"></td> <td style="width: 10%;"></td> </tr> <tr> <td></td> <td></td> <td colspan="8" style="text-align: center;"> <table border="1" style="width: 100%; border-collapse: collapse; text-align: center;"> <tr> <td style="width: 10%;"></td> <td style="width: 10%;"></td> <td style="width: 10%;"></td> <td style="width: 10%;"></td> <td style="width: 10%;"></td> <td style="width: 10%;"></td> <td style="width: 10%;"></td> <td style="width: 10%;"></td> <td style="width: 10%;"></td> <td style="width: 10%;"></td> </tr> <tr> <td></td> <td></td> <td colspan="8" style="text-align: center;"> <table border="1" style="width: 100%; border-collapse: collapse; text-align: center;"> <tr> <td style="width: 10%;"></td> <td style="width: 10%;"></td> <td style="width: 10%;"></td> <td style="width: 10%;"></td> <td style="width: 10%;"></td> <td style="width: 10%;"></td> <td style="width: 10%;"></td> <td style="width: 10%;"></td> <td style="width: 10%;"></td> <td style="width: 10%;"></td> </tr> <tr> <td></td> <td></td> <td colspan="8" style="text-align: center;"> <table border="1" style="width: 100%; border-collapse: collapse; text-align: center;"> <tr> <td style="width: 10%;"></td> <td style="width: 10%;"></td> <td style="width: 10%;"></td> <td style="width: 10%;"></td> <td style="width: 10%;"></td> <td style="width: 10%;"></td> <td style="width: 10%;"></td> <td style="width: 10%;"></td> <td style="width: 10%;"></td> <td style="width: 10%;"></td> </tr> <tr> <td></td> <td></td> <td colspan="8" style="text-align: center;"> <table border="1" style="width: 100%; border-collapse: collapse; text-align: center;"> <tr> <td style="width: 10%;"></td> <td style="width: 10%;"></td> <td style="width: 10%;"></td> <td style="width: 10%;"></td> <td style="width: 10%;"></td> <td style="width: 10%;"></td> <td style="width: 10%;"></td> <td style="width: 10%;"></td> <td style="width: 10%;"></td> <td style="width: 10%;"></td> </tr> <tr> <td></td> <td></td> <td colspan="8" style="text-align: center;"> <table border="1" style="width: 100%; border-collapse: collapse; text-align: center;"> <tr> <td style="width: 10%;"></td> <td style="width: 10%;"></td> <td style="width: 10%;"></td> <td style="width: 10%;"></td> <td style="width: 10%;"></td> <td style="width: 10%;"></td> <td style="width: 10%;"></td> <td style="width: 10%;"></td> <td style="width: 10%;"></td> <td style="width: 10%;"></td> </tr> <tr> <td></td> <td></td> <td colspan="8" style="text-align: center;"> <table border="1" style="width: 100%; border-collapse: collapse; text-align: center;"> <tr> <td style="width: 10%;"></td> <td style="width: 10%;"></td> <td style="width: 10%;"></td> <td style="width: 10%;"></td> <td style="width: 10%;"></td> <td style="width: 10%;"></td> <td style="width: 10%;"></td> <td style="width: 10%;"></td> <td style="width: 10%;"></td> <td style="width: 10%;"></td> </tr> <tr> <td></td> <td></td> <td colspan="8" style="text-align: center;"> <table border="1" style="width: 100%; border-collapse: collapse; text-align: center;"> <tr> <td style="width: 10%;"></td> <td style="width: 10%;"></td> <td style="width: 10%;"></td> <td style="width: 10%;"></td> <td style="width: 10%;"></td> <td style="width: 10%;"></td> <td style="width: 10%;"></td> <td style="width: 10%;"></td> <td style="width: 10%;"></td> <td style="width: 10%;"></td> </tr> <tr> <td></td> <td></td> <td colspan="8" style="text-align: center;"> <table border="1" style="width: 100%; border-collapse: collapse; text-align: center;"> <tr> <td style="width: 10%;"></td> <td style="width: 10%;"></td> <td style="width: 10%;"></td> <td style="width: 10%;"></td> <td style="width: 10%;"></td> <td style="width: 10%;"></td> <td style="width: 10%;"></td> <td style="width: 10%;"></td> <td style="width: 10%;"></td> <td style="width: 10%;"></td> </tr> <tr> <td></td> <td></td> <td colspan="8" style="text-align: center;"> <table border="1" style="width: 100%; border-collapse: collapse; text-align: center;"> <tr> <td style="width: 10%;"></td> <td style="width: 10%;"></td> <td style="width: 10%;"></td> <td style="width: 10%;"></td> <td style="width: 10%;"></td> <td style="width: 10%;"></td> <td style="width: 10%;"></td> <td style="width: 10%;"></td> <td style="width: 10%;"></td> <td style="width: 10%;"></td> </tr> <tr> <td></td> <td></td> <td colspan="8" style="text-align: center;"> <table border="1" style="width: 100%; border-collapse: collapse; text-align: center;"> <tr> <td style="width: 10%;"></td> <td style="width: 10%;"></td> <td style="width: 10%;"></td> <td style="width: 10%;"></td> <td style="width: 10%;"></td> <td style="width: 10%;"></td> <td style="width: 10%;"></td> <td style="width: 10%;"></td> <td style="width: 10%;"></td> <td style="width: 10%;"></td> </tr> <tr> <td></td> <td></td> <td colspan="8" style="text-align: center;"> <table border="1" style="width: 100%; border-collapse: collapse; text-align: center;"> <tr> <td style="width: 10%;"></td> <td style="width: 10%;"></td> <td style="width: 10%;"></td> <td style="width: 10%;"></td> <td style="width: 10%;"></td> <td style="width: 10%;"></td> <td style="width: 10%;"></td> <td style="width: 10%;"></td> <td style="width: 10%;"></td> <td style="width: 10%;"></td> </tr> <tr> <td></td> <td></td> <td colspan="8" style="text-align: center;"> <table border="1" style="width: 100%; border-collapse: collapse; text-align: center;"> <tr> <td style="width: 10%;"></td> <td style="width: 10%;"></td> <td style="width: 10%;"></td> <td style="width: 10%;"></td> <td style="width: 10%;"></td> <td style="width: 10%;"></td> <td style="width: 10%;"></td> <td style="width: 10%;"></td> <td style="width: 10%;"></td> <td style="width: 10%;"></td> </tr> <tr> <td></td> <td></td> <td colspan="8" style="text-align: center;"> <table border="1" style="width: 100%; border-collapse: collapse; text-align: center;"> <tr> <td style="width: 10%;"></td> <td style="width: 10%;"></td> <td style="width: 10%;"></td> <td style="width: 10%;"></td> <td style="width: 10%;"></td> <td style="width: 10%;"></td> <td style="width: 10%;"></td> <td style="width: 10%;"></td> <td style="width: 10%;"></td> <td style="width: 10%;"></td> </tr> <tr> <td></td> <td></td> <td colspan="8" style="text-align: center;"> <table border="1" style="width: 100%; border-collapse: collapse; text-align: center;"> <tr> <td style="width: 10%;"></td> <td style="width: 10%;"></td> <td style="width: 10%;"></td> <td style="width: 10%;"></td> <td style="width: 10%;"></td> <td style="width: 10%;"></td> <td style="width: 10%;"></td> <td style="width: 10%;"></td> <td style="width: 10%;"></td> <td style="width: 10%;"></td> </tr> <tr> <td></td> <td></td> <td colspan="8" style="text-align: center;"> <table border="1" style="width: 100%; border-collapse: collapse; text-align: center;"> <tr> <td style="width: 10%;"></td> <td style="width: 10%;"></td> <td style="width: 10%;"></td> <td style="width: 10%;"></td> <td style="width: 10%;"></td> <td style="width: 10%;"></td> <td style="width: 10%;"></td> <td style="width: 10%;"></td> <td style="width: 10%;"></td> <td style="width: 10%;"></td> </tr> <tr> <td></td> <td></td> <td colspan="8" style="text-align: center;"> <table border="1" style="width: 100%; border-collapse: collapse; text-align: center;"> <tr> <td style="width: 10%;"></td> <td style="width: 10%;"></td> <td style="width: 10%;"></td> <td style="width: 10%;"></td> <td style="width: 10%;"></td> <td style="width: 10%;"></td> <td style="width: 10%;"></td> <td style="width: 10%;"></td> <td style="width: 10%;"></td> <td style="width: 10%;"></td> </tr> <tr> <td></td> <td></td> <td colspan="8" style="text-align: center;"> <table border="1" style="width: 100%; border-collapse: collapse; text-align: center;"> <tr> <td style="width: 10%;"></td> <td style="width: 10%;"></td> <td style="width: 10%;"></td> <td style="width: 10%;"></td> <td style="width: 10%;"></td> <td style="width: 10%;"></td> <td style="width: 10%;"></td> <td style="width: 10%;"></td> <td style="width: 10%;"></td> <td style="width: 10%;"></td> </tr> <tr> <td></td> <td></td> <td colspan="8" style="text-align: center;"> <table border="1" style="width: 100%; border-collapse: collapse; text-align: center;"> <tr> <td style="width: 10%;"></td> <td style="width: 10%;"></td> <td style="width: 10%;"></td> <td style="width: 10%;"></td> <td style="width: 10%;"></td> <td style="width: 10%;"></td> <td style="width: 10%;"></td> <td style="width: 10%;"></td> <td style="width: 10%;"></td> <td style="width: 10%;"></td> </tr> <tr> <td></td> <td></td> <td colspan="8" style="text-align: center;"> <table border="1" style="width: 100%; border-collapse: collapse; text-align: center;"> <tr> <td style="width: 10%;"></td> <td style="width: 10%;"></td> <td style="width: 10%;"></td> <td style="width: 10%;"></td> <td style="width: 10%;"></td> <td style="width: 10%;"></td> <td style="width: 10%;"></td> <td style="width: 10%;"></td> <td style="width: 10%;"></td> <td style="width: 10%;"></td> </tr> <tr> <td></td> <td></td> <td colspan="8" style="text-align: center;"> <table border="1" style="width: 100%; border-collapse: collapse; text-align: center;"> <tr> <td style="width: 10%;"></td> <td style="width: 10%;"></td> <td style="width: 10%;"></td> <td style="width: 10%;"></td> <td style="width: 10%;"></td> <td style="width: 10%;"></td> <td style="width: 10%;"></td> <td style="width: 10%;"></td> <td style="width: 10%;"></td> <td style="width: 10%;"></td> </tr> <tr> <td></td> <td></td> <td colspan="8" style="text-align: center;"> <table border="1" style="width: 100%; border-collapse: collapse; text-align: center;"> <tr> <td style="width: 10%;"></td> <td style="width: 10%;"></td> <td
style="width: 10%;"></td> <td style="width: 10%;"></td> <td style="width: 10%;"></td> <td style="width: 10%;"></td> <td style="width: 10%;"></td> <td style="width: 10%;"></td> <td style="width: 10%;"></td> <td style="width: 10%;"></td> </tr> <tr> <td></td> <td></td> <td colspan="8" style="text-align: center;"> <table border="1" style="width: 100%; border-collapse: collapse; text-align: center;"> <tr> <td style="width: 10%;"></td> <td style="width: 10%;"></td> <td style="width: 10%;"></td> <td style="width: 10%;"></td> <td style="width: 10%;"></td> <td style="width: 10%;"></td> <td style="width: 10%;"></td> <td style="width: 10%;"></td> <td style="width: 10%;"></td> <td style="width: 10%;"></td> </tr> <tr> <td></td> <td></td> <td colspan="8" style="text-align: center;"> <table border="1" style="width: 100%; border-collapse: collapse; text-align: center;"> <tr> <td style="width: 10%;"></td> <td style="width: 10%;"></td> <td style="width: 10%;"></td> <td style="width: 10%;"></td> <td style="width: 10%;"></td> <td style="width: 10%;"></td> <td style="width: 10%;"></td> <td style="width: 10%;"></td> <td style="width: 10%;"></td> <td style="width: 10%;"></td> </tr> <tr> <td></td> <td></td> <td colspan="8" style="text-align: center;"> <table border="1" style="width: 100%; border-collapse: collapse; text-align: center;"> <tr> <td style="width: 10%;"></td> <td style="width: 10%;"></td> <td style="width: 10%;"></td> <td style="width: 10%;"></td> <td style="width: 10%;"></td> <td style="width: 10%;"></td> <td style="width: 10%;"></td> <td style="width: 10%;"></td> <td style="width: 10%;"></td> <td style="width: 10%;"></td> </tr> <tr> <td></td> <td></td> <td colspan="8" style="text-align: center;"> <table border="1" style="width: 100%; border-collapse: collapse; text-align: center;"> <tr> <td style="width: 10%;"></td> <td style="width: 10%;"></td> <td style="width: 10%;"></td> <td style="width: 10%;"></td> <td style="width: 10%;"></td> <td style="width: 10%;"></td> <td style="width: 10%;"></td> <td style="width: 10%;"></td> <td style="width: 10%;"></td> <td style="width: 10%;"></td> </tr> <tr> <td></td> <td></td> <td colspan="8" style="text-align: center;"> <table border="1" style="width: 100%; border-collapse: collapse; text-align: center;"> <tr> <td style="width: 10%;"></td> <td style="width: 10%;"></td> <td style="width: 10%;"></td> <td style="width: 10%;"></td> <td style="width: 10%;"></td> <td style="width: 10%;"></td> <td style="width: 10%;"></td> <td style="width: 10%;"></td> <td style="width: 10%;"></td> <td style="width: 10%;"></td> </tr> <tr> <td></td> <td></td> <td colspan="8" style="text-align: center;"> <table border="1" style="width: 100%; border-collapse: collapse; text-align: center;"> <tr> <td style="width: 10%;"></td> <td style="width: 10%;"></td> <td style="width: 10%;"></td> <td style="width: 10%;"></td> <td style="width: 10%;"></td> <td style="width: 10%;"></td> <td style="width: 10%;"></td> <td style="width: 10%;"></td> <td style="width: 10%;"></td> <td style="width: 10%;"></td> </tr> <tr> <td></td> <td></td> <td colspan="8" style="text-align: center;"> <table border="1" style="width: 100%; border-collapse: collapse; text-align: center;"> <tr> <td style="width: 10%;"></td> <td style="width: 10%;"></td> <td style="width: 10%;"></td> <td style="width: 10%;"></td> <td style="width: 10%;"></td> <td style="width: 10%;"></td> <td style="width: 10%;"></td> <td style="width: 10%;"></td> <td style="width: 10%;"></td> <td style="width: 10%;"></td> </tr> <tr> <td></td> <td></td> <td colspan="8" style="text-align: center;"> <table border="1" style="width: 100%; border-collapse: collapse; text-align: center;"> <tr> <td style="width: 10%;"></td> <td style="width: 10%;"></td> <td style="width: 10%;"></td> <td style="width: 10%;"></td> <td style="width: 10%;"></td> <td style="width: 10%;"></td> <td style="width: 10%;"></td> <td style="width: 10%;"></td> <td style="width: 10%;"></td> <td style="width: 10%;"></td> </tr> <tr> <td></td> <td></td> <td colspan="8" style="text-align: center;"> <table border="1" style="width: 100%; border-collapse: collapse; text-align: center;"> <tr> <td style="width: 10%;"></td> <td style="width: 10%;"></td> <td style="width: 10%;"></td> <td style="width: 10%;"></td> <td style="width: 10%;"></td> <td style="width: 10%;"></td> <td style="width: 10%;"></td> <td style="width: 10%;"></td> <td style="width: 10%;"></td> <td style="width: 10%;"></td> </tr> <tr> <td></td> <td></td> <td colspan="8" style="text-align: center;"> <table border="1" style="width: 100%; border-collapse: collapse; text-align: center;"> <tr> <td style="width: 10%;"></td> <td style="width: 10%;"></td> <td style="width: 10%;"></td> <td style="width: 10%;"></td> <td style="width: 10%;"></td> <td style="width: 10%;"></td> <td style="width: 10%;"></td> <td style="width: 10%;"></td> <td style="width: 10%;"></td> <td style="width: 10%;"></td> </tr> <tr> <td></td> <td></td> <td colspan="8" style="text-align: center;"> <table border="1" style="width: 100%; border-collapse: collapse; text-align: center;"> <tr> <td style="width: 10%;"></td> <td style="width: 10%;"></td> <td style="width: 10%;"></td> <td style="width: 10%;"></td> <td style="width: 10%;"></td> <td style="width: 10%;"></td> <td style="width: 10%;"></td> <td style="width: 10%;"></td> <td style="width: 10%;"></td> <td style="width: 10%;"></td> </tr> <tr> <td></td> <td></td> <td colspan="8" style="text-align: center;"> <table border="1" style="width: 100%; border-collapse: collapse; text-align: center;"> <tr> <td style="width: 10%;"></td> <td style="width: 10%;"></td> <td style="width: 10%;"></td> <td style="width: 10%;"></td> <td style="width: 10%;"></td> <td style="width: 10%;"></td> <td style="width: 10%;"></td> <td style="width: 10%;"></td> <td style="width: 10%;"></td> <td style="width: 10%;"></td> </tr> <tr> <td></td> <td></td> <td colspan="8" style="text-align: center;"> <table border="1" style="width: 100%; border-collapse: collapse; text-align: center;"> <tr> <td style="width: 10%;"></td> <td style="width: 10%;"></td> <td style="width: 10%;"></td> <td style="width: 10%;"></td> <td style="width: 10%;"></td> <td style="width: 10%;"></td> <td style="width: 10%;"></td> <td style="width: 10%;"></td> <td style="width: 10%;"></td> <td style="width: 10%;"></td> </tr> <tr> <td></td> <td></td> <td colspan="8" style="text-align: center;"> <table border="1" style="width: 100%; border-collapse: collapse; text-align: center;"> <tr> <td style="width: 10%;"></td> <td style="width: 10%;"></td> <td style="width: 10%;"></td> <td style="width: 10%;"></td> <td style="width: 10%;"></td> <td style="width: 10%;"></td> <td style="width: 10%;"></td> <td style="width: 10%;"></td> <td style="width: 10%;"></td> <td style="width: 10%;"></td> </tr> <tr> <td></td> <td></td> <td colspan="8" style="text-align: center;"> <table border="1" style="width: 100%; border-collapse: collapse; text-align: center;"> <tr> <td style="width: 10%;"></td> <td style="width: 10%;"></td> <td style="width: 10%;"></td> <td style="width: 10%;"></td> <td style="width: 10%;"></td> <td style="width: 10%;"></td> <td style="width: 10%;"></td> <td style="width: 10%;"></td> <td style="width: 10%;"></td> <td style="width: 10%;"></td> </tr> <tr> <td></td> <td></td> <td colspan="8" style="text-align: center;"> <table border="1" style="width: 100%; border-collapse: collapse; text-align: center;"> <tr> <td style="width: 10%;"></td> <td style="width: 10%;"></td> <td style="width: 10%;"></td> <td style="width: 10%;"></td> <td style="width: 10%;"></td> <td style="width: 10%;"></td> <td style="width: 10%;"></td> <td style="width: 10%;"></td> <td style="width: 10%;"></td> <td style="width: 10%;"></td> </tr> <tr> <td></td> <td></td> <td colspan="8" style="text-align: center;"> <table border="1" style="width: 100%; border-collapse: collapse; text-align: center;"> <tr> </tr></table></td></tr></table></td></tr></table></td></tr></table></td></tr></table></td></tr></table></td></tr></table></td></tr></table></td></tr></table></td></tr></table></td></tr></table></td></tr></table></td></tr></table></td></tr></table></td></tr></table></td></tr></table></td></tr></table></td></tr></table></td></tr></table></td></tr></table></td></tr></table></td></tr></table></td></tr></table></td></tr></table></td></tr></table></td></tr></table></td></tr></table></td></tr></table></td></tr></table></td></tr></table></td></tr></table></td></tr></table></td></tr></table></td></tr></table></td></tr></table></td></tr></table></td></tr></table></td></tr></table></td></tr></table></td></tr></table></td></tr></table>
 | | | | | | | | | | | | | | | | | | | | <table border="1" style="width: 100%; border-collapse: collapse; text-align: center;"> <tr> <td style="width: 10%;"></td> <td style="width: 10%;"></td> <td style="width: 10%;"></td> <td style="width: 10%;"></td> <td style="width: 10%;"></td> <td style="width: 10%;"></td> <td style="width: 10%;"></td> <td style="width: 10%;"></td> <td style="width: 10%;"></td> <td style="width: 10%;"></td> </tr> <tr> <td></td> <td></td> <td colspan="8" style="text-align: center;"> <table border="1" style="width: 100%; border-collapse: collapse; text-align: center;"> <tr> <td style="width: 10%;"></td> <td style="width: 10%;"></td> <td style="width: 10%;"></td> <td style="width: 10%;"></td> <td style="width: 10%;"></td> <td style="width: 10%;"></td> <td style="width: 10%;"></td> <td style="width: 10%;"></td> <td style="width: 10%;"></td> <td style="width: 10%;"></td> </tr> <tr> <td></td> <td></td> <td colspan="8" style="text-align: center;"> <table border="1" style="width: 100%; border-collapse: collapse; text-align: center;"> <tr> <td style="width: 10%;"></td> <td style="width: 10%;"></td> <td style="width: 10%;"></td> <td style="width: 10%;"></td> <td style="width: 10%;"></td> <td style="width: 10%;"></td> <td style="width: 10%;"></td> <td style="width: 10%;"></td> <td style="width: 10%;"></td> <td style="width: 10%;"></td> </tr> <tr> <td></td> <td></td> <td colspan="8" style="text-align: center;"> <table border="1" style="width: 100%; border-collapse: collapse; text-align: center;"> <tr> <td style="width: 10%;"></td> <td style="width: 10%;"></td> <td style="width: 10%;"></td> <td style="width: 10%;"></td> <td style="width: 10%;"></td> <td style="width: 10%;"></td> <td style="width: 10%;"></td> <td style="width: 10%;"></td> <td style="width: 10%;"></td> <td style="width: 10%;"></td> </tr> <tr> <td></td> <td></td> <td colspan="8" style="text-align: center;"> <table border="1" style="width: 100%; border-collapse: collapse; text-align: center;"> <tr> <td style="width: 10%;"></td> <td style="width: 10%;"></td> <td style="width: 10%;"></td> <td style="width: 10%;"></td> <td style="width: 10%;"></td> <td style="width: 10%;"></td> <td style="width: 10%;"></td> <td style="width: 10%;"></td> <td style="width: 10%;"></td> <td style="width: 10%;"></td> </tr> <tr> <td></td> <td></td> <td colspan="8" style="text-align: center;"> <table border="1" style="width: 100%; border-collapse: collapse; text-align: center;"> <tr> <td style="width: 10%;"></td> <td style="width: 10%;"></td> <td style="width: 10%;"></td> <td style="width: 10%;"></td> <td style="width: 10%;"></td> <td style="width: 10%;"></td> <td style="width: 10%;"></td> <td style="width: 10%;"></td> <td style="width: 10%;"></td> <td style="width: 10%;"></td> </tr> <tr> <td></td> <td></td> <td colspan="8" style="text-align: center;"> <table border="1" style="width: 100%; border-collapse: collapse; text-align: center;"> <tr> <td style="width: 10%;"></td> <td style="width: 10%;"></td> <td style="width: 10%;"></td> <td style="width: 10%;"></td> <td style="width: 10%;"></td>
<td style="width: 10%;"></td> <td style="width: 10%;"></td> <td style="width: 10%;"></td> <td style="width: 10%;"></td> <td style="width: 10%;"></td> </tr> <tr> <td></td> <td></td> <td colspan="8" style="text-align: center;"> <table border="1" style="width: 100%; border-collapse: collapse; text-align: center;"> <tr> <td style="width: 10%;"></td> <td style="width: 10%;"></td> <td style="width: 10%;"></td> <td style="width: 10%;"></td> <td style="width: 10%;"></td> <td style="width: 10%;"></td> <td style="width: 10%;"></td> <td style="width: 10%;"></td> <td style="width: 10%;"></td> <td style="width: 10%;"></td> </tr> <tr> <td></td> <td></td> <td colspan="8" style="text-align: center;"> <table border="1" style="width: 100%; border-collapse: collapse; text-align: center;"> <tr> <td style="width: 10%;"></td> <td style="width: 10%;"></td> <td style="width: 10%;"></td> <td style="width: 10%;"></td> <td style="width: 10%;"></td> <td style="width: 10%;"></td> <td style="width: 10%;"></td> <td style="width: 10%;"></td> <td style="width: 10%;"></td> <td style="width: 10%;"></td> </tr> <tr> <td></td> <td></td> <td colspan="8" style="text-align: center;"> <table border="1" style="width: 100%; border-collapse: collapse; text-align: center;"> <tr> <td style="width: 10%;"></td> <td style="width: 10%;"></td> <td style="width: 10%;"></td> <td style="width: 10%;"></td> <td style="width: 10%;"></td> <td style="width: 10%;"></td> <td style="width: 10%;"></td> <td style="width: 10%;"></td> <td style="width: 10%;"></td> <td style="width: 10%;"></td> </tr> <tr> <td></td> <td></td> <td colspan="8" style="text-align: center;"> <table border="1" style="width: 100%; border-collapse: collapse; text-align: center;"> <tr> <td style="width: 10%;"></td> <td style="width: 10%;"></td> <td style="width: 10%;"></td> <td style="width: 10%;"></td> <td style="width: 10%;"></td> <td style="width: 10%;"></td> <td style="width: 10%;"></td> <td style="width: 10%;"></td> <td style="width: 10%;"></td> <td style="width: 10%;"></td> </tr> <tr> <td></td> <td></td> <td colspan="8" style="text-align: center;"> <table border="1" style="width: 100%; border-collapse: collapse; text-align: center;"> <tr> <td style="width: 10%;"></td> <td style="width: 10%;"></td> <td style="width: 10%;"></td> <td style="width: 10%;"></td> <td style="width: 10%;"></td> <td style="width: 10%;"></td> <td style="width: 10%;"></td> <td style="width: 10%;"></td> <td style="width: 10%;"></td> <td style="width: 10%;"></td> </tr> <tr> <td></td> <td></td> <td colspan="8" style="text-align: center;"> <table border="1" style="width: 100%; border-collapse: collapse; text-align: center;"> <tr> <td style="width: 10%;"></td> <td style="width: 10%;"></td> <td style="width: 10%;"></td> <td style="width: 10%;"></td> <td style="width: 10%;"></td> <td style="width: 10%;"></td> <td style="width: 10%;"></td> <td style="width: 10%;"></td> <td style="width: 10%;"></td> <td style="width: 10%;"></td> </tr> <tr> <td></td> <td></td> <td colspan="8" style="text-align: center;"> <table border="1" style="width: 100%; border-collapse: collapse; text-align: center;"> <tr> <td style="width: 10%;"></td> <td style="width: 10%;"></td> <td style="width: 10%;"></td> <td style="width: 10%;"></td> <td style="width: 10%;"></td> <td style="width: 10%;"></td> <td style="width: 10%;"></td> <td style="width: 10%;"></td> <td style="width: 10%;"></td> <td style="width: 10%;"></td> </tr> <tr> <td></td> <td></td> <td colspan="8" style="text-align: center;"> <table border="1" style="width: 100%; border-collapse: collapse; text-align: center;"> <tr> <td style="width: 10%;"></td> <td style="width: 10%;"></td> <td style="width: 10%;"></td> <td style="width: 10%;"></td> <td style="width: 10%;"></td> <td style="width: 10%;"></td> <td style="width: 10%;"></td> <td style="width: 10%;"></td> <td style="width: 10%;"></td> <td style="width: 10%;"></td> </tr> <tr> <td></td> <td></td> <td colspan="8" style="text-align: center;"> <table border="1" style="width: 100%; border-collapse: collapse; text-align: center;"> <tr> <td style="width: 10%;"></td> <td style="width: 10%;"></td> <td style="width: 10%;"></td> <td style="width: 10%;"></td> <td style="width: 10%;"></td> <td style="width: 10%;"></td> <td style="width: 10%;"></td> <td style="width: 10%;"></td> <td style="width: 10%;"></td> <td style="width: 10%;"></td> </tr> <tr> <td></td> <td></td> <td colspan="8" style="text-align: center;"> <table border="1" style="width: 100%; border-collapse: collapse; text-align: center;"> <tr> <td style="width: 10%;"></td> <td style="width: 10%;"></td> <td style="width: 10%;"></td> <td style="width: 10%;"></td> <td style="width: 10%;"></td> <td style="width: 10%;"></td> <td style="width: 10%;"></td> <td style="width: 10%;"></td> <td style="width: 10%;"></td> <td style="width: 10%;"></td> </tr> <tr> <td></td> <td></td> <td colspan="8" style="text-align: center;"> <table border="1" style="width: 100%; border-collapse: collapse; text-align: center;"> <tr> <td style="width: 10%;"></td> <td style="width: 10%;"></td> <td style="width: 10%;"></td> <td style="width: 10%;"></td> <td style="width: 10%;"></td> <td style="width: 10%;"></td> <td style="width: 10%;"></td> <td style="width: 10%;"></td> <td style="width: 10%;"></td> <td style="width: 10%;"></td> </tr> <tr> <td></td> <td></td> <td colspan="8" style="text-align: center;"> <table border="1" style="width: 100%; border-collapse: collapse; text-align: center;"> <tr> <td style="width: 10%;"></td> <td style="width: 10%;"></td> <td style="width: 10%;"></td> <td style="width: 10%;"></td> <td style="width: 10%;"></td> <td style="width: 10%;"></td> <td style="width: 10%;"></td> <td style="width: 10%;"></td> <td style="width: 10%;"></td> <td style="width: 10%;"></td> </tr> <tr> <td></td> <td></td> <td colspan="8" style="text-align: center;"> <table border="1" style="width: 100%; border-collapse: collapse; text-align: center;"> <tr> <td style="width: 10%;"></td> <td style="width: 10%;"></td> <td style="width: 10%;"></td> <td style="width: 10%;"></td> <td style="width: 10%;"></td> <td style="width: 10%;"></td> <td style="width: 10%;"></td> <td style="width: 10%;"></td> <td style="width: 10%;"></td> <td style="width: 10%;"></td> </tr> <tr> <td></td> <td></td> <td colspan="8" style="text-align: center;"> <table border="1" style="width: 100%; border-collapse: collapse; text-align: center;"> <tr> <td style="width: 10%;"></td> <td style="width: 10%;"></td> <td style="width: 10%;"></td> <td style="width: 10%;"></td> <td style="width: 10%;"></td> <td style="width: 10%;"></td> <td style="width: 10%;"></td> <td style="width: 10%;"></td> <td style="width: 10%;"></td> <td style="width: 10%;"></td> </tr> <tr> <td></td> <td></td> <td colspan="8" style="text-align: center;"> <table border="1" style="width: 100%; border-collapse: collapse; text-align: center;"> <tr> <td style="width: 10%;"></td> <td style="width: 10%;"></td> <td style="width: 10%;"></td> <td style="width: 10%;"></td> <td style="width: 10%;"></td> <td style="width: 10%;"></td> <td style="width: 10%;"></td> <td style="width: 10%;"></td> <td style="width: 10%;"></td> <td style="width: 10%;"></td> </tr> <tr> <td></td> <td></td> <td colspan="8" style="text-align: center;"> <table border="1" style="width: 100%; border-collapse: collapse; text-align: center;"> <tr> <td style="width: 10%;"></td> <td style="width: 10%;"></td> <td style="width: 10%;"></td> <td style="width: 10%;"></td> <td style="width: 10%;"></td> <td style="width: 10%;"></td> <td style="width: 10%;"></td> <td style="width: 10%;"></td> <td style="width: 10%;"></td> <td style="width: 10%;"></td> </tr> <tr> <td></td> <td></td> <td colspan="8" style="text-align: center;"> <table border="1" style="width: 100%; border-collapse: collapse; text-align: center;"> <tr> <td style="width: 10%;"></td> <td style="width: 10%;"></td> <td style="width: 10%;"></td> <td style="width: 10%;"></td> <td style="width: 10%;"></td> <td style="width: 10%;"></td> <td style="width: 10%;"></td> <td style="width: 10%;"></td> <td style="width: 10%;"></td> <td style="width: 10%;"></td> </tr> <tr> <td></td> <td></td> <td colspan="8" style="text-align: center;"> <table border="1" style="width: 100%; border-collapse: collapse; text-align: center;"> <tr> <td style="width: 10%;"></td> <td style="width: 10%;"></td> <td style="width: 10%;"></td> <td style="width: 10%;"></td> <td style="width: 10%;"></td> <td style="width: 10%;"></td> <td style="width: 10%;"></td> <td style="width: 10%;"></td> <td style="width: 10%;"></td> <td style="width: 10%;"></td> </tr> <tr> <td></td> <td></td> <td colspan="8" style="text-align: center;"> <table border="1" style="width: 100%; border-collapse: collapse; text-align: center;"> <tr> <td style="width: 10%;"></td> <td style="width: 10%;"></td> <td style="width: 10%;"></td> <td style="width: 10%;"></td> <td style="width: 10%;"></td> <td style="width: 10%;"></td> <td style="width: 10%;"></td> <td style="width: 10%;"></td> <td style="width: 10%;"></td> <td style="width: 10%;"></td> </tr> <tr> <td></td> <td></td> <td colspan="8" style="text-align: center;"> <table border="1" style="width: 100%; border-collapse: collapse; text-align: center;"> <tr> <td style="width: 10%;"></td> <td style="width: 10%;"></td> <td style="width: 10%;"></td> <td style="width: 10%;"></td> <td style="width: 10%;"></td> <td style="width: 10%;"></td> <td style="width: 10%;"></td> <td style="width: 10%;"></td> <td style="width: 10%;"></td> <td style="width: 10%;"></td> </tr> <tr> <td></td> <td></td> <td colspan="8" style="text-align: center;"> <table border="1" style="width: 100%; border-collapse: collapse; text-align: center;"> <tr> <td style="width: 10%;"></td> <td style="width: 10%;"></td> <td style="width: 10%;"></td> <td style="width: 10%;"></td> <td style="width: 10%;"></td> <td style="width: 10%;"></td> <td style="width: 10%;"></td> <td style="width: 10%;"></td> <td style="width: 10%;"></td> <td style="width: 10%;"></td> </tr> <tr> <td></td>
<td></td> <td colspan="8" style="text-align: center;"> <table border="1" style="width: 100%; border-collapse: collapse; text-align: center;"> <tr> <td style="width: 10%;"></td> <td style="width: 10%;"></td> <td style="width: 10%;"></td> <td style="width: 10%;"></td> <td style="width: 10%;"></td> <td style="width: 10%;"></td> <td style="width: 10%;"></td> <td style="width: 10%;"></td> <td style="width: 10%;"></td> <td style="width: 10%;"></td> </tr> <tr> <td></td> <td></td> <td colspan="8" style="text-align: center;"> <table border="1" style="width: 100%; border-collapse: collapse; text-align: center;"> <tr> <td style="width: 10%;"></td> <td style="width: 10%;"></td> <td style="width: 10%;"></td> <td style="width: 10%;"></td> <td style="width: 10%;"></td> <td style="width: 10%;"></td> <td style="width: 10%;"></td> <td style="width: 10%;"></td> <td style="width: 10%;"></td> <td style="width: 10%;"></td> </tr> <tr> <td></td> <td></td> <td colspan="8" style="text-align: center;"> <table border="1" style="width: 100%; border-collapse: collapse; text-align: center;"> <tr> <td style="width: 10%;"></td> <td style="width: 10%;"></td> <td style="width: 10%;"></td> <td style="width: 10%;"></td> <td style="width: 10%;"></td> <td style="width: 10%;"></td> <td style="width: 10%;"></td> <td style="width: 10%;"></td> <td style="width: 10%;"></td> <td style="width: 10%;"></td> </tr> <tr> <td></td> <td></td> <td colspan="8" style="text-align: center;"> <table border="1" style="width: 100%; border-collapse: collapse; text-align: center;"> <tr> <td style="width: 10%;"></td> <td style="width: 10%;"></td> <td style="width: 10%;"></td> <td style="width: 10%;"></td> <td style="width: 10%;"></td> <td style="width: 10%;"></td> <td style="width: 10%;"></td> <td style="width: 10%;"></td> <td style="width: 10%;"></td> <td style="width: 10%;"></td> </tr> <tr> <td></td> <td></td> <td colspan="8" style="text-align: center;"> <table border="1" style="width: 100%; border-collapse: collapse; text-align: center;"> <tr> <td style="width: 10%;"></td> <td style="width: 10%;"></td> <td style="width: 10%;"></td> <td style="width: 10%;"></td> <td style="width: 10%;"></td> <td style="width: 10%;"></td> <td style="width: 10%;"></td> <td style="width: 10%;"></td> <td style="width: 10%;"></td> <td style="width: 10%;"></td> </tr> <tr> <td></td> <td></td> <td colspan="8" style="text-align: center;"> <table border="1" style="width: 100%; border-collapse: collapse; text-align: center;"> <tr> <td style="width: 10%;"></td> <td style="width: 10%;"></td> <td style="width: 10%;"></td> <td style="width: 10%;"></td> <td style="width: 10%;"></td> <td style="width: 10%;"></td> <td style="width: 10%;"></td> <td style="width: 10%;"></td> <td style="width: 10%;"></td> <td style="width: 10%;"></td> </tr> <tr> <td></td> <td></td> <td colspan="8" style="text-align: center;"> <table border="1" style="width: 100%; border-collapse: collapse; text-align: center;"> <tr> <td style="width: 10%;"></td> <td style="width: 10%;"></td> <td style="width: 10%;"></td> <td style="width: 10%;"></td> <td style="width: 10%;"></td> <td style="width: 10%;"></td> <td style="width: 10%;"></td> <td style="width: 10%;"></td> <td style="width: 10%;"></td> <td style="width: 10%;"></td> </tr> <tr> <td></td> <td></td> <td colspan="8" style="text-align: center;"> <table border="1" style="width: 100%; border-collapse: collapse; text-align: center;"> <tr> <td style="width: 10%;"></td> <td style="width: 10%;"></td> <td style="width: 10%;"></td> <td style="width: 10%;"></td> <td style="width: 10%;"></td> <td style="width: 10%;"></td> <td style="width: 10%;"></td> <td style="width: 10%;"></td> <td style="width: 10%;"></td> <td style="width: 10%;"></td> </tr> <tr> <td></td> <td></td> <td colspan="8" style="text-align: center;"> <table border="1" style="width: 100%; border-collapse: collapse; text-align: center;"> <tr> <td style="width: 10%;"></td> <td style="width: 10%;"></td> <td style="width: 10%;"></td> <td style="width: 10%;"></td> <td style="width: 10%;"></td> <td style="width: 10%;"></td> <td style="width: 10%;"></td> <td style="width: 10%;"></td> <td style="width: 10%;"></td> <td style="width: 10%;"></td> </tr> <tr> <td></td> <td></td> <td colspan="8" style="text-align: center;"> <table border="1" style="width: 100%; border-collapse: collapse; text-align: center;"> <tr> <td style="width: 10%;"></td> <td style="width: 10%;"></td> <td style="width: 10%;"></td> <td style="width: 10%;"></td> <td style="width: 10%;"></td> <td style="width: 10%;"></td> <td style="width: 10%;"></td> <td style="width: 10%;"></td> <td style="width: 10%;"></td> <td style="width: 10%;"></td> </tr> <tr> <td></td> <td></td> <td colspan="8" style="text-align: center;"> <table border="1" style="width: 100%; border-collapse: collapse; text-align: center;"> <tr> <td style="width: 10%;"></td> <td style="width: 10%;"></td> <td style="width: 10%;"></td> <td style="width: 10%;"></td> <td style="width: 10%;"></td> <td style="width: 10%;"></td> <td style="width: 10%;"></td> <td style="width: 10%;"></td> <td style="width: 10%;"></td> <td style="width: 10%;"></td> </tr> <tr> <td></td> <td></td> <td colspan="8" style="text-align: center;"> <table border="1" style="width: 100%; border-collapse: collapse; text-align: center;"> <tr> </tr></table></td></tr></table></td></tr></table></td></tr></table></td></tr></table></td></tr></table></td></tr></table></td></tr></table></td></tr></table></td></tr></table></td></tr></table></td></tr></table></td></tr></table></td></tr></table></td></tr></table></td></tr></table></td></tr></table></td></tr></table></td></tr></table></td></tr></table></td></tr></table></td></tr></table></td></tr></table></td></tr></table></td></tr></table></td></tr></table></td></tr></table></td></tr></table></td></tr></table></td></tr></table></td></tr></table></td></tr></table></td></tr></table></td></tr></table></td></tr></table></td></tr></table></td></tr></table></td></tr></table></td></tr></table></td></tr></table>
 | | | | | | | | | | | | | | | | | | | | <table border="1" style="width: 100%; border-collapse: collapse; text-align: center;"> <tr> <td style="width: 10%;"></td> <td style="width: 10%;"></td> <td style="width: 10%;"></td> <td style="width: 10%;"></td> <td style="width: 10%;"></td> <td style="width: 10%;"></td> <td style="width: 10%;"></td> <td style="width: 10%;"></td> <td style="width: 10%;"></td> <td style="width: 10%;"></td> </tr> <tr> <td></td> <td></td> <td colspan="8" style="text-align: center;"> <table border="1" style="width: 100%; border-collapse: collapse; text-align: center;"> <tr> <td style="width: 10%;"></td> <td style="width: 10%;"></td> <td style="width: 10%;"></td> <td style="width: 10%;"></td> <td style="width: 10%;"></td> <td style="width: 10%;"></td> <td style="width: 10%;"></td> <td style="width: 10%;"></td> <td style="width: 10%;"></td> <td style="width: 10%;"></td> </tr> <tr> <td></td> <td></td> <td colspan="8" style="text-align: center;"> <table border="1" style="width: 100%; border-collapse: collapse; text-align: center;"> <tr> <td style="width: 10%;"></td> <td style="width: 10%;"></td> <td style="width: 10%;"></td> <td style="width: 10%;"></td> <td style="width: 10%;"></td> <td style="width: 10%;"></td> <td style="width: 10%;"></td> <td style="width: 10%;"></td> <td style="width: 10%;"></td> <td style="width: 10%;"></td> </tr> <tr> <td></td> <td></td> <td colspan="8" style="text-align: center;"> <table border="1" style="width: 100%; border-collapse: collapse; text-align: center;"> <tr> <td style="width: 10%;"></td> <td style="width: 10%;"></td> <td style="width: 10%;"></td> <td style="width: 10%;"></td> <td style="width: 10%;"></td> <td style="width: 10%;"></td> <td style="width: 10%;"></td> <td style="width: 10%;"></td> <td style="width: 10%;"></td> <td style="width: 10%;"></td> </tr> <tr> <td></td> <td></td> <td colspan="8" style="text-align: center;"> <table border="1" style="width: 100%; border-collapse: collapse; text-align: center;"> <tr> <td style="width: 10%;"></td> <td style="width: 10%;"></td> <td style="width: 10%;"></td> <td style="width: 10%;"></td> <td style="width: 10%;"></td> <td style="width: 10%;"></td> <td style="width: 10%;"></td> <td style="width: 10%;"></td> <td style="width: 10%;"></td> <td style="width: 10%;"></td> </tr> <tr> <td></td> <td></td> <td colspan="8" style="text-align: center;"> <table border="1" style="width: 100%; border-collapse: collapse; text-align: center;"> <tr> <td style="width: 10%;"></td> <td style="width: 10%;"></td> <td style="width: 10%;"></td> <td style="width: 10%;"></td> <td style="width: 10%;"></td> <td style="width: 10%;"></td> <td style="width: 10%;"></td> <td style="width: 10%;"></td> <td style="width: 10%;"></td> <td style="width: 10%;"></td> </tr> <tr> <td></td> <td></td> <td colspan="8" style="text-align: center;"> <table border="1" style="width: 100%; border-collapse: collapse; text-align: center;"> <tr> <td style="width: 10%;"></td> <td style="width: 10%;"></td> <td style="width: 10%;"></td> <td style="width: 10%;"></td> <td style="width: 10%;"></td> <td style="width: 10%;"></td> <td style="width: 10%;"></td> <td style="width: 10%;"></td> <td style="width: 10%;"></td> <td style="width: 10%;"></td> </tr> <tr> <td></td> <td></td> <td colspan="8" style="text-align: center;"> <table border="1" style="width: 100%; border-collapse: collapse; text-align: center;"> <tr> <td style="width: 10%;"></td> <td style="width: 10%;"></td> <td style="width: 10%;"></td> <td style="width: 10%;"></td> <td style="width: 10%;"></td> <td style="width: 10%;"></td> <td style="width: 10%;"></td> <td style="width: 10%;"></td> <td style="width: 10%;"></td> <td style="width: 10%;"></td> </tr> <tr> <td></td> <td></td> <td colspan="8" style="text-align: center;"> <table border="1" style="width: 100%; border-collapse: collapse; text-align: center;"> <tr> <td style="width: 10%;"></td> <td style="width: 10%;"></td> <td style="width: 10%;"></td> <td style="width: 10%;"></td> <td style="width: 10%;"></td> <td style="width: 10%;"></td> <td style="width: 10%;"></td> <td style="width: 10%;"></td> <td style="width: 10%;"></td> <td style="width: 10%;"></td> </tr> <tr> <td></td> <td></td> <td colspan="8" style="text-align: center;"> <table border="1" style="width: 100%; border-collapse: collapse; text-align: center;"> <tr> <td style="width: 10%;"></td> <td style="width: 10%;"></td> <td style="width: 10%;"></td> <td style="width: 10%;"></td> <td style="width: 10%;"></td> <td style="width: 10%;"></td> <td style="width: 10%;"></td> <td style="width: 10%;"></td> <td style="width: 10%;"></td> <td style="width: 10%;"></td> </tr> <tr> <td></td> <td></td> <td colspan="8" style="text-align: center;"> <table border="1" style="width: 100%; border-collapse: collapse; text-align: center;"> <tr> <td style="width: 10%;"></td> <td style="width: 10%;"></td> <td style="width: 10%;"></td> <td style="width: 10%;"></td> <td style="width: 10%;"></td> <td style="width: 10%;"></td> <td style="width: 10%;"></td> <td style="width: 10%;"></td> <td style="width: 10%;"></td> <td style="width: 10%;"></td> </tr> <tr> <td></td> <td></td> <td colspan="8" style="text-align: center;"> <table border="1" style="width: 100%; border-collapse: collapse; text-align: center;"> <tr> <td style="width: 10%;"></td> <td style="width: 10%;"></td> <td style="width: 10%;"></td> <td style="width: 10%;"></td> <td style="width: 10%;"></td> <td style="width: 10%;"></td> <td style="width: 10%;"></td> <td style="width: 10%;"></td> <td style="width: 10%;"></td> <td style="width: 10%;"></td> </tr> <tr> <td></td> <td></td> <td colspan="8" style="text-align: center;"> <table border="1" style="width: 100%;
border-collapse: collapse; text-align: center;"> <tr> <td style="width: 10%;"></td> <td style="width: 10%;"></td> <td style="width: 10%;"></td> <td style="width: 10%;"></td> <td style="width: 10%;"></td> <td style="width: 10%;"></td> <td style="width: 10%;"></td> <td style="width: 10%;"></td> <td style="width: 10%;"></td> <td style="width: 10%;"></td> </tr> <tr> <td></td> <td></td> <td colspan="8" style="text-align: center;"> <table border="1" style="width: 100%; border-collapse: collapse; text-align: center;"> <tr> <td style="width: 10%;"></td> <td style="width: 10%;"></td> <td style="width: 10%;"></td> <td style="width: 10%;"></td> <td style="width: 10%;"></td> <td style="width: 10%;"></td> <td style="width: 10%;"></td> <td style="width: 10%;"></td> <td style="width: 10%;"></td> <td style="width: 10%;"></td> </tr> <tr> <td></td> <td></td> <td colspan="8" style="text-align: center;"> <table border="1" style="width: 100%; border-collapse: collapse; text-align: center;"> <tr> <td style="width: 10%;"></td> <td style="width: 10%;"></td> <td style="width: 10%;"></td> <td style="width: 10%;"></td> <td style="width: 10%;"></td> <td style="width: 10%;"></td> <td style="width: 10%;"></td> <td style="width: 10%;"></td> <td style="width: 10%;"></td> <td style="width: 10%;"></td> </tr> <tr> <td></td> <td></td> <td colspan="8" style="text-align: center;"> <table border="1" style="width: 100%; border-collapse: collapse; text-align: center;"> <tr> <td style="width: 10%;"></td> <td style="width: 10%;"></td> <td style="width: 10%;"></td> <td style="width: 10%;"></td> <td style="width: 10%;"></td> <td style="width: 10%;"></td> <td style="width: 10%;"></td> <td style="width: 10%;"></td> <td style="width: 10%;"></td> <td style="width: 10%;"></td> </tr> <tr> <td></td> <td></td> <td colspan="8" style="text-align: center;"> <table border="1" style="width: 100%; border-collapse: collapse; text-align: center;"> <tr> <td style="width: 10%;"></td> <td style="width: 10%;"></td> <td style="width: 10%;"></td> <td style="width: 10%;"></td> <td style="width: 10%;"></td> <td style="width: 10%;"></td> <td style="width: 10%;"></td> <td style="width: 10%;"></td> <td style="width: 10%;"></td> <td style="width: 10%;"></td> </tr> <tr> <td></td> <td></td> <td colspan="8" style="text-align: center;"> <table border="1" style="width: 100%; border-collapse: collapse; text-align: center;"> <tr> <td style="width: 10%;"></td> <td style="width: 10%;"></td> <td style="width: 10%;"></td> <td style="width: 10%;"></td> <td style="width: 10%;"></td> <td style="width: 10%;"></td> <td style="width: 10%;"></td> <td style="width: 10%;"></td> <td style="width: 10%;"></td> <td style="width: 10%;"></td> </tr> <tr> <td></td> <td></td> <td colspan="8" style="text-align: center;"> <table border="1" style="width: 100%; border-collapse: collapse; text-align: center;"> <tr> <td style="width: 10%;"></td> <td style="width: 10%;"></td> <td style="width: 10%;"></td> <td style="width: 10%;"></td> <td style="width: 10%;"></td> <td style="width: 10%;"></td> <td style="width: 10%;"></td> <td style="width: 10%;"></td> <td style="width: 10%;"></td> <td style="width: 10%;"></td> </tr> <tr> <td></td> <td></td> <td colspan="8" style="text-align: center;"> <table border="1" style="width: 100%; border-collapse: collapse; text-align: center;"> <tr> <td style="width: 10%;"></td> <td style="width: 10%;"></td> <td style="width: 10%;"></td> <td style="width: 10%;"></td> <td style="width: 10%;"></td> <td style="width: 10%;"></td> <td style="width: 10%;"></td> <td style="width: 10%;"></td> <td style="width: 10%;"></td> <td style="width: 10%;"></td> </tr> <tr> <td></td> <td></td> <td colspan="8" style="text-align: center;"> <table border="1" style="width: 100%; border-collapse: collapse; text-align: center;"> <tr> <td style="width: 10%;"></td> <td style="width: 10%;"></td> <td style="width: 10%;"></td> <td style="width: 10%;"></td> <td style="width: 10%;"></td> <td style="width: 10%;"></td> <td style="width: 10%;"></td> <td style="width: 10%;"></td> <td style="width: 10%;"></td> <td style="width: 10%;"></td> </tr> <tr> <td></td> <td></td> <td colspan="8" style="text-align: center;"> <table border="1" style="width: 100%; border-collapse: collapse; text-align: center;"> <tr> <td style="width: 10%;"></td> <td style="width: 10%;"></td> <td style="width: 10%;"></td> <td style="width: 10%;"></td> <td style="width: 10%;"></td> <td style="width: 10%;"></td> <td style="width: 10%;"></td> <td style="width: 10%;"></td> <td style="width: 10%;"></td> <td style="width: 10%;"></td> </tr> <tr> <td></td> <td></td> <td colspan="8" style="text-align: center;"> <table border="1" style="width: 100%; border-collapse: collapse; text-align: center;"> <tr> <td style="width: 10%;"></td> <td style="width: 10%;"></td> <td style="width: 10%;"></td> <td style="width: 10%;"></td> <td style="width: 10%;"></td> <td style="width: 10%;"></td> <td style="width: 10%;"></td> <td style="width: 10%;"></td> <td style="width: 10%;"></td> <td style="width: 10%;"></td> </tr> <tr> <td></td> <td></td> <td colspan="8" style="text-align: center;"> <table border="1" style="width: 100%; border-collapse: collapse; text-align: center;"> <tr> <td style="width: 10%;"></td> <td style="width: 10%;"></td> <td style="width: 10%;"></td> <td style="width: 10%;"></td> <td style="width: 10%;"></td> <td style="width: 10%;"></td> <td style="width: 10%;"></td> <td style="width: 10%;"></td> <td style="width: 10%;"></td> <td style="width: 10%;"></td> </tr> <tr> <td></td> <td></td> <td colspan="8" style="text-align: center;"> <table border="1" style="width: 100%; border-collapse: collapse; text-align: center;"> <tr> <td style="width: 10%;"></td> <td style="width: 10%;"></td> <td style="width: 10%;"></td> <td style="width: 10%;"></td> <td style="width: 10%;"></td> <td style="width: 10%;"></td> <td style="width: 10%;"></td> <td style="width: 10%;"></td> <td style="width: 10%;"></td> <td style="width: 10%;"></td> </tr> <tr> <td></td> <td></td> <td colspan="8" style="text-align: center;"> <table border="1" style="width: 100%; border-collapse: collapse; text-align: center;"> <tr> <td style="width: 10%;"></td> <td style="width: 10%;"></td> <td style="width: 10%;"></td> <td style="width: 10%;"></td> <td style="width: 10%;"></td> <td style="width: 10%;"></td> <td style="width: 10%;"></td> <td style="width: 10%;"></td> <td style="width: 10%;"></td> <td style="width: 10%;"></td> </tr> <tr> <td></td> <td></td> <td colspan="8" style="text-align: center;"> <table border="1" style="width: 100%; border-collapse: collapse; text-align: center;"> <tr> <td style="width: 10%;"></td> <td style="width: 10%;"></td> <td style="width: 10%;"></td> <td style="width: 10%;"></td> <td style="width: 10%;"></td> <td style="width: 10%;"></td> <td style="width: 10%;"></td> <td style="width: 10%;"></td> <td style="width: 10%;"></td> <td style="width: 10%;"></td> </tr> <tr> <td></td> <td></td> <td colspan="8" style="text-align: center;"> <table border="1" style="width: 100%; border-collapse: collapse; text-align: center;"> <tr> <td style="width: 10%;"></td> <td style="width: 10%;"></td> <td style="width: 10%;"></td> <td style="width: 10%;"></td> <td style="width: 10%;"></td> <td style="width: 10%;"></td> <td style="width: 10%;"></td> <td style="width: 10%;"></td> <td style="width: 10%;"></td> <td style="width: 10%;"></td> </tr> <tr> <td></td> <td></td> <td colspan="8" style="text-align: center;"> <table border="1" style="width: 100%; border-collapse: collapse; text-align: center;"> <tr> <td style="width: 10%;"></td> <td style="width: 10%;"></td> <td style="width: 10%;"></td> <td style="width: 10%;"></td> <td style="width: 10%;"></td> <td style="width: 10%;"></td> <td style="width: 10%;"></td> <td style="width: 10%;"></td> <td style="width: 10%;"></td> <td style="width: 10%;"></td> </tr> <tr> <td></td> <td></td> <td colspan="8" style="text-align: center;"> <table border="1" style="width: 100%; border-collapse: collapse; text-align: center;"> <tr> <td style="width: 10%;"></td> <td style="width: 10%;"></td> <td style="width: 10%;"></td> <td style="width: 10%;"></td> <td style="width: 10%;"></td> <td style="width: 10%;"></td> <td style="width: 10%;"></td> <td style="width: 10%;"></td> <td style="width: 10%;"></td> <td style="width: 10%;"></td> </tr> <tr> <td></td> <td></td> <td colspan="8" style="text-align: center;"> <table border="1" style="width: 100%; border-collapse: collapse; text-align: center;"> <tr> <td style="width: 10%;"></td> <td style="width: 10%;"></td> <td style="width: 10%;"></td> <td style="width: 10%;"></td> <td style="width: 10%;"></td> <td style="width: 10%;"></td> <td style="width: 10%;"></td> <td style="width: 10%;"></td> <td style="width: 10%;"></td> <td style="width: 10%;"></td> </tr> <tr> <td></td> <td></td> <td colspan="8" style="text-align: center;"> <table border="1" style="width: 100%; border-collapse: collapse; text-align: center;"> <tr> <td style="width: 10%;"></td> <td style="width: 10%;"></td> <td style="width: 10%;"></td> <td style="width: 10%;"></td> <td style="width: 10%;"></td> <td style="width: 10%;"></td> <td style="width: 10%;"></td> <td style="width: 10%;"></td> <td style="width: 10%;"></td> <td style="width: 10%;"></td> </tr> <tr> <td></td> <td></td> <td colspan="8" style="text-align: center;"> <table border="1" style="width: 100%; border-collapse: collapse; text-align: center;"> <tr> <td style="width: 10%;"></td> <td style="width: 10%;"></td> <td style="width: 10%;"></td> <td style="width: 10%;"></td> <td style="width: 10%;"></td> <td style="width: 10%;"></td> <td style="width: 10%;"></td> <td style="width: 10%;"></td> <td style="width: 10%;"></td> <td style="width: 10%;"></td> </tr> <tr> <td></td> <td></td> <td colspan="8" style="text-align: center;"> <table border="1" style="width: 100%; border-collapse: collapse; text-align: center;"> <tr> <td style="width: 10%;"></td> <td style="width: 10%;"></td> <td style="width: 10%;"></td> <td style="width:
10%;"></td> <td style="width: 10%;"></td> <td style="width: 10%;"></td> <td style="width: 10%;"></td> <td style="width: 10%;"></td> <td style="width: 10%;"></td> <td style="width: 10%;"></td> </tr> <tr> <td></td> <td></td> <td colspan="8" style="text-align: center;"> <table border="1" style="width: 100%; border-collapse: collapse; text-align: center;"> <tr> <td style="width: 10%;"></td> <td style="width: 10%;"></td> <td style="width: 10%;"></td> <td style="width: 10%;"></td> <td style="width: 10%;"></td> <td style="width: 10%;"></td> <td style="width: 10%;"></td> <td style="width: 10%;"></td> <td style="width: 10%;"></td> <td style="width: 10%;"></td> </tr> <tr> <td></td> <td></td> <td colspan="8" style="text-align: center;"> <table border="1" style="width: 100%; border-collapse: collapse; text-align: center;"> <tr> <td style="width: 10%;"></td> <td style="width: 10%;"></td> <td style="width: 10%;"></td> <td style="width: 10%;"></td> <td style="width: 10%;"></td> <td style="width: 10%;"></td> <td style="width: 10%;"></td> <td style="width: 10%;"></td> <td style="width: 10%;"></td> <td style="width: 10%;"></td> </tr> <tr> <td></td> <td></td> <td colspan="8" style="text-align: center;"> <table border="1" style="width: 100%; border-collapse: collapse; text-align: center;"> <tr> <td style="width: 10%;"></td> <td style="width: 10%;"></td> <td style="width: 10%;"></td> <td style="width: 10%;"></td> <td style="width: 10%;"></td> <td style="width: 10%;"></td> <td style="width: 10%;"></td> <td style="width: 10%;"></td> <td style="width: 10%;"></td> <td style="width: 10%;"></td> </tr> <tr> <td></td> <td></td> <td colspan="8" style="text-align: center;"> <table border="1" style="width: 100%; border-collapse: collapse; text-align: center;"> <tr> <td style="width: 10%;"></td> <td style="width: 10%;"></td> <td style="width: 10%;"></td> <td style="width: 10%;"></td> <td style="width: 10%;"></td> <td style="width: 10%;"></td> <td style="width: 10%;"></td> <td style="width: 10%;"></td> <td style="width: 10%;"></td> <td style="width: 10%;"></td> </tr> <tr> <td></td> <td></td> <td colspan="8" style="text-align: center;"> <table border="1" style="width: 100%; border-collapse: collapse; text-align: center;"> <tr> </tr></table></td></tr></table></td></tr></table></td></tr></table></td></tr></table></td></tr></table></td></tr></table></td></tr></table></td></tr></table></td></tr></table></td></tr></table></td></tr></table></td></tr></table></td></tr></table></td></tr></table></td></tr></table></td></tr></table></td></tr></table></td></tr></table></td></tr></table></td></tr></table></td></tr></table></td></tr></table></td></tr></table></td></tr></table></td></tr></table></td></tr></table></td></tr></table></td></tr></table></td></tr></table></td></tr></table></td></tr></table></td></tr></table></td></tr></table></td></tr></table></td></tr></table></td></tr></table></td></tr></table></td></tr></table>
 | | | | | | | | | | | | | | | | | | | | <table border="1" style="width: 100%; border-collapse: collapse; text-align: center;"> <tr> <td style="width: 10%;"></td> <td style="width: 10%;"></td> <td style="width: 10%;"></td> <td style="width: 10%;"></td> <td style="width: 10%;"></td> <td style="width: 10%;"></td> <td style="width: 10%;"></td> <td style="width: 10%;"></td> <td style="width: 10%;"></td> <td style="width: 10%;"></td> </tr> <tr> <td></td> <td></td> <td colspan="8" style="text-align: center;"> <table border="1" style="width: 100%; border-collapse: collapse; text-align: center;"> <tr> <td style="width: 10%;"></td> <td style="width: 10%;"></td> <td style="width: 10%;"></td> <td style="width: 10%;"></td> <td style="width: 10%;"></td> <td style="width: 10%;"></td> <td style="width: 10%;"></td> <td style="width: 10%;"></td> <td style="width: 10%;"></td> <td style="width: 10%;"></td> </tr> <tr> <td></td> <td></td> <td colspan="8" style="text-align: center;"> <table border="1" style="width: 100%; border-collapse: collapse; text-align: center;"> <tr> <td style="width: 10%;"></td> <td style="width: 10%;"></td> <td style="width: 10%;"></td> <td style="width: 10%;"></td> <td style="width: 10%;"></td> <td style="width: 10%;"></td> <td style="width: 10%;"></td> <td style="width: 10%;"></td> <td style="width: 10%;"></td> <td style="width: 10%;"></td> </tr> <tr> <td></td> <td></td> <td colspan="8" style="text-align: center;"> <table border="1" style="width: 100%; border-collapse: collapse; text-align: center;"> <tr> <td style="width: 10%;"></td> <td style="width: 10%;"></td> <td style="width: 10%;"></td> <td style="width: 10%;"></td> <td style="width: 10%;"></td> <td style="width: 10%;"></td> <td style="width: 10%;"></td> <td style="width: 10%;"></td> <td style="width: 10%;"></td> <td style="width: 10%;"></td> </tr> <tr> <td></td> <td></td> <td colspan="8" style="text-align: center;"> <table border="1" style="width: 100%; border-collapse: collapse; text-align: center;"> <tr> <td style="width: 10%;"></td> <td style="width: 10%;"></td> <td style="width: 10%;"></td> <td style="width: 10%;"></td> <td style="width: 10%;"></td> <td style="width: 10%;"></td> <td style="width: 10%;"></td> <td style="width: 10%;"></td> <td style="width: 10%;"></td> <td style="width: 10%;"></td> </tr> <tr> <td></td> <td></td> <td colspan="8" style="text-align: center;"> <table border="1" style="width: 100%; border-collapse: collapse; text-align: center;"> <tr> <td style="width: 10%;"></td> <td style="width: 10%;"></td> <td style="width: 10%;"></td> <td style="width: 10%;"></td> <td style="width: 10%;"></td> <td style="width: 10%;"></td> <td style="width: 10%;"></td> <td style="width: 10%;"></td> <td style="width: 10%;"></td> <td style="width: 10%;"></td> </tr> <tr> <td></td> <td></td> <td colspan="8" style="text-align: center;"> <table border="1" style="width: 100%; border-collapse: collapse; text-align: center;"> <tr> <td style="width: 10%;"></td> <td style="width: 10%;"></td> <td style="width: 10%;"></td> <td style="width: 10%;"></td> <td style="width: 10%;"></td> <td style="width: 10%;"></td> <td style="width: 10%;"></td> <td style="width: 10%;"></td> <td style="width: 10%;"></td> <td style="width: 10%;"></td> </tr> <tr> <td></td> <td></td> <td colspan="8" style="text-align: center;"> <table border="1" style="width: 100%; border-collapse: collapse; text-align: center;"> <tr> <td style="width: 10%;"></td> <td style="width: 10%;"></td> <td style="width: 10%;"></td> <td style="width: 10%;"></td> <td style="width: 10%;"></td> <td style="width: 10%;"></td> <td style="width: 10%;"></td> <td style="width: 10%;"></td> <td style="width: 10%;"></td> <td style="width: 10%;"></td> </tr> <tr> <td></td> <td></td> <td colspan="8" style="text-align: center;"> <table border="1" style="width: 100%; border-collapse: collapse; text-align: center;"> <tr> <td style="width: 10%;"></td> <td style="width: 10%;"></td> <td style="width: 10%;"></td> <td style="width: 10%;"></td> <td style="width: 10%;"></td> <td style="width: 10%;"></td> <td style="width: 10%;"></td> <td style="width: 10%;"></td> <td style="width: 10%;"></td> <td style="width: 10%;"></td> </tr> <tr> <td></td> <td></td> <td colspan="8" style="text-align: center;"> <table border="1" style="width: 100%; border-collapse: collapse; text-align: center;"> <tr> <td style="width: 10%;"></td> <td style="width: 10%;"></td> <td style="width: 10%;"></td> <td style="width: 10%;"></td> <td style="width: 10%;"></td> <td style="width: 10%;"></td> <td style="width: 10%;"></td> <td style="width: 10%;"></td> <td style="width: 10%;"></td> <td style="width: 10%;"></td> </tr> <tr> <td></td> <td></td> <td colspan="8" style="text-align: center;"> <table border="1" style="width: 100%; border-collapse: collapse; text-align: center;"> <tr> <td style="width: 10%;"></td> <td style="width: 10%;"></td> <td style="width: 10%;"></td> <td style="width: 10%;"></td> <td style="width: 10%;"></td> <td style="width: 10%;"></td> <td style="width: 10%;"></td> <td style="width: 10%;"></td> <td style="width: 10%;"></td> <td style="width: 10%;"></td> </tr> <tr> <td></td> <td></td> <td colspan="8" style="text-align: center;"> <table border="1" style="width: 100%; border-collapse: collapse; text-align: center;"> <tr> <td style="width: 10%;"></td> <td style="width: 10%;"></td> <td style="width: 10%;"></td> <td style="width: 10%;"></td> <td style="width: 10%;"></td> <td style="width: 10%;"></td> <td style="width: 10%;"></td> <td style="width: 10%;"></td> <td style="width: 10%;"></td> <td style="width: 10%;"></td> </tr> <tr> <td></td> <td></td> <td colspan="8" style="text-align: center;"> <table border="1" style="width: 100%; border-collapse: collapse; text-align: center;"> <tr> <td style="width: 10%;"></td> <td style="width: 10%;"></td> <td style="width: 10%;"></td> <td style="width: 10%;"></td> <td style="width: 10%;"></td> <td style="width: 10%;"></td> <td style="width: 10%;"></td> <td style="width: 10%;"></td> <td style="width: 10%;"></td> <td style="width: 10%;"></td> </tr> <tr> <td></td> <td></td> <td colspan="8" style="text-align: center;"> <table border="1" style="width: 100%; border-collapse: collapse; text-align: center;"> <tr> <td style="width: 10%;"></td> <td style="width: 10%;"></td> <td style="width: 10%;"></td> <td style="width: 10%;"></td> <td style="width: 10%;"></td> <td style="width: 10%;"></td> <td style="width: 10%;"></td> <td style="width: 10%;"></td> <td style="width: 10%;"></td> <td style="width: 10%;"></td> </tr> <tr> <td></td> <td></td> <td colspan="8" style="text-align: center;"> <table border="1" style="width: 100%; border-collapse: collapse; text-align: center;"> <tr> <td style="width: 10%;"></td> <td style="width: 10%;"></td> <td style="width: 10%;"></td> <td style="width: 10%;"></td> <td style="width: 10%;"></td> <td style="width: 10%;"></td> <td style="width: 10%;"></td> <td style="width: 10%;"></td> <td style="width: 10%;"></td> <td style="width: 10%;"></td> </tr> <tr> <td></td> <td></td> <td colspan="8" style="text-align: center;"> <table border="1" style="width: 100%; border-collapse: collapse; text-align: center;"> <tr> <td style="width: 10%;"></td> <td style="width: 10%;"></td> <td style="width: 10%;"></td> <td style="width: 10%;"></td> <td style="width: 10%;"></td> <td style="width: 10%;"></td> <td style="width: 10%;"></td> <td style="width: 10%;"></td> <td style="width: 10%;"></td> <td style="width: 10%;"></td> </tr> <tr> <td></td> <td></td> <td colspan="8" style="text-align: center;"> <table border="1" style="width: 100%; border-collapse: collapse; text-align: center;"> <tr> <td style="width: 10%;"></td> <td style="width: 10%;"></td> <td style="width: 10%;"></td> <td style="width: 10%;"></td> <td style="width: 10%;"></td> <td style="width: 10%;"></td> <td style="width: 10%;"></td> <td style="width: 10%;"></td> <td style="width: 10%;"></td> <td style="width: 10%;"></td> </tr> <tr> <td></td> <td></td> <td colspan="8" style="text-align: center;"> <table border="1" style="width: 100%; border-collapse: collapse; text-align: center;"> <tr> <td style="width: 10%;"></td> <td style="width: 10%;"></td> <td style="width: 10%;"></td> <td style="width: 10%;"></td> <td style="width: 10%;"></td> <td style="width: 10%;"></td> <td style="width: 10%;"></td> <td style="width: 10%;"></td> <td style="width: 10%;"></td> <td style="width: 10%;"></td> </tr> <tr> <td></td> <td></td> <td colspan="8" style="text-align: center;"> <table border="1" style="width: 100%; border-collapse: collapse; text-align: center;"> <tr> <td style="width: 10%;"></td> <td style="width: 10%;"></td> <td style="width: 10%;"></td> <td style="width: 10%;"></td> <td style="width: 10%;"></td> <td style="width: 10%;"></td> <td style="width: 10%;"></td> <td style="width:
10%;"></td> <td style="width: 10%;"></td> <td style="width: 10%;"></td> </tr> <tr> <td></td> <td></td> <td colspan="8" style="text-align: center;"> <table border="1" style="width: 100%; border-collapse: collapse; text-align: center;"> <tr> <td style="width: 10%;"></td> <td style="width: 10%;"></td> <td style="width: 10%;"></td> <td style="width: 10%;"></td> <td style="width: 10%;"></td> <td style="width: 10%;"></td> <td style="width: 10%;"></td> <td style="width: 10%;"></td> <td style="width: 10%;"></td> <td style="width: 10%;"></td> </tr> <tr> <td></td> <td></td> <td colspan="8" style="text-align: center;"> <table border="1" style="width: 100%; border-collapse: collapse; text-align: center;"> <tr> <td style="width: 10%;"></td> <td style="width: 10%;"></td> <td style="width: 10%;"></td> <td style="width: 10%;"></td> <td style="width: 10%;"></td> <td style="width: 10%;"></td> <td style="width: 10%;"></td> <td style="width: 10%;"></td> <td style="width: 10%;"></td> <td style="width: 10%;"></td> </tr> <tr> <td></td> <td></td> <td colspan="8" style="text-align: center;"> <table border="1" style="width: 100%; border-collapse: collapse; text-align: center;"> <tr> <td style="width: 10%;"></td> <td style="width: 10%;"></td> <td style="width: 10%;"></td> <td style="width: 10%;"></td> <td style="width: 10%;"></td> <td style="width: 10%;"></td> <td style="width: 10%;"></td> <td style="width: 10%;"></td> <td style="width: 10%;"></td> <td style="width: 10%;"></td> </tr> <tr> <td></td> <td></td> <td colspan="8" style="text-align: center;"> <table border="1" style="width: 100%; border-collapse: collapse; text-align: center;"> <tr> <td style="width: 10%;"></td> <td style="width: 10%;"></td> <td style="width: 10%;"></td> <td style="width: 10%;"></td> <td style="width: 10%;"></td> <td style="width: 10%;"></td> <td style="width: 10%;"></td> <td style="width: 10%;"></td> <td style="width: 10%;"></td> <td style="width: 10%;"></td> </tr> <tr> <td></td> <td></td> <td colspan="8" style="text-align: center;"> <table border="1" style="width: 100%; border-collapse: collapse; text-align: center;"> <tr> <td style="width: 10%;"></td> <td style="width: 10%;"></td> <td style="width: 10%;"></td> <td style="width: 10%;"></td> <td style="width: 10%;"></td> <td style="width: 10%;"></td> <td style="width: 10%;"></td> <td style="width: 10%;"></td> <td style="width: 10%;"></td> <td style="width: 10%;"></td> </tr> <tr> <td></td> <td></td> <td colspan="8" style="text-align: center;"> <table border="1" style="width: 100%; border-collapse: collapse; text-align: center;"> <tr> <td style="width: 10%;"></td> <td style="width: 10%;"></td> <td style="width: 10%;"></td> <td style="width: 10%;"></td> <td style="width: 10%;"></td> <td style="width: 10%;"></td> <td style="width: 10%;"></td> <td style="width: 10%;"></td> <td style="width: 10%;"></td> <td style="width: 10%;"></td> </tr> <tr> <td></td> <td></td> <td colspan="8" style="text-align: center;"> <table border="1" style="width: 100%; border-collapse: collapse; text-align: center;"> <tr> <td style="width: 10%;"></td> <td style="width: 10%;"></td> <td style="width: 10%;"></td> <td style="width: 10%;"></td> <td style="width: 10%;"></td> <td style="width: 10%;"></td> <td style="width: 10%;"></td> <td style="width: 10%;"></td> <td style="width: 10%;"></td> <td style="width: 10%;"></td> </tr> <tr> <td></td> <td></td> <td colspan="8" style="text-align: center;"> <table border="1" style="width: 100%; border-collapse: collapse; text-align: center;"> <tr> <td style="width: 10%;"></td> <td style="width: 10%;"></td> <td style="width: 10%;"></td> <td style="width: 10%;"></td> <td style="width: 10%;"></td> <td style="width: 10%;"></td> <td style="width: 10%;"></td> <td style="width: 10%;"></td> <td style="width: 10%;"></td> <td style="width: 10%;"></td> </tr> <tr> <td></td> <td></td> <td colspan="8" style="text-align: center;"> <table border="1" style="width: 100%; border-collapse: collapse; text-align: center;"> <tr> <td style="width: 10%;"></td> <td style="width: 10%;"></td> <td style="width: 10%;"></td> <td style="width: 10%;"></td> <td style="width: 10%;"></td> <td style="width: 10%;"></td> <td style="width: 10%;"></td> <td style="width: 10%;"></td> <td style="width: 10%;"></td> <td style="width: 10%;"></td> </tr> <tr> <td></td> <td></td> <td colspan="8" style="text-align: center;"> <table border="1" style="width: 100%; border-collapse: collapse; text-align: center;"> <tr> <td style="width: 10%;"></td> <td style="width: 10%;"></td> <td style="width: 10%;"></td> <td style="width: 10%;"></td> <td style="width: 10%;"></td> <td style="width: 10%;"></td> <td style="width: 10%;"></td> <td style="width: 10%;"></td> <td style="width: 10%;"></td> <td style="width: 10%;"></td> </tr> <tr> <td></td> <td></td> <td colspan="8" style="text-align: center;"> <table border="1" style="width: 100%; border-collapse: collapse; text-align: center;"> <tr> <td style="width: 10%;"></td> <td style="width: 10%;"></td> <td style="width: 10%;"></td> <td style="width: 10%;"></td> <td style="width: 10%;"></td> <td style="width: 10%;"></td> <td style="width: 10%;"></td> <td style="width: 10%;"></td> <td style="width: 10%;"></td> <td style="width: 10%;"></td> </tr> <tr> <td></td> <td></td> <td colspan="8" style="text-align: center;"> <table border="1" style="width: 100%; border-collapse: collapse; text-align: center;"> <tr> <td style="width: 10%;"></td> <td style="width: 10%;"></td> <td style="width: 10%;"></td> <td style="width: 10%;"></td> <td style="width: 10%;"></td> <td style="width: 10%;"></td> <td style="width: 10%;"></td> <td style="width: 10%;"></td> <td style="width: 10%;"></td> <td style="width: 10%;"></td> </tr> <tr> <td></td> <td></td> <td colspan="8" style="text-align: center;"> <table border="1" style="width: 100%; border-collapse: collapse; text-align: center;"> <tr> <td style="width: 10%;"></td> <td style="width: 10%;"></td> <td style="width: 10%;"></td> <td style="width: 10%;"></td> <td style="width: 10%;"></td> <td style="width: 10%;"></td> <td style="width: 10%;"></td> <td style="width: 10%;"></td> <td style="width: 10%;"></td> <td style="width: 10%;"></td> </tr> <tr> <td></td> <td></td> <td colspan="8" style="text-align: center;"> <table border="1" style="width: 100%; border-collapse: collapse; text-align: center;"> <tr> <td style="width: 10%;"></td> <td style="width: 10%;"></td> <td style="width: 10%;"></td> <td style="width: 10%;"></td> <td style="width: 10%;"></td> <td style="width: 10%;"></td> <td style="width: 10%;"></td> <td style="width: 10%;"></td> <td style="width: 10%;"></td> <td style="width: 10%;"></td> </tr> <tr> <td></td> <td></td> <td colspan="8" style="text-align: center;"> <table border="1" style="width: 100%; border-collapse: collapse; text-align: center;"> <tr> <td style="width: 10%;"></td> <td style="width: 10%;"></td> <td style="width: 10%;"></td> <td style="width: 10%;"></td> <td style="width: 10%;"></td> <td style="width: 10%;"></td> <td style="width: 10%;"></td> <td style="width: 10%;"></td> <td style="width: 10%;"></td> <td style="width: 10%;"></td> </tr> <tr> <td></td> <td></td> <td colspan="8" style="text-align: center;"> <table border="1" style="width: 100%; border-collapse: collapse; text-align: center;"> <tr> <td style="width: 10%;"></td> <td style="width: 10%;"></td> <td style="width: 10%;"></td> <td style="width: 10%;"></td> <td style="width: 10%;"></td> <td style="width: 10%;"></td> <td style="width: 10%;"></td> <td style="width: 10%;"></td> <td style="width: 10%;"></td> <td style="width: 10%;"></td> </tr> <tr> <td></td> <td></td> <td colspan="8" style="text-align: center;"> <table border="1" style="width: 100%; border-collapse: collapse; text-align: center;"> <tr> <td style="width: 10%;"></td> <td style="width: 10%;"></td> <td style="width: 10%;"></td> <td style="width: 10%;"></td> <td style="width: 10%;"></td> <td style="width: 10%;"></td> <td style="width: 10%;"></td> <td style="width: 10%;"></td> <td style="width: 10%;"></td> <td style="width: 10%;"></td> </tr> <tr> <td></td> <td></td> <td colspan="8" style="text-align: center;"> <table border="1" style="width: 100%; border-collapse: collapse; text-align: center;"> <tr> <td style="width: 10%;"></td> <td style="width: 10%;"></td> <td style="width: 10%;"></td> <td style="width: 10%;"></td> <td style="width: 10%;"></td> <td style="width: 10%;"></td> <td style="width: 10%;"></td> <td style="width: 10%;"></td> <td style="width: 10%;"></td> <td style="width: 10%;"></td> </tr> <tr> <td></td> <td></td> <td colspan="8" style="text-align: center;"> <table border="1" style="width: 100%; border-collapse: collapse; text-align: center;"> <tr> </tr></table></td></tr></table></td></tr></table></td></tr></table></td></tr></table></td></tr></table></td></tr></table></td></tr></table></td></tr></table></td></tr></table></td></tr></table></td></tr></table></td></tr></table></td></tr></table></td></tr></table></td></tr></table></td></tr></table></td></tr></table></td></tr></table></td></tr></table></td></tr></table></td></tr></table></td></tr></table></td></tr></table></td></tr></table></td></tr></table></td></tr></table></td></tr></table></td></tr></table></td></tr></table></td></tr></table></td></tr></table></td></tr></table></td></tr></table></td></tr></table></td></tr></table></td></tr></table></td></tr></table>
 | | | | | | | | | | | | | | | | | | | | <table border="1" style="width: 100%; border-collapse: collapse; text-align: center;"> <tr> <td style="width: 10%;"></td> <td style="width: 10%;"></td> <td style="width: 10%;"></td> <td style="width: 10%;"></td> <td style="width: 10%;"></td> <td style="width: 10%;"></td> <td style="width: 10%;"></td> <td style="width: 10%;"></td> <td style="width: 10%;"></td> <td style="width: 10%;"></td> </tr> <tr> <td></td> <td></td> <td colspan="8" style="text-align: center;"> <table border="1" style="width: 100%; border-collapse: collapse; text-align: center;"> <tr> <td style="width: 10%;"></td> <td style="width: 10%;"></td> <td style="width: 10%;"></td> <td style="width: 10%;"></td> <td style="width: 10%;"></td> <td style="width: 10%;"></td> <td style="width: 10%;"></td> <td style="width: 10%;"></td> <td style="width: 10%;"></td> <td style="width: 10%;"></td> </tr> <tr> <td></td> <td></td> <td colspan="8" style="text-align: center;"> <table border="1" style="width: 100%; border-collapse: collapse; text-align: center;"> <tr> <td style="width: 10%;"></td> <td style="width: 10%;"></td> <td style="width: 10%;"></td> <td style="width: 10%;"></td> <td style="width: 10%;"></td> <td style="width: 10%;"></td> <td style="width: 10%;"></td> <td style="width: 10%;"></td> <td style="width: 10%;"></td> <td style="width: 10%;"></td> </tr> <tr> <td></td> <td></td> <td colspan="8" style="text-align: center;"> <table border="1" style="width: 100%; border-collapse: collapse; text-align: center;"> <tr> <td style="width: 10%;"></td> <td style="width: 10%;"></td> <td style="width: 10%;"></td> <td style="width: 10%;"></td> <td style="width: 10%;"></td> <td style="width: 10%;"></td> <td style="width: 10%;"></td> <td style="width: 10%;"></td> <td style="width: 10%;"></td> <td style="width: 10%;"></td> </tr> <tr> <td></td> <td></td> <td colspan="8" style="text-align: center;"> <table border="1" style="width: 100%; border-collapse: collapse; text-align: center;"> <tr> <td style="width: 10%;"></td> <td style="width: 10%;"></td> <td style="width: 10%;"></td> <td style="width: 10%;"></td> <td style="width: 10%;"></td> <td style="width: 10%;"></td> <td style="width: 10%;"></td> <td style="width: 10%;"></td> <td style="width: 10%;"></td> <td style="width: 10%;"></td> </tr> <tr> <td></td> <td></td> <td colspan="8" style="text-align:
center;"> <table border="1" style="width: 100%; border-collapse: collapse; text-align: center;"> <tr> <td style="width: 10%;"></td> <td style="width: 10%;"></td> <td style="width: 10%;"></td> <td style="width: 10%;"></td> <td style="width: 10%;"></td> <td style="width: 10%;"></td> <td style="width: 10%;"></td> <td style="width: 10%;"></td> <td style="width: 10%;"></td> <td style="width: 10%;"></td> </tr> <tr> <td></td> <td></td> <td colspan="8" style="text-align: center;"> <table border="1" style="width: 100%; border-collapse: collapse; text-align: center;"> <tr> <td style="width: 10%;"></td> <td style="width: 10%;"></td> <td style="width: 10%;"></td> <td style="width: 10%;"></td> <td style="width: 10%;"></td> <td style="width: 10%;"></td> <td style="width: 10%;"></td> <td style="width: 10%;"></td> <td style="width: 10%;"></td> <td style="width: 10%;"></td> </tr> <tr> <td></td> <td></td> <td colspan="8" style="text-align: center;"> <table border="1" style="width: 100%; border-collapse: collapse; text-align: center;"> <tr> <td style="width: 10%;"></td> <td style="width: 10%;"></td> <td style="width: 10%;"></td> <td style="width: 10%;"></td> <td style="width: 10%;"></td> <td style="width: 10%;"></td> <td style="width: 10%;"></td> <td style="width: 10%;"></td> <td style="width: 10%;"></td> <td style="width: 10%;"></td> </tr> <tr> <td></td> <td></td> <td colspan="8" style="text-align: center;"> <table border="1" style="width: 100%; border-collapse: collapse; text-align: center;"> <tr> <td style="width: 10%;"></td> <td style="width: 10%;"></td> <td style="width: 10%;"></td> <td style="width: 10%;"></td> <td style="width: 10%;"></td> <td style="width: 10%;"></td> <td style="width: 10%;"></td> <td style="width: 10%;"></td> <td style="width: 10%;"></td> <td style="width: 10%;"></td> </tr> <tr> <td></td> <td></td> <td colspan="8" style="text-align: center;"> <table border="1" style="width: 100%; border-collapse: collapse; text-align: center;"> <tr> <td style="width: 10%;"></td> <td style="width: 10%;"></td> <td style="width: 10%;"></td> <td style="width: 10%;"></td> <td style="width: 10%;"></td> <td style="width: 10%;"></td> <td style="width: 10%;"></td> <td style="width: 10%;"></td> <td style="width: 10%;"></td> <td style="width: 10%;"></td> </tr> <tr> <td></td> <td></td> <td colspan="8" style="text-align: center;"> <table border="1" style="width: 100%; border-collapse: collapse; text-align: center;"> <tr> <td style="width: 10%;"></td> <td style="width: 10%;"></td> <td style="width: 10%;"></td> <td style="width: 10%;"></td> <td style="width: 10%;"></td> <td style="width: 10%;"></td> <td style="width: 10%;"></td> <td style="width: 10%;"></td> <td style="width: 10%;"></td> <td style="width: 10%;"></td> </tr> <tr> <td></td> <td></td> <td colspan="8" style="text-align: center;"> <table border="1" style="width: 100%; border-collapse: collapse; text-align: center;"> <tr> <td style="width: 10%;"></td> <td style="width: 10%;"></td> <td style="width: 10%;"></td> <td style="width: 10%;"></td> <td style="width: 10%;"></td> <td style="width: 10%;"></td> <td style="width: 10%;"></td> <td style="width: 10%;"></td> <td style="width: 10%;"></td> <td style="width: 10%;"></td> </tr> <tr> <td></td> <td></td> <td colspan="8" style="text-align: center;"> <table border="1" style="width: 100%; border-collapse: collapse; text-align: center;"> <tr> <td style="width: 10%;"></td> <td style="width: 10%;"></td> <td style="width: 10%;"></td> <td style="width: 10%;"></td> <td style="width: 10%;"></td> <td style="width: 10%;"></td> <td style="width: 10%;"></td> <td style="width: 10%;"></td> <td style="width: 10%;"></td> <td style="width: 10%;"></td> </tr> <tr> <td></td> <td></td> <td colspan="8" style="text-align: center;"> <table border="1" style="width: 100%; border-collapse: collapse; text-align: center;"> <tr> <td style="width: 10%;"></td> <td style="width: 10%;"></td> <td style="width: 10%;"></td> <td style="width: 10%;"></td> <td style="width: 10%;"></td> <td style="width: 10%;"></td> <td style="width: 10%;"></td> <td style="width: 10%;"></td> <td style="width: 10%;"></td> <td style="width: 10%;"></td> </tr> <tr> <td></td> <td></td> <td colspan="8" style="text-align: center;"> <table border="1" style="width: 100%; border-collapse: collapse; text-align: center;"> <tr> <td style="width: 10%;"></td> <td style="width: 10%;"></td> <td style="width: 10%;"></td> <td style="width: 10%;"></td> <td style="width: 10%;"></td> <td style="width: 10%;"></td> <td style="width: 10%;"></td> <td style="width: 10%;"></td> <td style="width: 10%;"></td> <td style="width: 10%;"></td> </tr> <tr> <td></td> <td></td> <td colspan="8" style="text-align: center;"> <table border="1" style="width: 100%; border-collapse: collapse; text-align: center;"> <tr> <td style="width: 10%;"></td> <td style="width: 10%;"></td> <td style="width: 10%;"></td> <td style="width: 10%;"></td> <td style="width: 10%;"></td> <td style="width: 10%;"></td> <td style="width: 10%;"></td> <td style="width: 10%;"></td> <td style="width: 10%;"></td> <td style="width: 10%;"></td> </tr> <tr> <td></td> <td></td> <td colspan="8" style="text-align: center;"> <table border="1" style="width: 100%; border-collapse: collapse; text-align: center;"> <tr> <td style="width: 10%;"></td> <td style="width: 10%;"></td> <td style="width: 10%;"></td> <td style="width: 10%;"></td> <td style="width: 10%;"></td> <td style="width: 10%;"></td> <td style="width: 10%;"></td> <td style="width: 10%;"></td> <td style="width: 10%;"></td> <td style="width: 10%;"></td> </tr> <tr> <td></td> <td></td> <td colspan="8" style="text-align: center;"> <table border="1" style="width: 100%; border-collapse: collapse; text-align: center;"> <tr> <td style="width: 10%;"></td> <td style="width: 10%;"></td> <td style="width: 10%;"></td> <td style="width: 10%;"></td> <td style="width: 10%;"></td> <td style="width: 10%;"></td> <td style="width: 10%;"></td> <td style="width: 10%;"></td> <td style="width: 10%;"></td> <td style="width: 10%;"></td> </tr> <tr> <td></td> <td></td> <td colspan="8" style="text-align: center;"> <table border="1" style="width: 100%; border-collapse: collapse; text-align: center;"> <tr> <td style="width: 10%;"></td> <td style="width: 10%;"></td> <td style="width: 10%;"></td> <td style="width: 10%;"></td> <td style="width: 10%;"></td> <td style="width: 10%;"></td> <td style="width: 10%;"></td> <td style="width: 10%;"></td> <td style="width: 10%;"></td> <td style="width: 10%;"></td> </tr> <tr> <td></td> <td></td> <td colspan="8" style="text-align: center;"> <table border="1" style="width: 100%; border-collapse: collapse; text-align: center;"> <tr> <td style="width: 10%;"></td> <td style="width: 10%;"></td> <td style="width: 10%;"></td> <td style="width: 10%;"></td> <td style="width: 10%;"></td> <td style="width: 10%;"></td> <td style="width: 10%;"></td> <td style="width: 10%;"></td> <td style="width: 10%;"></td> <td style="width: 10%;"></td> </tr> <tr> <td></td> <td></td> <td colspan="8" style="text-align: center;"> <table border="1" style="width: 100%; border-collapse: collapse; text-align: center;"> <tr> <td style="width: 10%;"></td> <td style="width: 10%;"></td> <td style="width: 10%;"></td> <td style="width: 10%;"></td> <td style="width: 10%;"></td> <td style="width: 10%;"></td> <td style="width: 10%;"></td> <td style="width: 10%;"></td> <td style="width: 10%;"></td> <td style="width: 10%;"></td> </tr> <tr> <td></td> <td></td> <td colspan="8" style="text-align: center;"> <table border="1" style="width: 100%; border-collapse: collapse; text-align: center;"> <tr> <td style="width: 10%;"></td> <td style="width: 10%;"></td> <td style="width: 10%;"></td> <td style="width: 10%;"></td> <td style="width: 10%;"></td> <td style="width: 10%;"></td> <td style="width: 10%;"></td> <td style="width: 10%;"></td> <td style="width: 10%;"></td> <td style="width: 10%;"></td> </tr> <tr> <td></td> <td></td> <td colspan="8" style="text-align: center;"> <table border="1" style="width: 100%; border-collapse: collapse; text-align: center;"> <tr> <td style="width: 10%;"></td> <td style="width: 10%;"></td> <td style="width: 10%;"></td> <td style="width: 10%;"></td> <td style="width: 10%;"></td> <td style="width: 10%;"></td> <td style="width: 10%;"></td> <td style="width: 10%;"></td> <td style="width: 10%;"></td> <td style="width: 10%;"></td> </tr> <tr> <td></td> <td></td> <td colspan="8" style="text-align: center;"> <table border="1" style="width: 100%; border-collapse: collapse; text-align: center;"> <tr> <td style="width: 10%;"></td> <td style="width: 10%;"></td> <td style="width: 10%;"></td> <td style="width: 10%;"></td> <td style="width: 10%;"></td> <td style="width: 10%;"></td> <td style="width: 10%;"></td> <td style="width: 10%;"></td> <td style="width: 10%;"></td> <td style="width: 10%;"></td> </tr> <tr> <td></td> <td></td> <td colspan="8" style="text-align: center;"> <table border="1" style="width: 100%; border-collapse: collapse; text-align: center;"> <tr> <td style="width: 10%;"></td> <td style="width: 10%;"></td> <td style="width: 10%;"></td> <td style="width: 10%;"></td> <td style="width: 10%;"></td> <td style="width: 10%;"></td> <td style="width: 10%;"></td> <td style="width: 10%;"></td> <td style="width: 10%;"></td> <td style="width: 10%;"></td> </tr> <tr> <td></td> <td></td> <td colspan="8" style="text-align: center;"> <table border="1" style="width: 100%; border-collapse: collapse; text-align: center;"> <tr> <td style="width: 10%;"></td> <td style="width: 10%;"></td> <td style="width: 10%;"></td> <td style="width: 10%;"></td> <td style="width: 10%;"></td> <td style="width: 10%;"></td> <td style="width: 10%;"></td> <td style="width: 10%;"></td> <td style="width: 10%;"></td> <td style="width: 10%;"></td> </tr> <tr> <td></td> <td></td> <td colspan="8" style="text-align: center;"> <table border="1" style="width: 100%; border-collapse: collapse; text-align: center;"> <tr> <td style="width: 10%;"></td> <td style="width: 10%;"></td> <td
style="width: 10%;"></td> <td style="width: 10%;"></td> <td style="width: 10%;"></td> <td style="width: 10%;"></td> <td style="width: 10%;"></td> <td style="width: 10%;"></td> <td style="width: 10%;"></td> <td style="width: 10%;"></td> </tr> <tr> <td></td> <td></td> <td colspan="8" style="text-align: center;"> <table border="1" style="width: 100%; border-collapse: collapse; text-align: center;"> <tr> <td style="width: 10%;"></td> <td style="width: 10%;"></td> <td style="width: 10%;"></td> <td style="width: 10%;"></td> <td style="width: 10%;"></td> <td style="width: 10%;"></td> <td style="width: 10%;"></td> <td style="width: 10%;"></td> <td style="width: 10%;"></td> <td style="width: 10%;"></td> </tr> <tr> <td></td> <td></td> <td colspan="8" style="text-align: center;"> <table border="1" style="width: 100%; border-collapse: collapse; text-align: center;"> <tr> <td style="width: 10%;"></td> <td style="width: 10%;"></td> <td style="width: 10%;"></td> <td style="width: 10%;"></td> <td style="width: 10%;"></td> <td style="width: 10%;"></td> <td style="width: 10%;"></td> <td style="width: 10%;"></td> <td style="width: 10%;"></td> <td style="width: 10%;"></td> </tr> <tr> <td></td> <td></td> <td colspan="8" style="text-align: center;"> <table border="1" style="width: 100%; border-collapse: collapse; text-align: center;"> <tr> <td style="width: 10%;"></td> <td style="width: 10%;"></td> <td style="width: 10%;"></td> <td style="width: 10%;"></td> <td style="width: 10%;"></td> <td style="width: 10%;"></td> <td style="width: 10%;"></td> <td style="width: 10%;"></td> <td style="width: 10%;"></td> <td style="width: 10%;"></td> </tr> <tr> <td></td> <td></td> <td colspan="8" style="text-align: center;"> <table border="1" style="width: 100%; border-collapse: collapse; text-align: center;"> <tr> <td style="width: 10%;"></td> <td style="width: 10%;"></td> <td style="width: 10%;"></td> <td style="width: 10%;"></td> <td style="width: 10%;"></td> <td style="width: 10%;"></td> <td style="width: 10%;"></td> <td style="width: 10%;"></td> <td style="width: 10%;"></td> <td style="width: 10%;"></td> </tr> <tr> <td></td> <td></td> <td colspan="8" style="text-align: center;"> <table border="1" style="width: 100%; border-collapse: collapse; text-align: center;"> <tr> <td style="width: 10%;"></td> <td style="width: 10%;"></td> <td style="width: 10%;"></td> <td style="width: 10%;"></td> <td style="width: 10%;"></td> <td style="width: 10%;"></td> <td style="width: 10%;"></td> <td style="width: 10%;"></td> <td style="width: 10%;"></td> <td style="width: 10%;"></td> </tr> <tr> <td></td> <td></td> <td colspan="8" style="text-align: center;"> <table border="1" style="width: 100%; border-collapse: collapse; text-align: center;"> <tr> <td style="width: 10%;"></td> <td style="width: 10%;"></td> <td style="width: 10%;"></td> <td style="width: 10%;"></td> <td style="width: 10%;"></td> <td style="width: 10%;"></td> <td style="width: 10%;"></td> <td style="width: 10%;"></td> <td style="width: 10%;"></td> <td style="width: 10%;"></td> </tr> <tr> <td></td> <td></td> <td colspan="8" style="text-align: center;"> <table border="1" style="width: 100%; border-collapse: collapse; text-align: center;"> <tr> <td style="width: 10%;"></td> <td style="width: 10%;"></td> <td style="width: 10%;"></td> <td style="width: 10%;"></td> <td style="width: 10%;"></td> <td style="width: 10%;"></td> <td style="width: 10%;"></td> <td style="width: 10%;"></td> <td style="width: 10%;"></td> <td style="width: 10%;"></td> </tr> <tr> <td></td> <td></td> <td colspan="8" style="text-align: center;"> <table border="1" style="width: 100%; border-collapse: collapse; text-align: center;"> <tr> <td style="width: 10%;"></td> <td style="width: 10%;"></td> <td style="width: 10%;"></td> <td style="width: 10%;"></td> <td style="width: 10%;"></td> <td style="width: 10%;"></td> <td style="width: 10%;"></td> <td style="width: 10%;"></td> <td style="width: 10%;"></td> <td style="width: 10%;"></td> </tr> <tr> <td></td> <td></td> <td colspan="8" style="text-align: center;"> <table border="1" style="width: 100%; border-collapse: collapse; text-align: center;"> <tr> <td style="width: 10%;"></td> <td style="width: 10%;"></td> <td style="width: 10%;"></td> <td style="width: 10%;"></td> <td style="width: 10%;"></td> <td style="width: 10%;"></td> <td style="width: 10%;"></td> <td style="width: 10%;"></td> <td style="width: 10%;"></td> <td style="width: 10%;"></td> </tr> <tr> <td></td> <td></td> <td colspan="8" style="text-align: center;"> <table border="1" style="width: 100%; border-collapse: collapse; text-align: center;"> <tr> </tr></table></td></tr></table></td></tr></table></td></tr></table></td></tr></table></td></tr></table></td></tr></table></td></tr></table></td></tr></table></td></tr></table></td></tr></table></td></tr></table></td></tr></table></td></tr></table></td></tr></table></td></tr></table></td></tr></table></td></tr></table></td></tr></table></td></tr></table></td></tr></table></td></tr></table></td></tr></table></td></tr></table></td></tr></table></td></tr></table></td></tr></table></td></tr></table></td></tr></table></td></tr></table></td></tr></table></td></tr></table></td></tr></table></td></tr></table></td></tr></table></td></tr></table></td></tr></table>
 | | | | | | | | | | | | | | | | | | | | <table border="1" style="width: 100%; border-collapse: collapse; text-align: center;"> <tr> <td style="width: 10%;"></td> <td style="width: 10%;"></td> <td style="width: 10%;"></td> <td style="width: 10%;"></td> <td style="width: 10%;"></td> <td style="width: 10%;"></td> <td style="width: 10%;"></td> <td style="width: 10%;"></td> <td style="width: 10%;"></td> <td style="width: 10%;"></td> </tr> <tr> <td></td> <td></td> <td colspan="8" style="text-align: center;"> <table border="1" style="width: 100%; border-collapse: collapse; text-align: center;"> <tr> <td style="width: 10%;"></td> <td style="width: 10%;"></td> <td style="width: 10%;"></td> <td style="width: 10%;"></td> <td style="width: 10%;"></td> <td style="width: 10%;"></td> <td style="width: 10%;"></td> <td style="width: 10%;"></td> <td style="width: 10%;"></td> <td style="width: 10%;"></td> </tr> <tr> <td></td> <td></td> <td colspan="8" style="text-align: center;"> <table border="1" style="width: 100%; border-collapse: collapse; text-align: center;"> <tr> <td style="width: 10%;"></td> <td style="width: 10%;"></td> <td style="width: 10%;"></td> <td style="width: 10%;"></td> <td style="width: 10%;"></td> <td style="width: 10%;"></td> <td style="width: 10%;"></td> <td style="width: 10%;"></td> <td style="width: 10%;"></td> <td style="width: 10%;"></td> </tr> <tr> <td></td> <td></td> <td colspan="8" style="text-align: center;"> <table border="1" style="width: 100%; border-collapse: collapse; text-align: center;"> <tr> <td style="width: 10%;"></td> <td style="width: 10%;"></td> <td style="width: 10%;"></td> <td style="width: 10%;"></td> <td style="width: 10%;"></td> <td style="width: 10%;"></td> <td style="width: 10%;"></td> <td style="width: 10%;"></td> <td style="width: 10%;"></td> <td style="width: 10%;"></td> </tr> <tr> <td></td> <td></td> <td colspan="8" style="text-align: center;"> <table border="1" style="width: 100%; border-collapse: collapse; text-align: center;"> <tr> <td style="width: 10%;"></td> <td style="width: 10%;"></td> <td style="width: 10%;"></td> <td style="width: 10%;"></td> <td style="width: 10%;"></td> <td style="width: 10%;"></td> <td style="width: 10%;"></td> <td style="width: 10%;"></td> <td style="width: 10%;"></td> <td style="width: 10%;"></td> </tr> <tr> <td></td> <td></td> <td colspan="8" style="text-align: center;"> <table border="1" style="width: 100%; border-collapse: collapse; text-align: center;"> <tr> <td style="width: 10%;"></td> <td style="width: 10%;"></td> <td style="width: 10%;"></td> <td style="width: 10%;"></td> <td style="width: 10%;"></td> <td style="width: 10%;"></td> <td style="width: 10%;"></td> <td style="width: 10%;"></td> <td style="width: 10%;"></td> <td style="width: 10%;"></td> </tr> <tr> <td></td> <td></td> <td colspan="8" style="text-align: center;"> <table border="1" style="width: 100%; border-collapse: collapse; text-align: center;"> <tr> <td style="width: 10%;"></td> <td style="width: 10%;"></td> <td style="width: 10%;"></td> <td style="width: 10%;"></td> <td style="width: 10%;"></td> <td style="width: 10%;"></td> <td style="width: 10%;"></td> <td style="width: 10%;"></td> <td style="width: 10%;"></td> <td style="width: 10%;"></td> </tr> <tr> <td></td> <td></td> <td colspan="8" style="text-align: center;"> <table border="1" style="width: 100%; border-collapse: collapse; text-align: center;"> <tr> <td style="width: 10%;"></td> <td style="width: 10%;"></td> <td style="width: 10%;"></td> <td style="width: 10%;"></td> <td style="width: 10%;"></td> <td style="width: 10%;"></td> <td style="width: 10%;"></td> <td style="width: 10%;"></td> <td style="width: 10%;"></td> <td style="width: 10%;"></td> </tr> <tr> <td></td> <td></td> <td colspan="8" style="text-align: center;"> <table border="1" style="width: 100%; border-collapse: collapse; text-align: center;"> <tr> <td style="width: 10%;"></td> <td style="width: 10%;"></td> <td style="width: 10%;"></td> <td style="width: 10%;"></td> <td style="width: 10%;"></td> <td style="width: 10%;"></td> <td style="width: 10%;"></td> <td style="width: 10%;"></td> <td style="width: 10%;"></td> <td style="width: 10%;"></td> </tr> <tr> <td></td> <td></td> <td colspan="8" style="text-align: center;"> <table border="1" style="width: 100%; border-collapse: collapse; text-align: center;"> <tr> <td style="width: 10%;"></td> <td style="width: 10%;"></td> <td style="width: 10%;"></td> <td style="width: 10%;"></td> <td style="width: 10%;"></td> <td style="width: 10%;"></td> <td style="width: 10%;"></td> <td style="width: 10%;"></td> <td style="width: 10%;"></td> <td style="width: 10%;"></td> </tr> <tr> <td></td> <td></td> <td colspan="8" style="text-align: center;"> <table border="1" style="width: 100%; border-collapse: collapse; text-align: center;"> <tr> <td style="width: 10%;"></td> <td style="width: 10%;"></td> <td style="width: 10%;"></td> <td style="width: 10%;"></td> <td style="width: 10%;"></td> <td style="width: 10%;"></td> <td style="width: 10%;"></td> <td style="width: 10%;"></td> <td style="width: 10%;"></td> <td style="width: 10%;"></td> </tr> <tr> <td></td> <td></td> <td colspan="8" style="text-align: center;"> <table border="1" style="width: 100%; border-collapse: collapse; text-align: center;"> <tr> <td style="width: 10%;"></td> <td style="width: 10%;"></td> <td style="width: 10%;"></td> <td style="width: 10%;"></td> <td style="width: 10%;"></td> <td style="width: 10%;"></td> <td style="width: 10%;"></td> <td style="width: 10%;"></td> <td style="width: 10%;"></td> <td style="width: 10%;"></td> </tr> <tr> <td></td> <td></td> <td colspan="8" style="text-align: center;"> <table border="1" style="width: 100%; border-collapse: collapse; text-align: center;"> <tr> <td style="width: 10%;"></td> <td style="width: 10%;"></td> <td style="width: 10%;"></td> <td style="width: 10%;"></td> <td style="width: 10%;"></td> <td style="width: 10%;"></td> <td style="width: 10%;"></td> <td style="width: 10%;"></td> <td style="width: 10%;"></td> <td style="width: 10%;"></td> </tr> <tr> <td></td> <td></td> <td colspan="8" style="text-align: center;"> <table border="1" style="width: 100%; border-collapse: collapse; text-align: center;"> <tr> <td style="width: 10%;"></td> <td style="width: 10%;"></td> <td style="width: 10%;"></td> <td style="width: 10%;"></td> <td style="width: 10%;"></td> <td style="width: 10%;"></td> <td style="width: 10%;"></td> <td
style="width: 10%;"></td> <td style="width: 10%;"></td> <td style="width: 10%;"></td> </tr> <tr> <td></td> <td></td> <td colspan="8" style="text-align: center;"> <table border="1" style="width: 100%; border-collapse: collapse; text-align: center;"> <tr> <td style="width: 10%;"></td> <td style="width: 10%;"></td> <td style="width: 10%;"></td> <td style="width: 10%;"></td> <td style="width: 10%;"></td> <td style="width: 10%;"></td> <td style="width: 10%;"></td> <td style="width: 10%;"></td> <td style="width: 10%;"></td> <td style="width: 10%;"></td> </tr> <tr> <td></td> <td></td> <td colspan="8" style="text-align: center;"> <table border="1" style="width: 100%; border-collapse: collapse; text-align: center;"> <tr> <td style="width: 10%;"></td> <td style="width: 10%;"></td> <td style="width: 10%;"></td> <td style="width: 10%;"></td> <td style="width: 10%;"></td> <td style="width: 10%;"></td> <td style="width: 10%;"></td> <td style="width: 10%;"></td> <td style="width: 10%;"></td> <td style="width: 10%;"></td> </tr> <tr> <td></td> <td></td> <td colspan="8" style="text-align: center;"> <table border="1" style="width: 100%; border-collapse: collapse; text-align: center;"> <tr> <td style="width: 10%;"></td> <td style="width: 10%;"></td> <td style="width: 10%;"></td> <td style="width: 10%;"></td> <td style="width: 10%;"></td> <td style="width: 10%;"></td> <td style="width: 10%;"></td> <td style="width: 10%;"></td> <td style="width: 10%;"></td> <td style="width: 10%;"></td> </tr> <tr> <td></td> <td></td> <td colspan="8" style="text-align: center;"> <table border="1" style="width: 100%; border-collapse: collapse; text-align: center;"> <tr> <td style="width: 10%;"></td> <td style="width: 10%;"></td> <td style="width: 10%;"></td> <td style="width: 10%;"></td> <td style="width: 10%;"></td> <td style="width: 10%;"></td> <td style="width: 10%;"></td> <td style="width: 10%;"></td> <td style="width: 10%;"></td> <td style="width: 10%;"></td> </tr> <tr> <td></td> <td></td> <td colspan="8" style="text-align: center;"> <table border="1" style="width: 100%; border-collapse: collapse; text-align: center;"> <tr> <td style="width: 10%;"></td> <td style="width: 10%;"></td> <td style="width: 10%;"></td> <td style="width: 10%;"></td> <td style="width: 10%;"></td> <td style="width: 10%;"></td> <td style="width: 10%;"></td> <td style="width: 10%;"></td> <td style="width: 10%;"></td> <td style="width: 10%;"></td> </tr> <tr> <td></td> <td></td> <td colspan="8" style="text-align: center;"> <table border="1" style="width: 100%; border-collapse: collapse; text-align: center;"> <tr> <td style="width: 10%;"></td> <td style="width: 10%;"></td> <td style="width: 10%;"></td> <td style="width: 10%;"></td> <td style="width: 10%;"></td> <td style="width: 10%;"></td> <td style="width: 10%;"></td> <td style="width: 10%;"></td> <td style="width: 10%;"></td> <td style="width: 10%;"></td> </tr> <tr> <td></td> <td></td> <td colspan="8" style="text-align: center;"> <table border="1" style="width: 100%; border-collapse: collapse; text-align: center;"> <tr> <td style="width: 10%;"></td> <td style="width: 10%;"></td> <td style="width: 10%;"></td> <td style="width: 10%;"></td> <td style="width: 10%;"></td> <td style="width: 10%;"></td> <td style="width: 10%;"></td> <td style="width: 10%;"></td> <td style="width: 10%;"></td> <td style="width: 10%;"></td> </tr> <tr> <td></td> <td></td> <td colspan="8" style="text-align: center;"> <table border="1" style="width: 100%; border-collapse: collapse; text-align: center;"> <tr> <td style="width: 10%;"></td> <td style="width: 10%;"></td> <td style="width: 10%;"></td> <td style="width: 10%;"></td> <td style="width: 10%;"></td> <td style="width: 10%;"></td> <td style="width: 10%;"></td> <td style="width: 10%;"></td> <td style="width: 10%;"></td> <td style="width: 10%;"></td> </tr> <tr> <td></td> <td></td> <td colspan="8" style="text-align: center;"> <table border="1" style="width: 100%; border-collapse: collapse; text-align: center;"> <tr> <td style="width: 10%;"></td> <td style="width: 10%;"></td> <td style="width: 10%;"></td> <td style="width: 10%;"></td> <td style="width: 10%;"></td> <td style="width: 10%;"></td> <td style="width: 10%;"></td> <td style="width: 10%;"></td> <td style="width: 10%;"></td> <td style="width: 10%;"></td> </tr> <tr> <td></td> <td></td> <td colspan="8" style="text-align: center;"> <table border="1" style="width: 100%; border-collapse: collapse; text-align: center;"> <tr> <td style="width: 10%;"></td> <td style="width: 10%;"></td> <td style="width: 10%;"></td> <td style="width: 10%;"></td> <td style="width: 10%;"></td> <td style="width: 10%;"></td> <td style="width: 10%;"></td> <td style="width: 10%;"></td> <td style="width: 10%;"></td> <td style="width: 10%;"></td> </tr> <tr> <td></td> <td></td> <td colspan="8" style="text-align: center;"> <table border="1" style="width: 100%; border-collapse: collapse; text-align: center;"> <tr> <td style="width: 10%;"></td> <td style="width: 10%;"></td> <td style="width: 10%;"></td> <td style="width: 10%;"></td> <td style="width: 10%;"></td> <td style="width: 10%;"></td> <td style="width: 10%;"></td> <td style="width: 10%;"></td> <td style="width: 10%;"></td> <td style="width: 10%;"></td> </tr> <tr> <td></td> <td></td> <td colspan="8" style="text-align: center;"> <table border="1" style="width: 100%; border-collapse: collapse; text-align: center;"> <tr> <td style="width: 10%;"></td> <td style="width: 10%;"></td> <td style="width: 10%;"></td> <td style="width: 10%;"></td> <td style="width: 10%;"></td> <td style="width: 10%;"></td> <td style="width: 10%;"></td> <td style="width: 10%;"></td> <td style="width: 10%;"></td> <td style="width: 10%;"></td> </tr> <tr> <td></td> <td></td> <td colspan="8" style="text-align: center;"> <table border="1" style="width: 100%; border-collapse: collapse; text-align: center;"> <tr> <td style="width: 10%;"></td> <td style="width: 10%;"></td> <td style="width: 10%;"></td> <td style="width: 10%;"></td> <td style="width: 10%;"></td> <td style="width: 10%;"></td> <td style="width: 10%;"></td> <td style="width: 10%;"></td> <td style="width: 10%;"></td> <td style="width: 10%;"></td> </tr> <tr> <td></td> <td></td> <td colspan="8" style="text-align: center;"> <table border="1" style="width: 100%; border-collapse: collapse; text-align: center;"> <tr> <td style="width: 10%;"></td> <td style="width: 10%;"></td> <td style="width: 10%;"></td> <td style="width: 10%;"></td> <td style="width: 10%;"></td> <td style="width: 10%;"></td> <td style="width: 10%;"></td> <td style="width: 10%;"></td> <td style="width: 10%;"></td> <td style="width: 10%;"></td> </tr> <tr> <td></td> <td></td> <td colspan="8" style="text-align: center;"> <table border="1" style="width: 100%; border-collapse: collapse; text-align: center;"> <tr> <td style="width: 10%;"></td> <td style="width: 10%;"></td> <td style="width: 10%;"></td> <td style="width: 10%;"></td> <td style="width: 10%;"></td> <td style="width: 10%;"></td> <td style="width: 10%;"></td> <td style="width: 10%;"></td> <td style="width: 10%;"></td> <td style="width: 10%;"></td> </tr> <tr> <td></td> <td></td> <td colspan="8" style="text-align: center;"> <table border="1" style="width: 100%; border-collapse: collapse; text-align: center;"> <tr> <td style="width: 10%;"></td> <td style="width: 10%;"></td> <td style="width: 10%;"></td> <td style="width: 10%;"></td> <td style="width: 10%;"></td> <td style="width: 10%;"></td> <td style="width: 10%;"></td> <td style="width: 10%;"></td> <td style="width: 10%;"></td> <td style="width: 10%;"></td> </tr> <tr> <td></td> <td></td> <td colspan="8" style="text-align: center;"> <table border="1" style="width: 100%; border-collapse: collapse; text-align: center;"> <tr> <td style="width: 10%;"></td> <td style="width: 10%;"></td> <td style="width: 10%;"></td> <td style="width: 10%;"></td> <td style="width: 10%;"></td> <td style="width: 10%;"></td> <td style="width: 10%;"></td> <td style="width: 10%;"></td> <td style="width: 10%;"></td> <td style="width: 10%;"></td> </tr> <tr> <td></td> <td></td> <td colspan="8" style="text-align: center;"> <table border="1" style="width: 100%; border-collapse: collapse; text-align: center;"> <tr> <td style="width: 10%;"></td> <td style="width: 10%;"></td> <td style="width: 10%;"></td> <td style="width: 10%;"></td> <td style="width: 10%;"></td> <td style="width: 10%;"></td> <td style="width: 10%;"></td> <td style="width: 10%;"></td> <td style="width: 10%;"></td> <td style="width: 10%;"></td> </tr> <tr> <td></td> <td></td> <td colspan="8" style="text-align: center;"> <table border="1" style="width: 100%; border-collapse: collapse; text-align: center;"> <tr> <td style="width: 10%;"></td> <td style="width: 10%;"></td> <td style="width: 10%;"></td> <td style="width: 10%;"></td> <td style="width: 10%;"></td> <td style="width: 10%;"></td> <td style="width: 10%;"></td> <td style="width: 10%;"></td> <td style="width: 10%;"></td> <td style="width: 10%;"></td> </tr> <tr> <td></td> <td></td> <td colspan="8" style="text-align: center;"> <table border="1" style="width: 100%; border-collapse: collapse; text-align: center;"> <tr> <td style="width: 10%;"></td> <td style="width: 10%;"></td> <td style="width: 10%;"></td> <td style="width: 10%;"></td> <td style="width: 10%;"></td> <td style="width: 10%;"></td> <td style="width: 10%;"></td> <td style="width: 10%;"></td> <td style="width: 10%;"></td> <td style="width: 10%;"></td> </tr> <tr> <td></td> <td></td> <td colspan="8" style="text-align: center;"> <table border="1" style="width: 100%; border-collapse: collapse; text-align: center;"> <tr> <td style="width: 10%;"></td> <td style="width: 10%;"></td> <td style="width: 10%;"></td> <td style="width: 10%;"></td> <td style="width: 10%;"></td> <td style="width: 10%;"></td> <td style="width: 10%;"></td> <td style="width: 10%;"></td> <td style="width: 10%;"></td> <td style="width: 10%;"></td> </tr> <tr> <td></td> <td></td> <td colspan="8" style="text-align: center;"> <table
border="1" style="width: 100%; border-collapse: collapse; text-align: center;"> <tr> </tr></table></td></tr></table></td></tr></table></td></tr></table></td></tr></table></td></tr></table></td></tr></table></td></tr></table></td></tr></table></td></tr></table></td></tr></table></td></tr></table></td></tr></table></td></tr></table></td></tr></table></td></tr></table></td></tr></table></td></tr></table></td></tr></table></td></tr></table></td></tr></table></td></tr></table></td></tr></table></td></tr></table></td></tr></table></td></tr></table></td></tr></table></td></tr></table></td></tr></table></td></tr></table></td></tr></table></td></tr></table></td></tr></table></td></tr></table></td></tr></table></td></tr></table> | | | | | | | | | | | | | | | | | | | | <table border="1" style="width: 100%; border-collapse: collapse; text-align: center;"> <tr> <td style="width: 10%;"></td> <td style="width: 10%;"></td> <td style="width: 10%;"></td> <td style="width: 10%;"></td> <td style="width: 10%;"></td> <td style="width: 10%;"></td> <td style="width: 10%;"></td> <td style="width: 10%;"></td> <td style="width: 10%;"></td> <td style="width: 10%;"></td> </tr> <tr> <td></td> <td></td> <td colspan="8" style="text-align: center;"> <table border="1" style="width: 100%; border-collapse: collapse; text-align: center;"> <tr> <td style="width: 10%;"></td> <td style="width: 10%;"></td> <td style="width: 10%;"></td> <td style="width: 10%;"></td> <td style="width: 10%;"></td> <td style="width: 10%;"></td> <td style="width: 10%;"></td> <td style="width: 10%;"></td> <td style="width: 10%;"></td> <td style="width: 10%;"></td> </tr> <tr> <td></td> <td></td> <td colspan="8" style="text-align: center;"> <table
border="1" style="width: 100%; border-collapse: collapse; text-align: center;"> <tr> <td style="width: 10%;"></td> <td style="width: 10%;"></td> <td style="width: 10%;"></td> <td style="width: 10%;"></td> <td style="width: 10%;"></td> <td style="width: 10%;"></td> <td style="width: 10%;"></td> <td style="width: 10%;"></td> <td style="width: 10%;"></td> <td style="width: 10%;"></td> </tr> <tr> <td></td> <td></td> <td colspan="8" style="text-align: center;"> <table border="1" style="width: 100%; border-collapse: collapse; text-align: center;"> <tr> <td style="width: 10%;"></td> <td style="width: 10%;"></td> <td style="width: 10%;"></td> <td style="width: 10%;"></td> <td style="width: 10%;"></td> <td style="width: 10%;"></td> <td style="width: 10%;"></td> <td style="width: 10%;"></td> <td style="width: 10%;"></td> <td style="width: 10%;"></td> </tr> <tr> <td></td> <td></td> <td colspan="8" style="text-align: center;"> <table border="1" style="width: 100%; border-collapse: collapse; text-align: center;"> <tr> <td style="width: 10%;"></td> <td style="width: 10%;"></td> <td style="width: 10%;"></td> <td style="width: 10%;"></td> <td style="width: 10%;"></td> <td style="width: 10%;"></td> <td style="width: 10%;"></td> <td style="width: 10%;"></td> <td style="width: 10%;"></td> <td style="width: 10%;"></td> </tr> <tr> <td></td> <td></td> <td colspan="8" style="text-align: center;"> <table border="1" style="width: 100%; border-collapse: collapse; text-align: center;"> <tr> <td style="width: 10%;"></td> <td style="width: 10%;"></td> <td style="width: 10%;"></td> <td style="width: 10%;"></td> <td style="width: 10%;"></td> <td style="width: 10%;"></td> <td style="width: 10%;"></td> <td style="width: 10%;"></td> <td style="width: 10%;"></td> <td style="width: 10%;"></td> </tr> <tr> <td></td> <td></td> <td colspan="8" style="text-align: center;"> <table border="1" style="width: 100%; border-collapse: collapse; text-align: center;"> <tr> <td style="width: 10%;"></td> <td style="width: 10%;"></td> <td style="width: 10%;"></td> <td style="width: 10%;"></td> <td style="width: 10%;"></td> <td style="width: 10%;"></td> <td style="width: 10%;"></td> <td style="width: 10%;"></td> <td style="width: 10%;"></td> <td style="width: 10%;"></td> </tr> <tr> <td></td> <td></td> <td colspan="8" style="text-align: center;"> <table border="1" style="width: 100%; border-collapse: collapse; text-align: center;"> <tr> <td style="width: 10%;"></td> <td style="width: 10%;"></td> <td style="width: 10%;"></td> <td style="width: 10%;"></td> <td style="width: 10%;"></td> <td style="width: 10%;"></td> <td style="width: 10%;"></td> <td style="width: 10%;"></td> <td style="width: 10%;"></td> <td style="width: 10%;"></td> </tr> <tr> <td></td> <td></td> <td colspan="8" style="text-align: center;"> <table border="1" style="width: 100%; border-collapse: collapse; text-align: center;"> <tr> <td style="width: 10%;"></td> <td style="width: 10%;"></td> <td style="width: 10%;"></td> <td style="width: 10%;"></td> <td style="width: 10%;"></td> <td style="width: 10%;"></td> <td style="width: 10%;"></td> <td style="width: 10%;"></td> <td style="width: 10%;"></td> <td style="width: 10%;"></td> </tr> <tr> <td></td> <td></td> <td colspan="8" style="text-align: center;"> <table border="1" style="width: 100%; border-collapse: collapse; text-align: center;"> <tr> <td style="width: 10%;"></td> <td style="width: 10%;"></td> <td style="width: 10%;"></td> <td style="width: 10%;"></td> <td style="width: 10%;"></td> <td style="width: 10%;"></td> <td style="width: 10%;"></td> <td style="width: 10%;"></td> <td style="width: 10%;"></td> <td style="width: 10%;"></td> </tr> <tr> <td></td> <td></td> <td colspan="8" style="text-align: center;"> <table border="1" style="width: 100%; border-collapse: collapse; text-align: center;"> <tr> <td style="width: 10%;"></td> <td style="width: 10%;"></td> <td style="width: 10%;"></td> <td style="width: 10%;"></td> <td style="width: 10%;"></td> <td style="width: 10%;"></td> <td style="width: 10%;"></td> <td style="width: 10%;"></td> <td style="width: 10%;"></td> <td style="width: 10%;"></td> </tr> <tr> <td></td> <td></td> <td colspan="8" style="text-align: center;"> <table border="1" style="width: 100%; border-collapse: collapse; text-align: center;"> <tr> <td style="width: 10%;"></td> <td style="width: 10%;"></td> <td style="width: 10%;"></td> <td style="width: 10%;"></td> <td style="width: 10%;"></td> <td style="width: 10%;"></td> <td style="width: 10%;"></td> <td style="width: 10%;"></td> <td style="width: 10%;"></td> <td style="width: 10%;"></td> </tr> <tr> <td></td> <td></td> <td colspan="8" style="text-align: center;"> <table border="1" style="width: 100%; border-collapse: collapse; text-align: center;"> <tr> <td style="width: 10%;"></td> <td style="width: 10%;"></td> <td style="width: 10%;"></td> <td style="width: 10%;"></td> <td style="width: 10%;"></td> <td style="width: 10%;"></td> <td style="width: 10%;"></td> <td style="width: 10%;"></td> <td style="width: 10%;"></td> <td style="width: 10%;"></td> </tr> <tr> <td></td> <td></td> <td colspan="8" style="text-align: center;"> <table border="1" style="width: 100%; border-collapse: collapse; text-align: center;"> <tr> <td style="width: 10%;"></td> <td style="width: 10%;"></td> <td style="width: 10%;"></td> <td style="width: 10%;"></td> <td style="width: 10%;"></td> <td style="width: 10%;"></td> <td style="width: 10%;"></td> <td style="width: 10%;"></td> <td style="width: 10%;"></td> <td style="width: 10%;"></td> </tr> <tr> <td></td> <td></td> <td colspan="8" style="text-align: center;"> <table border="1" style="width: 100%; border-collapse: collapse; text-align: center;"> <tr> <td style="width: 10%;"></td> <td style="width: 10%;"></td> <td style="width: 10%;"></td> <td style="width: 10%;"></td> <td style="width: 10%;"></td> <td style="width: 10%;"></td> <td style="width: 10%;"></td> <td style="width: 10%;"></td> <td style="width: 10%;"></td> <td style="width: 10%;"></td> </tr> <tr> <td></td> <td></td> <td colspan="8" style="text-align: center;"> <table border="1" style="width: 100%; border-collapse: collapse; text-align: center;"> <tr> <td style="width: 10%;"></td> <td style="width: 10%;"></td> <td style="width: 10%;"></td> <td style="width: 10%;"></td> <td style="width: 10%;"></td> <td style="width: 10%;"></td> <td style="width: 10%;"></td> <td style="width: 10%;"></td> <td style="width: 10%;"></td> <td style="width: 10%;"></td> </tr> <tr> <td></td> <td></td> <td colspan="8" style="text-align: center;"> <table border="1" style="width: 100%; border-collapse: collapse; text-align: center;"> <tr> <td style="width: 10%;"></td> <td style="width: 10%;"></td> <td style="width: 10%;"></td> <td style="width: 10%;"></td> <td style="width: 10%;"></td> <td style="width: 10%;"></td> <td style="width: 10%;"></td> <td style="width: 10%;"></td> <td style="width: 10%;"></td> <td style="width: 10%;"></td> </tr> <tr> <td></td> <td></td> <td colspan="8" style="text-align: center;"> <table border="1" style="width: 100%; border-collapse: collapse; text-align: center;"> <tr> <td style="width: 10%;"></td> <td style="width: 10%;"></td> <td style="width: 10%;"></td> <td style="width: 10%;"></td> <td style="width: 10%;"></td> <td style="width: 10%;"></td> <td style="width: 10%;"></td> <td style="width: 10%;"></td> <td style="width: 10%;"></td> <td style="width: 10%;"></td> </tr> <tr> <td></td> <td></td> <td colspan="8" style="text-align: center;"> <table border="1" style="width: 100%; border-collapse: collapse; text-align: center;"> <tr> <td style="width: 10%;"></td> <td style="width: 10%;"></td> <td style="width: 10%;"></td> <td style="width: 10%;"></td> <td style="width: 10%;"></td> <td style="width: 10%;"></td> <td style="width: 10%;"></td> <td style="width: 10%;"></td> <td style="width: 10%;"></td> <td style="width: 10%;"></td> </tr> <tr> <td></td> <td></td> <td colspan="8" style="text-align: center;"> <table border="1" style="width: 100%; border-collapse: collapse; text-align: center;"> <tr> <td style="width: 10%;"></td> <td style="width: 10%;"></td> <td style="width: 10%;"></td> <td style="width: 10%;"></td> <td style="width: 10%;"></td> <td style="width: 10%;"></td> <td style="width: 10%;"></td> <td style="width: 10%;"></td> <td style="width: 10%;"></td> <td style="width: 10%;"></td> </tr> <tr> <td></td> <td></td> <td colspan="8" style="text-align: center;"> <table border="1" style="width: 100%; border-collapse: collapse; text-align: center;"> <tr> <td style="width: 10%;"></td> <td style="width: 10%;"></td> <td style="width: 10%;"></td> <td style="width: 10%;"></td> <td style="width: 10%;"></td> <td style="width: 10%;"></td> <td style="width: 10%;"></td> <td style="width: 10%;"></td> <td style="width: 10%;"></td> <td style="width: 10%;"></td> </tr> <tr> <td></td> <td></td> <td colspan="8" style="text-align: center;"> <table border="1" style="width: 100%; border-collapse: collapse; text-align: center;"> <tr> <td style="width: 10%;"></td> <td style="width: 10%;"></td> <td style="width: 10%;"></td> <td style="width: 10%;"></td> <td style="width: 10%;"></td> <td style="width: 10%;"></td> <td style="width: 10%;"></td> <td style="width: 10%;"></td> <td style="width: 10%;"></td> <td style="width: 10%;"></td> </tr> <tr> <td></td> <td></td> <td colspan="8" style="text-align: center;"> <table border="1" style="width: 100%; border-collapse: collapse; text-align: center;"> <tr> <td style="width: 10%;"></td> <td style="width: 10%;"></td> <td style="width: 10%;"></td> <td style="width: 10%;"></td> <td style="width: 10%;"></td> <td style="width: 10%;"></td> <td style="width: 10%;"></td> <td style="width: 10%;"></td> <td style="width: 10%;"></td> <td style="width: 10%;"></td> </tr> <tr> <td></td> <td></td> <td colspan="8" style="text-align: center;"> <table border="1" style="width: 100%; border-collapse: collapse; text-align: center;"> <tr> <td style="width: 10%;"></td> <td style="width: 10%;"></td> <td style="width:
10%;"></td> <td style="width: 10%;"></td> <td style="width: 10%;"></td> <td style="width: 10%;"></td> <td style="width: 10%;"></td> <td style="width: 10%;"></td> <td style="width: 10%;"></td> <td style="width: 10%;"></td> </tr> <tr> <td></td> <td></td> <td colspan="8" style="text-align: center;"> <table border="1" style="width: 100%; border-collapse: collapse; text-align: center;"> <tr> <td style="width: 10%;"></td> <td style="width: 10%;"></td> <td style="width: 10%;"></td> <td style="width: 10%;"></td> <td style="width: 10%;"></td> <td style="width: 10%;"></td> <td style="width: 10%;"></td> <td style="width: 10%;"></td> <td style="width: 10%;"></td> <td style="width: 10%;"></td> </tr> <tr> <td></td> <td></td> <td colspan="8" style="text-align: center;"> <table border="1" style="width: 100%; border-collapse: collapse; text-align: center;"> <tr> <td style="width: 10%;"></td> <td style="width: 10%;"></td> <td style="width: 10%;"></td> <td style="width: 10%;"></td> <td style="width: 10%;"></td> <td style="width: 10%;"></td> <td style="width: 10%;"></td> <td style="width: 10%;"></td> <td style="width: 10%;"></td> <td style="width: 10%;"></td> </tr> <tr> <td></td> <td></td> <td colspan="8" style="text-align: center;"> <table border="1" style="width: 100%; border-collapse: collapse; text-align: center;"> <tr> <td style="width: 10%;"></td> <td style="width: 10%;"></td> <td style="width: 10%;"></td> <td style="width: 10%;"></td> <td style="width: 10%;"></td> <td style="width: 10%;"></td> <td style="width: 10%;"></td> <td style="width: 10%;"></td> <td style="width: 10%;"></td> <td style="width: 10%;"></td> </tr> <tr> <td></td> <td></td> <td colspan="8" style="text-align: center;"> <table border="1" style="width: 100%; border-collapse: collapse; text-align: center;"> <tr> <td style="width: 10%;"></td> <td style="width: 10%;"></td> <td style="width: 10%;"></td> <td style="width: 10%;"></td> <td style="width: 10%;"></td> <td style="width: 10%;"></td> <td style="width: 10%;"></td> <td style="width: 10%;"></td> <td style="width: 10%;"></td> <td style="width: 10%;"></td> </tr> <tr> <td></td> <td></td> <td colspan="8" style="text-align: center;"> <table border="1" style="width: 100%; border-collapse: collapse; text-align: center;"> <tr> <td style="width: 10%;"></td> <td style="width: 10%;"></td> <td style="width: 10%;"></td> <td style="width: 10%;"></td> <td style="width: 10%;"></td> <td style="width: 10%;"></td> <td style="width: 10%;"></td> <td style="width: 10%;"></td> <td style="width: 10%;"></td> <td style="width: 10%;"></td> </tr> <tr> <td></td> <td></td> <td colspan="8" style="text-align: center;"> <table border="1" style="width: 100%; border-collapse: collapse; text-align: center;"> <tr> <td style="width: 10%;"></td> <td style="width: 10%;"></td> <td style="width: 10%;"></td> <td style="width: 10%;"></td> <td style="width: 10%;"></td> <td style="width: 10%;"></td> <td style="width: 10%;"></td> <td style="width: 10%;"></td> <td style="width: 10%;"></td> <td style="width: 10%;"></td> </tr> <tr> <td></td> <td></td> <td colspan="8" style="text-align: center;"> <table border="1" style="width: 100%; border-collapse: collapse; text-align: center;"> <tr> <td style="width: 10%;"></td> <td style="width: 10%;"></td> <td style="width: 10%;"></td> <td style="width: 10%;"></td> <td style="width: 10%;"></td> <td style="width: 10%;"></td> <td style="width: 10%;"></td> <td style="width: 10%;"></td> <td style="width: 10%;"></td> <td style="width: 10%;"></td> </tr> <tr> <td></td> <td></td> <td colspan="8" style="text-align: center;"> <table border="1" style="width: 100%; border-collapse: collapse; text-align: center;"> <tr> <td style="width: 10%;"></td> <td style="width: 10%;"></td> <td style="width: 10%;"></td> <td style="width: 10%;"></td> <td style="width: 10%;"></td> <td style="width: 10%;"></td> <td style="width: 10%;"></td> <td style="width: 10%;"></td> <td style="width: 10%;"></td> <td style="width: 10%;"></td> </tr> <tr> <td></td> <td></td> <td colspan="8" style="text-align: center;"> <table border="1" style="width: 100%; border-collapse: collapse; text-align: center;"> <tr> <td style="width: 10%;"></td> <td style="width: 10%;"></td> <td style="width: 10%;"></td> <td style="width: 10%;"></td> <td style="width: 10%;"></td> <td style="width: 10%;"></td> <td style="width: 10%;"></td> <td style="width: 10%;"></td> <td style="width: 10%;"></td> <td style="width: 10%;"></td> </tr> <tr> <td></td> <td></td> <td colspan="8" style="text-align: center;"> <table border="1" style="width: 100%; border-collapse: collapse; text-align: center;"> <tr> <td style="width: 10%;"></td> <td style="width: 10%;"></td> <td style="width: 10%;"></td> <td style="width: 10%;"></td> <td style="width: 10%;"></td> <td style="width: 10%;"></td> <td style="width: 10%;"></td> <td style="width: 10%;"></td> <td style="width: 10%;"></td> <td style="width: 10%;"></td> </tr> <tr> <td></td> <td></td> <td colspan="8" style="text-align: center;"> <table border="1" style="width: 100%; border-collapse: collapse; text-align: center;"> <tr> </tr></table></td></tr></table></td></tr></table></td></tr></table></td></tr></table></td></tr></table></td></tr></table></td></tr></table></td></tr></table></td></tr></table></td></tr></table></td></tr></table></td></tr></table></td></tr></table></td></tr></table></td></tr></table></td></tr></table></td></tr></table></td></tr></table></td></tr></table></td></tr></table></td></tr></table></td></tr></table></td></tr></table></td></tr></table></td></tr></table></td></tr></table></td></tr></table></td></tr></table></td></tr></table></td></tr></table></td></tr></table></td></tr></table></td></tr></table></td></tr></table>
 | | | | | | | | | | | | | | | | | | | | <table border="1" style="width: 100%; border-collapse: collapse; text-align: center;"> <tr> <td style="width: 10%;"></td> <td style="width: 10%;"></td> <td style="width: 10%;"></td> <td style="width: 10%;"></td> <td style="width: 10%;"></td> <td style="width: 10%;"></td> <td style="width: 10%;"></td> <td style="width: 10%;"></td> <td style="width: 10%;"></td> <td style="width: 10%;"></td> </tr> <tr> <td></td> <td></td> <td colspan="8" style="text-align: center;"> <table border="1" style="width: 100%; border-collapse: collapse; text-align: center;"> <tr> <td style="width: 10%;"></td> <td style="width: 10%;"></td> <td style="width: 10%;"></td> <td style="width: 10%;"></td> <td style="width: 10%;"></td> <td style="width: 10%;"></td> <td style="width: 10%;"></td> <td style="width: 10%;"></td> <td style="width: 10%;"></td> <td style="width: 10%;"></td> </tr> <tr> <td></td> <td></td> <td colspan="8" style="text-align: center;"> <table border="1" style="width: 100%; border-collapse: collapse; text-align: center;"> <tr> <td style="width: 10%;"></td> <td style="width: 10%;"></td> <td style="width: 10%;"></td> <td style="width: 10%;"></td> <td style="width: 10%;"></td> <td style="width: 10%;"></td> <td style="width: 10%;"></td> <td style="width: 10%;"></td> <td style="width: 10%;"></td> <td style="width: 10%;"></td> </tr> <tr> <td></td> <td></td> <td colspan="8" style="text-align: center;"> <table border="1" style="width: 100%; border-collapse: collapse; text-align: center;"> <tr> <td style="width: 10%;"></td> <td style="width: 10%;"></td> <td style="width: 10%;"></td> <td style="width: 10%;"></td> <td style="width: 10%;"></td> <td style="width: 10%;"></td> <td style="width: 10%;"></td> <td style="width: 10%;"></td> <td style="width: 10%;"></td> <td style="width: 10%;"></td> </tr> <tr> <td></td> <td></td> <td colspan="8" style="text-align: center;"> <table border="1" style="width: 100%; border-collapse: collapse; text-align: center;"> <tr> <td style="width: 10%;"></td> <td style="width: 10%;"></td> <td style="width: 10%;"></td> <td style="width: 10%;"></td> <td style="width: 10%;"></td> <td style="width: 10%;"></td> <td style="width: 10%;"></td> <td style="width: 10%;"></td> <td style="width: 10%;"></td> <td style="width: 10%;"></td> </tr> <tr> <td></td> <td></td> <td colspan="8" style="text-align: center;"> <table border="1" style="width: 100%; border-collapse: collapse; text-align: center;"> <tr> <td style="width: 10%;"></td> <td style="width: 10%;"></td> <td style="width: 10%;"></td> <td style="width: 10%;"></td> <td style="width: 10%;"></td> <td style="width: 10%;"></td> <td style="width: 10%;"></td> <td style="width: 10%;"></td> <td style="width: 10%;"></td> <td style="width: 10%;"></td> </tr> <tr> <td></td> <td></td> <td colspan="8" style="text-align: center;"> <table border="1" style="width: 100%; border-collapse: collapse; text-align: center;"> <tr> <td style="width: 10%;"></td> <td style="width: 10%;"></td> <td style="width: 10%;"></td> <td style="width: 10%;"></td> <td style="width: 10%;"></td> <td style="width: 10%;"></td> <td style="width: 10%;"></td> <td style="width: 10%;"></td> <td style="width: 10%;"></td> <td style="width: 10%;"></td> </tr> <tr> <td></td> <td></td> <td colspan="8" style="text-align: center;"> <table border="1" style="width: 100%; border-collapse: collapse; text-align: center;"> <tr> <td style="width: 10%;"></td> <td style="width: 10%;"></td> <td style="width: 10%;"></td> <td style="width: 10%;"></td> <td style="width: 10%;"></td> <td style="width: 10%;"></td> <td style="width: 10%;"></td> <td style="width: 10%;"></td> <td style="width: 10%;"></td> <td style="width: 10%;"></td> </tr> <tr> <td></td> <td></td> <td colspan="8" style="text-align: center;"> <table border="1" style="width: 100%; border-collapse: collapse; text-align: center;"> <tr> <td style="width: 10%;"></td> <td style="width: 10%;"></td> <td style="width: 10%;"></td> <td style="width: 10%;"></td> <td style="width: 10%;"></td> <td style="width: 10%;"></td> <td style="width: 10%;"></td> <td style="width: 10%;"></td> <td style="width: 10%;"></td> <td style="width: 10%;"></td> </tr> <tr> <td></td> <td></td> <td colspan="8" style="text-align: center;"> <table border="1" style="width: 100%; border-collapse: collapse; text-align: center;"> <tr> <td style="width: 10%;"></td> <td style="width: 10%;"></td> <td style="width: 10%;"></td> <td style="width: 10%;"></td> <td style="width: 10%;"></td> <td style="width: 10%;"></td> <td style="width: 10%;"></td> <td style="width: 10%;"></td> <td style="width: 10%;"></td> <td style="width: 10%;"></td> </tr> <tr> <td></td> <td></td> <td colspan="8" style="text-align: center;"> <table border="1" style="width: 100%; border-collapse: collapse; text-align: center;"> <tr> <td style="width: 10%;"></td> <td style="width: 10%;"></td> <td style="width: 10%;"></td> <td style="width: 10%;"></td> <td style="width: 10%;"></td> <td style="width: 10%;"></td> <td style="width: 10%;"></td> <td style="width: 10%;"></td> <td style="width: 10%;"></td> <td style="width: 10%;"></td> </tr> <tr> <td></td> <td></td> <td colspan="8" style="text-align: center;"> <table border="1" style="width: 100%; border-collapse: collapse; text-align: center;"> <tr> <td style="width: 10%;"></td> <td style="width: 10%;"></td> <td style="width: 10%;"></td> <td style="width: 10%;"></td> <td style="width: 10%;"></td> <td style="width: 10%;"></td> <td style="width: 10%;"></td> <td style="width: 10%;"></td> <td style="width: 10%;"></td> <td style="width: 10%;"></td> </tr> <tr> <td></td> <td></td> <td colspan="8" style="text-align: center;"> <table border="1" style="width: 100%; border-collapse: collapse; text-align: center;"> <tr> <td style="width: 10%;"></td> <td style="width: 10%;"></td> <td style="width: 10%;"></td> <td style="width: 10%;"></td> <td style="width: 10%;"></td> <td style="width: 10%;"></td> <td style="width: 10%;"></td> <td style="width: 10%;"></td> <td style="width: 10%;"></td> <td
style="width: 10%;"></td> </tr> <tr> <td></td> <td></td> <td colspan="8" style="text-align: center;"> <table border="1" style="width: 100%; border-collapse: collapse; text-align: center;"> <tr> <td style="width: 10%;"></td> <td style="width: 10%;"></td> <td style="width: 10%;"></td> <td style="width: 10%;"></td> <td style="width: 10%;"></td> <td style="width: 10%;"></td> <td style="width: 10%;"></td> <td style="width: 10%;"></td> <td style="width: 10%;"></td> <td style="width: 10%;"></td> </tr> <tr> <td></td> <td></td> <td colspan="8" style="text-align: center;"> <table border="1" style="width: 100%; border-collapse: collapse; text-align: center;"> <tr> <td style="width: 10%;"></td> <td style="width: 10%;"></td> <td style="width: 10%;"></td> <td style="width: 10%;"></td> <td style="width: 10%;"></td> <td style="width: 10%;"></td> <td style="width: 10%;"></td> <td style="width: 10%;"></td> <td style="width: 10%;"></td> <td style="width: 10%;"></td> </tr> <tr> <td></td> <td></td> <td colspan="8" style="text-align: center;"> <table border="1" style="width: 100%; border-collapse: collapse; text-align: center;"> <tr> <td style="width: 10%;"></td> <td style="width: 10%;"></td> <td style="width: 10%;"></td> <td style="width: 10%;"></td> <td style="width: 10%;"></td> <td style="width: 10%;"></td> <td style="width: 10%;"></td> <td style="width: 10%;"></td> <td style="width: 10%;"></td> <td style="width: 10%;"></td> </tr> <tr> <td></td> <td></td> <td colspan="8" style="text-align: center;"> <table border="1" style="width: 100%; border-collapse: collapse; text-align: center;"> <tr> <td style="width: 10%;"></td> <td style="width: 10%;"></td> <td style="width: 10%;"></td> <td style="width: 10%;"></td> <td style="width: 10%;"></td> <td style="width: 10%;"></td> <td style="width: 10%;"></td> <td style="width: 10%;"></td> <td style="width: 10%;"></td> <td style="width: 10%;"></td> </tr> <tr> <td></td> <td></td> <td colspan="8" style="text-align: center;"> <table border="1" style="width: 100%; border-collapse: collapse; text-align: center;"> <tr> <td style="width: 10%;"></td> <td style="width: 10%;"></td> <td style="width: 10%;"></td> <td style="width: 10%;"></td> <td style="width: 10%;"></td> <td style="width: 10%;"></td> <td style="width: 10%;"></td> <td style="width: 10%;"></td> <td style="width: 10%;"></td> <td style="width: 10%;"></td> </tr> <tr> <td></td> <td></td> <td colspan="8" style="text-align: center;"> <table border="1" style="width: 100%; border-collapse: collapse; text-align: center;"> <tr> <td style="width: 10%;"></td> <td style="width: 10%;"></td> <td style="width: 10%;"></td> <td style="width: 10%;"></td> <td style="width: 10%;"></td> <td style="width: 10%;"></td> <td style="width: 10%;"></td> <td style="width: 10%;"></td> <td style="width: 10%;"></td> <td style="width: 10%;"></td> </tr> <tr> <td></td> <td></td> <td colspan="8" style="text-align: center;"> <table border="1" style="width: 100%; border-collapse: collapse; text-align: center;"> <tr> <td style="width: 10%;"></td> <td style="width: 10%;"></td> <td style="width: 10%;"></td> <td style="width: 10%;"></td> <td style="width: 10%;"></td> <td style="width: 10%;"></td> <td style="width: 10%;"></td> <td style="width: 10%;"></td> <td style="width: 10%;"></td> <td style="width: 10%;"></td> </tr> <tr> <td></td> <td></td> <td colspan="8" style="text-align: center;"> <table border="1" style="width: 100%; border-collapse: collapse; text-align: center;"> <tr> <td style="width: 10%;"></td> <td style="width: 10%;"></td> <td style="width: 10%;"></td> <td style="width: 10%;"></td> <td style="width: 10%;"></td> <td style="width: 10%;"></td> <td style="width: 10%;"></td> <td style="width: 10%;"></td> <td style="width: 10%;"></td> <td style="width: 10%;"></td> </tr> <tr> <td></td> <td></td> <td colspan="8" style="text-align: center;"> <table border="1" style="width: 100%; border-collapse: collapse; text-align: center;"> <tr> <td style="width: 10%;"></td> <td style="width: 10%;"></td> <td style="width: 10%;"></td> <td style="width: 10%;"></td> <td style="width: 10%;"></td> <td style="width: 10%;"></td> <td style="width: 10%;"></td> <td style="width: 10%;"></td> <td style="width: 10%;"></td> <td style="width: 10%;"></td> </tr> <tr> <td></td> <td></td> <td colspan="8" style="text-align: center;"> <table border="1" style="width: 100%; border-collapse: collapse; text-align: center;"> <tr> <td style="width: 10%;"></td> <td style="width: 10%;"></td> <td style="width: 10%;"></td> <td style="width: 10%;"></td> <td style="width: 10%;"></td> <td style="width: 10%;"></td> <td style="width: 10%;"></td> <td style="width: 10%;"></td> <td style="width: 10%;"></td> <td style="width: 10%;"></td> </tr> <tr> <td></td> <td></td> <td colspan="8" style="text-align: center;"> <table border="1" style="width: 100%; border-collapse: collapse; text-align: center;"> <tr> <td style="width: 10%;"></td> <td style="width: 10%;"></td> <td style="width: 10%;"></td> <td style="width: 10%;"></td> <td style="width: 10%;"></td> <td style="width: 10%;"></td> <td style="width: 10%;"></td> <td style="width: 10%;"></td> <td style="width: 10%;"></td> <td style="width: 10%;"></td> </tr> <tr> <td></td> <td></td> <td colspan="8" style="text-align: center;"> <table border="1" style="width: 100%; border-collapse: collapse; text-align: center;"> <tr> <td style="width: 10%;"></td> <td style="width: 10%;"></td> <td style="width: 10%;"></td> <td style="width: 10%;"></td> <td style="width: 10%;"></td> <td style="width: 10%;"></td> <td style="width: 10%;"></td> <td style="width: 10%;"></td> <td style="width: 10%;"></td> <td style="width: 10%;"></td> </tr> <tr> <td></td> <td></td> <td colspan="8" style="text-align: center;"> <table border="1" style="width: 100%; border-collapse: collapse; text-align: center;"> <tr> <td style="width: 10%;"></td> <td style="width: 10%;"></td> <td style="width: 10%;"></td> <td style="width: 10%;"></td> <td style="width: 10%;"></td> <td style="width: 10%;"></td> <td style="width: 10%;"></td> <td style="width: 10%;"></td> <td style="width: 10%;"></td> <td style="width: 10%;"></td> </tr> <tr> <td></td> <td></td> <td colspan="8" style="text-align: center;"> <table border="1" style="width: 100%; border-collapse: collapse; text-align: center;"> <tr> <td style="width: 10%;"></td> <td style="width: 10%;"></td> <td style="width: 10%;"></td> <td style="width: 10%;"></td> <td style="width: 10%;"></td> <td style="width: 10%;"></td> <td style="width: 10%;"></td> <td style="width: 10%;"></td> <td style="width: 10%;"></td> <td style="width: 10%;"></td> </tr> <tr> <td></td> <td></td> <td colspan="8" style="text-align: center;"> <table border="1" style="width: 100%; border-collapse: collapse; text-align: center;"> <tr> <td style="width: 10%;"></td> <td style="width: 10%;"></td> <td style="width: 10%;"></td> <td style="width: 10%;"></td> <td style="width: 10%;"></td> <td style="width: 10%;"></td> <td style="width: 10%;"></td> <td style="width: 10%;"></td> <td style="width: 10%;"></td> <td style="width: 10%;"></td> </tr> <tr> <td></td> <td></td> <td colspan="8" style="text-align: center;"> <table border="1" style="width: 100%; border-collapse: collapse; text-align: center;"> <tr> <td style="width: 10%;"></td> <td style="width: 10%;"></td> <td style="width: 10%;"></td> <td style="width: 10%;"></td> <td style="width: 10%;"></td> <td style="width: 10%;"></td> <td style="width: 10%;"></td> <td style="width: 10%;"></td> <td style="width: 10%;"></td> <td style="width: 10%;"></td> </tr> <tr> <td></td> <td></td> <td colspan="8" style="text-align: center;"> <table border="1" style="width: 100%; border-collapse: collapse; text-align: center;"> <tr> <td style="width: 10%;"></td> <td style="width: 10%;"></td> <td style="width: 10%;"></td> <td style="width: 10%;"></td> <td style="width: 10%;"></td> <td style="width: 10%;"></td> <td style="width: 10%;"></td> <td style="width: 10%;"></td> <td style="width: 10%;"></td> <td style="width: 10%;"></td> </tr> <tr> <td></td> <td></td> <td colspan="8" style="text-align: center;"> <table border="1" style="width: 100%; border-collapse: collapse; text-align: center;"> <tr> <td style="width: 10%;"></td> <td style="width: 10%;"></td> <td style="width: 10%;"></td> <td style="width: 10%;"></td> <td style="width: 10%;"></td> <td style="width: 10%;"></td> <td style="width: 10%;"></td> <td style="width: 10%;"></td> <td style="width: 10%;"></td> <td style="width: 10%;"></td> </tr> <tr> <td></td> <td></td> <td colspan="8" style="text-align: center;"> <table border="1" style="width: 100%; border-collapse: collapse; text-align: center;"> <tr> <td style="width: 10%;"></td> <td style="width: 10%;"></td> <td style="width: 10%;"></td> <td style="width: 10%;"></td> <td style="width: 10%;"></td> <td style="width: 10%;"></td> <td style="width: 10%;"></td> <td style="width: 10%;"></td> <td style="width: 10%;"></td> <td style="width: 10%;"></td> </tr> <tr> <td></td> <td></td> <td colspan="8" style="text-align: center;"> <table border="1" style="width: 100%; border-collapse: collapse; text-align: center;"> <tr> <td style="width: 10%;"></td> <td style="width: 10%;"></td> <td style="width: 10%;"></td> <td style="width: 10%;"></td> <td style="width: 10%;"></td> <td style="width: 10%;"></td> <td style="width: 10%;"></td> <td style="width: 10%;"></td> <td style="width: 10%;"></td> <td style="width: 10%;"></td> </tr> <tr> <td></td> <td></td> <td colspan="8" style="text-align: center;"> <table border="1" style="width: 100%; border-collapse: collapse; text-align: center;"> <tr>
</tr></table></td></tr></table></td></tr></table></td></tr></table></td></tr></table></td></tr></table></td></tr></table></td></tr></table></td></tr></table></td></tr></table></td></tr></table></td></tr></table></td></tr></table></td></tr></table></td></tr></table></td></tr></table></td></tr></table></td></tr></table></td></tr></table></td></tr></table></td></tr></table></td></tr></table></td></tr></table></td></tr></table></td></tr></table></td></tr></table></td></tr></table></td></tr></table></td></tr></table></td></tr></table></td></tr></table></td></tr></table></td></tr></table></td></tr></table> | | | | | | | | | | | | | | | | | | | | <table border="1" style="width: 100%; border-collapse: collapse; text-align: center;"> <tr> <td style="width: 10%;"></td> <td style="width: 10%;"></td> <td style="width: 10%;"></td> <td style="width: 10%;"></td> <td style="width: 10%;"></td> <td style="width: 10%;"></td> <td style="width: 10%;"></td> <td style="width: 10%;"></td> <td style="width: 10%;"></td> <td style="width: 10%;"></td> </tr> <tr> <td></td> <td></td> <td colspan="8" style="text-align: center;"> <table border="1" style="width: 100%; border-collapse: collapse; text-align: center;"> <tr> <td style="width: 10%;"></td> <td style="width: 10%;"></td> <td style="width: 10%;"></td> <td style="width: 10%;"></td> <td style="width: 10%;"></td> <td style="width: 10%;"></td> <td style="width: 10%;"></td> <td style="width: 10%;"></td> <td style="width: 10%;"></td> <td style="width: 10%;"></td> </tr> <tr> <td></td> <td></td> <td colspan="8" style="text-align: center;"> <table border="1" style="width: 100%; border-collapse: collapse; text-align: center;"> <tr> <td style="width: 10%;"></td> <td
style="width: 10%;"></td> <td style="width: 10%;"></td> <td style="width: 10%;"></td> <td style="width: 10%;"></td> <td style="width: 10%;"></td> <td style="width: 10%;"></td> <td style="width: 10%;"></td> <td style="width: 10%;"></td> <td style="width: 10%;"></td> </tr> <tr> <td></td> <td></td> <td colspan="8" style="text-align: center;"> <table border="1" style="width: 100%; border-collapse: collapse; text-align: center;"> <tr> <td style="width: 10%;"></td> <td style="width: 10%;"></td> <td style="width: 10%;"></td> <td style="width: 10%;"></td> <td style="width: 10%;"></td> <td style="width: 10%;"></td> <td style="width: 10%;"></td> <td style="width: 10%;"></td> <td style="width: 10%;"></td> <td style="width: 10%;"></td> </tr> <tr> <td></td> <td></td> <td colspan="8" style="text-align: center;"> <table border="1" style="width: 100%; border-collapse: collapse; text-align: center;"> <tr> <td style="width: 10%;"></td> <td style="width: 10%;"></td> <td style="width: 10%;"></td> <td style="width: 10%;"></td> <td style="width: 10%;"></td> <td style="width: 10%;"></td> <td style="width: 10%;"></td> <td style="width: 10%;"></td> <td style="width: 10%;"></td> <td style="width: 10%;"></td> </tr> <tr> <td></td> <td></td> <td colspan="8" style="text-align: center;"> <table border="1" style="width: 100%; border-collapse: collapse; text-align: center;"> <tr> <td style="width: 10%;"></td> <td style="width: 10%;"></td> <td style="width: 10%;"></td> <td style="width: 10%;"></td> <td style="width: 10%;"></td> <td style="width: 10%;"></td> <td style="width: 10%;"></td> <td style="width: 10%;"></td> <td style="width: 10%;"></td> <td style="width: 10%;"></td> </tr> <tr> <td></td> <td></td> <td colspan="8" style="text-align: center;"> <table border="1" style="width: 100%; border-collapse: collapse; text-align: center;"> <tr> <td style="width: 10%;"></td> <td style="width: 10%;"></td> <td style="width: 10%;"></td> <td style="width: 10%;"></td> <td style="width: 10%;"></td> <td style="width: 10%;"></td> <td style="width: 10%;"></td> <td style="width: 10%;"></td> <td style="width: 10%;"></td> <td style="width: 10%;"></td> </tr> <tr> <td></td> <td></td> <td colspan="8" style="text-align: center;"> <table border="1" style="width: 100%; border-collapse: collapse; text-align: center;"> <tr> <td style="width: 10%;"></td> <td style="width: 10%;"></td> <td style="width: 10%;"></td> <td style="width: 10%;"></td> <td style="width: 10%;"></td> <td style="width: 10%;"></td> <td style="width: 10%;"></td> <td style="width: 10%;"></td> <td style="width: 10%;"></td> <td style="width: 10%;"></td> </tr> <tr> <td></td> <td></td> <td colspan="8" style="text-align: center;"> <table border="1" style="width: 100%; border-collapse: collapse; text-align: center;"> <tr> <td style="width: 10%;"></td> <td style="width: 10%;"></td> <td style="width: 10%;"></td> <td style="width: 10%;"></td> <td style="width: 10%;"></td> <td style="width: 10%;"></td> <td style="width: 10%;"></td> <td style="width: 10%;"></td> <td style="width: 10%;"></td> <td style="width: 10%;"></td> </tr> <tr> <td></td> <td></td> <td colspan="8" style="text-align: center;"> <table border="1" style="width: 100%; border-collapse: collapse; text-align: center;"> <tr> <td style="width: 10%;"></td> <td style="width: 10%;"></td> <td style="width: 10%;"></td> <td style="width: 10%;"></td> <td style="width: 10%;"></td> <td style="width: 10%;"></td> <td style="width: 10%;"></td> <td style="width: 10%;"></td> <td style="width: 10%;"></td> <td style="width: 10%;"></td> </tr> <tr> <td></td> <td></td> <td colspan="8" style="text-align: center;"> <table border="1" style="width: 100%; border-collapse: collapse; text-align: center;"> <tr> <td style="width: 10%;"></td> <td style="width: 10%;"></td> <td style="width: 10%;"></td> <td style="width: 10%;"></td> <td style="width: 10%;"></td> <td style="width: 10%;"></td> <td style="width: 10%;"></td> <td style="width: 10%;"></td> <td style="width: 10%;"></td> <td style="width: 10%;"></td> </tr> <tr> <td></td> <td></td> <td colspan="8" style="text-align: center;"> <table border="1" style="width: 100%; border-collapse: collapse; text-align: center;"> <tr> <td style="width: 10%;"></td> <td style="width: 10%;"></td> <td style="width: 10%;"></td> <td style="width: 10%;"></td> <td style="width: 10%;"></td> <td style="width: 10%;"></td> <td style="width: 10%;"></td> <td style="width: 10%;"></td> <td style="width: 10%;"></td> <td style="width: 10%;"></td> </tr> <tr> <td></td> <td></td> <td colspan="8" style="text-align: center;"> <table border="1" style="width: 100%; border-collapse: collapse; text-align: center;"> <tr> <td style="width: 10%;"></td> <td style="width: 10%;"></td> <td style="width: 10%;"></td> <td style="width: 10%;"></td> <td style="width: 10%;"></td> <td style="width: 10%;"></td> <td style="width: 10%;"></td> <td style="width: 10%;"></td> <td style="width: 10%;"></td> <td style="width: 10%;"></td> </tr> <tr> <td></td> <td></td> <td colspan="8" style="text-align: center;"> <table border="1" style="width: 100%; border-collapse: collapse; text-align: center;"> <tr> <td style="width: 10%;"></td> <td style="width: 10%;"></td> <td style="width: 10%;"></td> <td style="width: 10%;"></td> <td style="width: 10%;"></td> <td style="width: 10%;"></td> <td style="width: 10%;"></td> <td style="width: 10%;"></td> <td style="width: 10%;"></td> <td style="width: 10%;"></td> </tr> <tr> <td></td> <td></td> <td colspan="8" style="text-align: center;"> <table border="1" style="width: 100%; border-collapse: collapse; text-align: center;"> <tr> <td style="width: 10%;"></td> <td style="width: 10%;"></td> <td style="width: 10%;"></td> <td style="width: 10%;"></td> <td style="width: 10%;"></td> <td style="width: 10%;"></td> <td style="width: 10%;"></td> <td style="width: 10%;"></td> <td style="width: 10%;"></td> <td style="width: 10%;"></td> </tr> <tr> <td></td> <td></td> <td colspan="8" style="text-align: center;"> <table border="1" style="width: 100%; border-collapse: collapse; text-align: center;"> <tr> <td style="width: 10%;"></td> <td style="width: 10%;"></td> <td style="width: 10%;"></td> <td style="width: 10%;"></td> <td style="width: 10%;"></td> <td style="width: 10%;"></td> <td style="width: 10%;"></td> <td style="width: 10%;"></td> <td style="width: 10%;"></td> <td style="width: 10%;"></td> </tr> <tr> <td></td> <td></td> <td colspan="8" style="text-align: center;"> <table border="1" style="width: 100%; border-collapse: collapse; text-align: center;"> <tr> <td style="width: 10%;"></td> <td style="width: 10%;"></td> <td style="width: 10%;"></td> <td style="width: 10%;"></td> <td style="width: 10%;"></td> <td style="width: 10%;"></td> <td style="width: 10%;"></td> <td style="width: 10%;"></td> <td style="width: 10%;"></td> <td style="width: 10%;"></td> </tr> <tr> <td></td> <td></td> <td colspan="8" style="text-align: center;"> <table border="1" style="width: 100%; border-collapse: collapse; text-align: center;"> <tr> <td style="width: 10%;"></td> <td style="width: 10%;"></td> <td style="width: 10%;"></td> <td style="width: 10%;"></td> <td style="width: 10%;"></td> <td style="width: 10%;"></td> <td style="width: 10%;"></td> <td style="width: 10%;"></td> <td style="width: 10%;"></td> <td style="width: 10%;"></td> </tr> <tr> <td></td> <td></td> <td colspan="8" style="text-align: center;"> <table border="1" style="width: 100%; border-collapse: collapse; text-align: center;"> <tr> <td style="width: 10%;"></td> <td style="width: 10%;"></td> <td style="width: 10%;"></td> <td style="width: 10%;"></td> <td style="width: 10%;"></td> <td style="width: 10%;"></td> <td style="width: 10%;"></td> <td style="width: 10%;"></td> <td style="width: 10%;"></td> <td style="width: 10%;"></td> </tr> <tr> <td></td> <td></td> <td colspan="8" style="text-align: center;"> <table border="1" style="width: 100%; border-collapse: collapse; text-align: center;"> <tr> <td style="width: 10%;"></td> <td style="width: 10%;"></td> <td style="width: 10%;"></td> <td style="width: 10%;"></td> <td style="width: 10%;"></td> <td style="width: 10%;"></td> <td style="width: 10%;"></td> <td style="width: 10%;"></td> <td style="width: 10%;"></td> <td style="width: 10%;"></td> </tr> <tr> <td></td> <td></td> <td colspan="8" style="text-align: center;"> <table border="1" style="width: 100%; border-collapse: collapse; text-align: center;"> <tr> <td style="width: 10%;"></td> <td style="width: 10%;"></td> <td style="width: 10%;"></td> <td style="width: 10%;"></td> <td style="width: 10%;"></td> <td style="width: 10%;"></td> <td style="width: 10%;"></td> <td style="width: 10%;"></td> <td style="width: 10%;"></td> <td style="width: 10%;"></td> </tr> <tr> <td></td> <td></td> <td colspan="8" style="text-align: center;"> <table border="1" style="width: 100%; border-collapse: collapse; text-align: center;"> <tr> <td style="width: 10%;"></td> <td style="width: 10%;"></td> <td style="width: 10%;"></td> <td style="width: 10%;"></td> <td style="width: 10%;"></td> <td style="width: 10%;"></td> <td style="width: 10%;"></td> <td style="width: 10%;"></td> <td style="width: 10%;"></td> <td style="width: 10%;"></td> </tr> <tr> <td></td> <td></td> <td colspan="8" style="text-align: center;"> <table border="1" style="width: 100%; border-collapse: collapse; text-align: center;"> <tr> <td style="width: 10%;"></td> <td style="width: 10%;"></td> <td style="width: 10%;"></td> <td style="width: 10%;"></td> <td style="width: 10%;"></td> <td style="width: 10%;"></td> <td style="width: 10%;"></td> <td style="width: 10%;"></td> <td style="width: 10%;"></td> <td style="width: 10%;"></td> </tr> <tr> <td></td> <td></td> <td colspan="8" style="text-align: center;"> <table border="1" style="width: 100%; border-collapse: collapse; text-align: center;"> <tr> <td style="width: 10%;"></td> <td style="width: 10%;"></td> <td style="width: 10%;"></td> <td style="width: 10%;"></td> <td style="width: 10%;"></td> <td style="width: 10%;"></td> <td style="width:
10%;"></td> <td style="width: 10%;"></td> <td style="width: 10%;"></td> <td style="width: 10%;"></td> </tr> <tr> <td></td> <td></td> <td colspan="8" style="text-align: center;"> <table border="1" style="width: 100%; border-collapse: collapse; text-align: center;"> <tr> <td style="width: 10%;"></td> <td style="width: 10%;"></td> <td style="width: 10%;"></td> <td style="width: 10%;"></td> <td style="width: 10%;"></td> <td style="width: 10%;"></td> <td style="width: 10%;"></td> <td style="width: 10%;"></td> <td style="width: 10%;"></td> <td style="width: 10%;"></td> </tr> <tr> <td></td> <td></td> <td colspan="8" style="text-align: center;"> <table border="1" style="width: 100%; border-collapse: collapse; text-align: center;"> <tr> <td style="width: 10%;"></td> <td style="width: 10%;"></td> <td style="width: 10%;"></td> <td style="width: 10%;"></td> <td style="width: 10%;"></td> <td style="width: 10%;"></td> <td style="width: 10%;"></td> <td style="width: 10%;"></td> <td style="width: 10%;"></td> <td style="width: 10%;"></td> </tr> <tr> <td></td> <td></td> <td colspan="8" style="text-align: center;"> <table border="1" style="width: 100%; border-collapse: collapse; text-align: center;"> <tr> <td style="width: 10%;"></td> <td style="width: 10%;"></td> <td style="width: 10%;"></td> <td style="width: 10%;"></td> <td style="width: 10%;"></td> <td style="width: 10%;"></td> <td style="width: 10%;"></td> <td style="width: 10%;"></td> <td style="width: 10%;"></td> <td style="width: 10%;"></td> </tr> <tr> <td></td> <td></td> <td colspan="8" style="text-align: center;"> <table border="1" style="width: 100%; border-collapse: collapse; text-align: center;"> <tr> <td style="width: 10%;"></td> <td style="width: 10%;"></td> <td style="width: 10%;"></td> <td style="width: 10%;"></td> <td style="width: 10%;"></td> <td style="width: 10%;"></td> <td style="width: 10%;"></td> <td style="width: 10%;"></td> <td style="width: 10%;"></td> <td style="width: 10%;"></td> </tr> <tr> <td></td> <td></td> <td colspan="8" style="text-align: center;"> <table border="1" style="width: 100%; border-collapse: collapse; text-align: center;"> <tr> <td style="width: 10%;"></td> <td style="width: 10%;"></td> <td style="width: 10%;"></td> <td style="width: 10%;"></td> <td style="width: 10%;"></td> <td style="width: 10%;"></td> <td style="width: 10%;"></td> <td style="width: 10%;"></td> <td style="width: 10%;"></td> <td style="width: 10%;"></td> </tr> <tr> <td></td> <td></td> <td colspan="8" style="text-align: center;"> <table border="1" style="width: 100%; border-collapse: collapse; text-align: center;"> <tr> <td style="width: 10%;"></td> <td style="width: 10%;"></td> <td style="width: 10%;"></td> <td style="width: 10%;"></td> <td style="width: 10%;"></td> <td style="width: 10%;"></td> <td style="width: 10%;"></td> <td style="width: 10%;"></td> <td style="width: 10%;"></td> <td style="width: 10%;"></td> </tr> <tr> <td></td> <td></td> <td colspan="8" style="text-align: center;"> <table border="1" style="width: 100%; border-collapse: collapse; text-align: center;"> <tr> <td style="width: 10%;"></td> <td style="width: 10%;"></td> <td style="width: 10%;"></td> <td style="width: 10%;"></td> <td style="width: 10%;"></td> <td style="width: 10%;"></td> <td style="width: 10%;"></td> <td style="width: 10%;"></td> <td style="width: 10%;"></td> <td style="width: 10%;"></td> </tr> <tr> <td></td> <td></td> <td colspan="8" style="text-align: center;"> <table border="1" style="width: 100%; border-collapse: collapse; text-align: center;"> <tr> <td style="width: 10%;"></td> <td style="width: 10%;"></td> <td style="width: 10%;"></td> <td style="width: 10%;"></td> <td style="width: 10%;"></td> <td style="width: 10%;"></td> <td style="width: 10%;"></td> <td style="width: 10%;"></td> <td style="width: 10%;"></td> <td style="width: 10%;"></td> </tr> <tr> <td></td> <td></td> <td colspan="8" style="text-align: center;"> <table border="1" style="width: 100%; border-collapse: collapse; text-align: center;"> <tr> </tr></table></td></tr></table></td></tr></table></td></tr></table></td></tr></table></td></tr></table></td></tr></table></td></tr></table></td></tr></table></td></tr></table></td></tr></table></td></tr></table></td></tr></table></td></tr></table></td></tr></table></td></tr></table></td></tr></table></td></tr></table></td></tr></table></td></tr></table></td></tr></table></td></tr></table></td></tr></table></td></tr></table></td></tr></table></td></tr></table></td></tr></table></td></tr></table></td></tr></table></td></tr></table></td></tr></table></td></tr></table></td></tr></table>
 | | | | | | | | | | | | | | | | | | | | <table border="1" style="width: 100%; border-collapse: collapse; text-align: center;"> <tr> <td style="width: 10%;"></td> <td style="width: 10%;"></td> <td style="width: 10%;"></td> <td style="width: 10%;"></td> <td style="width: 10%;"></td> <td style="width: 10%;"></td> <td style="width: 10%;"></td> <td style="width: 10%;"></td> <td style="width: 10%;"></td> <td style="width: 10%;"></td> </tr> <tr> <td></td> <td></td> <td colspan="8" style="text-align: center;"> <table border="1" style="width: 100%; border-collapse: collapse; text-align: center;"> <tr> <td style="width: 10%;"></td> <td style="width: 10%;"></td> <td style="width: 10%;"></td> <td style="width: 10%;"></td> <td style="width: 10%;"></td> <td style="width: 10%;"></td> <td style="width: 10%;"></td> <td style="width: 10%;"></td> <td style="width: 10%;"></td> <td style="width: 10%;"></td> </tr> <tr> <td></td> <td></td> <td colspan="8" style="text-align: center;"> <table border="1" style="width: 100%; border-collapse: collapse; text-align: center;"> <tr> <td style="width: 10%;"></td> <td style="width: 10%;"></td> <td style="width: 10%;"></td> <td style="width: 10%;"></td> <td style="width: 10%;"></td> <td style="width: 10%;"></td> <td style="width: 10%;"></td> <td style="width: 10%;"></td> <td style="width: 10%;"></td> <td style="width: 10%;"></td> </tr> <tr> <td></td> <td></td> <td colspan="8" style="text-align: center;"> <table border="1" style="width: 100%; border-collapse: collapse; text-align: center;"> <tr> <td style="width: 10%;"></td> <td style="width: 10%;"></td> <td style="width: 10%;"></td> <td style="width: 10%;"></td> <td style="width: 10%;"></td> <td style="width: 10%;"></td> <td style="width: 10%;"></td> <td style="width: 10%;"></td> <td style="width: 10%;"></td> <td style="width: 10%;"></td> </tr> <tr> <td></td> <td></td> <td colspan="8" style="text-align: center;"> <table border="1" style="width: 100%; border-collapse: collapse; text-align: center;"> <tr> <td style="width: 10%;"></td> <td style="width: 10%;"></td> <td style="width: 10%;"></td> <td style="width: 10%;"></td> <td style="width: 10%;"></td> <td style="width: 10%;"></td> <td style="width: 10%;"></td> <td style="width: 10%;"></td> <td style="width: 10%;"></td> <td style="width: 10%;"></td> </tr> <tr> <td></td> <td></td> <td colspan="8" style="text-align: center;"> <table border="1" style="width: 100%; border-collapse: collapse; text-align: center;"> <tr> <td style="width: 10%;"></td> <td style="width: 10%;"></td> <td style="width: 10%;"></td> <td style="width: 10%;"></td> <td style="width: 10%;"></td> <td style="width: 10%;"></td> <td style="width: 10%;"></td> <td style="width: 10%;"></td> <td style="width: 10%;"></td> <td style="width: 10%;"></td> </tr> <tr> <td></td> <td></td> <td colspan="8" style="text-align: center;"> <table border="1" style="width: 100%; border-collapse: collapse; text-align: center;"> <tr> <td style="width: 10%;"></td> <td style="width: 10%;"></td> <td style="width: 10%;"></td> <td style="width: 10%;"></td> <td style="width: 10%;"></td> <td style="width: 10%;"></td> <td style="width: 10%;"></td> <td style="width: 10%;"></td> <td style="width: 10%;"></td> <td style="width: 10%;"></td> </tr> <tr> <td></td> <td></td> <td colspan="8" style="text-align: center;"> <table border="1" style="width: 100%; border-collapse: collapse; text-align: center;"> <tr> <td style="width: 10%;"></td> <td style="width: 10%;"></td> <td style="width: 10%;"></td> <td style="width: 10%;"></td> <td style="width: 10%;"></td> <td style="width: 10%;"></td> <td style="width: 10%;"></td> <td style="width: 10%;"></td> <td style="width: 10%;"></td> <td style="width: 10%;"></td> </tr> <tr> <td></td> <td></td> <td colspan="8" style="text-align: center;"> <table border="1" style="width: 100%; border-collapse: collapse; text-align: center;"> <tr> <td style="width: 10%;"></td> <td style="width: 10%;"></td> <td style="width: 10%;"></td> <td style="width: 10%;"></td> <td style="width: 10%;"></td> <td style="width: 10%;"></td> <td style="width: 10%;"></td> <td style="width: 10%;"></td> <td style="width: 10%;"></td> <td style="width: 10%;"></td> </tr> <tr> <td></td> <td></td> <td colspan="8" style="text-align: center;"> <table border="1" style="width: 100%; border-collapse: collapse; text-align: center;"> <tr> <td style="width: 10%;"></td> <td style="width: 10%;"></td> <td style="width: 10%;"></td> <td style="width: 10%;"></td> <td style="width: 10%;"></td> <td style="width: 10%;"></td> <td style="width: 10%;"></td> <td style="width: 10%;"></td> <td style="width: 10%;"></td> <td style="width: 10%;"></td> </tr> <tr> <td></td> <td></td> <td colspan="8" style="text-align: center;"> <table border="1" style="width: 100%; border-collapse: collapse; text-align: center;"> <tr> <td style="width: 10%;"></td> <td style="width: 10%;"></td> <td style="width: 10%;"></td> <td style="width: 10%;"></td> <td style="width: 10%;"></td> <td style="width: 10%;"></td> <td style="width: 10%;"></td> <td style="width: 10%;"></td> <td style="width: 10%;"></td> <td style="width: 10%;"></td> </tr> <tr> <td></td> <td></td> <td colspan="8" style="text-align: center;"> <table border="1" style="width: 100%; border-collapse: collapse; text-align: center;"> <tr> <td style="width: 10%;"></td> <td style="width: 10%;"></td> <td style="width: 10%;"></td> <td style="width: 10%;"></td> <td style="width: 10%;"></td> <td style="width: 10%;"></td> <td style="width: 10%;"></td> <td style="width: 10%;"></td> <td style="width: 10%;"></td> <td style="width: 10%;"></td> </tr> <tr> <td></td> <td></td> <td colspan="8" style="text-align: center;"> <table border="1" style="width: 100%; border-collapse: collapse; text-align: center;"> <tr> <td style="width: 10%;"></td> <td style="width: 10%;"></td> <td style="width: 10%;"></td> <td style="width: 10%;"></td> <td style="width: 10%;"></td> <td style="width: 10%;"></td> <td style="width: 10%;"></td> <td style="width: 10%;"></td> <td style="width: 10%;"></td> <td style="width: 10%;"></td> </tr> <tr> <td></td> <td></td> <td colspan="8" style="text-align: center;"> <table border="1" style="width: 100%; border-collapse: collapse; text-align: center;"> <tr> <td style="width: 10%;"></td> <td style="width: 10%;"></td> <td style="width: 10%;"></td> <td style="width: 10%;"></td> <td style="width: 10%;"></td> <td style="width: 10%;"></td> <td style="width: 10%;"></td> <td style="width: 10%;"></td> <td style="width: 10%;"></td> <td style="width: 10%;"></td> </tr> <tr> <td></td> <td></td> <td colspan="8" style="text-align: center;"> <table border="1" style="width: 100%; border-collapse: collapse; text-align: center;"> <tr> <td style="width: 10%;"></td> <td style="width: 10%;"></td> <td style="width: 10%;"></td> <td style="width: 10%;"></td> <td style="width: 10%;"></td> <td style="width: 10%;"></td> <td style="width: 10%;"></td> <td style="width: 10%;"></td> <td style="width: 10%;"></td> <td style="width: 10%;"></td> </tr> <tr> <td></td> <td></td> <td colspan="8" style="text-align: center;"> <table border="1" style="width: 100%; border-collapse:
collapse; text-align: center;"> <tr> <td style="width: 10%;"></td> <td style="width: 10%;"></td> <td style="width: 10%;"></td> <td style="width: 10%;"></td> <td style="width: 10%;"></td> <td style="width: 10%;"></td> <td style="width: 10%;"></td> <td style="width: 10%;"></td> <td style="width: 10%;"></td> <td style="width: 10%;"></td> </tr> <tr> <td></td> <td></td> <td colspan="8" style="text-align: center;"> <table border="1" style="width: 100%; border-collapse: collapse; text-align: center;"> <tr> <td style="width: 10%;"></td> <td style="width: 10%;"></td> <td style="width: 10%;"></td> <td style="width: 10%;"></td> <td style="width: 10%;"></td> <td style="width: 10%;"></td> <td style="width: 10%;"></td> <td style="width: 10%;"></td> <td style="width: 10%;"></td> <td style="width: 10%;"></td> </tr> <tr> <td></td> <td></td> <td colspan="8" style="text-align: center;"> <table border="1" style="width: 100%; border-collapse: collapse; text-align: center;"> <tr> <td style="width: 10%;"></td> <td style="width: 10%;"></td> <td style="width: 10%;"></td> <td style="width: 10%;"></td> <td style="width: 10%;"></td> <td style="width: 10%;"></td> <td style="width: 10%;"></td> <td style="width: 10%;"></td> <td style="width: 10%;"></td> <td style="width: 10%;"></td> </tr> <tr> <td></td> <td></td> <td colspan="8" style="text-align: center;"> <table border="1" style="width: 100%; border-collapse: collapse; text-align: center;"> <tr> <td style="width: 10%;"></td> <td style="width: 10%;"></td> <td style="width: 10%;"></td> <td style="width: 10%;"></td> <td style="width: 10%;"></td> <td style="width: 10%;"></td> <td style="width: 10%;"></td> <td style="width: 10%;"></td> <td style="width: 10%;"></td> <td style="width: 10%;"></td> </tr> <tr> <td></td> <td></td> <td colspan="8" style="text-align: center;"> <table border="1" style="width: 100%; border-collapse: collapse; text-align: center;"> <tr> <td style="width: 10%;"></td> <td style="width: 10%;"></td> <td style="width: 10%;"></td> <td style="width: 10%;"></td> <td style="width: 10%;"></td> <td style="width: 10%;"></td> <td style="width: 10%;"></td> <td style="width: 10%;"></td> <td style="width: 10%;"></td> <td style="width: 10%;"></td> </tr> <tr> <td></td> <td></td> <td colspan="8" style="text-align: center;"> <table border="1" style="width: 100%; border-collapse: collapse; text-align: center;"> <tr> <td style="width: 10%;"></td> <td style="width: 10%;"></td> <td style="width: 10%;"></td> <td style="width: 10%;"></td> <td style="width: 10%;"></td> <td style="width: 10%;"></td> <td style="width: 10%;"></td> <td style="width: 10%;"></td> <td style="width: 10%;"></td> <td style="width: 10%;"></td> </tr> <tr> <td></td> <td></td> <td colspan="8" style="text-align: center;"> <table border="1" style="width: 100%; border-collapse: collapse; text-align: center;"> <tr> <td style="width: 10%;"></td> <td style="width: 10%;"></td> <td style="width: 10%;"></td> <td style="width: 10%;"></td> <td style="width: 10%;"></td> <td style="width: 10%;"></td> <td style="width: 10%;"></td> <td style="width: 10%;"></td> <td style="width: 10%;"></td> <td style="width: 10%;"></td> </tr> <tr> <td></td> <td></td> <td colspan="8" style="text-align: center;"> <table border="1" style="width: 100%; border-collapse: collapse; text-align: center;"> <tr> <td style="width: 10%;"></td> <td style="width: 10%;"></td> <td style="width: 10%;"></td> <td style="width: 10%;"></td> <td style="width: 10%;"></td> <td style="width: 10%;"></td> <td style="width: 10%;"></td> <td style="width: 10%;"></td> <td style="width: 10%;"></td> <td style="width: 10%;"></td> </tr> <tr> <td></td> <td></td> <td colspan="8" style="text-align: center;"> <table border="1" style="width: 100%; border-collapse: collapse; text-align: center;"> <tr> <td style="width: 10%;"></td> <td style="width: 10%;"></td> <td style="width: 10%;"></td> <td style="width: 10%;"></td> <td style="width: 10%;"></td> <td style="width: 10%;"></td> <td style="width: 10%;"></td> <td style="width: 10%;"></td> <td style="width: 10%;"></td> <td style="width: 10%;"></td> </tr> <tr> <td></td> <td></td> <td colspan="8" style="text-align: center;"> <table border="1" style="width: 100%; border-collapse: collapse; text-align: center;"> <tr> <td style="width: 10%;"></td> <td style="width: 10%;"></td> <td style="width: 10%;"></td> <td style="width: 10%;"></td> <td style="width: 10%;"></td> <td style="width: 10%;"></td> <td style="width: 10%;"></td> <td style="width: 10%;"></td> <td style="width: 10%;"></td> <td style="width: 10%;"></td> </tr> <tr> <td></td> <td></td> <td colspan="8" style="text-align: center;"> <table border="1" style="width: 100%; border-collapse: collapse; text-align: center;"> <tr> <td style="width: 10%;"></td> <td style="width: 10%;"></td> <td style="width: 10%;"></td> <td style="width: 10%;"></td> <td style="width: 10%;"></td> <td style="width: 10%;"></td> <td style="width: 10%;"></td> <td style="width: 10%;"></td> <td style="width: 10%;"></td> <td style="width: 10%;"></td> </tr> <tr> <td></td> <td></td> <td colspan="8" style="text-align: center;"> <table border="1" style="width: 100%; border-collapse: collapse; text-align: center;"> <tr> <td style="width: 10%;"></td> <td style="width: 10%;"></td> <td style="width: 10%;"></td> <td style="width: 10%;"></td> <td style="width: 10%;"></td> <td style="width: 10%;"></td> <td style="width: 10%;"></td> <td style="width: 10%;"></td> <td style="width: 10%;"></td> <td style="width: 10%;"></td> </tr> <tr> <td></td> <td></td> <td colspan="8" style="text-align: center;"> <table border="1" style="width: 100%; border-collapse: collapse; text-align: center;"> <tr> <td style="width: 10%;"></td> <td style="width: 10%;"></td> <td style="width: 10%;"></td> <td style="width: 10%;"></td> <td style="width: 10%;"></td> <td style="width: 10%;"></td> <td style="width: 10%;"></td> <td style="width: 10%;"></td> <td style="width: 10%;"></td> <td style="width: 10%;"></td> </tr> <tr> <td></td> <td></td> <td colspan="8" style="text-align: center;"> <table border="1" style="width: 100%; border-collapse: collapse; text-align: center;"> <tr> <td style="width: 10%;"></td> <td style="width: 10%;"></td> <td style="width: 10%;"></td> <td style="width: 10%;"></td> <td style="width: 10%;"></td> <td style="width: 10%;"></td> <td style="width: 10%;"></td> <td style="width: 10%;"></td> <td style="width: 10%;"></td> <td style="width: 10%;"></td> </tr> <tr> <td></td> <td></td> <td colspan="8" style="text-align: center;"> <table border="1" style="width: 100%; border-collapse: collapse; text-align: center;"> <tr> <td style="width: 10%;"></td> <td style="width: 10%;"></td> <td style="width: 10%;"></td> <td style="width: 10%;"></td> <td style="width: 10%;"></td> <td style="width: 10%;"></td> <td style="width: 10%;"></td> <td style="width: 10%;"></td> <td style="width: 10%;"></td> <td style="width: 10%;"></td> </tr> <tr> <td></td> <td></td> <td colspan="8" style="text-align: center;"> <table border="1" style="width: 100%; border-collapse: collapse; text-align: center;"> <tr> <td style="width: 10%;"></td> <td style="width: 10%;"></td> <td style="width: 10%;"></td> <td style="width: 10%;"></td> <td style="width: 10%;"></td> <td style="width: 10%;"></td> <td style="width: 10%;"></td> <td style="width: 10%;"></td> <td style="width: 10%;"></td> <td style="width: 10%;"></td> </tr> <tr> <td></td> <td></td> <td colspan="8" style="text-align: center;"> <table border="1" style="width: 100%; border-collapse: collapse; text-align: center;"> <tr> </tr></table></td></tr></table></td></tr></table></td></tr></table></td></tr></table></td></tr></table></td></tr></table></td></tr></table></td></tr></table></td></tr></table></td></tr></table></td></tr></table></td></tr></table></td></tr></table></td></tr></table></td></tr></table></td></tr></table></td></tr></table></td></tr></table></td></tr></table></td></tr></table></td></tr></table></td></tr></table></td></tr></table></td></tr></table></td></tr></table></td></tr></table></td></tr></table></td></tr></table></td></tr></table></td></tr></table></td></tr></table>
 | | | | | | | | | | | | | | | | | | | | <table border="1" style="width: 100%; border-collapse: collapse; text-align: center;"> <tr> <td style="width: 10%;"></td> <td style="width: 10%;"></td> <td style="width: 10%;"></td> <td style="width: 10%;"></td> <td style="width: 10%;"></td> <td style="width: 10%;"></td> <td style="width: 10%;"></td> <td style="width: 10%;"></td> <td style="width: 10%;"></td> <td style="width: 10%;"></td> </tr> <tr> <td></td> <td></td> <td colspan="8" style="text-align: center;"> <table border="1" style="width: 100%; border-collapse: collapse; text-align: center;"> <tr> <td style="width: 10%;"></td> <td style="width: 10%;"></td> <td style="width: 10%;"></td> <td style="width: 10%;"></td> <td style="width: 10%;"></td> <td style="width: 10%;"></td> <td style="width: 10%;"></td> <td style="width: 10%;"></td> <td style="width: 10%;"></td> <td style="width: 10%;"></td> </tr> <tr> <td></td> <td></td> <td colspan="8" style="text-align: center;"> <table border="1" style="width: 100%; border-collapse: collapse; text-align: center;"> <tr> <td style="width: 10%;"></td> <td style="width: 10%;"></td> <td style="width: 10%;"></td> <td style="width: 10%;"></td> <td style="width: 10%;"></td> <td style="width: 10%;"></td> <td style="width: 10%;"></td> <td style="width: 10%;"></td> <td style="width: 10%;"></td> <td style="width: 10%;"></td> </tr> <tr> <td></td> <td></td> <td colspan="8" style="text-align: center;"> <table border="1" style="width: 100%; border-collapse: collapse; text-align: center;"> <tr> <td style="width: 10%;"></td> <td style="width: 10%;"></td> <td style="width: 10%;"></td> <td style="width: 10%;"></td> <td style="width: 10%;"></td> <td style="width: 10%;"></td> <td style="width: 10%;"></td> <td style="width: 10%;"></td> <td style="width: 10%;"></td> <td style="width: 10%;"></td> </tr> <tr> <td></td> <td></td> <td colspan="8" style="text-align: center;"> <table border="1" style="width: 100%; border-collapse: collapse; text-align: center;"> <tr> <td style="width: 10%;"></td> <td style="width: 10%;"></td> <td style="width: 10%;"></td> <td style="width: 10%;"></td> <td style="width: 10%;"></td> <td style="width: 10%;"></td> <td style="width: 10%;"></td> <td style="width: 10%;"></td> <td style="width: 10%;"></td> <td style="width: 10%;"></td> </tr> <tr> <td></td> <td></td> <td colspan="8" style="text-align: center;"> <table border="1" style="width: 100%; border-collapse: collapse; text-align: center;"> <tr> <td style="width: 10%;"></td> <td style="width: 10%;"></td> <td style="width: 10%;"></td> <td style="width: 10%;"></td> <td style="width: 10%;"></td> <td style="width: 10%;"></td> <td style="width: 10%;"></td> <td style="width: 10%;"></td> <td style="width: 10%;"></td> <td style="width: 10%;"></td> </tr> <tr> <td></td> <td></td> <td colspan="8" style="text-align: center;"> <table border="1" style="width: 100%; border-collapse: collapse; text-align: center;"> <tr> <td style="width: 10%;"></td> <td style="width: 10%;"></td> <td style="width: 10%;"></td> <td style="width: 10%;"></td> <td style="width: 10%;"></td> <td style="width: 10%;"></td> <td style="width: 10%;"></td> <td style="width: 10%;"></td> <td style="width: 10%;"></td> <td style="width: 10%;"></td> </tr> <tr> <td></td> <td></td> <td colspan="8" style="text-align: center;"> <table border="1" style="width: 100%; border-collapse: collapse; text-align: center;"> <tr> <td style="width: 10%;"></td> <td style="width: 10%;"></td> <td style="width: 10%;"></td> <td style="width: 10%;"></td> <td style="width: 10%;"></td> <td style="width: 10%;"></td> <td style="width: 10%;"></td> <td
style="width: 10%;"></td> <td style="width: 10%;"></td> <td style="width: 10%;"></td> </tr> <tr> <td></td> <td></td> <td colspan="8" style="text-align: center;"> <table border="1" style="width: 100%; border-collapse: collapse; text-align: center;"> <tr> <td style="width: 10%;"></td> <td style="width: 10%;"></td> <td style="width: 10%;"></td> <td style="width: 10%;"></td> <td style="width: 10%;"></td> <td style="width: 10%;"></td> <td style="width: 10%;"></td> <td style="width: 10%;"></td> <td style="width: 10%;"></td> <td style="width: 10%;"></td> </tr> <tr> <td></td> <td></td> <td colspan="8" style="text-align: center;"> <table border="1" style="width: 100%; border-collapse: collapse; text-align: center;"> <tr> <td style="width: 10%;"></td> <td style="width: 10%;"></td> <td style="width: 10%;"></td> <td style="width: 10%;"></td> <td style="width: 10%;"></td> <td style="width: 10%;"></td> <td style="width: 10%;"></td> <td style="width: 10%;"></td> <td style="width: 10%;"></td> <td style="width: 10%;"></td> </tr> <tr> <td></td> <td></td> <td colspan="8" style="text-align: center;"> <table border="1" style="width: 100%; border-collapse: collapse; text-align: center;"> <tr> <td style="width: 10%;"></td> <td style="width: 10%;"></td> <td style="width: 10%;"></td> <td style="width: 10%;"></td> <td style="width: 10%;"></td> <td style="width: 10%;"></td> <td style="width: 10%;"></td> <td style="width: 10%;"></td> <td style="width: 10%;"></td> <td style="width: 10%;"></td> </tr> <tr> <td></td> <td></td> <td colspan="8" style="text-align: center;"> <table border="1" style="width: 100%; border-collapse: collapse; text-align: center;"> <tr> <td style="width: 10%;"></td> <td style="width: 10%;"></td> <td style="width: 10%;"></td> <td style="width: 10%;"></td> <td style="width: 10%;"></td> <td style="width: 10%;"></td> <td style="width: 10%;"></td> <td style="width: 10%;"></td> <td style="width: 10%;"></td> <td style="width: 10%;"></td> </tr> <tr> <td></td> <td></td> <td colspan="8" style="text-align: center;"> <table border="1" style="width: 100%; border-collapse: collapse; text-align: center;"> <tr> <td style="width: 10%;"></td> <td style="width: 10%;"></td> <td style="width: 10%;"></td> <td style="width: 10%;"></td> <td style="width: 10%;"></td> <td style="width: 10%;"></td> <td style="width: 10%;"></td> <td style="width: 10%;"></td> <td style="width: 10%;"></td> <td style="width: 10%;"></td> </tr> <tr> <td></td> <td></td> <td colspan="8" style="text-align: center;"> <table border="1" style="width: 100%; border-collapse: collapse; text-align: center;"> <tr> <td style="width: 10%;"></td> <td style="width: 10%;"></td> <td style="width: 10%;"></td> <td style="width: 10%;"></td> <td style="width: 10%;"></td> <td style="width: 10%;"></td> <td style="width: 10%;"></td> <td style="width: 10%;"></td> <td style="width: 10%;"></td> <td style="width: 10%;"></td> </tr> <tr> <td></td> <td></td> <td colspan="8" style="text-align: center;"> <table border="1" style="width: 100%; border-collapse: collapse; text-align: center;"> <tr> <td style="width: 10%;"></td> <td style="width: 10%;"></td> <td style="width: 10%;"></td> <td style="width: 10%;"></td> <td style="width: 10%;"></td> <td style="width: 10%;"></td> <td style="width: 10%;"></td> <td style="width: 10%;"></td> <td style="width: 10%;"></td> <td style="width: 10%;"></td> </tr> <tr> <td></td> <td></td> <td colspan="8" style="text-align: center;"> <table border="1" style="width: 100%; border-collapse: collapse; text-align: center;"> <tr> <td style="width: 10%;"></td> <td style="width: 10%;"></td> <td style="width: 10%;"></td> <td style="width: 10%;"></td> <td style="width: 10%;"></td> <td style="width: 10%;"></td> <td style="width: 10%;"></td> <td style="width: 10%;"></td> <td style="width: 10%;"></td> <td style="width: 10%;"></td> </tr> <tr> <td></td> <td></td> <td colspan="8" style="text-align: center;"> <table border="1" style="width: 100%; border-collapse: collapse; text-align: center;"> <tr> <td style="width: 10%;"></td> <td style="width: 10%;"></td> <td style="width: 10%;"></td> <td style="width: 10%;"></td> <td style="width: 10%;"></td> <td style="width: 10%;"></td> <td style="width: 10%;"></td> <td style="width: 10%;"></td> <td style="width: 10%;"></td> <td style="width: 10%;"></td> </tr> <tr> <td></td> <td></td> <td colspan="8" style="text-align: center;"> <table border="1" style="width: 100%; border-collapse: collapse; text-align: center;"> <tr> <td style="width: 10%;"></td> <td style="width: 10%;"></td> <td style="width: 10%;"></td> <td style="width: 10%;"></td> <td style="width: 10%;"></td> <td style="width: 10%;"></td> <td style="width: 10%;"></td> <td style="width: 10%;"></td> <td style="width: 10%;"></td> <td style="width: 10%;"></td> </tr> <tr> <td></td> <td></td> <td colspan="8" style="text-align: center;"> <table border="1" style="width: 100%; border-collapse: collapse; text-align: center;"> <tr> <td style="width: 10%;"></td> <td style="width: 10%;"></td> <td style="width: 10%;"></td> <td style="width: 10%;"></td> <td style="width: 10%;"></td> <td style="width: 10%;"></td> <td style="width: 10%;"></td> <td style="width: 10%;"></td> <td style="width: 10%;"></td> <td style="width: 10%;"></td> </tr> <tr> <td></td> <td></td> <td colspan="8" style="text-align: center;"> <table border="1" style="width: 100%; border-collapse: collapse; text-align: center;"> <tr> <td style="width: 10%;"></td> <td style="width: 10%;"></td> <td style="width: 10%;"></td> <td style="width: 10%;"></td> <td style="width: 10%;"></td> <td style="width: 10%;"></td> <td style="width: 10%;"></td> <td style="width: 10%;"></td> <td style="width: 10%;"></td> <td style="width: 10%;"></td> </tr> <tr> <td></td> <td></td> <td colspan="8" style="text-align: center;"> <table border="1" style="width: 100%; border-collapse: collapse; text-align: center;"> <tr> <td style="width: 10%;"></td> <td style="width: 10%;"></td> <td style="width: 10%;"></td> <td style="width: 10%;"></td> <td style="width: 10%;"></td> <td style="width: 10%;"></td> <td style="width: 10%;"></td> <td style="width: 10%;"></td> <td style="width: 10%;"></td> <td style="width: 10%;"></td> </tr> <tr> <td></td> <td></td> <td colspan="8" style="text-align: center;"> <table border="1" style="width: 100%; border-collapse: collapse; text-align: center;"> <tr> <td style="width: 10%;"></td> <td style="width: 10%;"></td> <td style="width: 10%;"></td> <td style="width: 10%;"></td> <td style="width: 10%;"></td> <td style="width: 10%;"></td> <td style="width: 10%;"></td> <td style="width: 10%;"></td> <td style="width: 10%;"></td> <td style="width: 10%;"></td> </tr> <tr> <td></td> <td></td> <td colspan="8" style="text-align: center;"> <table border="1" style="width: 100%; border-collapse: collapse; text-align: center;"> <tr> <td style="width: 10%;"></td> <td style="width: 10%;"></td> <td style="width: 10%;"></td> <td style="width: 10%;"></td> <td style="width: 10%;"></td> <td style="width: 10%;"></td> <td style="width: 10%;"></td> <td style="width: 10%;"></td> <td style="width: 10%;"></td> <td style="width: 10%;"></td> </tr> <tr> <td></td> <td></td> <td colspan="8" style="text-align: center;"> <table border="1" style="width: 100%; border-collapse: collapse; text-align: center;"> <tr> <td style="width: 10%;"></td> <td style="width: 10%;"></td> <td style="width: 10%;"></td> <td style="width: 10%;"></td> <td style="width: 10%;"></td> <td style="width: 10%;"></td> <td style="width: 10%;"></td> <td style="width: 10%;"></td> <td style="width: 10%;"></td> <td style="width: 10%;"></td> </tr> <tr> <td></td> <td></td> <td colspan="8" style="text-align: center;"> <table border="1" style="width: 100%; border-collapse: collapse; text-align: center;"> <tr> <td style="width: 10%;"></td> <td style="width: 10%;"></td> <td style="width: 10%;"></td> <td style="width: 10%;"></td> <td style="width: 10%;"></td> <td style="width: 10%;"></td> <td style="width: 10%;"></td> <td style="width: 10%;"></td> <td style="width: 10%;"></td> <td style="width: 10%;"></td> </tr> <tr> <td></td> <td></td> <td colspan="8" style="text-align: center;"> <table border="1" style="width: 100%; border-collapse: collapse; text-align: center;"> <tr> <td style="width: 10%;"></td> <td style="width: 10%;"></td> <td style="width: 10%;"></td> <td style="width: 10%;"></td> <td style="width: 10%;"></td> <td style="width: 10%;"></td> <td style="width: 10%;"></td> <td style="width: 10%;"></td> <td style="width: 10%;"></td> <td style="width: 10%;"></td> </tr> <tr> <td></td> <td></td> <td colspan="8" style="text-align: center;"> <table border="1" style="width: 100%; border-collapse: collapse; text-align: center;"> <tr> <td style="width: 10%;"></td> <td style="width: 10%;"></td> <td style="width: 10%;"></td> <td style="width: 10%;"></td> <td style="width: 10%;"></td> <td style="width: 10%;"></td> <td style="width: 10%;"></td> <td style="width: 10%;"></td> <td style="width: 10%;"></td> <td style="width: 10%;"></td> </tr> <tr> <td></td> <td></td> <td colspan="8" style="text-align: center;"> <table border="1" style="width: 100%; border-collapse: collapse; text-align: center;"> <tr> <td style="width: 10%;"></td> <td style="width: 10%;"></td> <td style="width: 10%;"></td> <td style="width: 10%;"></td> <td style="width: 10%;"></td> <td style="width: 10%;"></td> <td style="width: 10%;"></td> <td style="width: 10%;"></td> <td style="width: 10%;"></td> <td style="width: 10%;"></td> </tr> <tr> <td></td> <td></td> <td colspan="8" style="text-align: center;"> <table border="1" style="width: 100%; border-collapse: collapse; text-align: center;"> <tr> <td style="width: 10%;"></td> <td style="width: 10%;"></td> <td style="width: 10%;"></td> <td style="width: 10%;"></td> <td style="width: 10%;"></td> <td style="width: 10%;"></td> <td style="width: 10%;"></td> <td style="width: 10%;"></td> <td style="width: 10%;"></td> <td style="width: 10%;"></td> </tr> <tr> <td></td> <td></td> <td colspan="8" style="text-align: center;"> <table
border="1" style="width: 100%; border-collapse: collapse; text-align: center;"> <tr> <td style="width: 10%;"></td> <td style="width: 10%;"></td> <td style="width: 10%;"></td> <td style="width: 10%;"></td> <td style="width: 10%;"></td> <td style="width: 10%;"></td> <td style="width: 10%;"></td> <td style="width: 10%;"></td> <td style="width: 10%;"></td> <td style="width: 10%;"></td> </tr> <tr> <td></td> <td></td> <td colspan="8" style="text-align: center;"> <table border="1" style="width: 100%; border-collapse: collapse; text-align: center;"> <tr> </tr></table></td></tr></table></td></tr></table></td></tr></table></td></tr></table></td></tr></table></td></tr></table></td></tr></table></td></tr></table></td></tr></table></td></tr></table></td></tr></table></td></tr></table></td></tr></table></td></tr></table></td></tr></table></td></tr></table></td></tr></table></td></tr></table></td></tr></table></td></tr></table></td></tr></table></td></tr></table></td></tr></table></td></tr></table></td></tr></table></td></tr></table></td></tr></table></td></tr></table></td></tr></table></td></tr></table> | | | | | | | | | | | | | | | | | | | | <table border="1" style="width: 100%; border-collapse: collapse; text-align: center;"> <tr> <td style="width: 10%;"></td> <td style="width: 10%;"></td> <td style="width: 10%;"></td> <td style="width: 10%;"></td> <td style="width: 10%;"></td> <td style="width: 10%;"></td> <td style="width: 10%;"></td> <td style="width: 10%;"></td> <td style="width: 10%;"></td> <td style="width: 10%;"></td> </tr> <tr> <td></td> <td></td> <td colspan="8" style="text-align: center;"> <table border="1" style="width: 100%; border-collapse: collapse; text-align: center;"> <tr> <td
style="width: 10%;"></td> <td style="width: 10%;"></td> <td style="width: 10%;"></td> <td style="width: 10%;"></td> <td style="width: 10%;"></td> <td style="width: 10%;"></td> <td style="width: 10%;"></td> <td style="width: 10%;"></td> <td style="width: 10%;"></td> <td style="width: 10%;"></td> </tr> <tr> <td></td> <td></td> <td colspan="8" style="text-align: center;"> <table border="1" style="width: 100%; border-collapse: collapse; text-align: center;"> <tr> <td style="width: 10%;"></td> <td style="width: 10%;"></td> <td style="width: 10%;"></td> <td style="width: 10%;"></td> <td style="width: 10%;"></td> <td style="width: 10%;"></td> <td style="width: 10%;"></td> <td style="width: 10%;"></td> <td style="width: 10%;"></td> <td style="width: 10%;"></td> </tr> <tr> <td></td> <td></td> <td colspan="8" style="text-align: center;"> <table border="1" style="width: 100%; border-collapse: collapse; text-align: center;"> <tr> <td style="width: 10%;"></td> <td style="width: 10%;"></td> <td style="width: 10%;"></td> <td style="width: 10%;"></td> <td style="width: 10%;"></td> <td style="width: 10%;"></td> <td style="width: 10%;"></td> <td style="width: 10%;"></td> <td style="width: 10%;"></td> <td style="width: 10%;"></td> </tr> <tr> <td></td> <td></td> <td colspan="8" style="text-align: center;"> <table border="1" style="width: 100%; border-collapse: collapse; text-align: center;"> <tr> <td style="width: 10%;"></td> <td style="width: 10%;"></td> <td style="width: 10%;"></td> <td style="width: 10%;"></td> <td style="width: 10%;"></td> <td style="width: 10%;"></td> <td style="width: 10%;"></td> <td style="width: 10%;"></td> <td style="width: 10%;"></td> <td style="width: 10%;"></td> </tr> <tr> <td></td> <td></td> <td colspan="8" style="text-align: center;"> <table border="1" style="width: 100%; border-collapse: collapse; text-align: center;"> <tr> <td style="width: 10%;"></td> <td style="width: 10%;"></td> <td style="width: 10%;"></td> <td style="width: 10%;"></td> <td style="width: 10%;"></td> <td style="width: 10%;"></td> <td style="width: 10%;"></td> <td style="width: 10%;"></td> <td style="width: 10%;"></td> <td style="width: 10%;"></td> </tr> <tr> <td></td> <td></td> <td colspan="8" style="text-align: center;"> <table border="1" style="width: 100%; border-collapse: collapse; text-align: center;"> <tr> <td style="width: 10%;"></td> <td style="width: 10%;"></td> <td style="width: 10%;"></td> <td style="width: 10%;"></td> <td style="width: 10%;"></td> <td style="width: 10%;"></td> <td style="width: 10%;"></td> <td style="width: 10%;"></td> <td style="width: 10%;"></td> <td style="width: 10%;"></td> </tr> <tr> <td></td> <td></td> <td colspan="8" style="text-align: center;"> <table border="1" style="width: 100%; border-collapse: collapse; text-align: center;"> <tr> <td style="width: 10%;"></td> <td style="width: 10%;"></td> <td style="width: 10%;"></td> <td style="width: 10%;"></td> <td style="width: 10%;"></td> <td style="width: 10%;"></td> <td style="width: 10%;"></td> <td style="width: 10%;"></td> <td style="width: 10%;"></td> <td style="width: 10%;"></td> </tr> <tr> <td></td> <td></td> <td colspan="8" style="text-align: center;"> <table border="1" style="width: 100%; border-collapse: collapse; text-align: center;"> <tr> <td style="width: 10%;"></td> <td style="width: 10%;"></td> <td style="width: 10%;"></td> <td style="width: 10%;"></td> <td style="width: 10%;"></td> <td style="width: 10%;"></td> <td style="width: 10%;"></td> <td style="width: 10%;"></td> <td style="width: 10%;"></td> <td style="width: 10%;"></td> </tr> <tr> <td></td> <td></td> <td colspan="8" style="text-align: center;"> <table border="1" style="width: 100%; border-collapse: collapse; text-align: center;"> <tr> <td style="width: 10%;"></td> <td style="width: 10%;"></td> <td style="width: 10%;"></td> <td style="width: 10%;"></td> <td style="width: 10%;"></td> <td style="width: 10%;"></td> <td style="width: 10%;"></td> <td style="width: 10%;"></td> <td style="width: 10%;"></td> <td style="width: 10%;"></td> </tr> <tr> <td></td> <td></td> <td colspan="8" style="text-align: center;"> <table border="1" style="width: 100%; border-collapse: collapse; text-align: center;"> <tr> <td style="width: 10%;"></td> <td style="width: 10%;"></td> <td style="width: 10%;"></td> <td style="width: 10%;"></td> <td style="width: 10%;"></td> <td style="width: 10%;"></td> <td style="width: 10%;"></td> <td style="width: 10%;"></td> <td style="width: 10%;"></td> <td style="width: 10%;"></td> </tr> <tr> <td></td> <td></td> <td colspan="8" style="text-align: center;"> <table border="1" style="width: 100%; border-collapse: collapse; text-align: center;"> <tr> <td style="width: 10%;"></td> <td style="width: 10%;"></td> <td style="width: 10%;"></td> <td style="width: 10%;"></td> <td style="width: 10%;"></td> <td style="width: 10%;"></td> <td style="width: 10%;"></td> <td style="width: 10%;"></td> <td style="width: 10%;"></td> <td style="width: 10%;"></td> </tr> <tr> <td></td> <td></td> <td colspan="8" style="text-align: center;"> <table border="1" style="width: 100%; border-collapse: collapse; text-align: center;"> <tr> <td style="width: 10%;"></td> <td style="width: 10%;"></td> <td style="width: 10%;"></td> <td style="width: 10%;"></td> <td style="width: 10%;"></td> <td style="width: 10%;"></td> <td style="width: 10%;"></td> <td style="width: 10%;"></td> <td style="width: 10%;"></td> <td style="width: 10%;"></td> </tr> <tr> <td></td> <td></td> <td colspan="8" style="text-align: center;"> <table border="1" style="width: 100%; border-collapse: collapse; text-align: center;"> <tr> <td style="width: 10%;"></td> <td style="width: 10%;"></td> <td style="width: 10%;"></td> <td style="width: 10%;"></td> <td style="width: 10%;"></td> <td style="width: 10%;"></td> <td style="width: 10%;"></td> <td style="width: 10%;"></td> <td style="width: 10%;"></td> <td style="width: 10%;"></td> </tr> <tr> <td></td> <td></td> <td colspan="8" style="text-align: center;"> <table border="1" style="width: 100%; border-collapse: collapse; text-align: center;"> <tr> <td style="width: 10%;"></td> <td style="width: 10%;"></td> <td style="width: 10%;"></td> <td style="width: 10%;"></td> <td style="width: 10%;"></td> <td style="width: 10%;"></td> <td style="width: 10%;"></td> <td style="width: 10%;"></td> <td style="width: 10%;"></td> <td style="width: 10%;"></td> </tr> <tr> <td></td> <td></td> <td colspan="8" style="text-align: center;"> <table border="1" style="width: 100%; border-collapse: collapse; text-align: center;"> <tr> <td style="width: 10%;"></td> <td style="width: 10%;"></td> <td style="width: 10%;"></td> <td style="width: 10%;"></td> <td style="width: 10%;"></td> <td style="width: 10%;"></td> <td style="width: 10%;"></td> <td style="width: 10%;"></td> <td style="width: 10%;"></td> <td style="width: 10%;"></td> </tr> <tr> <td></td> <td></td> <td colspan="8" style="text-align: center;"> <table border="1" style="width: 100%; border-collapse: collapse; text-align: center;"> <tr> <td style="width: 10%;"></td> <td style="width: 10%;"></td> <td style="width: 10%;"></td> <td style="width: 10%;"></td> <td style="width: 10%;"></td> <td style="width: 10%;"></td> <td style="width: 10%;"></td> <td style="width: 10%;"></td> <td style="width: 10%;"></td> <td style="width: 10%;"></td> </tr> <tr> <td></td> <td></td> <td colspan="8" style="text-align: center;"> <table border="1" style="width: 100%; border-collapse: collapse; text-align: center;"> <tr> <td style="width: 10%;"></td> <td style="width: 10%;"></td> <td style="width: 10%;"></td> <td style="width: 10%;"></td> <td style="width: 10%;"></td> <td style="width: 10%;"></td> <td style="width: 10%;"></td> <td style="width: 10%;"></td> <td style="width: 10%;"></td> <td style="width: 10%;"></td> </tr> <tr> <td></td> <td></td> <td colspan="8" style="text-align: center;"> <table border="1" style="width: 100%; border-collapse: collapse; text-align: center;"> <tr> <td style="width: 10%;"></td> <td style="width: 10%;"></td> <td style="width: 10%;"></td> <td style="width: 10%;"></td> <td style="width: 10%;"></td> <td style="width: 10%;"></td> <td style="width: 10%;"></td> <td style="width: 10%;"></td> <td style="width: 10%;"></td> <td style="width: 10%;"></td> </tr> <tr> <td></td> <td></td> <td colspan="8" style="text-align: center;"> <table border="1" style="width: 100%; border-collapse: collapse; text-align: center;"> <tr> <td style="width: 10%;"></td> <td style="width: 10%;"></td> <td style="width: 10%;"></td> <td style="width: 10%;"></td> <td style="width: 10%;"></td> <td style="width: 10%;"></td> <td style="width: 10%;"></td> <td style="width: 10%;"></td> <td style="width: 10%;"></td> <td style="width: 10%;"></td> </tr> <tr> <td></td> <td></td> <td colspan="8" style="text-align: center;"> <table border="1" style="width: 100%; border-collapse: collapse; text-align: center;"> <tr> <td style="width: 10%;"></td> <td style="width: 10%;"></td> <td style="width: 10%;"></td> <td style="width: 10%;"></td> <td style="width: 10%;"></td> <td style="width: 10%;"></td> <td style="width: 10%;"></td> <td style="width: 10%;"></td> <td style="width: 10%;"></td> <td style="width: 10%;"></td> </tr> <tr> <td></td> <td></td> <td colspan="8" style="text-align: center;"> <table border="1" style="width: 100%; border-collapse: collapse; text-align: center;"> <tr> <td style="width: 10%;"></td> <td style="width: 10%;"></td> <td style="width: 10%;"></td> <td style="width: 10%;"></td> <td style="width: 10%;"></td> <td style="width: 10%;"></td> <td style="width: 10%;"></td> <td style="width: 10%;"></td> <td style="width: 10%;"></td> <td style="width: 10%;"></td> </tr> <tr> <td></td> <td></td> <td colspan="8" style="text-align: center;"> <table border="1" style="width: 100%; border-collapse: collapse; text-align: center;"> <tr> <td style="width: 10%;"></td> <td style="width: 10%;"></td> <td style="width: 10%;"></td> <td style="width: 10%;"></td> <td style="width: 10%;"></td> <td style="width:
10%;"></td> <td style="width: 10%;"></td> <td style="width: 10%;"></td> <td style="width: 10%;"></td> <td style="width: 10%;"></td> </tr> <tr> <td></td> <td></td> <td colspan="8" style="text-align: center;"> <table border="1" style="width: 100%; border-collapse: collapse; text-align: center;"> <tr> <td style="width: 10%;"></td> <td style="width: 10%;"></td> <td style="width: 10%;"></td> <td style="width: 10%;"></td> <td style="width: 10%;"></td> <td style="width: 10%;"></td> <td style="width: 10%;"></td> <td style="width: 10%;"></td> <td style="width: 10%;"></td> <td style="width: 10%;"></td> </tr> <tr> <td></td> <td></td> <td colspan="8" style="text-align: center;"> <table border="1" style="width: 100%; border-collapse: collapse; text-align: center;"> <tr> <td style="width: 10%;"></td> <td style="width: 10%;"></td> <td style="width: 10%;"></td> <td style="width: 10%;"></td> <td style="width: 10%;"></td> <td style="width: 10%;"></td> <td style="width: 10%;"></td> <td style="width: 10%;"></td> <td style="width: 10%;"></td> <td style="width: 10%;"></td> </tr> <tr> <td></td> <td></td> <td colspan="8" style="text-align: center;"> <table border="1" style="width: 100%; border-collapse: collapse; text-align: center;"> <tr> <td style="width: 10%;"></td> <td style="width: 10%;"></td> <td style="width: 10%;"></td> <td style="width: 10%;"></td> <td style="width: 10%;"></td> <td style="width: 10%;"></td> <td style="width: 10%;"></td> <td style="width: 10%;"></td> <td style="width: 10%;"></td> <td style="width: 10%;"></td> </tr> <tr> <td></td> <td></td> <td colspan="8" style="text-align: center;"> <table border="1" style="width: 100%; border-collapse: collapse; text-align: center;"> <tr> <td style="width: 10%;"></td> <td style="width: 10%;"></td> <td style="width: 10%;"></td> <td style="width: 10%;"></td> <td style="width: 10%;"></td> <td style="width: 10%;"></td> <td style="width: 10%;"></td> <td style="width: 10%;"></td> <td style="width: 10%;"></td> <td style="width: 10%;"></td> </tr> <tr> <td></td> <td></td> <td colspan="8" style="text-align: center;"> <table border="1" style="width: 100%; border-collapse: collapse; text-align: center;"> <tr> <td style="width: 10%;"></td> <td style="width: 10%;"></td> <td style="width: 10%;"></td> <td style="width: 10%;"></td> <td style="width: 10%;"></td> <td style="width: 10%;"></td> <td style="width: 10%;"></td> <td style="width: 10%;"></td> <td style="width: 10%;"></td> <td style="width: 10%;"></td> </tr> <tr> <td></td> <td></td> <td colspan="8" style="text-align: center;"> <table border="1" style="width: 100%; border-collapse: collapse; text-align: center;"> <tr> <td style="width: 10%;"></td> <td style="width: 10%;"></td> <td style="width: 10%;"></td> <td style="width: 10%;"></td> <td style="width: 10%;"></td> <td style="width: 10%;"></td> <td style="width: 10%;"></td> <td style="width: 10%;"></td> <td style="width: 10%;"></td> <td style="width: 10%;"></td> </tr> <tr> <td></td> <td></td> <td colspan="8" style="text-align: center;"> <table border="1" style="width: 100%; border-collapse: collapse; text-align: center;"> <tr> </tr></table></td></tr></table></td></tr></table></td></tr></table></td></tr></table></td></tr></table></td></tr></table></td></tr></table></td></tr></table></td></tr></table></td></tr></table></td></tr></table></td></tr></table></td></tr></table></td></tr></table></td></tr></table></td></tr></table></td></tr></table></td></tr></table></td></tr></table></td></tr></table></td></tr></table></td></tr></table></td></tr></table></td></tr></table></td></tr></table></td></tr></table></td></tr></table></td></tr></table></td></tr></table>
 | | | | | | | | | | | | | | | | | | | | <table border="1" style="width: 100%; border-collapse: collapse; text-align: center;"> <tr> <td style="width: 10%;"></td> <td style="width: 10%;"></td> <td style="width: 10%;"></td> <td style="width: 10%;"></td> <td style="width: 10%;"></td> <td style="width: 10%;"></td> <td style="width: 10%;"></td> <td style="width: 10%;"></td> <td style="width: 10%;"></td> <td style="width: 10%;"></td> </tr> <tr> <td></td> <td></td> <td colspan="8" style="text-align: center;"> <table border="1" style="width: 100%; border-collapse: collapse; text-align: center;"> <tr> <td style="width: 10%;"></td> <td style="width: 10%;"></td> <td style="width: 10%;"></td> <td style="width: 10%;"></td> <td style="width: 10%;"></td> <td style="width: 10%;"></td> <td style="width: 10%;"></td> <td style="width: 10%;"></td> <td style="width: 10%;"></td> <td style="width: 10%;"></td> </tr> <tr> <td></td> <td></td> <td colspan="8" style="text-align: center;"> <table border="1" style="width: 100%; border-collapse: collapse; text-align: center;"> <tr> <td style="width: 10%;"></td> <td style="width: 10%;"></td> <td style="width: 10%;"></td> <td style="width: 10%;"></td> <td style="width: 10%;"></td> <td style="width: 10%;"></td> <td style="width: 10%;"></td> <td style="width: 10%;"></td> <td style="width: 10%;"></td> <td style="width: 10%;"></td> </tr> <tr> <td></td> <td></td> <td colspan="8" style="text-align: center;"> <table border="1" style="width: 100%; border-collapse: collapse; text-align: center;"> <tr> <td style="width: 10%;"></td> <td style="width: 10%;"></td> <td style="width: 10%;"></td> <td style="width: 10%;"></td> <td style="width: 10%;"></td> <td style="width: 10%;"></td> <td style="width: 10%;"></td> <td style="width: 10%;"></td> <td style="width: 10%;"></td> <td style="width: 10%;"></td> </tr> <tr> <td></td> <td></td> <td colspan="8" style="text-align: center;"> <table border="1" style="width: 100%; border-collapse: collapse; text-align: center;"> <tr> <td style="width: 10%;"></td> <td style="width: 10%;"></td> <td style="width: 10%;"></td> <td style="width: 10%;"></td> <td style="width: 10%;"></td> <td style="width: 10%;"></td> <td style="width: 10%;"></td> <td style="width: 10%;"></td> <td style="width: 10%;"></td> <td style="width: 10%;"></td> </tr> <tr> <td></td> <td></td> <td colspan="8" style="text-align: center;"> <table border="1" style="width: 100%; border-collapse: collapse; text-align: center;"> <tr> <td style="width: 10%;"></td> <td style="width: 10%;"></td> <td style="width: 10%;"></td> <td style="width: 10%;"></td> <td style="width: 10%;"></td> <td style="width: 10%;"></td> <td style="width: 10%;"></td> <td style="width: 10%;"></td> <td style="width: 10%;"></td> <td style="width: 10%;"></td> </tr> <tr> <td></td> <td></td> <td colspan="8" style="text-align: center;"> <table border="1" style="width: 100%; border-collapse: collapse; text-align: center;"> <tr> <td style="width: 10%;"></td> <td style="width: 10%;"></td> <td style="width: 10%;"></td> <td style="width: 10%;"></td> <td style="width: 10%;"></td> <td style="width: 10%;"></td> <td style="width: 10%;"></td> <td style="width: 10%;"></td> <td style="width: 10%;"></td> <td style="width: 10%;"></td> </tr> <tr> <td></td> <td></td> <td colspan="8" style="text-align: center;"> <table border="1" style="width: 100%; border-collapse: collapse; text-align: center;"> <tr> <td style="width: 10%;"></td> <td style="width: 10%;"></td> <td style="width: 10%;"></td> <td style="width: 10%;"></td> <td style="width: 10%;"></td> <td style="width: 10%;"></td> <td style="width: 10%;"></td> <td style="width: 10%;"></td> <td style="width: 10%;"></td> <td style="width: 10%;"></td> </tr> <tr> <td></td> <td></td> <td colspan="8" style="text-align: center;"> <table border="1" style="width: 100%; border-collapse: collapse; text-align: center;"> <tr> <td style="width: 10%;"></td> <td style="width: 10%;"></td> <td style="width: 10%;"></td> <td style="width: 10%;"></td> <td style="width: 10%;"></td> <td style="width: 10%;"></td> <td style="width: 10%;"></td> <td style="width: 10%;"></td> <td style="width: 10%;"></td> <td style="width: 10%;"></td> </tr> <tr> <td></td> <td></td> <td colspan="8" style="text-align: center;"> <table border="1" style="width: 100%; border-collapse: collapse; text-align: center;"> <tr> <td style="width: 10%;"></td> <td style="width: 10%;"></td> <td style="width: 10%;"></td> <td style="width: 10%;"></td> <td style="width: 10%;"></td> <td style="width: 10%;"></td> <td style="width: 10%;"></td> <td style="width: 10%;"></td> <td style="width: 10%;"></td> <td style="width: 10%;"></td> </tr> <tr> <td></td> <td></td> <td colspan="8" style="text-align: center;"> <table border="1" style="width: 100%; border-collapse: collapse; text-align: center;"> <tr> <td style="width: 10%;"></td> <td style="width: 10%;"></td> <td style="width: 10%;"></td> <td style="width: 10%;"></td> <td style="width: 10%;"></td> <td style="width: 10%;"></td> <td style="width: 10%;"></td> <td style="width: 10%;"></td> <td style="width: 10%;"></td> <td style="width: 10%;"></td> </tr> <tr> <td></td> <td></td> <td colspan="8" style="text-align: center;"> <table border="1" style="width: 100%; border-collapse: collapse; text-align: center;"> <tr> <td style="width: 10%;"></td> <td style="width: 10%;"></td> <td style="width: 10%;"></td> <td style="width: 10%;"></td> <td style="width: 10%;"></td> <td style="width: 10%;"></td> <td style="width: 10%;"></td> <td style="width: 10%;"></td> <td style="width: 10%;"></td> <td style="width: 10%;"></td> </tr> <tr> <td></td> <td></td> <td colspan="8" style="text-align: center;"> <table border="1" style="width: 100%; border-collapse: collapse; text-align: center;"> <tr> <td style="width: 10%;"></td> <td style="width: 10%;"></td> <td style="width: 10%;"></td> <td style="width: 10%;"></td> <td style="width: 10%;"></td> <td style="width: 10%;"></td> <td style="width: 10%;"></td> <td style="width: 10%;"></td> <td style="width: 10%;"></td> <td style="width: 10%;"></td> </tr> <tr> <td></td> <td></td> <td colspan="8" style="text-align: center;"> <table border="1" style="width: 100%; border-collapse: collapse; text-align: center;"> <tr> <td style="width: 10%;"></td> <td style="width: 10%;"></td> <td style="width: 10%;"></td> <td style="width: 10%;"></td> <td style="width: 10%;"></td> <td style="width: 10%;"></td> <td style="width: 10%;"></td> <td style="width: 10%;"></td> <td style="width: 10%;"></td> <td style="width: 10%;"></td> </tr> <tr> <td></td> <td></td> <td colspan="8" style="text-align: center;"> <table border="1" style="width: 100%; border-collapse: collapse; text-align: center;"> <tr> <td style="width: 10%;"></td> <td style="width: 10%;"></td> <td style="width: 10%;"></td> <td style="width: 10%;"></td> <td style="width: 10%;"></td> <td style="width: 10%;"></td> <td style="width: 10%;"></td> <td style="width: 10%;"></td> <td style="width: 10%;"></td> <td style="width: 10%;"></td> </tr> <tr> <td></td> <td></td> <td colspan="8" style="text-align: center;"> <table border="1" style="width: 100%; border-collapse: collapse; text-align: center;"> <tr> <td style="width: 10%;"></td> <td style="width: 10%;"></td> <td style="width: 10%;"></td> <td style="width: 10%;"></td> <td style="width: 10%;"></td> <td style="width: 10%;"></td> <td style="width: 10%;"></td> <td style="width: 10%;"></td> <td style="width: 10%;"></td> <td style="width: 10%;"></td> </tr> <tr> <td></td> <td></td> <td colspan="8" style="text-align: center;"> <table border="1" style="width: 100%; border-collapse: collapse; text-align: center;"> <tr> <td style="width: 10%;"></td> <td style="width: 10%;"></td> <td style="width: 10%;"></td> <td style="width: 10%;"></td> <td style="width: 10%;"></td> <td style="width: 10%;"></td> <td style="width: 10%;"></td> <td style="width: 10%;"></td> <td style="width: 10%;"></td> <td style="width: 10%;"></td> </tr> <tr> <td></td> <td></td> <td colspan="8" style="text-align: center;"> <table border="1" style="width: 100%; border-collapse: collapse; text-align:
center;"> <tr> <td style="width: 10%;"></td> <td style="width: 10%;"></td> <td style="width: 10%;"></td> <td style="width: 10%;"></td> <td style="width: 10%;"></td> <td style="width: 10%;"></td> <td style="width: 10%;"></td> <td style="width: 10%;"></td> <td style="width: 10%;"></td> <td style="width: 10%;"></td> </tr> <tr> <td></td> <td></td> <td colspan="8" style="text-align: center;"> <table border="1" style="width: 100%; border-collapse: collapse; text-align: center;"> <tr> <td style="width: 10%;"></td> <td style="width: 10%;"></td> <td style="width: 10%;"></td> <td style="width: 10%;"></td> <td style="width: 10%;"></td> <td style="width: 10%;"></td> <td style="width: 10%;"></td> <td style="width: 10%;"></td> <td style="width: 10%;"></td> <td style="width: 10%;"></td> </tr> <tr> <td></td> <td></td> <td colspan="8" style="text-align: center;"> <table border="1" style="width: 100%; border-collapse: collapse; text-align: center;"> <tr> <td style="width: 10%;"></td> <td style="width: 10%;"></td> <td style="width: 10%;"></td> <td style="width: 10%;"></td> <td style="width: 10%;"></td> <td style="width: 10%;"></td> <td style="width: 10%;"></td> <td style="width: 10%;"></td> <td style="width: 10%;"></td> <td style="width: 10%;"></td> </tr> <tr> <td></td> <td></td> <td colspan="8" style="text-align: center;"> <table border="1" style="width: 100%; border-collapse: collapse; text-align: center;"> <tr> <td style="width: 10%;"></td> <td style="width: 10%;"></td> <td style="width: 10%;"></td> <td style="width: 10%;"></td> <td style="width: 10%;"></td> <td style="width: 10%;"></td> <td style="width: 10%;"></td> <td style="width: 10%;"></td> <td style="width: 10%;"></td> <td style="width: 10%;"></td> </tr> <tr> <td></td> <td></td> <td colspan="8" style="text-align: center;"> <table border="1" style="width: 100%; border-collapse: collapse; text-align: center;"> <tr> <td style="width: 10%;"></td> <td style="width: 10%;"></td> <td style="width: 10%;"></td> <td style="width: 10%;"></td> <td style="width: 10%;"></td> <td style="width: 10%;"></td> <td style="width: 10%;"></td> <td style="width: 10%;"></td> <td style="width: 10%;"></td> <td style="width: 10%;"></td> </tr> <tr> <td></td> <td></td> <td colspan="8" style="text-align: center;"> <table border="1" style="width: 100%; border-collapse: collapse; text-align: center;"> <tr> <td style="width: 10%;"></td> <td style="width: 10%;"></td> <td style="width: 10%;"></td> <td style="width: 10%;"></td> <td style="width: 10%;"></td> <td style="width: 10%;"></td> <td style="width: 10%;"></td> <td style="width: 10%;"></td> <td style="width: 10%;"></td> <td style="width: 10%;"></td> </tr> <tr> <td></td> <td></td> <td colspan="8" style="text-align: center;"> <table border="1" style="width: 100%; border-collapse: collapse; text-align: center;"> <tr> <td style="width: 10%;"></td> <td style="width: 10%;"></td> <td style="width: 10%;"></td> <td style="width: 10%;"></td> <td style="width: 10%;"></td> <td style="width: 10%;"></td> <td style="width: 10%;"></td> <td style="width: 10%;"></td> <td style="width: 10%;"></td> <td style="width: 10%;"></td> </tr> <tr> <td></td> <td></td> <td colspan="8" style="text-align: center;"> <table border="1" style="width: 100%; border-collapse: collapse; text-align: center;"> <tr> <td style="width: 10%;"></td> <td style="width: 10%;"></td> <td style="width: 10%;"></td> <td style="width: 10%;"></td> <td style="width: 10%;"></td> <td style="width: 10%;"></td> <td style="width: 10%;"></td> <td style="width: 10%;"></td> <td style="width: 10%;"></td> <td style="width: 10%;"></td> </tr> <tr> <td></td> <td></td> <td colspan="8" style="text-align: center;"> <table border="1" style="width: 100%; border-collapse: collapse; text-align: center;"> <tr> <td style="width: 10%;"></td> <td style="width: 10%;"></td> <td style="width: 10%;"></td> <td style="width: 10%;"></td> <td style="width: 10%;"></td> <td style="width: 10%;"></td> <td style="width: 10%;"></td> <td style="width: 10%;"></td> <td style="width: 10%;"></td> <td style="width: 10%;"></td> </tr> <tr> <td></td> <td></td> <td colspan="8" style="text-align: center;"> <table border="1" style="width: 100%; border-collapse: collapse; text-align: center;"> <tr> <td style="width: 10%;"></td> <td style="width: 10%;"></td> <td style="width: 10%;"></td> <td style="width: 10%;"></td> <td style="width: 10%;"></td> <td style="width: 10%;"></td> <td style="width: 10%;"></td> <td style="width: 10%;"></td> <td style="width: 10%;"></td> <td style="width: 10%;"></td> </tr> <tr> <td></td> <td></td> <td colspan="8" style="text-align: center;"> <table border="1" style="width: 100%; border-collapse: collapse; text-align: center;"> <tr> <td style="width: 10%;"></td> <td style="width: 10%;"></td> <td style="width: 10%;"></td> <td style="width: 10%;"></td> <td style="width: 10%;"></td> <td style="width: 10%;"></td> <td style="width: 10%;"></td> <td style="width: 10%;"></td> <td style="width: 10%;"></td> <td style="width: 10%;"></td> </tr> <tr> <td></td> <td></td> <td colspan="8" style="text-align: center;"> <table border="1" style="width: 100%; border-collapse: collapse; text-align: center;"> <tr> </tr></table></td></tr></table></td></tr></table></td></tr></table></td></tr></table></td></tr></table></td></tr></table></td></tr></table></td></tr></table></td></tr></table></td></tr></table></td></tr></table></td></tr></table></td></tr></table></td></tr></table></td></tr></table></td></tr></table></td></tr></table></td></tr></table></td></tr></table></td></tr></table></td></tr></table></td></tr></table></td></tr></table></td></tr></table></td></tr></table></td></tr></table></td></tr></table></td></tr></table>
 | | | | | | | | | | | | | | | | | | | | <table border="1" style="width: 100%; border-collapse: collapse; text-align: center;"> <tr> <td style="width: 10%;"></td> <td style="width: 10%;"></td> <td style="width: 10%;"></td> <td style="width: 10%;"></td> <td style="width: 10%;"></td> <td style="width: 10%;"></td> <td style="width: 10%;"></td> <td style="width: 10%;"></td> <td style="width: 10%;"></td> <td style="width: 10%;"></td> </tr> <tr> <td></td> <td></td> <td colspan="8" style="text-align: center;"> <table border="1" style="width: 100%; border-collapse: collapse; text-align: center;"> <tr> <td style="width: 10%;"></td> <td style="width: 10%;"></td> <td style="width: 10%;"></td> <td style="width: 10%;"></td> <td style="width: 10%;"></td> <td style="width: 10%;"></td> <td style="width: 10%;"></td> <td style="width: 10%;"></td> <td style="width: 10%;"></td> <td style="width: 10%;"></td> </tr> <tr> <td></td> <td></td> <td colspan="8" style="text-align: center;"> <table border="1" style="width: 100%; border-collapse: collapse; text-align: center;"> <tr> <td style="width: 10%;"></td> <td style="width: 10%;"></td> <td style="width: 10%;"></td> <td style="width: 10%;"></td> <td style="width: 10%;"></td> <td style="width: 10%;"></td> <td style="width: 10%;"></td> <td style="width: 10%;"></td> <td style="width: 10%;"></td> <td style="width: 10%;"></td> </tr> <tr> <td></td> <td></td> <td colspan="8" style="text-align: center;"> <table border="1" style="width: 100%; border-collapse: collapse; text-align: center;"> <tr> <td style="width: 10%;"></td> <td style="width: 10%;"></td> <td style="width: 10%;"></td> <td style="width: 10%;"></td> <td style="width: 10%;"></td> <td style="width: 10%;"></td> <td style="width: 10%;"></td> <td style="width: 10%;"></td> <td style="width: 10%;"></td> <td style="width: 10%;"></td> </tr> <tr> <td></td> <td></td> <td colspan="8" style="text-align: center;"> <table border="1" style="width: 100%; border-collapse: collapse; text-align: center;"> <tr> <td style="width: 10%;"></td> <td style="width: 10%;"></td> <td style="width: 10%;"></td> <td style="width: 10%;"></td> <td style="width: 10%;"></td> <td style="width: 10%;"></td> <td style="width: 10%;"></td> <td style="width: 10%;"></td> <td style="width: 10%;"></td> <td style="width: 10%;"></td> </tr> <tr> <td></td> <td></td> <td colspan="8" style="text-align: center;"> <table border="1" style="width: 100%; border-collapse: collapse; text-align: center;"> <tr> <td style="width: 10%;"></td> <td style="width: 10%;"></td> <td style="width: 10%;"></td> <td style="width: 10%;"></td> <td style="width: 10%;"></td> <td style="width: 10%;"></td> <td style="width: 10%;"></td> <td style="width: 10%;"></td> <td style="width: 10%;"></td> <td style="width: 10%;"></td> </tr> <tr> <td></td> <td></td> <td colspan="8" style="text-align: center;"> <table border="1" style="width: 100%; border-collapse: collapse; text-align: center;"> <tr> <td style="width: 10%;"></td> <td style="width: 10%;"></td> <td style="width: 10%;"></td> <td style="width: 10%;"></td> <td style="width: 10%;"></td> <td style="width: 10%;"></td> <td style="width: 10%;"></td> <td style="width: 10%;"></td> <td style="width: 10%;"></td> <td style="width: 10%;"></td> </tr> <tr> <td></td> <td></td> <td colspan="8" style="text-align: center;"> <table border="1" style="width: 100%; border-collapse: collapse; text-align: center;"> <tr> <td style="width: 10%;"></td> <td style="width: 10%;"></td> <td style="width: 10%;"></td> <td style="width: 10%;"></td> <td style="width: 10%;"></td> <td style="width: 10%;"></td> <td style="width: 10%;"></td> <td style="width: 10%;"></td> <td style="width: 10%;"></td> <td style="width: 10%;"></td> </tr> <tr> <td></td> <td></td> <td colspan="8" style="text-align: center;"> <table border="1" style="width: 100%; border-collapse: collapse; text-align: center;"> <tr> <td style="width: 10%;"></td> <td style="width: 10%;"></td> <td style="width: 10%;"></td> <td style="width: 10%;"></td> <td style="width: 10%;"></td> <td style="width: 10%;"></td> <td style="width: 10%;"></td> <td style="width: 10%;"></td> <td style="width: 10%;"></td> <td style="width: 10%;"></td> </tr> <tr> <td></td> <td></td> <td colspan="8" style="text-align: center;"> <table border="1" style="width: 100%; border-collapse: collapse; text-align: center;"> <tr> <td style="width: 10%;"></td> <td style="width: 10%;"></td> <td style="width: 10%;"></td> <td style="width: 10%;"></td> <td style="width: 10%;"></td> <td style="width: 10%;"></td> <td style="width: 10%;"></td> <td style="width: 10%;"></td> <td style="width: 10%;"></td> <td style="width: 10%;"></td> </tr> <tr> <td></td> <td></td> <td colspan="8" style="text-align: center;"> <table border="1" style="width: 100%; border-collapse: collapse; text-align: center;"> <tr> <td style="width: 10%;"></td> <td style="width: 10%;"></td> <td style="width: 10%;"></td> <td style="width: 10%;"></td> <td style="width: 10%;"></td> <td style="width: 10%;"></td> <td style="width: 10%;"></td> <td style="width: 10%;"></td> <td style="width: 10%;"></td> <td style="width: 10%;"></td> </tr> <tr> <td></td> <td></td> <td colspan="8" style="text-align: center;"> <table border="1" style="width: 100%; border-collapse: collapse; text-align: center;"> <tr> <td style="width: 10%;"></td> <td style="width: 10%;"></td> <td style="width: 10%;"></td> <td style="width: 10%;"></td> <td style="width: 10%;"></td> <td style="width: 10%;"></td> <td style="width: 10%;"></td> <td style="width: 10%;"></td> <td style="width: 10%;"></td> <td style="width: 10%;"></td> </tr> <tr> <td></td> <td></td> <td colspan="8" style="text-align: center;"> <table border="1" style="width: 100%; border-collapse: collapse; text-align: center;"> <tr> <td style="width: 10%;"></td> <td style="width: 10%;"></td> <td style="width: 10%;"></td> <td style="width: 10%;"></td> <td style="width: 10%;"></td> <td style="width: 10%;"></td> <td style="width: 10%;"></td> <td style="width: 10%;"></td> <td style="width: 10%;"></td> <td style="width:
10%;"></td> </tr> <tr> <td></td> <td></td> <td colspan="8" style="text-align: center;"> <table border="1" style="width: 100%; border-collapse: collapse; text-align: center;"> <tr> <td style="width: 10%;"></td> <td style="width: 10%;"></td> <td style="width: 10%;"></td> <td style="width: 10%;"></td> <td style="width: 10%;"></td> <td style="width: 10%;"></td> <td style="width: 10%;"></td> <td style="width: 10%;"></td> <td style="width: 10%;"></td> <td style="width: 10%;"></td> </tr> <tr> <td></td> <td></td> <td colspan="8" style="text-align: center;"> <table border="1" style="width: 100%; border-collapse: collapse; text-align: center;"> <tr> <td style="width: 10%;"></td> <td style="width: 10%;"></td> <td style="width: 10%;"></td> <td style="width: 10%;"></td> <td style="width: 10%;"></td> <td style="width: 10%;"></td> <td style="width: 10%;"></td> <td style="width: 10%;"></td> <td style="width: 10%;"></td> <td style="width: 10%;"></td> </tr> <tr> <td></td> <td></td> <td colspan="8" style="text-align: center;"> <table border="1" style="width: 100%; border-collapse: collapse; text-align: center;"> <tr> <td style="width: 10%;"></td> <td style="width: 10%;"></td> <td style="width: 10%;"></td> <td style="width: 10%;"></td> <td style="width: 10%;"></td> <td style="width: 10%;"></td> <td style="width: 10%;"></td> <td style="width: 10%;"></td> <td style="width: 10%;"></td> <td style="width: 10%;"></td> </tr> <tr> <td></td> <td></td> <td colspan="8" style="text-align: center;"> <table border="1" style="width: 100%; border-collapse: collapse; text-align: center;"> <tr> <td style="width: 10%;"></td> <td style="width: 10%;"></td> <td style="width: 10%;"></td> <td style="width: 10%;"></td> <td style="width: 10%;"></td> <td style="width: 10%;"></td> <td style="width: 10%;"></td> <td style="width: 10%;"></td> <td style="width: 10%;"></td> <td style="width: 10%;"></td> </tr> <tr> <td></td> <td></td> <td colspan="8" style="text-align: center;"> <table border="1" style="width: 100%; border-collapse: collapse; text-align: center;"> <tr> <td style="width: 10%;"></td> <td style="width: 10%;"></td> <td style="width: 10%;"></td> <td style="width: 10%;"></td> <td style="width: 10%;"></td> <td style="width: 10%;"></td> <td style="width: 10%;"></td> <td style="width: 10%;"></td> <td style="width: 10%;"></td> <td style="width: 10%;"></td> </tr> <tr> <td></td> <td></td> <td colspan="8" style="text-align: center;"> <table border="1" style="width: 100%; border-collapse: collapse; text-align: center;"> <tr> <td style="width: 10%;"></td> <td style="width: 10%;"></td> <td style="width: 10%;"></td> <td style="width: 10%;"></td> <td style="width: 10%;"></td> <td style="width: 10%;"></td> <td style="width: 10%;"></td> <td style="width: 10%;"></td> <td style="width: 10%;"></td> <td style="width: 10%;"></td> </tr> <tr> <td></td> <td></td> <td colspan="8" style="text-align: center;"> <table border="1" style="width: 100%; border-collapse: collapse; text-align: center;"> <tr> <td style="width: 10%;"></td> <td style="width: 10%;"></td> <td style="width: 10%;"></td> <td style="width: 10%;"></td> <td style="width: 10%;"></td> <td style="width: 10%;"></td> <td style="width: 10%;"></td> <td style="width: 10%;"></td> <td style="width: 10%;"></td> <td style="width: 10%;"></td> </tr> <tr> <td></td> <td></td> <td colspan="8" style="text-align: center;"> <table border="1" style="width: 100%; border-collapse: collapse; text-align: center;"> <tr> <td style="width: 10%;"></td> <td style="width: 10%;"></td> <td style="width: 10%;"></td> <td style="width: 10%;"></td> <td style="width: 10%;"></td> <td style="width: 10%;"></td> <td style="width: 10%;"></td> <td style="width: 10%;"></td> <td style="width: 10%;"></td> <td style="width: 10%;"></td> </tr> <tr> <td></td> <td></td> <td colspan="8" style="text-align: center;"> <table border="1" style="width: 100%; border-collapse: collapse; text-align: center;"> <tr> <td style="width: 10%;"></td> <td style="width: 10%;"></td> <td style="width: 10%;"></td> <td style="width: 10%;"></td> <td style="width: 10%;"></td> <td style="width: 10%;"></td> <td style="width: 10%;"></td> <td style="width: 10%;"></td> <td style="width: 10%;"></td> <td style="width: 10%;"></td> </tr> <tr> <td></td> <td></td> <td colspan="8" style="text-align: center;"> <table border="1" style="width: 100%; border-collapse: collapse; text-align: center;"> <tr> <td style="width: 10%;"></td> <td style="width: 10%;"></td> <td style="width: 10%;"></td> <td style="width: 10%;"></td> <td style="width: 10%;"></td> <td style="width: 10%;"></td> <td style="width: 10%;"></td> <td style="width: 10%;"></td> <td style="width: 10%;"></td> <td style="width: 10%;"></td> </tr> <tr> <td></td> <td></td> <td colspan="8" style="text-align: center;"> <table border="1" style="width: 100%; border-collapse: collapse; text-align: center;"> <tr> <td style="width: 10%;"></td> <td style="width: 10%;"></td> <td style="width: 10%;"></td> <td style="width: 10%;"></td> <td style="width: 10%;"></td> <td style="width: 10%;"></td> <td style="width: 10%;"></td> <td style="width: 10%;"></td> <td style="width: 10%;"></td> <td style="width: 10%;"></td> </tr> <tr> <td></td> <td></td> <td colspan="8" style="text-align: center;"> <table border="1" style="width: 100%; border-collapse: collapse; text-align: center;"> <tr> <td style="width: 10%;"></td> <td style="width: 10%;"></td> <td style="width: 10%;"></td> <td style="width: 10%;"></td> <td style="width: 10%;"></td> <td style="width: 10%;"></td> <td style="width: 10%;"></td> <td style="width: 10%;"></td> <td style="width: 10%;"></td> <td style="width: 10%;"></td> </tr> <tr> <td></td> <td></td> <td colspan="8" style="text-align: center;"> <table border="1" style="width: 100%; border-collapse: collapse; text-align: center;"> <tr> <td style="width: 10%;"></td> <td style="width: 10%;"></td> <td style="width: 10%;"></td> <td style="width: 10%;"></td> <td style="width: 10%;"></td> <td style="width: 10%;"></td> <td style="width: 10%;"></td> <td style="width: 10%;"></td> <td style="width: 10%;"></td> <td style="width: 10%;"></td> </tr> <tr> <td></td> <td></td> <td colspan="8" style="text-align: center;"> <table border="1" style="width: 100%; border-collapse: collapse; text-align: center;"> <tr> <td style="width: 10%;"></td> <td style="width: 10%;"></td> <td style="width: 10%;"></td> <td style="width: 10%;"></td> <td style="width: 10%;"></td> <td style="width: 10%;"></td> <td style="width: 10%;"></td> <td style="width: 10%;"></td> <td style="width: 10%;"></td> <td style="width: 10%;"></td> </tr> <tr> <td></td> <td></td> <td colspan="8" style="text-align: center;"> <table border="1" style="width: 100%; border-collapse: collapse; text-align: center;"> <tr> </tr></table></td></tr></table></td></tr></table></td></tr></table></td></tr></table></td></tr></table></td></tr></table></td></tr></table></td></tr></table></td></tr></table></td></tr></table></td></tr></table></td></tr></table></td></tr></table></td></tr></table></td></tr></table></td></tr></table></td></tr></table></td></tr></table></td></tr></table></td></tr></table></td></tr></table></td></tr></table></td></tr></table></td></tr></table></td></tr></table></td></tr></table></td></tr></table>
 | | | | | | | | | | | | | | | | | | | | <table border="1" style="width: 100%; border-collapse: collapse; text-align: center;"> <tr> <td style="width: 10%;"></td> <td style="width: 10%;"></td> <td style="width: 10%;"></td> <td style="width: 10%;"></td> <td style="width: 10%;"></td> <td style="width: 10%;"></td> <td style="width: 10%;"></td> <td style="width: 10%;"></td> <td style="width: 10%;"></td> <td style="width: 10%;"></td> </tr> <tr> <td></td> <td></td> <td colspan="8" style="text-align: center;"> <table border="1" style="width: 100%; border-collapse: collapse; text-align: center;"> <tr> <td style="width: 10%;"></td> <td style="width: 10%;"></td> <td style="width: 10%;"></td> <td style="width: 10%;"></td> <td style="width: 10%;"></td> <td style="width: 10%;"></td> <td style="width: 10%;"></td> <td style="width: 10%;"></td> <td style="width: 10%;"></td> <td style="width: 10%;"></td> </tr> <tr> <td></td> <td></td> <td colspan="8" style="text-align: center;"> <table border="1" style="width: 100%; border-collapse: collapse; text-align: center;"> <tr> <td style="width: 10%;"></td> <td style="width: 10%;"></td> <td style="width: 10%;"></td> <td style="width: 10%;"></td> <td style="width: 10%;"></td> <td style="width: 10%;"></td> <td style="width: 10%;"></td> <td style="width: 10%;"></td> <td style="width: 10%;"></td> <td style="width: 10%;"></td> </tr> <tr> <td></td> <td></td> <td colspan="8" style="text-align: center;"> <table border="1" style="width: 100%; border-collapse: collapse; text-align: center;"> <tr> <td style="width: 10%;"></td> <td style="width: 10%;"></td> <td style="width: 10%;"></td> <td style="width: 10%;"></td> <td style="width: 10%;"></td> <td style="width: 10%;"></td> <td style="width: 10%;"></td> <td style="width: 10%;"></td> <td style="width: 10%;"></td> <td style="width: 10%;"></td> </tr> <tr> <td></td> <td></td> <td colspan="8" style="text-align: center;"> <table border="1" style="width: 100%; border-collapse: collapse; text-align: center;"> <tr> <td style="width: 10%;"></td> <td style="width: 10%;"></td> <td style="width: 10%;"></td> <td style="width: 10%;"></td> <td style="width: 10%;"></td> <td style="width: 10%;"></td> <td style="width: 10%;"></td> <td style="width: 10%;"></td> <td style="width: 10%;"></td> <td style="width: 10%;"></td> </tr> <tr> <td></td> <td></td> <td colspan="8" style="text-align: center;"> <table border="1" style="width: 100%; border-collapse: collapse; text-align: center;"> <tr> <td style="width: 10%;"></td> <td style="width: 10%;"></td> <td style="width: 10%;"></td> <td style="width: 10%;"></td> <td style="width: 10%;"></td> <td style="width: 10%;"></td> <td style="width: 10%;"></td> <td style="width: 10%;"></td> <td style="width: 10%;"></td> <td style="width: 10%;"></td> </tr> <tr> <td></td> <td></td> <td colspan="8" style="text-align: center;"> <table border="1" style="width: 100%; border-collapse: collapse; text-align: center;"> <tr> <td style="width: 10%;"></td> <td style="width: 10%;"></td> <td style="width: 10%;"></td> <td style="width: 10%;"></td> <td style="width: 10%;"></td> <td style="width: 10%;"></td> <td style="width: 10%;"></td> <td style="width: 10%;"></td> <td style="width: 10%;"></td> <td style="width: 10%;"></td> </tr> <tr> <td></td> <td></td> <td colspan="8" style="text-align: center;"> <table border="1" style="width: 100%; border-collapse: collapse; text-align: center;"> <tr> <td style="width: 10%;"></td> <td style="width: 10%;"></td> <td style="width: 10%;"></td> <td style="width: 10%;"></td> <td style="width: 10%;"></td> <td style="width: 10%;"></td> <td style="width: 10%;"></td> <td style="width: 10%;"></td> <td style="width: 10%;"></td> <td style="width: 10%;"></td> </tr> <tr> <td></td> <td></td> <td colspan="8" style="text-align: center;"> <table border="1" style="width: 100%; border-collapse: collapse; text-align: center;"> <tr> <td style="width: 10%;"></td> <td style="width: 10%;"></td> <td style="width: 10%;"></td> <td style="width: 10%;"></td> <td style="width: 10%;"></td> <td style="width: 10%;"></td> <td style="width: 10%;"></td> <td style="width: 10%;"></td> <td style="width: 10%;"></td> <td style="width: 10%;"></td> </tr> <tr> <td></td> <td></td> <td colspan="8" style="text-align: center;"> <table border="1" style="width: 100%; border-collapse: collapse; text-align: center;"> <tr> <td style="width: 10%;"></td> <td style="width: 10%;"></td> <td style="width: 10%;"></td> <td style="width: 10%;"></td> <td style="width:
10%;"></td> <td style="width: 10%;"></td> <td style="width: 10%;"></td> <td style="width: 10%;"></td> <td style="width: 10%;"></td> <td style="width: 10%;"></td> </tr> <tr> <td></td> <td></td> <td colspan="8" style="text-align: center;"> <table border="1" style="width: 100%; border-collapse: collapse; text-align: center;"> <tr> <td style="width: 10%;"></td> <td style="width: 10%;"></td> <td style="width: 10%;"></td> <td style="width: 10%;"></td> <td style="width: 10%;"></td> <td style="width: 10%;"></td> <td style="width: 10%;"></td> <td style="width: 10%;"></td> <td style="width: 10%;"></td> <td style="width: 10%;"></td> </tr> <tr> <td></td> <td></td> <td colspan="8" style="text-align: center;"> <table border="1" style="width: 100%; border-collapse: collapse; text-align: center;"> <tr> <td style="width: 10%;"></td> <td style="width: 10%;"></td> <td style="width: 10%;"></td> <td style="width: 10%;"></td> <td style="width: 10%;"></td> <td style="width: 10%;"></td> <td style="width: 10%;"></td> <td style="width: 10%;"></td> <td style="width: 10%;"></td> <td style="width: 10%;"></td> </tr> <tr> <td></td> <td></td> <td colspan="8" style="text-align: center;"> <table border="1" style="width: 100%; border-collapse: collapse; text-align: center;"> <tr> <td style="width: 10%;"></td> <td style="width: 10%;"></td> <td style="width: 10%;"></td> <td style="width: 10%;"></td> <td style="width: 10%;"></td> <td style="width: 10%;"></td> <td style="width: 10%;"></td> <td style="width: 10%;"></td> <td style="width: 10%;"></td> <td style="width: 10%;"></td> </tr> <tr> <td></td> <td></td> <td colspan="8" style="text-align: center;"> <table border="1" style="width: 100%; border-collapse: collapse; text-align: center;"> <tr> <td style="width: 10%;"></td> <td style="width: 10%;"></td> <td style="width: 10%;"></td> <td style="width: 10%;"></td> <td style="width: 10%;"></td> <td style="width: 10%;"></td> <td style="width: 10%;"></td> <td style="width: 10%;"></td> <td style="width: 10%;"></td> <td style="width: 10%;"></td> </tr> <tr> <td></td> <td></td> <td colspan="8" style="text-align: center;"> <table border="1" style="width: 100%; border-collapse: collapse; text-align: center;"> <tr> <td style="width: 10%;"></td> <td style="width: 10%;"></td> <td style="width: 10%;"></td> <td style="width: 10%;"></td> <td style="width: 10%;"></td> <td style="width: 10%;"></td> <td style="width: 10%;"></td> <td style="width: 10%;"></td> <td style="width: 10%;"></td> <td style="width: 10%;"></td> </tr> <tr> <td></td> <td></td> <td colspan="8" style="text-align: center;"> <table border="1" style="width: 100%; border-collapse: collapse; text-align: center;"> <tr> <td style="width: 10%;"></td> <td style="width: 10%;"></td> <td style="width: 10%;"></td> <td style="width: 10%;"></td> <td style="width: 10%;"></td> <td style="width: 10%;"></td> <td style="width: 10%;"></td> <td style="width: 10%;"></td> <td style="width: 10%;"></td> <td style="width: 10%;"></td> </tr> <tr> <td></td> <td></td> <td colspan="8" style="text-align: center;"> <table border="1" style="width: 100%; border-collapse: collapse; text-align: center;"> <tr> <td style="width: 10%;"></td> <td style="width: 10%;"></td> <td style="width: 10%;"></td> <td style="width: 10%;"></td> <td style="width: 10%;"></td> <td style="width: 10%;"></td> <td style="width: 10%;"></td> <td style="width: 10%;"></td> <td style="width: 10%;"></td> <td style="width: 10%;"></td> </tr> <tr> <td></td> <td></td> <td colspan="8" style="text-align: center;"> <table border="1" style="width: 100%; border-collapse: collapse; text-align: center;"> <tr> <td style="width: 10%;"></td> <td style="width: 10%;"></td> <td style="width: 10%;"></td> <td style="width: 10%;"></td> <td style="width: 10%;"></td> <td style="width: 10%;"></td> <td style="width: 10%;"></td> <td style="width: 10%;"></td> <td style="width: 10%;"></td> <td style="width: 10%;"></td> </tr> <tr> <td></td> <td></td> <td colspan="8" style="text-align: center;"> <table border="1" style="width: 100%; border-collapse: collapse; text-align: center;"> <tr> <td style="width: 10%;"></td> <td style="width: 10%;"></td> <td style="width: 10%;"></td> <td style="width: 10%;"></td> <td style="width: 10%;"></td> <td style="width: 10%;"></td> <td style="width: 10%;"></td> <td style="width: 10%;"></td> <td style="width: 10%;"></td> <td style="width: 10%;"></td> </tr> <tr> <td></td> <td></td> <td colspan="8" style="text-align: center;"> <table border="1" style="width: 100%; border-collapse: collapse; text-align: center;"> <tr> <td style="width: 10%;"></td> <td style="width: 10%;"></td> <td style="width: 10%;"></td> <td style="width: 10%;"></td> <td style="width: 10%;"></td> <td style="width: 10%;"></td> <td style="width: 10%;"></td> <td style="width: 10%;"></td> <td style="width: 10%;"></td> <td style="width: 10%;"></td> </tr> <tr> <td></td> <td></td> <td colspan="8" style="text-align: center;"> <table border="1" style="width: 100%; border-collapse: collapse; text-align: center;"> <tr> <td style="width: 10%;"></td> <td style="width: 10%;"></td> <td style="width: 10%;"></td> <td style="width: 10%;"></td> <td style="width: 10%;"></td> <td style="width: 10%;"></td> <td style="width: 10%;"></td> <td style="width: 10%;"></td> <td style="width: 10%;"></td> <td style="width: 10%;"></td> </tr> <tr> <td></td> <td></td> <td colspan="8" style="text-align: center;"> <table border="1" style="width: 100%; border-collapse: collapse; text-align: center;"> <tr> <td style="width: 10%;"></td> <td style="width: 10%;"></td> <td style="width: 10%;"></td> <td style="width: 10%;"></td> <td style="width: 10%;"></td> <td style="width: 10%;"></td> <td style="width: 10%;"></td> <td style="width: 10%;"></td> <td style="width: 10%;"></td> <td style="width: 10%;"></td> </tr> <tr> <td></td> <td></td> <td colspan="8" style="text-align: center;"> <table border="1" style="width: 100%; border-collapse: collapse; text-align: center;"> <tr> <td style="width: 10%;"></td> <td style="width: 10%;"></td> <td style="width: 10%;"></td> <td style="width: 10%;"></td> <td style="width: 10%;"></td> <td style="width: 10%;"></td> <td style="width: 10%;"></td> <td style="width: 10%;"></td> <td style="width: 10%;"></td> <td style="width: 10%;"></td> </tr> <tr> <td></td> <td></td> <td colspan="8" style="text-align: center;"> <table border="1" style="width: 100%; border-collapse: collapse; text-align: center;"> <tr> <td style="width: 10%;"></td> <td style="width: 10%;"></td> <td style="width: 10%;"></td> <td style="width: 10%;"></td> <td style="width: 10%;"></td> <td style="width: 10%;"></td> <td style="width: 10%;"></td> <td style="width: 10%;"></td> <td style="width: 10%;"></td> <td style="width: 10%;"></td> </tr> <tr> <td></td> <td></td> <td colspan="8" style="text-align: center;"> <table border="1" style="width: 100%; border-collapse: collapse; text-align: center;"> <tr> <td style="width: 10%;"></td> <td style="width: 10%;"></td> <td style="width: 10%;"></td> <td style="width: 10%;"></td> <td style="width: 10%;"></td> <td style="width: 10%;"></td> <td style="width: 10%;"></td> <td style="width: 10%;"></td> <td style="width: 10%;"></td> <td style="width: 10%;"></td> </tr> <tr> <td></td> <td></td> <td colspan="8" style="text-align: center;"> <table border="1" style="width: 100%; border-collapse: collapse; text-align: center;"> <tr> <td style="width: 10%;"></td> <td style="width: 10%;"></td> <td style="width: 10%;"></td> <td style="width: 10%;"></td> <td style="width: 10%;"></td> <td style="width: 10%;"></td> <td style="width: 10%;"></td> <td style="width: 10%;"></td> <td style="width: 10%;"></td> <td style="width: 10%;"></td> </tr> <tr> <td></td> <td></td> <td colspan="8" style="text-align: center;"> <table border="1" style="width: 100%; border-collapse: collapse; text-align: center;"> <tr> </tr></table></td></tr></table></td></tr></table></td></tr></table></td></tr></table></td></tr></table></td></tr></table></td></tr></table></td></tr></table></td></tr></table></td></tr></table></td></tr></table></td></tr></table></td></tr></table></td></tr></table></td></tr></table></td></tr></table></td></tr></table></td></tr></table></td></tr></table></td></tr></table></td></tr></table></td></tr></table></td></tr></table></td></tr></table></td></tr></table></td></tr></table>
 | | | | | | | | | | | | | | | | | | | | <table border="1" style="width: 100%; border-collapse: collapse; text-align: center;"> <tr> <td style="width: 10%;"></td> <td style="width: 10%;"></td> <td style="width: 10%;"></td> <td style="width: 10%;"></td> <td style="width: 10%;"></td> <td style="width: 10%;"></td> <td style="width: 10%;"></td> <td style="width: 10%;"></td> <td style="width: 10%;"></td> <td style="width: 10%;"></td> </tr> <tr> <td></td> <td></td> <td colspan="8" style="text-align: center;"> <table border="1" style="width: 100%; border-collapse: collapse; text-align: center;"> <tr> <td style="width: 10%;"></td> <td style="width: 10%;"></td> <td style="width: 10%;"></td> <td style="width: 10%;"></td> <td style="width: 10%;"></td> <td style="width: 10%;"></td> <td style="width: 10%;"></td> <td style="width: 10%;"></td> <td style="width: 10%;"></td> <td style="width: 10%;"></td> </tr> <tr> <td></td> <td></td> <td colspan="8" style="text-align: center;"> <table border="1" style="width: 100%; border-collapse: collapse; text-align: center;"> <tr> <td style="width: 10%;"></td> <td style="width: 10%;"></td> <td style="width: 10%;"></td> <td style="width: 10%;"></td> <td style="width: 10%;"></td> <td style="width: 10%;"></td> <td style="width: 10%;"></td> <td style="width: 10%;"></td> <td style="width: 10%;"></td> <td style="width: 10%;"></td> </tr> <tr> <td></td> <td></td> <td colspan="8" style="text-align: center;"> <table border="1" style="width: 100%; border-collapse: collapse; text-align: center;"> <tr> <td style="width: 10%;"></td> <td style="width: 10%;"></td> <td style="width: 10%;"></td> <td style="width: 10%;"></td> <td style="width: 10%;"></td> <td style="width: 10%;"></td> <td style="width: 10%;"></td> <td style="width: 10%;"></td> <td style="width: 10%;"></td> <td style="width: 10%;"></td> </tr> <tr> <td></td> <td></td> <td colspan="8" style="text-align: center;"> <table border="1" style="width: 100%; border-collapse: collapse; text-align: center;"> <tr> <td style="width: 10%;"></td> <td style="width: 10%;"></td> <td style="width: 10%;"></td> <td style="width: 10%;"></td> <td style="width: 10%;"></td> <td style="width: 10%;"></td> <td style="width: 10%;"></td> <td style="width: 10%;"></td> <td style="width: 10%;"></td> <td style="width: 10%;"></td> </tr> <tr> <td></td> <td></td> <td colspan="8" style="text-align: center;"> <table border="1" style="width: 100%; border-collapse: collapse; text-align: center;"> <tr> <td style="width: 10%;"></td> <td style="width: 10%;"></td> <td style="width: 10%;"></td> <td style="width: 10%;"></td> <td style="width: 10%;"></td> <td style="width: 10%;"></td> <td style="width: 10%;"></td> <td style="width: 10%;"></td> <td style="width: 10%;"></td> <td style="width: 10%;"></td> </tr> <tr> <td></td> <td></td> <td colspan="8" style="text-align: center;"> <table border="1" style="width: 100%; border-collapse: collapse; text-align: center;"> <tr> <td style="width: 10%;"></td> <td style="width: 10%;"></td> <td style="width: 10%;"></td> <td style="width: 10%;"></td> <td style="width: 10%;"></td> <td style="width: 10%;"></td> <td style="width: 10%;"></td> <td style="width: 10%;"></td> <td style="width: 10%;"></td> <td style="width: 10%;"></td> </tr> <tr> <td></td> <td></td> <td colspan="8" style="text-align: center;"> <table border="1" style="width: 100%; border-collapse: collapse; text-align: center;"> <tr> <td
style="width: 10%;"></td> <td style="width: 10%;"></td> <td style="width: 10%;"></td> <td style="width: 10%;"></td> <td style="width: 10%;"></td> <td style="width: 10%;"></td> <td style="width: 10%;"></td> <td style="width: 10%;"></td> <td style="width: 10%;"></td> <td style="width: 10%;"></td> </tr> <tr> <td></td> <td></td> <td colspan="8" style="text-align: center;"> <table border="1" style="width: 100%; border-collapse: collapse; text-align: center;"> <tr> <td style="width: 10%;"></td> <td style="width: 10%;"></td> <td style="width: 10%;"></td> <td style="width: 10%;"></td> <td style="width: 10%;"></td> <td style="width: 10%;"></td> <td style="width: 10%;"></td> <td style="width: 10%;"></td> <td style="width: 10%;"></td> <td style="width: 10%;"></td> </tr> <tr> <td></td> <td></td> <td colspan="8" style="text-align: center;"> <table border="1" style="width: 100%; border-collapse: collapse; text-align: center;"> <tr> <td style="width: 10%;"></td> <td style="width: 10%;"></td> <td style="width: 10%;"></td> <td style="width: 10%;"></td> <td style="width: 10%;"></td> <td style="width: 10%;"></td> <td style="width: 10%;"></td> <td style="width: 10%;"></td> <td style="width: 10%;"></td> <td style="width: 10%;"></td> </tr> <tr> <td></td> <td></td> <td colspan="8" style="text-align: center;"> <table border="1" style="width: 100%; border-collapse: collapse; text-align: center;"> <tr> <td style="width: 10%;"></td> <td style="width: 10%;"></td> <td style="width: 10%;"></td> <td style="width: 10%;"></td> <td style="width: 10%;"></td> <td style="width: 10%;"></td> <td style="width: 10%;"></td> <td style="width: 10%;"></td> <td style="width: 10%;"></td> <td style="width: 10%;"></td> </tr> <tr> <td></td> <td></td> <td colspan="8" style="text-align: center;"> <table border="1" style="width: 100%; border-collapse: collapse; text-align: center;"> <tr> <td style="width: 10%;"></td> <td style="width: 10%;"></td> <td style="width: 10%;"></td> <td style="width: 10%;"></td> <td style="width: 10%;"></td> <td style="width: 10%;"></td> <td style="width: 10%;"></td> <td style="width: 10%;"></td> <td style="width: 10%;"></td> <td style="width: 10%;"></td> </tr> <tr> <td></td> <td></td> <td colspan="8" style="text-align: center;"> <table border="1" style="width: 100%; border-collapse: collapse; text-align: center;"> <tr> <td style="width: 10%;"></td> <td style="width: 10%;"></td> <td style="width: 10%;"></td> <td style="width: 10%;"></td> <td style="width: 10%;"></td> <td style="width: 10%;"></td> <td style="width: 10%;"></td> <td style="width: 10%;"></td> <td style="width: 10%;"></td> <td style="width: 10%;"></td> </tr> <tr> <td></td> <td></td> <td colspan="8" style="text-align: center;"> <table border="1" style="width: 100%; border-collapse: collapse; text-align: center;"> <tr> <td style="width: 10%;"></td> <td style="width: 10%;"></td> <td style="width: 10%;"></td> <td style="width: 10%;"></td> <td style="width: 10%;"></td> <td style="width: 10%;"></td> <td style="width: 10%;"></td> <td style="width: 10%;"></td> <td style="width: 10%;"></td> <td style="width: 10%;"></td> </tr> <tr> <td></td> <td></td> <td colspan="8" style="text-align: center;"> <table border="1" style="width: 100%; border-collapse: collapse; text-align: center;"> <tr> <td style="width: 10%;"></td> <td style="width: 10%;"></td> <td style="width: 10%;"></td> <td style="width: 10%;"></td> <td style="width: 10%;"></td> <td style="width: 10%;"></td> <td style="width: 10%;"></td> <td style="width: 10%;"></td> <td style="width: 10%;"></td> <td style="width: 10%;"></td> </tr> <tr> <td></td> <td></td> <td colspan="8" style="text-align: center;"> <table border="1" style="width: 100%; border-collapse: collapse; text-align: center;"> <tr> <td style="width: 10%;"></td> <td style="width: 10%;"></td> <td style="width: 10%;"></td> <td style="width: 10%;"></td> <td style="width: 10%;"></td> <td style="width: 10%;"></td> <td style="width: 10%;"></td> <td style="width: 10%;"></td> <td style="width: 10%;"></td> <td style="width: 10%;"></td> </tr> <tr> <td></td> <td></td> <td colspan="8" style="text-align: center;"> <table border="1" style="width: 100%; border-collapse: collapse; text-align: center;"> <tr> <td style="width: 10%;"></td> <td style="width: 10%;"></td> <td style="width: 10%;"></td> <td style="width: 10%;"></td> <td style="width: 10%;"></td> <td style="width: 10%;"></td> <td style="width: 10%;"></td> <td style="width: 10%;"></td> <td style="width: 10%;"></td> <td style="width: 10%;"></td> </tr> <tr> <td></td> <td></td> <td colspan="8" style="text-align: center;"> <table border="1" style="width: 100%; border-collapse: collapse; text-align: center;"> <tr> <td style="width: 10%;"></td> <td style="width: 10%;"></td> <td style="width: 10%;"></td> <td style="width: 10%;"></td> <td style="width: 10%;"></td> <td style="width: 10%;"></td> <td style="width: 10%;"></td> <td style="width: 10%;"></td> <td style="width: 10%;"></td> <td style="width: 10%;"></td> </tr> <tr> <td></td> <td></td> <td colspan="8" style="text-align: center;"> <table border="1" style="width: 100%; border-collapse: collapse; text-align: center;"> <tr> <td style="width: 10%;"></td> <td style="width: 10%;"></td> <td style="width: 10%;"></td> <td style="width: 10%;"></td> <td style="width: 10%;"></td> <td style="width: 10%;"></td> <td style="width: 10%;"></td> <td style="width: 10%;"></td> <td style="width: 10%;"></td> <td style="width: 10%;"></td> </tr> <tr> <td></td> <td></td> <td colspan="8" style="text-align: center;"> <table border="1" style="width: 100%; border-collapse: collapse; text-align: center;"> <tr> <td style="width: 10%;"></td> <td style="width: 10%;"></td> <td style="width: 10%;"></td> <td style="width: 10%;"></td> <td style="width: 10%;"></td> <td style="width: 10%;"></td> <td style="width: 10%;"></td> <td style="width: 10%;"></td> <td style="width: 10%;"></td> <td style="width: 10%;"></td> </tr> <tr> <td></td> <td></td> <td colspan="8" style="text-align: center;"> <table border="1" style="width: 100%; border-collapse: collapse; text-align: center;"> <tr> <td style="width: 10%;"></td> <td style="width: 10%;"></td> <td style="width: 10%;"></td> <td style="width: 10%;"></td> <td style="width: 10%;"></td> <td style="width: 10%;"></td> <td style="width: 10%;"></td> <td style="width: 10%;"></td> <td style="width: 10%;"></td> <td style="width: 10%;"></td> </tr> <tr> <td></td> <td></td> <td colspan="8" style="text-align: center;"> <table border="1" style="width: 100%; border-collapse: collapse; text-align: center;"> <tr> <td style="width: 10%;"></td> <td style="width: 10%;"></td> <td style="width: 10%;"></td> <td style="width: 10%;"></td> <td style="width: 10%;"></td> <td style="width: 10%;"></td> <td style="width: 10%;"></td> <td style="width: 10%;"></td> <td style="width: 10%;"></td> <td style="width: 10%;"></td> </tr> <tr> <td></td> <td></td> <td colspan="8" style="text-align: center;"> <table border="1" style="width: 100%; border-collapse: collapse; text-align: center;"> <tr> <td style="width: 10%;"></td> <td style="width: 10%;"></td> <td style="width: 10%;"></td> <td style="width: 10%;"></td> <td style="width: 10%;"></td> <td style="width: 10%;"></td> <td style="width: 10%;"></td> <td style="width: 10%;"></td> <td style="width: 10%;"></td> <td style="width: 10%;"></td> </tr> <tr> <td></td> <td></td> <td colspan="8" style="text-align: center;"> <table border="1" style="width: 100%; border-collapse: collapse; text-align: center;"> <tr> <td style="width: 10%;"></td> <td style="width: 10%;"></td> <td style="width: 10%;"></td> <td style="width: 10%;"></td> <td style="width: 10%;"></td> <td style="width: 10%;"></td> <td style="width: 10%;"></td> <td style="width: 10%;"></td> <td style="width: 10%;"></td> <td style="width: 10%;"></td> </tr> <tr> <td></td> <td></td> <td colspan="8" style="text-align: center;"> <table border="1" style="width: 100%; border-collapse: collapse; text-align: center;"> <tr> <td style="width: 10%;"></td> <td style="width: 10%;"></td> <td style="width: 10%;"></td> <td style="width: 10%;"></td> <td style="width: 10%;"></td> <td style="width: 10%;"></td> <td style="width: 10%;"></td> <td style="width: 10%;"></td> <td style="width: 10%;"></td> <td style="width: 10%;"></td> </tr> <tr> <td></td> <td></td> <td colspan="8" style="text-align: center;"> <table border="1" style="width: 100%; border-collapse: collapse; text-align: center;"> <tr> </tr></table></td></tr></table></td></tr></table></td></tr></table></td></tr></table></td></tr></table></td></tr></table></td></tr></table></td></tr></table></td></tr></table></td></tr></table></td></tr></table></td></tr></table></td></tr></table></td></tr></table></td></tr></table></td></tr></table></td></tr></table></td></tr></table></td></tr></table></td></tr></table></td></tr></table></td></tr></table></td></tr></table></td></tr></table></td></tr></table>
 | | | | | | | | | | | | | | | | | | | | <table border="1" style="width: 100%; border-collapse: collapse; text-align: center;"> <tr> <td style="width: 10%;"></td> <td style="width: 10%;"></td> <td style="width: 10%;"></td> <td style="width: 10%;"></td> <td style="width: 10%;"></td> <td style="width: 10%;"></td> <td style="width: 10%;"></td> <td style="width: 10%;"></td> <td style="width: 10%;"></td> <td style="width: 10%;"></td> </tr> <tr> <td></td> <td></td> <td colspan="8" style="text-align: center;"> <table border="1" style="width: 100%; border-collapse: collapse; text-align: center;"> <tr> <td style="width: 10%;"></td> <td style="width: 10%;"></td> <td style="width: 10%;"></td> <td style="width: 10%;"></td> <td style="width: 10%;"></td> <td style="width: 10%;"></td> <td style="width: 10%;"></td> <td style="width: 10%;"></td> <td style="width: 10%;"></td> <td style="width: 10%;"></td> </tr> <tr> <td></td> <td></td> <td colspan="8" style="text-align: center;"> <table border="1" style="width: 100%; border-collapse: collapse; text-align: center;"> <tr> <td style="width: 10%;"></td> <td style="width: 10%;"></td> <td style="width: 10%;"></td> <td style="width: 10%;"></td> <td style="width: 10%;"></td> <td style="width: 10%;"></td> <td style="width: 10%;"></td> <td style="width: 10%;"></td> <td style="width: 10%;"></td> <td style="width: 10%;"></td> </tr> <tr> <td></td> <td></td> <td colspan="8" style="text-align: center;"> <table border="1" style="width: 100%; border-collapse: collapse; text-align: center;"> <tr> <td style="width: 10%;"></td> <td style="width: 10%;"></td> <td style="width: 10%;"></td> <td style="width: 10%;"></td> <td style="width: 10%;"></td> <td style="width: 10%;"></td> <td style="width: 10%;"></td> <td style="width: 10%;"></td> <td style="width: 10%;"></td> <td style="width: 10%;"></td> </tr> <tr> <td></td> <td></td> <td colspan="8" style="text-align: center;"> <table border="1" style="width: 100%; border-collapse: collapse; text-align: center;"> <tr> <td style="width: 10%;"></td> <td style="width: 10%;"></td> <td style="width: 10%;"></td> <td style="width: 10%;"></td> <td style="width: 10%;"></td> <td style="width: 10%;"></td> <td style="width: 10%;"></td> <td style="width: 10%;"></td> <td style="width: 10%;"></td> <td style="width: 10%;"></td> </tr> <tr> <td></td> <td></td> <td colspan="8" style="text-align: center;"> <table border="1" style="width: 100%; border-collapse: collapse; text-align: center;"> <tr> <td style="width: 10%;"></td> <td style="width: 10%;"></td> <td style="width: 10%;"></td> <td style="width: 10%;"></td> <td style="width: 10%;"></td> <td style="width: 10%;"></td> <td style="width: 10%;"></td> <td style="width: 10%;"></td> <td style="width: 10%;"></td> <td style="width: 10%;"></td> </tr> <tr> <td></td> <td></td> <td colspan="8"
style="text-align: center;"> <table border="1" style="width: 100%; border-collapse: collapse; text-align: center;"> <tr> <td style="width: 10%;"></td> <td style="width: 10%;"></td> <td style="width: 10%;"></td> <td style="width: 10%;"></td> <td style="width: 10%;"></td> <td style="width: 10%;"></td> <td style="width: 10%;"></td> <td style="width: 10%;"></td> <td style="width: 10%;"></td> <td style="width: 10%;"></td> </tr> <tr> <td></td> <td></td> <td colspan="8" style="text-align: center;"> <table border="1" style="width: 100%; border-collapse: collapse; text-align: center;"> <tr> <td style="width: 10%;"></td> <td style="width: 10%;"></td> <td style="width: 10%;"></td> <td style="width: 10%;"></td> <td style="width: 10%;"></td> <td style="width: 10%;"></td> <td style="width: 10%;"></td> <td style="width: 10%;"></td> <td style="width: 10%;"></td> <td style="width: 10%;"></td> </tr> <tr> <td></td> <td></td> <td colspan="8" style="text-align: center;"> <table border="1" style="width: 100%; border-collapse: collapse; text-align: center;"> <tr> <td style="width: 10%;"></td> <td style="width: 10%;"></td> <td style="width: 10%;"></td> <td style="width: 10%;"></td> <td style="width: 10%;"></td> <td style="width: 10%;"></td> <td style="width: 10%;"></td> <td style="width: 10%;"></td> <td style="width: 10%;"></td> <td style="width: 10%;"></td> </tr> <tr> <td></td> <td></td> <td colspan="8" style="text-align: center;"> <table border="1" style="width: 100%; border-collapse: collapse; text-align: center;"> <tr> <td style="width: 10%;"></td> <td style="width: 10%;"></td> <td style="width: 10%;"></td> <td style="width: 10%;"></td> <td style="width: 10%;"></td> <td style="width: 10%;"></td> <td style="width: 10%;"></td> <td style="width: 10%;"></td> <td style="width: 10%;"></td> <td style="width: 10%;"></td> </tr> <tr> <td></td> <td></td> <td colspan="8" style="text-align: center;"> <table border="1" style="width: 100%; border-collapse: collapse; text-align: center;"> <tr> <td style="width: 10%;"></td> <td style="width: 10%;"></td> <td style="width: 10%;"></td> <td style="width: 10%;"></td> <td style="width: 10%;"></td> <td style="width: 10%;"></td> <td style="width: 10%;"></td> <td style="width: 10%;"></td> <td style="width: 10%;"></td> <td style="width: 10%;"></td> </tr> <tr> <td></td> <td></td> <td colspan="8" style="text-align: center;"> <table border="1" style="width: 100%; border-collapse: collapse; text-align: center;"> <tr> <td style="width: 10%;"></td> <td style="width: 10%;"></td> <td style="width: 10%;"></td> <td style="width: 10%;"></td> <td style="width: 10%;"></td> <td style="width: 10%;"></td> <td style="width: 10%;"></td> <td style="width: 10%;"></td> <td style="width: 10%;"></td> <td style="width: 10%;"></td> </tr> <tr> <td></td> <td></td> <td colspan="8" style="text-align: center;"> <table border="1" style="width: 100%; border-collapse: collapse; text-align: center;"> <tr> <td style="width: 10%;"></td> <td style="width: 10%;"></td> <td style="width: 10%;"></td> <td style="width: 10%;"></td> <td style="width: 10%;"></td> <td style="width: 10%;"></td> <td style="width: 10%;"></td> <td style="width: 10%;"></td> <td style="width: 10%;"></td> <td style="width: 10%;"></td> </tr> <tr> <td></td> <td></td> <td colspan="8" style="text-align: center;"> <table border="1" style="width: 100%; border-collapse: collapse; text-align: center;"> <tr> <td style="width: 10%;"></td> <td style="width: 10%;"></td> <td style="width: 10%;"></td> <td style="width: 10%;"></td> <td style="width: 10%;"></td> <td style="width: 10%;"></td> <td style="width: 10%;"></td> <td style="width: 10%;"></td> <td style="width: 10%;"></td> <td style="width: 10%;"></td> </tr> <tr> <td></td> <td></td> <td colspan="8" style="text-align: center;"> <table border="1" style="width: 100%; border-collapse: collapse; text-align: center;"> <tr> <td style="width: 10%;"></td> <td style="width: 10%;"></td> <td style="width: 10%;"></td> <td style="width: 10%;"></td> <td style="width: 10%;"></td> <td style="width: 10%;"></td> <td style="width: 10%;"></td> <td style="width: 10%;"></td> <td style="width: 10%;"></td> <td style="width: 10%;"></td> </tr> <tr> <td></td> <td></td> <td colspan="8" style="text-align: center;"> <table border="1" style="width: 100%; border-collapse: collapse; text-align: center;"> <tr> <td style="width: 10%;"></td> <td style="width: 10%;"></td> <td style="width: 10%;"></td> <td style="width: 10%;"></td> <td style="width: 10%;"></td> <td style="width: 10%;"></td> <td style="width: 10%;"></td> <td style="width: 10%;"></td> <td style="width: 10%;"></td> <td style="width: 10%;"></td> </tr> <tr> <td></td> <td></td> <td colspan="8" style="text-align: center;"> <table border="1" style="width: 100%; border-collapse: collapse; text-align: center;"> <tr> <td style="width: 10%;"></td> <td style="width: 10%;"></td> <td style="width: 10%;"></td> <td style="width: 10%;"></td> <td style="width: 10%;"></td> <td style="width: 10%;"></td> <td style="width: 10%;"></td> <td style="width: 10%;"></td> <td style="width: 10%;"></td> <td style="width: 10%;"></td> </tr> <tr> <td></td> <td></td> <td colspan="8" style="text-align: center;"> <table border="1" style="width: 100%; border-collapse: collapse; text-align: center;"> <tr> <td style="width: 10%;"></td> <td style="width: 10%;"></td> <td style="width: 10%;"></td> <td style="width: 10%;"></td> <td style="width: 10%;"></td> <td style="width: 10%;"></td> <td style="width: 10%;"></td> <td style="width: 10%;"></td> <td style="width: 10%;"></td> <td style="width: 10%;"></td> </tr> <tr> <td></td> <td></td> <td colspan="8" style="text-align: center;"> <table border="1" style="width: 100%; border-collapse: collapse; text-align: center;"> <tr> <td style="width: 10%;"></td> <td style="width: 10%;"></td> <td style="width: 10%;"></td> <td style="width: 10%;"></td> <td style="width: 10%;"></td> <td style="width: 10%;"></td> <td style="width: 10%;"></td> <td style="width: 10%;"></td> <td style="width: 10%;"></td> <td style="width: 10%;"></td> </tr> <tr> <td></td> <td></td> <td colspan="8" style="text-align: center;"> <table border="1" style="width: 100%; border-collapse: collapse; text-align: center;"> <tr> <td style="width: 10%;"></td> <td style="width: 10%;"></td> <td style="width: 10%;"></td> <td style="width: 10%;"></td> <td style="width: 10%;"></td> <td style="width: 10%;"></td> <td style="width: 10%;"></td> <td style="width: 10%;"></td> <td style="width: 10%;"></td> <td style="width: 10%;"></td> </tr> <tr> <td></td> <td></td> <td colspan="8" style="text-align: center;"> <table border="1" style="width: 100%; border-collapse: collapse; text-align: center;"> <tr> <td style="width: 10%;"></td> <td style="width: 10%;"></td> <td style="width: 10%;"></td> <td style="width: 10%;"></td> <td style="width: 10%;"></td> <td style="width: 10%;"></td> <td style="width: 10%;"></td> <td style="width: 10%;"></td> <td style="width: 10%;"></td> <td style="width: 10%;"></td> </tr> <tr> <td></td> <td></td> <td colspan="8" style="text-align: center;"> <table border="1" style="width: 100%; border-collapse: collapse; text-align: center;"> <tr> <td style="width: 10%;"></td> <td style="width: 10%;"></td> <td style="width: 10%;"></td> <td style="width: 10%;"></td> <td style="width: 10%;"></td> <td style="width: 10%;"></td> <td style="width: 10%;"></td> <td style="width: 10%;"></td> <td style="width: 10%;"></td> <td style="width: 10%;"></td> </tr> <tr> <td></td> <td></td> <td colspan="8" style="text-align: center;"> <table border="1" style="width: 100%; border-collapse: collapse; text-align: center;"> <tr> <td style="width: 10%;"></td> <td style="width: 10%;"></td> <td style="width: 10%;"></td> <td style="width: 10%;"></td> <td style="width: 10%;"></td> <td style="width: 10%;"></td> <td style="width: 10%;"></td> <td style="width: 10%;"></td> <td style="width: 10%;"></td> <td style="width: 10%;"></td> </tr> <tr> <td></td> <td></td> <td colspan="8" style="text-align: center;"> <table border="1" style="width: 100%; border-collapse: collapse; text-align: center;"> <tr> <td style="width: 10%;"></td> <td style="width: 10%;"></td> <td style="width: 10%;"></td> <td style="width: 10%;"></td> <td style="width: 10%;"></td> <td style="width: 10%;"></td> <td style="width: 10%;"></td> <td style="width: 10%;"></td> <td style="width: 10%;"></td> <td style="width: 10%;"></td> </tr> <tr> <td></td> <td></td> <td colspan="8" style="text-align: center;"> <table border="1" style="width: 100%; border-collapse: collapse; text-align: center;"> <tr> </tr></table></td></tr></table></td></tr></table></td></tr></table></td></tr></table></td></tr></table></td></tr></table></td></tr></table></td></tr></table></td></tr></table></td></tr></table></td></tr></table></td></tr></table></td></tr></table></td></tr></table></td></tr></table></td></tr></table></td></tr></table></td></tr></table></td></tr></table></td></tr></table></td></tr></table></td></tr></table></td></tr></table></td></tr></table>
 | | | | | | | | | | | | | | | | | | | | <table border="1" style="width: 100%; border-collapse: collapse; text-align: center;"> <tr> <td style="width: 10%;"></td> <td style="width: 10%;"></td> <td style="width: 10%;"></td> <td style="width: 10%;"></td> <td style="width: 10%;"></td> <td style="width: 10%;"></td> <td style="width: 10%;"></td> <td style="width: 10%;"></td> <td style="width: 10%;"></td> <td style="width: 10%;"></td> </tr> <tr> <td></td> <td></td> <td colspan="8" style="text-align: center;"> <table border="1" style="width: 100%; border-collapse: collapse; text-align: center;"> <tr> <td style="width: 10%;"></td> <td style="width: 10%;"></td> <td style="width: 10%;"></td> <td style="width: 10%;"></td> <td style="width: 10%;"></td> <td style="width: 10%;"></td> <td style="width: 10%;"></td> <td style="width: 10%;"></td> <td style="width: 10%;"></td> <td style="width: 10%;"></td> </tr> <tr> <td></td> <td></td> <td colspan="8" style="text-align: center;"> <table border="1" style="width: 100%; border-collapse: collapse; text-align: center;"> <tr> <td style="width: 10%;"></td> <td style="width: 10%;"></td> <td style="width: 10%;"></td> <td style="width: 10%;"></td> <td style="width: 10%;"></td> <td style="width: 10%;"></td> <td style="width: 10%;"></td> <td style="width: 10%;"></td> <td style="width: 10%;"></td> <td style="width: 10%;"></td> </tr> <tr> <td></td> <td></td> <td colspan="8" style="text-align: center;"> <table border="1" style="width: 100%; border-collapse: collapse; text-align: center;"> <tr> <td style="width: 10%;"></td> <td style="width: 10%;"></td> <td style="width: 10%;"></td> <td style="width: 10%;"></td> <td style="width: 10%;"></td> <td style="width: 10%;"></td> <td style="width: 10%;"></td> <td style="width: 10%;"></td> <td style="width: 10%;"></td> <td style="width: 10%;"></td> </tr> <tr> <td></td> <td></td> <td colspan="8" style="text-align: center;"> <table border="1" style="width: 100%; border-collapse: collapse; text-align: center;"> <tr> <td style="width: 10%;"></td> <td style="width: 10%;"></td> <td style="width: 10%;"></td> <td style="width: 10%;"></td> <td style="width: 10%;"></td> <td style="width: 10%;"></td> <td style="width: 10%;"></td> <td style="width: 10%;"></td> <td style="width: 10%;"></td> <td style="width: 10%;"></td> </tr> <tr> <td></td> <td></td> <td colspan="8" style="text-align: center;"> <table border="1" style="width: 100%; border-collapse: collapse; text-align: center;"> <tr> <td style="width: 10%;"></td> <td style="width: 10%;"></td> <td style="width: 10%;"></td> <td style="width: 10%;"></td> <td style="width: 10%;"></td> <td style="width: 10%;"></td> <td style="width: 10%;"></td> <td style="width: 10%;"></td> <td
style="width: 10%;"></td> <td style="width: 10%;"></td> </tr> <tr> <td></td> <td></td> <td colspan="8" style="text-align: center;"> <table border="1" style="width: 100%; border-collapse: collapse; text-align: center;"> <tr> <td style="width: 10%;"></td> <td style="width: 10%;"></td> <td style="width: 10%;"></td> <td style="width: 10%;"></td> <td style="width: 10%;"></td> <td style="width: 10%;"></td> <td style="width: 10%;"></td> <td style="width: 10%;"></td> <td style="width: 10%;"></td> <td style="width: 10%;"></td> </tr> <tr> <td></td> <td></td> <td colspan="8" style="text-align: center;"> <table border="1" style="width: 100%; border-collapse: collapse; text-align: center;"> <tr> <td style="width: 10%;"></td> <td style="width: 10%;"></td> <td style="width: 10%;"></td> <td style="width: 10%;"></td> <td style="width: 10%;"></td> <td style="width: 10%;"></td> <td style="width: 10%;"></td> <td style="width: 10%;"></td> <td style="width: 10%;"></td> <td style="width: 10%;"></td> </tr> <tr> <td></td> <td></td> <td colspan="8" style="text-align: center;"> <table border="1" style="width: 100%; border-collapse: collapse; text-align: center;"> <tr> <td style="width: 10%;"></td> <td style="width: 10%;"></td> <td style="width: 10%;"></td> <td style="width: 10%;"></td> <td style="width: 10%;"></td> <td style="width: 10%;"></td> <td style="width: 10%;"></td> <td style="width: 10%;"></td> <td style="width: 10%;"></td> <td style="width: 10%;"></td> </tr> <tr> <td></td> <td></td> <td colspan="8" style="text-align: center;"> <table border="1" style="width: 100%; border-collapse: collapse; text-align: center;"> <tr> <td style="width: 10%;"></td> <td style="width: 10%;"></td> <td style="width: 10%;"></td> <td style="width: 10%;"></td> <td style="width: 10%;"></td> <td style="width: 10%;"></td> <td style="width: 10%;"></td> <td style="width: 10%;"></td> <td style="width: 10%;"></td> <td style="width: 10%;"></td> </tr> <tr> <td></td> <td></td> <td colspan="8" style="text-align: center;"> <table border="1" style="width: 100%; border-collapse: collapse; text-align: center;"> <tr> <td style="width: 10%;"></td> <td style="width: 10%;"></td> <td style="width: 10%;"></td> <td style="width: 10%;"></td> <td style="width: 10%;"></td> <td style="width: 10%;"></td> <td style="width: 10%;"></td> <td style="width: 10%;"></td> <td style="width: 10%;"></td> <td style="width: 10%;"></td> </tr> <tr> <td></td> <td></td> <td colspan="8" style="text-align: center;"> <table border="1" style="width: 100%; border-collapse: collapse; text-align: center;"> <tr> <td style="width: 10%;"></td> <td style="width: 10%;"></td> <td style="width: 10%;"></td> <td style="width: 10%;"></td> <td style="width: 10%;"></td> <td style="width: 10%;"></td> <td style="width: 10%;"></td> <td style="width: 10%;"></td> <td style="width: 10%;"></td> <td style="width: 10%;"></td> </tr> <tr> <td></td> <td></td> <td colspan="8" style="text-align: center;"> <table border="1" style="width: 100%; border-collapse: collapse; text-align: center;"> <tr> <td style="width: 10%;"></td> <td style="width: 10%;"></td> <td style="width: 10%;"></td> <td style="width: 10%;"></td> <td style="width: 10%;"></td> <td style="width: 10%;"></td> <td style="width: 10%;"></td> <td style="width: 10%;"></td> <td style="width: 10%;"></td> <td style="width: 10%;"></td> </tr> <tr> <td></td> <td></td> <td colspan="8" style="text-align: center;"> <table border="1" style="width: 100%; border-collapse: collapse; text-align: center;"> <tr> <td style="width: 10%;"></td> <td style="width: 10%;"></td> <td style="width: 10%;"></td> <td style="width: 10%;"></td> <td style="width: 10%;"></td> <td style="width: 10%;"></td> <td style="width: 10%;"></td> <td style="width: 10%;"></td> <td style="width: 10%;"></td> <td style="width: 10%;"></td> </tr> <tr> <td></td> <td></td> <td colspan="8" style="text-align: center;"> <table border="1" style="width: 100%; border-collapse: collapse; text-align: center;"> <tr> <td style="width: 10%;"></td> <td style="width: 10%;"></td> <td style="width: 10%;"></td> <td style="width: 10%;"></td> <td style="width: 10%;"></td> <td style="width: 10%;"></td> <td style="width: 10%;"></td> <td style="width: 10%;"></td> <td style="width: 10%;"></td> <td style="width: 10%;"></td> </tr> <tr> <td></td> <td></td> <td colspan="8" style="text-align: center;"> <table border="1" style="width: 100%; border-collapse: collapse; text-align: center;"> <tr> <td style="width: 10%;"></td> <td style="width: 10%;"></td> <td style="width: 10%;"></td> <td style="width: 10%;"></td> <td style="width: 10%;"></td> <td style="width: 10%;"></td> <td style="width: 10%;"></td> <td style="width: 10%;"></td> <td style="width: 10%;"></td> <td style="width: 10%;"></td> </tr> <tr> <td></td> <td></td> <td colspan="8" style="text-align: center;"> <table border="1" style="width: 100%; border-collapse: collapse; text-align: center;"> <tr> <td style="width: 10%;"></td> <td style="width: 10%;"></td> <td style="width: 10%;"></td> <td style="width: 10%;"></td> <td style="width: 10%;"></td> <td style="width: 10%;"></td> <td style="width: 10%;"></td> <td style="width: 10%;"></td> <td style="width: 10%;"></td> <td style="width: 10%;"></td> </tr> <tr> <td></td> <td></td> <td colspan="8" style="text-align: center;"> <table border="1" style="width: 100%; border-collapse: collapse; text-align: center;"> <tr> <td style="width: 10%;"></td> <td style="width: 10%;"></td> <td style="width: 10%;"></td> <td style="width: 10%;"></td> <td style="width: 10%;"></td> <td style="width: 10%;"></td> <td style="width: 10%;"></td> <td style="width: 10%;"></td> <td style="width: 10%;"></td> <td style="width: 10%;"></td> </tr> <tr> <td></td> <td></td> <td colspan="8" style="text-align: center;"> <table border="1" style="width: 100%; border-collapse: collapse; text-align: center;"> <tr> <td style="width: 10%;"></td> <td style="width: 10%;"></td> <td style="width: 10%;"></td> <td style="width: 10%;"></td> <td style="width: 10%;"></td> <td style="width: 10%;"></td> <td style="width: 10%;"></td> <td style="width: 10%;"></td> <td style="width: 10%;"></td> <td style="width: 10%;"></td> </tr> <tr> <td></td> <td></td> <td colspan="8" style="text-align: center;"> <table border="1" style="width: 100%; border-collapse: collapse; text-align: center;"> <tr> <td style="width: 10%;"></td> <td style="width: 10%;"></td> <td style="width: 10%;"></td> <td style="width: 10%;"></td> <td style="width: 10%;"></td> <td style="width: 10%;"></td> <td style="width: 10%;"></td> <td style="width: 10%;"></td> <td style="width: 10%;"></td> <td style="width: 10%;"></td> </tr> <tr> <td></td> <td></td> <td colspan="8" style="text-align: center;"> <table border="1" style="width: 100%; border-collapse: collapse; text-align: center;"> <tr> <td style="width: 10%;"></td> <td style="width: 10%;"></td> <td style="width: 10%;"></td> <td style="width: 10%;"></td> <td style="width: 10%;"></td> <td style="width: 10%;"></td> <td style="width: 10%;"></td> <td style="width: 10%;"></td> <td style="width: 10%;"></td> <td style="width: 10%;"></td> </tr> <tr> <td></td> <td></td> <td colspan="8" style="text-align: center;"> <table border="1" style="width: 100%; border-collapse: collapse; text-align: center;"> <tr> <td style="width: 10%;"></td> <td style="width: 10%;"></td> <td style="width: 10%;"></td> <td style="width: 10%;"></td> <td style="width: 10%;"></td> <td style="width: 10%;"></td> <td style="width: 10%;"></td> <td style="width: 10%;"></td> <td style="width: 10%;"></td> <td style="width: 10%;"></td> </tr> <tr> <td></td> <td></td> <td colspan="8" style="text-align: center;"> <table border="1" style="width: 100%; border-collapse: collapse; text-align: center;"> <tr> <td style="width: 10%;"></td> <td style="width: 10%;"></td> <td style="width: 10%;"></td> <td style="width: 10%;"></td> <td style="width: 10%;"></td> <td style="width: 10%;"></td> <td style="width: 10%;"></td> <td style="width: 10%;"></td> <td style="width: 10%;"></td> <td style="width: 10%;"></td> </tr> <tr> <td></td> <td></td> <td colspan="8" style="text-align: center;"> <table border="1" style="width: 100%; border-collapse: collapse; text-align: center;"> <tr> </tr></table></td></tr></table></td></tr></table></td></tr></table></td></tr></table></td></tr></table></td></tr></table></td></tr></table></td></tr></table></td></tr></table></td></tr></table></td></tr></table></td></tr></table></td></tr></table></td></tr></table></td></tr></table></td></tr></table></td></tr></table></td></tr></table></td></tr></table></td></tr></table></td></tr></table></td></tr></table></td></tr></table>
 | | | | | | | | | | | | | | | | | | | | <table border="1" style="width: 100%; border-collapse: collapse; text-align: center;"> <tr> <td style="width: 10%;"></td> <td style="width: 10%;"></td> <td style="width: 10%;"></td> <td style="width: 10%;"></td> <td style="width: 10%;"></td> <td style="width: 10%;"></td> <td style="width: 10%;"></td> <td style="width: 10%;"></td> <td style="width: 10%;"></td> <td style="width: 10%;"></td> </tr> <tr> <td></td> <td></td> <td colspan="8" style="text-align: center;"> <table border="1" style="width: 100%; border-collapse: collapse; text-align: center;"> <tr> <td style="width: 10%;"></td> <td style="width: 10%;"></td> <td style="width: 10%;"></td> <td style="width: 10%;"></td> <td style="width: 10%;"></td> <td style="width: 10%;"></td> <td style="width: 10%;"></td> <td style="width: 10%;"></td> <td style="width: 10%;"></td> <td style="width: 10%;"></td> </tr> <tr> <td></td> <td></td> <td colspan="8" style="text-align: center;"> <table border="1" style="width: 100%; border-collapse: collapse; text-align: center;"> <tr> <td style="width: 10%;"></td> <td style="width: 10%;"></td> <td style="width: 10%;"></td> <td style="width: 10%;"></td> <td style="width: 10%;"></td> <td style="width: 10%;"></td> <td style="width: 10%;"></td> <td style="width: 10%;"></td> <td style="width: 10%;"></td> <td style="width: 10%;"></td> </tr> <tr> <td></td> <td></td> <td colspan="8" style="text-align: center;"> <table border="1" style="width: 100%; border-collapse: collapse; text-align: center;"> <tr> <td style="width: 10%;"></td> <td style="width: 10%;"></td> <td style="width: 10%;"></td> <td style="width: 10%;"></td> <td style="width: 10%;"></td> <td style="width: 10%;"></td> <td style="width: 10%;"></td> <td style="width: 10%;"></td> <td style="width: 10%;"></td> <td style="width: 10%;"></td> </tr> <tr> <td></td> <td></td> <td colspan="8" style="text-align: center;"> <table border="1" style="width: 100%; border-collapse: collapse; text-align: center;"> <tr> <td style="width: 10%;"></td> <td style="width: 10%;"></td> <td style="width: 10%;"></td> <td style="width: 10%;"></td> <td style="width: 10%;"></td> <td style="width: 10%;"></td> <td style="width: 10%;"></td> <td style="width: 10%;"></td> <td style="width: 10%;"></td> <td style="width: 10%;"></td> </tr> <tr> <td></td> <td></td> <td colspan="8" style="text-align: center;"> <table border="1" style="width: 100%; border-collapse: collapse; text-align: center;"> <tr> <td style="width: 10%;"></td> <td style="width: 10%;"></td> <td style="width: 10%;"></td> <td style="width: 10%;"></td> <td style="width: 10%;"></td> <td style="width: 10%;"></td> <td style="width: 10%;"></td> <td style="width: 10%;"></td> <td style="width: 10%;"></td> <td style="width: 10%;"></td> </tr> <tr> <td></td> <td></td> <td colspan="8" style="text-align: center;"> <table border="1" style="width: 100%; border-collapse: collapse; text-align: center;"> <tr> <td style="width: 10%;"></td> <td style="width: 10%;"></td> <td style="width: 10%;"></td> <td style="width: 10%;"></td> <td style="width: 10%;"></td> <td style="width:
10%;"></td> <td style="width: 10%;"></td> <td style="width: 10%;"></td> <td style="width: 10%;"></td> <td style="width: 10%;"></td> </tr> <tr> <td></td> <td></td> <td colspan="8" style="text-align: center;"> <table border="1" style="width: 100%; border-collapse: collapse; text-align: center;"> <tr> <td style="width: 10%;"></td> <td style="width: 10%;"></td> <td style="width: 10%;"></td> <td style="width: 10%;"></td> <td style="width: 10%;"></td> <td style="width: 10%;"></td> <td style="width: 10%;"></td> <td style="width: 10%;"></td> <td style="width: 10%;"></td> <td style="width: 10%;"></td> </tr> <tr> <td></td> <td></td> <td colspan="8" style="text-align: center;"> <table border="1" style="width: 100%; border-collapse: collapse; text-align: center;"> <tr> <td style="width: 10%;"></td> <td style="width: 10%;"></td> <td style="width: 10%;"></td> <td style="width: 10%;"></td> <td style="width: 10%;"></td> <td style="width: 10%;"></td> <td style="width: 10%;"></td> <td style="width: 10%;"></td> <td style="width: 10%;"></td> <td style="width: 10%;"></td> </tr> <tr> <td></td> <td></td> <td colspan="8" style="text-align: center;"> <table border="1" style="width: 100%; border-collapse: collapse; text-align: center;"> <tr> <td style="width: 10%;"></td> <td style="width: 10%;"></td> <td style="width: 10%;"></td> <td style="width: 10%;"></td> <td style="width: 10%;"></td> <td style="width: 10%;"></td> <td style="width: 10%;"></td> <td style="width: 10%;"></td> <td style="width: 10%;"></td> <td style="width: 10%;"></td> </tr> <tr> <td></td> <td></td> <td colspan="8" style="text-align: center;"> <table border="1" style="width: 100%; border-collapse: collapse; text-align: center;"> <tr> <td style="width: 10%;"></td> <td style="width: 10%;"></td> <td style="width: 10%;"></td> <td style="width: 10%;"></td> <td style="width: 10%;"></td> <td style="width: 10%;"></td> <td style="width: 10%;"></td> <td style="width: 10%;"></td> <td style="width: 10%;"></td> <td style="width: 10%;"></td> </tr> <tr> <td></td> <td></td> <td colspan="8" style="text-align: center;"> <table border="1" style="width: 100%; border-collapse: collapse; text-align: center;"> <tr> <td style="width: 10%;"></td> <td style="width: 10%;"></td> <td style="width: 10%;"></td> <td style="width: 10%;"></td> <td style="width: 10%;"></td> <td style="width: 10%;"></td> <td style="width: 10%;"></td> <td style="width: 10%;"></td> <td style="width: 10%;"></td> <td style="width: 10%;"></td> </tr> <tr> <td></td> <td></td> <td colspan="8" style="text-align: center;"> <table border="1" style="width: 100%; border-collapse: collapse; text-align: center;"> <tr> <td style="width: 10%;"></td> <td style="width: 10%;"></td> <td style="width: 10%;"></td> <td style="width: 10%;"></td> <td style="width: 10%;"></td> <td style="width: 10%;"></td> <td style="width: 10%;"></td> <td style="width: 10%;"></td> <td style="width: 10%;"></td> <td style="width: 10%;"></td> </tr> <tr> <td></td> <td></td> <td colspan="8" style="text-align: center;"> <table border="1" style="width: 100%; border-collapse: collapse; text-align: center;"> <tr> <td style="width: 10%;"></td> <td style="width: 10%;"></td> <td style="width: 10%;"></td> <td style="width: 10%;"></td> <td style="width: 10%;"></td> <td style="width: 10%;"></td> <td style="width: 10%;"></td> <td style="width: 10%;"></td> <td style="width: 10%;"></td> <td style="width: 10%;"></td> </tr> <tr> <td></td> <td></td> <td colspan="8" style="text-align: center;"> <table border="1" style="width: 100%; border-collapse: collapse; text-align: center;"> <tr> <td style="width: 10%;"></td> <td style="width: 10%;"></td> <td style="width: 10%;"></td> <td style="width: 10%;"></td> <td style="width: 10%;"></td> <td style="width: 10%;"></td> <td style="width: 10%;"></td> <td style="width: 10%;"></td> <td style="width: 10%;"></td> <td style="width: 10%;"></td> </tr> <tr> <td></td> <td></td> <td colspan="8" style="text-align: center;"> <table border="1" style="width: 100%; border-collapse: collapse; text-align: center;"> <tr> <td style="width: 10%;"></td> <td style="width: 10%;"></td> <td style="width: 10%;"></td> <td style="width: 10%;"></td> <td style="width: 10%;"></td> <td style="width: 10%;"></td> <td style="width: 10%;"></td> <td style="width: 10%;"></td> <td style="width: 10%;"></td> <td style="width: 10%;"></td> </tr> <tr> <td></td> <td></td> <td colspan="8" style="text-align: center;"> <table border="1" style="width: 100%; border-collapse: collapse; text-align: center;"> <tr> <td style="width: 10%;"></td> <td style="width: 10%;"></td> <td style="width: 10%;"></td> <td style="width: 10%;"></td> <td style="width: 10%;"></td> <td style="width: 10%;"></td> <td style="width: 10%;"></td> <td style="width: 10%;"></td> <td style="width: 10%;"></td> <td style="width: 10%;"></td> </tr> <tr> <td></td> <td></td> <td colspan="8" style="text-align: center;"> <table border="1" style="width: 100%; border-collapse: collapse; text-align: center;"> <tr> <td style="width: 10%;"></td> <td style="width: 10%;"></td> <td style="width: 10%;"></td> <td style="width: 10%;"></td> <td style="width: 10%;"></td> <td style="width: 10%;"></td> <td style="width: 10%;"></td> <td style="width: 10%;"></td> <td style="width: 10%;"></td> <td style="width: 10%;"></td> </tr> <tr> <td></td> <td></td> <td colspan="8" style="text-align: center;"> <table border="1" style="width: 100%; border-collapse: collapse; text-align: center;"> <tr> <td style="width: 10%;"></td> <td style="width: 10%;"></td> <td style="width: 10%;"></td> <td style="width: 10%;"></td> <td style="width: 10%;"></td> <td style="width: 10%;"></td> <td style="width: 10%;"></td> <td style="width: 10%;"></td> <td style="width: 10%;"></td> <td style="width: 10%;"></td> </tr> <tr> <td></td> <td></td> <td colspan="8" style="text-align: center;"> <table border="1" style="width: 100%; border-collapse: collapse; text-align: center;"> <tr> <td style="width: 10%;"></td> <td style="width: 10%;"></td> <td style="width: 10%;"></td> <td style="width: 10%;"></td> <td style="width: 10%;"></td> <td style="width: 10%;"></td> <td style="width: 10%;"></td> <td style="width: 10%;"></td> <td style="width: 10%;"></td> <td style="width: 10%;"></td> </tr> <tr> <td></td> <td></td> <td colspan="8" style="text-align: center;"> <table border="1" style="width: 100%; border-collapse: collapse; text-align: center;"> <tr> <td style="width: 10%;"></td> <td style="width: 10%;"></td> <td style="width: 10%;"></td> <td style="width: 10%;"></td> <td style="width: 10%;"></td> <td style="width: 10%;"></td> <td style="width: 10%;"></td> <td style="width: 10%;"></td> <td style="width: 10%;"></td> <td style="width: 10%;"></td> </tr> <tr> <td></td> <td></td> <td colspan="8" style="text-align: center;"> <table border="1" style="width: 100%; border-collapse: collapse; text-align: center;"> <tr> <td style="width: 10%;"></td> <td style="width: 10%;"></td> <td style="width: 10%;"></td> <td style="width: 10%;"></td> <td style="width: 10%;"></td> <td style="width: 10%;"></td> <td style="width: 10%;"></td> <td style="width: 10%;"></td> <td style="width: 10%;"></td> <td style="width: 10%;"></td> </tr> <tr> <td></td> <td></td> <td colspan="8" style="text-align: center;"> <table border="1" style="width: 100%; border-collapse: collapse; text-align: center;"> <tr> </tr></table></td></tr></table></td></tr></table></td></tr></table></td></tr></table></td></tr></table></td></tr></table></td></tr></table></td></tr></table></td></tr></table></td></tr></table></td></tr></table></td></tr></table></td></tr></table></td></tr></table></td></tr></table></td></tr></table></td></tr></table></td></tr></table></td></tr></table></td></tr></table></td></tr></table></td></tr></table>
 | | | | | | | | | | | | | | | | | | | | <table border="1" style="width: 100%; border-collapse: collapse; text-align: center;"> <tr> <td style="width: 10%;"></td> <td style="width: 10%;"></td> <td style="width: 10%;"></td> <td style="width: 10%;"></td> <td style="width: 10%;"></td> <td style="width: 10%;"></td> <td style="width: 10%;"></td> <td style="width: 10%;"></td> <td style="width: 10%;"></td> <td style="width: 10%;"></td> </tr> <tr> <td></td> <td></td> <td colspan="8" style="text-align: center;"> <table border="1" style="width: 100%; border-collapse: collapse; text-align: center;"> <tr> <td style="width: 10%;"></td> <td style="width: 10%;"></td> <td style="width: 10%;"></td> <td style="width: 10%;"></td> <td style="width: 10%;"></td> <td style="width: 10%;"></td> <td style="width: 10%;"></td> <td style="width: 10%;"></td> <td style="width: 10%;"></td> <td style="width: 10%;"></td> </tr> <tr> <td></td> <td></td> <td colspan="8" style="text-align: center;"> <table border="1" style="width: 100%; border-collapse: collapse; text-align: center;"> <tr> <td style="width: 10%;"></td> <td style="width: 10%;"></td> <td style="width: 10%;"></td> <td style="width: 10%;"></td> <td style="width: 10%;"></td> <td style="width: 10%;"></td> <td style="width: 10%;"></td> <td style="width: 10%;"></td> <td style="width: 10%;"></td> <td style="width: 10%;"></td> </tr> <tr> <td></td> <td></td> <td colspan="8" style="text-align: center;"> <table border="1" style="width: 100%; border-collapse: collapse; text-align: center;"> <tr> <td style="width: 10%;"></td> <td style="width: 10%;"></td> <td style="width: 10%;"></td> <td style="width: 10%;"></td> <td style="width: 10%;"></td> <td style="width: 10%;"></td> <td style="width: 10%;"></td> <td style="width: 10%;"></td> <td style="width: 10%;"></td> <td style="width: 10%;"></td> </tr> <tr> <td></td> <td></td> <td colspan="8" style="text-align: center;"> <table border="1" style="width: 100%; border-collapse: collapse; text-align: center;"> <tr> <td style="width: 10%;"></td> <td style="width: 10%;"></td> <td style="width: 10%;"></td> <td style="width: 10%;"></td> <td style="width: 10%;"></td> <td style="width: 10%;"></td> <td style="width: 10%;"></td> <td style="width: 10%;"></td> <td style="width: 10%;"></td> <td style="width: 10%;"></td> </tr> <tr> <td></td> <td></td> <td colspan="8" style="text-align: center;"> <table border="1" style="width: 100%; border-collapse: collapse; text-align: center;"> <tr> <td style="width: 10%;"></td> <td style="width: 10%;"></td> <td style="width: 10%;"></td> <td style="width: 10%;"></td> <td style="width: 10%;"></td> <td style="width: 10%;"></td> <td style="width: 10%;"></td> <td style="width: 10%;"></td> <td style="width: 10%;"></td> <td style="width: 10%;"></td> </tr> <tr> <td></td> <td></td> <td colspan="8" style="text-align: center;"> <table border="1" style="width: 100%; border-collapse: collapse; text-align: center;"> <tr> <td style="width: 10%;"></td> <td style="width: 10%;"></td> <td style="width: 10%;"></td> <td style="width: 10%;"></td> <td style="width: 10%;"></td> <td style="width: 10%;"></td> <td style="width: 10%;"></td> <td style="width: 10%;"></td> <td style="width: 10%;"></td> <td style="width: 10%;"></td> </tr> <tr> <td></td> <td></td> <td colspan="8" style="text-align: center;"> <table border="1" style="width: 100%; border-collapse: collapse; text-align: center;"> <tr> <td style="width: 10%;"></td> <td style="width: 10%;"></td> <td style="width: 10%;"></td> <td style="width: 10%;"></td> <td style="width: 10%;"></td> <td style="width: 10%;"></td> <td style="width: 10%;"></td> <td style="width: 10%;"></td> <td style="width: 10%;"></td> <td style="width: 10%;"></td> </tr> <tr> <td></td> <td></td> <td colspan="8" style="text-align: center;"> <table border="1" style="width: 100%; border-collapse: collapse; text-align: center;"> <tr> <td style="width: 10%;"></td> <td style="width: 10%;"></td> <td style="width: 10%;"></td> <td style="width:
10%;"></td> <td style="width: 10%;"></td> <td style="width: 10%;"></td> <td style="width: 10%;"></td> <td style="width: 10%;"></td> <td style="width: 10%;"></td> <td style="width: 10%;"></td> </tr> <tr> <td></td> <td></td> <td colspan="8" style="text-align: center;"> <table border="1" style="width: 100%; border-collapse: collapse; text-align: center;"> <tr> <td style="width: 10%;"></td> <td style="width: 10%;"></td> <td style="width: 10%;"></td> <td style="width: 10%;"></td> <td style="width: 10%;"></td> <td style="width: 10%;"></td> <td style="width: 10%;"></td> <td style="width: 10%;"></td> <td style="width: 10%;"></td> <td style="width: 10%;"></td> </tr> <tr> <td></td> <td></td> <td colspan="8" style="text-align: center;"> <table border="1" style="width: 100%; border-collapse: collapse; text-align: center;"> <tr> <td style="width: 10%;"></td> <td style="width: 10%;"></td> <td style="width: 10%;"></td> <td style="width: 10%;"></td> <td style="width: 10%;"></td> <td style="width: 10%;"></td> <td style="width: 10%;"></td> <td style="width: 10%;"></td> <td style="width: 10%;"></td> <td style="width: 10%;"></td> </tr> <tr> <td></td> <td></td> <td colspan="8" style="text-align: center;"> <table border="1" style="width: 100%; border-collapse: collapse; text-align: center;"> <tr> <td style="width: 10%;"></td> <td style="width: 10%;"></td> <td style="width: 10%;"></td> <td style="width: 10%;"></td> <td style="width: 10%;"></td> <td style="width: 10%;"></td> <td style="width: 10%;"></td> <td style="width: 10%;"></td> <td style="width: 10%;"></td> <td style="width: 10%;"></td> </tr> <tr> <td></td> <td></td> <td colspan="8" style="text-align: center;"> <table border="1" style="width: 100%; border-collapse: collapse; text-align: center;"> <tr> <td style="width: 10%;"></td> <td style="width: 10%;"></td> <td style="width: 10%;"></td> <td style="width: 10%;"></td> <td style="width: 10%;"></td> <td style="width: 10%;"></td> <td style="width: 10%;"></td> <td style="width: 10%;"></td> <td style="width: 10%;"></td> <td style="width: 10%;"></td> </tr> <tr> <td></td> <td></td> <td colspan="8" style="text-align: center;"> <table border="1" style="width: 100%; border-collapse: collapse; text-align: center;"> <tr> <td style="width: 10%;"></td> <td style="width: 10%;"></td> <td style="width: 10%;"></td> <td style="width: 10%;"></td> <td style="width: 10%;"></td> <td style="width: 10%;"></td> <td style="width: 10%;"></td> <td style="width: 10%;"></td> <td style="width: 10%;"></td> <td style="width: 10%;"></td> </tr> <tr> <td></td> <td></td> <td colspan="8" style="text-align: center;"> <table border="1" style="width: 100%; border-collapse: collapse; text-align: center;"> <tr> <td style="width: 10%;"></td> <td style="width: 10%;"></td> <td style="width: 10%;"></td> <td style="width: 10%;"></td> <td style="width: 10%;"></td> <td style="width: 10%;"></td> <td style="width: 10%;"></td> <td style="width: 10%;"></td> <td style="width: 10%;"></td> <td style="width: 10%;"></td> </tr> <tr> <td></td> <td></td> <td colspan="8" style="text-align: center;"> <table border="1" style="width: 100%; border-collapse: collapse; text-align: center;"> <tr> <td style="width: 10%;"></td> <td style="width: 10%;"></td> <td style="width: 10%;"></td> <td style="width: 10%;"></td> <td style="width: 10%;"></td> <td style="width: 10%;"></td> <td style="width: 10%;"></td> <td style="width: 10%;"></td> <td style="width: 10%;"></td> <td style="width: 10%;"></td> </tr> <tr> <td></td> <td></td> <td colspan="8" style="text-align: center;"> <table border="1" style="width: 100%; border-collapse: collapse; text-align: center;"> <tr> <td style="width: 10%;"></td> <td style="width: 10%;"></td> <td style="width: 10%;"></td> <td style="width: 10%;"></td> <td style="width: 10%;"></td> <td style="width: 10%;"></td> <td style="width: 10%;"></td> <td style="width: 10%;"></td> <td style="width: 10%;"></td> <td style="width: 10%;"></td> </tr> <tr> <td></td> <td></td> <td colspan="8" style="text-align: center;"> <table border="1" style="width: 100%; border-collapse: collapse; text-align: center;"> <tr> <td style="width: 10%;"></td> <td style="width: 10%;"></td> <td style="width: 10%;"></td> <td style="width: 10%;"></td> <td style="width: 10%;"></td> <td style="width: 10%;"></td> <td style="width: 10%;"></td> <td style="width: 10%;"></td> <td style="width: 10%;"></td> <td style="width: 10%;"></td> </tr> <tr> <td></td> <td></td> <td colspan="8" style="text-align: center;"> <table border="1" style="width: 100%; border-collapse: collapse; text-align: center;"> <tr> <td style="width: 10%;"></td> <td style="width: 10%;"></td> <td style="width: 10%;"></td> <td style="width: 10%;"></td> <td style="width: 10%;"></td> <td style="width: 10%;"></td> <td style="width: 10%;"></td> <td style="width: 10%;"></td> <td style="width: 10%;"></td> <td style="width: 10%;"></td> </tr> <tr> <td></td> <td></td> <td colspan="8" style="text-align: center;"> <table border="1" style="width: 100%; border-collapse: collapse; text-align: center;"> <tr> <td style="width: 10%;"></td> <td style="width: 10%;"></td> <td style="width: 10%;"></td> <td style="width: 10%;"></td> <td style="width: 10%;"></td> <td style="width: 10%;"></td> <td style="width: 10%;"></td> <td style="width: 10%;"></td> <td style="width: 10%;"></td> <td style="width: 10%;"></td> </tr> <tr> <td></td> <td></td> <td colspan="8" style="text-align: center;"> <table border="1" style="width: 100%; border-collapse: collapse; text-align: center;"> <tr> <td style="width: 10%;"></td> <td style="width: 10%;"></td> <td style="width: 10%;"></td> <td style="width: 10%;"></td> <td style="width: 10%;"></td> <td style="width: 10%;"></td> <td style="width: 10%;"></td> <td style="width: 10%;"></td> <td style="width: 10%;"></td> <td style="width: 10%;"></td> </tr> <tr> <td></td> <td></td> <td colspan="8" style="text-align: center;"> <table border="1" style="width: 100%; border-collapse: collapse; text-align: center;"> <tr> </tr></table></td></tr></table></td></tr></table></td></tr></table></td></tr></table></td></tr></table></td></tr></table></td></tr></table></td></tr></table></td></tr></table></td></tr></table></td></tr></table></td></tr></table></td></tr></table></td></tr></table></td></tr></table></td></tr></table></td></tr></table></td></tr></table></td></tr></table></td></tr></table></td></tr></table>
 | | | | | | | | | | | | | | | | | | | | <table border="1" style="width: 100%; border-collapse: collapse; text-align: center;"> <tr> <td style="width: 10%;"></td> <td style="width: 10%;"></td> <td style="width: 10%;"></td> <td style="width: 10%;"></td> <td style="width: 10%;"></td> <td style="width: 10%;"></td> <td style="width: 10%;"></td> <td style="width: 10%;"></td> <td style="width: 10%;"></td> <td style="width: 10%;"></td> </tr> <tr> <td></td> <td></td> <td colspan="8" style="text-align: center;"> <table border="1" style="width: 100%; border-collapse: collapse; text-align: center;"> <tr> <td style="width: 10%;"></td> <td style="width: 10%;"></td> <td style="width: 10%;"></td> <td style="width: 10%;"></td> <td style="width: 10%;"></td> <td style="width: 10%;"></td> <td style="width: 10%;"></td> <td style="width: 10%;"></td> <td style="width: 10%;"></td> <td style="width: 10%;"></td> </tr> <tr> <td></td> <td></td> <td colspan="8" style="text-align: center;"> <table border="1" style="width: 100%; border-collapse: collapse; text-align: center;"> <tr> <td style="width: 10%;"></td> <td style="width: 10%;"></td> <td style="width: 10%;"></td> <td style="width: 10%;"></td> <td style="width: 10%;"></td> <td style="width: 10%;"></td> <td style="width: 10%;"></td> <td style="width: 10%;"></td> <td style="width: 10%;"></td> <td style="width: 10%;"></td> </tr> <tr> <td></td> <td></td> <td colspan="8" style="text-align: center;"> <table border="1" style="width: 100%; border-collapse: collapse; text-align: center;"> <tr> <td style="width: 10%;"></td> <td style="width: 10%;"></td> <td style="width: 10%;"></td> <td style="width: 10%;"></td> <td style="width: 10%;"></td> <td style="width: 10%;"></td> <td style="width: 10%;"></td> <td style="width: 10%;"></td> <td style="width: 10%;"></td> <td style="width: 10%;"></td> </tr> <tr> <td></td> <td></td> <td colspan="8" style="text-align: center;"> <table border="1" style="width: 100%; border-collapse: collapse; text-align: center;"> <tr> <td style="width: 10%;"></td> <td style="width: 10%;"></td> <td style="width: 10%;"></td> <td style="width: 10%;"></td> <td style="width: 10%;"></td> <td style="width: 10%;"></td> <td style="width: 10%;"></td> <td style="width: 10%;"></td> <td style="width: 10%;"></td> <td style="width: 10%;"></td> </tr> <tr> <td></td> <td></td> <td colspan="8" style="text-align: center;"> <table border="1" style="width: 100%; border-collapse: collapse; text-align: center;"> <tr> <td style="width: 10%;"></td> <td style="width: 10%;"></td> <td style="width: 10%;"></td> <td style="width: 10%;"></td> <td style="width: 10%;"></td> <td style="width: 10%;"></td> <td style="width: 10%;"></td> <td style="width: 10%;"></td> <td style="width: 10%;"></td> <td style="width: 10%;"></td> </tr> <tr> <td></td> <td></td> <td colspan="8" style="text-align: center;"> <table border="1" style="width: 100%; border-collapse: collapse; text-align: center;"> <tr> <td style="width: 10%;"></td> <td style="width: 10%;"></td> <td style="width: 10%;"></td> <td style="width: 10%;"></td> <td style="width: 10%;"></td> <td style="width: 10%;"></td> <td style="width: 10%;"></td> <td style="width: 10%;"></td> <td style="width: 10%;"></td> <td style="width: 10%;"></td> </tr> <tr> <td></td> <td></td> <td colspan="8" style="text-align: center;"> <table border="1" style="width: 100%; border-collapse: collapse; text-align: center;"> <tr> <td style="width: 10%;"></td> <td style="width: 10%;"></td> <td style="width: 10%;"></td> <td style="width: 10%;"></td> <td style="width: 10%;"></td> <td style="width: 10%;"></td> <td style="width: 10%;"></td> <td style="width: 10%;"></td> <td style="width: 10%;"></td> <td style="width: 10%;"></td> </tr> <tr> <td></td> <td></td> <td colspan="8" style="text-align: center;"> <table border="1" style="width: 100%; border-collapse: collapse; text-align: center;"> <tr> <td style="width: 10%;"></td> <td style="width: 10%;"></td> <td style="width: 10%;"></td> <td style="width: 10%;"></td> <td style="width: 10%;"></td> <td style="width: 10%;"></td> <td style="width: 10%;"></td> <td style="width: 10%;"></td> <td style="width: 10%;"></td> <td style="width: 10%;"></td> </tr> <tr> <td></td> <td></td> <td colspan="8" style="text-align: center;"> <table border="1" style="width: 100%; border-collapse: collapse; text-align: center;"> <tr> <td style="width: 10%;"></td> <td style="width: 10%;"></td> <td style="width: 10%;"></td> <td style="width: 10%;"></td> <td style="width: 10%;"></td> <td style="width: 10%;"></td> <td style="width: 10%;"></td> <td style="width: 10%;"></td> <td style="width: 10%;"></td> <td style="width: 10%;"></td> </tr> <tr> <td></td> <td></td> <td colspan="8" style="text-align: center;"> <table border="1" style="width: 100%; border-collapse: collapse; text-align: center;"> <tr> <td style="width: 10%;"></td> <td style="width: 10%;"></td> <td style="width: 10%;"></td> <td style="width: 10%;"></td> <td style="width: 10%;"></td> <td style="width: 10%;"></td> <td style="width: 10%;"></td> <td style="width: 10%;"></td> <td style="width: 10%;"></td> <td style="width: 10%;"></td> </tr> <tr> <td></td> <td></td> <td colspan="8" style="text-align: center;"> <table border="1" style="width: 100%; border-collapse: collapse; text-align: center;"> <tr> <td style="width: 10%;"></td> <td style="width: 10%;"></td> <td
style="width: 10%;"></td> <td style="width: 10%;"></td> <td style="width: 10%;"></td> <td style="width: 10%;"></td> <td style="width: 10%;"></td> <td style="width: 10%;"></td> <td style="width: 10%;"></td> <td style="width: 10%;"></td> </tr> <tr> <td></td> <td></td> <td colspan="8" style="text-align: center;"> <table border="1" style="width: 100%; border-collapse: collapse; text-align: center;"> <tr> <td style="width: 10%;"></td> <td style="width: 10%;"></td> <td style="width: 10%;"></td> <td style="width: 10%;"></td> <td style="width: 10%;"></td> <td style="width: 10%;"></td> <td style="width: 10%;"></td> <td style="width: 10%;"></td> <td style="width: 10%;"></td> <td style="width: 10%;"></td> </tr> <tr> <td></td> <td></td> <td colspan="8" style="text-align: center;"> <table border="1" style="width: 100%; border-collapse: collapse; text-align: center;"> <tr> <td style="width: 10%;"></td> <td style="width: 10%;"></td> <td style="width: 10%;"></td> <td style="width: 10%;"></td> <td style="width: 10%;"></td> <td style="width: 10%;"></td> <td style="width: 10%;"></td> <td style="width: 10%;"></td> <td style="width: 10%;"></td> <td style="width: 10%;"></td> </tr> <tr> <td></td> <td></td> <td colspan="8" style="text-align: center;"> <table border="1" style="width: 100%; border-collapse: collapse; text-align: center;"> <tr> <td style="width: 10%;"></td> <td style="width: 10%;"></td> <td style="width: 10%;"></td> <td style="width: 10%;"></td> <td style="width: 10%;"></td> <td style="width: 10%;"></td> <td style="width: 10%;"></td> <td style="width: 10%;"></td> <td style="width: 10%;"></td> <td style="width: 10%;"></td> </tr> <tr> <td></td> <td></td> <td colspan="8" style="text-align: center;"> <table border="1" style="width: 100%; border-collapse: collapse; text-align: center;"> <tr> <td style="width: 10%;"></td> <td style="width: 10%;"></td> <td style="width: 10%;"></td> <td style="width: 10%;"></td> <td style="width: 10%;"></td> <td style="width: 10%;"></td> <td style="width: 10%;"></td> <td style="width: 10%;"></td> <td style="width: 10%;"></td> <td style="width: 10%;"></td> </tr> <tr> <td></td> <td></td> <td colspan="8" style="text-align: center;"> <table border="1" style="width: 100%; border-collapse: collapse; text-align: center;"> <tr> <td style="width: 10%;"></td> <td style="width: 10%;"></td> <td style="width: 10%;"></td> <td style="width: 10%;"></td> <td style="width: 10%;"></td> <td style="width: 10%;"></td> <td style="width: 10%;"></td> <td style="width: 10%;"></td> <td style="width: 10%;"></td> <td style="width: 10%;"></td> </tr> <tr> <td></td> <td></td> <td colspan="8" style="text-align: center;"> <table border="1" style="width: 100%; border-collapse: collapse; text-align: center;"> <tr> <td style="width: 10%;"></td> <td style="width: 10%;"></td> <td style="width: 10%;"></td> <td style="width: 10%;"></td> <td style="width: 10%;"></td> <td style="width: 10%;"></td> <td style="width: 10%;"></td> <td style="width: 10%;"></td> <td style="width: 10%;"></td> <td style="width: 10%;"></td> </tr> <tr> <td></td> <td></td> <td colspan="8" style="text-align: center;"> <table border="1" style="width: 100%; border-collapse: collapse; text-align: center;"> <tr> <td style="width: 10%;"></td> <td style="width: 10%;"></td> <td style="width: 10%;"></td> <td style="width: 10%;"></td> <td style="width: 10%;"></td> <td style="width: 10%;"></td> <td style="width: 10%;"></td> <td style="width: 10%;"></td> <td style="width: 10%;"></td> <td style="width: 10%;"></td> </tr> <tr> <td></td> <td></td> <td colspan="8" style="text-align: center;"> <table border="1" style="width: 100%; border-collapse: collapse; text-align: center;"> <tr> <td style="width: 10%;"></td> <td style="width: 10%;"></td> <td style="width: 10%;"></td> <td style="width: 10%;"></td> <td style="width: 10%;"></td> <td style="width: 10%;"></td> <td style="width: 10%;"></td> <td style="width: 10%;"></td> <td style="width: 10%;"></td> <td style="width: 10%;"></td> </tr> <tr> <td></td> <td></td> <td colspan="8" style="text-align: center;"> <table border="1" style="width: 100%; border-collapse: collapse; text-align: center;"> <tr> </tr></table></td></tr></table></td></tr></table></td></tr></table></td></tr></table></td></tr></table></td></tr></table></td></tr></table></td></tr></table></td></tr></table></td></tr></table></td></tr></table></td></tr></table></td></tr></table></td></tr></table></td></tr></table></td></tr></table></td></tr></table></td></tr></table></td></tr></table></td></tr></table>
 | | | | | | | | | | | | | | | | | | | | <table border="1" style="width: 100%; border-collapse: collapse; text-align: center;"> <tr> <td style="width: 10%;"></td> <td style="width: 10%;"></td> <td style="width: 10%;"></td> <td style="width: 10%;"></td> <td style="width: 10%;"></td> <td style="width: 10%;"></td> <td style="width: 10%;"></td> <td style="width: 10%;"></td> <td style="width: 10%;"></td> <td style="width: 10%;"></td> </tr> <tr> <td></td> <td></td> <td colspan="8" style="text-align: center;"> <table border="1" style="width: 100%; border-collapse: collapse; text-align: center;"> <tr> <td style="width: 10%;"></td> <td style="width: 10%;"></td> <td style="width: 10%;"></td> <td style="width: 10%;"></td> <td style="width: 10%;"></td> <td style="width: 10%;"></td> <td style="width: 10%;"></td> <td style="width: 10%;"></td> <td style="width: 10%;"></td> <td style="width: 10%;"></td> </tr> <tr> <td></td> <td></td> <td colspan="8" style="text-align: center;"> <table border="1" style="width: 100%; border-collapse: collapse; text-align: center;"> <tr> <td style="width: 10%;"></td> <td style="width: 10%;"></td> <td style="width: 10%;"></td> <td style="width: 10%;"></td> <td style="width: 10%;"></td> <td style="width: 10%;"></td> <td style="width: 10%;"></td> <td style="width: 10%;"></td> <td style="width: 10%;"></td> <td style="width: 10%;"></td> </tr> <tr> <td></td> <td></td> <td colspan="8" style="text-align: center;"> <table border="1" style="width: 100%; border-collapse: collapse; text-align: center;"> <tr> <td style="width: 10%;"></td> <td style="width: 10%;"></td> <td style="width: 10%;"></td> <td style="width: 10%;"></td> <td style="width: 10%;"></td> <td style="width: 10%;"></td> <td style="width: 10%;"></td> <td style="width: 10%;"></td> <td style="width: 10%;"></td> <td style="width: 10%;"></td> </tr> <tr> <td></td> <td></td> <td colspan="8" style="text-align: center;"> <table border="1" style="width: 100%; border-collapse: collapse; text-align: center;"> <tr> <td style="width: 10%;"></td> <td style="width: 10%;"></td> <td style="width: 10%;"></td> <td style="width: 10%;"></td> <td style="width: 10%;"></td> <td style="width: 10%;"></td> <td style="width: 10%;"></td> <td style="width: 10%;"></td> <td style="width: 10%;"></td> <td style="width: 10%;"></td> </tr> <tr> <td></td> <td></td> <td colspan="8" style="text-align: center;"> <table border="1" style="width: 100%; border-collapse: collapse; text-align: center;"> <tr> <td style="width: 10%;"></td> <td style="width: 10%;"></td> <td style="width: 10%;"></td> <td style="width: 10%;"></td> <td style="width: 10%;"></td> <td style="width: 10%;"></td> <td style="width: 10%;"></td> <td style="width: 10%;"></td> <td style="width: 10%;"></td> <td style="width: 10%;"></td> </tr> <tr> <td></td> <td></td> <td colspan="8" style="text-align: center;"> <table border="1" style="width: 100%; border-collapse: collapse; text-align: center;"> <tr> <td style="width: 10%;"></td> <td style="width: 10%;"></td> <td style="width: 10%;"></td> <td style="width: 10%;"></td> <td style="width: 10%;"></td> <td style="width: 10%;"></td> <td style="width: 10%;"></td> <td style="width: 10%;"></td> <td style="width: 10%;"></td> <td style="width: 10%;"></td> </tr> <tr> <td></td> <td></td> <td colspan="8" style="text-align: center;"> <table border="1" style="width: 100%; border-collapse: collapse; text-align: center;"> <tr> <td style="width: 10%;"></td> <td style="width: 10%;"></td> <td style="width: 10%;"></td> <td style="width: 10%;"></td> <td style="width: 10%;"></td> <td style="width: 10%;"></td> <td style="width: 10%;"></td> <td style="width: 10%;"></td> <td style="width: 10%;"></td> <td style="width: 10%;"></td> </tr> <tr> <td></td> <td></td> <td colspan="8" style="text-align: center;"> <table border="1" style="width: 100%; border-collapse: collapse; text-align: center;"> <tr> <td style="width: 10%;"></td> <td style="width: 10%;"></td> <td style="width: 10%;"></td> <td style="width: 10%;"></td> <td style="width: 10%;"></td> <td style="width: 10%;"></td> <td style="width: 10%;"></td> <td style="width: 10%;"></td> <td style="width: 10%;"></td> <td style="width: 10%;"></td> </tr> <tr> <td></td> <td></td> <td colspan="8" style="text-align: center;"> <table border="1" style="width: 100%; border-collapse: collapse; text-align: center;"> <tr> <td style="width: 10%;"></td> <td style="width: 10%;"></td> <td style="width: 10%;"></td> <td style="width: 10%;"></td> <td style="width: 10%;"></td> <td style="width: 10%;"></td> <td style="width: 10%;"></td> <td style="width: 10%;"></td> <td style="width: 10%;"></td> <td style="width: 10%;"></td> </tr> <tr> <td></td> <td></td> <td colspan="8" style="text-align: center;"> <table border="1" style="width: 100%; border-collapse: collapse; text-align: center;"> <tr> <td style="width: 10%;"></td> <td style="width: 10%;"></td> <td style="width: 10%;"></td> <td style="width: 10%;"></td> <td style="width: 10%;"></td> <td style="width: 10%;"></td> <td style="width: 10%;"></td> <td style="width: 10%;"></td> <td style="width: 10%;"></td> <td style="width: 10%;"></td> </tr> <tr> <td></td> <td></td> <td colspan="8" style="text-align: center;"> <table border="1" style="width: 100%; border-collapse: collapse; text-align: center;"> <tr> <td style="width: 10%;"></td> <td style="width: 10%;"></td> <td style="width: 10%;"></td> <td style="width: 10%;"></td> <td style="width: 10%;"></td> <td style="width: 10%;"></td> <td style="width: 10%;"></td> <td style="width: 10%;"></td> <td style="width: 10%;"></td> <td style="width: 10%;"></td> </tr> <tr> <td></td> <td></td> <td colspan="8" style="text-align: center;"> <table border="1" style="width: 100%; border-collapse: collapse; text-align: center;"> <tr> <td style="width: 10%;"></td> <td style="width: 10%;"></td> <td style="width: 10%;"></td> <td style="width: 10%;"></td> <td style="width: 10%;"></td> <td style="width: 10%;"></td> <td style="width: 10%;"></td> <td style="width: 10%;"></td> <td style="width: 10%;"></td> <td style="width: 10%;"></td> </tr> <tr> <td></td> <td></td> <td colspan="8" style="text-align: center;"> <table border="1" style="width: 100%; border-collapse: collapse; text-align: center;"> <tr> <td style="width: 10%;"></td> <td style="width: 10%;"></td> <td style="width: 10%;"></td> <td style="width: 10%;"></td> <td style="width: 10%;"></td> <td style="width: 10%;"></td> <td style="width: 10%;"></td> <td style="width: 10%;"></td> <td style="width: 10%;"></td> <td style="width: 10%;"></td> </tr> <tr> <td></td> <td></td> <td colspan="8" style="text-align: center;"> <table border="1" style="width: 100%; border-collapse: collapse; text-align: center;"> <tr> <td style="width: 10%;"></td> <td style="width: 10%;"></td> <td style="width: 10%;"></td> <td style="width: 10%;"></td> <td style="width: 10%;"></td> <td style="width: 10%;"></td> <td style="width: 10%;"></td> <td style="width: 10%;"></td> <td style="width: 10%;"></td> <td style="width: 10%;"></td> </tr> <tr> <td></td> <td></td> <td colspan="8" style="text-align: center;"> <table border="1" style="width: 100%; border-collapse: collapse; text-align: center;"> <tr> <td style="width: 10%;"></td> <td
style="width: 10%;"></td> <td style="width: 10%;"></td> <td style="width: 10%;"></td> <td style="width: 10%;"></td> <td style="width: 10%;"></td> <td style="width: 10%;"></td> <td style="width: 10%;"></td> <td style="width: 10%;"></td> <td style="width: 10%;"></td> </tr> <tr> <td></td> <td></td> <td colspan="8" style="text-align: center;"> <table border="1" style="width: 100%; border-collapse: collapse; text-align: center;"> <tr> <td style="width: 10%;"></td> <td style="width: 10%;"></td> <td style="width: 10%;"></td> <td style="width: 10%;"></td> <td style="width: 10%;"></td> <td style="width: 10%;"></td> <td style="width: 10%;"></td> <td style="width: 10%;"></td> <td style="width: 10%;"></td> <td style="width: 10%;"></td> </tr> <tr> <td></td> <td></td> <td colspan="8" style="text-align: center;"> <table border="1" style="width: 100%; border-collapse: collapse; text-align: center;"> <tr> <td style="width: 10%;"></td> <td style="width: 10%;"></td> <td style="width: 10%;"></td> <td style="width: 10%;"></td> <td style="width: 10%;"></td> <td style="width: 10%;"></td> <td style="width: 10%;"></td> <td style="width: 10%;"></td> <td style="width: 10%;"></td> <td style="width: 10%;"></td> </tr> <tr> <td></td> <td></td> <td colspan="8" style="text-align: center;"> <table border="1" style="width: 100%; border-collapse: collapse; text-align: center;"> <tr> <td style="width: 10%;"></td> <td style="width: 10%;"></td> <td style="width: 10%;"></td> <td style="width: 10%;"></td> <td style="width: 10%;"></td> <td style="width: 10%;"></td> <td style="width: 10%;"></td> <td style="width: 10%;"></td> <td style="width: 10%;"></td> <td style="width: 10%;"></td> </tr> <tr> <td></td> <td></td> <td colspan="8" style="text-align: center;"> <table border="1" style="width: 100%; border-collapse: collapse; text-align: center;"> <tr> </tr></table></td></tr></table></td></tr></table></td></tr></table></td></tr></table></td></tr></table></td></tr></table></td></tr></table></td></tr></table></td></tr></table></td></tr></table></td></tr></table></td></tr></table></td></tr></table></td></tr></table></td></tr></table></td></tr></table></td></tr></table></td></tr></table></td></tr></table>
 | | | | | | | | | | | | | | | | | | | | <table border="1" style="width: 100%; border-collapse: collapse; text-align: center;"> <tr> <td style="width: 10%;"></td> <td style="width: 10%;"></td> <td style="width: 10%;"></td> <td style="width: 10%;"></td> <td style="width: 10%;"></td> <td style="width: 10%;"></td> <td style="width: 10%;"></td> <td style="width: 10%;"></td> <td style="width: 10%;"></td> <td style="width: 10%;"></td> </tr> <tr> <td></td> <td></td> <td colspan="8" style="text-align: center;"> <table border="1" style="width: 100%; border-collapse: collapse; text-align: center;"> <tr> <td style="width: 10%;"></td> <td style="width: 10%;"></td> <td style="width: 10%;"></td> <td style="width: 10%;"></td> <td style="width: 10%;"></td> <td style="width: 10%;"></td> <td style="width: 10%;"></td> <td style="width: 10%;"></td> <td style="width: 10%;"></td> <td style="width: 10%;"></td> </tr> <tr> <td></td> <td></td> <td colspan="8" style="text-align: center;"> <table border="1" style="width: 100%; border-collapse: collapse; text-align: center;"> <tr> <td style="width: 10%;"></td> <td style="width: 10%;"></td> <td style="width: 10%;"></td> <td style="width: 10%;"></td> <td style="width: 10%;"></td> <td style="width: 10%;"></td> <td style="width: 10%;"></td> <td style="width: 10%;"></td> <td style="width: 10%;"></td> <td style="width: 10%;"></td> </tr> <tr> <td></td> <td></td> <td colspan="8" style="text-align: center;"> <table border="1" style="width: 100%; border-collapse: collapse; text-align: center;"> <tr> <td style="width: 10%;"></td> <td style="width: 10%;"></td> <td style="width: 10%;"></td> <td style="width: 10%;"></td> <td style="width: 10%;"></td> <td style="width: 10%;"></td> <td style="width: 10%;"></td> <td style="width: 10%;"></td> <td style="width: 10%;"></td> <td style="width: 10%;"></td> </tr> <tr> <td></td> <td></td> <td colspan="8" style="text-align: center;"> <table border="1" style="width: 100%; border-collapse: collapse; text-align: center;"> <tr> <td style="width: 10%;"></td> <td style="width: 10%;"></td> <td style="width: 10%;"></td> <td style="width: 10%;"></td> <td style="width: 10%;"></td> <td style="width: 10%;"></td> <td style="width: 10%;"></td> <td style="width: 10%;"></td> <td style="width: 10%;"></td> <td style="width: 10%;"></td> </tr> <tr> <td></td> <td></td> <td colspan="8" style="text-align: center;"> <table border="1" style="width: 100%; border-collapse: collapse; text-align: center;"> <tr> <td style="width: 10%;"></td> <td style="width: 10%;"></td> <td style="width: 10%;"></td> <td style="width: 10%;"></td> <td style="width: 10%;"></td> <td style="width: 10%;"></td> <td style="width: 10%;"></td> <td style="width: 10%;"></td> <td style="width: 10%;"></td> <td style="width: 10%;"></td> </tr> <tr> <td></td> <td></td> <td colspan="8" style="text-align: center;"> <table border="1" style="width: 100%; border-collapse: collapse; text-align: center;"> <tr> <td style="width: 10%;"></td> <td style="width: 10%;"></td> <td style="width: 10%;"></td> <td style="width: 10%;"></td> <td style="width: 10%;"></td> <td style="width: 10%;"></td> <td style="width: 10%;"></td> <td style="width: 10%;"></td> <td style="width: 10%;"></td> <td style="width: 10%;"></td> </tr> <tr> <td></td> <td></td> <td colspan="8" style="text-align: center;"> <table border="1" style="width: 100%; border-collapse: collapse; text-align: center;"> <tr> <td style="width: 10%;"></td> <td style="width: 10%;"></td> <td style="width: 10%;"></td> <td style="width: 10%;"></td> <td style="width: 10%;"></td> <td style="width: 10%;"></td> <td style="width: 10%;"></td> <td style="width: 10%;"></td> <td style="width: 10%;"></td> <td style="width: 10%;"></td> </tr> <tr> <td></td> <td></td> <td colspan="8" style="text-align: center;"> <table border="1" style="width: 100%; border-collapse: collapse; text-align: center;"> <tr> <td style="width: 10%;"></td> <td style="width: 10%;"></td> <td style="width: 10%;"></td> <td style="width: 10%;"></td> <td style="width: 10%;"></td> <td style="width: 10%;"></td> <td style="width: 10%;"></td> <td style="width: 10%;"></td> <td style="width: 10%;"></td> <td style="width: 10%;"></td> </tr> <tr> <td></td> <td></td> <td colspan="8" style="text-align: center;"> <table border="1" style="width: 100%; border-collapse: collapse; text-align: center;"> <tr> <td style="width: 10%;"></td> <td style="width: 10%;"></td> <td style="width: 10%;"></td> <td style="width: 10%;"></td> <td style="width: 10%;"></td> <td style="width: 10%;"></td> <td style="width: 10%;"></td> <td style="width: 10%;"></td> <td style="width: 10%;"></td> <td style="width: 10%;"></td> </tr> <tr> <td></td> <td></td> <td colspan="8" style="text-align: center;"> <table border="1" style="width: 100%; border-collapse: collapse; text-align: center;"> <tr> <td style="width: 10%;"></td> <td style="width: 10%;"></td> <td style="width: 10%;"></td> <td style="width: 10%;"></td> <td style="width: 10%;"></td> <td style="width: 10%;"></td> <td style="width: 10%;"></td> <td style="width: 10%;"></td> <td style="width: 10%;"></td> <td style="width: 10%;"></td> </tr> <tr> <td></td> <td></td> <td colspan="8" style="text-align: center;"> <table border="1" style="width: 100%; border-collapse: collapse; text-align: center;"> <tr> <td style="width: 10%;"></td> <td style="width: 10%;"></td> <td style="width: 10%;"></td> <td style="width: 10%;"></td> <td style="width: 10%;"></td> <td style="width: 10%;"></td> <td style="width: 10%;"></td> <td style="width: 10%;"></td> <td style="width: 10%;"></td> <td style="width: 10%;"></td> </tr> <tr> <td></td> <td></td> <td colspan="8" style="text-align: center;"> <table border="1" style="width: 100%; border-collapse: collapse; text-align: center;"> <tr> <td style="width: 10%;"></td> <td style="width: 10%;"></td> <td style="width: 10%;"></td> <td style="width: 10%;"></td> <td style="width: 10%;"></td> <td style="width: 10%;"></td> <td style="width: 10%;"></td> <td style="width: 10%;"></td> <td style="width: 10%;"></td> <td style="width: 10%;"></td> </tr> <tr> <td></td> <td></td> <td colspan="8" style="text-align: center;"> <table border="1" style="width: 100%; border-collapse: collapse; text-align: center;"> <tr> <td style="width: 10%;"></td> <td style="width: 10%;"></td> <td style="width: 10%;"></td> <td style="width: 10%;"></td> <td style="width: 10%;"></td> <td style="width: 10%;"></td> <td style="width: 10%;"></td> <td style="width: 10%;"></td> <td style="width: 10%;"></td> <td style="width: 10%;"></td> </tr> <tr> <td></td> <td></td> <td colspan="8" style="text-align: center;"> <table border="1" style="width: 100%; border-collapse: collapse; text-align: center;"> <tr> <td style="width: 10%;"></td> <td style="width: 10%;"></td> <td style="width: 10%;"></td> <td style="width: 10%;"></td> <td style="width: 10%;"></td> <td style="width: 10%;"></td> <td style="width: 10%;"></td> <td style="width: 10%;"></td> <td style="width: 10%;"></td> <td style="width: 10%;"></td> </tr> <tr> <td></td> <td></td> <td colspan="8" style="text-align: center;"> <table border="1" style="width: 100%; border-collapse: collapse; text-align: center;"> <tr> <td style="width: 10%;"></td> <td style="width: 10%;"></td> <td style="width: 10%;"></td> <td style="width: 10%;"></td> <td style="width: 10%;"></td> <td style="width: 10%;"></td> <td style="width: 10%;"></td> <td style="width: 10%;"></td> <td style="width: 10%;"></td> <td style="width: 10%;"></td> </tr> <tr> <td></td> <td></td> <td colspan="8" style="text-align: center;"> <table border="1" style="width: 100%; border-collapse: collapse; text-align: center;"> <tr> <td style="width: 10%;"></td> <td style="width: 10%;"></td> <td style="width: 10%;"></td> <td style="width: 10%;"></td> <td style="width: 10%;"></td> <td style="width: 10%;"></td> <td style="width: 10%;"></td> <td style="width: 10%;"></td> <td style="width: 10%;"></td> <td style="width: 10%;"></td> </tr> <tr> <td></td> <td></td> <td colspan="8" style="text-align: center;"> <table border="1" style="width: 100%; border-collapse: collapse; text-align: center;"> <tr> <td style="width: 10%;"></td> <td style="width: 10%;"></td> <td style="width: 10%;"></td> <td style="width: 10%;"></td> <td style="width: 10%;"></td> <td style="width: 10%;"></td> <td style="width: 10%;"></td> <td style="width: 10%;"></td> <td style="width: 10%;"></td> <td style="width: 10%;"></td> </tr> <tr> <td></td> <td></td> <td colspan="8" style="text-align: center;"> <table border="1" style="width: 100%; border-collapse: collapse; text-align: center;"> <tr> </tr></table></td></tr></table></td></tr></table></td></tr></table></td></tr></table></td></tr></table></td></tr></table></td></tr></table></td></tr></table></td></tr></table></td></tr></table></td></tr></table></td></tr></table></td></tr></table></td></tr></table></td></tr></table></td></tr></table></td></tr></table></td></tr></table>
 | | | | | | | | | | | | | | | | | | | | <table border="1" style="width: 100%; border-collapse: collapse; text-align: center;"> <tr> <td style="width: 10%;"></td> <td style="width: 10%;"></td> <td style="width: 10%;"></td> <td style="width: 10%;"></td> <td style="width: 10%;"></td> <td style="width: 10%;"></td> <td style="width: 10%;"></td> <td style="width: 10%;"></td> <td style="width: 10%;"></td> <td style="width: 10%;"></td> </tr> <tr> <td></td> <td></td> <td colspan="8" style="text-align: center;"> <table border="1" style="width: 100%; border-collapse: collapse; text-align: center;"> <tr> <td style="width: 10%;"></td> <td style="width: 10%;"></td> <td style="width: 10%;"></td> <td style="width: 10%;"></td> <td style="width: 10%;"></td> <td style="width: 10%;"></td> <td style="width: 10%;"></td> <td style="width: 10%;"></td> <td style="width: 10%;"></td> <td style="width: 10%;"></td> </tr> <tr> <td></td> <td></td> <td colspan="8" style="text-align: center;"> <table border="1" style="width: 100%; border-collapse: collapse; text-align: center;"> <tr> <td style="width: 10%;"></td> <td style="width: 10%;"></td> <td style="width: 10%;"></td> <td style="width: 10%;"></td> <td style="width: 10%;"></td> <td style="width: 10%;"></td> <td style="width: 10%;"></td> <td style="width: 10%;"></td> <td style="width: 10%;"></td> <td style="width: 10%;"></td> </tr> <tr> <td></td> <td></td> <td colspan="8" style="text-align: center;"> <table border="1" style="width: 100%; border-collapse: collapse; text-align: center;"> <tr> <td style="width: 10%;"></td> <td style="width: 10%;"></td> <td style="width: 10%;"></td> <td style="width: 10%;"></td> <td style="width: 10%;"></td> <td style="width: 10%;"></td> <td style="width: 10%;"></td> <td style="width: 10%;"></td> <td style="width: 10%;"></td> <td style="width: 10%;"></td> </tr> <tr> <td></td> <td></td> <td colspan="8" style="text-align: center;"> <table border="1" style="width: 100%; border-collapse: collapse; text-align: center;"> <tr> <td style="width: 10%;"></td> <td style="width: 10%;"></td> <td style="width: 10%;"></td> <td style="width: 10%;"></td> <td style="width: 10%;"></td> <td style="width: 10%;"></td> <td style="width: 10%;"></td> <td style="width: 10%;"></td> <td style="width: 10%;"></td> <td style="width: 10%;"></td> </tr> <tr> <td></td> <td></td> <td
colspan="8" style="text-align: center;"> <table border="1" style="width: 100%; border-collapse: collapse; text-align: center;"> <tr> <td style="width: 10%;"></td> <td style="width: 10%;"></td> <td style="width: 10%;"></td> <td style="width: 10%;"></td> <td style="width: 10%;"></td> <td style="width: 10%;"></td> <td style="width: 10%;"></td> <td style="width: 10%;"></td> <td style="width: 10%;"></td> <td style="width: 10%;"></td> </tr> <tr> <td></td> <td></td> <td colspan="8" style="text-align: center;"> <table border="1" style="width: 100%; border-collapse: collapse; text-align: center;"> <tr> <td style="width: 10%;"></td> <td style="width: 10%;"></td> <td style="width: 10%;"></td> <td style="width: 10%;"></td> <td style="width: 10%;"></td> <td style="width: 10%;"></td> <td style="width: 10%;"></td> <td style="width: 10%;"></td> <td style="width: 10%;"></td> <td style="width: 10%;"></td> </tr> <tr> <td></td> <td></td> <td colspan="8" style="text-align: center;"> <table border="1" style="width: 100%; border-collapse: collapse; text-align: center;"> <tr> <td style="width: 10%;"></td> <td style="width: 10%;"></td> <td style="width: 10%;"></td> <td style="width: 10%;"></td> <td style="width: 10%;"></td> <td style="width: 10%;"></td> <td style="width: 10%;"></td> <td style="width: 10%;"></td> <td style="width: 10%;"></td> <td style="width: 10%;"></td> </tr> <tr> <td></td> <td></td> <td colspan="8" style="text-align: center;"> <table border="1" style="width: 100%; border-collapse: collapse; text-align: center;"> <tr> <td style="width: 10%;"></td> <td style="width: 10%;"></td> <td style="width: 10%;"></td> <td style="width: 10%;"></td> <td style="width: 10%;"></td> <td style="width: 10%;"></td> <td style="width: 10%;"></td> <td style="width: 10%;"></td> <td style="width: 10%;"></td> <td style="width: 10%;"></td> </tr> <tr> <td></td> <td></td> <td colspan="8" style="text-align: center;"> <table border="1" style="width: 100%; border-collapse: collapse; text-align: center;"> <tr> <td style="width: 10%;"></td> <td style="width: 10%;"></td> <td style="width: 10%;"></td> <td style="width: 10%;"></td> <td style="width: 10%;"></td> <td style="width: 10%;"></td> <td style="width: 10%;"></td> <td style="width: 10%;"></td> <td style="width: 10%;"></td> <td style="width: 10%;"></td> </tr> <tr> <td></td> <td></td> <td colspan="8" style="text-align: center;"> <table border="1" style="width: 100%; border-collapse: collapse; text-align: center;"> <tr> <td style="width: 10%;"></td> <td style="width: 10%;"></td> <td style="width: 10%;"></td> <td style="width: 10%;"></td> <td style="width: 10%;"></td> <td style="width: 10%;"></td> <td style="width: 10%;"></td> <td style="width: 10%;"></td> <td style="width: 10%;"></td> <td style="width: 10%;"></td> </tr> <tr> <td></td> <td></td> <td colspan="8" style="text-align: center;"> <table border="1" style="width: 100%; border-collapse: collapse; text-align: center;"> <tr> <td style="width: 10%;"></td> <td style="width: 10%;"></td> <td style="width: 10%;"></td> <td style="width: 10%;"></td> <td style="width: 10%;"></td> <td style="width: 10%;"></td> <td style="width: 10%;"></td> <td style="width: 10%;"></td> <td style="width: 10%;"></td> <td style="width: 10%;"></td> </tr> <tr> <td></td> <td></td> <td colspan="8" style="text-align: center;"> <table border="1" style="width: 100%; border-collapse: collapse; text-align: center;"> <tr> <td style="width: 10%;"></td> <td style="width: 10%;"></td> <td style="width: 10%;"></td> <td style="width: 10%;"></td> <td style="width: 10%;"></td> <td style="width: 10%;"></td> <td style="width: 10%;"></td> <td style="width: 10%;"></td> <td style="width: 10%;"></td> <td style="width: 10%;"></td> </tr> <tr> <td></td> <td></td> <td colspan="8" style="text-align: center;"> <table border="1" style="width: 100%; border-collapse: collapse; text-align: center;"> <tr> <td style="width: 10%;"></td> <td style="width: 10%;"></td> <td style="width: 10%;"></td> <td style="width: 10%;"></td> <td style="width: 10%;"></td> <td style="width: 10%;"></td> <td style="width: 10%;"></td> <td style="width: 10%;"></td> <td style="width: 10%;"></td> <td style="width: 10%;"></td> </tr> <tr> <td></td> <td></td> <td colspan="8" style="text-align: center;"> <table border="1" style="width: 100%; border-collapse: collapse; text-align: center;"> <tr> <td style="width: 10%;"></td> <td style="width: 10%;"></td> <td style="width: 10%;"></td> <td style="width: 10%;"></td> <td style="width: 10%;"></td> <td style="width: 10%;"></td> <td style="width: 10%;"></td> <td style="width: 10%;"></td> <td style="width: 10%;"></td> <td style="width: 10%;"></td> </tr> <tr> <td></td> <td></td> <td colspan="8" style="text-align: center;"> <table border="1" style="width: 100%; border-collapse: collapse; text-align: center;"> <tr> <td style="width: 10%;"></td> <td style="width: 10%;"></td> <td style="width: 10%;"></td> <td style="width: 10%;"></td> <td style="width: 10%;"></td> <td style="width: 10%;"></td> <td style="width: 10%;"></td> <td style="width: 10%;"></td> <td style="width: 10%;"></td> <td style="width: 10%;"></td> </tr> <tr> <td></td> <td></td> <td colspan="8" style="text-align: center;"> <table border="1" style="width: 100%; border-collapse: collapse; text-align: center;"> <tr> <td style="width: 10%;"></td> <td style="width: 10%;"></td> <td style="width: 10%;"></td> <td style="width: 10%;"></td> <td style="width: 10%;"></td> <td style="width: 10%;"></td> <td style="width: 10%;"></td> <td style="width: 10%;"></td> <td style="width: 10%;"></td> <td style="width: 10%;"></td> </tr> <tr> <td></td> <td></td> <td colspan="8" style="text-align: center;"> <table border="1" style="width: 100%; border-collapse: collapse; text-align: center;"> <tr> </tr></table></td></tr></table></td></tr></table></td></tr></table></td></tr></table></td></tr></table></td></tr></table></td></tr></table></td></tr></table></td></tr></table></td></tr></table></td></tr></table></td></tr></table></td></tr></table></td></tr></table></td></tr></table></td></tr></table></td></tr></table>
 | | | | | | | | | | | | | | | | | | | | <table border="1" style="width: 100%; border-collapse: collapse; text-align: center;"> <tr> <td style="width: 10%;"></td> <td style="width: 10%;"></td> <td style="width: 10%;"></td> <td style="width: 10%;"></td> <td style="width: 10%;"></td> <td style="width: 10%;"></td> <td style="width: 10%;"></td> <td style="width: 10%;"></td> <td style="width: 10%;"></td> <td style="width: 10%;"></td> </tr> <tr> <td></td> <td></td> <td colspan="8" style="text-align: center;"> <table border="1" style="width: 100%; border-collapse: collapse; text-align: center;"> <tr> <td style="width: 10%;"></td> <td style="width: 10%;"></td> <td style="width: 10%;"></td> <td style="width: 10%;"></td> <td style="width: 10%;"></td> <td style="width: 10%;"></td> <td style="width: 10%;"></td> <td style="width: 10%;"></td> <td style="width: 10%;"></td> <td style="width: 10%;"></td> </tr> <tr> <td></td> <td></td> <td colspan="8" style="text-align: center;"> <table border="1" style="width: 100%; border-collapse: collapse; text-align: center;"> <tr> <td style="width: 10%;"></td> <td style="width: 10%;"></td> <td style="width: 10%;"></td> <td style="width: 10%;"></td> <td style="width: 10%;"></td> <td style="width: 10%;"></td> <td style="width: 10%;"></td> <td style="width: 10%;"></td> <td style="width: 10%;"></td> <td style="width: 10%;"></td> </tr> <tr> <td></td> <td></td> <td colspan="8" style="text-align: center;"> <table border="1" style="width: 100%; border-collapse: collapse; text-align: center;"> <tr> <td style="width: 10%;"></td> <td style="width: 10%;"></td> <td style="width: 10%;"></td> <td style="width: 10%;"></td> <td style="width: 10%;"></td> <td style="width: 10%;"></td> <td style="width: 10%;"></td> <td style="width: 10%;"></td> <td style="width: 10%;"></td> <td style="width: 10%;"></td> </tr> <tr> <td></td> <td></td> <td colspan="8" style="text-align: center;"> <table border="1" style="width: 100%; border-collapse: collapse; text-align: center;"> <tr> <td style="width: 10%;"></td> <td style="width: 10%;"></td> <td style="width: 10%;"></td> <td style="width: 10%;"></td> <td style="width: 10%;"></td> <td style="width: 10%;"></td> <td style="width: 10%;"></td> <td style="width: 10%;"></td> <td style="width: 10%;"></td> <td style="width: 10%;"></td> </tr> <tr> <td></td> <td></td> <td colspan="8" style="text-align: center;"> <table border="1" style="width: 100%; border-collapse: collapse; text-align: center;"> <tr> <td style="width: 10%;"></td> <td style="width: 10%;"></td> <td style="width: 10%;"></td> <td style="width: 10%;"></td> <td style="width: 10%;"></td> <td style="width: 10%;"></td> <td style="width: 10%;"></td> <td style="width: 10%;"></td> <td style="width: 10%;"></td> <td style="width: 10%;"></td> </tr> <tr> <td></td> <td></td> <td colspan="8" style="text-align: center;"> <table border="1" style="width: 100%; border-collapse: collapse; text-align: center;"> <tr> <td style="width: 10%;"></td> <td style="width: 10%;"></td> <td style="width: 10%;"></td> <td style="width: 10%;"></td> <td style="width: 10%;"></td> <td style="width: 10%;"></td> <td style="width: 10%;"></td> <td style="width: 10%;"></td> <td style="width: 10%;"></td> <td style="width: 10%;"></td> </tr> <tr> <td></td> <td></td> <td colspan="8" style="text-align: center;"> <table border="1" style="width: 100%; border-collapse: collapse; text-align: center;"> <tr> <td style="width: 10%;"></td> <td style="width: 10%;"></td> <td style="width: 10%;"></td> <td style="width: 10%;"></td> <td style="width: 10%;"></td> <td style="width: 10%;"></td> <td style="width: 10%;"></td> <td style="width: 10%;"></td> <td style="width: 10%;"></td> <td style="width: 10%;"></td> </tr> <tr> <td></td> <td></td> <td colspan="8" style="text-align: center;"> <table border="1" style="width: 100%; border-collapse: collapse; text-align: center;"> <tr> <td style="width: 10%;"></td> <td style="width: 10%;"></td> <td style="width: 10%;"></td> <td style="width: 10%;"></td> <td style="width: 10%;"></td> <td style="width: 10%;"></td> <td style="width: 10%;"></td> <td style="width: 10%;"></td> <td style="width: 10%;"></td> <td style="width: 10%;"></td> </tr> <tr> <td></td> <td></td> <td colspan="8" style="text-align: center;"> <table border="1" style="width: 100%; border-collapse: collapse; text-align: center;"> <tr> <td style="width: 10%;"></td> <td style="width: 10%;"></td> <td style="width: 10%;"></td> <td style="width: 10%;"></td> <td style="width: 10%;"></td> <td style="width: 10%;"></td> <td style="width: 10%;"></td> <td style="width: 10%;"></td> <td style="width: 10%;"></td> <td style="width: 10%;"></td> </tr> <tr> <td></td> <td></td> <td colspan="8" style="text-align: center;"> <table border="1" style="width: 100%; border-collapse: collapse; text-align: center;"> <tr> <td style="width: 10%;"></td> <td style="width: 10%;"></td> <td style="width: 10%;"></td> <td style="width: 10%;"></td> <td style="width: 10%;"></td> <td style="width: 10%;"></td> <td style="width: 10%;"></td> <td style="width: 10%;"></td> <td style="width: 10%;"></td> <td style="width: 10%;"></td> </tr> <tr> <td></td> <td></td> <td colspan="8" style="text-align: center;"> <table border="1" style="width: 100%; border-collapse: collapse; text-align: center;"> <tr> <td style="width: 10%;"></td> <td style="width: 10%;"></td> <td style="width: 10%;"></td> <td style="width: 10%;"></td> <td style="width: 10%;"></td> <td style="width: 10%;"></td> <td style="width: 10%;"></td> <td style="width: 10%;"></td> <td style="width: 10%;"></td> <td style="width: 10%;"></td> </tr> <tr> <td></td> <td></td> <td colspan="8" style="text-align:
center;"> <table border="1" style="width: 100%; border-collapse: collapse; text-align: center;"> <tr> <td style="width: 10%;"></td> <td style="width: 10%;"></td> <td style="width: 10%;"></td> <td style="width: 10%;"></td> <td style="width: 10%;"></td> <td style="width: 10%;"></td> <td style="width: 10%;"></td> <td style="width: 10%;"></td> <td style="width: 10%;"></td> <td style="width: 10%;"></td> </tr> <tr> <td></td> <td></td> <td colspan="8" style="text-align: center;"> <table border="1" style="width: 100%; border-collapse: collapse; text-align: center;"> <tr> <td style="width: 10%;"></td> <td style="width: 10%;"></td> <td style="width: 10%;"></td> <td style="width: 10%;"></td> <td style="width: 10%;"></td> <td style="width: 10%;"></td> <td style="width: 10%;"></td> <td style="width: 10%;"></td> <td style="width: 10%;"></td> <td style="width: 10%;"></td> </tr> <tr> <td></td> <td></td> <td colspan="8" style="text-align: center;"> <table border="1" style="width: 100%; border-collapse: collapse; text-align: center;"> <tr> <td style="width: 10%;"></td> <td style="width: 10%;"></td> <td style="width: 10%;"></td> <td style="width: 10%;"></td> <td style="width: 10%;"></td> <td style="width: 10%;"></td> <td style="width: 10%;"></td> <td style="width: 10%;"></td> <td style="width: 10%;"></td> <td style="width: 10%;"></td> </tr> <tr> <td></td> <td></td> <td colspan="8" style="text-align: center;"> <table border="1" style="width: 100%; border-collapse: collapse; text-align: center;"> <tr> <td style="width: 10%;"></td> <td style="width: 10%;"></td> <td style="width: 10%;"></td> <td style="width: 10%;"></td> <td style="width: 10%;"></td> <td style="width: 10%;"></td> <td style="width: 10%;"></td> <td style="width: 10%;"></td> <td style="width: 10%;"></td> <td style="width: 10%;"></td> </tr> <tr> <td></td> <td></td> <td colspan="8" style="text-align: center;"> <table border="1" style="width: 100%; border-collapse: collapse; text-align: center;"> <tr> </tr></table></td></tr></table></td></tr></table></td></tr></table></td></tr></table></td></tr></table></td></tr></table></td></tr></table></td></tr></table></td></tr></table></td></tr></table></td></tr></table></td></tr></table></td></tr></table></td></tr></table></td></tr></table></td></tr></table>
 | | | | | | | | | | | | | | | | | | | | <table border="1" style="width: 100%; border-collapse: collapse; text-align: center;"> <tr> <td style="width: 10%;"></td> <td style="width: 10%;"></td> <td style="width: 10%;"></td> <td style="width: 10%;"></td> <td style="width: 10%;"></td> <td style="width: 10%;"></td> <td style="width: 10%;"></td> <td style="width: 10%;"></td> <td style="width: 10%;"></td> <td style="width: 10%;"></td> </tr> <tr> <td></td> <td></td> <td colspan="8" style="text-align: center;"> <table border="1" style="width: 100%; border-collapse: collapse; text-align: center;"> <tr> <td style="width: 10%;"></td> <td style="width: 10%;"></td> <td style="width: 10%;"></td> <td style="width: 10%;"></td> <td style="width: 10%;"></td> <td style="width: 10%;"></td> <td style="width: 10%;"></td> <td style="width: 10%;"></td> <td style="width: 10%;"></td> <td style="width: 10%;"></td> </tr> <tr> <td></td> <td></td> <td colspan="8" style="text-align: center;"> <table border="1" style="width: 100%; border-collapse: collapse; text-align: center;"> <tr> <td style="width: 10%;"></td> <td style="width: 10%;"></td> <td style="width: 10%;"></td> <td style="width: 10%;"></td> <td style="width: 10%;"></td> <td style="width: 10%;"></td> <td style="width: 10%;"></td> <td style="width: 10%;"></td> <td style="width: 10%;"></td> <td style="width: 10%;"></td> </tr> <tr> <td></td> <td></td> <td colspan="8" style="text-align: center;"> <table border="1" style="width: 100%; border-collapse: collapse; text-align: center;"> <tr> <td style="width: 10%;"></td> <td style="width: 10%;"></td> <td style="width: 10%;"></td> <td style="width: 10%;"></td> <td style="width: 10%;"></td> <td style="width: 10%;"></td> <td style="width: 10%;"></td> <td style="width: 10%;"></td> <td style="width: 10%;"></td> <td style="width: 10%;"></td> </tr> <tr> <td></td> <td></td> <td colspan="8" style="text-align: center;"> <table border="1" style="width: 100%; border-collapse: collapse; text-align: center;"> <tr> <td style="width: 10%;"></td> <td style="width: 10%;"></td> <td style="width: 10%;"></td> <td style="width: 10%;"></td> <td style="width: 10%;"></td> <td style="width: 10%;"></td> <td style="width: 10%;"></td> <td style="width: 10%;"></td> <td style="width: 10%;"></td> <td style="width: 10%;"></td> </tr> <tr> <td></td> <td></td> <td colspan="8" style="text-align: center;"> <table border="1" style="width: 100%; border-collapse: collapse; text-align: center;"> <tr> <td style="width: 10%;"></td> <td style="width: 10%;"></td> <td style="width: 10%;"></td> <td style="width: 10%;"></td> <td style="width: 10%;"></td> <td style="width: 10%;"></td> <td style="width: 10%;"></td> <td style="width: 10%;"></td> <td style="width: 10%;"></td> <td style="width: 10%;"></td> </tr> <tr> <td></td> <td></td> <td colspan="8" style="text-align: center;"> <table border="1" style="width: 100%; border-collapse: collapse; text-align: center;"> <tr> <td style="width: 10%;"></td> <td style="width: 10%;"></td> <td style="width: 10%;"></td> <td style="width: 10%;"></td> <td style="width: 10%;"></td> <td style="width: 10%;"></td> <td style="width: 10%;"></td> <td style="width: 10%;"></td> <td style="width: 10%;"></td> <td style="width: 10%;"></td> </tr> <tr> <td></td> <td></td> <td colspan="8" style="text-align: center;"> <table border="1" style="width: 100%; border-collapse: collapse; text-align: center;"> <tr> <td style="width: 10%;"></td> <td style="width: 10%;"></td> <td style="width: 10%;"></td> <td style="width: 10%;"></td> <td style="width: 10%;"></td> <td style="width: 10%;"></td> <td style="width: 10%;"></td> <td style="width: 10%;"></td> <td style="width: 10%;"></td> <td style="width: 10%;"></td> </tr> <tr> <td></td> <td></td> <td colspan="8" style="text-align: center;"> <table border="1" style="width: 100%; border-collapse: collapse; text-align: center;"> <tr> <td style="width: 10%;"></td> <td style="width: 10%;"></td> <td style="width: 10%;"></td> <td style="width: 10%;"></td> <td style="width: 10%;"></td> <td style="width: 10%;"></td> <td style="width: 10%;"></td> <td style="width: 10%;"></td> <td style="width: 10%;"></td> <td style="width: 10%;"></td> </tr> <tr> <td></td> <td></td> <td colspan="8" style="text-align: center;"> <table border="1" style="width: 100%; border-collapse: collapse; text-align: center;"> <tr> <td style="width: 10%;"></td> <td style="width: 10%;"></td> <td style="width: 10%;"></td> <td style="width: 10%;"></td> <td style="width: 10%;"></td> <td style="width: 10%;"></td> <td style="width: 10%;"></td> <td style="width: 10%;"></td> <td style="width: 10%;"></td> <td style="width: 10%;"></td> </tr> <tr> <td></td> <td></td> <td colspan="8" style="text-align: center;"> <table border="1" style="width: 100%; border-collapse: collapse; text-align: center;"> <tr> <td style="width: 10%;"></td> <td style="width: 10%;"></td> <td style="width: 10%;"></td> <td style="width: 10%;"></td> <td style="width: 10%;"></td> <td style="width: 10%;"></td> <td style="width: 10%;"></td> <td style="width: 10%;"></td> <td style="width: 10%;"></td> <td style="width: 10%;"></td> </tr> <tr> <td></td> <td></td> <td colspan="8" style="text-align: center;"> <table border="1" style="width: 100%; border-collapse: collapse; text-align: center;"> <tr> <td style="width: 10%;"></td> <td style="width: 10%;"></td> <td style="width: 10%;"></td> <td style="width: 10%;"></td> <td style="width: 10%;"></td> <td style="width: 10%;"></td> <td style="width: 10%;"></td> <td style="width: 10%;"></td> <td style="width: 10%;"></td> <td style="width: 10%;"></td> </tr> <tr> <td></td> <td></td> <td colspan="8" style="text-align: center;"> <table border="1" style="width: 100%; border-collapse: collapse; text-align: center;"> <tr> <td style="width: 10%;"></td> <td style="width: 10%;"></td> <td style="width: 10%;"></td> <td style="width: 10%;"></td> <td style="width: 10%;"></td> <td style="width: 10%;"></td> <td style="width: 10%;"></td> <td style="width: 10%;"></td> <td style="width: 10%;"></td> <td style="width: 10%;"></td> </tr> <tr> <td></td> <td></td> <td colspan="8" style="text-align: center;"> <table border="1" style="width: 100%; border-collapse: collapse; text-align: center;"> <tr> <td style="width: 10%;"></td> <td style="width: 10%;"></td> <td style="width: 10%;"></td> <td style="width: 10%;"></td> <td style="width: 10%;"></td> <td style="width: 10%;"></td> <td style="width: 10%;"></td> <td style="width: 10%;"></td> <td style="width: 10%;"></td> <td style="width: 10%;"></td> </tr> <tr> <td></td> <td></td> <td colspan="8" style="text-align: center;"> <table border="1" style="width: 100%; border-collapse: collapse; text-align: center;"> <tr> <td style="width: 10%;"></td> <td style="width: 10%;"></td> <td style="width: 10%;"></td> <td style="width: 10%;"></td> <td style="width: 10%;"></td> <td style="width: 10%;"></td> <td style="width: 10%;"></td> <td style="width: 10%;"></td> <td style="width: 10%;"></td> <td style="width: 10%;"></td> </tr> <tr> <td></td> <td></td> <td colspan="8" style="text-align: center;"> <table border="1" style="width: 100%; border-collapse: collapse; text-align: center;"> <tr> </tr></table></td></tr></table></td></tr></table></td></tr></table></td></tr></table></td></tr></table></td></tr></table></td></tr></table></td></tr></table></td></tr></table></td></tr></table></td></tr></table></td></tr></table></td></tr></table></td></tr></table></td></tr></table>
 | | | | | | | | | | | | | | | | | | | | <table border="1" style="width: 100%; border-collapse: collapse; text-align: center;"> <tr> <td style="width: 10%;"></td> <td style="width: 10%;"></td> <td style="width: 10%;"></td> <td style="width: 10%;"></td> <td style="width: 10%;"></td> <td style="width: 10%;"></td> <td style="width: 10%;"></td> <td style="width: 10%;"></td> <td style="width: 10%;"></td> <td style="width: 10%;"></td> </tr> <tr> <td></td> <td></td> <td colspan="8" style="text-align: center;"> <table border="1" style="width: 100%; border-collapse: collapse; text-align: center;"> <tr> <td style="width: 10%;"></td> <td style="width: 10%;"></td> <td style="width: 10%;"></td> <td style="width: 10%;"></td> <td style="width: 10%;"></td> <td style="width: 10%;"></td> <td style="width: 10%;"></td> <td style="width: 10%;"></td> <td style="width: 10%;"></td> <td style="width: 10%;"></td> </tr> <tr> <td></td> <td></td> <td colspan="8" style="text-align: center;"> <table border="1" style="width: 100%; border-collapse: collapse; text-align: center;"> <tr> <td style="width: 10%;"></td> <td style="width: 10%;"></td> <td style="width: 10%;"></td> <td style="width: 10%;"></td> <td style="width: 10%;"></td> <td style="width: 10%;"></td> <td style="width: 10%;"></td> <td style="width: 10%;"></td> <td style="width: 10%;"></td> <td style="width: 10%;"></td> </tr> <tr> <td></td> <td></td> <td colspan="8" style="text-align: center;"> <table border="1" style="width: 100%; border-collapse: collapse; text-align: center;"> <tr> <td style="width: 10%;"></td> <td style="width: 10%;"></td> <td style="width: 10%;"></td> <td style="width: 10%;"></td> <td style="width: 10%;"></td> <td style="width: 10%;"></td> <td style="width: 10%;"></td> <td style="width: 10%;"></td> <td style="width: 10%;"></td> <td style="width: 10%;"></td> </tr> <tr> <td></td> <td></td> <td colspan="8" style="text-align: center;"> <table border="1" style="width: 100%; border-collapse: collapse; text-align: center;"> <tr> <td style="width: 10%;"></td> <td style="width: 10%;"></td> <td style="width: 10%;"></td> <td style="width: 10%;"></td> <td style="width: 10%;"></td> <td style="width: 10%;"></td> <td style="width: 10%;"></td> <td style="width: 10%;"></td> <td style="width: 10%;"></td> <td style="width: 10%;"></td> </tr> <tr> <td></td> <td></td> <td colspan="8" style="text-align: center;"> <table border="1" style="width: 100%; border-collapse: collapse; text-align: center;"> <tr> <td style="width: 10%;"></td> <td style="width: 10%;"></td> <td style="width: 10%;"></td> <td style="width: 10%;"></td> <td style="width: 10%;"></td> <td style="width: 10%;"></td> <td style="width: 10%;"></td> <td style="width: 10%;"></td> <td style="width: 10%;"></td> <td style="width: 10%;"></td> </tr> <tr> <td></td> <td></td> <td colspan="8" style="text-align: center;"> <table border="1" style="width: 100%; border-collapse: collapse; text-align: center;"> <tr> <td style="width: 10%;"></td> <td style="width: 10%;"></td> <td style="width: 10%;"></td> <td style="width: 10%;"></td> <td style="width: 10%;"></td> <td style="width: 10%;"></td> <td style="width: 10%;"></td> <td style="width: 10%;"></td> <td style="width: 10%;"></td> <td style="width: 10%;"></td> </tr> <tr> <td></td> <td></td> <td colspan="8" style="text-align: center;"> <table border="1" style="width: 100%; border-collapse: collapse; text-align: center;"> <tr> <td style="width: 10%;"></td> <td style="width: 10%;"></td> <td style="width: 10%;"></td> <td style="width: 10%;"></td> <td style="width: 10%;"></td> <td style="width: 10%;"></td> <td style="width: 10%;"></td> <td style="width: 10%;"></td> <td style="width: 10%;"></td> <td style="width: 10%;"></td> </tr> <tr>
<td></td> <td></td> <td colspan="8" style="text-align: center;"> <table border="1" style="width: 100%; border-collapse: collapse; text-align: center;"> <tr> <td style="width: 10%;"></td> <td style="width: 10%;"></td> <td style="width: 10%;"></td> <td style="width: 10%;"></td> <td style="width: 10%;"></td> <td style="width: 10%;"></td> <td style="width: 10%;"></td> <td style="width: 10%;"></td> <td style="width: 10%;"></td> <td style="width: 10%;"></td> </tr> <tr> <td></td> <td></td> <td colspan="8" style="text-align: center;"> <table border="1" style="width: 100%; border-collapse: collapse; text-align: center;"> <tr> <td style="width: 10%;"></td> <td style="width: 10%;"></td> <td style="width: 10%;"></td> <td style="width: 10%;"></td> <td style="width: 10%;"></td> <td style="width: 10%;"></td> <td style="width: 10%;"></td> <td style="width: 10%;"></td> <td style="width: 10%;"></td> <td style="width: 10%;"></td> </tr> <tr> <td></td> <td></td> <td colspan="8" style="text-align: center;"> <table border="1" style="width: 100%; border-collapse: collapse; text-align: center;"> <tr> <td style="width: 10%;"></td> <td style="width: 10%;"></td> <td style="width: 10%;"></td> <td style="width: 10%;"></td> <td style="width: 10%;"></td> <td style="width: 10%;"></td> <td style="width: 10%;"></td> <td style="width: 10%;"></td> <td style="width: 10%;"></td> <td style="width: 10%;"></td> </tr> <tr> <td></td> <td></td> <td colspan="8" style="text-align: center;"> <table border="1" style="width: 100%; border-collapse: collapse; text-align: center;"> <tr> <td style="width: 10%;"></td> <td style="width: 10%;"></td> <td style="width: 10%;"></td> <td style="width: 10%;"></td> <td style="width: 10%;"></td> <td style="width: 10%;"></td> <td style="width: 10%;"></td> <td style="width: 10%;"></td> <td style="width: 10%;"></td> <td style="width: 10%;"></td> </tr> <tr> <td></td> <td></td> <td colspan="8" style="text-align: center;"> <table border="1" style="width: 100%; border-collapse: collapse; text-align: center;"> <tr> <td style="width: 10%;"></td> <td style="width: 10%;"></td> <td style="width: 10%;"></td> <td style="width: 10%;"></td> <td style="width: 10%;"></td> <td style="width: 10%;"></td> <td style="width: 10%;"></td> <td style="width: 10%;"></td> <td style="width: 10%;"></td> <td style="width: 10%;"></td> </tr> <tr> <td></td> <td></td> <td colspan="8" style="text-align: center;"> <table border="1" style="width: 100%; border-collapse: collapse; text-align: center;"> <tr> <td style="width: 10%;"></td> <td style="width: 10%;"></td> <td style="width: 10%;"></td> <td style="width: 10%;"></td> <td style="width: 10%;"></td> <td style="width: 10%;"></td> <td style="width: 10%;"></td> <td style="width: 10%;"></td> <td style="width: 10%;"></td> <td style="width: 10%;"></td> </tr> <tr> <td></td> <td></td> <td colspan="8" style="text-align: center;"> <table border="1" style="width: 100%; border-collapse: collapse; text-align: center;"> <tr> </tr></table></td></tr></table></td></tr></table></td></tr></table></td></tr></table></td></tr></table></td></tr></table></td></tr></table></td></tr></table></td></tr></table></td></tr></table></td></tr></table></td></tr></table></td></tr></table></td></tr></table>
 | | | | | | | | | | | | | | | | | | | | <table border="1" style="width: 100%; border-collapse: collapse; text-align: center;"> <tr> <td style="width: 10%;"></td> <td style="width: 10%;"></td> <td style="width: 10%;"></td> <td style="width: 10%;"></td> <td style="width: 10%;"></td> <td style="width: 10%;"></td> <td style="width: 10%;"></td> <td style="width: 10%;"></td> <td style="width: 10%;"></td> <td style="width: 10%;"></td> </tr> <tr> <td></td> <td></td> <td colspan="8" style="text-align: center;"> <table border="1" style="width: 100%; border-collapse: collapse; text-align: center;"> <tr> <td style="width: 10%;"></td> <td style="width: 10%;"></td> <td style="width: 10%;"></td> <td style="width: 10%;"></td> <td style="width: 10%;"></td> <td style="width: 10%;"></td> <td style="width: 10%;"></td> <td style="width: 10%;"></td> <td style="width: 10%;"></td> <td style="width: 10%;"></td> </tr> <tr> <td></td> <td></td> <td colspan="8" style="text-align: center;"> <table border="1" style="width: 100%; border-collapse: collapse; text-align: center;"> <tr> <td style="width: 10%;"></td> <td style="width: 10%;"></td> <td style="width: 10%;"></td> <td style="width: 10%;"></td> <td style="width: 10%;"></td> <td style="width: 10%;"></td> <td style="width: 10%;"></td> <td style="width: 10%;"></td> <td style="width: 10%;"></td> <td style="width: 10%;"></td> </tr> <tr> <td></td> <td></td> <td colspan="8" style="text-align: center;"> <table border="1" style="width: 100%; border-collapse: collapse; text-align: center;"> <tr> <td style="width: 10%;"></td> <td style="width: 10%;"></td> <td style="width: 10%;"></td> <td style="width: 10%;"></td> <td style="width: 10%;"></td> <td style="width: 10%;"></td> <td style="width: 10%;"></td> <td style="width: 10%;"></td> <td style="width: 10%;"></td> <td style="width: 10%;"></td> </tr> <tr> <td></td> <td></td> <td colspan="8" style="text-align: center;"> <table border="1" style="width: 100%; border-collapse: collapse; text-align: center;"> <tr> <td style="width: 10%;"></td> <td style="width: 10%;"></td> <td style="width: 10%;"></td> <td style="width: 10%;"></td> <td style="width: 10%;"></td> <td style="width: 10%;"></td> <td style="width: 10%;"></td> <td style="width: 10%;"></td> <td style="width: 10%;"></td> <td style="width: 10%;"></td> </tr> <tr> <td></td> <td></td> <td colspan="8" style="text-align: center;"> <table border="1" style="width: 100%; border-collapse: collapse; text-align: center;"> <tr> <td style="width: 10%;"></td> <td style="width: 10%;"></td> <td style="width: 10%;"></td> <td style="width: 10%;"></td> <td style="width: 10%;"></td> <td style="width: 10%;"></td> <td style="width: 10%;"></td> <td style="width: 10%;"></td> <td style="width: 10%;"></td> <td style="width: 10%;"></td> </tr> <tr> <td></td> <td></td> <td colspan="8" style="text-align: center;"> <table border="1" style="width: 100%; border-collapse: collapse; text-align: center;"> <tr> <td style="width: 10%;"></td> <td style="width: 10%;"></td> <td style="width: 10%;"></td> <td style="width: 10%;"></td> <td style="width: 10%;"></td> <td style="width: 10%;"></td> <td style="width: 10%;"></td> <td style="width: 10%;"></td> <td style="width: 10%;"></td> <td style="width: 10%;"></td> </tr> <tr> <td></td> <td></td> <td colspan="8" style="text-align: center;"> <table border="1" style="width: 100%; border-collapse: collapse; text-align: center;"> <tr> <td style="width: 10%;"></td> <td style="width: 10%;"></td> <td style="width: 10%;"></td> <td style="width: 10%;"></td> <td style="width: 10%;"></td> <td style="width: 10%;"></td> <td style="width: 10%;"></td> <td style="width: 10%;"></td> <td style="width: 10%;"></td> <td style="width: 10%;"></td> </tr> <tr> <td></td> <td></td> <td colspan="8" style="text-align: center;"> <table border="1" style="width: 100%; border-collapse: collapse; text-align: center;"> <tr> <td style="width: 10%;"></td> <td style="width: 10%;"></td> <td style="width: 10%;"></td> <td style="width: 10%;"></td> <td style="width: 10%;"></td> <td style="width: 10%;"></td> <td style="width: 10%;"></td> <td style="width: 10%;"></td> <td style="width: 10%;"></td> <td style="width: 10%;"></td> </tr> <tr> <td></td> <td></td> <td colspan="8" style="text-align: center;"> <table border="1" style="width: 100%; border-collapse: collapse; text-align: center;"> <tr> <td style="width: 10%;"></td> <td style="width: 10%;"></td> <td style="width: 10%;"></td> <td style="width: 10%;"></td> <td style="width: 10%;"></td> <td style="width: 10%;"></td> <td style="width: 10%;"></td> <td style="width: 10%;"></td> <td style="width: 10%;"></td> <td style="width: 10%;"></td> </tr> <tr> <td></td> <td></td> <td colspan="8" style="text-align: center;"> <table border="1" style="width: 100%; border-collapse: collapse; text-align: center;"> <tr> <td style="width: 10%;"></td> <td style="width: 10%;"></td> <td style="width: 10%;"></td> <td style="width: 10%;"></td> <td style="width: 10%;"></td> <td style="width: 10%;"></td> <td style="width: 10%;"></td> <td style="width: 10%;"></td> <td style="width: 10%;"></td> <td style="width: 10%;"></td> </tr> <tr> <td></td> <td></td> <td colspan="8" style="text-align: center;"> <table border="1" style="width: 100%; border-collapse: collapse; text-align: center;"> <tr> <td style="width: 10%;"></td> <td style="width: 10%;"></td> <td style="width: 10%;"></td> <td style="width: 10%;"></td> <td style="width: 10%;"></td> <td style="width: 10%;"></td> <td style="width: 10%;"></td> <td style="width: 10%;"></td> <td style="width: 10%;"></td> <td style="width: 10%;"></td> </tr> <tr> <td></td> <td></td> <td colspan="8" style="text-align: center;"> <table border="1" style="width: 100%; border-collapse: collapse; text-align: center;"> <tr> <td style="width: 10%;"></td> <td style="width: 10%;"></td> <td style="width: 10%;"></td> <td style="width: 10%;"></td> <td style="width: 10%;"></td> <td style="width: 10%;"></td> <td style="width: 10%;"></td> <td style="width: 10%;"></td> <td style="width: 10%;"></td> <td style="width: 10%;"></td> </tr> <tr> <td></td> <td></td> <td colspan="8" style="text-align: center;"> <table border="1" style="width: 100%; border-collapse: collapse; text-align: center;"> <tr> </tr></table></td></tr></table></td></tr></table></td></tr></table></td></tr></table></td></tr></table></td></tr></table></td></tr></table></td></tr></table></td></tr></table></td></tr></table></td></tr></table></td></tr></table></td></tr></table>
 | | | | | | | | | | | | | | | | | | | | <table border="1" style="width: 100%; border-collapse: collapse; text-align: center;"> <tr> <td style="width: 10%;"></td> <td style="width: 10%;"></td> <td style="width: 10%;"></td> <td style="width: 10%;"></td> <td style="width: 10%;"></td> <td style="width: 10%;"></td> <td style="width: 10%;"></td> <td style="width: 10%;"></td> <td style="width: 10%;"></td> <td style="width: 10%;"></td> </tr> <tr> <td></td> <td></td> <td colspan="8" style="text-align: center;"> <table border="1" style="width: 100%; border-collapse: collapse; text-align: center;"> <tr> <td style="width: 10%;"></td> <td style="width: 10%;"></td> <td style="width: 10%;"></td> <td style="width: 10%;"></td> <td style="width: 10%;"></td> <td style="width: 10%;"></td> <td style="width: 10%;"></td> <td style="width: 10%;"></td> <td style="width: 10%;"></td> <td style="width: 10%;"></td> </tr> <tr> <td></td> <td></td> <td colspan="8" style="text-align: center;"> <table border="1" style="width: 100%; border-collapse: collapse; text-align: center;"> <tr> <td style="width: 10%;"></td> <td style="width: 10%;"></td> <td style="width: 10%;"></td> <td style="width: 10%;"></td> <td style="width: 10%;"></td> <td style="width: 10%;"></td> <td style="width: 10%;"></td> <td style="width: 10%;"></td> <td style="width: 10%;"></td> <td style="width: 10%;"></td> </tr> <tr> <td></td> <td></td> <td colspan="8" style="text-align: center;"> <table border="1" style="width: 100%; border-collapse: collapse; text-align: center;"> <tr> <td style="width: 10%;"></td> <td style="width: 10%;"></td> <td style="width: 10%;"></td> <td style="width: 10%;"></td> <td style="width: 10%;"></td> <td style="width: 10%;"></td> <td style="width: 10%;"></td> <td style="width: 10%;"></td> <td style="width: 10%;"></td> <td style="width: 10%;"></td> </tr> <tr> <td></td> <td></td> <td colspan="8" style="text-align: center;"> <table border="1" style="width: 100%; border-collapse: collapse; text-align: center;"> <tr> <td style="width: 10%;"></td> <td style="width: 10%;"></td> <td style="width: 10%;"></td> <td style="width: 10%;"></td> <td style="width: 10%;"></td> <td style="width: 10%;"></td> <td style="width: 10%;"></td> <td style="width: 10%;"></td> <td style="width: 10%;"></td> <td style="width: 10%;"></td> </tr> <tr> <td></td> <td></td> <td colspan="8" style="text-align: center;"> <table border="1" style="width: 100%; border-collapse: collapse; text-align: center;"> <tr> <td style="width: 10%;"></td> <td style="width: 10%;"></td> <td style="width: 10%;"></td> <td style="width: 10%;"></td> <td style="width: 10%;"></td> <td style="width: 10%;"></td> <td style="width: 10%;"></td> <td style="width: 10%;"></td> <td style="width: 10%;"></td> <td style="width: 10%;"></td> </tr> <tr> <td></td> <td></td> <td colspan="8" style="text-align: center;"> <table border="1" style="width: 100%; border-collapse: collapse; text-align: center;"> <tr> <td style="width: 10%;"></td> <td style="width: 10%;"></td> <td style="width: 10%;"></td> <td style="width: 10%;"></td> <td style="width: 10%;"></td> <td style="width: 10%;"></td> <td style="width: 10%;"></td> <td style="width: 10%;"></td> <td style="width: 10%;"></td> <td style="width: 10%;"></td> </tr> <tr> <td></td> <td></td> <td colspan="8" style="text-align: center;"> <table border="1" style="width: 100%; border-collapse: collapse; text-align: center;"> <tr> <td style="width: 10%;"></td> <td style="width: 10%;"></td> <td style="width: 10%;"></td> <td style="width: 10%;"></td> <td style="width: 10%;"></td> <td style="width: 10%;"></td> <td style="width: 10%;"></td> <td style="width: 10%;"></td> <td style="width: 10%;"></td> <td style="width: 10%;"></td> </tr> <tr> <td></td> <td></td> <td
colspan="8" style="text-align: center;"> <table border="1" style="width: 100%; border-collapse: collapse; text-align: center;"> <tr> <td style="width: 10%;"></td> <td style="width: 10%;"></td> <td style="width: 10%;"></td> <td style="width: 10%;"></td> <td style="width: 10%;"></td> <td style="width: 10%;"></td> <td style="width: 10%;"></td> <td style="width: 10%;"></td> <td style="width: 10%;"></td> <td style="width: 10%;"></td> </tr> <tr> <td></td> <td></td> <td colspan="8" style="text-align: center;"> <table border="1" style="width: 100%; border-collapse: collapse; text-align: center;"> <tr> <td style="width: 10%;"></td> <td style="width: 10%;"></td> <td style="width: 10%;"></td> <td style="width: 10%;"></td> <td style="width: 10%;"></td> <td style="width: 10%;"></td> <td style="width: 10%;"></td> <td style="width: 10%;"></td> <td style="width: 10%;"></td> <td style="width: 10%;"></td> </tr> <tr> <td></td> <td></td> <td colspan="8" style="text-align: center;"> <table border="1" style="width: 100%; border-collapse: collapse; text-align: center;"> <tr> <td style="width: 10%;"></td> <td style="width: 10%;"></td> <td style="width: 10%;"></td> <td style="width: 10%;"></td> <td style="width: 10%;"></td> <td style="width: 10%;"></td> <td style="width: 10%;"></td> <td style="width: 10%;"></td> <td style="width: 10%;"></td> <td style="width: 10%;"></td> </tr> <tr> <td></td> <td></td> <td colspan="8" style="text-align: center;"> <table border="1" style="width: 100%; border-collapse: collapse; text-align: center;"> <tr> <td style="width: 10%;"></td> <td style="width: 10%;"></td> <td style="width: 10%;"></td> <td style="width: 10%;"></td> <td style="width: 10%;"></td> <td style="width: 10%;"></td> <td style="width: 10%;"></td> <td style="width: 10%;"></td> <td style="width: 10%;"></td> <td style="width: 10%;"></td> </tr> <tr> <td></td> <td></td> <td colspan="8" style="text-align: center;"> <table border="1" style="width: 100%; border-collapse: collapse; text-align: center;"> <tr> </tr></table></td></tr></table></td></tr></table></td></tr></table></td></tr></table></td></tr></table></td></tr></table></td></tr></table></td></tr></table></td></tr></table></td></tr></table></td></tr></table></td></tr></table>
 | | | | | | | | | | | | | | | | | | | | <table border="1" style="width: 100%; border-collapse: collapse; text-align: center;"> <tr> <td style="width: 10%;"></td> <td style="width: 10%;"></td> <td style="width: 10%;"></td> <td style="width: 10%;"></td> <td style="width: 10%;"></td> <td style="width: 10%;"></td> <td style="width: 10%;"></td> <td style="width: 10%;"></td> <td style="width: 10%;"></td> <td style="width: 10%;"></td> </tr> <tr> <td></td> <td></td> <td colspan="8" style="text-align: center;"> <table border="1" style="width: 100%; border-collapse: collapse; text-align: center;"> <tr> <td style="width: 10%;"></td> <td style="width: 10%;"></td> <td style="width: 10%;"></td> <td style="width: 10%;"></td> <td style="width: 10%;"></td> <td style="width: 10%;"></td> <td style="width: 10%;"></td> <td style="width: 10%;"></td> <td style="width: 10%;"></td> <td style="width: 10%;"></td> </tr> <tr> <td></td> <td></td> <td colspan="8" style="text-align: center;"> <table border="1" style="width: 100%; border-collapse: collapse; text-align: center;"> <tr> <td style="width: 10%;"></td> <td style="width: 10%;"></td> <td style="width: 10%;"></td> <td style="width: 10%;"></td> <td style="width: 10%;"></td> <td style="width: 10%;"></td> <td style="width: 10%;"></td> <td style="width: 10%;"></td> <td style="width: 10%;"></td> <td style="width: 10%;"></td> </tr> <tr> <td></td> <td></td> <td colspan="8" style="text-align: center;"> <table border="1" style="width: 100%; border-collapse: collapse; text-align: center;"> <tr> <td style="width: 10%;"></td> <td style="width: 10%;"></td> <td style="width: 10%;"></td> <td style="width: 10%;"></td> <td style="width: 10%;"></td> <td style="width: 10%;"></td> <td style="width: 10%;"></td> <td style="width: 10%;"></td> <td style="width: 10%;"></td> <td style="width: 10%;"></td> </tr> <tr> <td></td> <td></td> <td colspan="8" style="text-align: center;"> <table border="1" style="width: 100%; border-collapse: collapse; text-align: center;"> <tr> <td style="width: 10%;"></td> <td style="width: 10%;"></td> <td style="width: 10%;"></td> <td style="width: 10%;"></td> <td style="width: 10%;"></td> <td style="width: 10%;"></td> <td style="width: 10%;"></td> <td style="width: 10%;"></td> <td style="width: 10%;"></td> <td style="width: 10%;"></td> </tr> <tr> <td></td> <td></td> <td colspan="8" style="text-align: center;"> <table border="1" style="width: 100%; border-collapse: collapse; text-align: center;"> <tr> <td style="width: 10%;"></td> <td style="width: 10%;"></td> <td style="width: 10%;"></td> <td style="width: 10%;"></td> <td style="width: 10%;"></td> <td style="width: 10%;"></td> <td style="width: 10%;"></td> <td style="width: 10%;"></td> <td style="width: 10%;"></td> <td style="width: 10%;"></td> </tr> <tr> <td></td> <td></td> <td colspan="8" style="text-align: center;"> <table border="1" style="width: 100%; border-collapse: collapse; text-align: center;"> <tr> <td style="width: 10%;"></td> <td style="width: 10%;"></td> <td style="width: 10%;"></td> <td style="width: 10%;"></td> <td style="width: 10%;"></td> <td style="width: 10%;"></td> <td style="width: 10%;"></td> <td style="width: 10%;"></td> <td style="width: 10%;"></td> <td style="width: 10%;"></td> </tr> <tr> <td></td> <td></td> <td colspan="8" style="text-align: center;"> <table border="1" style="width: 100%; border-collapse: collapse; text-align: center;"> <tr> <td style="width: 10%;"></td> <td style="width: 10%;"></td> <td style="width: 10%;"></td> <td style="width: 10%;"></td> <td style="width: 10%;"></td> <td style="width: 10%;"></td> <td style="width: 10%;"></td> <td style="width: 10%;"></td> <td style="width: 10%;"></td> <td style="width: 10%;"></td> </tr> <tr> <td></td> <td></td> <td colspan="8" style="text-align: center;"> <table border="1" style="width: 100%; border-collapse: collapse; text-align: center;"> <tr> <td style="width: 10%;"></td> <td style="width: 10%;"></td> <td style="width: 10%;"></td> <td style="width: 10%;"></td> <td style="width: 10%;"></td> <td style="width: 10%;"></td> <td style="width: 10%;"></td> <td style="width: 10%;"></td> <td style="width: 10%;"></td> <td style="width: 10%;"></td> </tr> <tr> <td></td> <td></td> <td colspan="8" style="text-align: center;"> <table border="1" style="width: 100%; border-collapse: collapse; text-align: center;"> <tr> <td style="width: 10%;"></td> <td style="width: 10%;"></td> <td style="width: 10%;"></td> <td style="width: 10%;"></td> <td style="width: 10%;"></td> <td style="width: 10%;"></td> <td style="width: 10%;"></td> <td style="width: 10%;"></td> <td style="width: 10%;"></td> <td style="width: 10%;"></td> </tr> <tr> <td></td> <td></td> <td colspan="8" style="text-align: center;"> <table border="1" style="width: 100%; border-collapse: collapse; text-align: center;"> <tr> <td style="width: 10%;"></td> <td style="width: 10%;"></td> <td style="width: 10%;"></td> <td style="width: 10%;"></td> <td style="width: 10%;"></td> <td style="width: 10%;"></td> <td style="width: 10%;"></td> <td style="width: 10%;"></td> <td style="width: 10%;"></td> <td style="width: 10%;"></td> </tr> <tr> <td></td> <td></td> <td colspan="8" style="text-align: center;"> <table border="1" style="width: 100%; border-collapse: collapse; text-align: center;"> <tr> </tr></table></td></tr></table></td></tr></table></td></tr></table></td></tr></table></td></tr></table></td></tr></table></td></tr></table></td></tr></table></td></tr></table></td></tr></table></td></tr></table>
 | | | | | | | | | | | | | | | | | | | | <table border="1" style="width: 100%; border-collapse: collapse; text-align: center;"> <tr> <td style="width: 10%;"></td> <td style="width: 10%;"></td> <td style="width: 10%;"></td> <td style="width: 10%;"></td> <td style="width: 10%;"></td> <td style="width: 10%;"></td> <td style="width: 10%;"></td> <td style="width: 10%;"></td> <td style="width: 10%;"></td> <td style="width: 10%;"></td> </tr> <tr> <td></td> <td></td> <td colspan="8" style="text-align: center;"> <table border="1" style="width: 100%; border-collapse: collapse; text-align: center;"> <tr> <td style="width: 10%;"></td> <td style="width: 10%;"></td> <td style="width: 10%;"></td> <td style="width: 10%;"></td> <td style="width: 10%;"></td> <td style="width: 10%;"></td> <td style="width: 10%;"></td> <td style="width: 10%;"></td> <td style="width: 10%;"></td> <td style="width: 10%;"></td> </tr> <tr> <td></td> <td></td> <td colspan="8" style="text-align: center;"> <table border="1" style="width: 100%; border-collapse: collapse; text-align: center;"> <tr> <td style="width: 10%;"></td> <td style="width: 10%;"></td> <td style="width: 10%;"></td> <td style="width: 10%;"></td> <td style="width: 10%;"></td> <td style="width: 10%;"></td> <td style="width: 10%;"></td> <td style="width: 10%;"></td> <td style="width: 10%;"></td> <td style="width: 10%;"></td> </tr> <tr> <td></td> <td></td> <td colspan="8" style="text-align: center;"> <table border="1" style="width: 100%; border-collapse: collapse; text-align: center;"> <tr> <td style="width: 10%;"></td> <td style="width: 10%;"></td> <td style="width: 10%;"></td> <td style="width: 10%;"></td> <td style="width: 10%;"></td> <td style="width: 10%;"></td> <td style="width: 10%;"></td> <td style="width: 10%;"></td> <td style="width: 10%;"></td> <td style="width: 10%;"></td> </tr> <tr> <td></td> <td></td> <td colspan="8" style="text-align: center;"> <table border="1" style="width: 100%; border-collapse: collapse; text-align: center;"> <tr> <td style="width: 10%;"></td> <td style="width: 10%;"></td> <td style="width: 10%;"></td> <td style="width: 10%;"></td> <td style="width: 10%;"></td> <td style="width: 10%;"></td> <td style="width: 10%;"></td> <td style="width: 10%;"></td> <td style="width: 10%;"></td> <td style="width: 10%;"></td> </tr> <tr> <td></td> <td></td> <td colspan="8" style="text-align: center;"> <table border="1" style="width: 100%; border-collapse: collapse; text-align: center;"> <tr> <td style="width: 10%;"></td> <td style="width: 10%;"></td> <td style="width: 10%;"></td> <td style="width: 10%;"></td> <td style="width: 10%;"></td> <td style="width: 10%;"></td> <td style="width: 10%;"></td> <td style="width: 10%;"></td> <td style="width: 10%;"></td> <td style="width: 10%;"></td> </tr> <tr> <td></td> <td></td> <td colspan="8" style="text-align: center;"> <table border="1" style="width: 100%; border-collapse: collapse; text-align: center;"> <tr> <td style="width: 10%;"></td> <td style="width: 10%;"></td> <td style="width: 10%;"></td> <td style="width: 10%;"></td> <td style="width: 10%;"></td> <td style="width: 10%;"></td> <td style="width: 10%;"></td> <td style="width: 10%;"></td> <td style="width: 10%;"></td> <td style="width: 10%;"></td> </tr> <tr> <td></td> <td></td> <td colspan="8" style="text-align: center;"> <table border="1" style="width: 100%; border-collapse: collapse; text-align: center;"> <tr> <td style="width: 10%;"></td> <td style="width: 10%;"></td> <td style="width: 10%;"></td> <td style="width: 10%;"></td> <td style="width: 10%;"></td> <td style="width: 10%;"></td> <td style="width: 10%;"></td> <td style="width: 10%;"></td> <td style="width: 10%;"></td> <td style="width: 10%;"></td> </tr> <tr> <td></td> <td></td> <td colspan="8" style="text-align: center;"> <table border="1" style="width: 100%; border-collapse: collapse; text-align: center;"> <tr> <td style="width: 10%;"></td> <td style="width: 10%;"></td> <td style="width: 10%;"></td> <td style="width: 10%;"></td> <td style="width: 10%;"></td> <td style="width: 10%;"></td> <td style="width: 10%;"></td> <td style="width: 10%;"></td> <td style="width: 10%;"></td> <td style="width: 10%;"></td> </tr> <tr> <td></td> <td></td> <td colspan="8" style="text-align: center;"> <table border="1" style="width: 100%; border-collapse: collapse; text-align: center;"> <tr> <td style="width: 10%;"></td> <td style="width: 10%;"></td> <td style="width: 10%;"></td> <td style="width: 10%;"></td> <td style="width: 10%;"></td> <td style="width: 10%;"></td> <td style="width: 10%;"></td> <td style="width: 10%;"></td> <td style="width: 10%;"></td> <td style="width: 10%;"></td> </tr> <tr> <td></td> <td></td> <td colspan="8" style="text-align: center;"> <table border="1" style="width: 100%; border-collapse: collapse; text-align: center;"> <tr> </tr></table></td></tr></table></td></tr></table></td></tr></table></td></tr></table></td></tr></table></td></tr></table></td></tr></table></td></tr></table></td></tr></table></td></tr></table>
 | | | | | | | | | | | | | | | | | | | | <table border="1" style="width: 100%; border-collapse: collapse; text-align: center;"> <tr> <td style="width: 10%;"></td> <td style="width: 10%;"></td> <td style="width: 10%;"></td> <td style="width: 10%;"></td> <td style="width: 10%;"></td> <td style="width: 10%;"></td> <td style="width: 10%;"></td> <td style="width: 10%;"></td> <td style="width: 10%;"></td> <td style="width: 10%;"></td> </tr> <tr> <td></td> <td></td> <td colspan="8" style="text-align: center;"> <table border="1" style="width: 100%; border-collapse: collapse; text-align: center;"> <tr> <td style="width: 10%;"></td> <td style="width: 10%;"></td> <td style="width: 10%;"></td> <td style="width: 10%;"></td> <td style="width: 10%;"></td> <td style="width: 10%;"></td> <td style="width: 10%;"></td> <td style="width: 10%;"></td> <td style="width: 10%;"></td> <td style="width: 10%;"></td> </tr> <tr> <td></td> <td></td> <td colspan="8" style="text-align: center;"> <table border="1" style="width: 100%; border-collapse: collapse; text-align: center;"> <tr> <td style="width: 10%;"></td> <td style="width: 10%;"></td> <td style="width: 10%;"></td> <td style="width: 10%;"></td> <td style="width: 10%;"></td> <td style="width: 10%;"></td> <td style="width: 10%;"></td> <td style="width: 10%;"></td> <td style="width: 10%;"></td> <td style="width: 10%;"></td> </tr> <tr> <td></td> <td></td> <td colspan="8" style="text-align: center;"> <table border="1" style="width: 100%; border-collapse: collapse; text-align: center;"> <tr> <td style="width: 10%;"></td> <td style="width: 10%;"></td> <td style="width: 10%;"></td> <td style="width: 10%;"></td> <td style="width: 10%;"></td> <td style="width: 10%;"></td> <td style="width: 10%;"></td> <td style="width: 10%;"></td> <td style="width: 10%;"></td> <td style="width: 10%;"></td> </tr> <tr> <td></td> <td></td> <td colspan="8" style="text-align: center;"> <table border="1" style="width: 100%; border-collapse: collapse; text-align: center;"> <tr> <td style="width: 10%;"></td> <td style="width: 10%;"></td> <td style="width: 10%;"></td> <td style="width: 10%;"></td> <td style="width: 10%;"></td> <td style="width: 10%;"></td> <td style="width: 10%;"></td> <td style="width: 10%;"></td> <td style="width: 10%;"></td> <td style="width: 10%;"></td> </tr> <tr> <td></td> <td></td> <td colspan="8" style="text-align: center;"> <table border="1" style="width: 100%;
border-collapse: collapse; text-align: center;"> <tr> <td style="width: 10%;"></td> <td style="width: 10%;"></td> <td style="width: 10%;"></td> <td style="width: 10%;"></td> <td style="width: 10%;"></td> <td style="width: 10%;"></td> <td style="width: 10%;"></td> <td style="width: 10%;"></td> <td style="width: 10%;"></td> <td style="width: 10%;"></td> </tr> <tr> <td></td> <td></td> <td colspan="8" style="text-align: center;"> <table border="1" style="width: 100%; border-collapse: collapse; text-align: center;"> <tr> <td style="width: 10%;"></td> <td style="width: 10%;"></td> <td style="width: 10%;"></td> <td style="width: 10%;"></td> <td style="width: 10%;"></td> <td style="width: 10%;"></td> <td style="width: 10%;"></td> <td style="width: 10%;"></td> <td style="width: 10%;"></td> <td style="width: 10%;"></td> </tr> <tr> <td></td> <td></td> <td colspan="8" style="text-align: center;"> <table border="1" style="width: 100%; border-collapse: collapse; text-align: center;"> <tr> <td style="width: 10%;"></td> <td style="width: 10%;"></td> <td style="width: 10%;"></td> <td style="width: 10%;"></td> <td style="width: 10%;"></td> <td style="width: 10%;"></td> <td style="width: 10%;"></td> <td style="width: 10%;"></td> <td style="width: 10%;"></td> <td style="width: 10%;"></td> </tr> <tr> <td></td> <td></td> <td colspan="8" style="text-align: center;"> <table border="1" style="width: 100%; border-collapse: collapse; text-align: center;"> <tr> <td style="width: 10%;"></td> <td style="width: 10%;"></td> <td style="width: 10%;"></td> <td style="width: 10%;"></td> <td style="width: 10%;"></td> <td style="width: 10%;"></td> <td style="width: 10%;"></td> <td style="width: 10%;"></td> <td style="width: 10%;"></td> <td style="width: 10%;"></td> </tr> <tr> <td></td> <td></td> <td colspan="8" style="text-align: center;"> <table border="1" style="width: 100%; border-collapse: collapse; text-align: center;"> <tr> </tr></table></td></tr></table></td></tr></table></td></tr></table></td></tr></table></td></tr></table></td></tr></table></td></tr></table></td></tr></table></td></tr></table>
 | | | | | | | | | | | | | | | | | | | | <table border="1" style="width: 100%; border-collapse: collapse; text-align: center;"> <tr> <td style="width: 10%;"></td> <td style="width: 10%;"></td> <td style="width: 10%;"></td> <td style="width: 10%;"></td> <td style="width: 10%;"></td> <td style="width: 10%;"></td> <td style="width: 10%;"></td> <td style="width: 10%;"></td> <td style="width: 10%;"></td> <td style="width: 10%;"></td> </tr> <tr> <td></td> <td></td> <td colspan="8" style="text-align: center;"> <table border="1" style="width: 100%; border-collapse: collapse; text-align: center;"> <tr> <td style="width: 10%;"></td> <td style="width: 10%;"></td> <td style="width: 10%;"></td> <td style="width: 10%;"></td> <td style="width: 10%;"></td> <td style="width: 10%;"></td> <td style="width: 10%;"></td> <td style="width: 10%;"></td> <td style="width: 10%;"></td> <td style="width: 10%;"></td> </tr> <tr> <td></td> <td></td> <td colspan="8" style="text-align: center;"> <table border="1" style="width: 100%; border-collapse: collapse; text-align: center;"> <tr> <td style="width: 10%;"></td> <td style="width: 10%;"></td> <td style="width: 10%;"></td> <td style="width: 10%;"></td> <td style="width: 10%;"></td> <td style="width: 10%;"></td> <td style="width: 10%;"></td> <td style="width: 10%;"></td> <td style="width: 10%;"></td> <td style="width: 10%;"></td> </tr> <tr> <td></td> <td></td> <td colspan="8" style="text-align: center;"> <table border="1" style="width: 100%; border-collapse: collapse; text-align: center;"> <tr> <td style="width: 10%;"></td> <td style="width: 10%;"></td> <td style="width: 10%;"></td> <td style="width: 10%;"></td> <td style="width: 10%;"></td> <td style="width: 10%;"></td> <td style="width: 10%;"></td> <td style="width: 10%;"></td> <td style="width: 10%;"></td> <td style="width: 10%;"></td> </tr> <tr> <td></td> <td></td> <td colspan="8" style="text-align: center;"> <table border="1" style="width: 100%; border-collapse: collapse; text-align: center;"> <tr> <td style="width: 10%;"></td> <td style="width: 10%;"></td> <td style="width: 10%;"></td> <td style="width: 10%;"></td> <td style="width: 10%;"></td> <td style="width: 10%;"></td> <td style="width: 10%;"></td> <td style="width: 10%;"></td> <td style="width: 10%;"></td> <td style="width: 10%;"></td> </tr> <tr> <td></td> <td></td> <td colspan="8" style="text-align: center;"> <table border="1" style="width: 100%; border-collapse: collapse; text-align: center;"> <tr> <td style="width: 10%;"></td> <td style="width: 10%;"></td> <td style="width: 10%;"></td> <td style="width: 10%;"></td> <td style="width: 10%;"></td> <td style="width: 10%;"></td> <td style="width: 10%;"></td> <td style="width: 10%;"></td> <td style="width: 10%;"></td> <td style="width: 10%;"></td> </tr> <tr> <td></td> <td></td> <td colspan="8" style="text-align: center;"> <table border="1" style="width: 100%; border-collapse: collapse; text-align: center;"> <tr> <td style="width: 10%;"></td> <td style="width: 10%;"></td> <td style="width: 10%;"></td> <td style="width: 10%;"></td> <td style="width: 10%;"></td> <td style="width: 10%;"></td> <td style="width: 10%;"></td> <td style="width: 10%;"></td> <td style="width: 10%;"></td> <td style="width: 10%;"></td> </tr> <tr> <td></td> <td></td> <td colspan="8" style="text-align: center;"> <table border="1" style="width: 100%; border-collapse: collapse; text-align: center;"> <tr> <td style="width: 10%;"></td> <td style="width: 10%;"></td> <td style="width: 10%;"></td> <td style="width: 10%;"></td> <td style="width: 10%;"></td> <td style="width: 10%;"></td> <td style="width: 10%;"></td> <td style="width: 10%;"></td> <td style="width: 10%;"></td> <td style="width: 10%;"></td> </tr> <tr> <td></td> <td></td> <td colspan="8" style="text-align: center;"> <table border="1" style="width: 100%; border-collapse: collapse; text-align: center;"> <tr> </tr></table></td></tr></table></td></tr></table></td></tr></table></td></tr></table></td></tr></table></td></tr></table></td></tr></table></td></tr></table>
 | | | | | | | | | | | | | | | | | | | | <table border="1" style="width: 100%; border-collapse: collapse; text-align: center;"> <tr> <td style="width: 10%;"></td> <td style="width: 10%;"></td> <td style="width: 10%;"></td> <td style="width: 10%;"></td> <td style="width: 10%;"></td> <td style="width: 10%;"></td> <td style="width: 10%;"></td> <td style="width: 10%;"></td> <td style="width: 10%;"></td> <td style="width: 10%;"></td> </tr> <tr> <td></td> <td></td> <td colspan="8" style="text-align: center;"> <table border="1" style="width: 100%; border-collapse: collapse; text-align: center;"> <tr> <td style="width: 10%;"></td> <td style="width: 10%;"></td> <td style="width: 10%;"></td> <td style="width: 10%;"></td> <td style="width: 10%;"></td> <td style="width: 10%;"></td> <td style="width: 10%;"></td> <td style="width: 10%;"></td> <td style="width: 10%;"></td> <td style="width: 10%;"></td> </tr> <tr> <td></td> <td></td> <td colspan="8" style="text-align: center;"> <table border="1" style="width: 100%; border-collapse: collapse; text-align: center;"> <tr> <td style="width: 10%;"></td> <td style="width: 10%;"></td> <td style="width: 10%;"></td> <td style="width: 10%;"></td> <td style="width: 10%;"></td> <td style="width: 10%;"></td> <td style="width: 10%;"></td> <td style="width: 10%;"></td> <td style="width: 10%;"></td> <td style="width: 10%;"></td> </tr> <tr> <td></td> <td></td> <td colspan="8" style="text-align: center;"> <table border="1" style="width: 100%; border-collapse: collapse; text-align: center;"> <tr> <td style="width: 10%;"></td> <td style="width: 10%;"></td> <td style="width: 10%;"></td> <td style="width: 10%;"></td> <td style="width: 10%;"></td> <td style="width: 10%;"></td> <td style="width: 10%;"></td> <td style="width: 10%;"></td> <td style="width: 10%;"></td> <td style="width: 10%;"></td> </tr> <tr> <td></td> <td></td> <td colspan="8" style="text-align: center;"> <table border="1" style="width: 100%; border-collapse: collapse; text-align: center;"> <tr> <td style="width: 10%;"></td> <td style="width: 10%;"></td> <td style="width: 10%;"></td> <td style="width: 10%;"></td> <td style="width: 10%;"></td> <td style="width: 10%;"></td> <td style="width: 10%;"></td> <td style="width: 10%;"></td> <td style="width: 10%;"></td> <td style="width: 10%;"></td> </tr> <tr> <td></td> <td></td> <td colspan="8" style="text-align: center;"> <table border="1" style="width: 100%; border-collapse: collapse; text-align: center;"> <tr> <td style="width: 10%;"></td> <td style="width: 10%;"></td> <td style="width: 10%;"></td> <td style="width: 10%;"></td> <td style="width: 10%;"></td> <td style="width: 10%;"></td> <td style="width: 10%;"></td> <td style="width: 10%;"></td> <td style="width: 10%;"></td> <td style="width: 10%;"></td> </tr> <tr> <td></td> <td></td> <td colspan="8" style="text-align: center;"> <table border="1" style="width: 100%; border-collapse: collapse; text-align: center;"> <tr> <td style="width: 10%;"></td> <td style="width: 10%;"></td> <td style="width: 10%;"></td> <td style="width: 10%;"></td> <td style="width: 10%;"></td> <td style="width: 10%;"></td> <td style="width: 10%;"></td> <td style="width: 10%;"></td> <td style="width: 10%;"></td> <td style="width: 10%;"></td> </tr> <tr> <td></td> <td></td> <td colspan="8" style="text-align: center;"> <table border="1" style="width: 100%; border-collapse: collapse; text-align: center;"> <tr> </tr></table></td></tr></table></td></tr></table></td></tr></table></td></tr></table></td></tr></table></td></tr></table></td></tr></table>
 | | | | | | | | | | | | | | | | | | | | <table border="1" style="width: 100%; border-collapse: collapse; text-align: center;"> <tr> <td style="width: 10%;"></td> <td style="width: 10%;"></td> <td style="width: 10%;"></td> <td style="width: 10%;"></td> <td style="width: 10%;"></td> <td style="width: 10%;"></td> <td style="width: 10%;"></td> <td style="width: 10%;"></td> <td style="width: 10%;"></td> <td style="width: 10%;"></td> </tr> <tr> <td></td> <td></td> <td colspan="8" style="text-align: center;"> <table border="1" style="width: 100%; border-collapse: collapse; text-align: center;"> <tr> <td style="width: 10%;"></td> <td style="width: 10%;"></td> <td style="width: 10%;"></td> <td style="width: 10%;"></td> <td style="width: 10%;"></td> <td style="width: 10%;"></td> <td style="width: 10%;"></td> <td style="width: 10%;"></td> <td style="width: 10%;"></td> <td style="width: 10%;"></td> </tr> <tr> <td></td> <td></td> <td colspan="8" style="text-align: center;"> <table border="1" style="width: 100%; border-collapse: collapse; text-align: center;"> <tr> <td style="width: 10%;"></td> <td style="width: 10%;"></td> <td style="width: 10%;"></td> <td style="width: 10%;"></td> <td style="width: 10%;"></td> <td style="width: 10%;"></td> <td style="width: 10%;"></td> <td style="width: 10%;"></td> <td style="width: 10%;"></td> <td style="width: 10%;"></td> </tr> <tr> <td></td> <td></td> <td colspan="8" style="text-align: center;"> <table border="1" style="width: 100%; border-collapse: collapse; text-align: center;"> <tr> <td style="width: 10%;"></td> <td style="width: 10%;"></td> <td style="width: 10%;"></td> <td style="width: 10%;"></td> <td style="width: 10%;"></td> <td style="width: 10%;"></td> <td style="width: 10%;"></td> <td style="width: 10%;"></td> <td style="width: 10%;"></td> <td style="width: 10%;"></td> </tr> <tr> <td></td> <td></td> <td colspan="8" style="text-align: center;"> <table border="1" style="width: 100%; border-collapse: collapse; text-align: center;"> <tr> <td style="width: 10%;"></td> <td style="width: 10%;"></td> <td style="width: 10%;"></td> <td style="width: 10%;"></td> <td style="width: 10%;"></td> <td style="width: 10%;"></td> <td style="width: 10%;"></td> <td style="width: 10%;"></td> <td style="width: 10%;"></td> <td style="width: 10%;"></td> </tr> <tr> <td></td> <td></td> <td colspan="8" style="text-align: center;"> <table border="1" style="width: 100%; border-collapse: collapse; text-align: center;"> <tr> <td style="width: 10%;"></td> <td style="width: 10%;"></td> <td style="width: 10%;"></td> <td style="width: 10%;"></td> <td style="width: 10%;"></td> <td style="width: 10%;"></td> <td style="width: 10%;"></td> <td style="width: 10%;"></td> <td style="width: 10%;"></td> <td style="width: 10%;"></td> </tr> <tr> <td></td> <td></td> <td colspan="8" style="text-align: center;"> <table border="1" style="width: 100%; border-collapse: collapse; text-align: center;"> <tr> </tr></table></td></tr></table></td></tr></table></td></tr></table></td></tr></table></td></tr></table></td></tr></table>
 | | | | | | | | | | | | | | | | | | | | <table border="1" style="width: 100%; border-collapse: collapse; text-align: center;"> <tr> <td style="width: 10%;"></td> <td style="width: 10%;"></td> <td style="width: 10%;"></td> <td style="width: 10%;"></td> <td style="width: 10%;"></td> <td style="width: 10%;"></td> <td style="width: 10%;"></td> <td style="width: 10%;"></td> <td style="width: 10%;"></td> <td style="width: 10%;"></td> </tr> <tr> <td></td> <td></td> <td colspan="8" style="text-align: center;"> <table border="1" style="width: 100%; border-collapse: collapse; text-align: center;"> <tr> <td style="width: 10%;"></td> <td style="width: 10%;"></td> <td style="width: 10%;"></td> <td style="width: 10%;"></td> <td style="width: 10%;"></td> <td style="width: 10%;"></td> <td style="width: 10%;"></td> <td style="width: 10%;"></td> <td style="width: 10%;"></td> <td style="width: 10%;"></td> </tr> <tr> <td></td> <td></td> <td colspan="8" style="text-align: center;"> <table border="1" style="width: 100%; border-collapse: collapse; text-align: center;"> <tr> <td style="width: 10%;"></td> <td style="width: 10%;"></td> <td style="width: 10%;"></td> <td style="width: 10%;"></td> <td style="width: 10%;"></td> <td style="width: 10%;"></td> <td style="width: 10%;"></td> <td style="width: 10%;"></td> <td style="width: 10%;"></td> <td style="width: 10%;"></td> </tr> <tr> <td></td> <td></td> <td colspan="8" style="text-align: center;"> <table border="1" style="width: 100%; border-collapse: collapse; text-align: center;"> <tr> <td style="width: 10%;"></td> <td style="width: 10%;"></td> <td style="width: 10%;"></td> <td style="width: 10%;"></td> <td style="width: 10%;"></td> <td style="width: 10%;"></td> <td style="width: 10%;"></td> <td style="width: 10%;"></td> <td style="width: 10%;"></td> <td style="width: 10%;"></td> </tr> <tr> <td></td> <td></td> <td colspan="8" style="text-align: center;"> <table border="1" style="width: 100%; border-collapse: collapse; text-align: center;"> <tr> <td style="width: 10%;"></td> <td style="width: 10%;"></td> <td style="width: 10%;"></td> <td style="width: 10%;"></td> <td style="width: 10%;"></td> <td style="width: 10%;"></td> <td style="width: 10%;"></td> <td style="width: 10%;"></td> <td style="width: 10%;"></td> <td style="width: 10%;"></td> </tr> <tr> <td></td> <td></td> <td colspan="8" style="text-align: center;"> <table border="1" style="width: 100%; border-collapse: collapse; text-align: center;"> <tr> </tr></table></td></tr></table></td></tr></table></td></tr></table></td></tr></table></td></tr></table>
 | | | | | | | | | | | | | | | | | | | | <table border="1" style="width: 100%; border-collapse: collapse; text-align: center;"> <tr> <td style="width: 10%;"></td> <td style="width: 10%;"></td> <td style="width: 10%;"></td> <td style="width: 10%;"></td> <td style="width: 10%;"></td> <td style="width: 10%;"></td> <td style="width: 10%;"></td> <td style="width: 10%;"></td> <td style="width: 10%;"></td> <td style="width: 10%;"></td> </tr> <tr> <td></td> <td></td> <td colspan="8" style="text-align: center;"> <table border="1" style="width: 100%; border-collapse: collapse; text-align: center;"> <tr> <td style="width: 10%;"></td> <td style="width: 10%;"></td> <td style="width: 10%;"></td> <td style="width: 10%;"></td> <td style="width: 10%;"></td> <td style="width: 10%;"></td> <td style="width: 10%;"></td> <td style="width: 10%;"></td> <td style="width: 10%;"></td> <td style="width: 10%;"></td> </tr> <tr> <td></td> <td></td> <td colspan="8" style="text-align: center;"> <table border="1" style="width: 100%; border-collapse: collapse; text-align: center;"> <tr> <td style="width: 10%;"></td> <td style="width: 10%;"></td> <td style="width: 10%;"></td> <td style="width: 10%;"></td> <td style="width: 10%;"></td> <td style="width: 10%;"></td> <td style="width: 10%;"></td> <td style="width: 10%;"></td> <td style="width: 10%;"></td> <td style="width: 10%;"></td> </tr> <tr> <td></td> <td></td> <td colspan="8" style="text-align: center;"> <table border="1" style="width: 100%; border-collapse: collapse; text-align: center;"> <tr> <td style="width: 10%;"></td> <td style="width: 10%;"></td> <td style="width: 10%;"></td> <td style="width: 10%;"></td> <td style="width: 10%;"></td> <td style="width: 10%;"></td> <td style="width: 10%;"></td> <td style="width: 10%;"></td> <td style="width: 10%;"></td> <td style="width: 10%;"></td> </tr> <tr> <td></td> <td></td> <td colspan="8" style="text-align: center;"> <table border="1" style="width: 100%; border-collapse: collapse; text-align: center;"> <tr> </tr></table></td></tr></table></td></tr></table></td></tr></table></td></tr></table>
 | | | | | | | | | | | | | | | | | | | | <table border="1" style="width: 100%; border-collapse: collapse; text-align: center;"> <tr> <td style="width: 10%;"></td> <td style="width: 10%;"></td> <td style="width: 10%;"></td> <td style="width: 10%;"></td> <td style="width: 10%;"></td> <td style="width: 10%;"></td> <td style="width: 10%;"></td> <td style="width: 10%;"></td> <td style="width: 10%;"></td> <td style="width: 10%;"></td> </tr> <tr> <td></td> <td></td> <td colspan="8" style="text-align: center;"> <table border="1" style="width: 100%; border-collapse: collapse; text-align: center;"> <tr> <td style="width: 10%;"></td> <td style="width: 10%;"></td> <td style="width: 10%;"></td> <td style="width: 10%;"></td> <td style="width: 10%;"></td> <td style="width: 10%;"></td> <td style="width: 10%;"></td> <td style="width: 10%;"></td> <td style="width: 10%;"></td> <td style="width: 10%;"></td> </tr> <tr> <td></td> <td></td> <td colspan="8" style="text-align: center;"> <table border="1" style="width: 100%; border-collapse: collapse; text-align: center;"> <tr> <td style="width: 10%;"></td> <td style="width: 10%;"></td> <td style="width: 10%;"></td> <td style="width: 10%;"></td> <td style="width: 10%;"></td> <td style="width: 10%;"></td> <td style="width: 10%;"></td> <td style="width: 10%;"></td> <td style="width: 10%;"></td> <td style="width: 10%;"></td> </tr> <tr> <td></td> <td></td> <td colspan="8" style="text-align: center;"> <table border="1" style="width: 100%; border-collapse: collapse; text-align: center;"> <tr> </tr></table></td></tr></table></td></tr></table></td></tr></table>
 | | | | | | | | | | | | | | | | | | | | <table border="1" style="width: 100%; border-collapse: collapse; text-align: center;"> <tr> <td style="width: 10%;"></td> <td style="width: 10%;"></td> <td style="width: 10%;"></td> <td style="width: 10%;"></td> <td style="width: 10%;"></td> <td style="width: 10%;"></td> <td style="width: 10%;"></td> <td style="width: 10%;"></td> <td style="width: 10%;"></td> <td style="width: 10%;"></td> </tr> <tr> <td></td> <td></td> <td colspan="8" style="text-align: center;"> <table border="1" style="width: 100%; border-collapse: collapse; text-align: center;"> <tr> <td style="width: 10%;"></td> <td style="width: 10%;"></td> <td style="width: 10%;"></td> <td style="width: 10%;"></td> <td style="width: 10%;"></td> <td style="width: 10%;"></td> <td style="width: 10%;"></td> <td style="width: 10%;"></td> <td style="width: 10%;"></td> <td style="width: 10%;"></td> </tr> <tr> <td></td> <td></td> <td colspan="8" style="text-align: center;"> <table border="1" style="width: 100%; border-collapse: collapse; text-align: center;"> <tr> </tr></table></td></tr></table></td></tr></table>
 | | | | | | | | | | | | | | | | | | | | <table border="1" style="width: 100%; border-collapse: collapse; text-align: center;"> <tr> <td style="width: 10%;"></td> <td style="width: 10%;"></td> <td style="width: 10%;"></td> <td style="width: 10%;"></td> <td style="width: 10%;"></td> <td style="width: 10%;"></td> <td style="width: 10%;"></td> <td style="width: 10%;"></td> <td style="width: 10%;"></td> <td style="width: 10%;"></td> </tr> <tr> <td></td> <td></td> <td colspan="8" style="text-align: center;"> <table border="1" style="width: 100%; border-collapse: collapse; text-align: center;"> <tr> </tr></table></td></tr></table>
 | | | | | | | | | | | | | | | | | | | | <table border="1" style="width: 100%; border-collapse: collapse; text-align: center;"> <tr> </tr></table>
 | | | | | | | | | | | | | | | | | | | | | | | | | | | | | | | | | | | | | | | | | | | | | | | | | | | | | | | | | | | | | | | | | | | | | | | | | | | | | | | |
 | | | | | | | | | | | | | | | | | | | | | | | | | | | | | | | | | | | | | | | |
 | | | | | | | | | | | | | | | | | | | |
 | | | | | | | | | | | | | | | | | | | | | | | | | | | | | | | | | | | | | | | |
 | | | | | | | | | | | | | | | | | | | | | | | | | | | | | | | | | | | | | | | |
 | | | | | | | | | | | | | | | | | | | | | | | | | | | | | | | | | | | | | | | |
 | | | | | | | | | | | | | | | | | | | | | | | | | | | | | | | | | | | | | | | | | | | | | | | | | | | | | | | | | | | | | | | | | | | | | | | | | | | | | | | |
 | | | | | | | | | | | | | | | | | | | | | | | | | | | | | | | | | | | | | | | | | | | | | | | | | | | | | | | | | | | | | | | | | | | |
| | |

 | | | | | | | | | | | | | | | | | | | |

 | | | | | | | | | | | | | | | | | | | |

 | | | | | | | | | | | | | | | | | | | |

 | | | | | | | | | | | | | | | | | | | |

 | | | | | | | | | | | | | | | | | | | |

 | | | | | | | | | | | | | | | | | | | |

 | | | | | | | | | | | | | | | | | | | |

 | | | | | | | | | | | | | | | | | | | |

 | | | | | | | | | | | | | | | | | | | |

 | | | | | | | | | | | | | | | | | | | |

 | | | | | | | | | | | | | | | | | | | |

 | | | | | | | | | | | | | | | | | | | |

 | | | | | | | | | | | | | | | | | | | |

 | | | | | | | | | | | | | | | | | | | |

 | | | | | | | | | | | | | | | | | | | |

 | | | | | | | | | | | | | | | | | | | |

 | | | | | | | | | | | | | | | | | | | |

 | | | | | | | | | | | | | | | | | | | |

 | | | | | | | | | | | | | | | | | | | |

 | | | | | | | | | | | | | | | | | | | |

 | | | | | | | | | | | | | | | | | | | |

 | | | | | | | | | | | | | | | | | | | |

 | | | | | | | | | | | | | | | | | | | |

 | | | | | | | | | | | | | | | | | | | |

 | | | | | | | | | | | | | | | | | | | |

 | | | | | | | | | | | | | | | | | | | |

 | | | | | | | | | | | | | | | | | | | |

 | | | | | | | | | | | | | | | | | | | |
 | | | | | | | | | | | | | | | | | | | |

 | | | | | | | | | | | | | | | | | | | |

 | | | | | | | | | | | | | | | | | | | |
 | | | | | | | | | | | | | | | | | | | |

 | | | | | | | | | | | | | | | | | | | |

 | | | | | | | | | | | | | | | | | | | |
 | | | | | | | | | | | | | | | | | | | |
 | | | | | | | | | | | | | | | | | | | |

 | | | | | | | | | | | | | | | | | | | |
 | | | | | | | | | | | | | | | | | | | |
 | | | | | | | | | | | | | | | | | | | |

 | | | | | | | | | | | | | | | | | | | | | | | | | | | | | | | | | | | | | | | | | | | | | | | | | | | | | | | | | | | | | | | | | | | | | | | | | | | | | | | | | | | | | | | | | | | | | | | | | | | |
 | | | | | | | | | | | | | | | | | | | |
 | | | | | | | | | | | | | | | | | | | |
 | | | | | | | | | | | | | | | | | | | |
 | | | | | | | | | | | | | | | | | | | |
 | | | | | | | | | | | | | | | | | | | |
 | | | | | | | | | | | | | | | | | | | |
 | | | | | | | | | | | | | | | | | | | |
 | | | | | | | | | | | | | | | | | | | |
 | | | | | | | | | | | | | | | | | | | | | | | | | | | | | | | | | | | | | | | |
 | | | | | | | | | | | | | | | | | | | |
 | | | | | | | | | | | | | | | | | | | | | | | | | | | | | | | | | | | | | | | |
 | | | | | | | | | | | | | | | | | | | | | | | | | | | | | | | | | | | | | | | |
 | | | | | | | | | | | | | | | | | | | | | | | | | | | | | | | | | | | | | | | |
 | | | | | | | | | | | | | | | | | | | | | | | | | | | | | | | | | | | | | | | | | | | | | | | | | | | | | | | | | | | | | | | | | | | | | | | | | | | | | | | | | | | | | | | | | | | | | | | | | | | |
 | | | | | | | | | | | | | | | | | | | | | | | | | | | | | | | | | | | | | | | | | | | | | | | |
| | | <table border="1" style="width: 100%; border-collapse: collapse; text-align: center;"> <tr> <td style="width: 10%;"></td> <td style="width: 10%;"></td> <td style="width: 10%;"></td> <td style="width: 10%;"></td> <td style="width: 10%;"></td> <td style="width: 10%;"></td> <td style="width: 10%;"></td> <td style="width: 10%;"></td> <td style="width: 10%;"></td> <td style="width: 10%;"></td> </tr> <tr> <td></td> <td></td> <td colspan="8" style="text-align: center;"> <table border="1" style="width: 100%; border-collapse: collapse; text-align: center;"> <tr> <td style="width: 10%;"></td> <td style="width: 10%;"></td> <td style="width: 10%;"></td> <td style="width: 10%;"></td> <td style="width: 10%;"></td> <td style="width: 10%;"></td> <td style="width: 10%;"></td> <td style="width: 10%;"></td> <td style="width: 10%;"></td> <td style="width: 10%;"></td> </tr> <tr> <td></td> <td></td> <td colspan="8" style="text-align: center;"> <table border="1" style="width: 100%; border-collapse: collapse; text-align: center;"> <tr> <td style="width: 10%;"></td> <td style="width: 10%;"></td> <td style="width: 10%;"></td> <td style="width: 10%;"></td> <td style="width: 10%;"></td> <td style="width: 10%;"></td> <td style="width: 10%;"></td> <td style="width: 10%;"></td> <td style="width: 10%;"></td> <td style="width: 10%;"></td> </tr> <tr> <td></td> <td></td> <td colspan="8" style="text-align: center;"> <table border="1" style="width: 100%; border-collapse: collapse; text-align: center;"> <tr> <td style="width: 10%;"></td> <td style="width: 10%;"></td> <td style="width: 10%;"></td> <td style="width: 10%;"></td> <td style="width: 10%;"></td> <td style="width: 10%;"></td> <td style="width: 10%;"></td> <td style="width: 10%;"></td> <td style="width: 10%;"></td> <td style="width: 10%;"></td> </tr> <tr> <td></td> <td></td> <td colspan="8" style="text-align: center;"> <table border="1" style="width: 100%; border-collapse: collapse; text-align: center;"> <tr> <td style="width: 10%;"></td> <td style="width: 10%;"></td> <td style="width: 10%;"></td> <td style="width: 10%;"></td> <td style="width: 10%;"></td> <td style="width: 10%;"></td> <td style="width: 10%;"></td> <td style="width: 10%;"></td> <td style="width: 10%;"></td> <td style="width: 10%;"></td> </tr> <tr> <td></td> <td></td> <td colspan="8" style="text-align: center;"> <table border="1" style="width: 100%; border-collapse: collapse; text-align: center;"> <tr> <td style="width: 10%;"></td> <td style="width: 10%;"></td> <td style="width: 10%;"></td> <td style="width: 10%;"></td> <td style="width: 10%;"></td> <td style="width: 10%;"></td> <td style="width: 10%;"></td> <td style="width: 10%;"></td> <td style="width: 10%;"></td> <td style="width: 10%;"></td> </tr> <tr> <td></td> <td></td> <td colspan="8" style="text-align: center;"> <table border="1" style="width: 100%; border-collapse: collapse; text-align: center;"> <tr> <td style="width: 10%;"></td> <td style="width: 10%;"></td> <td style="width: 10%;"></td> <td style="width: 10%;"></td> <td style="width: 10%;"></td> <td style="width: 10%;"></td> <td style="width: 10%;"></td> <td style="width: 10%;"></td> <td style="width: 10%;"></td> <td style="width: 10%;"></td> </tr> <tr> <td></td> <td></td> <td colspan="8" style="text-align: center;"> <table border="1" style="width: 100%; border-collapse: collapse; text-align: center;"> <tr> <td style="width: 10%;"></td> <td style="width: 10%;"></td> <td style="width: 10%;"></td> <td style="width: 10%;"></td> <td style="width: 10%;"></td> <td style="width: 10%;"></td> <td style="width: 10%;"></td> <td style="width: 10%;"></td> <td style="width: 10%;"></td> <td style="width: 10%;"></td> </tr> <tr> <td></td> <td></td> <td colspan="8" style="text-align: center;"> <table border="1" style="width: 100%; border-collapse: collapse; text-align: center;"> <tr> <td style="width: 10%;"></td> <td style="width: 10%;"></td> <td style="width: 10%;"></td> <td style="width: 10%;"></td> <td style="width: 10%;"></td> <td style="width: 10%;"></td> <td style="width: 10%;"></td> <td style="width: 10%;"></td> <td style="width: 10%;"></td> <td style="width: 10%;"></td> </tr> <tr> <td></td> <td></td> <td colspan="8" style="text-align: center;"> <table border="1" style="width: 100%; border-collapse: collapse; text-align: center;"> <tr> <td style="width: 10%;"></td> <td style="width: 10%;"></td> <td style="width: 10%;"></td> <td style="width: 10%;"></td> <td style="width: 10%;"></td> <td style="width: 10%;"></td> <td style="width: 10%;"></td> <td style="width: 10%;"></td> <td style="width: 10%;"></td> <td style="width: 10%;"></td> </tr> <tr> <td></td> <td></td> <td colspan="8" style="text-align: center;"> <table border="1" style="width: 100%; border-collapse: collapse; text-align: center;"> <tr> <td style="width: 10%;"></td> <td style="width: 10%;"></td> <td style="width: 10%;"></td> <td style="width: 10%;"></td> <td style="width: 10%;"></td> <td style="width: 10%;"></td> <td style="width: 10%;"></td> <td style="width: 10%;"></td> <td style="width: 10%;"></td> <td style="width: 10%;"></td> </tr> <tr> <td></td> <td></td> <td colspan="8" style="text-align: center;"> <table border="1" style="width: 100%; border-collapse: collapse; text-align: center;"> <tr> <td style="width: 10%;"></td> <td style="width: 10%;"></td> <td style="width: 10%;"></td> <td style="width: 10%;"></td> <td style="width: 10%;"></td> <td style="width: 10%;"></td> <td style="width: 10%;"></td> <td style="width: 10%;"></td> <td style="width: 10%;"></td> <td style="width: 10%;"></td> </tr> <tr> <td></td> <td></td> <td colspan="8" style="text-align: center;"> <table border="1" style="width: 100%; border-collapse: collapse; text-align: center;"> <tr> <td style="width: 10%;"></td> <td style="width: 10%;"></td> <td style="width: 10%;"></td> <td style="width: 10%;"></td> <td style="width: 10%;"></td> <td style="width: 10%;"></td> <td style="width: 10%;"></td> <td style="width: 10%;"></td> <td style="width: 10%;"></td> <td style="width: 10%;"></td> </tr> <tr> <td></td> <td></td> <td colspan="8" style="text-align: center;"> <table border="1" style="width: 100%; border-collapse: collapse; text-align: center;"> <tr> <td style="width: 10%;"></td> <td style="width: 10%;"></td> <td style="width: 10%;"></td> <td style="width: 10%;"></td> <td style="width: 10%;"></td> <td style="width: 10%;"></td> <td style="width: 10%;"></td> <td style="width: 10%;"></td> <td style="width: 10%;"></td> <td style="width: 10%;"></td> </tr> <tr> <td></td> <td></td> <td colspan="8" style="text-align: center;"> <table border="1" style="width: 100%; border-collapse: collapse; text-align: center;"> <tr> <td style="width: 10%;"></td> <td style="width: 10%;"></td> <td style="width: 10%;"></td> <td style="width: 10%;"></td> <td style="width: 10%;"></td> <td style="width: 10%;"></td> <td style="width: 10%;"></td> <td style="width: 10%;"></td> <td style="width: 10%;"></td> <td style="width: 10%;"></td> </tr> <tr> <td></td> <td></td> <td colspan="8" style="text-align: center;"> <table border="1" style="width: 100%; border-collapse: collapse; text-align: center;"> <tr> <td style="width: 10%;"></td> <td style="width: 10%;"></td> <td style="width: 10%;"></td> <td style="width: 10%;"></td> <td style="width: 10%;"></td> <td style="width: 10%;"></td> <td style="width: 10%;"></td> <td style="width: 10%;"></td> <td style="width: 10%;"></td> <td style="width: 10%;"></td> </tr> <tr> <td></td> <td></td> <td colspan="8" style="text-align: center;"> <table border="1" style="width: 100%; border-collapse: collapse; text-align: center;"> <tr> <td style="width: 10%;"></td> <td style="width: 10%;"></td> <td style="width: 10%;"></td> <td style="width: 10%;"></td> <td style="width: 10%;"></td> <td style="width: 10%;"></td> <td style="width: 10%;"></td> <td style="width: 10%;"></td> <td style="width: 10%;"></td> <td style="width: 10%;"></td> </tr> <tr> <td></td> <td></td> <td colspan="8" style="text-align: center;"> <table border="1" style="width: 100%; border-collapse: collapse; text-align: center;"> <tr> <td style="width: 10%;"></td> <td style="width: 10%;"></td> <td style="width: 10%;"></td> <td style="width: 10%;"></td> <td style="width: 10%;"></td> <td style="width: 10%;"></td> <td style="width: 10%;"></td> <td style="width: 10%;"></td> <td style="width: 10%;"></td> <td style="width: 10%;"></td> </tr> <tr> <td></td> <td></td> <td colspan="8" style="text-align: center;"> <table border="1" style="width: 100%; border-collapse: collapse; text-align: center;"> <tr> <td style="width: 10%;"></td> <td style="width: 10%;"></td> <td style="width: 10%;"></td> <td style="width: 10%;"></td> <td style="width: 10%;"></td> <td style="width: 10%;"></td> <td style="width: 10%;"></td> <td style="width: 10%;"></td> <td style="width: 10%;"></td> <td style="width: 10%;"></td> </tr> <tr> <td></td> <td></td> <td colspan="8" style="text-align: center;"> <table border="1" style="width: 100%; border-collapse: collapse; text-align: center;"> <tr> <td style="width: 10%;"></td> <td style="width: 10%;"></td> <td style="width: 10%;"></td> <td style="width: 10%;"></td> <td style="width: 10%;"></td> <td style="width: 10%;"></td> <td style="width: 10%;"></td> <td style="width: 10%;"></td> <td style="width: 10%;"></td> <td style="width: 10%;"></td> </tr> <tr> <td></td> <td></td> <td colspan="8" style="text-align: center;"> <table border="1" style="width: 100%; border-collapse: collapse; text-align: center;"> <tr> <td style="width: 10%;"></td> <td style="width: 10%;"></td> <td style="width: 10%;"></td> <td style="width: 10%;"></td> <td style="width: 10%;"></td> <td style="width: 10%;"></td> <td style="width: 10%;"></td> <td style="width: 10%;"></td> <td style="width: 10%;"></td> <td style="width: 10%;"></td> </tr> <tr> <td></td> <td></td> <td colspan="8" style="text-align: center;"> <table border="1" style="width: 100%; border-collapse: collapse; text-align: center;"> <tr> <td style="width: 10%;"></td> <td style="width: 10%;"></td> <td
style="width: 10%;"></td> <td style="width: 10%;"></td> <td style="width: 10%;"></td> <td style="width: 10%;"></td> <td style="width: 10%;"></td> <td style="width: 10%;"></td> <td style="width: 10%;"></td> <td style="width: 10%;"></td> </tr> <tr> <td></td> <td></td> <td colspan="8" style="text-align: center;"> <table border="1" style="width: 100%; border-collapse: collapse; text-align: center;"> <tr> <td style="width: 10%;"></td> <td style="width: 10%;"></td> <td style="width: 10%;"></td> <td style="width: 10%;"></td> <td style="width: 10%;"></td> <td style="width: 10%;"></td> <td style="width: 10%;"></td> <td style="width: 10%;"></td> <td style="width: 10%;"></td> <td style="width: 10%;"></td> </tr> <tr> <td></td> <td></td> <td colspan="8" style="text-align: center;"> <table border="1" style="width: 100%; border-collapse: collapse; text-align: center;"> <tr> <td style="width: 10%;"></td> <td style="width: 10%;"></td> <td style="width: 10%;"></td> <td style="width: 10%;"></td> <td style="width: 10%;"></td> <td style="width: 10%;"></td> <td style="width: 10%;"></td> <td style="width: 10%;"></td> <td style="width: 10%;"></td> <td style="width: 10%;"></td> </tr> <tr> <td></td> <td></td> <td colspan="8" style="text-align: center;"> <table border="1" style="width: 100%; border-collapse: collapse; text-align: center;"> <tr> <td style="width: 10%;"></td> <td style="width: 10%;"></td> <td style="width: 10%;"></td> <td style="width: 10%;"></td> <td style="width: 10%;"></td> <td style="width: 10%;"></td> <td style="width: 10%;"></td> <td style="width: 10%;"></td> <td style="width: 10%;"></td> <td style="width: 10%;"></td> </tr> <tr> <td></td> <td></td> <td colspan="8" style="text-align: center;"> <table border="1" style="width: 100%; border-collapse: collapse; text-align: center;"> <tr> <td style="width: 10%;"></td> <td style="width: 10%;"></td> <td style="width: 10%;"></td> <td style="width: 10%;"></td> <td style="width: 10%;"></td> <td style="width: 10%;"></td> <td style="width: 10%;"></td> <td style="width: 10%;"></td> <td style="width: 10%;"></td> <td style="width: 10%;"></td> </tr> <tr> <td></td> <td></td> <td colspan="8" style="text-align: center;"> <table border="1" style="width: 100%; border-collapse: collapse; text-align: center;"> <tr> <td style="width: 10%;"></td> <td style="width: 10%;"></td> <td style="width: 10%;"></td> <td style="width: 10%;"></td> <td style="width: 10%;"></td> <td style="width: 10%;"></td> <td style="width: 10%;"></td> <td style="width: 10%;"></td> <td style="width: 10%;"></td> <td style="width: 10%;"></td> </tr> <tr> <td></td> <td></td> <td colspan="8" style="text-align: center;"> <table border="1" style="width: 100%; border-collapse: collapse; text-align: center;"> <tr> <td style="width: 10%;"></td> <td style="width: 10%;"></td> <td style="width: 10%;"></td> <td style="width: 10%;"></td> <td style="width: 10%;"></td> <td style="width: 10%;"></td> <td style="width: 10%;"></td> <td style="width: 10%;"></td> <td style="width: 10%;"></td> <td style="width: 10%;"></td> </tr> <tr> <td></td> <td></td> <td colspan="8" style="text-align: center;"> <table border="1" style="width: 100%; border-collapse: collapse; text-align: center;"> <tr> <td style="width: 10%;"></td> <td style="width: 10%;"></td> <td style="width: 10%;"></td> <td style="width: 10%;"></td> <td style="width: 10%;"></td> <td style="width: 10%;"></td> <td style="width: 10%;"></td> <td style="width: 10%;"></td> <td style="width: 10%;"></td> <td style="width: 10%;"></td> </tr> <tr> <td></td> <td></td> <td colspan="8" style="text-align: center;"> <table border="1" style="width: 100%; border-collapse: collapse; text-align: center;"> <tr> <td style="width: 10%;"></td> <td style="width: 10%;"></td> <td style="width: 10%;"></td> <td style="width: 10%;"></td> <td style="width: 10%;"></td> <td style="width: 10%;"></td> <td style="width: 10%;"></td> <td style="width: 10%;"></td> <td style="width: 10%;"></td> <td style="width: 10%;"></td> </tr> <tr> <td></td> <td></td> <td colspan="8" style="text-align: center;"> <table border="1" style="width: 100%; border-collapse: collapse; text-align: center;"> <tr> <td style="width: 10%;"></td> <td style="width: 10%;"></td> <td style="width: 10%;"></td> <td style="width: 10%;"></td> <td style="width: 10%;"></td> <td style="width: 10%;"></td> <td style="width: 10%;"></td> <td style="width: 10%;"></td> <td style="width: 10%;"></td> <td style="width: 10%;"></td> </tr> <tr> <td></td> <td></td> <td colspan="8" style="text-align: center;"> <table border="1" style="width: 100%; border-collapse: collapse; text-align: center;"> <tr> <td style="width: 10%;"></td> <td style="width: 10%;"></td> <td style="width: 10%;"></td> <td style="width: 10%;"></td> <td style="width: 10%;"></td> <td style="width: 10%;"></td> <td style="width: 10%;"></td> <td style="width: 10%;"></td> <td style="width: 10%;"></td> <td style="width: 10%;"></td> </tr> <tr> <td></td> <td></td> <td colspan="8" style="text-align: center;"> <table border="1" style="width: 100%; border-collapse: collapse; text-align: center;"> <tr> <td style="width: 10%;"></td> <td style="width: 10%;"></td> <td style="width: 10%;"></td> <td style="width: 10%;"></td> <td style="width: 10%;"></td> <td style="width: 10%;"></td> <td style="width: 10%;"></td> <td style="width: 10%;"></td> <td style="width: 10%;"></td> <td style="width: 10%;"></td> </tr> <tr> <td></td> <td></td> <td colspan="8" style="text-align: center;"> <table border="1" style="width: 100%; border-collapse: collapse; text-align: center;"> <tr> <td style="width: 10%;"></td> <td style="width: 10%;"></td> <td style="width: 10%;"></td> <td style="width: 10%;"></td> <td style="width: 10%;"></td> <td style="width: 10%;"></td> <td style="width: 10%;"></td> <td style="width: 10%;"></td> <td style="width: 10%;"></td> <td style="width: 10%;"></td> </tr> <tr> <td></td> <td></td> <td colspan="8" style="text-align: center;"> <table border="1" style="width: 100%; border-collapse: collapse; text-align: center;"> <tr> <td style="width: 10%;"></td> <td style="width: 10%;"></td> <td style="width: 10%;"></td> <td style="width: 10%;"></td> <td style="width: 10%;"></td> <td style="width: 10%;"></td> <td style="width: 10%;"></td> <td style="width: 10%;"></td> <td style="width: 10%;"></td> <td style="width: 10%;"></td> </tr> <tr> <td></td> <td></td> <td colspan="8" style="text-align: center;"> <table border="1" style="width: 100%; border-collapse: collapse; text-align: center;"> <tr> <td style="width: 10%;"></td> <td style="width: 10%;"></td> <td style="width: 10%;"></td> <td style="width: 10%;"></td> <td style="width: 10%;"></td> <td style="width: 10%;"></td> <td style="width: 10%;"></td> <td style="width: 10%;"></td> <td style="width: 10%;"></td> <td style="width: 10%;"></td> </tr> <tr> <td></td> <td></td> <td colspan="8" style="text-align: center;"> <table border="1" style="width: 100%; border-collapse: collapse; text-align: center;"> <tr> <td style="width: 10%;"></td> <td style="width: 10%;"></td> <td style="width: 10%;"></td> <td style="width: 10%;"></td> <td style="width: 10%;"></td> <td style="width: 10%;"></td> <td style="width: 10%;"></td> <td style="width: 10%;"></td> <td style="width: 10%;"></td> <td style="width: 10%;"></td> </tr> <tr> <td></td> <td></td> <td colspan="8" style="text-align: center;"> <table border="1" style="width: 100%; border-collapse: collapse; text-align: center;"> <tr> <td style="width: 10%;"></td> <td style="width: 10%;"></td> <td style="width: 10%;"></td> <td style="width: 10%;"></td> <td style="width: 10%;"></td> <td style="width: 10%;"></td> <td style="width: 10%;"></td> <td style="width: 10%;"></td> <td style="width: 10%;"></td> <td style="width: 10%;"></td> </tr> <tr> <td></td> <td></td> <td colspan="8" style="text-align: center;"> <table border="1" style="width: 100%; border-collapse: collapse; text-align: center;"> <tr> <td style="width: 10%;"></td> <td style="width: 10%;"></td> <td style="width: 10%;"></td> <td style="width: 10%;"></td> <td style="width: 10%;"></td> <td style="width: 10%;"></td> <td style="width: 10%;"></td> <td style="width: 10%;"></td> <td style="width: 10%;"></td> <td style="width: 10%;"></td> </tr> <tr> <td></td> <td></td> <td colspan="8" style="text-align: center;"> <table border="1" style="width: 100%; border-collapse: collapse; text-align: center;"> <tr> <td style="width: 10%;"></td> <td style="width: 10%;"></td> <td style="width: 10%;"></td> <td style="width: 10%;"></td> <td style="width: 10%;"></td> <td style="width: 10%;"></td> <td style="width: 10%;"></td> <td style="width: 10%;"></td> <td style="width: 10%;"></td> <td style="width: 10%;"></td> </tr> <tr> <td></td> <td></td> <td colspan="8" style="text-align: center;"> <table border="1" style="width: 100%; border-collapse: collapse; text-align: center;"> <tr> <td style="width: 10%;"></td> <td style="width: 10%;"></td> <td style="width: 10%;"></td> <td style="width: 10%;"></td> <td style="width: 10%;"></td> <td style="width: 10%;"></td> <td style="width: 10%;"></td> <td style="width: 10%;"></td> <td style="width: 10%;"></td> <td style="width: 10%;"></td> </tr> <tr> <td></td> <td></td> <td colspan="8" style="text-align: center;"> <table border="1" style="width: 100%; border-collapse: collapse; text-align: center;"> <tr> <td style="width: 10%;"></td> <td style="width: 10%;"></td> <td style="width: 10%;"></td> <td style="width: 10%;"></td> <td style="width: 10%;"></td> <td style="width: 10%;"></td> <td style="width: 10%;"></td> <td style="width: 10%;"></td> <td style="width: 10%;"></td> <td style="width: 10%;"></td> </tr> <tr> <td></td> <td></td> <td colspan="8" style="text-align: center;"> <table border="1" style="width: 100%; border-collapse: collapse; text-align: center;"> <tr> <td style="width: 10%;"></td> <td style="width: 10%;"></td> <td style="width: 10%;"></td> <td style="width: 10%;"></td> <td style="width: 10%;"></td> <td style="width: 10%;"></td> <td style="width: 10%;"></td> <td style="width:
10%;"></td> <td style="width: 10%;"></td> <td style="width: 10%;"></td> </tr> <tr> <td></td> <td></td> <td colspan="8" style="text-align: center;"> <table border="1" style="width: 100%; border-collapse: collapse; text-align: center;"> <tr> <td style="width: 10%;"></td> <td style="width: 10%;"></td> <td style="width: 10%;"></td> <td style="width: 10%;"></td> <td style="width: 10%;"></td> <td style="width: 10%;"></td> <td style="width: 10%;"></td> <td style="width: 10%;"></td> <td style="width: 10%;"></td> <td style="width: 10%;"></td> </tr> <tr> <td></td> <td></td> <td colspan="8" style="text-align: center;"> <table border="1" style="width: 100%; border-collapse: collapse; text-align: center;"> <tr> <td style="width: 10%;"></td> <td style="width: 10%;"></td> <td style="width: 10%;"></td> <td style="width: 10%;"></td> <td style="width: 10%;"></td> <td style="width: 10%;"></td> <td style="width: 10%;"></td> <td style="width: 10%;"></td> <td style="width: 10%;"></td> <td style="width: 10%;"></td> </tr> <tr> <td></td> <td></td> <td colspan="8" style="text-align: center;"> <table border="1" style="width: 100%; border-collapse: collapse; text-align: center;"> <tr> <td style="width: 10%;"></td> <td style="width: 10%;"></td> <td style="width: 10%;"></td> <td style="width: 10%;"></td> <td style="width: 10%;"></td> <td style="width: 10%;"></td> <td style="width: 10%;"></td> <td style="width: 10%;"></td> <td style="width: 10%;"></td> <td style="width: 10%;"></td> </tr> <tr> <td></td> <td></td> <td colspan="8" style="text-align: center;"> <table border="1" style="width: 100%; border-collapse: collapse; text-align: center;"> <tr> </tr></table></td></tr></table></td></tr></table></td></tr></table></td></tr></table></td></tr></table></td></tr></table></td></tr></table></td></tr></table></td></tr></table></td></tr></table></td></tr></table></td></tr></table></td></tr></table></td></tr></table></td></tr></table></td></tr></table></td></tr></table></td></tr></table></td></tr></table></td></tr></table></td></tr></table></td></tr></table></td></tr></table></td></tr></table></td></tr></table></td></tr></table></td></tr></table></td></tr></table></td></tr></table></td></tr></table></td></tr></table></td></tr></table></td></tr></table></td></tr></table></td></tr></table></td></tr></table></td></tr></table></td></tr></table></td></tr></table></td></tr></table></td></tr></table></td></tr></table></td></tr></table></td></tr></table></td></tr></table></td></tr></table>
 | | | | | | | | | | | | | | | | | | | | <table border="1" style="width: 100%; border-collapse: collapse; text-align: center;"> <tr> <td style="width: 10%;"></td> <td style="width: 10%;"></td> <td style="width: 10%;"></td> <td style="width: 10%;"></td> <td style="width: 10%;"></td> <td style="width: 10%;"></td> <td style="width: 10%;"></td> <td style="width: 10%;"></td> <td style="width: 10%;"></td> <td style="width: 10%;"></td> </tr> <tr> <td></td> <td></td> <td colspan="8" style="text-align: center;"> <table border="1" style="width: 100%; border-collapse: collapse; text-align: center;"> <tr> <td style="width: 10%;"></td> <td style="width: 10%;"></td> <td style="width: 10%;"></td> <td style="width: 10%;"></td> <td style="width: 10%;"></td> <td style="width: 10%;"></td> <td style="width: 10%;"></td> <td style="width: 10%;"></td> <td style="width: 10%;"></td> <td style="width: 10%;"></td> </tr> <tr> <td></td> <td></td> <td colspan="8" style="text-align: center;"> <table border="1" style="width: 100%; border-collapse: collapse; text-align: center;"> <tr> <td style="width: 10%;"></td> <td style="width: 10%;"></td> <td style="width: 10%;"></td> <td style="width: 10%;"></td> <td style="width: 10%;"></td> <td style="width: 10%;"></td> <td style="width: 10%;"></td> <td style="width: 10%;"></td> <td style="width: 10%;"></td> <td style="width: 10%;"></td> </tr> <tr> <td></td> <td></td> <td colspan="8" style="text-align: center;"> <table border="1" style="width: 100%; border-collapse: collapse; text-align: center;"> <tr> <td style="width: 10%;"></td> <td style="width: 10%;"></td> <td style="width: 10%;"></td> <td style="width: 10%;"></td> <td style="width: 10%;"></td> <td style="width: 10%;"></td> <td style="width: 10%;"></td> <td style="width: 10%;"></td> <td style="width: 10%;"></td> <td style="width: 10%;"></td> </tr> <tr> <td></td> <td></td> <td colspan="8" style="text-align: center;"> <table border="1" style="width: 100%; border-collapse: collapse; text-align: center;"> <tr> <td style="width: 10%;"></td> <td style="width: 10%;"></td> <td style="width: 10%;"></td> <td style="width: 10%;"></td> <td style="width: 10%;"></td> <td style="width: 10%;"></td> <td style="width: 10%;"></td> <td style="width: 10%;"></td> <td style="width: 10%;"></td> <td style="width: 10%;"></td> </tr> <tr> <td></td> <td></td> <td colspan="8" style="text-align: center;"> <table border="1" style="width: 100%; border-collapse: collapse; text-align: center;"> <tr> <td style="width: 10%;"></td> <td style="width: 10%;"></td> <td style="width: 10%;"></td> <td style="width: 10%;"></td> <td style="width: 10%;"></td> <td style="width: 10%;"></td> <td style="width: 10%;"></td> <td style="width: 10%;"></td> <td style="width: 10%;"></td> <td style="width: 10%;"></td> </tr> <tr> <td></td> <td></td> <td colspan="8" style="text-align: center;"> <table border="1" style="width: 100%; border-collapse: collapse; text-align: center;"> <tr> <td style="width: 10%;"></td> <td style="width: 10%;"></td> <td style="width: 10%;"></td> <td style="width: 10%;"></td> <td style="width: 10%;"></td> <td style="width: 10%;"></td> <td style="width: 10%;"></td> <td style="width: 10%;"></td> <td style="width: 10%;"></td> <td style="width: 10%;"></td> </tr> <tr> <td></td> <td></td> <td colspan="8" style="text-align: center;"> <table border="1" style="width: 100%; border-collapse: collapse; text-align: center;"> <tr> <td style="width: 10%;"></td> <td style="width: 10%;"></td> <td style="width: 10%;"></td> <td style="width: 10%;"></td> <td style="width: 10%;"></td> <td style="width: 10%;"></td> <td style="width: 10%;"></td> <td style="width: 10%;"></td> <td style="width: 10%;"></td> <td style="width: 10%;"></td> </tr> <tr> <td></td> <td></td> <td colspan="8" style="text-align: center;"> <table border="1" style="width: 100%; border-collapse: collapse; text-align: center;"> <tr> <td style="width: 10%;"></td> <td style="width: 10%;"></td> <td style="width: 10%;"></td> <td style="width: 10%;"></td> <td style="width: 10%;"></td> <td style="width: 10%;"></td> <td style="width: 10%;"></td> <td style="width: 10%;"></td> <td style="width: 10%;"></td> <td style="width: 10%;"></td> </tr> <tr> <td></td> <td></td> <td colspan="8" style="text-align: center;"> <table border="1" style="width: 100%; border-collapse: collapse; text-align: center;"> <tr> <td style="width: 10%;"></td> <td style="width: 10%;"></td> <td style="width: 10%;"></td> <td style="width: 10%;"></td> <td style="width: 10%;"></td> <td style="width: 10%;"></td> <td style="width: 10%;"></td> <td style="width: 10%;"></td> <td style="width: 10%;"></td> <td style="width: 10%;"></td> </tr> <tr> <td></td> <td></td> <td colspan="8" style="text-align: center;"> <table border="1" style="width: 100%; border-collapse: collapse; text-align: center;"> <tr> <td style="width: 10%;"></td> <td style="width: 10%;"></td> <td style="width: 10%;"></td> <td style="width: 10%;"></td> <td style="width: 10%;"></td> <td style="width: 10%;"></td> <td style="width: 10%;"></td> <td style="width: 10%;"></td> <td style="width: 10%;"></td> <td style="width: 10%;"></td> </tr> <tr> <td></td> <td></td> <td colspan="8" style="text-align: center;"> <table border="1" style="width: 100%; border-collapse: collapse; text-align: center;"> <tr> <td style="width: 10%;"></td> <td style="width: 10%;"></td> <td style="width: 10%;"></td> <td style="width: 10%;"></td> <td style="width: 10%;"></td> <td style="width: 10%;"></td> <td style="width: 10%;"></td> <td style="width: 10%;"></td> <td style="width: 10%;"></td> <td style="width: 10%;"></td> </tr> <tr> <td></td> <td></td> <td colspan="8" style="text-align: center;"> <table border="1" style="width: 100%; border-collapse: collapse; text-align: center;"> <tr> <td style="width: 10%;"></td> <td style="width: 10%;"></td> <td style="width: 10%;"></td> <td style="width: 10%;"></td> <td style="width: 10%;"></td> <td style="width: 10%;"></td> <td style="width: 10%;"></td> <td style="width: 10%;"></td> <td style="width: 10%;"></td> <td style="width: 10%;"></td> </tr> <tr> <td></td> <td></td> <td colspan="8" style="text-align: center;"> <table border="1" style="width: 100%; border-collapse: collapse; text-align: center;"> <tr> <td style="width: 10%;"></td> <td style="width: 10%;"></td> <td style="width: 10%;"></td> <td style="width: 10%;"></td> <td style="width: 10%;"></td> <td style="width: 10%;"></td> <td style="width: 10%;"></td> <td style="width: 10%;"></td> <td style="width: 10%;"></td> <td style="width: 10%;"></td> </tr> <tr> <td></td> <td></td> <td colspan="8" style="text-align: center;"> <table border="1" style="width: 100%; border-collapse: collapse; text-align: center;"> <tr> <td style="width: 10%;"></td> <td style="width: 10%;"></td> <td style="width: 10%;"></td> <td style="width: 10%;"></td> <td style="width: 10%;"></td> <td style="width: 10%;"></td> <td style="width: 10%;"></td> <td style="width: 10%;"></td> <td style="width: 10%;"></td> <td style="width: 10%;"></td> </tr> <tr> <td></td> <td></td> <td colspan="8" style="text-align: center;"> <table border="1" style="width: 100%; border-collapse: collapse; text-align: center;"> <tr> <td style="width: 10%;"></td> <td style="width: 10%;"></td> <td style="width: 10%;"></td> <td style="width: 10%;"></td> <td style="width: 10%;"></td> <td style="width: 10%;"></td> <td style="width: 10%;"></td> <td style="width: 10%;"></td> <td style="width: 10%;"></td> <td style="width: 10%;"></td> </tr> <tr> <td></td> <td></td> <td colspan="8" style="text-align: center;"> <table border="1" style="width: 100%; border-collapse: collapse; text-align: center;"> <tr> <td style="width: 10%;"></td> <td style="width: 10%;"></td> <td style="width: 10%;"></td> <td style="width: 10%;"></td> <td style="width: 10%;"></td> <td style="width: 10%;"></td> <td style="width: 10%;"></td> <td style="width: 10%;"></td> <td style="width: 10%;"></td> <td style="width: 10%;"></td> </tr> <tr> <td></td> <td></td> <td colspan="8" style="text-align: center;"> <table border="1" style="width: 100%; border-collapse: collapse; text-align: center;"> <tr> <td style="width: 10%;"></td> <td style="width: 10%;"></td> <td style="width: 10%;"></td> <td style="width: 10%;"></td> <td style="width: 10%;"></td> <td style="width: 10%;"></td> <td style="width: 10%;"></td> <td style="width: 10%;"></td> <td style="width: 10%;"></td> <td style="width: 10%;"></td> </tr> <tr> <td></td> <td></td> <td colspan="8" style="text-align: center;"> <table border="1" style="width: 100%; border-collapse: collapse; text-align: center;"> <tr> <td style="width: 10%;"></td> <td style="width: 10%;"></td> <td style="width: 10%;"></td> <td style="width: 10%;"></td> <td style="width: 10%;"></td> <td style="width:
10%;"></td> <td style="width: 10%;"></td> <td style="width: 10%;"></td> <td style="width: 10%;"></td> <td style="width: 10%;"></td> </tr> <tr> <td></td> <td></td> <td colspan="8" style="text-align: center;"> <table border="1" style="width: 100%; border-collapse: collapse; text-align: center;"> <tr> <td style="width: 10%;"></td> <td style="width: 10%;"></td> <td style="width: 10%;"></td> <td style="width: 10%;"></td> <td style="width: 10%;"></td> <td style="width: 10%;"></td> <td style="width: 10%;"></td> <td style="width: 10%;"></td> <td style="width: 10%;"></td> <td style="width: 10%;"></td> </tr> <tr> <td></td> <td></td> <td colspan="8" style="text-align: center;"> <table border="1" style="width: 100%; border-collapse: collapse; text-align: center;"> <tr> <td style="width: 10%;"></td> <td style="width: 10%;"></td> <td style="width: 10%;"></td> <td style="width: 10%;"></td> <td style="width: 10%;"></td> <td style="width: 10%;"></td> <td style="width: 10%;"></td> <td style="width: 10%;"></td> <td style="width: 10%;"></td> <td style="width: 10%;"></td> </tr> <tr> <td></td> <td></td> <td colspan="8" style="text-align: center;"> <table border="1" style="width: 100%; border-collapse: collapse; text-align: center;"> <tr> <td style="width: 10%;"></td> <td style="width: 10%;"></td> <td style="width: 10%;"></td> <td style="width: 10%;"></td> <td style="width: 10%;"></td> <td style="width: 10%;"></td> <td style="width: 10%;"></td> <td style="width: 10%;"></td> <td style="width: 10%;"></td> <td style="width: 10%;"></td> </tr> <tr> <td></td> <td></td> <td colspan="8" style="text-align: center;"> <table border="1" style="width: 100%; border-collapse: collapse; text-align: center;"> <tr> <td style="width: 10%;"></td> <td style="width: 10%;"></td> <td style="width: 10%;"></td> <td style="width: 10%;"></td> <td style="width: 10%;"></td> <td style="width: 10%;"></td> <td style="width: 10%;"></td> <td style="width: 10%;"></td> <td style="width: 10%;"></td> <td style="width: 10%;"></td> </tr> <tr> <td></td> <td></td> <td colspan="8" style="text-align: center;"> <table border="1" style="width: 100%; border-collapse: collapse; text-align: center;"> <tr> <td style="width: 10%;"></td> <td style="width: 10%;"></td> <td style="width: 10%;"></td> <td style="width: 10%;"></td> <td style="width: 10%;"></td> <td style="width: 10%;"></td> <td style="width: 10%;"></td> <td style="width: 10%;"></td> <td style="width: 10%;"></td> <td style="width: 10%;"></td> </tr> <tr> <td></td> <td></td> <td colspan="8" style="text-align: center;"> <table border="1" style="width: 100%; border-collapse: collapse; text-align: center;"> <tr> <td style="width: 10%;"></td> <td style="width: 10%;"></td> <td style="width: 10%;"></td> <td style="width: 10%;"></td> <td style="width: 10%;"></td> <td style="width: 10%;"></td> <td style="width: 10%;"></td> <td style="width: 10%;"></td> <td style="width: 10%;"></td> <td style="width: 10%;"></td> </tr> <tr> <td></td> <td></td> <td colspan="8" style="text-align: center;"> <table border="1" style="width: 100%; border-collapse: collapse; text-align: center;"> <tr> <td style="width: 10%;"></td> <td style="width: 10%;"></td> <td style="width: 10%;"></td> <td style="width: 10%;"></td> <td style="width: 10%;"></td> <td style="width: 10%;"></td> <td style="width: 10%;"></td> <td style="width: 10%;"></td> <td style="width: 10%;"></td> <td style="width: 10%;"></td> </tr> <tr> <td></td> <td></td> <td colspan="8" style="text-align: center;"> <table border="1" style="width: 100%; border-collapse: collapse; text-align: center;"> <tr> <td style="width: 10%;"></td> <td style="width: 10%;"></td> <td style="width: 10%;"></td> <td style="width: 10%;"></td> <td style="width: 10%;"></td> <td style="width: 10%;"></td> <td style="width: 10%;"></td> <td style="width: 10%;"></td> <td style="width: 10%;"></td> <td style="width: 10%;"></td> </tr> <tr> <td></td> <td></td> <td colspan="8" style="text-align: center;"> <table border="1" style="width: 100%; border-collapse: collapse; text-align: center;"> <tr> <td style="width: 10%;"></td> <td style="width: 10%;"></td> <td style="width: 10%;"></td> <td style="width: 10%;"></td> <td style="width: 10%;"></td> <td style="width: 10%;"></td> <td style="width: 10%;"></td> <td style="width: 10%;"></td> <td style="width: 10%;"></td> <td style="width: 10%;"></td> </tr> <tr> <td></td> <td></td> <td colspan="8" style="text-align: center;"> <table border="1" style="width: 100%; border-collapse: collapse; text-align: center;"> <tr> <td style="width: 10%;"></td> <td style="width: 10%;"></td> <td style="width: 10%;"></td> <td style="width: 10%;"></td> <td style="width: 10%;"></td> <td style="width: 10%;"></td> <td style="width: 10%;"></td> <td style="width: 10%;"></td> <td style="width: 10%;"></td> <td style="width: 10%;"></td> </tr> <tr> <td></td> <td></td> <td colspan="8" style="text-align: center;"> <table border="1" style="width: 100%; border-collapse: collapse; text-align: center;"> <tr> <td style="width: 10%;"></td> <td style="width: 10%;"></td> <td style="width: 10%;"></td> <td style="width: 10%;"></td> <td style="width: 10%;"></td> <td style="width: 10%;"></td> <td style="width: 10%;"></td> <td style="width: 10%;"></td> <td style="width: 10%;"></td> <td style="width: 10%;"></td> </tr> <tr> <td></td> <td></td> <td colspan="8" style="text-align: center;"> <table border="1" style="width: 100%; border-collapse: collapse; text-align: center;"> <tr> <td style="width: 10%;"></td> <td style="width: 10%;"></td> <td style="width: 10%;"></td> <td style="width: 10%;"></td> <td style="width: 10%;"></td> <td style="width: 10%;"></td> <td style="width: 10%;"></td> <td style="width: 10%;"></td> <td style="width: 10%;"></td> <td style="width: 10%;"></td> </tr> <tr> <td></td> <td></td> <td colspan="8" style="text-align: center;"> <table border="1" style="width: 100%; border-collapse: collapse; text-align: center;"> <tr> <td style="width: 10%;"></td> <td style="width: 10%;"></td> <td style="width: 10%;"></td> <td style="width: 10%;"></td> <td style="width: 10%;"></td> <td style="width: 10%;"></td> <td style="width: 10%;"></td> <td style="width: 10%;"></td> <td style="width: 10%;"></td> <td style="width: 10%;"></td> </tr> <tr> <td></td> <td></td> <td colspan="8" style="text-align: center;"> <table border="1" style="width: 100%; border-collapse: collapse; text-align: center;"> <tr> <td style="width: 10%;"></td> <td style="width: 10%;"></td> <td style="width: 10%;"></td> <td style="width: 10%;"></td> <td style="width: 10%;"></td> <td style="width: 10%;"></td> <td style="width: 10%;"></td> <td style="width: 10%;"></td> <td style="width: 10%;"></td> <td style="width: 10%;"></td> </tr> <tr> <td></td> <td></td> <td colspan="8" style="text-align: center;"> <table border="1" style="width: 100%; border-collapse: collapse; text-align: center;"> <tr> <td style="width: 10%;"></td> <td style="width: 10%;"></td> <td style="width: 10%;"></td> <td style="width: 10%;"></td> <td style="width: 10%;"></td> <td style="width: 10%;"></td> <td style="width: 10%;"></td> <td style="width: 10%;"></td> <td style="width: 10%;"></td> <td style="width: 10%;"></td> </tr> <tr> <td></td> <td></td> <td colspan="8" style="text-align: center;"> <table border="1" style="width: 100%; border-collapse: collapse; text-align: center;"> <tr> <td style="width: 10%;"></td> <td style="width: 10%;"></td> <td style="width: 10%;"></td> <td style="width: 10%;"></td> <td style="width: 10%;"></td> <td style="width: 10%;"></td> <td style="width: 10%;"></td> <td style="width: 10%;"></td> <td style="width: 10%;"></td> <td style="width: 10%;"></td> </tr> <tr> <td></td> <td></td> <td colspan="8" style="text-align: center;"> <table border="1" style="width: 100%; border-collapse: collapse; text-align: center;"> <tr> <td style="width: 10%;"></td> <td style="width: 10%;"></td> <td style="width: 10%;"></td> <td style="width: 10%;"></td> <td style="width: 10%;"></td> <td style="width: 10%;"></td> <td style="width: 10%;"></td> <td style="width: 10%;"></td> <td style="width: 10%;"></td> <td style="width: 10%;"></td> </tr> <tr> <td></td> <td></td> <td colspan="8" style="text-align: center;"> <table border="1" style="width: 100%; border-collapse: collapse; text-align: center;"> <tr> <td style="width: 10%;"></td> <td style="width: 10%;"></td> <td style="width: 10%;"></td> <td style="width: 10%;"></td> <td style="width: 10%;"></td> <td style="width: 10%;"></td> <td style="width: 10%;"></td> <td style="width: 10%;"></td> <td style="width: 10%;"></td> <td style="width: 10%;"></td> </tr> <tr> <td></td> <td></td> <td colspan="8" style="text-align: center;"> <table border="1" style="width: 100%; border-collapse: collapse; text-align: center;"> <tr> <td style="width: 10%;"></td> <td style="width: 10%;"></td> <td style="width: 10%;"></td> <td style="width: 10%;"></td> <td style="width: 10%;"></td> <td style="width: 10%;"></td> <td style="width: 10%;"></td> <td style="width: 10%;"></td> <td style="width: 10%;"></td> <td style="width: 10%;"></td> </tr> <tr> <td></td> <td></td> <td colspan="8" style="text-align: center;"> <table border="1" style="width: 100%; border-collapse: collapse; text-align: center;"> <tr> <td style="width: 10%;"></td> <td style="width: 10%;"></td> <td style="width: 10%;"></td> <td style="width: 10%;"></td> <td style="width: 10%;"></td> <td style="width: 10%;"></td> <td style="width: 10%;"></td> <td style="width: 10%;"></td> <td style="width: 10%;"></td> <td style="width: 10%;"></td> </tr> <tr> <td></td> <td></td> <td colspan="8" style="text-align: center;"> <table border="1" style="width: 100%; border-collapse: collapse; text-align: center;"> <tr> <td style="width: 10%;"></td> <td style="width: 10%;"></td> <td style="width: 10%;"></td> <td style="width: 10%;"></td> <td style="width: 10%;"></td> <td style="width: 10%;"></td> <td style="width: 10%;"></td> <td style="width: 10%;"></td> <td style="width: 10%;"></td> <td style="width: 10%;"></td> </tr> <tr> <td></td> <td></td> <td
colspan="8" style="text-align: center;"> <table border="1" style="width: 100%; border-collapse: collapse; text-align: center;"> <tr> <td style="width: 10%;"></td> <td style="width: 10%;"></td> <td style="width: 10%;"></td> <td style="width: 10%;"></td> <td style="width: 10%;"></td> <td style="width: 10%;"></td> <td style="width: 10%;"></td> <td style="width: 10%;"></td> <td style="width: 10%;"></td> <td style="width: 10%;"></td> </tr> <tr> <td></td> <td></td> <td colspan="8" style="text-align: center;"> <table border="1" style="width: 100%; border-collapse: collapse; text-align: center;"> <tr> <td style="width: 10%;"></td> <td style="width: 10%;"></td> <td style="width: 10%;"></td> <td style="width: 10%;"></td> <td style="width: 10%;"></td> <td style="width: 10%;"></td> <td style="width: 10%;"></td> <td style="width: 10%;"></td> <td style="width: 10%;"></td> <td style="width: 10%;"></td> </tr> <tr> <td></td> <td></td> <td colspan="8" style="text-align: center;"> <table border="1" style="width: 100%; border-collapse: collapse; text-align: center;"> <tr> <td style="width: 10%;"></td> <td style="width: 10%;"></td> <td style="width: 10%;"></td> <td style="width: 10%;"></td> <td style="width: 10%;"></td> <td style="width: 10%;"></td> <td style="width: 10%;"></td> <td style="width: 10%;"></td> <td style="width: 10%;"></td> <td style="width: 10%;"></td> </tr> <tr> <td></td> <td></td> <td colspan="8" style="text-align: center;"> <table border="1" style="width: 100%; border-collapse: collapse; text-align: center;"> <tr> <td style="width: 10%;"></td> <td style="width: 10%;"></td> <td style="width: 10%;"></td> <td style="width: 10%;"></td> <td style="width: 10%;"></td> <td style="width: 10%;"></td> <td style="width: 10%;"></td> <td style="width: 10%;"></td> <td style="width: 10%;"></td> <td style="width: 10%;"></td> </tr> <tr> <td></td> <td></td> <td colspan="8" style="text-align: center;"> <table border="1" style="width: 100%; border-collapse: collapse; text-align: center;"> <tr> <td style="width: 10%;"></td> <td style="width: 10%;"></td> <td style="width: 10%;"></td> <td style="width: 10%;"></td> <td style="width: 10%;"></td> <td style="width: 10%;"></td> <td style="width: 10%;"></td> <td style="width: 10%;"></td> <td style="width: 10%;"></td> <td style="width: 10%;"></td> </tr> <tr> <td></td> <td></td> <td colspan="8" style="text-align: center;"> <table border="1" style="width: 100%; border-collapse: collapse; text-align: center;"> <tr> </tr></table></td></tr></table></td></tr></table></td></tr></table></td></tr></table></td></tr></table></td></tr></table></td></tr></table></td></tr></table></td></tr></table></td></tr></table></td></tr></table></td></tr></table></td></tr></table></td></tr></table></td></tr></table></td></tr></table></td></tr></table></td></tr></table></td></tr></table></td></tr></table></td></tr></table></td></tr></table></td></tr></table></td></tr></table></td></tr></table></td></tr></table></td></tr></table></td></tr></table></td></tr></table></td></tr></table></td></tr></table></td></tr></table></td></tr></table></td></tr></table></td></tr></table></td></tr></table></td></tr></table></td></tr></table></td></tr></table></td></tr></table></td></tr></table></td></tr></table></td></tr></table></td></tr></table></td></tr></table>
 | | | | | | | | | | | | | | | | | | | | <table border="1" style="width: 100%; border-collapse: collapse; text-align: center;"> <tr> <td style="width: 10%;"></td> <td style="width: 10%;"></td> <td style="width: 10%;"></td> <td style="width: 10%;"></td> <td style="width: 10%;"></td> <td style="width: 10%;"></td> <td style="width: 10%;"></td> <td style="width: 10%;"></td> <td style="width: 10%;"></td> <td style="width: 10%;"></td> </tr> <tr> <td></td> <td></td> <td colspan="8" style="text-align: center;"> <table border="1" style="width: 100%; border-collapse: collapse; text-align: center;"> <tr> <td style="width: 10%;"></td> <td style="width: 10%;"></td> <td style="width: 10%;"></td> <td style="width: 10%;"></td> <td style="width: 10%;"></td> <td style="width: 10%;"></td> <td style="width: 10%;"></td> <td style="width: 10%;"></td> <td style="width: 10%;"></td> <td style="width: 10%;"></td> </tr> <tr> <td></td> <td></td> <td colspan="8" style="text-align: center;"> <table border="1" style="width: 100%; border-collapse: collapse; text-align: center;"> <tr> <td style="width: 10%;"></td> <td style="width: 10%;"></td> <td style="width: 10%;"></td> <td style="width: 10%;"></td> <td style="width: 10%;"></td> <td style="width: 10%;"></td> <td style="width: 10%;"></td> <td style="width: 10%;"></td> <td style="width: 10%;"></td> <td style="width: 10%;"></td> </tr> <tr> <td></td> <td></td> <td colspan="8" style="text-align: center;"> <table border="1" style="width: 100%; border-collapse: collapse; text-align: center;"> <tr> <td style="width: 10%;"></td> <td style="width: 10%;"></td> <td style="width: 10%;"></td> <td style="width: 10%;"></td> <td style="width: 10%;"></td> <td style="width: 10%;"></td> <td style="width: 10%;"></td> <td style="width: 10%;"></td> <td style="width: 10%;"></td> <td style="width: 10%;"></td> </tr> <tr> <td></td> <td></td> <td colspan="8" style="text-align: center;"> <table border="1" style="width: 100%; border-collapse: collapse; text-align: center;"> <tr> <td style="width: 10%;"></td> <td style="width: 10%;"></td> <td style="width: 10%;"></td> <td style="width: 10%;"></td> <td style="width: 10%;"></td> <td style="width: 10%;"></td> <td style="width: 10%;"></td> <td style="width: 10%;"></td> <td style="width: 10%;"></td> <td style="width: 10%;"></td> </tr> <tr> <td></td> <td></td> <td colspan="8" style="text-align: center;"> <table border="1" style="width: 100%; border-collapse: collapse; text-align: center;"> <tr> <td style="width: 10%;"></td> <td style="width: 10%;"></td> <td style="width: 10%;"></td> <td style="width: 10%;"></td> <td style="width: 10%;"></td> <td style="width: 10%;"></td> <td style="width: 10%;"></td> <td style="width: 10%;"></td> <td style="width: 10%;"></td> <td style="width: 10%;"></td> </tr> <tr> <td></td> <td></td> <td colspan="8" style="text-align: center;"> <table border="1" style="width: 100%; border-collapse: collapse; text-align: center;"> <tr> <td style="width: 10%;"></td> <td style="width: 10%;"></td> <td style="width: 10%;"></td> <td style="width: 10%;"></td> <td style="width: 10%;"></td> <td style="width: 10%;"></td> <td style="width: 10%;"></td> <td style="width: 10%;"></td> <td style="width: 10%;"></td> <td style="width: 10%;"></td> </tr> <tr> <td></td> <td></td> <td colspan="8" style="text-align: center;"> <table border="1" style="width: 100%; border-collapse: collapse; text-align: center;"> <tr> <td style="width: 10%;"></td> <td style="width: 10%;"></td> <td style="width: 10%;"></td> <td style="width: 10%;"></td> <td style="width: 10%;"></td> <td style="width: 10%;"></td> <td style="width: 10%;"></td> <td style="width: 10%;"></td> <td style="width: 10%;"></td> <td style="width: 10%;"></td> </tr> <tr> <td></td> <td></td> <td colspan="8" style="text-align: center;"> <table border="1" style="width: 100%; border-collapse: collapse; text-align: center;"> <tr> <td style="width: 10%;"></td> <td style="width: 10%;"></td> <td style="width: 10%;"></td> <td style="width: 10%;"></td> <td style="width: 10%;"></td> <td style="width: 10%;"></td> <td style="width: 10%;"></td> <td style="width: 10%;"></td> <td style="width: 10%;"></td> <td style="width: 10%;"></td> </tr> <tr> <td></td> <td></td> <td colspan="8" style="text-align: center;"> <table border="1" style="width: 100%; border-collapse: collapse; text-align: center;"> <tr> <td style="width: 10%;"></td> <td style="width: 10%;"></td> <td style="width: 10%;"></td> <td style="width: 10%;"></td> <td style="width: 10%;"></td> <td style="width: 10%;"></td> <td style="width: 10%;"></td> <td style="width: 10%;"></td> <td style="width: 10%;"></td> <td style="width: 10%;"></td> </tr> <tr> <td></td> <td></td> <td colspan="8" style="text-align: center;"> <table border="1" style="width: 100%; border-collapse: collapse; text-align: center;"> <tr> <td style="width: 10%;"></td> <td style="width: 10%;"></td> <td style="width: 10%;"></td> <td style="width: 10%;"></td> <td style="width: 10%;"></td> <td style="width: 10%;"></td> <td style="width: 10%;"></td> <td style="width: 10%;"></td> <td style="width: 10%;"></td> <td style="width: 10%;"></td> </tr> <tr> <td></td> <td></td> <td colspan="8" style="text-align: center;"> <table border="1" style="width: 100%; border-collapse: collapse; text-align: center;"> <tr> <td style="width: 10%;"></td> <td style="width: 10%;"></td> <td style="width: 10%;"></td> <td style="width: 10%;"></td> <td style="width: 10%;"></td> <td style="width: 10%;"></td> <td style="width: 10%;"></td> <td style="width: 10%;"></td> <td style="width: 10%;"></td> <td style="width: 10%;"></td> </tr> <tr> <td></td> <td></td> <td colspan="8" style="text-align: center;"> <table border="1" style="width: 100%; border-collapse: collapse; text-align: center;"> <tr> <td style="width: 10%;"></td> <td style="width: 10%;"></td> <td style="width: 10%;"></td> <td style="width: 10%;"></td> <td style="width: 10%;"></td> <td style="width: 10%;"></td> <td style="width: 10%;"></td> <td style="width: 10%;"></td> <td style="width: 10%;"></td> <td style="width: 10%;"></td> </tr> <tr> <td></td> <td></td> <td colspan="8" style="text-align: center;"> <table border="1" style="width: 100%; border-collapse: collapse; text-align: center;"> <tr> <td style="width: 10%;"></td> <td style="width: 10%;"></td> <td style="width: 10%;"></td> <td style="width: 10%;"></td> <td style="width: 10%;"></td> <td style="width: 10%;"></td> <td style="width: 10%;"></td> <td style="width: 10%;"></td> <td style="width: 10%;"></td> <td style="width: 10%;"></td> </tr> <tr> <td></td> <td></td> <td colspan="8" style="text-align: center;"> <table border="1" style="width: 100%; border-collapse: collapse; text-align: center;"> <tr> <td style="width: 10%;"></td> <td style="width: 10%;"></td> <td style="width: 10%;"></td> <td style="width: 10%;"></td> <td style="width: 10%;"></td> <td style="width: 10%;"></td> <td style="width: 10%;"></td> <td style="width: 10%;"></td> <td style="width: 10%;"></td> <td style="width: 10%;"></td> </tr> <tr> <td></td> <td></td> <td colspan="8" style="text-align: center;"> <table border="1" style="width: 100%; border-collapse: collapse; text-align: center;"> <tr> <td style="width: 10%;"></td> <td style="width: 10%;"></td> <td style="width: 10%;"></td> <td style="width: 10%;"></td> <td style="width: 10%;"></td> <td style="width: 10%;"></td> <td style="width: 10%;"></td> <td style="width: 10%;"></td> <td style="width: 10%;"></td> <td style="width: 10%;"></td> </tr> <tr> <td></td> <td></td> <td colspan="8" style="text-align: center;"> <table border="1" style="width: 100%; border-collapse: collapse; text-align: center;"> <tr> <td style="width: 10%;"></td> <td style="width: 10%;"></td> <td style="width: 10%;"></td> <td style="width: 10%;"></td> <td style="width: 10%;"></td> <td style="width: 10%;"></td> <td style="width: 10%;"></td> <td style="width: 10%;"></td> <td style="width: 10%;"></td> <td style="width: 10%;"></td> </tr> <tr>
<td></td> <td></td> <td colspan="8" style="text-align: center;"> <table border="1" style="width: 100%; border-collapse: collapse; text-align: center;"> <tr> <td style="width: 10%;"></td> <td style="width: 10%;"></td> <td style="width: 10%;"></td> <td style="width: 10%;"></td> <td style="width: 10%;"></td> <td style="width: 10%;"></td> <td style="width: 10%;"></td> <td style="width: 10%;"></td> <td style="width: 10%;"></td> <td style="width: 10%;"></td> </tr> <tr> <td></td> <td></td> <td colspan="8" style="text-align: center;"> <table border="1" style="width: 100%; border-collapse: collapse; text-align: center;"> <tr> <td style="width: 10%;"></td> <td style="width: 10%;"></td> <td style="width: 10%;"></td> <td style="width: 10%;"></td> <td style="width: 10%;"></td> <td style="width: 10%;"></td> <td style="width: 10%;"></td> <td style="width: 10%;"></td> <td style="width: 10%;"></td> <td style="width: 10%;"></td> </tr> <tr> <td></td> <td></td> <td colspan="8" style="text-align: center;"> <table border="1" style="width: 100%; border-collapse: collapse; text-align: center;"> <tr> <td style="width: 10%;"></td> <td style="width: 10%;"></td> <td style="width: 10%;"></td> <td style="width: 10%;"></td> <td style="width: 10%;"></td> <td style="width: 10%;"></td> <td style="width: 10%;"></td> <td style="width: 10%;"></td> <td style="width: 10%;"></td> <td style="width: 10%;"></td> </tr> <tr> <td></td> <td></td> <td colspan="8" style="text-align: center;"> <table border="1" style="width: 100%; border-collapse: collapse; text-align: center;"> <tr> <td style="width: 10%;"></td> <td style="width: 10%;"></td> <td style="width: 10%;"></td> <td style="width: 10%;"></td> <td style="width: 10%;"></td> <td style="width: 10%;"></td> <td style="width: 10%;"></td> <td style="width: 10%;"></td> <td style="width: 10%;"></td> <td style="width: 10%;"></td> </tr> <tr> <td></td> <td></td> <td colspan="8" style="text-align: center;"> <table border="1" style="width: 100%; border-collapse: collapse; text-align: center;"> <tr> <td style="width: 10%;"></td> <td style="width: 10%;"></td> <td style="width: 10%;"></td> <td style="width: 10%;"></td> <td style="width: 10%;"></td> <td style="width: 10%;"></td> <td style="width: 10%;"></td> <td style="width: 10%;"></td> <td style="width: 10%;"></td> <td style="width: 10%;"></td> </tr> <tr> <td></td> <td></td> <td colspan="8" style="text-align: center;"> <table border="1" style="width: 100%; border-collapse: collapse; text-align: center;"> <tr> <td style="width: 10%;"></td> <td style="width: 10%;"></td> <td style="width: 10%;"></td> <td style="width: 10%;"></td> <td style="width: 10%;"></td> <td style="width: 10%;"></td> <td style="width: 10%;"></td> <td style="width: 10%;"></td> <td style="width: 10%;"></td> <td style="width: 10%;"></td> </tr> <tr> <td></td> <td></td> <td colspan="8" style="text-align: center;"> <table border="1" style="width: 100%; border-collapse: collapse; text-align: center;"> <tr> <td style="width: 10%;"></td> <td style="width: 10%;"></td> <td style="width: 10%;"></td> <td style="width: 10%;"></td> <td style="width: 10%;"></td> <td style="width: 10%;"></td> <td style="width: 10%;"></td> <td style="width: 10%;"></td> <td style="width: 10%;"></td> <td style="width: 10%;"></td> </tr> <tr> <td></td> <td></td> <td colspan="8" style="text-align: center;"> <table border="1" style="width: 100%; border-collapse: collapse; text-align: center;"> <tr> <td style="width: 10%;"></td> <td style="width: 10%;"></td> <td style="width: 10%;"></td> <td style="width: 10%;"></td> <td style="width: 10%;"></td> <td style="width: 10%;"></td> <td style="width: 10%;"></td> <td style="width: 10%;"></td> <td style="width: 10%;"></td> <td style="width: 10%;"></td> </tr> <tr> <td></td> <td></td> <td colspan="8" style="text-align: center;"> <table border="1" style="width: 100%; border-collapse: collapse; text-align: center;"> <tr> <td style="width: 10%;"></td> <td style="width: 10%;"></td> <td style="width: 10%;"></td> <td style="width: 10%;"></td> <td style="width: 10%;"></td> <td style="width: 10%;"></td> <td style="width: 10%;"></td> <td style="width: 10%;"></td> <td style="width: 10%;"></td> <td style="width: 10%;"></td> </tr> <tr> <td></td> <td></td> <td colspan="8" style="text-align: center;"> <table border="1" style="width: 100%; border-collapse: collapse; text-align: center;"> <tr> <td style="width: 10%;"></td> <td style="width: 10%;"></td> <td style="width: 10%;"></td> <td style="width: 10%;"></td> <td style="width: 10%;"></td> <td style="width: 10%;"></td> <td style="width: 10%;"></td> <td style="width: 10%;"></td> <td style="width: 10%;"></td> <td style="width: 10%;"></td> </tr> <tr> <td></td> <td></td> <td colspan="8" style="text-align: center;"> <table border="1" style="width: 100%; border-collapse: collapse; text-align: center;"> <tr> <td style="width: 10%;"></td> <td style="width: 10%;"></td> <td style="width: 10%;"></td> <td style="width: 10%;"></td> <td style="width: 10%;"></td> <td style="width: 10%;"></td> <td style="width: 10%;"></td> <td style="width: 10%;"></td> <td style="width: 10%;"></td> <td style="width: 10%;"></td> </tr> <tr> <td></td> <td></td> <td colspan="8" style="text-align: center;"> <table border="1" style="width: 100%; border-collapse: collapse; text-align: center;"> <tr> <td style="width: 10%;"></td> <td style="width: 10%;"></td> <td style="width: 10%;"></td> <td style="width: 10%;"></td> <td style="width: 10%;"></td> <td style="width: 10%;"></td> <td style="width: 10%;"></td> <td style="width: 10%;"></td> <td style="width: 10%;"></td> <td style="width: 10%;"></td> </tr> <tr> <td></td> <td></td> <td colspan="8" style="text-align: center;"> <table border="1" style="width: 100%; border-collapse: collapse; text-align: center;"> <tr> <td style="width: 10%;"></td> <td style="width: 10%;"></td> <td style="width: 10%;"></td> <td style="width: 10%;"></td> <td style="width: 10%;"></td> <td style="width: 10%;"></td> <td style="width: 10%;"></td> <td style="width: 10%;"></td> <td style="width: 10%;"></td> <td style="width: 10%;"></td> </tr> <tr> <td></td> <td></td> <td colspan="8" style="text-align: center;"> <table border="1" style="width: 100%; border-collapse: collapse; text-align: center;"> <tr> <td style="width: 10%;"></td> <td style="width: 10%;"></td> <td style="width: 10%;"></td> <td style="width: 10%;"></td> <td style="width: 10%;"></td> <td style="width: 10%;"></td> <td style="width: 10%;"></td> <td style="width: 10%;"></td> <td style="width: 10%;"></td> <td style="width: 10%;"></td> </tr> <tr> <td></td> <td></td> <td colspan="8" style="text-align: center;"> <table border="1" style="width: 100%; border-collapse: collapse; text-align: center;"> <tr> <td style="width: 10%;"></td> <td style="width: 10%;"></td> <td style="width: 10%;"></td> <td style="width: 10%;"></td> <td style="width: 10%;"></td> <td style="width: 10%;"></td> <td style="width: 10%;"></td> <td style="width: 10%;"></td> <td style="width: 10%;"></td> <td style="width: 10%;"></td> </tr> <tr> <td></td> <td></td> <td colspan="8" style="text-align: center;"> <table border="1" style="width: 100%; border-collapse: collapse; text-align: center;"> <tr> <td style="width: 10%;"></td> <td style="width: 10%;"></td> <td style="width: 10%;"></td> <td style="width: 10%;"></td> <td style="width: 10%;"></td> <td style="width: 10%;"></td> <td style="width: 10%;"></td> <td style="width: 10%;"></td> <td style="width: 10%;"></td> <td style="width: 10%;"></td> </tr> <tr> <td></td> <td></td> <td colspan="8" style="text-align: center;"> <table border="1" style="width: 100%; border-collapse: collapse; text-align: center;"> <tr> <td style="width: 10%;"></td> <td style="width: 10%;"></td> <td style="width: 10%;"></td> <td style="width: 10%;"></td> <td style="width: 10%;"></td> <td style="width: 10%;"></td> <td style="width: 10%;"></td> <td style="width: 10%;"></td> <td style="width: 10%;"></td> <td style="width: 10%;"></td> </tr> <tr> <td></td> <td></td> <td colspan="8" style="text-align: center;"> <table border="1" style="width: 100%; border-collapse: collapse; text-align: center;"> <tr> <td style="width: 10%;"></td> <td style="width: 10%;"></td> <td style="width: 10%;"></td> <td style="width: 10%;"></td> <td style="width: 10%;"></td> <td style="width: 10%;"></td> <td style="width: 10%;"></td> <td style="width: 10%;"></td> <td style="width: 10%;"></td> <td style="width: 10%;"></td> </tr> <tr> <td></td> <td></td> <td colspan="8" style="text-align: center;"> <table border="1" style="width: 100%; border-collapse: collapse; text-align: center;"> <tr> <td style="width: 10%;"></td> <td style="width: 10%;"></td> <td style="width: 10%;"></td> <td style="width: 10%;"></td> <td style="width: 10%;"></td> <td style="width: 10%;"></td> <td style="width: 10%;"></td> <td style="width: 10%;"></td> <td style="width: 10%;"></td> <td style="width: 10%;"></td> </tr> <tr> <td></td> <td></td> <td colspan="8" style="text-align: center;"> <table border="1" style="width: 100%; border-collapse: collapse; text-align: center;"> <tr> <td style="width: 10%;"></td> <td style="width: 10%;"></td> <td style="width: 10%;"></td> <td style="width: 10%;"></td> <td style="width: 10%;"></td> <td style="width: 10%;"></td> <td style="width: 10%;"></td> <td style="width: 10%;"></td> <td style="width: 10%;"></td> <td style="width: 10%;"></td> </tr> <tr> <td></td> <td></td> <td colspan="8" style="text-align: center;"> <table border="1" style="width: 100%; border-collapse: collapse; text-align: center;"> <tr> <td style="width: 10%;"></td> <td style="width: 10%;"></td> <td style="width: 10%;"></td> <td style="width: 10%;"></td> <td style="width: 10%;"></td> <td style="width: 10%;"></td> <td style="width: 10%;"></td> <td style="width: 10%;"></td> <td style="width: 10%;"></td> <td style="width: 10%;"></td> </tr> <tr> <td></td> <td></td> <td colspan="8" style="text-align: center;"> <table border="1" style="width: 100%; border-collapse: collapse; text-align: center;"> <tr> <td
style="width: 10%;"></td> <td style="width: 10%;"></td> <td style="width: 10%;"></td> <td style="width: 10%;"></td> <td style="width: 10%;"></td> <td style="width: 10%;"></td> <td style="width: 10%;"></td> <td style="width: 10%;"></td> <td style="width: 10%;"></td> <td style="width: 10%;"></td> </tr> <tr> <td></td> <td></td> <td colspan="8" style="text-align: center;"> <table border="1" style="width: 100%; border-collapse: collapse; text-align: center;"> <tr> <td style="width: 10%;"></td> <td style="width: 10%;"></td> <td style="width: 10%;"></td> <td style="width: 10%;"></td> <td style="width: 10%;"></td> <td style="width: 10%;"></td> <td style="width: 10%;"></td> <td style="width: 10%;"></td> <td style="width: 10%;"></td> <td style="width: 10%;"></td> </tr> <tr> <td></td> <td></td> <td colspan="8" style="text-align: center;"> <table border="1" style="width: 100%; border-collapse: collapse; text-align: center;"> <tr> <td style="width: 10%;"></td> <td style="width: 10%;"></td> <td style="width: 10%;"></td> <td style="width: 10%;"></td> <td style="width: 10%;"></td> <td style="width: 10%;"></td> <td style="width: 10%;"></td> <td style="width: 10%;"></td> <td style="width: 10%;"></td> <td style="width: 10%;"></td> </tr> <tr> <td></td> <td></td> <td colspan="8" style="text-align: center;"> <table border="1" style="width: 100%; border-collapse: collapse; text-align: center;"> <tr> <td style="width: 10%;"></td> <td style="width: 10%;"></td> <td style="width: 10%;"></td> <td style="width: 10%;"></td> <td style="width: 10%;"></td> <td style="width: 10%;"></td> <td style="width: 10%;"></td> <td style="width: 10%;"></td> <td style="width: 10%;"></td> <td style="width: 10%;"></td> </tr> <tr> <td></td> <td></td> <td colspan="8" style="text-align: center;"> <table border="1" style="width: 100%; border-collapse: collapse; text-align: center;"> <tr> <td style="width: 10%;"></td> <td style="width: 10%;"></td> <td style="width: 10%;"></td> <td style="width: 10%;"></td> <td style="width: 10%;"></td> <td style="width: 10%;"></td> <td style="width: 10%;"></td> <td style="width: 10%;"></td> <td style="width: 10%;"></td> <td style="width: 10%;"></td> </tr> <tr> <td></td> <td></td> <td colspan="8" style="text-align: center;"> <table border="1" style="width: 100%; border-collapse: collapse; text-align: center;"> <tr> <td style="width: 10%;"></td> <td style="width: 10%;"></td> <td style="width: 10%;"></td> <td style="width: 10%;"></td> <td style="width: 10%;"></td> <td style="width: 10%;"></td> <td style="width: 10%;"></td> <td style="width: 10%;"></td> <td style="width: 10%;"></td> <td style="width: 10%;"></td> </tr> <tr> <td></td> <td></td> <td colspan="8" style="text-align: center;"> <table border="1" style="width: 100%; border-collapse: collapse; text-align: center;"> <tr> </tr></table></td></tr></table></td></tr></table></td></tr></table></td></tr></table></td></tr></table></td></tr></table></td></tr></table></td></tr></table></td></tr></table></td></tr></table></td></tr></table></td></tr></table></td></tr></table></td></tr></table></td></tr></table></td></tr></table></td></tr></table></td></tr></table></td></tr></table></td></tr></table></td></tr></table></td></tr></table></td></tr></table></td></tr></table></td></tr></table></td></tr></table></td></tr></table></td></tr></table></td></tr></table></td></tr></table></td></tr></table></td></tr></table></td></tr></table></td></tr></table></td></tr></table></td></tr></table></td></tr></table></td></tr></table></td></tr></table></td></tr></table></td></tr></table></td></tr></table></td></tr></table></td></tr></table>
 | | | | | | | | | | | | | | | | | | | | <table border="1" style="width: 100%; border-collapse: collapse; text-align: center;"> <tr> <td style="width: 10%;"></td> <td style="width: 10%;"></td> <td style="width: 10%;"></td> <td style="width: 10%;"></td> <td style="width: 10%;"></td> <td style="width: 10%;"></td> <td style="width: 10%;"></td> <td style="width: 10%;"></td> <td style="width: 10%;"></td> <td style="width: 10%;"></td> </tr> <tr> <td></td> <td></td> <td colspan="8" style="text-align: center;"> <table border="1" style="width: 100%; border-collapse: collapse; text-align: center;"> <tr> <td style="width: 10%;"></td> <td style="width: 10%;"></td> <td style="width: 10%;"></td> <td style="width: 10%;"></td> <td style="width: 10%;"></td> <td style="width: 10%;"></td> <td style="width: 10%;"></td> <td style="width: 10%;"></td> <td style="width: 10%;"></td> <td style="width: 10%;"></td> </tr> <tr> <td></td> <td></td> <td colspan="8" style="text-align: center;"> <table border="1" style="width: 100%; border-collapse: collapse; text-align: center;"> <tr> <td style="width: 10%;"></td> <td style="width: 10%;"></td> <td style="width: 10%;"></td> <td style="width: 10%;"></td> <td style="width: 10%;"></td> <td style="width: 10%;"></td> <td style="width: 10%;"></td> <td style="width: 10%;"></td> <td style="width: 10%;"></td> <td style="width: 10%;"></td> </tr> <tr> <td></td> <td></td> <td colspan="8" style="text-align: center;"> <table border="1" style="width: 100%; border-collapse: collapse; text-align: center;"> <tr> <td style="width: 10%;"></td> <td style="width: 10%;"></td> <td style="width: 10%;"></td> <td style="width: 10%;"></td> <td style="width: 10%;"></td> <td style="width: 10%;"></td> <td style="width: 10%;"></td> <td style="width: 10%;"></td> <td style="width: 10%;"></td> <td style="width: 10%;"></td> </tr> <tr> <td></td> <td></td> <td colspan="8" style="text-align: center;"> <table border="1" style="width: 100%; border-collapse: collapse; text-align: center;"> <tr> <td style="width: 10%;"></td> <td style="width: 10%;"></td> <td style="width: 10%;"></td> <td style="width: 10%;"></td> <td style="width: 10%;"></td> <td style="width: 10%;"></td> <td style="width: 10%;"></td> <td style="width: 10%;"></td> <td style="width: 10%;"></td> <td style="width: 10%;"></td> </tr> <tr> <td></td> <td></td> <td colspan="8" style="text-align: center;"> <table border="1" style="width: 100%; border-collapse: collapse; text-align: center;"> <tr> <td style="width: 10%;"></td> <td style="width: 10%;"></td> <td style="width: 10%;"></td> <td style="width: 10%;"></td> <td style="width: 10%;"></td> <td style="width: 10%;"></td> <td style="width: 10%;"></td> <td style="width: 10%;"></td> <td style="width: 10%;"></td> <td style="width: 10%;"></td> </tr> <tr> <td></td> <td></td> <td colspan="8" style="text-align: center;"> <table border="1" style="width: 100%; border-collapse: collapse; text-align: center;"> <tr> <td style="width: 10%;"></td> <td style="width: 10%;"></td> <td style="width: 10%;"></td> <td style="width: 10%;"></td> <td style="width: 10%;"></td> <td style="width: 10%;"></td> <td style="width: 10%;"></td> <td style="width: 10%;"></td> <td style="width: 10%;"></td> <td style="width: 10%;"></td> </tr> <tr> <td></td> <td></td> <td colspan="8" style="text-align: center;"> <table border="1" style="width: 100%; border-collapse: collapse; text-align: center;"> <tr> <td style="width: 10%;"></td> <td style="width: 10%;"></td> <td style="width: 10%;"></td> <td style="width: 10%;"></td> <td style="width: 10%;"></td> <td style="width: 10%;"></td> <td style="width: 10%;"></td> <td style="width: 10%;"></td> <td style="width: 10%;"></td> <td style="width: 10%;"></td> </tr> <tr> <td></td> <td></td> <td colspan="8" style="text-align: center;"> <table border="1" style="width: 100%; border-collapse: collapse; text-align: center;"> <tr> <td style="width: 10%;"></td> <td style="width: 10%;"></td> <td style="width: 10%;"></td> <td style="width: 10%;"></td> <td style="width: 10%;"></td> <td style="width: 10%;"></td> <td style="width: 10%;"></td> <td style="width: 10%;"></td> <td style="width: 10%;"></td> <td style="width: 10%;"></td> </tr> <tr> <td></td> <td></td> <td colspan="8" style="text-align: center;"> <table border="1" style="width: 100%; border-collapse: collapse; text-align: center;"> <tr> <td style="width: 10%;"></td> <td style="width: 10%;"></td> <td style="width: 10%;"></td> <td style="width: 10%;"></td> <td style="width: 10%;"></td> <td style="width: 10%;"></td> <td style="width: 10%;"></td> <td style="width: 10%;"></td> <td style="width: 10%;"></td> <td style="width: 10%;"></td> </tr> <tr> <td></td> <td></td> <td colspan="8" style="text-align: center;"> <table border="1" style="width: 100%; border-collapse: collapse; text-align: center;"> <tr> <td style="width: 10%;"></td> <td style="width: 10%;"></td> <td style="width: 10%;"></td> <td style="width: 10%;"></td> <td style="width: 10%;"></td> <td style="width: 10%;"></td> <td style="width: 10%;"></td> <td style="width: 10%;"></td> <td style="width: 10%;"></td> <td style="width: 10%;"></td> </tr> <tr> <td></td> <td></td> <td colspan="8" style="text-align: center;"> <table border="1" style="width: 100%; border-collapse: collapse; text-align: center;"> <tr> <td style="width: 10%;"></td> <td style="width: 10%;"></td> <td style="width: 10%;"></td> <td style="width: 10%;"></td> <td style="width: 10%;"></td> <td style="width: 10%;"></td> <td style="width: 10%;"></td> <td style="width: 10%;"></td> <td style="width: 10%;"></td> <td style="width: 10%;"></td> </tr> <tr> <td></td> <td></td> <td colspan="8" style="text-align: center;"> <table border="1" style="width: 100%; border-collapse: collapse; text-align: center;"> <tr> <td style="width: 10%;"></td> <td style="width: 10%;"></td> <td style="width: 10%;"></td> <td style="width: 10%;"></td> <td style="width: 10%;"></td> <td style="width: 10%;"></td> <td style="width: 10%;"></td> <td style="width: 10%;"></td> <td style="width: 10%;"></td> <td style="width: 10%;"></td> </tr> <tr> <td></td> <td></td> <td colspan="8" style="text-align: center;"> <table border="1" style="width: 100%; border-collapse: collapse; text-align: center;"> <tr> <td style="width: 10%;"></td> <td style="width: 10%;"></td> <td style="width: 10%;"></td> <td style="width: 10%;"></td> <td style="width: 10%;"></td> <td style="width: 10%;"></td> <td style="width: 10%;"></td> <td style="width: 10%;"></td> <td style="width: 10%;"></td> <td style="width: 10%;"></td> </tr> <tr> <td></td> <td></td> <td colspan="8" style="text-align: center;"> <table border="1" style="width: 100%; border-collapse: collapse; text-align: center;"> <tr> <td style="width: 10%;"></td> <td style="width: 10%;"></td> <td style="width: 10%;"></td> <td style="width: 10%;"></td> <td style="width: 10%;"></td> <td style="width: 10%;"></td> <td style="width: 10%;"></td> <td style="width: 10%;"></td> <td style="width: 10%;"></td> <td style="width: 10%;"></td> </tr> <tr> <td></td> <td></td> <td colspan="8" style="text-align: center;"> <table border="1" style="width: 100%; border-collapse: collapse; text-align: center;"> <tr> <td style="width: 10%;"></td> <td style="width: 10%;"></td> <td style="width: 10%;"></td> <td style="width: 10%;"></td> <td style="width: 10%;"></td> <td style="width: 10%;"></td> <td style="width: 10%;"></td> <td style="width: 10%;"></td> <td style="width: 10%;"></td> <td style="width: 10%;"></td> </tr> <tr> <td></td> <td></td> <td colspan="8" style="text-align: center;"> <table border="1" style="width: 100%; border-collapse: collapse; text-align: center;"> <tr>
<td style="width: 10%;"></td> <td style="width: 10%;"></td> <td style="width: 10%;"></td> <td style="width: 10%;"></td> <td style="width: 10%;"></td> <td style="width: 10%;"></td> <td style="width: 10%;"></td> <td style="width: 10%;"></td> <td style="width: 10%;"></td> <td style="width: 10%;"></td> </tr> <tr> <td></td> <td></td> <td colspan="8" style="text-align: center;"> <table border="1" style="width: 100%; border-collapse: collapse; text-align: center;"> <tr> <td style="width: 10%;"></td> <td style="width: 10%;"></td> <td style="width: 10%;"></td> <td style="width: 10%;"></td> <td style="width: 10%;"></td> <td style="width: 10%;"></td> <td style="width: 10%;"></td> <td style="width: 10%;"></td> <td style="width: 10%;"></td> <td style="width: 10%;"></td> </tr> <tr> <td></td> <td></td> <td colspan="8" style="text-align: center;"> <table border="1" style="width: 100%; border-collapse: collapse; text-align: center;"> <tr> <td style="width: 10%;"></td> <td style="width: 10%;"></td> <td style="width: 10%;"></td> <td style="width: 10%;"></td> <td style="width: 10%;"></td> <td style="width: 10%;"></td> <td style="width: 10%;"></td> <td style="width: 10%;"></td> <td style="width: 10%;"></td> <td style="width: 10%;"></td> </tr> <tr> <td></td> <td></td> <td colspan="8" style="text-align: center;"> <table border="1" style="width: 100%; border-collapse: collapse; text-align: center;"> <tr> <td style="width: 10%;"></td> <td style="width: 10%;"></td> <td style="width: 10%;"></td> <td style="width: 10%;"></td> <td style="width: 10%;"></td> <td style="width: 10%;"></td> <td style="width: 10%;"></td> <td style="width: 10%;"></td> <td style="width: 10%;"></td> <td style="width: 10%;"></td> </tr> <tr> <td></td> <td></td> <td colspan="8" style="text-align: center;"> <table border="1" style="width: 100%; border-collapse: collapse; text-align: center;"> <tr> <td style="width: 10%;"></td> <td style="width: 10%;"></td> <td style="width: 10%;"></td> <td style="width: 10%;"></td> <td style="width: 10%;"></td> <td style="width: 10%;"></td> <td style="width: 10%;"></td> <td style="width: 10%;"></td> <td style="width: 10%;"></td> <td style="width: 10%;"></td> </tr> <tr> <td></td> <td></td> <td colspan="8" style="text-align: center;"> <table border="1" style="width: 100%; border-collapse: collapse; text-align: center;"> <tr> <td style="width: 10%;"></td> <td style="width: 10%;"></td> <td style="width: 10%;"></td> <td style="width: 10%;"></td> <td style="width: 10%;"></td> <td style="width: 10%;"></td> <td style="width: 10%;"></td> <td style="width: 10%;"></td> <td style="width: 10%;"></td> <td style="width: 10%;"></td> </tr> <tr> <td></td> <td></td> <td colspan="8" style="text-align: center;"> <table border="1" style="width: 100%; border-collapse: collapse; text-align: center;"> <tr> <td style="width: 10%;"></td> <td style="width: 10%;"></td> <td style="width: 10%;"></td> <td style="width: 10%;"></td> <td style="width: 10%;"></td> <td style="width: 10%;"></td> <td style="width: 10%;"></td> <td style="width: 10%;"></td> <td style="width: 10%;"></td> <td style="width: 10%;"></td> </tr> <tr> <td></td> <td></td> <td colspan="8" style="text-align: center;"> <table border="1" style="width: 100%; border-collapse: collapse; text-align: center;"> <tr> <td style="width: 10%;"></td> <td style="width: 10%;"></td> <td style="width: 10%;"></td> <td style="width: 10%;"></td> <td style="width: 10%;"></td> <td style="width: 10%;"></td> <td style="width: 10%;"></td> <td style="width: 10%;"></td> <td style="width: 10%;"></td> <td style="width: 10%;"></td> </tr> <tr> <td></td> <td></td> <td colspan="8" style="text-align: center;"> <table border="1" style="width: 100%; border-collapse: collapse; text-align: center;"> <tr> <td style="width: 10%;"></td> <td style="width: 10%;"></td> <td style="width: 10%;"></td> <td style="width: 10%;"></td> <td style="width: 10%;"></td> <td style="width: 10%;"></td> <td style="width: 10%;"></td> <td style="width: 10%;"></td> <td style="width: 10%;"></td> <td style="width: 10%;"></td> </tr> <tr> <td></td> <td></td> <td colspan="8" style="text-align: center;"> <table border="1" style="width: 100%; border-collapse: collapse; text-align: center;"> <tr> <td style="width: 10%;"></td> <td style="width: 10%;"></td> <td style="width: 10%;"></td> <td style="width: 10%;"></td> <td style="width: 10%;"></td> <td style="width: 10%;"></td> <td style="width: 10%;"></td> <td style="width: 10%;"></td> <td style="width: 10%;"></td> <td style="width: 10%;"></td> </tr> <tr> <td></td> <td></td> <td colspan="8" style="text-align: center;"> <table border="1" style="width: 100%; border-collapse: collapse; text-align: center;"> <tr> <td style="width: 10%;"></td> <td style="width: 10%;"></td> <td style="width: 10%;"></td> <td style="width: 10%;"></td> <td style="width: 10%;"></td> <td style="width: 10%;"></td> <td style="width: 10%;"></td> <td style="width: 10%;"></td> <td style="width: 10%;"></td> <td style="width: 10%;"></td> </tr> <tr> <td></td> <td></td> <td colspan="8" style="text-align: center;"> <table border="1" style="width: 100%; border-collapse: collapse; text-align: center;"> <tr> <td style="width: 10%;"></td> <td style="width: 10%;"></td> <td style="width: 10%;"></td> <td style="width: 10%;"></td> <td style="width: 10%;"></td> <td style="width: 10%;"></td> <td style="width: 10%;"></td> <td style="width: 10%;"></td> <td style="width: 10%;"></td> <td style="width: 10%;"></td> </tr> <tr> <td></td> <td></td> <td colspan="8" style="text-align: center;"> <table border="1" style="width: 100%; border-collapse: collapse; text-align: center;"> <tr> <td style="width: 10%;"></td> <td style="width: 10%;"></td> <td style="width: 10%;"></td> <td style="width: 10%;"></td> <td style="width: 10%;"></td> <td style="width: 10%;"></td> <td style="width: 10%;"></td> <td style="width: 10%;"></td> <td style="width: 10%;"></td> <td style="width: 10%;"></td> </tr> <tr> <td></td> <td></td> <td colspan="8" style="text-align: center;"> <table border="1" style="width: 100%; border-collapse: collapse; text-align: center;"> <tr> <td style="width: 10%;"></td> <td style="width: 10%;"></td> <td style="width: 10%;"></td> <td style="width: 10%;"></td> <td style="width: 10%;"></td> <td style="width: 10%;"></td> <td style="width: 10%;"></td> <td style="width: 10%;"></td> <td style="width: 10%;"></td> <td style="width: 10%;"></td> </tr> <tr> <td></td> <td></td> <td colspan="8" style="text-align: center;"> <table border="1" style="width: 100%; border-collapse: collapse; text-align: center;"> <tr> <td style="width: 10%;"></td> <td style="width: 10%;"></td> <td style="width: 10%;"></td> <td style="width: 10%;"></td> <td style="width: 10%;"></td> <td style="width: 10%;"></td> <td style="width: 10%;"></td> <td style="width: 10%;"></td> <td style="width: 10%;"></td> <td style="width: 10%;"></td> </tr> <tr> <td></td> <td></td> <td colspan="8" style="text-align: center;"> <table border="1" style="width: 100%; border-collapse: collapse; text-align: center;"> <tr> <td style="width: 10%;"></td> <td style="width: 10%;"></td> <td style="width: 10%;"></td> <td style="width: 10%;"></td> <td style="width: 10%;"></td> <td style="width: 10%;"></td> <td style="width: 10%;"></td> <td style="width: 10%;"></td> <td style="width: 10%;"></td> <td style="width: 10%;"></td> </tr> <tr> <td></td> <td></td> <td colspan="8" style="text-align: center;"> <table border="1" style="width: 100%; border-collapse: collapse; text-align: center;"> <tr> <td style="width: 10%;"></td> <td style="width: 10%;"></td> <td style="width: 10%;"></td> <td style="width: 10%;"></td> <td style="width: 10%;"></td> <td style="width: 10%;"></td> <td style="width: 10%;"></td> <td style="width: 10%;"></td> <td style="width: 10%;"></td> <td style="width: 10%;"></td> </tr> <tr> <td></td> <td></td> <td colspan="8" style="text-align: center;"> <table border="1" style="width: 100%; border-collapse: collapse; text-align: center;"> <tr> <td style="width: 10%;"></td> <td style="width: 10%;"></td> <td style="width: 10%;"></td> <td style="width: 10%;"></td> <td style="width: 10%;"></td> <td style="width: 10%;"></td> <td style="width: 10%;"></td> <td style="width: 10%;"></td> <td style="width: 10%;"></td> <td style="width: 10%;"></td> </tr> <tr> <td></td> <td></td> <td colspan="8" style="text-align: center;"> <table border="1" style="width: 100%; border-collapse: collapse; text-align: center;"> <tr> <td style="width: 10%;"></td> <td style="width: 10%;"></td> <td style="width: 10%;"></td> <td style="width: 10%;"></td> <td style="width: 10%;"></td> <td style="width: 10%;"></td> <td style="width: 10%;"></td> <td style="width: 10%;"></td> <td style="width: 10%;"></td> <td style="width: 10%;"></td> </tr> <tr> <td></td> <td></td> <td colspan="8" style="text-align: center;"> <table border="1" style="width: 100%; border-collapse: collapse; text-align: center;"> <tr> <td style="width: 10%;"></td> <td style="width: 10%;"></td> <td style="width: 10%;"></td> <td style="width: 10%;"></td> <td style="width: 10%;"></td> <td style="width: 10%;"></td> <td style="width: 10%;"></td> <td style="width: 10%;"></td> <td style="width: 10%;"></td> <td style="width: 10%;"></td> </tr> <tr> <td></td> <td></td> <td colspan="8" style="text-align: center;"> <table border="1" style="width: 100%; border-collapse: collapse; text-align: center;"> <tr> <td style="width: 10%;"></td> <td style="width: 10%;"></td> <td style="width: 10%;"></td> <td style="width: 10%;"></td> <td style="width: 10%;"></td> <td style="width: 10%;"></td> <td style="width: 10%;"></td> <td style="width: 10%;"></td> <td style="width: 10%;"></td> <td style="width: 10%;"></td> </tr> <tr> <td></td> <td></td> <td colspan="8" style="text-align: center;"> <table border="1" style="width: 100%; border-collapse: collapse; text-align: center;"> <tr> <td style="width: 10%;"></td> <td style="width: 10%;"></td> <td style="width: 10%;"></td> <td style="width: 10%;"></td> <td style="width: 10%;"></td> <td style="width:
10%;"></td> <td style="width: 10%;"></td> <td style="width: 10%;"></td> <td style="width: 10%;"></td> <td style="width: 10%;"></td> </tr> <tr> <td></td> <td></td> <td colspan="8" style="text-align: center;"> <table border="1" style="width: 100%; border-collapse: collapse; text-align: center;"> <tr> <td style="width: 10%;"></td> <td style="width: 10%;"></td> <td style="width: 10%;"></td> <td style="width: 10%;"></td> <td style="width: 10%;"></td> <td style="width: 10%;"></td> <td style="width: 10%;"></td> <td style="width: 10%;"></td> <td style="width: 10%;"></td> <td style="width: 10%;"></td> </tr> <tr> <td></td> <td></td> <td colspan="8" style="text-align: center;"> <table border="1" style="width: 100%; border-collapse: collapse; text-align: center;"> <tr> <td style="width: 10%;"></td> <td style="width: 10%;"></td> <td style="width: 10%;"></td> <td style="width: 10%;"></td> <td style="width: 10%;"></td> <td style="width: 10%;"></td> <td style="width: 10%;"></td> <td style="width: 10%;"></td> <td style="width: 10%;"></td> <td style="width: 10%;"></td> </tr> <tr> <td></td> <td></td> <td colspan="8" style="text-align: center;"> <table border="1" style="width: 100%; border-collapse: collapse; text-align: center;"> <tr> <td style="width: 10%;"></td> <td style="width: 10%;"></td> <td style="width: 10%;"></td> <td style="width: 10%;"></td> <td style="width: 10%;"></td> <td style="width: 10%;"></td> <td style="width: 10%;"></td> <td style="width: 10%;"></td> <td style="width: 10%;"></td> <td style="width: 10%;"></td> </tr> <tr> <td></td> <td></td> <td colspan="8" style="text-align: center;"> <table border="1" style="width: 100%; border-collapse: collapse; text-align: center;"> <tr> <td style="width: 10%;"></td> <td style="width: 10%;"></td> <td style="width: 10%;"></td> <td style="width: 10%;"></td> <td style="width: 10%;"></td> <td style="width: 10%;"></td> <td style="width: 10%;"></td> <td style="width: 10%;"></td> <td style="width: 10%;"></td> <td style="width: 10%;"></td> </tr> <tr> <td></td> <td></td> <td colspan="8" style="text-align: center;"> <table border="1" style="width: 100%; border-collapse: collapse; text-align: center;"> <tr> <td style="width: 10%;"></td> <td style="width: 10%;"></td> <td style="width: 10%;"></td> <td style="width: 10%;"></td> <td style="width: 10%;"></td> <td style="width: 10%;"></td> <td style="width: 10%;"></td> <td style="width: 10%;"></td> <td style="width: 10%;"></td> <td style="width: 10%;"></td> </tr> <tr> <td></td> <td></td> <td colspan="8" style="text-align: center;"> <table border="1" style="width: 100%; border-collapse: collapse; text-align: center;"> <tr> </tr></table></td></tr></table></td></tr></table></td></tr></table></td></tr></table></td></tr></table></td></tr></table></td></tr></table></td></tr></table></td></tr></table></td></tr></table></td></tr></table></td></tr></table></td></tr></table></td></tr></table></td></tr></table></td></tr></table></td></tr></table></td></tr></table></td></tr></table></td></tr></table></td></tr></table></td></tr></table></td></tr></table></td></tr></table></td></tr></table></td></tr></table></td></tr></table></td></tr></table></td></tr></table></td></tr></table></td></tr></table></td></tr></table></td></tr></table></td></tr></table></td></tr></table></td></tr></table></td></tr></table></td></tr></table></td></tr></table></td></tr></table></td></tr></table></td></tr></table></td></tr></table>
 | | | | | | | | | | | | | | | | | | | | <table border="1" style="width: 100%; border-collapse: collapse; text-align: center;"> <tr> <td style="width: 10%;"></td> <td style="width: 10%;"></td> <td style="width: 10%;"></td> <td style="width: 10%;"></td> <td style="width: 10%;"></td> <td style="width: 10%;"></td> <td style="width: 10%;"></td> <td style="width: 10%;"></td> <td style="width: 10%;"></td> <td style="width: 10%;"></td> </tr> <tr> <td></td> <td></td> <td colspan="8" style="text-align: center;"> <table border="1" style="width: 100%; border-collapse: collapse; text-align: center;"> <tr> <td style="width: 10%;"></td> <td style="width: 10%;"></td> <td style="width: 10%;"></td> <td style="width: 10%;"></td> <td style="width: 10%;"></td> <td style="width: 10%;"></td> <td style="width: 10%;"></td> <td style="width: 10%;"></td> <td style="width: 10%;"></td> <td style="width: 10%;"></td> </tr> <tr> <td></td> <td></td> <td colspan="8" style="text-align: center;"> <table border="1" style="width: 100%; border-collapse: collapse; text-align: center;"> <tr> <td style="width: 10%;"></td> <td style="width: 10%;"></td> <td style="width: 10%;"></td> <td style="width: 10%;"></td> <td style="width: 10%;"></td> <td style="width: 10%;"></td> <td style="width: 10%;"></td> <td style="width: 10%;"></td> <td style="width: 10%;"></td> <td style="width: 10%;"></td> </tr> <tr> <td></td> <td></td> <td colspan="8" style="text-align: center;"> <table border="1" style="width: 100%; border-collapse: collapse; text-align: center;"> <tr> <td style="width: 10%;"></td> <td style="width: 10%;"></td> <td style="width: 10%;"></td> <td style="width: 10%;"></td> <td style="width: 10%;"></td> <td style="width: 10%;"></td> <td style="width: 10%;"></td> <td style="width: 10%;"></td> <td style="width: 10%;"></td> <td style="width: 10%;"></td> </tr> <tr> <td></td> <td></td> <td colspan="8" style="text-align: center;"> <table border="1" style="width: 100%; border-collapse: collapse; text-align: center;"> <tr> <td style="width: 10%;"></td> <td style="width: 10%;"></td> <td style="width: 10%;"></td> <td style="width: 10%;"></td> <td style="width: 10%;"></td> <td style="width: 10%;"></td> <td style="width: 10%;"></td> <td style="width: 10%;"></td> <td style="width: 10%;"></td> <td style="width: 10%;"></td> </tr> <tr> <td></td> <td></td> <td colspan="8" style="text-align: center;"> <table border="1" style="width: 100%; border-collapse: collapse; text-align: center;"> <tr> <td style="width: 10%;"></td> <td style="width: 10%;"></td> <td style="width: 10%;"></td> <td style="width: 10%;"></td> <td style="width: 10%;"></td> <td style="width: 10%;"></td> <td style="width: 10%;"></td> <td style="width: 10%;"></td> <td style="width: 10%;"></td> <td style="width: 10%;"></td> </tr> <tr> <td></td> <td></td> <td colspan="8" style="text-align: center;"> <table border="1" style="width: 100%; border-collapse: collapse; text-align: center;"> <tr> <td style="width: 10%;"></td> <td style="width: 10%;"></td> <td style="width: 10%;"></td> <td style="width: 10%;"></td> <td style="width: 10%;"></td> <td style="width: 10%;"></td> <td style="width: 10%;"></td> <td style="width: 10%;"></td> <td style="width: 10%;"></td> <td style="width: 10%;"></td> </tr> <tr> <td></td> <td></td> <td colspan="8" style="text-align: center;"> <table border="1" style="width: 100%; border-collapse: collapse; text-align: center;"> <tr> <td style="width: 10%;"></td> <td style="width: 10%;"></td> <td style="width: 10%;"></td> <td style="width: 10%;"></td> <td style="width: 10%;"></td> <td style="width: 10%;"></td> <td style="width: 10%;"></td> <td style="width: 10%;"></td> <td style="width: 10%;"></td> <td style="width: 10%;"></td> </tr> <tr> <td></td> <td></td> <td colspan="8" style="text-align: center;"> <table border="1" style="width: 100%; border-collapse: collapse; text-align: center;"> <tr> <td style="width: 10%;"></td> <td style="width: 10%;"></td> <td style="width: 10%;"></td> <td style="width: 10%;"></td> <td style="width: 10%;"></td> <td style="width: 10%;"></td> <td style="width: 10%;"></td> <td style="width: 10%;"></td> <td style="width: 10%;"></td> <td style="width: 10%;"></td> </tr> <tr> <td></td> <td></td> <td colspan="8" style="text-align: center;"> <table border="1" style="width: 100%; border-collapse: collapse; text-align: center;"> <tr> <td style="width: 10%;"></td> <td style="width: 10%;"></td> <td style="width: 10%;"></td> <td style="width: 10%;"></td> <td style="width: 10%;"></td> <td style="width: 10%;"></td> <td style="width: 10%;"></td> <td style="width: 10%;"></td> <td style="width: 10%;"></td> <td style="width: 10%;"></td> </tr> <tr> <td></td> <td></td> <td colspan="8" style="text-align: center;"> <table border="1" style="width: 100%; border-collapse: collapse; text-align: center;"> <tr> <td style="width: 10%;"></td> <td style="width: 10%;"></td> <td style="width: 10%;"></td> <td style="width: 10%;"></td> <td style="width: 10%;"></td> <td style="width: 10%;"></td> <td style="width: 10%;"></td> <td style="width: 10%;"></td> <td style="width: 10%;"></td> <td style="width: 10%;"></td> </tr> <tr> <td></td> <td></td> <td colspan="8" style="text-align: center;"> <table border="1" style="width: 100%; border-collapse: collapse; text-align: center;"> <tr> <td style="width: 10%;"></td> <td style="width: 10%;"></td> <td style="width: 10%;"></td> <td style="width: 10%;"></td> <td style="width: 10%;"></td> <td style="width: 10%;"></td> <td style="width: 10%;"></td> <td style="width: 10%;"></td> <td style="width: 10%;"></td> <td style="width: 10%;"></td> </tr> <tr> <td></td> <td></td> <td colspan="8" style="text-align: center;"> <table border="1" style="width: 100%; border-collapse: collapse; text-align: center;"> <tr> <td style="width: 10%;"></td> <td style="width: 10%;"></td> <td style="width: 10%;"></td> <td style="width: 10%;"></td> <td style="width: 10%;"></td> <td style="width: 10%;"></td> <td style="width: 10%;"></td> <td style="width: 10%;"></td> <td style="width: 10%;"></td> <td style="width: 10%;"></td> </tr> <tr> <td></td> <td></td> <td colspan="8" style="text-align: center;"> <table border="1" style="width: 100%; border-collapse: collapse; text-align: center;"> <tr> <td style="width: 10%;"></td> <td style="width: 10%;"></td> <td style="width: 10%;"></td> <td style="width: 10%;"></td> <td style="width: 10%;"></td> <td style="width: 10%;"></td> <td style="width: 10%;"></td> <td style="width: 10%;"></td> <td style="width: 10%;"></td> <td style="width: 10%;"></td> </tr> <tr> <td></td> <td></td> <td colspan="8" style="text-align: center;"> <table border="1" style="width: 100%; border-collapse: collapse; text-align: center;"> <tr> <td style="width: 10%;"></td> <td style="width: 10%;"></td> <td style="width: 10%;"></td> <td style="width: 10%;"></td> <td style="width: 10%;"></td> <td style="width: 10%;"></td> <td style="width: 10%;"></td> <td style="width: 10%;"></td> <td style="width: 10%;"></td> <td style="width: 10%;"></td> </tr> <tr> <td></td> <td></td> <td colspan="8" style="text-align: center;"> <table border="1" style="width: 100%; border-collapse: collapse; text-align: center;"> <tr> <td style="width: 10%;"></td> <td style="width: 10%;"></td> <td style="width: 10%;"></td> <td style="width: 10%;"></td> <td style="width: 10%;"></td> <td style="width: 10%;"></td> <td style="width: 10%;"></td> <td style="width: 10%;"></td> <td style="width: 10%;"></td> <td style="width: 10%;"></td> </tr> <tr> <td></td> <td></td> <td colspan="8" style="text-align: center;"> <table border="1" style="width: 100%; border-collapse: collapse; text-align: center;"> <tr> <td style="width: 10%;"></td> <td style="width: 10%;"></td> <td style="width: 10%;"></td> <td style="width: 10%;"></td> <td style="width: 10%;"></td> <td style="width: 10%;"></td> <td
style="width: 10%;"></td> <td style="width: 10%;"></td> <td style="width: 10%;"></td> <td style="width: 10%;"></td> </tr> <tr> <td></td> <td></td> <td colspan="8" style="text-align: center;"> <table border="1" style="width: 100%; border-collapse: collapse; text-align: center;"> <tr> <td style="width: 10%;"></td> <td style="width: 10%;"></td> <td style="width: 10%;"></td> <td style="width: 10%;"></td> <td style="width: 10%;"></td> <td style="width: 10%;"></td> <td style="width: 10%;"></td> <td style="width: 10%;"></td> <td style="width: 10%;"></td> <td style="width: 10%;"></td> </tr> <tr> <td></td> <td></td> <td colspan="8" style="text-align: center;"> <table border="1" style="width: 100%; border-collapse: collapse; text-align: center;"> <tr> <td style="width: 10%;"></td> <td style="width: 10%;"></td> <td style="width: 10%;"></td> <td style="width: 10%;"></td> <td style="width: 10%;"></td> <td style="width: 10%;"></td> <td style="width: 10%;"></td> <td style="width: 10%;"></td> <td style="width: 10%;"></td> <td style="width: 10%;"></td> </tr> <tr> <td></td> <td></td> <td colspan="8" style="text-align: center;"> <table border="1" style="width: 100%; border-collapse: collapse; text-align: center;"> <tr> <td style="width: 10%;"></td> <td style="width: 10%;"></td> <td style="width: 10%;"></td> <td style="width: 10%;"></td> <td style="width: 10%;"></td> <td style="width: 10%;"></td> <td style="width: 10%;"></td> <td style="width: 10%;"></td> <td style="width: 10%;"></td> <td style="width: 10%;"></td> </tr> <tr> <td></td> <td></td> <td colspan="8" style="text-align: center;"> <table border="1" style="width: 100%; border-collapse: collapse; text-align: center;"> <tr> <td style="width: 10%;"></td> <td style="width: 10%;"></td> <td style="width: 10%;"></td> <td style="width: 10%;"></td> <td style="width: 10%;"></td> <td style="width: 10%;"></td> <td style="width: 10%;"></td> <td style="width: 10%;"></td> <td style="width: 10%;"></td> <td style="width: 10%;"></td> </tr> <tr> <td></td> <td></td> <td colspan="8" style="text-align: center;"> <table border="1" style="width: 100%; border-collapse: collapse; text-align: center;"> <tr> <td style="width: 10%;"></td> <td style="width: 10%;"></td> <td style="width: 10%;"></td> <td style="width: 10%;"></td> <td style="width: 10%;"></td> <td style="width: 10%;"></td> <td style="width: 10%;"></td> <td style="width: 10%;"></td> <td style="width: 10%;"></td> <td style="width: 10%;"></td> </tr> <tr> <td></td> <td></td> <td colspan="8" style="text-align: center;"> <table border="1" style="width: 100%; border-collapse: collapse; text-align: center;"> <tr> <td style="width: 10%;"></td> <td style="width: 10%;"></td> <td style="width: 10%;"></td> <td style="width: 10%;"></td> <td style="width: 10%;"></td> <td style="width: 10%;"></td> <td style="width: 10%;"></td> <td style="width: 10%;"></td> <td style="width: 10%;"></td> <td style="width: 10%;"></td> </tr> <tr> <td></td> <td></td> <td colspan="8" style="text-align: center;"> <table border="1" style="width: 100%; border-collapse: collapse; text-align: center;"> <tr> <td style="width: 10%;"></td> <td style="width: 10%;"></td> <td style="width: 10%;"></td> <td style="width: 10%;"></td> <td style="width: 10%;"></td> <td style="width: 10%;"></td> <td style="width: 10%;"></td> <td style="width: 10%;"></td> <td style="width: 10%;"></td> <td style="width: 10%;"></td> </tr> <tr> <td></td> <td></td> <td colspan="8" style="text-align: center;"> <table border="1" style="width: 100%; border-collapse: collapse; text-align: center;"> <tr> <td style="width: 10%;"></td> <td style="width: 10%;"></td> <td style="width: 10%;"></td> <td style="width: 10%;"></td> <td style="width: 10%;"></td> <td style="width: 10%;"></td> <td style="width: 10%;"></td> <td style="width: 10%;"></td> <td style="width: 10%;"></td> <td style="width: 10%;"></td> </tr> <tr> <td></td> <td></td> <td colspan="8" style="text-align: center;"> <table border="1" style="width: 100%; border-collapse: collapse; text-align: center;"> <tr> <td style="width: 10%;"></td> <td style="width: 10%;"></td> <td style="width: 10%;"></td> <td style="width: 10%;"></td> <td style="width: 10%;"></td> <td style="width: 10%;"></td> <td style="width: 10%;"></td> <td style="width: 10%;"></td> <td style="width: 10%;"></td> <td style="width: 10%;"></td> </tr> <tr> <td></td> <td></td> <td colspan="8" style="text-align: center;"> <table border="1" style="width: 100%; border-collapse: collapse; text-align: center;"> <tr> <td style="width: 10%;"></td> <td style="width: 10%;"></td> <td style="width: 10%;"></td> <td style="width: 10%;"></td> <td style="width: 10%;"></td> <td style="width: 10%;"></td> <td style="width: 10%;"></td> <td style="width: 10%;"></td> <td style="width: 10%;"></td> <td style="width: 10%;"></td> </tr> <tr> <td></td> <td></td> <td colspan="8" style="text-align: center;"> <table border="1" style="width: 100%; border-collapse: collapse; text-align: center;"> <tr> <td style="width: 10%;"></td> <td style="width: 10%;"></td> <td style="width: 10%;"></td> <td style="width: 10%;"></td> <td style="width: 10%;"></td> <td style="width: 10%;"></td> <td style="width: 10%;"></td> <td style="width: 10%;"></td> <td style="width: 10%;"></td> <td style="width: 10%;"></td> </tr> <tr> <td></td> <td></td> <td colspan="8" style="text-align: center;"> <table border="1" style="width: 100%; border-collapse: collapse; text-align: center;"> <tr> <td style="width: 10%;"></td> <td style="width: 10%;"></td> <td style="width: 10%;"></td> <td style="width: 10%;"></td> <td style="width: 10%;"></td> <td style="width: 10%;"></td> <td style="width: 10%;"></td> <td style="width: 10%;"></td> <td style="width: 10%;"></td> <td style="width: 10%;"></td> </tr> <tr> <td></td> <td></td> <td colspan="8" style="text-align: center;"> <table border="1" style="width: 100%; border-collapse: collapse; text-align: center;"> <tr> <td style="width: 10%;"></td> <td style="width: 10%;"></td> <td style="width: 10%;"></td> <td style="width: 10%;"></td> <td style="width: 10%;"></td> <td style="width: 10%;"></td> <td style="width: 10%;"></td> <td style="width: 10%;"></td> <td style="width: 10%;"></td> <td style="width: 10%;"></td> </tr> <tr> <td></td> <td></td> <td colspan="8" style="text-align: center;"> <table border="1" style="width: 100%; border-collapse: collapse; text-align: center;"> <tr> <td style="width: 10%;"></td> <td style="width: 10%;"></td> <td style="width: 10%;"></td> <td style="width: 10%;"></td> <td style="width: 10%;"></td> <td style="width: 10%;"></td> <td style="width: 10%;"></td> <td style="width: 10%;"></td> <td style="width: 10%;"></td> <td style="width: 10%;"></td> </tr> <tr> <td></td> <td></td> <td colspan="8" style="text-align: center;"> <table border="1" style="width: 100%; border-collapse: collapse; text-align: center;"> <tr> <td style="width: 10%;"></td> <td style="width: 10%;"></td> <td style="width: 10%;"></td> <td style="width: 10%;"></td> <td style="width: 10%;"></td> <td style="width: 10%;"></td> <td style="width: 10%;"></td> <td style="width: 10%;"></td> <td style="width: 10%;"></td> <td style="width: 10%;"></td> </tr> <tr> <td></td> <td></td> <td colspan="8" style="text-align: center;"> <table border="1" style="width: 100%; border-collapse: collapse; text-align: center;"> <tr> <td style="width: 10%;"></td> <td style="width: 10%;"></td> <td style="width: 10%;"></td> <td style="width: 10%;"></td> <td style="width: 10%;"></td> <td style="width: 10%;"></td> <td style="width: 10%;"></td> <td style="width: 10%;"></td> <td style="width: 10%;"></td> <td style="width: 10%;"></td> </tr> <tr> <td></td> <td></td> <td colspan="8" style="text-align: center;"> <table border="1" style="width: 100%; border-collapse: collapse; text-align: center;"> <tr> <td style="width: 10%;"></td> <td style="width: 10%;"></td> <td style="width: 10%;"></td> <td style="width: 10%;"></td> <td style="width: 10%;"></td> <td style="width: 10%;"></td> <td style="width: 10%;"></td> <td style="width: 10%;"></td> <td style="width: 10%;"></td> <td style="width: 10%;"></td> </tr> <tr> <td></td> <td></td> <td colspan="8" style="text-align: center;"> <table border="1" style="width: 100%; border-collapse: collapse; text-align: center;"> <tr> <td style="width: 10%;"></td> <td style="width: 10%;"></td> <td style="width: 10%;"></td> <td style="width: 10%;"></td> <td style="width: 10%;"></td> <td style="width: 10%;"></td> <td style="width: 10%;"></td> <td style="width: 10%;"></td> <td style="width: 10%;"></td> <td style="width: 10%;"></td> </tr> <tr> <td></td> <td></td> <td colspan="8" style="text-align: center;"> <table border="1" style="width: 100%; border-collapse: collapse; text-align: center;"> <tr> <td style="width: 10%;"></td> <td style="width: 10%;"></td> <td style="width: 10%;"></td> <td style="width: 10%;"></td> <td style="width: 10%;"></td> <td style="width: 10%;"></td> <td style="width: 10%;"></td> <td style="width: 10%;"></td> <td style="width: 10%;"></td> <td style="width: 10%;"></td> </tr> <tr> <td></td> <td></td> <td colspan="8" style="text-align: center;"> <table border="1" style="width: 100%; border-collapse: collapse; text-align: center;"> <tr> <td style="width: 10%;"></td> <td style="width: 10%;"></td> <td style="width: 10%;"></td> <td style="width: 10%;"></td> <td style="width: 10%;"></td> <td style="width: 10%;"></td> <td style="width: 10%;"></td> <td style="width: 10%;"></td> <td style="width: 10%;"></td> <td style="width: 10%;"></td> </tr> <tr> <td></td> <td></td> <td colspan="8" style="text-align: center;"> <table border="1" style="width: 100%; border-collapse: collapse; text-align: center;"> <tr> <td style="width: 10%;"></td> <td style="width: 10%;"></td> <td style="width: 10%;"></td> <td style="width: 10%;"></td> <td style="width: 10%;"></td> <td style="width: 10%;"></td> <td style="width: 10%;"></td> <td style="width: 10%;"></td> <td style="width: 10%;"></td> <td style="width: 10%;"></td> </tr> <tr> <td></td> <td></td> <td colspan="8"
style="text-align: center;"> <table border="1" style="width: 100%; border-collapse: collapse; text-align: center;"> <tr> <td style="width: 10%;"></td> <td style="width: 10%;"></td> <td style="width: 10%;"></td> <td style="width: 10%;"></td> <td style="width: 10%;"></td> <td style="width: 10%;"></td> <td style="width: 10%;"></td> <td style="width: 10%;"></td> <td style="width: 10%;"></td> <td style="width: 10%;"></td> </tr> <tr> <td></td> <td></td> <td colspan="8" style="text-align: center;"> <table border="1" style="width: 100%; border-collapse: collapse; text-align: center;"> <tr> <td style="width: 10%;"></td> <td style="width: 10%;"></td> <td style="width: 10%;"></td> <td style="width: 10%;"></td> <td style="width: 10%;"></td> <td style="width: 10%;"></td> <td style="width: 10%;"></td> <td style="width: 10%;"></td> <td style="width: 10%;"></td> <td style="width: 10%;"></td> </tr> <tr> <td></td> <td></td> <td colspan="8" style="text-align: center;"> <table border="1" style="width: 100%; border-collapse: collapse; text-align: center;"> <tr> <td style="width: 10%;"></td> <td style="width: 10%;"></td> <td style="width: 10%;"></td> <td style="width: 10%;"></td> <td style="width: 10%;"></td> <td style="width: 10%;"></td> <td style="width: 10%;"></td> <td style="width: 10%;"></td> <td style="width: 10%;"></td> <td style="width: 10%;"></td> </tr> <tr> <td></td> <td></td> <td colspan="8" style="text-align: center;"> <table border="1" style="width: 100%; border-collapse: collapse; text-align: center;"> <tr> <td style="width: 10%;"></td> <td style="width: 10%;"></td> <td style="width: 10%;"></td> <td style="width: 10%;"></td> <td style="width: 10%;"></td> <td style="width: 10%;"></td> <td style="width: 10%;"></td> <td style="width: 10%;"></td> <td style="width: 10%;"></td> <td style="width: 10%;"></td> </tr> <tr> <td></td> <td></td> <td colspan="8" style="text-align: center;"> <table border="1" style="width: 100%; border-collapse: collapse; text-align: center;"> <tr> </tr></table></td></tr></table></td></tr></table></td></tr></table></td></tr></table></td></tr></table></td></tr></table></td></tr></table></td></tr></table></td></tr></table></td></tr></table></td></tr></table></td></tr></table></td></tr></table></td></tr></table></td></tr></table></td></tr></table></td></tr></table></td></tr></table></td></tr></table></td></tr></table></td></tr></table></td></tr></table></td></tr></table></td></tr></table></td></tr></table></td></tr></table></td></tr></table></td></tr></table></td></tr></table></td></tr></table></td></tr></table></td></tr></table></td></tr></table></td></tr></table></td></tr></table></td></tr></table></td></tr></table></td></tr></table></td></tr></table></td></tr></table></td></tr></table></td></tr></table>
 | | | | | | | | | | | | | | | | | | | | <table border="1" style="width: 100%; border-collapse: collapse; text-align: center;"> <tr> <td style="width: 10%;"></td> <td style="width: 10%;"></td> <td style="width: 10%;"></td> <td style="width: 10%;"></td> <td style="width: 10%;"></td> <td style="width: 10%;"></td> <td style="width: 10%;"></td> <td style="width: 10%;"></td> <td style="width: 10%;"></td> <td style="width: 10%;"></td> </tr> <tr> <td></td> <td></td> <td colspan="8" style="text-align: center;"> <table border="1" style="width: 100%; border-collapse: collapse; text-align: center;"> <tr> <td style="width: 10%;"></td> <td style="width: 10%;"></td> <td style="width: 10%;"></td> <td style="width: 10%;"></td> <td style="width: 10%;"></td> <td style="width: 10%;"></td> <td style="width: 10%;"></td> <td style="width: 10%;"></td> <td style="width: 10%;"></td> <td style="width: 10%;"></td> </tr> <tr> <td></td> <td></td> <td colspan="8" style="text-align: center;"> <table border="1" style="width: 100%; border-collapse: collapse; text-align: center;"> <tr> <td style="width: 10%;"></td> <td style="width: 10%;"></td> <td style="width: 10%;"></td> <td style="width: 10%;"></td> <td style="width: 10%;"></td> <td style="width: 10%;"></td> <td style="width: 10%;"></td> <td style="width: 10%;"></td> <td style="width: 10%;"></td> <td style="width: 10%;"></td> </tr> <tr> <td></td> <td></td> <td colspan="8" style="text-align: center;"> <table border="1" style="width: 100%; border-collapse: collapse; text-align: center;"> <tr> <td style="width: 10%;"></td> <td style="width: 10%;"></td> <td style="width: 10%;"></td> <td style="width: 10%;"></td> <td style="width: 10%;"></td> <td style="width: 10%;"></td> <td style="width: 10%;"></td> <td style="width: 10%;"></td> <td style="width: 10%;"></td> <td style="width: 10%;"></td> </tr> <tr> <td></td> <td></td> <td colspan="8" style="text-align: center;"> <table border="1" style="width: 100%; border-collapse: collapse; text-align: center;"> <tr> <td style="width: 10%;"></td> <td style="width: 10%;"></td> <td style="width: 10%;"></td> <td style="width: 10%;"></td> <td style="width: 10%;"></td> <td style="width: 10%;"></td> <td style="width: 10%;"></td> <td style="width: 10%;"></td> <td style="width: 10%;"></td> <td style="width: 10%;"></td> </tr> <tr> <td></td> <td></td> <td colspan="8" style="text-align: center;"> <table border="1" style="width: 100%; border-collapse: collapse; text-align: center;"> <tr> <td style="width: 10%;"></td> <td style="width: 10%;"></td> <td style="width: 10%;"></td> <td style="width: 10%;"></td> <td style="width: 10%;"></td> <td style="width: 10%;"></td> <td style="width: 10%;"></td> <td style="width: 10%;"></td> <td style="width: 10%;"></td> <td style="width: 10%;"></td> </tr> <tr> <td></td> <td></td> <td colspan="8" style="text-align: center;"> <table border="1" style="width: 100%; border-collapse: collapse; text-align: center;"> <tr> <td style="width: 10%;"></td> <td style="width: 10%;"></td> <td style="width: 10%;"></td> <td style="width: 10%;"></td> <td style="width: 10%;"></td> <td style="width: 10%;"></td> <td style="width: 10%;"></td> <td style="width: 10%;"></td> <td style="width: 10%;"></td> <td style="width: 10%;"></td> </tr> <tr> <td></td> <td></td> <td colspan="8" style="text-align: center;"> <table border="1" style="width: 100%; border-collapse: collapse; text-align: center;"> <tr> <td style="width: 10%;"></td> <td style="width: 10%;"></td> <td style="width: 10%;"></td> <td style="width: 10%;"></td> <td style="width: 10%;"></td> <td style="width: 10%;"></td> <td style="width: 10%;"></td> <td style="width: 10%;"></td> <td style="width: 10%;"></td> <td style="width: 10%;"></td> </tr> <tr> <td></td> <td></td> <td colspan="8" style="text-align: center;"> <table border="1" style="width: 100%; border-collapse: collapse; text-align: center;"> <tr> <td style="width: 10%;"></td> <td style="width: 10%;"></td> <td style="width: 10%;"></td> <td style="width: 10%;"></td> <td style="width: 10%;"></td> <td style="width: 10%;"></td> <td style="width: 10%;"></td> <td style="width: 10%;"></td> <td style="width: 10%;"></td> <td style="width: 10%;"></td> </tr> <tr> <td></td> <td></td> <td colspan="8" style="text-align: center;"> <table border="1" style="width: 100%; border-collapse: collapse; text-align: center;"> <tr> <td style="width: 10%;"></td> <td style="width: 10%;"></td> <td style="width: 10%;"></td> <td style="width: 10%;"></td> <td style="width: 10%;"></td> <td style="width: 10%;"></td> <td style="width: 10%;"></td> <td style="width: 10%;"></td> <td style="width: 10%;"></td> <td style="width: 10%;"></td> </tr> <tr> <td></td> <td></td> <td colspan="8" style="text-align: center;"> <table border="1" style="width: 100%; border-collapse: collapse; text-align: center;"> <tr> <td style="width: 10%;"></td> <td style="width: 10%;"></td> <td style="width: 10%;"></td> <td style="width: 10%;"></td> <td style="width: 10%;"></td> <td style="width: 10%;"></td> <td style="width: 10%;"></td> <td style="width: 10%;"></td> <td style="width: 10%;"></td> <td style="width: 10%;"></td> </tr> <tr> <td></td> <td></td> <td colspan="8" style="text-align: center;"> <table border="1" style="width: 100%; border-collapse: collapse; text-align: center;"> <tr> <td style="width: 10%;"></td> <td style="width: 10%;"></td> <td style="width: 10%;"></td> <td style="width: 10%;"></td> <td style="width: 10%;"></td> <td style="width: 10%;"></td> <td style="width: 10%;"></td> <td style="width: 10%;"></td> <td style="width: 10%;"></td> <td style="width: 10%;"></td> </tr> <tr> <td></td> <td></td> <td colspan="8" style="text-align: center;"> <table border="1" style="width: 100%; border-collapse: collapse; text-align: center;"> <tr> <td style="width: 10%;"></td> <td style="width: 10%;"></td> <td style="width: 10%;"></td> <td style="width: 10%;"></td> <td style="width: 10%;"></td> <td style="width: 10%;"></td> <td style="width: 10%;"></td> <td style="width: 10%;"></td> <td style="width: 10%;"></td> <td style="width: 10%;"></td> </tr> <tr> <td></td> <td></td> <td colspan="8" style="text-align: center;"> <table border="1" style="width: 100%; border-collapse: collapse; text-align: center;"> <tr> <td style="width: 10%;"></td> <td style="width: 10%;"></td> <td style="width: 10%;"></td> <td style="width: 10%;"></td> <td style="width: 10%;"></td> <td style="width: 10%;"></td> <td style="width: 10%;"></td> <td style="width: 10%;"></td> <td style="width: 10%;"></td> <td style="width: 10%;"></td> </tr> <tr> <td></td> <td></td> <td colspan="8" style="text-align: center;"> <table border="1" style="width: 100%; border-collapse: collapse; text-align: center;"> <tr> <td style="width: 10%;"></td> <td style="width: 10%;"></td> <td style="width: 10%;"></td> <td style="width: 10%;"></td> <td style="width: 10%;"></td> <td style="width: 10%;"></td> <td style="width: 10%;"></td> <td style="width: 10%;"></td> <td style="width: 10%;"></td> <td style="width: 10%;"></td> </tr> <tr> <td></td> <td></td> <td colspan="8" style="text-align: center;"> <table border="1" style="width: 100%; border-collapse: collapse; text-align: center;"> <tr> <td style="width: 10%;"></td> <td style="width: 10%;"></td> <td style="width: 10%;"></td> <td style="width: 10%;"></td> <td style="width: 10%;"></td> <td style="width: 10%;"></td> <td style="width: 10%;"></td> <td style="width: 10%;"></td> <td style="width: 10%;"></td> <td style="width: 10%;"></td> </tr> <tr> <td></td> <td></td> <td colspan="8" style="text-align: center;"> <table border="1" style="width: 100%; border-collapse: collapse; text-align: center;"> <tr> <td style="width: 10%;"></td> <td style="width: 10%;"></td> <td style="width: 10%;"></td> <td style="width: 10%;"></td> <td style="width: 10%;"></td> <td style="width: 10%;"></td> <td style="width: 10%;"></td> <td style="width: 10%;"></td> <td style="width: 10%;"></td> <td style="width: 10%;"></td> </tr> <tr> <td></td> <td></td> <td colspan="8" style="text-align: center;"> <table border="1" style="width: 100%; border-collapse: collapse; text-align: center;"> <tr> <td style="width: 10%;"></td> <td style="width: 10%;"></td> <td style="width: 10%;"></td> <td style="width: 10%;"></td> <td style="width: 10%;"></td> <td style="width: 10%;"></td> <td style="width: 10%;"></td> <td style="width: 10%;"></td> <td style="width: 10%;"></td> <td style="width: 10%;"></td> </tr> <tr> <td></td> <td></td> <td colspan="8" style="text-align: center;">
<table border="1" style="width: 100%; border-collapse: collapse; text-align: center;"> <tr> <td style="width: 10%;"></td> <td style="width: 10%;"></td> <td style="width: 10%;"></td> <td style="width: 10%;"></td> <td style="width: 10%;"></td> <td style="width: 10%;"></td> <td style="width: 10%;"></td> <td style="width: 10%;"></td> <td style="width: 10%;"></td> <td style="width: 10%;"></td> </tr> <tr> <td></td> <td></td> <td colspan="8" style="text-align: center;"> <table border="1" style="width: 100%; border-collapse: collapse; text-align: center;"> <tr> <td style="width: 10%;"></td> <td style="width: 10%;"></td> <td style="width: 10%;"></td> <td style="width: 10%;"></td> <td style="width: 10%;"></td> <td style="width: 10%;"></td> <td style="width: 10%;"></td> <td style="width: 10%;"></td> <td style="width: 10%;"></td> <td style="width: 10%;"></td> </tr> <tr> <td></td> <td></td> <td colspan="8" style="text-align: center;"> <table border="1" style="width: 100%; border-collapse: collapse; text-align: center;"> <tr> <td style="width: 10%;"></td> <td style="width: 10%;"></td> <td style="width: 10%;"></td> <td style="width: 10%;"></td> <td style="width: 10%;"></td> <td style="width: 10%;"></td> <td style="width: 10%;"></td> <td style="width: 10%;"></td> <td style="width: 10%;"></td> <td style="width: 10%;"></td> </tr> <tr> <td></td> <td></td> <td colspan="8" style="text-align: center;"> <table border="1" style="width: 100%; border-collapse: collapse; text-align: center;"> <tr> <td style="width: 10%;"></td> <td style="width: 10%;"></td> <td style="width: 10%;"></td> <td style="width: 10%;"></td> <td style="width: 10%;"></td> <td style="width: 10%;"></td> <td style="width: 10%;"></td> <td style="width: 10%;"></td> <td style="width: 10%;"></td> <td style="width: 10%;"></td> </tr> <tr> <td></td> <td></td> <td colspan="8" style="text-align: center;"> <table border="1" style="width: 100%; border-collapse: collapse; text-align: center;"> <tr> <td style="width: 10%;"></td> <td style="width: 10%;"></td> <td style="width: 10%;"></td> <td style="width: 10%;"></td> <td style="width: 10%;"></td> <td style="width: 10%;"></td> <td style="width: 10%;"></td> <td style="width: 10%;"></td> <td style="width: 10%;"></td> <td style="width: 10%;"></td> </tr> <tr> <td></td> <td></td> <td colspan="8" style="text-align: center;"> <table border="1" style="width: 100%; border-collapse: collapse; text-align: center;"> <tr> <td style="width: 10%;"></td> <td style="width: 10%;"></td> <td style="width: 10%;"></td> <td style="width: 10%;"></td> <td style="width: 10%;"></td> <td style="width: 10%;"></td> <td style="width: 10%;"></td> <td style="width: 10%;"></td> <td style="width: 10%;"></td> <td style="width: 10%;"></td> </tr> <tr> <td></td> <td></td> <td colspan="8" style="text-align: center;"> <table border="1" style="width: 100%; border-collapse: collapse; text-align: center;"> <tr> <td style="width: 10%;"></td> <td style="width: 10%;"></td> <td style="width: 10%;"></td> <td style="width: 10%;"></td> <td style="width: 10%;"></td> <td style="width: 10%;"></td> <td style="width: 10%;"></td> <td style="width: 10%;"></td> <td style="width: 10%;"></td> <td style="width: 10%;"></td> </tr> <tr> <td></td> <td></td> <td colspan="8" style="text-align: center;"> <table border="1" style="width: 100%; border-collapse: collapse; text-align: center;"> <tr> <td style="width: 10%;"></td> <td style="width: 10%;"></td> <td style="width: 10%;"></td> <td style="width: 10%;"></td> <td style="width: 10%;"></td> <td style="width: 10%;"></td> <td style="width: 10%;"></td> <td style="width: 10%;"></td> <td style="width: 10%;"></td> <td style="width: 10%;"></td> </tr> <tr> <td></td> <td></td> <td colspan="8" style="text-align: center;"> <table border="1" style="width: 100%; border-collapse: collapse; text-align: center;"> <tr> <td style="width: 10%;"></td> <td style="width: 10%;"></td> <td style="width: 10%;"></td> <td style="width: 10%;"></td> <td style="width: 10%;"></td> <td style="width: 10%;"></td> <td style="width: 10%;"></td> <td style="width: 10%;"></td> <td style="width: 10%;"></td> <td style="width: 10%;"></td> </tr> <tr> <td></td> <td></td> <td colspan="8" style="text-align: center;"> <table border="1" style="width: 100%; border-collapse: collapse; text-align: center;"> <tr> <td style="width: 10%;"></td> <td style="width: 10%;"></td> <td style="width: 10%;"></td> <td style="width: 10%;"></td> <td style="width: 10%;"></td> <td style="width: 10%;"></td> <td style="width: 10%;"></td> <td style="width: 10%;"></td> <td style="width: 10%;"></td> <td style="width: 10%;"></td> </tr> <tr> <td></td> <td></td> <td colspan="8" style="text-align: center;"> <table border="1" style="width: 100%; border-collapse: collapse; text-align: center;"> <tr> <td style="width: 10%;"></td> <td style="width: 10%;"></td> <td style="width: 10%;"></td> <td style="width: 10%;"></td> <td style="width: 10%;"></td> <td style="width: 10%;"></td> <td style="width: 10%;"></td> <td style="width: 10%;"></td> <td style="width: 10%;"></td> <td style="width: 10%;"></td> </tr> <tr> <td></td> <td></td> <td colspan="8" style="text-align: center;"> <table border="1" style="width: 100%; border-collapse: collapse; text-align: center;"> <tr> <td style="width: 10%;"></td> <td style="width: 10%;"></td> <td style="width: 10%;"></td> <td style="width: 10%;"></td> <td style="width: 10%;"></td> <td style="width: 10%;"></td> <td style="width: 10%;"></td> <td style="width: 10%;"></td> <td style="width: 10%;"></td> <td style="width: 10%;"></td> </tr> <tr> <td></td> <td></td> <td colspan="8" style="text-align: center;"> <table border="1" style="width: 100%; border-collapse: collapse; text-align: center;"> <tr> <td style="width: 10%;"></td> <td style="width: 10%;"></td> <td style="width: 10%;"></td> <td style="width: 10%;"></td> <td style="width: 10%;"></td> <td style="width: 10%;"></td> <td style="width: 10%;"></td> <td style="width: 10%;"></td> <td style="width: 10%;"></td> <td style="width: 10%;"></td> </tr> <tr> <td></td> <td></td> <td colspan="8" style="text-align: center;"> <table border="1" style="width: 100%; border-collapse: collapse; text-align: center;"> <tr> <td style="width: 10%;"></td> <td style="width: 10%;"></td> <td style="width: 10%;"></td> <td style="width: 10%;"></td> <td style="width: 10%;"></td> <td style="width: 10%;"></td> <td style="width: 10%;"></td> <td style="width: 10%;"></td> <td style="width: 10%;"></td> <td style="width: 10%;"></td> </tr> <tr> <td></td> <td></td> <td colspan="8" style="text-align: center;"> <table border="1" style="width: 100%; border-collapse: collapse; text-align: center;"> <tr> <td style="width: 10%;"></td> <td style="width: 10%;"></td> <td style="width: 10%;"></td> <td style="width: 10%;"></td> <td style="width: 10%;"></td> <td style="width: 10%;"></td> <td style="width: 10%;"></td> <td style="width: 10%;"></td> <td style="width: 10%;"></td> <td style="width: 10%;"></td> </tr> <tr> <td></td> <td></td> <td colspan="8" style="text-align: center;"> <table border="1" style="width: 100%; border-collapse: collapse; text-align: center;"> <tr> <td style="width: 10%;"></td> <td style="width: 10%;"></td> <td style="width: 10%;"></td> <td style="width: 10%;"></td> <td style="width: 10%;"></td> <td style="width: 10%;"></td> <td style="width: 10%;"></td> <td style="width: 10%;"></td> <td style="width: 10%;"></td> <td style="width: 10%;"></td> </tr> <tr> <td></td> <td></td> <td colspan="8" style="text-align: center;"> <table border="1" style="width: 100%; border-collapse: collapse; text-align: center;"> <tr> <td style="width: 10%;"></td> <td style="width: 10%;"></td> <td style="width: 10%;"></td> <td style="width: 10%;"></td> <td style="width: 10%;"></td> <td style="width: 10%;"></td> <td style="width: 10%;"></td> <td style="width: 10%;"></td> <td style="width: 10%;"></td> <td style="width: 10%;"></td> </tr> <tr> <td></td> <td></td> <td colspan="8" style="text-align: center;"> <table border="1" style="width: 100%; border-collapse: collapse; text-align: center;"> <tr> <td style="width: 10%;"></td> <td style="width: 10%;"></td> <td style="width: 10%;"></td> <td style="width: 10%;"></td> <td style="width: 10%;"></td> <td style="width: 10%;"></td> <td style="width: 10%;"></td> <td style="width: 10%;"></td> <td style="width: 10%;"></td> <td style="width: 10%;"></td> </tr> <tr> <td></td> <td></td> <td colspan="8" style="text-align: center;"> <table border="1" style="width: 100%; border-collapse: collapse; text-align: center;"> <tr> <td style="width: 10%;"></td> <td style="width: 10%;"></td> <td style="width: 10%;"></td> <td style="width: 10%;"></td> <td style="width: 10%;"></td> <td style="width: 10%;"></td> <td style="width: 10%;"></td> <td style="width: 10%;"></td> <td style="width: 10%;"></td> <td style="width: 10%;"></td> </tr> <tr> <td></td> <td></td> <td colspan="8" style="text-align: center;"> <table border="1" style="width: 100%; border-collapse: collapse; text-align: center;"> <tr> <td style="width: 10%;"></td> <td style="width: 10%;"></td> <td style="width: 10%;"></td> <td style="width: 10%;"></td> <td style="width: 10%;"></td> <td style="width: 10%;"></td> <td style="width: 10%;"></td> <td style="width: 10%;"></td> <td style="width: 10%;"></td> <td style="width: 10%;"></td> </tr> <tr> <td></td> <td></td> <td colspan="8" style="text-align: center;"> <table border="1" style="width: 100%; border-collapse: collapse; text-align: center;"> <tr> <td style="width: 10%;"></td> <td style="width: 10%;"></td> <td style="width: 10%;"></td> <td style="width: 10%;"></td> <td style="width: 10%;"></td> <td style="width: 10%;"></td> <td style="width: 10%;"></td> <td style="width: 10%;"></td> <td style="width: 10%;"></td> <td style="width: 10%;"></td> </tr> <tr> <td></td> <td></td> <td colspan="8" style="text-align: center;"> <table border="1" style="width: 100%; border-collapse: collapse; text-align: center;"> <tr> <td style="width: 10%;"></td> <td style="width: 10%;"></td> <td style="width:
10%;"></td> <td style="width: 10%;"></td> <td style="width: 10%;"></td> <td style="width: 10%;"></td> <td style="width: 10%;"></td> <td style="width: 10%;"></td> <td style="width: 10%;"></td> <td style="width: 10%;"></td> </tr> <tr> <td></td> <td></td> <td colspan="8" style="text-align: center;"> <table border="1" style="width: 100%; border-collapse: collapse; text-align: center;"> <tr> <td style="width: 10%;"></td> <td style="width: 10%;"></td> <td style="width: 10%;"></td> <td style="width: 10%;"></td> <td style="width: 10%;"></td> <td style="width: 10%;"></td> <td style="width: 10%;"></td> <td style="width: 10%;"></td> <td style="width: 10%;"></td> <td style="width: 10%;"></td> </tr> <tr> <td></td> <td></td> <td colspan="8" style="text-align: center;"> <table border="1" style="width: 100%; border-collapse: collapse; text-align: center;"> <tr> </tr></table></td></tr></table></td></tr></table></td></tr></table></td></tr></table></td></tr></table></td></tr></table></td></tr></table></td></tr></table></td></tr></table></td></tr></table></td></tr></table></td></tr></table></td></tr></table></td></tr></table></td></tr></table></td></tr></table></td></tr></table></td></tr></table></td></tr></table></td></tr></table></td></tr></table></td></tr></table></td></tr></table></td></tr></table></td></tr></table></td></tr></table></td></tr></table></td></tr></table></td></tr></table></td></tr></table></td></tr></table></td></tr></table></td></tr></table></td></tr></table></td></tr></table></td></tr></table></td></tr></table></td></tr></table></td></tr></table></td></tr></table></td></tr></table>
 | | | | | | | | | | | | | | | | | | | | <table border="1" style="width: 100%; border-collapse: collapse; text-align: center;"> <tr> <td style="width: 10%;"></td> <td style="width: 10%;"></td> <td style="width: 10%;"></td> <td style="width: 10%;"></td> <td style="width: 10%;"></td> <td style="width: 10%;"></td> <td style="width: 10%;"></td> <td style="width: 10%;"></td> <td style="width: 10%;"></td> <td style="width: 10%;"></td> </tr> <tr> <td></td> <td></td> <td colspan="8" style="text-align: center;"> <table border="1" style="width: 100%; border-collapse: collapse; text-align: center;"> <tr> <td style="width: 10%;"></td> <td style="width: 10%;"></td> <td style="width: 10%;"></td> <td style="width: 10%;"></td> <td style="width: 10%;"></td> <td style="width: 10%;"></td> <td style="width: 10%;"></td> <td style="width: 10%;"></td> <td style="width: 10%;"></td> <td style="width: 10%;"></td> </tr> <tr> <td></td> <td></td> <td colspan="8" style="text-align: center;"> <table border="1" style="width: 100%; border-collapse: collapse; text-align: center;"> <tr> <td style="width: 10%;"></td> <td style="width: 10%;"></td> <td style="width: 10%;"></td> <td style="width: 10%;"></td> <td style="width: 10%;"></td> <td style="width: 10%;"></td> <td style="width: 10%;"></td> <td style="width: 10%;"></td> <td style="width: 10%;"></td> <td style="width: 10%;"></td> </tr> <tr> <td></td> <td></td> <td colspan="8" style="text-align: center;"> <table border="1" style="width: 100%; border-collapse: collapse; text-align: center;"> <tr> <td style="width: 10%;"></td> <td style="width: 10%;"></td> <td style="width: 10%;"></td> <td style="width: 10%;"></td> <td style="width: 10%;"></td> <td style="width: 10%;"></td> <td style="width: 10%;"></td> <td style="width: 10%;"></td> <td style="width: 10%;"></td> <td style="width: 10%;"></td> </tr> <tr> <td></td> <td></td> <td colspan="8" style="text-align: center;"> <table border="1" style="width: 100%; border-collapse: collapse; text-align: center;"> <tr> <td style="width: 10%;"></td> <td style="width: 10%;"></td> <td style="width: 10%;"></td> <td style="width: 10%;"></td> <td style="width: 10%;"></td> <td style="width: 10%;"></td> <td style="width: 10%;"></td> <td style="width: 10%;"></td> <td style="width: 10%;"></td> <td style="width: 10%;"></td> </tr> <tr> <td></td> <td></td> <td colspan="8" style="text-align: center;"> <table border="1" style="width: 100%; border-collapse: collapse; text-align: center;"> <tr> <td style="width: 10%;"></td> <td style="width: 10%;"></td> <td style="width: 10%;"></td> <td style="width: 10%;"></td> <td style="width: 10%;"></td> <td style="width: 10%;"></td> <td style="width: 10%;"></td> <td style="width: 10%;"></td> <td style="width: 10%;"></td> <td style="width: 10%;"></td> </tr> <tr> <td></td> <td></td> <td colspan="8" style="text-align: center;"> <table border="1" style="width: 100%; border-collapse: collapse; text-align: center;"> <tr> <td style="width: 10%;"></td> <td style="width: 10%;"></td> <td style="width: 10%;"></td> <td style="width: 10%;"></td> <td style="width: 10%;"></td> <td style="width: 10%;"></td> <td style="width: 10%;"></td> <td style="width: 10%;"></td> <td style="width: 10%;"></td> <td style="width: 10%;"></td> </tr> <tr> <td></td> <td></td> <td colspan="8" style="text-align: center;"> <table border="1" style="width: 100%; border-collapse: collapse; text-align: center;"> <tr> <td style="width: 10%;"></td> <td style="width: 10%;"></td> <td style="width: 10%;"></td> <td style="width: 10%;"></td> <td style="width: 10%;"></td> <td style="width: 10%;"></td> <td style="width: 10%;"></td> <td style="width: 10%;"></td> <td style="width: 10%;"></td> <td style="width: 10%;"></td> </tr> <tr> <td></td> <td></td> <td colspan="8" style="text-align: center;"> <table border="1" style="width: 100%; border-collapse: collapse; text-align: center;"> <tr> <td style="width: 10%;"></td> <td style="width: 10%;"></td> <td style="width: 10%;"></td> <td style="width: 10%;"></td> <td style="width: 10%;"></td> <td style="width: 10%;"></td> <td style="width: 10%;"></td> <td style="width: 10%;"></td> <td style="width: 10%;"></td> <td style="width: 10%;"></td> </tr> <tr> <td></td> <td></td> <td colspan="8" style="text-align: center;"> <table border="1" style="width: 100%; border-collapse: collapse; text-align: center;"> <tr> <td style="width: 10%;"></td> <td style="width: 10%;"></td> <td style="width: 10%;"></td> <td style="width: 10%;"></td> <td style="width: 10%;"></td> <td style="width: 10%;"></td> <td style="width: 10%;"></td> <td style="width: 10%;"></td> <td style="width: 10%;"></td> <td style="width: 10%;"></td> </tr> <tr> <td></td> <td></td> <td colspan="8" style="text-align: center;"> <table border="1" style="width: 100%; border-collapse: collapse; text-align: center;"> <tr> <td style="width: 10%;"></td> <td style="width: 10%;"></td> <td style="width: 10%;"></td> <td style="width: 10%;"></td> <td style="width: 10%;"></td> <td style="width: 10%;"></td> <td style="width: 10%;"></td> <td style="width: 10%;"></td> <td style="width: 10%;"></td> <td style="width: 10%;"></td> </tr> <tr> <td></td> <td></td> <td colspan="8" style="text-align: center;"> <table border="1" style="width: 100%; border-collapse: collapse; text-align: center;"> <tr> <td style="width: 10%;"></td> <td style="width: 10%;"></td> <td style="width: 10%;"></td> <td style="width: 10%;"></td> <td style="width: 10%;"></td> <td style="width: 10%;"></td> <td style="width: 10%;"></td> <td style="width: 10%;"></td> <td style="width: 10%;"></td> <td style="width: 10%;"></td> </tr> <tr> <td></td> <td></td> <td colspan="8" style="text-align: center;"> <table border="1" style="width: 100%; border-collapse: collapse; text-align: center;"> <tr> <td style="width: 10%;"></td> <td style="width: 10%;"></td> <td style="width: 10%;"></td> <td style="width: 10%;"></td> <td style="width: 10%;"></td> <td style="width: 10%;"></td> <td style="width: 10%;"></td> <td style="width: 10%;"></td> <td style="width: 10%;"></td> <td style="width: 10%;"></td> </tr> <tr> <td></td> <td></td> <td colspan="8" style="text-align: center;"> <table border="1" style="width: 100%; border-collapse: collapse; text-align: center;"> <tr> <td style="width: 10%;"></td> <td style="width: 10%;"></td> <td style="width: 10%;"></td> <td style="width: 10%;"></td> <td style="width: 10%;"></td> <td style="width: 10%;"></td> <td style="width: 10%;"></td> <td style="width: 10%;"></td> <td style="width: 10%;"></td> <td style="width: 10%;"></td> </tr> <tr> <td></td> <td></td> <td colspan="8" style="text-align: center;"> <table border="1" style="width: 100%; border-collapse: collapse; text-align: center;"> <tr> <td style="width: 10%;"></td> <td style="width: 10%;"></td> <td style="width: 10%;"></td> <td style="width: 10%;"></td> <td style="width: 10%;"></td> <td style="width: 10%;"></td> <td style="width: 10%;"></td> <td style="width: 10%;"></td> <td style="width: 10%;"></td> <td style="width: 10%;"></td> </tr> <tr> <td></td> <td></td> <td colspan="8" style="text-align: center;"> <table border="1" style="width: 100%; border-collapse: collapse; text-align: center;"> <tr> <td style="width: 10%;"></td> <td style="width: 10%;"></td> <td style="width: 10%;"></td> <td style="width: 10%;"></td> <td style="width: 10%;"></td> <td style="width: 10%;"></td> <td style="width: 10%;"></td> <td style="width: 10%;"></td> <td style="width: 10%;"></td> <td style="width: 10%;"></td> </tr> <tr> <td></td> <td></td> <td colspan="8" style="text-align: center;"> <table border="1" style="width: 100%; border-collapse: collapse; text-align: center;"> <tr> <td style="width: 10%;"></td> <td style="width: 10%;"></td> <td style="width: 10%;"></td> <td style="width: 10%;"></td> <td style="width: 10%;"></td> <td style="width: 10%;"></td> <td style="width: 10%;"></td> <td style="width: 10%;"></td> <td style="width: 10%;"></td> <td style="width: 10%;"></td> </tr> <tr> <td></td> <td></td> <td colspan="8" style="text-align: center;"> <table border="1" style="width: 100%; border-collapse: collapse; text-align: center;"> <tr> <td style="width: 10%;"></td> <td style="width: 10%;"></td> <td style="width: 10%;"></td> <td style="width: 10%;"></td> <td style="width: 10%;"></td> <td style="width: 10%;"></td> <td style="width: 10%;"></td> <td style="width: 10%;"></td> <td style="width: 10%;"></td> <td style="width: 10%;"></td> </tr> <tr> <td></td> <td></td> <td colspan="8" style="text-align: center;"> <table border="1" style="width: 100%; border-collapse: collapse; text-align: center;"> <tr> <td style="width: 10%;"></td> <td style="width: 10%;"></td> <td style="width: 10%;"></td> <td style="width: 10%;"></td> <td style="width: 10%;"></td> <td style="width: 10%;"></td> <td style="width: 10%;"></td> <td style="width: 10%;"></td> <td style="width: 10%;"></td> <td style="width: 10%;"></td> </tr> <tr> <td></td> <td></td> <td colspan="8" style="text-align: center;"> <table border="1" style="width: 100%; border-collapse: collapse; text-align: center;"> <tr> <td style="width: 10%;"></td> <td style="width: 10%;"></td> <td style="width: 10%;"></td> <td style="width: 10%;"></td> <td style="width: 10%;"></td> <td style="width: 10%;"></td> <td style="width: 10%;"></td> <td style="width: 10%;"></td> <td style="width: 10%;"></td> <td style="width: 10%;"></td> </tr> <tr> <td></td> <td></td> <td colspan="8" style="text-align: center;"> <table border="1" style="width: 100%; border-collapse: collapse; text-align: center;"> <tr> <td style="width: 10%;"></td> <td style="width: 10%;"></td> <td style="width: 10%;"></td> <td style="width: 10%;"></td> <td
style="width: 10%;"></td> <td style="width: 10%;"></td> <td style="width: 10%;"></td> <td style="width: 10%;"></td> <td style="width: 10%;"></td> <td style="width: 10%;"></td> </tr> <tr> <td></td> <td></td> <td colspan="8" style="text-align: center;"> <table border="1" style="width: 100%; border-collapse: collapse; text-align: center;"> <tr> <td style="width: 10%;"></td> <td style="width: 10%;"></td> <td style="width: 10%;"></td> <td style="width: 10%;"></td> <td style="width: 10%;"></td> <td style="width: 10%;"></td> <td style="width: 10%;"></td> <td style="width: 10%;"></td> <td style="width: 10%;"></td> <td style="width: 10%;"></td> </tr> <tr> <td></td> <td></td> <td colspan="8" style="text-align: center;"> <table border="1" style="width: 100%; border-collapse: collapse; text-align: center;"> <tr> <td style="width: 10%;"></td> <td style="width: 10%;"></td> <td style="width: 10%;"></td> <td style="width: 10%;"></td> <td style="width: 10%;"></td> <td style="width: 10%;"></td> <td style="width: 10%;"></td> <td style="width: 10%;"></td> <td style="width: 10%;"></td> <td style="width: 10%;"></td> </tr> <tr> <td></td> <td></td> <td colspan="8" style="text-align: center;"> <table border="1" style="width: 100%; border-collapse: collapse; text-align: center;"> <tr> <td style="width: 10%;"></td> <td style="width: 10%;"></td> <td style="width: 10%;"></td> <td style="width: 10%;"></td> <td style="width: 10%;"></td> <td style="width: 10%;"></td> <td style="width: 10%;"></td> <td style="width: 10%;"></td> <td style="width: 10%;"></td> <td style="width: 10%;"></td> </tr> <tr> <td></td> <td></td> <td colspan="8" style="text-align: center;"> <table border="1" style="width: 100%; border-collapse: collapse; text-align: center;"> <tr> <td style="width: 10%;"></td> <td style="width: 10%;"></td> <td style="width: 10%;"></td> <td style="width: 10%;"></td> <td style="width: 10%;"></td> <td style="width: 10%;"></td> <td style="width: 10%;"></td> <td style="width: 10%;"></td> <td style="width: 10%;"></td> <td style="width: 10%;"></td> </tr> <tr> <td></td> <td></td> <td colspan="8" style="text-align: center;"> <table border="1" style="width: 100%; border-collapse: collapse; text-align: center;"> <tr> <td style="width: 10%;"></td> <td style="width: 10%;"></td> <td style="width: 10%;"></td> <td style="width: 10%;"></td> <td style="width: 10%;"></td> <td style="width: 10%;"></td> <td style="width: 10%;"></td> <td style="width: 10%;"></td> <td style="width: 10%;"></td> <td style="width: 10%;"></td> </tr> <tr> <td></td> <td></td> <td colspan="8" style="text-align: center;"> <table border="1" style="width: 100%; border-collapse: collapse; text-align: center;"> <tr> <td style="width: 10%;"></td> <td style="width: 10%;"></td> <td style="width: 10%;"></td> <td style="width: 10%;"></td> <td style="width: 10%;"></td> <td style="width: 10%;"></td> <td style="width: 10%;"></td> <td style="width: 10%;"></td> <td style="width: 10%;"></td> <td style="width: 10%;"></td> </tr> <tr> <td></td> <td></td> <td colspan="8" style="text-align: center;"> <table border="1" style="width: 100%; border-collapse: collapse; text-align: center;"> <tr> <td style="width: 10%;"></td> <td style="width: 10%;"></td> <td style="width: 10%;"></td> <td style="width: 10%;"></td> <td style="width: 10%;"></td> <td style="width: 10%;"></td> <td style="width: 10%;"></td> <td style="width: 10%;"></td> <td style="width: 10%;"></td> <td style="width: 10%;"></td> </tr> <tr> <td></td> <td></td> <td colspan="8" style="text-align: center;"> <table border="1" style="width: 100%; border-collapse: collapse; text-align: center;"> <tr> <td style="width: 10%;"></td> <td style="width: 10%;"></td> <td style="width: 10%;"></td> <td style="width: 10%;"></td> <td style="width: 10%;"></td> <td style="width: 10%;"></td> <td style="width: 10%;"></td> <td style="width: 10%;"></td> <td style="width: 10%;"></td> <td style="width: 10%;"></td> </tr> <tr> <td></td> <td></td> <td colspan="8" style="text-align: center;"> <table border="1" style="width: 100%; border-collapse: collapse; text-align: center;"> <tr> <td style="width: 10%;"></td> <td style="width: 10%;"></td> <td style="width: 10%;"></td> <td style="width: 10%;"></td> <td style="width: 10%;"></td> <td style="width: 10%;"></td> <td style="width: 10%;"></td> <td style="width: 10%;"></td> <td style="width: 10%;"></td> <td style="width: 10%;"></td> </tr> <tr> <td></td> <td></td> <td colspan="8" style="text-align: center;"> <table border="1" style="width: 100%; border-collapse: collapse; text-align: center;"> <tr> <td style="width: 10%;"></td> <td style="width: 10%;"></td> <td style="width: 10%;"></td> <td style="width: 10%;"></td> <td style="width: 10%;"></td> <td style="width: 10%;"></td> <td style="width: 10%;"></td> <td style="width: 10%;"></td> <td style="width: 10%;"></td> <td style="width: 10%;"></td> </tr> <tr> <td></td> <td></td> <td colspan="8" style="text-align: center;"> <table border="1" style="width: 100%; border-collapse: collapse; text-align: center;"> <tr> <td style="width: 10%;"></td> <td style="width: 10%;"></td> <td style="width: 10%;"></td> <td style="width: 10%;"></td> <td style="width: 10%;"></td> <td style="width: 10%;"></td> <td style="width: 10%;"></td> <td style="width: 10%;"></td> <td style="width: 10%;"></td> <td style="width: 10%;"></td> </tr> <tr> <td></td> <td></td> <td colspan="8" style="text-align: center;"> <table border="1" style="width: 100%; border-collapse: collapse; text-align: center;"> <tr> <td style="width: 10%;"></td> <td style="width: 10%;"></td> <td style="width: 10%;"></td> <td style="width: 10%;"></td> <td style="width: 10%;"></td> <td style="width: 10%;"></td> <td style="width: 10%;"></td> <td style="width: 10%;"></td> <td style="width: 10%;"></td> <td style="width: 10%;"></td> </tr> <tr> <td></td> <td></td> <td colspan="8" style="text-align: center;"> <table border="1" style="width: 100%; border-collapse: collapse; text-align: center;"> <tr> <td style="width: 10%;"></td> <td style="width: 10%;"></td> <td style="width: 10%;"></td> <td style="width: 10%;"></td> <td style="width: 10%;"></td> <td style="width: 10%;"></td> <td style="width: 10%;"></td> <td style="width: 10%;"></td> <td style="width: 10%;"></td> <td style="width: 10%;"></td> </tr> <tr> <td></td> <td></td> <td colspan="8" style="text-align: center;"> <table border="1" style="width: 100%; border-collapse: collapse; text-align: center;"> <tr> <td style="width: 10%;"></td> <td style="width: 10%;"></td> <td style="width: 10%;"></td> <td style="width: 10%;"></td> <td style="width: 10%;"></td> <td style="width: 10%;"></td> <td style="width: 10%;"></td> <td style="width: 10%;"></td> <td style="width: 10%;"></td> <td style="width: 10%;"></td> </tr> <tr> <td></td> <td></td> <td colspan="8" style="text-align: center;"> <table border="1" style="width: 100%; border-collapse: collapse; text-align: center;"> <tr> <td style="width: 10%;"></td> <td style="width: 10%;"></td> <td style="width: 10%;"></td> <td style="width: 10%;"></td> <td style="width: 10%;"></td> <td style="width: 10%;"></td> <td style="width: 10%;"></td> <td style="width: 10%;"></td> <td style="width: 10%;"></td> <td style="width: 10%;"></td> </tr> <tr> <td></td> <td></td> <td colspan="8" style="text-align: center;"> <table border="1" style="width: 100%; border-collapse: collapse; text-align: center;"> <tr> <td style="width: 10%;"></td> <td style="width: 10%;"></td> <td style="width: 10%;"></td> <td style="width: 10%;"></td> <td style="width: 10%;"></td> <td style="width: 10%;"></td> <td style="width: 10%;"></td> <td style="width: 10%;"></td> <td style="width: 10%;"></td> <td style="width: 10%;"></td> </tr> <tr> <td></td> <td></td> <td colspan="8" style="text-align: center;"> <table border="1" style="width: 100%; border-collapse: collapse; text-align: center;"> <tr> <td style="width: 10%;"></td> <td style="width: 10%;"></td> <td style="width: 10%;"></td> <td style="width: 10%;"></td> <td style="width: 10%;"></td> <td style="width: 10%;"></td> <td style="width: 10%;"></td> <td style="width: 10%;"></td> <td style="width: 10%;"></td> <td style="width: 10%;"></td> </tr> <tr> <td></td> <td></td> <td colspan="8" style="text-align: center;"> <table border="1" style="width: 100%; border-collapse: collapse; text-align: center;"> <tr> <td style="width: 10%;"></td> <td style="width: 10%;"></td> <td style="width: 10%;"></td> <td style="width: 10%;"></td> <td style="width: 10%;"></td> <td style="width: 10%;"></td> <td style="width: 10%;"></td> <td style="width: 10%;"></td> <td style="width: 10%;"></td> <td style="width: 10%;"></td> </tr> <tr> <td></td> <td></td> <td colspan="8" style="text-align: center;"> <table border="1" style="width: 100%; border-collapse: collapse; text-align: center;"> <tr> <td style="width: 10%;"></td> <td style="width: 10%;"></td> <td style="width: 10%;"></td> <td style="width: 10%;"></td> <td style="width: 10%;"></td> <td style="width: 10%;"></td> <td style="width: 10%;"></td> <td style="width: 10%;"></td> <td style="width: 10%;"></td> <td style="width: 10%;"></td> </tr> <tr> <td></td> <td></td> <td colspan="8" style="text-align: center;"> <table border="1" style="width: 100%; border-collapse: collapse; text-align: center;"> <tr> </tr></table></td></tr></table></td></tr></table></td></tr></table></td></tr></table></td></tr></table></td></tr></table></td></tr></table></td></tr></table></td></tr></table></td></tr></table></td></tr></table></td></tr></table></td></tr></table></td></tr></table></td></tr></table></td></tr></table></td></tr></table></td></tr></table></td></tr></table></td></tr></table></td></tr></table></td></tr></table></td></tr></table></td></tr></table></td></tr></table></td></tr></table></td></tr></table></td></tr></table></td></tr></table></td></tr></table></td></tr></table></td></tr></table></td></tr></table></td></tr></table></td></tr></table></td></tr></table></td></tr></table></td></tr></table></td></tr></table></td></tr></table>
 | | | | | | | | | | | | | | | | | | | | <table border="1" style="width: 100%; border-collapse: collapse; text-align: center;"> <tr> <td style="width: 10%;"></td> <td style="width: 10%;"></td> <td style="width: 10%;"></td> <td style="width: 10%;"></td> <td style="width: 10%;"></td> <td style="width: 10%;"></td> <td style="width: 10%;"></td> <td style="width: 10%;"></td> <td style="width: 10%;"></td> <td style="width: 10%;"></td> </tr> <tr> <td></td> <td></td> <td colspan="8" style="text-align: center;"> <table border="1" style="width: 100%; border-collapse: collapse; text-align: center;"> <tr> <td style="width: 10%;"></td> <td style="width: 10%;"></td> <td style="width: 10%;"></td> <td style="width: 10%;"></td> <td style="width: 10%;"></td> <td style="width: 10%;"></td> <td style="width: 10%;"></td> <td style="width: 10%;"></td> <td style="width: 10%;"></td> <td style="width: 10%;"></td> </tr> <tr> <td></td> <td></td> <td colspan="8" style="text-align: center;"> <table border="1" style="width: 100%; border-collapse: collapse; text-align: center;"> <tr> <td style="width: 10%;"></td> <td style="width: 10%;"></td> <td style="width: 10%;"></td> <td style="width: 10%;"></td> <td style="width: 10%;"></td> <td style="width: 10%;"></td> <td
style="width: 10%;"></td> <td style="width: 10%;"></td> <td style="width: 10%;"></td> <td style="width: 10%;"></td> </tr> <tr> <td></td> <td></td> <td colspan="8" style="text-align: center;"> <table border="1" style="width: 100%; border-collapse: collapse; text-align: center;"> <tr> <td style="width: 10%;"></td> <td style="width: 10%;"></td> <td style="width: 10%;"></td> <td style="width: 10%;"></td> <td style="width: 10%;"></td> <td style="width: 10%;"></td> <td style="width: 10%;"></td> <td style="width: 10%;"></td> <td style="width: 10%;"></td> <td style="width: 10%;"></td> </tr> <tr> <td></td> <td></td> <td colspan="8" style="text-align: center;"> <table border="1" style="width: 100%; border-collapse: collapse; text-align: center;"> <tr> <td style="width: 10%;"></td> <td style="width: 10%;"></td> <td style="width: 10%;"></td> <td style="width: 10%;"></td> <td style="width: 10%;"></td> <td style="width: 10%;"></td> <td style="width: 10%;"></td> <td style="width: 10%;"></td> <td style="width: 10%;"></td> <td style="width: 10%;"></td> </tr> <tr> <td></td> <td></td> <td colspan="8" style="text-align: center;"> <table border="1" style="width: 100%; border-collapse: collapse; text-align: center;"> <tr> <td style="width: 10%;"></td> <td style="width: 10%;"></td> <td style="width: 10%;"></td> <td style="width: 10%;"></td> <td style="width: 10%;"></td> <td style="width: 10%;"></td> <td style="width: 10%;"></td> <td style="width: 10%;"></td> <td style="width: 10%;"></td> <td style="width: 10%;"></td> </tr> <tr> <td></td> <td></td> <td colspan="8" style="text-align: center;"> <table border="1" style="width: 100%; border-collapse: collapse; text-align: center;"> <tr> <td style="width: 10%;"></td> <td style="width: 10%;"></td> <td style="width: 10%;"></td> <td style="width: 10%;"></td> <td style="width: 10%;"></td> <td style="width: 10%;"></td> <td style="width: 10%;"></td> <td style="width: 10%;"></td> <td style="width: 10%;"></td> <td style="width: 10%;"></td> </tr> <tr> <td></td> <td></td> <td colspan="8" style="text-align: center;"> <table border="1" style="width: 100%; border-collapse: collapse; text-align: center;"> <tr> <td style="width: 10%;"></td> <td style="width: 10%;"></td> <td style="width: 10%;"></td> <td style="width: 10%;"></td> <td style="width: 10%;"></td> <td style="width: 10%;"></td> <td style="width: 10%;"></td> <td style="width: 10%;"></td> <td style="width: 10%;"></td> <td style="width: 10%;"></td> </tr> <tr> <td></td> <td></td> <td colspan="8" style="text-align: center;"> <table border="1" style="width: 100%; border-collapse: collapse; text-align: center;"> <tr> <td style="width: 10%;"></td> <td style="width: 10%;"></td> <td style="width: 10%;"></td> <td style="width: 10%;"></td> <td style="width: 10%;"></td> <td style="width: 10%;"></td> <td style="width: 10%;"></td> <td style="width: 10%;"></td> <td style="width: 10%;"></td> <td style="width: 10%;"></td> </tr> <tr> <td></td> <td></td> <td colspan="8" style="text-align: center;"> <table border="1" style="width: 100%; border-collapse: collapse; text-align: center;"> <tr> <td style="width: 10%;"></td> <td style="width: 10%;"></td> <td style="width: 10%;"></td> <td style="width: 10%;"></td> <td style="width: 10%;"></td> <td style="width: 10%;"></td> <td style="width: 10%;"></td> <td style="width: 10%;"></td> <td style="width: 10%;"></td> <td style="width: 10%;"></td> </tr> <tr> <td></td> <td></td> <td colspan="8" style="text-align: center;"> <table border="1" style="width: 100%; border-collapse: collapse; text-align: center;"> <tr> <td style="width: 10%;"></td> <td style="width: 10%;"></td> <td style="width: 10%;"></td> <td style="width: 10%;"></td> <td style="width: 10%;"></td> <td style="width: 10%;"></td> <td style="width: 10%;"></td> <td style="width: 10%;"></td> <td style="width: 10%;"></td> <td style="width: 10%;"></td> </tr> <tr> <td></td> <td></td> <td colspan="8" style="text-align: center;"> <table border="1" style="width: 100%; border-collapse: collapse; text-align: center;"> <tr> <td style="width: 10%;"></td> <td style="width: 10%;"></td> <td style="width: 10%;"></td> <td style="width: 10%;"></td> <td style="width: 10%;"></td> <td style="width: 10%;"></td> <td style="width: 10%;"></td> <td style="width: 10%;"></td> <td style="width: 10%;"></td> <td style="width: 10%;"></td> </tr> <tr> <td></td> <td></td> <td colspan="8" style="text-align: center;"> <table border="1" style="width: 100%; border-collapse: collapse; text-align: center;"> <tr> <td style="width: 10%;"></td> <td style="width: 10%;"></td> <td style="width: 10%;"></td> <td style="width: 10%;"></td> <td style="width: 10%;"></td> <td style="width: 10%;"></td> <td style="width: 10%;"></td> <td style="width: 10%;"></td> <td style="width: 10%;"></td> <td style="width: 10%;"></td> </tr> <tr> <td></td> <td></td> <td colspan="8" style="text-align: center;"> <table border="1" style="width: 100%; border-collapse: collapse; text-align: center;"> <tr> <td style="width: 10%;"></td> <td style="width: 10%;"></td> <td style="width: 10%;"></td> <td style="width: 10%;"></td> <td style="width: 10%;"></td> <td style="width: 10%;"></td> <td style="width: 10%;"></td> <td style="width: 10%;"></td> <td style="width: 10%;"></td> <td style="width: 10%;"></td> </tr> <tr> <td></td> <td></td> <td colspan="8" style="text-align: center;"> <table border="1" style="width: 100%; border-collapse: collapse; text-align: center;"> <tr> <td style="width: 10%;"></td> <td style="width: 10%;"></td> <td style="width: 10%;"></td> <td style="width: 10%;"></td> <td style="width: 10%;"></td> <td style="width: 10%;"></td> <td style="width: 10%;"></td> <td style="width: 10%;"></td> <td style="width: 10%;"></td> <td style="width: 10%;"></td> </tr> <tr> <td></td> <td></td> <td colspan="8" style="text-align: center;"> <table border="1" style="width: 100%; border-collapse: collapse; text-align: center;"> <tr> <td style="width: 10%;"></td> <td style="width: 10%;"></td> <td style="width: 10%;"></td> <td style="width: 10%;"></td> <td style="width: 10%;"></td> <td style="width: 10%;"></td> <td style="width: 10%;"></td> <td style="width: 10%;"></td> <td style="width: 10%;"></td> <td style="width: 10%;"></td> </tr> <tr> <td></td> <td></td> <td colspan="8" style="text-align: center;"> <table border="1" style="width: 100%; border-collapse: collapse; text-align: center;"> <tr> <td style="width: 10%;"></td> <td style="width: 10%;"></td> <td style="width: 10%;"></td> <td style="width: 10%;"></td> <td style="width: 10%;"></td> <td style="width: 10%;"></td> <td style="width: 10%;"></td> <td style="width: 10%;"></td> <td style="width: 10%;"></td> <td style="width: 10%;"></td> </tr> <tr> <td></td> <td></td> <td colspan="8" style="text-align: center;"> <table border="1" style="width: 100%; border-collapse: collapse; text-align: center;"> <tr> <td style="width: 10%;"></td> <td style="width: 10%;"></td> <td style="width: 10%;"></td> <td style="width: 10%;"></td> <td style="width: 10%;"></td> <td style="width: 10%;"></td> <td style="width: 10%;"></td> <td style="width: 10%;"></td> <td style="width: 10%;"></td> <td style="width: 10%;"></td> </tr> <tr> <td></td> <td></td> <td colspan="8" style="text-align: center;"> <table border="1" style="width: 100%; border-collapse: collapse; text-align: center;"> <tr> <td style="width: 10%;"></td> <td style="width: 10%;"></td> <td style="width: 10%;"></td> <td style="width: 10%;"></td> <td style="width: 10%;"></td> <td style="width: 10%;"></td> <td style="width: 10%;"></td> <td style="width: 10%;"></td> <td style="width: 10%;"></td> <td style="width: 10%;"></td> </tr> <tr> <td></td> <td></td> <td colspan="8" style="text-align: center;"> <table border="1" style="width: 100%; border-collapse: collapse; text-align: center;"> <tr> <td style="width: 10%;"></td> <td style="width: 10%;"></td> <td style="width: 10%;"></td> <td style="width: 10%;"></td> <td style="width: 10%;"></td> <td style="width: 10%;"></td> <td style="width: 10%;"></td> <td style="width: 10%;"></td> <td style="width: 10%;"></td> <td style="width: 10%;"></td> </tr> <tr> <td></td> <td></td> <td colspan="8" style="text-align: center;"> <table border="1" style="width: 100%; border-collapse: collapse; text-align: center;"> <tr> <td style="width: 10%;"></td> <td style="width: 10%;"></td> <td style="width: 10%;"></td> <td style="width: 10%;"></td> <td style="width: 10%;"></td> <td style="width: 10%;"></td> <td style="width: 10%;"></td> <td style="width: 10%;"></td> <td style="width: 10%;"></td> <td style="width: 10%;"></td> </tr> <tr> <td></td> <td></td> <td colspan="8" style="text-align: center;"> <table border="1" style="width: 100%; border-collapse: collapse; text-align: center;"> <tr> <td style="width: 10%;"></td> <td style="width: 10%;"></td> <td style="width: 10%;"></td> <td style="width: 10%;"></td> <td style="width: 10%;"></td> <td style="width: 10%;"></td> <td style="width: 10%;"></td> <td style="width: 10%;"></td> <td style="width: 10%;"></td> <td style="width: 10%;"></td> </tr> <tr> <td></td> <td></td> <td colspan="8" style="text-align: center;"> <table border="1" style="width: 100%; border-collapse: collapse; text-align: center;"> <tr> <td style="width: 10%;"></td> <td style="width: 10%;"></td> <td style="width: 10%;"></td> <td style="width: 10%;"></td> <td style="width: 10%;"></td> <td style="width: 10%;"></td> <td style="width: 10%;"></td> <td style="width: 10%;"></td> <td style="width: 10%;"></td> <td style="width: 10%;"></td> </tr> <tr> <td></td> <td></td> <td colspan="8" style="text-align: center;"> <table border="1" style="width: 100%; border-collapse: collapse; text-align: center;"> <tr> <td style="width: 10%;"></td> <td style="width: 10%;"></td> <td style="width: 10%;"></td> <td style="width: 10%;"></td> <td style="width: 10%;"></td> <td style="width: 10%;"></td> <td style="width: 10%;"></td> <td style="width: 10%;"></td> <td style="width: 10%;"></td> <td style="width: 10%;"></td> </tr> <tr> <td></td> <td></td> <td colspan="8"
style="text-align: center;"> <table border="1" style="width: 100%; border-collapse: collapse; text-align: center;"> <tr> <td style="width: 10%;"></td> <td style="width: 10%;"></td> <td style="width: 10%;"></td> <td style="width: 10%;"></td> <td style="width: 10%;"></td> <td style="width: 10%;"></td> <td style="width: 10%;"></td> <td style="width: 10%;"></td> <td style="width: 10%;"></td> <td style="width: 10%;"></td> </tr> <tr> <td></td> <td></td> <td colspan="8" style="text-align: center;"> <table border="1" style="width: 100%; border-collapse: collapse; text-align: center;"> <tr> <td style="width: 10%;"></td> <td style="width: 10%;"></td> <td style="width: 10%;"></td> <td style="width: 10%;"></td> <td style="width: 10%;"></td> <td style="width: 10%;"></td> <td style="width: 10%;"></td> <td style="width: 10%;"></td> <td style="width: 10%;"></td> <td style="width: 10%;"></td> </tr> <tr> <td></td> <td></td> <td colspan="8" style="text-align: center;"> <table border="1" style="width: 100%; border-collapse: collapse; text-align: center;"> <tr> <td style="width: 10%;"></td> <td style="width: 10%;"></td> <td style="width: 10%;"></td> <td style="width: 10%;"></td> <td style="width: 10%;"></td> <td style="width: 10%;"></td> <td style="width: 10%;"></td> <td style="width: 10%;"></td> <td style="width: 10%;"></td> <td style="width: 10%;"></td> </tr> <tr> <td></td> <td></td> <td colspan="8" style="text-align: center;"> <table border="1" style="width: 100%; border-collapse: collapse; text-align: center;"> <tr> <td style="width: 10%;"></td> <td style="width: 10%;"></td> <td style="width: 10%;"></td> <td style="width: 10%;"></td> <td style="width: 10%;"></td> <td style="width: 10%;"></td> <td style="width: 10%;"></td> <td style="width: 10%;"></td> <td style="width: 10%;"></td> <td style="width: 10%;"></td> </tr> <tr> <td></td> <td></td> <td colspan="8" style="text-align: center;"> <table border="1" style="width: 100%; border-collapse: collapse; text-align: center;"> <tr> <td style="width: 10%;"></td> <td style="width: 10%;"></td> <td style="width: 10%;"></td> <td style="width: 10%;"></td> <td style="width: 10%;"></td> <td style="width: 10%;"></td> <td style="width: 10%;"></td> <td style="width: 10%;"></td> <td style="width: 10%;"></td> <td style="width: 10%;"></td> </tr> <tr> <td></td> <td></td> <td colspan="8" style="text-align: center;"> <table border="1" style="width: 100%; border-collapse: collapse; text-align: center;"> <tr> <td style="width: 10%;"></td> <td style="width: 10%;"></td> <td style="width: 10%;"></td> <td style="width: 10%;"></td> <td style="width: 10%;"></td> <td style="width: 10%;"></td> <td style="width: 10%;"></td> <td style="width: 10%;"></td> <td style="width: 10%;"></td> <td style="width: 10%;"></td> </tr> <tr> <td></td> <td></td> <td colspan="8" style="text-align: center;"> <table border="1" style="width: 100%; border-collapse: collapse; text-align: center;"> <tr> <td style="width: 10%;"></td> <td style="width: 10%;"></td> <td style="width: 10%;"></td> <td style="width: 10%;"></td> <td style="width: 10%;"></td> <td style="width: 10%;"></td> <td style="width: 10%;"></td> <td style="width: 10%;"></td> <td style="width: 10%;"></td> <td style="width: 10%;"></td> </tr> <tr> <td></td> <td></td> <td colspan="8" style="text-align: center;"> <table border="1" style="width: 100%; border-collapse: collapse; text-align: center;"> <tr> <td style="width: 10%;"></td> <td style="width: 10%;"></td> <td style="width: 10%;"></td> <td style="width: 10%;"></td> <td style="width: 10%;"></td> <td style="width: 10%;"></td> <td style="width: 10%;"></td> <td style="width: 10%;"></td> <td style="width: 10%;"></td> <td style="width: 10%;"></td> </tr> <tr> <td></td> <td></td> <td colspan="8" style="text-align: center;"> <table border="1" style="width: 100%; border-collapse: collapse; text-align: center;"> <tr> <td style="width: 10%;"></td> <td style="width: 10%;"></td> <td style="width: 10%;"></td> <td style="width: 10%;"></td> <td style="width: 10%;"></td> <td style="width: 10%;"></td> <td style="width: 10%;"></td> <td style="width: 10%;"></td> <td style="width: 10%;"></td> <td style="width: 10%;"></td> </tr> <tr> <td></td> <td></td> <td colspan="8" style="text-align: center;"> <table border="1" style="width: 100%; border-collapse: collapse; text-align: center;"> <tr> <td style="width: 10%;"></td> <td style="width: 10%;"></td> <td style="width: 10%;"></td> <td style="width: 10%;"></td> <td style="width: 10%;"></td> <td style="width: 10%;"></td> <td style="width: 10%;"></td> <td style="width: 10%;"></td> <td style="width: 10%;"></td> <td style="width: 10%;"></td> </tr> <tr> <td></td> <td></td> <td colspan="8" style="text-align: center;"> <table border="1" style="width: 100%; border-collapse: collapse; text-align: center;"> <tr> <td style="width: 10%;"></td> <td style="width: 10%;"></td> <td style="width: 10%;"></td> <td style="width: 10%;"></td> <td style="width: 10%;"></td> <td style="width: 10%;"></td> <td style="width: 10%;"></td> <td style="width: 10%;"></td> <td style="width: 10%;"></td> <td style="width: 10%;"></td> </tr> <tr> <td></td> <td></td> <td colspan="8" style="text-align: center;"> <table border="1" style="width: 100%; border-collapse: collapse; text-align: center;"> <tr> <td style="width: 10%;"></td> <td style="width: 10%;"></td> <td style="width: 10%;"></td> <td style="width: 10%;"></td> <td style="width: 10%;"></td> <td style="width: 10%;"></td> <td style="width: 10%;"></td> <td style="width: 10%;"></td> <td style="width: 10%;"></td> <td style="width: 10%;"></td> </tr> <tr> <td></td> <td></td> <td colspan="8" style="text-align: center;"> <table border="1" style="width: 100%; border-collapse: collapse; text-align: center;"> <tr> <td style="width: 10%;"></td> <td style="width: 10%;"></td> <td style="width: 10%;"></td> <td style="width: 10%;"></td> <td style="width: 10%;"></td> <td style="width: 10%;"></td> <td style="width: 10%;"></td> <td style="width: 10%;"></td> <td style="width: 10%;"></td> <td style="width: 10%;"></td> </tr> <tr> <td></td> <td></td> <td colspan="8" style="text-align: center;"> <table border="1" style="width: 100%; border-collapse: collapse; text-align: center;"> <tr> <td style="width: 10%;"></td> <td style="width: 10%;"></td> <td style="width: 10%;"></td> <td style="width: 10%;"></td> <td style="width: 10%;"></td> <td style="width: 10%;"></td> <td style="width: 10%;"></td> <td style="width: 10%;"></td> <td style="width: 10%;"></td> <td style="width: 10%;"></td> </tr> <tr> <td></td> <td></td> <td colspan="8" style="text-align: center;"> <table border="1" style="width: 100%; border-collapse: collapse; text-align: center;"> <tr> <td style="width: 10%;"></td> <td style="width: 10%;"></td> <td style="width: 10%;"></td> <td style="width: 10%;"></td> <td style="width: 10%;"></td> <td style="width: 10%;"></td> <td style="width: 10%;"></td> <td style="width: 10%;"></td> <td style="width: 10%;"></td> <td style="width: 10%;"></td> </tr> <tr> <td></td> <td></td> <td colspan="8" style="text-align: center;"> <table border="1" style="width: 100%; border-collapse: collapse; text-align: center;"> <tr> </tr></table></td></tr></table></td></tr></table></td></tr></table></td></tr></table></td></tr></table></td></tr></table></td></tr></table></td></tr></table></td></tr></table></td></tr></table></td></tr></table></td></tr></table></td></tr></table></td></tr></table></td></tr></table></td></tr></table></td></tr></table></td></tr></table></td></tr></table></td></tr></table></td></tr></table></td></tr></table></td></tr></table></td></tr></table></td></tr></table></td></tr></table></td></tr></table></td></tr></table></td></tr></table></td></tr></table></td></tr></table></td></tr></table></td></tr></table></td></tr></table></td></tr></table></td></tr></table></td></tr></table></td></tr></table></td></tr></table>
 | | | | | | | | | | | | | | | | | | | | <table border="1" style="width: 100%; border-collapse: collapse; text-align: center;"> <tr> <td style="width: 10%;"></td> <td style="width: 10%;"></td> <td style="width: 10%;"></td> <td style="width: 10%;"></td> <td style="width: 10%;"></td> <td style="width: 10%;"></td> <td style="width: 10%;"></td> <td style="width: 10%;"></td> <td style="width: 10%;"></td> <td style="width: 10%;"></td> </tr> <tr> <td></td> <td></td> <td colspan="8" style="text-align: center;"> <table border="1" style="width: 100%; border-collapse: collapse; text-align: center;"> <tr> <td style="width: 10%;"></td> <td style="width: 10%;"></td> <td style="width: 10%;"></td> <td style="width: 10%;"></td> <td style="width: 10%;"></td> <td style="width: 10%;"></td> <td style="width: 10%;"></td> <td style="width: 10%;"></td> <td style="width: 10%;"></td> <td style="width: 10%;"></td> </tr> <tr> <td></td> <td></td> <td colspan="8" style="text-align: center;"> <table border="1" style="width: 100%; border-collapse: collapse; text-align: center;"> <tr> <td style="width: 10%;"></td> <td style="width: 10%;"></td> <td style="width: 10%;"></td> <td style="width: 10%;"></td> <td style="width: 10%;"></td> <td style="width: 10%;"></td> <td style="width: 10%;"></td> <td style="width: 10%;"></td> <td style="width: 10%;"></td> <td style="width: 10%;"></td> </tr> <tr> <td></td> <td></td> <td colspan="8" style="text-align: center;"> <table border="1" style="width: 100%; border-collapse: collapse; text-align: center;"> <tr> <td style="width: 10%;"></td> <td style="width: 10%;"></td> <td style="width: 10%;"></td> <td style="width: 10%;"></td> <td style="width: 10%;"></td> <td style="width: 10%;"></td> <td style="width: 10%;"></td> <td style="width: 10%;"></td> <td style="width: 10%;"></td> <td style="width: 10%;"></td> </tr> <tr> <td></td> <td></td> <td colspan="8" style="text-align: center;"> <table border="1" style="width: 100%; border-collapse: collapse; text-align: center;"> <tr> <td style="width: 10%;"></td> <td style="width: 10%;"></td> <td style="width: 10%;"></td> <td style="width: 10%;"></td> <td style="width: 10%;"></td> <td style="width: 10%;"></td> <td style="width: 10%;"></td> <td style="width: 10%;"></td> <td style="width: 10%;"></td> <td style="width: 10%;"></td> </tr> <tr> <td></td> <td></td> <td colspan="8" style="text-align: center;"> <table border="1" style="width: 100%; border-collapse: collapse; text-align: center;"> <tr> <td style="width: 10%;"></td> <td style="width: 10%;"></td> <td style="width: 10%;"></td> <td style="width: 10%;"></td> <td style="width: 10%;"></td> <td style="width: 10%;"></td> <td style="width: 10%;"></td> <td style="width: 10%;"></td> <td style="width: 10%;"></td> <td style="width: 10%;"></td> </tr> <tr> <td></td> <td></td> <td colspan="8" style="text-align: center;"> <table border="1" style="width: 100%; border-collapse: collapse; text-align: center;"> <tr> <td style="width: 10%;"></td> <td style="width: 10%;"></td> <td style="width: 10%;"></td> <td style="width: 10%;"></td> <td style="width: 10%;"></td> <td style="width: 10%;"></td> <td style="width: 10%;"></td> <td style="width: 10%;"></td> <td style="width: 10%;"></td> <td style="width: 10%;"></td> </tr> <tr> <td></td> <td></td> <td colspan="8" style="text-align: center;"> <table border="1" style="width: 100%; border-collapse:
collapse; text-align: center;"> <tr> <td style="width: 10%;"></td> <td style="width: 10%;"></td> <td style="width: 10%;"></td> <td style="width: 10%;"></td> <td style="width: 10%;"></td> <td style="width: 10%;"></td> <td style="width: 10%;"></td> <td style="width: 10%;"></td> <td style="width: 10%;"></td> <td style="width: 10%;"></td> </tr> <tr> <td></td> <td></td> <td colspan="8" style="text-align: center;"> <table border="1" style="width: 100%; border-collapse: collapse; text-align: center;"> <tr> <td style="width: 10%;"></td> <td style="width: 10%;"></td> <td style="width: 10%;"></td> <td style="width: 10%;"></td> <td style="width: 10%;"></td> <td style="width: 10%;"></td> <td style="width: 10%;"></td> <td style="width: 10%;"></td> <td style="width: 10%;"></td> <td style="width: 10%;"></td> </tr> <tr> <td></td> <td></td> <td colspan="8" style="text-align: center;"> <table border="1" style="width: 100%; border-collapse: collapse; text-align: center;"> <tr> <td style="width: 10%;"></td> <td style="width: 10%;"></td> <td style="width: 10%;"></td> <td style="width: 10%;"></td> <td style="width: 10%;"></td> <td style="width: 10%;"></td> <td style="width: 10%;"></td> <td style="width: 10%;"></td> <td style="width: 10%;"></td> <td style="width: 10%;"></td> </tr> <tr> <td></td> <td></td> <td colspan="8" style="text-align: center;"> <table border="1" style="width: 100%; border-collapse: collapse; text-align: center;"> <tr> <td style="width: 10%;"></td> <td style="width: 10%;"></td> <td style="width: 10%;"></td> <td style="width: 10%;"></td> <td style="width: 10%;"></td> <td style="width: 10%;"></td> <td style="width: 10%;"></td> <td style="width: 10%;"></td> <td style="width: 10%;"></td> <td style="width: 10%;"></td> </tr> <tr> <td></td> <td></td> <td colspan="8" style="text-align: center;"> <table border="1" style="width: 100%; border-collapse: collapse; text-align: center;"> <tr> <td style="width: 10%;"></td> <td style="width: 10%;"></td> <td style="width: 10%;"></td> <td style="width: 10%;"></td> <td style="width: 10%;"></td> <td style="width: 10%;"></td> <td style="width: 10%;"></td> <td style="width: 10%;"></td> <td style="width: 10%;"></td> <td style="width: 10%;"></td> </tr> <tr> <td></td> <td></td> <td colspan="8" style="text-align: center;"> <table border="1" style="width: 100%; border-collapse: collapse; text-align: center;"> <tr> <td style="width: 10%;"></td> <td style="width: 10%;"></td> <td style="width: 10%;"></td> <td style="width: 10%;"></td> <td style="width: 10%;"></td> <td style="width: 10%;"></td> <td style="width: 10%;"></td> <td style="width: 10%;"></td> <td style="width: 10%;"></td> <td style="width: 10%;"></td> </tr> <tr> <td></td> <td></td> <td colspan="8" style="text-align: center;"> <table border="1" style="width: 100%; border-collapse: collapse; text-align: center;"> <tr> <td style="width: 10%;"></td> <td style="width: 10%;"></td> <td style="width: 10%;"></td> <td style="width: 10%;"></td> <td style="width: 10%;"></td> <td style="width: 10%;"></td> <td style="width: 10%;"></td> <td style="width: 10%;"></td> <td style="width: 10%;"></td> <td style="width: 10%;"></td> </tr> <tr> <td></td> <td></td> <td colspan="8" style="text-align: center;"> <table border="1" style="width: 100%; border-collapse: collapse; text-align: center;"> <tr> <td style="width: 10%;"></td> <td style="width: 10%;"></td> <td style="width: 10%;"></td> <td style="width: 10%;"></td> <td style="width: 10%;"></td> <td style="width: 10%;"></td> <td style="width: 10%;"></td> <td style="width: 10%;"></td> <td style="width: 10%;"></td> <td style="width: 10%;"></td> </tr> <tr> <td></td> <td></td> <td colspan="8" style="text-align: center;"> <table border="1" style="width: 100%; border-collapse: collapse; text-align: center;"> <tr> <td style="width: 10%;"></td> <td style="width: 10%;"></td> <td style="width: 10%;"></td> <td style="width: 10%;"></td> <td style="width: 10%;"></td> <td style="width: 10%;"></td> <td style="width: 10%;"></td> <td style="width: 10%;"></td> <td style="width: 10%;"></td> <td style="width: 10%;"></td> </tr> <tr> <td></td> <td></td> <td colspan="8" style="text-align: center;"> <table border="1" style="width: 100%; border-collapse: collapse; text-align: center;"> <tr> <td style="width: 10%;"></td> <td style="width: 10%;"></td> <td style="width: 10%;"></td> <td style="width: 10%;"></td> <td style="width: 10%;"></td> <td style="width: 10%;"></td> <td style="width: 10%;"></td> <td style="width: 10%;"></td> <td style="width: 10%;"></td> <td style="width: 10%;"></td> </tr> <tr> <td></td> <td></td> <td colspan="8" style="text-align: center;"> <table border="1" style="width: 100%; border-collapse: collapse; text-align: center;"> <tr> <td style="width: 10%;"></td> <td style="width: 10%;"></td> <td style="width: 10%;"></td> <td style="width: 10%;"></td> <td style="width: 10%;"></td> <td style="width: 10%;"></td> <td style="width: 10%;"></td> <td style="width: 10%;"></td> <td style="width: 10%;"></td> <td style="width: 10%;"></td> </tr> <tr> <td></td> <td></td> <td colspan="8" style="text-align: center;"> <table border="1" style="width: 100%; border-collapse: collapse; text-align: center;"> <tr> <td style="width: 10%;"></td> <td style="width: 10%;"></td> <td style="width: 10%;"></td> <td style="width: 10%;"></td> <td style="width: 10%;"></td> <td style="width: 10%;"></td> <td style="width: 10%;"></td> <td style="width: 10%;"></td> <td style="width: 10%;"></td> <td style="width: 10%;"></td> </tr> <tr> <td></td> <td></td> <td colspan="8" style="text-align: center;"> <table border="1" style="width: 100%; border-collapse: collapse; text-align: center;"> <tr> <td style="width: 10%;"></td> <td style="width: 10%;"></td> <td style="width: 10%;"></td> <td style="width: 10%;"></td> <td style="width: 10%;"></td> <td style="width: 10%;"></td> <td style="width: 10%;"></td> <td style="width: 10%;"></td> <td style="width: 10%;"></td> <td style="width: 10%;"></td> </tr> <tr> <td></td> <td></td> <td colspan="8" style="text-align: center;"> <table border="1" style="width: 100%; border-collapse: collapse; text-align: center;"> <tr> <td style="width: 10%;"></td> <td style="width: 10%;"></td> <td style="width: 10%;"></td> <td style="width: 10%;"></td> <td style="width: 10%;"></td> <td style="width: 10%;"></td> <td style="width: 10%;"></td> <td style="width: 10%;"></td> <td style="width: 10%;"></td> <td style="width: 10%;"></td> </tr> <tr> <td></td> <td></td> <td colspan="8" style="text-align: center;"> <table border="1" style="width: 100%; border-collapse: collapse; text-align: center;"> <tr> <td style="width: 10%;"></td> <td style="width: 10%;"></td> <td style="width: 10%;"></td> <td style="width: 10%;"></td> <td style="width: 10%;"></td> <td style="width: 10%;"></td> <td style="width: 10%;"></td> <td style="width: 10%;"></td> <td style="width: 10%;"></td> <td style="width: 10%;"></td> </tr> <tr> <td></td> <td></td> <td colspan="8" style="text-align: center;"> <table border="1" style="width: 100%; border-collapse: collapse; text-align: center;"> <tr> <td style="width: 10%;"></td> <td style="width: 10%;"></td> <td style="width: 10%;"></td> <td style="width: 10%;"></td> <td style="width: 10%;"></td> <td style="width: 10%;"></td> <td style="width: 10%;"></td> <td style="width: 10%;"></td> <td style="width: 10%;"></td> <td style="width: 10%;"></td> </tr> <tr> <td></td> <td></td> <td colspan="8" style="text-align: center;"> <table border="1" style="width: 100%; border-collapse: collapse; text-align: center;"> <tr> <td style="width: 10%;"></td> <td style="width: 10%;"></td> <td style="width: 10%;"></td> <td style="width: 10%;"></td> <td style="width: 10%;"></td> <td style="width: 10%;"></td> <td style="width: 10%;"></td> <td style="width: 10%;"></td> <td style="width: 10%;"></td> <td style="width: 10%;"></td> </tr> <tr> <td></td> <td></td> <td colspan="8" style="text-align: center;"> <table border="1" style="width: 100%; border-collapse: collapse; text-align: center;"> <tr> <td style="width: 10%;"></td> <td style="width: 10%;"></td> <td style="width: 10%;"></td> <td style="width: 10%;"></td> <td style="width: 10%;"></td> <td style="width: 10%;"></td> <td style="width: 10%;"></td> <td style="width: 10%;"></td> <td style="width: 10%;"></td> <td style="width: 10%;"></td> </tr> <tr> <td></td> <td></td> <td colspan="8" style="text-align: center;"> <table border="1" style="width: 100%; border-collapse: collapse; text-align: center;"> <tr> <td style="width: 10%;"></td> <td style="width: 10%;"></td> <td style="width: 10%;"></td> <td style="width: 10%;"></td> <td style="width: 10%;"></td> <td style="width: 10%;"></td> <td style="width: 10%;"></td> <td style="width: 10%;"></td> <td style="width: 10%;"></td> <td style="width: 10%;"></td> </tr> <tr> <td></td> <td></td> <td colspan="8" style="text-align: center;"> <table border="1" style="width: 100%; border-collapse: collapse; text-align: center;"> <tr> <td style="width: 10%;"></td> <td style="width: 10%;"></td> <td style="width: 10%;"></td> <td style="width: 10%;"></td> <td style="width: 10%;"></td> <td style="width: 10%;"></td> <td style="width: 10%;"></td> <td style="width: 10%;"></td> <td style="width: 10%;"></td> <td style="width: 10%;"></td> </tr> <tr> <td></td> <td></td> <td colspan="8" style="text-align: center;"> <table border="1" style="width: 100%; border-collapse: collapse; text-align: center;"> <tr> <td style="width: 10%;"></td> <td style="width: 10%;"></td> <td style="width: 10%;"></td> <td style="width: 10%;"></td> <td style="width: 10%;"></td> <td style="width: 10%;"></td> <td style="width: 10%;"></td> <td style="width: 10%;"></td> <td style="width: 10%;"></td> <td style="width: 10%;"></td> </tr> <tr> <td></td> <td></td> <td colspan="8" style="text-align: center;"> <table border="1" style="width: 100%; border-collapse: collapse; text-align: center;"> <tr> <td style="width: 10%;"></td> <td style="width: 10%;"></td> <td style="width: 10%;"></td> <td style="width: 10%;"></td> <td
style="width: 10%;"></td> <td style="width: 10%;"></td> <td style="width: 10%;"></td> <td style="width: 10%;"></td> <td style="width: 10%;"></td> <td style="width: 10%;"></td> </tr> <tr> <td></td> <td></td> <td colspan="8" style="text-align: center;"> <table border="1" style="width: 100%; border-collapse: collapse; text-align: center;"> <tr> <td style="width: 10%;"></td> <td style="width: 10%;"></td> <td style="width: 10%;"></td> <td style="width: 10%;"></td> <td style="width: 10%;"></td> <td style="width: 10%;"></td> <td style="width: 10%;"></td> <td style="width: 10%;"></td> <td style="width: 10%;"></td> <td style="width: 10%;"></td> </tr> <tr> <td></td> <td></td> <td colspan="8" style="text-align: center;"> <table border="1" style="width: 100%; border-collapse: collapse; text-align: center;"> <tr> <td style="width: 10%;"></td> <td style="width: 10%;"></td> <td style="width: 10%;"></td> <td style="width: 10%;"></td> <td style="width: 10%;"></td> <td style="width: 10%;"></td> <td style="width: 10%;"></td> <td style="width: 10%;"></td> <td style="width: 10%;"></td> <td style="width: 10%;"></td> </tr> <tr> <td></td> <td></td> <td colspan="8" style="text-align: center;"> <table border="1" style="width: 100%; border-collapse: collapse; text-align: center;"> <tr> <td style="width: 10%;"></td> <td style="width: 10%;"></td> <td style="width: 10%;"></td> <td style="width: 10%;"></td> <td style="width: 10%;"></td> <td style="width: 10%;"></td> <td style="width: 10%;"></td> <td style="width: 10%;"></td> <td style="width: 10%;"></td> <td style="width: 10%;"></td> </tr> <tr> <td></td> <td></td> <td colspan="8" style="text-align: center;"> <table border="1" style="width: 100%; border-collapse: collapse; text-align: center;"> <tr> <td style="width: 10%;"></td> <td style="width: 10%;"></td> <td style="width: 10%;"></td> <td style="width: 10%;"></td> <td style="width: 10%;"></td> <td style="width: 10%;"></td> <td style="width: 10%;"></td> <td style="width: 10%;"></td> <td style="width: 10%;"></td> <td style="width: 10%;"></td> </tr> <tr> <td></td> <td></td> <td colspan="8" style="text-align: center;"> <table border="1" style="width: 100%; border-collapse: collapse; text-align: center;"> <tr> <td style="width: 10%;"></td> <td style="width: 10%;"></td> <td style="width: 10%;"></td> <td style="width: 10%;"></td> <td style="width: 10%;"></td> <td style="width: 10%;"></td> <td style="width: 10%;"></td> <td style="width: 10%;"></td> <td style="width: 10%;"></td> <td style="width: 10%;"></td> </tr> <tr> <td></td> <td></td> <td colspan="8" style="text-align: center;"> <table border="1" style="width: 100%; border-collapse: collapse; text-align: center;"> <tr> <td style="width: 10%;"></td> <td style="width: 10%;"></td> <td style="width: 10%;"></td> <td style="width: 10%;"></td> <td style="width: 10%;"></td> <td style="width: 10%;"></td> <td style="width: 10%;"></td> <td style="width: 10%;"></td> <td style="width: 10%;"></td> <td style="width: 10%;"></td> </tr> <tr> <td></td> <td></td> <td colspan="8" style="text-align: center;"> <table border="1" style="width: 100%; border-collapse: collapse; text-align: center;"> <tr> <td style="width: 10%;"></td> <td style="width: 10%;"></td> <td style="width: 10%;"></td> <td style="width: 10%;"></td> <td style="width: 10%;"></td> <td style="width: 10%;"></td> <td style="width: 10%;"></td> <td style="width: 10%;"></td> <td style="width: 10%;"></td> <td style="width: 10%;"></td> </tr> <tr> <td></td> <td></td> <td colspan="8" style="text-align: center;"> <table border="1" style="width: 100%; border-collapse: collapse; text-align: center;"> <tr> <td style="width: 10%;"></td> <td style="width: 10%;"></td> <td style="width: 10%;"></td> <td style="width: 10%;"></td> <td style="width: 10%;"></td> <td style="width: 10%;"></td> <td style="width: 10%;"></td> <td style="width: 10%;"></td> <td style="width: 10%;"></td> <td style="width: 10%;"></td> </tr> <tr> <td></td> <td></td> <td colspan="8" style="text-align: center;"> <table border="1" style="width: 100%; border-collapse: collapse; text-align: center;"> <tr> <td style="width: 10%;"></td> <td style="width: 10%;"></td> <td style="width: 10%;"></td> <td style="width: 10%;"></td> <td style="width: 10%;"></td> <td style="width: 10%;"></td> <td style="width: 10%;"></td> <td style="width: 10%;"></td> <td style="width: 10%;"></td> <td style="width: 10%;"></td> </tr> <tr> <td></td> <td></td> <td colspan="8" style="text-align: center;"> <table border="1" style="width: 100%; border-collapse: collapse; text-align: center;"> <tr> </tr></table></td></tr></table></td></tr></table></td></tr></table></td></tr></table></td></tr></table></td></tr></table></td></tr></table></td></tr></table></td></tr></table></td></tr></table></td></tr></table></td></tr></table></td></tr></table></td></tr></table></td></tr></table></td></tr></table></td></tr></table></td></tr></table></td></tr></table></td></tr></table></td></tr></table></td></tr></table></td></tr></table></td></tr></table></td></tr></table></td></tr></table></td></tr></table></td></tr></table></td></tr></table></td></tr></table></td></tr></table></td></tr></table></td></tr></table></td></tr></table></td></tr></table></td></tr></table></td></tr></table></td></tr></table>
 | | | | | | | | | | | | | | | | | | | | <table border="1" style="width: 100%; border-collapse: collapse; text-align: center;"> <tr> <td style="width: 10%;"></td> <td style="width: 10%;"></td> <td style="width: 10%;"></td> <td style="width: 10%;"></td> <td style="width: 10%;"></td> <td style="width: 10%;"></td> <td style="width: 10%;"></td> <td style="width: 10%;"></td> <td style="width: 10%;"></td> <td style="width: 10%;"></td> </tr> <tr> <td></td> <td></td> <td colspan="8" style="text-align: center;"> <table border="1" style="width: 100%; border-collapse: collapse; text-align: center;"> <tr> <td style="width: 10%;"></td> <td style="width: 10%;"></td> <td style="width: 10%;"></td> <td style="width: 10%;"></td> <td style="width: 10%;"></td> <td style="width: 10%;"></td> <td style="width: 10%;"></td> <td style="width: 10%;"></td> <td style="width: 10%;"></td> <td style="width: 10%;"></td> </tr> <tr> <td></td> <td></td> <td colspan="8" style="text-align: center;"> <table border="1" style="width: 100%; border-collapse: collapse; text-align: center;"> <tr> <td style="width: 10%;"></td> <td style="width: 10%;"></td> <td style="width: 10%;"></td> <td style="width: 10%;"></td> <td style="width: 10%;"></td> <td style="width: 10%;"></td> <td style="width: 10%;"></td> <td style="width: 10%;"></td> <td style="width: 10%;"></td> <td style="width: 10%;"></td> </tr> <tr> <td></td> <td></td> <td colspan="8" style="text-align: center;"> <table border="1" style="width: 100%; border-collapse: collapse; text-align: center;"> <tr> <td style="width: 10%;"></td> <td style="width: 10%;"></td> <td style="width: 10%;"></td> <td style="width: 10%;"></td> <td style="width: 10%;"></td> <td style="width: 10%;"></td> <td style="width: 10%;"></td> <td style="width: 10%;"></td> <td style="width: 10%;"></td> <td style="width: 10%;"></td> </tr> <tr> <td></td> <td></td> <td colspan="8" style="text-align: center;"> <table border="1" style="width: 100%; border-collapse: collapse; text-align: center;"> <tr> <td style="width: 10%;"></td> <td style="width: 10%;"></td> <td style="width: 10%;"></td> <td style="width: 10%;"></td> <td style="width: 10%;"></td> <td style="width: 10%;"></td> <td style="width: 10%;"></td> <td style="width: 10%;"></td> <td style="width: 10%;"></td> <td style="width: 10%;"></td> </tr> <tr> <td></td> <td></td> <td colspan="8" style="text-align: center;"> <table border="1" style="width: 100%; border-collapse: collapse; text-align: center;"> <tr> <td style="width: 10%;"></td> <td style="width: 10%;"></td> <td style="width: 10%;"></td> <td style="width: 10%;"></td> <td style="width: 10%;"></td> <td style="width: 10%;"></td> <td style="width: 10%;"></td> <td style="width: 10%;"></td> <td style="width: 10%;"></td> <td style="width: 10%;"></td> </tr> <tr> <td></td> <td></td> <td colspan="8" style="text-align: center;"> <table border="1" style="width: 100%; border-collapse: collapse; text-align: center;"> <tr> <td style="width: 10%;"></td> <td style="width: 10%;"></td> <td style="width: 10%;"></td> <td style="width: 10%;"></td> <td style="width: 10%;"></td> <td style="width: 10%;"></td> <td style="width: 10%;"></td> <td style="width: 10%;"></td> <td style="width: 10%;"></td> <td style="width: 10%;"></td> </tr> <tr> <td></td> <td></td> <td colspan="8" style="text-align: center;"> <table border="1" style="width: 100%; border-collapse: collapse; text-align: center;"> <tr> <td style="width: 10%;"></td> <td style="width: 10%;"></td> <td style="width: 10%;"></td> <td style="width: 10%;"></td> <td style="width: 10%;"></td> <td style="width: 10%;"></td> <td style="width: 10%;"></td> <td style="width: 10%;"></td> <td style="width: 10%;"></td> <td style="width: 10%;"></td> </tr> <tr> <td></td> <td></td> <td colspan="8" style="text-align: center;"> <table border="1" style="width: 100%; border-collapse: collapse; text-align: center;"> <tr> <td style="width: 10%;"></td> <td style="width: 10%;"></td> <td style="width: 10%;"></td> <td style="width: 10%;"></td> <td style="width: 10%;"></td> <td style="width: 10%;"></td> <td style="width: 10%;"></td> <td style="width: 10%;"></td> <td style="width: 10%;"></td> <td style="width: 10%;"></td> </tr> <tr> <td></td> <td></td> <td colspan="8" style="text-align: center;"> <table border="1" style="width: 100%; border-collapse: collapse; text-align: center;"> <tr> <td style="width: 10%;"></td> <td style="width: 10%;"></td> <td style="width: 10%;"></td> <td style="width: 10%;"></td> <td style="width: 10%;"></td> <td style="width: 10%;"></td> <td style="width: 10%;"></td> <td style="width: 10%;"></td> <td style="width: 10%;"></td> <td style="width: 10%;"></td> </tr> <tr> <td></td> <td></td> <td colspan="8" style="text-align: center;"> <table border="1" style="width: 100%; border-collapse: collapse; text-align: center;"> <tr> <td style="width: 10%;"></td> <td style="width: 10%;"></td> <td style="width: 10%;"></td> <td style="width: 10%;"></td> <td style="width: 10%;"></td> <td style="width: 10%;"></td> <td style="width: 10%;"></td> <td style="width: 10%;"></td> <td style="width: 10%;"></td> <td style="width: 10%;"></td> </tr> <tr> <td></td> <td></td> <td colspan="8" style="text-align: center;"> <table border="1" style="width: 100%; border-collapse: collapse; text-align: center;"> <tr> <td style="width: 10%;"></td> <td style="width: 10%;"></td> <td style="width: 10%;"></td> <td style="width: 10%;"></td> <td style="width: 10%;"></td> <td style="width: 10%;"></td> <td style="width: 10%;"></td> <td style="width: 10%;"></td> <td style="width: 10%;"></td> <td style="width: 10%;"></td> </tr> <tr> <td></td> <td></td> <td colspan="8" style="text-align: center;"> <table border="1" style="width: 100%; border-collapse: collapse; text-align: center;"> <tr> <td style="width: 10%;"></td> <td style="width: 10%;"></td> <td style="width: 10%;"></td> <td style="width: 10%;"></td> <td style="width: 10%;"></td> <td style="width: 10%;"></td> <td style="width: 10%;"></td> <td style="width:
10%;"></td> <td style="width: 10%;"></td> <td style="width: 10%;"></td> </tr> <tr> <td></td> <td></td> <td colspan="8" style="text-align: center;"> <table border="1" style="width: 100%; border-collapse: collapse; text-align: center;"> <tr> <td style="width: 10%;"></td> <td style="width: 10%;"></td> <td style="width: 10%;"></td> <td style="width: 10%;"></td> <td style="width: 10%;"></td> <td style="width: 10%;"></td> <td style="width: 10%;"></td> <td style="width: 10%;"></td> <td style="width: 10%;"></td> <td style="width: 10%;"></td> </tr> <tr> <td></td> <td></td> <td colspan="8" style="text-align: center;"> <table border="1" style="width: 100%; border-collapse: collapse; text-align: center;"> <tr> <td style="width: 10%;"></td> <td style="width: 10%;"></td> <td style="width: 10%;"></td> <td style="width: 10%;"></td> <td style="width: 10%;"></td> <td style="width: 10%;"></td> <td style="width: 10%;"></td> <td style="width: 10%;"></td> <td style="width: 10%;"></td> <td style="width: 10%;"></td> </tr> <tr> <td></td> <td></td> <td colspan="8" style="text-align: center;"> <table border="1" style="width: 100%; border-collapse: collapse; text-align: center;"> <tr> <td style="width: 10%;"></td> <td style="width: 10%;"></td> <td style="width: 10%;"></td> <td style="width: 10%;"></td> <td style="width: 10%;"></td> <td style="width: 10%;"></td> <td style="width: 10%;"></td> <td style="width: 10%;"></td> <td style="width: 10%;"></td> <td style="width: 10%;"></td> </tr> <tr> <td></td> <td></td> <td colspan="8" style="text-align: center;"> <table border="1" style="width: 100%; border-collapse: collapse; text-align: center;"> <tr> <td style="width: 10%;"></td> <td style="width: 10%;"></td> <td style="width: 10%;"></td> <td style="width: 10%;"></td> <td style="width: 10%;"></td> <td style="width: 10%;"></td> <td style="width: 10%;"></td> <td style="width: 10%;"></td> <td style="width: 10%;"></td> <td style="width: 10%;"></td> </tr> <tr> <td></td> <td></td> <td colspan="8" style="text-align: center;"> <table border="1" style="width: 100%; border-collapse: collapse; text-align: center;"> <tr> <td style="width: 10%;"></td> <td style="width: 10%;"></td> <td style="width: 10%;"></td> <td style="width: 10%;"></td> <td style="width: 10%;"></td> <td style="width: 10%;"></td> <td style="width: 10%;"></td> <td style="width: 10%;"></td> <td style="width: 10%;"></td> <td style="width: 10%;"></td> </tr> <tr> <td></td> <td></td> <td colspan="8" style="text-align: center;"> <table border="1" style="width: 100%; border-collapse: collapse; text-align: center;"> <tr> <td style="width: 10%;"></td> <td style="width: 10%;"></td> <td style="width: 10%;"></td> <td style="width: 10%;"></td> <td style="width: 10%;"></td> <td style="width: 10%;"></td> <td style="width: 10%;"></td> <td style="width: 10%;"></td> <td style="width: 10%;"></td> <td style="width: 10%;"></td> </tr> <tr> <td></td> <td></td> <td colspan="8" style="text-align: center;"> <table border="1" style="width: 100%; border-collapse: collapse; text-align: center;"> <tr> <td style="width: 10%;"></td> <td style="width: 10%;"></td> <td style="width: 10%;"></td> <td style="width: 10%;"></td> <td style="width: 10%;"></td> <td style="width: 10%;"></td> <td style="width: 10%;"></td> <td style="width: 10%;"></td> <td style="width: 10%;"></td> <td style="width: 10%;"></td> </tr> <tr> <td></td> <td></td> <td colspan="8" style="text-align: center;"> <table border="1" style="width: 100%; border-collapse: collapse; text-align: center;"> <tr> <td style="width: 10%;"></td> <td style="width: 10%;"></td> <td style="width: 10%;"></td> <td style="width: 10%;"></td> <td style="width: 10%;"></td> <td style="width: 10%;"></td> <td style="width: 10%;"></td> <td style="width: 10%;"></td> <td style="width: 10%;"></td> <td style="width: 10%;"></td> </tr> <tr> <td></td> <td></td> <td colspan="8" style="text-align: center;"> <table border="1" style="width: 100%; border-collapse: collapse; text-align: center;"> <tr> <td style="width: 10%;"></td> <td style="width: 10%;"></td> <td style="width: 10%;"></td> <td style="width: 10%;"></td> <td style="width: 10%;"></td> <td style="width: 10%;"></td> <td style="width: 10%;"></td> <td style="width: 10%;"></td> <td style="width: 10%;"></td> <td style="width: 10%;"></td> </tr> <tr> <td></td> <td></td> <td colspan="8" style="text-align: center;"> <table border="1" style="width: 100%; border-collapse: collapse; text-align: center;"> <tr> <td style="width: 10%;"></td> <td style="width: 10%;"></td> <td style="width: 10%;"></td> <td style="width: 10%;"></td> <td style="width: 10%;"></td> <td style="width: 10%;"></td> <td style="width: 10%;"></td> <td style="width: 10%;"></td> <td style="width: 10%;"></td> <td style="width: 10%;"></td> </tr> <tr> <td></td> <td></td> <td colspan="8" style="text-align: center;"> <table border="1" style="width: 100%; border-collapse: collapse; text-align: center;"> <tr> <td style="width: 10%;"></td> <td style="width: 10%;"></td> <td style="width: 10%;"></td> <td style="width: 10%;"></td> <td style="width: 10%;"></td> <td style="width: 10%;"></td> <td style="width: 10%;"></td> <td style="width: 10%;"></td> <td style="width: 10%;"></td> <td style="width: 10%;"></td> </tr> <tr> <td></td> <td></td> <td colspan="8" style="text-align: center;"> <table border="1" style="width: 100%; border-collapse: collapse; text-align: center;"> <tr> <td style="width: 10%;"></td> <td style="width: 10%;"></td> <td style="width: 10%;"></td> <td style="width: 10%;"></td> <td style="width: 10%;"></td> <td style="width: 10%;"></td> <td style="width: 10%;"></td> <td style="width: 10%;"></td> <td style="width: 10%;"></td> <td style="width: 10%;"></td> </tr> <tr> <td></td> <td></td> <td colspan="8" style="text-align: center;"> <table border="1" style="width: 100%; border-collapse: collapse; text-align: center;"> <tr> <td style="width: 10%;"></td> <td style="width: 10%;"></td> <td style="width: 10%;"></td> <td style="width: 10%;"></td> <td style="width: 10%;"></td> <td style="width: 10%;"></td> <td style="width: 10%;"></td> <td style="width: 10%;"></td> <td style="width: 10%;"></td> <td style="width: 10%;"></td> </tr> <tr> <td></td> <td></td> <td colspan="8" style="text-align: center;"> <table border="1" style="width: 100%; border-collapse: collapse; text-align: center;"> <tr> <td style="width: 10%;"></td> <td style="width: 10%;"></td> <td style="width: 10%;"></td> <td style="width: 10%;"></td> <td style="width: 10%;"></td> <td style="width: 10%;"></td> <td style="width: 10%;"></td> <td style="width: 10%;"></td> <td style="width: 10%;"></td> <td style="width: 10%;"></td> </tr> <tr> <td></td> <td></td> <td colspan="8" style="text-align: center;"> <table border="1" style="width: 100%; border-collapse: collapse; text-align: center;"> <tr> <td style="width: 10%;"></td> <td style="width: 10%;"></td> <td style="width: 10%;"></td> <td style="width: 10%;"></td> <td style="width: 10%;"></td> <td style="width: 10%;"></td> <td style="width: 10%;"></td> <td style="width: 10%;"></td> <td style="width: 10%;"></td> <td style="width: 10%;"></td> </tr> <tr> <td></td> <td></td> <td colspan="8" style="text-align: center;"> <table border="1" style="width: 100%; border-collapse: collapse; text-align: center;"> <tr> <td style="width: 10%;"></td> <td style="width: 10%;"></td> <td style="width: 10%;"></td> <td style="width: 10%;"></td> <td style="width: 10%;"></td> <td style="width: 10%;"></td> <td style="width: 10%;"></td> <td style="width: 10%;"></td> <td style="width: 10%;"></td> <td style="width: 10%;"></td> </tr> <tr> <td></td> <td></td> <td colspan="8" style="text-align: center;"> <table border="1" style="width: 100%; border-collapse: collapse; text-align: center;"> <tr> <td style="width: 10%;"></td> <td style="width: 10%;"></td> <td style="width: 10%;"></td> <td style="width: 10%;"></td> <td style="width: 10%;"></td> <td style="width: 10%;"></td> <td style="width: 10%;"></td> <td style="width: 10%;"></td> <td style="width: 10%;"></td> <td style="width: 10%;"></td> </tr> <tr> <td></td> <td></td> <td colspan="8" style="text-align: center;"> <table border="1" style="width: 100%; border-collapse: collapse; text-align: center;"> <tr> <td style="width: 10%;"></td> <td style="width: 10%;"></td> <td style="width: 10%;"></td> <td style="width: 10%;"></td> <td style="width: 10%;"></td> <td style="width: 10%;"></td> <td style="width: 10%;"></td> <td style="width: 10%;"></td> <td style="width: 10%;"></td> <td style="width: 10%;"></td> </tr> <tr> <td></td> <td></td> <td colspan="8" style="text-align: center;"> <table border="1" style="width: 100%; border-collapse: collapse; text-align: center;"> <tr> <td style="width: 10%;"></td> <td style="width: 10%;"></td> <td style="width: 10%;"></td> <td style="width: 10%;"></td> <td style="width: 10%;"></td> <td style="width: 10%;"></td> <td style="width: 10%;"></td> <td style="width: 10%;"></td> <td style="width: 10%;"></td> <td style="width: 10%;"></td> </tr> <tr> <td></td> <td></td> <td colspan="8" style="text-align: center;"> <table border="1" style="width: 100%; border-collapse: collapse; text-align: center;"> <tr> <td style="width: 10%;"></td> <td style="width: 10%;"></td> <td style="width: 10%;"></td> <td style="width: 10%;"></td> <td style="width: 10%;"></td> <td style="width: 10%;"></td> <td style="width: 10%;"></td> <td style="width: 10%;"></td> <td style="width: 10%;"></td> <td style="width: 10%;"></td> </tr> <tr> <td></td> <td></td> <td colspan="8" style="text-align: center;"> <table border="1" style="width: 100%; border-collapse: collapse; text-align: center;"> <tr> <td style="width: 10%;"></td> <td style="width: 10%;"></td> <td style="width: 10%;"></td> <td style="width: 10%;"></td> <td style="width: 10%;"></td> <td style="width: 10%;"></td> <td style="width: 10%;"></td> <td style="width: 10%;"></td> <td style="width: 10%;"></td> <td style="width: 10%;"></td> </tr> <tr> <td></td> <td></td> <td colspan="8" style="text-align: center;"> <table border="1"
style="width: 100%; border-collapse: collapse; text-align: center;"> <tr> <td style="width: 10%;"></td> <td style="width: 10%;"></td> <td style="width: 10%;"></td> <td style="width: 10%;"></td> <td style="width: 10%;"></td> <td style="width: 10%;"></td> <td style="width: 10%;"></td> <td style="width: 10%;"></td> <td style="width: 10%;"></td> <td style="width: 10%;"></td> </tr> <tr> <td></td> <td></td> <td colspan="8" style="text-align: center;"> <table border="1" style="width: 100%; border-collapse: collapse; text-align: center;"> <tr> <td style="width: 10%;"></td> <td style="width: 10%;"></td> <td style="width: 10%;"></td> <td style="width: 10%;"></td> <td style="width: 10%;"></td> <td style="width: 10%;"></td> <td style="width: 10%;"></td> <td style="width: 10%;"></td> <td style="width: 10%;"></td> <td style="width: 10%;"></td> </tr> <tr> <td></td> <td></td> <td colspan="8" style="text-align: center;"> <table border="1" style="width: 100%; border-collapse: collapse; text-align: center;"> <tr> <td style="width: 10%;"></td> <td style="width: 10%;"></td> <td style="width: 10%;"></td> <td style="width: 10%;"></td> <td style="width: 10%;"></td> <td style="width: 10%;"></td> <td style="width: 10%;"></td> <td style="width: 10%;"></td> <td style="width: 10%;"></td> <td style="width: 10%;"></td> </tr> <tr> <td></td> <td></td> <td colspan="8" style="text-align: center;"> <table border="1" style="width: 100%; border-collapse: collapse; text-align: center;"> <tr> </tr></table></td></tr></table></td></tr></table></td></tr></table></td></tr></table></td></tr></table></td></tr></table></td></tr></table></td></tr></table></td></tr></table></td></tr></table></td></tr></table></td></tr></table></td></tr></table></td></tr></table></td></tr></table></td></tr></table></td></tr></table></td></tr></table></td></tr></table></td></tr></table></td></tr></table></td></tr></table></td></tr></table></td></tr></table></td></tr></table></td></tr></table></td></tr></table></td></tr></table></td></tr></table></td></tr></table></td></tr></table></td></tr></table></td></tr></table></td></tr></table></td></tr></table></td></tr></table></td></tr></table>
 | | | | | | | | | | | | | | | | | | | | <table border="1" style="width: 100%; border-collapse: collapse; text-align: center;"> <tr> <td style="width: 10%;"></td> <td style="width: 10%;"></td> <td style="width: 10%;"></td> <td style="width: 10%;"></td> <td style="width: 10%;"></td> <td style="width: 10%;"></td> <td style="width: 10%;"></td> <td style="width: 10%;"></td> <td style="width: 10%;"></td> <td style="width: 10%;"></td> </tr> <tr> <td></td> <td></td> <td colspan="8" style="text-align: center;"> <table border="1" style="width: 100%; border-collapse: collapse; text-align: center;"> <tr> <td style="width: 10%;"></td> <td style="width: 10%;"></td> <td style="width: 10%;"></td> <td style="width: 10%;"></td> <td style="width: 10%;"></td> <td style="width: 10%;"></td> <td style="width: 10%;"></td> <td style="width: 10%;"></td> <td style="width: 10%;"></td> <td style="width: 10%;"></td> </tr> <tr> <td></td> <td></td> <td colspan="8" style="text-align: center;"> <table border="1" style="width: 100%; border-collapse: collapse; text-align: center;"> <tr> <td style="width: 10%;"></td> <td style="width: 10%;"></td> <td style="width: 10%;"></td> <td style="width: 10%;"></td> <td style="width: 10%;"></td> <td style="width: 10%;"></td> <td style="width: 10%;"></td> <td style="width: 10%;"></td> <td style="width: 10%;"></td> <td style="width: 10%;"></td> </tr> <tr> <td></td> <td></td> <td colspan="8" style="text-align: center;"> <table border="1" style="width: 100%; border-collapse: collapse; text-align: center;"> <tr> <td style="width: 10%;"></td> <td style="width: 10%;"></td> <td style="width: 10%;"></td> <td style="width: 10%;"></td> <td style="width: 10%;"></td> <td style="width: 10%;"></td> <td style="width: 10%;"></td> <td style="width: 10%;"></td> <td style="width: 10%;"></td> <td style="width: 10%;"></td> </tr> <tr> <td></td> <td></td> <td colspan="8" style="text-align: center;"> <table border="1" style="width: 100%; border-collapse: collapse; text-align: center;"> <tr> <td style="width: 10%;"></td> <td style="width: 10%;"></td> <td style="width: 10%;"></td> <td style="width: 10%;"></td> <td style="width: 10%;"></td> <td style="width: 10%;"></td> <td style="width: 10%;"></td> <td style="width: 10%;"></td> <td style="width: 10%;"></td> <td style="width: 10%;"></td> </tr> <tr> <td></td> <td></td> <td colspan="8" style="text-align: center;"> <table border="1" style="width: 100%; border-collapse: collapse; text-align: center;"> <tr> <td style="width: 10%;"></td> <td style="width: 10%;"></td> <td style="width: 10%;"></td> <td style="width: 10%;"></td> <td style="width: 10%;"></td> <td style="width: 10%;"></td> <td style="width: 10%;"></td> <td style="width: 10%;"></td> <td style="width: 10%;"></td> <td style="width: 10%;"></td> </tr> <tr> <td></td> <td></td> <td colspan="8" style="text-align: center;"> <table border="1" style="width: 100%; border-collapse: collapse; text-align: center;"> <tr> <td style="width: 10%;"></td> <td style="width: 10%;"></td> <td style="width: 10%;"></td> <td style="width: 10%;"></td> <td style="width: 10%;"></td> <td style="width: 10%;"></td> <td style="width: 10%;"></td> <td style="width: 10%;"></td> <td style="width: 10%;"></td> <td style="width: 10%;"></td> </tr> <tr> <td></td> <td></td> <td colspan="8" style="text-align: center;"> <table border="1" style="width: 100%; border-collapse: collapse; text-align: center;"> <tr> <td style="width: 10%;"></td> <td style="width: 10%;"></td> <td style="width: 10%;"></td> <td style="width: 10%;"></td> <td style="width: 10%;"></td> <td style="width: 10%;"></td> <td style="width: 10%;"></td> <td style="width: 10%;"></td> <td style="width: 10%;"></td> <td style="width: 10%;"></td> </tr> <tr> <td></td> <td></td> <td colspan="8" style="text-align: center;"> <table border="1" style="width: 100%; border-collapse: collapse; text-align: center;"> <tr> <td style="width: 10%;"></td> <td style="width: 10%;"></td> <td style="width: 10%;"></td> <td style="width: 10%;"></td> <td style="width: 10%;"></td> <td style="width: 10%;"></td> <td style="width: 10%;"></td> <td style="width: 10%;"></td> <td style="width: 10%;"></td> <td style="width: 10%;"></td> </tr> <tr> <td></td> <td></td> <td colspan="8" style="text-align: center;"> <table border="1" style="width: 100%; border-collapse: collapse; text-align: center;"> <tr> <td style="width: 10%;"></td> <td style="width: 10%;"></td> <td style="width: 10%;"></td> <td style="width: 10%;"></td> <td style="width: 10%;"></td> <td style="width: 10%;"></td> <td style="width: 10%;"></td> <td style="width: 10%;"></td> <td style="width: 10%;"></td> <td style="width: 10%;"></td> </tr> <tr> <td></td> <td></td> <td colspan="8" style="text-align: center;"> <table border="1" style="width: 100%; border-collapse: collapse; text-align: center;"> <tr> <td style="width: 10%;"></td> <td style="width: 10%;"></td> <td style="width: 10%;"></td> <td style="width: 10%;"></td> <td style="width: 10%;"></td> <td style="width: 10%;"></td> <td style="width: 10%;"></td> <td style="width: 10%;"></td> <td style="width: 10%;"></td> <td style="width: 10%;"></td> </tr> <tr> <td></td> <td></td> <td colspan="8" style="text-align: center;"> <table border="1" style="width: 100%; border-collapse: collapse; text-align: center;"> <tr> <td style="width: 10%;"></td> <td style="width: 10%;"></td> <td style="width: 10%;"></td> <td style="width: 10%;"></td> <td style="width: 10%;"></td> <td style="width: 10%;"></td> <td style="width: 10%;"></td> <td style="width: 10%;"></td> <td style="width: 10%;"></td> <td style="width: 10%;"></td> </tr> <tr> <td></td> <td></td> <td colspan="8" style="text-align: center;"> <table border="1" style="width: 100%; border-collapse: collapse; text-align: center;"> <tr> <td style="width: 10%;"></td> <td style="width: 10%;"></td> <td style="width: 10%;"></td> <td style="width: 10%;"></td> <td style="width: 10%;"></td> <td style="width: 10%;"></td> <td style="width: 10%;"></td> <td style="width: 10%;"></td> <td style="width: 10%;"></td> <td style="width: 10%;"></td> </tr> <tr> <td></td> <td></td> <td colspan="8" style="text-align: center;"> <table border="1" style="width: 100%; border-collapse: collapse; text-align: center;"> <tr> <td style="width: 10%;"></td> <td style="width: 10%;"></td> <td style="width: 10%;"></td> <td style="width: 10%;"></td> <td style="width: 10%;"></td> <td style="width: 10%;"></td> <td style="width: 10%;"></td> <td style="width: 10%;"></td> <td style="width: 10%;"></td> <td style="width: 10%;"></td> </tr> <tr> <td></td> <td></td> <td colspan="8" style="text-align: center;"> <table border="1" style="width: 100%; border-collapse: collapse; text-align: center;"> <tr> <td style="width: 10%;"></td> <td style="width: 10%;"></td> <td style="width: 10%;"></td> <td style="width: 10%;"></td> <td style="width: 10%;"></td> <td style="width: 10%;"></td> <td style="width: 10%;"></td> <td style="width: 10%;"></td> <td style="width: 10%;"></td> <td style="width: 10%;"></td> </tr> <tr> <td></td> <td></td> <td colspan="8" style="text-align: center;"> <table border="1" style="width: 100%; border-collapse: collapse; text-align: center;"> <tr> <td style="width: 10%;"></td> <td style="width: 10%;"></td> <td style="width: 10%;"></td> <td style="width: 10%;"></td> <td style="width: 10%;"></td> <td style="width: 10%;"></td> <td style="width: 10%;"></td> <td style="width: 10%;"></td> <td style="width: 10%;"></td> <td style="width: 10%;"></td> </tr> <tr> <td></td> <td></td> <td colspan="8" style="text-align: center;"> <table border="1" style="width: 100%; border-collapse: collapse; text-align: center;"> <tr> <td style="width: 10%;"></td> <td style="width: 10%;"></td> <td style="width: 10%;"></td> <td style="width: 10%;"></td> <td style="width: 10%;"></td> <td style="width: 10%;"></td> <td style="width: 10%;"></td> <td style="width: 10%;"></td> <td style="width: 10%;"></td> <td style="width: 10%;"></td> </tr> <tr> <td></td> <td></td> <td colspan="8" style="text-align: center;"> <table border="1" style="width: 100%; border-collapse: collapse; text-align: center;"> <tr> <td style="width: 10%;"></td> <td style="width: 10%;"></td> <td style="width: 10%;"></td> <td style="width: 10%;"></td> <td style="width: 10%;"></td> <td style="width: 10%;"></td> <td style="width: 10%;"></td> <td style="width: 10%;"></td> <td style="width: 10%;"></td> <td style="width: 10%;"></td> </tr> <tr> <td></td> <td></td> <td colspan="8" style="text-align: center;"> <table border="1" style="width: 100%; border-collapse: collapse; text-align: center;"> <tr> <td style="width: 10%;"></td> <td style="width: 10%;"></td> <td style="width: 10%;"></td> <td style="width: 10%;"></td> <td style="width: 10%;"></td> <td style="width: 10%;"></td> <td style="width: 10%;"></td> <td style="width: 10%;"></td> <td style="width: 10%;"></td> <td style="width: 10%;"></td> </tr> <tr> <td></td> <td></td> <td colspan="8" style="text-align: center;"> <table border="1" style="width: 100%; border-collapse: collapse; text-align: center;"> <tr> <td style="width: 10%;"></td> <td style="width:
10%;"></td> <td style="width: 10%;"></td> <td style="width: 10%;"></td> <td style="width: 10%;"></td> <td style="width: 10%;"></td> <td style="width: 10%;"></td> <td style="width: 10%;"></td> <td style="width: 10%;"></td> <td style="width: 10%;"></td> </tr> <tr> <td></td> <td></td> <td colspan="8" style="text-align: center;"> <table border="1" style="width: 100%; border-collapse: collapse; text-align: center;"> <tr> <td style="width: 10%;"></td> <td style="width: 10%;"></td> <td style="width: 10%;"></td> <td style="width: 10%;"></td> <td style="width: 10%;"></td> <td style="width: 10%;"></td> <td style="width: 10%;"></td> <td style="width: 10%;"></td> <td style="width: 10%;"></td> <td style="width: 10%;"></td> </tr> <tr> <td></td> <td></td> <td colspan="8" style="text-align: center;"> <table border="1" style="width: 100%; border-collapse: collapse; text-align: center;"> <tr> <td style="width: 10%;"></td> <td style="width: 10%;"></td> <td style="width: 10%;"></td> <td style="width: 10%;"></td> <td style="width: 10%;"></td> <td style="width: 10%;"></td> <td style="width: 10%;"></td> <td style="width: 10%;"></td> <td style="width: 10%;"></td> <td style="width: 10%;"></td> </tr> <tr> <td></td> <td></td> <td colspan="8" style="text-align: center;"> <table border="1" style="width: 100%; border-collapse: collapse; text-align: center;"> <tr> <td style="width: 10%;"></td> <td style="width: 10%;"></td> <td style="width: 10%;"></td> <td style="width: 10%;"></td> <td style="width: 10%;"></td> <td style="width: 10%;"></td> <td style="width: 10%;"></td> <td style="width: 10%;"></td> <td style="width: 10%;"></td> <td style="width: 10%;"></td> </tr> <tr> <td></td> <td></td> <td colspan="8" style="text-align: center;"> <table border="1" style="width: 100%; border-collapse: collapse; text-align: center;"> <tr> <td style="width: 10%;"></td> <td style="width: 10%;"></td> <td style="width: 10%;"></td> <td style="width: 10%;"></td> <td style="width: 10%;"></td> <td style="width: 10%;"></td> <td style="width: 10%;"></td> <td style="width: 10%;"></td> <td style="width: 10%;"></td> <td style="width: 10%;"></td> </tr> <tr> <td></td> <td></td> <td colspan="8" style="text-align: center;"> <table border="1" style="width: 100%; border-collapse: collapse; text-align: center;"> <tr> <td style="width: 10%;"></td> <td style="width: 10%;"></td> <td style="width: 10%;"></td> <td style="width: 10%;"></td> <td style="width: 10%;"></td> <td style="width: 10%;"></td> <td style="width: 10%;"></td> <td style="width: 10%;"></td> <td style="width: 10%;"></td> <td style="width: 10%;"></td> </tr> <tr> <td></td> <td></td> <td colspan="8" style="text-align: center;"> <table border="1" style="width: 100%; border-collapse: collapse; text-align: center;"> <tr> <td style="width: 10%;"></td> <td style="width: 10%;"></td> <td style="width: 10%;"></td> <td style="width: 10%;"></td> <td style="width: 10%;"></td> <td style="width: 10%;"></td> <td style="width: 10%;"></td> <td style="width: 10%;"></td> <td style="width: 10%;"></td> <td style="width: 10%;"></td> </tr> <tr> <td></td> <td></td> <td colspan="8" style="text-align: center;"> <table border="1" style="width: 100%; border-collapse: collapse; text-align: center;"> <tr> <td style="width: 10%;"></td> <td style="width: 10%;"></td> <td style="width: 10%;"></td> <td style="width: 10%;"></td> <td style="width: 10%;"></td> <td style="width: 10%;"></td> <td style="width: 10%;"></td> <td style="width: 10%;"></td> <td style="width: 10%;"></td> <td style="width: 10%;"></td> </tr> <tr> <td></td> <td></td> <td colspan="8" style="text-align: center;"> <table border="1" style="width: 100%; border-collapse: collapse; text-align: center;"> <tr> <td style="width: 10%;"></td> <td style="width: 10%;"></td> <td style="width: 10%;"></td> <td style="width: 10%;"></td> <td style="width: 10%;"></td> <td style="width: 10%;"></td> <td style="width: 10%;"></td> <td style="width: 10%;"></td> <td style="width: 10%;"></td> <td style="width: 10%;"></td> </tr> <tr> <td></td> <td></td> <td colspan="8" style="text-align: center;"> <table border="1" style="width: 100%; border-collapse: collapse; text-align: center;"> <tr> <td style="width: 10%;"></td> <td style="width: 10%;"></td> <td style="width: 10%;"></td> <td style="width: 10%;"></td> <td style="width: 10%;"></td> <td style="width: 10%;"></td> <td style="width: 10%;"></td> <td style="width: 10%;"></td> <td style="width: 10%;"></td> <td style="width: 10%;"></td> </tr> <tr> <td></td> <td></td> <td colspan="8" style="text-align: center;"> <table border="1" style="width: 100%; border-collapse: collapse; text-align: center;"> <tr> <td style="width: 10%;"></td> <td style="width: 10%;"></td> <td style="width: 10%;"></td> <td style="width: 10%;"></td> <td style="width: 10%;"></td> <td style="width: 10%;"></td> <td style="width: 10%;"></td> <td style="width: 10%;"></td> <td style="width: 10%;"></td> <td style="width: 10%;"></td> </tr> <tr> <td></td> <td></td> <td colspan="8" style="text-align: center;"> <table border="1" style="width: 100%; border-collapse: collapse; text-align: center;"> <tr> <td style="width: 10%;"></td> <td style="width: 10%;"></td> <td style="width: 10%;"></td> <td style="width: 10%;"></td> <td style="width: 10%;"></td> <td style="width: 10%;"></td> <td style="width: 10%;"></td> <td style="width: 10%;"></td> <td style="width: 10%;"></td> <td style="width: 10%;"></td> </tr> <tr> <td></td> <td></td> <td colspan="8" style="text-align: center;"> <table border="1" style="width: 100%; border-collapse: collapse; text-align: center;"> <tr> <td style="width: 10%;"></td> <td style="width: 10%;"></td> <td style="width: 10%;"></td> <td style="width: 10%;"></td> <td style="width: 10%;"></td> <td style="width: 10%;"></td> <td style="width: 10%;"></td> <td style="width: 10%;"></td> <td style="width: 10%;"></td> <td style="width: 10%;"></td> </tr> <tr> <td></td> <td></td> <td colspan="8" style="text-align: center;"> <table border="1" style="width: 100%; border-collapse: collapse; text-align: center;"> <tr> <td style="width: 10%;"></td> <td style="width: 10%;"></td> <td style="width: 10%;"></td> <td style="width: 10%;"></td> <td style="width: 10%;"></td> <td style="width: 10%;"></td> <td style="width: 10%;"></td> <td style="width: 10%;"></td> <td style="width: 10%;"></td> <td style="width: 10%;"></td> </tr> <tr> <td></td> <td></td> <td colspan="8" style="text-align: center;"> <table border="1" style="width: 100%; border-collapse: collapse; text-align: center;"> <tr> <td style="width: 10%;"></td> <td style="width: 10%;"></td> <td style="width: 10%;"></td> <td style="width: 10%;"></td> <td style="width: 10%;"></td> <td style="width: 10%;"></td> <td style="width: 10%;"></td> <td style="width: 10%;"></td> <td style="width: 10%;"></td> <td style="width: 10%;"></td> </tr> <tr> <td></td> <td></td> <td colspan="8" style="text-align: center;"> <table border="1" style="width: 100%; border-collapse: collapse; text-align: center;"> <tr> <td style="width: 10%;"></td> <td style="width: 10%;"></td> <td style="width: 10%;"></td> <td style="width: 10%;"></td> <td style="width: 10%;"></td> <td style="width: 10%;"></td> <td style="width: 10%;"></td> <td style="width: 10%;"></td> <td style="width: 10%;"></td> <td style="width: 10%;"></td> </tr> <tr> <td></td> <td></td> <td colspan="8" style="text-align: center;"> <table border="1" style="width: 100%; border-collapse: collapse; text-align: center;"> <tr> <td style="width: 10%;"></td> <td style="width: 10%;"></td> <td style="width: 10%;"></td> <td style="width: 10%;"></td> <td style="width: 10%;"></td> <td style="width: 10%;"></td> <td style="width: 10%;"></td> <td style="width: 10%;"></td> <td style="width: 10%;"></td> <td style="width: 10%;"></td> </tr> <tr> <td></td> <td></td> <td colspan="8" style="text-align: center;"> <table border="1" style="width: 100%; border-collapse: collapse; text-align: center;"> <tr> </tr></table></td></tr></table></td></tr></table></td></tr></table></td></tr></table></td></tr></table></td></tr></table></td></tr></table></td></tr></table></td></tr></table></td></tr></table></td></tr></table></td></tr></table></td></tr></table></td></tr></table></td></tr></table></td></tr></table></td></tr></table></td></tr></table></td></tr></table></td></tr></table></td></tr></table></td></tr></table></td></tr></table></td></tr></table></td></tr></table></td></tr></table></td></tr></table></td></tr></table></td></tr></table></td></tr></table></td></tr></table></td></tr></table></td></tr></table></td></tr></table></td></tr></table></td></tr></table>
 | | | | | | | | | | | | | | | | | | | | <table border="1" style="width: 100%; border-collapse: collapse; text-align: center;"> <tr> <td style="width: 10%;"></td> <td style="width: 10%;"></td> <td style="width: 10%;"></td> <td style="width: 10%;"></td> <td style="width: 10%;"></td> <td style="width: 10%;"></td> <td style="width: 10%;"></td> <td style="width: 10%;"></td> <td style="width: 10%;"></td> <td style="width: 10%;"></td> </tr> <tr> <td></td> <td></td> <td colspan="8" style="text-align: center;"> <table border="1" style="width: 100%; border-collapse: collapse; text-align: center;"> <tr> <td style="width: 10%;"></td> <td style="width: 10%;"></td> <td style="width: 10%;"></td> <td style="width: 10%;"></td> <td style="width: 10%;"></td> <td style="width: 10%;"></td> <td style="width: 10%;"></td> <td style="width: 10%;"></td> <td style="width: 10%;"></td> <td style="width: 10%;"></td> </tr> <tr> <td></td> <td></td> <td colspan="8" style="text-align: center;"> <table border="1" style="width: 100%; border-collapse: collapse; text-align: center;"> <tr> <td style="width: 10%;"></td> <td style="width: 10%;"></td> <td style="width: 10%;"></td> <td style="width: 10%;"></td> <td style="width: 10%;"></td> <td style="width: 10%;"></td> <td style="width: 10%;"></td> <td style="width: 10%;"></td> <td style="width: 10%;"></td> <td style="width: 10%;"></td> </tr> <tr> <td></td> <td></td> <td colspan="8" style="text-align: center;"> <table border="1" style="width: 100%; border-collapse: collapse; text-align: center;"> <tr> <td style="width: 10%;"></td> <td style="width: 10%;"></td> <td style="width: 10%;"></td> <td style="width: 10%;"></td> <td style="width: 10%;"></td> <td style="width: 10%;"></td> <td style="width: 10%;"></td> <td style="width: 10%;"></td> <td style="width: 10%;"></td> <td style="width: 10%;"></td> </tr> <tr> <td></td> <td></td> <td colspan="8" style="text-align: center;"> <table border="1" style="width: 100%; border-collapse: collapse; text-align: center;"> <tr> <td style="width: 10%;"></td> <td style="width: 10%;"></td> <td style="width: 10%;"></td> <td style="width: 10%;"></td> <td style="width: 10%;"></td> <td style="width: 10%;"></td> <td style="width: 10%;"></td> <td style="width: 10%;"></td> <td style="width: 10%;"></td> <td style="width: 10%;"></td> </tr> <tr> <td></td> <td></td> <td colspan="8" style="text-align: center;"> <table border="1" style="width: 100%; border-collapse: collapse; text-align: center;"> <tr> <td style="width: 10%;"></td> <td style="width: 10%;"></td> <td style="width: 10%;"></td> <td style="width: 10%;"></td> <td style="width: 10%;"></td> <td style="width: 10%;"></td> <td
style="width: 10%;"></td> <td style="width: 10%;"></td> <td style="width: 10%;"></td> <td style="width: 10%;"></td> </tr> <tr> <td></td> <td></td> <td colspan="8" style="text-align: center;"> <table border="1" style="width: 100%; border-collapse: collapse; text-align: center;"> <tr> <td style="width: 10%;"></td> <td style="width: 10%;"></td> <td style="width: 10%;"></td> <td style="width: 10%;"></td> <td style="width: 10%;"></td> <td style="width: 10%;"></td> <td style="width: 10%;"></td> <td style="width: 10%;"></td> <td style="width: 10%;"></td> <td style="width: 10%;"></td> </tr> <tr> <td></td> <td></td> <td colspan="8" style="text-align: center;"> <table border="1" style="width: 100%; border-collapse: collapse; text-align: center;"> <tr> <td style="width: 10%;"></td> <td style="width: 10%;"></td> <td style="width: 10%;"></td> <td style="width: 10%;"></td> <td style="width: 10%;"></td> <td style="width: 10%;"></td> <td style="width: 10%;"></td> <td style="width: 10%;"></td> <td style="width: 10%;"></td> <td style="width: 10%;"></td> </tr> <tr> <td></td> <td></td> <td colspan="8" style="text-align: center;"> <table border="1" style="width: 100%; border-collapse: collapse; text-align: center;"> <tr> <td style="width: 10%;"></td> <td style="width: 10%;"></td> <td style="width: 10%;"></td> <td style="width: 10%;"></td> <td style="width: 10%;"></td> <td style="width: 10%;"></td> <td style="width: 10%;"></td> <td style="width: 10%;"></td> <td style="width: 10%;"></td> <td style="width: 10%;"></td> </tr> <tr> <td></td> <td></td> <td colspan="8" style="text-align: center;"> <table border="1" style="width: 100%; border-collapse: collapse; text-align: center;"> <tr> <td style="width: 10%;"></td> <td style="width: 10%;"></td> <td style="width: 10%;"></td> <td style="width: 10%;"></td> <td style="width: 10%;"></td> <td style="width: 10%;"></td> <td style="width: 10%;"></td> <td style="width: 10%;"></td> <td style="width: 10%;"></td> <td style="width: 10%;"></td> </tr> <tr> <td></td> <td></td> <td colspan="8" style="text-align: center;"> <table border="1" style="width: 100%; border-collapse: collapse; text-align: center;"> <tr> <td style="width: 10%;"></td> <td style="width: 10%;"></td> <td style="width: 10%;"></td> <td style="width: 10%;"></td> <td style="width: 10%;"></td> <td style="width: 10%;"></td> <td style="width: 10%;"></td> <td style="width: 10%;"></td> <td style="width: 10%;"></td> <td style="width: 10%;"></td> </tr> <tr> <td></td> <td></td> <td colspan="8" style="text-align: center;"> <table border="1" style="width: 100%; border-collapse: collapse; text-align: center;"> <tr> <td style="width: 10%;"></td> <td style="width: 10%;"></td> <td style="width: 10%;"></td> <td style="width: 10%;"></td> <td style="width: 10%;"></td> <td style="width: 10%;"></td> <td style="width: 10%;"></td> <td style="width: 10%;"></td> <td style="width: 10%;"></td> <td style="width: 10%;"></td> </tr> <tr> <td></td> <td></td> <td colspan="8" style="text-align: center;"> <table border="1" style="width: 100%; border-collapse: collapse; text-align: center;"> <tr> <td style="width: 10%;"></td> <td style="width: 10%;"></td> <td style="width: 10%;"></td> <td style="width: 10%;"></td> <td style="width: 10%;"></td> <td style="width: 10%;"></td> <td style="width: 10%;"></td> <td style="width: 10%;"></td> <td style="width: 10%;"></td> <td style="width: 10%;"></td> </tr> <tr> <td></td> <td></td> <td colspan="8" style="text-align: center;"> <table border="1" style="width: 100%; border-collapse: collapse; text-align: center;"> <tr> <td style="width: 10%;"></td> <td style="width: 10%;"></td> <td style="width: 10%;"></td> <td style="width: 10%;"></td> <td style="width: 10%;"></td> <td style="width: 10%;"></td> <td style="width: 10%;"></td> <td style="width: 10%;"></td> <td style="width: 10%;"></td> <td style="width: 10%;"></td> </tr> <tr> <td></td> <td></td> <td colspan="8" style="text-align: center;"> <table border="1" style="width: 100%; border-collapse: collapse; text-align: center;"> <tr> <td style="width: 10%;"></td> <td style="width: 10%;"></td> <td style="width: 10%;"></td> <td style="width: 10%;"></td> <td style="width: 10%;"></td> <td style="width: 10%;"></td> <td style="width: 10%;"></td> <td style="width: 10%;"></td> <td style="width: 10%;"></td> <td style="width: 10%;"></td> </tr> <tr> <td></td> <td></td> <td colspan="8" style="text-align: center;"> <table border="1" style="width: 100%; border-collapse: collapse; text-align: center;"> <tr> <td style="width: 10%;"></td> <td style="width: 10%;"></td> <td style="width: 10%;"></td> <td style="width: 10%;"></td> <td style="width: 10%;"></td> <td style="width: 10%;"></td> <td style="width: 10%;"></td> <td style="width: 10%;"></td> <td style="width: 10%;"></td> <td style="width: 10%;"></td> </tr> <tr> <td></td> <td></td> <td colspan="8" style="text-align: center;"> <table border="1" style="width: 100%; border-collapse: collapse; text-align: center;"> <tr> <td style="width: 10%;"></td> <td style="width: 10%;"></td> <td style="width: 10%;"></td> <td style="width: 10%;"></td> <td style="width: 10%;"></td> <td style="width: 10%;"></td> <td style="width: 10%;"></td> <td style="width: 10%;"></td> <td style="width: 10%;"></td> <td style="width: 10%;"></td> </tr> <tr> <td></td> <td></td> <td colspan="8" style="text-align: center;"> <table border="1" style="width: 100%; border-collapse: collapse; text-align: center;"> <tr> <td style="width: 10%;"></td> <td style="width: 10%;"></td> <td style="width: 10%;"></td> <td style="width: 10%;"></td> <td style="width: 10%;"></td> <td style="width: 10%;"></td> <td style="width: 10%;"></td> <td style="width: 10%;"></td> <td style="width: 10%;"></td> <td style="width: 10%;"></td> </tr> <tr> <td></td> <td></td> <td colspan="8" style="text-align: center;"> <table border="1" style="width: 100%; border-collapse: collapse; text-align: center;"> <tr> <td style="width: 10%;"></td> <td style="width: 10%;"></td> <td style="width: 10%;"></td> <td style="width: 10%;"></td> <td style="width: 10%;"></td> <td style="width: 10%;"></td> <td style="width: 10%;"></td> <td style="width: 10%;"></td> <td style="width: 10%;"></td> <td style="width: 10%;"></td> </tr> <tr> <td></td> <td></td> <td colspan="8" style="text-align: center;"> <table border="1" style="width: 100%; border-collapse: collapse; text-align: center;"> <tr> <td style="width: 10%;"></td> <td style="width: 10%;"></td> <td style="width: 10%;"></td> <td style="width: 10%;"></td> <td style="width: 10%;"></td> <td style="width: 10%;"></td> <td style="width: 10%;"></td> <td style="width: 10%;"></td> <td style="width: 10%;"></td> <td style="width: 10%;"></td> </tr> <tr> <td></td> <td></td> <td colspan="8" style="text-align: center;"> <table border="1" style="width: 100%; border-collapse: collapse; text-align: center;"> <tr> <td style="width: 10%;"></td> <td style="width: 10%;"></td> <td style="width: 10%;"></td> <td style="width: 10%;"></td> <td style="width: 10%;"></td> <td style="width: 10%;"></td> <td style="width: 10%;"></td> <td style="width: 10%;"></td> <td style="width: 10%;"></td> <td style="width: 10%;"></td> </tr> <tr> <td></td> <td></td> <td colspan="8" style="text-align: center;"> <table border="1" style="width: 100%; border-collapse: collapse; text-align: center;"> <tr> <td style="width: 10%;"></td> <td style="width: 10%;"></td> <td style="width: 10%;"></td> <td style="width: 10%;"></td> <td style="width: 10%;"></td> <td style="width: 10%;"></td> <td style="width: 10%;"></td> <td style="width: 10%;"></td> <td style="width: 10%;"></td> <td style="width: 10%;"></td> </tr> <tr> <td></td> <td></td> <td colspan="8" style="text-align: center;"> <table border="1" style="width: 100%; border-collapse: collapse; text-align: center;"> <tr> <td style="width: 10%;"></td> <td style="width: 10%;"></td> <td style="width: 10%;"></td> <td style="width: 10%;"></td> <td style="width: 10%;"></td> <td style="width: 10%;"></td> <td style="width: 10%;"></td> <td style="width: 10%;"></td> <td style="width: 10%;"></td> <td style="width: 10%;"></td> </tr> <tr> <td></td> <td></td> <td colspan="8" style="text-align: center;"> <table border="1" style="width: 100%; border-collapse: collapse; text-align: center;"> <tr> <td style="width: 10%;"></td> <td style="width: 10%;"></td> <td style="width: 10%;"></td> <td style="width: 10%;"></td> <td style="width: 10%;"></td> <td style="width: 10%;"></td> <td style="width: 10%;"></td> <td style="width: 10%;"></td> <td style="width: 10%;"></td> <td style="width: 10%;"></td> </tr> <tr> <td></td> <td></td> <td colspan="8" style="text-align: center;"> <table border="1" style="width: 100%; border-collapse: collapse; text-align: center;"> <tr> <td style="width: 10%;"></td> <td style="width: 10%;"></td> <td style="width: 10%;"></td> <td style="width: 10%;"></td> <td style="width: 10%;"></td> <td style="width: 10%;"></td> <td style="width: 10%;"></td> <td style="width: 10%;"></td> <td style="width: 10%;"></td> <td style="width: 10%;"></td> </tr> <tr> <td></td> <td></td> <td colspan="8" style="text-align: center;"> <table border="1" style="width: 100%; border-collapse: collapse; text-align: center;"> <tr> <td style="width: 10%;"></td> <td style="width: 10%;"></td> <td style="width: 10%;"></td> <td style="width: 10%;"></td> <td style="width: 10%;"></td> <td style="width: 10%;"></td> <td style="width: 10%;"></td> <td style="width: 10%;"></td> <td style="width: 10%;"></td> <td style="width: 10%;"></td> </tr> <tr> <td></td> <td></td> <td colspan="8" style="text-align: center;"> <table border="1" style="width: 100%; border-collapse: collapse; text-align: center;"> <tr> <td style="width: 10%;"></td> <td style="width: 10%;"></td> <td style="width: 10%;"></td> <td style="width: 10%;"></td> <td style="width: 10%;"></td> <td style="width: 10%;"></td> <td style="width: 10%;"></td> <td style="width: 10%;"></td> <td style="width: 10%;"></td> <td style="width: 10%;"></td> </tr> <tr> <td></td> <td></td> <td colspan="8"
style="text-align: center;"> <table border="1" style="width: 100%; border-collapse: collapse; text-align: center;"> <tr> <td style="width: 10%;"></td> <td style="width: 10%;"></td> <td style="width: 10%;"></td> <td style="width: 10%;"></td> <td style="width: 10%;"></td> <td style="width: 10%;"></td> <td style="width: 10%;"></td> <td style="width: 10%;"></td> <td style="width: 10%;"></td> <td style="width: 10%;"></td> </tr> <tr> <td></td> <td></td> <td colspan="8" style="text-align: center;"> <table border="1" style="width: 100%; border-collapse: collapse; text-align: center;"> <tr> <td style="width: 10%;"></td> <td style="width: 10%;"></td> <td style="width: 10%;"></td> <td style="width: 10%;"></td> <td style="width: 10%;"></td> <td style="width: 10%;"></td> <td style="width: 10%;"></td> <td style="width: 10%;"></td> <td style="width: 10%;"></td> <td style="width: 10%;"></td> </tr> <tr> <td></td> <td></td> <td colspan="8" style="text-align: center;"> <table border="1" style="width: 100%; border-collapse: collapse; text-align: center;"> <tr> <td style="width: 10%;"></td> <td style="width: 10%;"></td> <td style="width: 10%;"></td> <td style="width: 10%;"></td> <td style="width: 10%;"></td> <td style="width: 10%;"></td> <td style="width: 10%;"></td> <td style="width: 10%;"></td> <td style="width: 10%;"></td> <td style="width: 10%;"></td> </tr> <tr> <td></td> <td></td> <td colspan="8" style="text-align: center;"> <table border="1" style="width: 100%; border-collapse: collapse; text-align: center;"> <tr> <td style="width: 10%;"></td> <td style="width: 10%;"></td> <td style="width: 10%;"></td> <td style="width: 10%;"></td> <td style="width: 10%;"></td> <td style="width: 10%;"></td> <td style="width: 10%;"></td> <td style="width: 10%;"></td> <td style="width: 10%;"></td> <td style="width: 10%;"></td> </tr> <tr> <td></td> <td></td> <td colspan="8" style="text-align: center;"> <table border="1" style="width: 100%; border-collapse: collapse; text-align: center;"> <tr> <td style="width: 10%;"></td> <td style="width: 10%;"></td> <td style="width: 10%;"></td> <td style="width: 10%;"></td> <td style="width: 10%;"></td> <td style="width: 10%;"></td> <td style="width: 10%;"></td> <td style="width: 10%;"></td> <td style="width: 10%;"></td> <td style="width: 10%;"></td> </tr> <tr> <td></td> <td></td> <td colspan="8" style="text-align: center;"> <table border="1" style="width: 100%; border-collapse: collapse; text-align: center;"> <tr> <td style="width: 10%;"></td> <td style="width: 10%;"></td> <td style="width: 10%;"></td> <td style="width: 10%;"></td> <td style="width: 10%;"></td> <td style="width: 10%;"></td> <td style="width: 10%;"></td> <td style="width: 10%;"></td> <td style="width: 10%;"></td> <td style="width: 10%;"></td> </tr> <tr> <td></td> <td></td> <td colspan="8" style="text-align: center;"> <table border="1" style="width: 100%; border-collapse: collapse; text-align: center;"> <tr> <td style="width: 10%;"></td> <td style="width: 10%;"></td> <td style="width: 10%;"></td> <td style="width: 10%;"></td> <td style="width: 10%;"></td> <td style="width: 10%;"></td> <td style="width: 10%;"></td> <td style="width: 10%;"></td> <td style="width: 10%;"></td> <td style="width: 10%;"></td> </tr> <tr> <td></td> <td></td> <td colspan="8" style="text-align: center;"> <table border="1" style="width: 100%; border-collapse: collapse; text-align: center;"> <tr> <td style="width: 10%;"></td> <td style="width: 10%;"></td> <td style="width: 10%;"></td> <td style="width: 10%;"></td> <td style="width: 10%;"></td> <td style="width: 10%;"></td> <td style="width: 10%;"></td> <td style="width: 10%;"></td> <td style="width: 10%;"></td> <td style="width: 10%;"></td> </tr> <tr> <td></td> <td></td> <td colspan="8" style="text-align: center;"> <table border="1" style="width: 100%; border-collapse: collapse; text-align: center;"> <tr> </tr></table></td></tr></table></td></tr></table></td></tr></table></td></tr></table></td></tr></table></td></tr></table></td></tr></table></td></tr></table></td></tr></table></td></tr></table></td></tr></table></td></tr></table></td></tr></table></td></tr></table></td></tr></table></td></tr></table></td></tr></table></td></tr></table></td></tr></table></td></tr></table></td></tr></table></td></tr></table></td></tr></table></td></tr></table></td></tr></table></td></tr></table></td></tr></table></td></tr></table></td></tr></table></td></tr></table></td></tr></table></td></tr></table></td></tr></table></td></tr></table></td></tr></table>
 | | | | | | | | | | | | | | | | | | | | <table border="1" style="width: 100%; border-collapse: collapse; text-align: center;"> <tr> <td style="width: 10%;"></td> <td style="width: 10%;"></td> <td style="width: 10%;"></td> <td style="width: 10%;"></td> <td style="width: 10%;"></td> <td style="width: 10%;"></td> <td style="width: 10%;"></td> <td style="width: 10%;"></td> <td style="width: 10%;"></td> <td style="width: 10%;"></td> </tr> <tr> <td></td> <td></td> <td colspan="8" style="text-align: center;"> <table border="1" style="width: 100%; border-collapse: collapse; text-align: center;"> <tr> <td style="width: 10%;"></td> <td style="width: 10%;"></td> <td style="width: 10%;"></td> <td style="width: 10%;"></td> <td style="width: 10%;"></td> <td style="width: 10%;"></td> <td style="width: 10%;"></td> <td style="width: 10%;"></td> <td style="width: 10%;"></td> <td style="width: 10%;"></td> </tr> <tr> <td></td> <td></td> <td colspan="8" style="text-align: center;"> <table border="1" style="width: 100%; border-collapse: collapse; text-align: center;"> <tr> <td style="width: 10%;"></td> <td style="width: 10%;"></td> <td style="width: 10%;"></td> <td style="width: 10%;"></td> <td style="width: 10%;"></td> <td style="width: 10%;"></td> <td style="width: 10%;"></td> <td style="width: 10%;"></td> <td style="width: 10%;"></td> <td style="width: 10%;"></td> </tr> <tr> <td></td> <td></td> <td colspan="8" style="text-align: center;"> <table border="1" style="width: 100%; border-collapse: collapse; text-align: center;"> <tr> <td style="width: 10%;"></td> <td style="width: 10%;"></td> <td style="width: 10%;"></td> <td style="width: 10%;"></td> <td style="width: 10%;"></td> <td style="width: 10%;"></td> <td style="width: 10%;"></td> <td style="width: 10%;"></td> <td style="width: 10%;"></td> <td style="width: 10%;"></td> </tr> <tr> <td></td> <td></td> <td colspan="8" style="text-align: center;"> <table border="1" style="width: 100%; border-collapse: collapse; text-align: center;"> <tr> <td style="width: 10%;"></td> <td style="width: 10%;"></td> <td style="width: 10%;"></td> <td style="width: 10%;"></td> <td style="width: 10%;"></td> <td style="width: 10%;"></td> <td style="width: 10%;"></td> <td style="width: 10%;"></td> <td style="width: 10%;"></td> <td style="width: 10%;"></td> </tr> <tr> <td></td> <td></td> <td colspan="8" style="text-align: center;"> <table border="1" style="width: 100%; border-collapse: collapse; text-align: center;"> <tr> <td style="width: 10%;"></td> <td style="width: 10%;"></td> <td style="width: 10%;"></td> <td style="width: 10%;"></td> <td style="width: 10%;"></td> <td style="width: 10%;"></td> <td style="width: 10%;"></td> <td style="width: 10%;"></td> <td style="width: 10%;"></td> <td style="width: 10%;"></td> </tr> <tr> <td></td> <td></td> <td colspan="8" style="text-align: center;"> <table border="1" style="width: 100%; border-collapse: collapse; text-align: center;"> <tr> <td style="width: 10%;"></td> <td style="width: 10%;"></td> <td style="width: 10%;"></td> <td style="width: 10%;"></td> <td style="width: 10%;"></td> <td style="width: 10%;"></td> <td style="width: 10%;"></td> <td style="width: 10%;"></td> <td style="width: 10%;"></td> <td style="width: 10%;"></td> </tr> <tr> <td></td> <td></td> <td colspan="8" style="text-align: center;"> <table border="1" style="width: 100%; border-collapse: collapse; text-align: center;"> <tr> <td style="width: 10%;"></td> <td style="width: 10%;"></td> <td style="width: 10%;"></td> <td style="width: 10%;"></td> <td style="width: 10%;"></td> <td style="width: 10%;"></td> <td style="width: 10%;"></td> <td style="width: 10%;"></td> <td style="width: 10%;"></td> <td style="width: 10%;"></td> </tr> <tr> <td></td> <td></td> <td colspan="8" style="text-align: center;"> <table border="1" style="width: 100%; border-collapse: collapse; text-align: center;"> <tr> <td style="width: 10%;"></td> <td style="width: 10%;"></td> <td style="width: 10%;"></td> <td style="width: 10%;"></td> <td style="width: 10%;"></td> <td style="width: 10%;"></td> <td style="width: 10%;"></td> <td style="width: 10%;"></td> <td style="width: 10%;"></td> <td style="width: 10%;"></td> </tr> <tr> <td></td> <td></td> <td colspan="8" style="text-align: center;"> <table border="1" style="width: 100%; border-collapse: collapse; text-align: center;"> <tr> <td style="width: 10%;"></td> <td style="width: 10%;"></td> <td style="width: 10%;"></td> <td style="width: 10%;"></td> <td style="width: 10%;"></td> <td style="width: 10%;"></td> <td style="width: 10%;"></td> <td style="width: 10%;"></td> <td style="width: 10%;"></td> <td style="width: 10%;"></td> </tr> <tr> <td></td> <td></td> <td colspan="8" style="text-align: center;"> <table border="1" style="width: 100%; border-collapse: collapse; text-align: center;"> <tr> <td style="width: 10%;"></td> <td style="width: 10%;"></td> <td style="width: 10%;"></td> <td style="width: 10%;"></td> <td style="width: 10%;"></td> <td style="width: 10%;"></td> <td style="width: 10%;"></td> <td style="width: 10%;"></td> <td style="width: 10%;"></td> <td style="width: 10%;"></td> </tr> <tr> <td></td> <td></td> <td colspan="8" style="text-align: center;"> <table border="1" style="width: 100%; border-collapse: collapse; text-align: center;"> <tr> <td style="width: 10%;"></td> <td style="width: 10%;"></td> <td style="width: 10%;"></td> <td style="width: 10%;"></td> <td style="width: 10%;"></td> <td style="width: 10%;"></td> <td style="width: 10%;"></td> <td style="width: 10%;"></td> <td style="width: 10%;"></td> <td style="width: 10%;"></td> </tr> <tr> <td></td> <td></td> <td colspan="8" style="text-align: center;"> <table border="1" style="width: 100%; border-collapse: collapse; text-align: center;"> <tr> <td style="width: 10%;"></td> <td style="width: 10%;"></td> <td style="width: 10%;"></td> <td style="width: 10%;"></td> <td style="width: 10%;"></td> <td style="width: 10%;"></td> <td style="width: 10%;"></td> <td style="width: 10%;"></td> <td style="width: 10%;"></td> <td style="width: 10%;"></td> </tr> <tr> <td></td> <td></td> <td colspan="8" style="text-align: center;"> <table border="1" style="width: 100%; border-collapse: collapse; text-align: center;"> <tr> <td style="width: 10%;"></td> <td style="width: 10%;"></td> <td style="width: 10%;"></td> <td style="width: 10%;"></td> <td style="width: 10%;"></td> <td style="width: 10%;"></td> <td style="width: 10%;"></td> <td style="width: 10%;"></td> <td style="width: 10%;"></td> <td style="width: 10%;"></td> </tr> <tr> <td></td> <td></td> <td colspan="8" style="text-align: center;"> <table border="1" style="width: 100%; border-collapse: collapse; text-align: center;"> <tr> <td style="width: 10%;"></td> <td
style="width: 10%;"></td> <td style="width: 10%;"></td> <td style="width: 10%;"></td> <td style="width: 10%;"></td> <td style="width: 10%;"></td> <td style="width: 10%;"></td> <td style="width: 10%;"></td> <td style="width: 10%;"></td> <td style="width: 10%;"></td> </tr> <tr> <td></td> <td></td> <td colspan="8" style="text-align: center;"> <table border="1" style="width: 100%; border-collapse: collapse; text-align: center;"> <tr> <td style="width: 10%;"></td> <td style="width: 10%;"></td> <td style="width: 10%;"></td> <td style="width: 10%;"></td> <td style="width: 10%;"></td> <td style="width: 10%;"></td> <td style="width: 10%;"></td> <td style="width: 10%;"></td> <td style="width: 10%;"></td> <td style="width: 10%;"></td> </tr> <tr> <td></td> <td></td> <td colspan="8" style="text-align: center;"> <table border="1" style="width: 100%; border-collapse: collapse; text-align: center;"> <tr> <td style="width: 10%;"></td> <td style="width: 10%;"></td> <td style="width: 10%;"></td> <td style="width: 10%;"></td> <td style="width: 10%;"></td> <td style="width: 10%;"></td> <td style="width: 10%;"></td> <td style="width: 10%;"></td> <td style="width: 10%;"></td> <td style="width: 10%;"></td> </tr> <tr> <td></td> <td></td> <td colspan="8" style="text-align: center;"> <table border="1" style="width: 100%; border-collapse: collapse; text-align: center;"> <tr> <td style="width: 10%;"></td> <td style="width: 10%;"></td> <td style="width: 10%;"></td> <td style="width: 10%;"></td> <td style="width: 10%;"></td> <td style="width: 10%;"></td> <td style="width: 10%;"></td> <td style="width: 10%;"></td> <td style="width: 10%;"></td> <td style="width: 10%;"></td> </tr> <tr> <td></td> <td></td> <td colspan="8" style="text-align: center;"> <table border="1" style="width: 100%; border-collapse: collapse; text-align: center;"> <tr> <td style="width: 10%;"></td> <td style="width: 10%;"></td> <td style="width: 10%;"></td> <td style="width: 10%;"></td> <td style="width: 10%;"></td> <td style="width: 10%;"></td> <td style="width: 10%;"></td> <td style="width: 10%;"></td> <td style="width: 10%;"></td> <td style="width: 10%;"></td> </tr> <tr> <td></td> <td></td> <td colspan="8" style="text-align: center;"> <table border="1" style="width: 100%; border-collapse: collapse; text-align: center;"> <tr> <td style="width: 10%;"></td> <td style="width: 10%;"></td> <td style="width: 10%;"></td> <td style="width: 10%;"></td> <td style="width: 10%;"></td> <td style="width: 10%;"></td> <td style="width: 10%;"></td> <td style="width: 10%;"></td> <td style="width: 10%;"></td> <td style="width: 10%;"></td> </tr> <tr> <td></td> <td></td> <td colspan="8" style="text-align: center;"> <table border="1" style="width: 100%; border-collapse: collapse; text-align: center;"> <tr> <td style="width: 10%;"></td> <td style="width: 10%;"></td> <td style="width: 10%;"></td> <td style="width: 10%;"></td> <td style="width: 10%;"></td> <td style="width: 10%;"></td> <td style="width: 10%;"></td> <td style="width: 10%;"></td> <td style="width: 10%;"></td> <td style="width: 10%;"></td> </tr> <tr> <td></td> <td></td> <td colspan="8" style="text-align: center;"> <table border="1" style="width: 100%; border-collapse: collapse; text-align: center;"> <tr> <td style="width: 10%;"></td> <td style="width: 10%;"></td> <td style="width: 10%;"></td> <td style="width: 10%;"></td> <td style="width: 10%;"></td> <td style="width: 10%;"></td> <td style="width: 10%;"></td> <td style="width: 10%;"></td> <td style="width: 10%;"></td> <td style="width: 10%;"></td> </tr> <tr> <td></td> <td></td> <td colspan="8" style="text-align: center;"> <table border="1" style="width: 100%; border-collapse: collapse; text-align: center;"> <tr> <td style="width: 10%;"></td> <td style="width: 10%;"></td> <td style="width: 10%;"></td> <td style="width: 10%;"></td> <td style="width: 10%;"></td> <td style="width: 10%;"></td> <td style="width: 10%;"></td> <td style="width: 10%;"></td> <td style="width: 10%;"></td> <td style="width: 10%;"></td> </tr> <tr> <td></td> <td></td> <td colspan="8" style="text-align: center;"> <table border="1" style="width: 100%; border-collapse: collapse; text-align: center;"> <tr> <td style="width: 10%;"></td> <td style="width: 10%;"></td> <td style="width: 10%;"></td> <td style="width: 10%;"></td> <td style="width: 10%;"></td> <td style="width: 10%;"></td> <td style="width: 10%;"></td> <td style="width: 10%;"></td> <td style="width: 10%;"></td> <td style="width: 10%;"></td> </tr> <tr> <td></td> <td></td> <td colspan="8" style="text-align: center;"> <table border="1" style="width: 100%; border-collapse: collapse; text-align: center;"> <tr> <td style="width: 10%;"></td> <td style="width: 10%;"></td> <td style="width: 10%;"></td> <td style="width: 10%;"></td> <td style="width: 10%;"></td> <td style="width: 10%;"></td> <td style="width: 10%;"></td> <td style="width: 10%;"></td> <td style="width: 10%;"></td> <td style="width: 10%;"></td> </tr> <tr> <td></td> <td></td> <td colspan="8" style="text-align: center;"> <table border="1" style="width: 100%; border-collapse: collapse; text-align: center;"> <tr> <td style="width: 10%;"></td> <td style="width: 10%;"></td> <td style="width: 10%;"></td> <td style="width: 10%;"></td> <td style="width: 10%;"></td> <td style="width: 10%;"></td> <td style="width: 10%;"></td> <td style="width: 10%;"></td> <td style="width: 10%;"></td> <td style="width: 10%;"></td> </tr> <tr> <td></td> <td></td> <td colspan="8" style="text-align: center;"> <table border="1" style="width: 100%; border-collapse: collapse; text-align: center;"> <tr> <td style="width: 10%;"></td> <td style="width: 10%;"></td> <td style="width: 10%;"></td> <td style="width: 10%;"></td> <td style="width: 10%;"></td> <td style="width: 10%;"></td> <td style="width: 10%;"></td> <td style="width: 10%;"></td> <td style="width: 10%;"></td> <td style="width: 10%;"></td> </tr> <tr> <td></td> <td></td> <td colspan="8" style="text-align: center;"> <table border="1" style="width: 100%; border-collapse: collapse; text-align: center;"> <tr> <td style="width: 10%;"></td> <td style="width: 10%;"></td> <td style="width: 10%;"></td> <td style="width: 10%;"></td> <td style="width: 10%;"></td> <td style="width: 10%;"></td> <td style="width: 10%;"></td> <td style="width: 10%;"></td> <td style="width: 10%;"></td> <td style="width: 10%;"></td> </tr> <tr> <td></td> <td></td> <td colspan="8" style="text-align: center;"> <table border="1" style="width: 100%; border-collapse: collapse; text-align: center;"> <tr> <td style="width: 10%;"></td> <td style="width: 10%;"></td> <td style="width: 10%;"></td> <td style="width: 10%;"></td> <td style="width: 10%;"></td> <td style="width: 10%;"></td> <td style="width: 10%;"></td> <td style="width: 10%;"></td> <td style="width: 10%;"></td> <td style="width: 10%;"></td> </tr> <tr> <td></td> <td></td> <td colspan="8" style="text-align: center;"> <table border="1" style="width: 100%; border-collapse: collapse; text-align: center;"> <tr> <td style="width: 10%;"></td> <td style="width: 10%;"></td> <td style="width: 10%;"></td> <td style="width: 10%;"></td> <td style="width: 10%;"></td> <td style="width: 10%;"></td> <td style="width: 10%;"></td> <td style="width: 10%;"></td> <td style="width: 10%;"></td> <td style="width: 10%;"></td> </tr> <tr> <td></td> <td></td> <td colspan="8" style="text-align: center;"> <table border="1" style="width: 100%; border-collapse: collapse; text-align: center;"> <tr> <td style="width: 10%;"></td> <td style="width: 10%;"></td> <td style="width: 10%;"></td> <td style="width: 10%;"></td> <td style="width: 10%;"></td> <td style="width: 10%;"></td> <td style="width: 10%;"></td> <td style="width: 10%;"></td> <td style="width: 10%;"></td> <td style="width: 10%;"></td> </tr> <tr> <td></td> <td></td> <td colspan="8" style="text-align: center;"> <table border="1" style="width: 100%; border-collapse: collapse; text-align: center;"> <tr> <td style="width: 10%;"></td> <td style="width: 10%;"></td> <td style="width: 10%;"></td> <td style="width: 10%;"></td> <td style="width: 10%;"></td> <td style="width: 10%;"></td> <td style="width: 10%;"></td> <td style="width: 10%;"></td> <td style="width: 10%;"></td> <td style="width: 10%;"></td> </tr> <tr> <td></td> <td></td> <td colspan="8" style="text-align: center;"> <table border="1" style="width: 100%; border-collapse: collapse; text-align: center;"> <tr> <td style="width: 10%;"></td> <td style="width: 10%;"></td> <td style="width: 10%;"></td> <td style="width: 10%;"></td> <td style="width: 10%;"></td> <td style="width: 10%;"></td> <td style="width: 10%;"></td> <td style="width: 10%;"></td> <td style="width: 10%;"></td> <td style="width: 10%;"></td> </tr> <tr> <td></td> <td></td> <td colspan="8" style="text-align: center;"> <table border="1" style="width: 100%; border-collapse: collapse; text-align: center;"> <tr> <td style="width: 10%;"></td> <td style="width: 10%;"></td> <td style="width: 10%;"></td> <td style="width: 10%;"></td> <td style="width: 10%;"></td> <td style="width: 10%;"></td> <td style="width: 10%;"></td> <td style="width: 10%;"></td> <td style="width: 10%;"></td> <td style="width: 10%;"></td> </tr> <tr> <td></td> <td></td> <td colspan="8" style="text-align: center;"> <table border="1" style="width: 100%; border-collapse: collapse; text-align: center;"> <tr> </tr></table></td></tr></table></td></tr></table></td></tr></table></td></tr></table></td></tr></table></td></tr></table></td></tr></table></td></tr></table></td></tr></table></td></tr></table></td></tr></table></td></tr></table></td></tr></table></td></tr></table></td></tr></table></td></tr></table></td></tr></table></td></tr></table></td></tr></table></td></tr></table></td></tr></table></td></tr></table></td></tr></table></td></tr></table></td></tr></table></td></tr></table></td></tr></table></td></tr></table></td></tr></table></td></tr></table></td></tr></table></td></tr></table></td></tr></table></td></tr></table>
 | | | | | | | | | | | | | | | | | | | | <table border="1" style="width: 100%; border-collapse: collapse; text-align: center;"> <tr> <td style="width: 10%;"></td> <td style="width: 10%;"></td> <td style="width: 10%;"></td> <td style="width: 10%;"></td> <td style="width: 10%;"></td> <td style="width: 10%;"></td> <td style="width: 10%;"></td> <td style="width: 10%;"></td> <td style="width: 10%;"></td> <td style="width: 10%;"></td> </tr> <tr> <td></td> <td></td> <td colspan="8" style="text-align: center;"> <table border="1" style="width: 100%; border-collapse: collapse; text-align: center;"> <tr> <td style="width: 10%;"></td> <td style="width: 10%;"></td> <td style="width: 10%;"></td> <td style="width: 10%;"></td> <td style="width: 10%;"></td> <td style="width: 10%;"></td> <td style="width: 10%;"></td> <td style="width: 10%;"></td> <td style="width: 10%;"></td> <td style="width: 10%;"></td> </tr> <tr> <td></td> <td></td> <td colspan="8" style="text-align: center;"> <table border="1" style="width: 100%; border-collapse: collapse; text-align: center;"> <tr> <td style="width: 10%;"></td> <td style="width: 10%;"></td> <td style="width: 10%;"></td> <td style="width: 10%;"></td> <td style="width: 10%;"></td> <td style="width: 10%;"></td> <td style="width: 10%;"></td>
<td style="width: 10%;"></td> <td style="width: 10%;"></td> <td style="width: 10%;"></td> </tr> <tr> <td></td> <td></td> <td colspan="8" style="text-align: center;"> <table border="1" style="width: 100%; border-collapse: collapse; text-align: center;"> <tr> <td style="width: 10%;"></td> <td style="width: 10%;"></td> <td style="width: 10%;"></td> <td style="width: 10%;"></td> <td style="width: 10%;"></td> <td style="width: 10%;"></td> <td style="width: 10%;"></td> <td style="width: 10%;"></td> <td style="width: 10%;"></td> <td style="width: 10%;"></td> </tr> <tr> <td></td> <td></td> <td colspan="8" style="text-align: center;"> <table border="1" style="width: 100%; border-collapse: collapse; text-align: center;"> <tr> <td style="width: 10%;"></td> <td style="width: 10%;"></td> <td style="width: 10%;"></td> <td style="width: 10%;"></td> <td style="width: 10%;"></td> <td style="width: 10%;"></td> <td style="width: 10%;"></td> <td style="width: 10%;"></td> <td style="width: 10%;"></td> <td style="width: 10%;"></td> </tr> <tr> <td></td> <td></td> <td colspan="8" style="text-align: center;"> <table border="1" style="width: 100%; border-collapse: collapse; text-align: center;"> <tr> <td style="width: 10%;"></td> <td style="width: 10%;"></td> <td style="width: 10%;"></td> <td style="width: 10%;"></td> <td style="width: 10%;"></td> <td style="width: 10%;"></td> <td style="width: 10%;"></td> <td style="width: 10%;"></td> <td style="width: 10%;"></td> <td style="width: 10%;"></td> </tr> <tr> <td></td> <td></td> <td colspan="8" style="text-align: center;"> <table border="1" style="width: 100%; border-collapse: collapse; text-align: center;"> <tr> <td style="width: 10%;"></td> <td style="width: 10%;"></td> <td style="width: 10%;"></td> <td style="width: 10%;"></td> <td style="width: 10%;"></td> <td style="width: 10%;"></td> <td style="width: 10%;"></td> <td style="width: 10%;"></td> <td style="width: 10%;"></td> <td style="width: 10%;"></td> </tr> <tr> <td></td> <td></td> <td colspan="8" style="text-align: center;"> <table border="1" style="width: 100%; border-collapse: collapse; text-align: center;"> <tr> <td style="width: 10%;"></td> <td style="width: 10%;"></td> <td style="width: 10%;"></td> <td style="width: 10%;"></td> <td style="width: 10%;"></td> <td style="width: 10%;"></td> <td style="width: 10%;"></td> <td style="width: 10%;"></td> <td style="width: 10%;"></td> <td style="width: 10%;"></td> </tr> <tr> <td></td> <td></td> <td colspan="8" style="text-align: center;"> <table border="1" style="width: 100%; border-collapse: collapse; text-align: center;"> <tr> <td style="width: 10%;"></td> <td style="width: 10%;"></td> <td style="width: 10%;"></td> <td style="width: 10%;"></td> <td style="width: 10%;"></td> <td style="width: 10%;"></td> <td style="width: 10%;"></td> <td style="width: 10%;"></td> <td style="width: 10%;"></td> <td style="width: 10%;"></td> </tr> <tr> <td></td> <td></td> <td colspan="8" style="text-align: center;"> <table border="1" style="width: 100%; border-collapse: collapse; text-align: center;"> <tr> <td style="width: 10%;"></td> <td style="width: 10%;"></td> <td style="width: 10%;"></td> <td style="width: 10%;"></td> <td style="width: 10%;"></td> <td style="width: 10%;"></td> <td style="width: 10%;"></td> <td style="width: 10%;"></td> <td style="width: 10%;"></td> <td style="width: 10%;"></td> </tr> <tr> <td></td> <td></td> <td colspan="8" style="text-align: center;"> <table border="1" style="width: 100%; border-collapse: collapse; text-align: center;"> <tr> <td style="width: 10%;"></td> <td style="width: 10%;"></td> <td style="width: 10%;"></td> <td style="width: 10%;"></td> <td style="width: 10%;"></td> <td style="width: 10%;"></td> <td style="width: 10%;"></td> <td style="width: 10%;"></td> <td style="width: 10%;"></td> <td style="width: 10%;"></td> </tr> <tr> <td></td> <td></td> <td colspan="8" style="text-align: center;"> <table border="1" style="width: 100%; border-collapse: collapse; text-align: center;"> <tr> <td style="width: 10%;"></td> <td style="width: 10%;"></td> <td style="width: 10%;"></td> <td style="width: 10%;"></td> <td style="width: 10%;"></td> <td style="width: 10%;"></td> <td style="width: 10%;"></td> <td style="width: 10%;"></td> <td style="width: 10%;"></td> <td style="width: 10%;"></td> </tr> <tr> <td></td> <td></td> <td colspan="8" style="text-align: center;"> <table border="1" style="width: 100%; border-collapse: collapse; text-align: center;"> <tr> <td style="width: 10%;"></td> <td style="width: 10%;"></td> <td style="width: 10%;"></td> <td style="width: 10%;"></td> <td style="width: 10%;"></td> <td style="width: 10%;"></td> <td style="width: 10%;"></td> <td style="width: 10%;"></td> <td style="width: 10%;"></td> <td style="width: 10%;"></td> </tr> <tr> <td></td> <td></td> <td colspan="8" style="text-align: center;"> <table border="1" style="width: 100%; border-collapse: collapse; text-align: center;"> <tr> <td style="width: 10%;"></td> <td style="width: 10%;"></td> <td style="width: 10%;"></td> <td style="width: 10%;"></td> <td style="width: 10%;"></td> <td style="width: 10%;"></td> <td style="width: 10%;"></td> <td style="width: 10%;"></td> <td style="width: 10%;"></td> <td style="width: 10%;"></td> </tr> <tr> <td></td> <td></td> <td colspan="8" style="text-align: center;"> <table border="1" style="width: 100%; border-collapse: collapse; text-align: center;"> <tr> <td style="width: 10%;"></td> <td style="width: 10%;"></td> <td style="width: 10%;"></td> <td style="width: 10%;"></td> <td style="width: 10%;"></td> <td style="width: 10%;"></td> <td style="width: 10%;"></td> <td style="width: 10%;"></td> <td style="width: 10%;"></td> <td style="width: 10%;"></td> </tr> <tr> <td></td> <td></td> <td colspan="8" style="text-align: center;"> <table border="1" style="width: 100%; border-collapse: collapse; text-align: center;"> <tr> <td style="width: 10%;"></td> <td style="width: 10%;"></td> <td style="width: 10%;"></td> <td style="width: 10%;"></td> <td style="width: 10%;"></td> <td style="width: 10%;"></td> <td style="width: 10%;"></td> <td style="width: 10%;"></td> <td style="width: 10%;"></td> <td style="width: 10%;"></td> </tr> <tr> <td></td> <td></td> <td colspan="8" style="text-align: center;"> <table border="1" style="width: 100%; border-collapse: collapse; text-align: center;"> <tr> <td style="width: 10%;"></td> <td style="width: 10%;"></td> <td style="width: 10%;"></td> <td style="width: 10%;"></td> <td style="width: 10%;"></td> <td style="width: 10%;"></td> <td style="width: 10%;"></td> <td style="width: 10%;"></td> <td style="width: 10%;"></td> <td style="width: 10%;"></td> </tr> <tr> <td></td> <td></td> <td colspan="8" style="text-align: center;"> <table border="1" style="width: 100%; border-collapse: collapse; text-align: center;"> <tr> <td style="width: 10%;"></td> <td style="width: 10%;"></td> <td style="width: 10%;"></td> <td style="width: 10%;"></td> <td style="width: 10%;"></td> <td style="width: 10%;"></td> <td style="width: 10%;"></td> <td style="width: 10%;"></td> <td style="width: 10%;"></td> <td style="width: 10%;"></td> </tr> <tr> <td></td> <td></td> <td colspan="8" style="text-align: center;"> <table border="1" style="width: 100%; border-collapse: collapse; text-align: center;"> <tr> <td style="width: 10%;"></td> <td style="width: 10%;"></td> <td style="width: 10%;"></td> <td style="width: 10%;"></td> <td style="width: 10%;"></td> <td style="width: 10%;"></td> <td style="width: 10%;"></td> <td style="width: 10%;"></td> <td style="width: 10%;"></td> <td style="width: 10%;"></td> </tr> <tr> <td></td> <td></td> <td colspan="8" style="text-align: center;"> <table border="1" style="width: 100%; border-collapse: collapse; text-align: center;"> <tr> <td style="width: 10%;"></td> <td style="width: 10%;"></td> <td style="width: 10%;"></td> <td style="width: 10%;"></td> <td style="width: 10%;"></td> <td style="width: 10%;"></td> <td style="width: 10%;"></td> <td style="width: 10%;"></td> <td style="width: 10%;"></td> <td style="width: 10%;"></td> </tr> <tr> <td></td> <td></td> <td colspan="8" style="text-align: center;"> <table border="1" style="width: 100%; border-collapse: collapse; text-align: center;"> <tr> <td style="width: 10%;"></td> <td style="width: 10%;"></td> <td style="width: 10%;"></td> <td style="width: 10%;"></td> <td style="width: 10%;"></td> <td style="width: 10%;"></td> <td style="width: 10%;"></td> <td style="width: 10%;"></td> <td style="width: 10%;"></td> <td style="width: 10%;"></td> </tr> <tr> <td></td> <td></td> <td colspan="8" style="text-align: center;"> <table border="1" style="width: 100%; border-collapse: collapse; text-align: center;"> <tr> <td style="width: 10%;"></td> <td style="width: 10%;"></td> <td style="width: 10%;"></td> <td style="width: 10%;"></td> <td style="width: 10%;"></td> <td style="width: 10%;"></td> <td style="width: 10%;"></td> <td style="width: 10%;"></td> <td style="width: 10%;"></td> <td style="width: 10%;"></td> </tr> <tr> <td></td> <td></td> <td colspan="8" style="text-align: center;"> <table border="1" style="width: 100%; border-collapse: collapse; text-align: center;"> <tr> <td style="width: 10%;"></td> <td style="width: 10%;"></td> <td style="width: 10%;"></td> <td style="width: 10%;"></td> <td style="width: 10%;"></td> <td style="width: 10%;"></td> <td style="width: 10%;"></td> <td style="width: 10%;"></td> <td style="width: 10%;"></td> <td style="width: 10%;"></td> </tr> <tr> <td></td> <td></td> <td colspan="8" style="text-align: center;"> <table border="1" style="width: 100%; border-collapse: collapse; text-align: center;"> <tr> <td style="width: 10%;"></td> <td style="width: 10%;"></td> <td style="width: 10%;"></td> <td style="width: 10%;"></td> <td style="width: 10%;"></td> <td style="width: 10%;"></td> <td style="width: 10%;"></td> <td style="width: 10%;"></td> <td style="width: 10%;"></td> <td style="width: 10%;"></td> </tr> <tr> <td></td> <td></td> <td colspan="8" style="text-align: center;">
<table border="1" style="width: 100%; border-collapse: collapse; text-align: center;"> <tr> <td style="width: 10%;"></td> <td style="width: 10%;"></td> <td style="width: 10%;"></td> <td style="width: 10%;"></td> <td style="width: 10%;"></td> <td style="width: 10%;"></td> <td style="width: 10%;"></td> <td style="width: 10%;"></td> <td style="width: 10%;"></td> <td style="width: 10%;"></td> </tr> <tr> <td></td> <td></td> <td colspan="8" style="text-align: center;"> <table border="1" style="width: 100%; border-collapse: collapse; text-align: center;"> <tr> <td style="width: 10%;"></td> <td style="width: 10%;"></td> <td style="width: 10%;"></td> <td style="width: 10%;"></td> <td style="width: 10%;"></td> <td style="width: 10%;"></td> <td style="width: 10%;"></td> <td style="width: 10%;"></td> <td style="width: 10%;"></td> <td style="width: 10%;"></td> </tr> <tr> <td></td> <td></td> <td colspan="8" style="text-align: center;"> <table border="1" style="width: 100%; border-collapse: collapse; text-align: center;"> <tr> <td style="width: 10%;"></td> <td style="width: 10%;"></td> <td style="width: 10%;"></td> <td style="width: 10%;"></td> <td style="width: 10%;"></td> <td style="width: 10%;"></td> <td style="width: 10%;"></td> <td style="width: 10%;"></td> <td style="width: 10%;"></td> <td style="width: 10%;"></td> </tr> <tr> <td></td> <td></td> <td colspan="8" style="text-align: center;"> <table border="1" style="width: 100%; border-collapse: collapse; text-align: center;"> <tr> <td style="width: 10%;"></td> <td style="width: 10%;"></td> <td style="width: 10%;"></td> <td style="width: 10%;"></td> <td style="width: 10%;"></td> <td style="width: 10%;"></td> <td style="width: 10%;"></td> <td style="width: 10%;"></td> <td style="width: 10%;"></td> <td style="width: 10%;"></td> </tr> <tr> <td></td> <td></td> <td colspan="8" style="text-align: center;"> <table border="1" style="width: 100%; border-collapse: collapse; text-align: center;"> <tr> <td style="width: 10%;"></td> <td style="width: 10%;"></td> <td style="width: 10%;"></td> <td style="width: 10%;"></td> <td style="width: 10%;"></td> <td style="width: 10%;"></td> <td style="width: 10%;"></td> <td style="width: 10%;"></td> <td style="width: 10%;"></td> <td style="width: 10%;"></td> </tr> <tr> <td></td> <td></td> <td colspan="8" style="text-align: center;"> <table border="1" style="width: 100%; border-collapse: collapse; text-align: center;"> <tr> <td style="width: 10%;"></td> <td style="width: 10%;"></td> <td style="width: 10%;"></td> <td style="width: 10%;"></td> <td style="width: 10%;"></td> <td style="width: 10%;"></td> <td style="width: 10%;"></td> <td style="width: 10%;"></td> <td style="width: 10%;"></td> <td style="width: 10%;"></td> </tr> <tr> <td></td> <td></td> <td colspan="8" style="text-align: center;"> <table border="1" style="width: 100%; border-collapse: collapse; text-align: center;"> <tr> <td style="width: 10%;"></td> <td style="width: 10%;"></td> <td style="width: 10%;"></td> <td style="width: 10%;"></td> <td style="width: 10%;"></td> <td style="width: 10%;"></td> <td style="width: 10%;"></td> <td style="width: 10%;"></td> <td style="width: 10%;"></td> <td style="width: 10%;"></td> </tr> <tr> <td></td> <td></td> <td colspan="8" style="text-align: center;"> <table border="1" style="width: 100%; border-collapse: collapse; text-align: center;"> <tr> <td style="width: 10%;"></td> <td style="width: 10%;"></td> <td style="width: 10%;"></td> <td style="width: 10%;"></td> <td style="width: 10%;"></td> <td style="width: 10%;"></td> <td style="width: 10%;"></td> <td style="width: 10%;"></td> <td style="width: 10%;"></td> <td style="width: 10%;"></td> </tr> <tr> <td></td> <td></td> <td colspan="8" style="text-align: center;"> <table border="1" style="width: 100%; border-collapse: collapse; text-align: center;"> <tr> <td style="width: 10%;"></td> <td style="width: 10%;"></td> <td style="width: 10%;"></td> <td style="width: 10%;"></td> <td style="width: 10%;"></td> <td style="width: 10%;"></td> <td style="width: 10%;"></td> <td style="width: 10%;"></td> <td style="width: 10%;"></td> <td style="width: 10%;"></td> </tr> <tr> <td></td> <td></td> <td colspan="8" style="text-align: center;"> <table border="1" style="width: 100%; border-collapse: collapse; text-align: center;"> <tr> </tr></table></td></tr></table></td></tr></table></td></tr></table></td></tr></table></td></tr></table></td></tr></table></td></tr></table></td></tr></table></td></tr></table></td></tr></table></td></tr></table></td></tr></table></td></tr></table></td></tr></table></td></tr></table></td></tr></table></td></tr></table></td></tr></table></td></tr></table></td></tr></table></td></tr></table></td></tr></table></td></tr></table></td></tr></table></td></tr></table></td></tr></table></td></tr></table></td></tr></table></td></tr></table></td></tr></table></td></tr></table></td></tr></table></td></tr></table>
 | | | | | | | | | | | | | | | | | | | | <table border="1" style="width: 100%; border-collapse: collapse; text-align: center;"> <tr> <td style="width: 10%;"></td> <td style="width: 10%;"></td> <td style="width: 10%;"></td> <td style="width: 10%;"></td> <td style="width: 10%;"></td> <td style="width: 10%;"></td> <td style="width: 10%;"></td> <td style="width: 10%;"></td> <td style="width: 10%;"></td> <td style="width: 10%;"></td> </tr> <tr> <td></td> <td></td> <td colspan="8" style="text-align: center;"> <table border="1" style="width: 100%; border-collapse: collapse; text-align: center;"> <tr> <td style="width: 10%;"></td> <td style="width: 10%;"></td> <td style="width: 10%;"></td> <td style="width: 10%;"></td> <td style="width: 10%;"></td> <td style="width: 10%;"></td> <td style="width: 10%;"></td> <td style="width: 10%;"></td> <td style="width: 10%;"></td> <td style="width: 10%;"></td> </tr> <tr> <td></td> <td></td> <td colspan="8" style="text-align: center;"> <table border="1" style="width: 100%; border-collapse: collapse; text-align: center;"> <tr> <td style="width: 10%;"></td> <td style="width: 10%;"></td> <td style="width: 10%;"></td> <td style="width: 10%;"></td> <td style="width: 10%;"></td> <td style="width: 10%;"></td> <td style="width: 10%;"></td> <td style="width: 10%;"></td> <td style="width: 10%;"></td> <td style="width: 10%;"></td> </tr> <tr> <td></td> <td></td> <td colspan="8" style="text-align: center;"> <table border="1" style="width: 100%; border-collapse: collapse; text-align: center;"> <tr> <td style="width: 10%;"></td> <td style="width: 10%;"></td> <td style="width: 10%;"></td> <td style="width: 10%;"></td> <td style="width: 10%;"></td> <td style="width: 10%;"></td> <td style="width: 10%;"></td> <td style="width: 10%;"></td> <td style="width: 10%;"></td> <td style="width: 10%;"></td> </tr> <tr> <td></td> <td></td> <td colspan="8" style="text-align: center;"> <table border="1" style="width: 100%; border-collapse: collapse; text-align: center;"> <tr> <td style="width: 10%;"></td> <td style="width: 10%;"></td> <td style="width: 10%;"></td> <td style="width: 10%;"></td> <td style="width: 10%;"></td> <td style="width: 10%;"></td> <td style="width: 10%;"></td> <td style="width: 10%;"></td> <td style="width: 10%;"></td> <td style="width: 10%;"></td> </tr> <tr> <td></td> <td></td> <td colspan="8" style="text-align: center;"> <table border="1" style="width: 100%; border-collapse: collapse; text-align: center;"> <tr> <td style="width: 10%;"></td> <td style="width: 10%;"></td> <td style="width: 10%;"></td> <td style="width: 10%;"></td> <td style="width: 10%;"></td> <td style="width: 10%;"></td> <td style="width: 10%;"></td> <td style="width: 10%;"></td> <td style="width: 10%;"></td> <td style="width: 10%;"></td> </tr> <tr> <td></td> <td></td> <td colspan="8" style="text-align: center;"> <table border="1" style="width: 100%; border-collapse: collapse; text-align: center;"> <tr> <td style="width: 10%;"></td> <td style="width: 10%;"></td> <td style="width: 10%;"></td> <td style="width: 10%;"></td> <td style="width: 10%;"></td> <td style="width: 10%;"></td> <td style="width: 10%;"></td> <td style="width: 10%;"></td> <td style="width: 10%;"></td> <td style="width: 10%;"></td> </tr> <tr> <td></td> <td></td> <td colspan="8" style="text-align: center;"> <table border="1" style="width: 100%; border-collapse: collapse; text-align: center;"> <tr> <td style="width: 10%;"></td> <td style="width: 10%;"></td> <td style="width: 10%;"></td> <td style="width: 10%;"></td> <td style="width: 10%;"></td> <td style="width: 10%;"></td> <td style="width: 10%;"></td> <td style="width: 10%;"></td> <td style="width: 10%;"></td> <td style="width: 10%;"></td> </tr> <tr> <td></td> <td></td> <td colspan="8" style="text-align: center;"> <table border="1" style="width: 100%; border-collapse: collapse; text-align: center;"> <tr> <td style="width: 10%;"></td> <td style="width: 10%;"></td> <td style="width: 10%;"></td> <td style="width: 10%;"></td> <td style="width: 10%;"></td> <td style="width: 10%;"></td> <td style="width: 10%;"></td> <td style="width: 10%;"></td> <td style="width: 10%;"></td> <td style="width: 10%;"></td> </tr> <tr> <td></td> <td></td> <td colspan="8" style="text-align: center;"> <table border="1" style="width: 100%; border-collapse: collapse; text-align: center;"> <tr> <td style="width: 10%;"></td> <td style="width: 10%;"></td> <td style="width: 10%;"></td> <td style="width: 10%;"></td> <td style="width: 10%;"></td> <td style="width: 10%;"></td> <td style="width: 10%;"></td> <td style="width: 10%;"></td> <td style="width: 10%;"></td> <td style="width: 10%;"></td> </tr> <tr> <td></td> <td></td> <td colspan="8" style="text-align: center;"> <table border="1" style="width: 100%; border-collapse: collapse; text-align: center;"> <tr> <td style="width: 10%;"></td> <td style="width: 10%;"></td> <td style="width: 10%;"></td> <td style="width: 10%;"></td> <td style="width: 10%;"></td> <td style="width: 10%;"></td> <td style="width: 10%;"></td> <td style="width: 10%;"></td> <td style="width: 10%;"></td> <td style="width: 10%;"></td> </tr> <tr> <td></td> <td></td> <td colspan="8" style="text-align: center;"> <table border="1" style="width: 100%; border-collapse: collapse; text-align: center;"> <tr> <td style="width: 10%;"></td> <td style="width: 10%;"></td> <td style="width: 10%;"></td> <td style="width: 10%;"></td> <td style="width: 10%;"></td> <td style="width: 10%;"></td> <td style="width: 10%;"></td> <td style="width: 10%;"></td> <td style="width: 10%;"></td> <td style="width: 10%;"></td> </tr> <tr> <td></td> <td></td> <td colspan="8" style="text-align: center;"> <table border="1" style="width: 100%; border-collapse: collapse; text-align: center;"> <tr> <td style="width: 10%;"></td> <td style="width: 10%;"></td> <td style="width: 10%;"></td> <td style="width: 10%;"></td> <td style="width: 10%;"></td> <td style="width: 10%;"></td> <td style="width: 10%;"></td> <td style="width: 10%;"></td> <td style="width: 10%;"></td> <td style="width: 10%;"></td> </tr> <tr> <td></td> <td></td> <td colspan="8" style="text-align: center;"> <table border="1" style="width: 100%; border-collapse: collapse; text-align: center;"> <tr> <td style="width: 10%;"></td> <td style="width: 10%;"></td> <td style="width: 10%;"></td> <td
style="width: 10%;"></td> <td style="width: 10%;"></td> <td style="width: 10%;"></td> <td style="width: 10%;"></td> <td style="width: 10%;"></td> <td style="width: 10%;"></td> <td style="width: 10%;"></td> </tr> <tr> <td></td> <td></td> <td colspan="8" style="text-align: center;"> <table border="1" style="width: 100%; border-collapse: collapse; text-align: center;"> <tr> <td style="width: 10%;"></td> <td style="width: 10%;"></td> <td style="width: 10%;"></td> <td style="width: 10%;"></td> <td style="width: 10%;"></td> <td style="width: 10%;"></td> <td style="width: 10%;"></td> <td style="width: 10%;"></td> <td style="width: 10%;"></td> <td style="width: 10%;"></td> </tr> <tr> <td></td> <td></td> <td colspan="8" style="text-align: center;"> <table border="1" style="width: 100%; border-collapse: collapse; text-align: center;"> <tr> <td style="width: 10%;"></td> <td style="width: 10%;"></td> <td style="width: 10%;"></td> <td style="width: 10%;"></td> <td style="width: 10%;"></td> <td style="width: 10%;"></td> <td style="width: 10%;"></td> <td style="width: 10%;"></td> <td style="width: 10%;"></td> <td style="width: 10%;"></td> </tr> <tr> <td></td> <td></td> <td colspan="8" style="text-align: center;"> <table border="1" style="width: 100%; border-collapse: collapse; text-align: center;"> <tr> <td style="width: 10%;"></td> <td style="width: 10%;"></td> <td style="width: 10%;"></td> <td style="width: 10%;"></td> <td style="width: 10%;"></td> <td style="width: 10%;"></td> <td style="width: 10%;"></td> <td style="width: 10%;"></td> <td style="width: 10%;"></td> <td style="width: 10%;"></td> </tr> <tr> <td></td> <td></td> <td colspan="8" style="text-align: center;"> <table border="1" style="width: 100%; border-collapse: collapse; text-align: center;"> <tr> <td style="width: 10%;"></td> <td style="width: 10%;"></td> <td style="width: 10%;"></td> <td style="width: 10%;"></td> <td style="width: 10%;"></td> <td style="width: 10%;"></td> <td style="width: 10%;"></td> <td style="width: 10%;"></td> <td style="width: 10%;"></td> <td style="width: 10%;"></td> </tr> <tr> <td></td> <td></td> <td colspan="8" style="text-align: center;"> <table border="1" style="width: 100%; border-collapse: collapse; text-align: center;"> <tr> <td style="width: 10%;"></td> <td style="width: 10%;"></td> <td style="width: 10%;"></td> <td style="width: 10%;"></td> <td style="width: 10%;"></td> <td style="width: 10%;"></td> <td style="width: 10%;"></td> <td style="width: 10%;"></td> <td style="width: 10%;"></td> <td style="width: 10%;"></td> </tr> <tr> <td></td> <td></td> <td colspan="8" style="text-align: center;"> <table border="1" style="width: 100%; border-collapse: collapse; text-align: center;"> <tr> <td style="width: 10%;"></td> <td style="width: 10%;"></td> <td style="width: 10%;"></td> <td style="width: 10%;"></td> <td style="width: 10%;"></td> <td style="width: 10%;"></td> <td style="width: 10%;"></td> <td style="width: 10%;"></td> <td style="width: 10%;"></td> <td style="width: 10%;"></td> </tr> <tr> <td></td> <td></td> <td colspan="8" style="text-align: center;"> <table border="1" style="width: 100%; border-collapse: collapse; text-align: center;"> <tr> <td style="width: 10%;"></td> <td style="width: 10%;"></td> <td style="width: 10%;"></td> <td style="width: 10%;"></td> <td style="width: 10%;"></td> <td style="width: 10%;"></td> <td style="width: 10%;"></td> <td style="width: 10%;"></td> <td style="width: 10%;"></td> <td style="width: 10%;"></td> </tr> <tr> <td></td> <td></td> <td colspan="8" style="text-align: center;"> <table border="1" style="width: 100%; border-collapse: collapse; text-align: center;"> <tr> <td style="width: 10%;"></td> <td style="width: 10%;"></td> <td style="width: 10%;"></td> <td style="width: 10%;"></td> <td style="width: 10%;"></td> <td style="width: 10%;"></td> <td style="width: 10%;"></td> <td style="width: 10%;"></td> <td style="width: 10%;"></td> <td style="width: 10%;"></td> </tr> <tr> <td></td> <td></td> <td colspan="8" style="text-align: center;"> <table border="1" style="width: 100%; border-collapse: collapse; text-align: center;"> <tr> <td style="width: 10%;"></td> <td style="width: 10%;"></td> <td style="width: 10%;"></td> <td style="width: 10%;"></td> <td style="width: 10%;"></td> <td style="width: 10%;"></td> <td style="width: 10%;"></td> <td style="width: 10%;"></td> <td style="width: 10%;"></td> <td style="width: 10%;"></td> </tr> <tr> <td></td> <td></td> <td colspan="8" style="text-align: center;"> <table border="1" style="width: 100%; border-collapse: collapse; text-align: center;"> <tr> <td style="width: 10%;"></td> <td style="width: 10%;"></td> <td style="width: 10%;"></td> <td style="width: 10%;"></td> <td style="width: 10%;"></td> <td style="width: 10%;"></td> <td style="width: 10%;"></td> <td style="width: 10%;"></td> <td style="width: 10%;"></td> <td style="width: 10%;"></td> </tr> <tr> <td></td> <td></td> <td colspan="8" style="text-align: center;"> <table border="1" style="width: 100%; border-collapse: collapse; text-align: center;"> <tr> <td style="width: 10%;"></td> <td style="width: 10%;"></td> <td style="width: 10%;"></td> <td style="width: 10%;"></td> <td style="width: 10%;"></td> <td style="width: 10%;"></td> <td style="width: 10%;"></td> <td style="width: 10%;"></td> <td style="width: 10%;"></td> <td style="width: 10%;"></td> </tr> <tr> <td></td> <td></td> <td colspan="8" style="text-align: center;"> <table border="1" style="width: 100%; border-collapse: collapse; text-align: center;"> <tr> <td style="width: 10%;"></td> <td style="width: 10%;"></td> <td style="width: 10%;"></td> <td style="width: 10%;"></td> <td style="width: 10%;"></td> <td style="width: 10%;"></td> <td style="width: 10%;"></td> <td style="width: 10%;"></td> <td style="width: 10%;"></td> <td style="width: 10%;"></td> </tr> <tr> <td></td> <td></td> <td colspan="8" style="text-align: center;"> <table border="1" style="width: 100%; border-collapse: collapse; text-align: center;"> <tr> <td style="width: 10%;"></td> <td style="width: 10%;"></td> <td style="width: 10%;"></td> <td style="width: 10%;"></td> <td style="width: 10%;"></td> <td style="width: 10%;"></td> <td style="width: 10%;"></td> <td style="width: 10%;"></td> <td style="width: 10%;"></td> <td style="width: 10%;"></td> </tr> <tr> <td></td> <td></td> <td colspan="8" style="text-align: center;"> <table border="1" style="width: 100%; border-collapse: collapse; text-align: center;"> <tr> <td style="width: 10%;"></td> <td style="width: 10%;"></td> <td style="width: 10%;"></td> <td style="width: 10%;"></td> <td style="width: 10%;"></td> <td style="width: 10%;"></td> <td style="width: 10%;"></td> <td style="width: 10%;"></td> <td style="width: 10%;"></td> <td style="width: 10%;"></td> </tr> <tr> <td></td> <td></td> <td colspan="8" style="text-align: center;"> <table border="1" style="width: 100%; border-collapse: collapse; text-align: center;"> <tr> <td style="width: 10%;"></td> <td style="width: 10%;"></td> <td style="width: 10%;"></td> <td style="width: 10%;"></td> <td style="width: 10%;"></td> <td style="width: 10%;"></td> <td style="width: 10%;"></td> <td style="width: 10%;"></td> <td style="width: 10%;"></td> <td style="width: 10%;"></td> </tr> <tr> <td></td> <td></td> <td colspan="8" style="text-align: center;"> <table border="1" style="width: 100%; border-collapse: collapse; text-align: center;"> <tr> <td style="width: 10%;"></td> <td style="width: 10%;"></td> <td style="width: 10%;"></td> <td style="width: 10%;"></td> <td style="width: 10%;"></td> <td style="width: 10%;"></td> <td style="width: 10%;"></td> <td style="width: 10%;"></td> <td style="width: 10%;"></td> <td style="width: 10%;"></td> </tr> <tr> <td></td> <td></td> <td colspan="8" style="text-align: center;"> <table border="1" style="width: 100%; border-collapse: collapse; text-align: center;"> <tr> <td style="width: 10%;"></td> <td style="width: 10%;"></td> <td style="width: 10%;"></td> <td style="width: 10%;"></td> <td style="width: 10%;"></td> <td style="width: 10%;"></td> <td style="width: 10%;"></td> <td style="width: 10%;"></td> <td style="width: 10%;"></td> <td style="width: 10%;"></td> </tr> <tr> <td></td> <td></td> <td colspan="8" style="text-align: center;"> <table border="1" style="width: 100%; border-collapse: collapse; text-align: center;"> <tr> <td style="width: 10%;"></td> <td style="width: 10%;"></td> <td style="width: 10%;"></td> <td style="width: 10%;"></td> <td style="width: 10%;"></td> <td style="width: 10%;"></td> <td style="width: 10%;"></td> <td style="width: 10%;"></td> <td style="width: 10%;"></td> <td style="width: 10%;"></td> </tr> <tr> <td></td> <td></td> <td colspan="8" style="text-align: center;"> <table border="1" style="width: 100%; border-collapse: collapse; text-align: center;"> <tr> </tr></table></td></tr></table></td></tr></table></td></tr></table></td></tr></table></td></tr></table></td></tr></table></td></tr></table></td></tr></table></td></tr></table></td></tr></table></td></tr></table></td></tr></table></td></tr></table></td></tr></table></td></tr></table></td></tr></table></td></tr></table></td></tr></table></td></tr></table></td></tr></table></td></tr></table></td></tr></table></td></tr></table></td></tr></table></td></tr></table></td></tr></table></td></tr></table></td></tr></table></td></tr></table></td></tr></table></td></tr></table></td></tr></table>
 | | | | | | | | | | | | | | | | | | | | <table border="1" style="width: 100%; border-collapse: collapse; text-align: center;"> <tr> <td style="width: 10%;"></td> <td style="width: 10%;"></td> <td style="width: 10%;"></td> <td style="width: 10%;"></td> <td style="width: 10%;"></td> <td style="width: 10%;"></td> <td style="width: 10%;"></td> <td style="width: 10%;"></td> <td style="width: 10%;"></td> <td style="width: 10%;"></td> </tr> <tr> <td></td> <td></td> <td colspan="8" style="text-align: center;"> <table border="1" style="width: 100%; border-collapse: collapse; text-align: center;"> <tr> <td style="width: 10%;"></td> <td style="width: 10%;"></td> <td style="width: 10%;"></td> <td style="width: 10%;"></td> <td style="width: 10%;"></td> <td style="width: 10%;"></td> <td style="width: 10%;"></td> <td style="width: 10%;"></td> <td style="width: 10%;"></td> <td style="width: 10%;"></td> </tr> <tr> <td></td> <td></td> <td colspan="8" style="text-align: center;"> <table border="1" style="width: 100%; border-collapse: collapse; text-align: center;"> <tr> <td style="width: 10%;"></td> <td style="width: 10%;"></td> <td style="width: 10%;"></td> <td style="width: 10%;"></td> <td style="width: 10%;"></td> <td style="width: 10%;"></td> <td style="width: 10%;"></td> <td style="width: 10%;"></td> <td style="width: 10%;"></td> <td style="width: 10%;"></td> </tr> <tr> <td></td> <td></td> <td colspan="8" style="text-align: center;"> <table border="1" style="width: 100%; border-collapse: collapse; text-align: center;"> <tr> <td style="width: 10%;"></td> <td style="width: 10%;"></td> <td style="width: 10%;"></td> <td style="width: 10%;"></td> <td style="width: 10%;"></td> <td style="width: 10%;"></td> <td style="width: 10%;"></td> <td style="width: 10%;"></td> <td style="width: 10%;"></td> <td style="width: 10%;"></td> </tr>
<tr> <td></td> <td></td> <td colspan="8" style="text-align: center;"> <table border="1" style="width: 100%; border-collapse: collapse; text-align: center;"> <tr> <td style="width: 10%;"></td> <td style="width: 10%;"></td> <td style="width: 10%;"></td> <td style="width: 10%;"></td> <td style="width: 10%;"></td> <td style="width: 10%;"></td> <td style="width: 10%;"></td> <td style="width: 10%;"></td> <td style="width: 10%;"></td> <td style="width: 10%;"></td> </tr> <tr> <td></td> <td></td> <td colspan="8" style="text-align: center;"> <table border="1" style="width: 100%; border-collapse: collapse; text-align: center;"> <tr> <td style="width: 10%;"></td> <td style="width: 10%;"></td> <td style="width: 10%;"></td> <td style="width: 10%;"></td> <td style="width: 10%;"></td> <td style="width: 10%;"></td> <td style="width: 10%;"></td> <td style="width: 10%;"></td> <td style="width: 10%;"></td> <td style="width: 10%;"></td> </tr> <tr> <td></td> <td></td> <td colspan="8" style="text-align: center;"> <table border="1" style="width: 100%; border-collapse: collapse; text-align: center;"> <tr> <td style="width: 10%;"></td> <td style="width: 10%;"></td> <td style="width: 10%;"></td> <td style="width: 10%;"></td> <td style="width: 10%;"></td> <td style="width: 10%;"></td> <td style="width: 10%;"></td> <td style="width: 10%;"></td> <td style="width: 10%;"></td> <td style="width: 10%;"></td> </tr> <tr> <td></td> <td></td> <td colspan="8" style="text-align: center;"> <table border="1" style="width: 100%; border-collapse: collapse; text-align: center;"> <tr> <td style="width: 10%;"></td> <td style="width: 10%;"></td> <td style="width: 10%;"></td> <td style="width: 10%;"></td> <td style="width: 10%;"></td> <td style="width: 10%;"></td> <td style="width: 10%;"></td> <td style="width: 10%;"></td> <td style="width: 10%;"></td> <td style="width: 10%;"></td> </tr> <tr> <td></td> <td></td> <td colspan="8" style="text-align: center;"> <table border="1" style="width: 100%; border-collapse: collapse; text-align: center;"> <tr> <td style="width: 10%;"></td> <td style="width: 10%;"></td> <td style="width: 10%;"></td> <td style="width: 10%;"></td> <td style="width: 10%;"></td> <td style="width: 10%;"></td> <td style="width: 10%;"></td> <td style="width: 10%;"></td> <td style="width: 10%;"></td> <td style="width: 10%;"></td> </tr> <tr> <td></td> <td></td> <td colspan="8" style="text-align: center;"> <table border="1" style="width: 100%; border-collapse: collapse; text-align: center;"> <tr> <td style="width: 10%;"></td> <td style="width: 10%;"></td> <td style="width: 10%;"></td> <td style="width: 10%;"></td> <td style="width: 10%;"></td> <td style="width: 10%;"></td> <td style="width: 10%;"></td> <td style="width: 10%;"></td> <td style="width: 10%;"></td> <td style="width: 10%;"></td> </tr> <tr> <td></td> <td></td> <td colspan="8" style="text-align: center;"> <table border="1" style="width: 100%; border-collapse: collapse; text-align: center;"> <tr> <td style="width: 10%;"></td> <td style="width: 10%;"></td> <td style="width: 10%;"></td> <td style="width: 10%;"></td> <td style="width: 10%;"></td> <td style="width: 10%;"></td> <td style="width: 10%;"></td> <td style="width: 10%;"></td> <td style="width: 10%;"></td> <td style="width: 10%;"></td> </tr> <tr> <td></td> <td></td> <td colspan="8" style="text-align: center;"> <table border="1" style="width: 100%; border-collapse: collapse; text-align: center;"> <tr> <td style="width: 10%;"></td> <td style="width: 10%;"></td> <td style="width: 10%;"></td> <td style="width: 10%;"></td> <td style="width: 10%;"></td> <td style="width: 10%;"></td> <td style="width: 10%;"></td> <td style="width: 10%;"></td> <td style="width: 10%;"></td> <td style="width: 10%;"></td> </tr> <tr> <td></td> <td></td> <td colspan="8" style="text-align: center;"> <table border="1" style="width: 100%; border-collapse: collapse; text-align: center;"> <tr> <td style="width: 10%;"></td> <td style="width: 10%;"></td> <td style="width: 10%;"></td> <td style="width: 10%;"></td> <td style="width: 10%;"></td> <td style="width: 10%;"></td> <td style="width: 10%;"></td> <td style="width: 10%;"></td> <td style="width: 10%;"></td> <td style="width: 10%;"></td> </tr> <tr> <td></td> <td></td> <td colspan="8" style="text-align: center;"> <table border="1" style="width: 100%; border-collapse: collapse; text-align: center;"> <tr> <td style="width: 10%;"></td> <td style="width: 10%;"></td> <td style="width: 10%;"></td> <td style="width: 10%;"></td> <td style="width: 10%;"></td> <td style="width: 10%;"></td> <td style="width: 10%;"></td> <td style="width: 10%;"></td> <td style="width: 10%;"></td> <td style="width: 10%;"></td> </tr> <tr> <td></td> <td></td> <td colspan="8" style="text-align: center;"> <table border="1" style="width: 100%; border-collapse: collapse; text-align: center;"> <tr> <td style="width: 10%;"></td> <td style="width: 10%;"></td> <td style="width: 10%;"></td> <td style="width: 10%;"></td> <td style="width: 10%;"></td> <td style="width: 10%;"></td> <td style="width: 10%;"></td> <td style="width: 10%;"></td> <td style="width: 10%;"></td> <td style="width: 10%;"></td> </tr> <tr> <td></td> <td></td> <td colspan="8" style="text-align: center;"> <table border="1" style="width: 100%; border-collapse: collapse; text-align: center;"> <tr> <td style="width: 10%;"></td> <td style="width: 10%;"></td> <td style="width: 10%;"></td> <td style="width: 10%;"></td> <td style="width: 10%;"></td> <td style="width: 10%;"></td> <td style="width: 10%;"></td> <td style="width: 10%;"></td> <td style="width: 10%;"></td> <td style="width: 10%;"></td> </tr> <tr> <td></td> <td></td> <td colspan="8" style="text-align: center;"> <table border="1" style="width: 100%; border-collapse: collapse; text-align: center;"> <tr> <td style="width: 10%;"></td> <td style="width: 10%;"></td> <td style="width: 10%;"></td> <td style="width: 10%;"></td> <td style="width: 10%;"></td> <td style="width: 10%;"></td> <td style="width: 10%;"></td> <td style="width: 10%;"></td> <td style="width: 10%;"></td> <td style="width: 10%;"></td> </tr> <tr> <td></td> <td></td> <td colspan="8" style="text-align: center;"> <table border="1" style="width: 100%; border-collapse: collapse; text-align: center;"> <tr> <td style="width: 10%;"></td> <td style="width: 10%;"></td> <td style="width: 10%;"></td> <td style="width: 10%;"></td> <td style="width: 10%;"></td> <td style="width: 10%;"></td> <td style="width: 10%;"></td> <td style="width: 10%;"></td> <td style="width: 10%;"></td> <td style="width: 10%;"></td> </tr> <tr> <td></td> <td></td> <td colspan="8" style="text-align: center;"> <table border="1" style="width: 100%; border-collapse: collapse; text-align: center;"> <tr> <td style="width: 10%;"></td> <td style="width: 10%;"></td> <td style="width: 10%;"></td> <td style="width: 10%;"></td> <td style="width: 10%;"></td> <td style="width: 10%;"></td> <td style="width: 10%;"></td> <td style="width: 10%;"></td> <td style="width: 10%;"></td> <td style="width: 10%;"></td> </tr> <tr> <td></td> <td></td> <td colspan="8" style="text-align: center;"> <table border="1" style="width: 100%; border-collapse: collapse; text-align: center;"> <tr> <td style="width: 10%;"></td> <td style="width: 10%;"></td> <td style="width: 10%;"></td> <td style="width: 10%;"></td> <td style="width: 10%;"></td> <td style="width: 10%;"></td> <td style="width: 10%;"></td> <td style="width: 10%;"></td> <td style="width: 10%;"></td> <td style="width: 10%;"></td> </tr> <tr> <td></td> <td></td> <td colspan="8" style="text-align: center;"> <table border="1" style="width: 100%; border-collapse: collapse; text-align: center;"> <tr> <td style="width: 10%;"></td> <td style="width: 10%;"></td> <td style="width: 10%;"></td> <td style="width: 10%;"></td> <td style="width: 10%;"></td> <td style="width: 10%;"></td> <td style="width: 10%;"></td> <td style="width: 10%;"></td> <td style="width: 10%;"></td> <td style="width: 10%;"></td> </tr> <tr> <td></td> <td></td> <td colspan="8" style="text-align: center;"> <table border="1" style="width: 100%; border-collapse: collapse; text-align: center;"> <tr> <td style="width: 10%;"></td> <td style="width: 10%;"></td> <td style="width: 10%;"></td> <td style="width: 10%;"></td> <td style="width: 10%;"></td> <td style="width: 10%;"></td> <td style="width: 10%;"></td> <td style="width: 10%;"></td> <td style="width: 10%;"></td> <td style="width: 10%;"></td> </tr> <tr> <td></td> <td></td> <td colspan="8" style="text-align: center;"> <table border="1" style="width: 100%; border-collapse: collapse; text-align: center;"> <tr> <td style="width: 10%;"></td> <td style="width: 10%;"></td> <td style="width: 10%;"></td> <td style="width: 10%;"></td> <td style="width: 10%;"></td> <td style="width: 10%;"></td> <td style="width: 10%;"></td> <td style="width: 10%;"></td> <td style="width: 10%;"></td> <td style="width: 10%;"></td> </tr> <tr> <td></td> <td></td> <td colspan="8" style="text-align: center;"> <table border="1" style="width: 100%; border-collapse: collapse; text-align: center;"> <tr> <td style="width: 10%;"></td> <td style="width: 10%;"></td> <td style="width: 10%;"></td> <td style="width: 10%;"></td> <td style="width: 10%;"></td> <td style="width: 10%;"></td> <td style="width: 10%;"></td> <td style="width: 10%;"></td> <td style="width: 10%;"></td> <td style="width: 10%;"></td> </tr> <tr> <td></td> <td></td> <td colspan="8" style="text-align: center;"> <table border="1" style="width: 100%; border-collapse: collapse; text-align: center;"> <tr> <td style="width: 10%;"></td> <td style="width: 10%;"></td> <td style="width: 10%;"></td> <td style="width: 10%;"></td> <td style="width: 10%;"></td> <td style="width: 10%;"></td> <td style="width: 10%;"></td> <td style="width: 10%;"></td> <td style="width: 10%;"></td> <td style="width: 10%;"></td> </tr> <tr> <td></td> <td></td> <td colspan="8" style="text-align: center;"> <table border="1" style="width: 100%; border-collapse: collapse; text-align: center;"> <tr> <td
style="width: 10%;"></td> <td style="width: 10%;"></td> <td style="width: 10%;"></td> <td style="width: 10%;"></td> <td style="width: 10%;"></td> <td style="width: 10%;"></td> <td style="width: 10%;"></td> <td style="width: 10%;"></td> <td style="width: 10%;"></td> <td style="width: 10%;"></td> </tr> <tr> <td></td> <td></td> <td colspan="8" style="text-align: center;"> <table border="1" style="width: 100%; border-collapse: collapse; text-align: center;"> <tr> <td style="width: 10%;"></td> <td style="width: 10%;"></td> <td style="width: 10%;"></td> <td style="width: 10%;"></td> <td style="width: 10%;"></td> <td style="width: 10%;"></td> <td style="width: 10%;"></td> <td style="width: 10%;"></td> <td style="width: 10%;"></td> <td style="width: 10%;"></td> </tr> <tr> <td></td> <td></td> <td colspan="8" style="text-align: center;"> <table border="1" style="width: 100%; border-collapse: collapse; text-align: center;"> <tr> <td style="width: 10%;"></td> <td style="width: 10%;"></td> <td style="width: 10%;"></td> <td style="width: 10%;"></td> <td style="width: 10%;"></td> <td style="width: 10%;"></td> <td style="width: 10%;"></td> <td style="width: 10%;"></td> <td style="width: 10%;"></td> <td style="width: 10%;"></td> </tr> <tr> <td></td> <td></td> <td colspan="8" style="text-align: center;"> <table border="1" style="width: 100%; border-collapse: collapse; text-align: center;"> <tr> <td style="width: 10%;"></td> <td style="width: 10%;"></td> <td style="width: 10%;"></td> <td style="width: 10%;"></td> <td style="width: 10%;"></td> <td style="width: 10%;"></td> <td style="width: 10%;"></td> <td style="width: 10%;"></td> <td style="width: 10%;"></td> <td style="width: 10%;"></td> </tr> <tr> <td></td> <td></td> <td colspan="8" style="text-align: center;"> <table border="1" style="width: 100%; border-collapse: collapse; text-align: center;"> <tr> <td style="width: 10%;"></td> <td style="width: 10%;"></td> <td style="width: 10%;"></td> <td style="width: 10%;"></td> <td style="width: 10%;"></td> <td style="width: 10%;"></td> <td style="width: 10%;"></td> <td style="width: 10%;"></td> <td style="width: 10%;"></td> <td style="width: 10%;"></td> </tr> <tr> <td></td> <td></td> <td colspan="8" style="text-align: center;"> <table border="1" style="width: 100%; border-collapse: collapse; text-align: center;"> <tr> <td style="width: 10%;"></td> <td style="width: 10%;"></td> <td style="width: 10%;"></td> <td style="width: 10%;"></td> <td style="width: 10%;"></td> <td style="width: 10%;"></td> <td style="width: 10%;"></td> <td style="width: 10%;"></td> <td style="width: 10%;"></td> <td style="width: 10%;"></td> </tr> <tr> <td></td> <td></td> <td colspan="8" style="text-align: center;"> <table border="1" style="width: 100%; border-collapse: collapse; text-align: center;"> <tr> </tr></table></td></tr></table></td></tr></table></td></tr></table></td></tr></table></td></tr></table></td></tr></table></td></tr></table></td></tr></table></td></tr></table></td></tr></table></td></tr></table></td></tr></table></td></tr></table></td></tr></table></td></tr></table></td></tr></table></td></tr></table></td></tr></table></td></tr></table></td></tr></table></td></tr></table></td></tr></table></td></tr></table></td></tr></table></td></tr></table></td></tr></table></td></tr></table></td></tr></table></td></tr></table></td></tr></table></td></tr></table>
 | | | | | | | | | | | | | | | | | | | | <table border="1" style="width: 100%; border-collapse: collapse; text-align: center;"> <tr> <td style="width: 10%;"></td> <td style="width: 10%;"></td> <td style="width: 10%;"></td> <td style="width: 10%;"></td> <td style="width: 10%;"></td> <td style="width: 10%;"></td> <td style="width: 10%;"></td> <td style="width: 10%;"></td> <td style="width: 10%;"></td> <td style="width: 10%;"></td> </tr> <tr> <td></td> <td></td> <td colspan="8" style="text-align: center;"> <table border="1" style="width: 100%; border-collapse: collapse; text-align: center;"> <tr> <td style="width: 10%;"></td> <td style="width: 10%;"></td> <td style="width: 10%;"></td> <td style="width: 10%;"></td> <td style="width: 10%;"></td> <td style="width: 10%;"></td> <td style="width: 10%;"></td> <td style="width: 10%;"></td> <td style="width: 10%;"></td> <td style="width: 10%;"></td> </tr> <tr> <td></td> <td></td> <td colspan="8" style="text-align: center;"> <table border="1" style="width: 100%; border-collapse: collapse; text-align: center;"> <tr> <td style="width: 10%;"></td> <td style="width: 10%;"></td> <td style="width: 10%;"></td> <td style="width: 10%;"></td> <td style="width: 10%;"></td> <td style="width: 10%;"></td> <td style="width: 10%;"></td> <td style="width: 10%;"></td> <td style="width: 10%;"></td> <td style="width: 10%;"></td> </tr> <tr> <td></td> <td></td> <td colspan="8" style="text-align: center;"> <table border="1" style="width: 100%; border-collapse: collapse; text-align: center;"> <tr> <td style="width: 10%;"></td> <td style="width: 10%;"></td> <td style="width: 10%;"></td> <td style="width: 10%;"></td> <td style="width: 10%;"></td> <td style="width: 10%;"></td> <td style="width: 10%;"></td> <td style="width: 10%;"></td> <td style="width: 10%;"></td> <td style="width: 10%;"></td> </tr> <tr> <td></td> <td></td> <td colspan="8" style="text-align: center;"> <table border="1" style="width: 100%; border-collapse: collapse; text-align: center;"> <tr> <td style="width: 10%;"></td> <td style="width: 10%;"></td> <td style="width: 10%;"></td> <td style="width: 10%;"></td> <td style="width: 10%;"></td> <td style="width: 10%;"></td> <td style="width: 10%;"></td> <td style="width: 10%;"></td> <td style="width: 10%;"></td> <td style="width: 10%;"></td> </tr> <tr> <td></td> <td></td> <td colspan="8" style="text-align: center;"> <table border="1" style="width: 100%; border-collapse: collapse; text-align: center;"> <tr> <td style="width: 10%;"></td> <td style="width: 10%;"></td> <td style="width: 10%;"></td> <td style="width: 10%;"></td> <td style="width: 10%;"></td> <td style="width: 10%;"></td> <td style="width: 10%;"></td> <td style="width: 10%;"></td> <td style="width: 10%;"></td> <td style="width: 10%;"></td> </tr> <tr> <td></td> <td></td> <td colspan="8" style="text-align: center;"> <table border="1" style="width: 100%; border-collapse: collapse; text-align: center;"> <tr> <td style="width: 10%;"></td> <td style="width: 10%;"></td> <td style="width: 10%;"></td> <td style="width: 10%;"></td> <td style="width: 10%;"></td> <td style="width: 10%;"></td> <td style="width: 10%;"></td> <td style="width: 10%;"></td> <td style="width: 10%;"></td> <td style="width: 10%;"></td> </tr> <tr> <td></td> <td></td> <td colspan="8" style="text-align: center;"> <table border="1" style="width: 100%; border-collapse: collapse; text-align: center;"> <tr> <td style="width: 10%;"></td> <td style="width: 10%;"></td> <td style="width: 10%;"></td> <td style="width: 10%;"></td> <td style="width: 10%;"></td> <td style="width: 10%;"></td> <td style="width: 10%;"></td> <td style="width: 10%;"></td> <td style="width: 10%;"></td> <td style="width: 10%;"></td> </tr> <tr> <td></td> <td></td> <td colspan="8" style="text-align: center;"> <table border="1" style="width: 100%; border-collapse: collapse; text-align: center;"> <tr> <td style="width: 10%;"></td> <td style="width: 10%;"></td> <td style="width: 10%;"></td> <td style="width: 10%;"></td> <td style="width: 10%;"></td> <td style="width: 10%;"></td> <td style="width: 10%;"></td> <td style="width: 10%;"></td> <td style="width: 10%;"></td> <td style="width: 10%;"></td> </tr> <tr> <td></td> <td></td> <td colspan="8" style="text-align: center;"> <table border="1" style="width: 100%; border-collapse: collapse; text-align: center;"> <tr> <td style="width: 10%;"></td> <td style="width: 10%;"></td> <td style="width: 10%;"></td> <td style="width: 10%;"></td> <td style="width: 10%;"></td> <td style="width: 10%;"></td> <td style="width: 10%;"></td> <td style="width: 10%;"></td> <td style="width: 10%;"></td> <td style="width: 10%;"></td> </tr> <tr> <td></td> <td></td> <td colspan="8" style="text-align: center;"> <table border="1" style="width: 100%; border-collapse: collapse; text-align: center;"> <tr> <td style="width: 10%;"></td> <td style="width: 10%;"></td> <td style="width: 10%;"></td> <td style="width: 10%;"></td> <td style="width: 10%;"></td> <td style="width: 10%;"></td> <td style="width: 10%;"></td> <td style="width: 10%;"></td> <td style="width: 10%;"></td> <td style="width: 10%;"></td> </tr> <tr> <td></td> <td></td> <td colspan="8" style="text-align: center;"> <table border="1" style="width: 100%; border-collapse: collapse; text-align: center;"> <tr> <td style="width: 10%;"></td> <td style="width: 10%;"></td> <td style="width: 10%;"></td> <td style="width: 10%;"></td> <td style="width: 10%;"></td> <td style="width: 10%;"></td> <td style="width: 10%;"></td> <td style="width: 10%;"></td> <td style="width: 10%;"></td> <td style="width: 10%;"></td> </tr> <tr> <td></td> <td></td> <td colspan="8" style="text-align: center;"> <table border="1" style="width: 100%; border-collapse: collapse; text-align: center;"> <tr> <td style="width: 10%;"></td> <td style="width: 10%;"></td> <td style="width: 10%;"></td> <td style="width: 10%;"></td> <td style="width: 10%;"></td> <td style="width: 10%;"></td> <td style="width: 10%;"></td> <td style="width: 10%;"></td> <td style="width: 10%;"></td> <td style="width: 10%;"></td> </tr> <tr> <td></td> <td></td> <td colspan="8" style="text-align: center;"> <table border="1" style="width: 100%; border-collapse: collapse; text-align: center;"> <tr> <td style="width: 10%;"></td> <td style="width: 10%;"></td> <td style="width: 10%;"></td> <td style="width: 10%;"></td> <td style="width: 10%;"></td> <td style="width: 10%;"></td> <td style="width: 10%;"></td> <td style="width: 10%;"></td> <td style="width: 10%;"></td> <td style="width: 10%;"></td> </tr> <tr> <td></td> <td></td> <td colspan="8" style="text-align: center;"> <table border="1" style="width: 100%; border-collapse: collapse; text-align: center;"> <tr> <td style="width: 10%;"></td> <td style="width: 10%;"></td> <td style="width: 10%;"></td> <td style="width: 10%;"></td> <td style="width: 10%;"></td> <td style="width: 10%;"></td> <td style="width: 10%;"></td> <td style="width: 10%;"></td> <td style="width: 10%;"></td> <td style="width: 10%;"></td> </tr> <tr> <td></td> <td></td> <td colspan="8" style="text-align: center;"> <table border="1" style="width: 100%; border-collapse: collapse; text-align: center;"> <tr> <td style="width: 10%;"></td> <td style="width: 10%;"></td> <td style="width: 10%;"></td> <td style="width: 10%;"></td> <td style="width: 10%;"></td> <td style="width: 10%;"></td> <td style="width: 10%;"></td> <td style="width: 10%;"></td> <td style="width: 10%;"></td> <td style="width: 10%;"></td> </tr> <tr> <td></td> <td></td> <td colspan="8" style="text-align: center;"> <table border="1" style="width: 100%; border-collapse: collapse; text-align: center;"> <tr> <td style="width: 10%;"></td> <td style="width: 10%;"></td> <td style="width: 10%;"></td> <td style="width: 10%;"></td> <td style="width: 10%;"></td> <td style="width: 10%;"></td> <td style="width: 10%;"></td> <td style="width:
10%;"></td> <td style="width: 10%;"></td> <td style="width: 10%;"></td> </tr> <tr> <td></td> <td></td> <td colspan="8" style="text-align: center;"> <table border="1" style="width: 100%; border-collapse: collapse; text-align: center;"> <tr> <td style="width: 10%;"></td> <td style="width: 10%;"></td> <td style="width: 10%;"></td> <td style="width: 10%;"></td> <td style="width: 10%;"></td> <td style="width: 10%;"></td> <td style="width: 10%;"></td> <td style="width: 10%;"></td> <td style="width: 10%;"></td> <td style="width: 10%;"></td> </tr> <tr> <td></td> <td></td> <td colspan="8" style="text-align: center;"> <table border="1" style="width: 100%; border-collapse: collapse; text-align: center;"> <tr> <td style="width: 10%;"></td> <td style="width: 10%;"></td> <td style="width: 10%;"></td> <td style="width: 10%;"></td> <td style="width: 10%;"></td> <td style="width: 10%;"></td> <td style="width: 10%;"></td> <td style="width: 10%;"></td> <td style="width: 10%;"></td> <td style="width: 10%;"></td> </tr> <tr> <td></td> <td></td> <td colspan="8" style="text-align: center;"> <table border="1" style="width: 100%; border-collapse: collapse; text-align: center;"> <tr> <td style="width: 10%;"></td> <td style="width: 10%;"></td> <td style="width: 10%;"></td> <td style="width: 10%;"></td> <td style="width: 10%;"></td> <td style="width: 10%;"></td> <td style="width: 10%;"></td> <td style="width: 10%;"></td> <td style="width: 10%;"></td> <td style="width: 10%;"></td> </tr> <tr> <td></td> <td></td> <td colspan="8" style="text-align: center;"> <table border="1" style="width: 100%; border-collapse: collapse; text-align: center;"> <tr> <td style="width: 10%;"></td> <td style="width: 10%;"></td> <td style="width: 10%;"></td> <td style="width: 10%;"></td> <td style="width: 10%;"></td> <td style="width: 10%;"></td> <td style="width: 10%;"></td> <td style="width: 10%;"></td> <td style="width: 10%;"></td> <td style="width: 10%;"></td> </tr> <tr> <td></td> <td></td> <td colspan="8" style="text-align: center;"> <table border="1" style="width: 100%; border-collapse: collapse; text-align: center;"> <tr> <td style="width: 10%;"></td> <td style="width: 10%;"></td> <td style="width: 10%;"></td> <td style="width: 10%;"></td> <td style="width: 10%;"></td> <td style="width: 10%;"></td> <td style="width: 10%;"></td> <td style="width: 10%;"></td> <td style="width: 10%;"></td> <td style="width: 10%;"></td> </tr> <tr> <td></td> <td></td> <td colspan="8" style="text-align: center;"> <table border="1" style="width: 100%; border-collapse: collapse; text-align: center;"> <tr> <td style="width: 10%;"></td> <td style="width: 10%;"></td> <td style="width: 10%;"></td> <td style="width: 10%;"></td> <td style="width: 10%;"></td> <td style="width: 10%;"></td> <td style="width: 10%;"></td> <td style="width: 10%;"></td> <td style="width: 10%;"></td> <td style="width: 10%;"></td> </tr> <tr> <td></td> <td></td> <td colspan="8" style="text-align: center;"> <table border="1" style="width: 100%; border-collapse: collapse; text-align: center;"> <tr> <td style="width: 10%;"></td> <td style="width: 10%;"></td> <td style="width: 10%;"></td> <td style="width: 10%;"></td> <td style="width: 10%;"></td> <td style="width: 10%;"></td> <td style="width: 10%;"></td> <td style="width: 10%;"></td> <td style="width: 10%;"></td> <td style="width: 10%;"></td> </tr> <tr> <td></td> <td></td> <td colspan="8" style="text-align: center;"> <table border="1" style="width: 100%; border-collapse: collapse; text-align: center;"> <tr> <td style="width: 10%;"></td> <td style="width: 10%;"></td> <td style="width: 10%;"></td> <td style="width: 10%;"></td> <td style="width: 10%;"></td> <td style="width: 10%;"></td> <td style="width: 10%;"></td> <td style="width: 10%;"></td> <td style="width: 10%;"></td> <td style="width: 10%;"></td> </tr> <tr> <td></td> <td></td> <td colspan="8" style="text-align: center;"> <table border="1" style="width: 100%; border-collapse: collapse; text-align: center;"> <tr> <td style="width: 10%;"></td> <td style="width: 10%;"></td> <td style="width: 10%;"></td> <td style="width: 10%;"></td> <td style="width: 10%;"></td> <td style="width: 10%;"></td> <td style="width: 10%;"></td> <td style="width: 10%;"></td> <td style="width: 10%;"></td> <td style="width: 10%;"></td> </tr> <tr> <td></td> <td></td> <td colspan="8" style="text-align: center;"> <table border="1" style="width: 100%; border-collapse: collapse; text-align: center;"> <tr> <td style="width: 10%;"></td> <td style="width: 10%;"></td> <td style="width: 10%;"></td> <td style="width: 10%;"></td> <td style="width: 10%;"></td> <td style="width: 10%;"></td> <td style="width: 10%;"></td> <td style="width: 10%;"></td> <td style="width: 10%;"></td> <td style="width: 10%;"></td> </tr> <tr> <td></td> <td></td> <td colspan="8" style="text-align: center;"> <table border="1" style="width: 100%; border-collapse: collapse; text-align: center;"> <tr> <td style="width: 10%;"></td> <td style="width: 10%;"></td> <td style="width: 10%;"></td> <td style="width: 10%;"></td> <td style="width: 10%;"></td> <td style="width: 10%;"></td> <td style="width: 10%;"></td> <td style="width: 10%;"></td> <td style="width: 10%;"></td> <td style="width: 10%;"></td> </tr> <tr> <td></td> <td></td> <td colspan="8" style="text-align: center;"> <table border="1" style="width: 100%; border-collapse: collapse; text-align: center;"> <tr> <td style="width: 10%;"></td> <td style="width: 10%;"></td> <td style="width: 10%;"></td> <td style="width: 10%;"></td> <td style="width: 10%;"></td> <td style="width: 10%;"></td> <td style="width: 10%;"></td> <td style="width: 10%;"></td> <td style="width: 10%;"></td> <td style="width: 10%;"></td> </tr> <tr> <td></td> <td></td> <td colspan="8" style="text-align: center;"> <table border="1" style="width: 100%; border-collapse: collapse; text-align: center;"> <tr> <td style="width: 10%;"></td> <td style="width: 10%;"></td> <td style="width: 10%;"></td> <td style="width: 10%;"></td> <td style="width: 10%;"></td> <td style="width: 10%;"></td> <td style="width: 10%;"></td> <td style="width: 10%;"></td> <td style="width: 10%;"></td> <td style="width: 10%;"></td> </tr> <tr> <td></td> <td></td> <td colspan="8" style="text-align: center;"> <table border="1" style="width: 100%; border-collapse: collapse; text-align: center;"> <tr> </tr></table></td></tr></table></td></tr></table></td></tr></table></td></tr></table></td></tr></table></td></tr></table></td></tr></table></td></tr></table></td></tr></table></td></tr></table></td></tr></table></td></tr></table></td></tr></table></td></tr></table></td></tr></table></td></tr></table></td></tr></table></td></tr></table></td></tr></table></td></tr></table></td></tr></table></td></tr></table></td></tr></table></td></tr></table></td></tr></table></td></tr></table></td></tr></table></td></tr></table></td></tr></table></td></tr></table>
 | | | | | | | | | | | | | | | | | | | | <table border="1" style="width: 100%; border-collapse: collapse; text-align: center;"> <tr> <td style="width: 10%;"></td> <td style="width: 10%;"></td> <td style="width: 10%;"></td> <td style="width: 10%;"></td> <td style="width: 10%;"></td> <td style="width: 10%;"></td> <td style="width: 10%;"></td> <td style="width: 10%;"></td> <td style="width: 10%;"></td> <td style="width: 10%;"></td> </tr> <tr> <td></td> <td></td> <td colspan="8" style="text-align: center;"> <table border="1" style="width: 100%; border-collapse: collapse; text-align: center;"> <tr> <td style="width: 10%;"></td> <td style="width: 10%;"></td> <td style="width: 10%;"></td> <td style="width: 10%;"></td> <td style="width: 10%;"></td> <td style="width: 10%;"></td> <td style="width: 10%;"></td> <td style="width: 10%;"></td> <td style="width: 10%;"></td> <td style="width: 10%;"></td> </tr> <tr> <td></td> <td></td> <td colspan="8" style="text-align: center;"> <table border="1" style="width: 100%; border-collapse: collapse; text-align: center;"> <tr> <td style="width: 10%;"></td> <td style="width: 10%;"></td> <td style="width: 10%;"></td> <td style="width: 10%;"></td> <td style="width: 10%;"></td> <td style="width: 10%;"></td> <td style="width: 10%;"></td> <td style="width: 10%;"></td> <td style="width: 10%;"></td> <td style="width: 10%;"></td> </tr> <tr> <td></td> <td></td> <td colspan="8" style="text-align: center;"> <table border="1" style="width: 100%; border-collapse: collapse; text-align: center;"> <tr> <td style="width: 10%;"></td> <td style="width: 10%;"></td> <td style="width: 10%;"></td> <td style="width: 10%;"></td> <td style="width: 10%;"></td> <td style="width: 10%;"></td> <td style="width: 10%;"></td> <td style="width: 10%;"></td> <td style="width: 10%;"></td> <td style="width: 10%;"></td> </tr> <tr> <td></td> <td></td> <td colspan="8" style="text-align: center;"> <table border="1" style="width: 100%; border-collapse: collapse; text-align: center;"> <tr> <td style="width: 10%;"></td> <td style="width: 10%;"></td> <td style="width: 10%;"></td> <td style="width: 10%;"></td> <td style="width: 10%;"></td> <td style="width: 10%;"></td> <td style="width: 10%;"></td> <td style="width: 10%;"></td> <td style="width: 10%;"></td> <td style="width: 10%;"></td> </tr> <tr> <td></td> <td></td> <td colspan="8" style="text-align: center;"> <table border="1" style="width: 100%; border-collapse: collapse; text-align: center;"> <tr> <td style="width: 10%;"></td> <td style="width: 10%;"></td> <td style="width: 10%;"></td> <td style="width: 10%;"></td> <td style="width: 10%;"></td> <td style="width: 10%;"></td> <td style="width: 10%;"></td> <td style="width: 10%;"></td> <td style="width: 10%;"></td> <td style="width: 10%;"></td> </tr> <tr> <td></td> <td></td> <td colspan="8" style="text-align: center;"> <table border="1" style="width: 100%; border-collapse: collapse; text-align: center;"> <tr> <td style="width: 10%;"></td> <td style="width: 10%;"></td> <td style="width: 10%;"></td> <td style="width: 10%;"></td> <td style="width: 10%;"></td> <td style="width: 10%;"></td> <td style="width: 10%;"></td> <td style="width: 10%;"></td> <td style="width: 10%;"></td> <td style="width: 10%;"></td> </tr> <tr> <td></td> <td></td> <td colspan="8" style="text-align: center;"> <table border="1" style="width: 100%; border-collapse: collapse; text-align: center;"> <tr> <td style="width: 10%;"></td> <td style="width: 10%;"></td> <td style="width: 10%;"></td> <td style="width: 10%;"></td> <td style="width: 10%;"></td> <td style="width: 10%;"></td> <td style="width: 10%;"></td> <td style="width: 10%;"></td> <td style="width: 10%;"></td> <td style="width: 10%;"></td> </tr> <tr> <td></td> <td></td> <td colspan="8" style="text-align: center;"> <table border="1" style="width: 100%; border-collapse: collapse; text-align: center;"> <tr> <td style="width: 10%;"></td> <td style="width: 10%;"></td> <td style="width: 10%;"></td> <td style="width: 10%;"></td> <td style="width: 10%;"></td> <td style="width: 10%;"></td> <td style="width: 10%;"></td> <td style="width: 10%;"></td> <td style="width: 10%;"></td> <td style="width: 10%;"></td> </tr> <tr> <td></td> <td></td> <td colspan="8" style="text-align: center;"> <table border="1" style="width: 100%; border-collapse: collapse; text-align: center;"> <tr> <td
style="width: 10%;"></td> <td style="width: 10%;"></td> <td style="width: 10%;"></td> <td style="width: 10%;"></td> <td style="width: 10%;"></td> <td style="width: 10%;"></td> <td style="width: 10%;"></td> <td style="width: 10%;"></td> <td style="width: 10%;"></td> <td style="width: 10%;"></td> </tr> <tr> <td></td> <td></td> <td colspan="8" style="text-align: center;"> <table border="1" style="width: 100%; border-collapse: collapse; text-align: center;"> <tr> <td style="width: 10%;"></td> <td style="width: 10%;"></td> <td style="width: 10%;"></td> <td style="width: 10%;"></td> <td style="width: 10%;"></td> <td style="width: 10%;"></td> <td style="width: 10%;"></td> <td style="width: 10%;"></td> <td style="width: 10%;"></td> <td style="width: 10%;"></td> </tr> <tr> <td></td> <td></td> <td colspan="8" style="text-align: center;"> <table border="1" style="width: 100%; border-collapse: collapse; text-align: center;"> <tr> <td style="width: 10%;"></td> <td style="width: 10%;"></td> <td style="width: 10%;"></td> <td style="width: 10%;"></td> <td style="width: 10%;"></td> <td style="width: 10%;"></td> <td style="width: 10%;"></td> <td style="width: 10%;"></td> <td style="width: 10%;"></td> <td style="width: 10%;"></td> </tr> <tr> <td></td> <td></td> <td colspan="8" style="text-align: center;"> <table border="1" style="width: 100%; border-collapse: collapse; text-align: center;"> <tr> <td style="width: 10%;"></td> <td style="width: 10%;"></td> <td style="width: 10%;"></td> <td style="width: 10%;"></td> <td style="width: 10%;"></td> <td style="width: 10%;"></td> <td style="width: 10%;"></td> <td style="width: 10%;"></td> <td style="width: 10%;"></td> <td style="width: 10%;"></td> </tr> <tr> <td></td> <td></td> <td colspan="8" style="text-align: center;"> <table border="1" style="width: 100%; border-collapse: collapse; text-align: center;"> <tr> <td style="width: 10%;"></td> <td style="width: 10%;"></td> <td style="width: 10%;"></td> <td style="width: 10%;"></td> <td style="width: 10%;"></td> <td style="width: 10%;"></td> <td style="width: 10%;"></td> <td style="width: 10%;"></td> <td style="width: 10%;"></td> <td style="width: 10%;"></td> </tr> <tr> <td></td> <td></td> <td colspan="8" style="text-align: center;"> <table border="1" style="width: 100%; border-collapse: collapse; text-align: center;"> <tr> <td style="width: 10%;"></td> <td style="width: 10%;"></td> <td style="width: 10%;"></td> <td style="width: 10%;"></td> <td style="width: 10%;"></td> <td style="width: 10%;"></td> <td style="width: 10%;"></td> <td style="width: 10%;"></td> <td style="width: 10%;"></td> <td style="width: 10%;"></td> </tr> <tr> <td></td> <td></td> <td colspan="8" style="text-align: center;"> <table border="1" style="width: 100%; border-collapse: collapse; text-align: center;"> <tr> <td style="width: 10%;"></td> <td style="width: 10%;"></td> <td style="width: 10%;"></td> <td style="width: 10%;"></td> <td style="width: 10%;"></td> <td style="width: 10%;"></td> <td style="width: 10%;"></td> <td style="width: 10%;"></td> <td style="width: 10%;"></td> <td style="width: 10%;"></td> </tr> <tr> <td></td> <td></td> <td colspan="8" style="text-align: center;"> <table border="1" style="width: 100%; border-collapse: collapse; text-align: center;"> <tr> <td style="width: 10%;"></td> <td style="width: 10%;"></td> <td style="width: 10%;"></td> <td style="width: 10%;"></td> <td style="width: 10%;"></td> <td style="width: 10%;"></td> <td style="width: 10%;"></td> <td style="width: 10%;"></td> <td style="width: 10%;"></td> <td style="width: 10%;"></td> </tr> <tr> <td></td> <td></td> <td colspan="8" style="text-align: center;"> <table border="1" style="width: 100%; border-collapse: collapse; text-align: center;"> <tr> <td style="width: 10%;"></td> <td style="width: 10%;"></td> <td style="width: 10%;"></td> <td style="width: 10%;"></td> <td style="width: 10%;"></td> <td style="width: 10%;"></td> <td style="width: 10%;"></td> <td style="width: 10%;"></td> <td style="width: 10%;"></td> <td style="width: 10%;"></td> </tr> <tr> <td></td> <td></td> <td colspan="8" style="text-align: center;"> <table border="1" style="width: 100%; border-collapse: collapse; text-align: center;"> <tr> <td style="width: 10%;"></td> <td style="width: 10%;"></td> <td style="width: 10%;"></td> <td style="width: 10%;"></td> <td style="width: 10%;"></td> <td style="width: 10%;"></td> <td style="width: 10%;"></td> <td style="width: 10%;"></td> <td style="width: 10%;"></td> <td style="width: 10%;"></td> </tr> <tr> <td></td> <td></td> <td colspan="8" style="text-align: center;"> <table border="1" style="width: 100%; border-collapse: collapse; text-align: center;"> <tr> <td style="width: 10%;"></td> <td style="width: 10%;"></td> <td style="width: 10%;"></td> <td style="width: 10%;"></td> <td style="width: 10%;"></td> <td style="width: 10%;"></td> <td style="width: 10%;"></td> <td style="width: 10%;"></td> <td style="width: 10%;"></td> <td style="width: 10%;"></td> </tr> <tr> <td></td> <td></td> <td colspan="8" style="text-align: center;"> <table border="1" style="width: 100%; border-collapse: collapse; text-align: center;"> <tr> <td style="width: 10%;"></td> <td style="width: 10%;"></td> <td style="width: 10%;"></td> <td style="width: 10%;"></td> <td style="width: 10%;"></td> <td style="width: 10%;"></td> <td style="width: 10%;"></td> <td style="width: 10%;"></td> <td style="width: 10%;"></td> <td style="width: 10%;"></td> </tr> <tr> <td></td> <td></td> <td colspan="8" style="text-align: center;"> <table border="1" style="width: 100%; border-collapse: collapse; text-align: center;"> <tr> <td style="width: 10%;"></td> <td style="width: 10%;"></td> <td style="width: 10%;"></td> <td style="width: 10%;"></td> <td style="width: 10%;"></td> <td style="width: 10%;"></td> <td style="width: 10%;"></td> <td style="width: 10%;"></td> <td style="width: 10%;"></td> <td style="width: 10%;"></td> </tr> <tr> <td></td> <td></td> <td colspan="8" style="text-align: center;"> <table border="1" style="width: 100%; border-collapse: collapse; text-align: center;"> <tr> <td style="width: 10%;"></td> <td style="width: 10%;"></td> <td style="width: 10%;"></td> <td style="width: 10%;"></td> <td style="width: 10%;"></td> <td style="width: 10%;"></td> <td style="width: 10%;"></td> <td style="width: 10%;"></td> <td style="width: 10%;"></td> <td style="width: 10%;"></td> </tr> <tr> <td></td> <td></td> <td colspan="8" style="text-align: center;"> <table border="1" style="width: 100%; border-collapse: collapse; text-align: center;"> <tr> <td style="width: 10%;"></td> <td style="width: 10%;"></td> <td style="width: 10%;"></td> <td style="width: 10%;"></td> <td style="width: 10%;"></td> <td style="width: 10%;"></td> <td style="width: 10%;"></td> <td style="width: 10%;"></td> <td style="width: 10%;"></td> <td style="width: 10%;"></td> </tr> <tr> <td></td> <td></td> <td colspan="8" style="text-align: center;"> <table border="1" style="width: 100%; border-collapse: collapse; text-align: center;"> <tr> <td style="width: 10%;"></td> <td style="width: 10%;"></td> <td style="width: 10%;"></td> <td style="width: 10%;"></td> <td style="width: 10%;"></td> <td style="width: 10%;"></td> <td style="width: 10%;"></td> <td style="width: 10%;"></td> <td style="width: 10%;"></td> <td style="width: 10%;"></td> </tr> <tr> <td></td> <td></td> <td colspan="8" style="text-align: center;"> <table border="1" style="width: 100%; border-collapse: collapse; text-align: center;"> <tr> <td style="width: 10%;"></td> <td style="width: 10%;"></td> <td style="width: 10%;"></td> <td style="width: 10%;"></td> <td style="width: 10%;"></td> <td style="width: 10%;"></td> <td style="width: 10%;"></td> <td style="width: 10%;"></td> <td style="width: 10%;"></td> <td style="width: 10%;"></td> </tr> <tr> <td></td> <td></td> <td colspan="8" style="text-align: center;"> <table border="1" style="width: 100%; border-collapse: collapse; text-align: center;"> <tr> <td style="width: 10%;"></td> <td style="width: 10%;"></td> <td style="width: 10%;"></td> <td style="width: 10%;"></td> <td style="width: 10%;"></td> <td style="width: 10%;"></td> <td style="width: 10%;"></td> <td style="width: 10%;"></td> <td style="width: 10%;"></td> <td style="width: 10%;"></td> </tr> <tr> <td></td> <td></td> <td colspan="8" style="text-align: center;"> <table border="1" style="width: 100%; border-collapse: collapse; text-align: center;"> <tr> <td style="width: 10%;"></td> <td style="width: 10%;"></td> <td style="width: 10%;"></td> <td style="width: 10%;"></td> <td style="width: 10%;"></td> <td style="width: 10%;"></td> <td style="width: 10%;"></td> <td style="width: 10%;"></td> <td style="width: 10%;"></td> <td style="width: 10%;"></td> </tr> <tr> <td></td> <td></td> <td colspan="8" style="text-align: center;"> <table border="1" style="width: 100%; border-collapse: collapse; text-align: center;"> <tr> <td style="width: 10%;"></td> <td style="width: 10%;"></td> <td style="width: 10%;"></td> <td style="width: 10%;"></td> <td style="width: 10%;"></td> <td style="width: 10%;"></td> <td style="width: 10%;"></td> <td style="width: 10%;"></td> <td style="width: 10%;"></td> <td style="width: 10%;"></td> </tr> <tr> <td></td> <td></td> <td colspan="8" style="text-align: center;"> <table border="1" style="width: 100%; border-collapse: collapse; text-align: center;"> <tr> </tr></table></td></tr></table></td></tr></table></td></tr></table></td></tr></table></td></tr></table></td></tr></table></td></tr></table></td></tr></table></td></tr></table></td></tr></table></td></tr></table></td></tr></table></td></tr></table></td></tr></table></td></tr></table></td></tr></table></td></tr></table></td></tr></table></td></tr></table></td></tr></table></td></tr></table></td></tr></table></td></tr></table></td></tr></table></td></tr></table></td></tr></table></td></tr></table></td></tr></table></td></tr></table>
 | | | | | | | | | | | | | | | | | | | | <table border="1" style="width: 100%; border-collapse: collapse; text-align: center;"> <tr> <td style="width: 10%;"></td> <td style="width: 10%;"></td> <td style="width: 10%;"></td> <td style="width: 10%;"></td> <td style="width: 10%;"></td> <td style="width: 10%;"></td> <td style="width: 10%;"></td> <td style="width: 10%;"></td> <td style="width: 10%;"></td> <td style="width: 10%;"></td> </tr> <tr> <td></td> <td></td> <td colspan="8" style="text-align: center;"> <table border="1" style="width: 100%; border-collapse: collapse; text-align: center;"> <tr> <td style="width: 10%;"></td> <td style="width: 10%;"></td> <td style="width: 10%;"></td> <td style="width: 10%;"></td> <td style="width: 10%;"></td> <td style="width: 10%;"></td> <td style="width: 10%;"></td> <td style="width: 10%;"></td> <td style="width: 10%;"></td> <td style="width: 10%;"></td> </tr> <tr> <td></td> <td></td> <td colspan="8" style="text-align: center;"> <table border="1" style="width: 100%; border-collapse: collapse; text-align: center;"> <tr> <td style="width: 10%;"></td> <td style="width: 10%;"></td> <td style="width: 10%;"></td> <td style="width: 10%;"></td> <td style="width: 10%;"></td> <td style="width: 10%;"></td> <td style="width: 10%;"></td> <td style="width: 10%;"></td> <td style="width: 10%;"></td>
<td style="width: 10%;"></td> </tr> <tr> <td></td> <td></td> <td colspan="8" style="text-align: center;"> <table border="1" style="width: 100%; border-collapse: collapse; text-align: center;"> <tr> <td style="width: 10%;"></td> <td style="width: 10%;"></td> <td style="width: 10%;"></td> <td style="width: 10%;"></td> <td style="width: 10%;"></td> <td style="width: 10%;"></td> <td style="width: 10%;"></td> <td style="width: 10%;"></td> <td style="width: 10%;"></td> <td style="width: 10%;"></td> </tr> <tr> <td></td> <td></td> <td colspan="8" style="text-align: center;"> <table border="1" style="width: 100%; border-collapse: collapse; text-align: center;"> <tr> <td style="width: 10%;"></td> <td style="width: 10%;"></td> <td style="width: 10%;"></td> <td style="width: 10%;"></td> <td style="width: 10%;"></td> <td style="width: 10%;"></td> <td style="width: 10%;"></td> <td style="width: 10%;"></td> <td style="width: 10%;"></td> <td style="width: 10%;"></td> </tr> <tr> <td></td> <td></td> <td colspan="8" style="text-align: center;"> <table border="1" style="width: 100%; border-collapse: collapse; text-align: center;"> <tr> <td style="width: 10%;"></td> <td style="width: 10%;"></td> <td style="width: 10%;"></td> <td style="width: 10%;"></td> <td style="width: 10%;"></td> <td style="width: 10%;"></td> <td style="width: 10%;"></td> <td style="width: 10%;"></td> <td style="width: 10%;"></td> <td style="width: 10%;"></td> </tr> <tr> <td></td> <td></td> <td colspan="8" style="text-align: center;"> <table border="1" style="width: 100%; border-collapse: collapse; text-align: center;"> <tr> <td style="width: 10%;"></td> <td style="width: 10%;"></td> <td style="width: 10%;"></td> <td style="width: 10%;"></td> <td style="width: 10%;"></td> <td style="width: 10%;"></td> <td style="width: 10%;"></td> <td style="width: 10%;"></td> <td style="width: 10%;"></td> <td style="width: 10%;"></td> </tr> <tr> <td></td> <td></td> <td colspan="8" style="text-align: center;"> <table border="1" style="width: 100%; border-collapse: collapse; text-align: center;"> <tr> <td style="width: 10%;"></td> <td style="width: 10%;"></td> <td style="width: 10%;"></td> <td style="width: 10%;"></td> <td style="width: 10%;"></td> <td style="width: 10%;"></td> <td style="width: 10%;"></td> <td style="width: 10%;"></td> <td style="width: 10%;"></td> <td style="width: 10%;"></td> </tr> <tr> <td></td> <td></td> <td colspan="8" style="text-align: center;"> <table border="1" style="width: 100%; border-collapse: collapse; text-align: center;"> <tr> <td style="width: 10%;"></td> <td style="width: 10%;"></td> <td style="width: 10%;"></td> <td style="width: 10%;"></td> <td style="width: 10%;"></td> <td style="width: 10%;"></td> <td style="width: 10%;"></td> <td style="width: 10%;"></td> <td style="width: 10%;"></td> <td style="width: 10%;"></td> </tr> <tr> <td></td> <td></td> <td colspan="8" style="text-align: center;"> <table border="1" style="width: 100%; border-collapse: collapse; text-align: center;"> <tr> <td style="width: 10%;"></td> <td style="width: 10%;"></td> <td style="width: 10%;"></td> <td style="width: 10%;"></td> <td style="width: 10%;"></td> <td style="width: 10%;"></td> <td style="width: 10%;"></td> <td style="width: 10%;"></td> <td style="width: 10%;"></td> <td style="width: 10%;"></td> </tr> <tr> <td></td> <td></td> <td colspan="8" style="text-align: center;"> <table border="1" style="width: 100%; border-collapse: collapse; text-align: center;"> <tr> <td style="width: 10%;"></td> <td style="width: 10%;"></td> <td style="width: 10%;"></td> <td style="width: 10%;"></td> <td style="width: 10%;"></td> <td style="width: 10%;"></td> <td style="width: 10%;"></td> <td style="width: 10%;"></td> <td style="width: 10%;"></td> <td style="width: 10%;"></td> </tr> <tr> <td></td> <td></td> <td colspan="8" style="text-align: center;"> <table border="1" style="width: 100%; border-collapse: collapse; text-align: center;"> <tr> <td style="width: 10%;"></td> <td style="width: 10%;"></td> <td style="width: 10%;"></td> <td style="width: 10%;"></td> <td style="width: 10%;"></td> <td style="width: 10%;"></td> <td style="width: 10%;"></td> <td style="width: 10%;"></td> <td style="width: 10%;"></td> <td style="width: 10%;"></td> </tr> <tr> <td></td> <td></td> <td colspan="8" style="text-align: center;"> <table border="1" style="width: 100%; border-collapse: collapse; text-align: center;"> <tr> <td style="width: 10%;"></td> <td style="width: 10%;"></td> <td style="width: 10%;"></td> <td style="width: 10%;"></td> <td style="width: 10%;"></td> <td style="width: 10%;"></td> <td style="width: 10%;"></td> <td style="width: 10%;"></td> <td style="width: 10%;"></td> <td style="width: 10%;"></td> </tr> <tr> <td></td> <td></td> <td colspan="8" style="text-align: center;"> <table border="1" style="width: 100%; border-collapse: collapse; text-align: center;"> <tr> <td style="width: 10%;"></td> <td style="width: 10%;"></td> <td style="width: 10%;"></td> <td style="width: 10%;"></td> <td style="width: 10%;"></td> <td style="width: 10%;"></td> <td style="width: 10%;"></td> <td style="width: 10%;"></td> <td style="width: 10%;"></td> <td style="width: 10%;"></td> </tr> <tr> <td></td> <td></td> <td colspan="8" style="text-align: center;"> <table border="1" style="width: 100%; border-collapse: collapse; text-align: center;"> <tr> <td style="width: 10%;"></td> <td style="width: 10%;"></td> <td style="width: 10%;"></td> <td style="width: 10%;"></td> <td style="width: 10%;"></td> <td style="width: 10%;"></td> <td style="width: 10%;"></td> <td style="width: 10%;"></td> <td style="width: 10%;"></td> <td style="width: 10%;"></td> </tr> <tr> <td></td> <td></td> <td colspan="8" style="text-align: center;"> <table border="1" style="width: 100%; border-collapse: collapse; text-align: center;"> <tr> <td style="width: 10%;"></td> <td style="width: 10%;"></td> <td style="width: 10%;"></td> <td style="width: 10%;"></td> <td style="width: 10%;"></td> <td style="width: 10%;"></td> <td style="width: 10%;"></td> <td style="width: 10%;"></td> <td style="width: 10%;"></td> <td style="width: 10%;"></td> </tr> <tr> <td></td> <td></td> <td colspan="8" style="text-align: center;"> <table border="1" style="width: 100%; border-collapse: collapse; text-align: center;"> <tr> <td style="width: 10%;"></td> <td style="width: 10%;"></td> <td style="width: 10%;"></td> <td style="width: 10%;"></td> <td style="width: 10%;"></td> <td style="width: 10%;"></td> <td style="width: 10%;"></td> <td style="width: 10%;"></td> <td style="width: 10%;"></td> <td style="width: 10%;"></td> </tr> <tr> <td></td> <td></td> <td colspan="8" style="text-align: center;"> <table border="1" style="width: 100%; border-collapse: collapse; text-align: center;"> <tr> <td style="width: 10%;"></td> <td style="width: 10%;"></td> <td style="width: 10%;"></td> <td style="width: 10%;"></td> <td style="width: 10%;"></td> <td style="width: 10%;"></td> <td style="width: 10%;"></td> <td style="width: 10%;"></td> <td style="width: 10%;"></td> <td style="width: 10%;"></td> </tr> <tr> <td></td> <td></td> <td colspan="8" style="text-align: center;"> <table border="1" style="width: 100%; border-collapse: collapse; text-align: center;"> <tr> <td style="width: 10%;"></td> <td style="width: 10%;"></td> <td style="width: 10%;"></td> <td style="width: 10%;"></td> <td style="width: 10%;"></td> <td style="width: 10%;"></td> <td style="width: 10%;"></td> <td style="width: 10%;"></td> <td style="width: 10%;"></td> <td style="width: 10%;"></td> </tr> <tr> <td></td> <td></td> <td colspan="8" style="text-align: center;"> <table border="1" style="width: 100%; border-collapse: collapse; text-align: center;"> <tr> <td style="width: 10%;"></td> <td style="width: 10%;"></td> <td style="width: 10%;"></td> <td style="width: 10%;"></td> <td style="width: 10%;"></td> <td style="width: 10%;"></td> <td style="width: 10%;"></td> <td style="width: 10%;"></td> <td style="width: 10%;"></td> <td style="width: 10%;"></td> </tr> <tr> <td></td> <td></td> <td colspan="8" style="text-align: center;"> <table border="1" style="width: 100%; border-collapse: collapse; text-align: center;"> <tr> <td style="width: 10%;"></td> <td style="width: 10%;"></td> <td style="width: 10%;"></td> <td style="width: 10%;"></td> <td style="width: 10%;"></td> <td style="width: 10%;"></td> <td style="width: 10%;"></td> <td style="width: 10%;"></td> <td style="width: 10%;"></td> <td style="width: 10%;"></td> </tr> <tr> <td></td> <td></td> <td colspan="8" style="text-align: center;"> <table border="1" style="width: 100%; border-collapse: collapse; text-align: center;"> <tr> <td style="width: 10%;"></td> <td style="width: 10%;"></td> <td style="width: 10%;"></td> <td style="width: 10%;"></td> <td style="width: 10%;"></td> <td style="width: 10%;"></td> <td style="width: 10%;"></td> <td style="width: 10%;"></td> <td style="width: 10%;"></td> <td style="width: 10%;"></td> </tr> <tr> <td></td> <td></td> <td colspan="8" style="text-align: center;"> <table border="1" style="width: 100%; border-collapse: collapse; text-align: center;"> <tr> <td style="width: 10%;"></td> <td style="width: 10%;"></td> <td style="width: 10%;"></td> <td style="width: 10%;"></td> <td style="width: 10%;"></td> <td style="width: 10%;"></td> <td style="width: 10%;"></td> <td style="width: 10%;"></td> <td style="width: 10%;"></td> <td style="width: 10%;"></td> </tr> <tr> <td></td> <td></td> <td colspan="8" style="text-align: center;"> <table border="1" style="width: 100%; border-collapse: collapse; text-align: center;"> <tr> <td style="width: 10%;"></td> <td style="width: 10%;"></td> <td style="width: 10%;"></td> <td style="width: 10%;"></td> <td style="width: 10%;"></td> <td style="width: 10%;"></td> <td style="width: 10%;"></td> <td style="width: 10%;"></td> <td style="width: 10%;"></td> <td style="width: 10%;"></td> </tr> <tr> <td></td> <td></td> <td colspan="8" style="text-align: center;"> <table border="1" style="width: 100%; border-collapse: collapse;
text-align: center;"> <tr> <td style="width: 10%;"></td> <td style="width: 10%;"></td> <td style="width: 10%;"></td> <td style="width: 10%;"></td> <td style="width: 10%;"></td> <td style="width: 10%;"></td> <td style="width: 10%;"></td> <td style="width: 10%;"></td> <td style="width: 10%;"></td> <td style="width: 10%;"></td> </tr> <tr> <td></td> <td></td> <td colspan="8" style="text-align: center;"> <table border="1" style="width: 100%; border-collapse: collapse; text-align: center;"> <tr> <td style="width: 10%;"></td> <td style="width: 10%;"></td> <td style="width: 10%;"></td> <td style="width: 10%;"></td> <td style="width: 10%;"></td> <td style="width: 10%;"></td> <td style="width: 10%;"></td> <td style="width: 10%;"></td> <td style="width: 10%;"></td> <td style="width: 10%;"></td> </tr> <tr> <td></td> <td></td> <td colspan="8" style="text-align: center;"> <table border="1" style="width: 100%; border-collapse: collapse; text-align: center;"> <tr> <td style="width: 10%;"></td> <td style="width: 10%;"></td> <td style="width: 10%;"></td> <td style="width: 10%;"></td> <td style="width: 10%;"></td> <td style="width: 10%;"></td> <td style="width: 10%;"></td> <td style="width: 10%;"></td> <td style="width: 10%;"></td> <td style="width: 10%;"></td> </tr> <tr> <td></td> <td></td> <td colspan="8" style="text-align: center;"> <table border="1" style="width: 100%; border-collapse: collapse; text-align: center;"> <tr> <td style="width: 10%;"></td> <td style="width: 10%;"></td> <td style="width: 10%;"></td> <td style="width: 10%;"></td> <td style="width: 10%;"></td> <td style="width: 10%;"></td> <td style="width: 10%;"></td> <td style="width: 10%;"></td> <td style="width: 10%;"></td> <td style="width: 10%;"></td> </tr> <tr> <td></td> <td></td> <td colspan="8" style="text-align: center;"> <table border="1" style="width: 100%; border-collapse: collapse; text-align: center;"> <tr> </tr></table></td></tr></table></td></tr></table></td></tr></table></td></tr></table></td></tr></table></td></tr></table></td></tr></table></td></tr></table></td></tr></table></td></tr></table></td></tr></table></td></tr></table></td></tr></table></td></tr></table></td></tr></table></td></tr></table></td></tr></table></td></tr></table></td></tr></table></td></tr></table></td></tr></table></td></tr></table></td></tr></table></td></tr></table></td></tr></table></td></tr></table></td></tr></table></td></tr></table>
 | | | | | | | | | | | | | | | | | | | | <table border="1" style="width: 100%; border-collapse: collapse; text-align: center;"> <tr> <td style="width: 10%;"></td> <td style="width: 10%;"></td> <td style="width: 10%;"></td> <td style="width: 10%;"></td> <td style="width: 10%;"></td> <td style="width: 10%;"></td> <td style="width: 10%;"></td> <td style="width: 10%;"></td> <td style="width: 10%;"></td> <td style="width: 10%;"></td> </tr> <tr> <td></td> <td></td> <td colspan="8" style="text-align: center;"> <table border="1" style="width: 100%; border-collapse: collapse; text-align: center;"> <tr> <td style="width: 10%;"></td> <td style="width: 10%;"></td> <td style="width: 10%;"></td> <td style="width: 10%;"></td> <td style="width: 10%;"></td> <td style="width: 10%;"></td> <td style="width: 10%;"></td> <td style="width: 10%;"></td> <td style="width: 10%;"></td> <td style="width: 10%;"></td> </tr> <tr> <td></td> <td></td> <td colspan="8" style="text-align: center;"> <table border="1" style="width: 100%; border-collapse: collapse; text-align: center;"> <tr> <td style="width: 10%;"></td> <td style="width: 10%;"></td> <td style="width: 10%;"></td> <td style="width: 10%;"></td> <td style="width: 10%;"></td> <td style="width: 10%;"></td> <td style="width: 10%;"></td> <td style="width: 10%;"></td> <td style="width: 10%;"></td> <td style="width: 10%;"></td> </tr> <tr> <td></td> <td></td> <td colspan="8" style="text-align: center;"> <table border="1" style="width: 100%; border-collapse: collapse; text-align: center;"> <tr> <td style="width: 10%;"></td> <td style="width: 10%;"></td> <td style="width: 10%;"></td> <td style="width: 10%;"></td> <td style="width: 10%;"></td> <td style="width: 10%;"></td> <td style="width: 10%;"></td> <td style="width: 10%;"></td> <td style="width: 10%;"></td> <td style="width: 10%;"></td> </tr> <tr> <td></td> <td></td> <td colspan="8" style="text-align: center;"> <table border="1" style="width: 100%; border-collapse: collapse; text-align: center;"> <tr> <td style="width: 10%;"></td> <td style="width: 10%;"></td> <td style="width: 10%;"></td> <td style="width: 10%;"></td> <td style="width: 10%;"></td> <td style="width: 10%;"></td> <td style="width: 10%;"></td> <td style="width: 10%;"></td> <td style="width: 10%;"></td> <td style="width: 10%;"></td> </tr> <tr> <td></td> <td></td> <td colspan="8" style="text-align: center;"> <table border="1" style="width: 100%; border-collapse: collapse; text-align: center;"> <tr> <td style="width: 10%;"></td> <td style="width: 10%;"></td> <td style="width: 10%;"></td> <td style="width: 10%;"></td> <td style="width: 10%;"></td> <td style="width: 10%;"></td> <td style="width: 10%;"></td> <td style="width: 10%;"></td> <td style="width: 10%;"></td> <td style="width: 10%;"></td> </tr> <tr> <td></td> <td></td> <td colspan="8" style="text-align: center;"> <table border="1" style="width: 100%; border-collapse: collapse; text-align: center;"> <tr> <td style="width: 10%;"></td> <td style="width: 10%;"></td> <td style="width: 10%;"></td> <td style="width: 10%;"></td> <td style="width: 10%;"></td> <td style="width: 10%;"></td> <td style="width: 10%;"></td> <td style="width: 10%;"></td> <td style="width: 10%;"></td> <td style="width: 10%;"></td> </tr> <tr> <td></td> <td></td> <td colspan="8" style="text-align: center;"> <table border="1" style="width: 100%; border-collapse: collapse; text-align: center;"> <tr> <td style="width: 10%;"></td> <td style="width: 10%;"></td> <td style="width: 10%;"></td> <td style="width: 10%;"></td> <td style="width: 10%;"></td> <td style="width: 10%;"></td> <td style="width: 10%;"></td> <td style="width: 10%;"></td> <td style="width: 10%;"></td> <td style="width: 10%;"></td> </tr> <tr> <td></td> <td></td> <td colspan="8" style="text-align: center;"> <table border="1" style="width: 100%; border-collapse: collapse; text-align: center;"> <tr> <td style="width: 10%;"></td> <td style="width: 10%;"></td> <td style="width: 10%;"></td> <td style="width: 10%;"></td> <td style="width: 10%;"></td> <td style="width: 10%;"></td> <td style="width: 10%;"></td> <td style="width: 10%;"></td> <td style="width: 10%;"></td> <td style="width: 10%;"></td> </tr> <tr> <td></td> <td></td> <td colspan="8" style="text-align: center;"> <table border="1" style="width: 100%; border-collapse: collapse; text-align: center;"> <tr> <td style="width: 10%;"></td> <td style="width: 10%;"></td> <td style="width: 10%;"></td> <td style="width: 10%;"></td> <td style="width: 10%;"></td> <td style="width: 10%;"></td> <td style="width: 10%;"></td> <td style="width: 10%;"></td> <td style="width: 10%;"></td> <td style="width: 10%;"></td> </tr> <tr> <td></td> <td></td> <td colspan="8" style="text-align: center;"> <table border="1" style="width: 100%; border-collapse: collapse; text-align: center;"> <tr> <td style="width: 10%;"></td> <td style="width: 10%;"></td> <td style="width: 10%;"></td> <td style="width: 10%;"></td> <td style="width: 10%;"></td> <td style="width: 10%;"></td> <td style="width: 10%;"></td> <td style="width: 10%;"></td> <td style="width: 10%;"></td> <td style="width: 10%;"></td> </tr> <tr> <td></td> <td></td> <td colspan="8" style="text-align: center;"> <table border="1" style="width: 100%; border-collapse: collapse; text-align: center;"> <tr> <td style="width: 10%;"></td> <td style="width: 10%;"></td> <td style="width: 10%;"></td> <td style="width: 10%;"></td> <td style="width: 10%;"></td> <td style="width: 10%;"></td> <td style="width: 10%;"></td> <td style="width: 10%;"></td> <td style="width: 10%;"></td> <td style="width: 10%;"></td> </tr> <tr> <td></td> <td></td> <td colspan="8" style="text-align: center;"> <table border="1" style="width: 100%; border-collapse: collapse; text-align: center;"> <tr> <td style="width: 10%;"></td> <td style="width: 10%;"></td> <td style="width: 10%;"></td> <td style="width: 10%;"></td> <td style="width: 10%;"></td> <td style="width: 10%;"></td> <td style="width: 10%;"></td> <td style="width: 10%;"></td> <td style="width: 10%;"></td> <td style="width: 10%;"></td> </tr> <tr> <td></td> <td></td> <td colspan="8" style="text-align: center;"> <table border="1" style="width: 100%; border-collapse: collapse; text-align: center;"> <tr> <td style="width: 10%;"></td> <td style="width: 10%;"></td> <td style="width: 10%;"></td> <td style="width: 10%;"></td> <td style="width: 10%;"></td> <td style="width: 10%;"></td> <td style="width: 10%;"></td> <td style="width: 10%;"></td> <td style="width: 10%;"></td> <td style="width: 10%;"></td> </tr> <tr> <td></td> <td></td> <td colspan="8" style="text-align: center;"> <table border="1" style="width: 100%; border-collapse: collapse; text-align: center;"> <tr> <td style="width: 10%;"></td> <td style="width: 10%;"></td> <td style="width: 10%;"></td> <td style="width: 10%;"></td> <td style="width: 10%;"></td> <td style="width: 10%;"></td> <td style="width: 10%;"></td> <td style="width: 10%;"></td> <td style="width: 10%;"></td> <td style="width: 10%;"></td> </tr> <tr> <td></td> <td></td> <td colspan="8" style="text-align: center;"> <table border="1" style="width: 100%; border-collapse: collapse; text-align: center;"> <tr> <td style="width: 10%;"></td> <td style="width: 10%;"></td> <td style="width: 10%;"></td> <td style="width: 10%;"></td> <td style="width: 10%;"></td> <td style="width: 10%;"></td> <td style="width: 10%;"></td> <td style="width: 10%;"></td> <td style="width: 10%;"></td> <td style="width: 10%;"></td> </tr> <tr> <td></td> <td></td> <td colspan="8" style="text-align: center;"> <table border="1" style="width: 100%; border-collapse: collapse; text-align: center;"> <tr> <td style="width: 10%;"></td> <td style="width: 10%;"></td> <td style="width: 10%;"></td> <td style="width: 10%;"></td> <td style="width: 10%;"></td> <td style="width: 10%;"></td> <td style="width: 10%;"></td> <td style="width: 10%;"></td> <td style="width: 10%;"></td> <td style="width: 10%;"></td> </tr> <tr> <td></td> <td></td> <td colspan="8" style="text-align: center;"> <table border="1" style="width: 100%; border-collapse: collapse; text-align: center;"> <tr> <td style="width: 10%;"></td> <td style="width: 10%;"></td> <td style="width: 10%;"></td> <td style="width: 10%;"></td> <td style="width: 10%;"></td> <td style="width: 10%;"></td> <td style="width: 10%;"></td> <td style="width: 10%;"></td> <td style="width: 10%;"></td> <td style="width: 10%;"></td> </tr> <tr> <td></td> <td></td> <td colspan="8" style="text-align: center;"> <table border="1" style="width: 100%; border-collapse: collapse; text-align: center;"> <tr> <td style="width: 10%;"></td> <td style="width: 10%;"></td> <td style="width: 10%;"></td> <td style="width: 10%;"></td> <td style="width: 10%;"></td> <td style="width: 10%;"></td> <td style="width: 10%;"></td> <td style="width: 10%;"></td> <td style="width:
10%;"></td> <td style="width: 10%;"></td> </tr> <tr> <td></td> <td></td> <td colspan="8" style="text-align: center;"> <table border="1" style="width: 100%; border-collapse: collapse; text-align: center;"> <tr> <td style="width: 10%;"></td> <td style="width: 10%;"></td> <td style="width: 10%;"></td> <td style="width: 10%;"></td> <td style="width: 10%;"></td> <td style="width: 10%;"></td> <td style="width: 10%;"></td> <td style="width: 10%;"></td> <td style="width: 10%;"></td> <td style="width: 10%;"></td> </tr> <tr> <td></td> <td></td> <td colspan="8" style="text-align: center;"> <table border="1" style="width: 100%; border-collapse: collapse; text-align: center;"> <tr> <td style="width: 10%;"></td> <td style="width: 10%;"></td> <td style="width: 10%;"></td> <td style="width: 10%;"></td> <td style="width: 10%;"></td> <td style="width: 10%;"></td> <td style="width: 10%;"></td> <td style="width: 10%;"></td> <td style="width: 10%;"></td> <td style="width: 10%;"></td> </tr> <tr> <td></td> <td></td> <td colspan="8" style="text-align: center;"> <table border="1" style="width: 100%; border-collapse: collapse; text-align: center;"> <tr> <td style="width: 10%;"></td> <td style="width: 10%;"></td> <td style="width: 10%;"></td> <td style="width: 10%;"></td> <td style="width: 10%;"></td> <td style="width: 10%;"></td> <td style="width: 10%;"></td> <td style="width: 10%;"></td> <td style="width: 10%;"></td> <td style="width: 10%;"></td> </tr> <tr> <td></td> <td></td> <td colspan="8" style="text-align: center;"> <table border="1" style="width: 100%; border-collapse: collapse; text-align: center;"> <tr> <td style="width: 10%;"></td> <td style="width: 10%;"></td> <td style="width: 10%;"></td> <td style="width: 10%;"></td> <td style="width: 10%;"></td> <td style="width: 10%;"></td> <td style="width: 10%;"></td> <td style="width: 10%;"></td> <td style="width: 10%;"></td> <td style="width: 10%;"></td> </tr> <tr> <td></td> <td></td> <td colspan="8" style="text-align: center;"> <table border="1" style="width: 100%; border-collapse: collapse; text-align: center;"> <tr> <td style="width: 10%;"></td> <td style="width: 10%;"></td> <td style="width: 10%;"></td> <td style="width: 10%;"></td> <td style="width: 10%;"></td> <td style="width: 10%;"></td> <td style="width: 10%;"></td> <td style="width: 10%;"></td> <td style="width: 10%;"></td> <td style="width: 10%;"></td> </tr> <tr> <td></td> <td></td> <td colspan="8" style="text-align: center;"> <table border="1" style="width: 100%; border-collapse: collapse; text-align: center;"> <tr> <td style="width: 10%;"></td> <td style="width: 10%;"></td> <td style="width: 10%;"></td> <td style="width: 10%;"></td> <td style="width: 10%;"></td> <td style="width: 10%;"></td> <td style="width: 10%;"></td> <td style="width: 10%;"></td> <td style="width: 10%;"></td> <td style="width: 10%;"></td> </tr> <tr> <td></td> <td></td> <td colspan="8" style="text-align: center;"> <table border="1" style="width: 100%; border-collapse: collapse; text-align: center;"> <tr> <td style="width: 10%;"></td> <td style="width: 10%;"></td> <td style="width: 10%;"></td> <td style="width: 10%;"></td> <td style="width: 10%;"></td> <td style="width: 10%;"></td> <td style="width: 10%;"></td> <td style="width: 10%;"></td> <td style="width: 10%;"></td> <td style="width: 10%;"></td> </tr> <tr> <td></td> <td></td> <td colspan="8" style="text-align: center;"> <table border="1" style="width: 100%; border-collapse: collapse; text-align: center;"> <tr> <td style="width: 10%;"></td> <td style="width: 10%;"></td> <td style="width: 10%;"></td> <td style="width: 10%;"></td> <td style="width: 10%;"></td> <td style="width: 10%;"></td> <td style="width: 10%;"></td> <td style="width: 10%;"></td> <td style="width: 10%;"></td> <td style="width: 10%;"></td> </tr> <tr> <td></td> <td></td> <td colspan="8" style="text-align: center;"> <table border="1" style="width: 100%; border-collapse: collapse; text-align: center;"> <tr> </tr></table></td></tr></table></td></tr></table></td></tr></table></td></tr></table></td></tr></table></td></tr></table></td></tr></table></td></tr></table></td></tr></table></td></tr></table></td></tr></table></td></tr></table></td></tr></table></td></tr></table></td></tr></table></td></tr></table></td></tr></table></td></tr></table></td></tr></table></td></tr></table></td></tr></table></td></tr></table></td></tr></table></td></tr></table></td></tr></table></td></tr></table></td></tr></table>
 | | | | | | | | | | | | | | | | | | | | <table border="1" style="width: 100%; border-collapse: collapse; text-align: center;"> <tr> <td style="width: 10%;"></td> <td style="width: 10%;"></td> <td style="width: 10%;"></td> <td style="width: 10%;"></td> <td style="width: 10%;"></td> <td style="width: 10%;"></td> <td style="width: 10%;"></td> <td style="width: 10%;"></td> <td style="width: 10%;"></td> <td style="width: 10%;"></td> </tr> <tr> <td></td> <td></td> <td colspan="8" style="text-align: center;"> <table border="1" style="width: 100%; border-collapse: collapse; text-align: center;"> <tr> <td style="width: 10%;"></td> <td style="width: 10%;"></td> <td style="width: 10%;"></td> <td style="width: 10%;"></td> <td style="width: 10%;"></td> <td style="width: 10%;"></td> <td style="width: 10%;"></td> <td style="width: 10%;"></td> <td style="width: 10%;"></td> <td style="width: 10%;"></td> </tr> <tr> <td></td> <td></td> <td colspan="8" style="text-align: center;"> <table border="1" style="width: 100%; border-collapse: collapse; text-align: center;"> <tr> <td style="width: 10%;"></td> <td style="width: 10%;"></td> <td style="width: 10%;"></td> <td style="width: 10%;"></td> <td style="width: 10%;"></td> <td style="width: 10%;"></td> <td style="width: 10%;"></td> <td style="width: 10%;"></td> <td style="width: 10%;"></td> <td style="width: 10%;"></td> </tr> <tr> <td></td> <td></td> <td colspan="8" style="text-align: center;"> <table border="1" style="width: 100%; border-collapse: collapse; text-align: center;"> <tr> <td style="width: 10%;"></td> <td style="width: 10%;"></td> <td style="width: 10%;"></td> <td style="width: 10%;"></td> <td style="width: 10%;"></td> <td style="width: 10%;"></td> <td style="width: 10%;"></td> <td style="width: 10%;"></td> <td style="width: 10%;"></td> <td style="width: 10%;"></td> </tr> <tr> <td></td> <td></td> <td colspan="8" style="text-align: center;"> <table border="1" style="width: 100%; border-collapse: collapse; text-align: center;"> <tr> <td style="width: 10%;"></td> <td style="width: 10%;"></td> <td style="width: 10%;"></td> <td style="width: 10%;"></td> <td style="width: 10%;"></td> <td style="width: 10%;"></td> <td style="width: 10%;"></td> <td style="width: 10%;"></td> <td style="width: 10%;"></td> <td style="width: 10%;"></td> </tr> <tr> <td></td> <td></td> <td colspan="8" style="text-align: center;"> <table border="1" style="width: 100%; border-collapse: collapse; text-align: center;"> <tr> <td style="width: 10%;"></td> <td style="width: 10%;"></td> <td style="width: 10%;"></td> <td style="width: 10%;"></td> <td style="width: 10%;"></td> <td style="width: 10%;"></td> <td style="width: 10%;"></td> <td style="width: 10%;"></td> <td style="width: 10%;"></td> <td style="width: 10%;"></td> </tr> <tr> <td></td> <td></td> <td colspan="8" style="text-align: center;"> <table border="1" style="width: 100%; border-collapse: collapse; text-align: center;"> <tr> <td style="width: 10%;"></td> <td style="width: 10%;"></td> <td style="width: 10%;"></td> <td style="width: 10%;"></td> <td style="width: 10%;"></td> <td style="width: 10%;"></td> <td style="width: 10%;"></td> <td style="width: 10%;"></td> <td style="width: 10%;"></td> <td style="width: 10%;"></td> </tr> <tr> <td></td> <td></td> <td colspan="8" style="text-align: center;"> <table border="1" style="width: 100%; border-collapse: collapse; text-align: center;"> <tr> <td style="width: 10%;"></td> <td style="width: 10%;"></td> <td style="width: 10%;"></td> <td style="width: 10%;"></td> <td style="width: 10%;"></td> <td style="width: 10%;"></td> <td style="width: 10%;"></td> <td style="width: 10%;"></td> <td style="width: 10%;"></td> <td style="width: 10%;"></td> </tr> <tr> <td></td> <td></td> <td colspan="8" style="text-align: center;"> <table border="1" style="width: 100%; border-collapse: collapse; text-align: center;"> <tr> <td style="width: 10%;"></td> <td style="width: 10%;"></td> <td style="width: 10%;"></td> <td style="width: 10%;"></td> <td style="width: 10%;"></td> <td style="width: 10%;"></td> <td style="width: 10%;"></td> <td style="width: 10%;"></td> <td style="width: 10%;"></td> <td style="width: 10%;"></td> </tr> <tr> <td></td> <td></td> <td colspan="8" style="text-align: center;"> <table border="1" style="width: 100%; border-collapse: collapse; text-align: center;"> <tr> <td style="width: 10%;"></td> <td style="width: 10%;"></td> <td style="width: 10%;"></td> <td style="width: 10%;"></td> <td style="width: 10%;"></td> <td style="width: 10%;"></td> <td style="width: 10%;"></td> <td style="width: 10%;"></td> <td style="width: 10%;"></td> <td style="width: 10%;"></td> </tr> <tr> <td></td> <td></td> <td colspan="8" style="text-align: center;"> <table border="1" style="width: 100%; border-collapse: collapse; text-align: center;"> <tr> <td style="width: 10%;"></td> <td style="width: 10%;"></td> <td style="width: 10%;"></td> <td style="width: 10%;"></td> <td style="width: 10%;"></td> <td style="width: 10%;"></td> <td style="width: 10%;"></td> <td style="width: 10%;"></td> <td style="width: 10%;"></td> <td style="width: 10%;"></td> </tr> <tr> <td></td> <td></td> <td colspan="8" style="text-align: center;"> <table border="1" style="width: 100%; border-collapse: collapse; text-align: center;"> <tr> <td style="width: 10%;"></td> <td style="width: 10%;"></td> <td style="width: 10%;"></td> <td style="width: 10%;"></td> <td style="width: 10%;"></td> <td style="width: 10%;"></td> <td style="width: 10%;"></td> <td style="width: 10%;"></td> <td style="width: 10%;"></td> <td style="width: 10%;"></td> </tr> <tr> <td></td> <td></td> <td colspan="8" style="text-align: center;"> <table border="1" style="width: 100%; border-collapse: collapse; text-align: center;"> <tr> <td style="width: 10%;"></td> <td style="width: 10%;"></td> <td style="width: 10%;"></td> <td style="width: 10%;"></td> <td style="width: 10%;"></td> <td style="width: 10%;"></td> <td style="width: 10%;"></td> <td style="width: 10%;"></td> <td style="width: 10%;"></td> <td style="width: 10%;"></td> </tr> <tr> <td></td> <td></td> <td colspan="8" style="text-align: center;"> <table border="1" style="width: 100%; border-collapse: collapse; text-align: center;"> <tr> <td style="width: 10%;"></td> <td style="width: 10%;"></td> <td style="width: 10%;"></td> <td style="width: 10%;"></td> <td style="width: 10%;"></td> <td style="width: 10%;"></td> <td style="width: 10%;"></td> <td style="width: 10%;"></td> <td style="width: 10%;"></td> <td style="width: 10%;"></td> </tr> <tr> <td></td> <td></td> <td colspan="8" style="text-align: center;"> <table border="1" style="width: 100%; border-collapse: collapse; text-align: center;"> <tr> <td style="width: 10%;"></td> <td style="width: 10%;"></td> <td style="width: 10%;"></td> <td
style="width: 10%;"></td> <td style="width: 10%;"></td> <td style="width: 10%;"></td> <td style="width: 10%;"></td> <td style="width: 10%;"></td> <td style="width: 10%;"></td> <td style="width: 10%;"></td> </tr> <tr> <td></td> <td></td> <td colspan="8" style="text-align: center;"> <table border="1" style="width: 100%; border-collapse: collapse; text-align: center;"> <tr> <td style="width: 10%;"></td> <td style="width: 10%;"></td> <td style="width: 10%;"></td> <td style="width: 10%;"></td> <td style="width: 10%;"></td> <td style="width: 10%;"></td> <td style="width: 10%;"></td> <td style="width: 10%;"></td> <td style="width: 10%;"></td> <td style="width: 10%;"></td> </tr> <tr> <td></td> <td></td> <td colspan="8" style="text-align: center;"> <table border="1" style="width: 100%; border-collapse: collapse; text-align: center;"> <tr> <td style="width: 10%;"></td> <td style="width: 10%;"></td> <td style="width: 10%;"></td> <td style="width: 10%;"></td> <td style="width: 10%;"></td> <td style="width: 10%;"></td> <td style="width: 10%;"></td> <td style="width: 10%;"></td> <td style="width: 10%;"></td> <td style="width: 10%;"></td> </tr> <tr> <td></td> <td></td> <td colspan="8" style="text-align: center;"> <table border="1" style="width: 100%; border-collapse: collapse; text-align: center;"> <tr> <td style="width: 10%;"></td> <td style="width: 10%;"></td> <td style="width: 10%;"></td> <td style="width: 10%;"></td> <td style="width: 10%;"></td> <td style="width: 10%;"></td> <td style="width: 10%;"></td> <td style="width: 10%;"></td> <td style="width: 10%;"></td> <td style="width: 10%;"></td> </tr> <tr> <td></td> <td></td> <td colspan="8" style="text-align: center;"> <table border="1" style="width: 100%; border-collapse: collapse; text-align: center;"> <tr> <td style="width: 10%;"></td> <td style="width: 10%;"></td> <td style="width: 10%;"></td> <td style="width: 10%;"></td> <td style="width: 10%;"></td> <td style="width: 10%;"></td> <td style="width: 10%;"></td> <td style="width: 10%;"></td> <td style="width: 10%;"></td> <td style="width: 10%;"></td> </tr> <tr> <td></td> <td></td> <td colspan="8" style="text-align: center;"> <table border="1" style="width: 100%; border-collapse: collapse; text-align: center;"> <tr> <td style="width: 10%;"></td> <td style="width: 10%;"></td> <td style="width: 10%;"></td> <td style="width: 10%;"></td> <td style="width: 10%;"></td> <td style="width: 10%;"></td> <td style="width: 10%;"></td> <td style="width: 10%;"></td> <td style="width: 10%;"></td> <td style="width: 10%;"></td> </tr> <tr> <td></td> <td></td> <td colspan="8" style="text-align: center;"> <table border="1" style="width: 100%; border-collapse: collapse; text-align: center;"> <tr> <td style="width: 10%;"></td> <td style="width: 10%;"></td> <td style="width: 10%;"></td> <td style="width: 10%;"></td> <td style="width: 10%;"></td> <td style="width: 10%;"></td> <td style="width: 10%;"></td> <td style="width: 10%;"></td> <td style="width: 10%;"></td> <td style="width: 10%;"></td> </tr> <tr> <td></td> <td></td> <td colspan="8" style="text-align: center;"> <table border="1" style="width: 100%; border-collapse: collapse; text-align: center;"> <tr> <td style="width: 10%;"></td> <td style="width: 10%;"></td> <td style="width: 10%;"></td> <td style="width: 10%;"></td> <td style="width: 10%;"></td> <td style="width: 10%;"></td> <td style="width: 10%;"></td> <td style="width: 10%;"></td> <td style="width: 10%;"></td> <td style="width: 10%;"></td> </tr> <tr> <td></td> <td></td> <td colspan="8" style="text-align: center;"> <table border="1" style="width: 100%; border-collapse: collapse; text-align: center;"> <tr> <td style="width: 10%;"></td> <td style="width: 10%;"></td> <td style="width: 10%;"></td> <td style="width: 10%;"></td> <td style="width: 10%;"></td> <td style="width: 10%;"></td> <td style="width: 10%;"></td> <td style="width: 10%;"></td> <td style="width: 10%;"></td> <td style="width: 10%;"></td> </tr> <tr> <td></td> <td></td> <td colspan="8" style="text-align: center;"> <table border="1" style="width: 100%; border-collapse: collapse; text-align: center;"> <tr> <td style="width: 10%;"></td> <td style="width: 10%;"></td> <td style="width: 10%;"></td> <td style="width: 10%;"></td> <td style="width: 10%;"></td> <td style="width: 10%;"></td> <td style="width: 10%;"></td> <td style="width: 10%;"></td> <td style="width: 10%;"></td> <td style="width: 10%;"></td> </tr> <tr> <td></td> <td></td> <td colspan="8" style="text-align: center;"> <table border="1" style="width: 100%; border-collapse: collapse; text-align: center;"> <tr> <td style="width: 10%;"></td> <td style="width: 10%;"></td> <td style="width: 10%;"></td> <td style="width: 10%;"></td> <td style="width: 10%;"></td> <td style="width: 10%;"></td> <td style="width: 10%;"></td> <td style="width: 10%;"></td> <td style="width: 10%;"></td> <td style="width: 10%;"></td> </tr> <tr> <td></td> <td></td> <td colspan="8" style="text-align: center;"> <table border="1" style="width: 100%; border-collapse: collapse; text-align: center;"> <tr> <td style="width: 10%;"></td> <td style="width: 10%;"></td> <td style="width: 10%;"></td> <td style="width: 10%;"></td> <td style="width: 10%;"></td> <td style="width: 10%;"></td> <td style="width: 10%;"></td> <td style="width: 10%;"></td> <td style="width: 10%;"></td> <td style="width: 10%;"></td> </tr> <tr> <td></td> <td></td> <td colspan="8" style="text-align: center;"> <table border="1" style="width: 100%; border-collapse: collapse; text-align: center;"> <tr> </tr></table></td></tr></table></td></tr></table></td></tr></table></td></tr></table></td></tr></table></td></tr></table></td></tr></table></td></tr></table></td></tr></table></td></tr></table></td></tr></table></td></tr></table></td></tr></table></td></tr></table></td></tr></table></td></tr></table></td></tr></table></td></tr></table></td></tr></table></td></tr></table></td></tr></table></td></tr></table></td></tr></table></td></tr></table></td></tr></table></td></tr></table>
 | | | | | | | | | | | | | | | | | | | | <table border="1" style="width: 100%; border-collapse: collapse; text-align: center;"> <tr> <td style="width: 10%;"></td> <td style="width: 10%;"></td> <td style="width: 10%;"></td> <td style="width: 10%;"></td> <td style="width: 10%;"></td> <td style="width: 10%;"></td> <td style="width: 10%;"></td> <td style="width: 10%;"></td> <td style="width: 10%;"></td> <td style="width: 10%;"></td> </tr> <tr> <td></td> <td></td> <td colspan="8" style="text-align: center;"> <table border="1" style="width: 100%; border-collapse: collapse; text-align: center;"> <tr> <td style="width: 10%;"></td> <td style="width: 10%;"></td> <td style="width: 10%;"></td> <td style="width: 10%;"></td> <td style="width: 10%;"></td> <td style="width: 10%;"></td> <td style="width: 10%;"></td> <td style="width: 10%;"></td> <td style="width: 10%;"></td> <td style="width: 10%;"></td> </tr> <tr> <td></td> <td></td> <td colspan="8" style="text-align: center;"> <table border="1" style="width: 100%; border-collapse: collapse; text-align: center;"> <tr> <td style="width: 10%;"></td> <td style="width: 10%;"></td> <td style="width: 10%;"></td> <td style="width: 10%;"></td> <td style="width: 10%;"></td> <td style="width: 10%;"></td> <td style="width: 10%;"></td> <td style="width: 10%;"></td> <td style="width: 10%;"></td> <td style="width: 10%;"></td> </tr> <tr> <td></td> <td></td> <td colspan="8" style="text-align: center;"> <table border="1" style="width: 100%; border-collapse: collapse; text-align: center;"> <tr> <td style="width: 10%;"></td> <td style="width: 10%;"></td> <td style="width: 10%;"></td> <td style="width: 10%;"></td> <td style="width: 10%;"></td> <td style="width: 10%;"></td> <td style="width: 10%;"></td> <td style="width: 10%;"></td> <td style="width: 10%;"></td> <td style="width: 10%;"></td> </tr> <tr> <td></td> <td></td> <td colspan="8" style="text-align: center;"> <table border="1" style="width: 100%; border-collapse: collapse; text-align: center;"> <tr> <td style="width: 10%;"></td> <td style="width: 10%;"></td> <td style="width: 10%;"></td> <td style="width: 10%;"></td> <td style="width: 10%;"></td> <td style="width: 10%;"></td> <td style="width: 10%;"></td> <td style="width: 10%;"></td> <td style="width: 10%;"></td> <td style="width: 10%;"></td> </tr> <tr> <td></td> <td></td> <td colspan="8" style="text-align: center;"> <table border="1" style="width: 100%; border-collapse: collapse; text-align: center;"> <tr> <td style="width: 10%;"></td> <td style="width: 10%;"></td> <td style="width: 10%;"></td> <td style="width: 10%;"></td> <td style="width: 10%;"></td> <td style="width: 10%;"></td> <td style="width: 10%;"></td> <td style="width: 10%;"></td> <td style="width: 10%;"></td> <td style="width: 10%;"></td> </tr> <tr> <td></td> <td></td> <td colspan="8" style="text-align: center;"> <table border="1" style="width: 100%; border-collapse: collapse; text-align: center;"> <tr> <td style="width: 10%;"></td> <td style="width: 10%;"></td> <td style="width: 10%;"></td> <td style="width: 10%;"></td> <td style="width: 10%;"></td> <td style="width: 10%;"></td> <td style="width: 10%;"></td> <td style="width: 10%;"></td> <td style="width: 10%;"></td> <td style="width: 10%;"></td> </tr> <tr> <td></td> <td></td> <td colspan="8" style="text-align: center;"> <table border="1" style="width: 100%; border-collapse: collapse; text-align: center;"> <tr> <td style="width: 10%;"></td> <td style="width: 10%;"></td> <td style="width: 10%;"></td> <td style="width: 10%;"></td> <td style="width: 10%;"></td> <td style="width: 10%;"></td> <td style="width: 10%;"></td> <td style="width: 10%;"></td> <td style="width: 10%;"></td> <td style="width: 10%;"></td> </tr> <tr> <td></td> <td></td> <td colspan="8" style="text-align: center;"> <table border="1" style="width: 100%; border-collapse: collapse; text-align: center;"> <tr> <td style="width: 10%;"></td> <td style="width: 10%;"></td> <td style="width: 10%;"></td> <td style="width: 10%;"></td> <td style="width: 10%;"></td> <td style="width: 10%;"></td> <td style="width: 10%;"></td> <td style="width: 10%;"></td> <td style="width: 10%;"></td> <td style="width: 10%;"></td> </tr> <tr> <td></td> <td></td> <td colspan="8" style="text-align: center;"> <table border="1" style="width: 100%; border-collapse: collapse; text-align: center;"> <tr> <td style="width: 10%;"></td> <td style="width: 10%;"></td> <td style="width: 10%;"></td> <td style="width: 10%;"></td> <td style="width: 10%;"></td> <td style="width: 10%;"></td> <td style="width: 10%;"></td> <td style="width: 10%;"></td> <td style="width: 10%;"></td> <td style="width: 10%;"></td> </tr> <tr> <td></td> <td></td> <td colspan="8" style="text-align: center;"> <table border="1" style="width: 100%; border-collapse: collapse; text-align: center;"> <tr> <td style="width: 10%;"></td> <td style="width: 10%;"></td> <td style="width: 10%;"></td> <td style="width: 10%;"></td> <td style="width: 10%;"></td> <td style="width: 10%;"></td> <td style="width: 10%;"></td> <td style="width: 10%;"></td> <td style="width: 10%;"></td> <td style="width: 10%;"></td> </tr> <tr> <td></td> <td></td> <td colspan="8" style="text-align: center;"> <table border="1" style="width: 100%;
border-collapse: collapse; text-align: center;"> <tr> <td style="width: 10%;"></td> <td style="width: 10%;"></td> <td style="width: 10%;"></td> <td style="width: 10%;"></td> <td style="width: 10%;"></td> <td style="width: 10%;"></td> <td style="width: 10%;"></td> <td style="width: 10%;"></td> <td style="width: 10%;"></td> <td style="width: 10%;"></td> </tr> <tr> <td></td> <td></td> <td colspan="8" style="text-align: center;"> <table border="1" style="width: 100%; border-collapse: collapse; text-align: center;"> <tr> <td style="width: 10%;"></td> <td style="width: 10%;"></td> <td style="width: 10%;"></td> <td style="width: 10%;"></td> <td style="width: 10%;"></td> <td style="width: 10%;"></td> <td style="width: 10%;"></td> <td style="width: 10%;"></td> <td style="width: 10%;"></td> <td style="width: 10%;"></td> </tr> <tr> <td></td> <td></td> <td colspan="8" style="text-align: center;"> <table border="1" style="width: 100%; border-collapse: collapse; text-align: center;"> <tr> <td style="width: 10%;"></td> <td style="width: 10%;"></td> <td style="width: 10%;"></td> <td style="width: 10%;"></td> <td style="width: 10%;"></td> <td style="width: 10%;"></td> <td style="width: 10%;"></td> <td style="width: 10%;"></td> <td style="width: 10%;"></td> <td style="width: 10%;"></td> </tr> <tr> <td></td> <td></td> <td colspan="8" style="text-align: center;"> <table border="1" style="width: 100%; border-collapse: collapse; text-align: center;"> <tr> <td style="width: 10%;"></td> <td style="width: 10%;"></td> <td style="width: 10%;"></td> <td style="width: 10%;"></td> <td style="width: 10%;"></td> <td style="width: 10%;"></td> <td style="width: 10%;"></td> <td style="width: 10%;"></td> <td style="width: 10%;"></td> <td style="width: 10%;"></td> </tr> <tr> <td></td> <td></td> <td colspan="8" style="text-align: center;"> <table border="1" style="width: 100%; border-collapse: collapse; text-align: center;"> <tr> <td style="width: 10%;"></td> <td style="width: 10%;"></td> <td style="width: 10%;"></td> <td style="width: 10%;"></td> <td style="width: 10%;"></td> <td style="width: 10%;"></td> <td style="width: 10%;"></td> <td style="width: 10%;"></td> <td style="width: 10%;"></td> <td style="width: 10%;"></td> </tr> <tr> <td></td> <td></td> <td colspan="8" style="text-align: center;"> <table border="1" style="width: 100%; border-collapse: collapse; text-align: center;"> <tr> <td style="width: 10%;"></td> <td style="width: 10%;"></td> <td style="width: 10%;"></td> <td style="width: 10%;"></td> <td style="width: 10%;"></td> <td style="width: 10%;"></td> <td style="width: 10%;"></td> <td style="width: 10%;"></td> <td style="width: 10%;"></td> <td style="width: 10%;"></td> </tr> <tr> <td></td> <td></td> <td colspan="8" style="text-align: center;"> <table border="1" style="width: 100%; border-collapse: collapse; text-align: center;"> <tr> <td style="width: 10%;"></td> <td style="width: 10%;"></td> <td style="width: 10%;"></td> <td style="width: 10%;"></td> <td style="width: 10%;"></td> <td style="width: 10%;"></td> <td style="width: 10%;"></td> <td style="width: 10%;"></td> <td style="width: 10%;"></td> <td style="width: 10%;"></td> </tr> <tr> <td></td> <td></td> <td colspan="8" style="text-align: center;"> <table border="1" style="width: 100%; border-collapse: collapse; text-align: center;"> <tr> <td style="width: 10%;"></td> <td style="width: 10%;"></td> <td style="width: 10%;"></td> <td style="width: 10%;"></td> <td style="width: 10%;"></td> <td style="width: 10%;"></td> <td style="width: 10%;"></td> <td style="width: 10%;"></td> <td style="width: 10%;"></td> <td style="width: 10%;"></td> </tr> <tr> <td></td> <td></td> <td colspan="8" style="text-align: center;"> <table border="1" style="width: 100%; border-collapse: collapse; text-align: center;"> <tr> <td style="width: 10%;"></td> <td style="width: 10%;"></td> <td style="width: 10%;"></td> <td style="width: 10%;"></td> <td style="width: 10%;"></td> <td style="width: 10%;"></td> <td style="width: 10%;"></td> <td style="width: 10%;"></td> <td style="width: 10%;"></td> <td style="width: 10%;"></td> </tr> <tr> <td></td> <td></td> <td colspan="8" style="text-align: center;"> <table border="1" style="width: 100%; border-collapse: collapse; text-align: center;"> <tr> <td style="width: 10%;"></td> <td style="width: 10%;"></td> <td style="width: 10%;"></td> <td style="width: 10%;"></td> <td style="width: 10%;"></td> <td style="width: 10%;"></td> <td style="width: 10%;"></td> <td style="width: 10%;"></td> <td style="width: 10%;"></td> <td style="width: 10%;"></td> </tr> <tr> <td></td> <td></td> <td colspan="8" style="text-align: center;"> <table border="1" style="width: 100%; border-collapse: collapse; text-align: center;"> <tr> <td style="width: 10%;"></td> <td style="width: 10%;"></td> <td style="width: 10%;"></td> <td style="width: 10%;"></td> <td style="width: 10%;"></td> <td style="width: 10%;"></td> <td style="width: 10%;"></td> <td style="width: 10%;"></td> <td style="width: 10%;"></td> <td style="width: 10%;"></td> </tr> <tr> <td></td> <td></td> <td colspan="8" style="text-align: center;"> <table border="1" style="width: 100%; border-collapse: collapse; text-align: center;"> <tr> <td style="width: 10%;"></td> <td style="width: 10%;"></td> <td style="width: 10%;"></td> <td style="width: 10%;"></td> <td style="width: 10%;"></td> <td style="width: 10%;"></td> <td style="width: 10%;"></td> <td style="width: 10%;"></td> <td style="width: 10%;"></td> <td style="width: 10%;"></td> </tr> <tr> <td></td> <td></td> <td colspan="8" style="text-align: center;"> <table border="1" style="width: 100%; border-collapse: collapse; text-align: center;"> <tr> <td style="width: 10%;"></td> <td style="width: 10%;"></td> <td style="width: 10%;"></td> <td style="width: 10%;"></td> <td style="width: 10%;"></td> <td style="width: 10%;"></td> <td style="width: 10%;"></td> <td style="width: 10%;"></td> <td style="width: 10%;"></td> <td style="width: 10%;"></td> </tr> <tr> <td></td> <td></td> <td colspan="8" style="text-align: center;"> <table border="1" style="width: 100%; border-collapse: collapse; text-align: center;"> <tr> <td style="width: 10%;"></td> <td style="width: 10%;"></td> <td style="width: 10%;"></td> <td style="width: 10%;"></td> <td style="width: 10%;"></td> <td style="width: 10%;"></td> <td style="width: 10%;"></td> <td style="width: 10%;"></td> <td style="width: 10%;"></td> <td style="width: 10%;"></td> </tr> <tr> <td></td> <td></td> <td colspan="8" style="text-align: center;"> <table border="1" style="width: 100%; border-collapse: collapse; text-align: center;"> <tr> </tr></table></td></tr></table></td></tr></table></td></tr></table></td></tr></table></td></tr></table></td></tr></table></td></tr></table></td></tr></table></td></tr></table></td></tr></table></td></tr></table></td></tr></table></td></tr></table></td></tr></table></td></tr></table></td></tr></table></td></tr></table></td></tr></table></td></tr></table></td></tr></table></td></tr></table></td></tr></table></td></tr></table></td></tr></table></td></tr></table>
 | | | | | | | | | | | | | | | | | | | | <table border="1" style="width: 100%; border-collapse: collapse; text-align: center;"> <tr> <td style="width: 10%;"></td> <td style="width: 10%;"></td> <td style="width: 10%;"></td> <td style="width: 10%;"></td> <td style="width: 10%;"></td> <td style="width: 10%;"></td> <td style="width: 10%;"></td> <td style="width: 10%;"></td> <td style="width: 10%;"></td> <td style="width: 10%;"></td> </tr> <tr> <td></td> <td></td> <td colspan="8" style="text-align: center;"> <table border="1" style="width: 100%; border-collapse: collapse; text-align: center;"> <tr> <td style="width: 10%;"></td> <td style="width: 10%;"></td> <td style="width: 10%;"></td> <td style="width: 10%;"></td> <td style="width: 10%;"></td> <td style="width: 10%;"></td> <td style="width: 10%;"></td> <td style="width: 10%;"></td> <td style="width: 10%;"></td> <td style="width: 10%;"></td> </tr> <tr> <td></td> <td></td> <td colspan="8" style="text-align: center;"> <table border="1" style="width: 100%; border-collapse: collapse; text-align: center;"> <tr> <td style="width: 10%;"></td> <td style="width: 10%;"></td> <td style="width: 10%;"></td> <td style="width: 10%;"></td> <td style="width: 10%;"></td> <td style="width: 10%;"></td> <td style="width: 10%;"></td> <td style="width: 10%;"></td> <td style="width: 10%;"></td> <td style="width: 10%;"></td> </tr> <tr> <td></td> <td></td> <td colspan="8" style="text-align: center;"> <table border="1" style="width: 100%; border-collapse: collapse; text-align: center;"> <tr> <td style="width: 10%;"></td> <td style="width: 10%;"></td> <td style="width: 10%;"></td> <td style="width: 10%;"></td> <td style="width: 10%;"></td> <td style="width: 10%;"></td> <td style="width: 10%;"></td> <td style="width: 10%;"></td> <td style="width: 10%;"></td> <td style="width: 10%;"></td> </tr> <tr> <td></td> <td></td> <td colspan="8" style="text-align: center;"> <table border="1" style="width: 100%; border-collapse: collapse; text-align: center;"> <tr> <td style="width: 10%;"></td> <td style="width: 10%;"></td> <td style="width: 10%;"></td> <td style="width: 10%;"></td> <td style="width: 10%;"></td> <td style="width: 10%;"></td> <td style="width: 10%;"></td> <td style="width: 10%;"></td> <td style="width: 10%;"></td> <td style="width: 10%;"></td> </tr> <tr> <td></td> <td></td> <td colspan="8" style="text-align: center;"> <table border="1" style="width: 100%; border-collapse: collapse; text-align: center;"> <tr> <td style="width: 10%;"></td> <td style="width: 10%;"></td> <td style="width: 10%;"></td> <td style="width: 10%;"></td> <td style="width: 10%;"></td> <td style="width: 10%;"></td> <td style="width: 10%;"></td> <td style="width: 10%;"></td> <td style="width: 10%;"></td> <td style="width: 10%;"></td> </tr> <tr> <td></td> <td></td> <td colspan="8" style="text-align: center;"> <table border="1" style="width: 100%; border-collapse: collapse; text-align: center;"> <tr> <td style="width: 10%;"></td> <td style="width: 10%;"></td> <td style="width: 10%;"></td> <td style="width: 10%;"></td> <td style="width: 10%;"></td> <td style="width: 10%;"></td> <td style="width: 10%;"></td> <td style="width: 10%;"></td> <td style="width: 10%;"></td> <td style="width: 10%;"></td> </tr> <tr> <td></td> <td></td> <td colspan="8" style="text-align: center;"> <table border="1" style="width: 100%; border-collapse: collapse; text-align: center;"> <tr> <td style="width: 10%;"></td> <td style="width: 10%;"></td> <td style="width: 10%;"></td> <td style="width: 10%;"></td> <td style="width: 10%;"></td> <td style="width: 10%;"></td> <td style="width: 10%;"></td> <td style="width: 10%;"></td> <td style="width: 10%;"></td> <td style="width: 10%;"></td> </tr> <tr> <td></td> <td></td> <td colspan="8" style="text-align: center;"> <table border="1" style="width: 100%; border-collapse: collapse; text-align: center;"> <tr> <td style="width: 10%;"></td> <td style="width: 10%;"></td> <td style="width: 10%;"></td> <td style="width: 10%;"></td> <td style="width: 10%;"></td> <td style="width: 10%;"></td> <td style="width: 10%;"></td> <td style="width: 10%;"></td> <td style="width: 10%;"></td> <td
style="width: 10%;"></td> </tr> <tr> <td></td> <td></td> <td colspan="8" style="text-align: center;"> <table border="1" style="width: 100%; border-collapse: collapse; text-align: center;"> <tr> <td style="width: 10%;"></td> <td style="width: 10%;"></td> <td style="width: 10%;"></td> <td style="width: 10%;"></td> <td style="width: 10%;"></td> <td style="width: 10%;"></td> <td style="width: 10%;"></td> <td style="width: 10%;"></td> <td style="width: 10%;"></td> <td style="width: 10%;"></td> </tr> <tr> <td></td> <td></td> <td colspan="8" style="text-align: center;"> <table border="1" style="width: 100%; border-collapse: collapse; text-align: center;"> <tr> <td style="width: 10%;"></td> <td style="width: 10%;"></td> <td style="width: 10%;"></td> <td style="width: 10%;"></td> <td style="width: 10%;"></td> <td style="width: 10%;"></td> <td style="width: 10%;"></td> <td style="width: 10%;"></td> <td style="width: 10%;"></td> <td style="width: 10%;"></td> </tr> <tr> <td></td> <td></td> <td colspan="8" style="text-align: center;"> <table border="1" style="width: 100%; border-collapse: collapse; text-align: center;"> <tr> <td style="width: 10%;"></td> <td style="width: 10%;"></td> <td style="width: 10%;"></td> <td style="width: 10%;"></td> <td style="width: 10%;"></td> <td style="width: 10%;"></td> <td style="width: 10%;"></td> <td style="width: 10%;"></td> <td style="width: 10%;"></td> <td style="width: 10%;"></td> </tr> <tr> <td></td> <td></td> <td colspan="8" style="text-align: center;"> <table border="1" style="width: 100%; border-collapse: collapse; text-align: center;"> <tr> <td style="width: 10%;"></td> <td style="width: 10%;"></td> <td style="width: 10%;"></td> <td style="width: 10%;"></td> <td style="width: 10%;"></td> <td style="width: 10%;"></td> <td style="width: 10%;"></td> <td style="width: 10%;"></td> <td style="width: 10%;"></td> <td style="width: 10%;"></td> </tr> <tr> <td></td> <td></td> <td colspan="8" style="text-align: center;"> <table border="1" style="width: 100%; border-collapse: collapse; text-align: center;"> <tr> <td style="width: 10%;"></td> <td style="width: 10%;"></td> <td style="width: 10%;"></td> <td style="width: 10%;"></td> <td style="width: 10%;"></td> <td style="width: 10%;"></td> <td style="width: 10%;"></td> <td style="width: 10%;"></td> <td style="width: 10%;"></td> <td style="width: 10%;"></td> </tr> <tr> <td></td> <td></td> <td colspan="8" style="text-align: center;"> <table border="1" style="width: 100%; border-collapse: collapse; text-align: center;"> <tr> <td style="width: 10%;"></td> <td style="width: 10%;"></td> <td style="width: 10%;"></td> <td style="width: 10%;"></td> <td style="width: 10%;"></td> <td style="width: 10%;"></td> <td style="width: 10%;"></td> <td style="width: 10%;"></td> <td style="width: 10%;"></td> <td style="width: 10%;"></td> </tr> <tr> <td></td> <td></td> <td colspan="8" style="text-align: center;"> <table border="1" style="width: 100%; border-collapse: collapse; text-align: center;"> <tr> <td style="width: 10%;"></td> <td style="width: 10%;"></td> <td style="width: 10%;"></td> <td style="width: 10%;"></td> <td style="width: 10%;"></td> <td style="width: 10%;"></td> <td style="width: 10%;"></td> <td style="width: 10%;"></td> <td style="width: 10%;"></td> <td style="width: 10%;"></td> </tr> <tr> <td></td> <td></td> <td colspan="8" style="text-align: center;"> <table border="1" style="width: 100%; border-collapse: collapse; text-align: center;"> <tr> <td style="width: 10%;"></td> <td style="width: 10%;"></td> <td style="width: 10%;"></td> <td style="width: 10%;"></td> <td style="width: 10%;"></td> <td style="width: 10%;"></td> <td style="width: 10%;"></td> <td style="width: 10%;"></td> <td style="width: 10%;"></td> <td style="width: 10%;"></td> </tr> <tr> <td></td> <td></td> <td colspan="8" style="text-align: center;"> <table border="1" style="width: 100%; border-collapse: collapse; text-align: center;"> <tr> <td style="width: 10%;"></td> <td style="width: 10%;"></td> <td style="width: 10%;"></td> <td style="width: 10%;"></td> <td style="width: 10%;"></td> <td style="width: 10%;"></td> <td style="width: 10%;"></td> <td style="width: 10%;"></td> <td style="width: 10%;"></td> <td style="width: 10%;"></td> </tr> <tr> <td></td> <td></td> <td colspan="8" style="text-align: center;"> <table border="1" style="width: 100%; border-collapse: collapse; text-align: center;"> <tr> <td style="width: 10%;"></td> <td style="width: 10%;"></td> <td style="width: 10%;"></td> <td style="width: 10%;"></td> <td style="width: 10%;"></td> <td style="width: 10%;"></td> <td style="width: 10%;"></td> <td style="width: 10%;"></td> <td style="width: 10%;"></td> <td style="width: 10%;"></td> </tr> <tr> <td></td> <td></td> <td colspan="8" style="text-align: center;"> <table border="1" style="width: 100%; border-collapse: collapse; text-align: center;"> <tr> <td style="width: 10%;"></td> <td style="width: 10%;"></td> <td style="width: 10%;"></td> <td style="width: 10%;"></td> <td style="width: 10%;"></td> <td style="width: 10%;"></td> <td style="width: 10%;"></td> <td style="width: 10%;"></td> <td style="width: 10%;"></td> <td style="width: 10%;"></td> </tr> <tr> <td></td> <td></td> <td colspan="8" style="text-align: center;"> <table border="1" style="width: 100%; border-collapse: collapse; text-align: center;"> <tr> <td style="width: 10%;"></td> <td style="width: 10%;"></td> <td style="width: 10%;"></td> <td style="width: 10%;"></td> <td style="width: 10%;"></td> <td style="width: 10%;"></td> <td style="width: 10%;"></td> <td style="width: 10%;"></td> <td style="width: 10%;"></td> <td style="width: 10%;"></td> </tr> <tr> <td></td> <td></td> <td colspan="8" style="text-align: center;"> <table border="1" style="width: 100%; border-collapse: collapse; text-align: center;"> <tr> <td style="width: 10%;"></td> <td style="width: 10%;"></td> <td style="width: 10%;"></td> <td style="width: 10%;"></td> <td style="width: 10%;"></td> <td style="width: 10%;"></td> <td style="width: 10%;"></td> <td style="width: 10%;"></td> <td style="width: 10%;"></td> <td style="width: 10%;"></td> </tr> <tr> <td></td> <td></td> <td colspan="8" style="text-align: center;"> <table border="1" style="width: 100%; border-collapse: collapse; text-align: center;"> <tr> <td style="width: 10%;"></td> <td style="width: 10%;"></td> <td style="width: 10%;"></td> <td style="width: 10%;"></td> <td style="width: 10%;"></td> <td style="width: 10%;"></td> <td style="width: 10%;"></td> <td style="width: 10%;"></td> <td style="width: 10%;"></td> <td style="width: 10%;"></td> </tr> <tr> <td></td> <td></td> <td colspan="8" style="text-align: center;"> <table border="1" style="width: 100%; border-collapse: collapse; text-align: center;"> <tr> <td style="width: 10%;"></td> <td style="width: 10%;"></td> <td style="width: 10%;"></td> <td style="width: 10%;"></td> <td style="width: 10%;"></td> <td style="width: 10%;"></td> <td style="width: 10%;"></td> <td style="width: 10%;"></td> <td style="width: 10%;"></td> <td style="width: 10%;"></td> </tr> <tr> <td></td> <td></td> <td colspan="8" style="text-align: center;"> <table border="1" style="width: 100%; border-collapse: collapse; text-align: center;"> <tr> </tr></table></td></tr></table></td></tr></table></td></tr></table></td></tr></table></td></tr></table></td></tr></table></td></tr></table></td></tr></table></td></tr></table></td></tr></table></td></tr></table></td></tr></table></td></tr></table></td></tr></table></td></tr></table></td></tr></table></td></tr></table></td></tr></table></td></tr></table></td></tr></table></td></tr></table></td></tr></table></td></tr></table></td></tr></table>
 | | | | | | | | | | | | | | | | | | | | <table border="1" style="width: 100%; border-collapse: collapse; text-align: center;"> <tr> <td style="width: 10%;"></td> <td style="width: 10%;"></td> <td style="width: 10%;"></td> <td style="width: 10%;"></td> <td style="width: 10%;"></td> <td style="width: 10%;"></td> <td style="width: 10%;"></td> <td style="width: 10%;"></td> <td style="width: 10%;"></td> <td style="width: 10%;"></td> </tr> <tr> <td></td> <td></td> <td colspan="8" style="text-align: center;"> <table border="1" style="width: 100%; border-collapse: collapse; text-align: center;"> <tr> <td style="width: 10%;"></td> <td style="width: 10%;"></td> <td style="width: 10%;"></td> <td style="width: 10%;"></td> <td style="width: 10%;"></td> <td style="width: 10%;"></td> <td style="width: 10%;"></td> <td style="width: 10%;"></td> <td style="width: 10%;"></td> <td style="width: 10%;"></td> </tr> <tr> <td></td> <td></td> <td colspan="8" style="text-align: center;"> <table border="1" style="width: 100%; border-collapse: collapse; text-align: center;"> <tr> <td style="width: 10%;"></td> <td style="width: 10%;"></td> <td style="width: 10%;"></td> <td style="width: 10%;"></td> <td style="width: 10%;"></td> <td style="width: 10%;"></td> <td style="width: 10%;"></td> <td style="width: 10%;"></td> <td style="width: 10%;"></td> <td style="width: 10%;"></td> </tr> <tr> <td></td> <td></td> <td colspan="8" style="text-align: center;"> <table border="1" style="width: 100%; border-collapse: collapse; text-align: center;"> <tr> <td style="width: 10%;"></td> <td style="width: 10%;"></td> <td style="width: 10%;"></td> <td style="width: 10%;"></td> <td style="width: 10%;"></td> <td style="width: 10%;"></td> <td style="width: 10%;"></td> <td style="width: 10%;"></td> <td style="width: 10%;"></td> <td style="width: 10%;"></td> </tr> <tr> <td></td> <td></td> <td colspan="8" style="text-align: center;"> <table border="1" style="width: 100%; border-collapse: collapse; text-align: center;"> <tr> <td style="width: 10%;"></td> <td style="width: 10%;"></td> <td style="width: 10%;"></td> <td style="width: 10%;"></td> <td style="width: 10%;"></td> <td style="width: 10%;"></td> <td style="width: 10%;"></td> <td style="width: 10%;"></td> <td style="width: 10%;"></td> <td style="width: 10%;"></td> </tr> <tr> <td></td> <td></td> <td colspan="8" style="text-align: center;"> <table border="1" style="width: 100%; border-collapse: collapse; text-align: center;"> <tr> <td style="width: 10%;"></td> <td style="width: 10%;"></td> <td style="width: 10%;"></td> <td style="width: 10%;"></td> <td style="width: 10%;"></td> <td style="width: 10%;"></td> <td style="width: 10%;"></td> <td style="width: 10%;"></td> <td style="width: 10%;"></td> <td style="width: 10%;"></td> </tr> <tr> <td></td> <td></td> <td colspan="8" style="text-align: center;"> <table border="1" style="width: 100%; border-collapse: collapse; text-align: center;"> <tr> <td style="width: 10%;"></td> <td style="width: 10%;"></td> <td style="width: 10%;"></td> <td style="width: 10%;"></td> <td style="width: 10%;"></td> <td style="width: 10%;"></td> <td style="width: 10%;"></td> <td style="width: 10%;"></td> <td style="width: 10%;"></td> <td style="width: 10%;"></td> </tr> <tr> <td></td> <td></td> <td colspan="8" style="text-align: center;"> <table border="1" style="width: 100%; border-collapse: collapse; text-align: center;"> <tr> <td style="width: 10%;"></td> <td style="width: 10%;"></td> <td style="width: 10%;"></td> <td style="width: 10%;"></td> <td style="width: 10%;"></td> <td
style="width: 10%;"></td> <td style="width: 10%;"></td> <td style="width: 10%;"></td> <td style="width: 10%;"></td> <td style="width: 10%;"></td> </tr> <tr> <td></td> <td></td> <td colspan="8" style="text-align: center;"> <table border="1" style="width: 100%; border-collapse: collapse; text-align: center;"> <tr> <td style="width: 10%;"></td> <td style="width: 10%;"></td> <td style="width: 10%;"></td> <td style="width: 10%;"></td> <td style="width: 10%;"></td> <td style="width: 10%;"></td> <td style="width: 10%;"></td> <td style="width: 10%;"></td> <td style="width: 10%;"></td> <td style="width: 10%;"></td> </tr> <tr> <td></td> <td></td> <td colspan="8" style="text-align: center;"> <table border="1" style="width: 100%; border-collapse: collapse; text-align: center;"> <tr> <td style="width: 10%;"></td> <td style="width: 10%;"></td> <td style="width: 10%;"></td> <td style="width: 10%;"></td> <td style="width: 10%;"></td> <td style="width: 10%;"></td> <td style="width: 10%;"></td> <td style="width: 10%;"></td> <td style="width: 10%;"></td> <td style="width: 10%;"></td> </tr> <tr> <td></td> <td></td> <td colspan="8" style="text-align: center;"> <table border="1" style="width: 100%; border-collapse: collapse; text-align: center;"> <tr> <td style="width: 10%;"></td> <td style="width: 10%;"></td> <td style="width: 10%;"></td> <td style="width: 10%;"></td> <td style="width: 10%;"></td> <td style="width: 10%;"></td> <td style="width: 10%;"></td> <td style="width: 10%;"></td> <td style="width: 10%;"></td> <td style="width: 10%;"></td> </tr> <tr> <td></td> <td></td> <td colspan="8" style="text-align: center;"> <table border="1" style="width: 100%; border-collapse: collapse; text-align: center;"> <tr> <td style="width: 10%;"></td> <td style="width: 10%;"></td> <td style="width: 10%;"></td> <td style="width: 10%;"></td> <td style="width: 10%;"></td> <td style="width: 10%;"></td> <td style="width: 10%;"></td> <td style="width: 10%;"></td> <td style="width: 10%;"></td> <td style="width: 10%;"></td> </tr> <tr> <td></td> <td></td> <td colspan="8" style="text-align: center;"> <table border="1" style="width: 100%; border-collapse: collapse; text-align: center;"> <tr> <td style="width: 10%;"></td> <td style="width: 10%;"></td> <td style="width: 10%;"></td> <td style="width: 10%;"></td> <td style="width: 10%;"></td> <td style="width: 10%;"></td> <td style="width: 10%;"></td> <td style="width: 10%;"></td> <td style="width: 10%;"></td> <td style="width: 10%;"></td> </tr> <tr> <td></td> <td></td> <td colspan="8" style="text-align: center;"> <table border="1" style="width: 100%; border-collapse: collapse; text-align: center;"> <tr> <td style="width: 10%;"></td> <td style="width: 10%;"></td> <td style="width: 10%;"></td> <td style="width: 10%;"></td> <td style="width: 10%;"></td> <td style="width: 10%;"></td> <td style="width: 10%;"></td> <td style="width: 10%;"></td> <td style="width: 10%;"></td> <td style="width: 10%;"></td> </tr> <tr> <td></td> <td></td> <td colspan="8" style="text-align: center;"> <table border="1" style="width: 100%; border-collapse: collapse; text-align: center;"> <tr> <td style="width: 10%;"></td> <td style="width: 10%;"></td> <td style="width: 10%;"></td> <td style="width: 10%;"></td> <td style="width: 10%;"></td> <td style="width: 10%;"></td> <td style="width: 10%;"></td> <td style="width: 10%;"></td> <td style="width: 10%;"></td> <td style="width: 10%;"></td> </tr> <tr> <td></td> <td></td> <td colspan="8" style="text-align: center;"> <table border="1" style="width: 100%; border-collapse: collapse; text-align: center;"> <tr> <td style="width: 10%;"></td> <td style="width: 10%;"></td> <td style="width: 10%;"></td> <td style="width: 10%;"></td> <td style="width: 10%;"></td> <td style="width: 10%;"></td> <td style="width: 10%;"></td> <td style="width: 10%;"></td> <td style="width: 10%;"></td> <td style="width: 10%;"></td> </tr> <tr> <td></td> <td></td> <td colspan="8" style="text-align: center;"> <table border="1" style="width: 100%; border-collapse: collapse; text-align: center;"> <tr> <td style="width: 10%;"></td> <td style="width: 10%;"></td> <td style="width: 10%;"></td> <td style="width: 10%;"></td> <td style="width: 10%;"></td> <td style="width: 10%;"></td> <td style="width: 10%;"></td> <td style="width: 10%;"></td> <td style="width: 10%;"></td> <td style="width: 10%;"></td> </tr> <tr> <td></td> <td></td> <td colspan="8" style="text-align: center;"> <table border="1" style="width: 100%; border-collapse: collapse; text-align: center;"> <tr> <td style="width: 10%;"></td> <td style="width: 10%;"></td> <td style="width: 10%;"></td> <td style="width: 10%;"></td> <td style="width: 10%;"></td> <td style="width: 10%;"></td> <td style="width: 10%;"></td> <td style="width: 10%;"></td> <td style="width: 10%;"></td> <td style="width: 10%;"></td> </tr> <tr> <td></td> <td></td> <td colspan="8" style="text-align: center;"> <table border="1" style="width: 100%; border-collapse: collapse; text-align: center;"> <tr> <td style="width: 10%;"></td> <td style="width: 10%;"></td> <td style="width: 10%;"></td> <td style="width: 10%;"></td> <td style="width: 10%;"></td> <td style="width: 10%;"></td> <td style="width: 10%;"></td> <td style="width: 10%;"></td> <td style="width: 10%;"></td> <td style="width: 10%;"></td> </tr> <tr> <td></td> <td></td> <td colspan="8" style="text-align: center;"> <table border="1" style="width: 100%; border-collapse: collapse; text-align: center;"> <tr> <td style="width: 10%;"></td> <td style="width: 10%;"></td> <td style="width: 10%;"></td> <td style="width: 10%;"></td> <td style="width: 10%;"></td> <td style="width: 10%;"></td> <td style="width: 10%;"></td> <td style="width: 10%;"></td> <td style="width: 10%;"></td> <td style="width: 10%;"></td> </tr> <tr> <td></td> <td></td> <td colspan="8" style="text-align: center;"> <table border="1" style="width: 100%; border-collapse: collapse; text-align: center;"> <tr> <td style="width: 10%;"></td> <td style="width: 10%;"></td> <td style="width: 10%;"></td> <td style="width: 10%;"></td> <td style="width: 10%;"></td> <td style="width: 10%;"></td> <td style="width: 10%;"></td> <td style="width: 10%;"></td> <td style="width: 10%;"></td> <td style="width: 10%;"></td> </tr> <tr> <td></td> <td></td> <td colspan="8" style="text-align: center;"> <table border="1" style="width: 100%; border-collapse: collapse; text-align: center;"> <tr> <td style="width: 10%;"></td> <td style="width: 10%;"></td> <td style="width: 10%;"></td> <td style="width: 10%;"></td> <td style="width: 10%;"></td> <td style="width: 10%;"></td> <td style="width: 10%;"></td> <td style="width: 10%;"></td> <td style="width: 10%;"></td> <td style="width: 10%;"></td> </tr> <tr> <td></td> <td></td> <td colspan="8" style="text-align: center;"> <table border="1" style="width: 100%; border-collapse: collapse; text-align: center;"> <tr> <td style="width: 10%;"></td> <td style="width: 10%;"></td> <td style="width: 10%;"></td> <td style="width: 10%;"></td> <td style="width: 10%;"></td> <td style="width: 10%;"></td> <td style="width: 10%;"></td> <td style="width: 10%;"></td> <td style="width: 10%;"></td> <td style="width: 10%;"></td> </tr> <tr> <td></td> <td></td> <td colspan="8" style="text-align: center;"> <table border="1" style="width: 100%; border-collapse: collapse; text-align: center;"> <tr> </tr></table></td></tr></table></td></tr></table></td></tr></table></td></tr></table></td></tr></table></td></tr></table></td></tr></table></td></tr></table></td></tr></table></td></tr></table></td></tr></table></td></tr></table></td></tr></table></td></tr></table></td></tr></table></td></tr></table></td></tr></table></td></tr></table></td></tr></table></td></tr></table></td></tr></table></td></tr></table></td></tr></table>
 | | | | | | | | | | | | | | | | | | | | <table border="1" style="width: 100%; border-collapse: collapse; text-align: center;"> <tr> <td style="width: 10%;"></td> <td style="width: 10%;"></td> <td style="width: 10%;"></td> <td style="width: 10%;"></td> <td style="width: 10%;"></td> <td style="width: 10%;"></td> <td style="width: 10%;"></td> <td style="width: 10%;"></td> <td style="width: 10%;"></td> <td style="width: 10%;"></td> </tr> <tr> <td></td> <td></td> <td colspan="8" style="text-align: center;"> <table border="1" style="width: 100%; border-collapse: collapse; text-align: center;"> <tr> <td style="width: 10%;"></td> <td style="width: 10%;"></td> <td style="width: 10%;"></td> <td style="width: 10%;"></td> <td style="width: 10%;"></td> <td style="width: 10%;"></td> <td style="width: 10%;"></td> <td style="width: 10%;"></td> <td style="width: 10%;"></td> <td style="width: 10%;"></td> </tr> <tr> <td></td> <td></td> <td colspan="8" style="text-align: center;"> <table border="1" style="width: 100%; border-collapse: collapse; text-align: center;"> <tr> <td style="width: 10%;"></td> <td style="width: 10%;"></td> <td style="width: 10%;"></td> <td style="width: 10%;"></td> <td style="width: 10%;"></td> <td style="width: 10%;"></td> <td style="width: 10%;"></td> <td style="width: 10%;"></td> <td style="width: 10%;"></td> <td style="width: 10%;"></td> </tr> <tr> <td></td> <td></td> <td colspan="8" style="text-align: center;"> <table border="1" style="width: 100%; border-collapse: collapse; text-align: center;"> <tr> <td style="width: 10%;"></td> <td style="width: 10%;"></td> <td style="width: 10%;"></td> <td style="width: 10%;"></td> <td style="width: 10%;"></td> <td style="width: 10%;"></td> <td style="width: 10%;"></td> <td style="width: 10%;"></td> <td style="width: 10%;"></td> <td style="width: 10%;"></td> </tr> <tr> <td></td> <td></td> <td colspan="8" style="text-align: center;"> <table border="1" style="width: 100%; border-collapse: collapse; text-align: center;"> <tr> <td style="width: 10%;"></td> <td style="width: 10%;"></td> <td style="width: 10%;"></td> <td style="width: 10%;"></td> <td style="width: 10%;"></td> <td style="width: 10%;"></td> <td style="width: 10%;"></td> <td style="width: 10%;"></td> <td style="width: 10%;"></td> <td style="width: 10%;"></td> </tr> <tr> <td></td> <td></td> <td colspan="8" style="text-align: center;"> <table border="1" style="width: 100%; border-collapse: collapse; text-align: center;"> <tr> <td style="width: 10%;"></td> <td style="width: 10%;"></td> <td style="width: 10%;"></td> <td style="width: 10%;"></td> <td style="width: 10%;"></td> <td style="width: 10%;"></td> <td style="width: 10%;"></td> <td style="width: 10%;"></td> <td style="width: 10%;"></td> <td style="width: 10%;"></td> </tr> <tr> <td></td> <td></td> <td colspan="8" style="text-align: center;"> <table border="1" style="width: 100%; border-collapse: collapse; text-align: center;"> <tr> <td style="width: 10%;"></td> <td style="width: 10%;"></td> <td style="width: 10%;"></td> <td style="width: 10%;"></td> <td style="width: 10%;"></td> <td style="width: 10%;"></td> <td style="width: 10%;"></td> <td style="width: 10%;"></td> <td style="width: 10%;"></td> <td style="width: 10%;"></td> </tr> <tr> <td></td> <td></td> <td colspan="8" style="text-align: center;"> <table border="1" style="width: 100%; border-collapse: collapse; text-align: center;"> <tr> <td style="width: 10%;"></td> <td style="width: 10%;"></td>
<td style="width: 10%;"></td> <td style="width: 10%;"></td> <td style="width: 10%;"></td> <td style="width: 10%;"></td> <td style="width: 10%;"></td> <td style="width: 10%;"></td> <td style="width: 10%;"></td> <td style="width: 10%;"></td> </tr> <tr> <td></td> <td></td> <td colspan="8" style="text-align: center;"> <table border="1" style="width: 100%; border-collapse: collapse; text-align: center;"> <tr> <td style="width: 10%;"></td> <td style="width: 10%;"></td> <td style="width: 10%;"></td> <td style="width: 10%;"></td> <td style="width: 10%;"></td> <td style="width: 10%;"></td> <td style="width: 10%;"></td> <td style="width: 10%;"></td> <td style="width: 10%;"></td> <td style="width: 10%;"></td> </tr> <tr> <td></td> <td></td> <td colspan="8" style="text-align: center;"> <table border="1" style="width: 100%; border-collapse: collapse; text-align: center;"> <tr> <td style="width: 10%;"></td> <td style="width: 10%;"></td> <td style="width: 10%;"></td> <td style="width: 10%;"></td> <td style="width: 10%;"></td> <td style="width: 10%;"></td> <td style="width: 10%;"></td> <td style="width: 10%;"></td> <td style="width: 10%;"></td> <td style="width: 10%;"></td> </tr> <tr> <td></td> <td></td> <td colspan="8" style="text-align: center;"> <table border="1" style="width: 100%; border-collapse: collapse; text-align: center;"> <tr> <td style="width: 10%;"></td> <td style="width: 10%;"></td> <td style="width: 10%;"></td> <td style="width: 10%;"></td> <td style="width: 10%;"></td> <td style="width: 10%;"></td> <td style="width: 10%;"></td> <td style="width: 10%;"></td> <td style="width: 10%;"></td> <td style="width: 10%;"></td> </tr> <tr> <td></td> <td></td> <td colspan="8" style="text-align: center;"> <table border="1" style="width: 100%; border-collapse: collapse; text-align: center;"> <tr> <td style="width: 10%;"></td> <td style="width: 10%;"></td> <td style="width: 10%;"></td> <td style="width: 10%;"></td> <td style="width: 10%;"></td> <td style="width: 10%;"></td> <td style="width: 10%;"></td> <td style="width: 10%;"></td> <td style="width: 10%;"></td> <td style="width: 10%;"></td> </tr> <tr> <td></td> <td></td> <td colspan="8" style="text-align: center;"> <table border="1" style="width: 100%; border-collapse: collapse; text-align: center;"> <tr> <td style="width: 10%;"></td> <td style="width: 10%;"></td> <td style="width: 10%;"></td> <td style="width: 10%;"></td> <td style="width: 10%;"></td> <td style="width: 10%;"></td> <td style="width: 10%;"></td> <td style="width: 10%;"></td> <td style="width: 10%;"></td> <td style="width: 10%;"></td> </tr> <tr> <td></td> <td></td> <td colspan="8" style="text-align: center;"> <table border="1" style="width: 100%; border-collapse: collapse; text-align: center;"> <tr> <td style="width: 10%;"></td> <td style="width: 10%;"></td> <td style="width: 10%;"></td> <td style="width: 10%;"></td> <td style="width: 10%;"></td> <td style="width: 10%;"></td> <td style="width: 10%;"></td> <td style="width: 10%;"></td> <td style="width: 10%;"></td> <td style="width: 10%;"></td> </tr> <tr> <td></td> <td></td> <td colspan="8" style="text-align: center;"> <table border="1" style="width: 100%; border-collapse: collapse; text-align: center;"> <tr> <td style="width: 10%;"></td> <td style="width: 10%;"></td> <td style="width: 10%;"></td> <td style="width: 10%;"></td> <td style="width: 10%;"></td> <td style="width: 10%;"></td> <td style="width: 10%;"></td> <td style="width: 10%;"></td> <td style="width: 10%;"></td> <td style="width: 10%;"></td> </tr> <tr> <td></td> <td></td> <td colspan="8" style="text-align: center;"> <table border="1" style="width: 100%; border-collapse: collapse; text-align: center;"> <tr> <td style="width: 10%;"></td> <td style="width: 10%;"></td> <td style="width: 10%;"></td> <td style="width: 10%;"></td> <td style="width: 10%;"></td> <td style="width: 10%;"></td> <td style="width: 10%;"></td> <td style="width: 10%;"></td> <td style="width: 10%;"></td> <td style="width: 10%;"></td> </tr> <tr> <td></td> <td></td> <td colspan="8" style="text-align: center;"> <table border="1" style="width: 100%; border-collapse: collapse; text-align: center;"> <tr> <td style="width: 10%;"></td> <td style="width: 10%;"></td> <td style="width: 10%;"></td> <td style="width: 10%;"></td> <td style="width: 10%;"></td> <td style="width: 10%;"></td> <td style="width: 10%;"></td> <td style="width: 10%;"></td> <td style="width: 10%;"></td> <td style="width: 10%;"></td> </tr> <tr> <td></td> <td></td> <td colspan="8" style="text-align: center;"> <table border="1" style="width: 100%; border-collapse: collapse; text-align: center;"> <tr> <td style="width: 10%;"></td> <td style="width: 10%;"></td> <td style="width: 10%;"></td> <td style="width: 10%;"></td> <td style="width: 10%;"></td> <td style="width: 10%;"></td> <td style="width: 10%;"></td> <td style="width: 10%;"></td> <td style="width: 10%;"></td> <td style="width: 10%;"></td> </tr> <tr> <td></td> <td></td> <td colspan="8" style="text-align: center;"> <table border="1" style="width: 100%; border-collapse: collapse; text-align: center;"> <tr> <td style="width: 10%;"></td> <td style="width: 10%;"></td> <td style="width: 10%;"></td> <td style="width: 10%;"></td> <td style="width: 10%;"></td> <td style="width: 10%;"></td> <td style="width: 10%;"></td> <td style="width: 10%;"></td> <td style="width: 10%;"></td> <td style="width: 10%;"></td> </tr> <tr> <td></td> <td></td> <td colspan="8" style="text-align: center;"> <table border="1" style="width: 100%; border-collapse: collapse; text-align: center;"> <tr> <td style="width: 10%;"></td> <td style="width: 10%;"></td> <td style="width: 10%;"></td> <td style="width: 10%;"></td> <td style="width: 10%;"></td> <td style="width: 10%;"></td> <td style="width: 10%;"></td> <td style="width: 10%;"></td> <td style="width: 10%;"></td> <td style="width: 10%;"></td> </tr> <tr> <td></td> <td></td> <td colspan="8" style="text-align: center;"> <table border="1" style="width: 100%; border-collapse: collapse; text-align: center;"> <tr> <td style="width: 10%;"></td> <td style="width: 10%;"></td> <td style="width: 10%;"></td> <td style="width: 10%;"></td> <td style="width: 10%;"></td> <td style="width: 10%;"></td> <td style="width: 10%;"></td> <td style="width: 10%;"></td> <td style="width: 10%;"></td> <td style="width: 10%;"></td> </tr> <tr> <td></td> <td></td> <td colspan="8" style="text-align: center;"> <table border="1" style="width: 100%; border-collapse: collapse; text-align: center;"> <tr> <td style="width: 10%;"></td> <td style="width: 10%;"></td> <td style="width: 10%;"></td> <td style="width: 10%;"></td> <td style="width: 10%;"></td> <td style="width: 10%;"></td> <td style="width: 10%;"></td> <td style="width: 10%;"></td> <td style="width: 10%;"></td> <td style="width: 10%;"></td> </tr> <tr> <td></td> <td></td> <td colspan="8" style="text-align: center;"> <table border="1" style="width: 100%; border-collapse: collapse; text-align: center;"> <tr> </tr></table></td></tr></table></td></tr></table></td></tr></table></td></tr></table></td></tr></table></td></tr></table></td></tr></table></td></tr></table></td></tr></table></td></tr></table></td></tr></table></td></tr></table></td></tr></table></td></tr></table></td></tr></table></td></tr></table></td></tr></table></td></tr></table></td></tr></table></td></tr></table></td></tr></table></td></tr></table>
 | | | | | | | | | | | | | | | | | | | | <table border="1" style="width: 100%; border-collapse: collapse; text-align: center;"> <tr> <td style="width: 10%;"></td> <td style="width: 10%;"></td> <td style="width: 10%;"></td> <td style="width: 10%;"></td> <td style="width: 10%;"></td> <td style="width: 10%;"></td> <td style="width: 10%;"></td> <td style="width: 10%;"></td> <td style="width: 10%;"></td> <td style="width: 10%;"></td> </tr> <tr> <td></td> <td></td> <td colspan="8" style="text-align: center;"> <table border="1" style="width: 100%; border-collapse: collapse; text-align: center;"> <tr> <td style="width: 10%;"></td> <td style="width: 10%;"></td> <td style="width: 10%;"></td> <td style="width: 10%;"></td> <td style="width: 10%;"></td> <td style="width: 10%;"></td> <td style="width: 10%;"></td> <td style="width: 10%;"></td> <td style="width: 10%;"></td> <td style="width: 10%;"></td> </tr> <tr> <td></td> <td></td> <td colspan="8" style="text-align: center;"> <table border="1" style="width: 100%; border-collapse: collapse; text-align: center;"> <tr> <td style="width: 10%;"></td> <td style="width: 10%;"></td> <td style="width: 10%;"></td> <td style="width: 10%;"></td> <td style="width: 10%;"></td> <td style="width: 10%;"></td> <td style="width: 10%;"></td> <td style="width: 10%;"></td> <td style="width: 10%;"></td> <td style="width: 10%;"></td> </tr> <tr> <td></td> <td></td> <td colspan="8" style="text-align: center;"> <table border="1" style="width: 100%; border-collapse: collapse; text-align: center;"> <tr> <td style="width: 10%;"></td> <td style="width: 10%;"></td> <td style="width: 10%;"></td> <td style="width: 10%;"></td> <td style="width: 10%;"></td> <td style="width: 10%;"></td> <td style="width: 10%;"></td> <td style="width: 10%;"></td> <td style="width: 10%;"></td> <td style="width: 10%;"></td> </tr> <tr> <td></td> <td></td> <td colspan="8" style="text-align: center;"> <table border="1" style="width: 100%; border-collapse: collapse; text-align: center;"> <tr> <td style="width: 10%;"></td> <td style="width: 10%;"></td> <td style="width: 10%;"></td> <td style="width: 10%;"></td> <td style="width: 10%;"></td> <td style="width: 10%;"></td> <td style="width: 10%;"></td> <td style="width: 10%;"></td> <td style="width: 10%;"></td> <td style="width: 10%;"></td> </tr> <tr> <td></td> <td></td> <td colspan="8" style="text-align: center;"> <table border="1" style="width: 100%; border-collapse: collapse; text-align: center;"> <tr> <td style="width: 10%;"></td> <td style="width: 10%;"></td> <td style="width: 10%;"></td> <td style="width: 10%;"></td> <td style="width: 10%;"></td> <td style="width: 10%;"></td> <td style="width: 10%;"></td> <td style="width: 10%;"></td> <td style="width: 10%;"></td> <td style="width: 10%;"></td> </tr> <tr> <td></td> <td></td> <td colspan="8" style="text-align: center;"> <table border="1" style="width: 100%; border-collapse: collapse; text-align: center;"> <tr> <td style="width: 10%;"></td> <td style="width: 10%;"></td> <td style="width: 10%;"></td> <td style="width: 10%;"></td> <td style="width: 10%;"></td> <td style="width: 10%;"></td> <td style="width: 10%;"></td> <td style="width: 10%;"></td> <td style="width: 10%;"></td> <td style="width: 10%;"></td> </tr> <tr> <td></td> <td></td> <td colspan="8" style="text-align: center;"> <table border="1" style="width: 100%; border-collapse: collapse; text-align: center;"> <tr> <td style="width: 10%;"></td> <td style="width: 10%;"></td> <td style="width: 10%;"></td> <td style="width: 10%;"></td> <td style="width: 10%;"></td> <td style="width: 10%;"></td> <td style="width: 10%;"></td> <td style="width: 10%;"></td> <td style="width: 10%;"></td> <td style="width: 10%;"></td> </tr> <tr> <td></td> <td></td> <td colspan="8" style="text-align: center;"> <table border="1" style="width: 100%; border-collapse: collapse; text-align:
center;"> <tr> <td style="width: 10%;"></td> <td style="width: 10%;"></td> <td style="width: 10%;"></td> <td style="width: 10%;"></td> <td style="width: 10%;"></td> <td style="width: 10%;"></td> <td style="width: 10%;"></td> <td style="width: 10%;"></td> <td style="width: 10%;"></td> <td style="width: 10%;"></td> </tr> <tr> <td></td> <td></td> <td colspan="8" style="text-align: center;"> <table border="1" style="width: 100%; border-collapse: collapse; text-align: center;"> <tr> <td style="width: 10%;"></td> <td style="width: 10%;"></td> <td style="width: 10%;"></td> <td style="width: 10%;"></td> <td style="width: 10%;"></td> <td style="width: 10%;"></td> <td style="width: 10%;"></td> <td style="width: 10%;"></td> <td style="width: 10%;"></td> <td style="width: 10%;"></td> </tr> <tr> <td></td> <td></td> <td colspan="8" style="text-align: center;"> <table border="1" style="width: 100%; border-collapse: collapse; text-align: center;"> <tr> <td style="width: 10%;"></td> <td style="width: 10%;"></td> <td style="width: 10%;"></td> <td style="width: 10%;"></td> <td style="width: 10%;"></td> <td style="width: 10%;"></td> <td style="width: 10%;"></td> <td style="width: 10%;"></td> <td style="width: 10%;"></td> <td style="width: 10%;"></td> </tr> <tr> <td></td> <td></td> <td colspan="8" style="text-align: center;"> <table border="1" style="width: 100%; border-collapse: collapse; text-align: center;"> <tr> <td style="width: 10%;"></td> <td style="width: 10%;"></td> <td style="width: 10%;"></td> <td style="width: 10%;"></td> <td style="width: 10%;"></td> <td style="width: 10%;"></td> <td style="width: 10%;"></td> <td style="width: 10%;"></td> <td style="width: 10%;"></td> <td style="width: 10%;"></td> </tr> <tr> <td></td> <td></td> <td colspan="8" style="text-align: center;"> <table border="1" style="width: 100%; border-collapse: collapse; text-align: center;"> <tr> <td style="width: 10%;"></td> <td style="width: 10%;"></td> <td style="width: 10%;"></td> <td style="width: 10%;"></td> <td style="width: 10%;"></td> <td style="width: 10%;"></td> <td style="width: 10%;"></td> <td style="width: 10%;"></td> <td style="width: 10%;"></td> <td style="width: 10%;"></td> </tr> <tr> <td></td> <td></td> <td colspan="8" style="text-align: center;"> <table border="1" style="width: 100%; border-collapse: collapse; text-align: center;"> <tr> <td style="width: 10%;"></td> <td style="width: 10%;"></td> <td style="width: 10%;"></td> <td style="width: 10%;"></td> <td style="width: 10%;"></td> <td style="width: 10%;"></td> <td style="width: 10%;"></td> <td style="width: 10%;"></td> <td style="width: 10%;"></td> <td style="width: 10%;"></td> </tr> <tr> <td></td> <td></td> <td colspan="8" style="text-align: center;"> <table border="1" style="width: 100%; border-collapse: collapse; text-align: center;"> <tr> <td style="width: 10%;"></td> <td style="width: 10%;"></td> <td style="width: 10%;"></td> <td style="width: 10%;"></td> <td style="width: 10%;"></td> <td style="width: 10%;"></td> <td style="width: 10%;"></td> <td style="width: 10%;"></td> <td style="width: 10%;"></td> <td style="width: 10%;"></td> </tr> <tr> <td></td> <td></td> <td colspan="8" style="text-align: center;"> <table border="1" style="width: 100%; border-collapse: collapse; text-align: center;"> <tr> <td style="width: 10%;"></td> <td style="width: 10%;"></td> <td style="width: 10%;"></td> <td style="width: 10%;"></td> <td style="width: 10%;"></td> <td style="width: 10%;"></td> <td style="width: 10%;"></td> <td style="width: 10%;"></td> <td style="width: 10%;"></td> <td style="width: 10%;"></td> </tr> <tr> <td></td> <td></td> <td colspan="8" style="text-align: center;"> <table border="1" style="width: 100%; border-collapse: collapse; text-align: center;"> <tr> <td style="width: 10%;"></td> <td style="width: 10%;"></td> <td style="width: 10%;"></td> <td style="width: 10%;"></td> <td style="width: 10%;"></td> <td style="width: 10%;"></td> <td style="width: 10%;"></td> <td style="width: 10%;"></td> <td style="width: 10%;"></td> <td style="width: 10%;"></td> </tr> <tr> <td></td> <td></td> <td colspan="8" style="text-align: center;"> <table border="1" style="width: 100%; border-collapse: collapse; text-align: center;"> <tr> <td style="width: 10%;"></td> <td style="width: 10%;"></td> <td style="width: 10%;"></td> <td style="width: 10%;"></td> <td style="width: 10%;"></td> <td style="width: 10%;"></td> <td style="width: 10%;"></td> <td style="width: 10%;"></td> <td style="width: 10%;"></td> <td style="width: 10%;"></td> </tr> <tr> <td></td> <td></td> <td colspan="8" style="text-align: center;"> <table border="1" style="width: 100%; border-collapse: collapse; text-align: center;"> <tr> <td style="width: 10%;"></td> <td style="width: 10%;"></td> <td style="width: 10%;"></td> <td style="width: 10%;"></td> <td style="width: 10%;"></td> <td style="width: 10%;"></td> <td style="width: 10%;"></td> <td style="width: 10%;"></td> <td style="width: 10%;"></td> <td style="width: 10%;"></td> </tr> <tr> <td></td> <td></td> <td colspan="8" style="text-align: center;"> <table border="1" style="width: 100%; border-collapse: collapse; text-align: center;"> <tr> <td style="width: 10%;"></td> <td style="width: 10%;"></td> <td style="width: 10%;"></td> <td style="width: 10%;"></td> <td style="width: 10%;"></td> <td style="width: 10%;"></td> <td style="width: 10%;"></td> <td style="width: 10%;"></td> <td style="width: 10%;"></td> <td style="width: 10%;"></td> </tr> <tr> <td></td> <td></td> <td colspan="8" style="text-align: center;"> <table border="1" style="width: 100%; border-collapse: collapse; text-align: center;"> <tr> <td style="width: 10%;"></td> <td style="width: 10%;"></td> <td style="width: 10%;"></td> <td style="width: 10%;"></td> <td style="width: 10%;"></td> <td style="width: 10%;"></td> <td style="width: 10%;"></td> <td style="width: 10%;"></td> <td style="width: 10%;"></td> <td style="width: 10%;"></td> </tr> <tr> <td></td> <td></td> <td colspan="8" style="text-align: center;"> <table border="1" style="width: 100%; border-collapse: collapse; text-align: center;"> <tr> </tr></table></td></tr></table></td></tr></table></td></tr></table></td></tr></table></td></tr></table></td></tr></table></td></tr></table></td></tr></table></td></tr></table></td></tr></table></td></tr></table></td></tr></table></td></tr></table></td></tr></table></td></tr></table></td></tr></table></td></tr></table></td></tr></table></td></tr></table></td></tr></table></td></tr></table>
 | | | | | | | | | | | | | | | | | | | | <table border="1" style="width: 100%; border-collapse: collapse; text-align: center;"> <tr> <td style="width: 10%;"></td> <td style="width: 10%;"></td> <td style="width: 10%;"></td> <td style="width: 10%;"></td> <td style="width: 10%;"></td> <td style="width: 10%;"></td> <td style="width: 10%;"></td> <td style="width: 10%;"></td> <td style="width: 10%;"></td> <td style="width: 10%;"></td> </tr> <tr> <td></td> <td></td> <td colspan="8" style="text-align: center;"> <table border="1" style="width: 100%; border-collapse: collapse; text-align: center;"> <tr> <td style="width: 10%;"></td> <td style="width: 10%;"></td> <td style="width: 10%;"></td> <td style="width: 10%;"></td> <td style="width: 10%;"></td> <td style="width: 10%;"></td> <td style="width: 10%;"></td> <td style="width: 10%;"></td> <td style="width: 10%;"></td> <td style="width: 10%;"></td> </tr> <tr> <td></td> <td></td> <td colspan="8" style="text-align: center;"> <table border="1" style="width: 100%; border-collapse: collapse; text-align: center;"> <tr> <td style="width: 10%;"></td> <td style="width: 10%;"></td> <td style="width: 10%;"></td> <td style="width: 10%;"></td> <td style="width: 10%;"></td> <td style="width: 10%;"></td> <td style="width: 10%;"></td> <td style="width: 10%;"></td> <td style="width: 10%;"></td> <td style="width: 10%;"></td> </tr> <tr> <td></td> <td></td> <td colspan="8" style="text-align: center;"> <table border="1" style="width: 100%; border-collapse: collapse; text-align: center;"> <tr> <td style="width: 10%;"></td> <td style="width: 10%;"></td> <td style="width: 10%;"></td> <td style="width: 10%;"></td> <td style="width: 10%;"></td> <td style="width: 10%;"></td> <td style="width: 10%;"></td> <td style="width: 10%;"></td> <td style="width: 10%;"></td> <td style="width: 10%;"></td> </tr> <tr> <td></td> <td></td> <td colspan="8" style="text-align: center;"> <table border="1" style="width: 100%; border-collapse: collapse; text-align: center;"> <tr> <td style="width: 10%;"></td> <td style="width: 10%;"></td> <td style="width: 10%;"></td> <td style="width: 10%;"></td> <td style="width: 10%;"></td> <td style="width: 10%;"></td> <td style="width: 10%;"></td> <td style="width: 10%;"></td> <td style="width: 10%;"></td> <td style="width: 10%;"></td> </tr> <tr> <td></td> <td></td> <td colspan="8" style="text-align: center;"> <table border="1" style="width: 100%; border-collapse: collapse; text-align: center;"> <tr> <td style="width: 10%;"></td> <td style="width: 10%;"></td> <td style="width: 10%;"></td> <td style="width: 10%;"></td> <td style="width: 10%;"></td> <td style="width: 10%;"></td> <td style="width: 10%;"></td> <td style="width: 10%;"></td> <td style="width: 10%;"></td> <td style="width: 10%;"></td> </tr> <tr> <td></td> <td></td> <td colspan="8" style="text-align: center;"> <table border="1" style="width: 100%; border-collapse: collapse; text-align: center;"> <tr> <td style="width: 10%;"></td> <td style="width: 10%;"></td> <td style="width: 10%;"></td> <td style="width: 10%;"></td> <td style="width: 10%;"></td> <td style="width: 10%;"></td> <td style="width: 10%;"></td> <td style="width: 10%;"></td> <td style="width: 10%;"></td> <td style="width: 10%;"></td> </tr> <tr> <td></td> <td></td> <td colspan="8" style="text-align: center;"> <table border="1" style="width: 100%; border-collapse: collapse; text-align: center;"> <tr> <td style="width: 10%;"></td> <td style="width: 10%;"></td> <td style="width: 10%;"></td> <td style="width: 10%;"></td> <td style="width: 10%;"></td> <td style="width: 10%;"></td> <td style="width: 10%;"></td> <td style="width: 10%;"></td> <td style="width: 10%;"></td> <td style="width: 10%;"></td> </tr> <tr> <td></td> <td></td> <td colspan="8" style="text-align: center;"> <table border="1" style="width: 100%; border-collapse: collapse; text-align: center;"> <tr> <td style="width: 10%;"></td> <td style="width: 10%;"></td> <td style="width: 10%;"></td> <td style="width: 10%;"></td> <td style="width: 10%;"></td> <td style="width: 10%;"></td> <td style="width: 10%;"></td> <td style="width: 10%;"></td> <td style="width: 10%;"></td> <td style="width: 10%;"></td> </tr> <tr> <td></td> <td></td> <td colspan="8" style="text-align: center;"> <table border="1" style="width: 100%; border-collapse: collapse; text-align: center;"> <tr> <td style="width: 10%;"></td> <td style="width: 10%;"></td> <td style="width: 10%;"></td> <td style="width: 10%;"></td> <td style="width: 10%;"></td> <td style="width: 10%;"></td> <td style="width: 10%;"></td> <td style="width: 10%;"></td> <td style="width: 10%;"></td> <td style="width: 10%;"></td> </tr> <tr> <td></td> <td></td> <td colspan="8" style="text-align: center;"> <table border="1"
style="width: 100%; border-collapse: collapse; text-align: center;"> <tr> <td style="width: 10%;"></td> <td style="width: 10%;"></td> <td style="width: 10%;"></td> <td style="width: 10%;"></td> <td style="width: 10%;"></td> <td style="width: 10%;"></td> <td style="width: 10%;"></td> <td style="width: 10%;"></td> <td style="width: 10%;"></td> <td style="width: 10%;"></td> </tr> <tr> <td></td> <td></td> <td colspan="8" style="text-align: center;"> <table border="1" style="width: 100%; border-collapse: collapse; text-align: center;"> <tr> <td style="width: 10%;"></td> <td style="width: 10%;"></td> <td style="width: 10%;"></td> <td style="width: 10%;"></td> <td style="width: 10%;"></td> <td style="width: 10%;"></td> <td style="width: 10%;"></td> <td style="width: 10%;"></td> <td style="width: 10%;"></td> <td style="width: 10%;"></td> </tr> <tr> <td></td> <td></td> <td colspan="8" style="text-align: center;"> <table border="1" style="width: 100%; border-collapse: collapse; text-align: center;"> <tr> <td style="width: 10%;"></td> <td style="width: 10%;"></td> <td style="width: 10%;"></td> <td style="width: 10%;"></td> <td style="width: 10%;"></td> <td style="width: 10%;"></td> <td style="width: 10%;"></td> <td style="width: 10%;"></td> <td style="width: 10%;"></td> <td style="width: 10%;"></td> </tr> <tr> <td></td> <td></td> <td colspan="8" style="text-align: center;"> <table border="1" style="width: 100%; border-collapse: collapse; text-align: center;"> <tr> <td style="width: 10%;"></td> <td style="width: 10%;"></td> <td style="width: 10%;"></td> <td style="width: 10%;"></td> <td style="width: 10%;"></td> <td style="width: 10%;"></td> <td style="width: 10%;"></td> <td style="width: 10%;"></td> <td style="width: 10%;"></td> <td style="width: 10%;"></td> </tr> <tr> <td></td> <td></td> <td colspan="8" style="text-align: center;"> <table border="1" style="width: 100%; border-collapse: collapse; text-align: center;"> <tr> <td style="width: 10%;"></td> <td style="width: 10%;"></td> <td style="width: 10%;"></td> <td style="width: 10%;"></td> <td style="width: 10%;"></td> <td style="width: 10%;"></td> <td style="width: 10%;"></td> <td style="width: 10%;"></td> <td style="width: 10%;"></td> <td style="width: 10%;"></td> </tr> <tr> <td></td> <td></td> <td colspan="8" style="text-align: center;"> <table border="1" style="width: 100%; border-collapse: collapse; text-align: center;"> <tr> <td style="width: 10%;"></td> <td style="width: 10%;"></td> <td style="width: 10%;"></td> <td style="width: 10%;"></td> <td style="width: 10%;"></td> <td style="width: 10%;"></td> <td style="width: 10%;"></td> <td style="width: 10%;"></td> <td style="width: 10%;"></td> <td style="width: 10%;"></td> </tr> <tr> <td></td> <td></td> <td colspan="8" style="text-align: center;"> <table border="1" style="width: 100%; border-collapse: collapse; text-align: center;"> <tr> <td style="width: 10%;"></td> <td style="width: 10%;"></td> <td style="width: 10%;"></td> <td style="width: 10%;"></td> <td style="width: 10%;"></td> <td style="width: 10%;"></td> <td style="width: 10%;"></td> <td style="width: 10%;"></td> <td style="width: 10%;"></td> <td style="width: 10%;"></td> </tr> <tr> <td></td> <td></td> <td colspan="8" style="text-align: center;"> <table border="1" style="width: 100%; border-collapse: collapse; text-align: center;"> <tr> <td style="width: 10%;"></td> <td style="width: 10%;"></td> <td style="width: 10%;"></td> <td style="width: 10%;"></td> <td style="width: 10%;"></td> <td style="width: 10%;"></td> <td style="width: 10%;"></td> <td style="width: 10%;"></td> <td style="width: 10%;"></td> <td style="width: 10%;"></td> </tr> <tr> <td></td> <td></td> <td colspan="8" style="text-align: center;"> <table border="1" style="width: 100%; border-collapse: collapse; text-align: center;"> <tr> <td style="width: 10%;"></td> <td style="width: 10%;"></td> <td style="width: 10%;"></td> <td style="width: 10%;"></td> <td style="width: 10%;"></td> <td style="width: 10%;"></td> <td style="width: 10%;"></td> <td style="width: 10%;"></td> <td style="width: 10%;"></td> <td style="width: 10%;"></td> </tr> <tr> <td></td> <td></td> <td colspan="8" style="text-align: center;"> <table border="1" style="width: 100%; border-collapse: collapse; text-align: center;"> <tr> <td style="width: 10%;"></td> <td style="width: 10%;"></td> <td style="width: 10%;"></td> <td style="width: 10%;"></td> <td style="width: 10%;"></td> <td style="width: 10%;"></td> <td style="width: 10%;"></td> <td style="width: 10%;"></td> <td style="width: 10%;"></td> <td style="width: 10%;"></td> </tr> <tr> <td></td> <td></td> <td colspan="8" style="text-align: center;"> <table border="1" style="width: 100%; border-collapse: collapse; text-align: center;"> <tr> </tr></table></td></tr></table></td></tr></table></td></tr></table></td></tr></table></td></tr></table></td></tr></table></td></tr></table></td></tr></table></td></tr></table></td></tr></table></td></tr></table></td></tr></table></td></tr></table></td></tr></table></td></tr></table></td></tr></table></td></tr></table></td></tr></table></td></tr></table></td></tr></table>
 | | | | | | | | | | | | | | | | | | | | <table border="1" style="width: 100%; border-collapse: collapse; text-align: center;"> <tr> <td style="width: 10%;"></td> <td style="width: 10%;"></td> <td style="width: 10%;"></td> <td style="width: 10%;"></td> <td style="width: 10%;"></td> <td style="width: 10%;"></td> <td style="width: 10%;"></td> <td style="width: 10%;"></td> <td style="width: 10%;"></td> <td style="width: 10%;"></td> </tr> <tr> <td></td> <td></td> <td colspan="8" style="text-align: center;"> <table border="1" style="width: 100%; border-collapse: collapse; text-align: center;"> <tr> <td style="width: 10%;"></td> <td style="width: 10%;"></td> <td style="width: 10%;"></td> <td style="width: 10%;"></td> <td style="width: 10%;"></td> <td style="width: 10%;"></td> <td style="width: 10%;"></td> <td style="width: 10%;"></td> <td style="width: 10%;"></td> <td style="width: 10%;"></td> </tr> <tr> <td></td> <td></td> <td colspan="8" style="text-align: center;"> <table border="1" style="width: 100%; border-collapse: collapse; text-align: center;"> <tr> <td style="width: 10%;"></td> <td style="width: 10%;"></td> <td style="width: 10%;"></td> <td style="width: 10%;"></td> <td style="width: 10%;"></td> <td style="width: 10%;"></td> <td style="width: 10%;"></td> <td style="width: 10%;"></td> <td style="width: 10%;"></td> <td style="width: 10%;"></td> </tr> <tr> <td></td> <td></td> <td colspan="8" style="text-align: center;"> <table border="1" style="width: 100%; border-collapse: collapse; text-align: center;"> <tr> <td style="width: 10%;"></td> <td style="width: 10%;"></td> <td style="width: 10%;"></td> <td style="width: 10%;"></td> <td style="width: 10%;"></td> <td style="width: 10%;"></td> <td style="width: 10%;"></td> <td style="width: 10%;"></td> <td style="width: 10%;"></td> <td style="width: 10%;"></td> </tr> <tr> <td></td> <td></td> <td colspan="8" style="text-align: center;"> <table border="1" style="width: 100%; border-collapse: collapse; text-align: center;"> <tr> <td style="width: 10%;"></td> <td style="width: 10%;"></td> <td style="width: 10%;"></td> <td style="width: 10%;"></td> <td style="width: 10%;"></td> <td style="width: 10%;"></td> <td style="width: 10%;"></td> <td style="width: 10%;"></td> <td style="width: 10%;"></td> <td style="width: 10%;"></td> </tr> <tr> <td></td> <td></td> <td colspan="8" style="text-align: center;"> <table border="1" style="width: 100%; border-collapse: collapse; text-align: center;"> <tr> <td style="width: 10%;"></td> <td style="width: 10%;"></td> <td style="width: 10%;"></td> <td style="width: 10%;"></td> <td style="width: 10%;"></td> <td style="width: 10%;"></td> <td style="width: 10%;"></td> <td style="width: 10%;"></td> <td style="width: 10%;"></td> <td style="width: 10%;"></td> </tr> <tr> <td></td> <td></td> <td colspan="8" style="text-align: center;"> <table border="1" style="width: 100%; border-collapse: collapse; text-align: center;"> <tr> <td style="width: 10%;"></td> <td style="width: 10%;"></td> <td style="width: 10%;"></td> <td style="width: 10%;"></td> <td style="width: 10%;"></td> <td style="width: 10%;"></td> <td style="width: 10%;"></td> <td style="width: 10%;"></td> <td style="width: 10%;"></td> <td style="width: 10%;"></td> </tr> <tr> <td></td> <td></td> <td colspan="8" style="text-align: center;"> <table border="1" style="width: 100%; border-collapse: collapse; text-align: center;"> <tr> <td style="width: 10%;"></td> <td style="width: 10%;"></td> <td style="width: 10%;"></td> <td style="width: 10%;"></td> <td style="width: 10%;"></td> <td style="width: 10%;"></td> <td style="width: 10%;"></td> <td style="width: 10%;"></td> <td style="width: 10%;"></td> <td style="width: 10%;"></td> </tr> <tr> <td></td> <td></td> <td colspan="8" style="text-align: center;"> <table border="1" style="width: 100%; border-collapse: collapse; text-align: center;"> <tr> <td style="width: 10%;"></td> <td style="width: 10%;"></td> <td style="width: 10%;"></td> <td style="width: 10%;"></td> <td style="width: 10%;"></td> <td style="width: 10%;"></td> <td style="width: 10%;"></td> <td style="width: 10%;"></td> <td style="width: 10%;"></td> <td style="width: 10%;"></td> </tr> <tr> <td></td> <td></td> <td colspan="8" style="text-align: center;"> <table border="1" style="width: 100%; border-collapse: collapse; text-align: center;"> <tr> <td style="width: 10%;"></td> <td style="width: 10%;"></td> <td style="width: 10%;"></td> <td style="width: 10%;"></td> <td style="width: 10%;"></td> <td style="width: 10%;"></td> <td style="width: 10%;"></td> <td style="width: 10%;"></td> <td style="width: 10%;"></td> <td style="width: 10%;"></td> </tr> <tr> <td></td> <td></td> <td colspan="8" style="text-align: center;"> <table border="1" style="width: 100%; border-collapse: collapse; text-align: center;"> <tr> <td style="width: 10%;"></td> <td style="width: 10%;"></td> <td style="width: 10%;"></td> <td style="width: 10%;"></td> <td style="width: 10%;"></td> <td style="width: 10%;"></td> <td style="width: 10%;"></td> <td style="width: 10%;"></td> <td style="width: 10%;"></td> <td style="width: 10%;"></td> </tr> <tr> <td></td> <td></td> <td colspan="8" style="text-align: center;"> <table border="1" style="width: 100%; border-collapse: collapse; text-align: center;"> <tr> <td style="width: 10%;"></td> <td style="width: 10%;"></td> <td style="width: 10%;"></td> <td style="width: 10%;"></td> <td style="width: 10%;"></td> <td style="width: 10%;"></td> <td style="width: 10%;"></td> <td style="width: 10%;"></td> <td style="width: 10%;"></td> <td style="width: 10%;"></td> </tr> <tr> <td></td> <td></td> <td colspan="8" style="text-align: center;"> <table border="1" style="width: 100%; border-collapse: collapse; text-align: center;"> <tr> <td style="width: 10%;"></td> <td style="width: 10%;"></td> <td style="width: 10%;"></td> <td style="width: 10%;"></td> <td style="width: 10%;"></td> <td style="width: 10%;"></td> <td style="width: 10%;"></td> <td style="width: 10%;"></td> <td style="width: 10%;"></td> <td style="width: 10%;"></td> </tr> <tr> <td></td> <td></td> <td colspan="8"
style="text-align: center;"> <table border="1" style="width: 100%; border-collapse: collapse; text-align: center;"> <tr> <td style="width: 10%;"></td> <td style="width: 10%;"></td> <td style="width: 10%;"></td> <td style="width: 10%;"></td> <td style="width: 10%;"></td> <td style="width: 10%;"></td> <td style="width: 10%;"></td> <td style="width: 10%;"></td> <td style="width: 10%;"></td> <td style="width: 10%;"></td> </tr> <tr> <td></td> <td></td> <td colspan="8" style="text-align: center;"> <table border="1" style="width: 100%; border-collapse: collapse; text-align: center;"> <tr> <td style="width: 10%;"></td> <td style="width: 10%;"></td> <td style="width: 10%;"></td> <td style="width: 10%;"></td> <td style="width: 10%;"></td> <td style="width: 10%;"></td> <td style="width: 10%;"></td> <td style="width: 10%;"></td> <td style="width: 10%;"></td> <td style="width: 10%;"></td> </tr> <tr> <td></td> <td></td> <td colspan="8" style="text-align: center;"> <table border="1" style="width: 100%; border-collapse: collapse; text-align: center;"> <tr> <td style="width: 10%;"></td> <td style="width: 10%;"></td> <td style="width: 10%;"></td> <td style="width: 10%;"></td> <td style="width: 10%;"></td> <td style="width: 10%;"></td> <td style="width: 10%;"></td> <td style="width: 10%;"></td> <td style="width: 10%;"></td> <td style="width: 10%;"></td> </tr> <tr> <td></td> <td></td> <td colspan="8" style="text-align: center;"> <table border="1" style="width: 100%; border-collapse: collapse; text-align: center;"> <tr> <td style="width: 10%;"></td> <td style="width: 10%;"></td> <td style="width: 10%;"></td> <td style="width: 10%;"></td> <td style="width: 10%;"></td> <td style="width: 10%;"></td> <td style="width: 10%;"></td> <td style="width: 10%;"></td> <td style="width: 10%;"></td> <td style="width: 10%;"></td> </tr> <tr> <td></td> <td></td> <td colspan="8" style="text-align: center;"> <table border="1" style="width: 100%; border-collapse: collapse; text-align: center;"> <tr> <td style="width: 10%;"></td> <td style="width: 10%;"></td> <td style="width: 10%;"></td> <td style="width: 10%;"></td> <td style="width: 10%;"></td> <td style="width: 10%;"></td> <td style="width: 10%;"></td> <td style="width: 10%;"></td> <td style="width: 10%;"></td> <td style="width: 10%;"></td> </tr> <tr> <td></td> <td></td> <td colspan="8" style="text-align: center;"> <table border="1" style="width: 100%; border-collapse: collapse; text-align: center;"> <tr> <td style="width: 10%;"></td> <td style="width: 10%;"></td> <td style="width: 10%;"></td> <td style="width: 10%;"></td> <td style="width: 10%;"></td> <td style="width: 10%;"></td> <td style="width: 10%;"></td> <td style="width: 10%;"></td> <td style="width: 10%;"></td> <td style="width: 10%;"></td> </tr> <tr> <td></td> <td></td> <td colspan="8" style="text-align: center;"> <table border="1" style="width: 100%; border-collapse: collapse; text-align: center;"> <tr> </tr></table></td></tr></table></td></tr></table></td></tr></table></td></tr></table></td></tr></table></td></tr></table></td></tr></table></td></tr></table></td></tr></table></td></tr></table></td></tr></table></td></tr></table></td></tr></table></td></tr></table></td></tr></table></td></tr></table></td></tr></table></td></tr></table></td></tr></table>
 | | | | | | | | | | | | | | | | | | | | <table border="1" style="width: 100%; border-collapse: collapse; text-align: center;"> <tr> <td style="width: 10%;"></td> <td style="width: 10%;"></td> <td style="width: 10%;"></td> <td style="width: 10%;"></td> <td style="width: 10%;"></td> <td style="width: 10%;"></td> <td style="width: 10%;"></td> <td style="width: 10%;"></td> <td style="width: 10%;"></td> <td style="width: 10%;"></td> </tr> <tr> <td></td> <td></td> <td colspan="8" style="text-align: center;"> <table border="1" style="width: 100%; border-collapse: collapse; text-align: center;"> <tr> <td style="width: 10%;"></td> <td style="width: 10%;"></td> <td style="width: 10%;"></td> <td style="width: 10%;"></td> <td style="width: 10%;"></td> <td style="width: 10%;"></td> <td style="width: 10%;"></td> <td style="width: 10%;"></td> <td style="width: 10%;"></td> <td style="width: 10%;"></td> </tr> <tr> <td></td> <td></td> <td colspan="8" style="text-align: center;"> <table border="1" style="width: 100%; border-collapse: collapse; text-align: center;"> <tr> <td style="width: 10%;"></td> <td style="width: 10%;"></td> <td style="width: 10%;"></td> <td style="width: 10%;"></td> <td style="width: 10%;"></td> <td style="width: 10%;"></td> <td style="width: 10%;"></td> <td style="width: 10%;"></td> <td style="width: 10%;"></td> <td style="width: 10%;"></td> </tr> <tr> <td></td> <td></td> <td colspan="8" style="text-align: center;"> <table border="1" style="width: 100%; border-collapse: collapse; text-align: center;"> <tr> <td style="width: 10%;"></td> <td style="width: 10%;"></td> <td style="width: 10%;"></td> <td style="width: 10%;"></td> <td style="width: 10%;"></td> <td style="width: 10%;"></td> <td style="width: 10%;"></td> <td style="width: 10%;"></td> <td style="width: 10%;"></td> <td style="width: 10%;"></td> </tr> <tr> <td></td> <td></td> <td colspan="8" style="text-align: center;"> <table border="1" style="width: 100%; border-collapse: collapse; text-align: center;"> <tr> <td style="width: 10%;"></td> <td style="width: 10%;"></td> <td style="width: 10%;"></td> <td style="width: 10%;"></td> <td style="width: 10%;"></td> <td style="width: 10%;"></td> <td style="width: 10%;"></td> <td style="width: 10%;"></td> <td style="width: 10%;"></td> <td style="width: 10%;"></td> </tr> <tr> <td></td> <td></td> <td colspan="8" style="text-align: center;"> <table border="1" style="width: 100%; border-collapse: collapse; text-align: center;"> <tr> <td style="width: 10%;"></td> <td style="width: 10%;"></td> <td style="width: 10%;"></td> <td style="width: 10%;"></td> <td style="width: 10%;"></td> <td style="width: 10%;"></td> <td style="width: 10%;"></td> <td style="width: 10%;"></td> <td style="width: 10%;"></td> <td style="width: 10%;"></td> </tr> <tr> <td></td> <td></td> <td colspan="8" style="text-align: center;"> <table border="1" style="width: 100%; border-collapse: collapse; text-align: center;"> <tr> <td style="width: 10%;"></td> <td style="width: 10%;"></td> <td style="width: 10%;"></td> <td style="width: 10%;"></td> <td style="width: 10%;"></td> <td style="width: 10%;"></td> <td style="width: 10%;"></td> <td style="width: 10%;"></td> <td style="width: 10%;"></td> <td style="width: 10%;"></td> </tr> <tr> <td></td> <td></td> <td colspan="8" style="text-align: center;"> <table border="1" style="width: 100%; border-collapse: collapse; text-align: center;"> <tr> <td style="width: 10%;"></td> <td style="width: 10%;"></td> <td style="width: 10%;"></td> <td style="width: 10%;"></td> <td style="width: 10%;"></td> <td style="width: 10%;"></td> <td style="width: 10%;"></td> <td style="width: 10%;"></td> <td style="width: 10%;"></td> <td style="width: 10%;"></td> </tr> <tr> <td></td> <td></td> <td colspan="8" style="text-align: center;"> <table border="1" style="width: 100%; border-collapse: collapse; text-align: center;"> <tr> <td style="width: 10%;"></td> <td style="width: 10%;"></td> <td style="width: 10%;"></td> <td style="width: 10%;"></td> <td style="width: 10%;"></td> <td style="width: 10%;"></td> <td style="width: 10%;"></td> <td style="width: 10%;"></td> <td style="width: 10%;"></td> <td style="width: 10%;"></td> </tr> <tr> <td></td> <td></td> <td colspan="8" style="text-align: center;"> <table border="1" style="width: 100%; border-collapse: collapse; text-align: center;"> <tr> <td style="width: 10%;"></td> <td style="width: 10%;"></td> <td style="width: 10%;"></td> <td style="width: 10%;"></td> <td style="width: 10%;"></td> <td style="width: 10%;"></td> <td style="width: 10%;"></td> <td style="width: 10%;"></td> <td style="width: 10%;"></td> <td style="width: 10%;"></td> </tr> <tr> <td></td> <td></td> <td colspan="8" style="text-align: center;"> <table border="1" style="width: 100%; border-collapse: collapse; text-align: center;"> <tr> <td style="width: 10%;"></td> <td style="width: 10%;"></td> <td style="width: 10%;"></td> <td style="width: 10%;"></td> <td style="width: 10%;"></td> <td style="width: 10%;"></td> <td style="width: 10%;"></td> <td style="width: 10%;"></td> <td style="width: 10%;"></td> <td style="width: 10%;"></td> </tr> <tr> <td></td> <td></td> <td colspan="8" style="text-align: center;"> <table border="1" style="width: 100%; border-collapse: collapse; text-align: center;"> <tr> <td style="width: 10%;"></td> <td style="width: 10%;"></td> <td style="width: 10%;"></td> <td style="width: 10%;"></td> <td style="width: 10%;"></td> <td style="width: 10%;"></td> <td style="width: 10%;"></td> <td style="width: 10%;"></td> <td style="width: 10%;"></td> <td style="width: 10%;"></td> </tr> <tr> <td></td> <td></td> <td colspan="8" style="text-align: center;"> <table border="1" style="width: 100%; border-collapse: collapse; text-align: center;"> <tr> <td style="width: 10%;"></td> <td style="width: 10%;"></td> <td style="width: 10%;"></td> <td style="width: 10%;"></td> <td style="width: 10%;"></td> <td style="width: 10%;"></td> <td style="width: 10%;"></td> <td style="width: 10%;"></td> <td style="width: 10%;"></td> <td style="width: 10%;"></td> </tr> <tr> <td></td> <td></td> <td colspan="8" style="text-align: center;"> <table border="1" style="width: 100%; border-collapse: collapse; text-align: center;"> <tr> <td style="width: 10%;"></td> <td style="width: 10%;"></td> <td style="width: 10%;"></td> <td style="width: 10%;"></td> <td style="width: 10%;"></td> <td style="width: 10%;"></td> <td style="width: 10%;"></td> <td style="width: 10%;"></td> <td style="width: 10%;"></td> <td style="width: 10%;"></td> </tr> <tr> <td></td> <td></td> <td colspan="8" style="text-align: center;"> <table border="1" style="width: 100%; border-collapse: collapse; text-align: center;"> <tr> <td style="width: 10%;"></td> <td style="width: 10%;"></td> <td style="width: 10%;"></td> <td style="width: 10%;"></td> <td style="width: 10%;"></td> <td style="width: 10%;"></td> <td style="width: 10%;"></td> <td style="width: 10%;"></td> <td style="width: 10%;"></td> <td style="width: 10%;"></td> </tr> <tr> <td></td> <td></td> <td colspan="8" style="text-align: center;"> <table border="1" style="width: 100%; border-collapse: collapse; text-align: center;"> <tr> <td style="width: 10%;"></td> <td style="width: 10%;"></td> <td style="width: 10%;"></td> <td style="width: 10%;"></td> <td style="width: 10%;"></td> <td style="width: 10%;"></td> <td style="width: 10%;"></td> <td style="width: 10%;"></td> <td style="width: 10%;"></td> <td style="width: 10%;"></td> </tr> <tr> <td></td> <td></td> <td colspan="8" style="text-align: center;"> <table border="1" style="width: 100%; border-collapse: collapse; text-align: center;"> <tr> <td style="width: 10%;"></td> <td style="width: 10%;"></td> <td style="width: 10%;"></td> <td style="width: 10%;"></td> <td style="width: 10%;"></td> <td style="width: 10%;"></td> <td style="width: 10%;"></td> <td style="width: 10%;"></td> <td style="width: 10%;"></td> <td style="width: 10%;"></td> </tr> <tr> <td></td>
<td></td> <td colspan="8" style="text-align: center;"> <table border="1" style="width: 100%; border-collapse: collapse; text-align: center;"> <tr> <td style="width: 10%;"></td> <td style="width: 10%;"></td> <td style="width: 10%;"></td> <td style="width: 10%;"></td> <td style="width: 10%;"></td> <td style="width: 10%;"></td> <td style="width: 10%;"></td> <td style="width: 10%;"></td> <td style="width: 10%;"></td> <td style="width: 10%;"></td> </tr> <tr> <td></td> <td></td> <td colspan="8" style="text-align: center;"> <table border="1" style="width: 100%; border-collapse: collapse; text-align: center;"> <tr> </tr></table></td></tr></table></td></tr></table></td></tr></table></td></tr></table></td></tr></table></td></tr></table></td></tr></table></td></tr></table></td></tr></table></td></tr></table></td></tr></table></td></tr></table></td></tr></table></td></tr></table></td></tr></table></td></tr></table></td></tr></table></td></tr></table> | | | | | | | | | | | | | | | | | | | | <table border="1" style="width: 100%; border-collapse: collapse; text-align: center;"> <tr> <td style="width: 10%;"></td> <td style="width: 10%;"></td> <td style="width: 10%;"></td> <td style="width: 10%;"></td> <td style="width:
10%;"></td> <td style="width: 10%;"></td> <td style="width: 10%;"></td> <td style="width: 10%;"></td> <td style="width: 10%;"></td> <td style="width: 10%;"></td> </tr> <tr> <td></td> <td></td> <td colspan="8" style="text-align: center;"> <table border="1" style="width: 100%; border-collapse: collapse; text-align: center;"> <tr> <td style="width: 10%;"></td> <td style="width: 10%;"></td> <td style="width: 10%;"></td> <td style="width: 10%;"></td> <td style="width: 10%;"></td> <td style="width: 10%;"></td> <td style="width: 10%;"></td> <td style="width: 10%;"></td> <td style="width: 10%;"></td> <td style="width: 10%;"></td> </tr> <tr> <td></td> <td></td> <td colspan="8" style="text-align: center;"> <table border="1" style="width: 100%; border-collapse: collapse; text-align: center;"> <tr> <td style="width: 10%;"></td> <td style="width: 10%;"></td> <td style="width: 10%;"></td> <td style="width: 10%;"></td> <td style="width: 10%;"></td> <td style="width: 10%;"></td> <td style="width: 10%;"></td> <td style="width: 10%;"></td> <td style="width: 10%;"></td> <td style="width: 10%;"></td> </tr> <tr> <td></td> <td></td> <td colspan="8" style="text-align: center;"> <table border="1" style="width: 100%; border-collapse: collapse; text-align: center;"> <tr> <td style="width: 10%;"></td> <td style="width: 10%;"></td> <td style="width: 10%;"></td> <td style="width: 10%;"></td> <td style="width: 10%;"></td> <td style="width: 10%;"></td> <td style="width: 10%;"></td> <td style="width: 10%;"></td> <td style="width: 10%;"></td> <td style="width: 10%;"></td> </tr> <tr> <td></td> <td></td> <td colspan="8" style="text-align: center;"> <table border="1" style="width: 100%; border-collapse: collapse; text-align: center;"> <tr> <td style="width: 10%;"></td> <td style="width: 10%;"></td> <td style="width: 10%;"></td> <td style="width: 10%;"></td> <td style="width: 10%;"></td> <td style="width: 10%;"></td> <td style="width: 10%;"></td> <td style="width: 10%;"></td> <td style="width: 10%;"></td> <td style="width: 10%;"></td> </tr> <tr> <td></td> <td></td> <td colspan="8" style="text-align: center;"> <table border="1" style="width: 100%; border-collapse: collapse; text-align: center;"> <tr> <td style="width: 10%;"></td> <td style="width: 10%;"></td> <td style="width: 10%;"></td> <td style="width: 10%;"></td> <td style="width: 10%;"></td> <td style="width: 10%;"></td> <td style="width: 10%;"></td> <td style="width: 10%;"></td> <td style="width: 10%;"></td> <td style="width: 10%;"></td> </tr> <tr> <td></td> <td></td> <td colspan="8" style="text-align: center;"> <table border="1" style="width: 100%; border-collapse: collapse; text-align: center;"> <tr> <td style="width: 10%;"></td> <td style="width: 10%;"></td> <td style="width: 10%;"></td> <td style="width: 10%;"></td> <td style="width: 10%;"></td> <td style="width: 10%;"></td> <td style="width: 10%;"></td> <td style="width: 10%;"></td> <td style="width: 10%;"></td> <td style="width: 10%;"></td> </tr> <tr> <td></td> <td></td> <td colspan="8" style="text-align: center;"> <table border="1" style="width: 100%; border-collapse: collapse; text-align: center;"> <tr> <td style="width: 10%;"></td> <td style="width: 10%;"></td> <td style="width: 10%;"></td> <td style="width: 10%;"></td> <td style="width: 10%;"></td> <td style="width: 10%;"></td> <td style="width: 10%;"></td> <td style="width: 10%;"></td> <td style="width: 10%;"></td> <td style="width: 10%;"></td> </tr> <tr> <td></td> <td></td> <td colspan="8" style="text-align: center;"> <table border="1" style="width: 100%; border-collapse: collapse; text-align: center;"> <tr> <td style="width: 10%;"></td> <td style="width: 10%;"></td> <td style="width: 10%;"></td> <td style="width: 10%;"></td> <td style="width: 10%;"></td> <td style="width: 10%;"></td> <td style="width: 10%;"></td> <td style="width: 10%;"></td> <td style="width: 10%;"></td> <td style="width: 10%;"></td> </tr> <tr> <td></td> <td></td> <td colspan="8" style="text-align: center;"> <table border="1" style="width: 100%; border-collapse: collapse; text-align: center;"> <tr> <td style="width: 10%;"></td> <td style="width: 10%;"></td> <td style="width: 10%;"></td> <td style="width: 10%;"></td> <td style="width: 10%;"></td> <td style="width: 10%;"></td> <td style="width: 10%;"></td> <td style="width: 10%;"></td> <td style="width: 10%;"></td> <td style="width: 10%;"></td> </tr> <tr> <td></td> <td></td> <td colspan="8" style="text-align: center;"> <table border="1" style="width: 100%; border-collapse: collapse; text-align: center;"> <tr> <td style="width: 10%;"></td> <td style="width: 10%;"></td> <td style="width: 10%;"></td> <td style="width: 10%;"></td> <td style="width: 10%;"></td> <td style="width: 10%;"></td> <td style="width: 10%;"></td> <td style="width: 10%;"></td> <td style="width: 10%;"></td> <td style="width: 10%;"></td> </tr> <tr> <td></td> <td></td> <td colspan="8" style="text-align: center;"> <table border="1" style="width: 100%; border-collapse: collapse; text-align: center;"> <tr> <td style="width: 10%;"></td> <td style="width: 10%;"></td> <td style="width: 10%;"></td> <td style="width: 10%;"></td> <td style="width: 10%;"></td> <td style="width: 10%;"></td> <td style="width: 10%;"></td> <td style="width: 10%;"></td> <td style="width: 10%;"></td> <td style="width: 10%;"></td> </tr> <tr> <td></td> <td></td> <td colspan="8" style="text-align: center;"> <table border="1" style="width: 100%; border-collapse: collapse; text-align: center;"> <tr> <td style="width: 10%;"></td> <td style="width: 10%;"></td> <td style="width: 10%;"></td> <td style="width: 10%;"></td> <td style="width: 10%;"></td> <td style="width: 10%;"></td> <td style="width: 10%;"></td> <td style="width: 10%;"></td> <td style="width: 10%;"></td> <td style="width: 10%;"></td> </tr> <tr> <td></td> <td></td> <td colspan="8" style="text-align: center;"> <table border="1" style="width: 100%; border-collapse: collapse; text-align: center;"> <tr> <td style="width: 10%;"></td> <td style="width: 10%;"></td> <td style="width: 10%;"></td> <td style="width: 10%;"></td> <td style="width: 10%;"></td> <td style="width: 10%;"></td> <td style="width: 10%;"></td> <td style="width: 10%;"></td> <td style="width: 10%;"></td> <td style="width: 10%;"></td> </tr> <tr> <td></td> <td></td> <td colspan="8" style="text-align: center;"> <table border="1" style="width: 100%; border-collapse: collapse; text-align: center;"> <tr> <td style="width: 10%;"></td> <td style="width: 10%;"></td> <td style="width: 10%;"></td> <td style="width: 10%;"></td> <td style="width: 10%;"></td> <td style="width: 10%;"></td> <td style="width: 10%;"></td> <td style="width: 10%;"></td> <td style="width: 10%;"></td> <td style="width: 10%;"></td> </tr> <tr> <td></td> <td></td> <td colspan="8" style="text-align: center;"> <table border="1" style="width: 100%; border-collapse: collapse; text-align: center;"> <tr> <td style="width: 10%;"></td> <td style="width: 10%;"></td> <td style="width: 10%;"></td> <td style="width: 10%;"></td> <td style="width: 10%;"></td> <td style="width: 10%;"></td> <td style="width: 10%;"></td> <td style="width: 10%;"></td> <td style="width: 10%;"></td> <td style="width: 10%;"></td> </tr> <tr> <td></td> <td></td> <td colspan="8" style="text-align: center;"> <table border="1" style="width: 100%; border-collapse: collapse; text-align: center;"> <tr> <td style="width: 10%;"></td> <td style="width: 10%;"></td> <td style="width: 10%;"></td> <td style="width: 10%;"></td> <td style="width: 10%;"></td> <td style="width: 10%;"></td> <td style="width: 10%;"></td> <td style="width: 10%;"></td> <td style="width: 10%;"></td> <td style="width: 10%;"></td> </tr> <tr> <td></td> <td></td> <td colspan="8" style="text-align: center;"> <table border="1" style="width: 100%; border-collapse: collapse; text-align: center;"> <tr> </tr></table></td></tr></table></td></tr></table></td></tr></table></td></tr></table></td></tr></table></td></tr></table></td></tr></table></td></tr></table></td></tr></table></td></tr></table></td></tr></table></td></tr></table></td></tr></table></td></tr></table></td></tr></table></td></tr></table></td></tr></table>
 | | | | | | | | | | | | | | | | | | | | <table border="1" style="width: 100%; border-collapse: collapse; text-align: center;"> <tr> <td style="width: 10%;"></td> <td style="width: 10%;"></td> <td style="width: 10%;"></td> <td style="width: 10%;"></td> <td style="width: 10%;"></td> <td style="width: 10%;"></td> <td style="width: 10%;"></td> <td style="width: 10%;"></td> <td style="width: 10%;"></td> <td style="width: 10%;"></td> </tr> <tr> <td></td> <td></td> <td colspan="8" style="text-align: center;"> <table border="1" style="width: 100%; border-collapse: collapse; text-align: center;"> <tr> <td style="width: 10%;"></td> <td style="width: 10%;"></td> <td style="width: 10%;"></td> <td style="width: 10%;"></td> <td style="width: 10%;"></td> <td style="width: 10%;"></td> <td style="width: 10%;"></td> <td style="width: 10%;"></td> <td style="width: 10%;"></td> <td style="width: 10%;"></td> </tr> <tr> <td></td> <td></td> <td colspan="8" style="text-align: center;"> <table border="1" style="width: 100%; border-collapse: collapse; text-align: center;"> <tr> <td style="width: 10%;"></td> <td style="width: 10%;"></td> <td style="width: 10%;"></td> <td style="width: 10%;"></td> <td style="width: 10%;"></td> <td style="width: 10%;"></td> <td style="width: 10%;"></td> <td style="width: 10%;"></td> <td style="width: 10%;"></td> <td style="width: 10%;"></td> </tr> <tr> <td></td> <td></td> <td colspan="8" style="text-align: center;"> <table border="1" style="width: 100%; border-collapse: collapse; text-align: center;"> <tr> <td style="width: 10%;"></td> <td style="width: 10%;"></td> <td style="width: 10%;"></td> <td style="width: 10%;"></td> <td style="width: 10%;"></td> <td style="width: 10%;"></td> <td style="width: 10%;"></td> <td style="width: 10%;"></td> <td style="width: 10%;"></td> <td style="width: 10%;"></td> </tr> <tr> <td></td> <td></td> <td colspan="8" style="text-align: center;"> <table border="1" style="width: 100%; border-collapse: collapse; text-align: center;"> <tr> <td style="width: 10%;"></td> <td style="width: 10%;"></td> <td style="width: 10%;"></td> <td style="width: 10%;"></td> <td style="width: 10%;"></td> <td style="width: 10%;"></td> <td style="width: 10%;"></td> <td style="width: 10%;"></td> <td style="width: 10%;"></td> <td style="width: 10%;"></td> </tr> <tr> <td></td> <td></td> <td colspan="8" style="text-align: center;"> <table border="1" style="width: 100%; border-collapse: collapse; text-align: center;"> <tr> <td style="width: 10%;"></td> <td style="width: 10%;"></td> <td style="width: 10%;"></td> <td style="width: 10%;"></td> <td style="width: 10%;"></td> <td style="width: 10%;"></td> <td style="width: 10%;"></td> <td style="width: 10%;"></td> <td style="width: 10%;"></td> <td style="width: 10%;"></td> </tr> <tr> <td></td> <td></td> <td colspan="8" style="text-align: center;"> <table border="1" style="width: 100%; border-collapse: collapse; text-align: center;"> <tr> <td style="width: 10%;"></td> <td style="width: 10%;"></td> <td style="width: 10%;"></td> <td style="width: 10%;"></td> <td style="width: 10%;"></td> <td
style="width: 10%;"></td> <td style="width: 10%;"></td> <td style="width: 10%;"></td> <td style="width: 10%;"></td> <td style="width: 10%;"></td> </tr> <tr> <td></td> <td></td> <td colspan="8" style="text-align: center;"> <table border="1" style="width: 100%; border-collapse: collapse; text-align: center;"> <tr> <td style="width: 10%;"></td> <td style="width: 10%;"></td> <td style="width: 10%;"></td> <td style="width: 10%;"></td> <td style="width: 10%;"></td> <td style="width: 10%;"></td> <td style="width: 10%;"></td> <td style="width: 10%;"></td> <td style="width: 10%;"></td> <td style="width: 10%;"></td> </tr> <tr> <td></td> <td></td> <td colspan="8" style="text-align: center;"> <table border="1" style="width: 100%; border-collapse: collapse; text-align: center;"> <tr> <td style="width: 10%;"></td> <td style="width: 10%;"></td> <td style="width: 10%;"></td> <td style="width: 10%;"></td> <td style="width: 10%;"></td> <td style="width: 10%;"></td> <td style="width: 10%;"></td> <td style="width: 10%;"></td> <td style="width: 10%;"></td> <td style="width: 10%;"></td> </tr> <tr> <td></td> <td></td> <td colspan="8" style="text-align: center;"> <table border="1" style="width: 100%; border-collapse: collapse; text-align: center;"> <tr> <td style="width: 10%;"></td> <td style="width: 10%;"></td> <td style="width: 10%;"></td> <td style="width: 10%;"></td> <td style="width: 10%;"></td> <td style="width: 10%;"></td> <td style="width: 10%;"></td> <td style="width: 10%;"></td> <td style="width: 10%;"></td> <td style="width: 10%;"></td> </tr> <tr> <td></td> <td></td> <td colspan="8" style="text-align: center;"> <table border="1" style="width: 100%; border-collapse: collapse; text-align: center;"> <tr> <td style="width: 10%;"></td> <td style="width: 10%;"></td> <td style="width: 10%;"></td> <td style="width: 10%;"></td> <td style="width: 10%;"></td> <td style="width: 10%;"></td> <td style="width: 10%;"></td> <td style="width: 10%;"></td> <td style="width: 10%;"></td> <td style="width: 10%;"></td> </tr> <tr> <td></td> <td></td> <td colspan="8" style="text-align: center;"> <table border="1" style="width: 100%; border-collapse: collapse; text-align: center;"> <tr> <td style="width: 10%;"></td> <td style="width: 10%;"></td> <td style="width: 10%;"></td> <td style="width: 10%;"></td> <td style="width: 10%;"></td> <td style="width: 10%;"></td> <td style="width: 10%;"></td> <td style="width: 10%;"></td> <td style="width: 10%;"></td> <td style="width: 10%;"></td> </tr> <tr> <td></td> <td></td> <td colspan="8" style="text-align: center;"> <table border="1" style="width: 100%; border-collapse: collapse; text-align: center;"> <tr> <td style="width: 10%;"></td> <td style="width: 10%;"></td> <td style="width: 10%;"></td> <td style="width: 10%;"></td> <td style="width: 10%;"></td> <td style="width: 10%;"></td> <td style="width: 10%;"></td> <td style="width: 10%;"></td> <td style="width: 10%;"></td> <td style="width: 10%;"></td> </tr> <tr> <td></td> <td></td> <td colspan="8" style="text-align: center;"> <table border="1" style="width: 100%; border-collapse: collapse; text-align: center;"> <tr> <td style="width: 10%;"></td> <td style="width: 10%;"></td> <td style="width: 10%;"></td> <td style="width: 10%;"></td> <td style="width: 10%;"></td> <td style="width: 10%;"></td> <td style="width: 10%;"></td> <td style="width: 10%;"></td> <td style="width: 10%;"></td> <td style="width: 10%;"></td> </tr> <tr> <td></td> <td></td> <td colspan="8" style="text-align: center;"> <table border="1" style="width: 100%; border-collapse: collapse; text-align: center;"> <tr> <td style="width: 10%;"></td> <td style="width: 10%;"></td> <td style="width: 10%;"></td> <td style="width: 10%;"></td> <td style="width: 10%;"></td> <td style="width: 10%;"></td> <td style="width: 10%;"></td> <td style="width: 10%;"></td> <td style="width: 10%;"></td> <td style="width: 10%;"></td> </tr> <tr> <td></td> <td></td> <td colspan="8" style="text-align: center;"> <table border="1" style="width: 100%; border-collapse: collapse; text-align: center;"> <tr> <td style="width: 10%;"></td> <td style="width: 10%;"></td> <td style="width: 10%;"></td> <td style="width: 10%;"></td> <td style="width: 10%;"></td> <td style="width: 10%;"></td> <td style="width: 10%;"></td> <td style="width: 10%;"></td> <td style="width: 10%;"></td> <td style="width: 10%;"></td> </tr> <tr> <td></td> <td></td> <td colspan="8" style="text-align: center;"> <table border="1" style="width: 100%; border-collapse: collapse; text-align: center;"> <tr> </tr></table></td></tr></table></td></tr></table></td></tr></table></td></tr></table></td></tr></table></td></tr></table></td></tr></table></td></tr></table></td></tr></table></td></tr></table></td></tr></table></td></tr></table></td></tr></table></td></tr></table></td></tr></table></td></tr></table>
 | | | | | | | | | | | | | | | | | | | | <table border="1" style="width: 100%; border-collapse: collapse; text-align: center;"> <tr> <td style="width: 10%;"></td> <td style="width: 10%;"></td> <td style="width: 10%;"></td> <td style="width: 10%;"></td> <td style="width: 10%;"></td> <td style="width: 10%;"></td> <td style="width: 10%;"></td> <td style="width: 10%;"></td> <td style="width: 10%;"></td> <td style="width: 10%;"></td> </tr> <tr> <td></td> <td></td> <td colspan="8" style="text-align: center;"> <table border="1" style="width: 100%; border-collapse: collapse; text-align: center;"> <tr> <td style="width: 10%;"></td> <td style="width: 10%;"></td> <td style="width: 10%;"></td> <td style="width: 10%;"></td> <td style="width: 10%;"></td> <td style="width: 10%;"></td> <td style="width: 10%;"></td> <td style="width: 10%;"></td> <td style="width: 10%;"></td> <td style="width: 10%;"></td> </tr> <tr> <td></td> <td></td> <td colspan="8" style="text-align: center;"> <table border="1" style="width: 100%; border-collapse: collapse; text-align: center;"> <tr> <td style="width: 10%;"></td> <td style="width: 10%;"></td> <td style="width: 10%;"></td> <td style="width: 10%;"></td> <td style="width: 10%;"></td> <td style="width: 10%;"></td> <td style="width: 10%;"></td> <td style="width: 10%;"></td> <td style="width: 10%;"></td> <td style="width: 10%;"></td> </tr> <tr> <td></td> <td></td> <td colspan="8" style="text-align: center;"> <table border="1" style="width: 100%; border-collapse: collapse; text-align: center;"> <tr> <td style="width: 10%;"></td> <td style="width: 10%;"></td> <td style="width: 10%;"></td> <td style="width: 10%;"></td> <td style="width: 10%;"></td> <td style="width: 10%;"></td> <td style="width: 10%;"></td> <td style="width: 10%;"></td> <td style="width: 10%;"></td> <td style="width: 10%;"></td> </tr> <tr> <td></td> <td></td> <td colspan="8" style="text-align: center;"> <table border="1" style="width: 100%; border-collapse: collapse; text-align: center;"> <tr> <td style="width: 10%;"></td> <td style="width: 10%;"></td> <td style="width: 10%;"></td> <td style="width: 10%;"></td> <td style="width: 10%;"></td> <td style="width: 10%;"></td> <td style="width: 10%;"></td> <td style="width: 10%;"></td> <td style="width: 10%;"></td> <td style="width: 10%;"></td> </tr> <tr> <td></td> <td></td> <td colspan="8" style="text-align: center;"> <table border="1" style="width: 100%; border-collapse: collapse; text-align: center;"> <tr> <td style="width: 10%;"></td> <td style="width: 10%;"></td> <td style="width: 10%;"></td> <td style="width: 10%;"></td> <td style="width: 10%;"></td> <td style="width: 10%;"></td> <td style="width: 10%;"></td> <td style="width: 10%;"></td> <td style="width: 10%;"></td> <td style="width: 10%;"></td> </tr> <tr> <td></td> <td></td> <td colspan="8" style="text-align: center;"> <table border="1" style="width: 100%; border-collapse: collapse; text-align: center;"> <tr> <td style="width: 10%;"></td> <td style="width: 10%;"></td> <td style="width: 10%;"></td> <td style="width: 10%;"></td> <td style="width: 10%;"></td> <td style="width: 10%;"></td> <td style="width: 10%;"></td> <td style="width: 10%;"></td> <td style="width: 10%;"></td> <td style="width: 10%;"></td> </tr> <tr> <td></td> <td></td> <td colspan="8" style="text-align: center;"> <table border="1" style="width: 100%; border-collapse: collapse; text-align: center;"> <tr> <td style="width: 10%;"></td> <td style="width: 10%;"></td> <td style="width: 10%;"></td> <td style="width: 10%;"></td> <td style="width: 10%;"></td> <td style="width: 10%;"></td> <td style="width: 10%;"></td> <td style="width: 10%;"></td> <td style="width: 10%;"></td> <td style="width: 10%;"></td> </tr> <tr> <td></td> <td></td> <td colspan="8" style="text-align: center;"> <table border="1" style="width: 100%; border-collapse: collapse; text-align: center;"> <tr> <td style="width: 10%;"></td> <td style="width: 10%;"></td> <td style="width: 10%;"></td> <td style="width: 10%;"></td> <td style="width: 10%;"></td> <td style="width: 10%;"></td> <td style="width: 10%;"></td> <td style="width: 10%;"></td> <td style="width: 10%;"></td> <td style="width: 10%;"></td> </tr> <tr> <td></td> <td></td> <td colspan="8" style="text-align: center;"> <table border="1" style="width: 100%; border-collapse: collapse; text-align: center;"> <tr> <td style="width: 10%;"></td> <td style="width: 10%;"></td> <td style="width: 10%;"></td> <td style="width: 10%;"></td> <td style="width: 10%;"></td> <td style="width: 10%;"></td> <td style="width: 10%;"></td> <td style="width: 10%;"></td> <td style="width: 10%;"></td> <td style="width: 10%;"></td> </tr> <tr> <td></td> <td></td> <td colspan="8" style="text-align: center;"> <table border="1" style="width: 100%; border-collapse: collapse; text-align: center;"> <tr> <td style="width: 10%;"></td> <td style="width: 10%;"></td> <td style="width: 10%;"></td> <td style="width: 10%;"></td> <td style="width: 10%;"></td> <td style="width: 10%;"></td> <td style="width: 10%;"></td> <td style="width: 10%;"></td> <td style="width: 10%;"></td> <td style="width: 10%;"></td> </tr> <tr> <td></td> <td></td> <td colspan="8" style="text-align: center;"> <table border="1" style="width: 100%; border-collapse: collapse; text-align: center;"> <tr> <td style="width: 10%;"></td> <td style="width: 10%;"></td> <td style="width: 10%;"></td> <td style="width: 10%;"></td> <td style="width: 10%;"></td> <td style="width: 10%;"></td> <td style="width: 10%;"></td> <td style="width: 10%;"></td> <td style="width: 10%;"></td> <td style="width: 10%;"></td> </tr> <tr> <td></td> <td></td> <td colspan="8" style="text-align: center;"> <table border="1" style="width: 100%; border-collapse: collapse; text-align: center;"> <tr> <td style="width: 10%;"></td> <td style="width: 10%;"></td> <td style="width: 10%;"></td> <td style="width: 10%;"></td> <td style="width: 10%;"></td> <td style="width: 10%;"></td> <td style="width: 10%;"></td> <td style="width: 10%;"></td> <td style="width: 10%;"></td> <td style="width: 10%;"></td> </tr> <tr> <td></td> <td></td> <td colspan="8" style="text-align: center;"> <table border="1" style="width: 100%; border-collapse: collapse; text-align: center;"> <tr> <td style="width: 10%;"></td> <td style="width: 10%;"></td> <td style="width: 10%;"></td> <td style="width: 10%;"></td> <td style="width: 10%;"></td> <td style="width: 10%;"></td> <td
style="width: 10%;"></td> <td style="width: 10%;"></td> <td style="width: 10%;"></td> <td style="width: 10%;"></td> </tr> <tr> <td></td> <td></td> <td colspan="8" style="text-align: center;"> <table border="1" style="width: 100%; border-collapse: collapse; text-align: center;"> <tr> <td style="width: 10%;"></td> <td style="width: 10%;"></td> <td style="width: 10%;"></td> <td style="width: 10%;"></td> <td style="width: 10%;"></td> <td style="width: 10%;"></td> <td style="width: 10%;"></td> <td style="width: 10%;"></td> <td style="width: 10%;"></td> <td style="width: 10%;"></td> </tr> <tr> <td></td> <td></td> <td colspan="8" style="text-align: center;"> <table border="1" style="width: 100%; border-collapse: collapse; text-align: center;"> <tr> </tr></table></td></tr></table></td></tr></table></td></tr></table></td></tr></table></td></tr></table></td></tr></table></td></tr></table></td></tr></table></td></tr></table></td></tr></table></td></tr></table></td></tr></table></td></tr></table></td></tr></table></td></tr></table> | | | | | | | | | | | | | | | | | | | | <table border="1" style="width: 100%; border-collapse: collapse; text-align: center;"> <tr> <td style="width: 10%;"></td> <td style="width: 10%;"></td> <td
style="width: 10%;"></td> <td style="width: 10%;"></td> <td style="width: 10%;"></td> <td style="width: 10%;"></td> <td style="width: 10%;"></td> <td style="width: 10%;"></td> <td style="width: 10%;"></td> <td style="width: 10%;"></td> </tr> <tr> <td></td> <td></td> <td colspan="8" style="text-align: center;"> <table border="1" style="width: 100%; border-collapse: collapse; text-align: center;"> <tr> <td style="width: 10%;"></td> <td style="width: 10%;"></td> <td style="width: 10%;"></td> <td style="width: 10%;"></td> <td style="width: 10%;"></td> <td style="width: 10%;"></td> <td style="width: 10%;"></td> <td style="width: 10%;"></td> <td style="width: 10%;"></td> <td style="width: 10%;"></td> </tr> <tr> <td></td> <td></td> <td colspan="8" style="text-align: center;"> <table border="1" style="width: 100%; border-collapse: collapse; text-align: center;"> <tr> <td style="width: 10%;"></td> <td style="width: 10%;"></td> <td style="width: 10%;"></td> <td style="width: 10%;"></td> <td style="width: 10%;"></td> <td style="width: 10%;"></td> <td style="width: 10%;"></td> <td style="width: 10%;"></td> <td style="width: 10%;"></td> <td style="width: 10%;"></td> </tr> <tr> <td></td> <td></td> <td colspan="8" style="text-align: center;"> <table border="1" style="width: 100%; border-collapse: collapse; text-align: center;"> <tr> <td style="width: 10%;"></td> <td style="width: 10%;"></td> <td style="width: 10%;"></td> <td style="width: 10%;"></td> <td style="width: 10%;"></td> <td style="width: 10%;"></td> <td style="width: 10%;"></td> <td style="width: 10%;"></td> <td style="width: 10%;"></td> <td style="width: 10%;"></td> </tr> <tr> <td></td> <td></td> <td colspan="8" style="text-align: center;"> <table border="1" style="width: 100%; border-collapse: collapse; text-align: center;"> <tr> <td style="width: 10%;"></td> <td style="width: 10%;"></td> <td style="width: 10%;"></td> <td style="width: 10%;"></td> <td style="width: 10%;"></td> <td style="width: 10%;"></td> <td style="width: 10%;"></td> <td style="width: 10%;"></td> <td style="width: 10%;"></td> <td style="width: 10%;"></td> </tr> <tr> <td></td> <td></td> <td colspan="8" style="text-align: center;"> <table border="1" style="width: 100%; border-collapse: collapse; text-align: center;"> <tr> <td style="width: 10%;"></td> <td style="width: 10%;"></td> <td style="width: 10%;"></td> <td style="width: 10%;"></td> <td style="width: 10%;"></td> <td style="width: 10%;"></td> <td style="width: 10%;"></td> <td style="width: 10%;"></td> <td style="width: 10%;"></td> <td style="width: 10%;"></td> </tr> <tr> <td></td> <td></td> <td colspan="8" style="text-align: center;"> <table border="1" style="width: 100%; border-collapse: collapse; text-align: center;"> <tr> <td style="width: 10%;"></td> <td style="width: 10%;"></td> <td style="width: 10%;"></td> <td style="width: 10%;"></td> <td style="width: 10%;"></td> <td style="width: 10%;"></td> <td style="width: 10%;"></td> <td style="width: 10%;"></td> <td style="width: 10%;"></td> <td style="width: 10%;"></td> </tr> <tr> <td></td> <td></td> <td colspan="8" style="text-align: center;"> <table border="1" style="width: 100%; border-collapse: collapse; text-align: center;"> <tr> <td style="width: 10%;"></td> <td style="width: 10%;"></td> <td style="width: 10%;"></td> <td style="width: 10%;"></td> <td style="width: 10%;"></td> <td style="width: 10%;"></td> <td style="width: 10%;"></td> <td style="width: 10%;"></td> <td style="width: 10%;"></td> <td style="width: 10%;"></td> </tr> <tr> <td></td> <td></td> <td colspan="8" style="text-align: center;"> <table border="1" style="width: 100%; border-collapse: collapse; text-align: center;"> <tr> <td style="width: 10%;"></td> <td style="width: 10%;"></td> <td style="width: 10%;"></td> <td style="width: 10%;"></td> <td style="width: 10%;"></td> <td style="width: 10%;"></td> <td style="width: 10%;"></td> <td style="width: 10%;"></td> <td style="width: 10%;"></td> <td style="width: 10%;"></td> </tr> <tr> <td></td> <td></td> <td colspan="8" style="text-align: center;"> <table border="1" style="width: 100%; border-collapse: collapse; text-align: center;"> <tr> <td style="width: 10%;"></td> <td style="width: 10%;"></td> <td style="width: 10%;"></td> <td style="width: 10%;"></td> <td style="width: 10%;"></td> <td style="width: 10%;"></td> <td style="width: 10%;"></td> <td style="width: 10%;"></td> <td style="width: 10%;"></td> <td style="width: 10%;"></td> </tr> <tr> <td></td> <td></td> <td colspan="8" style="text-align: center;"> <table border="1" style="width: 100%; border-collapse: collapse; text-align: center;"> <tr> <td style="width: 10%;"></td> <td style="width: 10%;"></td> <td style="width: 10%;"></td> <td style="width: 10%;"></td> <td style="width: 10%;"></td> <td style="width: 10%;"></td> <td style="width: 10%;"></td> <td style="width: 10%;"></td> <td style="width: 10%;"></td> <td style="width: 10%;"></td> </tr> <tr> <td></td> <td></td> <td colspan="8" style="text-align: center;"> <table border="1" style="width: 100%; border-collapse: collapse; text-align: center;"> <tr> <td style="width: 10%;"></td> <td style="width: 10%;"></td> <td style="width: 10%;"></td> <td style="width: 10%;"></td> <td style="width: 10%;"></td> <td style="width: 10%;"></td> <td style="width: 10%;"></td> <td style="width: 10%;"></td> <td style="width: 10%;"></td> <td style="width: 10%;"></td> </tr> <tr> <td></td> <td></td> <td colspan="8" style="text-align: center;"> <table border="1" style="width: 100%; border-collapse: collapse; text-align: center;"> <tr> <td style="width: 10%;"></td> <td style="width: 10%;"></td> <td style="width: 10%;"></td> <td style="width: 10%;"></td> <td style="width: 10%;"></td> <td style="width: 10%;"></td> <td style="width: 10%;"></td> <td style="width: 10%;"></td> <td style="width: 10%;"></td> <td style="width: 10%;"></td> </tr> <tr> <td></td> <td></td> <td colspan="8" style="text-align: center;"> <table border="1" style="width: 100%; border-collapse: collapse; text-align: center;"> <tr> <td style="width: 10%;"></td> <td style="width: 10%;"></td> <td style="width: 10%;"></td> <td style="width: 10%;"></td> <td style="width: 10%;"></td> <td style="width: 10%;"></td> <td style="width: 10%;"></td> <td style="width: 10%;"></td> <td style="width: 10%;"></td> <td style="width: 10%;"></td> </tr> <tr> <td></td> <td></td> <td colspan="8" style="text-align: center;"> <table border="1" style="width: 100%; border-collapse: collapse; text-align: center;"> <tr> </tr></table></td></tr></table></td></tr></table></td></tr></table></td></tr></table></td></tr></table></td></tr></table></td></tr></table></td></tr></table></td></tr></table></td></tr></table></td></tr></table></td></tr></table></td></tr></table></td></tr></table>
 | | | | | | | | | | | | | | | | | | | | <table border="1" style="width: 100%; border-collapse: collapse; text-align: center;"> <tr> <td style="width: 10%;"></td> <td style="width: 10%;"></td> <td style="width: 10%;"></td> <td style="width: 10%;"></td> <td style="width: 10%;"></td> <td style="width: 10%;"></td> <td style="width: 10%;"></td> <td style="width: 10%;"></td> <td style="width: 10%;"></td> <td style="width: 10%;"></td> </tr> <tr> <td></td> <td></td> <td colspan="8" style="text-align: center;"> <table border="1" style="width: 100%; border-collapse: collapse; text-align: center;"> <tr> <td style="width: 10%;"></td> <td style="width: 10%;"></td> <td style="width: 10%;"></td> <td style="width: 10%;"></td> <td style="width: 10%;"></td> <td style="width: 10%;"></td> <td style="width: 10%;"></td> <td style="width: 10%;"></td> <td style="width: 10%;"></td> <td style="width: 10%;"></td> </tr> <tr> <td></td> <td></td> <td colspan="8" style="text-align: center;"> <table border="1" style="width: 100%; border-collapse: collapse; text-align: center;"> <tr> <td style="width: 10%;"></td> <td style="width: 10%;"></td> <td style="width: 10%;"></td> <td style="width: 10%;"></td> <td style="width: 10%;"></td> <td style="width: 10%;"></td> <td style="width: 10%;"></td> <td style="width: 10%;"></td> <td style="width: 10%;"></td> <td style="width: 10%;"></td> </tr> <tr> <td></td> <td></td> <td colspan="8" style="text-align: center;"> <table border="1" style="width: 100%; border-collapse: collapse; text-align: center;"> <tr> <td style="width: 10%;"></td> <td style="width: 10%;"></td> <td style="width: 10%;"></td> <td style="width: 10%;"></td> <td style="width: 10%;"></td> <td style="width: 10%;"></td> <td style="width: 10%;"></td> <td style="width: 10%;"></td> <td style="width: 10%;"></td> <td style="width: 10%;"></td> </tr> <tr> <td></td> <td></td> <td colspan="8" style="text-align: center;"> <table border="1" style="width: 100%; border-collapse: collapse; text-align: center;"> <tr> <td style="width: 10%;"></td> <td style="width: 10%;"></td> <td style="width: 10%;"></td> <td style="width: 10%;"></td> <td style="width: 10%;"></td> <td style="width: 10%;"></td> <td style="width: 10%;"></td> <td style="width: 10%;"></td> <td style="width: 10%;"></td> <td style="width: 10%;"></td> </tr> <tr> <td></td> <td></td> <td colspan="8" style="text-align: center;"> <table border="1" style="width: 100%; border-collapse: collapse; text-align: center;"> <tr> <td style="width: 10%;"></td> <td style="width: 10%;"></td> <td style="width: 10%;"></td> <td style="width: 10%;"></td> <td style="width: 10%;"></td> <td style="width: 10%;"></td> <td style="width: 10%;"></td> <td style="width: 10%;"></td> <td style="width: 10%;"></td> <td style="width: 10%;"></td> </tr> <tr> <td></td> <td></td> <td colspan="8" style="text-align: center;"> <table border="1" style="width: 100%; border-collapse: collapse; text-align: center;"> <tr> <td style="width: 10%;"></td> <td style="width: 10%;"></td> <td style="width: 10%;"></td> <td style="width: 10%;"></td> <td style="width: 10%;"></td> <td style="width: 10%;"></td> <td style="width: 10%;"></td> <td style="width: 10%;"></td> <td style="width: 10%;"></td> <td style="width: 10%;"></td> </tr> <tr> <td></td> <td></td> <td colspan="8" style="text-align: center;"> <table border="1" style="width: 100%; border-collapse: collapse; text-align: center;"> <tr> <td style="width: 10%;"></td> <td style="width: 10%;"></td> <td style="width: 10%;"></td> <td style="width: 10%;"></td> <td style="width: 10%;"></td> <td style="width: 10%;"></td> <td style="width: 10%;"></td> <td style="width: 10%;"></td> <td style="width: 10%;"></td> <td style="width: 10%;"></td> </tr> <tr> <td></td> <td></td> <td colspan="8" style="text-align: center;"> <table border="1" style="width: 100%; border-collapse: collapse; text-align: center;"> <tr> <td style="width: 10%;"></td> <td style="width: 10%;"></td> <td style="width: 10%;"></td> <td style="width: 10%;"></td> <td style="width: 10%;"></td> <td style="width: 10%;"></td> <td style="width: 10%;"></td> <td style="width: 10%;"></td> <td style="width: 10%;"></td> <td style="width: 10%;"></td> </tr> <tr> <td></td> <td></td> <td colspan="8" style="text-align: center;"> <table border="1" style="width: 100%; border-collapse: collapse; text-align: center;"> <tr> <td style="width: 10%;"></td> <td style="width: 10%;"></td> <td style="width: 10%;"></td> <td style="width: 10%;"></td> <td
style="width: 10%;"></td> <td style="width: 10%;"></td> <td style="width: 10%;"></td> <td style="width: 10%;"></td> <td style="width: 10%;"></td> <td style="width: 10%;"></td> </tr> <tr> <td></td> <td></td> <td colspan="8" style="text-align: center;"> <table border="1" style="width: 100%; border-collapse: collapse; text-align: center;"> <tr> <td style="width: 10%;"></td> <td style="width: 10%;"></td> <td style="width: 10%;"></td> <td style="width: 10%;"></td> <td style="width: 10%;"></td> <td style="width: 10%;"></td> <td style="width: 10%;"></td> <td style="width: 10%;"></td> <td style="width: 10%;"></td> <td style="width: 10%;"></td> </tr> <tr> <td></td> <td></td> <td colspan="8" style="text-align: center;"> <table border="1" style="width: 100%; border-collapse: collapse; text-align: center;"> <tr> <td style="width: 10%;"></td> <td style="width: 10%;"></td> <td style="width: 10%;"></td> <td style="width: 10%;"></td> <td style="width: 10%;"></td> <td style="width: 10%;"></td> <td style="width: 10%;"></td> <td style="width: 10%;"></td> <td style="width: 10%;"></td> <td style="width: 10%;"></td> </tr> <tr> <td></td> <td></td> <td colspan="8" style="text-align: center;"> <table border="1" style="width: 100%; border-collapse: collapse; text-align: center;"> <tr> <td style="width: 10%;"></td> <td style="width: 10%;"></td> <td style="width: 10%;"></td> <td style="width: 10%;"></td> <td style="width: 10%;"></td> <td style="width: 10%;"></td> <td style="width: 10%;"></td> <td style="width: 10%;"></td> <td style="width: 10%;"></td> <td style="width: 10%;"></td> </tr> <tr> <td></td> <td></td> <td colspan="8" style="text-align: center;"> <table border="1" style="width: 100%; border-collapse: collapse; text-align: center;"> <tr> </tr></table></td></tr></table></td></tr></table></td></tr></table></td></tr></table></td></tr></table></td></tr></table></td></tr></table></td></tr></table></td></tr></table></td></tr></table></td></tr></table></td></tr></table></td></tr></table>
 | | | | | | | | | | | | | | | | | | | | <table border="1" style="width: 100%; border-collapse: collapse; text-align: center;"> <tr> <td style="width: 10%;"></td> <td style="width: 10%;"></td> <td style="width: 10%;"></td> <td style="width: 10%;"></td> <td style="width: 10%;"></td> <td style="width: 10%;"></td> <td style="width: 10%;"></td> <td style="width: 10%;"></td> <td style="width: 10%;"></td> <td style="width: 10%;"></td> </tr> <tr> <td></td> <td></td> <td colspan="8" style="text-align: center;"> <table border="1" style="width: 100%; border-collapse: collapse; text-align: center;"> <tr> <td style="width: 10%;"></td> <td style="width: 10%;"></td> <td style="width: 10%;"></td> <td style="width: 10%;"></td> <td style="width: 10%;"></td> <td style="width: 10%;"></td> <td style="width: 10%;"></td> <td style="width: 10%;"></td> <td style="width: 10%;"></td> <td style="width: 10%;"></td> </tr> <tr> <td></td> <td></td> <td colspan="8" style="text-align: center;"> <table border="1" style="width: 100%; border-collapse: collapse; text-align: center;"> <tr> <td style="width: 10%;"></td> <td style="width: 10%;"></td> <td style="width: 10%;"></td> <td style="width: 10%;"></td> <td style="width: 10%;"></td> <td style="width: 10%;"></td> <td style="width: 10%;"></td> <td style="width: 10%;"></td> <td style="width: 10%;"></td> <td style="width: 10%;"></td> </tr> <tr> <td></td> <td></td> <td colspan="8" style="text-align: center;"> <table border="1" style="width: 100%; border-collapse: collapse; text-align: center;"> <tr> <td style="width: 10%;"></td> <td style="width: 10%;"></td> <td style="width: 10%;"></td> <td style="width: 10%;"></td> <td style="width: 10%;"></td> <td style="width: 10%;"></td> <td style="width: 10%;"></td> <td style="width: 10%;"></td> <td style="width: 10%;"></td> <td style="width: 10%;"></td> </tr> <tr> <td></td> <td></td> <td colspan="8" style="text-align: center;"> <table border="1" style="width: 100%; border-collapse: collapse; text-align: center;"> <tr> <td style="width: 10%;"></td> <td style="width: 10%;"></td> <td style="width: 10%;"></td> <td style="width: 10%;"></td> <td style="width: 10%;"></td> <td style="width: 10%;"></td> <td style="width: 10%;"></td> <td style="width: 10%;"></td> <td style="width: 10%;"></td> <td style="width: 10%;"></td> </tr> <tr> <td></td> <td></td> <td colspan="8" style="text-align: center;"> <table border="1" style="width: 100%; border-collapse: collapse; text-align: center;"> <tr> <td style="width: 10%;"></td> <td style="width: 10%;"></td> <td style="width: 10%;"></td> <td style="width: 10%;"></td> <td style="width: 10%;"></td> <td style="width: 10%;"></td> <td style="width: 10%;"></td> <td style="width: 10%;"></td> <td style="width: 10%;"></td> <td style="width: 10%;"></td> </tr> <tr> <td></td> <td></td> <td colspan="8" style="text-align: center;"> <table border="1" style="width: 100%; border-collapse: collapse; text-align: center;"> <tr> <td style="width: 10%;"></td> <td style="width: 10%;"></td> <td style="width: 10%;"></td> <td style="width: 10%;"></td> <td style="width: 10%;"></td> <td style="width: 10%;"></td> <td style="width: 10%;"></td> <td style="width: 10%;"></td> <td style="width: 10%;"></td> <td style="width: 10%;"></td> </tr> <tr> <td></td> <td></td> <td colspan="8" style="text-align: center;"> <table border="1" style="width: 100%; border-collapse: collapse; text-align: center;"> <tr> <td style="width: 10%;"></td> <td style="width: 10%;"></td> <td style="width: 10%;"></td> <td style="width: 10%;"></td> <td style="width: 10%;"></td> <td style="width: 10%;"></td> <td style="width: 10%;"></td> <td style="width: 10%;"></td> <td style="width: 10%;"></td> <td style="width: 10%;"></td> </tr> <tr> <td></td> <td></td> <td colspan="8" style="text-align: center;"> <table border="1" style="width: 100%; border-collapse: collapse; text-align: center;"> <tr> <td style="width: 10%;"></td> <td style="width: 10%;"></td> <td style="width: 10%;"></td> <td style="width: 10%;"></td> <td style="width: 10%;"></td> <td style="width: 10%;"></td> <td style="width: 10%;"></td> <td style="width: 10%;"></td> <td style="width: 10%;"></td> <td style="width: 10%;"></td> </tr> <tr> <td></td> <td></td> <td colspan="8" style="text-align: center;"> <table border="1" style="width: 100%; border-collapse: collapse; text-align: center;"> <tr> <td style="width: 10%;"></td> <td style="width: 10%;"></td> <td style="width: 10%;"></td> <td style="width: 10%;"></td> <td style="width: 10%;"></td> <td style="width: 10%;"></td> <td style="width: 10%;"></td> <td style="width: 10%;"></td> <td style="width: 10%;"></td> <td style="width: 10%;"></td> </tr> <tr> <td></td> <td></td> <td colspan="8" style="text-align: center;"> <table border="1" style="width: 100%; border-collapse: collapse; text-align: center;"> <tr> <td style="width: 10%;"></td> <td style="width: 10%;"></td> <td style="width: 10%;"></td> <td style="width: 10%;"></td> <td style="width: 10%;"></td> <td style="width: 10%;"></td> <td style="width: 10%;"></td> <td style="width: 10%;"></td> <td style="width: 10%;"></td> <td style="width: 10%;"></td> </tr> <tr> <td></td> <td></td> <td colspan="8" style="text-align: center;"> <table border="1" style="width: 100%; border-collapse: collapse; text-align: center;"> <tr> <td style="width: 10%;"></td> <td style="width: 10%;"></td> <td style="width: 10%;"></td> <td style="width: 10%;"></td> <td style="width: 10%;"></td> <td style="width: 10%;"></td> <td style="width: 10%;"></td> <td style="width: 10%;"></td> <td style="width: 10%;"></td> <td style="width: 10%;"></td> </tr> <tr> <td></td> <td></td> <td colspan="8" style="text-align: center;"> <table border="1" style="width: 100%; border-collapse: collapse; text-align: center;"> <tr> </tr></table></td></tr></table></td></tr></table></td></tr></table></td></tr></table></td></tr></table></td></tr></table></td></tr></table></td></tr></table></td></tr></table></td></tr></table></td></tr></table></td></tr></table>
 | | | | | | | | | | | | | | | | | | | | <table border="1" style="width: 100%; border-collapse: collapse; text-align: center;"> <tr> <td style="width: 10%;"></td> <td style="width: 10%;"></td> <td style="width: 10%;"></td> <td style="width: 10%;"></td> <td style="width: 10%;"></td> <td style="width: 10%;"></td> <td style="width: 10%;"></td> <td style="width: 10%;"></td> <td style="width: 10%;"></td> <td style="width: 10%;"></td> </tr> <tr> <td></td> <td></td> <td colspan="8" style="text-align: center;"> <table border="1" style="width: 100%; border-collapse: collapse; text-align: center;"> <tr> <td style="width: 10%;"></td> <td style="width: 10%;"></td> <td style="width: 10%;"></td> <td style="width: 10%;"></td> <td style="width: 10%;"></td> <td style="width: 10%;"></td> <td style="width: 10%;"></td> <td style="width: 10%;"></td> <td style="width: 10%;"></td> <td style="width: 10%;"></td> </tr> <tr> <td></td> <td></td> <td colspan="8" style="text-align: center;"> <table border="1" style="width: 100%; border-collapse: collapse; text-align: center;"> <tr> <td style="width: 10%;"></td> <td style="width: 10%;"></td> <td style="width: 10%;"></td> <td style="width: 10%;"></td> <td style="width: 10%;"></td> <td style="width: 10%;"></td> <td style="width: 10%;"></td> <td style="width: 10%;"></td> <td style="width: 10%;"></td> <td style="width: 10%;"></td> </tr> <tr> <td></td> <td></td> <td colspan="8" style="text-align: center;"> <table border="1" style="width: 100%; border-collapse: collapse; text-align: center;"> <tr> <td style="width: 10%;"></td> <td style="width: 10%;"></td> <td style="width: 10%;"></td> <td style="width: 10%;"></td> <td style="width: 10%;"></td> <td style="width: 10%;"></td> <td style="width: 10%;"></td> <td style="width: 10%;"></td> <td style="width: 10%;"></td> <td style="width: 10%;"></td> </tr> <tr> <td></td> <td></td> <td colspan="8" style="text-align: center;"> <table border="1" style="width: 100%; border-collapse: collapse; text-align: center;"> <tr> <td style="width: 10%;"></td> <td style="width: 10%;"></td> <td style="width: 10%;"></td> <td style="width: 10%;"></td> <td style="width: 10%;"></td> <td style="width: 10%;"></td> <td style="width: 10%;"></td> <td style="width: 10%;"></td> <td style="width: 10%;"></td> <td style="width: 10%;"></td> </tr> <tr> <td></td> <td></td> <td colspan="8" style="text-align: center;"> <table border="1" style="width: 100%; border-collapse: collapse; text-align: center;"> <tr> <td style="width: 10%;"></td> <td style="width: 10%;"></td> <td style="width: 10%;"></td> <td style="width: 10%;"></td> <td style="width: 10%;"></td> <td style="width: 10%;"></td> <td style="width: 10%;"></td> <td style="width: 10%;"></td> <td style="width: 10%;"></td> <td style="width: 10%;"></td> </tr> <tr> <td></td> <td></td> <td colspan="8" style="text-align: center;"> <table border="1" style="width: 100%; border-collapse: collapse; text-align: center;"> <tr> <td style="width: 10%;"></td> <td style="width: 10%;"></td> <td style="width: 10%;"></td> <td style="width: 10%;"></td> <td style="width: 10%;"></td> <td style="width: 10%;"></td> <td style="width: 10%;"></td> <td style="width: 10%;"></td> <td style="width: 10%;"></td> <td style="width: 10%;"></td> </tr> <tr> <td></td> <td></td> <td colspan="8" style="text-align: center;"> <table border="1" style="width: 100%; border-collapse: collapse; text-align: center;"> <tr> <td style="width: 10%;"></td> <td style="width: 10%;"></td> <td style="width: 10%;"></td> <td style="width: 10%;"></td> <td style="width: 10%;"></td> <td style="width: 10%;"></td> <td style="width: 10%;"></td> <td style="width: 10%;"></td> <td style="width: 10%;"></td> <td style="width: 10%;"></td> </tr> <tr> <td></td> <td></td> <td colspan="8" style="text-align: center;"> <table border="1" style="width: 100%; border-collapse: collapse; text-align: center;"> <tr> <td style="width: 10%;"></td> <td style="width: 10%;"></td> <td style="width: 10%;"></td> <td style="width: 10%;"></td> <td style="width: 10%;"></td> <td style="width: 10%;"></td> <td style="width: 10%;"></td> <td style="width: 10%;"></td> <td style="width: 10%;"></td> <td style="width: 10%;"></td> </tr> <tr> <td></td> <td></td> <td colspan="8" style="text-align: center;"> <table border="1" style="width: 100%; border-collapse: collapse; text-align: center;"> <tr> <td style="width: 10%;"></td> <td style="width: 10%;"></td> <td style="width: 10%;"></td> <td style="width: 10%;"></td> <td style="width:
10%;"></td> <td style="width: 10%;"></td> <td style="width: 10%;"></td> <td style="width: 10%;"></td> <td style="width: 10%;"></td> <td style="width: 10%;"></td> </tr> <tr> <td></td> <td></td> <td colspan="8" style="text-align: center;"> <table border="1" style="width: 100%; border-collapse: collapse; text-align: center;"> <tr> <td style="width: 10%;"></td> <td style="width: 10%;"></td> <td style="width: 10%;"></td> <td style="width: 10%;"></td> <td style="width: 10%;"></td> <td style="width: 10%;"></td> <td style="width: 10%;"></td> <td style="width: 10%;"></td> <td style="width: 10%;"></td> <td style="width: 10%;"></td> </tr> <tr> <td></td> <td></td> <td colspan="8" style="text-align: center;"> <table border="1" style="width: 100%; border-collapse: collapse; text-align: center;"> <tr> </tr></table></td></tr></table></td></tr></table></td></tr></table></td></tr></table></td></tr></table></td></tr></table></td></tr></table></td></tr></table></td></tr></table></td></tr></table></td></tr></table> | | | | | | | | | | | | | | | | | | | | <table border="1" style="width: 100%; border-collapse: collapse; text-align: center;"> <tr> <td style="width: 10%;"></td> <td style="width: 10%;"></td> <td style="width: 10%;"></td>
<td style="width: 10%;"></td> <td style="width: 10%;"></td> <td style="width: 10%;"></td> <td style="width: 10%;"></td> <td style="width: 10%;"></td> <td style="width: 10%;"></td> <td style="width: 10%;"></td> </tr> <tr> <td></td> <td></td> <td colspan="8" style="text-align: center;"> <table border="1" style="width: 100%; border-collapse: collapse; text-align: center;"> <tr> <td style="width: 10%;"></td> <td style="width: 10%;"></td> <td style="width: 10%;"></td> <td style="width: 10%;"></td> <td style="width: 10%;"></td> <td style="width: 10%;"></td> <td style="width: 10%;"></td> <td style="width: 10%;"></td> <td style="width: 10%;"></td> <td style="width: 10%;"></td> </tr> <tr> <td></td> <td></td> <td colspan="8" style="text-align: center;"> <table border="1" style="width: 100%; border-collapse: collapse; text-align: center;"> <tr> <td style="width: 10%;"></td> <td style="width: 10%;"></td> <td style="width: 10%;"></td> <td style="width: 10%;"></td> <td style="width: 10%;"></td> <td style="width: 10%;"></td> <td style="width: 10%;"></td> <td style="width: 10%;"></td> <td style="width: 10%;"></td> <td style="width: 10%;"></td> </tr> <tr> <td></td> <td></td> <td colspan="8" style="text-align: center;"> <table border="1" style="width: 100%; border-collapse: collapse; text-align: center;"> <tr> <td style="width: 10%;"></td> <td style="width: 10%;"></td> <td style="width: 10%;"></td> <td style="width: 10%;"></td> <td style="width: 10%;"></td> <td style="width: 10%;"></td> <td style="width: 10%;"></td> <td style="width: 10%;"></td> <td style="width: 10%;"></td> <td style="width: 10%;"></td> </tr> <tr> <td></td> <td></td> <td colspan="8" style="text-align: center;"> <table border="1" style="width: 100%; border-collapse: collapse; text-align: center;"> <tr> <td style="width: 10%;"></td> <td style="width: 10%;"></td> <td style="width: 10%;"></td> <td style="width: 10%;"></td> <td style="width: 10%;"></td> <td style="width: 10%;"></td> <td style="width: 10%;"></td> <td style="width: 10%;"></td> <td style="width: 10%;"></td> <td style="width: 10%;"></td> </tr> <tr> <td></td> <td></td> <td colspan="8" style="text-align: center;"> <table border="1" style="width: 100%; border-collapse: collapse; text-align: center;"> <tr> <td style="width: 10%;"></td> <td style="width: 10%;"></td> <td style="width: 10%;"></td> <td style="width: 10%;"></td> <td style="width: 10%;"></td> <td style="width: 10%;"></td> <td style="width: 10%;"></td> <td style="width: 10%;"></td> <td style="width: 10%;"></td> <td style="width: 10%;"></td> </tr> <tr> <td></td> <td></td> <td colspan="8" style="text-align: center;"> <table border="1" style="width: 100%; border-collapse: collapse; text-align: center;"> <tr> <td style="width: 10%;"></td> <td style="width: 10%;"></td> <td style="width: 10%;"></td> <td style="width: 10%;"></td> <td style="width: 10%;"></td> <td style="width: 10%;"></td> <td style="width: 10%;"></td> <td style="width: 10%;"></td> <td style="width: 10%;"></td> <td style="width: 10%;"></td> </tr> <tr> <td></td> <td></td> <td colspan="8" style="text-align: center;"> <table border="1" style="width: 100%; border-collapse: collapse; text-align: center;"> <tr> <td style="width: 10%;"></td> <td style="width: 10%;"></td> <td style="width: 10%;"></td> <td style="width: 10%;"></td> <td style="width: 10%;"></td> <td style="width: 10%;"></td> <td style="width: 10%;"></td> <td style="width: 10%;"></td> <td style="width: 10%;"></td> <td style="width: 10%;"></td> </tr> <tr> <td></td> <td></td> <td colspan="8" style="text-align: center;"> <table border="1" style="width: 100%; border-collapse: collapse; text-align: center;"> <tr> <td style="width: 10%;"></td> <td style="width: 10%;"></td> <td style="width: 10%;"></td> <td style="width: 10%;"></td> <td style="width: 10%;"></td> <td style="width: 10%;"></td> <td style="width: 10%;"></td> <td style="width: 10%;"></td> <td style="width: 10%;"></td> <td style="width: 10%;"></td> </tr> <tr> <td></td> <td></td> <td colspan="8" style="text-align: center;"> <table border="1" style="width: 100%; border-collapse: collapse; text-align: center;"> <tr> <td style="width: 10%;"></td> <td style="width: 10%;"></td> <td style="width: 10%;"></td> <td style="width: 10%;"></td> <td style="width: 10%;"></td> <td style="width: 10%;"></td> <td style="width: 10%;"></td> <td style="width: 10%;"></td> <td style="width: 10%;"></td> <td style="width: 10%;"></td> </tr> <tr> <td></td> <td></td> <td colspan="8" style="text-align: center;"> <table border="1" style="width: 100%; border-collapse: collapse; text-align: center;"> <tr> </tr></table></td></tr></table></td></tr></table></td></tr></table></td></tr></table></td></tr></table></td></tr></table></td></tr></table></td></tr></table></td></tr></table></td></tr></table>
 | | | | | | | | | | | | | | | | | | | | <table border="1" style="width: 100%; border-collapse: collapse; text-align: center;"> <tr> <td style="width: 10%;"></td> <td style="width: 10%;"></td> <td style="width: 10%;"></td> <td style="width: 10%;"></td> <td style="width: 10%;"></td> <td style="width: 10%;"></td> <td style="width: 10%;"></td> <td style="width: 10%;"></td> <td style="width: 10%;"></td> <td style="width: 10%;"></td> </tr> <tr> <td></td> <td></td> <td colspan="8" style="text-align: center;"> <table border="1" style="width: 100%; border-collapse: collapse; text-align: center;"> <tr> <td style="width: 10%;"></td> <td style="width: 10%;"></td> <td style="width: 10%;"></td> <td style="width: 10%;"></td> <td style="width: 10%;"></td> <td style="width: 10%;"></td> <td style="width: 10%;"></td> <td style="width: 10%;"></td> <td style="width: 10%;"></td> <td style="width: 10%;"></td> </tr> <tr> <td></td> <td></td> <td colspan="8" style="text-align: center;"> <table border="1" style="width: 100%; border-collapse: collapse; text-align: center;"> <tr> <td style="width: 10%;"></td> <td style="width: 10%;"></td> <td style="width: 10%;"></td> <td style="width: 10%;"></td> <td style="width: 10%;"></td> <td style="width: 10%;"></td> <td style="width: 10%;"></td> <td style="width: 10%;"></td> <td style="width: 10%;"></td> <td style="width: 10%;"></td> </tr> <tr> <td></td> <td></td> <td colspan="8" style="text-align: center;"> <table border="1" style="width: 100%; border-collapse: collapse; text-align: center;"> <tr> <td style="width: 10%;"></td> <td style="width: 10%;"></td> <td style="width: 10%;"></td> <td style="width: 10%;"></td> <td style="width: 10%;"></td> <td style="width: 10%;"></td> <td style="width: 10%;"></td> <td style="width: 10%;"></td> <td style="width: 10%;"></td> <td style="width: 10%;"></td> </tr> <tr> <td></td> <td></td> <td colspan="8" style="text-align: center;"> <table border="1" style="width: 100%; border-collapse: collapse; text-align: center;"> <tr> <td style="width: 10%;"></td> <td style="width: 10%;"></td> <td style="width: 10%;"></td> <td style="width: 10%;"></td> <td style="width: 10%;"></td> <td style="width: 10%;"></td> <td style="width: 10%;"></td> <td style="width: 10%;"></td> <td style="width: 10%;"></td> <td style="width: 10%;"></td> </tr> <tr> <td></td> <td></td> <td colspan="8" style="text-align: center;"> <table border="1" style="width: 100%; border-collapse: collapse; text-align: center;"> <tr> <td style="width: 10%;"></td> <td style="width: 10%;"></td> <td style="width: 10%;"></td> <td style="width: 10%;"></td> <td style="width: 10%;"></td> <td style="width: 10%;"></td> <td style="width: 10%;"></td> <td style="width: 10%;"></td> <td style="width: 10%;"></td> <td style="width: 10%;"></td> </tr> <tr> <td></td> <td></td> <td colspan="8" style="text-align: center;"> <table border="1" style="width: 100%; border-collapse: collapse; text-align: center;"> <tr> <td style="width: 10%;"></td> <td style="width: 10%;"></td> <td style="width: 10%;"></td> <td style="width: 10%;"></td> <td style="width: 10%;"></td> <td style="width: 10%;"></td> <td style="width: 10%;"></td> <td style="width: 10%;"></td> <td style="width: 10%;"></td> <td style="width: 10%;"></td> </tr> <tr> <td></td> <td></td> <td colspan="8" style="text-align: center;"> <table border="1" style="width: 100%; border-collapse: collapse; text-align: center;"> <tr> <td style="width: 10%;"></td> <td style="width: 10%;"></td> <td style="width: 10%;"></td> <td style="width: 10%;"></td> <td style="width: 10%;"></td> <td style="width: 10%;"></td> <td style="width: 10%;"></td> <td style="width: 10%;"></td> <td style="width: 10%;"></td> <td style="width: 10%;"></td> </tr> <tr> <td></td> <td></td> <td colspan="8" style="text-align: center;"> <table border="1" style="width: 100%; border-collapse: collapse; text-align: center;"> <tr> <td style="width: 10%;"></td> <td style="width: 10%;"></td> <td style="width: 10%;"></td> <td style="width: 10%;"></td> <td style="width: 10%;"></td> <td style="width: 10%;"></td> <td style="width: 10%;"></td> <td style="width: 10%;"></td> <td style="width: 10%;"></td> <td style="width: 10%;"></td> </tr> <tr> <td></td> <td></td> <td colspan="8" style="text-align: center;"> <table border="1" style="width: 100%; border-collapse: collapse; text-align: center;"> <tr> </tr></table></td></tr></table></td></tr></table></td></tr></table></td></tr></table></td></tr></table></td></tr></table></td></tr></table></td></tr></table></td></tr></table>
 | | | | | | | | | | | | | | | | | | | | <table border="1" style="width: 100%; border-collapse: collapse; text-align: center;"> <tr> <td style="width: 10%;"></td> <td style="width: 10%;"></td> <td style="width: 10%;"></td> <td style="width: 10%;"></td> <td style="width: 10%;"></td> <td style="width: 10%;"></td> <td style="width: 10%;"></td> <td style="width: 10%;"></td> <td style="width: 10%;"></td> <td style="width: 10%;"></td> </tr> <tr> <td></td> <td></td> <td colspan="8" style="text-align: center;"> <table border="1" style="width: 100%; border-collapse: collapse; text-align: center;"> <tr> <td style="width: 10%;"></td> <td style="width: 10%;"></td> <td style="width: 10%;"></td> <td style="width: 10%;"></td> <td style="width: 10%;"></td> <td style="width: 10%;"></td> <td style="width: 10%;"></td> <td style="width: 10%;"></td> <td style="width: 10%;"></td> <td style="width: 10%;"></td> </tr> <tr> <td></td> <td></td> <td colspan="8" style="text-align: center;"> <table border="1" style="width: 100%; border-collapse: collapse; text-align: center;"> <tr> <td style="width: 10%;"></td> <td style="width: 10%;"></td> <td style="width: 10%;"></td> <td style="width: 10%;"></td> <td style="width: 10%;"></td> <td style="width: 10%;"></td> <td style="width: 10%;"></td> <td style="width: 10%;"></td> <td style="width: 10%;"></td> <td style="width: 10%;"></td> </tr> <tr> <td></td> <td></td> <td colspan="8" style="text-align: center;"> <table border="1" style="width: 100%; border-collapse: collapse; text-align: center;"> <tr> <td style="width: 10%;"></td> <td style="width: 10%;"></td> <td style="width: 10%;"></td> <td style="width: 10%;"></td> <td style="width: 10%;"></td> <td style="width: 10%;"></td> <td style="width: 10%;"></td> <td style="width: 10%;"></td> <td style="width: 10%;"></td> <td style="width: 10%;"></td> </tr> <tr> <td></td> <td></td> <td colspan="8" style="text-align: center;"> <table border="1" style="width: 100%; border-collapse: collapse; text-align: center;"> <tr> <td style="width: 10%;"></td> <td style="width: 10%;"></td> <td style="width: 10%;"></td> <td style="width: 10%;"></td> <td style="width: 10%;"></td> <td style="width: 10%;"></td> <td style="width: 10%;"></td> <td style="width: 10%;"></td> <td style="width: 10%;"></td> <td style="width: 10%;"></td> </tr> <tr> <td></td> <td></td> <td colspan="8" style="text-align: center;"> <table border="1" style="width: 100%; border-collapse: collapse; text-align: center;"> <tr> <td style="width: 10%;"></td> <td style="width: 10%;"></td> <td style="width: 10%;"></td> <td style="width: 10%;"></td> <td style="width: 10%;"></td> <td style="width: 10%;"></td> <td style="width: 10%;"></td> <td style="width: 10%;"></td> <td style="width: 10%;"></td> <td style="width: 10%;"></td> </tr> <tr> <td></td> <td></td> <td colspan="8" style="text-align: center;"> <table border="1" style="width: 100%; border-collapse: collapse; text-align: center;"> <tr> <td style="width: 10%;"></td> <td style="width: 10%;"></td> <td style="width: 10%;"></td> <td style="width: 10%;"></td> <td style="width: 10%;"></td> <td style="width: 10%;"></td> <td style="width: 10%;"></td> <td
style="width: 10%;"></td> <td style="width: 10%;"></td> <td style="width: 10%;"></td> </tr> <tr> <td></td> <td></td> <td colspan="8" style="text-align: center;"> <table border="1" style="width: 100%; border-collapse: collapse; text-align: center;"> <tr> <td style="width: 10%;"></td> <td style="width: 10%;"></td> <td style="width: 10%;"></td> <td style="width: 10%;"></td> <td style="width: 10%;"></td> <td style="width: 10%;"></td> <td style="width: 10%;"></td> <td style="width: 10%;"></td> <td style="width: 10%;"></td> <td style="width: 10%;"></td> </tr> <tr> <td></td> <td></td> <td colspan="8" style="text-align: center;"> <table border="1" style="width: 100%; border-collapse: collapse; text-align: center;"> <tr> </tr></table></td></tr></table></td></tr></table></td></tr></table></td></tr></table></td></tr></table></td></tr></table></td></tr></table></td></tr></table> | | | | | | | | | | | | | | | | | | | | <table border="1" style="width: 100%; border-collapse: collapse; text-align: center;"> <tr> <td style="width: 10%;"></td> <td style="width: 10%;"></td> <td style="width: 10%;"></td> <td style="width: 10%;"></td> <td style="width: 10%;"></td> <td style="width: 10%;"></td> <td style="width: 10%;"></td> <td
style="width: 10%;"></td> <td style="width: 10%;"></td> <td style="width: 10%;"></td> </tr> <tr> <td></td> <td></td> <td colspan="8" style="text-align: center;"> <table border="1" style="width: 100%; border-collapse: collapse; text-align: center;"> <tr> <td style="width: 10%;"></td> <td style="width: 10%;"></td> <td style="width: 10%;"></td> <td style="width: 10%;"></td> <td style="width: 10%;"></td> <td style="width: 10%;"></td> <td style="width: 10%;"></td> <td style="width: 10%;"></td> <td style="width: 10%;"></td> <td style="width: 10%;"></td> </tr> <tr> <td></td> <td></td> <td colspan="8" style="text-align: center;"> <table border="1" style="width: 100%; border-collapse: collapse; text-align: center;"> <tr> <td style="width: 10%;"></td> <td style="width: 10%;"></td> <td style="width: 10%;"></td> <td style="width: 10%;"></td> <td style="width: 10%;"></td> <td style="width: 10%;"></td> <td style="width: 10%;"></td> <td style="width: 10%;"></td> <td style="width: 10%;"></td> <td style="width: 10%;"></td> </tr> <tr> <td></td> <td></td> <td colspan="8" style="text-align: center;"> <table border="1" style="width: 100%; border-collapse: collapse; text-align: center;"> <tr> <td style="width: 10%;"></td> <td style="width: 10%;"></td> <td style="width: 10%;"></td> <td style="width: 10%;"></td> <td style="width: 10%;"></td> <td style="width: 10%;"></td> <td style="width: 10%;"></td> <td style="width: 10%;"></td> <td style="width: 10%;"></td> <td style="width: 10%;"></td> </tr> <tr> <td></td> <td></td> <td colspan="8" style="text-align: center;"> <table border="1" style="width: 100%; border-collapse: collapse; text-align: center;"> <tr> <td style="width: 10%;"></td> <td style="width: 10%;"></td> <td style="width: 10%;"></td> <td style="width: 10%;"></td> <td style="width: 10%;"></td> <td style="width: 10%;"></td> <td style="width: 10%;"></td> <td style="width: 10%;"></td> <td style="width: 10%;"></td> <td style="width: 10%;"></td> </tr> <tr> <td></td> <td></td> <td colspan="8" style="text-align: center;"> <table border="1" style="width: 100%; border-collapse: collapse; text-align: center;"> <tr> <td style="width: 10%;"></td> <td style="width: 10%;"></td> <td style="width: 10%;"></td> <td style="width: 10%;"></td> <td style="width: 10%;"></td> <td style="width: 10%;"></td> <td style="width: 10%;"></td> <td style="width: 10%;"></td> <td style="width: 10%;"></td> <td style="width: 10%;"></td> </tr> <tr> <td></td> <td></td> <td colspan="8" style="text-align: center;"> <table border="1" style="width: 100%; border-collapse: collapse; text-align: center;"> <tr> <td style="width: 10%;"></td> <td style="width: 10%;"></td> <td style="width: 10%;"></td> <td style="width: 10%;"></td> <td style="width: 10%;"></td> <td style="width: 10%;"></td> <td style="width: 10%;"></td> <td style="width: 10%;"></td> <td style="width: 10%;"></td> <td style="width: 10%;"></td> </tr> <tr> <td></td> <td></td> <td colspan="8" style="text-align: center;"> <table border="1" style="width: 100%; border-collapse: collapse; text-align: center;"> <tr> </tr></table></td></tr></table></td></tr></table></td></tr></table></td></tr></table></td></tr></table></td></tr></table></td></tr></table>
 | | | | | | | | | | | | | | | | | | | | <table border="1" style="width: 100%; border-collapse: collapse; text-align: center;"> <tr> <td style="width: 10%;"></td> <td style="width: 10%;"></td> <td style="width: 10%;"></td> <td style="width: 10%;"></td> <td style="width: 10%;"></td> <td style="width: 10%;"></td> <td style="width: 10%;"></td> <td style="width: 10%;"></td> <td style="width: 10%;"></td> <td style="width: 10%;"></td> </tr> <tr> <td></td> <td></td> <td colspan="8" style="text-align: center;"> <table border="1" style="width: 100%; border-collapse: collapse; text-align: center;"> <tr> <td style="width: 10%;"></td> <td style="width: 10%;"></td> <td style="width: 10%;"></td> <td style="width: 10%;"></td> <td style="width: 10%;"></td> <td style="width: 10%;"></td> <td style="width: 10%;"></td> <td style="width: 10%;"></td> <td style="width: 10%;"></td> <td style="width: 10%;"></td> </tr> <tr> <td></td> <td></td> <td colspan="8" style="text-align: center;"> <table border="1" style="width: 100%; border-collapse: collapse; text-align: center;"> <tr> <td style="width: 10%;"></td> <td style="width: 10%;"></td> <td style="width: 10%;"></td> <td style="width: 10%;"></td> <td style="width: 10%;"></td> <td style="width: 10%;"></td> <td style="width: 10%;"></td> <td style="width: 10%;"></td> <td style="width: 10%;"></td> <td style="width: 10%;"></td> </tr> <tr> <td></td> <td></td> <td colspan="8" style="text-align: center;"> <table border="1" style="width: 100%; border-collapse: collapse; text-align: center;"> <tr> <td style="width: 10%;"></td> <td style="width: 10%;"></td> <td style="width: 10%;"></td> <td style="width: 10%;"></td> <td style="width: 10%;"></td> <td style="width: 10%;"></td> <td style="width: 10%;"></td> <td style="width: 10%;"></td> <td style="width: 10%;"></td> <td style="width: 10%;"></td> </tr> <tr> <td></td> <td></td> <td colspan="8" style="text-align: center;"> <table border="1" style="width: 100%; border-collapse: collapse; text-align: center;"> <tr> <td style="width: 10%;"></td> <td style="width: 10%;"></td> <td style="width: 10%;"></td> <td style="width: 10%;"></td> <td style="width: 10%;"></td> <td style="width: 10%;"></td> <td style="width: 10%;"></td> <td style="width: 10%;"></td> <td style="width: 10%;"></td> <td style="width: 10%;"></td> </tr> <tr> <td></td> <td></td> <td colspan="8" style="text-align: center;"> <table border="1" style="width: 100%; border-collapse: collapse; text-align: center;"> <tr> <td style="width: 10%;"></td> <td style="width: 10%;"></td> <td style="width: 10%;"></td> <td style="width: 10%;"></td> <td style="width: 10%;"></td> <td style="width: 10%;"></td> <td style="width: 10%;"></td> <td style="width: 10%;"></td> <td style="width: 10%;"></td> <td style="width: 10%;"></td> </tr> <tr> <td></td> <td></td> <td colspan="8" style="text-align: center;"> <table border="1" style="width: 100%; border-collapse: collapse; text-align: center;"> <tr> </tr></table></td></tr></table></td></tr></table></td></tr></table></td></tr></table></td></tr></table></td></tr></table>
 | | | | | | | | | | | | | | | | | | | | <table border="1" style="width: 100%; border-collapse: collapse; text-align: center;"> <tr> <td style="width: 10%;"></td> <td style="width: 10%;"></td> <td style="width: 10%;"></td> <td style="width: 10%;"></td> <td style="width: 10%;"></td> <td style="width: 10%;"></td> <td style="width: 10%;"></td> <td style="width: 10%;"></td> <td style="width: 10%;"></td> <td style="width: 10%;"></td> </tr> <tr> <td></td> <td></td> <td colspan="8" style="text-align: center;"> <table border="1" style="width: 100%; border-collapse: collapse; text-align: center;"> <tr> <td style="width: 10%;"></td> <td style="width: 10%;"></td> <td style="width: 10%;"></td> <td style="width: 10%;"></td> <td style="width: 10%;"></td> <td style="width: 10%;"></td> <td style="width: 10%;"></td> <td style="width: 10%;"></td> <td style="width: 10%;"></td> <td style="width: 10%;"></td> </tr> <tr> <td></td> <td></td> <td colspan="8" style="text-align: center;"> <table border="1" style="width: 100%; border-collapse: collapse; text-align: center;"> <tr> <td style="width: 10%;"></td> <td style="width: 10%;"></td> <td style="width: 10%;"></td> <td style="width: 10%;"></td> <td style="width: 10%;"></td> <td style="width: 10%;"></td> <td style="width: 10%;"></td> <td style="width: 10%;"></td> <td style="width: 10%;"></td> <td style="width: 10%;"></td> </tr> <tr> <td></td> <td></td> <td colspan="8" style="text-align: center;"> <table border="1" style="width: 100%; border-collapse: collapse; text-align: center;"> <tr> <td style="width: 10%;"></td> <td style="width: 10%;"></td> <td style="width: 10%;"></td> <td style="width: 10%;"></td> <td style="width: 10%;"></td> <td style="width: 10%;"></td> <td style="width: 10%;"></td> <td style="width: 10%;"></td> <td style="width: 10%;"></td> <td style="width: 10%;"></td> </tr> <tr> <td></td> <td></td> <td colspan="8" style="text-align: center;"> <table border="1" style="width: 100%; border-collapse: collapse; text-align: center;"> <tr> <td style="width: 10%;"></td> <td style="width: 10%;"></td> <td style="width: 10%;"></td> <td style="width: 10%;"></td> <td style="width: 10%;"></td> <td style="width: 10%;"></td> <td style="width: 10%;"></td> <td style="width: 10%;"></td> <td style="width: 10%;"></td> <td style="width: 10%;"></td> </tr> <tr> <td></td> <td></td> <td colspan="8" style="text-align: center;"> <table border="1" style="width: 100%; border-collapse: collapse; text-align: center;"> <tr> </tr></table></td></tr></table></td></tr></table></td></tr></table></td></tr></table></td></tr></table>
 | | | | | | | | | | | | | | | | | | | | <table border="1" style="width: 100%; border-collapse: collapse; text-align: center;"> <tr> <td style="width: 10%;"></td> <td style="width: 10%;"></td> <td style="width: 10%;"></td> <td style="width: 10%;"></td> <td style="width: 10%;"></td> <td style="width: 10%;"></td> <td style="width: 10%;"></td> <td style="width: 10%;"></td> <td style="width: 10%;"></td> <td style="width: 10%;"></td> </tr> <tr> <td></td> <td></td> <td colspan="8" style="text-align: center;"> <table border="1" style="width: 100%; border-collapse: collapse; text-align: center;"> <tr> <td style="width: 10%;"></td> <td style="width: 10%;"></td> <td style="width: 10%;"></td> <td style="width: 10%;"></td> <td style="width: 10%;"></td> <td style="width: 10%;"></td> <td style="width: 10%;"></td> <td style="width: 10%;"></td> <td style="width: 10%;"></td> <td style="width: 10%;"></td> </tr> <tr> <td></td> <td></td> <td colspan="8" style="text-align: center;"> <table border="1" style="width: 100%; border-collapse: collapse; text-align: center;"> <tr> <td style="width: 10%;"></td> <td style="width: 10%;"></td> <td style="width: 10%;"></td> <td style="width: 10%;"></td> <td style="width: 10%;"></td> <td style="width: 10%;"></td> <td style="width: 10%;"></td> <td style="width: 10%;"></td> <td style="width: 10%;"></td> <td style="width: 10%;"></td> </tr> <tr> <td></td> <td></td> <td colspan="8" style="text-align: center;"> <table border="1" style="width: 100%; border-collapse: collapse; text-align: center;"> <tr> <td style="width: 10%;"></td> <td style="width: 10%;"></td> <td style="width: 10%;"></td> <td style="width: 10%;"></td> <td style="width: 10%;"></td> <td style="width: 10%;"></td> <td style="width: 10%;"></td> <td style="width: 10%;"></td> <td style="width: 10%;"></td> <td style="width: 10%;"></td> </tr> <tr> <td></td> <td></td> <td colspan="8" style="text-align: center;"> <table border="1" style="width: 100%; border-collapse: collapse; text-align: center;"> <tr> </tr></table></td></tr></table></td></tr></table></td></tr></table></td></tr></table>
 | | | | | | | | | | | | | | | | | | | | <table border="1" style="width: 100%; border-collapse: collapse; text-align: center;"> <tr> <td style="width: 10%;"></td> <td style="width: 10%;"></td> <td style="width: 10%;"></td> <td style="width: 10%;"></td> <td style="width: 10%;"></td> <td style="width: 10%;"></td> <td style="width: 10%;"></td> <td style="width: 10%;"></td> <td style="width: 10%;"></td> <td style="width: 10%;"></td> </tr> <tr> <td></td> <td></td> <td colspan="8" style="text-align: center;"> <table border="1" style="width: 100%; border-collapse: collapse; text-align: center;"> <tr> <td style="width: 10%;"></td> <td style="width: 10%;"></td> <td style="width: 10%;"></td> <td style="width: 10%;"></td> <td style="width: 10%;"></td> <td style="width: 10%;"></td> <td style="width: 10%;"></td> <td style="width: 10%;"></td> <td style="width: 10%;"></td> <td style="width: 10%;"></td> </tr> <tr> <td></td> <td></td> <td colspan="8" style="text-align: center;"> <table border="1" style="width: 100%; border-collapse: collapse; text-align: center;"> <tr> <td style="width: 10%;"></td> <td style="width: 10%;"></td> <td style="width: 10%;"></td> <td style="width: 10%;"></td> <td style="width: 10%;"></td> <td style="width: 10%;"></td> <td style="width: 10%;"></td> <td style="width: 10%;"></td> <td style="width: 10%;"></td> <td style="width: 10%;"></td> </tr> <tr> <td></td> <td></td> <td colspan="8" style="text-align: center;"> <table border="1" style="width: 100%; border-collapse: collapse; text-align: center;"> <tr> </tr></table></td></tr></table></td></tr></table></td></tr></table>
 | | | | | | | | | | | | | | | | | | | | <table border="1" style="width: 100%; border-collapse: collapse; text-align: center;"> <tr> <td style="width: 10%;"></td> <td style="width: 10%;"></td> <td style="width: 10%;"></td> <td style="width: 10%;"></td> <td style="width: 10%;"></td> <td style="width: 10%;"></td> <td style="width: 10%;"></td> <td style="width: 10%;"></td> <td style="width: 10%;"></td> <td style="width: 10%;"></td> </tr> <tr> <td></td> <td></td> <td colspan="8" style="text-align: center;"> <table border="1" style="width: 100%; border-collapse: collapse; text-align: center;"> <tr> <td style="width: 10%;"></td> <td style="width: 10%;"></td> <td style="width: 10%;"></td> <td style="width: 10%;"></td> <td style="width: 10%;"></td> <td style="width: 10%;"></td> <td style="width: 10%;"></td> <td style="width: 10%;"></td> <td style="width: 10%;"></td> <td style="width: 10%;"></td> </tr> <tr> <td></td> <td></td> <td colspan="8" style="text-align: center;"> <table border="1" style="width: 100%; border-collapse: collapse; text-align: center;"> <tr> </tr></table></td></tr></table></td></tr></table>
 | | | | | | | | | | | | | | | | | | | | <table border="1" style="width: 100%; border-collapse: collapse; text-align: center;"> <tr> <td style="width: 10%;"></td> <td style="width: 10%;"></td> <td style="width: 10%;"></td> <td style="width: 10%;"></td> <td style="width: 10%;"></td> <td style="width: 10%;"></td> <td style="width: 10%;"></td> <td style="width: 10%;"></td> <td style="width: 10%;"></td> <td style="width: 10%;"></td> </tr> <tr> <td></td> <td></td> <td colspan="8" style="text-align: center;"> <table border="1" style="width: 100%; border-collapse: collapse; text-align: center;"> <tr> </tr></table></td></tr></table>
 | | | | | | | | | | | | | | | | | | | | <table border="1" style="width: 100%; border-collapse: collapse; text-align: center;"> <tr> </tr></table>
 | | | | | | | | | | | | | | | | | | | | | | | | | | | | | | | | | | | | | | | | | | | | | | | | | | | | | | | | | | | | | | | | | | | | | | | | | | | | | | | | | | | | | | | | | | | | | | | | | | | |
 | | | | | | | | | | | | | | | | | | | |
 | | | | | | | | | | | | | | | | | | | | | | | | | | | | | | | | | | | | | | | |
 | | | | | | | | | | | | | | | | | | | |
 | | | | | | | | | | | | | | | | | | | | | | | | | | | | | | | | | | | | | | | |
 | | | | | | | | | | | | | | | | | | | | | | | | | | | | | | | | | | | | | | | |
 | | | | | | | | | | | | | | | | | | | | | | | | | | | | | | | | | | | | | | | |
 | | | | | | | | | | | | | | | | | | | | | | | | | | | | | | | | | | | | | | | | | | | | | | | | | | | | | | | | | | | | | | | | | | | | | | | | | | | | | | | | | | | | | | | | | | | | | | | | | | | |
 | | | | | | | | | | | | | | | | | | | | | | | | | | | | | | | | | | | | | | | | | | | | | | | |
| | |

 | | | | | | | | | | | | | | | | | | | |

 | | | | | | | | | | | | | | | | | | | |

 | | | | | | | | | | | | | | | | | | | |

 | | | | | | | | | | | | | | | | | | | |

 | | | | | | | | | | | | | | | | | | | |

 | | | | | | | | | | | | | | | | | | | |

 | | | | | | | | | | | | | | | | | | | |

 | | | | | | | | | | | | | | | | | | | |

 | | | | | | | | | | | | | | | | | | | |

 | | | | | | | | | | | | | | | | | | | |

 | | | | | | | | | | | | | | | | | | | |

 | | | | | | | | | | | | | | | | | | | |

 | | | | | | | | | | | | | | | | | | | |

 | | | | | | | | | | | | | | | | | | | |

 | | | | | | | | | | | | | | | | | | | |

 | | | | | | | | | | | | | | | | | | | |

 | | | | | | | | | | | | | | | | | | | |

 | | | | | | | | | | | | | | | | | | | |

 | | | | | | | | | | | | | | | | | | | |

 | | | | | | | | | | | | | | | | | | | |

 | | | | | | | | | | | | | | | | | | | |

 | | | | | | | | | | | | | | | | | | | |

 | | | | | | | | | | | | | | | | | | | |

 | | | | | | | | | | | | | | | | | | | |

 | | | | | | | | | | | | | | | | | | | |

 | | | | | | | | | | | | | | | | | | | |

 | | | | | | | | | | | | | | | | | | | |

 | | | | | | | | | | | | | | | | | | | |
 | | | | | | | | | | | | | | | | | | | |

 | | | | | | | | | | | | | | | | | | | |

 | | | | | | | | | | | | | | | | | | | |
 | | | | | | | | | | | | | | | | | | | |

 | | | | | | | | | | | | | | | | | | | |

 | | | | | | | | | | | | | | | | | | | |
 | | | | | | | | | | | | | | | | | | | |
 | | | | | | | | | | | | | | | | | | | |

 | | | | | | | | | | | | | | | | | | | |
 | | | | | | | | | | | | | | | | | | | |
 | | | | | | | | | | | | | | | | | | | |

 | | | | | | | | | | | | | | | | | | | | | | | | | | | | | | | | | | | | | | | | | | | | | | | | | | | | | | | | | | | | | | | | | | | | | | | | | | | | | | | | | | | | | | | | | | | | | | | | | | | |
 | | | | | | | | | | | | | | | | | | | |
 | | | | | | | | | | | | | | | | | | | |
 | | | | | | | | | | | | | | | | | | | |
 | | | | | | | | | | | | | | | | | | | |
 | | | | | | | | | | | | | | | | | | | |
 | | | | | | | | | | | | | | | | | | | |
 | | | | | | | | | | | | | | | | | | | |
 | | | | | | | | | | | | | | | | | | | |
 | | | | | | | | | | | | | | | | | | | | | | | | | | | | | | | | | | | | | | | |
 | | | | | | | | | | | | | | | | | | | |
 | | | | | | | | | | | | | | | | | | | | | | | | | | | | | | | | | | | | | | | |
 | | | | | | | | | | | | | | | | | | | | | | | | | | | | | | | | | | | | | | | |
 | | | | | | | | | | | | | | | | | | | | | | | | | | | | | | | | | | | | | | | |
 | | | | | | | | | | | | | | | | | | | | | | | | | | | | | | | | | | | | | | | | | | | | | | | | | | | | | | | | | | | | | | | | | | | | | | | | | | | | | | | | | | | | | | | | | | | | | | | | | | | |
 | | | | | | | | | | | | | | | | | | | | | | | | | | | | | | | | | | | | | | | | | | | | | | | |
| | | <table border="1" style="width: 100%; border-collapse: collapse; text-align: center;"> <tr> <td style="width: 10%;"></td> <td style="width: 10%;"></td> <td style="width: 10%;"></td> <td style="width: 10%;"></td> <td style="width: 10%;"></td> <td style="width: 10%;"></td> <td style="width: 10%;"></td> <td style="width: 10%;"></td> <td style="width: 10%;"></td> <td style="width: 10%;"></td> </tr> <tr> <td></td> <td></td> <td colspan="8" style="text-align: center;"> <table border="1" style="width: 100%; border-collapse: collapse; text-align: center;"> <tr> <td style="width: 10%;"></td> <td style="width: 10%;"></td> <td style="width: 10%;"></td> <td style="width: 10%;"></td> <td style="width: 10%;"></td> <td style="width: 10%;"></td> <td style="width: 10%;"></td> <td style="width: 10%;"></td> <td style="width: 10%;"></td> <td style="width: 10%;"></td> </tr> <tr> <td></td> <td></td> <td colspan="8" style="text-align: center;"> <table border="1" style="width: 100%; border-collapse: collapse; text-align: center;"> <tr> <td style="width: 10%;"></td> <td style="width: 10%;"></td> <td style="width: 10%;"></td> <td style="width: 10%;"></td> <td style="width: 10%;"></td> <td style="width: 10%;"></td> <td style="width: 10%;"></td> <td style="width: 10%;"></td> <td style="width: 10%;"></td> <td style="width: 10%;"></td> </tr> <tr> <td></td> <td></td> <td colspan="8" style="text-align: center;"> <table border="1" style="width: 100%; border-collapse: collapse; text-align: center;"> <tr> <td style="width: 10%;"></td> <td style="width: 10%;"></td> <td style="width: 10%;"></td> <td style="width: 10%;"></td> <td style="width: 10%;"></td> <td style="width: 10%;"></td> <td style="width: 10%;"></td> <td style="width: 10%;"></td> <td style="width: 10%;"></td> <td style="width: 10%;"></td> </tr> <tr> <td></td> <td></td> <td colspan="8" style="text-align: center;"> <table border="1" style="width: 100%; border-collapse: collapse; text-align: center;"> <tr> <td style="width: 10%;"></td> <td style="width: 10%;"></td> <td style="width: 10%;"></td> <td style="width: 10%;"></td> <td style="width: 10%;"></td> <td style="width: 10%;"></td> <td style="width: 10%;"></td> <td style="width: 10%;"></td> <td style="width: 10%;"></td> <td style="width: 10%;"></td> </tr> <tr> <td></td> <td></td> <td colspan="8" style="text-align: center;"> <table border="1" style="width: 100%; border-collapse: collapse; text-align: center;"> <tr> <td style="width: 10%;"></td> <td style="width: 10%;"></td> <td style="width: 10%;"></td> <td style="width: 10%;"></td> <td style="width: 10%;"></td> <td style="width: 10%;"></td> <td style="width: 10%;"></td> <td style="width: 10%;"></td> <td style="width: 10%;"></td> <td style="width: 10%;"></td> </tr> <tr> <td></td> <td></td> <td colspan="8" style="text-align: center;"> <table border="1" style="width: 100%; border-collapse: collapse; text-align: center;"> <tr> <td style="width: 10%;"></td> <td style="width: 10%;"></td> <td style="width: 10%;"></td> <td style="width: 10%;"></td> <td style="width: 10%;"></td> <td style="width: 10%;"></td> <td style="width: 10%;"></td> <td style="width: 10%;"></td> <td style="width: 10%;"></td> <td style="width: 10%;"></td> </tr> <tr> <td></td> <td></td> <td colspan="8" style="text-align: center;"> <table border="1" style="width: 100%; border-collapse: collapse; text-align: center;"> <tr> <td style="width: 10%;"></td> <td style="width: 10%;"></td> <td style="width: 10%;"></td> <td style="width: 10%;"></td> <td style="width: 10%;"></td> <td style="width: 10%;"></td> <td style="width: 10%;"></td> <td style="width: 10%;"></td> <td style="width: 10%;"></td> <td style="width: 10%;"></td> </tr> <tr> <td></td> <td></td> <td colspan="8" style="text-align: center;"> <table border="1" style="width: 100%; border-collapse: collapse; text-align: center;"> <tr> <td style="width: 10%;"></td> <td style="width: 10%;"></td> <td style="width: 10%;"></td> <td style="width: 10%;"></td> <td style="width: 10%;"></td> <td style="width: 10%;"></td> <td style="width: 10%;"></td> <td style="width: 10%;"></td> <td style="width: 10%;"></td> <td style="width: 10%;"></td> </tr> <tr> <td></td> <td></td> <td colspan="8" style="text-align: center;"> <table border="1" style="width: 100%; border-collapse: collapse; text-align: center;"> <tr> <td style="width: 10%;"></td> <td style="width: 10%;"></td> <td style="width: 10%;"></td> <td style="width: 10%;"></td> <td style="width: 10%;"></td> <td style="width: 10%;"></td> <td style="width: 10%;"></td> <td style="width: 10%;"></td> <td style="width: 10%;"></td> <td style="width: 10%;"></td> </tr> <tr> <td></td> <td></td> <td colspan="8" style="text-align: center;"> <table border="1" style="width: 100%; border-collapse: collapse; text-align: center;"> <tr> <td style="width: 10%;"></td> <td style="width: 10%;"></td> <td style="width: 10%;"></td> <td style="width: 10%;"></td> <td style="width: 10%;"></td> <td style="width: 10%;"></td> <td style="width: 10%;"></td> <td style="width: 10%;"></td> <td style="width: 10%;"></td> <td style="width: 10%;"></td> </tr> <tr> <td></td> <td></td> <td colspan="8" style="text-align: center;"> <table border="1" style="width: 100%; border-collapse: collapse; text-align: center;"> <tr> <td style="width: 10%;"></td> <td style="width: 10%;"></td> <td style="width: 10%;"></td> <td style="width: 10%;"></td> <td style="width: 10%;"></td> <td style="width: 10%;"></td> <td style="width: 10%;"></td> <td style="width: 10%;"></td> <td style="width: 10%;"></td> <td style="width: 10%;"></td> </tr> <tr> <td></td> <td></td> <td colspan="8" style="text-align: center;"> <table border="1" style="width: 100%; border-collapse: collapse; text-align: center;"> <tr> <td style="width: 10%;"></td> <td style="width: 10%;"></td> <td style="width: 10%;"></td> <td style="width: 10%;"></td> <td style="width: 10%;"></td> <td style="width: 10%;"></td> <td style="width: 10%;"></td> <td style="width: 10%;"></td> <td style="width: 10%;"></td> <td style="width: 10%;"></td> </tr> <tr> <td></td> <td></td> <td colspan="8" style="text-align: center;"> <table border="1" style="width: 100%; border-collapse: collapse; text-align: center;"> <tr> <td style="width: 10%;"></td> <td style="width: 10%;"></td> <td style="width: 10%;"></td> <td style="width: 10%;"></td> <td style="width: 10%;"></td> <td style="width: 10%;"></td> <td style="width: 10%;"></td> <td style="width: 10%;"></td> <td style="width: 10%;"></td> <td style="width: 10%;"></td> </tr> <tr> <td></td> <td></td> <td colspan="8" style="text-align: center;"> <table border="1" style="width: 100%; border-collapse: collapse; text-align: center;"> <tr> <td style="width: 10%;"></td> <td style="width: 10%;"></td> <td style="width: 10%;"></td> <td style="width: 10%;"></td> <td style="width: 10%;"></td> <td style="width: 10%;"></td> <td style="width: 10%;"></td> <td style="width: 10%;"></td> <td style="width: 10%;"></td> <td style="width: 10%;"></td> </tr> <tr> <td></td> <td></td> <td colspan="8" style="text-align: center;"> <table border="1" style="width: 100%; border-collapse: collapse; text-align: center;"> <tr> <td style="width: 10%;"></td> <td style="width: 10%;"></td> <td style="width: 10%;"></td> <td style="width: 10%;"></td> <td style="width: 10%;"></td> <td style="width: 10%;"></td> <td style="width: 10%;"></td> <td style="width: 10%;"></td> <td style="width: 10%;"></td> <td style="width: 10%;"></td> </tr> <tr> <td></td> <td></td> <td colspan="8" style="text-align: center;"> <table border="1" style="width: 100%; border-collapse: collapse; text-align: center;"> <tr> <td style="width: 10%;"></td> <td style="width: 10%;"></td> <td style="width: 10%;"></td> <td style="width: 10%;"></td> <td style="width: 10%;"></td> <td style="width: 10%;"></td> <td style="width: 10%;"></td> <td style="width: 10%;"></td> <td style="width: 10%;"></td> <td style="width: 10%;"></td> </tr> <tr> <td></td> <td></td> <td colspan="8" style="text-align: center;"> <table border="1" style="width: 100%; border-collapse: collapse; text-align: center;"> <tr> <td style="width: 10%;"></td> <td style="width: 10%;"></td> <td style="width: 10%;"></td> <td style="width: 10%;"></td> <td style="width: 10%;"></td> <td style="width: 10%;"></td> <td style="width: 10%;"></td> <td style="width: 10%;"></td> <td style="width: 10%;"></td> <td style="width: 10%;"></td> </tr> <tr> <td></td> <td></td> <td colspan="8" style="text-align: center;"> <table border="1" style="width: 100%; border-collapse: collapse; text-align: center;"> <tr> <td style="width: 10%;"></td> <td style="width: 10%;"></td> <td style="width: 10%;"></td> <td style="width: 10%;"></td> <td style="width: 10%;"></td> <td style="width: 10%;"></td> <td style="width: 10%;"></td> <td style="width: 10%;"></td> <td style="width: 10%;"></td> <td style="width: 10%;"></td> </tr> <tr> <td></td> <td></td> <td colspan="8" style="text-align: center;"> <table border="1" style="width: 100%; border-collapse: collapse; text-align: center;"> <tr> <td style="width: 10%;"></td> <td style="width: 10%;"></td> <td style="width: 10%;"></td> <td style="width: 10%;"></td> <td style="width: 10%;"></td> <td style="width: 10%;"></td> <td style="width: 10%;"></td> <td style="width: 10%;"></td> <td style="width: 10%;"></td> <td style="width: 10%;"></td> </tr> <tr> <td></td> <td></td> <td colspan="8" style="text-align: center;"> <table border="1" style="width: 100%; border-collapse: collapse; text-align: center;"> <tr> <td style="width: 10%;"></td> <td style="width: 10%;"></td> <td style="width: 10%;"></td> <td style="width: 10%;"></td> <td style="width: 10%;"></td> <td style="width: 10%;"></td> <td style="width: 10%;"></td> <td style="width: 10%;"></td> <td style="width: 10%;"></td> <td style="width: 10%;"></td> </tr> <tr> <td></td> <td></td> <td colspan="8" style="text-align: center;"> <table border="1" style="width: 100%; border-collapse: collapse; text-align: center;"> <tr> <td style="width: 10%;"></td> <td style="width: 10%;"></td> <td
style="width: 10%;"></td> <td style="width: 10%;"></td> <td style="width: 10%;"></td> <td style="width: 10%;"></td> <td style="width: 10%;"></td> <td style="width: 10%;"></td> <td style="width: 10%;"></td> <td style="width: 10%;"></td> </tr> <tr> <td></td> <td></td> <td colspan="8" style="text-align: center;"> <table border="1" style="width: 100%; border-collapse: collapse; text-align: center;"> <tr> <td style="width: 10%;"></td> <td style="width: 10%;"></td> <td style="width: 10%;"></td> <td style="width: 10%;"></td> <td style="width: 10%;"></td> <td style="width: 10%;"></td> <td style="width: 10%;"></td> <td style="width: 10%;"></td> <td style="width: 10%;"></td> <td style="width: 10%;"></td> </tr> <tr> <td></td> <td></td> <td colspan="8" style="text-align: center;"> <table border="1" style="width: 100%; border-collapse: collapse; text-align: center;"> <tr> <td style="width: 10%;"></td> <td style="width: 10%;"></td> <td style="width: 10%;"></td> <td style="width: 10%;"></td> <td style="width: 10%;"></td> <td style="width: 10%;"></td> <td style="width: 10%;"></td> <td style="width: 10%;"></td> <td style="width: 10%;"></td> <td style="width: 10%;"></td> </tr> <tr> <td></td> <td></td> <td colspan="8" style="text-align: center;"> <table border="1" style="width: 100%; border-collapse: collapse; text-align: center;"> <tr> <td style="width: 10%;"></td> <td style="width: 10%;"></td> <td style="width: 10%;"></td> <td style="width: 10%;"></td> <td style="width: 10%;"></td> <td style="width: 10%;"></td> <td style="width: 10%;"></td> <td style="width: 10%;"></td> <td style="width: 10%;"></td> <td style="width: 10%;"></td> </tr> <tr> <td></td> <td></td> <td colspan="8" style="text-align: center;"> <table border="1" style="width: 100%; border-collapse: collapse; text-align: center;"> <tr> <td style="width: 10%;"></td> <td style="width: 10%;"></td> <td style="width: 10%;"></td> <td style="width: 10%;"></td> <td style="width: 10%;"></td> <td style="width: 10%;"></td> <td style="width: 10%;"></td> <td style="width: 10%;"></td> <td style="width: 10%;"></td> <td style="width: 10%;"></td> </tr> <tr> <td></td> <td></td> <td colspan="8" style="text-align: center;"> <table border="1" style="width: 100%; border-collapse: collapse; text-align: center;"> <tr> <td style="width: 10%;"></td> <td style="width: 10%;"></td> <td style="width: 10%;"></td> <td style="width: 10%;"></td> <td style="width: 10%;"></td> <td style="width: 10%;"></td> <td style="width: 10%;"></td> <td style="width: 10%;"></td> <td style="width: 10%;"></td> <td style="width: 10%;"></td> </tr> <tr> <td></td> <td></td> <td colspan="8" style="text-align: center;"> <table border="1" style="width: 100%; border-collapse: collapse; text-align: center;"> <tr> <td style="width: 10%;"></td> <td style="width: 10%;"></td> <td style="width: 10%;"></td> <td style="width: 10%;"></td> <td style="width: 10%;"></td> <td style="width: 10%;"></td> <td style="width: 10%;"></td> <td style="width: 10%;"></td> <td style="width: 10%;"></td> <td style="width: 10%;"></td> </tr> <tr> <td></td> <td></td> <td colspan="8" style="text-align: center;"> <table border="1" style="width: 100%; border-collapse: collapse; text-align: center;"> <tr> <td style="width: 10%;"></td> <td style="width: 10%;"></td> <td style="width: 10%;"></td> <td style="width: 10%;"></td> <td style="width: 10%;"></td> <td style="width: 10%;"></td> <td style="width: 10%;"></td> <td style="width: 10%;"></td> <td style="width: 10%;"></td> <td style="width: 10%;"></td> </tr> <tr> <td></td> <td></td> <td colspan="8" style="text-align: center;"> <table border="1" style="width: 100%; border-collapse: collapse; text-align: center;"> <tr> <td style="width: 10%;"></td> <td style="width: 10%;"></td> <td style="width: 10%;"></td> <td style="width: 10%;"></td> <td style="width: 10%;"></td> <td style="width: 10%;"></td> <td style="width: 10%;"></td> <td style="width: 10%;"></td> <td style="width: 10%;"></td> <td style="width: 10%;"></td> </tr> <tr> <td></td> <td></td> <td colspan="8" style="text-align: center;"> <table border="1" style="width: 100%; border-collapse: collapse; text-align: center;"> <tr> <td style="width: 10%;"></td> <td style="width: 10%;"></td> <td style="width: 10%;"></td> <td style="width: 10%;"></td> <td style="width: 10%;"></td> <td style="width: 10%;"></td> <td style="width: 10%;"></td> <td style="width: 10%;"></td> <td style="width: 10%;"></td> <td style="width: 10%;"></td> </tr> <tr> <td></td> <td></td> <td colspan="8" style="text-align: center;"> <table border="1" style="width: 100%; border-collapse: collapse; text-align: center;"> <tr> <td style="width: 10%;"></td> <td style="width: 10%;"></td> <td style="width: 10%;"></td> <td style="width: 10%;"></td> <td style="width: 10%;"></td> <td style="width: 10%;"></td> <td style="width: 10%;"></td> <td style="width: 10%;"></td> <td style="width: 10%;"></td> <td style="width: 10%;"></td> </tr> <tr> <td></td> <td></td> <td colspan="8" style="text-align: center;"> <table border="1" style="width: 100%; border-collapse: collapse; text-align: center;"> <tr> <td style="width: 10%;"></td> <td style="width: 10%;"></td> <td style="width: 10%;"></td> <td style="width: 10%;"></td> <td style="width: 10%;"></td> <td style="width: 10%;"></td> <td style="width: 10%;"></td> <td style="width: 10%;"></td> <td style="width: 10%;"></td> <td style="width: 10%;"></td> </tr> <tr> <td></td> <td></td> <td colspan="8" style="text-align: center;"> <table border="1" style="width: 100%; border-collapse: collapse; text-align: center;"> <tr> <td style="width: 10%;"></td> <td style="width: 10%;"></td> <td style="width: 10%;"></td> <td style="width: 10%;"></td> <td style="width: 10%;"></td> <td style="width: 10%;"></td> <td style="width: 10%;"></td> <td style="width: 10%;"></td> <td style="width: 10%;"></td> <td style="width: 10%;"></td> </tr> <tr> <td></td> <td></td> <td colspan="8" style="text-align: center;"> <table border="1" style="width: 100%; border-collapse: collapse; text-align: center;"> <tr> <td style="width: 10%;"></td> <td style="width: 10%;"></td> <td style="width: 10%;"></td> <td style="width: 10%;"></td> <td style="width: 10%;"></td> <td style="width: 10%;"></td> <td style="width: 10%;"></td> <td style="width: 10%;"></td> <td style="width: 10%;"></td> <td style="width: 10%;"></td> </tr> <tr> <td></td> <td></td> <td colspan="8" style="text-align: center;"> <table border="1" style="width: 100%; border-collapse: collapse; text-align: center;"> <tr> <td style="width: 10%;"></td> <td style="width: 10%;"></td> <td style="width: 10%;"></td> <td style="width: 10%;"></td> <td style="width: 10%;"></td> <td style="width: 10%;"></td> <td style="width: 10%;"></td> <td style="width: 10%;"></td> <td style="width: 10%;"></td> <td style="width: 10%;"></td> </tr> <tr> <td></td> <td></td> <td colspan="8" style="text-align: center;"> <table border="1" style="width: 100%; border-collapse: collapse; text-align: center;"> <tr> <td style="width: 10%;"></td> <td style="width: 10%;"></td> <td style="width: 10%;"></td> <td style="width: 10%;"></td> <td style="width: 10%;"></td> <td style="width: 10%;"></td> <td style="width: 10%;"></td> <td style="width: 10%;"></td> <td style="width: 10%;"></td> <td style="width: 10%;"></td> </tr> <tr> <td></td> <td></td> <td colspan="8" style="text-align: center;"> <table border="1" style="width: 100%; border-collapse: collapse; text-align: center;"> <tr> <td style="width: 10%;"></td> <td style="width: 10%;"></td> <td style="width: 10%;"></td> <td style="width: 10%;"></td> <td style="width: 10%;"></td> <td style="width: 10%;"></td> <td style="width: 10%;"></td> <td style="width: 10%;"></td> <td style="width: 10%;"></td> <td style="width: 10%;"></td> </tr> <tr> <td></td> <td></td> <td colspan="8" style="text-align: center;"> <table border="1" style="width: 100%; border-collapse: collapse; text-align: center;"> <tr> <td style="width: 10%;"></td> <td style="width: 10%;"></td> <td style="width: 10%;"></td> <td style="width: 10%;"></td> <td style="width: 10%;"></td> <td style="width: 10%;"></td> <td style="width: 10%;"></td> <td style="width: 10%;"></td> <td style="width: 10%;"></td> <td style="width: 10%;"></td> </tr> <tr> <td></td> <td></td> <td colspan="8" style="text-align: center;"> <table border="1" style="width: 100%; border-collapse: collapse; text-align: center;"> <tr> <td style="width: 10%;"></td> <td style="width: 10%;"></td> <td style="width: 10%;"></td> <td style="width: 10%;"></td> <td style="width: 10%;"></td> <td style="width: 10%;"></td> <td style="width: 10%;"></td> <td style="width: 10%;"></td> <td style="width: 10%;"></td> <td style="width: 10%;"></td> </tr> <tr> <td></td> <td></td> <td colspan="8" style="text-align: center;"> <table border="1" style="width: 100%; border-collapse: collapse; text-align: center;"> <tr> <td style="width: 10%;"></td> <td style="width: 10%;"></td> <td style="width: 10%;"></td> <td style="width: 10%;"></td> <td style="width: 10%;"></td> <td style="width: 10%;"></td> <td style="width: 10%;"></td> <td style="width: 10%;"></td> <td style="width: 10%;"></td> <td style="width: 10%;"></td> </tr> <tr> <td></td> <td></td> <td colspan="8" style="text-align: center;"> <table border="1" style="width: 100%; border-collapse: collapse; text-align: center;"> <tr> <td style="width: 10%;"></td> <td style="width: 10%;"></td> <td style="width: 10%;"></td> <td style="width: 10%;"></td> <td style="width: 10%;"></td> <td style="width: 10%;"></td> <td style="width: 10%;"></td> <td style="width: 10%;"></td> <td style="width: 10%;"></td> <td style="width: 10%;"></td> </tr> <tr> <td></td> <td></td> <td colspan="8" style="text-align: center;"> <table border="1" style="width: 100%; border-collapse: collapse; text-align: center;"> <tr> <td style="width: 10%;"></td> <td style="width: 10%;"></td> <td style="width: 10%;"></td> <td style="width: 10%;"></td> <td style="width: 10%;"></td> <td style="width: 10%;"></td> <td style="width: 10%;"></td> <td style="width:
10%;"></td> <td style="width: 10%;"></td> <td style="width: 10%;"></td> </tr> <tr> <td></td> <td></td> <td colspan="8" style="text-align: center;"> <table border="1" style="width: 100%; border-collapse: collapse; text-align: center;"> <tr> <td style="width: 10%;"></td> <td style="width: 10%;"></td> <td style="width: 10%;"></td> <td style="width: 10%;"></td> <td style="width: 10%;"></td> <td style="width: 10%;"></td> <td style="width: 10%;"></td> <td style="width: 10%;"></td> <td style="width: 10%;"></td> <td style="width: 10%;"></td> </tr> <tr> <td></td> <td></td> <td colspan="8" style="text-align: center;"> <table border="1" style="width: 100%; border-collapse: collapse; text-align: center;"> <tr> <td style="width: 10%;"></td> <td style="width: 10%;"></td> <td style="width: 10%;"></td> <td style="width: 10%;"></td> <td style="width: 10%;"></td> <td style="width: 10%;"></td> <td style="width: 10%;"></td> <td style="width: 10%;"></td> <td style="width: 10%;"></td> <td style="width: 10%;"></td> </tr> <tr> <td></td> <td></td> <td colspan="8" style="text-align: center;"> <table border="1" style="width: 100%; border-collapse: collapse; text-align: center;"> <tr> </tr></table></td></tr></table></td></tr></table></td></tr></table></td></tr></table></td></tr></table></td></tr></table></td></tr></table></td></tr></table></td></tr></table></td></tr></table></td></tr></table></td></tr></table></td></tr></table></td></tr></table></td></tr></table></td></tr></table></td></tr></table></td></tr></table></td></tr></table></td></tr></table></td></tr></table></td></tr></table></td></tr></table></td></tr></table></td></tr></table></td></tr></table></td></tr></table></td></tr></table></td></tr></table></td></tr></table></td></tr></table></td></tr></table></td></tr></table></td></tr></table></td></tr></table></td></tr></table></td></tr></table></td></tr></table></td></tr></table></td></tr></table></td></tr></table></td></tr></table></td></tr></table></td></tr></table></td></tr></table>
 | | | | | | | | | | | | | | | | | | | | <table border="1" style="width: 100%; border-collapse: collapse; text-align: center;"> <tr> <td style="width: 10%;"></td> <td style="width: 10%;"></td> <td style="width: 10%;"></td> <td style="width: 10%;"></td> <td style="width: 10%;"></td> <td style="width: 10%;"></td> <td style="width: 10%;"></td> <td style="width: 10%;"></td> <td style="width: 10%;"></td> <td style="width: 10%;"></td> </tr> <tr> <td></td> <td></td> <td colspan="8" style="text-align: center;"> <table border="1" style="width: 100%; border-collapse: collapse; text-align: center;"> <tr> <td style="width: 10%;"></td> <td style="width: 10%;"></td> <td style="width: 10%;"></td> <td style="width: 10%;"></td> <td style="width: 10%;"></td> <td style="width: 10%;"></td> <td style="width: 10%;"></td> <td style="width: 10%;"></td> <td style="width: 10%;"></td> <td style="width: 10%;"></td> </tr> <tr> <td></td> <td></td> <td colspan="8" style="text-align: center;"> <table border="1" style="width: 100%; border-collapse: collapse; text-align: center;"> <tr> <td style="width: 10%;"></td> <td style="width: 10%;"></td> <td style="width: 10%;"></td> <td style="width: 10%;"></td> <td style="width: 10%;"></td> <td style="width: 10%;"></td> <td style="width: 10%;"></td> <td style="width: 10%;"></td> <td style="width: 10%;"></td> <td style="width: 10%;"></td> </tr> <tr> <td></td> <td></td> <td colspan="8" style="text-align: center;"> <table border="1" style="width: 100%; border-collapse: collapse; text-align: center;"> <tr> <td style="width: 10%;"></td> <td style="width: 10%;"></td> <td style="width: 10%;"></td> <td style="width: 10%;"></td> <td style="width: 10%;"></td> <td style="width: 10%;"></td> <td style="width: 10%;"></td> <td style="width: 10%;"></td> <td style="width: 10%;"></td> <td style="width: 10%;"></td> </tr> <tr> <td></td> <td></td> <td colspan="8" style="text-align: center;"> <table border="1" style="width: 100%; border-collapse: collapse; text-align: center;"> <tr> <td style="width: 10%;"></td> <td style="width: 10%;"></td> <td style="width: 10%;"></td> <td style="width: 10%;"></td> <td style="width: 10%;"></td> <td style="width: 10%;"></td> <td style="width: 10%;"></td> <td style="width: 10%;"></td> <td style="width: 10%;"></td> <td style="width: 10%;"></td> </tr> <tr> <td></td> <td></td> <td colspan="8" style="text-align: center;"> <table border="1" style="width: 100%; border-collapse: collapse; text-align: center;"> <tr> <td style="width: 10%;"></td> <td style="width: 10%;"></td> <td style="width: 10%;"></td> <td style="width: 10%;"></td> <td style="width: 10%;"></td> <td style="width: 10%;"></td> <td style="width: 10%;"></td> <td style="width: 10%;"></td> <td style="width: 10%;"></td> <td style="width: 10%;"></td> </tr> <tr> <td></td> <td></td> <td colspan="8" style="text-align: center;"> <table border="1" style="width: 100%; border-collapse: collapse; text-align: center;"> <tr> <td style="width: 10%;"></td> <td style="width: 10%;"></td> <td style="width: 10%;"></td> <td style="width: 10%;"></td> <td style="width: 10%;"></td> <td style="width: 10%;"></td> <td style="width: 10%;"></td> <td style="width: 10%;"></td> <td style="width: 10%;"></td> <td style="width: 10%;"></td> </tr> <tr> <td></td> <td></td> <td colspan="8" style="text-align: center;"> <table border="1" style="width: 100%; border-collapse: collapse; text-align: center;"> <tr> <td style="width: 10%;"></td> <td style="width: 10%;"></td> <td style="width: 10%;"></td> <td style="width: 10%;"></td> <td style="width: 10%;"></td> <td style="width: 10%;"></td> <td style="width: 10%;"></td> <td style="width: 10%;"></td> <td style="width: 10%;"></td> <td style="width: 10%;"></td> </tr> <tr> <td></td> <td></td> <td colspan="8" style="text-align: center;"> <table border="1" style="width: 100%; border-collapse: collapse; text-align: center;"> <tr> <td style="width: 10%;"></td> <td style="width: 10%;"></td> <td style="width: 10%;"></td> <td style="width: 10%;"></td> <td style="width: 10%;"></td> <td style="width: 10%;"></td> <td style="width: 10%;"></td> <td style="width: 10%;"></td> <td style="width: 10%;"></td> <td style="width: 10%;"></td> </tr> <tr> <td></td> <td></td> <td colspan="8" style="text-align: center;"> <table border="1" style="width: 100%; border-collapse: collapse; text-align: center;"> <tr> <td style="width: 10%;"></td> <td style="width: 10%;"></td> <td style="width: 10%;"></td> <td style="width: 10%;"></td> <td style="width: 10%;"></td> <td style="width: 10%;"></td> <td style="width: 10%;"></td> <td style="width: 10%;"></td> <td style="width: 10%;"></td> <td style="width: 10%;"></td> </tr> <tr> <td></td> <td></td> <td colspan="8" style="text-align: center;"> <table border="1" style="width: 100%; border-collapse: collapse; text-align: center;"> <tr> <td style="width: 10%;"></td> <td style="width: 10%;"></td> <td style="width: 10%;"></td> <td style="width: 10%;"></td> <td style="width: 10%;"></td> <td style="width: 10%;"></td> <td style="width: 10%;"></td> <td style="width: 10%;"></td> <td style="width: 10%;"></td> <td style="width: 10%;"></td> </tr> <tr> <td></td> <td></td> <td colspan="8" style="text-align: center;"> <table border="1" style="width: 100%; border-collapse: collapse; text-align: center;"> <tr> <td style="width: 10%;"></td> <td style="width: 10%;"></td> <td style="width: 10%;"></td> <td style="width: 10%;"></td> <td style="width: 10%;"></td> <td style="width: 10%;"></td> <td style="width: 10%;"></td> <td style="width: 10%;"></td> <td style="width: 10%;"></td> <td style="width: 10%;"></td> </tr> <tr> <td></td> <td></td> <td colspan="8" style="text-align: center;"> <table border="1" style="width: 100%; border-collapse: collapse; text-align: center;"> <tr> <td style="width: 10%;"></td> <td style="width: 10%;"></td> <td style="width: 10%;"></td> <td style="width: 10%;"></td> <td style="width: 10%;"></td> <td style="width: 10%;"></td> <td style="width: 10%;"></td> <td style="width: 10%;"></td> <td style="width: 10%;"></td> <td style="width: 10%;"></td> </tr> <tr> <td></td> <td></td> <td colspan="8" style="text-align: center;"> <table border="1" style="width: 100%; border-collapse: collapse; text-align: center;"> <tr> <td style="width: 10%;"></td> <td style="width: 10%;"></td> <td style="width: 10%;"></td> <td style="width: 10%;"></td> <td style="width: 10%;"></td> <td style="width: 10%;"></td> <td style="width: 10%;"></td> <td style="width: 10%;"></td> <td style="width: 10%;"></td> <td style="width: 10%;"></td> </tr> <tr> <td></td> <td></td> <td colspan="8" style="text-align: center;"> <table border="1" style="width: 100%; border-collapse: collapse; text-align: center;"> <tr> <td style="width: 10%;"></td> <td style="width: 10%;"></td> <td style="width: 10%;"></td> <td style="width: 10%;"></td> <td style="width: 10%;"></td> <td style="width: 10%;"></td> <td style="width: 10%;"></td> <td style="width: 10%;"></td> <td style="width: 10%;"></td> <td style="width: 10%;"></td> </tr> <tr> <td></td> <td></td> <td colspan="8" style="text-align: center;"> <table border="1" style="width: 100%; border-collapse: collapse; text-align: center;"> <tr> <td style="width: 10%;"></td> <td style="width: 10%;"></td> <td style="width: 10%;"></td> <td style="width: 10%;"></td> <td style="width: 10%;"></td> <td style="width: 10%;"></td> <td style="width: 10%;"></td> <td style="width: 10%;"></td> <td style="width: 10%;"></td> <td style="width: 10%;"></td> </tr> <tr> <td></td> <td></td> <td colspan="8" style="text-align: center;"> <table border="1" style="width: 100%; border-collapse: collapse; text-align: center;"> <tr> <td style="width: 10%;"></td> <td style="width: 10%;"></td> <td style="width: 10%;"></td> <td style="width: 10%;"></td> <td style="width: 10%;"></td> <td style="width: 10%;"></td> <td style="width: 10%;"></td> <td style="width: 10%;"></td> <td style="width: 10%;"></td> <td style="width: 10%;"></td> </tr> <tr> <td></td> <td></td> <td colspan="8" style="text-align: center;"> <table border="1" style="width: 100%; border-collapse: collapse; text-align: center;"> <tr> <td style="width: 10%;"></td> <td style="width: 10%;"></td> <td style="width: 10%;"></td> <td style="width: 10%;"></td> <td style="width: 10%;"></td> <td style="width: 10%;"></td> <td style="width: 10%;"></td> <td style="width: 10%;"></td> <td style="width: 10%;"></td> <td style="width: 10%;"></td> </tr> <tr> <td></td> <td></td> <td colspan="8" style="text-align: center;"> <table border="1" style="width: 100%; border-collapse: collapse; text-align: center;"> <tr> <td style="width: 10%;"></td> <td style="width: 10%;"></td> <td style="width: 10%;"></td> <td style="width: 10%;"></td> <td style="width: 10%;"></td> <td style="width:
10%;"></td> <td style="width: 10%;"></td> <td style="width: 10%;"></td> <td style="width: 10%;"></td> <td style="width: 10%;"></td> </tr> <tr> <td></td> <td></td> <td colspan="8" style="text-align: center;"> <table border="1" style="width: 100%; border-collapse: collapse; text-align: center;"> <tr> <td style="width: 10%;"></td> <td style="width: 10%;"></td> <td style="width: 10%;"></td> <td style="width: 10%;"></td> <td style="width: 10%;"></td> <td style="width: 10%;"></td> <td style="width: 10%;"></td> <td style="width: 10%;"></td> <td style="width: 10%;"></td> <td style="width: 10%;"></td> </tr> <tr> <td></td> <td></td> <td colspan="8" style="text-align: center;"> <table border="1" style="width: 100%; border-collapse: collapse; text-align: center;"> <tr> <td style="width: 10%;"></td> <td style="width: 10%;"></td> <td style="width: 10%;"></td> <td style="width: 10%;"></td> <td style="width: 10%;"></td> <td style="width: 10%;"></td> <td style="width: 10%;"></td> <td style="width: 10%;"></td> <td style="width: 10%;"></td> <td style="width: 10%;"></td> </tr> <tr> <td></td> <td></td> <td colspan="8" style="text-align: center;"> <table border="1" style="width: 100%; border-collapse: collapse; text-align: center;"> <tr> <td style="width: 10%;"></td> <td style="width: 10%;"></td> <td style="width: 10%;"></td> <td style="width: 10%;"></td> <td style="width: 10%;"></td> <td style="width: 10%;"></td> <td style="width: 10%;"></td> <td style="width: 10%;"></td> <td style="width: 10%;"></td> <td style="width: 10%;"></td> </tr> <tr> <td></td> <td></td> <td colspan="8" style="text-align: center;"> <table border="1" style="width: 100%; border-collapse: collapse; text-align: center;"> <tr> <td style="width: 10%;"></td> <td style="width: 10%;"></td> <td style="width: 10%;"></td> <td style="width: 10%;"></td> <td style="width: 10%;"></td> <td style="width: 10%;"></td> <td style="width: 10%;"></td> <td style="width: 10%;"></td> <td style="width: 10%;"></td> <td style="width: 10%;"></td> </tr> <tr> <td></td> <td></td> <td colspan="8" style="text-align: center;"> <table border="1" style="width: 100%; border-collapse: collapse; text-align: center;"> <tr> <td style="width: 10%;"></td> <td style="width: 10%;"></td> <td style="width: 10%;"></td> <td style="width: 10%;"></td> <td style="width: 10%;"></td> <td style="width: 10%;"></td> <td style="width: 10%;"></td> <td style="width: 10%;"></td> <td style="width: 10%;"></td> <td style="width: 10%;"></td> </tr> <tr> <td></td> <td></td> <td colspan="8" style="text-align: center;"> <table border="1" style="width: 100%; border-collapse: collapse; text-align: center;"> <tr> <td style="width: 10%;"></td> <td style="width: 10%;"></td> <td style="width: 10%;"></td> <td style="width: 10%;"></td> <td style="width: 10%;"></td> <td style="width: 10%;"></td> <td style="width: 10%;"></td> <td style="width: 10%;"></td> <td style="width: 10%;"></td> <td style="width: 10%;"></td> </tr> <tr> <td></td> <td></td> <td colspan="8" style="text-align: center;"> <table border="1" style="width: 100%; border-collapse: collapse; text-align: center;"> <tr> <td style="width: 10%;"></td> <td style="width: 10%;"></td> <td style="width: 10%;"></td> <td style="width: 10%;"></td> <td style="width: 10%;"></td> <td style="width: 10%;"></td> <td style="width: 10%;"></td> <td style="width: 10%;"></td> <td style="width: 10%;"></td> <td style="width: 10%;"></td> </tr> <tr> <td></td> <td></td> <td colspan="8" style="text-align: center;"> <table border="1" style="width: 100%; border-collapse: collapse; text-align: center;"> <tr> <td style="width: 10%;"></td> <td style="width: 10%;"></td> <td style="width: 10%;"></td> <td style="width: 10%;"></td> <td style="width: 10%;"></td> <td style="width: 10%;"></td> <td style="width: 10%;"></td> <td style="width: 10%;"></td> <td style="width: 10%;"></td> <td style="width: 10%;"></td> </tr> <tr> <td></td> <td></td> <td colspan="8" style="text-align: center;"> <table border="1" style="width: 100%; border-collapse: collapse; text-align: center;"> <tr> <td style="width: 10%;"></td> <td style="width: 10%;"></td> <td style="width: 10%;"></td> <td style="width: 10%;"></td> <td style="width: 10%;"></td> <td style="width: 10%;"></td> <td style="width: 10%;"></td> <td style="width: 10%;"></td> <td style="width: 10%;"></td> <td style="width: 10%;"></td> </tr> <tr> <td></td> <td></td> <td colspan="8" style="text-align: center;"> <table border="1" style="width: 100%; border-collapse: collapse; text-align: center;"> <tr> <td style="width: 10%;"></td> <td style="width: 10%;"></td> <td style="width: 10%;"></td> <td style="width: 10%;"></td> <td style="width: 10%;"></td> <td style="width: 10%;"></td> <td style="width: 10%;"></td> <td style="width: 10%;"></td> <td style="width: 10%;"></td> <td style="width: 10%;"></td> </tr> <tr> <td></td> <td></td> <td colspan="8" style="text-align: center;"> <table border="1" style="width: 100%; border-collapse: collapse; text-align: center;"> <tr> <td style="width: 10%;"></td> <td style="width: 10%;"></td> <td style="width: 10%;"></td> <td style="width: 10%;"></td> <td style="width: 10%;"></td> <td style="width: 10%;"></td> <td style="width: 10%;"></td> <td style="width: 10%;"></td> <td style="width: 10%;"></td> <td style="width: 10%;"></td> </tr> <tr> <td></td> <td></td> <td colspan="8" style="text-align: center;"> <table border="1" style="width: 100%; border-collapse: collapse; text-align: center;"> <tr> <td style="width: 10%;"></td> <td style="width: 10%;"></td> <td style="width: 10%;"></td> <td style="width: 10%;"></td> <td style="width: 10%;"></td> <td style="width: 10%;"></td> <td style="width: 10%;"></td> <td style="width: 10%;"></td> <td style="width: 10%;"></td> <td style="width: 10%;"></td> </tr> <tr> <td></td> <td></td> <td colspan="8" style="text-align: center;"> <table border="1" style="width: 100%; border-collapse: collapse; text-align: center;"> <tr> <td style="width: 10%;"></td> <td style="width: 10%;"></td> <td style="width: 10%;"></td> <td style="width: 10%;"></td> <td style="width: 10%;"></td> <td style="width: 10%;"></td> <td style="width: 10%;"></td> <td style="width: 10%;"></td> <td style="width: 10%;"></td> <td style="width: 10%;"></td> </tr> <tr> <td></td> <td></td> <td colspan="8" style="text-align: center;"> <table border="1" style="width: 100%; border-collapse: collapse; text-align: center;"> <tr> <td style="width: 10%;"></td> <td style="width: 10%;"></td> <td style="width: 10%;"></td> <td style="width: 10%;"></td> <td style="width: 10%;"></td> <td style="width: 10%;"></td> <td style="width: 10%;"></td> <td style="width: 10%;"></td> <td style="width: 10%;"></td> <td style="width: 10%;"></td> </tr> <tr> <td></td> <td></td> <td colspan="8" style="text-align: center;"> <table border="1" style="width: 100%; border-collapse: collapse; text-align: center;"> <tr> <td style="width: 10%;"></td> <td style="width: 10%;"></td> <td style="width: 10%;"></td> <td style="width: 10%;"></td> <td style="width: 10%;"></td> <td style="width: 10%;"></td> <td style="width: 10%;"></td> <td style="width: 10%;"></td> <td style="width: 10%;"></td> <td style="width: 10%;"></td> </tr> <tr> <td></td> <td></td> <td colspan="8" style="text-align: center;"> <table border="1" style="width: 100%; border-collapse: collapse; text-align: center;"> <tr> <td style="width: 10%;"></td> <td style="width: 10%;"></td> <td style="width: 10%;"></td> <td style="width: 10%;"></td> <td style="width: 10%;"></td> <td style="width: 10%;"></td> <td style="width: 10%;"></td> <td style="width: 10%;"></td> <td style="width: 10%;"></td> <td style="width: 10%;"></td> </tr> <tr> <td></td> <td></td> <td colspan="8" style="text-align: center;"> <table border="1" style="width: 100%; border-collapse: collapse; text-align: center;"> <tr> <td style="width: 10%;"></td> <td style="width: 10%;"></td> <td style="width: 10%;"></td> <td style="width: 10%;"></td> <td style="width: 10%;"></td> <td style="width: 10%;"></td> <td style="width: 10%;"></td> <td style="width: 10%;"></td> <td style="width: 10%;"></td> <td style="width: 10%;"></td> </tr> <tr> <td></td> <td></td> <td colspan="8" style="text-align: center;"> <table border="1" style="width: 100%; border-collapse: collapse; text-align: center;"> <tr> <td style="width: 10%;"></td> <td style="width: 10%;"></td> <td style="width: 10%;"></td> <td style="width: 10%;"></td> <td style="width: 10%;"></td> <td style="width: 10%;"></td> <td style="width: 10%;"></td> <td style="width: 10%;"></td> <td style="width: 10%;"></td> <td style="width: 10%;"></td> </tr> <tr> <td></td> <td></td> <td colspan="8" style="text-align: center;"> <table border="1" style="width: 100%; border-collapse: collapse; text-align: center;"> <tr> <td style="width: 10%;"></td> <td style="width: 10%;"></td> <td style="width: 10%;"></td> <td style="width: 10%;"></td> <td style="width: 10%;"></td> <td style="width: 10%;"></td> <td style="width: 10%;"></td> <td style="width: 10%;"></td> <td style="width: 10%;"></td> <td style="width: 10%;"></td> </tr> <tr> <td></td> <td></td> <td colspan="8" style="text-align: center;"> <table border="1" style="width: 100%; border-collapse: collapse; text-align: center;"> <tr> <td style="width: 10%;"></td> <td style="width: 10%;"></td> <td style="width: 10%;"></td> <td style="width: 10%;"></td> <td style="width: 10%;"></td> <td style="width: 10%;"></td> <td style="width: 10%;"></td> <td style="width: 10%;"></td> <td style="width: 10%;"></td> <td style="width: 10%;"></td> </tr> <tr> <td></td> <td></td> <td colspan="8" style="text-align: center;"> <table border="1" style="width: 100%; border-collapse: collapse; text-align: center;"> <tr> <td style="width: 10%;"></td> <td style="width: 10%;"></td> <td style="width: 10%;"></td> <td style="width: 10%;"></td> <td style="width: 10%;"></td> <td style="width: 10%;"></td> <td style="width: 10%;"></td> <td style="width: 10%;"></td> <td style="width: 10%;"></td> <td style="width: 10%;"></td> </tr> <tr> <td></td> <td></td> <td
colspan="8" style="text-align: center;"> <table border="1" style="width: 100%; border-collapse: collapse; text-align: center;"> <tr> <td style="width: 10%;"></td> <td style="width: 10%;"></td> <td style="width: 10%;"></td> <td style="width: 10%;"></td> <td style="width: 10%;"></td> <td style="width: 10%;"></td> <td style="width: 10%;"></td> <td style="width: 10%;"></td> <td style="width: 10%;"></td> <td style="width: 10%;"></td> </tr> <tr> <td></td> <td></td> <td colspan="8" style="text-align: center;"> <table border="1" style="width: 100%; border-collapse: collapse; text-align: center;"> <tr> <td style="width: 10%;"></td> <td style="width: 10%;"></td> <td style="width: 10%;"></td> <td style="width: 10%;"></td> <td style="width: 10%;"></td> <td style="width: 10%;"></td> <td style="width: 10%;"></td> <td style="width: 10%;"></td> <td style="width: 10%;"></td> <td style="width: 10%;"></td> </tr> <tr> <td></td> <td></td> <td colspan="8" style="text-align: center;"> <table border="1" style="width: 100%; border-collapse: collapse; text-align: center;"> <tr> <td style="width: 10%;"></td> <td style="width: 10%;"></td> <td style="width: 10%;"></td> <td style="width: 10%;"></td> <td style="width: 10%;"></td> <td style="width: 10%;"></td> <td style="width: 10%;"></td> <td style="width: 10%;"></td> <td style="width: 10%;"></td> <td style="width: 10%;"></td> </tr> <tr> <td></td> <td></td> <td colspan="8" style="text-align: center;"> <table border="1" style="width: 100%; border-collapse: collapse; text-align: center;"> <tr> <td style="width: 10%;"></td> <td style="width: 10%;"></td> <td style="width: 10%;"></td> <td style="width: 10%;"></td> <td style="width: 10%;"></td> <td style="width: 10%;"></td> <td style="width: 10%;"></td> <td style="width: 10%;"></td> <td style="width: 10%;"></td> <td style="width: 10%;"></td> </tr> <tr> <td></td> <td></td> <td colspan="8" style="text-align: center;"> <table border="1" style="width: 100%; border-collapse: collapse; text-align: center;"> <tr> </tr></table></td></tr></table></td></tr></table></td></tr></table></td></tr></table></td></tr></table></td></tr></table></td></tr></table></td></tr></table></td></tr></table></td></tr></table></td></tr></table></td></tr></table></td></tr></table></td></tr></table></td></tr></table></td></tr></table></td></tr></table></td></tr></table></td></tr></table></td></tr></table></td></tr></table></td></tr></table></td></tr></table></td></tr></table></td></tr></table></td></tr></table></td></tr></table></td></tr></table></td></tr></table></td></tr></table></td></tr></table></td></tr></table></td></tr></table></td></tr></table></td></tr></table></td></tr></table></td></tr></table></td></tr></table></td></tr></table></td></tr></table></td></tr></table></td></tr></table></td></tr></table></td></tr></table>
 | | | | | | | | | | | | | | | | | | | | <table border="1" style="width: 100%; border-collapse: collapse; text-align: center;"> <tr> <td style="width: 10%;"></td> <td style="width: 10%;"></td> <td style="width: 10%;"></td> <td style="width: 10%;"></td> <td style="width: 10%;"></td> <td style="width: 10%;"></td> <td style="width: 10%;"></td> <td style="width: 10%;"></td> <td style="width: 10%;"></td> <td style="width: 10%;"></td> </tr> <tr> <td></td> <td></td> <td colspan="8" style="text-align: center;"> <table border="1" style="width: 100%; border-collapse: collapse; text-align: center;"> <tr> <td style="width: 10%;"></td> <td style="width: 10%;"></td> <td style="width: 10%;"></td> <td style="width: 10%;"></td> <td style="width: 10%;"></td> <td style="width: 10%;"></td> <td style="width: 10%;"></td> <td style="width: 10%;"></td> <td style="width: 10%;"></td> <td style="width: 10%;"></td> </tr> <tr> <td></td> <td></td> <td colspan="8" style="text-align: center;"> <table border="1" style="width: 100%; border-collapse: collapse; text-align: center;"> <tr> <td style="width: 10%;"></td> <td style="width: 10%;"></td> <td style="width: 10%;"></td> <td style="width: 10%;"></td> <td style="width: 10%;"></td> <td style="width: 10%;"></td> <td style="width: 10%;"></td> <td style="width: 10%;"></td> <td style="width: 10%;"></td> <td style="width: 10%;"></td> </tr> <tr> <td></td> <td></td> <td colspan="8" style="text-align: center;"> <table border="1" style="width: 100%; border-collapse: collapse; text-align: center;"> <tr> <td style="width: 10%;"></td> <td style="width: 10%;"></td> <td style="width: 10%;"></td> <td style="width: 10%;"></td> <td style="width: 10%;"></td> <td style="width: 10%;"></td> <td style="width: 10%;"></td> <td style="width: 10%;"></td> <td style="width: 10%;"></td> <td style="width: 10%;"></td> </tr> <tr> <td></td> <td></td> <td colspan="8" style="text-align: center;"> <table border="1" style="width: 100%; border-collapse: collapse; text-align: center;"> <tr> <td style="width: 10%;"></td> <td style="width: 10%;"></td> <td style="width: 10%;"></td> <td style="width: 10%;"></td> <td style="width: 10%;"></td> <td style="width: 10%;"></td> <td style="width: 10%;"></td> <td style="width: 10%;"></td> <td style="width: 10%;"></td> <td style="width: 10%;"></td> </tr> <tr> <td></td> <td></td> <td colspan="8" style="text-align: center;"> <table border="1" style="width: 100%; border-collapse: collapse; text-align: center;"> <tr> <td style="width: 10%;"></td> <td style="width: 10%;"></td> <td style="width: 10%;"></td> <td style="width: 10%;"></td> <td style="width: 10%;"></td> <td style="width: 10%;"></td> <td style="width: 10%;"></td> <td style="width: 10%;"></td> <td style="width: 10%;"></td> <td style="width: 10%;"></td> </tr> <tr> <td></td> <td></td> <td colspan="8" style="text-align: center;"> <table border="1" style="width: 100%; border-collapse: collapse; text-align: center;"> <tr> <td style="width: 10%;"></td> <td style="width: 10%;"></td> <td style="width: 10%;"></td> <td style="width: 10%;"></td> <td style="width: 10%;"></td> <td style="width: 10%;"></td> <td style="width: 10%;"></td> <td style="width: 10%;"></td> <td style="width: 10%;"></td> <td style="width: 10%;"></td> </tr> <tr> <td></td> <td></td> <td colspan="8" style="text-align: center;"> <table border="1" style="width: 100%; border-collapse: collapse; text-align: center;"> <tr> <td style="width: 10%;"></td> <td style="width: 10%;"></td> <td style="width: 10%;"></td> <td style="width: 10%;"></td> <td style="width: 10%;"></td> <td style="width: 10%;"></td> <td style="width: 10%;"></td> <td style="width: 10%;"></td> <td style="width: 10%;"></td> <td style="width: 10%;"></td> </tr> <tr> <td></td> <td></td> <td colspan="8" style="text-align: center;"> <table border="1" style="width: 100%; border-collapse: collapse; text-align: center;"> <tr> <td style="width: 10%;"></td> <td style="width: 10%;"></td> <td style="width: 10%;"></td> <td style="width: 10%;"></td> <td style="width: 10%;"></td> <td style="width: 10%;"></td> <td style="width: 10%;"></td> <td style="width: 10%;"></td> <td style="width: 10%;"></td> <td style="width: 10%;"></td> </tr> <tr> <td></td> <td></td> <td colspan="8" style="text-align: center;"> <table border="1" style="width: 100%; border-collapse: collapse; text-align: center;"> <tr> <td style="width: 10%;"></td> <td style="width: 10%;"></td> <td style="width: 10%;"></td> <td style="width: 10%;"></td> <td style="width: 10%;"></td> <td style="width: 10%;"></td> <td style="width: 10%;"></td> <td style="width: 10%;"></td> <td style="width: 10%;"></td> <td style="width: 10%;"></td> </tr> <tr> <td></td> <td></td> <td colspan="8" style="text-align: center;"> <table border="1" style="width: 100%; border-collapse: collapse; text-align: center;"> <tr> <td style="width: 10%;"></td> <td style="width: 10%;"></td> <td style="width: 10%;"></td> <td style="width: 10%;"></td> <td style="width: 10%;"></td> <td style="width: 10%;"></td> <td style="width: 10%;"></td> <td style="width: 10%;"></td> <td style="width: 10%;"></td> <td style="width: 10%;"></td> </tr> <tr> <td></td> <td></td> <td colspan="8" style="text-align: center;"> <table border="1" style="width: 100%; border-collapse: collapse; text-align: center;"> <tr> <td style="width: 10%;"></td> <td style="width: 10%;"></td> <td style="width: 10%;"></td> <td style="width: 10%;"></td> <td style="width: 10%;"></td> <td style="width: 10%;"></td> <td style="width: 10%;"></td> <td style="width: 10%;"></td> <td style="width: 10%;"></td> <td style="width: 10%;"></td> </tr> <tr> <td></td> <td></td> <td colspan="8" style="text-align: center;"> <table border="1" style="width: 100%; border-collapse: collapse; text-align: center;"> <tr> <td style="width: 10%;"></td> <td style="width: 10%;"></td> <td style="width: 10%;"></td> <td style="width: 10%;"></td> <td style="width: 10%;"></td> <td style="width: 10%;"></td> <td style="width: 10%;"></td> <td style="width: 10%;"></td> <td style="width: 10%;"></td> <td style="width: 10%;"></td> </tr> <tr> <td></td> <td></td> <td colspan="8" style="text-align: center;"> <table border="1" style="width: 100%; border-collapse: collapse; text-align: center;"> <tr> <td style="width: 10%;"></td> <td style="width: 10%;"></td> <td style="width: 10%;"></td> <td style="width: 10%;"></td> <td style="width: 10%;"></td> <td style="width: 10%;"></td> <td style="width: 10%;"></td> <td style="width: 10%;"></td> <td style="width: 10%;"></td> <td style="width: 10%;"></td> </tr> <tr> <td></td> <td></td> <td colspan="8" style="text-align: center;"> <table border="1" style="width: 100%; border-collapse: collapse; text-align: center;"> <tr> <td style="width: 10%;"></td> <td style="width: 10%;"></td> <td style="width: 10%;"></td> <td style="width: 10%;"></td> <td style="width: 10%;"></td> <td style="width: 10%;"></td> <td style="width: 10%;"></td> <td style="width: 10%;"></td> <td style="width: 10%;"></td> <td style="width: 10%;"></td> </tr> <tr> <td></td> <td></td> <td colspan="8" style="text-align: center;"> <table border="1" style="width: 100%; border-collapse: collapse; text-align: center;"> <tr> <td style="width: 10%;"></td> <td style="width: 10%;"></td> <td style="width: 10%;"></td> <td style="width: 10%;"></td> <td style="width: 10%;"></td> <td style="width: 10%;"></td> <td style="width: 10%;"></td> <td style="width: 10%;"></td> <td style="width: 10%;"></td> <td style="width: 10%;"></td> </tr> <tr> <td></td> <td></td> <td colspan="8" style="text-align: center;"> <table border="1" style="width: 100%; border-collapse: collapse; text-align: center;"> <tr> <td style="width: 10%;"></td> <td style="width: 10%;"></td> <td style="width: 10%;"></td> <td style="width: 10%;"></td> <td style="width: 10%;"></td> <td style="width: 10%;"></td> <td style="width: 10%;"></td> <td style="width: 10%;"></td> <td style="width: 10%;"></td> <td style="width: 10%;"></td> </tr> <tr>
<td></td> <td></td> <td colspan="8" style="text-align: center;"> <table border="1" style="width: 100%; border-collapse: collapse; text-align: center;"> <tr> <td style="width: 10%;"></td> <td style="width: 10%;"></td> <td style="width: 10%;"></td> <td style="width: 10%;"></td> <td style="width: 10%;"></td> <td style="width: 10%;"></td> <td style="width: 10%;"></td> <td style="width: 10%;"></td> <td style="width: 10%;"></td> <td style="width: 10%;"></td> </tr> <tr> <td></td> <td></td> <td colspan="8" style="text-align: center;"> <table border="1" style="width: 100%; border-collapse: collapse; text-align: center;"> <tr> <td style="width: 10%;"></td> <td style="width: 10%;"></td> <td style="width: 10%;"></td> <td style="width: 10%;"></td> <td style="width: 10%;"></td> <td style="width: 10%;"></td> <td style="width: 10%;"></td> <td style="width: 10%;"></td> <td style="width: 10%;"></td> <td style="width: 10%;"></td> </tr> <tr> <td></td> <td></td> <td colspan="8" style="text-align: center;"> <table border="1" style="width: 100%; border-collapse: collapse; text-align: center;"> <tr> <td style="width: 10%;"></td> <td style="width: 10%;"></td> <td style="width: 10%;"></td> <td style="width: 10%;"></td> <td style="width: 10%;"></td> <td style="width: 10%;"></td> <td style="width: 10%;"></td> <td style="width: 10%;"></td> <td style="width: 10%;"></td> <td style="width: 10%;"></td> </tr> <tr> <td></td> <td></td> <td colspan="8" style="text-align: center;"> <table border="1" style="width: 100%; border-collapse: collapse; text-align: center;"> <tr> <td style="width: 10%;"></td> <td style="width: 10%;"></td> <td style="width: 10%;"></td> <td style="width: 10%;"></td> <td style="width: 10%;"></td> <td style="width: 10%;"></td> <td style="width: 10%;"></td> <td style="width: 10%;"></td> <td style="width: 10%;"></td> <td style="width: 10%;"></td> </tr> <tr> <td></td> <td></td> <td colspan="8" style="text-align: center;"> <table border="1" style="width: 100%; border-collapse: collapse; text-align: center;"> <tr> <td style="width: 10%;"></td> <td style="width: 10%;"></td> <td style="width: 10%;"></td> <td style="width: 10%;"></td> <td style="width: 10%;"></td> <td style="width: 10%;"></td> <td style="width: 10%;"></td> <td style="width: 10%;"></td> <td style="width: 10%;"></td> <td style="width: 10%;"></td> </tr> <tr> <td></td> <td></td> <td colspan="8" style="text-align: center;"> <table border="1" style="width: 100%; border-collapse: collapse; text-align: center;"> <tr> <td style="width: 10%;"></td> <td style="width: 10%;"></td> <td style="width: 10%;"></td> <td style="width: 10%;"></td> <td style="width: 10%;"></td> <td style="width: 10%;"></td> <td style="width: 10%;"></td> <td style="width: 10%;"></td> <td style="width: 10%;"></td> <td style="width: 10%;"></td> </tr> <tr> <td></td> <td></td> <td colspan="8" style="text-align: center;"> <table border="1" style="width: 100%; border-collapse: collapse; text-align: center;"> <tr> <td style="width: 10%;"></td> <td style="width: 10%;"></td> <td style="width: 10%;"></td> <td style="width: 10%;"></td> <td style="width: 10%;"></td> <td style="width: 10%;"></td> <td style="width: 10%;"></td> <td style="width: 10%;"></td> <td style="width: 10%;"></td> <td style="width: 10%;"></td> </tr> <tr> <td></td> <td></td> <td colspan="8" style="text-align: center;"> <table border="1" style="width: 100%; border-collapse: collapse; text-align: center;"> <tr> <td style="width: 10%;"></td> <td style="width: 10%;"></td> <td style="width: 10%;"></td> <td style="width: 10%;"></td> <td style="width: 10%;"></td> <td style="width: 10%;"></td> <td style="width: 10%;"></td> <td style="width: 10%;"></td> <td style="width: 10%;"></td> <td style="width: 10%;"></td> </tr> <tr> <td></td> <td></td> <td colspan="8" style="text-align: center;"> <table border="1" style="width: 100%; border-collapse: collapse; text-align: center;"> <tr> <td style="width: 10%;"></td> <td style="width: 10%;"></td> <td style="width: 10%;"></td> <td style="width: 10%;"></td> <td style="width: 10%;"></td> <td style="width: 10%;"></td> <td style="width: 10%;"></td> <td style="width: 10%;"></td> <td style="width: 10%;"></td> <td style="width: 10%;"></td> </tr> <tr> <td></td> <td></td> <td colspan="8" style="text-align: center;"> <table border="1" style="width: 100%; border-collapse: collapse; text-align: center;"> <tr> <td style="width: 10%;"></td> <td style="width: 10%;"></td> <td style="width: 10%;"></td> <td style="width: 10%;"></td> <td style="width: 10%;"></td> <td style="width: 10%;"></td> <td style="width: 10%;"></td> <td style="width: 10%;"></td> <td style="width: 10%;"></td> <td style="width: 10%;"></td> </tr> <tr> <td></td> <td></td> <td colspan="8" style="text-align: center;"> <table border="1" style="width: 100%; border-collapse: collapse; text-align: center;"> <tr> <td style="width: 10%;"></td> <td style="width: 10%;"></td> <td style="width: 10%;"></td> <td style="width: 10%;"></td> <td style="width: 10%;"></td> <td style="width: 10%;"></td> <td style="width: 10%;"></td> <td style="width: 10%;"></td> <td style="width: 10%;"></td> <td style="width: 10%;"></td> </tr> <tr> <td></td> <td></td> <td colspan="8" style="text-align: center;"> <table border="1" style="width: 100%; border-collapse: collapse; text-align: center;"> <tr> <td style="width: 10%;"></td> <td style="width: 10%;"></td> <td style="width: 10%;"></td> <td style="width: 10%;"></td> <td style="width: 10%;"></td> <td style="width: 10%;"></td> <td style="width: 10%;"></td> <td style="width: 10%;"></td> <td style="width: 10%;"></td> <td style="width: 10%;"></td> </tr> <tr> <td></td> <td></td> <td colspan="8" style="text-align: center;"> <table border="1" style="width: 100%; border-collapse: collapse; text-align: center;"> <tr> <td style="width: 10%;"></td> <td style="width: 10%;"></td> <td style="width: 10%;"></td> <td style="width: 10%;"></td> <td style="width: 10%;"></td> <td style="width: 10%;"></td> <td style="width: 10%;"></td> <td style="width: 10%;"></td> <td style="width: 10%;"></td> <td style="width: 10%;"></td> </tr> <tr> <td></td> <td></td> <td colspan="8" style="text-align: center;"> <table border="1" style="width: 100%; border-collapse: collapse; text-align: center;"> <tr> <td style="width: 10%;"></td> <td style="width: 10%;"></td> <td style="width: 10%;"></td> <td style="width: 10%;"></td> <td style="width: 10%;"></td> <td style="width: 10%;"></td> <td style="width: 10%;"></td> <td style="width: 10%;"></td> <td style="width: 10%;"></td> <td style="width: 10%;"></td> </tr> <tr> <td></td> <td></td> <td colspan="8" style="text-align: center;"> <table border="1" style="width: 100%; border-collapse: collapse; text-align: center;"> <tr> <td style="width: 10%;"></td> <td style="width: 10%;"></td> <td style="width: 10%;"></td> <td style="width: 10%;"></td> <td style="width: 10%;"></td> <td style="width: 10%;"></td> <td style="width: 10%;"></td> <td style="width: 10%;"></td> <td style="width: 10%;"></td> <td style="width: 10%;"></td> </tr> <tr> <td></td> <td></td> <td colspan="8" style="text-align: center;"> <table border="1" style="width: 100%; border-collapse: collapse; text-align: center;"> <tr> <td style="width: 10%;"></td> <td style="width: 10%;"></td> <td style="width: 10%;"></td> <td style="width: 10%;"></td> <td style="width: 10%;"></td> <td style="width: 10%;"></td> <td style="width: 10%;"></td> <td style="width: 10%;"></td> <td style="width: 10%;"></td> <td style="width: 10%;"></td> </tr> <tr> <td></td> <td></td> <td colspan="8" style="text-align: center;"> <table border="1" style="width: 100%; border-collapse: collapse; text-align: center;"> <tr> <td style="width: 10%;"></td> <td style="width: 10%;"></td> <td style="width: 10%;"></td> <td style="width: 10%;"></td> <td style="width: 10%;"></td> <td style="width: 10%;"></td> <td style="width: 10%;"></td> <td style="width: 10%;"></td> <td style="width: 10%;"></td> <td style="width: 10%;"></td> </tr> <tr> <td></td> <td></td> <td colspan="8" style="text-align: center;"> <table border="1" style="width: 100%; border-collapse: collapse; text-align: center;"> <tr> <td style="width: 10%;"></td> <td style="width: 10%;"></td> <td style="width: 10%;"></td> <td style="width: 10%;"></td> <td style="width: 10%;"></td> <td style="width: 10%;"></td> <td style="width: 10%;"></td> <td style="width: 10%;"></td> <td style="width: 10%;"></td> <td style="width: 10%;"></td> </tr> <tr> <td></td> <td></td> <td colspan="8" style="text-align: center;"> <table border="1" style="width: 100%; border-collapse: collapse; text-align: center;"> <tr> <td style="width: 10%;"></td> <td style="width: 10%;"></td> <td style="width: 10%;"></td> <td style="width: 10%;"></td> <td style="width: 10%;"></td> <td style="width: 10%;"></td> <td style="width: 10%;"></td> <td style="width: 10%;"></td> <td style="width: 10%;"></td> <td style="width: 10%;"></td> </tr> <tr> <td></td> <td></td> <td colspan="8" style="text-align: center;"> <table border="1" style="width: 100%; border-collapse: collapse; text-align: center;"> <tr> <td style="width: 10%;"></td> <td style="width: 10%;"></td> <td style="width: 10%;"></td> <td style="width: 10%;"></td> <td style="width: 10%;"></td> <td style="width: 10%;"></td> <td style="width: 10%;"></td> <td style="width: 10%;"></td> <td style="width: 10%;"></td> <td style="width: 10%;"></td> </tr> <tr> <td></td> <td></td> <td colspan="8" style="text-align: center;"> <table border="1" style="width: 100%; border-collapse: collapse; text-align: center;"> <tr> <td style="width: 10%;"></td> <td style="width: 10%;"></td> <td style="width: 10%;"></td> <td style="width: 10%;"></td> <td style="width: 10%;"></td> <td style="width: 10%;"></td> <td style="width: 10%;"></td> <td style="width: 10%;"></td> <td style="width: 10%;"></td> <td style="width: 10%;"></td> </tr> <tr> <td></td> <td></td> <td colspan="8" style="text-align: center;"> <table border="1" style="width: 100%; border-collapse: collapse; text-align: center;"> <tr> <td
style="width: 10%;"></td> <td style="width: 10%;"></td> <td style="width: 10%;"></td> <td style="width: 10%;"></td> <td style="width: 10%;"></td> <td style="width: 10%;"></td> <td style="width: 10%;"></td> <td style="width: 10%;"></td> <td style="width: 10%;"></td> <td style="width: 10%;"></td> </tr> <tr> <td></td> <td></td> <td colspan="8" style="text-align: center;"> <table border="1" style="width: 100%; border-collapse: collapse; text-align: center;"> <tr> <td style="width: 10%;"></td> <td style="width: 10%;"></td> <td style="width: 10%;"></td> <td style="width: 10%;"></td> <td style="width: 10%;"></td> <td style="width: 10%;"></td> <td style="width: 10%;"></td> <td style="width: 10%;"></td> <td style="width: 10%;"></td> <td style="width: 10%;"></td> </tr> <tr> <td></td> <td></td> <td colspan="8" style="text-align: center;"> <table border="1" style="width: 100%; border-collapse: collapse; text-align: center;"> <tr> <td style="width: 10%;"></td> <td style="width: 10%;"></td> <td style="width: 10%;"></td> <td style="width: 10%;"></td> <td style="width: 10%;"></td> <td style="width: 10%;"></td> <td style="width: 10%;"></td> <td style="width: 10%;"></td> <td style="width: 10%;"></td> <td style="width: 10%;"></td> </tr> <tr> <td></td> <td></td> <td colspan="8" style="text-align: center;"> <table border="1" style="width: 100%; border-collapse: collapse; text-align: center;"> <tr> <td style="width: 10%;"></td> <td style="width: 10%;"></td> <td style="width: 10%;"></td> <td style="width: 10%;"></td> <td style="width: 10%;"></td> <td style="width: 10%;"></td> <td style="width: 10%;"></td> <td style="width: 10%;"></td> <td style="width: 10%;"></td> <td style="width: 10%;"></td> </tr> <tr> <td></td> <td></td> <td colspan="8" style="text-align: center;"> <table border="1" style="width: 100%; border-collapse: collapse; text-align: center;"> <tr> <td style="width: 10%;"></td> <td style="width: 10%;"></td> <td style="width: 10%;"></td> <td style="width: 10%;"></td> <td style="width: 10%;"></td> <td style="width: 10%;"></td> <td style="width: 10%;"></td> <td style="width: 10%;"></td> <td style="width: 10%;"></td> <td style="width: 10%;"></td> </tr> <tr> <td></td> <td></td> <td colspan="8" style="text-align: center;"> <table border="1" style="width: 100%; border-collapse: collapse; text-align: center;"> <tr> </tr></table></td></tr></table></td></tr></table></td></tr></table></td></tr></table></td></tr></table></td></tr></table></td></tr></table></td></tr></table></td></tr></table></td></tr></table></td></tr></table></td></tr></table></td></tr></table></td></tr></table></td></tr></table></td></tr></table></td></tr></table></td></tr></table></td></tr></table></td></tr></table></td></tr></table></td></tr></table></td></tr></table></td></tr></table></td></tr></table></td></tr></table></td></tr></table></td></tr></table></td></tr></table></td></tr></table></td></tr></table></td></tr></table></td></tr></table></td></tr></table></td></tr></table></td></tr></table></td></tr></table></td></tr></table></td></tr></table></td></tr></table></td></tr></table></td></tr></table></td></tr></table>
 | | | | | | | | | | | | | | | | | | | | <table border="1" style="width: 100%; border-collapse: collapse; text-align: center;"> <tr> <td style="width: 10%;"></td> <td style="width: 10%;"></td> <td style="width: 10%;"></td> <td style="width: 10%;"></td> <td style="width: 10%;"></td> <td style="width: 10%;"></td> <td style="width: 10%;"></td> <td style="width: 10%;"></td> <td style="width: 10%;"></td> <td style="width: 10%;"></td> </tr> <tr> <td></td> <td></td> <td colspan="8" style="text-align: center;"> <table border="1" style="width: 100%; border-collapse: collapse; text-align: center;"> <tr> <td style="width: 10%;"></td> <td style="width: 10%;"></td> <td style="width: 10%;"></td> <td style="width: 10%;"></td> <td style="width: 10%;"></td> <td style="width: 10%;"></td> <td style="width: 10%;"></td> <td style="width: 10%;"></td> <td style="width: 10%;"></td> <td style="width: 10%;"></td> </tr> <tr> <td></td> <td></td> <td colspan="8" style="text-align: center;"> <table border="1" style="width: 100%; border-collapse: collapse; text-align: center;"> <tr> <td style="width: 10%;"></td> <td style="width: 10%;"></td> <td style="width: 10%;"></td> <td style="width: 10%;"></td> <td style="width: 10%;"></td> <td style="width: 10%;"></td> <td style="width: 10%;"></td> <td style="width: 10%;"></td> <td style="width: 10%;"></td> <td style="width: 10%;"></td> </tr> <tr> <td></td> <td></td> <td colspan="8" style="text-align: center;"> <table border="1" style="width: 100%; border-collapse: collapse; text-align: center;"> <tr> <td style="width: 10%;"></td> <td style="width: 10%;"></td> <td style="width: 10%;"></td> <td style="width: 10%;"></td> <td style="width: 10%;"></td> <td style="width: 10%;"></td> <td style="width: 10%;"></td> <td style="width: 10%;"></td> <td style="width: 10%;"></td> <td style="width: 10%;"></td> </tr> <tr> <td></td> <td></td> <td colspan="8" style="text-align: center;"> <table border="1" style="width: 100%; border-collapse: collapse; text-align: center;"> <tr> <td style="width: 10%;"></td> <td style="width: 10%;"></td> <td style="width: 10%;"></td> <td style="width: 10%;"></td> <td style="width: 10%;"></td> <td style="width: 10%;"></td> <td style="width: 10%;"></td> <td style="width: 10%;"></td> <td style="width: 10%;"></td> <td style="width: 10%;"></td> </tr> <tr> <td></td> <td></td> <td colspan="8" style="text-align: center;"> <table border="1" style="width: 100%; border-collapse: collapse; text-align: center;"> <tr> <td style="width: 10%;"></td> <td style="width: 10%;"></td> <td style="width: 10%;"></td> <td style="width: 10%;"></td> <td style="width: 10%;"></td> <td style="width: 10%;"></td> <td style="width: 10%;"></td> <td style="width: 10%;"></td> <td style="width: 10%;"></td> <td style="width: 10%;"></td> </tr> <tr> <td></td> <td></td> <td colspan="8" style="text-align: center;"> <table border="1" style="width: 100%; border-collapse: collapse; text-align: center;"> <tr> <td style="width: 10%;"></td> <td style="width: 10%;"></td> <td style="width: 10%;"></td> <td style="width: 10%;"></td> <td style="width: 10%;"></td> <td style="width: 10%;"></td> <td style="width: 10%;"></td> <td style="width: 10%;"></td> <td style="width: 10%;"></td> <td style="width: 10%;"></td> </tr> <tr> <td></td> <td></td> <td colspan="8" style="text-align: center;"> <table border="1" style="width: 100%; border-collapse: collapse; text-align: center;"> <tr> <td style="width: 10%;"></td> <td style="width: 10%;"></td> <td style="width: 10%;"></td> <td style="width: 10%;"></td> <td style="width: 10%;"></td> <td style="width: 10%;"></td> <td style="width: 10%;"></td> <td style="width: 10%;"></td> <td style="width: 10%;"></td> <td style="width: 10%;"></td> </tr> <tr> <td></td> <td></td> <td colspan="8" style="text-align: center;"> <table border="1" style="width: 100%; border-collapse: collapse; text-align: center;"> <tr> <td style="width: 10%;"></td> <td style="width: 10%;"></td> <td style="width: 10%;"></td> <td style="width: 10%;"></td> <td style="width: 10%;"></td> <td style="width: 10%;"></td> <td style="width: 10%;"></td> <td style="width: 10%;"></td> <td style="width: 10%;"></td> <td style="width: 10%;"></td> </tr> <tr> <td></td> <td></td> <td colspan="8" style="text-align: center;"> <table border="1" style="width: 100%; border-collapse: collapse; text-align: center;"> <tr> <td style="width: 10%;"></td> <td style="width: 10%;"></td> <td style="width: 10%;"></td> <td style="width: 10%;"></td> <td style="width: 10%;"></td> <td style="width: 10%;"></td> <td style="width: 10%;"></td> <td style="width: 10%;"></td> <td style="width: 10%;"></td> <td style="width: 10%;"></td> </tr> <tr> <td></td> <td></td> <td colspan="8" style="text-align: center;"> <table border="1" style="width: 100%; border-collapse: collapse; text-align: center;"> <tr> <td style="width: 10%;"></td> <td style="width: 10%;"></td> <td style="width: 10%;"></td> <td style="width: 10%;"></td> <td style="width: 10%;"></td> <td style="width: 10%;"></td> <td style="width: 10%;"></td> <td style="width: 10%;"></td> <td style="width: 10%;"></td> <td style="width: 10%;"></td> </tr> <tr> <td></td> <td></td> <td colspan="8" style="text-align: center;"> <table border="1" style="width: 100%; border-collapse: collapse; text-align: center;"> <tr> <td style="width: 10%;"></td> <td style="width: 10%;"></td> <td style="width: 10%;"></td> <td style="width: 10%;"></td> <td style="width: 10%;"></td> <td style="width: 10%;"></td> <td style="width: 10%;"></td> <td style="width: 10%;"></td> <td style="width: 10%;"></td> <td style="width: 10%;"></td> </tr> <tr> <td></td> <td></td> <td colspan="8" style="text-align: center;"> <table border="1" style="width: 100%; border-collapse: collapse; text-align: center;"> <tr> <td style="width: 10%;"></td> <td style="width: 10%;"></td> <td style="width: 10%;"></td> <td style="width: 10%;"></td> <td style="width: 10%;"></td> <td style="width: 10%;"></td> <td style="width: 10%;"></td> <td style="width: 10%;"></td> <td style="width: 10%;"></td> <td style="width: 10%;"></td> </tr> <tr> <td></td> <td></td> <td colspan="8" style="text-align: center;"> <table border="1" style="width: 100%; border-collapse: collapse; text-align: center;"> <tr> <td style="width: 10%;"></td> <td style="width: 10%;"></td> <td style="width: 10%;"></td> <td style="width: 10%;"></td> <td style="width: 10%;"></td> <td style="width: 10%;"></td> <td style="width: 10%;"></td> <td style="width: 10%;"></td> <td style="width: 10%;"></td> <td style="width: 10%;"></td> </tr> <tr> <td></td> <td></td> <td colspan="8" style="text-align: center;"> <table border="1" style="width: 100%; border-collapse: collapse; text-align: center;"> <tr> <td style="width: 10%;"></td> <td style="width: 10%;"></td> <td style="width: 10%;"></td> <td style="width: 10%;"></td> <td style="width: 10%;"></td> <td style="width: 10%;"></td> <td style="width: 10%;"></td> <td style="width: 10%;"></td> <td style="width: 10%;"></td> <td style="width: 10%;"></td> </tr> <tr> <td></td> <td></td> <td colspan="8" style="text-align: center;"> <table border="1" style="width: 100%; border-collapse: collapse; text-align: center;"> <tr> <td style="width: 10%;"></td> <td style="width: 10%;"></td> <td style="width: 10%;"></td> <td style="width: 10%;"></td> <td style="width: 10%;"></td> <td style="width: 10%;"></td> <td style="width: 10%;"></td> <td style="width: 10%;"></td> <td style="width: 10%;"></td> <td style="width: 10%;"></td> </tr> <tr> <td></td> <td></td> <td colspan="8" style="text-align: center;"> <table border="1" style="width: 100%; border-collapse: collapse; text-align: center;"> <tr>
<td style="width: 10%;"></td> <td style="width: 10%;"></td> <td style="width: 10%;"></td> <td style="width: 10%;"></td> <td style="width: 10%;"></td> <td style="width: 10%;"></td> <td style="width: 10%;"></td> <td style="width: 10%;"></td> <td style="width: 10%;"></td> <td style="width: 10%;"></td> </tr> <tr> <td></td> <td></td> <td colspan="8" style="text-align: center;"> <table border="1" style="width: 100%; border-collapse: collapse; text-align: center;"> <tr> <td style="width: 10%;"></td> <td style="width: 10%;"></td> <td style="width: 10%;"></td> <td style="width: 10%;"></td> <td style="width: 10%;"></td> <td style="width: 10%;"></td> <td style="width: 10%;"></td> <td style="width: 10%;"></td> <td style="width: 10%;"></td> <td style="width: 10%;"></td> </tr> <tr> <td></td> <td></td> <td colspan="8" style="text-align: center;"> <table border="1" style="width: 100%; border-collapse: collapse; text-align: center;"> <tr> <td style="width: 10%;"></td> <td style="width: 10%;"></td> <td style="width: 10%;"></td> <td style="width: 10%;"></td> <td style="width: 10%;"></td> <td style="width: 10%;"></td> <td style="width: 10%;"></td> <td style="width: 10%;"></td> <td style="width: 10%;"></td> <td style="width: 10%;"></td> </tr> <tr> <td></td> <td></td> <td colspan="8" style="text-align: center;"> <table border="1" style="width: 100%; border-collapse: collapse; text-align: center;"> <tr> <td style="width: 10%;"></td> <td style="width: 10%;"></td> <td style="width: 10%;"></td> <td style="width: 10%;"></td> <td style="width: 10%;"></td> <td style="width: 10%;"></td> <td style="width: 10%;"></td> <td style="width: 10%;"></td> <td style="width: 10%;"></td> <td style="width: 10%;"></td> </tr> <tr> <td></td> <td></td> <td colspan="8" style="text-align: center;"> <table border="1" style="width: 100%; border-collapse: collapse; text-align: center;"> <tr> <td style="width: 10%;"></td> <td style="width: 10%;"></td> <td style="width: 10%;"></td> <td style="width: 10%;"></td> <td style="width: 10%;"></td> <td style="width: 10%;"></td> <td style="width: 10%;"></td> <td style="width: 10%;"></td> <td style="width: 10%;"></td> <td style="width: 10%;"></td> </tr> <tr> <td></td> <td></td> <td colspan="8" style="text-align: center;"> <table border="1" style="width: 100%; border-collapse: collapse; text-align: center;"> <tr> <td style="width: 10%;"></td> <td style="width: 10%;"></td> <td style="width: 10%;"></td> <td style="width: 10%;"></td> <td style="width: 10%;"></td> <td style="width: 10%;"></td> <td style="width: 10%;"></td> <td style="width: 10%;"></td> <td style="width: 10%;"></td> <td style="width: 10%;"></td> </tr> <tr> <td></td> <td></td> <td colspan="8" style="text-align: center;"> <table border="1" style="width: 100%; border-collapse: collapse; text-align: center;"> <tr> <td style="width: 10%;"></td> <td style="width: 10%;"></td> <td style="width: 10%;"></td> <td style="width: 10%;"></td> <td style="width: 10%;"></td> <td style="width: 10%;"></td> <td style="width: 10%;"></td> <td style="width: 10%;"></td> <td style="width: 10%;"></td> <td style="width: 10%;"></td> </tr> <tr> <td></td> <td></td> <td colspan="8" style="text-align: center;"> <table border="1" style="width: 100%; border-collapse: collapse; text-align: center;"> <tr> <td style="width: 10%;"></td> <td style="width: 10%;"></td> <td style="width: 10%;"></td> <td style="width: 10%;"></td> <td style="width: 10%;"></td> <td style="width: 10%;"></td> <td style="width: 10%;"></td> <td style="width: 10%;"></td> <td style="width: 10%;"></td> <td style="width: 10%;"></td> </tr> <tr> <td></td> <td></td> <td colspan="8" style="text-align: center;"> <table border="1" style="width: 100%; border-collapse: collapse; text-align: center;"> <tr> <td style="width: 10%;"></td> <td style="width: 10%;"></td> <td style="width: 10%;"></td> <td style="width: 10%;"></td> <td style="width: 10%;"></td> <td style="width: 10%;"></td> <td style="width: 10%;"></td> <td style="width: 10%;"></td> <td style="width: 10%;"></td> <td style="width: 10%;"></td> </tr> <tr> <td></td> <td></td> <td colspan="8" style="text-align: center;"> <table border="1" style="width: 100%; border-collapse: collapse; text-align: center;"> <tr> <td style="width: 10%;"></td> <td style="width: 10%;"></td> <td style="width: 10%;"></td> <td style="width: 10%;"></td> <td style="width: 10%;"></td> <td style="width: 10%;"></td> <td style="width: 10%;"></td> <td style="width: 10%;"></td> <td style="width: 10%;"></td> <td style="width: 10%;"></td> </tr> <tr> <td></td> <td></td> <td colspan="8" style="text-align: center;"> <table border="1" style="width: 100%; border-collapse: collapse; text-align: center;"> <tr> <td style="width: 10%;"></td> <td style="width: 10%;"></td> <td style="width: 10%;"></td> <td style="width: 10%;"></td> <td style="width: 10%;"></td> <td style="width: 10%;"></td> <td style="width: 10%;"></td> <td style="width: 10%;"></td> <td style="width: 10%;"></td> <td style="width: 10%;"></td> </tr> <tr> <td></td> <td></td> <td colspan="8" style="text-align: center;"> <table border="1" style="width: 100%; border-collapse: collapse; text-align: center;"> <tr> <td style="width: 10%;"></td> <td style="width: 10%;"></td> <td style="width: 10%;"></td> <td style="width: 10%;"></td> <td style="width: 10%;"></td> <td style="width: 10%;"></td> <td style="width: 10%;"></td> <td style="width: 10%;"></td> <td style="width: 10%;"></td> <td style="width: 10%;"></td> </tr> <tr> <td></td> <td></td> <td colspan="8" style="text-align: center;"> <table border="1" style="width: 100%; border-collapse: collapse; text-align: center;"> <tr> <td style="width: 10%;"></td> <td style="width: 10%;"></td> <td style="width: 10%;"></td> <td style="width: 10%;"></td> <td style="width: 10%;"></td> <td style="width: 10%;"></td> <td style="width: 10%;"></td> <td style="width: 10%;"></td> <td style="width: 10%;"></td> <td style="width: 10%;"></td> </tr> <tr> <td></td> <td></td> <td colspan="8" style="text-align: center;"> <table border="1" style="width: 100%; border-collapse: collapse; text-align: center;"> <tr> <td style="width: 10%;"></td> <td style="width: 10%;"></td> <td style="width: 10%;"></td> <td style="width: 10%;"></td> <td style="width: 10%;"></td> <td style="width: 10%;"></td> <td style="width: 10%;"></td> <td style="width: 10%;"></td> <td style="width: 10%;"></td> <td style="width: 10%;"></td> </tr> <tr> <td></td> <td></td> <td colspan="8" style="text-align: center;"> <table border="1" style="width: 100%; border-collapse: collapse; text-align: center;"> <tr> <td style="width: 10%;"></td> <td style="width: 10%;"></td> <td style="width: 10%;"></td> <td style="width: 10%;"></td> <td style="width: 10%;"></td> <td style="width: 10%;"></td> <td style="width: 10%;"></td> <td style="width: 10%;"></td> <td style="width: 10%;"></td> <td style="width: 10%;"></td> </tr> <tr> <td></td> <td></td> <td colspan="8" style="text-align: center;"> <table border="1" style="width: 100%; border-collapse: collapse; text-align: center;"> <tr> <td style="width: 10%;"></td> <td style="width: 10%;"></td> <td style="width: 10%;"></td> <td style="width: 10%;"></td> <td style="width: 10%;"></td> <td style="width: 10%;"></td> <td style="width: 10%;"></td> <td style="width: 10%;"></td> <td style="width: 10%;"></td> <td style="width: 10%;"></td> </tr> <tr> <td></td> <td></td> <td colspan="8" style="text-align: center;"> <table border="1" style="width: 100%; border-collapse: collapse; text-align: center;"> <tr> <td style="width: 10%;"></td> <td style="width: 10%;"></td> <td style="width: 10%;"></td> <td style="width: 10%;"></td> <td style="width: 10%;"></td> <td style="width: 10%;"></td> <td style="width: 10%;"></td> <td style="width: 10%;"></td> <td style="width: 10%;"></td> <td style="width: 10%;"></td> </tr> <tr> <td></td> <td></td> <td colspan="8" style="text-align: center;"> <table border="1" style="width: 100%; border-collapse: collapse; text-align: center;"> <tr> <td style="width: 10%;"></td> <td style="width: 10%;"></td> <td style="width: 10%;"></td> <td style="width: 10%;"></td> <td style="width: 10%;"></td> <td style="width: 10%;"></td> <td style="width: 10%;"></td> <td style="width: 10%;"></td> <td style="width: 10%;"></td> <td style="width: 10%;"></td> </tr> <tr> <td></td> <td></td> <td colspan="8" style="text-align: center;"> <table border="1" style="width: 100%; border-collapse: collapse; text-align: center;"> <tr> <td style="width: 10%;"></td> <td style="width: 10%;"></td> <td style="width: 10%;"></td> <td style="width: 10%;"></td> <td style="width: 10%;"></td> <td style="width: 10%;"></td> <td style="width: 10%;"></td> <td style="width: 10%;"></td> <td style="width: 10%;"></td> <td style="width: 10%;"></td> </tr> <tr> <td></td> <td></td> <td colspan="8" style="text-align: center;"> <table border="1" style="width: 100%; border-collapse: collapse; text-align: center;"> <tr> <td style="width: 10%;"></td> <td style="width: 10%;"></td> <td style="width: 10%;"></td> <td style="width: 10%;"></td> <td style="width: 10%;"></td> <td style="width: 10%;"></td> <td style="width: 10%;"></td> <td style="width: 10%;"></td> <td style="width: 10%;"></td> <td style="width: 10%;"></td> </tr> <tr> <td></td> <td></td> <td colspan="8" style="text-align: center;"> <table border="1" style="width: 100%; border-collapse: collapse; text-align: center;"> <tr> <td style="width: 10%;"></td> <td style="width: 10%;"></td> <td style="width: 10%;"></td> <td style="width: 10%;"></td> <td style="width: 10%;"></td> <td style="width: 10%;"></td> <td style="width: 10%;"></td> <td style="width: 10%;"></td> <td style="width: 10%;"></td> <td style="width: 10%;"></td> </tr> <tr> <td></td> <td></td> <td colspan="8" style="text-align: center;"> <table border="1" style="width: 100%; border-collapse: collapse; text-align: center;"> <tr> <td style="width: 10%;"></td> <td style="width: 10%;"></td> <td style="width: 10%;"></td> <td style="width: 10%;"></td> <td style="width: 10%;"></td> <td style="width:
10%;"></td> <td style="width: 10%;"></td> <td style="width: 10%;"></td> <td style="width: 10%;"></td> <td style="width: 10%;"></td> </tr> <tr> <td></td> <td></td> <td colspan="8" style="text-align: center;"> <table border="1" style="width: 100%; border-collapse: collapse; text-align: center;"> <tr> <td style="width: 10%;"></td> <td style="width: 10%;"></td> <td style="width: 10%;"></td> <td style="width: 10%;"></td> <td style="width: 10%;"></td> <td style="width: 10%;"></td> <td style="width: 10%;"></td> <td style="width: 10%;"></td> <td style="width: 10%;"></td> <td style="width: 10%;"></td> </tr> <tr> <td></td> <td></td> <td colspan="8" style="text-align: center;"> <table border="1" style="width: 100%; border-collapse: collapse; text-align: center;"> <tr> <td style="width: 10%;"></td> <td style="width: 10%;"></td> <td style="width: 10%;"></td> <td style="width: 10%;"></td> <td style="width: 10%;"></td> <td style="width: 10%;"></td> <td style="width: 10%;"></td> <td style="width: 10%;"></td> <td style="width: 10%;"></td> <td style="width: 10%;"></td> </tr> <tr> <td></td> <td></td> <td colspan="8" style="text-align: center;"> <table border="1" style="width: 100%; border-collapse: collapse; text-align: center;"> <tr> <td style="width: 10%;"></td> <td style="width: 10%;"></td> <td style="width: 10%;"></td> <td style="width: 10%;"></td> <td style="width: 10%;"></td> <td style="width: 10%;"></td> <td style="width: 10%;"></td> <td style="width: 10%;"></td> <td style="width: 10%;"></td> <td style="width: 10%;"></td> </tr> <tr> <td></td> <td></td> <td colspan="8" style="text-align: center;"> <table border="1" style="width: 100%; border-collapse: collapse; text-align: center;"> <tr> <td style="width: 10%;"></td> <td style="width: 10%;"></td> <td style="width: 10%;"></td> <td style="width: 10%;"></td> <td style="width: 10%;"></td> <td style="width: 10%;"></td> <td style="width: 10%;"></td> <td style="width: 10%;"></td> <td style="width: 10%;"></td> <td style="width: 10%;"></td> </tr> <tr> <td></td> <td></td> <td colspan="8" style="text-align: center;"> <table border="1" style="width: 100%; border-collapse: collapse; text-align: center;"> <tr> </tr></table></td></tr></table></td></tr></table></td></tr></table></td></tr></table></td></tr></table></td></tr></table></td></tr></table></td></tr></table></td></tr></table></td></tr></table></td></tr></table></td></tr></table></td></tr></table></td></tr></table></td></tr></table></td></tr></table></td></tr></table></td></tr></table></td></tr></table></td></tr></table></td></tr></table></td></tr></table></td></tr></table></td></tr></table></td></tr></table></td></tr></table></td></tr></table></td></tr></table></td></tr></table></td></tr></table></td></tr></table></td></tr></table></td></tr></table></td></tr></table></td></tr></table></td></tr></table></td></tr></table></td></tr></table></td></tr></table></td></tr></table></td></tr></table></td></tr></table>
 | | | | | | | | | | | | | | | | | | | | <table border="1" style="width: 100%; border-collapse: collapse; text-align: center;"> <tr> <td style="width: 10%;"></td> <td style="width: 10%;"></td> <td style="width: 10%;"></td> <td style="width: 10%;"></td> <td style="width: 10%;"></td> <td style="width: 10%;"></td> <td style="width: 10%;"></td> <td style="width: 10%;"></td> <td style="width: 10%;"></td> <td style="width: 10%;"></td> </tr> <tr> <td></td> <td></td> <td colspan="8" style="text-align: center;"> <table border="1" style="width: 100%; border-collapse: collapse; text-align: center;"> <tr> <td style="width: 10%;"></td> <td style="width: 10%;"></td> <td style="width: 10%;"></td> <td style="width: 10%;"></td> <td style="width: 10%;"></td> <td style="width: 10%;"></td> <td style="width: 10%;"></td> <td style="width: 10%;"></td> <td style="width: 10%;"></td> <td style="width: 10%;"></td> </tr> <tr> <td></td> <td></td> <td colspan="8" style="text-align: center;"> <table border="1" style="width: 100%; border-collapse: collapse; text-align: center;"> <tr> <td style="width: 10%;"></td> <td style="width: 10%;"></td> <td style="width: 10%;"></td> <td style="width: 10%;"></td> <td style="width: 10%;"></td> <td style="width: 10%;"></td> <td style="width: 10%;"></td> <td style="width: 10%;"></td> <td style="width: 10%;"></td> <td style="width: 10%;"></td> </tr> <tr> <td></td> <td></td> <td colspan="8" style="text-align: center;"> <table border="1" style="width: 100%; border-collapse: collapse; text-align: center;"> <tr> <td style="width: 10%;"></td> <td style="width: 10%;"></td> <td style="width: 10%;"></td> <td style="width: 10%;"></td> <td style="width: 10%;"></td> <td style="width: 10%;"></td> <td style="width: 10%;"></td> <td style="width: 10%;"></td> <td style="width: 10%;"></td> <td style="width: 10%;"></td> </tr> <tr> <td></td> <td></td> <td colspan="8" style="text-align: center;"> <table border="1" style="width: 100%; border-collapse: collapse; text-align: center;"> <tr> <td style="width: 10%;"></td> <td style="width: 10%;"></td> <td style="width: 10%;"></td> <td style="width: 10%;"></td> <td style="width: 10%;"></td> <td style="width: 10%;"></td> <td style="width: 10%;"></td> <td style="width: 10%;"></td> <td style="width: 10%;"></td> <td style="width: 10%;"></td> </tr> <tr> <td></td> <td></td> <td colspan="8" style="text-align: center;"> <table border="1" style="width: 100%; border-collapse: collapse; text-align: center;"> <tr> <td style="width: 10%;"></td> <td style="width: 10%;"></td> <td style="width: 10%;"></td> <td style="width: 10%;"></td> <td style="width: 10%;"></td> <td style="width: 10%;"></td> <td style="width: 10%;"></td> <td style="width: 10%;"></td> <td style="width: 10%;"></td> <td style="width: 10%;"></td> </tr> <tr> <td></td> <td></td> <td colspan="8" style="text-align: center;"> <table border="1" style="width: 100%; border-collapse: collapse; text-align: center;"> <tr> <td style="width: 10%;"></td> <td style="width: 10%;"></td> <td style="width: 10%;"></td> <td style="width: 10%;"></td> <td style="width: 10%;"></td> <td style="width: 10%;"></td> <td style="width: 10%;"></td> <td style="width: 10%;"></td> <td style="width: 10%;"></td> <td style="width: 10%;"></td> </tr> <tr> <td></td> <td></td> <td colspan="8" style="text-align: center;"> <table border="1" style="width: 100%; border-collapse: collapse; text-align: center;"> <tr> <td style="width: 10%;"></td> <td style="width: 10%;"></td> <td style="width: 10%;"></td> <td style="width: 10%;"></td> <td style="width: 10%;"></td> <td style="width: 10%;"></td> <td style="width: 10%;"></td> <td style="width: 10%;"></td> <td style="width: 10%;"></td> <td style="width: 10%;"></td> </tr> <tr> <td></td> <td></td> <td colspan="8" style="text-align: center;"> <table border="1" style="width: 100%; border-collapse: collapse; text-align: center;"> <tr> <td style="width: 10%;"></td> <td style="width: 10%;"></td> <td style="width: 10%;"></td> <td style="width: 10%;"></td> <td style="width: 10%;"></td> <td style="width: 10%;"></td> <td style="width: 10%;"></td> <td style="width: 10%;"></td> <td style="width: 10%;"></td> <td style="width: 10%;"></td> </tr> <tr> <td></td> <td></td> <td colspan="8" style="text-align: center;"> <table border="1" style="width: 100%; border-collapse: collapse; text-align: center;"> <tr> <td style="width: 10%;"></td> <td style="width: 10%;"></td> <td style="width: 10%;"></td> <td style="width: 10%;"></td> <td style="width: 10%;"></td> <td style="width: 10%;"></td> <td style="width: 10%;"></td> <td style="width: 10%;"></td> <td style="width: 10%;"></td> <td style="width: 10%;"></td> </tr> <tr> <td></td> <td></td> <td colspan="8" style="text-align: center;"> <table border="1" style="width: 100%; border-collapse: collapse; text-align: center;"> <tr> <td style="width: 10%;"></td> <td style="width: 10%;"></td> <td style="width: 10%;"></td> <td style="width: 10%;"></td> <td style="width: 10%;"></td> <td style="width: 10%;"></td> <td style="width: 10%;"></td> <td style="width: 10%;"></td> <td style="width: 10%;"></td> <td style="width: 10%;"></td> </tr> <tr> <td></td> <td></td> <td colspan="8" style="text-align: center;"> <table border="1" style="width: 100%; border-collapse: collapse; text-align: center;"> <tr> <td style="width: 10%;"></td> <td style="width: 10%;"></td> <td style="width: 10%;"></td> <td style="width: 10%;"></td> <td style="width: 10%;"></td> <td style="width: 10%;"></td> <td style="width: 10%;"></td> <td style="width: 10%;"></td> <td style="width: 10%;"></td> <td style="width: 10%;"></td> </tr> <tr> <td></td> <td></td> <td colspan="8" style="text-align: center;"> <table border="1" style="width: 100%; border-collapse: collapse; text-align: center;"> <tr> <td style="width: 10%;"></td> <td style="width: 10%;"></td> <td style="width: 10%;"></td> <td style="width: 10%;"></td> <td style="width: 10%;"></td> <td style="width: 10%;"></td> <td style="width: 10%;"></td> <td style="width: 10%;"></td> <td style="width: 10%;"></td> <td style="width: 10%;"></td> </tr> <tr> <td></td> <td></td> <td colspan="8" style="text-align: center;"> <table border="1" style="width: 100%; border-collapse: collapse; text-align: center;"> <tr> <td style="width: 10%;"></td> <td style="width: 10%;"></td> <td style="width: 10%;"></td> <td style="width: 10%;"></td> <td style="width: 10%;"></td> <td style="width: 10%;"></td> <td style="width: 10%;"></td> <td style="width: 10%;"></td> <td style="width: 10%;"></td> <td style="width: 10%;"></td> </tr> <tr> <td></td> <td></td> <td colspan="8" style="text-align: center;"> <table border="1" style="width: 100%; border-collapse: collapse; text-align: center;"> <tr> <td style="width: 10%;"></td> <td style="width: 10%;"></td> <td style="width: 10%;"></td> <td style="width: 10%;"></td> <td style="width: 10%;"></td> <td style="width: 10%;"></td> <td style="width: 10%;"></td> <td style="width: 10%;"></td> <td style="width: 10%;"></td> <td style="width: 10%;"></td> </tr> <tr> <td></td> <td></td> <td colspan="8" style="text-align: center;"> <table border="1" style="width: 100%; border-collapse: collapse; text-align: center;"> <tr> <td style="width: 10%;"></td> <td style="width: 10%;"></td> <td style="width: 10%;"></td> <td style="width: 10%;"></td> <td style="width: 10%;"></td> <td style="width: 10%;"></td> <td style="width: 10%;"></td> <td style="width: 10%;"></td> <td style="width: 10%;"></td> <td style="width: 10%;"></td> </tr> <tr> <td></td> <td></td> <td colspan="8" style="text-align: center;"> <table border="1" style="width: 100%; border-collapse: collapse; text-align: center;"> <tr> <td style="width: 10%;"></td> <td style="width: 10%;"></td> <td style="width: 10%;"></td> <td style="width: 10%;"></td> <td style="width: 10%;"></td> <td style="width: 10%;"></td> <td
style="width: 10%;"></td> <td style="width: 10%;"></td> <td style="width: 10%;"></td> <td style="width: 10%;"></td> </tr> <tr> <td></td> <td></td> <td colspan="8" style="text-align: center;"> <table border="1" style="width: 100%; border-collapse: collapse; text-align: center;"> <tr> <td style="width: 10%;"></td> <td style="width: 10%;"></td> <td style="width: 10%;"></td> <td style="width: 10%;"></td> <td style="width: 10%;"></td> <td style="width: 10%;"></td> <td style="width: 10%;"></td> <td style="width: 10%;"></td> <td style="width: 10%;"></td> <td style="width: 10%;"></td> </tr> <tr> <td></td> <td></td> <td colspan="8" style="text-align: center;"> <table border="1" style="width: 100%; border-collapse: collapse; text-align: center;"> <tr> <td style="width: 10%;"></td> <td style="width: 10%;"></td> <td style="width: 10%;"></td> <td style="width: 10%;"></td> <td style="width: 10%;"></td> <td style="width: 10%;"></td> <td style="width: 10%;"></td> <td style="width: 10%;"></td> <td style="width: 10%;"></td> <td style="width: 10%;"></td> </tr> <tr> <td></td> <td></td> <td colspan="8" style="text-align: center;"> <table border="1" style="width: 100%; border-collapse: collapse; text-align: center;"> <tr> <td style="width: 10%;"></td> <td style="width: 10%;"></td> <td style="width: 10%;"></td> <td style="width: 10%;"></td> <td style="width: 10%;"></td> <td style="width: 10%;"></td> <td style="width: 10%;"></td> <td style="width: 10%;"></td> <td style="width: 10%;"></td> <td style="width: 10%;"></td> </tr> <tr> <td></td> <td></td> <td colspan="8" style="text-align: center;"> <table border="1" style="width: 100%; border-collapse: collapse; text-align: center;"> <tr> <td style="width: 10%;"></td> <td style="width: 10%;"></td> <td style="width: 10%;"></td> <td style="width: 10%;"></td> <td style="width: 10%;"></td> <td style="width: 10%;"></td> <td style="width: 10%;"></td> <td style="width: 10%;"></td> <td style="width: 10%;"></td> <td style="width: 10%;"></td> </tr> <tr> <td></td> <td></td> <td colspan="8" style="text-align: center;"> <table border="1" style="width: 100%; border-collapse: collapse; text-align: center;"> <tr> <td style="width: 10%;"></td> <td style="width: 10%;"></td> <td style="width: 10%;"></td> <td style="width: 10%;"></td> <td style="width: 10%;"></td> <td style="width: 10%;"></td> <td style="width: 10%;"></td> <td style="width: 10%;"></td> <td style="width: 10%;"></td> <td style="width: 10%;"></td> </tr> <tr> <td></td> <td></td> <td colspan="8" style="text-align: center;"> <table border="1" style="width: 100%; border-collapse: collapse; text-align: center;"> <tr> <td style="width: 10%;"></td> <td style="width: 10%;"></td> <td style="width: 10%;"></td> <td style="width: 10%;"></td> <td style="width: 10%;"></td> <td style="width: 10%;"></td> <td style="width: 10%;"></td> <td style="width: 10%;"></td> <td style="width: 10%;"></td> <td style="width: 10%;"></td> </tr> <tr> <td></td> <td></td> <td colspan="8" style="text-align: center;"> <table border="1" style="width: 100%; border-collapse: collapse; text-align: center;"> <tr> <td style="width: 10%;"></td> <td style="width: 10%;"></td> <td style="width: 10%;"></td> <td style="width: 10%;"></td> <td style="width: 10%;"></td> <td style="width: 10%;"></td> <td style="width: 10%;"></td> <td style="width: 10%;"></td> <td style="width: 10%;"></td> <td style="width: 10%;"></td> </tr> <tr> <td></td> <td></td> <td colspan="8" style="text-align: center;"> <table border="1" style="width: 100%; border-collapse: collapse; text-align: center;"> <tr> <td style="width: 10%;"></td> <td style="width: 10%;"></td> <td style="width: 10%;"></td> <td style="width: 10%;"></td> <td style="width: 10%;"></td> <td style="width: 10%;"></td> <td style="width: 10%;"></td> <td style="width: 10%;"></td> <td style="width: 10%;"></td> <td style="width: 10%;"></td> </tr> <tr> <td></td> <td></td> <td colspan="8" style="text-align: center;"> <table border="1" style="width: 100%; border-collapse: collapse; text-align: center;"> <tr> <td style="width: 10%;"></td> <td style="width: 10%;"></td> <td style="width: 10%;"></td> <td style="width: 10%;"></td> <td style="width: 10%;"></td> <td style="width: 10%;"></td> <td style="width: 10%;"></td> <td style="width: 10%;"></td> <td style="width: 10%;"></td> <td style="width: 10%;"></td> </tr> <tr> <td></td> <td></td> <td colspan="8" style="text-align: center;"> <table border="1" style="width: 100%; border-collapse: collapse; text-align: center;"> <tr> <td style="width: 10%;"></td> <td style="width: 10%;"></td> <td style="width: 10%;"></td> <td style="width: 10%;"></td> <td style="width: 10%;"></td> <td style="width: 10%;"></td> <td style="width: 10%;"></td> <td style="width: 10%;"></td> <td style="width: 10%;"></td> <td style="width: 10%;"></td> </tr> <tr> <td></td> <td></td> <td colspan="8" style="text-align: center;"> <table border="1" style="width: 100%; border-collapse: collapse; text-align: center;"> <tr> <td style="width: 10%;"></td> <td style="width: 10%;"></td> <td style="width: 10%;"></td> <td style="width: 10%;"></td> <td style="width: 10%;"></td> <td style="width: 10%;"></td> <td style="width: 10%;"></td> <td style="width: 10%;"></td> <td style="width: 10%;"></td> <td style="width: 10%;"></td> </tr> <tr> <td></td> <td></td> <td colspan="8" style="text-align: center;"> <table border="1" style="width: 100%; border-collapse: collapse; text-align: center;"> <tr> <td style="width: 10%;"></td> <td style="width: 10%;"></td> <td style="width: 10%;"></td> <td style="width: 10%;"></td> <td style="width: 10%;"></td> <td style="width: 10%;"></td> <td style="width: 10%;"></td> <td style="width: 10%;"></td> <td style="width: 10%;"></td> <td style="width: 10%;"></td> </tr> <tr> <td></td> <td></td> <td colspan="8" style="text-align: center;"> <table border="1" style="width: 100%; border-collapse: collapse; text-align: center;"> <tr> <td style="width: 10%;"></td> <td style="width: 10%;"></td> <td style="width: 10%;"></td> <td style="width: 10%;"></td> <td style="width: 10%;"></td> <td style="width: 10%;"></td> <td style="width: 10%;"></td> <td style="width: 10%;"></td> <td style="width: 10%;"></td> <td style="width: 10%;"></td> </tr> <tr> <td></td> <td></td> <td colspan="8" style="text-align: center;"> <table border="1" style="width: 100%; border-collapse: collapse; text-align: center;"> <tr> <td style="width: 10%;"></td> <td style="width: 10%;"></td> <td style="width: 10%;"></td> <td style="width: 10%;"></td> <td style="width: 10%;"></td> <td style="width: 10%;"></td> <td style="width: 10%;"></td> <td style="width: 10%;"></td> <td style="width: 10%;"></td> <td style="width: 10%;"></td> </tr> <tr> <td></td> <td></td> <td colspan="8" style="text-align: center;"> <table border="1" style="width: 100%; border-collapse: collapse; text-align: center;"> <tr> <td style="width: 10%;"></td> <td style="width: 10%;"></td> <td style="width: 10%;"></td> <td style="width: 10%;"></td> <td style="width: 10%;"></td> <td style="width: 10%;"></td> <td style="width: 10%;"></td> <td style="width: 10%;"></td> <td style="width: 10%;"></td> <td style="width: 10%;"></td> </tr> <tr> <td></td> <td></td> <td colspan="8" style="text-align: center;"> <table border="1" style="width: 100%; border-collapse: collapse; text-align: center;"> <tr> <td style="width: 10%;"></td> <td style="width: 10%;"></td> <td style="width: 10%;"></td> <td style="width: 10%;"></td> <td style="width: 10%;"></td> <td style="width: 10%;"></td> <td style="width: 10%;"></td> <td style="width: 10%;"></td> <td style="width: 10%;"></td> <td style="width: 10%;"></td> </tr> <tr> <td></td> <td></td> <td colspan="8" style="text-align: center;"> <table border="1" style="width: 100%; border-collapse: collapse; text-align: center;"> <tr> <td style="width: 10%;"></td> <td style="width: 10%;"></td> <td style="width: 10%;"></td> <td style="width: 10%;"></td> <td style="width: 10%;"></td> <td style="width: 10%;"></td> <td style="width: 10%;"></td> <td style="width: 10%;"></td> <td style="width: 10%;"></td> <td style="width: 10%;"></td> </tr> <tr> <td></td> <td></td> <td colspan="8" style="text-align: center;"> <table border="1" style="width: 100%; border-collapse: collapse; text-align: center;"> <tr> <td style="width: 10%;"></td> <td style="width: 10%;"></td> <td style="width: 10%;"></td> <td style="width: 10%;"></td> <td style="width: 10%;"></td> <td style="width: 10%;"></td> <td style="width: 10%;"></td> <td style="width: 10%;"></td> <td style="width: 10%;"></td> <td style="width: 10%;"></td> </tr> <tr> <td></td> <td></td> <td colspan="8" style="text-align: center;"> <table border="1" style="width: 100%; border-collapse: collapse; text-align: center;"> <tr> <td style="width: 10%;"></td> <td style="width: 10%;"></td> <td style="width: 10%;"></td> <td style="width: 10%;"></td> <td style="width: 10%;"></td> <td style="width: 10%;"></td> <td style="width: 10%;"></td> <td style="width: 10%;"></td> <td style="width: 10%;"></td> <td style="width: 10%;"></td> </tr> <tr> <td></td> <td></td> <td colspan="8" style="text-align: center;"> <table border="1" style="width: 100%; border-collapse: collapse; text-align: center;"> <tr> <td style="width: 10%;"></td> <td style="width: 10%;"></td> <td style="width: 10%;"></td> <td style="width: 10%;"></td> <td style="width: 10%;"></td> <td style="width: 10%;"></td> <td style="width: 10%;"></td> <td style="width: 10%;"></td> <td style="width: 10%;"></td> <td style="width: 10%;"></td> </tr> <tr> <td></td> <td></td> <td colspan="8" style="text-align: center;"> <table border="1" style="width: 100%; border-collapse: collapse; text-align: center;"> <tr> <td style="width: 10%;"></td> <td style="width: 10%;"></td> <td style="width: 10%;"></td> <td style="width: 10%;"></td> <td style="width: 10%;"></td> <td style="width: 10%;"></td> <td style="width: 10%;"></td> <td style="width: 10%;"></td> <td style="width: 10%;"></td> <td style="width: 10%;"></td> </tr> <tr> <td></td> <td></td> <td colspan="8"
style="text-align: center;"> <table border="1" style="width: 100%; border-collapse: collapse; text-align: center;"> <tr> <td style="width: 10%;"></td> <td style="width: 10%;"></td> <td style="width: 10%;"></td> <td style="width: 10%;"></td> <td style="width: 10%;"></td> <td style="width: 10%;"></td> <td style="width: 10%;"></td> <td style="width: 10%;"></td> <td style="width: 10%;"></td> <td style="width: 10%;"></td> </tr> <tr> <td></td> <td></td> <td colspan="8" style="text-align: center;"> <table border="1" style="width: 100%; border-collapse: collapse; text-align: center;"> <tr> <td style="width: 10%;"></td> <td style="width: 10%;"></td> <td style="width: 10%;"></td> <td style="width: 10%;"></td> <td style="width: 10%;"></td> <td style="width: 10%;"></td> <td style="width: 10%;"></td> <td style="width: 10%;"></td> <td style="width: 10%;"></td> <td style="width: 10%;"></td> </tr> <tr> <td></td> <td></td> <td colspan="8" style="text-align: center;"> <table border="1" style="width: 100%; border-collapse: collapse; text-align: center;"> <tr> <td style="width: 10%;"></td> <td style="width: 10%;"></td> <td style="width: 10%;"></td> <td style="width: 10%;"></td> <td style="width: 10%;"></td> <td style="width: 10%;"></td> <td style="width: 10%;"></td> <td style="width: 10%;"></td> <td style="width: 10%;"></td> <td style="width: 10%;"></td> </tr> <tr> <td></td> <td></td> <td colspan="8" style="text-align: center;"> <table border="1" style="width: 100%; border-collapse: collapse; text-align: center;"> <tr> </tr></table></td></tr></table></td></tr></table></td></tr></table></td></tr></table></td></tr></table></td></tr></table></td></tr></table></td></tr></table></td></tr></table></td></tr></table></td></tr></table></td></tr></table></td></tr></table></td></tr></table></td></tr></table></td></tr></table></td></tr></table></td></tr></table></td></tr></table></td></tr></table></td></tr></table></td></tr></table></td></tr></table></td></tr></table></td></tr></table></td></tr></table></td></tr></table></td></tr></table></td></tr></table></td></tr></table></td></tr></table></td></tr></table></td></tr></table></td></tr></table></td></tr></table></td></tr></table></td></tr></table></td></tr></table></td></tr></table></td></tr></table></td></tr></table>
 | | | | | | | | | | | | | | | | | | | | <table border="1" style="width: 100%; border-collapse: collapse; text-align: center;"> <tr> <td style="width: 10%;"></td> <td style="width: 10%;"></td> <td style="width: 10%;"></td> <td style="width: 10%;"></td> <td style="width: 10%;"></td> <td style="width: 10%;"></td> <td style="width: 10%;"></td> <td style="width: 10%;"></td> <td style="width: 10%;"></td> <td style="width: 10%;"></td> </tr> <tr> <td></td> <td></td> <td colspan="8" style="text-align: center;"> <table border="1" style="width: 100%; border-collapse: collapse; text-align: center;"> <tr> <td style="width: 10%;"></td> <td style="width: 10%;"></td> <td style="width: 10%;"></td> <td style="width: 10%;"></td> <td style="width: 10%;"></td> <td style="width: 10%;"></td> <td style="width: 10%;"></td> <td style="width: 10%;"></td> <td style="width: 10%;"></td> <td style="width: 10%;"></td> </tr> <tr> <td></td> <td></td> <td colspan="8" style="text-align: center;"> <table border="1" style="width: 100%; border-collapse: collapse; text-align: center;"> <tr> <td style="width: 10%;"></td> <td style="width: 10%;"></td> <td style="width: 10%;"></td> <td style="width: 10%;"></td> <td style="width: 10%;"></td> <td style="width: 10%;"></td> <td style="width: 10%;"></td> <td style="width: 10%;"></td> <td style="width: 10%;"></td> <td style="width: 10%;"></td> </tr> <tr> <td></td> <td></td> <td colspan="8" style="text-align: center;"> <table border="1" style="width: 100%; border-collapse: collapse; text-align: center;"> <tr> <td style="width: 10%;"></td> <td style="width: 10%;"></td> <td style="width: 10%;"></td> <td style="width: 10%;"></td> <td style="width: 10%;"></td> <td style="width: 10%;"></td> <td style="width: 10%;"></td> <td style="width: 10%;"></td> <td style="width: 10%;"></td> <td style="width: 10%;"></td> </tr> <tr> <td></td> <td></td> <td colspan="8" style="text-align: center;"> <table border="1" style="width: 100%; border-collapse: collapse; text-align: center;"> <tr> <td style="width: 10%;"></td> <td style="width: 10%;"></td> <td style="width: 10%;"></td> <td style="width: 10%;"></td> <td style="width: 10%;"></td> <td style="width: 10%;"></td> <td style="width: 10%;"></td> <td style="width: 10%;"></td> <td style="width: 10%;"></td> <td style="width: 10%;"></td> </tr> <tr> <td></td> <td></td> <td colspan="8" style="text-align: center;"> <table border="1" style="width: 100%; border-collapse: collapse; text-align: center;"> <tr> <td style="width: 10%;"></td> <td style="width: 10%;"></td> <td style="width: 10%;"></td> <td style="width: 10%;"></td> <td style="width: 10%;"></td> <td style="width: 10%;"></td> <td style="width: 10%;"></td> <td style="width: 10%;"></td> <td style="width: 10%;"></td> <td style="width: 10%;"></td> </tr> <tr> <td></td> <td></td> <td colspan="8" style="text-align: center;"> <table border="1" style="width: 100%; border-collapse: collapse; text-align: center;"> <tr> <td style="width: 10%;"></td> <td style="width: 10%;"></td> <td style="width: 10%;"></td> <td style="width: 10%;"></td> <td style="width: 10%;"></td> <td style="width: 10%;"></td> <td style="width: 10%;"></td> <td style="width: 10%;"></td> <td style="width: 10%;"></td> <td style="width: 10%;"></td> </tr> <tr> <td></td> <td></td> <td colspan="8" style="text-align: center;"> <table border="1" style="width: 100%; border-collapse: collapse; text-align: center;"> <tr> <td style="width: 10%;"></td> <td style="width: 10%;"></td> <td style="width: 10%;"></td> <td style="width: 10%;"></td> <td style="width: 10%;"></td> <td style="width: 10%;"></td> <td style="width: 10%;"></td> <td style="width: 10%;"></td> <td style="width: 10%;"></td> <td style="width: 10%;"></td> </tr> <tr> <td></td> <td></td> <td colspan="8" style="text-align: center;"> <table border="1" style="width: 100%; border-collapse: collapse; text-align: center;"> <tr> <td style="width: 10%;"></td> <td style="width: 10%;"></td> <td style="width: 10%;"></td> <td style="width: 10%;"></td> <td style="width: 10%;"></td> <td style="width: 10%;"></td> <td style="width: 10%;"></td> <td style="width: 10%;"></td> <td style="width: 10%;"></td> <td style="width: 10%;"></td> </tr> <tr> <td></td> <td></td> <td colspan="8" style="text-align: center;"> <table border="1" style="width: 100%; border-collapse: collapse; text-align: center;"> <tr> <td style="width: 10%;"></td> <td style="width: 10%;"></td> <td style="width: 10%;"></td> <td style="width: 10%;"></td> <td style="width: 10%;"></td> <td style="width: 10%;"></td> <td style="width: 10%;"></td> <td style="width: 10%;"></td> <td style="width: 10%;"></td> <td style="width: 10%;"></td> </tr> <tr> <td></td> <td></td> <td colspan="8" style="text-align: center;"> <table border="1" style="width: 100%; border-collapse: collapse; text-align: center;"> <tr> <td style="width: 10%;"></td> <td style="width: 10%;"></td> <td style="width: 10%;"></td> <td style="width: 10%;"></td> <td style="width: 10%;"></td> <td style="width: 10%;"></td> <td style="width: 10%;"></td> <td style="width: 10%;"></td> <td style="width: 10%;"></td> <td style="width: 10%;"></td> </tr> <tr> <td></td> <td></td> <td colspan="8" style="text-align: center;"> <table border="1" style="width: 100%; border-collapse: collapse; text-align: center;"> <tr> <td style="width: 10%;"></td> <td style="width: 10%;"></td> <td style="width: 10%;"></td> <td style="width: 10%;"></td> <td style="width: 10%;"></td> <td style="width: 10%;"></td> <td style="width: 10%;"></td> <td style="width: 10%;"></td> <td style="width: 10%;"></td> <td style="width: 10%;"></td> </tr> <tr> <td></td> <td></td> <td colspan="8" style="text-align: center;"> <table border="1" style="width: 100%; border-collapse: collapse; text-align: center;"> <tr> <td style="width: 10%;"></td> <td style="width: 10%;"></td> <td style="width: 10%;"></td> <td style="width: 10%;"></td> <td style="width: 10%;"></td> <td style="width: 10%;"></td> <td style="width: 10%;"></td> <td style="width: 10%;"></td> <td style="width: 10%;"></td> <td style="width: 10%;"></td> </tr> <tr> <td></td> <td></td> <td colspan="8" style="text-align: center;"> <table border="1" style="width: 100%; border-collapse: collapse; text-align: center;"> <tr> <td style="width: 10%;"></td> <td style="width: 10%;"></td> <td style="width: 10%;"></td> <td style="width: 10%;"></td> <td style="width: 10%;"></td> <td style="width: 10%;"></td> <td style="width: 10%;"></td> <td style="width: 10%;"></td> <td style="width: 10%;"></td> <td style="width: 10%;"></td> </tr> <tr> <td></td> <td></td> <td colspan="8" style="text-align: center;"> <table border="1" style="width: 100%; border-collapse: collapse; text-align: center;"> <tr> <td style="width: 10%;"></td> <td style="width: 10%;"></td> <td style="width: 10%;"></td> <td style="width: 10%;"></td> <td style="width: 10%;"></td> <td style="width: 10%;"></td> <td style="width: 10%;"></td> <td style="width: 10%;"></td> <td style="width: 10%;"></td> <td style="width: 10%;"></td> </tr> <tr> <td></td> <td></td> <td colspan="8" style="text-align: center;"> <table border="1" style="width: 100%; border-collapse: collapse; text-align: center;"> <tr> <td style="width: 10%;"></td> <td style="width: 10%;"></td> <td style="width: 10%;"></td> <td style="width: 10%;"></td> <td style="width: 10%;"></td> <td style="width: 10%;"></td> <td style="width: 10%;"></td> <td style="width: 10%;"></td> <td style="width: 10%;"></td> <td style="width: 10%;"></td> </tr> <tr> <td></td> <td></td> <td colspan="8" style="text-align: center;"> <table border="1" style="width: 100%; border-collapse: collapse; text-align: center;"> <tr> <td style="width: 10%;"></td> <td style="width: 10%;"></td> <td style="width: 10%;"></td> <td style="width: 10%;"></td> <td style="width: 10%;"></td> <td style="width: 10%;"></td> <td style="width: 10%;"></td> <td style="width: 10%;"></td> <td style="width: 10%;"></td> <td style="width: 10%;"></td> </tr> <tr> <td></td> <td></td> <td colspan="8" style="text-align: center;"> <table border="1" style="width: 100%; border-collapse: collapse; text-align: center;"> <tr> <td style="width: 10%;"></td> <td style="width: 10%;"></td> <td style="width: 10%;"></td> <td style="width: 10%;"></td> <td style="width: 10%;"></td> <td style="width: 10%;"></td> <td style="width: 10%;"></td> <td style="width: 10%;"></td> <td style="width: 10%;"></td> <td style="width: 10%;"></td> </tr> <tr> <td></td> <td></td> <td colspan="8" style="text-align: center;">
<table border="1" style="width: 100%; border-collapse: collapse; text-align: center;"> <tr> <td style="width: 10%;"></td> <td style="width: 10%;"></td> <td style="width: 10%;"></td> <td style="width: 10%;"></td> <td style="width: 10%;"></td> <td style="width: 10%;"></td> <td style="width: 10%;"></td> <td style="width: 10%;"></td> <td style="width: 10%;"></td> <td style="width: 10%;"></td> </tr> <tr> <td></td> <td></td> <td colspan="8" style="text-align: center;"> <table border="1" style="width: 100%; border-collapse: collapse; text-align: center;"> <tr> <td style="width: 10%;"></td> <td style="width: 10%;"></td> <td style="width: 10%;"></td> <td style="width: 10%;"></td> <td style="width: 10%;"></td> <td style="width: 10%;"></td> <td style="width: 10%;"></td> <td style="width: 10%;"></td> <td style="width: 10%;"></td> <td style="width: 10%;"></td> </tr> <tr> <td></td> <td></td> <td colspan="8" style="text-align: center;"> <table border="1" style="width: 100%; border-collapse: collapse; text-align: center;"> <tr> <td style="width: 10%;"></td> <td style="width: 10%;"></td> <td style="width: 10%;"></td> <td style="width: 10%;"></td> <td style="width: 10%;"></td> <td style="width: 10%;"></td> <td style="width: 10%;"></td> <td style="width: 10%;"></td> <td style="width: 10%;"></td> <td style="width: 10%;"></td> </tr> <tr> <td></td> <td></td> <td colspan="8" style="text-align: center;"> <table border="1" style="width: 100%; border-collapse: collapse; text-align: center;"> <tr> <td style="width: 10%;"></td> <td style="width: 10%;"></td> <td style="width: 10%;"></td> <td style="width: 10%;"></td> <td style="width: 10%;"></td> <td style="width: 10%;"></td> <td style="width: 10%;"></td> <td style="width: 10%;"></td> <td style="width: 10%;"></td> <td style="width: 10%;"></td> </tr> <tr> <td></td> <td></td> <td colspan="8" style="text-align: center;"> <table border="1" style="width: 100%; border-collapse: collapse; text-align: center;"> <tr> <td style="width: 10%;"></td> <td style="width: 10%;"></td> <td style="width: 10%;"></td> <td style="width: 10%;"></td> <td style="width: 10%;"></td> <td style="width: 10%;"></td> <td style="width: 10%;"></td> <td style="width: 10%;"></td> <td style="width: 10%;"></td> <td style="width: 10%;"></td> </tr> <tr> <td></td> <td></td> <td colspan="8" style="text-align: center;"> <table border="1" style="width: 100%; border-collapse: collapse; text-align: center;"> <tr> <td style="width: 10%;"></td> <td style="width: 10%;"></td> <td style="width: 10%;"></td> <td style="width: 10%;"></td> <td style="width: 10%;"></td> <td style="width: 10%;"></td> <td style="width: 10%;"></td> <td style="width: 10%;"></td> <td style="width: 10%;"></td> <td style="width: 10%;"></td> </tr> <tr> <td></td> <td></td> <td colspan="8" style="text-align: center;"> <table border="1" style="width: 100%; border-collapse: collapse; text-align: center;"> <tr> <td style="width: 10%;"></td> <td style="width: 10%;"></td> <td style="width: 10%;"></td> <td style="width: 10%;"></td> <td style="width: 10%;"></td> <td style="width: 10%;"></td> <td style="width: 10%;"></td> <td style="width: 10%;"></td> <td style="width: 10%;"></td> <td style="width: 10%;"></td> </tr> <tr> <td></td> <td></td> <td colspan="8" style="text-align: center;"> <table border="1" style="width: 100%; border-collapse: collapse; text-align: center;"> <tr> <td style="width: 10%;"></td> <td style="width: 10%;"></td> <td style="width: 10%;"></td> <td style="width: 10%;"></td> <td style="width: 10%;"></td> <td style="width: 10%;"></td> <td style="width: 10%;"></td> <td style="width: 10%;"></td> <td style="width: 10%;"></td> <td style="width: 10%;"></td> </tr> <tr> <td></td> <td></td> <td colspan="8" style="text-align: center;"> <table border="1" style="width: 100%; border-collapse: collapse; text-align: center;"> <tr> <td style="width: 10%;"></td> <td style="width: 10%;"></td> <td style="width: 10%;"></td> <td style="width: 10%;"></td> <td style="width: 10%;"></td> <td style="width: 10%;"></td> <td style="width: 10%;"></td> <td style="width: 10%;"></td> <td style="width: 10%;"></td> <td style="width: 10%;"></td> </tr> <tr> <td></td> <td></td> <td colspan="8" style="text-align: center;"> <table border="1" style="width: 100%; border-collapse: collapse; text-align: center;"> <tr> <td style="width: 10%;"></td> <td style="width: 10%;"></td> <td style="width: 10%;"></td> <td style="width: 10%;"></td> <td style="width: 10%;"></td> <td style="width: 10%;"></td> <td style="width: 10%;"></td> <td style="width: 10%;"></td> <td style="width: 10%;"></td> <td style="width: 10%;"></td> </tr> <tr> <td></td> <td></td> <td colspan="8" style="text-align: center;"> <table border="1" style="width: 100%; border-collapse: collapse; text-align: center;"> <tr> <td style="width: 10%;"></td> <td style="width: 10%;"></td> <td style="width: 10%;"></td> <td style="width: 10%;"></td> <td style="width: 10%;"></td> <td style="width: 10%;"></td> <td style="width: 10%;"></td> <td style="width: 10%;"></td> <td style="width: 10%;"></td> <td style="width: 10%;"></td> </tr> <tr> <td></td> <td></td> <td colspan="8" style="text-align: center;"> <table border="1" style="width: 100%; border-collapse: collapse; text-align: center;"> <tr> <td style="width: 10%;"></td> <td style="width: 10%;"></td> <td style="width: 10%;"></td> <td style="width: 10%;"></td> <td style="width: 10%;"></td> <td style="width: 10%;"></td> <td style="width: 10%;"></td> <td style="width: 10%;"></td> <td style="width: 10%;"></td> <td style="width: 10%;"></td> </tr> <tr> <td></td> <td></td> <td colspan="8" style="text-align: center;"> <table border="1" style="width: 100%; border-collapse: collapse; text-align: center;"> <tr> <td style="width: 10%;"></td> <td style="width: 10%;"></td> <td style="width: 10%;"></td> <td style="width: 10%;"></td> <td style="width: 10%;"></td> <td style="width: 10%;"></td> <td style="width: 10%;"></td> <td style="width: 10%;"></td> <td style="width: 10%;"></td> <td style="width: 10%;"></td> </tr> <tr> <td></td> <td></td> <td colspan="8" style="text-align: center;"> <table border="1" style="width: 100%; border-collapse: collapse; text-align: center;"> <tr> <td style="width: 10%;"></td> <td style="width: 10%;"></td> <td style="width: 10%;"></td> <td style="width: 10%;"></td> <td style="width: 10%;"></td> <td style="width: 10%;"></td> <td style="width: 10%;"></td> <td style="width: 10%;"></td> <td style="width: 10%;"></td> <td style="width: 10%;"></td> </tr> <tr> <td></td> <td></td> <td colspan="8" style="text-align: center;"> <table border="1" style="width: 100%; border-collapse: collapse; text-align: center;"> <tr> <td style="width: 10%;"></td> <td style="width: 10%;"></td> <td style="width: 10%;"></td> <td style="width: 10%;"></td> <td style="width: 10%;"></td> <td style="width: 10%;"></td> <td style="width: 10%;"></td> <td style="width: 10%;"></td> <td style="width: 10%;"></td> <td style="width: 10%;"></td> </tr> <tr> <td></td> <td></td> <td colspan="8" style="text-align: center;"> <table border="1" style="width: 100%; border-collapse: collapse; text-align: center;"> <tr> <td style="width: 10%;"></td> <td style="width: 10%;"></td> <td style="width: 10%;"></td> <td style="width: 10%;"></td> <td style="width: 10%;"></td> <td style="width: 10%;"></td> <td style="width: 10%;"></td> <td style="width: 10%;"></td> <td style="width: 10%;"></td> <td style="width: 10%;"></td> </tr> <tr> <td></td> <td></td> <td colspan="8" style="text-align: center;"> <table border="1" style="width: 100%; border-collapse: collapse; text-align: center;"> <tr> <td style="width: 10%;"></td> <td style="width: 10%;"></td> <td style="width: 10%;"></td> <td style="width: 10%;"></td> <td style="width: 10%;"></td> <td style="width: 10%;"></td> <td style="width: 10%;"></td> <td style="width: 10%;"></td> <td style="width: 10%;"></td> <td style="width: 10%;"></td> </tr> <tr> <td></td> <td></td> <td colspan="8" style="text-align: center;"> <table border="1" style="width: 100%; border-collapse: collapse; text-align: center;"> <tr> <td style="width: 10%;"></td> <td style="width: 10%;"></td> <td style="width: 10%;"></td> <td style="width: 10%;"></td> <td style="width: 10%;"></td> <td style="width: 10%;"></td> <td style="width: 10%;"></td> <td style="width: 10%;"></td> <td style="width: 10%;"></td> <td style="width: 10%;"></td> </tr> <tr> <td></td> <td></td> <td colspan="8" style="text-align: center;"> <table border="1" style="width: 100%; border-collapse: collapse; text-align: center;"> <tr> <td style="width: 10%;"></td> <td style="width: 10%;"></td> <td style="width: 10%;"></td> <td style="width: 10%;"></td> <td style="width: 10%;"></td> <td style="width: 10%;"></td> <td style="width: 10%;"></td> <td style="width: 10%;"></td> <td style="width: 10%;"></td> <td style="width: 10%;"></td> </tr> <tr> <td></td> <td></td> <td colspan="8" style="text-align: center;"> <table border="1" style="width: 100%; border-collapse: collapse; text-align: center;"> <tr> <td style="width: 10%;"></td> <td style="width: 10%;"></td> <td style="width: 10%;"></td> <td style="width: 10%;"></td> <td style="width: 10%;"></td> <td style="width: 10%;"></td> <td style="width: 10%;"></td> <td style="width: 10%;"></td> <td style="width: 10%;"></td> <td style="width: 10%;"></td> </tr> <tr> <td></td> <td></td> <td colspan="8" style="text-align: center;"> <table border="1" style="width: 100%; border-collapse: collapse; text-align: center;"> <tr> <td style="width: 10%;"></td> <td style="width: 10%;"></td> <td style="width: 10%;"></td> <td style="width: 10%;"></td> <td style="width: 10%;"></td> <td style="width: 10%;"></td> <td style="width: 10%;"></td> <td style="width: 10%;"></td> <td style="width: 10%;"></td> <td style="width: 10%;"></td> </tr> <tr> <td></td> <td></td> <td colspan="8" style="text-align: center;"> <table border="1" style="width: 100%; border-collapse: collapse; text-align: center;"> <tr> <td style="width: 10%;"></td> <td style="width: 10%;"></td> <td style="width:
10%;"></td> <td style="width: 10%;"></td> <td style="width: 10%;"></td> <td style="width: 10%;"></td> <td style="width: 10%;"></td> <td style="width: 10%;"></td> <td style="width: 10%;"></td> <td style="width: 10%;"></td> </tr> <tr> <td></td> <td></td> <td colspan="8" style="text-align: center;"> <table border="1" style="width: 100%; border-collapse: collapse; text-align: center;"> <tr> </tr></table></td></tr></table></td></tr></table></td></tr></table></td></tr></table></td></tr></table></td></tr></table></td></tr></table></td></tr></table></td></tr></table></td></tr></table></td></tr></table></td></tr></table></td></tr></table></td></tr></table></td></tr></table></td></tr></table></td></tr></table></td></tr></table></td></tr></table></td></tr></table></td></tr></table></td></tr></table></td></tr></table></td></tr></table></td></tr></table></td></tr></table></td></tr></table></td></tr></table></td></tr></table></td></tr></table></td></tr></table></td></tr></table></td></tr></table></td></tr></table></td></tr></table></td></tr></table></td></tr></table></td></tr></table></td></tr></table></td></tr></table>
 | | | | | | | | | | | | | | | | | | | | <table border="1" style="width: 100%; border-collapse: collapse; text-align: center;"> <tr> <td style="width: 10%;"></td> <td style="width: 10%;"></td> <td style="width: 10%;"></td> <td style="width: 10%;"></td> <td style="width: 10%;"></td> <td style="width: 10%;"></td> <td style="width: 10%;"></td> <td style="width: 10%;"></td> <td style="width: 10%;"></td> <td style="width: 10%;"></td> </tr> <tr> <td></td> <td></td> <td colspan="8" style="text-align: center;"> <table border="1" style="width: 100%; border-collapse: collapse; text-align: center;"> <tr> <td style="width: 10%;"></td> <td style="width: 10%;"></td> <td style="width: 10%;"></td> <td style="width: 10%;"></td> <td style="width: 10%;"></td> <td style="width: 10%;"></td> <td style="width: 10%;"></td> <td style="width: 10%;"></td> <td style="width: 10%;"></td> <td style="width: 10%;"></td> </tr> <tr> <td></td> <td></td> <td colspan="8" style="text-align: center;"> <table border="1" style="width: 100%; border-collapse: collapse; text-align: center;"> <tr> <td style="width: 10%;"></td> <td style="width: 10%;"></td> <td style="width: 10%;"></td> <td style="width: 10%;"></td> <td style="width: 10%;"></td> <td style="width: 10%;"></td> <td style="width: 10%;"></td> <td style="width: 10%;"></td> <td style="width: 10%;"></td> <td style="width: 10%;"></td> </tr> <tr> <td></td> <td></td> <td colspan="8" style="text-align: center;"> <table border="1" style="width: 100%; border-collapse: collapse; text-align: center;"> <tr> <td style="width: 10%;"></td> <td style="width: 10%;"></td> <td style="width: 10%;"></td> <td style="width: 10%;"></td> <td style="width: 10%;"></td> <td style="width: 10%;"></td> <td style="width: 10%;"></td> <td style="width: 10%;"></td> <td style="width: 10%;"></td> <td style="width: 10%;"></td> </tr> <tr> <td></td> <td></td> <td colspan="8" style="text-align: center;"> <table border="1" style="width: 100%; border-collapse: collapse; text-align: center;"> <tr> <td style="width: 10%;"></td> <td style="width: 10%;"></td> <td style="width: 10%;"></td> <td style="width: 10%;"></td> <td style="width: 10%;"></td> <td style="width: 10%;"></td> <td style="width: 10%;"></td> <td style="width: 10%;"></td> <td style="width: 10%;"></td> <td style="width: 10%;"></td> </tr> <tr> <td></td> <td></td> <td colspan="8" style="text-align: center;"> <table border="1" style="width: 100%; border-collapse: collapse; text-align: center;"> <tr> <td style="width: 10%;"></td> <td style="width: 10%;"></td> <td style="width: 10%;"></td> <td style="width: 10%;"></td> <td style="width: 10%;"></td> <td style="width: 10%;"></td> <td style="width: 10%;"></td> <td style="width: 10%;"></td> <td style="width: 10%;"></td> <td style="width: 10%;"></td> </tr> <tr> <td></td> <td></td> <td colspan="8" style="text-align: center;"> <table border="1" style="width: 100%; border-collapse: collapse; text-align: center;"> <tr> <td style="width: 10%;"></td> <td style="width: 10%;"></td> <td style="width: 10%;"></td> <td style="width: 10%;"></td> <td style="width: 10%;"></td> <td style="width: 10%;"></td> <td style="width: 10%;"></td> <td style="width: 10%;"></td> <td style="width: 10%;"></td> <td style="width: 10%;"></td> </tr> <tr> <td></td> <td></td> <td colspan="8" style="text-align: center;"> <table border="1" style="width: 100%; border-collapse: collapse; text-align: center;"> <tr> <td style="width: 10%;"></td> <td style="width: 10%;"></td> <td style="width: 10%;"></td> <td style="width: 10%;"></td> <td style="width: 10%;"></td> <td style="width: 10%;"></td> <td style="width: 10%;"></td> <td style="width: 10%;"></td> <td style="width: 10%;"></td> <td style="width: 10%;"></td> </tr> <tr> <td></td> <td></td> <td colspan="8" style="text-align: center;"> <table border="1" style="width: 100%; border-collapse: collapse; text-align: center;"> <tr> <td style="width: 10%;"></td> <td style="width: 10%;"></td> <td style="width: 10%;"></td> <td style="width: 10%;"></td> <td style="width: 10%;"></td> <td style="width: 10%;"></td> <td style="width: 10%;"></td> <td style="width: 10%;"></td> <td style="width: 10%;"></td> <td style="width: 10%;"></td> </tr> <tr> <td></td> <td></td> <td colspan="8" style="text-align: center;"> <table border="1" style="width: 100%; border-collapse: collapse; text-align: center;"> <tr> <td style="width: 10%;"></td> <td style="width: 10%;"></td> <td style="width: 10%;"></td> <td style="width: 10%;"></td> <td style="width: 10%;"></td> <td style="width: 10%;"></td> <td style="width: 10%;"></td> <td style="width: 10%;"></td> <td style="width: 10%;"></td> <td style="width: 10%;"></td> </tr> <tr> <td></td> <td></td> <td colspan="8" style="text-align: center;"> <table border="1" style="width: 100%; border-collapse: collapse; text-align: center;"> <tr> <td style="width: 10%;"></td> <td style="width: 10%;"></td> <td style="width: 10%;"></td> <td style="width: 10%;"></td> <td style="width: 10%;"></td> <td style="width: 10%;"></td> <td style="width: 10%;"></td> <td style="width: 10%;"></td> <td style="width: 10%;"></td> <td style="width: 10%;"></td> </tr> <tr> <td></td> <td></td> <td colspan="8" style="text-align: center;"> <table border="1" style="width: 100%; border-collapse: collapse; text-align: center;"> <tr> <td style="width: 10%;"></td> <td style="width: 10%;"></td> <td style="width: 10%;"></td> <td style="width: 10%;"></td> <td style="width: 10%;"></td> <td style="width: 10%;"></td> <td style="width: 10%;"></td> <td style="width: 10%;"></td> <td style="width: 10%;"></td> <td style="width: 10%;"></td> </tr> <tr> <td></td> <td></td> <td colspan="8" style="text-align: center;"> <table border="1" style="width: 100%; border-collapse: collapse; text-align: center;"> <tr> <td style="width: 10%;"></td> <td style="width: 10%;"></td> <td style="width: 10%;"></td> <td style="width: 10%;"></td> <td style="width: 10%;"></td> <td style="width: 10%;"></td> <td style="width: 10%;"></td> <td style="width: 10%;"></td> <td style="width: 10%;"></td> <td style="width: 10%;"></td> </tr> <tr> <td></td> <td></td> <td colspan="8" style="text-align: center;"> <table border="1" style="width: 100%; border-collapse: collapse; text-align: center;"> <tr> <td style="width: 10%;"></td> <td style="width: 10%;"></td> <td style="width: 10%;"></td> <td style="width: 10%;"></td> <td style="width: 10%;"></td> <td style="width: 10%;"></td> <td style="width: 10%;"></td> <td style="width: 10%;"></td> <td style="width: 10%;"></td> <td style="width: 10%;"></td> </tr> <tr> <td></td> <td></td> <td colspan="8" style="text-align: center;"> <table border="1" style="width: 100%; border-collapse: collapse; text-align: center;"> <tr> <td style="width: 10%;"></td> <td style="width: 10%;"></td> <td style="width: 10%;"></td> <td style="width: 10%;"></td> <td style="width: 10%;"></td> <td style="width: 10%;"></td> <td style="width: 10%;"></td> <td style="width: 10%;"></td> <td style="width: 10%;"></td> <td style="width: 10%;"></td> </tr> <tr> <td></td> <td></td> <td colspan="8" style="text-align: center;"> <table border="1" style="width: 100%; border-collapse: collapse; text-align: center;"> <tr> <td style="width: 10%;"></td> <td style="width: 10%;"></td> <td style="width: 10%;"></td> <td style="width: 10%;"></td> <td style="width: 10%;"></td> <td style="width: 10%;"></td> <td style="width: 10%;"></td> <td style="width: 10%;"></td> <td style="width: 10%;"></td> <td style="width: 10%;"></td> </tr> <tr> <td></td> <td></td> <td colspan="8" style="text-align: center;"> <table border="1" style="width: 100%; border-collapse: collapse; text-align: center;"> <tr> <td style="width: 10%;"></td> <td style="width: 10%;"></td> <td style="width: 10%;"></td> <td style="width: 10%;"></td> <td style="width: 10%;"></td> <td style="width: 10%;"></td> <td style="width: 10%;"></td> <td style="width: 10%;"></td> <td style="width: 10%;"></td> <td style="width: 10%;"></td> </tr> <tr> <td></td> <td></td> <td colspan="8" style="text-align: center;"> <table border="1" style="width: 100%; border-collapse: collapse; text-align: center;"> <tr> <td style="width: 10%;"></td> <td style="width: 10%;"></td> <td style="width: 10%;"></td> <td style="width: 10%;"></td> <td style="width: 10%;"></td> <td style="width: 10%;"></td> <td style="width: 10%;"></td> <td style="width: 10%;"></td> <td style="width: 10%;"></td> <td style="width: 10%;"></td> </tr> <tr> <td></td> <td></td> <td colspan="8" style="text-align: center;"> <table border="1" style="width: 100%; border-collapse: collapse; text-align: center;"> <tr> <td style="width: 10%;"></td> <td style="width: 10%;"></td> <td style="width: 10%;"></td> <td style="width: 10%;"></td> <td style="width: 10%;"></td> <td style="width: 10%;"></td> <td style="width: 10%;"></td> <td style="width: 10%;"></td> <td style="width: 10%;"></td> <td style="width: 10%;"></td> </tr> <tr> <td></td> <td></td> <td colspan="8" style="text-align: center;"> <table border="1" style="width: 100%; border-collapse: collapse; text-align: center;"> <tr> <td style="width: 10%;"></td> <td style="width: 10%;"></td> <td style="width: 10%;"></td> <td style="width: 10%;"></td> <td style="width: 10%;"></td> <td style="width: 10%;"></td> <td style="width: 10%;"></td> <td style="width: 10%;"></td> <td style="width: 10%;"></td> <td style="width: 10%;"></td> </tr> <tr> <td></td> <td></td> <td colspan="8" style="text-align: center;"> <table border="1" style="width: 100%; border-collapse: collapse; text-align: center;"> <tr> <td style="width: 10%;"></td> <td style="width: 10%;"></td> <td style="width: 10%;"></td> <td style="width: 10%;"></td> <td
style="width: 10%;"></td> <td style="width: 10%;"></td> <td style="width: 10%;"></td> <td style="width: 10%;"></td> <td style="width: 10%;"></td> <td style="width: 10%;"></td> </tr> <tr> <td></td> <td></td> <td colspan="8" style="text-align: center;"> <table border="1" style="width: 100%; border-collapse: collapse; text-align: center;"> <tr> <td style="width: 10%;"></td> <td style="width: 10%;"></td> <td style="width: 10%;"></td> <td style="width: 10%;"></td> <td style="width: 10%;"></td> <td style="width: 10%;"></td> <td style="width: 10%;"></td> <td style="width: 10%;"></td> <td style="width: 10%;"></td> <td style="width: 10%;"></td> </tr> <tr> <td></td> <td></td> <td colspan="8" style="text-align: center;"> <table border="1" style="width: 100%; border-collapse: collapse; text-align: center;"> <tr> <td style="width: 10%;"></td> <td style="width: 10%;"></td> <td style="width: 10%;"></td> <td style="width: 10%;"></td> <td style="width: 10%;"></td> <td style="width: 10%;"></td> <td style="width: 10%;"></td> <td style="width: 10%;"></td> <td style="width: 10%;"></td> <td style="width: 10%;"></td> </tr> <tr> <td></td> <td></td> <td colspan="8" style="text-align: center;"> <table border="1" style="width: 100%; border-collapse: collapse; text-align: center;"> <tr> <td style="width: 10%;"></td> <td style="width: 10%;"></td> <td style="width: 10%;"></td> <td style="width: 10%;"></td> <td style="width: 10%;"></td> <td style="width: 10%;"></td> <td style="width: 10%;"></td> <td style="width: 10%;"></td> <td style="width: 10%;"></td> <td style="width: 10%;"></td> </tr> <tr> <td></td> <td></td> <td colspan="8" style="text-align: center;"> <table border="1" style="width: 100%; border-collapse: collapse; text-align: center;"> <tr> <td style="width: 10%;"></td> <td style="width: 10%;"></td> <td style="width: 10%;"></td> <td style="width: 10%;"></td> <td style="width: 10%;"></td> <td style="width: 10%;"></td> <td style="width: 10%;"></td> <td style="width: 10%;"></td> <td style="width: 10%;"></td> <td style="width: 10%;"></td> </tr> <tr> <td></td> <td></td> <td colspan="8" style="text-align: center;"> <table border="1" style="width: 100%; border-collapse: collapse; text-align: center;"> <tr> <td style="width: 10%;"></td> <td style="width: 10%;"></td> <td style="width: 10%;"></td> <td style="width: 10%;"></td> <td style="width: 10%;"></td> <td style="width: 10%;"></td> <td style="width: 10%;"></td> <td style="width: 10%;"></td> <td style="width: 10%;"></td> <td style="width: 10%;"></td> </tr> <tr> <td></td> <td></td> <td colspan="8" style="text-align: center;"> <table border="1" style="width: 100%; border-collapse: collapse; text-align: center;"> <tr> <td style="width: 10%;"></td> <td style="width: 10%;"></td> <td style="width: 10%;"></td> <td style="width: 10%;"></td> <td style="width: 10%;"></td> <td style="width: 10%;"></td> <td style="width: 10%;"></td> <td style="width: 10%;"></td> <td style="width: 10%;"></td> <td style="width: 10%;"></td> </tr> <tr> <td></td> <td></td> <td colspan="8" style="text-align: center;"> <table border="1" style="width: 100%; border-collapse: collapse; text-align: center;"> <tr> <td style="width: 10%;"></td> <td style="width: 10%;"></td> <td style="width: 10%;"></td> <td style="width: 10%;"></td> <td style="width: 10%;"></td> <td style="width: 10%;"></td> <td style="width: 10%;"></td> <td style="width: 10%;"></td> <td style="width: 10%;"></td> <td style="width: 10%;"></td> </tr> <tr> <td></td> <td></td> <td colspan="8" style="text-align: center;"> <table border="1" style="width: 100%; border-collapse: collapse; text-align: center;"> <tr> <td style="width: 10%;"></td> <td style="width: 10%;"></td> <td style="width: 10%;"></td> <td style="width: 10%;"></td> <td style="width: 10%;"></td> <td style="width: 10%;"></td> <td style="width: 10%;"></td> <td style="width: 10%;"></td> <td style="width: 10%;"></td> <td style="width: 10%;"></td> </tr> <tr> <td></td> <td></td> <td colspan="8" style="text-align: center;"> <table border="1" style="width: 100%; border-collapse: collapse; text-align: center;"> <tr> <td style="width: 10%;"></td> <td style="width: 10%;"></td> <td style="width: 10%;"></td> <td style="width: 10%;"></td> <td style="width: 10%;"></td> <td style="width: 10%;"></td> <td style="width: 10%;"></td> <td style="width: 10%;"></td> <td style="width: 10%;"></td> <td style="width: 10%;"></td> </tr> <tr> <td></td> <td></td> <td colspan="8" style="text-align: center;"> <table border="1" style="width: 100%; border-collapse: collapse; text-align: center;"> <tr> <td style="width: 10%;"></td> <td style="width: 10%;"></td> <td style="width: 10%;"></td> <td style="width: 10%;"></td> <td style="width: 10%;"></td> <td style="width: 10%;"></td> <td style="width: 10%;"></td> <td style="width: 10%;"></td> <td style="width: 10%;"></td> <td style="width: 10%;"></td> </tr> <tr> <td></td> <td></td> <td colspan="8" style="text-align: center;"> <table border="1" style="width: 100%; border-collapse: collapse; text-align: center;"> <tr> <td style="width: 10%;"></td> <td style="width: 10%;"></td> <td style="width: 10%;"></td> <td style="width: 10%;"></td> <td style="width: 10%;"></td> <td style="width: 10%;"></td> <td style="width: 10%;"></td> <td style="width: 10%;"></td> <td style="width: 10%;"></td> <td style="width: 10%;"></td> </tr> <tr> <td></td> <td></td> <td colspan="8" style="text-align: center;"> <table border="1" style="width: 100%; border-collapse: collapse; text-align: center;"> <tr> <td style="width: 10%;"></td> <td style="width: 10%;"></td> <td style="width: 10%;"></td> <td style="width: 10%;"></td> <td style="width: 10%;"></td> <td style="width: 10%;"></td> <td style="width: 10%;"></td> <td style="width: 10%;"></td> <td style="width: 10%;"></td> <td style="width: 10%;"></td> </tr> <tr> <td></td> <td></td> <td colspan="8" style="text-align: center;"> <table border="1" style="width: 100%; border-collapse: collapse; text-align: center;"> <tr> <td style="width: 10%;"></td> <td style="width: 10%;"></td> <td style="width: 10%;"></td> <td style="width: 10%;"></td> <td style="width: 10%;"></td> <td style="width: 10%;"></td> <td style="width: 10%;"></td> <td style="width: 10%;"></td> <td style="width: 10%;"></td> <td style="width: 10%;"></td> </tr> <tr> <td></td> <td></td> <td colspan="8" style="text-align: center;"> <table border="1" style="width: 100%; border-collapse: collapse; text-align: center;"> <tr> <td style="width: 10%;"></td> <td style="width: 10%;"></td> <td style="width: 10%;"></td> <td style="width: 10%;"></td> <td style="width: 10%;"></td> <td style="width: 10%;"></td> <td style="width: 10%;"></td> <td style="width: 10%;"></td> <td style="width: 10%;"></td> <td style="width: 10%;"></td> </tr> <tr> <td></td> <td></td> <td colspan="8" style="text-align: center;"> <table border="1" style="width: 100%; border-collapse: collapse; text-align: center;"> <tr> <td style="width: 10%;"></td> <td style="width: 10%;"></td> <td style="width: 10%;"></td> <td style="width: 10%;"></td> <td style="width: 10%;"></td> <td style="width: 10%;"></td> <td style="width: 10%;"></td> <td style="width: 10%;"></td> <td style="width: 10%;"></td> <td style="width: 10%;"></td> </tr> <tr> <td></td> <td></td> <td colspan="8" style="text-align: center;"> <table border="1" style="width: 100%; border-collapse: collapse; text-align: center;"> <tr> <td style="width: 10%;"></td> <td style="width: 10%;"></td> <td style="width: 10%;"></td> <td style="width: 10%;"></td> <td style="width: 10%;"></td> <td style="width: 10%;"></td> <td style="width: 10%;"></td> <td style="width: 10%;"></td> <td style="width: 10%;"></td> <td style="width: 10%;"></td> </tr> <tr> <td></td> <td></td> <td colspan="8" style="text-align: center;"> <table border="1" style="width: 100%; border-collapse: collapse; text-align: center;"> <tr> <td style="width: 10%;"></td> <td style="width: 10%;"></td> <td style="width: 10%;"></td> <td style="width: 10%;"></td> <td style="width: 10%;"></td> <td style="width: 10%;"></td> <td style="width: 10%;"></td> <td style="width: 10%;"></td> <td style="width: 10%;"></td> <td style="width: 10%;"></td> </tr> <tr> <td></td> <td></td> <td colspan="8" style="text-align: center;"> <table border="1" style="width: 100%; border-collapse: collapse; text-align: center;"> <tr> <td style="width: 10%;"></td> <td style="width: 10%;"></td> <td style="width: 10%;"></td> <td style="width: 10%;"></td> <td style="width: 10%;"></td> <td style="width: 10%;"></td> <td style="width: 10%;"></td> <td style="width: 10%;"></td> <td style="width: 10%;"></td> <td style="width: 10%;"></td> </tr> <tr> <td></td> <td></td> <td colspan="8" style="text-align: center;"> <table border="1" style="width: 100%; border-collapse: collapse; text-align: center;"> <tr> </tr></table></td></tr></table></td></tr></table></td></tr></table></td></tr></table></td></tr></table></td></tr></table></td></tr></table></td></tr></table></td></tr></table></td></tr></table></td></tr></table></td></tr></table></td></tr></table></td></tr></table></td></tr></table></td></tr></table></td></tr></table></td></tr></table></td></tr></table></td></tr></table></td></tr></table></td></tr></table></td></tr></table></td></tr></table></td></tr></table></td></tr></table></td></tr></table></td></tr></table></td></tr></table></td></tr></table></td></tr></table></td></tr></table></td></tr></table></td></tr></table></td></tr></table></td></tr></table></td></tr></table></td></tr></table></td></tr></table>
 | | | | | | | | | | | | | | | | | | | | <table border="1" style="width: 100%; border-collapse: collapse; text-align: center;"> <tr> <td style="width: 10%;"></td> <td style="width: 10%;"></td> <td style="width: 10%;"></td> <td style="width: 10%;"></td> <td style="width: 10%;"></td> <td style="width: 10%;"></td> <td style="width: 10%;"></td> <td style="width: 10%;"></td> <td style="width: 10%;"></td> <td style="width: 10%;"></td> </tr> <tr> <td></td> <td></td> <td colspan="8" style="text-align: center;"> <table border="1" style="width: 100%; border-collapse: collapse; text-align: center;"> <tr> <td style="width: 10%;"></td> <td style="width: 10%;"></td> <td style="width: 10%;"></td> <td style="width: 10%;"></td> <td style="width: 10%;"></td> <td style="width: 10%;"></td> <td style="width: 10%;"></td> <td style="width: 10%;"></td> <td style="width: 10%;"></td> <td style="width: 10%;"></td> </tr> <tr> <td></td> <td></td> <td colspan="8" style="text-align: center;"> <table border="1" style="width: 100%; border-collapse: collapse; text-align: center;"> <tr> <td style="width: 10%;"></td> <td style="width: 10%;"></td> <td style="width: 10%;"></td> <td style="width: 10%;"></td> <td style="width: 10%;"></td> <td style="width: 10%;"></td> <td
style="width: 10%;"></td> <td style="width: 10%;"></td> <td style="width: 10%;"></td> <td style="width: 10%;"></td> </tr> <tr> <td></td> <td></td> <td colspan="8" style="text-align: center;"> <table border="1" style="width: 100%; border-collapse: collapse; text-align: center;"> <tr> <td style="width: 10%;"></td> <td style="width: 10%;"></td> <td style="width: 10%;"></td> <td style="width: 10%;"></td> <td style="width: 10%;"></td> <td style="width: 10%;"></td> <td style="width: 10%;"></td> <td style="width: 10%;"></td> <td style="width: 10%;"></td> <td style="width: 10%;"></td> </tr> <tr> <td></td> <td></td> <td colspan="8" style="text-align: center;"> <table border="1" style="width: 100%; border-collapse: collapse; text-align: center;"> <tr> <td style="width: 10%;"></td> <td style="width: 10%;"></td> <td style="width: 10%;"></td> <td style="width: 10%;"></td> <td style="width: 10%;"></td> <td style="width: 10%;"></td> <td style="width: 10%;"></td> <td style="width: 10%;"></td> <td style="width: 10%;"></td> <td style="width: 10%;"></td> </tr> <tr> <td></td> <td></td> <td colspan="8" style="text-align: center;"> <table border="1" style="width: 100%; border-collapse: collapse; text-align: center;"> <tr> <td style="width: 10%;"></td> <td style="width: 10%;"></td> <td style="width: 10%;"></td> <td style="width: 10%;"></td> <td style="width: 10%;"></td> <td style="width: 10%;"></td> <td style="width: 10%;"></td> <td style="width: 10%;"></td> <td style="width: 10%;"></td> <td style="width: 10%;"></td> </tr> <tr> <td></td> <td></td> <td colspan="8" style="text-align: center;"> <table border="1" style="width: 100%; border-collapse: collapse; text-align: center;"> <tr> <td style="width: 10%;"></td> <td style="width: 10%;"></td> <td style="width: 10%;"></td> <td style="width: 10%;"></td> <td style="width: 10%;"></td> <td style="width: 10%;"></td> <td style="width: 10%;"></td> <td style="width: 10%;"></td> <td style="width: 10%;"></td> <td style="width: 10%;"></td> </tr> <tr> <td></td> <td></td> <td colspan="8" style="text-align: center;"> <table border="1" style="width: 100%; border-collapse: collapse; text-align: center;"> <tr> <td style="width: 10%;"></td> <td style="width: 10%;"></td> <td style="width: 10%;"></td> <td style="width: 10%;"></td> <td style="width: 10%;"></td> <td style="width: 10%;"></td> <td style="width: 10%;"></td> <td style="width: 10%;"></td> <td style="width: 10%;"></td> <td style="width: 10%;"></td> </tr> <tr> <td></td> <td></td> <td colspan="8" style="text-align: center;"> <table border="1" style="width: 100%; border-collapse: collapse; text-align: center;"> <tr> <td style="width: 10%;"></td> <td style="width: 10%;"></td> <td style="width: 10%;"></td> <td style="width: 10%;"></td> <td style="width: 10%;"></td> <td style="width: 10%;"></td> <td style="width: 10%;"></td> <td style="width: 10%;"></td> <td style="width: 10%;"></td> <td style="width: 10%;"></td> </tr> <tr> <td></td> <td></td> <td colspan="8" style="text-align: center;"> <table border="1" style="width: 100%; border-collapse: collapse; text-align: center;"> <tr> <td style="width: 10%;"></td> <td style="width: 10%;"></td> <td style="width: 10%;"></td> <td style="width: 10%;"></td> <td style="width: 10%;"></td> <td style="width: 10%;"></td> <td style="width: 10%;"></td> <td style="width: 10%;"></td> <td style="width: 10%;"></td> <td style="width: 10%;"></td> </tr> <tr> <td></td> <td></td> <td colspan="8" style="text-align: center;"> <table border="1" style="width: 100%; border-collapse: collapse; text-align: center;"> <tr> <td style="width: 10%;"></td> <td style="width: 10%;"></td> <td style="width: 10%;"></td> <td style="width: 10%;"></td> <td style="width: 10%;"></td> <td style="width: 10%;"></td> <td style="width: 10%;"></td> <td style="width: 10%;"></td> <td style="width: 10%;"></td> <td style="width: 10%;"></td> </tr> <tr> <td></td> <td></td> <td colspan="8" style="text-align: center;"> <table border="1" style="width: 100%; border-collapse: collapse; text-align: center;"> <tr> <td style="width: 10%;"></td> <td style="width: 10%;"></td> <td style="width: 10%;"></td> <td style="width: 10%;"></td> <td style="width: 10%;"></td> <td style="width: 10%;"></td> <td style="width: 10%;"></td> <td style="width: 10%;"></td> <td style="width: 10%;"></td> <td style="width: 10%;"></td> </tr> <tr> <td></td> <td></td> <td colspan="8" style="text-align: center;"> <table border="1" style="width: 100%; border-collapse: collapse; text-align: center;"> <tr> <td style="width: 10%;"></td> <td style="width: 10%;"></td> <td style="width: 10%;"></td> <td style="width: 10%;"></td> <td style="width: 10%;"></td> <td style="width: 10%;"></td> <td style="width: 10%;"></td> <td style="width: 10%;"></td> <td style="width: 10%;"></td> <td style="width: 10%;"></td> </tr> <tr> <td></td> <td></td> <td colspan="8" style="text-align: center;"> <table border="1" style="width: 100%; border-collapse: collapse; text-align: center;"> <tr> <td style="width: 10%;"></td> <td style="width: 10%;"></td> <td style="width: 10%;"></td> <td style="width: 10%;"></td> <td style="width: 10%;"></td> <td style="width: 10%;"></td> <td style="width: 10%;"></td> <td style="width: 10%;"></td> <td style="width: 10%;"></td> <td style="width: 10%;"></td> </tr> <tr> <td></td> <td></td> <td colspan="8" style="text-align: center;"> <table border="1" style="width: 100%; border-collapse: collapse; text-align: center;"> <tr> <td style="width: 10%;"></td> <td style="width: 10%;"></td> <td style="width: 10%;"></td> <td style="width: 10%;"></td> <td style="width: 10%;"></td> <td style="width: 10%;"></td> <td style="width: 10%;"></td> <td style="width: 10%;"></td> <td style="width: 10%;"></td> <td style="width: 10%;"></td> </tr> <tr> <td></td> <td></td> <td colspan="8" style="text-align: center;"> <table border="1" style="width: 100%; border-collapse: collapse; text-align: center;"> <tr> <td style="width: 10%;"></td> <td style="width: 10%;"></td> <td style="width: 10%;"></td> <td style="width: 10%;"></td> <td style="width: 10%;"></td> <td style="width: 10%;"></td> <td style="width: 10%;"></td> <td style="width: 10%;"></td> <td style="width: 10%;"></td> <td style="width: 10%;"></td> </tr> <tr> <td></td> <td></td> <td colspan="8" style="text-align: center;"> <table border="1" style="width: 100%; border-collapse: collapse; text-align: center;"> <tr> <td style="width: 10%;"></td> <td style="width: 10%;"></td> <td style="width: 10%;"></td> <td style="width: 10%;"></td> <td style="width: 10%;"></td> <td style="width: 10%;"></td> <td style="width: 10%;"></td> <td style="width: 10%;"></td> <td style="width: 10%;"></td> <td style="width: 10%;"></td> </tr> <tr> <td></td> <td></td> <td colspan="8" style="text-align: center;"> <table border="1" style="width: 100%; border-collapse: collapse; text-align: center;"> <tr> <td style="width: 10%;"></td> <td style="width: 10%;"></td> <td style="width: 10%;"></td> <td style="width: 10%;"></td> <td style="width: 10%;"></td> <td style="width: 10%;"></td> <td style="width: 10%;"></td> <td style="width: 10%;"></td> <td style="width: 10%;"></td> <td style="width: 10%;"></td> </tr> <tr> <td></td> <td></td> <td colspan="8" style="text-align: center;"> <table border="1" style="width: 100%; border-collapse: collapse; text-align: center;"> <tr> <td style="width: 10%;"></td> <td style="width: 10%;"></td> <td style="width: 10%;"></td> <td style="width: 10%;"></td> <td style="width: 10%;"></td> <td style="width: 10%;"></td> <td style="width: 10%;"></td> <td style="width: 10%;"></td> <td style="width: 10%;"></td> <td style="width: 10%;"></td> </tr> <tr> <td></td> <td></td> <td colspan="8" style="text-align: center;"> <table border="1" style="width: 100%; border-collapse: collapse; text-align: center;"> <tr> <td style="width: 10%;"></td> <td style="width: 10%;"></td> <td style="width: 10%;"></td> <td style="width: 10%;"></td> <td style="width: 10%;"></td> <td style="width: 10%;"></td> <td style="width: 10%;"></td> <td style="width: 10%;"></td> <td style="width: 10%;"></td> <td style="width: 10%;"></td> </tr> <tr> <td></td> <td></td> <td colspan="8" style="text-align: center;"> <table border="1" style="width: 100%; border-collapse: collapse; text-align: center;"> <tr> <td style="width: 10%;"></td> <td style="width: 10%;"></td> <td style="width: 10%;"></td> <td style="width: 10%;"></td> <td style="width: 10%;"></td> <td style="width: 10%;"></td> <td style="width: 10%;"></td> <td style="width: 10%;"></td> <td style="width: 10%;"></td> <td style="width: 10%;"></td> </tr> <tr> <td></td> <td></td> <td colspan="8" style="text-align: center;"> <table border="1" style="width: 100%; border-collapse: collapse; text-align: center;"> <tr> <td style="width: 10%;"></td> <td style="width: 10%;"></td> <td style="width: 10%;"></td> <td style="width: 10%;"></td> <td style="width: 10%;"></td> <td style="width: 10%;"></td> <td style="width: 10%;"></td> <td style="width: 10%;"></td> <td style="width: 10%;"></td> <td style="width: 10%;"></td> </tr> <tr> <td></td> <td></td> <td colspan="8" style="text-align: center;"> <table border="1" style="width: 100%; border-collapse: collapse; text-align: center;"> <tr> <td style="width: 10%;"></td> <td style="width: 10%;"></td> <td style="width: 10%;"></td> <td style="width: 10%;"></td> <td style="width: 10%;"></td> <td style="width: 10%;"></td> <td style="width: 10%;"></td> <td style="width: 10%;"></td> <td style="width: 10%;"></td> <td style="width: 10%;"></td> </tr> <tr> <td></td> <td></td> <td colspan="8" style="text-align: center;"> <table border="1" style="width: 100%; border-collapse: collapse; text-align: center;"> <tr> <td style="width: 10%;"></td> <td style="width: 10%;"></td> <td style="width: 10%;"></td> <td style="width: 10%;"></td> <td style="width: 10%;"></td> <td style="width: 10%;"></td> <td style="width: 10%;"></td> <td style="width: 10%;"></td> <td style="width: 10%;"></td> <td style="width: 10%;"></td> </tr> <tr> <td></td> <td></td> <td colspan="8"
style="text-align: center;"> <table border="1" style="width: 100%; border-collapse: collapse; text-align: center;"> <tr> <td style="width: 10%;"></td> <td style="width: 10%;"></td> <td style="width: 10%;"></td> <td style="width: 10%;"></td> <td style="width: 10%;"></td> <td style="width: 10%;"></td> <td style="width: 10%;"></td> <td style="width: 10%;"></td> <td style="width: 10%;"></td> <td style="width: 10%;"></td> </tr> <tr> <td></td> <td></td> <td colspan="8" style="text-align: center;"> <table border="1" style="width: 100%; border-collapse: collapse; text-align: center;"> <tr> <td style="width: 10%;"></td> <td style="width: 10%;"></td> <td style="width: 10%;"></td> <td style="width: 10%;"></td> <td style="width: 10%;"></td> <td style="width: 10%;"></td> <td style="width: 10%;"></td> <td style="width: 10%;"></td> <td style="width: 10%;"></td> <td style="width: 10%;"></td> </tr> <tr> <td></td> <td></td> <td colspan="8" style="text-align: center;"> <table border="1" style="width: 100%; border-collapse: collapse; text-align: center;"> <tr> <td style="width: 10%;"></td> <td style="width: 10%;"></td> <td style="width: 10%;"></td> <td style="width: 10%;"></td> <td style="width: 10%;"></td> <td style="width: 10%;"></td> <td style="width: 10%;"></td> <td style="width: 10%;"></td> <td style="width: 10%;"></td> <td style="width: 10%;"></td> </tr> <tr> <td></td> <td></td> <td colspan="8" style="text-align: center;"> <table border="1" style="width: 100%; border-collapse: collapse; text-align: center;"> <tr> <td style="width: 10%;"></td> <td style="width: 10%;"></td> <td style="width: 10%;"></td> <td style="width: 10%;"></td> <td style="width: 10%;"></td> <td style="width: 10%;"></td> <td style="width: 10%;"></td> <td style="width: 10%;"></td> <td style="width: 10%;"></td> <td style="width: 10%;"></td> </tr> <tr> <td></td> <td></td> <td colspan="8" style="text-align: center;"> <table border="1" style="width: 100%; border-collapse: collapse; text-align: center;"> <tr> <td style="width: 10%;"></td> <td style="width: 10%;"></td> <td style="width: 10%;"></td> <td style="width: 10%;"></td> <td style="width: 10%;"></td> <td style="width: 10%;"></td> <td style="width: 10%;"></td> <td style="width: 10%;"></td> <td style="width: 10%;"></td> <td style="width: 10%;"></td> </tr> <tr> <td></td> <td></td> <td colspan="8" style="text-align: center;"> <table border="1" style="width: 100%; border-collapse: collapse; text-align: center;"> <tr> <td style="width: 10%;"></td> <td style="width: 10%;"></td> <td style="width: 10%;"></td> <td style="width: 10%;"></td> <td style="width: 10%;"></td> <td style="width: 10%;"></td> <td style="width: 10%;"></td> <td style="width: 10%;"></td> <td style="width: 10%;"></td> <td style="width: 10%;"></td> </tr> <tr> <td></td> <td></td> <td colspan="8" style="text-align: center;"> <table border="1" style="width: 100%; border-collapse: collapse; text-align: center;"> <tr> <td style="width: 10%;"></td> <td style="width: 10%;"></td> <td style="width: 10%;"></td> <td style="width: 10%;"></td> <td style="width: 10%;"></td> <td style="width: 10%;"></td> <td style="width: 10%;"></td> <td style="width: 10%;"></td> <td style="width: 10%;"></td> <td style="width: 10%;"></td> </tr> <tr> <td></td> <td></td> <td colspan="8" style="text-align: center;"> <table border="1" style="width: 100%; border-collapse: collapse; text-align: center;"> <tr> <td style="width: 10%;"></td> <td style="width: 10%;"></td> <td style="width: 10%;"></td> <td style="width: 10%;"></td> <td style="width: 10%;"></td> <td style="width: 10%;"></td> <td style="width: 10%;"></td> <td style="width: 10%;"></td> <td style="width: 10%;"></td> <td style="width: 10%;"></td> </tr> <tr> <td></td> <td></td> <td colspan="8" style="text-align: center;"> <table border="1" style="width: 100%; border-collapse: collapse; text-align: center;"> <tr> <td style="width: 10%;"></td> <td style="width: 10%;"></td> <td style="width: 10%;"></td> <td style="width: 10%;"></td> <td style="width: 10%;"></td> <td style="width: 10%;"></td> <td style="width: 10%;"></td> <td style="width: 10%;"></td> <td style="width: 10%;"></td> <td style="width: 10%;"></td> </tr> <tr> <td></td> <td></td> <td colspan="8" style="text-align: center;"> <table border="1" style="width: 100%; border-collapse: collapse; text-align: center;"> <tr> <td style="width: 10%;"></td> <td style="width: 10%;"></td> <td style="width: 10%;"></td> <td style="width: 10%;"></td> <td style="width: 10%;"></td> <td style="width: 10%;"></td> <td style="width: 10%;"></td> <td style="width: 10%;"></td> <td style="width: 10%;"></td> <td style="width: 10%;"></td> </tr> <tr> <td></td> <td></td> <td colspan="8" style="text-align: center;"> <table border="1" style="width: 100%; border-collapse: collapse; text-align: center;"> <tr> <td style="width: 10%;"></td> <td style="width: 10%;"></td> <td style="width: 10%;"></td> <td style="width: 10%;"></td> <td style="width: 10%;"></td> <td style="width: 10%;"></td> <td style="width: 10%;"></td> <td style="width: 10%;"></td> <td style="width: 10%;"></td> <td style="width: 10%;"></td> </tr> <tr> <td></td> <td></td> <td colspan="8" style="text-align: center;"> <table border="1" style="width: 100%; border-collapse: collapse; text-align: center;"> <tr> <td style="width: 10%;"></td> <td style="width: 10%;"></td> <td style="width: 10%;"></td> <td style="width: 10%;"></td> <td style="width: 10%;"></td> <td style="width: 10%;"></td> <td style="width: 10%;"></td> <td style="width: 10%;"></td> <td style="width: 10%;"></td> <td style="width: 10%;"></td> </tr> <tr> <td></td> <td></td> <td colspan="8" style="text-align: center;"> <table border="1" style="width: 100%; border-collapse: collapse; text-align: center;"> <tr> <td style="width: 10%;"></td> <td style="width: 10%;"></td> <td style="width: 10%;"></td> <td style="width: 10%;"></td> <td style="width: 10%;"></td> <td style="width: 10%;"></td> <td style="width: 10%;"></td> <td style="width: 10%;"></td> <td style="width: 10%;"></td> <td style="width: 10%;"></td> </tr> <tr> <td></td> <td></td> <td colspan="8" style="text-align: center;"> <table border="1" style="width: 100%; border-collapse: collapse; text-align: center;"> <tr> <td style="width: 10%;"></td> <td style="width: 10%;"></td> <td style="width: 10%;"></td> <td style="width: 10%;"></td> <td style="width: 10%;"></td> <td style="width: 10%;"></td> <td style="width: 10%;"></td> <td style="width: 10%;"></td> <td style="width: 10%;"></td> <td style="width: 10%;"></td> </tr> <tr> <td></td> <td></td> <td colspan="8" style="text-align: center;"> <table border="1" style="width: 100%; border-collapse: collapse; text-align: center;"> <tr> </tr></table></td></tr></table></td></tr></table></td></tr></table></td></tr></table></td></tr></table></td></tr></table></td></tr></table></td></tr></table></td></tr></table></td></tr></table></td></tr></table></td></tr></table></td></tr></table></td></tr></table></td></tr></table></td></tr></table></td></tr></table></td></tr></table></td></tr></table></td></tr></table></td></tr></table></td></tr></table></td></tr></table></td></tr></table></td></tr></table></td></tr></table></td></tr></table></td></tr></table></td></tr></table></td></tr></table></td></tr></table></td></tr></table></td></tr></table></td></tr></table></td></tr></table></td></tr></table></td></tr></table></td></tr></table>
 | | | | | | | | | | | | | | | | | | | | <table border="1" style="width: 100%; border-collapse: collapse; text-align: center;"> <tr> <td style="width: 10%;"></td> <td style="width: 10%;"></td> <td style="width: 10%;"></td> <td style="width: 10%;"></td> <td style="width: 10%;"></td> <td style="width: 10%;"></td> <td style="width: 10%;"></td> <td style="width: 10%;"></td> <td style="width: 10%;"></td> <td style="width: 10%;"></td> </tr> <tr> <td></td> <td></td> <td colspan="8" style="text-align: center;"> <table border="1" style="width: 100%; border-collapse: collapse; text-align: center;"> <tr> <td style="width: 10%;"></td> <td style="width: 10%;"></td> <td style="width: 10%;"></td> <td style="width: 10%;"></td> <td style="width: 10%;"></td> <td style="width: 10%;"></td> <td style="width: 10%;"></td> <td style="width: 10%;"></td> <td style="width: 10%;"></td> <td style="width: 10%;"></td> </tr> <tr> <td></td> <td></td> <td colspan="8" style="text-align: center;"> <table border="1" style="width: 100%; border-collapse: collapse; text-align: center;"> <tr> <td style="width: 10%;"></td> <td style="width: 10%;"></td> <td style="width: 10%;"></td> <td style="width: 10%;"></td> <td style="width: 10%;"></td> <td style="width: 10%;"></td> <td style="width: 10%;"></td> <td style="width: 10%;"></td> <td style="width: 10%;"></td> <td style="width: 10%;"></td> </tr> <tr> <td></td> <td></td> <td colspan="8" style="text-align: center;"> <table border="1" style="width: 100%; border-collapse: collapse; text-align: center;"> <tr> <td style="width: 10%;"></td> <td style="width: 10%;"></td> <td style="width: 10%;"></td> <td style="width: 10%;"></td> <td style="width: 10%;"></td> <td style="width: 10%;"></td> <td style="width: 10%;"></td> <td style="width: 10%;"></td> <td style="width: 10%;"></td> <td style="width: 10%;"></td> </tr> <tr> <td></td> <td></td> <td colspan="8" style="text-align: center;"> <table border="1" style="width: 100%; border-collapse: collapse; text-align: center;"> <tr> <td style="width: 10%;"></td> <td style="width: 10%;"></td> <td style="width: 10%;"></td> <td style="width: 10%;"></td> <td style="width: 10%;"></td> <td style="width: 10%;"></td> <td style="width: 10%;"></td> <td style="width: 10%;"></td> <td style="width: 10%;"></td> <td style="width: 10%;"></td> </tr> <tr> <td></td> <td></td> <td colspan="8" style="text-align: center;"> <table border="1" style="width: 100%; border-collapse: collapse; text-align: center;"> <tr> <td style="width: 10%;"></td> <td style="width: 10%;"></td> <td style="width: 10%;"></td> <td style="width: 10%;"></td> <td style="width: 10%;"></td> <td style="width: 10%;"></td> <td style="width: 10%;"></td> <td style="width: 10%;"></td> <td style="width: 10%;"></td> <td style="width: 10%;"></td> </tr> <tr> <td></td> <td></td> <td colspan="8" style="text-align: center;"> <table border="1" style="width: 100%; border-collapse: collapse; text-align: center;"> <tr> <td style="width: 10%;"></td> <td style="width: 10%;"></td> <td style="width: 10%;"></td> <td style="width: 10%;"></td> <td style="width: 10%;"></td> <td style="width: 10%;"></td> <td style="width: 10%;"></td> <td style="width: 10%;"></td> <td style="width: 10%;"></td> <td style="width: 10%;"></td> </tr> <tr> <td></td> <td></td> <td colspan="8" style="text-align: center;"> <table border="1" style="width: 100%; border-collapse:
collapse; text-align: center;"> <tr> <td style="width: 10%;"></td> <td style="width: 10%;"></td> <td style="width: 10%;"></td> <td style="width: 10%;"></td> <td style="width: 10%;"></td> <td style="width: 10%;"></td> <td style="width: 10%;"></td> <td style="width: 10%;"></td> <td style="width: 10%;"></td> <td style="width: 10%;"></td> </tr> <tr> <td></td> <td></td> <td colspan="8" style="text-align: center;"> <table border="1" style="width: 100%; border-collapse: collapse; text-align: center;"> <tr> <td style="width: 10%;"></td> <td style="width: 10%;"></td> <td style="width: 10%;"></td> <td style="width: 10%;"></td> <td style="width: 10%;"></td> <td style="width: 10%;"></td> <td style="width: 10%;"></td> <td style="width: 10%;"></td> <td style="width: 10%;"></td> <td style="width: 10%;"></td> </tr> <tr> <td></td> <td></td> <td colspan="8" style="text-align: center;"> <table border="1" style="width: 100%; border-collapse: collapse; text-align: center;"> <tr> <td style="width: 10%;"></td> <td style="width: 10%;"></td> <td style="width: 10%;"></td> <td style="width: 10%;"></td> <td style="width: 10%;"></td> <td style="width: 10%;"></td> <td style="width: 10%;"></td> <td style="width: 10%;"></td> <td style="width: 10%;"></td> <td style="width: 10%;"></td> </tr> <tr> <td></td> <td></td> <td colspan="8" style="text-align: center;"> <table border="1" style="width: 100%; border-collapse: collapse; text-align: center;"> <tr> <td style="width: 10%;"></td> <td style="width: 10%;"></td> <td style="width: 10%;"></td> <td style="width: 10%;"></td> <td style="width: 10%;"></td> <td style="width: 10%;"></td> <td style="width: 10%;"></td> <td style="width: 10%;"></td> <td style="width: 10%;"></td> <td style="width: 10%;"></td> </tr> <tr> <td></td> <td></td> <td colspan="8" style="text-align: center;"> <table border="1" style="width: 100%; border-collapse: collapse; text-align: center;"> <tr> <td style="width: 10%;"></td> <td style="width: 10%;"></td> <td style="width: 10%;"></td> <td style="width: 10%;"></td> <td style="width: 10%;"></td> <td style="width: 10%;"></td> <td style="width: 10%;"></td> <td style="width: 10%;"></td> <td style="width: 10%;"></td> <td style="width: 10%;"></td> </tr> <tr> <td></td> <td></td> <td colspan="8" style="text-align: center;"> <table border="1" style="width: 100%; border-collapse: collapse; text-align: center;"> <tr> <td style="width: 10%;"></td> <td style="width: 10%;"></td> <td style="width: 10%;"></td> <td style="width: 10%;"></td> <td style="width: 10%;"></td> <td style="width: 10%;"></td> <td style="width: 10%;"></td> <td style="width: 10%;"></td> <td style="width: 10%;"></td> <td style="width: 10%;"></td> </tr> <tr> <td></td> <td></td> <td colspan="8" style="text-align: center;"> <table border="1" style="width: 100%; border-collapse: collapse; text-align: center;"> <tr> <td style="width: 10%;"></td> <td style="width: 10%;"></td> <td style="width: 10%;"></td> <td style="width: 10%;"></td> <td style="width: 10%;"></td> <td style="width: 10%;"></td> <td style="width: 10%;"></td> <td style="width: 10%;"></td> <td style="width: 10%;"></td> <td style="width: 10%;"></td> </tr> <tr> <td></td> <td></td> <td colspan="8" style="text-align: center;"> <table border="1" style="width: 100%; border-collapse: collapse; text-align: center;"> <tr> <td style="width: 10%;"></td> <td style="width: 10%;"></td> <td style="width: 10%;"></td> <td style="width: 10%;"></td> <td style="width: 10%;"></td> <td style="width: 10%;"></td> <td style="width: 10%;"></td> <td style="width: 10%;"></td> <td style="width: 10%;"></td> <td style="width: 10%;"></td> </tr> <tr> <td></td> <td></td> <td colspan="8" style="text-align: center;"> <table border="1" style="width: 100%; border-collapse: collapse; text-align: center;"> <tr> <td style="width: 10%;"></td> <td style="width: 10%;"></td> <td style="width: 10%;"></td> <td style="width: 10%;"></td> <td style="width: 10%;"></td> <td style="width: 10%;"></td> <td style="width: 10%;"></td> <td style="width: 10%;"></td> <td style="width: 10%;"></td> <td style="width: 10%;"></td> </tr> <tr> <td></td> <td></td> <td colspan="8" style="text-align: center;"> <table border="1" style="width: 100%; border-collapse: collapse; text-align: center;"> <tr> <td style="width: 10%;"></td> <td style="width: 10%;"></td> <td style="width: 10%;"></td> <td style="width: 10%;"></td> <td style="width: 10%;"></td> <td style="width: 10%;"></td> <td style="width: 10%;"></td> <td style="width: 10%;"></td> <td style="width: 10%;"></td> <td style="width: 10%;"></td> </tr> <tr> <td></td> <td></td> <td colspan="8" style="text-align: center;"> <table border="1" style="width: 100%; border-collapse: collapse; text-align: center;"> <tr> <td style="width: 10%;"></td> <td style="width: 10%;"></td> <td style="width: 10%;"></td> <td style="width: 10%;"></td> <td style="width: 10%;"></td> <td style="width: 10%;"></td> <td style="width: 10%;"></td> <td style="width: 10%;"></td> <td style="width: 10%;"></td> <td style="width: 10%;"></td> </tr> <tr> <td></td> <td></td> <td colspan="8" style="text-align: center;"> <table border="1" style="width: 100%; border-collapse: collapse; text-align: center;"> <tr> <td style="width: 10%;"></td> <td style="width: 10%;"></td> <td style="width: 10%;"></td> <td style="width: 10%;"></td> <td style="width: 10%;"></td> <td style="width: 10%;"></td> <td style="width: 10%;"></td> <td style="width: 10%;"></td> <td style="width: 10%;"></td> <td style="width: 10%;"></td> </tr> <tr> <td></td> <td></td> <td colspan="8" style="text-align: center;"> <table border="1" style="width: 100%; border-collapse: collapse; text-align: center;"> <tr> <td style="width: 10%;"></td> <td style="width: 10%;"></td> <td style="width: 10%;"></td> <td style="width: 10%;"></td> <td style="width: 10%;"></td> <td style="width: 10%;"></td> <td style="width: 10%;"></td> <td style="width: 10%;"></td> <td style="width: 10%;"></td> <td style="width: 10%;"></td> </tr> <tr> <td></td> <td></td> <td colspan="8" style="text-align: center;"> <table border="1" style="width: 100%; border-collapse: collapse; text-align: center;"> <tr> <td style="width: 10%;"></td> <td style="width: 10%;"></td> <td style="width: 10%;"></td> <td style="width: 10%;"></td> <td style="width: 10%;"></td> <td style="width: 10%;"></td> <td style="width: 10%;"></td> <td style="width: 10%;"></td> <td style="width: 10%;"></td> <td style="width: 10%;"></td> </tr> <tr> <td></td> <td></td> <td colspan="8" style="text-align: center;"> <table border="1" style="width: 100%; border-collapse: collapse; text-align: center;"> <tr> <td style="width: 10%;"></td> <td style="width: 10%;"></td> <td style="width: 10%;"></td> <td style="width: 10%;"></td> <td style="width: 10%;"></td> <td style="width: 10%;"></td> <td style="width: 10%;"></td> <td style="width: 10%;"></td> <td style="width: 10%;"></td> <td style="width: 10%;"></td> </tr> <tr> <td></td> <td></td> <td colspan="8" style="text-align: center;"> <table border="1" style="width: 100%; border-collapse: collapse; text-align: center;"> <tr> <td style="width: 10%;"></td> <td style="width: 10%;"></td> <td style="width: 10%;"></td> <td style="width: 10%;"></td> <td style="width: 10%;"></td> <td style="width: 10%;"></td> <td style="width: 10%;"></td> <td style="width: 10%;"></td> <td style="width: 10%;"></td> <td style="width: 10%;"></td> </tr> <tr> <td></td> <td></td> <td colspan="8" style="text-align: center;"> <table border="1" style="width: 100%; border-collapse: collapse; text-align: center;"> <tr> <td style="width: 10%;"></td> <td style="width: 10%;"></td> <td style="width: 10%;"></td> <td style="width: 10%;"></td> <td style="width: 10%;"></td> <td style="width: 10%;"></td> <td style="width: 10%;"></td> <td style="width: 10%;"></td> <td style="width: 10%;"></td> <td style="width: 10%;"></td> </tr> <tr> <td></td> <td></td> <td colspan="8" style="text-align: center;"> <table border="1" style="width: 100%; border-collapse: collapse; text-align: center;"> <tr> <td style="width: 10%;"></td> <td style="width: 10%;"></td> <td style="width: 10%;"></td> <td style="width: 10%;"></td> <td style="width: 10%;"></td> <td style="width: 10%;"></td> <td style="width: 10%;"></td> <td style="width: 10%;"></td> <td style="width: 10%;"></td> <td style="width: 10%;"></td> </tr> <tr> <td></td> <td></td> <td colspan="8" style="text-align: center;"> <table border="1" style="width: 100%; border-collapse: collapse; text-align: center;"> <tr> <td style="width: 10%;"></td> <td style="width: 10%;"></td> <td style="width: 10%;"></td> <td style="width: 10%;"></td> <td style="width: 10%;"></td> <td style="width: 10%;"></td> <td style="width: 10%;"></td> <td style="width: 10%;"></td> <td style="width: 10%;"></td> <td style="width: 10%;"></td> </tr> <tr> <td></td> <td></td> <td colspan="8" style="text-align: center;"> <table border="1" style="width: 100%; border-collapse: collapse; text-align: center;"> <tr> <td style="width: 10%;"></td> <td style="width: 10%;"></td> <td style="width: 10%;"></td> <td style="width: 10%;"></td> <td style="width: 10%;"></td> <td style="width: 10%;"></td> <td style="width: 10%;"></td> <td style="width: 10%;"></td> <td style="width: 10%;"></td> <td style="width: 10%;"></td> </tr> <tr> <td></td> <td></td> <td colspan="8" style="text-align: center;"> <table border="1" style="width: 100%; border-collapse: collapse; text-align: center;"> <tr> <td style="width: 10%;"></td> <td style="width: 10%;"></td> <td style="width: 10%;"></td> <td style="width: 10%;"></td> <td style="width: 10%;"></td> <td style="width: 10%;"></td> <td style="width: 10%;"></td> <td style="width: 10%;"></td> <td style="width: 10%;"></td> <td style="width: 10%;"></td> </tr> <tr> <td></td> <td></td> <td colspan="8" style="text-align: center;"> <table border="1" style="width: 100%; border-collapse: collapse; text-align: center;"> <tr> <td style="width: 10%;"></td> <td style="width: 10%;"></td> <td style="width: 10%;"></td> <td style="width: 10%;"></td> <td
style="width: 10%;"></td> <td style="width: 10%;"></td> <td style="width: 10%;"></td> <td style="width: 10%;"></td> <td style="width: 10%;"></td> <td style="width: 10%;"></td> </tr> <tr> <td></td> <td></td> <td colspan="8" style="text-align: center;"> <table border="1" style="width: 100%; border-collapse: collapse; text-align: center;"> <tr> <td style="width: 10%;"></td> <td style="width: 10%;"></td> <td style="width: 10%;"></td> <td style="width: 10%;"></td> <td style="width: 10%;"></td> <td style="width: 10%;"></td> <td style="width: 10%;"></td> <td style="width: 10%;"></td> <td style="width: 10%;"></td> <td style="width: 10%;"></td> </tr> <tr> <td></td> <td></td> <td colspan="8" style="text-align: center;"> <table border="1" style="width: 100%; border-collapse: collapse; text-align: center;"> <tr> <td style="width: 10%;"></td> <td style="width: 10%;"></td> <td style="width: 10%;"></td> <td style="width: 10%;"></td> <td style="width: 10%;"></td> <td style="width: 10%;"></td> <td style="width: 10%;"></td> <td style="width: 10%;"></td> <td style="width: 10%;"></td> <td style="width: 10%;"></td> </tr> <tr> <td></td> <td></td> <td colspan="8" style="text-align: center;"> <table border="1" style="width: 100%; border-collapse: collapse; text-align: center;"> <tr> <td style="width: 10%;"></td> <td style="width: 10%;"></td> <td style="width: 10%;"></td> <td style="width: 10%;"></td> <td style="width: 10%;"></td> <td style="width: 10%;"></td> <td style="width: 10%;"></td> <td style="width: 10%;"></td> <td style="width: 10%;"></td> <td style="width: 10%;"></td> </tr> <tr> <td></td> <td></td> <td colspan="8" style="text-align: center;"> <table border="1" style="width: 100%; border-collapse: collapse; text-align: center;"> <tr> <td style="width: 10%;"></td> <td style="width: 10%;"></td> <td style="width: 10%;"></td> <td style="width: 10%;"></td> <td style="width: 10%;"></td> <td style="width: 10%;"></td> <td style="width: 10%;"></td> <td style="width: 10%;"></td> <td style="width: 10%;"></td> <td style="width: 10%;"></td> </tr> <tr> <td></td> <td></td> <td colspan="8" style="text-align: center;"> <table border="1" style="width: 100%; border-collapse: collapse; text-align: center;"> <tr> <td style="width: 10%;"></td> <td style="width: 10%;"></td> <td style="width: 10%;"></td> <td style="width: 10%;"></td> <td style="width: 10%;"></td> <td style="width: 10%;"></td> <td style="width: 10%;"></td> <td style="width: 10%;"></td> <td style="width: 10%;"></td> <td style="width: 10%;"></td> </tr> <tr> <td></td> <td></td> <td colspan="8" style="text-align: center;"> <table border="1" style="width: 100%; border-collapse: collapse; text-align: center;"> <tr> <td style="width: 10%;"></td> <td style="width: 10%;"></td> <td style="width: 10%;"></td> <td style="width: 10%;"></td> <td style="width: 10%;"></td> <td style="width: 10%;"></td> <td style="width: 10%;"></td> <td style="width: 10%;"></td> <td style="width: 10%;"></td> <td style="width: 10%;"></td> </tr> <tr> <td></td> <td></td> <td colspan="8" style="text-align: center;"> <table border="1" style="width: 100%; border-collapse: collapse; text-align: center;"> <tr> <td style="width: 10%;"></td> <td style="width: 10%;"></td> <td style="width: 10%;"></td> <td style="width: 10%;"></td> <td style="width: 10%;"></td> <td style="width: 10%;"></td> <td style="width: 10%;"></td> <td style="width: 10%;"></td> <td style="width: 10%;"></td> <td style="width: 10%;"></td> </tr> <tr> <td></td> <td></td> <td colspan="8" style="text-align: center;"> <table border="1" style="width: 100%; border-collapse: collapse; text-align: center;"> <tr> <td style="width: 10%;"></td> <td style="width: 10%;"></td> <td style="width: 10%;"></td> <td style="width: 10%;"></td> <td style="width: 10%;"></td> <td style="width: 10%;"></td> <td style="width: 10%;"></td> <td style="width: 10%;"></td> <td style="width: 10%;"></td> <td style="width: 10%;"></td> </tr> <tr> <td></td> <td></td> <td colspan="8" style="text-align: center;"> <table border="1" style="width: 100%; border-collapse: collapse; text-align: center;"> <tr> </tr></table></td></tr></table></td></tr></table></td></tr></table></td></tr></table></td></tr></table></td></tr></table></td></tr></table></td></tr></table></td></tr></table></td></tr></table></td></tr></table></td></tr></table></td></tr></table></td></tr></table></td></tr></table></td></tr></table></td></tr></table></td></tr></table></td></tr></table></td></tr></table></td></tr></table></td></tr></table></td></tr></table></td></tr></table></td></tr></table></td></tr></table></td></tr></table></td></tr></table></td></tr></table></td></tr></table></td></tr></table></td></tr></table></td></tr></table></td></tr></table></td></tr></table></td></tr></table></td></tr></table>
 | | | | | | | | | | | | | | | | | | | | <table border="1" style="width: 100%; border-collapse: collapse; text-align: center;"> <tr> <td style="width: 10%;"></td> <td style="width: 10%;"></td> <td style="width: 10%;"></td> <td style="width: 10%;"></td> <td style="width: 10%;"></td> <td style="width: 10%;"></td> <td style="width: 10%;"></td> <td style="width: 10%;"></td> <td style="width: 10%;"></td> <td style="width: 10%;"></td> </tr> <tr> <td></td> <td></td> <td colspan="8" style="text-align: center;"> <table border="1" style="width: 100%; border-collapse: collapse; text-align: center;"> <tr> <td style="width: 10%;"></td> <td style="width: 10%;"></td> <td style="width: 10%;"></td> <td style="width: 10%;"></td> <td style="width: 10%;"></td> <td style="width: 10%;"></td> <td style="width: 10%;"></td> <td style="width: 10%;"></td> <td style="width: 10%;"></td> <td style="width: 10%;"></td> </tr> <tr> <td></td> <td></td> <td colspan="8" style="text-align: center;"> <table border="1" style="width: 100%; border-collapse: collapse; text-align: center;"> <tr> <td style="width: 10%;"></td> <td style="width: 10%;"></td> <td style="width: 10%;"></td> <td style="width: 10%;"></td> <td style="width: 10%;"></td> <td style="width: 10%;"></td> <td style="width: 10%;"></td> <td style="width: 10%;"></td> <td style="width: 10%;"></td> <td style="width: 10%;"></td> </tr> <tr> <td></td> <td></td> <td colspan="8" style="text-align: center;"> <table border="1" style="width: 100%; border-collapse: collapse; text-align: center;"> <tr> <td style="width: 10%;"></td> <td style="width: 10%;"></td> <td style="width: 10%;"></td> <td style="width: 10%;"></td> <td style="width: 10%;"></td> <td style="width: 10%;"></td> <td style="width: 10%;"></td> <td style="width: 10%;"></td> <td style="width: 10%;"></td> <td style="width: 10%;"></td> </tr> <tr> <td></td> <td></td> <td colspan="8" style="text-align: center;"> <table border="1" style="width: 100%; border-collapse: collapse; text-align: center;"> <tr> <td style="width: 10%;"></td> <td style="width: 10%;"></td> <td style="width: 10%;"></td> <td style="width: 10%;"></td> <td style="width: 10%;"></td> <td style="width: 10%;"></td> <td style="width: 10%;"></td> <td style="width: 10%;"></td> <td style="width: 10%;"></td> <td style="width: 10%;"></td> </tr> <tr> <td></td> <td></td> <td colspan="8" style="text-align: center;"> <table border="1" style="width: 100%; border-collapse: collapse; text-align: center;"> <tr> <td style="width: 10%;"></td> <td style="width: 10%;"></td> <td style="width: 10%;"></td> <td style="width: 10%;"></td> <td style="width: 10%;"></td> <td style="width: 10%;"></td> <td style="width: 10%;"></td> <td style="width: 10%;"></td> <td style="width: 10%;"></td> <td style="width: 10%;"></td> </tr> <tr> <td></td> <td></td> <td colspan="8" style="text-align: center;"> <table border="1" style="width: 100%; border-collapse: collapse; text-align: center;"> <tr> <td style="width: 10%;"></td> <td style="width: 10%;"></td> <td style="width: 10%;"></td> <td style="width: 10%;"></td> <td style="width: 10%;"></td> <td style="width: 10%;"></td> <td style="width: 10%;"></td> <td style="width: 10%;"></td> <td style="width: 10%;"></td> <td style="width: 10%;"></td> </tr> <tr> <td></td> <td></td> <td colspan="8" style="text-align: center;"> <table border="1" style="width: 100%; border-collapse: collapse; text-align: center;"> <tr> <td style="width: 10%;"></td> <td style="width: 10%;"></td> <td style="width: 10%;"></td> <td style="width: 10%;"></td> <td style="width: 10%;"></td> <td style="width: 10%;"></td> <td style="width: 10%;"></td> <td style="width: 10%;"></td> <td style="width: 10%;"></td> <td style="width: 10%;"></td> </tr> <tr> <td></td> <td></td> <td colspan="8" style="text-align: center;"> <table border="1" style="width: 100%; border-collapse: collapse; text-align: center;"> <tr> <td style="width: 10%;"></td> <td style="width: 10%;"></td> <td style="width: 10%;"></td> <td style="width: 10%;"></td> <td style="width: 10%;"></td> <td style="width: 10%;"></td> <td style="width: 10%;"></td> <td style="width: 10%;"></td> <td style="width: 10%;"></td> <td style="width: 10%;"></td> </tr> <tr> <td></td> <td></td> <td colspan="8" style="text-align: center;"> <table border="1" style="width: 100%; border-collapse: collapse; text-align: center;"> <tr> <td style="width: 10%;"></td> <td style="width: 10%;"></td> <td style="width: 10%;"></td> <td style="width: 10%;"></td> <td style="width: 10%;"></td> <td style="width: 10%;"></td> <td style="width: 10%;"></td> <td style="width: 10%;"></td> <td style="width: 10%;"></td> <td style="width: 10%;"></td> </tr> <tr> <td></td> <td></td> <td colspan="8" style="text-align: center;"> <table border="1" style="width: 100%; border-collapse: collapse; text-align: center;"> <tr> <td style="width: 10%;"></td> <td style="width: 10%;"></td> <td style="width: 10%;"></td> <td style="width: 10%;"></td> <td style="width: 10%;"></td> <td style="width: 10%;"></td> <td style="width: 10%;"></td> <td style="width: 10%;"></td> <td style="width: 10%;"></td> <td style="width: 10%;"></td> </tr> <tr> <td></td> <td></td> <td colspan="8" style="text-align: center;"> <table border="1" style="width: 100%; border-collapse: collapse; text-align: center;"> <tr> <td style="width: 10%;"></td> <td style="width: 10%;"></td> <td style="width: 10%;"></td> <td style="width: 10%;"></td> <td style="width: 10%;"></td> <td style="width: 10%;"></td> <td style="width: 10%;"></td> <td style="width: 10%;"></td> <td style="width: 10%;"></td> <td style="width: 10%;"></td> </tr> <tr> <td></td> <td></td> <td colspan="8" style="text-align: center;"> <table border="1" style="width: 100%; border-collapse: collapse; text-align: center;"> <tr> <td style="width: 10%;"></td> <td style="width: 10%;"></td> <td style="width: 10%;"></td> <td style="width: 10%;"></td> <td style="width: 10%;"></td> <td style="width: 10%;"></td> <td style="width: 10%;"></td> <td style="width:
10%;"></td> <td style="width: 10%;"></td> <td style="width: 10%;"></td> </tr> <tr> <td></td> <td></td> <td colspan="8" style="text-align: center;"> <table border="1" style="width: 100%; border-collapse: collapse; text-align: center;"> <tr> <td style="width: 10%;"></td> <td style="width: 10%;"></td> <td style="width: 10%;"></td> <td style="width: 10%;"></td> <td style="width: 10%;"></td> <td style="width: 10%;"></td> <td style="width: 10%;"></td> <td style="width: 10%;"></td> <td style="width: 10%;"></td> <td style="width: 10%;"></td> </tr> <tr> <td></td> <td></td> <td colspan="8" style="text-align: center;"> <table border="1" style="width: 100%; border-collapse: collapse; text-align: center;"> <tr> <td style="width: 10%;"></td> <td style="width: 10%;"></td> <td style="width: 10%;"></td> <td style="width: 10%;"></td> <td style="width: 10%;"></td> <td style="width: 10%;"></td> <td style="width: 10%;"></td> <td style="width: 10%;"></td> <td style="width: 10%;"></td> <td style="width: 10%;"></td> </tr> <tr> <td></td> <td></td> <td colspan="8" style="text-align: center;"> <table border="1" style="width: 100%; border-collapse: collapse; text-align: center;"> <tr> <td style="width: 10%;"></td> <td style="width: 10%;"></td> <td style="width: 10%;"></td> <td style="width: 10%;"></td> <td style="width: 10%;"></td> <td style="width: 10%;"></td> <td style="width: 10%;"></td> <td style="width: 10%;"></td> <td style="width: 10%;"></td> <td style="width: 10%;"></td> </tr> <tr> <td></td> <td></td> <td colspan="8" style="text-align: center;"> <table border="1" style="width: 100%; border-collapse: collapse; text-align: center;"> <tr> <td style="width: 10%;"></td> <td style="width: 10%;"></td> <td style="width: 10%;"></td> <td style="width: 10%;"></td> <td style="width: 10%;"></td> <td style="width: 10%;"></td> <td style="width: 10%;"></td> <td style="width: 10%;"></td> <td style="width: 10%;"></td> <td style="width: 10%;"></td> </tr> <tr> <td></td> <td></td> <td colspan="8" style="text-align: center;"> <table border="1" style="width: 100%; border-collapse: collapse; text-align: center;"> <tr> <td style="width: 10%;"></td> <td style="width: 10%;"></td> <td style="width: 10%;"></td> <td style="width: 10%;"></td> <td style="width: 10%;"></td> <td style="width: 10%;"></td> <td style="width: 10%;"></td> <td style="width: 10%;"></td> <td style="width: 10%;"></td> <td style="width: 10%;"></td> </tr> <tr> <td></td> <td></td> <td colspan="8" style="text-align: center;"> <table border="1" style="width: 100%; border-collapse: collapse; text-align: center;"> <tr> <td style="width: 10%;"></td> <td style="width: 10%;"></td> <td style="width: 10%;"></td> <td style="width: 10%;"></td> <td style="width: 10%;"></td> <td style="width: 10%;"></td> <td style="width: 10%;"></td> <td style="width: 10%;"></td> <td style="width: 10%;"></td> <td style="width: 10%;"></td> </tr> <tr> <td></td> <td></td> <td colspan="8" style="text-align: center;"> <table border="1" style="width: 100%; border-collapse: collapse; text-align: center;"> <tr> <td style="width: 10%;"></td> <td style="width: 10%;"></td> <td style="width: 10%;"></td> <td style="width: 10%;"></td> <td style="width: 10%;"></td> <td style="width: 10%;"></td> <td style="width: 10%;"></td> <td style="width: 10%;"></td> <td style="width: 10%;"></td> <td style="width: 10%;"></td> </tr> <tr> <td></td> <td></td> <td colspan="8" style="text-align: center;"> <table border="1" style="width: 100%; border-collapse: collapse; text-align: center;"> <tr> <td style="width: 10%;"></td> <td style="width: 10%;"></td> <td style="width: 10%;"></td> <td style="width: 10%;"></td> <td style="width: 10%;"></td> <td style="width: 10%;"></td> <td style="width: 10%;"></td> <td style="width: 10%;"></td> <td style="width: 10%;"></td> <td style="width: 10%;"></td> </tr> <tr> <td></td> <td></td> <td colspan="8" style="text-align: center;"> <table border="1" style="width: 100%; border-collapse: collapse; text-align: center;"> <tr> <td style="width: 10%;"></td> <td style="width: 10%;"></td> <td style="width: 10%;"></td> <td style="width: 10%;"></td> <td style="width: 10%;"></td> <td style="width: 10%;"></td> <td style="width: 10%;"></td> <td style="width: 10%;"></td> <td style="width: 10%;"></td> <td style="width: 10%;"></td> </tr> <tr> <td></td> <td></td> <td colspan="8" style="text-align: center;"> <table border="1" style="width: 100%; border-collapse: collapse; text-align: center;"> <tr> <td style="width: 10%;"></td> <td style="width: 10%;"></td> <td style="width: 10%;"></td> <td style="width: 10%;"></td> <td style="width: 10%;"></td> <td style="width: 10%;"></td> <td style="width: 10%;"></td> <td style="width: 10%;"></td> <td style="width: 10%;"></td> <td style="width: 10%;"></td> </tr> <tr> <td></td> <td></td> <td colspan="8" style="text-align: center;"> <table border="1" style="width: 100%; border-collapse: collapse; text-align: center;"> <tr> <td style="width: 10%;"></td> <td style="width: 10%;"></td> <td style="width: 10%;"></td> <td style="width: 10%;"></td> <td style="width: 10%;"></td> <td style="width: 10%;"></td> <td style="width: 10%;"></td> <td style="width: 10%;"></td> <td style="width: 10%;"></td> <td style="width: 10%;"></td> </tr> <tr> <td></td> <td></td> <td colspan="8" style="text-align: center;"> <table border="1" style="width: 100%; border-collapse: collapse; text-align: center;"> <tr> <td style="width: 10%;"></td> <td style="width: 10%;"></td> <td style="width: 10%;"></td> <td style="width: 10%;"></td> <td style="width: 10%;"></td> <td style="width: 10%;"></td> <td style="width: 10%;"></td> <td style="width: 10%;"></td> <td style="width: 10%;"></td> <td style="width: 10%;"></td> </tr> <tr> <td></td> <td></td> <td colspan="8" style="text-align: center;"> <table border="1" style="width: 100%; border-collapse: collapse; text-align: center;"> <tr> <td style="width: 10%;"></td> <td style="width: 10%;"></td> <td style="width: 10%;"></td> <td style="width: 10%;"></td> <td style="width: 10%;"></td> <td style="width: 10%;"></td> <td style="width: 10%;"></td> <td style="width: 10%;"></td> <td style="width: 10%;"></td> <td style="width: 10%;"></td> </tr> <tr> <td></td> <td></td> <td colspan="8" style="text-align: center;"> <table border="1" style="width: 100%; border-collapse: collapse; text-align: center;"> <tr> <td style="width: 10%;"></td> <td style="width: 10%;"></td> <td style="width: 10%;"></td> <td style="width: 10%;"></td> <td style="width: 10%;"></td> <td style="width: 10%;"></td> <td style="width: 10%;"></td> <td style="width: 10%;"></td> <td style="width: 10%;"></td> <td style="width: 10%;"></td> </tr> <tr> <td></td> <td></td> <td colspan="8" style="text-align: center;"> <table border="1" style="width: 100%; border-collapse: collapse; text-align: center;"> <tr> <td style="width: 10%;"></td> <td style="width: 10%;"></td> <td style="width: 10%;"></td> <td style="width: 10%;"></td> <td style="width: 10%;"></td> <td style="width: 10%;"></td> <td style="width: 10%;"></td> <td style="width: 10%;"></td> <td style="width: 10%;"></td> <td style="width: 10%;"></td> </tr> <tr> <td></td> <td></td> <td colspan="8" style="text-align: center;"> <table border="1" style="width: 100%; border-collapse: collapse; text-align: center;"> <tr> <td style="width: 10%;"></td> <td style="width: 10%;"></td> <td style="width: 10%;"></td> <td style="width: 10%;"></td> <td style="width: 10%;"></td> <td style="width: 10%;"></td> <td style="width: 10%;"></td> <td style="width: 10%;"></td> <td style="width: 10%;"></td> <td style="width: 10%;"></td> </tr> <tr> <td></td> <td></td> <td colspan="8" style="text-align: center;"> <table border="1" style="width: 100%; border-collapse: collapse; text-align: center;"> <tr> <td style="width: 10%;"></td> <td style="width: 10%;"></td> <td style="width: 10%;"></td> <td style="width: 10%;"></td> <td style="width: 10%;"></td> <td style="width: 10%;"></td> <td style="width: 10%;"></td> <td style="width: 10%;"></td> <td style="width: 10%;"></td> <td style="width: 10%;"></td> </tr> <tr> <td></td> <td></td> <td colspan="8" style="text-align: center;"> <table border="1" style="width: 100%; border-collapse: collapse; text-align: center;"> <tr> <td style="width: 10%;"></td> <td style="width: 10%;"></td> <td style="width: 10%;"></td> <td style="width: 10%;"></td> <td style="width: 10%;"></td> <td style="width: 10%;"></td> <td style="width: 10%;"></td> <td style="width: 10%;"></td> <td style="width: 10%;"></td> <td style="width: 10%;"></td> </tr> <tr> <td></td> <td></td> <td colspan="8" style="text-align: center;"> <table border="1" style="width: 100%; border-collapse: collapse; text-align: center;"> <tr> <td style="width: 10%;"></td> <td style="width: 10%;"></td> <td style="width: 10%;"></td> <td style="width: 10%;"></td> <td style="width: 10%;"></td> <td style="width: 10%;"></td> <td style="width: 10%;"></td> <td style="width: 10%;"></td> <td style="width: 10%;"></td> <td style="width: 10%;"></td> </tr> <tr> <td></td> <td></td> <td colspan="8" style="text-align: center;"> <table border="1" style="width: 100%; border-collapse: collapse; text-align: center;"> <tr> <td style="width: 10%;"></td> <td style="width: 10%;"></td> <td style="width: 10%;"></td> <td style="width: 10%;"></td> <td style="width: 10%;"></td> <td style="width: 10%;"></td> <td style="width: 10%;"></td> <td style="width: 10%;"></td> <td style="width: 10%;"></td> <td style="width: 10%;"></td> </tr> <tr> <td></td> <td></td> <td colspan="8" style="text-align: center;"> <table border="1" style="width: 100%; border-collapse: collapse; text-align: center;"> <tr> <td style="width: 10%;"></td> <td style="width: 10%;"></td> <td style="width: 10%;"></td> <td style="width: 10%;"></td> <td style="width: 10%;"></td> <td style="width: 10%;"></td> <td style="width: 10%;"></td> <td style="width: 10%;"></td> <td style="width: 10%;"></td> <td style="width: 10%;"></td> </tr> <tr> <td></td> <td></td> <td colspan="8" style="text-align: center;"> <table border="1"
style="width: 100%; border-collapse: collapse; text-align: center;"> <tr> <td style="width: 10%;"></td> <td style="width: 10%;"></td> <td style="width: 10%;"></td> <td style="width: 10%;"></td> <td style="width: 10%;"></td> <td style="width: 10%;"></td> <td style="width: 10%;"></td> <td style="width: 10%;"></td> <td style="width: 10%;"></td> <td style="width: 10%;"></td> </tr> <tr> <td></td> <td></td> <td colspan="8" style="text-align: center;"> <table border="1" style="width: 100%; border-collapse: collapse; text-align: center;"> <tr> <td style="width: 10%;"></td> <td style="width: 10%;"></td> <td style="width: 10%;"></td> <td style="width: 10%;"></td> <td style="width: 10%;"></td> <td style="width: 10%;"></td> <td style="width: 10%;"></td> <td style="width: 10%;"></td> <td style="width: 10%;"></td> <td style="width: 10%;"></td> </tr> <tr> <td></td> <td></td> <td colspan="8" style="text-align: center;"> <table border="1" style="width: 100%; border-collapse: collapse; text-align: center;"> <tr> </tr></table></td></tr></table></td></tr></table></td></tr></table></td></tr></table></td></tr></table></td></tr></table></td></tr></table></td></tr></table></td></tr></table></td></tr></table></td></tr></table></td></tr></table></td></tr></table></td></tr></table></td></tr></table></td></tr></table></td></tr></table></td></tr></table></td></tr></table></td></tr></table></td></tr></table></td></tr></table></td></tr></table></td></tr></table></td></tr></table></td></tr></table></td></tr></table></td></tr></table></td></tr></table></td></tr></table></td></tr></table></td></tr></table></td></tr></table></td></tr></table></td></tr></table></td></tr></table>
 | | | | | | | | | | | | | | | | | | | | <table border="1" style="width: 100%; border-collapse: collapse; text-align: center;"> <tr> <td style="width: 10%;"></td> <td style="width: 10%;"></td> <td style="width: 10%;"></td> <td style="width: 10%;"></td> <td style="width: 10%;"></td> <td style="width: 10%;"></td> <td style="width: 10%;"></td> <td style="width: 10%;"></td> <td style="width: 10%;"></td> <td style="width: 10%;"></td> </tr> <tr> <td></td> <td></td> <td colspan="8" style="text-align: center;"> <table border="1" style="width: 100%; border-collapse: collapse; text-align: center;"> <tr> <td style="width: 10%;"></td> <td style="width: 10%;"></td> <td style="width: 10%;"></td> <td style="width: 10%;"></td> <td style="width: 10%;"></td> <td style="width: 10%;"></td> <td style="width: 10%;"></td> <td style="width: 10%;"></td> <td style="width: 10%;"></td> <td style="width: 10%;"></td> </tr> <tr> <td></td> <td></td> <td colspan="8" style="text-align: center;"> <table border="1" style="width: 100%; border-collapse: collapse; text-align: center;"> <tr> <td style="width: 10%;"></td> <td style="width: 10%;"></td> <td style="width: 10%;"></td> <td style="width: 10%;"></td> <td style="width: 10%;"></td> <td style="width: 10%;"></td> <td style="width: 10%;"></td> <td style="width: 10%;"></td> <td style="width: 10%;"></td> <td style="width: 10%;"></td> </tr> <tr> <td></td> <td></td> <td colspan="8" style="text-align: center;"> <table border="1" style="width: 100%; border-collapse: collapse; text-align: center;"> <tr> <td style="width: 10%;"></td> <td style="width: 10%;"></td> <td style="width: 10%;"></td> <td style="width: 10%;"></td> <td style="width: 10%;"></td> <td style="width: 10%;"></td> <td style="width: 10%;"></td> <td style="width: 10%;"></td> <td style="width: 10%;"></td> <td style="width: 10%;"></td> </tr> <tr> <td></td> <td></td> <td colspan="8" style="text-align: center;"> <table border="1" style="width: 100%; border-collapse: collapse; text-align: center;"> <tr> <td style="width: 10%;"></td> <td style="width: 10%;"></td> <td style="width: 10%;"></td> <td style="width: 10%;"></td> <td style="width: 10%;"></td> <td style="width: 10%;"></td> <td style="width: 10%;"></td> <td style="width: 10%;"></td> <td style="width: 10%;"></td> <td style="width: 10%;"></td> </tr> <tr> <td></td> <td></td> <td colspan="8" style="text-align: center;"> <table border="1" style="width: 100%; border-collapse: collapse; text-align: center;"> <tr> <td style="width: 10%;"></td> <td style="width: 10%;"></td> <td style="width: 10%;"></td> <td style="width: 10%;"></td> <td style="width: 10%;"></td> <td style="width: 10%;"></td> <td style="width: 10%;"></td> <td style="width: 10%;"></td> <td style="width: 10%;"></td> <td style="width: 10%;"></td> </tr> <tr> <td></td> <td></td> <td colspan="8" style="text-align: center;"> <table border="1" style="width: 100%; border-collapse: collapse; text-align: center;"> <tr> <td style="width: 10%;"></td> <td style="width: 10%;"></td> <td style="width: 10%;"></td> <td style="width: 10%;"></td> <td style="width: 10%;"></td> <td style="width: 10%;"></td> <td style="width: 10%;"></td> <td style="width: 10%;"></td> <td style="width: 10%;"></td> <td style="width: 10%;"></td> </tr> <tr> <td></td> <td></td> <td colspan="8" style="text-align: center;"> <table border="1" style="width: 100%; border-collapse: collapse; text-align: center;"> <tr> <td style="width: 10%;"></td> <td style="width: 10%;"></td> <td style="width: 10%;"></td> <td style="width: 10%;"></td> <td style="width: 10%;"></td> <td style="width: 10%;"></td> <td style="width: 10%;"></td> <td style="width: 10%;"></td> <td style="width: 10%;"></td> <td style="width: 10%;"></td> </tr> <tr> <td></td> <td></td> <td colspan="8" style="text-align: center;"> <table border="1" style="width: 100%; border-collapse: collapse; text-align: center;"> <tr> <td style="width: 10%;"></td> <td style="width: 10%;"></td> <td style="width: 10%;"></td> <td style="width: 10%;"></td> <td style="width: 10%;"></td> <td style="width: 10%;"></td> <td style="width: 10%;"></td> <td style="width: 10%;"></td> <td style="width: 10%;"></td> <td style="width: 10%;"></td> </tr> <tr> <td></td> <td></td> <td colspan="8" style="text-align: center;"> <table border="1" style="width: 100%; border-collapse: collapse; text-align: center;"> <tr> <td style="width: 10%;"></td> <td style="width: 10%;"></td> <td style="width: 10%;"></td> <td style="width: 10%;"></td> <td style="width: 10%;"></td> <td style="width: 10%;"></td> <td style="width: 10%;"></td> <td style="width: 10%;"></td> <td style="width: 10%;"></td> <td style="width: 10%;"></td> </tr> <tr> <td></td> <td></td> <td colspan="8" style="text-align: center;"> <table border="1" style="width: 100%; border-collapse: collapse; text-align: center;"> <tr> <td style="width: 10%;"></td> <td style="width: 10%;"></td> <td style="width: 10%;"></td> <td style="width: 10%;"></td> <td style="width: 10%;"></td> <td style="width: 10%;"></td> <td style="width: 10%;"></td> <td style="width: 10%;"></td> <td style="width: 10%;"></td> <td style="width: 10%;"></td> </tr> <tr> <td></td> <td></td> <td colspan="8" style="text-align: center;"> <table border="1" style="width: 100%; border-collapse: collapse; text-align: center;"> <tr> <td style="width: 10%;"></td> <td style="width: 10%;"></td> <td style="width: 10%;"></td> <td style="width: 10%;"></td> <td style="width: 10%;"></td> <td style="width: 10%;"></td> <td style="width: 10%;"></td> <td style="width: 10%;"></td> <td style="width: 10%;"></td> <td style="width: 10%;"></td> </tr> <tr> <td></td> <td></td> <td colspan="8" style="text-align: center;"> <table border="1" style="width: 100%; border-collapse: collapse; text-align: center;"> <tr> <td style="width: 10%;"></td> <td style="width: 10%;"></td> <td style="width: 10%;"></td> <td style="width: 10%;"></td> <td style="width: 10%;"></td> <td style="width: 10%;"></td> <td style="width: 10%;"></td> <td style="width: 10%;"></td> <td style="width: 10%;"></td> <td style="width: 10%;"></td> </tr> <tr> <td></td> <td></td> <td colspan="8" style="text-align: center;"> <table border="1" style="width: 100%; border-collapse: collapse; text-align: center;"> <tr> <td style="width: 10%;"></td> <td style="width: 10%;"></td> <td style="width: 10%;"></td> <td style="width: 10%;"></td> <td style="width: 10%;"></td> <td style="width: 10%;"></td> <td style="width: 10%;"></td> <td style="width: 10%;"></td> <td style="width: 10%;"></td> <td style="width: 10%;"></td> </tr> <tr> <td></td> <td></td> <td colspan="8" style="text-align: center;"> <table border="1" style="width: 100%; border-collapse: collapse; text-align: center;"> <tr> <td style="width: 10%;"></td> <td style="width: 10%;"></td> <td style="width: 10%;"></td> <td style="width: 10%;"></td> <td style="width: 10%;"></td> <td style="width: 10%;"></td> <td style="width: 10%;"></td> <td style="width: 10%;"></td> <td style="width: 10%;"></td> <td style="width: 10%;"></td> </tr> <tr> <td></td> <td></td> <td colspan="8" style="text-align: center;"> <table border="1" style="width: 100%; border-collapse: collapse; text-align: center;"> <tr> <td style="width: 10%;"></td> <td style="width: 10%;"></td> <td style="width: 10%;"></td> <td style="width: 10%;"></td> <td style="width: 10%;"></td> <td style="width: 10%;"></td> <td style="width: 10%;"></td> <td style="width: 10%;"></td> <td style="width: 10%;"></td> <td style="width: 10%;"></td> </tr> <tr> <td></td> <td></td> <td colspan="8" style="text-align: center;"> <table border="1" style="width: 100%; border-collapse: collapse; text-align: center;"> <tr> <td style="width: 10%;"></td> <td style="width: 10%;"></td> <td style="width: 10%;"></td> <td style="width: 10%;"></td> <td style="width: 10%;"></td> <td style="width: 10%;"></td> <td style="width: 10%;"></td> <td style="width: 10%;"></td> <td style="width: 10%;"></td> <td style="width: 10%;"></td> </tr> <tr> <td></td> <td></td> <td colspan="8" style="text-align: center;"> <table border="1" style="width: 100%; border-collapse: collapse; text-align: center;"> <tr> <td style="width: 10%;"></td> <td style="width: 10%;"></td> <td style="width: 10%;"></td> <td style="width: 10%;"></td> <td style="width: 10%;"></td> <td style="width: 10%;"></td> <td style="width: 10%;"></td> <td style="width: 10%;"></td> <td style="width: 10%;"></td> <td style="width: 10%;"></td> </tr> <tr> <td></td> <td></td> <td colspan="8" style="text-align: center;"> <table border="1" style="width: 100%; border-collapse: collapse; text-align: center;"> <tr> <td style="width: 10%;"></td> <td style="width: 10%;"></td> <td style="width: 10%;"></td> <td style="width: 10%;"></td> <td style="width: 10%;"></td> <td style="width: 10%;"></td> <td style="width: 10%;"></td> <td style="width: 10%;"></td> <td style="width: 10%;"></td> <td style="width: 10%;"></td> </tr> <tr> <td></td> <td></td> <td colspan="8" style="text-align: center;"> <table border="1" style="width: 100%; border-collapse: collapse; text-align: center;"> <tr> <td style="width: 10%;"></td> <td style="width:
10%;"></td> <td style="width: 10%;"></td> <td style="width: 10%;"></td> <td style="width: 10%;"></td> <td style="width: 10%;"></td> <td style="width: 10%;"></td> <td style="width: 10%;"></td> <td style="width: 10%;"></td> <td style="width: 10%;"></td> </tr> <tr> <td></td> <td></td> <td colspan="8" style="text-align: center;"> <table border="1" style="width: 100%; border-collapse: collapse; text-align: center;"> <tr> <td style="width: 10%;"></td> <td style="width: 10%;"></td> <td style="width: 10%;"></td> <td style="width: 10%;"></td> <td style="width: 10%;"></td> <td style="width: 10%;"></td> <td style="width: 10%;"></td> <td style="width: 10%;"></td> <td style="width: 10%;"></td> <td style="width: 10%;"></td> </tr> <tr> <td></td> <td></td> <td colspan="8" style="text-align: center;"> <table border="1" style="width: 100%; border-collapse: collapse; text-align: center;"> <tr> <td style="width: 10%;"></td> <td style="width: 10%;"></td> <td style="width: 10%;"></td> <td style="width: 10%;"></td> <td style="width: 10%;"></td> <td style="width: 10%;"></td> <td style="width: 10%;"></td> <td style="width: 10%;"></td> <td style="width: 10%;"></td> <td style="width: 10%;"></td> </tr> <tr> <td></td> <td></td> <td colspan="8" style="text-align: center;"> <table border="1" style="width: 100%; border-collapse: collapse; text-align: center;"> <tr> <td style="width: 10%;"></td> <td style="width: 10%;"></td> <td style="width: 10%;"></td> <td style="width: 10%;"></td> <td style="width: 10%;"></td> <td style="width: 10%;"></td> <td style="width: 10%;"></td> <td style="width: 10%;"></td> <td style="width: 10%;"></td> <td style="width: 10%;"></td> </tr> <tr> <td></td> <td></td> <td colspan="8" style="text-align: center;"> <table border="1" style="width: 100%; border-collapse: collapse; text-align: center;"> <tr> <td style="width: 10%;"></td> <td style="width: 10%;"></td> <td style="width: 10%;"></td> <td style="width: 10%;"></td> <td style="width: 10%;"></td> <td style="width: 10%;"></td> <td style="width: 10%;"></td> <td style="width: 10%;"></td> <td style="width: 10%;"></td> <td style="width: 10%;"></td> </tr> <tr> <td></td> <td></td> <td colspan="8" style="text-align: center;"> <table border="1" style="width: 100%; border-collapse: collapse; text-align: center;"> <tr> <td style="width: 10%;"></td> <td style="width: 10%;"></td> <td style="width: 10%;"></td> <td style="width: 10%;"></td> <td style="width: 10%;"></td> <td style="width: 10%;"></td> <td style="width: 10%;"></td> <td style="width: 10%;"></td> <td style="width: 10%;"></td> <td style="width: 10%;"></td> </tr> <tr> <td></td> <td></td> <td colspan="8" style="text-align: center;"> <table border="1" style="width: 100%; border-collapse: collapse; text-align: center;"> <tr> <td style="width: 10%;"></td> <td style="width: 10%;"></td> <td style="width: 10%;"></td> <td style="width: 10%;"></td> <td style="width: 10%;"></td> <td style="width: 10%;"></td> <td style="width: 10%;"></td> <td style="width: 10%;"></td> <td style="width: 10%;"></td> <td style="width: 10%;"></td> </tr> <tr> <td></td> <td></td> <td colspan="8" style="text-align: center;"> <table border="1" style="width: 100%; border-collapse: collapse; text-align: center;"> <tr> <td style="width: 10%;"></td> <td style="width: 10%;"></td> <td style="width: 10%;"></td> <td style="width: 10%;"></td> <td style="width: 10%;"></td> <td style="width: 10%;"></td> <td style="width: 10%;"></td> <td style="width: 10%;"></td> <td style="width: 10%;"></td> <td style="width: 10%;"></td> </tr> <tr> <td></td> <td></td> <td colspan="8" style="text-align: center;"> <table border="1" style="width: 100%; border-collapse: collapse; text-align: center;"> <tr> <td style="width: 10%;"></td> <td style="width: 10%;"></td> <td style="width: 10%;"></td> <td style="width: 10%;"></td> <td style="width: 10%;"></td> <td style="width: 10%;"></td> <td style="width: 10%;"></td> <td style="width: 10%;"></td> <td style="width: 10%;"></td> <td style="width: 10%;"></td> </tr> <tr> <td></td> <td></td> <td colspan="8" style="text-align: center;"> <table border="1" style="width: 100%; border-collapse: collapse; text-align: center;"> <tr> <td style="width: 10%;"></td> <td style="width: 10%;"></td> <td style="width: 10%;"></td> <td style="width: 10%;"></td> <td style="width: 10%;"></td> <td style="width: 10%;"></td> <td style="width: 10%;"></td> <td style="width: 10%;"></td> <td style="width: 10%;"></td> <td style="width: 10%;"></td> </tr> <tr> <td></td> <td></td> <td colspan="8" style="text-align: center;"> <table border="1" style="width: 100%; border-collapse: collapse; text-align: center;"> <tr> <td style="width: 10%;"></td> <td style="width: 10%;"></td> <td style="width: 10%;"></td> <td style="width: 10%;"></td> <td style="width: 10%;"></td> <td style="width: 10%;"></td> <td style="width: 10%;"></td> <td style="width: 10%;"></td> <td style="width: 10%;"></td> <td style="width: 10%;"></td> </tr> <tr> <td></td> <td></td> <td colspan="8" style="text-align: center;"> <table border="1" style="width: 100%; border-collapse: collapse; text-align: center;"> <tr> <td style="width: 10%;"></td> <td style="width: 10%;"></td> <td style="width: 10%;"></td> <td style="width: 10%;"></td> <td style="width: 10%;"></td> <td style="width: 10%;"></td> <td style="width: 10%;"></td> <td style="width: 10%;"></td> <td style="width: 10%;"></td> <td style="width: 10%;"></td> </tr> <tr> <td></td> <td></td> <td colspan="8" style="text-align: center;"> <table border="1" style="width: 100%; border-collapse: collapse; text-align: center;"> <tr> <td style="width: 10%;"></td> <td style="width: 10%;"></td> <td style="width: 10%;"></td> <td style="width: 10%;"></td> <td style="width: 10%;"></td> <td style="width: 10%;"></td> <td style="width: 10%;"></td> <td style="width: 10%;"></td> <td style="width: 10%;"></td> <td style="width: 10%;"></td> </tr> <tr> <td></td> <td></td> <td colspan="8" style="text-align: center;"> <table border="1" style="width: 100%; border-collapse: collapse; text-align: center;"> <tr> <td style="width: 10%;"></td> <td style="width: 10%;"></td> <td style="width: 10%;"></td> <td style="width: 10%;"></td> <td style="width: 10%;"></td> <td style="width: 10%;"></td> <td style="width: 10%;"></td> <td style="width: 10%;"></td> <td style="width: 10%;"></td> <td style="width: 10%;"></td> </tr> <tr> <td></td> <td></td> <td colspan="8" style="text-align: center;"> <table border="1" style="width: 100%; border-collapse: collapse; text-align: center;"> <tr> <td style="width: 10%;"></td> <td style="width: 10%;"></td> <td style="width: 10%;"></td> <td style="width: 10%;"></td> <td style="width: 10%;"></td> <td style="width: 10%;"></td> <td style="width: 10%;"></td> <td style="width: 10%;"></td> <td style="width: 10%;"></td> <td style="width: 10%;"></td> </tr> <tr> <td></td> <td></td> <td colspan="8" style="text-align: center;"> <table border="1" style="width: 100%; border-collapse: collapse; text-align: center;"> <tr> <td style="width: 10%;"></td> <td style="width: 10%;"></td> <td style="width: 10%;"></td> <td style="width: 10%;"></td> <td style="width: 10%;"></td> <td style="width: 10%;"></td> <td style="width: 10%;"></td> <td style="width: 10%;"></td> <td style="width: 10%;"></td> <td style="width: 10%;"></td> </tr> <tr> <td></td> <td></td> <td colspan="8" style="text-align: center;"> <table border="1" style="width: 100%; border-collapse: collapse; text-align: center;"> <tr> </tr></table></td></tr></table></td></tr></table></td></tr></table></td></tr></table></td></tr></table></td></tr></table></td></tr></table></td></tr></table></td></tr></table></td></tr></table></td></tr></table></td></tr></table></td></tr></table></td></tr></table></td></tr></table></td></tr></table></td></tr></table></td></tr></table></td></tr></table></td></tr></table></td></tr></table></td></tr></table></td></tr></table></td></tr></table></td></tr></table></td></tr></table></td></tr></table></td></tr></table></td></tr></table></td></tr></table></td></tr></table></td></tr></table></td></tr></table></td></tr></table></td></tr></table>
 | | | | | | | | | | | | | | | | | | | | <table border="1" style="width: 100%; border-collapse: collapse; text-align: center;"> <tr> <td style="width: 10%;"></td> <td style="width: 10%;"></td> <td style="width: 10%;"></td> <td style="width: 10%;"></td> <td style="width: 10%;"></td> <td style="width: 10%;"></td> <td style="width: 10%;"></td> <td style="width: 10%;"></td> <td style="width: 10%;"></td> <td style="width: 10%;"></td> </tr> <tr> <td></td> <td></td> <td colspan="8" style="text-align: center;"> <table border="1" style="width: 100%; border-collapse: collapse; text-align: center;"> <tr> <td style="width: 10%;"></td> <td style="width: 10%;"></td> <td style="width: 10%;"></td> <td style="width: 10%;"></td> <td style="width: 10%;"></td> <td style="width: 10%;"></td> <td style="width: 10%;"></td> <td style="width: 10%;"></td> <td style="width: 10%;"></td> <td style="width: 10%;"></td> </tr> <tr> <td></td> <td></td> <td colspan="8" style="text-align: center;"> <table border="1" style="width: 100%; border-collapse: collapse; text-align: center;"> <tr> <td style="width: 10%;"></td> <td style="width: 10%;"></td> <td style="width: 10%;"></td> <td style="width: 10%;"></td> <td style="width: 10%;"></td> <td style="width: 10%;"></td> <td style="width: 10%;"></td> <td style="width: 10%;"></td> <td style="width: 10%;"></td> <td style="width: 10%;"></td> </tr> <tr> <td></td> <td></td> <td colspan="8" style="text-align: center;"> <table border="1" style="width: 100%; border-collapse: collapse; text-align: center;"> <tr> <td style="width: 10%;"></td> <td style="width: 10%;"></td> <td style="width: 10%;"></td> <td style="width: 10%;"></td> <td style="width: 10%;"></td> <td style="width: 10%;"></td> <td style="width: 10%;"></td> <td style="width: 10%;"></td> <td style="width: 10%;"></td> <td style="width: 10%;"></td> </tr> <tr> <td></td> <td></td> <td colspan="8" style="text-align: center;"> <table border="1" style="width: 100%; border-collapse: collapse; text-align: center;"> <tr> <td style="width: 10%;"></td> <td style="width: 10%;"></td> <td style="width: 10%;"></td> <td style="width: 10%;"></td> <td style="width: 10%;"></td> <td style="width: 10%;"></td> <td style="width: 10%;"></td> <td style="width: 10%;"></td> <td style="width: 10%;"></td> <td style="width: 10%;"></td> </tr> <tr> <td></td> <td></td> <td colspan="8" style="text-align: center;"> <table border="1" style="width: 100%; border-collapse: collapse; text-align: center;"> <tr> <td style="width: 10%;"></td> <td style="width: 10%;"></td> <td style="width: 10%;"></td> <td style="width: 10%;"></td> <td style="width: 10%;"></td> <td style="width: 10%;"></td> <td
style="width: 10%;"></td> <td style="width: 10%;"></td> <td style="width: 10%;"></td> <td style="width: 10%;"></td> </tr> <tr> <td></td> <td></td> <td colspan="8" style="text-align: center;"> <table border="1" style="width: 100%; border-collapse: collapse; text-align: center;"> <tr> <td style="width: 10%;"></td> <td style="width: 10%;"></td> <td style="width: 10%;"></td> <td style="width: 10%;"></td> <td style="width: 10%;"></td> <td style="width: 10%;"></td> <td style="width: 10%;"></td> <td style="width: 10%;"></td> <td style="width: 10%;"></td> <td style="width: 10%;"></td> </tr> <tr> <td></td> <td></td> <td colspan="8" style="text-align: center;"> <table border="1" style="width: 100%; border-collapse: collapse; text-align: center;"> <tr> <td style="width: 10%;"></td> <td style="width: 10%;"></td> <td style="width: 10%;"></td> <td style="width: 10%;"></td> <td style="width: 10%;"></td> <td style="width: 10%;"></td> <td style="width: 10%;"></td> <td style="width: 10%;"></td> <td style="width: 10%;"></td> <td style="width: 10%;"></td> </tr> <tr> <td></td> <td></td> <td colspan="8" style="text-align: center;"> <table border="1" style="width: 100%; border-collapse: collapse; text-align: center;"> <tr> <td style="width: 10%;"></td> <td style="width: 10%;"></td> <td style="width: 10%;"></td> <td style="width: 10%;"></td> <td style="width: 10%;"></td> <td style="width: 10%;"></td> <td style="width: 10%;"></td> <td style="width: 10%;"></td> <td style="width: 10%;"></td> <td style="width: 10%;"></td> </tr> <tr> <td></td> <td></td> <td colspan="8" style="text-align: center;"> <table border="1" style="width: 100%; border-collapse: collapse; text-align: center;"> <tr> <td style="width: 10%;"></td> <td style="width: 10%;"></td> <td style="width: 10%;"></td> <td style="width: 10%;"></td> <td style="width: 10%;"></td> <td style="width: 10%;"></td> <td style="width: 10%;"></td> <td style="width: 10%;"></td> <td style="width: 10%;"></td> <td style="width: 10%;"></td> </tr> <tr> <td></td> <td></td> <td colspan="8" style="text-align: center;"> <table border="1" style="width: 100%; border-collapse: collapse; text-align: center;"> <tr> <td style="width: 10%;"></td> <td style="width: 10%;"></td> <td style="width: 10%;"></td> <td style="width: 10%;"></td> <td style="width: 10%;"></td> <td style="width: 10%;"></td> <td style="width: 10%;"></td> <td style="width: 10%;"></td> <td style="width: 10%;"></td> <td style="width: 10%;"></td> </tr> <tr> <td></td> <td></td> <td colspan="8" style="text-align: center;"> <table border="1" style="width: 100%; border-collapse: collapse; text-align: center;"> <tr> <td style="width: 10%;"></td> <td style="width: 10%;"></td> <td style="width: 10%;"></td> <td style="width: 10%;"></td> <td style="width: 10%;"></td> <td style="width: 10%;"></td> <td style="width: 10%;"></td> <td style="width: 10%;"></td> <td style="width: 10%;"></td> <td style="width: 10%;"></td> </tr> <tr> <td></td> <td></td> <td colspan="8" style="text-align: center;"> <table border="1" style="width: 100%; border-collapse: collapse; text-align: center;"> <tr> <td style="width: 10%;"></td> <td style="width: 10%;"></td> <td style="width: 10%;"></td> <td style="width: 10%;"></td> <td style="width: 10%;"></td> <td style="width: 10%;"></td> <td style="width: 10%;"></td> <td style="width: 10%;"></td> <td style="width: 10%;"></td> <td style="width: 10%;"></td> </tr> <tr> <td></td> <td></td> <td colspan="8" style="text-align: center;"> <table border="1" style="width: 100%; border-collapse: collapse; text-align: center;"> <tr> <td style="width: 10%;"></td> <td style="width: 10%;"></td> <td style="width: 10%;"></td> <td style="width: 10%;"></td> <td style="width: 10%;"></td> <td style="width: 10%;"></td> <td style="width: 10%;"></td> <td style="width: 10%;"></td> <td style="width: 10%;"></td> <td style="width: 10%;"></td> </tr> <tr> <td></td> <td></td> <td colspan="8" style="text-align: center;"> <table border="1" style="width: 100%; border-collapse: collapse; text-align: center;"> <tr> <td style="width: 10%;"></td> <td style="width: 10%;"></td> <td style="width: 10%;"></td> <td style="width: 10%;"></td> <td style="width: 10%;"></td> <td style="width: 10%;"></td> <td style="width: 10%;"></td> <td style="width: 10%;"></td> <td style="width: 10%;"></td> <td style="width: 10%;"></td> </tr> <tr> <td></td> <td></td> <td colspan="8" style="text-align: center;"> <table border="1" style="width: 100%; border-collapse: collapse; text-align: center;"> <tr> <td style="width: 10%;"></td> <td style="width: 10%;"></td> <td style="width: 10%;"></td> <td style="width: 10%;"></td> <td style="width: 10%;"></td> <td style="width: 10%;"></td> <td style="width: 10%;"></td> <td style="width: 10%;"></td> <td style="width: 10%;"></td> <td style="width: 10%;"></td> </tr> <tr> <td></td> <td></td> <td colspan="8" style="text-align: center;"> <table border="1" style="width: 100%; border-collapse: collapse; text-align: center;"> <tr> <td style="width: 10%;"></td> <td style="width: 10%;"></td> <td style="width: 10%;"></td> <td style="width: 10%;"></td> <td style="width: 10%;"></td> <td style="width: 10%;"></td> <td style="width: 10%;"></td> <td style="width: 10%;"></td> <td style="width: 10%;"></td> <td style="width: 10%;"></td> </tr> <tr> <td></td> <td></td> <td colspan="8" style="text-align: center;"> <table border="1" style="width: 100%; border-collapse: collapse; text-align: center;"> <tr> <td style="width: 10%;"></td> <td style="width: 10%;"></td> <td style="width: 10%;"></td> <td style="width: 10%;"></td> <td style="width: 10%;"></td> <td style="width: 10%;"></td> <td style="width: 10%;"></td> <td style="width: 10%;"></td> <td style="width: 10%;"></td> <td style="width: 10%;"></td> </tr> <tr> <td></td> <td></td> <td colspan="8" style="text-align: center;"> <table border="1" style="width: 100%; border-collapse: collapse; text-align: center;"> <tr> <td style="width: 10%;"></td> <td style="width: 10%;"></td> <td style="width: 10%;"></td> <td style="width: 10%;"></td> <td style="width: 10%;"></td> <td style="width: 10%;"></td> <td style="width: 10%;"></td> <td style="width: 10%;"></td> <td style="width: 10%;"></td> <td style="width: 10%;"></td> </tr> <tr> <td></td> <td></td> <td colspan="8" style="text-align: center;"> <table border="1" style="width: 100%; border-collapse: collapse; text-align: center;"> <tr> <td style="width: 10%;"></td> <td style="width: 10%;"></td> <td style="width: 10%;"></td> <td style="width: 10%;"></td> <td style="width: 10%;"></td> <td style="width: 10%;"></td> <td style="width: 10%;"></td> <td style="width: 10%;"></td> <td style="width: 10%;"></td> <td style="width: 10%;"></td> </tr> <tr> <td></td> <td></td> <td colspan="8" style="text-align: center;"> <table border="1" style="width: 100%; border-collapse: collapse; text-align: center;"> <tr> <td style="width: 10%;"></td> <td style="width: 10%;"></td> <td style="width: 10%;"></td> <td style="width: 10%;"></td> <td style="width: 10%;"></td> <td style="width: 10%;"></td> <td style="width: 10%;"></td> <td style="width: 10%;"></td> <td style="width: 10%;"></td> <td style="width: 10%;"></td> </tr> <tr> <td></td> <td></td> <td colspan="8" style="text-align: center;"> <table border="1" style="width: 100%; border-collapse: collapse; text-align: center;"> <tr> <td style="width: 10%;"></td> <td style="width: 10%;"></td> <td style="width: 10%;"></td> <td style="width: 10%;"></td> <td style="width: 10%;"></td> <td style="width: 10%;"></td> <td style="width: 10%;"></td> <td style="width: 10%;"></td> <td style="width: 10%;"></td> <td style="width: 10%;"></td> </tr> <tr> <td></td> <td></td> <td colspan="8" style="text-align: center;"> <table border="1" style="width: 100%; border-collapse: collapse; text-align: center;"> <tr> <td style="width: 10%;"></td> <td style="width: 10%;"></td> <td style="width: 10%;"></td> <td style="width: 10%;"></td> <td style="width: 10%;"></td> <td style="width: 10%;"></td> <td style="width: 10%;"></td> <td style="width: 10%;"></td> <td style="width: 10%;"></td> <td style="width: 10%;"></td> </tr> <tr> <td></td> <td></td> <td colspan="8" style="text-align: center;"> <table border="1" style="width: 100%; border-collapse: collapse; text-align: center;"> <tr> <td style="width: 10%;"></td> <td style="width: 10%;"></td> <td style="width: 10%;"></td> <td style="width: 10%;"></td> <td style="width: 10%;"></td> <td style="width: 10%;"></td> <td style="width: 10%;"></td> <td style="width: 10%;"></td> <td style="width: 10%;"></td> <td style="width: 10%;"></td> </tr> <tr> <td></td> <td></td> <td colspan="8" style="text-align: center;"> <table border="1" style="width: 100%; border-collapse: collapse; text-align: center;"> <tr> <td style="width: 10%;"></td> <td style="width: 10%;"></td> <td style="width: 10%;"></td> <td style="width: 10%;"></td> <td style="width: 10%;"></td> <td style="width: 10%;"></td> <td style="width: 10%;"></td> <td style="width: 10%;"></td> <td style="width: 10%;"></td> <td style="width: 10%;"></td> </tr> <tr> <td></td> <td></td> <td colspan="8" style="text-align: center;"> <table border="1" style="width: 100%; border-collapse: collapse; text-align: center;"> <tr> <td style="width: 10%;"></td> <td style="width: 10%;"></td> <td style="width: 10%;"></td> <td style="width: 10%;"></td> <td style="width: 10%;"></td> <td style="width: 10%;"></td> <td style="width: 10%;"></td> <td style="width: 10%;"></td> <td style="width: 10%;"></td> <td style="width: 10%;"></td> </tr> <tr> <td></td> <td></td> <td colspan="8" style="text-align: center;"> <table border="1" style="width: 100%; border-collapse: collapse; text-align: center;"> <tr> <td style="width: 10%;"></td> <td style="width: 10%;"></td> <td style="width: 10%;"></td> <td style="width: 10%;"></td> <td style="width: 10%;"></td> <td style="width: 10%;"></td> <td style="width: 10%;"></td> <td style="width: 10%;"></td> <td style="width: 10%;"></td> <td style="width: 10%;"></td> </tr> <tr> <td></td> <td></td> <td colspan="8"
style="text-align: center;"> <table border="1" style="width: 100%; border-collapse: collapse; text-align: center;"> <tr> <td style="width: 10%;"></td> <td style="width: 10%;"></td> <td style="width: 10%;"></td> <td style="width: 10%;"></td> <td style="width: 10%;"></td> <td style="width: 10%;"></td> <td style="width: 10%;"></td> <td style="width: 10%;"></td> <td style="width: 10%;"></td> <td style="width: 10%;"></td> </tr> <tr> <td></td> <td></td> <td colspan="8" style="text-align: center;"> <table border="1" style="width: 100%; border-collapse: collapse; text-align: center;"> <tr> <td style="width: 10%;"></td> <td style="width: 10%;"></td> <td style="width: 10%;"></td> <td style="width: 10%;"></td> <td style="width: 10%;"></td> <td style="width: 10%;"></td> <td style="width: 10%;"></td> <td style="width: 10%;"></td> <td style="width: 10%;"></td> <td style="width: 10%;"></td> </tr> <tr> <td></td> <td></td> <td colspan="8" style="text-align: center;"> <table border="1" style="width: 100%; border-collapse: collapse; text-align: center;"> <tr> <td style="width: 10%;"></td> <td style="width: 10%;"></td> <td style="width: 10%;"></td> <td style="width: 10%;"></td> <td style="width: 10%;"></td> <td style="width: 10%;"></td> <td style="width: 10%;"></td> <td style="width: 10%;"></td> <td style="width: 10%;"></td> <td style="width: 10%;"></td> </tr> <tr> <td></td> <td></td> <td colspan="8" style="text-align: center;"> <table border="1" style="width: 100%; border-collapse: collapse; text-align: center;"> <tr> <td style="width: 10%;"></td> <td style="width: 10%;"></td> <td style="width: 10%;"></td> <td style="width: 10%;"></td> <td style="width: 10%;"></td> <td style="width: 10%;"></td> <td style="width: 10%;"></td> <td style="width: 10%;"></td> <td style="width: 10%;"></td> <td style="width: 10%;"></td> </tr> <tr> <td></td> <td></td> <td colspan="8" style="text-align: center;"> <table border="1" style="width: 100%; border-collapse: collapse; text-align: center;"> <tr> <td style="width: 10%;"></td> <td style="width: 10%;"></td> <td style="width: 10%;"></td> <td style="width: 10%;"></td> <td style="width: 10%;"></td> <td style="width: 10%;"></td> <td style="width: 10%;"></td> <td style="width: 10%;"></td> <td style="width: 10%;"></td> <td style="width: 10%;"></td> </tr> <tr> <td></td> <td></td> <td colspan="8" style="text-align: center;"> <table border="1" style="width: 100%; border-collapse: collapse; text-align: center;"> <tr> <td style="width: 10%;"></td> <td style="width: 10%;"></td> <td style="width: 10%;"></td> <td style="width: 10%;"></td> <td style="width: 10%;"></td> <td style="width: 10%;"></td> <td style="width: 10%;"></td> <td style="width: 10%;"></td> <td style="width: 10%;"></td> <td style="width: 10%;"></td> </tr> <tr> <td></td> <td></td> <td colspan="8" style="text-align: center;"> <table border="1" style="width: 100%; border-collapse: collapse; text-align: center;"> <tr> <td style="width: 10%;"></td> <td style="width: 10%;"></td> <td style="width: 10%;"></td> <td style="width: 10%;"></td> <td style="width: 10%;"></td> <td style="width: 10%;"></td> <td style="width: 10%;"></td> <td style="width: 10%;"></td> <td style="width: 10%;"></td> <td style="width: 10%;"></td> </tr> <tr> <td></td> <td></td> <td colspan="8" style="text-align: center;"> <table border="1" style="width: 100%; border-collapse: collapse; text-align: center;"> <tr> </tr></table></td></tr></table></td></tr></table></td></tr></table></td></tr></table></td></tr></table></td></tr></table></td></tr></table></td></tr></table></td></tr></table></td></tr></table></td></tr></table></td></tr></table></td></tr></table></td></tr></table></td></tr></table></td></tr></table></td></tr></table></td></tr></table></td></tr></table></td></tr></table></td></tr></table></td></tr></table></td></tr></table></td></tr></table></td></tr></table></td></tr></table></td></tr></table></td></tr></table></td></tr></table></td></tr></table></td></tr></table></td></tr></table></td></tr></table></td></tr></table>
 | | | | | | | | | | | | | | | | | | | | <table border="1" style="width: 100%; border-collapse: collapse; text-align: center;"> <tr> <td style="width: 10%;"></td> <td style="width: 10%;"></td> <td style="width: 10%;"></td> <td style="width: 10%;"></td> <td style="width: 10%;"></td> <td style="width: 10%;"></td> <td style="width: 10%;"></td> <td style="width: 10%;"></td> <td style="width: 10%;"></td> <td style="width: 10%;"></td> </tr> <tr> <td></td> <td></td> <td colspan="8" style="text-align: center;"> <table border="1" style="width: 100%; border-collapse: collapse; text-align: center;"> <tr> <td style="width: 10%;"></td> <td style="width: 10%;"></td> <td style="width: 10%;"></td> <td style="width: 10%;"></td> <td style="width: 10%;"></td> <td style="width: 10%;"></td> <td style="width: 10%;"></td> <td style="width: 10%;"></td> <td style="width: 10%;"></td> <td style="width: 10%;"></td> </tr> <tr> <td></td> <td></td> <td colspan="8" style="text-align: center;"> <table border="1" style="width: 100%; border-collapse: collapse; text-align: center;"> <tr> <td style="width: 10%;"></td> <td style="width: 10%;"></td> <td style="width: 10%;"></td> <td style="width: 10%;"></td> <td style="width: 10%;"></td> <td style="width: 10%;"></td> <td style="width: 10%;"></td> <td style="width: 10%;"></td> <td style="width: 10%;"></td> <td style="width: 10%;"></td> </tr> <tr> <td></td> <td></td> <td colspan="8" style="text-align: center;"> <table border="1" style="width: 100%; border-collapse: collapse; text-align: center;"> <tr> <td style="width: 10%;"></td> <td style="width: 10%;"></td> <td style="width: 10%;"></td> <td style="width: 10%;"></td> <td style="width: 10%;"></td> <td style="width: 10%;"></td> <td style="width: 10%;"></td> <td style="width: 10%;"></td> <td style="width: 10%;"></td> <td style="width: 10%;"></td> </tr> <tr> <td></td> <td></td> <td colspan="8" style="text-align: center;"> <table border="1" style="width: 100%; border-collapse: collapse; text-align: center;"> <tr> <td style="width: 10%;"></td> <td style="width: 10%;"></td> <td style="width: 10%;"></td> <td style="width: 10%;"></td> <td style="width: 10%;"></td> <td style="width: 10%;"></td> <td style="width: 10%;"></td> <td style="width: 10%;"></td> <td style="width: 10%;"></td> <td style="width: 10%;"></td> </tr> <tr> <td></td> <td></td> <td colspan="8" style="text-align: center;"> <table border="1" style="width: 100%; border-collapse: collapse; text-align: center;"> <tr> <td style="width: 10%;"></td> <td style="width: 10%;"></td> <td style="width: 10%;"></td> <td style="width: 10%;"></td> <td style="width: 10%;"></td> <td style="width: 10%;"></td> <td style="width: 10%;"></td> <td style="width: 10%;"></td> <td style="width: 10%;"></td> <td style="width: 10%;"></td> </tr> <tr> <td></td> <td></td> <td colspan="8" style="text-align: center;"> <table border="1" style="width: 100%; border-collapse: collapse; text-align: center;"> <tr> <td style="width: 10%;"></td> <td style="width: 10%;"></td> <td style="width: 10%;"></td> <td style="width: 10%;"></td> <td style="width: 10%;"></td> <td style="width: 10%;"></td> <td style="width: 10%;"></td> <td style="width: 10%;"></td> <td style="width: 10%;"></td> <td style="width: 10%;"></td> </tr> <tr> <td></td> <td></td> <td colspan="8" style="text-align: center;"> <table border="1" style="width: 100%; border-collapse: collapse; text-align: center;"> <tr> <td style="width: 10%;"></td> <td style="width: 10%;"></td> <td style="width: 10%;"></td> <td style="width: 10%;"></td> <td style="width: 10%;"></td> <td style="width: 10%;"></td> <td style="width: 10%;"></td> <td style="width: 10%;"></td> <td style="width: 10%;"></td> <td style="width: 10%;"></td> </tr> <tr> <td></td> <td></td> <td colspan="8" style="text-align: center;"> <table border="1" style="width: 100%; border-collapse: collapse; text-align: center;"> <tr> <td style="width: 10%;"></td> <td style="width: 10%;"></td> <td style="width: 10%;"></td> <td style="width: 10%;"></td> <td style="width: 10%;"></td> <td style="width: 10%;"></td> <td style="width: 10%;"></td> <td style="width: 10%;"></td> <td style="width: 10%;"></td> <td style="width: 10%;"></td> </tr> <tr> <td></td> <td></td> <td colspan="8" style="text-align: center;"> <table border="1" style="width: 100%; border-collapse: collapse; text-align: center;"> <tr> <td style="width: 10%;"></td> <td style="width: 10%;"></td> <td style="width: 10%;"></td> <td style="width: 10%;"></td> <td style="width: 10%;"></td> <td style="width: 10%;"></td> <td style="width: 10%;"></td> <td style="width: 10%;"></td> <td style="width: 10%;"></td> <td style="width: 10%;"></td> </tr> <tr> <td></td> <td></td> <td colspan="8" style="text-align: center;"> <table border="1" style="width: 100%; border-collapse: collapse; text-align: center;"> <tr> <td style="width: 10%;"></td> <td style="width: 10%;"></td> <td style="width: 10%;"></td> <td style="width: 10%;"></td> <td style="width: 10%;"></td> <td style="width: 10%;"></td> <td style="width: 10%;"></td> <td style="width: 10%;"></td> <td style="width: 10%;"></td> <td style="width: 10%;"></td> </tr> <tr> <td></td> <td></td> <td colspan="8" style="text-align: center;"> <table border="1" style="width: 100%; border-collapse: collapse; text-align: center;"> <tr> <td style="width: 10%;"></td> <td style="width: 10%;"></td> <td style="width: 10%;"></td> <td style="width: 10%;"></td> <td style="width: 10%;"></td> <td style="width: 10%;"></td> <td style="width: 10%;"></td> <td style="width: 10%;"></td> <td style="width: 10%;"></td> <td style="width: 10%;"></td> </tr> <tr> <td></td> <td></td> <td colspan="8" style="text-align: center;"> <table border="1" style="width: 100%; border-collapse: collapse; text-align: center;"> <tr> <td style="width: 10%;"></td> <td style="width: 10%;"></td> <td style="width: 10%;"></td> <td style="width: 10%;"></td> <td style="width: 10%;"></td> <td style="width: 10%;"></td> <td style="width: 10%;"></td> <td style="width: 10%;"></td> <td style="width: 10%;"></td> <td style="width: 10%;"></td> </tr> <tr> <td></td> <td></td> <td colspan="8" style="text-align: center;"> <table border="1" style="width: 100%; border-collapse: collapse; text-align: center;"> <tr> <td style="width: 10%;"></td> <td style="width: 10%;"></td> <td style="width: 10%;"></td> <td style="width: 10%;"></td> <td style="width: 10%;"></td> <td style="width: 10%;"></td> <td style="width: 10%;"></td> <td style="width: 10%;"></td> <td style="width: 10%;"></td> <td style="width: 10%;"></td> </tr> <tr> <td></td> <td></td> <td colspan="8" style="text-align: center;"> <table border="1" style="width: 100%; border-collapse: collapse; text-align: center;"> <tr> <td style="width: 10%;"></td> <td
style="width: 10%;"></td> <td style="width: 10%;"></td> <td style="width: 10%;"></td> <td style="width: 10%;"></td> <td style="width: 10%;"></td> <td style="width: 10%;"></td> <td style="width: 10%;"></td> <td style="width: 10%;"></td> <td style="width: 10%;"></td> </tr> <tr> <td></td> <td></td> <td colspan="8" style="text-align: center;"> <table border="1" style="width: 100%; border-collapse: collapse; text-align: center;"> <tr> <td style="width: 10%;"></td> <td style="width: 10%;"></td> <td style="width: 10%;"></td> <td style="width: 10%;"></td> <td style="width: 10%;"></td> <td style="width: 10%;"></td> <td style="width: 10%;"></td> <td style="width: 10%;"></td> <td style="width: 10%;"></td> <td style="width: 10%;"></td> </tr> <tr> <td></td> <td></td> <td colspan="8" style="text-align: center;"> <table border="1" style="width: 100%; border-collapse: collapse; text-align: center;"> <tr> <td style="width: 10%;"></td> <td style="width: 10%;"></td> <td style="width: 10%;"></td> <td style="width: 10%;"></td> <td style="width: 10%;"></td> <td style="width: 10%;"></td> <td style="width: 10%;"></td> <td style="width: 10%;"></td> <td style="width: 10%;"></td> <td style="width: 10%;"></td> </tr> <tr> <td></td> <td></td> <td colspan="8" style="text-align: center;"> <table border="1" style="width: 100%; border-collapse: collapse; text-align: center;"> <tr> <td style="width: 10%;"></td> <td style="width: 10%;"></td> <td style="width: 10%;"></td> <td style="width: 10%;"></td> <td style="width: 10%;"></td> <td style="width: 10%;"></td> <td style="width: 10%;"></td> <td style="width: 10%;"></td> <td style="width: 10%;"></td> <td style="width: 10%;"></td> </tr> <tr> <td></td> <td></td> <td colspan="8" style="text-align: center;"> <table border="1" style="width: 100%; border-collapse: collapse; text-align: center;"> <tr> <td style="width: 10%;"></td> <td style="width: 10%;"></td> <td style="width: 10%;"></td> <td style="width: 10%;"></td> <td style="width: 10%;"></td> <td style="width: 10%;"></td> <td style="width: 10%;"></td> <td style="width: 10%;"></td> <td style="width: 10%;"></td> <td style="width: 10%;"></td> </tr> <tr> <td></td> <td></td> <td colspan="8" style="text-align: center;"> <table border="1" style="width: 100%; border-collapse: collapse; text-align: center;"> <tr> <td style="width: 10%;"></td> <td style="width: 10%;"></td> <td style="width: 10%;"></td> <td style="width: 10%;"></td> <td style="width: 10%;"></td> <td style="width: 10%;"></td> <td style="width: 10%;"></td> <td style="width: 10%;"></td> <td style="width: 10%;"></td> <td style="width: 10%;"></td> </tr> <tr> <td></td> <td></td> <td colspan="8" style="text-align: center;"> <table border="1" style="width: 100%; border-collapse: collapse; text-align: center;"> <tr> <td style="width: 10%;"></td> <td style="width: 10%;"></td> <td style="width: 10%;"></td> <td style="width: 10%;"></td> <td style="width: 10%;"></td> <td style="width: 10%;"></td> <td style="width: 10%;"></td> <td style="width: 10%;"></td> <td style="width: 10%;"></td> <td style="width: 10%;"></td> </tr> <tr> <td></td> <td></td> <td colspan="8" style="text-align: center;"> <table border="1" style="width: 100%; border-collapse: collapse; text-align: center;"> <tr> <td style="width: 10%;"></td> <td style="width: 10%;"></td> <td style="width: 10%;"></td> <td style="width: 10%;"></td> <td style="width: 10%;"></td> <td style="width: 10%;"></td> <td style="width: 10%;"></td> <td style="width: 10%;"></td> <td style="width: 10%;"></td> <td style="width: 10%;"></td> </tr> <tr> <td></td> <td></td> <td colspan="8" style="text-align: center;"> <table border="1" style="width: 100%; border-collapse: collapse; text-align: center;"> <tr> <td style="width: 10%;"></td> <td style="width: 10%;"></td> <td style="width: 10%;"></td> <td style="width: 10%;"></td> <td style="width: 10%;"></td> <td style="width: 10%;"></td> <td style="width: 10%;"></td> <td style="width: 10%;"></td> <td style="width: 10%;"></td> <td style="width: 10%;"></td> </tr> <tr> <td></td> <td></td> <td colspan="8" style="text-align: center;"> <table border="1" style="width: 100%; border-collapse: collapse; text-align: center;"> <tr> <td style="width: 10%;"></td> <td style="width: 10%;"></td> <td style="width: 10%;"></td> <td style="width: 10%;"></td> <td style="width: 10%;"></td> <td style="width: 10%;"></td> <td style="width: 10%;"></td> <td style="width: 10%;"></td> <td style="width: 10%;"></td> <td style="width: 10%;"></td> </tr> <tr> <td></td> <td></td> <td colspan="8" style="text-align: center;"> <table border="1" style="width: 100%; border-collapse: collapse; text-align: center;"> <tr> <td style="width: 10%;"></td> <td style="width: 10%;"></td> <td style="width: 10%;"></td> <td style="width: 10%;"></td> <td style="width: 10%;"></td> <td style="width: 10%;"></td> <td style="width: 10%;"></td> <td style="width: 10%;"></td> <td style="width: 10%;"></td> <td style="width: 10%;"></td> </tr> <tr> <td></td> <td></td> <td colspan="8" style="text-align: center;"> <table border="1" style="width: 100%; border-collapse: collapse; text-align: center;"> <tr> <td style="width: 10%;"></td> <td style="width: 10%;"></td> <td style="width: 10%;"></td> <td style="width: 10%;"></td> <td style="width: 10%;"></td> <td style="width: 10%;"></td> <td style="width: 10%;"></td> <td style="width: 10%;"></td> <td style="width: 10%;"></td> <td style="width: 10%;"></td> </tr> <tr> <td></td> <td></td> <td colspan="8" style="text-align: center;"> <table border="1" style="width: 100%; border-collapse: collapse; text-align: center;"> <tr> <td style="width: 10%;"></td> <td style="width: 10%;"></td> <td style="width: 10%;"></td> <td style="width: 10%;"></td> <td style="width: 10%;"></td> <td style="width: 10%;"></td> <td style="width: 10%;"></td> <td style="width: 10%;"></td> <td style="width: 10%;"></td> <td style="width: 10%;"></td> </tr> <tr> <td></td> <td></td> <td colspan="8" style="text-align: center;"> <table border="1" style="width: 100%; border-collapse: collapse; text-align: center;"> <tr> <td style="width: 10%;"></td> <td style="width: 10%;"></td> <td style="width: 10%;"></td> <td style="width: 10%;"></td> <td style="width: 10%;"></td> <td style="width: 10%;"></td> <td style="width: 10%;"></td> <td style="width: 10%;"></td> <td style="width: 10%;"></td> <td style="width: 10%;"></td> </tr> <tr> <td></td> <td></td> <td colspan="8" style="text-align: center;"> <table border="1" style="width: 100%; border-collapse: collapse; text-align: center;"> <tr> <td style="width: 10%;"></td> <td style="width: 10%;"></td> <td style="width: 10%;"></td> <td style="width: 10%;"></td> <td style="width: 10%;"></td> <td style="width: 10%;"></td> <td style="width: 10%;"></td> <td style="width: 10%;"></td> <td style="width: 10%;"></td> <td style="width: 10%;"></td> </tr> <tr> <td></td> <td></td> <td colspan="8" style="text-align: center;"> <table border="1" style="width: 100%; border-collapse: collapse; text-align: center;"> <tr> <td style="width: 10%;"></td> <td style="width: 10%;"></td> <td style="width: 10%;"></td> <td style="width: 10%;"></td> <td style="width: 10%;"></td> <td style="width: 10%;"></td> <td style="width: 10%;"></td> <td style="width: 10%;"></td> <td style="width: 10%;"></td> <td style="width: 10%;"></td> </tr> <tr> <td></td> <td></td> <td colspan="8" style="text-align: center;"> <table border="1" style="width: 100%; border-collapse: collapse; text-align: center;"> <tr> <td style="width: 10%;"></td> <td style="width: 10%;"></td> <td style="width: 10%;"></td> <td style="width: 10%;"></td> <td style="width: 10%;"></td> <td style="width: 10%;"></td> <td style="width: 10%;"></td> <td style="width: 10%;"></td> <td style="width: 10%;"></td> <td style="width: 10%;"></td> </tr> <tr> <td></td> <td></td> <td colspan="8" style="text-align: center;"> <table border="1" style="width: 100%; border-collapse: collapse; text-align: center;"> <tr> <td style="width: 10%;"></td> <td style="width: 10%;"></td> <td style="width: 10%;"></td> <td style="width: 10%;"></td> <td style="width: 10%;"></td> <td style="width: 10%;"></td> <td style="width: 10%;"></td> <td style="width: 10%;"></td> <td style="width: 10%;"></td> <td style="width: 10%;"></td> </tr> <tr> <td></td> <td></td> <td colspan="8" style="text-align: center;"> <table border="1" style="width: 100%; border-collapse: collapse; text-align: center;"> <tr> <td style="width: 10%;"></td> <td style="width: 10%;"></td> <td style="width: 10%;"></td> <td style="width: 10%;"></td> <td style="width: 10%;"></td> <td style="width: 10%;"></td> <td style="width: 10%;"></td> <td style="width: 10%;"></td> <td style="width: 10%;"></td> <td style="width: 10%;"></td> </tr> <tr> <td></td> <td></td> <td colspan="8" style="text-align: center;"> <table border="1" style="width: 100%; border-collapse: collapse; text-align: center;"> <tr> </tr></table></td></tr></table></td></tr></table></td></tr></table></td></tr></table></td></tr></table></td></tr></table></td></tr></table></td></tr></table></td></tr></table></td></tr></table></td></tr></table></td></tr></table></td></tr></table></td></tr></table></td></tr></table></td></tr></table></td></tr></table></td></tr></table></td></tr></table></td></tr></table></td></tr></table></td></tr></table></td></tr></table></td></tr></table></td></tr></table></td></tr></table></td></tr></table></td></tr></table></td></tr></table></td></tr></table></td></tr></table></td></tr></table></td></tr></table>
 | | | | | | | | | | | | | | | | | | | | <table border="1" style="width: 100%; border-collapse: collapse; text-align: center;"> <tr> <td style="width: 10%;"></td> <td style="width: 10%;"></td> <td style="width: 10%;"></td> <td style="width: 10%;"></td> <td style="width: 10%;"></td> <td style="width: 10%;"></td> <td style="width: 10%;"></td> <td style="width: 10%;"></td> <td style="width: 10%;"></td> <td style="width: 10%;"></td> </tr> <tr> <td></td> <td></td> <td colspan="8" style="text-align: center;"> <table border="1" style="width: 100%; border-collapse: collapse; text-align: center;"> <tr> <td style="width: 10%;"></td> <td style="width: 10%;"></td> <td style="width: 10%;"></td> <td style="width: 10%;"></td> <td style="width: 10%;"></td> <td style="width: 10%;"></td> <td style="width: 10%;"></td> <td style="width: 10%;"></td> <td style="width: 10%;"></td> <td style="width: 10%;"></td> </tr> <tr> <td></td> <td></td> <td colspan="8" style="text-align: center;"> <table border="1" style="width: 100%; border-collapse: collapse; text-align: center;"> <tr> <td style="width: 10%;"></td> <td style="width: 10%;"></td> <td style="width: 10%;"></td> <td style="width: 10%;"></td> <td style="width: 10%;"></td> <td style="width: 10%;"></td> <td style="width: 10%;"></td>
<td style="width: 10%;"></td> <td style="width: 10%;"></td> <td style="width: 10%;"></td> </tr> <tr> <td></td> <td></td> <td colspan="8" style="text-align: center;"> <table border="1" style="width: 100%; border-collapse: collapse; text-align: center;"> <tr> <td style="width: 10%;"></td> <td style="width: 10%;"></td> <td style="width: 10%;"></td> <td style="width: 10%;"></td> <td style="width: 10%;"></td> <td style="width: 10%;"></td> <td style="width: 10%;"></td> <td style="width: 10%;"></td> <td style="width: 10%;"></td> <td style="width: 10%;"></td> </tr> <tr> <td></td> <td></td> <td colspan="8" style="text-align: center;"> <table border="1" style="width: 100%; border-collapse: collapse; text-align: center;"> <tr> <td style="width: 10%;"></td> <td style="width: 10%;"></td> <td style="width: 10%;"></td> <td style="width: 10%;"></td> <td style="width: 10%;"></td> <td style="width: 10%;"></td> <td style="width: 10%;"></td> <td style="width: 10%;"></td> <td style="width: 10%;"></td> <td style="width: 10%;"></td> </tr> <tr> <td></td> <td></td> <td colspan="8" style="text-align: center;"> <table border="1" style="width: 100%; border-collapse: collapse; text-align: center;"> <tr> <td style="width: 10%;"></td> <td style="width: 10%;"></td> <td style="width: 10%;"></td> <td style="width: 10%;"></td> <td style="width: 10%;"></td> <td style="width: 10%;"></td> <td style="width: 10%;"></td> <td style="width: 10%;"></td> <td style="width: 10%;"></td> <td style="width: 10%;"></td> </tr> <tr> <td></td> <td></td> <td colspan="8" style="text-align: center;"> <table border="1" style="width: 100%; border-collapse: collapse; text-align: center;"> <tr> <td style="width: 10%;"></td> <td style="width: 10%;"></td> <td style="width: 10%;"></td> <td style="width: 10%;"></td> <td style="width: 10%;"></td> <td style="width: 10%;"></td> <td style="width: 10%;"></td> <td style="width: 10%;"></td> <td style="width: 10%;"></td> <td style="width: 10%;"></td> </tr> <tr> <td></td> <td></td> <td colspan="8" style="text-align: center;"> <table border="1" style="width: 100%; border-collapse: collapse; text-align: center;"> <tr> <td style="width: 10%;"></td> <td style="width: 10%;"></td> <td style="width: 10%;"></td> <td style="width: 10%;"></td> <td style="width: 10%;"></td> <td style="width: 10%;"></td> <td style="width: 10%;"></td> <td style="width: 10%;"></td> <td style="width: 10%;"></td> <td style="width: 10%;"></td> </tr> <tr> <td></td> <td></td> <td colspan="8" style="text-align: center;"> <table border="1" style="width: 100%; border-collapse: collapse; text-align: center;"> <tr> <td style="width: 10%;"></td> <td style="width: 10%;"></td> <td style="width: 10%;"></td> <td style="width: 10%;"></td> <td style="width: 10%;"></td> <td style="width: 10%;"></td> <td style="width: 10%;"></td> <td style="width: 10%;"></td> <td style="width: 10%;"></td> <td style="width: 10%;"></td> </tr> <tr> <td></td> <td></td> <td colspan="8" style="text-align: center;"> <table border="1" style="width: 100%; border-collapse: collapse; text-align: center;"> <tr> <td style="width: 10%;"></td> <td style="width: 10%;"></td> <td style="width: 10%;"></td> <td style="width: 10%;"></td> <td style="width: 10%;"></td> <td style="width: 10%;"></td> <td style="width: 10%;"></td> <td style="width: 10%;"></td> <td style="width: 10%;"></td> <td style="width: 10%;"></td> </tr> <tr> <td></td> <td></td> <td colspan="8" style="text-align: center;"> <table border="1" style="width: 100%; border-collapse: collapse; text-align: center;"> <tr> <td style="width: 10%;"></td> <td style="width: 10%;"></td> <td style="width: 10%;"></td> <td style="width: 10%;"></td> <td style="width: 10%;"></td> <td style="width: 10%;"></td> <td style="width: 10%;"></td> <td style="width: 10%;"></td> <td style="width: 10%;"></td> <td style="width: 10%;"></td> </tr> <tr> <td></td> <td></td> <td colspan="8" style="text-align: center;"> <table border="1" style="width: 100%; border-collapse: collapse; text-align: center;"> <tr> <td style="width: 10%;"></td> <td style="width: 10%;"></td> <td style="width: 10%;"></td> <td style="width: 10%;"></td> <td style="width: 10%;"></td> <td style="width: 10%;"></td> <td style="width: 10%;"></td> <td style="width: 10%;"></td> <td style="width: 10%;"></td> <td style="width: 10%;"></td> </tr> <tr> <td></td> <td></td> <td colspan="8" style="text-align: center;"> <table border="1" style="width: 100%; border-collapse: collapse; text-align: center;"> <tr> <td style="width: 10%;"></td> <td style="width: 10%;"></td> <td style="width: 10%;"></td> <td style="width: 10%;"></td> <td style="width: 10%;"></td> <td style="width: 10%;"></td> <td style="width: 10%;"></td> <td style="width: 10%;"></td> <td style="width: 10%;"></td> <td style="width: 10%;"></td> </tr> <tr> <td></td> <td></td> <td colspan="8" style="text-align: center;"> <table border="1" style="width: 100%; border-collapse: collapse; text-align: center;"> <tr> <td style="width: 10%;"></td> <td style="width: 10%;"></td> <td style="width: 10%;"></td> <td style="width: 10%;"></td> <td style="width: 10%;"></td> <td style="width: 10%;"></td> <td style="width: 10%;"></td> <td style="width: 10%;"></td> <td style="width: 10%;"></td> <td style="width: 10%;"></td> </tr> <tr> <td></td> <td></td> <td colspan="8" style="text-align: center;"> <table border="1" style="width: 100%; border-collapse: collapse; text-align: center;"> <tr> <td style="width: 10%;"></td> <td style="width: 10%;"></td> <td style="width: 10%;"></td> <td style="width: 10%;"></td> <td style="width: 10%;"></td> <td style="width: 10%;"></td> <td style="width: 10%;"></td> <td style="width: 10%;"></td> <td style="width: 10%;"></td> <td style="width: 10%;"></td> </tr> <tr> <td></td> <td></td> <td colspan="8" style="text-align: center;"> <table border="1" style="width: 100%; border-collapse: collapse; text-align: center;"> <tr> <td style="width: 10%;"></td> <td style="width: 10%;"></td> <td style="width: 10%;"></td> <td style="width: 10%;"></td> <td style="width: 10%;"></td> <td style="width: 10%;"></td> <td style="width: 10%;"></td> <td style="width: 10%;"></td> <td style="width: 10%;"></td> <td style="width: 10%;"></td> </tr> <tr> <td></td> <td></td> <td colspan="8" style="text-align: center;"> <table border="1" style="width: 100%; border-collapse: collapse; text-align: center;"> <tr> <td style="width: 10%;"></td> <td style="width: 10%;"></td> <td style="width: 10%;"></td> <td style="width: 10%;"></td> <td style="width: 10%;"></td> <td style="width: 10%;"></td> <td style="width: 10%;"></td> <td style="width: 10%;"></td> <td style="width: 10%;"></td> <td style="width: 10%;"></td> </tr> <tr> <td></td> <td></td> <td colspan="8" style="text-align: center;"> <table border="1" style="width: 100%; border-collapse: collapse; text-align: center;"> <tr> <td style="width: 10%;"></td> <td style="width: 10%;"></td> <td style="width: 10%;"></td> <td style="width: 10%;"></td> <td style="width: 10%;"></td> <td style="width: 10%;"></td> <td style="width: 10%;"></td> <td style="width: 10%;"></td> <td style="width: 10%;"></td> <td style="width: 10%;"></td> </tr> <tr> <td></td> <td></td> <td colspan="8" style="text-align: center;"> <table border="1" style="width: 100%; border-collapse: collapse; text-align: center;"> <tr> <td style="width: 10%;"></td> <td style="width: 10%;"></td> <td style="width: 10%;"></td> <td style="width: 10%;"></td> <td style="width: 10%;"></td> <td style="width: 10%;"></td> <td style="width: 10%;"></td> <td style="width: 10%;"></td> <td style="width: 10%;"></td> <td style="width: 10%;"></td> </tr> <tr> <td></td> <td></td> <td colspan="8" style="text-align: center;"> <table border="1" style="width: 100%; border-collapse: collapse; text-align: center;"> <tr> <td style="width: 10%;"></td> <td style="width: 10%;"></td> <td style="width: 10%;"></td> <td style="width: 10%;"></td> <td style="width: 10%;"></td> <td style="width: 10%;"></td> <td style="width: 10%;"></td> <td style="width: 10%;"></td> <td style="width: 10%;"></td> <td style="width: 10%;"></td> </tr> <tr> <td></td> <td></td> <td colspan="8" style="text-align: center;"> <table border="1" style="width: 100%; border-collapse: collapse; text-align: center;"> <tr> <td style="width: 10%;"></td> <td style="width: 10%;"></td> <td style="width: 10%;"></td> <td style="width: 10%;"></td> <td style="width: 10%;"></td> <td style="width: 10%;"></td> <td style="width: 10%;"></td> <td style="width: 10%;"></td> <td style="width: 10%;"></td> <td style="width: 10%;"></td> </tr> <tr> <td></td> <td></td> <td colspan="8" style="text-align: center;"> <table border="1" style="width: 100%; border-collapse: collapse; text-align: center;"> <tr> <td style="width: 10%;"></td> <td style="width: 10%;"></td> <td style="width: 10%;"></td> <td style="width: 10%;"></td> <td style="width: 10%;"></td> <td style="width: 10%;"></td> <td style="width: 10%;"></td> <td style="width: 10%;"></td> <td style="width: 10%;"></td> <td style="width: 10%;"></td> </tr> <tr> <td></td> <td></td> <td colspan="8" style="text-align: center;"> <table border="1" style="width: 100%; border-collapse: collapse; text-align: center;"> <tr> <td style="width: 10%;"></td> <td style="width: 10%;"></td> <td style="width: 10%;"></td> <td style="width: 10%;"></td> <td style="width: 10%;"></td> <td style="width: 10%;"></td> <td style="width: 10%;"></td> <td style="width: 10%;"></td> <td style="width: 10%;"></td> <td style="width: 10%;"></td> </tr> <tr> <td></td> <td></td> <td colspan="8" style="text-align: center;"> <table border="1" style="width: 100%; border-collapse: collapse; text-align: center;"> <tr> <td style="width: 10%;"></td> <td style="width: 10%;"></td> <td style="width: 10%;"></td> <td style="width: 10%;"></td> <td style="width: 10%;"></td> <td style="width: 10%;"></td> <td style="width: 10%;"></td> <td style="width: 10%;"></td> <td style="width: 10%;"></td> <td style="width: 10%;"></td> </tr> <tr> <td></td> <td></td> <td colspan="8" style="text-align: center;">
<table border="1" style="width: 100%; border-collapse: collapse; text-align: center;"> <tr> <td style="width: 10%;"></td> <td style="width: 10%;"></td> <td style="width: 10%;"></td> <td style="width: 10%;"></td> <td style="width: 10%;"></td> <td style="width: 10%;"></td> <td style="width: 10%;"></td> <td style="width: 10%;"></td> <td style="width: 10%;"></td> <td style="width: 10%;"></td> </tr> <tr> <td></td> <td></td> <td colspan="8" style="text-align: center;"> <table border="1" style="width: 100%; border-collapse: collapse; text-align: center;"> <tr> <td style="width: 10%;"></td> <td style="width: 10%;"></td> <td style="width: 10%;"></td> <td style="width: 10%;"></td> <td style="width: 10%;"></td> <td style="width: 10%;"></td> <td style="width: 10%;"></td> <td style="width: 10%;"></td> <td style="width: 10%;"></td> <td style="width: 10%;"></td> </tr> <tr> <td></td> <td></td> <td colspan="8" style="text-align: center;"> <table border="1" style="width: 100%; border-collapse: collapse; text-align: center;"> <tr> <td style="width: 10%;"></td> <td style="width: 10%;"></td> <td style="width: 10%;"></td> <td style="width: 10%;"></td> <td style="width: 10%;"></td> <td style="width: 10%;"></td> <td style="width: 10%;"></td> <td style="width: 10%;"></td> <td style="width: 10%;"></td> <td style="width: 10%;"></td> </tr> <tr> <td></td> <td></td> <td colspan="8" style="text-align: center;"> <table border="1" style="width: 100%; border-collapse: collapse; text-align: center;"> <tr> <td style="width: 10%;"></td> <td style="width: 10%;"></td> <td style="width: 10%;"></td> <td style="width: 10%;"></td> <td style="width: 10%;"></td> <td style="width: 10%;"></td> <td style="width: 10%;"></td> <td style="width: 10%;"></td> <td style="width: 10%;"></td> <td style="width: 10%;"></td> </tr> <tr> <td></td> <td></td> <td colspan="8" style="text-align: center;"> <table border="1" style="width: 100%; border-collapse: collapse; text-align: center;"> <tr> <td style="width: 10%;"></td> <td style="width: 10%;"></td> <td style="width: 10%;"></td> <td style="width: 10%;"></td> <td style="width: 10%;"></td> <td style="width: 10%;"></td> <td style="width: 10%;"></td> <td style="width: 10%;"></td> <td style="width: 10%;"></td> <td style="width: 10%;"></td> </tr> <tr> <td></td> <td></td> <td colspan="8" style="text-align: center;"> <table border="1" style="width: 100%; border-collapse: collapse; text-align: center;"> <tr> <td style="width: 10%;"></td> <td style="width: 10%;"></td> <td style="width: 10%;"></td> <td style="width: 10%;"></td> <td style="width: 10%;"></td> <td style="width: 10%;"></td> <td style="width: 10%;"></td> <td style="width: 10%;"></td> <td style="width: 10%;"></td> <td style="width: 10%;"></td> </tr> <tr> <td></td> <td></td> <td colspan="8" style="text-align: center;"> <table border="1" style="width: 100%; border-collapse: collapse; text-align: center;"> <tr> <td style="width: 10%;"></td> <td style="width: 10%;"></td> <td style="width: 10%;"></td> <td style="width: 10%;"></td> <td style="width: 10%;"></td> <td style="width: 10%;"></td> <td style="width: 10%;"></td> <td style="width: 10%;"></td> <td style="width: 10%;"></td> <td style="width: 10%;"></td> </tr> <tr> <td></td> <td></td> <td colspan="8" style="text-align: center;"> <table border="1" style="width: 100%; border-collapse: collapse; text-align: center;"> <tr> <td style="width: 10%;"></td> <td style="width: 10%;"></td> <td style="width: 10%;"></td> <td style="width: 10%;"></td> <td style="width: 10%;"></td> <td style="width: 10%;"></td> <td style="width: 10%;"></td> <td style="width: 10%;"></td> <td style="width: 10%;"></td> <td style="width: 10%;"></td> </tr> <tr> <td></td> <td></td> <td colspan="8" style="text-align: center;"> <table border="1" style="width: 100%; border-collapse: collapse; text-align: center;"> <tr> </tr></table></td></tr></table></td></tr></table></td></tr></table></td></tr></table></td></tr></table></td></tr></table></td></tr></table></td></tr></table></td></tr></table></td></tr></table></td></tr></table></td></tr></table></td></tr></table></td></tr></table></td></tr></table></td></tr></table></td></tr></table></td></tr></table></td></tr></table></td></tr></table></td></tr></table></td></tr></table></td></tr></table></td></tr></table></td></tr></table></td></tr></table></td></tr></table></td></tr></table></td></tr></table></td></tr></table></td></tr></table></td></tr></table>
 | | | | | | | | | | | | | | | | | | | | <table border="1" style="width: 100%; border-collapse: collapse; text-align: center;"> <tr> <td style="width: 10%;"></td> <td style="width: 10%;"></td> <td style="width: 10%;"></td> <td style="width: 10%;"></td> <td style="width: 10%;"></td> <td style="width: 10%;"></td> <td style="width: 10%;"></td> <td style="width: 10%;"></td> <td style="width: 10%;"></td> <td style="width: 10%;"></td> </tr> <tr> <td></td> <td></td> <td colspan="8" style="text-align: center;"> <table border="1" style="width: 100%; border-collapse: collapse; text-align: center;"> <tr> <td style="width: 10%;"></td> <td style="width: 10%;"></td> <td style="width: 10%;"></td> <td style="width: 10%;"></td> <td style="width: 10%;"></td> <td style="width: 10%;"></td> <td style="width: 10%;"></td> <td style="width: 10%;"></td> <td style="width: 10%;"></td> <td style="width: 10%;"></td> </tr> <tr> <td></td> <td></td> <td colspan="8" style="text-align: center;"> <table border="1" style="width: 100%; border-collapse: collapse; text-align: center;"> <tr> <td style="width: 10%;"></td> <td style="width: 10%;"></td> <td style="width: 10%;"></td> <td style="width: 10%;"></td> <td style="width: 10%;"></td> <td style="width: 10%;"></td> <td style="width: 10%;"></td> <td style="width: 10%;"></td> <td style="width: 10%;"></td> <td style="width: 10%;"></td> </tr> <tr> <td></td> <td></td> <td colspan="8" style="text-align: center;"> <table border="1" style="width: 100%; border-collapse: collapse; text-align: center;"> <tr> <td style="width: 10%;"></td> <td style="width: 10%;"></td> <td style="width: 10%;"></td> <td style="width: 10%;"></td> <td style="width: 10%;"></td> <td style="width: 10%;"></td> <td style="width: 10%;"></td> <td style="width: 10%;"></td> <td style="width: 10%;"></td> <td style="width: 10%;"></td> </tr> <tr> <td></td> <td></td> <td colspan="8" style="text-align: center;"> <table border="1" style="width: 100%; border-collapse: collapse; text-align: center;"> <tr> <td style="width: 10%;"></td> <td style="width: 10%;"></td> <td style="width: 10%;"></td> <td style="width: 10%;"></td> <td style="width: 10%;"></td> <td style="width: 10%;"></td> <td style="width: 10%;"></td> <td style="width: 10%;"></td> <td style="width: 10%;"></td> <td style="width: 10%;"></td> </tr> <tr> <td></td> <td></td> <td colspan="8" style="text-align: center;"> <table border="1" style="width: 100%; border-collapse: collapse; text-align: center;"> <tr> <td style="width: 10%;"></td> <td style="width: 10%;"></td> <td style="width: 10%;"></td> <td style="width: 10%;"></td> <td style="width: 10%;"></td> <td style="width: 10%;"></td> <td style="width: 10%;"></td> <td style="width: 10%;"></td> <td style="width: 10%;"></td> <td style="width: 10%;"></td> </tr> <tr> <td></td> <td></td> <td colspan="8" style="text-align: center;"> <table border="1" style="width: 100%; border-collapse: collapse; text-align: center;"> <tr> <td style="width: 10%;"></td> <td style="width: 10%;"></td> <td style="width: 10%;"></td> <td style="width: 10%;"></td> <td style="width: 10%;"></td> <td style="width: 10%;"></td> <td style="width: 10%;"></td> <td style="width: 10%;"></td> <td style="width: 10%;"></td> <td style="width: 10%;"></td> </tr> <tr> <td></td> <td></td> <td colspan="8" style="text-align: center;"> <table border="1" style="width: 100%; border-collapse: collapse; text-align: center;"> <tr> <td style="width: 10%;"></td> <td style="width: 10%;"></td> <td style="width: 10%;"></td> <td style="width: 10%;"></td> <td style="width: 10%;"></td> <td style="width: 10%;"></td> <td style="width: 10%;"></td> <td style="width: 10%;"></td> <td style="width: 10%;"></td> <td style="width: 10%;"></td> </tr> <tr> <td></td> <td></td> <td colspan="8" style="text-align: center;"> <table border="1" style="width: 100%; border-collapse: collapse; text-align: center;"> <tr> <td style="width: 10%;"></td> <td style="width: 10%;"></td> <td style="width: 10%;"></td> <td style="width: 10%;"></td> <td style="width: 10%;"></td> <td style="width: 10%;"></td> <td style="width: 10%;"></td> <td style="width: 10%;"></td> <td style="width: 10%;"></td> <td style="width: 10%;"></td> </tr> <tr> <td></td> <td></td> <td colspan="8" style="text-align: center;"> <table border="1" style="width: 100%; border-collapse: collapse; text-align: center;"> <tr> <td style="width: 10%;"></td> <td style="width: 10%;"></td> <td style="width: 10%;"></td> <td style="width: 10%;"></td> <td style="width: 10%;"></td> <td style="width: 10%;"></td> <td style="width: 10%;"></td> <td style="width: 10%;"></td> <td style="width: 10%;"></td> <td style="width: 10%;"></td> </tr> <tr> <td></td> <td></td> <td colspan="8" style="text-align: center;"> <table border="1" style="width: 100%; border-collapse: collapse; text-align: center;"> <tr> <td style="width: 10%;"></td> <td style="width: 10%;"></td> <td style="width: 10%;"></td> <td style="width: 10%;"></td> <td style="width: 10%;"></td> <td style="width: 10%;"></td> <td style="width: 10%;"></td> <td style="width: 10%;"></td> <td style="width: 10%;"></td> <td style="width: 10%;"></td> </tr> <tr> <td></td> <td></td> <td colspan="8" style="text-align: center;"> <table border="1" style="width: 100%; border-collapse: collapse; text-align: center;"> <tr> <td style="width: 10%;"></td> <td style="width: 10%;"></td> <td style="width: 10%;"></td> <td style="width: 10%;"></td> <td style="width: 10%;"></td> <td style="width: 10%;"></td> <td style="width: 10%;"></td> <td style="width: 10%;"></td> <td style="width: 10%;"></td> <td style="width: 10%;"></td> </tr> <tr> <td></td> <td></td> <td colspan="8" style="text-align: center;"> <table border="1" style="width: 100%; border-collapse: collapse; text-align: center;"> <tr> <td style="width: 10%;"></td> <td style="width: 10%;"></td> <td style="width: 10%;"></td> <td style="width: 10%;"></td> <td style="width: 10%;"></td> <td style="width: 10%;"></td> <td style="width: 10%;"></td> <td style="width: 10%;"></td> <td style="width: 10%;"></td> <td style="width: 10%;"></td> </tr> <tr> <td></td> <td></td> <td colspan="8" style="text-align: center;"> <table border="1" style="width: 100%; border-collapse: collapse; text-align: center;"> <tr> <td style="width: 10%;"></td> <td style="width: 10%;"></td> <td style="width: 10%;"></td> <td
style="width: 10%;"></td> <td style="width: 10%;"></td> <td style="width: 10%;"></td> <td style="width: 10%;"></td> <td style="width: 10%;"></td> <td style="width: 10%;"></td> <td style="width: 10%;"></td> </tr> <tr> <td></td> <td></td> <td colspan="8" style="text-align: center;"> <table border="1" style="width: 100%; border-collapse: collapse; text-align: center;"> <tr> <td style="width: 10%;"></td> <td style="width: 10%;"></td> <td style="width: 10%;"></td> <td style="width: 10%;"></td> <td style="width: 10%;"></td> <td style="width: 10%;"></td> <td style="width: 10%;"></td> <td style="width: 10%;"></td> <td style="width: 10%;"></td> <td style="width: 10%;"></td> </tr> <tr> <td></td> <td></td> <td colspan="8" style="text-align: center;"> <table border="1" style="width: 100%; border-collapse: collapse; text-align: center;"> <tr> <td style="width: 10%;"></td> <td style="width: 10%;"></td> <td style="width: 10%;"></td> <td style="width: 10%;"></td> <td style="width: 10%;"></td> <td style="width: 10%;"></td> <td style="width: 10%;"></td> <td style="width: 10%;"></td> <td style="width: 10%;"></td> <td style="width: 10%;"></td> </tr> <tr> <td></td> <td></td> <td colspan="8" style="text-align: center;"> <table border="1" style="width: 100%; border-collapse: collapse; text-align: center;"> <tr> <td style="width: 10%;"></td> <td style="width: 10%;"></td> <td style="width: 10%;"></td> <td style="width: 10%;"></td> <td style="width: 10%;"></td> <td style="width: 10%;"></td> <td style="width: 10%;"></td> <td style="width: 10%;"></td> <td style="width: 10%;"></td> <td style="width: 10%;"></td> </tr> <tr> <td></td> <td></td> <td colspan="8" style="text-align: center;"> <table border="1" style="width: 100%; border-collapse: collapse; text-align: center;"> <tr> <td style="width: 10%;"></td> <td style="width: 10%;"></td> <td style="width: 10%;"></td> <td style="width: 10%;"></td> <td style="width: 10%;"></td> <td style="width: 10%;"></td> <td style="width: 10%;"></td> <td style="width: 10%;"></td> <td style="width: 10%;"></td> <td style="width: 10%;"></td> </tr> <tr> <td></td> <td></td> <td colspan="8" style="text-align: center;"> <table border="1" style="width: 100%; border-collapse: collapse; text-align: center;"> <tr> <td style="width: 10%;"></td> <td style="width: 10%;"></td> <td style="width: 10%;"></td> <td style="width: 10%;"></td> <td style="width: 10%;"></td> <td style="width: 10%;"></td> <td style="width: 10%;"></td> <td style="width: 10%;"></td> <td style="width: 10%;"></td> <td style="width: 10%;"></td> </tr> <tr> <td></td> <td></td> <td colspan="8" style="text-align: center;"> <table border="1" style="width: 100%; border-collapse: collapse; text-align: center;"> <tr> <td style="width: 10%;"></td> <td style="width: 10%;"></td> <td style="width: 10%;"></td> <td style="width: 10%;"></td> <td style="width: 10%;"></td> <td style="width: 10%;"></td> <td style="width: 10%;"></td> <td style="width: 10%;"></td> <td style="width: 10%;"></td> <td style="width: 10%;"></td> </tr> <tr> <td></td> <td></td> <td colspan="8" style="text-align: center;"> <table border="1" style="width: 100%; border-collapse: collapse; text-align: center;"> <tr> <td style="width: 10%;"></td> <td style="width: 10%;"></td> <td style="width: 10%;"></td> <td style="width: 10%;"></td> <td style="width: 10%;"></td> <td style="width: 10%;"></td> <td style="width: 10%;"></td> <td style="width: 10%;"></td> <td style="width: 10%;"></td> <td style="width: 10%;"></td> </tr> <tr> <td></td> <td></td> <td colspan="8" style="text-align: center;"> <table border="1" style="width: 100%; border-collapse: collapse; text-align: center;"> <tr> <td style="width: 10%;"></td> <td style="width: 10%;"></td> <td style="width: 10%;"></td> <td style="width: 10%;"></td> <td style="width: 10%;"></td> <td style="width: 10%;"></td> <td style="width: 10%;"></td> <td style="width: 10%;"></td> <td style="width: 10%;"></td> <td style="width: 10%;"></td> </tr> <tr> <td></td> <td></td> <td colspan="8" style="text-align: center;"> <table border="1" style="width: 100%; border-collapse: collapse; text-align: center;"> <tr> <td style="width: 10%;"></td> <td style="width: 10%;"></td> <td style="width: 10%;"></td> <td style="width: 10%;"></td> <td style="width: 10%;"></td> <td style="width: 10%;"></td> <td style="width: 10%;"></td> <td style="width: 10%;"></td> <td style="width: 10%;"></td> <td style="width: 10%;"></td> </tr> <tr> <td></td> <td></td> <td colspan="8" style="text-align: center;"> <table border="1" style="width: 100%; border-collapse: collapse; text-align: center;"> <tr> <td style="width: 10%;"></td> <td style="width: 10%;"></td> <td style="width: 10%;"></td> <td style="width: 10%;"></td> <td style="width: 10%;"></td> <td style="width: 10%;"></td> <td style="width: 10%;"></td> <td style="width: 10%;"></td> <td style="width: 10%;"></td> <td style="width: 10%;"></td> </tr> <tr> <td></td> <td></td> <td colspan="8" style="text-align: center;"> <table border="1" style="width: 100%; border-collapse: collapse; text-align: center;"> <tr> <td style="width: 10%;"></td> <td style="width: 10%;"></td> <td style="width: 10%;"></td> <td style="width: 10%;"></td> <td style="width: 10%;"></td> <td style="width: 10%;"></td> <td style="width: 10%;"></td> <td style="width: 10%;"></td> <td style="width: 10%;"></td> <td style="width: 10%;"></td> </tr> <tr> <td></td> <td></td> <td colspan="8" style="text-align: center;"> <table border="1" style="width: 100%; border-collapse: collapse; text-align: center;"> <tr> <td style="width: 10%;"></td> <td style="width: 10%;"></td> <td style="width: 10%;"></td> <td style="width: 10%;"></td> <td style="width: 10%;"></td> <td style="width: 10%;"></td> <td style="width: 10%;"></td> <td style="width: 10%;"></td> <td style="width: 10%;"></td> <td style="width: 10%;"></td> </tr> <tr> <td></td> <td></td> <td colspan="8" style="text-align: center;"> <table border="1" style="width: 100%; border-collapse: collapse; text-align: center;"> <tr> <td style="width: 10%;"></td> <td style="width: 10%;"></td> <td style="width: 10%;"></td> <td style="width: 10%;"></td> <td style="width: 10%;"></td> <td style="width: 10%;"></td> <td style="width: 10%;"></td> <td style="width: 10%;"></td> <td style="width: 10%;"></td> <td style="width: 10%;"></td> </tr> <tr> <td></td> <td></td> <td colspan="8" style="text-align: center;"> <table border="1" style="width: 100%; border-collapse: collapse; text-align: center;"> <tr> <td style="width: 10%;"></td> <td style="width: 10%;"></td> <td style="width: 10%;"></td> <td style="width: 10%;"></td> <td style="width: 10%;"></td> <td style="width: 10%;"></td> <td style="width: 10%;"></td> <td style="width: 10%;"></td> <td style="width: 10%;"></td> <td style="width: 10%;"></td> </tr> <tr> <td></td> <td></td> <td colspan="8" style="text-align: center;"> <table border="1" style="width: 100%; border-collapse: collapse; text-align: center;"> <tr> <td style="width: 10%;"></td> <td style="width: 10%;"></td> <td style="width: 10%;"></td> <td style="width: 10%;"></td> <td style="width: 10%;"></td> <td style="width: 10%;"></td> <td style="width: 10%;"></td> <td style="width: 10%;"></td> <td style="width: 10%;"></td> <td style="width: 10%;"></td> </tr> <tr> <td></td> <td></td> <td colspan="8" style="text-align: center;"> <table border="1" style="width: 100%; border-collapse: collapse; text-align: center;"> <tr> <td style="width: 10%;"></td> <td style="width: 10%;"></td> <td style="width: 10%;"></td> <td style="width: 10%;"></td> <td style="width: 10%;"></td> <td style="width: 10%;"></td> <td style="width: 10%;"></td> <td style="width: 10%;"></td> <td style="width: 10%;"></td> <td style="width: 10%;"></td> </tr> <tr> <td></td> <td></td> <td colspan="8" style="text-align: center;"> <table border="1" style="width: 100%; border-collapse: collapse; text-align: center;"> <tr> <td style="width: 10%;"></td> <td style="width: 10%;"></td> <td style="width: 10%;"></td> <td style="width: 10%;"></td> <td style="width: 10%;"></td> <td style="width: 10%;"></td> <td style="width: 10%;"></td> <td style="width: 10%;"></td> <td style="width: 10%;"></td> <td style="width: 10%;"></td> </tr> <tr> <td></td> <td></td> <td colspan="8" style="text-align: center;"> <table border="1" style="width: 100%; border-collapse: collapse; text-align: center;"> <tr> </tr></table></td></tr></table></td></tr></table></td></tr></table></td></tr></table></td></tr></table></td></tr></table></td></tr></table></td></tr></table></td></tr></table></td></tr></table></td></tr></table></td></tr></table></td></tr></table></td></tr></table></td></tr></table></td></tr></table></td></tr></table></td></tr></table></td></tr></table></td></tr></table></td></tr></table></td></tr></table></td></tr></table></td></tr></table></td></tr></table></td></tr></table></td></tr></table></td></tr></table></td></tr></table></td></tr></table></td></tr></table>
 | | | | | | | | | | | | | | | | | | | | <table border="1" style="width: 100%; border-collapse: collapse; text-align: center;"> <tr> <td style="width: 10%;"></td> <td style="width: 10%;"></td> <td style="width: 10%;"></td> <td style="width: 10%;"></td> <td style="width: 10%;"></td> <td style="width: 10%;"></td> <td style="width: 10%;"></td> <td style="width: 10%;"></td> <td style="width: 10%;"></td> <td style="width: 10%;"></td> </tr> <tr> <td></td> <td></td> <td colspan="8" style="text-align: center;"> <table border="1" style="width: 100%; border-collapse: collapse; text-align: center;"> <tr> <td style="width: 10%;"></td> <td style="width: 10%;"></td> <td style="width: 10%;"></td> <td style="width: 10%;"></td> <td style="width: 10%;"></td> <td style="width: 10%;"></td> <td style="width: 10%;"></td> <td style="width: 10%;"></td> <td style="width: 10%;"></td> <td style="width: 10%;"></td> </tr> <tr> <td></td> <td></td> <td colspan="8" style="text-align: center;"> <table border="1" style="width: 100%; border-collapse: collapse; text-align: center;"> <tr> <td style="width: 10%;"></td> <td style="width: 10%;"></td> <td style="width: 10%;"></td> <td style="width: 10%;"></td> <td style="width: 10%;"></td> <td style="width: 10%;"></td> <td style="width: 10%;"></td> <td style="width: 10%;"></td> <td style="width: 10%;"></td> <td style="width: 10%;"></td> </tr> <tr> <td></td> <td></td> <td colspan="8" style="text-align: center;"> <table border="1" style="width: 100%; border-collapse: collapse; text-align: center;"> <tr> <td style="width: 10%;"></td> <td style="width: 10%;"></td> <td style="width: 10%;"></td> <td style="width: 10%;"></td> <td style="width: 10%;"></td> <td style="width: 10%;"></td> <td style="width: 10%;"></td> <td style="width: 10%;"></td> <td style="width: 10%;"></td> <td style="width: 10%;"></td> </tr>
<tr> <td></td> <td></td> <td colspan="8" style="text-align: center;"> <table border="1" style="width: 100%; border-collapse: collapse; text-align: center;"> <tr> <td style="width: 10%;"></td> <td style="width: 10%;"></td> <td style="width: 10%;"></td> <td style="width: 10%;"></td> <td style="width: 10%;"></td> <td style="width: 10%;"></td> <td style="width: 10%;"></td> <td style="width: 10%;"></td> <td style="width: 10%;"></td> <td style="width: 10%;"></td> </tr> <tr> <td></td> <td></td> <td colspan="8" style="text-align: center;"> <table border="1" style="width: 100%; border-collapse: collapse; text-align: center;"> <tr> <td style="width: 10%;"></td> <td style="width: 10%;"></td> <td style="width: 10%;"></td> <td style="width: 10%;"></td> <td style="width: 10%;"></td> <td style="width: 10%;"></td> <td style="width: 10%;"></td> <td style="width: 10%;"></td> <td style="width: 10%;"></td> <td style="width: 10%;"></td> </tr> <tr> <td></td> <td></td> <td colspan="8" style="text-align: center;"> <table border="1" style="width: 100%; border-collapse: collapse; text-align: center;"> <tr> <td style="width: 10%;"></td> <td style="width: 10%;"></td> <td style="width: 10%;"></td> <td style="width: 10%;"></td> <td style="width: 10%;"></td> <td style="width: 10%;"></td> <td style="width: 10%;"></td> <td style="width: 10%;"></td> <td style="width: 10%;"></td> <td style="width: 10%;"></td> </tr> <tr> <td></td> <td></td> <td colspan="8" style="text-align: center;"> <table border="1" style="width: 100%; border-collapse: collapse; text-align: center;"> <tr> <td style="width: 10%;"></td> <td style="width: 10%;"></td> <td style="width: 10%;"></td> <td style="width: 10%;"></td> <td style="width: 10%;"></td> <td style="width: 10%;"></td> <td style="width: 10%;"></td> <td style="width: 10%;"></td> <td style="width: 10%;"></td> <td style="width: 10%;"></td> </tr> <tr> <td></td> <td></td> <td colspan="8" style="text-align: center;"> <table border="1" style="width: 100%; border-collapse: collapse; text-align: center;"> <tr> <td style="width: 10%;"></td> <td style="width: 10%;"></td> <td style="width: 10%;"></td> <td style="width: 10%;"></td> <td style="width: 10%;"></td> <td style="width: 10%;"></td> <td style="width: 10%;"></td> <td style="width: 10%;"></td> <td style="width: 10%;"></td> <td style="width: 10%;"></td> </tr> <tr> <td></td> <td></td> <td colspan="8" style="text-align: center;"> <table border="1" style="width: 100%; border-collapse: collapse; text-align: center;"> <tr> <td style="width: 10%;"></td> <td style="width: 10%;"></td> <td style="width: 10%;"></td> <td style="width: 10%;"></td> <td style="width: 10%;"></td> <td style="width: 10%;"></td> <td style="width: 10%;"></td> <td style="width: 10%;"></td> <td style="width: 10%;"></td> <td style="width: 10%;"></td> </tr> <tr> <td></td> <td></td> <td colspan="8" style="text-align: center;"> <table border="1" style="width: 100%; border-collapse: collapse; text-align: center;"> <tr> <td style="width: 10%;"></td> <td style="width: 10%;"></td> <td style="width: 10%;"></td> <td style="width: 10%;"></td> <td style="width: 10%;"></td> <td style="width: 10%;"></td> <td style="width: 10%;"></td> <td style="width: 10%;"></td> <td style="width: 10%;"></td> <td style="width: 10%;"></td> </tr> <tr> <td></td> <td></td> <td colspan="8" style="text-align: center;"> <table border="1" style="width: 100%; border-collapse: collapse; text-align: center;"> <tr> <td style="width: 10%;"></td> <td style="width: 10%;"></td> <td style="width: 10%;"></td> <td style="width: 10%;"></td> <td style="width: 10%;"></td> <td style="width: 10%;"></td> <td style="width: 10%;"></td> <td style="width: 10%;"></td> <td style="width: 10%;"></td> <td style="width: 10%;"></td> </tr> <tr> <td></td> <td></td> <td colspan="8" style="text-align: center;"> <table border="1" style="width: 100%; border-collapse: collapse; text-align: center;"> <tr> <td style="width: 10%;"></td> <td style="width: 10%;"></td> <td style="width: 10%;"></td> <td style="width: 10%;"></td> <td style="width: 10%;"></td> <td style="width: 10%;"></td> <td style="width: 10%;"></td> <td style="width: 10%;"></td> <td style="width: 10%;"></td> <td style="width: 10%;"></td> </tr> <tr> <td></td> <td></td> <td colspan="8" style="text-align: center;"> <table border="1" style="width: 100%; border-collapse: collapse; text-align: center;"> <tr> <td style="width: 10%;"></td> <td style="width: 10%;"></td> <td style="width: 10%;"></td> <td style="width: 10%;"></td> <td style="width: 10%;"></td> <td style="width: 10%;"></td> <td style="width: 10%;"></td> <td style="width: 10%;"></td> <td style="width: 10%;"></td> <td style="width: 10%;"></td> </tr> <tr> <td></td> <td></td> <td colspan="8" style="text-align: center;"> <table border="1" style="width: 100%; border-collapse: collapse; text-align: center;"> <tr> <td style="width: 10%;"></td> <td style="width: 10%;"></td> <td style="width: 10%;"></td> <td style="width: 10%;"></td> <td style="width: 10%;"></td> <td style="width: 10%;"></td> <td style="width: 10%;"></td> <td style="width: 10%;"></td> <td style="width: 10%;"></td> <td style="width: 10%;"></td> </tr> <tr> <td></td> <td></td> <td colspan="8" style="text-align: center;"> <table border="1" style="width: 100%; border-collapse: collapse; text-align: center;"> <tr> <td style="width: 10%;"></td> <td style="width: 10%;"></td> <td style="width: 10%;"></td> <td style="width: 10%;"></td> <td style="width: 10%;"></td> <td style="width: 10%;"></td> <td style="width: 10%;"></td> <td style="width: 10%;"></td> <td style="width: 10%;"></td> <td style="width: 10%;"></td> </tr> <tr> <td></td> <td></td> <td colspan="8" style="text-align: center;"> <table border="1" style="width: 100%; border-collapse: collapse; text-align: center;"> <tr> <td style="width: 10%;"></td> <td style="width: 10%;"></td> <td style="width: 10%;"></td> <td style="width: 10%;"></td> <td style="width: 10%;"></td> <td style="width: 10%;"></td> <td style="width: 10%;"></td> <td style="width: 10%;"></td> <td style="width: 10%;"></td> <td style="width: 10%;"></td> </tr> <tr> <td></td> <td></td> <td colspan="8" style="text-align: center;"> <table border="1" style="width: 100%; border-collapse: collapse; text-align: center;"> <tr> <td style="width: 10%;"></td> <td style="width: 10%;"></td> <td style="width: 10%;"></td> <td style="width: 10%;"></td> <td style="width: 10%;"></td> <td style="width: 10%;"></td> <td style="width: 10%;"></td> <td style="width: 10%;"></td> <td style="width: 10%;"></td> <td style="width: 10%;"></td> </tr> <tr> <td></td> <td></td> <td colspan="8" style="text-align: center;"> <table border="1" style="width: 100%; border-collapse: collapse; text-align: center;"> <tr> <td style="width: 10%;"></td> <td style="width: 10%;"></td> <td style="width: 10%;"></td> <td style="width: 10%;"></td> <td style="width: 10%;"></td> <td style="width: 10%;"></td> <td style="width: 10%;"></td> <td style="width: 10%;"></td> <td style="width: 10%;"></td> <td style="width: 10%;"></td> </tr> <tr> <td></td> <td></td> <td colspan="8" style="text-align: center;"> <table border="1" style="width: 100%; border-collapse: collapse; text-align: center;"> <tr> <td style="width: 10%;"></td> <td style="width: 10%;"></td> <td style="width: 10%;"></td> <td style="width: 10%;"></td> <td style="width: 10%;"></td> <td style="width: 10%;"></td> <td style="width: 10%;"></td> <td style="width: 10%;"></td> <td style="width: 10%;"></td> <td style="width: 10%;"></td> </tr> <tr> <td></td> <td></td> <td colspan="8" style="text-align: center;"> <table border="1" style="width: 100%; border-collapse: collapse; text-align: center;"> <tr> <td style="width: 10%;"></td> <td style="width: 10%;"></td> <td style="width: 10%;"></td> <td style="width: 10%;"></td> <td style="width: 10%;"></td> <td style="width: 10%;"></td> <td style="width: 10%;"></td> <td style="width: 10%;"></td> <td style="width: 10%;"></td> <td style="width: 10%;"></td> </tr> <tr> <td></td> <td></td> <td colspan="8" style="text-align: center;"> <table border="1" style="width: 100%; border-collapse: collapse; text-align: center;"> <tr> <td style="width: 10%;"></td> <td style="width: 10%;"></td> <td style="width: 10%;"></td> <td style="width: 10%;"></td> <td style="width: 10%;"></td> <td style="width: 10%;"></td> <td style="width: 10%;"></td> <td style="width: 10%;"></td> <td style="width: 10%;"></td> <td style="width: 10%;"></td> </tr> <tr> <td></td> <td></td> <td colspan="8" style="text-align: center;"> <table border="1" style="width: 100%; border-collapse: collapse; text-align: center;"> <tr> <td style="width: 10%;"></td> <td style="width: 10%;"></td> <td style="width: 10%;"></td> <td style="width: 10%;"></td> <td style="width: 10%;"></td> <td style="width: 10%;"></td> <td style="width: 10%;"></td> <td style="width: 10%;"></td> <td style="width: 10%;"></td> <td style="width: 10%;"></td> </tr> <tr> <td></td> <td></td> <td colspan="8" style="text-align: center;"> <table border="1" style="width: 100%; border-collapse: collapse; text-align: center;"> <tr> <td style="width: 10%;"></td> <td style="width: 10%;"></td> <td style="width: 10%;"></td> <td style="width: 10%;"></td> <td style="width: 10%;"></td> <td style="width: 10%;"></td> <td style="width: 10%;"></td> <td style="width: 10%;"></td> <td style="width: 10%;"></td> <td style="width: 10%;"></td> </tr> <tr> <td></td> <td></td> <td colspan="8" style="text-align: center;"> <table border="1" style="width: 100%; border-collapse: collapse; text-align: center;"> <tr> <td style="width: 10%;"></td> <td style="width: 10%;"></td> <td style="width: 10%;"></td> <td style="width: 10%;"></td> <td style="width: 10%;"></td> <td style="width: 10%;"></td> <td style="width: 10%;"></td> <td style="width: 10%;"></td> <td style="width: 10%;"></td> <td style="width: 10%;"></td> </tr> <tr> <td></td> <td></td> <td colspan="8" style="text-align: center;"> <table border="1" style="width: 100%; border-collapse: collapse; text-align: center;"> <tr> <td
style="width: 10%;"></td> <td style="width: 10%;"></td> <td style="width: 10%;"></td> <td style="width: 10%;"></td> <td style="width: 10%;"></td> <td style="width: 10%;"></td> <td style="width: 10%;"></td> <td style="width: 10%;"></td> <td style="width: 10%;"></td> <td style="width: 10%;"></td> </tr> <tr> <td></td> <td></td> <td colspan="8" style="text-align: center;"> <table border="1" style="width: 100%; border-collapse: collapse; text-align: center;"> <tr> <td style="width: 10%;"></td> <td style="width: 10%;"></td> <td style="width: 10%;"></td> <td style="width: 10%;"></td> <td style="width: 10%;"></td> <td style="width: 10%;"></td> <td style="width: 10%;"></td> <td style="width: 10%;"></td> <td style="width: 10%;"></td> <td style="width: 10%;"></td> </tr> <tr> <td></td> <td></td> <td colspan="8" style="text-align: center;"> <table border="1" style="width: 100%; border-collapse: collapse; text-align: center;"> <tr> <td style="width: 10%;"></td> <td style="width: 10%;"></td> <td style="width: 10%;"></td> <td style="width: 10%;"></td> <td style="width: 10%;"></td> <td style="width: 10%;"></td> <td style="width: 10%;"></td> <td style="width: 10%;"></td> <td style="width: 10%;"></td> <td style="width: 10%;"></td> </tr> <tr> <td></td> <td></td> <td colspan="8" style="text-align: center;"> <table border="1" style="width: 100%; border-collapse: collapse; text-align: center;"> <tr> <td style="width: 10%;"></td> <td style="width: 10%;"></td> <td style="width: 10%;"></td> <td style="width: 10%;"></td> <td style="width: 10%;"></td> <td style="width: 10%;"></td> <td style="width: 10%;"></td> <td style="width: 10%;"></td> <td style="width: 10%;"></td> <td style="width: 10%;"></td> </tr> <tr> <td></td> <td></td> <td colspan="8" style="text-align: center;"> <table border="1" style="width: 100%; border-collapse: collapse; text-align: center;"> <tr> <td style="width: 10%;"></td> <td style="width: 10%;"></td> <td style="width: 10%;"></td> <td style="width: 10%;"></td> <td style="width: 10%;"></td> <td style="width: 10%;"></td> <td style="width: 10%;"></td> <td style="width: 10%;"></td> <td style="width: 10%;"></td> <td style="width: 10%;"></td> </tr> <tr> <td></td> <td></td> <td colspan="8" style="text-align: center;"> <table border="1" style="width: 100%; border-collapse: collapse; text-align: center;"> <tr> </tr></table></td></tr></table></td></tr></table></td></tr></table></td></tr></table></td></tr></table></td></tr></table></td></tr></table></td></tr></table></td></tr></table></td></tr></table></td></tr></table></td></tr></table></td></tr></table></td></tr></table></td></tr></table></td></tr></table></td></tr></table></td></tr></table></td></tr></table></td></tr></table></td></tr></table></td></tr></table></td></tr></table></td></tr></table></td></tr></table></td></tr></table></td></tr></table></td></tr></table></td></tr></table></td></tr></table>
 | | | | | | | | | | | | | | | | | | | | <table border="1" style="width: 100%; border-collapse: collapse; text-align: center;"> <tr> <td style="width: 10%;"></td> <td style="width: 10%;"></td> <td style="width: 10%;"></td> <td style="width: 10%;"></td> <td style="width: 10%;"></td> <td style="width: 10%;"></td> <td style="width: 10%;"></td> <td style="width: 10%;"></td> <td style="width: 10%;"></td> <td style="width: 10%;"></td> </tr> <tr> <td></td> <td></td> <td colspan="8" style="text-align: center;"> <table border="1" style="width: 100%; border-collapse: collapse; text-align: center;"> <tr> <td style="width: 10%;"></td> <td style="width: 10%;"></td> <td style="width: 10%;"></td> <td style="width: 10%;"></td> <td style="width: 10%;"></td> <td style="width: 10%;"></td> <td style="width: 10%;"></td> <td style="width: 10%;"></td> <td style="width: 10%;"></td> <td style="width: 10%;"></td> </tr> <tr> <td></td> <td></td> <td colspan="8" style="text-align: center;"> <table border="1" style="width: 100%; border-collapse: collapse; text-align: center;"> <tr> <td style="width: 10%;"></td> <td style="width: 10%;"></td> <td style="width: 10%;"></td> <td style="width: 10%;"></td> <td style="width: 10%;"></td> <td style="width: 10%;"></td> <td style="width: 10%;"></td> <td style="width: 10%;"></td> <td style="width: 10%;"></td> <td style="width: 10%;"></td> </tr> <tr> <td></td> <td></td> <td colspan="8" style="text-align: center;"> <table border="1" style="width: 100%; border-collapse: collapse; text-align: center;"> <tr> <td style="width: 10%;"></td> <td style="width: 10%;"></td> <td style="width: 10%;"></td> <td style="width: 10%;"></td> <td style="width: 10%;"></td> <td style="width: 10%;"></td> <td style="width: 10%;"></td> <td style="width: 10%;"></td> <td style="width: 10%;"></td> <td style="width: 10%;"></td> </tr> <tr> <td></td> <td></td> <td colspan="8" style="text-align: center;"> <table border="1" style="width: 100%; border-collapse: collapse; text-align: center;"> <tr> <td style="width: 10%;"></td> <td style="width: 10%;"></td> <td style="width: 10%;"></td> <td style="width: 10%;"></td> <td style="width: 10%;"></td> <td style="width: 10%;"></td> <td style="width: 10%;"></td> <td style="width: 10%;"></td> <td style="width: 10%;"></td> <td style="width: 10%;"></td> </tr> <tr> <td></td> <td></td> <td colspan="8" style="text-align: center;"> <table border="1" style="width: 100%; border-collapse: collapse; text-align: center;"> <tr> <td style="width: 10%;"></td> <td style="width: 10%;"></td> <td style="width: 10%;"></td> <td style="width: 10%;"></td> <td style="width: 10%;"></td> <td style="width: 10%;"></td> <td style="width: 10%;"></td> <td style="width: 10%;"></td> <td style="width: 10%;"></td> <td style="width: 10%;"></td> </tr> <tr> <td></td> <td></td> <td colspan="8" style="text-align: center;"> <table border="1" style="width: 100%; border-collapse: collapse; text-align: center;"> <tr> <td style="width: 10%;"></td> <td style="width: 10%;"></td> <td style="width: 10%;"></td> <td style="width: 10%;"></td> <td style="width: 10%;"></td> <td style="width: 10%;"></td> <td style="width: 10%;"></td> <td style="width: 10%;"></td> <td style="width: 10%;"></td> <td style="width: 10%;"></td> </tr> <tr> <td></td> <td></td> <td colspan="8" style="text-align: center;"> <table border="1" style="width: 100%; border-collapse: collapse; text-align: center;"> <tr> <td style="width: 10%;"></td> <td style="width: 10%;"></td> <td style="width: 10%;"></td> <td style="width: 10%;"></td> <td style="width: 10%;"></td> <td style="width: 10%;"></td> <td style="width: 10%;"></td> <td style="width: 10%;"></td> <td style="width: 10%;"></td> <td style="width: 10%;"></td> </tr> <tr> <td></td> <td></td> <td colspan="8" style="text-align: center;"> <table border="1" style="width: 100%; border-collapse: collapse; text-align: center;"> <tr> <td style="width: 10%;"></td> <td style="width: 10%;"></td> <td style="width: 10%;"></td> <td style="width: 10%;"></td> <td style="width: 10%;"></td> <td style="width: 10%;"></td> <td style="width: 10%;"></td> <td style="width: 10%;"></td> <td style="width: 10%;"></td> <td style="width: 10%;"></td> </tr> <tr> <td></td> <td></td> <td colspan="8" style="text-align: center;"> <table border="1" style="width: 100%; border-collapse: collapse; text-align: center;"> <tr> <td style="width: 10%;"></td> <td style="width: 10%;"></td> <td style="width: 10%;"></td> <td style="width: 10%;"></td> <td style="width: 10%;"></td> <td style="width: 10%;"></td> <td style="width: 10%;"></td> <td style="width: 10%;"></td> <td style="width: 10%;"></td> <td style="width: 10%;"></td> </tr> <tr> <td></td> <td></td> <td colspan="8" style="text-align: center;"> <table border="1" style="width: 100%; border-collapse: collapse; text-align: center;"> <tr> <td style="width: 10%;"></td> <td style="width: 10%;"></td> <td style="width: 10%;"></td> <td style="width: 10%;"></td> <td style="width: 10%;"></td> <td style="width: 10%;"></td> <td style="width: 10%;"></td> <td style="width: 10%;"></td> <td style="width: 10%;"></td> <td style="width: 10%;"></td> </tr> <tr> <td></td> <td></td> <td colspan="8" style="text-align: center;"> <table border="1" style="width: 100%; border-collapse: collapse; text-align: center;"> <tr> <td style="width: 10%;"></td> <td style="width: 10%;"></td> <td style="width: 10%;"></td> <td style="width: 10%;"></td> <td style="width: 10%;"></td> <td style="width: 10%;"></td> <td style="width: 10%;"></td> <td style="width: 10%;"></td> <td style="width: 10%;"></td> <td style="width: 10%;"></td> </tr> <tr> <td></td> <td></td> <td colspan="8" style="text-align: center;"> <table border="1" style="width: 100%; border-collapse: collapse; text-align: center;"> <tr> <td style="width: 10%;"></td> <td style="width: 10%;"></td> <td style="width: 10%;"></td> <td style="width: 10%;"></td> <td style="width: 10%;"></td> <td style="width: 10%;"></td> <td style="width: 10%;"></td> <td style="width: 10%;"></td> <td style="width: 10%;"></td> <td style="width: 10%;"></td> </tr> <tr> <td></td> <td></td> <td colspan="8" style="text-align: center;"> <table border="1" style="width: 100%; border-collapse: collapse; text-align: center;"> <tr> <td style="width: 10%;"></td> <td style="width: 10%;"></td> <td style="width: 10%;"></td> <td style="width: 10%;"></td> <td style="width: 10%;"></td> <td style="width: 10%;"></td> <td style="width: 10%;"></td> <td style="width: 10%;"></td> <td style="width: 10%;"></td> <td style="width: 10%;"></td> </tr> <tr> <td></td> <td></td> <td colspan="8" style="text-align: center;"> <table border="1" style="width: 100%; border-collapse: collapse; text-align: center;"> <tr> <td style="width: 10%;"></td> <td style="width: 10%;"></td> <td style="width: 10%;"></td> <td style="width: 10%;"></td> <td style="width: 10%;"></td> <td style="width: 10%;"></td> <td style="width: 10%;"></td> <td style="width: 10%;"></td> <td style="width: 10%;"></td> <td style="width: 10%;"></td> </tr> <tr> <td></td> <td></td> <td colspan="8" style="text-align: center;"> <table border="1" style="width: 100%; border-collapse: collapse; text-align: center;"> <tr> <td style="width: 10%;"></td> <td style="width: 10%;"></td> <td style="width: 10%;"></td> <td style="width: 10%;"></td> <td style="width: 10%;"></td> <td style="width: 10%;"></td> <td style="width: 10%;"></td> <td style="width: 10%;"></td> <td style="width: 10%;"></td> <td style="width: 10%;"></td> </tr> <tr> <td></td> <td></td> <td colspan="8" style="text-align: center;"> <table border="1" style="width: 100%; border-collapse: collapse; text-align: center;"> <tr> <td style="width: 10%;"></td> <td style="width: 10%;"></td> <td style="width: 10%;"></td> <td style="width: 10%;"></td> <td style="width: 10%;"></td> <td style="width: 10%;"></td> <td style="width: 10%;"></td> <td style="width:
10%;"></td> <td style="width: 10%;"></td> <td style="width: 10%;"></td> </tr> <tr> <td></td> <td></td> <td colspan="8" style="text-align: center;"> <table border="1" style="width: 100%; border-collapse: collapse; text-align: center;"> <tr> <td style="width: 10%;"></td> <td style="width: 10%;"></td> <td style="width: 10%;"></td> <td style="width: 10%;"></td> <td style="width: 10%;"></td> <td style="width: 10%;"></td> <td style="width: 10%;"></td> <td style="width: 10%;"></td> <td style="width: 10%;"></td> <td style="width: 10%;"></td> </tr> <tr> <td></td> <td></td> <td colspan="8" style="text-align: center;"> <table border="1" style="width: 100%; border-collapse: collapse; text-align: center;"> <tr> <td style="width: 10%;"></td> <td style="width: 10%;"></td> <td style="width: 10%;"></td> <td style="width: 10%;"></td> <td style="width: 10%;"></td> <td style="width: 10%;"></td> <td style="width: 10%;"></td> <td style="width: 10%;"></td> <td style="width: 10%;"></td> <td style="width: 10%;"></td> </tr> <tr> <td></td> <td></td> <td colspan="8" style="text-align: center;"> <table border="1" style="width: 100%; border-collapse: collapse; text-align: center;"> <tr> <td style="width: 10%;"></td> <td style="width: 10%;"></td> <td style="width: 10%;"></td> <td style="width: 10%;"></td> <td style="width: 10%;"></td> <td style="width: 10%;"></td> <td style="width: 10%;"></td> <td style="width: 10%;"></td> <td style="width: 10%;"></td> <td style="width: 10%;"></td> </tr> <tr> <td></td> <td></td> <td colspan="8" style="text-align: center;"> <table border="1" style="width: 100%; border-collapse: collapse; text-align: center;"> <tr> <td style="width: 10%;"></td> <td style="width: 10%;"></td> <td style="width: 10%;"></td> <td style="width: 10%;"></td> <td style="width: 10%;"></td> <td style="width: 10%;"></td> <td style="width: 10%;"></td> <td style="width: 10%;"></td> <td style="width: 10%;"></td> <td style="width: 10%;"></td> </tr> <tr> <td></td> <td></td> <td colspan="8" style="text-align: center;"> <table border="1" style="width: 100%; border-collapse: collapse; text-align: center;"> <tr> <td style="width: 10%;"></td> <td style="width: 10%;"></td> <td style="width: 10%;"></td> <td style="width: 10%;"></td> <td style="width: 10%;"></td> <td style="width: 10%;"></td> <td style="width: 10%;"></td> <td style="width: 10%;"></td> <td style="width: 10%;"></td> <td style="width: 10%;"></td> </tr> <tr> <td></td> <td></td> <td colspan="8" style="text-align: center;"> <table border="1" style="width: 100%; border-collapse: collapse; text-align: center;"> <tr> <td style="width: 10%;"></td> <td style="width: 10%;"></td> <td style="width: 10%;"></td> <td style="width: 10%;"></td> <td style="width: 10%;"></td> <td style="width: 10%;"></td> <td style="width: 10%;"></td> <td style="width: 10%;"></td> <td style="width: 10%;"></td> <td style="width: 10%;"></td> </tr> <tr> <td></td> <td></td> <td colspan="8" style="text-align: center;"> <table border="1" style="width: 100%; border-collapse: collapse; text-align: center;"> <tr> <td style="width: 10%;"></td> <td style="width: 10%;"></td> <td style="width: 10%;"></td> <td style="width: 10%;"></td> <td style="width: 10%;"></td> <td style="width: 10%;"></td> <td style="width: 10%;"></td> <td style="width: 10%;"></td> <td style="width: 10%;"></td> <td style="width: 10%;"></td> </tr> <tr> <td></td> <td></td> <td colspan="8" style="text-align: center;"> <table border="1" style="width: 100%; border-collapse: collapse; text-align: center;"> <tr> <td style="width: 10%;"></td> <td style="width: 10%;"></td> <td style="width: 10%;"></td> <td style="width: 10%;"></td> <td style="width: 10%;"></td> <td style="width: 10%;"></td> <td style="width: 10%;"></td> <td style="width: 10%;"></td> <td style="width: 10%;"></td> <td style="width: 10%;"></td> </tr> <tr> <td></td> <td></td> <td colspan="8" style="text-align: center;"> <table border="1" style="width: 100%; border-collapse: collapse; text-align: center;"> <tr> <td style="width: 10%;"></td> <td style="width: 10%;"></td> <td style="width: 10%;"></td> <td style="width: 10%;"></td> <td style="width: 10%;"></td> <td style="width: 10%;"></td> <td style="width: 10%;"></td> <td style="width: 10%;"></td> <td style="width: 10%;"></td> <td style="width: 10%;"></td> </tr> <tr> <td></td> <td></td> <td colspan="8" style="text-align: center;"> <table border="1" style="width: 100%; border-collapse: collapse; text-align: center;"> <tr> <td style="width: 10%;"></td> <td style="width: 10%;"></td> <td style="width: 10%;"></td> <td style="width: 10%;"></td> <td style="width: 10%;"></td> <td style="width: 10%;"></td> <td style="width: 10%;"></td> <td style="width: 10%;"></td> <td style="width: 10%;"></td> <td style="width: 10%;"></td> </tr> <tr> <td></td> <td></td> <td colspan="8" style="text-align: center;"> <table border="1" style="width: 100%; border-collapse: collapse; text-align: center;"> <tr> <td style="width: 10%;"></td> <td style="width: 10%;"></td> <td style="width: 10%;"></td> <td style="width: 10%;"></td> <td style="width: 10%;"></td> <td style="width: 10%;"></td> <td style="width: 10%;"></td> <td style="width: 10%;"></td> <td style="width: 10%;"></td> <td style="width: 10%;"></td> </tr> <tr> <td></td> <td></td> <td colspan="8" style="text-align: center;"> <table border="1" style="width: 100%; border-collapse: collapse; text-align: center;"> <tr> <td style="width: 10%;"></td> <td style="width: 10%;"></td> <td style="width: 10%;"></td> <td style="width: 10%;"></td> <td style="width: 10%;"></td> <td style="width: 10%;"></td> <td style="width: 10%;"></td> <td style="width: 10%;"></td> <td style="width: 10%;"></td> <td style="width: 10%;"></td> </tr> <tr> <td></td> <td></td> <td colspan="8" style="text-align: center;"> <table border="1" style="width: 100%; border-collapse: collapse; text-align: center;"> <tr> </tr></table></td></tr></table></td></tr></table></td></tr></table></td></tr></table></td></tr></table></td></tr></table></td></tr></table></td></tr></table></td></tr></table></td></tr></table></td></tr></table></td></tr></table></td></tr></table></td></tr></table></td></tr></table></td></tr></table></td></tr></table></td></tr></table></td></tr></table></td></tr></table></td></tr></table></td></tr></table></td></tr></table></td></tr></table></td></tr></table></td></tr></table></td></tr></table></td></tr></table></td></tr></table>
 | | | | | | | | | | | | | | | | | | | | <table border="1" style="width: 100%; border-collapse: collapse; text-align: center;"> <tr> <td style="width: 10%;"></td> <td style="width: 10%;"></td> <td style="width: 10%;"></td> <td style="width: 10%;"></td> <td style="width: 10%;"></td> <td style="width: 10%;"></td> <td style="width: 10%;"></td> <td style="width: 10%;"></td> <td style="width: 10%;"></td> <td style="width: 10%;"></td> </tr> <tr> <td></td> <td></td> <td colspan="8" style="text-align: center;"> <table border="1" style="width: 100%; border-collapse: collapse; text-align: center;"> <tr> <td style="width: 10%;"></td> <td style="width: 10%;"></td> <td style="width: 10%;"></td> <td style="width: 10%;"></td> <td style="width: 10%;"></td> <td style="width: 10%;"></td> <td style="width: 10%;"></td> <td style="width: 10%;"></td> <td style="width: 10%;"></td> <td style="width: 10%;"></td> </tr> <tr> <td></td> <td></td> <td colspan="8" style="text-align: center;"> <table border="1" style="width: 100%; border-collapse: collapse; text-align: center;"> <tr> <td style="width: 10%;"></td> <td style="width: 10%;"></td> <td style="width: 10%;"></td> <td style="width: 10%;"></td> <td style="width: 10%;"></td> <td style="width: 10%;"></td> <td style="width: 10%;"></td> <td style="width: 10%;"></td> <td style="width: 10%;"></td> <td style="width: 10%;"></td> </tr> <tr> <td></td> <td></td> <td colspan="8" style="text-align: center;"> <table border="1" style="width: 100%; border-collapse: collapse; text-align: center;"> <tr> <td style="width: 10%;"></td> <td style="width: 10%;"></td> <td style="width: 10%;"></td> <td style="width: 10%;"></td> <td style="width: 10%;"></td> <td style="width: 10%;"></td> <td style="width: 10%;"></td> <td style="width: 10%;"></td> <td style="width: 10%;"></td> <td style="width: 10%;"></td> </tr> <tr> <td></td> <td></td> <td colspan="8" style="text-align: center;"> <table border="1" style="width: 100%; border-collapse: collapse; text-align: center;"> <tr> <td style="width: 10%;"></td> <td style="width: 10%;"></td> <td style="width: 10%;"></td> <td style="width: 10%;"></td> <td style="width: 10%;"></td> <td style="width: 10%;"></td> <td style="width: 10%;"></td> <td style="width: 10%;"></td> <td style="width: 10%;"></td> <td style="width: 10%;"></td> </tr> <tr> <td></td> <td></td> <td colspan="8" style="text-align: center;"> <table border="1" style="width: 100%; border-collapse: collapse; text-align: center;"> <tr> <td style="width: 10%;"></td> <td style="width: 10%;"></td> <td style="width: 10%;"></td> <td style="width: 10%;"></td> <td style="width: 10%;"></td> <td style="width: 10%;"></td> <td style="width: 10%;"></td> <td style="width: 10%;"></td> <td style="width: 10%;"></td> <td style="width: 10%;"></td> </tr> <tr> <td></td> <td></td> <td colspan="8" style="text-align: center;"> <table border="1" style="width: 100%; border-collapse: collapse; text-align: center;"> <tr> <td style="width: 10%;"></td> <td style="width: 10%;"></td> <td style="width: 10%;"></td> <td style="width: 10%;"></td> <td style="width: 10%;"></td> <td style="width: 10%;"></td> <td style="width: 10%;"></td> <td style="width: 10%;"></td> <td style="width: 10%;"></td> <td style="width: 10%;"></td> </tr> <tr> <td></td> <td></td> <td colspan="8" style="text-align: center;"> <table border="1" style="width: 100%; border-collapse: collapse; text-align: center;"> <tr> <td style="width: 10%;"></td> <td style="width: 10%;"></td> <td style="width: 10%;"></td> <td style="width: 10%;"></td> <td style="width: 10%;"></td> <td style="width: 10%;"></td> <td style="width: 10%;"></td> <td style="width: 10%;"></td> <td style="width: 10%;"></td> <td style="width: 10%;"></td> </tr> <tr> <td></td> <td></td> <td colspan="8" style="text-align: center;"> <table border="1" style="width: 100%; border-collapse: collapse; text-align: center;"> <tr> <td style="width: 10%;"></td> <td style="width: 10%;"></td> <td style="width: 10%;"></td> <td style="width: 10%;"></td> <td style="width: 10%;"></td> <td style="width: 10%;"></td> <td style="width: 10%;"></td> <td style="width: 10%;"></td> <td style="width: 10%;"></td> <td style="width: 10%;"></td> </tr> <tr> <td></td> <td></td> <td colspan="8" style="text-align: center;"> <table border="1" style="width: 100%; border-collapse: collapse; text-align: center;"> <tr> <td
style="width: 10%;"></td> <td style="width: 10%;"></td> <td style="width: 10%;"></td> <td style="width: 10%;"></td> <td style="width: 10%;"></td> <td style="width: 10%;"></td> <td style="width: 10%;"></td> <td style="width: 10%;"></td> <td style="width: 10%;"></td> <td style="width: 10%;"></td> </tr> <tr> <td></td> <td></td> <td colspan="8" style="text-align: center;"> <table border="1" style="width: 100%; border-collapse: collapse; text-align: center;"> <tr> <td style="width: 10%;"></td> <td style="width: 10%;"></td> <td style="width: 10%;"></td> <td style="width: 10%;"></td> <td style="width: 10%;"></td> <td style="width: 10%;"></td> <td style="width: 10%;"></td> <td style="width: 10%;"></td> <td style="width: 10%;"></td> <td style="width: 10%;"></td> </tr> <tr> <td></td> <td></td> <td colspan="8" style="text-align: center;"> <table border="1" style="width: 100%; border-collapse: collapse; text-align: center;"> <tr> <td style="width: 10%;"></td> <td style="width: 10%;"></td> <td style="width: 10%;"></td> <td style="width: 10%;"></td> <td style="width: 10%;"></td> <td style="width: 10%;"></td> <td style="width: 10%;"></td> <td style="width: 10%;"></td> <td style="width: 10%;"></td> <td style="width: 10%;"></td> </tr> <tr> <td></td> <td></td> <td colspan="8" style="text-align: center;"> <table border="1" style="width: 100%; border-collapse: collapse; text-align: center;"> <tr> <td style="width: 10%;"></td> <td style="width: 10%;"></td> <td style="width: 10%;"></td> <td style="width: 10%;"></td> <td style="width: 10%;"></td> <td style="width: 10%;"></td> <td style="width: 10%;"></td> <td style="width: 10%;"></td> <td style="width: 10%;"></td> <td style="width: 10%;"></td> </tr> <tr> <td></td> <td></td> <td colspan="8" style="text-align: center;"> <table border="1" style="width: 100%; border-collapse: collapse; text-align: center;"> <tr> <td style="width: 10%;"></td> <td style="width: 10%;"></td> <td style="width: 10%;"></td> <td style="width: 10%;"></td> <td style="width: 10%;"></td> <td style="width: 10%;"></td> <td style="width: 10%;"></td> <td style="width: 10%;"></td> <td style="width: 10%;"></td> <td style="width: 10%;"></td> </tr> <tr> <td></td> <td></td> <td colspan="8" style="text-align: center;"> <table border="1" style="width: 100%; border-collapse: collapse; text-align: center;"> <tr> <td style="width: 10%;"></td> <td style="width: 10%;"></td> <td style="width: 10%;"></td> <td style="width: 10%;"></td> <td style="width: 10%;"></td> <td style="width: 10%;"></td> <td style="width: 10%;"></td> <td style="width: 10%;"></td> <td style="width: 10%;"></td> <td style="width: 10%;"></td> </tr> <tr> <td></td> <td></td> <td colspan="8" style="text-align: center;"> <table border="1" style="width: 100%; border-collapse: collapse; text-align: center;"> <tr> <td style="width: 10%;"></td> <td style="width: 10%;"></td> <td style="width: 10%;"></td> <td style="width: 10%;"></td> <td style="width: 10%;"></td> <td style="width: 10%;"></td> <td style="width: 10%;"></td> <td style="width: 10%;"></td> <td style="width: 10%;"></td> <td style="width: 10%;"></td> </tr> <tr> <td></td> <td></td> <td colspan="8" style="text-align: center;"> <table border="1" style="width: 100%; border-collapse: collapse; text-align: center;"> <tr> <td style="width: 10%;"></td> <td style="width: 10%;"></td> <td style="width: 10%;"></td> <td style="width: 10%;"></td> <td style="width: 10%;"></td> <td style="width: 10%;"></td> <td style="width: 10%;"></td> <td style="width: 10%;"></td> <td style="width: 10%;"></td> <td style="width: 10%;"></td> </tr> <tr> <td></td> <td></td> <td colspan="8" style="text-align: center;"> <table border="1" style="width: 100%; border-collapse: collapse; text-align: center;"> <tr> <td style="width: 10%;"></td> <td style="width: 10%;"></td> <td style="width: 10%;"></td> <td style="width: 10%;"></td> <td style="width: 10%;"></td> <td style="width: 10%;"></td> <td style="width: 10%;"></td> <td style="width: 10%;"></td> <td style="width: 10%;"></td> <td style="width: 10%;"></td> </tr> <tr> <td></td> <td></td> <td colspan="8" style="text-align: center;"> <table border="1" style="width: 100%; border-collapse: collapse; text-align: center;"> <tr> <td style="width: 10%;"></td> <td style="width: 10%;"></td> <td style="width: 10%;"></td> <td style="width: 10%;"></td> <td style="width: 10%;"></td> <td style="width: 10%;"></td> <td style="width: 10%;"></td> <td style="width: 10%;"></td> <td style="width: 10%;"></td> <td style="width: 10%;"></td> </tr> <tr> <td></td> <td></td> <td colspan="8" style="text-align: center;"> <table border="1" style="width: 100%; border-collapse: collapse; text-align: center;"> <tr> <td style="width: 10%;"></td> <td style="width: 10%;"></td> <td style="width: 10%;"></td> <td style="width: 10%;"></td> <td style="width: 10%;"></td> <td style="width: 10%;"></td> <td style="width: 10%;"></td> <td style="width: 10%;"></td> <td style="width: 10%;"></td> <td style="width: 10%;"></td> </tr> <tr> <td></td> <td></td> <td colspan="8" style="text-align: center;"> <table border="1" style="width: 100%; border-collapse: collapse; text-align: center;"> <tr> <td style="width: 10%;"></td> <td style="width: 10%;"></td> <td style="width: 10%;"></td> <td style="width: 10%;"></td> <td style="width: 10%;"></td> <td style="width: 10%;"></td> <td style="width: 10%;"></td> <td style="width: 10%;"></td> <td style="width: 10%;"></td> <td style="width: 10%;"></td> </tr> <tr> <td></td> <td></td> <td colspan="8" style="text-align: center;"> <table border="1" style="width: 100%; border-collapse: collapse; text-align: center;"> <tr> <td style="width: 10%;"></td> <td style="width: 10%;"></td> <td style="width: 10%;"></td> <td style="width: 10%;"></td> <td style="width: 10%;"></td> <td style="width: 10%;"></td> <td style="width: 10%;"></td> <td style="width: 10%;"></td> <td style="width: 10%;"></td> <td style="width: 10%;"></td> </tr> <tr> <td></td> <td></td> <td colspan="8" style="text-align: center;"> <table border="1" style="width: 100%; border-collapse: collapse; text-align: center;"> <tr> <td style="width: 10%;"></td> <td style="width: 10%;"></td> <td style="width: 10%;"></td> <td style="width: 10%;"></td> <td style="width: 10%;"></td> <td style="width: 10%;"></td> <td style="width: 10%;"></td> <td style="width: 10%;"></td> <td style="width: 10%;"></td> <td style="width: 10%;"></td> </tr> <tr> <td></td> <td></td> <td colspan="8" style="text-align: center;"> <table border="1" style="width: 100%; border-collapse: collapse; text-align: center;"> <tr> <td style="width: 10%;"></td> <td style="width: 10%;"></td> <td style="width: 10%;"></td> <td style="width: 10%;"></td> <td style="width: 10%;"></td> <td style="width: 10%;"></td> <td style="width: 10%;"></td> <td style="width: 10%;"></td> <td style="width: 10%;"></td> <td style="width: 10%;"></td> </tr> <tr> <td></td> <td></td> <td colspan="8" style="text-align: center;"> <table border="1" style="width: 100%; border-collapse: collapse; text-align: center;"> <tr> <td style="width: 10%;"></td> <td style="width: 10%;"></td> <td style="width: 10%;"></td> <td style="width: 10%;"></td> <td style="width: 10%;"></td> <td style="width: 10%;"></td> <td style="width: 10%;"></td> <td style="width: 10%;"></td> <td style="width: 10%;"></td> <td style="width: 10%;"></td> </tr> <tr> <td></td> <td></td> <td colspan="8" style="text-align: center;"> <table border="1" style="width: 100%; border-collapse: collapse; text-align: center;"> <tr> <td style="width: 10%;"></td> <td style="width: 10%;"></td> <td style="width: 10%;"></td> <td style="width: 10%;"></td> <td style="width: 10%;"></td> <td style="width: 10%;"></td> <td style="width: 10%;"></td> <td style="width: 10%;"></td> <td style="width: 10%;"></td> <td style="width: 10%;"></td> </tr> <tr> <td></td> <td></td> <td colspan="8" style="text-align: center;"> <table border="1" style="width: 100%; border-collapse: collapse; text-align: center;"> <tr> <td style="width: 10%;"></td> <td style="width: 10%;"></td> <td style="width: 10%;"></td> <td style="width: 10%;"></td> <td style="width: 10%;"></td> <td style="width: 10%;"></td> <td style="width: 10%;"></td> <td style="width: 10%;"></td> <td style="width: 10%;"></td> <td style="width: 10%;"></td> </tr> <tr> <td></td> <td></td> <td colspan="8" style="text-align: center;"> <table border="1" style="width: 100%; border-collapse: collapse; text-align: center;"> <tr> <td style="width: 10%;"></td> <td style="width: 10%;"></td> <td style="width: 10%;"></td> <td style="width: 10%;"></td> <td style="width: 10%;"></td> <td style="width: 10%;"></td> <td style="width: 10%;"></td> <td style="width: 10%;"></td> <td style="width: 10%;"></td> <td style="width: 10%;"></td> </tr> <tr> <td></td> <td></td> <td colspan="8" style="text-align: center;"> <table border="1" style="width: 100%; border-collapse: collapse; text-align: center;"> <tr> </tr></table></td></tr></table></td></tr></table></td></tr></table></td></tr></table></td></tr></table></td></tr></table></td></tr></table></td></tr></table></td></tr></table></td></tr></table></td></tr></table></td></tr></table></td></tr></table></td></tr></table></td></tr></table></td></tr></table></td></tr></table></td></tr></table></td></tr></table></td></tr></table></td></tr></table></td></tr></table></td></tr></table></td></tr></table></td></tr></table></td></tr></table></td></tr></table></td></tr></table>
 | | | | | | | | | | | | | | | | | | | | <table border="1" style="width: 100%; border-collapse: collapse; text-align: center;"> <tr> <td style="width: 10%;"></td> <td style="width: 10%;"></td> <td style="width: 10%;"></td> <td style="width: 10%;"></td> <td style="width: 10%;"></td> <td style="width: 10%;"></td> <td style="width: 10%;"></td> <td style="width: 10%;"></td> <td style="width: 10%;"></td> <td style="width: 10%;"></td> </tr> <tr> <td></td> <td></td> <td colspan="8" style="text-align: center;"> <table border="1" style="width: 100%; border-collapse: collapse; text-align: center;"> <tr> <td style="width: 10%;"></td> <td style="width: 10%;"></td> <td style="width: 10%;"></td> <td style="width: 10%;"></td> <td style="width: 10%;"></td> <td style="width: 10%;"></td> <td style="width: 10%;"></td> <td style="width: 10%;"></td> <td style="width: 10%;"></td> <td style="width: 10%;"></td> </tr> <tr> <td></td> <td></td> <td colspan="8" style="text-align: center;"> <table border="1" style="width: 100%; border-collapse: collapse; text-align: center;"> <tr> <td style="width: 10%;"></td> <td style="width: 10%;"></td> <td style="width: 10%;"></td> <td style="width: 10%;"></td> <td style="width: 10%;"></td> <td style="width: 10%;"></td> <td style="width: 10%;"></td> <td style="width: 10%;"></td> <td style="width: 10%;"></td>
<td style="width: 10%;"></td> </tr> <tr> <td></td> <td></td> <td colspan="8" style="text-align: center;"> <table border="1" style="width: 100%; border-collapse: collapse; text-align: center;"> <tr> <td style="width: 10%;"></td> <td style="width: 10%;"></td> <td style="width: 10%;"></td> <td style="width: 10%;"></td> <td style="width: 10%;"></td> <td style="width: 10%;"></td> <td style="width: 10%;"></td> <td style="width: 10%;"></td> <td style="width: 10%;"></td> <td style="width: 10%;"></td> </tr> <tr> <td></td> <td></td> <td colspan="8" style="text-align: center;"> <table border="1" style="width: 100%; border-collapse: collapse; text-align: center;"> <tr> <td style="width: 10%;"></td> <td style="width: 10%;"></td> <td style="width: 10%;"></td> <td style="width: 10%;"></td> <td style="width: 10%;"></td> <td style="width: 10%;"></td> <td style="width: 10%;"></td> <td style="width: 10%;"></td> <td style="width: 10%;"></td> <td style="width: 10%;"></td> </tr> <tr> <td></td> <td></td> <td colspan="8" style="text-align: center;"> <table border="1" style="width: 100%; border-collapse: collapse; text-align: center;"> <tr> <td style="width: 10%;"></td> <td style="width: 10%;"></td> <td style="width: 10%;"></td> <td style="width: 10%;"></td> <td style="width: 10%;"></td> <td style="width: 10%;"></td> <td style="width: 10%;"></td> <td style="width: 10%;"></td> <td style="width: 10%;"></td> <td style="width: 10%;"></td> </tr> <tr> <td></td> <td></td> <td colspan="8" style="text-align: center;"> <table border="1" style="width: 100%; border-collapse: collapse; text-align: center;"> <tr> <td style="width: 10%;"></td> <td style="width: 10%;"></td> <td style="width: 10%;"></td> <td style="width: 10%;"></td> <td style="width: 10%;"></td> <td style="width: 10%;"></td> <td style="width: 10%;"></td> <td style="width: 10%;"></td> <td style="width: 10%;"></td> <td style="width: 10%;"></td> </tr> <tr> <td></td> <td></td> <td colspan="8" style="text-align: center;"> <table border="1" style="width: 100%; border-collapse: collapse; text-align: center;"> <tr> <td style="width: 10%;"></td> <td style="width: 10%;"></td> <td style="width: 10%;"></td> <td style="width: 10%;"></td> <td style="width: 10%;"></td> <td style="width: 10%;"></td> <td style="width: 10%;"></td> <td style="width: 10%;"></td> <td style="width: 10%;"></td> <td style="width: 10%;"></td> </tr> <tr> <td></td> <td></td> <td colspan="8" style="text-align: center;"> <table border="1" style="width: 100%; border-collapse: collapse; text-align: center;"> <tr> <td style="width: 10%;"></td> <td style="width: 10%;"></td> <td style="width: 10%;"></td> <td style="width: 10%;"></td> <td style="width: 10%;"></td> <td style="width: 10%;"></td> <td style="width: 10%;"></td> <td style="width: 10%;"></td> <td style="width: 10%;"></td> <td style="width: 10%;"></td> </tr> <tr> <td></td> <td></td> <td colspan="8" style="text-align: center;"> <table border="1" style="width: 100%; border-collapse: collapse; text-align: center;"> <tr> <td style="width: 10%;"></td> <td style="width: 10%;"></td> <td style="width: 10%;"></td> <td style="width: 10%;"></td> <td style="width: 10%;"></td> <td style="width: 10%;"></td> <td style="width: 10%;"></td> <td style="width: 10%;"></td> <td style="width: 10%;"></td> <td style="width: 10%;"></td> </tr> <tr> <td></td> <td></td> <td colspan="8" style="text-align: center;"> <table border="1" style="width: 100%; border-collapse: collapse; text-align: center;"> <tr> <td style="width: 10%;"></td> <td style="width: 10%;"></td> <td style="width: 10%;"></td> <td style="width: 10%;"></td> <td style="width: 10%;"></td> <td style="width: 10%;"></td> <td style="width: 10%;"></td> <td style="width: 10%;"></td> <td style="width: 10%;"></td> <td style="width: 10%;"></td> </tr> <tr> <td></td> <td></td> <td colspan="8" style="text-align: center;"> <table border="1" style="width: 100%; border-collapse: collapse; text-align: center;"> <tr> <td style="width: 10%;"></td> <td style="width: 10%;"></td> <td style="width: 10%;"></td> <td style="width: 10%;"></td> <td style="width: 10%;"></td> <td style="width: 10%;"></td> <td style="width: 10%;"></td> <td style="width: 10%;"></td> <td style="width: 10%;"></td> <td style="width: 10%;"></td> </tr> <tr> <td></td> <td></td> <td colspan="8" style="text-align: center;"> <table border="1" style="width: 100%; border-collapse: collapse; text-align: center;"> <tr> <td style="width: 10%;"></td> <td style="width: 10%;"></td> <td style="width: 10%;"></td> <td style="width: 10%;"></td> <td style="width: 10%;"></td> <td style="width: 10%;"></td> <td style="width: 10%;"></td> <td style="width: 10%;"></td> <td style="width: 10%;"></td> <td style="width: 10%;"></td> </tr> <tr> <td></td> <td></td> <td colspan="8" style="text-align: center;"> <table border="1" style="width: 100%; border-collapse: collapse; text-align: center;"> <tr> <td style="width: 10%;"></td> <td style="width: 10%;"></td> <td style="width: 10%;"></td> <td style="width: 10%;"></td> <td style="width: 10%;"></td> <td style="width: 10%;"></td> <td style="width: 10%;"></td> <td style="width: 10%;"></td> <td style="width: 10%;"></td> <td style="width: 10%;"></td> </tr> <tr> <td></td> <td></td> <td colspan="8" style="text-align: center;"> <table border="1" style="width: 100%; border-collapse: collapse; text-align: center;"> <tr> <td style="width: 10%;"></td> <td style="width: 10%;"></td> <td style="width: 10%;"></td> <td style="width: 10%;"></td> <td style="width: 10%;"></td> <td style="width: 10%;"></td> <td style="width: 10%;"></td> <td style="width: 10%;"></td> <td style="width: 10%;"></td> <td style="width: 10%;"></td> </tr> <tr> <td></td> <td></td> <td colspan="8" style="text-align: center;"> <table border="1" style="width: 100%; border-collapse: collapse; text-align: center;"> <tr> <td style="width: 10%;"></td> <td style="width: 10%;"></td> <td style="width: 10%;"></td> <td style="width: 10%;"></td> <td style="width: 10%;"></td> <td style="width: 10%;"></td> <td style="width: 10%;"></td> <td style="width: 10%;"></td> <td style="width: 10%;"></td> <td style="width: 10%;"></td> </tr> <tr> <td></td> <td></td> <td colspan="8" style="text-align: center;"> <table border="1" style="width: 100%; border-collapse: collapse; text-align: center;"> <tr> <td style="width: 10%;"></td> <td style="width: 10%;"></td> <td style="width: 10%;"></td> <td style="width: 10%;"></td> <td style="width: 10%;"></td> <td style="width: 10%;"></td> <td style="width: 10%;"></td> <td style="width: 10%;"></td> <td style="width: 10%;"></td> <td style="width: 10%;"></td> </tr> <tr> <td></td> <td></td> <td colspan="8" style="text-align: center;"> <table border="1" style="width: 100%; border-collapse: collapse; text-align: center;"> <tr> <td style="width: 10%;"></td> <td style="width: 10%;"></td> <td style="width: 10%;"></td> <td style="width: 10%;"></td> <td style="width: 10%;"></td> <td style="width: 10%;"></td> <td style="width: 10%;"></td> <td style="width: 10%;"></td> <td style="width: 10%;"></td> <td style="width: 10%;"></td> </tr> <tr> <td></td> <td></td> <td colspan="8" style="text-align: center;"> <table border="1" style="width: 100%; border-collapse: collapse; text-align: center;"> <tr> <td style="width: 10%;"></td> <td style="width: 10%;"></td> <td style="width: 10%;"></td> <td style="width: 10%;"></td> <td style="width: 10%;"></td> <td style="width: 10%;"></td> <td style="width: 10%;"></td> <td style="width: 10%;"></td> <td style="width: 10%;"></td> <td style="width: 10%;"></td> </tr> <tr> <td></td> <td></td> <td colspan="8" style="text-align: center;"> <table border="1" style="width: 100%; border-collapse: collapse; text-align: center;"> <tr> <td style="width: 10%;"></td> <td style="width: 10%;"></td> <td style="width: 10%;"></td> <td style="width: 10%;"></td> <td style="width: 10%;"></td> <td style="width: 10%;"></td> <td style="width: 10%;"></td> <td style="width: 10%;"></td> <td style="width: 10%;"></td> <td style="width: 10%;"></td> </tr> <tr> <td></td> <td></td> <td colspan="8" style="text-align: center;"> <table border="1" style="width: 100%; border-collapse: collapse; text-align: center;"> <tr> <td style="width: 10%;"></td> <td style="width: 10%;"></td> <td style="width: 10%;"></td> <td style="width: 10%;"></td> <td style="width: 10%;"></td> <td style="width: 10%;"></td> <td style="width: 10%;"></td> <td style="width: 10%;"></td> <td style="width: 10%;"></td> <td style="width: 10%;"></td> </tr> <tr> <td></td> <td></td> <td colspan="8" style="text-align: center;"> <table border="1" style="width: 100%; border-collapse: collapse; text-align: center;"> <tr> <td style="width: 10%;"></td> <td style="width: 10%;"></td> <td style="width: 10%;"></td> <td style="width: 10%;"></td> <td style="width: 10%;"></td> <td style="width: 10%;"></td> <td style="width: 10%;"></td> <td style="width: 10%;"></td> <td style="width: 10%;"></td> <td style="width: 10%;"></td> </tr> <tr> <td></td> <td></td> <td colspan="8" style="text-align: center;"> <table border="1" style="width: 100%; border-collapse: collapse; text-align: center;"> <tr> <td style="width: 10%;"></td> <td style="width: 10%;"></td> <td style="width: 10%;"></td> <td style="width: 10%;"></td> <td style="width: 10%;"></td> <td style="width: 10%;"></td> <td style="width: 10%;"></td> <td style="width: 10%;"></td> <td style="width: 10%;"></td> <td style="width: 10%;"></td> </tr> <tr> <td></td> <td></td> <td colspan="8" style="text-align: center;"> <table border="1" style="width: 100%; border-collapse: collapse; text-align: center;"> <tr> <td style="width: 10%;"></td> <td style="width: 10%;"></td> <td style="width: 10%;"></td> <td style="width: 10%;"></td> <td style="width: 10%;"></td> <td style="width: 10%;"></td> <td style="width: 10%;"></td> <td style="width: 10%;"></td> <td style="width: 10%;"></td> <td style="width: 10%;"></td> </tr> <tr> <td></td> <td></td> <td colspan="8" style="text-align: center;"> <table border="1" style="width: 100%; border-collapse: collapse;
text-align: center;"> <tr> <td style="width: 10%;"></td> <td style="width: 10%;"></td> <td style="width: 10%;"></td> <td style="width: 10%;"></td> <td style="width: 10%;"></td> <td style="width: 10%;"></td> <td style="width: 10%;"></td> <td style="width: 10%;"></td> <td style="width: 10%;"></td> <td style="width: 10%;"></td> </tr> <tr> <td></td> <td></td> <td colspan="8" style="text-align: center;"> <table border="1" style="width: 100%; border-collapse: collapse; text-align: center;"> <tr> <td style="width: 10%;"></td> <td style="width: 10%;"></td> <td style="width: 10%;"></td> <td style="width: 10%;"></td> <td style="width: 10%;"></td> <td style="width: 10%;"></td> <td style="width: 10%;"></td> <td style="width: 10%;"></td> <td style="width: 10%;"></td> <td style="width: 10%;"></td> </tr> <tr> <td></td> <td></td> <td colspan="8" style="text-align: center;"> <table border="1" style="width: 100%; border-collapse: collapse; text-align: center;"> <tr> <td style="width: 10%;"></td> <td style="width: 10%;"></td> <td style="width: 10%;"></td> <td style="width: 10%;"></td> <td style="width: 10%;"></td> <td style="width: 10%;"></td> <td style="width: 10%;"></td> <td style="width: 10%;"></td> <td style="width: 10%;"></td> <td style="width: 10%;"></td> </tr> <tr> <td></td> <td></td> <td colspan="8" style="text-align: center;"> <table border="1" style="width: 100%; border-collapse: collapse; text-align: center;"> <tr> </tr></table></td></tr></table></td></tr></table></td></tr></table></td></tr></table></td></tr></table></td></tr></table></td></tr></table></td></tr></table></td></tr></table></td></tr></table></td></tr></table></td></tr></table></td></tr></table></td></tr></table></td></tr></table></td></tr></table></td></tr></table></td></tr></table></td></tr></table></td></tr></table></td></tr></table></td></tr></table></td></tr></table></td></tr></table></td></tr></table></td></tr></table></td></tr></table>
 | | | | | | | | | | | | | | | | | | | | <table border="1" style="width: 100%; border-collapse: collapse; text-align: center;"> <tr> <td style="width: 10%;"></td> <td style="width: 10%;"></td> <td style="width: 10%;"></td> <td style="width: 10%;"></td> <td style="width: 10%;"></td> <td style="width: 10%;"></td> <td style="width: 10%;"></td> <td style="width: 10%;"></td> <td style="width: 10%;"></td> <td style="width: 10%;"></td> </tr> <tr> <td></td> <td></td> <td colspan="8" style="text-align: center;"> <table border="1" style="width: 100%; border-collapse: collapse; text-align: center;"> <tr> <td style="width: 10%;"></td> <td style="width: 10%;"></td> <td style="width: 10%;"></td> <td style="width: 10%;"></td> <td style="width: 10%;"></td> <td style="width: 10%;"></td> <td style="width: 10%;"></td> <td style="width: 10%;"></td> <td style="width: 10%;"></td> <td style="width: 10%;"></td> </tr> <tr> <td></td> <td></td> <td colspan="8" style="text-align: center;"> <table border="1" style="width: 100%; border-collapse: collapse; text-align: center;"> <tr> <td style="width: 10%;"></td> <td style="width: 10%;"></td> <td style="width: 10%;"></td> <td style="width: 10%;"></td> <td style="width: 10%;"></td> <td style="width: 10%;"></td> <td style="width: 10%;"></td> <td style="width: 10%;"></td> <td style="width: 10%;"></td> <td style="width: 10%;"></td> </tr> <tr> <td></td> <td></td> <td colspan="8" style="text-align: center;"> <table border="1" style="width: 100%; border-collapse: collapse; text-align: center;"> <tr> <td style="width: 10%;"></td> <td style="width: 10%;"></td> <td style="width: 10%;"></td> <td style="width: 10%;"></td> <td style="width: 10%;"></td> <td style="width: 10%;"></td> <td style="width: 10%;"></td> <td style="width: 10%;"></td> <td style="width: 10%;"></td> <td style="width: 10%;"></td> </tr> <tr> <td></td> <td></td> <td colspan="8" style="text-align: center;"> <table border="1" style="width: 100%; border-collapse: collapse; text-align: center;"> <tr> <td style="width: 10%;"></td> <td style="width: 10%;"></td> <td style="width: 10%;"></td> <td style="width: 10%;"></td> <td style="width: 10%;"></td> <td style="width: 10%;"></td> <td style="width: 10%;"></td> <td style="width: 10%;"></td> <td style="width: 10%;"></td> <td style="width: 10%;"></td> </tr> <tr> <td></td> <td></td> <td colspan="8" style="text-align: center;"> <table border="1" style="width: 100%; border-collapse: collapse; text-align: center;"> <tr> <td style="width: 10%;"></td> <td style="width: 10%;"></td> <td style="width: 10%;"></td> <td style="width: 10%;"></td> <td style="width: 10%;"></td> <td style="width: 10%;"></td> <td style="width: 10%;"></td> <td style="width: 10%;"></td> <td style="width: 10%;"></td> <td style="width: 10%;"></td> </tr> <tr> <td></td> <td></td> <td colspan="8" style="text-align: center;"> <table border="1" style="width: 100%; border-collapse: collapse; text-align: center;"> <tr> <td style="width: 10%;"></td> <td style="width: 10%;"></td> <td style="width: 10%;"></td> <td style="width: 10%;"></td> <td style="width: 10%;"></td> <td style="width: 10%;"></td> <td style="width: 10%;"></td> <td style="width: 10%;"></td> <td style="width: 10%;"></td> <td style="width: 10%;"></td> </tr> <tr> <td></td> <td></td> <td colspan="8" style="text-align: center;"> <table border="1" style="width: 100%; border-collapse: collapse; text-align: center;"> <tr> <td style="width: 10%;"></td> <td style="width: 10%;"></td> <td style="width: 10%;"></td> <td style="width: 10%;"></td> <td style="width: 10%;"></td> <td style="width: 10%;"></td> <td style="width: 10%;"></td> <td style="width: 10%;"></td> <td style="width: 10%;"></td> <td style="width: 10%;"></td> </tr> <tr> <td></td> <td></td> <td colspan="8" style="text-align: center;"> <table border="1" style="width: 100%; border-collapse: collapse; text-align: center;"> <tr> <td style="width: 10%;"></td> <td style="width: 10%;"></td> <td style="width: 10%;"></td> <td style="width: 10%;"></td> <td style="width: 10%;"></td> <td style="width: 10%;"></td> <td style="width: 10%;"></td> <td style="width: 10%;"></td> <td style="width: 10%;"></td> <td style="width: 10%;"></td> </tr> <tr> <td></td> <td></td> <td colspan="8" style="text-align: center;"> <table border="1" style="width: 100%; border-collapse: collapse; text-align: center;"> <tr> <td style="width: 10%;"></td> <td style="width: 10%;"></td> <td style="width: 10%;"></td> <td style="width: 10%;"></td> <td style="width: 10%;"></td> <td style="width: 10%;"></td> <td style="width: 10%;"></td> <td style="width: 10%;"></td> <td style="width: 10%;"></td> <td style="width: 10%;"></td> </tr> <tr> <td></td> <td></td> <td colspan="8" style="text-align: center;"> <table border="1" style="width: 100%; border-collapse: collapse; text-align: center;"> <tr> <td style="width: 10%;"></td> <td style="width: 10%;"></td> <td style="width: 10%;"></td> <td style="width: 10%;"></td> <td style="width: 10%;"></td> <td style="width: 10%;"></td> <td style="width: 10%;"></td> <td style="width: 10%;"></td> <td style="width: 10%;"></td> <td style="width: 10%;"></td> </tr> <tr> <td></td> <td></td> <td colspan="8" style="text-align: center;"> <table border="1" style="width: 100%; border-collapse: collapse; text-align: center;"> <tr> <td style="width: 10%;"></td> <td style="width: 10%;"></td> <td style="width: 10%;"></td> <td style="width: 10%;"></td> <td style="width: 10%;"></td> <td style="width: 10%;"></td> <td style="width: 10%;"></td> <td style="width: 10%;"></td> <td style="width: 10%;"></td> <td style="width: 10%;"></td> </tr> <tr> <td></td> <td></td> <td colspan="8" style="text-align: center;"> <table border="1" style="width: 100%; border-collapse: collapse; text-align: center;"> <tr> <td style="width: 10%;"></td> <td style="width: 10%;"></td> <td style="width: 10%;"></td> <td style="width: 10%;"></td> <td style="width: 10%;"></td> <td style="width: 10%;"></td> <td style="width: 10%;"></td> <td style="width: 10%;"></td> <td style="width: 10%;"></td> <td style="width: 10%;"></td> </tr> <tr> <td></td> <td></td> <td colspan="8" style="text-align: center;"> <table border="1" style="width: 100%; border-collapse: collapse; text-align: center;"> <tr> <td style="width: 10%;"></td> <td style="width: 10%;"></td> <td style="width: 10%;"></td> <td style="width: 10%;"></td> <td style="width: 10%;"></td> <td style="width: 10%;"></td> <td style="width: 10%;"></td> <td style="width: 10%;"></td> <td style="width: 10%;"></td> <td style="width: 10%;"></td> </tr> <tr> <td></td> <td></td> <td colspan="8" style="text-align: center;"> <table border="1" style="width: 100%; border-collapse: collapse; text-align: center;"> <tr> <td style="width: 10%;"></td> <td style="width: 10%;"></td> <td style="width: 10%;"></td> <td style="width: 10%;"></td> <td style="width: 10%;"></td> <td style="width: 10%;"></td> <td style="width: 10%;"></td> <td style="width: 10%;"></td> <td style="width: 10%;"></td> <td style="width: 10%;"></td> </tr> <tr> <td></td> <td></td> <td colspan="8" style="text-align: center;"> <table border="1" style="width: 100%; border-collapse: collapse; text-align: center;"> <tr> <td style="width: 10%;"></td> <td style="width: 10%;"></td> <td style="width: 10%;"></td> <td style="width: 10%;"></td> <td style="width: 10%;"></td> <td style="width: 10%;"></td> <td style="width: 10%;"></td> <td style="width: 10%;"></td> <td style="width: 10%;"></td> <td style="width: 10%;"></td> </tr> <tr> <td></td> <td></td> <td colspan="8" style="text-align: center;"> <table border="1" style="width: 100%; border-collapse: collapse; text-align: center;"> <tr> <td style="width: 10%;"></td> <td style="width: 10%;"></td> <td style="width: 10%;"></td> <td style="width: 10%;"></td> <td style="width: 10%;"></td> <td style="width: 10%;"></td> <td style="width: 10%;"></td> <td style="width: 10%;"></td> <td style="width: 10%;"></td> <td style="width: 10%;"></td> </tr> <tr> <td></td> <td></td> <td colspan="8" style="text-align: center;"> <table border="1" style="width: 100%; border-collapse: collapse; text-align: center;"> <tr> <td style="width: 10%;"></td> <td style="width: 10%;"></td> <td style="width: 10%;"></td> <td style="width: 10%;"></td> <td style="width: 10%;"></td> <td style="width: 10%;"></td> <td style="width: 10%;"></td> <td style="width: 10%;"></td> <td style="width: 10%;"></td> <td style="width: 10%;"></td> </tr> <tr> <td></td> <td></td> <td colspan="8" style="text-align: center;"> <table border="1" style="width: 100%; border-collapse: collapse; text-align: center;"> <tr> <td style="width: 10%;"></td> <td style="width: 10%;"></td> <td style="width: 10%;"></td> <td style="width: 10%;"></td> <td style="width: 10%;"></td> <td style="width: 10%;"></td> <td style="width: 10%;"></td> <td style="width: 10%;"></td> <td style="width:
10%;"></td> <td style="width: 10%;"></td> </tr> <tr> <td></td> <td></td> <td colspan="8" style="text-align: center;"> <table border="1" style="width: 100%; border-collapse: collapse; text-align: center;"> <tr> <td style="width: 10%;"></td> <td style="width: 10%;"></td> <td style="width: 10%;"></td> <td style="width: 10%;"></td> <td style="width: 10%;"></td> <td style="width: 10%;"></td> <td style="width: 10%;"></td> <td style="width: 10%;"></td> <td style="width: 10%;"></td> <td style="width: 10%;"></td> </tr> <tr> <td></td> <td></td> <td colspan="8" style="text-align: center;"> <table border="1" style="width: 100%; border-collapse: collapse; text-align: center;"> <tr> <td style="width: 10%;"></td> <td style="width: 10%;"></td> <td style="width: 10%;"></td> <td style="width: 10%;"></td> <td style="width: 10%;"></td> <td style="width: 10%;"></td> <td style="width: 10%;"></td> <td style="width: 10%;"></td> <td style="width: 10%;"></td> <td style="width: 10%;"></td> </tr> <tr> <td></td> <td></td> <td colspan="8" style="text-align: center;"> <table border="1" style="width: 100%; border-collapse: collapse; text-align: center;"> <tr> <td style="width: 10%;"></td> <td style="width: 10%;"></td> <td style="width: 10%;"></td> <td style="width: 10%;"></td> <td style="width: 10%;"></td> <td style="width: 10%;"></td> <td style="width: 10%;"></td> <td style="width: 10%;"></td> <td style="width: 10%;"></td> <td style="width: 10%;"></td> </tr> <tr> <td></td> <td></td> <td colspan="8" style="text-align: center;"> <table border="1" style="width: 100%; border-collapse: collapse; text-align: center;"> <tr> <td style="width: 10%;"></td> <td style="width: 10%;"></td> <td style="width: 10%;"></td> <td style="width: 10%;"></td> <td style="width: 10%;"></td> <td style="width: 10%;"></td> <td style="width: 10%;"></td> <td style="width: 10%;"></td> <td style="width: 10%;"></td> <td style="width: 10%;"></td> </tr> <tr> <td></td> <td></td> <td colspan="8" style="text-align: center;"> <table border="1" style="width: 100%; border-collapse: collapse; text-align: center;"> <tr> <td style="width: 10%;"></td> <td style="width: 10%;"></td> <td style="width: 10%;"></td> <td style="width: 10%;"></td> <td style="width: 10%;"></td> <td style="width: 10%;"></td> <td style="width: 10%;"></td> <td style="width: 10%;"></td> <td style="width: 10%;"></td> <td style="width: 10%;"></td> </tr> <tr> <td></td> <td></td> <td colspan="8" style="text-align: center;"> <table border="1" style="width: 100%; border-collapse: collapse; text-align: center;"> <tr> <td style="width: 10%;"></td> <td style="width: 10%;"></td> <td style="width: 10%;"></td> <td style="width: 10%;"></td> <td style="width: 10%;"></td> <td style="width: 10%;"></td> <td style="width: 10%;"></td> <td style="width: 10%;"></td> <td style="width: 10%;"></td> <td style="width: 10%;"></td> </tr> <tr> <td></td> <td></td> <td colspan="8" style="text-align: center;"> <table border="1" style="width: 100%; border-collapse: collapse; text-align: center;"> <tr> <td style="width: 10%;"></td> <td style="width: 10%;"></td> <td style="width: 10%;"></td> <td style="width: 10%;"></td> <td style="width: 10%;"></td> <td style="width: 10%;"></td> <td style="width: 10%;"></td> <td style="width: 10%;"></td> <td style="width: 10%;"></td> <td style="width: 10%;"></td> </tr> <tr> <td></td> <td></td> <td colspan="8" style="text-align: center;"> <table border="1" style="width: 100%; border-collapse: collapse; text-align: center;"> <tr> </tr></table></td></tr></table></td></tr></table></td></tr></table></td></tr></table></td></tr></table></td></tr></table></td></tr></table></td></tr></table></td></tr></table></td></tr></table></td></tr></table></td></tr></table></td></tr></table></td></tr></table></td></tr></table></td></tr></table></td></tr></table></td></tr></table></td></tr></table></td></tr></table></td></tr></table></td></tr></table></td></tr></table></td></tr></table></td></tr></table></td></tr></table>
 | | | | | | | | | | | | | | | | | | | | <table border="1" style="width: 100%; border-collapse: collapse; text-align: center;"> <tr> <td style="width: 10%;"></td> <td style="width: 10%;"></td> <td style="width: 10%;"></td> <td style="width: 10%;"></td> <td style="width: 10%;"></td> <td style="width: 10%;"></td> <td style="width: 10%;"></td> <td style="width: 10%;"></td> <td style="width: 10%;"></td> <td style="width: 10%;"></td> </tr> <tr> <td></td> <td></td> <td colspan="8" style="text-align: center;"> <table border="1" style="width: 100%; border-collapse: collapse; text-align: center;"> <tr> <td style="width: 10%;"></td> <td style="width: 10%;"></td> <td style="width: 10%;"></td> <td style="width: 10%;"></td> <td style="width: 10%;"></td> <td style="width: 10%;"></td> <td style="width: 10%;"></td> <td style="width: 10%;"></td> <td style="width: 10%;"></td> <td style="width: 10%;"></td> </tr> <tr> <td></td> <td></td> <td colspan="8" style="text-align: center;"> <table border="1" style="width: 100%; border-collapse: collapse; text-align: center;"> <tr> <td style="width: 10%;"></td> <td style="width: 10%;"></td> <td style="width: 10%;"></td> <td style="width: 10%;"></td> <td style="width: 10%;"></td> <td style="width: 10%;"></td> <td style="width: 10%;"></td> <td style="width: 10%;"></td> <td style="width: 10%;"></td> <td style="width: 10%;"></td> </tr> <tr> <td></td> <td></td> <td colspan="8" style="text-align: center;"> <table border="1" style="width: 100%; border-collapse: collapse; text-align: center;"> <tr> <td style="width: 10%;"></td> <td style="width: 10%;"></td> <td style="width: 10%;"></td> <td style="width: 10%;"></td> <td style="width: 10%;"></td> <td style="width: 10%;"></td> <td style="width: 10%;"></td> <td style="width: 10%;"></td> <td style="width: 10%;"></td> <td style="width: 10%;"></td> </tr> <tr> <td></td> <td></td> <td colspan="8" style="text-align: center;"> <table border="1" style="width: 100%; border-collapse: collapse; text-align: center;"> <tr> <td style="width: 10%;"></td> <td style="width: 10%;"></td> <td style="width: 10%;"></td> <td style="width: 10%;"></td> <td style="width: 10%;"></td> <td style="width: 10%;"></td> <td style="width: 10%;"></td> <td style="width: 10%;"></td> <td style="width: 10%;"></td> <td style="width: 10%;"></td> </tr> <tr> <td></td> <td></td> <td colspan="8" style="text-align: center;"> <table border="1" style="width: 100%; border-collapse: collapse; text-align: center;"> <tr> <td style="width: 10%;"></td> <td style="width: 10%;"></td> <td style="width: 10%;"></td> <td style="width: 10%;"></td> <td style="width: 10%;"></td> <td style="width: 10%;"></td> <td style="width: 10%;"></td> <td style="width: 10%;"></td> <td style="width: 10%;"></td> <td style="width: 10%;"></td> </tr> <tr> <td></td> <td></td> <td colspan="8" style="text-align: center;"> <table border="1" style="width: 100%; border-collapse: collapse; text-align: center;"> <tr> <td style="width: 10%;"></td> <td style="width: 10%;"></td> <td style="width: 10%;"></td> <td style="width: 10%;"></td> <td style="width: 10%;"></td> <td style="width: 10%;"></td> <td style="width: 10%;"></td> <td style="width: 10%;"></td> <td style="width: 10%;"></td> <td style="width: 10%;"></td> </tr> <tr> <td></td> <td></td> <td colspan="8" style="text-align: center;"> <table border="1" style="width: 100%; border-collapse: collapse; text-align: center;"> <tr> <td style="width: 10%;"></td> <td style="width: 10%;"></td> <td style="width: 10%;"></td> <td style="width: 10%;"></td> <td style="width: 10%;"></td> <td style="width: 10%;"></td> <td style="width: 10%;"></td> <td style="width: 10%;"></td> <td style="width: 10%;"></td> <td style="width: 10%;"></td> </tr> <tr> <td></td> <td></td> <td colspan="8" style="text-align: center;"> <table border="1" style="width: 100%; border-collapse: collapse; text-align: center;"> <tr> <td style="width: 10%;"></td> <td style="width: 10%;"></td> <td style="width: 10%;"></td> <td style="width: 10%;"></td> <td style="width: 10%;"></td> <td style="width: 10%;"></td> <td style="width: 10%;"></td> <td style="width: 10%;"></td> <td style="width: 10%;"></td> <td style="width: 10%;"></td> </tr> <tr> <td></td> <td></td> <td colspan="8" style="text-align: center;"> <table border="1" style="width: 100%; border-collapse: collapse; text-align: center;"> <tr> <td style="width: 10%;"></td> <td style="width: 10%;"></td> <td style="width: 10%;"></td> <td style="width: 10%;"></td> <td style="width: 10%;"></td> <td style="width: 10%;"></td> <td style="width: 10%;"></td> <td style="width: 10%;"></td> <td style="width: 10%;"></td> <td style="width: 10%;"></td> </tr> <tr> <td></td> <td></td> <td colspan="8" style="text-align: center;"> <table border="1" style="width: 100%; border-collapse: collapse; text-align: center;"> <tr> <td style="width: 10%;"></td> <td style="width: 10%;"></td> <td style="width: 10%;"></td> <td style="width: 10%;"></td> <td style="width: 10%;"></td> <td style="width: 10%;"></td> <td style="width: 10%;"></td> <td style="width: 10%;"></td> <td style="width: 10%;"></td> <td style="width: 10%;"></td> </tr> <tr> <td></td> <td></td> <td colspan="8" style="text-align: center;"> <table border="1" style="width: 100%; border-collapse: collapse; text-align: center;"> <tr> <td style="width: 10%;"></td> <td style="width: 10%;"></td> <td style="width: 10%;"></td> <td style="width: 10%;"></td> <td style="width: 10%;"></td> <td style="width: 10%;"></td> <td style="width: 10%;"></td> <td style="width: 10%;"></td> <td style="width: 10%;"></td> <td style="width: 10%;"></td> </tr> <tr> <td></td> <td></td> <td colspan="8" style="text-align: center;"> <table border="1" style="width: 100%; border-collapse: collapse; text-align: center;"> <tr> <td style="width: 10%;"></td> <td style="width: 10%;"></td> <td style="width: 10%;"></td> <td style="width: 10%;"></td> <td style="width: 10%;"></td> <td style="width: 10%;"></td> <td style="width: 10%;"></td> <td style="width: 10%;"></td> <td style="width: 10%;"></td> <td style="width: 10%;"></td> </tr> <tr> <td></td> <td></td> <td colspan="8" style="text-align: center;"> <table border="1" style="width: 100%; border-collapse: collapse; text-align: center;"> <tr> <td style="width: 10%;"></td> <td style="width: 10%;"></td> <td style="width: 10%;"></td> <td style="width: 10%;"></td> <td style="width: 10%;"></td> <td style="width: 10%;"></td> <td style="width: 10%;"></td> <td style="width: 10%;"></td> <td style="width: 10%;"></td> <td style="width: 10%;"></td> </tr> <tr> <td></td> <td></td> <td colspan="8" style="text-align: center;"> <table border="1" style="width: 100%; border-collapse: collapse; text-align: center;"> <tr> <td style="width: 10%;"></td> <td style="width: 10%;"></td> <td style="width: 10%;"></td> <td
style="width: 10%;"></td> <td style="width: 10%;"></td> <td style="width: 10%;"></td> <td style="width: 10%;"></td> <td style="width: 10%;"></td> <td style="width: 10%;"></td> <td style="width: 10%;"></td> </tr> <tr> <td></td> <td></td> <td colspan="8" style="text-align: center;"> <table border="1" style="width: 100%; border-collapse: collapse; text-align: center;"> <tr> <td style="width: 10%;"></td> <td style="width: 10%;"></td> <td style="width: 10%;"></td> <td style="width: 10%;"></td> <td style="width: 10%;"></td> <td style="width: 10%;"></td> <td style="width: 10%;"></td> <td style="width: 10%;"></td> <td style="width: 10%;"></td> <td style="width: 10%;"></td> </tr> <tr> <td></td> <td></td> <td colspan="8" style="text-align: center;"> <table border="1" style="width: 100%; border-collapse: collapse; text-align: center;"> <tr> <td style="width: 10%;"></td> <td style="width: 10%;"></td> <td style="width: 10%;"></td> <td style="width: 10%;"></td> <td style="width: 10%;"></td> <td style="width: 10%;"></td> <td style="width: 10%;"></td> <td style="width: 10%;"></td> <td style="width: 10%;"></td> <td style="width: 10%;"></td> </tr> <tr> <td></td> <td></td> <td colspan="8" style="text-align: center;"> <table border="1" style="width: 100%; border-collapse: collapse; text-align: center;"> <tr> <td style="width: 10%;"></td> <td style="width: 10%;"></td> <td style="width: 10%;"></td> <td style="width: 10%;"></td> <td style="width: 10%;"></td> <td style="width: 10%;"></td> <td style="width: 10%;"></td> <td style="width: 10%;"></td> <td style="width: 10%;"></td> <td style="width: 10%;"></td> </tr> <tr> <td></td> <td></td> <td colspan="8" style="text-align: center;"> <table border="1" style="width: 100%; border-collapse: collapse; text-align: center;"> <tr> <td style="width: 10%;"></td> <td style="width: 10%;"></td> <td style="width: 10%;"></td> <td style="width: 10%;"></td> <td style="width: 10%;"></td> <td style="width: 10%;"></td> <td style="width: 10%;"></td> <td style="width: 10%;"></td> <td style="width: 10%;"></td> <td style="width: 10%;"></td> </tr> <tr> <td></td> <td></td> <td colspan="8" style="text-align: center;"> <table border="1" style="width: 100%; border-collapse: collapse; text-align: center;"> <tr> <td style="width: 10%;"></td> <td style="width: 10%;"></td> <td style="width: 10%;"></td> <td style="width: 10%;"></td> <td style="width: 10%;"></td> <td style="width: 10%;"></td> <td style="width: 10%;"></td> <td style="width: 10%;"></td> <td style="width: 10%;"></td> <td style="width: 10%;"></td> </tr> <tr> <td></td> <td></td> <td colspan="8" style="text-align: center;"> <table border="1" style="width: 100%; border-collapse: collapse; text-align: center;"> <tr> <td style="width: 10%;"></td> <td style="width: 10%;"></td> <td style="width: 10%;"></td> <td style="width: 10%;"></td> <td style="width: 10%;"></td> <td style="width: 10%;"></td> <td style="width: 10%;"></td> <td style="width: 10%;"></td> <td style="width: 10%;"></td> <td style="width: 10%;"></td> </tr> <tr> <td></td> <td></td> <td colspan="8" style="text-align: center;"> <table border="1" style="width: 100%; border-collapse: collapse; text-align: center;"> <tr> <td style="width: 10%;"></td> <td style="width: 10%;"></td> <td style="width: 10%;"></td> <td style="width: 10%;"></td> <td style="width: 10%;"></td> <td style="width: 10%;"></td> <td style="width: 10%;"></td> <td style="width: 10%;"></td> <td style="width: 10%;"></td> <td style="width: 10%;"></td> </tr> <tr> <td></td> <td></td> <td colspan="8" style="text-align: center;"> <table border="1" style="width: 100%; border-collapse: collapse; text-align: center;"> <tr> <td style="width: 10%;"></td> <td style="width: 10%;"></td> <td style="width: 10%;"></td> <td style="width: 10%;"></td> <td style="width: 10%;"></td> <td style="width: 10%;"></td> <td style="width: 10%;"></td> <td style="width: 10%;"></td> <td style="width: 10%;"></td> <td style="width: 10%;"></td> </tr> <tr> <td></td> <td></td> <td colspan="8" style="text-align: center;"> <table border="1" style="width: 100%; border-collapse: collapse; text-align: center;"> <tr> <td style="width: 10%;"></td> <td style="width: 10%;"></td> <td style="width: 10%;"></td> <td style="width: 10%;"></td> <td style="width: 10%;"></td> <td style="width: 10%;"></td> <td style="width: 10%;"></td> <td style="width: 10%;"></td> <td style="width: 10%;"></td> <td style="width: 10%;"></td> </tr> <tr> <td></td> <td></td> <td colspan="8" style="text-align: center;"> <table border="1" style="width: 100%; border-collapse: collapse; text-align: center;"> <tr> <td style="width: 10%;"></td> <td style="width: 10%;"></td> <td style="width: 10%;"></td> <td style="width: 10%;"></td> <td style="width: 10%;"></td> <td style="width: 10%;"></td> <td style="width: 10%;"></td> <td style="width: 10%;"></td> <td style="width: 10%;"></td> <td style="width: 10%;"></td> </tr> <tr> <td></td> <td></td> <td colspan="8" style="text-align: center;"> <table border="1" style="width: 100%; border-collapse: collapse; text-align: center;"> <tr> </tr></table></td></tr></table></td></tr></table></td></tr></table></td></tr></table></td></tr></table></td></tr></table></td></tr></table></td></tr></table></td></tr></table></td></tr></table></td></tr></table></td></tr></table></td></tr></table></td></tr></table></td></tr></table></td></tr></table></td></tr></table></td></tr></table></td></tr></table></td></tr></table></td></tr></table></td></tr></table></td></tr></table></td></tr></table></td></tr></table>
 | | | | | | | | | | | | | | | | | | | | <table border="1" style="width: 100%; border-collapse: collapse; text-align: center;"> <tr> <td style="width: 10%;"></td> <td style="width: 10%;"></td> <td style="width: 10%;"></td> <td style="width: 10%;"></td> <td style="width: 10%;"></td> <td style="width: 10%;"></td> <td style="width: 10%;"></td> <td style="width: 10%;"></td> <td style="width: 10%;"></td> <td style="width: 10%;"></td> </tr> <tr> <td></td> <td></td> <td colspan="8" style="text-align: center;"> <table border="1" style="width: 100%; border-collapse: collapse; text-align: center;"> <tr> <td style="width: 10%;"></td> <td style="width: 10%;"></td> <td style="width: 10%;"></td> <td style="width: 10%;"></td> <td style="width: 10%;"></td> <td style="width: 10%;"></td> <td style="width: 10%;"></td> <td style="width: 10%;"></td> <td style="width: 10%;"></td> <td style="width: 10%;"></td> </tr> <tr> <td></td> <td></td> <td colspan="8" style="text-align: center;"> <table border="1" style="width: 100%; border-collapse: collapse; text-align: center;"> <tr> <td style="width: 10%;"></td> <td style="width: 10%;"></td> <td style="width: 10%;"></td> <td style="width: 10%;"></td> <td style="width: 10%;"></td> <td style="width: 10%;"></td> <td style="width: 10%;"></td> <td style="width: 10%;"></td> <td style="width: 10%;"></td> <td style="width: 10%;"></td> </tr> <tr> <td></td> <td></td> <td colspan="8" style="text-align: center;"> <table border="1" style="width: 100%; border-collapse: collapse; text-align: center;"> <tr> <td style="width: 10%;"></td> <td style="width: 10%;"></td> <td style="width: 10%;"></td> <td style="width: 10%;"></td> <td style="width: 10%;"></td> <td style="width: 10%;"></td> <td style="width: 10%;"></td> <td style="width: 10%;"></td> <td style="width: 10%;"></td> <td style="width: 10%;"></td> </tr> <tr> <td></td> <td></td> <td colspan="8" style="text-align: center;"> <table border="1" style="width: 100%; border-collapse: collapse; text-align: center;"> <tr> <td style="width: 10%;"></td> <td style="width: 10%;"></td> <td style="width: 10%;"></td> <td style="width: 10%;"></td> <td style="width: 10%;"></td> <td style="width: 10%;"></td> <td style="width: 10%;"></td> <td style="width: 10%;"></td> <td style="width: 10%;"></td> <td style="width: 10%;"></td> </tr> <tr> <td></td> <td></td> <td colspan="8" style="text-align: center;"> <table border="1" style="width: 100%; border-collapse: collapse; text-align: center;"> <tr> <td style="width: 10%;"></td> <td style="width: 10%;"></td> <td style="width: 10%;"></td> <td style="width: 10%;"></td> <td style="width: 10%;"></td> <td style="width: 10%;"></td> <td style="width: 10%;"></td> <td style="width: 10%;"></td> <td style="width: 10%;"></td> <td style="width: 10%;"></td> </tr> <tr> <td></td> <td></td> <td colspan="8" style="text-align: center;"> <table border="1" style="width: 100%; border-collapse: collapse; text-align: center;"> <tr> <td style="width: 10%;"></td> <td style="width: 10%;"></td> <td style="width: 10%;"></td> <td style="width: 10%;"></td> <td style="width: 10%;"></td> <td style="width: 10%;"></td> <td style="width: 10%;"></td> <td style="width: 10%;"></td> <td style="width: 10%;"></td> <td style="width: 10%;"></td> </tr> <tr> <td></td> <td></td> <td colspan="8" style="text-align: center;"> <table border="1" style="width: 100%; border-collapse: collapse; text-align: center;"> <tr> <td style="width: 10%;"></td> <td style="width: 10%;"></td> <td style="width: 10%;"></td> <td style="width: 10%;"></td> <td style="width: 10%;"></td> <td style="width: 10%;"></td> <td style="width: 10%;"></td> <td style="width: 10%;"></td> <td style="width: 10%;"></td> <td style="width: 10%;"></td> </tr> <tr> <td></td> <td></td> <td colspan="8" style="text-align: center;"> <table border="1" style="width: 100%; border-collapse: collapse; text-align: center;"> <tr> <td style="width: 10%;"></td> <td style="width: 10%;"></td> <td style="width: 10%;"></td> <td style="width: 10%;"></td> <td style="width: 10%;"></td> <td style="width: 10%;"></td> <td style="width: 10%;"></td> <td style="width: 10%;"></td> <td style="width: 10%;"></td> <td style="width: 10%;"></td> </tr> <tr> <td></td> <td></td> <td colspan="8" style="text-align: center;"> <table border="1" style="width: 100%; border-collapse: collapse; text-align: center;"> <tr> <td style="width: 10%;"></td> <td style="width: 10%;"></td> <td style="width: 10%;"></td> <td style="width: 10%;"></td> <td style="width: 10%;"></td> <td style="width: 10%;"></td> <td style="width: 10%;"></td> <td style="width: 10%;"></td> <td style="width: 10%;"></td> <td style="width: 10%;"></td> </tr> <tr> <td></td> <td></td> <td colspan="8" style="text-align: center;"> <table border="1" style="width: 100%; border-collapse: collapse; text-align: center;"> <tr> <td style="width: 10%;"></td> <td style="width: 10%;"></td> <td style="width: 10%;"></td> <td style="width: 10%;"></td> <td style="width: 10%;"></td> <td style="width: 10%;"></td> <td style="width: 10%;"></td> <td style="width: 10%;"></td> <td style="width: 10%;"></td> <td style="width: 10%;"></td> </tr> <tr> <td></td> <td></td> <td colspan="8" style="text-align: center;"> <table border="1" style="width: 100%;
border-collapse: collapse; text-align: center;"> <tr> <td style="width: 10%;"></td> <td style="width: 10%;"></td> <td style="width: 10%;"></td> <td style="width: 10%;"></td> <td style="width: 10%;"></td> <td style="width: 10%;"></td> <td style="width: 10%;"></td> <td style="width: 10%;"></td> <td style="width: 10%;"></td> <td style="width: 10%;"></td> </tr> <tr> <td></td> <td></td> <td colspan="8" style="text-align: center;"> <table border="1" style="width: 100%; border-collapse: collapse; text-align: center;"> <tr> <td style="width: 10%;"></td> <td style="width: 10%;"></td> <td style="width: 10%;"></td> <td style="width: 10%;"></td> <td style="width: 10%;"></td> <td style="width: 10%;"></td> <td style="width: 10%;"></td> <td style="width: 10%;"></td> <td style="width: 10%;"></td> <td style="width: 10%;"></td> </tr> <tr> <td></td> <td></td> <td colspan="8" style="text-align: center;"> <table border="1" style="width: 100%; border-collapse: collapse; text-align: center;"> <tr> <td style="width: 10%;"></td> <td style="width: 10%;"></td> <td style="width: 10%;"></td> <td style="width: 10%;"></td> <td style="width: 10%;"></td> <td style="width: 10%;"></td> <td style="width: 10%;"></td> <td style="width: 10%;"></td> <td style="width: 10%;"></td> <td style="width: 10%;"></td> </tr> <tr> <td></td> <td></td> <td colspan="8" style="text-align: center;"> <table border="1" style="width: 100%; border-collapse: collapse; text-align: center;"> <tr> <td style="width: 10%;"></td> <td style="width: 10%;"></td> <td style="width: 10%;"></td> <td style="width: 10%;"></td> <td style="width: 10%;"></td> <td style="width: 10%;"></td> <td style="width: 10%;"></td> <td style="width: 10%;"></td> <td style="width: 10%;"></td> <td style="width: 10%;"></td> </tr> <tr> <td></td> <td></td> <td colspan="8" style="text-align: center;"> <table border="1" style="width: 100%; border-collapse: collapse; text-align: center;"> <tr> <td style="width: 10%;"></td> <td style="width: 10%;"></td> <td style="width: 10%;"></td> <td style="width: 10%;"></td> <td style="width: 10%;"></td> <td style="width: 10%;"></td> <td style="width: 10%;"></td> <td style="width: 10%;"></td> <td style="width: 10%;"></td> <td style="width: 10%;"></td> </tr> <tr> <td></td> <td></td> <td colspan="8" style="text-align: center;"> <table border="1" style="width: 100%; border-collapse: collapse; text-align: center;"> <tr> <td style="width: 10%;"></td> <td style="width: 10%;"></td> <td style="width: 10%;"></td> <td style="width: 10%;"></td> <td style="width: 10%;"></td> <td style="width: 10%;"></td> <td style="width: 10%;"></td> <td style="width: 10%;"></td> <td style="width: 10%;"></td> <td style="width: 10%;"></td> </tr> <tr> <td></td> <td></td> <td colspan="8" style="text-align: center;"> <table border="1" style="width: 100%; border-collapse: collapse; text-align: center;"> <tr> <td style="width: 10%;"></td> <td style="width: 10%;"></td> <td style="width: 10%;"></td> <td style="width: 10%;"></td> <td style="width: 10%;"></td> <td style="width: 10%;"></td> <td style="width: 10%;"></td> <td style="width: 10%;"></td> <td style="width: 10%;"></td> <td style="width: 10%;"></td> </tr> <tr> <td></td> <td></td> <td colspan="8" style="text-align: center;"> <table border="1" style="width: 100%; border-collapse: collapse; text-align: center;"> <tr> <td style="width: 10%;"></td> <td style="width: 10%;"></td> <td style="width: 10%;"></td> <td style="width: 10%;"></td> <td style="width: 10%;"></td> <td style="width: 10%;"></td> <td style="width: 10%;"></td> <td style="width: 10%;"></td> <td style="width: 10%;"></td> <td style="width: 10%;"></td> </tr> <tr> <td></td> <td></td> <td colspan="8" style="text-align: center;"> <table border="1" style="width: 100%; border-collapse: collapse; text-align: center;"> <tr> <td style="width: 10%;"></td> <td style="width: 10%;"></td> <td style="width: 10%;"></td> <td style="width: 10%;"></td> <td style="width: 10%;"></td> <td style="width: 10%;"></td> <td style="width: 10%;"></td> <td style="width: 10%;"></td> <td style="width: 10%;"></td> <td style="width: 10%;"></td> </tr> <tr> <td></td> <td></td> <td colspan="8" style="text-align: center;"> <table border="1" style="width: 100%; border-collapse: collapse; text-align: center;"> <tr> <td style="width: 10%;"></td> <td style="width: 10%;"></td> <td style="width: 10%;"></td> <td style="width: 10%;"></td> <td style="width: 10%;"></td> <td style="width: 10%;"></td> <td style="width: 10%;"></td> <td style="width: 10%;"></td> <td style="width: 10%;"></td> <td style="width: 10%;"></td> </tr> <tr> <td></td> <td></td> <td colspan="8" style="text-align: center;"> <table border="1" style="width: 100%; border-collapse: collapse; text-align: center;"> <tr> <td style="width: 10%;"></td> <td style="width: 10%;"></td> <td style="width: 10%;"></td> <td style="width: 10%;"></td> <td style="width: 10%;"></td> <td style="width: 10%;"></td> <td style="width: 10%;"></td> <td style="width: 10%;"></td> <td style="width: 10%;"></td> <td style="width: 10%;"></td> </tr> <tr> <td></td> <td></td> <td colspan="8" style="text-align: center;"> <table border="1" style="width: 100%; border-collapse: collapse; text-align: center;"> <tr> <td style="width: 10%;"></td> <td style="width: 10%;"></td> <td style="width: 10%;"></td> <td style="width: 10%;"></td> <td style="width: 10%;"></td> <td style="width: 10%;"></td> <td style="width: 10%;"></td> <td style="width: 10%;"></td> <td style="width: 10%;"></td> <td style="width: 10%;"></td> </tr> <tr> <td></td> <td></td> <td colspan="8" style="text-align: center;"> <table border="1" style="width: 100%; border-collapse: collapse; text-align: center;"> <tr> <td style="width: 10%;"></td> <td style="width: 10%;"></td> <td style="width: 10%;"></td> <td style="width: 10%;"></td> <td style="width: 10%;"></td> <td style="width: 10%;"></td> <td style="width: 10%;"></td> <td style="width: 10%;"></td> <td style="width: 10%;"></td> <td style="width: 10%;"></td> </tr> <tr> <td></td> <td></td> <td colspan="8" style="text-align: center;"> <table border="1" style="width: 100%; border-collapse: collapse; text-align: center;"> <tr> </tr></table></td></tr></table></td></tr></table></td></tr></table></td></tr></table></td></tr></table></td></tr></table></td></tr></table></td></tr></table></td></tr></table></td></tr></table></td></tr></table></td></tr></table></td></tr></table></td></tr></table></td></tr></table></td></tr></table></td></tr></table></td></tr></table></td></tr></table></td></tr></table></td></tr></table></td></tr></table></td></tr></table></td></tr></table>
 | | | | | | | | | | | | | | | | | | | | <table border="1" style="width: 100%; border-collapse: collapse; text-align: center;"> <tr> <td style="width: 10%;"></td> <td style="width: 10%;"></td> <td style="width: 10%;"></td> <td style="width: 10%;"></td> <td style="width: 10%;"></td> <td style="width: 10%;"></td> <td style="width: 10%;"></td> <td style="width: 10%;"></td> <td style="width: 10%;"></td> <td style="width: 10%;"></td> </tr> <tr> <td></td> <td></td> <td colspan="8" style="text-align: center;"> <table border="1" style="width: 100%; border-collapse: collapse; text-align: center;"> <tr> <td style="width: 10%;"></td> <td style="width: 10%;"></td> <td style="width: 10%;"></td> <td style="width: 10%;"></td> <td style="width: 10%;"></td> <td style="width: 10%;"></td> <td style="width: 10%;"></td> <td style="width: 10%;"></td> <td style="width: 10%;"></td> <td style="width: 10%;"></td> </tr> <tr> <td></td> <td></td> <td colspan="8" style="text-align: center;"> <table border="1" style="width: 100%; border-collapse: collapse; text-align: center;"> <tr> <td style="width: 10%;"></td> <td style="width: 10%;"></td> <td style="width: 10%;"></td> <td style="width: 10%;"></td> <td style="width: 10%;"></td> <td style="width: 10%;"></td> <td style="width: 10%;"></td> <td style="width: 10%;"></td> <td style="width: 10%;"></td> <td style="width: 10%;"></td> </tr> <tr> <td></td> <td></td> <td colspan="8" style="text-align: center;"> <table border="1" style="width: 100%; border-collapse: collapse; text-align: center;"> <tr> <td style="width: 10%;"></td> <td style="width: 10%;"></td> <td style="width: 10%;"></td> <td style="width: 10%;"></td> <td style="width: 10%;"></td> <td style="width: 10%;"></td> <td style="width: 10%;"></td> <td style="width: 10%;"></td> <td style="width: 10%;"></td> <td style="width: 10%;"></td> </tr> <tr> <td></td> <td></td> <td colspan="8" style="text-align: center;"> <table border="1" style="width: 100%; border-collapse: collapse; text-align: center;"> <tr> <td style="width: 10%;"></td> <td style="width: 10%;"></td> <td style="width: 10%;"></td> <td style="width: 10%;"></td> <td style="width: 10%;"></td> <td style="width: 10%;"></td> <td style="width: 10%;"></td> <td style="width: 10%;"></td> <td style="width: 10%;"></td> <td style="width: 10%;"></td> </tr> <tr> <td></td> <td></td> <td colspan="8" style="text-align: center;"> <table border="1" style="width: 100%; border-collapse: collapse; text-align: center;"> <tr> <td style="width: 10%;"></td> <td style="width: 10%;"></td> <td style="width: 10%;"></td> <td style="width: 10%;"></td> <td style="width: 10%;"></td> <td style="width: 10%;"></td> <td style="width: 10%;"></td> <td style="width: 10%;"></td> <td style="width: 10%;"></td> <td style="width: 10%;"></td> </tr> <tr> <td></td> <td></td> <td colspan="8" style="text-align: center;"> <table border="1" style="width: 100%; border-collapse: collapse; text-align: center;"> <tr> <td style="width: 10%;"></td> <td style="width: 10%;"></td> <td style="width: 10%;"></td> <td style="width: 10%;"></td> <td style="width: 10%;"></td> <td style="width: 10%;"></td> <td style="width: 10%;"></td> <td style="width: 10%;"></td> <td style="width: 10%;"></td> <td style="width: 10%;"></td> </tr> <tr> <td></td> <td></td> <td colspan="8" style="text-align: center;"> <table border="1" style="width: 100%; border-collapse: collapse; text-align: center;"> <tr> <td style="width: 10%;"></td> <td style="width: 10%;"></td> <td style="width: 10%;"></td> <td style="width: 10%;"></td> <td style="width: 10%;"></td> <td style="width: 10%;"></td> <td style="width: 10%;"></td> <td style="width: 10%;"></td> <td style="width: 10%;"></td> <td style="width: 10%;"></td> </tr> <tr> <td></td> <td></td> <td colspan="8" style="text-align: center;"> <table border="1" style="width: 100%; border-collapse: collapse; text-align: center;"> <tr> <td style="width: 10%;"></td> <td style="width: 10%;"></td> <td style="width: 10%;"></td> <td style="width: 10%;"></td> <td style="width: 10%;"></td> <td style="width: 10%;"></td> <td style="width: 10%;"></td> <td style="width: 10%;"></td> <td style="width: 10%;"></td> <td
style="width: 10%;"></td> </tr> <tr> <td></td> <td></td> <td colspan="8" style="text-align: center;"> <table border="1" style="width: 100%; border-collapse: collapse; text-align: center;"> <tr> <td style="width: 10%;"></td> <td style="width: 10%;"></td> <td style="width: 10%;"></td> <td style="width: 10%;"></td> <td style="width: 10%;"></td> <td style="width: 10%;"></td> <td style="width: 10%;"></td> <td style="width: 10%;"></td> <td style="width: 10%;"></td> <td style="width: 10%;"></td> </tr> <tr> <td></td> <td></td> <td colspan="8" style="text-align: center;"> <table border="1" style="width: 100%; border-collapse: collapse; text-align: center;"> <tr> <td style="width: 10%;"></td> <td style="width: 10%;"></td> <td style="width: 10%;"></td> <td style="width: 10%;"></td> <td style="width: 10%;"></td> <td style="width: 10%;"></td> <td style="width: 10%;"></td> <td style="width: 10%;"></td> <td style="width: 10%;"></td> <td style="width: 10%;"></td> </tr> <tr> <td></td> <td></td> <td colspan="8" style="text-align: center;"> <table border="1" style="width: 100%; border-collapse: collapse; text-align: center;"> <tr> <td style="width: 10%;"></td> <td style="width: 10%;"></td> <td style="width: 10%;"></td> <td style="width: 10%;"></td> <td style="width: 10%;"></td> <td style="width: 10%;"></td> <td style="width: 10%;"></td> <td style="width: 10%;"></td> <td style="width: 10%;"></td> <td style="width: 10%;"></td> </tr> <tr> <td></td> <td></td> <td colspan="8" style="text-align: center;"> <table border="1" style="width: 100%; border-collapse: collapse; text-align: center;"> <tr> <td style="width: 10%;"></td> <td style="width: 10%;"></td> <td style="width: 10%;"></td> <td style="width: 10%;"></td> <td style="width: 10%;"></td> <td style="width: 10%;"></td> <td style="width: 10%;"></td> <td style="width: 10%;"></td> <td style="width: 10%;"></td> <td style="width: 10%;"></td> </tr> <tr> <td></td> <td></td> <td colspan="8" style="text-align: center;"> <table border="1" style="width: 100%; border-collapse: collapse; text-align: center;"> <tr> <td style="width: 10%;"></td> <td style="width: 10%;"></td> <td style="width: 10%;"></td> <td style="width: 10%;"></td> <td style="width: 10%;"></td> <td style="width: 10%;"></td> <td style="width: 10%;"></td> <td style="width: 10%;"></td> <td style="width: 10%;"></td> <td style="width: 10%;"></td> </tr> <tr> <td></td> <td></td> <td colspan="8" style="text-align: center;"> <table border="1" style="width: 100%; border-collapse: collapse; text-align: center;"> <tr> <td style="width: 10%;"></td> <td style="width: 10%;"></td> <td style="width: 10%;"></td> <td style="width: 10%;"></td> <td style="width: 10%;"></td> <td style="width: 10%;"></td> <td style="width: 10%;"></td> <td style="width: 10%;"></td> <td style="width: 10%;"></td> <td style="width: 10%;"></td> </tr> <tr> <td></td> <td></td> <td colspan="8" style="text-align: center;"> <table border="1" style="width: 100%; border-collapse: collapse; text-align: center;"> <tr> <td style="width: 10%;"></td> <td style="width: 10%;"></td> <td style="width: 10%;"></td> <td style="width: 10%;"></td> <td style="width: 10%;"></td> <td style="width: 10%;"></td> <td style="width: 10%;"></td> <td style="width: 10%;"></td> <td style="width: 10%;"></td> <td style="width: 10%;"></td> </tr> <tr> <td></td> <td></td> <td colspan="8" style="text-align: center;"> <table border="1" style="width: 100%; border-collapse: collapse; text-align: center;"> <tr> <td style="width: 10%;"></td> <td style="width: 10%;"></td> <td style="width: 10%;"></td> <td style="width: 10%;"></td> <td style="width: 10%;"></td> <td style="width: 10%;"></td> <td style="width: 10%;"></td> <td style="width: 10%;"></td> <td style="width: 10%;"></td> <td style="width: 10%;"></td> </tr> <tr> <td></td> <td></td> <td colspan="8" style="text-align: center;"> <table border="1" style="width: 100%; border-collapse: collapse; text-align: center;"> <tr> <td style="width: 10%;"></td> <td style="width: 10%;"></td> <td style="width: 10%;"></td> <td style="width: 10%;"></td> <td style="width: 10%;"></td> <td style="width: 10%;"></td> <td style="width: 10%;"></td> <td style="width: 10%;"></td> <td style="width: 10%;"></td> <td style="width: 10%;"></td> </tr> <tr> <td></td> <td></td> <td colspan="8" style="text-align: center;"> <table border="1" style="width: 100%; border-collapse: collapse; text-align: center;"> <tr> <td style="width: 10%;"></td> <td style="width: 10%;"></td> <td style="width: 10%;"></td> <td style="width: 10%;"></td> <td style="width: 10%;"></td> <td style="width: 10%;"></td> <td style="width: 10%;"></td> <td style="width: 10%;"></td> <td style="width: 10%;"></td> <td style="width: 10%;"></td> </tr> <tr> <td></td> <td></td> <td colspan="8" style="text-align: center;"> <table border="1" style="width: 100%; border-collapse: collapse; text-align: center;"> <tr> <td style="width: 10%;"></td> <td style="width: 10%;"></td> <td style="width: 10%;"></td> <td style="width: 10%;"></td> <td style="width: 10%;"></td> <td style="width: 10%;"></td> <td style="width: 10%;"></td> <td style="width: 10%;"></td> <td style="width: 10%;"></td> <td style="width: 10%;"></td> </tr> <tr> <td></td> <td></td> <td colspan="8" style="text-align: center;"> <table border="1" style="width: 100%; border-collapse: collapse; text-align: center;"> <tr> <td style="width: 10%;"></td> <td style="width: 10%;"></td> <td style="width: 10%;"></td> <td style="width: 10%;"></td> <td style="width: 10%;"></td> <td style="width: 10%;"></td> <td style="width: 10%;"></td> <td style="width: 10%;"></td> <td style="width: 10%;"></td> <td style="width: 10%;"></td> </tr> <tr> <td></td> <td></td> <td colspan="8" style="text-align: center;"> <table border="1" style="width: 100%; border-collapse: collapse; text-align: center;"> <tr> <td style="width: 10%;"></td> <td style="width: 10%;"></td> <td style="width: 10%;"></td> <td style="width: 10%;"></td> <td style="width: 10%;"></td> <td style="width: 10%;"></td> <td style="width: 10%;"></td> <td style="width: 10%;"></td> <td style="width: 10%;"></td> <td style="width: 10%;"></td> </tr> <tr> <td></td> <td></td> <td colspan="8" style="text-align: center;"> <table border="1" style="width: 100%; border-collapse: collapse; text-align: center;"> <tr> <td style="width: 10%;"></td> <td style="width: 10%;"></td> <td style="width: 10%;"></td> <td style="width: 10%;"></td> <td style="width: 10%;"></td> <td style="width: 10%;"></td> <td style="width: 10%;"></td> <td style="width: 10%;"></td> <td style="width: 10%;"></td> <td style="width: 10%;"></td> </tr> <tr> <td></td> <td></td> <td colspan="8" style="text-align: center;"> <table border="1" style="width: 100%; border-collapse: collapse; text-align: center;"> <tr> </tr></table></td></tr></table></td></tr></table></td></tr></table></td></tr></table></td></tr></table></td></tr></table></td></tr></table></td></tr></table></td></tr></table></td></tr></table></td></tr></table></td></tr></table></td></tr></table></td></tr></table></td></tr></table></td></tr></table></td></tr></table></td></tr></table></td></tr></table></td></tr></table></td></tr></table></td></tr></table></td></tr></table>
 | | | | | | | | | | | | | | | | | | | | <table border="1" style="width: 100%; border-collapse: collapse; text-align: center;"> <tr> <td style="width: 10%;"></td> <td style="width: 10%;"></td> <td style="width: 10%;"></td> <td style="width: 10%;"></td> <td style="width: 10%;"></td> <td style="width: 10%;"></td> <td style="width: 10%;"></td> <td style="width: 10%;"></td> <td style="width: 10%;"></td> <td style="width: 10%;"></td> </tr> <tr> <td></td> <td></td> <td colspan="8" style="text-align: center;"> <table border="1" style="width: 100%; border-collapse: collapse; text-align: center;"> <tr> <td style="width: 10%;"></td> <td style="width: 10%;"></td> <td style="width: 10%;"></td> <td style="width: 10%;"></td> <td style="width: 10%;"></td> <td style="width: 10%;"></td> <td style="width: 10%;"></td> <td style="width: 10%;"></td> <td style="width: 10%;"></td> <td style="width: 10%;"></td> </tr> <tr> <td></td> <td></td> <td colspan="8" style="text-align: center;"> <table border="1" style="width: 100%; border-collapse: collapse; text-align: center;"> <tr> <td style="width: 10%;"></td> <td style="width: 10%;"></td> <td style="width: 10%;"></td> <td style="width: 10%;"></td> <td style="width: 10%;"></td> <td style="width: 10%;"></td> <td style="width: 10%;"></td> <td style="width: 10%;"></td> <td style="width: 10%;"></td> <td style="width: 10%;"></td> </tr> <tr> <td></td> <td></td> <td colspan="8" style="text-align: center;"> <table border="1" style="width: 100%; border-collapse: collapse; text-align: center;"> <tr> <td style="width: 10%;"></td> <td style="width: 10%;"></td> <td style="width: 10%;"></td> <td style="width: 10%;"></td> <td style="width: 10%;"></td> <td style="width: 10%;"></td> <td style="width: 10%;"></td> <td style="width: 10%;"></td> <td style="width: 10%;"></td> <td style="width: 10%;"></td> </tr> <tr> <td></td> <td></td> <td colspan="8" style="text-align: center;"> <table border="1" style="width: 100%; border-collapse: collapse; text-align: center;"> <tr> <td style="width: 10%;"></td> <td style="width: 10%;"></td> <td style="width: 10%;"></td> <td style="width: 10%;"></td> <td style="width: 10%;"></td> <td style="width: 10%;"></td> <td style="width: 10%;"></td> <td style="width: 10%;"></td> <td style="width: 10%;"></td> <td style="width: 10%;"></td> </tr> <tr> <td></td> <td></td> <td colspan="8" style="text-align: center;"> <table border="1" style="width: 100%; border-collapse: collapse; text-align: center;"> <tr> <td style="width: 10%;"></td> <td style="width: 10%;"></td> <td style="width: 10%;"></td> <td style="width: 10%;"></td> <td style="width: 10%;"></td> <td style="width: 10%;"></td> <td style="width: 10%;"></td> <td style="width: 10%;"></td> <td style="width: 10%;"></td> <td style="width: 10%;"></td> </tr> <tr> <td></td> <td></td> <td colspan="8" style="text-align: center;"> <table border="1" style="width: 100%; border-collapse: collapse; text-align: center;"> <tr> <td style="width: 10%;"></td> <td style="width: 10%;"></td> <td style="width: 10%;"></td> <td style="width: 10%;"></td> <td style="width: 10%;"></td> <td style="width: 10%;"></td> <td style="width: 10%;"></td> <td style="width: 10%;"></td> <td style="width: 10%;"></td> <td style="width: 10%;"></td> </tr> <tr> <td></td> <td></td> <td colspan="8" style="text-align: center;"> <table border="1" style="width: 100%; border-collapse: collapse; text-align: center;"> <tr> <td style="width: 10%;"></td> <td style="width: 10%;"></td> <td style="width: 10%;"></td> <td style="width: 10%;"></td> <td style="width: 10%;"></td> <td
style="width: 10%;"></td> <td style="width: 10%;"></td> <td style="width: 10%;"></td> <td style="width: 10%;"></td> <td style="width: 10%;"></td> </tr> <tr> <td></td> <td></td> <td colspan="8" style="text-align: center;"> <table border="1" style="width: 100%; border-collapse: collapse; text-align: center;"> <tr> <td style="width: 10%;"></td> <td style="width: 10%;"></td> <td style="width: 10%;"></td> <td style="width: 10%;"></td> <td style="width: 10%;"></td> <td style="width: 10%;"></td> <td style="width: 10%;"></td> <td style="width: 10%;"></td> <td style="width: 10%;"></td> <td style="width: 10%;"></td> </tr> <tr> <td></td> <td></td> <td colspan="8" style="text-align: center;"> <table border="1" style="width: 100%; border-collapse: collapse; text-align: center;"> <tr> <td style="width: 10%;"></td> <td style="width: 10%;"></td> <td style="width: 10%;"></td> <td style="width: 10%;"></td> <td style="width: 10%;"></td> <td style="width: 10%;"></td> <td style="width: 10%;"></td> <td style="width: 10%;"></td> <td style="width: 10%;"></td> <td style="width: 10%;"></td> </tr> <tr> <td></td> <td></td> <td colspan="8" style="text-align: center;"> <table border="1" style="width: 100%; border-collapse: collapse; text-align: center;"> <tr> <td style="width: 10%;"></td> <td style="width: 10%;"></td> <td style="width: 10%;"></td> <td style="width: 10%;"></td> <td style="width: 10%;"></td> <td style="width: 10%;"></td> <td style="width: 10%;"></td> <td style="width: 10%;"></td> <td style="width: 10%;"></td> <td style="width: 10%;"></td> </tr> <tr> <td></td> <td></td> <td colspan="8" style="text-align: center;"> <table border="1" style="width: 100%; border-collapse: collapse; text-align: center;"> <tr> <td style="width: 10%;"></td> <td style="width: 10%;"></td> <td style="width: 10%;"></td> <td style="width: 10%;"></td> <td style="width: 10%;"></td> <td style="width: 10%;"></td> <td style="width: 10%;"></td> <td style="width: 10%;"></td> <td style="width: 10%;"></td> <td style="width: 10%;"></td> </tr> <tr> <td></td> <td></td> <td colspan="8" style="text-align: center;"> <table border="1" style="width: 100%; border-collapse: collapse; text-align: center;"> <tr> <td style="width: 10%;"></td> <td style="width: 10%;"></td> <td style="width: 10%;"></td> <td style="width: 10%;"></td> <td style="width: 10%;"></td> <td style="width: 10%;"></td> <td style="width: 10%;"></td> <td style="width: 10%;"></td> <td style="width: 10%;"></td> <td style="width: 10%;"></td> </tr> <tr> <td></td> <td></td> <td colspan="8" style="text-align: center;"> <table border="1" style="width: 100%; border-collapse: collapse; text-align: center;"> <tr> <td style="width: 10%;"></td> <td style="width: 10%;"></td> <td style="width: 10%;"></td> <td style="width: 10%;"></td> <td style="width: 10%;"></td> <td style="width: 10%;"></td> <td style="width: 10%;"></td> <td style="width: 10%;"></td> <td style="width: 10%;"></td> <td style="width: 10%;"></td> </tr> <tr> <td></td> <td></td> <td colspan="8" style="text-align: center;"> <table border="1" style="width: 100%; border-collapse: collapse; text-align: center;"> <tr> <td style="width: 10%;"></td> <td style="width: 10%;"></td> <td style="width: 10%;"></td> <td style="width: 10%;"></td> <td style="width: 10%;"></td> <td style="width: 10%;"></td> <td style="width: 10%;"></td> <td style="width: 10%;"></td> <td style="width: 10%;"></td> <td style="width: 10%;"></td> </tr> <tr> <td></td> <td></td> <td colspan="8" style="text-align: center;"> <table border="1" style="width: 100%; border-collapse: collapse; text-align: center;"> <tr> <td style="width: 10%;"></td> <td style="width: 10%;"></td> <td style="width: 10%;"></td> <td style="width: 10%;"></td> <td style="width: 10%;"></td> <td style="width: 10%;"></td> <td style="width: 10%;"></td> <td style="width: 10%;"></td> <td style="width: 10%;"></td> <td style="width: 10%;"></td> </tr> <tr> <td></td> <td></td> <td colspan="8" style="text-align: center;"> <table border="1" style="width: 100%; border-collapse: collapse; text-align: center;"> <tr> <td style="width: 10%;"></td> <td style="width: 10%;"></td> <td style="width: 10%;"></td> <td style="width: 10%;"></td> <td style="width: 10%;"></td> <td style="width: 10%;"></td> <td style="width: 10%;"></td> <td style="width: 10%;"></td> <td style="width: 10%;"></td> <td style="width: 10%;"></td> </tr> <tr> <td></td> <td></td> <td colspan="8" style="text-align: center;"> <table border="1" style="width: 100%; border-collapse: collapse; text-align: center;"> <tr> <td style="width: 10%;"></td> <td style="width: 10%;"></td> <td style="width: 10%;"></td> <td style="width: 10%;"></td> <td style="width: 10%;"></td> <td style="width: 10%;"></td> <td style="width: 10%;"></td> <td style="width: 10%;"></td> <td style="width: 10%;"></td> <td style="width: 10%;"></td> </tr> <tr> <td></td> <td></td> <td colspan="8" style="text-align: center;"> <table border="1" style="width: 100%; border-collapse: collapse; text-align: center;"> <tr> <td style="width: 10%;"></td> <td style="width: 10%;"></td> <td style="width: 10%;"></td> <td style="width: 10%;"></td> <td style="width: 10%;"></td> <td style="width: 10%;"></td> <td style="width: 10%;"></td> <td style="width: 10%;"></td> <td style="width: 10%;"></td> <td style="width: 10%;"></td> </tr> <tr> <td></td> <td></td> <td colspan="8" style="text-align: center;"> <table border="1" style="width: 100%; border-collapse: collapse; text-align: center;"> <tr> <td style="width: 10%;"></td> <td style="width: 10%;"></td> <td style="width: 10%;"></td> <td style="width: 10%;"></td> <td style="width: 10%;"></td> <td style="width: 10%;"></td> <td style="width: 10%;"></td> <td style="width: 10%;"></td> <td style="width: 10%;"></td> <td style="width: 10%;"></td> </tr> <tr> <td></td> <td></td> <td colspan="8" style="text-align: center;"> <table border="1" style="width: 100%; border-collapse: collapse; text-align: center;"> <tr> <td style="width: 10%;"></td> <td style="width: 10%;"></td> <td style="width: 10%;"></td> <td style="width: 10%;"></td> <td style="width: 10%;"></td> <td style="width: 10%;"></td> <td style="width: 10%;"></td> <td style="width: 10%;"></td> <td style="width: 10%;"></td> <td style="width: 10%;"></td> </tr> <tr> <td></td> <td></td> <td colspan="8" style="text-align: center;"> <table border="1" style="width: 100%; border-collapse: collapse; text-align: center;"> <tr> <td style="width: 10%;"></td> <td style="width: 10%;"></td> <td style="width: 10%;"></td> <td style="width: 10%;"></td> <td style="width: 10%;"></td> <td style="width: 10%;"></td> <td style="width: 10%;"></td> <td style="width: 10%;"></td> <td style="width: 10%;"></td> <td style="width: 10%;"></td> </tr> <tr> <td></td> <td></td> <td colspan="8" style="text-align: center;"> <table border="1" style="width: 100%; border-collapse: collapse; text-align: center;"> <tr> </tr></table></td></tr></table></td></tr></table></td></tr></table></td></tr></table></td></tr></table></td></tr></table></td></tr></table></td></tr></table></td></tr></table></td></tr></table></td></tr></table></td></tr></table></td></tr></table></td></tr></table></td></tr></table></td></tr></table></td></tr></table></td></tr></table></td></tr></table></td></tr></table></td></tr></table></td></tr></table>
 | | | | | | | | | | | | | | | | | | | | <table border="1" style="width: 100%; border-collapse: collapse; text-align: center;"> <tr> <td style="width: 10%;"></td> <td style="width: 10%;"></td> <td style="width: 10%;"></td> <td style="width: 10%;"></td> <td style="width: 10%;"></td> <td style="width: 10%;"></td> <td style="width: 10%;"></td> <td style="width: 10%;"></td> <td style="width: 10%;"></td> <td style="width: 10%;"></td> </tr> <tr> <td></td> <td></td> <td colspan="8" style="text-align: center;"> <table border="1" style="width: 100%; border-collapse: collapse; text-align: center;"> <tr> <td style="width: 10%;"></td> <td style="width: 10%;"></td> <td style="width: 10%;"></td> <td style="width: 10%;"></td> <td style="width: 10%;"></td> <td style="width: 10%;"></td> <td style="width: 10%;"></td> <td style="width: 10%;"></td> <td style="width: 10%;"></td> <td style="width: 10%;"></td> </tr> <tr> <td></td> <td></td> <td colspan="8" style="text-align: center;"> <table border="1" style="width: 100%; border-collapse: collapse; text-align: center;"> <tr> <td style="width: 10%;"></td> <td style="width: 10%;"></td> <td style="width: 10%;"></td> <td style="width: 10%;"></td> <td style="width: 10%;"></td> <td style="width: 10%;"></td> <td style="width: 10%;"></td> <td style="width: 10%;"></td> <td style="width: 10%;"></td> <td style="width: 10%;"></td> </tr> <tr> <td></td> <td></td> <td colspan="8" style="text-align: center;"> <table border="1" style="width: 100%; border-collapse: collapse; text-align: center;"> <tr> <td style="width: 10%;"></td> <td style="width: 10%;"></td> <td style="width: 10%;"></td> <td style="width: 10%;"></td> <td style="width: 10%;"></td> <td style="width: 10%;"></td> <td style="width: 10%;"></td> <td style="width: 10%;"></td> <td style="width: 10%;"></td> <td style="width: 10%;"></td> </tr> <tr> <td></td> <td></td> <td colspan="8" style="text-align: center;"> <table border="1" style="width: 100%; border-collapse: collapse; text-align: center;"> <tr> <td style="width: 10%;"></td> <td style="width: 10%;"></td> <td style="width: 10%;"></td> <td style="width: 10%;"></td> <td style="width: 10%;"></td> <td style="width: 10%;"></td> <td style="width: 10%;"></td> <td style="width: 10%;"></td> <td style="width: 10%;"></td> <td style="width: 10%;"></td> </tr> <tr> <td></td> <td></td> <td colspan="8" style="text-align: center;"> <table border="1" style="width: 100%; border-collapse: collapse; text-align: center;"> <tr> <td style="width: 10%;"></td> <td style="width: 10%;"></td> <td style="width: 10%;"></td> <td style="width: 10%;"></td> <td style="width: 10%;"></td> <td style="width: 10%;"></td> <td style="width: 10%;"></td> <td style="width: 10%;"></td> <td style="width: 10%;"></td> <td style="width: 10%;"></td> </tr> <tr> <td></td> <td></td> <td colspan="8" style="text-align: center;"> <table border="1" style="width: 100%; border-collapse: collapse; text-align: center;"> <tr> <td style="width: 10%;"></td> <td style="width: 10%;"></td> <td style="width: 10%;"></td> <td style="width: 10%;"></td> <td style="width: 10%;"></td> <td style="width: 10%;"></td> <td style="width: 10%;"></td> <td style="width: 10%;"></td> <td style="width: 10%;"></td> <td style="width: 10%;"></td> </tr> <tr> <td></td> <td></td> <td colspan="8" style="text-align: center;"> <table border="1" style="width: 100%; border-collapse: collapse; text-align: center;"> <tr> <td style="width: 10%;"></td> <td style="width: 10%;"></td>
<td style="width: 10%;"></td> <td style="width: 10%;"></td> <td style="width: 10%;"></td> <td style="width: 10%;"></td> <td style="width: 10%;"></td> <td style="width: 10%;"></td> <td style="width: 10%;"></td> <td style="width: 10%;"></td> </tr> <tr> <td></td> <td></td> <td colspan="8" style="text-align: center;"> <table border="1" style="width: 100%; border-collapse: collapse; text-align: center;"> <tr> <td style="width: 10%;"></td> <td style="width: 10%;"></td> <td style="width: 10%;"></td> <td style="width: 10%;"></td> <td style="width: 10%;"></td> <td style="width: 10%;"></td> <td style="width: 10%;"></td> <td style="width: 10%;"></td> <td style="width: 10%;"></td> <td style="width: 10%;"></td> </tr> <tr> <td></td> <td></td> <td colspan="8" style="text-align: center;"> <table border="1" style="width: 100%; border-collapse: collapse; text-align: center;"> <tr> <td style="width: 10%;"></td> <td style="width: 10%;"></td> <td style="width: 10%;"></td> <td style="width: 10%;"></td> <td style="width: 10%;"></td> <td style="width: 10%;"></td> <td style="width: 10%;"></td> <td style="width: 10%;"></td> <td style="width: 10%;"></td> <td style="width: 10%;"></td> </tr> <tr> <td></td> <td></td> <td colspan="8" style="text-align: center;"> <table border="1" style="width: 100%; border-collapse: collapse; text-align: center;"> <tr> <td style="width: 10%;"></td> <td style="width: 10%;"></td> <td style="width: 10%;"></td> <td style="width: 10%;"></td> <td style="width: 10%;"></td> <td style="width: 10%;"></td> <td style="width: 10%;"></td> <td style="width: 10%;"></td> <td style="width: 10%;"></td> <td style="width: 10%;"></td> </tr> <tr> <td></td> <td></td> <td colspan="8" style="text-align: center;"> <table border="1" style="width: 100%; border-collapse: collapse; text-align: center;"> <tr> <td style="width: 10%;"></td> <td style="width: 10%;"></td> <td style="width: 10%;"></td> <td style="width: 10%;"></td> <td style="width: 10%;"></td> <td style="width: 10%;"></td> <td style="width: 10%;"></td> <td style="width: 10%;"></td> <td style="width: 10%;"></td> <td style="width: 10%;"></td> </tr> <tr> <td></td> <td></td> <td colspan="8" style="text-align: center;"> <table border="1" style="width: 100%; border-collapse: collapse; text-align: center;"> <tr> <td style="width: 10%;"></td> <td style="width: 10%;"></td> <td style="width: 10%;"></td> <td style="width: 10%;"></td> <td style="width: 10%;"></td> <td style="width: 10%;"></td> <td style="width: 10%;"></td> <td style="width: 10%;"></td> <td style="width: 10%;"></td> <td style="width: 10%;"></td> </tr> <tr> <td></td> <td></td> <td colspan="8" style="text-align: center;"> <table border="1" style="width: 100%; border-collapse: collapse; text-align: center;"> <tr> <td style="width: 10%;"></td> <td style="width: 10%;"></td> <td style="width: 10%;"></td> <td style="width: 10%;"></td> <td style="width: 10%;"></td> <td style="width: 10%;"></td> <td style="width: 10%;"></td> <td style="width: 10%;"></td> <td style="width: 10%;"></td> <td style="width: 10%;"></td> </tr> <tr> <td></td> <td></td> <td colspan="8" style="text-align: center;"> <table border="1" style="width: 100%; border-collapse: collapse; text-align: center;"> <tr> <td style="width: 10%;"></td> <td style="width: 10%;"></td> <td style="width: 10%;"></td> <td style="width: 10%;"></td> <td style="width: 10%;"></td> <td style="width: 10%;"></td> <td style="width: 10%;"></td> <td style="width: 10%;"></td> <td style="width: 10%;"></td> <td style="width: 10%;"></td> </tr> <tr> <td></td> <td></td> <td colspan="8" style="text-align: center;"> <table border="1" style="width: 100%; border-collapse: collapse; text-align: center;"> <tr> <td style="width: 10%;"></td> <td style="width: 10%;"></td> <td style="width: 10%;"></td> <td style="width: 10%;"></td> <td style="width: 10%;"></td> <td style="width: 10%;"></td> <td style="width: 10%;"></td> <td style="width: 10%;"></td> <td style="width: 10%;"></td> <td style="width: 10%;"></td> </tr> <tr> <td></td> <td></td> <td colspan="8" style="text-align: center;"> <table border="1" style="width: 100%; border-collapse: collapse; text-align: center;"> <tr> <td style="width: 10%;"></td> <td style="width: 10%;"></td> <td style="width: 10%;"></td> <td style="width: 10%;"></td> <td style="width: 10%;"></td> <td style="width: 10%;"></td> <td style="width: 10%;"></td> <td style="width: 10%;"></td> <td style="width: 10%;"></td> <td style="width: 10%;"></td> </tr> <tr> <td></td> <td></td> <td colspan="8" style="text-align: center;"> <table border="1" style="width: 100%; border-collapse: collapse; text-align: center;"> <tr> <td style="width: 10%;"></td> <td style="width: 10%;"></td> <td style="width: 10%;"></td> <td style="width: 10%;"></td> <td style="width: 10%;"></td> <td style="width: 10%;"></td> <td style="width: 10%;"></td> <td style="width: 10%;"></td> <td style="width: 10%;"></td> <td style="width: 10%;"></td> </tr> <tr> <td></td> <td></td> <td colspan="8" style="text-align: center;"> <table border="1" style="width: 100%; border-collapse: collapse; text-align: center;"> <tr> <td style="width: 10%;"></td> <td style="width: 10%;"></td> <td style="width: 10%;"></td> <td style="width: 10%;"></td> <td style="width: 10%;"></td> <td style="width: 10%;"></td> <td style="width: 10%;"></td> <td style="width: 10%;"></td> <td style="width: 10%;"></td> <td style="width: 10%;"></td> </tr> <tr> <td></td> <td></td> <td colspan="8" style="text-align: center;"> <table border="1" style="width: 100%; border-collapse: collapse; text-align: center;"> <tr> <td style="width: 10%;"></td> <td style="width: 10%;"></td> <td style="width: 10%;"></td> <td style="width: 10%;"></td> <td style="width: 10%;"></td> <td style="width: 10%;"></td> <td style="width: 10%;"></td> <td style="width: 10%;"></td> <td style="width: 10%;"></td> <td style="width: 10%;"></td> </tr> <tr> <td></td> <td></td> <td colspan="8" style="text-align: center;"> <table border="1" style="width: 100%; border-collapse: collapse; text-align: center;"> <tr> <td style="width: 10%;"></td> <td style="width: 10%;"></td> <td style="width: 10%;"></td> <td style="width: 10%;"></td> <td style="width: 10%;"></td> <td style="width: 10%;"></td> <td style="width: 10%;"></td> <td style="width: 10%;"></td> <td style="width: 10%;"></td> <td style="width: 10%;"></td> </tr> <tr> <td></td> <td></td> <td colspan="8" style="text-align: center;"> <table border="1" style="width: 100%; border-collapse: collapse; text-align: center;"> <tr> </tr></table></td></tr></table></td></tr></table></td></tr></table></td></tr></table></td></tr></table></td></tr></table></td></tr></table></td></tr></table></td></tr></table></td></tr></table></td></tr></table></td></tr></table></td></tr></table></td></tr></table></td></tr></table></td></tr></table></td></tr></table></td></tr></table></td></tr></table></td></tr></table></td></tr></table>
 | | | | | | | | | | | | | | | | | | | | <table border="1" style="width: 100%; border-collapse: collapse; text-align: center;"> <tr> <td style="width: 10%;"></td> <td style="width: 10%;"></td> <td style="width: 10%;"></td> <td style="width: 10%;"></td> <td style="width: 10%;"></td> <td style="width: 10%;"></td> <td style="width: 10%;"></td> <td style="width: 10%;"></td> <td style="width: 10%;"></td> <td style="width: 10%;"></td> </tr> <tr> <td></td> <td></td> <td colspan="8" style="text-align: center;"> <table border="1" style="width: 100%; border-collapse: collapse; text-align: center;"> <tr> <td style="width: 10%;"></td> <td style="width: 10%;"></td> <td style="width: 10%;"></td> <td style="width: 10%;"></td> <td style="width: 10%;"></td> <td style="width: 10%;"></td> <td style="width: 10%;"></td> <td style="width: 10%;"></td> <td style="width: 10%;"></td> <td style="width: 10%;"></td> </tr> <tr> <td></td> <td></td> <td colspan="8" style="text-align: center;"> <table border="1" style="width: 100%; border-collapse: collapse; text-align: center;"> <tr> <td style="width: 10%;"></td> <td style="width: 10%;"></td> <td style="width: 10%;"></td> <td style="width: 10%;"></td> <td style="width: 10%;"></td> <td style="width: 10%;"></td> <td style="width: 10%;"></td> <td style="width: 10%;"></td> <td style="width: 10%;"></td> <td style="width: 10%;"></td> </tr> <tr> <td></td> <td></td> <td colspan="8" style="text-align: center;"> <table border="1" style="width: 100%; border-collapse: collapse; text-align: center;"> <tr> <td style="width: 10%;"></td> <td style="width: 10%;"></td> <td style="width: 10%;"></td> <td style="width: 10%;"></td> <td style="width: 10%;"></td> <td style="width: 10%;"></td> <td style="width: 10%;"></td> <td style="width: 10%;"></td> <td style="width: 10%;"></td> <td style="width: 10%;"></td> </tr> <tr> <td></td> <td></td> <td colspan="8" style="text-align: center;"> <table border="1" style="width: 100%; border-collapse: collapse; text-align: center;"> <tr> <td style="width: 10%;"></td> <td style="width: 10%;"></td> <td style="width: 10%;"></td> <td style="width: 10%;"></td> <td style="width: 10%;"></td> <td style="width: 10%;"></td> <td style="width: 10%;"></td> <td style="width: 10%;"></td> <td style="width: 10%;"></td> <td style="width: 10%;"></td> </tr> <tr> <td></td> <td></td> <td colspan="8" style="text-align: center;"> <table border="1" style="width: 100%; border-collapse: collapse; text-align: center;"> <tr> <td style="width: 10%;"></td> <td style="width: 10%;"></td> <td style="width: 10%;"></td> <td style="width: 10%;"></td> <td style="width: 10%;"></td> <td style="width: 10%;"></td> <td style="width: 10%;"></td> <td style="width: 10%;"></td> <td style="width: 10%;"></td> <td style="width: 10%;"></td> </tr> <tr> <td></td> <td></td> <td colspan="8" style="text-align: center;"> <table border="1" style="width: 100%; border-collapse: collapse; text-align: center;"> <tr> <td style="width: 10%;"></td> <td style="width: 10%;"></td> <td style="width: 10%;"></td> <td style="width: 10%;"></td> <td style="width: 10%;"></td> <td style="width: 10%;"></td> <td style="width: 10%;"></td> <td style="width: 10%;"></td> <td style="width: 10%;"></td> <td style="width: 10%;"></td> </tr> <tr> <td></td> <td></td> <td colspan="8" style="text-align: center;"> <table border="1" style="width: 100%; border-collapse: collapse; text-align: center;"> <tr> <td style="width: 10%;"></td> <td style="width: 10%;"></td> <td style="width: 10%;"></td> <td style="width: 10%;"></td> <td style="width: 10%;"></td> <td style="width: 10%;"></td> <td style="width: 10%;"></td> <td style="width: 10%;"></td> <td style="width: 10%;"></td> <td style="width: 10%;"></td> </tr> <tr> <td></td> <td></td> <td colspan="8" style="text-align: center;"> <table border="1" style="width: 100%; border-collapse: collapse; text-align:
center;"> <tr> <td style="width: 10%;"></td> <td style="width: 10%;"></td> <td style="width: 10%;"></td> <td style="width: 10%;"></td> <td style="width: 10%;"></td> <td style="width: 10%;"></td> <td style="width: 10%;"></td> <td style="width: 10%;"></td> <td style="width: 10%;"></td> <td style="width: 10%;"></td> </tr> <tr> <td></td> <td></td> <td colspan="8" style="text-align: center;"> <table border="1" style="width: 100%; border-collapse: collapse; text-align: center;"> <tr> <td style="width: 10%;"></td> <td style="width: 10%;"></td> <td style="width: 10%;"></td> <td style="width: 10%;"></td> <td style="width: 10%;"></td> <td style="width: 10%;"></td> <td style="width: 10%;"></td> <td style="width: 10%;"></td> <td style="width: 10%;"></td> <td style="width: 10%;"></td> </tr> <tr> <td></td> <td></td> <td colspan="8" style="text-align: center;"> <table border="1" style="width: 100%; border-collapse: collapse; text-align: center;"> <tr> <td style="width: 10%;"></td> <td style="width: 10%;"></td> <td style="width: 10%;"></td> <td style="width: 10%;"></td> <td style="width: 10%;"></td> <td style="width: 10%;"></td> <td style="width: 10%;"></td> <td style="width: 10%;"></td> <td style="width: 10%;"></td> <td style="width: 10%;"></td> </tr> <tr> <td></td> <td></td> <td colspan="8" style="text-align: center;"> <table border="1" style="width: 100%; border-collapse: collapse; text-align: center;"> <tr> <td style="width: 10%;"></td> <td style="width: 10%;"></td> <td style="width: 10%;"></td> <td style="width: 10%;"></td> <td style="width: 10%;"></td> <td style="width: 10%;"></td> <td style="width: 10%;"></td> <td style="width: 10%;"></td> <td style="width: 10%;"></td> <td style="width: 10%;"></td> </tr> <tr> <td></td> <td></td> <td colspan="8" style="text-align: center;"> <table border="1" style="width: 100%; border-collapse: collapse; text-align: center;"> <tr> <td style="width: 10%;"></td> <td style="width: 10%;"></td> <td style="width: 10%;"></td> <td style="width: 10%;"></td> <td style="width: 10%;"></td> <td style="width: 10%;"></td> <td style="width: 10%;"></td> <td style="width: 10%;"></td> <td style="width: 10%;"></td> <td style="width: 10%;"></td> </tr> <tr> <td></td> <td></td> <td colspan="8" style="text-align: center;"> <table border="1" style="width: 100%; border-collapse: collapse; text-align: center;"> <tr> <td style="width: 10%;"></td> <td style="width: 10%;"></td> <td style="width: 10%;"></td> <td style="width: 10%;"></td> <td style="width: 10%;"></td> <td style="width: 10%;"></td> <td style="width: 10%;"></td> <td style="width: 10%;"></td> <td style="width: 10%;"></td> <td style="width: 10%;"></td> </tr> <tr> <td></td> <td></td> <td colspan="8" style="text-align: center;"> <table border="1" style="width: 100%; border-collapse: collapse; text-align: center;"> <tr> <td style="width: 10%;"></td> <td style="width: 10%;"></td> <td style="width: 10%;"></td> <td style="width: 10%;"></td> <td style="width: 10%;"></td> <td style="width: 10%;"></td> <td style="width: 10%;"></td> <td style="width: 10%;"></td> <td style="width: 10%;"></td> <td style="width: 10%;"></td> </tr> <tr> <td></td> <td></td> <td colspan="8" style="text-align: center;"> <table border="1" style="width: 100%; border-collapse: collapse; text-align: center;"> <tr> <td style="width: 10%;"></td> <td style="width: 10%;"></td> <td style="width: 10%;"></td> <td style="width: 10%;"></td> <td style="width: 10%;"></td> <td style="width: 10%;"></td> <td style="width: 10%;"></td> <td style="width: 10%;"></td> <td style="width: 10%;"></td> <td style="width: 10%;"></td> </tr> <tr> <td></td> <td></td> <td colspan="8" style="text-align: center;"> <table border="1" style="width: 100%; border-collapse: collapse; text-align: center;"> <tr> <td style="width: 10%;"></td> <td style="width: 10%;"></td> <td style="width: 10%;"></td> <td style="width: 10%;"></td> <td style="width: 10%;"></td> <td style="width: 10%;"></td> <td style="width: 10%;"></td> <td style="width: 10%;"></td> <td style="width: 10%;"></td> <td style="width: 10%;"></td> </tr> <tr> <td></td> <td></td> <td colspan="8" style="text-align: center;"> <table border="1" style="width: 100%; border-collapse: collapse; text-align: center;"> <tr> <td style="width: 10%;"></td> <td style="width: 10%;"></td> <td style="width: 10%;"></td> <td style="width: 10%;"></td> <td style="width: 10%;"></td> <td style="width: 10%;"></td> <td style="width: 10%;"></td> <td style="width: 10%;"></td> <td style="width: 10%;"></td> <td style="width: 10%;"></td> </tr> <tr> <td></td> <td></td> <td colspan="8" style="text-align: center;"> <table border="1" style="width: 100%; border-collapse: collapse; text-align: center;"> <tr> <td style="width: 10%;"></td> <td style="width: 10%;"></td> <td style="width: 10%;"></td> <td style="width: 10%;"></td> <td style="width: 10%;"></td> <td style="width: 10%;"></td> <td style="width: 10%;"></td> <td style="width: 10%;"></td> <td style="width: 10%;"></td> <td style="width: 10%;"></td> </tr> <tr> <td></td> <td></td> <td colspan="8" style="text-align: center;"> <table border="1" style="width: 100%; border-collapse: collapse; text-align: center;"> <tr> <td style="width: 10%;"></td> <td style="width: 10%;"></td> <td style="width: 10%;"></td> <td style="width: 10%;"></td> <td style="width: 10%;"></td> <td style="width: 10%;"></td> <td style="width: 10%;"></td> <td style="width: 10%;"></td> <td style="width: 10%;"></td> <td style="width: 10%;"></td> </tr> <tr> <td></td> <td></td> <td colspan="8" style="text-align: center;"> <table border="1" style="width: 100%; border-collapse: collapse; text-align: center;"> <tr> </tr></table></td></tr></table></td></tr></table></td></tr></table></td></tr></table></td></tr></table></td></tr></table></td></tr></table></td></tr></table></td></tr></table></td></tr></table></td></tr></table></td></tr></table></td></tr></table></td></tr></table></td></tr></table></td></tr></table></td></tr></table></td></tr></table></td></tr></table></td></tr></table>
 | | | | | | | | | | | | | | | | | | | | <table border="1" style="width: 100%; border-collapse: collapse; text-align: center;"> <tr> <td style="width: 10%;"></td> <td style="width: 10%;"></td> <td style="width: 10%;"></td> <td style="width: 10%;"></td> <td style="width: 10%;"></td> <td style="width: 10%;"></td> <td style="width: 10%;"></td> <td style="width: 10%;"></td> <td style="width: 10%;"></td> <td style="width: 10%;"></td> </tr> <tr> <td></td> <td></td> <td colspan="8" style="text-align: center;"> <table border="1" style="width: 100%; border-collapse: collapse; text-align: center;"> <tr> <td style="width: 10%;"></td> <td style="width: 10%;"></td> <td style="width: 10%;"></td> <td style="width: 10%;"></td> <td style="width: 10%;"></td> <td style="width: 10%;"></td> <td style="width: 10%;"></td> <td style="width: 10%;"></td> <td style="width: 10%;"></td> <td style="width: 10%;"></td> </tr> <tr> <td></td> <td></td> <td colspan="8" style="text-align: center;"> <table border="1" style="width: 100%; border-collapse: collapse; text-align: center;"> <tr> <td style="width: 10%;"></td> <td style="width: 10%;"></td> <td style="width: 10%;"></td> <td style="width: 10%;"></td> <td style="width: 10%;"></td> <td style="width: 10%;"></td> <td style="width: 10%;"></td> <td style="width: 10%;"></td> <td style="width: 10%;"></td> <td style="width: 10%;"></td> </tr> <tr> <td></td> <td></td> <td colspan="8" style="text-align: center;"> <table border="1" style="width: 100%; border-collapse: collapse; text-align: center;"> <tr> <td style="width: 10%;"></td> <td style="width: 10%;"></td> <td style="width: 10%;"></td> <td style="width: 10%;"></td> <td style="width: 10%;"></td> <td style="width: 10%;"></td> <td style="width: 10%;"></td> <td style="width: 10%;"></td> <td style="width: 10%;"></td> <td style="width: 10%;"></td> </tr> <tr> <td></td> <td></td> <td colspan="8" style="text-align: center;"> <table border="1" style="width: 100%; border-collapse: collapse; text-align: center;"> <tr> <td style="width: 10%;"></td> <td style="width: 10%;"></td> <td style="width: 10%;"></td> <td style="width: 10%;"></td> <td style="width: 10%;"></td> <td style="width: 10%;"></td> <td style="width: 10%;"></td> <td style="width: 10%;"></td> <td style="width: 10%;"></td> <td style="width: 10%;"></td> </tr> <tr> <td></td> <td></td> <td colspan="8" style="text-align: center;"> <table border="1" style="width: 100%; border-collapse: collapse; text-align: center;"> <tr> <td style="width: 10%;"></td> <td style="width: 10%;"></td> <td style="width: 10%;"></td> <td style="width: 10%;"></td> <td style="width: 10%;"></td> <td style="width: 10%;"></td> <td style="width: 10%;"></td> <td style="width: 10%;"></td> <td style="width: 10%;"></td> <td style="width: 10%;"></td> </tr> <tr> <td></td> <td></td> <td colspan="8" style="text-align: center;"> <table border="1" style="width: 100%; border-collapse: collapse; text-align: center;"> <tr> <td style="width: 10%;"></td> <td style="width: 10%;"></td> <td style="width: 10%;"></td> <td style="width: 10%;"></td> <td style="width: 10%;"></td> <td style="width: 10%;"></td> <td style="width: 10%;"></td> <td style="width: 10%;"></td> <td style="width: 10%;"></td> <td style="width: 10%;"></td> </tr> <tr> <td></td> <td></td> <td colspan="8" style="text-align: center;"> <table border="1" style="width: 100%; border-collapse: collapse; text-align: center;"> <tr> <td style="width: 10%;"></td> <td style="width: 10%;"></td> <td style="width: 10%;"></td> <td style="width: 10%;"></td> <td style="width: 10%;"></td> <td style="width: 10%;"></td> <td style="width: 10%;"></td> <td style="width: 10%;"></td> <td style="width: 10%;"></td> <td style="width: 10%;"></td> </tr> <tr> <td></td> <td></td> <td colspan="8" style="text-align: center;"> <table border="1" style="width: 100%; border-collapse: collapse; text-align: center;"> <tr> <td style="width: 10%;"></td> <td style="width: 10%;"></td> <td style="width: 10%;"></td> <td style="width: 10%;"></td> <td style="width: 10%;"></td> <td style="width: 10%;"></td> <td style="width: 10%;"></td> <td style="width: 10%;"></td> <td style="width: 10%;"></td> <td style="width: 10%;"></td> </tr> <tr> <td></td> <td></td> <td colspan="8" style="text-align: center;"> <table border="1" style="width: 100%; border-collapse: collapse; text-align: center;"> <tr> <td style="width: 10%;"></td> <td style="width: 10%;"></td> <td style="width: 10%;"></td> <td style="width: 10%;"></td> <td style="width: 10%;"></td> <td style="width: 10%;"></td> <td style="width: 10%;"></td> <td style="width: 10%;"></td> <td style="width: 10%;"></td> <td style="width: 10%;"></td> </tr> <tr> <td></td> <td></td> <td colspan="8" style="text-align: center;"> <table border="1"
style="width: 100%; border-collapse: collapse; text-align: center;"> <tr> <td style="width: 10%;"></td> <td style="width: 10%;"></td> <td style="width: 10%;"></td> <td style="width: 10%;"></td> <td style="width: 10%;"></td> <td style="width: 10%;"></td> <td style="width: 10%;"></td> <td style="width: 10%;"></td> <td style="width: 10%;"></td> <td style="width: 10%;"></td> </tr> <tr> <td></td> <td></td> <td colspan="8" style="text-align: center;"> <table border="1" style="width: 100%; border-collapse: collapse; text-align: center;"> <tr> <td style="width: 10%;"></td> <td style="width: 10%;"></td> <td style="width: 10%;"></td> <td style="width: 10%;"></td> <td style="width: 10%;"></td> <td style="width: 10%;"></td> <td style="width: 10%;"></td> <td style="width: 10%;"></td> <td style="width: 10%;"></td> <td style="width: 10%;"></td> </tr> <tr> <td></td> <td></td> <td colspan="8" style="text-align: center;"> <table border="1" style="width: 100%; border-collapse: collapse; text-align: center;"> <tr> <td style="width: 10%;"></td> <td style="width: 10%;"></td> <td style="width: 10%;"></td> <td style="width: 10%;"></td> <td style="width: 10%;"></td> <td style="width: 10%;"></td> <td style="width: 10%;"></td> <td style="width: 10%;"></td> <td style="width: 10%;"></td> <td style="width: 10%;"></td> </tr> <tr> <td></td> <td></td> <td colspan="8" style="text-align: center;"> <table border="1" style="width: 100%; border-collapse: collapse; text-align: center;"> <tr> <td style="width: 10%;"></td> <td style="width: 10%;"></td> <td style="width: 10%;"></td> <td style="width: 10%;"></td> <td style="width: 10%;"></td> <td style="width: 10%;"></td> <td style="width: 10%;"></td> <td style="width: 10%;"></td> <td style="width: 10%;"></td> <td style="width: 10%;"></td> </tr> <tr> <td></td> <td></td> <td colspan="8" style="text-align: center;"> <table border="1" style="width: 100%; border-collapse: collapse; text-align: center;"> <tr> <td style="width: 10%;"></td> <td style="width: 10%;"></td> <td style="width: 10%;"></td> <td style="width: 10%;"></td> <td style="width: 10%;"></td> <td style="width: 10%;"></td> <td style="width: 10%;"></td> <td style="width: 10%;"></td> <td style="width: 10%;"></td> <td style="width: 10%;"></td> </tr> <tr> <td></td> <td></td> <td colspan="8" style="text-align: center;"> <table border="1" style="width: 100%; border-collapse: collapse; text-align: center;"> <tr> <td style="width: 10%;"></td> <td style="width: 10%;"></td> <td style="width: 10%;"></td> <td style="width: 10%;"></td> <td style="width: 10%;"></td> <td style="width: 10%;"></td> <td style="width: 10%;"></td> <td style="width: 10%;"></td> <td style="width: 10%;"></td> <td style="width: 10%;"></td> </tr> <tr> <td></td> <td></td> <td colspan="8" style="text-align: center;"> <table border="1" style="width: 100%; border-collapse: collapse; text-align: center;"> <tr> <td style="width: 10%;"></td> <td style="width: 10%;"></td> <td style="width: 10%;"></td> <td style="width: 10%;"></td> <td style="width: 10%;"></td> <td style="width: 10%;"></td> <td style="width: 10%;"></td> <td style="width: 10%;"></td> <td style="width: 10%;"></td> <td style="width: 10%;"></td> </tr> <tr> <td></td> <td></td> <td colspan="8" style="text-align: center;"> <table border="1" style="width: 100%; border-collapse: collapse; text-align: center;"> <tr> <td style="width: 10%;"></td> <td style="width: 10%;"></td> <td style="width: 10%;"></td> <td style="width: 10%;"></td> <td style="width: 10%;"></td> <td style="width: 10%;"></td> <td style="width: 10%;"></td> <td style="width: 10%;"></td> <td style="width: 10%;"></td> <td style="width: 10%;"></td> </tr> <tr> <td></td> <td></td> <td colspan="8" style="text-align: center;"> <table border="1" style="width: 100%; border-collapse: collapse; text-align: center;"> <tr> <td style="width: 10%;"></td> <td style="width: 10%;"></td> <td style="width: 10%;"></td> <td style="width: 10%;"></td> <td style="width: 10%;"></td> <td style="width: 10%;"></td> <td style="width: 10%;"></td> <td style="width: 10%;"></td> <td style="width: 10%;"></td> <td style="width: 10%;"></td> </tr> <tr> <td></td> <td></td> <td colspan="8" style="text-align: center;"> <table border="1" style="width: 100%; border-collapse: collapse; text-align: center;"> <tr> </tr></table></td></tr></table></td></tr></table></td></tr></table></td></tr></table></td></tr></table></td></tr></table></td></tr></table></td></tr></table></td></tr></table></td></tr></table></td></tr></table></td></tr></table></td></tr></table></td></tr></table></td></tr></table></td></tr></table></td></tr></table></td></tr></table></td></tr></table>
 | | | | | | | | | | | | | | | | | | | | <table border="1" style="width: 100%; border-collapse: collapse; text-align: center;"> <tr> <td style="width: 10%;"></td> <td style="width: 10%;"></td> <td style="width: 10%;"></td> <td style="width: 10%;"></td> <td style="width: 10%;"></td> <td style="width: 10%;"></td> <td style="width: 10%;"></td> <td style="width: 10%;"></td> <td style="width: 10%;"></td> <td style="width: 10%;"></td> </tr> <tr> <td></td> <td></td> <td colspan="8" style="text-align: center;"> <table border="1" style="width: 100%; border-collapse: collapse; text-align: center;"> <tr> <td style="width: 10%;"></td> <td style="width: 10%;"></td> <td style="width: 10%;"></td> <td style="width: 10%;"></td> <td style="width: 10%;"></td> <td style="width: 10%;"></td> <td style="width: 10%;"></td> <td style="width: 10%;"></td> <td style="width: 10%;"></td> <td style="width: 10%;"></td> </tr> <tr> <td></td> <td></td> <td colspan="8" style="text-align: center;"> <table border="1" style="width: 100%; border-collapse: collapse; text-align: center;"> <tr> <td style="width: 10%;"></td> <td style="width: 10%;"></td> <td style="width: 10%;"></td> <td style="width: 10%;"></td> <td style="width: 10%;"></td> <td style="width: 10%;"></td> <td style="width: 10%;"></td> <td style="width: 10%;"></td> <td style="width: 10%;"></td> <td style="width: 10%;"></td> </tr> <tr> <td></td> <td></td> <td colspan="8" style="text-align: center;"> <table border="1" style="width: 100%; border-collapse: collapse; text-align: center;"> <tr> <td style="width: 10%;"></td> <td style="width: 10%;"></td> <td style="width: 10%;"></td> <td style="width: 10%;"></td> <td style="width: 10%;"></td> <td style="width: 10%;"></td> <td style="width: 10%;"></td> <td style="width: 10%;"></td> <td style="width: 10%;"></td> <td style="width: 10%;"></td> </tr> <tr> <td></td> <td></td> <td colspan="8" style="text-align: center;"> <table border="1" style="width: 100%; border-collapse: collapse; text-align: center;"> <tr> <td style="width: 10%;"></td> <td style="width: 10%;"></td> <td style="width: 10%;"></td> <td style="width: 10%;"></td> <td style="width: 10%;"></td> <td style="width: 10%;"></td> <td style="width: 10%;"></td> <td style="width: 10%;"></td> <td style="width: 10%;"></td> <td style="width: 10%;"></td> </tr> <tr> <td></td> <td></td> <td colspan="8" style="text-align: center;"> <table border="1" style="width: 100%; border-collapse: collapse; text-align: center;"> <tr> <td style="width: 10%;"></td> <td style="width: 10%;"></td> <td style="width: 10%;"></td> <td style="width: 10%;"></td> <td style="width: 10%;"></td> <td style="width: 10%;"></td> <td style="width: 10%;"></td> <td style="width: 10%;"></td> <td style="width: 10%;"></td> <td style="width: 10%;"></td> </tr> <tr> <td></td> <td></td> <td colspan="8" style="text-align: center;"> <table border="1" style="width: 100%; border-collapse: collapse; text-align: center;"> <tr> <td style="width: 10%;"></td> <td style="width: 10%;"></td> <td style="width: 10%;"></td> <td style="width: 10%;"></td> <td style="width: 10%;"></td> <td style="width: 10%;"></td> <td style="width: 10%;"></td> <td style="width: 10%;"></td> <td style="width: 10%;"></td> <td style="width: 10%;"></td> </tr> <tr> <td></td> <td></td> <td colspan="8" style="text-align: center;"> <table border="1" style="width: 100%; border-collapse: collapse; text-align: center;"> <tr> <td style="width: 10%;"></td> <td style="width: 10%;"></td> <td style="width: 10%;"></td> <td style="width: 10%;"></td> <td style="width: 10%;"></td> <td style="width: 10%;"></td> <td style="width: 10%;"></td> <td style="width: 10%;"></td> <td style="width: 10%;"></td> <td style="width: 10%;"></td> </tr> <tr> <td></td> <td></td> <td colspan="8" style="text-align: center;"> <table border="1" style="width: 100%; border-collapse: collapse; text-align: center;"> <tr> <td style="width: 10%;"></td> <td style="width: 10%;"></td> <td style="width: 10%;"></td> <td style="width: 10%;"></td> <td style="width: 10%;"></td> <td style="width: 10%;"></td> <td style="width: 10%;"></td> <td style="width: 10%;"></td> <td style="width: 10%;"></td> <td style="width: 10%;"></td> </tr> <tr> <td></td> <td></td> <td colspan="8" style="text-align: center;"> <table border="1" style="width: 100%; border-collapse: collapse; text-align: center;"> <tr> <td style="width: 10%;"></td> <td style="width: 10%;"></td> <td style="width: 10%;"></td> <td style="width: 10%;"></td> <td style="width: 10%;"></td> <td style="width: 10%;"></td> <td style="width: 10%;"></td> <td style="width: 10%;"></td> <td style="width: 10%;"></td> <td style="width: 10%;"></td> </tr> <tr> <td></td> <td></td> <td colspan="8" style="text-align: center;"> <table border="1" style="width: 100%; border-collapse: collapse; text-align: center;"> <tr> <td style="width: 10%;"></td> <td style="width: 10%;"></td> <td style="width: 10%;"></td> <td style="width: 10%;"></td> <td style="width: 10%;"></td> <td style="width: 10%;"></td> <td style="width: 10%;"></td> <td style="width: 10%;"></td> <td style="width: 10%;"></td> <td style="width: 10%;"></td> </tr> <tr> <td></td> <td></td> <td colspan="8" style="text-align: center;"> <table border="1" style="width: 100%; border-collapse: collapse; text-align: center;"> <tr> <td style="width: 10%;"></td> <td style="width: 10%;"></td> <td style="width: 10%;"></td> <td style="width: 10%;"></td> <td style="width: 10%;"></td> <td style="width: 10%;"></td> <td style="width: 10%;"></td> <td style="width: 10%;"></td> <td style="width: 10%;"></td> <td style="width: 10%;"></td> </tr> <tr> <td></td> <td></td> <td colspan="8" style="text-align: center;"> <table border="1" style="width: 100%; border-collapse: collapse; text-align: center;"> <tr> <td style="width: 10%;"></td> <td style="width: 10%;"></td> <td style="width: 10%;"></td> <td style="width: 10%;"></td> <td style="width: 10%;"></td> <td style="width: 10%;"></td> <td style="width: 10%;"></td> <td style="width: 10%;"></td> <td style="width: 10%;"></td> <td style="width: 10%;"></td> </tr> <tr> <td></td> <td></td> <td colspan="8"
style="text-align: center;"> <table border="1" style="width: 100%; border-collapse: collapse; text-align: center;"> <tr> <td style="width: 10%;"></td> <td style="width: 10%;"></td> <td style="width: 10%;"></td> <td style="width: 10%;"></td> <td style="width: 10%;"></td> <td style="width: 10%;"></td> <td style="width: 10%;"></td> <td style="width: 10%;"></td> <td style="width: 10%;"></td> <td style="width: 10%;"></td> </tr> <tr> <td></td> <td></td> <td colspan="8" style="text-align: center;"> <table border="1" style="width: 100%; border-collapse: collapse; text-align: center;"> <tr> <td style="width: 10%;"></td> <td style="width: 10%;"></td> <td style="width: 10%;"></td> <td style="width: 10%;"></td> <td style="width: 10%;"></td> <td style="width: 10%;"></td> <td style="width: 10%;"></td> <td style="width: 10%;"></td> <td style="width: 10%;"></td> <td style="width: 10%;"></td> </tr> <tr> <td></td> <td></td> <td colspan="8" style="text-align: center;"> <table border="1" style="width: 100%; border-collapse: collapse; text-align: center;"> <tr> <td style="width: 10%;"></td> <td style="width: 10%;"></td> <td style="width: 10%;"></td> <td style="width: 10%;"></td> <td style="width: 10%;"></td> <td style="width: 10%;"></td> <td style="width: 10%;"></td> <td style="width: 10%;"></td> <td style="width: 10%;"></td> <td style="width: 10%;"></td> </tr> <tr> <td></td> <td></td> <td colspan="8" style="text-align: center;"> <table border="1" style="width: 100%; border-collapse: collapse; text-align: center;"> <tr> <td style="width: 10%;"></td> <td style="width: 10%;"></td> <td style="width: 10%;"></td> <td style="width: 10%;"></td> <td style="width: 10%;"></td> <td style="width: 10%;"></td> <td style="width: 10%;"></td> <td style="width: 10%;"></td> <td style="width: 10%;"></td> <td style="width: 10%;"></td> </tr> <tr> <td></td> <td></td> <td colspan="8" style="text-align: center;"> <table border="1" style="width: 100%; border-collapse: collapse; text-align: center;"> <tr> <td style="width: 10%;"></td> <td style="width: 10%;"></td> <td style="width: 10%;"></td> <td style="width: 10%;"></td> <td style="width: 10%;"></td> <td style="width: 10%;"></td> <td style="width: 10%;"></td> <td style="width: 10%;"></td> <td style="width: 10%;"></td> <td style="width: 10%;"></td> </tr> <tr> <td></td> <td></td> <td colspan="8" style="text-align: center;"> <table border="1" style="width: 100%; border-collapse: collapse; text-align: center;"> <tr> </tr></table></td></tr></table></td></tr></table></td></tr></table></td></tr></table></td></tr></table></td></tr></table></td></tr></table></td></tr></table></td></tr></table></td></tr></table></td></tr></table></td></tr></table></td></tr></table></td></tr></table></td></tr></table></td></tr></table></td></tr></table></td></tr></table>
 | | | | | | | | | | | | | | | | | | | | <table border="1" style="width: 100%; border-collapse: collapse; text-align: center;"> <tr> <td style="width: 10%;"></td> <td style="width: 10%;"></td> <td style="width: 10%;"></td> <td style="width: 10%;"></td> <td style="width: 10%;"></td> <td style="width: 10%;"></td> <td style="width: 10%;"></td> <td style="width: 10%;"></td> <td style="width: 10%;"></td> <td style="width: 10%;"></td> </tr> <tr> <td></td> <td></td> <td colspan="8" style="text-align: center;"> <table border="1" style="width: 100%; border-collapse: collapse; text-align: center;"> <tr> <td style="width: 10%;"></td> <td style="width: 10%;"></td> <td style="width: 10%;"></td> <td style="width: 10%;"></td> <td style="width: 10%;"></td> <td style="width: 10%;"></td> <td style="width: 10%;"></td> <td style="width: 10%;"></td> <td style="width: 10%;"></td> <td style="width: 10%;"></td> </tr> <tr> <td></td> <td></td> <td colspan="8" style="text-align: center;"> <table border="1" style="width: 100%; border-collapse: collapse; text-align: center;"> <tr> <td style="width: 10%;"></td> <td style="width: 10%;"></td> <td style="width: 10%;"></td> <td style="width: 10%;"></td> <td style="width: 10%;"></td> <td style="width: 10%;"></td> <td style="width: 10%;"></td> <td style="width: 10%;"></td> <td style="width: 10%;"></td> <td style="width: 10%;"></td> </tr> <tr> <td></td> <td></td> <td colspan="8" style="text-align: center;"> <table border="1" style="width: 100%; border-collapse: collapse; text-align: center;"> <tr> <td style="width: 10%;"></td> <td style="width: 10%;"></td> <td style="width: 10%;"></td> <td style="width: 10%;"></td> <td style="width: 10%;"></td> <td style="width: 10%;"></td> <td style="width: 10%;"></td> <td style="width: 10%;"></td> <td style="width: 10%;"></td> <td style="width: 10%;"></td> </tr> <tr> <td></td> <td></td> <td colspan="8" style="text-align: center;"> <table border="1" style="width: 100%; border-collapse: collapse; text-align: center;"> <tr> <td style="width: 10%;"></td> <td style="width: 10%;"></td> <td style="width: 10%;"></td> <td style="width: 10%;"></td> <td style="width: 10%;"></td> <td style="width: 10%;"></td> <td style="width: 10%;"></td> <td style="width: 10%;"></td> <td style="width: 10%;"></td> <td style="width: 10%;"></td> </tr> <tr> <td></td> <td></td> <td colspan="8" style="text-align: center;"> <table border="1" style="width: 100%; border-collapse: collapse; text-align: center;"> <tr> <td style="width: 10%;"></td> <td style="width: 10%;"></td> <td style="width: 10%;"></td> <td style="width: 10%;"></td> <td style="width: 10%;"></td> <td style="width: 10%;"></td> <td style="width: 10%;"></td> <td style="width: 10%;"></td> <td style="width: 10%;"></td> <td style="width: 10%;"></td> </tr> <tr> <td></td> <td></td> <td colspan="8" style="text-align: center;"> <table border="1" style="width: 100%; border-collapse: collapse; text-align: center;"> <tr> <td style="width: 10%;"></td> <td style="width: 10%;"></td> <td style="width: 10%;"></td> <td style="width: 10%;"></td> <td style="width: 10%;"></td> <td style="width: 10%;"></td> <td style="width: 10%;"></td> <td style="width: 10%;"></td> <td style="width: 10%;"></td> <td style="width: 10%;"></td> </tr> <tr> <td></td> <td></td> <td colspan="8" style="text-align: center;"> <table border="1" style="width: 100%; border-collapse: collapse; text-align: center;"> <tr> <td style="width: 10%;"></td> <td style="width: 10%;"></td> <td style="width: 10%;"></td> <td style="width: 10%;"></td> <td style="width: 10%;"></td> <td style="width: 10%;"></td> <td style="width: 10%;"></td> <td style="width: 10%;"></td> <td style="width: 10%;"></td> <td style="width: 10%;"></td> </tr> <tr> <td></td> <td></td> <td colspan="8" style="text-align: center;"> <table border="1" style="width: 100%; border-collapse: collapse; text-align: center;"> <tr> <td style="width: 10%;"></td> <td style="width: 10%;"></td> <td style="width: 10%;"></td> <td style="width: 10%;"></td> <td style="width: 10%;"></td> <td style="width: 10%;"></td> <td style="width: 10%;"></td> <td style="width: 10%;"></td> <td style="width: 10%;"></td> <td style="width: 10%;"></td> </tr> <tr> <td></td> <td></td> <td colspan="8" style="text-align: center;"> <table border="1" style="width: 100%; border-collapse: collapse; text-align: center;"> <tr> <td style="width: 10%;"></td> <td style="width: 10%;"></td> <td style="width: 10%;"></td> <td style="width: 10%;"></td> <td style="width: 10%;"></td> <td style="width: 10%;"></td> <td style="width: 10%;"></td> <td style="width: 10%;"></td> <td style="width: 10%;"></td> <td style="width: 10%;"></td> </tr> <tr> <td></td> <td></td> <td colspan="8" style="text-align: center;"> <table border="1" style="width: 100%; border-collapse: collapse; text-align: center;"> <tr> <td style="width: 10%;"></td> <td style="width: 10%;"></td> <td style="width: 10%;"></td> <td style="width: 10%;"></td> <td style="width: 10%;"></td> <td style="width: 10%;"></td> <td style="width: 10%;"></td> <td style="width: 10%;"></td> <td style="width: 10%;"></td> <td style="width: 10%;"></td> </tr> <tr> <td></td> <td></td> <td colspan="8" style="text-align: center;"> <table border="1" style="width: 100%; border-collapse: collapse; text-align: center;"> <tr> <td style="width: 10%;"></td> <td style="width: 10%;"></td> <td style="width: 10%;"></td> <td style="width: 10%;"></td> <td style="width: 10%;"></td> <td style="width: 10%;"></td> <td style="width: 10%;"></td> <td style="width: 10%;"></td> <td style="width: 10%;"></td> <td style="width: 10%;"></td> </tr> <tr> <td></td> <td></td> <td colspan="8" style="text-align: center;"> <table border="1" style="width: 100%; border-collapse: collapse; text-align: center;"> <tr> <td style="width: 10%;"></td> <td style="width: 10%;"></td> <td style="width: 10%;"></td> <td style="width: 10%;"></td> <td style="width: 10%;"></td> <td style="width: 10%;"></td> <td style="width: 10%;"></td> <td style="width: 10%;"></td> <td style="width: 10%;"></td> <td style="width: 10%;"></td> </tr> <tr> <td></td> <td></td> <td colspan="8" style="text-align: center;"> <table border="1" style="width: 100%; border-collapse: collapse; text-align: center;"> <tr> <td style="width: 10%;"></td> <td style="width: 10%;"></td> <td style="width: 10%;"></td> <td style="width: 10%;"></td> <td style="width: 10%;"></td> <td style="width: 10%;"></td> <td style="width: 10%;"></td> <td style="width: 10%;"></td> <td style="width: 10%;"></td> <td style="width: 10%;"></td> </tr> <tr> <td></td> <td></td> <td colspan="8" style="text-align: center;"> <table border="1" style="width: 100%; border-collapse: collapse; text-align: center;"> <tr> <td style="width: 10%;"></td> <td style="width: 10%;"></td> <td style="width: 10%;"></td> <td style="width: 10%;"></td> <td style="width: 10%;"></td> <td style="width: 10%;"></td> <td style="width: 10%;"></td> <td style="width: 10%;"></td> <td style="width: 10%;"></td> <td style="width: 10%;"></td> </tr> <tr> <td></td> <td></td> <td colspan="8" style="text-align: center;"> <table border="1" style="width: 100%; border-collapse: collapse; text-align: center;"> <tr> <td style="width: 10%;"></td> <td style="width: 10%;"></td> <td style="width: 10%;"></td> <td style="width: 10%;"></td> <td style="width: 10%;"></td> <td style="width: 10%;"></td> <td style="width: 10%;"></td> <td style="width: 10%;"></td> <td style="width: 10%;"></td> <td style="width: 10%;"></td> </tr> <tr> <td></td> <td></td> <td colspan="8" style="text-align: center;"> <table border="1" style="width: 100%; border-collapse: collapse; text-align: center;"> <tr> <td style="width: 10%;"></td> <td style="width: 10%;"></td> <td style="width: 10%;"></td> <td style="width: 10%;"></td> <td style="width: 10%;"></td> <td style="width: 10%;"></td> <td style="width: 10%;"></td> <td style="width: 10%;"></td> <td style="width: 10%;"></td> <td style="width: 10%;"></td> </tr> <tr> <td></td>
<td></td> <td colspan="8" style="text-align: center;"> <table border="1" style="width: 100%; border-collapse: collapse; text-align: center;"> <tr> </tr></table></td></tr></table></td></tr></table></td></tr></table></td></tr></table></td></tr></table></td></tr></table></td></tr></table></td></tr></table></td></tr></table></td></tr></table></td></tr></table></td></tr></table></td></tr></table></td></tr></table></td></tr></table></td></tr></table></td></tr></table> | | | | | | | | | | | | | | | | | | | | <table border="1" style="width: 100%; border-collapse: collapse; text-align: center;"> <tr> <td style="width: 10%;"></td> <td style="width: 10%;"></td> <td style="width: 10%;"></td> <td style="width: 10%;"></td> <td style="width:
10%;"></td> <td style="width: 10%;"></td> <td style="width: 10%;"></td> <td style="width: 10%;"></td> <td style="width: 10%;"></td> <td style="width: 10%;"></td> </tr> <tr> <td></td> <td></td> <td colspan="8" style="text-align: center;"> <table border="1" style="width: 100%; border-collapse: collapse; text-align: center;"> <tr> <td style="width: 10%;"></td> <td style="width: 10%;"></td> <td style="width: 10%;"></td> <td style="width: 10%;"></td> <td style="width: 10%;"></td> <td style="width: 10%;"></td> <td style="width: 10%;"></td> <td style="width: 10%;"></td> <td style="width: 10%;"></td> <td style="width: 10%;"></td> </tr> <tr> <td></td> <td></td> <td colspan="8" style="text-align: center;"> <table border="1" style="width: 100%; border-collapse: collapse; text-align: center;"> <tr> <td style="width: 10%;"></td> <td style="width: 10%;"></td> <td style="width: 10%;"></td> <td style="width: 10%;"></td> <td style="width: 10%;"></td> <td style="width: 10%;"></td> <td style="width: 10%;"></td> <td style="width: 10%;"></td> <td style="width: 10%;"></td> <td style="width: 10%;"></td> </tr> <tr> <td></td> <td></td> <td colspan="8" style="text-align: center;"> <table border="1" style="width: 100%; border-collapse: collapse; text-align: center;"> <tr> <td style="width: 10%;"></td> <td style="width: 10%;"></td> <td style="width: 10%;"></td> <td style="width: 10%;"></td> <td style="width: 10%;"></td> <td style="width: 10%;"></td> <td style="width: 10%;"></td> <td style="width: 10%;"></td> <td style="width: 10%;"></td> <td style="width: 10%;"></td> </tr> <tr> <td></td> <td></td> <td colspan="8" style="text-align: center;"> <table border="1" style="width: 100%; border-collapse: collapse; text-align: center;"> <tr> <td style="width: 10%;"></td> <td style="width: 10%;"></td> <td style="width: 10%;"></td> <td style="width: 10%;"></td> <td style="width: 10%;"></td> <td style="width: 10%;"></td> <td style="width: 10%;"></td> <td style="width: 10%;"></td> <td style="width: 10%;"></td> <td style="width: 10%;"></td> </tr> <tr> <td></td> <td></td> <td colspan="8" style="text-align: center;"> <table border="1" style="width: 100%; border-collapse: collapse; text-align: center;"> <tr> <td style="width: 10%;"></td> <td style="width: 10%;"></td> <td style="width: 10%;"></td> <td style="width: 10%;"></td> <td style="width: 10%;"></td> <td style="width: 10%;"></td> <td style="width: 10%;"></td> <td style="width: 10%;"></td> <td style="width: 10%;"></td> <td style="width: 10%;"></td> </tr> <tr> <td></td> <td></td> <td colspan="8" style="text-align: center;"> <table border="1" style="width: 100%; border-collapse: collapse; text-align: center;"> <tr> <td style="width: 10%;"></td> <td style="width: 10%;"></td> <td style="width: 10%;"></td> <td style="width: 10%;"></td> <td style="width: 10%;"></td> <td style="width: 10%;"></td> <td style="width: 10%;"></td> <td style="width: 10%;"></td> <td style="width: 10%;"></td> <td style="width: 10%;"></td> </tr> <tr> <td></td> <td></td> <td colspan="8" style="text-align: center;"> <table border="1" style="width: 100%; border-collapse: collapse; text-align: center;"> <tr> <td style="width: 10%;"></td> <td style="width: 10%;"></td> <td style="width: 10%;"></td> <td style="width: 10%;"></td> <td style="width: 10%;"></td> <td style="width: 10%;"></td> <td style="width: 10%;"></td> <td style="width: 10%;"></td> <td style="width: 10%;"></td> <td style="width: 10%;"></td> </tr> <tr> <td></td> <td></td> <td colspan="8" style="text-align: center;"> <table border="1" style="width: 100%; border-collapse: collapse; text-align: center;"> <tr> <td style="width: 10%;"></td> <td style="width: 10%;"></td> <td style="width: 10%;"></td> <td style="width: 10%;"></td> <td style="width: 10%;"></td> <td style="width: 10%;"></td> <td style="width: 10%;"></td> <td style="width: 10%;"></td> <td style="width: 10%;"></td> <td style="width: 10%;"></td> </tr> <tr> <td></td> <td></td> <td colspan="8" style="text-align: center;"> <table border="1" style="width: 100%; border-collapse: collapse; text-align: center;"> <tr> <td style="width: 10%;"></td> <td style="width: 10%;"></td> <td style="width: 10%;"></td> <td style="width: 10%;"></td> <td style="width: 10%;"></td> <td style="width: 10%;"></td> <td style="width: 10%;"></td> <td style="width: 10%;"></td> <td style="width: 10%;"></td> <td style="width: 10%;"></td> </tr> <tr> <td></td> <td></td> <td colspan="8" style="text-align: center;"> <table border="1" style="width: 100%; border-collapse: collapse; text-align: center;"> <tr> <td style="width: 10%;"></td> <td style="width: 10%;"></td> <td style="width: 10%;"></td> <td style="width: 10%;"></td> <td style="width: 10%;"></td> <td style="width: 10%;"></td> <td style="width: 10%;"></td> <td style="width: 10%;"></td> <td style="width: 10%;"></td> <td style="width: 10%;"></td> </tr> <tr> <td></td> <td></td> <td colspan="8" style="text-align: center;"> <table border="1" style="width: 100%; border-collapse: collapse; text-align: center;"> <tr> <td style="width: 10%;"></td> <td style="width: 10%;"></td> <td style="width: 10%;"></td> <td style="width: 10%;"></td> <td style="width: 10%;"></td> <td style="width: 10%;"></td> <td style="width: 10%;"></td> <td style="width: 10%;"></td> <td style="width: 10%;"></td> <td style="width: 10%;"></td> </tr> <tr> <td></td> <td></td> <td colspan="8" style="text-align: center;"> <table border="1" style="width: 100%; border-collapse: collapse; text-align: center;"> <tr> <td style="width: 10%;"></td> <td style="width: 10%;"></td> <td style="width: 10%;"></td> <td style="width: 10%;"></td> <td style="width: 10%;"></td> <td style="width: 10%;"></td> <td style="width: 10%;"></td> <td style="width: 10%;"></td> <td style="width: 10%;"></td> <td style="width: 10%;"></td> </tr> <tr> <td></td> <td></td> <td colspan="8" style="text-align: center;"> <table border="1" style="width: 100%; border-collapse: collapse; text-align: center;"> <tr> <td style="width: 10%;"></td> <td style="width: 10%;"></td> <td style="width: 10%;"></td> <td style="width: 10%;"></td> <td style="width: 10%;"></td> <td style="width: 10%;"></td> <td style="width: 10%;"></td> <td style="width: 10%;"></td> <td style="width: 10%;"></td> <td style="width: 10%;"></td> </tr> <tr> <td></td> <td></td> <td colspan="8" style="text-align: center;"> <table border="1" style="width: 100%; border-collapse: collapse; text-align: center;"> <tr> <td style="width: 10%;"></td> <td style="width: 10%;"></td> <td style="width: 10%;"></td> <td style="width: 10%;"></td> <td style="width: 10%;"></td> <td style="width: 10%;"></td> <td style="width: 10%;"></td> <td style="width: 10%;"></td> <td style="width: 10%;"></td> <td style="width: 10%;"></td> </tr> <tr> <td></td> <td></td> <td colspan="8" style="text-align: center;"> <table border="1" style="width: 100%; border-collapse: collapse; text-align: center;"> <tr> <td style="width: 10%;"></td> <td style="width: 10%;"></td> <td style="width: 10%;"></td> <td style="width: 10%;"></td> <td style="width: 10%;"></td> <td style="width: 10%;"></td> <td style="width: 10%;"></td> <td style="width: 10%;"></td> <td style="width: 10%;"></td> <td style="width: 10%;"></td> </tr> <tr> <td></td> <td></td> <td colspan="8" style="text-align: center;"> <table border="1" style="width: 100%; border-collapse: collapse; text-align: center;"> <tr> </tr></table></td></tr></table></td></tr></table></td></tr></table></td></tr></table></td></tr></table></td></tr></table></td></tr></table></td></tr></table></td></tr></table></td></tr></table></td></tr></table></td></tr></table></td></tr></table></td></tr></table></td></tr></table></td></tr></table>
 | | | | | | | | | | | | | | | | | | | | <table border="1" style="width: 100%; border-collapse: collapse; text-align: center;"> <tr> <td style="width: 10%;"></td> <td style="width: 10%;"></td> <td style="width: 10%;"></td> <td style="width: 10%;"></td> <td style="width: 10%;"></td> <td style="width: 10%;"></td> <td style="width: 10%;"></td> <td style="width: 10%;"></td> <td style="width: 10%;"></td> <td style="width: 10%;"></td> </tr> <tr> <td></td> <td></td> <td colspan="8" style="text-align: center;"> <table border="1" style="width: 100%; border-collapse: collapse; text-align: center;"> <tr> <td style="width: 10%;"></td> <td style="width: 10%;"></td> <td style="width: 10%;"></td> <td style="width: 10%;"></td> <td style="width: 10%;"></td> <td style="width: 10%;"></td> <td style="width: 10%;"></td> <td style="width: 10%;"></td> <td style="width: 10%;"></td> <td style="width: 10%;"></td> </tr> <tr> <td></td> <td></td> <td colspan="8" style="text-align: center;"> <table border="1" style="width: 100%; border-collapse: collapse; text-align: center;"> <tr> <td style="width: 10%;"></td> <td style="width: 10%;"></td> <td style="width: 10%;"></td> <td style="width: 10%;"></td> <td style="width: 10%;"></td> <td style="width: 10%;"></td> <td style="width: 10%;"></td> <td style="width: 10%;"></td> <td style="width: 10%;"></td> <td style="width: 10%;"></td> </tr> <tr> <td></td> <td></td> <td colspan="8" style="text-align: center;"> <table border="1" style="width: 100%; border-collapse: collapse; text-align: center;"> <tr> <td style="width: 10%;"></td> <td style="width: 10%;"></td> <td style="width: 10%;"></td> <td style="width: 10%;"></td> <td style="width: 10%;"></td> <td style="width: 10%;"></td> <td style="width: 10%;"></td> <td style="width: 10%;"></td> <td style="width: 10%;"></td> <td style="width: 10%;"></td> </tr> <tr> <td></td> <td></td> <td colspan="8" style="text-align: center;"> <table border="1" style="width: 100%; border-collapse: collapse; text-align: center;"> <tr> <td style="width: 10%;"></td> <td style="width: 10%;"></td> <td style="width: 10%;"></td> <td style="width: 10%;"></td> <td style="width: 10%;"></td> <td style="width: 10%;"></td> <td style="width: 10%;"></td> <td style="width: 10%;"></td> <td style="width: 10%;"></td> <td style="width: 10%;"></td> </tr> <tr> <td></td> <td></td> <td colspan="8" style="text-align: center;"> <table border="1" style="width: 100%; border-collapse: collapse; text-align: center;"> <tr> <td style="width: 10%;"></td> <td style="width: 10%;"></td> <td style="width: 10%;"></td> <td style="width: 10%;"></td> <td style="width: 10%;"></td> <td style="width: 10%;"></td> <td style="width: 10%;"></td> <td style="width: 10%;"></td> <td style="width: 10%;"></td> <td style="width: 10%;"></td> </tr> <tr> <td></td> <td></td> <td colspan="8" style="text-align: center;"> <table border="1" style="width: 100%; border-collapse: collapse; text-align: center;"> <tr> <td style="width: 10%;"></td> <td style="width: 10%;"></td> <td style="width: 10%;"></td> <td style="width: 10%;"></td> <td style="width: 10%;"></td> <td
style="width: 10%;"></td> <td style="width: 10%;"></td> <td style="width: 10%;"></td> <td style="width: 10%;"></td> <td style="width: 10%;"></td> </tr> <tr> <td></td> <td></td> <td colspan="8" style="text-align: center;"> <table border="1" style="width: 100%; border-collapse: collapse; text-align: center;"> <tr> <td style="width: 10%;"></td> <td style="width: 10%;"></td> <td style="width: 10%;"></td> <td style="width: 10%;"></td> <td style="width: 10%;"></td> <td style="width: 10%;"></td> <td style="width: 10%;"></td> <td style="width: 10%;"></td> <td style="width: 10%;"></td> <td style="width: 10%;"></td> </tr> <tr> <td></td> <td></td> <td colspan="8" style="text-align: center;"> <table border="1" style="width: 100%; border-collapse: collapse; text-align: center;"> <tr> <td style="width: 10%;"></td> <td style="width: 10%;"></td> <td style="width: 10%;"></td> <td style="width: 10%;"></td> <td style="width: 10%;"></td> <td style="width: 10%;"></td> <td style="width: 10%;"></td> <td style="width: 10%;"></td> <td style="width: 10%;"></td> <td style="width: 10%;"></td> </tr> <tr> <td></td> <td></td> <td colspan="8" style="text-align: center;"> <table border="1" style="width: 100%; border-collapse: collapse; text-align: center;"> <tr> <td style="width: 10%;"></td> <td style="width: 10%;"></td> <td style="width: 10%;"></td> <td style="width: 10%;"></td> <td style="width: 10%;"></td> <td style="width: 10%;"></td> <td style="width: 10%;"></td> <td style="width: 10%;"></td> <td style="width: 10%;"></td> <td style="width: 10%;"></td> </tr> <tr> <td></td> <td></td> <td colspan="8" style="text-align: center;"> <table border="1" style="width: 100%; border-collapse: collapse; text-align: center;"> <tr> <td style="width: 10%;"></td> <td style="width: 10%;"></td> <td style="width: 10%;"></td> <td style="width: 10%;"></td> <td style="width: 10%;"></td> <td style="width: 10%;"></td> <td style="width: 10%;"></td> <td style="width: 10%;"></td> <td style="width: 10%;"></td> <td style="width: 10%;"></td> </tr> <tr> <td></td> <td></td> <td colspan="8" style="text-align: center;"> <table border="1" style="width: 100%; border-collapse: collapse; text-align: center;"> <tr> <td style="width: 10%;"></td> <td style="width: 10%;"></td> <td style="width: 10%;"></td> <td style="width: 10%;"></td> <td style="width: 10%;"></td> <td style="width: 10%;"></td> <td style="width: 10%;"></td> <td style="width: 10%;"></td> <td style="width: 10%;"></td> <td style="width: 10%;"></td> </tr> <tr> <td></td> <td></td> <td colspan="8" style="text-align: center;"> <table border="1" style="width: 100%; border-collapse: collapse; text-align: center;"> <tr> <td style="width: 10%;"></td> <td style="width: 10%;"></td> <td style="width: 10%;"></td> <td style="width: 10%;"></td> <td style="width: 10%;"></td> <td style="width: 10%;"></td> <td style="width: 10%;"></td> <td style="width: 10%;"></td> <td style="width: 10%;"></td> <td style="width: 10%;"></td> </tr> <tr> <td></td> <td></td> <td colspan="8" style="text-align: center;"> <table border="1" style="width: 100%; border-collapse: collapse; text-align: center;"> <tr> <td style="width: 10%;"></td> <td style="width: 10%;"></td> <td style="width: 10%;"></td> <td style="width: 10%;"></td> <td style="width: 10%;"></td> <td style="width: 10%;"></td> <td style="width: 10%;"></td> <td style="width: 10%;"></td> <td style="width: 10%;"></td> <td style="width: 10%;"></td> </tr> <tr> <td></td> <td></td> <td colspan="8" style="text-align: center;"> <table border="1" style="width: 100%; border-collapse: collapse; text-align: center;"> <tr> <td style="width: 10%;"></td> <td style="width: 10%;"></td> <td style="width: 10%;"></td> <td style="width: 10%;"></td> <td style="width: 10%;"></td> <td style="width: 10%;"></td> <td style="width: 10%;"></td> <td style="width: 10%;"></td> <td style="width: 10%;"></td> <td style="width: 10%;"></td> </tr> <tr> <td></td> <td></td> <td colspan="8" style="text-align: center;"> <table border="1" style="width: 100%; border-collapse: collapse; text-align: center;"> <tr> </tr></table></td></tr></table></td></tr></table></td></tr></table></td></tr></table></td></tr></table></td></tr></table></td></tr></table></td></tr></table></td></tr></table></td></tr></table></td></tr></table></td></tr></table></td></tr></table></td></tr></table></td></tr></table>
 | | | | | | | | | | | | | | | | | | | | <table border="1" style="width: 100%; border-collapse: collapse; text-align: center;"> <tr> <td style="width: 10%;"></td> <td style="width: 10%;"></td> <td style="width: 10%;"></td> <td style="width: 10%;"></td> <td style="width: 10%;"></td> <td style="width: 10%;"></td> <td style="width: 10%;"></td> <td style="width: 10%;"></td> <td style="width: 10%;"></td> <td style="width: 10%;"></td> </tr> <tr> <td></td> <td></td> <td colspan="8" style="text-align: center;"> <table border="1" style="width: 100%; border-collapse: collapse; text-align: center;"> <tr> <td style="width: 10%;"></td> <td style="width: 10%;"></td> <td style="width: 10%;"></td> <td style="width: 10%;"></td> <td style="width: 10%;"></td> <td style="width: 10%;"></td> <td style="width: 10%;"></td> <td style="width: 10%;"></td> <td style="width: 10%;"></td> <td style="width: 10%;"></td> </tr> <tr> <td></td> <td></td> <td colspan="8" style="text-align: center;"> <table border="1" style="width: 100%; border-collapse: collapse; text-align: center;"> <tr> <td style="width: 10%;"></td> <td style="width: 10%;"></td> <td style="width: 10%;"></td> <td style="width: 10%;"></td> <td style="width: 10%;"></td> <td style="width: 10%;"></td> <td style="width: 10%;"></td> <td style="width: 10%;"></td> <td style="width: 10%;"></td> <td style="width: 10%;"></td> </tr> <tr> <td></td> <td></td> <td colspan="8" style="text-align: center;"> <table border="1" style="width: 100%; border-collapse: collapse; text-align: center;"> <tr> <td style="width: 10%;"></td> <td style="width: 10%;"></td> <td style="width: 10%;"></td> <td style="width: 10%;"></td> <td style="width: 10%;"></td> <td style="width: 10%;"></td> <td style="width: 10%;"></td> <td style="width: 10%;"></td> <td style="width: 10%;"></td> <td style="width: 10%;"></td> </tr> <tr> <td></td> <td></td> <td colspan="8" style="text-align: center;"> <table border="1" style="width: 100%; border-collapse: collapse; text-align: center;"> <tr> <td style="width: 10%;"></td> <td style="width: 10%;"></td> <td style="width: 10%;"></td> <td style="width: 10%;"></td> <td style="width: 10%;"></td> <td style="width: 10%;"></td> <td style="width: 10%;"></td> <td style="width: 10%;"></td> <td style="width: 10%;"></td> <td style="width: 10%;"></td> </tr> <tr> <td></td> <td></td> <td colspan="8" style="text-align: center;"> <table border="1" style="width: 100%; border-collapse: collapse; text-align: center;"> <tr> <td style="width: 10%;"></td> <td style="width: 10%;"></td> <td style="width: 10%;"></td> <td style="width: 10%;"></td> <td style="width: 10%;"></td> <td style="width: 10%;"></td> <td style="width: 10%;"></td> <td style="width: 10%;"></td> <td style="width: 10%;"></td> <td style="width: 10%;"></td> </tr> <tr> <td></td> <td></td> <td colspan="8" style="text-align: center;"> <table border="1" style="width: 100%; border-collapse: collapse; text-align: center;"> <tr> <td style="width: 10%;"></td> <td style="width: 10%;"></td> <td style="width: 10%;"></td> <td style="width: 10%;"></td> <td style="width: 10%;"></td> <td style="width: 10%;"></td> <td style="width: 10%;"></td> <td style="width: 10%;"></td> <td style="width: 10%;"></td> <td style="width: 10%;"></td> </tr> <tr> <td></td> <td></td> <td colspan="8" style="text-align: center;"> <table border="1" style="width: 100%; border-collapse: collapse; text-align: center;"> <tr> <td style="width: 10%;"></td> <td style="width: 10%;"></td> <td style="width: 10%;"></td> <td style="width: 10%;"></td> <td style="width: 10%;"></td> <td style="width: 10%;"></td> <td style="width: 10%;"></td> <td style="width: 10%;"></td> <td style="width: 10%;"></td> <td style="width: 10%;"></td> </tr> <tr> <td></td> <td></td> <td colspan="8" style="text-align: center;"> <table border="1" style="width: 100%; border-collapse: collapse; text-align: center;"> <tr> <td style="width: 10%;"></td> <td style="width: 10%;"></td> <td style="width: 10%;"></td> <td style="width: 10%;"></td> <td style="width: 10%;"></td> <td style="width: 10%;"></td> <td style="width: 10%;"></td> <td style="width: 10%;"></td> <td style="width: 10%;"></td> <td style="width: 10%;"></td> </tr> <tr> <td></td> <td></td> <td colspan="8" style="text-align: center;"> <table border="1" style="width: 100%; border-collapse: collapse; text-align: center;"> <tr> <td style="width: 10%;"></td> <td style="width: 10%;"></td> <td style="width: 10%;"></td> <td style="width: 10%;"></td> <td style="width: 10%;"></td> <td style="width: 10%;"></td> <td style="width: 10%;"></td> <td style="width: 10%;"></td> <td style="width: 10%;"></td> <td style="width: 10%;"></td> </tr> <tr> <td></td> <td></td> <td colspan="8" style="text-align: center;"> <table border="1" style="width: 100%; border-collapse: collapse; text-align: center;"> <tr> <td style="width: 10%;"></td> <td style="width: 10%;"></td> <td style="width: 10%;"></td> <td style="width: 10%;"></td> <td style="width: 10%;"></td> <td style="width: 10%;"></td> <td style="width: 10%;"></td> <td style="width: 10%;"></td> <td style="width: 10%;"></td> <td style="width: 10%;"></td> </tr> <tr> <td></td> <td></td> <td colspan="8" style="text-align: center;"> <table border="1" style="width: 100%; border-collapse: collapse; text-align: center;"> <tr> <td style="width: 10%;"></td> <td style="width: 10%;"></td> <td style="width: 10%;"></td> <td style="width: 10%;"></td> <td style="width: 10%;"></td> <td style="width: 10%;"></td> <td style="width: 10%;"></td> <td style="width: 10%;"></td> <td style="width: 10%;"></td> <td style="width: 10%;"></td> </tr> <tr> <td></td> <td></td> <td colspan="8" style="text-align: center;"> <table border="1" style="width: 100%; border-collapse: collapse; text-align: center;"> <tr> <td style="width: 10%;"></td> <td style="width: 10%;"></td> <td style="width: 10%;"></td> <td style="width: 10%;"></td> <td style="width: 10%;"></td> <td style="width: 10%;"></td> <td style="width: 10%;"></td> <td style="width: 10%;"></td> <td style="width: 10%;"></td> <td style="width: 10%;"></td> </tr> <tr> <td></td> <td></td> <td colspan="8" style="text-align: center;"> <table border="1" style="width: 100%; border-collapse: collapse; text-align: center;"> <tr> <td style="width: 10%;"></td> <td style="width: 10%;"></td> <td style="width: 10%;"></td> <td style="width: 10%;"></td> <td style="width: 10%;"></td> <td style="width: 10%;"></td> <td
style="width: 10%;"></td> <td style="width: 10%;"></td> <td style="width: 10%;"></td> <td style="width: 10%;"></td> </tr> <tr> <td></td> <td></td> <td colspan="8" style="text-align: center;"> <table border="1" style="width: 100%; border-collapse: collapse; text-align: center;"> <tr> </tr></table></td></tr></table></td></tr></table></td></tr></table></td></tr></table></td></tr></table></td></tr></table></td></tr></table></td></tr></table></td></tr></table></td></tr></table></td></tr></table></td></tr></table></td></tr></table></td></tr></table> | | | | | | | | | | | | | | | | | | | | <table border="1" style="width: 100%; border-collapse: collapse; text-align: center;"> <tr> <td style="width: 10%;"></td> <td style="width: 10%;"></td> <td
style="width: 10%;"></td> <td style="width: 10%;"></td> <td style="width: 10%;"></td> <td style="width: 10%;"></td> <td style="width: 10%;"></td> <td style="width: 10%;"></td> <td style="width: 10%;"></td> <td style="width: 10%;"></td> </tr> <tr> <td></td> <td></td> <td colspan="8" style="text-align: center;"> <table border="1" style="width: 100%; border-collapse: collapse; text-align: center;"> <tr> <td style="width: 10%;"></td> <td style="width: 10%;"></td> <td style="width: 10%;"></td> <td style="width: 10%;"></td> <td style="width: 10%;"></td> <td style="width: 10%;"></td> <td style="width: 10%;"></td> <td style="width: 10%;"></td> <td style="width: 10%;"></td> <td style="width: 10%;"></td> </tr> <tr> <td></td> <td></td> <td colspan="8" style="text-align: center;"> <table border="1" style="width: 100%; border-collapse: collapse; text-align: center;"> <tr> <td style="width: 10%;"></td> <td style="width: 10%;"></td> <td style="width: 10%;"></td> <td style="width: 10%;"></td> <td style="width: 10%;"></td> <td style="width: 10%;"></td> <td style="width: 10%;"></td> <td style="width: 10%;"></td> <td style="width: 10%;"></td> <td style="width: 10%;"></td> </tr> <tr> <td></td> <td></td> <td colspan="8" style="text-align: center;"> <table border="1" style="width: 100%; border-collapse: collapse; text-align: center;"> <tr> <td style="width: 10%;"></td> <td style="width: 10%;"></td> <td style="width: 10%;"></td> <td style="width: 10%;"></td> <td style="width: 10%;"></td> <td style="width: 10%;"></td> <td style="width: 10%;"></td> <td style="width: 10%;"></td> <td style="width: 10%;"></td> <td style="width: 10%;"></td> </tr> <tr> <td></td> <td></td> <td colspan="8" style="text-align: center;"> <table border="1" style="width: 100%; border-collapse: collapse; text-align: center;"> <tr> <td style="width: 10%;"></td> <td style="width: 10%;"></td> <td style="width: 10%;"></td> <td style="width: 10%;"></td> <td style="width: 10%;"></td> <td style="width: 10%;"></td> <td style="width: 10%;"></td> <td style="width: 10%;"></td> <td style="width: 10%;"></td> <td style="width: 10%;"></td> </tr> <tr> <td></td> <td></td> <td colspan="8" style="text-align: center;"> <table border="1" style="width: 100%; border-collapse: collapse; text-align: center;"> <tr> <td style="width: 10%;"></td> <td style="width: 10%;"></td> <td style="width: 10%;"></td> <td style="width: 10%;"></td> <td style="width: 10%;"></td> <td style="width: 10%;"></td> <td style="width: 10%;"></td> <td style="width: 10%;"></td> <td style="width: 10%;"></td> <td style="width: 10%;"></td> </tr> <tr> <td></td> <td></td> <td colspan="8" style="text-align: center;"> <table border="1" style="width: 100%; border-collapse: collapse; text-align: center;"> <tr> <td style="width: 10%;"></td> <td style="width: 10%;"></td> <td style="width: 10%;"></td> <td style="width: 10%;"></td> <td style="width: 10%;"></td> <td style="width: 10%;"></td> <td style="width: 10%;"></td> <td style="width: 10%;"></td> <td style="width: 10%;"></td> <td style="width: 10%;"></td> </tr> <tr> <td></td> <td></td> <td colspan="8" style="text-align: center;"> <table border="1" style="width: 100%; border-collapse: collapse; text-align: center;"> <tr> <td style="width: 10%;"></td> <td style="width: 10%;"></td> <td style="width: 10%;"></td> <td style="width: 10%;"></td> <td style="width: 10%;"></td> <td style="width: 10%;"></td> <td style="width: 10%;"></td> <td style="width: 10%;"></td> <td style="width: 10%;"></td> <td style="width: 10%;"></td> </tr> <tr> <td></td> <td></td> <td colspan="8" style="text-align: center;"> <table border="1" style="width: 100%; border-collapse: collapse; text-align: center;"> <tr> <td style="width: 10%;"></td> <td style="width: 10%;"></td> <td style="width: 10%;"></td> <td style="width: 10%;"></td> <td style="width: 10%;"></td> <td style="width: 10%;"></td> <td style="width: 10%;"></td> <td style="width: 10%;"></td> <td style="width: 10%;"></td> <td style="width: 10%;"></td> </tr> <tr> <td></td> <td></td> <td colspan="8" style="text-align: center;"> <table border="1" style="width: 100%; border-collapse: collapse; text-align: center;"> <tr> <td style="width: 10%;"></td> <td style="width: 10%;"></td> <td style="width: 10%;"></td> <td style="width: 10%;"></td> <td style="width: 10%;"></td> <td style="width: 10%;"></td> <td style="width: 10%;"></td> <td style="width: 10%;"></td> <td style="width: 10%;"></td> <td style="width: 10%;"></td> </tr> <tr> <td></td> <td></td> <td colspan="8" style="text-align: center;"> <table border="1" style="width: 100%; border-collapse: collapse; text-align: center;"> <tr> <td style="width: 10%;"></td> <td style="width: 10%;"></td> <td style="width: 10%;"></td> <td style="width: 10%;"></td> <td style="width: 10%;"></td> <td style="width: 10%;"></td> <td style="width: 10%;"></td> <td style="width: 10%;"></td> <td style="width: 10%;"></td> <td style="width: 10%;"></td> </tr> <tr> <td></td> <td></td> <td colspan="8" style="text-align: center;"> <table border="1" style="width: 100%; border-collapse: collapse; text-align: center;"> <tr> <td style="width: 10%;"></td> <td style="width: 10%;"></td> <td style="width: 10%;"></td> <td style="width: 10%;"></td> <td style="width: 10%;"></td> <td style="width: 10%;"></td> <td style="width: 10%;"></td> <td style="width: 10%;"></td> <td style="width: 10%;"></td> <td style="width: 10%;"></td> </tr> <tr> <td></td> <td></td> <td colspan="8" style="text-align: center;"> <table border="1" style="width: 100%; border-collapse: collapse; text-align: center;"> <tr> <td style="width: 10%;"></td> <td style="width: 10%;"></td> <td style="width: 10%;"></td> <td style="width: 10%;"></td> <td style="width: 10%;"></td> <td style="width: 10%;"></td> <td style="width: 10%;"></td> <td style="width: 10%;"></td> <td style="width: 10%;"></td> <td style="width: 10%;"></td> </tr> <tr> <td></td> <td></td> <td colspan="8" style="text-align: center;"> <table border="1" style="width: 100%; border-collapse: collapse; text-align: center;"> <tr> </tr></table></td></tr></table></td></tr></table></td></tr></table></td></tr></table></td></tr></table></td></tr></table></td></tr></table></td></tr></table></td></tr></table></td></tr></table></td></tr></table></td></tr></table></td></tr></table>
 | | | | | | | | | | | | | | | | | | | | <table border="1" style="width: 100%; border-collapse: collapse; text-align: center;"> <tr> <td style="width: 10%;"></td> <td style="width: 10%;"></td> <td style="width: 10%;"></td> <td style="width: 10%;"></td> <td style="width: 10%;"></td> <td style="width: 10%;"></td> <td style="width: 10%;"></td> <td style="width: 10%;"></td> <td style="width: 10%;"></td> <td style="width: 10%;"></td> </tr> <tr> <td></td> <td></td> <td colspan="8" style="text-align: center;"> <table border="1" style="width: 100%; border-collapse: collapse; text-align: center;"> <tr> <td style="width: 10%;"></td> <td style="width: 10%;"></td> <td style="width: 10%;"></td> <td style="width: 10%;"></td> <td style="width: 10%;"></td> <td style="width: 10%;"></td> <td style="width: 10%;"></td> <td style="width: 10%;"></td> <td style="width: 10%;"></td> <td style="width: 10%;"></td> </tr> <tr> <td></td> <td></td> <td colspan="8" style="text-align: center;"> <table border="1" style="width: 100%; border-collapse: collapse; text-align: center;"> <tr> <td style="width: 10%;"></td> <td style="width: 10%;"></td> <td style="width: 10%;"></td> <td style="width: 10%;"></td> <td style="width: 10%;"></td> <td style="width: 10%;"></td> <td style="width: 10%;"></td> <td style="width: 10%;"></td> <td style="width: 10%;"></td> <td style="width: 10%;"></td> </tr> <tr> <td></td> <td></td> <td colspan="8" style="text-align: center;"> <table border="1" style="width: 100%; border-collapse: collapse; text-align: center;"> <tr> <td style="width: 10%;"></td> <td style="width: 10%;"></td> <td style="width: 10%;"></td> <td style="width: 10%;"></td> <td style="width: 10%;"></td> <td style="width: 10%;"></td> <td style="width: 10%;"></td> <td style="width: 10%;"></td> <td style="width: 10%;"></td> <td style="width: 10%;"></td> </tr> <tr> <td></td> <td></td> <td colspan="8" style="text-align: center;"> <table border="1" style="width: 100%; border-collapse: collapse; text-align: center;"> <tr> <td style="width: 10%;"></td> <td style="width: 10%;"></td> <td style="width: 10%;"></td> <td style="width: 10%;"></td> <td style="width: 10%;"></td> <td style="width: 10%;"></td> <td style="width: 10%;"></td> <td style="width: 10%;"></td> <td style="width: 10%;"></td> <td style="width: 10%;"></td> </tr> <tr> <td></td> <td></td> <td colspan="8" style="text-align: center;"> <table border="1" style="width: 100%; border-collapse: collapse; text-align: center;"> <tr> <td style="width: 10%;"></td> <td style="width: 10%;"></td> <td style="width: 10%;"></td> <td style="width: 10%;"></td> <td style="width: 10%;"></td> <td style="width: 10%;"></td> <td style="width: 10%;"></td> <td style="width: 10%;"></td> <td style="width: 10%;"></td> <td style="width: 10%;"></td> </tr> <tr> <td></td> <td></td> <td colspan="8" style="text-align: center;"> <table border="1" style="width: 100%; border-collapse: collapse; text-align: center;"> <tr> <td style="width: 10%;"></td> <td style="width: 10%;"></td> <td style="width: 10%;"></td> <td style="width: 10%;"></td> <td style="width: 10%;"></td> <td style="width: 10%;"></td> <td style="width: 10%;"></td> <td style="width: 10%;"></td> <td style="width: 10%;"></td> <td style="width: 10%;"></td> </tr> <tr> <td></td> <td></td> <td colspan="8" style="text-align: center;"> <table border="1" style="width: 100%; border-collapse: collapse; text-align: center;"> <tr> <td style="width: 10%;"></td> <td style="width: 10%;"></td> <td style="width: 10%;"></td> <td style="width: 10%;"></td> <td style="width: 10%;"></td> <td style="width: 10%;"></td> <td style="width: 10%;"></td> <td style="width: 10%;"></td> <td style="width: 10%;"></td> <td style="width: 10%;"></td> </tr> <tr> <td></td> <td></td> <td colspan="8" style="text-align: center;"> <table border="1" style="width: 100%; border-collapse: collapse; text-align: center;"> <tr> <td style="width: 10%;"></td> <td style="width: 10%;"></td> <td style="width: 10%;"></td> <td style="width: 10%;"></td> <td style="width: 10%;"></td> <td style="width: 10%;"></td> <td style="width: 10%;"></td> <td style="width: 10%;"></td> <td style="width: 10%;"></td> <td style="width: 10%;"></td> </tr> <tr> <td></td> <td></td> <td colspan="8" style="text-align: center;"> <table border="1" style="width: 100%; border-collapse: collapse; text-align: center;"> <tr> <td style="width: 10%;"></td> <td style="width: 10%;"></td> <td style="width: 10%;"></td> <td style="width: 10%;"></td> <td
style="width: 10%;"></td> <td style="width: 10%;"></td> <td style="width: 10%;"></td> <td style="width: 10%;"></td> <td style="width: 10%;"></td> <td style="width: 10%;"></td> </tr> <tr> <td></td> <td></td> <td colspan="8" style="text-align: center;"> <table border="1" style="width: 100%; border-collapse: collapse; text-align: center;"> <tr> <td style="width: 10%;"></td> <td style="width: 10%;"></td> <td style="width: 10%;"></td> <td style="width: 10%;"></td> <td style="width: 10%;"></td> <td style="width: 10%;"></td> <td style="width: 10%;"></td> <td style="width: 10%;"></td> <td style="width: 10%;"></td> <td style="width: 10%;"></td> </tr> <tr> <td></td> <td></td> <td colspan="8" style="text-align: center;"> <table border="1" style="width: 100%; border-collapse: collapse; text-align: center;"> <tr> <td style="width: 10%;"></td> <td style="width: 10%;"></td> <td style="width: 10%;"></td> <td style="width: 10%;"></td> <td style="width: 10%;"></td> <td style="width: 10%;"></td> <td style="width: 10%;"></td> <td style="width: 10%;"></td> <td style="width: 10%;"></td> <td style="width: 10%;"></td> </tr> <tr> <td></td> <td></td> <td colspan="8" style="text-align: center;"> <table border="1" style="width: 100%; border-collapse: collapse; text-align: center;"> <tr> </tr></table></td></tr></table></td></tr></table></td></tr></table></td></tr></table></td></tr></table></td></tr></table></td></tr></table></td></tr></table></td></tr></table></td></tr></table></td></tr></table></td></tr></table>
 | | | | | | | | | | | | | | | | | | | | <table border="1" style="width: 100%; border-collapse: collapse; text-align: center;"> <tr> <td style="width: 10%;"></td> <td style="width: 10%;"></td> <td style="width: 10%;"></td> <td style="width: 10%;"></td> <td style="width: 10%;"></td> <td style="width: 10%;"></td> <td style="width: 10%;"></td> <td style="width: 10%;"></td> <td style="width: 10%;"></td> <td style="width: 10%;"></td> </tr> <tr> <td></td> <td></td> <td colspan="8" style="text-align: center;"> <table border="1" style="width: 100%; border-collapse: collapse; text-align: center;"> <tr> <td style="width: 10%;"></td> <td style="width: 10%;"></td> <td style="width: 10%;"></td> <td style="width: 10%;"></td> <td style="width: 10%;"></td> <td style="width: 10%;"></td> <td style="width: 10%;"></td> <td style="width: 10%;"></td> <td style="width: 10%;"></td> <td style="width: 10%;"></td> </tr> <tr> <td></td> <td></td> <td colspan="8" style="text-align: center;"> <table border="1" style="width: 100%; border-collapse: collapse; text-align: center;"> <tr> <td style="width: 10%;"></td> <td style="width: 10%;"></td> <td style="width: 10%;"></td> <td style="width: 10%;"></td> <td style="width: 10%;"></td> <td style="width: 10%;"></td> <td style="width: 10%;"></td> <td style="width: 10%;"></td> <td style="width: 10%;"></td> <td style="width: 10%;"></td> </tr> <tr> <td></td> <td></td> <td colspan="8" style="text-align: center;"> <table border="1" style="width: 100%; border-collapse: collapse; text-align: center;"> <tr> <td style="width: 10%;"></td> <td style="width: 10%;"></td> <td style="width: 10%;"></td> <td style="width: 10%;"></td> <td style="width: 10%;"></td> <td style="width: 10%;"></td> <td style="width: 10%;"></td> <td style="width: 10%;"></td> <td style="width: 10%;"></td> <td style="width: 10%;"></td> </tr> <tr> <td></td> <td></td> <td colspan="8" style="text-align: center;"> <table border="1" style="width: 100%; border-collapse: collapse; text-align: center;"> <tr> <td style="width: 10%;"></td> <td style="width: 10%;"></td> <td style="width: 10%;"></td> <td style="width: 10%;"></td> <td style="width: 10%;"></td> <td style="width: 10%;"></td> <td style="width: 10%;"></td> <td style="width: 10%;"></td> <td style="width: 10%;"></td> <td style="width: 10%;"></td> </tr> <tr> <td></td> <td></td> <td colspan="8" style="text-align: center;"> <table border="1" style="width: 100%; border-collapse: collapse; text-align: center;"> <tr> <td style="width: 10%;"></td> <td style="width: 10%;"></td> <td style="width: 10%;"></td> <td style="width: 10%;"></td> <td style="width: 10%;"></td> <td style="width: 10%;"></td> <td style="width: 10%;"></td> <td style="width: 10%;"></td> <td style="width: 10%;"></td> <td style="width: 10%;"></td> </tr> <tr> <td></td> <td></td> <td colspan="8" style="text-align: center;"> <table border="1" style="width: 100%; border-collapse: collapse; text-align: center;"> <tr> <td style="width: 10%;"></td> <td style="width: 10%;"></td> <td style="width: 10%;"></td> <td style="width: 10%;"></td> <td style="width: 10%;"></td> <td style="width: 10%;"></td> <td style="width: 10%;"></td> <td style="width: 10%;"></td> <td style="width: 10%;"></td> <td style="width: 10%;"></td> </tr> <tr> <td></td> <td></td> <td colspan="8" style="text-align: center;"> <table border="1" style="width: 100%; border-collapse: collapse; text-align: center;"> <tr> <td style="width: 10%;"></td> <td style="width: 10%;"></td> <td style="width: 10%;"></td> <td style="width: 10%;"></td> <td style="width: 10%;"></td> <td style="width: 10%;"></td> <td style="width: 10%;"></td> <td style="width: 10%;"></td> <td style="width: 10%;"></td> <td style="width: 10%;"></td> </tr> <tr> <td></td> <td></td> <td colspan="8" style="text-align: center;"> <table border="1" style="width: 100%; border-collapse: collapse; text-align: center;"> <tr> <td style="width: 10%;"></td> <td style="width: 10%;"></td> <td style="width: 10%;"></td> <td style="width: 10%;"></td> <td style="width: 10%;"></td> <td style="width: 10%;"></td> <td style="width: 10%;"></td> <td style="width: 10%;"></td> <td style="width: 10%;"></td> <td style="width: 10%;"></td> </tr> <tr> <td></td> <td></td> <td colspan="8" style="text-align: center;"> <table border="1" style="width: 100%; border-collapse: collapse; text-align: center;"> <tr> <td style="width: 10%;"></td> <td style="width: 10%;"></td> <td style="width: 10%;"></td> <td style="width: 10%;"></td> <td style="width: 10%;"></td> <td style="width: 10%;"></td> <td style="width: 10%;"></td> <td style="width: 10%;"></td> <td style="width: 10%;"></td> <td style="width: 10%;"></td> </tr> <tr> <td></td> <td></td> <td colspan="8" style="text-align: center;"> <table border="1" style="width: 100%; border-collapse: collapse; text-align: center;"> <tr> <td style="width: 10%;"></td> <td style="width: 10%;"></td> <td style="width: 10%;"></td> <td style="width: 10%;"></td> <td style="width: 10%;"></td> <td style="width: 10%;"></td> <td style="width: 10%;"></td> <td style="width: 10%;"></td> <td style="width: 10%;"></td> <td style="width: 10%;"></td> </tr> <tr> <td></td> <td></td> <td colspan="8" style="text-align: center;"> <table border="1" style="width: 100%; border-collapse: collapse; text-align: center;"> <tr> </tr></table></td></tr></table></td></tr></table></td></tr></table></td></tr></table></td></tr></table></td></tr></table></td></tr></table></td></tr></table></td></tr></table></td></tr></table></td></tr></table>
 | | | | | | | | | | | | | | | | | | | | <table border="1" style="width: 100%; border-collapse: collapse; text-align: center;"> <tr> <td style="width: 10%;"></td> <td style="width: 10%;"></td> <td style="width: 10%;"></td> <td style="width: 10%;"></td> <td style="width: 10%;"></td> <td style="width: 10%;"></td> <td style="width: 10%;"></td> <td style="width: 10%;"></td> <td style="width: 10%;"></td> <td style="width: 10%;"></td> </tr> <tr> <td></td> <td></td> <td colspan="8" style="text-align: center;"> <table border="1" style="width: 100%; border-collapse: collapse; text-align: center;"> <tr> <td style="width: 10%;"></td> <td style="width: 10%;"></td> <td style="width: 10%;"></td> <td style="width: 10%;"></td> <td style="width: 10%;"></td> <td style="width: 10%;"></td> <td style="width: 10%;"></td> <td style="width: 10%;"></td> <td style="width: 10%;"></td> <td style="width: 10%;"></td> </tr> <tr> <td></td> <td></td> <td colspan="8" style="text-align: center;"> <table border="1" style="width: 100%; border-collapse: collapse; text-align: center;"> <tr> <td style="width: 10%;"></td> <td style="width: 10%;"></td> <td style="width: 10%;"></td> <td style="width: 10%;"></td> <td style="width: 10%;"></td> <td style="width: 10%;"></td> <td style="width: 10%;"></td> <td style="width: 10%;"></td> <td style="width: 10%;"></td> <td style="width: 10%;"></td> </tr> <tr> <td></td> <td></td> <td colspan="8" style="text-align: center;"> <table border="1" style="width: 100%; border-collapse: collapse; text-align: center;"> <tr> <td style="width: 10%;"></td> <td style="width: 10%;"></td> <td style="width: 10%;"></td> <td style="width: 10%;"></td> <td style="width: 10%;"></td> <td style="width: 10%;"></td> <td style="width: 10%;"></td> <td style="width: 10%;"></td> <td style="width: 10%;"></td> <td style="width: 10%;"></td> </tr> <tr> <td></td> <td></td> <td colspan="8" style="text-align: center;"> <table border="1" style="width: 100%; border-collapse: collapse; text-align: center;"> <tr> <td style="width: 10%;"></td> <td style="width: 10%;"></td> <td style="width: 10%;"></td> <td style="width: 10%;"></td> <td style="width: 10%;"></td> <td style="width: 10%;"></td> <td style="width: 10%;"></td> <td style="width: 10%;"></td> <td style="width: 10%;"></td> <td style="width: 10%;"></td> </tr> <tr> <td></td> <td></td> <td colspan="8" style="text-align: center;"> <table border="1" style="width: 100%; border-collapse: collapse; text-align: center;"> <tr> <td style="width: 10%;"></td> <td style="width: 10%;"></td> <td style="width: 10%;"></td> <td style="width: 10%;"></td> <td style="width: 10%;"></td> <td style="width: 10%;"></td> <td style="width: 10%;"></td> <td style="width: 10%;"></td> <td style="width: 10%;"></td> <td style="width: 10%;"></td> </tr> <tr> <td></td> <td></td> <td colspan="8" style="text-align: center;"> <table border="1" style="width: 100%; border-collapse: collapse; text-align: center;"> <tr> <td style="width: 10%;"></td> <td style="width: 10%;"></td> <td style="width: 10%;"></td> <td style="width: 10%;"></td> <td style="width: 10%;"></td> <td style="width: 10%;"></td> <td style="width: 10%;"></td> <td style="width: 10%;"></td> <td style="width: 10%;"></td> <td style="width: 10%;"></td> </tr> <tr> <td></td> <td></td> <td colspan="8" style="text-align: center;"> <table border="1" style="width: 100%; border-collapse: collapse; text-align: center;"> <tr> <td style="width: 10%;"></td> <td style="width: 10%;"></td> <td style="width: 10%;"></td> <td style="width: 10%;"></td> <td style="width: 10%;"></td> <td style="width: 10%;"></td> <td style="width: 10%;"></td> <td style="width: 10%;"></td> <td style="width: 10%;"></td> <td style="width: 10%;"></td> </tr> <tr> <td></td> <td></td> <td colspan="8" style="text-align: center;"> <table border="1" style="width: 100%; border-collapse: collapse; text-align: center;"> <tr> <td style="width: 10%;"></td> <td style="width: 10%;"></td> <td style="width: 10%;"></td> <td style="width: 10%;"></td> <td style="width: 10%;"></td> <td style="width: 10%;"></td> <td style="width: 10%;"></td> <td style="width: 10%;"></td> <td style="width: 10%;"></td> <td style="width: 10%;"></td> </tr> <tr> <td></td> <td></td> <td colspan="8" style="text-align: center;"> <table border="1" style="width: 100%; border-collapse: collapse; text-align: center;"> <tr> <td style="width: 10%;"></td> <td style="width: 10%;"></td> <td style="width: 10%;"></td> <td style="width: 10%;"></td> <td style="width:
10%;"></td> <td style="width: 10%;"></td> <td style="width: 10%;"></td> <td style="width: 10%;"></td> <td style="width: 10%;"></td> <td style="width: 10%;"></td> </tr> <tr> <td></td> <td></td> <td colspan="8" style="text-align: center;"> <table border="1" style="width: 100%; border-collapse: collapse; text-align: center;"> <tr> </tr></table></td></tr></table></td></tr></table></td></tr></table></td></tr></table></td></tr></table></td></tr></table></td></tr></table></td></tr></table></td></tr></table></td></tr></table> | | | | | | | | | | | | | | | | | | | | <table border="1" style="width: 100%; border-collapse: collapse; text-align: center;"> <tr> <td style="width: 10%;"></td> <td style="width: 10%;"></td> <td style="width: 10%;"></td>
<td style="width: 10%;"></td> <td style="width: 10%;"></td> <td style="width: 10%;"></td> <td style="width: 10%;"></td> <td style="width: 10%;"></td> <td style="width: 10%;"></td> <td style="width: 10%;"></td> </tr> <tr> <td></td> <td></td> <td colspan="8" style="text-align: center;"> <table border="1" style="width: 100%; border-collapse: collapse; text-align: center;"> <tr> <td style="width: 10%;"></td> <td style="width: 10%;"></td> <td style="width: 10%;"></td> <td style="width: 10%;"></td> <td style="width: 10%;"></td> <td style="width: 10%;"></td> <td style="width: 10%;"></td> <td style="width: 10%;"></td> <td style="width: 10%;"></td> <td style="width: 10%;"></td> </tr> <tr> <td></td> <td></td> <td colspan="8" style="text-align: center;"> <table border="1" style="width: 100%; border-collapse: collapse; text-align: center;"> <tr> <td style="width: 10%;"></td> <td style="width: 10%;"></td> <td style="width: 10%;"></td> <td style="width: 10%;"></td> <td style="width: 10%;"></td> <td style="width: 10%;"></td> <td style="width: 10%;"></td> <td style="width: 10%;"></td> <td style="width: 10%;"></td> <td style="width: 10%;"></td> </tr> <tr> <td></td> <td></td> <td colspan="8" style="text-align: center;"> <table border="1" style="width: 100%; border-collapse: collapse; text-align: center;"> <tr> <td style="width: 10%;"></td> <td style="width: 10%;"></td> <td style="width: 10%;"></td> <td style="width: 10%;"></td> <td style="width: 10%;"></td> <td style="width: 10%;"></td> <td style="width: 10%;"></td> <td style="width: 10%;"></td> <td style="width: 10%;"></td> <td style="width: 10%;"></td> </tr> <tr> <td></td> <td></td> <td colspan="8" style="text-align: center;"> <table border="1" style="width: 100%; border-collapse: collapse; text-align: center;"> <tr> <td style="width: 10%;"></td> <td style="width: 10%;"></td> <td style="width: 10%;"></td> <td style="width: 10%;"></td> <td style="width: 10%;"></td> <td style="width: 10%;"></td> <td style="width: 10%;"></td> <td style="width: 10%;"></td> <td style="width: 10%;"></td> <td style="width: 10%;"></td> </tr> <tr> <td></td> <td></td> <td colspan="8" style="text-align: center;"> <table border="1" style="width: 100%; border-collapse: collapse; text-align: center;"> <tr> <td style="width: 10%;"></td> <td style="width: 10%;"></td> <td style="width: 10%;"></td> <td style="width: 10%;"></td> <td style="width: 10%;"></td> <td style="width: 10%;"></td> <td style="width: 10%;"></td> <td style="width: 10%;"></td> <td style="width: 10%;"></td> <td style="width: 10%;"></td> </tr> <tr> <td></td> <td></td> <td colspan="8" style="text-align: center;"> <table border="1" style="width: 100%; border-collapse: collapse; text-align: center;"> <tr> <td style="width: 10%;"></td> <td style="width: 10%;"></td> <td style="width: 10%;"></td> <td style="width: 10%;"></td> <td style="width: 10%;"></td> <td style="width: 10%;"></td> <td style="width: 10%;"></td> <td style="width: 10%;"></td> <td style="width: 10%;"></td> <td style="width: 10%;"></td> </tr> <tr> <td></td> <td></td> <td colspan="8" style="text-align: center;"> <table border="1" style="width: 100%; border-collapse: collapse; text-align: center;"> <tr> <td style="width: 10%;"></td> <td style="width: 10%;"></td> <td style="width: 10%;"></td> <td style="width: 10%;"></td> <td style="width: 10%;"></td> <td style="width: 10%;"></td> <td style="width: 10%;"></td> <td style="width: 10%;"></td> <td style="width: 10%;"></td> <td style="width: 10%;"></td> </tr> <tr> <td></td> <td></td> <td colspan="8" style="text-align: center;"> <table border="1" style="width: 100%; border-collapse: collapse; text-align: center;"> <tr> <td style="width: 10%;"></td> <td style="width: 10%;"></td> <td style="width: 10%;"></td> <td style="width: 10%;"></td> <td style="width: 10%;"></td> <td style="width: 10%;"></td> <td style="width: 10%;"></td> <td style="width: 10%;"></td> <td style="width: 10%;"></td> <td style="width: 10%;"></td> </tr> <tr> <td></td> <td></td> <td colspan="8" style="text-align: center;"> <table border="1" style="width: 100%; border-collapse: collapse; text-align: center;"> <tr> </tr></table></td></tr></table></td></tr></table></td></tr></table></td></tr></table></td></tr></table></td></tr></table></td></tr></table></td></tr></table></td></tr></table>
 | | | | | | | | | | | | | | | | | | | | <table border="1" style="width: 100%; border-collapse: collapse; text-align: center;"> <tr> <td style="width: 10%;"></td> <td style="width: 10%;"></td> <td style="width: 10%;"></td> <td style="width: 10%;"></td> <td style="width: 10%;"></td> <td style="width: 10%;"></td> <td style="width: 10%;"></td> <td style="width: 10%;"></td> <td style="width: 10%;"></td> <td style="width: 10%;"></td> </tr> <tr> <td></td> <td></td> <td colspan="8" style="text-align: center;"> <table border="1" style="width: 100%; border-collapse: collapse; text-align: center;"> <tr> <td style="width: 10%;"></td> <td style="width: 10%;"></td> <td style="width: 10%;"></td> <td style="width: 10%;"></td> <td style="width: 10%;"></td> <td style="width: 10%;"></td> <td style="width: 10%;"></td> <td style="width: 10%;"></td> <td style="width: 10%;"></td> <td style="width: 10%;"></td> </tr> <tr> <td></td> <td></td> <td colspan="8" style="text-align: center;"> <table border="1" style="width: 100%; border-collapse: collapse; text-align: center;"> <tr> <td style="width: 10%;"></td> <td style="width: 10%;"></td> <td style="width: 10%;"></td> <td style="width: 10%;"></td> <td style="width: 10%;"></td> <td style="width: 10%;"></td> <td style="width: 10%;"></td> <td style="width: 10%;"></td> <td style="width: 10%;"></td> <td style="width: 10%;"></td> </tr> <tr> <td></td> <td></td> <td colspan="8" style="text-align: center;"> <table border="1" style="width: 100%; border-collapse: collapse; text-align: center;"> <tr> <td style="width: 10%;"></td> <td style="width: 10%;"></td> <td style="width: 10%;"></td> <td style="width: 10%;"></td> <td style="width: 10%;"></td> <td style="width: 10%;"></td> <td style="width: 10%;"></td> <td style="width: 10%;"></td> <td style="width: 10%;"></td> <td style="width: 10%;"></td> </tr> <tr> <td></td> <td></td> <td colspan="8" style="text-align: center;"> <table border="1" style="width: 100%; border-collapse: collapse; text-align: center;"> <tr> <td style="width: 10%;"></td> <td style="width: 10%;"></td> <td style="width: 10%;"></td> <td style="width: 10%;"></td> <td style="width: 10%;"></td> <td style="width: 10%;"></td> <td style="width: 10%;"></td> <td style="width: 10%;"></td> <td style="width: 10%;"></td> <td style="width: 10%;"></td> </tr> <tr> <td></td> <td></td> <td colspan="8" style="text-align: center;"> <table border="1" style="width: 100%; border-collapse: collapse; text-align: center;"> <tr> <td style="width: 10%;"></td> <td style="width: 10%;"></td> <td style="width: 10%;"></td> <td style="width: 10%;"></td> <td style="width: 10%;"></td> <td style="width: 10%;"></td> <td style="width: 10%;"></td> <td style="width: 10%;"></td> <td style="width: 10%;"></td> <td style="width: 10%;"></td> </tr> <tr> <td></td> <td></td> <td colspan="8" style="text-align: center;"> <table border="1" style="width: 100%; border-collapse: collapse; text-align: center;"> <tr> <td style="width: 10%;"></td> <td style="width: 10%;"></td> <td style="width: 10%;"></td> <td style="width: 10%;"></td> <td style="width: 10%;"></td> <td style="width: 10%;"></td> <td style="width: 10%;"></td> <td style="width: 10%;"></td> <td style="width: 10%;"></td> <td style="width: 10%;"></td> </tr> <tr> <td></td> <td></td> <td colspan="8" style="text-align: center;"> <table border="1" style="width: 100%; border-collapse: collapse; text-align: center;"> <tr> <td style="width: 10%;"></td> <td style="width: 10%;"></td> <td style="width: 10%;"></td> <td style="width: 10%;"></td> <td style="width: 10%;"></td> <td style="width: 10%;"></td> <td style="width: 10%;"></td> <td style="width: 10%;"></td> <td style="width: 10%;"></td> <td style="width: 10%;"></td> </tr> <tr> <td></td> <td></td> <td colspan="8" style="text-align: center;"> <table border="1" style="width: 100%; border-collapse: collapse; text-align: center;"> <tr> </tr></table></td></tr></table></td></tr></table></td></tr></table></td></tr></table></td></tr></table></td></tr></table></td></tr></table></td></tr></table>
 | | | | | | | | | | | | | | | | | | | | <table border="1" style="width: 100%; border-collapse: collapse; text-align: center;"> <tr> <td style="width: 10%;"></td> <td style="width: 10%;"></td> <td style="width: 10%;"></td> <td style="width: 10%;"></td> <td style="width: 10%;"></td> <td style="width: 10%;"></td> <td style="width: 10%;"></td> <td style="width: 10%;"></td> <td style="width: 10%;"></td> <td style="width: 10%;"></td> </tr> <tr> <td></td> <td></td> <td colspan="8" style="text-align: center;"> <table border="1" style="width: 100%; border-collapse: collapse; text-align: center;"> <tr> <td style="width: 10%;"></td> <td style="width: 10%;"></td> <td style="width: 10%;"></td> <td style="width: 10%;"></td> <td style="width: 10%;"></td> <td style="width: 10%;"></td> <td style="width: 10%;"></td> <td style="width: 10%;"></td> <td style="width: 10%;"></td> <td style="width: 10%;"></td> </tr> <tr> <td></td> <td></td> <td colspan="8" style="text-align: center;"> <table border="1" style="width: 100%; border-collapse: collapse; text-align: center;"> <tr> <td style="width: 10%;"></td> <td style="width: 10%;"></td> <td style="width: 10%;"></td> <td style="width: 10%;"></td> <td style="width: 10%;"></td> <td style="width: 10%;"></td> <td style="width: 10%;"></td> <td style="width: 10%;"></td> <td style="width: 10%;"></td> <td style="width: 10%;"></td> </tr> <tr> <td></td> <td></td> <td colspan="8" style="text-align: center;"> <table border="1" style="width: 100%; border-collapse: collapse; text-align: center;"> <tr> <td style="width: 10%;"></td> <td style="width: 10%;"></td> <td style="width: 10%;"></td> <td style="width: 10%;"></td> <td style="width: 10%;"></td> <td style="width: 10%;"></td> <td style="width: 10%;"></td> <td style="width: 10%;"></td> <td style="width: 10%;"></td> <td style="width: 10%;"></td> </tr> <tr> <td></td> <td></td> <td colspan="8" style="text-align: center;"> <table border="1" style="width: 100%; border-collapse: collapse; text-align: center;"> <tr> <td style="width: 10%;"></td> <td style="width: 10%;"></td> <td style="width: 10%;"></td> <td style="width: 10%;"></td> <td style="width: 10%;"></td> <td style="width: 10%;"></td> <td style="width: 10%;"></td> <td style="width: 10%;"></td> <td style="width: 10%;"></td> <td style="width: 10%;"></td> </tr> <tr> <td></td> <td></td> <td colspan="8" style="text-align: center;"> <table border="1" style="width: 100%; border-collapse: collapse; text-align: center;"> <tr> <td style="width: 10%;"></td> <td style="width: 10%;"></td> <td style="width: 10%;"></td> <td style="width: 10%;"></td> <td style="width: 10%;"></td> <td style="width: 10%;"></td> <td style="width: 10%;"></td> <td style="width: 10%;"></td> <td style="width: 10%;"></td> <td style="width: 10%;"></td> </tr> <tr> <td></td> <td></td> <td colspan="8" style="text-align: center;"> <table border="1" style="width: 100%; border-collapse: collapse; text-align: center;"> <tr> <td style="width: 10%;"></td> <td style="width: 10%;"></td> <td style="width: 10%;"></td> <td style="width: 10%;"></td> <td style="width: 10%;"></td> <td style="width: 10%;"></td> <td style="width: 10%;"></td> <td
style="width: 10%;"></td> <td style="width: 10%;"></td> <td style="width: 10%;"></td> </tr> <tr> <td></td> <td></td> <td colspan="8" style="text-align: center;"> <table border="1" style="width: 100%; border-collapse: collapse; text-align: center;"> <tr> </tr></table></td></tr></table></td></tr></table></td></tr></table></td></tr></table></td></tr></table></td></tr></table></td></tr></table> | | | | | | | | | | | | | | | | | | | | <table border="1" style="width: 100%; border-collapse: collapse; text-align: center;"> <tr> <td style="width: 10%;"></td> <td style="width: 10%;"></td> <td style="width: 10%;"></td> <td style="width: 10%;"></td> <td style="width: 10%;"></td> <td style="width: 10%;"></td> <td style="width: 10%;"></td> <td
style="width: 10%;"></td> <td style="width: 10%;"></td> <td style="width: 10%;"></td> </tr> <tr> <td></td> <td></td> <td colspan="8" style="text-align: center;"> <table border="1" style="width: 100%; border-collapse: collapse; text-align: center;"> <tr> <td style="width: 10%;"></td> <td style="width: 10%;"></td> <td style="width: 10%;"></td> <td style="width: 10%;"></td> <td style="width: 10%;"></td> <td style="width: 10%;"></td> <td style="width: 10%;"></td> <td style="width: 10%;"></td> <td style="width: 10%;"></td> <td style="width: 10%;"></td> </tr> <tr> <td></td> <td></td> <td colspan="8" style="text-align: center;"> <table border="1" style="width: 100%; border-collapse: collapse; text-align: center;"> <tr> <td style="width: 10%;"></td> <td style="width: 10%;"></td> <td style="width: 10%;"></td> <td style="width: 10%;"></td> <td style="width: 10%;"></td> <td style="width: 10%;"></td> <td style="width: 10%;"></td> <td style="width: 10%;"></td> <td style="width: 10%;"></td> <td style="width: 10%;"></td> </tr> <tr> <td></td> <td></td> <td colspan="8" style="text-align: center;"> <table border="1" style="width: 100%; border-collapse: collapse; text-align: center;"> <tr> <td style="width: 10%;"></td> <td style="width: 10%;"></td> <td style="width: 10%;"></td> <td style="width: 10%;"></td> <td style="width: 10%;"></td> <td style="width: 10%;"></td> <td style="width: 10%;"></td> <td style="width: 10%;"></td> <td style="width: 10%;"></td> <td style="width: 10%;"></td> </tr> <tr> <td></td> <td></td> <td colspan="8" style="text-align: center;"> <table border="1" style="width: 100%; border-collapse: collapse; text-align: center;"> <tr> <td style="width: 10%;"></td> <td style="width: 10%;"></td> <td style="width: 10%;"></td> <td style="width: 10%;"></td> <td style="width: 10%;"></td> <td style="width: 10%;"></td> <td style="width: 10%;"></td> <td style="width: 10%;"></td> <td style="width: 10%;"></td> <td style="width: 10%;"></td> </tr> <tr> <td></td> <td></td> <td colspan="8" style="text-align: center;"> <table border="1" style="width: 100%; border-collapse: collapse; text-align: center;"> <tr> <td style="width: 10%;"></td> <td style="width: 10%;"></td> <td style="width: 10%;"></td> <td style="width: 10%;"></td> <td style="width: 10%;"></td> <td style="width: 10%;"></td> <td style="width: 10%;"></td> <td style="width: 10%;"></td> <td style="width: 10%;"></td> <td style="width: 10%;"></td> </tr> <tr> <td></td> <td></td> <td colspan="8" style="text-align: center;"> <table border="1" style="width: 100%; border-collapse: collapse; text-align: center;"> <tr> </tr></table></td></tr></table></td></tr></table></td></tr></table></td></tr></table></td></tr></table></td></tr></table>
 | | | | | | | | | | | | | | | | | | | | <table border="1" style="width: 100%; border-collapse: collapse; text-align: center;"> <tr> <td style="width: 10%;"></td> <td style="width: 10%;"></td> <td style="width: 10%;"></td> <td style="width: 10%;"></td> <td style="width: 10%;"></td> <td style="width: 10%;"></td> <td style="width: 10%;"></td> <td style="width: 10%;"></td> <td style="width: 10%;"></td> <td style="width: 10%;"></td> </tr> <tr> <td></td> <td></td> <td colspan="8" style="text-align: center;"> <table border="1" style="width: 100%; border-collapse: collapse; text-align: center;"> <tr> <td style="width: 10%;"></td> <td style="width: 10%;"></td> <td style="width: 10%;"></td> <td style="width: 10%;"></td> <td style="width: 10%;"></td> <td style="width: 10%;"></td> <td style="width: 10%;"></td> <td style="width: 10%;"></td> <td style="width: 10%;"></td> <td style="width: 10%;"></td> </tr> <tr> <td></td> <td></td> <td colspan="8" style="text-align: center;"> <table border="1" style="width: 100%; border-collapse: collapse; text-align: center;"> <tr> <td style="width: 10%;"></td> <td style="width: 10%;"></td> <td style="width: 10%;"></td> <td style="width: 10%;"></td> <td style="width: 10%;"></td> <td style="width: 10%;"></td> <td style="width: 10%;"></td> <td style="width: 10%;"></td> <td style="width: 10%;"></td> <td style="width: 10%;"></td> </tr> <tr> <td></td> <td></td> <td colspan="8" style="text-align: center;"> <table border="1" style="width: 100%; border-collapse: collapse; text-align: center;"> <tr> <td style="width: 10%;"></td> <td style="width: 10%;"></td> <td style="width: 10%;"></td> <td style="width: 10%;"></td> <td style="width: 10%;"></td> <td style="width: 10%;"></td> <td style="width: 10%;"></td> <td style="width: 10%;"></td> <td style="width: 10%;"></td> <td style="width: 10%;"></td> </tr> <tr> <td></td> <td></td> <td colspan="8" style="text-align: center;"> <table border="1" style="width: 100%; border-collapse: collapse; text-align: center;"> <tr> <td style="width: 10%;"></td> <td style="width: 10%;"></td> <td style="width: 10%;"></td> <td style="width: 10%;"></td> <td style="width: 10%;"></td> <td style="width: 10%;"></td> <td style="width: 10%;"></td> <td style="width: 10%;"></td> <td style="width: 10%;"></td> <td style="width: 10%;"></td> </tr> <tr> <td></td> <td></td> <td colspan="8" style="text-align: center;"> <table border="1" style="width: 100%; border-collapse: collapse; text-align: center;"> <tr> </tr></table></td></tr></table></td></tr></table></td></tr></table></td></tr></table></td></tr></table>
 | | | | | | | | | | | | | | | | | | | | <table border="1" style="width: 100%; border-collapse: collapse; text-align: center;"> <tr> <td style="width: 10%;"></td> <td style="width: 10%;"></td> <td style="width: 10%;"></td> <td style="width: 10%;"></td> <td style="width: 10%;"></td> <td style="width: 10%;"></td> <td style="width: 10%;"></td> <td style="width: 10%;"></td> <td style="width: 10%;"></td> <td style="width: 10%;"></td> </tr> <tr> <td></td> <td></td> <td colspan="8" style="text-align: center;"> <table border="1" style="width: 100%; border-collapse: collapse; text-align: center;"> <tr> <td style="width: 10%;"></td> <td style="width: 10%;"></td> <td style="width: 10%;"></td> <td style="width: 10%;"></td> <td style="width: 10%;"></td> <td style="width: 10%;"></td> <td style="width: 10%;"></td> <td style="width: 10%;"></td> <td style="width: 10%;"></td> <td style="width: 10%;"></td> </tr> <tr> <td></td> <td></td> <td colspan="8" style="text-align: center;"> <table border="1" style="width: 100%; border-collapse: collapse; text-align: center;"> <tr> <td style="width: 10%;"></td> <td style="width: 10%;"></td> <td style="width: 10%;"></td> <td style="width: 10%;"></td> <td style="width: 10%;"></td> <td style="width: 10%;"></td> <td style="width: 10%;"></td> <td style="width: 10%;"></td> <td style="width: 10%;"></td> <td style="width: 10%;"></td> </tr> <tr> <td></td> <td></td> <td colspan="8" style="text-align: center;"> <table border="1" style="width: 100%; border-collapse: collapse; text-align: center;"> <tr> <td style="width: 10%;"></td> <td style="width: 10%;"></td> <td style="width: 10%;"></td> <td style="width: 10%;"></td> <td style="width: 10%;"></td> <td style="width: 10%;"></td> <td style="width: 10%;"></td> <td style="width: 10%;"></td> <td style="width: 10%;"></td> <td style="width: 10%;"></td> </tr> <tr> <td></td> <td></td> <td colspan="8" style="text-align: center;"> <table border="1" style="width: 100%; border-collapse: collapse; text-align: center;"> <tr> </tr></table></td></tr></table></td></tr></table></td></tr></table></td></tr></table>
 | | | | | | | | | | | | | | | | | | | | <table border="1" style="width: 100%; border-collapse: collapse; text-align: center;"> <tr> <td style="width: 10%;"></td> <td style="width: 10%;"></td> <td style="width: 10%;"></td> <td style="width: 10%;"></td> <td style="width: 10%;"></td> <td style="width: 10%;"></td> <td style="width: 10%;"></td> <td style="width: 10%;"></td> <td style="width: 10%;"></td> <td style="width: 10%;"></td> </tr> <tr> <td></td> <td></td> <td colspan="8" style="text-align: center;"> <table border="1" style="width: 100%; border-collapse: collapse; text-align: center;"> <tr> <td style="width: 10%;"></td> <td style="width: 10%;"></td> <td style="width: 10%;"></td> <td style="width: 10%;"></td> <td style="width: 10%;"></td> <td style="width: 10%;"></td> <td style="width: 10%;"></td> <td style="width: 10%;"></td> <td style="width: 10%;"></td> <td style="width: 10%;"></td> </tr> <tr> <td></td> <td></td> <td colspan="8" style="text-align: center;"> <table border="1" style="width: 100%; border-collapse: collapse; text-align: center;"> <tr> <td style="width: 10%;"></td> <td style="width: 10%;"></td> <td style="width: 10%;"></td> <td style="width: 10%;"></td> <td style="width: 10%;"></td> <td style="width: 10%;"></td> <td style="width: 10%;"></td> <td style="width: 10%;"></td> <td style="width: 10%;"></td> <td style="width: 10%;"></td> </tr> <tr> <td></td> <td></td> <td colspan="8" style="text-align: center;"> <table border="1" style="width: 100%; border-collapse: collapse; text-align: center;"> <tr> </tr></table></td></tr></table></td></tr></table></td></tr></table>
 | | | | | | | | | | | | | | | | | | | | <table border="1" style="width: 100%; border-collapse: collapse; text-align: center;"> <tr> <td style="width: 10%;"></td> <td style="width: 10%;"></td> <td style="width: 10%;"></td> <td style="width: 10%;"></td> <td style="width: 10%;"></td> <td style="width: 10%;"></td> <td style="width: 10%;"></td> <td style="width: 10%;"></td> <td style="width: 10%;"></td> <td style="width: 10%;"></td> </tr> <tr> <td></td> <td></td> <td colspan="8" style="text-align: center;"> <table border="1" style="width: 100%; border-collapse: collapse; text-align: center;"> <tr> <td style="width: 10%;"></td> <td style="width: 10%;"></td> <td style="width: 10%;"></td> <td style="width: 10%;"></td> <td style="width: 10%;"></td> <td style="width: 10%;"></td> <td style="width: 10%;"></td> <td style="width: 10%;"></td> <td style="width: 10%;"></td> <td style="width: 10%;"></td> </tr> <tr> <td></td> <td></td> <td colspan="8" style="text-align: center;"> <table border="1" style="width: 100%; border-collapse: collapse; text-align: center;"> <tr> </tr></table></td></tr></table></td></tr></table>
 | | | | | | | | | | | | | | | | | | | | <table border="1" style="width: 100%; border-collapse: collapse; text-align: center;"> <tr> <td style="width: 10%;"></td> <td style="width: 10%;"></td> <td style="width: 10%;"></td> <td style="width: 10%;"></td> <td style="width: 10%;"></td> <td style="width: 10%;"></td> <td style="width: 10%;"></td> <td style="width: 10%;"></td> <td style="width: 10%;"></td> <td style="width: 10%;"></td> </tr> <tr> <td></td> <td></td> <td colspan="8" style="text-align: center;"> <table border="1" style="width: 100%; border-collapse: collapse; text-align: center;"> <tr> </tr></table></td></tr></table>
 | | | | | | | | | | | | | | | | | | | | <table border="1" style="width: 100%; border-collapse: collapse; text-align: center;"> <tr> </tr></table>
 | | | | | | | | | | | | | | | | | | | | | | | | | | | | | | | | | | | | | | | | | | | | | | | | | | | | | | | | | | | | | | | | | | | | | | | | | | | | | | | | | | | | | | | | | | | | | | | | | | | |
 | | | | | | | | | | | | | | | | | | | |
 | | | | | | | | | | | | | | | | | | | |
 | | | | | | | | | | | | | | | | | | | | | | | | | | | | | | | | | | | | | | | |
 | | | | | | | | | | | | | | | | | | | |
 | | | | | | | | | | | | | | | | | | | | | | | | | | | | | | | | | | | | | | | |
 | | | | | | | | | | | | | | | | | | | | | | | | | | | | | | | | | | | | | | | |
 | | | | | | | | | | | | | | | | | | | | | | | | | | | | | | | | | | | | | | | |
 | | | | | | | | | | | | | | | | | | | | | | | | | | | | | | | | | | | | | | | | | | | | | | | | | | | | | | | | | | | | | | | | | | | | | | | | | | | | | | | | | | | | | | | | | | | | | | | | | | | |
 | | | | | | | | | | | | | | | | | | | | | | | | | | | | | | | | | | | | | | | | | | | | | | | |
| | |

 | | | | | | | | | | | | | | | | | | | |

 | | | | | | | | | | | | | | | | | | | |

 | | | | | | | | | | | | | | | | | | | |

 | | | | | | | | | | | | | | | | | | | |

 | | | | | | | | | | | | | | | | | | | |

 | | | | | | | | | | | | | | | | | | | |

 | | | | | | | | | | | | | | | | | | | |

 | | | | | | | | | | | | | | | | | | | |

 | | | | | | | | | | | | | | | | | | | |

 | | | | | | | | | | | | | | | | | | | |

 | | | | | | | | | | | | | | | | | | | |

 | | | | | | | | | | | | | | | | | | | |

 | | | | | | | | | | | | | | | | | | | |

 | | | | | | | | | | | | | | | | | | | |

 | | | | | | | | | | | | | | | | | | | |

 | | | | | | | | | | | | | | | | | | | |

 | | | | | | | | | | | | | | | | | | | |

 | | | | | | | | | | | | | | | | | | | |

 | | | | | | | | | | | | | | | | | | | |

 | | | | | | | | | | | | | | | | | | | |

 | | | | | | | | | | | | | | | | | | | |

 | | | | | | | | | | | | | | | | | | | |

 | | | | | | | | | | | | | | | | | | | |

 | | | | | | | | | | | | | | | | | | | |

 | | | | | | | | | | | | | | | | | | | |

 | | | | | | | | | | | | | | | | | | | |

 | | | | | | | | | | | | | | | | | | | |

 | | | | | | | | | | | | | | | | | | | |
 | | | | | | | | | | | | | | | | | | | |

 | | | | | | | | | | | | | | | | | | | |

 | | | | | | | | | | | | | | | | | | | |
 | | | | | | | | | | | | | | | | | | | |

 | | | | | | | | | | | | | | | | | | | |

 | | | | | | | | | | | | | | | | | | | |
 | | | | | | | | | | | | | | | | | | | |
 | | | | | | | | | | | | | | | | | | | |

 | | | | | | | | | | | | | | | | | | | |
 | | | | | | | | | | | | | | | | | | | |
 | | | | | | | | | | | | | | | | | | | |

 | | | | | | | | | | | | | | | | | | | | | | | | | | | | | | | | | | | | | | | | | | | | | | | | | | | | | | | | | | | | | | | | | | | | | | | | | | | | | | | | | | | | | | | | | | | | | | | | | | | |
 | | | | | | | | | | | | | | | | | | | |
 | | | | | | | | | | | | | | | | | | | |
 | | | | | | | | | | | | | | | | | | | |
 | | | | | | | | | | | | | | | | | | | |
 | | | | | | | | | | | | | | | | | | | |
 | | | | | | | | | | | | | | | | | | | |
 | | | | | | | | | | | | | | | | | | | |
 | | | | | | | | | | | | | | | | | | | |
 | | | | | | | | | | | | | | | | | | | | | | | | | | | | | | | | | | | | | | | |
 | | | | | | | | | | | | | | | | | | | |
 | | | | | | | | | | | | | | | | | | | | | | | | | | | | | | | | | | | | | | | |
 | | | | | | | | | | | | | | | | | | | | | | | | | | | | | | | | | | | | | | | |
 | | | | | | | | | | | | | | | | | | | | | | | | | | | | | | | | | | | | | | | |
 | | | | | | | | | | | | | | | | | | | | | | | | | | | | | | | | | | | | | | | | | | | | | | | | | | | | | | | | | | | | | | | | | | | | | | | | | | | | | | | | | | | | | | | | | | | | | | | | | | | |
 | | | | | | | | | | | | | | | | | | | | | | | | | | | | | | | | | | | | | | | | | | | | | | | |
| | | <table border="1" style="width: 100%; border-collapse: collapse; text-align: center;"> <tr> <td style="width: 10%;"></td> <td style="width: 10%;"></td> <td style="width: 10%;"></td> <td style="width: 10%;"></td> <td style="width: 10%;"></td> <td style="width: 10%;"></td> <td style="width: 10%;"></td> <td style="width: 10%;"></td> <td style="width: 10%;"></td> <td style="width: 10%;"></td> </tr> <tr> <td></td> <td></td> <td colspan="8" style="text-align: center;"> <table border="1" style="width: 100%; border-collapse: collapse; text-align: center;"> <tr> <td style="width: 10%;"></td> <td style="width: 10%;"></td> <td style="width: 10%;"></td> <td style="width: 10%;"></td> <td style="width: 10%;"></td> <td style="width: 10%;"></td> <td style="width: 10%;"></td> <td style="width: 10%;"></td> <td style="width: 10%;"></td> <td style="width: 10%;"></td> </tr> <tr> <td></td> <td></td> <td colspan="8" style="text-align: center;"> <table border="1" style="width: 100%; border-collapse: collapse; text-align: center;"> <tr> <td style="width: 10%;"></td> <td style="width: 10%;"></td> <td style="width: 10%;"></td> <td style="width: 10%;"></td> <td style="width: 10%;"></td> <td style="width: 10%;"></td> <td style="width: 10%;"></td> <td style="width: 10%;"></td> <td style="width: 10%;"></td> <td style="width: 10%;"></td> </tr> <tr> <td></td> <td></td> <td colspan="8" style="text-align: center;"> <table border="1" style="width: 100%; border-collapse: collapse; text-align: center;"> <tr> <td style="width: 10%;"></td> <td style="width: 10%;"></td> <td style="width: 10%;"></td> <td style="width: 10%;"></td> <td style="width: 10%;"></td> <td style="width: 10%;"></td> <td style="width: 10%;"></td> <td style="width: 10%;"></td> <td style="width: 10%;"></td> <td style="width: 10%;"></td> </tr> <tr> <td></td> <td></td> <td colspan="8" style="text-align: center;"> <table border="1" style="width: 100%; border-collapse: collapse; text-align: center;"> <tr> <td style="width: 10%;"></td> <td style="width: 10%;"></td> <td style="width: 10%;"></td> <td style="width: 10%;"></td> <td style="width: 10%;"></td> <td style="width: 10%;"></td> <td style="width: 10%;"></td> <td style="width: 10%;"></td> <td style="width: 10%;"></td> <td style="width: 10%;"></td> </tr> <tr> <td></td> <td></td> <td colspan="8" style="text-align: center;"> <table border="1" style="width: 100%; border-collapse: collapse; text-align: center;"> <tr> <td style="width: 10%;"></td> <td style="width: 10%;"></td> <td style="width: 10%;"></td> <td style="width: 10%;"></td> <td style="width: 10%;"></td> <td style="width: 10%;"></td> <td style="width: 10%;"></td> <td style="width: 10%;"></td> <td style="width: 10%;"></td> <td style="width: 10%;"></td> </tr> <tr> <td></td> <td></td> <td colspan="8" style="text-align: center;"> <table border="1" style="width: 100%; border-collapse: collapse; text-align: center;"> <tr> <td style="width: 10%;"></td> <td style="width: 10%;"></td> <td style="width: 10%;"></td> <td style="width: 10%;"></td> <td style="width: 10%;"></td> <td style="width: 10%;"></td> <td style="width: 10%;"></td> <td style="width: 10%;"></td> <td style="width: 10%;"></td> <td style="width: 10%;"></td> </tr> <tr> <td></td> <td></td> <td colspan="8" style="text-align: center;"> <table border="1" style="width: 100%; border-collapse: collapse; text-align: center;"> <tr> <td style="width: 10%;"></td> <td style="width: 10%;"></td> <td style="width: 10%;"></td> <td style="width: 10%;"></td> <td style="width: 10%;"></td> <td style="width: 10%;"></td> <td style="width: 10%;"></td> <td style="width: 10%;"></td> <td style="width: 10%;"></td> <td style="width: 10%;"></td> </tr> <tr> <td></td> <td></td> <td colspan="8" style="text-align: center;"> <table border="1" style="width: 100%; border-collapse: collapse; text-align: center;"> <tr> <td style="width: 10%;"></td> <td style="width: 10%;"></td> <td style="width: 10%;"></td> <td style="width: 10%;"></td> <td style="width: 10%;"></td> <td style="width: 10%;"></td> <td style="width: 10%;"></td> <td style="width: 10%;"></td> <td style="width: 10%;"></td> <td style="width: 10%;"></td> </tr> <tr> <td></td> <td></td> <td colspan="8" style="text-align: center;"> <table border="1" style="width: 100%; border-collapse: collapse; text-align: center;"> <tr> <td style="width: 10%;"></td> <td style="width: 10%;"></td> <td style="width: 10%;"></td> <td style="width: 10%;"></td> <td style="width: 10%;"></td> <td style="width: 10%;"></td> <td style="width: 10%;"></td> <td style="width: 10%;"></td> <td style="width: 10%;"></td> <td style="width: 10%;"></td> </tr> <tr> <td></td> <td></td> <td colspan="8" style="text-align: center;"> <table border="1" style="width: 100%; border-collapse: collapse; text-align: center;"> <tr> <td style="width: 10%;"></td> <td style="width: 10%;"></td> <td style="width: 10%;"></td> <td style="width: 10%;"></td> <td style="width: 10%;"></td> <td style="width: 10%;"></td> <td style="width: 10%;"></td> <td style="width: 10%;"></td> <td style="width: 10%;"></td> <td style="width: 10%;"></td> </tr> <tr> <td></td> <td></td> <td colspan="8" style="text-align: center;"> <table border="1" style="width: 100%; border-collapse: collapse; text-align: center;"> <tr> <td style="width: 10%;"></td> <td style="width: 10%;"></td> <td style="width: 10%;"></td> <td style="width: 10%;"></td> <td style="width: 10%;"></td> <td style="width: 10%;"></td> <td style="width: 10%;"></td> <td style="width: 10%;"></td> <td style="width: 10%;"></td> <td style="width: 10%;"></td> </tr> <tr> <td></td> <td></td> <td colspan="8" style="text-align: center;"> <table border="1" style="width: 100%; border-collapse: collapse; text-align: center;"> <tr> <td style="width: 10%;"></td> <td style="width: 10%;"></td> <td style="width: 10%;"></td> <td style="width: 10%;"></td> <td style="width: 10%;"></td> <td style="width: 10%;"></td> <td style="width: 10%;"></td> <td style="width: 10%;"></td> <td style="width: 10%;"></td> <td style="width: 10%;"></td> </tr> <tr> <td></td> <td></td> <td colspan="8" style="text-align: center;"> <table border="1" style="width: 100%; border-collapse: collapse; text-align: center;"> <tr> <td style="width: 10%;"></td> <td style="width: 10%;"></td> <td style="width: 10%;"></td> <td style="width: 10%;"></td> <td style="width: 10%;"></td> <td style="width: 10%;"></td> <td style="width: 10%;"></td> <td style="width: 10%;"></td> <td style="width: 10%;"></td> <td style="width: 10%;"></td> </tr> <tr> <td></td> <td></td> <td colspan="8" style="text-align: center;"> <table border="1" style="width: 100%; border-collapse: collapse; text-align: center;"> <tr> <td style="width: 10%;"></td> <td style="width: 10%;"></td> <td style="width: 10%;"></td> <td style="width: 10%;"></td> <td style="width: 10%;"></td> <td style="width: 10%;"></td> <td style="width: 10%;"></td> <td style="width: 10%;"></td> <td style="width: 10%;"></td> <td style="width: 10%;"></td> </tr> <tr> <td></td> <td></td> <td colspan="8" style="text-align: center;"> <table border="1" style="width: 100%; border-collapse: collapse; text-align: center;"> <tr> <td style="width: 10%;"></td> <td style="width: 10%;"></td> <td style="width: 10%;"></td> <td style="width: 10%;"></td> <td style="width: 10%;"></td> <td style="width: 10%;"></td> <td style="width: 10%;"></td> <td style="width: 10%;"></td> <td style="width: 10%;"></td> <td style="width: 10%;"></td> </tr> <tr> <td></td> <td></td> <td colspan="8" style="text-align: center;"> <table border="1" style="width: 100%; border-collapse: collapse; text-align: center;"> <tr> <td style="width: 10%;"></td> <td style="width: 10%;"></td> <td style="width: 10%;"></td> <td style="width: 10%;"></td> <td style="width: 10%;"></td> <td style="width: 10%;"></td> <td style="width: 10%;"></td> <td style="width: 10%;"></td> <td style="width: 10%;"></td> <td style="width: 10%;"></td> </tr> <tr> <td></td> <td></td> <td colspan="8" style="text-align: center;"> <table border="1" style="width: 100%; border-collapse: collapse; text-align: center;"> <tr> <td style="width: 10%;"></td> <td style="width: 10%;"></td> <td style="width: 10%;"></td> <td style="width: 10%;"></td> <td style="width: 10%;"></td> <td style="width: 10%;"></td> <td style="width: 10%;"></td> <td style="width: 10%;"></td> <td style="width: 10%;"></td> <td style="width: 10%;"></td> </tr> <tr> <td></td> <td></td> <td colspan="8" style="text-align: center;"> <table border="1" style="width: 100%; border-collapse: collapse; text-align: center;"> <tr> <td style="width: 10%;"></td> <td style="width: 10%;"></td> <td style="width: 10%;"></td> <td style="width: 10%;"></td> <td style="width: 10%;"></td> <td style="width: 10%;"></td> <td style="width: 10%;"></td> <td style="width: 10%;"></td> <td style="width: 10%;"></td> <td style="width: 10%;"></td> </tr> <tr> <td></td> <td></td> <td colspan="8" style="text-align: center;"> <table border="1" style="width: 100%; border-collapse: collapse; text-align: center;"> <tr> <td style="width: 10%;"></td> <td style="width: 10%;"></td> <td style="width: 10%;"></td> <td style="width: 10%;"></td> <td style="width: 10%;"></td> <td style="width: 10%;"></td> <td style="width: 10%;"></td> <td style="width: 10%;"></td> <td style="width: 10%;"></td> <td style="width: 10%;"></td> </tr> <tr> <td></td> <td></td> <td colspan="8" style="text-align: center;"> <table border="1" style="width: 100%; border-collapse: collapse; text-align: center;"> <tr> <td style="width: 10%;"></td> <td style="width: 10%;"></td> <td style="width: 10%;"></td> <td style="width: 10%;"></td> <td style="width: 10%;"></td> <td style="width: 10%;"></td> <td style="width: 10%;"></td> <td style="width: 10%;"></td> <td style="width: 10%;"></td> <td style="width: 10%;"></td> </tr> <tr> <td></td> <td></td> <td colspan="8" style="text-align: center;"> <table border="1" style="width: 100%; border-collapse: collapse; text-align: center;"> <tr> <td style="width: 10%;"></td> <td style="width: 10%;"></td> <td
style="width: 10%;"></td> <td style="width: 10%;"></td> <td style="width: 10%;"></td> <td style="width: 10%;"></td> <td style="width: 10%;"></td> <td style="width: 10%;"></td> <td style="width: 10%;"></td> <td style="width: 10%;"></td> </tr> <tr> <td></td> <td></td> <td colspan="8" style="text-align: center;"> <table border="1" style="width: 100%; border-collapse: collapse; text-align: center;"> <tr> <td style="width: 10%;"></td> <td style="width: 10%;"></td> <td style="width: 10%;"></td> <td style="width: 10%;"></td> <td style="width: 10%;"></td> <td style="width: 10%;"></td> <td style="width: 10%;"></td> <td style="width: 10%;"></td> <td style="width: 10%;"></td> <td style="width: 10%;"></td> </tr> <tr> <td></td> <td></td> <td colspan="8" style="text-align: center;"> <table border="1" style="width: 100%; border-collapse: collapse; text-align: center;"> <tr> <td style="width: 10%;"></td> <td style="width: 10%;"></td> <td style="width: 10%;"></td> <td style="width: 10%;"></td> <td style="width: 10%;"></td> <td style="width: 10%;"></td> <td style="width: 10%;"></td> <td style="width: 10%;"></td> <td style="width: 10%;"></td> <td style="width: 10%;"></td> </tr> <tr> <td></td> <td></td> <td colspan="8" style="text-align: center;"> <table border="1" style="width: 100%; border-collapse: collapse; text-align: center;"> <tr> <td style="width: 10%;"></td> <td style="width: 10%;"></td> <td style="width: 10%;"></td> <td style="width: 10%;"></td> <td style="width: 10%;"></td> <td style="width: 10%;"></td> <td style="width: 10%;"></td> <td style="width: 10%;"></td> <td style="width: 10%;"></td> <td style="width: 10%;"></td> </tr> <tr> <td></td> <td></td> <td colspan="8" style="text-align: center;"> <table border="1" style="width: 100%; border-collapse: collapse; text-align: center;"> <tr> <td style="width: 10%;"></td> <td style="width: 10%;"></td> <td style="width: 10%;"></td> <td style="width: 10%;"></td> <td style="width: 10%;"></td> <td style="width: 10%;"></td> <td style="width: 10%;"></td> <td style="width: 10%;"></td> <td style="width: 10%;"></td> <td style="width: 10%;"></td> </tr> <tr> <td></td> <td></td> <td colspan="8" style="text-align: center;"> <table border="1" style="width: 100%; border-collapse: collapse; text-align: center;"> <tr> <td style="width: 10%;"></td> <td style="width: 10%;"></td> <td style="width: 10%;"></td> <td style="width: 10%;"></td> <td style="width: 10%;"></td> <td style="width: 10%;"></td> <td style="width: 10%;"></td> <td style="width: 10%;"></td> <td style="width: 10%;"></td> <td style="width: 10%;"></td> </tr> <tr> <td></td> <td></td> <td colspan="8" style="text-align: center;"> <table border="1" style="width: 100%; border-collapse: collapse; text-align: center;"> <tr> <td style="width: 10%;"></td> <td style="width: 10%;"></td> <td style="width: 10%;"></td> <td style="width: 10%;"></td> <td style="width: 10%;"></td> <td style="width: 10%;"></td> <td style="width: 10%;"></td> <td style="width: 10%;"></td> <td style="width: 10%;"></td> <td style="width: 10%;"></td> </tr> <tr> <td></td> <td></td> <td colspan="8" style="text-align: center;"> <table border="1" style="width: 100%; border-collapse: collapse; text-align: center;"> <tr> <td style="width: 10%;"></td> <td style="width: 10%;"></td> <td style="width: 10%;"></td> <td style="width: 10%;"></td> <td style="width: 10%;"></td> <td style="width: 10%;"></td> <td style="width: 10%;"></td> <td style="width: 10%;"></td> <td style="width: 10%;"></td> <td style="width: 10%;"></td> </tr> <tr> <td></td> <td></td> <td colspan="8" style="text-align: center;"> <table border="1" style="width: 100%; border-collapse: collapse; text-align: center;"> <tr> <td style="width: 10%;"></td> <td style="width: 10%;"></td> <td style="width: 10%;"></td> <td style="width: 10%;"></td> <td style="width: 10%;"></td> <td style="width: 10%;"></td> <td style="width: 10%;"></td> <td style="width: 10%;"></td> <td style="width: 10%;"></td> <td style="width: 10%;"></td> </tr> <tr> <td></td> <td></td> <td colspan="8" style="text-align: center;"> <table border="1" style="width: 100%; border-collapse: collapse; text-align: center;"> <tr> <td style="width: 10%;"></td> <td style="width: 10%;"></td> <td style="width: 10%;"></td> <td style="width: 10%;"></td> <td style="width: 10%;"></td> <td style="width: 10%;"></td> <td style="width: 10%;"></td> <td style="width: 10%;"></td> <td style="width: 10%;"></td> <td style="width: 10%;"></td> </tr> <tr> <td></td> <td></td> <td colspan="8" style="text-align: center;"> <table border="1" style="width: 100%; border-collapse: collapse; text-align: center;"> <tr> <td style="width: 10%;"></td> <td style="width: 10%;"></td> <td style="width: 10%;"></td> <td style="width: 10%;"></td> <td style="width: 10%;"></td> <td style="width: 10%;"></td> <td style="width: 10%;"></td> <td style="width: 10%;"></td> <td style="width: 10%;"></td> <td style="width: 10%;"></td> </tr> <tr> <td></td> <td></td> <td colspan="8" style="text-align: center;"> <table border="1" style="width: 100%; border-collapse: collapse; text-align: center;"> <tr> <td style="width: 10%;"></td> <td style="width: 10%;"></td> <td style="width: 10%;"></td> <td style="width: 10%;"></td> <td style="width: 10%;"></td> <td style="width: 10%;"></td> <td style="width: 10%;"></td> <td style="width: 10%;"></td> <td style="width: 10%;"></td> <td style="width: 10%;"></td> </tr> <tr> <td></td> <td></td> <td colspan="8" style="text-align: center;"> <table border="1" style="width: 100%; border-collapse: collapse; text-align: center;"> <tr> <td style="width: 10%;"></td> <td style="width: 10%;"></td> <td style="width: 10%;"></td> <td style="width: 10%;"></td> <td style="width: 10%;"></td> <td style="width: 10%;"></td> <td style="width: 10%;"></td> <td style="width: 10%;"></td> <td style="width: 10%;"></td> <td style="width: 10%;"></td> </tr> <tr> <td></td> <td></td> <td colspan="8" style="text-align: center;"> <table border="1" style="width: 100%; border-collapse: collapse; text-align: center;"> <tr> <td style="width: 10%;"></td> <td style="width: 10%;"></td> <td style="width: 10%;"></td> <td style="width: 10%;"></td> <td style="width: 10%;"></td> <td style="width: 10%;"></td> <td style="width: 10%;"></td> <td style="width: 10%;"></td> <td style="width: 10%;"></td> <td style="width: 10%;"></td> </tr> <tr> <td></td> <td></td> <td colspan="8" style="text-align: center;"> <table border="1" style="width: 100%; border-collapse: collapse; text-align: center;"> <tr> <td style="width: 10%;"></td> <td style="width: 10%;"></td> <td style="width: 10%;"></td> <td style="width: 10%;"></td> <td style="width: 10%;"></td> <td style="width: 10%;"></td> <td style="width: 10%;"></td> <td style="width: 10%;"></td> <td style="width: 10%;"></td> <td style="width: 10%;"></td> </tr> <tr> <td></td> <td></td> <td colspan="8" style="text-align: center;"> <table border="1" style="width: 100%; border-collapse: collapse; text-align: center;"> <tr> <td style="width: 10%;"></td> <td style="width: 10%;"></td> <td style="width: 10%;"></td> <td style="width: 10%;"></td> <td style="width: 10%;"></td> <td style="width: 10%;"></td> <td style="width: 10%;"></td> <td style="width: 10%;"></td> <td style="width: 10%;"></td> <td style="width: 10%;"></td> </tr> <tr> <td></td> <td></td> <td colspan="8" style="text-align: center;"> <table border="1" style="width: 100%; border-collapse: collapse; text-align: center;"> <tr> <td style="width: 10%;"></td> <td style="width: 10%;"></td> <td style="width: 10%;"></td> <td style="width: 10%;"></td> <td style="width: 10%;"></td> <td style="width: 10%;"></td> <td style="width: 10%;"></td> <td style="width: 10%;"></td> <td style="width: 10%;"></td> <td style="width: 10%;"></td> </tr> <tr> <td></td> <td></td> <td colspan="8" style="text-align: center;"> <table border="1" style="width: 100%; border-collapse: collapse; text-align: center;"> <tr> <td style="width: 10%;"></td> <td style="width: 10%;"></td> <td style="width: 10%;"></td> <td style="width: 10%;"></td> <td style="width: 10%;"></td> <td style="width: 10%;"></td> <td style="width: 10%;"></td> <td style="width: 10%;"></td> <td style="width: 10%;"></td> <td style="width: 10%;"></td> </tr> <tr> <td></td> <td></td> <td colspan="8" style="text-align: center;"> <table border="1" style="width: 100%; border-collapse: collapse; text-align: center;"> <tr> <td style="width: 10%;"></td> <td style="width: 10%;"></td> <td style="width: 10%;"></td> <td style="width: 10%;"></td> <td style="width: 10%;"></td> <td style="width: 10%;"></td> <td style="width: 10%;"></td> <td style="width: 10%;"></td> <td style="width: 10%;"></td> <td style="width: 10%;"></td> </tr> <tr> <td></td> <td></td> <td colspan="8" style="text-align: center;"> <table border="1" style="width: 100%; border-collapse: collapse; text-align: center;"> <tr> <td style="width: 10%;"></td> <td style="width: 10%;"></td> <td style="width: 10%;"></td> <td style="width: 10%;"></td> <td style="width: 10%;"></td> <td style="width: 10%;"></td> <td style="width: 10%;"></td> <td style="width: 10%;"></td> <td style="width: 10%;"></td> <td style="width: 10%;"></td> </tr> <tr> <td></td> <td></td> <td colspan="8" style="text-align: center;"> <table border="1" style="width: 100%; border-collapse: collapse; text-align: center;"> <tr> <td style="width: 10%;"></td> <td style="width: 10%;"></td> <td style="width: 10%;"></td> <td style="width: 10%;"></td> <td style="width: 10%;"></td> <td style="width: 10%;"></td> <td style="width: 10%;"></td> <td style="width: 10%;"></td> <td style="width: 10%;"></td> <td style="width: 10%;"></td> </tr> <tr> <td></td> <td></td> <td colspan="8" style="text-align: center;"> <table border="1" style="width: 100%; border-collapse: collapse; text-align: center;"> <tr> <td style="width: 10%;"></td> <td style="width: 10%;"></td> <td style="width: 10%;"></td> <td style="width: 10%;"></td> <td style="width: 10%;"></td> <td style="width: 10%;"></td> <td style="width: 10%;"></td> <td style="width:
10%;"></td> <td style="width: 10%;"></td> <td style="width: 10%;"></td> </tr> <tr> <td></td> <td></td> <td colspan="8" style="text-align: center;"> <table border="1" style="width: 100%; border-collapse: collapse; text-align: center;"> <tr> <td style="width: 10%;"></td> <td style="width: 10%;"></td> <td style="width: 10%;"></td> <td style="width: 10%;"></td> <td style="width: 10%;"></td> <td style="width: 10%;"></td> <td style="width: 10%;"></td> <td style="width: 10%;"></td> <td style="width: 10%;"></td> <td style="width: 10%;"></td> </tr> <tr> <td></td> <td></td> <td colspan="8" style="text-align: center;"> <table border="1" style="width: 100%; border-collapse: collapse; text-align: center;"> <tr> </tr></table></td></tr></table></td></tr></table></td></tr></table></td></tr></table></td></tr></table></td></tr></table></td></tr></table></td></tr></table></td></tr></table></td></tr></table></td></tr></table></td></tr></table></td></tr></table></td></tr></table></td></tr></table></td></tr></table></td></tr></table></td></tr></table></td></tr></table></td></tr></table></td></tr></table></td></tr></table></td></tr></table></td></tr></table></td></tr></table></td></tr></table></td></tr></table></td></tr></table></td></tr></table></td></tr></table></td></tr></table></td></tr></table></td></tr></table></td></tr></table></td></tr></table></td></tr></table></td></tr></table></td></tr></table></td></tr></table></td></tr></table></td></tr></table></td></tr></table></td></tr></table></td></tr></table>
 | | | | | | | | | | | | | | | | | | | | <table border="1" style="width: 100%; border-collapse: collapse; text-align: center;"> <tr> <td style="width: 10%;"></td> <td style="width: 10%;"></td> <td style="width: 10%;"></td> <td style="width: 10%;"></td> <td style="width: 10%;"></td> <td style="width: 10%;"></td> <td style="width: 10%;"></td> <td style="width: 10%;"></td> <td style="width: 10%;"></td> <td style="width: 10%;"></td> </tr> <tr> <td></td> <td></td> <td colspan="8" style="text-align: center;"> <table border="1" style="width: 100%; border-collapse: collapse; text-align: center;"> <tr> <td style="width: 10%;"></td> <td style="width: 10%;"></td> <td style="width: 10%;"></td> <td style="width: 10%;"></td> <td style="width: 10%;"></td> <td style="width: 10%;"></td> <td style="width: 10%;"></td> <td style="width: 10%;"></td> <td style="width: 10%;"></td> <td style="width: 10%;"></td> </tr> <tr> <td></td> <td></td> <td colspan="8" style="text-align: center;"> <table border="1" style="width: 100%; border-collapse: collapse; text-align: center;"> <tr> <td style="width: 10%;"></td> <td style="width: 10%;"></td> <td style="width: 10%;"></td> <td style="width: 10%;"></td> <td style="width: 10%;"></td> <td style="width: 10%;"></td> <td style="width: 10%;"></td> <td style="width: 10%;"></td> <td style="width: 10%;"></td> <td style="width: 10%;"></td> </tr> <tr> <td></td> <td></td> <td colspan="8" style="text-align: center;"> <table border="1" style="width: 100%; border-collapse: collapse; text-align: center;"> <tr> <td style="width: 10%;"></td> <td style="width: 10%;"></td> <td style="width: 10%;"></td> <td style="width: 10%;"></td> <td style="width: 10%;"></td> <td style="width: 10%;"></td> <td style="width: 10%;"></td> <td style="width: 10%;"></td> <td style="width: 10%;"></td> <td style="width: 10%;"></td> </tr> <tr> <td></td> <td></td> <td colspan="8" style="text-align: center;"> <table border="1" style="width: 100%; border-collapse: collapse; text-align: center;"> <tr> <td style="width: 10%;"></td> <td style="width: 10%;"></td> <td style="width: 10%;"></td> <td style="width: 10%;"></td> <td style="width: 10%;"></td> <td style="width: 10%;"></td> <td style="width: 10%;"></td> <td style="width: 10%;"></td> <td style="width: 10%;"></td> <td style="width: 10%;"></td> </tr> <tr> <td></td> <td></td> <td colspan="8" style="text-align: center;"> <table border="1" style="width: 100%; border-collapse: collapse; text-align: center;"> <tr> <td style="width: 10%;"></td> <td style="width: 10%;"></td> <td style="width: 10%;"></td> <td style="width: 10%;"></td> <td style="width: 10%;"></td> <td style="width: 10%;"></td> <td style="width: 10%;"></td> <td style="width: 10%;"></td> <td style="width: 10%;"></td> <td style="width: 10%;"></td> </tr> <tr> <td></td> <td></td> <td colspan="8" style="text-align: center;"> <table border="1" style="width: 100%; border-collapse: collapse; text-align: center;"> <tr> <td style="width: 10%;"></td> <td style="width: 10%;"></td> <td style="width: 10%;"></td> <td style="width: 10%;"></td> <td style="width: 10%;"></td> <td style="width: 10%;"></td> <td style="width: 10%;"></td> <td style="width: 10%;"></td> <td style="width: 10%;"></td> <td style="width: 10%;"></td> </tr> <tr> <td></td> <td></td> <td colspan="8" style="text-align: center;"> <table border="1" style="width: 100%; border-collapse: collapse; text-align: center;"> <tr> <td style="width: 10%;"></td> <td style="width: 10%;"></td> <td style="width: 10%;"></td> <td style="width: 10%;"></td> <td style="width: 10%;"></td> <td style="width: 10%;"></td> <td style="width: 10%;"></td> <td style="width: 10%;"></td> <td style="width: 10%;"></td> <td style="width: 10%;"></td> </tr> <tr> <td></td> <td></td> <td colspan="8" style="text-align: center;"> <table border="1" style="width: 100%; border-collapse: collapse; text-align: center;"> <tr> <td style="width: 10%;"></td> <td style="width: 10%;"></td> <td style="width: 10%;"></td> <td style="width: 10%;"></td> <td style="width: 10%;"></td> <td style="width: 10%;"></td> <td style="width: 10%;"></td> <td style="width: 10%;"></td> <td style="width: 10%;"></td> <td style="width: 10%;"></td> </tr> <tr> <td></td> <td></td> <td colspan="8" style="text-align: center;"> <table border="1" style="width: 100%; border-collapse: collapse; text-align: center;"> <tr> <td style="width: 10%;"></td> <td style="width: 10%;"></td> <td style="width: 10%;"></td> <td style="width: 10%;"></td> <td style="width: 10%;"></td> <td style="width: 10%;"></td> <td style="width: 10%;"></td> <td style="width: 10%;"></td> <td style="width: 10%;"></td> <td style="width: 10%;"></td> </tr> <tr> <td></td> <td></td> <td colspan="8" style="text-align: center;"> <table border="1" style="width: 100%; border-collapse: collapse; text-align: center;"> <tr> <td style="width: 10%;"></td> <td style="width: 10%;"></td> <td style="width: 10%;"></td> <td style="width: 10%;"></td> <td style="width: 10%;"></td> <td style="width: 10%;"></td> <td style="width: 10%;"></td> <td style="width: 10%;"></td> <td style="width: 10%;"></td> <td style="width: 10%;"></td> </tr> <tr> <td></td> <td></td> <td colspan="8" style="text-align: center;"> <table border="1" style="width: 100%; border-collapse: collapse; text-align: center;"> <tr> <td style="width: 10%;"></td> <td style="width: 10%;"></td> <td style="width: 10%;"></td> <td style="width: 10%;"></td> <td style="width: 10%;"></td> <td style="width: 10%;"></td> <td style="width: 10%;"></td> <td style="width: 10%;"></td> <td style="width: 10%;"></td> <td style="width: 10%;"></td> </tr> <tr> <td></td> <td></td> <td colspan="8" style="text-align: center;"> <table border="1" style="width: 100%; border-collapse: collapse; text-align: center;"> <tr> <td style="width: 10%;"></td> <td style="width: 10%;"></td> <td style="width: 10%;"></td> <td style="width: 10%;"></td> <td style="width: 10%;"></td> <td style="width: 10%;"></td> <td style="width: 10%;"></td> <td style="width: 10%;"></td> <td style="width: 10%;"></td> <td style="width: 10%;"></td> </tr> <tr> <td></td> <td></td> <td colspan="8" style="text-align: center;"> <table border="1" style="width: 100%; border-collapse: collapse; text-align: center;"> <tr> <td style="width: 10%;"></td> <td style="width: 10%;"></td> <td style="width: 10%;"></td> <td style="width: 10%;"></td> <td style="width: 10%;"></td> <td style="width: 10%;"></td> <td style="width: 10%;"></td> <td style="width: 10%;"></td> <td style="width: 10%;"></td> <td style="width: 10%;"></td> </tr> <tr> <td></td> <td></td> <td colspan="8" style="text-align: center;"> <table border="1" style="width: 100%; border-collapse: collapse; text-align: center;"> <tr> <td style="width: 10%;"></td> <td style="width: 10%;"></td> <td style="width: 10%;"></td> <td style="width: 10%;"></td> <td style="width: 10%;"></td> <td style="width: 10%;"></td> <td style="width: 10%;"></td> <td style="width: 10%;"></td> <td style="width: 10%;"></td> <td style="width: 10%;"></td> </tr> <tr> <td></td> <td></td> <td colspan="8" style="text-align: center;"> <table border="1" style="width: 100%; border-collapse: collapse; text-align: center;"> <tr> <td style="width: 10%;"></td> <td style="width: 10%;"></td> <td style="width: 10%;"></td> <td style="width: 10%;"></td> <td style="width: 10%;"></td> <td style="width: 10%;"></td> <td style="width: 10%;"></td> <td style="width: 10%;"></td> <td style="width: 10%;"></td> <td style="width: 10%;"></td> </tr> <tr> <td></td> <td></td> <td colspan="8" style="text-align: center;"> <table border="1" style="width: 100%; border-collapse: collapse; text-align: center;"> <tr> <td style="width: 10%;"></td> <td style="width: 10%;"></td> <td style="width: 10%;"></td> <td style="width: 10%;"></td> <td style="width: 10%;"></td> <td style="width: 10%;"></td> <td style="width: 10%;"></td> <td style="width: 10%;"></td> <td style="width: 10%;"></td> <td style="width: 10%;"></td> </tr> <tr> <td></td> <td></td> <td colspan="8" style="text-align: center;"> <table border="1" style="width: 100%; border-collapse: collapse; text-align: center;"> <tr> <td style="width: 10%;"></td> <td style="width: 10%;"></td> <td style="width: 10%;"></td> <td style="width: 10%;"></td> <td style="width: 10%;"></td> <td style="width: 10%;"></td> <td style="width: 10%;"></td> <td style="width: 10%;"></td> <td style="width: 10%;"></td> <td style="width: 10%;"></td> </tr> <tr> <td></td> <td></td> <td colspan="8" style="text-align: center;"> <table border="1" style="width: 100%; border-collapse: collapse; text-align: center;"> <tr> <td style="width: 10%;"></td> <td style="width: 10%;"></td> <td style="width: 10%;"></td> <td style="width: 10%;"></td> <td style="width: 10%;"></td> <td style="width:
10%;"></td> <td style="width: 10%;"></td> <td style="width: 10%;"></td> <td style="width: 10%;"></td> <td style="width: 10%;"></td> </tr> <tr> <td></td> <td></td> <td colspan="8" style="text-align: center;"> <table border="1" style="width: 100%; border-collapse: collapse; text-align: center;"> <tr> <td style="width: 10%;"></td> <td style="width: 10%;"></td> <td style="width: 10%;"></td> <td style="width: 10%;"></td> <td style="width: 10%;"></td> <td style="width: 10%;"></td> <td style="width: 10%;"></td> <td style="width: 10%;"></td> <td style="width: 10%;"></td> <td style="width: 10%;"></td> </tr> <tr> <td></td> <td></td> <td colspan="8" style="text-align: center;"> <table border="1" style="width: 100%; border-collapse: collapse; text-align: center;"> <tr> <td style="width: 10%;"></td> <td style="width: 10%;"></td> <td style="width: 10%;"></td> <td style="width: 10%;"></td> <td style="width: 10%;"></td> <td style="width: 10%;"></td> <td style="width: 10%;"></td> <td style="width: 10%;"></td> <td style="width: 10%;"></td> <td style="width: 10%;"></td> </tr> <tr> <td></td> <td></td> <td colspan="8" style="text-align: center;"> <table border="1" style="width: 100%; border-collapse: collapse; text-align: center;"> <tr> <td style="width: 10%;"></td> <td style="width: 10%;"></td> <td style="width: 10%;"></td> <td style="width: 10%;"></td> <td style="width: 10%;"></td> <td style="width: 10%;"></td> <td style="width: 10%;"></td> <td style="width: 10%;"></td> <td style="width: 10%;"></td> <td style="width: 10%;"></td> </tr> <tr> <td></td> <td></td> <td colspan="8" style="text-align: center;"> <table border="1" style="width: 100%; border-collapse: collapse; text-align: center;"> <tr> <td style="width: 10%;"></td> <td style="width: 10%;"></td> <td style="width: 10%;"></td> <td style="width: 10%;"></td> <td style="width: 10%;"></td> <td style="width: 10%;"></td> <td style="width: 10%;"></td> <td style="width: 10%;"></td> <td style="width: 10%;"></td> <td style="width: 10%;"></td> </tr> <tr> <td></td> <td></td> <td colspan="8" style="text-align: center;"> <table border="1" style="width: 100%; border-collapse: collapse; text-align: center;"> <tr> <td style="width: 10%;"></td> <td style="width: 10%;"></td> <td style="width: 10%;"></td> <td style="width: 10%;"></td> <td style="width: 10%;"></td> <td style="width: 10%;"></td> <td style="width: 10%;"></td> <td style="width: 10%;"></td> <td style="width: 10%;"></td> <td style="width: 10%;"></td> </tr> <tr> <td></td> <td></td> <td colspan="8" style="text-align: center;"> <table border="1" style="width: 100%; border-collapse: collapse; text-align: center;"> <tr> <td style="width: 10%;"></td> <td style="width: 10%;"></td> <td style="width: 10%;"></td> <td style="width: 10%;"></td> <td style="width: 10%;"></td> <td style="width: 10%;"></td> <td style="width: 10%;"></td> <td style="width: 10%;"></td> <td style="width: 10%;"></td> <td style="width: 10%;"></td> </tr> <tr> <td></td> <td></td> <td colspan="8" style="text-align: center;"> <table border="1" style="width: 100%; border-collapse: collapse; text-align: center;"> <tr> <td style="width: 10%;"></td> <td style="width: 10%;"></td> <td style="width: 10%;"></td> <td style="width: 10%;"></td> <td style="width: 10%;"></td> <td style="width: 10%;"></td> <td style="width: 10%;"></td> <td style="width: 10%;"></td> <td style="width: 10%;"></td> <td style="width: 10%;"></td> </tr> <tr> <td></td> <td></td> <td colspan="8" style="text-align: center;"> <table border="1" style="width: 100%; border-collapse: collapse; text-align: center;"> <tr> <td style="width: 10%;"></td> <td style="width: 10%;"></td> <td style="width: 10%;"></td> <td style="width: 10%;"></td> <td style="width: 10%;"></td> <td style="width: 10%;"></td> <td style="width: 10%;"></td> <td style="width: 10%;"></td> <td style="width: 10%;"></td> <td style="width: 10%;"></td> </tr> <tr> <td></td> <td></td> <td colspan="8" style="text-align: center;"> <table border="1" style="width: 100%; border-collapse: collapse; text-align: center;"> <tr> <td style="width: 10%;"></td> <td style="width: 10%;"></td> <td style="width: 10%;"></td> <td style="width: 10%;"></td> <td style="width: 10%;"></td> <td style="width: 10%;"></td> <td style="width: 10%;"></td> <td style="width: 10%;"></td> <td style="width: 10%;"></td> <td style="width: 10%;"></td> </tr> <tr> <td></td> <td></td> <td colspan="8" style="text-align: center;"> <table border="1" style="width: 100%; border-collapse: collapse; text-align: center;"> <tr> <td style="width: 10%;"></td> <td style="width: 10%;"></td> <td style="width: 10%;"></td> <td style="width: 10%;"></td> <td style="width: 10%;"></td> <td style="width: 10%;"></td> <td style="width: 10%;"></td> <td style="width: 10%;"></td> <td style="width: 10%;"></td> <td style="width: 10%;"></td> </tr> <tr> <td></td> <td></td> <td colspan="8" style="text-align: center;"> <table border="1" style="width: 100%; border-collapse: collapse; text-align: center;"> <tr> <td style="width: 10%;"></td> <td style="width: 10%;"></td> <td style="width: 10%;"></td> <td style="width: 10%;"></td> <td style="width: 10%;"></td> <td style="width: 10%;"></td> <td style="width: 10%;"></td> <td style="width: 10%;"></td> <td style="width: 10%;"></td> <td style="width: 10%;"></td> </tr> <tr> <td></td> <td></td> <td colspan="8" style="text-align: center;"> <table border="1" style="width: 100%; border-collapse: collapse; text-align: center;"> <tr> <td style="width: 10%;"></td> <td style="width: 10%;"></td> <td style="width: 10%;"></td> <td style="width: 10%;"></td> <td style="width: 10%;"></td> <td style="width: 10%;"></td> <td style="width: 10%;"></td> <td style="width: 10%;"></td> <td style="width: 10%;"></td> <td style="width: 10%;"></td> </tr> <tr> <td></td> <td></td> <td colspan="8" style="text-align: center;"> <table border="1" style="width: 100%; border-collapse: collapse; text-align: center;"> <tr> <td style="width: 10%;"></td> <td style="width: 10%;"></td> <td style="width: 10%;"></td> <td style="width: 10%;"></td> <td style="width: 10%;"></td> <td style="width: 10%;"></td> <td style="width: 10%;"></td> <td style="width: 10%;"></td> <td style="width: 10%;"></td> <td style="width: 10%;"></td> </tr> <tr> <td></td> <td></td> <td colspan="8" style="text-align: center;"> <table border="1" style="width: 100%; border-collapse: collapse; text-align: center;"> <tr> <td style="width: 10%;"></td> <td style="width: 10%;"></td> <td style="width: 10%;"></td> <td style="width: 10%;"></td> <td style="width: 10%;"></td> <td style="width: 10%;"></td> <td style="width: 10%;"></td> <td style="width: 10%;"></td> <td style="width: 10%;"></td> <td style="width: 10%;"></td> </tr> <tr> <td></td> <td></td> <td colspan="8" style="text-align: center;"> <table border="1" style="width: 100%; border-collapse: collapse; text-align: center;"> <tr> <td style="width: 10%;"></td> <td style="width: 10%;"></td> <td style="width: 10%;"></td> <td style="width: 10%;"></td> <td style="width: 10%;"></td> <td style="width: 10%;"></td> <td style="width: 10%;"></td> <td style="width: 10%;"></td> <td style="width: 10%;"></td> <td style="width: 10%;"></td> </tr> <tr> <td></td> <td></td> <td colspan="8" style="text-align: center;"> <table border="1" style="width: 100%; border-collapse: collapse; text-align: center;"> <tr> <td style="width: 10%;"></td> <td style="width: 10%;"></td> <td style="width: 10%;"></td> <td style="width: 10%;"></td> <td style="width: 10%;"></td> <td style="width: 10%;"></td> <td style="width: 10%;"></td> <td style="width: 10%;"></td> <td style="width: 10%;"></td> <td style="width: 10%;"></td> </tr> <tr> <td></td> <td></td> <td colspan="8" style="text-align: center;"> <table border="1" style="width: 100%; border-collapse: collapse; text-align: center;"> <tr> <td style="width: 10%;"></td> <td style="width: 10%;"></td> <td style="width: 10%;"></td> <td style="width: 10%;"></td> <td style="width: 10%;"></td> <td style="width: 10%;"></td> <td style="width: 10%;"></td> <td style="width: 10%;"></td> <td style="width: 10%;"></td> <td style="width: 10%;"></td> </tr> <tr> <td></td> <td></td> <td colspan="8" style="text-align: center;"> <table border="1" style="width: 100%; border-collapse: collapse; text-align: center;"> <tr> <td style="width: 10%;"></td> <td style="width: 10%;"></td> <td style="width: 10%;"></td> <td style="width: 10%;"></td> <td style="width: 10%;"></td> <td style="width: 10%;"></td> <td style="width: 10%;"></td> <td style="width: 10%;"></td> <td style="width: 10%;"></td> <td style="width: 10%;"></td> </tr> <tr> <td></td> <td></td> <td colspan="8" style="text-align: center;"> <table border="1" style="width: 100%; border-collapse: collapse; text-align: center;"> <tr> <td style="width: 10%;"></td> <td style="width: 10%;"></td> <td style="width: 10%;"></td> <td style="width: 10%;"></td> <td style="width: 10%;"></td> <td style="width: 10%;"></td> <td style="width: 10%;"></td> <td style="width: 10%;"></td> <td style="width: 10%;"></td> <td style="width: 10%;"></td> </tr> <tr> <td></td> <td></td> <td colspan="8" style="text-align: center;"> <table border="1" style="width: 100%; border-collapse: collapse; text-align: center;"> <tr> <td style="width: 10%;"></td> <td style="width: 10%;"></td> <td style="width: 10%;"></td> <td style="width: 10%;"></td> <td style="width: 10%;"></td> <td style="width: 10%;"></td> <td style="width: 10%;"></td> <td style="width: 10%;"></td> <td style="width: 10%;"></td> <td style="width: 10%;"></td> </tr> <tr> <td></td> <td></td> <td colspan="8" style="text-align: center;"> <table border="1" style="width: 100%; border-collapse: collapse; text-align: center;"> <tr> <td style="width: 10%;"></td> <td style="width: 10%;"></td> <td style="width: 10%;"></td> <td style="width: 10%;"></td> <td style="width: 10%;"></td> <td style="width: 10%;"></td> <td style="width: 10%;"></td> <td style="width: 10%;"></td> <td style="width: 10%;"></td> <td style="width: 10%;"></td> </tr> <tr> <td></td> <td></td> <td
colspan="8" style="text-align: center;"> <table border="1" style="width: 100%; border-collapse: collapse; text-align: center;"> <tr> <td style="width: 10%;"></td> <td style="width: 10%;"></td> <td style="width: 10%;"></td> <td style="width: 10%;"></td> <td style="width: 10%;"></td> <td style="width: 10%;"></td> <td style="width: 10%;"></td> <td style="width: 10%;"></td> <td style="width: 10%;"></td> <td style="width: 10%;"></td> </tr> <tr> <td></td> <td></td> <td colspan="8" style="text-align: center;"> <table border="1" style="width: 100%; border-collapse: collapse; text-align: center;"> <tr> <td style="width: 10%;"></td> <td style="width: 10%;"></td> <td style="width: 10%;"></td> <td style="width: 10%;"></td> <td style="width: 10%;"></td> <td style="width: 10%;"></td> <td style="width: 10%;"></td> <td style="width: 10%;"></td> <td style="width: 10%;"></td> <td style="width: 10%;"></td> </tr> <tr> <td></td> <td></td> <td colspan="8" style="text-align: center;"> <table border="1" style="width: 100%; border-collapse: collapse; text-align: center;"> <tr> <td style="width: 10%;"></td> <td style="width: 10%;"></td> <td style="width: 10%;"></td> <td style="width: 10%;"></td> <td style="width: 10%;"></td> <td style="width: 10%;"></td> <td style="width: 10%;"></td> <td style="width: 10%;"></td> <td style="width: 10%;"></td> <td style="width: 10%;"></td> </tr> <tr> <td></td> <td></td> <td colspan="8" style="text-align: center;"> <table border="1" style="width: 100%; border-collapse: collapse; text-align: center;"> <tr> </tr></table></td></tr></table></td></tr></table></td></tr></table></td></tr></table></td></tr></table></td></tr></table></td></tr></table></td></tr></table></td></tr></table></td></tr></table></td></tr></table></td></tr></table></td></tr></table></td></tr></table></td></tr></table></td></tr></table></td></tr></table></td></tr></table></td></tr></table></td></tr></table></td></tr></table></td></tr></table></td></tr></table></td></tr></table></td></tr></table></td></tr></table></td></tr></table></td></tr></table></td></tr></table></td></tr></table></td></tr></table></td></tr></table></td></tr></table></td></tr></table></td></tr></table></td></tr></table></td></tr></table></td></tr></table></td></tr></table></td></tr></table></td></tr></table></td></tr></table></td></tr></table>
 | | | | | | | | | | | | | | | | | | | | <table border="1" style="width: 100%; border-collapse: collapse; text-align: center;"> <tr> <td style="width: 10%;"></td> <td style="width: 10%;"></td> <td style="width: 10%;"></td> <td style="width: 10%;"></td> <td style="width: 10%;"></td> <td style="width: 10%;"></td> <td style="width: 10%;"></td> <td style="width: 10%;"></td> <td style="width: 10%;"></td> <td style="width: 10%;"></td> </tr> <tr> <td></td> <td></td> <td colspan="8" style="text-align: center;"> <table border="1" style="width: 100%; border-collapse: collapse; text-align: center;"> <tr> <td style="width: 10%;"></td> <td style="width: 10%;"></td> <td style="width: 10%;"></td> <td style="width: 10%;"></td> <td style="width: 10%;"></td> <td style="width: 10%;"></td> <td style="width: 10%;"></td> <td style="width: 10%;"></td> <td style="width: 10%;"></td> <td style="width: 10%;"></td> </tr> <tr> <td></td> <td></td> <td colspan="8" style="text-align: center;"> <table border="1" style="width: 100%; border-collapse: collapse; text-align: center;"> <tr> <td style="width: 10%;"></td> <td style="width: 10%;"></td> <td style="width: 10%;"></td> <td style="width: 10%;"></td> <td style="width: 10%;"></td> <td style="width: 10%;"></td> <td style="width: 10%;"></td> <td style="width: 10%;"></td> <td style="width: 10%;"></td> <td style="width: 10%;"></td> </tr> <tr> <td></td> <td></td> <td colspan="8" style="text-align: center;"> <table border="1" style="width: 100%; border-collapse: collapse; text-align: center;"> <tr> <td style="width: 10%;"></td> <td style="width: 10%;"></td> <td style="width: 10%;"></td> <td style="width: 10%;"></td> <td style="width: 10%;"></td> <td style="width: 10%;"></td> <td style="width: 10%;"></td> <td style="width: 10%;"></td> <td style="width: 10%;"></td> <td style="width: 10%;"></td> </tr> <tr> <td></td> <td></td> <td colspan="8" style="text-align: center;"> <table border="1" style="width: 100%; border-collapse: collapse; text-align: center;"> <tr> <td style="width: 10%;"></td> <td style="width: 10%;"></td> <td style="width: 10%;"></td> <td style="width: 10%;"></td> <td style="width: 10%;"></td> <td style="width: 10%;"></td> <td style="width: 10%;"></td> <td style="width: 10%;"></td> <td style="width: 10%;"></td> <td style="width: 10%;"></td> </tr> <tr> <td></td> <td></td> <td colspan="8" style="text-align: center;"> <table border="1" style="width: 100%; border-collapse: collapse; text-align: center;"> <tr> <td style="width: 10%;"></td> <td style="width: 10%;"></td> <td style="width: 10%;"></td> <td style="width: 10%;"></td> <td style="width: 10%;"></td> <td style="width: 10%;"></td> <td style="width: 10%;"></td> <td style="width: 10%;"></td> <td style="width: 10%;"></td> <td style="width: 10%;"></td> </tr> <tr> <td></td> <td></td> <td colspan="8" style="text-align: center;"> <table border="1" style="width: 100%; border-collapse: collapse; text-align: center;"> <tr> <td style="width: 10%;"></td> <td style="width: 10%;"></td> <td style="width: 10%;"></td> <td style="width: 10%;"></td> <td style="width: 10%;"></td> <td style="width: 10%;"></td> <td style="width: 10%;"></td> <td style="width: 10%;"></td> <td style="width: 10%;"></td> <td style="width: 10%;"></td> </tr> <tr> <td></td> <td></td> <td colspan="8" style="text-align: center;"> <table border="1" style="width: 100%; border-collapse: collapse; text-align: center;"> <tr> <td style="width: 10%;"></td> <td style="width: 10%;"></td> <td style="width: 10%;"></td> <td style="width: 10%;"></td> <td style="width: 10%;"></td> <td style="width: 10%;"></td> <td style="width: 10%;"></td> <td style="width: 10%;"></td> <td style="width: 10%;"></td> <td style="width: 10%;"></td> </tr> <tr> <td></td> <td></td> <td colspan="8" style="text-align: center;"> <table border="1" style="width: 100%; border-collapse: collapse; text-align: center;"> <tr> <td style="width: 10%;"></td> <td style="width: 10%;"></td> <td style="width: 10%;"></td> <td style="width: 10%;"></td> <td style="width: 10%;"></td> <td style="width: 10%;"></td> <td style="width: 10%;"></td> <td style="width: 10%;"></td> <td style="width: 10%;"></td> <td style="width: 10%;"></td> </tr> <tr> <td></td> <td></td> <td colspan="8" style="text-align: center;"> <table border="1" style="width: 100%; border-collapse: collapse; text-align: center;"> <tr> <td style="width: 10%;"></td> <td style="width: 10%;"></td> <td style="width: 10%;"></td> <td style="width: 10%;"></td> <td style="width: 10%;"></td> <td style="width: 10%;"></td> <td style="width: 10%;"></td> <td style="width: 10%;"></td> <td style="width: 10%;"></td> <td style="width: 10%;"></td> </tr> <tr> <td></td> <td></td> <td colspan="8" style="text-align: center;"> <table border="1" style="width: 100%; border-collapse: collapse; text-align: center;"> <tr> <td style="width: 10%;"></td> <td style="width: 10%;"></td> <td style="width: 10%;"></td> <td style="width: 10%;"></td> <td style="width: 10%;"></td> <td style="width: 10%;"></td> <td style="width: 10%;"></td> <td style="width: 10%;"></td> <td style="width: 10%;"></td> <td style="width: 10%;"></td> </tr> <tr> <td></td> <td></td> <td colspan="8" style="text-align: center;"> <table border="1" style="width: 100%; border-collapse: collapse; text-align: center;"> <tr> <td style="width: 10%;"></td> <td style="width: 10%;"></td> <td style="width: 10%;"></td> <td style="width: 10%;"></td> <td style="width: 10%;"></td> <td style="width: 10%;"></td> <td style="width: 10%;"></td> <td style="width: 10%;"></td> <td style="width: 10%;"></td> <td style="width: 10%;"></td> </tr> <tr> <td></td> <td></td> <td colspan="8" style="text-align: center;"> <table border="1" style="width: 100%; border-collapse: collapse; text-align: center;"> <tr> <td style="width: 10%;"></td> <td style="width: 10%;"></td> <td style="width: 10%;"></td> <td style="width: 10%;"></td> <td style="width: 10%;"></td> <td style="width: 10%;"></td> <td style="width: 10%;"></td> <td style="width: 10%;"></td> <td style="width: 10%;"></td> <td style="width: 10%;"></td> </tr> <tr> <td></td> <td></td> <td colspan="8" style="text-align: center;"> <table border="1" style="width: 100%; border-collapse: collapse; text-align: center;"> <tr> <td style="width: 10%;"></td> <td style="width: 10%;"></td> <td style="width: 10%;"></td> <td style="width: 10%;"></td> <td style="width: 10%;"></td> <td style="width: 10%;"></td> <td style="width: 10%;"></td> <td style="width: 10%;"></td> <td style="width: 10%;"></td> <td style="width: 10%;"></td> </tr> <tr> <td></td> <td></td> <td colspan="8" style="text-align: center;"> <table border="1" style="width: 100%; border-collapse: collapse; text-align: center;"> <tr> <td style="width: 10%;"></td> <td style="width: 10%;"></td> <td style="width: 10%;"></td> <td style="width: 10%;"></td> <td style="width: 10%;"></td> <td style="width: 10%;"></td> <td style="width: 10%;"></td> <td style="width: 10%;"></td> <td style="width: 10%;"></td> <td style="width: 10%;"></td> </tr> <tr> <td></td> <td></td> <td colspan="8" style="text-align: center;"> <table border="1" style="width: 100%; border-collapse: collapse; text-align: center;"> <tr> <td style="width: 10%;"></td> <td style="width: 10%;"></td> <td style="width: 10%;"></td> <td style="width: 10%;"></td> <td style="width: 10%;"></td> <td style="width: 10%;"></td> <td style="width: 10%;"></td> <td style="width: 10%;"></td> <td style="width: 10%;"></td> <td style="width: 10%;"></td> </tr> <tr> <td></td> <td></td> <td colspan="8" style="text-align: center;"> <table border="1" style="width: 100%; border-collapse: collapse; text-align: center;"> <tr> <td style="width: 10%;"></td> <td style="width: 10%;"></td> <td style="width: 10%;"></td> <td style="width: 10%;"></td> <td style="width: 10%;"></td> <td style="width: 10%;"></td> <td style="width: 10%;"></td> <td style="width: 10%;"></td> <td style="width: 10%;"></td> <td style="width: 10%;"></td> </tr> <tr>
<td></td> <td></td> <td colspan="8" style="text-align: center;"> <table border="1" style="width: 100%; border-collapse: collapse; text-align: center;"> <tr> <td style="width: 10%;"></td> <td style="width: 10%;"></td> <td style="width: 10%;"></td> <td style="width: 10%;"></td> <td style="width: 10%;"></td> <td style="width: 10%;"></td> <td style="width: 10%;"></td> <td style="width: 10%;"></td> <td style="width: 10%;"></td> <td style="width: 10%;"></td> </tr> <tr> <td></td> <td></td> <td colspan="8" style="text-align: center;"> <table border="1" style="width: 100%; border-collapse: collapse; text-align: center;"> <tr> <td style="width: 10%;"></td> <td style="width: 10%;"></td> <td style="width: 10%;"></td> <td style="width: 10%;"></td> <td style="width: 10%;"></td> <td style="width: 10%;"></td> <td style="width: 10%;"></td> <td style="width: 10%;"></td> <td style="width: 10%;"></td> <td style="width: 10%;"></td> </tr> <tr> <td></td> <td></td> <td colspan="8" style="text-align: center;"> <table border="1" style="width: 100%; border-collapse: collapse; text-align: center;"> <tr> <td style="width: 10%;"></td> <td style="width: 10%;"></td> <td style="width: 10%;"></td> <td style="width: 10%;"></td> <td style="width: 10%;"></td> <td style="width: 10%;"></td> <td style="width: 10%;"></td> <td style="width: 10%;"></td> <td style="width: 10%;"></td> <td style="width: 10%;"></td> </tr> <tr> <td></td> <td></td> <td colspan="8" style="text-align: center;"> <table border="1" style="width: 100%; border-collapse: collapse; text-align: center;"> <tr> <td style="width: 10%;"></td> <td style="width: 10%;"></td> <td style="width: 10%;"></td> <td style="width: 10%;"></td> <td style="width: 10%;"></td> <td style="width: 10%;"></td> <td style="width: 10%;"></td> <td style="width: 10%;"></td> <td style="width: 10%;"></td> <td style="width: 10%;"></td> </tr> <tr> <td></td> <td></td> <td colspan="8" style="text-align: center;"> <table border="1" style="width: 100%; border-collapse: collapse; text-align: center;"> <tr> <td style="width: 10%;"></td> <td style="width: 10%;"></td> <td style="width: 10%;"></td> <td style="width: 10%;"></td> <td style="width: 10%;"></td> <td style="width: 10%;"></td> <td style="width: 10%;"></td> <td style="width: 10%;"></td> <td style="width: 10%;"></td> <td style="width: 10%;"></td> </tr> <tr> <td></td> <td></td> <td colspan="8" style="text-align: center;"> <table border="1" style="width: 100%; border-collapse: collapse; text-align: center;"> <tr> <td style="width: 10%;"></td> <td style="width: 10%;"></td> <td style="width: 10%;"></td> <td style="width: 10%;"></td> <td style="width: 10%;"></td> <td style="width: 10%;"></td> <td style="width: 10%;"></td> <td style="width: 10%;"></td> <td style="width: 10%;"></td> <td style="width: 10%;"></td> </tr> <tr> <td></td> <td></td> <td colspan="8" style="text-align: center;"> <table border="1" style="width: 100%; border-collapse: collapse; text-align: center;"> <tr> <td style="width: 10%;"></td> <td style="width: 10%;"></td> <td style="width: 10%;"></td> <td style="width: 10%;"></td> <td style="width: 10%;"></td> <td style="width: 10%;"></td> <td style="width: 10%;"></td> <td style="width: 10%;"></td> <td style="width: 10%;"></td> <td style="width: 10%;"></td> </tr> <tr> <td></td> <td></td> <td colspan="8" style="text-align: center;"> <table border="1" style="width: 100%; border-collapse: collapse; text-align: center;"> <tr> <td style="width: 10%;"></td> <td style="width: 10%;"></td> <td style="width: 10%;"></td> <td style="width: 10%;"></td> <td style="width: 10%;"></td> <td style="width: 10%;"></td> <td style="width: 10%;"></td> <td style="width: 10%;"></td> <td style="width: 10%;"></td> <td style="width: 10%;"></td> </tr> <tr> <td></td> <td></td> <td colspan="8" style="text-align: center;"> <table border="1" style="width: 100%; border-collapse: collapse; text-align: center;"> <tr> <td style="width: 10%;"></td> <td style="width: 10%;"></td> <td style="width: 10%;"></td> <td style="width: 10%;"></td> <td style="width: 10%;"></td> <td style="width: 10%;"></td> <td style="width: 10%;"></td> <td style="width: 10%;"></td> <td style="width: 10%;"></td> <td style="width: 10%;"></td> </tr> <tr> <td></td> <td></td> <td colspan="8" style="text-align: center;"> <table border="1" style="width: 100%; border-collapse: collapse; text-align: center;"> <tr> <td style="width: 10%;"></td> <td style="width: 10%;"></td> <td style="width: 10%;"></td> <td style="width: 10%;"></td> <td style="width: 10%;"></td> <td style="width: 10%;"></td> <td style="width: 10%;"></td> <td style="width: 10%;"></td> <td style="width: 10%;"></td> <td style="width: 10%;"></td> </tr> <tr> <td></td> <td></td> <td colspan="8" style="text-align: center;"> <table border="1" style="width: 100%; border-collapse: collapse; text-align: center;"> <tr> <td style="width: 10%;"></td> <td style="width: 10%;"></td> <td style="width: 10%;"></td> <td style="width: 10%;"></td> <td style="width: 10%;"></td> <td style="width: 10%;"></td> <td style="width: 10%;"></td> <td style="width: 10%;"></td> <td style="width: 10%;"></td> <td style="width: 10%;"></td> </tr> <tr> <td></td> <td></td> <td colspan="8" style="text-align: center;"> <table border="1" style="width: 100%; border-collapse: collapse; text-align: center;"> <tr> <td style="width: 10%;"></td> <td style="width: 10%;"></td> <td style="width: 10%;"></td> <td style="width: 10%;"></td> <td style="width: 10%;"></td> <td style="width: 10%;"></td> <td style="width: 10%;"></td> <td style="width: 10%;"></td> <td style="width: 10%;"></td> <td style="width: 10%;"></td> </tr> <tr> <td></td> <td></td> <td colspan="8" style="text-align: center;"> <table border="1" style="width: 100%; border-collapse: collapse; text-align: center;"> <tr> <td style="width: 10%;"></td> <td style="width: 10%;"></td> <td style="width: 10%;"></td> <td style="width: 10%;"></td> <td style="width: 10%;"></td> <td style="width: 10%;"></td> <td style="width: 10%;"></td> <td style="width: 10%;"></td> <td style="width: 10%;"></td> <td style="width: 10%;"></td> </tr> <tr> <td></td> <td></td> <td colspan="8" style="text-align: center;"> <table border="1" style="width: 100%; border-collapse: collapse; text-align: center;"> <tr> <td style="width: 10%;"></td> <td style="width: 10%;"></td> <td style="width: 10%;"></td> <td style="width: 10%;"></td> <td style="width: 10%;"></td> <td style="width: 10%;"></td> <td style="width: 10%;"></td> <td style="width: 10%;"></td> <td style="width: 10%;"></td> <td style="width: 10%;"></td> </tr> <tr> <td></td> <td></td> <td colspan="8" style="text-align: center;"> <table border="1" style="width: 100%; border-collapse: collapse; text-align: center;"> <tr> <td style="width: 10%;"></td> <td style="width: 10%;"></td> <td style="width: 10%;"></td> <td style="width: 10%;"></td> <td style="width: 10%;"></td> <td style="width: 10%;"></td> <td style="width: 10%;"></td> <td style="width: 10%;"></td> <td style="width: 10%;"></td> <td style="width: 10%;"></td> </tr> <tr> <td></td> <td></td> <td colspan="8" style="text-align: center;"> <table border="1" style="width: 100%; border-collapse: collapse; text-align: center;"> <tr> <td style="width: 10%;"></td> <td style="width: 10%;"></td> <td style="width: 10%;"></td> <td style="width: 10%;"></td> <td style="width: 10%;"></td> <td style="width: 10%;"></td> <td style="width: 10%;"></td> <td style="width: 10%;"></td> <td style="width: 10%;"></td> <td style="width: 10%;"></td> </tr> <tr> <td></td> <td></td> <td colspan="8" style="text-align: center;"> <table border="1" style="width: 100%; border-collapse: collapse; text-align: center;"> <tr> <td style="width: 10%;"></td> <td style="width: 10%;"></td> <td style="width: 10%;"></td> <td style="width: 10%;"></td> <td style="width: 10%;"></td> <td style="width: 10%;"></td> <td style="width: 10%;"></td> <td style="width: 10%;"></td> <td style="width: 10%;"></td> <td style="width: 10%;"></td> </tr> <tr> <td></td> <td></td> <td colspan="8" style="text-align: center;"> <table border="1" style="width: 100%; border-collapse: collapse; text-align: center;"> <tr> <td style="width: 10%;"></td> <td style="width: 10%;"></td> <td style="width: 10%;"></td> <td style="width: 10%;"></td> <td style="width: 10%;"></td> <td style="width: 10%;"></td> <td style="width: 10%;"></td> <td style="width: 10%;"></td> <td style="width: 10%;"></td> <td style="width: 10%;"></td> </tr> <tr> <td></td> <td></td> <td colspan="8" style="text-align: center;"> <table border="1" style="width: 100%; border-collapse: collapse; text-align: center;"> <tr> <td style="width: 10%;"></td> <td style="width: 10%;"></td> <td style="width: 10%;"></td> <td style="width: 10%;"></td> <td style="width: 10%;"></td> <td style="width: 10%;"></td> <td style="width: 10%;"></td> <td style="width: 10%;"></td> <td style="width: 10%;"></td> <td style="width: 10%;"></td> </tr> <tr> <td></td> <td></td> <td colspan="8" style="text-align: center;"> <table border="1" style="width: 100%; border-collapse: collapse; text-align: center;"> <tr> <td style="width: 10%;"></td> <td style="width: 10%;"></td> <td style="width: 10%;"></td> <td style="width: 10%;"></td> <td style="width: 10%;"></td> <td style="width: 10%;"></td> <td style="width: 10%;"></td> <td style="width: 10%;"></td> <td style="width: 10%;"></td> <td style="width: 10%;"></td> </tr> <tr> <td></td> <td></td> <td colspan="8" style="text-align: center;"> <table border="1" style="width: 100%; border-collapse: collapse; text-align: center;"> <tr> <td style="width: 10%;"></td> <td style="width: 10%;"></td> <td style="width: 10%;"></td> <td style="width: 10%;"></td> <td style="width: 10%;"></td> <td style="width: 10%;"></td> <td style="width: 10%;"></td> <td style="width: 10%;"></td> <td style="width: 10%;"></td> <td style="width: 10%;"></td> </tr> <tr> <td></td> <td></td> <td colspan="8" style="text-align: center;"> <table border="1" style="width: 100%; border-collapse: collapse; text-align: center;"> <tr> <td
style="width: 10%;"></td> <td style="width: 10%;"></td> <td style="width: 10%;"></td> <td style="width: 10%;"></td> <td style="width: 10%;"></td> <td style="width: 10%;"></td> <td style="width: 10%;"></td> <td style="width: 10%;"></td> <td style="width: 10%;"></td> <td style="width: 10%;"></td> </tr> <tr> <td></td> <td></td> <td colspan="8" style="text-align: center;"> <table border="1" style="width: 100%; border-collapse: collapse; text-align: center;"> <tr> <td style="width: 10%;"></td> <td style="width: 10%;"></td> <td style="width: 10%;"></td> <td style="width: 10%;"></td> <td style="width: 10%;"></td> <td style="width: 10%;"></td> <td style="width: 10%;"></td> <td style="width: 10%;"></td> <td style="width: 10%;"></td> <td style="width: 10%;"></td> </tr> <tr> <td></td> <td></td> <td colspan="8" style="text-align: center;"> <table border="1" style="width: 100%; border-collapse: collapse; text-align: center;"> <tr> <td style="width: 10%;"></td> <td style="width: 10%;"></td> <td style="width: 10%;"></td> <td style="width: 10%;"></td> <td style="width: 10%;"></td> <td style="width: 10%;"></td> <td style="width: 10%;"></td> <td style="width: 10%;"></td> <td style="width: 10%;"></td> <td style="width: 10%;"></td> </tr> <tr> <td></td> <td></td> <td colspan="8" style="text-align: center;"> <table border="1" style="width: 100%; border-collapse: collapse; text-align: center;"> <tr> <td style="width: 10%;"></td> <td style="width: 10%;"></td> <td style="width: 10%;"></td> <td style="width: 10%;"></td> <td style="width: 10%;"></td> <td style="width: 10%;"></td> <td style="width: 10%;"></td> <td style="width: 10%;"></td> <td style="width: 10%;"></td> <td style="width: 10%;"></td> </tr> <tr> <td></td> <td></td> <td colspan="8" style="text-align: center;"> <table border="1" style="width: 100%; border-collapse: collapse; text-align: center;"> <tr> </tr></table></td></tr></table></td></tr></table></td></tr></table></td></tr></table></td></tr></table></td></tr></table></td></tr></table></td></tr></table></td></tr></table></td></tr></table></td></tr></table></td></tr></table></td></tr></table></td></tr></table></td></tr></table></td></tr></table></td></tr></table></td></tr></table></td></tr></table></td></tr></table></td></tr></table></td></tr></table></td></tr></table></td></tr></table></td></tr></table></td></tr></table></td></tr></table></td></tr></table></td></tr></table></td></tr></table></td></tr></table></td></tr></table></td></tr></table></td></tr></table></td></tr></table></td></tr></table></td></tr></table></td></tr></table></td></tr></table></td></tr></table></td></tr></table></td></tr></table>
 | | | | | | | | | | | | | | | | | | | | <table border="1" style="width: 100%; border-collapse: collapse; text-align: center;"> <tr> <td style="width: 10%;"></td> <td style="width: 10%;"></td> <td style="width: 10%;"></td> <td style="width: 10%;"></td> <td style="width: 10%;"></td> <td style="width: 10%;"></td> <td style="width: 10%;"></td> <td style="width: 10%;"></td> <td style="width: 10%;"></td> <td style="width: 10%;"></td> </tr> <tr> <td></td> <td></td> <td colspan="8" style="text-align: center;"> <table border="1" style="width: 100%; border-collapse: collapse; text-align: center;"> <tr> <td style="width: 10%;"></td> <td style="width: 10%;"></td> <td style="width: 10%;"></td> <td style="width: 10%;"></td> <td style="width: 10%;"></td> <td style="width: 10%;"></td> <td style="width: 10%;"></td> <td style="width: 10%;"></td> <td style="width: 10%;"></td> <td style="width: 10%;"></td> </tr> <tr> <td></td> <td></td> <td colspan="8" style="text-align: center;"> <table border="1" style="width: 100%; border-collapse: collapse; text-align: center;"> <tr> <td style="width: 10%;"></td> <td style="width: 10%;"></td> <td style="width: 10%;"></td> <td style="width: 10%;"></td> <td style="width: 10%;"></td> <td style="width: 10%;"></td> <td style="width: 10%;"></td> <td style="width: 10%;"></td> <td style="width: 10%;"></td> <td style="width: 10%;"></td> </tr> <tr> <td></td> <td></td> <td colspan="8" style="text-align: center;"> <table border="1" style="width: 100%; border-collapse: collapse; text-align: center;"> <tr> <td style="width: 10%;"></td> <td style="width: 10%;"></td> <td style="width: 10%;"></td> <td style="width: 10%;"></td> <td style="width: 10%;"></td> <td style="width: 10%;"></td> <td style="width: 10%;"></td> <td style="width: 10%;"></td> <td style="width: 10%;"></td> <td style="width: 10%;"></td> </tr> <tr> <td></td> <td></td> <td colspan="8" style="text-align: center;"> <table border="1" style="width: 100%; border-collapse: collapse; text-align: center;"> <tr> <td style="width: 10%;"></td> <td style="width: 10%;"></td> <td style="width: 10%;"></td> <td style="width: 10%;"></td> <td style="width: 10%;"></td> <td style="width: 10%;"></td> <td style="width: 10%;"></td> <td style="width: 10%;"></td> <td style="width: 10%;"></td> <td style="width: 10%;"></td> </tr> <tr> <td></td> <td></td> <td colspan="8" style="text-align: center;"> <table border="1" style="width: 100%; border-collapse: collapse; text-align: center;"> <tr> <td style="width: 10%;"></td> <td style="width: 10%;"></td> <td style="width: 10%;"></td> <td style="width: 10%;"></td> <td style="width: 10%;"></td> <td style="width: 10%;"></td> <td style="width: 10%;"></td> <td style="width: 10%;"></td> <td style="width: 10%;"></td> <td style="width: 10%;"></td> </tr> <tr> <td></td> <td></td> <td colspan="8" style="text-align: center;"> <table border="1" style="width: 100%; border-collapse: collapse; text-align: center;"> <tr> <td style="width: 10%;"></td> <td style="width: 10%;"></td> <td style="width: 10%;"></td> <td style="width: 10%;"></td> <td style="width: 10%;"></td> <td style="width: 10%;"></td> <td style="width: 10%;"></td> <td style="width: 10%;"></td> <td style="width: 10%;"></td> <td style="width: 10%;"></td> </tr> <tr> <td></td> <td></td> <td colspan="8" style="text-align: center;"> <table border="1" style="width: 100%; border-collapse: collapse; text-align: center;"> <tr> <td style="width: 10%;"></td> <td style="width: 10%;"></td> <td style="width: 10%;"></td> <td style="width: 10%;"></td> <td style="width: 10%;"></td> <td style="width: 10%;"></td> <td style="width: 10%;"></td> <td style="width: 10%;"></td> <td style="width: 10%;"></td> <td style="width: 10%;"></td> </tr> <tr> <td></td> <td></td> <td colspan="8" style="text-align: center;"> <table border="1" style="width: 100%; border-collapse: collapse; text-align: center;"> <tr> <td style="width: 10%;"></td> <td style="width: 10%;"></td> <td style="width: 10%;"></td> <td style="width: 10%;"></td> <td style="width: 10%;"></td> <td style="width: 10%;"></td> <td style="width: 10%;"></td> <td style="width: 10%;"></td> <td style="width: 10%;"></td> <td style="width: 10%;"></td> </tr> <tr> <td></td> <td></td> <td colspan="8" style="text-align: center;"> <table border="1" style="width: 100%; border-collapse: collapse; text-align: center;"> <tr> <td style="width: 10%;"></td> <td style="width: 10%;"></td> <td style="width: 10%;"></td> <td style="width: 10%;"></td> <td style="width: 10%;"></td> <td style="width: 10%;"></td> <td style="width: 10%;"></td> <td style="width: 10%;"></td> <td style="width: 10%;"></td> <td style="width: 10%;"></td> </tr> <tr> <td></td> <td></td> <td colspan="8" style="text-align: center;"> <table border="1" style="width: 100%; border-collapse: collapse; text-align: center;"> <tr> <td style="width: 10%;"></td> <td style="width: 10%;"></td> <td style="width: 10%;"></td> <td style="width: 10%;"></td> <td style="width: 10%;"></td> <td style="width: 10%;"></td> <td style="width: 10%;"></td> <td style="width: 10%;"></td> <td style="width: 10%;"></td> <td style="width: 10%;"></td> </tr> <tr> <td></td> <td></td> <td colspan="8" style="text-align: center;"> <table border="1" style="width: 100%; border-collapse: collapse; text-align: center;"> <tr> <td style="width: 10%;"></td> <td style="width: 10%;"></td> <td style="width: 10%;"></td> <td style="width: 10%;"></td> <td style="width: 10%;"></td> <td style="width: 10%;"></td> <td style="width: 10%;"></td> <td style="width: 10%;"></td> <td style="width: 10%;"></td> <td style="width: 10%;"></td> </tr> <tr> <td></td> <td></td> <td colspan="8" style="text-align: center;"> <table border="1" style="width: 100%; border-collapse: collapse; text-align: center;"> <tr> <td style="width: 10%;"></td> <td style="width: 10%;"></td> <td style="width: 10%;"></td> <td style="width: 10%;"></td> <td style="width: 10%;"></td> <td style="width: 10%;"></td> <td style="width: 10%;"></td> <td style="width: 10%;"></td> <td style="width: 10%;"></td> <td style="width: 10%;"></td> </tr> <tr> <td></td> <td></td> <td colspan="8" style="text-align: center;"> <table border="1" style="width: 100%; border-collapse: collapse; text-align: center;"> <tr> <td style="width: 10%;"></td> <td style="width: 10%;"></td> <td style="width: 10%;"></td> <td style="width: 10%;"></td> <td style="width: 10%;"></td> <td style="width: 10%;"></td> <td style="width: 10%;"></td> <td style="width: 10%;"></td> <td style="width: 10%;"></td> <td style="width: 10%;"></td> </tr> <tr> <td></td> <td></td> <td colspan="8" style="text-align: center;"> <table border="1" style="width: 100%; border-collapse: collapse; text-align: center;"> <tr> <td style="width: 10%;"></td> <td style="width: 10%;"></td> <td style="width: 10%;"></td> <td style="width: 10%;"></td> <td style="width: 10%;"></td> <td style="width: 10%;"></td> <td style="width: 10%;"></td> <td style="width: 10%;"></td> <td style="width: 10%;"></td> <td style="width: 10%;"></td> </tr> <tr> <td></td> <td></td> <td colspan="8" style="text-align: center;"> <table border="1" style="width: 100%; border-collapse: collapse; text-align: center;"> <tr> <td style="width: 10%;"></td> <td style="width: 10%;"></td> <td style="width: 10%;"></td> <td style="width: 10%;"></td> <td style="width: 10%;"></td> <td style="width: 10%;"></td> <td style="width: 10%;"></td> <td style="width: 10%;"></td> <td style="width: 10%;"></td> <td style="width: 10%;"></td> </tr> <tr> <td></td> <td></td> <td colspan="8" style="text-align: center;"> <table border="1" style="width: 100%; border-collapse: collapse; text-align: center;"> <tr>
<td style="width: 10%;"></td> <td style="width: 10%;"></td> <td style="width: 10%;"></td> <td style="width: 10%;"></td> <td style="width: 10%;"></td> <td style="width: 10%;"></td> <td style="width: 10%;"></td> <td style="width: 10%;"></td> <td style="width: 10%;"></td> <td style="width: 10%;"></td> </tr> <tr> <td></td> <td></td> <td colspan="8" style="text-align: center;"> <table border="1" style="width: 100%; border-collapse: collapse; text-align: center;"> <tr> <td style="width: 10%;"></td> <td style="width: 10%;"></td> <td style="width: 10%;"></td> <td style="width: 10%;"></td> <td style="width: 10%;"></td> <td style="width: 10%;"></td> <td style="width: 10%;"></td> <td style="width: 10%;"></td> <td style="width: 10%;"></td> <td style="width: 10%;"></td> </tr> <tr> <td></td> <td></td> <td colspan="8" style="text-align: center;"> <table border="1" style="width: 100%; border-collapse: collapse; text-align: center;"> <tr> <td style="width: 10%;"></td> <td style="width: 10%;"></td> <td style="width: 10%;"></td> <td style="width: 10%;"></td> <td style="width: 10%;"></td> <td style="width: 10%;"></td> <td style="width: 10%;"></td> <td style="width: 10%;"></td> <td style="width: 10%;"></td> <td style="width: 10%;"></td> </tr> <tr> <td></td> <td></td> <td colspan="8" style="text-align: center;"> <table border="1" style="width: 100%; border-collapse: collapse; text-align: center;"> <tr> <td style="width: 10%;"></td> <td style="width: 10%;"></td> <td style="width: 10%;"></td> <td style="width: 10%;"></td> <td style="width: 10%;"></td> <td style="width: 10%;"></td> <td style="width: 10%;"></td> <td style="width: 10%;"></td> <td style="width: 10%;"></td> <td style="width: 10%;"></td> </tr> <tr> <td></td> <td></td> <td colspan="8" style="text-align: center;"> <table border="1" style="width: 100%; border-collapse: collapse; text-align: center;"> <tr> <td style="width: 10%;"></td> <td style="width: 10%;"></td> <td style="width: 10%;"></td> <td style="width: 10%;"></td> <td style="width: 10%;"></td> <td style="width: 10%;"></td> <td style="width: 10%;"></td> <td style="width: 10%;"></td> <td style="width: 10%;"></td> <td style="width: 10%;"></td> </tr> <tr> <td></td> <td></td> <td colspan="8" style="text-align: center;"> <table border="1" style="width: 100%; border-collapse: collapse; text-align: center;"> <tr> <td style="width: 10%;"></td> <td style="width: 10%;"></td> <td style="width: 10%;"></td> <td style="width: 10%;"></td> <td style="width: 10%;"></td> <td style="width: 10%;"></td> <td style="width: 10%;"></td> <td style="width: 10%;"></td> <td style="width: 10%;"></td> <td style="width: 10%;"></td> </tr> <tr> <td></td> <td></td> <td colspan="8" style="text-align: center;"> <table border="1" style="width: 100%; border-collapse: collapse; text-align: center;"> <tr> <td style="width: 10%;"></td> <td style="width: 10%;"></td> <td style="width: 10%;"></td> <td style="width: 10%;"></td> <td style="width: 10%;"></td> <td style="width: 10%;"></td> <td style="width: 10%;"></td> <td style="width: 10%;"></td> <td style="width: 10%;"></td> <td style="width: 10%;"></td> </tr> <tr> <td></td> <td></td> <td colspan="8" style="text-align: center;"> <table border="1" style="width: 100%; border-collapse: collapse; text-align: center;"> <tr> <td style="width: 10%;"></td> <td style="width: 10%;"></td> <td style="width: 10%;"></td> <td style="width: 10%;"></td> <td style="width: 10%;"></td> <td style="width: 10%;"></td> <td style="width: 10%;"></td> <td style="width: 10%;"></td> <td style="width: 10%;"></td> <td style="width: 10%;"></td> </tr> <tr> <td></td> <td></td> <td colspan="8" style="text-align: center;"> <table border="1" style="width: 100%; border-collapse: collapse; text-align: center;"> <tr> <td style="width: 10%;"></td> <td style="width: 10%;"></td> <td style="width: 10%;"></td> <td style="width: 10%;"></td> <td style="width: 10%;"></td> <td style="width: 10%;"></td> <td style="width: 10%;"></td> <td style="width: 10%;"></td> <td style="width: 10%;"></td> <td style="width: 10%;"></td> </tr> <tr> <td></td> <td></td> <td colspan="8" style="text-align: center;"> <table border="1" style="width: 100%; border-collapse: collapse; text-align: center;"> <tr> <td style="width: 10%;"></td> <td style="width: 10%;"></td> <td style="width: 10%;"></td> <td style="width: 10%;"></td> <td style="width: 10%;"></td> <td style="width: 10%;"></td> <td style="width: 10%;"></td> <td style="width: 10%;"></td> <td style="width: 10%;"></td> <td style="width: 10%;"></td> </tr> <tr> <td></td> <td></td> <td colspan="8" style="text-align: center;"> <table border="1" style="width: 100%; border-collapse: collapse; text-align: center;"> <tr> <td style="width: 10%;"></td> <td style="width: 10%;"></td> <td style="width: 10%;"></td> <td style="width: 10%;"></td> <td style="width: 10%;"></td> <td style="width: 10%;"></td> <td style="width: 10%;"></td> <td style="width: 10%;"></td> <td style="width: 10%;"></td> <td style="width: 10%;"></td> </tr> <tr> <td></td> <td></td> <td colspan="8" style="text-align: center;"> <table border="1" style="width: 100%; border-collapse: collapse; text-align: center;"> <tr> <td style="width: 10%;"></td> <td style="width: 10%;"></td> <td style="width: 10%;"></td> <td style="width: 10%;"></td> <td style="width: 10%;"></td> <td style="width: 10%;"></td> <td style="width: 10%;"></td> <td style="width: 10%;"></td> <td style="width: 10%;"></td> <td style="width: 10%;"></td> </tr> <tr> <td></td> <td></td> <td colspan="8" style="text-align: center;"> <table border="1" style="width: 100%; border-collapse: collapse; text-align: center;"> <tr> <td style="width: 10%;"></td> <td style="width: 10%;"></td> <td style="width: 10%;"></td> <td style="width: 10%;"></td> <td style="width: 10%;"></td> <td style="width: 10%;"></td> <td style="width: 10%;"></td> <td style="width: 10%;"></td> <td style="width: 10%;"></td> <td style="width: 10%;"></td> </tr> <tr> <td></td> <td></td> <td colspan="8" style="text-align: center;"> <table border="1" style="width: 100%; border-collapse: collapse; text-align: center;"> <tr> <td style="width: 10%;"></td> <td style="width: 10%;"></td> <td style="width: 10%;"></td> <td style="width: 10%;"></td> <td style="width: 10%;"></td> <td style="width: 10%;"></td> <td style="width: 10%;"></td> <td style="width: 10%;"></td> <td style="width: 10%;"></td> <td style="width: 10%;"></td> </tr> <tr> <td></td> <td></td> <td colspan="8" style="text-align: center;"> <table border="1" style="width: 100%; border-collapse: collapse; text-align: center;"> <tr> <td style="width: 10%;"></td> <td style="width: 10%;"></td> <td style="width: 10%;"></td> <td style="width: 10%;"></td> <td style="width: 10%;"></td> <td style="width: 10%;"></td> <td style="width: 10%;"></td> <td style="width: 10%;"></td> <td style="width: 10%;"></td> <td style="width: 10%;"></td> </tr> <tr> <td></td> <td></td> <td colspan="8" style="text-align: center;"> <table border="1" style="width: 100%; border-collapse: collapse; text-align: center;"> <tr> <td style="width: 10%;"></td> <td style="width: 10%;"></td> <td style="width: 10%;"></td> <td style="width: 10%;"></td> <td style="width: 10%;"></td> <td style="width: 10%;"></td> <td style="width: 10%;"></td> <td style="width: 10%;"></td> <td style="width: 10%;"></td> <td style="width: 10%;"></td> </tr> <tr> <td></td> <td></td> <td colspan="8" style="text-align: center;"> <table border="1" style="width: 100%; border-collapse: collapse; text-align: center;"> <tr> <td style="width: 10%;"></td> <td style="width: 10%;"></td> <td style="width: 10%;"></td> <td style="width: 10%;"></td> <td style="width: 10%;"></td> <td style="width: 10%;"></td> <td style="width: 10%;"></td> <td style="width: 10%;"></td> <td style="width: 10%;"></td> <td style="width: 10%;"></td> </tr> <tr> <td></td> <td></td> <td colspan="8" style="text-align: center;"> <table border="1" style="width: 100%; border-collapse: collapse; text-align: center;"> <tr> <td style="width: 10%;"></td> <td style="width: 10%;"></td> <td style="width: 10%;"></td> <td style="width: 10%;"></td> <td style="width: 10%;"></td> <td style="width: 10%;"></td> <td style="width: 10%;"></td> <td style="width: 10%;"></td> <td style="width: 10%;"></td> <td style="width: 10%;"></td> </tr> <tr> <td></td> <td></td> <td colspan="8" style="text-align: center;"> <table border="1" style="width: 100%; border-collapse: collapse; text-align: center;"> <tr> <td style="width: 10%;"></td> <td style="width: 10%;"></td> <td style="width: 10%;"></td> <td style="width: 10%;"></td> <td style="width: 10%;"></td> <td style="width: 10%;"></td> <td style="width: 10%;"></td> <td style="width: 10%;"></td> <td style="width: 10%;"></td> <td style="width: 10%;"></td> </tr> <tr> <td></td> <td></td> <td colspan="8" style="text-align: center;"> <table border="1" style="width: 100%; border-collapse: collapse; text-align: center;"> <tr> <td style="width: 10%;"></td> <td style="width: 10%;"></td> <td style="width: 10%;"></td> <td style="width: 10%;"></td> <td style="width: 10%;"></td> <td style="width: 10%;"></td> <td style="width: 10%;"></td> <td style="width: 10%;"></td> <td style="width: 10%;"></td> <td style="width: 10%;"></td> </tr> <tr> <td></td> <td></td> <td colspan="8" style="text-align: center;"> <table border="1" style="width: 100%; border-collapse: collapse; text-align: center;"> <tr> <td style="width: 10%;"></td> <td style="width: 10%;"></td> <td style="width: 10%;"></td> <td style="width: 10%;"></td> <td style="width: 10%;"></td> <td style="width: 10%;"></td> <td style="width: 10%;"></td> <td style="width: 10%;"></td> <td style="width: 10%;"></td> <td style="width: 10%;"></td> </tr> <tr> <td></td> <td></td> <td colspan="8" style="text-align: center;"> <table border="1" style="width: 100%; border-collapse: collapse; text-align: center;"> <tr> <td style="width: 10%;"></td> <td style="width: 10%;"></td> <td style="width: 10%;"></td> <td style="width: 10%;"></td> <td style="width: 10%;"></td> <td style="width:
10%;"></td> <td style="width: 10%;"></td> <td style="width: 10%;"></td> <td style="width: 10%;"></td> <td style="width: 10%;"></td> </tr> <tr> <td></td> <td></td> <td colspan="8" style="text-align: center;"> <table border="1" style="width: 100%; border-collapse: collapse; text-align: center;"> <tr> <td style="width: 10%;"></td> <td style="width: 10%;"></td> <td style="width: 10%;"></td> <td style="width: 10%;"></td> <td style="width: 10%;"></td> <td style="width: 10%;"></td> <td style="width: 10%;"></td> <td style="width: 10%;"></td> <td style="width: 10%;"></td> <td style="width: 10%;"></td> </tr> <tr> <td></td> <td></td> <td colspan="8" style="text-align: center;"> <table border="1" style="width: 100%; border-collapse: collapse; text-align: center;"> <tr> <td style="width: 10%;"></td> <td style="width: 10%;"></td> <td style="width: 10%;"></td> <td style="width: 10%;"></td> <td style="width: 10%;"></td> <td style="width: 10%;"></td> <td style="width: 10%;"></td> <td style="width: 10%;"></td> <td style="width: 10%;"></td> <td style="width: 10%;"></td> </tr> <tr> <td></td> <td></td> <td colspan="8" style="text-align: center;"> <table border="1" style="width: 100%; border-collapse: collapse; text-align: center;"> <tr> <td style="width: 10%;"></td> <td style="width: 10%;"></td> <td style="width: 10%;"></td> <td style="width: 10%;"></td> <td style="width: 10%;"></td> <td style="width: 10%;"></td> <td style="width: 10%;"></td> <td style="width: 10%;"></td> <td style="width: 10%;"></td> <td style="width: 10%;"></td> </tr> <tr> <td></td> <td></td> <td colspan="8" style="text-align: center;"> <table border="1" style="width: 100%; border-collapse: collapse; text-align: center;"> <tr> </tr></table></td></tr></table></td></tr></table></td></tr></table></td></tr></table></td></tr></table></td></tr></table></td></tr></table></td></tr></table></td></tr></table></td></tr></table></td></tr></table></td></tr></table></td></tr></table></td></tr></table></td></tr></table></td></tr></table></td></tr></table></td></tr></table></td></tr></table></td></tr></table></td></tr></table></td></tr></table></td></tr></table></td></tr></table></td></tr></table></td></tr></table></td></tr></table></td></tr></table></td></tr></table></td></tr></table></td></tr></table></td></tr></table></td></tr></table></td></tr></table></td></tr></table></td></tr></table></td></tr></table></td></tr></table></td></tr></table></td></tr></table></td></tr></table>
 | | | | | | | | | | | | | | | | | | | | <table border="1" style="width: 100%; border-collapse: collapse; text-align: center;"> <tr> <td style="width: 10%;"></td> <td style="width: 10%;"></td> <td style="width: 10%;"></td> <td style="width: 10%;"></td> <td style="width: 10%;"></td> <td style="width: 10%;"></td> <td style="width: 10%;"></td> <td style="width: 10%;"></td> <td style="width: 10%;"></td> <td style="width: 10%;"></td> </tr> <tr> <td></td> <td></td> <td colspan="8" style="text-align: center;"> <table border="1" style="width: 100%; border-collapse: collapse; text-align: center;"> <tr> <td style="width: 10%;"></td> <td style="width: 10%;"></td> <td style="width: 10%;"></td> <td style="width: 10%;"></td> <td style="width: 10%;"></td> <td style="width: 10%;"></td> <td style="width: 10%;"></td> <td style="width: 10%;"></td> <td style="width: 10%;"></td> <td style="width: 10%;"></td> </tr> <tr> <td></td> <td></td> <td colspan="8" style="text-align: center;"> <table border="1" style="width: 100%; border-collapse: collapse; text-align: center;"> <tr> <td style="width: 10%;"></td> <td style="width: 10%;"></td> <td style="width: 10%;"></td> <td style="width: 10%;"></td> <td style="width: 10%;"></td> <td style="width: 10%;"></td> <td style="width: 10%;"></td> <td style="width: 10%;"></td> <td style="width: 10%;"></td> <td style="width: 10%;"></td> </tr> <tr> <td></td> <td></td> <td colspan="8" style="text-align: center;"> <table border="1" style="width: 100%; border-collapse: collapse; text-align: center;"> <tr> <td style="width: 10%;"></td> <td style="width: 10%;"></td> <td style="width: 10%;"></td> <td style="width: 10%;"></td> <td style="width: 10%;"></td> <td style="width: 10%;"></td> <td style="width: 10%;"></td> <td style="width: 10%;"></td> <td style="width: 10%;"></td> <td style="width: 10%;"></td> </tr> <tr> <td></td> <td></td> <td colspan="8" style="text-align: center;"> <table border="1" style="width: 100%; border-collapse: collapse; text-align: center;"> <tr> <td style="width: 10%;"></td> <td style="width: 10%;"></td> <td style="width: 10%;"></td> <td style="width: 10%;"></td> <td style="width: 10%;"></td> <td style="width: 10%;"></td> <td style="width: 10%;"></td> <td style="width: 10%;"></td> <td style="width: 10%;"></td> <td style="width: 10%;"></td> </tr> <tr> <td></td> <td></td> <td colspan="8" style="text-align: center;"> <table border="1" style="width: 100%; border-collapse: collapse; text-align: center;"> <tr> <td style="width: 10%;"></td> <td style="width: 10%;"></td> <td style="width: 10%;"></td> <td style="width: 10%;"></td> <td style="width: 10%;"></td> <td style="width: 10%;"></td> <td style="width: 10%;"></td> <td style="width: 10%;"></td> <td style="width: 10%;"></td> <td style="width: 10%;"></td> </tr> <tr> <td></td> <td></td> <td colspan="8" style="text-align: center;"> <table border="1" style="width: 100%; border-collapse: collapse; text-align: center;"> <tr> <td style="width: 10%;"></td> <td style="width: 10%;"></td> <td style="width: 10%;"></td> <td style="width: 10%;"></td> <td style="width: 10%;"></td> <td style="width: 10%;"></td> <td style="width: 10%;"></td> <td style="width: 10%;"></td> <td style="width: 10%;"></td> <td style="width: 10%;"></td> </tr> <tr> <td></td> <td></td> <td colspan="8" style="text-align: center;"> <table border="1" style="width: 100%; border-collapse: collapse; text-align: center;"> <tr> <td style="width: 10%;"></td> <td style="width: 10%;"></td> <td style="width: 10%;"></td> <td style="width: 10%;"></td> <td style="width: 10%;"></td> <td style="width: 10%;"></td> <td style="width: 10%;"></td> <td style="width: 10%;"></td> <td style="width: 10%;"></td> <td style="width: 10%;"></td> </tr> <tr> <td></td> <td></td> <td colspan="8" style="text-align: center;"> <table border="1" style="width: 100%; border-collapse: collapse; text-align: center;"> <tr> <td style="width: 10%;"></td> <td style="width: 10%;"></td> <td style="width: 10%;"></td> <td style="width: 10%;"></td> <td style="width: 10%;"></td> <td style="width: 10%;"></td> <td style="width: 10%;"></td> <td style="width: 10%;"></td> <td style="width: 10%;"></td> <td style="width: 10%;"></td> </tr> <tr> <td></td> <td></td> <td colspan="8" style="text-align: center;"> <table border="1" style="width: 100%; border-collapse: collapse; text-align: center;"> <tr> <td style="width: 10%;"></td> <td style="width: 10%;"></td> <td style="width: 10%;"></td> <td style="width: 10%;"></td> <td style="width: 10%;"></td> <td style="width: 10%;"></td> <td style="width: 10%;"></td> <td style="width: 10%;"></td> <td style="width: 10%;"></td> <td style="width: 10%;"></td> </tr> <tr> <td></td> <td></td> <td colspan="8" style="text-align: center;"> <table border="1" style="width: 100%; border-collapse: collapse; text-align: center;"> <tr> <td style="width: 10%;"></td> <td style="width: 10%;"></td> <td style="width: 10%;"></td> <td style="width: 10%;"></td> <td style="width: 10%;"></td> <td style="width: 10%;"></td> <td style="width: 10%;"></td> <td style="width: 10%;"></td> <td style="width: 10%;"></td> <td style="width: 10%;"></td> </tr> <tr> <td></td> <td></td> <td colspan="8" style="text-align: center;"> <table border="1" style="width: 100%; border-collapse: collapse; text-align: center;"> <tr> <td style="width: 10%;"></td> <td style="width: 10%;"></td> <td style="width: 10%;"></td> <td style="width: 10%;"></td> <td style="width: 10%;"></td> <td style="width: 10%;"></td> <td style="width: 10%;"></td> <td style="width: 10%;"></td> <td style="width: 10%;"></td> <td style="width: 10%;"></td> </tr> <tr> <td></td> <td></td> <td colspan="8" style="text-align: center;"> <table border="1" style="width: 100%; border-collapse: collapse; text-align: center;"> <tr> <td style="width: 10%;"></td> <td style="width: 10%;"></td> <td style="width: 10%;"></td> <td style="width: 10%;"></td> <td style="width: 10%;"></td> <td style="width: 10%;"></td> <td style="width: 10%;"></td> <td style="width: 10%;"></td> <td style="width: 10%;"></td> <td style="width: 10%;"></td> </tr> <tr> <td></td> <td></td> <td colspan="8" style="text-align: center;"> <table border="1" style="width: 100%; border-collapse: collapse; text-align: center;"> <tr> <td style="width: 10%;"></td> <td style="width: 10%;"></td> <td style="width: 10%;"></td> <td style="width: 10%;"></td> <td style="width: 10%;"></td> <td style="width: 10%;"></td> <td style="width: 10%;"></td> <td style="width: 10%;"></td> <td style="width: 10%;"></td> <td style="width: 10%;"></td> </tr> <tr> <td></td> <td></td> <td colspan="8" style="text-align: center;"> <table border="1" style="width: 100%; border-collapse: collapse; text-align: center;"> <tr> <td style="width: 10%;"></td> <td style="width: 10%;"></td> <td style="width: 10%;"></td> <td style="width: 10%;"></td> <td style="width: 10%;"></td> <td style="width: 10%;"></td> <td style="width: 10%;"></td> <td style="width: 10%;"></td> <td style="width: 10%;"></td> <td style="width: 10%;"></td> </tr> <tr> <td></td> <td></td> <td colspan="8" style="text-align: center;"> <table border="1" style="width: 100%; border-collapse: collapse; text-align: center;"> <tr> <td style="width: 10%;"></td> <td style="width: 10%;"></td> <td style="width: 10%;"></td> <td style="width: 10%;"></td> <td style="width: 10%;"></td> <td style="width: 10%;"></td> <td style="width: 10%;"></td> <td style="width: 10%;"></td> <td style="width: 10%;"></td> <td style="width: 10%;"></td> </tr> <tr> <td></td> <td></td> <td colspan="8" style="text-align: center;"> <table border="1" style="width: 100%; border-collapse: collapse; text-align: center;"> <tr> <td style="width: 10%;"></td> <td style="width: 10%;"></td> <td style="width: 10%;"></td> <td style="width: 10%;"></td> <td style="width: 10%;"></td> <td style="width: 10%;"></td> <td
style="width: 10%;"></td> <td style="width: 10%;"></td> <td style="width: 10%;"></td> <td style="width: 10%;"></td> </tr> <tr> <td></td> <td></td> <td colspan="8" style="text-align: center;"> <table border="1" style="width: 100%; border-collapse: collapse; text-align: center;"> <tr> <td style="width: 10%;"></td> <td style="width: 10%;"></td> <td style="width: 10%;"></td> <td style="width: 10%;"></td> <td style="width: 10%;"></td> <td style="width: 10%;"></td> <td style="width: 10%;"></td> <td style="width: 10%;"></td> <td style="width: 10%;"></td> <td style="width: 10%;"></td> </tr> <tr> <td></td> <td></td> <td colspan="8" style="text-align: center;"> <table border="1" style="width: 100%; border-collapse: collapse; text-align: center;"> <tr> <td style="width: 10%;"></td> <td style="width: 10%;"></td> <td style="width: 10%;"></td> <td style="width: 10%;"></td> <td style="width: 10%;"></td> <td style="width: 10%;"></td> <td style="width: 10%;"></td> <td style="width: 10%;"></td> <td style="width: 10%;"></td> <td style="width: 10%;"></td> </tr> <tr> <td></td> <td></td> <td colspan="8" style="text-align: center;"> <table border="1" style="width: 100%; border-collapse: collapse; text-align: center;"> <tr> <td style="width: 10%;"></td> <td style="width: 10%;"></td> <td style="width: 10%;"></td> <td style="width: 10%;"></td> <td style="width: 10%;"></td> <td style="width: 10%;"></td> <td style="width: 10%;"></td> <td style="width: 10%;"></td> <td style="width: 10%;"></td> <td style="width: 10%;"></td> </tr> <tr> <td></td> <td></td> <td colspan="8" style="text-align: center;"> <table border="1" style="width: 100%; border-collapse: collapse; text-align: center;"> <tr> <td style="width: 10%;"></td> <td style="width: 10%;"></td> <td style="width: 10%;"></td> <td style="width: 10%;"></td> <td style="width: 10%;"></td> <td style="width: 10%;"></td> <td style="width: 10%;"></td> <td style="width: 10%;"></td> <td style="width: 10%;"></td> <td style="width: 10%;"></td> </tr> <tr> <td></td> <td></td> <td colspan="8" style="text-align: center;"> <table border="1" style="width: 100%; border-collapse: collapse; text-align: center;"> <tr> <td style="width: 10%;"></td> <td style="width: 10%;"></td> <td style="width: 10%;"></td> <td style="width: 10%;"></td> <td style="width: 10%;"></td> <td style="width: 10%;"></td> <td style="width: 10%;"></td> <td style="width: 10%;"></td> <td style="width: 10%;"></td> <td style="width: 10%;"></td> </tr> <tr> <td></td> <td></td> <td colspan="8" style="text-align: center;"> <table border="1" style="width: 100%; border-collapse: collapse; text-align: center;"> <tr> <td style="width: 10%;"></td> <td style="width: 10%;"></td> <td style="width: 10%;"></td> <td style="width: 10%;"></td> <td style="width: 10%;"></td> <td style="width: 10%;"></td> <td style="width: 10%;"></td> <td style="width: 10%;"></td> <td style="width: 10%;"></td> <td style="width: 10%;"></td> </tr> <tr> <td></td> <td></td> <td colspan="8" style="text-align: center;"> <table border="1" style="width: 100%; border-collapse: collapse; text-align: center;"> <tr> <td style="width: 10%;"></td> <td style="width: 10%;"></td> <td style="width: 10%;"></td> <td style="width: 10%;"></td> <td style="width: 10%;"></td> <td style="width: 10%;"></td> <td style="width: 10%;"></td> <td style="width: 10%;"></td> <td style="width: 10%;"></td> <td style="width: 10%;"></td> </tr> <tr> <td></td> <td></td> <td colspan="8" style="text-align: center;"> <table border="1" style="width: 100%; border-collapse: collapse; text-align: center;"> <tr> <td style="width: 10%;"></td> <td style="width: 10%;"></td> <td style="width: 10%;"></td> <td style="width: 10%;"></td> <td style="width: 10%;"></td> <td style="width: 10%;"></td> <td style="width: 10%;"></td> <td style="width: 10%;"></td> <td style="width: 10%;"></td> <td style="width: 10%;"></td> </tr> <tr> <td></td> <td></td> <td colspan="8" style="text-align: center;"> <table border="1" style="width: 100%; border-collapse: collapse; text-align: center;"> <tr> <td style="width: 10%;"></td> <td style="width: 10%;"></td> <td style="width: 10%;"></td> <td style="width: 10%;"></td> <td style="width: 10%;"></td> <td style="width: 10%;"></td> <td style="width: 10%;"></td> <td style="width: 10%;"></td> <td style="width: 10%;"></td> <td style="width: 10%;"></td> </tr> <tr> <td></td> <td></td> <td colspan="8" style="text-align: center;"> <table border="1" style="width: 100%; border-collapse: collapse; text-align: center;"> <tr> <td style="width: 10%;"></td> <td style="width: 10%;"></td> <td style="width: 10%;"></td> <td style="width: 10%;"></td> <td style="width: 10%;"></td> <td style="width: 10%;"></td> <td style="width: 10%;"></td> <td style="width: 10%;"></td> <td style="width: 10%;"></td> <td style="width: 10%;"></td> </tr> <tr> <td></td> <td></td> <td colspan="8" style="text-align: center;"> <table border="1" style="width: 100%; border-collapse: collapse; text-align: center;"> <tr> <td style="width: 10%;"></td> <td style="width: 10%;"></td> <td style="width: 10%;"></td> <td style="width: 10%;"></td> <td style="width: 10%;"></td> <td style="width: 10%;"></td> <td style="width: 10%;"></td> <td style="width: 10%;"></td> <td style="width: 10%;"></td> <td style="width: 10%;"></td> </tr> <tr> <td></td> <td></td> <td colspan="8" style="text-align: center;"> <table border="1" style="width: 100%; border-collapse: collapse; text-align: center;"> <tr> <td style="width: 10%;"></td> <td style="width: 10%;"></td> <td style="width: 10%;"></td> <td style="width: 10%;"></td> <td style="width: 10%;"></td> <td style="width: 10%;"></td> <td style="width: 10%;"></td> <td style="width: 10%;"></td> <td style="width: 10%;"></td> <td style="width: 10%;"></td> </tr> <tr> <td></td> <td></td> <td colspan="8" style="text-align: center;"> <table border="1" style="width: 100%; border-collapse: collapse; text-align: center;"> <tr> <td style="width: 10%;"></td> <td style="width: 10%;"></td> <td style="width: 10%;"></td> <td style="width: 10%;"></td> <td style="width: 10%;"></td> <td style="width: 10%;"></td> <td style="width: 10%;"></td> <td style="width: 10%;"></td> <td style="width: 10%;"></td> <td style="width: 10%;"></td> </tr> <tr> <td></td> <td></td> <td colspan="8" style="text-align: center;"> <table border="1" style="width: 100%; border-collapse: collapse; text-align: center;"> <tr> <td style="width: 10%;"></td> <td style="width: 10%;"></td> <td style="width: 10%;"></td> <td style="width: 10%;"></td> <td style="width: 10%;"></td> <td style="width: 10%;"></td> <td style="width: 10%;"></td> <td style="width: 10%;"></td> <td style="width: 10%;"></td> <td style="width: 10%;"></td> </tr> <tr> <td></td> <td></td> <td colspan="8" style="text-align: center;"> <table border="1" style="width: 100%; border-collapse: collapse; text-align: center;"> <tr> <td style="width: 10%;"></td> <td style="width: 10%;"></td> <td style="width: 10%;"></td> <td style="width: 10%;"></td> <td style="width: 10%;"></td> <td style="width: 10%;"></td> <td style="width: 10%;"></td> <td style="width: 10%;"></td> <td style="width: 10%;"></td> <td style="width: 10%;"></td> </tr> <tr> <td></td> <td></td> <td colspan="8" style="text-align: center;"> <table border="1" style="width: 100%; border-collapse: collapse; text-align: center;"> <tr> <td style="width: 10%;"></td> <td style="width: 10%;"></td> <td style="width: 10%;"></td> <td style="width: 10%;"></td> <td style="width: 10%;"></td> <td style="width: 10%;"></td> <td style="width: 10%;"></td> <td style="width: 10%;"></td> <td style="width: 10%;"></td> <td style="width: 10%;"></td> </tr> <tr> <td></td> <td></td> <td colspan="8" style="text-align: center;"> <table border="1" style="width: 100%; border-collapse: collapse; text-align: center;"> <tr> <td style="width: 10%;"></td> <td style="width: 10%;"></td> <td style="width: 10%;"></td> <td style="width: 10%;"></td> <td style="width: 10%;"></td> <td style="width: 10%;"></td> <td style="width: 10%;"></td> <td style="width: 10%;"></td> <td style="width: 10%;"></td> <td style="width: 10%;"></td> </tr> <tr> <td></td> <td></td> <td colspan="8" style="text-align: center;"> <table border="1" style="width: 100%; border-collapse: collapse; text-align: center;"> <tr> <td style="width: 10%;"></td> <td style="width: 10%;"></td> <td style="width: 10%;"></td> <td style="width: 10%;"></td> <td style="width: 10%;"></td> <td style="width: 10%;"></td> <td style="width: 10%;"></td> <td style="width: 10%;"></td> <td style="width: 10%;"></td> <td style="width: 10%;"></td> </tr> <tr> <td></td> <td></td> <td colspan="8" style="text-align: center;"> <table border="1" style="width: 100%; border-collapse: collapse; text-align: center;"> <tr> <td style="width: 10%;"></td> <td style="width: 10%;"></td> <td style="width: 10%;"></td> <td style="width: 10%;"></td> <td style="width: 10%;"></td> <td style="width: 10%;"></td> <td style="width: 10%;"></td> <td style="width: 10%;"></td> <td style="width: 10%;"></td> <td style="width: 10%;"></td> </tr> <tr> <td></td> <td></td> <td colspan="8" style="text-align: center;"> <table border="1" style="width: 100%; border-collapse: collapse; text-align: center;"> <tr> <td style="width: 10%;"></td> <td style="width: 10%;"></td> <td style="width: 10%;"></td> <td style="width: 10%;"></td> <td style="width: 10%;"></td> <td style="width: 10%;"></td> <td style="width: 10%;"></td> <td style="width: 10%;"></td> <td style="width: 10%;"></td> <td style="width: 10%;"></td> </tr> <tr> <td></td> <td></td> <td colspan="8" style="text-align: center;"> <table border="1" style="width: 100%; border-collapse: collapse; text-align: center;"> <tr> <td style="width: 10%;"></td> <td style="width: 10%;"></td> <td style="width: 10%;"></td> <td style="width: 10%;"></td> <td style="width: 10%;"></td> <td style="width: 10%;"></td> <td style="width: 10%;"></td> <td style="width: 10%;"></td> <td style="width: 10%;"></td> <td style="width: 10%;"></td> </tr> <tr> <td></td> <td></td> <td colspan="8"
style="text-align: center;"> <table border="1" style="width: 100%; border-collapse: collapse; text-align: center;"> <tr> <td style="width: 10%;"></td> <td style="width: 10%;"></td> <td style="width: 10%;"></td> <td style="width: 10%;"></td> <td style="width: 10%;"></td> <td style="width: 10%;"></td> <td style="width: 10%;"></td> <td style="width: 10%;"></td> <td style="width: 10%;"></td> <td style="width: 10%;"></td> </tr> <tr> <td></td> <td></td> <td colspan="8" style="text-align: center;"> <table border="1" style="width: 100%; border-collapse: collapse; text-align: center;"> <tr> <td style="width: 10%;"></td> <td style="width: 10%;"></td> <td style="width: 10%;"></td> <td style="width: 10%;"></td> <td style="width: 10%;"></td> <td style="width: 10%;"></td> <td style="width: 10%;"></td> <td style="width: 10%;"></td> <td style="width: 10%;"></td> <td style="width: 10%;"></td> </tr> <tr> <td></td> <td></td> <td colspan="8" style="text-align: center;"> <table border="1" style="width: 100%; border-collapse: collapse; text-align: center;"> <tr> </tr></table></td></tr></table></td></tr></table></td></tr></table></td></tr></table></td></tr></table></td></tr></table></td></tr></table></td></tr></table></td></tr></table></td></tr></table></td></tr></table></td></tr></table></td></tr></table></td></tr></table></td></tr></table></td></tr></table></td></tr></table></td></tr></table></td></tr></table></td></tr></table></td></tr></table></td></tr></table></td></tr></table></td></tr></table></td></tr></table></td></tr></table></td></tr></table></td></tr></table></td></tr></table></td></tr></table></td></tr></table></td></tr></table></td></tr></table></td></tr></table></td></tr></table></td></tr></table></td></tr></table></td></tr></table></td></tr></table></td></tr></table>
 | | | | | | | | | | | | | | | | | | | | <table border="1" style="width: 100%; border-collapse: collapse; text-align: center;"> <tr> <td style="width: 10%;"></td> <td style="width: 10%;"></td> <td style="width: 10%;"></td> <td style="width: 10%;"></td> <td style="width: 10%;"></td> <td style="width: 10%;"></td> <td style="width: 10%;"></td> <td style="width: 10%;"></td> <td style="width: 10%;"></td> <td style="width: 10%;"></td> </tr> <tr> <td></td> <td></td> <td colspan="8" style="text-align: center;"> <table border="1" style="width: 100%; border-collapse: collapse; text-align: center;"> <tr> <td style="width: 10%;"></td> <td style="width: 10%;"></td> <td style="width: 10%;"></td> <td style="width: 10%;"></td> <td style="width: 10%;"></td> <td style="width: 10%;"></td> <td style="width: 10%;"></td> <td style="width: 10%;"></td> <td style="width: 10%;"></td> <td style="width: 10%;"></td> </tr> <tr> <td></td> <td></td> <td colspan="8" style="text-align: center;"> <table border="1" style="width: 100%; border-collapse: collapse; text-align: center;"> <tr> <td style="width: 10%;"></td> <td style="width: 10%;"></td> <td style="width: 10%;"></td> <td style="width: 10%;"></td> <td style="width: 10%;"></td> <td style="width: 10%;"></td> <td style="width: 10%;"></td> <td style="width: 10%;"></td> <td style="width: 10%;"></td> <td style="width: 10%;"></td> </tr> <tr> <td></td> <td></td> <td colspan="8" style="text-align: center;"> <table border="1" style="width: 100%; border-collapse: collapse; text-align: center;"> <tr> <td style="width: 10%;"></td> <td style="width: 10%;"></td> <td style="width: 10%;"></td> <td style="width: 10%;"></td> <td style="width: 10%;"></td> <td style="width: 10%;"></td> <td style="width: 10%;"></td> <td style="width: 10%;"></td> <td style="width: 10%;"></td> <td style="width: 10%;"></td> </tr> <tr> <td></td> <td></td> <td colspan="8" style="text-align: center;"> <table border="1" style="width: 100%; border-collapse: collapse; text-align: center;"> <tr> <td style="width: 10%;"></td> <td style="width: 10%;"></td> <td style="width: 10%;"></td> <td style="width: 10%;"></td> <td style="width: 10%;"></td> <td style="width: 10%;"></td> <td style="width: 10%;"></td> <td style="width: 10%;"></td> <td style="width: 10%;"></td> <td style="width: 10%;"></td> </tr> <tr> <td></td> <td></td> <td colspan="8" style="text-align: center;"> <table border="1" style="width: 100%; border-collapse: collapse; text-align: center;"> <tr> <td style="width: 10%;"></td> <td style="width: 10%;"></td> <td style="width: 10%;"></td> <td style="width: 10%;"></td> <td style="width: 10%;"></td> <td style="width: 10%;"></td> <td style="width: 10%;"></td> <td style="width: 10%;"></td> <td style="width: 10%;"></td> <td style="width: 10%;"></td> </tr> <tr> <td></td> <td></td> <td colspan="8" style="text-align: center;"> <table border="1" style="width: 100%; border-collapse: collapse; text-align: center;"> <tr> <td style="width: 10%;"></td> <td style="width: 10%;"></td> <td style="width: 10%;"></td> <td style="width: 10%;"></td> <td style="width: 10%;"></td> <td style="width: 10%;"></td> <td style="width: 10%;"></td> <td style="width: 10%;"></td> <td style="width: 10%;"></td> <td style="width: 10%;"></td> </tr> <tr> <td></td> <td></td> <td colspan="8" style="text-align: center;"> <table border="1" style="width: 100%; border-collapse: collapse; text-align: center;"> <tr> <td style="width: 10%;"></td> <td style="width: 10%;"></td> <td style="width: 10%;"></td> <td style="width: 10%;"></td> <td style="width: 10%;"></td> <td style="width: 10%;"></td> <td style="width: 10%;"></td> <td style="width: 10%;"></td> <td style="width: 10%;"></td> <td style="width: 10%;"></td> </tr> <tr> <td></td> <td></td> <td colspan="8" style="text-align: center;"> <table border="1" style="width: 100%; border-collapse: collapse; text-align: center;"> <tr> <td style="width: 10%;"></td> <td style="width: 10%;"></td> <td style="width: 10%;"></td> <td style="width: 10%;"></td> <td style="width: 10%;"></td> <td style="width: 10%;"></td> <td style="width: 10%;"></td> <td style="width: 10%;"></td> <td style="width: 10%;"></td> <td style="width: 10%;"></td> </tr> <tr> <td></td> <td></td> <td colspan="8" style="text-align: center;"> <table border="1" style="width: 100%; border-collapse: collapse; text-align: center;"> <tr> <td style="width: 10%;"></td> <td style="width: 10%;"></td> <td style="width: 10%;"></td> <td style="width: 10%;"></td> <td style="width: 10%;"></td> <td style="width: 10%;"></td> <td style="width: 10%;"></td> <td style="width: 10%;"></td> <td style="width: 10%;"></td> <td style="width: 10%;"></td> </tr> <tr> <td></td> <td></td> <td colspan="8" style="text-align: center;"> <table border="1" style="width: 100%; border-collapse: collapse; text-align: center;"> <tr> <td style="width: 10%;"></td> <td style="width: 10%;"></td> <td style="width: 10%;"></td> <td style="width: 10%;"></td> <td style="width: 10%;"></td> <td style="width: 10%;"></td> <td style="width: 10%;"></td> <td style="width: 10%;"></td> <td style="width: 10%;"></td> <td style="width: 10%;"></td> </tr> <tr> <td></td> <td></td> <td colspan="8" style="text-align: center;"> <table border="1" style="width: 100%; border-collapse: collapse; text-align: center;"> <tr> <td style="width: 10%;"></td> <td style="width: 10%;"></td> <td style="width: 10%;"></td> <td style="width: 10%;"></td> <td style="width: 10%;"></td> <td style="width: 10%;"></td> <td style="width: 10%;"></td> <td style="width: 10%;"></td> <td style="width: 10%;"></td> <td style="width: 10%;"></td> </tr> <tr> <td></td> <td></td> <td colspan="8" style="text-align: center;"> <table border="1" style="width: 100%; border-collapse: collapse; text-align: center;"> <tr> <td style="width: 10%;"></td> <td style="width: 10%;"></td> <td style="width: 10%;"></td> <td style="width: 10%;"></td> <td style="width: 10%;"></td> <td style="width: 10%;"></td> <td style="width: 10%;"></td> <td style="width: 10%;"></td> <td style="width: 10%;"></td> <td style="width: 10%;"></td> </tr> <tr> <td></td> <td></td> <td colspan="8" style="text-align: center;"> <table border="1" style="width: 100%; border-collapse: collapse; text-align: center;"> <tr> <td style="width: 10%;"></td> <td style="width: 10%;"></td> <td style="width: 10%;"></td> <td style="width: 10%;"></td> <td style="width: 10%;"></td> <td style="width: 10%;"></td> <td style="width: 10%;"></td> <td style="width: 10%;"></td> <td style="width: 10%;"></td> <td style="width: 10%;"></td> </tr> <tr> <td></td> <td></td> <td colspan="8" style="text-align: center;"> <table border="1" style="width: 100%; border-collapse: collapse; text-align: center;"> <tr> <td style="width: 10%;"></td> <td style="width: 10%;"></td> <td style="width: 10%;"></td> <td style="width: 10%;"></td> <td style="width: 10%;"></td> <td style="width: 10%;"></td> <td style="width: 10%;"></td> <td style="width: 10%;"></td> <td style="width: 10%;"></td> <td style="width: 10%;"></td> </tr> <tr> <td></td> <td></td> <td colspan="8" style="text-align: center;"> <table border="1" style="width: 100%; border-collapse: collapse; text-align: center;"> <tr> <td style="width: 10%;"></td> <td style="width: 10%;"></td> <td style="width: 10%;"></td> <td style="width: 10%;"></td> <td style="width: 10%;"></td> <td style="width: 10%;"></td> <td style="width: 10%;"></td> <td style="width: 10%;"></td> <td style="width: 10%;"></td> <td style="width: 10%;"></td> </tr> <tr> <td></td> <td></td> <td colspan="8" style="text-align: center;"> <table border="1" style="width: 100%; border-collapse: collapse; text-align: center;"> <tr> <td style="width: 10%;"></td> <td style="width: 10%;"></td> <td style="width: 10%;"></td> <td style="width: 10%;"></td> <td style="width: 10%;"></td> <td style="width: 10%;"></td> <td style="width: 10%;"></td> <td style="width: 10%;"></td> <td style="width: 10%;"></td> <td style="width: 10%;"></td> </tr> <tr> <td></td> <td></td> <td colspan="8" style="text-align: center;"> <table border="1" style="width: 100%; border-collapse: collapse; text-align: center;"> <tr> <td style="width: 10%;"></td> <td style="width: 10%;"></td> <td style="width: 10%;"></td> <td style="width: 10%;"></td> <td style="width: 10%;"></td> <td style="width: 10%;"></td> <td style="width: 10%;"></td> <td style="width: 10%;"></td> <td style="width: 10%;"></td> <td style="width: 10%;"></td> </tr> <tr> <td></td> <td></td> <td colspan="8" style="text-align: center;">
<table border="1" style="width: 100%; border-collapse: collapse; text-align: center;"> <tr> <td style="width: 10%;"></td> <td style="width: 10%;"></td> <td style="width: 10%;"></td> <td style="width: 10%;"></td> <td style="width: 10%;"></td> <td style="width: 10%;"></td> <td style="width: 10%;"></td> <td style="width: 10%;"></td> <td style="width: 10%;"></td> <td style="width: 10%;"></td> </tr> <tr> <td></td> <td></td> <td colspan="8" style="text-align: center;"> <table border="1" style="width: 100%; border-collapse: collapse; text-align: center;"> <tr> <td style="width: 10%;"></td> <td style="width: 10%;"></td> <td style="width: 10%;"></td> <td style="width: 10%;"></td> <td style="width: 10%;"></td> <td style="width: 10%;"></td> <td style="width: 10%;"></td> <td style="width: 10%;"></td> <td style="width: 10%;"></td> <td style="width: 10%;"></td> </tr> <tr> <td></td> <td></td> <td colspan="8" style="text-align: center;"> <table border="1" style="width: 100%; border-collapse: collapse; text-align: center;"> <tr> <td style="width: 10%;"></td> <td style="width: 10%;"></td> <td style="width: 10%;"></td> <td style="width: 10%;"></td> <td style="width: 10%;"></td> <td style="width: 10%;"></td> <td style="width: 10%;"></td> <td style="width: 10%;"></td> <td style="width: 10%;"></td> <td style="width: 10%;"></td> </tr> <tr> <td></td> <td></td> <td colspan="8" style="text-align: center;"> <table border="1" style="width: 100%; border-collapse: collapse; text-align: center;"> <tr> <td style="width: 10%;"></td> <td style="width: 10%;"></td> <td style="width: 10%;"></td> <td style="width: 10%;"></td> <td style="width: 10%;"></td> <td style="width: 10%;"></td> <td style="width: 10%;"></td> <td style="width: 10%;"></td> <td style="width: 10%;"></td> <td style="width: 10%;"></td> </tr> <tr> <td></td> <td></td> <td colspan="8" style="text-align: center;"> <table border="1" style="width: 100%; border-collapse: collapse; text-align: center;"> <tr> <td style="width: 10%;"></td> <td style="width: 10%;"></td> <td style="width: 10%;"></td> <td style="width: 10%;"></td> <td style="width: 10%;"></td> <td style="width: 10%;"></td> <td style="width: 10%;"></td> <td style="width: 10%;"></td> <td style="width: 10%;"></td> <td style="width: 10%;"></td> </tr> <tr> <td></td> <td></td> <td colspan="8" style="text-align: center;"> <table border="1" style="width: 100%; border-collapse: collapse; text-align: center;"> <tr> <td style="width: 10%;"></td> <td style="width: 10%;"></td> <td style="width: 10%;"></td> <td style="width: 10%;"></td> <td style="width: 10%;"></td> <td style="width: 10%;"></td> <td style="width: 10%;"></td> <td style="width: 10%;"></td> <td style="width: 10%;"></td> <td style="width: 10%;"></td> </tr> <tr> <td></td> <td></td> <td colspan="8" style="text-align: center;"> <table border="1" style="width: 100%; border-collapse: collapse; text-align: center;"> <tr> <td style="width: 10%;"></td> <td style="width: 10%;"></td> <td style="width: 10%;"></td> <td style="width: 10%;"></td> <td style="width: 10%;"></td> <td style="width: 10%;"></td> <td style="width: 10%;"></td> <td style="width: 10%;"></td> <td style="width: 10%;"></td> <td style="width: 10%;"></td> </tr> <tr> <td></td> <td></td> <td colspan="8" style="text-align: center;"> <table border="1" style="width: 100%; border-collapse: collapse; text-align: center;"> <tr> <td style="width: 10%;"></td> <td style="width: 10%;"></td> <td style="width: 10%;"></td> <td style="width: 10%;"></td> <td style="width: 10%;"></td> <td style="width: 10%;"></td> <td style="width: 10%;"></td> <td style="width: 10%;"></td> <td style="width: 10%;"></td> <td style="width: 10%;"></td> </tr> <tr> <td></td> <td></td> <td colspan="8" style="text-align: center;"> <table border="1" style="width: 100%; border-collapse: collapse; text-align: center;"> <tr> <td style="width: 10%;"></td> <td style="width: 10%;"></td> <td style="width: 10%;"></td> <td style="width: 10%;"></td> <td style="width: 10%;"></td> <td style="width: 10%;"></td> <td style="width: 10%;"></td> <td style="width: 10%;"></td> <td style="width: 10%;"></td> <td style="width: 10%;"></td> </tr> <tr> <td></td> <td></td> <td colspan="8" style="text-align: center;"> <table border="1" style="width: 100%; border-collapse: collapse; text-align: center;"> <tr> <td style="width: 10%;"></td> <td style="width: 10%;"></td> <td style="width: 10%;"></td> <td style="width: 10%;"></td> <td style="width: 10%;"></td> <td style="width: 10%;"></td> <td style="width: 10%;"></td> <td style="width: 10%;"></td> <td style="width: 10%;"></td> <td style="width: 10%;"></td> </tr> <tr> <td></td> <td></td> <td colspan="8" style="text-align: center;"> <table border="1" style="width: 100%; border-collapse: collapse; text-align: center;"> <tr> <td style="width: 10%;"></td> <td style="width: 10%;"></td> <td style="width: 10%;"></td> <td style="width: 10%;"></td> <td style="width: 10%;"></td> <td style="width: 10%;"></td> <td style="width: 10%;"></td> <td style="width: 10%;"></td> <td style="width: 10%;"></td> <td style="width: 10%;"></td> </tr> <tr> <td></td> <td></td> <td colspan="8" style="text-align: center;"> <table border="1" style="width: 100%; border-collapse: collapse; text-align: center;"> <tr> <td style="width: 10%;"></td> <td style="width: 10%;"></td> <td style="width: 10%;"></td> <td style="width: 10%;"></td> <td style="width: 10%;"></td> <td style="width: 10%;"></td> <td style="width: 10%;"></td> <td style="width: 10%;"></td> <td style="width: 10%;"></td> <td style="width: 10%;"></td> </tr> <tr> <td></td> <td></td> <td colspan="8" style="text-align: center;"> <table border="1" style="width: 100%; border-collapse: collapse; text-align: center;"> <tr> <td style="width: 10%;"></td> <td style="width: 10%;"></td> <td style="width: 10%;"></td> <td style="width: 10%;"></td> <td style="width: 10%;"></td> <td style="width: 10%;"></td> <td style="width: 10%;"></td> <td style="width: 10%;"></td> <td style="width: 10%;"></td> <td style="width: 10%;"></td> </tr> <tr> <td></td> <td></td> <td colspan="8" style="text-align: center;"> <table border="1" style="width: 100%; border-collapse: collapse; text-align: center;"> <tr> <td style="width: 10%;"></td> <td style="width: 10%;"></td> <td style="width: 10%;"></td> <td style="width: 10%;"></td> <td style="width: 10%;"></td> <td style="width: 10%;"></td> <td style="width: 10%;"></td> <td style="width: 10%;"></td> <td style="width: 10%;"></td> <td style="width: 10%;"></td> </tr> <tr> <td></td> <td></td> <td colspan="8" style="text-align: center;"> <table border="1" style="width: 100%; border-collapse: collapse; text-align: center;"> <tr> <td style="width: 10%;"></td> <td style="width: 10%;"></td> <td style="width: 10%;"></td> <td style="width: 10%;"></td> <td style="width: 10%;"></td> <td style="width: 10%;"></td> <td style="width: 10%;"></td> <td style="width: 10%;"></td> <td style="width: 10%;"></td> <td style="width: 10%;"></td> </tr> <tr> <td></td> <td></td> <td colspan="8" style="text-align: center;"> <table border="1" style="width: 100%; border-collapse: collapse; text-align: center;"> <tr> <td style="width: 10%;"></td> <td style="width: 10%;"></td> <td style="width: 10%;"></td> <td style="width: 10%;"></td> <td style="width: 10%;"></td> <td style="width: 10%;"></td> <td style="width: 10%;"></td> <td style="width: 10%;"></td> <td style="width: 10%;"></td> <td style="width: 10%;"></td> </tr> <tr> <td></td> <td></td> <td colspan="8" style="text-align: center;"> <table border="1" style="width: 100%; border-collapse: collapse; text-align: center;"> <tr> <td style="width: 10%;"></td> <td style="width: 10%;"></td> <td style="width: 10%;"></td> <td style="width: 10%;"></td> <td style="width: 10%;"></td> <td style="width: 10%;"></td> <td style="width: 10%;"></td> <td style="width: 10%;"></td> <td style="width: 10%;"></td> <td style="width: 10%;"></td> </tr> <tr> <td></td> <td></td> <td colspan="8" style="text-align: center;"> <table border="1" style="width: 100%; border-collapse: collapse; text-align: center;"> <tr> <td style="width: 10%;"></td> <td style="width: 10%;"></td> <td style="width: 10%;"></td> <td style="width: 10%;"></td> <td style="width: 10%;"></td> <td style="width: 10%;"></td> <td style="width: 10%;"></td> <td style="width: 10%;"></td> <td style="width: 10%;"></td> <td style="width: 10%;"></td> </tr> <tr> <td></td> <td></td> <td colspan="8" style="text-align: center;"> <table border="1" style="width: 100%; border-collapse: collapse; text-align: center;"> <tr> <td style="width: 10%;"></td> <td style="width: 10%;"></td> <td style="width: 10%;"></td> <td style="width: 10%;"></td> <td style="width: 10%;"></td> <td style="width: 10%;"></td> <td style="width: 10%;"></td> <td style="width: 10%;"></td> <td style="width: 10%;"></td> <td style="width: 10%;"></td> </tr> <tr> <td></td> <td></td> <td colspan="8" style="text-align: center;"> <table border="1" style="width: 100%; border-collapse: collapse; text-align: center;"> <tr> <td style="width: 10%;"></td> <td style="width: 10%;"></td> <td style="width: 10%;"></td> <td style="width: 10%;"></td> <td style="width: 10%;"></td> <td style="width: 10%;"></td> <td style="width: 10%;"></td> <td style="width: 10%;"></td> <td style="width: 10%;"></td> <td style="width: 10%;"></td> </tr> <tr> <td></td> <td></td> <td colspan="8" style="text-align: center;"> <table border="1" style="width: 100%; border-collapse: collapse; text-align: center;"> <tr> <td style="width: 10%;"></td> <td style="width: 10%;"></td> <td style="width: 10%;"></td> <td style="width: 10%;"></td> <td style="width: 10%;"></td> <td style="width: 10%;"></td> <td style="width: 10%;"></td> <td style="width: 10%;"></td> <td style="width: 10%;"></td> <td style="width: 10%;"></td> </tr> <tr> <td></td> <td></td> <td colspan="8" style="text-align: center;"> <table border="1" style="width: 100%; border-collapse: collapse; text-align: center;"> <tr>
</tr></table></td></tr></table></td></tr></table></td></tr></table></td></tr></table></td></tr></table></td></tr></table></td></tr></table></td></tr></table></td></tr></table></td></tr></table></td></tr></table></td></tr></table></td></tr></table></td></tr></table></td></tr></table></td></tr></table></td></tr></table></td></tr></table></td></tr></table></td></tr></table></td></tr></table></td></tr></table></td></tr></table></td></tr></table></td></tr></table></td></tr></table></td></tr></table></td></tr></table></td></tr></table></td></tr></table></td></tr></table></td></tr></table></td></tr></table></td></tr></table></td></tr></table></td></tr></table></td></tr></table></td></tr></table></td></tr></table>
 | | | | | | | | | | | | | | | | | | | | <table border="1" style="width: 100%; border-collapse: collapse; text-align: center;"> <tr> <td style="width: 10%;"></td> <td style="width: 10%;"></td> <td style="width: 10%;"></td> <td style="width: 10%;"></td> <td style="width: 10%;"></td> <td style="width: 10%;"></td> <td style="width: 10%;"></td> <td style="width: 10%;"></td> <td style="width: 10%;"></td> <td style="width: 10%;"></td> </tr> <tr> <td></td> <td></td> <td colspan="8" style="text-align: center;"> <table border="1" style="width: 100%; border-collapse: collapse; text-align: center;"> <tr> <td style="width: 10%;"></td> <td style="width: 10%;"></td> <td style="width: 10%;"></td> <td style="width: 10%;"></td> <td style="width: 10%;"></td> <td style="width: 10%;"></td> <td style="width: 10%;"></td> <td style="width: 10%;"></td> <td style="width: 10%;"></td> <td style="width: 10%;"></td> </tr> <tr> <td></td> <td></td> <td colspan="8" style="text-align: center;"> <table border="1" style="width: 100%; border-collapse: collapse; text-align: center;"> <tr> <td style="width: 10%;"></td> <td style="width: 10%;"></td> <td style="width: 10%;"></td> <td style="width: 10%;"></td> <td style="width: 10%;"></td> <td style="width: 10%;"></td> <td style="width: 10%;"></td> <td style="width: 10%;"></td> <td style="width: 10%;"></td> <td style="width: 10%;"></td> </tr> <tr> <td></td> <td></td> <td colspan="8" style="text-align: center;"> <table border="1" style="width: 100%; border-collapse: collapse; text-align: center;"> <tr> <td style="width: 10%;"></td> <td style="width: 10%;"></td> <td style="width: 10%;"></td> <td style="width: 10%;"></td> <td style="width: 10%;"></td> <td style="width: 10%;"></td> <td style="width: 10%;"></td> <td style="width: 10%;"></td> <td style="width: 10%;"></td> <td style="width: 10%;"></td> </tr> <tr> <td></td> <td></td> <td colspan="8" style="text-align: center;"> <table border="1" style="width: 100%; border-collapse: collapse; text-align: center;"> <tr> <td style="width: 10%;"></td> <td style="width: 10%;"></td> <td style="width: 10%;"></td> <td style="width: 10%;"></td> <td style="width: 10%;"></td> <td style="width: 10%;"></td> <td style="width: 10%;"></td> <td style="width: 10%;"></td> <td style="width: 10%;"></td> <td style="width: 10%;"></td> </tr> <tr> <td></td> <td></td> <td colspan="8" style="text-align: center;"> <table border="1" style="width: 100%; border-collapse: collapse; text-align: center;"> <tr> <td style="width: 10%;"></td> <td style="width: 10%;"></td> <td style="width: 10%;"></td> <td style="width: 10%;"></td> <td style="width: 10%;"></td> <td style="width: 10%;"></td> <td style="width: 10%;"></td> <td style="width: 10%;"></td> <td style="width: 10%;"></td> <td style="width: 10%;"></td> </tr> <tr> <td></td> <td></td> <td colspan="8" style="text-align: center;"> <table border="1" style="width: 100%; border-collapse: collapse; text-align: center;"> <tr> <td style="width: 10%;"></td> <td style="width: 10%;"></td> <td style="width: 10%;"></td> <td style="width: 10%;"></td> <td style="width: 10%;"></td> <td style="width: 10%;"></td> <td style="width: 10%;"></td> <td style="width: 10%;"></td> <td style="width: 10%;"></td> <td style="width: 10%;"></td> </tr> <tr> <td></td> <td></td> <td colspan="8" style="text-align: center;"> <table border="1" style="width: 100%; border-collapse: collapse; text-align: center;"> <tr> <td style="width: 10%;"></td> <td style="width: 10%;"></td> <td style="width: 10%;"></td> <td style="width: 10%;"></td> <td style="width: 10%;"></td> <td style="width: 10%;"></td> <td style="width: 10%;"></td> <td style="width: 10%;"></td> <td style="width: 10%;"></td> <td style="width: 10%;"></td> </tr> <tr> <td></td> <td></td> <td colspan="8" style="text-align: center;"> <table border="1" style="width: 100%; border-collapse: collapse; text-align: center;"> <tr> <td style="width: 10%;"></td> <td style="width: 10%;"></td> <td style="width: 10%;"></td> <td style="width: 10%;"></td> <td style="width: 10%;"></td> <td style="width: 10%;"></td> <td style="width: 10%;"></td> <td style="width: 10%;"></td> <td style="width: 10%;"></td> <td style="width: 10%;"></td> </tr> <tr> <td></td> <td></td> <td colspan="8" style="text-align: center;"> <table border="1" style="width: 100%; border-collapse: collapse; text-align: center;"> <tr> <td style="width: 10%;"></td> <td style="width: 10%;"></td> <td style="width: 10%;"></td> <td style="width: 10%;"></td> <td style="width: 10%;"></td> <td style="width: 10%;"></td> <td style="width: 10%;"></td> <td style="width: 10%;"></td> <td style="width: 10%;"></td> <td style="width: 10%;"></td> </tr> <tr> <td></td> <td></td> <td colspan="8" style="text-align: center;"> <table border="1" style="width: 100%; border-collapse: collapse; text-align: center;"> <tr> <td style="width: 10%;"></td> <td style="width: 10%;"></td> <td style="width: 10%;"></td> <td style="width: 10%;"></td> <td style="width: 10%;"></td> <td style="width: 10%;"></td> <td style="width: 10%;"></td> <td style="width: 10%;"></td> <td style="width: 10%;"></td> <td style="width: 10%;"></td> </tr> <tr> <td></td> <td></td> <td colspan="8" style="text-align: center;"> <table border="1" style="width: 100%; border-collapse: collapse; text-align: center;"> <tr> <td style="width: 10%;"></td> <td style="width: 10%;"></td> <td style="width: 10%;"></td> <td style="width: 10%;"></td> <td style="width: 10%;"></td> <td style="width: 10%;"></td> <td style="width: 10%;"></td> <td style="width: 10%;"></td> <td style="width: 10%;"></td> <td style="width: 10%;"></td> </tr> <tr> <td></td> <td></td> <td colspan="8" style="text-align: center;"> <table border="1" style="width: 100%; border-collapse: collapse; text-align: center;"> <tr> <td style="width: 10%;"></td> <td style="width: 10%;"></td> <td style="width: 10%;"></td> <td style="width: 10%;"></td> <td style="width: 10%;"></td> <td style="width: 10%;"></td> <td style="width: 10%;"></td> <td style="width: 10%;"></td> <td style="width: 10%;"></td> <td style="width: 10%;"></td> </tr> <tr> <td></td> <td></td> <td colspan="8" style="text-align: center;"> <table border="1" style="width: 100%; border-collapse: collapse; text-align: center;"> <tr> <td style="width: 10%;"></td> <td style="width: 10%;"></td> <td style="width: 10%;"></td> <td style="width: 10%;"></td> <td style="width: 10%;"></td> <td style="width: 10%;"></td> <td style="width: 10%;"></td> <td style="width: 10%;"></td> <td style="width: 10%;"></td> <td style="width: 10%;"></td> </tr> <tr> <td></td> <td></td> <td colspan="8" style="text-align: center;"> <table border="1" style="width: 100%; border-collapse: collapse; text-align: center;"> <tr> <td style="width: 10%;"></td> <td style="width: 10%;"></td> <td style="width: 10%;"></td> <td style="width: 10%;"></td> <td style="width: 10%;"></td> <td style="width: 10%;"></td> <td style="width: 10%;"></td> <td style="width: 10%;"></td> <td style="width: 10%;"></td> <td style="width: 10%;"></td> </tr> <tr> <td></td> <td></td> <td colspan="8" style="text-align: center;"> <table border="1" style="width: 100%; border-collapse: collapse; text-align: center;"> <tr> <td style="width: 10%;"></td> <td style="width: 10%;"></td> <td style="width: 10%;"></td> <td style="width: 10%;"></td> <td style="width: 10%;"></td> <td style="width: 10%;"></td> <td style="width: 10%;"></td> <td style="width: 10%;"></td> <td style="width: 10%;"></td> <td style="width: 10%;"></td> </tr> <tr> <td></td> <td></td> <td colspan="8" style="text-align: center;"> <table border="1" style="width: 100%; border-collapse: collapse; text-align: center;"> <tr> <td style="width: 10%;"></td> <td style="width: 10%;"></td> <td style="width: 10%;"></td> <td style="width: 10%;"></td> <td style="width: 10%;"></td> <td style="width: 10%;"></td> <td style="width: 10%;"></td> <td style="width: 10%;"></td> <td style="width: 10%;"></td> <td style="width: 10%;"></td> </tr> <tr> <td></td> <td></td> <td colspan="8" style="text-align: center;"> <table border="1" style="width: 100%; border-collapse: collapse; text-align: center;"> <tr> <td style="width: 10%;"></td> <td style="width: 10%;"></td> <td style="width: 10%;"></td> <td style="width: 10%;"></td> <td style="width: 10%;"></td> <td style="width: 10%;"></td> <td style="width: 10%;"></td> <td style="width: 10%;"></td> <td style="width: 10%;"></td> <td style="width: 10%;"></td> </tr> <tr> <td></td> <td></td> <td colspan="8" style="text-align: center;"> <table border="1" style="width: 100%; border-collapse: collapse; text-align: center;"> <tr> <td style="width: 10%;"></td> <td style="width: 10%;"></td> <td style="width: 10%;"></td> <td style="width: 10%;"></td> <td style="width: 10%;"></td> <td style="width: 10%;"></td> <td style="width: 10%;"></td> <td style="width: 10%;"></td> <td style="width: 10%;"></td> <td style="width: 10%;"></td> </tr> <tr> <td></td> <td></td> <td colspan="8" style="text-align: center;"> <table border="1" style="width: 100%; border-collapse: collapse; text-align: center;"> <tr> <td style="width: 10%;"></td> <td style="width: 10%;"></td> <td style="width: 10%;"></td> <td style="width: 10%;"></td> <td style="width: 10%;"></td> <td style="width: 10%;"></td> <td style="width: 10%;"></td> <td style="width: 10%;"></td> <td style="width: 10%;"></td> <td style="width: 10%;"></td> </tr> <tr> <td></td> <td></td> <td colspan="8" style="text-align: center;"> <table border="1" style="width: 100%; border-collapse: collapse; text-align: center;"> <tr> <td style="width: 10%;"></td> <td style="width:
10%;"></td> <td style="width: 10%;"></td> <td style="width: 10%;"></td> <td style="width: 10%;"></td> <td style="width: 10%;"></td> <td style="width: 10%;"></td> <td style="width: 10%;"></td> <td style="width: 10%;"></td> <td style="width: 10%;"></td> </tr> <tr> <td></td> <td></td> <td colspan="8" style="text-align: center;"> <table border="1" style="width: 100%; border-collapse: collapse; text-align: center;"> <tr> <td style="width: 10%;"></td> <td style="width: 10%;"></td> <td style="width: 10%;"></td> <td style="width: 10%;"></td> <td style="width: 10%;"></td> <td style="width: 10%;"></td> <td style="width: 10%;"></td> <td style="width: 10%;"></td> <td style="width: 10%;"></td> <td style="width: 10%;"></td> </tr> <tr> <td></td> <td></td> <td colspan="8" style="text-align: center;"> <table border="1" style="width: 100%; border-collapse: collapse; text-align: center;"> <tr> <td style="width: 10%;"></td> <td style="width: 10%;"></td> <td style="width: 10%;"></td> <td style="width: 10%;"></td> <td style="width: 10%;"></td> <td style="width: 10%;"></td> <td style="width: 10%;"></td> <td style="width: 10%;"></td> <td style="width: 10%;"></td> <td style="width: 10%;"></td> </tr> <tr> <td></td> <td></td> <td colspan="8" style="text-align: center;"> <table border="1" style="width: 100%; border-collapse: collapse; text-align: center;"> <tr> <td style="width: 10%;"></td> <td style="width: 10%;"></td> <td style="width: 10%;"></td> <td style="width: 10%;"></td> <td style="width: 10%;"></td> <td style="width: 10%;"></td> <td style="width: 10%;"></td> <td style="width: 10%;"></td> <td style="width: 10%;"></td> <td style="width: 10%;"></td> </tr> <tr> <td></td> <td></td> <td colspan="8" style="text-align: center;"> <table border="1" style="width: 100%; border-collapse: collapse; text-align: center;"> <tr> <td style="width: 10%;"></td> <td style="width: 10%;"></td> <td style="width: 10%;"></td> <td style="width: 10%;"></td> <td style="width: 10%;"></td> <td style="width: 10%;"></td> <td style="width: 10%;"></td> <td style="width: 10%;"></td> <td style="width: 10%;"></td> <td style="width: 10%;"></td> </tr> <tr> <td></td> <td></td> <td colspan="8" style="text-align: center;"> <table border="1" style="width: 100%; border-collapse: collapse; text-align: center;"> <tr> <td style="width: 10%;"></td> <td style="width: 10%;"></td> <td style="width: 10%;"></td> <td style="width: 10%;"></td> <td style="width: 10%;"></td> <td style="width: 10%;"></td> <td style="width: 10%;"></td> <td style="width: 10%;"></td> <td style="width: 10%;"></td> <td style="width: 10%;"></td> </tr> <tr> <td></td> <td></td> <td colspan="8" style="text-align: center;"> <table border="1" style="width: 100%; border-collapse: collapse; text-align: center;"> <tr> <td style="width: 10%;"></td> <td style="width: 10%;"></td> <td style="width: 10%;"></td> <td style="width: 10%;"></td> <td style="width: 10%;"></td> <td style="width: 10%;"></td> <td style="width: 10%;"></td> <td style="width: 10%;"></td> <td style="width: 10%;"></td> <td style="width: 10%;"></td> </tr> <tr> <td></td> <td></td> <td colspan="8" style="text-align: center;"> <table border="1" style="width: 100%; border-collapse: collapse; text-align: center;"> <tr> <td style="width: 10%;"></td> <td style="width: 10%;"></td> <td style="width: 10%;"></td> <td style="width: 10%;"></td> <td style="width: 10%;"></td> <td style="width: 10%;"></td> <td style="width: 10%;"></td> <td style="width: 10%;"></td> <td style="width: 10%;"></td> <td style="width: 10%;"></td> </tr> <tr> <td></td> <td></td> <td colspan="8" style="text-align: center;"> <table border="1" style="width: 100%; border-collapse: collapse; text-align: center;"> <tr> <td style="width: 10%;"></td> <td style="width: 10%;"></td> <td style="width: 10%;"></td> <td style="width: 10%;"></td> <td style="width: 10%;"></td> <td style="width: 10%;"></td> <td style="width: 10%;"></td> <td style="width: 10%;"></td> <td style="width: 10%;"></td> <td style="width: 10%;"></td> </tr> <tr> <td></td> <td></td> <td colspan="8" style="text-align: center;"> <table border="1" style="width: 100%; border-collapse: collapse; text-align: center;"> <tr> <td style="width: 10%;"></td> <td style="width: 10%;"></td> <td style="width: 10%;"></td> <td style="width: 10%;"></td> <td style="width: 10%;"></td> <td style="width: 10%;"></td> <td style="width: 10%;"></td> <td style="width: 10%;"></td> <td style="width: 10%;"></td> <td style="width: 10%;"></td> </tr> <tr> <td></td> <td></td> <td colspan="8" style="text-align: center;"> <table border="1" style="width: 100%; border-collapse: collapse; text-align: center;"> <tr> <td style="width: 10%;"></td> <td style="width: 10%;"></td> <td style="width: 10%;"></td> <td style="width: 10%;"></td> <td style="width: 10%;"></td> <td style="width: 10%;"></td> <td style="width: 10%;"></td> <td style="width: 10%;"></td> <td style="width: 10%;"></td> <td style="width: 10%;"></td> </tr> <tr> <td></td> <td></td> <td colspan="8" style="text-align: center;"> <table border="1" style="width: 100%; border-collapse: collapse; text-align: center;"> <tr> <td style="width: 10%;"></td> <td style="width: 10%;"></td> <td style="width: 10%;"></td> <td style="width: 10%;"></td> <td style="width: 10%;"></td> <td style="width: 10%;"></td> <td style="width: 10%;"></td> <td style="width: 10%;"></td> <td style="width: 10%;"></td> <td style="width: 10%;"></td> </tr> <tr> <td></td> <td></td> <td colspan="8" style="text-align: center;"> <table border="1" style="width: 100%; border-collapse: collapse; text-align: center;"> <tr> <td style="width: 10%;"></td> <td style="width: 10%;"></td> <td style="width: 10%;"></td> <td style="width: 10%;"></td> <td style="width: 10%;"></td> <td style="width: 10%;"></td> <td style="width: 10%;"></td> <td style="width: 10%;"></td> <td style="width: 10%;"></td> <td style="width: 10%;"></td> </tr> <tr> <td></td> <td></td> <td colspan="8" style="text-align: center;"> <table border="1" style="width: 100%; border-collapse: collapse; text-align: center;"> <tr> <td style="width: 10%;"></td> <td style="width: 10%;"></td> <td style="width: 10%;"></td> <td style="width: 10%;"></td> <td style="width: 10%;"></td> <td style="width: 10%;"></td> <td style="width: 10%;"></td> <td style="width: 10%;"></td> <td style="width: 10%;"></td> <td style="width: 10%;"></td> </tr> <tr> <td></td> <td></td> <td colspan="8" style="text-align: center;"> <table border="1" style="width: 100%; border-collapse: collapse; text-align: center;"> <tr> <td style="width: 10%;"></td> <td style="width: 10%;"></td> <td style="width: 10%;"></td> <td style="width: 10%;"></td> <td style="width: 10%;"></td> <td style="width: 10%;"></td> <td style="width: 10%;"></td> <td style="width: 10%;"></td> <td style="width: 10%;"></td> <td style="width: 10%;"></td> </tr> <tr> <td></td> <td></td> <td colspan="8" style="text-align: center;"> <table border="1" style="width: 100%; border-collapse: collapse; text-align: center;"> <tr> <td style="width: 10%;"></td> <td style="width: 10%;"></td> <td style="width: 10%;"></td> <td style="width: 10%;"></td> <td style="width: 10%;"></td> <td style="width: 10%;"></td> <td style="width: 10%;"></td> <td style="width: 10%;"></td> <td style="width: 10%;"></td> <td style="width: 10%;"></td> </tr> <tr> <td></td> <td></td> <td colspan="8" style="text-align: center;"> <table border="1" style="width: 100%; border-collapse: collapse; text-align: center;"> <tr> <td style="width: 10%;"></td> <td style="width: 10%;"></td> <td style="width: 10%;"></td> <td style="width: 10%;"></td> <td style="width: 10%;"></td> <td style="width: 10%;"></td> <td style="width: 10%;"></td> <td style="width: 10%;"></td> <td style="width: 10%;"></td> <td style="width: 10%;"></td> </tr> <tr> <td></td> <td></td> <td colspan="8" style="text-align: center;"> <table border="1" style="width: 100%; border-collapse: collapse; text-align: center;"> <tr> <td style="width: 10%;"></td> <td style="width: 10%;"></td> <td style="width: 10%;"></td> <td style="width: 10%;"></td> <td style="width: 10%;"></td> <td style="width: 10%;"></td> <td style="width: 10%;"></td> <td style="width: 10%;"></td> <td style="width: 10%;"></td> <td style="width: 10%;"></td> </tr> <tr> <td></td> <td></td> <td colspan="8" style="text-align: center;"> <table border="1" style="width: 100%; border-collapse: collapse; text-align: center;"> <tr> </tr></table></td></tr></table></td></tr></table></td></tr></table></td></tr></table></td></tr></table></td></tr></table></td></tr></table></td></tr></table></td></tr></table></td></tr></table></td></tr></table></td></tr></table></td></tr></table></td></tr></table></td></tr></table></td></tr></table></td></tr></table></td></tr></table></td></tr></table></td></tr></table></td></tr></table></td></tr></table></td></tr></table></td></tr></table></td></tr></table></td></tr></table></td></tr></table></td></tr></table></td></tr></table></td></tr></table></td></tr></table></td></tr></table></td></tr></table></td></tr></table></td></tr></table></td></tr></table></td></tr></table></td></tr></table>
 | | | | | | | | | | | | | | | | | | | | <table border="1" style="width: 100%; border-collapse: collapse; text-align: center;"> <tr> <td style="width: 10%;"></td> <td style="width: 10%;"></td> <td style="width: 10%;"></td> <td style="width: 10%;"></td> <td style="width: 10%;"></td> <td style="width: 10%;"></td> <td style="width: 10%;"></td> <td style="width: 10%;"></td> <td style="width: 10%;"></td> <td style="width: 10%;"></td> </tr> <tr> <td></td> <td></td> <td colspan="8" style="text-align: center;"> <table border="1" style="width: 100%; border-collapse: collapse; text-align: center;"> <tr> <td style="width: 10%;"></td> <td style="width: 10%;"></td> <td style="width: 10%;"></td> <td style="width: 10%;"></td> <td style="width: 10%;"></td> <td style="width: 10%;"></td> <td style="width: 10%;"></td> <td style="width: 10%;"></td> <td style="width: 10%;"></td> <td style="width: 10%;"></td> </tr> <tr> <td></td> <td></td> <td colspan="8" style="text-align: center;"> <table border="1" style="width: 100%; border-collapse: collapse; text-align: center;"> <tr> <td style="width: 10%;"></td> <td style="width: 10%;"></td> <td style="width: 10%;"></td> <td style="width:
10%;"></td> <td style="width: 10%;"></td> <td style="width: 10%;"></td> <td style="width: 10%;"></td> <td style="width: 10%;"></td> <td style="width: 10%;"></td> <td style="width: 10%;"></td> </tr> <tr> <td></td> <td></td> <td colspan="8" style="text-align: center;"> <table border="1" style="width: 100%; border-collapse: collapse; text-align: center;"> <tr> <td style="width: 10%;"></td> <td style="width: 10%;"></td> <td style="width: 10%;"></td> <td style="width: 10%;"></td> <td style="width: 10%;"></td> <td style="width: 10%;"></td> <td style="width: 10%;"></td> <td style="width: 10%;"></td> <td style="width: 10%;"></td> <td style="width: 10%;"></td> </tr> <tr> <td></td> <td></td> <td colspan="8" style="text-align: center;"> <table border="1" style="width: 100%; border-collapse: collapse; text-align: center;"> <tr> <td style="width: 10%;"></td> <td style="width: 10%;"></td> <td style="width: 10%;"></td> <td style="width: 10%;"></td> <td style="width: 10%;"></td> <td style="width: 10%;"></td> <td style="width: 10%;"></td> <td style="width: 10%;"></td> <td style="width: 10%;"></td> <td style="width: 10%;"></td> </tr> <tr> <td></td> <td></td> <td colspan="8" style="text-align: center;"> <table border="1" style="width: 100%; border-collapse: collapse; text-align: center;"> <tr> <td style="width: 10%;"></td> <td style="width: 10%;"></td> <td style="width: 10%;"></td> <td style="width: 10%;"></td> <td style="width: 10%;"></td> <td style="width: 10%;"></td> <td style="width: 10%;"></td> <td style="width: 10%;"></td> <td style="width: 10%;"></td> <td style="width: 10%;"></td> </tr> <tr> <td></td> <td></td> <td colspan="8" style="text-align: center;"> <table border="1" style="width: 100%; border-collapse: collapse; text-align: center;"> <tr> <td style="width: 10%;"></td> <td style="width: 10%;"></td> <td style="width: 10%;"></td> <td style="width: 10%;"></td> <td style="width: 10%;"></td> <td style="width: 10%;"></td> <td style="width: 10%;"></td> <td style="width: 10%;"></td> <td style="width: 10%;"></td> <td style="width: 10%;"></td> </tr> <tr> <td></td> <td></td> <td colspan="8" style="text-align: center;"> <table border="1" style="width: 100%; border-collapse: collapse; text-align: center;"> <tr> <td style="width: 10%;"></td> <td style="width: 10%;"></td> <td style="width: 10%;"></td> <td style="width: 10%;"></td> <td style="width: 10%;"></td> <td style="width: 10%;"></td> <td style="width: 10%;"></td> <td style="width: 10%;"></td> <td style="width: 10%;"></td> <td style="width: 10%;"></td> </tr> <tr> <td></td> <td></td> <td colspan="8" style="text-align: center;"> <table border="1" style="width: 100%; border-collapse: collapse; text-align: center;"> <tr> <td style="width: 10%;"></td> <td style="width: 10%;"></td> <td style="width: 10%;"></td> <td style="width: 10%;"></td> <td style="width: 10%;"></td> <td style="width: 10%;"></td> <td style="width: 10%;"></td> <td style="width: 10%;"></td> <td style="width: 10%;"></td> <td style="width: 10%;"></td> </tr> <tr> <td></td> <td></td> <td colspan="8" style="text-align: center;"> <table border="1" style="width: 100%; border-collapse: collapse; text-align: center;"> <tr> <td style="width: 10%;"></td> <td style="width: 10%;"></td> <td style="width: 10%;"></td> <td style="width: 10%;"></td> <td style="width: 10%;"></td> <td style="width: 10%;"></td> <td style="width: 10%;"></td> <td style="width: 10%;"></td> <td style="width: 10%;"></td> <td style="width: 10%;"></td> </tr> <tr> <td></td> <td></td> <td colspan="8" style="text-align: center;"> <table border="1" style="width: 100%; border-collapse: collapse; text-align: center;"> <tr> <td style="width: 10%;"></td> <td style="width: 10%;"></td> <td style="width: 10%;"></td> <td style="width: 10%;"></td> <td style="width: 10%;"></td> <td style="width: 10%;"></td> <td style="width: 10%;"></td> <td style="width: 10%;"></td> <td style="width: 10%;"></td> <td style="width: 10%;"></td> </tr> <tr> <td></td> <td></td> <td colspan="8" style="text-align: center;"> <table border="1" style="width: 100%; border-collapse: collapse; text-align: center;"> <tr> <td style="width: 10%;"></td> <td style="width: 10%;"></td> <td style="width: 10%;"></td> <td style="width: 10%;"></td> <td style="width: 10%;"></td> <td style="width: 10%;"></td> <td style="width: 10%;"></td> <td style="width: 10%;"></td> <td style="width: 10%;"></td> <td style="width: 10%;"></td> </tr> <tr> <td></td> <td></td> <td colspan="8" style="text-align: center;"> <table border="1" style="width: 100%; border-collapse: collapse; text-align: center;"> <tr> <td style="width: 10%;"></td> <td style="width: 10%;"></td> <td style="width: 10%;"></td> <td style="width: 10%;"></td> <td style="width: 10%;"></td> <td style="width: 10%;"></td> <td style="width: 10%;"></td> <td style="width: 10%;"></td> <td style="width: 10%;"></td> <td style="width: 10%;"></td> </tr> <tr> <td></td> <td></td> <td colspan="8" style="text-align: center;"> <table border="1" style="width: 100%; border-collapse: collapse; text-align: center;"> <tr> <td style="width: 10%;"></td> <td style="width: 10%;"></td> <td style="width: 10%;"></td> <td style="width: 10%;"></td> <td style="width: 10%;"></td> <td style="width: 10%;"></td> <td style="width: 10%;"></td> <td style="width: 10%;"></td> <td style="width: 10%;"></td> <td style="width: 10%;"></td> </tr> <tr> <td></td> <td></td> <td colspan="8" style="text-align: center;"> <table border="1" style="width: 100%; border-collapse: collapse; text-align: center;"> <tr> <td style="width: 10%;"></td> <td style="width: 10%;"></td> <td style="width: 10%;"></td> <td style="width: 10%;"></td> <td style="width: 10%;"></td> <td style="width: 10%;"></td> <td style="width: 10%;"></td> <td style="width: 10%;"></td> <td style="width: 10%;"></td> <td style="width: 10%;"></td> </tr> <tr> <td></td> <td></td> <td colspan="8" style="text-align: center;"> <table border="1" style="width: 100%; border-collapse: collapse; text-align: center;"> <tr> <td style="width: 10%;"></td> <td style="width: 10%;"></td> <td style="width: 10%;"></td> <td style="width: 10%;"></td> <td style="width: 10%;"></td> <td style="width: 10%;"></td> <td style="width: 10%;"></td> <td style="width: 10%;"></td> <td style="width: 10%;"></td> <td style="width: 10%;"></td> </tr> <tr> <td></td> <td></td> <td colspan="8" style="text-align: center;"> <table border="1" style="width: 100%; border-collapse: collapse; text-align: center;"> <tr> <td style="width: 10%;"></td> <td style="width: 10%;"></td> <td style="width: 10%;"></td> <td style="width: 10%;"></td> <td style="width: 10%;"></td> <td style="width: 10%;"></td> <td style="width: 10%;"></td> <td style="width: 10%;"></td> <td style="width: 10%;"></td> <td style="width: 10%;"></td> </tr> <tr> <td></td> <td></td> <td colspan="8" style="text-align: center;"> <table border="1" style="width: 100%; border-collapse: collapse; text-align: center;"> <tr> <td style="width: 10%;"></td> <td style="width: 10%;"></td> <td style="width: 10%;"></td> <td style="width: 10%;"></td> <td style="width: 10%;"></td> <td style="width: 10%;"></td> <td style="width: 10%;"></td> <td style="width: 10%;"></td> <td style="width: 10%;"></td> <td style="width: 10%;"></td> </tr> <tr> <td></td> <td></td> <td colspan="8" style="text-align: center;"> <table border="1" style="width: 100%; border-collapse: collapse; text-align: center;"> <tr> <td style="width: 10%;"></td> <td style="width: 10%;"></td> <td style="width: 10%;"></td> <td style="width: 10%;"></td> <td style="width: 10%;"></td> <td style="width: 10%;"></td> <td style="width: 10%;"></td> <td style="width: 10%;"></td> <td style="width: 10%;"></td> <td style="width: 10%;"></td> </tr> <tr> <td></td> <td></td> <td colspan="8" style="text-align: center;"> <table border="1" style="width: 100%; border-collapse: collapse; text-align: center;"> <tr> <td style="width: 10%;"></td> <td style="width: 10%;"></td> <td style="width: 10%;"></td> <td style="width: 10%;"></td> <td style="width: 10%;"></td> <td style="width: 10%;"></td> <td style="width: 10%;"></td> <td style="width: 10%;"></td> <td style="width: 10%;"></td> <td style="width: 10%;"></td> </tr> <tr> <td></td> <td></td> <td colspan="8" style="text-align: center;"> <table border="1" style="width: 100%; border-collapse: collapse; text-align: center;"> <tr> <td style="width: 10%;"></td> <td style="width: 10%;"></td> <td style="width: 10%;"></td> <td style="width: 10%;"></td> <td style="width: 10%;"></td> <td style="width: 10%;"></td> <td style="width: 10%;"></td> <td style="width: 10%;"></td> <td style="width: 10%;"></td> <td style="width: 10%;"></td> </tr> <tr> <td></td> <td></td> <td colspan="8" style="text-align: center;"> <table border="1" style="width: 100%; border-collapse: collapse; text-align: center;"> <tr> <td style="width: 10%;"></td> <td style="width: 10%;"></td> <td style="width: 10%;"></td> <td style="width: 10%;"></td> <td style="width: 10%;"></td> <td style="width: 10%;"></td> <td style="width: 10%;"></td> <td style="width: 10%;"></td> <td style="width: 10%;"></td> <td style="width: 10%;"></td> </tr> <tr> <td></td> <td></td> <td colspan="8" style="text-align: center;"> <table border="1" style="width: 100%; border-collapse: collapse; text-align: center;"> <tr> <td style="width: 10%;"></td> <td style="width: 10%;"></td> <td style="width: 10%;"></td> <td style="width: 10%;"></td> <td style="width: 10%;"></td> <td style="width: 10%;"></td> <td style="width: 10%;"></td> <td style="width: 10%;"></td> <td style="width: 10%;"></td> <td style="width: 10%;"></td> </tr> <tr> <td></td> <td></td> <td colspan="8" style="text-align: center;"> <table border="1" style="width: 100%; border-collapse: collapse; text-align: center;"> <tr> <td style="width: 10%;"></td> <td style="width: 10%;"></td> <td style="width: 10%;"></td> <td style="width: 10%;"></td> <td style="width: 10%;"></td> <td style="width: 10%;"></td> <td style="width: 10%;"></td> <td style="width: 10%;"></td> <td style="width: 10%;"></td> <td
style="width: 10%;"></td> </tr> <tr> <td></td> <td></td> <td colspan="8" style="text-align: center;"> <table border="1" style="width: 100%; border-collapse: collapse; text-align: center;"> <tr> <td style="width: 10%;"></td> <td style="width: 10%;"></td> <td style="width: 10%;"></td> <td style="width: 10%;"></td> <td style="width: 10%;"></td> <td style="width: 10%;"></td> <td style="width: 10%;"></td> <td style="width: 10%;"></td> <td style="width: 10%;"></td> <td style="width: 10%;"></td> </tr> <tr> <td></td> <td></td> <td colspan="8" style="text-align: center;"> <table border="1" style="width: 100%; border-collapse: collapse; text-align: center;"> <tr> <td style="width: 10%;"></td> <td style="width: 10%;"></td> <td style="width: 10%;"></td> <td style="width: 10%;"></td> <td style="width: 10%;"></td> <td style="width: 10%;"></td> <td style="width: 10%;"></td> <td style="width: 10%;"></td> <td style="width: 10%;"></td> <td style="width: 10%;"></td> </tr> <tr> <td></td> <td></td> <td colspan="8" style="text-align: center;"> <table border="1" style="width: 100%; border-collapse: collapse; text-align: center;"> <tr> <td style="width: 10%;"></td> <td style="width: 10%;"></td> <td style="width: 10%;"></td> <td style="width: 10%;"></td> <td style="width: 10%;"></td> <td style="width: 10%;"></td> <td style="width: 10%;"></td> <td style="width: 10%;"></td> <td style="width: 10%;"></td> <td style="width: 10%;"></td> </tr> <tr> <td></td> <td></td> <td colspan="8" style="text-align: center;"> <table border="1" style="width: 100%; border-collapse: collapse; text-align: center;"> <tr> <td style="width: 10%;"></td> <td style="width: 10%;"></td> <td style="width: 10%;"></td> <td style="width: 10%;"></td> <td style="width: 10%;"></td> <td style="width: 10%;"></td> <td style="width: 10%;"></td> <td style="width: 10%;"></td> <td style="width: 10%;"></td> <td style="width: 10%;"></td> </tr> <tr> <td></td> <td></td> <td colspan="8" style="text-align: center;"> <table border="1" style="width: 100%; border-collapse: collapse; text-align: center;"> <tr> <td style="width: 10%;"></td> <td style="width: 10%;"></td> <td style="width: 10%;"></td> <td style="width: 10%;"></td> <td style="width: 10%;"></td> <td style="width: 10%;"></td> <td style="width: 10%;"></td> <td style="width: 10%;"></td> <td style="width: 10%;"></td> <td style="width: 10%;"></td> </tr> <tr> <td></td> <td></td> <td colspan="8" style="text-align: center;"> <table border="1" style="width: 100%; border-collapse: collapse; text-align: center;"> <tr> <td style="width: 10%;"></td> <td style="width: 10%;"></td> <td style="width: 10%;"></td> <td style="width: 10%;"></td> <td style="width: 10%;"></td> <td style="width: 10%;"></td> <td style="width: 10%;"></td> <td style="width: 10%;"></td> <td style="width: 10%;"></td> <td style="width: 10%;"></td> </tr> <tr> <td></td> <td></td> <td colspan="8" style="text-align: center;"> <table border="1" style="width: 100%; border-collapse: collapse; text-align: center;"> <tr> <td style="width: 10%;"></td> <td style="width: 10%;"></td> <td style="width: 10%;"></td> <td style="width: 10%;"></td> <td style="width: 10%;"></td> <td style="width: 10%;"></td> <td style="width: 10%;"></td> <td style="width: 10%;"></td> <td style="width: 10%;"></td> <td style="width: 10%;"></td> </tr> <tr> <td></td> <td></td> <td colspan="8" style="text-align: center;"> <table border="1" style="width: 100%; border-collapse: collapse; text-align: center;"> <tr> <td style="width: 10%;"></td> <td style="width: 10%;"></td> <td style="width: 10%;"></td> <td style="width: 10%;"></td> <td style="width: 10%;"></td> <td style="width: 10%;"></td> <td style="width: 10%;"></td> <td style="width: 10%;"></td> <td style="width: 10%;"></td> <td style="width: 10%;"></td> </tr> <tr> <td></td> <td></td> <td colspan="8" style="text-align: center;"> <table border="1" style="width: 100%; border-collapse: collapse; text-align: center;"> <tr> <td style="width: 10%;"></td> <td style="width: 10%;"></td> <td style="width: 10%;"></td> <td style="width: 10%;"></td> <td style="width: 10%;"></td> <td style="width: 10%;"></td> <td style="width: 10%;"></td> <td style="width: 10%;"></td> <td style="width: 10%;"></td> <td style="width: 10%;"></td> </tr> <tr> <td></td> <td></td> <td colspan="8" style="text-align: center;"> <table border="1" style="width: 100%; border-collapse: collapse; text-align: center;"> <tr> <td style="width: 10%;"></td> <td style="width: 10%;"></td> <td style="width: 10%;"></td> <td style="width: 10%;"></td> <td style="width: 10%;"></td> <td style="width: 10%;"></td> <td style="width: 10%;"></td> <td style="width: 10%;"></td> <td style="width: 10%;"></td> <td style="width: 10%;"></td> </tr> <tr> <td></td> <td></td> <td colspan="8" style="text-align: center;"> <table border="1" style="width: 100%; border-collapse: collapse; text-align: center;"> <tr> <td style="width: 10%;"></td> <td style="width: 10%;"></td> <td style="width: 10%;"></td> <td style="width: 10%;"></td> <td style="width: 10%;"></td> <td style="width: 10%;"></td> <td style="width: 10%;"></td> <td style="width: 10%;"></td> <td style="width: 10%;"></td> <td style="width: 10%;"></td> </tr> <tr> <td></td> <td></td> <td colspan="8" style="text-align: center;"> <table border="1" style="width: 100%; border-collapse: collapse; text-align: center;"> <tr> <td style="width: 10%;"></td> <td style="width: 10%;"></td> <td style="width: 10%;"></td> <td style="width: 10%;"></td> <td style="width: 10%;"></td> <td style="width: 10%;"></td> <td style="width: 10%;"></td> <td style="width: 10%;"></td> <td style="width: 10%;"></td> <td style="width: 10%;"></td> </tr> <tr> <td></td> <td></td> <td colspan="8" style="text-align: center;"> <table border="1" style="width: 100%; border-collapse: collapse; text-align: center;"> <tr> <td style="width: 10%;"></td> <td style="width: 10%;"></td> <td style="width: 10%;"></td> <td style="width: 10%;"></td> <td style="width: 10%;"></td> <td style="width: 10%;"></td> <td style="width: 10%;"></td> <td style="width: 10%;"></td> <td style="width: 10%;"></td> <td style="width: 10%;"></td> </tr> <tr> <td></td> <td></td> <td colspan="8" style="text-align: center;"> <table border="1" style="width: 100%; border-collapse: collapse; text-align: center;"> <tr> </tr></table></td></tr></table></td></tr></table></td></tr></table></td></tr></table></td></tr></table></td></tr></table></td></tr></table></td></tr></table></td></tr></table></td></tr></table></td></tr></table></td></tr></table></td></tr></table></td></tr></table></td></tr></table></td></tr></table></td></tr></table></td></tr></table></td></tr></table></td></tr></table></td></tr></table></td></tr></table></td></tr></table></td></tr></table></td></tr></table></td></tr></table></td></tr></table></td></tr></table></td></tr></table></td></tr></table></td></tr></table></td></tr></table></td></tr></table></td></tr></table></td></tr></table></td></tr></table></td></tr></table>
 | | | | | | | | | | | | | | | | | | | | <table border="1" style="width: 100%; border-collapse: collapse; text-align: center;"> <tr> <td style="width: 10%;"></td> <td style="width: 10%;"></td> <td style="width: 10%;"></td> <td style="width: 10%;"></td> <td style="width: 10%;"></td> <td style="width: 10%;"></td> <td style="width: 10%;"></td> <td style="width: 10%;"></td> <td style="width: 10%;"></td> <td style="width: 10%;"></td> </tr> <tr> <td></td> <td></td> <td colspan="8" style="text-align: center;"> <table border="1" style="width: 100%; border-collapse: collapse; text-align: center;"> <tr> <td style="width: 10%;"></td> <td style="width: 10%;"></td> <td style="width: 10%;"></td> <td style="width: 10%;"></td> <td style="width: 10%;"></td> <td style="width: 10%;"></td> <td style="width: 10%;"></td> <td style="width: 10%;"></td> <td style="width: 10%;"></td> <td style="width: 10%;"></td> </tr> <tr> <td></td> <td></td> <td colspan="8" style="text-align: center;"> <table border="1" style="width: 100%; border-collapse: collapse; text-align: center;"> <tr> <td style="width: 10%;"></td> <td style="width: 10%;"></td> <td style="width: 10%;"></td> <td style="width: 10%;"></td> <td style="width: 10%;"></td> <td style="width: 10%;"></td> <td style="width: 10%;"></td> <td style="width: 10%;"></td> <td style="width: 10%;"></td> <td style="width: 10%;"></td> </tr> <tr> <td></td> <td></td> <td colspan="8" style="text-align: center;"> <table border="1" style="width: 100%; border-collapse: collapse; text-align: center;"> <tr> <td style="width: 10%;"></td> <td style="width: 10%;"></td> <td style="width: 10%;"></td> <td style="width: 10%;"></td> <td style="width: 10%;"></td> <td style="width: 10%;"></td> <td style="width: 10%;"></td> <td style="width: 10%;"></td> <td style="width: 10%;"></td> <td style="width: 10%;"></td> </tr> <tr> <td></td> <td></td> <td colspan="8" style="text-align: center;"> <table border="1" style="width: 100%; border-collapse: collapse; text-align: center;"> <tr> <td style="width: 10%;"></td> <td style="width: 10%;"></td> <td style="width: 10%;"></td> <td style="width: 10%;"></td> <td style="width: 10%;"></td> <td style="width: 10%;"></td> <td style="width: 10%;"></td> <td style="width: 10%;"></td> <td style="width: 10%;"></td> <td style="width: 10%;"></td> </tr> <tr> <td></td> <td></td> <td colspan="8" style="text-align: center;"> <table border="1" style="width: 100%; border-collapse: collapse; text-align: center;"> <tr> <td style="width: 10%;"></td> <td style="width: 10%;"></td> <td style="width: 10%;"></td> <td style="width: 10%;"></td> <td style="width: 10%;"></td> <td style="width: 10%;"></td> <td style="width: 10%;"></td> <td style="width: 10%;"></td> <td style="width: 10%;"></td> <td style="width: 10%;"></td> </tr> <tr> <td></td> <td></td> <td colspan="8" style="text-align: center;"> <table border="1" style="width: 100%; border-collapse: collapse; text-align: center;"> <tr> <td style="width: 10%;"></td> <td style="width: 10%;"></td> <td style="width: 10%;"></td> <td style="width: 10%;"></td> <td style="width: 10%;"></td> <td style="width: 10%;"></td> <td style="width: 10%;"></td> <td style="width: 10%;"></td> <td style="width: 10%;"></td> <td style="width: 10%;"></td> </tr> <tr> <td></td> <td></td> <td colspan="8"
style="text-align: center;"> <table border="1" style="width: 100%; border-collapse: collapse; text-align: center;"> <tr> <td style="width: 10%;"></td> <td style="width: 10%;"></td> <td style="width: 10%;"></td> <td style="width: 10%;"></td> <td style="width: 10%;"></td> <td style="width: 10%;"></td> <td style="width: 10%;"></td> <td style="width: 10%;"></td> <td style="width: 10%;"></td> <td style="width: 10%;"></td> </tr> <tr> <td></td> <td></td> <td colspan="8" style="text-align: center;"> <table border="1" style="width: 100%; border-collapse: collapse; text-align: center;"> <tr> <td style="width: 10%;"></td> <td style="width: 10%;"></td> <td style="width: 10%;"></td> <td style="width: 10%;"></td> <td style="width: 10%;"></td> <td style="width: 10%;"></td> <td style="width: 10%;"></td> <td style="width: 10%;"></td> <td style="width: 10%;"></td> <td style="width: 10%;"></td> </tr> <tr> <td></td> <td></td> <td colspan="8" style="text-align: center;"> <table border="1" style="width: 100%; border-collapse: collapse; text-align: center;"> <tr> <td style="width: 10%;"></td> <td style="width: 10%;"></td> <td style="width: 10%;"></td> <td style="width: 10%;"></td> <td style="width: 10%;"></td> <td style="width: 10%;"></td> <td style="width: 10%;"></td> <td style="width: 10%;"></td> <td style="width: 10%;"></td> <td style="width: 10%;"></td> </tr> <tr> <td></td> <td></td> <td colspan="8" style="text-align: center;"> <table border="1" style="width: 100%; border-collapse: collapse; text-align: center;"> <tr> <td style="width: 10%;"></td> <td style="width: 10%;"></td> <td style="width: 10%;"></td> <td style="width: 10%;"></td> <td style="width: 10%;"></td> <td style="width: 10%;"></td> <td style="width: 10%;"></td> <td style="width: 10%;"></td> <td style="width: 10%;"></td> <td style="width: 10%;"></td> </tr> <tr> <td></td> <td></td> <td colspan="8" style="text-align: center;"> <table border="1" style="width: 100%; border-collapse: collapse; text-align: center;"> <tr> <td style="width: 10%;"></td> <td style="width: 10%;"></td> <td style="width: 10%;"></td> <td style="width: 10%;"></td> <td style="width: 10%;"></td> <td style="width: 10%;"></td> <td style="width: 10%;"></td> <td style="width: 10%;"></td> <td style="width: 10%;"></td> <td style="width: 10%;"></td> </tr> <tr> <td></td> <td></td> <td colspan="8" style="text-align: center;"> <table border="1" style="width: 100%; border-collapse: collapse; text-align: center;"> <tr> <td style="width: 10%;"></td> <td style="width: 10%;"></td> <td style="width: 10%;"></td> <td style="width: 10%;"></td> <td style="width: 10%;"></td> <td style="width: 10%;"></td> <td style="width: 10%;"></td> <td style="width: 10%;"></td> <td style="width: 10%;"></td> <td style="width: 10%;"></td> </tr> <tr> <td></td> <td></td> <td colspan="8" style="text-align: center;"> <table border="1" style="width: 100%; border-collapse: collapse; text-align: center;"> <tr> <td style="width: 10%;"></td> <td style="width: 10%;"></td> <td style="width: 10%;"></td> <td style="width: 10%;"></td> <td style="width: 10%;"></td> <td style="width: 10%;"></td> <td style="width: 10%;"></td> <td style="width: 10%;"></td> <td style="width: 10%;"></td> <td style="width: 10%;"></td> </tr> <tr> <td></td> <td></td> <td colspan="8" style="text-align: center;"> <table border="1" style="width: 100%; border-collapse: collapse; text-align: center;"> <tr> <td style="width: 10%;"></td> <td style="width: 10%;"></td> <td style="width: 10%;"></td> <td style="width: 10%;"></td> <td style="width: 10%;"></td> <td style="width: 10%;"></td> <td style="width: 10%;"></td> <td style="width: 10%;"></td> <td style="width: 10%;"></td> <td style="width: 10%;"></td> </tr> <tr> <td></td> <td></td> <td colspan="8" style="text-align: center;"> <table border="1" style="width: 100%; border-collapse: collapse; text-align: center;"> <tr> <td style="width: 10%;"></td> <td style="width: 10%;"></td> <td style="width: 10%;"></td> <td style="width: 10%;"></td> <td style="width: 10%;"></td> <td style="width: 10%;"></td> <td style="width: 10%;"></td> <td style="width: 10%;"></td> <td style="width: 10%;"></td> <td style="width: 10%;"></td> </tr> <tr> <td></td> <td></td> <td colspan="8" style="text-align: center;"> <table border="1" style="width: 100%; border-collapse: collapse; text-align: center;"> <tr> <td style="width: 10%;"></td> <td style="width: 10%;"></td> <td style="width: 10%;"></td> <td style="width: 10%;"></td> <td style="width: 10%;"></td> <td style="width: 10%;"></td> <td style="width: 10%;"></td> <td style="width: 10%;"></td> <td style="width: 10%;"></td> <td style="width: 10%;"></td> </tr> <tr> <td></td> <td></td> <td colspan="8" style="text-align: center;"> <table border="1" style="width: 100%; border-collapse: collapse; text-align: center;"> <tr> <td style="width: 10%;"></td> <td style="width: 10%;"></td> <td style="width: 10%;"></td> <td style="width: 10%;"></td> <td style="width: 10%;"></td> <td style="width: 10%;"></td> <td style="width: 10%;"></td> <td style="width: 10%;"></td> <td style="width: 10%;"></td> <td style="width: 10%;"></td> </tr> <tr> <td></td> <td></td> <td colspan="8" style="text-align: center;"> <table border="1" style="width: 100%; border-collapse: collapse; text-align: center;"> <tr> <td style="width: 10%;"></td> <td style="width: 10%;"></td> <td style="width: 10%;"></td> <td style="width: 10%;"></td> <td style="width: 10%;"></td> <td style="width: 10%;"></td> <td style="width: 10%;"></td> <td style="width: 10%;"></td> <td style="width: 10%;"></td> <td style="width: 10%;"></td> </tr> <tr> <td></td> <td></td> <td colspan="8" style="text-align: center;"> <table border="1" style="width: 100%; border-collapse: collapse; text-align: center;"> <tr> <td style="width: 10%;"></td> <td style="width: 10%;"></td> <td style="width: 10%;"></td> <td style="width: 10%;"></td> <td style="width: 10%;"></td> <td style="width: 10%;"></td> <td style="width: 10%;"></td> <td style="width: 10%;"></td> <td style="width: 10%;"></td> <td style="width: 10%;"></td> </tr> <tr> <td></td> <td></td> <td colspan="8" style="text-align: center;"> <table border="1" style="width: 100%; border-collapse: collapse; text-align: center;"> <tr> <td style="width: 10%;"></td> <td style="width: 10%;"></td> <td style="width: 10%;"></td> <td style="width: 10%;"></td> <td style="width: 10%;"></td> <td style="width: 10%;"></td> <td style="width: 10%;"></td> <td style="width: 10%;"></td> <td style="width: 10%;"></td> <td style="width: 10%;"></td> </tr> <tr> <td></td> <td></td> <td colspan="8" style="text-align: center;"> <table border="1" style="width: 100%; border-collapse: collapse; text-align: center;"> <tr> <td style="width: 10%;"></td> <td style="width: 10%;"></td> <td style="width: 10%;"></td> <td style="width: 10%;"></td> <td style="width: 10%;"></td> <td style="width: 10%;"></td> <td style="width: 10%;"></td> <td style="width: 10%;"></td> <td style="width: 10%;"></td> <td style="width: 10%;"></td> </tr> <tr> <td></td> <td></td> <td colspan="8" style="text-align: center;"> <table border="1" style="width: 100%; border-collapse: collapse; text-align: center;"> <tr> <td style="width: 10%;"></td> <td style="width: 10%;"></td> <td style="width: 10%;"></td> <td style="width: 10%;"></td> <td style="width: 10%;"></td> <td style="width: 10%;"></td> <td style="width: 10%;"></td> <td style="width: 10%;"></td> <td style="width: 10%;"></td> <td style="width: 10%;"></td> </tr> <tr> <td></td> <td></td> <td colspan="8" style="text-align: center;"> <table border="1" style="width: 100%; border-collapse: collapse; text-align: center;"> <tr> <td style="width: 10%;"></td> <td style="width: 10%;"></td> <td style="width: 10%;"></td> <td style="width: 10%;"></td> <td style="width: 10%;"></td> <td style="width: 10%;"></td> <td style="width: 10%;"></td> <td style="width: 10%;"></td> <td style="width: 10%;"></td> <td style="width: 10%;"></td> </tr> <tr> <td></td> <td></td> <td colspan="8" style="text-align: center;"> <table border="1" style="width: 100%; border-collapse: collapse; text-align: center;"> <tr> <td style="width: 10%;"></td> <td style="width: 10%;"></td> <td style="width: 10%;"></td> <td style="width: 10%;"></td> <td style="width: 10%;"></td> <td style="width: 10%;"></td> <td style="width: 10%;"></td> <td style="width: 10%;"></td> <td style="width: 10%;"></td> <td style="width: 10%;"></td> </tr> <tr> <td></td> <td></td> <td colspan="8" style="text-align: center;"> <table border="1" style="width: 100%; border-collapse: collapse; text-align: center;"> <tr> <td style="width: 10%;"></td> <td style="width: 10%;"></td> <td style="width: 10%;"></td> <td style="width: 10%;"></td> <td style="width: 10%;"></td> <td style="width: 10%;"></td> <td style="width: 10%;"></td> <td style="width: 10%;"></td> <td style="width: 10%;"></td> <td style="width: 10%;"></td> </tr> <tr> <td></td> <td></td> <td colspan="8" style="text-align: center;"> <table border="1" style="width: 100%; border-collapse: collapse; text-align: center;"> <tr> <td style="width: 10%;"></td> <td style="width: 10%;"></td> <td style="width: 10%;"></td> <td style="width: 10%;"></td> <td style="width: 10%;"></td> <td style="width: 10%;"></td> <td style="width: 10%;"></td> <td style="width: 10%;"></td> <td style="width: 10%;"></td> <td style="width: 10%;"></td> </tr> <tr> <td></td> <td></td> <td colspan="8" style="text-align: center;"> <table border="1" style="width: 100%; border-collapse: collapse; text-align: center;"> <tr> <td style="width: 10%;"></td> <td style="width: 10%;"></td> <td style="width: 10%;"></td> <td style="width: 10%;"></td> <td style="width: 10%;"></td> <td style="width: 10%;"></td> <td style="width: 10%;"></td> <td style="width: 10%;"></td> <td style="width: 10%;"></td> <td style="width: 10%;"></td> </tr> <tr> <td></td> <td></td> <td colspan="8" style="text-align: center;"> <table border="1" style="width: 100%; border-collapse: collapse; text-align: center;"> <tr> <td style="width: 10%;"></td> <td style="width:
10%;"></td> <td style="width: 10%;"></td> <td style="width: 10%;"></td> <td style="width: 10%;"></td> <td style="width: 10%;"></td> <td style="width: 10%;"></td> <td style="width: 10%;"></td> <td style="width: 10%;"></td> <td style="width: 10%;"></td> </tr> <tr> <td></td> <td></td> <td colspan="8" style="text-align: center;"> <table border="1" style="width: 100%; border-collapse: collapse; text-align: center;"> <tr> <td style="width: 10%;"></td> <td style="width: 10%;"></td> <td style="width: 10%;"></td> <td style="width: 10%;"></td> <td style="width: 10%;"></td> <td style="width: 10%;"></td> <td style="width: 10%;"></td> <td style="width: 10%;"></td> <td style="width: 10%;"></td> <td style="width: 10%;"></td> </tr> <tr> <td></td> <td></td> <td colspan="8" style="text-align: center;"> <table border="1" style="width: 100%; border-collapse: collapse; text-align: center;"> <tr> <td style="width: 10%;"></td> <td style="width: 10%;"></td> <td style="width: 10%;"></td> <td style="width: 10%;"></td> <td style="width: 10%;"></td> <td style="width: 10%;"></td> <td style="width: 10%;"></td> <td style="width: 10%;"></td> <td style="width: 10%;"></td> <td style="width: 10%;"></td> </tr> <tr> <td></td> <td></td> <td colspan="8" style="text-align: center;"> <table border="1" style="width: 100%; border-collapse: collapse; text-align: center;"> <tr> <td style="width: 10%;"></td> <td style="width: 10%;"></td> <td style="width: 10%;"></td> <td style="width: 10%;"></td> <td style="width: 10%;"></td> <td style="width: 10%;"></td> <td style="width: 10%;"></td> <td style="width: 10%;"></td> <td style="width: 10%;"></td> <td style="width: 10%;"></td> </tr> <tr> <td></td> <td></td> <td colspan="8" style="text-align: center;"> <table border="1" style="width: 100%; border-collapse: collapse; text-align: center;"> <tr> <td style="width: 10%;"></td> <td style="width: 10%;"></td> <td style="width: 10%;"></td> <td style="width: 10%;"></td> <td style="width: 10%;"></td> <td style="width: 10%;"></td> <td style="width: 10%;"></td> <td style="width: 10%;"></td> <td style="width: 10%;"></td> <td style="width: 10%;"></td> </tr> <tr> <td></td> <td></td> <td colspan="8" style="text-align: center;"> <table border="1" style="width: 100%; border-collapse: collapse; text-align: center;"> <tr> <td style="width: 10%;"></td> <td style="width: 10%;"></td> <td style="width: 10%;"></td> <td style="width: 10%;"></td> <td style="width: 10%;"></td> <td style="width: 10%;"></td> <td style="width: 10%;"></td> <td style="width: 10%;"></td> <td style="width: 10%;"></td> <td style="width: 10%;"></td> </tr> <tr> <td></td> <td></td> <td colspan="8" style="text-align: center;"> <table border="1" style="width: 100%; border-collapse: collapse; text-align: center;"> <tr> <td style="width: 10%;"></td> <td style="width: 10%;"></td> <td style="width: 10%;"></td> <td style="width: 10%;"></td> <td style="width: 10%;"></td> <td style="width: 10%;"></td> <td style="width: 10%;"></td> <td style="width: 10%;"></td> <td style="width: 10%;"></td> <td style="width: 10%;"></td> </tr> <tr> <td></td> <td></td> <td colspan="8" style="text-align: center;"> <table border="1" style="width: 100%; border-collapse: collapse; text-align: center;"> <tr> <td style="width: 10%;"></td> <td style="width: 10%;"></td> <td style="width: 10%;"></td> <td style="width: 10%;"></td> <td style="width: 10%;"></td> <td style="width: 10%;"></td> <td style="width: 10%;"></td> <td style="width: 10%;"></td> <td style="width: 10%;"></td> <td style="width: 10%;"></td> </tr> <tr> <td></td> <td></td> <td colspan="8" style="text-align: center;"> <table border="1" style="width: 100%; border-collapse: collapse; text-align: center;"> <tr> </tr></table></td></tr></table></td></tr></table></td></tr></table></td></tr></table></td></tr></table></td></tr></table></td></tr></table></td></tr></table></td></tr></table></td></tr></table></td></tr></table></td></tr></table></td></tr></table></td></tr></table></td></tr></table></td></tr></table></td></tr></table></td></tr></table></td></tr></table></td></tr></table></td></tr></table></td></tr></table></td></tr></table></td></tr></table></td></tr></table></td></tr></table></td></tr></table></td></tr></table></td></tr></table></td></tr></table></td></tr></table></td></tr></table></td></tr></table></td></tr></table></td></tr></table></td></tr></table>
 | | | | | | | | | | | | | | | | | | | | <table border="1" style="width: 100%; border-collapse: collapse; text-align: center;"> <tr> <td style="width: 10%;"></td> <td style="width: 10%;"></td> <td style="width: 10%;"></td> <td style="width: 10%;"></td> <td style="width: 10%;"></td> <td style="width: 10%;"></td> <td style="width: 10%;"></td> <td style="width: 10%;"></td> <td style="width: 10%;"></td> <td style="width: 10%;"></td> </tr> <tr> <td></td> <td></td> <td colspan="8" style="text-align: center;"> <table border="1" style="width: 100%; border-collapse: collapse; text-align: center;"> <tr> <td style="width: 10%;"></td> <td style="width: 10%;"></td> <td style="width: 10%;"></td> <td style="width: 10%;"></td> <td style="width: 10%;"></td> <td style="width: 10%;"></td> <td style="width: 10%;"></td> <td style="width: 10%;"></td> <td style="width: 10%;"></td> <td style="width: 10%;"></td> </tr> <tr> <td></td> <td></td> <td colspan="8" style="text-align: center;"> <table border="1" style="width: 100%; border-collapse: collapse; text-align: center;"> <tr> <td style="width: 10%;"></td> <td style="width: 10%;"></td> <td style="width: 10%;"></td> <td style="width: 10%;"></td> <td style="width: 10%;"></td> <td style="width: 10%;"></td> <td style="width: 10%;"></td> <td style="width: 10%;"></td> <td style="width: 10%;"></td> <td style="width: 10%;"></td> </tr> <tr> <td></td> <td></td> <td colspan="8" style="text-align: center;"> <table border="1" style="width: 100%; border-collapse: collapse; text-align: center;"> <tr> <td style="width: 10%;"></td> <td style="width: 10%;"></td> <td style="width: 10%;"></td> <td style="width: 10%;"></td> <td style="width: 10%;"></td> <td style="width: 10%;"></td> <td style="width: 10%;"></td> <td style="width: 10%;"></td> <td style="width: 10%;"></td> <td style="width: 10%;"></td> </tr> <tr> <td></td> <td></td> <td colspan="8" style="text-align: center;"> <table border="1" style="width: 100%; border-collapse: collapse; text-align: center;"> <tr> <td style="width: 10%;"></td> <td style="width: 10%;"></td> <td style="width: 10%;"></td> <td style="width: 10%;"></td> <td style="width: 10%;"></td> <td style="width: 10%;"></td> <td style="width: 10%;"></td> <td style="width: 10%;"></td> <td style="width: 10%;"></td> <td style="width: 10%;"></td> </tr> <tr> <td></td> <td></td> <td colspan="8" style="text-align: center;"> <table border="1" style="width: 100%; border-collapse: collapse; text-align: center;"> <tr> <td style="width: 10%;"></td> <td style="width: 10%;"></td> <td style="width: 10%;"></td> <td style="width: 10%;"></td> <td style="width: 10%;"></td> <td style="width: 10%;"></td> <td style="width: 10%;"></td> <td style="width: 10%;"></td> <td style="width: 10%;"></td> <td style="width: 10%;"></td> </tr> <tr> <td></td> <td></td> <td colspan="8" style="text-align: center;"> <table border="1" style="width: 100%; border-collapse: collapse; text-align: center;"> <tr> <td style="width: 10%;"></td> <td style="width: 10%;"></td> <td style="width: 10%;"></td> <td style="width: 10%;"></td> <td style="width: 10%;"></td> <td style="width: 10%;"></td> <td style="width: 10%;"></td> <td style="width: 10%;"></td> <td style="width: 10%;"></td> <td style="width: 10%;"></td> </tr> <tr> <td></td> <td></td> <td colspan="8" style="text-align: center;"> <table border="1" style="width: 100%; border-collapse: collapse; text-align: center;"> <tr> <td style="width: 10%;"></td> <td style="width: 10%;"></td> <td style="width: 10%;"></td> <td style="width: 10%;"></td> <td style="width: 10%;"></td> <td style="width: 10%;"></td> <td style="width: 10%;"></td> <td style="width: 10%;"></td> <td style="width: 10%;"></td> <td style="width: 10%;"></td> </tr> <tr> <td></td> <td></td> <td colspan="8" style="text-align: center;"> <table border="1" style="width: 100%; border-collapse: collapse; text-align: center;"> <tr> <td style="width: 10%;"></td> <td style="width: 10%;"></td> <td style="width: 10%;"></td> <td style="width: 10%;"></td> <td style="width: 10%;"></td> <td style="width: 10%;"></td> <td style="width: 10%;"></td> <td style="width: 10%;"></td> <td style="width: 10%;"></td> <td style="width: 10%;"></td> </tr> <tr> <td></td> <td></td> <td colspan="8" style="text-align: center;"> <table border="1" style="width: 100%; border-collapse: collapse; text-align: center;"> <tr> <td style="width: 10%;"></td> <td style="width: 10%;"></td> <td style="width: 10%;"></td> <td style="width: 10%;"></td> <td style="width: 10%;"></td> <td style="width: 10%;"></td> <td style="width: 10%;"></td> <td style="width: 10%;"></td> <td style="width: 10%;"></td> <td style="width: 10%;"></td> </tr> <tr> <td></td> <td></td> <td colspan="8" style="text-align: center;"> <table border="1" style="width: 100%; border-collapse: collapse; text-align: center;"> <tr> <td style="width: 10%;"></td> <td style="width: 10%;"></td> <td style="width: 10%;"></td> <td style="width: 10%;"></td> <td style="width: 10%;"></td> <td style="width: 10%;"></td> <td style="width: 10%;"></td> <td style="width: 10%;"></td> <td style="width: 10%;"></td> <td style="width: 10%;"></td> </tr> <tr> <td></td> <td></td> <td colspan="8" style="text-align: center;"> <table border="1" style="width: 100%; border-collapse: collapse; text-align: center;"> <tr> <td style="width: 10%;"></td> <td style="width: 10%;"></td> <td style="width: 10%;"></td> <td style="width: 10%;"></td> <td style="width: 10%;"></td> <td style="width: 10%;"></td> <td style="width: 10%;"></td> <td style="width: 10%;"></td> <td style="width: 10%;"></td> <td style="width: 10%;"></td> </tr> <tr> <td></td> <td></td> <td colspan="8" style="text-align: center;"> <table border="1" style="width: 100%; border-collapse: collapse; text-align: center;"> <tr> <td style="width: 10%;"></td> <td style="width: 10%;"></td> <td style="width: 10%;"></td> <td style="width: 10%;"></td> <td style="width: 10%;"></td> <td
style="width: 10%;"></td> <td style="width: 10%;"></td> <td style="width: 10%;"></td> <td style="width: 10%;"></td> <td style="width: 10%;"></td> </tr> <tr> <td></td> <td></td> <td colspan="8" style="text-align: center;"> <table border="1" style="width: 100%; border-collapse: collapse; text-align: center;"> <tr> <td style="width: 10%;"></td> <td style="width: 10%;"></td> <td style="width: 10%;"></td> <td style="width: 10%;"></td> <td style="width: 10%;"></td> <td style="width: 10%;"></td> <td style="width: 10%;"></td> <td style="width: 10%;"></td> <td style="width: 10%;"></td> <td style="width: 10%;"></td> </tr> <tr> <td></td> <td></td> <td colspan="8" style="text-align: center;"> <table border="1" style="width: 100%; border-collapse: collapse; text-align: center;"> <tr> <td style="width: 10%;"></td> <td style="width: 10%;"></td> <td style="width: 10%;"></td> <td style="width: 10%;"></td> <td style="width: 10%;"></td> <td style="width: 10%;"></td> <td style="width: 10%;"></td> <td style="width: 10%;"></td> <td style="width: 10%;"></td> <td style="width: 10%;"></td> </tr> <tr> <td></td> <td></td> <td colspan="8" style="text-align: center;"> <table border="1" style="width: 100%; border-collapse: collapse; text-align: center;"> <tr> <td style="width: 10%;"></td> <td style="width: 10%;"></td> <td style="width: 10%;"></td> <td style="width: 10%;"></td> <td style="width: 10%;"></td> <td style="width: 10%;"></td> <td style="width: 10%;"></td> <td style="width: 10%;"></td> <td style="width: 10%;"></td> <td style="width: 10%;"></td> </tr> <tr> <td></td> <td></td> <td colspan="8" style="text-align: center;"> <table border="1" style="width: 100%; border-collapse: collapse; text-align: center;"> <tr> <td style="width: 10%;"></td> <td style="width: 10%;"></td> <td style="width: 10%;"></td> <td style="width: 10%;"></td> <td style="width: 10%;"></td> <td style="width: 10%;"></td> <td style="width: 10%;"></td> <td style="width: 10%;"></td> <td style="width: 10%;"></td> <td style="width: 10%;"></td> </tr> <tr> <td></td> <td></td> <td colspan="8" style="text-align: center;"> <table border="1" style="width: 100%; border-collapse: collapse; text-align: center;"> <tr> <td style="width: 10%;"></td> <td style="width: 10%;"></td> <td style="width: 10%;"></td> <td style="width: 10%;"></td> <td style="width: 10%;"></td> <td style="width: 10%;"></td> <td style="width: 10%;"></td> <td style="width: 10%;"></td> <td style="width: 10%;"></td> <td style="width: 10%;"></td> </tr> <tr> <td></td> <td></td> <td colspan="8" style="text-align: center;"> <table border="1" style="width: 100%; border-collapse: collapse; text-align: center;"> <tr> <td style="width: 10%;"></td> <td style="width: 10%;"></td> <td style="width: 10%;"></td> <td style="width: 10%;"></td> <td style="width: 10%;"></td> <td style="width: 10%;"></td> <td style="width: 10%;"></td> <td style="width: 10%;"></td> <td style="width: 10%;"></td> <td style="width: 10%;"></td> </tr> <tr> <td></td> <td></td> <td colspan="8" style="text-align: center;"> <table border="1" style="width: 100%; border-collapse: collapse; text-align: center;"> <tr> <td style="width: 10%;"></td> <td style="width: 10%;"></td> <td style="width: 10%;"></td> <td style="width: 10%;"></td> <td style="width: 10%;"></td> <td style="width: 10%;"></td> <td style="width: 10%;"></td> <td style="width: 10%;"></td> <td style="width: 10%;"></td> <td style="width: 10%;"></td> </tr> <tr> <td></td> <td></td> <td colspan="8" style="text-align: center;"> <table border="1" style="width: 100%; border-collapse: collapse; text-align: center;"> <tr> <td style="width: 10%;"></td> <td style="width: 10%;"></td> <td style="width: 10%;"></td> <td style="width: 10%;"></td> <td style="width: 10%;"></td> <td style="width: 10%;"></td> <td style="width: 10%;"></td> <td style="width: 10%;"></td> <td style="width: 10%;"></td> <td style="width: 10%;"></td> </tr> <tr> <td></td> <td></td> <td colspan="8" style="text-align: center;"> <table border="1" style="width: 100%; border-collapse: collapse; text-align: center;"> <tr> <td style="width: 10%;"></td> <td style="width: 10%;"></td> <td style="width: 10%;"></td> <td style="width: 10%;"></td> <td style="width: 10%;"></td> <td style="width: 10%;"></td> <td style="width: 10%;"></td> <td style="width: 10%;"></td> <td style="width: 10%;"></td> <td style="width: 10%;"></td> </tr> <tr> <td></td> <td></td> <td colspan="8" style="text-align: center;"> <table border="1" style="width: 100%; border-collapse: collapse; text-align: center;"> <tr> <td style="width: 10%;"></td> <td style="width: 10%;"></td> <td style="width: 10%;"></td> <td style="width: 10%;"></td> <td style="width: 10%;"></td> <td style="width: 10%;"></td> <td style="width: 10%;"></td> <td style="width: 10%;"></td> <td style="width: 10%;"></td> <td style="width: 10%;"></td> </tr> <tr> <td></td> <td></td> <td colspan="8" style="text-align: center;"> <table border="1" style="width: 100%; border-collapse: collapse; text-align: center;"> <tr> <td style="width: 10%;"></td> <td style="width: 10%;"></td> <td style="width: 10%;"></td> <td style="width: 10%;"></td> <td style="width: 10%;"></td> <td style="width: 10%;"></td> <td style="width: 10%;"></td> <td style="width: 10%;"></td> <td style="width: 10%;"></td> <td style="width: 10%;"></td> </tr> <tr> <td></td> <td></td> <td colspan="8" style="text-align: center;"> <table border="1" style="width: 100%; border-collapse: collapse; text-align: center;"> <tr> <td style="width: 10%;"></td> <td style="width: 10%;"></td> <td style="width: 10%;"></td> <td style="width: 10%;"></td> <td style="width: 10%;"></td> <td style="width: 10%;"></td> <td style="width: 10%;"></td> <td style="width: 10%;"></td> <td style="width: 10%;"></td> <td style="width: 10%;"></td> </tr> <tr> <td></td> <td></td> <td colspan="8" style="text-align: center;"> <table border="1" style="width: 100%; border-collapse: collapse; text-align: center;"> <tr> <td style="width: 10%;"></td> <td style="width: 10%;"></td> <td style="width: 10%;"></td> <td style="width: 10%;"></td> <td style="width: 10%;"></td> <td style="width: 10%;"></td> <td style="width: 10%;"></td> <td style="width: 10%;"></td> <td style="width: 10%;"></td> <td style="width: 10%;"></td> </tr> <tr> <td></td> <td></td> <td colspan="8" style="text-align: center;"> <table border="1" style="width: 100%; border-collapse: collapse; text-align: center;"> <tr> <td style="width: 10%;"></td> <td style="width: 10%;"></td> <td style="width: 10%;"></td> <td style="width: 10%;"></td> <td style="width: 10%;"></td> <td style="width: 10%;"></td> <td style="width: 10%;"></td> <td style="width: 10%;"></td> <td style="width: 10%;"></td> <td style="width: 10%;"></td> </tr> <tr> <td></td> <td></td> <td colspan="8" style="text-align: center;"> <table border="1" style="width: 100%; border-collapse: collapse; text-align: center;"> <tr> <td style="width: 10%;"></td> <td style="width: 10%;"></td> <td style="width: 10%;"></td> <td style="width: 10%;"></td> <td style="width: 10%;"></td> <td style="width: 10%;"></td> <td style="width: 10%;"></td> <td style="width: 10%;"></td> <td style="width: 10%;"></td> <td style="width: 10%;"></td> </tr> <tr> <td></td> <td></td> <td colspan="8" style="text-align: center;"> <table border="1" style="width: 100%; border-collapse: collapse; text-align: center;"> <tr> <td style="width: 10%;"></td> <td style="width: 10%;"></td> <td style="width: 10%;"></td> <td style="width: 10%;"></td> <td style="width: 10%;"></td> <td style="width: 10%;"></td> <td style="width: 10%;"></td> <td style="width: 10%;"></td> <td style="width: 10%;"></td> <td style="width: 10%;"></td> </tr> <tr> <td></td> <td></td> <td colspan="8" style="text-align: center;"> <table border="1" style="width: 100%; border-collapse: collapse; text-align: center;"> <tr> <td style="width: 10%;"></td> <td style="width: 10%;"></td> <td style="width: 10%;"></td> <td style="width: 10%;"></td> <td style="width: 10%;"></td> <td style="width: 10%;"></td> <td style="width: 10%;"></td> <td style="width: 10%;"></td> <td style="width: 10%;"></td> <td style="width: 10%;"></td> </tr> <tr> <td></td> <td></td> <td colspan="8" style="text-align: center;"> <table border="1" style="width: 100%; border-collapse: collapse; text-align: center;"> <tr> <td style="width: 10%;"></td> <td style="width: 10%;"></td> <td style="width: 10%;"></td> <td style="width: 10%;"></td> <td style="width: 10%;"></td> <td style="width: 10%;"></td> <td style="width: 10%;"></td> <td style="width: 10%;"></td> <td style="width: 10%;"></td> <td style="width: 10%;"></td> </tr> <tr> <td></td> <td></td> <td colspan="8" style="text-align: center;"> <table border="1" style="width: 100%; border-collapse: collapse; text-align: center;"> <tr> <td style="width: 10%;"></td> <td style="width: 10%;"></td> <td style="width: 10%;"></td> <td style="width: 10%;"></td> <td style="width: 10%;"></td> <td style="width: 10%;"></td> <td style="width: 10%;"></td> <td style="width: 10%;"></td> <td style="width: 10%;"></td> <td style="width: 10%;"></td> </tr> <tr> <td></td> <td></td> <td colspan="8" style="text-align: center;"> <table border="1" style="width: 100%; border-collapse: collapse; text-align: center;"> <tr> <td style="width: 10%;"></td> <td style="width: 10%;"></td> <td style="width: 10%;"></td> <td style="width: 10%;"></td> <td style="width: 10%;"></td> <td style="width: 10%;"></td> <td style="width: 10%;"></td> <td style="width: 10%;"></td> <td style="width: 10%;"></td> <td style="width: 10%;"></td> </tr> <tr> <td></td> <td></td> <td colspan="8" style="text-align: center;"> <table border="1" style="width: 100%; border-collapse: collapse; text-align: center;"> <tr> <td style="width: 10%;"></td> <td style="width: 10%;"></td> <td style="width: 10%;"></td> <td style="width: 10%;"></td> <td style="width: 10%;"></td> <td style="width: 10%;"></td> <td style="width: 10%;"></td> <td style="width: 10%;"></td> <td style="width: 10%;"></td> <td style="width: 10%;"></td> </tr> <tr> <td></td>
<td></td> <td colspan="8" style="text-align: center;"> <table border="1" style="width: 100%; border-collapse: collapse; text-align: center;"> <tr> <td style="width: 10%;"></td> <td style="width: 10%;"></td> <td style="width: 10%;"></td> <td style="width: 10%;"></td> <td style="width: 10%;"></td> <td style="width: 10%;"></td> <td style="width: 10%;"></td> <td style="width: 10%;"></td> <td style="width: 10%;"></td> <td style="width: 10%;"></td> </tr> <tr> <td></td> <td></td> <td colspan="8" style="text-align: center;"> <table border="1" style="width: 100%; border-collapse: collapse; text-align: center;"> <tr> </tr></table></td></tr></table></td></tr></table></td></tr></table></td></tr></table></td></tr></table></td></tr></table></td></tr></table></td></tr></table></td></tr></table></td></tr></table></td></tr></table></td></tr></table></td></tr></table></td></tr></table></td></tr></table></td></tr></table></td></tr></table></td></tr></table></td></tr></table></td></tr></table></td></tr></table></td></tr></table></td></tr></table></td></tr></table></td></tr></table></td></tr></table></td></tr></table></td></tr></table></td></tr></table></td></tr></table></td></tr></table></td></tr></table></td></tr></table></td></tr></table></td></tr></table>
 | | | | | | | | | | | | | | | | | | | | <table border="1" style="width: 100%; border-collapse: collapse; text-align: center;"> <tr> <td style="width: 10%;"></td> <td style="width: 10%;"></td> <td style="width: 10%;"></td> <td style="width: 10%;"></td> <td style="width: 10%;"></td> <td style="width: 10%;"></td> <td style="width: 10%;"></td> <td style="width: 10%;"></td> <td style="width: 10%;"></td> <td style="width: 10%;"></td> </tr> <tr> <td></td> <td></td> <td colspan="8" style="text-align: center;"> <table border="1" style="width: 100%; border-collapse: collapse; text-align: center;"> <tr> <td style="width: 10%;"></td> <td style="width: 10%;"></td> <td style="width: 10%;"></td> <td style="width: 10%;"></td> <td style="width: 10%;"></td> <td style="width: 10%;"></td> <td style="width: 10%;"></td> <td style="width: 10%;"></td> <td style="width: 10%;"></td> <td style="width: 10%;"></td> </tr> <tr> <td></td> <td></td> <td colspan="8" style="text-align: center;"> <table border="1" style="width: 100%; border-collapse: collapse; text-align: center;"> <tr> <td style="width: 10%;"></td> <td style="width: 10%;"></td> <td style="width: 10%;"></td> <td style="width: 10%;"></td> <td style="width: 10%;"></td> <td style="width: 10%;"></td> <td style="width: 10%;"></td> <td style="width: 10%;"></td> <td style="width: 10%;"></td> <td style="width: 10%;"></td> </tr> <tr> <td></td> <td></td> <td colspan="8" style="text-align: center;"> <table border="1" style="width: 100%; border-collapse: collapse; text-align: center;"> <tr> <td style="width: 10%;"></td> <td style="width: 10%;"></td> <td style="width: 10%;"></td> <td style="width: 10%;"></td> <td style="width: 10%;"></td> <td style="width: 10%;"></td> <td style="width: 10%;"></td> <td style="width: 10%;"></td> <td style="width: 10%;"></td> <td style="width: 10%;"></td> </tr> <tr> <td></td> <td></td> <td colspan="8" style="text-align: center;"> <table border="1" style="width: 100%; border-collapse: collapse; text-align: center;"> <tr> <td style="width: 10%;"></td> <td style="width: 10%;"></td> <td style="width: 10%;"></td> <td style="width: 10%;"></td> <td style="width: 10%;"></td> <td style="width: 10%;"></td> <td style="width: 10%;"></td> <td style="width: 10%;"></td> <td style="width: 10%;"></td> <td style="width: 10%;"></td> </tr> <tr> <td></td> <td></td> <td colspan="8" style="text-align: center;"> <table border="1" style="width: 100%; border-collapse: collapse; text-align: center;"> <tr> <td style="width: 10%;"></td> <td style="width: 10%;"></td> <td style="width: 10%;"></td> <td style="width: 10%;"></td> <td style="width: 10%;"></td> <td style="width: 10%;"></td> <td style="width: 10%;"></td> <td style="width: 10%;"></td> <td style="width: 10%;"></td> <td style="width: 10%;"></td> </tr> <tr> <td></td> <td></td> <td colspan="8" style="text-align: center;"> <table border="1" style="width: 100%; border-collapse: collapse; text-align: center;"> <tr> <td style="width: 10%;"></td> <td style="width: 10%;"></td> <td style="width: 10%;"></td> <td style="width: 10%;"></td> <td style="width: 10%;"></td> <td style="width: 10%;"></td> <td style="width: 10%;"></td> <td style="width: 10%;"></td> <td style="width: 10%;"></td> <td style="width: 10%;"></td> </tr> <tr> <td></td> <td></td> <td colspan="8" style="text-align: center;"> <table border="1" style="width: 100%; border-collapse: collapse; text-align: center;"> <tr> <td style="width: 10%;"></td> <td style="width: 10%;"></td> <td style="width: 10%;"></td> <td style="width: 10%;"></td> <td style="width: 10%;"></td> <td style="width: 10%;"></td> <td style="width: 10%;"></td> <td style="width: 10%;"></td> <td style="width: 10%;"></td> <td style="width: 10%;"></td> </tr> <tr> <td></td> <td></td> <td colspan="8" style="text-align: center;"> <table border="1" style="width: 100%; border-collapse: collapse; text-align: center;"> <tr> <td style="width: 10%;"></td> <td style="width: 10%;"></td> <td style="width: 10%;"></td> <td style="width: 10%;"></td> <td style="width: 10%;"></td> <td style="width: 10%;"></td> <td style="width: 10%;"></td> <td style="width: 10%;"></td> <td style="width: 10%;"></td> <td style="width: 10%;"></td> </tr> <tr> <td></td> <td></td> <td colspan="8" style="text-align: center;"> <table border="1" style="width: 100%; border-collapse: collapse; text-align: center;"> <tr> <td style="width: 10%;"></td> <td style="width: 10%;"></td> <td style="width: 10%;"></td> <td style="width: 10%;"></td> <td style="width: 10%;"></td> <td style="width: 10%;"></td> <td style="width: 10%;"></td> <td style="width: 10%;"></td> <td style="width: 10%;"></td> <td style="width: 10%;"></td> </tr> <tr> <td></td> <td></td> <td colspan="8" style="text-align: center;"> <table border="1" style="width: 100%; border-collapse: collapse; text-align: center;"> <tr> <td style="width: 10%;"></td> <td style="width: 10%;"></td> <td style="width: 10%;"></td> <td style="width: 10%;"></td> <td style="width: 10%;"></td> <td style="width: 10%;"></td> <td style="width: 10%;"></td> <td style="width: 10%;"></td> <td style="width: 10%;"></td> <td style="width: 10%;"></td> </tr> <tr> <td></td> <td></td> <td colspan="8" style="text-align: center;"> <table border="1" style="width: 100%; border-collapse: collapse; text-align: center;"> <tr> <td style="width: 10%;"></td> <td style="width: 10%;"></td> <td style="width: 10%;"></td> <td style="width: 10%;"></td> <td style="width: 10%;"></td> <td style="width: 10%;"></td> <td style="width: 10%;"></td> <td style="width: 10%;"></td> <td style="width: 10%;"></td> <td style="width: 10%;"></td> </tr> <tr> <td></td> <td></td> <td colspan="8" style="text-align: center;"> <table border="1" style="width: 100%; border-collapse: collapse; text-align: center;"> <tr> <td style="width: 10%;"></td> <td style="width: 10%;"></td> <td style="width: 10%;"></td> <td style="width: 10%;"></td> <td style="width: 10%;"></td> <td style="width: 10%;"></td> <td style="width: 10%;"></td> <td style="width: 10%;"></td> <td style="width: 10%;"></td> <td style="width: 10%;"></td> </tr> <tr> <td></td> <td></td> <td colspan="8" style="text-align: center;"> <table border="1" style="width: 100%; border-collapse: collapse; text-align: center;"> <tr> <td style="width: 10%;"></td> <td style="width: 10%;"></td> <td style="width: 10%;"></td> <td style="width: 10%;"></td> <td style="width: 10%;"></td> <td style="width: 10%;"></td> <td style="width: 10%;"></td> <td style="width: 10%;"></td> <td style="width: 10%;"></td> <td style="width: 10%;"></td> </tr> <tr> <td></td> <td></td> <td colspan="8" style="text-align: center;"> <table border="1" style="width: 100%; border-collapse: collapse; text-align: center;"> <tr> <td style="width: 10%;"></td> <td style="width: 10%;"></td> <td style="width: 10%;"></td> <td style="width: 10%;"></td> <td style="width: 10%;"></td> <td style="width: 10%;"></td> <td style="width: 10%;"></td> <td style="width: 10%;"></td> <td style="width: 10%;"></td> <td style="width: 10%;"></td> </tr> <tr> <td></td> <td></td> <td colspan="8" style="text-align: center;"> <table border="1" style="width: 100%; border-collapse: collapse; text-align: center;"> <tr> <td style="width: 10%;"></td> <td style="width: 10%;"></td> <td style="width: 10%;"></td> <td style="width: 10%;"></td> <td style="width: 10%;"></td> <td style="width: 10%;"></td> <td style="width: 10%;"></td> <td style="width: 10%;"></td> <td style="width: 10%;"></td> <td style="width: 10%;"></td> </tr> <tr> <td></td> <td></td> <td colspan="8" style="text-align: center;"> <table border="1" style="width: 100%; border-collapse: collapse; text-align: center;"> <tr> <td style="width: 10%;"></td> <td style="width: 10%;"></td> <td style="width: 10%;"></td> <td style="width: 10%;"></td> <td style="width: 10%;"></td> <td style="width: 10%;"></td> <td style="width: 10%;"></td> <td style="width: 10%;"></td> <td style="width: 10%;"></td> <td style="width: 10%;"></td> </tr> <tr> <td></td> <td></td> <td colspan="8" style="text-align: center;"> <table border="1" style="width: 100%; border-collapse: collapse; text-align: center;"> <tr> <td style="width: 10%;"></td> <td style="width: 10%;"></td> <td style="width: 10%;"></td> <td style="width: 10%;"></td> <td style="width: 10%;"></td> <td style="width: 10%;"></td> <td style="width: 10%;"></td> <td style="width: 10%;"></td> <td style="width: 10%;"></td> <td style="width: 10%;"></td> </tr> <tr> <td></td> <td></td> <td colspan="8" style="text-align: center;"> <table border="1" style="width: 100%; border-collapse: collapse; text-align: center;"> <tr> <td style="width: 10%;"></td> <td style="width: 10%;"></td> <td style="width: 10%;"></td> <td style="width: 10%;"></td> <td style="width: 10%;"></td> <td style="width: 10%;"></td> <td style="width: 10%;"></td> <td style="width: 10%;"></td> <td style="width: 10%;"></td> <td style="width: 10%;"></td> </tr> <tr> <td></td> <td></td> <td colspan="8" style="text-align: center;"> <table border="1" style="width: 100%; border-collapse: collapse;
text-align: center;"> <tr> <td style="width: 10%;"></td> <td style="width: 10%;"></td> <td style="width: 10%;"></td> <td style="width: 10%;"></td> <td style="width: 10%;"></td> <td style="width: 10%;"></td> <td style="width: 10%;"></td> <td style="width: 10%;"></td> <td style="width: 10%;"></td> <td style="width: 10%;"></td> </tr> <tr> <td></td> <td></td> <td colspan="8" style="text-align: center;"> <table border="1" style="width: 100%; border-collapse: collapse; text-align: center;"> <tr> <td style="width: 10%;"></td> <td style="width: 10%;"></td> <td style="width: 10%;"></td> <td style="width: 10%;"></td> <td style="width: 10%;"></td> <td style="width: 10%;"></td> <td style="width: 10%;"></td> <td style="width: 10%;"></td> <td style="width: 10%;"></td> <td style="width: 10%;"></td> </tr> <tr> <td></td> <td></td> <td colspan="8" style="text-align: center;"> <table border="1" style="width: 100%; border-collapse: collapse; text-align: center;"> <tr> <td style="width: 10%;"></td> <td style="width: 10%;"></td> <td style="width: 10%;"></td> <td style="width: 10%;"></td> <td style="width: 10%;"></td> <td style="width: 10%;"></td> <td style="width: 10%;"></td> <td style="width: 10%;"></td> <td style="width: 10%;"></td> <td style="width: 10%;"></td> </tr> <tr> <td></td> <td></td> <td colspan="8" style="text-align: center;"> <table border="1" style="width: 100%; border-collapse: collapse; text-align: center;"> <tr> <td style="width: 10%;"></td> <td style="width: 10%;"></td> <td style="width: 10%;"></td> <td style="width: 10%;"></td> <td style="width: 10%;"></td> <td style="width: 10%;"></td> <td style="width: 10%;"></td> <td style="width: 10%;"></td> <td style="width: 10%;"></td> <td style="width: 10%;"></td> </tr> <tr> <td></td> <td></td> <td colspan="8" style="text-align: center;"> <table border="1" style="width: 100%; border-collapse: collapse; text-align: center;"> <tr> <td style="width: 10%;"></td> <td style="width: 10%;"></td> <td style="width: 10%;"></td> <td style="width: 10%;"></td> <td style="width: 10%;"></td> <td style="width: 10%;"></td> <td style="width: 10%;"></td> <td style="width: 10%;"></td> <td style="width: 10%;"></td> <td style="width: 10%;"></td> </tr> <tr> <td></td> <td></td> <td colspan="8" style="text-align: center;"> <table border="1" style="width: 100%; border-collapse: collapse; text-align: center;"> <tr> <td style="width: 10%;"></td> <td style="width: 10%;"></td> <td style="width: 10%;"></td> <td style="width: 10%;"></td> <td style="width: 10%;"></td> <td style="width: 10%;"></td> <td style="width: 10%;"></td> <td style="width: 10%;"></td> <td style="width: 10%;"></td> <td style="width: 10%;"></td> </tr> <tr> <td></td> <td></td> <td colspan="8" style="text-align: center;"> <table border="1" style="width: 100%; border-collapse: collapse; text-align: center;"> <tr> <td style="width: 10%;"></td> <td style="width: 10%;"></td> <td style="width: 10%;"></td> <td style="width: 10%;"></td> <td style="width: 10%;"></td> <td style="width: 10%;"></td> <td style="width: 10%;"></td> <td style="width: 10%;"></td> <td style="width: 10%;"></td> <td style="width: 10%;"></td> </tr> <tr> <td></td> <td></td> <td colspan="8" style="text-align: center;"> <table border="1" style="width: 100%; border-collapse: collapse; text-align: center;"> <tr> <td style="width: 10%;"></td> <td style="width: 10%;"></td> <td style="width: 10%;"></td> <td style="width: 10%;"></td> <td style="width: 10%;"></td> <td style="width: 10%;"></td> <td style="width: 10%;"></td> <td style="width: 10%;"></td> <td style="width: 10%;"></td> <td style="width: 10%;"></td> </tr> <tr> <td></td> <td></td> <td colspan="8" style="text-align: center;"> <table border="1" style="width: 100%; border-collapse: collapse; text-align: center;"> <tr> <td style="width: 10%;"></td> <td style="width: 10%;"></td> <td style="width: 10%;"></td> <td style="width: 10%;"></td> <td style="width: 10%;"></td> <td style="width: 10%;"></td> <td style="width: 10%;"></td> <td style="width: 10%;"></td> <td style="width: 10%;"></td> <td style="width: 10%;"></td> </tr> <tr> <td></td> <td></td> <td colspan="8" style="text-align: center;"> <table border="1" style="width: 100%; border-collapse: collapse; text-align: center;"> <tr> <td style="width: 10%;"></td> <td style="width: 10%;"></td> <td style="width: 10%;"></td> <td style="width: 10%;"></td> <td style="width: 10%;"></td> <td style="width: 10%;"></td> <td style="width: 10%;"></td> <td style="width: 10%;"></td> <td style="width: 10%;"></td> <td style="width: 10%;"></td> </tr> <tr> <td></td> <td></td> <td colspan="8" style="text-align: center;"> <table border="1" style="width: 100%; border-collapse: collapse; text-align: center;"> <tr> <td style="width: 10%;"></td> <td style="width: 10%;"></td> <td style="width: 10%;"></td> <td style="width: 10%;"></td> <td style="width: 10%;"></td> <td style="width: 10%;"></td> <td style="width: 10%;"></td> <td style="width: 10%;"></td> <td style="width: 10%;"></td> <td style="width: 10%;"></td> </tr> <tr> <td></td> <td></td> <td colspan="8" style="text-align: center;"> <table border="1" style="width: 100%; border-collapse: collapse; text-align: center;"> <tr> <td style="width: 10%;"></td> <td style="width: 10%;"></td> <td style="width: 10%;"></td> <td style="width: 10%;"></td> <td style="width: 10%;"></td> <td style="width: 10%;"></td> <td style="width: 10%;"></td> <td style="width: 10%;"></td> <td style="width: 10%;"></td> <td style="width: 10%;"></td> </tr> <tr> <td></td> <td></td> <td colspan="8" style="text-align: center;"> <table border="1" style="width: 100%; border-collapse: collapse; text-align: center;"> <tr> <td style="width: 10%;"></td> <td style="width: 10%;"></td> <td style="width: 10%;"></td> <td style="width: 10%;"></td> <td style="width: 10%;"></td> <td style="width: 10%;"></td> <td style="width: 10%;"></td> <td style="width: 10%;"></td> <td style="width: 10%;"></td> <td style="width: 10%;"></td> </tr> <tr> <td></td> <td></td> <td colspan="8" style="text-align: center;"> <table border="1" style="width: 100%; border-collapse: collapse; text-align: center;"> <tr> <td style="width: 10%;"></td> <td style="width: 10%;"></td> <td style="width: 10%;"></td> <td style="width: 10%;"></td> <td style="width: 10%;"></td> <td style="width: 10%;"></td> <td style="width: 10%;"></td> <td style="width: 10%;"></td> <td style="width: 10%;"></td> <td style="width: 10%;"></td> </tr> <tr> <td></td> <td></td> <td colspan="8" style="text-align: center;"> <table border="1" style="width: 100%; border-collapse: collapse; text-align: center;"> <tr> <td style="width: 10%;"></td> <td style="width: 10%;"></td> <td style="width: 10%;"></td> <td style="width: 10%;"></td> <td style="width: 10%;"></td> <td style="width: 10%;"></td> <td style="width: 10%;"></td> <td style="width: 10%;"></td> <td style="width: 10%;"></td> <td style="width: 10%;"></td> </tr> <tr> <td></td> <td></td> <td colspan="8" style="text-align: center;"> <table border="1" style="width: 100%; border-collapse: collapse; text-align: center;"> <tr> </tr></table></td></tr></table></td></tr></table></td></tr></table></td></tr></table></td></tr></table></td></tr></table></td></tr></table></td></tr></table></td></tr></table></td></tr></table></td></tr></table></td></tr></table></td></tr></table></td></tr></table></td></tr></table></td></tr></table></td></tr></table></td></tr></table></td></tr></table></td></tr></table></td></tr></table></td></tr></table></td></tr></table></td></tr></table></td></tr></table></td></tr></table></td></tr></table></td></tr></table></td></tr></table></td></tr></table></td></tr></table></td></tr></table></td></tr></table></td></tr></table>
 | | | | | | | | | | | | | | | | | | | | <table border="1" style="width: 100%; border-collapse: collapse; text-align: center;"> <tr> <td style="width: 10%;"></td> <td style="width: 10%;"></td> <td style="width: 10%;"></td> <td style="width: 10%;"></td> <td style="width: 10%;"></td> <td style="width: 10%;"></td> <td style="width: 10%;"></td> <td style="width: 10%;"></td> <td style="width: 10%;"></td> <td style="width: 10%;"></td> </tr> <tr> <td></td> <td></td> <td colspan="8" style="text-align: center;"> <table border="1" style="width: 100%; border-collapse: collapse; text-align: center;"> <tr> <td style="width: 10%;"></td> <td style="width: 10%;"></td> <td style="width: 10%;"></td> <td style="width: 10%;"></td> <td style="width: 10%;"></td> <td style="width: 10%;"></td> <td style="width: 10%;"></td> <td style="width: 10%;"></td> <td style="width: 10%;"></td> <td style="width: 10%;"></td> </tr> <tr> <td></td> <td></td> <td colspan="8" style="text-align: center;"> <table border="1" style="width: 100%; border-collapse: collapse; text-align: center;"> <tr> <td style="width: 10%;"></td> <td style="width: 10%;"></td> <td style="width: 10%;"></td> <td style="width: 10%;"></td> <td style="width: 10%;"></td> <td style="width: 10%;"></td> <td style="width: 10%;"></td> <td style="width: 10%;"></td> <td style="width: 10%;"></td> <td style="width: 10%;"></td> </tr> <tr> <td></td> <td></td> <td colspan="8" style="text-align: center;"> <table border="1" style="width: 100%; border-collapse: collapse; text-align: center;"> <tr> <td style="width: 10%;"></td> <td style="width: 10%;"></td> <td style="width: 10%;"></td> <td style="width: 10%;"></td> <td style="width: 10%;"></td> <td style="width: 10%;"></td> <td style="width: 10%;"></td> <td style="width: 10%;"></td> <td style="width: 10%;"></td> <td style="width: 10%;"></td> </tr> <tr> <td></td> <td></td> <td colspan="8" style="text-align: center;"> <table border="1" style="width: 100%; border-collapse: collapse; text-align: center;"> <tr> <td style="width: 10%;"></td> <td style="width: 10%;"></td> <td style="width: 10%;"></td> <td style="width: 10%;"></td> <td style="width: 10%;"></td> <td style="width: 10%;"></td> <td style="width: 10%;"></td> <td style="width: 10%;"></td> <td style="width: 10%;"></td> <td style="width: 10%;"></td> </tr> <tr> <td></td> <td></td> <td colspan="8" style="text-align: center;"> <table border="1" style="width: 100%; border-collapse: collapse; text-align: center;"> <tr> <td style="width: 10%;"></td> <td style="width: 10%;"></td> <td style="width: 10%;"></td> <td style="width:
10%;"></td> <td style="width: 10%;"></td> <td style="width: 10%;"></td> <td style="width: 10%;"></td> <td style="width: 10%;"></td> <td style="width: 10%;"></td> <td style="width: 10%;"></td> </tr> <tr> <td></td> <td></td> <td colspan="8" style="text-align: center;"> <table border="1" style="width: 100%; border-collapse: collapse; text-align: center;"> <tr> <td style="width: 10%;"></td> <td style="width: 10%;"></td> <td style="width: 10%;"></td> <td style="width: 10%;"></td> <td style="width: 10%;"></td> <td style="width: 10%;"></td> <td style="width: 10%;"></td> <td style="width: 10%;"></td> <td style="width: 10%;"></td> <td style="width: 10%;"></td> </tr> <tr> <td></td> <td></td> <td colspan="8" style="text-align: center;"> <table border="1" style="width: 100%; border-collapse: collapse; text-align: center;"> <tr> <td style="width: 10%;"></td> <td style="width: 10%;"></td> <td style="width: 10%;"></td> <td style="width: 10%;"></td> <td style="width: 10%;"></td> <td style="width: 10%;"></td> <td style="width: 10%;"></td> <td style="width: 10%;"></td> <td style="width: 10%;"></td> <td style="width: 10%;"></td> </tr> <tr> <td></td> <td></td> <td colspan="8" style="text-align: center;"> <table border="1" style="width: 100%; border-collapse: collapse; text-align: center;"> <tr> <td style="width: 10%;"></td> <td style="width: 10%;"></td> <td style="width: 10%;"></td> <td style="width: 10%;"></td> <td style="width: 10%;"></td> <td style="width: 10%;"></td> <td style="width: 10%;"></td> <td style="width: 10%;"></td> <td style="width: 10%;"></td> <td style="width: 10%;"></td> </tr> <tr> <td></td> <td></td> <td colspan="8" style="text-align: center;"> <table border="1" style="width: 100%; border-collapse: collapse; text-align: center;"> <tr> <td style="width: 10%;"></td> <td style="width: 10%;"></td> <td style="width: 10%;"></td> <td style="width: 10%;"></td> <td style="width: 10%;"></td> <td style="width: 10%;"></td> <td style="width: 10%;"></td> <td style="width: 10%;"></td> <td style="width: 10%;"></td> <td style="width: 10%;"></td> </tr> <tr> <td></td> <td></td> <td colspan="8" style="text-align: center;"> <table border="1" style="width: 100%; border-collapse: collapse; text-align: center;"> <tr> <td style="width: 10%;"></td> <td style="width: 10%;"></td> <td style="width: 10%;"></td> <td style="width: 10%;"></td> <td style="width: 10%;"></td> <td style="width: 10%;"></td> <td style="width: 10%;"></td> <td style="width: 10%;"></td> <td style="width: 10%;"></td> <td style="width: 10%;"></td> </tr> <tr> <td></td> <td></td> <td colspan="8" style="text-align: center;"> <table border="1" style="width: 100%; border-collapse: collapse; text-align: center;"> <tr> <td style="width: 10%;"></td> <td style="width: 10%;"></td> <td style="width: 10%;"></td> <td style="width: 10%;"></td> <td style="width: 10%;"></td> <td style="width: 10%;"></td> <td style="width: 10%;"></td> <td style="width: 10%;"></td> <td style="width: 10%;"></td> <td style="width: 10%;"></td> </tr> <tr> <td></td> <td></td> <td colspan="8" style="text-align: center;"> <table border="1" style="width: 100%; border-collapse: collapse; text-align: center;"> <tr> <td style="width: 10%;"></td> <td style="width: 10%;"></td> <td style="width: 10%;"></td> <td style="width: 10%;"></td> <td style="width: 10%;"></td> <td style="width: 10%;"></td> <td style="width: 10%;"></td> <td style="width: 10%;"></td> <td style="width: 10%;"></td> <td style="width: 10%;"></td> </tr> <tr> <td></td> <td></td> <td colspan="8" style="text-align: center;"> <table border="1" style="width: 100%; border-collapse: collapse; text-align: center;"> <tr> <td style="width: 10%;"></td> <td style="width: 10%;"></td> <td style="width: 10%;"></td> <td style="width: 10%;"></td> <td style="width: 10%;"></td> <td style="width: 10%;"></td> <td style="width: 10%;"></td> <td style="width: 10%;"></td> <td style="width: 10%;"></td> <td style="width: 10%;"></td> </tr> <tr> <td></td> <td></td> <td colspan="8" style="text-align: center;"> <table border="1" style="width: 100%; border-collapse: collapse; text-align: center;"> <tr> <td style="width: 10%;"></td> <td style="width: 10%;"></td> <td style="width: 10%;"></td> <td style="width: 10%;"></td> <td style="width: 10%;"></td> <td style="width: 10%;"></td> <td style="width: 10%;"></td> <td style="width: 10%;"></td> <td style="width: 10%;"></td> <td style="width: 10%;"></td> </tr> <tr> <td></td> <td></td> <td colspan="8" style="text-align: center;"> <table border="1" style="width: 100%; border-collapse: collapse; text-align: center;"> <tr> <td style="width: 10%;"></td> <td style="width: 10%;"></td> <td style="width: 10%;"></td> <td style="width: 10%;"></td> <td style="width: 10%;"></td> <td style="width: 10%;"></td> <td style="width: 10%;"></td> <td style="width: 10%;"></td> <td style="width: 10%;"></td> <td style="width: 10%;"></td> </tr> <tr> <td></td> <td></td> <td colspan="8" style="text-align: center;"> <table border="1" style="width: 100%; border-collapse: collapse; text-align: center;"> <tr> <td style="width: 10%;"></td> <td style="width: 10%;"></td> <td style="width: 10%;"></td> <td style="width: 10%;"></td> <td style="width: 10%;"></td> <td style="width: 10%;"></td> <td style="width: 10%;"></td> <td style="width: 10%;"></td> <td style="width: 10%;"></td> <td style="width: 10%;"></td> </tr> <tr> <td></td> <td></td> <td colspan="8" style="text-align: center;"> <table border="1" style="width: 100%; border-collapse: collapse; text-align: center;"> <tr> <td style="width: 10%;"></td> <td style="width: 10%;"></td> <td style="width: 10%;"></td> <td style="width: 10%;"></td> <td style="width: 10%;"></td> <td style="width: 10%;"></td> <td style="width: 10%;"></td> <td style="width: 10%;"></td> <td style="width: 10%;"></td> <td style="width: 10%;"></td> </tr> <tr> <td></td> <td></td> <td colspan="8" style="text-align: center;"> <table border="1" style="width: 100%; border-collapse: collapse; text-align: center;"> <tr> <td style="width: 10%;"></td> <td style="width: 10%;"></td> <td style="width: 10%;"></td> <td style="width: 10%;"></td> <td style="width: 10%;"></td> <td style="width: 10%;"></td> <td style="width: 10%;"></td> <td style="width: 10%;"></td> <td style="width: 10%;"></td> <td style="width: 10%;"></td> </tr> <tr> <td></td> <td></td> <td colspan="8" style="text-align: center;"> <table border="1" style="width: 100%; border-collapse: collapse; text-align: center;"> <tr> <td style="width: 10%;"></td> <td style="width: 10%;"></td> <td style="width: 10%;"></td> <td style="width: 10%;"></td> <td style="width: 10%;"></td> <td style="width: 10%;"></td> <td style="width: 10%;"></td> <td style="width: 10%;"></td> <td style="width: 10%;"></td> <td style="width: 10%;"></td> </tr> <tr> <td></td> <td></td> <td colspan="8" style="text-align: center;"> <table border="1" style="width: 100%; border-collapse: collapse; text-align: center;"> <tr> <td style="width: 10%;"></td> <td style="width: 10%;"></td> <td style="width: 10%;"></td> <td style="width: 10%;"></td> <td style="width: 10%;"></td> <td style="width: 10%;"></td> <td style="width: 10%;"></td> <td style="width: 10%;"></td> <td style="width: 10%;"></td> <td style="width: 10%;"></td> </tr> <tr> <td></td> <td></td> <td colspan="8" style="text-align: center;"> <table border="1" style="width: 100%; border-collapse: collapse; text-align: center;"> <tr> <td style="width: 10%;"></td> <td style="width: 10%;"></td> <td style="width: 10%;"></td> <td style="width: 10%;"></td> <td style="width: 10%;"></td> <td style="width: 10%;"></td> <td style="width: 10%;"></td> <td style="width: 10%;"></td> <td style="width: 10%;"></td> <td style="width: 10%;"></td> </tr> <tr> <td></td> <td></td> <td colspan="8" style="text-align: center;"> <table border="1" style="width: 100%; border-collapse: collapse; text-align: center;"> <tr> <td style="width: 10%;"></td> <td style="width: 10%;"></td> <td style="width: 10%;"></td> <td style="width: 10%;"></td> <td style="width: 10%;"></td> <td style="width: 10%;"></td> <td style="width: 10%;"></td> <td style="width: 10%;"></td> <td style="width: 10%;"></td> <td style="width: 10%;"></td> </tr> <tr> <td></td> <td></td> <td colspan="8" style="text-align: center;"> <table border="1" style="width: 100%; border-collapse: collapse; text-align: center;"> <tr> <td style="width: 10%;"></td> <td style="width: 10%;"></td> <td style="width: 10%;"></td> <td style="width: 10%;"></td> <td style="width: 10%;"></td> <td style="width: 10%;"></td> <td style="width: 10%;"></td> <td style="width: 10%;"></td> <td style="width: 10%;"></td> <td style="width: 10%;"></td> </tr> <tr> <td></td> <td></td> <td colspan="8" style="text-align: center;"> <table border="1" style="width: 100%; border-collapse: collapse; text-align: center;"> <tr> <td style="width: 10%;"></td> <td style="width: 10%;"></td> <td style="width: 10%;"></td> <td style="width: 10%;"></td> <td style="width: 10%;"></td> <td style="width: 10%;"></td> <td style="width: 10%;"></td> <td style="width: 10%;"></td> <td style="width: 10%;"></td> <td style="width: 10%;"></td> </tr> <tr> <td></td> <td></td> <td colspan="8" style="text-align: center;"> <table border="1" style="width: 100%; border-collapse: collapse; text-align: center;"> <tr> <td style="width: 10%;"></td> <td style="width: 10%;"></td> <td style="width: 10%;"></td> <td style="width: 10%;"></td> <td style="width: 10%;"></td> <td style="width: 10%;"></td> <td style="width: 10%;"></td> <td style="width: 10%;"></td> <td style="width: 10%;"></td> <td style="width: 10%;"></td> </tr> <tr> <td></td> <td></td> <td colspan="8" style="text-align: center;"> <table border="1" style="width: 100%; border-collapse: collapse; text-align: center;"> <tr> <td style="width: 10%;"></td> <td style="width: 10%;"></td> <td style="width: 10%;"></td> <td style="width: 10%;"></td> <td style="width: 10%;"></td> <td style="width: 10%;"></td> <td style="width: 10%;"></td> <td style="width: 10%;"></td> <td style="width: 10%;"></td> <td
style="width: 10%;"></td> </tr> <tr> <td></td> <td></td> <td colspan="8" style="text-align: center;"> <table border="1" style="width: 100%; border-collapse: collapse; text-align: center;"> <tr> <td style="width: 10%;"></td> <td style="width: 10%;"></td> <td style="width: 10%;"></td> <td style="width: 10%;"></td> <td style="width: 10%;"></td> <td style="width: 10%;"></td> <td style="width: 10%;"></td> <td style="width: 10%;"></td> <td style="width: 10%;"></td> <td style="width: 10%;"></td> </tr> <tr> <td></td> <td></td> <td colspan="8" style="text-align: center;"> <table border="1" style="width: 100%; border-collapse: collapse; text-align: center;"> <tr> <td style="width: 10%;"></td> <td style="width: 10%;"></td> <td style="width: 10%;"></td> <td style="width: 10%;"></td> <td style="width: 10%;"></td> <td style="width: 10%;"></td> <td style="width: 10%;"></td> <td style="width: 10%;"></td> <td style="width: 10%;"></td> <td style="width: 10%;"></td> </tr> <tr> <td></td> <td></td> <td colspan="8" style="text-align: center;"> <table border="1" style="width: 100%; border-collapse: collapse; text-align: center;"> <tr> <td style="width: 10%;"></td> <td style="width: 10%;"></td> <td style="width: 10%;"></td> <td style="width: 10%;"></td> <td style="width: 10%;"></td> <td style="width: 10%;"></td> <td style="width: 10%;"></td> <td style="width: 10%;"></td> <td style="width: 10%;"></td> <td style="width: 10%;"></td> </tr> <tr> <td></td> <td></td> <td colspan="8" style="text-align: center;"> <table border="1" style="width: 100%; border-collapse: collapse; text-align: center;"> <tr> <td style="width: 10%;"></td> <td style="width: 10%;"></td> <td style="width: 10%;"></td> <td style="width: 10%;"></td> <td style="width: 10%;"></td> <td style="width: 10%;"></td> <td style="width: 10%;"></td> <td style="width: 10%;"></td> <td style="width: 10%;"></td> <td style="width: 10%;"></td> </tr> <tr> <td></td> <td></td> <td colspan="8" style="text-align: center;"> <table border="1" style="width: 100%; border-collapse: collapse; text-align: center;"> <tr> <td style="width: 10%;"></td> <td style="width: 10%;"></td> <td style="width: 10%;"></td> <td style="width: 10%;"></td> <td style="width: 10%;"></td> <td style="width: 10%;"></td> <td style="width: 10%;"></td> <td style="width: 10%;"></td> <td style="width: 10%;"></td> <td style="width: 10%;"></td> </tr> <tr> <td></td> <td></td> <td colspan="8" style="text-align: center;"> <table border="1" style="width: 100%; border-collapse: collapse; text-align: center;"> <tr> <td style="width: 10%;"></td> <td style="width: 10%;"></td> <td style="width: 10%;"></td> <td style="width: 10%;"></td> <td style="width: 10%;"></td> <td style="width: 10%;"></td> <td style="width: 10%;"></td> <td style="width: 10%;"></td> <td style="width: 10%;"></td> <td style="width: 10%;"></td> </tr> <tr> <td></td> <td></td> <td colspan="8" style="text-align: center;"> <table border="1" style="width: 100%; border-collapse: collapse; text-align: center;"> <tr> </tr></table></td></tr></table></td></tr></table></td></tr></table></td></tr></table></td></tr></table></td></tr></table></td></tr></table></td></tr></table></td></tr></table></td></tr></table></td></tr></table></td></tr></table></td></tr></table></td></tr></table></td></tr></table></td></tr></table></td></tr></table></td></tr></table></td></tr></table></td></tr></table></td></tr></table></td></tr></table></td></tr></table></td></tr></table></td></tr></table></td></tr></table></td></tr></table></td></tr></table></td></tr></table></td></tr></table></td></tr></table></td></tr></table></td></tr></table>
 | | | | | | | | | | | | | | | | | | | | <table border="1" style="width: 100%; border-collapse: collapse; text-align: center;"> <tr> <td style="width: 10%;"></td> <td style="width: 10%;"></td> <td style="width: 10%;"></td> <td style="width: 10%;"></td> <td style="width: 10%;"></td> <td style="width: 10%;"></td> <td style="width: 10%;"></td> <td style="width: 10%;"></td> <td style="width: 10%;"></td> <td style="width: 10%;"></td> </tr> <tr> <td></td> <td></td> <td colspan="8" style="text-align: center;"> <table border="1" style="width: 100%; border-collapse: collapse; text-align: center;"> <tr> <td style="width: 10%;"></td> <td style="width: 10%;"></td> <td style="width: 10%;"></td> <td style="width: 10%;"></td> <td style="width: 10%;"></td> <td style="width: 10%;"></td> <td style="width: 10%;"></td> <td style="width: 10%;"></td> <td style="width: 10%;"></td> <td style="width: 10%;"></td> </tr> <tr> <td></td> <td></td> <td colspan="8" style="text-align: center;"> <table border="1" style="width: 100%; border-collapse: collapse; text-align: center;"> <tr> <td style="width: 10%;"></td> <td style="width: 10%;"></td> <td style="width: 10%;"></td> <td style="width: 10%;"></td> <td style="width: 10%;"></td> <td style="width: 10%;"></td> <td style="width: 10%;"></td> <td style="width: 10%;"></td> <td style="width: 10%;"></td> <td style="width: 10%;"></td> </tr> <tr> <td></td> <td></td> <td colspan="8" style="text-align: center;"> <table border="1" style="width: 100%; border-collapse: collapse; text-align: center;"> <tr> <td style="width: 10%;"></td> <td style="width: 10%;"></td> <td style="width: 10%;"></td> <td style="width: 10%;"></td> <td style="width: 10%;"></td> <td style="width: 10%;"></td> <td style="width: 10%;"></td> <td style="width: 10%;"></td> <td style="width: 10%;"></td> <td style="width: 10%;"></td> </tr> <tr> <td></td> <td></td> <td colspan="8" style="text-align: center;"> <table border="1" style="width: 100%; border-collapse: collapse; text-align: center;"> <tr> <td style="width: 10%;"></td> <td style="width: 10%;"></td> <td style="width: 10%;"></td> <td style="width: 10%;"></td> <td style="width: 10%;"></td> <td style="width: 10%;"></td> <td style="width: 10%;"></td> <td style="width: 10%;"></td> <td style="width: 10%;"></td> <td style="width: 10%;"></td> </tr> <tr> <td></td> <td></td> <td colspan="8" style="text-align: center;"> <table border="1" style="width: 100%; border-collapse: collapse; text-align: center;"> <tr> <td style="width: 10%;"></td> <td style="width: 10%;"></td> <td style="width: 10%;"></td> <td style="width: 10%;"></td> <td style="width: 10%;"></td> <td style="width: 10%;"></td> <td style="width: 10%;"></td> <td style="width: 10%;"></td> <td style="width: 10%;"></td> <td style="width: 10%;"></td> </tr> <tr> <td></td> <td></td> <td colspan="8" style="text-align: center;"> <table border="1" style="width: 100%; border-collapse: collapse; text-align: center;"> <tr> <td style="width: 10%;"></td> <td style="width: 10%;"></td> <td style="width: 10%;"></td> <td style="width: 10%;"></td> <td style="width: 10%;"></td> <td style="width: 10%;"></td> <td style="width: 10%;"></td> <td style="width: 10%;"></td> <td style="width: 10%;"></td> <td style="width: 10%;"></td> </tr> <tr> <td></td> <td></td> <td colspan="8" style="text-align: center;"> <table border="1" style="width: 100%; border-collapse: collapse; text-align: center;"> <tr> <td style="width: 10%;"></td> <td style="width: 10%;"></td> <td style="width: 10%;"></td> <td style="width: 10%;"></td> <td style="width: 10%;"></td> <td style="width: 10%;"></td> <td style="width: 10%;"></td> <td style="width: 10%;"></td> <td style="width: 10%;"></td> <td style="width: 10%;"></td> </tr> <tr> <td></td> <td></td> <td colspan="8" style="text-align: center;"> <table border="1" style="width: 100%; border-collapse: collapse; text-align: center;"> <tr> <td style="width: 10%;"></td> <td style="width: 10%;"></td> <td style="width: 10%;"></td> <td style="width: 10%;"></td> <td style="width: 10%;"></td> <td style="width: 10%;"></td> <td style="width: 10%;"></td> <td style="width: 10%;"></td> <td style="width: 10%;"></td> <td style="width: 10%;"></td> </tr> <tr> <td></td> <td></td> <td colspan="8" style="text-align: center;"> <table border="1" style="width: 100%; border-collapse: collapse; text-align: center;"> <tr> <td style="width: 10%;"></td> <td style="width: 10%;"></td> <td style="width: 10%;"></td> <td style="width: 10%;"></td> <td style="width: 10%;"></td> <td style="width: 10%;"></td> <td style="width: 10%;"></td> <td style="width: 10%;"></td> <td style="width: 10%;"></td> <td style="width: 10%;"></td> </tr> <tr> <td></td> <td></td> <td colspan="8" style="text-align: center;"> <table border="1" style="width: 100%; border-collapse: collapse; text-align: center;"> <tr> <td style="width: 10%;"></td> <td style="width: 10%;"></td> <td style="width: 10%;"></td> <td style="width: 10%;"></td> <td style="width: 10%;"></td> <td style="width: 10%;"></td> <td style="width: 10%;"></td> <td style="width: 10%;"></td> <td style="width: 10%;"></td> <td style="width: 10%;"></td> </tr> <tr> <td></td> <td></td> <td colspan="8" style="text-align: center;"> <table border="1" style="width: 100%; border-collapse: collapse; text-align: center;"> <tr> <td style="width: 10%;"></td> <td style="width: 10%;"></td> <td style="width: 10%;"></td> <td style="width: 10%;"></td> <td style="width: 10%;"></td> <td style="width: 10%;"></td> <td style="width: 10%;"></td> <td style="width: 10%;"></td> <td style="width: 10%;"></td> <td style="width: 10%;"></td> </tr> <tr> <td></td> <td></td> <td colspan="8" style="text-align: center;"> <table border="1" style="width: 100%; border-collapse: collapse; text-align: center;"> <tr> <td style="width: 10%;"></td> <td style="width: 10%;"></td> <td style="width: 10%;"></td> <td style="width: 10%;"></td> <td style="width: 10%;"></td> <td style="width: 10%;"></td> <td style="width: 10%;"></td> <td style="width: 10%;"></td> <td style="width: 10%;"></td> <td style="width: 10%;"></td> </tr> <tr> <td></td> <td></td> <td colspan="8" style="text-align: center;"> <table border="1" style="width: 100%; border-collapse: collapse; text-align: center;"> <tr> <td style="width: 10%;"></td> <td style="width: 10%;"></td> <td style="width: 10%;"></td> <td style="width: 10%;"></td> <td style="width: 10%;"></td> <td style="width: 10%;"></td> <td style="width: 10%;"></td> <td style="width: 10%;"></td> <td style="width: 10%;"></td> <td style="width: 10%;"></td> </tr> <tr> <td></td> <td></td> <td colspan="8" style="text-align: center;"> <table border="1" style="width: 100%; border-collapse:
collapse; text-align: center;"> <tr> <td style="width: 10%;"></td> <td style="width: 10%;"></td> <td style="width: 10%;"></td> <td style="width: 10%;"></td> <td style="width: 10%;"></td> <td style="width: 10%;"></td> <td style="width: 10%;"></td> <td style="width: 10%;"></td> <td style="width: 10%;"></td> <td style="width: 10%;"></td> </tr> <tr> <td></td> <td></td> <td colspan="8" style="text-align: center;"> <table border="1" style="width: 100%; border-collapse: collapse; text-align: center;"> <tr> <td style="width: 10%;"></td> <td style="width: 10%;"></td> <td style="width: 10%;"></td> <td style="width: 10%;"></td> <td style="width: 10%;"></td> <td style="width: 10%;"></td> <td style="width: 10%;"></td> <td style="width: 10%;"></td> <td style="width: 10%;"></td> <td style="width: 10%;"></td> </tr> <tr> <td></td> <td></td> <td colspan="8" style="text-align: center;"> <table border="1" style="width: 100%; border-collapse: collapse; text-align: center;"> <tr> <td style="width: 10%;"></td> <td style="width: 10%;"></td> <td style="width: 10%;"></td> <td style="width: 10%;"></td> <td style="width: 10%;"></td> <td style="width: 10%;"></td> <td style="width: 10%;"></td> <td style="width: 10%;"></td> <td style="width: 10%;"></td> <td style="width: 10%;"></td> </tr> <tr> <td></td> <td></td> <td colspan="8" style="text-align: center;"> <table border="1" style="width: 100%; border-collapse: collapse; text-align: center;"> <tr> <td style="width: 10%;"></td> <td style="width: 10%;"></td> <td style="width: 10%;"></td> <td style="width: 10%;"></td> <td style="width: 10%;"></td> <td style="width: 10%;"></td> <td style="width: 10%;"></td> <td style="width: 10%;"></td> <td style="width: 10%;"></td> <td style="width: 10%;"></td> </tr> <tr> <td></td> <td></td> <td colspan="8" style="text-align: center;"> <table border="1" style="width: 100%; border-collapse: collapse; text-align: center;"> <tr> <td style="width: 10%;"></td> <td style="width: 10%;"></td> <td style="width: 10%;"></td> <td style="width: 10%;"></td> <td style="width: 10%;"></td> <td style="width: 10%;"></td> <td style="width: 10%;"></td> <td style="width: 10%;"></td> <td style="width: 10%;"></td> <td style="width: 10%;"></td> </tr> <tr> <td></td> <td></td> <td colspan="8" style="text-align: center;"> <table border="1" style="width: 100%; border-collapse: collapse; text-align: center;"> <tr> <td style="width: 10%;"></td> <td style="width: 10%;"></td> <td style="width: 10%;"></td> <td style="width: 10%;"></td> <td style="width: 10%;"></td> <td style="width: 10%;"></td> <td style="width: 10%;"></td> <td style="width: 10%;"></td> <td style="width: 10%;"></td> <td style="width: 10%;"></td> </tr> <tr> <td></td> <td></td> <td colspan="8" style="text-align: center;"> <table border="1" style="width: 100%; border-collapse: collapse; text-align: center;"> <tr> <td style="width: 10%;"></td> <td style="width: 10%;"></td> <td style="width: 10%;"></td> <td style="width: 10%;"></td> <td style="width: 10%;"></td> <td style="width: 10%;"></td> <td style="width: 10%;"></td> <td style="width: 10%;"></td> <td style="width: 10%;"></td> <td style="width: 10%;"></td> </tr> <tr> <td></td> <td></td> <td colspan="8" style="text-align: center;"> <table border="1" style="width: 100%; border-collapse: collapse; text-align: center;"> <tr> <td style="width: 10%;"></td> <td style="width: 10%;"></td> <td style="width: 10%;"></td> <td style="width: 10%;"></td> <td style="width: 10%;"></td> <td style="width: 10%;"></td> <td style="width: 10%;"></td> <td style="width: 10%;"></td> <td style="width: 10%;"></td> <td style="width: 10%;"></td> </tr> <tr> <td></td> <td></td> <td colspan="8" style="text-align: center;"> <table border="1" style="width: 100%; border-collapse: collapse; text-align: center;"> <tr> <td style="width: 10%;"></td> <td style="width: 10%;"></td> <td style="width: 10%;"></td> <td style="width: 10%;"></td> <td style="width: 10%;"></td> <td style="width: 10%;"></td> <td style="width: 10%;"></td> <td style="width: 10%;"></td> <td style="width: 10%;"></td> <td style="width: 10%;"></td> </tr> <tr> <td></td> <td></td> <td colspan="8" style="text-align: center;"> <table border="1" style="width: 100%; border-collapse: collapse; text-align: center;"> <tr> <td style="width: 10%;"></td> <td style="width: 10%;"></td> <td style="width: 10%;"></td> <td style="width: 10%;"></td> <td style="width: 10%;"></td> <td style="width: 10%;"></td> <td style="width: 10%;"></td> <td style="width: 10%;"></td> <td style="width: 10%;"></td> <td style="width: 10%;"></td> </tr> <tr> <td></td> <td></td> <td colspan="8" style="text-align: center;"> <table border="1" style="width: 100%; border-collapse: collapse; text-align: center;"> <tr> <td style="width: 10%;"></td> <td style="width: 10%;"></td> <td style="width: 10%;"></td> <td style="width: 10%;"></td> <td style="width: 10%;"></td> <td style="width: 10%;"></td> <td style="width: 10%;"></td> <td style="width: 10%;"></td> <td style="width: 10%;"></td> <td style="width: 10%;"></td> </tr> <tr> <td></td> <td></td> <td colspan="8" style="text-align: center;"> <table border="1" style="width: 100%; border-collapse: collapse; text-align: center;"> <tr> <td style="width: 10%;"></td> <td style="width: 10%;"></td> <td style="width: 10%;"></td> <td style="width: 10%;"></td> <td style="width: 10%;"></td> <td style="width: 10%;"></td> <td style="width: 10%;"></td> <td style="width: 10%;"></td> <td style="width: 10%;"></td> <td style="width: 10%;"></td> </tr> <tr> <td></td> <td></td> <td colspan="8" style="text-align: center;"> <table border="1" style="width: 100%; border-collapse: collapse; text-align: center;"> <tr> <td style="width: 10%;"></td> <td style="width: 10%;"></td> <td style="width: 10%;"></td> <td style="width: 10%;"></td> <td style="width: 10%;"></td> <td style="width: 10%;"></td> <td style="width: 10%;"></td> <td style="width: 10%;"></td> <td style="width: 10%;"></td> <td style="width: 10%;"></td> </tr> <tr> <td></td> <td></td> <td colspan="8" style="text-align: center;"> <table border="1" style="width: 100%; border-collapse: collapse; text-align: center;"> <tr> <td style="width: 10%;"></td> <td style="width: 10%;"></td> <td style="width: 10%;"></td> <td style="width: 10%;"></td> <td style="width: 10%;"></td> <td style="width: 10%;"></td> <td style="width: 10%;"></td> <td style="width: 10%;"></td> <td style="width: 10%;"></td> <td style="width: 10%;"></td> </tr> <tr> <td></td> <td></td> <td colspan="8" style="text-align: center;"> <table border="1" style="width: 100%; border-collapse: collapse; text-align: center;"> <tr> <td style="width: 10%;"></td> <td style="width: 10%;"></td> <td style="width: 10%;"></td> <td style="width: 10%;"></td> <td style="width: 10%;"></td> <td style="width: 10%;"></td> <td style="width: 10%;"></td> <td style="width: 10%;"></td> <td style="width: 10%;"></td> <td style="width: 10%;"></td> </tr> <tr> <td></td> <td></td> <td colspan="8" style="text-align: center;"> <table border="1" style="width: 100%; border-collapse: collapse; text-align: center;"> <tr> <td style="width: 10%;"></td> <td style="width: 10%;"></td> <td style="width: 10%;"></td> <td style="width: 10%;"></td> <td style="width: 10%;"></td> <td style="width: 10%;"></td> <td style="width: 10%;"></td> <td style="width: 10%;"></td> <td style="width: 10%;"></td> <td style="width: 10%;"></td> </tr> <tr> <td></td> <td></td> <td colspan="8" style="text-align: center;"> <table border="1" style="width: 100%; border-collapse: collapse; text-align: center;"> <tr> <td style="width: 10%;"></td> <td style="width: 10%;"></td> <td style="width: 10%;"></td> <td style="width: 10%;"></td> <td style="width: 10%;"></td> <td style="width: 10%;"></td> <td style="width: 10%;"></td> <td style="width: 10%;"></td> <td style="width: 10%;"></td> <td style="width: 10%;"></td> </tr> <tr> <td></td> <td></td> <td colspan="8" style="text-align: center;"> <table border="1" style="width: 100%; border-collapse: collapse; text-align: center;"> <tr> <td style="width: 10%;"></td> <td style="width: 10%;"></td> <td style="width: 10%;"></td> <td style="width: 10%;"></td> <td style="width: 10%;"></td> <td style="width: 10%;"></td> <td style="width: 10%;"></td> <td style="width: 10%;"></td> <td style="width: 10%;"></td> <td style="width: 10%;"></td> </tr> <tr> <td></td> <td></td> <td colspan="8" style="text-align: center;"> <table border="1" style="width: 100%; border-collapse: collapse; text-align: center;"> <tr> </tr></table></td></tr></table></td></tr></table></td></tr></table></td></tr></table></td></tr></table></td></tr></table></td></tr></table></td></tr></table></td></tr></table></td></tr></table></td></tr></table></td></tr></table></td></tr></table></td></tr></table></td></tr></table></td></tr></table></td></tr></table></td></tr></table></td></tr></table></td></tr></table></td></tr></table></td></tr></table></td></tr></table></td></tr></table></td></tr></table></td></tr></table></td></tr></table></td></tr></table></td></tr></table></td></tr></table></td></tr></table></td></tr></table>
 | | | | | | | | | | | | | | | | | | | | <table border="1" style="width: 100%; border-collapse: collapse; text-align: center;"> <tr> <td style="width: 10%;"></td> <td style="width: 10%;"></td> <td style="width: 10%;"></td> <td style="width: 10%;"></td> <td style="width: 10%;"></td> <td style="width: 10%;"></td> <td style="width: 10%;"></td> <td style="width: 10%;"></td> <td style="width: 10%;"></td> <td style="width: 10%;"></td> </tr> <tr> <td></td> <td></td> <td colspan="8" style="text-align: center;"> <table border="1" style="width: 100%; border-collapse: collapse; text-align: center;"> <tr> <td style="width: 10%;"></td> <td style="width: 10%;"></td> <td style="width: 10%;"></td> <td style="width: 10%;"></td> <td style="width: 10%;"></td> <td style="width: 10%;"></td> <td style="width: 10%;"></td> <td style="width: 10%;"></td> <td style="width: 10%;"></td> <td style="width: 10%;"></td> </tr> <tr> <td></td> <td></td> <td colspan="8" style="text-align: center;"> <table border="1" style="width: 100%; border-collapse: collapse; text-align: center;"> <tr> <td style="width: 10%;"></td> <td style="width: 10%;"></td> <td style="width: 10%;"></td> <td style="width: 10%;"></td> <td style="width:
10%;"></td> <td style="width: 10%;"></td> <td style="width: 10%;"></td> <td style="width: 10%;"></td> <td style="width: 10%;"></td> <td style="width: 10%;"></td> </tr> <tr> <td></td> <td></td> <td colspan="8" style="text-align: center;"> <table border="1" style="width: 100%; border-collapse: collapse; text-align: center;"> <tr> <td style="width: 10%;"></td> <td style="width: 10%;"></td> <td style="width: 10%;"></td> <td style="width: 10%;"></td> <td style="width: 10%;"></td> <td style="width: 10%;"></td> <td style="width: 10%;"></td> <td style="width: 10%;"></td> <td style="width: 10%;"></td> <td style="width: 10%;"></td> </tr> <tr> <td></td> <td></td> <td colspan="8" style="text-align: center;"> <table border="1" style="width: 100%; border-collapse: collapse; text-align: center;"> <tr> <td style="width: 10%;"></td> <td style="width: 10%;"></td> <td style="width: 10%;"></td> <td style="width: 10%;"></td> <td style="width: 10%;"></td> <td style="width: 10%;"></td> <td style="width: 10%;"></td> <td style="width: 10%;"></td> <td style="width: 10%;"></td> <td style="width: 10%;"></td> </tr> <tr> <td></td> <td></td> <td colspan="8" style="text-align: center;"> <table border="1" style="width: 100%; border-collapse: collapse; text-align: center;"> <tr> <td style="width: 10%;"></td> <td style="width: 10%;"></td> <td style="width: 10%;"></td> <td style="width: 10%;"></td> <td style="width: 10%;"></td> <td style="width: 10%;"></td> <td style="width: 10%;"></td> <td style="width: 10%;"></td> <td style="width: 10%;"></td> <td style="width: 10%;"></td> </tr> <tr> <td></td> <td></td> <td colspan="8" style="text-align: center;"> <table border="1" style="width: 100%; border-collapse: collapse; text-align: center;"> <tr> <td style="width: 10%;"></td> <td style="width: 10%;"></td> <td style="width: 10%;"></td> <td style="width: 10%;"></td> <td style="width: 10%;"></td> <td style="width: 10%;"></td> <td style="width: 10%;"></td> <td style="width: 10%;"></td> <td style="width: 10%;"></td> <td style="width: 10%;"></td> </tr> <tr> <td></td> <td></td> <td colspan="8" style="text-align: center;"> <table border="1" style="width: 100%; border-collapse: collapse; text-align: center;"> <tr> <td style="width: 10%;"></td> <td style="width: 10%;"></td> <td style="width: 10%;"></td> <td style="width: 10%;"></td> <td style="width: 10%;"></td> <td style="width: 10%;"></td> <td style="width: 10%;"></td> <td style="width: 10%;"></td> <td style="width: 10%;"></td> <td style="width: 10%;"></td> </tr> <tr> <td></td> <td></td> <td colspan="8" style="text-align: center;"> <table border="1" style="width: 100%; border-collapse: collapse; text-align: center;"> <tr> <td style="width: 10%;"></td> <td style="width: 10%;"></td> <td style="width: 10%;"></td> <td style="width: 10%;"></td> <td style="width: 10%;"></td> <td style="width: 10%;"></td> <td style="width: 10%;"></td> <td style="width: 10%;"></td> <td style="width: 10%;"></td> <td style="width: 10%;"></td> </tr> <tr> <td></td> <td></td> <td colspan="8" style="text-align: center;"> <table border="1" style="width: 100%; border-collapse: collapse; text-align: center;"> <tr> <td style="width: 10%;"></td> <td style="width: 10%;"></td> <td style="width: 10%;"></td> <td style="width: 10%;"></td> <td style="width: 10%;"></td> <td style="width: 10%;"></td> <td style="width: 10%;"></td> <td style="width: 10%;"></td> <td style="width: 10%;"></td> <td style="width: 10%;"></td> </tr> <tr> <td></td> <td></td> <td colspan="8" style="text-align: center;"> <table border="1" style="width: 100%; border-collapse: collapse; text-align: center;"> <tr> <td style="width: 10%;"></td> <td style="width: 10%;"></td> <td style="width: 10%;"></td> <td style="width: 10%;"></td> <td style="width: 10%;"></td> <td style="width: 10%;"></td> <td style="width: 10%;"></td> <td style="width: 10%;"></td> <td style="width: 10%;"></td> <td style="width: 10%;"></td> </tr> <tr> <td></td> <td></td> <td colspan="8" style="text-align: center;"> <table border="1" style="width: 100%; border-collapse: collapse; text-align: center;"> <tr> <td style="width: 10%;"></td> <td style="width: 10%;"></td> <td style="width: 10%;"></td> <td style="width: 10%;"></td> <td style="width: 10%;"></td> <td style="width: 10%;"></td> <td style="width: 10%;"></td> <td style="width: 10%;"></td> <td style="width: 10%;"></td> <td style="width: 10%;"></td> </tr> <tr> <td></td> <td></td> <td colspan="8" style="text-align: center;"> <table border="1" style="width: 100%; border-collapse: collapse; text-align: center;"> <tr> <td style="width: 10%;"></td> <td style="width: 10%;"></td> <td style="width: 10%;"></td> <td style="width: 10%;"></td> <td style="width: 10%;"></td> <td style="width: 10%;"></td> <td style="width: 10%;"></td> <td style="width: 10%;"></td> <td style="width: 10%;"></td> <td style="width: 10%;"></td> </tr> <tr> <td></td> <td></td> <td colspan="8" style="text-align: center;"> <table border="1" style="width: 100%; border-collapse: collapse; text-align: center;"> <tr> <td style="width: 10%;"></td> <td style="width: 10%;"></td> <td style="width: 10%;"></td> <td style="width: 10%;"></td> <td style="width: 10%;"></td> <td style="width: 10%;"></td> <td style="width: 10%;"></td> <td style="width: 10%;"></td> <td style="width: 10%;"></td> <td style="width: 10%;"></td> </tr> <tr> <td></td> <td></td> <td colspan="8" style="text-align: center;"> <table border="1" style="width: 100%; border-collapse: collapse; text-align: center;"> <tr> <td style="width: 10%;"></td> <td style="width: 10%;"></td> <td style="width: 10%;"></td> <td style="width: 10%;"></td> <td style="width: 10%;"></td> <td style="width: 10%;"></td> <td style="width: 10%;"></td> <td style="width: 10%;"></td> <td style="width: 10%;"></td> <td style="width: 10%;"></td> </tr> <tr> <td></td> <td></td> <td colspan="8" style="text-align: center;"> <table border="1" style="width: 100%; border-collapse: collapse; text-align: center;"> <tr> <td style="width: 10%;"></td> <td style="width: 10%;"></td> <td style="width: 10%;"></td> <td style="width: 10%;"></td> <td style="width: 10%;"></td> <td style="width: 10%;"></td> <td style="width: 10%;"></td> <td style="width: 10%;"></td> <td style="width: 10%;"></td> <td style="width: 10%;"></td> </tr> <tr> <td></td> <td></td> <td colspan="8" style="text-align: center;"> <table border="1" style="width: 100%; border-collapse: collapse; text-align: center;"> <tr> <td style="width: 10%;"></td> <td style="width: 10%;"></td> <td style="width: 10%;"></td> <td style="width: 10%;"></td> <td style="width: 10%;"></td> <td style="width: 10%;"></td> <td style="width: 10%;"></td> <td style="width: 10%;"></td> <td style="width: 10%;"></td> <td style="width: 10%;"></td> </tr> <tr> <td></td> <td></td> <td colspan="8" style="text-align: center;"> <table border="1" style="width: 100%; border-collapse: collapse; text-align: center;"> <tr> <td style="width: 10%;"></td> <td style="width: 10%;"></td> <td style="width: 10%;"></td> <td style="width: 10%;"></td> <td style="width: 10%;"></td> <td style="width: 10%;"></td> <td style="width: 10%;"></td> <td style="width: 10%;"></td> <td style="width: 10%;"></td> <td style="width: 10%;"></td> </tr> <tr> <td></td> <td></td> <td colspan="8" style="text-align: center;"> <table border="1" style="width: 100%; border-collapse: collapse; text-align: center;"> <tr> <td style="width: 10%;"></td> <td style="width: 10%;"></td> <td style="width: 10%;"></td> <td style="width: 10%;"></td> <td style="width: 10%;"></td> <td style="width: 10%;"></td> <td style="width: 10%;"></td> <td style="width: 10%;"></td> <td style="width: 10%;"></td> <td style="width: 10%;"></td> </tr> <tr> <td></td> <td></td> <td colspan="8" style="text-align: center;"> <table border="1" style="width: 100%; border-collapse: collapse; text-align: center;"> <tr> <td style="width: 10%;"></td> <td style="width: 10%;"></td> <td style="width: 10%;"></td> <td style="width: 10%;"></td> <td style="width: 10%;"></td> <td style="width: 10%;"></td> <td style="width: 10%;"></td> <td style="width: 10%;"></td> <td style="width: 10%;"></td> <td style="width: 10%;"></td> </tr> <tr> <td></td> <td></td> <td colspan="8" style="text-align: center;"> <table border="1" style="width: 100%; border-collapse: collapse; text-align: center;"> <tr> <td style="width: 10%;"></td> <td style="width: 10%;"></td> <td style="width: 10%;"></td> <td style="width: 10%;"></td> <td style="width: 10%;"></td> <td style="width: 10%;"></td> <td style="width: 10%;"></td> <td style="width: 10%;"></td> <td style="width: 10%;"></td> <td style="width: 10%;"></td> </tr> <tr> <td></td> <td></td> <td colspan="8" style="text-align: center;"> <table border="1" style="width: 100%; border-collapse: collapse; text-align: center;"> <tr> <td style="width: 10%;"></td> <td style="width: 10%;"></td> <td style="width: 10%;"></td> <td style="width: 10%;"></td> <td style="width: 10%;"></td> <td style="width: 10%;"></td> <td style="width: 10%;"></td> <td style="width: 10%;"></td> <td style="width: 10%;"></td> <td style="width: 10%;"></td> </tr> <tr> <td></td> <td></td> <td colspan="8" style="text-align: center;"> <table border="1" style="width: 100%; border-collapse: collapse; text-align: center;"> <tr> <td style="width: 10%;"></td> <td style="width: 10%;"></td> <td style="width: 10%;"></td> <td style="width: 10%;"></td> <td style="width: 10%;"></td> <td style="width: 10%;"></td> <td style="width: 10%;"></td> <td style="width: 10%;"></td> <td style="width: 10%;"></td> <td style="width: 10%;"></td> </tr> <tr> <td></td> <td></td> <td colspan="8" style="text-align: center;"> <table border="1" style="width: 100%; border-collapse: collapse; text-align: center;"> <tr> <td style="width: 10%;"></td> <td style="width: 10%;"></td> <td style="width: 10%;"></td> <td style="width: 10%;"></td> <td style="width: 10%;"></td> <td style="width: 10%;"></td> <td style="width: 10%;"></td> <td style="width: 10%;"></td> <td style="width: 10%;"></td> <td style="width: 10%;"></td> </tr>
<tr> <td></td> <td></td> <td colspan="8" style="text-align: center;"> <table border="1" style="width: 100%; border-collapse: collapse; text-align: center;"> <tr> <td style="width: 10%;"></td> <td style="width: 10%;"></td> <td style="width: 10%;"></td> <td style="width: 10%;"></td> <td style="width: 10%;"></td> <td style="width: 10%;"></td> <td style="width: 10%;"></td> <td style="width: 10%;"></td> <td style="width: 10%;"></td> <td style="width: 10%;"></td> </tr> <tr> <td></td> <td></td> <td colspan="8" style="text-align: center;"> <table border="1" style="width: 100%; border-collapse: collapse; text-align: center;"> <tr> <td style="width: 10%;"></td> <td style="width: 10%;"></td> <td style="width: 10%;"></td> <td style="width: 10%;"></td> <td style="width: 10%;"></td> <td style="width: 10%;"></td> <td style="width: 10%;"></td> <td style="width: 10%;"></td> <td style="width: 10%;"></td> <td style="width: 10%;"></td> </tr> <tr> <td></td> <td></td> <td colspan="8" style="text-align: center;"> <table border="1" style="width: 100%; border-collapse: collapse; text-align: center;"> <tr> <td style="width: 10%;"></td> <td style="width: 10%;"></td> <td style="width: 10%;"></td> <td style="width: 10%;"></td> <td style="width: 10%;"></td> <td style="width: 10%;"></td> <td style="width: 10%;"></td> <td style="width: 10%;"></td> <td style="width: 10%;"></td> <td style="width: 10%;"></td> </tr> <tr> <td></td> <td></td> <td colspan="8" style="text-align: center;"> <table border="1" style="width: 100%; border-collapse: collapse; text-align: center;"> <tr> <td style="width: 10%;"></td> <td style="width: 10%;"></td> <td style="width: 10%;"></td> <td style="width: 10%;"></td> <td style="width: 10%;"></td> <td style="width: 10%;"></td> <td style="width: 10%;"></td> <td style="width: 10%;"></td> <td style="width: 10%;"></td> <td style="width: 10%;"></td> </tr> <tr> <td></td> <td></td> <td colspan="8" style="text-align: center;"> <table border="1" style="width: 100%; border-collapse: collapse; text-align: center;"> <tr> <td style="width: 10%;"></td> <td style="width: 10%;"></td> <td style="width: 10%;"></td> <td style="width: 10%;"></td> <td style="width: 10%;"></td> <td style="width: 10%;"></td> <td style="width: 10%;"></td> <td style="width: 10%;"></td> <td style="width: 10%;"></td> <td style="width: 10%;"></td> </tr> <tr> <td></td> <td></td> <td colspan="8" style="text-align: center;"> <table border="1" style="width: 100%; border-collapse: collapse; text-align: center;"> <tr> <td style="width: 10%;"></td> <td style="width: 10%;"></td> <td style="width: 10%;"></td> <td style="width: 10%;"></td> <td style="width: 10%;"></td> <td style="width: 10%;"></td> <td style="width: 10%;"></td> <td style="width: 10%;"></td> <td style="width: 10%;"></td> <td style="width: 10%;"></td> </tr> <tr> <td></td> <td></td> <td colspan="8" style="text-align: center;"> <table border="1" style="width: 100%; border-collapse: collapse; text-align: center;"> <tr> <td style="width: 10%;"></td> <td style="width: 10%;"></td> <td style="width: 10%;"></td> <td style="width: 10%;"></td> <td style="width: 10%;"></td> <td style="width: 10%;"></td> <td style="width: 10%;"></td> <td style="width: 10%;"></td> <td style="width: 10%;"></td> <td style="width: 10%;"></td> </tr> <tr> <td></td> <td></td> <td colspan="8" style="text-align: center;"> <table border="1" style="width: 100%; border-collapse: collapse; text-align: center;"> <tr> </tr></table></td></tr></table></td></tr></table></td></tr></table></td></tr></table></td></tr></table></td></tr></table></td></tr></table></td></tr></table></td></tr></table></td></tr></table></td></tr></table></td></tr></table></td></tr></table></td></tr></table></td></tr></table></td></tr></table></td></tr></table></td></tr></table></td></tr></table></td></tr></table></td></tr></table></td></tr></table></td></tr></table></td></tr></table></td></tr></table></td></tr></table></td></tr></table></td></tr></table></td></tr></table></td></tr></table></td></tr></table>
 | | | | | | | | | | | | | | | | | | | | <table border="1" style="width: 100%; border-collapse: collapse; text-align: center;"> <tr> <td style="width: 10%;"></td> <td style="width: 10%;"></td> <td style="width: 10%;"></td> <td style="width: 10%;"></td> <td style="width: 10%;"></td> <td style="width: 10%;"></td> <td style="width: 10%;"></td> <td style="width: 10%;"></td> <td style="width: 10%;"></td> <td style="width: 10%;"></td> </tr> <tr> <td></td> <td></td> <td colspan="8" style="text-align: center;"> <table border="1" style="width: 100%; border-collapse: collapse; text-align: center;"> <tr> <td style="width: 10%;"></td> <td style="width: 10%;"></td> <td style="width: 10%;"></td> <td style="width: 10%;"></td> <td style="width: 10%;"></td> <td style="width: 10%;"></td> <td style="width: 10%;"></td> <td style="width: 10%;"></td> <td style="width: 10%;"></td> <td style="width: 10%;"></td> </tr> <tr> <td></td> <td></td> <td colspan="8" style="text-align: center;"> <table border="1" style="width: 100%; border-collapse: collapse; text-align: center;"> <tr> <td style="width: 10%;"></td> <td style="width: 10%;"></td> <td style="width: 10%;"></td> <td style="width: 10%;"></td> <td style="width: 10%;"></td> <td style="width: 10%;"></td> <td style="width: 10%;"></td> <td style="width: 10%;"></td> <td style="width: 10%;"></td> <td style="width: 10%;"></td> </tr> <tr> <td></td> <td></td> <td colspan="8" style="text-align: center;"> <table border="1" style="width: 100%; border-collapse: collapse; text-align: center;"> <tr> <td style="width: 10%;"></td> <td style="width: 10%;"></td> <td style="width: 10%;"></td> <td style="width: 10%;"></td> <td style="width: 10%;"></td> <td style="width: 10%;"></td> <td style="width: 10%;"></td> <td style="width: 10%;"></td> <td style="width: 10%;"></td> <td style="width: 10%;"></td> </tr> <tr> <td></td> <td></td> <td colspan="8" style="text-align: center;"> <table border="1" style="width: 100%; border-collapse: collapse; text-align: center;"> <tr> <td style="width: 10%;"></td> <td style="width: 10%;"></td> <td style="width: 10%;"></td> <td style="width: 10%;"></td> <td style="width: 10%;"></td> <td style="width: 10%;"></td> <td style="width: 10%;"></td> <td style="width: 10%;"></td> <td style="width: 10%;"></td> <td style="width: 10%;"></td> </tr> <tr> <td></td> <td></td> <td colspan="8" style="text-align: center;"> <table border="1" style="width: 100%; border-collapse: collapse; text-align: center;"> <tr> <td style="width: 10%;"></td> <td style="width: 10%;"></td> <td style="width: 10%;"></td> <td style="width: 10%;"></td> <td style="width: 10%;"></td> <td style="width: 10%;"></td> <td style="width: 10%;"></td> <td style="width: 10%;"></td> <td style="width: 10%;"></td> <td style="width: 10%;"></td> </tr> <tr> <td></td> <td></td> <td colspan="8" style="text-align: center;"> <table border="1" style="width: 100%; border-collapse: collapse; text-align: center;"> <tr> <td style="width: 10%;"></td> <td style="width: 10%;"></td> <td style="width: 10%;"></td> <td style="width: 10%;"></td> <td style="width: 10%;"></td> <td style="width: 10%;"></td> <td style="width: 10%;"></td> <td style="width: 10%;"></td> <td style="width: 10%;"></td> <td style="width: 10%;"></td> </tr> <tr> <td></td> <td></td> <td colspan="8" style="text-align: center;"> <table border="1" style="width: 100%; border-collapse: collapse; text-align: center;"> <tr> <td style="width: 10%;"></td> <td style="width: 10%;"></td> <td style="width: 10%;"></td> <td style="width: 10%;"></td> <td style="width: 10%;"></td> <td style="width: 10%;"></td> <td style="width: 10%;"></td> <td style="width: 10%;"></td> <td style="width: 10%;"></td> <td style="width: 10%;"></td> </tr> <tr> <td></td> <td></td> <td colspan="8" style="text-align: center;"> <table border="1" style="width: 100%; border-collapse: collapse; text-align: center;"> <tr> <td style="width: 10%;"></td> <td style="width: 10%;"></td> <td style="width: 10%;"></td> <td style="width: 10%;"></td> <td style="width: 10%;"></td> <td style="width: 10%;"></td> <td style="width: 10%;"></td> <td style="width: 10%;"></td> <td style="width: 10%;"></td> <td style="width: 10%;"></td> </tr> <tr> <td></td> <td></td> <td colspan="8" style="text-align: center;"> <table border="1" style="width: 100%; border-collapse: collapse; text-align: center;"> <tr> <td style="width: 10%;"></td> <td style="width: 10%;"></td> <td style="width: 10%;"></td> <td style="width: 10%;"></td> <td style="width: 10%;"></td> <td style="width: 10%;"></td> <td style="width: 10%;"></td> <td style="width: 10%;"></td> <td style="width: 10%;"></td> <td style="width: 10%;"></td> </tr> <tr> <td></td> <td></td> <td colspan="8" style="text-align: center;"> <table border="1" style="width: 100%; border-collapse: collapse; text-align: center;"> <tr> <td style="width: 10%;"></td> <td style="width: 10%;"></td> <td style="width: 10%;"></td> <td style="width: 10%;"></td> <td style="width: 10%;"></td> <td style="width: 10%;"></td> <td style="width: 10%;"></td> <td style="width: 10%;"></td> <td style="width: 10%;"></td> <td style="width: 10%;"></td> </tr> <tr> <td></td> <td></td> <td colspan="8" style="text-align: center;"> <table border="1" style="width: 100%; border-collapse: collapse; text-align: center;"> <tr> <td style="width: 10%;"></td> <td style="width: 10%;"></td> <td style="width: 10%;"></td> <td style="width: 10%;"></td> <td style="width: 10%;"></td> <td style="width: 10%;"></td> <td style="width: 10%;"></td> <td style="width: 10%;"></td> <td style="width: 10%;"></td> <td style="width: 10%;"></td> </tr> <tr> <td></td> <td></td> <td colspan="8" style="text-align: center;"> <table border="1" style="width: 100%; border-collapse: collapse; text-align: center;"> <tr> <td style="width: 10%;"></td> <td style="width: 10%;"></td> <td style="width: 10%;"></td> <td style="width: 10%;"></td> <td style="width: 10%;"></td> <td style="width: 10%;"></td> <td style="width: 10%;"></td> <td style="width: 10%;"></td> <td style="width: 10%;"></td> <td style="width: 10%;"></td> </tr> <tr> <td></td> <td></td> <td colspan="8" style="text-align: center;"> <table border="1" style="width: 100%; border-collapse: collapse; text-align: center;"> <tr> <td style="width: 10%;"></td> <td
style="width: 10%;"></td> <td style="width: 10%;"></td> <td style="width: 10%;"></td> <td style="width: 10%;"></td> <td style="width: 10%;"></td> <td style="width: 10%;"></td> <td style="width: 10%;"></td> <td style="width: 10%;"></td> <td style="width: 10%;"></td> </tr> <tr> <td></td> <td></td> <td colspan="8" style="text-align: center;"> <table border="1" style="width: 100%; border-collapse: collapse; text-align: center;"> <tr> <td style="width: 10%;"></td> <td style="width: 10%;"></td> <td style="width: 10%;"></td> <td style="width: 10%;"></td> <td style="width: 10%;"></td> <td style="width: 10%;"></td> <td style="width: 10%;"></td> <td style="width: 10%;"></td> <td style="width: 10%;"></td> <td style="width: 10%;"></td> </tr> <tr> <td></td> <td></td> <td colspan="8" style="text-align: center;"> <table border="1" style="width: 100%; border-collapse: collapse; text-align: center;"> <tr> <td style="width: 10%;"></td> <td style="width: 10%;"></td> <td style="width: 10%;"></td> <td style="width: 10%;"></td> <td style="width: 10%;"></td> <td style="width: 10%;"></td> <td style="width: 10%;"></td> <td style="width: 10%;"></td> <td style="width: 10%;"></td> <td style="width: 10%;"></td> </tr> <tr> <td></td> <td></td> <td colspan="8" style="text-align: center;"> <table border="1" style="width: 100%; border-collapse: collapse; text-align: center;"> <tr> <td style="width: 10%;"></td> <td style="width: 10%;"></td> <td style="width: 10%;"></td> <td style="width: 10%;"></td> <td style="width: 10%;"></td> <td style="width: 10%;"></td> <td style="width: 10%;"></td> <td style="width: 10%;"></td> <td style="width: 10%;"></td> <td style="width: 10%;"></td> </tr> <tr> <td></td> <td></td> <td colspan="8" style="text-align: center;"> <table border="1" style="width: 100%; border-collapse: collapse; text-align: center;"> <tr> <td style="width: 10%;"></td> <td style="width: 10%;"></td> <td style="width: 10%;"></td> <td style="width: 10%;"></td> <td style="width: 10%;"></td> <td style="width: 10%;"></td> <td style="width: 10%;"></td> <td style="width: 10%;"></td> <td style="width: 10%;"></td> <td style="width: 10%;"></td> </tr> <tr> <td></td> <td></td> <td colspan="8" style="text-align: center;"> <table border="1" style="width: 100%; border-collapse: collapse; text-align: center;"> <tr> <td style="width: 10%;"></td> <td style="width: 10%;"></td> <td style="width: 10%;"></td> <td style="width: 10%;"></td> <td style="width: 10%;"></td> <td style="width: 10%;"></td> <td style="width: 10%;"></td> <td style="width: 10%;"></td> <td style="width: 10%;"></td> <td style="width: 10%;"></td> </tr> <tr> <td></td> <td></td> <td colspan="8" style="text-align: center;"> <table border="1" style="width: 100%; border-collapse: collapse; text-align: center;"> <tr> <td style="width: 10%;"></td> <td style="width: 10%;"></td> <td style="width: 10%;"></td> <td style="width: 10%;"></td> <td style="width: 10%;"></td> <td style="width: 10%;"></td> <td style="width: 10%;"></td> <td style="width: 10%;"></td> <td style="width: 10%;"></td> <td style="width: 10%;"></td> </tr> <tr> <td></td> <td></td> <td colspan="8" style="text-align: center;"> <table border="1" style="width: 100%; border-collapse: collapse; text-align: center;"> <tr> <td style="width: 10%;"></td> <td style="width: 10%;"></td> <td style="width: 10%;"></td> <td style="width: 10%;"></td> <td style="width: 10%;"></td> <td style="width: 10%;"></td> <td style="width: 10%;"></td> <td style="width: 10%;"></td> <td style="width: 10%;"></td> <td style="width: 10%;"></td> </tr> <tr> <td></td> <td></td> <td colspan="8" style="text-align: center;"> <table border="1" style="width: 100%; border-collapse: collapse; text-align: center;"> <tr> <td style="width: 10%;"></td> <td style="width: 10%;"></td> <td style="width: 10%;"></td> <td style="width: 10%;"></td> <td style="width: 10%;"></td> <td style="width: 10%;"></td> <td style="width: 10%;"></td> <td style="width: 10%;"></td> <td style="width: 10%;"></td> <td style="width: 10%;"></td> </tr> <tr> <td></td> <td></td> <td colspan="8" style="text-align: center;"> <table border="1" style="width: 100%; border-collapse: collapse; text-align: center;"> <tr> <td style="width: 10%;"></td> <td style="width: 10%;"></td> <td style="width: 10%;"></td> <td style="width: 10%;"></td> <td style="width: 10%;"></td> <td style="width: 10%;"></td> <td style="width: 10%;"></td> <td style="width: 10%;"></td> <td style="width: 10%;"></td> <td style="width: 10%;"></td> </tr> <tr> <td></td> <td></td> <td colspan="8" style="text-align: center;"> <table border="1" style="width: 100%; border-collapse: collapse; text-align: center;"> <tr> <td style="width: 10%;"></td> <td style="width: 10%;"></td> <td style="width: 10%;"></td> <td style="width: 10%;"></td> <td style="width: 10%;"></td> <td style="width: 10%;"></td> <td style="width: 10%;"></td> <td style="width: 10%;"></td> <td style="width: 10%;"></td> <td style="width: 10%;"></td> </tr> <tr> <td></td> <td></td> <td colspan="8" style="text-align: center;"> <table border="1" style="width: 100%; border-collapse: collapse; text-align: center;"> <tr> <td style="width: 10%;"></td> <td style="width: 10%;"></td> <td style="width: 10%;"></td> <td style="width: 10%;"></td> <td style="width: 10%;"></td> <td style="width: 10%;"></td> <td style="width: 10%;"></td> <td style="width: 10%;"></td> <td style="width: 10%;"></td> <td style="width: 10%;"></td> </tr> <tr> <td></td> <td></td> <td colspan="8" style="text-align: center;"> <table border="1" style="width: 100%; border-collapse: collapse; text-align: center;"> <tr> <td style="width: 10%;"></td> <td style="width: 10%;"></td> <td style="width: 10%;"></td> <td style="width: 10%;"></td> <td style="width: 10%;"></td> <td style="width: 10%;"></td> <td style="width: 10%;"></td> <td style="width: 10%;"></td> <td style="width: 10%;"></td> <td style="width: 10%;"></td> </tr> <tr> <td></td> <td></td> <td colspan="8" style="text-align: center;"> <table border="1" style="width: 100%; border-collapse: collapse; text-align: center;"> <tr> <td style="width: 10%;"></td> <td style="width: 10%;"></td> <td style="width: 10%;"></td> <td style="width: 10%;"></td> <td style="width: 10%;"></td> <td style="width: 10%;"></td> <td style="width: 10%;"></td> <td style="width: 10%;"></td> <td style="width: 10%;"></td> <td style="width: 10%;"></td> </tr> <tr> <td></td> <td></td> <td colspan="8" style="text-align: center;"> <table border="1" style="width: 100%; border-collapse: collapse; text-align: center;"> <tr> <td style="width: 10%;"></td> <td style="width: 10%;"></td> <td style="width: 10%;"></td> <td style="width: 10%;"></td> <td style="width: 10%;"></td> <td style="width: 10%;"></td> <td style="width: 10%;"></td> <td style="width: 10%;"></td> <td style="width: 10%;"></td> <td style="width: 10%;"></td> </tr> <tr> <td></td> <td></td> <td colspan="8" style="text-align: center;"> <table border="1" style="width: 100%; border-collapse: collapse; text-align: center;"> <tr> <td style="width: 10%;"></td> <td style="width: 10%;"></td> <td style="width: 10%;"></td> <td style="width: 10%;"></td> <td style="width: 10%;"></td> <td style="width: 10%;"></td> <td style="width: 10%;"></td> <td style="width: 10%;"></td> <td style="width: 10%;"></td> <td style="width: 10%;"></td> </tr> <tr> <td></td> <td></td> <td colspan="8" style="text-align: center;"> <table border="1" style="width: 100%; border-collapse: collapse; text-align: center;"> <tr> <td style="width: 10%;"></td> <td style="width: 10%;"></td> <td style="width: 10%;"></td> <td style="width: 10%;"></td> <td style="width: 10%;"></td> <td style="width: 10%;"></td> <td style="width: 10%;"></td> <td style="width: 10%;"></td> <td style="width: 10%;"></td> <td style="width: 10%;"></td> </tr> <tr> <td></td> <td></td> <td colspan="8" style="text-align: center;"> <table border="1" style="width: 100%; border-collapse: collapse; text-align: center;"> <tr> </tr></table></td></tr></table></td></tr></table></td></tr></table></td></tr></table></td></tr></table></td></tr></table></td></tr></table></td></tr></table></td></tr></table></td></tr></table></td></tr></table></td></tr></table></td></tr></table></td></tr></table></td></tr></table></td></tr></table></td></tr></table></td></tr></table></td></tr></table></td></tr></table></td></tr></table></td></tr></table></td></tr></table></td></tr></table></td></tr></table></td></tr></table></td></tr></table></td></tr></table></td></tr></table></td></tr></table>
 | | | | | | | | | | | | | | | | | | | | <table border="1" style="width: 100%; border-collapse: collapse; text-align: center;"> <tr> <td style="width: 10%;"></td> <td style="width: 10%;"></td> <td style="width: 10%;"></td> <td style="width: 10%;"></td> <td style="width: 10%;"></td> <td style="width: 10%;"></td> <td style="width: 10%;"></td> <td style="width: 10%;"></td> <td style="width: 10%;"></td> <td style="width: 10%;"></td> </tr> <tr> <td></td> <td></td> <td colspan="8" style="text-align: center;"> <table border="1" style="width: 100%; border-collapse: collapse; text-align: center;"> <tr> <td style="width: 10%;"></td> <td style="width: 10%;"></td> <td style="width: 10%;"></td> <td style="width: 10%;"></td> <td style="width: 10%;"></td> <td style="width: 10%;"></td> <td style="width: 10%;"></td> <td style="width: 10%;"></td> <td style="width: 10%;"></td> <td style="width: 10%;"></td> </tr> <tr> <td></td> <td></td> <td colspan="8" style="text-align: center;"> <table border="1" style="width: 100%; border-collapse: collapse; text-align: center;"> <tr> <td style="width: 10%;"></td> <td style="width: 10%;"></td> <td style="width: 10%;"></td> <td style="width: 10%;"></td> <td style="width: 10%;"></td> <td style="width: 10%;"></td> <td style="width: 10%;"></td> <td style="width: 10%;"></td> <td style="width: 10%;"></td> <td style="width: 10%;"></td> </tr> <tr> <td></td> <td></td> <td colspan="8" style="text-align: center;"> <table border="1" style="width: 100%; border-collapse: collapse; text-align: center;"> <tr> <td style="width: 10%;"></td> <td style="width: 10%;"></td> <td style="width: 10%;"></td> <td style="width: 10%;"></td> <td style="width: 10%;"></td> <td style="width: 10%;"></td> <td style="width: 10%;"></td> <td style="width: 10%;"></td> <td
style="width: 10%;"></td> <td style="width: 10%;"></td> </tr> <tr> <td></td> <td></td> <td colspan="8" style="text-align: center;"> <table border="1" style="width: 100%; border-collapse: collapse; text-align: center;"> <tr> <td style="width: 10%;"></td> <td style="width: 10%;"></td> <td style="width: 10%;"></td> <td style="width: 10%;"></td> <td style="width: 10%;"></td> <td style="width: 10%;"></td> <td style="width: 10%;"></td> <td style="width: 10%;"></td> <td style="width: 10%;"></td> <td style="width: 10%;"></td> </tr> <tr> <td></td> <td></td> <td colspan="8" style="text-align: center;"> <table border="1" style="width: 100%; border-collapse: collapse; text-align: center;"> <tr> <td style="width: 10%;"></td> <td style="width: 10%;"></td> <td style="width: 10%;"></td> <td style="width: 10%;"></td> <td style="width: 10%;"></td> <td style="width: 10%;"></td> <td style="width: 10%;"></td> <td style="width: 10%;"></td> <td style="width: 10%;"></td> <td style="width: 10%;"></td> </tr> <tr> <td></td> <td></td> <td colspan="8" style="text-align: center;"> <table border="1" style="width: 100%; border-collapse: collapse; text-align: center;"> <tr> <td style="width: 10%;"></td> <td style="width: 10%;"></td> <td style="width: 10%;"></td> <td style="width: 10%;"></td> <td style="width: 10%;"></td> <td style="width: 10%;"></td> <td style="width: 10%;"></td> <td style="width: 10%;"></td> <td style="width: 10%;"></td> <td style="width: 10%;"></td> </tr> <tr> <td></td> <td></td> <td colspan="8" style="text-align: center;"> <table border="1" style="width: 100%; border-collapse: collapse; text-align: center;"> <tr> <td style="width: 10%;"></td> <td style="width: 10%;"></td> <td style="width: 10%;"></td> <td style="width: 10%;"></td> <td style="width: 10%;"></td> <td style="width: 10%;"></td> <td style="width: 10%;"></td> <td style="width: 10%;"></td> <td style="width: 10%;"></td> <td style="width: 10%;"></td> </tr> <tr> <td></td> <td></td> <td colspan="8" style="text-align: center;"> <table border="1" style="width: 100%; border-collapse: collapse; text-align: center;"> <tr> <td style="width: 10%;"></td> <td style="width: 10%;"></td> <td style="width: 10%;"></td> <td style="width: 10%;"></td> <td style="width: 10%;"></td> <td style="width: 10%;"></td> <td style="width: 10%;"></td> <td style="width: 10%;"></td> <td style="width: 10%;"></td> <td style="width: 10%;"></td> </tr> <tr> <td></td> <td></td> <td colspan="8" style="text-align: center;"> <table border="1" style="width: 100%; border-collapse: collapse; text-align: center;"> <tr> <td style="width: 10%;"></td> <td style="width: 10%;"></td> <td style="width: 10%;"></td> <td style="width: 10%;"></td> <td style="width: 10%;"></td> <td style="width: 10%;"></td> <td style="width: 10%;"></td> <td style="width: 10%;"></td> <td style="width: 10%;"></td> <td style="width: 10%;"></td> </tr> <tr> <td></td> <td></td> <td colspan="8" style="text-align: center;"> <table border="1" style="width: 100%; border-collapse: collapse; text-align: center;"> <tr> <td style="width: 10%;"></td> <td style="width: 10%;"></td> <td style="width: 10%;"></td> <td style="width: 10%;"></td> <td style="width: 10%;"></td> <td style="width: 10%;"></td> <td style="width: 10%;"></td> <td style="width: 10%;"></td> <td style="width: 10%;"></td> <td style="width: 10%;"></td> </tr> <tr> <td></td> <td></td> <td colspan="8" style="text-align: center;"> <table border="1" style="width: 100%; border-collapse: collapse; text-align: center;"> <tr> <td style="width: 10%;"></td> <td style="width: 10%;"></td> <td style="width: 10%;"></td> <td style="width: 10%;"></td> <td style="width: 10%;"></td> <td style="width: 10%;"></td> <td style="width: 10%;"></td> <td style="width: 10%;"></td> <td style="width: 10%;"></td> <td style="width: 10%;"></td> </tr> <tr> <td></td> <td></td> <td colspan="8" style="text-align: center;"> <table border="1" style="width: 100%; border-collapse: collapse; text-align: center;"> <tr> <td style="width: 10%;"></td> <td style="width: 10%;"></td> <td style="width: 10%;"></td> <td style="width: 10%;"></td> <td style="width: 10%;"></td> <td style="width: 10%;"></td> <td style="width: 10%;"></td> <td style="width: 10%;"></td> <td style="width: 10%;"></td> <td style="width: 10%;"></td> </tr> <tr> <td></td> <td></td> <td colspan="8" style="text-align: center;"> <table border="1" style="width: 100%; border-collapse: collapse; text-align: center;"> <tr> <td style="width: 10%;"></td> <td style="width: 10%;"></td> <td style="width: 10%;"></td> <td style="width: 10%;"></td> <td style="width: 10%;"></td> <td style="width: 10%;"></td> <td style="width: 10%;"></td> <td style="width: 10%;"></td> <td style="width: 10%;"></td> <td style="width: 10%;"></td> </tr> <tr> <td></td> <td></td> <td colspan="8" style="text-align: center;"> <table border="1" style="width: 100%; border-collapse: collapse; text-align: center;"> <tr> <td style="width: 10%;"></td> <td style="width: 10%;"></td> <td style="width: 10%;"></td> <td style="width: 10%;"></td> <td style="width: 10%;"></td> <td style="width: 10%;"></td> <td style="width: 10%;"></td> <td style="width: 10%;"></td> <td style="width: 10%;"></td> <td style="width: 10%;"></td> </tr> <tr> <td></td> <td></td> <td colspan="8" style="text-align: center;"> <table border="1" style="width: 100%; border-collapse: collapse; text-align: center;"> <tr> <td style="width: 10%;"></td> <td style="width: 10%;"></td> <td style="width: 10%;"></td> <td style="width: 10%;"></td> <td style="width: 10%;"></td> <td style="width: 10%;"></td> <td style="width: 10%;"></td> <td style="width: 10%;"></td> <td style="width: 10%;"></td> <td style="width: 10%;"></td> </tr> <tr> <td></td> <td></td> <td colspan="8" style="text-align: center;"> <table border="1" style="width: 100%; border-collapse: collapse; text-align: center;"> <tr> <td style="width: 10%;"></td> <td style="width: 10%;"></td> <td style="width: 10%;"></td> <td style="width: 10%;"></td> <td style="width: 10%;"></td> <td style="width: 10%;"></td> <td style="width: 10%;"></td> <td style="width: 10%;"></td> <td style="width: 10%;"></td> <td style="width: 10%;"></td> </tr> <tr> <td></td> <td></td> <td colspan="8" style="text-align: center;"> <table border="1" style="width: 100%; border-collapse: collapse; text-align: center;"> <tr> <td style="width: 10%;"></td> <td style="width: 10%;"></td> <td style="width: 10%;"></td> <td style="width: 10%;"></td> <td style="width: 10%;"></td> <td style="width: 10%;"></td> <td style="width: 10%;"></td> <td style="width: 10%;"></td> <td style="width: 10%;"></td> <td style="width: 10%;"></td> </tr> <tr> <td></td> <td></td> <td colspan="8" style="text-align: center;"> <table border="1" style="width: 100%; border-collapse: collapse; text-align: center;"> <tr> <td style="width: 10%;"></td> <td style="width: 10%;"></td> <td style="width: 10%;"></td> <td style="width: 10%;"></td> <td style="width: 10%;"></td> <td style="width: 10%;"></td> <td style="width: 10%;"></td> <td style="width: 10%;"></td> <td style="width: 10%;"></td> <td style="width: 10%;"></td> </tr> <tr> <td></td> <td></td> <td colspan="8" style="text-align: center;"> <table border="1" style="width: 100%; border-collapse: collapse; text-align: center;"> <tr> <td style="width: 10%;"></td> <td style="width: 10%;"></td> <td style="width: 10%;"></td> <td style="width: 10%;"></td> <td style="width: 10%;"></td> <td style="width: 10%;"></td> <td style="width: 10%;"></td> <td style="width: 10%;"></td> <td style="width: 10%;"></td> <td style="width: 10%;"></td> </tr> <tr> <td></td> <td></td> <td colspan="8" style="text-align: center;"> <table border="1" style="width: 100%; border-collapse: collapse; text-align: center;"> <tr> <td style="width: 10%;"></td> <td style="width: 10%;"></td> <td style="width: 10%;"></td> <td style="width: 10%;"></td> <td style="width: 10%;"></td> <td style="width: 10%;"></td> <td style="width: 10%;"></td> <td style="width: 10%;"></td> <td style="width: 10%;"></td> <td style="width: 10%;"></td> </tr> <tr> <td></td> <td></td> <td colspan="8" style="text-align: center;"> <table border="1" style="width: 100%; border-collapse: collapse; text-align: center;"> <tr> <td style="width: 10%;"></td> <td style="width: 10%;"></td> <td style="width: 10%;"></td> <td style="width: 10%;"></td> <td style="width: 10%;"></td> <td style="width: 10%;"></td> <td style="width: 10%;"></td> <td style="width: 10%;"></td> <td style="width: 10%;"></td> <td style="width: 10%;"></td> </tr> <tr> <td></td> <td></td> <td colspan="8" style="text-align: center;"> <table border="1" style="width: 100%; border-collapse: collapse; text-align: center;"> <tr> <td style="width: 10%;"></td> <td style="width: 10%;"></td> <td style="width: 10%;"></td> <td style="width: 10%;"></td> <td style="width: 10%;"></td> <td style="width: 10%;"></td> <td style="width: 10%;"></td> <td style="width: 10%;"></td> <td style="width: 10%;"></td> <td style="width: 10%;"></td> </tr> <tr> <td></td> <td></td> <td colspan="8" style="text-align: center;"> <table border="1" style="width: 100%; border-collapse: collapse; text-align: center;"> <tr> <td style="width: 10%;"></td> <td style="width: 10%;"></td> <td style="width: 10%;"></td> <td style="width: 10%;"></td> <td style="width: 10%;"></td> <td style="width: 10%;"></td> <td style="width: 10%;"></td> <td style="width: 10%;"></td> <td style="width: 10%;"></td> <td style="width: 10%;"></td> </tr> <tr> <td></td> <td></td> <td colspan="8" style="text-align: center;"> <table border="1" style="width: 100%; border-collapse: collapse; text-align: center;"> <tr> <td style="width: 10%;"></td> <td style="width: 10%;"></td> <td style="width: 10%;"></td> <td style="width: 10%;"></td> <td style="width: 10%;"></td> <td style="width: 10%;"></td> <td style="width: 10%;"></td> <td style="width: 10%;"></td> <td style="width: 10%;"></td> <td style="width: 10%;"></td> </tr> <tr> <td></td> <td></td> <td colspan="8" style="text-align: center;"> <table border="1" style="width: 100%;
border-collapse: collapse; text-align: center;"> <tr> <td style="width: 10%;"></td> <td style="width: 10%;"></td> <td style="width: 10%;"></td> <td style="width: 10%;"></td> <td style="width: 10%;"></td> <td style="width: 10%;"></td> <td style="width: 10%;"></td> <td style="width: 10%;"></td> <td style="width: 10%;"></td> <td style="width: 10%;"></td> </tr> <tr> <td></td> <td></td> <td colspan="8" style="text-align: center;"> <table border="1" style="width: 100%; border-collapse: collapse; text-align: center;"> <tr> <td style="width: 10%;"></td> <td style="width: 10%;"></td> <td style="width: 10%;"></td> <td style="width: 10%;"></td> <td style="width: 10%;"></td> <td style="width: 10%;"></td> <td style="width: 10%;"></td> <td style="width: 10%;"></td> <td style="width: 10%;"></td> <td style="width: 10%;"></td> </tr> <tr> <td></td> <td></td> <td colspan="8" style="text-align: center;"> <table border="1" style="width: 100%; border-collapse: collapse; text-align: center;"> <tr> <td style="width: 10%;"></td> <td style="width: 10%;"></td> <td style="width: 10%;"></td> <td style="width: 10%;"></td> <td style="width: 10%;"></td> <td style="width: 10%;"></td> <td style="width: 10%;"></td> <td style="width: 10%;"></td> <td style="width: 10%;"></td> <td style="width: 10%;"></td> </tr> <tr> <td></td> <td></td> <td colspan="8" style="text-align: center;"> <table border="1" style="width: 100%; border-collapse: collapse; text-align: center;"> <tr> <td style="width: 10%;"></td> <td style="width: 10%;"></td> <td style="width: 10%;"></td> <td style="width: 10%;"></td> <td style="width: 10%;"></td> <td style="width: 10%;"></td> <td style="width: 10%;"></td> <td style="width: 10%;"></td> <td style="width: 10%;"></td> <td style="width: 10%;"></td> </tr> <tr> <td></td> <td></td> <td colspan="8" style="text-align: center;"> <table border="1" style="width: 100%; border-collapse: collapse; text-align: center;"> <tr> </tr></table></td></tr></table></td></tr></table></td></tr></table></td></tr></table></td></tr></table></td></tr></table></td></tr></table></td></tr></table></td></tr></table></td></tr></table></td></tr></table></td></tr></table></td></tr></table></td></tr></table></td></tr></table></td></tr></table></td></tr></table></td></tr></table></td></tr></table></td></tr></table></td></tr></table></td></tr></table></td></tr></table></td></tr></table></td></tr></table></td></tr></table></td></tr></table></td></tr></table></td></tr></table>
 | | | | | | | | | | | | | | | | | | | | <table border="1" style="width: 100%; border-collapse: collapse; text-align: center;"> <tr> <td style="width: 10%;"></td> <td style="width: 10%;"></td> <td style="width: 10%;"></td> <td style="width: 10%;"></td> <td style="width: 10%;"></td> <td style="width: 10%;"></td> <td style="width: 10%;"></td> <td style="width: 10%;"></td> <td style="width: 10%;"></td> <td style="width: 10%;"></td> </tr> <tr> <td></td> <td></td> <td colspan="8" style="text-align: center;"> <table border="1" style="width: 100%; border-collapse: collapse; text-align: center;"> <tr> <td style="width: 10%;"></td> <td style="width: 10%;"></td> <td style="width: 10%;"></td> <td style="width: 10%;"></td> <td style="width: 10%;"></td> <td style="width: 10%;"></td> <td style="width: 10%;"></td> <td style="width: 10%;"></td> <td style="width: 10%;"></td> <td style="width: 10%;"></td> </tr> <tr> <td></td> <td></td> <td colspan="8" style="text-align: center;"> <table border="1" style="width: 100%; border-collapse: collapse; text-align: center;"> <tr> <td style="width: 10%;"></td> <td style="width: 10%;"></td> <td style="width: 10%;"></td> <td style="width: 10%;"></td> <td style="width: 10%;"></td> <td style="width: 10%;"></td> <td style="width: 10%;"></td> <td style="width: 10%;"></td> <td style="width: 10%;"></td> <td style="width: 10%;"></td> </tr> <tr> <td></td> <td></td> <td colspan="8" style="text-align: center;"> <table border="1" style="width: 100%; border-collapse: collapse; text-align: center;"> <tr> <td style="width: 10%;"></td> <td style="width: 10%;"></td> <td style="width: 10%;"></td> <td style="width: 10%;"></td> <td style="width: 10%;"></td> <td style="width: 10%;"></td> <td style="width: 10%;"></td> <td style="width: 10%;"></td> <td style="width: 10%;"></td> <td style="width: 10%;"></td> </tr> <tr> <td></td> <td></td> <td colspan="8" style="text-align: center;"> <table border="1" style="width: 100%; border-collapse: collapse; text-align: center;"> <tr> <td style="width: 10%;"></td> <td style="width: 10%;"></td> <td style="width: 10%;"></td> <td style="width: 10%;"></td> <td style="width: 10%;"></td> <td style="width: 10%;"></td> <td style="width: 10%;"></td> <td style="width: 10%;"></td> <td style="width: 10%;"></td> <td style="width: 10%;"></td> </tr> <tr> <td></td> <td></td> <td colspan="8" style="text-align: center;"> <table border="1" style="width: 100%; border-collapse: collapse; text-align: center;"> <tr> <td style="width: 10%;"></td> <td style="width: 10%;"></td> <td style="width: 10%;"></td> <td style="width: 10%;"></td> <td style="width: 10%;"></td> <td style="width: 10%;"></td> <td style="width: 10%;"></td> <td style="width: 10%;"></td> <td style="width: 10%;"></td> <td style="width: 10%;"></td> </tr> <tr> <td></td> <td></td> <td colspan="8" style="text-align: center;"> <table border="1" style="width: 100%; border-collapse: collapse; text-align: center;"> <tr> <td style="width: 10%;"></td> <td style="width: 10%;"></td> <td style="width: 10%;"></td> <td style="width: 10%;"></td> <td style="width: 10%;"></td> <td style="width: 10%;"></td> <td style="width: 10%;"></td> <td style="width: 10%;"></td> <td style="width: 10%;"></td> <td style="width: 10%;"></td> </tr> <tr> <td></td> <td></td> <td colspan="8" style="text-align: center;"> <table border="1" style="width: 100%; border-collapse: collapse; text-align: center;"> <tr> <td style="width: 10%;"></td> <td style="width: 10%;"></td> <td style="width: 10%;"></td> <td style="width: 10%;"></td> <td style="width: 10%;"></td> <td style="width: 10%;"></td> <td style="width: 10%;"></td> <td style="width: 10%;"></td> <td style="width: 10%;"></td> <td style="width: 10%;"></td> </tr> <tr> <td></td> <td></td> <td colspan="8" style="text-align: center;"> <table border="1" style="width: 100%; border-collapse: collapse; text-align: center;"> <tr> <td style="width: 10%;"></td> <td style="width: 10%;"></td> <td style="width: 10%;"></td> <td style="width: 10%;"></td> <td style="width: 10%;"></td> <td style="width: 10%;"></td> <td style="width: 10%;"></td> <td style="width: 10%;"></td> <td style="width: 10%;"></td> <td style="width: 10%;"></td> </tr> <tr> <td></td> <td></td> <td colspan="8" style="text-align: center;"> <table border="1" style="width: 100%; border-collapse: collapse; text-align: center;"> <tr> <td style="width: 10%;"></td> <td style="width: 10%;"></td> <td style="width: 10%;"></td> <td style="width: 10%;"></td> <td style="width: 10%;"></td> <td style="width: 10%;"></td> <td style="width: 10%;"></td> <td style="width: 10%;"></td> <td style="width: 10%;"></td> <td style="width: 10%;"></td> </tr> <tr> <td></td> <td></td> <td colspan="8" style="text-align: center;"> <table border="1" style="width: 100%; border-collapse: collapse; text-align: center;"> <tr> <td style="width: 10%;"></td> <td style="width: 10%;"></td> <td style="width: 10%;"></td> <td style="width: 10%;"></td> <td style="width: 10%;"></td> <td style="width: 10%;"></td> <td style="width: 10%;"></td> <td style="width: 10%;"></td> <td style="width: 10%;"></td> <td style="width: 10%;"></td> </tr> <tr> <td></td> <td></td> <td colspan="8" style="text-align: center;"> <table border="1" style="width: 100%; border-collapse: collapse; text-align: center;"> <tr> <td style="width: 10%;"></td> <td style="width: 10%;"></td> <td style="width: 10%;"></td> <td style="width: 10%;"></td> <td style="width: 10%;"></td> <td style="width: 10%;"></td> <td style="width: 10%;"></td> <td style="width: 10%;"></td> <td style="width: 10%;"></td> <td style="width: 10%;"></td> </tr> <tr> <td></td> <td></td> <td colspan="8" style="text-align: center;"> <table border="1" style="width: 100%; border-collapse: collapse; text-align: center;"> <tr> <td style="width: 10%;"></td> <td style="width: 10%;"></td> <td style="width: 10%;"></td> <td style="width: 10%;"></td> <td style="width: 10%;"></td> <td style="width: 10%;"></td> <td style="width: 10%;"></td> <td style="width: 10%;"></td> <td style="width: 10%;"></td> <td style="width: 10%;"></td> </tr> <tr> <td></td> <td></td> <td colspan="8" style="text-align: center;"> <table border="1" style="width: 100%; border-collapse: collapse; text-align: center;"> <tr> <td style="width: 10%;"></td> <td style="width: 10%;"></td> <td style="width: 10%;"></td> <td style="width: 10%;"></td> <td style="width: 10%;"></td> <td style="width: 10%;"></td> <td style="width: 10%;"></td> <td style="width: 10%;"></td> <td style="width: 10%;"></td> <td style="width: 10%;"></td> </tr> <tr> <td></td> <td></td> <td colspan="8" style="text-align: center;"> <table border="1" style="width: 100%; border-collapse: collapse; text-align: center;"> <tr> <td style="width: 10%;"></td> <td style="width: 10%;"></td> <td style="width: 10%;"></td> <td style="width: 10%;"></td> <td style="width: 10%;"></td> <td style="width: 10%;"></td> <td style="width: 10%;"></td> <td style="width: 10%;"></td> <td style="width: 10%;"></td> <td style="width: 10%;"></td> </tr> <tr> <td></td> <td></td> <td colspan="8" style="text-align: center;"> <table border="1" style="width: 100%; border-collapse: collapse; text-align: center;"> <tr> <td style="width: 10%;"></td> <td style="width: 10%;"></td> <td style="width: 10%;"></td> <td style="width: 10%;"></td> <td style="width: 10%;"></td> <td style="width: 10%;"></td> <td style="width: 10%;"></td> <td style="width: 10%;"></td> <td style="width: 10%;"></td> <td style="width: 10%;"></td> </tr> <tr> <td></td> <td></td> <td colspan="8" style="text-align: center;"> <table border="1" style="width: 100%; border-collapse: collapse; text-align: center;"> <tr> <td style="width: 10%;"></td> <td style="width: 10%;"></td> <td style="width: 10%;"></td> <td style="width: 10%;"></td> <td style="width: 10%;"></td> <td style="width:
10%;"></td> <td style="width: 10%;"></td> <td style="width: 10%;"></td> <td style="width: 10%;"></td> <td style="width: 10%;"></td> </tr> <tr> <td></td> <td></td> <td colspan="8" style="text-align: center;"> <table border="1" style="width: 100%; border-collapse: collapse; text-align: center;"> <tr> <td style="width: 10%;"></td> <td style="width: 10%;"></td> <td style="width: 10%;"></td> <td style="width: 10%;"></td> <td style="width: 10%;"></td> <td style="width: 10%;"></td> <td style="width: 10%;"></td> <td style="width: 10%;"></td> <td style="width: 10%;"></td> <td style="width: 10%;"></td> </tr> <tr> <td></td> <td></td> <td colspan="8" style="text-align: center;"> <table border="1" style="width: 100%; border-collapse: collapse; text-align: center;"> <tr> <td style="width: 10%;"></td> <td style="width: 10%;"></td> <td style="width: 10%;"></td> <td style="width: 10%;"></td> <td style="width: 10%;"></td> <td style="width: 10%;"></td> <td style="width: 10%;"></td> <td style="width: 10%;"></td> <td style="width: 10%;"></td> <td style="width: 10%;"></td> </tr> <tr> <td></td> <td></td> <td colspan="8" style="text-align: center;"> <table border="1" style="width: 100%; border-collapse: collapse; text-align: center;"> <tr> <td style="width: 10%;"></td> <td style="width: 10%;"></td> <td style="width: 10%;"></td> <td style="width: 10%;"></td> <td style="width: 10%;"></td> <td style="width: 10%;"></td> <td style="width: 10%;"></td> <td style="width: 10%;"></td> <td style="width: 10%;"></td> <td style="width: 10%;"></td> </tr> <tr> <td></td> <td></td> <td colspan="8" style="text-align: center;"> <table border="1" style="width: 100%; border-collapse: collapse; text-align: center;"> <tr> <td style="width: 10%;"></td> <td style="width: 10%;"></td> <td style="width: 10%;"></td> <td style="width: 10%;"></td> <td style="width: 10%;"></td> <td style="width: 10%;"></td> <td style="width: 10%;"></td> <td style="width: 10%;"></td> <td style="width: 10%;"></td> <td style="width: 10%;"></td> </tr> <tr> <td></td> <td></td> <td colspan="8" style="text-align: center;"> <table border="1" style="width: 100%; border-collapse: collapse; text-align: center;"> <tr> <td style="width: 10%;"></td> <td style="width: 10%;"></td> <td style="width: 10%;"></td> <td style="width: 10%;"></td> <td style="width: 10%;"></td> <td style="width: 10%;"></td> <td style="width: 10%;"></td> <td style="width: 10%;"></td> <td style="width: 10%;"></td> <td style="width: 10%;"></td> </tr> <tr> <td></td> <td></td> <td colspan="8" style="text-align: center;"> <table border="1" style="width: 100%; border-collapse: collapse; text-align: center;"> <tr> <td style="width: 10%;"></td> <td style="width: 10%;"></td> <td style="width: 10%;"></td> <td style="width: 10%;"></td> <td style="width: 10%;"></td> <td style="width: 10%;"></td> <td style="width: 10%;"></td> <td style="width: 10%;"></td> <td style="width: 10%;"></td> <td style="width: 10%;"></td> </tr> <tr> <td></td> <td></td> <td colspan="8" style="text-align: center;"> <table border="1" style="width: 100%; border-collapse: collapse; text-align: center;"> <tr> <td style="width: 10%;"></td> <td style="width: 10%;"></td> <td style="width: 10%;"></td> <td style="width: 10%;"></td> <td style="width: 10%;"></td> <td style="width: 10%;"></td> <td style="width: 10%;"></td> <td style="width: 10%;"></td> <td style="width: 10%;"></td> <td style="width: 10%;"></td> </tr> <tr> <td></td> <td></td> <td colspan="8" style="text-align: center;"> <table border="1" style="width: 100%; border-collapse: collapse; text-align: center;"> <tr> <td style="width: 10%;"></td> <td style="width: 10%;"></td> <td style="width: 10%;"></td> <td style="width: 10%;"></td> <td style="width: 10%;"></td> <td style="width: 10%;"></td> <td style="width: 10%;"></td> <td style="width: 10%;"></td> <td style="width: 10%;"></td> <td style="width: 10%;"></td> </tr> <tr> <td></td> <td></td> <td colspan="8" style="text-align: center;"> <table border="1" style="width: 100%; border-collapse: collapse; text-align: center;"> <tr> <td style="width: 10%;"></td> <td style="width: 10%;"></td> <td style="width: 10%;"></td> <td style="width: 10%;"></td> <td style="width: 10%;"></td> <td style="width: 10%;"></td> <td style="width: 10%;"></td> <td style="width: 10%;"></td> <td style="width: 10%;"></td> <td style="width: 10%;"></td> </tr> <tr> <td></td> <td></td> <td colspan="8" style="text-align: center;"> <table border="1" style="width: 100%; border-collapse: collapse; text-align: center;"> <tr> <td style="width: 10%;"></td> <td style="width: 10%;"></td> <td style="width: 10%;"></td> <td style="width: 10%;"></td> <td style="width: 10%;"></td> <td style="width: 10%;"></td> <td style="width: 10%;"></td> <td style="width: 10%;"></td> <td style="width: 10%;"></td> <td style="width: 10%;"></td> </tr> <tr> <td></td> <td></td> <td colspan="8" style="text-align: center;"> <table border="1" style="width: 100%; border-collapse: collapse; text-align: center;"> <tr> <td style="width: 10%;"></td> <td style="width: 10%;"></td> <td style="width: 10%;"></td> <td style="width: 10%;"></td> <td style="width: 10%;"></td> <td style="width: 10%;"></td> <td style="width: 10%;"></td> <td style="width: 10%;"></td> <td style="width: 10%;"></td> <td style="width: 10%;"></td> </tr> <tr> <td></td> <td></td> <td colspan="8" style="text-align: center;"> <table border="1" style="width: 100%; border-collapse: collapse; text-align: center;"> <tr> </tr></table></td></tr></table></td></tr></table></td></tr></table></td></tr></table></td></tr></table></td></tr></table></td></tr></table></td></tr></table></td></tr></table></td></tr></table></td></tr></table></td></tr></table></td></tr></table></td></tr></table></td></tr></table></td></tr></table></td></tr></table></td></tr></table></td></tr></table></td></tr></table></td></tr></table></td></tr></table></td></tr></table></td></tr></table></td></tr></table></td></tr></table></td></tr></table></td></tr></table>
 | | | | | | | | | | | | | | | | | | | | <table border="1" style="width: 100%; border-collapse: collapse; text-align: center;"> <tr> <td style="width: 10%;"></td> <td style="width: 10%;"></td> <td style="width: 10%;"></td> <td style="width: 10%;"></td> <td style="width: 10%;"></td> <td style="width: 10%;"></td> <td style="width: 10%;"></td> <td style="width: 10%;"></td> <td style="width: 10%;"></td> <td style="width: 10%;"></td> </tr> <tr> <td></td> <td></td> <td colspan="8" style="text-align: center;"> <table border="1" style="width: 100%; border-collapse: collapse; text-align: center;"> <tr> <td style="width: 10%;"></td> <td style="width: 10%;"></td> <td style="width: 10%;"></td> <td style="width: 10%;"></td> <td style="width: 10%;"></td> <td style="width: 10%;"></td> <td style="width: 10%;"></td> <td style="width: 10%;"></td> <td style="width: 10%;"></td> <td style="width: 10%;"></td> </tr> <tr> <td></td> <td></td> <td colspan="8" style="text-align: center;"> <table border="1" style="width: 100%; border-collapse: collapse; text-align: center;"> <tr> <td style="width: 10%;"></td> <td style="width: 10%;"></td> <td style="width: 10%;"></td> <td style="width: 10%;"></td> <td style="width: 10%;"></td> <td style="width: 10%;"></td> <td style="width: 10%;"></td> <td style="width: 10%;"></td> <td style="width: 10%;"></td> <td style="width: 10%;"></td> </tr> <tr> <td></td> <td></td> <td colspan="8" style="text-align: center;"> <table border="1" style="width: 100%; border-collapse: collapse; text-align: center;"> <tr> <td style="width: 10%;"></td> <td style="width: 10%;"></td> <td style="width: 10%;"></td> <td style="width: 10%;"></td> <td style="width: 10%;"></td> <td style="width: 10%;"></td> <td style="width: 10%;"></td> <td style="width: 10%;"></td> <td style="width: 10%;"></td> <td style="width: 10%;"></td> </tr> <tr> <td></td> <td></td> <td colspan="8" style="text-align: center;"> <table border="1" style="width: 100%; border-collapse: collapse; text-align: center;"> <tr> <td style="width: 10%;"></td> <td style="width: 10%;"></td> <td style="width: 10%;"></td> <td style="width: 10%;"></td> <td style="width: 10%;"></td> <td style="width: 10%;"></td> <td style="width: 10%;"></td> <td style="width: 10%;"></td> <td style="width: 10%;"></td> <td style="width: 10%;"></td> </tr> <tr> <td></td> <td></td> <td colspan="8" style="text-align: center;"> <table border="1" style="width: 100%; border-collapse: collapse; text-align: center;"> <tr> <td style="width: 10%;"></td> <td style="width: 10%;"></td> <td style="width: 10%;"></td> <td style="width: 10%;"></td> <td style="width: 10%;"></td> <td style="width: 10%;"></td> <td style="width: 10%;"></td> <td style="width: 10%;"></td> <td style="width: 10%;"></td> <td style="width: 10%;"></td> </tr> <tr> <td></td> <td></td> <td colspan="8" style="text-align: center;"> <table border="1" style="width: 100%; border-collapse: collapse; text-align: center;"> <tr> <td style="width: 10%;"></td> <td style="width: 10%;"></td> <td style="width: 10%;"></td> <td style="width: 10%;"></td> <td style="width: 10%;"></td> <td style="width: 10%;"></td> <td style="width: 10%;"></td> <td style="width: 10%;"></td> <td style="width: 10%;"></td> <td style="width: 10%;"></td> </tr> <tr> <td></td> <td></td> <td colspan="8" style="text-align: center;"> <table border="1" style="width: 100%; border-collapse: collapse; text-align: center;"> <tr> <td style="width: 10%;"></td> <td style="width: 10%;"></td> <td style="width: 10%;"></td> <td style="width: 10%;"></td> <td style="width: 10%;"></td> <td style="width: 10%;"></td> <td style="width: 10%;"></td> <td style="width: 10%;"></td> <td style="width: 10%;"></td> <td style="width: 10%;"></td> </tr> <tr> <td></td> <td></td> <td colspan="8" style="text-align: center;"> <table border="1" style="width: 100%; border-collapse: collapse; text-align: center;"> <tr> <td style="width: 10%;"></td> <td style="width: 10%;"></td> <td style="width: 10%;"></td> <td style="width: 10%;"></td> <td style="width: 10%;"></td> <td style="width: 10%;"></td> <td style="width: 10%;"></td> <td style="width: 10%;"></td> <td style="width: 10%;"></td> <td style="width: 10%;"></td> </tr> <tr> <td></td> <td></td> <td colspan="8" style="text-align: center;"> <table border="1" style="width: 100%;
border-collapse: collapse; text-align: center;"> <tr> <td style="width: 10%;"></td> <td style="width: 10%;"></td> <td style="width: 10%;"></td> <td style="width: 10%;"></td> <td style="width: 10%;"></td> <td style="width: 10%;"></td> <td style="width: 10%;"></td> <td style="width: 10%;"></td> <td style="width: 10%;"></td> <td style="width: 10%;"></td> </tr> <tr> <td></td> <td></td> <td colspan="8" style="text-align: center;"> <table border="1" style="width: 100%; border-collapse: collapse; text-align: center;"> <tr> <td style="width: 10%;"></td> <td style="width: 10%;"></td> <td style="width: 10%;"></td> <td style="width: 10%;"></td> <td style="width: 10%;"></td> <td style="width: 10%;"></td> <td style="width: 10%;"></td> <td style="width: 10%;"></td> <td style="width: 10%;"></td> <td style="width: 10%;"></td> </tr> <tr> <td></td> <td></td> <td colspan="8" style="text-align: center;"> <table border="1" style="width: 100%; border-collapse: collapse; text-align: center;"> <tr> <td style="width: 10%;"></td> <td style="width: 10%;"></td> <td style="width: 10%;"></td> <td style="width: 10%;"></td> <td style="width: 10%;"></td> <td style="width: 10%;"></td> <td style="width: 10%;"></td> <td style="width: 10%;"></td> <td style="width: 10%;"></td> <td style="width: 10%;"></td> </tr> <tr> <td></td> <td></td> <td colspan="8" style="text-align: center;"> <table border="1" style="width: 100%; border-collapse: collapse; text-align: center;"> <tr> <td style="width: 10%;"></td> <td style="width: 10%;"></td> <td style="width: 10%;"></td> <td style="width: 10%;"></td> <td style="width: 10%;"></td> <td style="width: 10%;"></td> <td style="width: 10%;"></td> <td style="width: 10%;"></td> <td style="width: 10%;"></td> <td style="width: 10%;"></td> </tr> <tr> <td></td> <td></td> <td colspan="8" style="text-align: center;"> <table border="1" style="width: 100%; border-collapse: collapse; text-align: center;"> <tr> <td style="width: 10%;"></td> <td style="width: 10%;"></td> <td style="width: 10%;"></td> <td style="width: 10%;"></td> <td style="width: 10%;"></td> <td style="width: 10%;"></td> <td style="width: 10%;"></td> <td style="width: 10%;"></td> <td style="width: 10%;"></td> <td style="width: 10%;"></td> </tr> <tr> <td></td> <td></td> <td colspan="8" style="text-align: center;"> <table border="1" style="width: 100%; border-collapse: collapse; text-align: center;"> <tr> <td style="width: 10%;"></td> <td style="width: 10%;"></td> <td style="width: 10%;"></td> <td style="width: 10%;"></td> <td style="width: 10%;"></td> <td style="width: 10%;"></td> <td style="width: 10%;"></td> <td style="width: 10%;"></td> <td style="width: 10%;"></td> <td style="width: 10%;"></td> </tr> <tr> <td></td> <td></td> <td colspan="8" style="text-align: center;"> <table border="1" style="width: 100%; border-collapse: collapse; text-align: center;"> <tr> <td style="width: 10%;"></td> <td style="width: 10%;"></td> <td style="width: 10%;"></td> <td style="width: 10%;"></td> <td style="width: 10%;"></td> <td style="width: 10%;"></td> <td style="width: 10%;"></td> <td style="width: 10%;"></td> <td style="width: 10%;"></td> <td style="width: 10%;"></td> </tr> <tr> <td></td> <td></td> <td colspan="8" style="text-align: center;"> <table border="1" style="width: 100%; border-collapse: collapse; text-align: center;"> <tr> <td style="width: 10%;"></td> <td style="width: 10%;"></td> <td style="width: 10%;"></td> <td style="width: 10%;"></td> <td style="width: 10%;"></td> <td style="width: 10%;"></td> <td style="width: 10%;"></td> <td style="width: 10%;"></td> <td style="width: 10%;"></td> <td style="width: 10%;"></td> </tr> <tr> <td></td> <td></td> <td colspan="8" style="text-align: center;"> <table border="1" style="width: 100%; border-collapse: collapse; text-align: center;"> <tr> <td style="width: 10%;"></td> <td style="width: 10%;"></td> <td style="width: 10%;"></td> <td style="width: 10%;"></td> <td style="width: 10%;"></td> <td style="width: 10%;"></td> <td style="width: 10%;"></td> <td style="width: 10%;"></td> <td style="width: 10%;"></td> <td style="width: 10%;"></td> </tr> <tr> <td></td> <td></td> <td colspan="8" style="text-align: center;"> <table border="1" style="width: 100%; border-collapse: collapse; text-align: center;"> <tr> <td style="width: 10%;"></td> <td style="width: 10%;"></td> <td style="width: 10%;"></td> <td style="width: 10%;"></td> <td style="width: 10%;"></td> <td style="width: 10%;"></td> <td style="width: 10%;"></td> <td style="width: 10%;"></td> <td style="width: 10%;"></td> <td style="width: 10%;"></td> </tr> <tr> <td></td> <td></td> <td colspan="8" style="text-align: center;"> <table border="1" style="width: 100%; border-collapse: collapse; text-align: center;"> <tr> <td style="width: 10%;"></td> <td style="width: 10%;"></td> <td style="width: 10%;"></td> <td style="width: 10%;"></td> <td style="width: 10%;"></td> <td style="width: 10%;"></td> <td style="width: 10%;"></td> <td style="width: 10%;"></td> <td style="width: 10%;"></td> <td style="width: 10%;"></td> </tr> <tr> <td></td> <td></td> <td colspan="8" style="text-align: center;"> <table border="1" style="width: 100%; border-collapse: collapse; text-align: center;"> <tr> <td style="width: 10%;"></td> <td style="width: 10%;"></td> <td style="width: 10%;"></td> <td style="width: 10%;"></td> <td style="width: 10%;"></td> <td style="width: 10%;"></td> <td style="width: 10%;"></td> <td style="width: 10%;"></td> <td style="width: 10%;"></td> <td style="width: 10%;"></td> </tr> <tr> <td></td> <td></td> <td colspan="8" style="text-align: center;"> <table border="1" style="width: 100%; border-collapse: collapse; text-align: center;"> <tr> <td style="width: 10%;"></td> <td style="width: 10%;"></td> <td style="width: 10%;"></td> <td style="width: 10%;"></td> <td style="width: 10%;"></td> <td style="width: 10%;"></td> <td style="width: 10%;"></td> <td style="width: 10%;"></td> <td style="width: 10%;"></td> <td style="width: 10%;"></td> </tr> <tr> <td></td> <td></td> <td colspan="8" style="text-align: center;"> <table border="1" style="width: 100%; border-collapse: collapse; text-align: center;"> <tr> <td style="width: 10%;"></td> <td style="width: 10%;"></td> <td style="width: 10%;"></td> <td style="width: 10%;"></td> <td style="width: 10%;"></td> <td style="width: 10%;"></td> <td style="width: 10%;"></td> <td style="width: 10%;"></td> <td style="width: 10%;"></td> <td style="width: 10%;"></td> </tr> <tr> <td></td> <td></td> <td colspan="8" style="text-align: center;"> <table border="1" style="width: 100%; border-collapse: collapse; text-align: center;"> <tr> <td style="width: 10%;"></td> <td style="width: 10%;"></td> <td style="width: 10%;"></td> <td style="width: 10%;"></td> <td style="width: 10%;"></td> <td style="width: 10%;"></td> <td style="width: 10%;"></td> <td style="width: 10%;"></td> <td style="width: 10%;"></td> <td style="width: 10%;"></td> </tr> <tr> <td></td> <td></td> <td colspan="8" style="text-align: center;"> <table border="1" style="width: 100%; border-collapse: collapse; text-align: center;"> <tr> <td style="width: 10%;"></td> <td style="width: 10%;"></td> <td style="width: 10%;"></td> <td style="width: 10%;"></td> <td style="width: 10%;"></td> <td style="width: 10%;"></td> <td style="width: 10%;"></td> <td style="width: 10%;"></td> <td style="width: 10%;"></td> <td style="width: 10%;"></td> </tr> <tr> <td></td> <td></td> <td colspan="8" style="text-align: center;"> <table border="1" style="width: 100%; border-collapse: collapse; text-align: center;"> <tr> <td style="width: 10%;"></td> <td style="width: 10%;"></td> <td style="width: 10%;"></td> <td style="width: 10%;"></td> <td style="width: 10%;"></td> <td style="width: 10%;"></td> <td style="width: 10%;"></td> <td style="width: 10%;"></td> <td style="width: 10%;"></td> <td style="width: 10%;"></td> </tr> <tr> <td></td> <td></td> <td colspan="8" style="text-align: center;"> <table border="1" style="width: 100%; border-collapse: collapse; text-align: center;"> <tr> <td style="width: 10%;"></td> <td style="width: 10%;"></td> <td style="width: 10%;"></td> <td style="width: 10%;"></td> <td style="width: 10%;"></td> <td style="width: 10%;"></td> <td style="width: 10%;"></td> <td style="width: 10%;"></td> <td style="width: 10%;"></td> <td style="width: 10%;"></td> </tr> <tr> <td></td> <td></td> <td colspan="8" style="text-align: center;"> <table border="1" style="width: 100%; border-collapse: collapse; text-align: center;"> <tr> </tr></table></td></tr></table></td></tr></table></td></tr></table></td></tr></table></td></tr></table></td></tr></table></td></tr></table></td></tr></table></td></tr></table></td></tr></table></td></tr></table></td></tr></table></td></tr></table></td></tr></table></td></tr></table></td></tr></table></td></tr></table></td></tr></table></td></tr></table></td></tr></table></td></tr></table></td></tr></table></td></tr></table></td></tr></table></td></tr></table></td></tr></table></td></tr></table>
 | | | | | | | | | | | | | | | | | | | | <table border="1" style="width: 100%; border-collapse: collapse; text-align: center;"> <tr> <td style="width: 10%;"></td> <td style="width: 10%;"></td> <td style="width: 10%;"></td> <td style="width: 10%;"></td> <td style="width: 10%;"></td> <td style="width: 10%;"></td> <td style="width: 10%;"></td> <td style="width: 10%;"></td> <td style="width: 10%;"></td> <td style="width: 10%;"></td> </tr> <tr> <td></td> <td></td> <td colspan="8" style="text-align: center;"> <table border="1" style="width: 100%; border-collapse: collapse; text-align: center;"> <tr> <td style="width: 10%;"></td> <td style="width: 10%;"></td> <td style="width: 10%;"></td> <td style="width: 10%;"></td> <td style="width: 10%;"></td> <td style="width: 10%;"></td> <td style="width: 10%;"></td> <td style="width: 10%;"></td> <td style="width: 10%;"></td> <td style="width: 10%;"></td> </tr> <tr> <td></td> <td></td> <td colspan="8" style="text-align: center;"> <table border="1" style="width: 100%; border-collapse: collapse; text-align: center;"> <tr> <td style="width: 10%;"></td> <td style="width: 10%;"></td> <td style="width: 10%;"></td> <td style="width: 10%;"></td> <td style="width: 10%;"></td> <td style="width: 10%;"></td> <td style="width: 10%;"></td> <td
style="width: 10%;"></td> <td style="width: 10%;"></td> <td style="width: 10%;"></td> </tr> <tr> <td></td> <td></td> <td colspan="8" style="text-align: center;"> <table border="1" style="width: 100%; border-collapse: collapse; text-align: center;"> <tr> <td style="width: 10%;"></td> <td style="width: 10%;"></td> <td style="width: 10%;"></td> <td style="width: 10%;"></td> <td style="width: 10%;"></td> <td style="width: 10%;"></td> <td style="width: 10%;"></td> <td style="width: 10%;"></td> <td style="width: 10%;"></td> <td style="width: 10%;"></td> </tr> <tr> <td></td> <td></td> <td colspan="8" style="text-align: center;"> <table border="1" style="width: 100%; border-collapse: collapse; text-align: center;"> <tr> <td style="width: 10%;"></td> <td style="width: 10%;"></td> <td style="width: 10%;"></td> <td style="width: 10%;"></td> <td style="width: 10%;"></td> <td style="width: 10%;"></td> <td style="width: 10%;"></td> <td style="width: 10%;"></td> <td style="width: 10%;"></td> <td style="width: 10%;"></td> </tr> <tr> <td></td> <td></td> <td colspan="8" style="text-align: center;"> <table border="1" style="width: 100%; border-collapse: collapse; text-align: center;"> <tr> <td style="width: 10%;"></td> <td style="width: 10%;"></td> <td style="width: 10%;"></td> <td style="width: 10%;"></td> <td style="width: 10%;"></td> <td style="width: 10%;"></td> <td style="width: 10%;"></td> <td style="width: 10%;"></td> <td style="width: 10%;"></td> <td style="width: 10%;"></td> </tr> <tr> <td></td> <td></td> <td colspan="8" style="text-align: center;"> <table border="1" style="width: 100%; border-collapse: collapse; text-align: center;"> <tr> <td style="width: 10%;"></td> <td style="width: 10%;"></td> <td style="width: 10%;"></td> <td style="width: 10%;"></td> <td style="width: 10%;"></td> <td style="width: 10%;"></td> <td style="width: 10%;"></td> <td style="width: 10%;"></td> <td style="width: 10%;"></td> <td style="width: 10%;"></td> </tr> <tr> <td></td> <td></td> <td colspan="8" style="text-align: center;"> <table border="1" style="width: 100%; border-collapse: collapse; text-align: center;"> <tr> <td style="width: 10%;"></td> <td style="width: 10%;"></td> <td style="width: 10%;"></td> <td style="width: 10%;"></td> <td style="width: 10%;"></td> <td style="width: 10%;"></td> <td style="width: 10%;"></td> <td style="width: 10%;"></td> <td style="width: 10%;"></td> <td style="width: 10%;"></td> </tr> <tr> <td></td> <td></td> <td colspan="8" style="text-align: center;"> <table border="1" style="width: 100%; border-collapse: collapse; text-align: center;"> <tr> <td style="width: 10%;"></td> <td style="width: 10%;"></td> <td style="width: 10%;"></td> <td style="width: 10%;"></td> <td style="width: 10%;"></td> <td style="width: 10%;"></td> <td style="width: 10%;"></td> <td style="width: 10%;"></td> <td style="width: 10%;"></td> <td style="width: 10%;"></td> </tr> <tr> <td></td> <td></td> <td colspan="8" style="text-align: center;"> <table border="1" style="width: 100%; border-collapse: collapse; text-align: center;"> <tr> <td style="width: 10%;"></td> <td style="width: 10%;"></td> <td style="width: 10%;"></td> <td style="width: 10%;"></td> <td style="width: 10%;"></td> <td style="width: 10%;"></td> <td style="width: 10%;"></td> <td style="width: 10%;"></td> <td style="width: 10%;"></td> <td style="width: 10%;"></td> </tr> <tr> <td></td> <td></td> <td colspan="8" style="text-align: center;"> <table border="1" style="width: 100%; border-collapse: collapse; text-align: center;"> <tr> <td style="width: 10%;"></td> <td style="width: 10%;"></td> <td style="width: 10%;"></td> <td style="width: 10%;"></td> <td style="width: 10%;"></td> <td style="width: 10%;"></td> <td style="width: 10%;"></td> <td style="width: 10%;"></td> <td style="width: 10%;"></td> <td style="width: 10%;"></td> </tr> <tr> <td></td> <td></td> <td colspan="8" style="text-align: center;"> <table border="1" style="width: 100%; border-collapse: collapse; text-align: center;"> <tr> <td style="width: 10%;"></td> <td style="width: 10%;"></td> <td style="width: 10%;"></td> <td style="width: 10%;"></td> <td style="width: 10%;"></td> <td style="width: 10%;"></td> <td style="width: 10%;"></td> <td style="width: 10%;"></td> <td style="width: 10%;"></td> <td style="width: 10%;"></td> </tr> <tr> <td></td> <td></td> <td colspan="8" style="text-align: center;"> <table border="1" style="width: 100%; border-collapse: collapse; text-align: center;"> <tr> <td style="width: 10%;"></td> <td style="width: 10%;"></td> <td style="width: 10%;"></td> <td style="width: 10%;"></td> <td style="width: 10%;"></td> <td style="width: 10%;"></td> <td style="width: 10%;"></td> <td style="width: 10%;"></td> <td style="width: 10%;"></td> <td style="width: 10%;"></td> </tr> <tr> <td></td> <td></td> <td colspan="8" style="text-align: center;"> <table border="1" style="width: 100%; border-collapse: collapse; text-align: center;"> <tr> <td style="width: 10%;"></td> <td style="width: 10%;"></td> <td style="width: 10%;"></td> <td style="width: 10%;"></td> <td style="width: 10%;"></td> <td style="width: 10%;"></td> <td style="width: 10%;"></td> <td style="width: 10%;"></td> <td style="width: 10%;"></td> <td style="width: 10%;"></td> </tr> <tr> <td></td> <td></td> <td colspan="8" style="text-align: center;"> <table border="1" style="width: 100%; border-collapse: collapse; text-align: center;"> <tr> <td style="width: 10%;"></td> <td style="width: 10%;"></td> <td style="width: 10%;"></td> <td style="width: 10%;"></td> <td style="width: 10%;"></td> <td style="width: 10%;"></td> <td style="width: 10%;"></td> <td style="width: 10%;"></td> <td style="width: 10%;"></td> <td style="width: 10%;"></td> </tr> <tr> <td></td> <td></td> <td colspan="8" style="text-align: center;"> <table border="1" style="width: 100%; border-collapse: collapse; text-align: center;"> <tr> <td style="width: 10%;"></td> <td style="width: 10%;"></td> <td style="width: 10%;"></td> <td style="width: 10%;"></td> <td style="width: 10%;"></td> <td style="width: 10%;"></td> <td style="width: 10%;"></td> <td style="width: 10%;"></td> <td style="width: 10%;"></td> <td style="width: 10%;"></td> </tr> <tr> <td></td> <td></td> <td colspan="8" style="text-align: center;"> <table border="1" style="width: 100%; border-collapse: collapse; text-align: center;"> <tr> <td style="width: 10%;"></td> <td style="width: 10%;"></td> <td style="width: 10%;"></td> <td style="width: 10%;"></td> <td style="width: 10%;"></td> <td style="width: 10%;"></td> <td style="width: 10%;"></td> <td style="width: 10%;"></td> <td style="width: 10%;"></td> <td style="width: 10%;"></td> </tr> <tr> <td></td> <td></td> <td colspan="8" style="text-align: center;"> <table border="1" style="width: 100%; border-collapse: collapse; text-align: center;"> <tr> <td style="width: 10%;"></td> <td style="width: 10%;"></td> <td style="width: 10%;"></td> <td style="width: 10%;"></td> <td style="width: 10%;"></td> <td style="width: 10%;"></td> <td style="width: 10%;"></td> <td style="width: 10%;"></td> <td style="width: 10%;"></td> <td style="width: 10%;"></td> </tr> <tr> <td></td> <td></td> <td colspan="8" style="text-align: center;"> <table border="1" style="width: 100%; border-collapse: collapse; text-align: center;"> <tr> <td style="width: 10%;"></td> <td style="width: 10%;"></td> <td style="width: 10%;"></td> <td style="width: 10%;"></td> <td style="width: 10%;"></td> <td style="width: 10%;"></td> <td style="width: 10%;"></td> <td style="width: 10%;"></td> <td style="width: 10%;"></td> <td style="width: 10%;"></td> </tr> <tr> <td></td> <td></td> <td colspan="8" style="text-align: center;"> <table border="1" style="width: 100%; border-collapse: collapse; text-align: center;"> <tr> <td style="width: 10%;"></td> <td style="width: 10%;"></td> <td style="width: 10%;"></td> <td style="width: 10%;"></td> <td style="width: 10%;"></td> <td style="width: 10%;"></td> <td style="width: 10%;"></td> <td style="width: 10%;"></td> <td style="width: 10%;"></td> <td style="width: 10%;"></td> </tr> <tr> <td></td> <td></td> <td colspan="8" style="text-align: center;"> <table border="1" style="width: 100%; border-collapse: collapse; text-align: center;"> <tr> <td style="width: 10%;"></td> <td style="width: 10%;"></td> <td style="width: 10%;"></td> <td style="width: 10%;"></td> <td style="width: 10%;"></td> <td style="width: 10%;"></td> <td style="width: 10%;"></td> <td style="width: 10%;"></td> <td style="width: 10%;"></td> <td style="width: 10%;"></td> </tr> <tr> <td></td> <td></td> <td colspan="8" style="text-align: center;"> <table border="1" style="width: 100%; border-collapse: collapse; text-align: center;"> <tr> <td style="width: 10%;"></td> <td style="width: 10%;"></td> <td style="width: 10%;"></td> <td style="width: 10%;"></td> <td style="width: 10%;"></td> <td style="width: 10%;"></td> <td style="width: 10%;"></td> <td style="width: 10%;"></td> <td style="width: 10%;"></td> <td style="width: 10%;"></td> </tr> <tr> <td></td> <td></td> <td colspan="8" style="text-align: center;"> <table border="1" style="width: 100%; border-collapse: collapse; text-align: center;"> <tr> <td style="width: 10%;"></td> <td style="width: 10%;"></td> <td style="width: 10%;"></td> <td style="width: 10%;"></td> <td style="width: 10%;"></td> <td style="width: 10%;"></td> <td style="width: 10%;"></td> <td style="width: 10%;"></td> <td style="width: 10%;"></td> <td style="width: 10%;"></td> </tr> <tr> <td></td> <td></td> <td colspan="8" style="text-align: center;"> <table border="1" style="width: 100%; border-collapse: collapse; text-align: center;"> <tr> <td style="width: 10%;"></td> <td style="width: 10%;"></td> <td style="width: 10%;"></td> <td style="width: 10%;"></td> <td style="width: 10%;"></td> <td style="width: 10%;"></td> <td style="width: 10%;"></td> <td style="width: 10%;"></td> <td style="width: 10%;"></td> <td style="width: 10%;"></td> </tr> <tr> <td></td> <td></td> <td colspan="8" style="text-align: center;"> <table
border="1" style="width: 100%; border-collapse: collapse; text-align: center;"> <tr> <td style="width: 10%;"></td> <td style="width: 10%;"></td> <td style="width: 10%;"></td> <td style="width: 10%;"></td> <td style="width: 10%;"></td> <td style="width: 10%;"></td> <td style="width: 10%;"></td> <td style="width: 10%;"></td> <td style="width: 10%;"></td> <td style="width: 10%;"></td> </tr> <tr> <td></td> <td></td> <td colspan="8" style="text-align: center;"> <table border="1" style="width: 100%; border-collapse: collapse; text-align: center;"> <tr> <td style="width: 10%;"></td> <td style="width: 10%;"></td> <td style="width: 10%;"></td> <td style="width: 10%;"></td> <td style="width: 10%;"></td> <td style="width: 10%;"></td> <td style="width: 10%;"></td> <td style="width: 10%;"></td> <td style="width: 10%;"></td> <td style="width: 10%;"></td> </tr> <tr> <td></td> <td></td> <td colspan="8" style="text-align: center;"> <table border="1" style="width: 100%; border-collapse: collapse; text-align: center;"> <tr> </tr></table></td></tr></table></td></tr></table></td></tr></table></td></tr></table></td></tr></table></td></tr></table></td></tr></table></td></tr></table></td></tr></table></td></tr></table></td></tr></table></td></tr></table></td></tr></table></td></tr></table></td></tr></table></td></tr></table></td></tr></table></td></tr></table></td></tr></table></td></tr></table></td></tr></table></td></tr></table></td></tr></table></td></tr></table></td></tr></table></td></tr></table>
 | | | | | | | | | | | | | | | | | | | | <table border="1" style="width: 100%; border-collapse: collapse; text-align: center;"> <tr> <td style="width: 10%;"></td> <td style="width: 10%;"></td> <td style="width: 10%;"></td> <td style="width: 10%;"></td> <td style="width: 10%;"></td> <td style="width: 10%;"></td> <td style="width: 10%;"></td> <td style="width: 10%;"></td> <td style="width: 10%;"></td> <td style="width: 10%;"></td> </tr> <tr> <td></td> <td></td> <td colspan="8" style="text-align: center;"> <table border="1" style="width: 100%; border-collapse: collapse; text-align: center;"> <tr> <td style="width: 10%;"></td> <td style="width: 10%;"></td> <td style="width: 10%;"></td> <td style="width: 10%;"></td> <td style="width: 10%;"></td> <td style="width: 10%;"></td> <td style="width: 10%;"></td> <td style="width: 10%;"></td> <td style="width: 10%;"></td> <td style="width: 10%;"></td> </tr> <tr> <td></td> <td></td> <td colspan="8" style="text-align: center;"> <table border="1" style="width: 100%; border-collapse: collapse; text-align: center;"> <tr> <td style="width: 10%;"></td> <td style="width: 10%;"></td> <td style="width: 10%;"></td> <td style="width: 10%;"></td> <td style="width: 10%;"></td> <td style="width: 10%;"></td> <td style="width: 10%;"></td> <td style="width: 10%;"></td> <td style="width: 10%;"></td> <td style="width: 10%;"></td> </tr> <tr> <td></td> <td></td> <td colspan="8" style="text-align: center;"> <table border="1" style="width: 100%; border-collapse: collapse; text-align: center;"> <tr> <td style="width: 10%;"></td> <td style="width: 10%;"></td> <td style="width: 10%;"></td> <td style="width: 10%;"></td> <td style="width: 10%;"></td> <td style="width: 10%;"></td> <td style="width: 10%;"></td> <td style="width: 10%;"></td> <td style="width: 10%;"></td> <td style="width: 10%;"></td> </tr> <tr> <td></td> <td></td> <td colspan="8" style="text-align: center;"> <table border="1" style="width: 100%; border-collapse: collapse; text-align: center;"> <tr> <td style="width: 10%;"></td> <td style="width: 10%;"></td> <td style="width: 10%;"></td> <td style="width: 10%;"></td> <td style="width: 10%;"></td> <td style="width: 10%;"></td> <td style="width: 10%;"></td> <td style="width: 10%;"></td> <td style="width: 10%;"></td> <td style="width: 10%;"></td> </tr> <tr> <td></td> <td></td> <td colspan="8" style="text-align: center;"> <table border="1" style="width: 100%; border-collapse: collapse; text-align: center;"> <tr> <td style="width: 10%;"></td> <td style="width: 10%;"></td> <td style="width: 10%;"></td> <td style="width: 10%;"></td> <td style="width: 10%;"></td> <td style="width: 10%;"></td> <td style="width: 10%;"></td> <td style="width: 10%;"></td> <td style="width: 10%;"></td> <td style="width: 10%;"></td> </tr> <tr> <td></td> <td></td> <td colspan="8" style="text-align: center;"> <table border="1" style="width: 100%; border-collapse: collapse; text-align: center;"> <tr> <td style="width: 10%;"></td> <td style="width: 10%;"></td> <td style="width: 10%;"></td> <td style="width: 10%;"></td> <td style="width: 10%;"></td> <td style="width: 10%;"></td> <td style="width: 10%;"></td> <td style="width: 10%;"></td> <td style="width: 10%;"></td> <td style="width: 10%;"></td> </tr> <tr> <td></td> <td></td> <td colspan="8" style="text-align: center;"> <table border="1" style="width: 100%; border-collapse: collapse; text-align: center;"> <tr> <td style="width: 10%;"></td> <td style="width: 10%;"></td> <td style="width: 10%;"></td> <td style="width: 10%;"></td> <td style="width: 10%;"></td> <td style="width: 10%;"></td> <td style="width: 10%;"></td> <td style="width: 10%;"></td> <td style="width: 10%;"></td> <td style="width: 10%;"></td> </tr> <tr> <td></td> <td></td> <td colspan="8" style="text-align: center;"> <table border="1" style="width: 100%; border-collapse: collapse; text-align: center;"> <tr> <td style="width: 10%;"></td> <td style="width: 10%;"></td> <td style="width: 10%;"></td> <td style="width: 10%;"></td> <td style="width: 10%;"></td> <td style="width: 10%;"></td> <td style="width: 10%;"></td> <td style="width: 10%;"></td> <td style="width: 10%;"></td> <td style="width: 10%;"></td> </tr> <tr> <td></td> <td></td> <td colspan="8" style="text-align: center;"> <table border="1" style="width: 100%; border-collapse: collapse; text-align: center;"> <tr> <td style="width: 10%;"></td> <td style="width: 10%;"></td> <td style="width: 10%;"></td> <td style="width: 10%;"></td> <td style="width: 10%;"></td> <td style="width: 10%;"></td> <td style="width: 10%;"></td> <td style="width: 10%;"></td> <td style="width: 10%;"></td> <td style="width: 10%;"></td> </tr> <tr> <td></td> <td></td> <td colspan="8" style="text-align: center;"> <table border="1" style="width: 100%; border-collapse: collapse; text-align: center;"> <tr> <td style="width: 10%;"></td> <td style="width: 10%;"></td> <td style="width: 10%;"></td> <td style="width: 10%;"></td> <td style="width: 10%;"></td> <td style="width: 10%;"></td> <td style="width: 10%;"></td> <td style="width: 10%;"></td> <td style="width: 10%;"></td> <td style="width: 10%;"></td> </tr> <tr> <td></td> <td></td> <td colspan="8" style="text-align: center;"> <table border="1" style="width: 100%; border-collapse: collapse; text-align: center;"> <tr> <td style="width: 10%;"></td> <td style="width: 10%;"></td> <td style="width: 10%;"></td> <td style="width: 10%;"></td> <td style="width: 10%;"></td> <td style="width: 10%;"></td> <td style="width: 10%;"></td> <td style="width: 10%;"></td> <td style="width: 10%;"></td> <td style="width: 10%;"></td> </tr> <tr> <td></td> <td></td> <td colspan="8" style="text-align: center;"> <table border="1" style="width: 100%; border-collapse: collapse; text-align: center;"> <tr> <td style="width: 10%;"></td> <td style="width: 10%;"></td> <td style="width: 10%;"></td> <td style="width: 10%;"></td> <td style="width: 10%;"></td> <td style="width: 10%;"></td> <td style="width: 10%;"></td> <td style="width: 10%;"></td> <td style="width: 10%;"></td> <td style="width: 10%;"></td> </tr> <tr> <td></td> <td></td> <td colspan="8" style="text-align: center;"> <table border="1" style="width: 100%; border-collapse: collapse; text-align: center;"> <tr> <td style="width: 10%;"></td> <td style="width: 10%;"></td> <td style="width: 10%;"></td> <td style="width: 10%;"></td> <td style="width: 10%;"></td> <td style="width: 10%;"></td> <td style="width: 10%;"></td> <td style="width: 10%;"></td> <td style="width: 10%;"></td> <td style="width: 10%;"></td> </tr> <tr> <td></td> <td></td> <td colspan="8" style="text-align: center;"> <table border="1" style="width: 100%; border-collapse: collapse; text-align: center;"> <tr> <td style="width: 10%;"></td> <td style="width: 10%;"></td> <td style="width: 10%;"></td> <td style="width: 10%;"></td> <td style="width: 10%;"></td> <td style="width: 10%;"></td> <td style="width: 10%;"></td> <td style="width: 10%;"></td> <td style="width: 10%;"></td> <td style="width: 10%;"></td> </tr> <tr> <td></td> <td></td> <td colspan="8" style="text-align: center;"> <table border="1" style="width: 100%; border-collapse: collapse; text-align: center;"> <tr> <td style="width: 10%;"></td> <td style="width: 10%;"></td> <td style="width: 10%;"></td> <td style="width: 10%;"></td> <td style="width: 10%;"></td> <td style="width: 10%;"></td> <td style="width: 10%;"></td> <td style="width: 10%;"></td> <td style="width: 10%;"></td> <td style="width: 10%;"></td> </tr> <tr> <td></td> <td></td> <td colspan="8" style="text-align: center;"> <table border="1" style="width: 100%; border-collapse: collapse; text-align: center;"> <tr> <td style="width: 10%;"></td> <td style="width: 10%;"></td> <td style="width: 10%;"></td> <td style="width: 10%;"></td> <td style="width: 10%;"></td> <td style="width: 10%;"></td> <td style="width: 10%;"></td> <td style="width: 10%;"></td> <td style="width: 10%;"></td> <td style="width: 10%;"></td> </tr> <tr> <td></td> <td></td> <td colspan="8" style="text-align: center;"> <table border="1" style="width: 100%; border-collapse: collapse; text-align: center;"> <tr> <td style="width: 10%;"></td> <td style="width: 10%;"></td> <td style="width: 10%;"></td> <td style="width: 10%;"></td> <td style="width: 10%;"></td> <td style="width: 10%;"></td> <td style="width: 10%;"></td> <td style="width: 10%;"></td> <td style="width: 10%;"></td> <td style="width: 10%;"></td> </tr> <tr> <td></td> <td></td> <td colspan="8" style="text-align: center;"> <table border="1" style="width: 100%; border-collapse: collapse; text-align: center;"> <tr> <td style="width: 10%;"></td> <td style="width: 10%;"></td> <td style="width: 10%;"></td> <td style="width: 10%;"></td> <td style="width: 10%;"></td> <td style="width: 10%;"></td> <td style="width:
10%;"></td> <td style="width: 10%;"></td> <td style="width: 10%;"></td> <td style="width: 10%;"></td> </tr> <tr> <td></td> <td></td> <td colspan="8" style="text-align: center;"> <table border="1" style="width: 100%; border-collapse: collapse; text-align: center;"> <tr> <td style="width: 10%;"></td> <td style="width: 10%;"></td> <td style="width: 10%;"></td> <td style="width: 10%;"></td> <td style="width: 10%;"></td> <td style="width: 10%;"></td> <td style="width: 10%;"></td> <td style="width: 10%;"></td> <td style="width: 10%;"></td> <td style="width: 10%;"></td> </tr> <tr> <td></td> <td></td> <td colspan="8" style="text-align: center;"> <table border="1" style="width: 100%; border-collapse: collapse; text-align: center;"> <tr> <td style="width: 10%;"></td> <td style="width: 10%;"></td> <td style="width: 10%;"></td> <td style="width: 10%;"></td> <td style="width: 10%;"></td> <td style="width: 10%;"></td> <td style="width: 10%;"></td> <td style="width: 10%;"></td> <td style="width: 10%;"></td> <td style="width: 10%;"></td> </tr> <tr> <td></td> <td></td> <td colspan="8" style="text-align: center;"> <table border="1" style="width: 100%; border-collapse: collapse; text-align: center;"> <tr> <td style="width: 10%;"></td> <td style="width: 10%;"></td> <td style="width: 10%;"></td> <td style="width: 10%;"></td> <td style="width: 10%;"></td> <td style="width: 10%;"></td> <td style="width: 10%;"></td> <td style="width: 10%;"></td> <td style="width: 10%;"></td> <td style="width: 10%;"></td> </tr> <tr> <td></td> <td></td> <td colspan="8" style="text-align: center;"> <table border="1" style="width: 100%; border-collapse: collapse; text-align: center;"> <tr> <td style="width: 10%;"></td> <td style="width: 10%;"></td> <td style="width: 10%;"></td> <td style="width: 10%;"></td> <td style="width: 10%;"></td> <td style="width: 10%;"></td> <td style="width: 10%;"></td> <td style="width: 10%;"></td> <td style="width: 10%;"></td> <td style="width: 10%;"></td> </tr> <tr> <td></td> <td></td> <td colspan="8" style="text-align: center;"> <table border="1" style="width: 100%; border-collapse: collapse; text-align: center;"> <tr> <td style="width: 10%;"></td> <td style="width: 10%;"></td> <td style="width: 10%;"></td> <td style="width: 10%;"></td> <td style="width: 10%;"></td> <td style="width: 10%;"></td> <td style="width: 10%;"></td> <td style="width: 10%;"></td> <td style="width: 10%;"></td> <td style="width: 10%;"></td> </tr> <tr> <td></td> <td></td> <td colspan="8" style="text-align: center;"> <table border="1" style="width: 100%; border-collapse: collapse; text-align: center;"> <tr> <td style="width: 10%;"></td> <td style="width: 10%;"></td> <td style="width: 10%;"></td> <td style="width: 10%;"></td> <td style="width: 10%;"></td> <td style="width: 10%;"></td> <td style="width: 10%;"></td> <td style="width: 10%;"></td> <td style="width: 10%;"></td> <td style="width: 10%;"></td> </tr> <tr> <td></td> <td></td> <td colspan="8" style="text-align: center;"> <table border="1" style="width: 100%; border-collapse: collapse; text-align: center;"> <tr> </tr></table></td></tr></table></td></tr></table></td></tr></table></td></tr></table></td></tr></table></td></tr></table></td></tr></table></td></tr></table></td></tr></table></td></tr></table></td></tr></table></td></tr></table></td></tr></table></td></tr></table></td></tr></table></td></tr></table></td></tr></table></td></tr></table></td></tr></table></td></tr></table></td></tr></table></td></tr></table></td></tr></table></td></tr></table></td></tr></table>
 | | | | | | | | | | | | | | | | | | | | <table border="1" style="width: 100%; border-collapse: collapse; text-align: center;"> <tr> <td style="width: 10%;"></td> <td style="width: 10%;"></td> <td style="width: 10%;"></td> <td style="width: 10%;"></td> <td style="width: 10%;"></td> <td style="width: 10%;"></td> <td style="width: 10%;"></td> <td style="width: 10%;"></td> <td style="width: 10%;"></td> <td style="width: 10%;"></td> </tr> <tr> <td></td> <td></td> <td colspan="8" style="text-align: center;"> <table border="1" style="width: 100%; border-collapse: collapse; text-align: center;"> <tr> <td style="width: 10%;"></td> <td style="width: 10%;"></td> <td style="width: 10%;"></td> <td style="width: 10%;"></td> <td style="width: 10%;"></td> <td style="width: 10%;"></td> <td style="width: 10%;"></td> <td style="width: 10%;"></td> <td style="width: 10%;"></td> <td style="width: 10%;"></td> </tr> <tr> <td></td> <td></td> <td colspan="8" style="text-align: center;"> <table border="1" style="width: 100%; border-collapse: collapse; text-align: center;"> <tr> <td style="width: 10%;"></td> <td style="width: 10%;"></td> <td style="width: 10%;"></td> <td style="width: 10%;"></td> <td style="width: 10%;"></td> <td style="width: 10%;"></td> <td style="width: 10%;"></td> <td style="width: 10%;"></td> <td style="width: 10%;"></td> <td style="width: 10%;"></td> </tr> <tr> <td></td> <td></td> <td colspan="8" style="text-align: center;"> <table border="1" style="width: 100%; border-collapse: collapse; text-align: center;"> <tr> <td style="width: 10%;"></td> <td style="width: 10%;"></td> <td style="width: 10%;"></td> <td style="width: 10%;"></td> <td style="width: 10%;"></td> <td style="width: 10%;"></td> <td style="width: 10%;"></td> <td style="width: 10%;"></td> <td style="width: 10%;"></td> <td style="width: 10%;"></td> </tr> <tr> <td></td> <td></td> <td colspan="8" style="text-align: center;"> <table border="1" style="width: 100%; border-collapse: collapse; text-align: center;"> <tr> <td style="width: 10%;"></td> <td style="width: 10%;"></td> <td style="width: 10%;"></td> <td style="width: 10%;"></td> <td style="width: 10%;"></td> <td style="width: 10%;"></td> <td style="width: 10%;"></td> <td style="width: 10%;"></td> <td style="width: 10%;"></td> <td style="width: 10%;"></td> </tr> <tr> <td></td> <td></td> <td colspan="8" style="text-align: center;"> <table border="1" style="width: 100%; border-collapse: collapse; text-align: center;"> <tr> <td style="width: 10%;"></td> <td style="width: 10%;"></td> <td style="width: 10%;"></td> <td style="width: 10%;"></td> <td style="width: 10%;"></td> <td style="width: 10%;"></td> <td style="width: 10%;"></td> <td style="width: 10%;"></td> <td style="width: 10%;"></td> <td style="width: 10%;"></td> </tr> <tr> <td></td> <td></td> <td colspan="8" style="text-align: center;"> <table border="1" style="width: 100%; border-collapse: collapse; text-align: center;"> <tr> <td style="width: 10%;"></td> <td style="width: 10%;"></td> <td style="width: 10%;"></td> <td style="width: 10%;"></td> <td style="width: 10%;"></td> <td style="width: 10%;"></td> <td style="width: 10%;"></td> <td style="width: 10%;"></td> <td style="width: 10%;"></td> <td style="width: 10%;"></td> </tr> <tr> <td></td> <td></td> <td colspan="8" style="text-align: center;"> <table border="1" style="width: 100%; border-collapse: collapse; text-align: center;"> <tr> <td style="width: 10%;"></td> <td style="width: 10%;"></td> <td style="width: 10%;"></td> <td style="width: 10%;"></td> <td style="width: 10%;"></td> <td style="width: 10%;"></td> <td style="width: 10%;"></td> <td style="width: 10%;"></td> <td style="width: 10%;"></td> <td style="width: 10%;"></td> </tr> <tr> <td></td> <td></td> <td colspan="8" style="text-align: center;"> <table border="1" style="width: 100%; border-collapse: collapse; text-align: center;"> <tr> <td style="width: 10%;"></td> <td style="width: 10%;"></td> <td style="width: 10%;"></td> <td style="width: 10%;"></td> <td style="width: 10%;"></td> <td style="width: 10%;"></td> <td style="width: 10%;"></td> <td style="width: 10%;"></td> <td style="width: 10%;"></td> <td style="width: 10%;"></td> </tr> <tr> <td></td> <td></td> <td colspan="8" style="text-align: center;"> <table border="1" style="width: 100%; border-collapse: collapse; text-align: center;"> <tr> <td style="width: 10%;"></td> <td style="width: 10%;"></td> <td style="width: 10%;"></td> <td style="width: 10%;"></td> <td style="width: 10%;"></td> <td style="width: 10%;"></td> <td style="width: 10%;"></td> <td style="width: 10%;"></td> <td style="width: 10%;"></td> <td style="width: 10%;"></td> </tr> <tr> <td></td> <td></td> <td colspan="8" style="text-align: center;"> <table border="1" style="width: 100%; border-collapse: collapse; text-align: center;"> <tr> <td style="width: 10%;"></td> <td style="width: 10%;"></td> <td style="width: 10%;"></td> <td style="width: 10%;"></td> <td style="width: 10%;"></td> <td style="width: 10%;"></td> <td style="width: 10%;"></td> <td style="width: 10%;"></td> <td style="width: 10%;"></td> <td style="width: 10%;"></td> </tr> <tr> <td></td> <td></td> <td colspan="8" style="text-align: center;"> <table border="1" style="width: 100%; border-collapse: collapse; text-align: center;"> <tr> <td style="width: 10%;"></td> <td style="width: 10%;"></td> <td style="width: 10%;"></td> <td style="width: 10%;"></td> <td style="width: 10%;"></td> <td style="width: 10%;"></td> <td style="width: 10%;"></td> <td style="width: 10%;"></td> <td style="width: 10%;"></td> <td style="width: 10%;"></td> </tr> <tr> <td></td> <td></td> <td colspan="8" style="text-align: center;"> <table border="1" style="width: 100%; border-collapse: collapse; text-align: center;"> <tr> <td style="width: 10%;"></td> <td style="width: 10%;"></td> <td style="width: 10%;"></td> <td style="width: 10%;"></td> <td style="width: 10%;"></td> <td style="width: 10%;"></td> <td style="width: 10%;"></td> <td style="width: 10%;"></td> <td style="width: 10%;"></td> <td style="width: 10%;"></td> </tr> <tr> <td></td> <td></td> <td colspan="8" style="text-align: center;"> <table border="1" style="width: 100%; border-collapse: collapse; text-align: center;"> <tr> <td style="width: 10%;"></td> <td style="width: 10%;"></td> <td style="width: 10%;"></td> <td style="width: 10%;"></td> <td style="width: 10%;"></td> <td style="width: 10%;"></td> <td style="width: 10%;"></td> <td style="width: 10%;"></td> <td style="width: 10%;"></td> <td style="width: 10%;"></td> </tr> <tr> <td></td> <td></td> <td colspan="8" style="text-align: center;"> <table border="1" style="width: 100%; border-collapse: collapse; text-align: center;"> <tr> <td style="width: 10%;"></td> <td
style="width: 10%;"></td> <td style="width: 10%;"></td> <td style="width: 10%;"></td> <td style="width: 10%;"></td> <td style="width: 10%;"></td> <td style="width: 10%;"></td> <td style="width: 10%;"></td> <td style="width: 10%;"></td> <td style="width: 10%;"></td> </tr> <tr> <td></td> <td></td> <td colspan="8" style="text-align: center;"> <table border="1" style="width: 100%; border-collapse: collapse; text-align: center;"> <tr> <td style="width: 10%;"></td> <td style="width: 10%;"></td> <td style="width: 10%;"></td> <td style="width: 10%;"></td> <td style="width: 10%;"></td> <td style="width: 10%;"></td> <td style="width: 10%;"></td> <td style="width: 10%;"></td> <td style="width: 10%;"></td> <td style="width: 10%;"></td> </tr> <tr> <td></td> <td></td> <td colspan="8" style="text-align: center;"> <table border="1" style="width: 100%; border-collapse: collapse; text-align: center;"> <tr> <td style="width: 10%;"></td> <td style="width: 10%;"></td> <td style="width: 10%;"></td> <td style="width: 10%;"></td> <td style="width: 10%;"></td> <td style="width: 10%;"></td> <td style="width: 10%;"></td> <td style="width: 10%;"></td> <td style="width: 10%;"></td> <td style="width: 10%;"></td> </tr> <tr> <td></td> <td></td> <td colspan="8" style="text-align: center;"> <table border="1" style="width: 100%; border-collapse: collapse; text-align: center;"> <tr> <td style="width: 10%;"></td> <td style="width: 10%;"></td> <td style="width: 10%;"></td> <td style="width: 10%;"></td> <td style="width: 10%;"></td> <td style="width: 10%;"></td> <td style="width: 10%;"></td> <td style="width: 10%;"></td> <td style="width: 10%;"></td> <td style="width: 10%;"></td> </tr> <tr> <td></td> <td></td> <td colspan="8" style="text-align: center;"> <table border="1" style="width: 100%; border-collapse: collapse; text-align: center;"> <tr> <td style="width: 10%;"></td> <td style="width: 10%;"></td> <td style="width: 10%;"></td> <td style="width: 10%;"></td> <td style="width: 10%;"></td> <td style="width: 10%;"></td> <td style="width: 10%;"></td> <td style="width: 10%;"></td> <td style="width: 10%;"></td> <td style="width: 10%;"></td> </tr> <tr> <td></td> <td></td> <td colspan="8" style="text-align: center;"> <table border="1" style="width: 100%; border-collapse: collapse; text-align: center;"> <tr> <td style="width: 10%;"></td> <td style="width: 10%;"></td> <td style="width: 10%;"></td> <td style="width: 10%;"></td> <td style="width: 10%;"></td> <td style="width: 10%;"></td> <td style="width: 10%;"></td> <td style="width: 10%;"></td> <td style="width: 10%;"></td> <td style="width: 10%;"></td> </tr> <tr> <td></td> <td></td> <td colspan="8" style="text-align: center;"> <table border="1" style="width: 100%; border-collapse: collapse; text-align: center;"> <tr> <td style="width: 10%;"></td> <td style="width: 10%;"></td> <td style="width: 10%;"></td> <td style="width: 10%;"></td> <td style="width: 10%;"></td> <td style="width: 10%;"></td> <td style="width: 10%;"></td> <td style="width: 10%;"></td> <td style="width: 10%;"></td> <td style="width: 10%;"></td> </tr> <tr> <td></td> <td></td> <td colspan="8" style="text-align: center;"> <table border="1" style="width: 100%; border-collapse: collapse; text-align: center;"> <tr> <td style="width: 10%;"></td> <td style="width: 10%;"></td> <td style="width: 10%;"></td> <td style="width: 10%;"></td> <td style="width: 10%;"></td> <td style="width: 10%;"></td> <td style="width: 10%;"></td> <td style="width: 10%;"></td> <td style="width: 10%;"></td> <td style="width: 10%;"></td> </tr> <tr> <td></td> <td></td> <td colspan="8" style="text-align: center;"> <table border="1" style="width: 100%; border-collapse: collapse; text-align: center;"> <tr> <td style="width: 10%;"></td> <td style="width: 10%;"></td> <td style="width: 10%;"></td> <td style="width: 10%;"></td> <td style="width: 10%;"></td> <td style="width: 10%;"></td> <td style="width: 10%;"></td> <td style="width: 10%;"></td> <td style="width: 10%;"></td> <td style="width: 10%;"></td> </tr> <tr> <td></td> <td></td> <td colspan="8" style="text-align: center;"> <table border="1" style="width: 100%; border-collapse: collapse; text-align: center;"> <tr> <td style="width: 10%;"></td> <td style="width: 10%;"></td> <td style="width: 10%;"></td> <td style="width: 10%;"></td> <td style="width: 10%;"></td> <td style="width: 10%;"></td> <td style="width: 10%;"></td> <td style="width: 10%;"></td> <td style="width: 10%;"></td> <td style="width: 10%;"></td> </tr> <tr> <td></td> <td></td> <td colspan="8" style="text-align: center;"> <table border="1" style="width: 100%; border-collapse: collapse; text-align: center;"> <tr> </tr></table></td></tr></table></td></tr></table></td></tr></table></td></tr></table></td></tr></table></td></tr></table></td></tr></table></td></tr></table></td></tr></table></td></tr></table></td></tr></table></td></tr></table></td></tr></table></td></tr></table></td></tr></table></td></tr></table></td></tr></table></td></tr></table></td></tr></table></td></tr></table></td></tr></table></td></tr></table></td></tr></table></td></tr></table>
 | | | | | | | | | | | | | | | | | | | | <table border="1" style="width: 100%; border-collapse: collapse; text-align: center;"> <tr> <td style="width: 10%;"></td> <td style="width: 10%;"></td> <td style="width: 10%;"></td> <td style="width: 10%;"></td> <td style="width: 10%;"></td> <td style="width: 10%;"></td> <td style="width: 10%;"></td> <td style="width: 10%;"></td> <td style="width: 10%;"></td> <td style="width: 10%;"></td> </tr> <tr> <td></td> <td></td> <td colspan="8" style="text-align: center;"> <table border="1" style="width: 100%; border-collapse: collapse; text-align: center;"> <tr> <td style="width: 10%;"></td> <td style="width: 10%;"></td> <td style="width: 10%;"></td> <td style="width: 10%;"></td> <td style="width: 10%;"></td> <td style="width: 10%;"></td> <td style="width: 10%;"></td> <td style="width: 10%;"></td> <td style="width: 10%;"></td> <td style="width: 10%;"></td> </tr> <tr> <td></td> <td></td> <td colspan="8" style="text-align: center;"> <table border="1" style="width: 100%; border-collapse: collapse; text-align: center;"> <tr> <td style="width: 10%;"></td> <td style="width: 10%;"></td> <td style="width: 10%;"></td> <td style="width: 10%;"></td> <td style="width: 10%;"></td> <td style="width: 10%;"></td> <td style="width: 10%;"></td> <td style="width: 10%;"></td> <td style="width: 10%;"></td> <td style="width: 10%;"></td> </tr> <tr> <td></td> <td></td> <td colspan="8" style="text-align: center;"> <table border="1" style="width: 100%; border-collapse: collapse; text-align: center;"> <tr> <td style="width: 10%;"></td> <td style="width: 10%;"></td> <td style="width: 10%;"></td> <td style="width: 10%;"></td> <td style="width: 10%;"></td> <td style="width: 10%;"></td> <td style="width: 10%;"></td> <td style="width: 10%;"></td> <td style="width: 10%;"></td> <td style="width: 10%;"></td> </tr> <tr> <td></td> <td></td> <td colspan="8" style="text-align: center;"> <table border="1" style="width: 100%; border-collapse: collapse; text-align: center;"> <tr> <td style="width: 10%;"></td> <td style="width: 10%;"></td> <td style="width: 10%;"></td> <td style="width: 10%;"></td> <td style="width: 10%;"></td> <td style="width: 10%;"></td> <td style="width: 10%;"></td> <td style="width: 10%;"></td> <td style="width: 10%;"></td> <td style="width: 10%;"></td> </tr> <tr> <td></td> <td></td> <td colspan="8" style="text-align: center;"> <table border="1" style="width: 100%; border-collapse: collapse; text-align: center;"> <tr> <td style="width: 10%;"></td> <td style="width: 10%;"></td> <td style="width: 10%;"></td> <td style="width: 10%;"></td> <td style="width: 10%;"></td> <td style="width: 10%;"></td> <td style="width: 10%;"></td> <td style="width: 10%;"></td> <td style="width: 10%;"></td> <td style="width: 10%;"></td> </tr> <tr> <td></td> <td></td> <td colspan="8" style="text-align: center;"> <table border="1" style="width: 100%; border-collapse: collapse; text-align: center;"> <tr> <td style="width: 10%;"></td> <td style="width: 10%;"></td> <td style="width: 10%;"></td> <td style="width: 10%;"></td> <td style="width: 10%;"></td> <td style="width: 10%;"></td> <td style="width: 10%;"></td> <td style="width: 10%;"></td> <td style="width: 10%;"></td> <td style="width: 10%;"></td> </tr> <tr> <td></td> <td></td> <td colspan="8" style="text-align: center;"> <table border="1" style="width: 100%; border-collapse: collapse; text-align: center;"> <tr> <td style="width: 10%;"></td> <td style="width: 10%;"></td> <td style="width: 10%;"></td> <td style="width: 10%;"></td> <td style="width: 10%;"></td> <td style="width: 10%;"></td> <td style="width: 10%;"></td> <td style="width: 10%;"></td> <td style="width: 10%;"></td> <td style="width: 10%;"></td> </tr> <tr> <td></td> <td></td> <td colspan="8" style="text-align: center;"> <table border="1" style="width: 100%; border-collapse: collapse; text-align: center;"> <tr> <td style="width: 10%;"></td> <td style="width: 10%;"></td> <td style="width: 10%;"></td> <td style="width: 10%;"></td> <td style="width: 10%;"></td> <td style="width: 10%;"></td> <td style="width: 10%;"></td> <td style="width: 10%;"></td> <td style="width: 10%;"></td> <td style="width: 10%;"></td> </tr> <tr> <td></td> <td></td> <td colspan="8" style="text-align: center;"> <table border="1" style="width: 100%; border-collapse: collapse; text-align: center;"> <tr> <td style="width: 10%;"></td> <td style="width: 10%;"></td> <td style="width: 10%;"></td> <td style="width: 10%;"></td> <td style="width: 10%;"></td> <td style="width: 10%;"></td> <td style="width: 10%;"></td> <td style="width: 10%;"></td> <td style="width: 10%;"></td> <td style="width: 10%;"></td> </tr> <tr> <td></td> <td></td> <td colspan="8" style="text-align: center;"> <table border="1" style="width: 100%; border-collapse: collapse; text-align: center;"> <tr> <td style="width: 10%;"></td> <td style="width: 10%;"></td> <td style="width: 10%;"></td> <td style="width: 10%;"></td> <td style="width: 10%;"></td> <td style="width: 10%;"></td> <td style="width: 10%;"></td> <td style="width: 10%;"></td> <td style="width: 10%;"></td> <td style="width: 10%;"></td> </tr> <tr> <td></td> <td></td> <td colspan="8"
style="text-align: center;"> <table border="1" style="width: 100%; border-collapse: collapse; text-align: center;"> <tr> <td style="width: 10%;"></td> <td style="width: 10%;"></td> <td style="width: 10%;"></td> <td style="width: 10%;"></td> <td style="width: 10%;"></td> <td style="width: 10%;"></td> <td style="width: 10%;"></td> <td style="width: 10%;"></td> <td style="width: 10%;"></td> <td style="width: 10%;"></td> </tr> <tr> <td></td> <td></td> <td colspan="8" style="text-align: center;"> <table border="1" style="width: 100%; border-collapse: collapse; text-align: center;"> <tr> <td style="width: 10%;"></td> <td style="width: 10%;"></td> <td style="width: 10%;"></td> <td style="width: 10%;"></td> <td style="width: 10%;"></td> <td style="width: 10%;"></td> <td style="width: 10%;"></td> <td style="width: 10%;"></td> <td style="width: 10%;"></td> <td style="width: 10%;"></td> </tr> <tr> <td></td> <td></td> <td colspan="8" style="text-align: center;"> <table border="1" style="width: 100%; border-collapse: collapse; text-align: center;"> <tr> <td style="width: 10%;"></td> <td style="width: 10%;"></td> <td style="width: 10%;"></td> <td style="width: 10%;"></td> <td style="width: 10%;"></td> <td style="width: 10%;"></td> <td style="width: 10%;"></td> <td style="width: 10%;"></td> <td style="width: 10%;"></td> <td style="width: 10%;"></td> </tr> <tr> <td></td> <td></td> <td colspan="8" style="text-align: center;"> <table border="1" style="width: 100%; border-collapse: collapse; text-align: center;"> <tr> <td style="width: 10%;"></td> <td style="width: 10%;"></td> <td style="width: 10%;"></td> <td style="width: 10%;"></td> <td style="width: 10%;"></td> <td style="width: 10%;"></td> <td style="width: 10%;"></td> <td style="width: 10%;"></td> <td style="width: 10%;"></td> <td style="width: 10%;"></td> </tr> <tr> <td></td> <td></td> <td colspan="8" style="text-align: center;"> <table border="1" style="width: 100%; border-collapse: collapse; text-align: center;"> <tr> <td style="width: 10%;"></td> <td style="width: 10%;"></td> <td style="width: 10%;"></td> <td style="width: 10%;"></td> <td style="width: 10%;"></td> <td style="width: 10%;"></td> <td style="width: 10%;"></td> <td style="width: 10%;"></td> <td style="width: 10%;"></td> <td style="width: 10%;"></td> </tr> <tr> <td></td> <td></td> <td colspan="8" style="text-align: center;"> <table border="1" style="width: 100%; border-collapse: collapse; text-align: center;"> <tr> <td style="width: 10%;"></td> <td style="width: 10%;"></td> <td style="width: 10%;"></td> <td style="width: 10%;"></td> <td style="width: 10%;"></td> <td style="width: 10%;"></td> <td style="width: 10%;"></td> <td style="width: 10%;"></td> <td style="width: 10%;"></td> <td style="width: 10%;"></td> </tr> <tr> <td></td> <td></td> <td colspan="8" style="text-align: center;"> <table border="1" style="width: 100%; border-collapse: collapse; text-align: center;"> <tr> <td style="width: 10%;"></td> <td style="width: 10%;"></td> <td style="width: 10%;"></td> <td style="width: 10%;"></td> <td style="width: 10%;"></td> <td style="width: 10%;"></td> <td style="width: 10%;"></td> <td style="width: 10%;"></td> <td style="width: 10%;"></td> <td style="width: 10%;"></td> </tr> <tr> <td></td> <td></td> <td colspan="8" style="text-align: center;"> <table border="1" style="width: 100%; border-collapse: collapse; text-align: center;"> <tr> <td style="width: 10%;"></td> <td style="width: 10%;"></td> <td style="width: 10%;"></td> <td style="width: 10%;"></td> <td style="width: 10%;"></td> <td style="width: 10%;"></td> <td style="width: 10%;"></td> <td style="width: 10%;"></td> <td style="width: 10%;"></td> <td style="width: 10%;"></td> </tr> <tr> <td></td> <td></td> <td colspan="8" style="text-align: center;"> <table border="1" style="width: 100%; border-collapse: collapse; text-align: center;"> <tr> <td style="width: 10%;"></td> <td style="width: 10%;"></td> <td style="width: 10%;"></td> <td style="width: 10%;"></td> <td style="width: 10%;"></td> <td style="width: 10%;"></td> <td style="width: 10%;"></td> <td style="width: 10%;"></td> <td style="width: 10%;"></td> <td style="width: 10%;"></td> </tr> <tr> <td></td> <td></td> <td colspan="8" style="text-align: center;"> <table border="1" style="width: 100%; border-collapse: collapse; text-align: center;"> <tr> <td style="width: 10%;"></td> <td style="width: 10%;"></td> <td style="width: 10%;"></td> <td style="width: 10%;"></td> <td style="width: 10%;"></td> <td style="width: 10%;"></td> <td style="width: 10%;"></td> <td style="width: 10%;"></td> <td style="width: 10%;"></td> <td style="width: 10%;"></td> </tr> <tr> <td></td> <td></td> <td colspan="8" style="text-align: center;"> <table border="1" style="width: 100%; border-collapse: collapse; text-align: center;"> <tr> <td style="width: 10%;"></td> <td style="width: 10%;"></td> <td style="width: 10%;"></td> <td style="width: 10%;"></td> <td style="width: 10%;"></td> <td style="width: 10%;"></td> <td style="width: 10%;"></td> <td style="width: 10%;"></td> <td style="width: 10%;"></td> <td style="width: 10%;"></td> </tr> <tr> <td></td> <td></td> <td colspan="8" style="text-align: center;"> <table border="1" style="width: 100%; border-collapse: collapse; text-align: center;"> <tr> <td style="width: 10%;"></td> <td style="width: 10%;"></td> <td style="width: 10%;"></td> <td style="width: 10%;"></td> <td style="width: 10%;"></td> <td style="width: 10%;"></td> <td style="width: 10%;"></td> <td style="width: 10%;"></td> <td style="width: 10%;"></td> <td style="width: 10%;"></td> </tr> <tr> <td></td> <td></td> <td colspan="8" style="text-align: center;"> <table border="1" style="width: 100%; border-collapse: collapse; text-align: center;"> <tr> </tr></table></td></tr></table></td></tr></table></td></tr></table></td></tr></table></td></tr></table></td></tr></table></td></tr></table></td></tr></table></td></tr></table></td></tr></table></td></tr></table></td></tr></table></td></tr></table></td></tr></table></td></tr></table></td></tr></table></td></tr></table></td></tr></table></td></tr></table></td></tr></table></td></tr></table></td></tr></table></td></tr></table>
 | | | | | | | | | | | | | | | | | | | | <table border="1" style="width: 100%; border-collapse: collapse; text-align: center;"> <tr> <td style="width: 10%;"></td> <td style="width: 10%;"></td> <td style="width: 10%;"></td> <td style="width: 10%;"></td> <td style="width: 10%;"></td> <td style="width: 10%;"></td> <td style="width: 10%;"></td> <td style="width: 10%;"></td> <td style="width: 10%;"></td> <td style="width: 10%;"></td> </tr> <tr> <td></td> <td></td> <td colspan="8" style="text-align: center;"> <table border="1" style="width: 100%; border-collapse: collapse; text-align: center;"> <tr> <td style="width: 10%;"></td> <td style="width: 10%;"></td> <td style="width: 10%;"></td> <td style="width: 10%;"></td> <td style="width: 10%;"></td> <td style="width: 10%;"></td> <td style="width: 10%;"></td> <td style="width: 10%;"></td> <td style="width: 10%;"></td> <td style="width: 10%;"></td> </tr> <tr> <td></td> <td></td> <td colspan="8" style="text-align: center;"> <table border="1" style="width: 100%; border-collapse: collapse; text-align: center;"> <tr> <td style="width: 10%;"></td> <td style="width: 10%;"></td> <td style="width: 10%;"></td> <td style="width: 10%;"></td> <td style="width: 10%;"></td> <td style="width: 10%;"></td> <td style="width: 10%;"></td> <td style="width: 10%;"></td> <td style="width: 10%;"></td> <td style="width: 10%;"></td> </tr> <tr> <td></td> <td></td> <td colspan="8" style="text-align: center;"> <table border="1" style="width: 100%; border-collapse: collapse; text-align: center;"> <tr> <td style="width: 10%;"></td> <td style="width: 10%;"></td> <td style="width: 10%;"></td> <td style="width: 10%;"></td> <td style="width: 10%;"></td> <td style="width: 10%;"></td> <td style="width: 10%;"></td> <td style="width: 10%;"></td> <td style="width: 10%;"></td> <td style="width: 10%;"></td> </tr> <tr> <td></td> <td></td> <td colspan="8" style="text-align: center;"> <table border="1" style="width: 100%; border-collapse: collapse; text-align: center;"> <tr> <td style="width: 10%;"></td> <td style="width: 10%;"></td> <td style="width: 10%;"></td> <td style="width: 10%;"></td> <td style="width: 10%;"></td> <td style="width: 10%;"></td> <td style="width: 10%;"></td> <td style="width: 10%;"></td> <td style="width: 10%;"></td> <td style="width: 10%;"></td> </tr> <tr> <td></td> <td></td> <td colspan="8" style="text-align: center;"> <table border="1" style="width: 100%; border-collapse: collapse; text-align: center;"> <tr> <td style="width: 10%;"></td> <td style="width: 10%;"></td> <td style="width: 10%;"></td> <td style="width: 10%;"></td> <td style="width: 10%;"></td> <td style="width: 10%;"></td> <td style="width: 10%;"></td> <td style="width: 10%;"></td> <td style="width: 10%;"></td> <td style="width: 10%;"></td> </tr> <tr> <td></td> <td></td> <td colspan="8" style="text-align: center;"> <table border="1" style="width: 100%; border-collapse: collapse; text-align: center;"> <tr> <td style="width: 10%;"></td> <td style="width: 10%;"></td> <td style="width: 10%;"></td> <td style="width: 10%;"></td> <td style="width: 10%;"></td> <td style="width: 10%;"></td> <td style="width: 10%;"></td> <td style="width: 10%;"></td> <td style="width: 10%;"></td> <td style="width: 10%;"></td> </tr> <tr> <td></td> <td></td> <td colspan="8" style="text-align: center;"> <table border="1" style="width: 100%; border-collapse: collapse; text-align: center;"> <tr> <td style="width: 10%;"></td> <td style="width: 10%;"></td> <td style="width: 10%;"></td> <td style="width: 10%;"></td> <td style="width: 10%;"></td> <td style="width: 10%;"></td> <td style="width: 10%;"></td> <td style="width: 10%;"></td> <td style="width: 10%;"></td> <td style="width: 10%;"></td> </tr> <tr> <td></td> <td></td> <td colspan="8" style="text-align: center;"> <table border="1" style="width: 100%; border-collapse: collapse; text-align: center;"> <tr> <td style="width: 10%;"></td> <td style="width: 10%;"></td> <td style="width: 10%;"></td> <td style="width: 10%;"></td> <td style="width: 10%;"></td> <td style="width: 10%;"></td> <td style="width: 10%;"></td> <td
style="width: 10%;"></td> <td style="width: 10%;"></td> <td style="width: 10%;"></td> </tr> <tr> <td></td> <td></td> <td colspan="8" style="text-align: center;"> <table border="1" style="width: 100%; border-collapse: collapse; text-align: center;"> <tr> <td style="width: 10%;"></td> <td style="width: 10%;"></td> <td style="width: 10%;"></td> <td style="width: 10%;"></td> <td style="width: 10%;"></td> <td style="width: 10%;"></td> <td style="width: 10%;"></td> <td style="width: 10%;"></td> <td style="width: 10%;"></td> <td style="width: 10%;"></td> </tr> <tr> <td></td> <td></td> <td colspan="8" style="text-align: center;"> <table border="1" style="width: 100%; border-collapse: collapse; text-align: center;"> <tr> <td style="width: 10%;"></td> <td style="width: 10%;"></td> <td style="width: 10%;"></td> <td style="width: 10%;"></td> <td style="width: 10%;"></td> <td style="width: 10%;"></td> <td style="width: 10%;"></td> <td style="width: 10%;"></td> <td style="width: 10%;"></td> <td style="width: 10%;"></td> </tr> <tr> <td></td> <td></td> <td colspan="8" style="text-align: center;"> <table border="1" style="width: 100%; border-collapse: collapse; text-align: center;"> <tr> <td style="width: 10%;"></td> <td style="width: 10%;"></td> <td style="width: 10%;"></td> <td style="width: 10%;"></td> <td style="width: 10%;"></td> <td style="width: 10%;"></td> <td style="width: 10%;"></td> <td style="width: 10%;"></td> <td style="width: 10%;"></td> <td style="width: 10%;"></td> </tr> <tr> <td></td> <td></td> <td colspan="8" style="text-align: center;"> <table border="1" style="width: 100%; border-collapse: collapse; text-align: center;"> <tr> <td style="width: 10%;"></td> <td style="width: 10%;"></td> <td style="width: 10%;"></td> <td style="width: 10%;"></td> <td style="width: 10%;"></td> <td style="width: 10%;"></td> <td style="width: 10%;"></td> <td style="width: 10%;"></td> <td style="width: 10%;"></td> <td style="width: 10%;"></td> </tr> <tr> <td></td> <td></td> <td colspan="8" style="text-align: center;"> <table border="1" style="width: 100%; border-collapse: collapse; text-align: center;"> <tr> <td style="width: 10%;"></td> <td style="width: 10%;"></td> <td style="width: 10%;"></td> <td style="width: 10%;"></td> <td style="width: 10%;"></td> <td style="width: 10%;"></td> <td style="width: 10%;"></td> <td style="width: 10%;"></td> <td style="width: 10%;"></td> <td style="width: 10%;"></td> </tr> <tr> <td></td> <td></td> <td colspan="8" style="text-align: center;"> <table border="1" style="width: 100%; border-collapse: collapse; text-align: center;"> <tr> <td style="width: 10%;"></td> <td style="width: 10%;"></td> <td style="width: 10%;"></td> <td style="width: 10%;"></td> <td style="width: 10%;"></td> <td style="width: 10%;"></td> <td style="width: 10%;"></td> <td style="width: 10%;"></td> <td style="width: 10%;"></td> <td style="width: 10%;"></td> </tr> <tr> <td></td> <td></td> <td colspan="8" style="text-align: center;"> <table border="1" style="width: 100%; border-collapse: collapse; text-align: center;"> <tr> <td style="width: 10%;"></td> <td style="width: 10%;"></td> <td style="width: 10%;"></td> <td style="width: 10%;"></td> <td style="width: 10%;"></td> <td style="width: 10%;"></td> <td style="width: 10%;"></td> <td style="width: 10%;"></td> <td style="width: 10%;"></td> <td style="width: 10%;"></td> </tr> <tr> <td></td> <td></td> <td colspan="8" style="text-align: center;"> <table border="1" style="width: 100%; border-collapse: collapse; text-align: center;"> <tr> <td style="width: 10%;"></td> <td style="width: 10%;"></td> <td style="width: 10%;"></td> <td style="width: 10%;"></td> <td style="width: 10%;"></td> <td style="width: 10%;"></td> <td style="width: 10%;"></td> <td style="width: 10%;"></td> <td style="width: 10%;"></td> <td style="width: 10%;"></td> </tr> <tr> <td></td> <td></td> <td colspan="8" style="text-align: center;"> <table border="1" style="width: 100%; border-collapse: collapse; text-align: center;"> <tr> <td style="width: 10%;"></td> <td style="width: 10%;"></td> <td style="width: 10%;"></td> <td style="width: 10%;"></td> <td style="width: 10%;"></td> <td style="width: 10%;"></td> <td style="width: 10%;"></td> <td style="width: 10%;"></td> <td style="width: 10%;"></td> <td style="width: 10%;"></td> </tr> <tr> <td></td> <td></td> <td colspan="8" style="text-align: center;"> <table border="1" style="width: 100%; border-collapse: collapse; text-align: center;"> <tr> <td style="width: 10%;"></td> <td style="width: 10%;"></td> <td style="width: 10%;"></td> <td style="width: 10%;"></td> <td style="width: 10%;"></td> <td style="width: 10%;"></td> <td style="width: 10%;"></td> <td style="width: 10%;"></td> <td style="width: 10%;"></td> <td style="width: 10%;"></td> </tr> <tr> <td></td> <td></td> <td colspan="8" style="text-align: center;"> <table border="1" style="width: 100%; border-collapse: collapse; text-align: center;"> <tr> <td style="width: 10%;"></td> <td style="width: 10%;"></td> <td style="width: 10%;"></td> <td style="width: 10%;"></td> <td style="width: 10%;"></td> <td style="width: 10%;"></td> <td style="width: 10%;"></td> <td style="width: 10%;"></td> <td style="width: 10%;"></td> <td style="width: 10%;"></td> </tr> <tr> <td></td> <td></td> <td colspan="8" style="text-align: center;"> <table border="1" style="width: 100%; border-collapse: collapse; text-align: center;"> <tr> <td style="width: 10%;"></td> <td style="width: 10%;"></td> <td style="width: 10%;"></td> <td style="width: 10%;"></td> <td style="width: 10%;"></td> <td style="width: 10%;"></td> <td style="width: 10%;"></td> <td style="width: 10%;"></td> <td style="width: 10%;"></td> <td style="width: 10%;"></td> </tr> <tr> <td></td> <td></td> <td colspan="8" style="text-align: center;"> <table border="1" style="width: 100%; border-collapse: collapse; text-align: center;"> <tr> <td style="width: 10%;"></td> <td style="width: 10%;"></td> <td style="width: 10%;"></td> <td style="width: 10%;"></td> <td style="width: 10%;"></td> <td style="width: 10%;"></td> <td style="width: 10%;"></td> <td style="width: 10%;"></td> <td style="width: 10%;"></td> <td style="width: 10%;"></td> </tr> <tr> <td></td> <td></td> <td colspan="8" style="text-align: center;"> <table border="1" style="width: 100%; border-collapse: collapse; text-align: center;"> <tr> </tr></table></td></tr></table></td></tr></table></td></tr></table></td></tr></table></td></tr></table></td></tr></table></td></tr></table></td></tr></table></td></tr></table></td></tr></table></td></tr></table></td></tr></table></td></tr></table></td></tr></table></td></tr></table></td></tr></table></td></tr></table></td></tr></table></td></tr></table></td></tr></table></td></tr></table></td></tr></table>
 | | | | | | | | | | | | | | | | | | | | <table border="1" style="width: 100%; border-collapse: collapse; text-align: center;"> <tr> <td style="width: 10%;"></td> <td style="width: 10%;"></td> <td style="width: 10%;"></td> <td style="width: 10%;"></td> <td style="width: 10%;"></td> <td style="width: 10%;"></td> <td style="width: 10%;"></td> <td style="width: 10%;"></td> <td style="width: 10%;"></td> <td style="width: 10%;"></td> </tr> <tr> <td></td> <td></td> <td colspan="8" style="text-align: center;"> <table border="1" style="width: 100%; border-collapse: collapse; text-align: center;"> <tr> <td style="width: 10%;"></td> <td style="width: 10%;"></td> <td style="width: 10%;"></td> <td style="width: 10%;"></td> <td style="width: 10%;"></td> <td style="width: 10%;"></td> <td style="width: 10%;"></td> <td style="width: 10%;"></td> <td style="width: 10%;"></td> <td style="width: 10%;"></td> </tr> <tr> <td></td> <td></td> <td colspan="8" style="text-align: center;"> <table border="1" style="width: 100%; border-collapse: collapse; text-align: center;"> <tr> <td style="width: 10%;"></td> <td style="width: 10%;"></td> <td style="width: 10%;"></td> <td style="width: 10%;"></td> <td style="width: 10%;"></td> <td style="width: 10%;"></td> <td style="width: 10%;"></td> <td style="width: 10%;"></td> <td style="width: 10%;"></td> <td style="width: 10%;"></td> </tr> <tr> <td></td> <td></td> <td colspan="8" style="text-align: center;"> <table border="1" style="width: 100%; border-collapse: collapse; text-align: center;"> <tr> <td style="width: 10%;"></td> <td style="width: 10%;"></td> <td style="width: 10%;"></td> <td style="width: 10%;"></td> <td style="width: 10%;"></td> <td style="width: 10%;"></td> <td style="width: 10%;"></td> <td style="width: 10%;"></td> <td style="width: 10%;"></td> <td style="width: 10%;"></td> </tr> <tr> <td></td> <td></td> <td colspan="8" style="text-align: center;"> <table border="1" style="width: 100%; border-collapse: collapse; text-align: center;"> <tr> <td style="width: 10%;"></td> <td style="width: 10%;"></td> <td style="width: 10%;"></td> <td style="width: 10%;"></td> <td style="width: 10%;"></td> <td style="width: 10%;"></td> <td style="width: 10%;"></td> <td style="width: 10%;"></td> <td style="width: 10%;"></td> <td style="width: 10%;"></td> </tr> <tr> <td></td> <td></td> <td colspan="8" style="text-align: center;"> <table border="1" style="width: 100%; border-collapse: collapse; text-align: center;"> <tr> <td style="width: 10%;"></td> <td style="width: 10%;"></td> <td style="width: 10%;"></td> <td style="width: 10%;"></td> <td style="width: 10%;"></td> <td style="width: 10%;"></td> <td style="width: 10%;"></td> <td style="width: 10%;"></td> <td style="width: 10%;"></td> <td style="width: 10%;"></td> </tr> <tr> <td></td> <td></td> <td colspan="8" style="text-align: center;"> <table border="1" style="width: 100%; border-collapse: collapse; text-align: center;"> <tr> <td style="width: 10%;"></td> <td style="width: 10%;"></td> <td style="width: 10%;"></td> <td style="width: 10%;"></td> <td style="width: 10%;"></td> <td style="width: 10%;"></td> <td style="width: 10%;"></td> <td style="width: 10%;"></td> <td style="width: 10%;"></td> <td style="width: 10%;"></td> </tr> <tr> <td></td> <td></td> <td colspan="8" style="text-align: center;"> <table border="1" style="width: 100%; border-collapse: collapse; text-align: center;"> <tr> <td style="width: 10%;"></td> <td style="width: 10%;"></td> <td style="width: 10%;"></td> <td
style="width: 10%;"></td> <td style="width: 10%;"></td> <td style="width: 10%;"></td> <td style="width: 10%;"></td> <td style="width: 10%;"></td> <td style="width: 10%;"></td> <td style="width: 10%;"></td> </tr> <tr> <td></td> <td></td> <td colspan="8" style="text-align: center;"> <table border="1" style="width: 100%; border-collapse: collapse; text-align: center;"> <tr> <td style="width: 10%;"></td> <td style="width: 10%;"></td> <td style="width: 10%;"></td> <td style="width: 10%;"></td> <td style="width: 10%;"></td> <td style="width: 10%;"></td> <td style="width: 10%;"></td> <td style="width: 10%;"></td> <td style="width: 10%;"></td> <td style="width: 10%;"></td> </tr> <tr> <td></td> <td></td> <td colspan="8" style="text-align: center;"> <table border="1" style="width: 100%; border-collapse: collapse; text-align: center;"> <tr> <td style="width: 10%;"></td> <td style="width: 10%;"></td> <td style="width: 10%;"></td> <td style="width: 10%;"></td> <td style="width: 10%;"></td> <td style="width: 10%;"></td> <td style="width: 10%;"></td> <td style="width: 10%;"></td> <td style="width: 10%;"></td> <td style="width: 10%;"></td> </tr> <tr> <td></td> <td></td> <td colspan="8" style="text-align: center;"> <table border="1" style="width: 100%; border-collapse: collapse; text-align: center;"> <tr> <td style="width: 10%;"></td> <td style="width: 10%;"></td> <td style="width: 10%;"></td> <td style="width: 10%;"></td> <td style="width: 10%;"></td> <td style="width: 10%;"></td> <td style="width: 10%;"></td> <td style="width: 10%;"></td> <td style="width: 10%;"></td> <td style="width: 10%;"></td> </tr> <tr> <td></td> <td></td> <td colspan="8" style="text-align: center;"> <table border="1" style="width: 100%; border-collapse: collapse; text-align: center;"> <tr> <td style="width: 10%;"></td> <td style="width: 10%;"></td> <td style="width: 10%;"></td> <td style="width: 10%;"></td> <td style="width: 10%;"></td> <td style="width: 10%;"></td> <td style="width: 10%;"></td> <td style="width: 10%;"></td> <td style="width: 10%;"></td> <td style="width: 10%;"></td> </tr> <tr> <td></td> <td></td> <td colspan="8" style="text-align: center;"> <table border="1" style="width: 100%; border-collapse: collapse; text-align: center;"> <tr> <td style="width: 10%;"></td> <td style="width: 10%;"></td> <td style="width: 10%;"></td> <td style="width: 10%;"></td> <td style="width: 10%;"></td> <td style="width: 10%;"></td> <td style="width: 10%;"></td> <td style="width: 10%;"></td> <td style="width: 10%;"></td> <td style="width: 10%;"></td> </tr> <tr> <td></td> <td></td> <td colspan="8" style="text-align: center;"> <table border="1" style="width: 100%; border-collapse: collapse; text-align: center;"> <tr> <td style="width: 10%;"></td> <td style="width: 10%;"></td> <td style="width: 10%;"></td> <td style="width: 10%;"></td> <td style="width: 10%;"></td> <td style="width: 10%;"></td> <td style="width: 10%;"></td> <td style="width: 10%;"></td> <td style="width: 10%;"></td> <td style="width: 10%;"></td> </tr> <tr> <td></td> <td></td> <td colspan="8" style="text-align: center;"> <table border="1" style="width: 100%; border-collapse: collapse; text-align: center;"> <tr> <td style="width: 10%;"></td> <td style="width: 10%;"></td> <td style="width: 10%;"></td> <td style="width: 10%;"></td> <td style="width: 10%;"></td> <td style="width: 10%;"></td> <td style="width: 10%;"></td> <td style="width: 10%;"></td> <td style="width: 10%;"></td> <td style="width: 10%;"></td> </tr> <tr> <td></td> <td></td> <td colspan="8" style="text-align: center;"> <table border="1" style="width: 100%; border-collapse: collapse; text-align: center;"> <tr> <td style="width: 10%;"></td> <td style="width: 10%;"></td> <td style="width: 10%;"></td> <td style="width: 10%;"></td> <td style="width: 10%;"></td> <td style="width: 10%;"></td> <td style="width: 10%;"></td> <td style="width: 10%;"></td> <td style="width: 10%;"></td> <td style="width: 10%;"></td> </tr> <tr> <td></td> <td></td> <td colspan="8" style="text-align: center;"> <table border="1" style="width: 100%; border-collapse: collapse; text-align: center;"> <tr> <td style="width: 10%;"></td> <td style="width: 10%;"></td> <td style="width: 10%;"></td> <td style="width: 10%;"></td> <td style="width: 10%;"></td> <td style="width: 10%;"></td> <td style="width: 10%;"></td> <td style="width: 10%;"></td> <td style="width: 10%;"></td> <td style="width: 10%;"></td> </tr> <tr> <td></td> <td></td> <td colspan="8" style="text-align: center;"> <table border="1" style="width: 100%; border-collapse: collapse; text-align: center;"> <tr> <td style="width: 10%;"></td> <td style="width: 10%;"></td> <td style="width: 10%;"></td> <td style="width: 10%;"></td> <td style="width: 10%;"></td> <td style="width: 10%;"></td> <td style="width: 10%;"></td> <td style="width: 10%;"></td> <td style="width: 10%;"></td> <td style="width: 10%;"></td> </tr> <tr> <td></td> <td></td> <td colspan="8" style="text-align: center;"> <table border="1" style="width: 100%; border-collapse: collapse; text-align: center;"> <tr> <td style="width: 10%;"></td> <td style="width: 10%;"></td> <td style="width: 10%;"></td> <td style="width: 10%;"></td> <td style="width: 10%;"></td> <td style="width: 10%;"></td> <td style="width: 10%;"></td> <td style="width: 10%;"></td> <td style="width: 10%;"></td> <td style="width: 10%;"></td> </tr> <tr> <td></td> <td></td> <td colspan="8" style="text-align: center;"> <table border="1" style="width: 100%; border-collapse: collapse; text-align: center;"> <tr> <td style="width: 10%;"></td> <td style="width: 10%;"></td> <td style="width: 10%;"></td> <td style="width: 10%;"></td> <td style="width: 10%;"></td> <td style="width: 10%;"></td> <td style="width: 10%;"></td> <td style="width: 10%;"></td> <td style="width: 10%;"></td> <td style="width: 10%;"></td> </tr> <tr> <td></td> <td></td> <td colspan="8" style="text-align: center;"> <table border="1" style="width: 100%; border-collapse: collapse; text-align: center;"> <tr> <td style="width: 10%;"></td> <td style="width: 10%;"></td> <td style="width: 10%;"></td> <td style="width: 10%;"></td> <td style="width: 10%;"></td> <td style="width: 10%;"></td> <td style="width: 10%;"></td> <td style="width: 10%;"></td> <td style="width: 10%;"></td> <td style="width: 10%;"></td> </tr> <tr> <td></td> <td></td> <td colspan="8" style="text-align: center;"> <table border="1" style="width: 100%; border-collapse: collapse; text-align: center;"> <tr> </tr></table></td></tr></table></td></tr></table></td></tr></table></td></tr></table></td></tr></table></td></tr></table></td></tr></table></td></tr></table></td></tr></table></td></tr></table></td></tr></table></td></tr></table></td></tr></table></td></tr></table></td></tr></table></td></tr></table></td></tr></table></td></tr></table></td></tr></table></td></tr></table></td></tr></table>
 | | | | | | | | | | | | | | | | | | | | <table border="1" style="width: 100%; border-collapse: collapse; text-align: center;"> <tr> <td style="width: 10%;"></td> <td style="width: 10%;"></td> <td style="width: 10%;"></td> <td style="width: 10%;"></td> <td style="width: 10%;"></td> <td style="width: 10%;"></td> <td style="width: 10%;"></td> <td style="width: 10%;"></td> <td style="width: 10%;"></td> <td style="width: 10%;"></td> </tr> <tr> <td></td> <td></td> <td colspan="8" style="text-align: center;"> <table border="1" style="width: 100%; border-collapse: collapse; text-align: center;"> <tr> <td style="width: 10%;"></td> <td style="width: 10%;"></td> <td style="width: 10%;"></td> <td style="width: 10%;"></td> <td style="width: 10%;"></td> <td style="width: 10%;"></td> <td style="width: 10%;"></td> <td style="width: 10%;"></td> <td style="width: 10%;"></td> <td style="width: 10%;"></td> </tr> <tr> <td></td> <td></td> <td colspan="8" style="text-align: center;"> <table border="1" style="width: 100%; border-collapse: collapse; text-align: center;"> <tr> <td style="width: 10%;"></td> <td style="width: 10%;"></td> <td style="width: 10%;"></td> <td style="width: 10%;"></td> <td style="width: 10%;"></td> <td style="width: 10%;"></td> <td style="width: 10%;"></td> <td style="width: 10%;"></td> <td style="width: 10%;"></td> <td style="width: 10%;"></td> </tr> <tr> <td></td> <td></td> <td colspan="8" style="text-align: center;"> <table border="1" style="width: 100%; border-collapse: collapse; text-align: center;"> <tr> <td style="width: 10%;"></td> <td style="width: 10%;"></td> <td style="width: 10%;"></td> <td style="width: 10%;"></td> <td style="width: 10%;"></td> <td style="width: 10%;"></td> <td style="width: 10%;"></td> <td style="width: 10%;"></td> <td style="width: 10%;"></td> <td style="width: 10%;"></td> </tr> <tr> <td></td> <td></td> <td colspan="8" style="text-align: center;"> <table border="1" style="width: 100%; border-collapse: collapse; text-align: center;"> <tr> <td style="width: 10%;"></td> <td style="width: 10%;"></td> <td style="width: 10%;"></td> <td style="width: 10%;"></td> <td style="width: 10%;"></td> <td style="width: 10%;"></td> <td style="width: 10%;"></td> <td style="width: 10%;"></td> <td style="width: 10%;"></td> <td style="width: 10%;"></td> </tr> <tr> <td></td> <td></td> <td colspan="8" style="text-align: center;"> <table border="1" style="width: 100%; border-collapse: collapse; text-align: center;"> <tr> <td style="width: 10%;"></td> <td style="width: 10%;"></td> <td style="width: 10%;"></td> <td style="width: 10%;"></td> <td style="width: 10%;"></td> <td style="width: 10%;"></td> <td style="width: 10%;"></td> <td style="width: 10%;"></td> <td style="width: 10%;"></td> <td style="width: 10%;"></td> </tr> <tr> <td></td> <td></td> <td colspan="8" style="text-align: center;"> <table border="1" style="width: 100%; border-collapse: collapse; text-align: center;"> <tr> <td style="width: 10%;"></td> <td style="width: 10%;"></td> <td style="width: 10%;"></td> <td style="width: 10%;"></td> <td style="width: 10%;"></td> <td style="width: 10%;"></td> <td style="width: 10%;"></td> <td style="width: 10%;"></td> <td style="width: 10%;"></td> <td style="width: 10%;"></td> </tr> <tr> <td></td> <td></td> <td colspan="8" style="text-align: center;"> <table border="1" style="width: 100%; border-collapse: collapse; text-align: center;"> <tr>
<td style="width: 10%;"></td> <td style="width: 10%;"></td> <td style="width: 10%;"></td> <td style="width: 10%;"></td> <td style="width: 10%;"></td> <td style="width: 10%;"></td> <td style="width: 10%;"></td> <td style="width: 10%;"></td> <td style="width: 10%;"></td> <td style="width: 10%;"></td> </tr> <tr> <td></td> <td></td> <td colspan="8" style="text-align: center;"> <table border="1" style="width: 100%; border-collapse: collapse; text-align: center;"> <tr> <td style="width: 10%;"></td> <td style="width: 10%;"></td> <td style="width: 10%;"></td> <td style="width: 10%;"></td> <td style="width: 10%;"></td> <td style="width: 10%;"></td> <td style="width: 10%;"></td> <td style="width: 10%;"></td> <td style="width: 10%;"></td> <td style="width: 10%;"></td> </tr> <tr> <td></td> <td></td> <td colspan="8" style="text-align: center;"> <table border="1" style="width: 100%; border-collapse: collapse; text-align: center;"> <tr> <td style="width: 10%;"></td> <td style="width: 10%;"></td> <td style="width: 10%;"></td> <td style="width: 10%;"></td> <td style="width: 10%;"></td> <td style="width: 10%;"></td> <td style="width: 10%;"></td> <td style="width: 10%;"></td> <td style="width: 10%;"></td> <td style="width: 10%;"></td> </tr> <tr> <td></td> <td></td> <td colspan="8" style="text-align: center;"> <table border="1" style="width: 100%; border-collapse: collapse; text-align: center;"> <tr> <td style="width: 10%;"></td> <td style="width: 10%;"></td> <td style="width: 10%;"></td> <td style="width: 10%;"></td> <td style="width: 10%;"></td> <td style="width: 10%;"></td> <td style="width: 10%;"></td> <td style="width: 10%;"></td> <td style="width: 10%;"></td> <td style="width: 10%;"></td> </tr> <tr> <td></td> <td></td> <td colspan="8" style="text-align: center;"> <table border="1" style="width: 100%; border-collapse: collapse; text-align: center;"> <tr> <td style="width: 10%;"></td> <td style="width: 10%;"></td> <td style="width: 10%;"></td> <td style="width: 10%;"></td> <td style="width: 10%;"></td> <td style="width: 10%;"></td> <td style="width: 10%;"></td> <td style="width: 10%;"></td> <td style="width: 10%;"></td> <td style="width: 10%;"></td> </tr> <tr> <td></td> <td></td> <td colspan="8" style="text-align: center;"> <table border="1" style="width: 100%; border-collapse: collapse; text-align: center;"> <tr> <td style="width: 10%;"></td> <td style="width: 10%;"></td> <td style="width: 10%;"></td> <td style="width: 10%;"></td> <td style="width: 10%;"></td> <td style="width: 10%;"></td> <td style="width: 10%;"></td> <td style="width: 10%;"></td> <td style="width: 10%;"></td> <td style="width: 10%;"></td> </tr> <tr> <td></td> <td></td> <td colspan="8" style="text-align: center;"> <table border="1" style="width: 100%; border-collapse: collapse; text-align: center;"> <tr> <td style="width: 10%;"></td> <td style="width: 10%;"></td> <td style="width: 10%;"></td> <td style="width: 10%;"></td> <td style="width: 10%;"></td> <td style="width: 10%;"></td> <td style="width: 10%;"></td> <td style="width: 10%;"></td> <td style="width: 10%;"></td> <td style="width: 10%;"></td> </tr> <tr> <td></td> <td></td> <td colspan="8" style="text-align: center;"> <table border="1" style="width: 100%; border-collapse: collapse; text-align: center;"> <tr> <td style="width: 10%;"></td> <td style="width: 10%;"></td> <td style="width: 10%;"></td> <td style="width: 10%;"></td> <td style="width: 10%;"></td> <td style="width: 10%;"></td> <td style="width: 10%;"></td> <td style="width: 10%;"></td> <td style="width: 10%;"></td> <td style="width: 10%;"></td> </tr> <tr> <td></td> <td></td> <td colspan="8" style="text-align: center;"> <table border="1" style="width: 100%; border-collapse: collapse; text-align: center;"> <tr> <td style="width: 10%;"></td> <td style="width: 10%;"></td> <td style="width: 10%;"></td> <td style="width: 10%;"></td> <td style="width: 10%;"></td> <td style="width: 10%;"></td> <td style="width: 10%;"></td> <td style="width: 10%;"></td> <td style="width: 10%;"></td> <td style="width: 10%;"></td> </tr> <tr> <td></td> <td></td> <td colspan="8" style="text-align: center;"> <table border="1" style="width: 100%; border-collapse: collapse; text-align: center;"> <tr> <td style="width: 10%;"></td> <td style="width: 10%;"></td> <td style="width: 10%;"></td> <td style="width: 10%;"></td> <td style="width: 10%;"></td> <td style="width: 10%;"></td> <td style="width: 10%;"></td> <td style="width: 10%;"></td> <td style="width: 10%;"></td> <td style="width: 10%;"></td> </tr> <tr> <td></td> <td></td> <td colspan="8" style="text-align: center;"> <table border="1" style="width: 100%; border-collapse: collapse; text-align: center;"> <tr> <td style="width: 10%;"></td> <td style="width: 10%;"></td> <td style="width: 10%;"></td> <td style="width: 10%;"></td> <td style="width: 10%;"></td> <td style="width: 10%;"></td> <td style="width: 10%;"></td> <td style="width: 10%;"></td> <td style="width: 10%;"></td> <td style="width: 10%;"></td> </tr> <tr> <td></td> <td></td> <td colspan="8" style="text-align: center;"> <table border="1" style="width: 100%; border-collapse: collapse; text-align: center;"> <tr> <td style="width: 10%;"></td> <td style="width: 10%;"></td> <td style="width: 10%;"></td> <td style="width: 10%;"></td> <td style="width: 10%;"></td> <td style="width: 10%;"></td> <td style="width: 10%;"></td> <td style="width: 10%;"></td> <td style="width: 10%;"></td> <td style="width: 10%;"></td> </tr> <tr> <td></td> <td></td> <td colspan="8" style="text-align: center;"> <table border="1" style="width: 100%; border-collapse: collapse; text-align: center;"> <tr> <td style="width: 10%;"></td> <td style="width: 10%;"></td> <td style="width: 10%;"></td> <td style="width: 10%;"></td> <td style="width: 10%;"></td> <td style="width: 10%;"></td> <td style="width: 10%;"></td> <td style="width: 10%;"></td> <td style="width: 10%;"></td> <td style="width: 10%;"></td> </tr> <tr> <td></td> <td></td> <td colspan="8" style="text-align: center;"> <table border="1" style="width: 100%; border-collapse: collapse; text-align: center;"> <tr> </tr></table></td></tr></table></td></tr></table></td></tr></table></td></tr></table></td></tr></table></td></tr></table></td></tr></table></td></tr></table></td></tr></table></td></tr></table></td></tr></table></td></tr></table></td></tr></table></td></tr></table></td></tr></table></td></tr></table></td></tr></table></td></tr></table></td></tr></table></td></tr></table>
 | | | | | | | | | | | | | | | | | | | | <table border="1" style="width: 100%; border-collapse: collapse; text-align: center;"> <tr> <td style="width: 10%;"></td> <td style="width: 10%;"></td> <td style="width: 10%;"></td> <td style="width: 10%;"></td> <td style="width: 10%;"></td> <td style="width: 10%;"></td> <td style="width: 10%;"></td> <td style="width: 10%;"></td> <td style="width: 10%;"></td> <td style="width: 10%;"></td> </tr> <tr> <td></td> <td></td> <td colspan="8" style="text-align: center;"> <table border="1" style="width: 100%; border-collapse: collapse; text-align: center;"> <tr> <td style="width: 10%;"></td> <td style="width: 10%;"></td> <td style="width: 10%;"></td> <td style="width: 10%;"></td> <td style="width: 10%;"></td> <td style="width: 10%;"></td> <td style="width: 10%;"></td> <td style="width: 10%;"></td> <td style="width: 10%;"></td> <td style="width: 10%;"></td> </tr> <tr> <td></td> <td></td> <td colspan="8" style="text-align: center;"> <table border="1" style="width: 100%; border-collapse: collapse; text-align: center;"> <tr> <td style="width: 10%;"></td> <td style="width: 10%;"></td> <td style="width: 10%;"></td> <td style="width: 10%;"></td> <td style="width: 10%;"></td> <td style="width: 10%;"></td> <td style="width: 10%;"></td> <td style="width: 10%;"></td> <td style="width: 10%;"></td> <td style="width: 10%;"></td> </tr> <tr> <td></td> <td></td> <td colspan="8" style="text-align: center;"> <table border="1" style="width: 100%; border-collapse: collapse; text-align: center;"> <tr> <td style="width: 10%;"></td> <td style="width: 10%;"></td> <td style="width: 10%;"></td> <td style="width: 10%;"></td> <td style="width: 10%;"></td> <td style="width: 10%;"></td> <td style="width: 10%;"></td> <td style="width: 10%;"></td> <td style="width: 10%;"></td> <td style="width: 10%;"></td> </tr> <tr> <td></td> <td></td> <td colspan="8" style="text-align: center;"> <table border="1" style="width: 100%; border-collapse: collapse; text-align: center;"> <tr> <td style="width: 10%;"></td> <td style="width: 10%;"></td> <td style="width: 10%;"></td> <td style="width: 10%;"></td> <td style="width: 10%;"></td> <td style="width: 10%;"></td> <td style="width: 10%;"></td> <td style="width: 10%;"></td> <td style="width: 10%;"></td> <td style="width: 10%;"></td> </tr> <tr> <td></td> <td></td> <td colspan="8" style="text-align: center;"> <table border="1" style="width: 100%; border-collapse: collapse; text-align: center;"> <tr> <td style="width: 10%;"></td> <td style="width: 10%;"></td> <td style="width: 10%;"></td> <td style="width: 10%;"></td> <td style="width: 10%;"></td> <td style="width: 10%;"></td> <td style="width: 10%;"></td> <td style="width: 10%;"></td> <td style="width: 10%;"></td> <td style="width: 10%;"></td> </tr> <tr> <td></td> <td></td> <td colspan="8" style="text-align: center;"> <table border="1" style="width: 100%; border-collapse: collapse; text-align: center;"> <tr> <td style="width: 10%;"></td> <td style="width: 10%;"></td> <td style="width: 10%;"></td> <td style="width: 10%;"></td> <td style="width: 10%;"></td> <td style="width: 10%;"></td> <td style="width: 10%;"></td> <td style="width: 10%;"></td> <td style="width: 10%;"></td> <td style="width: 10%;"></td> </tr> <tr> <td></td> <td></td> <td colspan="8" style="text-align: center;"> <table border="1" style="width: 100%; border-collapse: collapse; text-align: center;"> <tr> <td style="width: 10%;"></td> <td style="width: 10%;"></td> <td style="width: 10%;"></td> <td style="width: 10%;"></td> <td style="width: 10%;"></td> <td style="width: 10%;"></td> <td style="width: 10%;"></td> <td style="width: 10%;"></td> <td style="width: 10%;"></td> <td style="width: 10%;"></td> </tr> <tr> <td></td> <td></td> <td colspan="8" style="text-align: center;"> <table border="1"
style="width: 100%; border-collapse: collapse; text-align: center;"> <tr> <td style="width: 10%;"></td> <td style="width: 10%;"></td> <td style="width: 10%;"></td> <td style="width: 10%;"></td> <td style="width: 10%;"></td> <td style="width: 10%;"></td> <td style="width: 10%;"></td> <td style="width: 10%;"></td> <td style="width: 10%;"></td> <td style="width: 10%;"></td> </tr> <tr> <td></td> <td></td> <td colspan="8" style="text-align: center;"> <table border="1" style="width: 100%; border-collapse: collapse; text-align: center;"> <tr> <td style="width: 10%;"></td> <td style="width: 10%;"></td> <td style="width: 10%;"></td> <td style="width: 10%;"></td> <td style="width: 10%;"></td> <td style="width: 10%;"></td> <td style="width: 10%;"></td> <td style="width: 10%;"></td> <td style="width: 10%;"></td> <td style="width: 10%;"></td> </tr> <tr> <td></td> <td></td> <td colspan="8" style="text-align: center;"> <table border="1" style="width: 100%; border-collapse: collapse; text-align: center;"> <tr> <td style="width: 10%;"></td> <td style="width: 10%;"></td> <td style="width: 10%;"></td> <td style="width: 10%;"></td> <td style="width: 10%;"></td> <td style="width: 10%;"></td> <td style="width: 10%;"></td> <td style="width: 10%;"></td> <td style="width: 10%;"></td> <td style="width: 10%;"></td> </tr> <tr> <td></td> <td></td> <td colspan="8" style="text-align: center;"> <table border="1" style="width: 100%; border-collapse: collapse; text-align: center;"> <tr> <td style="width: 10%;"></td> <td style="width: 10%;"></td> <td style="width: 10%;"></td> <td style="width: 10%;"></td> <td style="width: 10%;"></td> <td style="width: 10%;"></td> <td style="width: 10%;"></td> <td style="width: 10%;"></td> <td style="width: 10%;"></td> <td style="width: 10%;"></td> </tr> <tr> <td></td> <td></td> <td colspan="8" style="text-align: center;"> <table border="1" style="width: 100%; border-collapse: collapse; text-align: center;"> <tr> <td style="width: 10%;"></td> <td style="width: 10%;"></td> <td style="width: 10%;"></td> <td style="width: 10%;"></td> <td style="width: 10%;"></td> <td style="width: 10%;"></td> <td style="width: 10%;"></td> <td style="width: 10%;"></td> <td style="width: 10%;"></td> <td style="width: 10%;"></td> </tr> <tr> <td></td> <td></td> <td colspan="8" style="text-align: center;"> <table border="1" style="width: 100%; border-collapse: collapse; text-align: center;"> <tr> <td style="width: 10%;"></td> <td style="width: 10%;"></td> <td style="width: 10%;"></td> <td style="width: 10%;"></td> <td style="width: 10%;"></td> <td style="width: 10%;"></td> <td style="width: 10%;"></td> <td style="width: 10%;"></td> <td style="width: 10%;"></td> <td style="width: 10%;"></td> </tr> <tr> <td></td> <td></td> <td colspan="8" style="text-align: center;"> <table border="1" style="width: 100%; border-collapse: collapse; text-align: center;"> <tr> <td style="width: 10%;"></td> <td style="width: 10%;"></td> <td style="width: 10%;"></td> <td style="width: 10%;"></td> <td style="width: 10%;"></td> <td style="width: 10%;"></td> <td style="width: 10%;"></td> <td style="width: 10%;"></td> <td style="width: 10%;"></td> <td style="width: 10%;"></td> </tr> <tr> <td></td> <td></td> <td colspan="8" style="text-align: center;"> <table border="1" style="width: 100%; border-collapse: collapse; text-align: center;"> <tr> <td style="width: 10%;"></td> <td style="width: 10%;"></td> <td style="width: 10%;"></td> <td style="width: 10%;"></td> <td style="width: 10%;"></td> <td style="width: 10%;"></td> <td style="width: 10%;"></td> <td style="width: 10%;"></td> <td style="width: 10%;"></td> <td style="width: 10%;"></td> </tr> <tr> <td></td> <td></td> <td colspan="8" style="text-align: center;"> <table border="1" style="width: 100%; border-collapse: collapse; text-align: center;"> <tr> <td style="width: 10%;"></td> <td style="width: 10%;"></td> <td style="width: 10%;"></td> <td style="width: 10%;"></td> <td style="width: 10%;"></td> <td style="width: 10%;"></td> <td style="width: 10%;"></td> <td style="width: 10%;"></td> <td style="width: 10%;"></td> <td style="width: 10%;"></td> </tr> <tr> <td></td> <td></td> <td colspan="8" style="text-align: center;"> <table border="1" style="width: 100%; border-collapse: collapse; text-align: center;"> <tr> <td style="width: 10%;"></td> <td style="width: 10%;"></td> <td style="width: 10%;"></td> <td style="width: 10%;"></td> <td style="width: 10%;"></td> <td style="width: 10%;"></td> <td style="width: 10%;"></td> <td style="width: 10%;"></td> <td style="width: 10%;"></td> <td style="width: 10%;"></td> </tr> <tr> <td></td> <td></td> <td colspan="8" style="text-align: center;"> <table border="1" style="width: 100%; border-collapse: collapse; text-align: center;"> <tr> <td style="width: 10%;"></td> <td style="width: 10%;"></td> <td style="width: 10%;"></td> <td style="width: 10%;"></td> <td style="width: 10%;"></td> <td style="width: 10%;"></td> <td style="width: 10%;"></td> <td style="width: 10%;"></td> <td style="width: 10%;"></td> <td style="width: 10%;"></td> </tr> <tr> <td></td> <td></td> <td colspan="8" style="text-align: center;"> <table border="1" style="width: 100%; border-collapse: collapse; text-align: center;"> <tr> </tr></table></td></tr></table></td></tr></table></td></tr></table></td></tr></table></td></tr></table></td></tr></table></td></tr></table></td></tr></table></td></tr></table></td></tr></table></td></tr></table></td></tr></table></td></tr></table></td></tr></table></td></tr></table></td></tr></table></td></tr></table></td></tr></table></td></tr></table>
 | | | | | | | | | | | | | | | | | | | | <table border="1" style="width: 100%; border-collapse: collapse; text-align: center;"> <tr> <td style="width: 10%;"></td> <td style="width: 10%;"></td> <td style="width: 10%;"></td> <td style="width: 10%;"></td> <td style="width: 10%;"></td> <td style="width: 10%;"></td> <td style="width: 10%;"></td> <td style="width: 10%;"></td> <td style="width: 10%;"></td> <td style="width: 10%;"></td> </tr> <tr> <td></td> <td></td> <td colspan="8" style="text-align: center;"> <table border="1" style="width: 100%; border-collapse: collapse; text-align: center;"> <tr> <td style="width: 10%;"></td> <td style="width: 10%;"></td> <td style="width: 10%;"></td> <td style="width: 10%;"></td> <td style="width: 10%;"></td> <td style="width: 10%;"></td> <td style="width: 10%;"></td> <td style="width: 10%;"></td> <td style="width: 10%;"></td> <td style="width: 10%;"></td> </tr> <tr> <td></td> <td></td> <td colspan="8" style="text-align: center;"> <table border="1" style="width: 100%; border-collapse: collapse; text-align: center;"> <tr> <td style="width: 10%;"></td> <td style="width: 10%;"></td> <td style="width: 10%;"></td> <td style="width: 10%;"></td> <td style="width: 10%;"></td> <td style="width: 10%;"></td> <td style="width: 10%;"></td> <td style="width: 10%;"></td> <td style="width: 10%;"></td> <td style="width: 10%;"></td> </tr> <tr> <td></td> <td></td> <td colspan="8" style="text-align: center;"> <table border="1" style="width: 100%; border-collapse: collapse; text-align: center;"> <tr> <td style="width: 10%;"></td> <td style="width: 10%;"></td> <td style="width: 10%;"></td> <td style="width: 10%;"></td> <td style="width: 10%;"></td> <td style="width: 10%;"></td> <td style="width: 10%;"></td> <td style="width: 10%;"></td> <td style="width: 10%;"></td> <td style="width: 10%;"></td> </tr> <tr> <td></td> <td></td> <td colspan="8" style="text-align: center;"> <table border="1" style="width: 100%; border-collapse: collapse; text-align: center;"> <tr> <td style="width: 10%;"></td> <td style="width: 10%;"></td> <td style="width: 10%;"></td> <td style="width: 10%;"></td> <td style="width: 10%;"></td> <td style="width: 10%;"></td> <td style="width: 10%;"></td> <td style="width: 10%;"></td> <td style="width: 10%;"></td> <td style="width: 10%;"></td> </tr> <tr> <td></td> <td></td> <td colspan="8" style="text-align: center;"> <table border="1" style="width: 100%; border-collapse: collapse; text-align: center;"> <tr> <td style="width: 10%;"></td> <td style="width: 10%;"></td> <td style="width: 10%;"></td> <td style="width: 10%;"></td> <td style="width: 10%;"></td> <td style="width: 10%;"></td> <td style="width: 10%;"></td> <td style="width: 10%;"></td> <td style="width: 10%;"></td> <td style="width: 10%;"></td> </tr> <tr> <td></td> <td></td> <td colspan="8" style="text-align: center;"> <table border="1" style="width: 100%; border-collapse: collapse; text-align: center;"> <tr> <td style="width: 10%;"></td> <td style="width: 10%;"></td> <td style="width: 10%;"></td> <td style="width: 10%;"></td> <td style="width: 10%;"></td> <td style="width: 10%;"></td> <td style="width: 10%;"></td> <td style="width: 10%;"></td> <td style="width: 10%;"></td> <td style="width: 10%;"></td> </tr> <tr> <td></td> <td></td> <td colspan="8" style="text-align: center;"> <table border="1" style="width: 100%; border-collapse: collapse; text-align: center;"> <tr> <td style="width: 10%;"></td> <td style="width: 10%;"></td> <td style="width: 10%;"></td> <td style="width: 10%;"></td> <td style="width: 10%;"></td> <td style="width: 10%;"></td> <td style="width: 10%;"></td> <td style="width: 10%;"></td> <td style="width: 10%;"></td> <td style="width: 10%;"></td> </tr> <tr> <td></td> <td></td> <td colspan="8" style="text-align: center;"> <table border="1" style="width: 100%; border-collapse: collapse; text-align: center;"> <tr> <td style="width: 10%;"></td> <td style="width: 10%;"></td> <td style="width: 10%;"></td> <td style="width: 10%;"></td> <td style="width: 10%;"></td> <td style="width: 10%;"></td> <td style="width: 10%;"></td> <td style="width: 10%;"></td> <td style="width: 10%;"></td> <td style="width: 10%;"></td> </tr> <tr> <td></td> <td></td> <td colspan="8" style="text-align: center;"> <table border="1" style="width: 100%; border-collapse: collapse; text-align: center;"> <tr> <td style="width: 10%;"></td> <td style="width: 10%;"></td> <td style="width: 10%;"></td> <td style="width: 10%;"></td> <td style="width: 10%;"></td> <td style="width: 10%;"></td> <td style="width: 10%;"></td> <td style="width: 10%;"></td> <td style="width: 10%;"></td> <td style="width: 10%;"></td> </tr> <tr> <td></td> <td></td> <td
colspan="8" style="text-align: center;"> <table border="1" style="width: 100%; border-collapse: collapse; text-align: center;"> <tr> <td style="width: 10%;"></td> <td style="width: 10%;"></td> <td style="width: 10%;"></td> <td style="width: 10%;"></td> <td style="width: 10%;"></td> <td style="width: 10%;"></td> <td style="width: 10%;"></td> <td style="width: 10%;"></td> <td style="width: 10%;"></td> <td style="width: 10%;"></td> </tr> <tr> <td></td> <td></td> <td colspan="8" style="text-align: center;"> <table border="1" style="width: 100%; border-collapse: collapse; text-align: center;"> <tr> <td style="width: 10%;"></td> <td style="width: 10%;"></td> <td style="width: 10%;"></td> <td style="width: 10%;"></td> <td style="width: 10%;"></td> <td style="width: 10%;"></td> <td style="width: 10%;"></td> <td style="width: 10%;"></td> <td style="width: 10%;"></td> <td style="width: 10%;"></td> </tr> <tr> <td></td> <td></td> <td colspan="8" style="text-align: center;"> <table border="1" style="width: 100%; border-collapse: collapse; text-align: center;"> <tr> <td style="width: 10%;"></td> <td style="width: 10%;"></td> <td style="width: 10%;"></td> <td style="width: 10%;"></td> <td style="width: 10%;"></td> <td style="width: 10%;"></td> <td style="width: 10%;"></td> <td style="width: 10%;"></td> <td style="width: 10%;"></td> <td style="width: 10%;"></td> </tr> <tr> <td></td> <td></td> <td colspan="8" style="text-align: center;"> <table border="1" style="width: 100%; border-collapse: collapse; text-align: center;"> <tr> <td style="width: 10%;"></td> <td style="width: 10%;"></td> <td style="width: 10%;"></td> <td style="width: 10%;"></td> <td style="width: 10%;"></td> <td style="width: 10%;"></td> <td style="width: 10%;"></td> <td style="width: 10%;"></td> <td style="width: 10%;"></td> <td style="width: 10%;"></td> </tr> <tr> <td></td> <td></td> <td colspan="8" style="text-align: center;"> <table border="1" style="width: 100%; border-collapse: collapse; text-align: center;"> <tr> <td style="width: 10%;"></td> <td style="width: 10%;"></td> <td style="width: 10%;"></td> <td style="width: 10%;"></td> <td style="width: 10%;"></td> <td style="width: 10%;"></td> <td style="width: 10%;"></td> <td style="width: 10%;"></td> <td style="width: 10%;"></td> <td style="width: 10%;"></td> </tr> <tr> <td></td> <td></td> <td colspan="8" style="text-align: center;"> <table border="1" style="width: 100%; border-collapse: collapse; text-align: center;"> <tr> <td style="width: 10%;"></td> <td style="width: 10%;"></td> <td style="width: 10%;"></td> <td style="width: 10%;"></td> <td style="width: 10%;"></td> <td style="width: 10%;"></td> <td style="width: 10%;"></td> <td style="width: 10%;"></td> <td style="width: 10%;"></td> <td style="width: 10%;"></td> </tr> <tr> <td></td> <td></td> <td colspan="8" style="text-align: center;"> <table border="1" style="width: 100%; border-collapse: collapse; text-align: center;"> <tr> <td style="width: 10%;"></td> <td style="width: 10%;"></td> <td style="width: 10%;"></td> <td style="width: 10%;"></td> <td style="width: 10%;"></td> <td style="width: 10%;"></td> <td style="width: 10%;"></td> <td style="width: 10%;"></td> <td style="width: 10%;"></td> <td style="width: 10%;"></td> </tr> <tr> <td></td> <td></td> <td colspan="8" style="text-align: center;"> <table border="1" style="width: 100%; border-collapse: collapse; text-align: center;"> <tr> <td style="width: 10%;"></td> <td style="width: 10%;"></td> <td style="width: 10%;"></td> <td style="width: 10%;"></td> <td style="width: 10%;"></td> <td style="width: 10%;"></td> <td style="width: 10%;"></td> <td style="width: 10%;"></td> <td style="width: 10%;"></td> <td style="width: 10%;"></td> </tr> <tr> <td></td> <td></td> <td colspan="8" style="text-align: center;"> <table border="1" style="width: 100%; border-collapse: collapse; text-align: center;"> <tr> </tr></table></td></tr></table></td></tr></table></td></tr></table></td></tr></table></td></tr></table></td></tr></table></td></tr></table></td></tr></table></td></tr></table></td></tr></table></td></tr></table></td></tr></table></td></tr></table></td></tr></table></td></tr></table></td></tr></table></td></tr></table></td></tr></table>
 | | | | | | | | | | | | | | | | | | | | <table border="1" style="width: 100%; border-collapse: collapse; text-align: center;"> <tr> <td style="width: 10%;"></td> <td style="width: 10%;"></td> <td style="width: 10%;"></td> <td style="width: 10%;"></td> <td style="width: 10%;"></td> <td style="width: 10%;"></td> <td style="width: 10%;"></td> <td style="width: 10%;"></td> <td style="width: 10%;"></td> <td style="width: 10%;"></td> </tr> <tr> <td></td> <td></td> <td colspan="8" style="text-align: center;"> <table border="1" style="width: 100%; border-collapse: collapse; text-align: center;"> <tr> <td style="width: 10%;"></td> <td style="width: 10%;"></td> <td style="width: 10%;"></td> <td style="width: 10%;"></td> <td style="width: 10%;"></td> <td style="width: 10%;"></td> <td style="width: 10%;"></td> <td style="width: 10%;"></td> <td style="width: 10%;"></td> <td style="width: 10%;"></td> </tr> <tr> <td></td> <td></td> <td colspan="8" style="text-align: center;"> <table border="1" style="width: 100%; border-collapse: collapse; text-align: center;"> <tr> <td style="width: 10%;"></td> <td style="width: 10%;"></td> <td style="width: 10%;"></td> <td style="width: 10%;"></td> <td style="width: 10%;"></td> <td style="width: 10%;"></td> <td style="width: 10%;"></td> <td style="width: 10%;"></td> <td style="width: 10%;"></td> <td style="width: 10%;"></td> </tr> <tr> <td></td> <td></td> <td colspan="8" style="text-align: center;"> <table border="1" style="width: 100%; border-collapse: collapse; text-align: center;"> <tr> <td style="width: 10%;"></td> <td style="width: 10%;"></td> <td style="width: 10%;"></td> <td style="width: 10%;"></td> <td style="width: 10%;"></td> <td style="width: 10%;"></td> <td style="width: 10%;"></td> <td style="width: 10%;"></td> <td style="width: 10%;"></td> <td style="width: 10%;"></td> </tr> <tr> <td></td> <td></td> <td colspan="8" style="text-align: center;"> <table border="1" style="width: 100%; border-collapse: collapse; text-align: center;"> <tr> <td style="width: 10%;"></td> <td style="width: 10%;"></td> <td style="width: 10%;"></td> <td style="width: 10%;"></td> <td style="width: 10%;"></td> <td style="width: 10%;"></td> <td style="width: 10%;"></td> <td style="width: 10%;"></td> <td style="width: 10%;"></td> <td style="width: 10%;"></td> </tr> <tr> <td></td> <td></td> <td colspan="8" style="text-align: center;"> <table border="1" style="width: 100%; border-collapse: collapse; text-align: center;"> <tr> <td style="width: 10%;"></td> <td style="width: 10%;"></td> <td style="width: 10%;"></td> <td style="width: 10%;"></td> <td style="width: 10%;"></td> <td style="width: 10%;"></td> <td style="width: 10%;"></td> <td style="width: 10%;"></td> <td style="width: 10%;"></td> <td style="width: 10%;"></td> </tr> <tr> <td></td> <td></td> <td colspan="8" style="text-align: center;"> <table border="1" style="width: 100%; border-collapse: collapse; text-align: center;"> <tr> <td style="width: 10%;"></td> <td style="width: 10%;"></td> <td style="width: 10%;"></td> <td style="width: 10%;"></td> <td style="width: 10%;"></td> <td style="width: 10%;"></td> <td style="width: 10%;"></td> <td style="width: 10%;"></td> <td style="width: 10%;"></td> <td style="width: 10%;"></td> </tr> <tr> <td></td> <td></td> <td colspan="8" style="text-align: center;"> <table border="1" style="width: 100%; border-collapse: collapse; text-align: center;"> <tr> <td style="width: 10%;"></td> <td style="width: 10%;"></td> <td style="width: 10%;"></td> <td style="width: 10%;"></td> <td style="width: 10%;"></td> <td style="width: 10%;"></td> <td style="width: 10%;"></td> <td style="width: 10%;"></td> <td style="width: 10%;"></td> <td style="width: 10%;"></td> </tr> <tr> <td></td> <td></td> <td colspan="8" style="text-align: center;"> <table border="1" style="width: 100%; border-collapse: collapse; text-align: center;"> <tr> <td style="width: 10%;"></td> <td style="width: 10%;"></td> <td style="width: 10%;"></td> <td style="width: 10%;"></td> <td style="width: 10%;"></td> <td style="width: 10%;"></td> <td style="width: 10%;"></td> <td style="width: 10%;"></td> <td style="width: 10%;"></td> <td style="width: 10%;"></td> </tr> <tr> <td></td> <td></td> <td colspan="8" style="text-align: center;"> <table border="1" style="width: 100%; border-collapse: collapse; text-align: center;"> <tr> <td style="width: 10%;"></td> <td style="width: 10%;"></td> <td style="width: 10%;"></td> <td style="width: 10%;"></td> <td style="width: 10%;"></td> <td style="width: 10%;"></td> <td style="width: 10%;"></td> <td style="width: 10%;"></td> <td style="width: 10%;"></td> <td style="width: 10%;"></td> </tr> <tr> <td></td> <td></td> <td colspan="8" style="text-align: center;"> <table border="1" style="width: 100%; border-collapse: collapse; text-align: center;"> <tr> <td style="width: 10%;"></td> <td style="width: 10%;"></td> <td style="width: 10%;"></td> <td style="width: 10%;"></td> <td style="width: 10%;"></td> <td style="width: 10%;"></td> <td style="width: 10%;"></td> <td style="width: 10%;"></td> <td style="width: 10%;"></td> <td style="width: 10%;"></td> </tr> <tr> <td></td> <td></td> <td colspan="8" style="text-align: center;"> <table border="1" style="width: 100%; border-collapse: collapse; text-align: center;"> <tr> <td style="width: 10%;"></td> <td style="width: 10%;"></td> <td style="width: 10%;"></td> <td style="width: 10%;"></td> <td style="width: 10%;"></td> <td style="width: 10%;"></td> <td style="width: 10%;"></td> <td style="width: 10%;"></td> <td style="width: 10%;"></td> <td style="width: 10%;"></td> </tr> <tr> <td></td> <td></td> <td colspan="8" style="text-align: center;"> <table border="1" style="width: 100%; border-collapse: collapse; text-align: center;"> <tr> <td style="width: 10%;"></td> <td style="width: 10%;"></td> <td style="width: 10%;"></td> <td style="width: 10%;"></td> <td style="width: 10%;"></td> <td style="width: 10%;"></td> <td style="width: 10%;"></td> <td style="width: 10%;"></td> <td style="width: 10%;"></td> <td style="width:
10%;"></td> </tr> <tr> <td></td> <td></td> <td colspan="8" style="text-align: center;"> <table border="1" style="width: 100%; border-collapse: collapse; text-align: center;"> <tr> <td style="width: 10%;"></td> <td style="width: 10%;"></td> <td style="width: 10%;"></td> <td style="width: 10%;"></td> <td style="width: 10%;"></td> <td style="width: 10%;"></td> <td style="width: 10%;"></td> <td style="width: 10%;"></td> <td style="width: 10%;"></td> <td style="width: 10%;"></td> </tr> <tr> <td></td> <td></td> <td colspan="8" style="text-align: center;"> <table border="1" style="width: 100%; border-collapse: collapse; text-align: center;"> <tr> <td style="width: 10%;"></td> <td style="width: 10%;"></td> <td style="width: 10%;"></td> <td style="width: 10%;"></td> <td style="width: 10%;"></td> <td style="width: 10%;"></td> <td style="width: 10%;"></td> <td style="width: 10%;"></td> <td style="width: 10%;"></td> <td style="width: 10%;"></td> </tr> <tr> <td></td> <td></td> <td colspan="8" style="text-align: center;"> <table border="1" style="width: 100%; border-collapse: collapse; text-align: center;"> <tr> <td style="width: 10%;"></td> <td style="width: 10%;"></td> <td style="width: 10%;"></td> <td style="width: 10%;"></td> <td style="width: 10%;"></td> <td style="width: 10%;"></td> <td style="width: 10%;"></td> <td style="width: 10%;"></td> <td style="width: 10%;"></td> <td style="width: 10%;"></td> </tr> <tr> <td></td> <td></td> <td colspan="8" style="text-align: center;"> <table border="1" style="width: 100%; border-collapse: collapse; text-align: center;"> <tr> <td style="width: 10%;"></td> <td style="width: 10%;"></td> <td style="width: 10%;"></td> <td style="width: 10%;"></td> <td style="width: 10%;"></td> <td style="width: 10%;"></td> <td style="width: 10%;"></td> <td style="width: 10%;"></td> <td style="width: 10%;"></td> <td style="width: 10%;"></td> </tr> <tr> <td></td> <td></td> <td colspan="8" style="text-align: center;"> <table border="1" style="width: 100%; border-collapse: collapse; text-align: center;"> <tr> </tr></table></td></tr></table></td></tr></table></td></tr></table></td></tr></table></td></tr></table></td></tr></table></td></tr></table></td></tr></table></td></tr></table></td></tr></table></td></tr></table></td></tr></table></td></tr></table></td></tr></table></td></tr></table></td></tr></table></td></tr></table>
 | | | | | | | | | | | | | | | | | | | | <table border="1" style="width: 100%; border-collapse: collapse; text-align: center;"> <tr> <td style="width: 10%;"></td> <td style="width: 10%;"></td> <td style="width: 10%;"></td> <td style="width: 10%;"></td> <td style="width: 10%;"></td> <td style="width: 10%;"></td> <td style="width: 10%;"></td> <td style="width: 10%;"></td> <td style="width: 10%;"></td> <td style="width: 10%;"></td> </tr> <tr> <td></td> <td></td> <td colspan="8" style="text-align: center;"> <table border="1" style="width: 100%; border-collapse: collapse; text-align: center;"> <tr> <td style="width: 10%;"></td> <td style="width: 10%;"></td> <td style="width: 10%;"></td> <td style="width: 10%;"></td> <td style="width: 10%;"></td> <td style="width: 10%;"></td> <td style="width: 10%;"></td> <td style="width: 10%;"></td> <td style="width: 10%;"></td> <td style="width: 10%;"></td> </tr> <tr> <td></td> <td></td> <td colspan="8" style="text-align: center;"> <table border="1" style="width: 100%; border-collapse: collapse; text-align: center;"> <tr> <td style="width: 10%;"></td> <td style="width: 10%;"></td> <td style="width: 10%;"></td> <td style="width: 10%;"></td> <td style="width: 10%;"></td> <td style="width: 10%;"></td> <td style="width: 10%;"></td> <td style="width: 10%;"></td> <td style="width: 10%;"></td> <td style="width: 10%;"></td> </tr> <tr> <td></td> <td></td> <td colspan="8" style="text-align: center;"> <table border="1" style="width: 100%; border-collapse: collapse; text-align: center;"> <tr> <td style="width: 10%;"></td> <td style="width: 10%;"></td> <td style="width: 10%;"></td> <td style="width: 10%;"></td> <td style="width: 10%;"></td> <td style="width: 10%;"></td> <td style="width: 10%;"></td> <td style="width: 10%;"></td> <td style="width: 10%;"></td> <td style="width: 10%;"></td> </tr> <tr> <td></td> <td></td> <td colspan="8" style="text-align: center;"> <table border="1" style="width: 100%; border-collapse: collapse; text-align: center;"> <tr> <td style="width: 10%;"></td> <td style="width: 10%;"></td> <td style="width: 10%;"></td> <td style="width: 10%;"></td> <td style="width: 10%;"></td> <td style="width: 10%;"></td> <td style="width: 10%;"></td> <td style="width: 10%;"></td> <td style="width: 10%;"></td> <td style="width: 10%;"></td> </tr> <tr> <td></td> <td></td> <td colspan="8" style="text-align: center;"> <table border="1" style="width: 100%; border-collapse: collapse; text-align: center;"> <tr> <td style="width: 10%;"></td> <td style="width: 10%;"></td> <td style="width: 10%;"></td> <td style="width: 10%;"></td> <td style="width: 10%;"></td> <td style="width: 10%;"></td> <td style="width: 10%;"></td> <td style="width: 10%;"></td> <td style="width: 10%;"></td> <td style="width: 10%;"></td> </tr> <tr> <td></td> <td></td> <td colspan="8" style="text-align: center;"> <table border="1" style="width: 100%; border-collapse: collapse; text-align: center;"> <tr> <td style="width: 10%;"></td> <td style="width: 10%;"></td> <td style="width: 10%;"></td> <td style="width: 10%;"></td> <td style="width: 10%;"></td> <td style="width: 10%;"></td> <td style="width: 10%;"></td> <td style="width: 10%;"></td> <td style="width: 10%;"></td> <td style="width: 10%;"></td> </tr> <tr> <td></td> <td></td> <td colspan="8" style="text-align: center;"> <table border="1" style="width: 100%; border-collapse: collapse; text-align: center;"> <tr> <td style="width: 10%;"></td> <td style="width: 10%;"></td> <td style="width: 10%;"></td> <td style="width: 10%;"></td> <td style="width: 10%;"></td> <td style="width: 10%;"></td> <td style="width: 10%;"></td> <td style="width: 10%;"></td> <td style="width: 10%;"></td> <td style="width: 10%;"></td> </tr> <tr> <td></td> <td></td> <td colspan="8" style="text-align: center;"> <table border="1" style="width: 100%; border-collapse: collapse; text-align: center;"> <tr> <td style="width: 10%;"></td> <td style="width: 10%;"></td> <td style="width: 10%;"></td> <td style="width: 10%;"></td> <td style="width: 10%;"></td> <td style="width: 10%;"></td> <td style="width: 10%;"></td> <td style="width: 10%;"></td> <td style="width: 10%;"></td> <td style="width: 10%;"></td> </tr> <tr> <td></td> <td></td> <td colspan="8" style="text-align: center;"> <table border="1" style="width: 100%; border-collapse: collapse; text-align: center;"> <tr> <td style="width: 10%;"></td> <td style="width: 10%;"></td> <td style="width: 10%;"></td> <td style="width: 10%;"></td> <td style="width: 10%;"></td> <td style="width: 10%;"></td> <td style="width: 10%;"></td> <td style="width: 10%;"></td> <td style="width: 10%;"></td> <td style="width: 10%;"></td> </tr> <tr> <td></td> <td></td> <td colspan="8" style="text-align: center;"> <table border="1" style="width: 100%; border-collapse: collapse; text-align: center;"> <tr> <td style="width: 10%;"></td> <td style="width: 10%;"></td> <td style="width: 10%;"></td> <td style="width: 10%;"></td> <td style="width: 10%;"></td> <td style="width: 10%;"></td> <td style="width: 10%;"></td> <td style="width: 10%;"></td> <td style="width: 10%;"></td> <td style="width: 10%;"></td> </tr> <tr> <td></td> <td></td> <td colspan="8" style="text-align: center;"> <table border="1" style="width: 100%; border-collapse: collapse; text-align: center;"> <tr> <td style="width: 10%;"></td> <td style="width: 10%;"></td> <td style="width: 10%;"></td> <td style="width: 10%;"></td> <td style="width: 10%;"></td> <td style="width: 10%;"></td> <td style="width: 10%;"></td> <td style="width: 10%;"></td> <td style="width: 10%;"></td> <td style="width: 10%;"></td> </tr> <tr> <td></td> <td></td> <td colspan="8" style="text-align: center;"> <table border="1" style="width: 100%; border-collapse: collapse; text-align: center;"> <tr> <td style="width: 10%;"></td> <td style="width: 10%;"></td> <td style="width: 10%;"></td> <td style="width: 10%;"></td> <td style="width: 10%;"></td> <td style="width: 10%;"></td> <td style="width: 10%;"></td> <td style="width: 10%;"></td> <td style="width: 10%;"></td> <td style="width: 10%;"></td> </tr> <tr> <td></td> <td></td> <td colspan="8" style="text-align: center;"> <table border="1" style="width: 100%; border-collapse: collapse; text-align: center;"> <tr> <td style="width: 10%;"></td> <td style="width: 10%;"></td> <td style="width: 10%;"></td> <td style="width: 10%;"></td> <td style="width: 10%;"></td> <td style="width: 10%;"></td> <td style="width: 10%;"></td> <td style="width: 10%;"></td> <td style="width: 10%;"></td> <td style="width: 10%;"></td> </tr> <tr> <td></td> <td></td> <td colspan="8" style="text-align: center;"> <table border="1" style="width: 100%; border-collapse: collapse; text-align: center;"> <tr> <td style="width: 10%;"></td> <td style="width: 10%;"></td> <td style="width: 10%;"></td> <td style="width: 10%;"></td> <td style="width: 10%;"></td> <td style="width: 10%;"></td> <td style="width: 10%;"></td> <td style="width: 10%;"></td> <td style="width: 10%;"></td> <td style="width: 10%;"></td> </tr> <tr> <td></td> <td></td> <td colspan="8" style="text-align: center;"> <table border="1" style="width: 100%; border-collapse: collapse; text-align: center;"> <tr> <td style="width: 10%;"></td> <td style="width: 10%;"></td> <td style="width: 10%;"></td> <td style="width: 10%;"></td> <td style="width: 10%;"></td> <td style="width: 10%;"></td> <td style="width: 10%;"></td> <td style="width: 10%;"></td> <td style="width: 10%;"></td> <td style="width: 10%;"></td> </tr> <tr> <td></td> <td></td> <td colspan="8" style="text-align: center;"> <table border="1" style="width: 100%; border-collapse: collapse; text-align: center;"> <tr>
</tr></table></td></tr></table></td></tr></table></td></tr></table></td></tr></table></td></tr></table></td></tr></table></td></tr></table></td></tr></table></td></tr></table></td></tr></table></td></tr></table></td></tr></table></td></tr></table></td></tr></table></td></tr></table></td></tr></table>
 | | | | | | | | | | | | | | | | | | | | <table border="1" style="width: 100%; border-collapse: collapse; text-align: center;"> <tr> <td style="width: 10%;"></td> <td style="width: 10%;"></td> <td style="width: 10%;"></td> <td style="width: 10%;"></td> <td style="width: 10%;"></td> <td style="width: 10%;"></td> <td style="width: 10%;"></td> <td style="width: 10%;"></td> <td style="width: 10%;"></td> <td style="width: 10%;"></td> </tr> <tr> <td></td> <td></td> <td colspan="8" style="text-align: center;"> <table border="1" style="width: 100%; border-collapse: collapse; text-align: center;"> <tr> <td style="width: 10%;"></td> <td style="width: 10%;"></td> <td style="width: 10%;"></td> <td style="width: 10%;"></td> <td style="width: 10%;"></td> <td style="width: 10%;"></td> <td style="width: 10%;"></td> <td style="width: 10%;"></td> <td style="width: 10%;"></td> <td style="width: 10%;"></td> </tr> <tr> <td></td> <td></td> <td colspan="8" style="text-align: center;"> <table border="1" style="width: 100%; border-collapse: collapse; text-align: center;"> <tr> <td style="width: 10%;"></td> <td style="width: 10%;"></td> <td style="width: 10%;"></td> <td style="width: 10%;"></td> <td style="width: 10%;"></td> <td style="width: 10%;"></td> <td style="width: 10%;"></td> <td style="width: 10%;"></td> <td style="width: 10%;"></td> <td style="width: 10%;"></td> </tr> <tr> <td></td> <td></td> <td colspan="8" style="text-align: center;"> <table border="1" style="width: 100%; border-collapse: collapse; text-align: center;"> <tr> <td style="width: 10%;"></td> <td style="width: 10%;"></td> <td style="width: 10%;"></td> <td style="width: 10%;"></td> <td style="width: 10%;"></td> <td style="width: 10%;"></td> <td style="width: 10%;"></td> <td style="width: 10%;"></td> <td style="width: 10%;"></td> <td style="width: 10%;"></td> </tr> <tr> <td></td> <td></td> <td colspan="8" style="text-align: center;"> <table border="1" style="width: 100%; border-collapse: collapse; text-align: center;"> <tr> <td style="width: 10%;"></td> <td style="width: 10%;"></td> <td style="width: 10%;"></td> <td style="width: 10%;"></td> <td style="width: 10%;"></td> <td style="width: 10%;"></td> <td style="width: 10%;"></td> <td style="width: 10%;"></td> <td style="width: 10%;"></td> <td style="width: 10%;"></td> </tr> <tr> <td></td> <td></td> <td colspan="8" style="text-align: center;"> <table border="1" style="width: 100%; border-collapse: collapse; text-align: center;"> <tr> <td style="width: 10%;"></td> <td style="width: 10%;"></td> <td style="width: 10%;"></td> <td style="width: 10%;"></td> <td style="width: 10%;"></td> <td style="width: 10%;"></td> <td style="width: 10%;"></td> <td style="width: 10%;"></td> <td style="width: 10%;"></td> <td style="width: 10%;"></td> </tr> <tr> <td></td> <td></td> <td colspan="8" style="text-align: center;"> <table border="1" style="width: 100%; border-collapse: collapse; text-align: center;"> <tr> <td style="width: 10%;"></td> <td style="width: 10%;"></td> <td style="width: 10%;"></td> <td style="width: 10%;"></td> <td style="width: 10%;"></td> <td style="width: 10%;"></td> <td style="width: 10%;"></td> <td style="width: 10%;"></td> <td style="width: 10%;"></td> <td style="width: 10%;"></td> </tr> <tr> <td></td> <td></td> <td colspan="8" style="text-align: center;"> <table border="1" style="width: 100%; border-collapse: collapse; text-align: center;"> <tr> <td style="width: 10%;"></td> <td style="width: 10%;"></td> <td style="width: 10%;"></td> <td style="width: 10%;"></td> <td style="width: 10%;"></td> <td style="width: 10%;"></td> <td style="width: 10%;"></td> <td style="width: 10%;"></td> <td style="width: 10%;"></td> <td style="width: 10%;"></td> </tr> <tr> <td></td> <td></td> <td colspan="8" style="text-align: center;"> <table border="1" style="width: 100%; border-collapse: collapse; text-align: center;"> <tr> <td style="width: 10%;"></td> <td style="width: 10%;"></td> <td style="width: 10%;"></td> <td style="width: 10%;"></td> <td style="width: 10%;"></td> <td style="width: 10%;"></td> <td style="width: 10%;"></td> <td style="width: 10%;"></td> <td style="width: 10%;"></td> <td style="width: 10%;"></td> </tr> <tr> <td></td> <td></td> <td colspan="8" style="text-align: center;"> <table border="1" style="width: 100%; border-collapse: collapse; text-align: center;"> <tr> <td style="width: 10%;"></td> <td style="width: 10%;"></td> <td style="width: 10%;"></td> <td style="width: 10%;"></td> <td style="width: 10%;"></td> <td style="width: 10%;"></td> <td style="width: 10%;"></td> <td style="width: 10%;"></td> <td style="width: 10%;"></td> <td style="width: 10%;"></td> </tr> <tr> <td></td> <td></td> <td colspan="8" style="text-align: center;"> <table border="1" style="width: 100%; border-collapse: collapse; text-align: center;"> <tr> <td style="width: 10%;"></td> <td style="width: 10%;"></td> <td style="width: 10%;"></td> <td style="width: 10%;"></td> <td style="width: 10%;"></td> <td style="width: 10%;"></td> <td style="width: 10%;"></td> <td style="width: 10%;"></td> <td style="width: 10%;"></td> <td style="width: 10%;"></td> </tr> <tr> <td></td> <td></td> <td colspan="8" style="text-align: center;"> <table border="1" style="width: 100%; border-collapse: collapse; text-align: center;"> <tr> <td style="width: 10%;"></td> <td style="width: 10%;"></td> <td style="width: 10%;"></td> <td style="width: 10%;"></td> <td style="width: 10%;"></td> <td style="width: 10%;"></td> <td style="width: 10%;"></td> <td style="width: 10%;"></td> <td style="width: 10%;"></td> <td style="width: 10%;"></td> </tr> <tr> <td></td> <td></td> <td colspan="8" style="text-align: center;"> <table border="1" style="width: 100%; border-collapse: collapse; text-align: center;"> <tr> <td style="width: 10%;"></td> <td style="width: 10%;"></td> <td style="width: 10%;"></td> <td style="width: 10%;"></td> <td style="width: 10%;"></td> <td style="width: 10%;"></td> <td style="width: 10%;"></td> <td style="width: 10%;"></td> <td style="width: 10%;"></td> <td style="width: 10%;"></td> </tr> <tr> <td></td> <td></td> <td colspan="8" style="text-align: center;"> <table border="1" style="width: 100%; border-collapse: collapse; text-align: center;"> <tr> <td style="width: 10%;"></td> <td style="width: 10%;"></td> <td style="width: 10%;"></td> <td style="width: 10%;"></td> <td style="width: 10%;"></td> <td style="width: 10%;"></td> <td style="width: 10%;"></td> <td style="width: 10%;"></td> <td style="width: 10%;"></td> <td style="width: 10%;"></td> </tr> <tr> <td></td> <td></td> <td colspan="8" style="text-align: center;"> <table border="1" style="width: 100%; border-collapse: collapse; text-align: center;"> <tr> <td style="width: 10%;"></td> <td style="width: 10%;"></td> <td style="width: 10%;"></td> <td style="width: 10%;"></td> <td style="width: 10%;"></td> <td style="width: 10%;"></td> <td style="width: 10%;"></td> <td style="width: 10%;"></td> <td style="width: 10%;"></td> <td style="width: 10%;"></td> </tr> <tr> <td></td> <td></td> <td colspan="8" style="text-align: center;"> <table border="1" style="width: 100%; border-collapse: collapse; text-align: center;"> <tr> </tr></table></td></tr></table></td></tr></table></td></tr></table></td></tr></table></td></tr></table></td></tr></table></td></tr></table></td></tr></table></td></tr></table></td></tr></table></td></tr></table></td></tr></table></td></tr></table></td></tr></table></td></tr></table>
 | | | | | | | | | | | | | | | | | | | | <table border="1" style="width: 100%; border-collapse: collapse; text-align: center;"> <tr> <td style="width: 10%;"></td> <td style="width: 10%;"></td> <td style="width: 10%;"></td> <td style="width: 10%;"></td> <td style="width: 10%;"></td> <td style="width: 10%;"></td> <td style="width: 10%;"></td> <td style="width: 10%;"></td> <td style="width: 10%;"></td> <td style="width: 10%;"></td> </tr> <tr> <td></td> <td></td> <td colspan="8" style="text-align: center;"> <table border="1" style="width: 100%; border-collapse: collapse; text-align: center;"> <tr> <td style="width: 10%;"></td> <td style="width: 10%;"></td> <td style="width: 10%;"></td> <td style="width: 10%;"></td> <td style="width: 10%;"></td> <td style="width: 10%;"></td> <td style="width: 10%;"></td> <td style="width: 10%;"></td> <td style="width: 10%;"></td> <td style="width: 10%;"></td> </tr> <tr> <td></td> <td></td> <td colspan="8" style="text-align: center;"> <table border="1" style="width: 100%; border-collapse: collapse; text-align: center;"> <tr> <td style="width: 10%;"></td> <td style="width: 10%;"></td> <td style="width: 10%;"></td> <td style="width: 10%;"></td> <td style="width: 10%;"></td> <td style="width: 10%;"></td> <td style="width: 10%;"></td> <td style="width: 10%;"></td> <td style="width: 10%;"></td> <td style="width: 10%;"></td> </tr> <tr> <td></td> <td></td> <td colspan="8" style="text-align: center;"> <table border="1" style="width: 100%; border-collapse: collapse; text-align: center;"> <tr> <td style="width: 10%;"></td> <td style="width: 10%;"></td> <td style="width: 10%;"></td> <td style="width: 10%;"></td> <td style="width: 10%;"></td> <td style="width: 10%;"></td> <td style="width: 10%;"></td> <td style="width: 10%;"></td> <td style="width: 10%;"></td> <td style="width: 10%;"></td> </tr> <tr> <td></td> <td></td> <td colspan="8" style="text-align: center;"> <table border="1" style="width: 100%; border-collapse: collapse; text-align: center;"> <tr> <td style="width: 10%;"></td> <td style="width: 10%;"></td> <td style="width: 10%;"></td> <td style="width: 10%;"></td> <td style="width: 10%;"></td> <td style="width: 10%;"></td> <td style="width: 10%;"></td> <td style="width: 10%;"></td> <td style="width: 10%;"></td> <td style="width: 10%;"></td> </tr> <tr> <td></td> <td></td> <td colspan="8" style="text-align: center;"> <table border="1" style="width: 100%; border-collapse: collapse; text-align: center;"> <tr> <td style="width: 10%;"></td> <td style="width: 10%;"></td> <td style="width: 10%;"></td> <td style="width: 10%;"></td> <td style="width: 10%;"></td> <td style="width: 10%;"></td> <td style="width: 10%;"></td> <td style="width: 10%;"></td> <td style="width: 10%;"></td> <td style="width: 10%;"></td> </tr> <tr>
<td></td> <td></td> <td colspan="8" style="text-align: center;"> <table border="1" style="width: 100%; border-collapse: collapse; text-align: center;"> <tr> <td style="width: 10%;"></td> <td style="width: 10%;"></td> <td style="width: 10%;"></td> <td style="width: 10%;"></td> <td style="width: 10%;"></td> <td style="width: 10%;"></td> <td style="width: 10%;"></td> <td style="width: 10%;"></td> <td style="width: 10%;"></td> <td style="width: 10%;"></td> </tr> <tr> <td></td> <td></td> <td colspan="8" style="text-align: center;"> <table border="1" style="width: 100%; border-collapse: collapse; text-align: center;"> <tr> <td style="width: 10%;"></td> <td style="width: 10%;"></td> <td style="width: 10%;"></td> <td style="width: 10%;"></td> <td style="width: 10%;"></td> <td style="width: 10%;"></td> <td style="width: 10%;"></td> <td style="width: 10%;"></td> <td style="width: 10%;"></td> <td style="width: 10%;"></td> </tr> <tr> <td></td> <td></td> <td colspan="8" style="text-align: center;"> <table border="1" style="width: 100%; border-collapse: collapse; text-align: center;"> <tr> <td style="width: 10%;"></td> <td style="width: 10%;"></td> <td style="width: 10%;"></td> <td style="width: 10%;"></td> <td style="width: 10%;"></td> <td style="width: 10%;"></td> <td style="width: 10%;"></td> <td style="width: 10%;"></td> <td style="width: 10%;"></td> <td style="width: 10%;"></td> </tr> <tr> <td></td> <td></td> <td colspan="8" style="text-align: center;"> <table border="1" style="width: 100%; border-collapse: collapse; text-align: center;"> <tr> <td style="width: 10%;"></td> <td style="width: 10%;"></td> <td style="width: 10%;"></td> <td style="width: 10%;"></td> <td style="width: 10%;"></td> <td style="width: 10%;"></td> <td style="width: 10%;"></td> <td style="width: 10%;"></td> <td style="width: 10%;"></td> <td style="width: 10%;"></td> </tr> <tr> <td></td> <td></td> <td colspan="8" style="text-align: center;"> <table border="1" style="width: 100%; border-collapse: collapse; text-align: center;"> <tr> <td style="width: 10%;"></td> <td style="width: 10%;"></td> <td style="width: 10%;"></td> <td style="width: 10%;"></td> <td style="width: 10%;"></td> <td style="width: 10%;"></td> <td style="width: 10%;"></td> <td style="width: 10%;"></td> <td style="width: 10%;"></td> <td style="width: 10%;"></td> </tr> <tr> <td></td> <td></td> <td colspan="8" style="text-align: center;"> <table border="1" style="width: 100%; border-collapse: collapse; text-align: center;"> <tr> <td style="width: 10%;"></td> <td style="width: 10%;"></td> <td style="width: 10%;"></td> <td style="width: 10%;"></td> <td style="width: 10%;"></td> <td style="width: 10%;"></td> <td style="width: 10%;"></td> <td style="width: 10%;"></td> <td style="width: 10%;"></td> <td style="width: 10%;"></td> </tr> <tr> <td></td> <td></td> <td colspan="8" style="text-align: center;"> <table border="1" style="width: 100%; border-collapse: collapse; text-align: center;"> <tr> <td style="width: 10%;"></td> <td style="width: 10%;"></td> <td style="width: 10%;"></td> <td style="width: 10%;"></td> <td style="width: 10%;"></td> <td style="width: 10%;"></td> <td style="width: 10%;"></td> <td style="width: 10%;"></td> <td style="width: 10%;"></td> <td style="width: 10%;"></td> </tr> <tr> <td></td> <td></td> <td colspan="8" style="text-align: center;"> <table border="1" style="width: 100%; border-collapse: collapse; text-align: center;"> <tr> <td style="width: 10%;"></td> <td style="width: 10%;"></td> <td style="width: 10%;"></td> <td style="width: 10%;"></td> <td style="width: 10%;"></td> <td style="width: 10%;"></td> <td style="width: 10%;"></td> <td style="width: 10%;"></td> <td style="width: 10%;"></td> <td style="width: 10%;"></td> </tr> <tr> <td></td> <td></td> <td colspan="8" style="text-align: center;"> <table border="1" style="width: 100%; border-collapse: collapse; text-align: center;"> <tr> </tr></table></td></tr></table></td></tr></table></td></tr></table></td></tr></table></td></tr></table></td></tr></table></td></tr></table></td></tr></table></td></tr></table></td></tr></table></td></tr></table></td></tr></table></td></tr></table></td></tr></table>
 | | | | | | | | | | | | | | | | | | | | <table border="1" style="width: 100%; border-collapse: collapse; text-align: center;"> <tr> <td style="width: 10%;"></td> <td style="width: 10%;"></td> <td style="width: 10%;"></td> <td style="width: 10%;"></td> <td style="width: 10%;"></td> <td style="width: 10%;"></td> <td style="width: 10%;"></td> <td style="width: 10%;"></td> <td style="width: 10%;"></td> <td style="width: 10%;"></td> </tr> <tr> <td></td> <td></td> <td colspan="8" style="text-align: center;"> <table border="1" style="width: 100%; border-collapse: collapse; text-align: center;"> <tr> <td style="width: 10%;"></td> <td style="width: 10%;"></td> <td style="width: 10%;"></td> <td style="width: 10%;"></td> <td style="width: 10%;"></td> <td style="width: 10%;"></td> <td style="width: 10%;"></td> <td style="width: 10%;"></td> <td style="width: 10%;"></td> <td style="width: 10%;"></td> </tr> <tr> <td></td> <td></td> <td colspan="8" style="text-align: center;"> <table border="1" style="width: 100%; border-collapse: collapse; text-align: center;"> <tr> <td style="width: 10%;"></td> <td style="width: 10%;"></td> <td style="width: 10%;"></td> <td style="width: 10%;"></td> <td style="width: 10%;"></td> <td style="width: 10%;"></td> <td style="width: 10%;"></td> <td style="width: 10%;"></td> <td style="width: 10%;"></td> <td style="width: 10%;"></td> </tr> <tr> <td></td> <td></td> <td colspan="8" style="text-align: center;"> <table border="1" style="width: 100%; border-collapse: collapse; text-align: center;"> <tr> <td style="width: 10%;"></td> <td style="width: 10%;"></td> <td style="width: 10%;"></td> <td style="width: 10%;"></td> <td style="width: 10%;"></td> <td style="width: 10%;"></td> <td style="width: 10%;"></td> <td style="width: 10%;"></td> <td style="width: 10%;"></td> <td style="width: 10%;"></td> </tr> <tr> <td></td> <td></td> <td colspan="8" style="text-align: center;"> <table border="1" style="width: 100%; border-collapse: collapse; text-align: center;"> <tr> <td style="width: 10%;"></td> <td style="width: 10%;"></td> <td style="width: 10%;"></td> <td style="width: 10%;"></td> <td style="width: 10%;"></td> <td style="width: 10%;"></td> <td style="width: 10%;"></td> <td style="width: 10%;"></td> <td style="width: 10%;"></td> <td style="width: 10%;"></td> </tr> <tr> <td></td> <td></td> <td colspan="8" style="text-align: center;"> <table border="1" style="width: 100%; border-collapse: collapse; text-align: center;"> <tr> <td style="width: 10%;"></td> <td style="width: 10%;"></td> <td style="width: 10%;"></td> <td style="width: 10%;"></td> <td style="width: 10%;"></td> <td style="width: 10%;"></td> <td style="width: 10%;"></td> <td style="width: 10%;"></td> <td style="width: 10%;"></td> <td style="width: 10%;"></td> </tr> <tr> <td></td> <td></td> <td colspan="8" style="text-align: center;"> <table border="1" style="width: 100%; border-collapse: collapse; text-align: center;"> <tr> <td style="width: 10%;"></td> <td style="width: 10%;"></td> <td style="width: 10%;"></td> <td style="width: 10%;"></td> <td style="width: 10%;"></td> <td style="width: 10%;"></td> <td style="width: 10%;"></td> <td style="width: 10%;"></td> <td style="width: 10%;"></td> <td style="width: 10%;"></td> </tr> <tr> <td></td> <td></td> <td colspan="8" style="text-align: center;"> <table border="1" style="width: 100%; border-collapse: collapse; text-align: center;"> <tr> <td style="width: 10%;"></td> <td style="width: 10%;"></td> <td style="width: 10%;"></td> <td style="width: 10%;"></td> <td style="width: 10%;"></td> <td style="width: 10%;"></td> <td style="width: 10%;"></td> <td style="width: 10%;"></td> <td style="width: 10%;"></td> <td style="width: 10%;"></td> </tr> <tr> <td></td> <td></td> <td colspan="8" style="text-align: center;"> <table border="1" style="width: 100%; border-collapse: collapse; text-align: center;"> <tr> <td style="width: 10%;"></td> <td style="width: 10%;"></td> <td style="width: 10%;"></td> <td style="width: 10%;"></td> <td style="width: 10%;"></td> <td style="width: 10%;"></td> <td style="width: 10%;"></td> <td style="width: 10%;"></td> <td style="width: 10%;"></td> <td style="width: 10%;"></td> </tr> <tr> <td></td> <td></td> <td colspan="8" style="text-align: center;"> <table border="1" style="width: 100%; border-collapse: collapse; text-align: center;"> <tr> <td style="width: 10%;"></td> <td style="width: 10%;"></td> <td style="width: 10%;"></td> <td style="width: 10%;"></td> <td style="width: 10%;"></td> <td style="width: 10%;"></td> <td style="width: 10%;"></td> <td style="width: 10%;"></td> <td style="width: 10%;"></td> <td style="width: 10%;"></td> </tr> <tr> <td></td> <td></td> <td colspan="8" style="text-align: center;"> <table border="1" style="width: 100%; border-collapse: collapse; text-align: center;"> <tr> <td style="width: 10%;"></td> <td style="width: 10%;"></td> <td style="width: 10%;"></td> <td style="width: 10%;"></td> <td style="width: 10%;"></td> <td style="width: 10%;"></td> <td style="width: 10%;"></td> <td style="width: 10%;"></td> <td style="width: 10%;"></td> <td style="width: 10%;"></td> </tr> <tr> <td></td> <td></td> <td colspan="8" style="text-align: center;"> <table border="1" style="width: 100%; border-collapse: collapse; text-align: center;"> <tr> <td style="width: 10%;"></td> <td style="width: 10%;"></td> <td style="width: 10%;"></td> <td style="width: 10%;"></td> <td style="width: 10%;"></td> <td style="width: 10%;"></td> <td style="width: 10%;"></td> <td style="width: 10%;"></td> <td style="width: 10%;"></td> <td style="width: 10%;"></td> </tr> <tr> <td></td> <td></td> <td colspan="8" style="text-align: center;"> <table border="1" style="width: 100%; border-collapse: collapse; text-align: center;"> <tr> <td style="width: 10%;"></td> <td style="width: 10%;"></td> <td style="width: 10%;"></td> <td style="width: 10%;"></td> <td style="width: 10%;"></td> <td style="width: 10%;"></td> <td style="width: 10%;"></td> <td style="width: 10%;"></td> <td style="width: 10%;"></td> <td style="width: 10%;"></td> </tr> <tr> <td></td> <td></td> <td
colspan="8" style="text-align: center;"> <table border="1" style="width: 100%; border-collapse: collapse; text-align: center;"> <tr> </tr></table></td></tr></table></td></tr></table></td></tr></table></td></tr></table></td></tr></table></td></tr></table></td></tr></table></td></tr></table></td></tr></table></td></tr></table></td></tr></table></td></tr></table></td></tr></table>
 | | | | | | | | | | | | | | | | | | | | <table border="1" style="width: 100%; border-collapse: collapse; text-align: center;"> <tr> <td style="width: 10%;"></td> <td style="width: 10%;"></td> <td style="width: 10%;"></td> <td style="width: 10%;"></td> <td style="width: 10%;"></td> <td style="width: 10%;"></td> <td style="width: 10%;"></td> <td style="width: 10%;"></td> <td style="width: 10%;"></td> <td style="width: 10%;"></td> </tr> <tr> <td></td> <td></td> <td colspan="8" style="text-align: center;"> <table border="1" style="width: 100%; border-collapse: collapse; text-align: center;"> <tr> <td style="width: 10%;"></td> <td style="width: 10%;"></td> <td style="width: 10%;"></td> <td style="width: 10%;"></td> <td style="width: 10%;"></td> <td style="width: 10%;"></td> <td style="width: 10%;"></td> <td style="width: 10%;"></td> <td style="width: 10%;"></td> <td style="width: 10%;"></td> </tr> <tr> <td></td> <td></td> <td colspan="8" style="text-align: center;"> <table border="1" style="width: 100%; border-collapse: collapse; text-align: center;"> <tr> <td style="width: 10%;"></td> <td style="width: 10%;"></td> <td style="width: 10%;"></td> <td style="width: 10%;"></td> <td style="width: 10%;"></td> <td style="width: 10%;"></td> <td style="width: 10%;"></td> <td style="width: 10%;"></td> <td style="width: 10%;"></td> <td style="width: 10%;"></td> </tr> <tr> <td></td> <td></td> <td colspan="8" style="text-align: center;"> <table border="1" style="width: 100%; border-collapse: collapse; text-align: center;"> <tr> <td style="width: 10%;"></td> <td style="width: 10%;"></td> <td style="width: 10%;"></td> <td style="width: 10%;"></td> <td style="width: 10%;"></td> <td style="width: 10%;"></td> <td style="width: 10%;"></td> <td style="width: 10%;"></td> <td style="width: 10%;"></td> <td style="width: 10%;"></td> </tr> <tr> <td></td> <td></td> <td colspan="8" style="text-align: center;"> <table border="1" style="width: 100%; border-collapse: collapse; text-align: center;"> <tr> <td style="width: 10%;"></td> <td style="width: 10%;"></td> <td style="width: 10%;"></td> <td style="width: 10%;"></td> <td style="width: 10%;"></td> <td style="width: 10%;"></td> <td style="width: 10%;"></td> <td style="width: 10%;"></td> <td style="width: 10%;"></td> <td style="width: 10%;"></td> </tr> <tr> <td></td> <td></td> <td colspan="8" style="text-align: center;"> <table border="1" style="width: 100%; border-collapse: collapse; text-align: center;"> <tr> <td style="width: 10%;"></td> <td style="width: 10%;"></td> <td style="width: 10%;"></td> <td style="width: 10%;"></td> <td style="width: 10%;"></td> <td style="width: 10%;"></td> <td style="width: 10%;"></td> <td style="width: 10%;"></td> <td style="width: 10%;"></td> <td style="width: 10%;"></td> </tr> <tr> <td></td> <td></td> <td colspan="8" style="text-align: center;"> <table border="1" style="width: 100%; border-collapse: collapse; text-align: center;"> <tr> <td style="width: 10%;"></td> <td style="width: 10%;"></td> <td style="width: 10%;"></td> <td style="width: 10%;"></td> <td style="width: 10%;"></td> <td style="width: 10%;"></td> <td style="width: 10%;"></td> <td style="width: 10%;"></td> <td style="width: 10%;"></td> <td style="width: 10%;"></td> </tr> <tr> <td></td> <td></td> <td colspan="8" style="text-align: center;"> <table border="1" style="width: 100%; border-collapse: collapse; text-align: center;"> <tr> <td style="width: 10%;"></td> <td style="width: 10%;"></td> <td style="width: 10%;"></td> <td style="width: 10%;"></td> <td style="width: 10%;"></td> <td style="width: 10%;"></td> <td style="width: 10%;"></td> <td style="width: 10%;"></td> <td style="width: 10%;"></td> <td style="width: 10%;"></td> </tr> <tr> <td></td> <td></td> <td colspan="8" style="text-align: center;"> <table border="1" style="width: 100%; border-collapse: collapse; text-align: center;"> <tr> <td style="width: 10%;"></td> <td style="width: 10%;"></td> <td style="width: 10%;"></td> <td style="width: 10%;"></td> <td style="width: 10%;"></td> <td style="width: 10%;"></td> <td style="width: 10%;"></td> <td style="width: 10%;"></td> <td style="width: 10%;"></td> <td style="width: 10%;"></td> </tr> <tr> <td></td> <td></td> <td colspan="8" style="text-align: center;"> <table border="1" style="width: 100%; border-collapse: collapse; text-align: center;"> <tr> <td style="width: 10%;"></td> <td style="width: 10%;"></td> <td style="width: 10%;"></td> <td style="width: 10%;"></td> <td style="width: 10%;"></td> <td style="width: 10%;"></td> <td style="width: 10%;"></td> <td style="width: 10%;"></td> <td style="width: 10%;"></td> <td style="width: 10%;"></td> </tr> <tr> <td></td> <td></td> <td colspan="8" style="text-align: center;"> <table border="1" style="width: 100%; border-collapse: collapse; text-align: center;"> <tr> <td style="width: 10%;"></td> <td style="width: 10%;"></td> <td style="width: 10%;"></td> <td style="width: 10%;"></td> <td style="width: 10%;"></td> <td style="width: 10%;"></td> <td style="width: 10%;"></td> <td style="width: 10%;"></td> <td style="width: 10%;"></td> <td style="width: 10%;"></td> </tr> <tr> <td></td> <td></td> <td colspan="8" style="text-align: center;"> <table border="1" style="width: 100%; border-collapse: collapse; text-align: center;"> <tr> <td style="width: 10%;"></td> <td style="width: 10%;"></td> <td style="width: 10%;"></td> <td style="width: 10%;"></td> <td style="width: 10%;"></td> <td style="width: 10%;"></td> <td style="width: 10%;"></td> <td style="width: 10%;"></td> <td style="width: 10%;"></td> <td style="width: 10%;"></td> </tr> <tr> <td></td> <td></td> <td colspan="8" style="text-align: center;"> <table border="1" style="width: 100%; border-collapse: collapse; text-align: center;"> <tr> </tr></table></td></tr></table></td></tr></table></td></tr></table></td></tr></table></td></tr></table></td></tr></table></td></tr></table></td></tr></table></td></tr></table></td></tr></table></td></tr></table></td></tr></table>
 | | | | | | | | | | | | | | | | | | | | <table border="1" style="width: 100%; border-collapse: collapse; text-align: center;"> <tr> <td style="width: 10%;"></td> <td style="width: 10%;"></td> <td style="width: 10%;"></td> <td style="width: 10%;"></td> <td style="width: 10%;"></td> <td style="width: 10%;"></td> <td style="width: 10%;"></td> <td style="width: 10%;"></td> <td style="width: 10%;"></td> <td style="width: 10%;"></td> </tr> <tr> <td></td> <td></td> <td colspan="8" style="text-align: center;"> <table border="1" style="width: 100%; border-collapse: collapse; text-align: center;"> <tr> <td style="width: 10%;"></td> <td style="width: 10%;"></td> <td style="width: 10%;"></td> <td style="width: 10%;"></td> <td style="width: 10%;"></td> <td style="width: 10%;"></td> <td style="width: 10%;"></td> <td style="width: 10%;"></td> <td style="width: 10%;"></td> <td style="width: 10%;"></td> </tr> <tr> <td></td> <td></td> <td colspan="8" style="text-align: center;"> <table border="1" style="width: 100%; border-collapse: collapse; text-align: center;"> <tr> <td style="width: 10%;"></td> <td style="width: 10%;"></td> <td style="width: 10%;"></td> <td style="width: 10%;"></td> <td style="width: 10%;"></td> <td style="width: 10%;"></td> <td style="width: 10%;"></td> <td style="width: 10%;"></td> <td style="width: 10%;"></td> <td style="width: 10%;"></td> </tr> <tr> <td></td> <td></td> <td colspan="8" style="text-align: center;"> <table border="1" style="width: 100%; border-collapse: collapse; text-align: center;"> <tr> <td style="width: 10%;"></td> <td style="width: 10%;"></td> <td style="width: 10%;"></td> <td style="width: 10%;"></td> <td style="width: 10%;"></td> <td style="width: 10%;"></td> <td style="width: 10%;"></td> <td style="width: 10%;"></td> <td style="width: 10%;"></td> <td style="width: 10%;"></td> </tr> <tr> <td></td> <td></td> <td colspan="8" style="text-align: center;"> <table border="1" style="width: 100%; border-collapse: collapse; text-align: center;"> <tr> <td style="width: 10%;"></td> <td style="width: 10%;"></td> <td style="width: 10%;"></td> <td style="width: 10%;"></td> <td style="width: 10%;"></td> <td style="width: 10%;"></td> <td style="width: 10%;"></td> <td style="width: 10%;"></td> <td style="width: 10%;"></td> <td style="width: 10%;"></td> </tr> <tr> <td></td> <td></td> <td colspan="8" style="text-align: center;"> <table border="1" style="width: 100%; border-collapse: collapse; text-align: center;"> <tr> <td style="width: 10%;"></td> <td style="width: 10%;"></td> <td style="width: 10%;"></td> <td style="width: 10%;"></td> <td style="width: 10%;"></td> <td style="width: 10%;"></td> <td style="width: 10%;"></td> <td style="width: 10%;"></td> <td style="width: 10%;"></td> <td style="width: 10%;"></td> </tr> <tr> <td></td> <td></td> <td colspan="8" style="text-align: center;"> <table border="1" style="width: 100%; border-collapse: collapse; text-align: center;"> <tr> <td style="width: 10%;"></td> <td style="width: 10%;"></td> <td style="width: 10%;"></td> <td style="width: 10%;"></td> <td style="width: 10%;"></td> <td style="width: 10%;"></td> <td style="width: 10%;"></td> <td style="width: 10%;"></td> <td style="width: 10%;"></td> <td style="width: 10%;"></td> </tr> <tr> <td></td> <td></td> <td colspan="8" style="text-align: center;"> <table border="1" style="width: 100%; border-collapse: collapse; text-align: center;"> <tr> <td style="width: 10%;"></td> <td style="width: 10%;"></td> <td style="width: 10%;"></td> <td style="width: 10%;"></td> <td style="width: 10%;"></td> <td style="width: 10%;"></td> <td style="width: 10%;"></td> <td style="width: 10%;"></td> <td style="width: 10%;"></td> <td style="width: 10%;"></td> </tr> <tr> <td></td> <td></td> <td colspan="8" style="text-align: center;"> <table border="1" style="width: 100%; border-collapse: collapse; text-align: center;"> <tr> <td style="width: 10%;"></td> <td style="width: 10%;"></td> <td style="width: 10%;"></td> <td style="width: 10%;"></td> <td style="width: 10%;"></td> <td style="width: 10%;"></td> <td style="width: 10%;"></td> <td style="width: 10%;"></td> <td style="width: 10%;"></td> <td
style="width: 10%;"></td> </tr> <tr> <td></td> <td></td> <td colspan="8" style="text-align: center;"> <table border="1" style="width: 100%; border-collapse: collapse; text-align: center;"> <tr> <td style="width: 10%;"></td> <td style="width: 10%;"></td> <td style="width: 10%;"></td> <td style="width: 10%;"></td> <td style="width: 10%;"></td> <td style="width: 10%;"></td> <td style="width: 10%;"></td> <td style="width: 10%;"></td> <td style="width: 10%;"></td> <td style="width: 10%;"></td> </tr> <tr> <td></td> <td></td> <td colspan="8" style="text-align: center;"> <table border="1" style="width: 100%; border-collapse: collapse; text-align: center;"> <tr> <td style="width: 10%;"></td> <td style="width: 10%;"></td> <td style="width: 10%;"></td> <td style="width: 10%;"></td> <td style="width: 10%;"></td> <td style="width: 10%;"></td> <td style="width: 10%;"></td> <td style="width: 10%;"></td> <td style="width: 10%;"></td> <td style="width: 10%;"></td> </tr> <tr> <td></td> <td></td> <td colspan="8" style="text-align: center;"> <table border="1" style="width: 100%; border-collapse: collapse; text-align: center;"> <tr> </tr></table></td></tr></table></td></tr></table></td></tr></table></td></tr></table></td></tr></table></td></tr></table></td></tr></table></td></tr></table></td></tr></table></td></tr></table></td></tr></table>
 | | | | | | | | | | | | | | | | | | | | <table border="1" style="width: 100%; border-collapse: collapse; text-align: center;"> <tr> <td style="width: 10%;"></td> <td style="width: 10%;"></td> <td style="width: 10%;"></td> <td style="width: 10%;"></td> <td style="width: 10%;"></td> <td style="width: 10%;"></td> <td style="width: 10%;"></td> <td style="width: 10%;"></td> <td style="width: 10%;"></td> <td style="width: 10%;"></td> </tr> <tr> <td></td> <td></td> <td colspan="8" style="text-align: center;"> <table border="1" style="width: 100%; border-collapse: collapse; text-align: center;"> <tr> <td style="width: 10%;"></td> <td style="width: 10%;"></td> <td style="width: 10%;"></td> <td style="width: 10%;"></td> <td style="width: 10%;"></td> <td style="width: 10%;"></td> <td style="width: 10%;"></td> <td style="width: 10%;"></td> <td style="width: 10%;"></td> <td style="width: 10%;"></td> </tr> <tr> <td></td> <td></td> <td colspan="8" style="text-align: center;"> <table border="1" style="width: 100%; border-collapse: collapse; text-align: center;"> <tr> <td style="width: 10%;"></td> <td style="width: 10%;"></td> <td style="width: 10%;"></td> <td style="width: 10%;"></td> <td style="width: 10%;"></td> <td style="width: 10%;"></td> <td style="width: 10%;"></td> <td style="width: 10%;"></td> <td style="width: 10%;"></td> <td style="width: 10%;"></td> </tr> <tr> <td></td> <td></td> <td colspan="8" style="text-align: center;"> <table border="1" style="width: 100%; border-collapse: collapse; text-align: center;"> <tr> <td style="width: 10%;"></td> <td style="width: 10%;"></td> <td style="width: 10%;"></td> <td style="width: 10%;"></td> <td style="width: 10%;"></td> <td style="width: 10%;"></td> <td style="width: 10%;"></td> <td style="width: 10%;"></td> <td style="width: 10%;"></td> <td style="width: 10%;"></td> </tr> <tr> <td></td> <td></td> <td colspan="8" style="text-align: center;"> <table border="1" style="width: 100%; border-collapse: collapse; text-align: center;"> <tr> <td style="width: 10%;"></td> <td style="width: 10%;"></td> <td style="width: 10%;"></td> <td style="width: 10%;"></td> <td style="width: 10%;"></td> <td style="width: 10%;"></td> <td style="width: 10%;"></td> <td style="width: 10%;"></td> <td style="width: 10%;"></td> <td style="width: 10%;"></td> </tr> <tr> <td></td> <td></td> <td colspan="8" style="text-align: center;"> <table border="1" style="width: 100%; border-collapse: collapse; text-align: center;"> <tr> <td style="width: 10%;"></td> <td style="width: 10%;"></td> <td style="width: 10%;"></td> <td style="width: 10%;"></td> <td style="width: 10%;"></td> <td style="width: 10%;"></td> <td style="width: 10%;"></td> <td style="width: 10%;"></td> <td style="width: 10%;"></td> <td style="width: 10%;"></td> </tr> <tr> <td></td> <td></td> <td colspan="8" style="text-align: center;"> <table border="1" style="width: 100%; border-collapse: collapse; text-align: center;"> <tr> <td style="width: 10%;"></td> <td style="width: 10%;"></td> <td style="width: 10%;"></td> <td style="width: 10%;"></td> <td style="width: 10%;"></td> <td style="width: 10%;"></td> <td style="width: 10%;"></td> <td style="width: 10%;"></td> <td style="width: 10%;"></td> <td style="width: 10%;"></td> </tr> <tr> <td></td> <td></td> <td colspan="8" style="text-align: center;"> <table border="1" style="width: 100%; border-collapse: collapse; text-align: center;"> <tr> <td style="width: 10%;"></td> <td style="width: 10%;"></td> <td style="width: 10%;"></td> <td style="width: 10%;"></td> <td style="width: 10%;"></td> <td style="width: 10%;"></td> <td style="width: 10%;"></td> <td style="width: 10%;"></td> <td style="width: 10%;"></td> <td style="width: 10%;"></td> </tr> <tr> <td></td> <td></td> <td colspan="8" style="text-align: center;"> <table border="1" style="width: 100%; border-collapse: collapse; text-align: center;"> <tr> <td style="width: 10%;"></td> <td style="width: 10%;"></td> <td style="width: 10%;"></td> <td style="width: 10%;"></td> <td style="width: 10%;"></td> <td style="width: 10%;"></td> <td style="width: 10%;"></td> <td style="width: 10%;"></td> <td style="width: 10%;"></td> <td style="width: 10%;"></td> </tr> <tr> <td></td> <td></td> <td colspan="8" style="text-align: center;"> <table border="1" style="width: 100%; border-collapse: collapse; text-align: center;"> <tr> <td style="width: 10%;"></td> <td style="width: 10%;"></td> <td style="width: 10%;"></td> <td style="width: 10%;"></td> <td style="width: 10%;"></td> <td style="width: 10%;"></td> <td style="width: 10%;"></td> <td style="width: 10%;"></td> <td style="width: 10%;"></td> <td style="width: 10%;"></td> </tr> <tr> <td></td> <td></td> <td colspan="8" style="text-align: center;"> <table border="1" style="width: 100%; border-collapse: collapse; text-align: center;"> <tr> </tr></table></td></tr></table></td></tr></table></td></tr></table></td></tr></table></td></tr></table></td></tr></table></td></tr></table></td></tr></table></td></tr></table></td></tr></table>
 | | | | | | | | | | | | | | | | | | | | <table border="1" style="width: 100%; border-collapse: collapse; text-align: center;"> <tr> <td style="width: 10%;"></td> <td style="width: 10%;"></td> <td style="width: 10%;"></td> <td style="width: 10%;"></td> <td style="width: 10%;"></td> <td style="width: 10%;"></td> <td style="width: 10%;"></td> <td style="width: 10%;"></td> <td style="width: 10%;"></td> <td style="width: 10%;"></td> </tr> <tr> <td></td> <td></td> <td colspan="8" style="text-align: center;"> <table border="1" style="width: 100%; border-collapse: collapse; text-align: center;"> <tr> <td style="width: 10%;"></td> <td style="width: 10%;"></td> <td style="width: 10%;"></td> <td style="width: 10%;"></td> <td style="width: 10%;"></td> <td style="width: 10%;"></td> <td style="width: 10%;"></td> <td style="width: 10%;"></td> <td style="width: 10%;"></td> <td style="width: 10%;"></td> </tr> <tr> <td></td> <td></td> <td colspan="8" style="text-align: center;"> <table border="1" style="width: 100%; border-collapse: collapse; text-align: center;"> <tr> <td style="width: 10%;"></td> <td style="width: 10%;"></td> <td style="width: 10%;"></td> <td style="width: 10%;"></td> <td style="width: 10%;"></td> <td style="width: 10%;"></td> <td style="width: 10%;"></td> <td style="width: 10%;"></td> <td style="width: 10%;"></td> <td style="width: 10%;"></td> </tr> <tr> <td></td> <td></td> <td colspan="8" style="text-align: center;"> <table border="1" style="width: 100%; border-collapse: collapse; text-align: center;"> <tr> <td style="width: 10%;"></td> <td style="width: 10%;"></td> <td style="width: 10%;"></td> <td style="width: 10%;"></td> <td style="width: 10%;"></td> <td style="width: 10%;"></td> <td style="width: 10%;"></td> <td style="width: 10%;"></td> <td style="width: 10%;"></td> <td style="width: 10%;"></td> </tr> <tr> <td></td> <td></td> <td colspan="8" style="text-align: center;"> <table border="1" style="width: 100%; border-collapse: collapse; text-align: center;"> <tr> <td style="width: 10%;"></td> <td style="width: 10%;"></td> <td style="width: 10%;"></td> <td style="width: 10%;"></td> <td style="width: 10%;"></td> <td style="width: 10%;"></td> <td style="width: 10%;"></td> <td style="width: 10%;"></td> <td style="width: 10%;"></td> <td style="width: 10%;"></td> </tr> <tr> <td></td> <td></td> <td colspan="8" style="text-align: center;"> <table border="1" style="width: 100%; border-collapse: collapse; text-align: center;"> <tr> <td style="width: 10%;"></td> <td style="width: 10%;"></td> <td style="width: 10%;"></td> <td style="width: 10%;"></td> <td style="width: 10%;"></td> <td style="width: 10%;"></td> <td style="width: 10%;"></td> <td style="width: 10%;"></td> <td style="width: 10%;"></td> <td style="width: 10%;"></td> </tr> <tr> <td></td> <td></td> <td colspan="8" style="text-align: center;"> <table border="1" style="width: 100%; border-collapse: collapse; text-align: center;"> <tr> <td style="width: 10%;"></td> <td style="width: 10%;"></td> <td style="width: 10%;"></td> <td style="width: 10%;"></td> <td style="width: 10%;"></td> <td style="width: 10%;"></td> <td style="width: 10%;"></td> <td style="width: 10%;"></td> <td style="width: 10%;"></td> <td style="width: 10%;"></td> </tr> <tr> <td></td> <td></td> <td colspan="8" style="text-align: center;"> <table border="1" style="width: 100%; border-collapse: collapse; text-align: center;"> <tr> <td style="width: 10%;"></td> <td style="width: 10%;"></td> <td style="width: 10%;"></td> <td style="width: 10%;"></td> <td style="width: 10%;"></td> <td style="width: 10%;"></td> <td style="width: 10%;"></td> <td style="width: 10%;"></td> <td style="width: 10%;"></td> <td style="width: 10%;"></td> </tr> <tr> <td></td> <td></td> <td colspan="8" style="text-align: center;"> <table border="1" style="width: 100%; border-collapse: collapse; text-align: center;"> <tr> <td style="width: 10%;"></td> <td style="width: 10%;"></td> <td style="width: 10%;"></td> <td style="width: 10%;"></td> <td style="width: 10%;"></td> <td style="width: 10%;"></td> <td style="width: 10%;"></td> <td style="width: 10%;"></td> <td style="width: 10%;"></td> <td style="width:
10%;"></td> </tr> <tr> <td></td> <td></td> <td colspan="8" style="text-align: center;"> <table border="1" style="width: 100%; border-collapse: collapse; text-align: center;"> <tr> </tr></table></td></tr></table></td></tr></table></td></tr></table></td></tr></table></td></tr></table></td></tr></table></td></tr></table></td></tr></table></td></tr></table>
 | | | | | | | | | | | | | | | | | | | | <table border="1" style="width: 100%; border-collapse: collapse; text-align: center;"> <tr> <td style="width: 10%;"></td> <td style="width: 10%;"></td> <td style="width: 10%;"></td> <td style="width: 10%;"></td> <td style="width: 10%;"></td> <td style="width: 10%;"></td> <td style="width: 10%;"></td> <td style="width: 10%;"></td> <td style="width: 10%;"></td> <td style="width: 10%;"></td> </tr> <tr> <td></td> <td></td> <td colspan="8" style="text-align: center;"> <table border="1" style="width: 100%; border-collapse: collapse; text-align: center;"> <tr> <td style="width: 10%;"></td> <td style="width: 10%;"></td> <td style="width: 10%;"></td> <td style="width: 10%;"></td> <td style="width: 10%;"></td> <td style="width: 10%;"></td> <td style="width: 10%;"></td> <td style="width: 10%;"></td> <td style="width: 10%;"></td> <td style="width: 10%;"></td> </tr> <tr> <td></td> <td></td> <td colspan="8" style="text-align: center;"> <table border="1" style="width: 100%; border-collapse: collapse; text-align: center;"> <tr> <td style="width: 10%;"></td> <td style="width: 10%;"></td> <td style="width: 10%;"></td> <td style="width: 10%;"></td> <td style="width: 10%;"></td> <td style="width: 10%;"></td> <td style="width: 10%;"></td> <td style="width: 10%;"></td> <td style="width: 10%;"></td> <td style="width: 10%;"></td> </tr> <tr> <td></td> <td></td> <td colspan="8" style="text-align: center;"> <table border="1" style="width: 100%; border-collapse: collapse; text-align: center;"> <tr> <td style="width: 10%;"></td> <td style="width: 10%;"></td> <td style="width: 10%;"></td> <td style="width: 10%;"></td> <td style="width: 10%;"></td> <td style="width: 10%;"></td> <td style="width: 10%;"></td> <td style="width: 10%;"></td> <td style="width: 10%;"></td> <td style="width: 10%;"></td> </tr> <tr> <td></td> <td></td> <td colspan="8" style="text-align: center;"> <table border="1" style="width: 100%; border-collapse: collapse; text-align: center;"> <tr> <td style="width: 10%;"></td> <td style="width: 10%;"></td> <td style="width: 10%;"></td> <td style="width: 10%;"></td> <td style="width: 10%;"></td> <td style="width: 10%;"></td> <td style="width: 10%;"></td> <td style="width: 10%;"></td> <td style="width: 10%;"></td> <td style="width: 10%;"></td> </tr> <tr> <td></td> <td></td> <td colspan="8" style="text-align: center;"> <table border="1" style="width: 100%; border-collapse: collapse; text-align: center;"> <tr> <td style="width: 10%;"></td> <td style="width: 10%;"></td> <td style="width: 10%;"></td> <td style="width: 10%;"></td> <td style="width: 10%;"></td> <td style="width: 10%;"></td> <td style="width: 10%;"></td> <td style="width: 10%;"></td> <td style="width: 10%;"></td> <td style="width: 10%;"></td> </tr> <tr> <td></td> <td></td> <td colspan="8" style="text-align: center;"> <table border="1" style="width: 100%; border-collapse: collapse; text-align: center;"> <tr> <td style="width: 10%;"></td> <td style="width: 10%;"></td> <td style="width: 10%;"></td> <td style="width: 10%;"></td> <td style="width: 10%;"></td> <td style="width: 10%;"></td> <td style="width: 10%;"></td> <td style="width: 10%;"></td> <td style="width: 10%;"></td> <td style="width: 10%;"></td> </tr> <tr> <td></td> <td></td> <td colspan="8" style="text-align: center;"> <table border="1" style="width: 100%; border-collapse: collapse; text-align: center;"> <tr> <td style="width: 10%;"></td> <td style="width: 10%;"></td> <td style="width: 10%;"></td> <td style="width: 10%;"></td> <td style="width: 10%;"></td> <td style="width: 10%;"></td> <td style="width: 10%;"></td> <td style="width: 10%;"></td> <td style="width: 10%;"></td> <td style="width: 10%;"></td> </tr> <tr> <td></td> <td></td> <td colspan="8" style="text-align: center;"> <table border="1" style="width: 100%; border-collapse: collapse; text-align: center;"> <tr> </tr></table></td></tr></table></td></tr></table></td></tr></table></td></tr></table></td></tr></table></td></tr></table></td></tr></table></td></tr></table>
 | | | | | | | | | | | | | | | | | | | | <table border="1" style="width: 100%; border-collapse: collapse; text-align: center;"> <tr> <td style="width: 10%;"></td> <td style="width: 10%;"></td> <td style="width: 10%;"></td> <td style="width: 10%;"></td> <td style="width: 10%;"></td> <td style="width: 10%;"></td> <td style="width: 10%;"></td> <td style="width: 10%;"></td> <td style="width: 10%;"></td> <td style="width: 10%;"></td> </tr> <tr> <td></td> <td></td> <td colspan="8" style="text-align: center;"> <table border="1" style="width: 100%; border-collapse: collapse; text-align: center;"> <tr> <td style="width: 10%;"></td> <td style="width: 10%;"></td> <td style="width: 10%;"></td> <td style="width: 10%;"></td> <td style="width: 10%;"></td> <td style="width: 10%;"></td> <td style="width: 10%;"></td> <td style="width: 10%;"></td> <td style="width: 10%;"></td> <td style="width: 10%;"></td> </tr> <tr> <td></td> <td></td> <td colspan="8" style="text-align: center;"> <table border="1" style="width: 100%; border-collapse: collapse; text-align: center;"> <tr> <td style="width: 10%;"></td> <td style="width: 10%;"></td> <td style="width: 10%;"></td> <td style="width: 10%;"></td> <td style="width: 10%;"></td> <td style="width: 10%;"></td> <td style="width: 10%;"></td> <td style="width: 10%;"></td> <td style="width: 10%;"></td> <td style="width: 10%;"></td> </tr> <tr> <td></td> <td></td> <td colspan="8" style="text-align: center;"> <table border="1" style="width: 100%; border-collapse: collapse; text-align: center;"> <tr> <td style="width: 10%;"></td> <td style="width: 10%;"></td> <td style="width: 10%;"></td> <td style="width: 10%;"></td> <td style="width: 10%;"></td> <td style="width: 10%;"></td> <td style="width: 10%;"></td> <td style="width: 10%;"></td> <td style="width: 10%;"></td> <td style="width: 10%;"></td> </tr> <tr> <td></td> <td></td> <td colspan="8" style="text-align: center;"> <table border="1" style="width: 100%; border-collapse: collapse; text-align: center;"> <tr> <td style="width: 10%;"></td> <td style="width: 10%;"></td> <td style="width: 10%;"></td> <td style="width: 10%;"></td> <td style="width: 10%;"></td> <td style="width: 10%;"></td> <td style="width: 10%;"></td> <td style="width: 10%;"></td> <td style="width: 10%;"></td> <td style="width: 10%;"></td> </tr> <tr> <td></td> <td></td> <td colspan="8" style="text-align: center;"> <table border="1" style="width: 100%; border-collapse: collapse; text-align: center;"> <tr> <td style="width: 10%;"></td> <td style="width: 10%;"></td> <td style="width: 10%;"></td> <td style="width: 10%;"></td> <td style="width: 10%;"></td> <td style="width: 10%;"></td> <td style="width: 10%;"></td> <td style="width: 10%;"></td> <td style="width: 10%;"></td> <td style="width: 10%;"></td> </tr> <tr> <td></td> <td></td> <td colspan="8" style="text-align: center;"> <table border="1" style="width: 100%; border-collapse: collapse; text-align: center;"> <tr> <td style="width: 10%;"></td> <td style="width: 10%;"></td> <td style="width: 10%;"></td> <td style="width: 10%;"></td> <td style="width: 10%;"></td> <td style="width: 10%;"></td> <td style="width: 10%;"></td> <td style="width: 10%;"></td> <td style="width: 10%;"></td> <td style="width: 10%;"></td> </tr> <tr> <td></td> <td></td> <td colspan="8" style="text-align: center;"> <table border="1" style="width: 100%; border-collapse: collapse; text-align: center;"> <tr> </tr></table></td></tr></table></td></tr></table></td></tr></table></td></tr></table></td></tr></table></td></tr></table></td></tr></table>
 | | | | | | | | | | | | | | | | | | | | <table border="1" style="width: 100%; border-collapse: collapse; text-align: center;"> <tr> <td style="width: 10%;"></td> <td style="width: 10%;"></td> <td style="width: 10%;"></td> <td style="width: 10%;"></td> <td style="width: 10%;"></td> <td style="width: 10%;"></td> <td style="width: 10%;"></td> <td style="width: 10%;"></td> <td style="width: 10%;"></td> <td style="width: 10%;"></td> </tr> <tr> <td></td> <td></td> <td colspan="8" style="text-align: center;"> <table border="1" style="width: 100%; border-collapse: collapse; text-align: center;"> <tr> <td style="width: 10%;"></td> <td style="width: 10%;"></td> <td style="width: 10%;"></td> <td style="width: 10%;"></td> <td style="width: 10%;"></td> <td style="width: 10%;"></td> <td style="width: 10%;"></td> <td style="width: 10%;"></td> <td style="width: 10%;"></td> <td style="width: 10%;"></td> </tr> <tr> <td></td> <td></td> <td colspan="8" style="text-align: center;"> <table border="1" style="width: 100%; border-collapse: collapse; text-align: center;"> <tr> <td style="width: 10%;"></td> <td style="width: 10%;"></td> <td style="width: 10%;"></td> <td style="width: 10%;"></td> <td style="width: 10%;"></td> <td style="width: 10%;"></td> <td style="width: 10%;"></td> <td style="width: 10%;"></td> <td style="width: 10%;"></td> <td style="width: 10%;"></td> </tr> <tr> <td></td> <td></td> <td colspan="8" style="text-align: center;"> <table border="1" style="width: 100%; border-collapse: collapse; text-align: center;"> <tr> <td style="width: 10%;"></td> <td style="width: 10%;"></td> <td style="width: 10%;"></td> <td style="width: 10%;"></td> <td style="width: 10%;"></td> <td style="width: 10%;"></td> <td style="width: 10%;"></td> <td style="width: 10%;"></td> <td style="width: 10%;"></td> <td style="width: 10%;"></td> </tr> <tr> <td></td> <td></td> <td colspan="8" style="text-align: center;"> <table border="1" style="width: 100%; border-collapse: collapse; text-align: center;"> <tr> <td style="width: 10%;"></td> <td style="width: 10%;"></td> <td style="width: 10%;"></td> <td style="width: 10%;"></td> <td style="width: 10%;"></td> <td style="width: 10%;"></td> <td style="width: 10%;"></td> <td style="width: 10%;"></td> <td style="width: 10%;"></td> <td style="width: 10%;"></td> </tr> <tr> <td></td> <td></td> <td colspan="8" style="text-align: center;"> <table border="1" style="width: 100%; border-collapse: collapse; text-align: center;"> <tr> <td style="width: 10%;"></td> <td style="width: 10%;"></td> <td style="width: 10%;"></td> <td style="width: 10%;"></td> <td style="width: 10%;"></td> <td style="width: 10%;"></td> <td style="width: 10%;"></td> <td style="width: 10%;"></td> <td style="width: 10%;"></td> <td style="width: 10%;"></td> </tr> <tr> <td></td> <td></td> <td colspan="8" style="text-align:
center;"> <table border="1" style="width: 100%; border-collapse: collapse; text-align: center;"> <tr> </tr></table></td></tr></table></td></tr></table></td></tr></table></td></tr></table></td></tr></table></td></tr></table> | | | | | | | | | | | | | | | | | | |
 | <table border="1" style="width: 100%; border-collapse: collapse; text-align: center;"> <tr> <td style="width: 10%;"></td> <td style="width: 10%;"></td> <td style="width: 10%;"></td> <td style="width: 10%;"></td> <td style="width: 10%;"></td> <td style="width: 10%;"></td> <td style="width: 10%;"></td> <td style="width: 10%;"></td> <td style="width: 10%;"></td> <td style="width: 10%;"></td> </tr> <tr> <td></td> <td></td> <td colspan="8" style="text-align: center;"> <table border="1" style="width: 100%; border-collapse: collapse; text-align: center;"> <tr> <td style="width: 10%;"></td> <td style="width: 10%;"></td> <td style="width: 10%;"></td> <td style="width: 10%;"></td> <td style="width: 10%;"></td> <td style="width: 10%;"></td> <td style="width: 10%;"></td> <td style="width: 10%;"></td> <td style="width: 10%;"></td> <td style="width: 10%;"></td> </tr> <tr> <td></td> <td></td> <td colspan="8" style="text-align: center;"> <table border="1" style="width: 100%; border-collapse: collapse; text-align: center;"> <tr> <td style="width: 10%;"></td> <td style="width: 10%;"></td> <td style="width: 10%;"></td> <td style="width: 10%;"></td> <td style="width: 10%;"></td> <td style="width: 10%;"></td> <td style="width: 10%;"></td> <td style="width: 10%;"></td> <td style="width: 10%;"></td> <td style="width: 10%;"></td> </tr> <tr> <td></td> <td></td> <td colspan="8" style="text-align: center;"> <table border="1" style="width: 100%; border-collapse: collapse; text-align: center;"> <tr> <td style="width: 10%;"></td> <td style="width: 10%;"></td> <td style="width: 10%;"></td> <td style="width: 10%;"></td> <td style="width: 10%;"></td> <td style="width: 10%;"></td> <td style="width: 10%;"></td> <td style="width: 10%;"></td> <td style="width: 10%;"></td> <td style="width: 10%;"></td> </tr> <tr> <td></td> <td></td> <td colspan="8" style="text-align: center;"> <table border="1" style="width: 100%; border-collapse: collapse; text-align: center;"> <tr> <td style="width: 10%;"></td> <td style="width: 10%;"></td> <td style="width: 10%;"></td> <td style="width: 10%;"></td> <td style="width: 10%;"></td> <td style="width: 10%;"></td> <td style="width: 10%;"></td> <td style="width: 10%;"></td> <td style="width: 10%;"></td> <td style="width: 10%;"></td> </tr> <tr> <td></td> <td></td> <td colspan="8" style="text-align: center;"> <table border="1" style="width: 100%; border-collapse: collapse; text-align: center;"> <tr> </tr></table></td></tr></table></td></tr></table></td></tr></table></td></tr></table></td></tr></table>
 | | | | | | | | | | | | | | | | | | | | <table border="1" style="width: 100%; border-collapse: collapse; text-align: center;"> <tr> <td style="width: 10%;"></td> <td style="width: 10%;"></td> <td style="width: 10%;"></td> <td style="width: 10%;"></td> <td style="width: 10%;"></td> <td style="width: 10%;"></td> <td style="width: 10%;"></td> <td style="width: 10%;"></td> <td style="width: 10%;"></td> <td style="width: 10%;"></td> </tr> <tr> <td></td> <td></td> <td colspan="8" style="text-align: center;"> <table border="1" style="width: 100%; border-collapse: collapse; text-align: center;"> <tr> <td style="width: 10%;"></td> <td style="width: 10%;"></td> <td style="width: 10%;"></td> <td style="width: 10%;"></td> <td style="width: 10%;"></td> <td style="width: 10%;"></td> <td style="width: 10%;"></td> <td style="width: 10%;"></td> <td style="width: 10%;"></td> <td style="width: 10%;"></td> </tr> <tr> <td></td> <td></td> <td colspan="8" style="text-align: center;"> <table border="1" style="width: 100%; border-collapse: collapse; text-align: center;"> <tr> <td style="width: 10%;"></td> <td style="width: 10%;"></td> <td style="width: 10%;"></td> <td style="width: 10%;"></td> <td style="width: 10%;"></td> <td style="width: 10%;"></td> <td style="width: 10%;"></td> <td style="width: 10%;"></td> <td style="width: 10%;"></td> <td style="width: 10%;"></td> </tr> <tr> <td></td> <td></td> <td colspan="8" style="text-align: center;"> <table border="1" style="width: 100%; border-collapse: collapse; text-align: center;"> <tr> <td style="width: 10%;"></td> <td style="width: 10%;"></td> <td style="width: 10%;"></td> <td style="width: 10%;"></td> <td style="width: 10%;"></td> <td style="width: 10%;"></td> <td style="width: 10%;"></td> <td style="width: 10%;"></td> <td style="width: 10%;"></td> <td style="width: 10%;"></td> </tr> <tr> <td></td> <td></td> <td colspan="8" style="text-align: center;"> <table border="1" style="width: 100%; border-collapse: collapse; text-align: center;"> <tr> </tr></table></td></tr></table></td></tr></table></td></tr></table></td></tr></table>
 | | | | | | | | | | | | | | | | | | | | <table border="1" style="width: 100%; border-collapse: collapse; text-align: center;"> <tr> <td style="width: 10%;"></td> <td style="width: 10%;"></td> <td style="width: 10%;"></td> <td style="width: 10%;"></td> <td style="width: 10%;"></td> <td style="width: 10%;"></td> <td style="width: 10%;"></td> <td style="width: 10%;"></td> <td style="width: 10%;"></td> <td style="width: 10%;"></td> </tr> <tr> <td></td> <td></td> <td colspan="8" style="text-align: center;"> <table border="1" style="width: 100%; border-collapse: collapse; text-align: center;"> <tr> <td style="width: 10%;"></td> <td style="width: 10%;"></td> <td style="width: 10%;"></td> <td style="width: 10%;"></td> <td style="width: 10%;"></td> <td style="width: 10%;"></td> <td style="width: 10%;"></td> <td style="width: 10%;"></td> <td style="width: 10%;"></td> <td style="width: 10%;"></td> </tr> <tr> <td></td> <td></td> <td colspan="8" style="text-align: center;"> <table border="1" style="width: 100%; border-collapse: collapse; text-align: center;"> <tr> <td style="width: 10%;"></td> <td style="width: 10%;"></td> <td style="width: 10%;"></td> <td style="width: 10%;"></td> <td style="width: 10%;"></td> <td style="width: 10%;"></td> <td style="width: 10%;"></td> <td style="width: 10%;"></td> <td style="width: 10%;"></td> <td style="width: 10%;"></td> </tr> <tr> <td></td> <td></td> <td colspan="8" style="text-align: center;"> <table border="1" style="width: 100%; border-collapse: collapse; text-align: center;"> <tr> </tr></table></td></tr></table></td></tr></table></td></tr></table>
 | | | | | | | | | | | | | | | | | | | | <table border="1" style="width: 100%; border-collapse: collapse; text-align: center;"> <tr> <td style="width: 10%;"></td> <td style="width: 10%;"></td> <td style="width: 10%;"></td> <td style="width: 10%;"></td> <td style="width: 10%;"></td> <td style="width: 10%;"></td> <td style="width: 10%;"></td> <td style="width: 10%;"></td> <td style="width: 10%;"></td> <td style="width: 10%;"></td> </tr> <tr> <td></td> <td></td> <td colspan="8" style="text-align: center;"> <table border="1" style="width: 100%; border-collapse: collapse; text-align: center;"> <tr> <td style="width: 10%;"></td> <td style="width: 10%;"></td> <td style="width: 10%;"></td> <td style="width: 10%;"></td> <td style="width: 10%;"></td> <td style="width: 10%;"></td> <td style="width: 10%;"></td> <td style="width: 10%;"></td> <td style="width: 10%;"></td> <td style="width: 10%;"></td> </tr> <tr> <td></td> <td></td> <td colspan="8" style="text-align: center;"> <table border="1" style="width: 100%; border-collapse: collapse; text-align: center;"> <tr> </tr></table></td></tr></table></td></tr></table>
 | | | | | | | | | | | | | | | | | | | | <table border="1" style="width: 100%; border-collapse: collapse; text-align: center;"> <tr> <td style="width: 10%;"></td> <td style="width: 10%;"></td> <td style="width: 10%;"></td> <td style="width: 10%;"></td> <td style="width: 10%;"></td> <td style="width: 10%;"></td> <td style="width: 10%;"></td> <td style="width: 10%;"></td> <td style="width: 10%;"></td> <td style="width: 10%;"></td> </tr> <tr> <td></td> <td></td> <td colspan="8" style="text-align: center;"> <table border="1" style="width: 100%; border-collapse: collapse; text-align: center;"> <tr> </tr></table></td></tr></table>
 | | | | | | | | | | | | | | | | | | | | <table border="1" style="width: 100%; border-collapse: collapse; text-align: center;"> <tr> </tr></table>
 | | | | | | | | | | | | | | | | | | | | | | | | | | | | | | | | | | | | | | | | | | | | | | | | | | | | | | | | | | | | | | | | | | | | | | | | | | | | | | | |
 | | | | | | | | | | | | | | | | | | | |
 | | | | | | | | | | | | | | | | | | | |
 | | | | | | | | | | | | | | | | | | | |
 | | | | | | | | | | | | | | | | | | | | | | | | | | | | | | | | | | | | | | | |
 | | | | | | | | | | | | | | | | | | | |
 | | | | | | | | | | | | | | | | | | | | | | | | | | | | | | | | | | | | | | | |
 | | | | | | | | | | | | | | | | | | | | | | | | | | | | | | | | | | | | | | | |
 | | | | | | | | | | | | | | | | | | | | | | | | | | | | | | | | | | | | | | | |
 | | | | | | | | | | | | | | | | | | | | | | | | | | | | | | | | | | | | | | | | | | | | | | | | | | | | | | | | | | | | | | | | | | | | | | | | | | | | | | | |
 | | | | | | | | | | | | | | | | | | | | | | | | | | | | | | | | | | | | | | | | | | | | | | | | | | | | | | | | | | | | | | | | | | | |
| | |

 | | | | | | | | | | | | | | | | | | | |

 | | | | | | | | | | | | | | | | | | | |

 | | | | | | | | | | | | | | | | | | | |

 | | | | | | | | | | | | | | | | | | | |

 | | | | | | | | | | | | | | | | | | | |

 | | | | | | | | | | | | | | | | | | | |

 | | | | | | | | | | | | | | | | | | | |

 | | | | | | | | | | | | | | | | | | | |

 | | | | | | | | | | | | | | | | | | | |

 | | | | | | | | | | | | | | | | | | | |

 | | | | | | | | | | | | | | | | | | | |

 | | | | | | | | | | | | | | | | | | | |

 | | | | | | | | | | | | | | | | | | | |

 | | | | | | | | | | | | | | | | | | | |

 | | | | | | | | | | | | | | | | | | | |

 | | | | | | | | | | | | | | | | | | | |

 | | | | | | | | | | | | | | | | | | | |

 | | | | | | | | | | | | | | | | | | | |

 | | | | | | | | | | | | | | | | | | | |

 | | | | | | | | | | | | | | | | | | | |

 | | | | | | | | | | | | | | | | | | | |

 | | | | | | | | | | | | | | | | | | | |

 | | | | | | | | | | | | | | | | | | | |

 | | | | | | | | | | | | | | | | | | | |

 | | | | | | | | | | | | | | | | | | | |

 | | | | | | | | | | | | | | | | | | | |

 | | | | | | | | | | | | | | | | | | | |

 | | | | | | | | | | | | | | | | | | | |
 | | | | | | | | | | | | | | | | | | | |

 | | | | | | | | | | | | | | | | | | | |

 | | | | | | | | | | | | | | | | | | | |
 | | | | | | | | | | | | | | | | | | | |

 | | | | | | | | | | | | | | | | | | | |

 | | | | | | | | | | | | | | | | | | | |
 | | | | | | | | | | | | | | | | | | | |
 | | | | | | | | | | | | | | | | | | | |

 | | | | | | | | | | | | | | | | | | | |
 | | | | | | | | | | | | | | | | | | | |
 | | | | | | | | | | | | | | | | | | | |

 | | | | | | | | | | | | | | | | | | | | | | | | | | | | | | | | | | | | | | | | | | | | | | | | | | | | | | | | | | | | | | | | | | | | | | | | | | | | | | | | | | | | | | | | | | | | | | | | | | | |
 | | | | | | | | | | | | | | | | | | | |
 | | | | | | | | | | | | | | | | | | | |
 | | | | | | | | | | | | | | | | | | | |
 | | | | | | | | | | | | | | | | | | | |
 | | | | | | | | | | | | | | | | | | | |
 | | | | | | | | | | | | | | | | | | | |
 | | | | | | | | | | | | | | | | | | | |
 | | | | | | | | | | | | | | | | | | | |
 | | | | | | | | | | | | | | | | | | | | | | | | | | | | | | | | | | | | | | | |
 | | | | | | | | | | | | | | | | | | | |
 | | | | | | | | | | | | | | | | | | | | | | | | | | | | | | | | | | | | | | | |
 | | | | | | | | | | | | | | | | | | | | | | | | | | | | | | | | | | | | | | | |
 | | | | | | | | | | | | | | | | | | | | | | | | | | | | | | | | | | | | | | | |
 | | | | | | | | | | | | | | | | | | | | | | | | | | | | | | | | | | | | | | | | | | | | | | | | | | | | | | | | | | | | | | | | | | | | | | | | | | | | | | | | | | | | | | | | | | | | | | | | | | | |
 | | | | | | | | | | | | | | | | | | | | | | | | | | | | | | | | | | | | | | | | | | | | | | | |
| | | <table border="1" style="width: 100%; border-collapse: collapse; text-align: center;"> <tr> <td style="width: 10%;"></td> <td style="width: 10%;"></td> <td style="width: 10%;"></td> <td style="width: 10%;"></td> <td style="width: 10%;"></td> <td style="width: 10%;"></td> <td style="width: 10%;"></td> <td style="width: 10%;"></td> <td style="width: 10%;"></td> <td style="width: 10%;"></td> </tr> <tr> <td></td> <td></td> <td colspan="8" style="text-align: center;"> <table border="1" style="width: 100%; border-collapse: collapse; text-align: center;"> <tr> <td style="width: 10%;"></td> <td style="width: 10%;"></td> <td style="width: 10%;"></td> <td style="width: 10%;"></td> <td style="width: 10%;"></td> <td style="width: 10%;"></td> <td style="width: 10%;"></td> <td style="width: 10%;"></td> <td style="width: 10%;"></td> <td style="width: 10%;"></td> </tr> <tr> <td></td> <td></td> <td colspan="8" style="text-align: center;"> <table border="1" style="width: 100%; border-collapse: collapse; text-align: center;"> <tr> <td style="width: 10%;"></td> <td style="width: 10%;"></td> <td style="width: 10%;"></td> <td style="width: 10%;"></td> <td style="width: 10%;"></td> <td style="width: 10%;"></td> <td style="width: 10%;"></td> <td style="width: 10%;"></td> <td style="width: 10%;"></td> <td style="width: 10%;"></td> </tr> <tr> <td></td> <td></td> <td colspan="8" style="text-align: center;"> <table border="1" style="width: 100%; border-collapse: collapse; text-align: center;"> <tr> <td style="width: 10%;"></td> <td style="width: 10%;"></td> <td style="width: 10%;"></td> <td style="width: 10%;"></td> <td style="width: 10%;"></td> <td style="width: 10%;"></td> <td style="width: 10%;"></td> <td style="width: 10%;"></td> <td style="width: 10%;"></td> <td style="width: 10%;"></td> </tr> <tr> <td></td> <td></td> <td colspan="8" style="text-align: center;"> <table border="1" style="width: 100%; border-collapse: collapse; text-align: center;"> <tr> <td style="width: 10%;"></td> <td style="width: 10%;"></td> <td style="width: 10%;"></td> <td style="width: 10%;"></td> <td style="width: 10%;"></td> <td style="width: 10%;"></td> <td style="width: 10%;"></td> <td style="width: 10%;"></td> <td style="width: 10%;"></td> <td style="width: 10%;"></td> </tr> <tr> <td></td> <td></td> <td colspan="8" style="text-align: center;"> <table border="1" style="width: 100%; border-collapse: collapse; text-align: center;"> <tr> <td style="width: 10%;"></td> <td style="width: 10%;"></td> <td style="width: 10%;"></td> <td style="width: 10%;"></td> <td style="width: 10%;"></td> <td style="width: 10%;"></td> <td style="width: 10%;"></td> <td style="width: 10%;"></td> <td style="width: 10%;"></td> <td style="width: 10%;"></td> </tr> <tr> <td></td> <td></td> <td colspan="8" style="text-align: center;"> <table border="1" style="width: 100%; border-collapse: collapse; text-align: center;"> <tr> <td style="width: 10%;"></td> <td style="width: 10%;"></td> <td style="width: 10%;"></td> <td style="width: 10%;"></td> <td style="width: 10%;"></td> <td style="width: 10%;"></td> <td style="width: 10%;"></td> <td style="width: 10%;"></td> <td style="width: 10%;"></td> <td style="width: 10%;"></td> </tr> <tr> <td></td> <td></td> <td colspan="8" style="text-align: center;"> <table border="1" style="width: 100%; border-collapse: collapse; text-align: center;"> <tr> <td style="width: 10%;"></td> <td style="width: 10%;"></td> <td style="width: 10%;"></td> <td style="width: 10%;"></td> <td style="width: 10%;"></td> <td style="width: 10%;"></td> <td style="width: 10%;"></td> <td style="width: 10%;"></td> <td style="width: 10%;"></td> <td style="width: 10%;"></td> </tr> <tr> <td></td> <td></td> <td colspan="8" style="text-align: center;"> <table border="1" style="width: 100%; border-collapse: collapse; text-align: center;"> <tr> <td style="width: 10%;"></td> <td style="width: 10%;"></td> <td style="width: 10%;"></td> <td style="width: 10%;"></td> <td style="width: 10%;"></td> <td style="width: 10%;"></td> <td style="width: 10%;"></td> <td style="width: 10%;"></td> <td style="width: 10%;"></td> <td style="width: 10%;"></td> </tr> <tr> <td></td> <td></td> <td colspan="8" style="text-align: center;"> <table border="1" style="width: 100%; border-collapse: collapse; text-align: center;"> <tr> <td style="width: 10%;"></td> <td style="width: 10%;"></td> <td style="width: 10%;"></td> <td style="width: 10%;"></td> <td style="width: 10%;"></td> <td style="width: 10%;"></td> <td style="width: 10%;"></td> <td style="width: 10%;"></td> <td style="width: 10%;"></td> <td style="width: 10%;"></td> </tr> <tr> <td></td> <td></td> <td colspan="8" style="text-align: center;"> <table border="1" style="width: 100%; border-collapse: collapse; text-align: center;"> <tr> <td style="width: 10%;"></td> <td style="width: 10%;"></td> <td style="width: 10%;"></td> <td style="width: 10%;"></td> <td style="width: 10%;"></td> <td style="width: 10%;"></td> <td style="width: 10%;"></td> <td style="width: 10%;"></td> <td style="width: 10%;"></td> <td style="width: 10%;"></td> </tr> <tr> <td></td> <td></td> <td colspan="8" style="text-align: center;"> <table border="1" style="width: 100%; border-collapse: collapse; text-align: center;"> <tr> <td style="width: 10%;"></td> <td style="width: 10%;"></td> <td style="width: 10%;"></td> <td style="width: 10%;"></td> <td style="width: 10%;"></td> <td style="width: 10%;"></td> <td style="width: 10%;"></td> <td style="width: 10%;"></td> <td style="width: 10%;"></td> <td style="width: 10%;"></td> </tr> <tr> <td></td> <td></td> <td colspan="8" style="text-align: center;"> <table border="1" style="width: 100%; border-collapse: collapse; text-align: center;"> <tr> <td style="width: 10%;"></td> <td style="width: 10%;"></td> <td style="width: 10%;"></td> <td style="width: 10%;"></td> <td style="width: 10%;"></td> <td style="width: 10%;"></td> <td style="width: 10%;"></td> <td style="width: 10%;"></td> <td style="width: 10%;"></td> <td style="width: 10%;"></td> </tr> <tr> <td></td> <td></td> <td colspan="8" style="text-align: center;"> <table border="1" style="width: 100%; border-collapse: collapse; text-align: center;"> <tr> <td style="width: 10%;"></td> <td style="width: 10%;"></td> <td style="width: 10%;"></td> <td style="width: 10%;"></td> <td style="width: 10%;"></td> <td style="width: 10%;"></td> <td style="width: 10%;"></td> <td style="width: 10%;"></td> <td style="width: 10%;"></td> <td style="width: 10%;"></td> </tr> <tr> <td></td> <td></td> <td colspan="8" style="text-align: center;"> <table border="1" style="width: 100%; border-collapse: collapse; text-align: center;"> <tr> <td style="width: 10%;"></td> <td style="width: 10%;"></td> <td style="width: 10%;"></td> <td style="width: 10%;"></td> <td style="width: 10%;"></td> <td style="width: 10%;"></td> <td style="width: 10%;"></td> <td style="width: 10%;"></td> <td style="width: 10%;"></td> <td style="width: 10%;"></td> </tr> <tr> <td></td> <td></td> <td colspan="8" style="text-align: center;"> <table border="1" style="width: 100%; border-collapse: collapse; text-align: center;"> <tr> <td style="width: 10%;"></td> <td style="width: 10%;"></td> <td style="width: 10%;"></td> <td style="width: 10%;"></td> <td style="width: 10%;"></td> <td style="width: 10%;"></td> <td style="width: 10%;"></td> <td style="width: 10%;"></td> <td style="width: 10%;"></td> <td style="width: 10%;"></td> </tr> <tr> <td></td> <td></td> <td colspan="8" style="text-align: center;"> <table border="1" style="width: 100%; border-collapse: collapse; text-align: center;"> <tr> <td style="width: 10%;"></td> <td style="width: 10%;"></td> <td style="width: 10%;"></td> <td style="width: 10%;"></td> <td style="width: 10%;"></td> <td style="width: 10%;"></td> <td style="width: 10%;"></td> <td style="width: 10%;"></td> <td style="width: 10%;"></td> <td style="width: 10%;"></td> </tr> <tr> <td></td> <td></td> <td colspan="8" style="text-align: center;"> <table border="1" style="width: 100%; border-collapse: collapse; text-align: center;"> <tr> <td style="width: 10%;"></td> <td style="width: 10%;"></td> <td style="width: 10%;"></td> <td style="width: 10%;"></td> <td style="width: 10%;"></td> <td style="width: 10%;"></td> <td style="width: 10%;"></td> <td style="width: 10%;"></td> <td style="width: 10%;"></td> <td style="width: 10%;"></td> </tr> <tr> <td></td> <td></td> <td colspan="8" style="text-align: center;"> <table border="1" style="width: 100%; border-collapse: collapse; text-align: center;"> <tr> <td style="width: 10%;"></td> <td style="width: 10%;"></td> <td style="width: 10%;"></td> <td style="width: 10%;"></td> <td style="width: 10%;"></td> <td style="width: 10%;"></td> <td style="width: 10%;"></td> <td style="width: 10%;"></td> <td style="width: 10%;"></td> <td style="width: 10%;"></td> </tr> <tr> <td></td> <td></td> <td colspan="8" style="text-align: center;"> <table border="1" style="width: 100%; border-collapse: collapse; text-align: center;"> <tr> <td style="width: 10%;"></td> <td style="width: 10%;"></td> <td style="width: 10%;"></td> <td style="width: 10%;"></td> <td style="width: 10%;"></td> <td style="width: 10%;"></td> <td style="width: 10%;"></td> <td style="width: 10%;"></td> <td style="width: 10%;"></td> <td style="width: 10%;"></td> </tr> <tr> <td></td> <td></td> <td colspan="8" style="text-align: center;"> <table border="1" style="width: 100%; border-collapse: collapse; text-align: center;"> <tr> <td style="width: 10%;"></td> <td style="width: 10%;"></td> <td style="width: 10%;"></td> <td style="width: 10%;"></td> <td style="width: 10%;"></td> <td style="width: 10%;"></td> <td style="width: 10%;"></td> <td style="width: 10%;"></td> <td style="width: 10%;"></td> <td style="width: 10%;"></td> </tr> <tr> <td></td> <td></td> <td colspan="8" style="text-align: center;"> <table border="1" style="width: 100%; border-collapse: collapse; text-align: center;"> <tr> <td style="width: 10%;"></td> <td style="width: 10%;"></td> <td
style="width: 10%;"></td> <td style="width: 10%;"></td> <td style="width: 10%;"></td> <td style="width: 10%;"></td> <td style="width: 10%;"></td> <td style="width: 10%;"></td> <td style="width: 10%;"></td> <td style="width: 10%;"></td> </tr> <tr> <td></td> <td></td> <td colspan="8" style="text-align: center;"> <table border="1" style="width: 100%; border-collapse: collapse; text-align: center;"> <tr> <td style="width: 10%;"></td> <td style="width: 10%;"></td> <td style="width: 10%;"></td> <td style="width: 10%;"></td> <td style="width: 10%;"></td> <td style="width: 10%;"></td> <td style="width: 10%;"></td> <td style="width: 10%;"></td> <td style="width: 10%;"></td> <td style="width: 10%;"></td> </tr> <tr> <td></td> <td></td> <td colspan="8" style="text-align: center;"> <table border="1" style="width: 100%; border-collapse: collapse; text-align: center;"> <tr> <td style="width: 10%;"></td> <td style="width: 10%;"></td> <td style="width: 10%;"></td> <td style="width: 10%;"></td> <td style="width: 10%;"></td> <td style="width: 10%;"></td> <td style="width: 10%;"></td> <td style="width: 10%;"></td> <td style="width: 10%;"></td> <td style="width: 10%;"></td> </tr> <tr> <td></td> <td></td> <td colspan="8" style="text-align: center;"> <table border="1" style="width: 100%; border-collapse: collapse; text-align: center;"> <tr> <td style="width: 10%;"></td> <td style="width: 10%;"></td> <td style="width: 10%;"></td> <td style="width: 10%;"></td> <td style="width: 10%;"></td> <td style="width: 10%;"></td> <td style="width: 10%;"></td> <td style="width: 10%;"></td> <td style="width: 10%;"></td> <td style="width: 10%;"></td> </tr> <tr> <td></td> <td></td> <td colspan="8" style="text-align: center;"> <table border="1" style="width: 100%; border-collapse: collapse; text-align: center;"> <tr> <td style="width: 10%;"></td> <td style="width: 10%;"></td> <td style="width: 10%;"></td> <td style="width: 10%;"></td> <td style="width: 10%;"></td> <td style="width: 10%;"></td> <td style="width: 10%;"></td> <td style="width: 10%;"></td> <td style="width: 10%;"></td> <td style="width: 10%;"></td> </tr> <tr> <td></td> <td></td> <td colspan="8" style="text-align: center;"> <table border="1" style="width: 100%; border-collapse: collapse; text-align: center;"> <tr> <td style="width: 10%;"></td> <td style="width: 10%;"></td> <td style="width: 10%;"></td> <td style="width: 10%;"></td> <td style="width: 10%;"></td> <td style="width: 10%;"></td> <td style="width: 10%;"></td> <td style="width: 10%;"></td> <td style="width: 10%;"></td> <td style="width: 10%;"></td> </tr> <tr> <td></td> <td></td> <td colspan="8" style="text-align: center;"> <table border="1" style="width: 100%; border-collapse: collapse; text-align: center;"> <tr> <td style="width: 10%;"></td> <td style="width: 10%;"></td> <td style="width: 10%;"></td> <td style="width: 10%;"></td> <td style="width: 10%;"></td> <td style="width: 10%;"></td> <td style="width: 10%;"></td> <td style="width: 10%;"></td> <td style="width: 10%;"></td> <td style="width: 10%;"></td> </tr> <tr> <td></td> <td></td> <td colspan="8" style="text-align: center;"> <table border="1" style="width: 100%; border-collapse: collapse; text-align: center;"> <tr> <td style="width: 10%;"></td> <td style="width: 10%;"></td> <td style="width: 10%;"></td> <td style="width: 10%;"></td> <td style="width: 10%;"></td> <td style="width: 10%;"></td> <td style="width: 10%;"></td> <td style="width: 10%;"></td> <td style="width: 10%;"></td> <td style="width: 10%;"></td> </tr> <tr> <td></td> <td></td> <td colspan="8" style="text-align: center;"> <table border="1" style="width: 100%; border-collapse: collapse; text-align: center;"> <tr> <td style="width: 10%;"></td> <td style="width: 10%;"></td> <td style="width: 10%;"></td> <td style="width: 10%;"></td> <td style="width: 10%;"></td> <td style="width: 10%;"></td> <td style="width: 10%;"></td> <td style="width: 10%;"></td> <td style="width: 10%;"></td> <td style="width: 10%;"></td> </tr> <tr> <td></td> <td></td> <td colspan="8" style="text-align: center;"> <table border="1" style="width: 100%; border-collapse: collapse; text-align: center;"> <tr> <td style="width: 10%;"></td> <td style="width: 10%;"></td> <td style="width: 10%;"></td> <td style="width: 10%;"></td> <td style="width: 10%;"></td> <td style="width: 10%;"></td> <td style="width: 10%;"></td> <td style="width: 10%;"></td> <td style="width: 10%;"></td> <td style="width: 10%;"></td> </tr> <tr> <td></td> <td></td> <td colspan="8" style="text-align: center;"> <table border="1" style="width: 100%; border-collapse: collapse; text-align: center;"> <tr> <td style="width: 10%;"></td> <td style="width: 10%;"></td> <td style="width: 10%;"></td> <td style="width: 10%;"></td> <td style="width: 10%;"></td> <td style="width: 10%;"></td> <td style="width: 10%;"></td> <td style="width: 10%;"></td> <td style="width: 10%;"></td> <td style="width: 10%;"></td> </tr> <tr> <td></td> <td></td> <td colspan="8" style="text-align: center;"> <table border="1" style="width: 100%; border-collapse: collapse; text-align: center;"> <tr> <td style="width: 10%;"></td> <td style="width: 10%;"></td> <td style="width: 10%;"></td> <td style="width: 10%;"></td> <td style="width: 10%;"></td> <td style="width: 10%;"></td> <td style="width: 10%;"></td> <td style="width: 10%;"></td> <td style="width: 10%;"></td> <td style="width: 10%;"></td> </tr> <tr> <td></td> <td></td> <td colspan="8" style="text-align: center;"> <table border="1" style="width: 100%; border-collapse: collapse; text-align: center;"> <tr> <td style="width: 10%;"></td> <td style="width: 10%;"></td> <td style="width: 10%;"></td> <td style="width: 10%;"></td> <td style="width: 10%;"></td> <td style="width: 10%;"></td> <td style="width: 10%;"></td> <td style="width: 10%;"></td> <td style="width: 10%;"></td> <td style="width: 10%;"></td> </tr> <tr> <td></td> <td></td> <td colspan="8" style="text-align: center;"> <table border="1" style="width: 100%; border-collapse: collapse; text-align: center;"> <tr> <td style="width: 10%;"></td> <td style="width: 10%;"></td> <td style="width: 10%;"></td> <td style="width: 10%;"></td> <td style="width: 10%;"></td> <td style="width: 10%;"></td> <td style="width: 10%;"></td> <td style="width: 10%;"></td> <td style="width: 10%;"></td> <td style="width: 10%;"></td> </tr> <tr> <td></td> <td></td> <td colspan="8" style="text-align: center;"> <table border="1" style="width: 100%; border-collapse: collapse; text-align: center;"> <tr> <td style="width: 10%;"></td> <td style="width: 10%;"></td> <td style="width: 10%;"></td> <td style="width: 10%;"></td> <td style="width: 10%;"></td> <td style="width: 10%;"></td> <td style="width: 10%;"></td> <td style="width: 10%;"></td> <td style="width: 10%;"></td> <td style="width: 10%;"></td> </tr> <tr> <td></td> <td></td> <td colspan="8" style="text-align: center;"> <table border="1" style="width: 100%; border-collapse: collapse; text-align: center;"> <tr> <td style="width: 10%;"></td> <td style="width: 10%;"></td> <td style="width: 10%;"></td> <td style="width: 10%;"></td> <td style="width: 10%;"></td> <td style="width: 10%;"></td> <td style="width: 10%;"></td> <td style="width: 10%;"></td> <td style="width: 10%;"></td> <td style="width: 10%;"></td> </tr> <tr> <td></td> <td></td> <td colspan="8" style="text-align: center;"> <table border="1" style="width: 100%; border-collapse: collapse; text-align: center;"> <tr> <td style="width: 10%;"></td> <td style="width: 10%;"></td> <td style="width: 10%;"></td> <td style="width: 10%;"></td> <td style="width: 10%;"></td> <td style="width: 10%;"></td> <td style="width: 10%;"></td> <td style="width: 10%;"></td> <td style="width: 10%;"></td> <td style="width: 10%;"></td> </tr> <tr> <td></td> <td></td> <td colspan="8" style="text-align: center;"> <table border="1" style="width: 100%; border-collapse: collapse; text-align: center;"> <tr> <td style="width: 10%;"></td> <td style="width: 10%;"></td> <td style="width: 10%;"></td> <td style="width: 10%;"></td> <td style="width: 10%;"></td> <td style="width: 10%;"></td> <td style="width: 10%;"></td> <td style="width: 10%;"></td> <td style="width: 10%;"></td> <td style="width: 10%;"></td> </tr> <tr> <td></td> <td></td> <td colspan="8" style="text-align: center;"> <table border="1" style="width: 100%; border-collapse: collapse; text-align: center;"> <tr> <td style="width: 10%;"></td> <td style="width: 10%;"></td> <td style="width: 10%;"></td> <td style="width: 10%;"></td> <td style="width: 10%;"></td> <td style="width: 10%;"></td> <td style="width: 10%;"></td> <td style="width: 10%;"></td> <td style="width: 10%;"></td> <td style="width: 10%;"></td> </tr> <tr> <td></td> <td></td> <td colspan="8" style="text-align: center;"> <table border="1" style="width: 100%; border-collapse: collapse; text-align: center;"> <tr> <td style="width: 10%;"></td> <td style="width: 10%;"></td> <td style="width: 10%;"></td> <td style="width: 10%;"></td> <td style="width: 10%;"></td> <td style="width: 10%;"></td> <td style="width: 10%;"></td> <td style="width: 10%;"></td> <td style="width: 10%;"></td> <td style="width: 10%;"></td> </tr> <tr> <td></td> <td></td> <td colspan="8" style="text-align: center;"> <table border="1" style="width: 100%; border-collapse: collapse; text-align: center;"> <tr> <td style="width: 10%;"></td> <td style="width: 10%;"></td> <td style="width: 10%;"></td> <td style="width: 10%;"></td> <td style="width: 10%;"></td> <td style="width: 10%;"></td> <td style="width: 10%;"></td> <td style="width: 10%;"></td> <td style="width: 10%;"></td> <td style="width: 10%;"></td> </tr> <tr> <td></td> <td></td> <td colspan="8" style="text-align: center;"> <table border="1" style="width: 100%; border-collapse: collapse; text-align: center;"> <tr> <td style="width: 10%;"></td> <td style="width: 10%;"></td> <td style="width: 10%;"></td> <td style="width: 10%;"></td> <td style="width: 10%;"></td> <td style="width: 10%;"></td> <td style="width: 10%;"></td> <td style="width:
10%;"></td> <td style="width: 10%;"></td> <td style="width: 10%;"></td> </tr> <tr> <td></td> <td></td> <td colspan="8" style="text-align: center;"> <table border="1" style="width: 100%; border-collapse: collapse; text-align: center;"> <tr> </tr></table></td></tr></table></td></tr></table></td></tr></table></td></tr></table></td></tr></table></td></tr></table></td></tr></table></td></tr></table></td></tr></table></td></tr></table></td></tr></table></td></tr></table></td></tr></table></td></tr></table></td></tr></table></td></tr></table></td></tr></table></td></tr></table></td></tr></table></td></tr></table></td></tr></table></td></tr></table></td></tr></table></td></tr></table></td></tr></table></td></tr></table></td></tr></table></td></tr></table></td></tr></table></td></tr></table></td></tr></table></td></tr></table></td></tr></table></td></tr></table></td></tr></table></td></tr></table></td></tr></table></td></tr></table></td></tr></table></td></tr></table></td></tr></table></td></tr></table></td></tr></table>
 | | | | | | | | | | | | | | | | | | | | <table border="1" style="width: 100%; border-collapse: collapse; text-align: center;"> <tr> <td style="width: 10%;"></td> <td style="width: 10%;"></td> <td style="width: 10%;"></td> <td style="width: 10%;"></td> <td style="width: 10%;"></td> <td style="width: 10%;"></td> <td style="width: 10%;"></td> <td style="width: 10%;"></td> <td style="width: 10%;"></td> <td style="width: 10%;"></td> </tr> <tr> <td></td> <td></td> <td colspan="8" style="text-align: center;"> <table border="1" style="width: 100%; border-collapse: collapse; text-align: center;"> <tr> <td style="width: 10%;"></td> <td style="width: 10%;"></td> <td style="width: 10%;"></td> <td style="width: 10%;"></td> <td style="width: 10%;"></td> <td style="width: 10%;"></td> <td style="width: 10%;"></td> <td style="width: 10%;"></td> <td style="width: 10%;"></td> <td style="width: 10%;"></td> </tr> <tr> <td></td> <td></td> <td colspan="8" style="text-align: center;"> <table border="1" style="width: 100%; border-collapse: collapse; text-align: center;"> <tr> <td style="width: 10%;"></td> <td style="width: 10%;"></td> <td style="width: 10%;"></td> <td style="width: 10%;"></td> <td style="width: 10%;"></td> <td style="width: 10%;"></td> <td style="width: 10%;"></td> <td style="width: 10%;"></td> <td style="width: 10%;"></td> <td style="width: 10%;"></td> </tr> <tr> <td></td> <td></td> <td colspan="8" style="text-align: center;"> <table border="1" style="width: 100%; border-collapse: collapse; text-align: center;"> <tr> <td style="width: 10%;"></td> <td style="width: 10%;"></td> <td style="width: 10%;"></td> <td style="width: 10%;"></td> <td style="width: 10%;"></td> <td style="width: 10%;"></td> <td style="width: 10%;"></td> <td style="width: 10%;"></td> <td style="width: 10%;"></td> <td style="width: 10%;"></td> </tr> <tr> <td></td> <td></td> <td colspan="8" style="text-align: center;"> <table border="1" style="width: 100%; border-collapse: collapse; text-align: center;"> <tr> <td style="width: 10%;"></td> <td style="width: 10%;"></td> <td style="width: 10%;"></td> <td style="width: 10%;"></td> <td style="width: 10%;"></td> <td style="width: 10%;"></td> <td style="width: 10%;"></td> <td style="width: 10%;"></td> <td style="width: 10%;"></td> <td style="width: 10%;"></td> </tr> <tr> <td></td> <td></td> <td colspan="8" style="text-align: center;"> <table border="1" style="width: 100%; border-collapse: collapse; text-align: center;"> <tr> <td style="width: 10%;"></td> <td style="width: 10%;"></td> <td style="width: 10%;"></td> <td style="width: 10%;"></td> <td style="width: 10%;"></td> <td style="width: 10%;"></td> <td style="width: 10%;"></td> <td style="width: 10%;"></td> <td style="width: 10%;"></td> <td style="width: 10%;"></td> </tr> <tr> <td></td> <td></td> <td colspan="8" style="text-align: center;"> <table border="1" style="width: 100%; border-collapse: collapse; text-align: center;"> <tr> <td style="width: 10%;"></td> <td style="width: 10%;"></td> <td style="width: 10%;"></td> <td style="width: 10%;"></td> <td style="width: 10%;"></td> <td style="width: 10%;"></td> <td style="width: 10%;"></td> <td style="width: 10%;"></td> <td style="width: 10%;"></td> <td style="width: 10%;"></td> </tr> <tr> <td></td> <td></td> <td colspan="8" style="text-align: center;"> <table border="1" style="width: 100%; border-collapse: collapse; text-align: center;"> <tr> <td style="width: 10%;"></td> <td style="width: 10%;"></td> <td style="width: 10%;"></td> <td style="width: 10%;"></td> <td style="width: 10%;"></td> <td style="width: 10%;"></td> <td style="width: 10%;"></td> <td style="width: 10%;"></td> <td style="width: 10%;"></td> <td style="width: 10%;"></td> </tr> <tr> <td></td> <td></td> <td colspan="8" style="text-align: center;"> <table border="1" style="width: 100%; border-collapse: collapse; text-align: center;"> <tr> <td style="width: 10%;"></td> <td style="width: 10%;"></td> <td style="width: 10%;"></td> <td style="width: 10%;"></td> <td style="width: 10%;"></td> <td style="width: 10%;"></td> <td style="width: 10%;"></td> <td style="width: 10%;"></td> <td style="width: 10%;"></td> <td style="width: 10%;"></td> </tr> <tr> <td></td> <td></td> <td colspan="8" style="text-align: center;"> <table border="1" style="width: 100%; border-collapse: collapse; text-align: center;"> <tr> <td style="width: 10%;"></td> <td style="width: 10%;"></td> <td style="width: 10%;"></td> <td style="width: 10%;"></td> <td style="width: 10%;"></td> <td style="width: 10%;"></td> <td style="width: 10%;"></td> <td style="width: 10%;"></td> <td style="width: 10%;"></td> <td style="width: 10%;"></td> </tr> <tr> <td></td> <td></td> <td colspan="8" style="text-align: center;"> <table border="1" style="width: 100%; border-collapse: collapse; text-align: center;"> <tr> <td style="width: 10%;"></td> <td style="width: 10%;"></td> <td style="width: 10%;"></td> <td style="width: 10%;"></td> <td style="width: 10%;"></td> <td style="width: 10%;"></td> <td style="width: 10%;"></td> <td style="width: 10%;"></td> <td style="width: 10%;"></td> <td style="width: 10%;"></td> </tr> <tr> <td></td> <td></td> <td colspan="8" style="text-align: center;"> <table border="1" style="width: 100%; border-collapse: collapse; text-align: center;"> <tr> <td style="width: 10%;"></td> <td style="width: 10%;"></td> <td style="width: 10%;"></td> <td style="width: 10%;"></td> <td style="width: 10%;"></td> <td style="width: 10%;"></td> <td style="width: 10%;"></td> <td style="width: 10%;"></td> <td style="width: 10%;"></td> <td style="width: 10%;"></td> </tr> <tr> <td></td> <td></td> <td colspan="8" style="text-align: center;"> <table border="1" style="width: 100%; border-collapse: collapse; text-align: center;"> <tr> <td style="width: 10%;"></td> <td style="width: 10%;"></td> <td style="width: 10%;"></td> <td style="width: 10%;"></td> <td style="width: 10%;"></td> <td style="width: 10%;"></td> <td style="width: 10%;"></td> <td style="width: 10%;"></td> <td style="width: 10%;"></td> <td style="width: 10%;"></td> </tr> <tr> <td></td> <td></td> <td colspan="8" style="text-align: center;"> <table border="1" style="width: 100%; border-collapse: collapse; text-align: center;"> <tr> <td style="width: 10%;"></td> <td style="width: 10%;"></td> <td style="width: 10%;"></td> <td style="width: 10%;"></td> <td style="width: 10%;"></td> <td style="width: 10%;"></td> <td style="width: 10%;"></td> <td style="width: 10%;"></td> <td style="width: 10%;"></td> <td style="width: 10%;"></td> </tr> <tr> <td></td> <td></td> <td colspan="8" style="text-align: center;"> <table border="1" style="width: 100%; border-collapse: collapse; text-align: center;"> <tr> <td style="width: 10%;"></td> <td style="width: 10%;"></td> <td style="width: 10%;"></td> <td style="width: 10%;"></td> <td style="width: 10%;"></td> <td style="width: 10%;"></td> <td style="width: 10%;"></td> <td style="width: 10%;"></td> <td style="width: 10%;"></td> <td style="width: 10%;"></td> </tr> <tr> <td></td> <td></td> <td colspan="8" style="text-align: center;"> <table border="1" style="width: 100%; border-collapse: collapse; text-align: center;"> <tr> <td style="width: 10%;"></td> <td style="width: 10%;"></td> <td style="width: 10%;"></td> <td style="width: 10%;"></td> <td style="width: 10%;"></td> <td style="width: 10%;"></td> <td style="width: 10%;"></td> <td style="width: 10%;"></td> <td style="width: 10%;"></td> <td style="width: 10%;"></td> </tr> <tr> <td></td> <td></td> <td colspan="8" style="text-align: center;"> <table border="1" style="width: 100%; border-collapse: collapse; text-align: center;"> <tr> <td style="width: 10%;"></td> <td style="width: 10%;"></td> <td style="width: 10%;"></td> <td style="width: 10%;"></td> <td style="width: 10%;"></td> <td style="width: 10%;"></td> <td style="width: 10%;"></td> <td style="width: 10%;"></td> <td style="width: 10%;"></td> <td style="width: 10%;"></td> </tr> <tr> <td></td> <td></td> <td colspan="8" style="text-align: center;"> <table border="1" style="width: 100%; border-collapse: collapse; text-align: center;"> <tr> <td style="width: 10%;"></td> <td style="width: 10%;"></td> <td style="width: 10%;"></td> <td style="width: 10%;"></td> <td style="width: 10%;"></td> <td style="width: 10%;"></td> <td style="width: 10%;"></td> <td style="width: 10%;"></td> <td style="width: 10%;"></td> <td style="width: 10%;"></td> </tr> <tr> <td></td> <td></td> <td colspan="8" style="text-align: center;"> <table border="1" style="width: 100%; border-collapse: collapse; text-align: center;"> <tr> <td style="width: 10%;"></td> <td style="width: 10%;"></td> <td style="width: 10%;"></td> <td style="width: 10%;"></td> <td style="width: 10%;"></td> <td style="width:
10%;"></td> <td style="width: 10%;"></td> <td style="width: 10%;"></td> <td style="width: 10%;"></td> <td style="width: 10%;"></td> </tr> <tr> <td></td> <td></td> <td colspan="8" style="text-align: center;"> <table border="1" style="width: 100%; border-collapse: collapse; text-align: center;"> <tr> <td style="width: 10%;"></td> <td style="width: 10%;"></td> <td style="width: 10%;"></td> <td style="width: 10%;"></td> <td style="width: 10%;"></td> <td style="width: 10%;"></td> <td style="width: 10%;"></td> <td style="width: 10%;"></td> <td style="width: 10%;"></td> <td style="width: 10%;"></td> </tr> <tr> <td></td> <td></td> <td colspan="8" style="text-align: center;"> <table border="1" style="width: 100%; border-collapse: collapse; text-align: center;"> <tr> <td style="width: 10%;"></td> <td style="width: 10%;"></td> <td style="width: 10%;"></td> <td style="width: 10%;"></td> <td style="width: 10%;"></td> <td style="width: 10%;"></td> <td style="width: 10%;"></td> <td style="width: 10%;"></td> <td style="width: 10%;"></td> <td style="width: 10%;"></td> </tr> <tr> <td></td> <td></td> <td colspan="8" style="text-align: center;"> <table border="1" style="width: 100%; border-collapse: collapse; text-align: center;"> <tr> <td style="width: 10%;"></td> <td style="width: 10%;"></td> <td style="width: 10%;"></td> <td style="width: 10%;"></td> <td style="width: 10%;"></td> <td style="width: 10%;"></td> <td style="width: 10%;"></td> <td style="width: 10%;"></td> <td style="width: 10%;"></td> <td style="width: 10%;"></td> </tr> <tr> <td></td> <td></td> <td colspan="8" style="text-align: center;"> <table border="1" style="width: 100%; border-collapse: collapse; text-align: center;"> <tr> <td style="width: 10%;"></td> <td style="width: 10%;"></td> <td style="width: 10%;"></td> <td style="width: 10%;"></td> <td style="width: 10%;"></td> <td style="width: 10%;"></td> <td style="width: 10%;"></td> <td style="width: 10%;"></td> <td style="width: 10%;"></td> <td style="width: 10%;"></td> </tr> <tr> <td></td> <td></td> <td colspan="8" style="text-align: center;"> <table border="1" style="width: 100%; border-collapse: collapse; text-align: center;"> <tr> <td style="width: 10%;"></td> <td style="width: 10%;"></td> <td style="width: 10%;"></td> <td style="width: 10%;"></td> <td style="width: 10%;"></td> <td style="width: 10%;"></td> <td style="width: 10%;"></td> <td style="width: 10%;"></td> <td style="width: 10%;"></td> <td style="width: 10%;"></td> </tr> <tr> <td></td> <td></td> <td colspan="8" style="text-align: center;"> <table border="1" style="width: 100%; border-collapse: collapse; text-align: center;"> <tr> <td style="width: 10%;"></td> <td style="width: 10%;"></td> <td style="width: 10%;"></td> <td style="width: 10%;"></td> <td style="width: 10%;"></td> <td style="width: 10%;"></td> <td style="width: 10%;"></td> <td style="width: 10%;"></td> <td style="width: 10%;"></td> <td style="width: 10%;"></td> </tr> <tr> <td></td> <td></td> <td colspan="8" style="text-align: center;"> <table border="1" style="width: 100%; border-collapse: collapse; text-align: center;"> <tr> <td style="width: 10%;"></td> <td style="width: 10%;"></td> <td style="width: 10%;"></td> <td style="width: 10%;"></td> <td style="width: 10%;"></td> <td style="width: 10%;"></td> <td style="width: 10%;"></td> <td style="width: 10%;"></td> <td style="width: 10%;"></td> <td style="width: 10%;"></td> </tr> <tr> <td></td> <td></td> <td colspan="8" style="text-align: center;"> <table border="1" style="width: 100%; border-collapse: collapse; text-align: center;"> <tr> <td style="width: 10%;"></td> <td style="width: 10%;"></td> <td style="width: 10%;"></td> <td style="width: 10%;"></td> <td style="width: 10%;"></td> <td style="width: 10%;"></td> <td style="width: 10%;"></td> <td style="width: 10%;"></td> <td style="width: 10%;"></td> <td style="width: 10%;"></td> </tr> <tr> <td></td> <td></td> <td colspan="8" style="text-align: center;"> <table border="1" style="width: 100%; border-collapse: collapse; text-align: center;"> <tr> <td style="width: 10%;"></td> <td style="width: 10%;"></td> <td style="width: 10%;"></td> <td style="width: 10%;"></td> <td style="width: 10%;"></td> <td style="width: 10%;"></td> <td style="width: 10%;"></td> <td style="width: 10%;"></td> <td style="width: 10%;"></td> <td style="width: 10%;"></td> </tr> <tr> <td></td> <td></td> <td colspan="8" style="text-align: center;"> <table border="1" style="width: 100%; border-collapse: collapse; text-align: center;"> <tr> <td style="width: 10%;"></td> <td style="width: 10%;"></td> <td style="width: 10%;"></td> <td style="width: 10%;"></td> <td style="width: 10%;"></td> <td style="width: 10%;"></td> <td style="width: 10%;"></td> <td style="width: 10%;"></td> <td style="width: 10%;"></td> <td style="width: 10%;"></td> </tr> <tr> <td></td> <td></td> <td colspan="8" style="text-align: center;"> <table border="1" style="width: 100%; border-collapse: collapse; text-align: center;"> <tr> <td style="width: 10%;"></td> <td style="width: 10%;"></td> <td style="width: 10%;"></td> <td style="width: 10%;"></td> <td style="width: 10%;"></td> <td style="width: 10%;"></td> <td style="width: 10%;"></td> <td style="width: 10%;"></td> <td style="width: 10%;"></td> <td style="width: 10%;"></td> </tr> <tr> <td></td> <td></td> <td colspan="8" style="text-align: center;"> <table border="1" style="width: 100%; border-collapse: collapse; text-align: center;"> <tr> <td style="width: 10%;"></td> <td style="width: 10%;"></td> <td style="width: 10%;"></td> <td style="width: 10%;"></td> <td style="width: 10%;"></td> <td style="width: 10%;"></td> <td style="width: 10%;"></td> <td style="width: 10%;"></td> <td style="width: 10%;"></td> <td style="width: 10%;"></td> </tr> <tr> <td></td> <td></td> <td colspan="8" style="text-align: center;"> <table border="1" style="width: 100%; border-collapse: collapse; text-align: center;"> <tr> <td style="width: 10%;"></td> <td style="width: 10%;"></td> <td style="width: 10%;"></td> <td style="width: 10%;"></td> <td style="width: 10%;"></td> <td style="width: 10%;"></td> <td style="width: 10%;"></td> <td style="width: 10%;"></td> <td style="width: 10%;"></td> <td style="width: 10%;"></td> </tr> <tr> <td></td> <td></td> <td colspan="8" style="text-align: center;"> <table border="1" style="width: 100%; border-collapse: collapse; text-align: center;"> <tr> <td style="width: 10%;"></td> <td style="width: 10%;"></td> <td style="width: 10%;"></td> <td style="width: 10%;"></td> <td style="width: 10%;"></td> <td style="width: 10%;"></td> <td style="width: 10%;"></td> <td style="width: 10%;"></td> <td style="width: 10%;"></td> <td style="width: 10%;"></td> </tr> <tr> <td></td> <td></td> <td colspan="8" style="text-align: center;"> <table border="1" style="width: 100%; border-collapse: collapse; text-align: center;"> <tr> <td style="width: 10%;"></td> <td style="width: 10%;"></td> <td style="width: 10%;"></td> <td style="width: 10%;"></td> <td style="width: 10%;"></td> <td style="width: 10%;"></td> <td style="width: 10%;"></td> <td style="width: 10%;"></td> <td style="width: 10%;"></td> <td style="width: 10%;"></td> </tr> <tr> <td></td> <td></td> <td colspan="8" style="text-align: center;"> <table border="1" style="width: 100%; border-collapse: collapse; text-align: center;"> <tr> <td style="width: 10%;"></td> <td style="width: 10%;"></td> <td style="width: 10%;"></td> <td style="width: 10%;"></td> <td style="width: 10%;"></td> <td style="width: 10%;"></td> <td style="width: 10%;"></td> <td style="width: 10%;"></td> <td style="width: 10%;"></td> <td style="width: 10%;"></td> </tr> <tr> <td></td> <td></td> <td colspan="8" style="text-align: center;"> <table border="1" style="width: 100%; border-collapse: collapse; text-align: center;"> <tr> <td style="width: 10%;"></td> <td style="width: 10%;"></td> <td style="width: 10%;"></td> <td style="width: 10%;"></td> <td style="width: 10%;"></td> <td style="width: 10%;"></td> <td style="width: 10%;"></td> <td style="width: 10%;"></td> <td style="width: 10%;"></td> <td style="width: 10%;"></td> </tr> <tr> <td></td> <td></td> <td colspan="8" style="text-align: center;"> <table border="1" style="width: 100%; border-collapse: collapse; text-align: center;"> <tr> <td style="width: 10%;"></td> <td style="width: 10%;"></td> <td style="width: 10%;"></td> <td style="width: 10%;"></td> <td style="width: 10%;"></td> <td style="width: 10%;"></td> <td style="width: 10%;"></td> <td style="width: 10%;"></td> <td style="width: 10%;"></td> <td style="width: 10%;"></td> </tr> <tr> <td></td> <td></td> <td colspan="8" style="text-align: center;"> <table border="1" style="width: 100%; border-collapse: collapse; text-align: center;"> <tr> <td style="width: 10%;"></td> <td style="width: 10%;"></td> <td style="width: 10%;"></td> <td style="width: 10%;"></td> <td style="width: 10%;"></td> <td style="width: 10%;"></td> <td style="width: 10%;"></td> <td style="width: 10%;"></td> <td style="width: 10%;"></td> <td style="width: 10%;"></td> </tr> <tr> <td></td> <td></td> <td colspan="8" style="text-align: center;"> <table border="1" style="width: 100%; border-collapse: collapse; text-align: center;"> <tr> <td style="width: 10%;"></td> <td style="width: 10%;"></td> <td style="width: 10%;"></td> <td style="width: 10%;"></td> <td style="width: 10%;"></td> <td style="width: 10%;"></td> <td style="width: 10%;"></td> <td style="width: 10%;"></td> <td style="width: 10%;"></td> <td style="width: 10%;"></td> </tr> <tr> <td></td> <td></td> <td colspan="8" style="text-align: center;"> <table border="1" style="width: 100%; border-collapse: collapse; text-align: center;"> <tr> <td style="width: 10%;"></td> <td style="width: 10%;"></td> <td style="width: 10%;"></td> <td style="width: 10%;"></td> <td style="width: 10%;"></td> <td style="width: 10%;"></td> <td style="width: 10%;"></td> <td style="width: 10%;"></td> <td style="width: 10%;"></td> <td style="width: 10%;"></td> </tr> <tr> <td></td> <td></td> <td
colspan="8" style="text-align: center;"> <table border="1" style="width: 100%; border-collapse: collapse; text-align: center;"> <tr> <td style="width: 10%;"></td> <td style="width: 10%;"></td> <td style="width: 10%;"></td> <td style="width: 10%;"></td> <td style="width: 10%;"></td> <td style="width: 10%;"></td> <td style="width: 10%;"></td> <td style="width: 10%;"></td> <td style="width: 10%;"></td> <td style="width: 10%;"></td> </tr> <tr> <td></td> <td></td> <td colspan="8" style="text-align: center;"> <table border="1" style="width: 100%; border-collapse: collapse; text-align: center;"> <tr> <td style="width: 10%;"></td> <td style="width: 10%;"></td> <td style="width: 10%;"></td> <td style="width: 10%;"></td> <td style="width: 10%;"></td> <td style="width: 10%;"></td> <td style="width: 10%;"></td> <td style="width: 10%;"></td> <td style="width: 10%;"></td> <td style="width: 10%;"></td> </tr> <tr> <td></td> <td></td> <td colspan="8" style="text-align: center;"> <table border="1" style="width: 100%; border-collapse: collapse; text-align: center;"> <tr> </tr></table></td></tr></table></td></tr></table></td></tr></table></td></tr></table></td></tr></table></td></tr></table></td></tr></table></td></tr></table></td></tr></table></td></tr></table></td></tr></table></td></tr></table></td></tr></table></td></tr></table></td></tr></table></td></tr></table></td></tr></table></td></tr></table></td></tr></table></td></tr></table></td></tr></table></td></tr></table></td></tr></table></td></tr></table></td></tr></table></td></tr></table></td></tr></table></td></tr></table></td></tr></table></td></tr></table></td></tr></table></td></tr></table></td></tr></table></td></tr></table></td></tr></table></td></tr></table></td></tr></table></td></tr></table></td></tr></table></td></tr></table></td></tr></table></td></tr></table>
 | | | | | | | | | | | | | | | | | | | | <table border="1" style="width: 100%; border-collapse: collapse; text-align: center;"> <tr> <td style="width: 10%;"></td> <td style="width: 10%;"></td> <td style="width: 10%;"></td> <td style="width: 10%;"></td> <td style="width: 10%;"></td> <td style="width: 10%;"></td> <td style="width: 10%;"></td> <td style="width: 10%;"></td> <td style="width: 10%;"></td> <td style="width: 10%;"></td> </tr> <tr> <td></td> <td></td> <td colspan="8" style="text-align: center;"> <table border="1" style="width: 100%; border-collapse: collapse; text-align: center;"> <tr> <td style="width: 10%;"></td> <td style="width: 10%;"></td> <td style="width: 10%;"></td> <td style="width: 10%;"></td> <td style="width: 10%;"></td> <td style="width: 10%;"></td> <td style="width: 10%;"></td> <td style="width: 10%;"></td> <td style="width: 10%;"></td> <td style="width: 10%;"></td> </tr> <tr> <td></td> <td></td> <td colspan="8" style="text-align: center;"> <table border="1" style="width: 100%; border-collapse: collapse; text-align: center;"> <tr> <td style="width: 10%;"></td> <td style="width: 10%;"></td> <td style="width: 10%;"></td> <td style="width: 10%;"></td> <td style="width: 10%;"></td> <td style="width: 10%;"></td> <td style="width: 10%;"></td> <td style="width: 10%;"></td> <td style="width: 10%;"></td> <td style="width: 10%;"></td> </tr> <tr> <td></td> <td></td> <td colspan="8" style="text-align: center;"> <table border="1" style="width: 100%; border-collapse: collapse; text-align: center;"> <tr> <td style="width: 10%;"></td> <td style="width: 10%;"></td> <td style="width: 10%;"></td> <td style="width: 10%;"></td> <td style="width: 10%;"></td> <td style="width: 10%;"></td> <td style="width: 10%;"></td> <td style="width: 10%;"></td> <td style="width: 10%;"></td> <td style="width: 10%;"></td> </tr> <tr> <td></td> <td></td> <td colspan="8" style="text-align: center;"> <table border="1" style="width: 100%; border-collapse: collapse; text-align: center;"> <tr> <td style="width: 10%;"></td> <td style="width: 10%;"></td> <td style="width: 10%;"></td> <td style="width: 10%;"></td> <td style="width: 10%;"></td> <td style="width: 10%;"></td> <td style="width: 10%;"></td> <td style="width: 10%;"></td> <td style="width: 10%;"></td> <td style="width: 10%;"></td> </tr> <tr> <td></td> <td></td> <td colspan="8" style="text-align: center;"> <table border="1" style="width: 100%; border-collapse: collapse; text-align: center;"> <tr> <td style="width: 10%;"></td> <td style="width: 10%;"></td> <td style="width: 10%;"></td> <td style="width: 10%;"></td> <td style="width: 10%;"></td> <td style="width: 10%;"></td> <td style="width: 10%;"></td> <td style="width: 10%;"></td> <td style="width: 10%;"></td> <td style="width: 10%;"></td> </tr> <tr> <td></td> <td></td> <td colspan="8" style="text-align: center;"> <table border="1" style="width: 100%; border-collapse: collapse; text-align: center;"> <tr> <td style="width: 10%;"></td> <td style="width: 10%;"></td> <td style="width: 10%;"></td> <td style="width: 10%;"></td> <td style="width: 10%;"></td> <td style="width: 10%;"></td> <td style="width: 10%;"></td> <td style="width: 10%;"></td> <td style="width: 10%;"></td> <td style="width: 10%;"></td> </tr> <tr> <td></td> <td></td> <td colspan="8" style="text-align: center;"> <table border="1" style="width: 100%; border-collapse: collapse; text-align: center;"> <tr> <td style="width: 10%;"></td> <td style="width: 10%;"></td> <td style="width: 10%;"></td> <td style="width: 10%;"></td> <td style="width: 10%;"></td> <td style="width: 10%;"></td> <td style="width: 10%;"></td> <td style="width: 10%;"></td> <td style="width: 10%;"></td> <td style="width: 10%;"></td> </tr> <tr> <td></td> <td></td> <td colspan="8" style="text-align: center;"> <table border="1" style="width: 100%; border-collapse: collapse; text-align: center;"> <tr> <td style="width: 10%;"></td> <td style="width: 10%;"></td> <td style="width: 10%;"></td> <td style="width: 10%;"></td> <td style="width: 10%;"></td> <td style="width: 10%;"></td> <td style="width: 10%;"></td> <td style="width: 10%;"></td> <td style="width: 10%;"></td> <td style="width: 10%;"></td> </tr> <tr> <td></td> <td></td> <td colspan="8" style="text-align: center;"> <table border="1" style="width: 100%; border-collapse: collapse; text-align: center;"> <tr> <td style="width: 10%;"></td> <td style="width: 10%;"></td> <td style="width: 10%;"></td> <td style="width: 10%;"></td> <td style="width: 10%;"></td> <td style="width: 10%;"></td> <td style="width: 10%;"></td> <td style="width: 10%;"></td> <td style="width: 10%;"></td> <td style="width: 10%;"></td> </tr> <tr> <td></td> <td></td> <td colspan="8" style="text-align: center;"> <table border="1" style="width: 100%; border-collapse: collapse; text-align: center;"> <tr> <td style="width: 10%;"></td> <td style="width: 10%;"></td> <td style="width: 10%;"></td> <td style="width: 10%;"></td> <td style="width: 10%;"></td> <td style="width: 10%;"></td> <td style="width: 10%;"></td> <td style="width: 10%;"></td> <td style="width: 10%;"></td> <td style="width: 10%;"></td> </tr> <tr> <td></td> <td></td> <td colspan="8" style="text-align: center;"> <table border="1" style="width: 100%; border-collapse: collapse; text-align: center;"> <tr> <td style="width: 10%;"></td> <td style="width: 10%;"></td> <td style="width: 10%;"></td> <td style="width: 10%;"></td> <td style="width: 10%;"></td> <td style="width: 10%;"></td> <td style="width: 10%;"></td> <td style="width: 10%;"></td> <td style="width: 10%;"></td> <td style="width: 10%;"></td> </tr> <tr> <td></td> <td></td> <td colspan="8" style="text-align: center;"> <table border="1" style="width: 100%; border-collapse: collapse; text-align: center;"> <tr> <td style="width: 10%;"></td> <td style="width: 10%;"></td> <td style="width: 10%;"></td> <td style="width: 10%;"></td> <td style="width: 10%;"></td> <td style="width: 10%;"></td> <td style="width: 10%;"></td> <td style="width: 10%;"></td> <td style="width: 10%;"></td> <td style="width: 10%;"></td> </tr> <tr> <td></td> <td></td> <td colspan="8" style="text-align: center;"> <table border="1" style="width: 100%; border-collapse: collapse; text-align: center;"> <tr> <td style="width: 10%;"></td> <td style="width: 10%;"></td> <td style="width: 10%;"></td> <td style="width: 10%;"></td> <td style="width: 10%;"></td> <td style="width: 10%;"></td> <td style="width: 10%;"></td> <td style="width: 10%;"></td> <td style="width: 10%;"></td> <td style="width: 10%;"></td> </tr> <tr> <td></td> <td></td> <td colspan="8" style="text-align: center;"> <table border="1" style="width: 100%; border-collapse: collapse; text-align: center;"> <tr> <td style="width: 10%;"></td> <td style="width: 10%;"></td> <td style="width: 10%;"></td> <td style="width: 10%;"></td> <td style="width: 10%;"></td> <td style="width: 10%;"></td> <td style="width: 10%;"></td> <td style="width: 10%;"></td> <td style="width: 10%;"></td> <td style="width: 10%;"></td> </tr> <tr> <td></td> <td></td> <td colspan="8" style="text-align: center;"> <table border="1" style="width: 100%; border-collapse: collapse; text-align: center;"> <tr> <td style="width: 10%;"></td> <td style="width: 10%;"></td> <td style="width: 10%;"></td> <td style="width: 10%;"></td> <td style="width: 10%;"></td> <td style="width: 10%;"></td> <td style="width: 10%;"></td> <td style="width: 10%;"></td> <td style="width: 10%;"></td> <td style="width: 10%;"></td> </tr> <tr> <td></td> <td></td> <td colspan="8" style="text-align: center;"> <table border="1" style="width: 100%; border-collapse: collapse; text-align: center;"> <tr> <td style="width: 10%;"></td> <td style="width: 10%;"></td> <td style="width: 10%;"></td> <td style="width: 10%;"></td> <td style="width: 10%;"></td> <td style="width: 10%;"></td> <td style="width: 10%;"></td> <td style="width: 10%;"></td> <td style="width: 10%;"></td> <td style="width: 10%;"></td> </tr> <tr>
<td></td> <td></td> <td colspan="8" style="text-align: center;"> <table border="1" style="width: 100%; border-collapse: collapse; text-align: center;"> <tr> <td style="width: 10%;"></td> <td style="width: 10%;"></td> <td style="width: 10%;"></td> <td style="width: 10%;"></td> <td style="width: 10%;"></td> <td style="width: 10%;"></td> <td style="width: 10%;"></td> <td style="width: 10%;"></td> <td style="width: 10%;"></td> <td style="width: 10%;"></td> </tr> <tr> <td></td> <td></td> <td colspan="8" style="text-align: center;"> <table border="1" style="width: 100%; border-collapse: collapse; text-align: center;"> <tr> <td style="width: 10%;"></td> <td style="width: 10%;"></td> <td style="width: 10%;"></td> <td style="width: 10%;"></td> <td style="width: 10%;"></td> <td style="width: 10%;"></td> <td style="width: 10%;"></td> <td style="width: 10%;"></td> <td style="width: 10%;"></td> <td style="width: 10%;"></td> </tr> <tr> <td></td> <td></td> <td colspan="8" style="text-align: center;"> <table border="1" style="width: 100%; border-collapse: collapse; text-align: center;"> <tr> <td style="width: 10%;"></td> <td style="width: 10%;"></td> <td style="width: 10%;"></td> <td style="width: 10%;"></td> <td style="width: 10%;"></td> <td style="width: 10%;"></td> <td style="width: 10%;"></td> <td style="width: 10%;"></td> <td style="width: 10%;"></td> <td style="width: 10%;"></td> </tr> <tr> <td></td> <td></td> <td colspan="8" style="text-align: center;"> <table border="1" style="width: 100%; border-collapse: collapse; text-align: center;"> <tr> <td style="width: 10%;"></td> <td style="width: 10%;"></td> <td style="width: 10%;"></td> <td style="width: 10%;"></td> <td style="width: 10%;"></td> <td style="width: 10%;"></td> <td style="width: 10%;"></td> <td style="width: 10%;"></td> <td style="width: 10%;"></td> <td style="width: 10%;"></td> </tr> <tr> <td></td> <td></td> <td colspan="8" style="text-align: center;"> <table border="1" style="width: 100%; border-collapse: collapse; text-align: center;"> <tr> <td style="width: 10%;"></td> <td style="width: 10%;"></td> <td style="width: 10%;"></td> <td style="width: 10%;"></td> <td style="width: 10%;"></td> <td style="width: 10%;"></td> <td style="width: 10%;"></td> <td style="width: 10%;"></td> <td style="width: 10%;"></td> <td style="width: 10%;"></td> </tr> <tr> <td></td> <td></td> <td colspan="8" style="text-align: center;"> <table border="1" style="width: 100%; border-collapse: collapse; text-align: center;"> <tr> <td style="width: 10%;"></td> <td style="width: 10%;"></td> <td style="width: 10%;"></td> <td style="width: 10%;"></td> <td style="width: 10%;"></td> <td style="width: 10%;"></td> <td style="width: 10%;"></td> <td style="width: 10%;"></td> <td style="width: 10%;"></td> <td style="width: 10%;"></td> </tr> <tr> <td></td> <td></td> <td colspan="8" style="text-align: center;"> <table border="1" style="width: 100%; border-collapse: collapse; text-align: center;"> <tr> <td style="width: 10%;"></td> <td style="width: 10%;"></td> <td style="width: 10%;"></td> <td style="width: 10%;"></td> <td style="width: 10%;"></td> <td style="width: 10%;"></td> <td style="width: 10%;"></td> <td style="width: 10%;"></td> <td style="width: 10%;"></td> <td style="width: 10%;"></td> </tr> <tr> <td></td> <td></td> <td colspan="8" style="text-align: center;"> <table border="1" style="width: 100%; border-collapse: collapse; text-align: center;"> <tr> <td style="width: 10%;"></td> <td style="width: 10%;"></td> <td style="width: 10%;"></td> <td style="width: 10%;"></td> <td style="width: 10%;"></td> <td style="width: 10%;"></td> <td style="width: 10%;"></td> <td style="width: 10%;"></td> <td style="width: 10%;"></td> <td style="width: 10%;"></td> </tr> <tr> <td></td> <td></td> <td colspan="8" style="text-align: center;"> <table border="1" style="width: 100%; border-collapse: collapse; text-align: center;"> <tr> <td style="width: 10%;"></td> <td style="width: 10%;"></td> <td style="width: 10%;"></td> <td style="width: 10%;"></td> <td style="width: 10%;"></td> <td style="width: 10%;"></td> <td style="width: 10%;"></td> <td style="width: 10%;"></td> <td style="width: 10%;"></td> <td style="width: 10%;"></td> </tr> <tr> <td></td> <td></td> <td colspan="8" style="text-align: center;"> <table border="1" style="width: 100%; border-collapse: collapse; text-align: center;"> <tr> <td style="width: 10%;"></td> <td style="width: 10%;"></td> <td style="width: 10%;"></td> <td style="width: 10%;"></td> <td style="width: 10%;"></td> <td style="width: 10%;"></td> <td style="width: 10%;"></td> <td style="width: 10%;"></td> <td style="width: 10%;"></td> <td style="width: 10%;"></td> </tr> <tr> <td></td> <td></td> <td colspan="8" style="text-align: center;"> <table border="1" style="width: 100%; border-collapse: collapse; text-align: center;"> <tr> <td style="width: 10%;"></td> <td style="width: 10%;"></td> <td style="width: 10%;"></td> <td style="width: 10%;"></td> <td style="width: 10%;"></td> <td style="width: 10%;"></td> <td style="width: 10%;"></td> <td style="width: 10%;"></td> <td style="width: 10%;"></td> <td style="width: 10%;"></td> </tr> <tr> <td></td> <td></td> <td colspan="8" style="text-align: center;"> <table border="1" style="width: 100%; border-collapse: collapse; text-align: center;"> <tr> <td style="width: 10%;"></td> <td style="width: 10%;"></td> <td style="width: 10%;"></td> <td style="width: 10%;"></td> <td style="width: 10%;"></td> <td style="width: 10%;"></td> <td style="width: 10%;"></td> <td style="width: 10%;"></td> <td style="width: 10%;"></td> <td style="width: 10%;"></td> </tr> <tr> <td></td> <td></td> <td colspan="8" style="text-align: center;"> <table border="1" style="width: 100%; border-collapse: collapse; text-align: center;"> <tr> <td style="width: 10%;"></td> <td style="width: 10%;"></td> <td style="width: 10%;"></td> <td style="width: 10%;"></td> <td style="width: 10%;"></td> <td style="width: 10%;"></td> <td style="width: 10%;"></td> <td style="width: 10%;"></td> <td style="width: 10%;"></td> <td style="width: 10%;"></td> </tr> <tr> <td></td> <td></td> <td colspan="8" style="text-align: center;"> <table border="1" style="width: 100%; border-collapse: collapse; text-align: center;"> <tr> <td style="width: 10%;"></td> <td style="width: 10%;"></td> <td style="width: 10%;"></td> <td style="width: 10%;"></td> <td style="width: 10%;"></td> <td style="width: 10%;"></td> <td style="width: 10%;"></td> <td style="width: 10%;"></td> <td style="width: 10%;"></td> <td style="width: 10%;"></td> </tr> <tr> <td></td> <td></td> <td colspan="8" style="text-align: center;"> <table border="1" style="width: 100%; border-collapse: collapse; text-align: center;"> <tr> <td style="width: 10%;"></td> <td style="width: 10%;"></td> <td style="width: 10%;"></td> <td style="width: 10%;"></td> <td style="width: 10%;"></td> <td style="width: 10%;"></td> <td style="width: 10%;"></td> <td style="width: 10%;"></td> <td style="width: 10%;"></td> <td style="width: 10%;"></td> </tr> <tr> <td></td> <td></td> <td colspan="8" style="text-align: center;"> <table border="1" style="width: 100%; border-collapse: collapse; text-align: center;"> <tr> <td style="width: 10%;"></td> <td style="width: 10%;"></td> <td style="width: 10%;"></td> <td style="width: 10%;"></td> <td style="width: 10%;"></td> <td style="width: 10%;"></td> <td style="width: 10%;"></td> <td style="width: 10%;"></td> <td style="width: 10%;"></td> <td style="width: 10%;"></td> </tr> <tr> <td></td> <td></td> <td colspan="8" style="text-align: center;"> <table border="1" style="width: 100%; border-collapse: collapse; text-align: center;"> <tr> <td style="width: 10%;"></td> <td style="width: 10%;"></td> <td style="width: 10%;"></td> <td style="width: 10%;"></td> <td style="width: 10%;"></td> <td style="width: 10%;"></td> <td style="width: 10%;"></td> <td style="width: 10%;"></td> <td style="width: 10%;"></td> <td style="width: 10%;"></td> </tr> <tr> <td></td> <td></td> <td colspan="8" style="text-align: center;"> <table border="1" style="width: 100%; border-collapse: collapse; text-align: center;"> <tr> <td style="width: 10%;"></td> <td style="width: 10%;"></td> <td style="width: 10%;"></td> <td style="width: 10%;"></td> <td style="width: 10%;"></td> <td style="width: 10%;"></td> <td style="width: 10%;"></td> <td style="width: 10%;"></td> <td style="width: 10%;"></td> <td style="width: 10%;"></td> </tr> <tr> <td></td> <td></td> <td colspan="8" style="text-align: center;"> <table border="1" style="width: 100%; border-collapse: collapse; text-align: center;"> <tr> <td style="width: 10%;"></td> <td style="width: 10%;"></td> <td style="width: 10%;"></td> <td style="width: 10%;"></td> <td style="width: 10%;"></td> <td style="width: 10%;"></td> <td style="width: 10%;"></td> <td style="width: 10%;"></td> <td style="width: 10%;"></td> <td style="width: 10%;"></td> </tr> <tr> <td></td> <td></td> <td colspan="8" style="text-align: center;"> <table border="1" style="width: 100%; border-collapse: collapse; text-align: center;"> <tr> <td style="width: 10%;"></td> <td style="width: 10%;"></td> <td style="width: 10%;"></td> <td style="width: 10%;"></td> <td style="width: 10%;"></td> <td style="width: 10%;"></td> <td style="width: 10%;"></td> <td style="width: 10%;"></td> <td style="width: 10%;"></td> <td style="width: 10%;"></td> </tr> <tr> <td></td> <td></td> <td colspan="8" style="text-align: center;"> <table border="1" style="width: 100%; border-collapse: collapse; text-align: center;"> <tr> <td style="width: 10%;"></td> <td style="width: 10%;"></td> <td style="width: 10%;"></td> <td style="width: 10%;"></td> <td style="width: 10%;"></td> <td style="width: 10%;"></td> <td style="width: 10%;"></td> <td style="width: 10%;"></td> <td style="width: 10%;"></td> <td style="width: 10%;"></td> </tr> <tr> <td></td> <td></td> <td colspan="8" style="text-align: center;"> <table border="1" style="width: 100%; border-collapse: collapse; text-align: center;"> <tr> <td
style="width: 10%;"></td> <td style="width: 10%;"></td> <td style="width: 10%;"></td> <td style="width: 10%;"></td> <td style="width: 10%;"></td> <td style="width: 10%;"></td> <td style="width: 10%;"></td> <td style="width: 10%;"></td> <td style="width: 10%;"></td> <td style="width: 10%;"></td> </tr> <tr> <td></td> <td></td> <td colspan="8" style="text-align: center;"> <table border="1" style="width: 100%; border-collapse: collapse; text-align: center;"> <tr> <td style="width: 10%;"></td> <td style="width: 10%;"></td> <td style="width: 10%;"></td> <td style="width: 10%;"></td> <td style="width: 10%;"></td> <td style="width: 10%;"></td> <td style="width: 10%;"></td> <td style="width: 10%;"></td> <td style="width: 10%;"></td> <td style="width: 10%;"></td> </tr> <tr> <td></td> <td></td> <td colspan="8" style="text-align: center;"> <table border="1" style="width: 100%; border-collapse: collapse; text-align: center;"> <tr> <td style="width: 10%;"></td> <td style="width: 10%;"></td> <td style="width: 10%;"></td> <td style="width: 10%;"></td> <td style="width: 10%;"></td> <td style="width: 10%;"></td> <td style="width: 10%;"></td> <td style="width: 10%;"></td> <td style="width: 10%;"></td> <td style="width: 10%;"></td> </tr> <tr> <td></td> <td></td> <td colspan="8" style="text-align: center;"> <table border="1" style="width: 100%; border-collapse: collapse; text-align: center;"> <tr> </tr></table></td></tr></table></td></tr></table></td></tr></table></td></tr></table></td></tr></table></td></tr></table></td></tr></table></td></tr></table></td></tr></table></td></tr></table></td></tr></table></td></tr></table></td></tr></table></td></tr></table></td></tr></table></td></tr></table></td></tr></table></td></tr></table></td></tr></table></td></tr></table></td></tr></table></td></tr></table></td></tr></table></td></tr></table></td></tr></table></td></tr></table></td></tr></table></td></tr></table></td></tr></table></td></tr></table></td></tr></table></td></tr></table></td></tr></table></td></tr></table></td></tr></table></td></tr></table></td></tr></table></td></tr></table></td></tr></table></td></tr></table></td></tr></table>
 | | | | | | | | | | | | | | | | | | | | <table border="1" style="width: 100%; border-collapse: collapse; text-align: center;"> <tr> <td style="width: 10%;"></td> <td style="width: 10%;"></td> <td style="width: 10%;"></td> <td style="width: 10%;"></td> <td style="width: 10%;"></td> <td style="width: 10%;"></td> <td style="width: 10%;"></td> <td style="width: 10%;"></td> <td style="width: 10%;"></td> <td style="width: 10%;"></td> </tr> <tr> <td></td> <td></td> <td colspan="8" style="text-align: center;"> <table border="1" style="width: 100%; border-collapse: collapse; text-align: center;"> <tr> <td style="width: 10%;"></td> <td style="width: 10%;"></td> <td style="width: 10%;"></td> <td style="width: 10%;"></td> <td style="width: 10%;"></td> <td style="width: 10%;"></td> <td style="width: 10%;"></td> <td style="width: 10%;"></td> <td style="width: 10%;"></td> <td style="width: 10%;"></td> </tr> <tr> <td></td> <td></td> <td colspan="8" style="text-align: center;"> <table border="1" style="width: 100%; border-collapse: collapse; text-align: center;"> <tr> <td style="width: 10%;"></td> <td style="width: 10%;"></td> <td style="width: 10%;"></td> <td style="width: 10%;"></td> <td style="width: 10%;"></td> <td style="width: 10%;"></td> <td style="width: 10%;"></td> <td style="width: 10%;"></td> <td style="width: 10%;"></td> <td style="width: 10%;"></td> </tr> <tr> <td></td> <td></td> <td colspan="8" style="text-align: center;"> <table border="1" style="width: 100%; border-collapse: collapse; text-align: center;"> <tr> <td style="width: 10%;"></td> <td style="width: 10%;"></td> <td style="width: 10%;"></td> <td style="width: 10%;"></td> <td style="width: 10%;"></td> <td style="width: 10%;"></td> <td style="width: 10%;"></td> <td style="width: 10%;"></td> <td style="width: 10%;"></td> <td style="width: 10%;"></td> </tr> <tr> <td></td> <td></td> <td colspan="8" style="text-align: center;"> <table border="1" style="width: 100%; border-collapse: collapse; text-align: center;"> <tr> <td style="width: 10%;"></td> <td style="width: 10%;"></td> <td style="width: 10%;"></td> <td style="width: 10%;"></td> <td style="width: 10%;"></td> <td style="width: 10%;"></td> <td style="width: 10%;"></td> <td style="width: 10%;"></td> <td style="width: 10%;"></td> <td style="width: 10%;"></td> </tr> <tr> <td></td> <td></td> <td colspan="8" style="text-align: center;"> <table border="1" style="width: 100%; border-collapse: collapse; text-align: center;"> <tr> <td style="width: 10%;"></td> <td style="width: 10%;"></td> <td style="width: 10%;"></td> <td style="width: 10%;"></td> <td style="width: 10%;"></td> <td style="width: 10%;"></td> <td style="width: 10%;"></td> <td style="width: 10%;"></td> <td style="width: 10%;"></td> <td style="width: 10%;"></td> </tr> <tr> <td></td> <td></td> <td colspan="8" style="text-align: center;"> <table border="1" style="width: 100%; border-collapse: collapse; text-align: center;"> <tr> <td style="width: 10%;"></td> <td style="width: 10%;"></td> <td style="width: 10%;"></td> <td style="width: 10%;"></td> <td style="width: 10%;"></td> <td style="width: 10%;"></td> <td style="width: 10%;"></td> <td style="width: 10%;"></td> <td style="width: 10%;"></td> <td style="width: 10%;"></td> </tr> <tr> <td></td> <td></td> <td colspan="8" style="text-align: center;"> <table border="1" style="width: 100%; border-collapse: collapse; text-align: center;"> <tr> <td style="width: 10%;"></td> <td style="width: 10%;"></td> <td style="width: 10%;"></td> <td style="width: 10%;"></td> <td style="width: 10%;"></td> <td style="width: 10%;"></td> <td style="width: 10%;"></td> <td style="width: 10%;"></td> <td style="width: 10%;"></td> <td style="width: 10%;"></td> </tr> <tr> <td></td> <td></td> <td colspan="8" style="text-align: center;"> <table border="1" style="width: 100%; border-collapse: collapse; text-align: center;"> <tr> <td style="width: 10%;"></td> <td style="width: 10%;"></td> <td style="width: 10%;"></td> <td style="width: 10%;"></td> <td style="width: 10%;"></td> <td style="width: 10%;"></td> <td style="width: 10%;"></td> <td style="width: 10%;"></td> <td style="width: 10%;"></td> <td style="width: 10%;"></td> </tr> <tr> <td></td> <td></td> <td colspan="8" style="text-align: center;"> <table border="1" style="width: 100%; border-collapse: collapse; text-align: center;"> <tr> <td style="width: 10%;"></td> <td style="width: 10%;"></td> <td style="width: 10%;"></td> <td style="width: 10%;"></td> <td style="width: 10%;"></td> <td style="width: 10%;"></td> <td style="width: 10%;"></td> <td style="width: 10%;"></td> <td style="width: 10%;"></td> <td style="width: 10%;"></td> </tr> <tr> <td></td> <td></td> <td colspan="8" style="text-align: center;"> <table border="1" style="width: 100%; border-collapse: collapse; text-align: center;"> <tr> <td style="width: 10%;"></td> <td style="width: 10%;"></td> <td style="width: 10%;"></td> <td style="width: 10%;"></td> <td style="width: 10%;"></td> <td style="width: 10%;"></td> <td style="width: 10%;"></td> <td style="width: 10%;"></td> <td style="width: 10%;"></td> <td style="width: 10%;"></td> </tr> <tr> <td></td> <td></td> <td colspan="8" style="text-align: center;"> <table border="1" style="width: 100%; border-collapse: collapse; text-align: center;"> <tr> <td style="width: 10%;"></td> <td style="width: 10%;"></td> <td style="width: 10%;"></td> <td style="width: 10%;"></td> <td style="width: 10%;"></td> <td style="width: 10%;"></td> <td style="width: 10%;"></td> <td style="width: 10%;"></td> <td style="width: 10%;"></td> <td style="width: 10%;"></td> </tr> <tr> <td></td> <td></td> <td colspan="8" style="text-align: center;"> <table border="1" style="width: 100%; border-collapse: collapse; text-align: center;"> <tr> <td style="width: 10%;"></td> <td style="width: 10%;"></td> <td style="width: 10%;"></td> <td style="width: 10%;"></td> <td style="width: 10%;"></td> <td style="width: 10%;"></td> <td style="width: 10%;"></td> <td style="width: 10%;"></td> <td style="width: 10%;"></td> <td style="width: 10%;"></td> </tr> <tr> <td></td> <td></td> <td colspan="8" style="text-align: center;"> <table border="1" style="width: 100%; border-collapse: collapse; text-align: center;"> <tr> <td style="width: 10%;"></td> <td style="width: 10%;"></td> <td style="width: 10%;"></td> <td style="width: 10%;"></td> <td style="width: 10%;"></td> <td style="width: 10%;"></td> <td style="width: 10%;"></td> <td style="width: 10%;"></td> <td style="width: 10%;"></td> <td style="width: 10%;"></td> </tr> <tr> <td></td> <td></td> <td colspan="8" style="text-align: center;"> <table border="1" style="width: 100%; border-collapse: collapse; text-align: center;"> <tr> <td style="width: 10%;"></td> <td style="width: 10%;"></td> <td style="width: 10%;"></td> <td style="width: 10%;"></td> <td style="width: 10%;"></td> <td style="width: 10%;"></td> <td style="width: 10%;"></td> <td style="width: 10%;"></td> <td style="width: 10%;"></td> <td style="width: 10%;"></td> </tr> <tr> <td></td> <td></td> <td colspan="8" style="text-align: center;"> <table border="1" style="width: 100%; border-collapse: collapse; text-align: center;"> <tr> <td style="width: 10%;"></td> <td style="width: 10%;"></td> <td style="width: 10%;"></td> <td style="width: 10%;"></td> <td style="width: 10%;"></td> <td style="width: 10%;"></td> <td style="width: 10%;"></td> <td style="width: 10%;"></td> <td style="width: 10%;"></td> <td style="width: 10%;"></td> </tr> <tr> <td></td> <td></td> <td colspan="8" style="text-align: center;"> <table border="1" style="width: 100%; border-collapse: collapse; text-align: center;"> <tr>
<td style="width: 10%;"></td> <td style="width: 10%;"></td> <td style="width: 10%;"></td> <td style="width: 10%;"></td> <td style="width: 10%;"></td> <td style="width: 10%;"></td> <td style="width: 10%;"></td> <td style="width: 10%;"></td> <td style="width: 10%;"></td> <td style="width: 10%;"></td> </tr> <tr> <td></td> <td></td> <td colspan="8" style="text-align: center;"> <table border="1" style="width: 100%; border-collapse: collapse; text-align: center;"> <tr> <td style="width: 10%;"></td> <td style="width: 10%;"></td> <td style="width: 10%;"></td> <td style="width: 10%;"></td> <td style="width: 10%;"></td> <td style="width: 10%;"></td> <td style="width: 10%;"></td> <td style="width: 10%;"></td> <td style="width: 10%;"></td> <td style="width: 10%;"></td> </tr> <tr> <td></td> <td></td> <td colspan="8" style="text-align: center;"> <table border="1" style="width: 100%; border-collapse: collapse; text-align: center;"> <tr> <td style="width: 10%;"></td> <td style="width: 10%;"></td> <td style="width: 10%;"></td> <td style="width: 10%;"></td> <td style="width: 10%;"></td> <td style="width: 10%;"></td> <td style="width: 10%;"></td> <td style="width: 10%;"></td> <td style="width: 10%;"></td> <td style="width: 10%;"></td> </tr> <tr> <td></td> <td></td> <td colspan="8" style="text-align: center;"> <table border="1" style="width: 100%; border-collapse: collapse; text-align: center;"> <tr> <td style="width: 10%;"></td> <td style="width: 10%;"></td> <td style="width: 10%;"></td> <td style="width: 10%;"></td> <td style="width: 10%;"></td> <td style="width: 10%;"></td> <td style="width: 10%;"></td> <td style="width: 10%;"></td> <td style="width: 10%;"></td> <td style="width: 10%;"></td> </tr> <tr> <td></td> <td></td> <td colspan="8" style="text-align: center;"> <table border="1" style="width: 100%; border-collapse: collapse; text-align: center;"> <tr> <td style="width: 10%;"></td> <td style="width: 10%;"></td> <td style="width: 10%;"></td> <td style="width: 10%;"></td> <td style="width: 10%;"></td> <td style="width: 10%;"></td> <td style="width: 10%;"></td> <td style="width: 10%;"></td> <td style="width: 10%;"></td> <td style="width: 10%;"></td> </tr> <tr> <td></td> <td></td> <td colspan="8" style="text-align: center;"> <table border="1" style="width: 100%; border-collapse: collapse; text-align: center;"> <tr> <td style="width: 10%;"></td> <td style="width: 10%;"></td> <td style="width: 10%;"></td> <td style="width: 10%;"></td> <td style="width: 10%;"></td> <td style="width: 10%;"></td> <td style="width: 10%;"></td> <td style="width: 10%;"></td> <td style="width: 10%;"></td> <td style="width: 10%;"></td> </tr> <tr> <td></td> <td></td> <td colspan="8" style="text-align: center;"> <table border="1" style="width: 100%; border-collapse: collapse; text-align: center;"> <tr> <td style="width: 10%;"></td> <td style="width: 10%;"></td> <td style="width: 10%;"></td> <td style="width: 10%;"></td> <td style="width: 10%;"></td> <td style="width: 10%;"></td> <td style="width: 10%;"></td> <td style="width: 10%;"></td> <td style="width: 10%;"></td> <td style="width: 10%;"></td> </tr> <tr> <td></td> <td></td> <td colspan="8" style="text-align: center;"> <table border="1" style="width: 100%; border-collapse: collapse; text-align: center;"> <tr> <td style="width: 10%;"></td> <td style="width: 10%;"></td> <td style="width: 10%;"></td> <td style="width: 10%;"></td> <td style="width: 10%;"></td> <td style="width: 10%;"></td> <td style="width: 10%;"></td> <td style="width: 10%;"></td> <td style="width: 10%;"></td> <td style="width: 10%;"></td> </tr> <tr> <td></td> <td></td> <td colspan="8" style="text-align: center;"> <table border="1" style="width: 100%; border-collapse: collapse; text-align: center;"> <tr> <td style="width: 10%;"></td> <td style="width: 10%;"></td> <td style="width: 10%;"></td> <td style="width: 10%;"></td> <td style="width: 10%;"></td> <td style="width: 10%;"></td> <td style="width: 10%;"></td> <td style="width: 10%;"></td> <td style="width: 10%;"></td> <td style="width: 10%;"></td> </tr> <tr> <td></td> <td></td> <td colspan="8" style="text-align: center;"> <table border="1" style="width: 100%; border-collapse: collapse; text-align: center;"> <tr> <td style="width: 10%;"></td> <td style="width: 10%;"></td> <td style="width: 10%;"></td> <td style="width: 10%;"></td> <td style="width: 10%;"></td> <td style="width: 10%;"></td> <td style="width: 10%;"></td> <td style="width: 10%;"></td> <td style="width: 10%;"></td> <td style="width: 10%;"></td> </tr> <tr> <td></td> <td></td> <td colspan="8" style="text-align: center;"> <table border="1" style="width: 100%; border-collapse: collapse; text-align: center;"> <tr> <td style="width: 10%;"></td> <td style="width: 10%;"></td> <td style="width: 10%;"></td> <td style="width: 10%;"></td> <td style="width: 10%;"></td> <td style="width: 10%;"></td> <td style="width: 10%;"></td> <td style="width: 10%;"></td> <td style="width: 10%;"></td> <td style="width: 10%;"></td> </tr> <tr> <td></td> <td></td> <td colspan="8" style="text-align: center;"> <table border="1" style="width: 100%; border-collapse: collapse; text-align: center;"> <tr> <td style="width: 10%;"></td> <td style="width: 10%;"></td> <td style="width: 10%;"></td> <td style="width: 10%;"></td> <td style="width: 10%;"></td> <td style="width: 10%;"></td> <td style="width: 10%;"></td> <td style="width: 10%;"></td> <td style="width: 10%;"></td> <td style="width: 10%;"></td> </tr> <tr> <td></td> <td></td> <td colspan="8" style="text-align: center;"> <table border="1" style="width: 100%; border-collapse: collapse; text-align: center;"> <tr> <td style="width: 10%;"></td> <td style="width: 10%;"></td> <td style="width: 10%;"></td> <td style="width: 10%;"></td> <td style="width: 10%;"></td> <td style="width: 10%;"></td> <td style="width: 10%;"></td> <td style="width: 10%;"></td> <td style="width: 10%;"></td> <td style="width: 10%;"></td> </tr> <tr> <td></td> <td></td> <td colspan="8" style="text-align: center;"> <table border="1" style="width: 100%; border-collapse: collapse; text-align: center;"> <tr> <td style="width: 10%;"></td> <td style="width: 10%;"></td> <td style="width: 10%;"></td> <td style="width: 10%;"></td> <td style="width: 10%;"></td> <td style="width: 10%;"></td> <td style="width: 10%;"></td> <td style="width: 10%;"></td> <td style="width: 10%;"></td> <td style="width: 10%;"></td> </tr> <tr> <td></td> <td></td> <td colspan="8" style="text-align: center;"> <table border="1" style="width: 100%; border-collapse: collapse; text-align: center;"> <tr> <td style="width: 10%;"></td> <td style="width: 10%;"></td> <td style="width: 10%;"></td> <td style="width: 10%;"></td> <td style="width: 10%;"></td> <td style="width: 10%;"></td> <td style="width: 10%;"></td> <td style="width: 10%;"></td> <td style="width: 10%;"></td> <td style="width: 10%;"></td> </tr> <tr> <td></td> <td></td> <td colspan="8" style="text-align: center;"> <table border="1" style="width: 100%; border-collapse: collapse; text-align: center;"> <tr> <td style="width: 10%;"></td> <td style="width: 10%;"></td> <td style="width: 10%;"></td> <td style="width: 10%;"></td> <td style="width: 10%;"></td> <td style="width: 10%;"></td> <td style="width: 10%;"></td> <td style="width: 10%;"></td> <td style="width: 10%;"></td> <td style="width: 10%;"></td> </tr> <tr> <td></td> <td></td> <td colspan="8" style="text-align: center;"> <table border="1" style="width: 100%; border-collapse: collapse; text-align: center;"> <tr> <td style="width: 10%;"></td> <td style="width: 10%;"></td> <td style="width: 10%;"></td> <td style="width: 10%;"></td> <td style="width: 10%;"></td> <td style="width: 10%;"></td> <td style="width: 10%;"></td> <td style="width: 10%;"></td> <td style="width: 10%;"></td> <td style="width: 10%;"></td> </tr> <tr> <td></td> <td></td> <td colspan="8" style="text-align: center;"> <table border="1" style="width: 100%; border-collapse: collapse; text-align: center;"> <tr> <td style="width: 10%;"></td> <td style="width: 10%;"></td> <td style="width: 10%;"></td> <td style="width: 10%;"></td> <td style="width: 10%;"></td> <td style="width: 10%;"></td> <td style="width: 10%;"></td> <td style="width: 10%;"></td> <td style="width: 10%;"></td> <td style="width: 10%;"></td> </tr> <tr> <td></td> <td></td> <td colspan="8" style="text-align: center;"> <table border="1" style="width: 100%; border-collapse: collapse; text-align: center;"> <tr> <td style="width: 10%;"></td> <td style="width: 10%;"></td> <td style="width: 10%;"></td> <td style="width: 10%;"></td> <td style="width: 10%;"></td> <td style="width: 10%;"></td> <td style="width: 10%;"></td> <td style="width: 10%;"></td> <td style="width: 10%;"></td> <td style="width: 10%;"></td> </tr> <tr> <td></td> <td></td> <td colspan="8" style="text-align: center;"> <table border="1" style="width: 100%; border-collapse: collapse; text-align: center;"> <tr> <td style="width: 10%;"></td> <td style="width: 10%;"></td> <td style="width: 10%;"></td> <td style="width: 10%;"></td> <td style="width: 10%;"></td> <td style="width: 10%;"></td> <td style="width: 10%;"></td> <td style="width: 10%;"></td> <td style="width: 10%;"></td> <td style="width: 10%;"></td> </tr> <tr> <td></td> <td></td> <td colspan="8" style="text-align: center;"> <table border="1" style="width: 100%; border-collapse: collapse; text-align: center;"> <tr> <td style="width: 10%;"></td> <td style="width: 10%;"></td> <td style="width: 10%;"></td> <td style="width: 10%;"></td> <td style="width: 10%;"></td> <td style="width: 10%;"></td> <td style="width: 10%;"></td> <td style="width: 10%;"></td> <td style="width: 10%;"></td> <td style="width: 10%;"></td> </tr> <tr> <td></td> <td></td> <td colspan="8" style="text-align: center;"> <table border="1" style="width: 100%; border-collapse: collapse; text-align: center;"> <tr> <td style="width: 10%;"></td> <td style="width: 10%;"></td> <td style="width: 10%;"></td> <td style="width: 10%;"></td> <td style="width: 10%;"></td> <td style="width:
10%;"></td> <td style="width: 10%;"></td> <td style="width: 10%;"></td> <td style="width: 10%;"></td> <td style="width: 10%;"></td> </tr> <tr> <td></td> <td></td> <td colspan="8" style="text-align: center;"> <table border="1" style="width: 100%; border-collapse: collapse; text-align: center;"> <tr> <td style="width: 10%;"></td> <td style="width: 10%;"></td> <td style="width: 10%;"></td> <td style="width: 10%;"></td> <td style="width: 10%;"></td> <td style="width: 10%;"></td> <td style="width: 10%;"></td> <td style="width: 10%;"></td> <td style="width: 10%;"></td> <td style="width: 10%;"></td> </tr> <tr> <td></td> <td></td> <td colspan="8" style="text-align: center;"> <table border="1" style="width: 100%; border-collapse: collapse; text-align: center;"> <tr> <td style="width: 10%;"></td> <td style="width: 10%;"></td> <td style="width: 10%;"></td> <td style="width: 10%;"></td> <td style="width: 10%;"></td> <td style="width: 10%;"></td> <td style="width: 10%;"></td> <td style="width: 10%;"></td> <td style="width: 10%;"></td> <td style="width: 10%;"></td> </tr> <tr> <td></td> <td></td> <td colspan="8" style="text-align: center;"> <table border="1" style="width: 100%; border-collapse: collapse; text-align: center;"> <tr> </tr></table></td></tr></table></td></tr></table></td></tr></table></td></tr></table></td></tr></table></td></tr></table></td></tr></table></td></tr></table></td></tr></table></td></tr></table></td></tr></table></td></tr></table></td></tr></table></td></tr></table></td></tr></table></td></tr></table></td></tr></table></td></tr></table></td></tr></table></td></tr></table></td></tr></table></td></tr></table></td></tr></table></td></tr></table></td></tr></table></td></tr></table></td></tr></table></td></tr></table></td></tr></table></td></tr></table></td></tr></table></td></tr></table></td></tr></table></td></tr></table></td></tr></table></td></tr></table></td></tr></table></td></tr></table></td></tr></table></td></tr></table>
 | | | | | | | | | | | | | | | | | | | | <table border="1" style="width: 100%; border-collapse: collapse; text-align: center;"> <tr> <td style="width: 10%;"></td> <td style="width: 10%;"></td> <td style="width: 10%;"></td> <td style="width: 10%;"></td> <td style="width: 10%;"></td> <td style="width: 10%;"></td> <td style="width: 10%;"></td> <td style="width: 10%;"></td> <td style="width: 10%;"></td> <td style="width: 10%;"></td> </tr> <tr> <td></td> <td></td> <td colspan="8" style="text-align: center;"> <table border="1" style="width: 100%; border-collapse: collapse; text-align: center;"> <tr> <td style="width: 10%;"></td> <td style="width: 10%;"></td> <td style="width: 10%;"></td> <td style="width: 10%;"></td> <td style="width: 10%;"></td> <td style="width: 10%;"></td> <td style="width: 10%;"></td> <td style="width: 10%;"></td> <td style="width: 10%;"></td> <td style="width: 10%;"></td> </tr> <tr> <td></td> <td></td> <td colspan="8" style="text-align: center;"> <table border="1" style="width: 100%; border-collapse: collapse; text-align: center;"> <tr> <td style="width: 10%;"></td> <td style="width: 10%;"></td> <td style="width: 10%;"></td> <td style="width: 10%;"></td> <td style="width: 10%;"></td> <td style="width: 10%;"></td> <td style="width: 10%;"></td> <td style="width: 10%;"></td> <td style="width: 10%;"></td> <td style="width: 10%;"></td> </tr> <tr> <td></td> <td></td> <td colspan="8" style="text-align: center;"> <table border="1" style="width: 100%; border-collapse: collapse; text-align: center;"> <tr> <td style="width: 10%;"></td> <td style="width: 10%;"></td> <td style="width: 10%;"></td> <td style="width: 10%;"></td> <td style="width: 10%;"></td> <td style="width: 10%;"></td> <td style="width: 10%;"></td> <td style="width: 10%;"></td> <td style="width: 10%;"></td> <td style="width: 10%;"></td> </tr> <tr> <td></td> <td></td> <td colspan="8" style="text-align: center;"> <table border="1" style="width: 100%; border-collapse: collapse; text-align: center;"> <tr> <td style="width: 10%;"></td> <td style="width: 10%;"></td> <td style="width: 10%;"></td> <td style="width: 10%;"></td> <td style="width: 10%;"></td> <td style="width: 10%;"></td> <td style="width: 10%;"></td> <td style="width: 10%;"></td> <td style="width: 10%;"></td> <td style="width: 10%;"></td> </tr> <tr> <td></td> <td></td> <td colspan="8" style="text-align: center;"> <table border="1" style="width: 100%; border-collapse: collapse; text-align: center;"> <tr> <td style="width: 10%;"></td> <td style="width: 10%;"></td> <td style="width: 10%;"></td> <td style="width: 10%;"></td> <td style="width: 10%;"></td> <td style="width: 10%;"></td> <td style="width: 10%;"></td> <td style="width: 10%;"></td> <td style="width: 10%;"></td> <td style="width: 10%;"></td> </tr> <tr> <td></td> <td></td> <td colspan="8" style="text-align: center;"> <table border="1" style="width: 100%; border-collapse: collapse; text-align: center;"> <tr> <td style="width: 10%;"></td> <td style="width: 10%;"></td> <td style="width: 10%;"></td> <td style="width: 10%;"></td> <td style="width: 10%;"></td> <td style="width: 10%;"></td> <td style="width: 10%;"></td> <td style="width: 10%;"></td> <td style="width: 10%;"></td> <td style="width: 10%;"></td> </tr> <tr> <td></td> <td></td> <td colspan="8" style="text-align: center;"> <table border="1" style="width: 100%; border-collapse: collapse; text-align: center;"> <tr> <td style="width: 10%;"></td> <td style="width: 10%;"></td> <td style="width: 10%;"></td> <td style="width: 10%;"></td> <td style="width: 10%;"></td> <td style="width: 10%;"></td> <td style="width: 10%;"></td> <td style="width: 10%;"></td> <td style="width: 10%;"></td> <td style="width: 10%;"></td> </tr> <tr> <td></td> <td></td> <td colspan="8" style="text-align: center;"> <table border="1" style="width: 100%; border-collapse: collapse; text-align: center;"> <tr> <td style="width: 10%;"></td> <td style="width: 10%;"></td> <td style="width: 10%;"></td> <td style="width: 10%;"></td> <td style="width: 10%;"></td> <td style="width: 10%;"></td> <td style="width: 10%;"></td> <td style="width: 10%;"></td> <td style="width: 10%;"></td> <td style="width: 10%;"></td> </tr> <tr> <td></td> <td></td> <td colspan="8" style="text-align: center;"> <table border="1" style="width: 100%; border-collapse: collapse; text-align: center;"> <tr> <td style="width: 10%;"></td> <td style="width: 10%;"></td> <td style="width: 10%;"></td> <td style="width: 10%;"></td> <td style="width: 10%;"></td> <td style="width: 10%;"></td> <td style="width: 10%;"></td> <td style="width: 10%;"></td> <td style="width: 10%;"></td> <td style="width: 10%;"></td> </tr> <tr> <td></td> <td></td> <td colspan="8" style="text-align: center;"> <table border="1" style="width: 100%; border-collapse: collapse; text-align: center;"> <tr> <td style="width: 10%;"></td> <td style="width: 10%;"></td> <td style="width: 10%;"></td> <td style="width: 10%;"></td> <td style="width: 10%;"></td> <td style="width: 10%;"></td> <td style="width: 10%;"></td> <td style="width: 10%;"></td> <td style="width: 10%;"></td> <td style="width: 10%;"></td> </tr> <tr> <td></td> <td></td> <td colspan="8" style="text-align: center;"> <table border="1" style="width: 100%; border-collapse: collapse; text-align: center;"> <tr> <td style="width: 10%;"></td> <td style="width: 10%;"></td> <td style="width: 10%;"></td> <td style="width: 10%;"></td> <td style="width: 10%;"></td> <td style="width: 10%;"></td> <td style="width: 10%;"></td> <td style="width: 10%;"></td> <td style="width: 10%;"></td> <td style="width: 10%;"></td> </tr> <tr> <td></td> <td></td> <td colspan="8" style="text-align: center;"> <table border="1" style="width: 100%; border-collapse: collapse; text-align: center;"> <tr> <td style="width: 10%;"></td> <td style="width: 10%;"></td> <td style="width: 10%;"></td> <td style="width: 10%;"></td> <td style="width: 10%;"></td> <td style="width: 10%;"></td> <td style="width: 10%;"></td> <td style="width: 10%;"></td> <td style="width: 10%;"></td> <td style="width: 10%;"></td> </tr> <tr> <td></td> <td></td> <td colspan="8" style="text-align: center;"> <table border="1" style="width: 100%; border-collapse: collapse; text-align: center;"> <tr> <td style="width: 10%;"></td> <td style="width: 10%;"></td> <td style="width: 10%;"></td> <td style="width: 10%;"></td> <td style="width: 10%;"></td> <td style="width: 10%;"></td> <td style="width: 10%;"></td> <td style="width: 10%;"></td> <td style="width: 10%;"></td> <td style="width: 10%;"></td> </tr> <tr> <td></td> <td></td> <td colspan="8" style="text-align: center;"> <table border="1" style="width: 100%; border-collapse: collapse; text-align: center;"> <tr> <td style="width: 10%;"></td> <td style="width: 10%;"></td> <td style="width: 10%;"></td> <td style="width: 10%;"></td> <td style="width: 10%;"></td> <td style="width: 10%;"></td> <td style="width: 10%;"></td> <td style="width: 10%;"></td> <td style="width: 10%;"></td> <td style="width: 10%;"></td> </tr> <tr> <td></td> <td></td> <td colspan="8" style="text-align: center;"> <table border="1" style="width: 100%; border-collapse: collapse; text-align: center;"> <tr> <td style="width: 10%;"></td> <td style="width: 10%;"></td> <td style="width: 10%;"></td> <td style="width: 10%;"></td> <td style="width: 10%;"></td> <td style="width: 10%;"></td> <td style="width: 10%;"></td> <td style="width: 10%;"></td> <td style="width: 10%;"></td> <td style="width: 10%;"></td> </tr> <tr> <td></td> <td></td> <td colspan="8" style="text-align: center;"> <table border="1" style="width: 100%; border-collapse: collapse; text-align: center;"> <tr> <td style="width: 10%;"></td> <td style="width: 10%;"></td> <td style="width: 10%;"></td> <td style="width: 10%;"></td> <td style="width: 10%;"></td> <td style="width: 10%;"></td> <td
style="width: 10%;"></td> <td style="width: 10%;"></td> <td style="width: 10%;"></td> <td style="width: 10%;"></td> </tr> <tr> <td></td> <td></td> <td colspan="8" style="text-align: center;"> <table border="1" style="width: 100%; border-collapse: collapse; text-align: center;"> <tr> <td style="width: 10%;"></td> <td style="width: 10%;"></td> <td style="width: 10%;"></td> <td style="width: 10%;"></td> <td style="width: 10%;"></td> <td style="width: 10%;"></td> <td style="width: 10%;"></td> <td style="width: 10%;"></td> <td style="width: 10%;"></td> <td style="width: 10%;"></td> </tr> <tr> <td></td> <td></td> <td colspan="8" style="text-align: center;"> <table border="1" style="width: 100%; border-collapse: collapse; text-align: center;"> <tr> <td style="width: 10%;"></td> <td style="width: 10%;"></td> <td style="width: 10%;"></td> <td style="width: 10%;"></td> <td style="width: 10%;"></td> <td style="width: 10%;"></td> <td style="width: 10%;"></td> <td style="width: 10%;"></td> <td style="width: 10%;"></td> <td style="width: 10%;"></td> </tr> <tr> <td></td> <td></td> <td colspan="8" style="text-align: center;"> <table border="1" style="width: 100%; border-collapse: collapse; text-align: center;"> <tr> <td style="width: 10%;"></td> <td style="width: 10%;"></td> <td style="width: 10%;"></td> <td style="width: 10%;"></td> <td style="width: 10%;"></td> <td style="width: 10%;"></td> <td style="width: 10%;"></td> <td style="width: 10%;"></td> <td style="width: 10%;"></td> <td style="width: 10%;"></td> </tr> <tr> <td></td> <td></td> <td colspan="8" style="text-align: center;"> <table border="1" style="width: 100%; border-collapse: collapse; text-align: center;"> <tr> <td style="width: 10%;"></td> <td style="width: 10%;"></td> <td style="width: 10%;"></td> <td style="width: 10%;"></td> <td style="width: 10%;"></td> <td style="width: 10%;"></td> <td style="width: 10%;"></td> <td style="width: 10%;"></td> <td style="width: 10%;"></td> <td style="width: 10%;"></td> </tr> <tr> <td></td> <td></td> <td colspan="8" style="text-align: center;"> <table border="1" style="width: 100%; border-collapse: collapse; text-align: center;"> <tr> <td style="width: 10%;"></td> <td style="width: 10%;"></td> <td style="width: 10%;"></td> <td style="width: 10%;"></td> <td style="width: 10%;"></td> <td style="width: 10%;"></td> <td style="width: 10%;"></td> <td style="width: 10%;"></td> <td style="width: 10%;"></td> <td style="width: 10%;"></td> </tr> <tr> <td></td> <td></td> <td colspan="8" style="text-align: center;"> <table border="1" style="width: 100%; border-collapse: collapse; text-align: center;"> <tr> <td style="width: 10%;"></td> <td style="width: 10%;"></td> <td style="width: 10%;"></td> <td style="width: 10%;"></td> <td style="width: 10%;"></td> <td style="width: 10%;"></td> <td style="width: 10%;"></td> <td style="width: 10%;"></td> <td style="width: 10%;"></td> <td style="width: 10%;"></td> </tr> <tr> <td></td> <td></td> <td colspan="8" style="text-align: center;"> <table border="1" style="width: 100%; border-collapse: collapse; text-align: center;"> <tr> <td style="width: 10%;"></td> <td style="width: 10%;"></td> <td style="width: 10%;"></td> <td style="width: 10%;"></td> <td style="width: 10%;"></td> <td style="width: 10%;"></td> <td style="width: 10%;"></td> <td style="width: 10%;"></td> <td style="width: 10%;"></td> <td style="width: 10%;"></td> </tr> <tr> <td></td> <td></td> <td colspan="8" style="text-align: center;"> <table border="1" style="width: 100%; border-collapse: collapse; text-align: center;"> <tr> <td style="width: 10%;"></td> <td style="width: 10%;"></td> <td style="width: 10%;"></td> <td style="width: 10%;"></td> <td style="width: 10%;"></td> <td style="width: 10%;"></td> <td style="width: 10%;"></td> <td style="width: 10%;"></td> <td style="width: 10%;"></td> <td style="width: 10%;"></td> </tr> <tr> <td></td> <td></td> <td colspan="8" style="text-align: center;"> <table border="1" style="width: 100%; border-collapse: collapse; text-align: center;"> <tr> <td style="width: 10%;"></td> <td style="width: 10%;"></td> <td style="width: 10%;"></td> <td style="width: 10%;"></td> <td style="width: 10%;"></td> <td style="width: 10%;"></td> <td style="width: 10%;"></td> <td style="width: 10%;"></td> <td style="width: 10%;"></td> <td style="width: 10%;"></td> </tr> <tr> <td></td> <td></td> <td colspan="8" style="text-align: center;"> <table border="1" style="width: 100%; border-collapse: collapse; text-align: center;"> <tr> <td style="width: 10%;"></td> <td style="width: 10%;"></td> <td style="width: 10%;"></td> <td style="width: 10%;"></td> <td style="width: 10%;"></td> <td style="width: 10%;"></td> <td style="width: 10%;"></td> <td style="width: 10%;"></td> <td style="width: 10%;"></td> <td style="width: 10%;"></td> </tr> <tr> <td></td> <td></td> <td colspan="8" style="text-align: center;"> <table border="1" style="width: 100%; border-collapse: collapse; text-align: center;"> <tr> <td style="width: 10%;"></td> <td style="width: 10%;"></td> <td style="width: 10%;"></td> <td style="width: 10%;"></td> <td style="width: 10%;"></td> <td style="width: 10%;"></td> <td style="width: 10%;"></td> <td style="width: 10%;"></td> <td style="width: 10%;"></td> <td style="width: 10%;"></td> </tr> <tr> <td></td> <td></td> <td colspan="8" style="text-align: center;"> <table border="1" style="width: 100%; border-collapse: collapse; text-align: center;"> <tr> <td style="width: 10%;"></td> <td style="width: 10%;"></td> <td style="width: 10%;"></td> <td style="width: 10%;"></td> <td style="width: 10%;"></td> <td style="width: 10%;"></td> <td style="width: 10%;"></td> <td style="width: 10%;"></td> <td style="width: 10%;"></td> <td style="width: 10%;"></td> </tr> <tr> <td></td> <td></td> <td colspan="8" style="text-align: center;"> <table border="1" style="width: 100%; border-collapse: collapse; text-align: center;"> <tr> <td style="width: 10%;"></td> <td style="width: 10%;"></td> <td style="width: 10%;"></td> <td style="width: 10%;"></td> <td style="width: 10%;"></td> <td style="width: 10%;"></td> <td style="width: 10%;"></td> <td style="width: 10%;"></td> <td style="width: 10%;"></td> <td style="width: 10%;"></td> </tr> <tr> <td></td> <td></td> <td colspan="8" style="text-align: center;"> <table border="1" style="width: 100%; border-collapse: collapse; text-align: center;"> <tr> <td style="width: 10%;"></td> <td style="width: 10%;"></td> <td style="width: 10%;"></td> <td style="width: 10%;"></td> <td style="width: 10%;"></td> <td style="width: 10%;"></td> <td style="width: 10%;"></td> <td style="width: 10%;"></td> <td style="width: 10%;"></td> <td style="width: 10%;"></td> </tr> <tr> <td></td> <td></td> <td colspan="8" style="text-align: center;"> <table border="1" style="width: 100%; border-collapse: collapse; text-align: center;"> <tr> <td style="width: 10%;"></td> <td style="width: 10%;"></td> <td style="width: 10%;"></td> <td style="width: 10%;"></td> <td style="width: 10%;"></td> <td style="width: 10%;"></td> <td style="width: 10%;"></td> <td style="width: 10%;"></td> <td style="width: 10%;"></td> <td style="width: 10%;"></td> </tr> <tr> <td></td> <td></td> <td colspan="8" style="text-align: center;"> <table border="1" style="width: 100%; border-collapse: collapse; text-align: center;"> <tr> <td style="width: 10%;"></td> <td style="width: 10%;"></td> <td style="width: 10%;"></td> <td style="width: 10%;"></td> <td style="width: 10%;"></td> <td style="width: 10%;"></td> <td style="width: 10%;"></td> <td style="width: 10%;"></td> <td style="width: 10%;"></td> <td style="width: 10%;"></td> </tr> <tr> <td></td> <td></td> <td colspan="8" style="text-align: center;"> <table border="1" style="width: 100%; border-collapse: collapse; text-align: center;"> <tr> <td style="width: 10%;"></td> <td style="width: 10%;"></td> <td style="width: 10%;"></td> <td style="width: 10%;"></td> <td style="width: 10%;"></td> <td style="width: 10%;"></td> <td style="width: 10%;"></td> <td style="width: 10%;"></td> <td style="width: 10%;"></td> <td style="width: 10%;"></td> </tr> <tr> <td></td> <td></td> <td colspan="8" style="text-align: center;"> <table border="1" style="width: 100%; border-collapse: collapse; text-align: center;"> <tr> <td style="width: 10%;"></td> <td style="width: 10%;"></td> <td style="width: 10%;"></td> <td style="width: 10%;"></td> <td style="width: 10%;"></td> <td style="width: 10%;"></td> <td style="width: 10%;"></td> <td style="width: 10%;"></td> <td style="width: 10%;"></td> <td style="width: 10%;"></td> </tr> <tr> <td></td> <td></td> <td colspan="8" style="text-align: center;"> <table border="1" style="width: 100%; border-collapse: collapse; text-align: center;"> <tr> <td style="width: 10%;"></td> <td style="width: 10%;"></td> <td style="width: 10%;"></td> <td style="width: 10%;"></td> <td style="width: 10%;"></td> <td style="width: 10%;"></td> <td style="width: 10%;"></td> <td style="width: 10%;"></td> <td style="width: 10%;"></td> <td style="width: 10%;"></td> </tr> <tr> <td></td> <td></td> <td colspan="8" style="text-align: center;"> <table border="1" style="width: 100%; border-collapse: collapse; text-align: center;"> <tr> <td style="width: 10%;"></td> <td style="width: 10%;"></td> <td style="width: 10%;"></td> <td style="width: 10%;"></td> <td style="width: 10%;"></td> <td style="width: 10%;"></td> <td style="width: 10%;"></td> <td style="width: 10%;"></td> <td style="width: 10%;"></td> <td style="width: 10%;"></td> </tr> <tr> <td></td> <td></td> <td colspan="8" style="text-align: center;"> <table border="1" style="width: 100%; border-collapse: collapse; text-align: center;"> <tr> <td style="width: 10%;"></td> <td style="width: 10%;"></td> <td style="width: 10%;"></td> <td style="width: 10%;"></td> <td style="width: 10%;"></td> <td style="width: 10%;"></td> <td style="width: 10%;"></td> <td style="width: 10%;"></td> <td style="width: 10%;"></td> <td style="width: 10%;"></td> </tr> <tr> <td></td> <td></td> <td colspan="8"
style="text-align: center;"> <table border="1" style="width: 100%; border-collapse: collapse; text-align: center;"> <tr> <td style="width: 10%;"></td> <td style="width: 10%;"></td> <td style="width: 10%;"></td> <td style="width: 10%;"></td> <td style="width: 10%;"></td> <td style="width: 10%;"></td> <td style="width: 10%;"></td> <td style="width: 10%;"></td> <td style="width: 10%;"></td> <td style="width: 10%;"></td> </tr> <tr> <td></td> <td></td> <td colspan="8" style="text-align: center;"> <table border="1" style="width: 100%; border-collapse: collapse; text-align: center;"> <tr> </tr></table></td></tr></table></td></tr></table></td></tr></table></td></tr></table></td></tr></table></td></tr></table></td></tr></table></td></tr></table></td></tr></table></td></tr></table></td></tr></table></td></tr></table></td></tr></table></td></tr></table></td></tr></table></td></tr></table></td></tr></table></td></tr></table></td></tr></table></td></tr></table></td></tr></table></td></tr></table></td></tr></table></td></tr></table></td></tr></table></td></tr></table></td></tr></table></td></tr></table></td></tr></table></td></tr></table></td></tr></table></td></tr></table></td></tr></table></td></tr></table></td></tr></table></td></tr></table></td></tr></table></td></tr></table></td></tr></table>
 | | | | | | | | | | | | | | | | | | | | <table border="1" style="width: 100%; border-collapse: collapse; text-align: center;"> <tr> <td style="width: 10%;"></td> <td style="width: 10%;"></td> <td style="width: 10%;"></td> <td style="width: 10%;"></td> <td style="width: 10%;"></td> <td style="width: 10%;"></td> <td style="width: 10%;"></td> <td style="width: 10%;"></td> <td style="width: 10%;"></td> <td style="width: 10%;"></td> </tr> <tr> <td></td> <td></td> <td colspan="8" style="text-align: center;"> <table border="1" style="width: 100%; border-collapse: collapse; text-align: center;"> <tr> <td style="width: 10%;"></td> <td style="width: 10%;"></td> <td style="width: 10%;"></td> <td style="width: 10%;"></td> <td style="width: 10%;"></td> <td style="width: 10%;"></td> <td style="width: 10%;"></td> <td style="width: 10%;"></td> <td style="width: 10%;"></td> <td style="width: 10%;"></td> </tr> <tr> <td></td> <td></td> <td colspan="8" style="text-align: center;"> <table border="1" style="width: 100%; border-collapse: collapse; text-align: center;"> <tr> <td style="width: 10%;"></td> <td style="width: 10%;"></td> <td style="width: 10%;"></td> <td style="width: 10%;"></td> <td style="width: 10%;"></td> <td style="width: 10%;"></td> <td style="width: 10%;"></td> <td style="width: 10%;"></td> <td style="width: 10%;"></td> <td style="width: 10%;"></td> </tr> <tr> <td></td> <td></td> <td colspan="8" style="text-align: center;"> <table border="1" style="width: 100%; border-collapse: collapse; text-align: center;"> <tr> <td style="width: 10%;"></td> <td style="width: 10%;"></td> <td style="width: 10%;"></td> <td style="width: 10%;"></td> <td style="width: 10%;"></td> <td style="width: 10%;"></td> <td style="width: 10%;"></td> <td style="width: 10%;"></td> <td style="width: 10%;"></td> <td style="width: 10%;"></td> </tr> <tr> <td></td> <td></td> <td colspan="8" style="text-align: center;"> <table border="1" style="width: 100%; border-collapse: collapse; text-align: center;"> <tr> <td style="width: 10%;"></td> <td style="width: 10%;"></td> <td style="width: 10%;"></td> <td style="width: 10%;"></td> <td style="width: 10%;"></td> <td style="width: 10%;"></td> <td style="width: 10%;"></td> <td style="width: 10%;"></td> <td style="width: 10%;"></td> <td style="width: 10%;"></td> </tr> <tr> <td></td> <td></td> <td colspan="8" style="text-align: center;"> <table border="1" style="width: 100%; border-collapse: collapse; text-align: center;"> <tr> <td style="width: 10%;"></td> <td style="width: 10%;"></td> <td style="width: 10%;"></td> <td style="width: 10%;"></td> <td style="width: 10%;"></td> <td style="width: 10%;"></td> <td style="width: 10%;"></td> <td style="width: 10%;"></td> <td style="width: 10%;"></td> <td style="width: 10%;"></td> </tr> <tr> <td></td> <td></td> <td colspan="8" style="text-align: center;"> <table border="1" style="width: 100%; border-collapse: collapse; text-align: center;"> <tr> <td style="width: 10%;"></td> <td style="width: 10%;"></td> <td style="width: 10%;"></td> <td style="width: 10%;"></td> <td style="width: 10%;"></td> <td style="width: 10%;"></td> <td style="width: 10%;"></td> <td style="width: 10%;"></td> <td style="width: 10%;"></td> <td style="width: 10%;"></td> </tr> <tr> <td></td> <td></td> <td colspan="8" style="text-align: center;"> <table border="1" style="width: 100%; border-collapse: collapse; text-align: center;"> <tr> <td style="width: 10%;"></td> <td style="width: 10%;"></td> <td style="width: 10%;"></td> <td style="width: 10%;"></td> <td style="width: 10%;"></td> <td style="width: 10%;"></td> <td style="width: 10%;"></td> <td style="width: 10%;"></td> <td style="width: 10%;"></td> <td style="width: 10%;"></td> </tr> <tr> <td></td> <td></td> <td colspan="8" style="text-align: center;"> <table border="1" style="width: 100%; border-collapse: collapse; text-align: center;"> <tr> <td style="width: 10%;"></td> <td style="width: 10%;"></td> <td style="width: 10%;"></td> <td style="width: 10%;"></td> <td style="width: 10%;"></td> <td style="width: 10%;"></td> <td style="width: 10%;"></td> <td style="width: 10%;"></td> <td style="width: 10%;"></td> <td style="width: 10%;"></td> </tr> <tr> <td></td> <td></td> <td colspan="8" style="text-align: center;"> <table border="1" style="width: 100%; border-collapse: collapse; text-align: center;"> <tr> <td style="width: 10%;"></td> <td style="width: 10%;"></td> <td style="width: 10%;"></td> <td style="width: 10%;"></td> <td style="width: 10%;"></td> <td style="width: 10%;"></td> <td style="width: 10%;"></td> <td style="width: 10%;"></td> <td style="width: 10%;"></td> <td style="width: 10%;"></td> </tr> <tr> <td></td> <td></td> <td colspan="8" style="text-align: center;"> <table border="1" style="width: 100%; border-collapse: collapse; text-align: center;"> <tr> <td style="width: 10%;"></td> <td style="width: 10%;"></td> <td style="width: 10%;"></td> <td style="width: 10%;"></td> <td style="width: 10%;"></td> <td style="width: 10%;"></td> <td style="width: 10%;"></td> <td style="width: 10%;"></td> <td style="width: 10%;"></td> <td style="width: 10%;"></td> </tr> <tr> <td></td> <td></td> <td colspan="8" style="text-align: center;"> <table border="1" style="width: 100%; border-collapse: collapse; text-align: center;"> <tr> <td style="width: 10%;"></td> <td style="width: 10%;"></td> <td style="width: 10%;"></td> <td style="width: 10%;"></td> <td style="width: 10%;"></td> <td style="width: 10%;"></td> <td style="width: 10%;"></td> <td style="width: 10%;"></td> <td style="width: 10%;"></td> <td style="width: 10%;"></td> </tr> <tr> <td></td> <td></td> <td colspan="8" style="text-align: center;"> <table border="1" style="width: 100%; border-collapse: collapse; text-align: center;"> <tr> <td style="width: 10%;"></td> <td style="width: 10%;"></td> <td style="width: 10%;"></td> <td style="width: 10%;"></td> <td style="width: 10%;"></td> <td style="width: 10%;"></td> <td style="width: 10%;"></td> <td style="width: 10%;"></td> <td style="width: 10%;"></td> <td style="width: 10%;"></td> </tr> <tr> <td></td> <td></td> <td colspan="8" style="text-align: center;"> <table border="1" style="width: 100%; border-collapse: collapse; text-align: center;"> <tr> <td style="width: 10%;"></td> <td style="width: 10%;"></td> <td style="width: 10%;"></td> <td style="width: 10%;"></td> <td style="width: 10%;"></td> <td style="width: 10%;"></td> <td style="width: 10%;"></td> <td style="width: 10%;"></td> <td style="width: 10%;"></td> <td style="width: 10%;"></td> </tr> <tr> <td></td> <td></td> <td colspan="8" style="text-align: center;"> <table border="1" style="width: 100%; border-collapse: collapse; text-align: center;"> <tr> <td style="width: 10%;"></td> <td style="width: 10%;"></td> <td style="width: 10%;"></td> <td style="width: 10%;"></td> <td style="width: 10%;"></td> <td style="width: 10%;"></td> <td style="width: 10%;"></td> <td style="width: 10%;"></td> <td style="width: 10%;"></td> <td style="width: 10%;"></td> </tr> <tr> <td></td> <td></td> <td colspan="8" style="text-align: center;"> <table border="1" style="width: 100%; border-collapse: collapse; text-align: center;"> <tr> <td style="width: 10%;"></td> <td style="width: 10%;"></td> <td style="width: 10%;"></td> <td style="width: 10%;"></td> <td style="width: 10%;"></td> <td style="width: 10%;"></td> <td style="width: 10%;"></td> <td style="width: 10%;"></td> <td style="width: 10%;"></td> <td style="width: 10%;"></td> </tr> <tr> <td></td> <td></td> <td colspan="8" style="text-align: center;"> <table border="1" style="width: 100%; border-collapse: collapse; text-align: center;"> <tr> <td style="width: 10%;"></td> <td style="width: 10%;"></td> <td style="width: 10%;"></td> <td style="width: 10%;"></td> <td style="width: 10%;"></td> <td style="width: 10%;"></td> <td style="width: 10%;"></td> <td style="width: 10%;"></td> <td style="width: 10%;"></td> <td style="width: 10%;"></td> </tr> <tr> <td></td> <td></td> <td colspan="8" style="text-align: center;"> <table border="1" style="width: 100%; border-collapse: collapse; text-align: center;"> <tr> <td style="width: 10%;"></td> <td style="width: 10%;"></td> <td style="width: 10%;"></td> <td style="width: 10%;"></td> <td style="width: 10%;"></td> <td style="width: 10%;"></td> <td style="width: 10%;"></td> <td style="width: 10%;"></td> <td style="width: 10%;"></td> <td style="width: 10%;"></td> </tr> <tr> <td></td> <td></td> <td colspan="8" style="text-align: center;">
<table border="1" style="width: 100%; border-collapse: collapse; text-align: center;"> <tr> <td style="width: 10%;"></td> <td style="width: 10%;"></td> <td style="width: 10%;"></td> <td style="width: 10%;"></td> <td style="width: 10%;"></td> <td style="width: 10%;"></td> <td style="width: 10%;"></td> <td style="width: 10%;"></td> <td style="width: 10%;"></td> <td style="width: 10%;"></td> </tr> <tr> <td></td> <td></td> <td colspan="8" style="text-align: center;"> <table border="1" style="width: 100%; border-collapse: collapse; text-align: center;"> <tr> <td style="width: 10%;"></td> <td style="width: 10%;"></td> <td style="width: 10%;"></td> <td style="width: 10%;"></td> <td style="width: 10%;"></td> <td style="width: 10%;"></td> <td style="width: 10%;"></td> <td style="width: 10%;"></td> <td style="width: 10%;"></td> <td style="width: 10%;"></td> </tr> <tr> <td></td> <td></td> <td colspan="8" style="text-align: center;"> <table border="1" style="width: 100%; border-collapse: collapse; text-align: center;"> <tr> <td style="width: 10%;"></td> <td style="width: 10%;"></td> <td style="width: 10%;"></td> <td style="width: 10%;"></td> <td style="width: 10%;"></td> <td style="width: 10%;"></td> <td style="width: 10%;"></td> <td style="width: 10%;"></td> <td style="width: 10%;"></td> <td style="width: 10%;"></td> </tr> <tr> <td></td> <td></td> <td colspan="8" style="text-align: center;"> <table border="1" style="width: 100%; border-collapse: collapse; text-align: center;"> <tr> <td style="width: 10%;"></td> <td style="width: 10%;"></td> <td style="width: 10%;"></td> <td style="width: 10%;"></td> <td style="width: 10%;"></td> <td style="width: 10%;"></td> <td style="width: 10%;"></td> <td style="width: 10%;"></td> <td style="width: 10%;"></td> <td style="width: 10%;"></td> </tr> <tr> <td></td> <td></td> <td colspan="8" style="text-align: center;"> <table border="1" style="width: 100%; border-collapse: collapse; text-align: center;"> <tr> <td style="width: 10%;"></td> <td style="width: 10%;"></td> <td style="width: 10%;"></td> <td style="width: 10%;"></td> <td style="width: 10%;"></td> <td style="width: 10%;"></td> <td style="width: 10%;"></td> <td style="width: 10%;"></td> <td style="width: 10%;"></td> <td style="width: 10%;"></td> </tr> <tr> <td></td> <td></td> <td colspan="8" style="text-align: center;"> <table border="1" style="width: 100%; border-collapse: collapse; text-align: center;"> <tr> <td style="width: 10%;"></td> <td style="width: 10%;"></td> <td style="width: 10%;"></td> <td style="width: 10%;"></td> <td style="width: 10%;"></td> <td style="width: 10%;"></td> <td style="width: 10%;"></td> <td style="width: 10%;"></td> <td style="width: 10%;"></td> <td style="width: 10%;"></td> </tr> <tr> <td></td> <td></td> <td colspan="8" style="text-align: center;"> <table border="1" style="width: 100%; border-collapse: collapse; text-align: center;"> <tr> <td style="width: 10%;"></td> <td style="width: 10%;"></td> <td style="width: 10%;"></td> <td style="width: 10%;"></td> <td style="width: 10%;"></td> <td style="width: 10%;"></td> <td style="width: 10%;"></td> <td style="width: 10%;"></td> <td style="width: 10%;"></td> <td style="width: 10%;"></td> </tr> <tr> <td></td> <td></td> <td colspan="8" style="text-align: center;"> <table border="1" style="width: 100%; border-collapse: collapse; text-align: center;"> <tr> <td style="width: 10%;"></td> <td style="width: 10%;"></td> <td style="width: 10%;"></td> <td style="width: 10%;"></td> <td style="width: 10%;"></td> <td style="width: 10%;"></td> <td style="width: 10%;"></td> <td style="width: 10%;"></td> <td style="width: 10%;"></td> <td style="width: 10%;"></td> </tr> <tr> <td></td> <td></td> <td colspan="8" style="text-align: center;"> <table border="1" style="width: 100%; border-collapse: collapse; text-align: center;"> <tr> <td style="width: 10%;"></td> <td style="width: 10%;"></td> <td style="width: 10%;"></td> <td style="width: 10%;"></td> <td style="width: 10%;"></td> <td style="width: 10%;"></td> <td style="width: 10%;"></td> <td style="width: 10%;"></td> <td style="width: 10%;"></td> <td style="width: 10%;"></td> </tr> <tr> <td></td> <td></td> <td colspan="8" style="text-align: center;"> <table border="1" style="width: 100%; border-collapse: collapse; text-align: center;"> <tr> <td style="width: 10%;"></td> <td style="width: 10%;"></td> <td style="width: 10%;"></td> <td style="width: 10%;"></td> <td style="width: 10%;"></td> <td style="width: 10%;"></td> <td style="width: 10%;"></td> <td style="width: 10%;"></td> <td style="width: 10%;"></td> <td style="width: 10%;"></td> </tr> <tr> <td></td> <td></td> <td colspan="8" style="text-align: center;"> <table border="1" style="width: 100%; border-collapse: collapse; text-align: center;"> <tr> <td style="width: 10%;"></td> <td style="width: 10%;"></td> <td style="width: 10%;"></td> <td style="width: 10%;"></td> <td style="width: 10%;"></td> <td style="width: 10%;"></td> <td style="width: 10%;"></td> <td style="width: 10%;"></td> <td style="width: 10%;"></td> <td style="width: 10%;"></td> </tr> <tr> <td></td> <td></td> <td colspan="8" style="text-align: center;"> <table border="1" style="width: 100%; border-collapse: collapse; text-align: center;"> <tr> <td style="width: 10%;"></td> <td style="width: 10%;"></td> <td style="width: 10%;"></td> <td style="width: 10%;"></td> <td style="width: 10%;"></td> <td style="width: 10%;"></td> <td style="width: 10%;"></td> <td style="width: 10%;"></td> <td style="width: 10%;"></td> <td style="width: 10%;"></td> </tr> <tr> <td></td> <td></td> <td colspan="8" style="text-align: center;"> <table border="1" style="width: 100%; border-collapse: collapse; text-align: center;"> <tr> <td style="width: 10%;"></td> <td style="width: 10%;"></td> <td style="width: 10%;"></td> <td style="width: 10%;"></td> <td style="width: 10%;"></td> <td style="width: 10%;"></td> <td style="width: 10%;"></td> <td style="width: 10%;"></td> <td style="width: 10%;"></td> <td style="width: 10%;"></td> </tr> <tr> <td></td> <td></td> <td colspan="8" style="text-align: center;"> <table border="1" style="width: 100%; border-collapse: collapse; text-align: center;"> <tr> <td style="width: 10%;"></td> <td style="width: 10%;"></td> <td style="width: 10%;"></td> <td style="width: 10%;"></td> <td style="width: 10%;"></td> <td style="width: 10%;"></td> <td style="width: 10%;"></td> <td style="width: 10%;"></td> <td style="width: 10%;"></td> <td style="width: 10%;"></td> </tr> <tr> <td></td> <td></td> <td colspan="8" style="text-align: center;"> <table border="1" style="width: 100%; border-collapse: collapse; text-align: center;"> <tr> <td style="width: 10%;"></td> <td style="width: 10%;"></td> <td style="width: 10%;"></td> <td style="width: 10%;"></td> <td style="width: 10%;"></td> <td style="width: 10%;"></td> <td style="width: 10%;"></td> <td style="width: 10%;"></td> <td style="width: 10%;"></td> <td style="width: 10%;"></td> </tr> <tr> <td></td> <td></td> <td colspan="8" style="text-align: center;"> <table border="1" style="width: 100%; border-collapse: collapse; text-align: center;"> <tr> <td style="width: 10%;"></td> <td style="width: 10%;"></td> <td style="width: 10%;"></td> <td style="width: 10%;"></td> <td style="width: 10%;"></td> <td style="width: 10%;"></td> <td style="width: 10%;"></td> <td style="width: 10%;"></td> <td style="width: 10%;"></td> <td style="width: 10%;"></td> </tr> <tr> <td></td> <td></td> <td colspan="8" style="text-align: center;"> <table border="1" style="width: 100%; border-collapse: collapse; text-align: center;"> <tr> <td style="width: 10%;"></td> <td style="width: 10%;"></td> <td style="width: 10%;"></td> <td style="width: 10%;"></td> <td style="width: 10%;"></td> <td style="width: 10%;"></td> <td style="width: 10%;"></td> <td style="width: 10%;"></td> <td style="width: 10%;"></td> <td style="width: 10%;"></td> </tr> <tr> <td></td> <td></td> <td colspan="8" style="text-align: center;"> <table border="1" style="width: 100%; border-collapse: collapse; text-align: center;"> <tr> <td style="width: 10%;"></td> <td style="width: 10%;"></td> <td style="width: 10%;"></td> <td style="width: 10%;"></td> <td style="width: 10%;"></td> <td style="width: 10%;"></td> <td style="width: 10%;"></td> <td style="width: 10%;"></td> <td style="width: 10%;"></td> <td style="width: 10%;"></td> </tr> <tr> <td></td> <td></td> <td colspan="8" style="text-align: center;"> <table border="1" style="width: 100%; border-collapse: collapse; text-align: center;"> <tr> <td style="width: 10%;"></td> <td style="width: 10%;"></td> <td style="width: 10%;"></td> <td style="width: 10%;"></td> <td style="width: 10%;"></td> <td style="width: 10%;"></td> <td style="width: 10%;"></td> <td style="width: 10%;"></td> <td style="width: 10%;"></td> <td style="width: 10%;"></td> </tr> <tr> <td></td> <td></td> <td colspan="8" style="text-align: center;"> <table border="1" style="width: 100%; border-collapse: collapse; text-align: center;"> <tr> <td style="width: 10%;"></td> <td style="width: 10%;"></td> <td style="width: 10%;"></td> <td style="width: 10%;"></td> <td style="width: 10%;"></td> <td style="width: 10%;"></td> <td style="width: 10%;"></td> <td style="width: 10%;"></td> <td style="width: 10%;"></td> <td style="width: 10%;"></td> </tr> <tr> <td></td> <td></td> <td colspan="8" style="text-align: center;"> <table border="1" style="width: 100%; border-collapse: collapse; text-align: center;"> <tr>
</tr></table></td></tr></table></td></tr></table></td></tr></table></td></tr></table></td></tr></table></td></tr></table></td></tr></table></td></tr></table></td></tr></table></td></tr></table></td></tr></table></td></tr></table></td></tr></table></td></tr></table></td></tr></table></td></tr></table></td></tr></table></td></tr></table></td></tr></table></td></tr></table></td></tr></table></td></tr></table></td></tr></table></td></tr></table></td></tr></table></td></tr></table></td></tr></table></td></tr></table></td></tr></table></td></tr></table></td></tr></table></td></tr></table></td></tr></table></td></tr></table></td></tr></table></td></tr></table></td></tr></table></td></tr></table>
 | | | | | | | | | | | | | | | | | | | | <table border="1" style="width: 100%; border-collapse: collapse; text-align: center;"> <tr> <td style="width: 10%;"></td> <td style="width: 10%;"></td> <td style="width: 10%;"></td> <td style="width: 10%;"></td> <td style="width: 10%;"></td> <td style="width: 10%;"></td> <td style="width: 10%;"></td> <td style="width: 10%;"></td> <td style="width: 10%;"></td> <td style="width: 10%;"></td> </tr> <tr> <td></td> <td></td> <td colspan="8" style="text-align: center;"> <table border="1" style="width: 100%; border-collapse: collapse; text-align: center;"> <tr> <td style="width: 10%;"></td> <td style="width: 10%;"></td> <td style="width: 10%;"></td> <td style="width: 10%;"></td> <td style="width: 10%;"></td> <td style="width: 10%;"></td> <td style="width: 10%;"></td> <td style="width: 10%;"></td> <td style="width: 10%;"></td> <td style="width: 10%;"></td> </tr> <tr> <td></td> <td></td> <td colspan="8" style="text-align: center;"> <table border="1" style="width: 100%; border-collapse: collapse; text-align: center;"> <tr> <td style="width: 10%;"></td> <td style="width: 10%;"></td> <td style="width: 10%;"></td> <td style="width: 10%;"></td> <td style="width: 10%;"></td> <td style="width: 10%;"></td> <td style="width: 10%;"></td> <td style="width: 10%;"></td> <td style="width: 10%;"></td> <td style="width: 10%;"></td> </tr> <tr> <td></td> <td></td> <td colspan="8" style="text-align: center;"> <table border="1" style="width: 100%; border-collapse: collapse; text-align: center;"> <tr> <td style="width: 10%;"></td> <td style="width: 10%;"></td> <td style="width: 10%;"></td> <td style="width: 10%;"></td> <td style="width: 10%;"></td> <td style="width: 10%;"></td> <td style="width: 10%;"></td> <td style="width: 10%;"></td> <td style="width: 10%;"></td> <td style="width: 10%;"></td> </tr> <tr> <td></td> <td></td> <td colspan="8" style="text-align: center;"> <table border="1" style="width: 100%; border-collapse: collapse; text-align: center;"> <tr> <td style="width: 10%;"></td> <td style="width: 10%;"></td> <td style="width: 10%;"></td> <td style="width: 10%;"></td> <td style="width: 10%;"></td> <td style="width: 10%;"></td> <td style="width: 10%;"></td> <td style="width: 10%;"></td> <td style="width: 10%;"></td> <td style="width: 10%;"></td> </tr> <tr> <td></td> <td></td> <td colspan="8" style="text-align: center;"> <table border="1" style="width: 100%; border-collapse: collapse; text-align: center;"> <tr> <td style="width: 10%;"></td> <td style="width: 10%;"></td> <td style="width: 10%;"></td> <td style="width: 10%;"></td> <td style="width: 10%;"></td> <td style="width: 10%;"></td> <td style="width: 10%;"></td> <td style="width: 10%;"></td> <td style="width: 10%;"></td> <td style="width: 10%;"></td> </tr> <tr> <td></td> <td></td> <td colspan="8" style="text-align: center;"> <table border="1" style="width: 100%; border-collapse: collapse; text-align: center;"> <tr> <td style="width: 10%;"></td> <td style="width: 10%;"></td> <td style="width: 10%;"></td> <td style="width: 10%;"></td> <td style="width: 10%;"></td> <td style="width: 10%;"></td> <td style="width: 10%;"></td> <td style="width: 10%;"></td> <td style="width: 10%;"></td> <td style="width: 10%;"></td> </tr> <tr> <td></td> <td></td> <td colspan="8" style="text-align: center;"> <table border="1" style="width: 100%; border-collapse: collapse; text-align: center;"> <tr> <td style="width: 10%;"></td> <td style="width: 10%;"></td> <td style="width: 10%;"></td> <td style="width: 10%;"></td> <td style="width: 10%;"></td> <td style="width: 10%;"></td> <td style="width: 10%;"></td> <td style="width: 10%;"></td> <td style="width: 10%;"></td> <td style="width: 10%;"></td> </tr> <tr> <td></td> <td></td> <td colspan="8" style="text-align: center;"> <table border="1" style="width: 100%; border-collapse: collapse; text-align: center;"> <tr> <td style="width: 10%;"></td> <td style="width: 10%;"></td> <td style="width: 10%;"></td> <td style="width: 10%;"></td> <td style="width: 10%;"></td> <td style="width: 10%;"></td> <td style="width: 10%;"></td> <td style="width: 10%;"></td> <td style="width: 10%;"></td> <td style="width: 10%;"></td> </tr> <tr> <td></td> <td></td> <td colspan="8" style="text-align: center;"> <table border="1" style="width: 100%; border-collapse: collapse; text-align: center;"> <tr> <td style="width: 10%;"></td> <td style="width: 10%;"></td> <td style="width: 10%;"></td> <td style="width: 10%;"></td> <td style="width: 10%;"></td> <td style="width: 10%;"></td> <td style="width: 10%;"></td> <td style="width: 10%;"></td> <td style="width: 10%;"></td> <td style="width: 10%;"></td> </tr> <tr> <td></td> <td></td> <td colspan="8" style="text-align: center;"> <table border="1" style="width: 100%; border-collapse: collapse; text-align: center;"> <tr> <td style="width: 10%;"></td> <td style="width: 10%;"></td> <td style="width: 10%;"></td> <td style="width: 10%;"></td> <td style="width: 10%;"></td> <td style="width: 10%;"></td> <td style="width: 10%;"></td> <td style="width: 10%;"></td> <td style="width: 10%;"></td> <td style="width: 10%;"></td> </tr> <tr> <td></td> <td></td> <td colspan="8" style="text-align: center;"> <table border="1" style="width: 100%; border-collapse: collapse; text-align: center;"> <tr> <td style="width: 10%;"></td> <td style="width: 10%;"></td> <td style="width: 10%;"></td> <td style="width: 10%;"></td> <td style="width: 10%;"></td> <td style="width: 10%;"></td> <td style="width: 10%;"></td> <td style="width: 10%;"></td> <td style="width: 10%;"></td> <td style="width: 10%;"></td> </tr> <tr> <td></td> <td></td> <td colspan="8" style="text-align: center;"> <table border="1" style="width: 100%; border-collapse: collapse; text-align: center;"> <tr> <td style="width: 10%;"></td> <td style="width: 10%;"></td> <td style="width: 10%;"></td> <td style="width: 10%;"></td> <td style="width: 10%;"></td> <td style="width: 10%;"></td> <td style="width: 10%;"></td> <td style="width: 10%;"></td> <td style="width: 10%;"></td> <td style="width: 10%;"></td> </tr> <tr> <td></td> <td></td> <td colspan="8" style="text-align: center;"> <table border="1" style="width: 100%; border-collapse: collapse; text-align: center;"> <tr> <td style="width: 10%;"></td> <td style="width: 10%;"></td> <td style="width: 10%;"></td> <td style="width: 10%;"></td> <td style="width: 10%;"></td> <td style="width: 10%;"></td> <td style="width: 10%;"></td> <td style="width: 10%;"></td> <td style="width: 10%;"></td> <td style="width: 10%;"></td> </tr> <tr> <td></td> <td></td> <td colspan="8" style="text-align: center;"> <table border="1" style="width: 100%; border-collapse: collapse; text-align: center;"> <tr> <td style="width: 10%;"></td> <td style="width: 10%;"></td> <td style="width: 10%;"></td> <td style="width: 10%;"></td> <td style="width: 10%;"></td> <td style="width: 10%;"></td> <td style="width: 10%;"></td> <td style="width: 10%;"></td> <td style="width: 10%;"></td> <td style="width: 10%;"></td> </tr> <tr> <td></td> <td></td> <td colspan="8" style="text-align: center;"> <table border="1" style="width: 100%; border-collapse: collapse; text-align: center;"> <tr> <td style="width: 10%;"></td> <td style="width: 10%;"></td> <td style="width: 10%;"></td> <td style="width: 10%;"></td> <td style="width: 10%;"></td> <td style="width: 10%;"></td> <td style="width: 10%;"></td> <td style="width: 10%;"></td> <td style="width: 10%;"></td> <td style="width: 10%;"></td> </tr> <tr> <td></td> <td></td> <td colspan="8" style="text-align: center;"> <table border="1" style="width: 100%; border-collapse: collapse; text-align: center;"> <tr> <td style="width: 10%;"></td> <td style="width: 10%;"></td> <td style="width: 10%;"></td> <td style="width: 10%;"></td> <td style="width: 10%;"></td> <td style="width: 10%;"></td> <td style="width: 10%;"></td> <td style="width: 10%;"></td> <td style="width: 10%;"></td> <td style="width: 10%;"></td> </tr> <tr> <td></td> <td></td> <td colspan="8" style="text-align: center;"> <table border="1" style="width: 100%; border-collapse: collapse; text-align: center;"> <tr> <td style="width: 10%;"></td> <td style="width: 10%;"></td> <td style="width: 10%;"></td> <td style="width: 10%;"></td> <td style="width: 10%;"></td> <td style="width: 10%;"></td> <td style="width: 10%;"></td> <td style="width: 10%;"></td> <td style="width: 10%;"></td> <td style="width: 10%;"></td> </tr> <tr> <td></td> <td></td> <td colspan="8" style="text-align: center;"> <table border="1" style="width: 100%; border-collapse: collapse; text-align: center;"> <tr> <td style="width: 10%;"></td> <td style="width: 10%;"></td> <td style="width: 10%;"></td> <td style="width: 10%;"></td> <td style="width: 10%;"></td> <td style="width: 10%;"></td> <td style="width: 10%;"></td> <td style="width: 10%;"></td> <td style="width: 10%;"></td> <td style="width: 10%;"></td> </tr> <tr> <td></td> <td></td> <td colspan="8" style="text-align: center;"> <table border="1" style="width: 100%; border-collapse: collapse; text-align: center;"> <tr> <td style="width: 10%;"></td> <td style="width:
10%;"></td> <td style="width: 10%;"></td> <td style="width: 10%;"></td> <td style="width: 10%;"></td> <td style="width: 10%;"></td> <td style="width: 10%;"></td> <td style="width: 10%;"></td> <td style="width: 10%;"></td> <td style="width: 10%;"></td> </tr> <tr> <td></td> <td></td> <td colspan="8" style="text-align: center;"> <table border="1" style="width: 100%; border-collapse: collapse; text-align: center;"> <tr> <td style="width: 10%;"></td> <td style="width: 10%;"></td> <td style="width: 10%;"></td> <td style="width: 10%;"></td> <td style="width: 10%;"></td> <td style="width: 10%;"></td> <td style="width: 10%;"></td> <td style="width: 10%;"></td> <td style="width: 10%;"></td> <td style="width: 10%;"></td> </tr> <tr> <td></td> <td></td> <td colspan="8" style="text-align: center;"> <table border="1" style="width: 100%; border-collapse: collapse; text-align: center;"> <tr> <td style="width: 10%;"></td> <td style="width: 10%;"></td> <td style="width: 10%;"></td> <td style="width: 10%;"></td> <td style="width: 10%;"></td> <td style="width: 10%;"></td> <td style="width: 10%;"></td> <td style="width: 10%;"></td> <td style="width: 10%;"></td> <td style="width: 10%;"></td> </tr> <tr> <td></td> <td></td> <td colspan="8" style="text-align: center;"> <table border="1" style="width: 100%; border-collapse: collapse; text-align: center;"> <tr> <td style="width: 10%;"></td> <td style="width: 10%;"></td> <td style="width: 10%;"></td> <td style="width: 10%;"></td> <td style="width: 10%;"></td> <td style="width: 10%;"></td> <td style="width: 10%;"></td> <td style="width: 10%;"></td> <td style="width: 10%;"></td> <td style="width: 10%;"></td> </tr> <tr> <td></td> <td></td> <td colspan="8" style="text-align: center;"> <table border="1" style="width: 100%; border-collapse: collapse; text-align: center;"> <tr> <td style="width: 10%;"></td> <td style="width: 10%;"></td> <td style="width: 10%;"></td> <td style="width: 10%;"></td> <td style="width: 10%;"></td> <td style="width: 10%;"></td> <td style="width: 10%;"></td> <td style="width: 10%;"></td> <td style="width: 10%;"></td> <td style="width: 10%;"></td> </tr> <tr> <td></td> <td></td> <td colspan="8" style="text-align: center;"> <table border="1" style="width: 100%; border-collapse: collapse; text-align: center;"> <tr> <td style="width: 10%;"></td> <td style="width: 10%;"></td> <td style="width: 10%;"></td> <td style="width: 10%;"></td> <td style="width: 10%;"></td> <td style="width: 10%;"></td> <td style="width: 10%;"></td> <td style="width: 10%;"></td> <td style="width: 10%;"></td> <td style="width: 10%;"></td> </tr> <tr> <td></td> <td></td> <td colspan="8" style="text-align: center;"> <table border="1" style="width: 100%; border-collapse: collapse; text-align: center;"> <tr> <td style="width: 10%;"></td> <td style="width: 10%;"></td> <td style="width: 10%;"></td> <td style="width: 10%;"></td> <td style="width: 10%;"></td> <td style="width: 10%;"></td> <td style="width: 10%;"></td> <td style="width: 10%;"></td> <td style="width: 10%;"></td> <td style="width: 10%;"></td> </tr> <tr> <td></td> <td></td> <td colspan="8" style="text-align: center;"> <table border="1" style="width: 100%; border-collapse: collapse; text-align: center;"> <tr> <td style="width: 10%;"></td> <td style="width: 10%;"></td> <td style="width: 10%;"></td> <td style="width: 10%;"></td> <td style="width: 10%;"></td> <td style="width: 10%;"></td> <td style="width: 10%;"></td> <td style="width: 10%;"></td> <td style="width: 10%;"></td> <td style="width: 10%;"></td> </tr> <tr> <td></td> <td></td> <td colspan="8" style="text-align: center;"> <table border="1" style="width: 100%; border-collapse: collapse; text-align: center;"> <tr> <td style="width: 10%;"></td> <td style="width: 10%;"></td> <td style="width: 10%;"></td> <td style="width: 10%;"></td> <td style="width: 10%;"></td> <td style="width: 10%;"></td> <td style="width: 10%;"></td> <td style="width: 10%;"></td> <td style="width: 10%;"></td> <td style="width: 10%;"></td> </tr> <tr> <td></td> <td></td> <td colspan="8" style="text-align: center;"> <table border="1" style="width: 100%; border-collapse: collapse; text-align: center;"> <tr> <td style="width: 10%;"></td> <td style="width: 10%;"></td> <td style="width: 10%;"></td> <td style="width: 10%;"></td> <td style="width: 10%;"></td> <td style="width: 10%;"></td> <td style="width: 10%;"></td> <td style="width: 10%;"></td> <td style="width: 10%;"></td> <td style="width: 10%;"></td> </tr> <tr> <td></td> <td></td> <td colspan="8" style="text-align: center;"> <table border="1" style="width: 100%; border-collapse: collapse; text-align: center;"> <tr> <td style="width: 10%;"></td> <td style="width: 10%;"></td> <td style="width: 10%;"></td> <td style="width: 10%;"></td> <td style="width: 10%;"></td> <td style="width: 10%;"></td> <td style="width: 10%;"></td> <td style="width: 10%;"></td> <td style="width: 10%;"></td> <td style="width: 10%;"></td> </tr> <tr> <td></td> <td></td> <td colspan="8" style="text-align: center;"> <table border="1" style="width: 100%; border-collapse: collapse; text-align: center;"> <tr> <td style="width: 10%;"></td> <td style="width: 10%;"></td> <td style="width: 10%;"></td> <td style="width: 10%;"></td> <td style="width: 10%;"></td> <td style="width: 10%;"></td> <td style="width: 10%;"></td> <td style="width: 10%;"></td> <td style="width: 10%;"></td> <td style="width: 10%;"></td> </tr> <tr> <td></td> <td></td> <td colspan="8" style="text-align: center;"> <table border="1" style="width: 100%; border-collapse: collapse; text-align: center;"> <tr> <td style="width: 10%;"></td> <td style="width: 10%;"></td> <td style="width: 10%;"></td> <td style="width: 10%;"></td> <td style="width: 10%;"></td> <td style="width: 10%;"></td> <td style="width: 10%;"></td> <td style="width: 10%;"></td> <td style="width: 10%;"></td> <td style="width: 10%;"></td> </tr> <tr> <td></td> <td></td> <td colspan="8" style="text-align: center;"> <table border="1" style="width: 100%; border-collapse: collapse; text-align: center;"> <tr> <td style="width: 10%;"></td> <td style="width: 10%;"></td> <td style="width: 10%;"></td> <td style="width: 10%;"></td> <td style="width: 10%;"></td> <td style="width: 10%;"></td> <td style="width: 10%;"></td> <td style="width: 10%;"></td> <td style="width: 10%;"></td> <td style="width: 10%;"></td> </tr> <tr> <td></td> <td></td> <td colspan="8" style="text-align: center;"> <table border="1" style="width: 100%; border-collapse: collapse; text-align: center;"> <tr> <td style="width: 10%;"></td> <td style="width: 10%;"></td> <td style="width: 10%;"></td> <td style="width: 10%;"></td> <td style="width: 10%;"></td> <td style="width: 10%;"></td> <td style="width: 10%;"></td> <td style="width: 10%;"></td> <td style="width: 10%;"></td> <td style="width: 10%;"></td> </tr> <tr> <td></td> <td></td> <td colspan="8" style="text-align: center;"> <table border="1" style="width: 100%; border-collapse: collapse; text-align: center;"> <tr> <td style="width: 10%;"></td> <td style="width: 10%;"></td> <td style="width: 10%;"></td> <td style="width: 10%;"></td> <td style="width: 10%;"></td> <td style="width: 10%;"></td> <td style="width: 10%;"></td> <td style="width: 10%;"></td> <td style="width: 10%;"></td> <td style="width: 10%;"></td> </tr> <tr> <td></td> <td></td> <td colspan="8" style="text-align: center;"> <table border="1" style="width: 100%; border-collapse: collapse; text-align: center;"> <tr> <td style="width: 10%;"></td> <td style="width: 10%;"></td> <td style="width: 10%;"></td> <td style="width: 10%;"></td> <td style="width: 10%;"></td> <td style="width: 10%;"></td> <td style="width: 10%;"></td> <td style="width: 10%;"></td> <td style="width: 10%;"></td> <td style="width: 10%;"></td> </tr> <tr> <td></td> <td></td> <td colspan="8" style="text-align: center;"> <table border="1" style="width: 100%; border-collapse: collapse; text-align: center;"> <tr> <td style="width: 10%;"></td> <td style="width: 10%;"></td> <td style="width: 10%;"></td> <td style="width: 10%;"></td> <td style="width: 10%;"></td> <td style="width: 10%;"></td> <td style="width: 10%;"></td> <td style="width: 10%;"></td> <td style="width: 10%;"></td> <td style="width: 10%;"></td> </tr> <tr> <td></td> <td></td> <td colspan="8" style="text-align: center;"> <table border="1" style="width: 100%; border-collapse: collapse; text-align: center;"> <tr> </tr></table></td></tr></table></td></tr></table></td></tr></table></td></tr></table></td></tr></table></td></tr></table></td></tr></table></td></tr></table></td></tr></table></td></tr></table></td></tr></table></td></tr></table></td></tr></table></td></tr></table></td></tr></table></td></tr></table></td></tr></table></td></tr></table></td></tr></table></td></tr></table></td></tr></table></td></tr></table></td></tr></table></td></tr></table></td></tr></table></td></tr></table></td></tr></table></td></tr></table></td></tr></table></td></tr></table></td></tr></table></td></tr></table></td></tr></table></td></tr></table></td></tr></table></td></tr></table></td></tr></table>
 | | | | | | | | | | | | | | | | | | | | <table border="1" style="width: 100%; border-collapse: collapse; text-align: center;"> <tr> <td style="width: 10%;"></td> <td style="width: 10%;"></td> <td style="width: 10%;"></td> <td style="width: 10%;"></td> <td style="width: 10%;"></td> <td style="width: 10%;"></td> <td style="width: 10%;"></td> <td style="width: 10%;"></td> <td style="width: 10%;"></td> <td style="width: 10%;"></td> </tr> <tr> <td></td> <td></td> <td colspan="8" style="text-align: center;"> <table border="1" style="width: 100%; border-collapse: collapse; text-align: center;"> <tr> <td style="width: 10%;"></td> <td style="width: 10%;"></td> <td style="width: 10%;"></td> <td style="width:
10%;"></td> <td style="width: 10%;"></td> <td style="width: 10%;"></td> <td style="width: 10%;"></td> <td style="width: 10%;"></td> <td style="width: 10%;"></td> <td style="width: 10%;"></td> </tr> <tr> <td></td> <td></td> <td colspan="8" style="text-align: center;"> <table border="1" style="width: 100%; border-collapse: collapse; text-align: center;"> <tr> <td style="width: 10%;"></td> <td style="width: 10%;"></td> <td style="width: 10%;"></td> <td style="width: 10%;"></td> <td style="width: 10%;"></td> <td style="width: 10%;"></td> <td style="width: 10%;"></td> <td style="width: 10%;"></td> <td style="width: 10%;"></td> <td style="width: 10%;"></td> </tr> <tr> <td></td> <td></td> <td colspan="8" style="text-align: center;"> <table border="1" style="width: 100%; border-collapse: collapse; text-align: center;"> <tr> <td style="width: 10%;"></td> <td style="width: 10%;"></td> <td style="width: 10%;"></td> <td style="width: 10%;"></td> <td style="width: 10%;"></td> <td style="width: 10%;"></td> <td style="width: 10%;"></td> <td style="width: 10%;"></td> <td style="width: 10%;"></td> <td style="width: 10%;"></td> </tr> <tr> <td></td> <td></td> <td colspan="8" style="text-align: center;"> <table border="1" style="width: 100%; border-collapse: collapse; text-align: center;"> <tr> <td style="width: 10%;"></td> <td style="width: 10%;"></td> <td style="width: 10%;"></td> <td style="width: 10%;"></td> <td style="width: 10%;"></td> <td style="width: 10%;"></td> <td style="width: 10%;"></td> <td style="width: 10%;"></td> <td style="width: 10%;"></td> <td style="width: 10%;"></td> </tr> <tr> <td></td> <td></td> <td colspan="8" style="text-align: center;"> <table border="1" style="width: 100%; border-collapse: collapse; text-align: center;"> <tr> <td style="width: 10%;"></td> <td style="width: 10%;"></td> <td style="width: 10%;"></td> <td style="width: 10%;"></td> <td style="width: 10%;"></td> <td style="width: 10%;"></td> <td style="width: 10%;"></td> <td style="width: 10%;"></td> <td style="width: 10%;"></td> <td style="width: 10%;"></td> </tr> <tr> <td></td> <td></td> <td colspan="8" style="text-align: center;"> <table border="1" style="width: 100%; border-collapse: collapse; text-align: center;"> <tr> <td style="width: 10%;"></td> <td style="width: 10%;"></td> <td style="width: 10%;"></td> <td style="width: 10%;"></td> <td style="width: 10%;"></td> <td style="width: 10%;"></td> <td style="width: 10%;"></td> <td style="width: 10%;"></td> <td style="width: 10%;"></td> <td style="width: 10%;"></td> </tr> <tr> <td></td> <td></td> <td colspan="8" style="text-align: center;"> <table border="1" style="width: 100%; border-collapse: collapse; text-align: center;"> <tr> <td style="width: 10%;"></td> <td style="width: 10%;"></td> <td style="width: 10%;"></td> <td style="width: 10%;"></td> <td style="width: 10%;"></td> <td style="width: 10%;"></td> <td style="width: 10%;"></td> <td style="width: 10%;"></td> <td style="width: 10%;"></td> <td style="width: 10%;"></td> </tr> <tr> <td></td> <td></td> <td colspan="8" style="text-align: center;"> <table border="1" style="width: 100%; border-collapse: collapse; text-align: center;"> <tr> <td style="width: 10%;"></td> <td style="width: 10%;"></td> <td style="width: 10%;"></td> <td style="width: 10%;"></td> <td style="width: 10%;"></td> <td style="width: 10%;"></td> <td style="width: 10%;"></td> <td style="width: 10%;"></td> <td style="width: 10%;"></td> <td style="width: 10%;"></td> </tr> <tr> <td></td> <td></td> <td colspan="8" style="text-align: center;"> <table border="1" style="width: 100%; border-collapse: collapse; text-align: center;"> <tr> <td style="width: 10%;"></td> <td style="width: 10%;"></td> <td style="width: 10%;"></td> <td style="width: 10%;"></td> <td style="width: 10%;"></td> <td style="width: 10%;"></td> <td style="width: 10%;"></td> <td style="width: 10%;"></td> <td style="width: 10%;"></td> <td style="width: 10%;"></td> </tr> <tr> <td></td> <td></td> <td colspan="8" style="text-align: center;"> <table border="1" style="width: 100%; border-collapse: collapse; text-align: center;"> <tr> <td style="width: 10%;"></td> <td style="width: 10%;"></td> <td style="width: 10%;"></td> <td style="width: 10%;"></td> <td style="width: 10%;"></td> <td style="width: 10%;"></td> <td style="width: 10%;"></td> <td style="width: 10%;"></td> <td style="width: 10%;"></td> <td style="width: 10%;"></td> </tr> <tr> <td></td> <td></td> <td colspan="8" style="text-align: center;"> <table border="1" style="width: 100%; border-collapse: collapse; text-align: center;"> <tr> <td style="width: 10%;"></td> <td style="width: 10%;"></td> <td style="width: 10%;"></td> <td style="width: 10%;"></td> <td style="width: 10%;"></td> <td style="width: 10%;"></td> <td style="width: 10%;"></td> <td style="width: 10%;"></td> <td style="width: 10%;"></td> <td style="width: 10%;"></td> </tr> <tr> <td></td> <td></td> <td colspan="8" style="text-align: center;"> <table border="1" style="width: 100%; border-collapse: collapse; text-align: center;"> <tr> <td style="width: 10%;"></td> <td style="width: 10%;"></td> <td style="width: 10%;"></td> <td style="width: 10%;"></td> <td style="width: 10%;"></td> <td style="width: 10%;"></td> <td style="width: 10%;"></td> <td style="width: 10%;"></td> <td style="width: 10%;"></td> <td style="width: 10%;"></td> </tr> <tr> <td></td> <td></td> <td colspan="8" style="text-align: center;"> <table border="1" style="width: 100%; border-collapse: collapse; text-align: center;"> <tr> <td style="width: 10%;"></td> <td style="width: 10%;"></td> <td style="width: 10%;"></td> <td style="width: 10%;"></td> <td style="width: 10%;"></td> <td style="width: 10%;"></td> <td style="width: 10%;"></td> <td style="width: 10%;"></td> <td style="width: 10%;"></td> <td style="width: 10%;"></td> </tr> <tr> <td></td> <td></td> <td colspan="8" style="text-align: center;"> <table border="1" style="width: 100%; border-collapse: collapse; text-align: center;"> <tr> <td style="width: 10%;"></td> <td style="width: 10%;"></td> <td style="width: 10%;"></td> <td style="width: 10%;"></td> <td style="width: 10%;"></td> <td style="width: 10%;"></td> <td style="width: 10%;"></td> <td style="width: 10%;"></td> <td style="width: 10%;"></td> <td style="width: 10%;"></td> </tr> <tr> <td></td> <td></td> <td colspan="8" style="text-align: center;"> <table border="1" style="width: 100%; border-collapse: collapse; text-align: center;"> <tr> <td style="width: 10%;"></td> <td style="width: 10%;"></td> <td style="width: 10%;"></td> <td style="width: 10%;"></td> <td style="width: 10%;"></td> <td style="width: 10%;"></td> <td style="width: 10%;"></td> <td style="width: 10%;"></td> <td style="width: 10%;"></td> <td style="width: 10%;"></td> </tr> <tr> <td></td> <td></td> <td colspan="8" style="text-align: center;"> <table border="1" style="width: 100%; border-collapse: collapse; text-align: center;"> <tr> <td style="width: 10%;"></td> <td style="width: 10%;"></td> <td style="width: 10%;"></td> <td style="width: 10%;"></td> <td style="width: 10%;"></td> <td style="width: 10%;"></td> <td style="width: 10%;"></td> <td style="width: 10%;"></td> <td style="width: 10%;"></td> <td style="width: 10%;"></td> </tr> <tr> <td></td> <td></td> <td colspan="8" style="text-align: center;"> <table border="1" style="width: 100%; border-collapse: collapse; text-align: center;"> <tr> <td style="width: 10%;"></td> <td style="width: 10%;"></td> <td style="width: 10%;"></td> <td style="width: 10%;"></td> <td style="width: 10%;"></td> <td style="width: 10%;"></td> <td style="width: 10%;"></td> <td style="width: 10%;"></td> <td style="width: 10%;"></td> <td style="width: 10%;"></td> </tr> <tr> <td></td> <td></td> <td colspan="8" style="text-align: center;"> <table border="1" style="width: 100%; border-collapse: collapse; text-align: center;"> <tr> <td style="width: 10%;"></td> <td style="width: 10%;"></td> <td style="width: 10%;"></td> <td style="width: 10%;"></td> <td style="width: 10%;"></td> <td style="width: 10%;"></td> <td style="width: 10%;"></td> <td style="width: 10%;"></td> <td style="width: 10%;"></td> <td style="width: 10%;"></td> </tr> <tr> <td></td> <td></td> <td colspan="8" style="text-align: center;"> <table border="1" style="width: 100%; border-collapse: collapse; text-align: center;"> <tr> <td style="width: 10%;"></td> <td style="width: 10%;"></td> <td style="width: 10%;"></td> <td style="width: 10%;"></td> <td style="width: 10%;"></td> <td style="width: 10%;"></td> <td style="width: 10%;"></td> <td style="width: 10%;"></td> <td style="width: 10%;"></td> <td style="width: 10%;"></td> </tr> <tr> <td></td> <td></td> <td colspan="8" style="text-align: center;"> <table border="1" style="width: 100%; border-collapse: collapse; text-align: center;"> <tr> <td style="width: 10%;"></td> <td style="width: 10%;"></td> <td style="width: 10%;"></td> <td style="width: 10%;"></td> <td style="width: 10%;"></td> <td style="width: 10%;"></td> <td style="width: 10%;"></td> <td style="width: 10%;"></td> <td style="width: 10%;"></td> <td style="width: 10%;"></td> </tr> <tr> <td></td> <td></td> <td colspan="8" style="text-align: center;"> <table border="1" style="width: 100%; border-collapse: collapse; text-align: center;"> <tr> <td style="width: 10%;"></td> <td style="width: 10%;"></td> <td style="width: 10%;"></td> <td style="width: 10%;"></td> <td style="width: 10%;"></td> <td style="width: 10%;"></td> <td style="width: 10%;"></td> <td style="width: 10%;"></td> <td style="width: 10%;"></td> <td style="width: 10%;"></td> </tr> <tr> <td></td> <td></td> <td colspan="8" style="text-align: center;"> <table border="1" style="width: 100%; border-collapse: collapse; text-align: center;"> <tr> <td style="width: 10%;"></td> <td style="width: 10%;"></td> <td style="width: 10%;"></td> <td style="width: 10%;"></td> <td style="width: 10%;"></td> <td style="width: 10%;"></td> <td style="width: 10%;"></td> <td style="width: 10%;"></td> <td style="width: 10%;"></td> <td
style="width: 10%;"></td> </tr> <tr> <td></td> <td></td> <td colspan="8" style="text-align: center;"> <table border="1" style="width: 100%; border-collapse: collapse; text-align: center;"> <tr> <td style="width: 10%;"></td> <td style="width: 10%;"></td> <td style="width: 10%;"></td> <td style="width: 10%;"></td> <td style="width: 10%;"></td> <td style="width: 10%;"></td> <td style="width: 10%;"></td> <td style="width: 10%;"></td> <td style="width: 10%;"></td> <td style="width: 10%;"></td> </tr> <tr> <td></td> <td></td> <td colspan="8" style="text-align: center;"> <table border="1" style="width: 100%; border-collapse: collapse; text-align: center;"> <tr> <td style="width: 10%;"></td> <td style="width: 10%;"></td> <td style="width: 10%;"></td> <td style="width: 10%;"></td> <td style="width: 10%;"></td> <td style="width: 10%;"></td> <td style="width: 10%;"></td> <td style="width: 10%;"></td> <td style="width: 10%;"></td> <td style="width: 10%;"></td> </tr> <tr> <td></td> <td></td> <td colspan="8" style="text-align: center;"> <table border="1" style="width: 100%; border-collapse: collapse; text-align: center;"> <tr> <td style="width: 10%;"></td> <td style="width: 10%;"></td> <td style="width: 10%;"></td> <td style="width: 10%;"></td> <td style="width: 10%;"></td> <td style="width: 10%;"></td> <td style="width: 10%;"></td> <td style="width: 10%;"></td> <td style="width: 10%;"></td> <td style="width: 10%;"></td> </tr> <tr> <td></td> <td></td> <td colspan="8" style="text-align: center;"> <table border="1" style="width: 100%; border-collapse: collapse; text-align: center;"> <tr> <td style="width: 10%;"></td> <td style="width: 10%;"></td> <td style="width: 10%;"></td> <td style="width: 10%;"></td> <td style="width: 10%;"></td> <td style="width: 10%;"></td> <td style="width: 10%;"></td> <td style="width: 10%;"></td> <td style="width: 10%;"></td> <td style="width: 10%;"></td> </tr> <tr> <td></td> <td></td> <td colspan="8" style="text-align: center;"> <table border="1" style="width: 100%; border-collapse: collapse; text-align: center;"> <tr> <td style="width: 10%;"></td> <td style="width: 10%;"></td> <td style="width: 10%;"></td> <td style="width: 10%;"></td> <td style="width: 10%;"></td> <td style="width: 10%;"></td> <td style="width: 10%;"></td> <td style="width: 10%;"></td> <td style="width: 10%;"></td> <td style="width: 10%;"></td> </tr> <tr> <td></td> <td></td> <td colspan="8" style="text-align: center;"> <table border="1" style="width: 100%; border-collapse: collapse; text-align: center;"> <tr> <td style="width: 10%;"></td> <td style="width: 10%;"></td> <td style="width: 10%;"></td> <td style="width: 10%;"></td> <td style="width: 10%;"></td> <td style="width: 10%;"></td> <td style="width: 10%;"></td> <td style="width: 10%;"></td> <td style="width: 10%;"></td> <td style="width: 10%;"></td> </tr> <tr> <td></td> <td></td> <td colspan="8" style="text-align: center;"> <table border="1" style="width: 100%; border-collapse: collapse; text-align: center;"> <tr> <td style="width: 10%;"></td> <td style="width: 10%;"></td> <td style="width: 10%;"></td> <td style="width: 10%;"></td> <td style="width: 10%;"></td> <td style="width: 10%;"></td> <td style="width: 10%;"></td> <td style="width: 10%;"></td> <td style="width: 10%;"></td> <td style="width: 10%;"></td> </tr> <tr> <td></td> <td></td> <td colspan="8" style="text-align: center;"> <table border="1" style="width: 100%; border-collapse: collapse; text-align: center;"> <tr> <td style="width: 10%;"></td> <td style="width: 10%;"></td> <td style="width: 10%;"></td> <td style="width: 10%;"></td> <td style="width: 10%;"></td> <td style="width: 10%;"></td> <td style="width: 10%;"></td> <td style="width: 10%;"></td> <td style="width: 10%;"></td> <td style="width: 10%;"></td> </tr> <tr> <td></td> <td></td> <td colspan="8" style="text-align: center;"> <table border="1" style="width: 100%; border-collapse: collapse; text-align: center;"> <tr> <td style="width: 10%;"></td> <td style="width: 10%;"></td> <td style="width: 10%;"></td> <td style="width: 10%;"></td> <td style="width: 10%;"></td> <td style="width: 10%;"></td> <td style="width: 10%;"></td> <td style="width: 10%;"></td> <td style="width: 10%;"></td> <td style="width: 10%;"></td> </tr> <tr> <td></td> <td></td> <td colspan="8" style="text-align: center;"> <table border="1" style="width: 100%; border-collapse: collapse; text-align: center;"> <tr> <td style="width: 10%;"></td> <td style="width: 10%;"></td> <td style="width: 10%;"></td> <td style="width: 10%;"></td> <td style="width: 10%;"></td> <td style="width: 10%;"></td> <td style="width: 10%;"></td> <td style="width: 10%;"></td> <td style="width: 10%;"></td> <td style="width: 10%;"></td> </tr> <tr> <td></td> <td></td> <td colspan="8" style="text-align: center;"> <table border="1" style="width: 100%; border-collapse: collapse; text-align: center;"> <tr> <td style="width: 10%;"></td> <td style="width: 10%;"></td> <td style="width: 10%;"></td> <td style="width: 10%;"></td> <td style="width: 10%;"></td> <td style="width: 10%;"></td> <td style="width: 10%;"></td> <td style="width: 10%;"></td> <td style="width: 10%;"></td> <td style="width: 10%;"></td> </tr> <tr> <td></td> <td></td> <td colspan="8" style="text-align: center;"> <table border="1" style="width: 100%; border-collapse: collapse; text-align: center;"> <tr> <td style="width: 10%;"></td> <td style="width: 10%;"></td> <td style="width: 10%;"></td> <td style="width: 10%;"></td> <td style="width: 10%;"></td> <td style="width: 10%;"></td> <td style="width: 10%;"></td> <td style="width: 10%;"></td> <td style="width: 10%;"></td> <td style="width: 10%;"></td> </tr> <tr> <td></td> <td></td> <td colspan="8" style="text-align: center;"> <table border="1" style="width: 100%; border-collapse: collapse; text-align: center;"> <tr> <td style="width: 10%;"></td> <td style="width: 10%;"></td> <td style="width: 10%;"></td> <td style="width: 10%;"></td> <td style="width: 10%;"></td> <td style="width: 10%;"></td> <td style="width: 10%;"></td> <td style="width: 10%;"></td> <td style="width: 10%;"></td> <td style="width: 10%;"></td> </tr> <tr> <td></td> <td></td> <td colspan="8" style="text-align: center;"> <table border="1" style="width: 100%; border-collapse: collapse; text-align: center;"> <tr> </tr></table></td></tr></table></td></tr></table></td></tr></table></td></tr></table></td></tr></table></td></tr></table></td></tr></table></td></tr></table></td></tr></table></td></tr></table></td></tr></table></td></tr></table></td></tr></table></td></tr></table></td></tr></table></td></tr></table></td></tr></table></td></tr></table></td></tr></table></td></tr></table></td></tr></table></td></tr></table></td></tr></table></td></tr></table></td></tr></table></td></tr></table></td></tr></table></td></tr></table></td></tr></table></td></tr></table></td></tr></table></td></tr></table></td></tr></table></td></tr></table></td></tr></table></td></tr></table>
 | | | | | | | | | | | | | | | | | | | | <table border="1" style="width: 100%; border-collapse: collapse; text-align: center;"> <tr> <td style="width: 10%;"></td> <td style="width: 10%;"></td> <td style="width: 10%;"></td> <td style="width: 10%;"></td> <td style="width: 10%;"></td> <td style="width: 10%;"></td> <td style="width: 10%;"></td> <td style="width: 10%;"></td> <td style="width: 10%;"></td> <td style="width: 10%;"></td> </tr> <tr> <td></td> <td></td> <td colspan="8" style="text-align: center;"> <table border="1" style="width: 100%; border-collapse: collapse; text-align: center;"> <tr> <td style="width: 10%;"></td> <td style="width: 10%;"></td> <td style="width: 10%;"></td> <td style="width: 10%;"></td> <td style="width: 10%;"></td> <td style="width: 10%;"></td> <td style="width: 10%;"></td> <td style="width: 10%;"></td> <td style="width: 10%;"></td> <td style="width: 10%;"></td> </tr> <tr> <td></td> <td></td> <td colspan="8" style="text-align: center;"> <table border="1" style="width: 100%; border-collapse: collapse; text-align: center;"> <tr> <td style="width: 10%;"></td> <td style="width: 10%;"></td> <td style="width: 10%;"></td> <td style="width: 10%;"></td> <td style="width: 10%;"></td> <td style="width: 10%;"></td> <td style="width: 10%;"></td> <td style="width: 10%;"></td> <td style="width: 10%;"></td> <td style="width: 10%;"></td> </tr> <tr> <td></td> <td></td> <td colspan="8" style="text-align: center;"> <table border="1" style="width: 100%; border-collapse: collapse; text-align: center;"> <tr> <td style="width: 10%;"></td> <td style="width: 10%;"></td> <td style="width: 10%;"></td> <td style="width: 10%;"></td> <td style="width: 10%;"></td> <td style="width: 10%;"></td> <td style="width: 10%;"></td> <td style="width: 10%;"></td> <td style="width: 10%;"></td> <td style="width: 10%;"></td> </tr> <tr> <td></td> <td></td> <td colspan="8" style="text-align: center;"> <table border="1" style="width: 100%; border-collapse: collapse; text-align: center;"> <tr> <td style="width: 10%;"></td> <td style="width: 10%;"></td> <td style="width: 10%;"></td> <td style="width: 10%;"></td> <td style="width: 10%;"></td> <td style="width: 10%;"></td> <td style="width: 10%;"></td> <td style="width: 10%;"></td> <td style="width: 10%;"></td> <td style="width: 10%;"></td> </tr> <tr> <td></td> <td></td> <td colspan="8" style="text-align: center;"> <table border="1" style="width: 100%; border-collapse: collapse; text-align: center;"> <tr> <td style="width: 10%;"></td> <td style="width: 10%;"></td> <td style="width: 10%;"></td> <td style="width: 10%;"></td> <td style="width: 10%;"></td> <td style="width: 10%;"></td> <td style="width: 10%;"></td> <td style="width: 10%;"></td> <td style="width: 10%;"></td> <td style="width: 10%;"></td> </tr> <tr> <td></td> <td></td> <td colspan="8"
style="text-align: center;"> <table border="1" style="width: 100%; border-collapse: collapse; text-align: center;"> <tr> <td style="width: 10%;"></td> <td style="width: 10%;"></td> <td style="width: 10%;"></td> <td style="width: 10%;"></td> <td style="width: 10%;"></td> <td style="width: 10%;"></td> <td style="width: 10%;"></td> <td style="width: 10%;"></td> <td style="width: 10%;"></td> <td style="width: 10%;"></td> </tr> <tr> <td></td> <td></td> <td colspan="8" style="text-align: center;"> <table border="1" style="width: 100%; border-collapse: collapse; text-align: center;"> <tr> <td style="width: 10%;"></td> <td style="width: 10%;"></td> <td style="width: 10%;"></td> <td style="width: 10%;"></td> <td style="width: 10%;"></td> <td style="width: 10%;"></td> <td style="width: 10%;"></td> <td style="width: 10%;"></td> <td style="width: 10%;"></td> <td style="width: 10%;"></td> </tr> <tr> <td></td> <td></td> <td colspan="8" style="text-align: center;"> <table border="1" style="width: 100%; border-collapse: collapse; text-align: center;"> <tr> <td style="width: 10%;"></td> <td style="width: 10%;"></td> <td style="width: 10%;"></td> <td style="width: 10%;"></td> <td style="width: 10%;"></td> <td style="width: 10%;"></td> <td style="width: 10%;"></td> <td style="width: 10%;"></td> <td style="width: 10%;"></td> <td style="width: 10%;"></td> </tr> <tr> <td></td> <td></td> <td colspan="8" style="text-align: center;"> <table border="1" style="width: 100%; border-collapse: collapse; text-align: center;"> <tr> <td style="width: 10%;"></td> <td style="width: 10%;"></td> <td style="width: 10%;"></td> <td style="width: 10%;"></td> <td style="width: 10%;"></td> <td style="width: 10%;"></td> <td style="width: 10%;"></td> <td style="width: 10%;"></td> <td style="width: 10%;"></td> <td style="width: 10%;"></td> </tr> <tr> <td></td> <td></td> <td colspan="8" style="text-align: center;"> <table border="1" style="width: 100%; border-collapse: collapse; text-align: center;"> <tr> <td style="width: 10%;"></td> <td style="width: 10%;"></td> <td style="width: 10%;"></td> <td style="width: 10%;"></td> <td style="width: 10%;"></td> <td style="width: 10%;"></td> <td style="width: 10%;"></td> <td style="width: 10%;"></td> <td style="width: 10%;"></td> <td style="width: 10%;"></td> </tr> <tr> <td></td> <td></td> <td colspan="8" style="text-align: center;"> <table border="1" style="width: 100%; border-collapse: collapse; text-align: center;"> <tr> <td style="width: 10%;"></td> <td style="width: 10%;"></td> <td style="width: 10%;"></td> <td style="width: 10%;"></td> <td style="width: 10%;"></td> <td style="width: 10%;"></td> <td style="width: 10%;"></td> <td style="width: 10%;"></td> <td style="width: 10%;"></td> <td style="width: 10%;"></td> </tr> <tr> <td></td> <td></td> <td colspan="8" style="text-align: center;"> <table border="1" style="width: 100%; border-collapse: collapse; text-align: center;"> <tr> <td style="width: 10%;"></td> <td style="width: 10%;"></td> <td style="width: 10%;"></td> <td style="width: 10%;"></td> <td style="width: 10%;"></td> <td style="width: 10%;"></td> <td style="width: 10%;"></td> <td style="width: 10%;"></td> <td style="width: 10%;"></td> <td style="width: 10%;"></td> </tr> <tr> <td></td> <td></td> <td colspan="8" style="text-align: center;"> <table border="1" style="width: 100%; border-collapse: collapse; text-align: center;"> <tr> <td style="width: 10%;"></td> <td style="width: 10%;"></td> <td style="width: 10%;"></td> <td style="width: 10%;"></td> <td style="width: 10%;"></td> <td style="width: 10%;"></td> <td style="width: 10%;"></td> <td style="width: 10%;"></td> <td style="width: 10%;"></td> <td style="width: 10%;"></td> </tr> <tr> <td></td> <td></td> <td colspan="8" style="text-align: center;"> <table border="1" style="width: 100%; border-collapse: collapse; text-align: center;"> <tr> <td style="width: 10%;"></td> <td style="width: 10%;"></td> <td style="width: 10%;"></td> <td style="width: 10%;"></td> <td style="width: 10%;"></td> <td style="width: 10%;"></td> <td style="width: 10%;"></td> <td style="width: 10%;"></td> <td style="width: 10%;"></td> <td style="width: 10%;"></td> </tr> <tr> <td></td> <td></td> <td colspan="8" style="text-align: center;"> <table border="1" style="width: 100%; border-collapse: collapse; text-align: center;"> <tr> <td style="width: 10%;"></td> <td style="width: 10%;"></td> <td style="width: 10%;"></td> <td style="width: 10%;"></td> <td style="width: 10%;"></td> <td style="width: 10%;"></td> <td style="width: 10%;"></td> <td style="width: 10%;"></td> <td style="width: 10%;"></td> <td style="width: 10%;"></td> </tr> <tr> <td></td> <td></td> <td colspan="8" style="text-align: center;"> <table border="1" style="width: 100%; border-collapse: collapse; text-align: center;"> <tr> <td style="width: 10%;"></td> <td style="width: 10%;"></td> <td style="width: 10%;"></td> <td style="width: 10%;"></td> <td style="width: 10%;"></td> <td style="width: 10%;"></td> <td style="width: 10%;"></td> <td style="width: 10%;"></td> <td style="width: 10%;"></td> <td style="width: 10%;"></td> </tr> <tr> <td></td> <td></td> <td colspan="8" style="text-align: center;"> <table border="1" style="width: 100%; border-collapse: collapse; text-align: center;"> <tr> <td style="width: 10%;"></td> <td style="width: 10%;"></td> <td style="width: 10%;"></td> <td style="width: 10%;"></td> <td style="width: 10%;"></td> <td style="width: 10%;"></td> <td style="width: 10%;"></td> <td style="width: 10%;"></td> <td style="width: 10%;"></td> <td style="width: 10%;"></td> </tr> <tr> <td></td> <td></td> <td colspan="8" style="text-align: center;"> <table border="1" style="width: 100%; border-collapse: collapse; text-align: center;"> <tr> <td style="width: 10%;"></td> <td style="width: 10%;"></td> <td style="width: 10%;"></td> <td style="width: 10%;"></td> <td style="width: 10%;"></td> <td style="width: 10%;"></td> <td style="width: 10%;"></td> <td style="width: 10%;"></td> <td style="width: 10%;"></td> <td style="width: 10%;"></td> </tr> <tr> <td></td> <td></td> <td colspan="8" style="text-align: center;"> <table border="1" style="width: 100%; border-collapse: collapse; text-align: center;"> <tr> <td style="width: 10%;"></td> <td style="width: 10%;"></td> <td style="width: 10%;"></td> <td style="width: 10%;"></td> <td style="width: 10%;"></td> <td style="width: 10%;"></td> <td style="width: 10%;"></td> <td style="width: 10%;"></td> <td style="width: 10%;"></td> <td style="width: 10%;"></td> </tr> <tr> <td></td> <td></td> <td colspan="8" style="text-align: center;"> <table border="1" style="width: 100%; border-collapse: collapse; text-align: center;"> <tr> <td style="width: 10%;"></td> <td style="width: 10%;"></td> <td style="width: 10%;"></td> <td style="width: 10%;"></td> <td style="width: 10%;"></td> <td style="width: 10%;"></td> <td style="width: 10%;"></td> <td style="width: 10%;"></td> <td style="width: 10%;"></td> <td style="width: 10%;"></td> </tr> <tr> <td></td> <td></td> <td colspan="8" style="text-align: center;"> <table border="1" style="width: 100%; border-collapse: collapse; text-align: center;"> <tr> <td style="width: 10%;"></td> <td style="width: 10%;"></td> <td style="width: 10%;"></td> <td style="width: 10%;"></td> <td style="width: 10%;"></td> <td style="width: 10%;"></td> <td style="width: 10%;"></td> <td style="width: 10%;"></td> <td style="width: 10%;"></td> <td style="width: 10%;"></td> </tr> <tr> <td></td> <td></td> <td colspan="8" style="text-align: center;"> <table border="1" style="width: 100%; border-collapse: collapse; text-align: center;"> <tr> <td style="width: 10%;"></td> <td style="width: 10%;"></td> <td style="width: 10%;"></td> <td style="width: 10%;"></td> <td style="width: 10%;"></td> <td style="width: 10%;"></td> <td style="width: 10%;"></td> <td style="width: 10%;"></td> <td style="width: 10%;"></td> <td style="width: 10%;"></td> </tr> <tr> <td></td> <td></td> <td colspan="8" style="text-align: center;"> <table border="1" style="width: 100%; border-collapse: collapse; text-align: center;"> <tr> <td style="width: 10%;"></td> <td style="width: 10%;"></td> <td style="width: 10%;"></td> <td style="width: 10%;"></td> <td style="width: 10%;"></td> <td style="width: 10%;"></td> <td style="width: 10%;"></td> <td style="width: 10%;"></td> <td style="width: 10%;"></td> <td style="width: 10%;"></td> </tr> <tr> <td></td> <td></td> <td colspan="8" style="text-align: center;"> <table border="1" style="width: 100%; border-collapse: collapse; text-align: center;"> <tr> <td style="width: 10%;"></td> <td style="width: 10%;"></td> <td style="width: 10%;"></td> <td style="width: 10%;"></td> <td style="width: 10%;"></td> <td style="width: 10%;"></td> <td style="width: 10%;"></td> <td style="width: 10%;"></td> <td style="width: 10%;"></td> <td style="width: 10%;"></td> </tr> <tr> <td></td> <td></td> <td colspan="8" style="text-align: center;"> <table border="1" style="width: 100%; border-collapse: collapse; text-align: center;"> <tr> <td style="width: 10%;"></td> <td style="width: 10%;"></td> <td style="width: 10%;"></td> <td style="width: 10%;"></td> <td style="width: 10%;"></td> <td style="width: 10%;"></td> <td style="width: 10%;"></td> <td style="width: 10%;"></td> <td style="width: 10%;"></td> <td style="width: 10%;"></td> </tr> <tr> <td></td> <td></td> <td colspan="8" style="text-align: center;"> <table border="1" style="width: 100%; border-collapse: collapse; text-align: center;"> <tr> <td style="width: 10%;"></td> <td style="width: 10%;"></td> <td style="width: 10%;"></td> <td style="width: 10%;"></td> <td style="width: 10%;"></td> <td style="width: 10%;"></td> <td style="width: 10%;"></td> <td style="width: 10%;"></td> <td style="width: 10%;"></td> <td style="width: 10%;"></td> </tr> <tr> <td></td> <td></td> <td colspan="8" style="text-align: center;"> <table border="1" style="width: 100%; border-collapse: collapse; text-align: center;"> <tr> <td style="width: 10%;"></td> <td style="width:
10%;"></td> <td style="width: 10%;"></td> <td style="width: 10%;"></td> <td style="width: 10%;"></td> <td style="width: 10%;"></td> <td style="width: 10%;"></td> <td style="width: 10%;"></td> <td style="width: 10%;"></td> <td style="width: 10%;"></td> </tr> <tr> <td></td> <td></td> <td colspan="8" style="text-align: center;"> <table border="1" style="width: 100%; border-collapse: collapse; text-align: center;"> <tr> <td style="width: 10%;"></td> <td style="width: 10%;"></td> <td style="width: 10%;"></td> <td style="width: 10%;"></td> <td style="width: 10%;"></td> <td style="width: 10%;"></td> <td style="width: 10%;"></td> <td style="width: 10%;"></td> <td style="width: 10%;"></td> <td style="width: 10%;"></td> </tr> <tr> <td></td> <td></td> <td colspan="8" style="text-align: center;"> <table border="1" style="width: 100%; border-collapse: collapse; text-align: center;"> <tr> <td style="width: 10%;"></td> <td style="width: 10%;"></td> <td style="width: 10%;"></td> <td style="width: 10%;"></td> <td style="width: 10%;"></td> <td style="width: 10%;"></td> <td style="width: 10%;"></td> <td style="width: 10%;"></td> <td style="width: 10%;"></td> <td style="width: 10%;"></td> </tr> <tr> <td></td> <td></td> <td colspan="8" style="text-align: center;"> <table border="1" style="width: 100%; border-collapse: collapse; text-align: center;"> <tr> <td style="width: 10%;"></td> <td style="width: 10%;"></td> <td style="width: 10%;"></td> <td style="width: 10%;"></td> <td style="width: 10%;"></td> <td style="width: 10%;"></td> <td style="width: 10%;"></td> <td style="width: 10%;"></td> <td style="width: 10%;"></td> <td style="width: 10%;"></td> </tr> <tr> <td></td> <td></td> <td colspan="8" style="text-align: center;"> <table border="1" style="width: 100%; border-collapse: collapse; text-align: center;"> <tr> <td style="width: 10%;"></td> <td style="width: 10%;"></td> <td style="width: 10%;"></td> <td style="width: 10%;"></td> <td style="width: 10%;"></td> <td style="width: 10%;"></td> <td style="width: 10%;"></td> <td style="width: 10%;"></td> <td style="width: 10%;"></td> <td style="width: 10%;"></td> </tr> <tr> <td></td> <td></td> <td colspan="8" style="text-align: center;"> <table border="1" style="width: 100%; border-collapse: collapse; text-align: center;"> <tr> <td style="width: 10%;"></td> <td style="width: 10%;"></td> <td style="width: 10%;"></td> <td style="width: 10%;"></td> <td style="width: 10%;"></td> <td style="width: 10%;"></td> <td style="width: 10%;"></td> <td style="width: 10%;"></td> <td style="width: 10%;"></td> <td style="width: 10%;"></td> </tr> <tr> <td></td> <td></td> <td colspan="8" style="text-align: center;"> <table border="1" style="width: 100%; border-collapse: collapse; text-align: center;"> <tr> <td style="width: 10%;"></td> <td style="width: 10%;"></td> <td style="width: 10%;"></td> <td style="width: 10%;"></td> <td style="width: 10%;"></td> <td style="width: 10%;"></td> <td style="width: 10%;"></td> <td style="width: 10%;"></td> <td style="width: 10%;"></td> <td style="width: 10%;"></td> </tr> <tr> <td></td> <td></td> <td colspan="8" style="text-align: center;"> <table border="1" style="width: 100%; border-collapse: collapse; text-align: center;"> <tr> <td style="width: 10%;"></td> <td style="width: 10%;"></td> <td style="width: 10%;"></td> <td style="width: 10%;"></td> <td style="width: 10%;"></td> <td style="width: 10%;"></td> <td style="width: 10%;"></td> <td style="width: 10%;"></td> <td style="width: 10%;"></td> <td style="width: 10%;"></td> </tr> <tr> <td></td> <td></td> <td colspan="8" style="text-align: center;"> <table border="1" style="width: 100%; border-collapse: collapse; text-align: center;"> <tr> </tr></table></td></tr></table></td></tr></table></td></tr></table></td></tr></table></td></tr></table></td></tr></table></td></tr></table></td></tr></table></td></tr></table></td></tr></table></td></tr></table></td></tr></table></td></tr></table></td></tr></table></td></tr></table></td></tr></table></td></tr></table></td></tr></table></td></tr></table></td></tr></table></td></tr></table></td></tr></table></td></tr></table></td></tr></table></td></tr></table></td></tr></table></td></tr></table></td></tr></table></td></tr></table></td></tr></table></td></tr></table></td></tr></table></td></tr></table></td></tr></table></td></tr></table>
 | | | | | | | | | | | | | | | | | | | | <table border="1" style="width: 100%; border-collapse: collapse; text-align: center;"> <tr> <td style="width: 10%;"></td> <td style="width: 10%;"></td> <td style="width: 10%;"></td> <td style="width: 10%;"></td> <td style="width: 10%;"></td> <td style="width: 10%;"></td> <td style="width: 10%;"></td> <td style="width: 10%;"></td> <td style="width: 10%;"></td> <td style="width: 10%;"></td> </tr> <tr> <td></td> <td></td> <td colspan="8" style="text-align: center;"> <table border="1" style="width: 100%; border-collapse: collapse; text-align: center;"> <tr> <td style="width: 10%;"></td> <td style="width: 10%;"></td> <td style="width: 10%;"></td> <td style="width: 10%;"></td> <td style="width: 10%;"></td> <td style="width: 10%;"></td> <td style="width: 10%;"></td> <td style="width: 10%;"></td> <td style="width: 10%;"></td> <td style="width: 10%;"></td> </tr> <tr> <td></td> <td></td> <td colspan="8" style="text-align: center;"> <table border="1" style="width: 100%; border-collapse: collapse; text-align: center;"> <tr> <td style="width: 10%;"></td> <td style="width: 10%;"></td> <td style="width: 10%;"></td> <td style="width: 10%;"></td> <td style="width: 10%;"></td> <td style="width: 10%;"></td> <td style="width: 10%;"></td> <td style="width: 10%;"></td> <td style="width: 10%;"></td> <td style="width: 10%;"></td> </tr> <tr> <td></td> <td></td> <td colspan="8" style="text-align: center;"> <table border="1" style="width: 100%; border-collapse: collapse; text-align: center;"> <tr> <td style="width: 10%;"></td> <td style="width: 10%;"></td> <td style="width: 10%;"></td> <td style="width: 10%;"></td> <td style="width: 10%;"></td> <td style="width: 10%;"></td> <td style="width: 10%;"></td> <td style="width: 10%;"></td> <td style="width: 10%;"></td> <td style="width: 10%;"></td> </tr> <tr> <td></td> <td></td> <td colspan="8" style="text-align: center;"> <table border="1" style="width: 100%; border-collapse: collapse; text-align: center;"> <tr> <td style="width: 10%;"></td> <td style="width: 10%;"></td> <td style="width: 10%;"></td> <td style="width: 10%;"></td> <td style="width: 10%;"></td> <td style="width: 10%;"></td> <td style="width: 10%;"></td> <td style="width: 10%;"></td> <td style="width: 10%;"></td> <td style="width: 10%;"></td> </tr> <tr> <td></td> <td></td> <td colspan="8" style="text-align: center;"> <table border="1" style="width: 100%; border-collapse: collapse; text-align: center;"> <tr> <td style="width: 10%;"></td> <td style="width: 10%;"></td> <td style="width: 10%;"></td> <td style="width: 10%;"></td> <td style="width: 10%;"></td> <td style="width: 10%;"></td> <td style="width: 10%;"></td> <td style="width: 10%;"></td> <td style="width: 10%;"></td> <td style="width: 10%;"></td> </tr> <tr> <td></td> <td></td> <td colspan="8" style="text-align: center;"> <table border="1" style="width: 100%; border-collapse: collapse; text-align: center;"> <tr> <td style="width: 10%;"></td> <td style="width: 10%;"></td> <td style="width: 10%;"></td> <td style="width: 10%;"></td> <td style="width: 10%;"></td> <td style="width: 10%;"></td> <td style="width: 10%;"></td> <td style="width: 10%;"></td> <td style="width: 10%;"></td> <td style="width: 10%;"></td> </tr> <tr> <td></td> <td></td> <td colspan="8" style="text-align: center;"> <table border="1" style="width: 100%; border-collapse: collapse; text-align: center;"> <tr> <td style="width: 10%;"></td> <td style="width: 10%;"></td> <td style="width: 10%;"></td> <td style="width: 10%;"></td> <td style="width: 10%;"></td> <td style="width: 10%;"></td> <td style="width: 10%;"></td> <td style="width: 10%;"></td> <td style="width: 10%;"></td> <td style="width: 10%;"></td> </tr> <tr> <td></td> <td></td> <td colspan="8" style="text-align: center;"> <table border="1" style="width: 100%; border-collapse: collapse; text-align: center;"> <tr> <td style="width: 10%;"></td> <td style="width: 10%;"></td> <td style="width: 10%;"></td> <td style="width: 10%;"></td> <td style="width: 10%;"></td> <td style="width: 10%;"></td> <td style="width: 10%;"></td> <td style="width: 10%;"></td> <td style="width: 10%;"></td> <td style="width: 10%;"></td> </tr> <tr> <td></td> <td></td> <td colspan="8" style="text-align: center;"> <table border="1" style="width: 100%; border-collapse: collapse; text-align: center;"> <tr> <td style="width: 10%;"></td> <td style="width: 10%;"></td> <td style="width: 10%;"></td> <td style="width: 10%;"></td> <td style="width: 10%;"></td> <td style="width: 10%;"></td> <td style="width: 10%;"></td> <td style="width: 10%;"></td> <td style="width: 10%;"></td> <td style="width: 10%;"></td> </tr> <tr> <td></td> <td></td> <td colspan="8" style="text-align: center;"> <table border="1" style="width: 100%; border-collapse: collapse; text-align: center;"> <tr> <td style="width: 10%;"></td> <td style="width: 10%;"></td> <td style="width: 10%;"></td> <td style="width: 10%;"></td> <td style="width: 10%;"></td> <td style="width: 10%;"></td> <td style="width: 10%;"></td> <td style="width: 10%;"></td> <td style="width: 10%;"></td> <td style="width: 10%;"></td> </tr> <tr> <td></td> <td></td> <td colspan="8" style="text-align: center;"> <table border="1" style="width: 100%; border-collapse: collapse; text-align: center;"> <tr> <td style="width: 10%;"></td> <td style="width: 10%;"></td> <td style="width: 10%;"></td> <td style="width: 10%;"></td> <td style="width: 10%;"></td> <td
style="width: 10%;"></td> <td style="width: 10%;"></td> <td style="width: 10%;"></td> <td style="width: 10%;"></td> <td style="width: 10%;"></td> </tr> <tr> <td></td> <td></td> <td colspan="8" style="text-align: center;"> <table border="1" style="width: 100%; border-collapse: collapse; text-align: center;"> <tr> <td style="width: 10%;"></td> <td style="width: 10%;"></td> <td style="width: 10%;"></td> <td style="width: 10%;"></td> <td style="width: 10%;"></td> <td style="width: 10%;"></td> <td style="width: 10%;"></td> <td style="width: 10%;"></td> <td style="width: 10%;"></td> <td style="width: 10%;"></td> </tr> <tr> <td></td> <td></td> <td colspan="8" style="text-align: center;"> <table border="1" style="width: 100%; border-collapse: collapse; text-align: center;"> <tr> <td style="width: 10%;"></td> <td style="width: 10%;"></td> <td style="width: 10%;"></td> <td style="width: 10%;"></td> <td style="width: 10%;"></td> <td style="width: 10%;"></td> <td style="width: 10%;"></td> <td style="width: 10%;"></td> <td style="width: 10%;"></td> <td style="width: 10%;"></td> </tr> <tr> <td></td> <td></td> <td colspan="8" style="text-align: center;"> <table border="1" style="width: 100%; border-collapse: collapse; text-align: center;"> <tr> <td style="width: 10%;"></td> <td style="width: 10%;"></td> <td style="width: 10%;"></td> <td style="width: 10%;"></td> <td style="width: 10%;"></td> <td style="width: 10%;"></td> <td style="width: 10%;"></td> <td style="width: 10%;"></td> <td style="width: 10%;"></td> <td style="width: 10%;"></td> </tr> <tr> <td></td> <td></td> <td colspan="8" style="text-align: center;"> <table border="1" style="width: 100%; border-collapse: collapse; text-align: center;"> <tr> <td style="width: 10%;"></td> <td style="width: 10%;"></td> <td style="width: 10%;"></td> <td style="width: 10%;"></td> <td style="width: 10%;"></td> <td style="width: 10%;"></td> <td style="width: 10%;"></td> <td style="width: 10%;"></td> <td style="width: 10%;"></td> <td style="width: 10%;"></td> </tr> <tr> <td></td> <td></td> <td colspan="8" style="text-align: center;"> <table border="1" style="width: 100%; border-collapse: collapse; text-align: center;"> <tr> <td style="width: 10%;"></td> <td style="width: 10%;"></td> <td style="width: 10%;"></td> <td style="width: 10%;"></td> <td style="width: 10%;"></td> <td style="width: 10%;"></td> <td style="width: 10%;"></td> <td style="width: 10%;"></td> <td style="width: 10%;"></td> <td style="width: 10%;"></td> </tr> <tr> <td></td> <td></td> <td colspan="8" style="text-align: center;"> <table border="1" style="width: 100%; border-collapse: collapse; text-align: center;"> <tr> <td style="width: 10%;"></td> <td style="width: 10%;"></td> <td style="width: 10%;"></td> <td style="width: 10%;"></td> <td style="width: 10%;"></td> <td style="width: 10%;"></td> <td style="width: 10%;"></td> <td style="width: 10%;"></td> <td style="width: 10%;"></td> <td style="width: 10%;"></td> </tr> <tr> <td></td> <td></td> <td colspan="8" style="text-align: center;"> <table border="1" style="width: 100%; border-collapse: collapse; text-align: center;"> <tr> <td style="width: 10%;"></td> <td style="width: 10%;"></td> <td style="width: 10%;"></td> <td style="width: 10%;"></td> <td style="width: 10%;"></td> <td style="width: 10%;"></td> <td style="width: 10%;"></td> <td style="width: 10%;"></td> <td style="width: 10%;"></td> <td style="width: 10%;"></td> </tr> <tr> <td></td> <td></td> <td colspan="8" style="text-align: center;"> <table border="1" style="width: 100%; border-collapse: collapse; text-align: center;"> <tr> <td style="width: 10%;"></td> <td style="width: 10%;"></td> <td style="width: 10%;"></td> <td style="width: 10%;"></td> <td style="width: 10%;"></td> <td style="width: 10%;"></td> <td style="width: 10%;"></td> <td style="width: 10%;"></td> <td style="width: 10%;"></td> <td style="width: 10%;"></td> </tr> <tr> <td></td> <td></td> <td colspan="8" style="text-align: center;"> <table border="1" style="width: 100%; border-collapse: collapse; text-align: center;"> <tr> <td style="width: 10%;"></td> <td style="width: 10%;"></td> <td style="width: 10%;"></td> <td style="width: 10%;"></td> <td style="width: 10%;"></td> <td style="width: 10%;"></td> <td style="width: 10%;"></td> <td style="width: 10%;"></td> <td style="width: 10%;"></td> <td style="width: 10%;"></td> </tr> <tr> <td></td> <td></td> <td colspan="8" style="text-align: center;"> <table border="1" style="width: 100%; border-collapse: collapse; text-align: center;"> <tr> <td style="width: 10%;"></td> <td style="width: 10%;"></td> <td style="width: 10%;"></td> <td style="width: 10%;"></td> <td style="width: 10%;"></td> <td style="width: 10%;"></td> <td style="width: 10%;"></td> <td style="width: 10%;"></td> <td style="width: 10%;"></td> <td style="width: 10%;"></td> </tr> <tr> <td></td> <td></td> <td colspan="8" style="text-align: center;"> <table border="1" style="width: 100%; border-collapse: collapse; text-align: center;"> <tr> <td style="width: 10%;"></td> <td style="width: 10%;"></td> <td style="width: 10%;"></td> <td style="width: 10%;"></td> <td style="width: 10%;"></td> <td style="width: 10%;"></td> <td style="width: 10%;"></td> <td style="width: 10%;"></td> <td style="width: 10%;"></td> <td style="width: 10%;"></td> </tr> <tr> <td></td> <td></td> <td colspan="8" style="text-align: center;"> <table border="1" style="width: 100%; border-collapse: collapse; text-align: center;"> <tr> <td style="width: 10%;"></td> <td style="width: 10%;"></td> <td style="width: 10%;"></td> <td style="width: 10%;"></td> <td style="width: 10%;"></td> <td style="width: 10%;"></td> <td style="width: 10%;"></td> <td style="width: 10%;"></td> <td style="width: 10%;"></td> <td style="width: 10%;"></td> </tr> <tr> <td></td> <td></td> <td colspan="8" style="text-align: center;"> <table border="1" style="width: 100%; border-collapse: collapse; text-align: center;"> <tr> <td style="width: 10%;"></td> <td style="width: 10%;"></td> <td style="width: 10%;"></td> <td style="width: 10%;"></td> <td style="width: 10%;"></td> <td style="width: 10%;"></td> <td style="width: 10%;"></td> <td style="width: 10%;"></td> <td style="width: 10%;"></td> <td style="width: 10%;"></td> </tr> <tr> <td></td> <td></td> <td colspan="8" style="text-align: center;"> <table border="1" style="width: 100%; border-collapse: collapse; text-align: center;"> <tr> <td style="width: 10%;"></td> <td style="width: 10%;"></td> <td style="width: 10%;"></td> <td style="width: 10%;"></td> <td style="width: 10%;"></td> <td style="width: 10%;"></td> <td style="width: 10%;"></td> <td style="width: 10%;"></td> <td style="width: 10%;"></td> <td style="width: 10%;"></td> </tr> <tr> <td></td> <td></td> <td colspan="8" style="text-align: center;"> <table border="1" style="width: 100%; border-collapse: collapse; text-align: center;"> <tr> <td style="width: 10%;"></td> <td style="width: 10%;"></td> <td style="width: 10%;"></td> <td style="width: 10%;"></td> <td style="width: 10%;"></td> <td style="width: 10%;"></td> <td style="width: 10%;"></td> <td style="width: 10%;"></td> <td style="width: 10%;"></td> <td style="width: 10%;"></td> </tr> <tr> <td></td> <td></td> <td colspan="8" style="text-align: center;"> <table border="1" style="width: 100%; border-collapse: collapse; text-align: center;"> <tr> <td style="width: 10%;"></td> <td style="width: 10%;"></td> <td style="width: 10%;"></td> <td style="width: 10%;"></td> <td style="width: 10%;"></td> <td style="width: 10%;"></td> <td style="width: 10%;"></td> <td style="width: 10%;"></td> <td style="width: 10%;"></td> <td style="width: 10%;"></td> </tr> <tr> <td></td> <td></td> <td colspan="8" style="text-align: center;"> <table border="1" style="width: 100%; border-collapse: collapse; text-align: center;"> <tr> <td style="width: 10%;"></td> <td style="width: 10%;"></td> <td style="width: 10%;"></td> <td style="width: 10%;"></td> <td style="width: 10%;"></td> <td style="width: 10%;"></td> <td style="width: 10%;"></td> <td style="width: 10%;"></td> <td style="width: 10%;"></td> <td style="width: 10%;"></td> </tr> <tr> <td></td> <td></td> <td colspan="8" style="text-align: center;"> <table border="1" style="width: 100%; border-collapse: collapse; text-align: center;"> <tr> <td style="width: 10%;"></td> <td style="width: 10%;"></td> <td style="width: 10%;"></td> <td style="width: 10%;"></td> <td style="width: 10%;"></td> <td style="width: 10%;"></td> <td style="width: 10%;"></td> <td style="width: 10%;"></td> <td style="width: 10%;"></td> <td style="width: 10%;"></td> </tr> <tr> <td></td> <td></td> <td colspan="8" style="text-align: center;"> <table border="1" style="width: 100%; border-collapse: collapse; text-align: center;"> <tr> <td style="width: 10%;"></td> <td style="width: 10%;"></td> <td style="width: 10%;"></td> <td style="width: 10%;"></td> <td style="width: 10%;"></td> <td style="width: 10%;"></td> <td style="width: 10%;"></td> <td style="width: 10%;"></td> <td style="width: 10%;"></td> <td style="width: 10%;"></td> </tr> <tr> <td></td> <td></td> <td colspan="8" style="text-align: center;"> <table border="1" style="width: 100%; border-collapse: collapse; text-align: center;"> <tr> <td style="width: 10%;"></td> <td style="width: 10%;"></td> <td style="width: 10%;"></td> <td style="width: 10%;"></td> <td style="width: 10%;"></td> <td style="width: 10%;"></td> <td style="width: 10%;"></td> <td style="width: 10%;"></td> <td style="width: 10%;"></td> <td style="width: 10%;"></td> </tr> <tr> <td></td> <td></td> <td colspan="8" style="text-align: center;"> <table border="1" style="width: 100%; border-collapse: collapse; text-align: center;"> <tr> <td style="width: 10%;"></td> <td style="width: 10%;"></td> <td style="width: 10%;"></td> <td style="width: 10%;"></td> <td style="width: 10%;"></td> <td style="width: 10%;"></td> <td style="width: 10%;"></td> <td style="width: 10%;"></td> <td style="width: 10%;"></td> <td style="width: 10%;"></td> </tr> <tr> <td></td>
<td></td> <td colspan="8" style="text-align: center;"> <table border="1" style="width: 100%; border-collapse: collapse; text-align: center;"> <tr> <td style="width: 10%;"></td> <td style="width: 10%;"></td> <td style="width: 10%;"></td> <td style="width: 10%;"></td> <td style="width: 10%;"></td> <td style="width: 10%;"></td> <td style="width: 10%;"></td> <td style="width: 10%;"></td> <td style="width: 10%;"></td> <td style="width: 10%;"></td> </tr> <tr> <td></td> <td></td> <td colspan="8" style="text-align: center;"> <table border="1" style="width: 100%; border-collapse: collapse; text-align: center;"> <tr> </tr></table></td></tr></table></td></tr></table></td></tr></table></td></tr></table></td></tr></table></td></tr></table></td></tr></table></td></tr></table></td></tr></table></td></tr></table></td></tr></table></td></tr></table></td></tr></table></td></tr></table></td></tr></table></td></tr></table></td></tr></table></td></tr></table></td></tr></table></td></tr></table></td></tr></table></td></tr></table></td></tr></table></td></tr></table></td></tr></table></td></tr></table></td></tr></table></td></tr></table></td></tr></table></td></tr></table></td></tr></table></td></tr></table></td></tr></table></td></tr></table>
 | | | | | | | | | | | | | | | | | | | | <table border="1" style="width: 100%; border-collapse: collapse; text-align: center;"> <tr> <td style="width: 10%;"></td> <td style="width: 10%;"></td> <td style="width: 10%;"></td> <td style="width: 10%;"></td> <td style="width: 10%;"></td> <td style="width: 10%;"></td> <td style="width: 10%;"></td> <td style="width: 10%;"></td> <td style="width: 10%;"></td> <td style="width: 10%;"></td> </tr> <tr> <td></td> <td></td> <td colspan="8" style="text-align: center;"> <table border="1" style="width: 100%; border-collapse: collapse; text-align: center;"> <tr> <td style="width: 10%;"></td> <td style="width: 10%;"></td> <td style="width: 10%;"></td> <td style="width: 10%;"></td> <td style="width: 10%;"></td> <td style="width: 10%;"></td> <td style="width: 10%;"></td> <td style="width: 10%;"></td> <td style="width: 10%;"></td> <td style="width: 10%;"></td> </tr> <tr> <td></td> <td></td> <td colspan="8" style="text-align: center;"> <table border="1" style="width: 100%; border-collapse: collapse; text-align: center;"> <tr> <td style="width: 10%;"></td> <td style="width: 10%;"></td> <td style="width: 10%;"></td> <td style="width: 10%;"></td> <td style="width: 10%;"></td> <td style="width: 10%;"></td> <td style="width: 10%;"></td> <td style="width: 10%;"></td> <td style="width: 10%;"></td> <td style="width: 10%;"></td> </tr> <tr> <td></td> <td></td> <td colspan="8" style="text-align: center;"> <table border="1" style="width: 100%; border-collapse: collapse; text-align: center;"> <tr> <td style="width: 10%;"></td> <td style="width: 10%;"></td> <td style="width: 10%;"></td> <td style="width: 10%;"></td> <td style="width: 10%;"></td> <td style="width: 10%;"></td> <td style="width: 10%;"></td> <td style="width: 10%;"></td> <td style="width: 10%;"></td> <td style="width: 10%;"></td> </tr> <tr> <td></td> <td></td> <td colspan="8" style="text-align: center;"> <table border="1" style="width: 100%; border-collapse: collapse; text-align: center;"> <tr> <td style="width: 10%;"></td> <td style="width: 10%;"></td> <td style="width: 10%;"></td> <td style="width: 10%;"></td> <td style="width: 10%;"></td> <td style="width: 10%;"></td> <td style="width: 10%;"></td> <td style="width: 10%;"></td> <td style="width: 10%;"></td> <td style="width: 10%;"></td> </tr> <tr> <td></td> <td></td> <td colspan="8" style="text-align: center;"> <table border="1" style="width: 100%; border-collapse: collapse; text-align: center;"> <tr> <td style="width: 10%;"></td> <td style="width: 10%;"></td> <td style="width: 10%;"></td> <td style="width: 10%;"></td> <td style="width: 10%;"></td> <td style="width: 10%;"></td> <td style="width: 10%;"></td> <td style="width: 10%;"></td> <td style="width: 10%;"></td> <td style="width: 10%;"></td> </tr> <tr> <td></td> <td></td> <td colspan="8" style="text-align: center;"> <table border="1" style="width: 100%; border-collapse: collapse; text-align: center;"> <tr> <td style="width: 10%;"></td> <td style="width: 10%;"></td> <td style="width: 10%;"></td> <td style="width: 10%;"></td> <td style="width: 10%;"></td> <td style="width: 10%;"></td> <td style="width: 10%;"></td> <td style="width: 10%;"></td> <td style="width: 10%;"></td> <td style="width: 10%;"></td> </tr> <tr> <td></td> <td></td> <td colspan="8" style="text-align: center;"> <table border="1" style="width: 100%; border-collapse: collapse; text-align: center;"> <tr> <td style="width: 10%;"></td> <td style="width: 10%;"></td> <td style="width: 10%;"></td> <td style="width: 10%;"></td> <td style="width: 10%;"></td> <td style="width: 10%;"></td> <td style="width: 10%;"></td> <td style="width: 10%;"></td> <td style="width: 10%;"></td> <td style="width: 10%;"></td> </tr> <tr> <td></td> <td></td> <td colspan="8" style="text-align: center;"> <table border="1" style="width: 100%; border-collapse: collapse; text-align: center;"> <tr> <td style="width: 10%;"></td> <td style="width: 10%;"></td> <td style="width: 10%;"></td> <td style="width: 10%;"></td> <td style="width: 10%;"></td> <td style="width: 10%;"></td> <td style="width: 10%;"></td> <td style="width: 10%;"></td> <td style="width: 10%;"></td> <td style="width: 10%;"></td> </tr> <tr> <td></td> <td></td> <td colspan="8" style="text-align: center;"> <table border="1" style="width: 100%; border-collapse: collapse; text-align: center;"> <tr> <td style="width: 10%;"></td> <td style="width: 10%;"></td> <td style="width: 10%;"></td> <td style="width: 10%;"></td> <td style="width: 10%;"></td> <td style="width: 10%;"></td> <td style="width: 10%;"></td> <td style="width: 10%;"></td> <td style="width: 10%;"></td> <td style="width: 10%;"></td> </tr> <tr> <td></td> <td></td> <td colspan="8" style="text-align: center;"> <table border="1" style="width: 100%; border-collapse: collapse; text-align: center;"> <tr> <td style="width: 10%;"></td> <td style="width: 10%;"></td> <td style="width: 10%;"></td> <td style="width: 10%;"></td> <td style="width: 10%;"></td> <td style="width: 10%;"></td> <td style="width: 10%;"></td> <td style="width: 10%;"></td> <td style="width: 10%;"></td> <td style="width: 10%;"></td> </tr> <tr> <td></td> <td></td> <td colspan="8" style="text-align: center;"> <table border="1" style="width: 100%; border-collapse: collapse; text-align: center;"> <tr> <td style="width: 10%;"></td> <td style="width: 10%;"></td> <td style="width: 10%;"></td> <td style="width: 10%;"></td> <td style="width: 10%;"></td> <td style="width: 10%;"></td> <td style="width: 10%;"></td> <td style="width: 10%;"></td> <td style="width: 10%;"></td> <td style="width: 10%;"></td> </tr> <tr> <td></td> <td></td> <td colspan="8" style="text-align: center;"> <table border="1" style="width: 100%; border-collapse: collapse; text-align: center;"> <tr> <td style="width: 10%;"></td> <td style="width: 10%;"></td> <td style="width: 10%;"></td> <td style="width: 10%;"></td> <td style="width: 10%;"></td> <td style="width: 10%;"></td> <td style="width: 10%;"></td> <td style="width: 10%;"></td> <td style="width: 10%;"></td> <td style="width: 10%;"></td> </tr> <tr> <td></td> <td></td> <td colspan="8" style="text-align: center;"> <table border="1" style="width: 100%; border-collapse: collapse; text-align: center;"> <tr> <td style="width: 10%;"></td> <td style="width: 10%;"></td> <td style="width: 10%;"></td> <td style="width: 10%;"></td> <td style="width: 10%;"></td> <td style="width: 10%;"></td> <td style="width: 10%;"></td> <td style="width: 10%;"></td> <td style="width: 10%;"></td> <td style="width: 10%;"></td> </tr> <tr> <td></td> <td></td> <td colspan="8" style="text-align: center;"> <table border="1" style="width: 100%; border-collapse: collapse; text-align: center;"> <tr> <td style="width: 10%;"></td> <td style="width: 10%;"></td> <td style="width: 10%;"></td> <td style="width: 10%;"></td> <td style="width: 10%;"></td> <td style="width: 10%;"></td> <td style="width: 10%;"></td> <td style="width: 10%;"></td> <td style="width: 10%;"></td> <td style="width: 10%;"></td> </tr> <tr> <td></td> <td></td> <td colspan="8" style="text-align: center;"> <table border="1" style="width: 100%; border-collapse: collapse; text-align: center;"> <tr> <td style="width: 10%;"></td> <td style="width: 10%;"></td> <td style="width: 10%;"></td> <td style="width: 10%;"></td> <td style="width: 10%;"></td> <td style="width: 10%;"></td> <td style="width: 10%;"></td> <td style="width: 10%;"></td> <td style="width: 10%;"></td> <td style="width: 10%;"></td> </tr> <tr> <td></td> <td></td> <td colspan="8" style="text-align: center;"> <table border="1" style="width: 100%; border-collapse: collapse; text-align: center;"> <tr> <td style="width: 10%;"></td> <td style="width: 10%;"></td> <td style="width: 10%;"></td> <td style="width: 10%;"></td> <td style="width: 10%;"></td> <td style="width: 10%;"></td> <td style="width: 10%;"></td> <td style="width: 10%;"></td> <td style="width: 10%;"></td> <td style="width: 10%;"></td> </tr> <tr> <td></td> <td></td> <td colspan="8" style="text-align: center;"> <table border="1" style="width: 100%; border-collapse: collapse; text-align: center;"> <tr> <td style="width: 10%;"></td> <td style="width: 10%;"></td> <td style="width: 10%;"></td> <td style="width: 10%;"></td> <td style="width: 10%;"></td> <td style="width: 10%;"></td> <td style="width: 10%;"></td> <td style="width: 10%;"></td> <td style="width: 10%;"></td> <td style="width: 10%;"></td> </tr> <tr> <td></td> <td></td> <td colspan="8" style="text-align: center;"> <table border="1" style="width: 100%; border-collapse: collapse;
text-align: center;"> <tr> <td style="width: 10%;"></td> <td style="width: 10%;"></td> <td style="width: 10%;"></td> <td style="width: 10%;"></td> <td style="width: 10%;"></td> <td style="width: 10%;"></td> <td style="width: 10%;"></td> <td style="width: 10%;"></td> <td style="width: 10%;"></td> <td style="width: 10%;"></td> </tr> <tr> <td></td> <td></td> <td colspan="8" style="text-align: center;"> <table border="1" style="width: 100%; border-collapse: collapse; text-align: center;"> <tr> <td style="width: 10%;"></td> <td style="width: 10%;"></td> <td style="width: 10%;"></td> <td style="width: 10%;"></td> <td style="width: 10%;"></td> <td style="width: 10%;"></td> <td style="width: 10%;"></td> <td style="width: 10%;"></td> <td style="width: 10%;"></td> <td style="width: 10%;"></td> </tr> <tr> <td></td> <td></td> <td colspan="8" style="text-align: center;"> <table border="1" style="width: 100%; border-collapse: collapse; text-align: center;"> <tr> <td style="width: 10%;"></td> <td style="width: 10%;"></td> <td style="width: 10%;"></td> <td style="width: 10%;"></td> <td style="width: 10%;"></td> <td style="width: 10%;"></td> <td style="width: 10%;"></td> <td style="width: 10%;"></td> <td style="width: 10%;"></td> <td style="width: 10%;"></td> </tr> <tr> <td></td> <td></td> <td colspan="8" style="text-align: center;"> <table border="1" style="width: 100%; border-collapse: collapse; text-align: center;"> <tr> <td style="width: 10%;"></td> <td style="width: 10%;"></td> <td style="width: 10%;"></td> <td style="width: 10%;"></td> <td style="width: 10%;"></td> <td style="width: 10%;"></td> <td style="width: 10%;"></td> <td style="width: 10%;"></td> <td style="width: 10%;"></td> <td style="width: 10%;"></td> </tr> <tr> <td></td> <td></td> <td colspan="8" style="text-align: center;"> <table border="1" style="width: 100%; border-collapse: collapse; text-align: center;"> <tr> <td style="width: 10%;"></td> <td style="width: 10%;"></td> <td style="width: 10%;"></td> <td style="width: 10%;"></td> <td style="width: 10%;"></td> <td style="width: 10%;"></td> <td style="width: 10%;"></td> <td style="width: 10%;"></td> <td style="width: 10%;"></td> <td style="width: 10%;"></td> </tr> <tr> <td></td> <td></td> <td colspan="8" style="text-align: center;"> <table border="1" style="width: 100%; border-collapse: collapse; text-align: center;"> <tr> <td style="width: 10%;"></td> <td style="width: 10%;"></td> <td style="width: 10%;"></td> <td style="width: 10%;"></td> <td style="width: 10%;"></td> <td style="width: 10%;"></td> <td style="width: 10%;"></td> <td style="width: 10%;"></td> <td style="width: 10%;"></td> <td style="width: 10%;"></td> </tr> <tr> <td></td> <td></td> <td colspan="8" style="text-align: center;"> <table border="1" style="width: 100%; border-collapse: collapse; text-align: center;"> <tr> <td style="width: 10%;"></td> <td style="width: 10%;"></td> <td style="width: 10%;"></td> <td style="width: 10%;"></td> <td style="width: 10%;"></td> <td style="width: 10%;"></td> <td style="width: 10%;"></td> <td style="width: 10%;"></td> <td style="width: 10%;"></td> <td style="width: 10%;"></td> </tr> <tr> <td></td> <td></td> <td colspan="8" style="text-align: center;"> <table border="1" style="width: 100%; border-collapse: collapse; text-align: center;"> <tr> <td style="width: 10%;"></td> <td style="width: 10%;"></td> <td style="width: 10%;"></td> <td style="width: 10%;"></td> <td style="width: 10%;"></td> <td style="width: 10%;"></td> <td style="width: 10%;"></td> <td style="width: 10%;"></td> <td style="width: 10%;"></td> <td style="width: 10%;"></td> </tr> <tr> <td></td> <td></td> <td colspan="8" style="text-align: center;"> <table border="1" style="width: 100%; border-collapse: collapse; text-align: center;"> <tr> <td style="width: 10%;"></td> <td style="width: 10%;"></td> <td style="width: 10%;"></td> <td style="width: 10%;"></td> <td style="width: 10%;"></td> <td style="width: 10%;"></td> <td style="width: 10%;"></td> <td style="width: 10%;"></td> <td style="width: 10%;"></td> <td style="width: 10%;"></td> </tr> <tr> <td></td> <td></td> <td colspan="8" style="text-align: center;"> <table border="1" style="width: 100%; border-collapse: collapse; text-align: center;"> <tr> <td style="width: 10%;"></td> <td style="width: 10%;"></td> <td style="width: 10%;"></td> <td style="width: 10%;"></td> <td style="width: 10%;"></td> <td style="width: 10%;"></td> <td style="width: 10%;"></td> <td style="width: 10%;"></td> <td style="width: 10%;"></td> <td style="width: 10%;"></td> </tr> <tr> <td></td> <td></td> <td colspan="8" style="text-align: center;"> <table border="1" style="width: 100%; border-collapse: collapse; text-align: center;"> <tr> <td style="width: 10%;"></td> <td style="width: 10%;"></td> <td style="width: 10%;"></td> <td style="width: 10%;"></td> <td style="width: 10%;"></td> <td style="width: 10%;"></td> <td style="width: 10%;"></td> <td style="width: 10%;"></td> <td style="width: 10%;"></td> <td style="width: 10%;"></td> </tr> <tr> <td></td> <td></td> <td colspan="8" style="text-align: center;"> <table border="1" style="width: 100%; border-collapse: collapse; text-align: center;"> <tr> <td style="width: 10%;"></td> <td style="width: 10%;"></td> <td style="width: 10%;"></td> <td style="width: 10%;"></td> <td style="width: 10%;"></td> <td style="width: 10%;"></td> <td style="width: 10%;"></td> <td style="width: 10%;"></td> <td style="width: 10%;"></td> <td style="width: 10%;"></td> </tr> <tr> <td></td> <td></td> <td colspan="8" style="text-align: center;"> <table border="1" style="width: 100%; border-collapse: collapse; text-align: center;"> <tr> <td style="width: 10%;"></td> <td style="width: 10%;"></td> <td style="width: 10%;"></td> <td style="width: 10%;"></td> <td style="width: 10%;"></td> <td style="width: 10%;"></td> <td style="width: 10%;"></td> <td style="width: 10%;"></td> <td style="width: 10%;"></td> <td style="width: 10%;"></td> </tr> <tr> <td></td> <td></td> <td colspan="8" style="text-align: center;"> <table border="1" style="width: 100%; border-collapse: collapse; text-align: center;"> <tr> <td style="width: 10%;"></td> <td style="width: 10%;"></td> <td style="width: 10%;"></td> <td style="width: 10%;"></td> <td style="width: 10%;"></td> <td style="width: 10%;"></td> <td style="width: 10%;"></td> <td style="width: 10%;"></td> <td style="width: 10%;"></td> <td style="width: 10%;"></td> </tr> <tr> <td></td> <td></td> <td colspan="8" style="text-align: center;"> <table border="1" style="width: 100%; border-collapse: collapse; text-align: center;"> <tr> <td style="width: 10%;"></td> <td style="width: 10%;"></td> <td style="width: 10%;"></td> <td style="width: 10%;"></td> <td style="width: 10%;"></td> <td style="width: 10%;"></td> <td style="width: 10%;"></td> <td style="width: 10%;"></td> <td style="width: 10%;"></td> <td style="width: 10%;"></td> </tr> <tr> <td></td> <td></td> <td colspan="8" style="text-align: center;"> <table border="1" style="width: 100%; border-collapse: collapse; text-align: center;"> <tr> </tr></table></td></tr></table></td></tr></table></td></tr></table></td></tr></table></td></tr></table></td></tr></table></td></tr></table></td></tr></table></td></tr></table></td></tr></table></td></tr></table></td></tr></table></td></tr></table></td></tr></table></td></tr></table></td></tr></table></td></tr></table></td></tr></table></td></tr></table></td></tr></table></td></tr></table></td></tr></table></td></tr></table></td></tr></table></td></tr></table></td></tr></table></td></tr></table></td></tr></table></td></tr></table></td></tr></table></td></tr></table></td></tr></table></td></tr></table>
 | | | | | | | | | | | | | | | | | | | | <table border="1" style="width: 100%; border-collapse: collapse; text-align: center;"> <tr> <td style="width: 10%;"></td> <td style="width: 10%;"></td> <td style="width: 10%;"></td> <td style="width: 10%;"></td> <td style="width: 10%;"></td> <td style="width: 10%;"></td> <td style="width: 10%;"></td> <td style="width: 10%;"></td> <td style="width: 10%;"></td> <td style="width: 10%;"></td> </tr> <tr> <td></td> <td></td> <td colspan="8" style="text-align: center;"> <table border="1" style="width: 100%; border-collapse: collapse; text-align: center;"> <tr> <td style="width: 10%;"></td> <td style="width: 10%;"></td> <td style="width: 10%;"></td> <td style="width: 10%;"></td> <td style="width: 10%;"></td> <td style="width: 10%;"></td> <td style="width: 10%;"></td> <td style="width: 10%;"></td> <td style="width: 10%;"></td> <td style="width: 10%;"></td> </tr> <tr> <td></td> <td></td> <td colspan="8" style="text-align: center;"> <table border="1" style="width: 100%; border-collapse: collapse; text-align: center;"> <tr> <td style="width: 10%;"></td> <td style="width: 10%;"></td> <td style="width: 10%;"></td> <td style="width: 10%;"></td> <td style="width: 10%;"></td> <td style="width: 10%;"></td> <td style="width: 10%;"></td> <td style="width: 10%;"></td> <td style="width: 10%;"></td> <td style="width: 10%;"></td> </tr> <tr> <td></td> <td></td> <td colspan="8" style="text-align: center;"> <table border="1" style="width: 100%; border-collapse: collapse; text-align: center;"> <tr> <td style="width: 10%;"></td> <td style="width: 10%;"></td> <td style="width: 10%;"></td> <td style="width: 10%;"></td> <td style="width: 10%;"></td> <td style="width: 10%;"></td> <td style="width: 10%;"></td> <td style="width: 10%;"></td> <td style="width: 10%;"></td> <td style="width: 10%;"></td> </tr> <tr> <td></td> <td></td> <td colspan="8" style="text-align: center;"> <table border="1" style="width: 100%; border-collapse: collapse; text-align: center;"> <tr> <td style="width: 10%;"></td> <td style="width: 10%;"></td> <td style="width: 10%;"></td> <td style="width:
10%;"></td> <td style="width: 10%;"></td> <td style="width: 10%;"></td> <td style="width: 10%;"></td> <td style="width: 10%;"></td> <td style="width: 10%;"></td> <td style="width: 10%;"></td> </tr> <tr> <td></td> <td></td> <td colspan="8" style="text-align: center;"> <table border="1" style="width: 100%; border-collapse: collapse; text-align: center;"> <tr> <td style="width: 10%;"></td> <td style="width: 10%;"></td> <td style="width: 10%;"></td> <td style="width: 10%;"></td> <td style="width: 10%;"></td> <td style="width: 10%;"></td> <td style="width: 10%;"></td> <td style="width: 10%;"></td> <td style="width: 10%;"></td> <td style="width: 10%;"></td> </tr> <tr> <td></td> <td></td> <td colspan="8" style="text-align: center;"> <table border="1" style="width: 100%; border-collapse: collapse; text-align: center;"> <tr> <td style="width: 10%;"></td> <td style="width: 10%;"></td> <td style="width: 10%;"></td> <td style="width: 10%;"></td> <td style="width: 10%;"></td> <td style="width: 10%;"></td> <td style="width: 10%;"></td> <td style="width: 10%;"></td> <td style="width: 10%;"></td> <td style="width: 10%;"></td> </tr> <tr> <td></td> <td></td> <td colspan="8" style="text-align: center;"> <table border="1" style="width: 100%; border-collapse: collapse; text-align: center;"> <tr> <td style="width: 10%;"></td> <td style="width: 10%;"></td> <td style="width: 10%;"></td> <td style="width: 10%;"></td> <td style="width: 10%;"></td> <td style="width: 10%;"></td> <td style="width: 10%;"></td> <td style="width: 10%;"></td> <td style="width: 10%;"></td> <td style="width: 10%;"></td> </tr> <tr> <td></td> <td></td> <td colspan="8" style="text-align: center;"> <table border="1" style="width: 100%; border-collapse: collapse; text-align: center;"> <tr> <td style="width: 10%;"></td> <td style="width: 10%;"></td> <td style="width: 10%;"></td> <td style="width: 10%;"></td> <td style="width: 10%;"></td> <td style="width: 10%;"></td> <td style="width: 10%;"></td> <td style="width: 10%;"></td> <td style="width: 10%;"></td> <td style="width: 10%;"></td> </tr> <tr> <td></td> <td></td> <td colspan="8" style="text-align: center;"> <table border="1" style="width: 100%; border-collapse: collapse; text-align: center;"> <tr> <td style="width: 10%;"></td> <td style="width: 10%;"></td> <td style="width: 10%;"></td> <td style="width: 10%;"></td> <td style="width: 10%;"></td> <td style="width: 10%;"></td> <td style="width: 10%;"></td> <td style="width: 10%;"></td> <td style="width: 10%;"></td> <td style="width: 10%;"></td> </tr> <tr> <td></td> <td></td> <td colspan="8" style="text-align: center;"> <table border="1" style="width: 100%; border-collapse: collapse; text-align: center;"> <tr> <td style="width: 10%;"></td> <td style="width: 10%;"></td> <td style="width: 10%;"></td> <td style="width: 10%;"></td> <td style="width: 10%;"></td> <td style="width: 10%;"></td> <td style="width: 10%;"></td> <td style="width: 10%;"></td> <td style="width: 10%;"></td> <td style="width: 10%;"></td> </tr> <tr> <td></td> <td></td> <td colspan="8" style="text-align: center;"> <table border="1" style="width: 100%; border-collapse: collapse; text-align: center;"> <tr> <td style="width: 10%;"></td> <td style="width: 10%;"></td> <td style="width: 10%;"></td> <td style="width: 10%;"></td> <td style="width: 10%;"></td> <td style="width: 10%;"></td> <td style="width: 10%;"></td> <td style="width: 10%;"></td> <td style="width: 10%;"></td> <td style="width: 10%;"></td> </tr> <tr> <td></td> <td></td> <td colspan="8" style="text-align: center;"> <table border="1" style="width: 100%; border-collapse: collapse; text-align: center;"> <tr> <td style="width: 10%;"></td> <td style="width: 10%;"></td> <td style="width: 10%;"></td> <td style="width: 10%;"></td> <td style="width: 10%;"></td> <td style="width: 10%;"></td> <td style="width: 10%;"></td> <td style="width: 10%;"></td> <td style="width: 10%;"></td> <td style="width: 10%;"></td> </tr> <tr> <td></td> <td></td> <td colspan="8" style="text-align: center;"> <table border="1" style="width: 100%; border-collapse: collapse; text-align: center;"> <tr> <td style="width: 10%;"></td> <td style="width: 10%;"></td> <td style="width: 10%;"></td> <td style="width: 10%;"></td> <td style="width: 10%;"></td> <td style="width: 10%;"></td> <td style="width: 10%;"></td> <td style="width: 10%;"></td> <td style="width: 10%;"></td> <td style="width: 10%;"></td> </tr> <tr> <td></td> <td></td> <td colspan="8" style="text-align: center;"> <table border="1" style="width: 100%; border-collapse: collapse; text-align: center;"> <tr> <td style="width: 10%;"></td> <td style="width: 10%;"></td> <td style="width: 10%;"></td> <td style="width: 10%;"></td> <td style="width: 10%;"></td> <td style="width: 10%;"></td> <td style="width: 10%;"></td> <td style="width: 10%;"></td> <td style="width: 10%;"></td> <td style="width: 10%;"></td> </tr> <tr> <td></td> <td></td> <td colspan="8" style="text-align: center;"> <table border="1" style="width: 100%; border-collapse: collapse; text-align: center;"> <tr> <td style="width: 10%;"></td> <td style="width: 10%;"></td> <td style="width: 10%;"></td> <td style="width: 10%;"></td> <td style="width: 10%;"></td> <td style="width: 10%;"></td> <td style="width: 10%;"></td> <td style="width: 10%;"></td> <td style="width: 10%;"></td> <td style="width: 10%;"></td> </tr> <tr> <td></td> <td></td> <td colspan="8" style="text-align: center;"> <table border="1" style="width: 100%; border-collapse: collapse; text-align: center;"> <tr> <td style="width: 10%;"></td> <td style="width: 10%;"></td> <td style="width: 10%;"></td> <td style="width: 10%;"></td> <td style="width: 10%;"></td> <td style="width: 10%;"></td> <td style="width: 10%;"></td> <td style="width: 10%;"></td> <td style="width: 10%;"></td> <td style="width: 10%;"></td> </tr> <tr> <td></td> <td></td> <td colspan="8" style="text-align: center;"> <table border="1" style="width: 100%; border-collapse: collapse; text-align: center;"> <tr> <td style="width: 10%;"></td> <td style="width: 10%;"></td> <td style="width: 10%;"></td> <td style="width: 10%;"></td> <td style="width: 10%;"></td> <td style="width: 10%;"></td> <td style="width: 10%;"></td> <td style="width: 10%;"></td> <td style="width: 10%;"></td> <td style="width: 10%;"></td> </tr> <tr> <td></td> <td></td> <td colspan="8" style="text-align: center;"> <table border="1" style="width: 100%; border-collapse: collapse; text-align: center;"> <tr> <td style="width: 10%;"></td> <td style="width: 10%;"></td> <td style="width: 10%;"></td> <td style="width: 10%;"></td> <td style="width: 10%;"></td> <td style="width: 10%;"></td> <td style="width: 10%;"></td> <td style="width: 10%;"></td> <td style="width: 10%;"></td> <td style="width: 10%;"></td> </tr> <tr> <td></td> <td></td> <td colspan="8" style="text-align: center;"> <table border="1" style="width: 100%; border-collapse: collapse; text-align: center;"> <tr> <td style="width: 10%;"></td> <td style="width: 10%;"></td> <td style="width: 10%;"></td> <td style="width: 10%;"></td> <td style="width: 10%;"></td> <td style="width: 10%;"></td> <td style="width: 10%;"></td> <td style="width: 10%;"></td> <td style="width: 10%;"></td> <td style="width: 10%;"></td> </tr> <tr> <td></td> <td></td> <td colspan="8" style="text-align: center;"> <table border="1" style="width: 100%; border-collapse: collapse; text-align: center;"> <tr> <td style="width: 10%;"></td> <td style="width: 10%;"></td> <td style="width: 10%;"></td> <td style="width: 10%;"></td> <td style="width: 10%;"></td> <td style="width: 10%;"></td> <td style="width: 10%;"></td> <td style="width: 10%;"></td> <td style="width: 10%;"></td> <td style="width: 10%;"></td> </tr> <tr> <td></td> <td></td> <td colspan="8" style="text-align: center;"> <table border="1" style="width: 100%; border-collapse: collapse; text-align: center;"> <tr> <td style="width: 10%;"></td> <td style="width: 10%;"></td> <td style="width: 10%;"></td> <td style="width: 10%;"></td> <td style="width: 10%;"></td> <td style="width: 10%;"></td> <td style="width: 10%;"></td> <td style="width: 10%;"></td> <td style="width: 10%;"></td> <td style="width: 10%;"></td> </tr> <tr> <td></td> <td></td> <td colspan="8" style="text-align: center;"> <table border="1" style="width: 100%; border-collapse: collapse; text-align: center;"> <tr> <td style="width: 10%;"></td> <td style="width: 10%;"></td> <td style="width: 10%;"></td> <td style="width: 10%;"></td> <td style="width: 10%;"></td> <td style="width: 10%;"></td> <td style="width: 10%;"></td> <td style="width: 10%;"></td> <td style="width: 10%;"></td> <td style="width: 10%;"></td> </tr> <tr> <td></td> <td></td> <td colspan="8" style="text-align: center;"> <table border="1" style="width: 100%; border-collapse: collapse; text-align: center;"> <tr> <td style="width: 10%;"></td> <td style="width: 10%;"></td> <td style="width: 10%;"></td> <td style="width: 10%;"></td> <td style="width: 10%;"></td> <td style="width: 10%;"></td> <td style="width: 10%;"></td> <td style="width: 10%;"></td> <td style="width: 10%;"></td> <td style="width: 10%;"></td> </tr> <tr> <td></td> <td></td> <td colspan="8" style="text-align: center;"> <table border="1" style="width: 100%; border-collapse: collapse; text-align: center;"> <tr> <td style="width: 10%;"></td> <td style="width: 10%;"></td> <td style="width: 10%;"></td> <td style="width: 10%;"></td> <td style="width: 10%;"></td> <td style="width: 10%;"></td> <td style="width: 10%;"></td> <td style="width: 10%;"></td> <td style="width: 10%;"></td> <td style="width: 10%;"></td> </tr> <tr> <td></td> <td></td> <td colspan="8" style="text-align: center;"> <table border="1" style="width: 100%; border-collapse: collapse; text-align: center;"> <tr> <td style="width: 10%;"></td> <td style="width: 10%;"></td> <td style="width: 10%;"></td> <td style="width: 10%;"></td> <td style="width: 10%;"></td> <td style="width: 10%;"></td> <td style="width: 10%;"></td> <td style="width: 10%;"></td> <td style="width: 10%;"></td> <td
style="width: 10%;"></td> </tr> <tr> <td></td> <td></td> <td colspan="8" style="text-align: center;"> <table border="1" style="width: 100%; border-collapse: collapse; text-align: center;"> <tr> <td style="width: 10%;"></td> <td style="width: 10%;"></td> <td style="width: 10%;"></td> <td style="width: 10%;"></td> <td style="width: 10%;"></td> <td style="width: 10%;"></td> <td style="width: 10%;"></td> <td style="width: 10%;"></td> <td style="width: 10%;"></td> <td style="width: 10%;"></td> </tr> <tr> <td></td> <td></td> <td colspan="8" style="text-align: center;"> <table border="1" style="width: 100%; border-collapse: collapse; text-align: center;"> <tr> <td style="width: 10%;"></td> <td style="width: 10%;"></td> <td style="width: 10%;"></td> <td style="width: 10%;"></td> <td style="width: 10%;"></td> <td style="width: 10%;"></td> <td style="width: 10%;"></td> <td style="width: 10%;"></td> <td style="width: 10%;"></td> <td style="width: 10%;"></td> </tr> <tr> <td></td> <td></td> <td colspan="8" style="text-align: center;"> <table border="1" style="width: 100%; border-collapse: collapse; text-align: center;"> <tr> <td style="width: 10%;"></td> <td style="width: 10%;"></td> <td style="width: 10%;"></td> <td style="width: 10%;"></td> <td style="width: 10%;"></td> <td style="width: 10%;"></td> <td style="width: 10%;"></td> <td style="width: 10%;"></td> <td style="width: 10%;"></td> <td style="width: 10%;"></td> </tr> <tr> <td></td> <td></td> <td colspan="8" style="text-align: center;"> <table border="1" style="width: 100%; border-collapse: collapse; text-align: center;"> <tr> <td style="width: 10%;"></td> <td style="width: 10%;"></td> <td style="width: 10%;"></td> <td style="width: 10%;"></td> <td style="width: 10%;"></td> <td style="width: 10%;"></td> <td style="width: 10%;"></td> <td style="width: 10%;"></td> <td style="width: 10%;"></td> <td style="width: 10%;"></td> </tr> <tr> <td></td> <td></td> <td colspan="8" style="text-align: center;"> <table border="1" style="width: 100%; border-collapse: collapse; text-align: center;"> <tr> <td style="width: 10%;"></td> <td style="width: 10%;"></td> <td style="width: 10%;"></td> <td style="width: 10%;"></td> <td style="width: 10%;"></td> <td style="width: 10%;"></td> <td style="width: 10%;"></td> <td style="width: 10%;"></td> <td style="width: 10%;"></td> <td style="width: 10%;"></td> </tr> <tr> <td></td> <td></td> <td colspan="8" style="text-align: center;"> <table border="1" style="width: 100%; border-collapse: collapse; text-align: center;"> <tr> <td style="width: 10%;"></td> <td style="width: 10%;"></td> <td style="width: 10%;"></td> <td style="width: 10%;"></td> <td style="width: 10%;"></td> <td style="width: 10%;"></td> <td style="width: 10%;"></td> <td style="width: 10%;"></td> <td style="width: 10%;"></td> <td style="width: 10%;"></td> </tr> <tr> <td></td> <td></td> <td colspan="8" style="text-align: center;"> <table border="1" style="width: 100%; border-collapse: collapse; text-align: center;"> <tr> </tr></table></td></tr></table></td></tr></table></td></tr></table></td></tr></table></td></tr></table></td></tr></table></td></tr></table></td></tr></table></td></tr></table></td></tr></table></td></tr></table></td></tr></table></td></tr></table></td></tr></table></td></tr></table></td></tr></table></td></tr></table></td></tr></table></td></tr></table></td></tr></table></td></tr></table></td></tr></table></td></tr></table></td></tr></table></td></tr></table></td></tr></table></td></tr></table></td></tr></table></td></tr></table></td></tr></table></td></tr></table></td></tr></table>
 | | | | | | | | | | | | | | | | | | | | <table border="1" style="width: 100%; border-collapse: collapse; text-align: center;"> <tr> <td style="width: 10%;"></td> <td style="width: 10%;"></td> <td style="width: 10%;"></td> <td style="width: 10%;"></td> <td style="width: 10%;"></td> <td style="width: 10%;"></td> <td style="width: 10%;"></td> <td style="width: 10%;"></td> <td style="width: 10%;"></td> <td style="width: 10%;"></td> </tr> <tr> <td></td> <td></td> <td colspan="8" style="text-align: center;"> <table border="1" style="width: 100%; border-collapse: collapse; text-align: center;"> <tr> <td style="width: 10%;"></td> <td style="width: 10%;"></td> <td style="width: 10%;"></td> <td style="width: 10%;"></td> <td style="width: 10%;"></td> <td style="width: 10%;"></td> <td style="width: 10%;"></td> <td style="width: 10%;"></td> <td style="width: 10%;"></td> <td style="width: 10%;"></td> </tr> <tr> <td></td> <td></td> <td colspan="8" style="text-align: center;"> <table border="1" style="width: 100%; border-collapse: collapse; text-align: center;"> <tr> <td style="width: 10%;"></td> <td style="width: 10%;"></td> <td style="width: 10%;"></td> <td style="width: 10%;"></td> <td style="width: 10%;"></td> <td style="width: 10%;"></td> <td style="width: 10%;"></td> <td style="width: 10%;"></td> <td style="width: 10%;"></td> <td style="width: 10%;"></td> </tr> <tr> <td></td> <td></td> <td colspan="8" style="text-align: center;"> <table border="1" style="width: 100%; border-collapse: collapse; text-align: center;"> <tr> <td style="width: 10%;"></td> <td style="width: 10%;"></td> <td style="width: 10%;"></td> <td style="width: 10%;"></td> <td style="width: 10%;"></td> <td style="width: 10%;"></td> <td style="width: 10%;"></td> <td style="width: 10%;"></td> <td style="width: 10%;"></td> <td style="width: 10%;"></td> </tr> <tr> <td></td> <td></td> <td colspan="8" style="text-align: center;"> <table border="1" style="width: 100%; border-collapse: collapse; text-align: center;"> <tr> <td style="width: 10%;"></td> <td style="width: 10%;"></td> <td style="width: 10%;"></td> <td style="width: 10%;"></td> <td style="width: 10%;"></td> <td style="width: 10%;"></td> <td style="width: 10%;"></td> <td style="width: 10%;"></td> <td style="width: 10%;"></td> <td style="width: 10%;"></td> </tr> <tr> <td></td> <td></td> <td colspan="8" style="text-align: center;"> <table border="1" style="width: 100%; border-collapse: collapse; text-align: center;"> <tr> <td style="width: 10%;"></td> <td style="width: 10%;"></td> <td style="width: 10%;"></td> <td style="width: 10%;"></td> <td style="width: 10%;"></td> <td style="width: 10%;"></td> <td style="width: 10%;"></td> <td style="width: 10%;"></td> <td style="width: 10%;"></td> <td style="width: 10%;"></td> </tr> <tr> <td></td> <td></td> <td colspan="8" style="text-align: center;"> <table border="1" style="width: 100%; border-collapse: collapse; text-align: center;"> <tr> <td style="width: 10%;"></td> <td style="width: 10%;"></td> <td style="width: 10%;"></td> <td style="width: 10%;"></td> <td style="width: 10%;"></td> <td style="width: 10%;"></td> <td style="width: 10%;"></td> <td style="width: 10%;"></td> <td style="width: 10%;"></td> <td style="width: 10%;"></td> </tr> <tr> <td></td> <td></td> <td colspan="8" style="text-align: center;"> <table border="1" style="width: 100%; border-collapse: collapse; text-align: center;"> <tr> <td style="width: 10%;"></td> <td style="width: 10%;"></td> <td style="width: 10%;"></td> <td style="width: 10%;"></td> <td style="width: 10%;"></td> <td style="width: 10%;"></td> <td style="width: 10%;"></td> <td style="width: 10%;"></td> <td style="width: 10%;"></td> <td style="width: 10%;"></td> </tr> <tr> <td></td> <td></td> <td colspan="8" style="text-align: center;"> <table border="1" style="width: 100%; border-collapse: collapse; text-align: center;"> <tr> <td style="width: 10%;"></td> <td style="width: 10%;"></td> <td style="width: 10%;"></td> <td style="width: 10%;"></td> <td style="width: 10%;"></td> <td style="width: 10%;"></td> <td style="width: 10%;"></td> <td style="width: 10%;"></td> <td style="width: 10%;"></td> <td style="width: 10%;"></td> </tr> <tr> <td></td> <td></td> <td colspan="8" style="text-align: center;"> <table border="1" style="width: 100%; border-collapse: collapse; text-align: center;"> <tr> <td style="width: 10%;"></td> <td style="width: 10%;"></td> <td style="width: 10%;"></td> <td style="width: 10%;"></td> <td style="width: 10%;"></td> <td style="width: 10%;"></td> <td style="width: 10%;"></td> <td style="width: 10%;"></td> <td style="width: 10%;"></td> <td style="width: 10%;"></td> </tr> <tr> <td></td> <td></td> <td colspan="8" style="text-align: center;"> <table border="1" style="width: 100%; border-collapse: collapse; text-align: center;"> <tr> <td style="width: 10%;"></td> <td style="width: 10%;"></td> <td style="width: 10%;"></td> <td style="width: 10%;"></td> <td style="width: 10%;"></td> <td style="width: 10%;"></td> <td style="width: 10%;"></td> <td style="width: 10%;"></td> <td style="width: 10%;"></td> <td style="width: 10%;"></td> </tr> <tr> <td></td> <td></td> <td colspan="8" style="text-align: center;"> <table border="1" style="width: 100%; border-collapse: collapse; text-align: center;"> <tr> <td style="width: 10%;"></td> <td style="width: 10%;"></td> <td style="width: 10%;"></td> <td style="width: 10%;"></td> <td style="width: 10%;"></td> <td style="width: 10%;"></td> <td style="width: 10%;"></td> <td style="width: 10%;"></td> <td style="width: 10%;"></td> <td style="width: 10%;"></td> </tr> <tr> <td></td> <td></td> <td colspan="8" style="text-align: center;"> <table border="1" style="width: 100%; border-collapse: collapse; text-align: center;"> <tr> <td style="width: 10%;"></td> <td style="width: 10%;"></td> <td style="width: 10%;"></td> <td style="width: 10%;"></td> <td style="width: 10%;"></td> <td style="width: 10%;"></td> <td style="width: 10%;"></td> <td style="width: 10%;"></td> <td style="width: 10%;"></td> <td style="width: 10%;"></td> </tr> <tr> <td></td> <td></td> <td colspan="8" style="text-align: center;"> <table border="1" style="width: 100%; border-collapse:
collapse; text-align: center;"> <tr> <td style="width: 10%;"></td> <td style="width: 10%;"></td> <td style="width: 10%;"></td> <td style="width: 10%;"></td> <td style="width: 10%;"></td> <td style="width: 10%;"></td> <td style="width: 10%;"></td> <td style="width: 10%;"></td> <td style="width: 10%;"></td> <td style="width: 10%;"></td> </tr> <tr> <td></td> <td></td> <td colspan="8" style="text-align: center;"> <table border="1" style="width: 100%; border-collapse: collapse; text-align: center;"> <tr> <td style="width: 10%;"></td> <td style="width: 10%;"></td> <td style="width: 10%;"></td> <td style="width: 10%;"></td> <td style="width: 10%;"></td> <td style="width: 10%;"></td> <td style="width: 10%;"></td> <td style="width: 10%;"></td> <td style="width: 10%;"></td> <td style="width: 10%;"></td> </tr> <tr> <td></td> <td></td> <td colspan="8" style="text-align: center;"> <table border="1" style="width: 100%; border-collapse: collapse; text-align: center;"> <tr> <td style="width: 10%;"></td> <td style="width: 10%;"></td> <td style="width: 10%;"></td> <td style="width: 10%;"></td> <td style="width: 10%;"></td> <td style="width: 10%;"></td> <td style="width: 10%;"></td> <td style="width: 10%;"></td> <td style="width: 10%;"></td> <td style="width: 10%;"></td> </tr> <tr> <td></td> <td></td> <td colspan="8" style="text-align: center;"> <table border="1" style="width: 100%; border-collapse: collapse; text-align: center;"> <tr> <td style="width: 10%;"></td> <td style="width: 10%;"></td> <td style="width: 10%;"></td> <td style="width: 10%;"></td> <td style="width: 10%;"></td> <td style="width: 10%;"></td> <td style="width: 10%;"></td> <td style="width: 10%;"></td> <td style="width: 10%;"></td> <td style="width: 10%;"></td> </tr> <tr> <td></td> <td></td> <td colspan="8" style="text-align: center;"> <table border="1" style="width: 100%; border-collapse: collapse; text-align: center;"> <tr> <td style="width: 10%;"></td> <td style="width: 10%;"></td> <td style="width: 10%;"></td> <td style="width: 10%;"></td> <td style="width: 10%;"></td> <td style="width: 10%;"></td> <td style="width: 10%;"></td> <td style="width: 10%;"></td> <td style="width: 10%;"></td> <td style="width: 10%;"></td> </tr> <tr> <td></td> <td></td> <td colspan="8" style="text-align: center;"> <table border="1" style="width: 100%; border-collapse: collapse; text-align: center;"> <tr> <td style="width: 10%;"></td> <td style="width: 10%;"></td> <td style="width: 10%;"></td> <td style="width: 10%;"></td> <td style="width: 10%;"></td> <td style="width: 10%;"></td> <td style="width: 10%;"></td> <td style="width: 10%;"></td> <td style="width: 10%;"></td> <td style="width: 10%;"></td> </tr> <tr> <td></td> <td></td> <td colspan="8" style="text-align: center;"> <table border="1" style="width: 100%; border-collapse: collapse; text-align: center;"> <tr> <td style="width: 10%;"></td> <td style="width: 10%;"></td> <td style="width: 10%;"></td> <td style="width: 10%;"></td> <td style="width: 10%;"></td> <td style="width: 10%;"></td> <td style="width: 10%;"></td> <td style="width: 10%;"></td> <td style="width: 10%;"></td> <td style="width: 10%;"></td> </tr> <tr> <td></td> <td></td> <td colspan="8" style="text-align: center;"> <table border="1" style="width: 100%; border-collapse: collapse; text-align: center;"> <tr> <td style="width: 10%;"></td> <td style="width: 10%;"></td> <td style="width: 10%;"></td> <td style="width: 10%;"></td> <td style="width: 10%;"></td> <td style="width: 10%;"></td> <td style="width: 10%;"></td> <td style="width: 10%;"></td> <td style="width: 10%;"></td> <td style="width: 10%;"></td> </tr> <tr> <td></td> <td></td> <td colspan="8" style="text-align: center;"> <table border="1" style="width: 100%; border-collapse: collapse; text-align: center;"> <tr> <td style="width: 10%;"></td> <td style="width: 10%;"></td> <td style="width: 10%;"></td> <td style="width: 10%;"></td> <td style="width: 10%;"></td> <td style="width: 10%;"></td> <td style="width: 10%;"></td> <td style="width: 10%;"></td> <td style="width: 10%;"></td> <td style="width: 10%;"></td> </tr> <tr> <td></td> <td></td> <td colspan="8" style="text-align: center;"> <table border="1" style="width: 100%; border-collapse: collapse; text-align: center;"> <tr> <td style="width: 10%;"></td> <td style="width: 10%;"></td> <td style="width: 10%;"></td> <td style="width: 10%;"></td> <td style="width: 10%;"></td> <td style="width: 10%;"></td> <td style="width: 10%;"></td> <td style="width: 10%;"></td> <td style="width: 10%;"></td> <td style="width: 10%;"></td> </tr> <tr> <td></td> <td></td> <td colspan="8" style="text-align: center;"> <table border="1" style="width: 100%; border-collapse: collapse; text-align: center;"> <tr> <td style="width: 10%;"></td> <td style="width: 10%;"></td> <td style="width: 10%;"></td> <td style="width: 10%;"></td> <td style="width: 10%;"></td> <td style="width: 10%;"></td> <td style="width: 10%;"></td> <td style="width: 10%;"></td> <td style="width: 10%;"></td> <td style="width: 10%;"></td> </tr> <tr> <td></td> <td></td> <td colspan="8" style="text-align: center;"> <table border="1" style="width: 100%; border-collapse: collapse; text-align: center;"> <tr> <td style="width: 10%;"></td> <td style="width: 10%;"></td> <td style="width: 10%;"></td> <td style="width: 10%;"></td> <td style="width: 10%;"></td> <td style="width: 10%;"></td> <td style="width: 10%;"></td> <td style="width: 10%;"></td> <td style="width: 10%;"></td> <td style="width: 10%;"></td> </tr> <tr> <td></td> <td></td> <td colspan="8" style="text-align: center;"> <table border="1" style="width: 100%; border-collapse: collapse; text-align: center;"> <tr> <td style="width: 10%;"></td> <td style="width: 10%;"></td> <td style="width: 10%;"></td> <td style="width: 10%;"></td> <td style="width: 10%;"></td> <td style="width: 10%;"></td> <td style="width: 10%;"></td> <td style="width: 10%;"></td> <td style="width: 10%;"></td> <td style="width: 10%;"></td> </tr> <tr> <td></td> <td></td> <td colspan="8" style="text-align: center;"> <table border="1" style="width: 100%; border-collapse: collapse; text-align: center;"> <tr> <td style="width: 10%;"></td> <td style="width: 10%;"></td> <td style="width: 10%;"></td> <td style="width: 10%;"></td> <td style="width: 10%;"></td> <td style="width: 10%;"></td> <td style="width: 10%;"></td> <td style="width: 10%;"></td> <td style="width: 10%;"></td> <td style="width: 10%;"></td> </tr> <tr> <td></td> <td></td> <td colspan="8" style="text-align: center;"> <table border="1" style="width: 100%; border-collapse: collapse; text-align: center;"> <tr> <td style="width: 10%;"></td> <td style="width: 10%;"></td> <td style="width: 10%;"></td> <td style="width: 10%;"></td> <td style="width: 10%;"></td> <td style="width: 10%;"></td> <td style="width: 10%;"></td> <td style="width: 10%;"></td> <td style="width: 10%;"></td> <td style="width: 10%;"></td> </tr> <tr> <td></td> <td></td> <td colspan="8" style="text-align: center;"> <table border="1" style="width: 100%; border-collapse: collapse; text-align: center;"> <tr> <td style="width: 10%;"></td> <td style="width: 10%;"></td> <td style="width: 10%;"></td> <td style="width: 10%;"></td> <td style="width: 10%;"></td> <td style="width: 10%;"></td> <td style="width: 10%;"></td> <td style="width: 10%;"></td> <td style="width: 10%;"></td> <td style="width: 10%;"></td> </tr> <tr> <td></td> <td></td> <td colspan="8" style="text-align: center;"> <table border="1" style="width: 100%; border-collapse: collapse; text-align: center;"> <tr> <td style="width: 10%;"></td> <td style="width: 10%;"></td> <td style="width: 10%;"></td> <td style="width: 10%;"></td> <td style="width: 10%;"></td> <td style="width: 10%;"></td> <td style="width: 10%;"></td> <td style="width: 10%;"></td> <td style="width: 10%;"></td> <td style="width: 10%;"></td> </tr> <tr> <td></td> <td></td> <td colspan="8" style="text-align: center;"> <table border="1" style="width: 100%; border-collapse: collapse; text-align: center;"> <tr> <td style="width: 10%;"></td> <td style="width: 10%;"></td> <td style="width: 10%;"></td> <td style="width: 10%;"></td> <td style="width: 10%;"></td> <td style="width: 10%;"></td> <td style="width: 10%;"></td> <td style="width: 10%;"></td> <td style="width: 10%;"></td> <td style="width: 10%;"></td> </tr> <tr> <td></td> <td></td> <td colspan="8" style="text-align: center;"> <table border="1" style="width: 100%; border-collapse: collapse; text-align: center;"> <tr> </tr></table></td></tr></table></td></tr></table></td></tr></table></td></tr></table></td></tr></table></td></tr></table></td></tr></table></td></tr></table></td></tr></table></td></tr></table></td></tr></table></td></tr></table></td></tr></table></td></tr></table></td></tr></table></td></tr></table></td></tr></table></td></tr></table></td></tr></table></td></tr></table></td></tr></table></td></tr></table></td></tr></table></td></tr></table></td></tr></table></td></tr></table></td></tr></table></td></tr></table></td></tr></table></td></tr></table></td></tr></table>
 | | | | | | | | | | | | | | | | | | | | <table border="1" style="width: 100%; border-collapse: collapse; text-align: center;"> <tr> <td style="width: 10%;"></td> <td style="width: 10%;"></td> <td style="width: 10%;"></td> <td style="width: 10%;"></td> <td style="width: 10%;"></td> <td style="width: 10%;"></td> <td style="width: 10%;"></td> <td style="width: 10%;"></td> <td style="width: 10%;"></td> <td style="width: 10%;"></td> </tr> <tr> <td></td> <td></td> <td colspan="8" style="text-align: center;"> <table border="1" style="width: 100%; border-collapse: collapse; text-align: center;"> <tr> <td style="width: 10%;"></td> <td style="width: 10%;"></td> <td style="width: 10%;"></td> <td style="width: 10%;"></td> <td style="width:
10%;"></td> <td style="width: 10%;"></td> <td style="width: 10%;"></td> <td style="width: 10%;"></td> <td style="width: 10%;"></td> <td style="width: 10%;"></td> </tr> <tr> <td></td> <td></td> <td colspan="8" style="text-align: center;"> <table border="1" style="width: 100%; border-collapse: collapse; text-align: center;"> <tr> <td style="width: 10%;"></td> <td style="width: 10%;"></td> <td style="width: 10%;"></td> <td style="width: 10%;"></td> <td style="width: 10%;"></td> <td style="width: 10%;"></td> <td style="width: 10%;"></td> <td style="width: 10%;"></td> <td style="width: 10%;"></td> <td style="width: 10%;"></td> </tr> <tr> <td></td> <td></td> <td colspan="8" style="text-align: center;"> <table border="1" style="width: 100%; border-collapse: collapse; text-align: center;"> <tr> <td style="width: 10%;"></td> <td style="width: 10%;"></td> <td style="width: 10%;"></td> <td style="width: 10%;"></td> <td style="width: 10%;"></td> <td style="width: 10%;"></td> <td style="width: 10%;"></td> <td style="width: 10%;"></td> <td style="width: 10%;"></td> <td style="width: 10%;"></td> </tr> <tr> <td></td> <td></td> <td colspan="8" style="text-align: center;"> <table border="1" style="width: 100%; border-collapse: collapse; text-align: center;"> <tr> <td style="width: 10%;"></td> <td style="width: 10%;"></td> <td style="width: 10%;"></td> <td style="width: 10%;"></td> <td style="width: 10%;"></td> <td style="width: 10%;"></td> <td style="width: 10%;"></td> <td style="width: 10%;"></td> <td style="width: 10%;"></td> <td style="width: 10%;"></td> </tr> <tr> <td></td> <td></td> <td colspan="8" style="text-align: center;"> <table border="1" style="width: 100%; border-collapse: collapse; text-align: center;"> <tr> <td style="width: 10%;"></td> <td style="width: 10%;"></td> <td style="width: 10%;"></td> <td style="width: 10%;"></td> <td style="width: 10%;"></td> <td style="width: 10%;"></td> <td style="width: 10%;"></td> <td style="width: 10%;"></td> <td style="width: 10%;"></td> <td style="width: 10%;"></td> </tr> <tr> <td></td> <td></td> <td colspan="8" style="text-align: center;"> <table border="1" style="width: 100%; border-collapse: collapse; text-align: center;"> <tr> <td style="width: 10%;"></td> <td style="width: 10%;"></td> <td style="width: 10%;"></td> <td style="width: 10%;"></td> <td style="width: 10%;"></td> <td style="width: 10%;"></td> <td style="width: 10%;"></td> <td style="width: 10%;"></td> <td style="width: 10%;"></td> <td style="width: 10%;"></td> </tr> <tr> <td></td> <td></td> <td colspan="8" style="text-align: center;"> <table border="1" style="width: 100%; border-collapse: collapse; text-align: center;"> <tr> <td style="width: 10%;"></td> <td style="width: 10%;"></td> <td style="width: 10%;"></td> <td style="width: 10%;"></td> <td style="width: 10%;"></td> <td style="width: 10%;"></td> <td style="width: 10%;"></td> <td style="width: 10%;"></td> <td style="width: 10%;"></td> <td style="width: 10%;"></td> </tr> <tr> <td></td> <td></td> <td colspan="8" style="text-align: center;"> <table border="1" style="width: 100%; border-collapse: collapse; text-align: center;"> <tr> <td style="width: 10%;"></td> <td style="width: 10%;"></td> <td style="width: 10%;"></td> <td style="width: 10%;"></td> <td style="width: 10%;"></td> <td style="width: 10%;"></td> <td style="width: 10%;"></td> <td style="width: 10%;"></td> <td style="width: 10%;"></td> <td style="width: 10%;"></td> </tr> <tr> <td></td> <td></td> <td colspan="8" style="text-align: center;"> <table border="1" style="width: 100%; border-collapse: collapse; text-align: center;"> <tr> <td style="width: 10%;"></td> <td style="width: 10%;"></td> <td style="width: 10%;"></td> <td style="width: 10%;"></td> <td style="width: 10%;"></td> <td style="width: 10%;"></td> <td style="width: 10%;"></td> <td style="width: 10%;"></td> <td style="width: 10%;"></td> <td style="width: 10%;"></td> </tr> <tr> <td></td> <td></td> <td colspan="8" style="text-align: center;"> <table border="1" style="width: 100%; border-collapse: collapse; text-align: center;"> <tr> <td style="width: 10%;"></td> <td style="width: 10%;"></td> <td style="width: 10%;"></td> <td style="width: 10%;"></td> <td style="width: 10%;"></td> <td style="width: 10%;"></td> <td style="width: 10%;"></td> <td style="width: 10%;"></td> <td style="width: 10%;"></td> <td style="width: 10%;"></td> </tr> <tr> <td></td> <td></td> <td colspan="8" style="text-align: center;"> <table border="1" style="width: 100%; border-collapse: collapse; text-align: center;"> <tr> <td style="width: 10%;"></td> <td style="width: 10%;"></td> <td style="width: 10%;"></td> <td style="width: 10%;"></td> <td style="width: 10%;"></td> <td style="width: 10%;"></td> <td style="width: 10%;"></td> <td style="width: 10%;"></td> <td style="width: 10%;"></td> <td style="width: 10%;"></td> </tr> <tr> <td></td> <td></td> <td colspan="8" style="text-align: center;"> <table border="1" style="width: 100%; border-collapse: collapse; text-align: center;"> <tr> <td style="width: 10%;"></td> <td style="width: 10%;"></td> <td style="width: 10%;"></td> <td style="width: 10%;"></td> <td style="width: 10%;"></td> <td style="width: 10%;"></td> <td style="width: 10%;"></td> <td style="width: 10%;"></td> <td style="width: 10%;"></td> <td style="width: 10%;"></td> </tr> <tr> <td></td> <td></td> <td colspan="8" style="text-align: center;"> <table border="1" style="width: 100%; border-collapse: collapse; text-align: center;"> <tr> <td style="width: 10%;"></td> <td style="width: 10%;"></td> <td style="width: 10%;"></td> <td style="width: 10%;"></td> <td style="width: 10%;"></td> <td style="width: 10%;"></td> <td style="width: 10%;"></td> <td style="width: 10%;"></td> <td style="width: 10%;"></td> <td style="width: 10%;"></td> </tr> <tr> <td></td> <td></td> <td colspan="8" style="text-align: center;"> <table border="1" style="width: 100%; border-collapse: collapse; text-align: center;"> <tr> <td style="width: 10%;"></td> <td style="width: 10%;"></td> <td style="width: 10%;"></td> <td style="width: 10%;"></td> <td style="width: 10%;"></td> <td style="width: 10%;"></td> <td style="width: 10%;"></td> <td style="width: 10%;"></td> <td style="width: 10%;"></td> <td style="width: 10%;"></td> </tr> <tr> <td></td> <td></td> <td colspan="8" style="text-align: center;"> <table border="1" style="width: 100%; border-collapse: collapse; text-align: center;"> <tr> <td style="width: 10%;"></td> <td style="width: 10%;"></td> <td style="width: 10%;"></td> <td style="width: 10%;"></td> <td style="width: 10%;"></td> <td style="width: 10%;"></td> <td style="width: 10%;"></td> <td style="width: 10%;"></td> <td style="width: 10%;"></td> <td style="width: 10%;"></td> </tr> <tr> <td></td> <td></td> <td colspan="8" style="text-align: center;"> <table border="1" style="width: 100%; border-collapse: collapse; text-align: center;"> <tr> <td style="width: 10%;"></td> <td style="width: 10%;"></td> <td style="width: 10%;"></td> <td style="width: 10%;"></td> <td style="width: 10%;"></td> <td style="width: 10%;"></td> <td style="width: 10%;"></td> <td style="width: 10%;"></td> <td style="width: 10%;"></td> <td style="width: 10%;"></td> </tr> <tr> <td></td> <td></td> <td colspan="8" style="text-align: center;"> <table border="1" style="width: 100%; border-collapse: collapse; text-align: center;"> <tr> <td style="width: 10%;"></td> <td style="width: 10%;"></td> <td style="width: 10%;"></td> <td style="width: 10%;"></td> <td style="width: 10%;"></td> <td style="width: 10%;"></td> <td style="width: 10%;"></td> <td style="width: 10%;"></td> <td style="width: 10%;"></td> <td style="width: 10%;"></td> </tr> <tr> <td></td> <td></td> <td colspan="8" style="text-align: center;"> <table border="1" style="width: 100%; border-collapse: collapse; text-align: center;"> <tr> <td style="width: 10%;"></td> <td style="width: 10%;"></td> <td style="width: 10%;"></td> <td style="width: 10%;"></td> <td style="width: 10%;"></td> <td style="width: 10%;"></td> <td style="width: 10%;"></td> <td style="width: 10%;"></td> <td style="width: 10%;"></td> <td style="width: 10%;"></td> </tr> <tr> <td></td> <td></td> <td colspan="8" style="text-align: center;"> <table border="1" style="width: 100%; border-collapse: collapse; text-align: center;"> <tr> <td style="width: 10%;"></td> <td style="width: 10%;"></td> <td style="width: 10%;"></td> <td style="width: 10%;"></td> <td style="width: 10%;"></td> <td style="width: 10%;"></td> <td style="width: 10%;"></td> <td style="width: 10%;"></td> <td style="width: 10%;"></td> <td style="width: 10%;"></td> </tr> <tr> <td></td> <td></td> <td colspan="8" style="text-align: center;"> <table border="1" style="width: 100%; border-collapse: collapse; text-align: center;"> <tr> <td style="width: 10%;"></td> <td style="width: 10%;"></td> <td style="width: 10%;"></td> <td style="width: 10%;"></td> <td style="width: 10%;"></td> <td style="width: 10%;"></td> <td style="width: 10%;"></td> <td style="width: 10%;"></td> <td style="width: 10%;"></td> <td style="width: 10%;"></td> </tr> <tr> <td></td> <td></td> <td colspan="8" style="text-align: center;"> <table border="1" style="width: 100%; border-collapse: collapse; text-align: center;"> <tr> <td style="width: 10%;"></td> <td style="width: 10%;"></td> <td style="width: 10%;"></td> <td style="width: 10%;"></td> <td style="width: 10%;"></td> <td style="width: 10%;"></td> <td style="width: 10%;"></td> <td style="width: 10%;"></td> <td style="width: 10%;"></td> <td style="width: 10%;"></td> </tr> <tr> <td></td> <td></td> <td colspan="8" style="text-align: center;"> <table border="1" style="width: 100%; border-collapse: collapse; text-align: center;"> <tr> <td style="width: 10%;"></td> <td style="width: 10%;"></td> <td style="width: 10%;"></td> <td style="width: 10%;"></td> <td style="width: 10%;"></td> <td style="width: 10%;"></td> <td style="width: 10%;"></td> <td style="width: 10%;"></td> <td style="width: 10%;"></td> <td style="width: 10%;"></td> </tr>
<tr> <td></td> <td></td> <td colspan="8" style="text-align: center;"> <table border="1" style="width: 100%; border-collapse: collapse; text-align: center;"> <tr> <td style="width: 10%;"></td> <td style="width: 10%;"></td> <td style="width: 10%;"></td> <td style="width: 10%;"></td> <td style="width: 10%;"></td> <td style="width: 10%;"></td> <td style="width: 10%;"></td> <td style="width: 10%;"></td> <td style="width: 10%;"></td> <td style="width: 10%;"></td> </tr> <tr> <td></td> <td></td> <td colspan="8" style="text-align: center;"> <table border="1" style="width: 100%; border-collapse: collapse; text-align: center;"> <tr> <td style="width: 10%;"></td> <td style="width: 10%;"></td> <td style="width: 10%;"></td> <td style="width: 10%;"></td> <td style="width: 10%;"></td> <td style="width: 10%;"></td> <td style="width: 10%;"></td> <td style="width: 10%;"></td> <td style="width: 10%;"></td> <td style="width: 10%;"></td> </tr> <tr> <td></td> <td></td> <td colspan="8" style="text-align: center;"> <table border="1" style="width: 100%; border-collapse: collapse; text-align: center;"> <tr> <td style="width: 10%;"></td> <td style="width: 10%;"></td> <td style="width: 10%;"></td> <td style="width: 10%;"></td> <td style="width: 10%;"></td> <td style="width: 10%;"></td> <td style="width: 10%;"></td> <td style="width: 10%;"></td> <td style="width: 10%;"></td> <td style="width: 10%;"></td> </tr> <tr> <td></td> <td></td> <td colspan="8" style="text-align: center;"> <table border="1" style="width: 100%; border-collapse: collapse; text-align: center;"> <tr> <td style="width: 10%;"></td> <td style="width: 10%;"></td> <td style="width: 10%;"></td> <td style="width: 10%;"></td> <td style="width: 10%;"></td> <td style="width: 10%;"></td> <td style="width: 10%;"></td> <td style="width: 10%;"></td> <td style="width: 10%;"></td> <td style="width: 10%;"></td> </tr> <tr> <td></td> <td></td> <td colspan="8" style="text-align: center;"> <table border="1" style="width: 100%; border-collapse: collapse; text-align: center;"> <tr> <td style="width: 10%;"></td> <td style="width: 10%;"></td> <td style="width: 10%;"></td> <td style="width: 10%;"></td> <td style="width: 10%;"></td> <td style="width: 10%;"></td> <td style="width: 10%;"></td> <td style="width: 10%;"></td> <td style="width: 10%;"></td> <td style="width: 10%;"></td> </tr> <tr> <td></td> <td></td> <td colspan="8" style="text-align: center;"> <table border="1" style="width: 100%; border-collapse: collapse; text-align: center;"> <tr> <td style="width: 10%;"></td> <td style="width: 10%;"></td> <td style="width: 10%;"></td> <td style="width: 10%;"></td> <td style="width: 10%;"></td> <td style="width: 10%;"></td> <td style="width: 10%;"></td> <td style="width: 10%;"></td> <td style="width: 10%;"></td> <td style="width: 10%;"></td> </tr> <tr> <td></td> <td></td> <td colspan="8" style="text-align: center;"> <table border="1" style="width: 100%; border-collapse: collapse; text-align: center;"> <tr> <td style="width: 10%;"></td> <td style="width: 10%;"></td> <td style="width: 10%;"></td> <td style="width: 10%;"></td> <td style="width: 10%;"></td> <td style="width: 10%;"></td> <td style="width: 10%;"></td> <td style="width: 10%;"></td> <td style="width: 10%;"></td> <td style="width: 10%;"></td> </tr> <tr> <td></td> <td></td> <td colspan="8" style="text-align: center;"> <table border="1" style="width: 100%; border-collapse: collapse; text-align: center;"> <tr> </tr></table></td></tr></table></td></tr></table></td></tr></table></td></tr></table></td></tr></table></td></tr></table></td></tr></table></td></tr></table></td></tr></table></td></tr></table></td></tr></table></td></tr></table></td></tr></table></td></tr></table></td></tr></table></td></tr></table></td></tr></table></td></tr></table></td></tr></table></td></tr></table></td></tr></table></td></tr></table></td></tr></table></td></tr></table></td></tr></table></td></tr></table></td></tr></table></td></tr></table></td></tr></table></td></tr></table>
 | | | | | | | | | | | | | | | | | | | | <table border="1" style="width: 100%; border-collapse: collapse; text-align: center;"> <tr> <td style="width: 10%;"></td> <td style="width: 10%;"></td> <td style="width: 10%;"></td> <td style="width: 10%;"></td> <td style="width: 10%;"></td> <td style="width: 10%;"></td> <td style="width: 10%;"></td> <td style="width: 10%;"></td> <td style="width: 10%;"></td> <td style="width: 10%;"></td> </tr> <tr> <td></td> <td></td> <td colspan="8" style="text-align: center;"> <table border="1" style="width: 100%; border-collapse: collapse; text-align: center;"> <tr> <td style="width: 10%;"></td> <td style="width: 10%;"></td> <td style="width: 10%;"></td> <td style="width: 10%;"></td> <td style="width: 10%;"></td> <td style="width: 10%;"></td> <td style="width: 10%;"></td> <td style="width: 10%;"></td> <td style="width: 10%;"></td> <td style="width: 10%;"></td> </tr> <tr> <td></td> <td></td> <td colspan="8" style="text-align: center;"> <table border="1" style="width: 100%; border-collapse: collapse; text-align: center;"> <tr> <td style="width: 10%;"></td> <td style="width: 10%;"></td> <td style="width: 10%;"></td> <td style="width: 10%;"></td> <td style="width: 10%;"></td> <td style="width: 10%;"></td> <td style="width: 10%;"></td> <td style="width: 10%;"></td> <td style="width: 10%;"></td> <td style="width: 10%;"></td> </tr> <tr> <td></td> <td></td> <td colspan="8" style="text-align: center;"> <table border="1" style="width: 100%; border-collapse: collapse; text-align: center;"> <tr> <td style="width: 10%;"></td> <td style="width: 10%;"></td> <td style="width: 10%;"></td> <td style="width: 10%;"></td> <td style="width: 10%;"></td> <td style="width: 10%;"></td> <td style="width: 10%;"></td> <td style="width: 10%;"></td> <td style="width: 10%;"></td> <td style="width: 10%;"></td> </tr> <tr> <td></td> <td></td> <td colspan="8" style="text-align: center;"> <table border="1" style="width: 100%; border-collapse: collapse; text-align: center;"> <tr> <td style="width: 10%;"></td> <td style="width: 10%;"></td> <td style="width: 10%;"></td> <td style="width: 10%;"></td> <td style="width: 10%;"></td> <td style="width: 10%;"></td> <td style="width: 10%;"></td> <td style="width: 10%;"></td> <td style="width: 10%;"></td> <td style="width: 10%;"></td> </tr> <tr> <td></td> <td></td> <td colspan="8" style="text-align: center;"> <table border="1" style="width: 100%; border-collapse: collapse; text-align: center;"> <tr> <td style="width: 10%;"></td> <td style="width: 10%;"></td> <td style="width: 10%;"></td> <td style="width: 10%;"></td> <td style="width: 10%;"></td> <td style="width: 10%;"></td> <td style="width: 10%;"></td> <td style="width: 10%;"></td> <td style="width: 10%;"></td> <td style="width: 10%;"></td> </tr> <tr> <td></td> <td></td> <td colspan="8" style="text-align: center;"> <table border="1" style="width: 100%; border-collapse: collapse; text-align: center;"> <tr> <td style="width: 10%;"></td> <td style="width: 10%;"></td> <td style="width: 10%;"></td> <td style="width: 10%;"></td> <td style="width: 10%;"></td> <td style="width: 10%;"></td> <td style="width: 10%;"></td> <td style="width: 10%;"></td> <td style="width: 10%;"></td> <td style="width: 10%;"></td> </tr> <tr> <td></td> <td></td> <td colspan="8" style="text-align: center;"> <table border="1" style="width: 100%; border-collapse: collapse; text-align: center;"> <tr> <td style="width: 10%;"></td> <td style="width: 10%;"></td> <td style="width: 10%;"></td> <td style="width: 10%;"></td> <td style="width: 10%;"></td> <td style="width: 10%;"></td> <td style="width: 10%;"></td> <td style="width: 10%;"></td> <td style="width: 10%;"></td> <td style="width: 10%;"></td> </tr> <tr> <td></td> <td></td> <td colspan="8" style="text-align: center;"> <table border="1" style="width: 100%; border-collapse: collapse; text-align: center;"> <tr> <td style="width: 10%;"></td> <td style="width: 10%;"></td> <td style="width: 10%;"></td> <td style="width: 10%;"></td> <td style="width: 10%;"></td> <td style="width: 10%;"></td> <td style="width: 10%;"></td> <td style="width: 10%;"></td> <td style="width: 10%;"></td> <td style="width: 10%;"></td> </tr> <tr> <td></td> <td></td> <td colspan="8" style="text-align: center;"> <table border="1" style="width: 100%; border-collapse: collapse; text-align: center;"> <tr> <td style="width: 10%;"></td> <td style="width: 10%;"></td> <td style="width: 10%;"></td> <td style="width: 10%;"></td> <td style="width: 10%;"></td> <td style="width: 10%;"></td> <td style="width: 10%;"></td> <td style="width: 10%;"></td> <td style="width: 10%;"></td> <td style="width: 10%;"></td> </tr> <tr> <td></td> <td></td> <td colspan="8" style="text-align: center;"> <table border="1" style="width: 100%; border-collapse: collapse; text-align: center;"> <tr> <td style="width: 10%;"></td> <td style="width: 10%;"></td> <td style="width: 10%;"></td> <td style="width: 10%;"></td> <td style="width: 10%;"></td> <td style="width: 10%;"></td> <td style="width: 10%;"></td> <td style="width: 10%;"></td> <td style="width: 10%;"></td> <td style="width: 10%;"></td> </tr> <tr> <td></td> <td></td> <td colspan="8" style="text-align: center;"> <table border="1" style="width: 100%; border-collapse: collapse; text-align: center;"> <tr> <td style="width: 10%;"></td> <td style="width: 10%;"></td> <td style="width: 10%;"></td> <td style="width: 10%;"></td> <td style="width: 10%;"></td> <td style="width: 10%;"></td> <td style="width: 10%;"></td> <td style="width: 10%;"></td> <td style="width: 10%;"></td> <td style="width: 10%;"></td> </tr> <tr> <td></td> <td></td> <td colspan="8" style="text-align: center;"> <table border="1" style="width: 100%; border-collapse: collapse; text-align: center;"> <tr> <td style="width: 10%;"></td> <td
style="width: 10%;"></td> <td style="width: 10%;"></td> <td style="width: 10%;"></td> <td style="width: 10%;"></td> <td style="width: 10%;"></td> <td style="width: 10%;"></td> <td style="width: 10%;"></td> <td style="width: 10%;"></td> <td style="width: 10%;"></td> </tr> <tr> <td></td> <td></td> <td colspan="8" style="text-align: center;"> <table border="1" style="width: 100%; border-collapse: collapse; text-align: center;"> <tr> <td style="width: 10%;"></td> <td style="width: 10%;"></td> <td style="width: 10%;"></td> <td style="width: 10%;"></td> <td style="width: 10%;"></td> <td style="width: 10%;"></td> <td style="width: 10%;"></td> <td style="width: 10%;"></td> <td style="width: 10%;"></td> <td style="width: 10%;"></td> </tr> <tr> <td></td> <td></td> <td colspan="8" style="text-align: center;"> <table border="1" style="width: 100%; border-collapse: collapse; text-align: center;"> <tr> <td style="width: 10%;"></td> <td style="width: 10%;"></td> <td style="width: 10%;"></td> <td style="width: 10%;"></td> <td style="width: 10%;"></td> <td style="width: 10%;"></td> <td style="width: 10%;"></td> <td style="width: 10%;"></td> <td style="width: 10%;"></td> <td style="width: 10%;"></td> </tr> <tr> <td></td> <td></td> <td colspan="8" style="text-align: center;"> <table border="1" style="width: 100%; border-collapse: collapse; text-align: center;"> <tr> <td style="width: 10%;"></td> <td style="width: 10%;"></td> <td style="width: 10%;"></td> <td style="width: 10%;"></td> <td style="width: 10%;"></td> <td style="width: 10%;"></td> <td style="width: 10%;"></td> <td style="width: 10%;"></td> <td style="width: 10%;"></td> <td style="width: 10%;"></td> </tr> <tr> <td></td> <td></td> <td colspan="8" style="text-align: center;"> <table border="1" style="width: 100%; border-collapse: collapse; text-align: center;"> <tr> <td style="width: 10%;"></td> <td style="width: 10%;"></td> <td style="width: 10%;"></td> <td style="width: 10%;"></td> <td style="width: 10%;"></td> <td style="width: 10%;"></td> <td style="width: 10%;"></td> <td style="width: 10%;"></td> <td style="width: 10%;"></td> <td style="width: 10%;"></td> </tr> <tr> <td></td> <td></td> <td colspan="8" style="text-align: center;"> <table border="1" style="width: 100%; border-collapse: collapse; text-align: center;"> <tr> <td style="width: 10%;"></td> <td style="width: 10%;"></td> <td style="width: 10%;"></td> <td style="width: 10%;"></td> <td style="width: 10%;"></td> <td style="width: 10%;"></td> <td style="width: 10%;"></td> <td style="width: 10%;"></td> <td style="width: 10%;"></td> <td style="width: 10%;"></td> </tr> <tr> <td></td> <td></td> <td colspan="8" style="text-align: center;"> <table border="1" style="width: 100%; border-collapse: collapse; text-align: center;"> <tr> <td style="width: 10%;"></td> <td style="width: 10%;"></td> <td style="width: 10%;"></td> <td style="width: 10%;"></td> <td style="width: 10%;"></td> <td style="width: 10%;"></td> <td style="width: 10%;"></td> <td style="width: 10%;"></td> <td style="width: 10%;"></td> <td style="width: 10%;"></td> </tr> <tr> <td></td> <td></td> <td colspan="8" style="text-align: center;"> <table border="1" style="width: 100%; border-collapse: collapse; text-align: center;"> <tr> <td style="width: 10%;"></td> <td style="width: 10%;"></td> <td style="width: 10%;"></td> <td style="width: 10%;"></td> <td style="width: 10%;"></td> <td style="width: 10%;"></td> <td style="width: 10%;"></td> <td style="width: 10%;"></td> <td style="width: 10%;"></td> <td style="width: 10%;"></td> </tr> <tr> <td></td> <td></td> <td colspan="8" style="text-align: center;"> <table border="1" style="width: 100%; border-collapse: collapse; text-align: center;"> <tr> <td style="width: 10%;"></td> <td style="width: 10%;"></td> <td style="width: 10%;"></td> <td style="width: 10%;"></td> <td style="width: 10%;"></td> <td style="width: 10%;"></td> <td style="width: 10%;"></td> <td style="width: 10%;"></td> <td style="width: 10%;"></td> <td style="width: 10%;"></td> </tr> <tr> <td></td> <td></td> <td colspan="8" style="text-align: center;"> <table border="1" style="width: 100%; border-collapse: collapse; text-align: center;"> <tr> <td style="width: 10%;"></td> <td style="width: 10%;"></td> <td style="width: 10%;"></td> <td style="width: 10%;"></td> <td style="width: 10%;"></td> <td style="width: 10%;"></td> <td style="width: 10%;"></td> <td style="width: 10%;"></td> <td style="width: 10%;"></td> <td style="width: 10%;"></td> </tr> <tr> <td></td> <td></td> <td colspan="8" style="text-align: center;"> <table border="1" style="width: 100%; border-collapse: collapse; text-align: center;"> <tr> <td style="width: 10%;"></td> <td style="width: 10%;"></td> <td style="width: 10%;"></td> <td style="width: 10%;"></td> <td style="width: 10%;"></td> <td style="width: 10%;"></td> <td style="width: 10%;"></td> <td style="width: 10%;"></td> <td style="width: 10%;"></td> <td style="width: 10%;"></td> </tr> <tr> <td></td> <td></td> <td colspan="8" style="text-align: center;"> <table border="1" style="width: 100%; border-collapse: collapse; text-align: center;"> <tr> <td style="width: 10%;"></td> <td style="width: 10%;"></td> <td style="width: 10%;"></td> <td style="width: 10%;"></td> <td style="width: 10%;"></td> <td style="width: 10%;"></td> <td style="width: 10%;"></td> <td style="width: 10%;"></td> <td style="width: 10%;"></td> <td style="width: 10%;"></td> </tr> <tr> <td></td> <td></td> <td colspan="8" style="text-align: center;"> <table border="1" style="width: 100%; border-collapse: collapse; text-align: center;"> <tr> <td style="width: 10%;"></td> <td style="width: 10%;"></td> <td style="width: 10%;"></td> <td style="width: 10%;"></td> <td style="width: 10%;"></td> <td style="width: 10%;"></td> <td style="width: 10%;"></td> <td style="width: 10%;"></td> <td style="width: 10%;"></td> <td style="width: 10%;"></td> </tr> <tr> <td></td> <td></td> <td colspan="8" style="text-align: center;"> <table border="1" style="width: 100%; border-collapse: collapse; text-align: center;"> <tr> <td style="width: 10%;"></td> <td style="width: 10%;"></td> <td style="width: 10%;"></td> <td style="width: 10%;"></td> <td style="width: 10%;"></td> <td style="width: 10%;"></td> <td style="width: 10%;"></td> <td style="width: 10%;"></td> <td style="width: 10%;"></td> <td style="width: 10%;"></td> </tr> <tr> <td></td> <td></td> <td colspan="8" style="text-align: center;"> <table border="1" style="width: 100%; border-collapse: collapse; text-align: center;"> <tr> <td style="width: 10%;"></td> <td style="width: 10%;"></td> <td style="width: 10%;"></td> <td style="width: 10%;"></td> <td style="width: 10%;"></td> <td style="width: 10%;"></td> <td style="width: 10%;"></td> <td style="width: 10%;"></td> <td style="width: 10%;"></td> <td style="width: 10%;"></td> </tr> <tr> <td></td> <td></td> <td colspan="8" style="text-align: center;"> <table border="1" style="width: 100%; border-collapse: collapse; text-align: center;"> <tr> <td style="width: 10%;"></td> <td style="width: 10%;"></td> <td style="width: 10%;"></td> <td style="width: 10%;"></td> <td style="width: 10%;"></td> <td style="width: 10%;"></td> <td style="width: 10%;"></td> <td style="width: 10%;"></td> <td style="width: 10%;"></td> <td style="width: 10%;"></td> </tr> <tr> <td></td> <td></td> <td colspan="8" style="text-align: center;"> <table border="1" style="width: 100%; border-collapse: collapse; text-align: center;"> <tr> <td style="width: 10%;"></td> <td style="width: 10%;"></td> <td style="width: 10%;"></td> <td style="width: 10%;"></td> <td style="width: 10%;"></td> <td style="width: 10%;"></td> <td style="width: 10%;"></td> <td style="width: 10%;"></td> <td style="width: 10%;"></td> <td style="width: 10%;"></td> </tr> <tr> <td></td> <td></td> <td colspan="8" style="text-align: center;"> <table border="1" style="width: 100%; border-collapse: collapse; text-align: center;"> <tr> </tr></table></td></tr></table></td></tr></table></td></tr></table></td></tr></table></td></tr></table></td></tr></table></td></tr></table></td></tr></table></td></tr></table></td></tr></table></td></tr></table></td></tr></table></td></tr></table></td></tr></table></td></tr></table></td></tr></table></td></tr></table></td></tr></table></td></tr></table></td></tr></table></td></tr></table></td></tr></table></td></tr></table></td></tr></table></td></tr></table></td></tr></table></td></tr></table></td></tr></table></td></tr></table>
 | | | | | | | | | | | | | | | | | | | | <table border="1" style="width: 100%; border-collapse: collapse; text-align: center;"> <tr> <td style="width: 10%;"></td> <td style="width: 10%;"></td> <td style="width: 10%;"></td> <td style="width: 10%;"></td> <td style="width: 10%;"></td> <td style="width: 10%;"></td> <td style="width: 10%;"></td> <td style="width: 10%;"></td> <td style="width: 10%;"></td> <td style="width: 10%;"></td> </tr> <tr> <td></td> <td></td> <td colspan="8" style="text-align: center;"> <table border="1" style="width: 100%; border-collapse: collapse; text-align: center;"> <tr> <td style="width: 10%;"></td> <td style="width: 10%;"></td> <td style="width: 10%;"></td> <td style="width: 10%;"></td> <td style="width: 10%;"></td> <td style="width: 10%;"></td> <td style="width: 10%;"></td> <td style="width: 10%;"></td> <td style="width: 10%;"></td> <td style="width: 10%;"></td> </tr> <tr> <td></td> <td></td> <td colspan="8" style="text-align: center;"> <table border="1" style="width: 100%; border-collapse: collapse; text-align: center;"> <tr> <td style="width: 10%;"></td> <td style="width: 10%;"></td> <td style="width: 10%;"></td> <td style="width: 10%;"></td> <td style="width: 10%;"></td> <td style="width: 10%;"></td> <td style="width: 10%;"></td> <td style="width: 10%;"></td> <td
style="width: 10%;"></td> <td style="width: 10%;"></td> </tr> <tr> <td></td> <td></td> <td colspan="8" style="text-align: center;"> <table border="1" style="width: 100%; border-collapse: collapse; text-align: center;"> <tr> <td style="width: 10%;"></td> <td style="width: 10%;"></td> <td style="width: 10%;"></td> <td style="width: 10%;"></td> <td style="width: 10%;"></td> <td style="width: 10%;"></td> <td style="width: 10%;"></td> <td style="width: 10%;"></td> <td style="width: 10%;"></td> <td style="width: 10%;"></td> </tr> <tr> <td></td> <td></td> <td colspan="8" style="text-align: center;"> <table border="1" style="width: 100%; border-collapse: collapse; text-align: center;"> <tr> <td style="width: 10%;"></td> <td style="width: 10%;"></td> <td style="width: 10%;"></td> <td style="width: 10%;"></td> <td style="width: 10%;"></td> <td style="width: 10%;"></td> <td style="width: 10%;"></td> <td style="width: 10%;"></td> <td style="width: 10%;"></td> <td style="width: 10%;"></td> </tr> <tr> <td></td> <td></td> <td colspan="8" style="text-align: center;"> <table border="1" style="width: 100%; border-collapse: collapse; text-align: center;"> <tr> <td style="width: 10%;"></td> <td style="width: 10%;"></td> <td style="width: 10%;"></td> <td style="width: 10%;"></td> <td style="width: 10%;"></td> <td style="width: 10%;"></td> <td style="width: 10%;"></td> <td style="width: 10%;"></td> <td style="width: 10%;"></td> <td style="width: 10%;"></td> </tr> <tr> <td></td> <td></td> <td colspan="8" style="text-align: center;"> <table border="1" style="width: 100%; border-collapse: collapse; text-align: center;"> <tr> <td style="width: 10%;"></td> <td style="width: 10%;"></td> <td style="width: 10%;"></td> <td style="width: 10%;"></td> <td style="width: 10%;"></td> <td style="width: 10%;"></td> <td style="width: 10%;"></td> <td style="width: 10%;"></td> <td style="width: 10%;"></td> <td style="width: 10%;"></td> </tr> <tr> <td></td> <td></td> <td colspan="8" style="text-align: center;"> <table border="1" style="width: 100%; border-collapse: collapse; text-align: center;"> <tr> <td style="width: 10%;"></td> <td style="width: 10%;"></td> <td style="width: 10%;"></td> <td style="width: 10%;"></td> <td style="width: 10%;"></td> <td style="width: 10%;"></td> <td style="width: 10%;"></td> <td style="width: 10%;"></td> <td style="width: 10%;"></td> <td style="width: 10%;"></td> </tr> <tr> <td></td> <td></td> <td colspan="8" style="text-align: center;"> <table border="1" style="width: 100%; border-collapse: collapse; text-align: center;"> <tr> <td style="width: 10%;"></td> <td style="width: 10%;"></td> <td style="width: 10%;"></td> <td style="width: 10%;"></td> <td style="width: 10%;"></td> <td style="width: 10%;"></td> <td style="width: 10%;"></td> <td style="width: 10%;"></td> <td style="width: 10%;"></td> <td style="width: 10%;"></td> </tr> <tr> <td></td> <td></td> <td colspan="8" style="text-align: center;"> <table border="1" style="width: 100%; border-collapse: collapse; text-align: center;"> <tr> <td style="width: 10%;"></td> <td style="width: 10%;"></td> <td style="width: 10%;"></td> <td style="width: 10%;"></td> <td style="width: 10%;"></td> <td style="width: 10%;"></td> <td style="width: 10%;"></td> <td style="width: 10%;"></td> <td style="width: 10%;"></td> <td style="width: 10%;"></td> </tr> <tr> <td></td> <td></td> <td colspan="8" style="text-align: center;"> <table border="1" style="width: 100%; border-collapse: collapse; text-align: center;"> <tr> <td style="width: 10%;"></td> <td style="width: 10%;"></td> <td style="width: 10%;"></td> <td style="width: 10%;"></td> <td style="width: 10%;"></td> <td style="width: 10%;"></td> <td style="width: 10%;"></td> <td style="width: 10%;"></td> <td style="width: 10%;"></td> <td style="width: 10%;"></td> </tr> <tr> <td></td> <td></td> <td colspan="8" style="text-align: center;"> <table border="1" style="width: 100%; border-collapse: collapse; text-align: center;"> <tr> <td style="width: 10%;"></td> <td style="width: 10%;"></td> <td style="width: 10%;"></td> <td style="width: 10%;"></td> <td style="width: 10%;"></td> <td style="width: 10%;"></td> <td style="width: 10%;"></td> <td style="width: 10%;"></td> <td style="width: 10%;"></td> <td style="width: 10%;"></td> </tr> <tr> <td></td> <td></td> <td colspan="8" style="text-align: center;"> <table border="1" style="width: 100%; border-collapse: collapse; text-align: center;"> <tr> <td style="width: 10%;"></td> <td style="width: 10%;"></td> <td style="width: 10%;"></td> <td style="width: 10%;"></td> <td style="width: 10%;"></td> <td style="width: 10%;"></td> <td style="width: 10%;"></td> <td style="width: 10%;"></td> <td style="width: 10%;"></td> <td style="width: 10%;"></td> </tr> <tr> <td></td> <td></td> <td colspan="8" style="text-align: center;"> <table border="1" style="width: 100%; border-collapse: collapse; text-align: center;"> <tr> <td style="width: 10%;"></td> <td style="width: 10%;"></td> <td style="width: 10%;"></td> <td style="width: 10%;"></td> <td style="width: 10%;"></td> <td style="width: 10%;"></td> <td style="width: 10%;"></td> <td style="width: 10%;"></td> <td style="width: 10%;"></td> <td style="width: 10%;"></td> </tr> <tr> <td></td> <td></td> <td colspan="8" style="text-align: center;"> <table border="1" style="width: 100%; border-collapse: collapse; text-align: center;"> <tr> <td style="width: 10%;"></td> <td style="width: 10%;"></td> <td style="width: 10%;"></td> <td style="width: 10%;"></td> <td style="width: 10%;"></td> <td style="width: 10%;"></td> <td style="width: 10%;"></td> <td style="width: 10%;"></td> <td style="width: 10%;"></td> <td style="width: 10%;"></td> </tr> <tr> <td></td> <td></td> <td colspan="8" style="text-align: center;"> <table border="1" style="width: 100%; border-collapse: collapse; text-align: center;"> <tr> <td style="width: 10%;"></td> <td style="width: 10%;"></td> <td style="width: 10%;"></td> <td style="width: 10%;"></td> <td style="width: 10%;"></td> <td style="width: 10%;"></td> <td style="width: 10%;"></td> <td style="width: 10%;"></td> <td style="width: 10%;"></td> <td style="width: 10%;"></td> </tr> <tr> <td></td> <td></td> <td colspan="8" style="text-align: center;"> <table border="1" style="width: 100%; border-collapse: collapse; text-align: center;"> <tr> <td style="width: 10%;"></td> <td style="width: 10%;"></td> <td style="width: 10%;"></td> <td style="width: 10%;"></td> <td style="width: 10%;"></td> <td style="width: 10%;"></td> <td style="width: 10%;"></td> <td style="width: 10%;"></td> <td style="width: 10%;"></td> <td style="width: 10%;"></td> </tr> <tr> <td></td> <td></td> <td colspan="8" style="text-align: center;"> <table border="1" style="width: 100%; border-collapse: collapse; text-align: center;"> <tr> <td style="width: 10%;"></td> <td style="width: 10%;"></td> <td style="width: 10%;"></td> <td style="width: 10%;"></td> <td style="width: 10%;"></td> <td style="width: 10%;"></td> <td style="width: 10%;"></td> <td style="width: 10%;"></td> <td style="width: 10%;"></td> <td style="width: 10%;"></td> </tr> <tr> <td></td> <td></td> <td colspan="8" style="text-align: center;"> <table border="1" style="width: 100%; border-collapse: collapse; text-align: center;"> <tr> <td style="width: 10%;"></td> <td style="width: 10%;"></td> <td style="width: 10%;"></td> <td style="width: 10%;"></td> <td style="width: 10%;"></td> <td style="width: 10%;"></td> <td style="width: 10%;"></td> <td style="width: 10%;"></td> <td style="width: 10%;"></td> <td style="width: 10%;"></td> </tr> <tr> <td></td> <td></td> <td colspan="8" style="text-align: center;"> <table border="1" style="width: 100%; border-collapse: collapse; text-align: center;"> <tr> <td style="width: 10%;"></td> <td style="width: 10%;"></td> <td style="width: 10%;"></td> <td style="width: 10%;"></td> <td style="width: 10%;"></td> <td style="width: 10%;"></td> <td style="width: 10%;"></td> <td style="width: 10%;"></td> <td style="width: 10%;"></td> <td style="width: 10%;"></td> </tr> <tr> <td></td> <td></td> <td colspan="8" style="text-align: center;"> <table border="1" style="width: 100%; border-collapse: collapse; text-align: center;"> <tr> <td style="width: 10%;"></td> <td style="width: 10%;"></td> <td style="width: 10%;"></td> <td style="width: 10%;"></td> <td style="width: 10%;"></td> <td style="width: 10%;"></td> <td style="width: 10%;"></td> <td style="width: 10%;"></td> <td style="width: 10%;"></td> <td style="width: 10%;"></td> </tr> <tr> <td></td> <td></td> <td colspan="8" style="text-align: center;"> <table border="1" style="width: 100%; border-collapse: collapse; text-align: center;"> <tr> <td style="width: 10%;"></td> <td style="width: 10%;"></td> <td style="width: 10%;"></td> <td style="width: 10%;"></td> <td style="width: 10%;"></td> <td style="width: 10%;"></td> <td style="width: 10%;"></td> <td style="width: 10%;"></td> <td style="width: 10%;"></td> <td style="width: 10%;"></td> </tr> <tr> <td></td> <td></td> <td colspan="8" style="text-align: center;"> <table border="1" style="width: 100%; border-collapse: collapse; text-align: center;"> <tr> <td style="width: 10%;"></td> <td style="width: 10%;"></td> <td style="width: 10%;"></td> <td style="width: 10%;"></td> <td style="width: 10%;"></td> <td style="width: 10%;"></td> <td style="width: 10%;"></td> <td style="width: 10%;"></td> <td style="width: 10%;"></td> <td style="width: 10%;"></td> </tr> <tr> <td></td> <td></td> <td colspan="8" style="text-align: center;"> <table border="1" style="width: 100%; border-collapse: collapse; text-align: center;"> <tr> <td style="width: 10%;"></td> <td style="width: 10%;"></td> <td style="width: 10%;"></td> <td style="width: 10%;"></td> <td style="width: 10%;"></td> <td style="width: 10%;"></td> <td style="width: 10%;"></td> <td style="width: 10%;"></td> <td style="width: 10%;"></td> <td style="width: 10%;"></td> </tr> <tr> <td></td> <td></td> <td colspan="8" style="text-align: center;"> <table border="1" style="width: 100%;
border-collapse: collapse; text-align: center;"> <tr> <td style="width: 10%;"></td> <td style="width: 10%;"></td> <td style="width: 10%;"></td> <td style="width: 10%;"></td> <td style="width: 10%;"></td> <td style="width: 10%;"></td> <td style="width: 10%;"></td> <td style="width: 10%;"></td> <td style="width: 10%;"></td> <td style="width: 10%;"></td> </tr> <tr> <td></td> <td></td> <td colspan="8" style="text-align: center;"> <table border="1" style="width: 100%; border-collapse: collapse; text-align: center;"> <tr> <td style="width: 10%;"></td> <td style="width: 10%;"></td> <td style="width: 10%;"></td> <td style="width: 10%;"></td> <td style="width: 10%;"></td> <td style="width: 10%;"></td> <td style="width: 10%;"></td> <td style="width: 10%;"></td> <td style="width: 10%;"></td> <td style="width: 10%;"></td> </tr> <tr> <td></td> <td></td> <td colspan="8" style="text-align: center;"> <table border="1" style="width: 100%; border-collapse: collapse; text-align: center;"> <tr> <td style="width: 10%;"></td> <td style="width: 10%;"></td> <td style="width: 10%;"></td> <td style="width: 10%;"></td> <td style="width: 10%;"></td> <td style="width: 10%;"></td> <td style="width: 10%;"></td> <td style="width: 10%;"></td> <td style="width: 10%;"></td> <td style="width: 10%;"></td> </tr> <tr> <td></td> <td></td> <td colspan="8" style="text-align: center;"> <table border="1" style="width: 100%; border-collapse: collapse; text-align: center;"> <tr> <td style="width: 10%;"></td> <td style="width: 10%;"></td> <td style="width: 10%;"></td> <td style="width: 10%;"></td> <td style="width: 10%;"></td> <td style="width: 10%;"></td> <td style="width: 10%;"></td> <td style="width: 10%;"></td> <td style="width: 10%;"></td> <td style="width: 10%;"></td> </tr> <tr> <td></td> <td></td> <td colspan="8" style="text-align: center;"> <table border="1" style="width: 100%; border-collapse: collapse; text-align: center;"> <tr> </tr></table></td></tr></table></td></tr></table></td></tr></table></td></tr></table></td></tr></table></td></tr></table></td></tr></table></td></tr></table></td></tr></table></td></tr></table></td></tr></table></td></tr></table></td></tr></table></td></tr></table></td></tr></table></td></tr></table></td></tr></table></td></tr></table></td></tr></table></td></tr></table></td></tr></table></td></tr></table></td></tr></table></td></tr></table></td></tr></table></td></tr></table></td></tr></table></td></tr></table>
 | | | | | | | | | | | | | | | | | | | | <table border="1" style="width: 100%; border-collapse: collapse; text-align: center;"> <tr> <td style="width: 10%;"></td> <td style="width: 10%;"></td> <td style="width: 10%;"></td> <td style="width: 10%;"></td> <td style="width: 10%;"></td> <td style="width: 10%;"></td> <td style="width: 10%;"></td> <td style="width: 10%;"></td> <td style="width: 10%;"></td> <td style="width: 10%;"></td> </tr> <tr> <td></td> <td></td> <td colspan="8" style="text-align: center;"> <table border="1" style="width: 100%; border-collapse: collapse; text-align: center;"> <tr> <td style="width: 10%;"></td> <td style="width: 10%;"></td> <td style="width: 10%;"></td> <td style="width: 10%;"></td> <td style="width: 10%;"></td> <td style="width: 10%;"></td> <td style="width: 10%;"></td> <td style="width: 10%;"></td> <td style="width: 10%;"></td> <td style="width: 10%;"></td> </tr> <tr> <td></td> <td></td> <td colspan="8" style="text-align: center;"> <table border="1" style="width: 100%; border-collapse: collapse; text-align: center;"> <tr> <td style="width: 10%;"></td> <td style="width: 10%;"></td> <td style="width: 10%;"></td> <td style="width: 10%;"></td> <td style="width: 10%;"></td> <td style="width: 10%;"></td> <td style="width: 10%;"></td> <td style="width: 10%;"></td> <td style="width: 10%;"></td> <td style="width: 10%;"></td> </tr> <tr> <td></td> <td></td> <td colspan="8" style="text-align: center;"> <table border="1" style="width: 100%; border-collapse: collapse; text-align: center;"> <tr> <td style="width: 10%;"></td> <td style="width: 10%;"></td> <td style="width: 10%;"></td> <td style="width: 10%;"></td> <td style="width: 10%;"></td> <td style="width: 10%;"></td> <td style="width: 10%;"></td> <td style="width: 10%;"></td> <td style="width: 10%;"></td> <td style="width: 10%;"></td> </tr> <tr> <td></td> <td></td> <td colspan="8" style="text-align: center;"> <table border="1" style="width: 100%; border-collapse: collapse; text-align: center;"> <tr> <td style="width: 10%;"></td> <td style="width: 10%;"></td> <td style="width: 10%;"></td> <td style="width: 10%;"></td> <td style="width: 10%;"></td> <td style="width: 10%;"></td> <td style="width: 10%;"></td> <td style="width: 10%;"></td> <td style="width: 10%;"></td> <td style="width: 10%;"></td> </tr> <tr> <td></td> <td></td> <td colspan="8" style="text-align: center;"> <table border="1" style="width: 100%; border-collapse: collapse; text-align: center;"> <tr> <td style="width: 10%;"></td> <td style="width: 10%;"></td> <td style="width: 10%;"></td> <td style="width: 10%;"></td> <td style="width: 10%;"></td> <td style="width: 10%;"></td> <td style="width: 10%;"></td> <td style="width: 10%;"></td> <td style="width: 10%;"></td> <td style="width: 10%;"></td> </tr> <tr> <td></td> <td></td> <td colspan="8" style="text-align: center;"> <table border="1" style="width: 100%; border-collapse: collapse; text-align: center;"> <tr> <td style="width: 10%;"></td> <td style="width: 10%;"></td> <td style="width: 10%;"></td> <td style="width: 10%;"></td> <td style="width: 10%;"></td> <td style="width: 10%;"></td> <td style="width: 10%;"></td> <td style="width: 10%;"></td> <td style="width: 10%;"></td> <td style="width: 10%;"></td> </tr> <tr> <td></td> <td></td> <td colspan="8" style="text-align: center;"> <table border="1" style="width: 100%; border-collapse: collapse; text-align: center;"> <tr> <td style="width: 10%;"></td> <td style="width: 10%;"></td> <td style="width: 10%;"></td> <td style="width: 10%;"></td> <td style="width: 10%;"></td> <td style="width: 10%;"></td> <td style="width: 10%;"></td> <td style="width: 10%;"></td> <td style="width: 10%;"></td> <td style="width: 10%;"></td> </tr> <tr> <td></td> <td></td> <td colspan="8" style="text-align: center;"> <table border="1" style="width: 100%; border-collapse: collapse; text-align: center;"> <tr> <td style="width: 10%;"></td> <td style="width: 10%;"></td> <td style="width: 10%;"></td> <td style="width: 10%;"></td> <td style="width: 10%;"></td> <td style="width: 10%;"></td> <td style="width: 10%;"></td> <td style="width: 10%;"></td> <td style="width: 10%;"></td> <td style="width: 10%;"></td> </tr> <tr> <td></td> <td></td> <td colspan="8" style="text-align: center;"> <table border="1" style="width: 100%; border-collapse: collapse; text-align: center;"> <tr> <td style="width: 10%;"></td> <td style="width: 10%;"></td> <td style="width: 10%;"></td> <td style="width: 10%;"></td> <td style="width: 10%;"></td> <td style="width: 10%;"></td> <td style="width: 10%;"></td> <td style="width: 10%;"></td> <td style="width: 10%;"></td> <td style="width: 10%;"></td> </tr> <tr> <td></td> <td></td> <td colspan="8" style="text-align: center;"> <table border="1" style="width: 100%; border-collapse: collapse; text-align: center;"> <tr> <td style="width: 10%;"></td> <td style="width: 10%;"></td> <td style="width: 10%;"></td> <td style="width: 10%;"></td> <td style="width: 10%;"></td> <td style="width: 10%;"></td> <td style="width: 10%;"></td> <td style="width: 10%;"></td> <td style="width: 10%;"></td> <td style="width: 10%;"></td> </tr> <tr> <td></td> <td></td> <td colspan="8" style="text-align: center;"> <table border="1" style="width: 100%; border-collapse: collapse; text-align: center;"> <tr> <td style="width: 10%;"></td> <td style="width: 10%;"></td> <td style="width: 10%;"></td> <td style="width: 10%;"></td> <td style="width: 10%;"></td> <td style="width: 10%;"></td> <td style="width: 10%;"></td> <td style="width: 10%;"></td> <td style="width: 10%;"></td> <td style="width: 10%;"></td> </tr> <tr> <td></td> <td></td> <td colspan="8" style="text-align: center;"> <table border="1" style="width: 100%; border-collapse: collapse; text-align: center;"> <tr> <td style="width: 10%;"></td> <td style="width: 10%;"></td> <td style="width: 10%;"></td> <td style="width: 10%;"></td> <td style="width: 10%;"></td> <td style="width: 10%;"></td> <td style="width: 10%;"></td> <td style="width: 10%;"></td> <td style="width: 10%;"></td> <td style="width: 10%;"></td> </tr> <tr> <td></td> <td></td> <td colspan="8" style="text-align: center;"> <table border="1" style="width: 100%; border-collapse: collapse; text-align: center;"> <tr> <td style="width: 10%;"></td> <td style="width: 10%;"></td> <td style="width: 10%;"></td> <td style="width: 10%;"></td> <td style="width: 10%;"></td> <td style="width: 10%;"></td> <td style="width: 10%;"></td> <td style="width: 10%;"></td> <td style="width: 10%;"></td> <td style="width: 10%;"></td> </tr> <tr> <td></td> <td></td> <td colspan="8" style="text-align: center;"> <table border="1" style="width: 100%; border-collapse: collapse; text-align: center;"> <tr> <td style="width: 10%;"></td> <td style="width: 10%;"></td> <td style="width: 10%;"></td> <td style="width: 10%;"></td> <td style="width: 10%;"></td> <td style="width: 10%;"></td> <td style="width: 10%;"></td> <td style="width: 10%;"></td> <td style="width: 10%;"></td> <td style="width: 10%;"></td> </tr> <tr> <td></td> <td></td> <td colspan="8" style="text-align: center;"> <table border="1" style="width: 100%; border-collapse: collapse; text-align: center;"> <tr> <td style="width: 10%;"></td> <td style="width: 10%;"></td> <td style="width: 10%;"></td> <td style="width: 10%;"></td> <td style="width: 10%;"></td> <td style="width:
10%;"></td> <td style="width: 10%;"></td> <td style="width: 10%;"></td> <td style="width: 10%;"></td> <td style="width: 10%;"></td> </tr> <tr> <td></td> <td></td> <td colspan="8" style="text-align: center;"> <table border="1" style="width: 100%; border-collapse: collapse; text-align: center;"> <tr> <td style="width: 10%;"></td> <td style="width: 10%;"></td> <td style="width: 10%;"></td> <td style="width: 10%;"></td> <td style="width: 10%;"></td> <td style="width: 10%;"></td> <td style="width: 10%;"></td> <td style="width: 10%;"></td> <td style="width: 10%;"></td> <td style="width: 10%;"></td> </tr> <tr> <td></td> <td></td> <td colspan="8" style="text-align: center;"> <table border="1" style="width: 100%; border-collapse: collapse; text-align: center;"> <tr> <td style="width: 10%;"></td> <td style="width: 10%;"></td> <td style="width: 10%;"></td> <td style="width: 10%;"></td> <td style="width: 10%;"></td> <td style="width: 10%;"></td> <td style="width: 10%;"></td> <td style="width: 10%;"></td> <td style="width: 10%;"></td> <td style="width: 10%;"></td> </tr> <tr> <td></td> <td></td> <td colspan="8" style="text-align: center;"> <table border="1" style="width: 100%; border-collapse: collapse; text-align: center;"> <tr> <td style="width: 10%;"></td> <td style="width: 10%;"></td> <td style="width: 10%;"></td> <td style="width: 10%;"></td> <td style="width: 10%;"></td> <td style="width: 10%;"></td> <td style="width: 10%;"></td> <td style="width: 10%;"></td> <td style="width: 10%;"></td> <td style="width: 10%;"></td> </tr> <tr> <td></td> <td></td> <td colspan="8" style="text-align: center;"> <table border="1" style="width: 100%; border-collapse: collapse; text-align: center;"> <tr> <td style="width: 10%;"></td> <td style="width: 10%;"></td> <td style="width: 10%;"></td> <td style="width: 10%;"></td> <td style="width: 10%;"></td> <td style="width: 10%;"></td> <td style="width: 10%;"></td> <td style="width: 10%;"></td> <td style="width: 10%;"></td> <td style="width: 10%;"></td> </tr> <tr> <td></td> <td></td> <td colspan="8" style="text-align: center;"> <table border="1" style="width: 100%; border-collapse: collapse; text-align: center;"> <tr> <td style="width: 10%;"></td> <td style="width: 10%;"></td> <td style="width: 10%;"></td> <td style="width: 10%;"></td> <td style="width: 10%;"></td> <td style="width: 10%;"></td> <td style="width: 10%;"></td> <td style="width: 10%;"></td> <td style="width: 10%;"></td> <td style="width: 10%;"></td> </tr> <tr> <td></td> <td></td> <td colspan="8" style="text-align: center;"> <table border="1" style="width: 100%; border-collapse: collapse; text-align: center;"> <tr> <td style="width: 10%;"></td> <td style="width: 10%;"></td> <td style="width: 10%;"></td> <td style="width: 10%;"></td> <td style="width: 10%;"></td> <td style="width: 10%;"></td> <td style="width: 10%;"></td> <td style="width: 10%;"></td> <td style="width: 10%;"></td> <td style="width: 10%;"></td> </tr> <tr> <td></td> <td></td> <td colspan="8" style="text-align: center;"> <table border="1" style="width: 100%; border-collapse: collapse; text-align: center;"> <tr> <td style="width: 10%;"></td> <td style="width: 10%;"></td> <td style="width: 10%;"></td> <td style="width: 10%;"></td> <td style="width: 10%;"></td> <td style="width: 10%;"></td> <td style="width: 10%;"></td> <td style="width: 10%;"></td> <td style="width: 10%;"></td> <td style="width: 10%;"></td> </tr> <tr> <td></td> <td></td> <td colspan="8" style="text-align: center;"> <table border="1" style="width: 100%; border-collapse: collapse; text-align: center;"> <tr> <td style="width: 10%;"></td> <td style="width: 10%;"></td> <td style="width: 10%;"></td> <td style="width: 10%;"></td> <td style="width: 10%;"></td> <td style="width: 10%;"></td> <td style="width: 10%;"></td> <td style="width: 10%;"></td> <td style="width: 10%;"></td> <td style="width: 10%;"></td> </tr> <tr> <td></td> <td></td> <td colspan="8" style="text-align: center;"> <table border="1" style="width: 100%; border-collapse: collapse; text-align: center;"> <tr> <td style="width: 10%;"></td> <td style="width: 10%;"></td> <td style="width: 10%;"></td> <td style="width: 10%;"></td> <td style="width: 10%;"></td> <td style="width: 10%;"></td> <td style="width: 10%;"></td> <td style="width: 10%;"></td> <td style="width: 10%;"></td> <td style="width: 10%;"></td> </tr> <tr> <td></td> <td></td> <td colspan="8" style="text-align: center;"> <table border="1" style="width: 100%; border-collapse: collapse; text-align: center;"> <tr> <td style="width: 10%;"></td> <td style="width: 10%;"></td> <td style="width: 10%;"></td> <td style="width: 10%;"></td> <td style="width: 10%;"></td> <td style="width: 10%;"></td> <td style="width: 10%;"></td> <td style="width: 10%;"></td> <td style="width: 10%;"></td> <td style="width: 10%;"></td> </tr> <tr> <td></td> <td></td> <td colspan="8" style="text-align: center;"> <table border="1" style="width: 100%; border-collapse: collapse; text-align: center;"> <tr> <td style="width: 10%;"></td> <td style="width: 10%;"></td> <td style="width: 10%;"></td> <td style="width: 10%;"></td> <td style="width: 10%;"></td> <td style="width: 10%;"></td> <td style="width: 10%;"></td> <td style="width: 10%;"></td> <td style="width: 10%;"></td> <td style="width: 10%;"></td> </tr> <tr> <td></td> <td></td> <td colspan="8" style="text-align: center;"> <table border="1" style="width: 100%; border-collapse: collapse; text-align: center;"> <tr> </tr></table></td></tr></table></td></tr></table></td></tr></table></td></tr></table></td></tr></table></td></tr></table></td></tr></table></td></tr></table></td></tr></table></td></tr></table></td></tr></table></td></tr></table></td></tr></table></td></tr></table></td></tr></table></td></tr></table></td></tr></table></td></tr></table></td></tr></table></td></tr></table></td></tr></table></td></tr></table></td></tr></table></td></tr></table></td></tr></table></td></tr></table></td></tr></table>
 | | | | | | | | | | | | | | | | | | | | <table border="1" style="width: 100%; border-collapse: collapse; text-align: center;"> <tr> <td style="width: 10%;"></td> <td style="width: 10%;"></td> <td style="width: 10%;"></td> <td style="width: 10%;"></td> <td style="width: 10%;"></td> <td style="width: 10%;"></td> <td style="width: 10%;"></td> <td style="width: 10%;"></td> <td style="width: 10%;"></td> <td style="width: 10%;"></td> </tr> <tr> <td></td> <td></td> <td colspan="8" style="text-align: center;"> <table border="1" style="width: 100%; border-collapse: collapse; text-align: center;"> <tr> <td style="width: 10%;"></td> <td style="width: 10%;"></td> <td style="width: 10%;"></td> <td style="width: 10%;"></td> <td style="width: 10%;"></td> <td style="width: 10%;"></td> <td style="width: 10%;"></td> <td style="width: 10%;"></td> <td style="width: 10%;"></td> <td style="width: 10%;"></td> </tr> <tr> <td></td> <td></td> <td colspan="8" style="text-align: center;"> <table border="1" style="width: 100%; border-collapse: collapse; text-align: center;"> <tr> <td style="width: 10%;"></td> <td style="width: 10%;"></td> <td style="width: 10%;"></td> <td style="width: 10%;"></td> <td style="width: 10%;"></td> <td style="width: 10%;"></td> <td style="width: 10%;"></td> <td style="width: 10%;"></td> <td style="width: 10%;"></td> <td style="width: 10%;"></td> </tr> <tr> <td></td> <td></td> <td colspan="8" style="text-align: center;"> <table border="1" style="width: 100%; border-collapse: collapse; text-align: center;"> <tr> <td style="width: 10%;"></td> <td style="width: 10%;"></td> <td style="width: 10%;"></td> <td style="width: 10%;"></td> <td style="width: 10%;"></td> <td style="width: 10%;"></td> <td style="width: 10%;"></td> <td style="width: 10%;"></td> <td style="width: 10%;"></td> <td style="width: 10%;"></td> </tr> <tr> <td></td> <td></td> <td colspan="8" style="text-align: center;"> <table border="1" style="width: 100%; border-collapse: collapse; text-align: center;"> <tr> <td style="width: 10%;"></td> <td style="width: 10%;"></td> <td style="width: 10%;"></td> <td style="width: 10%;"></td> <td style="width: 10%;"></td> <td style="width: 10%;"></td> <td style="width: 10%;"></td> <td style="width: 10%;"></td> <td style="width: 10%;"></td> <td style="width: 10%;"></td> </tr> <tr> <td></td> <td></td> <td colspan="8" style="text-align: center;"> <table border="1" style="width: 100%; border-collapse: collapse; text-align: center;"> <tr> <td style="width: 10%;"></td> <td style="width: 10%;"></td> <td style="width: 10%;"></td> <td style="width: 10%;"></td> <td style="width: 10%;"></td> <td style="width: 10%;"></td> <td style="width: 10%;"></td> <td style="width: 10%;"></td> <td style="width: 10%;"></td> <td style="width: 10%;"></td> </tr> <tr> <td></td> <td></td> <td colspan="8" style="text-align: center;"> <table border="1" style="width: 100%; border-collapse: collapse; text-align: center;"> <tr> <td style="width: 10%;"></td> <td style="width: 10%;"></td> <td style="width: 10%;"></td> <td style="width: 10%;"></td> <td style="width: 10%;"></td> <td style="width: 10%;"></td> <td style="width: 10%;"></td> <td style="width: 10%;"></td> <td style="width: 10%;"></td> <td style="width: 10%;"></td> </tr> <tr> <td></td> <td></td> <td colspan="8" style="text-align: center;"> <table border="1" style="width: 100%; border-collapse: collapse; text-align: center;"> <tr> <td style="width: 10%;"></td> <td style="width: 10%;"></td> <td style="width: 10%;"></td> <td style="width: 10%;"></td> <td style="width: 10%;"></td> <td style="width: 10%;"></td> <td style="width: 10%;"></td> <td style="width: 10%;"></td> <td style="width: 10%;"></td> <td style="width: 10%;"></td> </tr> <tr> <td></td> <td></td> <td colspan="8" style="text-align: center;"> <table border="1" style="width: 100%;
border-collapse: collapse; text-align: center;"> <tr> <td style="width: 10%;"></td> <td style="width: 10%;"></td> <td style="width: 10%;"></td> <td style="width: 10%;"></td> <td style="width: 10%;"></td> <td style="width: 10%;"></td> <td style="width: 10%;"></td> <td style="width: 10%;"></td> <td style="width: 10%;"></td> <td style="width: 10%;"></td> </tr> <tr> <td></td> <td></td> <td colspan="8" style="text-align: center;"> <table border="1" style="width: 100%; border-collapse: collapse; text-align: center;"> <tr> <td style="width: 10%;"></td> <td style="width: 10%;"></td> <td style="width: 10%;"></td> <td style="width: 10%;"></td> <td style="width: 10%;"></td> <td style="width: 10%;"></td> <td style="width: 10%;"></td> <td style="width: 10%;"></td> <td style="width: 10%;"></td> <td style="width: 10%;"></td> </tr> <tr> <td></td> <td></td> <td colspan="8" style="text-align: center;"> <table border="1" style="width: 100%; border-collapse: collapse; text-align: center;"> <tr> <td style="width: 10%;"></td> <td style="width: 10%;"></td> <td style="width: 10%;"></td> <td style="width: 10%;"></td> <td style="width: 10%;"></td> <td style="width: 10%;"></td> <td style="width: 10%;"></td> <td style="width: 10%;"></td> <td style="width: 10%;"></td> <td style="width: 10%;"></td> </tr> <tr> <td></td> <td></td> <td colspan="8" style="text-align: center;"> <table border="1" style="width: 100%; border-collapse: collapse; text-align: center;"> <tr> <td style="width: 10%;"></td> <td style="width: 10%;"></td> <td style="width: 10%;"></td> <td style="width: 10%;"></td> <td style="width: 10%;"></td> <td style="width: 10%;"></td> <td style="width: 10%;"></td> <td style="width: 10%;"></td> <td style="width: 10%;"></td> <td style="width: 10%;"></td> </tr> <tr> <td></td> <td></td> <td colspan="8" style="text-align: center;"> <table border="1" style="width: 100%; border-collapse: collapse; text-align: center;"> <tr> <td style="width: 10%;"></td> <td style="width: 10%;"></td> <td style="width: 10%;"></td> <td style="width: 10%;"></td> <td style="width: 10%;"></td> <td style="width: 10%;"></td> <td style="width: 10%;"></td> <td style="width: 10%;"></td> <td style="width: 10%;"></td> <td style="width: 10%;"></td> </tr> <tr> <td></td> <td></td> <td colspan="8" style="text-align: center;"> <table border="1" style="width: 100%; border-collapse: collapse; text-align: center;"> <tr> <td style="width: 10%;"></td> <td style="width: 10%;"></td> <td style="width: 10%;"></td> <td style="width: 10%;"></td> <td style="width: 10%;"></td> <td style="width: 10%;"></td> <td style="width: 10%;"></td> <td style="width: 10%;"></td> <td style="width: 10%;"></td> <td style="width: 10%;"></td> </tr> <tr> <td></td> <td></td> <td colspan="8" style="text-align: center;"> <table border="1" style="width: 100%; border-collapse: collapse; text-align: center;"> <tr> <td style="width: 10%;"></td> <td style="width: 10%;"></td> <td style="width: 10%;"></td> <td style="width: 10%;"></td> <td style="width: 10%;"></td> <td style="width: 10%;"></td> <td style="width: 10%;"></td> <td style="width: 10%;"></td> <td style="width: 10%;"></td> <td style="width: 10%;"></td> </tr> <tr> <td></td> <td></td> <td colspan="8" style="text-align: center;"> <table border="1" style="width: 100%; border-collapse: collapse; text-align: center;"> <tr> <td style="width: 10%;"></td> <td style="width: 10%;"></td> <td style="width: 10%;"></td> <td style="width: 10%;"></td> <td style="width: 10%;"></td> <td style="width: 10%;"></td> <td style="width: 10%;"></td> <td style="width: 10%;"></td> <td style="width: 10%;"></td> <td style="width: 10%;"></td> </tr> <tr> <td></td> <td></td> <td colspan="8" style="text-align: center;"> <table border="1" style="width: 100%; border-collapse: collapse; text-align: center;"> <tr> <td style="width: 10%;"></td> <td style="width: 10%;"></td> <td style="width: 10%;"></td> <td style="width: 10%;"></td> <td style="width: 10%;"></td> <td style="width: 10%;"></td> <td style="width: 10%;"></td> <td style="width: 10%;"></td> <td style="width: 10%;"></td> <td style="width: 10%;"></td> </tr> <tr> <td></td> <td></td> <td colspan="8" style="text-align: center;"> <table border="1" style="width: 100%; border-collapse: collapse; text-align: center;"> <tr> <td style="width: 10%;"></td> <td style="width: 10%;"></td> <td style="width: 10%;"></td> <td style="width: 10%;"></td> <td style="width: 10%;"></td> <td style="width: 10%;"></td> <td style="width: 10%;"></td> <td style="width: 10%;"></td> <td style="width: 10%;"></td> <td style="width: 10%;"></td> </tr> <tr> <td></td> <td></td> <td colspan="8" style="text-align: center;"> <table border="1" style="width: 100%; border-collapse: collapse; text-align: center;"> <tr> <td style="width: 10%;"></td> <td style="width: 10%;"></td> <td style="width: 10%;"></td> <td style="width: 10%;"></td> <td style="width: 10%;"></td> <td style="width: 10%;"></td> <td style="width: 10%;"></td> <td style="width: 10%;"></td> <td style="width: 10%;"></td> <td style="width: 10%;"></td> </tr> <tr> <td></td> <td></td> <td colspan="8" style="text-align: center;"> <table border="1" style="width: 100%; border-collapse: collapse; text-align: center;"> <tr> <td style="width: 10%;"></td> <td style="width: 10%;"></td> <td style="width: 10%;"></td> <td style="width: 10%;"></td> <td style="width: 10%;"></td> <td style="width: 10%;"></td> <td style="width: 10%;"></td> <td style="width: 10%;"></td> <td style="width: 10%;"></td> <td style="width: 10%;"></td> </tr> <tr> <td></td> <td></td> <td colspan="8" style="text-align: center;"> <table border="1" style="width: 100%; border-collapse: collapse; text-align: center;"> <tr> <td style="width: 10%;"></td> <td style="width: 10%;"></td> <td style="width: 10%;"></td> <td style="width: 10%;"></td> <td style="width: 10%;"></td> <td style="width: 10%;"></td> <td style="width: 10%;"></td> <td style="width: 10%;"></td> <td style="width: 10%;"></td> <td style="width: 10%;"></td> </tr> <tr> <td></td> <td></td> <td colspan="8" style="text-align: center;"> <table border="1" style="width: 100%; border-collapse: collapse; text-align: center;"> <tr> <td style="width: 10%;"></td> <td style="width: 10%;"></td> <td style="width: 10%;"></td> <td style="width: 10%;"></td> <td style="width: 10%;"></td> <td style="width: 10%;"></td> <td style="width: 10%;"></td> <td style="width: 10%;"></td> <td style="width: 10%;"></td> <td style="width: 10%;"></td> </tr> <tr> <td></td> <td></td> <td colspan="8" style="text-align: center;"> <table border="1" style="width: 100%; border-collapse: collapse; text-align: center;"> <tr> <td style="width: 10%;"></td> <td style="width: 10%;"></td> <td style="width: 10%;"></td> <td style="width: 10%;"></td> <td style="width: 10%;"></td> <td style="width: 10%;"></td> <td style="width: 10%;"></td> <td style="width: 10%;"></td> <td style="width: 10%;"></td> <td style="width: 10%;"></td> </tr> <tr> <td></td> <td></td> <td colspan="8" style="text-align: center;"> <table border="1" style="width: 100%; border-collapse: collapse; text-align: center;"> <tr> <td style="width: 10%;"></td> <td style="width: 10%;"></td> <td style="width: 10%;"></td> <td style="width: 10%;"></td> <td style="width: 10%;"></td> <td style="width: 10%;"></td> <td style="width: 10%;"></td> <td style="width: 10%;"></td> <td style="width: 10%;"></td> <td style="width: 10%;"></td> </tr> <tr> <td></td> <td></td> <td colspan="8" style="text-align: center;"> <table border="1" style="width: 100%; border-collapse: collapse; text-align: center;"> <tr> <td style="width: 10%;"></td> <td style="width: 10%;"></td> <td style="width: 10%;"></td> <td style="width: 10%;"></td> <td style="width: 10%;"></td> <td style="width: 10%;"></td> <td style="width: 10%;"></td> <td style="width: 10%;"></td> <td style="width: 10%;"></td> <td style="width: 10%;"></td> </tr> <tr> <td></td> <td></td> <td colspan="8" style="text-align: center;"> <table border="1" style="width: 100%; border-collapse: collapse; text-align: center;"> <tr> <td style="width: 10%;"></td> <td style="width: 10%;"></td> <td style="width: 10%;"></td> <td style="width: 10%;"></td> <td style="width: 10%;"></td> <td style="width: 10%;"></td> <td style="width: 10%;"></td> <td style="width: 10%;"></td> <td style="width: 10%;"></td> <td style="width: 10%;"></td> </tr> <tr> <td></td> <td></td> <td colspan="8" style="text-align: center;"> <table border="1" style="width: 100%; border-collapse: collapse; text-align: center;"> <tr> </tr></table></td></tr></table></td></tr></table></td></tr></table></td></tr></table></td></tr></table></td></tr></table></td></tr></table></td></tr></table></td></tr></table></td></tr></table></td></tr></table></td></tr></table></td></tr></table></td></tr></table></td></tr></table></td></tr></table></td></tr></table></td></tr></table></td></tr></table></td></tr></table></td></tr></table></td></tr></table></td></tr></table></td></tr></table></td></tr></table></td></tr></table>
 | | | | | | | | | | | | | | | | | | | | <table border="1" style="width: 100%; border-collapse: collapse; text-align: center;"> <tr> <td style="width: 10%;"></td> <td style="width: 10%;"></td> <td style="width: 10%;"></td> <td style="width: 10%;"></td> <td style="width: 10%;"></td> <td style="width: 10%;"></td> <td style="width: 10%;"></td> <td style="width: 10%;"></td> <td style="width: 10%;"></td> <td style="width: 10%;"></td> </tr> <tr> <td></td> <td></td> <td colspan="8" style="text-align: center;"> <table border="1" style="width: 100%; border-collapse: collapse; text-align: center;"> <tr> <td style="width: 10%;"></td> <td style="width: 10%;"></td> <td style="width: 10%;"></td> <td style="width: 10%;"></td> <td style="width: 10%;"></td> <td style="width: 10%;"></td> <td style="width: 10%;"></td> <td
style="width: 10%;"></td> <td style="width: 10%;"></td> <td style="width: 10%;"></td> </tr> <tr> <td></td> <td></td> <td colspan="8" style="text-align: center;"> <table border="1" style="width: 100%; border-collapse: collapse; text-align: center;"> <tr> <td style="width: 10%;"></td> <td style="width: 10%;"></td> <td style="width: 10%;"></td> <td style="width: 10%;"></td> <td style="width: 10%;"></td> <td style="width: 10%;"></td> <td style="width: 10%;"></td> <td style="width: 10%;"></td> <td style="width: 10%;"></td> <td style="width: 10%;"></td> </tr> <tr> <td></td> <td></td> <td colspan="8" style="text-align: center;"> <table border="1" style="width: 100%; border-collapse: collapse; text-align: center;"> <tr> <td style="width: 10%;"></td> <td style="width: 10%;"></td> <td style="width: 10%;"></td> <td style="width: 10%;"></td> <td style="width: 10%;"></td> <td style="width: 10%;"></td> <td style="width: 10%;"></td> <td style="width: 10%;"></td> <td style="width: 10%;"></td> <td style="width: 10%;"></td> </tr> <tr> <td></td> <td></td> <td colspan="8" style="text-align: center;"> <table border="1" style="width: 100%; border-collapse: collapse; text-align: center;"> <tr> <td style="width: 10%;"></td> <td style="width: 10%;"></td> <td style="width: 10%;"></td> <td style="width: 10%;"></td> <td style="width: 10%;"></td> <td style="width: 10%;"></td> <td style="width: 10%;"></td> <td style="width: 10%;"></td> <td style="width: 10%;"></td> <td style="width: 10%;"></td> </tr> <tr> <td></td> <td></td> <td colspan="8" style="text-align: center;"> <table border="1" style="width: 100%; border-collapse: collapse; text-align: center;"> <tr> <td style="width: 10%;"></td> <td style="width: 10%;"></td> <td style="width: 10%;"></td> <td style="width: 10%;"></td> <td style="width: 10%;"></td> <td style="width: 10%;"></td> <td style="width: 10%;"></td> <td style="width: 10%;"></td> <td style="width: 10%;"></td> <td style="width: 10%;"></td> </tr> <tr> <td></td> <td></td> <td colspan="8" style="text-align: center;"> <table border="1" style="width: 100%; border-collapse: collapse; text-align: center;"> <tr> <td style="width: 10%;"></td> <td style="width: 10%;"></td> <td style="width: 10%;"></td> <td style="width: 10%;"></td> <td style="width: 10%;"></td> <td style="width: 10%;"></td> <td style="width: 10%;"></td> <td style="width: 10%;"></td> <td style="width: 10%;"></td> <td style="width: 10%;"></td> </tr> <tr> <td></td> <td></td> <td colspan="8" style="text-align: center;"> <table border="1" style="width: 100%; border-collapse: collapse; text-align: center;"> <tr> <td style="width: 10%;"></td> <td style="width: 10%;"></td> <td style="width: 10%;"></td> <td style="width: 10%;"></td> <td style="width: 10%;"></td> <td style="width: 10%;"></td> <td style="width: 10%;"></td> <td style="width: 10%;"></td> <td style="width: 10%;"></td> <td style="width: 10%;"></td> </tr> <tr> <td></td> <td></td> <td colspan="8" style="text-align: center;"> <table border="1" style="width: 100%; border-collapse: collapse; text-align: center;"> <tr> <td style="width: 10%;"></td> <td style="width: 10%;"></td> <td style="width: 10%;"></td> <td style="width: 10%;"></td> <td style="width: 10%;"></td> <td style="width: 10%;"></td> <td style="width: 10%;"></td> <td style="width: 10%;"></td> <td style="width: 10%;"></td> <td style="width: 10%;"></td> </tr> <tr> <td></td> <td></td> <td colspan="8" style="text-align: center;"> <table border="1" style="width: 100%; border-collapse: collapse; text-align: center;"> <tr> <td style="width: 10%;"></td> <td style="width: 10%;"></td> <td style="width: 10%;"></td> <td style="width: 10%;"></td> <td style="width: 10%;"></td> <td style="width: 10%;"></td> <td style="width: 10%;"></td> <td style="width: 10%;"></td> <td style="width: 10%;"></td> <td style="width: 10%;"></td> </tr> <tr> <td></td> <td></td> <td colspan="8" style="text-align: center;"> <table border="1" style="width: 100%; border-collapse: collapse; text-align: center;"> <tr> <td style="width: 10%;"></td> <td style="width: 10%;"></td> <td style="width: 10%;"></td> <td style="width: 10%;"></td> <td style="width: 10%;"></td> <td style="width: 10%;"></td> <td style="width: 10%;"></td> <td style="width: 10%;"></td> <td style="width: 10%;"></td> <td style="width: 10%;"></td> </tr> <tr> <td></td> <td></td> <td colspan="8" style="text-align: center;"> <table border="1" style="width: 100%; border-collapse: collapse; text-align: center;"> <tr> <td style="width: 10%;"></td> <td style="width: 10%;"></td> <td style="width: 10%;"></td> <td style="width: 10%;"></td> <td style="width: 10%;"></td> <td style="width: 10%;"></td> <td style="width: 10%;"></td> <td style="width: 10%;"></td> <td style="width: 10%;"></td> <td style="width: 10%;"></td> </tr> <tr> <td></td> <td></td> <td colspan="8" style="text-align: center;"> <table border="1" style="width: 100%; border-collapse: collapse; text-align: center;"> <tr> <td style="width: 10%;"></td> <td style="width: 10%;"></td> <td style="width: 10%;"></td> <td style="width: 10%;"></td> <td style="width: 10%;"></td> <td style="width: 10%;"></td> <td style="width: 10%;"></td> <td style="width: 10%;"></td> <td style="width: 10%;"></td> <td style="width: 10%;"></td> </tr> <tr> <td></td> <td></td> <td colspan="8" style="text-align: center;"> <table border="1" style="width: 100%; border-collapse: collapse; text-align: center;"> <tr> <td style="width: 10%;"></td> <td style="width: 10%;"></td> <td style="width: 10%;"></td> <td style="width: 10%;"></td> <td style="width: 10%;"></td> <td style="width: 10%;"></td> <td style="width: 10%;"></td> <td style="width: 10%;"></td> <td style="width: 10%;"></td> <td style="width: 10%;"></td> </tr> <tr> <td></td> <td></td> <td colspan="8" style="text-align: center;"> <table border="1" style="width: 100%; border-collapse: collapse; text-align: center;"> <tr> <td style="width: 10%;"></td> <td style="width: 10%;"></td> <td style="width: 10%;"></td> <td style="width: 10%;"></td> <td style="width: 10%;"></td> <td style="width: 10%;"></td> <td style="width: 10%;"></td> <td style="width: 10%;"></td> <td style="width: 10%;"></td> <td style="width: 10%;"></td> </tr> <tr> <td></td> <td></td> <td colspan="8" style="text-align: center;"> <table border="1" style="width: 100%; border-collapse: collapse; text-align: center;"> <tr> <td style="width: 10%;"></td> <td style="width: 10%;"></td> <td style="width: 10%;"></td> <td style="width: 10%;"></td> <td style="width: 10%;"></td> <td style="width: 10%;"></td> <td style="width: 10%;"></td> <td style="width: 10%;"></td> <td style="width: 10%;"></td> <td style="width: 10%;"></td> </tr> <tr> <td></td> <td></td> <td colspan="8" style="text-align: center;"> <table border="1" style="width: 100%; border-collapse: collapse; text-align: center;"> <tr> <td style="width: 10%;"></td> <td style="width: 10%;"></td> <td style="width: 10%;"></td> <td style="width: 10%;"></td> <td style="width: 10%;"></td> <td style="width: 10%;"></td> <td style="width: 10%;"></td> <td style="width: 10%;"></td> <td style="width: 10%;"></td> <td style="width: 10%;"></td> </tr> <tr> <td></td> <td></td> <td colspan="8" style="text-align: center;"> <table border="1" style="width: 100%; border-collapse: collapse; text-align: center;"> <tr> <td style="width: 10%;"></td> <td style="width: 10%;"></td> <td style="width: 10%;"></td> <td style="width: 10%;"></td> <td style="width: 10%;"></td> <td style="width: 10%;"></td> <td style="width: 10%;"></td> <td style="width: 10%;"></td> <td style="width: 10%;"></td> <td style="width: 10%;"></td> </tr> <tr> <td></td> <td></td> <td colspan="8" style="text-align: center;"> <table border="1" style="width: 100%; border-collapse: collapse; text-align: center;"> <tr> <td style="width: 10%;"></td> <td style="width: 10%;"></td> <td style="width: 10%;"></td> <td style="width: 10%;"></td> <td style="width: 10%;"></td> <td style="width: 10%;"></td> <td style="width: 10%;"></td> <td style="width: 10%;"></td> <td style="width: 10%;"></td> <td style="width: 10%;"></td> </tr> <tr> <td></td> <td></td> <td colspan="8" style="text-align: center;"> <table border="1" style="width: 100%; border-collapse: collapse; text-align: center;"> <tr> <td style="width: 10%;"></td> <td style="width: 10%;"></td> <td style="width: 10%;"></td> <td style="width: 10%;"></td> <td style="width: 10%;"></td> <td style="width: 10%;"></td> <td style="width: 10%;"></td> <td style="width: 10%;"></td> <td style="width: 10%;"></td> <td style="width: 10%;"></td> </tr> <tr> <td></td> <td></td> <td colspan="8" style="text-align: center;"> <table border="1" style="width: 100%; border-collapse: collapse; text-align: center;"> <tr> <td style="width: 10%;"></td> <td style="width: 10%;"></td> <td style="width: 10%;"></td> <td style="width: 10%;"></td> <td style="width: 10%;"></td> <td style="width: 10%;"></td> <td style="width: 10%;"></td> <td style="width: 10%;"></td> <td style="width: 10%;"></td> <td style="width: 10%;"></td> </tr> <tr> <td></td> <td></td> <td colspan="8" style="text-align: center;"> <table border="1" style="width: 100%; border-collapse: collapse; text-align: center;"> <tr> <td style="width: 10%;"></td> <td style="width: 10%;"></td> <td style="width: 10%;"></td> <td style="width: 10%;"></td> <td style="width: 10%;"></td> <td style="width: 10%;"></td> <td style="width: 10%;"></td> <td style="width: 10%;"></td> <td style="width: 10%;"></td> <td style="width: 10%;"></td> </tr> <tr> <td></td> <td></td> <td colspan="8" style="text-align: center;"> <table border="1" style="width: 100%; border-collapse: collapse; text-align: center;"> <tr> <td style="width: 10%;"></td> <td style="width: 10%;"></td> <td style="width: 10%;"></td> <td style="width: 10%;"></td> <td style="width: 10%;"></td> <td style="width: 10%;"></td> <td style="width: 10%;"></td> <td style="width: 10%;"></td> <td style="width: 10%;"></td> <td style="width: 10%;"></td> </tr> <tr> <td></td> <td></td> <td colspan="8" style="text-align: center;"> <table
border="1" style="width: 100%; border-collapse: collapse; text-align: center;"> <tr> <td style="width: 10%;"></td> <td style="width: 10%;"></td> <td style="width: 10%;"></td> <td style="width: 10%;"></td> <td style="width: 10%;"></td> <td style="width: 10%;"></td> <td style="width: 10%;"></td> <td style="width: 10%;"></td> <td style="width: 10%;"></td> <td style="width: 10%;"></td> </tr> <tr> <td></td> <td></td> <td colspan="8" style="text-align: center;"> <table border="1" style="width: 100%; border-collapse: collapse; text-align: center;"> <tr> <td style="width: 10%;"></td> <td style="width: 10%;"></td> <td style="width: 10%;"></td> <td style="width: 10%;"></td> <td style="width: 10%;"></td> <td style="width: 10%;"></td> <td style="width: 10%;"></td> <td style="width: 10%;"></td> <td style="width: 10%;"></td> <td style="width: 10%;"></td> </tr> <tr> <td></td> <td></td> <td colspan="8" style="text-align: center;"> <table border="1" style="width: 100%; border-collapse: collapse; text-align: center;"> <tr> </tr></table></td></tr></table></td></tr></table></td></tr></table></td></tr></table></td></tr></table></td></tr></table></td></tr></table></td></tr></table></td></tr></table></td></tr></table></td></tr></table></td></tr></table></td></tr></table></td></tr></table></td></tr></table></td></tr></table></td></tr></table></td></tr></table></td></tr></table></td></tr></table></td></tr></table></td></tr></table></td></tr></table></td></tr></table></td></tr></table>
 | | | | | | | | | | | | | | | | | | | | <table border="1" style="width: 100%; border-collapse: collapse; text-align: center;"> <tr> <td style="width: 10%;"></td> <td style="width: 10%;"></td> <td style="width: 10%;"></td> <td style="width: 10%;"></td> <td style="width: 10%;"></td> <td style="width: 10%;"></td> <td style="width: 10%;"></td> <td style="width: 10%;"></td> <td style="width: 10%;"></td> <td style="width: 10%;"></td> </tr> <tr> <td></td> <td></td> <td colspan="8" style="text-align: center;"> <table border="1" style="width: 100%; border-collapse: collapse; text-align: center;"> <tr> <td style="width: 10%;"></td> <td style="width: 10%;"></td> <td style="width: 10%;"></td> <td style="width: 10%;"></td> <td style="width: 10%;"></td> <td style="width: 10%;"></td> <td style="width: 10%;"></td> <td style="width: 10%;"></td> <td style="width: 10%;"></td> <td style="width: 10%;"></td> </tr> <tr> <td></td> <td></td> <td colspan="8" style="text-align: center;"> <table border="1" style="width: 100%; border-collapse: collapse; text-align: center;"> <tr> <td style="width: 10%;"></td> <td style="width: 10%;"></td> <td style="width: 10%;"></td> <td style="width: 10%;"></td> <td style="width: 10%;"></td> <td style="width: 10%;"></td> <td style="width: 10%;"></td> <td style="width: 10%;"></td> <td style="width: 10%;"></td> <td style="width: 10%;"></td> </tr> <tr> <td></td> <td></td> <td colspan="8" style="text-align: center;"> <table border="1" style="width: 100%; border-collapse: collapse; text-align: center;"> <tr> <td style="width: 10%;"></td> <td style="width: 10%;"></td> <td style="width: 10%;"></td> <td style="width: 10%;"></td> <td style="width: 10%;"></td> <td style="width: 10%;"></td> <td style="width: 10%;"></td> <td style="width: 10%;"></td> <td style="width: 10%;"></td> <td style="width: 10%;"></td> </tr> <tr> <td></td> <td></td> <td colspan="8" style="text-align: center;"> <table border="1" style="width: 100%; border-collapse: collapse; text-align: center;"> <tr> <td style="width: 10%;"></td> <td style="width: 10%;"></td> <td style="width: 10%;"></td> <td style="width: 10%;"></td> <td style="width: 10%;"></td> <td style="width: 10%;"></td> <td style="width: 10%;"></td> <td style="width: 10%;"></td> <td style="width: 10%;"></td> <td style="width: 10%;"></td> </tr> <tr> <td></td> <td></td> <td colspan="8" style="text-align: center;"> <table border="1" style="width: 100%; border-collapse: collapse; text-align: center;"> <tr> <td style="width: 10%;"></td> <td style="width: 10%;"></td> <td style="width: 10%;"></td> <td style="width: 10%;"></td> <td style="width: 10%;"></td> <td style="width: 10%;"></td> <td style="width: 10%;"></td> <td style="width: 10%;"></td> <td style="width: 10%;"></td> <td style="width: 10%;"></td> </tr> <tr> <td></td> <td></td> <td colspan="8" style="text-align: center;"> <table border="1" style="width: 100%; border-collapse: collapse; text-align: center;"> <tr> <td style="width: 10%;"></td> <td style="width: 10%;"></td> <td style="width: 10%;"></td> <td style="width: 10%;"></td> <td style="width: 10%;"></td> <td style="width: 10%;"></td> <td style="width: 10%;"></td> <td style="width: 10%;"></td> <td style="width: 10%;"></td> <td style="width: 10%;"></td> </tr> <tr> <td></td> <td></td> <td colspan="8" style="text-align: center;"> <table border="1" style="width: 100%; border-collapse: collapse; text-align: center;"> <tr> <td style="width: 10%;"></td> <td style="width: 10%;"></td> <td style="width: 10%;"></td> <td style="width: 10%;"></td> <td style="width: 10%;"></td> <td style="width: 10%;"></td> <td style="width: 10%;"></td> <td style="width: 10%;"></td> <td style="width: 10%;"></td> <td style="width: 10%;"></td> </tr> <tr> <td></td> <td></td> <td colspan="8" style="text-align: center;"> <table border="1" style="width: 100%; border-collapse: collapse; text-align: center;"> <tr> <td style="width: 10%;"></td> <td style="width: 10%;"></td> <td style="width: 10%;"></td> <td style="width: 10%;"></td> <td style="width: 10%;"></td> <td style="width: 10%;"></td> <td style="width: 10%;"></td> <td style="width: 10%;"></td> <td style="width: 10%;"></td> <td style="width: 10%;"></td> </tr> <tr> <td></td> <td></td> <td colspan="8" style="text-align: center;"> <table border="1" style="width: 100%; border-collapse: collapse; text-align: center;"> <tr> <td style="width: 10%;"></td> <td style="width: 10%;"></td> <td style="width: 10%;"></td> <td style="width: 10%;"></td> <td style="width: 10%;"></td> <td style="width: 10%;"></td> <td style="width: 10%;"></td> <td style="width: 10%;"></td> <td style="width: 10%;"></td> <td style="width: 10%;"></td> </tr> <tr> <td></td> <td></td> <td colspan="8" style="text-align: center;"> <table border="1" style="width: 100%; border-collapse: collapse; text-align: center;"> <tr> <td style="width: 10%;"></td> <td style="width: 10%;"></td> <td style="width: 10%;"></td> <td style="width: 10%;"></td> <td style="width: 10%;"></td> <td style="width: 10%;"></td> <td style="width: 10%;"></td> <td style="width: 10%;"></td> <td style="width: 10%;"></td> <td style="width: 10%;"></td> </tr> <tr> <td></td> <td></td> <td colspan="8" style="text-align: center;"> <table border="1" style="width: 100%; border-collapse: collapse; text-align: center;"> <tr> <td style="width: 10%;"></td> <td style="width: 10%;"></td> <td style="width: 10%;"></td> <td style="width: 10%;"></td> <td style="width: 10%;"></td> <td style="width: 10%;"></td> <td style="width: 10%;"></td> <td style="width: 10%;"></td> <td style="width: 10%;"></td> <td style="width: 10%;"></td> </tr> <tr> <td></td> <td></td> <td colspan="8" style="text-align: center;"> <table border="1" style="width: 100%; border-collapse: collapse; text-align: center;"> <tr> <td style="width: 10%;"></td> <td style="width: 10%;"></td> <td style="width: 10%;"></td> <td style="width: 10%;"></td> <td style="width: 10%;"></td> <td style="width: 10%;"></td> <td style="width: 10%;"></td> <td style="width: 10%;"></td> <td style="width: 10%;"></td> <td style="width: 10%;"></td> </tr> <tr> <td></td> <td></td> <td colspan="8" style="text-align: center;"> <table border="1" style="width: 100%; border-collapse: collapse; text-align: center;"> <tr> <td style="width: 10%;"></td> <td style="width: 10%;"></td> <td style="width: 10%;"></td> <td style="width: 10%;"></td> <td style="width: 10%;"></td> <td style="width: 10%;"></td> <td style="width: 10%;"></td> <td style="width: 10%;"></td> <td style="width: 10%;"></td> <td style="width: 10%;"></td> </tr> <tr> <td></td> <td></td> <td colspan="8" style="text-align: center;"> <table border="1" style="width: 100%; border-collapse: collapse; text-align: center;"> <tr> <td style="width: 10%;"></td> <td style="width: 10%;"></td> <td style="width: 10%;"></td> <td style="width: 10%;"></td> <td style="width: 10%;"></td> <td style="width: 10%;"></td> <td style="width: 10%;"></td> <td style="width: 10%;"></td> <td style="width: 10%;"></td> <td style="width: 10%;"></td> </tr> <tr> <td></td> <td></td> <td colspan="8" style="text-align: center;"> <table border="1" style="width: 100%; border-collapse: collapse; text-align: center;"> <tr> <td style="width: 10%;"></td> <td style="width: 10%;"></td> <td style="width: 10%;"></td> <td style="width: 10%;"></td> <td style="width: 10%;"></td> <td style="width: 10%;"></td> <td style="width: 10%;"></td> <td style="width: 10%;"></td> <td style="width: 10%;"></td> <td style="width: 10%;"></td> </tr> <tr> <td></td> <td></td> <td colspan="8" style="text-align: center;"> <table border="1" style="width: 100%; border-collapse: collapse; text-align: center;"> <tr> <td style="width: 10%;"></td> <td style="width: 10%;"></td> <td style="width: 10%;"></td> <td style="width: 10%;"></td> <td style="width: 10%;"></td> <td style="width: 10%;"></td> <td style="width: 10%;"></td> <td style="width: 10%;"></td> <td style="width: 10%;"></td> <td style="width: 10%;"></td> </tr> <tr> <td></td> <td></td> <td colspan="8" style="text-align: center;"> <table border="1" style="width: 100%; border-collapse: collapse; text-align: center;"> <tr> <td style="width: 10%;"></td> <td style="width: 10%;"></td> <td style="width: 10%;"></td> <td style="width: 10%;"></td> <td style="width: 10%;"></td> <td style="width: 10%;"></td> <td style="width:
10%;"></td> <td style="width: 10%;"></td> <td style="width: 10%;"></td> <td style="width: 10%;"></td> </tr> <tr> <td></td> <td></td> <td colspan="8" style="text-align: center;"> <table border="1" style="width: 100%; border-collapse: collapse; text-align: center;"> <tr> <td style="width: 10%;"></td> <td style="width: 10%;"></td> <td style="width: 10%;"></td> <td style="width: 10%;"></td> <td style="width: 10%;"></td> <td style="width: 10%;"></td> <td style="width: 10%;"></td> <td style="width: 10%;"></td> <td style="width: 10%;"></td> <td style="width: 10%;"></td> </tr> <tr> <td></td> <td></td> <td colspan="8" style="text-align: center;"> <table border="1" style="width: 100%; border-collapse: collapse; text-align: center;"> <tr> <td style="width: 10%;"></td> <td style="width: 10%;"></td> <td style="width: 10%;"></td> <td style="width: 10%;"></td> <td style="width: 10%;"></td> <td style="width: 10%;"></td> <td style="width: 10%;"></td> <td style="width: 10%;"></td> <td style="width: 10%;"></td> <td style="width: 10%;"></td> </tr> <tr> <td></td> <td></td> <td colspan="8" style="text-align: center;"> <table border="1" style="width: 100%; border-collapse: collapse; text-align: center;"> <tr> <td style="width: 10%;"></td> <td style="width: 10%;"></td> <td style="width: 10%;"></td> <td style="width: 10%;"></td> <td style="width: 10%;"></td> <td style="width: 10%;"></td> <td style="width: 10%;"></td> <td style="width: 10%;"></td> <td style="width: 10%;"></td> <td style="width: 10%;"></td> </tr> <tr> <td></td> <td></td> <td colspan="8" style="text-align: center;"> <table border="1" style="width: 100%; border-collapse: collapse; text-align: center;"> <tr> <td style="width: 10%;"></td> <td style="width: 10%;"></td> <td style="width: 10%;"></td> <td style="width: 10%;"></td> <td style="width: 10%;"></td> <td style="width: 10%;"></td> <td style="width: 10%;"></td> <td style="width: 10%;"></td> <td style="width: 10%;"></td> <td style="width: 10%;"></td> </tr> <tr> <td></td> <td></td> <td colspan="8" style="text-align: center;"> <table border="1" style="width: 100%; border-collapse: collapse; text-align: center;"> <tr> <td style="width: 10%;"></td> <td style="width: 10%;"></td> <td style="width: 10%;"></td> <td style="width: 10%;"></td> <td style="width: 10%;"></td> <td style="width: 10%;"></td> <td style="width: 10%;"></td> <td style="width: 10%;"></td> <td style="width: 10%;"></td> <td style="width: 10%;"></td> </tr> <tr> <td></td> <td></td> <td colspan="8" style="text-align: center;"> <table border="1" style="width: 100%; border-collapse: collapse; text-align: center;"> <tr> <td style="width: 10%;"></td> <td style="width: 10%;"></td> <td style="width: 10%;"></td> <td style="width: 10%;"></td> <td style="width: 10%;"></td> <td style="width: 10%;"></td> <td style="width: 10%;"></td> <td style="width: 10%;"></td> <td style="width: 10%;"></td> <td style="width: 10%;"></td> </tr> <tr> <td></td> <td></td> <td colspan="8" style="text-align: center;"> <table border="1" style="width: 100%; border-collapse: collapse; text-align: center;"> <tr> </tr></table></td></tr></table></td></tr></table></td></tr></table></td></tr></table></td></tr></table></td></tr></table></td></tr></table></td></tr></table></td></tr></table></td></tr></table></td></tr></table></td></tr></table></td></tr></table></td></tr></table></td></tr></table></td></tr></table></td></tr></table></td></tr></table></td></tr></table></td></tr></table></td></tr></table></td></tr></table></td></tr></table></td></tr></table>
 | | | | | | | | | | | | | | | | | | | | <table border="1" style="width: 100%; border-collapse: collapse; text-align: center;"> <tr> <td style="width: 10%;"></td> <td style="width: 10%;"></td> <td style="width: 10%;"></td> <td style="width: 10%;"></td> <td style="width: 10%;"></td> <td style="width: 10%;"></td> <td style="width: 10%;"></td> <td style="width: 10%;"></td> <td style="width: 10%;"></td> <td style="width: 10%;"></td> </tr> <tr> <td></td> <td></td> <td colspan="8" style="text-align: center;"> <table border="1" style="width: 100%; border-collapse: collapse; text-align: center;"> <tr> <td style="width: 10%;"></td> <td style="width: 10%;"></td> <td style="width: 10%;"></td> <td style="width: 10%;"></td> <td style="width: 10%;"></td> <td style="width: 10%;"></td> <td style="width: 10%;"></td> <td style="width: 10%;"></td> <td style="width: 10%;"></td> <td style="width: 10%;"></td> </tr> <tr> <td></td> <td></td> <td colspan="8" style="text-align: center;"> <table border="1" style="width: 100%; border-collapse: collapse; text-align: center;"> <tr> <td style="width: 10%;"></td> <td style="width: 10%;"></td> <td style="width: 10%;"></td> <td style="width: 10%;"></td> <td style="width: 10%;"></td> <td style="width: 10%;"></td> <td style="width: 10%;"></td> <td style="width: 10%;"></td> <td style="width: 10%;"></td> <td style="width: 10%;"></td> </tr> <tr> <td></td> <td></td> <td colspan="8" style="text-align: center;"> <table border="1" style="width: 100%; border-collapse: collapse; text-align: center;"> <tr> <td style="width: 10%;"></td> <td style="width: 10%;"></td> <td style="width: 10%;"></td> <td style="width: 10%;"></td> <td style="width: 10%;"></td> <td style="width: 10%;"></td> <td style="width: 10%;"></td> <td style="width: 10%;"></td> <td style="width: 10%;"></td> <td style="width: 10%;"></td> </tr> <tr> <td></td> <td></td> <td colspan="8" style="text-align: center;"> <table border="1" style="width: 100%; border-collapse: collapse; text-align: center;"> <tr> <td style="width: 10%;"></td> <td style="width: 10%;"></td> <td style="width: 10%;"></td> <td style="width: 10%;"></td> <td style="width: 10%;"></td> <td style="width: 10%;"></td> <td style="width: 10%;"></td> <td style="width: 10%;"></td> <td style="width: 10%;"></td> <td style="width: 10%;"></td> </tr> <tr> <td></td> <td></td> <td colspan="8" style="text-align: center;"> <table border="1" style="width: 100%; border-collapse: collapse; text-align: center;"> <tr> <td style="width: 10%;"></td> <td style="width: 10%;"></td> <td style="width: 10%;"></td> <td style="width: 10%;"></td> <td style="width: 10%;"></td> <td style="width: 10%;"></td> <td style="width: 10%;"></td> <td style="width: 10%;"></td> <td style="width: 10%;"></td> <td style="width: 10%;"></td> </tr> <tr> <td></td> <td></td> <td colspan="8" style="text-align: center;"> <table border="1" style="width: 100%; border-collapse: collapse; text-align: center;"> <tr> <td style="width: 10%;"></td> <td style="width: 10%;"></td> <td style="width: 10%;"></td> <td style="width: 10%;"></td> <td style="width: 10%;"></td> <td style="width: 10%;"></td> <td style="width: 10%;"></td> <td style="width: 10%;"></td> <td style="width: 10%;"></td> <td style="width: 10%;"></td> </tr> <tr> <td></td> <td></td> <td colspan="8" style="text-align: center;"> <table border="1" style="width: 100%; border-collapse: collapse; text-align: center;"> <tr> <td style="width: 10%;"></td> <td style="width: 10%;"></td> <td style="width: 10%;"></td> <td style="width: 10%;"></td> <td style="width: 10%;"></td> <td style="width: 10%;"></td> <td style="width: 10%;"></td> <td style="width: 10%;"></td> <td style="width: 10%;"></td> <td style="width: 10%;"></td> </tr> <tr> <td></td> <td></td> <td colspan="8" style="text-align: center;"> <table border="1" style="width: 100%; border-collapse: collapse; text-align: center;"> <tr> <td style="width: 10%;"></td> <td style="width: 10%;"></td> <td style="width: 10%;"></td> <td style="width: 10%;"></td> <td style="width: 10%;"></td> <td style="width: 10%;"></td> <td style="width: 10%;"></td> <td style="width: 10%;"></td> <td style="width: 10%;"></td> <td style="width: 10%;"></td> </tr> <tr> <td></td> <td></td> <td colspan="8" style="text-align: center;"> <table border="1" style="width: 100%; border-collapse: collapse; text-align: center;"> <tr> <td style="width: 10%;"></td> <td style="width: 10%;"></td> <td style="width: 10%;"></td> <td style="width: 10%;"></td> <td style="width: 10%;"></td> <td style="width: 10%;"></td> <td style="width: 10%;"></td> <td style="width: 10%;"></td> <td style="width: 10%;"></td> <td style="width: 10%;"></td> </tr> <tr> <td></td> <td></td> <td colspan="8" style="text-align: center;"> <table border="1" style="width: 100%; border-collapse: collapse; text-align: center;"> <tr> <td style="width: 10%;"></td> <td style="width: 10%;"></td> <td style="width: 10%;"></td> <td style="width: 10%;"></td> <td style="width: 10%;"></td> <td style="width: 10%;"></td> <td style="width: 10%;"></td> <td style="width: 10%;"></td> <td style="width: 10%;"></td> <td style="width: 10%;"></td> </tr> <tr> <td></td> <td></td> <td colspan="8" style="text-align: center;"> <table border="1" style="width: 100%; border-collapse: collapse; text-align: center;"> <tr> <td style="width: 10%;"></td> <td style="width: 10%;"></td> <td style="width: 10%;"></td> <td style="width: 10%;"></td> <td style="width: 10%;"></td> <td style="width: 10%;"></td> <td style="width: 10%;"></td> <td style="width: 10%;"></td> <td style="width: 10%;"></td> <td style="width: 10%;"></td> </tr> <tr> <td></td> <td></td> <td colspan="8" style="text-align: center;"> <table border="1" style="width: 100%; border-collapse: collapse; text-align: center;"> <tr> <td style="width: 10%;"></td> <td style="width: 10%;"></td> <td style="width: 10%;"></td> <td style="width: 10%;"></td> <td style="width: 10%;"></td> <td style="width: 10%;"></td> <td style="width: 10%;"></td> <td style="width: 10%;"></td> <td style="width: 10%;"></td> <td style="width: 10%;"></td> </tr> <tr> <td></td> <td></td> <td colspan="8" style="text-align: center;"> <table border="1" style="width: 100%; border-collapse: collapse; text-align: center;"> <tr> <td style="width: 10%;"></td> <td
style="width: 10%;"></td> <td style="width: 10%;"></td> <td style="width: 10%;"></td> <td style="width: 10%;"></td> <td style="width: 10%;"></td> <td style="width: 10%;"></td> <td style="width: 10%;"></td> <td style="width: 10%;"></td> <td style="width: 10%;"></td> </tr> <tr> <td></td> <td></td> <td colspan="8" style="text-align: center;"> <table border="1" style="width: 100%; border-collapse: collapse; text-align: center;"> <tr> <td style="width: 10%;"></td> <td style="width: 10%;"></td> <td style="width: 10%;"></td> <td style="width: 10%;"></td> <td style="width: 10%;"></td> <td style="width: 10%;"></td> <td style="width: 10%;"></td> <td style="width: 10%;"></td> <td style="width: 10%;"></td> <td style="width: 10%;"></td> </tr> <tr> <td></td> <td></td> <td colspan="8" style="text-align: center;"> <table border="1" style="width: 100%; border-collapse: collapse; text-align: center;"> <tr> <td style="width: 10%;"></td> <td style="width: 10%;"></td> <td style="width: 10%;"></td> <td style="width: 10%;"></td> <td style="width: 10%;"></td> <td style="width: 10%;"></td> <td style="width: 10%;"></td> <td style="width: 10%;"></td> <td style="width: 10%;"></td> <td style="width: 10%;"></td> </tr> <tr> <td></td> <td></td> <td colspan="8" style="text-align: center;"> <table border="1" style="width: 100%; border-collapse: collapse; text-align: center;"> <tr> <td style="width: 10%;"></td> <td style="width: 10%;"></td> <td style="width: 10%;"></td> <td style="width: 10%;"></td> <td style="width: 10%;"></td> <td style="width: 10%;"></td> <td style="width: 10%;"></td> <td style="width: 10%;"></td> <td style="width: 10%;"></td> <td style="width: 10%;"></td> </tr> <tr> <td></td> <td></td> <td colspan="8" style="text-align: center;"> <table border="1" style="width: 100%; border-collapse: collapse; text-align: center;"> <tr> <td style="width: 10%;"></td> <td style="width: 10%;"></td> <td style="width: 10%;"></td> <td style="width: 10%;"></td> <td style="width: 10%;"></td> <td style="width: 10%;"></td> <td style="width: 10%;"></td> <td style="width: 10%;"></td> <td style="width: 10%;"></td> <td style="width: 10%;"></td> </tr> <tr> <td></td> <td></td> <td colspan="8" style="text-align: center;"> <table border="1" style="width: 100%; border-collapse: collapse; text-align: center;"> <tr> <td style="width: 10%;"></td> <td style="width: 10%;"></td> <td style="width: 10%;"></td> <td style="width: 10%;"></td> <td style="width: 10%;"></td> <td style="width: 10%;"></td> <td style="width: 10%;"></td> <td style="width: 10%;"></td> <td style="width: 10%;"></td> <td style="width: 10%;"></td> </tr> <tr> <td></td> <td></td> <td colspan="8" style="text-align: center;"> <table border="1" style="width: 100%; border-collapse: collapse; text-align: center;"> <tr> <td style="width: 10%;"></td> <td style="width: 10%;"></td> <td style="width: 10%;"></td> <td style="width: 10%;"></td> <td style="width: 10%;"></td> <td style="width: 10%;"></td> <td style="width: 10%;"></td> <td style="width: 10%;"></td> <td style="width: 10%;"></td> <td style="width: 10%;"></td> </tr> <tr> <td></td> <td></td> <td colspan="8" style="text-align: center;"> <table border="1" style="width: 100%; border-collapse: collapse; text-align: center;"> <tr> <td style="width: 10%;"></td> <td style="width: 10%;"></td> <td style="width: 10%;"></td> <td style="width: 10%;"></td> <td style="width: 10%;"></td> <td style="width: 10%;"></td> <td style="width: 10%;"></td> <td style="width: 10%;"></td> <td style="width: 10%;"></td> <td style="width: 10%;"></td> </tr> <tr> <td></td> <td></td> <td colspan="8" style="text-align: center;"> <table border="1" style="width: 100%; border-collapse: collapse; text-align: center;"> <tr> <td style="width: 10%;"></td> <td style="width: 10%;"></td> <td style="width: 10%;"></td> <td style="width: 10%;"></td> <td style="width: 10%;"></td> <td style="width: 10%;"></td> <td style="width: 10%;"></td> <td style="width: 10%;"></td> <td style="width: 10%;"></td> <td style="width: 10%;"></td> </tr> <tr> <td></td> <td></td> <td colspan="8" style="text-align: center;"> <table border="1" style="width: 100%; border-collapse: collapse; text-align: center;"> <tr> <td style="width: 10%;"></td> <td style="width: 10%;"></td> <td style="width: 10%;"></td> <td style="width: 10%;"></td> <td style="width: 10%;"></td> <td style="width: 10%;"></td> <td style="width: 10%;"></td> <td style="width: 10%;"></td> <td style="width: 10%;"></td> <td style="width: 10%;"></td> </tr> <tr> <td></td> <td></td> <td colspan="8" style="text-align: center;"> <table border="1" style="width: 100%; border-collapse: collapse; text-align: center;"> <tr> </tr></table></td></tr></table></td></tr></table></td></tr></table></td></tr></table></td></tr></table></td></tr></table></td></tr></table></td></tr></table></td></tr></table></td></tr></table></td></tr></table></td></tr></table></td></tr></table></td></tr></table></td></tr></table></td></tr></table></td></tr></table></td></tr></table></td></tr></table></td></tr></table></td></tr></table></td></tr></table></td></tr></table>
 | | | | | | | | | | | | | | | | | | | | <table border="1" style="width: 100%; border-collapse: collapse; text-align: center;"> <tr> <td style="width: 10%;"></td> <td style="width: 10%;"></td> <td style="width: 10%;"></td> <td style="width: 10%;"></td> <td style="width: 10%;"></td> <td style="width: 10%;"></td> <td style="width: 10%;"></td> <td style="width: 10%;"></td> <td style="width: 10%;"></td> <td style="width: 10%;"></td> </tr> <tr> <td></td> <td></td> <td colspan="8" style="text-align: center;"> <table border="1" style="width: 100%; border-collapse: collapse; text-align: center;"> <tr> <td style="width: 10%;"></td> <td style="width: 10%;"></td> <td style="width: 10%;"></td> <td style="width: 10%;"></td> <td style="width: 10%;"></td> <td style="width: 10%;"></td> <td style="width: 10%;"></td> <td style="width: 10%;"></td> <td style="width: 10%;"></td> <td style="width: 10%;"></td> </tr> <tr> <td></td> <td></td> <td colspan="8" style="text-align: center;"> <table border="1" style="width: 100%; border-collapse: collapse; text-align: center;"> <tr> <td style="width: 10%;"></td> <td style="width: 10%;"></td> <td style="width: 10%;"></td> <td style="width: 10%;"></td> <td style="width: 10%;"></td> <td style="width: 10%;"></td> <td style="width: 10%;"></td> <td style="width: 10%;"></td> <td style="width: 10%;"></td> <td style="width: 10%;"></td> </tr> <tr> <td></td> <td></td> <td colspan="8" style="text-align: center;"> <table border="1" style="width: 100%; border-collapse: collapse; text-align: center;"> <tr> <td style="width: 10%;"></td> <td style="width: 10%;"></td> <td style="width: 10%;"></td> <td style="width: 10%;"></td> <td style="width: 10%;"></td> <td style="width: 10%;"></td> <td style="width: 10%;"></td> <td style="width: 10%;"></td> <td style="width: 10%;"></td> <td style="width: 10%;"></td> </tr> <tr> <td></td> <td></td> <td colspan="8" style="text-align: center;"> <table border="1" style="width: 100%; border-collapse: collapse; text-align: center;"> <tr> <td style="width: 10%;"></td> <td style="width: 10%;"></td> <td style="width: 10%;"></td> <td style="width: 10%;"></td> <td style="width: 10%;"></td> <td style="width: 10%;"></td> <td style="width: 10%;"></td> <td style="width: 10%;"></td> <td style="width: 10%;"></td> <td style="width: 10%;"></td> </tr> <tr> <td></td> <td></td> <td colspan="8" style="text-align: center;"> <table border="1" style="width: 100%; border-collapse: collapse; text-align: center;"> <tr> <td style="width: 10%;"></td> <td style="width: 10%;"></td> <td style="width: 10%;"></td> <td style="width: 10%;"></td> <td style="width: 10%;"></td> <td style="width: 10%;"></td> <td style="width: 10%;"></td> <td style="width: 10%;"></td> <td style="width: 10%;"></td> <td style="width: 10%;"></td> </tr> <tr> <td></td> <td></td> <td colspan="8" style="text-align: center;"> <table border="1" style="width: 100%; border-collapse: collapse; text-align: center;"> <tr> <td style="width: 10%;"></td> <td style="width: 10%;"></td> <td style="width: 10%;"></td> <td style="width: 10%;"></td> <td style="width: 10%;"></td> <td style="width: 10%;"></td> <td style="width: 10%;"></td> <td style="width: 10%;"></td> <td style="width: 10%;"></td> <td style="width: 10%;"></td> </tr> <tr> <td></td> <td></td> <td colspan="8" style="text-align: center;"> <table border="1" style="width: 100%; border-collapse: collapse; text-align: center;"> <tr> <td style="width: 10%;"></td> <td style="width: 10%;"></td> <td style="width: 10%;"></td> <td style="width: 10%;"></td> <td style="width: 10%;"></td> <td style="width: 10%;"></td> <td style="width: 10%;"></td> <td style="width: 10%;"></td> <td style="width: 10%;"></td> <td style="width: 10%;"></td> </tr> <tr> <td></td> <td></td> <td colspan="8" style="text-align: center;"> <table border="1" style="width: 100%; border-collapse: collapse; text-align: center;"> <tr> <td style="width: 10%;"></td> <td style="width: 10%;"></td> <td style="width: 10%;"></td> <td style="width: 10%;"></td> <td style="width: 10%;"></td> <td style="width: 10%;"></td> <td style="width: 10%;"></td> <td style="width: 10%;"></td> <td style="width: 10%;"></td> <td style="width: 10%;"></td> </tr> <tr> <td></td> <td></td> <td colspan="8" style="text-align: center;"> <table border="1" style="width: 100%; border-collapse: collapse; text-align: center;"> <tr> <td style="width: 10%;"></td> <td style="width: 10%;"></td> <td style="width: 10%;"></td> <td style="width: 10%;"></td> <td style="width: 10%;"></td> <td style="width: 10%;"></td> <td style="width: 10%;"></td> <td style="width: 10%;"></td> <td style="width: 10%;"></td> <td style="width: 10%;"></td> </tr> <tr> <td></td> <td></td> <td colspan="8"
style="text-align: center;"> <table border="1" style="width: 100%; border-collapse: collapse; text-align: center;"> <tr> <td style="width: 10%;"></td> <td style="width: 10%;"></td> <td style="width: 10%;"></td> <td style="width: 10%;"></td> <td style="width: 10%;"></td> <td style="width: 10%;"></td> <td style="width: 10%;"></td> <td style="width: 10%;"></td> <td style="width: 10%;"></td> <td style="width: 10%;"></td> </tr> <tr> <td></td> <td></td> <td colspan="8" style="text-align: center;"> <table border="1" style="width: 100%; border-collapse: collapse; text-align: center;"> <tr> <td style="width: 10%;"></td> <td style="width: 10%;"></td> <td style="width: 10%;"></td> <td style="width: 10%;"></td> <td style="width: 10%;"></td> <td style="width: 10%;"></td> <td style="width: 10%;"></td> <td style="width: 10%;"></td> <td style="width: 10%;"></td> <td style="width: 10%;"></td> </tr> <tr> <td></td> <td></td> <td colspan="8" style="text-align: center;"> <table border="1" style="width: 100%; border-collapse: collapse; text-align: center;"> <tr> <td style="width: 10%;"></td> <td style="width: 10%;"></td> <td style="width: 10%;"></td> <td style="width: 10%;"></td> <td style="width: 10%;"></td> <td style="width: 10%;"></td> <td style="width: 10%;"></td> <td style="width: 10%;"></td> <td style="width: 10%;"></td> <td style="width: 10%;"></td> </tr> <tr> <td></td> <td></td> <td colspan="8" style="text-align: center;"> <table border="1" style="width: 100%; border-collapse: collapse; text-align: center;"> <tr> <td style="width: 10%;"></td> <td style="width: 10%;"></td> <td style="width: 10%;"></td> <td style="width: 10%;"></td> <td style="width: 10%;"></td> <td style="width: 10%;"></td> <td style="width: 10%;"></td> <td style="width: 10%;"></td> <td style="width: 10%;"></td> <td style="width: 10%;"></td> </tr> <tr> <td></td> <td></td> <td colspan="8" style="text-align: center;"> <table border="1" style="width: 100%; border-collapse: collapse; text-align: center;"> <tr> <td style="width: 10%;"></td> <td style="width: 10%;"></td> <td style="width: 10%;"></td> <td style="width: 10%;"></td> <td style="width: 10%;"></td> <td style="width: 10%;"></td> <td style="width: 10%;"></td> <td style="width: 10%;"></td> <td style="width: 10%;"></td> <td style="width: 10%;"></td> </tr> <tr> <td></td> <td></td> <td colspan="8" style="text-align: center;"> <table border="1" style="width: 100%; border-collapse: collapse; text-align: center;"> <tr> <td style="width: 10%;"></td> <td style="width: 10%;"></td> <td style="width: 10%;"></td> <td style="width: 10%;"></td> <td style="width: 10%;"></td> <td style="width: 10%;"></td> <td style="width: 10%;"></td> <td style="width: 10%;"></td> <td style="width: 10%;"></td> <td style="width: 10%;"></td> </tr> <tr> <td></td> <td></td> <td colspan="8" style="text-align: center;"> <table border="1" style="width: 100%; border-collapse: collapse; text-align: center;"> <tr> <td style="width: 10%;"></td> <td style="width: 10%;"></td> <td style="width: 10%;"></td> <td style="width: 10%;"></td> <td style="width: 10%;"></td> <td style="width: 10%;"></td> <td style="width: 10%;"></td> <td style="width: 10%;"></td> <td style="width: 10%;"></td> <td style="width: 10%;"></td> </tr> <tr> <td></td> <td></td> <td colspan="8" style="text-align: center;"> <table border="1" style="width: 100%; border-collapse: collapse; text-align: center;"> <tr> <td style="width: 10%;"></td> <td style="width: 10%;"></td> <td style="width: 10%;"></td> <td style="width: 10%;"></td> <td style="width: 10%;"></td> <td style="width: 10%;"></td> <td style="width: 10%;"></td> <td style="width: 10%;"></td> <td style="width: 10%;"></td> <td style="width: 10%;"></td> </tr> <tr> <td></td> <td></td> <td colspan="8" style="text-align: center;"> <table border="1" style="width: 100%; border-collapse: collapse; text-align: center;"> <tr> <td style="width: 10%;"></td> <td style="width: 10%;"></td> <td style="width: 10%;"></td> <td style="width: 10%;"></td> <td style="width: 10%;"></td> <td style="width: 10%;"></td> <td style="width: 10%;"></td> <td style="width: 10%;"></td> <td style="width: 10%;"></td> <td style="width: 10%;"></td> </tr> <tr> <td></td> <td></td> <td colspan="8" style="text-align: center;"> <table border="1" style="width: 100%; border-collapse: collapse; text-align: center;"> <tr> <td style="width: 10%;"></td> <td style="width: 10%;"></td> <td style="width: 10%;"></td> <td style="width: 10%;"></td> <td style="width: 10%;"></td> <td style="width: 10%;"></td> <td style="width: 10%;"></td> <td style="width: 10%;"></td> <td style="width: 10%;"></td> <td style="width: 10%;"></td> </tr> <tr> <td></td> <td></td> <td colspan="8" style="text-align: center;"> <table border="1" style="width: 100%; border-collapse: collapse; text-align: center;"> <tr> <td style="width: 10%;"></td> <td style="width: 10%;"></td> <td style="width: 10%;"></td> <td style="width: 10%;"></td> <td style="width: 10%;"></td> <td style="width: 10%;"></td> <td style="width: 10%;"></td> <td style="width: 10%;"></td> <td style="width: 10%;"></td> <td style="width: 10%;"></td> </tr> <tr> <td></td> <td></td> <td colspan="8" style="text-align: center;"> <table border="1" style="width: 100%; border-collapse: collapse; text-align: center;"> <tr> <td style="width: 10%;"></td> <td style="width: 10%;"></td> <td style="width: 10%;"></td> <td style="width: 10%;"></td> <td style="width: 10%;"></td> <td style="width: 10%;"></td> <td style="width: 10%;"></td> <td style="width: 10%;"></td> <td style="width: 10%;"></td> <td style="width: 10%;"></td> </tr> <tr> <td></td> <td></td> <td colspan="8" style="text-align: center;"> <table border="1" style="width: 100%; border-collapse: collapse; text-align: center;"> <tr> </tr></table></td></tr></table></td></tr></table></td></tr></table></td></tr></table></td></tr></table></td></tr></table></td></tr></table></td></tr></table></td></tr></table></td></tr></table></td></tr></table></td></tr></table></td></tr></table></td></tr></table></td></tr></table></td></tr></table></td></tr></table></td></tr></table></td></tr></table></td></tr></table></td></tr></table></td></tr></table>
 | | | | | | | | | | | | | | | | | | | | <table border="1" style="width: 100%; border-collapse: collapse; text-align: center;"> <tr> <td style="width: 10%;"></td> <td style="width: 10%;"></td> <td style="width: 10%;"></td> <td style="width: 10%;"></td> <td style="width: 10%;"></td> <td style="width: 10%;"></td> <td style="width: 10%;"></td> <td style="width: 10%;"></td> <td style="width: 10%;"></td> <td style="width: 10%;"></td> </tr> <tr> <td></td> <td></td> <td colspan="8" style="text-align: center;"> <table border="1" style="width: 100%; border-collapse: collapse; text-align: center;"> <tr> <td style="width: 10%;"></td> <td style="width: 10%;"></td> <td style="width: 10%;"></td> <td style="width: 10%;"></td> <td style="width: 10%;"></td> <td style="width: 10%;"></td> <td style="width: 10%;"></td> <td style="width: 10%;"></td> <td style="width: 10%;"></td> <td style="width: 10%;"></td> </tr> <tr> <td></td> <td></td> <td colspan="8" style="text-align: center;"> <table border="1" style="width: 100%; border-collapse: collapse; text-align: center;"> <tr> <td style="width: 10%;"></td> <td style="width: 10%;"></td> <td style="width: 10%;"></td> <td style="width: 10%;"></td> <td style="width: 10%;"></td> <td style="width: 10%;"></td> <td style="width: 10%;"></td> <td style="width: 10%;"></td> <td style="width: 10%;"></td> <td style="width: 10%;"></td> </tr> <tr> <td></td> <td></td> <td colspan="8" style="text-align: center;"> <table border="1" style="width: 100%; border-collapse: collapse; text-align: center;"> <tr> <td style="width: 10%;"></td> <td style="width: 10%;"></td> <td style="width: 10%;"></td> <td style="width: 10%;"></td> <td style="width: 10%;"></td> <td style="width: 10%;"></td> <td style="width: 10%;"></td> <td style="width: 10%;"></td> <td style="width: 10%;"></td> <td style="width: 10%;"></td> </tr> <tr> <td></td> <td></td> <td colspan="8" style="text-align: center;"> <table border="1" style="width: 100%; border-collapse: collapse; text-align: center;"> <tr> <td style="width: 10%;"></td> <td style="width: 10%;"></td> <td style="width: 10%;"></td> <td style="width: 10%;"></td> <td style="width: 10%;"></td> <td style="width: 10%;"></td> <td style="width: 10%;"></td> <td style="width: 10%;"></td> <td style="width: 10%;"></td> <td style="width: 10%;"></td> </tr> <tr> <td></td> <td></td> <td colspan="8" style="text-align: center;"> <table border="1" style="width: 100%; border-collapse: collapse; text-align: center;"> <tr> <td style="width: 10%;"></td> <td style="width: 10%;"></td> <td style="width: 10%;"></td> <td style="width: 10%;"></td> <td style="width: 10%;"></td> <td style="width: 10%;"></td> <td style="width: 10%;"></td> <td style="width: 10%;"></td> <td style="width: 10%;"></td> <td style="width: 10%;"></td> </tr> <tr> <td></td> <td></td> <td colspan="8" style="text-align: center;"> <table border="1" style="width: 100%; border-collapse: collapse; text-align: center;"> <tr> <td style="width: 10%;"></td> <td style="width: 10%;"></td> <td style="width: 10%;"></td> <td style="width: 10%;"></td> <td style="width: 10%;"></td> <td style="width: 10%;"></td> <td style="width: 10%;"></td> <td style="width: 10%;"></td> <td style="width: 10%;"></td> <td style="width: 10%;"></td> </tr> <tr> <td></td> <td></td> <td colspan="8" style="text-align: center;"> <table border="1" style="width: 100%; border-collapse: collapse; text-align: center;"> <tr> <td style="width: 10%;"></td> <td style="width: 10%;"></td> <td style="width: 10%;"></td> <td style="width: 10%;"></td> <td style="width: 10%;"></td> <td style="width: 10%;"></td> <td style="width: 10%;"></td> <td
style="width: 10%;"></td> <td style="width: 10%;"></td> <td style="width: 10%;"></td> </tr> <tr> <td></td> <td></td> <td colspan="8" style="text-align: center;"> <table border="1" style="width: 100%; border-collapse: collapse; text-align: center;"> <tr> <td style="width: 10%;"></td> <td style="width: 10%;"></td> <td style="width: 10%;"></td> <td style="width: 10%;"></td> <td style="width: 10%;"></td> <td style="width: 10%;"></td> <td style="width: 10%;"></td> <td style="width: 10%;"></td> <td style="width: 10%;"></td> <td style="width: 10%;"></td> </tr> <tr> <td></td> <td></td> <td colspan="8" style="text-align: center;"> <table border="1" style="width: 100%; border-collapse: collapse; text-align: center;"> <tr> <td style="width: 10%;"></td> <td style="width: 10%;"></td> <td style="width: 10%;"></td> <td style="width: 10%;"></td> <td style="width: 10%;"></td> <td style="width: 10%;"></td> <td style="width: 10%;"></td> <td style="width: 10%;"></td> <td style="width: 10%;"></td> <td style="width: 10%;"></td> </tr> <tr> <td></td> <td></td> <td colspan="8" style="text-align: center;"> <table border="1" style="width: 100%; border-collapse: collapse; text-align: center;"> <tr> <td style="width: 10%;"></td> <td style="width: 10%;"></td> <td style="width: 10%;"></td> <td style="width: 10%;"></td> <td style="width: 10%;"></td> <td style="width: 10%;"></td> <td style="width: 10%;"></td> <td style="width: 10%;"></td> <td style="width: 10%;"></td> <td style="width: 10%;"></td> </tr> <tr> <td></td> <td></td> <td colspan="8" style="text-align: center;"> <table border="1" style="width: 100%; border-collapse: collapse; text-align: center;"> <tr> <td style="width: 10%;"></td> <td style="width: 10%;"></td> <td style="width: 10%;"></td> <td style="width: 10%;"></td> <td style="width: 10%;"></td> <td style="width: 10%;"></td> <td style="width: 10%;"></td> <td style="width: 10%;"></td> <td style="width: 10%;"></td> <td style="width: 10%;"></td> </tr> <tr> <td></td> <td></td> <td colspan="8" style="text-align: center;"> <table border="1" style="width: 100%; border-collapse: collapse; text-align: center;"> <tr> <td style="width: 10%;"></td> <td style="width: 10%;"></td> <td style="width: 10%;"></td> <td style="width: 10%;"></td> <td style="width: 10%;"></td> <td style="width: 10%;"></td> <td style="width: 10%;"></td> <td style="width: 10%;"></td> <td style="width: 10%;"></td> <td style="width: 10%;"></td> </tr> <tr> <td></td> <td></td> <td colspan="8" style="text-align: center;"> <table border="1" style="width: 100%; border-collapse: collapse; text-align: center;"> <tr> <td style="width: 10%;"></td> <td style="width: 10%;"></td> <td style="width: 10%;"></td> <td style="width: 10%;"></td> <td style="width: 10%;"></td> <td style="width: 10%;"></td> <td style="width: 10%;"></td> <td style="width: 10%;"></td> <td style="width: 10%;"></td> <td style="width: 10%;"></td> </tr> <tr> <td></td> <td></td> <td colspan="8" style="text-align: center;"> <table border="1" style="width: 100%; border-collapse: collapse; text-align: center;"> <tr> <td style="width: 10%;"></td> <td style="width: 10%;"></td> <td style="width: 10%;"></td> <td style="width: 10%;"></td> <td style="width: 10%;"></td> <td style="width: 10%;"></td> <td style="width: 10%;"></td> <td style="width: 10%;"></td> <td style="width: 10%;"></td> <td style="width: 10%;"></td> </tr> <tr> <td></td> <td></td> <td colspan="8" style="text-align: center;"> <table border="1" style="width: 100%; border-collapse: collapse; text-align: center;"> <tr> <td style="width: 10%;"></td> <td style="width: 10%;"></td> <td style="width: 10%;"></td> <td style="width: 10%;"></td> <td style="width: 10%;"></td> <td style="width: 10%;"></td> <td style="width: 10%;"></td> <td style="width: 10%;"></td> <td style="width: 10%;"></td> <td style="width: 10%;"></td> </tr> <tr> <td></td> <td></td> <td colspan="8" style="text-align: center;"> <table border="1" style="width: 100%; border-collapse: collapse; text-align: center;"> <tr> <td style="width: 10%;"></td> <td style="width: 10%;"></td> <td style="width: 10%;"></td> <td style="width: 10%;"></td> <td style="width: 10%;"></td> <td style="width: 10%;"></td> <td style="width: 10%;"></td> <td style="width: 10%;"></td> <td style="width: 10%;"></td> <td style="width: 10%;"></td> </tr> <tr> <td></td> <td></td> <td colspan="8" style="text-align: center;"> <table border="1" style="width: 100%; border-collapse: collapse; text-align: center;"> <tr> <td style="width: 10%;"></td> <td style="width: 10%;"></td> <td style="width: 10%;"></td> <td style="width: 10%;"></td> <td style="width: 10%;"></td> <td style="width: 10%;"></td> <td style="width: 10%;"></td> <td style="width: 10%;"></td> <td style="width: 10%;"></td> <td style="width: 10%;"></td> </tr> <tr> <td></td> <td></td> <td colspan="8" style="text-align: center;"> <table border="1" style="width: 100%; border-collapse: collapse; text-align: center;"> <tr> <td style="width: 10%;"></td> <td style="width: 10%;"></td> <td style="width: 10%;"></td> <td style="width: 10%;"></td> <td style="width: 10%;"></td> <td style="width: 10%;"></td> <td style="width: 10%;"></td> <td style="width: 10%;"></td> <td style="width: 10%;"></td> <td style="width: 10%;"></td> </tr> <tr> <td></td> <td></td> <td colspan="8" style="text-align: center;"> <table border="1" style="width: 100%; border-collapse: collapse; text-align: center;"> <tr> <td style="width: 10%;"></td> <td style="width: 10%;"></td> <td style="width: 10%;"></td> <td style="width: 10%;"></td> <td style="width: 10%;"></td> <td style="width: 10%;"></td> <td style="width: 10%;"></td> <td style="width: 10%;"></td> <td style="width: 10%;"></td> <td style="width: 10%;"></td> </tr> <tr> <td></td> <td></td> <td colspan="8" style="text-align: center;"> <table border="1" style="width: 100%; border-collapse: collapse; text-align: center;"> <tr> <td style="width: 10%;"></td> <td style="width: 10%;"></td> <td style="width: 10%;"></td> <td style="width: 10%;"></td> <td style="width: 10%;"></td> <td style="width: 10%;"></td> <td style="width: 10%;"></td> <td style="width: 10%;"></td> <td style="width: 10%;"></td> <td style="width: 10%;"></td> </tr> <tr> <td></td> <td></td> <td colspan="8" style="text-align: center;"> <table border="1" style="width: 100%; border-collapse: collapse; text-align: center;"> <tr> </tr></table></td></tr></table></td></tr></table></td></tr></table></td></tr></table></td></tr></table></td></tr></table></td></tr></table></td></tr></table></td></tr></table></td></tr></table></td></tr></table></td></tr></table></td></tr></table></td></tr></table></td></tr></table></td></tr></table></td></tr></table></td></tr></table></td></tr></table></td></tr></table></td></tr></table>
 | | | | | | | | | | | | | | | | | | | | <table border="1" style="width: 100%; border-collapse: collapse; text-align: center;"> <tr> <td style="width: 10%;"></td> <td style="width: 10%;"></td> <td style="width: 10%;"></td> <td style="width: 10%;"></td> <td style="width: 10%;"></td> <td style="width: 10%;"></td> <td style="width: 10%;"></td> <td style="width: 10%;"></td> <td style="width: 10%;"></td> <td style="width: 10%;"></td> </tr> <tr> <td></td> <td></td> <td colspan="8" style="text-align: center;"> <table border="1" style="width: 100%; border-collapse: collapse; text-align: center;"> <tr> <td style="width: 10%;"></td> <td style="width: 10%;"></td> <td style="width: 10%;"></td> <td style="width: 10%;"></td> <td style="width: 10%;"></td> <td style="width: 10%;"></td> <td style="width: 10%;"></td> <td style="width: 10%;"></td> <td style="width: 10%;"></td> <td style="width: 10%;"></td> </tr> <tr> <td></td> <td></td> <td colspan="8" style="text-align: center;"> <table border="1" style="width: 100%; border-collapse: collapse; text-align: center;"> <tr> <td style="width: 10%;"></td> <td style="width: 10%;"></td> <td style="width: 10%;"></td> <td style="width: 10%;"></td> <td style="width: 10%;"></td> <td style="width: 10%;"></td> <td style="width: 10%;"></td> <td style="width: 10%;"></td> <td style="width: 10%;"></td> <td style="width: 10%;"></td> </tr> <tr> <td></td> <td></td> <td colspan="8" style="text-align: center;"> <table border="1" style="width: 100%; border-collapse: collapse; text-align: center;"> <tr> <td style="width: 10%;"></td> <td style="width: 10%;"></td> <td style="width: 10%;"></td> <td style="width: 10%;"></td> <td style="width: 10%;"></td> <td style="width: 10%;"></td> <td style="width: 10%;"></td> <td style="width: 10%;"></td> <td style="width: 10%;"></td> <td style="width: 10%;"></td> </tr> <tr> <td></td> <td></td> <td colspan="8" style="text-align: center;"> <table border="1" style="width: 100%; border-collapse: collapse; text-align: center;"> <tr> <td style="width: 10%;"></td> <td style="width: 10%;"></td> <td style="width: 10%;"></td> <td style="width: 10%;"></td> <td style="width: 10%;"></td> <td style="width: 10%;"></td> <td style="width: 10%;"></td> <td style="width: 10%;"></td> <td style="width: 10%;"></td> <td style="width: 10%;"></td> </tr> <tr> <td></td> <td></td> <td colspan="8" style="text-align: center;"> <table border="1" style="width: 100%; border-collapse: collapse; text-align: center;"> <tr> <td style="width: 10%;"></td> <td style="width: 10%;"></td> <td style="width: 10%;"></td> <td style="width: 10%;"></td> <td style="width: 10%;"></td> <td style="width: 10%;"></td> <td style="width: 10%;"></td> <td style="width: 10%;"></td> <td style="width: 10%;"></td> <td style="width: 10%;"></td> </tr> <tr> <td></td> <td></td> <td colspan="8" style="text-align: center;"> <table border="1" style="width: 100%; border-collapse: collapse; text-align: center;"> <tr> <td style="width: 10%;"></td> <td style="width: 10%;"></td> <td style="width: 10%;"></td> <td
style="width: 10%;"></td> <td style="width: 10%;"></td> <td style="width: 10%;"></td> <td style="width: 10%;"></td> <td style="width: 10%;"></td> <td style="width: 10%;"></td> <td style="width: 10%;"></td> </tr> <tr> <td></td> <td></td> <td colspan="8" style="text-align: center;"> <table border="1" style="width: 100%; border-collapse: collapse; text-align: center;"> <tr> <td style="width: 10%;"></td> <td style="width: 10%;"></td> <td style="width: 10%;"></td> <td style="width: 10%;"></td> <td style="width: 10%;"></td> <td style="width: 10%;"></td> <td style="width: 10%;"></td> <td style="width: 10%;"></td> <td style="width: 10%;"></td> <td style="width: 10%;"></td> </tr> <tr> <td></td> <td></td> <td colspan="8" style="text-align: center;"> <table border="1" style="width: 100%; border-collapse: collapse; text-align: center;"> <tr> <td style="width: 10%;"></td> <td style="width: 10%;"></td> <td style="width: 10%;"></td> <td style="width: 10%;"></td> <td style="width: 10%;"></td> <td style="width: 10%;"></td> <td style="width: 10%;"></td> <td style="width: 10%;"></td> <td style="width: 10%;"></td> <td style="width: 10%;"></td> </tr> <tr> <td></td> <td></td> <td colspan="8" style="text-align: center;"> <table border="1" style="width: 100%; border-collapse: collapse; text-align: center;"> <tr> <td style="width: 10%;"></td> <td style="width: 10%;"></td> <td style="width: 10%;"></td> <td style="width: 10%;"></td> <td style="width: 10%;"></td> <td style="width: 10%;"></td> <td style="width: 10%;"></td> <td style="width: 10%;"></td> <td style="width: 10%;"></td> <td style="width: 10%;"></td> </tr> <tr> <td></td> <td></td> <td colspan="8" style="text-align: center;"> <table border="1" style="width: 100%; border-collapse: collapse; text-align: center;"> <tr> <td style="width: 10%;"></td> <td style="width: 10%;"></td> <td style="width: 10%;"></td> <td style="width: 10%;"></td> <td style="width: 10%;"></td> <td style="width: 10%;"></td> <td style="width: 10%;"></td> <td style="width: 10%;"></td> <td style="width: 10%;"></td> <td style="width: 10%;"></td> </tr> <tr> <td></td> <td></td> <td colspan="8" style="text-align: center;"> <table border="1" style="width: 100%; border-collapse: collapse; text-align: center;"> <tr> <td style="width: 10%;"></td> <td style="width: 10%;"></td> <td style="width: 10%;"></td> <td style="width: 10%;"></td> <td style="width: 10%;"></td> <td style="width: 10%;"></td> <td style="width: 10%;"></td> <td style="width: 10%;"></td> <td style="width: 10%;"></td> <td style="width: 10%;"></td> </tr> <tr> <td></td> <td></td> <td colspan="8" style="text-align: center;"> <table border="1" style="width: 100%; border-collapse: collapse; text-align: center;"> <tr> <td style="width: 10%;"></td> <td style="width: 10%;"></td> <td style="width: 10%;"></td> <td style="width: 10%;"></td> <td style="width: 10%;"></td> <td style="width: 10%;"></td> <td style="width: 10%;"></td> <td style="width: 10%;"></td> <td style="width: 10%;"></td> <td style="width: 10%;"></td> </tr> <tr> <td></td> <td></td> <td colspan="8" style="text-align: center;"> <table border="1" style="width: 100%; border-collapse: collapse; text-align: center;"> <tr> <td style="width: 10%;"></td> <td style="width: 10%;"></td> <td style="width: 10%;"></td> <td style="width: 10%;"></td> <td style="width: 10%;"></td> <td style="width: 10%;"></td> <td style="width: 10%;"></td> <td style="width: 10%;"></td> <td style="width: 10%;"></td> <td style="width: 10%;"></td> </tr> <tr> <td></td> <td></td> <td colspan="8" style="text-align: center;"> <table border="1" style="width: 100%; border-collapse: collapse; text-align: center;"> <tr> <td style="width: 10%;"></td> <td style="width: 10%;"></td> <td style="width: 10%;"></td> <td style="width: 10%;"></td> <td style="width: 10%;"></td> <td style="width: 10%;"></td> <td style="width: 10%;"></td> <td style="width: 10%;"></td> <td style="width: 10%;"></td> <td style="width: 10%;"></td> </tr> <tr> <td></td> <td></td> <td colspan="8" style="text-align: center;"> <table border="1" style="width: 100%; border-collapse: collapse; text-align: center;"> <tr> <td style="width: 10%;"></td> <td style="width: 10%;"></td> <td style="width: 10%;"></td> <td style="width: 10%;"></td> <td style="width: 10%;"></td> <td style="width: 10%;"></td> <td style="width: 10%;"></td> <td style="width: 10%;"></td> <td style="width: 10%;"></td> <td style="width: 10%;"></td> </tr> <tr> <td></td> <td></td> <td colspan="8" style="text-align: center;"> <table border="1" style="width: 100%; border-collapse: collapse; text-align: center;"> <tr> <td style="width: 10%;"></td> <td style="width: 10%;"></td> <td style="width: 10%;"></td> <td style="width: 10%;"></td> <td style="width: 10%;"></td> <td style="width: 10%;"></td> <td style="width: 10%;"></td> <td style="width: 10%;"></td> <td style="width: 10%;"></td> <td style="width: 10%;"></td> </tr> <tr> <td></td> <td></td> <td colspan="8" style="text-align: center;"> <table border="1" style="width: 100%; border-collapse: collapse; text-align: center;"> <tr> <td style="width: 10%;"></td> <td style="width: 10%;"></td> <td style="width: 10%;"></td> <td style="width: 10%;"></td> <td style="width: 10%;"></td> <td style="width: 10%;"></td> <td style="width: 10%;"></td> <td style="width: 10%;"></td> <td style="width: 10%;"></td> <td style="width: 10%;"></td> </tr> <tr> <td></td> <td></td> <td colspan="8" style="text-align: center;"> <table border="1" style="width: 100%; border-collapse: collapse; text-align: center;"> <tr> <td style="width: 10%;"></td> <td style="width: 10%;"></td> <td style="width: 10%;"></td> <td style="width: 10%;"></td> <td style="width: 10%;"></td> <td style="width: 10%;"></td> <td style="width: 10%;"></td> <td style="width: 10%;"></td> <td style="width: 10%;"></td> <td style="width: 10%;"></td> </tr> <tr> <td></td> <td></td> <td colspan="8" style="text-align: center;"> <table border="1" style="width: 100%; border-collapse: collapse; text-align: center;"> <tr> <td style="width: 10%;"></td> <td style="width: 10%;"></td> <td style="width: 10%;"></td> <td style="width: 10%;"></td> <td style="width: 10%;"></td> <td style="width: 10%;"></td> <td style="width: 10%;"></td> <td style="width: 10%;"></td> <td style="width: 10%;"></td> <td style="width: 10%;"></td> </tr> <tr> <td></td> <td></td> <td colspan="8" style="text-align: center;"> <table border="1" style="width: 100%; border-collapse: collapse; text-align: center;"> <tr> </tr></table></td></tr></table></td></tr></table></td></tr></table></td></tr></table></td></tr></table></td></tr></table></td></tr></table></td></tr></table></td></tr></table></td></tr></table></td></tr></table></td></tr></table></td></tr></table></td></tr></table></td></tr></table></td></tr></table></td></tr></table></td></tr></table></td></tr></table></td></tr></table>
 | | | | | | | | | | | | | | | | | | | | <table border="1" style="width: 100%; border-collapse: collapse; text-align: center;"> <tr> <td style="width: 10%;"></td> <td style="width: 10%;"></td> <td style="width: 10%;"></td> <td style="width: 10%;"></td> <td style="width: 10%;"></td> <td style="width: 10%;"></td> <td style="width: 10%;"></td> <td style="width: 10%;"></td> <td style="width: 10%;"></td> <td style="width: 10%;"></td> </tr> <tr> <td></td> <td></td> <td colspan="8" style="text-align: center;"> <table border="1" style="width: 100%; border-collapse: collapse; text-align: center;"> <tr> <td style="width: 10%;"></td> <td style="width: 10%;"></td> <td style="width: 10%;"></td> <td style="width: 10%;"></td> <td style="width: 10%;"></td> <td style="width: 10%;"></td> <td style="width: 10%;"></td> <td style="width: 10%;"></td> <td style="width: 10%;"></td> <td style="width: 10%;"></td> </tr> <tr> <td></td> <td></td> <td colspan="8" style="text-align: center;"> <table border="1" style="width: 100%; border-collapse: collapse; text-align: center;"> <tr> <td style="width: 10%;"></td> <td style="width: 10%;"></td> <td style="width: 10%;"></td> <td style="width: 10%;"></td> <td style="width: 10%;"></td> <td style="width: 10%;"></td> <td style="width: 10%;"></td> <td style="width: 10%;"></td> <td style="width: 10%;"></td> <td style="width: 10%;"></td> </tr> <tr> <td></td> <td></td> <td colspan="8" style="text-align: center;"> <table border="1" style="width: 100%; border-collapse: collapse; text-align: center;"> <tr> <td style="width: 10%;"></td> <td style="width: 10%;"></td> <td style="width: 10%;"></td> <td style="width: 10%;"></td> <td style="width: 10%;"></td> <td style="width: 10%;"></td> <td style="width: 10%;"></td> <td style="width: 10%;"></td> <td style="width: 10%;"></td> <td style="width: 10%;"></td> </tr> <tr> <td></td> <td></td> <td colspan="8" style="text-align: center;"> <table border="1" style="width: 100%; border-collapse: collapse; text-align: center;"> <tr> <td style="width: 10%;"></td> <td style="width: 10%;"></td> <td style="width: 10%;"></td> <td style="width: 10%;"></td> <td style="width: 10%;"></td> <td style="width: 10%;"></td> <td style="width: 10%;"></td> <td style="width: 10%;"></td> <td style="width: 10%;"></td> <td style="width: 10%;"></td> </tr> <tr> <td></td> <td></td> <td colspan="8" style="text-align: center;"> <table border="1" style="width: 100%; border-collapse: collapse; text-align: center;"> <tr> <td style="width: 10%;"></td> <td style="width: 10%;"></td> <td style="width: 10%;"></td> <td style="width: 10%;"></td> <td style="width: 10%;"></td> <td style="width: 10%;"></td> <td style="width: 10%;"></td> <td style="width: 10%;"></td> <td style="width: 10%;"></td> <td style="width: 10%;"></td> </tr> <tr> <td></td> <td></td> <td colspan="8" style="text-align: center;"> <table border="1" style="width: 100%; border-collapse: collapse; text-align: center;"> <tr>
<td style="width: 10%;"></td> <td style="width: 10%;"></td> <td style="width: 10%;"></td> <td style="width: 10%;"></td> <td style="width: 10%;"></td> <td style="width: 10%;"></td> <td style="width: 10%;"></td> <td style="width: 10%;"></td> <td style="width: 10%;"></td> <td style="width: 10%;"></td> </tr> <tr> <td></td> <td></td> <td colspan="8" style="text-align: center;"> <table border="1" style="width: 100%; border-collapse: collapse; text-align: center;"> <tr> <td style="width: 10%;"></td> <td style="width: 10%;"></td> <td style="width: 10%;"></td> <td style="width: 10%;"></td> <td style="width: 10%;"></td> <td style="width: 10%;"></td> <td style="width: 10%;"></td> <td style="width: 10%;"></td> <td style="width: 10%;"></td> <td style="width: 10%;"></td> </tr> <tr> <td></td> <td></td> <td colspan="8" style="text-align: center;"> <table border="1" style="width: 100%; border-collapse: collapse; text-align: center;"> <tr> <td style="width: 10%;"></td> <td style="width: 10%;"></td> <td style="width: 10%;"></td> <td style="width: 10%;"></td> <td style="width: 10%;"></td> <td style="width: 10%;"></td> <td style="width: 10%;"></td> <td style="width: 10%;"></td> <td style="width: 10%;"></td> <td style="width: 10%;"></td> </tr> <tr> <td></td> <td></td> <td colspan="8" style="text-align: center;"> <table border="1" style="width: 100%; border-collapse: collapse; text-align: center;"> <tr> <td style="width: 10%;"></td> <td style="width: 10%;"></td> <td style="width: 10%;"></td> <td style="width: 10%;"></td> <td style="width: 10%;"></td> <td style="width: 10%;"></td> <td style="width: 10%;"></td> <td style="width: 10%;"></td> <td style="width: 10%;"></td> <td style="width: 10%;"></td> </tr> <tr> <td></td> <td></td> <td colspan="8" style="text-align: center;"> <table border="1" style="width: 100%; border-collapse: collapse; text-align: center;"> <tr> <td style="width: 10%;"></td> <td style="width: 10%;"></td> <td style="width: 10%;"></td> <td style="width: 10%;"></td> <td style="width: 10%;"></td> <td style="width: 10%;"></td> <td style="width: 10%;"></td> <td style="width: 10%;"></td> <td style="width: 10%;"></td> <td style="width: 10%;"></td> </tr> <tr> <td></td> <td></td> <td colspan="8" style="text-align: center;"> <table border="1" style="width: 100%; border-collapse: collapse; text-align: center;"> <tr> <td style="width: 10%;"></td> <td style="width: 10%;"></td> <td style="width: 10%;"></td> <td style="width: 10%;"></td> <td style="width: 10%;"></td> <td style="width: 10%;"></td> <td style="width: 10%;"></td> <td style="width: 10%;"></td> <td style="width: 10%;"></td> <td style="width: 10%;"></td> </tr> <tr> <td></td> <td></td> <td colspan="8" style="text-align: center;"> <table border="1" style="width: 100%; border-collapse: collapse; text-align: center;"> <tr> <td style="width: 10%;"></td> <td style="width: 10%;"></td> <td style="width: 10%;"></td> <td style="width: 10%;"></td> <td style="width: 10%;"></td> <td style="width: 10%;"></td> <td style="width: 10%;"></td> <td style="width: 10%;"></td> <td style="width: 10%;"></td> <td style="width: 10%;"></td> </tr> <tr> <td></td> <td></td> <td colspan="8" style="text-align: center;"> <table border="1" style="width: 100%; border-collapse: collapse; text-align: center;"> <tr> <td style="width: 10%;"></td> <td style="width: 10%;"></td> <td style="width: 10%;"></td> <td style="width: 10%;"></td> <td style="width: 10%;"></td> <td style="width: 10%;"></td> <td style="width: 10%;"></td> <td style="width: 10%;"></td> <td style="width: 10%;"></td> <td style="width: 10%;"></td> </tr> <tr> <td></td> <td></td> <td colspan="8" style="text-align: center;"> <table border="1" style="width: 100%; border-collapse: collapse; text-align: center;"> <tr> <td style="width: 10%;"></td> <td style="width: 10%;"></td> <td style="width: 10%;"></td> <td style="width: 10%;"></td> <td style="width: 10%;"></td> <td style="width: 10%;"></td> <td style="width: 10%;"></td> <td style="width: 10%;"></td> <td style="width: 10%;"></td> <td style="width: 10%;"></td> </tr> <tr> <td></td> <td></td> <td colspan="8" style="text-align: center;"> <table border="1" style="width: 100%; border-collapse: collapse; text-align: center;"> <tr> <td style="width: 10%;"></td> <td style="width: 10%;"></td> <td style="width: 10%;"></td> <td style="width: 10%;"></td> <td style="width: 10%;"></td> <td style="width: 10%;"></td> <td style="width: 10%;"></td> <td style="width: 10%;"></td> <td style="width: 10%;"></td> <td style="width: 10%;"></td> </tr> <tr> <td></td> <td></td> <td colspan="8" style="text-align: center;"> <table border="1" style="width: 100%; border-collapse: collapse; text-align: center;"> <tr> <td style="width: 10%;"></td> <td style="width: 10%;"></td> <td style="width: 10%;"></td> <td style="width: 10%;"></td> <td style="width: 10%;"></td> <td style="width: 10%;"></td> <td style="width: 10%;"></td> <td style="width: 10%;"></td> <td style="width: 10%;"></td> <td style="width: 10%;"></td> </tr> <tr> <td></td> <td></td> <td colspan="8" style="text-align: center;"> <table border="1" style="width: 100%; border-collapse: collapse; text-align: center;"> <tr> <td style="width: 10%;"></td> <td style="width: 10%;"></td> <td style="width: 10%;"></td> <td style="width: 10%;"></td> <td style="width: 10%;"></td> <td style="width: 10%;"></td> <td style="width: 10%;"></td> <td style="width: 10%;"></td> <td style="width: 10%;"></td> <td style="width: 10%;"></td> </tr> <tr> <td></td> <td></td> <td colspan="8" style="text-align: center;"> <table border="1" style="width: 100%; border-collapse: collapse; text-align: center;"> <tr> <td style="width: 10%;"></td> <td style="width: 10%;"></td> <td style="width: 10%;"></td> <td style="width: 10%;"></td> <td style="width: 10%;"></td> <td style="width: 10%;"></td> <td style="width: 10%;"></td> <td style="width: 10%;"></td> <td style="width: 10%;"></td> <td style="width: 10%;"></td> </tr> <tr> <td></td> <td></td> <td colspan="8" style="text-align: center;"> <table border="1" style="width: 100%; border-collapse: collapse; text-align: center;"> <tr> </tr></table></td></tr></table></td></tr></table></td></tr></table></td></tr></table></td></tr></table></td></tr></table></td></tr></table></td></tr></table></td></tr></table></td></tr></table></td></tr></table></td></tr></table></td></tr></table></td></tr></table></td></tr></table></td></tr></table></td></tr></table></td></tr></table></td></tr></table>
 | | | | | | | | | | | | | | | | | | | | <table border="1" style="width: 100%; border-collapse: collapse; text-align: center;"> <tr> <td style="width: 10%;"></td> <td style="width: 10%;"></td> <td style="width: 10%;"></td> <td style="width: 10%;"></td> <td style="width: 10%;"></td> <td style="width: 10%;"></td> <td style="width: 10%;"></td> <td style="width: 10%;"></td> <td style="width: 10%;"></td> <td style="width: 10%;"></td> </tr> <tr> <td></td> <td></td> <td colspan="8" style="text-align: center;"> <table border="1" style="width: 100%; border-collapse: collapse; text-align: center;"> <tr> <td style="width: 10%;"></td> <td style="width: 10%;"></td> <td style="width: 10%;"></td> <td style="width: 10%;"></td> <td style="width: 10%;"></td> <td style="width: 10%;"></td> <td style="width: 10%;"></td> <td style="width: 10%;"></td> <td style="width: 10%;"></td> <td style="width: 10%;"></td> </tr> <tr> <td></td> <td></td> <td colspan="8" style="text-align: center;"> <table border="1" style="width: 100%; border-collapse: collapse; text-align: center;"> <tr> <td style="width: 10%;"></td> <td style="width: 10%;"></td> <td style="width: 10%;"></td> <td style="width: 10%;"></td> <td style="width: 10%;"></td> <td style="width: 10%;"></td> <td style="width: 10%;"></td> <td style="width: 10%;"></td> <td style="width: 10%;"></td> <td style="width: 10%;"></td> </tr> <tr> <td></td> <td></td> <td colspan="8" style="text-align: center;"> <table border="1" style="width: 100%; border-collapse: collapse; text-align: center;"> <tr> <td style="width: 10%;"></td> <td style="width: 10%;"></td> <td style="width: 10%;"></td> <td style="width: 10%;"></td> <td style="width: 10%;"></td> <td style="width: 10%;"></td> <td style="width: 10%;"></td> <td style="width: 10%;"></td> <td style="width: 10%;"></td> <td style="width: 10%;"></td> </tr> <tr> <td></td> <td></td> <td colspan="8" style="text-align: center;"> <table border="1" style="width: 100%; border-collapse: collapse; text-align: center;"> <tr> <td style="width: 10%;"></td> <td style="width: 10%;"></td> <td style="width: 10%;"></td> <td style="width: 10%;"></td> <td style="width: 10%;"></td> <td style="width: 10%;"></td> <td style="width: 10%;"></td> <td style="width: 10%;"></td> <td style="width: 10%;"></td> <td style="width: 10%;"></td> </tr> <tr> <td></td> <td></td> <td colspan="8" style="text-align: center;"> <table border="1" style="width: 100%; border-collapse: collapse; text-align: center;"> <tr> <td style="width: 10%;"></td> <td style="width: 10%;"></td> <td style="width: 10%;"></td> <td style="width: 10%;"></td> <td style="width: 10%;"></td> <td style="width: 10%;"></td> <td style="width: 10%;"></td> <td style="width: 10%;"></td> <td style="width: 10%;"></td> <td style="width: 10%;"></td> </tr> <tr> <td></td> <td></td> <td colspan="8" style="text-align: center;"> <table border="1" style="width: 100%; border-collapse: collapse; text-align: center;"> <tr> <td style="width: 10%;"></td> <td style="width: 10%;"></td> <td style="width: 10%;"></td> <td style="width: 10%;"></td> <td style="width: 10%;"></td> <td style="width: 10%;"></td> <td style="width: 10%;"></td> <td style="width: 10%;"></td> <td style="width: 10%;"></td> <td style="width: 10%;"></td> </tr> <tr> <td></td> <td></td> <td colspan="8" style="text-align: center;"> <table border="1"
style="width: 100%; border-collapse: collapse; text-align: center;"> <tr> <td style="width: 10%;"></td> <td style="width: 10%;"></td> <td style="width: 10%;"></td> <td style="width: 10%;"></td> <td style="width: 10%;"></td> <td style="width: 10%;"></td> <td style="width: 10%;"></td> <td style="width: 10%;"></td> <td style="width: 10%;"></td> <td style="width: 10%;"></td> </tr> <tr> <td></td> <td></td> <td colspan="8" style="text-align: center;"> <table border="1" style="width: 100%; border-collapse: collapse; text-align: center;"> <tr> <td style="width: 10%;"></td> <td style="width: 10%;"></td> <td style="width: 10%;"></td> <td style="width: 10%;"></td> <td style="width: 10%;"></td> <td style="width: 10%;"></td> <td style="width: 10%;"></td> <td style="width: 10%;"></td> <td style="width: 10%;"></td> <td style="width: 10%;"></td> </tr> <tr> <td></td> <td></td> <td colspan="8" style="text-align: center;"> <table border="1" style="width: 100%; border-collapse: collapse; text-align: center;"> <tr> <td style="width: 10%;"></td> <td style="width: 10%;"></td> <td style="width: 10%;"></td> <td style="width: 10%;"></td> <td style="width: 10%;"></td> <td style="width: 10%;"></td> <td style="width: 10%;"></td> <td style="width: 10%;"></td> <td style="width: 10%;"></td> <td style="width: 10%;"></td> </tr> <tr> <td></td> <td></td> <td colspan="8" style="text-align: center;"> <table border="1" style="width: 100%; border-collapse: collapse; text-align: center;"> <tr> <td style="width: 10%;"></td> <td style="width: 10%;"></td> <td style="width: 10%;"></td> <td style="width: 10%;"></td> <td style="width: 10%;"></td> <td style="width: 10%;"></td> <td style="width: 10%;"></td> <td style="width: 10%;"></td> <td style="width: 10%;"></td> <td style="width: 10%;"></td> </tr> <tr> <td></td> <td></td> <td colspan="8" style="text-align: center;"> <table border="1" style="width: 100%; border-collapse: collapse; text-align: center;"> <tr> <td style="width: 10%;"></td> <td style="width: 10%;"></td> <td style="width: 10%;"></td> <td style="width: 10%;"></td> <td style="width: 10%;"></td> <td style="width: 10%;"></td> <td style="width: 10%;"></td> <td style="width: 10%;"></td> <td style="width: 10%;"></td> <td style="width: 10%;"></td> </tr> <tr> <td></td> <td></td> <td colspan="8" style="text-align: center;"> <table border="1" style="width: 100%; border-collapse: collapse; text-align: center;"> <tr> <td style="width: 10%;"></td> <td style="width: 10%;"></td> <td style="width: 10%;"></td> <td style="width: 10%;"></td> <td style="width: 10%;"></td> <td style="width: 10%;"></td> <td style="width: 10%;"></td> <td style="width: 10%;"></td> <td style="width: 10%;"></td> <td style="width: 10%;"></td> </tr> <tr> <td></td> <td></td> <td colspan="8" style="text-align: center;"> <table border="1" style="width: 100%; border-collapse: collapse; text-align: center;"> <tr> <td style="width: 10%;"></td> <td style="width: 10%;"></td> <td style="width: 10%;"></td> <td style="width: 10%;"></td> <td style="width: 10%;"></td> <td style="width: 10%;"></td> <td style="width: 10%;"></td> <td style="width: 10%;"></td> <td style="width: 10%;"></td> <td style="width: 10%;"></td> </tr> <tr> <td></td> <td></td> <td colspan="8" style="text-align: center;"> <table border="1" style="width: 100%; border-collapse: collapse; text-align: center;"> <tr> <td style="width: 10%;"></td> <td style="width: 10%;"></td> <td style="width: 10%;"></td> <td style="width: 10%;"></td> <td style="width: 10%;"></td> <td style="width: 10%;"></td> <td style="width: 10%;"></td> <td style="width: 10%;"></td> <td style="width: 10%;"></td> <td style="width: 10%;"></td> </tr> <tr> <td></td> <td></td> <td colspan="8" style="text-align: center;"> <table border="1" style="width: 100%; border-collapse: collapse; text-align: center;"> <tr> <td style="width: 10%;"></td> <td style="width: 10%;"></td> <td style="width: 10%;"></td> <td style="width: 10%;"></td> <td style="width: 10%;"></td> <td style="width: 10%;"></td> <td style="width: 10%;"></td> <td style="width: 10%;"></td> <td style="width: 10%;"></td> <td style="width: 10%;"></td> </tr> <tr> <td></td> <td></td> <td colspan="8" style="text-align: center;"> <table border="1" style="width: 100%; border-collapse: collapse; text-align: center;"> <tr> <td style="width: 10%;"></td> <td style="width: 10%;"></td> <td style="width: 10%;"></td> <td style="width: 10%;"></td> <td style="width: 10%;"></td> <td style="width: 10%;"></td> <td style="width: 10%;"></td> <td style="width: 10%;"></td> <td style="width: 10%;"></td> <td style="width: 10%;"></td> </tr> <tr> <td></td> <td></td> <td colspan="8" style="text-align: center;"> <table border="1" style="width: 100%; border-collapse: collapse; text-align: center;"> <tr> <td style="width: 10%;"></td> <td style="width: 10%;"></td> <td style="width: 10%;"></td> <td style="width: 10%;"></td> <td style="width: 10%;"></td> <td style="width: 10%;"></td> <td style="width: 10%;"></td> <td style="width: 10%;"></td> <td style="width: 10%;"></td> <td style="width: 10%;"></td> </tr> <tr> <td></td> <td></td> <td colspan="8" style="text-align: center;"> <table border="1" style="width: 100%; border-collapse: collapse; text-align: center;"> <tr> </tr></table></td></tr></table></td></tr></table></td></tr></table></td></tr></table></td></tr></table></td></tr></table></td></tr></table></td></tr></table></td></tr></table></td></tr></table></td></tr></table></td></tr></table></td></tr></table></td></tr></table></td></tr></table></td></tr></table></td></tr></table></td></tr></table>
 | | | | | | | | | | | | | | | | | | | | <table border="1" style="width: 100%; border-collapse: collapse; text-align: center;"> <tr> <td style="width: 10%;"></td> <td style="width: 10%;"></td> <td style="width: 10%;"></td> <td style="width: 10%;"></td> <td style="width: 10%;"></td> <td style="width: 10%;"></td> <td style="width: 10%;"></td> <td style="width: 10%;"></td> <td style="width: 10%;"></td> <td style="width: 10%;"></td> </tr> <tr> <td></td> <td></td> <td colspan="8" style="text-align: center;"> <table border="1" style="width: 100%; border-collapse: collapse; text-align: center;"> <tr> <td style="width: 10%;"></td> <td style="width: 10%;"></td> <td style="width: 10%;"></td> <td style="width: 10%;"></td> <td style="width: 10%;"></td> <td style="width: 10%;"></td> <td style="width: 10%;"></td> <td style="width: 10%;"></td> <td style="width: 10%;"></td> <td style="width: 10%;"></td> </tr> <tr> <td></td> <td></td> <td colspan="8" style="text-align: center;"> <table border="1" style="width: 100%; border-collapse: collapse; text-align: center;"> <tr> <td style="width: 10%;"></td> <td style="width: 10%;"></td> <td style="width: 10%;"></td> <td style="width: 10%;"></td> <td style="width: 10%;"></td> <td style="width: 10%;"></td> <td style="width: 10%;"></td> <td style="width: 10%;"></td> <td style="width: 10%;"></td> <td style="width: 10%;"></td> </tr> <tr> <td></td> <td></td> <td colspan="8" style="text-align: center;"> <table border="1" style="width: 100%; border-collapse: collapse; text-align: center;"> <tr> <td style="width: 10%;"></td> <td style="width: 10%;"></td> <td style="width: 10%;"></td> <td style="width: 10%;"></td> <td style="width: 10%;"></td> <td style="width: 10%;"></td> <td style="width: 10%;"></td> <td style="width: 10%;"></td> <td style="width: 10%;"></td> <td style="width: 10%;"></td> </tr> <tr> <td></td> <td></td> <td colspan="8" style="text-align: center;"> <table border="1" style="width: 100%; border-collapse: collapse; text-align: center;"> <tr> <td style="width: 10%;"></td> <td style="width: 10%;"></td> <td style="width: 10%;"></td> <td style="width: 10%;"></td> <td style="width: 10%;"></td> <td style="width: 10%;"></td> <td style="width: 10%;"></td> <td style="width: 10%;"></td> <td style="width: 10%;"></td> <td style="width: 10%;"></td> </tr> <tr> <td></td> <td></td> <td colspan="8" style="text-align: center;"> <table border="1" style="width: 100%; border-collapse: collapse; text-align: center;"> <tr> <td style="width: 10%;"></td> <td style="width: 10%;"></td> <td style="width: 10%;"></td> <td style="width: 10%;"></td> <td style="width: 10%;"></td> <td style="width: 10%;"></td> <td style="width: 10%;"></td> <td style="width: 10%;"></td> <td style="width: 10%;"></td> <td style="width: 10%;"></td> </tr> <tr> <td></td> <td></td> <td colspan="8" style="text-align: center;"> <table border="1" style="width: 100%; border-collapse: collapse; text-align: center;"> <tr> <td style="width: 10%;"></td> <td style="width: 10%;"></td> <td style="width: 10%;"></td> <td style="width: 10%;"></td> <td style="width: 10%;"></td> <td style="width: 10%;"></td> <td style="width: 10%;"></td> <td style="width: 10%;"></td> <td style="width: 10%;"></td> <td style="width: 10%;"></td> </tr> <tr> <td></td> <td></td> <td colspan="8" style="text-align: center;"> <table border="1" style="width: 100%; border-collapse: collapse; text-align: center;"> <tr> <td style="width: 10%;"></td> <td style="width: 10%;"></td> <td style="width: 10%;"></td> <td style="width: 10%;"></td> <td style="width: 10%;"></td> <td style="width: 10%;"></td> <td style="width: 10%;"></td> <td style="width: 10%;"></td> <td style="width: 10%;"></td> <td style="width: 10%;"></td> </tr> <tr> <td></td> <td></td> <td colspan="8" style="text-align: center;"> <table border="1" style="width: 100%; border-collapse: collapse; text-align: center;"> <tr> <td style="width: 10%;"></td> <td style="width: 10%;"></td> <td style="width: 10%;"></td> <td style="width: 10%;"></td> <td style="width: 10%;"></td> <td style="width: 10%;"></td> <td style="width: 10%;"></td> <td style="width: 10%;"></td> <td style="width: 10%;"></td> <td style="width: 10%;"></td> </tr> <tr> <td></td> <td></td> <td
colspan="8" style="text-align: center;"> <table border="1" style="width: 100%; border-collapse: collapse; text-align: center;"> <tr> <td style="width: 10%;"></td> <td style="width: 10%;"></td> <td style="width: 10%;"></td> <td style="width: 10%;"></td> <td style="width: 10%;"></td> <td style="width: 10%;"></td> <td style="width: 10%;"></td> <td style="width: 10%;"></td> <td style="width: 10%;"></td> <td style="width: 10%;"></td> </tr> <tr> <td></td> <td></td> <td colspan="8" style="text-align: center;"> <table border="1" style="width: 100%; border-collapse: collapse; text-align: center;"> <tr> <td style="width: 10%;"></td> <td style="width: 10%;"></td> <td style="width: 10%;"></td> <td style="width: 10%;"></td> <td style="width: 10%;"></td> <td style="width: 10%;"></td> <td style="width: 10%;"></td> <td style="width: 10%;"></td> <td style="width: 10%;"></td> <td style="width: 10%;"></td> </tr> <tr> <td></td> <td></td> <td colspan="8" style="text-align: center;"> <table border="1" style="width: 100%; border-collapse: collapse; text-align: center;"> <tr> <td style="width: 10%;"></td> <td style="width: 10%;"></td> <td style="width: 10%;"></td> <td style="width: 10%;"></td> <td style="width: 10%;"></td> <td style="width: 10%;"></td> <td style="width: 10%;"></td> <td style="width: 10%;"></td> <td style="width: 10%;"></td> <td style="width: 10%;"></td> </tr> <tr> <td></td> <td></td> <td colspan="8" style="text-align: center;"> <table border="1" style="width: 100%; border-collapse: collapse; text-align: center;"> <tr> <td style="width: 10%;"></td> <td style="width: 10%;"></td> <td style="width: 10%;"></td> <td style="width: 10%;"></td> <td style="width: 10%;"></td> <td style="width: 10%;"></td> <td style="width: 10%;"></td> <td style="width: 10%;"></td> <td style="width: 10%;"></td> <td style="width: 10%;"></td> </tr> <tr> <td></td> <td></td> <td colspan="8" style="text-align: center;"> <table border="1" style="width: 100%; border-collapse: collapse; text-align: center;"> <tr> <td style="width: 10%;"></td> <td style="width: 10%;"></td> <td style="width: 10%;"></td> <td style="width: 10%;"></td> <td style="width: 10%;"></td> <td style="width: 10%;"></td> <td style="width: 10%;"></td> <td style="width: 10%;"></td> <td style="width: 10%;"></td> <td style="width: 10%;"></td> </tr> <tr> <td></td> <td></td> <td colspan="8" style="text-align: center;"> <table border="1" style="width: 100%; border-collapse: collapse; text-align: center;"> <tr> <td style="width: 10%;"></td> <td style="width: 10%;"></td> <td style="width: 10%;"></td> <td style="width: 10%;"></td> <td style="width: 10%;"></td> <td style="width: 10%;"></td> <td style="width: 10%;"></td> <td style="width: 10%;"></td> <td style="width: 10%;"></td> <td style="width: 10%;"></td> </tr> <tr> <td></td> <td></td> <td colspan="8" style="text-align: center;"> <table border="1" style="width: 100%; border-collapse: collapse; text-align: center;"> <tr> <td style="width: 10%;"></td> <td style="width: 10%;"></td> <td style="width: 10%;"></td> <td style="width: 10%;"></td> <td style="width: 10%;"></td> <td style="width: 10%;"></td> <td style="width: 10%;"></td> <td style="width: 10%;"></td> <td style="width: 10%;"></td> <td style="width: 10%;"></td> </tr> <tr> <td></td> <td></td> <td colspan="8" style="text-align: center;"> <table border="1" style="width: 100%; border-collapse: collapse; text-align: center;"> <tr> <td style="width: 10%;"></td> <td style="width: 10%;"></td> <td style="width: 10%;"></td> <td style="width: 10%;"></td> <td style="width: 10%;"></td> <td style="width: 10%;"></td> <td style="width: 10%;"></td> <td style="width: 10%;"></td> <td style="width: 10%;"></td> <td style="width: 10%;"></td> </tr> <tr> <td></td> <td></td> <td colspan="8" style="text-align: center;"> <table border="1" style="width: 100%; border-collapse: collapse; text-align: center;"> <tr> </tr></table></td></tr></table></td></tr></table></td></tr></table></td></tr></table></td></tr></table></td></tr></table></td></tr></table></td></tr></table></td></tr></table></td></tr></table></td></tr></table></td></tr></table></td></tr></table></td></tr></table></td></tr></table></td></tr></table></td></tr></table>
 | | | | | | | | | | | | | | | | | | | | <table border="1" style="width: 100%; border-collapse: collapse; text-align: center;"> <tr> <td style="width: 10%;"></td> <td style="width: 10%;"></td> <td style="width: 10%;"></td> <td style="width: 10%;"></td> <td style="width: 10%;"></td> <td style="width: 10%;"></td> <td style="width: 10%;"></td> <td style="width: 10%;"></td> <td style="width: 10%;"></td> <td style="width: 10%;"></td> </tr> <tr> <td></td> <td></td> <td colspan="8" style="text-align: center;"> <table border="1" style="width: 100%; border-collapse: collapse; text-align: center;"> <tr> <td style="width: 10%;"></td> <td style="width: 10%;"></td> <td style="width: 10%;"></td> <td style="width: 10%;"></td> <td style="width: 10%;"></td> <td style="width: 10%;"></td> <td style="width: 10%;"></td> <td style="width: 10%;"></td> <td style="width: 10%;"></td> <td style="width: 10%;"></td> </tr> <tr> <td></td> <td></td> <td colspan="8" style="text-align: center;"> <table border="1" style="width: 100%; border-collapse: collapse; text-align: center;"> <tr> <td style="width: 10%;"></td> <td style="width: 10%;"></td> <td style="width: 10%;"></td> <td style="width: 10%;"></td> <td style="width: 10%;"></td> <td style="width: 10%;"></td> <td style="width: 10%;"></td> <td style="width: 10%;"></td> <td style="width: 10%;"></td> <td style="width: 10%;"></td> </tr> <tr> <td></td> <td></td> <td colspan="8" style="text-align: center;"> <table border="1" style="width: 100%; border-collapse: collapse; text-align: center;"> <tr> <td style="width: 10%;"></td> <td style="width: 10%;"></td> <td style="width: 10%;"></td> <td style="width: 10%;"></td> <td style="width: 10%;"></td> <td style="width: 10%;"></td> <td style="width: 10%;"></td> <td style="width: 10%;"></td> <td style="width: 10%;"></td> <td style="width: 10%;"></td> </tr> <tr> <td></td> <td></td> <td colspan="8" style="text-align: center;"> <table border="1" style="width: 100%; border-collapse: collapse; text-align: center;"> <tr> <td style="width: 10%;"></td> <td style="width: 10%;"></td> <td style="width: 10%;"></td> <td style="width: 10%;"></td> <td style="width: 10%;"></td> <td style="width: 10%;"></td> <td style="width: 10%;"></td> <td style="width: 10%;"></td> <td style="width: 10%;"></td> <td style="width: 10%;"></td> </tr> <tr> <td></td> <td></td> <td colspan="8" style="text-align: center;"> <table border="1" style="width: 100%; border-collapse: collapse; text-align: center;"> <tr> <td style="width: 10%;"></td> <td style="width: 10%;"></td> <td style="width: 10%;"></td> <td style="width: 10%;"></td> <td style="width: 10%;"></td> <td style="width: 10%;"></td> <td style="width: 10%;"></td> <td style="width: 10%;"></td> <td style="width: 10%;"></td> <td style="width: 10%;"></td> </tr> <tr> <td></td> <td></td> <td colspan="8" style="text-align: center;"> <table border="1" style="width: 100%; border-collapse: collapse; text-align: center;"> <tr> <td style="width: 10%;"></td> <td style="width: 10%;"></td> <td style="width: 10%;"></td> <td style="width: 10%;"></td> <td style="width: 10%;"></td> <td style="width: 10%;"></td> <td style="width: 10%;"></td> <td style="width: 10%;"></td> <td style="width: 10%;"></td> <td style="width: 10%;"></td> </tr> <tr> <td></td> <td></td> <td colspan="8" style="text-align: center;"> <table border="1" style="width: 100%; border-collapse: collapse; text-align: center;"> <tr> <td style="width: 10%;"></td> <td style="width: 10%;"></td> <td style="width: 10%;"></td> <td style="width: 10%;"></td> <td style="width: 10%;"></td> <td style="width: 10%;"></td> <td style="width: 10%;"></td> <td style="width: 10%;"></td> <td style="width: 10%;"></td> <td style="width: 10%;"></td> </tr> <tr> <td></td> <td></td> <td colspan="8" style="text-align: center;"> <table border="1" style="width: 100%; border-collapse: collapse; text-align: center;"> <tr> <td style="width: 10%;"></td> <td style="width: 10%;"></td> <td style="width: 10%;"></td> <td style="width: 10%;"></td> <td style="width: 10%;"></td> <td style="width: 10%;"></td> <td style="width: 10%;"></td> <td style="width: 10%;"></td> <td style="width: 10%;"></td> <td style="width: 10%;"></td> </tr> <tr> <td></td> <td></td> <td colspan="8" style="text-align: center;"> <table border="1" style="width: 100%; border-collapse: collapse; text-align: center;"> <tr> <td style="width: 10%;"></td> <td style="width: 10%;"></td> <td style="width: 10%;"></td> <td style="width: 10%;"></td> <td style="width: 10%;"></td> <td style="width: 10%;"></td> <td style="width: 10%;"></td> <td style="width: 10%;"></td> <td style="width: 10%;"></td> <td style="width: 10%;"></td> </tr> <tr> <td></td> <td></td> <td colspan="8" style="text-align: center;"> <table border="1" style="width: 100%; border-collapse: collapse; text-align: center;"> <tr> <td style="width: 10%;"></td> <td style="width: 10%;"></td> <td style="width: 10%;"></td> <td style="width: 10%;"></td> <td style="width: 10%;"></td> <td style="width: 10%;"></td> <td style="width: 10%;"></td> <td style="width: 10%;"></td> <td style="width: 10%;"></td> <td style="width: 10%;"></td> </tr> <tr> <td></td> <td></td> <td colspan="8" style="text-align: center;"> <table border="1" style="width: 100%; border-collapse: collapse; text-align: center;"> <tr> <td style="width: 10%;"></td> <td style="width: 10%;"></td> <td style="width: 10%;"></td> <td style="width: 10%;"></td> <td style="width: 10%;"></td> <td style="width: 10%;"></td> <td style="width: 10%;"></td> <td style="width: 10%;"></td> <td style="width: 10%;"></td> <td style="width:
10%;"></td> </tr> <tr> <td></td> <td></td> <td colspan="8" style="text-align: center;"> <table border="1" style="width: 100%; border-collapse: collapse; text-align: center;"> <tr> <td style="width: 10%;"></td> <td style="width: 10%;"></td> <td style="width: 10%;"></td> <td style="width: 10%;"></td> <td style="width: 10%;"></td> <td style="width: 10%;"></td> <td style="width: 10%;"></td> <td style="width: 10%;"></td> <td style="width: 10%;"></td> <td style="width: 10%;"></td> </tr> <tr> <td></td> <td></td> <td colspan="8" style="text-align: center;"> <table border="1" style="width: 100%; border-collapse: collapse; text-align: center;"> <tr> <td style="width: 10%;"></td> <td style="width: 10%;"></td> <td style="width: 10%;"></td> <td style="width: 10%;"></td> <td style="width: 10%;"></td> <td style="width: 10%;"></td> <td style="width: 10%;"></td> <td style="width: 10%;"></td> <td style="width: 10%;"></td> <td style="width: 10%;"></td> </tr> <tr> <td></td> <td></td> <td colspan="8" style="text-align: center;"> <table border="1" style="width: 100%; border-collapse: collapse; text-align: center;"> <tr> <td style="width: 10%;"></td> <td style="width: 10%;"></td> <td style="width: 10%;"></td> <td style="width: 10%;"></td> <td style="width: 10%;"></td> <td style="width: 10%;"></td> <td style="width: 10%;"></td> <td style="width: 10%;"></td> <td style="width: 10%;"></td> <td style="width: 10%;"></td> </tr> <tr> <td></td> <td></td> <td colspan="8" style="text-align: center;"> <table border="1" style="width: 100%; border-collapse: collapse; text-align: center;"> <tr> <td style="width: 10%;"></td> <td style="width: 10%;"></td> <td style="width: 10%;"></td> <td style="width: 10%;"></td> <td style="width: 10%;"></td> <td style="width: 10%;"></td> <td style="width: 10%;"></td> <td style="width: 10%;"></td> <td style="width: 10%;"></td> <td style="width: 10%;"></td> </tr> <tr> <td></td> <td></td> <td colspan="8" style="text-align: center;"> <table border="1" style="width: 100%; border-collapse: collapse; text-align: center;"> <tr> </tr></table></td></tr></table></td></tr></table></td></tr></table></td></tr></table></td></tr></table></td></tr></table></td></tr></table></td></tr></table></td></tr></table></td></tr></table></td></tr></table></td></tr></table></td></tr></table></td></tr></table></td></tr></table></td></tr></table>
 | | | | | | | | | | | | | | | | | | | | <table border="1" style="width: 100%; border-collapse: collapse; text-align: center;"> <tr> <td style="width: 10%;"></td> <td style="width: 10%;"></td> <td style="width: 10%;"></td> <td style="width: 10%;"></td> <td style="width: 10%;"></td> <td style="width: 10%;"></td> <td style="width: 10%;"></td> <td style="width: 10%;"></td> <td style="width: 10%;"></td> <td style="width: 10%;"></td> </tr> <tr> <td></td> <td></td> <td colspan="8" style="text-align: center;"> <table border="1" style="width: 100%; border-collapse: collapse; text-align: center;"> <tr> <td style="width: 10%;"></td> <td style="width: 10%;"></td> <td style="width: 10%;"></td> <td style="width: 10%;"></td> <td style="width: 10%;"></td> <td style="width: 10%;"></td> <td style="width: 10%;"></td> <td style="width: 10%;"></td> <td style="width: 10%;"></td> <td style="width: 10%;"></td> </tr> <tr> <td></td> <td></td> <td colspan="8" style="text-align: center;"> <table border="1" style="width: 100%; border-collapse: collapse; text-align: center;"> <tr> <td style="width: 10%;"></td> <td style="width: 10%;"></td> <td style="width: 10%;"></td> <td style="width: 10%;"></td> <td style="width: 10%;"></td> <td style="width: 10%;"></td> <td style="width: 10%;"></td> <td style="width: 10%;"></td> <td style="width: 10%;"></td> <td style="width: 10%;"></td> </tr> <tr> <td></td> <td></td> <td colspan="8" style="text-align: center;"> <table border="1" style="width: 100%; border-collapse: collapse; text-align: center;"> <tr> <td style="width: 10%;"></td> <td style="width: 10%;"></td> <td style="width: 10%;"></td> <td style="width: 10%;"></td> <td style="width: 10%;"></td> <td style="width: 10%;"></td> <td style="width: 10%;"></td> <td style="width: 10%;"></td> <td style="width: 10%;"></td> <td style="width: 10%;"></td> </tr> <tr> <td></td> <td></td> <td colspan="8" style="text-align: center;"> <table border="1" style="width: 100%; border-collapse: collapse; text-align: center;"> <tr> <td style="width: 10%;"></td> <td style="width: 10%;"></td> <td style="width: 10%;"></td> <td style="width: 10%;"></td> <td style="width: 10%;"></td> <td style="width: 10%;"></td> <td style="width: 10%;"></td> <td style="width: 10%;"></td> <td style="width: 10%;"></td> <td style="width: 10%;"></td> </tr> <tr> <td></td> <td></td> <td colspan="8" style="text-align: center;"> <table border="1" style="width: 100%; border-collapse: collapse; text-align: center;"> <tr> <td style="width: 10%;"></td> <td style="width: 10%;"></td> <td style="width: 10%;"></td> <td style="width: 10%;"></td> <td style="width: 10%;"></td> <td style="width: 10%;"></td> <td style="width: 10%;"></td> <td style="width: 10%;"></td> <td style="width: 10%;"></td> <td style="width: 10%;"></td> </tr> <tr> <td></td> <td></td> <td colspan="8" style="text-align: center;"> <table border="1" style="width: 100%; border-collapse: collapse; text-align: center;"> <tr> <td style="width: 10%;"></td> <td style="width: 10%;"></td> <td style="width: 10%;"></td> <td style="width: 10%;"></td> <td style="width: 10%;"></td> <td style="width: 10%;"></td> <td style="width: 10%;"></td> <td style="width: 10%;"></td> <td style="width: 10%;"></td> <td style="width: 10%;"></td> </tr> <tr> <td></td> <td></td> <td colspan="8" style="text-align: center;"> <table border="1" style="width: 100%; border-collapse: collapse; text-align: center;"> <tr> <td style="width: 10%;"></td> <td style="width: 10%;"></td> <td style="width: 10%;"></td> <td style="width: 10%;"></td> <td style="width: 10%;"></td> <td style="width: 10%;"></td> <td style="width: 10%;"></td> <td style="width: 10%;"></td> <td style="width: 10%;"></td> <td style="width: 10%;"></td> </tr> <tr> <td></td> <td></td> <td colspan="8" style="text-align: center;"> <table border="1" style="width: 100%; border-collapse: collapse; text-align: center;"> <tr> <td style="width: 10%;"></td> <td style="width: 10%;"></td> <td style="width: 10%;"></td> <td style="width: 10%;"></td> <td style="width: 10%;"></td> <td style="width: 10%;"></td> <td style="width: 10%;"></td> <td style="width: 10%;"></td> <td style="width: 10%;"></td> <td style="width: 10%;"></td> </tr> <tr> <td></td> <td></td> <td colspan="8" style="text-align: center;"> <table border="1" style="width: 100%; border-collapse: collapse; text-align: center;"> <tr> <td style="width: 10%;"></td> <td style="width: 10%;"></td> <td style="width: 10%;"></td> <td style="width: 10%;"></td> <td style="width: 10%;"></td> <td style="width: 10%;"></td> <td style="width: 10%;"></td> <td style="width: 10%;"></td> <td style="width: 10%;"></td> <td style="width: 10%;"></td> </tr> <tr> <td></td> <td></td> <td colspan="8" style="text-align: center;"> <table border="1" style="width: 100%; border-collapse: collapse; text-align: center;"> <tr> <td style="width: 10%;"></td> <td style="width: 10%;"></td> <td style="width: 10%;"></td> <td style="width: 10%;"></td> <td style="width: 10%;"></td> <td style="width: 10%;"></td> <td style="width: 10%;"></td> <td style="width: 10%;"></td> <td style="width: 10%;"></td> <td style="width: 10%;"></td> </tr> <tr> <td></td> <td></td> <td colspan="8" style="text-align: center;"> <table border="1" style="width: 100%; border-collapse: collapse; text-align: center;"> <tr> <td style="width: 10%;"></td> <td style="width: 10%;"></td> <td style="width: 10%;"></td> <td style="width: 10%;"></td> <td style="width: 10%;"></td> <td style="width: 10%;"></td> <td style="width: 10%;"></td> <td style="width: 10%;"></td> <td style="width: 10%;"></td> <td style="width: 10%;"></td> </tr> <tr> <td></td> <td></td> <td colspan="8" style="text-align: center;"> <table border="1" style="width: 100%; border-collapse: collapse; text-align: center;"> <tr> <td style="width: 10%;"></td> <td style="width: 10%;"></td> <td style="width: 10%;"></td> <td style="width: 10%;"></td> <td style="width: 10%;"></td> <td style="width: 10%;"></td> <td style="width: 10%;"></td> <td style="width: 10%;"></td> <td style="width: 10%;"></td> <td style="width: 10%;"></td> </tr> <tr> <td></td> <td></td> <td colspan="8" style="text-align: center;"> <table border="1" style="width: 100%; border-collapse: collapse; text-align: center;"> <tr> <td style="width: 10%;"></td> <td style="width: 10%;"></td> <td style="width: 10%;"></td> <td style="width: 10%;"></td> <td style="width: 10%;"></td> <td style="width: 10%;"></td> <td style="width: 10%;"></td> <td style="width: 10%;"></td> <td style="width: 10%;"></td> <td style="width: 10%;"></td> </tr> <tr> <td></td> <td></td> <td colspan="8" style="text-align: center;"> <table border="1" style="width: 100%; border-collapse: collapse; text-align: center;"> <tr> <td style="width: 10%;"></td> <td style="width: 10%;"></td> <td style="width: 10%;"></td> <td style="width: 10%;"></td> <td style="width: 10%;"></td> <td style="width: 10%;"></td> <td style="width: 10%;"></td> <td style="width: 10%;"></td> <td style="width: 10%;"></td> <td style="width: 10%;"></td> </tr> <tr> <td></td> <td></td> <td colspan="8" style="text-align: center;"> <table border="1" style="width: 100%; border-collapse: collapse; text-align: center;"> <tr>
</tr></table></td></tr></table></td></tr></table></td></tr></table></td></tr></table></td></tr></table></td></tr></table></td></tr></table></td></tr></table></td></tr></table></td></tr></table></td></tr></table></td></tr></table></td></tr></table></td></tr></table></td></tr></table>
 | | | | | | | | | | | | | | | | | | | | <table border="1" style="width: 100%; border-collapse: collapse; text-align: center;"> <tr> <td style="width: 10%;"></td> <td style="width: 10%;"></td> <td style="width: 10%;"></td> <td style="width: 10%;"></td> <td style="width: 10%;"></td> <td style="width: 10%;"></td> <td style="width: 10%;"></td> <td style="width: 10%;"></td> <td style="width: 10%;"></td> <td style="width: 10%;"></td> </tr> <tr> <td></td> <td></td> <td colspan="8" style="text-align: center;"> <table border="1" style="width: 100%; border-collapse: collapse; text-align: center;"> <tr> <td style="width: 10%;"></td> <td style="width: 10%;"></td> <td style="width: 10%;"></td> <td style="width: 10%;"></td> <td style="width: 10%;"></td> <td style="width: 10%;"></td> <td style="width: 10%;"></td> <td style="width: 10%;"></td> <td style="width: 10%;"></td> <td style="width: 10%;"></td> </tr> <tr> <td></td> <td></td> <td colspan="8" style="text-align: center;"> <table border="1" style="width: 100%; border-collapse: collapse; text-align: center;"> <tr> <td style="width: 10%;"></td> <td style="width: 10%;"></td> <td style="width: 10%;"></td> <td style="width: 10%;"></td> <td style="width: 10%;"></td> <td style="width: 10%;"></td> <td style="width: 10%;"></td> <td style="width: 10%;"></td> <td style="width: 10%;"></td> <td style="width: 10%;"></td> </tr> <tr> <td></td> <td></td> <td colspan="8" style="text-align: center;"> <table border="1" style="width: 100%; border-collapse: collapse; text-align: center;"> <tr> <td style="width: 10%;"></td> <td style="width: 10%;"></td> <td style="width: 10%;"></td> <td style="width: 10%;"></td> <td style="width: 10%;"></td> <td style="width: 10%;"></td> <td style="width: 10%;"></td> <td style="width: 10%;"></td> <td style="width: 10%;"></td> <td style="width: 10%;"></td> </tr> <tr> <td></td> <td></td> <td colspan="8" style="text-align: center;"> <table border="1" style="width: 100%; border-collapse: collapse; text-align: center;"> <tr> <td style="width: 10%;"></td> <td style="width: 10%;"></td> <td style="width: 10%;"></td> <td style="width: 10%;"></td> <td style="width: 10%;"></td> <td style="width: 10%;"></td> <td style="width: 10%;"></td> <td style="width: 10%;"></td> <td style="width: 10%;"></td> <td style="width: 10%;"></td> </tr> <tr> <td></td> <td></td> <td colspan="8" style="text-align: center;"> <table border="1" style="width: 100%; border-collapse: collapse; text-align: center;"> <tr> <td style="width: 10%;"></td> <td style="width: 10%;"></td> <td style="width: 10%;"></td> <td style="width: 10%;"></td> <td style="width: 10%;"></td> <td style="width: 10%;"></td> <td style="width: 10%;"></td> <td style="width: 10%;"></td> <td style="width: 10%;"></td> <td style="width: 10%;"></td> </tr> <tr> <td></td> <td></td> <td colspan="8" style="text-align: center;"> <table border="1" style="width: 100%; border-collapse: collapse; text-align: center;"> <tr> <td style="width: 10%;"></td> <td style="width: 10%;"></td> <td style="width: 10%;"></td> <td style="width: 10%;"></td> <td style="width: 10%;"></td> <td style="width: 10%;"></td> <td style="width: 10%;"></td> <td style="width: 10%;"></td> <td style="width: 10%;"></td> <td style="width: 10%;"></td> </tr> <tr> <td></td> <td></td> <td colspan="8" style="text-align: center;"> <table border="1" style="width: 100%; border-collapse: collapse; text-align: center;"> <tr> <td style="width: 10%;"></td> <td style="width: 10%;"></td> <td style="width: 10%;"></td> <td style="width: 10%;"></td> <td style="width: 10%;"></td> <td style="width: 10%;"></td> <td style="width: 10%;"></td> <td style="width: 10%;"></td> <td style="width: 10%;"></td> <td style="width: 10%;"></td> </tr> <tr> <td></td> <td></td> <td colspan="8" style="text-align: center;"> <table border="1" style="width: 100%; border-collapse: collapse; text-align: center;"> <tr> <td style="width: 10%;"></td> <td style="width: 10%;"></td> <td style="width: 10%;"></td> <td style="width: 10%;"></td> <td style="width: 10%;"></td> <td style="width: 10%;"></td> <td style="width: 10%;"></td> <td style="width: 10%;"></td> <td style="width: 10%;"></td> <td style="width: 10%;"></td> </tr> <tr> <td></td> <td></td> <td colspan="8" style="text-align: center;"> <table border="1" style="width: 100%; border-collapse: collapse; text-align: center;"> <tr> <td style="width: 10%;"></td> <td style="width: 10%;"></td> <td style="width: 10%;"></td> <td style="width: 10%;"></td> <td style="width: 10%;"></td> <td style="width: 10%;"></td> <td style="width: 10%;"></td> <td style="width: 10%;"></td> <td style="width: 10%;"></td> <td style="width: 10%;"></td> </tr> <tr> <td></td> <td></td> <td colspan="8" style="text-align: center;"> <table border="1" style="width: 100%; border-collapse: collapse; text-align: center;"> <tr> <td style="width: 10%;"></td> <td style="width: 10%;"></td> <td style="width: 10%;"></td> <td style="width: 10%;"></td> <td style="width: 10%;"></td> <td style="width: 10%;"></td> <td style="width: 10%;"></td> <td style="width: 10%;"></td> <td style="width: 10%;"></td> <td style="width: 10%;"></td> </tr> <tr> <td></td> <td></td> <td colspan="8" style="text-align: center;"> <table border="1" style="width: 100%; border-collapse: collapse; text-align: center;"> <tr> <td style="width: 10%;"></td> <td style="width: 10%;"></td> <td style="width: 10%;"></td> <td style="width: 10%;"></td> <td style="width: 10%;"></td> <td style="width: 10%;"></td> <td style="width: 10%;"></td> <td style="width: 10%;"></td> <td style="width: 10%;"></td> <td style="width: 10%;"></td> </tr> <tr> <td></td> <td></td> <td colspan="8" style="text-align: center;"> <table border="1" style="width: 100%; border-collapse: collapse; text-align: center;"> <tr> <td style="width: 10%;"></td> <td style="width: 10%;"></td> <td style="width: 10%;"></td> <td style="width: 10%;"></td> <td style="width: 10%;"></td> <td style="width: 10%;"></td> <td style="width: 10%;"></td> <td style="width: 10%;"></td> <td style="width: 10%;"></td> <td style="width: 10%;"></td> </tr> <tr> <td></td> <td></td> <td colspan="8" style="text-align: center;"> <table border="1" style="width: 100%; border-collapse: collapse; text-align: center;"> <tr> <td style="width: 10%;"></td> <td style="width: 10%;"></td> <td style="width: 10%;"></td> <td style="width: 10%;"></td> <td style="width: 10%;"></td> <td style="width: 10%;"></td> <td style="width: 10%;"></td> <td style="width: 10%;"></td> <td style="width: 10%;"></td> <td style="width: 10%;"></td> </tr> <tr> <td></td> <td></td> <td colspan="8" style="text-align: center;"> <table border="1" style="width: 100%; border-collapse: collapse; text-align: center;"> <tr> </tr></table></td></tr></table></td></tr></table></td></tr></table></td></tr></table></td></tr></table></td></tr></table></td></tr></table></td></tr></table></td></tr></table></td></tr></table></td></tr></table></td></tr></table></td></tr></table></td></tr></table>
 | | | | | | | | | | | | | | | | | | | | <table border="1" style="width: 100%; border-collapse: collapse; text-align: center;"> <tr> <td style="width: 10%;"></td> <td style="width: 10%;"></td> <td style="width: 10%;"></td> <td style="width: 10%;"></td> <td style="width: 10%;"></td> <td style="width: 10%;"></td> <td style="width: 10%;"></td> <td style="width: 10%;"></td> <td style="width: 10%;"></td> <td style="width: 10%;"></td> </tr> <tr> <td></td> <td></td> <td colspan="8" style="text-align: center;"> <table border="1" style="width: 100%; border-collapse: collapse; text-align: center;"> <tr> <td style="width: 10%;"></td> <td style="width: 10%;"></td> <td style="width: 10%;"></td> <td style="width: 10%;"></td> <td style="width: 10%;"></td> <td style="width: 10%;"></td> <td style="width: 10%;"></td> <td style="width: 10%;"></td> <td style="width: 10%;"></td> <td style="width: 10%;"></td> </tr> <tr> <td></td> <td></td> <td colspan="8" style="text-align: center;"> <table border="1" style="width: 100%; border-collapse: collapse; text-align: center;"> <tr> <td style="width: 10%;"></td> <td style="width: 10%;"></td> <td style="width: 10%;"></td> <td style="width: 10%;"></td> <td style="width: 10%;"></td> <td style="width: 10%;"></td> <td style="width: 10%;"></td> <td style="width: 10%;"></td> <td style="width: 10%;"></td> <td style="width: 10%;"></td> </tr> <tr> <td></td> <td></td> <td colspan="8" style="text-align: center;"> <table border="1" style="width: 100%; border-collapse: collapse; text-align: center;"> <tr> <td style="width: 10%;"></td> <td style="width: 10%;"></td> <td style="width: 10%;"></td> <td style="width: 10%;"></td> <td style="width: 10%;"></td> <td style="width: 10%;"></td> <td style="width: 10%;"></td> <td style="width: 10%;"></td> <td style="width: 10%;"></td> <td style="width: 10%;"></td> </tr> <tr> <td></td> <td></td> <td colspan="8" style="text-align: center;"> <table border="1" style="width: 100%; border-collapse: collapse; text-align: center;"> <tr> <td style="width: 10%;"></td> <td style="width: 10%;"></td> <td style="width: 10%;"></td> <td style="width: 10%;"></td> <td style="width: 10%;"></td> <td style="width: 10%;"></td> <td style="width: 10%;"></td> <td style="width: 10%;"></td> <td style="width: 10%;"></td> <td style="width: 10%;"></td> </tr> <tr>
<td></td> <td></td> <td colspan="8" style="text-align: center;"> <table border="1" style="width: 100%; border-collapse: collapse; text-align: center;"> <tr> <td style="width: 10%;"></td> <td style="width: 10%;"></td> <td style="width: 10%;"></td> <td style="width: 10%;"></td> <td style="width: 10%;"></td> <td style="width: 10%;"></td> <td style="width: 10%;"></td> <td style="width: 10%;"></td> <td style="width: 10%;"></td> <td style="width: 10%;"></td> </tr> <tr> <td></td> <td></td> <td colspan="8" style="text-align: center;"> <table border="1" style="width: 100%; border-collapse: collapse; text-align: center;"> <tr> <td style="width: 10%;"></td> <td style="width: 10%;"></td> <td style="width: 10%;"></td> <td style="width: 10%;"></td> <td style="width: 10%;"></td> <td style="width: 10%;"></td> <td style="width: 10%;"></td> <td style="width: 10%;"></td> <td style="width: 10%;"></td> <td style="width: 10%;"></td> </tr> <tr> <td></td> <td></td> <td colspan="8" style="text-align: center;"> <table border="1" style="width: 100%; border-collapse: collapse; text-align: center;"> <tr> <td style="width: 10%;"></td> <td style="width: 10%;"></td> <td style="width: 10%;"></td> <td style="width: 10%;"></td> <td style="width: 10%;"></td> <td style="width: 10%;"></td> <td style="width: 10%;"></td> <td style="width: 10%;"></td> <td style="width: 10%;"></td> <td style="width: 10%;"></td> </tr> <tr> <td></td> <td></td> <td colspan="8" style="text-align: center;"> <table border="1" style="width: 100%; border-collapse: collapse; text-align: center;"> <tr> <td style="width: 10%;"></td> <td style="width: 10%;"></td> <td style="width: 10%;"></td> <td style="width: 10%;"></td> <td style="width: 10%;"></td> <td style="width: 10%;"></td> <td style="width: 10%;"></td> <td style="width: 10%;"></td> <td style="width: 10%;"></td> <td style="width: 10%;"></td> </tr> <tr> <td></td> <td></td> <td colspan="8" style="text-align: center;"> <table border="1" style="width: 100%; border-collapse: collapse; text-align: center;"> <tr> <td style="width: 10%;"></td> <td style="width: 10%;"></td> <td style="width: 10%;"></td> <td style="width: 10%;"></td> <td style="width: 10%;"></td> <td style="width: 10%;"></td> <td style="width: 10%;"></td> <td style="width: 10%;"></td> <td style="width: 10%;"></td> <td style="width: 10%;"></td> </tr> <tr> <td></td> <td></td> <td colspan="8" style="text-align: center;"> <table border="1" style="width: 100%; border-collapse: collapse; text-align: center;"> <tr> <td style="width: 10%;"></td> <td style="width: 10%;"></td> <td style="width: 10%;"></td> <td style="width: 10%;"></td> <td style="width: 10%;"></td> <td style="width: 10%;"></td> <td style="width: 10%;"></td> <td style="width: 10%;"></td> <td style="width: 10%;"></td> <td style="width: 10%;"></td> </tr> <tr> <td></td> <td></td> <td colspan="8" style="text-align: center;"> <table border="1" style="width: 100%; border-collapse: collapse; text-align: center;"> <tr> <td style="width: 10%;"></td> <td style="width: 10%;"></td> <td style="width: 10%;"></td> <td style="width: 10%;"></td> <td style="width: 10%;"></td> <td style="width: 10%;"></td> <td style="width: 10%;"></td> <td style="width: 10%;"></td> <td style="width: 10%;"></td> <td style="width: 10%;"></td> </tr> <tr> <td></td> <td></td> <td colspan="8" style="text-align: center;"> <table border="1" style="width: 100%; border-collapse: collapse; text-align: center;"> <tr> <td style="width: 10%;"></td> <td style="width: 10%;"></td> <td style="width: 10%;"></td> <td style="width: 10%;"></td> <td style="width: 10%;"></td> <td style="width: 10%;"></td> <td style="width: 10%;"></td> <td style="width: 10%;"></td> <td style="width: 10%;"></td> <td style="width: 10%;"></td> </tr> <tr> <td></td> <td></td> <td colspan="8" style="text-align: center;"> <table border="1" style="width: 100%; border-collapse: collapse; text-align: center;"> <tr> </tr></table></td></tr></table></td></tr></table></td></tr></table></td></tr></table></td></tr></table></td></tr></table></td></tr></table></td></tr></table></td></tr></table></td></tr></table></td></tr></table></td></tr></table></td></tr></table>
 | | | | | | | | | | | | | | | | | | | | <table border="1" style="width: 100%; border-collapse: collapse; text-align: center;"> <tr> <td style="width: 10%;"></td> <td style="width: 10%;"></td> <td style="width: 10%;"></td> <td style="width: 10%;"></td> <td style="width: 10%;"></td> <td style="width: 10%;"></td> <td style="width: 10%;"></td> <td style="width: 10%;"></td> <td style="width: 10%;"></td> <td style="width: 10%;"></td> </tr> <tr> <td></td> <td></td> <td colspan="8" style="text-align: center;"> <table border="1" style="width: 100%; border-collapse: collapse; text-align: center;"> <tr> <td style="width: 10%;"></td> <td style="width: 10%;"></td> <td style="width: 10%;"></td> <td style="width: 10%;"></td> <td style="width: 10%;"></td> <td style="width: 10%;"></td> <td style="width: 10%;"></td> <td style="width: 10%;"></td> <td style="width: 10%;"></td> <td style="width: 10%;"></td> </tr> <tr> <td></td> <td></td> <td colspan="8" style="text-align: center;"> <table border="1" style="width: 100%; border-collapse: collapse; text-align: center;"> <tr> <td style="width: 10%;"></td> <td style="width: 10%;"></td> <td style="width: 10%;"></td> <td style="width: 10%;"></td> <td style="width: 10%;"></td> <td style="width: 10%;"></td> <td style="width: 10%;"></td> <td style="width: 10%;"></td> <td style="width: 10%;"></td> <td style="width: 10%;"></td> </tr> <tr> <td></td> <td></td> <td colspan="8" style="text-align: center;"> <table border="1" style="width: 100%; border-collapse: collapse; text-align: center;"> <tr> <td style="width: 10%;"></td> <td style="width: 10%;"></td> <td style="width: 10%;"></td> <td style="width: 10%;"></td> <td style="width: 10%;"></td> <td style="width: 10%;"></td> <td style="width: 10%;"></td> <td style="width: 10%;"></td> <td style="width: 10%;"></td> <td style="width: 10%;"></td> </tr> <tr> <td></td> <td></td> <td colspan="8" style="text-align: center;"> <table border="1" style="width: 100%; border-collapse: collapse; text-align: center;"> <tr> <td style="width: 10%;"></td> <td style="width: 10%;"></td> <td style="width: 10%;"></td> <td style="width: 10%;"></td> <td style="width: 10%;"></td> <td style="width: 10%;"></td> <td style="width: 10%;"></td> <td style="width: 10%;"></td> <td style="width: 10%;"></td> <td style="width: 10%;"></td> </tr> <tr> <td></td> <td></td> <td colspan="8" style="text-align: center;"> <table border="1" style="width: 100%; border-collapse: collapse; text-align: center;"> <tr> <td style="width: 10%;"></td> <td style="width: 10%;"></td> <td style="width: 10%;"></td> <td style="width: 10%;"></td> <td style="width: 10%;"></td> <td style="width: 10%;"></td> <td style="width: 10%;"></td> <td style="width: 10%;"></td> <td style="width: 10%;"></td> <td style="width: 10%;"></td> </tr> <tr> <td></td> <td></td> <td colspan="8" style="text-align: center;"> <table border="1" style="width: 100%; border-collapse: collapse; text-align: center;"> <tr> <td style="width: 10%;"></td> <td style="width: 10%;"></td> <td style="width: 10%;"></td> <td style="width: 10%;"></td> <td style="width: 10%;"></td> <td style="width: 10%;"></td> <td style="width: 10%;"></td> <td style="width: 10%;"></td> <td style="width: 10%;"></td> <td style="width: 10%;"></td> </tr> <tr> <td></td> <td></td> <td colspan="8" style="text-align: center;"> <table border="1" style="width: 100%; border-collapse: collapse; text-align: center;"> <tr> <td style="width: 10%;"></td> <td style="width: 10%;"></td> <td style="width: 10%;"></td> <td style="width: 10%;"></td> <td style="width: 10%;"></td> <td style="width: 10%;"></td> <td style="width: 10%;"></td> <td style="width: 10%;"></td> <td style="width: 10%;"></td> <td style="width: 10%;"></td> </tr> <tr> <td></td> <td></td> <td colspan="8" style="text-align: center;"> <table border="1" style="width: 100%; border-collapse: collapse; text-align: center;"> <tr> <td style="width: 10%;"></td> <td style="width: 10%;"></td> <td style="width: 10%;"></td> <td style="width: 10%;"></td> <td style="width: 10%;"></td> <td style="width: 10%;"></td> <td style="width: 10%;"></td> <td style="width: 10%;"></td> <td style="width: 10%;"></td> <td style="width: 10%;"></td> </tr> <tr> <td></td> <td></td> <td colspan="8" style="text-align: center;"> <table border="1" style="width: 100%; border-collapse: collapse; text-align: center;"> <tr> <td style="width: 10%;"></td> <td style="width: 10%;"></td> <td style="width: 10%;"></td> <td style="width: 10%;"></td> <td style="width: 10%;"></td> <td style="width: 10%;"></td> <td style="width: 10%;"></td> <td style="width: 10%;"></td> <td style="width: 10%;"></td> <td style="width: 10%;"></td> </tr> <tr> <td></td> <td></td> <td colspan="8" style="text-align: center;"> <table border="1" style="width: 100%; border-collapse: collapse; text-align: center;"> <tr> <td style="width: 10%;"></td> <td style="width: 10%;"></td> <td style="width: 10%;"></td> <td style="width: 10%;"></td> <td style="width: 10%;"></td> <td style="width: 10%;"></td> <td style="width: 10%;"></td> <td style="width: 10%;"></td> <td style="width: 10%;"></td> <td style="width: 10%;"></td> </tr> <tr> <td></td> <td></td> <td colspan="8" style="text-align: center;"> <table border="1" style="width: 100%; border-collapse: collapse; text-align: center;"> <tr> <td style="width: 10%;"></td> <td style="width: 10%;"></td> <td style="width: 10%;"></td> <td style="width: 10%;"></td> <td style="width: 10%;"></td> <td style="width: 10%;"></td> <td style="width: 10%;"></td> <td style="width: 10%;"></td> <td style="width: 10%;"></td> <td style="width: 10%;"></td> </tr> <tr> <td></td> <td></td> <td
colspan="8" style="text-align: center;"> <table border="1" style="width: 100%; border-collapse: collapse; text-align: center;"> <tr> </tr></table></td></tr></table></td></tr></table></td></tr></table></td></tr></table></td></tr></table></td></tr></table></td></tr></table></td></tr></table></td></tr></table></td></tr></table></td></tr></table></td></tr></table>
 | | | | | | | | | | | | | | | | | | | | <table border="1" style="width: 100%; border-collapse: collapse; text-align: center;"> <tr> <td style="width: 10%;"></td> <td style="width: 10%;"></td> <td style="width: 10%;"></td> <td style="width: 10%;"></td> <td style="width: 10%;"></td> <td style="width: 10%;"></td> <td style="width: 10%;"></td> <td style="width: 10%;"></td> <td style="width: 10%;"></td> <td style="width: 10%;"></td> </tr> <tr> <td></td> <td></td> <td colspan="8" style="text-align: center;"> <table border="1" style="width: 100%; border-collapse: collapse; text-align: center;"> <tr> <td style="width: 10%;"></td> <td style="width: 10%;"></td> <td style="width: 10%;"></td> <td style="width: 10%;"></td> <td style="width: 10%;"></td> <td style="width: 10%;"></td> <td style="width: 10%;"></td> <td style="width: 10%;"></td> <td style="width: 10%;"></td> <td style="width: 10%;"></td> </tr> <tr> <td></td> <td></td> <td colspan="8" style="text-align: center;"> <table border="1" style="width: 100%; border-collapse: collapse; text-align: center;"> <tr> <td style="width: 10%;"></td> <td style="width: 10%;"></td> <td style="width: 10%;"></td> <td style="width: 10%;"></td> <td style="width: 10%;"></td> <td style="width: 10%;"></td> <td style="width: 10%;"></td> <td style="width: 10%;"></td> <td style="width: 10%;"></td> <td style="width: 10%;"></td> </tr> <tr> <td></td> <td></td> <td colspan="8" style="text-align: center;"> <table border="1" style="width: 100%; border-collapse: collapse; text-align: center;"> <tr> <td style="width: 10%;"></td> <td style="width: 10%;"></td> <td style="width: 10%;"></td> <td style="width: 10%;"></td> <td style="width: 10%;"></td> <td style="width: 10%;"></td> <td style="width: 10%;"></td> <td style="width: 10%;"></td> <td style="width: 10%;"></td> <td style="width: 10%;"></td> </tr> <tr> <td></td> <td></td> <td colspan="8" style="text-align: center;"> <table border="1" style="width: 100%; border-collapse: collapse; text-align: center;"> <tr> <td style="width: 10%;"></td> <td style="width: 10%;"></td> <td style="width: 10%;"></td> <td style="width: 10%;"></td> <td style="width: 10%;"></td> <td style="width: 10%;"></td> <td style="width: 10%;"></td> <td style="width: 10%;"></td> <td style="width: 10%;"></td> <td style="width: 10%;"></td> </tr> <tr> <td></td> <td></td> <td colspan="8" style="text-align: center;"> <table border="1" style="width: 100%; border-collapse: collapse; text-align: center;"> <tr> <td style="width: 10%;"></td> <td style="width: 10%;"></td> <td style="width: 10%;"></td> <td style="width: 10%;"></td> <td style="width: 10%;"></td> <td style="width: 10%;"></td> <td style="width: 10%;"></td> <td style="width: 10%;"></td> <td style="width: 10%;"></td> <td style="width: 10%;"></td> </tr> <tr> <td></td> <td></td> <td colspan="8" style="text-align: center;"> <table border="1" style="width: 100%; border-collapse: collapse; text-align: center;"> <tr> <td style="width: 10%;"></td> <td style="width: 10%;"></td> <td style="width: 10%;"></td> <td style="width: 10%;"></td> <td style="width: 10%;"></td> <td style="width: 10%;"></td> <td style="width: 10%;"></td> <td style="width: 10%;"></td> <td style="width: 10%;"></td> <td style="width: 10%;"></td> </tr> <tr> <td></td> <td></td> <td colspan="8" style="text-align: center;"> <table border="1" style="width: 100%; border-collapse: collapse; text-align: center;"> <tr> <td style="width: 10%;"></td> <td style="width: 10%;"></td> <td style="width: 10%;"></td> <td style="width: 10%;"></td> <td style="width: 10%;"></td> <td style="width: 10%;"></td> <td style="width: 10%;"></td> <td style="width: 10%;"></td> <td style="width: 10%;"></td> <td style="width: 10%;"></td> </tr> <tr> <td></td> <td></td> <td colspan="8" style="text-align: center;"> <table border="1" style="width: 100%; border-collapse: collapse; text-align: center;"> <tr> <td style="width: 10%;"></td> <td style="width: 10%;"></td> <td style="width: 10%;"></td> <td style="width: 10%;"></td> <td style="width: 10%;"></td> <td style="width: 10%;"></td> <td style="width: 10%;"></td> <td style="width: 10%;"></td> <td style="width: 10%;"></td> <td style="width: 10%;"></td> </tr> <tr> <td></td> <td></td> <td colspan="8" style="text-align: center;"> <table border="1" style="width: 100%; border-collapse: collapse; text-align: center;"> <tr> <td style="width: 10%;"></td> <td style="width: 10%;"></td> <td style="width: 10%;"></td> <td style="width: 10%;"></td> <td style="width: 10%;"></td> <td style="width: 10%;"></td> <td style="width: 10%;"></td> <td style="width: 10%;"></td> <td style="width: 10%;"></td> <td style="width: 10%;"></td> </tr> <tr> <td></td> <td></td> <td colspan="8" style="text-align: center;"> <table border="1" style="width: 100%; border-collapse: collapse; text-align: center;"> <tr> <td style="width: 10%;"></td> <td style="width: 10%;"></td> <td style="width: 10%;"></td> <td style="width: 10%;"></td> <td style="width: 10%;"></td> <td style="width: 10%;"></td> <td style="width: 10%;"></td> <td style="width: 10%;"></td> <td style="width: 10%;"></td> <td style="width: 10%;"></td> </tr> <tr> <td></td> <td></td> <td colspan="8" style="text-align: center;"> <table border="1" style="width: 100%; border-collapse: collapse; text-align: center;"> <tr> </tr></table></td></tr></table></td></tr></table></td></tr></table></td></tr></table></td></tr></table></td></tr></table></td></tr></table></td></tr></table></td></tr></table></td></tr></table></td></tr></table>
 | | | | | | | | | | | | | | | | | | | | <table border="1" style="width: 100%; border-collapse: collapse; text-align: center;"> <tr> <td style="width: 10%;"></td> <td style="width: 10%;"></td> <td style="width: 10%;"></td> <td style="width: 10%;"></td> <td style="width: 10%;"></td> <td style="width: 10%;"></td> <td style="width: 10%;"></td> <td style="width: 10%;"></td> <td style="width: 10%;"></td> <td style="width: 10%;"></td> </tr> <tr> <td></td> <td></td> <td colspan="8" style="text-align: center;"> <table border="1" style="width: 100%; border-collapse: collapse; text-align: center;"> <tr> <td style="width: 10%;"></td> <td style="width: 10%;"></td> <td style="width: 10%;"></td> <td style="width: 10%;"></td> <td style="width: 10%;"></td> <td style="width: 10%;"></td> <td style="width: 10%;"></td> <td style="width: 10%;"></td> <td style="width: 10%;"></td> <td style="width: 10%;"></td> </tr> <tr> <td></td> <td></td> <td colspan="8" style="text-align: center;"> <table border="1" style="width: 100%; border-collapse: collapse; text-align: center;"> <tr> <td style="width: 10%;"></td> <td style="width: 10%;"></td> <td style="width: 10%;"></td> <td style="width: 10%;"></td> <td style="width: 10%;"></td> <td style="width: 10%;"></td> <td style="width: 10%;"></td> <td style="width: 10%;"></td> <td style="width: 10%;"></td> <td style="width: 10%;"></td> </tr> <tr> <td></td> <td></td> <td colspan="8" style="text-align: center;"> <table border="1" style="width: 100%; border-collapse: collapse; text-align: center;"> <tr> <td style="width: 10%;"></td> <td style="width: 10%;"></td> <td style="width: 10%;"></td> <td style="width: 10%;"></td> <td style="width: 10%;"></td> <td style="width: 10%;"></td> <td style="width: 10%;"></td> <td style="width: 10%;"></td> <td style="width: 10%;"></td> <td style="width: 10%;"></td> </tr> <tr> <td></td> <td></td> <td colspan="8" style="text-align: center;"> <table border="1" style="width: 100%; border-collapse: collapse; text-align: center;"> <tr> <td style="width: 10%;"></td> <td style="width: 10%;"></td> <td style="width: 10%;"></td> <td style="width: 10%;"></td> <td style="width: 10%;"></td> <td style="width: 10%;"></td> <td style="width: 10%;"></td> <td style="width: 10%;"></td> <td style="width: 10%;"></td> <td style="width: 10%;"></td> </tr> <tr> <td></td> <td></td> <td colspan="8" style="text-align: center;"> <table border="1" style="width: 100%; border-collapse: collapse; text-align: center;"> <tr> <td style="width: 10%;"></td> <td style="width: 10%;"></td> <td style="width: 10%;"></td> <td style="width: 10%;"></td> <td style="width: 10%;"></td> <td style="width: 10%;"></td> <td style="width: 10%;"></td> <td style="width: 10%;"></td> <td style="width: 10%;"></td> <td style="width: 10%;"></td> </tr> <tr> <td></td> <td></td> <td colspan="8" style="text-align: center;"> <table border="1" style="width: 100%; border-collapse: collapse; text-align: center;"> <tr> <td style="width: 10%;"></td> <td style="width: 10%;"></td> <td style="width: 10%;"></td> <td style="width: 10%;"></td> <td style="width: 10%;"></td> <td style="width: 10%;"></td> <td style="width: 10%;"></td> <td style="width: 10%;"></td> <td style="width: 10%;"></td> <td style="width: 10%;"></td> </tr> <tr> <td></td> <td></td> <td colspan="8" style="text-align: center;"> <table border="1" style="width: 100%; border-collapse: collapse; text-align: center;"> <tr> <td style="width: 10%;"></td> <td style="width: 10%;"></td> <td style="width: 10%;"></td> <td style="width: 10%;"></td> <td style="width: 10%;"></td> <td style="width: 10%;"></td> <td style="width: 10%;"></td> <td style="width: 10%;"></td> <td style="width: 10%;"></td> <td
style="width: 10%;"></td> </tr> <tr> <td></td> <td></td> <td colspan="8" style="text-align: center;"> <table border="1" style="width: 100%; border-collapse: collapse; text-align: center;"> <tr> <td style="width: 10%;"></td> <td style="width: 10%;"></td> <td style="width: 10%;"></td> <td style="width: 10%;"></td> <td style="width: 10%;"></td> <td style="width: 10%;"></td> <td style="width: 10%;"></td> <td style="width: 10%;"></td> <td style="width: 10%;"></td> <td style="width: 10%;"></td> </tr> <tr> <td></td> <td></td> <td colspan="8" style="text-align: center;"> <table border="1" style="width: 100%; border-collapse: collapse; text-align: center;"> <tr> <td style="width: 10%;"></td> <td style="width: 10%;"></td> <td style="width: 10%;"></td> <td style="width: 10%;"></td> <td style="width: 10%;"></td> <td style="width: 10%;"></td> <td style="width: 10%;"></td> <td style="width: 10%;"></td> <td style="width: 10%;"></td> <td style="width: 10%;"></td> </tr> <tr> <td></td> <td></td> <td colspan="8" style="text-align: center;"> <table border="1" style="width: 100%; border-collapse: collapse; text-align: center;"> <tr> </tr></table></td></tr></table></td></tr></table></td></tr></table></td></tr></table></td></tr></table></td></tr></table></td></tr></table></td></tr></table></td></tr></table></td></tr></table>
 | | | | | | | | | | | | | | | | | | | | <table border="1" style="width: 100%; border-collapse: collapse; text-align: center;"> <tr> <td style="width: 10%;"></td> <td style="width: 10%;"></td> <td style="width: 10%;"></td> <td style="width: 10%;"></td> <td style="width: 10%;"></td> <td style="width: 10%;"></td> <td style="width: 10%;"></td> <td style="width: 10%;"></td> <td style="width: 10%;"></td> <td style="width: 10%;"></td> </tr> <tr> <td></td> <td></td> <td colspan="8" style="text-align: center;"> <table border="1" style="width: 100%; border-collapse: collapse; text-align: center;"> <tr> <td style="width: 10%;"></td> <td style="width: 10%;"></td> <td style="width: 10%;"></td> <td style="width: 10%;"></td> <td style="width: 10%;"></td> <td style="width: 10%;"></td> <td style="width: 10%;"></td> <td style="width: 10%;"></td> <td style="width: 10%;"></td> <td style="width: 10%;"></td> </tr> <tr> <td></td> <td></td> <td colspan="8" style="text-align: center;"> <table border="1" style="width: 100%; border-collapse: collapse; text-align: center;"> <tr> <td style="width: 10%;"></td> <td style="width: 10%;"></td> <td style="width: 10%;"></td> <td style="width: 10%;"></td> <td style="width: 10%;"></td> <td style="width: 10%;"></td> <td style="width: 10%;"></td> <td style="width: 10%;"></td> <td style="width: 10%;"></td> <td style="width: 10%;"></td> </tr> <tr> <td></td> <td></td> <td colspan="8" style="text-align: center;"> <table border="1" style="width: 100%; border-collapse: collapse; text-align: center;"> <tr> <td style="width: 10%;"></td> <td style="width: 10%;"></td> <td style="width: 10%;"></td> <td style="width: 10%;"></td> <td style="width: 10%;"></td> <td style="width: 10%;"></td> <td style="width: 10%;"></td> <td style="width: 10%;"></td> <td style="width: 10%;"></td> <td style="width: 10%;"></td> </tr> <tr> <td></td> <td></td> <td colspan="8" style="text-align: center;"> <table border="1" style="width: 100%; border-collapse: collapse; text-align: center;"> <tr> <td style="width: 10%;"></td> <td style="width: 10%;"></td> <td style="width: 10%;"></td> <td style="width: 10%;"></td> <td style="width: 10%;"></td> <td style="width: 10%;"></td> <td style="width: 10%;"></td> <td style="width: 10%;"></td> <td style="width: 10%;"></td> <td style="width: 10%;"></td> </tr> <tr> <td></td> <td></td> <td colspan="8" style="text-align: center;"> <table border="1" style="width: 100%; border-collapse: collapse; text-align: center;"> <tr> <td style="width: 10%;"></td> <td style="width: 10%;"></td> <td style="width: 10%;"></td> <td style="width: 10%;"></td> <td style="width: 10%;"></td> <td style="width: 10%;"></td> <td style="width: 10%;"></td> <td style="width: 10%;"></td> <td style="width: 10%;"></td> <td style="width: 10%;"></td> </tr> <tr> <td></td> <td></td> <td colspan="8" style="text-align: center;"> <table border="1" style="width: 100%; border-collapse: collapse; text-align: center;"> <tr> <td style="width: 10%;"></td> <td style="width: 10%;"></td> <td style="width: 10%;"></td> <td style="width: 10%;"></td> <td style="width: 10%;"></td> <td style="width: 10%;"></td> <td style="width: 10%;"></td> <td style="width: 10%;"></td> <td style="width: 10%;"></td> <td style="width: 10%;"></td> </tr> <tr> <td></td> <td></td> <td colspan="8" style="text-align: center;"> <table border="1" style="width: 100%; border-collapse: collapse; text-align: center;"> <tr> <td style="width: 10%;"></td> <td style="width: 10%;"></td> <td style="width: 10%;"></td> <td style="width: 10%;"></td> <td style="width: 10%;"></td> <td style="width: 10%;"></td> <td style="width: 10%;"></td> <td style="width: 10%;"></td> <td style="width: 10%;"></td> <td style="width: 10%;"></td> </tr> <tr> <td></td> <td></td> <td colspan="8" style="text-align: center;"> <table border="1" style="width: 100%; border-collapse: collapse; text-align: center;"> <tr> <td style="width: 10%;"></td> <td style="width: 10%;"></td> <td style="width: 10%;"></td> <td style="width: 10%;"></td> <td style="width: 10%;"></td> <td style="width: 10%;"></td> <td style="width: 10%;"></td> <td style="width: 10%;"></td> <td style="width: 10%;"></td> <td style="width: 10%;"></td> </tr> <tr> <td></td> <td></td> <td colspan="8" style="text-align: center;"> <table border="1" style="width: 100%; border-collapse: collapse; text-align: center;"> <tr> </tr></table></td></tr></table></td></tr></table></td></tr></table></td></tr></table></td></tr></table></td></tr></table></td></tr></table></td></tr></table></td></tr></table>
 | | | | | | | | | | | | | | | | | | | | <table border="1" style="width: 100%; border-collapse: collapse; text-align: center;"> <tr> <td style="width: 10%;"></td> <td style="width: 10%;"></td> <td style="width: 10%;"></td> <td style="width: 10%;"></td> <td style="width: 10%;"></td> <td style="width: 10%;"></td> <td style="width: 10%;"></td> <td style="width: 10%;"></td> <td style="width: 10%;"></td> <td style="width: 10%;"></td> </tr> <tr> <td></td> <td></td> <td colspan="8" style="text-align: center;"> <table border="1" style="width: 100%; border-collapse: collapse; text-align: center;"> <tr> <td style="width: 10%;"></td> <td style="width: 10%;"></td> <td style="width: 10%;"></td> <td style="width: 10%;"></td> <td style="width: 10%;"></td> <td style="width: 10%;"></td> <td style="width: 10%;"></td> <td style="width: 10%;"></td> <td style="width: 10%;"></td> <td style="width: 10%;"></td> </tr> <tr> <td></td> <td></td> <td colspan="8" style="text-align: center;"> <table border="1" style="width: 100%; border-collapse: collapse; text-align: center;"> <tr> <td style="width: 10%;"></td> <td style="width: 10%;"></td> <td style="width: 10%;"></td> <td style="width: 10%;"></td> <td style="width: 10%;"></td> <td style="width: 10%;"></td> <td style="width: 10%;"></td> <td style="width: 10%;"></td> <td style="width: 10%;"></td> <td style="width: 10%;"></td> </tr> <tr> <td></td> <td></td> <td colspan="8" style="text-align: center;"> <table border="1" style="width: 100%; border-collapse: collapse; text-align: center;"> <tr> <td style="width: 10%;"></td> <td style="width: 10%;"></td> <td style="width: 10%;"></td> <td style="width: 10%;"></td> <td style="width: 10%;"></td> <td style="width: 10%;"></td> <td style="width: 10%;"></td> <td style="width: 10%;"></td> <td style="width: 10%;"></td> <td style="width: 10%;"></td> </tr> <tr> <td></td> <td></td> <td colspan="8" style="text-align: center;"> <table border="1" style="width: 100%; border-collapse: collapse; text-align: center;"> <tr> <td style="width: 10%;"></td> <td style="width: 10%;"></td> <td style="width: 10%;"></td> <td style="width: 10%;"></td> <td style="width: 10%;"></td> <td style="width: 10%;"></td> <td style="width: 10%;"></td> <td style="width: 10%;"></td> <td style="width: 10%;"></td> <td style="width: 10%;"></td> </tr> <tr> <td></td> <td></td> <td colspan="8" style="text-align: center;"> <table border="1" style="width: 100%; border-collapse: collapse; text-align: center;"> <tr> <td style="width: 10%;"></td> <td style="width: 10%;"></td> <td style="width: 10%;"></td> <td style="width: 10%;"></td> <td style="width: 10%;"></td> <td style="width: 10%;"></td> <td style="width: 10%;"></td> <td style="width: 10%;"></td> <td style="width: 10%;"></td> <td style="width: 10%;"></td> </tr> <tr> <td></td> <td></td> <td colspan="8" style="text-align: center;"> <table border="1" style="width: 100%; border-collapse: collapse; text-align: center;"> <tr> <td style="width: 10%;"></td> <td style="width: 10%;"></td> <td style="width: 10%;"></td> <td style="width: 10%;"></td> <td style="width: 10%;"></td> <td style="width: 10%;"></td> <td style="width: 10%;"></td> <td style="width: 10%;"></td> <td style="width: 10%;"></td> <td style="width: 10%;"></td> </tr> <tr> <td></td> <td></td> <td colspan="8" style="text-align: center;"> <table border="1" style="width: 100%; border-collapse: collapse; text-align: center;"> <tr> <td style="width: 10%;"></td> <td style="width: 10%;"></td> <td style="width: 10%;"></td> <td style="width: 10%;"></td> <td style="width: 10%;"></td> <td style="width: 10%;"></td> <td style="width: 10%;"></td> <td style="width: 10%;"></td> <td style="width: 10%;"></td> <td style="width:
10%;"></td> </tr> <tr> <td></td> <td></td> <td colspan="8" style="text-align: center;"> <table border="1" style="width: 100%; border-collapse: collapse; text-align: center;"> <tr> </tr></table></td></tr></table></td></tr></table></td></tr></table></td></tr></table></td></tr></table></td></tr></table></td></tr></table></td></tr></table>
 | | | | | | | | | | | | | | | | | | | | <table border="1" style="width: 100%; border-collapse: collapse; text-align: center;"> <tr> <td style="width: 10%;"></td> <td style="width: 10%;"></td> <td style="width: 10%;"></td> <td style="width: 10%;"></td> <td style="width: 10%;"></td> <td style="width: 10%;"></td> <td style="width: 10%;"></td> <td style="width: 10%;"></td> <td style="width: 10%;"></td> <td style="width: 10%;"></td> </tr> <tr> <td></td> <td></td> <td colspan="8" style="text-align: center;"> <table border="1" style="width: 100%; border-collapse: collapse; text-align: center;"> <tr> <td style="width: 10%;"></td> <td style="width: 10%;"></td> <td style="width: 10%;"></td> <td style="width: 10%;"></td> <td style="width: 10%;"></td> <td style="width: 10%;"></td> <td style="width: 10%;"></td> <td style="width: 10%;"></td> <td style="width: 10%;"></td> <td style="width: 10%;"></td> </tr> <tr> <td></td> <td></td> <td colspan="8" style="text-align: center;"> <table border="1" style="width: 100%; border-collapse: collapse; text-align: center;"> <tr> <td style="width: 10%;"></td> <td style="width: 10%;"></td> <td style="width: 10%;"></td> <td style="width: 10%;"></td> <td style="width: 10%;"></td> <td style="width: 10%;"></td> <td style="width: 10%;"></td> <td style="width: 10%;"></td> <td style="width: 10%;"></td> <td style="width: 10%;"></td> </tr> <tr> <td></td> <td></td> <td colspan="8" style="text-align: center;"> <table border="1" style="width: 100%; border-collapse: collapse; text-align: center;"> <tr> <td style="width: 10%;"></td> <td style="width: 10%;"></td> <td style="width: 10%;"></td> <td style="width: 10%;"></td> <td style="width: 10%;"></td> <td style="width: 10%;"></td> <td style="width: 10%;"></td> <td style="width: 10%;"></td> <td style="width: 10%;"></td> <td style="width: 10%;"></td> </tr> <tr> <td></td> <td></td> <td colspan="8" style="text-align: center;"> <table border="1" style="width: 100%; border-collapse: collapse; text-align: center;"> <tr> <td style="width: 10%;"></td> <td style="width: 10%;"></td> <td style="width: 10%;"></td> <td style="width: 10%;"></td> <td style="width: 10%;"></td> <td style="width: 10%;"></td> <td style="width: 10%;"></td> <td style="width: 10%;"></td> <td style="width: 10%;"></td> <td style="width: 10%;"></td> </tr> <tr> <td></td> <td></td> <td colspan="8" style="text-align: center;"> <table border="1" style="width: 100%; border-collapse: collapse; text-align: center;"> <tr> <td style="width: 10%;"></td> <td style="width: 10%;"></td> <td style="width: 10%;"></td> <td style="width: 10%;"></td> <td style="width: 10%;"></td> <td style="width: 10%;"></td> <td style="width: 10%;"></td> <td style="width: 10%;"></td> <td style="width: 10%;"></td> <td style="width: 10%;"></td> </tr> <tr> <td></td> <td></td> <td colspan="8" style="text-align: center;"> <table border="1" style="width: 100%; border-collapse: collapse; text-align: center;"> <tr> <td style="width: 10%;"></td> <td style="width: 10%;"></td> <td style="width: 10%;"></td> <td style="width: 10%;"></td> <td style="width: 10%;"></td> <td style="width: 10%;"></td> <td style="width: 10%;"></td> <td style="width: 10%;"></td> <td style="width: 10%;"></td> <td style="width: 10%;"></td> </tr> <tr> <td></td> <td></td> <td colspan="8" style="text-align: center;"> <table border="1" style="width: 100%; border-collapse: collapse; text-align: center;"> <tr> </tr></table></td></tr></table></td></tr></table></td></tr></table></td></tr></table></td></tr></table></td></tr></table></td></tr></table>
 | | | | | | | | | | | | | | | | | | | | <table border="1" style="width: 100%; border-collapse: collapse; text-align: center;"> <tr> <td style="width: 10%;"></td> <td style="width: 10%;"></td> <td style="width: 10%;"></td> <td style="width: 10%;"></td> <td style="width: 10%;"></td> <td style="width: 10%;"></td> <td style="width: 10%;"></td> <td style="width: 10%;"></td> <td style="width: 10%;"></td> <td style="width: 10%;"></td> </tr> <tr> <td></td> <td></td> <td colspan="8" style="text-align: center;"> <table border="1" style="width: 100%; border-collapse: collapse; text-align: center;"> <tr> <td style="width: 10%;"></td> <td style="width: 10%;"></td> <td style="width: 10%;"></td> <td style="width: 10%;"></td> <td style="width: 10%;"></td> <td style="width: 10%;"></td> <td style="width: 10%;"></td> <td style="width: 10%;"></td> <td style="width: 10%;"></td> <td style="width: 10%;"></td> </tr> <tr> <td></td> <td></td> <td colspan="8" style="text-align: center;"> <table border="1" style="width: 100%; border-collapse: collapse; text-align: center;"> <tr> <td style="width: 10%;"></td> <td style="width: 10%;"></td> <td style="width: 10%;"></td> <td style="width: 10%;"></td> <td style="width: 10%;"></td> <td style="width: 10%;"></td> <td style="width: 10%;"></td> <td style="width: 10%;"></td> <td style="width: 10%;"></td> <td style="width: 10%;"></td> </tr> <tr> <td></td> <td></td> <td colspan="8" style="text-align: center;"> <table border="1" style="width: 100%; border-collapse: collapse; text-align: center;"> <tr> <td style="width: 10%;"></td> <td style="width: 10%;"></td> <td style="width: 10%;"></td> <td style="width: 10%;"></td> <td style="width: 10%;"></td> <td style="width: 10%;"></td> <td style="width: 10%;"></td> <td style="width: 10%;"></td> <td style="width: 10%;"></td> <td style="width: 10%;"></td> </tr> <tr> <td></td> <td></td> <td colspan="8" style="text-align: center;"> <table border="1" style="width: 100%; border-collapse: collapse; text-align: center;"> <tr> <td style="width: 10%;"></td> <td style="width: 10%;"></td> <td style="width: 10%;"></td> <td style="width: 10%;"></td> <td style="width: 10%;"></td> <td style="width: 10%;"></td> <td style="width: 10%;"></td> <td style="width: 10%;"></td> <td style="width: 10%;"></td> <td style="width: 10%;"></td> </tr> <tr> <td></td> <td></td> <td colspan="8" style="text-align: center;"> <table border="1" style="width: 100%; border-collapse: collapse; text-align: center;"> <tr> <td style="width: 10%;"></td> <td style="width: 10%;"></td> <td style="width: 10%;"></td> <td style="width: 10%;"></td> <td style="width: 10%;"></td> <td style="width: 10%;"></td> <td style="width: 10%;"></td> <td style="width: 10%;"></td> <td style="width: 10%;"></td> <td style="width: 10%;"></td> </tr> <tr> <td></td> <td></td> <td colspan="8" style="text-align: center;"> <table border="1" style="width: 100%; border-collapse: collapse; text-align: center;"> <tr> </tr></table></td></tr></table></td></tr></table></td></tr></table></td></tr></table></td></tr></table></td></tr></table>
 | | | | | | | | | | | | | | | | | | | | <table border="1" style="width: 100%; border-collapse: collapse; text-align: center;"> <tr> <td style="width: 10%;"></td> <td style="width: 10%;"></td> <td style="width: 10%;"></td> <td style="width: 10%;"></td> <td style="width: 10%;"></td> <td style="width: 10%;"></td> <td style="width: 10%;"></td> <td style="width: 10%;"></td> <td style="width: 10%;"></td> <td style="width: 10%;"></td> </tr> <tr> <td></td> <td></td> <td colspan="8" style="text-align: center;"> <table border="1" style="width: 100%; border-collapse: collapse; text-align: center;"> <tr> <td style="width: 10%;"></td> <td style="width: 10%;"></td> <td style="width: 10%;"></td> <td style="width: 10%;"></td> <td style="width: 10%;"></td> <td style="width: 10%;"></td> <td style="width: 10%;"></td> <td style="width: 10%;"></td> <td style="width: 10%;"></td> <td style="width: 10%;"></td> </tr> <tr> <td></td> <td></td> <td colspan="8" style="text-align: center;"> <table border="1" style="width: 100%; border-collapse: collapse; text-align: center;"> <tr> <td style="width: 10%;"></td> <td style="width: 10%;"></td> <td style="width: 10%;"></td> <td style="width: 10%;"></td> <td style="width: 10%;"></td> <td style="width: 10%;"></td> <td style="width: 10%;"></td> <td style="width: 10%;"></td> <td style="width: 10%;"></td> <td style="width: 10%;"></td> </tr> <tr> <td></td> <td></td> <td colspan="8" style="text-align: center;"> <table border="1" style="width: 100%; border-collapse: collapse; text-align: center;"> <tr> <td style="width: 10%;"></td> <td style="width: 10%;"></td> <td style="width: 10%;"></td> <td style="width: 10%;"></td> <td style="width: 10%;"></td> <td style="width: 10%;"></td> <td style="width: 10%;"></td> <td style="width: 10%;"></td> <td style="width: 10%;"></td> <td style="width: 10%;"></td> </tr> <tr> <td></td> <td></td> <td colspan="8" style="text-align: center;"> <table border="1" style="width: 100%; border-collapse: collapse; text-align: center;"> <tr> <td style="width: 10%;"></td> <td style="width: 10%;"></td> <td style="width: 10%;"></td> <td style="width: 10%;"></td> <td style="width: 10%;"></td> <td style="width: 10%;"></td> <td style="width: 10%;"></td> <td style="width: 10%;"></td> <td style="width: 10%;"></td> <td style="width: 10%;"></td> </tr> <tr> <td></td> <td></td> <td colspan="8" style="text-align:
center;"> <table border="1" style="width: 100%; border-collapse: collapse; text-align: center;"> <tr> </tr></table></td></tr></table></td></tr></table></td></tr></table></td></tr></table></td></tr></table>
 | | | | | | | | | | | | | | | | | | | | <table border="1" style="width: 100%; border-collapse: collapse; text-align: center;"> <tr> <td style="width: 10%;"></td> <td style="width: 10%;"></td> <td style="width: 10%;"></td> <td style="width: 10%;"></td> <td style="width: 10%;"></td> <td style="width: 10%;"></td> <td style="width: 10%;"></td> <td style="width: 10%;"></td> <td style="width: 10%;"></td> <td style="width: 10%;"></td> </tr> <tr> <td></td> <td></td> <td colspan="8" style="text-align: center;"> <table border="1" style="width: 100%; border-collapse: collapse; text-align: center;"> <tr> <td style="width: 10%;"></td> <td style="width: 10%;"></td> <td style="width: 10%;"></td> <td style="width: 10%;"></td> <td style="width: 10%;"></td> <td style="width: 10%;"></td> <td style="width: 10%;"></td> <td style="width: 10%;"></td> <td style="width: 10%;"></td> <td style="width: 10%;"></td> </tr> <tr> <td></td> <td></td> <td colspan="8" style="text-align: center;"> <table border="1" style="width: 100%; border-collapse: collapse; text-align: center;"> <tr> <td style="width: 10%;"></td> <td style="width: 10%;"></td> <td style="width: 10%;"></td> <td style="width: 10%;"></td> <td style="width: 10%;"></td> <td style="width: 10%;"></td> <td style="width: 10%;"></td> <td style="width: 10%;"></td> <td style="width: 10%;"></td> <td style="width: 10%;"></td> </tr> <tr> <td></td> <td></td> <td colspan="8" style="text-align: center;"> <table border="1" style="width: 100%; border-collapse: collapse; text-align: center;"> <tr> <td style="width: 10%;"></td> <td style="width: 10%;"></td> <td style="width: 10%;"></td> <td style="width: 10%;"></td> <td style="width: 10%;"></td> <td style="width: 10%;"></td> <td style="width: 10%;"></td> <td style="width: 10%;"></td> <td style="width: 10%;"></td> <td style="width: 10%;"></td> </tr> <tr> <td></td> <td></td> <td colspan="8" style="text-align: center;"> <table border="1" style="width: 100%; border-collapse: collapse; text-align: center;"> <tr> </tr></table></td></tr></table></td></tr></table></td></tr></table></td></tr></table>
 | | | | | | | | | | | | | | | | | | | | <table border="1" style="width: 100%; border-collapse: collapse; text-align: center;"> <tr> <td style="width: 10%;"></td> <td style="width: 10%;"></td> <td style="width: 10%;"></td> <td style="width: 10%;"></td> <td style="width: 10%;"></td> <td style="width: 10%;"></td> <td style="width: 10%;"></td> <td style="width: 10%;"></td> <td style="width: 10%;"></td> <td style="width: 10%;"></td> </tr> <tr> <td></td> <td></td> <td colspan="8" style="text-align: center;"> <table border="1" style="width: 100%; border-collapse: collapse; text-align: center;"> <tr> <td style="width: 10%;"></td> <td style="width: 10%;"></td> <td style="width: 10%;"></td> <td style="width: 10%;"></td> <td style="width: 10%;"></td> <td style="width: 10%;"></td> <td style="width: 10%;"></td> <td style="width: 10%;"></td> <td style="width: 10%;"></td> <td style="width: 10%;"></td> </tr> <tr> <td></td> <td></td> <td colspan="8" style="text-align: center;"> <table border="1" style="width: 100%; border-collapse: collapse; text-align: center;"> <tr> <td style="width: 10%;"></td> <td style="width: 10%;"></td> <td style="width: 10%;"></td> <td style="width: 10%;"></td> <td style="width: 10%;"></td> <td style="width: 10%;"></td> <td style="width: 10%;"></td> <td style="width: 10%;"></td> <td style="width: 10%;"></td> <td style="width: 10%;"></td> </tr> <tr> <td></td> <td></td> <td colspan="8" style="text-align: center;"> <table border="1" style="width: 100%; border-collapse: collapse; text-align: center;"> <tr> </tr></table></td></tr></table></td></tr></table></td></tr></table>
 | | | | | | | | | | | | | | | | | | | | <table border="1" style="width: 100%; border-collapse: collapse; text-align: center;"> <tr> <td style="width: 10%;"></td> <td style="width: 10%;"></td> <td style="width: 10%;"></td> <td style="width: 10%;"></td> <td style="width: 10%;"></td> <td style="width: 10%;"></td> <td style="width: 10%;"></td> <td style="width: 10%;"></td> <td style="width: 10%;"></td> <td style="width: 10%;"></td> </tr> <tr> <td></td> <td></td> <td colspan="8" style="text-align: center;"> <table border="1" style="width: 100%; border-collapse: collapse; text-align: center;"> <tr> <td style="width: 10%;"></td> <td style="width: 10%;"></td> <td style="width: 10%;"></td> <td style="width: 10%;"></td> <td style="width: 10%;"></td> <td style="width: 10%;"></td> <td style="width: 10%;"></td> <td style="width: 10%;"></td> <td style="width: 10%;"></td> <td style="width: 10%;"></td> </tr> <tr> <td></td> <td></td> <td colspan="8" style="text-align: center;"> <table border="1" style="width: 100%; border-collapse: collapse; text-align: center;"> <tr> </tr></table></td></tr></table></td></tr></table>
 | | | | | | | | | | | | | | | | | | | | <table border="1" style="width: 100%; border-collapse: collapse; text-align: center;"> <tr> <td style="width: 10%;"></td> <td style="width: 10%;"></td> <td style="width: 10%;"></td> <td style="width: 10%;"></td> <td style="width: 10%;"></td> <td style="width: 10%;"></td> <td style="width: 10%;"></td> <td style="width: 10%;"></td> <td style="width: 10%;"></td> <td style="width: 10%;"></td> </tr> <tr> <td></td> <td></td> <td colspan="8" style="text-align: center;"> <table border="1" style="width: 100%; border-collapse: collapse; text-align: center;"> <tr> </tr></table></td></tr></table>
 | | | | | | | | | | | | | | | | | | | | <table border="1" style="width: 100%; border-collapse: collapse; text-align: center;"> <tr> </tr></table>
 | | | | | | | | | | | | | | | | | | | | | | | | | | | | | | | | | | | | | | | | | | | | | | | | | | | | | | | | | | | | | | | | | | | | | | | | | | | | | | | |
 | | | | | | | | | | | | | | | | | | | |
 | | | | | | | | | | | | | | | | | | | |
 | | | | | | | | | | | | | | | | | | | |
 | | | | | | | | | | | | | | | | | | | |
 | | | | | | | | | | | | | | | | | | | | | | | | | | | | | | | | | | | | | | | |
 | | | | | | | | | | | | | | | | | | | |
 | | | | | | | | | | | | | | | | | | | | | | | | | | | | | | | | | | | | | | | |
 | | | | | | | | | | | | | | | | | | | | | | | | | | | | | | | | | | | | | | | |
 | | | | | | | | | | | | | | | | | | | | | | | | | | | | | | | | | | | | | | | |
 | | | | | | | | | | | | | | | | | | | | | | | | | | | | | | | | | | | | | | | | | | | | | | | | | | | | | | | | | | | | | | | | | | | | | | | | | | | | | | | |
 | | | | | | | | | | | | | | | | | | | | | | | | | | | | | | | | | | | | | | | | | | | | | | | | | | | | | | | | | | | | | | | | | | | |
| | |

 | | | | | | | | | | | | | | | | | | | |

 | | | | | | | | | | | | | | | | | | | |

 | | | | | | | | | | | | | | | | | | | |

 | | | | | | | | | | | | | | | | | | | |

 | | | | | | | | | | | | | | | | | | | |

 | | | | | | | | | | | | | | | | | | | |

 | | | | | | | | | | | | | | | | | | | |

 | | | | | | | | | | | | | | | | | | | |

 | | | | | | | | | | | | | | | | | | | |

 | | | | | | | | | | | | | | | | | | | |

 | | | | | | | | | | | | | | | | | | | |

 | | | | | | | | | | | | | | | | | | | |

 | | | | | | | | | | | | | | | | | | | |

 | | | | | | | | | | | | | | | | | | | |

 | | | | | | | | | | | | | | | | | | | |

 | | | | | | | | | | | | | | | | | | | |

 | | | | | | | | | | | | | | | | | | | |

 | | | | | | | | | | | | | | | | | | | |

 | | | | | | | | | | | | | | | | | | | |

 | | | | | | | | | | | | | | | | | | | |

 | | | | | | | | | | | | | | | | | | | |

 | | | | | | | | | | | | | | | | | | | |

 | | | | | | | | | | | | | | | | | | | |

 | | | | | | | | | | | | | | | | | | | |

 | | | | | | | | | | | | | | | | | | | |

 | | | | | | | | | | | | | | | | | | | |

 | | | | | | | | | | | | | | | | | | | |

 | | | | | | | | | | | | | | | | | | | |
 | | | | | | | | | | | | | | | | | | | |

 | | | | | | | | | | | | | | | | | | | |

 | | | | | | | | | | | | | | | | | | | |
 | | | | | | | | | | | | | | | | | | | |

 | | | | | | | | | | | | | | | | | | | |

 | | | | | | | | | | | | | | | | | | | |
 | | | | | | | | | | | | | | | | | | | |
 | | | | | | | | | | | | | | | | | | | |

 | | | | | | | | | | | | | | | | | | | |
 | | | | | | | | | | | | | | | | | | | |
 | | | | | | | | | | | | | | | | | | | |

 | | | | | | | | | | | | | | | | | | | | | | | | | | | | | | | | | | | | | | | | | | | | | | | | | | | | | | | | | | | | | | | | | | | | | | | | | | | | | | | | | | | | | | | | | | | | | | | | | | | |
 | | | | | | | | | | | | | | | | | | | |
 | | | | | | | | | | | | | | | | | | | |
 | | | | | | | | | | | | | | | | | | | |
 | | | | | | | | | | | | | | | | | | | |
 | | | | | | | | | | | | | | | | | | | |
 | | | | | | | | | | | | | | | | | | | |
 | | | | | | | | | | | | | | | | | | | |
 | | | | | | | | | | | | | | | | | | | |
 | | | | | | | | | | | | | | | | | | | | | | | | | | | | | | | | | | | | | | | |
 | | | | | | | | | | | | | | | | | | | |
 | | | | | | | | | | | | | | | | | | | | | | | | | | | | | | | | | | | | | | | |
 | | | | | | | | | | | | | | | | | | | | | | | | | | | | | | | | | | | | | | | |
 | | | | | | | | | | | | | | | | | | | | | | | | | | | | | | | | | | | | | | | |
 | | | | | | | | | | | | | | | | | | | | | | | | | | | | | | | | | | | | | | | | | | | | | | | | | | | | | | | | | | | | | | | | | | | | | | | | | | | | | | | | | | | | | | | | | | | | | | | | | | | |
 | | | | | | | | | | | | | | | | | | | | | | | | | | | | | | | | | | | | | | | | | | | | | | | |
| | | <table border="1" style="width: 100%; border-collapse: collapse; text-align: center;"> <tr> <td style="width: 10%;"></td> <td style="width: 10%;"></td> <td style="width: 10%;"></td> <td style="width: 10%;"></td> <td style="width: 10%;"></td> <td style="width: 10%;"></td> <td style="width: 10%;"></td> <td style="width: 10%;"></td> <td style="width: 10%;"></td> <td style="width: 10%;"></td> </tr> <tr> <td></td> <td></td> <td colspan="8" style="text-align: center;"> <table border="1" style="width: 100%; border-collapse: collapse; text-align: center;"> <tr> <td style="width: 10%;"></td> <td style="width: 10%;"></td> <td style="width: 10%;"></td> <td style="width: 10%;"></td> <td style="width: 10%;"></td> <td style="width: 10%;"></td> <td style="width: 10%;"></td> <td style="width: 10%;"></td> <td style="width: 10%;"></td> <td style="width: 10%;"></td> </tr> <tr> <td></td> <td></td> <td colspan="8" style="text-align: center;"> <table border="1" style="width: 100%; border-collapse: collapse; text-align: center;"> <tr> <td style="width: 10%;"></td> <td style="width: 10%;"></td> <td style="width: 10%;"></td> <td style="width: 10%;"></td> <td style="width: 10%;"></td> <td style="width: 10%;"></td> <td style="width: 10%;"></td> <td style="width: 10%;"></td> <td style="width: 10%;"></td> <td style="width: 10%;"></td> </tr> <tr> <td></td> <td></td> <td colspan="8" style="text-align: center;"> <table border="1" style="width: 100%; border-collapse: collapse; text-align: center;"> <tr> <td style="width: 10%;"></td> <td style="width: 10%;"></td> <td style="width: 10%;"></td> <td style="width: 10%;"></td> <td style="width: 10%;"></td> <td style="width: 10%;"></td> <td style="width: 10%;"></td> <td style="width: 10%;"></td> <td style="width: 10%;"></td> <td style="width: 10%;"></td> </tr> <tr> <td></td> <td></td> <td colspan="8" style="text-align: center;"> <table border="1" style="width: 100%; border-collapse: collapse; text-align: center;"> <tr> <td style="width: 10%;"></td> <td style="width: 10%;"></td> <td style="width: 10%;"></td> <td style="width: 10%;"></td> <td style="width: 10%;"></td> <td style="width: 10%;"></td> <td style="width: 10%;"></td> <td style="width: 10%;"></td> <td style="width: 10%;"></td> <td style="width: 10%;"></td> </tr> <tr> <td></td> <td></td> <td colspan="8" style="text-align: center;"> <table border="1" style="width: 100%; border-collapse: collapse; text-align: center;"> <tr> <td style="width: 10%;"></td> <td style="width: 10%;"></td> <td style="width: 10%;"></td> <td style="width: 10%;"></td> <td style="width: 10%;"></td> <td style="width: 10%;"></td> <td style="width: 10%;"></td> <td style="width: 10%;"></td> <td style="width: 10%;"></td> <td style="width: 10%;"></td> </tr> <tr> <td></td> <td></td> <td colspan="8" style="text-align: center;"> <table border="1" style="width: 100%; border-collapse: collapse; text-align: center;"> <tr> <td style="width: 10%;"></td> <td style="width: 10%;"></td> <td style="width: 10%;"></td> <td style="width: 10%;"></td> <td style="width: 10%;"></td> <td style="width: 10%;"></td> <td style="width: 10%;"></td> <td style="width: 10%;"></td> <td style="width: 10%;"></td> <td style="width: 10%;"></td> </tr> <tr> <td></td> <td></td> <td colspan="8" style="text-align: center;"> <table border="1" style="width: 100%; border-collapse: collapse; text-align: center;"> <tr> <td style="width: 10%;"></td> <td style="width: 10%;"></td> <td style="width: 10%;"></td> <td style="width: 10%;"></td> <td style="width: 10%;"></td> <td style="width: 10%;"></td> <td style="width: 10%;"></td> <td style="width: 10%;"></td> <td style="width: 10%;"></td> <td style="width: 10%;"></td> </tr> <tr> <td></td> <td></td> <td colspan="8" style="text-align: center;"> <table border="1" style="width: 100%; border-collapse: collapse; text-align: center;"> <tr> <td style="width: 10%;"></td> <td style="width: 10%;"></td> <td style="width: 10%;"></td> <td style="width: 10%;"></td> <td style="width: 10%;"></td> <td style="width: 10%;"></td> <td style="width: 10%;"></td> <td style="width: 10%;"></td> <td style="width: 10%;"></td> <td style="width: 10%;"></td> </tr> <tr> <td></td> <td></td> <td colspan="8" style="text-align: center;"> <table border="1" style="width: 100%; border-collapse: collapse; text-align: center;"> <tr> <td style="width: 10%;"></td> <td style="width: 10%;"></td> <td style="width: 10%;"></td> <td style="width: 10%;"></td> <td style="width: 10%;"></td> <td style="width: 10%;"></td> <td style="width: 10%;"></td> <td style="width: 10%;"></td> <td style="width: 10%;"></td> <td style="width: 10%;"></td> </tr> <tr> <td></td> <td></td> <td colspan="8" style="text-align: center;"> <table border="1" style="width: 100%; border-collapse: collapse; text-align: center;"> <tr> <td style="width: 10%;"></td> <td style="width: 10%;"></td> <td style="width: 10%;"></td> <td style="width: 10%;"></td> <td style="width: 10%;"></td> <td style="width: 10%;"></td> <td style="width: 10%;"></td> <td style="width: 10%;"></td> <td style="width: 10%;"></td> <td style="width: 10%;"></td> </tr> <tr> <td></td> <td></td> <td colspan="8" style="text-align: center;"> <table border="1" style="width: 100%; border-collapse: collapse; text-align: center;"> <tr> <td style="width: 10%;"></td> <td style="width: 10%;"></td> <td style="width: 10%;"></td> <td style="width: 10%;"></td> <td style="width: 10%;"></td> <td style="width: 10%;"></td> <td style="width: 10%;"></td> <td style="width: 10%;"></td> <td style="width: 10%;"></td> <td style="width: 10%;"></td> </tr> <tr> <td></td> <td></td> <td colspan="8" style="text-align: center;"> <table border="1" style="width: 100%; border-collapse: collapse; text-align: center;"> <tr> <td style="width: 10%;"></td> <td style="width: 10%;"></td> <td style="width: 10%;"></td> <td style="width: 10%;"></td> <td style="width: 10%;"></td> <td style="width: 10%;"></td> <td style="width: 10%;"></td> <td style="width: 10%;"></td> <td style="width: 10%;"></td> <td style="width: 10%;"></td> </tr> <tr> <td></td> <td></td> <td colspan="8" style="text-align: center;"> <table border="1" style="width: 100%; border-collapse: collapse; text-align: center;"> <tr> <td style="width: 10%;"></td> <td style="width: 10%;"></td> <td style="width: 10%;"></td> <td style="width: 10%;"></td> <td style="width: 10%;"></td> <td style="width: 10%;"></td> <td style="width: 10%;"></td> <td style="width: 10%;"></td> <td style="width: 10%;"></td> <td style="width: 10%;"></td> </tr> <tr> <td></td> <td></td> <td colspan="8" style="text-align: center;"> <table border="1" style="width: 100%; border-collapse: collapse; text-align: center;"> <tr> <td style="width: 10%;"></td> <td style="width: 10%;"></td> <td style="width: 10%;"></td> <td style="width: 10%;"></td> <td style="width: 10%;"></td> <td style="width: 10%;"></td> <td style="width: 10%;"></td> <td style="width: 10%;"></td> <td style="width: 10%;"></td> <td style="width: 10%;"></td> </tr> <tr> <td></td> <td></td> <td colspan="8" style="text-align: center;"> <table border="1" style="width: 100%; border-collapse: collapse; text-align: center;"> <tr> <td style="width: 10%;"></td> <td style="width: 10%;"></td> <td style="width: 10%;"></td> <td style="width: 10%;"></td> <td style="width: 10%;"></td> <td style="width: 10%;"></td> <td style="width: 10%;"></td> <td style="width: 10%;"></td> <td style="width: 10%;"></td> <td style="width: 10%;"></td> </tr> <tr> <td></td> <td></td> <td colspan="8" style="text-align: center;"> <table border="1" style="width: 100%; border-collapse: collapse; text-align: center;"> <tr> <td style="width: 10%;"></td> <td style="width: 10%;"></td> <td style="width: 10%;"></td> <td style="width: 10%;"></td> <td style="width: 10%;"></td> <td style="width: 10%;"></td> <td style="width: 10%;"></td> <td style="width: 10%;"></td> <td style="width: 10%;"></td> <td style="width: 10%;"></td> </tr> <tr> <td></td> <td></td> <td colspan="8" style="text-align: center;"> <table border="1" style="width: 100%; border-collapse: collapse; text-align: center;"> <tr> <td style="width: 10%;"></td> <td style="width: 10%;"></td> <td style="width: 10%;"></td> <td style="width: 10%;"></td> <td style="width: 10%;"></td> <td style="width: 10%;"></td> <td style="width: 10%;"></td> <td style="width: 10%;"></td> <td style="width: 10%;"></td> <td style="width: 10%;"></td> </tr> <tr> <td></td> <td></td> <td colspan="8" style="text-align: center;"> <table border="1" style="width: 100%; border-collapse: collapse; text-align: center;"> <tr> <td style="width: 10%;"></td> <td style="width: 10%;"></td> <td style="width: 10%;"></td> <td style="width: 10%;"></td> <td style="width: 10%;"></td> <td style="width: 10%;"></td> <td style="width: 10%;"></td> <td style="width: 10%;"></td> <td style="width: 10%;"></td> <td style="width: 10%;"></td> </tr> <tr> <td></td> <td></td> <td colspan="8" style="text-align: center;"> <table border="1" style="width: 100%; border-collapse: collapse; text-align: center;"> <tr> <td style="width: 10%;"></td> <td style="width: 10%;"></td> <td style="width: 10%;"></td> <td style="width: 10%;"></td> <td style="width: 10%;"></td> <td style="width: 10%;"></td> <td style="width: 10%;"></td> <td style="width: 10%;"></td> <td style="width: 10%;"></td> <td style="width: 10%;"></td> </tr> <tr> <td></td> <td></td> <td colspan="8" style="text-align: center;"> <table border="1" style="width: 100%; border-collapse: collapse; text-align: center;"> <tr> <td style="width: 10%;"></td> <td style="width: 10%;"></td> <td style="width: 10%;"></td> <td style="width: 10%;"></td> <td style="width: 10%;"></td> <td style="width: 10%;"></td> <td style="width: 10%;"></td> <td style="width: 10%;"></td> <td style="width: 10%;"></td> <td style="width: 10%;"></td> </tr> <tr> <td></td> <td></td> <td colspan="8" style="text-align: center;"> <table border="1" style="width: 100%; border-collapse: collapse; text-align: center;"> <tr> <td style="width: 10%;"></td> <td style="width: 10%;"></td> <td
style="width: 10%;"></td> <td style="width: 10%;"></td> <td style="width: 10%;"></td> <td style="width: 10%;"></td> <td style="width: 10%;"></td> <td style="width: 10%;"></td> <td style="width: 10%;"></td> <td style="width: 10%;"></td> </tr> <tr> <td></td> <td></td> <td colspan="8" style="text-align: center;"> <table border="1" style="width: 100%; border-collapse: collapse; text-align: center;"> <tr> <td style="width: 10%;"></td> <td style="width: 10%;"></td> <td style="width: 10%;"></td> <td style="width: 10%;"></td> <td style="width: 10%;"></td> <td style="width: 10%;"></td> <td style="width: 10%;"></td> <td style="width: 10%;"></td> <td style="width: 10%;"></td> <td style="width: 10%;"></td> </tr> <tr> <td></td> <td></td> <td colspan="8" style="text-align: center;"> <table border="1" style="width: 100%; border-collapse: collapse; text-align: center;"> <tr> <td style="width: 10%;"></td> <td style="width: 10%;"></td> <td style="width: 10%;"></td> <td style="width: 10%;"></td> <td style="width: 10%;"></td> <td style="width: 10%;"></td> <td style="width: 10%;"></td> <td style="width: 10%;"></td> <td style="width: 10%;"></td> <td style="width: 10%;"></td> </tr> <tr> <td></td> <td></td> <td colspan="8" style="text-align: center;"> <table border="1" style="width: 100%; border-collapse: collapse; text-align: center;"> <tr> <td style="width: 10%;"></td> <td style="width: 10%;"></td> <td style="width: 10%;"></td> <td style="width: 10%;"></td> <td style="width: 10%;"></td> <td style="width: 10%;"></td> <td style="width: 10%;"></td> <td style="width: 10%;"></td> <td style="width: 10%;"></td> <td style="width: 10%;"></td> </tr> <tr> <td></td> <td></td> <td colspan="8" style="text-align: center;"> <table border="1" style="width: 100%; border-collapse: collapse; text-align: center;"> <tr> <td style="width: 10%;"></td> <td style="width: 10%;"></td> <td style="width: 10%;"></td> <td style="width: 10%;"></td> <td style="width: 10%;"></td> <td style="width: 10%;"></td> <td style="width: 10%;"></td> <td style="width: 10%;"></td> <td style="width: 10%;"></td> <td style="width: 10%;"></td> </tr> <tr> <td></td> <td></td> <td colspan="8" style="text-align: center;"> <table border="1" style="width: 100%; border-collapse: collapse; text-align: center;"> <tr> <td style="width: 10%;"></td> <td style="width: 10%;"></td> <td style="width: 10%;"></td> <td style="width: 10%;"></td> <td style="width: 10%;"></td> <td style="width: 10%;"></td> <td style="width: 10%;"></td> <td style="width: 10%;"></td> <td style="width: 10%;"></td> <td style="width: 10%;"></td> </tr> <tr> <td></td> <td></td> <td colspan="8" style="text-align: center;"> <table border="1" style="width: 100%; border-collapse: collapse; text-align: center;"> <tr> <td style="width: 10%;"></td> <td style="width: 10%;"></td> <td style="width: 10%;"></td> <td style="width: 10%;"></td> <td style="width: 10%;"></td> <td style="width: 10%;"></td> <td style="width: 10%;"></td> <td style="width: 10%;"></td> <td style="width: 10%;"></td> <td style="width: 10%;"></td> </tr> <tr> <td></td> <td></td> <td colspan="8" style="text-align: center;"> <table border="1" style="width: 100%; border-collapse: collapse; text-align: center;"> <tr> <td style="width: 10%;"></td> <td style="width: 10%;"></td> <td style="width: 10%;"></td> <td style="width: 10%;"></td> <td style="width: 10%;"></td> <td style="width: 10%;"></td> <td style="width: 10%;"></td> <td style="width: 10%;"></td> <td style="width: 10%;"></td> <td style="width: 10%;"></td> </tr> <tr> <td></td> <td></td> <td colspan="8" style="text-align: center;"> <table border="1" style="width: 100%; border-collapse: collapse; text-align: center;"> <tr> <td style="width: 10%;"></td> <td style="width: 10%;"></td> <td style="width: 10%;"></td> <td style="width: 10%;"></td> <td style="width: 10%;"></td> <td style="width: 10%;"></td> <td style="width: 10%;"></td> <td style="width: 10%;"></td> <td style="width: 10%;"></td> <td style="width: 10%;"></td> </tr> <tr> <td></td> <td></td> <td colspan="8" style="text-align: center;"> <table border="1" style="width: 100%; border-collapse: collapse; text-align: center;"> <tr> <td style="width: 10%;"></td> <td style="width: 10%;"></td> <td style="width: 10%;"></td> <td style="width: 10%;"></td> <td style="width: 10%;"></td> <td style="width: 10%;"></td> <td style="width: 10%;"></td> <td style="width: 10%;"></td> <td style="width: 10%;"></td> <td style="width: 10%;"></td> </tr> <tr> <td></td> <td></td> <td colspan="8" style="text-align: center;"> <table border="1" style="width: 100%; border-collapse: collapse; text-align: center;"> <tr> <td style="width: 10%;"></td> <td style="width: 10%;"></td> <td style="width: 10%;"></td> <td style="width: 10%;"></td> <td style="width: 10%;"></td> <td style="width: 10%;"></td> <td style="width: 10%;"></td> <td style="width: 10%;"></td> <td style="width: 10%;"></td> <td style="width: 10%;"></td> </tr> <tr> <td></td> <td></td> <td colspan="8" style="text-align: center;"> <table border="1" style="width: 100%; border-collapse: collapse; text-align: center;"> <tr> <td style="width: 10%;"></td> <td style="width: 10%;"></td> <td style="width: 10%;"></td> <td style="width: 10%;"></td> <td style="width: 10%;"></td> <td style="width: 10%;"></td> <td style="width: 10%;"></td> <td style="width: 10%;"></td> <td style="width: 10%;"></td> <td style="width: 10%;"></td> </tr> <tr> <td></td> <td></td> <td colspan="8" style="text-align: center;"> <table border="1" style="width: 100%; border-collapse: collapse; text-align: center;"> <tr> <td style="width: 10%;"></td> <td style="width: 10%;"></td> <td style="width: 10%;"></td> <td style="width: 10%;"></td> <td style="width: 10%;"></td> <td style="width: 10%;"></td> <td style="width: 10%;"></td> <td style="width: 10%;"></td> <td style="width: 10%;"></td> <td style="width: 10%;"></td> </tr> <tr> <td></td> <td></td> <td colspan="8" style="text-align: center;"> <table border="1" style="width: 100%; border-collapse: collapse; text-align: center;"> <tr> <td style="width: 10%;"></td> <td style="width: 10%;"></td> <td style="width: 10%;"></td> <td style="width: 10%;"></td> <td style="width: 10%;"></td> <td style="width: 10%;"></td> <td style="width: 10%;"></td> <td style="width: 10%;"></td> <td style="width: 10%;"></td> <td style="width: 10%;"></td> </tr> <tr> <td></td> <td></td> <td colspan="8" style="text-align: center;"> <table border="1" style="width: 100%; border-collapse: collapse; text-align: center;"> <tr> <td style="width: 10%;"></td> <td style="width: 10%;"></td> <td style="width: 10%;"></td> <td style="width: 10%;"></td> <td style="width: 10%;"></td> <td style="width: 10%;"></td> <td style="width: 10%;"></td> <td style="width: 10%;"></td> <td style="width: 10%;"></td> <td style="width: 10%;"></td> </tr> <tr> <td></td> <td></td> <td colspan="8" style="text-align: center;"> <table border="1" style="width: 100%; border-collapse: collapse; text-align: center;"> <tr> <td style="width: 10%;"></td> <td style="width: 10%;"></td> <td style="width: 10%;"></td> <td style="width: 10%;"></td> <td style="width: 10%;"></td> <td style="width: 10%;"></td> <td style="width: 10%;"></td> <td style="width: 10%;"></td> <td style="width: 10%;"></td> <td style="width: 10%;"></td> </tr> <tr> <td></td> <td></td> <td colspan="8" style="text-align: center;"> <table border="1" style="width: 100%; border-collapse: collapse; text-align: center;"> <tr> <td style="width: 10%;"></td> <td style="width: 10%;"></td> <td style="width: 10%;"></td> <td style="width: 10%;"></td> <td style="width: 10%;"></td> <td style="width: 10%;"></td> <td style="width: 10%;"></td> <td style="width: 10%;"></td> <td style="width: 10%;"></td> <td style="width: 10%;"></td> </tr> <tr> <td></td> <td></td> <td colspan="8" style="text-align: center;"> <table border="1" style="width: 100%; border-collapse: collapse; text-align: center;"> <tr> <td style="width: 10%;"></td> <td style="width: 10%;"></td> <td style="width: 10%;"></td> <td style="width: 10%;"></td> <td style="width: 10%;"></td> <td style="width: 10%;"></td> <td style="width: 10%;"></td> <td style="width: 10%;"></td> <td style="width: 10%;"></td> <td style="width: 10%;"></td> </tr> <tr> <td></td> <td></td> <td colspan="8" style="text-align: center;"> <table border="1" style="width: 100%; border-collapse: collapse; text-align: center;"> <tr> <td style="width: 10%;"></td> <td style="width: 10%;"></td> <td style="width: 10%;"></td> <td style="width: 10%;"></td> <td style="width: 10%;"></td> <td style="width: 10%;"></td> <td style="width: 10%;"></td> <td style="width: 10%;"></td> <td style="width: 10%;"></td> <td style="width: 10%;"></td> </tr> <tr> <td></td> <td></td> <td colspan="8" style="text-align: center;"> <table border="1" style="width: 100%; border-collapse: collapse; text-align: center;"> <tr> <td style="width: 10%;"></td> <td style="width: 10%;"></td> <td style="width: 10%;"></td> <td style="width: 10%;"></td> <td style="width: 10%;"></td> <td style="width: 10%;"></td> <td style="width: 10%;"></td> <td style="width: 10%;"></td> <td style="width: 10%;"></td> <td style="width: 10%;"></td> </tr> <tr> <td></td> <td></td> <td colspan="8" style="text-align: center;"> <table border="1" style="width: 100%; border-collapse: collapse; text-align: center;"> <tr> <td style="width: 10%;"></td> <td style="width: 10%;"></td> <td style="width: 10%;"></td> <td style="width: 10%;"></td> <td style="width: 10%;"></td> <td style="width: 10%;"></td> <td style="width: 10%;"></td> <td style="width: 10%;"></td> <td style="width: 10%;"></td> <td style="width: 10%;"></td> </tr> <tr> <td></td> <td></td> <td colspan="8" style="text-align: center;"> <table border="1" style="width: 100%; border-collapse: collapse; text-align: center;"> <tr>
</tr></table></td></tr></table></td></tr></table></td></tr></table></td></tr></table></td></tr></table></td></tr></table></td></tr></table></td></tr></table></td></tr></table></td></tr></table></td></tr></table></td></tr></table></td></tr></table></td></tr></table></td></tr></table></td></tr></table></td></tr></table></td></tr></table></td></tr></table></td></tr></table></td></tr></table></td></tr></table></td></tr></table></td></tr></table></td></tr></table></td></tr></table></td></tr></table></td></tr></table></td></tr></table></td></tr></table></td></tr></table></td></tr></table></td></tr></table></td></tr></table></td></tr></table></td></tr></table></td></tr></table></td></tr></table></td></tr></table></td></tr></table></td></tr></table></td></tr></table>
 | | | | | | | | | | | | | | | | | | | | <table border="1" style="width: 100%; border-collapse: collapse; text-align: center;"> <tr> <td style="width: 10%;"></td> <td style="width: 10%;"></td> <td style="width: 10%;"></td> <td style="width: 10%;"></td> <td style="width: 10%;"></td> <td style="width: 10%;"></td> <td style="width: 10%;"></td> <td style="width: 10%;"></td> <td style="width: 10%;"></td> <td style="width: 10%;"></td> </tr> <tr> <td></td> <td></td> <td colspan="8" style="text-align: center;"> <table border="1" style="width: 100%; border-collapse: collapse; text-align: center;"> <tr> <td style="width: 10%;"></td> <td style="width: 10%;"></td> <td style="width: 10%;"></td> <td style="width: 10%;"></td> <td style="width: 10%;"></td> <td style="width: 10%;"></td> <td style="width: 10%;"></td> <td style="width: 10%;"></td> <td style="width: 10%;"></td> <td style="width: 10%;"></td> </tr> <tr> <td></td> <td></td> <td colspan="8" style="text-align: center;"> <table border="1" style="width: 100%; border-collapse: collapse; text-align: center;"> <tr> <td style="width: 10%;"></td> <td style="width: 10%;"></td> <td style="width: 10%;"></td> <td style="width: 10%;"></td> <td style="width: 10%;"></td> <td style="width: 10%;"></td> <td style="width: 10%;"></td> <td style="width: 10%;"></td> <td style="width: 10%;"></td> <td style="width: 10%;"></td> </tr> <tr> <td></td> <td></td> <td colspan="8" style="text-align: center;"> <table border="1" style="width: 100%; border-collapse: collapse; text-align: center;"> <tr> <td style="width: 10%;"></td> <td style="width: 10%;"></td> <td style="width: 10%;"></td> <td style="width: 10%;"></td> <td style="width: 10%;"></td> <td style="width: 10%;"></td> <td style="width: 10%;"></td> <td style="width: 10%;"></td> <td style="width: 10%;"></td> <td style="width: 10%;"></td> </tr> <tr> <td></td> <td></td> <td colspan="8" style="text-align: center;"> <table border="1" style="width: 100%; border-collapse: collapse; text-align: center;"> <tr> <td style="width: 10%;"></td> <td style="width: 10%;"></td> <td style="width: 10%;"></td> <td style="width: 10%;"></td> <td style="width: 10%;"></td> <td style="width: 10%;"></td> <td style="width: 10%;"></td> <td style="width: 10%;"></td> <td style="width: 10%;"></td> <td style="width: 10%;"></td> </tr> <tr> <td></td> <td></td> <td colspan="8" style="text-align: center;"> <table border="1" style="width: 100%; border-collapse: collapse; text-align: center;"> <tr> <td style="width: 10%;"></td> <td style="width: 10%;"></td> <td style="width: 10%;"></td> <td style="width: 10%;"></td> <td style="width: 10%;"></td> <td style="width: 10%;"></td> <td style="width: 10%;"></td> <td style="width: 10%;"></td> <td style="width: 10%;"></td> <td style="width: 10%;"></td> </tr> <tr> <td></td> <td></td> <td colspan="8" style="text-align: center;"> <table border="1" style="width: 100%; border-collapse: collapse; text-align: center;"> <tr> <td style="width: 10%;"></td> <td style="width: 10%;"></td> <td style="width: 10%;"></td> <td style="width: 10%;"></td> <td style="width: 10%;"></td> <td style="width: 10%;"></td> <td style="width: 10%;"></td> <td style="width: 10%;"></td> <td style="width: 10%;"></td> <td style="width: 10%;"></td> </tr> <tr> <td></td> <td></td> <td colspan="8" style="text-align: center;"> <table border="1" style="width: 100%; border-collapse: collapse; text-align: center;"> <tr> <td style="width: 10%;"></td> <td style="width: 10%;"></td> <td style="width: 10%;"></td> <td style="width: 10%;"></td> <td style="width: 10%;"></td> <td style="width: 10%;"></td> <td style="width: 10%;"></td> <td style="width: 10%;"></td> <td style="width: 10%;"></td> <td style="width: 10%;"></td> </tr> <tr> <td></td> <td></td> <td colspan="8" style="text-align: center;"> <table border="1" style="width: 100%; border-collapse: collapse; text-align: center;"> <tr> <td style="width: 10%;"></td> <td style="width: 10%;"></td> <td style="width: 10%;"></td> <td style="width: 10%;"></td> <td style="width: 10%;"></td> <td style="width: 10%;"></td> <td style="width: 10%;"></td> <td style="width: 10%;"></td> <td style="width: 10%;"></td> <td style="width: 10%;"></td> </tr> <tr> <td></td> <td></td> <td colspan="8" style="text-align: center;"> <table border="1" style="width: 100%; border-collapse: collapse; text-align: center;"> <tr> <td style="width: 10%;"></td> <td style="width: 10%;"></td> <td style="width: 10%;"></td> <td style="width: 10%;"></td> <td style="width: 10%;"></td> <td style="width: 10%;"></td> <td style="width: 10%;"></td> <td style="width: 10%;"></td> <td style="width: 10%;"></td> <td style="width: 10%;"></td> </tr> <tr> <td></td> <td></td> <td colspan="8" style="text-align: center;"> <table border="1" style="width: 100%; border-collapse: collapse; text-align: center;"> <tr> <td style="width: 10%;"></td> <td style="width: 10%;"></td> <td style="width: 10%;"></td> <td style="width: 10%;"></td> <td style="width: 10%;"></td> <td style="width: 10%;"></td> <td style="width: 10%;"></td> <td style="width: 10%;"></td> <td style="width: 10%;"></td> <td style="width: 10%;"></td> </tr> <tr> <td></td> <td></td> <td colspan="8" style="text-align: center;"> <table border="1" style="width: 100%; border-collapse: collapse; text-align: center;"> <tr> <td style="width: 10%;"></td> <td style="width: 10%;"></td> <td style="width: 10%;"></td> <td style="width: 10%;"></td> <td style="width: 10%;"></td> <td style="width: 10%;"></td> <td style="width: 10%;"></td> <td style="width: 10%;"></td> <td style="width: 10%;"></td> <td style="width: 10%;"></td> </tr> <tr> <td></td> <td></td> <td colspan="8" style="text-align: center;"> <table border="1" style="width: 100%; border-collapse: collapse; text-align: center;"> <tr> <td style="width: 10%;"></td> <td style="width: 10%;"></td> <td style="width: 10%;"></td> <td style="width: 10%;"></td> <td style="width: 10%;"></td> <td style="width: 10%;"></td> <td style="width: 10%;"></td> <td style="width: 10%;"></td> <td style="width: 10%;"></td> <td style="width: 10%;"></td> </tr> <tr> <td></td> <td></td> <td colspan="8" style="text-align: center;"> <table border="1" style="width: 100%; border-collapse: collapse; text-align: center;"> <tr> <td style="width: 10%;"></td> <td style="width: 10%;"></td> <td style="width: 10%;"></td> <td style="width: 10%;"></td> <td style="width: 10%;"></td> <td style="width: 10%;"></td> <td style="width: 10%;"></td> <td style="width: 10%;"></td> <td style="width: 10%;"></td> <td style="width: 10%;"></td> </tr> <tr> <td></td> <td></td> <td colspan="8" style="text-align: center;"> <table border="1" style="width: 100%; border-collapse: collapse; text-align: center;"> <tr> <td style="width: 10%;"></td> <td style="width: 10%;"></td> <td style="width: 10%;"></td> <td style="width: 10%;"></td> <td style="width: 10%;"></td> <td style="width: 10%;"></td> <td style="width: 10%;"></td> <td style="width: 10%;"></td> <td style="width: 10%;"></td> <td style="width: 10%;"></td> </tr> <tr> <td></td> <td></td> <td colspan="8" style="text-align: center;"> <table border="1" style="width: 100%; border-collapse: collapse; text-align: center;"> <tr> <td style="width: 10%;"></td> <td style="width: 10%;"></td> <td style="width: 10%;"></td> <td style="width: 10%;"></td> <td style="width: 10%;"></td> <td style="width: 10%;"></td> <td style="width: 10%;"></td> <td style="width: 10%;"></td> <td style="width: 10%;"></td> <td style="width: 10%;"></td> </tr> <tr> <td></td> <td></td> <td colspan="8" style="text-align: center;"> <table border="1" style="width: 100%; border-collapse: collapse; text-align: center;"> <tr> <td style="width: 10%;"></td> <td style="width: 10%;"></td> <td style="width: 10%;"></td> <td style="width: 10%;"></td> <td style="width: 10%;"></td> <td style="width: 10%;"></td> <td style="width: 10%;"></td> <td style="width: 10%;"></td> <td style="width: 10%;"></td> <td style="width: 10%;"></td> </tr> <tr> <td></td> <td></td> <td colspan="8" style="text-align: center;"> <table border="1" style="width: 100%; border-collapse: collapse; text-align: center;"> <tr> <td style="width: 10%;"></td> <td style="width: 10%;"></td> <td style="width: 10%;"></td> <td style="width: 10%;"></td> <td style="width: 10%;"></td> <td style="width: 10%;"></td> <td style="width: 10%;"></td> <td style="width: 10%;"></td> <td style="width: 10%;"></td> <td style="width: 10%;"></td> </tr> <tr> <td></td> <td></td> <td colspan="8" style="text-align: center;"> <table border="1" style="width: 100%;
border-collapse: collapse; text-align: center;"> <tr> <td style="width: 10%;"></td> <td style="width: 10%;"></td> <td style="width: 10%;"></td> <td style="width: 10%;"></td> <td style="width: 10%;"></td> <td style="width: 10%;"></td> <td style="width: 10%;"></td> <td style="width: 10%;"></td> <td style="width: 10%;"></td> <td style="width: 10%;"></td> </tr> <tr> <td></td> <td></td> <td colspan="8" style="text-align: center;"> <table border="1" style="width: 100%; border-collapse: collapse; text-align: center;"> <tr> <td style="width: 10%;"></td> <td style="width: 10%;"></td> <td style="width: 10%;"></td> <td style="width: 10%;"></td> <td style="width: 10%;"></td> <td style="width: 10%;"></td> <td style="width: 10%;"></td> <td style="width: 10%;"></td> <td style="width: 10%;"></td> <td style="width: 10%;"></td> </tr> <tr> <td></td> <td></td> <td colspan="8" style="text-align: center;"> <table border="1" style="width: 100%; border-collapse: collapse; text-align: center;"> <tr> <td style="width: 10%;"></td> <td style="width: 10%;"></td> <td style="width: 10%;"></td> <td style="width: 10%;"></td> <td style="width: 10%;"></td> <td style="width: 10%;"></td> <td style="width: 10%;"></td> <td style="width: 10%;"></td> <td style="width: 10%;"></td> <td style="width: 10%;"></td> </tr> <tr> <td></td> <td></td> <td colspan="8" style="text-align: center;"> <table border="1" style="width: 100%; border-collapse: collapse; text-align: center;"> <tr> <td style="width: 10%;"></td> <td style="width: 10%;"></td> <td style="width: 10%;"></td> <td style="width: 10%;"></td> <td style="width: 10%;"></td> <td style="width: 10%;"></td> <td style="width: 10%;"></td> <td style="width: 10%;"></td> <td style="width: 10%;"></td> <td style="width: 10%;"></td> </tr> <tr> <td></td> <td></td> <td colspan="8" style="text-align: center;"> <table border="1" style="width: 100%; border-collapse: collapse; text-align: center;"> <tr> <td style="width: 10%;"></td> <td style="width: 10%;"></td> <td style="width: 10%;"></td> <td style="width: 10%;"></td> <td style="width: 10%;"></td> <td style="width: 10%;"></td> <td style="width: 10%;"></td> <td style="width: 10%;"></td> <td style="width: 10%;"></td> <td style="width: 10%;"></td> </tr> <tr> <td></td> <td></td> <td colspan="8" style="text-align: center;"> <table border="1" style="width: 100%; border-collapse: collapse; text-align: center;"> <tr> <td style="width: 10%;"></td> <td style="width: 10%;"></td> <td style="width: 10%;"></td> <td style="width: 10%;"></td> <td style="width: 10%;"></td> <td style="width: 10%;"></td> <td style="width: 10%;"></td> <td style="width: 10%;"></td> <td style="width: 10%;"></td> <td style="width: 10%;"></td> </tr> <tr> <td></td> <td></td> <td colspan="8" style="text-align: center;"> <table border="1" style="width: 100%; border-collapse: collapse; text-align: center;"> <tr> <td style="width: 10%;"></td> <td style="width: 10%;"></td> <td style="width: 10%;"></td> <td style="width: 10%;"></td> <td style="width: 10%;"></td> <td style="width: 10%;"></td> <td style="width: 10%;"></td> <td style="width: 10%;"></td> <td style="width: 10%;"></td> <td style="width: 10%;"></td> </tr> <tr> <td></td> <td></td> <td colspan="8" style="text-align: center;"> <table border="1" style="width: 100%; border-collapse: collapse; text-align: center;"> <tr> <td style="width: 10%;"></td> <td style="width: 10%;"></td> <td style="width: 10%;"></td> <td style="width: 10%;"></td> <td style="width: 10%;"></td> <td style="width: 10%;"></td> <td style="width: 10%;"></td> <td style="width: 10%;"></td> <td style="width: 10%;"></td> <td style="width: 10%;"></td> </tr> <tr> <td></td> <td></td> <td colspan="8" style="text-align: center;"> <table border="1" style="width: 100%; border-collapse: collapse; text-align: center;"> <tr> <td style="width: 10%;"></td> <td style="width: 10%;"></td> <td style="width: 10%;"></td> <td style="width: 10%;"></td> <td style="width: 10%;"></td> <td style="width: 10%;"></td> <td style="width: 10%;"></td> <td style="width: 10%;"></td> <td style="width: 10%;"></td> <td style="width: 10%;"></td> </tr> <tr> <td></td> <td></td> <td colspan="8" style="text-align: center;"> <table border="1" style="width: 100%; border-collapse: collapse; text-align: center;"> <tr> <td style="width: 10%;"></td> <td style="width: 10%;"></td> <td style="width: 10%;"></td> <td style="width: 10%;"></td> <td style="width: 10%;"></td> <td style="width: 10%;"></td> <td style="width: 10%;"></td> <td style="width: 10%;"></td> <td style="width: 10%;"></td> <td style="width: 10%;"></td> </tr> <tr> <td></td> <td></td> <td colspan="8" style="text-align: center;"> <table border="1" style="width: 100%; border-collapse: collapse; text-align: center;"> <tr> <td style="width: 10%;"></td> <td style="width: 10%;"></td> <td style="width: 10%;"></td> <td style="width: 10%;"></td> <td style="width: 10%;"></td> <td style="width: 10%;"></td> <td style="width: 10%;"></td> <td style="width: 10%;"></td> <td style="width: 10%;"></td> <td style="width: 10%;"></td> </tr> <tr> <td></td> <td></td> <td colspan="8" style="text-align: center;"> <table border="1" style="width: 100%; border-collapse: collapse; text-align: center;"> <tr> <td style="width: 10%;"></td> <td style="width: 10%;"></td> <td style="width: 10%;"></td> <td style="width: 10%;"></td> <td style="width: 10%;"></td> <td style="width: 10%;"></td> <td style="width: 10%;"></td> <td style="width: 10%;"></td> <td style="width: 10%;"></td> <td style="width: 10%;"></td> </tr> <tr> <td></td> <td></td> <td colspan="8" style="text-align: center;"> <table border="1" style="width: 100%; border-collapse: collapse; text-align: center;"> <tr> <td style="width: 10%;"></td> <td style="width: 10%;"></td> <td style="width: 10%;"></td> <td style="width: 10%;"></td> <td style="width: 10%;"></td> <td style="width: 10%;"></td> <td style="width: 10%;"></td> <td style="width: 10%;"></td> <td style="width: 10%;"></td> <td style="width: 10%;"></td> </tr> <tr> <td></td> <td></td> <td colspan="8" style="text-align: center;"> <table border="1" style="width: 100%; border-collapse: collapse; text-align: center;"> <tr> <td style="width: 10%;"></td> <td style="width: 10%;"></td> <td style="width: 10%;"></td> <td style="width: 10%;"></td> <td style="width: 10%;"></td> <td style="width: 10%;"></td> <td style="width: 10%;"></td> <td style="width: 10%;"></td> <td style="width: 10%;"></td> <td style="width: 10%;"></td> </tr> <tr> <td></td> <td></td> <td colspan="8" style="text-align: center;"> <table border="1" style="width: 100%; border-collapse: collapse; text-align: center;"> <tr> <td style="width: 10%;"></td> <td style="width: 10%;"></td> <td style="width: 10%;"></td> <td style="width: 10%;"></td> <td style="width: 10%;"></td> <td style="width: 10%;"></td> <td style="width: 10%;"></td> <td style="width: 10%;"></td> <td style="width: 10%;"></td> <td style="width: 10%;"></td> </tr> <tr> <td></td> <td></td> <td colspan="8" style="text-align: center;"> <table border="1" style="width: 100%; border-collapse: collapse; text-align: center;"> <tr> <td style="width: 10%;"></td> <td style="width: 10%;"></td> <td style="width: 10%;"></td> <td style="width: 10%;"></td> <td style="width: 10%;"></td> <td style="width: 10%;"></td> <td style="width: 10%;"></td> <td style="width: 10%;"></td> <td style="width: 10%;"></td> <td style="width: 10%;"></td> </tr> <tr> <td></td> <td></td> <td colspan="8" style="text-align: center;"> <table border="1" style="width: 100%; border-collapse: collapse; text-align: center;"> <tr> <td style="width: 10%;"></td> <td style="width: 10%;"></td> <td style="width: 10%;"></td> <td style="width: 10%;"></td> <td style="width: 10%;"></td> <td style="width: 10%;"></td> <td style="width: 10%;"></td> <td style="width: 10%;"></td> <td style="width: 10%;"></td> <td style="width: 10%;"></td> </tr> <tr> <td></td> <td></td> <td colspan="8" style="text-align: center;"> <table border="1" style="width: 100%; border-collapse: collapse; text-align: center;"> <tr> <td style="width: 10%;"></td> <td style="width: 10%;"></td> <td style="width: 10%;"></td> <td style="width: 10%;"></td> <td style="width: 10%;"></td> <td style="width: 10%;"></td> <td style="width: 10%;"></td> <td style="width: 10%;"></td> <td style="width: 10%;"></td> <td style="width: 10%;"></td> </tr> <tr> <td></td> <td></td> <td colspan="8" style="text-align: center;"> <table border="1" style="width: 100%; border-collapse: collapse; text-align: center;"> <tr> <td style="width: 10%;"></td> <td style="width: 10%;"></td> <td style="width: 10%;"></td> <td style="width: 10%;"></td> <td style="width: 10%;"></td> <td style="width: 10%;"></td> <td style="width: 10%;"></td> <td style="width: 10%;"></td> <td style="width: 10%;"></td> <td style="width: 10%;"></td> </tr> <tr> <td></td> <td></td> <td colspan="8" style="text-align: center;"> <table border="1" style="width: 100%; border-collapse: collapse; text-align: center;"> <tr> <td style="width: 10%;"></td> <td style="width: 10%;"></td> <td style="width: 10%;"></td> <td style="width: 10%;"></td> <td style="width: 10%;"></td> <td style="width: 10%;"></td> <td style="width: 10%;"></td> <td style="width: 10%;"></td> <td style="width: 10%;"></td> <td style="width: 10%;"></td> </tr> <tr> <td></td> <td></td> <td colspan="8" style="text-align: center;"> <table border="1" style="width: 100%; border-collapse: collapse; text-align: center;"> <tr> <td style="width: 10%;"></td> <td style="width: 10%;"></td> <td style="width: 10%;"></td> <td style="width: 10%;"></td> <td style="width: 10%;"></td> <td style="width: 10%;"></td> <td style="width: 10%;"></td> <td style="width: 10%;"></td> <td style="width: 10%;"></td> <td style="width: 10%;"></td> </tr> <tr> <td></td> <td></td> <td colspan="8" style="text-align: center;"> <table border="1" style="width: 100%; border-collapse: collapse; text-align: center;"> <tr> <td style="width: 10%;"></td> <td style="width: 10%;"></td> <td style="width: 10%;"></td> <td style="width:
10%;"></td> <td style="width: 10%;"></td> <td style="width: 10%;"></td> <td style="width: 10%;"></td> <td style="width: 10%;"></td> <td style="width: 10%;"></td> <td style="width: 10%;"></td> </tr> <tr> <td></td> <td></td> <td colspan="8" style="text-align: center;"> <table border="1" style="width: 100%; border-collapse: collapse; text-align: center;"> <tr> <td style="width: 10%;"></td> <td style="width: 10%;"></td> <td style="width: 10%;"></td> <td style="width: 10%;"></td> <td style="width: 10%;"></td> <td style="width: 10%;"></td> <td style="width: 10%;"></td> <td style="width: 10%;"></td> <td style="width: 10%;"></td> <td style="width: 10%;"></td> </tr> <tr> <td></td> <td></td> <td colspan="8" style="text-align: center;"> <table border="1" style="width: 100%; border-collapse: collapse; text-align: center;"> <tr> </tr></table></td></tr></table></td></tr></table></td></tr></table></td></tr></table></td></tr></table></td></tr></table></td></tr></table></td></tr></table></td></tr></table></td></tr></table></td></tr></table></td></tr></table></td></tr></table></td></tr></table></td></tr></table></td></tr></table></td></tr></table></td></tr></table></td></tr></table></td></tr></table></td></tr></table></td></tr></table></td></tr></table></td></tr></table></td></tr></table></td></tr></table></td></tr></table></td></tr></table></td></tr></table></td></tr></table></td></tr></table></td></tr></table></td></tr></table></td></tr></table></td></tr></table></td></tr></table></td></tr></table></td></tr></table></td></tr></table></td></tr></table></td></tr></table>
 | | | | | | | | | | | | | | | | | | | | <table border="1" style="width: 100%; border-collapse: collapse; text-align: center;"> <tr> <td style="width: 10%;"></td> <td style="width: 10%;"></td> <td style="width: 10%;"></td> <td style="width: 10%;"></td> <td style="width: 10%;"></td> <td style="width: 10%;"></td> <td style="width: 10%;"></td> <td style="width: 10%;"></td> <td style="width: 10%;"></td> <td style="width: 10%;"></td> </tr> <tr> <td></td> <td></td> <td colspan="8" style="text-align: center;"> <table border="1" style="width: 100%; border-collapse: collapse; text-align: center;"> <tr> <td style="width: 10%;"></td> <td style="width: 10%;"></td> <td style="width: 10%;"></td> <td style="width: 10%;"></td> <td style="width: 10%;"></td> <td style="width: 10%;"></td> <td style="width: 10%;"></td> <td style="width: 10%;"></td> <td style="width: 10%;"></td> <td style="width: 10%;"></td> </tr> <tr> <td></td> <td></td> <td colspan="8" style="text-align: center;"> <table border="1" style="width: 100%; border-collapse: collapse; text-align: center;"> <tr> <td style="width: 10%;"></td> <td style="width: 10%;"></td> <td style="width: 10%;"></td> <td style="width: 10%;"></td> <td style="width: 10%;"></td> <td style="width: 10%;"></td> <td style="width: 10%;"></td> <td style="width: 10%;"></td> <td style="width: 10%;"></td> <td style="width: 10%;"></td> </tr> <tr> <td></td> <td></td> <td colspan="8" style="text-align: center;"> <table border="1" style="width: 100%; border-collapse: collapse; text-align: center;"> <tr> <td style="width: 10%;"></td> <td style="width: 10%;"></td> <td style="width: 10%;"></td> <td style="width: 10%;"></td> <td style="width: 10%;"></td> <td style="width: 10%;"></td> <td style="width: 10%;"></td> <td style="width: 10%;"></td> <td style="width: 10%;"></td> <td style="width: 10%;"></td> </tr> <tr> <td></td> <td></td> <td colspan="8" style="text-align: center;"> <table border="1" style="width: 100%; border-collapse: collapse; text-align: center;"> <tr> <td style="width: 10%;"></td> <td style="width: 10%;"></td> <td style="width: 10%;"></td> <td style="width: 10%;"></td> <td style="width: 10%;"></td> <td style="width: 10%;"></td> <td style="width: 10%;"></td> <td style="width: 10%;"></td> <td style="width: 10%;"></td> <td style="width: 10%;"></td> </tr> <tr> <td></td> <td></td> <td colspan="8" style="text-align: center;"> <table border="1" style="width: 100%; border-collapse: collapse; text-align: center;"> <tr> <td style="width: 10%;"></td> <td style="width: 10%;"></td> <td style="width: 10%;"></td> <td style="width: 10%;"></td> <td style="width: 10%;"></td> <td style="width: 10%;"></td> <td style="width: 10%;"></td> <td style="width: 10%;"></td> <td style="width: 10%;"></td> <td style="width: 10%;"></td> </tr> <tr> <td></td> <td></td> <td colspan="8" style="text-align: center;"> <table border="1" style="width: 100%; border-collapse: collapse; text-align: center;"> <tr> <td style="width: 10%;"></td> <td style="width: 10%;"></td> <td style="width: 10%;"></td> <td style="width: 10%;"></td> <td style="width: 10%;"></td> <td style="width: 10%;"></td> <td style="width: 10%;"></td> <td style="width: 10%;"></td> <td style="width: 10%;"></td> <td style="width: 10%;"></td> </tr> <tr> <td></td> <td></td> <td colspan="8" style="text-align: center;"> <table border="1" style="width: 100%; border-collapse: collapse; text-align: center;"> <tr> <td style="width: 10%;"></td> <td style="width: 10%;"></td> <td style="width: 10%;"></td> <td style="width: 10%;"></td> <td style="width: 10%;"></td> <td style="width: 10%;"></td> <td style="width: 10%;"></td> <td style="width: 10%;"></td> <td style="width: 10%;"></td> <td style="width: 10%;"></td> </tr> <tr> <td></td> <td></td> <td colspan="8" style="text-align: center;"> <table border="1" style="width: 100%; border-collapse: collapse; text-align: center;"> <tr> <td style="width: 10%;"></td> <td style="width: 10%;"></td> <td style="width: 10%;"></td> <td style="width: 10%;"></td> <td style="width: 10%;"></td> <td style="width: 10%;"></td> <td style="width: 10%;"></td> <td style="width: 10%;"></td> <td style="width: 10%;"></td> <td style="width: 10%;"></td> </tr> <tr> <td></td> <td></td> <td colspan="8" style="text-align: center;"> <table border="1" style="width: 100%; border-collapse: collapse; text-align: center;"> <tr> <td style="width: 10%;"></td> <td style="width: 10%;"></td> <td style="width: 10%;"></td> <td style="width: 10%;"></td> <td style="width: 10%;"></td> <td style="width: 10%;"></td> <td style="width: 10%;"></td> <td style="width: 10%;"></td> <td style="width: 10%;"></td> <td style="width: 10%;"></td> </tr> <tr> <td></td> <td></td> <td colspan="8" style="text-align: center;"> <table border="1" style="width: 100%; border-collapse: collapse; text-align: center;"> <tr> <td style="width: 10%;"></td> <td style="width: 10%;"></td> <td style="width: 10%;"></td> <td style="width: 10%;"></td> <td style="width: 10%;"></td> <td style="width: 10%;"></td> <td style="width: 10%;"></td> <td style="width: 10%;"></td> <td style="width: 10%;"></td> <td style="width: 10%;"></td> </tr> <tr> <td></td> <td></td> <td colspan="8" style="text-align: center;"> <table border="1" style="width: 100%; border-collapse: collapse; text-align: center;"> <tr> <td style="width: 10%;"></td> <td style="width: 10%;"></td> <td style="width: 10%;"></td> <td style="width: 10%;"></td> <td style="width: 10%;"></td> <td style="width: 10%;"></td> <td style="width: 10%;"></td> <td style="width: 10%;"></td> <td style="width: 10%;"></td> <td style="width: 10%;"></td> </tr> <tr> <td></td> <td></td> <td colspan="8" style="text-align: center;"> <table border="1" style="width: 100%; border-collapse: collapse; text-align: center;"> <tr> <td style="width: 10%;"></td> <td style="width: 10%;"></td> <td style="width: 10%;"></td> <td style="width: 10%;"></td> <td style="width: 10%;"></td> <td style="width: 10%;"></td> <td style="width: 10%;"></td> <td style="width: 10%;"></td> <td style="width: 10%;"></td> <td style="width: 10%;"></td> </tr> <tr> <td></td> <td></td> <td colspan="8" style="text-align: center;"> <table border="1" style="width: 100%; border-collapse: collapse; text-align: center;"> <tr> <td style="width: 10%;"></td> <td style="width: 10%;"></td> <td style="width: 10%;"></td> <td style="width: 10%;"></td> <td style="width: 10%;"></td> <td style="width: 10%;"></td> <td style="width: 10%;"></td> <td style="width: 10%;"></td> <td style="width: 10%;"></td> <td style="width: 10%;"></td> </tr> <tr> <td></td> <td></td> <td colspan="8" style="text-align: center;"> <table border="1" style="width: 100%; border-collapse: collapse; text-align: center;"> <tr> <td style="width: 10%;"></td> <td style="width: 10%;"></td> <td style="width: 10%;"></td> <td style="width: 10%;"></td> <td style="width: 10%;"></td> <td style="width: 10%;"></td> <td style="width: 10%;"></td> <td style="width: 10%;"></td> <td style="width: 10%;"></td> <td style="width: 10%;"></td> </tr> <tr> <td></td> <td></td> <td colspan="8" style="text-align: center;"> <table border="1" style="width: 100%; border-collapse: collapse; text-align: center;"> <tr> <td style="width: 10%;"></td> <td style="width: 10%;"></td> <td style="width: 10%;"></td> <td style="width: 10%;"></td> <td style="width: 10%;"></td> <td style="width: 10%;"></td> <td style="width: 10%;"></td> <td style="width: 10%;"></td> <td style="width: 10%;"></td> <td style="width: 10%;"></td> </tr> <tr> <td></td> <td></td> <td colspan="8" style="text-align: center;"> <table border="1" style="width: 100%; border-collapse: collapse; text-align: center;"> <tr> <td style="width: 10%;"></td> <td style="width: 10%;"></td> <td style="width:
10%;"></td> <td style="width: 10%;"></td> <td style="width: 10%;"></td> <td style="width: 10%;"></td> <td style="width: 10%;"></td> <td style="width: 10%;"></td> <td style="width: 10%;"></td> <td style="width: 10%;"></td> </tr> <tr> <td></td> <td></td> <td colspan="8" style="text-align: center;"> <table border="1" style="width: 100%; border-collapse: collapse; text-align: center;"> <tr> <td style="width: 10%;"></td> <td style="width: 10%;"></td> <td style="width: 10%;"></td> <td style="width: 10%;"></td> <td style="width: 10%;"></td> <td style="width: 10%;"></td> <td style="width: 10%;"></td> <td style="width: 10%;"></td> <td style="width: 10%;"></td> <td style="width: 10%;"></td> </tr> <tr> <td></td> <td></td> <td colspan="8" style="text-align: center;"> <table border="1" style="width: 100%; border-collapse: collapse; text-align: center;"> <tr> <td style="width: 10%;"></td> <td style="width: 10%;"></td> <td style="width: 10%;"></td> <td style="width: 10%;"></td> <td style="width: 10%;"></td> <td style="width: 10%;"></td> <td style="width: 10%;"></td> <td style="width: 10%;"></td> <td style="width: 10%;"></td> <td style="width: 10%;"></td> </tr> <tr> <td></td> <td></td> <td colspan="8" style="text-align: center;"> <table border="1" style="width: 100%; border-collapse: collapse; text-align: center;"> <tr> <td style="width: 10%;"></td> <td style="width: 10%;"></td> <td style="width: 10%;"></td> <td style="width: 10%;"></td> <td style="width: 10%;"></td> <td style="width: 10%;"></td> <td style="width: 10%;"></td> <td style="width: 10%;"></td> <td style="width: 10%;"></td> <td style="width: 10%;"></td> </tr> <tr> <td></td> <td></td> <td colspan="8" style="text-align: center;"> <table border="1" style="width: 100%; border-collapse: collapse; text-align: center;"> <tr> <td style="width: 10%;"></td> <td style="width: 10%;"></td> <td style="width: 10%;"></td> <td style="width: 10%;"></td> <td style="width: 10%;"></td> <td style="width: 10%;"></td> <td style="width: 10%;"></td> <td style="width: 10%;"></td> <td style="width: 10%;"></td> <td style="width: 10%;"></td> </tr> <tr> <td></td> <td></td> <td colspan="8" style="text-align: center;"> <table border="1" style="width: 100%; border-collapse: collapse; text-align: center;"> <tr> <td style="width: 10%;"></td> <td style="width: 10%;"></td> <td style="width: 10%;"></td> <td style="width: 10%;"></td> <td style="width: 10%;"></td> <td style="width: 10%;"></td> <td style="width: 10%;"></td> <td style="width: 10%;"></td> <td style="width: 10%;"></td> <td style="width: 10%;"></td> </tr> <tr> <td></td> <td></td> <td colspan="8" style="text-align: center;"> <table border="1" style="width: 100%; border-collapse: collapse; text-align: center;"> <tr> <td style="width: 10%;"></td> <td style="width: 10%;"></td> <td style="width: 10%;"></td> <td style="width: 10%;"></td> <td style="width: 10%;"></td> <td style="width: 10%;"></td> <td style="width: 10%;"></td> <td style="width: 10%;"></td> <td style="width: 10%;"></td> <td style="width: 10%;"></td> </tr> <tr> <td></td> <td></td> <td colspan="8" style="text-align: center;"> <table border="1" style="width: 100%; border-collapse: collapse; text-align: center;"> <tr> <td style="width: 10%;"></td> <td style="width: 10%;"></td> <td style="width: 10%;"></td> <td style="width: 10%;"></td> <td style="width: 10%;"></td> <td style="width: 10%;"></td> <td style="width: 10%;"></td> <td style="width: 10%;"></td> <td style="width: 10%;"></td> <td style="width: 10%;"></td> </tr> <tr> <td></td> <td></td> <td colspan="8" style="text-align: center;"> <table border="1" style="width: 100%; border-collapse: collapse; text-align: center;"> <tr> <td style="width: 10%;"></td> <td style="width: 10%;"></td> <td style="width: 10%;"></td> <td style="width: 10%;"></td> <td style="width: 10%;"></td> <td style="width: 10%;"></td> <td style="width: 10%;"></td> <td style="width: 10%;"></td> <td style="width: 10%;"></td> <td style="width: 10%;"></td> </tr> <tr> <td></td> <td></td> <td colspan="8" style="text-align: center;"> <table border="1" style="width: 100%; border-collapse: collapse; text-align: center;"> <tr> <td style="width: 10%;"></td> <td style="width: 10%;"></td> <td style="width: 10%;"></td> <td style="width: 10%;"></td> <td style="width: 10%;"></td> <td style="width: 10%;"></td> <td style="width: 10%;"></td> <td style="width: 10%;"></td> <td style="width: 10%;"></td> <td style="width: 10%;"></td> </tr> <tr> <td></td> <td></td> <td colspan="8" style="text-align: center;"> <table border="1" style="width: 100%; border-collapse: collapse; text-align: center;"> <tr> <td style="width: 10%;"></td> <td style="width: 10%;"></td> <td style="width: 10%;"></td> <td style="width: 10%;"></td> <td style="width: 10%;"></td> <td style="width: 10%;"></td> <td style="width: 10%;"></td> <td style="width: 10%;"></td> <td style="width: 10%;"></td> <td style="width: 10%;"></td> </tr> <tr> <td></td> <td></td> <td colspan="8" style="text-align: center;"> <table border="1" style="width: 100%; border-collapse: collapse; text-align: center;"> <tr> <td style="width: 10%;"></td> <td style="width: 10%;"></td> <td style="width: 10%;"></td> <td style="width: 10%;"></td> <td style="width: 10%;"></td> <td style="width: 10%;"></td> <td style="width: 10%;"></td> <td style="width: 10%;"></td> <td style="width: 10%;"></td> <td style="width: 10%;"></td> </tr> <tr> <td></td> <td></td> <td colspan="8" style="text-align: center;"> <table border="1" style="width: 100%; border-collapse: collapse; text-align: center;"> <tr> <td style="width: 10%;"></td> <td style="width: 10%;"></td> <td style="width: 10%;"></td> <td style="width: 10%;"></td> <td style="width: 10%;"></td> <td style="width: 10%;"></td> <td style="width: 10%;"></td> <td style="width: 10%;"></td> <td style="width: 10%;"></td> <td style="width: 10%;"></td> </tr> <tr> <td></td> <td></td> <td colspan="8" style="text-align: center;"> <table border="1" style="width: 100%; border-collapse: collapse; text-align: center;"> <tr> <td style="width: 10%;"></td> <td style="width: 10%;"></td> <td style="width: 10%;"></td> <td style="width: 10%;"></td> <td style="width: 10%;"></td> <td style="width: 10%;"></td> <td style="width: 10%;"></td> <td style="width: 10%;"></td> <td style="width: 10%;"></td> <td style="width: 10%;"></td> </tr> <tr> <td></td> <td></td> <td colspan="8" style="text-align: center;"> <table border="1" style="width: 100%; border-collapse: collapse; text-align: center;"> <tr> <td style="width: 10%;"></td> <td style="width: 10%;"></td> <td style="width: 10%;"></td> <td style="width: 10%;"></td> <td style="width: 10%;"></td> <td style="width: 10%;"></td> <td style="width: 10%;"></td> <td style="width: 10%;"></td> <td style="width: 10%;"></td> <td style="width: 10%;"></td> </tr> <tr> <td></td> <td></td> <td colspan="8" style="text-align: center;"> <table border="1" style="width: 100%; border-collapse: collapse; text-align: center;"> <tr> <td style="width: 10%;"></td> <td style="width: 10%;"></td> <td style="width: 10%;"></td> <td style="width: 10%;"></td> <td style="width: 10%;"></td> <td style="width: 10%;"></td> <td style="width: 10%;"></td> <td style="width: 10%;"></td> <td style="width: 10%;"></td> <td style="width: 10%;"></td> </tr> <tr> <td></td> <td></td> <td colspan="8" style="text-align: center;"> <table border="1" style="width: 100%; border-collapse: collapse; text-align: center;"> <tr> <td style="width: 10%;"></td> <td style="width: 10%;"></td> <td style="width: 10%;"></td> <td style="width: 10%;"></td> <td style="width: 10%;"></td> <td style="width: 10%;"></td> <td style="width: 10%;"></td> <td style="width: 10%;"></td> <td style="width: 10%;"></td> <td style="width: 10%;"></td> </tr> <tr> <td></td> <td></td> <td colspan="8" style="text-align: center;"> <table border="1" style="width: 100%; border-collapse: collapse; text-align: center;"> <tr> <td style="width: 10%;"></td> <td style="width: 10%;"></td> <td style="width: 10%;"></td> <td style="width: 10%;"></td> <td style="width: 10%;"></td> <td style="width: 10%;"></td> <td style="width: 10%;"></td> <td style="width: 10%;"></td> <td style="width: 10%;"></td> <td style="width: 10%;"></td> </tr> <tr> <td></td> <td></td> <td colspan="8" style="text-align: center;"> <table border="1" style="width: 100%; border-collapse: collapse; text-align: center;"> <tr> <td style="width: 10%;"></td> <td style="width: 10%;"></td> <td style="width: 10%;"></td> <td style="width: 10%;"></td> <td style="width: 10%;"></td> <td style="width: 10%;"></td> <td style="width: 10%;"></td> <td style="width: 10%;"></td> <td style="width: 10%;"></td> <td style="width: 10%;"></td> </tr> <tr> <td></td> <td></td> <td colspan="8" style="text-align: center;"> <table border="1" style="width: 100%; border-collapse: collapse; text-align: center;"> <tr> <td style="width: 10%;"></td> <td style="width: 10%;"></td> <td style="width: 10%;"></td> <td style="width: 10%;"></td> <td style="width: 10%;"></td> <td style="width: 10%;"></td> <td style="width: 10%;"></td> <td style="width: 10%;"></td> <td style="width: 10%;"></td> <td style="width: 10%;"></td> </tr> <tr> <td></td> <td></td> <td colspan="8" style="text-align: center;"> <table border="1" style="width: 100%; border-collapse: collapse; text-align: center;"> <tr> <td style="width: 10%;"></td> <td style="width: 10%;"></td> <td style="width: 10%;"></td> <td style="width: 10%;"></td> <td style="width: 10%;"></td> <td style="width: 10%;"></td> <td style="width: 10%;"></td> <td style="width: 10%;"></td> <td style="width: 10%;"></td> <td style="width: 10%;"></td> </tr> <tr> <td></td> <td></td> <td colspan="8" style="text-align: center;"> <table border="1" style="width: 100%; border-collapse: collapse; text-align: center;"> <tr> <td style="width: 10%;"></td> <td style="width: 10%;"></td> <td style="width: 10%;"></td> <td style="width: 10%;"></td> <td style="width: 10%;"></td> <td style="width: 10%;"></td> <td style="width: 10%;"></td> <td style="width: 10%;"></td> <td
style="width: 10%;"></td> <td style="width: 10%;"></td> </tr> <tr> <td></td> <td></td> <td colspan="8" style="text-align: center;"> <table border="1" style="width: 100%; border-collapse: collapse; text-align: center;"> <tr> <td style="width: 10%;"></td> <td style="width: 10%;"></td> <td style="width: 10%;"></td> <td style="width: 10%;"></td> <td style="width: 10%;"></td> <td style="width: 10%;"></td> <td style="width: 10%;"></td> <td style="width: 10%;"></td> <td style="width: 10%;"></td> <td style="width: 10%;"></td> </tr> <tr> <td></td> <td></td> <td colspan="8" style="text-align: center;"> <table border="1" style="width: 100%; border-collapse: collapse; text-align: center;"> <tr> <td style="width: 10%;"></td> <td style="width: 10%;"></td> <td style="width: 10%;"></td> <td style="width: 10%;"></td> <td style="width: 10%;"></td> <td style="width: 10%;"></td> <td style="width: 10%;"></td> <td style="width: 10%;"></td> <td style="width: 10%;"></td> <td style="width: 10%;"></td> </tr> <tr> <td></td> <td></td> <td colspan="8" style="text-align: center;"> <table border="1" style="width: 100%; border-collapse: collapse; text-align: center;"> <tr> </tr></table></td></tr></table></td></tr></table></td></tr></table></td></tr></table></td></tr></table></td></tr></table></td></tr></table></td></tr></table></td></tr></table></td></tr></table></td></tr></table></td></tr></table></td></tr></table></td></tr></table></td></tr></table></td></tr></table></td></tr></table></td></tr></table></td></tr></table></td></tr></table></td></tr></table></td></tr></table></td></tr></table></td></tr></table></td></tr></table></td></tr></table></td></tr></table></td></tr></table></td></tr></table></td></tr></table></td></tr></table></td></tr></table></td></tr></table></td></tr></table></td></tr></table></td></tr></table></td></tr></table></td></tr></table></td></tr></table></td></tr></table>
 | | | | | | | | | | | | | | | | | | | | <table border="1" style="width: 100%; border-collapse: collapse; text-align: center;"> <tr> <td style="width: 10%;"></td> <td style="width: 10%;"></td> <td style="width: 10%;"></td> <td style="width: 10%;"></td> <td style="width: 10%;"></td> <td style="width: 10%;"></td> <td style="width: 10%;"></td> <td style="width: 10%;"></td> <td style="width: 10%;"></td> <td style="width: 10%;"></td> </tr> <tr> <td></td> <td></td> <td colspan="8" style="text-align: center;"> <table border="1" style="width: 100%; border-collapse: collapse; text-align: center;"> <tr> <td style="width: 10%;"></td> <td style="width: 10%;"></td> <td style="width: 10%;"></td> <td style="width: 10%;"></td> <td style="width: 10%;"></td> <td style="width: 10%;"></td> <td style="width: 10%;"></td> <td style="width: 10%;"></td> <td style="width: 10%;"></td> <td style="width: 10%;"></td> </tr> <tr> <td></td> <td></td> <td colspan="8" style="text-align: center;"> <table border="1" style="width: 100%; border-collapse: collapse; text-align: center;"> <tr> <td style="width: 10%;"></td> <td style="width: 10%;"></td> <td style="width: 10%;"></td> <td style="width: 10%;"></td> <td style="width: 10%;"></td> <td style="width: 10%;"></td> <td style="width: 10%;"></td> <td style="width: 10%;"></td> <td style="width: 10%;"></td> <td style="width: 10%;"></td> </tr> <tr> <td></td> <td></td> <td colspan="8" style="text-align: center;"> <table border="1" style="width: 100%; border-collapse: collapse; text-align: center;"> <tr> <td style="width: 10%;"></td> <td style="width: 10%;"></td> <td style="width: 10%;"></td> <td style="width: 10%;"></td> <td style="width: 10%;"></td> <td style="width: 10%;"></td> <td style="width: 10%;"></td> <td style="width: 10%;"></td> <td style="width: 10%;"></td> <td style="width: 10%;"></td> </tr> <tr> <td></td> <td></td> <td colspan="8" style="text-align: center;"> <table border="1" style="width: 100%; border-collapse: collapse; text-align: center;"> <tr> <td style="width: 10%;"></td> <td style="width: 10%;"></td> <td style="width: 10%;"></td> <td style="width: 10%;"></td> <td style="width: 10%;"></td> <td style="width: 10%;"></td> <td style="width: 10%;"></td> <td style="width: 10%;"></td> <td style="width: 10%;"></td> <td style="width: 10%;"></td> </tr> <tr> <td></td> <td></td> <td colspan="8" style="text-align: center;"> <table border="1" style="width: 100%; border-collapse: collapse; text-align: center;"> <tr> <td style="width: 10%;"></td> <td style="width: 10%;"></td> <td style="width: 10%;"></td> <td style="width: 10%;"></td> <td style="width: 10%;"></td> <td style="width: 10%;"></td> <td style="width: 10%;"></td> <td style="width: 10%;"></td> <td style="width: 10%;"></td> <td style="width: 10%;"></td> </tr> <tr> <td></td> <td></td> <td colspan="8" style="text-align: center;"> <table border="1" style="width: 100%; border-collapse: collapse; text-align: center;"> <tr> <td style="width: 10%;"></td> <td style="width: 10%;"></td> <td style="width: 10%;"></td> <td style="width: 10%;"></td> <td style="width: 10%;"></td> <td style="width: 10%;"></td> <td style="width: 10%;"></td> <td style="width: 10%;"></td> <td style="width: 10%;"></td> <td style="width: 10%;"></td> </tr> <tr> <td></td> <td></td> <td colspan="8" style="text-align: center;"> <table border="1" style="width: 100%; border-collapse: collapse; text-align: center;"> <tr> <td style="width: 10%;"></td> <td style="width: 10%;"></td> <td style="width: 10%;"></td> <td style="width: 10%;"></td> <td style="width: 10%;"></td> <td style="width: 10%;"></td> <td style="width: 10%;"></td> <td style="width: 10%;"></td> <td style="width: 10%;"></td> <td style="width: 10%;"></td> </tr> <tr> <td></td> <td></td> <td colspan="8" style="text-align: center;"> <table border="1" style="width: 100%; border-collapse: collapse; text-align: center;"> <tr> <td style="width: 10%;"></td> <td style="width: 10%;"></td> <td style="width: 10%;"></td> <td style="width: 10%;"></td> <td style="width: 10%;"></td> <td style="width: 10%;"></td> <td style="width: 10%;"></td> <td style="width: 10%;"></td> <td style="width: 10%;"></td> <td style="width: 10%;"></td> </tr> <tr> <td></td> <td></td> <td colspan="8" style="text-align: center;"> <table border="1" style="width: 100%; border-collapse: collapse; text-align: center;"> <tr> <td style="width: 10%;"></td> <td style="width: 10%;"></td> <td style="width: 10%;"></td> <td style="width: 10%;"></td> <td style="width: 10%;"></td> <td style="width: 10%;"></td> <td style="width: 10%;"></td> <td style="width: 10%;"></td> <td style="width: 10%;"></td> <td style="width: 10%;"></td> </tr> <tr> <td></td> <td></td> <td colspan="8" style="text-align: center;"> <table border="1" style="width: 100%; border-collapse: collapse; text-align: center;"> <tr> <td style="width: 10%;"></td> <td style="width: 10%;"></td> <td style="width: 10%;"></td> <td style="width: 10%;"></td> <td style="width: 10%;"></td> <td style="width: 10%;"></td> <td style="width: 10%;"></td> <td style="width: 10%;"></td> <td style="width: 10%;"></td> <td style="width: 10%;"></td> </tr> <tr> <td></td> <td></td> <td colspan="8" style="text-align: center;"> <table border="1" style="width: 100%; border-collapse: collapse; text-align: center;"> <tr> <td style="width: 10%;"></td> <td style="width: 10%;"></td> <td style="width: 10%;"></td> <td style="width: 10%;"></td> <td style="width: 10%;"></td> <td style="width: 10%;"></td> <td style="width: 10%;"></td> <td style="width: 10%;"></td> <td style="width: 10%;"></td> <td style="width: 10%;"></td> </tr> <tr> <td></td> <td></td> <td colspan="8" style="text-align: center;"> <table border="1" style="width: 100%; border-collapse: collapse; text-align: center;"> <tr> <td style="width: 10%;"></td> <td style="width: 10%;"></td> <td style="width: 10%;"></td> <td style="width: 10%;"></td> <td style="width: 10%;"></td> <td style="width: 10%;"></td> <td style="width: 10%;"></td> <td style="width: 10%;"></td> <td style="width: 10%;"></td> <td style="width: 10%;"></td> </tr> <tr> <td></td> <td></td> <td colspan="8" style="text-align: center;"> <table border="1" style="width: 100%; border-collapse: collapse; text-align: center;"> <tr> <td style="width: 10%;"></td> <td style="width: 10%;"></td> <td style="width: 10%;"></td> <td style="width: 10%;"></td> <td style="width: 10%;"></td> <td style="width: 10%;"></td> <td style="width: 10%;"></td> <td style="width: 10%;"></td> <td style="width: 10%;"></td> <td style="width: 10%;"></td> </tr> <tr> <td></td> <td></td> <td colspan="8" style="text-align: center;"> <table border="1" style="width: 100%; border-collapse: collapse; text-align: center;"> <tr> <td style="width: 10%;"></td> <td style="width: 10%;"></td> <td style="width: 10%;"></td> <td style="width: 10%;"></td> <td style="width: 10%;"></td> <td style="width: 10%;"></td> <td style="width: 10%;"></td> <td style="width: 10%;"></td> <td style="width: 10%;"></td> <td style="width: 10%;"></td> </tr> <tr> <td></td> <td></td> <td colspan="8" style="text-align: center;"> <table border="1" style="width: 100%; border-collapse: collapse; text-align: center;"> <tr> <td style="width: 10%;"></td> <td style="width: 10%;"></td> <td style="width: 10%;"></td> <td style="width: 10%;"></td> <td style="width: 10%;"></td> <td style="width: 10%;"></td> <td style="width: 10%;"></td> <td style="width: 10%;"></td>
<td style="width: 10%;"></td> <td style="width: 10%;"></td> </tr> <tr> <td></td> <td></td> <td colspan="8" style="text-align: center;"> <table border="1" style="width: 100%; border-collapse: collapse; text-align: center;"> <tr> <td style="width: 10%;"></td> <td style="width: 10%;"></td> <td style="width: 10%;"></td> <td style="width: 10%;"></td> <td style="width: 10%;"></td> <td style="width: 10%;"></td> <td style="width: 10%;"></td> <td style="width: 10%;"></td> <td style="width: 10%;"></td> <td style="width: 10%;"></td> </tr> <tr> <td></td> <td></td> <td colspan="8" style="text-align: center;"> <table border="1" style="width: 100%; border-collapse: collapse; text-align: center;"> <tr> <td style="width: 10%;"></td> <td style="width: 10%;"></td> <td style="width: 10%;"></td> <td style="width: 10%;"></td> <td style="width: 10%;"></td> <td style="width: 10%;"></td> <td style="width: 10%;"></td> <td style="width: 10%;"></td> <td style="width: 10%;"></td> <td style="width: 10%;"></td> </tr> <tr> <td></td> <td></td> <td colspan="8" style="text-align: center;"> <table border="1" style="width: 100%; border-collapse: collapse; text-align: center;"> <tr> <td style="width: 10%;"></td> <td style="width: 10%;"></td> <td style="width: 10%;"></td> <td style="width: 10%;"></td> <td style="width: 10%;"></td> <td style="width: 10%;"></td> <td style="width: 10%;"></td> <td style="width: 10%;"></td> <td style="width: 10%;"></td> <td style="width: 10%;"></td> </tr> <tr> <td></td> <td></td> <td colspan="8" style="text-align: center;"> <table border="1" style="width: 100%; border-collapse: collapse; text-align: center;"> <tr> <td style="width: 10%;"></td> <td style="width: 10%;"></td> <td style="width: 10%;"></td> <td style="width: 10%;"></td> <td style="width: 10%;"></td> <td style="width: 10%;"></td> <td style="width: 10%;"></td> <td style="width: 10%;"></td> <td style="width: 10%;"></td> <td style="width: 10%;"></td> </tr> <tr> <td></td> <td></td> <td colspan="8" style="text-align: center;"> <table border="1" style="width: 100%; border-collapse: collapse; text-align: center;"> <tr> <td style="width: 10%;"></td> <td style="width: 10%;"></td> <td style="width: 10%;"></td> <td style="width: 10%;"></td> <td style="width: 10%;"></td> <td style="width: 10%;"></td> <td style="width: 10%;"></td> <td style="width: 10%;"></td> <td style="width: 10%;"></td> <td style="width: 10%;"></td> </tr> <tr> <td></td> <td></td> <td colspan="8" style="text-align: center;"> <table border="1" style="width: 100%; border-collapse: collapse; text-align: center;"> <tr> <td style="width: 10%;"></td> <td style="width: 10%;"></td> <td style="width: 10%;"></td> <td style="width: 10%;"></td> <td style="width: 10%;"></td> <td style="width: 10%;"></td> <td style="width: 10%;"></td> <td style="width: 10%;"></td> <td style="width: 10%;"></td> <td style="width: 10%;"></td> </tr> <tr> <td></td> <td></td> <td colspan="8" style="text-align: center;"> <table border="1" style="width: 100%; border-collapse: collapse; text-align: center;"> <tr> <td style="width: 10%;"></td> <td style="width: 10%;"></td> <td style="width: 10%;"></td> <td style="width: 10%;"></td> <td style="width: 10%;"></td> <td style="width: 10%;"></td> <td style="width: 10%;"></td> <td style="width: 10%;"></td> <td style="width: 10%;"></td> <td style="width: 10%;"></td> </tr> <tr> <td></td> <td></td> <td colspan="8" style="text-align: center;"> <table border="1" style="width: 100%; border-collapse: collapse; text-align: center;"> <tr> <td style="width: 10%;"></td> <td style="width: 10%;"></td> <td style="width: 10%;"></td> <td style="width: 10%;"></td> <td style="width: 10%;"></td> <td style="width: 10%;"></td> <td style="width: 10%;"></td> <td style="width: 10%;"></td> <td style="width: 10%;"></td> <td style="width: 10%;"></td> </tr> <tr> <td></td> <td></td> <td colspan="8" style="text-align: center;"> <table border="1" style="width: 100%; border-collapse: collapse; text-align: center;"> <tr> <td style="width: 10%;"></td> <td style="width: 10%;"></td> <td style="width: 10%;"></td> <td style="width: 10%;"></td> <td style="width: 10%;"></td> <td style="width: 10%;"></td> <td style="width: 10%;"></td> <td style="width: 10%;"></td> <td style="width: 10%;"></td> <td style="width: 10%;"></td> </tr> <tr> <td></td> <td></td> <td colspan="8" style="text-align: center;"> <table border="1" style="width: 100%; border-collapse: collapse; text-align: center;"> <tr> <td style="width: 10%;"></td> <td style="width: 10%;"></td> <td style="width: 10%;"></td> <td style="width: 10%;"></td> <td style="width: 10%;"></td> <td style="width: 10%;"></td> <td style="width: 10%;"></td> <td style="width: 10%;"></td> <td style="width: 10%;"></td> <td style="width: 10%;"></td> </tr> <tr> <td></td> <td></td> <td colspan="8" style="text-align: center;"> <table border="1" style="width: 100%; border-collapse: collapse; text-align: center;"> <tr> <td style="width: 10%;"></td> <td style="width: 10%;"></td> <td style="width: 10%;"></td> <td style="width: 10%;"></td> <td style="width: 10%;"></td> <td style="width: 10%;"></td> <td style="width: 10%;"></td> <td style="width: 10%;"></td> <td style="width: 10%;"></td> <td style="width: 10%;"></td> </tr> <tr> <td></td> <td></td> <td colspan="8" style="text-align: center;"> <table border="1" style="width: 100%; border-collapse: collapse; text-align: center;"> <tr> <td style="width: 10%;"></td> <td style="width: 10%;"></td> <td style="width: 10%;"></td> <td style="width: 10%;"></td> <td style="width: 10%;"></td> <td style="width: 10%;"></td> <td style="width: 10%;"></td> <td style="width: 10%;"></td> <td style="width: 10%;"></td> <td style="width: 10%;"></td> </tr> <tr> <td></td> <td></td> <td colspan="8" style="text-align: center;"> <table border="1" style="width: 100%; border-collapse: collapse; text-align: center;"> <tr> <td style="width: 10%;"></td> <td style="width: 10%;"></td> <td style="width: 10%;"></td> <td style="width: 10%;"></td> <td style="width: 10%;"></td> <td style="width: 10%;"></td> <td style="width: 10%;"></td> <td style="width: 10%;"></td> <td style="width: 10%;"></td> <td style="width: 10%;"></td> </tr> <tr> <td></td> <td></td> <td colspan="8" style="text-align: center;"> <table border="1" style="width: 100%; border-collapse: collapse; text-align: center;"> <tr> <td style="width: 10%;"></td> <td style="width: 10%;"></td> <td style="width: 10%;"></td> <td style="width: 10%;"></td> <td style="width: 10%;"></td> <td style="width: 10%;"></td> <td style="width: 10%;"></td> <td style="width: 10%;"></td> <td style="width: 10%;"></td> <td style="width: 10%;"></td> </tr> <tr> <td></td> <td></td> <td colspan="8" style="text-align: center;"> <table border="1" style="width: 100%; border-collapse: collapse; text-align: center;"> <tr> <td style="width: 10%;"></td> <td style="width: 10%;"></td> <td style="width: 10%;"></td> <td style="width: 10%;"></td> <td style="width: 10%;"></td> <td style="width: 10%;"></td> <td style="width: 10%;"></td> <td style="width: 10%;"></td> <td style="width: 10%;"></td> <td style="width: 10%;"></td> </tr> <tr> <td></td> <td></td> <td colspan="8" style="text-align: center;"> <table border="1" style="width: 100%; border-collapse: collapse; text-align: center;"> <tr> <td style="width: 10%;"></td> <td style="width: 10%;"></td> <td style="width: 10%;"></td> <td style="width: 10%;"></td> <td style="width: 10%;"></td> <td style="width: 10%;"></td> <td style="width: 10%;"></td> <td style="width: 10%;"></td> <td style="width: 10%;"></td> <td style="width: 10%;"></td> </tr> <tr> <td></td> <td></td> <td colspan="8" style="text-align: center;"> <table border="1" style="width: 100%; border-collapse: collapse; text-align: center;"> <tr> <td style="width: 10%;"></td> <td style="width: 10%;"></td> <td style="width: 10%;"></td> <td style="width: 10%;"></td> <td style="width: 10%;"></td> <td style="width: 10%;"></td> <td style="width: 10%;"></td> <td style="width: 10%;"></td> <td style="width: 10%;"></td> <td style="width: 10%;"></td> </tr> <tr> <td></td> <td></td> <td colspan="8" style="text-align: center;"> <table border="1" style="width: 100%; border-collapse: collapse; text-align: center;"> <tr> <td style="width: 10%;"></td> <td style="width: 10%;"></td> <td style="width: 10%;"></td> <td style="width: 10%;"></td> <td style="width: 10%;"></td> <td style="width: 10%;"></td> <td style="width: 10%;"></td> <td style="width: 10%;"></td> <td style="width: 10%;"></td> <td style="width: 10%;"></td> </tr> <tr> <td></td> <td></td> <td colspan="8" style="text-align: center;"> <table border="1" style="width: 100%; border-collapse: collapse; text-align: center;"> <tr> <td style="width: 10%;"></td> <td style="width: 10%;"></td> <td style="width: 10%;"></td> <td style="width: 10%;"></td> <td style="width: 10%;"></td> <td style="width: 10%;"></td> <td style="width: 10%;"></td> <td style="width: 10%;"></td> <td style="width: 10%;"></td> <td style="width: 10%;"></td> </tr> <tr> <td></td> <td></td> <td colspan="8" style="text-align: center;"> <table border="1" style="width: 100%; border-collapse: collapse; text-align: center;"> <tr> <td style="width: 10%;"></td> <td style="width: 10%;"></td> <td style="width: 10%;"></td> <td style="width: 10%;"></td> <td style="width: 10%;"></td> <td style="width: 10%;"></td> <td style="width: 10%;"></td> <td style="width: 10%;"></td> <td style="width: 10%;"></td> <td style="width: 10%;"></td> </tr> <tr> <td></td> <td></td> <td colspan="8" style="text-align: center;"> <table border="1" style="width: 100%; border-collapse: collapse; text-align: center;"> <tr> <td style="width: 10%;"></td> <td style="width: 10%;"></td> <td style="width: 10%;"></td> <td style="width: 10%;"></td> <td style="width: 10%;"></td> <td style="width: 10%;"></td> <td style="width: 10%;"></td> <td style="width: 10%;"></td> <td style="width: 10%;"></td> <td style="width: 10%;"></td> </tr> <tr> <td></td> <td></td> <td colspan="8" style="text-align: center;"> <table border="1" style="width:
100%; border-collapse: collapse; text-align: center;"> <tr> <td style="width: 10%;"></td> <td style="width: 10%;"></td> <td style="width: 10%;"></td> <td style="width: 10%;"></td> <td style="width: 10%;"></td> <td style="width: 10%;"></td> <td style="width: 10%;"></td> <td style="width: 10%;"></td> <td style="width: 10%;"></td> <td style="width: 10%;"></td> </tr> <tr> <td></td> <td></td> <td colspan="8" style="text-align: center;"> <table border="1" style="width: 100%; border-collapse: collapse; text-align: center;"> <tr> <td style="width: 10%;"></td> <td style="width: 10%;"></td> <td style="width: 10%;"></td> <td style="width: 10%;"></td> <td style="width: 10%;"></td> <td style="width: 10%;"></td> <td style="width: 10%;"></td> <td style="width: 10%;"></td> <td style="width: 10%;"></td> <td style="width: 10%;"></td> </tr> <tr> <td></td> <td></td> <td colspan="8" style="text-align: center;"> <table border="1" style="width: 100%; border-collapse: collapse; text-align: center;"> <tr> </tr></table></td></tr></table></td></tr></table></td></tr></table></td></tr></table></td></tr></table></td></tr></table></td></tr></table></td></tr></table></td></tr></table></td></tr></table></td></tr></table></td></tr></table></td></tr></table></td></tr></table></td></tr></table></td></tr></table></td></tr></table></td></tr></table></td></tr></table></td></tr></table></td></tr></table></td></tr></table></td></tr></table></td></tr></table></td></tr></table></td></tr></table></td></tr></table></td></tr></table></td></tr></table></td></tr></table></td></tr></table></td></tr></table></td></tr></table></td></tr></table></td></tr></table></td></tr></table></td></tr></table></td></tr></table></td></tr></table>
 | | | | | | | | | | | | | | | | | | | | <table border="1" style="width: 100%; border-collapse: collapse; text-align: center;"> <tr> <td style="width: 10%;"></td> <td style="width: 10%;"></td> <td style="width: 10%;"></td> <td style="width: 10%;"></td> <td style="width: 10%;"></td> <td style="width: 10%;"></td> <td style="width: 10%;"></td> <td style="width: 10%;"></td> <td style="width: 10%;"></td> <td style="width: 10%;"></td> </tr> <tr> <td></td> <td></td> <td colspan="8" style="text-align: center;"> <table border="1" style="width: 100%; border-collapse: collapse; text-align: center;"> <tr> <td style="width: 10%;"></td> <td style="width: 10%;"></td> <td style="width: 10%;"></td> <td style="width: 10%;"></td> <td style="width: 10%;"></td> <td style="width: 10%;"></td> <td style="width: 10%;"></td> <td style="width: 10%;"></td> <td style="width: 10%;"></td> <td style="width: 10%;"></td> </tr> <tr> <td></td> <td></td> <td colspan="8" style="text-align: center;"> <table border="1" style="width: 100%; border-collapse: collapse; text-align: center;"> <tr> <td style="width: 10%;"></td> <td style="width: 10%;"></td> <td style="width: 10%;"></td> <td style="width: 10%;"></td> <td style="width: 10%;"></td> <td style="width: 10%;"></td> <td style="width: 10%;"></td> <td style="width: 10%;"></td> <td style="width: 10%;"></td> <td style="width: 10%;"></td> </tr> <tr> <td></td> <td></td> <td colspan="8" style="text-align: center;"> <table border="1" style="width: 100%; border-collapse: collapse; text-align: center;"> <tr> <td style="width: 10%;"></td> <td style="width: 10%;"></td> <td style="width: 10%;"></td> <td style="width: 10%;"></td> <td style="width: 10%;"></td> <td style="width: 10%;"></td> <td style="width: 10%;"></td> <td style="width: 10%;"></td> <td style="width: 10%;"></td> <td style="width: 10%;"></td> </tr> <tr> <td></td> <td></td> <td colspan="8" style="text-align: center;"> <table border="1" style="width: 100%; border-collapse: collapse; text-align: center;"> <tr> <td style="width: 10%;"></td> <td style="width: 10%;"></td> <td style="width: 10%;"></td> <td style="width: 10%;"></td> <td style="width: 10%;"></td> <td style="width: 10%;"></td> <td style="width: 10%;"></td> <td style="width: 10%;"></td> <td style="width: 10%;"></td> <td style="width: 10%;"></td> </tr> <tr> <td></td> <td></td> <td colspan="8" style="text-align: center;"> <table border="1" style="width: 100%; border-collapse: collapse; text-align: center;"> <tr> <td style="width: 10%;"></td> <td style="width: 10%;"></td> <td style="width: 10%;"></td> <td style="width: 10%;"></td> <td style="width: 10%;"></td> <td style="width: 10%;"></td> <td style="width: 10%;"></td> <td style="width: 10%;"></td> <td style="width: 10%;"></td> <td style="width: 10%;"></td> </tr> <tr> <td></td> <td></td> <td colspan="8" style="text-align: center;"> <table border="1" style="width: 100%; border-collapse: collapse; text-align: center;"> <tr> <td style="width: 10%;"></td> <td style="width: 10%;"></td> <td style="width: 10%;"></td> <td style="width: 10%;"></td> <td style="width: 10%;"></td> <td style="width: 10%;"></td> <td style="width: 10%;"></td> <td style="width: 10%;"></td> <td style="width: 10%;"></td> <td style="width: 10%;"></td> </tr> <tr> <td></td> <td></td> <td colspan="8" style="text-align: center;"> <table border="1" style="width: 100%; border-collapse: collapse; text-align: center;"> <tr> <td style="width: 10%;"></td> <td style="width: 10%;"></td> <td style="width: 10%;"></td> <td style="width: 10%;"></td> <td style="width: 10%;"></td> <td style="width: 10%;"></td> <td style="width: 10%;"></td> <td style="width: 10%;"></td> <td style="width: 10%;"></td> <td style="width: 10%;"></td> </tr> <tr> <td></td> <td></td> <td colspan="8" style="text-align: center;"> <table border="1" style="width: 100%; border-collapse: collapse; text-align: center;"> <tr> <td style="width: 10%;"></td> <td style="width: 10%;"></td> <td style="width: 10%;"></td> <td style="width: 10%;"></td> <td style="width: 10%;"></td> <td style="width: 10%;"></td> <td style="width: 10%;"></td> <td style="width: 10%;"></td> <td style="width: 10%;"></td> <td style="width: 10%;"></td> </tr> <tr> <td></td> <td></td> <td colspan="8" style="text-align: center;"> <table border="1" style="width: 100%; border-collapse: collapse; text-align: center;"> <tr> <td style="width: 10%;"></td> <td style="width: 10%;"></td> <td style="width: 10%;"></td> <td style="width: 10%;"></td> <td style="width: 10%;"></td> <td style="width: 10%;"></td> <td style="width: 10%;"></td> <td style="width: 10%;"></td> <td style="width: 10%;"></td> <td style="width: 10%;"></td> </tr> <tr> <td></td> <td></td> <td colspan="8" style="text-align: center;"> <table border="1" style="width: 100%; border-collapse: collapse; text-align: center;"> <tr> <td style="width: 10%;"></td> <td style="width: 10%;"></td> <td style="width: 10%;"></td> <td style="width: 10%;"></td> <td style="width: 10%;"></td> <td style="width: 10%;"></td> <td style="width: 10%;"></td> <td style="width: 10%;"></td> <td style="width: 10%;"></td> <td style="width: 10%;"></td> </tr> <tr> <td></td> <td></td> <td colspan="8" style="text-align: center;"> <table border="1" style="width: 100%; border-collapse: collapse; text-align: center;"> <tr> <td style="width: 10%;"></td> <td style="width: 10%;"></td> <td style="width: 10%;"></td> <td style="width: 10%;"></td> <td style="width: 10%;"></td> <td style="width: 10%;"></td> <td style="width: 10%;"></td> <td style="width: 10%;"></td> <td style="width: 10%;"></td> <td style="width: 10%;"></td> </tr> <tr> <td></td> <td></td> <td colspan="8" style="text-align: center;"> <table border="1" style="width: 100%; border-collapse: collapse; text-align: center;"> <tr> <td style="width: 10%;"></td> <td style="width: 10%;"></td> <td style="width: 10%;"></td> <td style="width: 10%;"></td> <td style="width: 10%;"></td> <td style="width: 10%;"></td> <td style="width: 10%;"></td> <td style="width: 10%;"></td> <td style="width: 10%;"></td> <td style="width: 10%;"></td> </tr> <tr> <td></td> <td></td> <td colspan="8" style="text-align: center;"> <table border="1" style="width: 100%; border-collapse: collapse; text-align: center;"> <tr> <td style="width: 10%;"></td> <td style="width: 10%;"></td> <td style="width: 10%;"></td> <td style="width: 10%;"></td> <td style="width: 10%;"></td> <td style="width: 10%;"></td> <td style="width: 10%;"></td> <td style="width: 10%;"></td> <td style="width: 10%;"></td> <td style="width: 10%;"></td> </tr> <tr> <td></td> <td></td> <td colspan="8" style="text-align: center;"> <table border="1" style="width: 100%; border-collapse: collapse; text-align: center;"> <tr> <td style="width: 10%;"></td> <td style="width: 10%;"></td> <td style="width: 10%;"></td> <td style="width: 10%;"></td> <td style="width: 10%;"></td> <td style="width: 10%;"></td> <td style="width: 10%;"></td> <td style="width: 10%;"></td> <td style="width: 10%;"></td> <td style="width: 10%;"></td> </tr> <tr> <td></td> <td></td> <td colspan="8" style="text-align: center;"> <table border="1" style="width: 100%; border-collapse: collapse; text-align: center;"> <tr> <td style="width: 10%;"></td> <td style="width: 10%;"></td> <td style="width: 10%;"></td> <td style="width: 10%;"></td> <td style="width: 10%;"></td> <td style="width: 10%;"></td> <td style="width: 10%;"></td> <td style="width: 10%;"></td> <td style="width: 10%;"></td> <td style="width: 10%;"></td> </tr> <tr> <td></td> <td></td> <td colspan="8" style="text-align: center;"> <table border="1" style="width: 100%;
border-collapse: collapse; text-align: center;"> <tr> <td style="width: 10%;"></td> <td style="width: 10%;"></td> <td style="width: 10%;"></td> <td style="width: 10%;"></td> <td style="width: 10%;"></td> <td style="width: 10%;"></td> <td style="width: 10%;"></td> <td style="width: 10%;"></td> <td style="width: 10%;"></td> <td style="width: 10%;"></td> </tr> <tr> <td></td> <td></td> <td colspan="8" style="text-align: center;"> <table border="1" style="width: 100%; border-collapse: collapse; text-align: center;"> <tr> <td style="width: 10%;"></td> <td style="width: 10%;"></td> <td style="width: 10%;"></td> <td style="width: 10%;"></td> <td style="width: 10%;"></td> <td style="width: 10%;"></td> <td style="width: 10%;"></td> <td style="width: 10%;"></td> <td style="width: 10%;"></td> <td style="width: 10%;"></td> </tr> <tr> <td></td> <td></td> <td colspan="8" style="text-align: center;"> <table border="1" style="width: 100%; border-collapse: collapse; text-align: center;"> <tr> <td style="width: 10%;"></td> <td style="width: 10%;"></td> <td style="width: 10%;"></td> <td style="width: 10%;"></td> <td style="width: 10%;"></td> <td style="width: 10%;"></td> <td style="width: 10%;"></td> <td style="width: 10%;"></td> <td style="width: 10%;"></td> <td style="width: 10%;"></td> </tr> <tr> <td></td> <td></td> <td colspan="8" style="text-align: center;"> <table border="1" style="width: 100%; border-collapse: collapse; text-align: center;"> <tr> <td style="width: 10%;"></td> <td style="width: 10%;"></td> <td style="width: 10%;"></td> <td style="width: 10%;"></td> <td style="width: 10%;"></td> <td style="width: 10%;"></td> <td style="width: 10%;"></td> <td style="width: 10%;"></td> <td style="width: 10%;"></td> <td style="width: 10%;"></td> </tr> <tr> <td></td> <td></td> <td colspan="8" style="text-align: center;"> <table border="1" style="width: 100%; border-collapse: collapse; text-align: center;"> <tr> <td style="width: 10%;"></td> <td style="width: 10%;"></td> <td style="width: 10%;"></td> <td style="width: 10%;"></td> <td style="width: 10%;"></td> <td style="width: 10%;"></td> <td style="width: 10%;"></td> <td style="width: 10%;"></td> <td style="width: 10%;"></td> <td style="width: 10%;"></td> </tr> <tr> <td></td> <td></td> <td colspan="8" style="text-align: center;"> <table border="1" style="width: 100%; border-collapse: collapse; text-align: center;"> <tr> <td style="width: 10%;"></td> <td style="width: 10%;"></td> <td style="width: 10%;"></td> <td style="width: 10%;"></td> <td style="width: 10%;"></td> <td style="width: 10%;"></td> <td style="width: 10%;"></td> <td style="width: 10%;"></td> <td style="width: 10%;"></td> <td style="width: 10%;"></td> </tr> <tr> <td></td> <td></td> <td colspan="8" style="text-align: center;"> <table border="1" style="width: 100%; border-collapse: collapse; text-align: center;"> <tr> <td style="width: 10%;"></td> <td style="width: 10%;"></td> <td style="width: 10%;"></td> <td style="width: 10%;"></td> <td style="width: 10%;"></td> <td style="width: 10%;"></td> <td style="width: 10%;"></td> <td style="width: 10%;"></td> <td style="width: 10%;"></td> <td style="width: 10%;"></td> </tr> <tr> <td></td> <td></td> <td colspan="8" style="text-align: center;"> <table border="1" style="width: 100%; border-collapse: collapse; text-align: center;"> <tr> <td style="width: 10%;"></td> <td style="width: 10%;"></td> <td style="width: 10%;"></td> <td style="width: 10%;"></td> <td style="width: 10%;"></td> <td style="width: 10%;"></td> <td style="width: 10%;"></td> <td style="width: 10%;"></td> <td style="width: 10%;"></td> <td style="width: 10%;"></td> </tr> <tr> <td></td> <td></td> <td colspan="8" style="text-align: center;"> <table border="1" style="width: 100%; border-collapse: collapse; text-align: center;"> <tr> <td style="width: 10%;"></td> <td style="width: 10%;"></td> <td style="width: 10%;"></td> <td style="width: 10%;"></td> <td style="width: 10%;"></td> <td style="width: 10%;"></td> <td style="width: 10%;"></td> <td style="width: 10%;"></td> <td style="width: 10%;"></td> <td style="width: 10%;"></td> </tr> <tr> <td></td> <td></td> <td colspan="8" style="text-align: center;"> <table border="1" style="width: 100%; border-collapse: collapse; text-align: center;"> <tr> <td style="width: 10%;"></td> <td style="width: 10%;"></td> <td style="width: 10%;"></td> <td style="width: 10%;"></td> <td style="width: 10%;"></td> <td style="width: 10%;"></td> <td style="width: 10%;"></td> <td style="width: 10%;"></td> <td style="width: 10%;"></td> <td style="width: 10%;"></td> </tr> <tr> <td></td> <td></td> <td colspan="8" style="text-align: center;"> <table border="1" style="width: 100%; border-collapse: collapse; text-align: center;"> <tr> <td style="width: 10%;"></td> <td style="width: 10%;"></td> <td style="width: 10%;"></td> <td style="width: 10%;"></td> <td style="width: 10%;"></td> <td style="width: 10%;"></td> <td style="width: 10%;"></td> <td style="width: 10%;"></td> <td style="width: 10%;"></td> <td style="width: 10%;"></td> </tr> <tr> <td></td> <td></td> <td colspan="8" style="text-align: center;"> <table border="1" style="width: 100%; border-collapse: collapse; text-align: center;"> <tr> <td style="width: 10%;"></td> <td style="width: 10%;"></td> <td style="width: 10%;"></td> <td style="width: 10%;"></td> <td style="width: 10%;"></td> <td style="width: 10%;"></td> <td style="width: 10%;"></td> <td style="width: 10%;"></td> <td style="width: 10%;"></td> <td style="width: 10%;"></td> </tr> <tr> <td></td> <td></td> <td colspan="8" style="text-align: center;"> <table border="1" style="width: 100%; border-collapse: collapse; text-align: center;"> <tr> <td style="width: 10%;"></td> <td style="width: 10%;"></td> <td style="width: 10%;"></td> <td style="width: 10%;"></td> <td style="width: 10%;"></td> <td style="width: 10%;"></td> <td style="width: 10%;"></td> <td style="width: 10%;"></td> <td style="width: 10%;"></td> <td style="width: 10%;"></td> </tr> <tr> <td></td> <td></td> <td colspan="8" style="text-align: center;"> <table border="1" style="width: 100%; border-collapse: collapse; text-align: center;"> <tr> <td style="width: 10%;"></td> <td style="width: 10%;"></td> <td style="width: 10%;"></td> <td style="width: 10%;"></td> <td style="width: 10%;"></td> <td style="width: 10%;"></td> <td style="width: 10%;"></td> <td style="width: 10%;"></td> <td style="width: 10%;"></td> <td style="width: 10%;"></td> </tr> <tr> <td></td> <td></td> <td colspan="8" style="text-align: center;"> <table border="1" style="width: 100%; border-collapse: collapse; text-align: center;"> <tr> <td style="width: 10%;"></td> <td style="width: 10%;"></td> <td style="width: 10%;"></td> <td style="width: 10%;"></td> <td style="width: 10%;"></td> <td style="width: 10%;"></td> <td style="width: 10%;"></td> <td style="width: 10%;"></td> <td style="width: 10%;"></td> <td style="width: 10%;"></td> </tr> <tr> <td></td> <td></td> <td colspan="8" style="text-align: center;"> <table border="1" style="width: 100%; border-collapse: collapse; text-align: center;"> <tr> <td style="width: 10%;"></td> <td style="width: 10%;"></td> <td style="width: 10%;"></td> <td style="width: 10%;"></td> <td style="width: 10%;"></td> <td style="width: 10%;"></td> <td style="width: 10%;"></td> <td style="width: 10%;"></td> <td style="width: 10%;"></td> <td style="width: 10%;"></td> </tr> <tr> <td></td> <td></td> <td colspan="8" style="text-align: center;"> <table border="1" style="width: 100%; border-collapse: collapse; text-align: center;"> <tr> <td style="width: 10%;"></td> <td style="width: 10%;"></td> <td style="width: 10%;"></td> <td style="width: 10%;"></td> <td style="width: 10%;"></td> <td style="width: 10%;"></td> <td style="width: 10%;"></td> <td style="width: 10%;"></td> <td style="width: 10%;"></td> <td style="width: 10%;"></td> </tr> <tr> <td></td> <td></td> <td colspan="8" style="text-align: center;"> <table border="1" style="width: 100%; border-collapse: collapse; text-align: center;"> <tr> <td style="width: 10%;"></td> <td style="width: 10%;"></td> <td style="width: 10%;"></td> <td style="width: 10%;"></td> <td style="width: 10%;"></td> <td style="width: 10%;"></td> <td style="width: 10%;"></td> <td style="width: 10%;"></td> <td style="width: 10%;"></td> <td style="width: 10%;"></td> </tr> <tr> <td></td> <td></td> <td colspan="8" style="text-align: center;"> <table border="1" style="width: 100%; border-collapse: collapse; text-align: center;"> <tr> <td style="width: 10%;"></td> <td style="width: 10%;"></td> <td style="width: 10%;"></td> <td style="width: 10%;"></td> <td style="width: 10%;"></td> <td style="width: 10%;"></td> <td style="width: 10%;"></td> <td style="width: 10%;"></td> <td style="width: 10%;"></td> <td style="width: 10%;"></td> </tr> <tr> <td></td> <td></td> <td colspan="8" style="text-align: center;"> <table border="1" style="width: 100%; border-collapse: collapse; text-align: center;"> <tr> <td style="width: 10%;"></td> <td style="width: 10%;"></td> <td style="width: 10%;"></td> <td style="width: 10%;"></td> <td style="width: 10%;"></td> <td style="width: 10%;"></td> <td style="width: 10%;"></td> <td style="width: 10%;"></td> <td style="width: 10%;"></td> <td style="width: 10%;"></td> </tr> <tr> <td></td> <td></td> <td colspan="8" style="text-align: center;"> <table border="1" style="width: 100%; border-collapse: collapse; text-align: center;"> <tr> <td style="width: 10%;"></td> <td style="width: 10%;"></td> <td style="width: 10%;"></td> <td style="width: 10%;"></td> <td style="width: 10%;"></td> <td style="width: 10%;"></td> <td style="width: 10%;"></td> <td style="width: 10%;"></td> <td style="width: 10%;"></td> <td style="width: 10%;"></td> </tr> <tr> <td></td> <td></td> <td colspan="8" style="text-align: center;"> <table border="1" style="width: 100%; border-collapse: collapse; text-align: center;"> <tr> <td style="width: 10%;"></td> <td style="width: 10%;"></td> <td style="width: 10%;"></td> <td style="width:
10%;"></td> <td style="width: 10%;"></td> <td style="width: 10%;"></td> <td style="width: 10%;"></td> <td style="width: 10%;"></td> <td style="width: 10%;"></td> <td style="width: 10%;"></td> </tr> <tr> <td></td> <td></td> <td colspan="8" style="text-align: center;"> <table border="1" style="width: 100%; border-collapse: collapse; text-align: center;"> <tr> </tr></table></td></tr></table></td></tr></table></td></tr></table></td></tr></table></td></tr></table></td></tr></table></td></tr></table></td></tr></table></td></tr></table></td></tr></table></td></tr></table></td></tr></table></td></tr></table></td></tr></table></td></tr></table></td></tr></table></td></tr></table></td></tr></table></td></tr></table></td></tr></table></td></tr></table></td></tr></table></td></tr></table></td></tr></table></td></tr></table></td></tr></table></td></tr></table></td></tr></table></td></tr></table></td></tr></table></td></tr></table></td></tr></table></td></tr></table></td></tr></table></td></tr></table></td></tr></table></td></tr></table></td></tr></table>
 | | | | | | | | | | | | | | | | | | | | <table border="1" style="width: 100%; border-collapse: collapse; text-align: center;"> <tr> <td style="width: 10%;"></td> <td style="width: 10%;"></td> <td style="width: 10%;"></td> <td style="width: 10%;"></td> <td style="width: 10%;"></td> <td style="width: 10%;"></td> <td style="width: 10%;"></td> <td style="width: 10%;"></td> <td style="width: 10%;"></td> <td style="width: 10%;"></td> </tr> <tr> <td></td> <td></td> <td colspan="8" style="text-align: center;"> <table border="1" style="width: 100%; border-collapse: collapse; text-align: center;"> <tr> <td style="width: 10%;"></td> <td style="width: 10%;"></td> <td style="width: 10%;"></td> <td style="width: 10%;"></td> <td style="width: 10%;"></td> <td style="width: 10%;"></td> <td style="width: 10%;"></td> <td style="width: 10%;"></td> <td style="width: 10%;"></td> <td style="width: 10%;"></td> </tr> <tr> <td></td> <td></td> <td colspan="8" style="text-align: center;"> <table border="1" style="width: 100%; border-collapse: collapse; text-align: center;"> <tr> <td style="width: 10%;"></td> <td style="width: 10%;"></td> <td style="width: 10%;"></td> <td style="width: 10%;"></td> <td style="width: 10%;"></td> <td style="width: 10%;"></td> <td style="width: 10%;"></td> <td style="width: 10%;"></td> <td style="width: 10%;"></td> <td style="width: 10%;"></td> </tr> <tr> <td></td> <td></td> <td colspan="8" style="text-align: center;"> <table border="1" style="width: 100%; border-collapse: collapse; text-align: center;"> <tr> <td style="width: 10%;"></td> <td style="width: 10%;"></td> <td style="width: 10%;"></td> <td style="width: 10%;"></td> <td style="width: 10%;"></td> <td style="width: 10%;"></td> <td style="width: 10%;"></td> <td style="width: 10%;"></td> <td style="width: 10%;"></td> <td style="width: 10%;"></td> </tr> <tr> <td></td> <td></td> <td colspan="8" style="text-align: center;"> <table border="1" style="width: 100%; border-collapse: collapse; text-align: center;"> <tr> <td style="width: 10%;"></td> <td style="width: 10%;"></td> <td style="width: 10%;"></td> <td style="width: 10%;"></td> <td style="width: 10%;"></td> <td style="width: 10%;"></td> <td style="width: 10%;"></td> <td style="width: 10%;"></td> <td style="width: 10%;"></td> <td style="width: 10%;"></td> </tr> <tr> <td></td> <td></td> <td colspan="8" style="text-align: center;"> <table border="1" style="width: 100%; border-collapse: collapse; text-align: center;"> <tr> <td style="width: 10%;"></td> <td style="width: 10%;"></td> <td style="width: 10%;"></td> <td style="width: 10%;"></td> <td style="width: 10%;"></td> <td style="width: 10%;"></td> <td style="width: 10%;"></td> <td style="width: 10%;"></td> <td style="width: 10%;"></td> <td style="width: 10%;"></td> </tr> <tr> <td></td> <td></td> <td colspan="8" style="text-align: center;"> <table border="1" style="width: 100%; border-collapse: collapse; text-align: center;"> <tr> <td style="width: 10%;"></td> <td style="width: 10%;"></td> <td style="width: 10%;"></td> <td style="width: 10%;"></td> <td style="width: 10%;"></td> <td style="width: 10%;"></td> <td style="width: 10%;"></td> <td style="width: 10%;"></td> <td style="width: 10%;"></td> <td style="width: 10%;"></td> </tr> <tr> <td></td> <td></td> <td colspan="8" style="text-align: center;"> <table border="1" style="width: 100%; border-collapse: collapse; text-align: center;"> <tr> <td style="width: 10%;"></td> <td style="width: 10%;"></td> <td style="width: 10%;"></td> <td style="width: 10%;"></td> <td style="width: 10%;"></td> <td style="width: 10%;"></td> <td style="width: 10%;"></td> <td style="width: 10%;"></td> <td style="width: 10%;"></td> <td style="width: 10%;"></td> </tr> <tr> <td></td> <td></td> <td colspan="8" style="text-align: center;"> <table border="1" style="width: 100%; border-collapse: collapse; text-align: center;"> <tr> <td style="width: 10%;"></td> <td style="width: 10%;"></td> <td style="width: 10%;"></td> <td style="width: 10%;"></td> <td style="width: 10%;"></td> <td style="width: 10%;"></td> <td style="width: 10%;"></td> <td style="width: 10%;"></td> <td style="width: 10%;"></td> <td style="width: 10%;"></td> </tr> <tr> <td></td> <td></td> <td colspan="8" style="text-align: center;"> <table border="1" style="width: 100%; border-collapse: collapse; text-align: center;"> <tr> <td style="width: 10%;"></td> <td style="width: 10%;"></td> <td style="width: 10%;"></td> <td style="width: 10%;"></td> <td style="width: 10%;"></td> <td style="width: 10%;"></td> <td style="width: 10%;"></td> <td style="width: 10%;"></td> <td style="width: 10%;"></td> <td style="width: 10%;"></td> </tr> <tr> <td></td> <td></td> <td colspan="8" style="text-align: center;"> <table border="1" style="width: 100%; border-collapse: collapse; text-align: center;"> <tr> <td style="width: 10%;"></td> <td style="width: 10%;"></td> <td style="width: 10%;"></td> <td style="width: 10%;"></td> <td style="width: 10%;"></td> <td style="width: 10%;"></td> <td style="width: 10%;"></td> <td style="width: 10%;"></td> <td style="width: 10%;"></td> <td style="width: 10%;"></td> </tr> <tr> <td></td> <td></td> <td colspan="8" style="text-align: center;"> <table border="1" style="width: 100%; border-collapse: collapse; text-align: center;"> <tr> <td style="width: 10%;"></td> <td style="width: 10%;"></td> <td style="width: 10%;"></td> <td style="width: 10%;"></td> <td style="width: 10%;"></td> <td style="width: 10%;"></td> <td style="width: 10%;"></td> <td style="width: 10%;"></td> <td style="width: 10%;"></td> <td style="width: 10%;"></td> </tr> <tr> <td></td> <td></td> <td colspan="8" style="text-align: center;"> <table border="1" style="width: 100%; border-collapse: collapse; text-align: center;"> <tr> <td style="width: 10%;"></td> <td style="width: 10%;"></td> <td style="width: 10%;"></td> <td style="width: 10%;"></td> <td style="width: 10%;"></td> <td style="width: 10%;"></td> <td style="width: 10%;"></td> <td style="width: 10%;"></td> <td style="width: 10%;"></td> <td style="width: 10%;"></td> </tr> <tr> <td></td> <td></td> <td colspan="8" style="text-align: center;"> <table border="1" style="width: 100%; border-collapse: collapse; text-align: center;"> <tr> <td style="width: 10%;"></td> <td style="width: 10%;"></td> <td style="width: 10%;"></td> <td style="width: 10%;"></td> <td style="width: 10%;"></td> <td style="width: 10%;"></td> <td style="width: 10%;"></td> <td style="width: 10%;"></td> <td style="width: 10%;"></td> <td style="width: 10%;"></td> </tr> <tr> <td></td> <td></td> <td colspan="8" style="text-align: center;"> <table border="1" style="width: 100%; border-collapse: collapse; text-align: center;"> <tr> <td style="width: 10%;"></td> <td style="width: 10%;"></td> <td style="width: 10%;"></td> <td style="width: 10%;"></td> <td style="width: 10%;"></td> <td style="width: 10%;"></td> <td style="width: 10%;"></td> <td style="width: 10%;"></td> <td style="width: 10%;"></td> <td style="width: 10%;"></td> </tr> <tr> <td></td> <td></td> <td colspan="8" style="text-align: center;"> <table border="1" style="width: 100%; border-collapse: collapse; text-align: center;"> <tr> <td style="width: 10%;"></td> <td style="width: 10%;"></td> <td style="width: 10%;"></td> <td style="width: 10%;"></td> <td style="width: 10%;"></td> <td style="width: 10%;"></td> <td style="width: 10%;"></td> <td style="width: 10%;"></td> <td style="width: 10%;"></td> <td style="width: 10%;"></td> </tr> <tr> <td></td> <td></td> <td colspan="8" style="text-align: center;"> <table border="1" style="width: 100%; border-collapse: collapse; text-align: center;"> <tr> <td style="width: 10%;"></td> <td style="width: 10%;"></td> <td style="width: 10%;"></td> <td style="width: 10%;"></td> <td style="width: 10%;"></td> <td style="width: 10%;"></td> <td style="width: 10%;"></td> <td style="width: 10%;"></td> <td style="width: 10%;"></td> <td style="width: 10%;"></td> </tr> <tr> <td></td> <td></td> <td colspan="8" style="text-align: center;"> <table border="1" style="width: 100%; border-collapse: collapse; text-align: center;"> <tr> <td style="width: 10%;"></td> <td style="width: 10%;"></td> <td style="width: 10%;"></td> <td style="width: 10%;"></td> <td style="width:
10%;"></td> <td style="width: 10%;"></td> <td style="width: 10%;"></td> <td style="width: 10%;"></td> <td style="width: 10%;"></td> <td style="width: 10%;"></td> </tr> <tr> <td></td> <td></td> <td colspan="8" style="text-align: center;"> <table border="1" style="width: 100%; border-collapse: collapse; text-align: center;"> <tr> <td style="width: 10%;"></td> <td style="width: 10%;"></td> <td style="width: 10%;"></td> <td style="width: 10%;"></td> <td style="width: 10%;"></td> <td style="width: 10%;"></td> <td style="width: 10%;"></td> <td style="width: 10%;"></td> <td style="width: 10%;"></td> <td style="width: 10%;"></td> </tr> <tr> <td></td> <td></td> <td colspan="8" style="text-align: center;"> <table border="1" style="width: 100%; border-collapse: collapse; text-align: center;"> <tr> <td style="width: 10%;"></td> <td style="width: 10%;"></td> <td style="width: 10%;"></td> <td style="width: 10%;"></td> <td style="width: 10%;"></td> <td style="width: 10%;"></td> <td style="width: 10%;"></td> <td style="width: 10%;"></td> <td style="width: 10%;"></td> <td style="width: 10%;"></td> </tr> <tr> <td></td> <td></td> <td colspan="8" style="text-align: center;"> <table border="1" style="width: 100%; border-collapse: collapse; text-align: center;"> <tr> <td style="width: 10%;"></td> <td style="width: 10%;"></td> <td style="width: 10%;"></td> <td style="width: 10%;"></td> <td style="width: 10%;"></td> <td style="width: 10%;"></td> <td style="width: 10%;"></td> <td style="width: 10%;"></td> <td style="width: 10%;"></td> <td style="width: 10%;"></td> </tr> <tr> <td></td> <td></td> <td colspan="8" style="text-align: center;"> <table border="1" style="width: 100%; border-collapse: collapse; text-align: center;"> <tr> <td style="width: 10%;"></td> <td style="width: 10%;"></td> <td style="width: 10%;"></td> <td style="width: 10%;"></td> <td style="width: 10%;"></td> <td style="width: 10%;"></td> <td style="width: 10%;"></td> <td style="width: 10%;"></td> <td style="width: 10%;"></td> <td style="width: 10%;"></td> </tr> <tr> <td></td> <td></td> <td colspan="8" style="text-align: center;"> <table border="1" style="width: 100%; border-collapse: collapse; text-align: center;"> <tr> <td style="width: 10%;"></td> <td style="width: 10%;"></td> <td style="width: 10%;"></td> <td style="width: 10%;"></td> <td style="width: 10%;"></td> <td style="width: 10%;"></td> <td style="width: 10%;"></td> <td style="width: 10%;"></td> <td style="width: 10%;"></td> <td style="width: 10%;"></td> </tr> <tr> <td></td> <td></td> <td colspan="8" style="text-align: center;"> <table border="1" style="width: 100%; border-collapse: collapse; text-align: center;"> <tr> <td style="width: 10%;"></td> <td style="width: 10%;"></td> <td style="width: 10%;"></td> <td style="width: 10%;"></td> <td style="width: 10%;"></td> <td style="width: 10%;"></td> <td style="width: 10%;"></td> <td style="width: 10%;"></td> <td style="width: 10%;"></td> <td style="width: 10%;"></td> </tr> <tr> <td></td> <td></td> <td colspan="8" style="text-align: center;"> <table border="1" style="width: 100%; border-collapse: collapse; text-align: center;"> <tr> <td style="width: 10%;"></td> <td style="width: 10%;"></td> <td style="width: 10%;"></td> <td style="width: 10%;"></td> <td style="width: 10%;"></td> <td style="width: 10%;"></td> <td style="width: 10%;"></td> <td style="width: 10%;"></td> <td style="width: 10%;"></td> <td style="width: 10%;"></td> </tr> <tr> <td></td> <td></td> <td colspan="8" style="text-align: center;"> <table border="1" style="width: 100%; border-collapse: collapse; text-align: center;"> <tr> <td style="width: 10%;"></td> <td style="width: 10%;"></td> <td style="width: 10%;"></td> <td style="width: 10%;"></td> <td style="width: 10%;"></td> <td style="width: 10%;"></td> <td style="width: 10%;"></td> <td style="width: 10%;"></td> <td style="width: 10%;"></td> <td style="width: 10%;"></td> </tr> <tr> <td></td> <td></td> <td colspan="8" style="text-align: center;"> <table border="1" style="width: 100%; border-collapse: collapse; text-align: center;"> <tr> <td style="width: 10%;"></td> <td style="width: 10%;"></td> <td style="width: 10%;"></td> <td style="width: 10%;"></td> <td style="width: 10%;"></td> <td style="width: 10%;"></td> <td style="width: 10%;"></td> <td style="width: 10%;"></td> <td style="width: 10%;"></td> <td style="width: 10%;"></td> </tr> <tr> <td></td> <td></td> <td colspan="8" style="text-align: center;"> <table border="1" style="width: 100%; border-collapse: collapse; text-align: center;"> <tr> <td style="width: 10%;"></td> <td style="width: 10%;"></td> <td style="width: 10%;"></td> <td style="width: 10%;"></td> <td style="width: 10%;"></td> <td style="width: 10%;"></td> <td style="width: 10%;"></td> <td style="width: 10%;"></td> <td style="width: 10%;"></td> <td style="width: 10%;"></td> </tr> <tr> <td></td> <td></td> <td colspan="8" style="text-align: center;"> <table border="1" style="width: 100%; border-collapse: collapse; text-align: center;"> <tr> <td style="width: 10%;"></td> <td style="width: 10%;"></td> <td style="width: 10%;"></td> <td style="width: 10%;"></td> <td style="width: 10%;"></td> <td style="width: 10%;"></td> <td style="width: 10%;"></td> <td style="width: 10%;"></td> <td style="width: 10%;"></td> <td style="width: 10%;"></td> </tr> <tr> <td></td> <td></td> <td colspan="8" style="text-align: center;"> <table border="1" style="width: 100%; border-collapse: collapse; text-align: center;"> <tr> <td style="width: 10%;"></td> <td style="width: 10%;"></td> <td style="width: 10%;"></td> <td style="width: 10%;"></td> <td style="width: 10%;"></td> <td style="width: 10%;"></td> <td style="width: 10%;"></td> <td style="width: 10%;"></td> <td style="width: 10%;"></td> <td style="width: 10%;"></td> </tr> <tr> <td></td> <td></td> <td colspan="8" style="text-align: center;"> <table border="1" style="width: 100%; border-collapse: collapse; text-align: center;"> <tr> <td style="width: 10%;"></td> <td style="width: 10%;"></td> <td style="width: 10%;"></td> <td style="width: 10%;"></td> <td style="width: 10%;"></td> <td style="width: 10%;"></td> <td style="width: 10%;"></td> <td style="width: 10%;"></td> <td style="width: 10%;"></td> <td style="width: 10%;"></td> </tr> <tr> <td></td> <td></td> <td colspan="8" style="text-align: center;"> <table border="1" style="width: 100%; border-collapse: collapse; text-align: center;"> <tr> <td style="width: 10%;"></td> <td style="width: 10%;"></td> <td style="width: 10%;"></td> <td style="width: 10%;"></td> <td style="width: 10%;"></td> <td style="width: 10%;"></td> <td style="width: 10%;"></td> <td style="width: 10%;"></td> <td style="width: 10%;"></td> <td style="width: 10%;"></td> </tr> <tr> <td></td> <td></td> <td colspan="8" style="text-align: center;"> <table border="1" style="width: 100%; border-collapse: collapse; text-align: center;"> <tr> <td style="width: 10%;"></td> <td style="width: 10%;"></td> <td style="width: 10%;"></td> <td style="width: 10%;"></td> <td style="width: 10%;"></td> <td style="width: 10%;"></td> <td style="width: 10%;"></td> <td style="width: 10%;"></td> <td style="width: 10%;"></td> <td style="width: 10%;"></td> </tr> <tr> <td></td> <td></td> <td colspan="8" style="text-align: center;"> <table border="1" style="width: 100%; border-collapse: collapse; text-align: center;"> <tr> <td style="width: 10%;"></td> <td style="width: 10%;"></td> <td style="width: 10%;"></td> <td style="width: 10%;"></td> <td style="width: 10%;"></td> <td style="width: 10%;"></td> <td style="width: 10%;"></td> <td style="width: 10%;"></td> <td style="width: 10%;"></td> <td style="width: 10%;"></td> </tr> <tr> <td></td> <td></td> <td colspan="8" style="text-align: center;"> <table border="1" style="width: 100%; border-collapse: collapse; text-align: center;"> <tr> <td style="width: 10%;"></td> <td style="width: 10%;"></td> <td style="width: 10%;"></td> <td style="width: 10%;"></td> <td style="width: 10%;"></td> <td style="width: 10%;"></td> <td style="width: 10%;"></td> <td style="width: 10%;"></td> <td style="width: 10%;"></td> <td style="width: 10%;"></td> </tr> <tr> <td></td> <td></td> <td colspan="8" style="text-align: center;"> <table border="1" style="width: 100%; border-collapse: collapse; text-align: center;"> <tr> <td style="width: 10%;"></td> <td style="width: 10%;"></td> <td style="width: 10%;"></td> <td style="width: 10%;"></td> <td style="width: 10%;"></td> <td style="width: 10%;"></td> <td style="width: 10%;"></td> <td style="width: 10%;"></td> <td style="width: 10%;"></td> <td style="width: 10%;"></td> </tr> <tr> <td></td> <td></td> <td colspan="8" style="text-align: center;"> <table border="1" style="width: 100%; border-collapse: collapse; text-align: center;"> <tr> <td style="width: 10%;"></td> <td style="width: 10%;"></td> <td style="width: 10%;"></td> <td style="width: 10%;"></td> <td style="width: 10%;"></td> <td style="width: 10%;"></td> <td style="width: 10%;"></td> <td style="width: 10%;"></td> <td style="width: 10%;"></td> <td style="width: 10%;"></td> </tr> <tr> <td></td> <td></td> <td colspan="8" style="text-align: center;"> <table border="1" style="width: 100%; border-collapse: collapse; text-align: center;"> <tr> </tr></table></td></tr></table></td></tr></table></td></tr></table></td></tr></table></td></tr></table></td></tr></table></td></tr></table></td></tr></table></td></tr></table></td></tr></table></td></tr></table></td></tr></table></td></tr></table></td></tr></table></td></tr></table></td></tr></table></td></tr></table></td></tr></table></td></tr></table></td></tr></table></td></tr></table></td></tr></table></td></tr></table></td></tr></table></td></tr></table></td></tr></table></td></tr></table></td></tr></table></td></tr></table></td></tr></table></td></tr></table></td></tr></table></td></tr></table></td></tr></table></td></tr></table></td></tr></table></td></tr></table>

 | | | | | | | | | | | | | | | | | | | | <table border="1" style="width: 100%; border-collapse: collapse; text-align: center;"> <tr> <td style="width: 10%;"></td> <td style="width: 10%;"></td> <td style="width: 10%;"></td> <td style="width: 10%;"></td> <td style="width: 10%;"></td> <td style="width: 10%;"></td> <td style="width: 10%;"></td> <td style="width: 10%;"></td> <td style="width: 10%;"></td> <td style="width: 10%;"></td> </tr> <tr> <td></td> <td></td> <td colspan="8" style="text-align: center;"> <table border="1" style="width: 100%; border-collapse: collapse; text-align: center;"> <tr> <td style="width: 10%;"></td> <td style="width: 10%;"></td> <td style="width: 10%;"></td> <td style="width: 10%;"></td> <td style="width: 10%;"></td> <td style="width: 10%;"></td> <td style="width: 10%;"></td> <td style="width: 10%;"></td> <td style="width: 10%;"></td> <td style="width: 10%;"></td> </tr> <tr> <td></td> <td></td> <td colspan="8" style="text-align: center;"> <table border="1" style="width: 100%; border-collapse: collapse; text-align: center;"> <tr> <td style="width: 10%;"></td> <td style="width: 10%;"></td> <td style="width: 10%;"></td> <td style="width: 10%;"></td> <td style="width: 10%;"></td> <td style="width: 10%;"></td> <td style="width: 10%;"></td> <td style="width: 10%;"></td> <td style="width: 10%;"></td> <td style="width: 10%;"></td> </tr> <tr> <td></td> <td></td> <td colspan="8" style="text-align: center;"> <table border="1" style="width: 100%; border-collapse: collapse; text-align: center;"> <tr> <td style="width: 10%;"></td> <td style="width: 10%;"></td> <td style="width: 10%;"></td> <td style="width: 10%;"></td> <td style="width: 10%;"></td> <td style="width: 10%;"></td> <td style="width: 10%;"></td> <td style="width: 10%;"></td> <td style="width: 10%;"></td> <td style="width: 10%;"></td> </tr> <tr> <td></td> <td></td> <td colspan="8" style="text-align: center;"> <table border="1" style="width: 100%; border-collapse: collapse; text-align: center;"> <tr> <td style="width: 10%;"></td> <td style="width: 10%;"></td> <td style="width: 10%;"></td> <td style="width: 10%;"></td> <td style="width: 10%;"></td> <td style="width: 10%;"></td> <td style="width: 10%;"></td> <td style="width: 10%;"></td> <td style="width: 10%;"></td> <td style="width: 10%;"></td> </tr> <tr> <td></td> <td></td> <td colspan="8" style="text-align: center;"> <table border="1" style="width: 100%; border-collapse: collapse; text-align: center;"> <tr> <td style="width: 10%;"></td> <td style="width: 10%;"></td> <td style="width: 10%;"></td> <td style="width: 10%;"></td> <td style="width: 10%;"></td> <td style="width: 10%;"></td> <td style="width: 10%;"></td> <td style="width: 10%;"></td> <td style="width: 10%;"></td> <td style="width: 10%;"></td> </tr> <tr> <td></td> <td></td> <td colspan="8" style="text-align: center;"> <table border="1" style="width: 100%; border-collapse: collapse; text-align: center;"> <tr> <td style="width: 10%;"></td> <td style="width: 10%;"></td> <td style="width: 10%;"></td> <td style="width: 10%;"></td> <td style="width: 10%;"></td> <td style="width: 10%;"></td> <td style="width: 10%;"></td> <td style="width: 10%;"></td> <td style="width: 10%;"></td> <td style="width: 10%;"></td> </tr> <tr> <td></td> <td></td> <td colspan="8" style="text-align: center;"> <table border="1" style="width: 100%; border-collapse: collapse; text-align: center;"> <tr> <td style="width: 10%;"></td> <td style="width: 10%;"></td> <td style="width: 10%;"></td> <td style="width: 10%;"></td> <td style="width: 10%;"></td> <td style="width: 10%;"></td> <td style="width: 10%;"></td> <td style="width: 10%;"></td> <td style="width: 10%;"></td> <td style="width: 10%;"></td> </tr> <tr> <td></td> <td></td> <td colspan="8" style="text-align: center;"> <table border="1" style="width: 100%; border-collapse: collapse; text-align: center;"> <tr> <td style="width: 10%;"></td> <td style="width: 10%;"></td> <td style="width: 10%;"></td> <td style="width: 10%;"></td> <td style="width: 10%;"></td> <td style="width: 10%;"></td> <td style="width: 10%;"></td> <td style="width: 10%;"></td> <td style="width: 10%;"></td> <td style="width: 10%;"></td> </tr> <tr> <td></td> <td></td> <td colspan="8" style="text-align: center;"> <table border="1" style="width: 100%; border-collapse: collapse; text-align: center;"> <tr> <td style="width: 10%;"></td> <td style="width: 10%;"></td> <td style="width: 10%;"></td> <td style="width: 10%;"></td> <td style="width: 10%;"></td> <td style="width: 10%;"></td> <td style="width: 10%;"></td> <td style="width: 10%;"></td> <td style="width: 10%;"></td> <td style="width: 10%;"></td> </tr> <tr> <td></td> <td></td> <td colspan="8" style="text-align: center;"> <table border="1" style="width: 100%; border-collapse: collapse; text-align: center;"> <tr> <td style="width: 10%;"></td> <td style="width: 10%;"></td> <td style="width: 10%;"></td> <td style="width: 10%;"></td> <td style="width: 10%;"></td> <td style="width: 10%;"></td> <td style="width: 10%;"></td> <td style="width: 10%;"></td> <td style="width: 10%;"></td> <td style="width: 10%;"></td> </tr> <tr> <td></td> <td></td> <td colspan="8" style="text-align: center;"> <table border="1" style="width: 100%; border-collapse: collapse; text-align: center;"> <tr> <td style="width: 10%;"></td> <td style="width: 10%;"></td> <td style="width: 10%;"></td> <td style="width: 10%;"></td> <td style="width: 10%;"></td> <td style="width: 10%;"></td> <td style="width: 10%;"></td> <td style="width: 10%;"></td> <td style="width: 10%;"></td> <td style="width: 10%;"></td> </tr> <tr> <td></td> <td></td> <td colspan="8" style="text-align: center;"> <table border="1" style="width: 100%; border-collapse: collapse; text-align: center;"> <tr> <td style="width: 10%;"></td> <td style="width: 10%;"></td> <td style="width: 10%;"></td> <td style="width: 10%;"></td> <td style="width: 10%;"></td> <td style="width: 10%;"></td> <td style="width: 10%;"></td> <td style="width: 10%;"></td> <td style="width: 10%;"></td> <td style="width: 10%;"></td> </tr> <tr> <td></td> <td></td> <td colspan="8" style="text-align: center;"> <table border="1" style="width: 100%; border-collapse: collapse; text-align: center;"> <tr> <td style="width: 10%;"></td> <td style="width: 10%;"></td> <td style="width: 10%;"></td> <td style="width: 10%;"></td> <td style="width: 10%;"></td> <td style="width: 10%;"></td> <td style="width: 10%;"></td> <td style="width: 10%;"></td> <td style="width: 10%;"></td> <td style="width: 10%;"></td> </tr> <tr> <td></td> <td></td> <td colspan="8" style="text-align: center;"> <table border="1" style="width: 100%; border-collapse: collapse; text-align: center;"> <tr> <td style="width: 10%;"></td> <td style="width: 10%;"></td> <td style="width: 10%;"></td> <td style="width: 10%;"></td> <td style="width: 10%;"></td> <td style="width: 10%;"></td> <td style="width: 10%;"></td> <td style="width: 10%;"></td> <td style="width: 10%;"></td> <td style="width: 10%;"></td> </tr> <tr> <td></td> <td></td> <td colspan="8" style="text-align: center;"> <table border="1" style="width: 100%; border-collapse: collapse; text-align: center;"> <tr> <td style="width: 10%;"></td> <td style="width: 10%;"></td> <td style="width: 10%;"></td> <td style="width: 10%;"></td> <td style="width: 10%;"></td> <td style="width: 10%;"></td> <td style="width: 10%;"></td> <td style="width: 10%;"></td> <td style="width: 10%;"></td> <td style="width: 10%;"></td> </tr> <tr> <td></td> <td></td> <td colspan="8" style="text-align: center;"> <table border="1" style="width: 100%; border-collapse: collapse; text-align: center;"> <tr> <td style="width: 10%;"></td> <td style="width: 10%;"></td> <td style="width: 10%;"></td> <td style="width: 10%;"></td> <td style="width: 10%;"></td> <td style="width: 10%;"></td> <td style="width: 10%;"></td> <td style="width: 10%;"></td> <td style="width: 10%;"></td> <td style="width: 10%;"></td> </tr> <tr> <td></td> <td></td> <td colspan="8" style="text-align: center;"> <table border="1" style="width: 100%; border-collapse: collapse; text-align: center;"> <tr> <td style="width: 10%;"></td> <td style="width: 10%;"></td> <td style="width: 10%;"></td> <td style="width: 10%;"></td> <td style="width: 10%;"></td> <td style="width: 10%;"></td> <td style="width: 10%;"></td> <td style="width: 10%;"></td> <td style="width: 10%;"></td> <td style="width: 10%;"></td> </tr> <tr> <td></td> <td></td> <td colspan="8" style="text-align: center;"> <table border="1" style="width: 100%; border-collapse: collapse; text-align: center;"> <tr> <td style="width: 10%;"></td> <td style="width: 10%;"></td> <td style="width: 10%;"></td> <td style="width: 10%;"></td> <td style="width: 10%;"></td> <td style="width: 10%;"></td> <td style="width: 10%;"></td> <td style="width: 10%;"></td> <td style="width: 10%;"></td> <td style="width: 10%;"></td> </tr> <tr> <td></td> <td></td> <td colspan="8" style="text-align: center;"> <table border="1" style="width: 100%; border-collapse: collapse; text-align: center;"> <tr> <td style="width: 10%;"></td> <td style="width: 10%;"></td> <td style="width: 10%;"></td> <td style="width: 10%;"></td> <td style="width: 10%;"></td> <td style="width: 10%;"></td> <td style="width: 10%;"></td> <td style="width: 10%;"></td> <td style="width: 10%;"></td> <td style="width: 10%;"></td> </tr> <tr> <td></td> <td></td> <td colspan="8"
style="text-align: center;"> <table border="1" style="width: 100%; border-collapse: collapse; text-align: center;"> <tr> <td style="width: 10%;"></td> <td style="width: 10%;"></td> <td style="width: 10%;"></td> <td style="width: 10%;"></td> <td style="width: 10%;"></td> <td style="width: 10%;"></td> <td style="width: 10%;"></td> <td style="width: 10%;"></td> <td style="width: 10%;"></td> <td style="width: 10%;"></td> </tr> <tr> <td></td> <td></td> <td colspan="8" style="text-align: center;"> <table border="1" style="width: 100%; border-collapse: collapse; text-align: center;"> <tr> <td style="width: 10%;"></td> <td style="width: 10%;"></td> <td style="width: 10%;"></td> <td style="width: 10%;"></td> <td style="width: 10%;"></td> <td style="width: 10%;"></td> <td style="width: 10%;"></td> <td style="width: 10%;"></td> <td style="width: 10%;"></td> <td style="width: 10%;"></td> </tr> <tr> <td></td> <td></td> <td colspan="8" style="text-align: center;"> <table border="1" style="width: 100%; border-collapse: collapse; text-align: center;"> <tr> <td style="width: 10%;"></td> <td style="width: 10%;"></td> <td style="width: 10%;"></td> <td style="width: 10%;"></td> <td style="width: 10%;"></td> <td style="width: 10%;"></td> <td style="width: 10%;"></td> <td style="width: 10%;"></td> <td style="width: 10%;"></td> <td style="width: 10%;"></td> </tr> <tr> <td></td> <td></td> <td colspan="8" style="text-align: center;"> <table border="1" style="width: 100%; border-collapse: collapse; text-align: center;"> <tr> <td style="width: 10%;"></td> <td style="width: 10%;"></td> <td style="width: 10%;"></td> <td style="width: 10%;"></td> <td style="width: 10%;"></td> <td style="width: 10%;"></td> <td style="width: 10%;"></td> <td style="width: 10%;"></td> <td style="width: 10%;"></td> <td style="width: 10%;"></td> </tr> <tr> <td></td> <td></td> <td colspan="8" style="text-align: center;"> <table border="1" style="width: 100%; border-collapse: collapse; text-align: center;"> <tr> <td style="width: 10%;"></td> <td style="width: 10%;"></td> <td style="width: 10%;"></td> <td style="width: 10%;"></td> <td style="width: 10%;"></td> <td style="width: 10%;"></td> <td style="width: 10%;"></td> <td style="width: 10%;"></td> <td style="width: 10%;"></td> <td style="width: 10%;"></td> </tr> <tr> <td></td> <td></td> <td colspan="8" style="text-align: center;"> <table border="1" style="width: 100%; border-collapse: collapse; text-align: center;"> <tr> <td style="width: 10%;"></td> <td style="width: 10%;"></td> <td style="width: 10%;"></td> <td style="width: 10%;"></td> <td style="width: 10%;"></td> <td style="width: 10%;"></td> <td style="width: 10%;"></td> <td style="width: 10%;"></td> <td style="width: 10%;"></td> <td style="width: 10%;"></td> </tr> <tr> <td></td> <td></td> <td colspan="8" style="text-align: center;"> <table border="1" style="width: 100%; border-collapse: collapse; text-align: center;"> <tr> <td style="width: 10%;"></td> <td style="width: 10%;"></td> <td style="width: 10%;"></td> <td style="width: 10%;"></td> <td style="width: 10%;"></td> <td style="width: 10%;"></td> <td style="width: 10%;"></td> <td style="width: 10%;"></td> <td style="width: 10%;"></td> <td style="width: 10%;"></td> </tr> <tr> <td></td> <td></td> <td colspan="8" style="text-align: center;"> <table border="1" style="width: 100%; border-collapse: collapse; text-align: center;"> <tr> <td style="width: 10%;"></td> <td style="width: 10%;"></td> <td style="width: 10%;"></td> <td style="width: 10%;"></td> <td style="width: 10%;"></td> <td style="width: 10%;"></td> <td style="width: 10%;"></td> <td style="width: 10%;"></td> <td style="width: 10%;"></td> <td style="width: 10%;"></td> </tr> <tr> <td></td> <td></td> <td colspan="8" style="text-align: center;"> <table border="1" style="width: 100%; border-collapse: collapse; text-align: center;"> <tr> <td style="width: 10%;"></td> <td style="width: 10%;"></td> <td style="width: 10%;"></td> <td style="width: 10%;"></td> <td style="width: 10%;"></td> <td style="width: 10%;"></td> <td style="width: 10%;"></td> <td style="width: 10%;"></td> <td style="width: 10%;"></td> <td style="width: 10%;"></td> </tr> <tr> <td></td> <td></td> <td colspan="8" style="text-align: center;"> <table border="1" style="width: 100%; border-collapse: collapse; text-align: center;"> <tr> <td style="width: 10%;"></td> <td style="width: 10%;"></td> <td style="width: 10%;"></td> <td style="width: 10%;"></td> <td style="width: 10%;"></td> <td style="width: 10%;"></td> <td style="width: 10%;"></td> <td style="width: 10%;"></td> <td style="width: 10%;"></td> <td style="width: 10%;"></td> </tr> <tr> <td></td> <td></td> <td colspan="8" style="text-align: center;"> <table border="1" style="width: 100%; border-collapse: collapse; text-align: center;"> <tr> <td style="width: 10%;"></td> <td style="width: 10%;"></td> <td style="width: 10%;"></td> <td style="width: 10%;"></td> <td style="width: 10%;"></td> <td style="width: 10%;"></td> <td style="width: 10%;"></td> <td style="width: 10%;"></td> <td style="width: 10%;"></td> <td style="width: 10%;"></td> </tr> <tr> <td></td> <td></td> <td colspan="8" style="text-align: center;"> <table border="1" style="width: 100%; border-collapse: collapse; text-align: center;"> <tr> <td style="width: 10%;"></td> <td style="width: 10%;"></td> <td style="width: 10%;"></td> <td style="width: 10%;"></td> <td style="width: 10%;"></td> <td style="width: 10%;"></td> <td style="width: 10%;"></td> <td style="width: 10%;"></td> <td style="width: 10%;"></td> <td style="width: 10%;"></td> </tr> <tr> <td></td> <td></td> <td colspan="8" style="text-align: center;"> <table border="1" style="width: 100%; border-collapse: collapse; text-align: center;"> <tr> <td style="width: 10%;"></td> <td style="width: 10%;"></td> <td style="width: 10%;"></td> <td style="width: 10%;"></td> <td style="width: 10%;"></td> <td style="width: 10%;"></td> <td style="width: 10%;"></td> <td style="width: 10%;"></td> <td style="width: 10%;"></td> <td style="width: 10%;"></td> </tr> <tr> <td></td> <td></td> <td colspan="8" style="text-align: center;"> <table border="1" style="width: 100%; border-collapse: collapse; text-align: center;"> <tr> <td style="width: 10%;"></td> <td style="width: 10%;"></td> <td style="width: 10%;"></td> <td style="width: 10%;"></td> <td style="width: 10%;"></td> <td style="width: 10%;"></td> <td style="width: 10%;"></td> <td style="width: 10%;"></td> <td style="width: 10%;"></td> <td style="width: 10%;"></td> </tr> <tr> <td></td> <td></td> <td colspan="8" style="text-align: center;"> <table border="1" style="width: 100%; border-collapse: collapse; text-align: center;"> <tr> <td style="width: 10%;"></td> <td style="width: 10%;"></td> <td style="width: 10%;"></td> <td style="width: 10%;"></td> <td style="width: 10%;"></td> <td style="width: 10%;"></td> <td style="width: 10%;"></td> <td style="width: 10%;"></td> <td style="width: 10%;"></td> <td style="width: 10%;"></td> </tr> <tr> <td></td> <td></td> <td colspan="8" style="text-align: center;"> <table border="1" style="width: 100%; border-collapse: collapse; text-align: center;"> <tr> <td style="width: 10%;"></td> <td style="width: 10%;"></td> <td style="width: 10%;"></td> <td style="width: 10%;"></td> <td style="width: 10%;"></td> <td style="width: 10%;"></td> <td style="width: 10%;"></td> <td style="width: 10%;"></td> <td style="width: 10%;"></td> <td style="width: 10%;"></td> </tr> <tr> <td></td> <td></td> <td colspan="8" style="text-align: center;"> <table border="1" style="width: 100%; border-collapse: collapse; text-align: center;"> <tr> </tr></table></td></tr></table></td></tr></table></td></tr></table></td></tr></table></td></tr></table></td></tr></table></td></tr></table></td></tr></table></td></tr></table></td></tr></table></td></tr></table></td></tr></table></td></tr></table></td></tr></table></td></tr></table></td></tr></table></td></tr></table></td></tr></table></td></tr></table></td></tr></table></td></tr></table></td></tr></table></td></tr></table></td></tr></table></td></tr></table></td></tr></table></td></tr></table></td></tr></table></td></tr></table></td></tr></table></td></tr></table></td></tr></table></td></tr></table></td></tr></table></td></tr></table></td></tr></table>
 | | | | | | | | | | | | | | | | | | | | <table border="1" style="width: 100%; border-collapse: collapse; text-align: center;"> <tr> <td style="width: 10%;"></td> <td style="width: 10%;"></td> <td style="width: 10%;"></td> <td style="width: 10%;"></td> <td style="width: 10%;"></td> <td style="width: 10%;"></td> <td style="width: 10%;"></td> <td style="width: 10%;"></td> <td style="width: 10%;"></td> <td style="width: 10%;"></td> </tr> <tr> <td></td> <td></td> <td colspan="8" style="text-align: center;"> <table border="1" style="width: 100%; border-collapse: collapse; text-align: center;"> <tr> <td style="width: 10%;"></td> <td style="width: 10%;"></td> <td style="width: 10%;"></td> <td style="width: 10%;"></td> <td style="width: 10%;"></td> <td style="width: 10%;"></td> <td style="width: 10%;"></td> <td style="width: 10%;"></td> <td style="width: 10%;"></td> <td style="width: 10%;"></td> </tr> <tr> <td></td> <td></td> <td colspan="8" style="text-align: center;"> <table border="1" style="width: 100%;
border-collapse: collapse; text-align: center;"> <tr> <td style="width: 10%;"></td> <td style="width: 10%;"></td> <td style="width: 10%;"></td> <td style="width: 10%;"></td> <td style="width: 10%;"></td> <td style="width: 10%;"></td> <td style="width: 10%;"></td> <td style="width: 10%;"></td> <td style="width: 10%;"></td> <td style="width: 10%;"></td> </tr> <tr> <td></td> <td></td> <td colspan="8" style="text-align: center;"> <table border="1" style="width: 100%; border-collapse: collapse; text-align: center;"> <tr> <td style="width: 10%;"></td> <td style="width: 10%;"></td> <td style="width: 10%;"></td> <td style="width: 10%;"></td> <td style="width: 10%;"></td> <td style="width: 10%;"></td> <td style="width: 10%;"></td> <td style="width: 10%;"></td> <td style="width: 10%;"></td> <td style="width: 10%;"></td> </tr> <tr> <td></td> <td></td> <td colspan="8" style="text-align: center;"> <table border="1" style="width: 100%; border-collapse: collapse; text-align: center;"> <tr> <td style="width: 10%;"></td> <td style="width: 10%;"></td> <td style="width: 10%;"></td> <td style="width: 10%;"></td> <td style="width: 10%;"></td> <td style="width: 10%;"></td> <td style="width: 10%;"></td> <td style="width: 10%;"></td> <td style="width: 10%;"></td> <td style="width: 10%;"></td> </tr> <tr> <td></td> <td></td> <td colspan="8" style="text-align: center;"> <table border="1" style="width: 100%; border-collapse: collapse; text-align: center;"> <tr> <td style="width: 10%;"></td> <td style="width: 10%;"></td> <td style="width: 10%;"></td> <td style="width: 10%;"></td> <td style="width: 10%;"></td> <td style="width: 10%;"></td> <td style="width: 10%;"></td> <td style="width: 10%;"></td> <td style="width: 10%;"></td> <td style="width: 10%;"></td> </tr> <tr> <td></td> <td></td> <td colspan="8" style="text-align: center;"> <table border="1" style="width: 100%; border-collapse: collapse; text-align: center;"> <tr> <td style="width: 10%;"></td> <td style="width: 10%;"></td> <td style="width: 10%;"></td> <td style="width: 10%;"></td> <td style="width: 10%;"></td> <td style="width: 10%;"></td> <td style="width: 10%;"></td> <td style="width: 10%;"></td> <td style="width: 10%;"></td> <td style="width: 10%;"></td> </tr> <tr> <td></td> <td></td> <td colspan="8" style="text-align: center;"> <table border="1" style="width: 100%; border-collapse: collapse; text-align: center;"> <tr> <td style="width: 10%;"></td> <td style="width: 10%;"></td> <td style="width: 10%;"></td> <td style="width: 10%;"></td> <td style="width: 10%;"></td> <td style="width: 10%;"></td> <td style="width: 10%;"></td> <td style="width: 10%;"></td> <td style="width: 10%;"></td> <td style="width: 10%;"></td> </tr> <tr> <td></td> <td></td> <td colspan="8" style="text-align: center;"> <table border="1" style="width: 100%; border-collapse: collapse; text-align: center;"> <tr> <td style="width: 10%;"></td> <td style="width: 10%;"></td> <td style="width: 10%;"></td> <td style="width: 10%;"></td> <td style="width: 10%;"></td> <td style="width: 10%;"></td> <td style="width: 10%;"></td> <td style="width: 10%;"></td> <td style="width: 10%;"></td> <td style="width: 10%;"></td> </tr> <tr> <td></td> <td></td> <td colspan="8" style="text-align: center;"> <table border="1" style="width: 100%; border-collapse: collapse; text-align: center;"> <tr> <td style="width: 10%;"></td> <td style="width: 10%;"></td> <td style="width: 10%;"></td> <td style="width: 10%;"></td> <td style="width: 10%;"></td> <td style="width: 10%;"></td> <td style="width: 10%;"></td> <td style="width: 10%;"></td> <td style="width: 10%;"></td> <td style="width: 10%;"></td> </tr> <tr> <td></td> <td></td> <td colspan="8" style="text-align: center;"> <table border="1" style="width: 100%; border-collapse: collapse; text-align: center;"> <tr> <td style="width: 10%;"></td> <td style="width: 10%;"></td> <td style="width: 10%;"></td> <td style="width: 10%;"></td> <td style="width: 10%;"></td> <td style="width: 10%;"></td> <td style="width: 10%;"></td> <td style="width: 10%;"></td> <td style="width: 10%;"></td> <td style="width: 10%;"></td> </tr> <tr> <td></td> <td></td> <td colspan="8" style="text-align: center;"> <table border="1" style="width: 100%; border-collapse: collapse; text-align: center;"> <tr> <td style="width: 10%;"></td> <td style="width: 10%;"></td> <td style="width: 10%;"></td> <td style="width: 10%;"></td> <td style="width: 10%;"></td> <td style="width: 10%;"></td> <td style="width: 10%;"></td> <td style="width: 10%;"></td> <td style="width: 10%;"></td> <td style="width: 10%;"></td> </tr> <tr> <td></td> <td></td> <td colspan="8" style="text-align: center;"> <table border="1" style="width: 100%; border-collapse: collapse; text-align: center;"> <tr> <td style="width: 10%;"></td> <td style="width: 10%;"></td> <td style="width: 10%;"></td> <td style="width: 10%;"></td> <td style="width: 10%;"></td> <td style="width: 10%;"></td> <td style="width: 10%;"></td> <td style="width: 10%;"></td> <td style="width: 10%;"></td> <td style="width: 10%;"></td> </tr> <tr> <td></td> <td></td> <td colspan="8" style="text-align: center;"> <table border="1" style="width: 100%; border-collapse: collapse; text-align: center;"> <tr> <td style="width: 10%;"></td> <td style="width: 10%;"></td> <td style="width: 10%;"></td> <td style="width: 10%;"></td> <td style="width: 10%;"></td> <td style="width: 10%;"></td> <td style="width: 10%;"></td> <td style="width: 10%;"></td> <td style="width: 10%;"></td> <td style="width: 10%;"></td> </tr> <tr> <td></td> <td></td> <td colspan="8" style="text-align: center;"> <table border="1" style="width: 100%; border-collapse: collapse; text-align: center;"> <tr> <td style="width: 10%;"></td> <td style="width: 10%;"></td> <td style="width: 10%;"></td> <td style="width: 10%;"></td> <td style="width: 10%;"></td> <td style="width: 10%;"></td> <td style="width: 10%;"></td> <td style="width: 10%;"></td> <td style="width: 10%;"></td> <td style="width: 10%;"></td> </tr> <tr> <td></td> <td></td> <td colspan="8" style="text-align: center;"> <table border="1" style="width: 100%; border-collapse: collapse; text-align: center;"> <tr> <td style="width: 10%;"></td> <td style="width: 10%;"></td> <td style="width: 10%;"></td> <td style="width: 10%;"></td> <td style="width: 10%;"></td> <td style="width: 10%;"></td> <td style="width: 10%;"></td> <td style="width: 10%;"></td> <td style="width: 10%;"></td> <td style="width: 10%;"></td> </tr> <tr> <td></td> <td></td> <td colspan="8" style="text-align: center;"> <table border="1" style="width: 100%; border-collapse: collapse; text-align: center;"> <tr> <td style="width: 10%;"></td> <td style="width: 10%;"></td> <td style="width: 10%;"></td> <td style="width: 10%;"></td> <td style="width: 10%;"></td> <td style="width: 10%;"></td> <td style="width: 10%;"></td> <td style="width: 10%;"></td> <td style="width: 10%;"></td> <td style="width: 10%;"></td> </tr> <tr> <td></td> <td></td> <td colspan="8" style="text-align: center;"> <table border="1" style="width: 100%; border-collapse: collapse; text-align: center;"> <tr> <td style="width: 10%;"></td> <td style="width: 10%;"></td> <td style="width: 10%;"></td> <td style="width: 10%;"></td> <td style="width: 10%;"></td> <td style="width: 10%;"></td> <td style="width: 10%;"></td> <td style="width: 10%;"></td> <td style="width: 10%;"></td> <td style="width: 10%;"></td> </tr> <tr> <td></td> <td></td> <td colspan="8" style="text-align: center;"> <table border="1" style="width: 100%; border-collapse: collapse; text-align: center;"> <tr> <td style="width: 10%;"></td> <td style="width: 10%;"></td> <td style="width: 10%;"></td> <td style="width: 10%;"></td> <td style="width: 10%;"></td> <td style="width: 10%;"></td> <td style="width: 10%;"></td> <td style="width: 10%;"></td> <td style="width: 10%;"></td> <td style="width: 10%;"></td> </tr> <tr> <td></td> <td></td> <td colspan="8" style="text-align: center;"> <table border="1" style="width: 100%; border-collapse: collapse; text-align: center;"> <tr> <td style="width: 10%;"></td> <td style="width: 10%;"></td> <td style="width: 10%;"></td> <td style="width: 10%;"></td> <td style="width: 10%;"></td> <td style="width: 10%;"></td> <td style="width: 10%;"></td> <td style="width: 10%;"></td> <td style="width: 10%;"></td> <td style="width: 10%;"></td> </tr> <tr> <td></td> <td></td> <td colspan="8" style="text-align: center;"> <table border="1" style="width: 100%; border-collapse: collapse; text-align: center;"> <tr> <td style="width: 10%;"></td> <td style="width: 10%;"></td> <td style="width: 10%;"></td> <td style="width: 10%;"></td> <td style="width: 10%;"></td> <td style="width: 10%;"></td> <td style="width: 10%;"></td> <td style="width: 10%;"></td> <td style="width: 10%;"></td> <td style="width: 10%;"></td> </tr> <tr> <td></td> <td></td> <td colspan="8" style="text-align: center;"> <table border="1" style="width: 100%; border-collapse: collapse; text-align: center;"> <tr> <td style="width: 10%;"></td> <td style="width: 10%;"></td> <td style="width: 10%;"></td> <td style="width: 10%;"></td> <td style="width: 10%;"></td> <td style="width: 10%;"></td> <td style="width: 10%;"></td> <td style="width: 10%;"></td> <td style="width: 10%;"></td> <td style="width: 10%;"></td> </tr> <tr> <td></td> <td></td> <td colspan="8" style="text-align: center;"> <table border="1" style="width: 100%; border-collapse: collapse; text-align: center;"> <tr> <td style="width: 10%;"></td> <td style="width: 10%;"></td> <td style="width: 10%;"></td> <td style="width: 10%;"></td> <td style="width: 10%;"></td> <td style="width: 10%;"></td> <td style="width: 10%;"></td> <td style="width: 10%;"></td> <td style="width: 10%;"></td> <td style="width: 10%;"></td> </tr> <tr> <td></td> <td></td> <td colspan="8" style="text-align: center;"> <table border="1" style="width: 100%; border-collapse: collapse; text-align: center;"> <tr> <td style="width: 10%;"></td> <td style="width: 10%;"></td> <td style="width: 10%;"></td> <td style="width:
10%;"></td> <td style="width: 10%;"></td> <td style="width: 10%;"></td> <td style="width: 10%;"></td> <td style="width: 10%;"></td> <td style="width: 10%;"></td> <td style="width: 10%;"></td> </tr> <tr> <td></td> <td></td> <td colspan="8" style="text-align: center;"> <table border="1" style="width: 100%; border-collapse: collapse; text-align: center;"> <tr> <td style="width: 10%;"></td> <td style="width: 10%;"></td> <td style="width: 10%;"></td> <td style="width: 10%;"></td> <td style="width: 10%;"></td> <td style="width: 10%;"></td> <td style="width: 10%;"></td> <td style="width: 10%;"></td> <td style="width: 10%;"></td> <td style="width: 10%;"></td> </tr> <tr> <td></td> <td></td> <td colspan="8" style="text-align: center;"> <table border="1" style="width: 100%; border-collapse: collapse; text-align: center;"> <tr> <td style="width: 10%;"></td> <td style="width: 10%;"></td> <td style="width: 10%;"></td> <td style="width: 10%;"></td> <td style="width: 10%;"></td> <td style="width: 10%;"></td> <td style="width: 10%;"></td> <td style="width: 10%;"></td> <td style="width: 10%;"></td> <td style="width: 10%;"></td> </tr> <tr> <td></td> <td></td> <td colspan="8" style="text-align: center;"> <table border="1" style="width: 100%; border-collapse: collapse; text-align: center;"> <tr> <td style="width: 10%;"></td> <td style="width: 10%;"></td> <td style="width: 10%;"></td> <td style="width: 10%;"></td> <td style="width: 10%;"></td> <td style="width: 10%;"></td> <td style="width: 10%;"></td> <td style="width: 10%;"></td> <td style="width: 10%;"></td> <td style="width: 10%;"></td> </tr> <tr> <td></td> <td></td> <td colspan="8" style="text-align: center;"> <table border="1" style="width: 100%; border-collapse: collapse; text-align: center;"> <tr> <td style="width: 10%;"></td> <td style="width: 10%;"></td> <td style="width: 10%;"></td> <td style="width: 10%;"></td> <td style="width: 10%;"></td> <td style="width: 10%;"></td> <td style="width: 10%;"></td> <td style="width: 10%;"></td> <td style="width: 10%;"></td> <td style="width: 10%;"></td> </tr> <tr> <td></td> <td></td> <td colspan="8" style="text-align: center;"> <table border="1" style="width: 100%; border-collapse: collapse; text-align: center;"> <tr> <td style="width: 10%;"></td> <td style="width: 10%;"></td> <td style="width: 10%;"></td> <td style="width: 10%;"></td> <td style="width: 10%;"></td> <td style="width: 10%;"></td> <td style="width: 10%;"></td> <td style="width: 10%;"></td> <td style="width: 10%;"></td> <td style="width: 10%;"></td> </tr> <tr> <td></td> <td></td> <td colspan="8" style="text-align: center;"> <table border="1" style="width: 100%; border-collapse: collapse; text-align: center;"> <tr> <td style="width: 10%;"></td> <td style="width: 10%;"></td> <td style="width: 10%;"></td> <td style="width: 10%;"></td> <td style="width: 10%;"></td> <td style="width: 10%;"></td> <td style="width: 10%;"></td> <td style="width: 10%;"></td> <td style="width: 10%;"></td> <td style="width: 10%;"></td> </tr> <tr> <td></td> <td></td> <td colspan="8" style="text-align: center;"> <table border="1" style="width: 100%; border-collapse: collapse; text-align: center;"> <tr> <td style="width: 10%;"></td> <td style="width: 10%;"></td> <td style="width: 10%;"></td> <td style="width: 10%;"></td> <td style="width: 10%;"></td> <td style="width: 10%;"></td> <td style="width: 10%;"></td> <td style="width: 10%;"></td> <td style="width: 10%;"></td> <td style="width: 10%;"></td> </tr> <tr> <td></td> <td></td> <td colspan="8" style="text-align: center;"> <table border="1" style="width: 100%; border-collapse: collapse; text-align: center;"> <tr> <td style="width: 10%;"></td> <td style="width: 10%;"></td> <td style="width: 10%;"></td> <td style="width: 10%;"></td> <td style="width: 10%;"></td> <td style="width: 10%;"></td> <td style="width: 10%;"></td> <td style="width: 10%;"></td> <td style="width: 10%;"></td> <td style="width: 10%;"></td> </tr> <tr> <td></td> <td></td> <td colspan="8" style="text-align: center;"> <table border="1" style="width: 100%; border-collapse: collapse; text-align: center;"> <tr> <td style="width: 10%;"></td> <td style="width: 10%;"></td> <td style="width: 10%;"></td> <td style="width: 10%;"></td> <td style="width: 10%;"></td> <td style="width: 10%;"></td> <td style="width: 10%;"></td> <td style="width: 10%;"></td> <td style="width: 10%;"></td> <td style="width: 10%;"></td> </tr> <tr> <td></td> <td></td> <td colspan="8" style="text-align: center;"> <table border="1" style="width: 100%; border-collapse: collapse; text-align: center;"> <tr> <td style="width: 10%;"></td> <td style="width: 10%;"></td> <td style="width: 10%;"></td> <td style="width: 10%;"></td> <td style="width: 10%;"></td> <td style="width: 10%;"></td> <td style="width: 10%;"></td> <td style="width: 10%;"></td> <td style="width: 10%;"></td> <td style="width: 10%;"></td> </tr> <tr> <td></td> <td></td> <td colspan="8" style="text-align: center;"> <table border="1" style="width: 100%; border-collapse: collapse; text-align: center;"> <tr> <td style="width: 10%;"></td> <td style="width: 10%;"></td> <td style="width: 10%;"></td> <td style="width: 10%;"></td> <td style="width: 10%;"></td> <td style="width: 10%;"></td> <td style="width: 10%;"></td> <td style="width: 10%;"></td> <td style="width: 10%;"></td> <td style="width: 10%;"></td> </tr> <tr> <td></td> <td></td> <td colspan="8" style="text-align: center;"> <table border="1" style="width: 100%; border-collapse: collapse; text-align: center;"> <tr> </tr></table></td></tr></table></td></tr></table></td></tr></table></td></tr></table></td></tr></table></td></tr></table></td></tr></table></td></tr></table></td></tr></table></td></tr></table></td></tr></table></td></tr></table></td></tr></table></td></tr></table></td></tr></table></td></tr></table></td></tr></table></td></tr></table></td></tr></table></td></tr></table></td></tr></table></td></tr></table></td></tr></table></td></tr></table></td></tr></table></td></tr></table></td></tr></table></td></tr></table></td></tr></table></td></tr></table></td></tr></table></td></tr></table></td></tr></table></td></tr></table></td></tr></table>
 | | | | | | | | | | | | | | | | | | | | <table border="1" style="width: 100%; border-collapse: collapse; text-align: center;"> <tr> <td style="width: 10%;"></td> <td style="width: 10%;"></td> <td style="width: 10%;"></td> <td style="width: 10%;"></td> <td style="width: 10%;"></td> <td style="width: 10%;"></td> <td style="width: 10%;"></td> <td style="width: 10%;"></td> <td style="width: 10%;"></td> <td style="width: 10%;"></td> </tr> <tr> <td></td> <td></td> <td colspan="8" style="text-align: center;"> <table border="1" style="width: 100%; border-collapse: collapse; text-align: center;"> <tr> <td style="width: 10%;"></td> <td style="width: 10%;"></td> <td style="width: 10%;"></td> <td style="width: 10%;"></td> <td style="width: 10%;"></td> <td style="width: 10%;"></td> <td style="width: 10%;"></td> <td style="width: 10%;"></td> <td style="width: 10%;"></td> <td style="width: 10%;"></td> </tr> <tr> <td></td> <td></td> <td colspan="8" style="text-align: center;"> <table border="1" style="width: 100%; border-collapse: collapse; text-align: center;"> <tr> <td style="width: 10%;"></td> <td style="width: 10%;"></td> <td style="width: 10%;"></td> <td style="width: 10%;"></td> <td style="width: 10%;"></td> <td style="width: 10%;"></td> <td style="width: 10%;"></td> <td style="width: 10%;"></td> <td style="width: 10%;"></td> <td style="width: 10%;"></td> </tr> <tr> <td></td> <td></td> <td colspan="8" style="text-align: center;"> <table border="1" style="width: 100%; border-collapse: collapse; text-align: center;"> <tr> <td style="width: 10%;"></td> <td style="width: 10%;"></td> <td style="width: 10%;"></td> <td style="width: 10%;"></td> <td style="width: 10%;"></td> <td style="width: 10%;"></td> <td style="width: 10%;"></td> <td style="width: 10%;"></td> <td style="width: 10%;"></td> <td style="width: 10%;"></td> </tr> <tr> <td></td> <td></td> <td colspan="8" style="text-align: center;"> <table border="1" style="width: 100%; border-collapse: collapse; text-align: center;"> <tr> <td style="width: 10%;"></td> <td style="width: 10%;"></td> <td style="width: 10%;"></td> <td style="width: 10%;"></td> <td style="width: 10%;"></td> <td style="width: 10%;"></td> <td style="width: 10%;"></td> <td style="width: 10%;"></td> <td style="width: 10%;"></td> <td style="width: 10%;"></td> </tr> <tr> <td></td> <td></td> <td colspan="8" style="text-align: center;"> <table border="1" style="width: 100%; border-collapse: collapse; text-align: center;"> <tr> <td style="width: 10%;"></td> <td style="width: 10%;"></td> <td style="width: 10%;"></td> <td style="width: 10%;"></td> <td style="width: 10%;"></td> <td style="width: 10%;"></td> <td style="width: 10%;"></td> <td style="width: 10%;"></td> <td style="width: 10%;"></td> <td style="width: 10%;"></td> </tr> <tr> <td></td> <td></td> <td colspan="8" style="text-align: center;"> <table border="1" style="width: 100%; border-collapse: collapse; text-align: center;"> <tr> <td style="width: 10%;"></td> <td style="width: 10%;"></td> <td style="width: 10%;"></td> <td style="width: 10%;"></td> <td style="width: 10%;"></td> <td style="width: 10%;"></td> <td
style="width: 10%;"></td> <td style="width: 10%;"></td> <td style="width: 10%;"></td> <td style="width: 10%;"></td> </tr> <tr> <td></td> <td></td> <td colspan="8" style="text-align: center;"> <table border="1" style="width: 100%; border-collapse: collapse; text-align: center;"> <tr> <td style="width: 10%;"></td> <td style="width: 10%;"></td> <td style="width: 10%;"></td> <td style="width: 10%;"></td> <td style="width: 10%;"></td> <td style="width: 10%;"></td> <td style="width: 10%;"></td> <td style="width: 10%;"></td> <td style="width: 10%;"></td> <td style="width: 10%;"></td> </tr> <tr> <td></td> <td></td> <td colspan="8" style="text-align: center;"> <table border="1" style="width: 100%; border-collapse: collapse; text-align: center;"> <tr> <td style="width: 10%;"></td> <td style="width: 10%;"></td> <td style="width: 10%;"></td> <td style="width: 10%;"></td> <td style="width: 10%;"></td> <td style="width: 10%;"></td> <td style="width: 10%;"></td> <td style="width: 10%;"></td> <td style="width: 10%;"></td> <td style="width: 10%;"></td> </tr> <tr> <td></td> <td></td> <td colspan="8" style="text-align: center;"> <table border="1" style="width: 100%; border-collapse: collapse; text-align: center;"> <tr> <td style="width: 10%;"></td> <td style="width: 10%;"></td> <td style="width: 10%;"></td> <td style="width: 10%;"></td> <td style="width: 10%;"></td> <td style="width: 10%;"></td> <td style="width: 10%;"></td> <td style="width: 10%;"></td> <td style="width: 10%;"></td> <td style="width: 10%;"></td> </tr> <tr> <td></td> <td></td> <td colspan="8" style="text-align: center;"> <table border="1" style="width: 100%; border-collapse: collapse; text-align: center;"> <tr> <td style="width: 10%;"></td> <td style="width: 10%;"></td> <td style="width: 10%;"></td> <td style="width: 10%;"></td> <td style="width: 10%;"></td> <td style="width: 10%;"></td> <td style="width: 10%;"></td> <td style="width: 10%;"></td> <td style="width: 10%;"></td> <td style="width: 10%;"></td> </tr> <tr> <td></td> <td></td> <td colspan="8" style="text-align: center;"> <table border="1" style="width: 100%; border-collapse: collapse; text-align: center;"> <tr> <td style="width: 10%;"></td> <td style="width: 10%;"></td> <td style="width: 10%;"></td> <td style="width: 10%;"></td> <td style="width: 10%;"></td> <td style="width: 10%;"></td> <td style="width: 10%;"></td> <td style="width: 10%;"></td> <td style="width: 10%;"></td> <td style="width: 10%;"></td> </tr> <tr> <td></td> <td></td> <td colspan="8" style="text-align: center;"> <table border="1" style="width: 100%; border-collapse: collapse; text-align: center;"> <tr> <td style="width: 10%;"></td> <td style="width: 10%;"></td> <td style="width: 10%;"></td> <td style="width: 10%;"></td> <td style="width: 10%;"></td> <td style="width: 10%;"></td> <td style="width: 10%;"></td> <td style="width: 10%;"></td> <td style="width: 10%;"></td> <td style="width: 10%;"></td> </tr> <tr> <td></td> <td></td> <td colspan="8" style="text-align: center;"> <table border="1" style="width: 100%; border-collapse: collapse; text-align: center;"> <tr> <td style="width: 10%;"></td> <td style="width: 10%;"></td> <td style="width: 10%;"></td> <td style="width: 10%;"></td> <td style="width: 10%;"></td> <td style="width: 10%;"></td> <td style="width: 10%;"></td> <td style="width: 10%;"></td> <td style="width: 10%;"></td> <td style="width: 10%;"></td> </tr> <tr> <td></td> <td></td> <td colspan="8" style="text-align: center;"> <table border="1" style="width: 100%; border-collapse: collapse; text-align: center;"> <tr> <td style="width: 10%;"></td> <td style="width: 10%;"></td> <td style="width: 10%;"></td> <td style="width: 10%;"></td> <td style="width: 10%;"></td> <td style="width: 10%;"></td> <td style="width: 10%;"></td> <td style="width: 10%;"></td> <td style="width: 10%;"></td> <td style="width: 10%;"></td> </tr> <tr> <td></td> <td></td> <td colspan="8" style="text-align: center;"> <table border="1" style="width: 100%; border-collapse: collapse; text-align: center;"> <tr> <td style="width: 10%;"></td> <td style="width: 10%;"></td> <td style="width: 10%;"></td> <td style="width: 10%;"></td> <td style="width: 10%;"></td> <td style="width: 10%;"></td> <td style="width: 10%;"></td> <td style="width: 10%;"></td> <td style="width: 10%;"></td> <td style="width: 10%;"></td> </tr> <tr> <td></td> <td></td> <td colspan="8" style="text-align: center;"> <table border="1" style="width: 100%; border-collapse: collapse; text-align: center;"> <tr> <td style="width: 10%;"></td> <td style="width: 10%;"></td> <td style="width: 10%;"></td> <td style="width: 10%;"></td> <td style="width: 10%;"></td> <td style="width: 10%;"></td> <td style="width: 10%;"></td> <td style="width: 10%;"></td> <td style="width: 10%;"></td> <td style="width: 10%;"></td> </tr> <tr> <td></td> <td></td> <td colspan="8" style="text-align: center;"> <table border="1" style="width: 100%; border-collapse: collapse; text-align: center;"> <tr> <td style="width: 10%;"></td> <td style="width: 10%;"></td> <td style="width: 10%;"></td> <td style="width: 10%;"></td> <td style="width: 10%;"></td> <td style="width: 10%;"></td> <td style="width: 10%;"></td> <td style="width: 10%;"></td> <td style="width: 10%;"></td> <td style="width: 10%;"></td> </tr> <tr> <td></td> <td></td> <td colspan="8" style="text-align: center;"> <table border="1" style="width: 100%; border-collapse: collapse; text-align: center;"> <tr> <td style="width: 10%;"></td> <td style="width: 10%;"></td> <td style="width: 10%;"></td> <td style="width: 10%;"></td> <td style="width: 10%;"></td> <td style="width: 10%;"></td> <td style="width: 10%;"></td> <td style="width: 10%;"></td> <td style="width: 10%;"></td> <td style="width: 10%;"></td> </tr> <tr> <td></td> <td></td> <td colspan="8" style="text-align: center;"> <table border="1" style="width: 100%; border-collapse: collapse; text-align: center;"> <tr> <td style="width: 10%;"></td> <td style="width: 10%;"></td> <td style="width: 10%;"></td> <td style="width: 10%;"></td> <td style="width: 10%;"></td> <td style="width: 10%;"></td> <td style="width: 10%;"></td> <td style="width: 10%;"></td> <td style="width: 10%;"></td> <td style="width: 10%;"></td> </tr> <tr> <td></td> <td></td> <td colspan="8" style="text-align: center;"> <table border="1" style="width: 100%; border-collapse: collapse; text-align: center;"> <tr> <td style="width: 10%;"></td> <td style="width: 10%;"></td> <td style="width: 10%;"></td> <td style="width: 10%;"></td> <td style="width: 10%;"></td> <td style="width: 10%;"></td> <td style="width: 10%;"></td> <td style="width: 10%;"></td> <td style="width: 10%;"></td> <td style="width: 10%;"></td> </tr> <tr> <td></td> <td></td> <td colspan="8" style="text-align: center;"> <table border="1" style="width: 100%; border-collapse: collapse; text-align: center;"> <tr> <td style="width: 10%;"></td> <td style="width: 10%;"></td> <td style="width: 10%;"></td> <td style="width: 10%;"></td> <td style="width: 10%;"></td> <td style="width: 10%;"></td> <td style="width: 10%;"></td> <td style="width: 10%;"></td> <td style="width: 10%;"></td> <td style="width: 10%;"></td> </tr> <tr> <td></td> <td></td> <td colspan="8" style="text-align: center;"> <table border="1" style="width: 100%; border-collapse: collapse; text-align: center;"> <tr> <td style="width: 10%;"></td> <td style="width: 10%;"></td> <td style="width: 10%;"></td> <td style="width: 10%;"></td> <td style="width: 10%;"></td> <td style="width: 10%;"></td> <td style="width: 10%;"></td> <td style="width: 10%;"></td> <td style="width: 10%;"></td> <td style="width: 10%;"></td> </tr> <tr> <td></td> <td></td> <td colspan="8" style="text-align: center;"> <table border="1" style="width: 100%; border-collapse: collapse; text-align: center;"> <tr> <td style="width: 10%;"></td> <td style="width: 10%;"></td> <td style="width: 10%;"></td> <td style="width: 10%;"></td> <td style="width: 10%;"></td> <td style="width: 10%;"></td> <td style="width: 10%;"></td> <td style="width: 10%;"></td> <td style="width: 10%;"></td> <td style="width: 10%;"></td> </tr> <tr> <td></td> <td></td> <td colspan="8" style="text-align: center;"> <table border="1" style="width: 100%; border-collapse: collapse; text-align: center;"> <tr> <td style="width: 10%;"></td> <td style="width: 10%;"></td> <td style="width: 10%;"></td> <td style="width: 10%;"></td> <td style="width: 10%;"></td> <td style="width: 10%;"></td> <td style="width: 10%;"></td> <td style="width: 10%;"></td> <td style="width: 10%;"></td> <td style="width: 10%;"></td> </tr> <tr> <td></td> <td></td> <td colspan="8" style="text-align: center;"> <table border="1" style="width: 100%; border-collapse: collapse; text-align: center;"> <tr> <td style="width: 10%;"></td> <td style="width: 10%;"></td> <td style="width: 10%;"></td> <td style="width: 10%;"></td> <td style="width: 10%;"></td> <td style="width: 10%;"></td> <td style="width: 10%;"></td> <td style="width: 10%;"></td> <td style="width: 10%;"></td> <td style="width: 10%;"></td> </tr> <tr> <td></td> <td></td> <td colspan="8" style="text-align: center;"> <table border="1" style="width: 100%; border-collapse: collapse; text-align: center;"> <tr> <td style="width: 10%;"></td> <td style="width: 10%;"></td> <td style="width: 10%;"></td> <td style="width: 10%;"></td> <td style="width: 10%;"></td> <td style="width: 10%;"></td> <td style="width: 10%;"></td> <td style="width: 10%;"></td> <td style="width: 10%;"></td> <td style="width: 10%;"></td> </tr> <tr> <td></td> <td></td> <td colspan="8" style="text-align: center;"> <table border="1" style="width: 100%; border-collapse: collapse; text-align: center;"> <tr> <td style="width: 10%;"></td> <td style="width: 10%;"></td> <td style="width: 10%;"></td> <td style="width: 10%;"></td> <td style="width: 10%;"></td> <td style="width: 10%;"></td> <td style="width: 10%;"></td> <td style="width: 10%;"></td> <td style="width: 10%;"></td> <td style="width: 10%;"></td> </tr> <tr> <td></td> <td></td> <td colspan="8"
style="text-align: center;"> <table border="1" style="width: 100%; border-collapse: collapse; text-align: center;"> <tr> <td style="width: 10%;"></td> <td style="width: 10%;"></td> <td style="width: 10%;"></td> <td style="width: 10%;"></td> <td style="width: 10%;"></td> <td style="width: 10%;"></td> <td style="width: 10%;"></td> <td style="width: 10%;"></td> <td style="width: 10%;"></td> <td style="width: 10%;"></td> </tr> <tr> <td></td> <td></td> <td colspan="8" style="text-align: center;"> <table border="1" style="width: 100%; border-collapse: collapse; text-align: center;"> <tr> <td style="width: 10%;"></td> <td style="width: 10%;"></td> <td style="width: 10%;"></td> <td style="width: 10%;"></td> <td style="width: 10%;"></td> <td style="width: 10%;"></td> <td style="width: 10%;"></td> <td style="width: 10%;"></td> <td style="width: 10%;"></td> <td style="width: 10%;"></td> </tr> <tr> <td></td> <td></td> <td colspan="8" style="text-align: center;"> <table border="1" style="width: 100%; border-collapse: collapse; text-align: center;"> <tr> <td style="width: 10%;"></td> <td style="width: 10%;"></td> <td style="width: 10%;"></td> <td style="width: 10%;"></td> <td style="width: 10%;"></td> <td style="width: 10%;"></td> <td style="width: 10%;"></td> <td style="width: 10%;"></td> <td style="width: 10%;"></td> <td style="width: 10%;"></td> </tr> <tr> <td></td> <td></td> <td colspan="8" style="text-align: center;"> <table border="1" style="width: 100%; border-collapse: collapse; text-align: center;"> <tr> <td style="width: 10%;"></td> <td style="width: 10%;"></td> <td style="width: 10%;"></td> <td style="width: 10%;"></td> <td style="width: 10%;"></td> <td style="width: 10%;"></td> <td style="width: 10%;"></td> <td style="width: 10%;"></td> <td style="width: 10%;"></td> <td style="width: 10%;"></td> </tr> <tr> <td></td> <td></td> <td colspan="8" style="text-align: center;"> <table border="1" style="width: 100%; border-collapse: collapse; text-align: center;"> <tr> <td style="width: 10%;"></td> <td style="width: 10%;"></td> <td style="width: 10%;"></td> <td style="width: 10%;"></td> <td style="width: 10%;"></td> <td style="width: 10%;"></td> <td style="width: 10%;"></td> <td style="width: 10%;"></td> <td style="width: 10%;"></td> <td style="width: 10%;"></td> </tr> <tr> <td></td> <td></td> <td colspan="8" style="text-align: center;"> <table border="1" style="width: 100%; border-collapse: collapse; text-align: center;"> <tr> <td style="width: 10%;"></td> <td style="width: 10%;"></td> <td style="width: 10%;"></td> <td style="width: 10%;"></td> <td style="width: 10%;"></td> <td style="width: 10%;"></td> <td style="width: 10%;"></td> <td style="width: 10%;"></td> <td style="width: 10%;"></td> <td style="width: 10%;"></td> </tr> <tr> <td></td> <td></td> <td colspan="8" style="text-align: center;"> <table border="1" style="width: 100%; border-collapse: collapse; text-align: center;"> <tr> </tr></table></td></tr></table></td></tr></table></td></tr></table></td></tr></table></td></tr></table></td></tr></table></td></tr></table></td></tr></table></td></tr></table></td></tr></table></td></tr></table></td></tr></table></td></tr></table></td></tr></table></td></tr></table></td></tr></table></td></tr></table></td></tr></table></td></tr></table></td></tr></table></td></tr></table></td></tr></table></td></tr></table></td></tr></table></td></tr></table></td></tr></table></td></tr></table></td></tr></table></td></tr></table></td></tr></table></td></tr></table></td></tr></table></td></tr></table></td></tr></table>
 | | | | | | | | | | | | | | | | | | | | <table border="1" style="width: 100%; border-collapse: collapse; text-align: center;"> <tr> <td style="width: 10%;"></td> <td style="width: 10%;"></td> <td style="width: 10%;"></td> <td style="width: 10%;"></td> <td style="width: 10%;"></td> <td style="width: 10%;"></td> <td style="width: 10%;"></td> <td style="width: 10%;"></td> <td style="width: 10%;"></td> <td style="width: 10%;"></td> </tr> <tr> <td></td> <td></td> <td colspan="8" style="text-align: center;"> <table border="1" style="width: 100%; border-collapse: collapse; text-align: center;"> <tr> <td style="width: 10%;"></td> <td style="width: 10%;"></td> <td style="width: 10%;"></td> <td style="width: 10%;"></td> <td style="width: 10%;"></td> <td style="width: 10%;"></td> <td style="width: 10%;"></td> <td style="width: 10%;"></td> <td style="width: 10%;"></td> <td style="width: 10%;"></td> </tr> <tr> <td></td> <td></td> <td colspan="8" style="text-align: center;"> <table border="1" style="width: 100%; border-collapse: collapse; text-align: center;"> <tr> <td style="width: 10%;"></td> <td style="width: 10%;"></td> <td style="width: 10%;"></td> <td style="width: 10%;"></td> <td style="width: 10%;"></td> <td style="width: 10%;"></td> <td style="width: 10%;"></td> <td style="width: 10%;"></td> <td style="width: 10%;"></td> <td style="width: 10%;"></td> </tr> <tr> <td></td> <td></td> <td colspan="8" style="text-align: center;"> <table border="1" style="width: 100%; border-collapse: collapse; text-align: center;"> <tr> <td style="width: 10%;"></td> <td style="width: 10%;"></td> <td style="width: 10%;"></td> <td style="width: 10%;"></td> <td style="width: 10%;"></td> <td style="width: 10%;"></td> <td style="width: 10%;"></td> <td style="width: 10%;"></td> <td style="width: 10%;"></td> <td style="width: 10%;"></td> </tr> <tr> <td></td> <td></td> <td colspan="8" style="text-align: center;"> <table border="1" style="width: 100%; border-collapse: collapse; text-align: center;"> <tr> <td style="width: 10%;"></td> <td style="width: 10%;"></td> <td style="width: 10%;"></td> <td style="width: 10%;"></td> <td style="width: 10%;"></td> <td style="width: 10%;"></td> <td style="width: 10%;"></td> <td style="width: 10%;"></td> <td style="width: 10%;"></td> <td style="width: 10%;"></td> </tr> <tr> <td></td> <td></td> <td colspan="8" style="text-align: center;"> <table border="1" style="width: 100%; border-collapse: collapse; text-align: center;"> <tr> <td style="width: 10%;"></td> <td style="width: 10%;"></td> <td style="width: 10%;"></td> <td style="width: 10%;"></td> <td style="width: 10%;"></td> <td style="width: 10%;"></td> <td style="width: 10%;"></td> <td style="width: 10%;"></td> <td style="width: 10%;"></td> <td style="width: 10%;"></td> </tr> <tr> <td></td> <td></td> <td colspan="8" style="text-align: center;"> <table border="1" style="width: 100%; border-collapse: collapse; text-align: center;"> <tr> <td style="width: 10%;"></td> <td style="width: 10%;"></td> <td style="width: 10%;"></td> <td style="width: 10%;"></td> <td style="width: 10%;"></td> <td style="width: 10%;"></td> <td style="width: 10%;"></td> <td style="width: 10%;"></td> <td style="width: 10%;"></td> <td style="width: 10%;"></td> </tr> <tr> <td></td> <td></td> <td colspan="8" style="text-align: center;"> <table border="1" style="width: 100%; border-collapse: collapse; text-align: center;"> <tr> <td style="width: 10%;"></td> <td style="width: 10%;"></td> <td style="width: 10%;"></td> <td style="width: 10%;"></td> <td style="width: 10%;"></td> <td style="width: 10%;"></td> <td style="width: 10%;"></td> <td style="width: 10%;"></td> <td style="width: 10%;"></td> <td style="width: 10%;"></td> </tr> <tr> <td></td> <td></td> <td colspan="8" style="text-align: center;"> <table border="1" style="width: 100%; border-collapse: collapse; text-align: center;"> <tr> <td style="width: 10%;"></td> <td style="width: 10%;"></td> <td style="width: 10%;"></td> <td style="width: 10%;"></td> <td style="width: 10%;"></td> <td style="width: 10%;"></td> <td style="width: 10%;"></td> <td style="width: 10%;"></td> <td style="width: 10%;"></td> <td style="width: 10%;"></td> </tr> <tr> <td></td> <td></td> <td colspan="8" style="text-align: center;"> <table border="1" style="width: 100%; border-collapse: collapse; text-align: center;"> <tr> <td style="width: 10%;"></td> <td style="width: 10%;"></td> <td style="width: 10%;"></td> <td style="width: 10%;"></td> <td style="width: 10%;"></td> <td style="width: 10%;"></td> <td style="width: 10%;"></td> <td style="width: 10%;"></td> <td style="width: 10%;"></td> <td style="width: 10%;"></td> </tr> <tr> <td></td> <td></td> <td colspan="8" style="text-align: center;"> <table border="1" style="width: 100%; border-collapse: collapse; text-align: center;"> <tr> <td style="width: 10%;"></td> <td style="width: 10%;"></td> <td style="width: 10%;"></td> <td style="width: 10%;"></td> <td style="width: 10%;"></td> <td style="width: 10%;"></td> <td style="width: 10%;"></td> <td style="width: 10%;"></td> <td style="width: 10%;"></td> <td style="width: 10%;"></td> </tr> <tr> <td></td> <td></td> <td colspan="8" style="text-align: center;"> <table border="1" style="width: 100%; border-collapse: collapse; text-align: center;"> <tr> <td style="width: 10%;"></td> <td style="width: 10%;"></td> <td style="width: 10%;"></td> <td style="width: 10%;"></td> <td style="width: 10%;"></td> <td style="width: 10%;"></td> <td style="width: 10%;"></td> <td style="width: 10%;"></td> <td style="width: 10%;"></td> <td style="width: 10%;"></td> </tr> <tr> <td></td> <td></td> <td colspan="8" style="text-align: center;"> <table border="1" style="width: 100%; border-collapse: collapse; text-align:
center;"> <tr> <td style="width: 10%;"></td> <td style="width: 10%;"></td> <td style="width: 10%;"></td> <td style="width: 10%;"></td> <td style="width: 10%;"></td> <td style="width: 10%;"></td> <td style="width: 10%;"></td> <td style="width: 10%;"></td> <td style="width: 10%;"></td> <td style="width: 10%;"></td> </tr> <tr> <td></td> <td></td> <td colspan="8" style="text-align: center;"> <table border="1" style="width: 100%; border-collapse: collapse; text-align: center;"> <tr> <td style="width: 10%;"></td> <td style="width: 10%;"></td> <td style="width: 10%;"></td> <td style="width: 10%;"></td> <td style="width: 10%;"></td> <td style="width: 10%;"></td> <td style="width: 10%;"></td> <td style="width: 10%;"></td> <td style="width: 10%;"></td> <td style="width: 10%;"></td> </tr> <tr> <td></td> <td></td> <td colspan="8" style="text-align: center;"> <table border="1" style="width: 100%; border-collapse: collapse; text-align: center;"> <tr> <td style="width: 10%;"></td> <td style="width: 10%;"></td> <td style="width: 10%;"></td> <td style="width: 10%;"></td> <td style="width: 10%;"></td> <td style="width: 10%;"></td> <td style="width: 10%;"></td> <td style="width: 10%;"></td> <td style="width: 10%;"></td> <td style="width: 10%;"></td> </tr> <tr> <td></td> <td></td> <td colspan="8" style="text-align: center;"> <table border="1" style="width: 100%; border-collapse: collapse; text-align: center;"> <tr> <td style="width: 10%;"></td> <td style="width: 10%;"></td> <td style="width: 10%;"></td> <td style="width: 10%;"></td> <td style="width: 10%;"></td> <td style="width: 10%;"></td> <td style="width: 10%;"></td> <td style="width: 10%;"></td> <td style="width: 10%;"></td> <td style="width: 10%;"></td> </tr> <tr> <td></td> <td></td> <td colspan="8" style="text-align: center;"> <table border="1" style="width: 100%; border-collapse: collapse; text-align: center;"> <tr> <td style="width: 10%;"></td> <td style="width: 10%;"></td> <td style="width: 10%;"></td> <td style="width: 10%;"></td> <td style="width: 10%;"></td> <td style="width: 10%;"></td> <td style="width: 10%;"></td> <td style="width: 10%;"></td> <td style="width: 10%;"></td> <td style="width: 10%;"></td> </tr> <tr> <td></td> <td></td> <td colspan="8" style="text-align: center;"> <table border="1" style="width: 100%; border-collapse: collapse; text-align: center;"> <tr> <td style="width: 10%;"></td> <td style="width: 10%;"></td> <td style="width: 10%;"></td> <td style="width: 10%;"></td> <td style="width: 10%;"></td> <td style="width: 10%;"></td> <td style="width: 10%;"></td> <td style="width: 10%;"></td> <td style="width: 10%;"></td> <td style="width: 10%;"></td> </tr> <tr> <td></td> <td></td> <td colspan="8" style="text-align: center;"> <table border="1" style="width: 100%; border-collapse: collapse; text-align: center;"> <tr> <td style="width: 10%;"></td> <td style="width: 10%;"></td> <td style="width: 10%;"></td> <td style="width: 10%;"></td> <td style="width: 10%;"></td> <td style="width: 10%;"></td> <td style="width: 10%;"></td> <td style="width: 10%;"></td> <td style="width: 10%;"></td> <td style="width: 10%;"></td> </tr> <tr> <td></td> <td></td> <td colspan="8" style="text-align: center;"> <table border="1" style="width: 100%; border-collapse: collapse; text-align: center;"> <tr> <td style="width: 10%;"></td> <td style="width: 10%;"></td> <td style="width: 10%;"></td> <td style="width: 10%;"></td> <td style="width: 10%;"></td> <td style="width: 10%;"></td> <td style="width: 10%;"></td> <td style="width: 10%;"></td> <td style="width: 10%;"></td> <td style="width: 10%;"></td> </tr> <tr> <td></td> <td></td> <td colspan="8" style="text-align: center;"> <table border="1" style="width: 100%; border-collapse: collapse; text-align: center;"> <tr> <td style="width: 10%;"></td> <td style="width: 10%;"></td> <td style="width: 10%;"></td> <td style="width: 10%;"></td> <td style="width: 10%;"></td> <td style="width: 10%;"></td> <td style="width: 10%;"></td> <td style="width: 10%;"></td> <td style="width: 10%;"></td> <td style="width: 10%;"></td> </tr> <tr> <td></td> <td></td> <td colspan="8" style="text-align: center;"> <table border="1" style="width: 100%; border-collapse: collapse; text-align: center;"> <tr> <td style="width: 10%;"></td> <td style="width: 10%;"></td> <td style="width: 10%;"></td> <td style="width: 10%;"></td> <td style="width: 10%;"></td> <td style="width: 10%;"></td> <td style="width: 10%;"></td> <td style="width: 10%;"></td> <td style="width: 10%;"></td> <td style="width: 10%;"></td> </tr> <tr> <td></td> <td></td> <td colspan="8" style="text-align: center;"> <table border="1" style="width: 100%; border-collapse: collapse; text-align: center;"> <tr> <td style="width: 10%;"></td> <td style="width: 10%;"></td> <td style="width: 10%;"></td> <td style="width: 10%;"></td> <td style="width: 10%;"></td> <td style="width: 10%;"></td> <td style="width: 10%;"></td> <td style="width: 10%;"></td> <td style="width: 10%;"></td> <td style="width: 10%;"></td> </tr> <tr> <td></td> <td></td> <td colspan="8" style="text-align: center;"> <table border="1" style="width: 100%; border-collapse: collapse; text-align: center;"> <tr> <td style="width: 10%;"></td> <td style="width: 10%;"></td> <td style="width: 10%;"></td> <td style="width: 10%;"></td> <td style="width: 10%;"></td> <td style="width: 10%;"></td> <td style="width: 10%;"></td> <td style="width: 10%;"></td> <td style="width: 10%;"></td> <td style="width: 10%;"></td> </tr> <tr> <td></td> <td></td> <td colspan="8" style="text-align: center;"> <table border="1" style="width: 100%; border-collapse: collapse; text-align: center;"> <tr> <td style="width: 10%;"></td> <td style="width: 10%;"></td> <td style="width: 10%;"></td> <td style="width: 10%;"></td> <td style="width: 10%;"></td> <td style="width: 10%;"></td> <td style="width: 10%;"></td> <td style="width: 10%;"></td> <td style="width: 10%;"></td> <td style="width: 10%;"></td> </tr> <tr> <td></td> <td></td> <td colspan="8" style="text-align: center;"> <table border="1" style="width: 100%; border-collapse: collapse; text-align: center;"> <tr> <td style="width: 10%;"></td> <td style="width: 10%;"></td> <td style="width: 10%;"></td> <td style="width: 10%;"></td> <td style="width: 10%;"></td> <td style="width: 10%;"></td> <td style="width: 10%;"></td> <td style="width: 10%;"></td> <td style="width: 10%;"></td> <td style="width: 10%;"></td> </tr> <tr> <td></td> <td></td> <td colspan="8" style="text-align: center;"> <table border="1" style="width: 100%; border-collapse: collapse; text-align: center;"> <tr> <td style="width: 10%;"></td> <td style="width: 10%;"></td> <td style="width: 10%;"></td> <td style="width: 10%;"></td> <td style="width: 10%;"></td> <td style="width: 10%;"></td> <td style="width: 10%;"></td> <td style="width: 10%;"></td> <td style="width: 10%;"></td> <td style="width: 10%;"></td> </tr> <tr> <td></td> <td></td> <td colspan="8" style="text-align: center;"> <table border="1" style="width: 100%; border-collapse: collapse; text-align: center;"> <tr> <td style="width: 10%;"></td> <td style="width: 10%;"></td> <td style="width: 10%;"></td> <td style="width: 10%;"></td> <td style="width: 10%;"></td> <td style="width: 10%;"></td> <td style="width: 10%;"></td> <td style="width: 10%;"></td> <td style="width: 10%;"></td> <td style="width: 10%;"></td> </tr> <tr> <td></td> <td></td> <td colspan="8" style="text-align: center;"> <table border="1" style="width: 100%; border-collapse: collapse; text-align: center;"> <tr> <td style="width: 10%;"></td> <td style="width: 10%;"></td> <td style="width: 10%;"></td> <td style="width: 10%;"></td> <td style="width: 10%;"></td> <td style="width: 10%;"></td> <td style="width: 10%;"></td> <td style="width: 10%;"></td> <td style="width: 10%;"></td> <td style="width: 10%;"></td> </tr> <tr> <td></td> <td></td> <td colspan="8" style="text-align: center;"> <table border="1" style="width: 100%; border-collapse: collapse; text-align: center;"> <tr> <td style="width: 10%;"></td> <td style="width: 10%;"></td> <td style="width: 10%;"></td> <td style="width: 10%;"></td> <td style="width: 10%;"></td> <td style="width: 10%;"></td> <td style="width: 10%;"></td> <td style="width: 10%;"></td> <td style="width: 10%;"></td> <td style="width: 10%;"></td> </tr> <tr> <td></td> <td></td> <td colspan="8" style="text-align: center;"> <table border="1" style="width: 100%; border-collapse: collapse; text-align: center;"> <tr> <td style="width: 10%;"></td> <td style="width: 10%;"></td> <td style="width: 10%;"></td> <td style="width: 10%;"></td> <td style="width: 10%;"></td> <td style="width: 10%;"></td> <td style="width: 10%;"></td> <td style="width: 10%;"></td> <td style="width: 10%;"></td> <td style="width: 10%;"></td> </tr> <tr> <td></td> <td></td> <td colspan="8" style="text-align: center;"> <table border="1" style="width: 100%; border-collapse: collapse; text-align: center;"> <tr> <td style="width: 10%;"></td> <td style="width: 10%;"></td> <td style="width: 10%;"></td> <td style="width: 10%;"></td> <td style="width: 10%;"></td> <td style="width: 10%;"></td> <td style="width: 10%;"></td> <td style="width: 10%;"></td> <td style="width: 10%;"></td> <td style="width: 10%;"></td> </tr> <tr> <td></td> <td></td> <td colspan="8" style="text-align: center;"> <table border="1" style="width: 100%; border-collapse: collapse; text-align: center;"> <tr> <td style="width: 10%;"></td> <td style="width: 10%;"></td> <td style="width: 10%;"></td> <td style="width: 10%;"></td> <td style="width: 10%;"></td> <td style="width: 10%;"></td> <td style="width: 10%;"></td> <td style="width: 10%;"></td> <td style="width: 10%;"></td> <td style="width: 10%;"></td> </tr> <tr> <td></td> <td></td> <td colspan="8" style="text-align: center;"> <table border="1" style="width: 100%; border-collapse: collapse; text-align: center;"> <tr>
</tr></table></td></tr></table></td></tr></table></td></tr></table></td></tr></table></td></tr></table></td></tr></table></td></tr></table></td></tr></table></td></tr></table></td></tr></table></td></tr></table></td></tr></table></td></tr></table></td></tr></table></td></tr></table></td></tr></table></td></tr></table></td></tr></table></td></tr></table></td></tr></table></td></tr></table></td></tr></table></td></tr></table></td></tr></table></td></tr></table></td></tr></table></td></tr></table></td></tr></table></td></tr></table></td></tr></table></td></tr></table></td></tr></table></td></tr></table>
 | | | | | | | | | | | | | | | | | | | | <table border="1" style="width: 100%; border-collapse: collapse; text-align: center;"> <tr> <td style="width: 10%;"></td> <td style="width: 10%;"></td> <td style="width: 10%;"></td> <td style="width: 10%;"></td> <td style="width: 10%;"></td> <td style="width: 10%;"></td> <td style="width: 10%;"></td> <td style="width: 10%;"></td> <td style="width: 10%;"></td> <td style="width: 10%;"></td> </tr> <tr> <td></td> <td></td> <td colspan="8" style="text-align: center;"> <table border="1" style="width: 100%; border-collapse: collapse; text-align: center;"> <tr> <td style="width: 10%;"></td> <td style="width: 10%;"></td> <td style="width: 10%;"></td> <td style="width: 10%;"></td> <td style="width: 10%;"></td> <td style="width: 10%;"></td> <td style="width: 10%;"></td> <td style="width: 10%;"></td> <td style="width: 10%;"></td> <td style="width: 10%;"></td> </tr> <tr> <td></td> <td></td> <td colspan="8" style="text-align: center;"> <table border="1" style="width: 100%; border-collapse: collapse; text-align: center;"> <tr> <td style="width: 10%;"></td> <td style="width: 10%;"></td> <td style="width: 10%;"></td> <td style="width: 10%;"></td> <td style="width: 10%;"></td> <td style="width: 10%;"></td> <td style="width: 10%;"></td> <td style="width: 10%;"></td> <td style="width: 10%;"></td> <td style="width: 10%;"></td> </tr> <tr> <td></td> <td></td> <td colspan="8" style="text-align: center;"> <table border="1" style="width: 100%; border-collapse: collapse; text-align: center;"> <tr> <td style="width: 10%;"></td> <td style="width: 10%;"></td> <td style="width: 10%;"></td> <td style="width: 10%;"></td> <td style="width: 10%;"></td> <td style="width: 10%;"></td> <td style="width: 10%;"></td> <td style="width: 10%;"></td> <td style="width: 10%;"></td> <td style="width: 10%;"></td> </tr> <tr> <td></td> <td></td> <td colspan="8" style="text-align: center;"> <table border="1" style="width: 100%; border-collapse: collapse; text-align: center;"> <tr> <td style="width: 10%;"></td> <td style="width: 10%;"></td> <td style="width: 10%;"></td> <td style="width: 10%;"></td> <td style="width: 10%;"></td> <td style="width: 10%;"></td> <td style="width: 10%;"></td> <td style="width: 10%;"></td> <td style="width: 10%;"></td> <td style="width: 10%;"></td> </tr> <tr> <td></td> <td></td> <td colspan="8" style="text-align: center;"> <table border="1" style="width: 100%; border-collapse: collapse; text-align: center;"> <tr> <td style="width: 10%;"></td> <td style="width: 10%;"></td> <td style="width: 10%;"></td> <td style="width: 10%;"></td> <td style="width: 10%;"></td> <td style="width: 10%;"></td> <td style="width: 10%;"></td> <td style="width: 10%;"></td> <td style="width: 10%;"></td> <td style="width: 10%;"></td> </tr> <tr> <td></td> <td></td> <td colspan="8" style="text-align: center;"> <table border="1" style="width: 100%; border-collapse: collapse; text-align: center;"> <tr> <td style="width: 10%;"></td> <td style="width: 10%;"></td> <td style="width: 10%;"></td> <td style="width: 10%;"></td> <td style="width: 10%;"></td> <td style="width: 10%;"></td> <td style="width: 10%;"></td> <td style="width: 10%;"></td> <td style="width: 10%;"></td> <td style="width: 10%;"></td> </tr> <tr> <td></td> <td></td> <td colspan="8" style="text-align: center;"> <table border="1" style="width: 100%; border-collapse: collapse; text-align: center;"> <tr> <td style="width: 10%;"></td> <td style="width: 10%;"></td> <td style="width: 10%;"></td> <td style="width: 10%;"></td> <td style="width: 10%;"></td> <td style="width: 10%;"></td> <td style="width: 10%;"></td> <td style="width: 10%;"></td> <td style="width: 10%;"></td> <td style="width: 10%;"></td> </tr> <tr> <td></td> <td></td> <td colspan="8" style="text-align: center;"> <table border="1" style="width: 100%; border-collapse: collapse; text-align: center;"> <tr> <td style="width: 10%;"></td> <td style="width: 10%;"></td> <td style="width: 10%;"></td> <td style="width: 10%;"></td> <td style="width: 10%;"></td> <td style="width: 10%;"></td> <td style="width: 10%;"></td> <td style="width: 10%;"></td> <td style="width: 10%;"></td> <td style="width: 10%;"></td> </tr> <tr> <td></td> <td></td> <td colspan="8" style="text-align: center;"> <table border="1" style="width: 100%; border-collapse: collapse; text-align: center;"> <tr> <td style="width: 10%;"></td> <td style="width: 10%;"></td> <td style="width: 10%;"></td> <td style="width: 10%;"></td> <td style="width: 10%;"></td> <td style="width: 10%;"></td> <td style="width: 10%;"></td> <td style="width: 10%;"></td> <td style="width: 10%;"></td> <td style="width: 10%;"></td> </tr> <tr> <td></td> <td></td> <td colspan="8" style="text-align: center;"> <table border="1" style="width: 100%; border-collapse: collapse; text-align: center;"> <tr> <td style="width: 10%;"></td> <td style="width: 10%;"></td> <td style="width: 10%;"></td> <td style="width: 10%;"></td> <td style="width: 10%;"></td> <td style="width: 10%;"></td> <td style="width: 10%;"></td> <td style="width: 10%;"></td> <td style="width: 10%;"></td> <td style="width: 10%;"></td> </tr> <tr> <td></td> <td></td> <td colspan="8" style="text-align: center;"> <table border="1" style="width: 100%; border-collapse: collapse; text-align: center;"> <tr> <td style="width: 10%;"></td> <td style="width: 10%;"></td> <td style="width: 10%;"></td> <td style="width: 10%;"></td> <td style="width: 10%;"></td> <td style="width: 10%;"></td> <td style="width: 10%;"></td> <td style="width: 10%;"></td> <td style="width: 10%;"></td> <td style="width: 10%;"></td> </tr> <tr> <td></td> <td></td> <td colspan="8" style="text-align: center;"> <table border="1" style="width: 100%; border-collapse: collapse; text-align: center;"> <tr> <td style="width: 10%;"></td> <td style="width: 10%;"></td> <td style="width: 10%;"></td> <td style="width: 10%;"></td> <td style="width: 10%;"></td> <td style="width: 10%;"></td> <td style="width: 10%;"></td> <td style="width: 10%;"></td> <td style="width: 10%;"></td> <td style="width: 10%;"></td> </tr> <tr> <td></td> <td></td> <td colspan="8" style="text-align: center;"> <table border="1" style="width: 100%; border-collapse: collapse; text-align: center;"> <tr> <td style="width: 10%;"></td> <td style="width: 10%;"></td> <td style="width: 10%;"></td> <td style="width: 10%;"></td> <td style="width: 10%;"></td> <td style="width: 10%;"></td> <td style="width: 10%;"></td> <td style="width: 10%;"></td> <td style="width: 10%;"></td> <td style="width: 10%;"></td> </tr> <tr> <td></td> <td></td> <td colspan="8" style="text-align: center;"> <table border="1" style="width: 100%; border-collapse: collapse; text-align: center;"> <tr> <td style="width: 10%;"></td> <td style="width: 10%;"></td> <td style="width: 10%;"></td> <td style="width: 10%;"></td> <td style="width: 10%;"></td> <td style="width: 10%;"></td> <td style="width: 10%;"></td> <td style="width: 10%;"></td> <td style="width: 10%;"></td> <td style="width: 10%;"></td> </tr> <tr> <td></td> <td></td> <td colspan="8" style="text-align: center;"> <table border="1" style="width: 100%; border-collapse: collapse; text-align: center;"> <tr> <td style="width: 10%;"></td> <td style="width: 10%;"></td> <td style="width: 10%;"></td> <td style="width: 10%;"></td> <td style="width: 10%;"></td> <td style="width: 10%;"></td> <td style="width: 10%;"></td> <td style="width: 10%;"></td> <td style="width: 10%;"></td> <td style="width: 10%;"></td> </tr> <tr> <td></td> <td></td> <td colspan="8" style="text-align: center;"> <table border="1" style="width: 100%; border-collapse: collapse; text-align: center;"> <tr> <td style="width: 10%;"></td> <td style="width: 10%;"></td> <td style="width: 10%;"></td> <td style="width: 10%;"></td> <td style="width: 10%;"></td> <td style="width: 10%;"></td> <td style="width: 10%;"></td> <td style="width: 10%;"></td> <td style="width: 10%;"></td> <td style="width: 10%;"></td> </tr> <tr> <td></td> <td></td> <td colspan="8" style="text-align: center;"> <table border="1" style="width: 100%; border-collapse: collapse; text-align: center;"> <tr> <td style="width: 10%;"></td> <td style="width: 10%;"></td> <td style="width: 10%;"></td> <td style="width: 10%;"></td> <td style="width: 10%;"></td> <td style="width: 10%;"></td> <td style="width: 10%;"></td> <td style="width: 10%;"></td> <td style="width: 10%;"></td> <td style="width: 10%;"></td> </tr> <tr> <td></td> <td></td> <td colspan="8" style="text-align: center;"> <table border="1" style="width: 100%; border-collapse: collapse; text-align: center;"> <tr> <td style="width: 10%;"></td> <td style="width: 10%;"></td> <td style="width: 10%;"></td> <td style="width: 10%;"></td> <td
style="width: 10%;"></td> <td style="width: 10%;"></td> <td style="width: 10%;"></td> <td style="width: 10%;"></td> <td style="width: 10%;"></td> <td style="width: 10%;"></td> </tr> <tr> <td></td> <td></td> <td colspan="8" style="text-align: center;"> <table border="1" style="width: 100%; border-collapse: collapse; text-align: center;"> <tr> <td style="width: 10%;"></td> <td style="width: 10%;"></td> <td style="width: 10%;"></td> <td style="width: 10%;"></td> <td style="width: 10%;"></td> <td style="width: 10%;"></td> <td style="width: 10%;"></td> <td style="width: 10%;"></td> <td style="width: 10%;"></td> <td style="width: 10%;"></td> </tr> <tr> <td></td> <td></td> <td colspan="8" style="text-align: center;"> <table border="1" style="width: 100%; border-collapse: collapse; text-align: center;"> <tr> <td style="width: 10%;"></td> <td style="width: 10%;"></td> <td style="width: 10%;"></td> <td style="width: 10%;"></td> <td style="width: 10%;"></td> <td style="width: 10%;"></td> <td style="width: 10%;"></td> <td style="width: 10%;"></td> <td style="width: 10%;"></td> <td style="width: 10%;"></td> </tr> <tr> <td></td> <td></td> <td colspan="8" style="text-align: center;"> <table border="1" style="width: 100%; border-collapse: collapse; text-align: center;"> <tr> <td style="width: 10%;"></td> <td style="width: 10%;"></td> <td style="width: 10%;"></td> <td style="width: 10%;"></td> <td style="width: 10%;"></td> <td style="width: 10%;"></td> <td style="width: 10%;"></td> <td style="width: 10%;"></td> <td style="width: 10%;"></td> <td style="width: 10%;"></td> </tr> <tr> <td></td> <td></td> <td colspan="8" style="text-align: center;"> <table border="1" style="width: 100%; border-collapse: collapse; text-align: center;"> <tr> <td style="width: 10%;"></td> <td style="width: 10%;"></td> <td style="width: 10%;"></td> <td style="width: 10%;"></td> <td style="width: 10%;"></td> <td style="width: 10%;"></td> <td style="width: 10%;"></td> <td style="width: 10%;"></td> <td style="width: 10%;"></td> <td style="width: 10%;"></td> </tr> <tr> <td></td> <td></td> <td colspan="8" style="text-align: center;"> <table border="1" style="width: 100%; border-collapse: collapse; text-align: center;"> <tr> <td style="width: 10%;"></td> <td style="width: 10%;"></td> <td style="width: 10%;"></td> <td style="width: 10%;"></td> <td style="width: 10%;"></td> <td style="width: 10%;"></td> <td style="width: 10%;"></td> <td style="width: 10%;"></td> <td style="width: 10%;"></td> <td style="width: 10%;"></td> </tr> <tr> <td></td> <td></td> <td colspan="8" style="text-align: center;"> <table border="1" style="width: 100%; border-collapse: collapse; text-align: center;"> <tr> <td style="width: 10%;"></td> <td style="width: 10%;"></td> <td style="width: 10%;"></td> <td style="width: 10%;"></td> <td style="width: 10%;"></td> <td style="width: 10%;"></td> <td style="width: 10%;"></td> <td style="width: 10%;"></td> <td style="width: 10%;"></td> <td style="width: 10%;"></td> </tr> <tr> <td></td> <td></td> <td colspan="8" style="text-align: center;"> <table border="1" style="width: 100%; border-collapse: collapse; text-align: center;"> <tr> <td style="width: 10%;"></td> <td style="width: 10%;"></td> <td style="width: 10%;"></td> <td style="width: 10%;"></td> <td style="width: 10%;"></td> <td style="width: 10%;"></td> <td style="width: 10%;"></td> <td style="width: 10%;"></td> <td style="width: 10%;"></td> <td style="width: 10%;"></td> </tr> <tr> <td></td> <td></td> <td colspan="8" style="text-align: center;"> <table border="1" style="width: 100%; border-collapse: collapse; text-align: center;"> <tr> <td style="width: 10%;"></td> <td style="width: 10%;"></td> <td style="width: 10%;"></td> <td style="width: 10%;"></td> <td style="width: 10%;"></td> <td style="width: 10%;"></td> <td style="width: 10%;"></td> <td style="width: 10%;"></td> <td style="width: 10%;"></td> <td style="width: 10%;"></td> </tr> <tr> <td></td> <td></td> <td colspan="8" style="text-align: center;"> <table border="1" style="width: 100%; border-collapse: collapse; text-align: center;"> <tr> <td style="width: 10%;"></td> <td style="width: 10%;"></td> <td style="width: 10%;"></td> <td style="width: 10%;"></td> <td style="width: 10%;"></td> <td style="width: 10%;"></td> <td style="width: 10%;"></td> <td style="width: 10%;"></td> <td style="width: 10%;"></td> <td style="width: 10%;"></td> </tr> <tr> <td></td> <td></td> <td colspan="8" style="text-align: center;"> <table border="1" style="width: 100%; border-collapse: collapse; text-align: center;"> <tr> <td style="width: 10%;"></td> <td style="width: 10%;"></td> <td style="width: 10%;"></td> <td style="width: 10%;"></td> <td style="width: 10%;"></td> <td style="width: 10%;"></td> <td style="width: 10%;"></td> <td style="width: 10%;"></td> <td style="width: 10%;"></td> <td style="width: 10%;"></td> </tr> <tr> <td></td> <td></td> <td colspan="8" style="text-align: center;"> <table border="1" style="width: 100%; border-collapse: collapse; text-align: center;"> <tr> <td style="width: 10%;"></td> <td style="width: 10%;"></td> <td style="width: 10%;"></td> <td style="width: 10%;"></td> <td style="width: 10%;"></td> <td style="width: 10%;"></td> <td style="width: 10%;"></td> <td style="width: 10%;"></td> <td style="width: 10%;"></td> <td style="width: 10%;"></td> </tr> <tr> <td></td> <td></td> <td colspan="8" style="text-align: center;"> <table border="1" style="width: 100%; border-collapse: collapse; text-align: center;"> <tr> <td style="width: 10%;"></td> <td style="width: 10%;"></td> <td style="width: 10%;"></td> <td style="width: 10%;"></td> <td style="width: 10%;"></td> <td style="width: 10%;"></td> <td style="width: 10%;"></td> <td style="width: 10%;"></td> <td style="width: 10%;"></td> <td style="width: 10%;"></td> </tr> <tr> <td></td> <td></td> <td colspan="8" style="text-align: center;"> <table border="1" style="width: 100%; border-collapse: collapse; text-align: center;"> <tr> <td style="width: 10%;"></td> <td style="width: 10%;"></td> <td style="width: 10%;"></td> <td style="width: 10%;"></td> <td style="width: 10%;"></td> <td style="width: 10%;"></td> <td style="width: 10%;"></td> <td style="width: 10%;"></td> <td style="width: 10%;"></td> <td style="width: 10%;"></td> </tr> <tr> <td></td> <td></td> <td colspan="8" style="text-align: center;"> <table border="1" style="width: 100%; border-collapse: collapse; text-align: center;"> <tr> </tr></table></td></tr></table></td></tr></table></td></tr></table></td></tr></table></td></tr></table></td></tr></table></td></tr></table></td></tr></table></td></tr></table></td></tr></table></td></tr></table></td></tr></table></td></tr></table></td></tr></table></td></tr></table></td></tr></table></td></tr></table></td></tr></table></td></tr></table></td></tr></table></td></tr></table></td></tr></table></td></tr></table></td></tr></table></td></tr></table></td></tr></table></td></tr></table></td></tr></table></td></tr></table></td></tr></table></td></tr></table></td></tr></table>
 | | | | | | | | | | | | | | | | | | | | <table border="1" style="width: 100%; border-collapse: collapse; text-align: center;"> <tr> <td style="width: 10%;"></td> <td style="width: 10%;"></td> <td style="width: 10%;"></td> <td style="width: 10%;"></td> <td style="width: 10%;"></td> <td style="width: 10%;"></td> <td style="width: 10%;"></td> <td style="width: 10%;"></td> <td style="width: 10%;"></td> <td style="width: 10%;"></td> </tr> <tr> <td></td> <td></td> <td colspan="8" style="text-align: center;"> <table border="1" style="width: 100%; border-collapse: collapse; text-align: center;"> <tr> <td style="width: 10%;"></td> <td style="width: 10%;"></td> <td style="width: 10%;"></td> <td style="width: 10%;"></td> <td style="width: 10%;"></td> <td style="width: 10%;"></td> <td style="width: 10%;"></td> <td style="width: 10%;"></td> <td style="width: 10%;"></td> <td style="width: 10%;"></td> </tr> <tr> <td></td> <td></td> <td colspan="8" style="text-align: center;"> <table border="1" style="width: 100%; border-collapse: collapse; text-align: center;"> <tr> <td style="width: 10%;"></td> <td style="width: 10%;"></td> <td style="width: 10%;"></td> <td style="width: 10%;"></td> <td style="width: 10%;"></td> <td style="width: 10%;"></td> <td style="width: 10%;"></td> <td style="width: 10%;"></td> <td style="width: 10%;"></td> <td style="width: 10%;"></td> </tr> <tr> <td></td> <td></td> <td colspan="8" style="text-align: center;"> <table border="1" style="width: 100%; border-collapse: collapse; text-align: center;"> <tr> <td style="width: 10%;"></td> <td style="width: 10%;"></td> <td style="width: 10%;"></td> <td style="width: 10%;"></td> <td style="width: 10%;"></td> <td style="width: 10%;"></td> <td style="width: 10%;"></td> <td style="width: 10%;"></td> <td style="width: 10%;"></td> <td style="width: 10%;"></td> </tr> <tr> <td></td> <td></td> <td colspan="8" style="text-align: center;"> <table border="1" style="width: 100%; border-collapse: collapse; text-align: center;"> <tr> <td style="width: 10%;"></td> <td style="width: 10%;"></td> <td style="width: 10%;"></td> <td style="width: 10%;"></td> <td style="width: 10%;"></td> <td style="width: 10%;"></td> <td style="width: 10%;"></td> <td style="width: 10%;"></td> <td style="width:
10%;"></td> <td style="width: 10%;"></td> </tr> <tr> <td></td> <td></td> <td colspan="8" style="text-align: center;"> <table border="1" style="width: 100%; border-collapse: collapse; text-align: center;"> <tr> <td style="width: 10%;"></td> <td style="width: 10%;"></td> <td style="width: 10%;"></td> <td style="width: 10%;"></td> <td style="width: 10%;"></td> <td style="width: 10%;"></td> <td style="width: 10%;"></td> <td style="width: 10%;"></td> <td style="width: 10%;"></td> <td style="width: 10%;"></td> </tr> <tr> <td></td> <td></td> <td colspan="8" style="text-align: center;"> <table border="1" style="width: 100%; border-collapse: collapse; text-align: center;"> <tr> <td style="width: 10%;"></td> <td style="width: 10%;"></td> <td style="width: 10%;"></td> <td style="width: 10%;"></td> <td style="width: 10%;"></td> <td style="width: 10%;"></td> <td style="width: 10%;"></td> <td style="width: 10%;"></td> <td style="width: 10%;"></td> <td style="width: 10%;"></td> </tr> <tr> <td></td> <td></td> <td colspan="8" style="text-align: center;"> <table border="1" style="width: 100%; border-collapse: collapse; text-align: center;"> <tr> <td style="width: 10%;"></td> <td style="width: 10%;"></td> <td style="width: 10%;"></td> <td style="width: 10%;"></td> <td style="width: 10%;"></td> <td style="width: 10%;"></td> <td style="width: 10%;"></td> <td style="width: 10%;"></td> <td style="width: 10%;"></td> <td style="width: 10%;"></td> </tr> <tr> <td></td> <td></td> <td colspan="8" style="text-align: center;"> <table border="1" style="width: 100%; border-collapse: collapse; text-align: center;"> <tr> <td style="width: 10%;"></td> <td style="width: 10%;"></td> <td style="width: 10%;"></td> <td style="width: 10%;"></td> <td style="width: 10%;"></td> <td style="width: 10%;"></td> <td style="width: 10%;"></td> <td style="width: 10%;"></td> <td style="width: 10%;"></td> <td style="width: 10%;"></td> </tr> <tr> <td></td> <td></td> <td colspan="8" style="text-align: center;"> <table border="1" style="width: 100%; border-collapse: collapse; text-align: center;"> <tr> <td style="width: 10%;"></td> <td style="width: 10%;"></td> <td style="width: 10%;"></td> <td style="width: 10%;"></td> <td style="width: 10%;"></td> <td style="width: 10%;"></td> <td style="width: 10%;"></td> <td style="width: 10%;"></td> <td style="width: 10%;"></td> <td style="width: 10%;"></td> </tr> <tr> <td></td> <td></td> <td colspan="8" style="text-align: center;"> <table border="1" style="width: 100%; border-collapse: collapse; text-align: center;"> <tr> <td style="width: 10%;"></td> <td style="width: 10%;"></td> <td style="width: 10%;"></td> <td style="width: 10%;"></td> <td style="width: 10%;"></td> <td style="width: 10%;"></td> <td style="width: 10%;"></td> <td style="width: 10%;"></td> <td style="width: 10%;"></td> <td style="width: 10%;"></td> </tr> <tr> <td></td> <td></td> <td colspan="8" style="text-align: center;"> <table border="1" style="width: 100%; border-collapse: collapse; text-align: center;"> <tr> <td style="width: 10%;"></td> <td style="width: 10%;"></td> <td style="width: 10%;"></td> <td style="width: 10%;"></td> <td style="width: 10%;"></td> <td style="width: 10%;"></td> <td style="width: 10%;"></td> <td style="width: 10%;"></td> <td style="width: 10%;"></td> <td style="width: 10%;"></td> </tr> <tr> <td></td> <td></td> <td colspan="8" style="text-align: center;"> <table border="1" style="width: 100%; border-collapse: collapse; text-align: center;"> <tr> <td style="width: 10%;"></td> <td style="width: 10%;"></td> <td style="width: 10%;"></td> <td style="width: 10%;"></td> <td style="width: 10%;"></td> <td style="width: 10%;"></td> <td style="width: 10%;"></td> <td style="width: 10%;"></td> <td style="width: 10%;"></td> <td style="width: 10%;"></td> </tr> <tr> <td></td> <td></td> <td colspan="8" style="text-align: center;"> <table border="1" style="width: 100%; border-collapse: collapse; text-align: center;"> <tr> <td style="width: 10%;"></td> <td style="width: 10%;"></td> <td style="width: 10%;"></td> <td style="width: 10%;"></td> <td style="width: 10%;"></td> <td style="width: 10%;"></td> <td style="width: 10%;"></td> <td style="width: 10%;"></td> <td style="width: 10%;"></td> <td style="width: 10%;"></td> </tr> <tr> <td></td> <td></td> <td colspan="8" style="text-align: center;"> <table border="1" style="width: 100%; border-collapse: collapse; text-align: center;"> <tr> <td style="width: 10%;"></td> <td style="width: 10%;"></td> <td style="width: 10%;"></td> <td style="width: 10%;"></td> <td style="width: 10%;"></td> <td style="width: 10%;"></td> <td style="width: 10%;"></td> <td style="width: 10%;"></td> <td style="width: 10%;"></td> <td style="width: 10%;"></td> </tr> <tr> <td></td> <td></td> <td colspan="8" style="text-align: center;"> <table border="1" style="width: 100%; border-collapse: collapse; text-align: center;"> <tr> <td style="width: 10%;"></td> <td style="width: 10%;"></td> <td style="width: 10%;"></td> <td style="width: 10%;"></td> <td style="width: 10%;"></td> <td style="width: 10%;"></td> <td style="width: 10%;"></td> <td style="width: 10%;"></td> <td style="width: 10%;"></td> <td style="width: 10%;"></td> </tr> <tr> <td></td> <td></td> <td colspan="8" style="text-align: center;"> <table border="1" style="width: 100%; border-collapse: collapse; text-align: center;"> <tr> <td style="width: 10%;"></td> <td style="width: 10%;"></td> <td style="width: 10%;"></td> <td style="width: 10%;"></td> <td style="width: 10%;"></td> <td style="width: 10%;"></td> <td style="width: 10%;"></td> <td style="width: 10%;"></td> <td style="width: 10%;"></td> <td style="width: 10%;"></td> </tr> <tr> <td></td> <td></td> <td colspan="8" style="text-align: center;"> <table border="1" style="width: 100%; border-collapse: collapse; text-align: center;"> <tr> <td style="width: 10%;"></td> <td style="width: 10%;"></td> <td style="width: 10%;"></td> <td style="width: 10%;"></td> <td style="width: 10%;"></td> <td style="width: 10%;"></td> <td style="width: 10%;"></td> <td style="width: 10%;"></td> <td style="width: 10%;"></td> <td style="width: 10%;"></td> </tr> <tr> <td></td> <td></td> <td colspan="8" style="text-align: center;"> <table border="1" style="width: 100%; border-collapse: collapse; text-align: center;"> <tr> <td style="width: 10%;"></td> <td style="width: 10%;"></td> <td style="width: 10%;"></td> <td style="width: 10%;"></td> <td style="width: 10%;"></td> <td style="width: 10%;"></td> <td style="width: 10%;"></td> <td style="width: 10%;"></td> <td style="width: 10%;"></td> <td style="width: 10%;"></td> </tr> <tr> <td></td> <td></td> <td colspan="8" style="text-align: center;"> <table border="1" style="width: 100%; border-collapse: collapse; text-align: center;"> <tr> <td style="width: 10%;"></td> <td style="width: 10%;"></td> <td style="width: 10%;"></td> <td style="width: 10%;"></td> <td style="width: 10%;"></td> <td style="width: 10%;"></td> <td style="width: 10%;"></td> <td style="width: 10%;"></td> <td style="width: 10%;"></td> <td style="width: 10%;"></td> </tr> <tr> <td></td> <td></td> <td colspan="8" style="text-align: center;"> <table border="1" style="width: 100%; border-collapse: collapse; text-align: center;"> <tr> <td style="width: 10%;"></td> <td style="width: 10%;"></td> <td style="width: 10%;"></td> <td style="width: 10%;"></td> <td style="width: 10%;"></td> <td style="width: 10%;"></td> <td style="width: 10%;"></td> <td style="width: 10%;"></td> <td style="width: 10%;"></td> <td style="width: 10%;"></td> </tr> <tr> <td></td> <td></td> <td colspan="8" style="text-align: center;"> <table border="1" style="width: 100%; border-collapse: collapse; text-align: center;"> <tr> <td style="width: 10%;"></td> <td style="width: 10%;"></td> <td style="width: 10%;"></td> <td style="width: 10%;"></td> <td style="width: 10%;"></td> <td style="width: 10%;"></td> <td style="width: 10%;"></td> <td style="width: 10%;"></td> <td style="width: 10%;"></td> <td style="width: 10%;"></td> </tr> <tr> <td></td> <td></td> <td colspan="8" style="text-align: center;"> <table border="1" style="width: 100%; border-collapse: collapse; text-align: center;"> <tr> <td style="width: 10%;"></td> <td style="width: 10%;"></td> <td style="width: 10%;"></td> <td style="width: 10%;"></td> <td style="width: 10%;"></td> <td style="width: 10%;"></td> <td style="width: 10%;"></td> <td style="width: 10%;"></td> <td style="width: 10%;"></td> <td style="width: 10%;"></td> </tr> <tr> <td></td> <td></td> <td colspan="8" style="text-align: center;"> <table border="1" style="width: 100%; border-collapse: collapse; text-align: center;"> <tr> <td style="width: 10%;"></td> <td style="width: 10%;"></td> <td style="width: 10%;"></td> <td style="width: 10%;"></td> <td style="width: 10%;"></td> <td style="width: 10%;"></td> <td style="width: 10%;"></td> <td style="width: 10%;"></td> <td style="width: 10%;"></td> <td style="width: 10%;"></td> </tr> <tr> <td></td> <td></td> <td colspan="8" style="text-align: center;"> <table border="1" style="width: 100%; border-collapse: collapse; text-align: center;"> <tr> <td style="width: 10%;"></td> <td style="width: 10%;"></td> <td style="width: 10%;"></td> <td style="width: 10%;"></td> <td style="width: 10%;"></td> <td style="width: 10%;"></td> <td style="width: 10%;"></td> <td style="width: 10%;"></td> <td style="width: 10%;"></td> <td style="width: 10%;"></td> </tr> <tr> <td></td> <td></td> <td colspan="8" style="text-align: center;"> <table border="1" style="width: 100%; border-collapse: collapse; text-align: center;"> <tr> <td style="width: 10%;"></td> <td style="width: 10%;"></td> <td style="width: 10%;"></td> <td style="width: 10%;"></td> <td style="width: 10%;"></td> <td style="width: 10%;"></td> <td style="width: 10%;"></td> <td style="width: 10%;"></td> <td style="width: 10%;"></td> <td style="width: 10%;"></td> </tr> <tr> <td></td> <td></td> <td colspan="8" style="text-align: center;"> <table border="1" style="width: 100%;
border-collapse: collapse; text-align: center;"> <tr> <td style="width: 10%;"></td> <td style="width: 10%;"></td> <td style="width: 10%;"></td> <td style="width: 10%;"></td> <td style="width: 10%;"></td> <td style="width: 10%;"></td> <td style="width: 10%;"></td> <td style="width: 10%;"></td> <td style="width: 10%;"></td> <td style="width: 10%;"></td> </tr> <tr> <td></td> <td></td> <td colspan="8" style="text-align: center;"> <table border="1" style="width: 100%; border-collapse: collapse; text-align: center;"> <tr> <td style="width: 10%;"></td> <td style="width: 10%;"></td> <td style="width: 10%;"></td> <td style="width: 10%;"></td> <td style="width: 10%;"></td> <td style="width: 10%;"></td> <td style="width: 10%;"></td> <td style="width: 10%;"></td> <td style="width: 10%;"></td> <td style="width: 10%;"></td> </tr> <tr> <td></td> <td></td> <td colspan="8" style="text-align: center;"> <table border="1" style="width: 100%; border-collapse: collapse; text-align: center;"> <tr> <td style="width: 10%;"></td> <td style="width: 10%;"></td> <td style="width: 10%;"></td> <td style="width: 10%;"></td> <td style="width: 10%;"></td> <td style="width: 10%;"></td> <td style="width: 10%;"></td> <td style="width: 10%;"></td> <td style="width: 10%;"></td> <td style="width: 10%;"></td> </tr> <tr> <td></td> <td></td> <td colspan="8" style="text-align: center;"> <table border="1" style="width: 100%; border-collapse: collapse; text-align: center;"> <tr> <td style="width: 10%;"></td> <td style="width: 10%;"></td> <td style="width: 10%;"></td> <td style="width: 10%;"></td> <td style="width: 10%;"></td> <td style="width: 10%;"></td> <td style="width: 10%;"></td> <td style="width: 10%;"></td> <td style="width: 10%;"></td> <td style="width: 10%;"></td> </tr> <tr> <td></td> <td></td> <td colspan="8" style="text-align: center;"> <table border="1" style="width: 100%; border-collapse: collapse; text-align: center;"> <tr> <td style="width: 10%;"></td> <td style="width: 10%;"></td> <td style="width: 10%;"></td> <td style="width: 10%;"></td> <td style="width: 10%;"></td> <td style="width: 10%;"></td> <td style="width: 10%;"></td> <td style="width: 10%;"></td> <td style="width: 10%;"></td> <td style="width: 10%;"></td> </tr> <tr> <td></td> <td></td> <td colspan="8" style="text-align: center;"> <table border="1" style="width: 100%; border-collapse: collapse; text-align: center;"> <tr> </tr></table></td></tr></table></td></tr></table></td></tr></table></td></tr></table></td></tr></table></td></tr></table></td></tr></table></td></tr></table></td></tr></table></td></tr></table></td></tr></table></td></tr></table></td></tr></table></td></tr></table></td></tr></table></td></tr></table></td></tr></table></td></tr></table></td></tr></table></td></tr></table></td></tr></table></td></tr></table></td></tr></table></td></tr></table></td></tr></table></td></tr></table></td></tr></table></td></tr></table></td></tr></table></td></tr></table></td></tr></table>
 | | | | | | | | | | | | | | | | | | | | <table border="1" style="width: 100%; border-collapse: collapse; text-align: center;"> <tr> <td style="width: 10%;"></td> <td style="width: 10%;"></td> <td style="width: 10%;"></td> <td style="width: 10%;"></td> <td style="width: 10%;"></td> <td style="width: 10%;"></td> <td style="width: 10%;"></td> <td style="width: 10%;"></td> <td style="width: 10%;"></td> <td style="width: 10%;"></td> </tr> <tr> <td></td> <td></td> <td colspan="8" style="text-align: center;"> <table border="1" style="width: 100%; border-collapse: collapse; text-align: center;"> <tr> <td style="width: 10%;"></td> <td style="width: 10%;"></td> <td style="width: 10%;"></td> <td style="width: 10%;"></td> <td style="width: 10%;"></td> <td style="width: 10%;"></td> <td style="width: 10%;"></td> <td style="width: 10%;"></td> <td style="width: 10%;"></td> <td style="width: 10%;"></td> </tr> <tr> <td></td> <td></td> <td colspan="8" style="text-align: center;"> <table border="1" style="width: 100%; border-collapse: collapse; text-align: center;"> <tr> <td style="width: 10%;"></td> <td style="width: 10%;"></td> <td style="width: 10%;"></td> <td style="width: 10%;"></td> <td style="width: 10%;"></td> <td style="width: 10%;"></td> <td style="width: 10%;"></td> <td style="width: 10%;"></td> <td style="width: 10%;"></td> <td style="width: 10%;"></td> </tr> <tr> <td></td> <td></td> <td colspan="8" style="text-align: center;"> <table border="1" style="width: 100%; border-collapse: collapse; text-align: center;"> <tr> <td style="width: 10%;"></td> <td style="width: 10%;"></td> <td style="width: 10%;"></td> <td style="width: 10%;"></td> <td style="width: 10%;"></td> <td style="width: 10%;"></td> <td style="width: 10%;"></td> <td style="width: 10%;"></td> <td style="width: 10%;"></td> <td style="width: 10%;"></td> </tr> <tr> <td></td> <td></td> <td colspan="8" style="text-align: center;"> <table border="1" style="width: 100%; border-collapse: collapse; text-align: center;"> <tr> <td style="width: 10%;"></td> <td style="width: 10%;"></td> <td style="width: 10%;"></td> <td style="width: 10%;"></td> <td style="width: 10%;"></td> <td style="width: 10%;"></td> <td style="width: 10%;"></td> <td style="width: 10%;"></td> <td style="width: 10%;"></td> <td style="width: 10%;"></td> </tr> <tr> <td></td> <td></td> <td colspan="8" style="text-align: center;"> <table border="1" style="width: 100%; border-collapse: collapse; text-align: center;"> <tr> <td style="width: 10%;"></td> <td style="width: 10%;"></td> <td style="width: 10%;"></td> <td style="width: 10%;"></td> <td style="width: 10%;"></td> <td style="width: 10%;"></td> <td style="width: 10%;"></td> <td style="width: 10%;"></td> <td style="width: 10%;"></td> <td style="width: 10%;"></td> </tr> <tr> <td></td> <td></td> <td colspan="8" style="text-align: center;"> <table border="1" style="width: 100%; border-collapse: collapse; text-align: center;"> <tr> <td style="width: 10%;"></td> <td style="width: 10%;"></td> <td style="width: 10%;"></td> <td style="width: 10%;"></td> <td style="width: 10%;"></td> <td style="width: 10%;"></td> <td style="width: 10%;"></td> <td style="width: 10%;"></td> <td style="width: 10%;"></td> <td style="width: 10%;"></td> </tr> <tr> <td></td> <td></td> <td colspan="8" style="text-align: center;"> <table border="1" style="width: 100%; border-collapse: collapse; text-align: center;"> <tr> <td style="width: 10%;"></td> <td style="width: 10%;"></td> <td style="width: 10%;"></td> <td style="width: 10%;"></td> <td style="width: 10%;"></td> <td style="width: 10%;"></td> <td style="width: 10%;"></td> <td style="width: 10%;"></td> <td style="width: 10%;"></td> <td style="width: 10%;"></td> </tr> <tr> <td></td> <td></td> <td colspan="8" style="text-align: center;"> <table border="1" style="width: 100%; border-collapse: collapse; text-align: center;"> <tr> <td style="width: 10%;"></td> <td style="width: 10%;"></td> <td style="width: 10%;"></td> <td style="width: 10%;"></td> <td style="width: 10%;"></td> <td style="width: 10%;"></td> <td style="width: 10%;"></td> <td style="width: 10%;"></td> <td style="width: 10%;"></td> <td style="width: 10%;"></td> </tr> <tr> <td></td> <td></td> <td colspan="8" style="text-align: center;"> <table border="1" style="width: 100%; border-collapse: collapse; text-align: center;"> <tr> <td style="width: 10%;"></td> <td style="width: 10%;"></td> <td style="width: 10%;"></td> <td style="width: 10%;"></td> <td style="width: 10%;"></td> <td style="width: 10%;"></td> <td style="width: 10%;"></td> <td style="width: 10%;"></td> <td style="width: 10%;"></td> <td style="width: 10%;"></td> </tr> <tr> <td></td> <td></td> <td colspan="8" style="text-align: center;"> <table border="1" style="width: 100%; border-collapse: collapse; text-align: center;"> <tr> <td style="width: 10%;"></td> <td style="width: 10%;"></td> <td style="width: 10%;"></td> <td style="width: 10%;"></td> <td style="width: 10%;"></td> <td style="width: 10%;"></td> <td style="width: 10%;"></td> <td style="width: 10%;"></td> <td style="width: 10%;"></td> <td style="width: 10%;"></td> </tr> <tr> <td></td> <td></td> <td colspan="8" style="text-align: center;"> <table border="1" style="width: 100%; border-collapse: collapse; text-align: center;"> <tr> <td style="width: 10%;"></td> <td style="width: 10%;"></td> <td style="width: 10%;"></td> <td style="width: 10%;"></td> <td style="width: 10%;"></td> <td style="width: 10%;"></td> <td style="width: 10%;"></td> <td style="width: 10%;"></td> <td style="width: 10%;"></td> <td style="width: 10%;"></td> </tr> <tr> <td></td> <td></td> <td colspan="8" style="text-align: center;"> <table border="1" style="width: 100%; border-collapse: collapse; text-align: center;"> <tr> <td style="width: 10%;"></td> <td style="width: 10%;"></td> <td style="width: 10%;"></td> <td style="width: 10%;"></td> <td style="width: 10%;"></td> <td style="width: 10%;"></td> <td style="width: 10%;"></td> <td style="width: 10%;"></td> <td style="width: 10%;"></td> <td style="width: 10%;"></td> </tr> <tr> <td></td> <td></td> <td colspan="8" style="text-align: center;"> <table border="1" style="width: 100%; border-collapse: collapse; text-align: center;"> <tr> <td style="width: 10%;"></td> <td style="width: 10%;"></td> <td style="width: 10%;"></td> <td
style="width: 10%;"></td> <td style="width: 10%;"></td> <td style="width: 10%;"></td> <td style="width: 10%;"></td> <td style="width: 10%;"></td> <td style="width: 10%;"></td> <td style="width: 10%;"></td> </tr> <tr> <td></td> <td></td> <td colspan="8" style="text-align: center;"> <table border="1" style="width: 100%; border-collapse: collapse; text-align: center;"> <tr> <td style="width: 10%;"></td> <td style="width: 10%;"></td> <td style="width: 10%;"></td> <td style="width: 10%;"></td> <td style="width: 10%;"></td> <td style="width: 10%;"></td> <td style="width: 10%;"></td> <td style="width: 10%;"></td> <td style="width: 10%;"></td> <td style="width: 10%;"></td> </tr> <tr> <td></td> <td></td> <td colspan="8" style="text-align: center;"> <table border="1" style="width: 100%; border-collapse: collapse; text-align: center;"> <tr> <td style="width: 10%;"></td> <td style="width: 10%;"></td> <td style="width: 10%;"></td> <td style="width: 10%;"></td> <td style="width: 10%;"></td> <td style="width: 10%;"></td> <td style="width: 10%;"></td> <td style="width: 10%;"></td> <td style="width: 10%;"></td> <td style="width: 10%;"></td> </tr> <tr> <td></td> <td></td> <td colspan="8" style="text-align: center;"> <table border="1" style="width: 100%; border-collapse: collapse; text-align: center;"> <tr> <td style="width: 10%;"></td> <td style="width: 10%;"></td> <td style="width: 10%;"></td> <td style="width: 10%;"></td> <td style="width: 10%;"></td> <td style="width: 10%;"></td> <td style="width: 10%;"></td> <td style="width: 10%;"></td> <td style="width: 10%;"></td> <td style="width: 10%;"></td> </tr> <tr> <td></td> <td></td> <td colspan="8" style="text-align: center;"> <table border="1" style="width: 100%; border-collapse: collapse; text-align: center;"> <tr> <td style="width: 10%;"></td> <td style="width: 10%;"></td> <td style="width: 10%;"></td> <td style="width: 10%;"></td> <td style="width: 10%;"></td> <td style="width: 10%;"></td> <td style="width: 10%;"></td> <td style="width: 10%;"></td> <td style="width: 10%;"></td> <td style="width: 10%;"></td> </tr> <tr> <td></td> <td></td> <td colspan="8" style="text-align: center;"> <table border="1" style="width: 100%; border-collapse: collapse; text-align: center;"> <tr> <td style="width: 10%;"></td> <td style="width: 10%;"></td> <td style="width: 10%;"></td> <td style="width: 10%;"></td> <td style="width: 10%;"></td> <td style="width: 10%;"></td> <td style="width: 10%;"></td> <td style="width: 10%;"></td> <td style="width: 10%;"></td> <td style="width: 10%;"></td> </tr> <tr> <td></td> <td></td> <td colspan="8" style="text-align: center;"> <table border="1" style="width: 100%; border-collapse: collapse; text-align: center;"> <tr> <td style="width: 10%;"></td> <td style="width: 10%;"></td> <td style="width: 10%;"></td> <td style="width: 10%;"></td> <td style="width: 10%;"></td> <td style="width: 10%;"></td> <td style="width: 10%;"></td> <td style="width: 10%;"></td> <td style="width: 10%;"></td> <td style="width: 10%;"></td> </tr> <tr> <td></td> <td></td> <td colspan="8" style="text-align: center;"> <table border="1" style="width: 100%; border-collapse: collapse; text-align: center;"> <tr> <td style="width: 10%;"></td> <td style="width: 10%;"></td> <td style="width: 10%;"></td> <td style="width: 10%;"></td> <td style="width: 10%;"></td> <td style="width: 10%;"></td> <td style="width: 10%;"></td> <td style="width: 10%;"></td> <td style="width: 10%;"></td> <td style="width: 10%;"></td> </tr> <tr> <td></td> <td></td> <td colspan="8" style="text-align: center;"> <table border="1" style="width: 100%; border-collapse: collapse; text-align: center;"> <tr> <td style="width: 10%;"></td> <td style="width: 10%;"></td> <td style="width: 10%;"></td> <td style="width: 10%;"></td> <td style="width: 10%;"></td> <td style="width: 10%;"></td> <td style="width: 10%;"></td> <td style="width: 10%;"></td> <td style="width: 10%;"></td> <td style="width: 10%;"></td> </tr> <tr> <td></td> <td></td> <td colspan="8" style="text-align: center;"> <table border="1" style="width: 100%; border-collapse: collapse; text-align: center;"> <tr> <td style="width: 10%;"></td> <td style="width: 10%;"></td> <td style="width: 10%;"></td> <td style="width: 10%;"></td> <td style="width: 10%;"></td> <td style="width: 10%;"></td> <td style="width: 10%;"></td> <td style="width: 10%;"></td> <td style="width: 10%;"></td> <td style="width: 10%;"></td> </tr> <tr> <td></td> <td></td> <td colspan="8" style="text-align: center;"> <table border="1" style="width: 100%; border-collapse: collapse; text-align: center;"> <tr> <td style="width: 10%;"></td> <td style="width: 10%;"></td> <td style="width: 10%;"></td> <td style="width: 10%;"></td> <td style="width: 10%;"></td> <td style="width: 10%;"></td> <td style="width: 10%;"></td> <td style="width: 10%;"></td> <td style="width: 10%;"></td> <td style="width: 10%;"></td> </tr> <tr> <td></td> <td></td> <td colspan="8" style="text-align: center;"> <table border="1" style="width: 100%; border-collapse: collapse; text-align: center;"> <tr> <td style="width: 10%;"></td> <td style="width: 10%;"></td> <td style="width: 10%;"></td> <td style="width: 10%;"></td> <td style="width: 10%;"></td> <td style="width: 10%;"></td> <td style="width: 10%;"></td> <td style="width: 10%;"></td> <td style="width: 10%;"></td> <td style="width: 10%;"></td> </tr> <tr> <td></td> <td></td> <td colspan="8" style="text-align: center;"> <table border="1" style="width: 100%; border-collapse: collapse; text-align: center;"> <tr> <td style="width: 10%;"></td> <td style="width: 10%;"></td> <td style="width: 10%;"></td> <td style="width: 10%;"></td> <td style="width: 10%;"></td> <td style="width: 10%;"></td> <td style="width: 10%;"></td> <td style="width: 10%;"></td> <td style="width: 10%;"></td> <td style="width: 10%;"></td> </tr> <tr> <td></td> <td></td> <td colspan="8" style="text-align: center;"> <table border="1" style="width: 100%; border-collapse: collapse; text-align: center;"> <tr> <td style="width: 10%;"></td> <td style="width: 10%;"></td> <td style="width: 10%;"></td> <td style="width: 10%;"></td> <td style="width: 10%;"></td> <td style="width: 10%;"></td> <td style="width: 10%;"></td> <td style="width: 10%;"></td> <td style="width: 10%;"></td> <td style="width: 10%;"></td> </tr> <tr> <td></td> <td></td> <td colspan="8" style="text-align: center;"> <table border="1" style="width: 100%; border-collapse: collapse; text-align: center;"> <tr> <td style="width: 10%;"></td> <td style="width: 10%;"></td> <td style="width: 10%;"></td> <td style="width: 10%;"></td> <td style="width: 10%;"></td> <td style="width: 10%;"></td> <td style="width: 10%;"></td> <td style="width: 10%;"></td> <td style="width: 10%;"></td> <td style="width: 10%;"></td> </tr> <tr> <td></td> <td></td> <td colspan="8" style="text-align: center;"> <table border="1" style="width: 100%; border-collapse: collapse; text-align: center;"> <tr> <td style="width: 10%;"></td> <td style="width: 10%;"></td> <td style="width: 10%;"></td> <td style="width: 10%;"></td> <td style="width: 10%;"></td> <td style="width: 10%;"></td> <td style="width: 10%;"></td> <td style="width: 10%;"></td> <td style="width: 10%;"></td> <td style="width: 10%;"></td> </tr> <tr> <td></td> <td></td> <td colspan="8" style="text-align: center;"> <table border="1" style="width: 100%; border-collapse: collapse; text-align: center;"> <tr> <td style="width: 10%;"></td> <td style="width: 10%;"></td> <td style="width: 10%;"></td> <td style="width: 10%;"></td> <td style="width: 10%;"></td> <td style="width: 10%;"></td> <td style="width: 10%;"></td> <td style="width: 10%;"></td> <td style="width: 10%;"></td> <td style="width: 10%;"></td> </tr> <tr> <td></td> <td></td> <td colspan="8" style="text-align: center;"> <table border="1" style="width: 100%; border-collapse: collapse; text-align: center;"> <tr> </tr></table></td></tr></table></td></tr></table></td></tr></table></td></tr></table></td></tr></table></td></tr></table></td></tr></table></td></tr></table></td></tr></table></td></tr></table></td></tr></table></td></tr></table></td></tr></table></td></tr></table></td></tr></table></td></tr></table></td></tr></table></td></tr></table></td></tr></table></td></tr></table></td></tr></table></td></tr></table></td></tr></table></td></tr></table></td></tr></table></td></tr></table></td></tr></table></td></tr></table></td></tr></table></td></tr></table>
 | | | | | | | | | | | | | | | | | | | | <table border="1" style="width: 100%; border-collapse: collapse; text-align: center;"> <tr> <td style="width: 10%;"></td> <td style="width: 10%;"></td> <td style="width: 10%;"></td> <td style="width: 10%;"></td> <td style="width: 10%;"></td> <td style="width: 10%;"></td> <td style="width: 10%;"></td> <td style="width: 10%;"></td> <td style="width: 10%;"></td> <td style="width: 10%;"></td> </tr> <tr> <td></td> <td></td> <td colspan="8" style="text-align: center;"> <table border="1" style="width: 100%; border-collapse: collapse; text-align: center;"> <tr> <td style="width: 10%;"></td> <td style="width: 10%;"></td> <td style="width: 10%;"></td> <td style="width: 10%;"></td> <td style="width: 10%;"></td> <td style="width: 10%;"></td> <td style="width: 10%;"></td> <td style="width: 10%;"></td> <td style="width: 10%;"></td>
<td style="width: 10%;"></td> </tr> <tr> <td></td> <td></td> <td colspan="8" style="text-align: center;"> <table border="1" style="width: 100%; border-collapse: collapse; text-align: center;"> <tr> <td style="width: 10%;"></td> <td style="width: 10%;"></td> <td style="width: 10%;"></td> <td style="width: 10%;"></td> <td style="width: 10%;"></td> <td style="width: 10%;"></td> <td style="width: 10%;"></td> <td style="width: 10%;"></td> <td style="width: 10%;"></td> <td style="width: 10%;"></td> </tr> <tr> <td></td> <td></td> <td colspan="8" style="text-align: center;"> <table border="1" style="width: 100%; border-collapse: collapse; text-align: center;"> <tr> <td style="width: 10%;"></td> <td style="width: 10%;"></td> <td style="width: 10%;"></td> <td style="width: 10%;"></td> <td style="width: 10%;"></td> <td style="width: 10%;"></td> <td style="width: 10%;"></td> <td style="width: 10%;"></td> <td style="width: 10%;"></td> <td style="width: 10%;"></td> </tr> <tr> <td></td> <td></td> <td colspan="8" style="text-align: center;"> <table border="1" style="width: 100%; border-collapse: collapse; text-align: center;"> <tr> <td style="width: 10%;"></td> <td style="width: 10%;"></td> <td style="width: 10%;"></td> <td style="width: 10%;"></td> <td style="width: 10%;"></td> <td style="width: 10%;"></td> <td style="width: 10%;"></td> <td style="width: 10%;"></td> <td style="width: 10%;"></td> <td style="width: 10%;"></td> </tr> <tr> <td></td> <td></td> <td colspan="8" style="text-align: center;"> <table border="1" style="width: 100%; border-collapse: collapse; text-align: center;"> <tr> <td style="width: 10%;"></td> <td style="width: 10%;"></td> <td style="width: 10%;"></td> <td style="width: 10%;"></td> <td style="width: 10%;"></td> <td style="width: 10%;"></td> <td style="width: 10%;"></td> <td style="width: 10%;"></td> <td style="width: 10%;"></td> <td style="width: 10%;"></td> </tr> <tr> <td></td> <td></td> <td colspan="8" style="text-align: center;"> <table border="1" style="width: 100%; border-collapse: collapse; text-align: center;"> <tr> <td style="width: 10%;"></td> <td style="width: 10%;"></td> <td style="width: 10%;"></td> <td style="width: 10%;"></td> <td style="width: 10%;"></td> <td style="width: 10%;"></td> <td style="width: 10%;"></td> <td style="width: 10%;"></td> <td style="width: 10%;"></td> <td style="width: 10%;"></td> </tr> <tr> <td></td> <td></td> <td colspan="8" style="text-align: center;"> <table border="1" style="width: 100%; border-collapse: collapse; text-align: center;"> <tr> <td style="width: 10%;"></td> <td style="width: 10%;"></td> <td style="width: 10%;"></td> <td style="width: 10%;"></td> <td style="width: 10%;"></td> <td style="width: 10%;"></td> <td style="width: 10%;"></td> <td style="width: 10%;"></td> <td style="width: 10%;"></td> <td style="width: 10%;"></td> </tr> <tr> <td></td> <td></td> <td colspan="8" style="text-align: center;"> <table border="1" style="width: 100%; border-collapse: collapse; text-align: center;"> <tr> <td style="width: 10%;"></td> <td style="width: 10%;"></td> <td style="width: 10%;"></td> <td style="width: 10%;"></td> <td style="width: 10%;"></td> <td style="width: 10%;"></td> <td style="width: 10%;"></td> <td style="width: 10%;"></td> <td style="width: 10%;"></td> <td style="width: 10%;"></td> </tr> <tr> <td></td> <td></td> <td colspan="8" style="text-align: center;"> <table border="1" style="width: 100%; border-collapse: collapse; text-align: center;"> <tr> <td style="width: 10%;"></td> <td style="width: 10%;"></td> <td style="width: 10%;"></td> <td style="width: 10%;"></td> <td style="width: 10%;"></td> <td style="width: 10%;"></td> <td style="width: 10%;"></td> <td style="width: 10%;"></td> <td style="width: 10%;"></td> <td style="width: 10%;"></td> </tr> <tr> <td></td> <td></td> <td colspan="8" style="text-align: center;"> <table border="1" style="width: 100%; border-collapse: collapse; text-align: center;"> <tr> <td style="width: 10%;"></td> <td style="width: 10%;"></td> <td style="width: 10%;"></td> <td style="width: 10%;"></td> <td style="width: 10%;"></td> <td style="width: 10%;"></td> <td style="width: 10%;"></td> <td style="width: 10%;"></td> <td style="width: 10%;"></td> <td style="width: 10%;"></td> </tr> <tr> <td></td> <td></td> <td colspan="8" style="text-align: center;"> <table border="1" style="width: 100%; border-collapse: collapse; text-align: center;"> <tr> <td style="width: 10%;"></td> <td style="width: 10%;"></td> <td style="width: 10%;"></td> <td style="width: 10%;"></td> <td style="width: 10%;"></td> <td style="width: 10%;"></td> <td style="width: 10%;"></td> <td style="width: 10%;"></td> <td style="width: 10%;"></td> <td style="width: 10%;"></td> </tr> <tr> <td></td> <td></td> <td colspan="8" style="text-align: center;"> <table border="1" style="width: 100%; border-collapse: collapse; text-align: center;"> <tr> <td style="width: 10%;"></td> <td style="width: 10%;"></td> <td style="width: 10%;"></td> <td style="width: 10%;"></td> <td style="width: 10%;"></td> <td style="width: 10%;"></td> <td style="width: 10%;"></td> <td style="width: 10%;"></td> <td style="width: 10%;"></td> <td style="width: 10%;"></td> </tr> <tr> <td></td> <td></td> <td colspan="8" style="text-align: center;"> <table border="1" style="width: 100%; border-collapse: collapse; text-align: center;"> <tr> <td style="width: 10%;"></td> <td style="width: 10%;"></td> <td style="width: 10%;"></td> <td style="width: 10%;"></td> <td style="width: 10%;"></td> <td style="width: 10%;"></td> <td style="width: 10%;"></td> <td style="width: 10%;"></td> <td style="width: 10%;"></td> <td style="width: 10%;"></td> </tr> <tr> <td></td> <td></td> <td colspan="8" style="text-align: center;"> <table border="1" style="width: 100%; border-collapse: collapse; text-align: center;"> <tr> <td style="width: 10%;"></td> <td style="width: 10%;"></td> <td style="width: 10%;"></td> <td style="width: 10%;"></td> <td style="width: 10%;"></td> <td style="width: 10%;"></td> <td style="width: 10%;"></td> <td style="width: 10%;"></td> <td style="width: 10%;"></td> <td style="width: 10%;"></td> </tr> <tr> <td></td> <td></td> <td colspan="8" style="text-align: center;"> <table border="1" style="width: 100%; border-collapse: collapse; text-align: center;"> <tr> <td style="width: 10%;"></td> <td style="width: 10%;"></td> <td style="width: 10%;"></td> <td style="width: 10%;"></td> <td style="width: 10%;"></td> <td style="width: 10%;"></td> <td style="width: 10%;"></td> <td style="width: 10%;"></td> <td style="width: 10%;"></td> <td style="width: 10%;"></td> </tr> <tr> <td></td> <td></td> <td colspan="8" style="text-align: center;"> <table border="1" style="width: 100%; border-collapse: collapse; text-align: center;"> <tr> <td style="width: 10%;"></td> <td style="width: 10%;"></td> <td style="width: 10%;"></td> <td style="width: 10%;"></td> <td style="width: 10%;"></td> <td style="width: 10%;"></td> <td style="width: 10%;"></td> <td style="width: 10%;"></td> <td style="width: 10%;"></td> <td style="width: 10%;"></td> </tr> <tr> <td></td> <td></td> <td colspan="8" style="text-align: center;"> <table border="1" style="width: 100%; border-collapse: collapse; text-align: center;"> <tr> <td style="width: 10%;"></td> <td style="width: 10%;"></td> <td style="width: 10%;"></td> <td style="width: 10%;"></td> <td style="width: 10%;"></td> <td style="width: 10%;"></td> <td style="width: 10%;"></td> <td style="width: 10%;"></td> <td style="width: 10%;"></td> <td style="width: 10%;"></td> </tr> <tr> <td></td> <td></td> <td colspan="8" style="text-align: center;"> <table border="1" style="width: 100%; border-collapse: collapse; text-align: center;"> <tr> <td style="width: 10%;"></td> <td style="width: 10%;"></td> <td style="width: 10%;"></td> <td style="width: 10%;"></td> <td style="width: 10%;"></td> <td style="width: 10%;"></td> <td style="width: 10%;"></td> <td style="width: 10%;"></td> <td style="width: 10%;"></td> <td style="width: 10%;"></td> </tr> <tr> <td></td> <td></td> <td colspan="8" style="text-align: center;"> <table border="1" style="width: 100%; border-collapse: collapse; text-align: center;"> <tr> <td style="width: 10%;"></td> <td style="width: 10%;"></td> <td style="width: 10%;"></td> <td style="width: 10%;"></td> <td style="width: 10%;"></td> <td style="width: 10%;"></td> <td style="width: 10%;"></td> <td style="width: 10%;"></td> <td style="width: 10%;"></td> <td style="width: 10%;"></td> </tr> <tr> <td></td> <td></td> <td colspan="8" style="text-align: center;"> <table border="1" style="width: 100%; border-collapse: collapse; text-align: center;"> <tr> <td style="width: 10%;"></td> <td style="width: 10%;"></td> <td style="width: 10%;"></td> <td style="width: 10%;"></td> <td style="width: 10%;"></td> <td style="width: 10%;"></td> <td style="width: 10%;"></td> <td style="width: 10%;"></td> <td style="width: 10%;"></td> <td style="width: 10%;"></td> </tr> <tr> <td></td> <td></td> <td colspan="8" style="text-align: center;"> <table border="1" style="width: 100%; border-collapse: collapse; text-align: center;"> <tr> <td style="width: 10%;"></td> <td style="width: 10%;"></td> <td style="width: 10%;"></td> <td style="width: 10%;"></td> <td style="width: 10%;"></td> <td style="width: 10%;"></td> <td style="width: 10%;"></td> <td style="width: 10%;"></td> <td style="width: 10%;"></td> <td style="width: 10%;"></td> </tr> <tr> <td></td> <td></td> <td colspan="8" style="text-align: center;"> <table border="1" style="width: 100%; border-collapse: collapse; text-align: center;"> <tr> <td style="width: 10%;"></td> <td style="width: 10%;"></td> <td style="width: 10%;"></td> <td style="width: 10%;"></td> <td style="width: 10%;"></td> <td style="width: 10%;"></td> <td style="width: 10%;"></td> <td style="width: 10%;"></td> <td style="width: 10%;"></td> <td style="width: 10%;"></td> </tr> <tr> <td></td> <td></td> <td colspan="8" style="text-align: center;"> <table border="1" style="width: 100%; border-collapse: collapse;
text-align: center;"> <tr> <td style="width: 10%;"></td> <td style="width: 10%;"></td> <td style="width: 10%;"></td> <td style="width: 10%;"></td> <td style="width: 10%;"></td> <td style="width: 10%;"></td> <td style="width: 10%;"></td> <td style="width: 10%;"></td> <td style="width: 10%;"></td> <td style="width: 10%;"></td> </tr> <tr> <td></td> <td></td> <td colspan="8" style="text-align: center;"> <table border="1" style="width: 100%; border-collapse: collapse; text-align: center;"> <tr> <td style="width: 10%;"></td> <td style="width: 10%;"></td> <td style="width: 10%;"></td> <td style="width: 10%;"></td> <td style="width: 10%;"></td> <td style="width: 10%;"></td> <td style="width: 10%;"></td> <td style="width: 10%;"></td> <td style="width: 10%;"></td> <td style="width: 10%;"></td> </tr> <tr> <td></td> <td></td> <td colspan="8" style="text-align: center;"> <table border="1" style="width: 100%; border-collapse: collapse; text-align: center;"> <tr> <td style="width: 10%;"></td> <td style="width: 10%;"></td> <td style="width: 10%;"></td> <td style="width: 10%;"></td> <td style="width: 10%;"></td> <td style="width: 10%;"></td> <td style="width: 10%;"></td> <td style="width: 10%;"></td> <td style="width: 10%;"></td> <td style="width: 10%;"></td> </tr> <tr> <td></td> <td></td> <td colspan="8" style="text-align: center;"> <table border="1" style="width: 100%; border-collapse: collapse; text-align: center;"> <tr> <td style="width: 10%;"></td> <td style="width: 10%;"></td> <td style="width: 10%;"></td> <td style="width: 10%;"></td> <td style="width: 10%;"></td> <td style="width: 10%;"></td> <td style="width: 10%;"></td> <td style="width: 10%;"></td> <td style="width: 10%;"></td> <td style="width: 10%;"></td> </tr> <tr> <td></td> <td></td> <td colspan="8" style="text-align: center;"> <table border="1" style="width: 100%; border-collapse: collapse; text-align: center;"> <tr> <td style="width: 10%;"></td> <td style="width: 10%;"></td> <td style="width: 10%;"></td> <td style="width: 10%;"></td> <td style="width: 10%;"></td> <td style="width: 10%;"></td> <td style="width: 10%;"></td> <td style="width: 10%;"></td> <td style="width: 10%;"></td> <td style="width: 10%;"></td> </tr> <tr> <td></td> <td></td> <td colspan="8" style="text-align: center;"> <table border="1" style="width: 100%; border-collapse: collapse; text-align: center;"> <tr> <td style="width: 10%;"></td> <td style="width: 10%;"></td> <td style="width: 10%;"></td> <td style="width: 10%;"></td> <td style="width: 10%;"></td> <td style="width: 10%;"></td> <td style="width: 10%;"></td> <td style="width: 10%;"></td> <td style="width: 10%;"></td> <td style="width: 10%;"></td> </tr> <tr> <td></td> <td></td> <td colspan="8" style="text-align: center;"> <table border="1" style="width: 100%; border-collapse: collapse; text-align: center;"> <tr> </tr></table></td></tr></table></td></tr></table></td></tr></table></td></tr></table></td></tr></table></td></tr></table></td></tr></table></td></tr></table></td></tr></table></td></tr></table></td></tr></table></td></tr></table></td></tr></table></td></tr></table></td></tr></table></td></tr></table></td></tr></table></td></tr></table></td></tr></table></td></tr></table></td></tr></table></td></tr></table></td></tr></table></td></tr></table></td></tr></table></td></tr></table></td></tr></table></td></tr></table></td></tr></table>
 | | | | | | | | | | | | | | | | | | | | <table border="1" style="width: 100%; border-collapse: collapse; text-align: center;"> <tr> <td style="width: 10%;"></td> <td style="width: 10%;"></td> <td style="width: 10%;"></td> <td style="width: 10%;"></td> <td style="width: 10%;"></td> <td style="width: 10%;"></td> <td style="width: 10%;"></td> <td style="width: 10%;"></td> <td style="width: 10%;"></td> <td style="width: 10%;"></td> </tr> <tr> <td></td> <td></td> <td colspan="8" style="text-align: center;"> <table border="1" style="width: 100%; border-collapse: collapse; text-align: center;"> <tr> <td style="width: 10%;"></td> <td style="width: 10%;"></td> <td style="width: 10%;"></td> <td style="width: 10%;"></td> <td style="width: 10%;"></td> <td style="width: 10%;"></td> <td style="width: 10%;"></td> <td style="width: 10%;"></td> <td style="width: 10%;"></td> <td style="width: 10%;"></td> </tr> <tr> <td></td> <td></td> <td colspan="8" style="text-align: center;"> <table border="1" style="width: 100%; border-collapse: collapse; text-align: center;"> <tr> <td style="width: 10%;"></td> <td style="width: 10%;"></td> <td style="width: 10%;"></td> <td style="width: 10%;"></td> <td style="width: 10%;"></td> <td style="width: 10%;"></td> <td style="width: 10%;"></td> <td style="width: 10%;"></td> <td style="width: 10%;"></td> <td style="width: 10%;"></td> </tr> <tr> <td></td> <td></td> <td colspan="8" style="text-align: center;"> <table border="1" style="width: 100%; border-collapse: collapse; text-align: center;"> <tr> <td style="width: 10%;"></td> <td style="width: 10%;"></td> <td style="width: 10%;"></td> <td style="width: 10%;"></td> <td style="width: 10%;"></td> <td style="width: 10%;"></td> <td style="width: 10%;"></td> <td style="width: 10%;"></td> <td style="width: 10%;"></td> <td style="width: 10%;"></td> </tr> <tr> <td></td> <td></td> <td colspan="8" style="text-align: center;"> <table border="1" style="width: 100%; border-collapse: collapse; text-align: center;"> <tr> <td style="width: 10%;"></td> <td style="width: 10%;"></td> <td style="width: 10%;"></td> <td style="width: 10%;"></td> <td style="width: 10%;"></td> <td style="width: 10%;"></td> <td style="width: 10%;"></td> <td style="width: 10%;"></td> <td style="width: 10%;"></td> <td style="width: 10%;"></td> </tr> <tr> <td></td> <td></td> <td colspan="8" style="text-align: center;"> <table border="1" style="width: 100%; border-collapse: collapse; text-align: center;"> <tr> <td style="width: 10%;"></td> <td style="width: 10%;"></td> <td style="width: 10%;"></td> <td style="width: 10%;"></td> <td style="width: 10%;"></td> <td style="width: 10%;"></td> <td style="width: 10%;"></td> <td style="width: 10%;"></td> <td style="width: 10%;"></td> <td style="width: 10%;"></td> </tr> <tr> <td></td> <td></td> <td colspan="8" style="text-align: center;"> <table border="1" style="width: 100%; border-collapse: collapse; text-align: center;"> <tr> <td style="width: 10%;"></td> <td style="width: 10%;"></td> <td style="width: 10%;"></td> <td style="width: 10%;"></td> <td style="width: 10%;"></td> <td style="width: 10%;"></td> <td style="width: 10%;"></td> <td style="width: 10%;"></td> <td style="width: 10%;"></td> <td style="width: 10%;"></td> </tr> <tr> <td></td> <td></td> <td colspan="8" style="text-align: center;"> <table border="1" style="width: 100%; border-collapse: collapse; text-align: center;"> <tr> <td style="width: 10%;"></td> <td style="width: 10%;"></td> <td style="width: 10%;"></td> <td style="width: 10%;"></td> <td style="width: 10%;"></td> <td style="width: 10%;"></td> <td style="width: 10%;"></td> <td style="width: 10%;"></td> <td style="width: 10%;"></td> <td style="width: 10%;"></td> </tr> <tr> <td></td> <td></td> <td colspan="8" style="text-align: center;"> <table border="1" style="width: 100%; border-collapse: collapse; text-align: center;"> <tr> <td style="width: 10%;"></td> <td style="width: 10%;"></td> <td style="width: 10%;"></td> <td style="width: 10%;"></td> <td style="width: 10%;"></td> <td style="width: 10%;"></td> <td style="width: 10%;"></td> <td style="width: 10%;"></td> <td style="width: 10%;"></td> <td style="width: 10%;"></td> </tr> <tr> <td></td> <td></td> <td colspan="8" style="text-align: center;"> <table border="1" style="width: 100%; border-collapse: collapse; text-align: center;"> <tr> <td style="width: 10%;"></td> <td style="width: 10%;"></td> <td style="width: 10%;"></td> <td style="width: 10%;"></td> <td style="width: 10%;"></td> <td style="width: 10%;"></td> <td style="width: 10%;"></td> <td style="width: 10%;"></td> <td style="width: 10%;"></td> <td style="width: 10%;"></td> </tr> <tr> <td></td> <td></td> <td colspan="8" style="text-align: center;"> <table border="1" style="width: 100%; border-collapse: collapse; text-align: center;"> <tr> <td style="width: 10%;"></td> <td style="width: 10%;"></td> <td style="width: 10%;"></td> <td style="width: 10%;"></td> <td style="width: 10%;"></td> <td style="width: 10%;"></td> <td style="width: 10%;"></td> <td style="width: 10%;"></td> <td style="width: 10%;"></td> <td style="width: 10%;"></td> </tr> <tr> <td></td> <td></td> <td colspan="8" style="text-align: center;"> <table border="1" style="width: 100%; border-collapse: collapse; text-align: center;"> <tr> <td style="width: 10%;"></td> <td style="width: 10%;"></td> <td style="width: 10%;"></td> <td style="width: 10%;"></td> <td style="width: 10%;"></td> <td style="width: 10%;"></td> <td style="width: 10%;"></td> <td style="width: 10%;"></td> <td style="width: 10%;"></td> <td style="width: 10%;"></td> </tr> <tr> <td></td> <td></td> <td colspan="8" style="text-align: center;"> <table border="1" style="width: 100%; border-collapse: collapse; text-align: center;"> <tr> <td style="width: 10%;"></td> <td style="width: 10%;"></td> <td style="width: 10%;"></td> <td style="width: 10%;"></td> <td style="width: 10%;"></td> <td style="width:
10%;"></td> <td style="width: 10%;"></td> <td style="width: 10%;"></td> <td style="width: 10%;"></td> <td style="width: 10%;"></td> </tr> <tr> <td></td> <td></td> <td colspan="8" style="text-align: center;"> <table border="1" style="width: 100%; border-collapse: collapse; text-align: center;"> <tr> <td style="width: 10%;"></td> <td style="width: 10%;"></td> <td style="width: 10%;"></td> <td style="width: 10%;"></td> <td style="width: 10%;"></td> <td style="width: 10%;"></td> <td style="width: 10%;"></td> <td style="width: 10%;"></td> <td style="width: 10%;"></td> <td style="width: 10%;"></td> </tr> <tr> <td></td> <td></td> <td colspan="8" style="text-align: center;"> <table border="1" style="width: 100%; border-collapse: collapse; text-align: center;"> <tr> <td style="width: 10%;"></td> <td style="width: 10%;"></td> <td style="width: 10%;"></td> <td style="width: 10%;"></td> <td style="width: 10%;"></td> <td style="width: 10%;"></td> <td style="width: 10%;"></td> <td style="width: 10%;"></td> <td style="width: 10%;"></td> <td style="width: 10%;"></td> </tr> <tr> <td></td> <td></td> <td colspan="8" style="text-align: center;"> <table border="1" style="width: 100%; border-collapse: collapse; text-align: center;"> <tr> <td style="width: 10%;"></td> <td style="width: 10%;"></td> <td style="width: 10%;"></td> <td style="width: 10%;"></td> <td style="width: 10%;"></td> <td style="width: 10%;"></td> <td style="width: 10%;"></td> <td style="width: 10%;"></td> <td style="width: 10%;"></td> <td style="width: 10%;"></td> </tr> <tr> <td></td> <td></td> <td colspan="8" style="text-align: center;"> <table border="1" style="width: 100%; border-collapse: collapse; text-align: center;"> <tr> <td style="width: 10%;"></td> <td style="width: 10%;"></td> <td style="width: 10%;"></td> <td style="width: 10%;"></td> <td style="width: 10%;"></td> <td style="width: 10%;"></td> <td style="width: 10%;"></td> <td style="width: 10%;"></td> <td style="width: 10%;"></td> <td style="width: 10%;"></td> </tr> <tr> <td></td> <td></td> <td colspan="8" style="text-align: center;"> <table border="1" style="width: 100%; border-collapse: collapse; text-align: center;"> <tr> <td style="width: 10%;"></td> <td style="width: 10%;"></td> <td style="width: 10%;"></td> <td style="width: 10%;"></td> <td style="width: 10%;"></td> <td style="width: 10%;"></td> <td style="width: 10%;"></td> <td style="width: 10%;"></td> <td style="width: 10%;"></td> <td style="width: 10%;"></td> </tr> <tr> <td></td> <td></td> <td colspan="8" style="text-align: center;"> <table border="1" style="width: 100%; border-collapse: collapse; text-align: center;"> <tr> <td style="width: 10%;"></td> <td style="width: 10%;"></td> <td style="width: 10%;"></td> <td style="width: 10%;"></td> <td style="width: 10%;"></td> <td style="width: 10%;"></td> <td style="width: 10%;"></td> <td style="width: 10%;"></td> <td style="width: 10%;"></td> <td style="width: 10%;"></td> </tr> <tr> <td></td> <td></td> <td colspan="8" style="text-align: center;"> <table border="1" style="width: 100%; border-collapse: collapse; text-align: center;"> <tr> <td style="width: 10%;"></td> <td style="width: 10%;"></td> <td style="width: 10%;"></td> <td style="width: 10%;"></td> <td style="width: 10%;"></td> <td style="width: 10%;"></td> <td style="width: 10%;"></td> <td style="width: 10%;"></td> <td style="width: 10%;"></td> <td style="width: 10%;"></td> </tr> <tr> <td></td> <td></td> <td colspan="8" style="text-align: center;"> <table border="1" style="width: 100%; border-collapse: collapse; text-align: center;"> <tr> <td style="width: 10%;"></td> <td style="width: 10%;"></td> <td style="width: 10%;"></td> <td style="width: 10%;"></td> <td style="width: 10%;"></td> <td style="width: 10%;"></td> <td style="width: 10%;"></td> <td style="width: 10%;"></td> <td style="width: 10%;"></td> <td style="width: 10%;"></td> </tr> <tr> <td></td> <td></td> <td colspan="8" style="text-align: center;"> <table border="1" style="width: 100%; border-collapse: collapse; text-align: center;"> <tr> <td style="width: 10%;"></td> <td style="width: 10%;"></td> <td style="width: 10%;"></td> <td style="width: 10%;"></td> <td style="width: 10%;"></td> <td style="width: 10%;"></td> <td style="width: 10%;"></td> <td style="width: 10%;"></td> <td style="width: 10%;"></td> <td style="width: 10%;"></td> </tr> <tr> <td></td> <td></td> <td colspan="8" style="text-align: center;"> <table border="1" style="width: 100%; border-collapse: collapse; text-align: center;"> <tr> <td style="width: 10%;"></td> <td style="width: 10%;"></td> <td style="width: 10%;"></td> <td style="width: 10%;"></td> <td style="width: 10%;"></td> <td style="width: 10%;"></td> <td style="width: 10%;"></td> <td style="width: 10%;"></td> <td style="width: 10%;"></td> <td style="width: 10%;"></td> </tr> <tr> <td></td> <td></td> <td colspan="8" style="text-align: center;"> <table border="1" style="width: 100%; border-collapse: collapse; text-align: center;"> <tr> <td style="width: 10%;"></td> <td style="width: 10%;"></td> <td style="width: 10%;"></td> <td style="width: 10%;"></td> <td style="width: 10%;"></td> <td style="width: 10%;"></td> <td style="width: 10%;"></td> <td style="width: 10%;"></td> <td style="width: 10%;"></td> <td style="width: 10%;"></td> </tr> <tr> <td></td> <td></td> <td colspan="8" style="text-align: center;"> <table border="1" style="width: 100%; border-collapse: collapse; text-align: center;"> <tr> <td style="width: 10%;"></td> <td style="width: 10%;"></td> <td style="width: 10%;"></td> <td style="width: 10%;"></td> <td style="width: 10%;"></td> <td style="width: 10%;"></td> <td style="width: 10%;"></td> <td style="width: 10%;"></td> <td style="width: 10%;"></td> <td style="width: 10%;"></td> </tr> <tr> <td></td> <td></td> <td colspan="8" style="text-align: center;"> <table border="1" style="width: 100%; border-collapse: collapse; text-align: center;"> <tr> <td style="width: 10%;"></td> <td style="width: 10%;"></td> <td style="width: 10%;"></td> <td style="width: 10%;"></td> <td style="width: 10%;"></td> <td style="width: 10%;"></td> <td style="width: 10%;"></td> <td style="width: 10%;"></td> <td style="width: 10%;"></td> <td style="width: 10%;"></td> </tr> <tr> <td></td> <td></td> <td colspan="8" style="text-align: center;"> <table border="1" style="width: 100%; border-collapse: collapse; text-align: center;"> <tr> <td style="width: 10%;"></td> <td style="width: 10%;"></td> <td style="width: 10%;"></td> <td style="width: 10%;"></td> <td style="width: 10%;"></td> <td style="width: 10%;"></td> <td style="width: 10%;"></td> <td style="width: 10%;"></td> <td style="width: 10%;"></td> <td style="width: 10%;"></td> </tr> <tr> <td></td> <td></td> <td colspan="8" style="text-align: center;"> <table border="1" style="width: 100%; border-collapse: collapse; text-align: center;"> <tr> <td style="width: 10%;"></td> <td style="width: 10%;"></td> <td style="width: 10%;"></td> <td style="width: 10%;"></td> <td style="width: 10%;"></td> <td style="width: 10%;"></td> <td style="width: 10%;"></td> <td style="width: 10%;"></td> <td style="width: 10%;"></td> <td style="width: 10%;"></td> </tr> <tr> <td></td> <td></td> <td colspan="8" style="text-align: center;"> <table border="1" style="width: 100%; border-collapse: collapse; text-align: center;"> <tr> </tr></table></td></tr></table></td></tr></table></td></tr></table></td></tr></table></td></tr></table></td></tr></table></td></tr></table></td></tr></table></td></tr></table></td></tr></table></td></tr></table></td></tr></table></td></tr></table></td></tr></table></td></tr></table></td></tr></table></td></tr></table></td></tr></table></td></tr></table></td></tr></table></td></tr></table></td></tr></table></td></tr></table></td></tr></table></td></tr></table></td></tr></table></td></tr></table></td></tr></table>
 | | | | | | | | | | | | | | | | | | | | <table border="1" style="width: 100%; border-collapse: collapse; text-align: center;"> <tr> <td style="width: 10%;"></td> <td style="width: 10%;"></td> <td style="width: 10%;"></td> <td style="width: 10%;"></td> <td style="width: 10%;"></td> <td style="width: 10%;"></td> <td style="width: 10%;"></td> <td style="width: 10%;"></td> <td style="width: 10%;"></td> <td style="width: 10%;"></td> </tr> <tr> <td></td> <td></td> <td colspan="8" style="text-align: center;"> <table border="1" style="width: 100%; border-collapse: collapse; text-align: center;"> <tr> <td style="width: 10%;"></td> <td style="width: 10%;"></td> <td style="width: 10%;"></td> <td style="width: 10%;"></td> <td style="width: 10%;"></td> <td style="width: 10%;"></td> <td style="width: 10%;"></td> <td style="width: 10%;"></td> <td style="width: 10%;"></td> <td style="width: 10%;"></td> </tr> <tr> <td></td> <td></td> <td colspan="8" style="text-align: center;"> <table border="1" style="width: 100%; border-collapse: collapse; text-align: center;"> <tr> <td style="width: 10%;"></td> <td style="width: 10%;"></td> <td style="width: 10%;"></td> <td style="width: 10%;"></td> <td style="width: 10%;"></td> <td style="width: 10%;"></td> <td style="width: 10%;"></td> <td style="width: 10%;"></td> <td style="width: 10%;"></td> <td style="width: 10%;"></td> </tr> <tr> <td></td> <td></td> <td colspan="8" style="text-align: center;"> <table
border="1" style="width: 100%; border-collapse: collapse; text-align: center;"> <tr> <td style="width: 10%;"></td> <td style="width: 10%;"></td> <td style="width: 10%;"></td> <td style="width: 10%;"></td> <td style="width: 10%;"></td> <td style="width: 10%;"></td> <td style="width: 10%;"></td> <td style="width: 10%;"></td> <td style="width: 10%;"></td> <td style="width: 10%;"></td> </tr> <tr> <td></td> <td></td> <td colspan="8" style="text-align: center;"> <table border="1" style="width: 100%; border-collapse: collapse; text-align: center;"> <tr> <td style="width: 10%;"></td> <td style="width: 10%;"></td> <td style="width: 10%;"></td> <td style="width: 10%;"></td> <td style="width: 10%;"></td> <td style="width: 10%;"></td> <td style="width: 10%;"></td> <td style="width: 10%;"></td> <td style="width: 10%;"></td> <td style="width: 10%;"></td> </tr> <tr> <td></td> <td></td> <td colspan="8" style="text-align: center;"> <table border="1" style="width: 100%; border-collapse: collapse; text-align: center;"> <tr> <td style="width: 10%;"></td> <td style="width: 10%;"></td> <td style="width: 10%;"></td> <td style="width: 10%;"></td> <td style="width: 10%;"></td> <td style="width: 10%;"></td> <td style="width: 10%;"></td> <td style="width: 10%;"></td> <td style="width: 10%;"></td> <td style="width: 10%;"></td> </tr> <tr> <td></td> <td></td> <td colspan="8" style="text-align: center;"> <table border="1" style="width: 100%; border-collapse: collapse; text-align: center;"> <tr> <td style="width: 10%;"></td> <td style="width: 10%;"></td> <td style="width: 10%;"></td> <td style="width: 10%;"></td> <td style="width: 10%;"></td> <td style="width: 10%;"></td> <td style="width: 10%;"></td> <td style="width: 10%;"></td> <td style="width: 10%;"></td> <td style="width: 10%;"></td> </tr> <tr> <td></td> <td></td> <td colspan="8" style="text-align: center;"> <table border="1" style="width: 100%; border-collapse: collapse; text-align: center;"> <tr> <td style="width: 10%;"></td> <td style="width: 10%;"></td> <td style="width: 10%;"></td> <td style="width: 10%;"></td> <td style="width: 10%;"></td> <td style="width: 10%;"></td> <td style="width: 10%;"></td> <td style="width: 10%;"></td> <td style="width: 10%;"></td> <td style="width: 10%;"></td> </tr> <tr> <td></td> <td></td> <td colspan="8" style="text-align: center;"> <table border="1" style="width: 100%; border-collapse: collapse; text-align: center;"> <tr> <td style="width: 10%;"></td> <td style="width: 10%;"></td> <td style="width: 10%;"></td> <td style="width: 10%;"></td> <td style="width: 10%;"></td> <td style="width: 10%;"></td> <td style="width: 10%;"></td> <td style="width: 10%;"></td> <td style="width: 10%;"></td> <td style="width: 10%;"></td> </tr> <tr> <td></td> <td></td> <td colspan="8" style="text-align: center;"> <table border="1" style="width: 100%; border-collapse: collapse; text-align: center;"> <tr> <td style="width: 10%;"></td> <td style="width: 10%;"></td> <td style="width: 10%;"></td> <td style="width: 10%;"></td> <td style="width: 10%;"></td> <td style="width: 10%;"></td> <td style="width: 10%;"></td> <td style="width: 10%;"></td> <td style="width: 10%;"></td> <td style="width: 10%;"></td> </tr> <tr> <td></td> <td></td> <td colspan="8" style="text-align: center;"> <table border="1" style="width: 100%; border-collapse: collapse; text-align: center;"> <tr> <td style="width: 10%;"></td> <td style="width: 10%;"></td> <td style="width: 10%;"></td> <td style="width: 10%;"></td> <td style="width: 10%;"></td> <td style="width: 10%;"></td> <td style="width: 10%;"></td> <td style="width: 10%;"></td> <td style="width: 10%;"></td> <td style="width: 10%;"></td> </tr> <tr> <td></td> <td></td> <td colspan="8" style="text-align: center;"> <table border="1" style="width: 100%; border-collapse: collapse; text-align: center;"> <tr> <td style="width: 10%;"></td> <td style="width: 10%;"></td> <td style="width: 10%;"></td> <td style="width: 10%;"></td> <td style="width: 10%;"></td> <td style="width: 10%;"></td> <td style="width: 10%;"></td> <td style="width: 10%;"></td> <td style="width: 10%;"></td> <td style="width: 10%;"></td> </tr> <tr> <td></td> <td></td> <td colspan="8" style="text-align: center;"> <table border="1" style="width: 100%; border-collapse: collapse; text-align: center;"> <tr> <td style="width: 10%;"></td> <td style="width: 10%;"></td> <td style="width: 10%;"></td> <td style="width: 10%;"></td> <td style="width: 10%;"></td> <td style="width: 10%;"></td> <td style="width: 10%;"></td> <td style="width: 10%;"></td> <td style="width: 10%;"></td> <td style="width: 10%;"></td> </tr> <tr> <td></td> <td></td> <td colspan="8" style="text-align: center;"> <table border="1" style="width: 100%; border-collapse: collapse; text-align: center;"> <tr> <td style="width: 10%;"></td> <td style="width: 10%;"></td> <td style="width: 10%;"></td> <td style="width: 10%;"></td> <td style="width: 10%;"></td> <td style="width: 10%;"></td> <td style="width: 10%;"></td> <td style="width: 10%;"></td> <td style="width: 10%;"></td> <td style="width: 10%;"></td> </tr> <tr> <td></td> <td></td> <td colspan="8" style="text-align: center;"> <table border="1" style="width: 100%; border-collapse: collapse; text-align: center;"> <tr> <td style="width: 10%;"></td> <td style="width: 10%;"></td> <td style="width: 10%;"></td> <td style="width: 10%;"></td> <td style="width: 10%;"></td> <td style="width: 10%;"></td> <td style="width: 10%;"></td> <td style="width: 10%;"></td> <td style="width: 10%;"></td> <td style="width: 10%;"></td> </tr> <tr> <td></td> <td></td> <td colspan="8" style="text-align: center;"> <table border="1" style="width: 100%; border-collapse: collapse; text-align: center;"> <tr> <td style="width: 10%;"></td> <td style="width: 10%;"></td> <td style="width: 10%;"></td> <td style="width: 10%;"></td> <td style="width: 10%;"></td> <td style="width: 10%;"></td> <td style="width: 10%;"></td> <td style="width: 10%;"></td> <td style="width: 10%;"></td> <td style="width: 10%;"></td> </tr> <tr> <td></td> <td></td> <td colspan="8" style="text-align: center;"> <table border="1" style="width: 100%; border-collapse: collapse; text-align: center;"> <tr> <td style="width: 10%;"></td> <td style="width: 10%;"></td> <td style="width: 10%;"></td> <td style="width: 10%;"></td> <td style="width: 10%;"></td> <td style="width: 10%;"></td> <td style="width: 10%;"></td> <td style="width: 10%;"></td> <td style="width: 10%;"></td> <td style="width: 10%;"></td> </tr> <tr> <td></td> <td></td> <td colspan="8" style="text-align: center;"> <table border="1" style="width: 100%; border-collapse: collapse; text-align: center;"> <tr> <td style="width: 10%;"></td> <td style="width: 10%;"></td> <td style="width: 10%;"></td> <td style="width: 10%;"></td> <td style="width: 10%;"></td> <td style="width: 10%;"></td> <td style="width: 10%;"></td> <td style="width: 10%;"></td> <td style="width: 10%;"></td> <td style="width: 10%;"></td> </tr> <tr> <td></td> <td></td> <td colspan="8" style="text-align: center;"> <table border="1" style="width: 100%; border-collapse: collapse; text-align: center;"> <tr> <td style="width: 10%;"></td> <td style="width: 10%;"></td> <td style="width: 10%;"></td> <td style="width: 10%;"></td> <td style="width: 10%;"></td> <td style="width: 10%;"></td> <td style="width: 10%;"></td> <td style="width: 10%;"></td> <td style="width: 10%;"></td> <td style="width: 10%;"></td> </tr> <tr> <td></td> <td></td> <td colspan="8" style="text-align: center;"> <table border="1" style="width: 100%; border-collapse: collapse; text-align: center;"> <tr> <td style="width: 10%;"></td> <td style="width: 10%;"></td> <td style="width: 10%;"></td> <td style="width: 10%;"></td> <td style="width: 10%;"></td> <td style="width: 10%;"></td> <td style="width: 10%;"></td> <td style="width: 10%;"></td> <td style="width: 10%;"></td> <td style="width: 10%;"></td> </tr> <tr> <td></td> <td></td> <td colspan="8" style="text-align: center;"> <table border="1" style="width: 100%; border-collapse: collapse; text-align: center;"> <tr> <td style="width: 10%;"></td> <td style="width: 10%;"></td> <td style="width: 10%;"></td> <td style="width: 10%;"></td> <td style="width: 10%;"></td> <td style="width: 10%;"></td> <td style="width: 10%;"></td> <td style="width: 10%;"></td> <td style="width: 10%;"></td> <td style="width: 10%;"></td> </tr> <tr> <td></td> <td></td> <td colspan="8" style="text-align: center;"> <table border="1" style="width: 100%; border-collapse: collapse; text-align: center;"> <tr> <td style="width: 10%;"></td> <td style="width: 10%;"></td> <td style="width: 10%;"></td> <td style="width: 10%;"></td> <td style="width: 10%;"></td> <td style="width: 10%;"></td> <td style="width: 10%;"></td> <td style="width: 10%;"></td> <td style="width: 10%;"></td> <td style="width: 10%;"></td> </tr> <tr> <td></td> <td></td> <td colspan="8" style="text-align: center;"> <table border="1" style="width: 100%; border-collapse: collapse; text-align: center;"> <tr> <td style="width: 10%;"></td> <td style="width: 10%;"></td> <td style="width: 10%;"></td> <td style="width: 10%;"></td> <td style="width: 10%;"></td> <td style="width: 10%;"></td> <td style="width: 10%;"></td> <td style="width: 10%;"></td> <td style="width: 10%;"></td> <td style="width: 10%;"></td> </tr> <tr> <td></td> <td></td> <td colspan="8" style="text-align: center;"> <table border="1" style="width: 100%; border-collapse: collapse; text-align: center;"> <tr> <td style="width: 10%;"></td> <td style="width: 10%;"></td> <td style="width: 10%;"></td> <td style="width: 10%;"></td> <td style="width: 10%;"></td> <td style="width: 10%;"></td> <td style="width: 10%;"></td> <td style="width: 10%;"></td> <td style="width: 10%;"></td> <td style="width: 10%;"></td> </tr> <tr> <td></td> <td></td> <td colspan="8" style="text-align: center;"> <table border="1" style="width: 100%; border-collapse: collapse; text-align: center;"> <tr> <td style="width: 10%;"></td> <td style="width: 10%;"></td> <td style="width:
10%;"></td> <td style="width: 10%;"></td> <td style="width: 10%;"></td> <td style="width: 10%;"></td> <td style="width: 10%;"></td> <td style="width: 10%;"></td> <td style="width: 10%;"></td> <td style="width: 10%;"></td> </tr> <tr> <td></td> <td></td> <td colspan="8" style="text-align: center;"> <table border="1" style="width: 100%; border-collapse: collapse; text-align: center;"> <tr> <td style="width: 10%;"></td> <td style="width: 10%;"></td> <td style="width: 10%;"></td> <td style="width: 10%;"></td> <td style="width: 10%;"></td> <td style="width: 10%;"></td> <td style="width: 10%;"></td> <td style="width: 10%;"></td> <td style="width: 10%;"></td> <td style="width: 10%;"></td> </tr> <tr> <td></td> <td></td> <td colspan="8" style="text-align: center;"> <table border="1" style="width: 100%; border-collapse: collapse; text-align: center;"> <tr> <td style="width: 10%;"></td> <td style="width: 10%;"></td> <td style="width: 10%;"></td> <td style="width: 10%;"></td> <td style="width: 10%;"></td> <td style="width: 10%;"></td> <td style="width: 10%;"></td> <td style="width: 10%;"></td> <td style="width: 10%;"></td> <td style="width: 10%;"></td> </tr> <tr> <td></td> <td></td> <td colspan="8" style="text-align: center;"> <table border="1" style="width: 100%; border-collapse: collapse; text-align: center;"> <tr> </tr></table></td></tr></table></td></tr></table></td></tr></table></td></tr></table></td></tr></table></td></tr></table></td></tr></table></td></tr></table></td></tr></table></td></tr></table></td></tr></table></td></tr></table></td></tr></table></td></tr></table></td></tr></table></td></tr></table></td></tr></table></td></tr></table></td></tr></table></td></tr></table></td></tr></table></td></tr></table></td></tr></table></td></tr></table></td></tr></table></td></tr></table></td></tr></table>
 | | | | | | | | | | | | | | | | | | | | <table border="1" style="width: 100%; border-collapse: collapse; text-align: center;"> <tr> <td style="width: 10%;"></td> <td style="width: 10%;"></td> <td style="width: 10%;"></td> <td style="width: 10%;"></td> <td style="width: 10%;"></td> <td style="width: 10%;"></td> <td style="width: 10%;"></td> <td style="width: 10%;"></td> <td style="width: 10%;"></td> <td style="width: 10%;"></td> </tr> <tr> <td></td> <td></td> <td colspan="8" style="text-align: center;"> <table border="1" style="width: 100%; border-collapse: collapse; text-align: center;"> <tr> <td style="width: 10%;"></td> <td style="width: 10%;"></td> <td style="width: 10%;"></td> <td style="width: 10%;"></td> <td style="width: 10%;"></td> <td style="width: 10%;"></td> <td style="width: 10%;"></td> <td style="width: 10%;"></td> <td style="width: 10%;"></td> <td style="width: 10%;"></td> </tr> <tr> <td></td> <td></td> <td colspan="8" style="text-align: center;"> <table border="1" style="width: 100%; border-collapse: collapse; text-align: center;"> <tr> <td style="width: 10%;"></td> <td style="width: 10%;"></td> <td style="width: 10%;"></td> <td style="width: 10%;"></td> <td style="width: 10%;"></td> <td style="width: 10%;"></td> <td style="width: 10%;"></td> <td style="width: 10%;"></td> <td style="width: 10%;"></td> <td style="width: 10%;"></td> </tr> <tr> <td></td> <td></td> <td colspan="8" style="text-align: center;"> <table border="1" style="width: 100%; border-collapse: collapse; text-align: center;"> <tr> <td style="width: 10%;"></td> <td style="width: 10%;"></td> <td style="width: 10%;"></td> <td style="width: 10%;"></td> <td style="width: 10%;"></td> <td style="width: 10%;"></td> <td style="width: 10%;"></td> <td style="width: 10%;"></td> <td style="width: 10%;"></td> <td style="width: 10%;"></td> </tr> <tr> <td></td> <td></td> <td colspan="8" style="text-align: center;"> <table border="1" style="width: 100%; border-collapse: collapse; text-align: center;"> <tr> <td style="width: 10%;"></td> <td style="width: 10%;"></td> <td style="width: 10%;"></td> <td style="width: 10%;"></td> <td style="width: 10%;"></td> <td style="width: 10%;"></td> <td style="width: 10%;"></td> <td style="width: 10%;"></td> <td style="width: 10%;"></td> <td style="width: 10%;"></td> </tr> <tr> <td></td> <td></td> <td colspan="8" style="text-align: center;"> <table border="1" style="width: 100%; border-collapse: collapse; text-align: center;"> <tr> <td style="width: 10%;"></td> <td style="width: 10%;"></td> <td style="width: 10%;"></td> <td style="width: 10%;"></td> <td style="width: 10%;"></td> <td style="width: 10%;"></td> <td style="width: 10%;"></td> <td style="width: 10%;"></td> <td style="width: 10%;"></td> <td style="width: 10%;"></td> </tr> <tr> <td></td> <td></td> <td colspan="8" style="text-align: center;"> <table border="1" style="width: 100%; border-collapse: collapse; text-align: center;"> <tr> <td style="width: 10%;"></td> <td style="width: 10%;"></td> <td style="width: 10%;"></td> <td style="width: 10%;"></td> <td style="width: 10%;"></td> <td style="width: 10%;"></td> <td style="width: 10%;"></td> <td style="width: 10%;"></td> <td style="width: 10%;"></td> <td style="width: 10%;"></td> </tr> <tr> <td></td> <td></td> <td colspan="8" style="text-align: center;"> <table border="1" style="width: 100%; border-collapse: collapse; text-align: center;"> <tr> <td style="width: 10%;"></td> <td style="width: 10%;"></td> <td style="width: 10%;"></td> <td style="width: 10%;"></td> <td style="width: 10%;"></td> <td style="width: 10%;"></td> <td style="width: 10%;"></td> <td style="width: 10%;"></td> <td style="width: 10%;"></td> <td style="width: 10%;"></td> </tr> <tr> <td></td> <td></td> <td colspan="8" style="text-align: center;"> <table border="1" style="width: 100%; border-collapse: collapse; text-align: center;"> <tr> <td style="width: 10%;"></td> <td style="width: 10%;"></td> <td style="width: 10%;"></td> <td style="width: 10%;"></td> <td style="width: 10%;"></td> <td style="width: 10%;"></td> <td style="width: 10%;"></td> <td style="width: 10%;"></td> <td style="width: 10%;"></td> <td style="width: 10%;"></td> </tr> <tr> <td></td> <td></td> <td colspan="8" style="text-align: center;"> <table border="1" style="width: 100%; border-collapse: collapse; text-align: center;"> <tr> <td style="width: 10%;"></td> <td style="width: 10%;"></td> <td style="width: 10%;"></td> <td style="width: 10%;"></td> <td style="width: 10%;"></td> <td style="width: 10%;"></td> <td style="width: 10%;"></td> <td style="width: 10%;"></td> <td style="width: 10%;"></td> <td style="width: 10%;"></td> </tr> <tr> <td></td> <td></td> <td colspan="8" style="text-align: center;"> <table border="1" style="width: 100%; border-collapse: collapse; text-align: center;"> <tr> <td style="width: 10%;"></td> <td style="width: 10%;"></td> <td style="width: 10%;"></td> <td style="width: 10%;"></td> <td style="width: 10%;"></td> <td style="width: 10%;"></td> <td style="width: 10%;"></td> <td style="width: 10%;"></td> <td style="width: 10%;"></td> <td style="width: 10%;"></td> </tr> <tr> <td></td> <td></td> <td colspan="8" style="text-align: center;"> <table border="1" style="width: 100%; border-collapse: collapse; text-align: center;"> <tr> <td style="width: 10%;"></td> <td style="width: 10%;"></td> <td style="width: 10%;"></td> <td style="width: 10%;"></td> <td style="width: 10%;"></td> <td style="width: 10%;"></td> <td style="width: 10%;"></td> <td style="width: 10%;"></td> <td style="width: 10%;"></td> <td style="width: 10%;"></td> </tr> <tr> <td></td> <td></td> <td colspan="8" style="text-align: center;"> <table border="1" style="width: 100%; border-collapse: collapse; text-align: center;"> <tr> <td style="width: 10%;"></td> <td style="width: 10%;"></td> <td style="width: 10%;"></td> <td style="width: 10%;"></td> <td style="width: 10%;"></td> <td style="width: 10%;"></td> <td style="width: 10%;"></td> <td style="width: 10%;"></td> <td style="width: 10%;"></td> <td style="width: 10%;"></td> </tr> <tr> <td></td> <td></td> <td colspan="8" style="text-align: center;"> <table border="1" style="width: 100%; border-collapse: collapse; text-align: center;"> <tr> <td style="width: 10%;"></td> <td style="width: 10%;"></td> <td style="width: 10%;"></td> <td style="width: 10%;"></td> <td style="width: 10%;"></td> <td style="width: 10%;"></td> <td style="width: 10%;"></td> <td style="width: 10%;"></td> <td style="width: 10%;"></td> <td style="width: 10%;"></td> </tr> <tr> <td></td> <td></td> <td colspan="8" style="text-align: center;"> <table border="1" style="width: 100%; border-collapse: collapse; text-align: center;"> <tr> <td style="width: 10%;"></td> <td style="width: 10%;"></td> <td style="width: 10%;"></td> <td style="width: 10%;"></td> <td style="width: 10%;"></td> <td style="width: 10%;"></td> <td style="width: 10%;"></td> <td style="width: 10%;"></td> <td style="width: 10%;"></td> <td style="width: 10%;"></td> </tr> <tr> <td></td> <td></td> <td colspan="8" style="text-align: center;"> <table border="1" style="width: 100%; border-collapse: collapse; text-align: center;"> <tr> <td style="width: 10%;"></td> <td style="width: 10%;"></td> <td style="width: 10%;"></td> <td style="width: 10%;"></td> <td style="width: 10%;"></td> <td style="width: 10%;"></td> <td style="width: 10%;"></td> <td style="width: 10%;"></td> <td style="width: 10%;"></td> <td style="width: 10%;"></td> </tr> <tr>
<td></td> <td></td> <td colspan="8" style="text-align: center;"> <table border="1" style="width: 100%; border-collapse: collapse; text-align: center;"> <tr> <td style="width: 10%;"></td> <td style="width: 10%;"></td> <td style="width: 10%;"></td> <td style="width: 10%;"></td> <td style="width: 10%;"></td> <td style="width: 10%;"></td> <td style="width: 10%;"></td> <td style="width: 10%;"></td> <td style="width: 10%;"></td> <td style="width: 10%;"></td> </tr> <tr> <td></td> <td></td> <td colspan="8" style="text-align: center;"> <table border="1" style="width: 100%; border-collapse: collapse; text-align: center;"> <tr> <td style="width: 10%;"></td> <td style="width: 10%;"></td> <td style="width: 10%;"></td> <td style="width: 10%;"></td> <td style="width: 10%;"></td> <td style="width: 10%;"></td> <td style="width: 10%;"></td> <td style="width: 10%;"></td> <td style="width: 10%;"></td> <td style="width: 10%;"></td> </tr> <tr> <td></td> <td></td> <td colspan="8" style="text-align: center;"> <table border="1" style="width: 100%; border-collapse: collapse; text-align: center;"> <tr> <td style="width: 10%;"></td> <td style="width: 10%;"></td> <td style="width: 10%;"></td> <td style="width: 10%;"></td> <td style="width: 10%;"></td> <td style="width: 10%;"></td> <td style="width: 10%;"></td> <td style="width: 10%;"></td> <td style="width: 10%;"></td> <td style="width: 10%;"></td> </tr> <tr> <td></td> <td></td> <td colspan="8" style="text-align: center;"> <table border="1" style="width: 100%; border-collapse: collapse; text-align: center;"> <tr> <td style="width: 10%;"></td> <td style="width: 10%;"></td> <td style="width: 10%;"></td> <td style="width: 10%;"></td> <td style="width: 10%;"></td> <td style="width: 10%;"></td> <td style="width: 10%;"></td> <td style="width: 10%;"></td> <td style="width: 10%;"></td> <td style="width: 10%;"></td> </tr> <tr> <td></td> <td></td> <td colspan="8" style="text-align: center;"> <table border="1" style="width: 100%; border-collapse: collapse; text-align: center;"> <tr> <td style="width: 10%;"></td> <td style="width: 10%;"></td> <td style="width: 10%;"></td> <td style="width: 10%;"></td> <td style="width: 10%;"></td> <td style="width: 10%;"></td> <td style="width: 10%;"></td> <td style="width: 10%;"></td> <td style="width: 10%;"></td> <td style="width: 10%;"></td> </tr> <tr> <td></td> <td></td> <td colspan="8" style="text-align: center;"> <table border="1" style="width: 100%; border-collapse: collapse; text-align: center;"> <tr> <td style="width: 10%;"></td> <td style="width: 10%;"></td> <td style="width: 10%;"></td> <td style="width: 10%;"></td> <td style="width: 10%;"></td> <td style="width: 10%;"></td> <td style="width: 10%;"></td> <td style="width: 10%;"></td> <td style="width: 10%;"></td> <td style="width: 10%;"></td> </tr> <tr> <td></td> <td></td> <td colspan="8" style="text-align: center;"> <table border="1" style="width: 100%; border-collapse: collapse; text-align: center;"> <tr> <td style="width: 10%;"></td> <td style="width: 10%;"></td> <td style="width: 10%;"></td> <td style="width: 10%;"></td> <td style="width: 10%;"></td> <td style="width: 10%;"></td> <td style="width: 10%;"></td> <td style="width: 10%;"></td> <td style="width: 10%;"></td> <td style="width: 10%;"></td> </tr> <tr> <td></td> <td></td> <td colspan="8" style="text-align: center;"> <table border="1" style="width: 100%; border-collapse: collapse; text-align: center;"> <tr> <td style="width: 10%;"></td> <td style="width: 10%;"></td> <td style="width: 10%;"></td> <td style="width: 10%;"></td> <td style="width: 10%;"></td> <td style="width: 10%;"></td> <td style="width: 10%;"></td> <td style="width: 10%;"></td> <td style="width: 10%;"></td> <td style="width: 10%;"></td> </tr> <tr> <td></td> <td></td> <td colspan="8" style="text-align: center;"> <table border="1" style="width: 100%; border-collapse: collapse; text-align: center;"> <tr> <td style="width: 10%;"></td> <td style="width: 10%;"></td> <td style="width: 10%;"></td> <td style="width: 10%;"></td> <td style="width: 10%;"></td> <td style="width: 10%;"></td> <td style="width: 10%;"></td> <td style="width: 10%;"></td> <td style="width: 10%;"></td> <td style="width: 10%;"></td> </tr> <tr> <td></td> <td></td> <td colspan="8" style="text-align: center;"> <table border="1" style="width: 100%; border-collapse: collapse; text-align: center;"> <tr> <td style="width: 10%;"></td> <td style="width: 10%;"></td> <td style="width: 10%;"></td> <td style="width: 10%;"></td> <td style="width: 10%;"></td> <td style="width: 10%;"></td> <td style="width: 10%;"></td> <td style="width: 10%;"></td> <td style="width: 10%;"></td> <td style="width: 10%;"></td> </tr> <tr> <td></td> <td></td> <td colspan="8" style="text-align: center;"> <table border="1" style="width: 100%; border-collapse: collapse; text-align: center;"> <tr> </tr></table></td></tr></table></td></tr></table></td></tr></table></td></tr></table></td></tr></table></td></tr></table></td></tr></table></td></tr></table></td></tr></table></td></tr></table></td></tr></table></td></tr></table></td></tr></table></td></tr></table></td></tr></table></td></tr></table></td></tr></table></td></tr></table></td></tr></table></td></tr></table></td></tr></table></td></tr></table></td></tr></table></td></tr></table></td></tr></table></td></tr></table>
 | | | | | | | | | | | | | | | | | | | | <table border="1" style="width: 100%; border-collapse: collapse; text-align: center;"> <tr> <td style="width: 10%;"></td> <td style="width: 10%;"></td> <td style="width: 10%;"></td> <td style="width: 10%;"></td> <td style="width: 10%;"></td> <td style="width: 10%;"></td> <td style="width: 10%;"></td> <td style="width: 10%;"></td> <td style="width: 10%;"></td> <td style="width: 10%;"></td> </tr> <tr> <td></td> <td></td> <td colspan="8" style="text-align: center;"> <table border="1" style="width: 100%; border-collapse: collapse; text-align: center;"> <tr> <td style="width: 10%;"></td> <td style="width: 10%;"></td> <td style="width: 10%;"></td> <td style="width: 10%;"></td> <td style="width: 10%;"></td> <td style="width: 10%;"></td> <td style="width: 10%;"></td> <td style="width: 10%;"></td> <td style="width: 10%;"></td> <td style="width: 10%;"></td> </tr> <tr> <td></td> <td></td> <td colspan="8" style="text-align: center;"> <table border="1" style="width: 100%; border-collapse: collapse; text-align: center;"> <tr> <td style="width: 10%;"></td> <td style="width: 10%;"></td> <td style="width: 10%;"></td> <td style="width: 10%;"></td> <td style="width: 10%;"></td> <td style="width: 10%;"></td> <td style="width: 10%;"></td> <td style="width: 10%;"></td> <td style="width: 10%;"></td> <td style="width: 10%;"></td> </tr> <tr> <td></td> <td></td> <td colspan="8" style="text-align: center;"> <table border="1" style="width: 100%; border-collapse: collapse; text-align: center;"> <tr> <td style="width: 10%;"></td> <td style="width: 10%;"></td> <td style="width: 10%;"></td> <td style="width: 10%;"></td> <td style="width: 10%;"></td> <td style="width: 10%;"></td> <td style="width: 10%;"></td> <td style="width: 10%;"></td> <td style="width: 10%;"></td> <td style="width: 10%;"></td> </tr> <tr> <td></td> <td></td> <td colspan="8" style="text-align: center;"> <table border="1" style="width: 100%; border-collapse: collapse; text-align: center;"> <tr> <td style="width: 10%;"></td> <td style="width: 10%;"></td> <td style="width: 10%;"></td> <td style="width: 10%;"></td> <td style="width: 10%;"></td> <td style="width: 10%;"></td> <td style="width: 10%;"></td> <td style="width: 10%;"></td> <td style="width: 10%;"></td> <td style="width: 10%;"></td> </tr> <tr> <td></td> <td></td> <td colspan="8" style="text-align: center;"> <table border="1" style="width: 100%; border-collapse: collapse; text-align: center;"> <tr> <td style="width: 10%;"></td> <td style="width: 10%;"></td> <td style="width: 10%;"></td> <td style="width: 10%;"></td> <td style="width: 10%;"></td> <td style="width: 10%;"></td> <td style="width: 10%;"></td> <td style="width: 10%;"></td> <td style="width: 10%;"></td> <td style="width: 10%;"></td> </tr> <tr> <td></td> <td></td> <td colspan="8" style="text-align: center;"> <table border="1" style="width: 100%; border-collapse: collapse; text-align: center;"> <tr> <td style="width: 10%;"></td> <td style="width: 10%;"></td> <td style="width: 10%;"></td> <td style="width: 10%;"></td> <td style="width: 10%;"></td> <td style="width: 10%;"></td> <td style="width: 10%;"></td> <td style="width: 10%;"></td> <td style="width: 10%;"></td> <td style="width: 10%;"></td> </tr> <tr> <td></td> <td></td> <td colspan="8" style="text-align: center;"> <table border="1" style="width: 100%; border-collapse: collapse; text-align: center;"> <tr> <td style="width: 10%;"></td> <td style="width: 10%;"></td> <td style="width: 10%;"></td> <td style="width: 10%;"></td> <td style="width: 10%;"></td> <td style="width: 10%;"></td> <td style="width: 10%;"></td> <td style="width: 10%;"></td> <td style="width: 10%;"></td> <td style="width: 10%;"></td> </tr> <tr> <td></td> <td></td> <td colspan="8" style="text-align: center;"> <table border="1" style="width: 100%; border-collapse: collapse; text-align: center;"> <tr> <td style="width: 10%;"></td> <td style="width: 10%;"></td> <td style="width: 10%;"></td> <td
style="width: 10%;"></td> <td style="width: 10%;"></td> <td style="width: 10%;"></td> <td style="width: 10%;"></td> <td style="width: 10%;"></td> <td style="width: 10%;"></td> <td style="width: 10%;"></td> </tr> <tr> <td></td> <td></td> <td colspan="8" style="text-align: center;"> <table border="1" style="width: 100%; border-collapse: collapse; text-align: center;"> <tr> <td style="width: 10%;"></td> <td style="width: 10%;"></td> <td style="width: 10%;"></td> <td style="width: 10%;"></td> <td style="width: 10%;"></td> <td style="width: 10%;"></td> <td style="width: 10%;"></td> <td style="width: 10%;"></td> <td style="width: 10%;"></td> <td style="width: 10%;"></td> </tr> <tr> <td></td> <td></td> <td colspan="8" style="text-align: center;"> <table border="1" style="width: 100%; border-collapse: collapse; text-align: center;"> <tr> <td style="width: 10%;"></td> <td style="width: 10%;"></td> <td style="width: 10%;"></td> <td style="width: 10%;"></td> <td style="width: 10%;"></td> <td style="width: 10%;"></td> <td style="width: 10%;"></td> <td style="width: 10%;"></td> <td style="width: 10%;"></td> <td style="width: 10%;"></td> </tr> <tr> <td></td> <td></td> <td colspan="8" style="text-align: center;"> <table border="1" style="width: 100%; border-collapse: collapse; text-align: center;"> <tr> <td style="width: 10%;"></td> <td style="width: 10%;"></td> <td style="width: 10%;"></td> <td style="width: 10%;"></td> <td style="width: 10%;"></td> <td style="width: 10%;"></td> <td style="width: 10%;"></td> <td style="width: 10%;"></td> <td style="width: 10%;"></td> <td style="width: 10%;"></td> </tr> <tr> <td></td> <td></td> <td colspan="8" style="text-align: center;"> <table border="1" style="width: 100%; border-collapse: collapse; text-align: center;"> <tr> <td style="width: 10%;"></td> <td style="width: 10%;"></td> <td style="width: 10%;"></td> <td style="width: 10%;"></td> <td style="width: 10%;"></td> <td style="width: 10%;"></td> <td style="width: 10%;"></td> <td style="width: 10%;"></td> <td style="width: 10%;"></td> <td style="width: 10%;"></td> </tr> <tr> <td></td> <td></td> <td colspan="8" style="text-align: center;"> <table border="1" style="width: 100%; border-collapse: collapse; text-align: center;"> <tr> <td style="width: 10%;"></td> <td style="width: 10%;"></td> <td style="width: 10%;"></td> <td style="width: 10%;"></td> <td style="width: 10%;"></td> <td style="width: 10%;"></td> <td style="width: 10%;"></td> <td style="width: 10%;"></td> <td style="width: 10%;"></td> <td style="width: 10%;"></td> </tr> <tr> <td></td> <td></td> <td colspan="8" style="text-align: center;"> <table border="1" style="width: 100%; border-collapse: collapse; text-align: center;"> <tr> <td style="width: 10%;"></td> <td style="width: 10%;"></td> <td style="width: 10%;"></td> <td style="width: 10%;"></td> <td style="width: 10%;"></td> <td style="width: 10%;"></td> <td style="width: 10%;"></td> <td style="width: 10%;"></td> <td style="width: 10%;"></td> <td style="width: 10%;"></td> </tr> <tr> <td></td> <td></td> <td colspan="8" style="text-align: center;"> <table border="1" style="width: 100%; border-collapse: collapse; text-align: center;"> <tr> <td style="width: 10%;"></td> <td style="width: 10%;"></td> <td style="width: 10%;"></td> <td style="width: 10%;"></td> <td style="width: 10%;"></td> <td style="width: 10%;"></td> <td style="width: 10%;"></td> <td style="width: 10%;"></td> <td style="width: 10%;"></td> <td style="width: 10%;"></td> </tr> <tr> <td></td> <td></td> <td colspan="8" style="text-align: center;"> <table border="1" style="width: 100%; border-collapse: collapse; text-align: center;"> <tr> <td style="width: 10%;"></td> <td style="width: 10%;"></td> <td style="width: 10%;"></td> <td style="width: 10%;"></td> <td style="width: 10%;"></td> <td style="width: 10%;"></td> <td style="width: 10%;"></td> <td style="width: 10%;"></td> <td style="width: 10%;"></td> <td style="width: 10%;"></td> </tr> <tr> <td></td> <td></td> <td colspan="8" style="text-align: center;"> <table border="1" style="width: 100%; border-collapse: collapse; text-align: center;"> <tr> <td style="width: 10%;"></td> <td style="width: 10%;"></td> <td style="width: 10%;"></td> <td style="width: 10%;"></td> <td style="width: 10%;"></td> <td style="width: 10%;"></td> <td style="width: 10%;"></td> <td style="width: 10%;"></td> <td style="width: 10%;"></td> <td style="width: 10%;"></td> </tr> <tr> <td></td> <td></td> <td colspan="8" style="text-align: center;"> <table border="1" style="width: 100%; border-collapse: collapse; text-align: center;"> <tr> <td style="width: 10%;"></td> <td style="width: 10%;"></td> <td style="width: 10%;"></td> <td style="width: 10%;"></td> <td style="width: 10%;"></td> <td style="width: 10%;"></td> <td style="width: 10%;"></td> <td style="width: 10%;"></td> <td style="width: 10%;"></td> <td style="width: 10%;"></td> </tr> <tr> <td></td> <td></td> <td colspan="8" style="text-align: center;"> <table border="1" style="width: 100%; border-collapse: collapse; text-align: center;"> <tr> <td style="width: 10%;"></td> <td style="width: 10%;"></td> <td style="width: 10%;"></td> <td style="width: 10%;"></td> <td style="width: 10%;"></td> <td style="width: 10%;"></td> <td style="width: 10%;"></td> <td style="width: 10%;"></td> <td style="width: 10%;"></td> <td style="width: 10%;"></td> </tr> <tr> <td></td> <td></td> <td colspan="8" style="text-align: center;"> <table border="1" style="width: 100%; border-collapse: collapse; text-align: center;"> <tr> <td style="width: 10%;"></td> <td style="width: 10%;"></td> <td style="width: 10%;"></td> <td style="width: 10%;"></td> <td style="width: 10%;"></td> <td style="width: 10%;"></td> <td style="width: 10%;"></td> <td style="width: 10%;"></td> <td style="width: 10%;"></td> <td style="width: 10%;"></td> </tr> <tr> <td></td> <td></td> <td colspan="8" style="text-align: center;"> <table border="1" style="width: 100%; border-collapse: collapse; text-align: center;"> <tr> <td style="width: 10%;"></td> <td style="width: 10%;"></td> <td style="width: 10%;"></td> <td style="width: 10%;"></td> <td style="width: 10%;"></td> <td style="width: 10%;"></td> <td style="width: 10%;"></td> <td style="width: 10%;"></td> <td style="width: 10%;"></td> <td style="width: 10%;"></td> </tr> <tr> <td></td> <td></td> <td colspan="8" style="text-align: center;"> <table border="1" style="width: 100%; border-collapse: collapse; text-align: center;"> <tr> <td style="width: 10%;"></td> <td style="width: 10%;"></td> <td style="width: 10%;"></td> <td style="width: 10%;"></td> <td style="width: 10%;"></td> <td style="width: 10%;"></td> <td style="width: 10%;"></td> <td style="width: 10%;"></td> <td style="width: 10%;"></td> <td style="width: 10%;"></td> </tr> <tr> <td></td> <td></td> <td colspan="8" style="text-align: center;"> <table border="1" style="width: 100%; border-collapse: collapse; text-align: center;"> <tr> <td style="width: 10%;"></td> <td style="width: 10%;"></td> <td style="width: 10%;"></td> <td style="width: 10%;"></td> <td style="width: 10%;"></td> <td style="width: 10%;"></td> <td style="width: 10%;"></td> <td style="width: 10%;"></td> <td style="width: 10%;"></td> <td style="width: 10%;"></td> </tr> <tr> <td></td> <td></td> <td colspan="8" style="text-align: center;"> <table border="1" style="width: 100%; border-collapse: collapse; text-align: center;"> <tr> <td style="width: 10%;"></td> <td style="width: 10%;"></td> <td style="width: 10%;"></td> <td style="width: 10%;"></td> <td style="width: 10%;"></td> <td style="width: 10%;"></td> <td style="width: 10%;"></td> <td style="width: 10%;"></td> <td style="width: 10%;"></td> <td style="width: 10%;"></td> </tr> <tr> <td></td> <td></td> <td colspan="8" style="text-align: center;"> <table border="1" style="width: 100%; border-collapse: collapse; text-align: center;"> <tr> </tr></table></td></tr></table></td></tr></table></td></tr></table></td></tr></table></td></tr></table></td></tr></table></td></tr></table></td></tr></table></td></tr></table></td></tr></table></td></tr></table></td></tr></table></td></tr></table></td></tr></table></td></tr></table></td></tr></table></td></tr></table></td></tr></table></td></tr></table></td></tr></table></td></tr></table></td></tr></table></td></tr></table></td></tr></table></td></tr></table>
 | | | | | | | | | | | | | | | | | | | | <table border="1" style="width: 100%; border-collapse: collapse; text-align: center;"> <tr> <td style="width: 10%;"></td> <td style="width: 10%;"></td> <td style="width: 10%;"></td> <td style="width: 10%;"></td> <td style="width: 10%;"></td> <td style="width: 10%;"></td> <td style="width: 10%;"></td> <td style="width: 10%;"></td> <td style="width: 10%;"></td> <td style="width: 10%;"></td> </tr> <tr> <td></td> <td></td> <td colspan="8" style="text-align: center;"> <table border="1" style="width: 100%; border-collapse: collapse; text-align: center;"> <tr> <td style="width: 10%;"></td> <td style="width: 10%;"></td> <td style="width: 10%;"></td> <td style="width: 10%;"></td> <td style="width: 10%;"></td> <td style="width: 10%;"></td> <td style="width: 10%;"></td> <td style="width: 10%;"></td> <td style="width: 10%;"></td> <td style="width: 10%;"></td> </tr> <tr> <td></td> <td></td> <td colspan="8"
style="text-align: center;"> <table border="1" style="width: 100%; border-collapse: collapse; text-align: center;"> <tr> <td style="width: 10%;"></td> <td style="width: 10%;"></td> <td style="width: 10%;"></td> <td style="width: 10%;"></td> <td style="width: 10%;"></td> <td style="width: 10%;"></td> <td style="width: 10%;"></td> <td style="width: 10%;"></td> <td style="width: 10%;"></td> <td style="width: 10%;"></td> </tr> <tr> <td></td> <td></td> <td colspan="8" style="text-align: center;"> <table border="1" style="width: 100%; border-collapse: collapse; text-align: center;"> <tr> <td style="width: 10%;"></td> <td style="width: 10%;"></td> <td style="width: 10%;"></td> <td style="width: 10%;"></td> <td style="width: 10%;"></td> <td style="width: 10%;"></td> <td style="width: 10%;"></td> <td style="width: 10%;"></td> <td style="width: 10%;"></td> <td style="width: 10%;"></td> </tr> <tr> <td></td> <td></td> <td colspan="8" style="text-align: center;"> <table border="1" style="width: 100%; border-collapse: collapse; text-align: center;"> <tr> <td style="width: 10%;"></td> <td style="width: 10%;"></td> <td style="width: 10%;"></td> <td style="width: 10%;"></td> <td style="width: 10%;"></td> <td style="width: 10%;"></td> <td style="width: 10%;"></td> <td style="width: 10%;"></td> <td style="width: 10%;"></td> <td style="width: 10%;"></td> </tr> <tr> <td></td> <td></td> <td colspan="8" style="text-align: center;"> <table border="1" style="width: 100%; border-collapse: collapse; text-align: center;"> <tr> <td style="width: 10%;"></td> <td style="width: 10%;"></td> <td style="width: 10%;"></td> <td style="width: 10%;"></td> <td style="width: 10%;"></td> <td style="width: 10%;"></td> <td style="width: 10%;"></td> <td style="width: 10%;"></td> <td style="width: 10%;"></td> <td style="width: 10%;"></td> </tr> <tr> <td></td> <td></td> <td colspan="8" style="text-align: center;"> <table border="1" style="width: 100%; border-collapse: collapse; text-align: center;"> <tr> <td style="width: 10%;"></td> <td style="width: 10%;"></td> <td style="width: 10%;"></td> <td style="width: 10%;"></td> <td style="width: 10%;"></td> <td style="width: 10%;"></td> <td style="width: 10%;"></td> <td style="width: 10%;"></td> <td style="width: 10%;"></td> <td style="width: 10%;"></td> </tr> <tr> <td></td> <td></td> <td colspan="8" style="text-align: center;"> <table border="1" style="width: 100%; border-collapse: collapse; text-align: center;"> <tr> <td style="width: 10%;"></td> <td style="width: 10%;"></td> <td style="width: 10%;"></td> <td style="width: 10%;"></td> <td style="width: 10%;"></td> <td style="width: 10%;"></td> <td style="width: 10%;"></td> <td style="width: 10%;"></td> <td style="width: 10%;"></td> <td style="width: 10%;"></td> </tr> <tr> <td></td> <td></td> <td colspan="8" style="text-align: center;"> <table border="1" style="width: 100%; border-collapse: collapse; text-align: center;"> <tr> <td style="width: 10%;"></td> <td style="width: 10%;"></td> <td style="width: 10%;"></td> <td style="width: 10%;"></td> <td style="width: 10%;"></td> <td style="width: 10%;"></td> <td style="width: 10%;"></td> <td style="width: 10%;"></td> <td style="width: 10%;"></td> <td style="width: 10%;"></td> </tr> <tr> <td></td> <td></td> <td colspan="8" style="text-align: center;"> <table border="1" style="width: 100%; border-collapse: collapse; text-align: center;"> <tr> <td style="width: 10%;"></td> <td style="width: 10%;"></td> <td style="width: 10%;"></td> <td style="width: 10%;"></td> <td style="width: 10%;"></td> <td style="width: 10%;"></td> <td style="width: 10%;"></td> <td style="width: 10%;"></td> <td style="width: 10%;"></td> <td style="width: 10%;"></td> </tr> <tr> <td></td> <td></td> <td colspan="8" style="text-align: center;"> <table border="1" style="width: 100%; border-collapse: collapse; text-align: center;"> <tr> <td style="width: 10%;"></td> <td style="width: 10%;"></td> <td style="width: 10%;"></td> <td style="width: 10%;"></td> <td style="width: 10%;"></td> <td style="width: 10%;"></td> <td style="width: 10%;"></td> <td style="width: 10%;"></td> <td style="width: 10%;"></td> <td style="width: 10%;"></td> </tr> <tr> <td></td> <td></td> <td colspan="8" style="text-align: center;"> <table border="1" style="width: 100%; border-collapse: collapse; text-align: center;"> <tr> <td style="width: 10%;"></td> <td style="width: 10%;"></td> <td style="width: 10%;"></td> <td style="width: 10%;"></td> <td style="width: 10%;"></td> <td style="width: 10%;"></td> <td style="width: 10%;"></td> <td style="width: 10%;"></td> <td style="width: 10%;"></td> <td style="width: 10%;"></td> </tr> <tr> <td></td> <td></td> <td colspan="8" style="text-align: center;"> <table border="1" style="width: 100%; border-collapse: collapse; text-align: center;"> <tr> <td style="width: 10%;"></td> <td style="width: 10%;"></td> <td style="width: 10%;"></td> <td style="width: 10%;"></td> <td style="width: 10%;"></td> <td style="width: 10%;"></td> <td style="width: 10%;"></td> <td style="width: 10%;"></td> <td style="width: 10%;"></td> <td style="width: 10%;"></td> </tr> <tr> <td></td> <td></td> <td colspan="8" style="text-align: center;"> <table border="1" style="width: 100%; border-collapse: collapse; text-align: center;"> <tr> <td style="width: 10%;"></td> <td style="width: 10%;"></td> <td style="width: 10%;"></td> <td style="width: 10%;"></td> <td style="width: 10%;"></td> <td style="width: 10%;"></td> <td style="width: 10%;"></td> <td style="width: 10%;"></td> <td style="width: 10%;"></td> <td style="width: 10%;"></td> </tr> <tr> <td></td> <td></td> <td colspan="8" style="text-align: center;"> <table border="1" style="width: 100%; border-collapse: collapse; text-align: center;"> <tr> <td style="width: 10%;"></td> <td style="width: 10%;"></td> <td style="width: 10%;"></td> <td style="width: 10%;"></td> <td style="width: 10%;"></td> <td style="width: 10%;"></td> <td style="width: 10%;"></td> <td style="width: 10%;"></td> <td style="width: 10%;"></td> <td style="width: 10%;"></td> </tr> <tr> <td></td> <td></td> <td colspan="8" style="text-align: center;"> <table border="1" style="width: 100%; border-collapse: collapse; text-align: center;"> <tr> <td style="width: 10%;"></td> <td style="width: 10%;"></td> <td style="width: 10%;"></td> <td style="width: 10%;"></td> <td style="width: 10%;"></td> <td style="width: 10%;"></td> <td style="width: 10%;"></td> <td style="width: 10%;"></td> <td style="width: 10%;"></td> <td style="width: 10%;"></td> </tr> <tr> <td></td> <td></td> <td colspan="8" style="text-align: center;"> <table border="1" style="width: 100%; border-collapse: collapse; text-align: center;"> <tr> <td style="width: 10%;"></td> <td style="width: 10%;"></td> <td style="width: 10%;"></td> <td style="width: 10%;"></td> <td style="width: 10%;"></td> <td style="width: 10%;"></td> <td style="width: 10%;"></td> <td style="width: 10%;"></td> <td style="width: 10%;"></td> <td style="width: 10%;"></td> </tr> <tr> <td></td> <td></td> <td colspan="8" style="text-align: center;"> <table border="1" style="width: 100%; border-collapse: collapse; text-align: center;"> <tr> <td style="width: 10%;"></td> <td style="width: 10%;"></td> <td style="width: 10%;"></td> <td style="width: 10%;"></td> <td style="width: 10%;"></td> <td style="width: 10%;"></td> <td style="width: 10%;"></td> <td style="width: 10%;"></td> <td style="width: 10%;"></td> <td style="width: 10%;"></td> </tr> <tr> <td></td> <td></td> <td colspan="8" style="text-align: center;"> <table border="1" style="width: 100%; border-collapse: collapse; text-align: center;"> <tr> <td style="width: 10%;"></td> <td style="width: 10%;"></td> <td style="width: 10%;"></td> <td style="width: 10%;"></td> <td style="width: 10%;"></td> <td style="width: 10%;"></td> <td style="width: 10%;"></td> <td style="width: 10%;"></td> <td style="width: 10%;"></td> <td style="width: 10%;"></td> </tr> <tr> <td></td> <td></td> <td colspan="8" style="text-align: center;"> <table border="1" style="width: 100%; border-collapse: collapse; text-align: center;"> <tr> <td style="width: 10%;"></td> <td style="width: 10%;"></td> <td style="width: 10%;"></td> <td style="width: 10%;"></td> <td style="width: 10%;"></td> <td style="width: 10%;"></td> <td style="width: 10%;"></td> <td style="width: 10%;"></td> <td style="width: 10%;"></td> <td style="width: 10%;"></td> </tr> <tr> <td></td> <td></td> <td colspan="8" style="text-align: center;"> <table border="1" style="width: 100%; border-collapse: collapse; text-align: center;"> <tr> <td style="width: 10%;"></td> <td style="width: 10%;"></td> <td style="width: 10%;"></td> <td style="width: 10%;"></td> <td style="width: 10%;"></td> <td style="width: 10%;"></td> <td style="width: 10%;"></td> <td style="width: 10%;"></td> <td style="width: 10%;"></td> <td style="width: 10%;"></td> </tr> <tr> <td></td> <td></td> <td colspan="8" style="text-align: center;"> <table border="1" style="width: 100%; border-collapse: collapse; text-align: center;"> <tr> <td style="width: 10%;"></td> <td style="width: 10%;"></td> <td style="width: 10%;"></td> <td style="width: 10%;"></td> <td style="width: 10%;"></td> <td style="width: 10%;"></td> <td style="width: 10%;"></td> <td style="width: 10%;"></td> <td style="width: 10%;"></td> <td style="width: 10%;"></td> </tr> <tr> <td></td> <td></td> <td colspan="8" style="text-align: center;"> <table border="1" style="width: 100%; border-collapse: collapse; text-align: center;"> <tr> <td style="width: 10%;"></td> <td style="width: 10%;"></td> <td style="width: 10%;"></td> <td style="width: 10%;"></td> <td style="width: 10%;"></td> <td style="width: 10%;"></td> <td style="width: 10%;"></td> <td style="width: 10%;"></td> <td style="width: 10%;"></td> <td style="width: 10%;"></td> </tr> <tr> <td></td> <td></td> <td colspan="8" style="text-align: center;"> <table border="1" style="width: 100%; border-collapse: collapse; text-align: center;"> <tr> <td style="width: 10%;"></td> <td style="width:
10%;"></td> <td style="width: 10%;"></td> <td style="width: 10%;"></td> <td style="width: 10%;"></td> <td style="width: 10%;"></td> <td style="width: 10%;"></td> <td style="width: 10%;"></td> <td style="width: 10%;"></td> <td style="width: 10%;"></td> </tr> <tr> <td></td> <td></td> <td colspan="8" style="text-align: center;"> <table border="1" style="width: 100%; border-collapse: collapse; text-align: center;"> <tr> </tr></table></td></tr></table></td></tr></table></td></tr></table></td></tr></table></td></tr></table></td></tr></table></td></tr></table></td></tr></table></td></tr></table></td></tr></table></td></tr></table></td></tr></table></td></tr></table></td></tr></table></td></tr></table></td></tr></table></td></tr></table></td></tr></table></td></tr></table></td></tr></table></td></tr></table></td></tr></table></td></tr></table></td></tr></table>
 | | | | | | | | | | | | | | | | | | | | <table border="1" style="width: 100%; border-collapse: collapse; text-align: center;"> <tr> <td style="width: 10%;"></td> <td style="width: 10%;"></td> <td style="width: 10%;"></td> <td style="width: 10%;"></td> <td style="width: 10%;"></td> <td style="width: 10%;"></td> <td style="width: 10%;"></td> <td style="width: 10%;"></td> <td style="width: 10%;"></td> <td style="width: 10%;"></td> </tr> <tr> <td></td> <td></td> <td colspan="8" style="text-align: center;"> <table border="1" style="width: 100%; border-collapse: collapse; text-align: center;"> <tr> <td style="width: 10%;"></td> <td style="width: 10%;"></td> <td style="width: 10%;"></td> <td style="width: 10%;"></td> <td style="width: 10%;"></td> <td style="width: 10%;"></td> <td style="width: 10%;"></td> <td style="width: 10%;"></td> <td style="width: 10%;"></td> <td style="width: 10%;"></td> </tr> <tr> <td></td> <td></td> <td colspan="8" style="text-align: center;"> <table border="1" style="width: 100%; border-collapse: collapse; text-align: center;"> <tr> <td style="width: 10%;"></td> <td style="width: 10%;"></td> <td style="width: 10%;"></td> <td style="width: 10%;"></td> <td style="width: 10%;"></td> <td style="width: 10%;"></td> <td style="width: 10%;"></td> <td style="width: 10%;"></td> <td style="width: 10%;"></td> <td style="width: 10%;"></td> </tr> <tr> <td></td> <td></td> <td colspan="8" style="text-align: center;"> <table border="1" style="width: 100%; border-collapse: collapse; text-align: center;"> <tr> <td style="width: 10%;"></td> <td style="width: 10%;"></td> <td style="width: 10%;"></td> <td style="width: 10%;"></td> <td style="width: 10%;"></td> <td style="width: 10%;"></td> <td style="width: 10%;"></td> <td style="width: 10%;"></td> <td style="width: 10%;"></td> <td style="width: 10%;"></td> </tr> <tr> <td></td> <td></td> <td colspan="8" style="text-align: center;"> <table border="1" style="width: 100%; border-collapse: collapse; text-align: center;"> <tr> <td style="width: 10%;"></td> <td style="width: 10%;"></td> <td style="width: 10%;"></td> <td style="width: 10%;"></td> <td style="width: 10%;"></td> <td style="width: 10%;"></td> <td style="width: 10%;"></td> <td style="width: 10%;"></td> <td style="width: 10%;"></td> <td style="width: 10%;"></td> </tr> <tr> <td></td> <td></td> <td colspan="8" style="text-align: center;"> <table border="1" style="width: 100%; border-collapse: collapse; text-align: center;"> <tr> <td style="width: 10%;"></td> <td style="width: 10%;"></td> <td style="width: 10%;"></td> <td style="width: 10%;"></td> <td style="width: 10%;"></td> <td style="width: 10%;"></td> <td style="width: 10%;"></td> <td style="width: 10%;"></td> <td style="width: 10%;"></td> <td style="width: 10%;"></td> </tr> <tr> <td></td> <td></td> <td colspan="8" style="text-align: center;"> <table border="1" style="width: 100%; border-collapse: collapse; text-align: center;"> <tr> <td style="width: 10%;"></td> <td style="width: 10%;"></td> <td style="width: 10%;"></td> <td style="width: 10%;"></td> <td style="width: 10%;"></td> <td style="width: 10%;"></td> <td style="width: 10%;"></td> <td style="width: 10%;"></td> <td style="width: 10%;"></td> <td style="width: 10%;"></td> </tr> <tr> <td></td> <td></td> <td colspan="8" style="text-align: center;"> <table border="1" style="width: 100%; border-collapse: collapse; text-align: center;"> <tr> <td style="width: 10%;"></td> <td style="width: 10%;"></td> <td style="width: 10%;"></td> <td style="width: 10%;"></td> <td style="width: 10%;"></td> <td style="width: 10%;"></td> <td style="width: 10%;"></td> <td style="width: 10%;"></td> <td style="width: 10%;"></td> <td style="width: 10%;"></td> </tr> <tr> <td></td> <td></td> <td colspan="8" style="text-align: center;"> <table border="1" style="width: 100%; border-collapse: collapse; text-align: center;"> <tr> <td style="width: 10%;"></td> <td style="width: 10%;"></td> <td style="width: 10%;"></td> <td style="width: 10%;"></td> <td style="width: 10%;"></td> <td style="width: 10%;"></td> <td style="width: 10%;"></td> <td style="width: 10%;"></td> <td style="width: 10%;"></td> <td style="width: 10%;"></td> </tr> <tr> <td></td> <td></td> <td colspan="8" style="text-align: center;"> <table border="1" style="width: 100%; border-collapse: collapse; text-align: center;"> <tr> <td style="width: 10%;"></td> <td style="width: 10%;"></td> <td style="width: 10%;"></td> <td style="width: 10%;"></td> <td style="width: 10%;"></td> <td style="width: 10%;"></td> <td style="width: 10%;"></td> <td style="width: 10%;"></td> <td style="width: 10%;"></td> <td style="width: 10%;"></td> </tr> <tr> <td></td> <td></td> <td colspan="8" style="text-align: center;"> <table border="1" style="width: 100%; border-collapse: collapse; text-align: center;"> <tr> <td style="width: 10%;"></td> <td style="width: 10%;"></td> <td style="width: 10%;"></td> <td style="width: 10%;"></td> <td style="width: 10%;"></td> <td style="width: 10%;"></td> <td style="width: 10%;"></td> <td style="width: 10%;"></td> <td style="width: 10%;"></td> <td style="width: 10%;"></td> </tr> <tr> <td></td> <td></td> <td colspan="8" style="text-align: center;"> <table border="1" style="width: 100%; border-collapse: collapse; text-align: center;"> <tr> <td style="width: 10%;"></td> <td style="width: 10%;"></td> <td style="width: 10%;"></td> <td style="width: 10%;"></td> <td style="width: 10%;"></td> <td style="width: 10%;"></td> <td style="width: 10%;"></td> <td style="width: 10%;"></td> <td style="width: 10%;"></td> <td style="width: 10%;"></td> </tr> <tr> <td></td> <td></td> <td colspan="8" style="text-align: center;"> <table border="1" style="width: 100%; border-collapse: collapse; text-align: center;"> <tr> <td style="width: 10%;"></td> <td style="width: 10%;"></td> <td style="width: 10%;"></td> <td style="width: 10%;"></td> <td style="width: 10%;"></td> <td style="width: 10%;"></td> <td style="width: 10%;"></td> <td style="width: 10%;"></td> <td style="width: 10%;"></td> <td style="width: 10%;"></td> </tr> <tr> <td></td> <td></td> <td colspan="8" style="text-align: center;"> <table border="1" style="width: 100%; border-collapse: collapse; text-align: center;"> <tr> <td style="width: 10%;"></td> <td style="width: 10%;"></td> <td style="width: 10%;"></td> <td style="width: 10%;"></td> <td style="width: 10%;"></td> <td style="width: 10%;"></td> <td style="width: 10%;"></td> <td style="width: 10%;"></td> <td style="width: 10%;"></td> <td style="width: 10%;"></td> </tr> <tr> <td></td> <td></td> <td colspan="8" style="text-align: center;"> <table border="1" style="width: 100%; border-collapse: collapse; text-align: center;"> <tr> <td style="width: 10%;"></td> <td style="width: 10%;"></td> <td style="width: 10%;"></td> <td style="width: 10%;"></td> <td style="width: 10%;"></td> <td style="width: 10%;"></td> <td style="width: 10%;"></td> <td style="width: 10%;"></td> <td style="width: 10%;"></td> <td style="width: 10%;"></td> </tr> <tr> <td></td> <td></td> <td colspan="8" style="text-align: center;"> <table border="1" style="width: 100%; border-collapse: collapse; text-align: center;"> <tr> <td style="width: 10%;"></td> <td style="width: 10%;"></td> <td style="width: 10%;"></td> <td style="width: 10%;"></td> <td style="width: 10%;"></td> <td style="width: 10%;"></td> <td style="width: 10%;"></td> <td style="width: 10%;"></td> <td style="width: 10%;"></td> <td style="width: 10%;"></td> </tr> <tr> <td></td> <td></td> <td colspan="8" style="text-align: center;"> <table border="1" style="width: 100%; border-collapse: collapse; text-align: center;"> <tr> <td style="width: 10%;"></td> <td style="width: 10%;"></td> <td style="width: 10%;"></td> <td style="width: 10%;"></td> <td style="width: 10%;"></td> <td style="width: 10%;"></td> <td style="width: 10%;"></td> <td style="width: 10%;"></td> <td style="width: 10%;"></td> <td style="width: 10%;"></td> </tr> <tr> <td></td> <td></td> <td colspan="8" style="text-align: center;"> <table border="1" style="width: 100%; border-collapse: collapse; text-align: center;"> <tr> <td style="width: 10%;"></td> <td style="width: 10%;"></td> <td style="width: 10%;"></td> <td style="width: 10%;"></td> <td style="width: 10%;"></td> <td style="width: 10%;"></td> <td style="width: 10%;"></td> <td style="width: 10%;"></td> <td style="width: 10%;"></td> <td style="width: 10%;"></td> </tr> <tr> <td></td> <td></td> <td
colspan="8" style="text-align: center;"> <table border="1" style="width: 100%; border-collapse: collapse; text-align: center;"> <tr> <td style="width: 10%;"></td> <td style="width: 10%;"></td> <td style="width: 10%;"></td> <td style="width: 10%;"></td> <td style="width: 10%;"></td> <td style="width: 10%;"></td> <td style="width: 10%;"></td> <td style="width: 10%;"></td> <td style="width: 10%;"></td> <td style="width: 10%;"></td> </tr> <tr> <td></td> <td></td> <td colspan="8" style="text-align: center;"> <table border="1" style="width: 100%; border-collapse: collapse; text-align: center;"> <tr> <td style="width: 10%;"></td> <td style="width: 10%;"></td> <td style="width: 10%;"></td> <td style="width: 10%;"></td> <td style="width: 10%;"></td> <td style="width: 10%;"></td> <td style="width: 10%;"></td> <td style="width: 10%;"></td> <td style="width: 10%;"></td> <td style="width: 10%;"></td> </tr> <tr> <td></td> <td></td> <td colspan="8" style="text-align: center;"> <table border="1" style="width: 100%; border-collapse: collapse; text-align: center;"> <tr> <td style="width: 10%;"></td> <td style="width: 10%;"></td> <td style="width: 10%;"></td> <td style="width: 10%;"></td> <td style="width: 10%;"></td> <td style="width: 10%;"></td> <td style="width: 10%;"></td> <td style="width: 10%;"></td> <td style="width: 10%;"></td> <td style="width: 10%;"></td> </tr> <tr> <td></td> <td></td> <td colspan="8" style="text-align: center;"> <table border="1" style="width: 100%; border-collapse: collapse; text-align: center;"> <tr> <td style="width: 10%;"></td> <td style="width: 10%;"></td> <td style="width: 10%;"></td> <td style="width: 10%;"></td> <td style="width: 10%;"></td> <td style="width: 10%;"></td> <td style="width: 10%;"></td> <td style="width: 10%;"></td> <td style="width: 10%;"></td> <td style="width: 10%;"></td> </tr> <tr> <td></td> <td></td> <td colspan="8" style="text-align: center;"> <table border="1" style="width: 100%; border-collapse: collapse; text-align: center;"> <tr> <td style="width: 10%;"></td> <td style="width: 10%;"></td> <td style="width: 10%;"></td> <td style="width: 10%;"></td> <td style="width: 10%;"></td> <td style="width: 10%;"></td> <td style="width: 10%;"></td> <td style="width: 10%;"></td> <td style="width: 10%;"></td> <td style="width: 10%;"></td> </tr> <tr> <td></td> <td></td> <td colspan="8" style="text-align: center;"> <table border="1" style="width: 100%; border-collapse: collapse; text-align: center;"> <tr> </tr></table></td></tr></table></td></tr></table></td></tr></table></td></tr></table></td></tr></table></td></tr></table></td></tr></table></td></tr></table></td></tr></table></td></tr></table></td></tr></table></td></tr></table></td></tr></table></td></tr></table></td></tr></table></td></tr></table></td></tr></table></td></tr></table></td></tr></table></td></tr></table></td></tr></table></td></tr></table></td></tr></table>
 | | | | | | | | | | | | | | | | | | | | <table border="1" style="width: 100%; border-collapse: collapse; text-align: center;"> <tr> <td style="width: 10%;"></td> <td style="width: 10%;"></td> <td style="width: 10%;"></td> <td style="width: 10%;"></td> <td style="width: 10%;"></td> <td style="width: 10%;"></td> <td style="width: 10%;"></td> <td style="width: 10%;"></td> <td style="width: 10%;"></td> <td style="width: 10%;"></td> </tr> <tr> <td></td> <td></td> <td colspan="8" style="text-align: center;"> <table border="1" style="width: 100%; border-collapse: collapse; text-align: center;"> <tr> <td style="width: 10%;"></td> <td style="width: 10%;"></td> <td style="width: 10%;"></td> <td style="width: 10%;"></td> <td style="width: 10%;"></td> <td style="width: 10%;"></td> <td style="width: 10%;"></td> <td style="width: 10%;"></td> <td style="width: 10%;"></td> <td style="width: 10%;"></td> </tr> <tr> <td></td> <td></td> <td colspan="8" style="text-align: center;"> <table border="1" style="width: 100%; border-collapse: collapse; text-align: center;"> <tr> <td style="width: 10%;"></td> <td style="width: 10%;"></td> <td style="width: 10%;"></td> <td style="width: 10%;"></td> <td style="width: 10%;"></td> <td style="width: 10%;"></td> <td style="width: 10%;"></td> <td style="width: 10%;"></td> <td style="width: 10%;"></td> <td style="width: 10%;"></td> </tr> <tr> <td></td> <td></td> <td colspan="8" style="text-align: center;"> <table border="1" style="width: 100%; border-collapse: collapse; text-align: center;"> <tr> <td style="width: 10%;"></td> <td style="width: 10%;"></td> <td style="width: 10%;"></td> <td style="width: 10%;"></td> <td style="width: 10%;"></td> <td style="width: 10%;"></td> <td style="width: 10%;"></td> <td style="width: 10%;"></td> <td style="width: 10%;"></td> <td style="width: 10%;"></td> </tr> <tr> <td></td> <td></td> <td colspan="8" style="text-align: center;"> <table border="1" style="width: 100%; border-collapse: collapse; text-align: center;"> <tr> <td style="width: 10%;"></td> <td style="width: 10%;"></td> <td style="width: 10%;"></td> <td style="width: 10%;"></td> <td style="width: 10%;"></td> <td style="width: 10%;"></td> <td style="width: 10%;"></td> <td style="width: 10%;"></td> <td style="width: 10%;"></td> <td style="width: 10%;"></td> </tr> <tr> <td></td> <td></td> <td colspan="8" style="text-align: center;"> <table border="1" style="width: 100%; border-collapse: collapse; text-align: center;"> <tr> <td style="width: 10%;"></td> <td style="width: 10%;"></td> <td style="width: 10%;"></td> <td style="width: 10%;"></td> <td style="width: 10%;"></td> <td style="width: 10%;"></td> <td style="width: 10%;"></td> <td style="width: 10%;"></td> <td style="width: 10%;"></td> <td style="width: 10%;"></td> </tr> <tr> <td></td> <td></td> <td colspan="8" style="text-align: center;"> <table border="1" style="width: 100%; border-collapse: collapse; text-align: center;"> <tr> <td style="width: 10%;"></td> <td style="width: 10%;"></td> <td style="width: 10%;"></td> <td style="width: 10%;"></td> <td style="width: 10%;"></td> <td style="width: 10%;"></td> <td style="width: 10%;"></td> <td style="width: 10%;"></td> <td style="width: 10%;"></td> <td style="width: 10%;"></td> </tr> <tr> <td></td> <td></td> <td colspan="8" style="text-align: center;"> <table border="1" style="width: 100%; border-collapse: collapse; text-align: center;"> <tr> <td style="width: 10%;"></td> <td style="width: 10%;"></td> <td style="width: 10%;"></td> <td style="width: 10%;"></td> <td style="width: 10%;"></td> <td style="width: 10%;"></td> <td style="width: 10%;"></td> <td style="width: 10%;"></td> <td style="width: 10%;"></td> <td style="width: 10%;"></td> </tr> <tr> <td></td> <td></td> <td colspan="8" style="text-align: center;"> <table border="1" style="width: 100%; border-collapse: collapse; text-align: center;"> <tr> <td style="width: 10%;"></td> <td style="width: 10%;"></td> <td style="width: 10%;"></td> <td style="width: 10%;"></td> <td style="width: 10%;"></td> <td style="width: 10%;"></td> <td style="width: 10%;"></td> <td style="width: 10%;"></td> <td style="width: 10%;"></td> <td style="width: 10%;"></td> </tr> <tr> <td></td> <td></td> <td colspan="8" style="text-align: center;"> <table border="1" style="width: 100%; border-collapse: collapse; text-align: center;"> <tr> <td style="width: 10%;"></td> <td style="width: 10%;"></td> <td style="width: 10%;"></td> <td style="width: 10%;"></td> <td style="width: 10%;"></td> <td style="width: 10%;"></td> <td style="width: 10%;"></td> <td style="width: 10%;"></td> <td style="width: 10%;"></td> <td style="width: 10%;"></td> </tr> <tr> <td></td> <td></td> <td colspan="8" style="text-align: center;"> <table border="1" style="width: 100%; border-collapse: collapse; text-align: center;"> <tr> <td style="width: 10%;"></td> <td style="width: 10%;"></td> <td style="width: 10%;"></td> <td style="width: 10%;"></td> <td style="width: 10%;"></td> <td style="width: 10%;"></td> <td style="width: 10%;"></td> <td style="width: 10%;"></td> <td style="width: 10%;"></td> <td style="width: 10%;"></td> </tr> <tr> <td></td> <td></td> <td colspan="8" style="text-align: center;"> <table border="1" style="width: 100%; border-collapse: collapse; text-align: center;"> <tr> <td style="width: 10%;"></td> <td style="width: 10%;"></td> <td style="width: 10%;"></td> <td style="width: 10%;"></td> <td style="width: 10%;"></td> <td style="width: 10%;"></td> <td style="width: 10%;"></td> <td style="width: 10%;"></td> <td style="width: 10%;"></td> <td style="width: 10%;"></td> </tr> <tr> <td></td> <td></td> <td colspan="8" style="text-align: center;"> <table border="1" style="width: 100%; border-collapse: collapse; text-align: center;"> <tr> <td style="width: 10%;"></td> <td style="width: 10%;"></td> <td style="width: 10%;"></td> <td style="width: 10%;"></td> <td style="width: 10%;"></td> <td style="width: 10%;"></td> <td style="width: 10%;"></td> <td style="width: 10%;"></td> <td style="width: 10%;"></td> <td style="width: 10%;"></td> </tr> <tr> <td></td> <td></td> <td colspan="8" style="text-align: center;"> <table border="1" style="width: 100%; border-collapse: collapse; text-align: center;"> <tr> <td style="width: 10%;"></td> <td style="width: 10%;"></td> <td style="width: 10%;"></td> <td style="width: 10%;"></td> <td style="width: 10%;"></td> <td style="width:
10%;"></td> <td style="width: 10%;"></td> <td style="width: 10%;"></td> <td style="width: 10%;"></td> <td style="width: 10%;"></td> </tr> <tr> <td></td> <td></td> <td colspan="8" style="text-align: center;"> <table border="1" style="width: 100%; border-collapse: collapse; text-align: center;"> <tr> <td style="width: 10%;"></td> <td style="width: 10%;"></td> <td style="width: 10%;"></td> <td style="width: 10%;"></td> <td style="width: 10%;"></td> <td style="width: 10%;"></td> <td style="width: 10%;"></td> <td style="width: 10%;"></td> <td style="width: 10%;"></td> <td style="width: 10%;"></td> </tr> <tr> <td></td> <td></td> <td colspan="8" style="text-align: center;"> <table border="1" style="width: 100%; border-collapse: collapse; text-align: center;"> <tr> <td style="width: 10%;"></td> <td style="width: 10%;"></td> <td style="width: 10%;"></td> <td style="width: 10%;"></td> <td style="width: 10%;"></td> <td style="width: 10%;"></td> <td style="width: 10%;"></td> <td style="width: 10%;"></td> <td style="width: 10%;"></td> <td style="width: 10%;"></td> </tr> <tr> <td></td> <td></td> <td colspan="8" style="text-align: center;"> <table border="1" style="width: 100%; border-collapse: collapse; text-align: center;"> <tr> <td style="width: 10%;"></td> <td style="width: 10%;"></td> <td style="width: 10%;"></td> <td style="width: 10%;"></td> <td style="width: 10%;"></td> <td style="width: 10%;"></td> <td style="width: 10%;"></td> <td style="width: 10%;"></td> <td style="width: 10%;"></td> <td style="width: 10%;"></td> </tr> <tr> <td></td> <td></td> <td colspan="8" style="text-align: center;"> <table border="1" style="width: 100%; border-collapse: collapse; text-align: center;"> <tr> <td style="width: 10%;"></td> <td style="width: 10%;"></td> <td style="width: 10%;"></td> <td style="width: 10%;"></td> <td style="width: 10%;"></td> <td style="width: 10%;"></td> <td style="width: 10%;"></td> <td style="width: 10%;"></td> <td style="width: 10%;"></td> <td style="width: 10%;"></td> </tr> <tr> <td></td> <td></td> <td colspan="8" style="text-align: center;"> <table border="1" style="width: 100%; border-collapse: collapse; text-align: center;"> <tr> <td style="width: 10%;"></td> <td style="width: 10%;"></td> <td style="width: 10%;"></td> <td style="width: 10%;"></td> <td style="width: 10%;"></td> <td style="width: 10%;"></td> <td style="width: 10%;"></td> <td style="width: 10%;"></td> <td style="width: 10%;"></td> <td style="width: 10%;"></td> </tr> <tr> <td></td> <td></td> <td colspan="8" style="text-align: center;"> <table border="1" style="width: 100%; border-collapse: collapse; text-align: center;"> <tr> <td style="width: 10%;"></td> <td style="width: 10%;"></td> <td style="width: 10%;"></td> <td style="width: 10%;"></td> <td style="width: 10%;"></td> <td style="width: 10%;"></td> <td style="width: 10%;"></td> <td style="width: 10%;"></td> <td style="width: 10%;"></td> <td style="width: 10%;"></td> </tr> <tr> <td></td> <td></td> <td colspan="8" style="text-align: center;"> <table border="1" style="width: 100%; border-collapse: collapse; text-align: center;"> <tr> <td style="width: 10%;"></td> <td style="width: 10%;"></td> <td style="width: 10%;"></td> <td style="width: 10%;"></td> <td style="width: 10%;"></td> <td style="width: 10%;"></td> <td style="width: 10%;"></td> <td style="width: 10%;"></td> <td style="width: 10%;"></td> <td style="width: 10%;"></td> </tr> <tr> <td></td> <td></td> <td colspan="8" style="text-align: center;"> <table border="1" style="width: 100%; border-collapse: collapse; text-align: center;"> <tr> <td style="width: 10%;"></td> <td style="width: 10%;"></td> <td style="width: 10%;"></td> <td style="width: 10%;"></td> <td style="width: 10%;"></td> <td style="width: 10%;"></td> <td style="width: 10%;"></td> <td style="width: 10%;"></td> <td style="width: 10%;"></td> <td style="width: 10%;"></td> </tr> <tr> <td></td> <td></td> <td colspan="8" style="text-align: center;"> <table border="1" style="width: 100%; border-collapse: collapse; text-align: center;"> <tr> </tr></table></td></tr></table></td></tr></table></td></tr></table></td></tr></table></td></tr></table></td></tr></table></td></tr></table></td></tr></table></td></tr></table></td></tr></table></td></tr></table></td></tr></table></td></tr></table></td></tr></table></td></tr></table></td></tr></table></td></tr></table></td></tr></table></td></tr></table></td></tr></table></td></tr></table></td></tr></table>
 | | | | | | | | | | | | | | | | | | | | <table border="1" style="width: 100%; border-collapse: collapse; text-align: center;"> <tr> <td style="width: 10%;"></td> <td style="width: 10%;"></td> <td style="width: 10%;"></td> <td style="width: 10%;"></td> <td style="width: 10%;"></td> <td style="width: 10%;"></td> <td style="width: 10%;"></td> <td style="width: 10%;"></td> <td style="width: 10%;"></td> <td style="width: 10%;"></td> </tr> <tr> <td></td> <td></td> <td colspan="8" style="text-align: center;"> <table border="1" style="width: 100%; border-collapse: collapse; text-align: center;"> <tr> <td style="width: 10%;"></td> <td style="width: 10%;"></td> <td style="width: 10%;"></td> <td style="width: 10%;"></td> <td style="width: 10%;"></td> <td style="width: 10%;"></td> <td style="width: 10%;"></td> <td style="width: 10%;"></td> <td style="width: 10%;"></td> <td style="width: 10%;"></td> </tr> <tr> <td></td> <td></td> <td colspan="8" style="text-align: center;"> <table border="1" style="width: 100%; border-collapse: collapse; text-align: center;"> <tr> <td style="width: 10%;"></td> <td style="width: 10%;"></td> <td style="width: 10%;"></td> <td style="width: 10%;"></td> <td style="width: 10%;"></td> <td style="width: 10%;"></td> <td style="width: 10%;"></td> <td style="width: 10%;"></td> <td style="width: 10%;"></td> <td style="width: 10%;"></td> </tr> <tr> <td></td> <td></td> <td colspan="8" style="text-align: center;"> <table border="1" style="width: 100%; border-collapse: collapse; text-align: center;"> <tr> <td style="width: 10%;"></td> <td style="width: 10%;"></td> <td style="width: 10%;"></td> <td style="width: 10%;"></td> <td style="width: 10%;"></td> <td style="width: 10%;"></td> <td style="width: 10%;"></td> <td style="width: 10%;"></td> <td style="width: 10%;"></td> <td style="width: 10%;"></td> </tr> <tr> <td></td> <td></td> <td colspan="8" style="text-align: center;"> <table border="1" style="width: 100%; border-collapse: collapse; text-align: center;"> <tr> <td style="width: 10%;"></td> <td style="width: 10%;"></td> <td style="width: 10%;"></td> <td style="width: 10%;"></td> <td style="width: 10%;"></td> <td style="width: 10%;"></td> <td style="width: 10%;"></td> <td style="width: 10%;"></td> <td style="width: 10%;"></td> <td style="width: 10%;"></td> </tr> <tr> <td></td> <td></td> <td colspan="8" style="text-align: center;"> <table border="1" style="width: 100%; border-collapse: collapse; text-align: center;"> <tr> <td style="width: 10%;"></td> <td style="width: 10%;"></td> <td style="width: 10%;"></td> <td style="width: 10%;"></td> <td style="width: 10%;"></td> <td style="width: 10%;"></td> <td style="width: 10%;"></td> <td style="width: 10%;"></td> <td style="width: 10%;"></td> <td style="width: 10%;"></td> </tr> <tr> <td></td> <td></td> <td colspan="8" style="text-align: center;"> <table border="1" style="width: 100%; border-collapse: collapse; text-align: center;"> <tr> <td style="width: 10%;"></td> <td style="width: 10%;"></td> <td style="width: 10%;"></td> <td style="width: 10%;"></td> <td style="width: 10%;"></td> <td style="width: 10%;"></td> <td style="width: 10%;"></td> <td style="width: 10%;"></td> <td style="width: 10%;"></td> <td style="width: 10%;"></td> </tr> <tr> <td></td> <td></td> <td colspan="8" style="text-align: center;"> <table border="1" style="width: 100%; border-collapse: collapse; text-align: center;"> <tr> <td style="width: 10%;"></td> <td style="width: 10%;"></td> <td style="width: 10%;"></td> <td style="width: 10%;"></td> <td style="width: 10%;"></td> <td style="width: 10%;"></td> <td style="width: 10%;"></td> <td style="width: 10%;"></td> <td style="width: 10%;"></td> <td style="width: 10%;"></td> </tr> <tr> <td></td> <td></td> <td colspan="8" style="text-align: center;"> <table border="1" style="width: 100%; border-collapse: collapse; text-align: center;"> <tr> <td style="width: 10%;"></td> <td style="width: 10%;"></td> <td style="width: 10%;"></td> <td style="width: 10%;"></td> <td style="width: 10%;"></td> <td style="width: 10%;"></td> <td style="width: 10%;"></td> <td style="width: 10%;"></td> <td style="width: 10%;"></td> <td style="width: 10%;"></td> </tr> <tr> <td></td> <td></td> <td colspan="8" style="text-align: center;"> <table border="1" style="width: 100%; border-collapse: collapse; text-align: center;"> <tr> <td style="width: 10%;"></td> <td style="width: 10%;"></td> <td style="width: 10%;"></td> <td style="width: 10%;"></td> <td style="width: 10%;"></td> <td style="width: 10%;"></td> <td style="width: 10%;"></td> <td style="width: 10%;"></td> <td style="width: 10%;"></td> <td style="width: 10%;"></td> </tr> <tr> <td></td> <td></td> <td colspan="8" style="text-align: center;"> <table border="1" style="width: 100%; border-collapse: collapse; text-align: center;"> <tr> <td style="width:
10%;"></td> <td style="width: 10%;"></td> <td style="width: 10%;"></td> <td style="width: 10%;"></td> <td style="width: 10%;"></td> <td style="width: 10%;"></td> <td style="width: 10%;"></td> <td style="width: 10%;"></td> <td style="width: 10%;"></td> <td style="width: 10%;"></td> </tr> <tr> <td></td> <td></td> <td colspan="8" style="text-align: center;"> <table border="1" style="width: 100%; border-collapse: collapse; text-align: center;"> <tr> <td style="width: 10%;"></td> <td style="width: 10%;"></td> <td style="width: 10%;"></td> <td style="width: 10%;"></td> <td style="width: 10%;"></td> <td style="width: 10%;"></td> <td style="width: 10%;"></td> <td style="width: 10%;"></td> <td style="width: 10%;"></td> <td style="width: 10%;"></td> </tr> <tr> <td></td> <td></td> <td colspan="8" style="text-align: center;"> <table border="1" style="width: 100%; border-collapse: collapse; text-align: center;"> <tr> <td style="width: 10%;"></td> <td style="width: 10%;"></td> <td style="width: 10%;"></td> <td style="width: 10%;"></td> <td style="width: 10%;"></td> <td style="width: 10%;"></td> <td style="width: 10%;"></td> <td style="width: 10%;"></td> <td style="width: 10%;"></td> <td style="width: 10%;"></td> </tr> <tr> <td></td> <td></td> <td colspan="8" style="text-align: center;"> <table border="1" style="width: 100%; border-collapse: collapse; text-align: center;"> <tr> <td style="width: 10%;"></td> <td style="width: 10%;"></td> <td style="width: 10%;"></td> <td style="width: 10%;"></td> <td style="width: 10%;"></td> <td style="width: 10%;"></td> <td style="width: 10%;"></td> <td style="width: 10%;"></td> <td style="width: 10%;"></td> <td style="width: 10%;"></td> </tr> <tr> <td></td> <td></td> <td colspan="8" style="text-align: center;"> <table border="1" style="width: 100%; border-collapse: collapse; text-align: center;"> <tr> <td style="width: 10%;"></td> <td style="width: 10%;"></td> <td style="width: 10%;"></td> <td style="width: 10%;"></td> <td style="width: 10%;"></td> <td style="width: 10%;"></td> <td style="width: 10%;"></td> <td style="width: 10%;"></td> <td style="width: 10%;"></td> <td style="width: 10%;"></td> </tr> <tr> <td></td> <td></td> <td colspan="8" style="text-align: center;"> <table border="1" style="width: 100%; border-collapse: collapse; text-align: center;"> <tr> <td style="width: 10%;"></td> <td style="width: 10%;"></td> <td style="width: 10%;"></td> <td style="width: 10%;"></td> <td style="width: 10%;"></td> <td style="width: 10%;"></td> <td style="width: 10%;"></td> <td style="width: 10%;"></td> <td style="width: 10%;"></td> <td style="width: 10%;"></td> </tr> <tr> <td></td> <td></td> <td colspan="8" style="text-align: center;"> <table border="1" style="width: 100%; border-collapse: collapse; text-align: center;"> <tr> <td style="width: 10%;"></td> <td style="width: 10%;"></td> <td style="width: 10%;"></td> <td style="width: 10%;"></td> <td style="width: 10%;"></td> <td style="width: 10%;"></td> <td style="width: 10%;"></td> <td style="width: 10%;"></td> <td style="width: 10%;"></td> <td style="width: 10%;"></td> </tr> <tr> <td></td> <td></td> <td colspan="8" style="text-align: center;"> <table border="1" style="width: 100%; border-collapse: collapse; text-align: center;"> <tr> <td style="width: 10%;"></td> <td style="width: 10%;"></td> <td style="width: 10%;"></td> <td style="width: 10%;"></td> <td style="width: 10%;"></td> <td style="width: 10%;"></td> <td style="width: 10%;"></td> <td style="width: 10%;"></td> <td style="width: 10%;"></td> <td style="width: 10%;"></td> </tr> <tr> <td></td> <td></td> <td colspan="8" style="text-align: center;"> <table border="1" style="width: 100%; border-collapse: collapse; text-align: center;"> <tr> <td style="width: 10%;"></td> <td style="width: 10%;"></td> <td style="width: 10%;"></td> <td style="width: 10%;"></td> <td style="width: 10%;"></td> <td style="width: 10%;"></td> <td style="width: 10%;"></td> <td style="width: 10%;"></td> <td style="width: 10%;"></td> <td style="width: 10%;"></td> </tr> <tr> <td></td> <td></td> <td colspan="8" style="text-align: center;"> <table border="1" style="width: 100%; border-collapse: collapse; text-align: center;"> <tr> <td style="width: 10%;"></td> <td style="width: 10%;"></td> <td style="width: 10%;"></td> <td style="width: 10%;"></td> <td style="width: 10%;"></td> <td style="width: 10%;"></td> <td style="width: 10%;"></td> <td style="width: 10%;"></td> <td style="width: 10%;"></td> <td style="width: 10%;"></td> </tr> <tr> <td></td> <td></td> <td colspan="8" style="text-align: center;"> <table border="1" style="width: 100%; border-collapse: collapse; text-align: center;"> <tr> <td style="width: 10%;"></td> <td style="width: 10%;"></td> <td style="width: 10%;"></td> <td style="width: 10%;"></td> <td style="width: 10%;"></td> <td style="width: 10%;"></td> <td style="width: 10%;"></td> <td style="width: 10%;"></td> <td style="width: 10%;"></td> <td style="width: 10%;"></td> </tr> <tr> <td></td> <td></td> <td colspan="8" style="text-align: center;"> <table border="1" style="width: 100%; border-collapse: collapse; text-align: center;"> <tr> </tr></table></td></tr></table></td></tr></table></td></tr></table></td></tr></table></td></tr></table></td></tr></table></td></tr></table></td></tr></table></td></tr></table></td></tr></table></td></tr></table></td></tr></table></td></tr></table></td></tr></table></td></tr></table></td></tr></table></td></tr></table></td></tr></table></td></tr></table></td></tr></table></td></tr></table>
 | | | | | | | | | | | | | | | | | | | | <table border="1" style="width: 100%; border-collapse: collapse; text-align: center;"> <tr> <td style="width: 10%;"></td> <td style="width: 10%;"></td> <td style="width: 10%;"></td> <td style="width: 10%;"></td> <td style="width: 10%;"></td> <td style="width: 10%;"></td> <td style="width: 10%;"></td> <td style="width: 10%;"></td> <td style="width: 10%;"></td> <td style="width: 10%;"></td> </tr> <tr> <td></td> <td></td> <td colspan="8" style="text-align: center;"> <table border="1" style="width: 100%; border-collapse: collapse; text-align: center;"> <tr> <td style="width: 10%;"></td> <td style="width: 10%;"></td> <td style="width: 10%;"></td> <td style="width: 10%;"></td> <td style="width: 10%;"></td> <td style="width: 10%;"></td> <td style="width: 10%;"></td> <td style="width: 10%;"></td> <td style="width: 10%;"></td> <td style="width: 10%;"></td> </tr> <tr> <td></td> <td></td> <td colspan="8" style="text-align: center;"> <table border="1" style="width: 100%; border-collapse: collapse; text-align: center;"> <tr> <td style="width: 10%;"></td> <td style="width: 10%;"></td> <td style="width: 10%;"></td> <td style="width: 10%;"></td> <td style="width: 10%;"></td> <td style="width: 10%;"></td> <td style="width: 10%;"></td> <td style="width: 10%;"></td> <td style="width: 10%;"></td> <td style="width: 10%;"></td> </tr> <tr> <td></td> <td></td> <td colspan="8" style="text-align: center;"> <table border="1" style="width: 100%; border-collapse: collapse; text-align: center;"> <tr> <td style="width: 10%;"></td> <td style="width: 10%;"></td> <td style="width: 10%;"></td> <td style="width: 10%;"></td> <td style="width: 10%;"></td> <td style="width: 10%;"></td> <td style="width: 10%;"></td> <td style="width: 10%;"></td> <td style="width: 10%;"></td> <td style="width: 10%;"></td> </tr> <tr> <td></td> <td></td> <td colspan="8" style="text-align: center;"> <table border="1" style="width: 100%; border-collapse: collapse; text-align: center;"> <tr> <td style="width: 10%;"></td> <td style="width: 10%;"></td> <td style="width: 10%;"></td> <td style="width: 10%;"></td> <td style="width: 10%;"></td> <td style="width: 10%;"></td> <td style="width: 10%;"></td> <td style="width: 10%;"></td> <td style="width: 10%;"></td> <td style="width: 10%;"></td> </tr> <tr> <td></td> <td></td> <td colspan="8" style="text-align: center;"> <table border="1" style="width: 100%; border-collapse: collapse; text-align: center;"> <tr> <td style="width: 10%;"></td> <td style="width: 10%;"></td> <td style="width: 10%;"></td> <td style="width: 10%;"></td> <td style="width: 10%;"></td> <td style="width: 10%;"></td> <td style="width: 10%;"></td> <td style="width: 10%;"></td> <td style="width: 10%;"></td> <td style="width: 10%;"></td> </tr> <tr> <td></td> <td></td> <td colspan="8" style="text-align: center;"> <table border="1" style="width: 100%; border-collapse: collapse; text-align: center;"> <tr> <td style="width: 10%;"></td> <td style="width: 10%;"></td> <td style="width: 10%;"></td> <td style="width: 10%;"></td> <td style="width: 10%;"></td> <td style="width: 10%;"></td> <td style="width: 10%;"></td> <td style="width: 10%;"></td> <td style="width: 10%;"></td> <td style="width: 10%;"></td> </tr> <tr> <td></td> <td></td> <td colspan="8" style="text-align: center;"> <table border="1" style="width: 100%; border-collapse: collapse; text-align: center;"> <tr> <td style="width: 10%;"></td> <td style="width: 10%;"></td> <td style="width: 10%;"></td> <td style="width: 10%;"></td> <td style="width: 10%;"></td> <td style="width: 10%;"></td> <td style="width: 10%;"></td> <td style="width: 10%;"></td> <td style="width: 10%;"></td> <td style="width: 10%;"></td> </tr> <tr> <td></td> <td></td> <td colspan="8"
style="text-align: center;"> <table border="1" style="width: 100%; border-collapse: collapse; text-align: center;"> <tr> <td style="width: 10%;"></td> <td style="width: 10%;"></td> <td style="width: 10%;"></td> <td style="width: 10%;"></td> <td style="width: 10%;"></td> <td style="width: 10%;"></td> <td style="width: 10%;"></td> <td style="width: 10%;"></td> <td style="width: 10%;"></td> <td style="width: 10%;"></td> </tr> <tr> <td></td> <td></td> <td colspan="8" style="text-align: center;"> <table border="1" style="width: 100%; border-collapse: collapse; text-align: center;"> <tr> <td style="width: 10%;"></td> <td style="width: 10%;"></td> <td style="width: 10%;"></td> <td style="width: 10%;"></td> <td style="width: 10%;"></td> <td style="width: 10%;"></td> <td style="width: 10%;"></td> <td style="width: 10%;"></td> <td style="width: 10%;"></td> <td style="width: 10%;"></td> </tr> <tr> <td></td> <td></td> <td colspan="8" style="text-align: center;"> <table border="1" style="width: 100%; border-collapse: collapse; text-align: center;"> <tr> <td style="width: 10%;"></td> <td style="width: 10%;"></td> <td style="width: 10%;"></td> <td style="width: 10%;"></td> <td style="width: 10%;"></td> <td style="width: 10%;"></td> <td style="width: 10%;"></td> <td style="width: 10%;"></td> <td style="width: 10%;"></td> <td style="width: 10%;"></td> </tr> <tr> <td></td> <td></td> <td colspan="8" style="text-align: center;"> <table border="1" style="width: 100%; border-collapse: collapse; text-align: center;"> <tr> <td style="width: 10%;"></td> <td style="width: 10%;"></td> <td style="width: 10%;"></td> <td style="width: 10%;"></td> <td style="width: 10%;"></td> <td style="width: 10%;"></td> <td style="width: 10%;"></td> <td style="width: 10%;"></td> <td style="width: 10%;"></td> <td style="width: 10%;"></td> </tr> <tr> <td></td> <td></td> <td colspan="8" style="text-align: center;"> <table border="1" style="width: 100%; border-collapse: collapse; text-align: center;"> <tr> <td style="width: 10%;"></td> <td style="width: 10%;"></td> <td style="width: 10%;"></td> <td style="width: 10%;"></td> <td style="width: 10%;"></td> <td style="width: 10%;"></td> <td style="width: 10%;"></td> <td style="width: 10%;"></td> <td style="width: 10%;"></td> <td style="width: 10%;"></td> </tr> <tr> <td></td> <td></td> <td colspan="8" style="text-align: center;"> <table border="1" style="width: 100%; border-collapse: collapse; text-align: center;"> <tr> <td style="width: 10%;"></td> <td style="width: 10%;"></td> <td style="width: 10%;"></td> <td style="width: 10%;"></td> <td style="width: 10%;"></td> <td style="width: 10%;"></td> <td style="width: 10%;"></td> <td style="width: 10%;"></td> <td style="width: 10%;"></td> <td style="width: 10%;"></td> </tr> <tr> <td></td> <td></td> <td colspan="8" style="text-align: center;"> <table border="1" style="width: 100%; border-collapse: collapse; text-align: center;"> <tr> <td style="width: 10%;"></td> <td style="width: 10%;"></td> <td style="width: 10%;"></td> <td style="width: 10%;"></td> <td style="width: 10%;"></td> <td style="width: 10%;"></td> <td style="width: 10%;"></td> <td style="width: 10%;"></td> <td style="width: 10%;"></td> <td style="width: 10%;"></td> </tr> <tr> <td></td> <td></td> <td colspan="8" style="text-align: center;"> <table border="1" style="width: 100%; border-collapse: collapse; text-align: center;"> <tr> <td style="width: 10%;"></td> <td style="width: 10%;"></td> <td style="width: 10%;"></td> <td style="width: 10%;"></td> <td style="width: 10%;"></td> <td style="width: 10%;"></td> <td style="width: 10%;"></td> <td style="width: 10%;"></td> <td style="width: 10%;"></td> <td style="width: 10%;"></td> </tr> <tr> <td></td> <td></td> <td colspan="8" style="text-align: center;"> <table border="1" style="width: 100%; border-collapse: collapse; text-align: center;"> <tr> <td style="width: 10%;"></td> <td style="width: 10%;"></td> <td style="width: 10%;"></td> <td style="width: 10%;"></td> <td style="width: 10%;"></td> <td style="width: 10%;"></td> <td style="width: 10%;"></td> <td style="width: 10%;"></td> <td style="width: 10%;"></td> <td style="width: 10%;"></td> </tr> <tr> <td></td> <td></td> <td colspan="8" style="text-align: center;"> <table border="1" style="width: 100%; border-collapse: collapse; text-align: center;"> <tr> <td style="width: 10%;"></td> <td style="width: 10%;"></td> <td style="width: 10%;"></td> <td style="width: 10%;"></td> <td style="width: 10%;"></td> <td style="width: 10%;"></td> <td style="width: 10%;"></td> <td style="width: 10%;"></td> <td style="width: 10%;"></td> <td style="width: 10%;"></td> </tr> <tr> <td></td> <td></td> <td colspan="8" style="text-align: center;"> <table border="1" style="width: 100%; border-collapse: collapse; text-align: center;"> <tr> <td style="width: 10%;"></td> <td style="width: 10%;"></td> <td style="width: 10%;"></td> <td style="width: 10%;"></td> <td style="width: 10%;"></td> <td style="width: 10%;"></td> <td style="width: 10%;"></td> <td style="width: 10%;"></td> <td style="width: 10%;"></td> <td style="width: 10%;"></td> </tr> <tr> <td></td> <td></td> <td colspan="8" style="text-align: center;"> <table border="1" style="width: 100%; border-collapse: collapse; text-align: center;"> <tr> <td style="width: 10%;"></td> <td style="width: 10%;"></td> <td style="width: 10%;"></td> <td style="width: 10%;"></td> <td style="width: 10%;"></td> <td style="width: 10%;"></td> <td style="width: 10%;"></td> <td style="width: 10%;"></td> <td style="width: 10%;"></td> <td style="width: 10%;"></td> </tr> <tr> <td></td> <td></td> <td colspan="8" style="text-align: center;"> <table border="1" style="width: 100%; border-collapse: collapse; text-align: center;"> <tr> </tr></table></td></tr></table></td></tr></table></td></tr></table></td></tr></table></td></tr></table></td></tr></table></td></tr></table></td></tr></table></td></tr></table></td></tr></table></td></tr></table></td></tr></table></td></tr></table></td></tr></table></td></tr></table></td></tr></table></td></tr></table></td></tr></table></td></tr></table></td></tr></table>
 | | | | | | | | | | | | | | | | | | | | <table border="1" style="width: 100%; border-collapse: collapse; text-align: center;"> <tr> <td style="width: 10%;"></td> <td style="width: 10%;"></td> <td style="width: 10%;"></td> <td style="width: 10%;"></td> <td style="width: 10%;"></td> <td style="width: 10%;"></td> <td style="width: 10%;"></td> <td style="width: 10%;"></td> <td style="width: 10%;"></td> <td style="width: 10%;"></td> </tr> <tr> <td></td> <td></td> <td colspan="8" style="text-align: center;"> <table border="1" style="width: 100%; border-collapse: collapse; text-align: center;"> <tr> <td style="width: 10%;"></td> <td style="width: 10%;"></td> <td style="width: 10%;"></td> <td style="width: 10%;"></td> <td style="width: 10%;"></td> <td style="width: 10%;"></td> <td style="width: 10%;"></td> <td style="width: 10%;"></td> <td style="width: 10%;"></td> <td style="width: 10%;"></td> </tr> <tr> <td></td> <td></td> <td colspan="8" style="text-align: center;"> <table border="1" style="width: 100%; border-collapse: collapse; text-align: center;"> <tr> <td style="width: 10%;"></td> <td style="width: 10%;"></td> <td style="width: 10%;"></td> <td style="width: 10%;"></td> <td style="width: 10%;"></td> <td style="width: 10%;"></td> <td style="width: 10%;"></td> <td style="width: 10%;"></td> <td style="width: 10%;"></td> <td style="width: 10%;"></td> </tr> <tr> <td></td> <td></td> <td colspan="8" style="text-align: center;"> <table border="1" style="width: 100%; border-collapse: collapse; text-align: center;"> <tr> <td style="width: 10%;"></td> <td style="width: 10%;"></td> <td style="width: 10%;"></td> <td style="width: 10%;"></td> <td style="width: 10%;"></td> <td style="width: 10%;"></td> <td style="width: 10%;"></td> <td style="width: 10%;"></td> <td style="width: 10%;"></td> <td style="width: 10%;"></td> </tr> <tr> <td></td> <td></td> <td colspan="8" style="text-align: center;"> <table border="1" style="width: 100%; border-collapse: collapse; text-align: center;"> <tr> <td style="width: 10%;"></td> <td style="width: 10%;"></td> <td style="width: 10%;"></td> <td style="width: 10%;"></td> <td style="width: 10%;"></td> <td style="width: 10%;"></td> <td style="width: 10%;"></td> <td style="width: 10%;"></td> <td style="width: 10%;"></td> <td style="width: 10%;"></td> </tr> <tr> <td></td> <td></td> <td colspan="8" style="text-align: center;"> <table border="1" style="width: 100%; border-collapse: collapse; text-align: center;"> <tr> <td style="width: 10%;"></td> <td style="width: 10%;"></td> <td style="width: 10%;"></td> <td style="width: 10%;"></td> <td style="width: 10%;"></td> <td style="width: 10%;"></td> <td style="width: 10%;"></td> <td style="width: 10%;"></td> <td style="width: 10%;"></td> <td style="width: 10%;"></td> </tr> <tr> <td></td> <td></td> <td colspan="8" style="text-align: center;"> <table border="1" style="width: 100%; border-collapse: collapse; text-align: center;"> <tr> <td style="width: 10%;"></td> <td style="width: 10%;"></td> <td style="width: 10%;"></td> <td style="width: 10%;"></td> <td style="width: 10%;"></td> <td style="width: 10%;"></td> <td style="width: 10%;"></td> <td style="width:
10%;"></td> <td style="width: 10%;"></td> <td style="width: 10%;"></td> </tr> <tr> <td></td> <td></td> <td colspan="8" style="text-align: center;"> <table border="1" style="width: 100%; border-collapse: collapse; text-align: center;"> <tr> <td style="width: 10%;"></td> <td style="width: 10%;"></td> <td style="width: 10%;"></td> <td style="width: 10%;"></td> <td style="width: 10%;"></td> <td style="width: 10%;"></td> <td style="width: 10%;"></td> <td style="width: 10%;"></td> <td style="width: 10%;"></td> <td style="width: 10%;"></td> </tr> <tr> <td></td> <td></td> <td colspan="8" style="text-align: center;"> <table border="1" style="width: 100%; border-collapse: collapse; text-align: center;"> <tr> <td style="width: 10%;"></td> <td style="width: 10%;"></td> <td style="width: 10%;"></td> <td style="width: 10%;"></td> <td style="width: 10%;"></td> <td style="width: 10%;"></td> <td style="width: 10%;"></td> <td style="width: 10%;"></td> <td style="width: 10%;"></td> <td style="width: 10%;"></td> </tr> <tr> <td></td> <td></td> <td colspan="8" style="text-align: center;"> <table border="1" style="width: 100%; border-collapse: collapse; text-align: center;"> <tr> <td style="width: 10%;"></td> <td style="width: 10%;"></td> <td style="width: 10%;"></td> <td style="width: 10%;"></td> <td style="width: 10%;"></td> <td style="width: 10%;"></td> <td style="width: 10%;"></td> <td style="width: 10%;"></td> <td style="width: 10%;"></td> <td style="width: 10%;"></td> </tr> <tr> <td></td> <td></td> <td colspan="8" style="text-align: center;"> <table border="1" style="width: 100%; border-collapse: collapse; text-align: center;"> <tr> <td style="width: 10%;"></td> <td style="width: 10%;"></td> <td style="width: 10%;"></td> <td style="width: 10%;"></td> <td style="width: 10%;"></td> <td style="width: 10%;"></td> <td style="width: 10%;"></td> <td style="width: 10%;"></td> <td style="width: 10%;"></td> <td style="width: 10%;"></td> </tr> <tr> <td></td> <td></td> <td colspan="8" style="text-align: center;"> <table border="1" style="width: 100%; border-collapse: collapse; text-align: center;"> <tr> <td style="width: 10%;"></td> <td style="width: 10%;"></td> <td style="width: 10%;"></td> <td style="width: 10%;"></td> <td style="width: 10%;"></td> <td style="width: 10%;"></td> <td style="width: 10%;"></td> <td style="width: 10%;"></td> <td style="width: 10%;"></td> <td style="width: 10%;"></td> </tr> <tr> <td></td> <td></td> <td colspan="8" style="text-align: center;"> <table border="1" style="width: 100%; border-collapse: collapse; text-align: center;"> <tr> <td style="width: 10%;"></td> <td style="width: 10%;"></td> <td style="width: 10%;"></td> <td style="width: 10%;"></td> <td style="width: 10%;"></td> <td style="width: 10%;"></td> <td style="width: 10%;"></td> <td style="width: 10%;"></td> <td style="width: 10%;"></td> <td style="width: 10%;"></td> </tr> <tr> <td></td> <td></td> <td colspan="8" style="text-align: center;"> <table border="1" style="width: 100%; border-collapse: collapse; text-align: center;"> <tr> <td style="width: 10%;"></td> <td style="width: 10%;"></td> <td style="width: 10%;"></td> <td style="width: 10%;"></td> <td style="width: 10%;"></td> <td style="width: 10%;"></td> <td style="width: 10%;"></td> <td style="width: 10%;"></td> <td style="width: 10%;"></td> <td style="width: 10%;"></td> </tr> <tr> <td></td> <td></td> <td colspan="8" style="text-align: center;"> <table border="1" style="width: 100%; border-collapse: collapse; text-align: center;"> <tr> <td style="width: 10%;"></td> <td style="width: 10%;"></td> <td style="width: 10%;"></td> <td style="width: 10%;"></td> <td style="width: 10%;"></td> <td style="width: 10%;"></td> <td style="width: 10%;"></td> <td style="width: 10%;"></td> <td style="width: 10%;"></td> <td style="width: 10%;"></td> </tr> <tr> <td></td> <td></td> <td colspan="8" style="text-align: center;"> <table border="1" style="width: 100%; border-collapse: collapse; text-align: center;"> <tr> <td style="width: 10%;"></td> <td style="width: 10%;"></td> <td style="width: 10%;"></td> <td style="width: 10%;"></td> <td style="width: 10%;"></td> <td style="width: 10%;"></td> <td style="width: 10%;"></td> <td style="width: 10%;"></td> <td style="width: 10%;"></td> <td style="width: 10%;"></td> </tr> <tr> <td></td> <td></td> <td colspan="8" style="text-align: center;"> <table border="1" style="width: 100%; border-collapse: collapse; text-align: center;"> <tr> <td style="width: 10%;"></td> <td style="width: 10%;"></td> <td style="width: 10%;"></td> <td style="width: 10%;"></td> <td style="width: 10%;"></td> <td style="width: 10%;"></td> <td style="width: 10%;"></td> <td style="width: 10%;"></td> <td style="width: 10%;"></td> <td style="width: 10%;"></td> </tr> <tr> <td></td> <td></td> <td colspan="8" style="text-align: center;"> <table border="1" style="width: 100%; border-collapse: collapse; text-align: center;"> <tr> <td style="width: 10%;"></td> <td style="width: 10%;"></td> <td style="width: 10%;"></td> <td style="width: 10%;"></td> <td style="width: 10%;"></td> <td style="width: 10%;"></td> <td style="width: 10%;"></td> <td style="width: 10%;"></td> <td style="width: 10%;"></td> <td style="width: 10%;"></td> </tr> <tr> <td></td> <td></td> <td colspan="8" style="text-align: center;"> <table border="1" style="width: 100%; border-collapse: collapse; text-align: center;"> <tr> <td style="width: 10%;"></td> <td style="width: 10%;"></td> <td style="width: 10%;"></td> <td style="width: 10%;"></td> <td style="width: 10%;"></td> <td style="width: 10%;"></td> <td style="width: 10%;"></td> <td style="width: 10%;"></td> <td style="width: 10%;"></td> <td style="width: 10%;"></td> </tr> <tr> <td></td> <td></td> <td colspan="8" style="text-align: center;"> <table border="1" style="width: 100%; border-collapse: collapse; text-align: center;"> <tr> </tr></table></td></tr></table></td></tr></table></td></tr></table></td></tr></table></td></tr></table></td></tr></table></td></tr></table></td></tr></table></td></tr></table></td></tr></table></td></tr></table></td></tr></table></td></tr></table></td></tr></table></td></tr></table></td></tr></table></td></tr></table></td></tr></table></td></tr></table>
 | | | | | | | | | | | | | | | | | | | | <table border="1" style="width: 100%; border-collapse: collapse; text-align: center;"> <tr> <td style="width: 10%;"></td> <td style="width: 10%;"></td> <td style="width: 10%;"></td> <td style="width: 10%;"></td> <td style="width: 10%;"></td> <td style="width: 10%;"></td> <td style="width: 10%;"></td> <td style="width: 10%;"></td> <td style="width: 10%;"></td> <td style="width: 10%;"></td> </tr> <tr> <td></td> <td></td> <td colspan="8" style="text-align: center;"> <table border="1" style="width: 100%; border-collapse: collapse; text-align: center;"> <tr> <td style="width: 10%;"></td> <td style="width: 10%;"></td> <td style="width: 10%;"></td> <td style="width: 10%;"></td> <td style="width: 10%;"></td> <td style="width: 10%;"></td> <td style="width: 10%;"></td> <td style="width: 10%;"></td> <td style="width: 10%;"></td> <td style="width: 10%;"></td> </tr> <tr> <td></td> <td></td> <td colspan="8" style="text-align: center;"> <table border="1" style="width: 100%; border-collapse: collapse; text-align: center;"> <tr> <td style="width: 10%;"></td> <td style="width: 10%;"></td> <td style="width: 10%;"></td> <td style="width: 10%;"></td> <td style="width: 10%;"></td> <td style="width: 10%;"></td> <td style="width: 10%;"></td> <td style="width: 10%;"></td> <td style="width: 10%;"></td> <td style="width: 10%;"></td> </tr> <tr> <td></td> <td></td> <td colspan="8" style="text-align: center;"> <table border="1" style="width: 100%; border-collapse: collapse; text-align: center;"> <tr> <td style="width: 10%;"></td> <td style="width: 10%;"></td> <td style="width: 10%;"></td> <td style="width: 10%;"></td> <td style="width: 10%;"></td> <td style="width: 10%;"></td> <td style="width: 10%;"></td> <td style="width: 10%;"></td> <td style="width: 10%;"></td> <td style="width: 10%;"></td> </tr> <tr> <td></td> <td></td> <td colspan="8" style="text-align: center;"> <table border="1" style="width: 100%; border-collapse: collapse; text-align: center;"> <tr> <td style="width: 10%;"></td> <td style="width: 10%;"></td> <td style="width: 10%;"></td> <td style="width: 10%;"></td> <td style="width: 10%;"></td> <td style="width: 10%;"></td> <td style="width: 10%;"></td> <td style="width: 10%;"></td> <td style="width: 10%;"></td> <td style="width: 10%;"></td> </tr> <tr> <td></td> <td></td> <td colspan="8" style="text-align: center;"> <table border="1" style="width: 100%; border-collapse: collapse; text-align: center;"> <tr> <td style="width: 10%;"></td> <td style="width: 10%;"></td> <td style="width: 10%;"></td> <td style="width: 10%;"></td> <td style="width: 10%;"></td> <td style="width: 10%;"></td> <td style="width: 10%;"></td> <td style="width: 10%;"></td> <td style="width: 10%;"></td> <td style="width: 10%;"></td> </tr> <tr> <td></td> <td></td> <td colspan="8" style="text-align: center;"> <table border="1" style="width: 100%; border-collapse: collapse; text-align: center;"> <tr> <td style="width: 10%;"></td> <td style="width: 10%;"></td> <td style="width: 10%;"></td> <td style="width: 10%;"></td> <td
style="width: 10%;"></td> <td style="width: 10%;"></td> <td style="width: 10%;"></td> <td style="width: 10%;"></td> <td style="width: 10%;"></td> <td style="width: 10%;"></td> </tr> <tr> <td></td> <td></td> <td colspan="8" style="text-align: center;"> <table border="1" style="width: 100%; border-collapse: collapse; text-align: center;"> <tr> <td style="width: 10%;"></td> <td style="width: 10%;"></td> <td style="width: 10%;"></td> <td style="width: 10%;"></td> <td style="width: 10%;"></td> <td style="width: 10%;"></td> <td style="width: 10%;"></td> <td style="width: 10%;"></td> <td style="width: 10%;"></td> <td style="width: 10%;"></td> </tr> <tr> <td></td> <td></td> <td colspan="8" style="text-align: center;"> <table border="1" style="width: 100%; border-collapse: collapse; text-align: center;"> <tr> <td style="width: 10%;"></td> <td style="width: 10%;"></td> <td style="width: 10%;"></td> <td style="width: 10%;"></td> <td style="width: 10%;"></td> <td style="width: 10%;"></td> <td style="width: 10%;"></td> <td style="width: 10%;"></td> <td style="width: 10%;"></td> <td style="width: 10%;"></td> </tr> <tr> <td></td> <td></td> <td colspan="8" style="text-align: center;"> <table border="1" style="width: 100%; border-collapse: collapse; text-align: center;"> <tr> <td style="width: 10%;"></td> <td style="width: 10%;"></td> <td style="width: 10%;"></td> <td style="width: 10%;"></td> <td style="width: 10%;"></td> <td style="width: 10%;"></td> <td style="width: 10%;"></td> <td style="width: 10%;"></td> <td style="width: 10%;"></td> <td style="width: 10%;"></td> </tr> <tr> <td></td> <td></td> <td colspan="8" style="text-align: center;"> <table border="1" style="width: 100%; border-collapse: collapse; text-align: center;"> <tr> <td style="width: 10%;"></td> <td style="width: 10%;"></td> <td style="width: 10%;"></td> <td style="width: 10%;"></td> <td style="width: 10%;"></td> <td style="width: 10%;"></td> <td style="width: 10%;"></td> <td style="width: 10%;"></td> <td style="width: 10%;"></td> <td style="width: 10%;"></td> </tr> <tr> <td></td> <td></td> <td colspan="8" style="text-align: center;"> <table border="1" style="width: 100%; border-collapse: collapse; text-align: center;"> <tr> <td style="width: 10%;"></td> <td style="width: 10%;"></td> <td style="width: 10%;"></td> <td style="width: 10%;"></td> <td style="width: 10%;"></td> <td style="width: 10%;"></td> <td style="width: 10%;"></td> <td style="width: 10%;"></td> <td style="width: 10%;"></td> <td style="width: 10%;"></td> </tr> <tr> <td></td> <td></td> <td colspan="8" style="text-align: center;"> <table border="1" style="width: 100%; border-collapse: collapse; text-align: center;"> <tr> <td style="width: 10%;"></td> <td style="width: 10%;"></td> <td style="width: 10%;"></td> <td style="width: 10%;"></td> <td style="width: 10%;"></td> <td style="width: 10%;"></td> <td style="width: 10%;"></td> <td style="width: 10%;"></td> <td style="width: 10%;"></td> <td style="width: 10%;"></td> </tr> <tr> <td></td> <td></td> <td colspan="8" style="text-align: center;"> <table border="1" style="width: 100%; border-collapse: collapse; text-align: center;"> <tr> <td style="width: 10%;"></td> <td style="width: 10%;"></td> <td style="width: 10%;"></td> <td style="width: 10%;"></td> <td style="width: 10%;"></td> <td style="width: 10%;"></td> <td style="width: 10%;"></td> <td style="width: 10%;"></td> <td style="width: 10%;"></td> <td style="width: 10%;"></td> </tr> <tr> <td></td> <td></td> <td colspan="8" style="text-align: center;"> <table border="1" style="width: 100%; border-collapse: collapse; text-align: center;"> <tr> <td style="width: 10%;"></td> <td style="width: 10%;"></td> <td style="width: 10%;"></td> <td style="width: 10%;"></td> <td style="width: 10%;"></td> <td style="width: 10%;"></td> <td style="width: 10%;"></td> <td style="width: 10%;"></td> <td style="width: 10%;"></td> <td style="width: 10%;"></td> </tr> <tr> <td></td> <td></td> <td colspan="8" style="text-align: center;"> <table border="1" style="width: 100%; border-collapse: collapse; text-align: center;"> <tr> <td style="width: 10%;"></td> <td style="width: 10%;"></td> <td style="width: 10%;"></td> <td style="width: 10%;"></td> <td style="width: 10%;"></td> <td style="width: 10%;"></td> <td style="width: 10%;"></td> <td style="width: 10%;"></td> <td style="width: 10%;"></td> <td style="width: 10%;"></td> </tr> <tr> <td></td> <td></td> <td colspan="8" style="text-align: center;"> <table border="1" style="width: 100%; border-collapse: collapse; text-align: center;"> <tr> <td style="width: 10%;"></td> <td style="width: 10%;"></td> <td style="width: 10%;"></td> <td style="width: 10%;"></td> <td style="width: 10%;"></td> <td style="width: 10%;"></td> <td style="width: 10%;"></td> <td style="width: 10%;"></td> <td style="width: 10%;"></td> <td style="width: 10%;"></td> </tr> <tr> <td></td> <td></td> <td colspan="8" style="text-align: center;"> <table border="1" style="width: 100%; border-collapse: collapse; text-align: center;"> <tr> <td style="width: 10%;"></td> <td style="width: 10%;"></td> <td style="width: 10%;"></td> <td style="width: 10%;"></td> <td style="width: 10%;"></td> <td style="width: 10%;"></td> <td style="width: 10%;"></td> <td style="width: 10%;"></td> <td style="width: 10%;"></td> <td style="width: 10%;"></td> </tr> <tr> <td></td> <td></td> <td colspan="8" style="text-align: center;"> <table border="1" style="width: 100%; border-collapse: collapse; text-align: center;"> <tr> </tr></table></td></tr></table></td></tr></table></td></tr></table></td></tr></table></td></tr></table></td></tr></table></td></tr></table></td></tr></table></td></tr></table></td></tr></table></td></tr></table></td></tr></table></td></tr></table></td></tr></table></td></tr></table></td></tr></table></td></tr></table></td></tr></table>
 | | | | | | | | | | | | | | | | | | | | <table border="1" style="width: 100%; border-collapse: collapse; text-align: center;"> <tr> <td style="width: 10%;"></td> <td style="width: 10%;"></td> <td style="width: 10%;"></td> <td style="width: 10%;"></td> <td style="width: 10%;"></td> <td style="width: 10%;"></td> <td style="width: 10%;"></td> <td style="width: 10%;"></td> <td style="width: 10%;"></td> <td style="width: 10%;"></td> </tr> <tr> <td></td> <td></td> <td colspan="8" style="text-align: center;"> <table border="1" style="width: 100%; border-collapse: collapse; text-align: center;"> <tr> <td style="width: 10%;"></td> <td style="width: 10%;"></td> <td style="width: 10%;"></td> <td style="width: 10%;"></td> <td style="width: 10%;"></td> <td style="width: 10%;"></td> <td style="width: 10%;"></td> <td style="width: 10%;"></td> <td style="width: 10%;"></td> <td style="width: 10%;"></td> </tr> <tr> <td></td> <td></td> <td colspan="8" style="text-align: center;"> <table border="1" style="width: 100%; border-collapse: collapse; text-align: center;"> <tr> <td style="width: 10%;"></td> <td style="width: 10%;"></td> <td style="width: 10%;"></td> <td style="width: 10%;"></td> <td style="width: 10%;"></td> <td style="width: 10%;"></td> <td style="width: 10%;"></td> <td style="width: 10%;"></td> <td style="width: 10%;"></td> <td style="width: 10%;"></td> </tr> <tr> <td></td> <td></td> <td colspan="8" style="text-align: center;"> <table border="1" style="width: 100%; border-collapse: collapse; text-align: center;"> <tr> <td style="width: 10%;"></td> <td style="width: 10%;"></td> <td style="width: 10%;"></td> <td style="width: 10%;"></td> <td style="width: 10%;"></td> <td style="width: 10%;"></td> <td style="width: 10%;"></td> <td style="width: 10%;"></td> <td style="width: 10%;"></td> <td style="width: 10%;"></td> </tr> <tr> <td></td> <td></td> <td colspan="8" style="text-align: center;"> <table border="1" style="width: 100%; border-collapse: collapse; text-align: center;"> <tr> <td style="width: 10%;"></td> <td style="width: 10%;"></td> <td style="width: 10%;"></td> <td style="width: 10%;"></td> <td style="width: 10%;"></td> <td style="width: 10%;"></td> <td style="width: 10%;"></td> <td style="width: 10%;"></td> <td style="width: 10%;"></td> <td style="width: 10%;"></td> </tr> <tr> <td></td> <td></td> <td colspan="8" style="text-align: center;"> <table border="1" style="width: 100%; border-collapse: collapse; text-align: center;"> <tr> <td style="width: 10%;"></td> <td style="width: 10%;"></td> <td style="width: 10%;"></td> <td style="width: 10%;"></td> <td style="width: 10%;"></td> <td style="width: 10%;"></td> <td style="width: 10%;"></td> <td style="width: 10%;"></td> <td style="width: 10%;"></td> <td style="width: 10%;"></td> </tr> <tr> <td></td> <td></td> <td colspan="8" style="text-align: center;"> <table border="1" style="width: 100%; border-collapse: collapse; text-align: center;"> <tr> <td style="width: 10%;"></td> <td style="width: 10%;"></td> <td style="width: 10%;"></td> <td style="width: 10%;"></td> <td style="width: 10%;"></td> <td style="width: 10%;"></td> <td style="width: 10%;"></td> <td style="width: 10%;"></td> <td style="width: 10%;"></td> <td style="width: 10%;"></td> </tr> <tr> <td></td> <td></td> <td colspan="8" style="text-align: center;"> <table border="1" style="width: 100%; border-collapse: collapse; text-align: center;"> <tr> <td style="width: 10%;"></td> <td style="width:
10%;"></td> <td style="width: 10%;"></td> <td style="width: 10%;"></td> <td style="width: 10%;"></td> <td style="width: 10%;"></td> <td style="width: 10%;"></td> <td style="width: 10%;"></td> <td style="width: 10%;"></td> <td style="width: 10%;"></td> </tr> <tr> <td></td> <td></td> <td colspan="8" style="text-align: center;"> <table border="1" style="width: 100%; border-collapse: collapse; text-align: center;"> <tr> <td style="width: 10%;"></td> <td style="width: 10%;"></td> <td style="width: 10%;"></td> <td style="width: 10%;"></td> <td style="width: 10%;"></td> <td style="width: 10%;"></td> <td style="width: 10%;"></td> <td style="width: 10%;"></td> <td style="width: 10%;"></td> <td style="width: 10%;"></td> </tr> <tr> <td></td> <td></td> <td colspan="8" style="text-align: center;"> <table border="1" style="width: 100%; border-collapse: collapse; text-align: center;"> <tr> <td style="width: 10%;"></td> <td style="width: 10%;"></td> <td style="width: 10%;"></td> <td style="width: 10%;"></td> <td style="width: 10%;"></td> <td style="width: 10%;"></td> <td style="width: 10%;"></td> <td style="width: 10%;"></td> <td style="width: 10%;"></td> <td style="width: 10%;"></td> </tr> <tr> <td></td> <td></td> <td colspan="8" style="text-align: center;"> <table border="1" style="width: 100%; border-collapse: collapse; text-align: center;"> <tr> <td style="width: 10%;"></td> <td style="width: 10%;"></td> <td style="width: 10%;"></td> <td style="width: 10%;"></td> <td style="width: 10%;"></td> <td style="width: 10%;"></td> <td style="width: 10%;"></td> <td style="width: 10%;"></td> <td style="width: 10%;"></td> <td style="width: 10%;"></td> </tr> <tr> <td></td> <td></td> <td colspan="8" style="text-align: center;"> <table border="1" style="width: 100%; border-collapse: collapse; text-align: center;"> <tr> <td style="width: 10%;"></td> <td style="width: 10%;"></td> <td style="width: 10%;"></td> <td style="width: 10%;"></td> <td style="width: 10%;"></td> <td style="width: 10%;"></td> <td style="width: 10%;"></td> <td style="width: 10%;"></td> <td style="width: 10%;"></td> <td style="width: 10%;"></td> </tr> <tr> <td></td> <td></td> <td colspan="8" style="text-align: center;"> <table border="1" style="width: 100%; border-collapse: collapse; text-align: center;"> <tr> <td style="width: 10%;"></td> <td style="width: 10%;"></td> <td style="width: 10%;"></td> <td style="width: 10%;"></td> <td style="width: 10%;"></td> <td style="width: 10%;"></td> <td style="width: 10%;"></td> <td style="width: 10%;"></td> <td style="width: 10%;"></td> <td style="width: 10%;"></td> </tr> <tr> <td></td> <td></td> <td colspan="8" style="text-align: center;"> <table border="1" style="width: 100%; border-collapse: collapse; text-align: center;"> <tr> <td style="width: 10%;"></td> <td style="width: 10%;"></td> <td style="width: 10%;"></td> <td style="width: 10%;"></td> <td style="width: 10%;"></td> <td style="width: 10%;"></td> <td style="width: 10%;"></td> <td style="width: 10%;"></td> <td style="width: 10%;"></td> <td style="width: 10%;"></td> </tr> <tr> <td></td> <td></td> <td colspan="8" style="text-align: center;"> <table border="1" style="width: 100%; border-collapse: collapse; text-align: center;"> <tr> <td style="width: 10%;"></td> <td style="width: 10%;"></td> <td style="width: 10%;"></td> <td style="width: 10%;"></td> <td style="width: 10%;"></td> <td style="width: 10%;"></td> <td style="width: 10%;"></td> <td style="width: 10%;"></td> <td style="width: 10%;"></td> <td style="width: 10%;"></td> </tr> <tr> <td></td> <td></td> <td colspan="8" style="text-align: center;"> <table border="1" style="width: 100%; border-collapse: collapse; text-align: center;"> <tr> <td style="width: 10%;"></td> <td style="width: 10%;"></td> <td style="width: 10%;"></td> <td style="width: 10%;"></td> <td style="width: 10%;"></td> <td style="width: 10%;"></td> <td style="width: 10%;"></td> <td style="width: 10%;"></td> <td style="width: 10%;"></td> <td style="width: 10%;"></td> </tr> <tr> <td></td> <td></td> <td colspan="8" style="text-align: center;"> <table border="1" style="width: 100%; border-collapse: collapse; text-align: center;"> <tr> <td style="width: 10%;"></td> <td style="width: 10%;"></td> <td style="width: 10%;"></td> <td style="width: 10%;"></td> <td style="width: 10%;"></td> <td style="width: 10%;"></td> <td style="width: 10%;"></td> <td style="width: 10%;"></td> <td style="width: 10%;"></td> <td style="width: 10%;"></td> </tr> <tr> <td></td> <td></td> <td colspan="8" style="text-align: center;"> <table border="1" style="width: 100%; border-collapse: collapse; text-align: center;"> <tr> </tr></table></td></tr></table></td></tr></table></td></tr></table></td></tr></table></td></tr></table></td></tr></table></td></tr></table></td></tr></table></td></tr></table></td></tr></table></td></tr></table></td></tr></table></td></tr></table></td></tr></table></td></tr></table></td></tr></table></td></tr></table>
 | | | | | | | | | | | | | | | | | | | | <table border="1" style="width: 100%; border-collapse: collapse; text-align: center;"> <tr> <td style="width: 10%;"></td> <td style="width: 10%;"></td> <td style="width: 10%;"></td> <td style="width: 10%;"></td> <td style="width: 10%;"></td> <td style="width: 10%;"></td> <td style="width: 10%;"></td> <td style="width: 10%;"></td> <td style="width: 10%;"></td> <td style="width: 10%;"></td> </tr> <tr> <td></td> <td></td> <td colspan="8" style="text-align: center;"> <table border="1" style="width: 100%; border-collapse: collapse; text-align: center;"> <tr> <td style="width: 10%;"></td> <td style="width: 10%;"></td> <td style="width: 10%;"></td> <td style="width: 10%;"></td> <td style="width: 10%;"></td> <td style="width: 10%;"></td> <td style="width: 10%;"></td> <td style="width: 10%;"></td> <td style="width: 10%;"></td> <td style="width: 10%;"></td> </tr> <tr> <td></td> <td></td> <td colspan="8" style="text-align: center;"> <table border="1" style="width: 100%; border-collapse: collapse; text-align: center;"> <tr> <td style="width: 10%;"></td> <td style="width: 10%;"></td> <td style="width: 10%;"></td> <td style="width: 10%;"></td> <td style="width: 10%;"></td> <td style="width: 10%;"></td> <td style="width: 10%;"></td> <td style="width: 10%;"></td> <td style="width: 10%;"></td> <td style="width: 10%;"></td> </tr> <tr> <td></td> <td></td> <td colspan="8" style="text-align: center;"> <table border="1" style="width: 100%; border-collapse: collapse; text-align: center;"> <tr> <td style="width: 10%;"></td> <td style="width: 10%;"></td> <td style="width: 10%;"></td> <td style="width: 10%;"></td> <td style="width: 10%;"></td> <td style="width: 10%;"></td> <td style="width: 10%;"></td> <td style="width: 10%;"></td> <td style="width: 10%;"></td> <td style="width: 10%;"></td> </tr> <tr> <td></td> <td></td> <td colspan="8" style="text-align: center;"> <table border="1" style="width: 100%; border-collapse: collapse; text-align: center;"> <tr> <td style="width: 10%;"></td> <td style="width: 10%;"></td> <td style="width: 10%;"></td> <td style="width: 10%;"></td> <td style="width: 10%;"></td> <td style="width: 10%;"></td> <td style="width: 10%;"></td> <td style="width: 10%;"></td> <td style="width: 10%;"></td> <td style="width: 10%;"></td> </tr> <tr> <td></td> <td></td> <td colspan="8" style="text-align: center;"> <table border="1" style="width: 100%; border-collapse: collapse; text-align: center;"> <tr> <td style="width: 10%;"></td> <td style="width: 10%;"></td> <td style="width: 10%;"></td> <td style="width: 10%;"></td> <td style="width: 10%;"></td> <td style="width: 10%;"></td> <td style="width: 10%;"></td> <td style="width: 10%;"></td> <td style="width: 10%;"></td> <td style="width: 10%;"></td> </tr> <tr> <td></td> <td></td> <td colspan="8" style="text-align: center;"> <table border="1" style="width: 100%; border-collapse: collapse; text-align: center;"> <tr> <td style="width: 10%;"></td> <td style="width: 10%;"></td> <td style="width: 10%;"></td> <td style="width: 10%;"></td> <td style="width: 10%;"></td> <td style="width: 10%;"></td> <td style="width: 10%;"></td> <td style="width: 10%;"></td> <td style="width: 10%;"></td> <td style="width: 10%;"></td> </tr> <tr> <td></td> <td></td> <td colspan="8" style="text-align: center;"> <table border="1" style="width: 100%; border-collapse: collapse; text-align: center;"> <tr> <td style="width: 10%;"></td> <td style="width: 10%;"></td> <td style="width: 10%;"></td> <td style="width: 10%;"></td> <td style="width: 10%;"></td> <td style="width: 10%;"></td> <td style="width: 10%;"></td> <td style="width: 10%;"></td> <td style="width: 10%;"></td> <td style="width: 10%;"></td> </tr> <tr> <td></td> <td></td> <td colspan="8" style="text-align: center;"> <table border="1" style="width: 100%; border-collapse: collapse; text-align: center;"> <tr> <td style="width: 10%;"></td> <td style="width: 10%;"></td> <td style="width: 10%;"></td> <td style="width: 10%;"></td> <td style="width: 10%;"></td> <td style="width: 10%;"></td> <td style="width: 10%;"></td> <td style="width: 10%;"></td> <td style="width: 10%;"></td> <td style="width: 10%;"></td> </tr> <tr> <td></td> <td></td> <td colspan="8" style="text-align: center;"> <table border="1" style="width: 100%; border-collapse: collapse; text-align:
center;"> <tr> <td style="width: 10%;"></td> <td style="width: 10%;"></td> <td style="width: 10%;"></td> <td style="width: 10%;"></td> <td style="width: 10%;"></td> <td style="width: 10%;"></td> <td style="width: 10%;"></td> <td style="width: 10%;"></td> <td style="width: 10%;"></td> <td style="width: 10%;"></td> </tr> <tr> <td></td> <td></td> <td colspan="8" style="text-align: center;"> <table border="1" style="width: 100%; border-collapse: collapse; text-align: center;"> <tr> <td style="width: 10%;"></td> <td style="width: 10%;"></td> <td style="width: 10%;"></td> <td style="width: 10%;"></td> <td style="width: 10%;"></td> <td style="width: 10%;"></td> <td style="width: 10%;"></td> <td style="width: 10%;"></td> <td style="width: 10%;"></td> <td style="width: 10%;"></td> </tr> <tr> <td></td> <td></td> <td colspan="8" style="text-align: center;"> <table border="1" style="width: 100%; border-collapse: collapse; text-align: center;"> <tr> <td style="width: 10%;"></td> <td style="width: 10%;"></td> <td style="width: 10%;"></td> <td style="width: 10%;"></td> <td style="width: 10%;"></td> <td style="width: 10%;"></td> <td style="width: 10%;"></td> <td style="width: 10%;"></td> <td style="width: 10%;"></td> <td style="width: 10%;"></td> </tr> <tr> <td></td> <td></td> <td colspan="8" style="text-align: center;"> <table border="1" style="width: 100%; border-collapse: collapse; text-align: center;"> <tr> <td style="width: 10%;"></td> <td style="width: 10%;"></td> <td style="width: 10%;"></td> <td style="width: 10%;"></td> <td style="width: 10%;"></td> <td style="width: 10%;"></td> <td style="width: 10%;"></td> <td style="width: 10%;"></td> <td style="width: 10%;"></td> <td style="width: 10%;"></td> </tr> <tr> <td></td> <td></td> <td colspan="8" style="text-align: center;"> <table border="1" style="width: 100%; border-collapse: collapse; text-align: center;"> <tr> <td style="width: 10%;"></td> <td style="width: 10%;"></td> <td style="width: 10%;"></td> <td style="width: 10%;"></td> <td style="width: 10%;"></td> <td style="width: 10%;"></td> <td style="width: 10%;"></td> <td style="width: 10%;"></td> <td style="width: 10%;"></td> <td style="width: 10%;"></td> </tr> <tr> <td></td> <td></td> <td colspan="8" style="text-align: center;"> <table border="1" style="width: 100%; border-collapse: collapse; text-align: center;"> <tr> <td style="width: 10%;"></td> <td style="width: 10%;"></td> <td style="width: 10%;"></td> <td style="width: 10%;"></td> <td style="width: 10%;"></td> <td style="width: 10%;"></td> <td style="width: 10%;"></td> <td style="width: 10%;"></td> <td style="width: 10%;"></td> <td style="width: 10%;"></td> </tr> <tr> <td></td> <td></td> <td colspan="8" style="text-align: center;"> <table border="1" style="width: 100%; border-collapse: collapse; text-align: center;"> <tr> <td style="width: 10%;"></td> <td style="width: 10%;"></td> <td style="width: 10%;"></td> <td style="width: 10%;"></td> <td style="width: 10%;"></td> <td style="width: 10%;"></td> <td style="width: 10%;"></td> <td style="width: 10%;"></td> <td style="width: 10%;"></td> <td style="width: 10%;"></td> </tr> <tr> <td></td> <td></td> <td colspan="8" style="text-align: center;"> <table border="1" style="width: 100%; border-collapse: collapse; text-align: center;"> <tr> </tr></table></td></tr></table></td></tr></table></td></tr></table></td></tr></table></td></tr></table></td></tr></table></td></tr></table></td></tr></table></td></tr></table></td></tr></table></td></tr></table></td></tr></table></td></tr></table></td></tr></table></td></tr></table></td></tr></table>
 | | | | | | | | | | | | | | | | | | | | <table border="1" style="width: 100%; border-collapse: collapse; text-align: center;"> <tr> <td style="width: 10%;"></td> <td style="width: 10%;"></td> <td style="width: 10%;"></td> <td style="width: 10%;"></td> <td style="width: 10%;"></td> <td style="width: 10%;"></td> <td style="width: 10%;"></td> <td style="width: 10%;"></td> <td style="width: 10%;"></td> <td style="width: 10%;"></td> </tr> <tr> <td></td> <td></td> <td colspan="8" style="text-align: center;"> <table border="1" style="width: 100%; border-collapse: collapse; text-align: center;"> <tr> <td style="width: 10%;"></td> <td style="width: 10%;"></td> <td style="width: 10%;"></td> <td style="width: 10%;"></td> <td style="width: 10%;"></td> <td style="width: 10%;"></td> <td style="width: 10%;"></td> <td style="width: 10%;"></td> <td style="width: 10%;"></td> <td style="width: 10%;"></td> </tr> <tr> <td></td> <td></td> <td colspan="8" style="text-align: center;"> <table border="1" style="width: 100%; border-collapse: collapse; text-align: center;"> <tr> <td style="width: 10%;"></td> <td style="width: 10%;"></td> <td style="width: 10%;"></td> <td style="width: 10%;"></td> <td style="width: 10%;"></td> <td style="width: 10%;"></td> <td style="width: 10%;"></td> <td style="width: 10%;"></td> <td style="width: 10%;"></td> <td style="width: 10%;"></td> </tr> <tr> <td></td> <td></td> <td colspan="8" style="text-align: center;"> <table border="1" style="width: 100%; border-collapse: collapse; text-align: center;"> <tr> <td style="width: 10%;"></td> <td style="width: 10%;"></td> <td style="width: 10%;"></td> <td style="width: 10%;"></td> <td style="width: 10%;"></td> <td style="width: 10%;"></td> <td style="width: 10%;"></td> <td style="width: 10%;"></td> <td style="width: 10%;"></td> <td style="width: 10%;"></td> </tr> <tr> <td></td> <td></td> <td colspan="8" style="text-align: center;"> <table border="1" style="width: 100%; border-collapse: collapse; text-align: center;"> <tr> <td style="width: 10%;"></td> <td style="width: 10%;"></td> <td style="width: 10%;"></td> <td style="width: 10%;"></td> <td style="width: 10%;"></td> <td style="width: 10%;"></td> <td style="width: 10%;"></td> <td style="width: 10%;"></td> <td style="width: 10%;"></td> <td style="width: 10%;"></td> </tr> <tr> <td></td> <td></td> <td colspan="8" style="text-align: center;"> <table border="1" style="width: 100%; border-collapse: collapse; text-align: center;"> <tr> <td style="width: 10%;"></td> <td style="width: 10%;"></td> <td style="width: 10%;"></td> <td style="width: 10%;"></td> <td style="width: 10%;"></td> <td style="width: 10%;"></td> <td style="width: 10%;"></td> <td style="width: 10%;"></td> <td style="width: 10%;"></td> <td style="width: 10%;"></td> </tr> <tr> <td></td> <td></td> <td colspan="8" style="text-align: center;"> <table border="1" style="width: 100%; border-collapse: collapse; text-align: center;"> <tr> <td style="width: 10%;"></td> <td style="width: 10%;"></td> <td style="width: 10%;"></td> <td style="width: 10%;"></td> <td style="width: 10%;"></td> <td style="width: 10%;"></td> <td style="width: 10%;"></td> <td style="width: 10%;"></td> <td style="width: 10%;"></td> <td style="width: 10%;"></td> </tr> <tr> <td></td> <td></td> <td colspan="8" style="text-align: center;"> <table border="1" style="width: 100%; border-collapse: collapse; text-align: center;"> <tr> <td style="width: 10%;"></td> <td style="width: 10%;"></td> <td style="width: 10%;"></td> <td style="width: 10%;"></td> <td style="width: 10%;"></td> <td style="width: 10%;"></td> <td style="width: 10%;"></td> <td style="width: 10%;"></td> <td style="width: 10%;"></td> <td style="width: 10%;"></td> </tr> <tr> <td></td> <td></td> <td colspan="8" style="text-align: center;"> <table border="1" style="width: 100%; border-collapse: collapse; text-align: center;"> <tr> <td style="width: 10%;"></td> <td style="width: 10%;"></td> <td style="width: 10%;"></td> <td style="width: 10%;"></td> <td style="width: 10%;"></td> <td style="width: 10%;"></td> <td style="width: 10%;"></td> <td style="width: 10%;"></td> <td style="width: 10%;"></td> <td style="width: 10%;"></td> </tr> <tr> <td></td> <td></td> <td colspan="8" style="text-align: center;"> <table border="1" style="width: 100%; border-collapse: collapse; text-align: center;"> <tr> <td style="width: 10%;"></td> <td style="width: 10%;"></td> <td style="width: 10%;"></td> <td style="width: 10%;"></td> <td style="width: 10%;"></td> <td style="width: 10%;"></td> <td style="width: 10%;"></td> <td style="width: 10%;"></td> <td style="width: 10%;"></td> <td style="width: 10%;"></td> </tr> <tr> <td></td> <td></td> <td colspan="8" style="text-align: center;"> <table border="1" style="width: 100%; border-collapse: collapse; text-align: center;"> <tr> <td style="width: 10%;"></td> <td style="width: 10%;"></td> <td style="width: 10%;"></td> <td style="width: 10%;"></td> <td style="width: 10%;"></td> <td style="width: 10%;"></td> <td style="width: 10%;"></td> <td style="width: 10%;"></td> <td style="width: 10%;"></td> <td style="width: 10%;"></td> </tr> <tr> <td></td> <td></td> <td colspan="8" style="text-align: center;"> <table border="1" style="width: 100%; border-collapse: collapse; text-align: center;"> <tr> <td style="width: 10%;"></td> <td style="width: 10%;"></td> <td style="width: 10%;"></td> <td style="width: 10%;"></td> <td style="width: 10%;"></td> <td style="width: 10%;"></td> <td style="width: 10%;"></td> <td style="width: 10%;"></td> <td style="width: 10%;"></td> <td style="width: 10%;"></td> </tr> <tr> <td></td> <td></td> <td colspan="8" style="text-align: center;"> <table border="1" style="width: 100%;
border-collapse: collapse; text-align: center;"> <tr> <td style="width: 10%;"></td> <td style="width: 10%;"></td> <td style="width: 10%;"></td> <td style="width: 10%;"></td> <td style="width: 10%;"></td> <td style="width: 10%;"></td> <td style="width: 10%;"></td> <td style="width: 10%;"></td> <td style="width: 10%;"></td> <td style="width: 10%;"></td> </tr> <tr> <td></td> <td></td> <td colspan="8" style="text-align: center;"> <table border="1" style="width: 100%; border-collapse: collapse; text-align: center;"> <tr> <td style="width: 10%;"></td> <td style="width: 10%;"></td> <td style="width: 10%;"></td> <td style="width: 10%;"></td> <td style="width: 10%;"></td> <td style="width: 10%;"></td> <td style="width: 10%;"></td> <td style="width: 10%;"></td> <td style="width: 10%;"></td> <td style="width: 10%;"></td> </tr> <tr> <td></td> <td></td> <td colspan="8" style="text-align: center;"> <table border="1" style="width: 100%; border-collapse: collapse; text-align: center;"> <tr> <td style="width: 10%;"></td> <td style="width: 10%;"></td> <td style="width: 10%;"></td> <td style="width: 10%;"></td> <td style="width: 10%;"></td> <td style="width: 10%;"></td> <td style="width: 10%;"></td> <td style="width: 10%;"></td> <td style="width: 10%;"></td> <td style="width: 10%;"></td> </tr> <tr> <td></td> <td></td> <td colspan="8" style="text-align: center;"> <table border="1" style="width: 100%; border-collapse: collapse; text-align: center;"> <tr> </tr></table></td></tr></table></td></tr></table></td></tr></table></td></tr></table></td></tr></table></td></tr></table></td></tr></table></td></tr></table></td></tr></table></td></tr></table></td></tr></table></td></tr></table></td></tr></table></td></tr></table></td></tr></table>
 | | | | | | | | | | | | | | | | | | | | <table border="1" style="width: 100%; border-collapse: collapse; text-align: center;"> <tr> <td style="width: 10%;"></td> <td style="width: 10%;"></td> <td style="width: 10%;"></td> <td style="width: 10%;"></td> <td style="width: 10%;"></td> <td style="width: 10%;"></td> <td style="width: 10%;"></td> <td style="width: 10%;"></td> <td style="width: 10%;"></td> <td style="width: 10%;"></td> </tr> <tr> <td></td> <td></td> <td colspan="8" style="text-align: center;"> <table border="1" style="width: 100%; border-collapse: collapse; text-align: center;"> <tr> <td style="width: 10%;"></td> <td style="width: 10%;"></td> <td style="width: 10%;"></td> <td style="width: 10%;"></td> <td style="width: 10%;"></td> <td style="width: 10%;"></td> <td style="width: 10%;"></td> <td style="width: 10%;"></td> <td style="width: 10%;"></td> <td style="width: 10%;"></td> </tr> <tr> <td></td> <td></td> <td colspan="8" style="text-align: center;"> <table border="1" style="width: 100%; border-collapse: collapse; text-align: center;"> <tr> <td style="width: 10%;"></td> <td style="width: 10%;"></td> <td style="width: 10%;"></td> <td style="width: 10%;"></td> <td style="width: 10%;"></td> <td style="width: 10%;"></td> <td style="width: 10%;"></td> <td style="width: 10%;"></td> <td style="width: 10%;"></td> <td style="width: 10%;"></td> </tr> <tr> <td></td> <td></td> <td colspan="8" style="text-align: center;"> <table border="1" style="width: 100%; border-collapse: collapse; text-align: center;"> <tr> <td style="width: 10%;"></td> <td style="width: 10%;"></td> <td style="width: 10%;"></td> <td style="width: 10%;"></td> <td style="width: 10%;"></td> <td style="width: 10%;"></td> <td style="width: 10%;"></td> <td style="width: 10%;"></td> <td style="width: 10%;"></td> <td style="width: 10%;"></td> </tr> <tr> <td></td> <td></td> <td colspan="8" style="text-align: center;"> <table border="1" style="width: 100%; border-collapse: collapse; text-align: center;"> <tr> <td style="width: 10%;"></td> <td style="width: 10%;"></td> <td style="width: 10%;"></td> <td style="width: 10%;"></td> <td style="width: 10%;"></td> <td style="width: 10%;"></td> <td style="width: 10%;"></td> <td style="width: 10%;"></td> <td style="width: 10%;"></td> <td style="width: 10%;"></td> </tr> <tr> <td></td> <td></td> <td colspan="8" style="text-align: center;"> <table border="1" style="width: 100%; border-collapse: collapse; text-align: center;"> <tr> <td style="width: 10%;"></td> <td style="width: 10%;"></td> <td style="width: 10%;"></td> <td style="width: 10%;"></td> <td style="width: 10%;"></td> <td style="width: 10%;"></td> <td style="width: 10%;"></td> <td style="width: 10%;"></td> <td style="width: 10%;"></td> <td style="width: 10%;"></td> </tr> <tr> <td></td> <td></td> <td colspan="8" style="text-align: center;"> <table border="1" style="width: 100%; border-collapse: collapse; text-align: center;"> <tr> <td style="width: 10%;"></td> <td style="width: 10%;"></td> <td style="width: 10%;"></td> <td style="width: 10%;"></td> <td style="width: 10%;"></td> <td style="width: 10%;"></td> <td style="width: 10%;"></td> <td style="width: 10%;"></td> <td style="width: 10%;"></td> <td style="width: 10%;"></td> </tr> <tr> <td></td> <td></td> <td colspan="8" style="text-align: center;"> <table border="1" style="width: 100%; border-collapse: collapse; text-align: center;"> <tr> <td style="width: 10%;"></td> <td style="width: 10%;"></td> <td style="width: 10%;"></td> <td style="width: 10%;"></td> <td style="width: 10%;"></td> <td style="width: 10%;"></td> <td style="width: 10%;"></td> <td style="width: 10%;"></td> <td style="width: 10%;"></td> <td style="width: 10%;"></td> </tr> <tr> <td></td> <td></td> <td colspan="8" style="text-align: center;"> <table border="1" style="width: 100%; border-collapse: collapse; text-align: center;"> <tr> <td style="width: 10%;"></td> <td style="width: 10%;"></td> <td style="width: 10%;"></td> <td style="width: 10%;"></td> <td style="width: 10%;"></td> <td style="width: 10%;"></td> <td style="width: 10%;"></td> <td style="width: 10%;"></td> <td style="width: 10%;"></td> <td style="width: 10%;"></td> </tr> <tr> <td></td> <td></td> <td colspan="8" style="text-align: center;"> <table border="1" style="width: 100%; border-collapse: collapse; text-align: center;"> <tr> <td style="width: 10%;"></td> <td style="width: 10%;"></td> <td style="width: 10%;"></td> <td style="width: 10%;"></td> <td style="width: 10%;"></td> <td style="width: 10%;"></td> <td style="width: 10%;"></td> <td style="width: 10%;"></td> <td style="width: 10%;"></td> <td style="width: 10%;"></td> </tr> <tr> <td></td> <td></td> <td colspan="8" style="text-align: center;"> <table border="1" style="width: 100%; border-collapse: collapse; text-align: center;"> <tr> <td style="width: 10%;"></td> <td style="width: 10%;"></td> <td style="width: 10%;"></td> <td style="width: 10%;"></td> <td style="width: 10%;"></td> <td style="width: 10%;"></td> <td style="width: 10%;"></td> <td style="width: 10%;"></td> <td style="width: 10%;"></td> <td style="width: 10%;"></td> </tr> <tr> <td></td> <td></td> <td colspan="8" style="text-align: center;"> <table border="1" style="width: 100%; border-collapse: collapse; text-align: center;"> <tr> <td style="width: 10%;"></td> <td style="width: 10%;"></td> <td style="width: 10%;"></td> <td style="width: 10%;"></td> <td style="width: 10%;"></td> <td style="width: 10%;"></td> <td style="width: 10%;"></td> <td style="width: 10%;"></td> <td style="width: 10%;"></td> <td style="width: 10%;"></td> </tr> <tr> <td></td> <td></td> <td colspan="8" style="text-align: center;"> <table border="1" style="width: 100%; border-collapse: collapse; text-align: center;"> <tr> <td style="width: 10%;"></td> <td style="width: 10%;"></td> <td style="width: 10%;"></td> <td style="width: 10%;"></td> <td style="width: 10%;"></td> <td style="width: 10%;"></td> <td style="width: 10%;"></td> <td style="width: 10%;"></td> <td style="width: 10%;"></td> <td style="width: 10%;"></td> </tr> <tr> <td></td> <td></td> <td colspan="8" style="text-align: center;"> <table border="1" style="width: 100%; border-collapse: collapse; text-align: center;"> <tr> <td style="width: 10%;"></td> <td style="width: 10%;"></td> <td style="width: 10%;"></td> <td style="width: 10%;"></td> <td style="width: 10%;"></td> <td style="width: 10%;"></td> <td style="width: 10%;"></td> <td style="width: 10%;"></td> <td style="width: 10%;"></td> <td style="width: 10%;"></td> </tr> <tr> <td></td> <td></td> <td colspan="8" style="text-align: center;"> <table border="1" style="width: 100%; border-collapse: collapse; text-align: center;"> <tr> </tr></table></td></tr></table></td></tr></table></td></tr></table></td></tr></table></td></tr></table></td></tr></table></td></tr></table></td></tr></table></td></tr></table></td></tr></table></td></tr></table></td></tr></table></td></tr></table></td></tr></table>

 | | | | | | | | | | | | | | | | | | | | <table border="1" style="width: 100%; border-collapse: collapse; text-align: center;"> <tr> <td style="width: 10%;"></td> <td style="width: 10%;"></td> <td style="width: 10%;"></td> <td style="width: 10%;"></td> <td style="width: 10%;"></td> <td style="width: 10%;"></td> <td style="width: 10%;"></td> <td style="width: 10%;"></td> <td style="width: 10%;"></td> <td style="width: 10%;"></td> </tr> <tr> <td></td> <td></td> <td colspan="8" style="text-align: center;"> <table border="1" style="width: 100%; border-collapse: collapse; text-align: center;"> <tr> <td style="width: 10%;"></td> <td style="width: 10%;"></td> <td style="width: 10%;"></td> <td style="width: 10%;"></td> <td style="width: 10%;"></td> <td style="width: 10%;"></td> <td style="width: 10%;"></td> <td style="width: 10%;"></td> <td style="width: 10%;"></td> <td style="width: 10%;"></td> </tr> <tr> <td></td> <td></td> <td colspan="8" style="text-align: center;"> <table border="1" style="width: 100%; border-collapse: collapse; text-align: center;"> <tr> <td style="width: 10%;"></td> <td style="width: 10%;"></td> <td style="width: 10%;"></td> <td style="width: 10%;"></td> <td style="width: 10%;"></td> <td style="width: 10%;"></td> <td style="width: 10%;"></td> <td style="width: 10%;"></td> <td style="width: 10%;"></td> <td style="width: 10%;"></td> </tr> <tr> <td></td> <td></td> <td colspan="8" style="text-align: center;"> <table border="1" style="width: 100%; border-collapse: collapse; text-align: center;"> <tr> <td style="width: 10%;"></td> <td style="width: 10%;"></td> <td style="width: 10%;"></td> <td style="width: 10%;"></td> <td style="width: 10%;"></td> <td style="width: 10%;"></td> <td style="width: 10%;"></td> <td style="width: 10%;"></td> <td style="width: 10%;"></td> <td style="width: 10%;"></td> </tr> <tr> <td></td> <td></td> <td colspan="8" style="text-align: center;"> <table border="1" style="width: 100%; border-collapse: collapse; text-align: center;"> <tr> <td style="width: 10%;"></td> <td style="width: 10%;"></td> <td style="width: 10%;"></td> <td style="width: 10%;"></td> <td style="width: 10%;"></td> <td style="width: 10%;"></td> <td style="width: 10%;"></td> <td style="width: 10%;"></td> <td style="width: 10%;"></td> <td style="width: 10%;"></td> </tr> <tr> <td></td> <td></td> <td colspan="8" style="text-align: center;"> <table border="1" style="width: 100%; border-collapse: collapse; text-align: center;"> <tr> <td style="width: 10%;"></td> <td style="width: 10%;"></td> <td style="width: 10%;"></td> <td style="width: 10%;"></td> <td style="width: 10%;"></td> <td style="width: 10%;"></td> <td style="width: 10%;"></td> <td style="width: 10%;"></td> <td style="width: 10%;"></td> <td style="width: 10%;"></td> </tr> <tr> <td></td> <td></td> <td colspan="8" style="text-align: center;"> <table border="1" style="width: 100%; border-collapse: collapse; text-align: center;"> <tr> <td style="width: 10%;"></td> <td style="width: 10%;"></td> <td style="width: 10%;"></td> <td style="width: 10%;"></td> <td style="width: 10%;"></td> <td style="width: 10%;"></td> <td style="width: 10%;"></td> <td style="width: 10%;"></td> <td style="width: 10%;"></td> <td style="width: 10%;"></td> </tr> <tr> <td></td> <td></td> <td colspan="8" style="text-align: center;"> <table border="1" style="width: 100%; border-collapse: collapse; text-align: center;"> <tr> <td style="width: 10%;"></td> <td style="width: 10%;"></td> <td style="width: 10%;"></td> <td style="width: 10%;"></td> <td style="width: 10%;"></td> <td style="width: 10%;"></td> <td style="width: 10%;"></td> <td style="width: 10%;"></td> <td style="width: 10%;"></td> <td style="width: 10%;"></td> </tr> <tr> <td></td> <td></td> <td colspan="8" style="text-align: center;"> <table border="1" style="width: 100%; border-collapse: collapse; text-align: center;"> <tr> <td style="width: 10%;"></td> <td style="width: 10%;"></td> <td style="width: 10%;"></td> <td style="width: 10%;"></td> <td style="width: 10%;"></td> <td style="width: 10%;"></td> <td style="width: 10%;"></td> <td style="width: 10%;"></td> <td style="width: 10%;"></td> <td style="width: 10%;"></td> </tr> <tr> <td></td> <td></td> <td colspan="8" style="text-align: center;"> <table border="1" style="width: 100%; border-collapse: collapse; text-align: center;"> <tr> <td style="width: 10%;"></td> <td style="width: 10%;"></td> <td style="width: 10%;"></td> <td style="width: 10%;"></td> <td style="width: 10%;"></td> <td style="width: 10%;"></td> <td style="width: 10%;"></td> <td style="width: 10%;"></td> <td style="width: 10%;"></td> <td style="width: 10%;"></td> </tr> <tr> <td></td> <td></td> <td colspan="8" style="text-align: center;"> <table border="1" style="width: 100%; border-collapse: collapse; text-align: center;"> <tr> <td style="width: 10%;"></td> <td style="width: 10%;"></td> <td style="width: 10%;"></td> <td style="width: 10%;"></td> <td style="width: 10%;"></td> <td style="width: 10%;"></td> <td style="width: 10%;"></td> <td style="width: 10%;"></td> <td style="width: 10%;"></td> <td style="width: 10%;"></td> </tr> <tr> <td></td> <td></td> <td colspan="8" style="text-align: center;"> <table border="1" style="width: 100%; border-collapse: collapse; text-align: center;"> <tr> <td style="width: 10%;"></td> <td style="width: 10%;"></td> <td style="width: 10%;"></td> <td style="width: 10%;"></td> <td style="width: 10%;"></td> <td style="width: 10%;"></td> <td style="width: 10%;"></td> <td style="width: 10%;"></td> <td style="width: 10%;"></td> <td style="width: 10%;"></td> </tr> <tr> <td></td> <td></td> <td colspan="8" style="text-align: center;"> <table border="1" style="width: 100%; border-collapse: collapse; text-align: center;"> <tr> <td style="width: 10%;"></td> <td style="width: 10%;"></td> <td style="width: 10%;"></td> <td style="width: 10%;"></td> <td style="width: 10%;"></td> <td style="width: 10%;"></td> <td style="width: 10%;"></td> <td style="width: 10%;"></td> <td style="width: 10%;"></td> <td style="width: 10%;"></td> </tr> <tr> <td></td> <td></td> <td colspan="8" style="text-align: center;"> <table border="1" style="width: 100%; border-collapse: collapse; text-align: center;"> <tr> </tr></table></td></tr></table></td></tr></table></td></tr></table></td></tr></table></td></tr></table></td></tr></table></td></tr></table></td></tr></table></td></tr></table></td></tr></table></td></tr></table></td></tr></table></td></tr></table>
 | | | | | | | | | | | | | | | | | | | | <table border="1" style="width: 100%; border-collapse: collapse; text-align: center;"> <tr> <td style="width: 10%;"></td> <td style="width: 10%;"></td> <td style="width: 10%;"></td> <td style="width: 10%;"></td> <td style="width: 10%;"></td> <td style="width: 10%;"></td> <td style="width: 10%;"></td> <td style="width: 10%;"></td> <td style="width: 10%;"></td> <td style="width: 10%;"></td> </tr> <tr> <td></td> <td></td> <td colspan="8" style="text-align: center;"> <table border="1" style="width: 100%; border-collapse: collapse; text-align: center;"> <tr> <td style="width: 10%;"></td> <td style="width: 10%;"></td> <td style="width: 10%;"></td> <td style="width: 10%;"></td> <td style="width: 10%;"></td> <td style="width: 10%;"></td> <td style="width: 10%;"></td> <td style="width: 10%;"></td> <td style="width: 10%;"></td> <td style="width: 10%;"></td> </tr> <tr> <td></td> <td></td> <td colspan="8" style="text-align: center;"> <table border="1" style="width: 100%; border-collapse: collapse; text-align: center;"> <tr> <td style="width: 10%;"></td> <td style="width: 10%;"></td> <td style="width: 10%;"></td> <td style="width: 10%;"></td> <td style="width: 10%;"></td> <td style="width: 10%;"></td> <td style="width: 10%;"></td> <td style="width: 10%;"></td> <td style="width: 10%;"></td> <td style="width: 10%;"></td> </tr> <tr> <td></td> <td></td> <td colspan="8" style="text-align: center;"> <table border="1" style="width: 100%; border-collapse: collapse; text-align: center;"> <tr> <td style="width: 10%;"></td> <td style="width: 10%;"></td> <td style="width: 10%;"></td> <td style="width: 10%;"></td> <td style="width: 10%;"></td> <td style="width: 10%;"></td> <td style="width: 10%;"></td> <td style="width: 10%;"></td> <td style="width: 10%;"></td> <td style="width: 10%;"></td> </tr> <tr> <td></td> <td></td> <td colspan="8" style="text-align: center;"> <table border="1" style="width: 100%; border-collapse: collapse; text-align: center;"> <tr> <td style="width: 10%;"></td> <td style="width: 10%;"></td> <td style="width: 10%;"></td> <td style="width: 10%;"></td> <td style="width: 10%;"></td> <td style="width: 10%;"></td> <td style="width: 10%;"></td> <td style="width: 10%;"></td> <td style="width: 10%;"></td> <td style="width: 10%;"></td> </tr> <tr> <td></td> <td></td> <td colspan="8" style="text-align: center;"> <table border="1" style="width: 100%; border-collapse: collapse; text-align: center;"> <tr> <td style="width: 10%;"></td> <td style="width: 10%;"></td> <td style="width: 10%;"></td> <td style="width: 10%;"></td> <td style="width: 10%;"></td> <td style="width: 10%;"></td> <td style="width: 10%;"></td> <td style="width:
10%;"></td> <td style="width: 10%;"></td> <td style="width: 10%;"></td> </tr> <tr> <td></td> <td></td> <td colspan="8" style="text-align: center;"> <table border="1" style="width: 100%; border-collapse: collapse; text-align: center;"> <tr> <td style="width: 10%;"></td> <td style="width: 10%;"></td> <td style="width: 10%;"></td> <td style="width: 10%;"></td> <td style="width: 10%;"></td> <td style="width: 10%;"></td> <td style="width: 10%;"></td> <td style="width: 10%;"></td> <td style="width: 10%;"></td> <td style="width: 10%;"></td> </tr> <tr> <td></td> <td></td> <td colspan="8" style="text-align: center;"> <table border="1" style="width: 100%; border-collapse: collapse; text-align: center;"> <tr> <td style="width: 10%;"></td> <td style="width: 10%;"></td> <td style="width: 10%;"></td> <td style="width: 10%;"></td> <td style="width: 10%;"></td> <td style="width: 10%;"></td> <td style="width: 10%;"></td> <td style="width: 10%;"></td> <td style="width: 10%;"></td> <td style="width: 10%;"></td> </tr> <tr> <td></td> <td></td> <td colspan="8" style="text-align: center;"> <table border="1" style="width: 100%; border-collapse: collapse; text-align: center;"> <tr> <td style="width: 10%;"></td> <td style="width: 10%;"></td> <td style="width: 10%;"></td> <td style="width: 10%;"></td> <td style="width: 10%;"></td> <td style="width: 10%;"></td> <td style="width: 10%;"></td> <td style="width: 10%;"></td> <td style="width: 10%;"></td> <td style="width: 10%;"></td> </tr> <tr> <td></td> <td></td> <td colspan="8" style="text-align: center;"> <table border="1" style="width: 100%; border-collapse: collapse; text-align: center;"> <tr> <td style="width: 10%;"></td> <td style="width: 10%;"></td> <td style="width: 10%;"></td> <td style="width: 10%;"></td> <td style="width: 10%;"></td> <td style="width: 10%;"></td> <td style="width: 10%;"></td> <td style="width: 10%;"></td> <td style="width: 10%;"></td> <td style="width: 10%;"></td> </tr> <tr> <td></td> <td></td> <td colspan="8" style="text-align: center;"> <table border="1" style="width: 100%; border-collapse: collapse; text-align: center;"> <tr> <td style="width: 10%;"></td> <td style="width: 10%;"></td> <td style="width: 10%;"></td> <td style="width: 10%;"></td> <td style="width: 10%;"></td> <td style="width: 10%;"></td> <td style="width: 10%;"></td> <td style="width: 10%;"></td> <td style="width: 10%;"></td> <td style="width: 10%;"></td> </tr> <tr> <td></td> <td></td> <td colspan="8" style="text-align: center;"> <table border="1" style="width: 100%; border-collapse: collapse; text-align: center;"> <tr> <td style="width: 10%;"></td> <td style="width: 10%;"></td> <td style="width: 10%;"></td> <td style="width: 10%;"></td> <td style="width: 10%;"></td> <td style="width: 10%;"></td> <td style="width: 10%;"></td> <td style="width: 10%;"></td> <td style="width: 10%;"></td> <td style="width: 10%;"></td> </tr> <tr> <td></td> <td></td> <td colspan="8" style="text-align: center;"> <table border="1" style="width: 100%; border-collapse: collapse; text-align: center;"> <tr> </tr></table></td></tr></table></td></tr></table></td></tr></table></td></tr></table></td></tr></table></td></tr></table></td></tr></table></td></tr></table></td></tr></table></td></tr></table></td></tr></table></td></tr></table>
 | | | | | | | | | | | | | | | | | | | | <table border="1" style="width: 100%; border-collapse: collapse; text-align: center;"> <tr> <td style="width: 10%;"></td> <td style="width: 10%;"></td> <td style="width: 10%;"></td> <td style="width: 10%;"></td> <td style="width: 10%;"></td> <td style="width: 10%;"></td> <td style="width: 10%;"></td> <td style="width: 10%;"></td> <td style="width: 10%;"></td> <td style="width: 10%;"></td> </tr> <tr> <td></td> <td></td> <td colspan="8" style="text-align: center;"> <table border="1" style="width: 100%; border-collapse: collapse; text-align: center;"> <tr> <td style="width: 10%;"></td> <td style="width: 10%;"></td> <td style="width: 10%;"></td> <td style="width: 10%;"></td> <td style="width: 10%;"></td> <td style="width: 10%;"></td> <td style="width: 10%;"></td> <td style="width: 10%;"></td> <td style="width: 10%;"></td> <td style="width: 10%;"></td> </tr> <tr> <td></td> <td></td> <td colspan="8" style="text-align: center;"> <table border="1" style="width: 100%; border-collapse: collapse; text-align: center;"> <tr> <td style="width: 10%;"></td> <td style="width: 10%;"></td> <td style="width: 10%;"></td> <td style="width: 10%;"></td> <td style="width: 10%;"></td> <td style="width: 10%;"></td> <td style="width: 10%;"></td> <td style="width: 10%;"></td> <td style="width: 10%;"></td> <td style="width: 10%;"></td> </tr> <tr> <td></td> <td></td> <td colspan="8" style="text-align: center;"> <table border="1" style="width: 100%; border-collapse: collapse; text-align: center;"> <tr> <td style="width: 10%;"></td> <td style="width: 10%;"></td> <td style="width: 10%;"></td> <td style="width: 10%;"></td> <td style="width: 10%;"></td> <td style="width: 10%;"></td> <td style="width: 10%;"></td> <td style="width: 10%;"></td> <td style="width: 10%;"></td> <td style="width: 10%;"></td> </tr> <tr> <td></td> <td></td> <td colspan="8" style="text-align: center;"> <table border="1" style="width: 100%; border-collapse: collapse; text-align: center;"> <tr> <td style="width: 10%;"></td> <td style="width: 10%;"></td> <td style="width: 10%;"></td> <td style="width: 10%;"></td> <td style="width: 10%;"></td> <td style="width: 10%;"></td> <td style="width: 10%;"></td> <td style="width: 10%;"></td> <td style="width: 10%;"></td> <td style="width: 10%;"></td> </tr> <tr> <td></td> <td></td> <td colspan="8" style="text-align: center;"> <table border="1" style="width: 100%; border-collapse: collapse; text-align: center;"> <tr> <td style="width: 10%;"></td> <td style="width: 10%;"></td> <td style="width: 10%;"></td> <td style="width: 10%;"></td> <td style="width: 10%;"></td> <td style="width: 10%;"></td> <td style="width: 10%;"></td> <td style="width: 10%;"></td> <td style="width: 10%;"></td> <td style="width: 10%;"></td> </tr> <tr> <td></td> <td></td> <td colspan="8" style="text-align: center;"> <table border="1" style="width: 100%; border-collapse: collapse; text-align: center;"> <tr> <td style="width: 10%;"></td> <td style="width: 10%;"></td> <td style="width: 10%;"></td> <td style="width: 10%;"></td> <td style="width: 10%;"></td> <td style="width: 10%;"></td> <td style="width: 10%;"></td> <td style="width: 10%;"></td> <td style="width: 10%;"></td> <td style="width: 10%;"></td> </tr> <tr> <td></td> <td></td> <td colspan="8" style="text-align: center;"> <table border="1" style="width: 100%; border-collapse: collapse; text-align: center;"> <tr> <td style="width: 10%;"></td> <td style="width: 10%;"></td> <td style="width: 10%;"></td> <td style="width: 10%;"></td> <td style="width: 10%;"></td> <td style="width: 10%;"></td> <td style="width: 10%;"></td> <td style="width: 10%;"></td> <td style="width: 10%;"></td> <td style="width: 10%;"></td> </tr> <tr> <td></td> <td></td> <td colspan="8" style="text-align: center;"> <table border="1" style="width: 100%; border-collapse: collapse; text-align: center;"> <tr> <td style="width: 10%;"></td> <td style="width: 10%;"></td> <td style="width: 10%;"></td> <td style="width: 10%;"></td> <td style="width: 10%;"></td> <td style="width: 10%;"></td> <td style="width: 10%;"></td> <td style="width: 10%;"></td> <td style="width: 10%;"></td> <td style="width: 10%;"></td> </tr> <tr> <td></td> <td></td> <td colspan="8" style="text-align: center;"> <table border="1" style="width: 100%; border-collapse: collapse; text-align: center;"> <tr> <td style="width: 10%;"></td> <td style="width: 10%;"></td> <td style="width: 10%;"></td> <td style="width: 10%;"></td> <td style="width: 10%;"></td> <td style="width: 10%;"></td> <td style="width: 10%;"></td> <td style="width: 10%;"></td> <td style="width: 10%;"></td> <td style="width: 10%;"></td> </tr> <tr> <td></td> <td></td> <td colspan="8" style="text-align: center;"> <table border="1" style="width: 100%; border-collapse: collapse; text-align: center;"> <tr> <td style="width: 10%;"></td> <td style="width: 10%;"></td> <td style="width: 10%;"></td> <td style="width: 10%;"></td> <td style="width: 10%;"></td> <td style="width: 10%;"></td> <td style="width: 10%;"></td> <td style="width: 10%;"></td> <td style="width: 10%;"></td> <td style="width: 10%;"></td> </tr> <tr> <td></td> <td></td> <td colspan="8" style="text-align: center;"> <table border="1" style="width: 100%; border-collapse: collapse; text-align: center;"> <tr> </tr></table></td></tr></table></td></tr></table></td></tr></table></td></tr></table></td></tr></table></td></tr></table></td></tr></table></td></tr></table></td></tr></table></td></tr></table></td></tr></table>

 | | | | | | | | | | | | | | | | | | | | <table border="1" style="width: 100%; border-collapse: collapse; text-align: center;"> <tr> <td style="width: 10%;"></td> <td style="width: 10%;"></td> <td style="width: 10%;"></td> <td style="width: 10%;"></td> <td style="width: 10%;"></td> <td style="width: 10%;"></td> <td style="width: 10%;"></td> <td style="width: 10%;"></td> <td style="width: 10%;"></td> <td style="width: 10%;"></td> </tr> <tr> <td></td> <td></td> <td colspan="8" style="text-align: center;"> <table border="1" style="width: 100%; border-collapse: collapse; text-align: center;"> <tr> <td style="width: 10%;"></td> <td style="width: 10%;"></td> <td style="width: 10%;"></td> <td style="width: 10%;"></td> <td style="width: 10%;"></td> <td style="width: 10%;"></td> <td style="width: 10%;"></td> <td style="width: 10%;"></td> <td style="width: 10%;"></td> <td style="width: 10%;"></td> </tr> <tr> <td></td> <td></td> <td colspan="8" style="text-align: center;"> <table border="1" style="width: 100%; border-collapse: collapse; text-align: center;"> <tr> <td style="width: 10%;"></td> <td style="width: 10%;"></td> <td style="width: 10%;"></td> <td style="width: 10%;"></td> <td style="width: 10%;"></td> <td style="width: 10%;"></td> <td style="width: 10%;"></td> <td style="width: 10%;"></td> <td style="width: 10%;"></td> <td style="width: 10%;"></td> </tr> <tr> <td></td> <td></td> <td colspan="8" style="text-align: center;"> <table border="1" style="width: 100%; border-collapse: collapse; text-align: center;"> <tr> <td style="width: 10%;"></td> <td style="width: 10%;"></td> <td style="width: 10%;"></td> <td style="width: 10%;"></td> <td style="width: 10%;"></td> <td style="width: 10%;"></td> <td style="width: 10%;"></td> <td style="width: 10%;"></td> <td style="width: 10%;"></td> <td style="width: 10%;"></td> </tr> <tr> <td></td> <td></td> <td colspan="8" style="text-align: center;"> <table border="1" style="width: 100%; border-collapse: collapse; text-align: center;"> <tr> <td style="width: 10%;"></td> <td style="width: 10%;"></td> <td style="width: 10%;"></td> <td style="width: 10%;"></td> <td style="width: 10%;"></td> <td style="width: 10%;"></td> <td style="width: 10%;"></td> <td style="width: 10%;"></td> <td style="width: 10%;"></td> <td style="width: 10%;"></td> </tr> <tr> <td></td> <td></td> <td colspan="8" style="text-align: center;"> <table border="1" style="width: 100%; border-collapse: collapse; text-align: center;"> <tr> <td style="width: 10%;"></td> <td style="width: 10%;"></td> <td style="width: 10%;"></td> <td style="width: 10%;"></td> <td style="width: 10%;"></td> <td style="width: 10%;"></td> <td style="width: 10%;"></td> <td style="width: 10%;"></td> <td style="width: 10%;"></td> <td style="width: 10%;"></td> </tr> <tr> <td></td> <td></td> <td colspan="8" style="text-align: center;"> <table border="1" style="width: 100%; border-collapse: collapse; text-align: center;"> <tr> <td style="width: 10%;"></td> <td style="width: 10%;"></td> <td style="width: 10%;"></td> <td style="width: 10%;"></td> <td style="width: 10%;"></td> <td style="width: 10%;"></td> <td style="width: 10%;"></td> <td style="width: 10%;"></td> <td style="width: 10%;"></td> <td style="width: 10%;"></td> </tr> <tr> <td></td> <td></td> <td colspan="8" style="text-align: center;"> <table border="1" style="width: 100%; border-collapse: collapse; text-align: center;"> <tr> <td style="width: 10%;"></td> <td style="width: 10%;"></td> <td style="width: 10%;"></td> <td style="width: 10%;"></td> <td style="width: 10%;"></td> <td style="width: 10%;"></td> <td style="width: 10%;"></td> <td style="width: 10%;"></td> <td style="width: 10%;"></td> <td style="width: 10%;"></td> </tr> <tr> <td></td> <td></td> <td colspan="8" style="text-align: center;"> <table border="1" style="width: 100%; border-collapse: collapse; text-align: center;"> <tr> <td style="width: 10%;"></td> <td style="width: 10%;"></td> <td style="width: 10%;"></td> <td style="width: 10%;"></td> <td style="width: 10%;"></td> <td style="width: 10%;"></td> <td style="width: 10%;"></td> <td style="width: 10%;"></td> <td style="width: 10%;"></td> <td style="width: 10%;"></td> </tr> <tr> <td></td> <td></td> <td colspan="8" style="text-align: center;"> <table border="1" style="width: 100%; border-collapse: collapse; text-align: center;"> <tr> <td style="width: 10%;"></td> <td style="width: 10%;"></td> <td style="width: 10%;"></td> <td style="width: 10%;"></td> <td style="width: 10%;"></td> <td style="width: 10%;"></td> <td style="width: 10%;"></td> <td style="width: 10%;"></td> <td style="width: 10%;"></td> <td style="width: 10%;"></td> </tr> <tr> <td></td> <td></td> <td colspan="8" style="text-align: center;"> <table border="1" style="width: 100%; border-collapse: collapse; text-align: center;"> <tr> </tr></table></td></tr></table></td></tr></table></td></tr></table></td></tr></table></td></tr></table></td></tr></table></td></tr></table></td></tr></table></td></tr></table></td></tr></table>
 | | | | | | | | | | | | | | | | | | | | <table border="1" style="width: 100%; border-collapse: collapse; text-align: center;"> <tr> <td style="width: 10%;"></td> <td style="width: 10%;"></td> <td style="width: 10%;"></td> <td style="width: 10%;"></td> <td style="width: 10%;"></td> <td style="width: 10%;"></td> <td style="width: 10%;"></td> <td style="width: 10%;"></td> <td style="width: 10%;"></td> <td style="width: 10%;"></td> </tr> <tr> <td></td> <td></td> <td colspan="8" style="text-align: center;"> <table border="1" style="width: 100%; border-collapse: collapse; text-align: center;"> <tr> <td style="width: 10%;"></td> <td style="width: 10%;"></td> <td style="width: 10%;"></td> <td style="width: 10%;"></td> <td style="width: 10%;"></td> <td style="width: 10%;"></td> <td style="width: 10%;"></td> <td style="width: 10%;"></td> <td style="width: 10%;"></td> <td style="width: 10%;"></td> </tr> <tr> <td></td> <td></td> <td colspan="8" style="text-align: center;"> <table border="1" style="width: 100%; border-collapse: collapse; text-align: center;"> <tr> <td style="width: 10%;"></td> <td style="width: 10%;"></td> <td style="width: 10%;"></td> <td style="width: 10%;"></td> <td style="width: 10%;"></td> <td style="width: 10%;"></td> <td style="width: 10%;"></td> <td style="width: 10%;"></td> <td style="width: 10%;"></td> <td style="width: 10%;"></td> </tr> <tr> <td></td> <td></td> <td colspan="8" style="text-align: center;"> <table border="1" style="width: 100%; border-collapse: collapse; text-align: center;"> <tr> <td style="width: 10%;"></td> <td style="width: 10%;"></td> <td style="width: 10%;"></td> <td style="width: 10%;"></td> <td style="width: 10%;"></td> <td style="width: 10%;"></td> <td style="width: 10%;"></td> <td style="width: 10%;"></td> <td style="width: 10%;"></td> <td style="width: 10%;"></td> </tr> <tr> <td></td> <td></td> <td colspan="8" style="text-align: center;"> <table border="1" style="width: 100%; border-collapse: collapse; text-align: center;"> <tr> <td style="width: 10%;"></td> <td style="width: 10%;"></td> <td style="width: 10%;"></td> <td style="width: 10%;"></td> <td style="width: 10%;"></td> <td style="width: 10%;"></td> <td style="width: 10%;"></td> <td style="width: 10%;"></td> <td style="width: 10%;"></td> <td style="width: 10%;"></td> </tr> <tr> <td></td> <td></td> <td colspan="8" style="text-align: center;"> <table border="1" style="width: 100%; border-collapse: collapse; text-align: center;"> <tr> <td style="width: 10%;"></td> <td style="width: 10%;"></td> <td style="width: 10%;"></td> <td style="width: 10%;"></td> <td style="width: 10%;"></td> <td style="width: 10%;"></td> <td style="width: 10%;"></td> <td style="width: 10%;"></td> <td style="width: 10%;"></td> <td style="width: 10%;"></td> </tr> <tr> <td></td> <td></td> <td colspan="8" style="text-align: center;"> <table border="1" style="width: 100%; border-collapse: collapse; text-align: center;"> <tr> <td style="width: 10%;"></td> <td style="width: 10%;"></td> <td style="width: 10%;"></td> <td style="width: 10%;"></td> <td style="width: 10%;"></td> <td style="width: 10%;"></td> <td style="width: 10%;"></td> <td style="width: 10%;"></td> <td style="width: 10%;"></td> <td style="width: 10%;"></td> </tr> <tr> <td></td> <td></td> <td colspan="8" style="text-align: center;"> <table border="1" style="width: 100%; border-collapse: collapse; text-align: center;"> <tr> <td style="width: 10%;"></td> <td style="width: 10%;"></td> <td style="width: 10%;"></td> <td style="width: 10%;"></td> <td style="width: 10%;"></td> <td style="width: 10%;"></td> <td style="width: 10%;"></td> <td style="width: 10%;"></td> <td style="width: 10%;"></td> <td style="width: 10%;"></td> </tr> <tr> <td></td> <td></td> <td colspan="8" style="text-align: center;"> <table border="1" style="width: 100%; border-collapse: collapse; text-align: center;"> <tr> <td style="width: 10%;"></td> <td style="width: 10%;"></td> <td style="width: 10%;"></td> <td style="width: 10%;"></td> <td style="width: 10%;"></td> <td style="width: 10%;"></td> <td style="width: 10%;"></td> <td
style="width: 10%;"></td> <td style="width: 10%;"></td> <td style="width: 10%;"></td> </tr> <tr> <td></td> <td></td> <td colspan="8" style="text-align: center;"> <table border="1" style="width: 100%; border-collapse: collapse; text-align: center;"> <tr> </tr></table></td></tr></table></td></tr></table></td></tr></table></td></tr></table></td></tr></table></td></tr></table></td></tr></table></td></tr></table></td></tr></table>
 | | | | | | | | | | | | | | | | | | | | <table border="1" style="width: 100%; border-collapse: collapse; text-align: center;"> <tr> <td style="width: 10%;"></td> <td style="width: 10%;"></td> <td style="width: 10%;"></td> <td style="width: 10%;"></td> <td style="width: 10%;"></td> <td style="width: 10%;"></td> <td style="width: 10%;"></td> <td style="width: 10%;"></td> <td style="width: 10%;"></td> <td style="width: 10%;"></td> </tr> <tr> <td></td> <td></td> <td colspan="8" style="text-align: center;"> <table border="1" style="width: 100%; border-collapse: collapse; text-align: center;"> <tr> <td style="width: 10%;"></td> <td style="width: 10%;"></td> <td style="width: 10%;"></td> <td style="width: 10%;"></td> <td style="width: 10%;"></td> <td style="width: 10%;"></td> <td style="width: 10%;"></td> <td style="width: 10%;"></td> <td style="width: 10%;"></td> <td style="width: 10%;"></td> </tr> <tr> <td></td> <td></td> <td colspan="8" style="text-align: center;"> <table border="1" style="width: 100%; border-collapse: collapse; text-align: center;"> <tr> <td style="width: 10%;"></td> <td style="width: 10%;"></td> <td style="width: 10%;"></td> <td style="width: 10%;"></td> <td style="width: 10%;"></td> <td style="width: 10%;"></td> <td style="width: 10%;"></td> <td style="width: 10%;"></td> <td style="width: 10%;"></td> <td style="width: 10%;"></td> </tr> <tr> <td></td> <td></td> <td colspan="8" style="text-align: center;"> <table border="1" style="width: 100%; border-collapse: collapse; text-align: center;"> <tr> <td style="width: 10%;"></td> <td style="width: 10%;"></td> <td style="width: 10%;"></td> <td style="width: 10%;"></td> <td style="width: 10%;"></td> <td style="width: 10%;"></td> <td style="width: 10%;"></td> <td style="width: 10%;"></td> <td style="width: 10%;"></td> <td style="width: 10%;"></td> </tr> <tr> <td></td> <td></td> <td colspan="8" style="text-align: center;"> <table border="1" style="width: 100%; border-collapse: collapse; text-align: center;"> <tr> <td style="width: 10%;"></td> <td style="width: 10%;"></td> <td style="width: 10%;"></td> <td style="width: 10%;"></td> <td style="width: 10%;"></td> <td style="width: 10%;"></td> <td style="width: 10%;"></td> <td style="width: 10%;"></td> <td style="width: 10%;"></td> <td style="width: 10%;"></td> </tr> <tr> <td></td> <td></td> <td colspan="8" style="text-align: center;"> <table border="1" style="width: 100%; border-collapse: collapse; text-align: center;"> <tr> <td style="width: 10%;"></td> <td style="width: 10%;"></td> <td style="width: 10%;"></td> <td style="width: 10%;"></td> <td style="width: 10%;"></td> <td style="width: 10%;"></td> <td style="width: 10%;"></td> <td style="width: 10%;"></td> <td style="width: 10%;"></td> <td style="width: 10%;"></td> </tr> <tr> <td></td> <td></td> <td colspan="8" style="text-align: center;"> <table border="1" style="width: 100%; border-collapse: collapse; text-align: center;"> <tr> <td style="width: 10%;"></td> <td style="width: 10%;"></td> <td style="width: 10%;"></td> <td style="width: 10%;"></td> <td style="width: 10%;"></td> <td style="width: 10%;"></td> <td style="width: 10%;"></td> <td style="width: 10%;"></td> <td style="width: 10%;"></td> <td style="width: 10%;"></td> </tr> <tr> <td></td> <td></td> <td colspan="8" style="text-align: center;"> <table border="1" style="width: 100%; border-collapse: collapse; text-align: center;"> <tr> <td style="width: 10%;"></td> <td style="width: 10%;"></td> <td style="width: 10%;"></td> <td style="width: 10%;"></td> <td style="width: 10%;"></td> <td style="width: 10%;"></td> <td style="width: 10%;"></td> <td style="width: 10%;"></td> <td style="width: 10%;"></td> <td style="width: 10%;"></td> </tr> <tr> <td></td> <td></td> <td colspan="8" style="text-align: center;"> <table border="1" style="width: 100%; border-collapse: collapse; text-align: center;"> <tr> </tr></table></td></tr></table></td></tr></table></td></tr></table></td></tr></table></td></tr></table></td></tr></table></td></tr></table></td></tr></table>
 | | | | | | | | | | | | | | | | | | | | <table border="1" style="width: 100%; border-collapse: collapse; text-align: center;"> <tr> <td style="width: 10%;"></td> <td style="width: 10%;"></td> <td style="width: 10%;"></td> <td style="width: 10%;"></td> <td style="width: 10%;"></td> <td style="width: 10%;"></td> <td style="width: 10%;"></td> <td style="width: 10%;"></td> <td style="width: 10%;"></td> <td style="width: 10%;"></td> </tr> <tr> <td></td> <td></td> <td colspan="8" style="text-align: center;"> <table border="1" style="width: 100%; border-collapse: collapse; text-align: center;"> <tr> <td style="width: 10%;"></td> <td style="width: 10%;"></td> <td style="width: 10%;"></td> <td style="width: 10%;"></td> <td style="width: 10%;"></td> <td style="width: 10%;"></td> <td style="width: 10%;"></td> <td style="width: 10%;"></td> <td style="width: 10%;"></td> <td style="width: 10%;"></td> </tr> <tr> <td></td> <td></td> <td colspan="8" style="text-align: center;"> <table border="1" style="width: 100%; border-collapse: collapse; text-align: center;"> <tr> <td style="width: 10%;"></td> <td style="width: 10%;"></td> <td style="width: 10%;"></td> <td style="width: 10%;"></td> <td style="width: 10%;"></td> <td style="width: 10%;"></td> <td style="width: 10%;"></td> <td style="width: 10%;"></td> <td style="width: 10%;"></td> <td style="width: 10%;"></td> </tr> <tr> <td></td> <td></td> <td colspan="8" style="text-align: center;"> <table border="1" style="width: 100%; border-collapse: collapse; text-align: center;"> <tr> <td style="width: 10%;"></td> <td style="width: 10%;"></td> <td style="width: 10%;"></td> <td style="width: 10%;"></td> <td style="width: 10%;"></td> <td style="width: 10%;"></td> <td style="width: 10%;"></td> <td style="width: 10%;"></td> <td style="width: 10%;"></td> <td style="width: 10%;"></td> </tr> <tr> <td></td> <td></td> <td colspan="8" style="text-align: center;"> <table border="1" style="width: 100%; border-collapse: collapse; text-align: center;"> <tr> <td style="width: 10%;"></td> <td style="width: 10%;"></td> <td style="width: 10%;"></td> <td style="width: 10%;"></td> <td style="width: 10%;"></td> <td style="width: 10%;"></td> <td style="width: 10%;"></td> <td style="width: 10%;"></td> <td style="width: 10%;"></td> <td style="width: 10%;"></td> </tr> <tr> <td></td> <td></td> <td colspan="8" style="text-align: center;"> <table border="1" style="width: 100%; border-collapse: collapse; text-align: center;"> <tr> <td style="width: 10%;"></td> <td style="width: 10%;"></td> <td style="width: 10%;"></td> <td style="width: 10%;"></td> <td style="width: 10%;"></td> <td style="width: 10%;"></td> <td style="width: 10%;"></td> <td style="width: 10%;"></td> <td style="width: 10%;"></td> <td style="width: 10%;"></td> </tr> <tr> <td></td> <td></td> <td colspan="8" style="text-align: center;"> <table border="1" style="width: 100%; border-collapse: collapse; text-align: center;"> <tr> <td style="width: 10%;"></td> <td style="width: 10%;"></td> <td style="width: 10%;"></td> <td style="width: 10%;"></td> <td style="width: 10%;"></td> <td style="width: 10%;"></td> <td style="width: 10%;"></td> <td style="width: 10%;"></td> <td style="width: 10%;"></td> <td style="width: 10%;"></td> </tr> <tr> <td></td> <td></td> <td colspan="8" style="text-align: center;"> <table border="1" style="width: 100%; border-collapse: collapse; text-align: center;"> <tr> </tr></table></td></tr></table></td></tr></table></td></tr></table></td></tr></table></td></tr></table></td></tr></table></td></tr></table>

 | | | | | | | | | | | | | | | | | | | | <table border="1" style="width: 100%; border-collapse: collapse; text-align: center;"> <tr> <td style="width: 10%;"></td> <td style="width: 10%;"></td> <td style="width: 10%;"></td> <td style="width: 10%;"></td> <td style="width: 10%;"></td> <td style="width: 10%;"></td> <td style="width: 10%;"></td> <td style="width: 10%;"></td> <td style="width: 10%;"></td> <td style="width: 10%;"></td> </tr> <tr> <td></td> <td></td> <td colspan="8" style="text-align: center;"> <table border="1" style="width: 100%; border-collapse: collapse; text-align: center;"> <tr> <td style="width: 10%;"></td> <td style="width: 10%;"></td> <td style="width: 10%;"></td> <td style="width: 10%;"></td> <td style="width: 10%;"></td> <td style="width: 10%;"></td> <td style="width: 10%;"></td> <td style="width: 10%;"></td> <td style="width: 10%;"></td> <td style="width: 10%;"></td> </tr> <tr> <td></td> <td></td> <td colspan="8" style="text-align: center;"> <table border="1" style="width: 100%; border-collapse: collapse; text-align: center;"> <tr> <td style="width: 10%;"></td> <td style="width: 10%;"></td> <td style="width: 10%;"></td> <td style="width: 10%;"></td> <td style="width: 10%;"></td> <td style="width: 10%;"></td> <td style="width: 10%;"></td> <td style="width: 10%;"></td> <td style="width: 10%;"></td> <td style="width: 10%;"></td> </tr> <tr> <td></td> <td></td> <td colspan="8" style="text-align: center;"> <table border="1" style="width: 100%; border-collapse: collapse; text-align: center;"> <tr> <td style="width: 10%;"></td> <td style="width: 10%;"></td> <td style="width: 10%;"></td> <td style="width: 10%;"></td> <td style="width: 10%;"></td> <td style="width: 10%;"></td> <td style="width: 10%;"></td> <td style="width: 10%;"></td> <td style="width: 10%;"></td> <td style="width: 10%;"></td> </tr> <tr> <td></td> <td></td> <td colspan="8" style="text-align: center;"> <table border="1" style="width: 100%; border-collapse: collapse; text-align: center;"> <tr> <td style="width: 10%;"></td> <td style="width: 10%;"></td> <td style="width: 10%;"></td> <td style="width: 10%;"></td> <td style="width: 10%;"></td> <td style="width: 10%;"></td> <td style="width: 10%;"></td> <td style="width: 10%;"></td> <td style="width: 10%;"></td> <td style="width: 10%;"></td> </tr> <tr> <td></td> <td></td> <td colspan="8" style="text-align: center;"> <table border="1" style="width: 100%; border-collapse: collapse; text-align: center;"> <tr> <td style="width: 10%;"></td> <td style="width: 10%;"></td> <td style="width: 10%;"></td> <td style="width: 10%;"></td> <td style="width: 10%;"></td> <td style="width: 10%;"></td> <td style="width: 10%;"></td> <td style="width: 10%;"></td> <td style="width: 10%;"></td> <td style="width: 10%;"></td> </tr> <tr> <td></td> <td></td> <td colspan="8" style="text-align: center;"> <table border="1" style="width: 100%; border-collapse: collapse; text-align: center;"> <tr> </tr></table></td></tr></table></td></tr></table></td></tr></table></td></tr></table></td></tr></table></td></tr></table>
 | | | | | | | | | | | | | | | | | | | | <table border="1" style="width: 100%; border-collapse: collapse; text-align: center;"> <tr> <td style="width: 10%;"></td> <td style="width: 10%;"></td> <td style="width: 10%;"></td> <td style="width: 10%;"></td> <td style="width: 10%;"></td> <td style="width: 10%;"></td> <td style="width: 10%;"></td> <td style="width: 10%;"></td> <td style="width: 10%;"></td> <td style="width: 10%;"></td> </tr> <tr> <td></td> <td></td> <td colspan="8" style="text-align: center;"> <table border="1" style="width: 100%; border-collapse: collapse; text-align: center;"> <tr> <td style="width: 10%;"></td> <td style="width: 10%;"></td> <td style="width: 10%;"></td> <td style="width: 10%;"></td> <td style="width: 10%;"></td> <td style="width: 10%;"></td> <td style="width: 10%;"></td> <td style="width: 10%;"></td> <td style="width: 10%;"></td> <td style="width: 10%;"></td> </tr> <tr> <td></td> <td></td> <td colspan="8" style="text-align: center;"> <table border="1" style="width: 100%; border-collapse: collapse; text-align: center;"> <tr> <td style="width: 10%;"></td> <td style="width: 10%;"></td> <td style="width: 10%;"></td> <td style="width: 10%;"></td> <td style="width: 10%;"></td> <td style="width: 10%;"></td> <td style="width: 10%;"></td> <td style="width: 10%;"></td> <td style="width: 10%;"></td> <td style="width: 10%;"></td> </tr> <tr> <td></td> <td></td> <td colspan="8" style="text-align: center;"> <table border="1" style="width: 100%; border-collapse: collapse; text-align: center;"> <tr> <td style="width: 10%;"></td> <td style="width: 10%;"></td> <td style="width: 10%;"></td> <td style="width: 10%;"></td> <td style="width: 10%;"></td> <td style="width: 10%;"></td> <td style="width: 10%;"></td> <td style="width: 10%;"></td> <td style="width: 10%;"></td> <td style="width: 10%;"></td> </tr> <tr> <td></td> <td></td> <td colspan="8" style="text-align: center;"> <table border="1" style="width: 100%; border-collapse: collapse; text-align: center;"> <tr> <td style="width: 10%;"></td> <td style="width: 10%;"></td> <td style="width: 10%;"></td> <td style="width: 10%;"></td> <td style="width: 10%;"></td> <td style="width: 10%;"></td> <td style="width: 10%;"></td> <td style="width: 10%;"></td> <td style="width: 10%;"></td> <td style="width: 10%;"></td> </tr> <tr> <td></td> <td></td> <td colspan="8" style="text-align: center;"> <table border="1" style="width: 100%; border-collapse: collapse; text-align: center;"> <tr> </tr></table></td></tr></table></td></tr></table></td></tr></table></td></tr></table></td></tr></table>
 | | | | | | | | | | | | | | | | | | | | <table border="1" style="width: 100%; border-collapse: collapse; text-align: center;"> <tr> <td style="width: 10%;"></td> <td style="width: 10%;"></td> <td style="width: 10%;"></td> <td style="width: 10%;"></td> <td style="width: 10%;"></td> <td style="width: 10%;"></td> <td style="width: 10%;"></td> <td style="width: 10%;"></td> <td style="width: 10%;"></td> <td style="width: 10%;"></td> </tr> <tr> <td></td> <td></td> <td colspan="8" style="text-align: center;"> <table border="1" style="width: 100%; border-collapse: collapse; text-align: center;"> <tr> <td style="width: 10%;"></td> <td style="width: 10%;"></td> <td style="width: 10%;"></td> <td style="width: 10%;"></td> <td style="width: 10%;"></td> <td style="width: 10%;"></td> <td style="width: 10%;"></td> <td style="width: 10%;"></td> <td style="width: 10%;"></td> <td style="width: 10%;"></td> </tr> <tr> <td></td> <td></td> <td colspan="8" style="text-align: center;"> <table border="1" style="width: 100%; border-collapse: collapse; text-align: center;"> <tr> <td style="width: 10%;"></td> <td style="width: 10%;"></td> <td style="width: 10%;"></td> <td style="width: 10%;"></td> <td style="width: 10%;"></td> <td style="width: 10%;"></td> <td style="width: 10%;"></td> <td style="width: 10%;"></td> <td style="width: 10%;"></td> <td style="width: 10%;"></td> </tr> <tr> <td></td> <td></td> <td colspan="8" style="text-align: center;"> <table border="1" style="width: 100%; border-collapse: collapse; text-align: center;"> <tr> <td style="width: 10%;"></td> <td style="width: 10%;"></td> <td style="width: 10%;"></td> <td style="width: 10%;"></td> <td style="width: 10%;"></td> <td style="width: 10%;"></td> <td style="width: 10%;"></td> <td style="width: 10%;"></td> <td style="width: 10%;"></td> <td style="width: 10%;"></td> </tr> <tr> <td></td> <td></td> <td colspan="8" style="text-align: center;"> <table border="1" style="width: 100%; border-collapse: collapse; text-align: center;"> <tr> </tr></table></td></tr></table></td></tr></table></td></tr></table></td></tr></table>
 | | | |
 | | | | | | | | | | | | | | | <table border="1" style="width: 100%; border-collapse: collapse; text-align: center;"> <tr> <td style="width: 10%;"></td> <td style="width: 10%;"></td> <td style="width: 10%;"></td> <td style="width: 10%;"></td> <td style="width: 10%;"></td> <td style="width: 10%;"></td> <td style="width: 10%;"></td> <td style="width: 10%;"></td> <td style="width: 10%;"></td> <td style="width: 10%;"></td> </tr> <tr> <td></td> <td></td> <td colspan="8" style="text-align: center;"> <table border="1" style="width: 100%; border-collapse: collapse; text-align: center;"> <tr> <td style="width: 10%;"></td> <td style="width: 10%;"></td> <td style="width: 10%;"></td> <td style="width: 10%;"></td> <td style="width: 10%;"></td> <td style="width: 10%;"></td> <td style="width: 10%;"></td> <td style="width: 10%;"></td> <td style="width: 10%;"></td> <td style="width: 10%;"></td> </tr> <tr> <td></td> <td></td> <td colspan="8" style="text-align: center;"> <table border="1" style="width: 100%; border-collapse: collapse; text-align: center;"> <tr> <td style="width: 10%;"></td> <td style="width: 10%;"></td> <td style="width: 10%;"></td> <td style="width: 10%;"></td> <td style="width: 10%;"></td> <td style="width: 10%;"></td> <td style="width: 10%;"></td> <td style="width: 10%;"></td> <td style="width: 10%;"></td> <td style="width: 10%;"></td> </tr> <tr> <td></td> <td></td> <td colspan="8" style="text-align: center;"> <table border="1" style="width: 100%; border-collapse: collapse; text-align: center;"> <tr> </tr></table></td></tr></table></td></tr></table></td></tr></table>
 | | | | | | | | | | | | | | | | | | | | <table border="1" style="width: 100%; border-collapse: collapse; text-align: center;"> <tr> <td style="width: 10%;"></td> <td style="width: 10%;"></td> <td style="width: 10%;"></td> <td style="width: 10%;"></td> <td style="width: 10%;"></td> <td style="width: 10%;"></td> <td style="width: 10%;"></td> <td style="width: 10%;"></td> <td style="width: 10%;"></td> <td style="width: 10%;"></td> </tr> <tr> <td></td> <td></td> <td colspan="8" style="text-align: center;"> <table border="1" style="width: 100%; border-collapse: collapse; text-align: center;"> <tr> <td style="width: 10%;"></td> <td style="width: 10%;"></td> <td style="width: 10%;"></td> <td style="width: 10%;"></td> <td style="width: 10%;"></td> <td style="width: 10%;"></td> <td style="width: 10%;"></td> <td style="width: 10%;"></td> <td style="width: 10%;"></td> <td style="width: 10%;"></td> </tr> <tr> <td></td> <td></td> <td colspan="8" style="text-align: center;"> <table border="1" style="width: 100%; border-collapse: collapse; text-align: center;"> <tr> </tr></table></td></tr></table></td></tr></table>
 | | | | | | | | | | | | | | | | | | | | <table border="1" style="width: 100%; border-collapse: collapse; text-align: center;"> <tr> <td style="width: 10%;"></td> <td style="width: 10%;"></td> <td style="width: 10%;"></td> <td style="width: 10%;"></td> <td style="width: 10%;"></td> <td style="width: 10%;"></td> <td style="width: 10%;"></td> <td style="width: 10%;"></td> <td style="width: 10%;"></td> <td style="width: 10%;"></td> </tr> <tr> <td></td> <td></td> <td colspan="8" style="text-align: center;"> <table border="1" style="width: 100%; border-collapse: collapse; text-align: center;"> <tr> </tr></table></td></tr></table>
 | | | | | | | | | | | | | | | | | | | | <table border="1" style="width: 100%; border-collapse: collapse; text-align: center;"> <tr> </tr></table>
 | | | | | | | | | | | | | | | | | | | | | | | | | | | | | | | | | | | | | | | | | | | | | | | | | | | | | | | | | | | | | | | | | | | | | | | | | | | | | | | |
 | | | | | | | | | | | | | | | | | | | |
 | | | | | | | | | | | | | | | | | | | |
 | | | | | | | | | | | | | | | | | | | |
 | | | | | | | | | | | | | | | | | | | |
 | | | | | | | | | | | | | | | | | | | |
 | | | | | | | | | | | | | | | | | | | | | | | | | | | | | | | | | | | | | | | |
 | | | | | | | | | | | | | | | | | | | |
 | | | | | | | | | | | | | | | | | | | | | | | | | | | | | | | | | | | | | | | |
 | | | | | | | | | | | | | | | | | | | | | | | | | | | | | | | | | | | | | | | |
 | | | | | | | | | | | | | | | | | | | | | | | | | | | | | | | | | | | | | | | |
 | | | | | | | | | | | | | | | | | | | | | | | | | | | | | | | | | | | | | | | | | | | | | | | | | | | | | | | | | | | | | | | | | | | | | | | | | | | | | | | |
 | | | | | | | | | | | | | | | | | | | | | | | | | | | | | | | | | | | | | | | | | | | | | | | | | | | | | | | | | | | | | | | | | | | |
| | |

 | | | | | | | | | | | | | | | | | | | |

 | | | | | | | | | | | | | | | | | | | |

 | | | | | | | | | | | | | | | | | | | |

 | | | | | | | | | | | | | | | | | | | |

 | | | | | | | | | | | | | | | | | | | |

 | | | | | | | | | | | | | | | | | | | |

 | | | | | | | | | | | | | | | | | | | |

 | | | | | | | | | | | | | | | | | | | |

 | | | | | | | | | | | | | | | | | | | |

 | | | | | | | | | | | | | | | | | | | |

 | | | | | | | | | | | | | | | | | | | |

 | | | | | | | | | | | | | | | | | | | |

 | | | | | | | | | | | | | | | | | | | |

 | | | | | | | | | | | | | | | | | | | |

 | | | | | | | | | | | | | | | | | | | |

 | | | | | | | | | | | | | | | | | | | |

 | | | | | | | | | | | | | | | | | | | |

 | | | | | | | | | | | | | | | | | | | |

 | | | | | | | | | | | | | | | | | | | |

 | | | | | | | | | | | | | | | | | | | |

 | | | | | | | | | | | | | | | | | | | |

 | | | | | | | | | | | | | | | | | | | |

 | | | | | | | | | | | | | | | | | | | |

 | | | | | | | | | | | | | | | | | | | |

 | | | | | | | | | | | | | | | | | | | |

 | | | | | | | | | | | | | | | | | | | |

 | | | | | | | | | | | | | | | | | | | |

 | | | | | | | | | | | | | | | | | | | |
 | | | | | | | | | | | | | | | | | | | |

 | | | | | | | | | | | | | | | | | | | |

 | | | | | | | | | | | | | | | | | | | |
 | | | | | | | | | | | | | | | | | | | |

 | | | | | | | | | | | | | | | | | | | |

 | | | | | | | | | | | | | | | | | | | |
 | | | | | | | | | | | | | | | | | | | |
 | | | | | | | | | | | | | | | | | | | |

 | | | | | | | | | | | | | | | | | | | |
 | | | | | | | | | | | | | | | | | | | |
 | | | | | | | | | | | | | | | | | | | |

 | | | | | | | | | | | | | | | | | | | | | | | | | | | | | | | | | | | | | | | | | | | | | | | | | | | | | | | | | | | | | | | | | | | | | | | | | | | | | | | | | | | | | | | | | | | | | | | | | | | |
 | | | | | | | | | | | | | | | | | | | |
 | | | | | | | | | | | | | | | | | | | |
 | | | | | | | | | | | | | | | | | | | |
 | | | | | | | | | | | | | | | | | | | |
 | | | | | | | | | | | | | | | | | | | |
 | | | | | | | | | | | | | | | | | | | |
 | | | | | | | | | | | | | | | | | | | |
 | | | | | | | | | | | | | | | | | | | |
 | | | | | | | | | | | | | | | | | | | | | | | | | | | | | | | | | | | | | | | |
 | | | | | | | | | | | | | | | | | | | |
 | | | | | | | | | | | | | | | | | | | | | | | | | | | | | | | | | | | | | | | |
 | | | | | | | | | | | | | | | | | | | | | | | | | | | | | | | | | | | | | | | |
 | | | | | | | | | | | | | | | | | | | | | | | | | | | | | | | | | | | | | | | |
 | | | | | | | | | | | | | | | | | | | | | | | | | | | | | | | | | | | | | | | | | | | | | | | | | | | | | | | | | | | | | | | | | | | | | | | | | | | | | | | | | | | | | | | | | | | | | | | | | | | |
 | | | | | | | | | | | | | | | | | | | | | | | | | | | | | | | | | | | | | | | | | | | | | | | |
| | | <table border="1" style="width: 100%; border-collapse: collapse; text-align: center;"> <tr> <td style="width: 10%;"></td> <td style="width: 10%;"></td> <td style="width: 10%;"></td> <td style="width: 10%;"></td> <td style="width: 10%;"></td> <td style="width: 10%;"></td> <td style="width: 10%;"></td> <td style="width: 10%;"></td> <td style="width: 10%;"></td> <td style="width: 10%;"></td> </tr> <tr> <td></td> <td></td> <td colspan="8" style="text-align: center;"> <table border="1" style="width: 100%; border-collapse: collapse; text-align: center;"> <tr> <td style="width: 10%;"></td> <td style="width: 10%;"></td> <td style="width: 10%;"></td> <td style="width: 10%;"></td> <td style="width: 10%;"></td> <td style="width: 10%;"></td> <td style="width: 10%;"></td> <td style="width: 10%;"></td> <td style="width: 10%;"></td> <td style="width: 10%;"></td> </tr> <tr> <td></td> <td></td> <td colspan="8" style="text-align: center;"> <table border="1" style="width: 100%; border-collapse: collapse; text-align: center;"> <tr> <td style="width: 10%;"></td> <td style="width: 10%;"></td> <td style="width: 10%;"></td> <td style="width: 10%;"></td> <td style="width: 10%;"></td> <td style="width: 10%;"></td> <td style="width: 10%;"></td> <td style="width: 10%;"></td> <td style="width: 10%;"></td> <td style="width: 10%;"></td> </tr> <tr> <td></td> <td></td> <td colspan="8" style="text-align: center;"> <table border="1" style="width: 100%; border-collapse: collapse; text-align: center;"> <tr> <td style="width: 10%;"></td> <td style="width: 10%;"></td> <td style="width: 10%;"></td> <td style="width: 10%;"></td> <td style="width: 10%;"></td> <td style="width: 10%;"></td> <td style="width: 10%;"></td> <td style="width: 10%;"></td> <td style="width: 10%;"></td> <td style="width: 10%;"></td> </tr> <tr> <td></td> <td></td> <td colspan="8" style="text-align: center;"> <table border="1" style="width: 100%; border-collapse: collapse; text-align: center;"> <tr> <td style="width: 10%;"></td> <td style="width: 10%;"></td> <td style="width: 10%;"></td> <td style="width: 10%;"></td> <td style="width: 10%;"></td> <td style="width: 10%;"></td> <td style="width: 10%;"></td> <td style="width: 10%;"></td> <td style="width: 10%;"></td> <td style="width: 10%;"></td> </tr> <tr> <td></td> <td></td> <td colspan="8" style="text-align: center;"> <table border="1" style="width: 100%; border-collapse: collapse; text-align: center;"> <tr> <td style="width: 10%;"></td> <td style="width: 10%;"></td> <td style="width: 10%;"></td> <td style="width: 10%;"></td> <td style="width: 10%;"></td> <td style="width: 10%;"></td> <td style="width: 10%;"></td> <td style="width: 10%;"></td> <td style="width: 10%;"></td> <td style="width: 10%;"></td> </tr> <tr> <td></td> <td></td> <td colspan="8" style="text-align: center;"> <table border="1" style="width: 100%; border-collapse: collapse; text-align: center;"> <tr> <td style="width: 10%;"></td> <td style="width: 10%;"></td> <td style="width: 10%;"></td> <td style="width: 10%;"></td> <td style="width: 10%;"></td> <td style="width: 10%;"></td> <td style="width: 10%;"></td> <td style="width: 10%;"></td> <td style="width: 10%;"></td> <td style="width: 10%;"></td> </tr> <tr> <td></td> <td></td> <td colspan="8" style="text-align: center;"> <table border="1" style="width: 100%; border-collapse: collapse; text-align: center;"> <tr> <td style="width: 10%;"></td> <td style="width: 10%;"></td> <td style="width: 10%;"></td> <td style="width: 10%;"></td> <td style="width: 10%;"></td> <td style="width: 10%;"></td> <td style="width: 10%;"></td> <td style="width: 10%;"></td> <td style="width: 10%;"></td> <td style="width: 10%;"></td> </tr> <tr> <td></td> <td></td> <td colspan="8" style="text-align: center;"> <table border="1" style="width: 100%; border-collapse: collapse; text-align: center;"> <tr> <td style="width: 10%;"></td> <td style="width: 10%;"></td> <td style="width: 10%;"></td> <td style="width: 10%;"></td> <td style="width: 10%;"></td> <td style="width: 10%;"></td> <td style="width: 10%;"></td> <td style="width: 10%;"></td> <td style="width: 10%;"></td> <td style="width: 10%;"></td> </tr> <tr> <td></td> <td></td> <td colspan="8" style="text-align: center;"> <table border="1" style="width: 100%; border-collapse: collapse; text-align: center;"> <tr> <td style="width: 10%;"></td> <td style="width: 10%;"></td> <td style="width: 10%;"></td> <td style="width: 10%;"></td> <td style="width: 10%;"></td> <td style="width: 10%;"></td> <td style="width: 10%;"></td> <td style="width: 10%;"></td> <td style="width: 10%;"></td> <td style="width: 10%;"></td> </tr> <tr> <td></td> <td></td> <td colspan="8" style="text-align: center;"> <table border="1" style="width: 100%; border-collapse: collapse; text-align: center;"> <tr> <td style="width: 10%;"></td> <td style="width: 10%;"></td> <td style="width: 10%;"></td> <td style="width: 10%;"></td> <td style="width: 10%;"></td> <td style="width: 10%;"></td> <td style="width: 10%;"></td> <td style="width: 10%;"></td> <td style="width: 10%;"></td> <td style="width: 10%;"></td> </tr> <tr> <td></td> <td></td> <td colspan="8" style="text-align: center;"> <table border="1" style="width: 100%; border-collapse: collapse; text-align: center;"> <tr> <td style="width: 10%;"></td> <td style="width: 10%;"></td> <td style="width: 10%;"></td> <td style="width: 10%;"></td> <td style="width: 10%;"></td> <td style="width: 10%;"></td> <td style="width: 10%;"></td> <td style="width: 10%;"></td> <td style="width: 10%;"></td> <td style="width: 10%;"></td> </tr> <tr> <td></td> <td></td> <td colspan="8" style="text-align: center;"> <table border="1" style="width: 100%; border-collapse: collapse; text-align: center;"> <tr> <td style="width: 10%;"></td> <td style="width: 10%;"></td> <td style="width: 10%;"></td> <td style="width: 10%;"></td> <td style="width: 10%;"></td> <td style="width: 10%;"></td> <td style="width: 10%;"></td> <td style="width: 10%;"></td> <td style="width: 10%;"></td> <td style="width: 10%;"></td> </tr> <tr> <td></td> <td></td> <td colspan="8" style="text-align: center;"> <table border="1" style="width: 100%; border-collapse: collapse; text-align: center;"> <tr> <td style="width: 10%;"></td> <td style="width: 10%;"></td> <td style="width: 10%;"></td> <td style="width: 10%;"></td> <td style="width: 10%;"></td> <td style="width: 10%;"></td> <td style="width: 10%;"></td> <td style="width: 10%;"></td> <td style="width: 10%;"></td> <td style="width: 10%;"></td> </tr> <tr> <td></td> <td></td> <td colspan="8" style="text-align: center;"> <table border="1" style="width: 100%; border-collapse: collapse; text-align: center;"> <tr> <td style="width: 10%;"></td> <td style="width: 10%;"></td> <td style="width: 10%;"></td> <td style="width: 10%;"></td> <td style="width: 10%;"></td> <td style="width: 10%;"></td> <td style="width: 10%;"></td> <td style="width: 10%;"></td> <td style="width: 10%;"></td> <td style="width: 10%;"></td> </tr> <tr> <td></td> <td></td> <td colspan="8" style="text-align: center;"> <table border="1" style="width: 100%; border-collapse: collapse; text-align: center;"> <tr> <td style="width: 10%;"></td> <td style="width: 10%;"></td> <td style="width: 10%;"></td> <td style="width: 10%;"></td> <td style="width: 10%;"></td> <td style="width: 10%;"></td> <td style="width: 10%;"></td> <td style="width: 10%;"></td> <td style="width: 10%;"></td> <td style="width: 10%;"></td> </tr> <tr> <td></td> <td></td> <td colspan="8" style="text-align: center;"> <table border="1" style="width: 100%; border-collapse: collapse; text-align: center;"> <tr> <td style="width: 10%;"></td> <td style="width: 10%;"></td> <td style="width: 10%;"></td> <td style="width: 10%;"></td> <td style="width: 10%;"></td> <td style="width: 10%;"></td> <td style="width: 10%;"></td> <td style="width: 10%;"></td> <td style="width: 10%;"></td> <td style="width: 10%;"></td> </tr> <tr> <td></td> <td></td> <td colspan="8" style="text-align: center;"> <table border="1" style="width: 100%; border-collapse: collapse; text-align: center;"> <tr> <td style="width: 10%;"></td> <td style="width: 10%;"></td> <td style="width: 10%;"></td> <td style="width: 10%;"></td> <td style="width: 10%;"></td> <td style="width: 10%;"></td> <td style="width: 10%;"></td> <td style="width: 10%;"></td> <td style="width: 10%;"></td> <td style="width: 10%;"></td> </tr> <tr> <td></td> <td></td> <td colspan="8" style="text-align: center;"> <table border="1" style="width: 100%; border-collapse: collapse; text-align: center;"> <tr> <td style="width: 10%;"></td> <td style="width: 10%;"></td> <td style="width: 10%;"></td> <td style="width: 10%;"></td> <td style="width: 10%;"></td> <td style="width: 10%;"></td> <td style="width: 10%;"></td> <td style="width: 10%;"></td> <td style="width: 10%;"></td> <td style="width: 10%;"></td> </tr> <tr> <td></td> <td></td> <td colspan="8" style="text-align: center;"> <table border="1" style="width: 100%; border-collapse: collapse; text-align: center;"> <tr> <td style="width: 10%;"></td> <td style="width: 10%;"></td> <td style="width: 10%;"></td> <td style="width: 10%;"></td> <td style="width: 10%;"></td> <td style="width: 10%;"></td> <td style="width: 10%;"></td> <td style="width: 10%;"></td> <td style="width: 10%;"></td> <td style="width: 10%;"></td> </tr> <tr> <td></td> <td></td> <td colspan="8" style="text-align: center;"> <table border="1" style="width: 100%; border-collapse: collapse; text-align: center;"> <tr> <td style="width: 10%;"></td> <td style="width: 10%;"></td> <td style="width: 10%;"></td> <td style="width: 10%;"></td> <td style="width: 10%;"></td> <td style="width: 10%;"></td> <td style="width: 10%;"></td> <td style="width: 10%;"></td> <td style="width: 10%;"></td> <td style="width: 10%;"></td> </tr> <tr> <td></td> <td></td> <td colspan="8" style="text-align: center;"> <table border="1" style="width: 100%; border-collapse: collapse; text-align: center;"> <tr> <td style="width: 10%;"></td> <td style="width: 10%;"></td> <td
style="width: 10%;"></td> <td style="width: 10%;"></td> <td style="width: 10%;"></td> <td style="width: 10%;"></td> <td style="width: 10%;"></td> <td style="width: 10%;"></td> <td style="width: 10%;"></td> <td style="width: 10%;"></td> </tr> <tr> <td></td> <td></td> <td colspan="8" style="text-align: center;"> <table border="1" style="width: 100%; border-collapse: collapse; text-align: center;"> <tr> <td style="width: 10%;"></td> <td style="width: 10%;"></td> <td style="width: 10%;"></td> <td style="width: 10%;"></td> <td style="width: 10%;"></td> <td style="width: 10%;"></td> <td style="width: 10%;"></td> <td style="width: 10%;"></td> <td style="width: 10%;"></td> <td style="width: 10%;"></td> </tr> <tr> <td></td> <td></td> <td colspan="8" style="text-align: center;"> <table border="1" style="width: 100%; border-collapse: collapse; text-align: center;"> <tr> <td style="width: 10%;"></td> <td style="width: 10%;"></td> <td style="width: 10%;"></td> <td style="width: 10%;"></td> <td style="width: 10%;"></td> <td style="width: 10%;"></td> <td style="width: 10%;"></td> <td style="width: 10%;"></td> <td style="width: 10%;"></td> <td style="width: 10%;"></td> </tr> <tr> <td></td> <td></td> <td colspan="8" style="text-align: center;"> <table border="1" style="width: 100%; border-collapse: collapse; text-align: center;"> <tr> <td style="width: 10%;"></td> <td style="width: 10%;"></td> <td style="width: 10%;"></td> <td style="width: 10%;"></td> <td style="width: 10%;"></td> <td style="width: 10%;"></td> <td style="width: 10%;"></td> <td style="width: 10%;"></td> <td style="width: 10%;"></td> <td style="width: 10%;"></td> </tr> <tr> <td></td> <td></td> <td colspan="8" style="text-align: center;"> <table border="1" style="width: 100%; border-collapse: collapse; text-align: center;"> <tr> <td style="width: 10%;"></td> <td style="width: 10%;"></td> <td style="width: 10%;"></td> <td style="width: 10%;"></td> <td style="width: 10%;"></td> <td style="width: 10%;"></td> <td style="width: 10%;"></td> <td style="width: 10%;"></td> <td style="width: 10%;"></td> <td style="width: 10%;"></td> </tr> <tr> <td></td> <td></td> <td colspan="8" style="text-align: center;"> <table border="1" style="width: 100%; border-collapse: collapse; text-align: center;"> <tr> <td style="width: 10%;"></td> <td style="width: 10%;"></td> <td style="width: 10%;"></td> <td style="width: 10%;"></td> <td style="width: 10%;"></td> <td style="width: 10%;"></td> <td style="width: 10%;"></td> <td style="width: 10%;"></td> <td style="width: 10%;"></td> <td style="width: 10%;"></td> </tr> <tr> <td></td> <td></td> <td colspan="8" style="text-align: center;"> <table border="1" style="width: 100%; border-collapse: collapse; text-align: center;"> <tr> <td style="width: 10%;"></td> <td style="width: 10%;"></td> <td style="width: 10%;"></td> <td style="width: 10%;"></td> <td style="width: 10%;"></td> <td style="width: 10%;"></td> <td style="width: 10%;"></td> <td style="width: 10%;"></td> <td style="width: 10%;"></td> <td style="width: 10%;"></td> </tr> <tr> <td></td> <td></td> <td colspan="8" style="text-align: center;"> <table border="1" style="width: 100%; border-collapse: collapse; text-align: center;"> <tr> <td style="width: 10%;"></td> <td style="width: 10%;"></td> <td style="width: 10%;"></td> <td style="width: 10%;"></td> <td style="width: 10%;"></td> <td style="width: 10%;"></td> <td style="width: 10%;"></td> <td style="width: 10%;"></td> <td style="width: 10%;"></td> <td style="width: 10%;"></td> </tr> <tr> <td></td> <td></td> <td colspan="8" style="text-align: center;"> <table border="1" style="width: 100%; border-collapse: collapse; text-align: center;"> <tr> <td style="width: 10%;"></td> <td style="width: 10%;"></td> <td style="width: 10%;"></td> <td style="width: 10%;"></td> <td style="width: 10%;"></td> <td style="width: 10%;"></td> <td style="width: 10%;"></td> <td style="width: 10%;"></td> <td style="width: 10%;"></td> <td style="width: 10%;"></td> </tr> <tr> <td></td> <td></td> <td colspan="8" style="text-align: center;"> <table border="1" style="width: 100%; border-collapse: collapse; text-align: center;"> <tr> <td style="width: 10%;"></td> <td style="width: 10%;"></td> <td style="width: 10%;"></td> <td style="width: 10%;"></td> <td style="width: 10%;"></td> <td style="width: 10%;"></td> <td style="width: 10%;"></td> <td style="width: 10%;"></td> <td style="width: 10%;"></td> <td style="width: 10%;"></td> </tr> <tr> <td></td> <td></td> <td colspan="8" style="text-align: center;"> <table border="1" style="width: 100%; border-collapse: collapse; text-align: center;"> <tr> <td style="width: 10%;"></td> <td style="width: 10%;"></td> <td style="width: 10%;"></td> <td style="width: 10%;"></td> <td style="width: 10%;"></td> <td style="width: 10%;"></td> <td style="width: 10%;"></td> <td style="width: 10%;"></td> <td style="width: 10%;"></td> <td style="width: 10%;"></td> </tr> <tr> <td></td> <td></td> <td colspan="8" style="text-align: center;"> <table border="1" style="width: 100%; border-collapse: collapse; text-align: center;"> <tr> <td style="width: 10%;"></td> <td style="width: 10%;"></td> <td style="width: 10%;"></td> <td style="width: 10%;"></td> <td style="width: 10%;"></td> <td style="width: 10%;"></td> <td style="width: 10%;"></td> <td style="width: 10%;"></td> <td style="width: 10%;"></td> <td style="width: 10%;"></td> </tr> <tr> <td></td> <td></td> <td colspan="8" style="text-align: center;"> <table border="1" style="width: 100%; border-collapse: collapse; text-align: center;"> <tr> <td style="width: 10%;"></td> <td style="width: 10%;"></td> <td style="width: 10%;"></td> <td style="width: 10%;"></td> <td style="width: 10%;"></td> <td style="width: 10%;"></td> <td style="width: 10%;"></td> <td style="width: 10%;"></td> <td style="width: 10%;"></td> <td style="width: 10%;"></td> </tr> <tr> <td></td> <td></td> <td colspan="8" style="text-align: center;"> <table border="1" style="width: 100%; border-collapse: collapse; text-align: center;"> <tr> <td style="width: 10%;"></td> <td style="width: 10%;"></td> <td style="width: 10%;"></td> <td style="width: 10%;"></td> <td style="width: 10%;"></td> <td style="width: 10%;"></td> <td style="width: 10%;"></td> <td style="width: 10%;"></td> <td style="width: 10%;"></td> <td style="width: 10%;"></td> </tr> <tr> <td></td> <td></td> <td colspan="8" style="text-align: center;"> <table border="1" style="width: 100%; border-collapse: collapse; text-align: center;"> <tr> <td style="width: 10%;"></td> <td style="width: 10%;"></td> <td style="width: 10%;"></td> <td style="width: 10%;"></td> <td style="width: 10%;"></td> <td style="width: 10%;"></td> <td style="width: 10%;"></td> <td style="width: 10%;"></td> <td style="width: 10%;"></td> <td style="width: 10%;"></td> </tr> <tr> <td></td> <td></td> <td colspan="8" style="text-align: center;"> <table border="1" style="width: 100%; border-collapse: collapse; text-align: center;"> <tr> <td style="width: 10%;"></td> <td style="width: 10%;"></td> <td style="width: 10%;"></td> <td style="width: 10%;"></td> <td style="width: 10%;"></td> <td style="width: 10%;"></td> <td style="width: 10%;"></td> <td style="width: 10%;"></td> <td style="width: 10%;"></td> <td style="width: 10%;"></td> </tr> <tr> <td></td> <td></td> <td colspan="8" style="text-align: center;"> <table border="1" style="width: 100%; border-collapse: collapse; text-align: center;"> <tr> <td style="width: 10%;"></td> <td style="width: 10%;"></td> <td style="width: 10%;"></td> <td style="width: 10%;"></td> <td style="width: 10%;"></td> <td style="width: 10%;"></td> <td style="width: 10%;"></td> <td style="width: 10%;"></td> <td style="width: 10%;"></td> <td style="width: 10%;"></td> </tr> <tr> <td></td> <td></td> <td colspan="8" style="text-align: center;"> <table border="1" style="width: 100%; border-collapse: collapse; text-align: center;"> <tr> <td style="width: 10%;"></td> <td style="width: 10%;"></td> <td style="width: 10%;"></td> <td style="width: 10%;"></td> <td style="width: 10%;"></td> <td style="width: 10%;"></td> <td style="width: 10%;"></td> <td style="width: 10%;"></td> <td style="width: 10%;"></td> <td style="width: 10%;"></td> </tr> <tr> <td></td> <td></td> <td colspan="8" style="text-align: center;"> <table border="1" style="width: 100%; border-collapse: collapse; text-align: center;"> <tr> <td style="width: 10%;"></td> <td style="width: 10%;"></td> <td style="width: 10%;"></td> <td style="width: 10%;"></td> <td style="width: 10%;"></td> <td style="width: 10%;"></td> <td style="width: 10%;"></td> <td style="width: 10%;"></td> <td style="width: 10%;"></td> <td style="width: 10%;"></td> </tr> <tr> <td></td> <td></td> <td colspan="8" style="text-align: center;"> <table border="1" style="width: 100%; border-collapse: collapse; text-align: center;"> <tr> <td style="width: 10%;"></td> <td style="width: 10%;"></td> <td style="width: 10%;"></td> <td style="width: 10%;"></td> <td style="width: 10%;"></td> <td style="width: 10%;"></td> <td style="width: 10%;"></td> <td style="width: 10%;"></td> <td style="width: 10%;"></td> <td style="width: 10%;"></td> </tr> <tr> <td></td> <td></td> <td colspan="8" style="text-align: center;"> <table border="1" style="width: 100%; border-collapse: collapse; text-align: center;"> <tr>
</tr></table></td></tr></table></td></tr></table></td></tr></table></td></tr></table></td></tr></table></td></tr></table></td></tr></table></td></tr></table></td></tr></table></td></tr></table></td></tr></table></td></tr></table></td></tr></table></td></tr></table></td></tr></table></td></tr></table></td></tr></table></td></tr></table></td></tr></table></td></tr></table></td></tr></table></td></tr></table></td></tr></table></td></tr></table></td></tr></table></td></tr></table></td></tr></table></td></tr></table></td></tr></table></td></tr></table></td></tr></table></td></tr></table></td></tr></table></td></tr></table></td></tr></table></td></tr></table></td></tr></table></td></tr></table></td></tr></table></td></tr></table></td></tr></table>
 | | | | | | | | | | | | | | | | | | | | <table border="1" style="width: 100%; border-collapse: collapse; text-align: center;"> <tr> <td style="width: 10%;"></td> <td style="width: 10%;"></td> <td style="width: 10%;"></td> <td style="width: 10%;"></td> <td style="width: 10%;"></td> <td style="width: 10%;"></td> <td style="width: 10%;"></td> <td style="width: 10%;"></td> <td style="width: 10%;"></td> <td style="width: 10%;"></td> </tr> <tr> <td></td> <td></td> <td colspan="8" style="text-align: center;"> <table border="1" style="width: 100%; border-collapse: collapse; text-align: center;"> <tr> <td style="width: 10%;"></td> <td style="width: 10%;"></td> <td style="width: 10%;"></td> <td style="width: 10%;"></td> <td style="width: 10%;"></td> <td style="width: 10%;"></td> <td style="width: 10%;"></td> <td style="width: 10%;"></td> <td style="width: 10%;"></td> <td style="width: 10%;"></td> </tr> <tr> <td></td> <td></td> <td colspan="8" style="text-align: center;"> <table border="1" style="width: 100%; border-collapse: collapse; text-align: center;"> <tr> <td style="width: 10%;"></td> <td style="width: 10%;"></td> <td style="width: 10%;"></td> <td style="width: 10%;"></td> <td style="width: 10%;"></td> <td style="width: 10%;"></td> <td style="width: 10%;"></td> <td style="width: 10%;"></td> <td style="width: 10%;"></td> <td style="width: 10%;"></td> </tr> <tr> <td></td> <td></td> <td colspan="8" style="text-align: center;"> <table border="1" style="width: 100%; border-collapse: collapse; text-align: center;"> <tr> <td style="width: 10%;"></td> <td style="width: 10%;"></td> <td style="width: 10%;"></td> <td style="width: 10%;"></td> <td style="width: 10%;"></td> <td style="width: 10%;"></td> <td style="width: 10%;"></td> <td style="width: 10%;"></td> <td style="width: 10%;"></td> <td style="width: 10%;"></td> </tr> <tr> <td></td> <td></td> <td colspan="8" style="text-align: center;"> <table border="1" style="width: 100%; border-collapse: collapse; text-align: center;"> <tr> <td style="width: 10%;"></td> <td style="width: 10%;"></td> <td style="width: 10%;"></td> <td style="width: 10%;"></td> <td style="width: 10%;"></td> <td style="width: 10%;"></td> <td style="width: 10%;"></td> <td style="width: 10%;"></td> <td style="width: 10%;"></td> <td style="width: 10%;"></td> </tr> <tr> <td></td> <td></td> <td colspan="8" style="text-align: center;"> <table border="1" style="width: 100%; border-collapse: collapse; text-align: center;"> <tr> <td style="width: 10%;"></td> <td style="width: 10%;"></td> <td style="width: 10%;"></td> <td style="width: 10%;"></td> <td style="width: 10%;"></td> <td style="width: 10%;"></td> <td style="width: 10%;"></td> <td style="width: 10%;"></td> <td style="width: 10%;"></td> <td style="width: 10%;"></td> </tr> <tr> <td></td> <td></td> <td colspan="8" style="text-align: center;"> <table border="1" style="width: 100%; border-collapse: collapse; text-align: center;"> <tr> <td style="width: 10%;"></td> <td style="width: 10%;"></td> <td style="width: 10%;"></td> <td style="width: 10%;"></td> <td style="width: 10%;"></td> <td style="width: 10%;"></td> <td style="width: 10%;"></td> <td style="width: 10%;"></td> <td style="width: 10%;"></td> <td style="width: 10%;"></td> </tr> <tr> <td></td> <td></td> <td colspan="8" style="text-align: center;"> <table border="1" style="width: 100%; border-collapse: collapse; text-align: center;"> <tr> <td style="width: 10%;"></td> <td style="width: 10%;"></td> <td style="width: 10%;"></td> <td style="width: 10%;"></td> <td style="width: 10%;"></td> <td style="width: 10%;"></td> <td style="width: 10%;"></td> <td style="width: 10%;"></td> <td style="width: 10%;"></td> <td style="width: 10%;"></td> </tr> <tr> <td></td> <td></td> <td colspan="8" style="text-align: center;"> <table border="1" style="width: 100%; border-collapse: collapse; text-align: center;"> <tr> <td style="width: 10%;"></td> <td style="width: 10%;"></td> <td style="width: 10%;"></td> <td style="width: 10%;"></td> <td style="width: 10%;"></td> <td style="width: 10%;"></td> <td style="width: 10%;"></td> <td style="width: 10%;"></td> <td style="width: 10%;"></td> <td style="width: 10%;"></td> </tr> <tr> <td></td> <td></td> <td colspan="8" style="text-align: center;"> <table border="1" style="width: 100%; border-collapse: collapse; text-align: center;"> <tr> <td style="width: 10%;"></td> <td style="width: 10%;"></td> <td style="width: 10%;"></td> <td style="width: 10%;"></td> <td style="width: 10%;"></td> <td style="width: 10%;"></td> <td style="width: 10%;"></td> <td style="width: 10%;"></td> <td style="width: 10%;"></td> <td style="width: 10%;"></td> </tr> <tr> <td></td> <td></td> <td colspan="8" style="text-align: center;"> <table border="1" style="width: 100%; border-collapse: collapse; text-align: center;"> <tr> <td style="width: 10%;"></td> <td style="width: 10%;"></td> <td style="width: 10%;"></td> <td style="width: 10%;"></td> <td style="width: 10%;"></td> <td style="width: 10%;"></td> <td style="width: 10%;"></td> <td style="width: 10%;"></td> <td style="width: 10%;"></td> <td style="width: 10%;"></td> </tr> <tr> <td></td> <td></td> <td colspan="8" style="text-align: center;"> <table border="1" style="width: 100%; border-collapse: collapse; text-align: center;"> <tr> <td style="width: 10%;"></td> <td style="width: 10%;"></td> <td style="width: 10%;"></td> <td style="width: 10%;"></td> <td style="width: 10%;"></td> <td style="width: 10%;"></td> <td style="width: 10%;"></td> <td style="width: 10%;"></td> <td style="width: 10%;"></td> <td style="width: 10%;"></td> </tr> <tr> <td></td> <td></td> <td colspan="8" style="text-align: center;"> <table border="1" style="width: 100%; border-collapse: collapse; text-align: center;"> <tr> <td style="width: 10%;"></td> <td style="width: 10%;"></td> <td style="width: 10%;"></td> <td style="width: 10%;"></td> <td style="width: 10%;"></td> <td style="width: 10%;"></td> <td style="width: 10%;"></td> <td style="width: 10%;"></td> <td style="width: 10%;"></td> <td style="width: 10%;"></td> </tr> <tr> <td></td> <td></td> <td colspan="8" style="text-align: center;"> <table border="1" style="width: 100%; border-collapse: collapse; text-align: center;"> <tr> <td style="width: 10%;"></td> <td style="width: 10%;"></td> <td style="width: 10%;"></td> <td style="width: 10%;"></td> <td style="width: 10%;"></td> <td style="width: 10%;"></td> <td style="width: 10%;"></td> <td style="width: 10%;"></td> <td style="width: 10%;"></td> <td style="width: 10%;"></td> </tr> <tr> <td></td> <td></td> <td colspan="8" style="text-align: center;"> <table border="1" style="width: 100%; border-collapse: collapse; text-align: center;"> <tr> <td style="width: 10%;"></td> <td style="width: 10%;"></td> <td style="width: 10%;"></td> <td style="width: 10%;"></td> <td style="width: 10%;"></td> <td style="width: 10%;"></td> <td style="width: 10%;"></td> <td style="width: 10%;"></td> <td style="width: 10%;"></td> <td style="width: 10%;"></td> </tr> <tr> <td></td> <td></td> <td colspan="8" style="text-align: center;"> <table border="1" style="width: 100%; border-collapse: collapse; text-align: center;"> <tr> <td style="width: 10%;"></td> <td style="width: 10%;"></td> <td style="width: 10%;"></td> <td style="width: 10%;"></td> <td style="width: 10%;"></td> <td style="width: 10%;"></td> <td style="width: 10%;"></td> <td style="width: 10%;"></td> <td style="width: 10%;"></td> <td style="width: 10%;"></td> </tr> <tr> <td></td> <td></td> <td colspan="8" style="text-align: center;"> <table border="1" style="width: 100%; border-collapse: collapse; text-align: center;"> <tr> <td style="width: 10%;"></td> <td style="width: 10%;"></td> <td style="width: 10%;"></td> <td style="width: 10%;"></td> <td style="width: 10%;"></td> <td style="width: 10%;"></td> <td style="width: 10%;"></td> <td style="width: 10%;"></td> <td style="width: 10%;"></td> <td style="width: 10%;"></td> </tr> <tr> <td></td> <td></td> <td colspan="8" style="text-align: center;"> <table border="1" style="width: 100%;
border-collapse: collapse; text-align: center;"> <tr> <td style="width: 10%;"></td> <td style="width: 10%;"></td> <td style="width: 10%;"></td> <td style="width: 10%;"></td> <td style="width: 10%;"></td> <td style="width: 10%;"></td> <td style="width: 10%;"></td> <td style="width: 10%;"></td> <td style="width: 10%;"></td> <td style="width: 10%;"></td> </tr> <tr> <td></td> <td></td> <td colspan="8" style="text-align: center;"> <table border="1" style="width: 100%; border-collapse: collapse; text-align: center;"> <tr> <td style="width: 10%;"></td> <td style="width: 10%;"></td> <td style="width: 10%;"></td> <td style="width: 10%;"></td> <td style="width: 10%;"></td> <td style="width: 10%;"></td> <td style="width: 10%;"></td> <td style="width: 10%;"></td> <td style="width: 10%;"></td> <td style="width: 10%;"></td> </tr> <tr> <td></td> <td></td> <td colspan="8" style="text-align: center;"> <table border="1" style="width: 100%; border-collapse: collapse; text-align: center;"> <tr> <td style="width: 10%;"></td> <td style="width: 10%;"></td> <td style="width: 10%;"></td> <td style="width: 10%;"></td> <td style="width: 10%;"></td> <td style="width: 10%;"></td> <td style="width: 10%;"></td> <td style="width: 10%;"></td> <td style="width: 10%;"></td> <td style="width: 10%;"></td> </tr> <tr> <td></td> <td></td> <td colspan="8" style="text-align: center;"> <table border="1" style="width: 100%; border-collapse: collapse; text-align: center;"> <tr> <td style="width: 10%;"></td> <td style="width: 10%;"></td> <td style="width: 10%;"></td> <td style="width: 10%;"></td> <td style="width: 10%;"></td> <td style="width: 10%;"></td> <td style="width: 10%;"></td> <td style="width: 10%;"></td> <td style="width: 10%;"></td> <td style="width: 10%;"></td> </tr> <tr> <td></td> <td></td> <td colspan="8" style="text-align: center;"> <table border="1" style="width: 100%; border-collapse: collapse; text-align: center;"> <tr> <td style="width: 10%;"></td> <td style="width: 10%;"></td> <td style="width: 10%;"></td> <td style="width: 10%;"></td> <td style="width: 10%;"></td> <td style="width: 10%;"></td> <td style="width: 10%;"></td> <td style="width: 10%;"></td> <td style="width: 10%;"></td> <td style="width: 10%;"></td> </tr> <tr> <td></td> <td></td> <td colspan="8" style="text-align: center;"> <table border="1" style="width: 100%; border-collapse: collapse; text-align: center;"> <tr> <td style="width: 10%;"></td> <td style="width: 10%;"></td> <td style="width: 10%;"></td> <td style="width: 10%;"></td> <td style="width: 10%;"></td> <td style="width: 10%;"></td> <td style="width: 10%;"></td> <td style="width: 10%;"></td> <td style="width: 10%;"></td> <td style="width: 10%;"></td> </tr> <tr> <td></td> <td></td> <td colspan="8" style="text-align: center;"> <table border="1" style="width: 100%; border-collapse: collapse; text-align: center;"> <tr> <td style="width: 10%;"></td> <td style="width: 10%;"></td> <td style="width: 10%;"></td> <td style="width: 10%;"></td> <td style="width: 10%;"></td> <td style="width: 10%;"></td> <td style="width: 10%;"></td> <td style="width: 10%;"></td> <td style="width: 10%;"></td> <td style="width: 10%;"></td> </tr> <tr> <td></td> <td></td> <td colspan="8" style="text-align: center;"> <table border="1" style="width: 100%; border-collapse: collapse; text-align: center;"> <tr> <td style="width: 10%;"></td> <td style="width: 10%;"></td> <td style="width: 10%;"></td> <td style="width: 10%;"></td> <td style="width: 10%;"></td> <td style="width: 10%;"></td> <td style="width: 10%;"></td> <td style="width: 10%;"></td> <td style="width: 10%;"></td> <td style="width: 10%;"></td> </tr> <tr> <td></td> <td></td> <td colspan="8" style="text-align: center;"> <table border="1" style="width: 100%; border-collapse: collapse; text-align: center;"> <tr> <td style="width: 10%;"></td> <td style="width: 10%;"></td> <td style="width: 10%;"></td> <td style="width: 10%;"></td> <td style="width: 10%;"></td> <td style="width: 10%;"></td> <td style="width: 10%;"></td> <td style="width: 10%;"></td> <td style="width: 10%;"></td> <td style="width: 10%;"></td> </tr> <tr> <td></td> <td></td> <td colspan="8" style="text-align: center;"> <table border="1" style="width: 100%; border-collapse: collapse; text-align: center;"> <tr> <td style="width: 10%;"></td> <td style="width: 10%;"></td> <td style="width: 10%;"></td> <td style="width: 10%;"></td> <td style="width: 10%;"></td> <td style="width: 10%;"></td> <td style="width: 10%;"></td> <td style="width: 10%;"></td> <td style="width: 10%;"></td> <td style="width: 10%;"></td> </tr> <tr> <td></td> <td></td> <td colspan="8" style="text-align: center;"> <table border="1" style="width: 100%; border-collapse: collapse; text-align: center;"> <tr> <td style="width: 10%;"></td> <td style="width: 10%;"></td> <td style="width: 10%;"></td> <td style="width: 10%;"></td> <td style="width: 10%;"></td> <td style="width: 10%;"></td> <td style="width: 10%;"></td> <td style="width: 10%;"></td> <td style="width: 10%;"></td> <td style="width: 10%;"></td> </tr> <tr> <td></td> <td></td> <td colspan="8" style="text-align: center;"> <table border="1" style="width: 100%; border-collapse: collapse; text-align: center;"> <tr> <td style="width: 10%;"></td> <td style="width: 10%;"></td> <td style="width: 10%;"></td> <td style="width: 10%;"></td> <td style="width: 10%;"></td> <td style="width: 10%;"></td> <td style="width: 10%;"></td> <td style="width: 10%;"></td> <td style="width: 10%;"></td> <td style="width: 10%;"></td> </tr> <tr> <td></td> <td></td> <td colspan="8" style="text-align: center;"> <table border="1" style="width: 100%; border-collapse: collapse; text-align: center;"> <tr> <td style="width: 10%;"></td> <td style="width: 10%;"></td> <td style="width: 10%;"></td> <td style="width: 10%;"></td> <td style="width: 10%;"></td> <td style="width: 10%;"></td> <td style="width: 10%;"></td> <td style="width: 10%;"></td> <td style="width: 10%;"></td> <td style="width: 10%;"></td> </tr> <tr> <td></td> <td></td> <td colspan="8" style="text-align: center;"> <table border="1" style="width: 100%; border-collapse: collapse; text-align: center;"> <tr> <td style="width: 10%;"></td> <td style="width: 10%;"></td> <td style="width: 10%;"></td> <td style="width: 10%;"></td> <td style="width: 10%;"></td> <td style="width: 10%;"></td> <td style="width: 10%;"></td> <td style="width: 10%;"></td> <td style="width: 10%;"></td> <td style="width: 10%;"></td> </tr> <tr> <td></td> <td></td> <td colspan="8" style="text-align: center;"> <table border="1" style="width: 100%; border-collapse: collapse; text-align: center;"> <tr> <td style="width: 10%;"></td> <td style="width: 10%;"></td> <td style="width: 10%;"></td> <td style="width: 10%;"></td> <td style="width: 10%;"></td> <td style="width: 10%;"></td> <td style="width: 10%;"></td> <td style="width: 10%;"></td> <td style="width: 10%;"></td> <td style="width: 10%;"></td> </tr> <tr> <td></td> <td></td> <td colspan="8" style="text-align: center;"> <table border="1" style="width: 100%; border-collapse: collapse; text-align: center;"> <tr> <td style="width: 10%;"></td> <td style="width: 10%;"></td> <td style="width: 10%;"></td> <td style="width: 10%;"></td> <td style="width: 10%;"></td> <td style="width: 10%;"></td> <td style="width: 10%;"></td> <td style="width: 10%;"></td> <td style="width: 10%;"></td> <td style="width: 10%;"></td> </tr> <tr> <td></td> <td></td> <td colspan="8" style="text-align: center;"> <table border="1" style="width: 100%; border-collapse: collapse; text-align: center;"> <tr> <td style="width: 10%;"></td> <td style="width: 10%;"></td> <td style="width: 10%;"></td> <td style="width: 10%;"></td> <td style="width: 10%;"></td> <td style="width: 10%;"></td> <td style="width: 10%;"></td> <td style="width: 10%;"></td> <td style="width: 10%;"></td> <td style="width: 10%;"></td> </tr> <tr> <td></td> <td></td> <td colspan="8" style="text-align: center;"> <table border="1" style="width: 100%; border-collapse: collapse; text-align: center;"> <tr> <td style="width: 10%;"></td> <td style="width: 10%;"></td> <td style="width: 10%;"></td> <td style="width: 10%;"></td> <td style="width: 10%;"></td> <td style="width: 10%;"></td> <td style="width: 10%;"></td> <td style="width: 10%;"></td> <td style="width: 10%;"></td> <td style="width: 10%;"></td> </tr> <tr> <td></td> <td></td> <td colspan="8" style="text-align: center;"> <table border="1" style="width: 100%; border-collapse: collapse; text-align: center;"> <tr> <td style="width: 10%;"></td> <td style="width: 10%;"></td> <td style="width: 10%;"></td> <td style="width: 10%;"></td> <td style="width: 10%;"></td> <td style="width: 10%;"></td> <td style="width: 10%;"></td> <td style="width: 10%;"></td> <td style="width: 10%;"></td> <td style="width: 10%;"></td> </tr> <tr> <td></td> <td></td> <td colspan="8" style="text-align: center;"> <table border="1" style="width: 100%; border-collapse: collapse; text-align: center;"> <tr> <td style="width: 10%;"></td> <td style="width: 10%;"></td> <td style="width: 10%;"></td> <td style="width: 10%;"></td> <td style="width: 10%;"></td> <td style="width: 10%;"></td> <td style="width: 10%;"></td> <td style="width: 10%;"></td> <td style="width: 10%;"></td> <td style="width: 10%;"></td> </tr> <tr> <td></td> <td></td> <td colspan="8" style="text-align: center;"> <table border="1" style="width: 100%; border-collapse: collapse; text-align: center;"> <tr> <td style="width: 10%;"></td> <td style="width: 10%;"></td> <td style="width: 10%;"></td> <td style="width: 10%;"></td> <td style="width: 10%;"></td> <td style="width: 10%;"></td> <td style="width: 10%;"></td> <td style="width: 10%;"></td> <td style="width: 10%;"></td> <td style="width: 10%;"></td> </tr> <tr> <td></td> <td></td> <td colspan="8" style="text-align: center;"> <table border="1" style="width: 100%; border-collapse: collapse; text-align: center;"> <tr> <td style="width: 10%;"></td> <td style="width: 10%;"></td> <td style="width: 10%;"></td> <td style="width:
10%;"></td> <td style="width: 10%;"></td> <td style="width: 10%;"></td> <td style="width: 10%;"></td> <td style="width: 10%;"></td> <td style="width: 10%;"></td> <td style="width: 10%;"></td> </tr> <tr> <td></td> <td></td> <td colspan="8" style="text-align: center;"> <table border="1" style="width: 100%; border-collapse: collapse; text-align: center;"> <tr> <td style="width: 10%;"></td> <td style="width: 10%;"></td> <td style="width: 10%;"></td> <td style="width: 10%;"></td> <td style="width: 10%;"></td> <td style="width: 10%;"></td> <td style="width: 10%;"></td> <td style="width: 10%;"></td> <td style="width: 10%;"></td> <td style="width: 10%;"></td> </tr> <tr> <td></td> <td></td> <td colspan="8" style="text-align: center;"> <table border="1" style="width: 100%; border-collapse: collapse; text-align: center;"> <tr> </tr></table></td></tr></table></td></tr></table></td></tr></table></td></tr></table></td></tr></table></td></tr></table></td></tr></table></td></tr></table></td></tr></table></td></tr></table></td></tr></table></td></tr></table></td></tr></table></td></tr></table></td></tr></table></td></tr></table></td></tr></table></td></tr></table></td></tr></table></td></tr></table></td></tr></table></td></tr></table></td></tr></table></td></tr></table></td></tr></table></td></tr></table></td></tr></table></td></tr></table></td></tr></table></td></tr></table></td></tr></table></td></tr></table></td></tr></table></td></tr></table></td></tr></table></td></tr></table></td></tr></table></td></tr></table></td></tr></table></td></tr></table>
 | | | | | | | | | | | | | | | | | | | | <table border="1" style="width: 100%; border-collapse: collapse; text-align: center;"> <tr> <td style="width: 10%;"></td> <td style="width: 10%;"></td> <td style="width: 10%;"></td> <td style="width: 10%;"></td> <td style="width: 10%;"></td> <td style="width: 10%;"></td> <td style="width: 10%;"></td> <td style="width: 10%;"></td> <td style="width: 10%;"></td> <td style="width: 10%;"></td> </tr> <tr> <td></td> <td></td> <td colspan="8" style="text-align: center;"> <table border="1" style="width: 100%; border-collapse: collapse; text-align: center;"> <tr> <td style="width: 10%;"></td> <td style="width: 10%;"></td> <td style="width: 10%;"></td> <td style="width: 10%;"></td> <td style="width: 10%;"></td> <td style="width: 10%;"></td> <td style="width: 10%;"></td> <td style="width: 10%;"></td> <td style="width: 10%;"></td> <td style="width: 10%;"></td> </tr> <tr> <td></td> <td></td> <td colspan="8" style="text-align: center;"> <table border="1" style="width: 100%; border-collapse: collapse; text-align: center;"> <tr> <td style="width: 10%;"></td> <td style="width: 10%;"></td> <td style="width: 10%;"></td> <td style="width: 10%;"></td> <td style="width: 10%;"></td> <td style="width: 10%;"></td> <td style="width: 10%;"></td> <td style="width: 10%;"></td> <td style="width: 10%;"></td> <td style="width: 10%;"></td> </tr> <tr> <td></td> <td></td> <td colspan="8" style="text-align: center;"> <table border="1" style="width: 100%; border-collapse: collapse; text-align: center;"> <tr> <td style="width: 10%;"></td> <td style="width: 10%;"></td> <td style="width: 10%;"></td> <td style="width: 10%;"></td> <td style="width: 10%;"></td> <td style="width: 10%;"></td> <td style="width: 10%;"></td> <td style="width: 10%;"></td> <td style="width: 10%;"></td> <td style="width: 10%;"></td> </tr> <tr> <td></td> <td></td> <td colspan="8" style="text-align: center;"> <table border="1" style="width: 100%; border-collapse: collapse; text-align: center;"> <tr> <td style="width: 10%;"></td> <td style="width: 10%;"></td> <td style="width: 10%;"></td> <td style="width: 10%;"></td> <td style="width: 10%;"></td> <td style="width: 10%;"></td> <td style="width: 10%;"></td> <td style="width: 10%;"></td> <td style="width: 10%;"></td> <td style="width: 10%;"></td> </tr> <tr> <td></td> <td></td> <td colspan="8" style="text-align: center;"> <table border="1" style="width: 100%; border-collapse: collapse; text-align: center;"> <tr> <td style="width: 10%;"></td> <td style="width: 10%;"></td> <td style="width: 10%;"></td> <td style="width: 10%;"></td> <td style="width: 10%;"></td> <td style="width: 10%;"></td> <td style="width: 10%;"></td> <td style="width: 10%;"></td> <td style="width: 10%;"></td> <td style="width: 10%;"></td> </tr> <tr> <td></td> <td></td> <td colspan="8" style="text-align: center;"> <table border="1" style="width: 100%; border-collapse: collapse; text-align: center;"> <tr> <td style="width: 10%;"></td> <td style="width: 10%;"></td> <td style="width: 10%;"></td> <td style="width: 10%;"></td> <td style="width: 10%;"></td> <td style="width: 10%;"></td> <td style="width: 10%;"></td> <td style="width: 10%;"></td> <td style="width: 10%;"></td> <td style="width: 10%;"></td> </tr> <tr> <td></td> <td></td> <td colspan="8" style="text-align: center;"> <table border="1" style="width: 100%; border-collapse: collapse; text-align: center;"> <tr> <td style="width: 10%;"></td> <td style="width: 10%;"></td> <td style="width: 10%;"></td> <td style="width: 10%;"></td> <td style="width: 10%;"></td> <td style="width: 10%;"></td> <td style="width: 10%;"></td> <td style="width: 10%;"></td> <td style="width: 10%;"></td> <td style="width: 10%;"></td> </tr> <tr> <td></td> <td></td> <td colspan="8" style="text-align: center;"> <table border="1" style="width: 100%; border-collapse: collapse; text-align: center;"> <tr> <td style="width: 10%;"></td> <td style="width: 10%;"></td> <td style="width: 10%;"></td> <td style="width: 10%;"></td> <td style="width: 10%;"></td> <td style="width: 10%;"></td> <td style="width: 10%;"></td> <td style="width: 10%;"></td> <td style="width: 10%;"></td> <td style="width: 10%;"></td> </tr> <tr> <td></td> <td></td> <td colspan="8" style="text-align: center;"> <table border="1" style="width: 100%; border-collapse: collapse; text-align: center;"> <tr> <td style="width: 10%;"></td> <td style="width: 10%;"></td> <td style="width: 10%;"></td> <td style="width: 10%;"></td> <td style="width: 10%;"></td> <td style="width: 10%;"></td> <td style="width: 10%;"></td> <td style="width: 10%;"></td> <td style="width: 10%;"></td> <td style="width: 10%;"></td> </tr> <tr> <td></td> <td></td> <td colspan="8" style="text-align: center;"> <table border="1" style="width: 100%; border-collapse: collapse; text-align: center;"> <tr> <td style="width: 10%;"></td> <td style="width: 10%;"></td> <td style="width: 10%;"></td> <td style="width: 10%;"></td> <td style="width: 10%;"></td> <td style="width: 10%;"></td> <td style="width: 10%;"></td> <td style="width: 10%;"></td> <td style="width: 10%;"></td> <td style="width: 10%;"></td> </tr> <tr> <td></td> <td></td> <td colspan="8" style="text-align: center;"> <table border="1" style="width: 100%; border-collapse: collapse; text-align: center;"> <tr> <td style="width: 10%;"></td> <td style="width: 10%;"></td> <td style="width: 10%;"></td> <td style="width: 10%;"></td> <td style="width: 10%;"></td> <td style="width: 10%;"></td> <td style="width: 10%;"></td> <td style="width: 10%;"></td> <td style="width: 10%;"></td> <td style="width: 10%;"></td> </tr> <tr> <td></td> <td></td> <td colspan="8" style="text-align: center;"> <table border="1" style="width: 100%; border-collapse: collapse; text-align: center;"> <tr> <td style="width: 10%;"></td> <td style="width: 10%;"></td> <td style="width: 10%;"></td> <td style="width: 10%;"></td> <td style="width: 10%;"></td> <td style="width: 10%;"></td> <td style="width: 10%;"></td> <td style="width: 10%;"></td> <td style="width: 10%;"></td> <td style="width: 10%;"></td> </tr> <tr> <td></td> <td></td> <td colspan="8" style="text-align: center;"> <table border="1" style="width: 100%; border-collapse: collapse; text-align: center;"> <tr> <td style="width: 10%;"></td> <td style="width: 10%;"></td> <td style="width: 10%;"></td> <td style="width: 10%;"></td> <td style="width: 10%;"></td> <td style="width: 10%;"></td> <td style="width: 10%;"></td> <td style="width: 10%;"></td> <td style="width: 10%;"></td> <td style="width: 10%;"></td> </tr> <tr> <td></td> <td></td> <td colspan="8" style="text-align: center;"> <table border="1" style="width: 100%; border-collapse: collapse; text-align: center;"> <tr> <td style="width: 10%;"></td> <td style="width: 10%;"></td> <td style="width: 10%;"></td> <td style="width: 10%;"></td> <td style="width: 10%;"></td> <td style="width: 10%;"></td> <td style="width: 10%;"></td> <td style="width: 10%;"></td> <td style="width: 10%;"></td> <td style="width: 10%;"></td> </tr> <tr> <td></td> <td></td> <td colspan="8" style="text-align: center;"> <table border="1" style="width: 100%; border-collapse: collapse; text-align: center;"> <tr> <td style="width: 10%;"></td> <td style="width: 10%;"></td> <td style="width:
10%;"></td> <td style="width: 10%;"></td> <td style="width: 10%;"></td> <td style="width: 10%;"></td> <td style="width: 10%;"></td> <td style="width: 10%;"></td> <td style="width: 10%;"></td> <td style="width: 10%;"></td> </tr> <tr> <td></td> <td></td> <td colspan="8" style="text-align: center;"> <table border="1" style="width: 100%; border-collapse: collapse; text-align: center;"> <tr> <td style="width: 10%;"></td> <td style="width: 10%;"></td> <td style="width: 10%;"></td> <td style="width: 10%;"></td> <td style="width: 10%;"></td> <td style="width: 10%;"></td> <td style="width: 10%;"></td> <td style="width: 10%;"></td> <td style="width: 10%;"></td> <td style="width: 10%;"></td> </tr> <tr> <td></td> <td></td> <td colspan="8" style="text-align: center;"> <table border="1" style="width: 100%; border-collapse: collapse; text-align: center;"> <tr> <td style="width: 10%;"></td> <td style="width: 10%;"></td> <td style="width: 10%;"></td> <td style="width: 10%;"></td> <td style="width: 10%;"></td> <td style="width: 10%;"></td> <td style="width: 10%;"></td> <td style="width: 10%;"></td> <td style="width: 10%;"></td> <td style="width: 10%;"></td> </tr> <tr> <td></td> <td></td> <td colspan="8" style="text-align: center;"> <table border="1" style="width: 100%; border-collapse: collapse; text-align: center;"> <tr> <td style="width: 10%;"></td> <td style="width: 10%;"></td> <td style="width: 10%;"></td> <td style="width: 10%;"></td> <td style="width: 10%;"></td> <td style="width: 10%;"></td> <td style="width: 10%;"></td> <td style="width: 10%;"></td> <td style="width: 10%;"></td> <td style="width: 10%;"></td> </tr> <tr> <td></td> <td></td> <td colspan="8" style="text-align: center;"> <table border="1" style="width: 100%; border-collapse: collapse; text-align: center;"> <tr> <td style="width: 10%;"></td> <td style="width: 10%;"></td> <td style="width: 10%;"></td> <td style="width: 10%;"></td> <td style="width: 10%;"></td> <td style="width: 10%;"></td> <td style="width: 10%;"></td> <td style="width: 10%;"></td> <td style="width: 10%;"></td> <td style="width: 10%;"></td> </tr> <tr> <td></td> <td></td> <td colspan="8" style="text-align: center;"> <table border="1" style="width: 100%; border-collapse: collapse; text-align: center;"> <tr> <td style="width: 10%;"></td> <td style="width: 10%;"></td> <td style="width: 10%;"></td> <td style="width: 10%;"></td> <td style="width: 10%;"></td> <td style="width: 10%;"></td> <td style="width: 10%;"></td> <td style="width: 10%;"></td> <td style="width: 10%;"></td> <td style="width: 10%;"></td> </tr> <tr> <td></td> <td></td> <td colspan="8" style="text-align: center;"> <table border="1" style="width: 100%; border-collapse: collapse; text-align: center;"> <tr> <td style="width: 10%;"></td> <td style="width: 10%;"></td> <td style="width: 10%;"></td> <td style="width: 10%;"></td> <td style="width: 10%;"></td> <td style="width: 10%;"></td> <td style="width: 10%;"></td> <td style="width: 10%;"></td> <td style="width: 10%;"></td> <td style="width: 10%;"></td> </tr> <tr> <td></td> <td></td> <td colspan="8" style="text-align: center;"> <table border="1" style="width: 100%; border-collapse: collapse; text-align: center;"> <tr> <td style="width: 10%;"></td> <td style="width: 10%;"></td> <td style="width: 10%;"></td> <td style="width: 10%;"></td> <td style="width: 10%;"></td> <td style="width: 10%;"></td> <td style="width: 10%;"></td> <td style="width: 10%;"></td> <td style="width: 10%;"></td> <td style="width: 10%;"></td> </tr> <tr> <td></td> <td></td> <td colspan="8" style="text-align: center;"> <table border="1" style="width: 100%; border-collapse: collapse; text-align: center;"> <tr> <td style="width: 10%;"></td> <td style="width: 10%;"></td> <td style="width: 10%;"></td> <td style="width: 10%;"></td> <td style="width: 10%;"></td> <td style="width: 10%;"></td> <td style="width: 10%;"></td> <td style="width: 10%;"></td> <td style="width: 10%;"></td> <td style="width: 10%;"></td> </tr> <tr> <td></td> <td></td> <td colspan="8" style="text-align: center;"> <table border="1" style="width: 100%; border-collapse: collapse; text-align: center;"> <tr> <td style="width: 10%;"></td> <td style="width: 10%;"></td> <td style="width: 10%;"></td> <td style="width: 10%;"></td> <td style="width: 10%;"></td> <td style="width: 10%;"></td> <td style="width: 10%;"></td> <td style="width: 10%;"></td> <td style="width: 10%;"></td> <td style="width: 10%;"></td> </tr> <tr> <td></td> <td></td> <td colspan="8" style="text-align: center;"> <table border="1" style="width: 100%; border-collapse: collapse; text-align: center;"> <tr> <td style="width: 10%;"></td> <td style="width: 10%;"></td> <td style="width: 10%;"></td> <td style="width: 10%;"></td> <td style="width: 10%;"></td> <td style="width: 10%;"></td> <td style="width: 10%;"></td> <td style="width: 10%;"></td> <td style="width: 10%;"></td> <td style="width: 10%;"></td> </tr> <tr> <td></td> <td></td> <td colspan="8" style="text-align: center;"> <table border="1" style="width: 100%; border-collapse: collapse; text-align: center;"> <tr> <td style="width: 10%;"></td> <td style="width: 10%;"></td> <td style="width: 10%;"></td> <td style="width: 10%;"></td> <td style="width: 10%;"></td> <td style="width: 10%;"></td> <td style="width: 10%;"></td> <td style="width: 10%;"></td> <td style="width: 10%;"></td> <td style="width: 10%;"></td> </tr> <tr> <td></td> <td></td> <td colspan="8" style="text-align: center;"> <table border="1" style="width: 100%; border-collapse: collapse; text-align: center;"> <tr> <td style="width: 10%;"></td> <td style="width: 10%;"></td> <td style="width: 10%;"></td> <td style="width: 10%;"></td> <td style="width: 10%;"></td> <td style="width: 10%;"></td> <td style="width: 10%;"></td> <td style="width: 10%;"></td> <td style="width: 10%;"></td> <td style="width: 10%;"></td> </tr> <tr> <td></td> <td></td> <td colspan="8" style="text-align: center;"> <table border="1" style="width: 100%; border-collapse: collapse; text-align: center;"> <tr> <td style="width: 10%;"></td> <td style="width: 10%;"></td> <td style="width: 10%;"></td> <td style="width: 10%;"></td> <td style="width: 10%;"></td> <td style="width: 10%;"></td> <td style="width: 10%;"></td> <td style="width: 10%;"></td> <td style="width: 10%;"></td> <td style="width: 10%;"></td> </tr> <tr> <td></td> <td></td> <td colspan="8" style="text-align: center;"> <table border="1" style="width: 100%; border-collapse: collapse; text-align: center;"> <tr> <td style="width: 10%;"></td> <td style="width: 10%;"></td> <td style="width: 10%;"></td> <td style="width: 10%;"></td> <td style="width: 10%;"></td> <td style="width: 10%;"></td> <td style="width: 10%;"></td> <td style="width: 10%;"></td> <td style="width: 10%;"></td> <td style="width: 10%;"></td> </tr> <tr> <td></td> <td></td> <td colspan="8" style="text-align: center;"> <table border="1" style="width: 100%; border-collapse: collapse; text-align: center;"> <tr> <td style="width: 10%;"></td> <td style="width: 10%;"></td> <td style="width: 10%;"></td> <td style="width: 10%;"></td> <td style="width: 10%;"></td> <td style="width: 10%;"></td> <td style="width: 10%;"></td> <td style="width: 10%;"></td> <td style="width: 10%;"></td> <td style="width: 10%;"></td> </tr> <tr> <td></td> <td></td> <td colspan="8" style="text-align: center;"> <table border="1" style="width: 100%; border-collapse: collapse; text-align: center;"> <tr> <td style="width: 10%;"></td> <td style="width: 10%;"></td> <td style="width: 10%;"></td> <td style="width: 10%;"></td> <td style="width: 10%;"></td> <td style="width: 10%;"></td> <td style="width: 10%;"></td> <td style="width: 10%;"></td> <td style="width: 10%;"></td> <td style="width: 10%;"></td> </tr> <tr> <td></td> <td></td> <td colspan="8" style="text-align: center;"> <table border="1" style="width: 100%; border-collapse: collapse; text-align: center;"> <tr> <td style="width: 10%;"></td> <td style="width: 10%;"></td> <td style="width: 10%;"></td> <td style="width: 10%;"></td> <td style="width: 10%;"></td> <td style="width: 10%;"></td> <td style="width: 10%;"></td> <td style="width: 10%;"></td> <td style="width: 10%;"></td> <td style="width: 10%;"></td> </tr> <tr> <td></td> <td></td> <td colspan="8" style="text-align: center;"> <table border="1" style="width: 100%; border-collapse: collapse; text-align: center;"> <tr> <td style="width: 10%;"></td> <td style="width: 10%;"></td> <td style="width: 10%;"></td> <td style="width: 10%;"></td> <td style="width: 10%;"></td> <td style="width: 10%;"></td> <td style="width: 10%;"></td> <td style="width: 10%;"></td> <td style="width: 10%;"></td> <td style="width: 10%;"></td> </tr> <tr> <td></td> <td></td> <td colspan="8" style="text-align: center;"> <table border="1" style="width: 100%; border-collapse: collapse; text-align: center;"> <tr> <td style="width: 10%;"></td> <td style="width: 10%;"></td> <td style="width: 10%;"></td> <td style="width: 10%;"></td> <td style="width: 10%;"></td> <td style="width: 10%;"></td> <td style="width: 10%;"></td> <td style="width: 10%;"></td> <td style="width: 10%;"></td> <td style="width: 10%;"></td> </tr> <tr> <td></td> <td></td> <td colspan="8" style="text-align: center;"> <table border="1" style="width: 100%; border-collapse: collapse; text-align: center;"> <tr> <td style="width: 10%;"></td> <td style="width: 10%;"></td> <td style="width: 10%;"></td> <td style="width: 10%;"></td> <td style="width: 10%;"></td> <td style="width: 10%;"></td> <td style="width: 10%;"></td> <td style="width: 10%;"></td> <td style="width: 10%;"></td> <td style="width: 10%;"></td> </tr> <tr> <td></td> <td></td> <td colspan="8" style="text-align: center;"> <table border="1" style="width: 100%; border-collapse: collapse; text-align: center;"> <tr> <td style="width: 10%;"></td> <td style="width: 10%;"></td> <td style="width: 10%;"></td> <td style="width: 10%;"></td> <td style="width: 10%;"></td> <td style="width: 10%;"></td> <td style="width: 10%;"></td> <td style="width: 10%;"></td> <td
style="width: 10%;"></td> <td style="width: 10%;"></td> </tr> <tr> <td></td> <td></td> <td colspan="8" style="text-align: center;"> <table border="1" style="width: 100%; border-collapse: collapse; text-align: center;"> <tr> <td style="width: 10%;"></td> <td style="width: 10%;"></td> <td style="width: 10%;"></td> <td style="width: 10%;"></td> <td style="width: 10%;"></td> <td style="width: 10%;"></td> <td style="width: 10%;"></td> <td style="width: 10%;"></td> <td style="width: 10%;"></td> <td style="width: 10%;"></td> </tr> <tr> <td></td> <td></td> <td colspan="8" style="text-align: center;"> <table border="1" style="width: 100%; border-collapse: collapse; text-align: center;"> <tr> <td style="width: 10%;"></td> <td style="width: 10%;"></td> <td style="width: 10%;"></td> <td style="width: 10%;"></td> <td style="width: 10%;"></td> <td style="width: 10%;"></td> <td style="width: 10%;"></td> <td style="width: 10%;"></td> <td style="width: 10%;"></td> <td style="width: 10%;"></td> </tr> <tr> <td></td> <td></td> <td colspan="8" style="text-align: center;"> <table border="1" style="width: 100%; border-collapse: collapse; text-align: center;"> <tr> </tr></table></td></tr></table></td></tr></table></td></tr></table></td></tr></table></td></tr></table></td></tr></table></td></tr></table></td></tr></table></td></tr></table></td></tr></table></td></tr></table></td></tr></table></td></tr></table></td></tr></table></td></tr></table></td></tr></table></td></tr></table></td></tr></table></td></tr></table></td></tr></table></td></tr></table></td></tr></table></td></tr></table></td></tr></table></td></tr></table></td></tr></table></td></tr></table></td></tr></table></td></tr></table></td></tr></table></td></tr></table></td></tr></table></td></tr></table></td></tr></table></td></tr></table></td></tr></table></td></tr></table></td></tr></table></td></tr></table>
 | | | | | | | | | | | | | | | | | | | | <table border="1" style="width: 100%; border-collapse: collapse; text-align: center;"> <tr> <td style="width: 10%;"></td> <td style="width: 10%;"></td> <td style="width: 10%;"></td> <td style="width: 10%;"></td> <td style="width: 10%;"></td> <td style="width: 10%;"></td> <td style="width: 10%;"></td> <td style="width: 10%;"></td> <td style="width: 10%;"></td> <td style="width: 10%;"></td> </tr> <tr> <td></td> <td></td> <td colspan="8" style="text-align: center;"> <table border="1" style="width: 100%; border-collapse: collapse; text-align: center;"> <tr> <td style="width: 10%;"></td> <td style="width: 10%;"></td> <td style="width: 10%;"></td> <td style="width: 10%;"></td> <td style="width: 10%;"></td> <td style="width: 10%;"></td> <td style="width: 10%;"></td> <td style="width: 10%;"></td> <td style="width: 10%;"></td> <td style="width: 10%;"></td> </tr> <tr> <td></td> <td></td> <td colspan="8" style="text-align: center;"> <table border="1" style="width: 100%; border-collapse: collapse; text-align: center;"> <tr> <td style="width: 10%;"></td> <td style="width: 10%;"></td> <td style="width: 10%;"></td> <td style="width: 10%;"></td> <td style="width: 10%;"></td> <td style="width: 10%;"></td> <td style="width: 10%;"></td> <td style="width: 10%;"></td> <td style="width: 10%;"></td> <td style="width: 10%;"></td> </tr> <tr> <td></td> <td></td> <td colspan="8" style="text-align: center;"> <table border="1" style="width: 100%; border-collapse: collapse; text-align: center;"> <tr> <td style="width: 10%;"></td> <td style="width: 10%;"></td> <td style="width: 10%;"></td> <td style="width: 10%;"></td> <td style="width: 10%;"></td> <td style="width: 10%;"></td> <td style="width: 10%;"></td> <td style="width: 10%;"></td> <td style="width: 10%;"></td> <td style="width: 10%;"></td> </tr> <tr> <td></td> <td></td> <td colspan="8" style="text-align: center;"> <table border="1" style="width: 100%; border-collapse: collapse; text-align: center;"> <tr> <td style="width: 10%;"></td> <td style="width: 10%;"></td> <td style="width: 10%;"></td> <td style="width: 10%;"></td> <td style="width: 10%;"></td> <td style="width: 10%;"></td> <td style="width: 10%;"></td> <td style="width: 10%;"></td> <td style="width: 10%;"></td> <td style="width: 10%;"></td> </tr> <tr> <td></td> <td></td> <td colspan="8" style="text-align: center;"> <table border="1" style="width: 100%; border-collapse: collapse; text-align: center;"> <tr> <td style="width: 10%;"></td> <td style="width: 10%;"></td> <td style="width: 10%;"></td> <td style="width: 10%;"></td> <td style="width: 10%;"></td> <td style="width: 10%;"></td> <td style="width: 10%;"></td> <td style="width: 10%;"></td> <td style="width: 10%;"></td> <td style="width: 10%;"></td> </tr> <tr> <td></td> <td></td> <td colspan="8" style="text-align: center;"> <table border="1" style="width: 100%; border-collapse: collapse; text-align: center;"> <tr> <td style="width: 10%;"></td> <td style="width: 10%;"></td> <td style="width: 10%;"></td> <td style="width: 10%;"></td> <td style="width: 10%;"></td> <td style="width: 10%;"></td> <td style="width: 10%;"></td> <td style="width: 10%;"></td> <td style="width: 10%;"></td> <td style="width: 10%;"></td> </tr> <tr> <td></td> <td></td> <td colspan="8" style="text-align: center;"> <table border="1" style="width: 100%; border-collapse: collapse; text-align: center;"> <tr> <td style="width: 10%;"></td> <td style="width: 10%;"></td> <td style="width: 10%;"></td> <td style="width: 10%;"></td> <td style="width: 10%;"></td> <td style="width: 10%;"></td> <td style="width: 10%;"></td> <td style="width: 10%;"></td> <td style="width: 10%;"></td> <td style="width: 10%;"></td> </tr> <tr> <td></td> <td></td> <td colspan="8" style="text-align: center;"> <table border="1" style="width: 100%; border-collapse: collapse; text-align: center;"> <tr> <td style="width: 10%;"></td> <td style="width: 10%;"></td> <td style="width: 10%;"></td> <td style="width: 10%;"></td> <td style="width: 10%;"></td> <td style="width: 10%;"></td> <td style="width: 10%;"></td> <td style="width: 10%;"></td> <td style="width: 10%;"></td> <td style="width: 10%;"></td> </tr> <tr> <td></td> <td></td> <td colspan="8" style="text-align: center;"> <table border="1" style="width: 100%; border-collapse: collapse; text-align: center;"> <tr> <td style="width: 10%;"></td> <td style="width: 10%;"></td> <td style="width: 10%;"></td> <td style="width: 10%;"></td> <td style="width: 10%;"></td> <td style="width: 10%;"></td> <td style="width: 10%;"></td> <td style="width: 10%;"></td> <td style="width: 10%;"></td> <td style="width: 10%;"></td> </tr> <tr> <td></td> <td></td> <td colspan="8" style="text-align: center;"> <table border="1" style="width: 100%; border-collapse: collapse; text-align: center;"> <tr> <td style="width: 10%;"></td> <td style="width: 10%;"></td> <td style="width: 10%;"></td> <td style="width: 10%;"></td> <td style="width: 10%;"></td> <td style="width: 10%;"></td> <td style="width: 10%;"></td> <td style="width: 10%;"></td> <td style="width: 10%;"></td> <td style="width: 10%;"></td> </tr> <tr> <td></td> <td></td> <td colspan="8" style="text-align: center;"> <table border="1" style="width: 100%; border-collapse: collapse; text-align: center;"> <tr> <td style="width: 10%;"></td> <td style="width: 10%;"></td> <td style="width: 10%;"></td> <td style="width: 10%;"></td> <td style="width: 10%;"></td> <td style="width: 10%;"></td> <td style="width: 10%;"></td> <td style="width: 10%;"></td> <td style="width: 10%;"></td> <td style="width: 10%;"></td> </tr> <tr> <td></td> <td></td> <td colspan="8" style="text-align: center;"> <table border="1" style="width: 100%; border-collapse: collapse; text-align: center;"> <tr> <td style="width: 10%;"></td> <td style="width: 10%;"></td> <td style="width: 10%;"></td> <td style="width: 10%;"></td> <td style="width: 10%;"></td> <td style="width: 10%;"></td> <td style="width: 10%;"></td> <td style="width: 10%;"></td> <td style="width: 10%;"></td> <td style="width: 10%;"></td> </tr> <tr> <td></td> <td></td> <td colspan="8" style="text-align: center;"> <table border="1" style="width: 100%; border-collapse: collapse; text-align: center;"> <tr> <td style="width: 10%;"></td> <td style="width: 10%;"></td> <td style="width: 10%;"></td> <td style="width: 10%;"></td> <td style="width: 10%;"></td> <td style="width: 10%;"></td> <td style="width: 10%;"></td> <td style="width: 10%;"></td> <td style="width: 10%;"></td> <td style="width: 10%;"></td> </tr> <tr> <td></td> <td></td> <td colspan="8" style="text-align: center;"> <table border="1" style="width: 100%; border-collapse: collapse; text-align: center;"> <tr> <td style="width: 10%;"></td> <td style="width: 10%;"></td> <td style="width: 10%;"></td> <td style="width: 10%;"></td> <td style="width: 10%;"></td> <td style="width: 10%;"></td> <td style="width: 10%;"></td> <td style="width: 10%;"></td>
<td style="width: 10%;"></td> <td style="width: 10%;"></td> </tr> <tr> <td></td> <td></td> <td colspan="8" style="text-align: center;"> <table border="1" style="width: 100%; border-collapse: collapse; text-align: center;"> <tr> <td style="width: 10%;"></td> <td style="width: 10%;"></td> <td style="width: 10%;"></td> <td style="width: 10%;"></td> <td style="width: 10%;"></td> <td style="width: 10%;"></td> <td style="width: 10%;"></td> <td style="width: 10%;"></td> <td style="width: 10%;"></td> <td style="width: 10%;"></td> </tr> <tr> <td></td> <td></td> <td colspan="8" style="text-align: center;"> <table border="1" style="width: 100%; border-collapse: collapse; text-align: center;"> <tr> <td style="width: 10%;"></td> <td style="width: 10%;"></td> <td style="width: 10%;"></td> <td style="width: 10%;"></td> <td style="width: 10%;"></td> <td style="width: 10%;"></td> <td style="width: 10%;"></td> <td style="width: 10%;"></td> <td style="width: 10%;"></td> <td style="width: 10%;"></td> </tr> <tr> <td></td> <td></td> <td colspan="8" style="text-align: center;"> <table border="1" style="width: 100%; border-collapse: collapse; text-align: center;"> <tr> <td style="width: 10%;"></td> <td style="width: 10%;"></td> <td style="width: 10%;"></td> <td style="width: 10%;"></td> <td style="width: 10%;"></td> <td style="width: 10%;"></td> <td style="width: 10%;"></td> <td style="width: 10%;"></td> <td style="width: 10%;"></td> <td style="width: 10%;"></td> </tr> <tr> <td></td> <td></td> <td colspan="8" style="text-align: center;"> <table border="1" style="width: 100%; border-collapse: collapse; text-align: center;"> <tr> <td style="width: 10%;"></td> <td style="width: 10%;"></td> <td style="width: 10%;"></td> <td style="width: 10%;"></td> <td style="width: 10%;"></td> <td style="width: 10%;"></td> <td style="width: 10%;"></td> <td style="width: 10%;"></td> <td style="width: 10%;"></td> <td style="width: 10%;"></td> </tr> <tr> <td></td> <td></td> <td colspan="8" style="text-align: center;"> <table border="1" style="width: 100%; border-collapse: collapse; text-align: center;"> <tr> <td style="width: 10%;"></td> <td style="width: 10%;"></td> <td style="width: 10%;"></td> <td style="width: 10%;"></td> <td style="width: 10%;"></td> <td style="width: 10%;"></td> <td style="width: 10%;"></td> <td style="width: 10%;"></td> <td style="width: 10%;"></td> <td style="width: 10%;"></td> </tr> <tr> <td></td> <td></td> <td colspan="8" style="text-align: center;"> <table border="1" style="width: 100%; border-collapse: collapse; text-align: center;"> <tr> <td style="width: 10%;"></td> <td style="width: 10%;"></td> <td style="width: 10%;"></td> <td style="width: 10%;"></td> <td style="width: 10%;"></td> <td style="width: 10%;"></td> <td style="width: 10%;"></td> <td style="width: 10%;"></td> <td style="width: 10%;"></td> <td style="width: 10%;"></td> </tr> <tr> <td></td> <td></td> <td colspan="8" style="text-align: center;"> <table border="1" style="width: 100%; border-collapse: collapse; text-align: center;"> <tr> <td style="width: 10%;"></td> <td style="width: 10%;"></td> <td style="width: 10%;"></td> <td style="width: 10%;"></td> <td style="width: 10%;"></td> <td style="width: 10%;"></td> <td style="width: 10%;"></td> <td style="width: 10%;"></td> <td style="width: 10%;"></td> <td style="width: 10%;"></td> </tr> <tr> <td></td> <td></td> <td colspan="8" style="text-align: center;"> <table border="1" style="width: 100%; border-collapse: collapse; text-align: center;"> <tr> <td style="width: 10%;"></td> <td style="width: 10%;"></td> <td style="width: 10%;"></td> <td style="width: 10%;"></td> <td style="width: 10%;"></td> <td style="width: 10%;"></td> <td style="width: 10%;"></td> <td style="width: 10%;"></td> <td style="width: 10%;"></td> <td style="width: 10%;"></td> </tr> <tr> <td></td> <td></td> <td colspan="8" style="text-align: center;"> <table border="1" style="width: 100%; border-collapse: collapse; text-align: center;"> <tr> <td style="width: 10%;"></td> <td style="width: 10%;"></td> <td style="width: 10%;"></td> <td style="width: 10%;"></td> <td style="width: 10%;"></td> <td style="width: 10%;"></td> <td style="width: 10%;"></td> <td style="width: 10%;"></td> <td style="width: 10%;"></td> <td style="width: 10%;"></td> </tr> <tr> <td></td> <td></td> <td colspan="8" style="text-align: center;"> <table border="1" style="width: 100%; border-collapse: collapse; text-align: center;"> <tr> <td style="width: 10%;"></td> <td style="width: 10%;"></td> <td style="width: 10%;"></td> <td style="width: 10%;"></td> <td style="width: 10%;"></td> <td style="width: 10%;"></td> <td style="width: 10%;"></td> <td style="width: 10%;"></td> <td style="width: 10%;"></td> <td style="width: 10%;"></td> </tr> <tr> <td></td> <td></td> <td colspan="8" style="text-align: center;"> <table border="1" style="width: 100%; border-collapse: collapse; text-align: center;"> <tr> <td style="width: 10%;"></td> <td style="width: 10%;"></td> <td style="width: 10%;"></td> <td style="width: 10%;"></td> <td style="width: 10%;"></td> <td style="width: 10%;"></td> <td style="width: 10%;"></td> <td style="width: 10%;"></td> <td style="width: 10%;"></td> <td style="width: 10%;"></td> </tr> <tr> <td></td> <td></td> <td colspan="8" style="text-align: center;"> <table border="1" style="width: 100%; border-collapse: collapse; text-align: center;"> <tr> <td style="width: 10%;"></td> <td style="width: 10%;"></td> <td style="width: 10%;"></td> <td style="width: 10%;"></td> <td style="width: 10%;"></td> <td style="width: 10%;"></td> <td style="width: 10%;"></td> <td style="width: 10%;"></td> <td style="width: 10%;"></td> <td style="width: 10%;"></td> </tr> <tr> <td></td> <td></td> <td colspan="8" style="text-align: center;"> <table border="1" style="width: 100%; border-collapse: collapse; text-align: center;"> <tr> <td style="width: 10%;"></td> <td style="width: 10%;"></td> <td style="width: 10%;"></td> <td style="width: 10%;"></td> <td style="width: 10%;"></td> <td style="width: 10%;"></td> <td style="width: 10%;"></td> <td style="width: 10%;"></td> <td style="width: 10%;"></td> <td style="width: 10%;"></td> </tr> <tr> <td></td> <td></td> <td colspan="8" style="text-align: center;"> <table border="1" style="width: 100%; border-collapse: collapse; text-align: center;"> <tr> <td style="width: 10%;"></td> <td style="width: 10%;"></td> <td style="width: 10%;"></td> <td style="width: 10%;"></td> <td style="width: 10%;"></td> <td style="width: 10%;"></td> <td style="width: 10%;"></td> <td style="width: 10%;"></td> <td style="width: 10%;"></td> <td style="width: 10%;"></td> </tr> <tr> <td></td> <td></td> <td colspan="8" style="text-align: center;"> <table border="1" style="width: 100%; border-collapse: collapse; text-align: center;"> <tr> <td style="width: 10%;"></td> <td style="width: 10%;"></td> <td style="width: 10%;"></td> <td style="width: 10%;"></td> <td style="width: 10%;"></td> <td style="width: 10%;"></td> <td style="width: 10%;"></td> <td style="width: 10%;"></td> <td style="width: 10%;"></td> <td style="width: 10%;"></td> </tr> <tr> <td></td> <td></td> <td colspan="8" style="text-align: center;"> <table border="1" style="width: 100%; border-collapse: collapse; text-align: center;"> <tr> <td style="width: 10%;"></td> <td style="width: 10%;"></td> <td style="width: 10%;"></td> <td style="width: 10%;"></td> <td style="width: 10%;"></td> <td style="width: 10%;"></td> <td style="width: 10%;"></td> <td style="width: 10%;"></td> <td style="width: 10%;"></td> <td style="width: 10%;"></td> </tr> <tr> <td></td> <td></td> <td colspan="8" style="text-align: center;"> <table border="1" style="width: 100%; border-collapse: collapse; text-align: center;"> <tr> <td style="width: 10%;"></td> <td style="width: 10%;"></td> <td style="width: 10%;"></td> <td style="width: 10%;"></td> <td style="width: 10%;"></td> <td style="width: 10%;"></td> <td style="width: 10%;"></td> <td style="width: 10%;"></td> <td style="width: 10%;"></td> <td style="width: 10%;"></td> </tr> <tr> <td></td> <td></td> <td colspan="8" style="text-align: center;"> <table border="1" style="width: 100%; border-collapse: collapse; text-align: center;"> <tr> <td style="width: 10%;"></td> <td style="width: 10%;"></td> <td style="width: 10%;"></td> <td style="width: 10%;"></td> <td style="width: 10%;"></td> <td style="width: 10%;"></td> <td style="width: 10%;"></td> <td style="width: 10%;"></td> <td style="width: 10%;"></td> <td style="width: 10%;"></td> </tr> <tr> <td></td> <td></td> <td colspan="8" style="text-align: center;"> <table border="1" style="width: 100%; border-collapse: collapse; text-align: center;"> <tr> <td style="width: 10%;"></td> <td style="width: 10%;"></td> <td style="width: 10%;"></td> <td style="width: 10%;"></td> <td style="width: 10%;"></td> <td style="width: 10%;"></td> <td style="width: 10%;"></td> <td style="width: 10%;"></td> <td style="width: 10%;"></td> <td style="width: 10%;"></td> </tr> <tr> <td></td> <td></td> <td colspan="8" style="text-align: center;"> <table border="1" style="width: 100%; border-collapse: collapse; text-align: center;"> <tr> <td style="width: 10%;"></td> <td style="width: 10%;"></td> <td style="width: 10%;"></td> <td style="width: 10%;"></td> <td style="width: 10%;"></td> <td style="width: 10%;"></td> <td style="width: 10%;"></td> <td style="width: 10%;"></td> <td style="width: 10%;"></td> <td style="width: 10%;"></td> </tr> <tr> <td></td> <td></td> <td colspan="8" style="text-align: center;"> <table border="1" style="width: 100%; border-collapse: collapse; text-align: center;"> <tr> <td style="width: 10%;"></td> <td style="width: 10%;"></td> <td style="width: 10%;"></td> <td style="width: 10%;"></td> <td style="width: 10%;"></td> <td style="width: 10%;"></td> <td style="width: 10%;"></td> <td style="width: 10%;"></td> <td style="width: 10%;"></td> <td style="width: 10%;"></td> </tr> <tr> <td></td> <td></td> <td colspan="8" style="text-align: center;"> <table border="1" style="width:
100%; border-collapse: collapse; text-align: center;"> <tr> <td style="width: 10%;"></td> <td style="width: 10%;"></td> <td style="width: 10%;"></td> <td style="width: 10%;"></td> <td style="width: 10%;"></td> <td style="width: 10%;"></td> <td style="width: 10%;"></td> <td style="width: 10%;"></td> <td style="width: 10%;"></td> <td style="width: 10%;"></td> </tr> <tr> <td></td> <td></td> <td colspan="8" style="text-align: center;"> <table border="1" style="width: 100%; border-collapse: collapse; text-align: center;"> <tr> <td style="width: 10%;"></td> <td style="width: 10%;"></td> <td style="width: 10%;"></td> <td style="width: 10%;"></td> <td style="width: 10%;"></td> <td style="width: 10%;"></td> <td style="width: 10%;"></td> <td style="width: 10%;"></td> <td style="width: 10%;"></td> <td style="width: 10%;"></td> </tr> <tr> <td></td> <td></td> <td colspan="8" style="text-align: center;"> <table border="1" style="width: 100%; border-collapse: collapse; text-align: center;"> <tr> </tr></table></td></tr></table></td></tr></table></td></tr></table></td></tr></table></td></tr></table></td></tr></table></td></tr></table></td></tr></table></td></tr></table></td></tr></table></td></tr></table></td></tr></table></td></tr></table></td></tr></table></td></tr></table></td></tr></table></td></tr></table></td></tr></table></td></tr></table></td></tr></table></td></tr></table></td></tr></table></td></tr></table></td></tr></table></td></tr></table></td></tr></table></td></tr></table></td></tr></table></td></tr></table></td></tr></table></td></tr></table></td></tr></table></td></tr></table></td></tr></table></td></tr></table></td></tr></table></td></tr></table></td></tr></table>
 | | | | | | | | | | | | | | | | | | | | <table border="1" style="width: 100%; border-collapse: collapse; text-align: center;"> <tr> <td style="width: 10%;"></td> <td style="width: 10%;"></td> <td style="width: 10%;"></td> <td style="width: 10%;"></td> <td style="width: 10%;"></td> <td style="width: 10%;"></td> <td style="width: 10%;"></td> <td style="width: 10%;"></td> <td style="width: 10%;"></td> <td style="width: 10%;"></td> </tr> <tr> <td></td> <td></td> <td colspan="8" style="text-align: center;"> <table border="1" style="width: 100%; border-collapse: collapse; text-align: center;"> <tr> <td style="width: 10%;"></td> <td style="width: 10%;"></td> <td style="width: 10%;"></td> <td style="width: 10%;"></td> <td style="width: 10%;"></td> <td style="width: 10%;"></td> <td style="width: 10%;"></td> <td style="width: 10%;"></td> <td style="width: 10%;"></td> <td style="width: 10%;"></td> </tr> <tr> <td></td> <td></td> <td colspan="8" style="text-align: center;"> <table border="1" style="width: 100%; border-collapse: collapse; text-align: center;"> <tr> <td style="width: 10%;"></td> <td style="width: 10%;"></td> <td style="width: 10%;"></td> <td style="width: 10%;"></td> <td style="width: 10%;"></td> <td style="width: 10%;"></td> <td style="width: 10%;"></td> <td style="width: 10%;"></td> <td style="width: 10%;"></td> <td style="width: 10%;"></td> </tr> <tr> <td></td> <td></td> <td colspan="8" style="text-align: center;"> <table border="1" style="width: 100%; border-collapse: collapse; text-align: center;"> <tr> <td style="width: 10%;"></td> <td style="width: 10%;"></td> <td style="width: 10%;"></td> <td style="width: 10%;"></td> <td style="width: 10%;"></td> <td style="width: 10%;"></td> <td style="width: 10%;"></td> <td style="width: 10%;"></td> <td style="width: 10%;"></td> <td style="width: 10%;"></td> </tr> <tr> <td></td> <td></td> <td colspan="8" style="text-align: center;"> <table border="1" style="width: 100%; border-collapse: collapse; text-align: center;"> <tr> <td style="width: 10%;"></td> <td style="width: 10%;"></td> <td style="width: 10%;"></td> <td style="width: 10%;"></td> <td style="width: 10%;"></td> <td style="width: 10%;"></td> <td style="width: 10%;"></td> <td style="width: 10%;"></td> <td style="width: 10%;"></td> <td style="width: 10%;"></td> </tr> <tr> <td></td> <td></td> <td colspan="8" style="text-align: center;"> <table border="1" style="width: 100%; border-collapse: collapse; text-align: center;"> <tr> <td style="width: 10%;"></td> <td style="width: 10%;"></td> <td style="width: 10%;"></td> <td style="width: 10%;"></td> <td style="width: 10%;"></td> <td style="width: 10%;"></td> <td style="width: 10%;"></td> <td style="width: 10%;"></td> <td style="width: 10%;"></td> <td style="width: 10%;"></td> </tr> <tr> <td></td> <td></td> <td colspan="8" style="text-align: center;"> <table border="1" style="width: 100%; border-collapse: collapse; text-align: center;"> <tr> <td style="width: 10%;"></td> <td style="width: 10%;"></td> <td style="width: 10%;"></td> <td style="width: 10%;"></td> <td style="width: 10%;"></td> <td style="width: 10%;"></td> <td style="width: 10%;"></td> <td style="width: 10%;"></td> <td style="width: 10%;"></td> <td style="width: 10%;"></td> </tr> <tr> <td></td> <td></td> <td colspan="8" style="text-align: center;"> <table border="1" style="width: 100%; border-collapse: collapse; text-align: center;"> <tr> <td style="width: 10%;"></td> <td style="width: 10%;"></td> <td style="width: 10%;"></td> <td style="width: 10%;"></td> <td style="width: 10%;"></td> <td style="width: 10%;"></td> <td style="width: 10%;"></td> <td style="width: 10%;"></td> <td style="width: 10%;"></td> <td style="width: 10%;"></td> </tr> <tr> <td></td> <td></td> <td colspan="8" style="text-align: center;"> <table border="1" style="width: 100%; border-collapse: collapse; text-align: center;"> <tr> <td style="width: 10%;"></td> <td style="width: 10%;"></td> <td style="width: 10%;"></td> <td style="width: 10%;"></td> <td style="width: 10%;"></td> <td style="width: 10%;"></td> <td style="width: 10%;"></td> <td style="width: 10%;"></td> <td style="width: 10%;"></td> <td style="width: 10%;"></td> </tr> <tr> <td></td> <td></td> <td colspan="8" style="text-align: center;"> <table border="1" style="width: 100%; border-collapse: collapse; text-align: center;"> <tr> <td style="width: 10%;"></td> <td style="width: 10%;"></td> <td style="width: 10%;"></td> <td style="width: 10%;"></td> <td style="width: 10%;"></td> <td style="width: 10%;"></td> <td style="width: 10%;"></td> <td style="width: 10%;"></td> <td style="width: 10%;"></td> <td style="width: 10%;"></td> </tr> <tr> <td></td> <td></td> <td colspan="8" style="text-align: center;"> <table border="1" style="width: 100%; border-collapse: collapse; text-align: center;"> <tr> <td style="width: 10%;"></td> <td style="width: 10%;"></td> <td style="width: 10%;"></td> <td style="width: 10%;"></td> <td style="width: 10%;"></td> <td style="width: 10%;"></td> <td style="width: 10%;"></td> <td style="width: 10%;"></td> <td style="width: 10%;"></td> <td style="width: 10%;"></td> </tr> <tr> <td></td> <td></td> <td colspan="8" style="text-align: center;"> <table border="1" style="width: 100%; border-collapse: collapse; text-align: center;"> <tr> <td style="width: 10%;"></td> <td style="width: 10%;"></td> <td style="width: 10%;"></td> <td style="width: 10%;"></td> <td style="width: 10%;"></td> <td style="width: 10%;"></td> <td style="width: 10%;"></td> <td style="width: 10%;"></td> <td style="width: 10%;"></td> <td style="width: 10%;"></td> </tr> <tr> <td></td> <td></td> <td colspan="8" style="text-align: center;"> <table border="1" style="width: 100%; border-collapse: collapse; text-align: center;"> <tr> <td style="width: 10%;"></td> <td style="width: 10%;"></td> <td style="width: 10%;"></td> <td style="width: 10%;"></td> <td style="width: 10%;"></td> <td style="width: 10%;"></td> <td style="width: 10%;"></td> <td style="width: 10%;"></td> <td style="width: 10%;"></td> <td style="width: 10%;"></td> </tr> <tr> <td></td> <td></td> <td colspan="8" style="text-align: center;"> <table border="1" style="width: 100%; border-collapse: collapse; text-align: center;"> <tr> <td style="width: 10%;"></td> <td style="width: 10%;"></td> <td style="width: 10%;"></td> <td style="width: 10%;"></td> <td style="width: 10%;"></td> <td style="width: 10%;"></td> <td style="width: 10%;"></td> <td style="width: 10%;"></td> <td style="width: 10%;"></td> <td style="width: 10%;"></td> </tr> <tr> <td></td> <td></td> <td colspan="8" style="text-align: center;"> <table border="1" style="width: 100%; border-collapse: collapse; text-align: center;"> <tr> <td style="width: 10%;"></td> <td style="width: 10%;"></td> <td style="width: 10%;"></td> <td style="width: 10%;"></td> <td style="width: 10%;"></td> <td style="width: 10%;"></td> <td style="width: 10%;"></td> <td style="width: 10%;"></td> <td style="width: 10%;"></td> <td style="width: 10%;"></td> </tr> <tr> <td></td> <td></td> <td colspan="8" style="text-align: center;"> <table border="1" style="width: 100%;
border-collapse: collapse; text-align: center;"> <tr> <td style="width: 10%;"></td> <td style="width: 10%;"></td> <td style="width: 10%;"></td> <td style="width: 10%;"></td> <td style="width: 10%;"></td> <td style="width: 10%;"></td> <td style="width: 10%;"></td> <td style="width: 10%;"></td> <td style="width: 10%;"></td> <td style="width: 10%;"></td> </tr> <tr> <td></td> <td></td> <td colspan="8" style="text-align: center;"> <table border="1" style="width: 100%; border-collapse: collapse; text-align: center;"> <tr> <td style="width: 10%;"></td> <td style="width: 10%;"></td> <td style="width: 10%;"></td> <td style="width: 10%;"></td> <td style="width: 10%;"></td> <td style="width: 10%;"></td> <td style="width: 10%;"></td> <td style="width: 10%;"></td> <td style="width: 10%;"></td> <td style="width: 10%;"></td> </tr> <tr> <td></td> <td></td> <td colspan="8" style="text-align: center;"> <table border="1" style="width: 100%; border-collapse: collapse; text-align: center;"> <tr> <td style="width: 10%;"></td> <td style="width: 10%;"></td> <td style="width: 10%;"></td> <td style="width: 10%;"></td> <td style="width: 10%;"></td> <td style="width: 10%;"></td> <td style="width: 10%;"></td> <td style="width: 10%;"></td> <td style="width: 10%;"></td> <td style="width: 10%;"></td> </tr> <tr> <td></td> <td></td> <td colspan="8" style="text-align: center;"> <table border="1" style="width: 100%; border-collapse: collapse; text-align: center;"> <tr> <td style="width: 10%;"></td> <td style="width: 10%;"></td> <td style="width: 10%;"></td> <td style="width: 10%;"></td> <td style="width: 10%;"></td> <td style="width: 10%;"></td> <td style="width: 10%;"></td> <td style="width: 10%;"></td> <td style="width: 10%;"></td> <td style="width: 10%;"></td> </tr> <tr> <td></td> <td></td> <td colspan="8" style="text-align: center;"> <table border="1" style="width: 100%; border-collapse: collapse; text-align: center;"> <tr> <td style="width: 10%;"></td> <td style="width: 10%;"></td> <td style="width: 10%;"></td> <td style="width: 10%;"></td> <td style="width: 10%;"></td> <td style="width: 10%;"></td> <td style="width: 10%;"></td> <td style="width: 10%;"></td> <td style="width: 10%;"></td> <td style="width: 10%;"></td> </tr> <tr> <td></td> <td></td> <td colspan="8" style="text-align: center;"> <table border="1" style="width: 100%; border-collapse: collapse; text-align: center;"> <tr> <td style="width: 10%;"></td> <td style="width: 10%;"></td> <td style="width: 10%;"></td> <td style="width: 10%;"></td> <td style="width: 10%;"></td> <td style="width: 10%;"></td> <td style="width: 10%;"></td> <td style="width: 10%;"></td> <td style="width: 10%;"></td> <td style="width: 10%;"></td> </tr> <tr> <td></td> <td></td> <td colspan="8" style="text-align: center;"> <table border="1" style="width: 100%; border-collapse: collapse; text-align: center;"> <tr> <td style="width: 10%;"></td> <td style="width: 10%;"></td> <td style="width: 10%;"></td> <td style="width: 10%;"></td> <td style="width: 10%;"></td> <td style="width: 10%;"></td> <td style="width: 10%;"></td> <td style="width: 10%;"></td> <td style="width: 10%;"></td> <td style="width: 10%;"></td> </tr> <tr> <td></td> <td></td> <td colspan="8" style="text-align: center;"> <table border="1" style="width: 100%; border-collapse: collapse; text-align: center;"> <tr> <td style="width: 10%;"></td> <td style="width: 10%;"></td> <td style="width: 10%;"></td> <td style="width: 10%;"></td> <td style="width: 10%;"></td> <td style="width: 10%;"></td> <td style="width: 10%;"></td> <td style="width: 10%;"></td> <td style="width: 10%;"></td> <td style="width: 10%;"></td> </tr> <tr> <td></td> <td></td> <td colspan="8" style="text-align: center;"> <table border="1" style="width: 100%; border-collapse: collapse; text-align: center;"> <tr> <td style="width: 10%;"></td> <td style="width: 10%;"></td> <td style="width: 10%;"></td> <td style="width: 10%;"></td> <td style="width: 10%;"></td> <td style="width: 10%;"></td> <td style="width: 10%;"></td> <td style="width: 10%;"></td> <td style="width: 10%;"></td> <td style="width: 10%;"></td> </tr> <tr> <td></td> <td></td> <td colspan="8" style="text-align: center;"> <table border="1" style="width: 100%; border-collapse: collapse; text-align: center;"> <tr> <td style="width: 10%;"></td> <td style="width: 10%;"></td> <td style="width: 10%;"></td> <td style="width: 10%;"></td> <td style="width: 10%;"></td> <td style="width: 10%;"></td> <td style="width: 10%;"></td> <td style="width: 10%;"></td> <td style="width: 10%;"></td> <td style="width: 10%;"></td> </tr> <tr> <td></td> <td></td> <td colspan="8" style="text-align: center;"> <table border="1" style="width: 100%; border-collapse: collapse; text-align: center;"> <tr> <td style="width: 10%;"></td> <td style="width: 10%;"></td> <td style="width: 10%;"></td> <td style="width: 10%;"></td> <td style="width: 10%;"></td> <td style="width: 10%;"></td> <td style="width: 10%;"></td> <td style="width: 10%;"></td> <td style="width: 10%;"></td> <td style="width: 10%;"></td> </tr> <tr> <td></td> <td></td> <td colspan="8" style="text-align: center;"> <table border="1" style="width: 100%; border-collapse: collapse; text-align: center;"> <tr> <td style="width: 10%;"></td> <td style="width: 10%;"></td> <td style="width: 10%;"></td> <td style="width: 10%;"></td> <td style="width: 10%;"></td> <td style="width: 10%;"></td> <td style="width: 10%;"></td> <td style="width: 10%;"></td> <td style="width: 10%;"></td> <td style="width: 10%;"></td> </tr> <tr> <td></td> <td></td> <td colspan="8" style="text-align: center;"> <table border="1" style="width: 100%; border-collapse: collapse; text-align: center;"> <tr> <td style="width: 10%;"></td> <td style="width: 10%;"></td> <td style="width: 10%;"></td> <td style="width: 10%;"></td> <td style="width: 10%;"></td> <td style="width: 10%;"></td> <td style="width: 10%;"></td> <td style="width: 10%;"></td> <td style="width: 10%;"></td> <td style="width: 10%;"></td> </tr> <tr> <td></td> <td></td> <td colspan="8" style="text-align: center;"> <table border="1" style="width: 100%; border-collapse: collapse; text-align: center;"> <tr> <td style="width: 10%;"></td> <td style="width: 10%;"></td> <td style="width: 10%;"></td> <td style="width: 10%;"></td> <td style="width: 10%;"></td> <td style="width: 10%;"></td> <td style="width: 10%;"></td> <td style="width: 10%;"></td> <td style="width: 10%;"></td> <td style="width: 10%;"></td> </tr> <tr> <td></td> <td></td> <td colspan="8" style="text-align: center;"> <table border="1" style="width: 100%; border-collapse: collapse; text-align: center;"> <tr> <td style="width: 10%;"></td> <td style="width: 10%;"></td> <td style="width: 10%;"></td> <td style="width: 10%;"></td> <td style="width: 10%;"></td> <td style="width: 10%;"></td> <td style="width: 10%;"></td> <td style="width: 10%;"></td> <td style="width: 10%;"></td> <td style="width: 10%;"></td> </tr> <tr> <td></td> <td></td> <td colspan="8" style="text-align: center;"> <table border="1" style="width: 100%; border-collapse: collapse; text-align: center;"> <tr> <td style="width: 10%;"></td> <td style="width: 10%;"></td> <td style="width: 10%;"></td> <td style="width: 10%;"></td> <td style="width: 10%;"></td> <td style="width: 10%;"></td> <td style="width: 10%;"></td> <td style="width: 10%;"></td> <td style="width: 10%;"></td> <td style="width: 10%;"></td> </tr> <tr> <td></td> <td></td> <td colspan="8" style="text-align: center;"> <table border="1" style="width: 100%; border-collapse: collapse; text-align: center;"> <tr> <td style="width: 10%;"></td> <td style="width: 10%;"></td> <td style="width: 10%;"></td> <td style="width: 10%;"></td> <td style="width: 10%;"></td> <td style="width: 10%;"></td> <td style="width: 10%;"></td> <td style="width: 10%;"></td> <td style="width: 10%;"></td> <td style="width: 10%;"></td> </tr> <tr> <td></td> <td></td> <td colspan="8" style="text-align: center;"> <table border="1" style="width: 100%; border-collapse: collapse; text-align: center;"> <tr> <td style="width: 10%;"></td> <td style="width: 10%;"></td> <td style="width: 10%;"></td> <td style="width: 10%;"></td> <td style="width: 10%;"></td> <td style="width: 10%;"></td> <td style="width: 10%;"></td> <td style="width: 10%;"></td> <td style="width: 10%;"></td> <td style="width: 10%;"></td> </tr> <tr> <td></td> <td></td> <td colspan="8" style="text-align: center;"> <table border="1" style="width: 100%; border-collapse: collapse; text-align: center;"> <tr> <td style="width: 10%;"></td> <td style="width: 10%;"></td> <td style="width: 10%;"></td> <td style="width: 10%;"></td> <td style="width: 10%;"></td> <td style="width: 10%;"></td> <td style="width: 10%;"></td> <td style="width: 10%;"></td> <td style="width: 10%;"></td> <td style="width: 10%;"></td> </tr> <tr> <td></td> <td></td> <td colspan="8" style="text-align: center;"> <table border="1" style="width: 100%; border-collapse: collapse; text-align: center;"> <tr> <td style="width: 10%;"></td> <td style="width: 10%;"></td> <td style="width: 10%;"></td> <td style="width: 10%;"></td> <td style="width: 10%;"></td> <td style="width: 10%;"></td> <td style="width: 10%;"></td> <td style="width: 10%;"></td> <td style="width: 10%;"></td> <td style="width: 10%;"></td> </tr> <tr> <td></td> <td></td> <td colspan="8" style="text-align: center;"> <table border="1" style="width: 100%; border-collapse: collapse; text-align: center;"> <tr> <td style="width: 10%;"></td> <td style="width: 10%;"></td> <td style="width: 10%;"></td> <td style="width: 10%;"></td> <td style="width: 10%;"></td> <td style="width: 10%;"></td> <td style="width: 10%;"></td> <td style="width: 10%;"></td> <td style="width: 10%;"></td> <td style="width: 10%;"></td> </tr> <tr> <td></td> <td></td> <td colspan="8" style="text-align: center;"> <table border="1" style="width: 100%; border-collapse: collapse; text-align: center;"> <tr> <td style="width: 10%;"></td> <td style="width: 10%;"></td> <td style="width: 10%;"></td> <td style="width:
10%;"></td> <td style="width: 10%;"></td> <td style="width: 10%;"></td> <td style="width: 10%;"></td> <td style="width: 10%;"></td> <td style="width: 10%;"></td> <td style="width: 10%;"></td> </tr> <tr> <td></td> <td></td> <td colspan="8" style="text-align: center;"> <table border="1" style="width: 100%; border-collapse: collapse; text-align: center;"> <tr> </tr></table></td></tr></table></td></tr></table></td></tr></table></td></tr></table></td></tr></table></td></tr></table></td></tr></table></td></tr></table></td></tr></table></td></tr></table></td></tr></table></td></tr></table></td></tr></table></td></tr></table></td></tr></table></td></tr></table></td></tr></table></td></tr></table></td></tr></table></td></tr></table></td></tr></table></td></tr></table></td></tr></table></td></tr></table></td></tr></table></td></tr></table></td></tr></table></td></tr></table></td></tr></table></td></tr></table></td></tr></table></td></tr></table></td></tr></table></td></tr></table></td></tr></table></td></tr></table></td></tr></table>
 | | | | | | | | | | | | | | | | | | | | <table border="1" style="width: 100%; border-collapse: collapse; text-align: center;"> <tr> <td style="width: 10%;"></td> <td style="width: 10%;"></td> <td style="width: 10%;"></td> <td style="width: 10%;"></td> <td style="width: 10%;"></td> <td style="width: 10%;"></td> <td style="width: 10%;"></td> <td style="width: 10%;"></td> <td style="width: 10%;"></td> <td style="width: 10%;"></td> </tr> <tr> <td></td> <td></td> <td colspan="8" style="text-align: center;"> <table border="1" style="width: 100%; border-collapse: collapse; text-align: center;"> <tr> <td style="width: 10%;"></td> <td style="width: 10%;"></td> <td style="width: 10%;"></td> <td style="width: 10%;"></td> <td style="width: 10%;"></td> <td style="width: 10%;"></td> <td style="width: 10%;"></td> <td style="width: 10%;"></td> <td style="width: 10%;"></td> <td style="width: 10%;"></td> </tr> <tr> <td></td> <td></td> <td colspan="8" style="text-align: center;"> <table border="1" style="width: 100%; border-collapse: collapse; text-align: center;"> <tr> <td style="width: 10%;"></td> <td style="width: 10%;"></td> <td style="width: 10%;"></td> <td style="width: 10%;"></td> <td style="width: 10%;"></td> <td style="width: 10%;"></td> <td style="width: 10%;"></td> <td style="width: 10%;"></td> <td style="width: 10%;"></td> <td style="width: 10%;"></td> </tr> <tr> <td></td> <td></td> <td colspan="8" style="text-align: center;"> <table border="1" style="width: 100%; border-collapse: collapse; text-align: center;"> <tr> <td style="width: 10%;"></td> <td style="width: 10%;"></td> <td style="width: 10%;"></td> <td style="width: 10%;"></td> <td style="width: 10%;"></td> <td style="width: 10%;"></td> <td style="width: 10%;"></td> <td style="width: 10%;"></td> <td style="width: 10%;"></td> <td style="width: 10%;"></td> </tr> <tr> <td></td> <td></td> <td colspan="8" style="text-align: center;"> <table border="1" style="width: 100%; border-collapse: collapse; text-align: center;"> <tr> <td style="width: 10%;"></td> <td style="width: 10%;"></td> <td style="width: 10%;"></td> <td style="width: 10%;"></td> <td style="width: 10%;"></td> <td style="width: 10%;"></td> <td style="width: 10%;"></td> <td style="width: 10%;"></td> <td style="width: 10%;"></td> <td style="width: 10%;"></td> </tr> <tr> <td></td> <td></td> <td colspan="8" style="text-align: center;"> <table border="1" style="width: 100%; border-collapse: collapse; text-align: center;"> <tr> <td style="width: 10%;"></td> <td style="width: 10%;"></td> <td style="width: 10%;"></td> <td style="width: 10%;"></td> <td style="width: 10%;"></td> <td style="width: 10%;"></td> <td style="width: 10%;"></td> <td style="width: 10%;"></td> <td style="width: 10%;"></td> <td style="width: 10%;"></td> </tr> <tr> <td></td> <td></td> <td colspan="8" style="text-align: center;"> <table border="1" style="width: 100%; border-collapse: collapse; text-align: center;"> <tr> <td style="width: 10%;"></td> <td style="width: 10%;"></td> <td style="width: 10%;"></td> <td style="width: 10%;"></td> <td style="width: 10%;"></td> <td style="width: 10%;"></td> <td style="width: 10%;"></td> <td style="width: 10%;"></td> <td style="width: 10%;"></td> <td style="width: 10%;"></td> </tr> <tr> <td></td> <td></td> <td colspan="8" style="text-align: center;"> <table border="1" style="width: 100%; border-collapse: collapse; text-align: center;"> <tr> <td style="width: 10%;"></td> <td style="width: 10%;"></td> <td style="width: 10%;"></td> <td style="width: 10%;"></td> <td style="width: 10%;"></td> <td style="width: 10%;"></td> <td style="width: 10%;"></td> <td style="width: 10%;"></td> <td style="width: 10%;"></td> <td style="width: 10%;"></td> </tr> <tr> <td></td> <td></td> <td colspan="8" style="text-align: center;"> <table border="1" style="width: 100%; border-collapse: collapse; text-align: center;"> <tr> <td style="width: 10%;"></td> <td style="width: 10%;"></td> <td style="width: 10%;"></td> <td style="width: 10%;"></td> <td style="width: 10%;"></td> <td style="width: 10%;"></td> <td style="width: 10%;"></td> <td style="width: 10%;"></td> <td style="width: 10%;"></td> <td style="width: 10%;"></td> </tr> <tr> <td></td> <td></td> <td colspan="8" style="text-align: center;"> <table border="1" style="width: 100%; border-collapse: collapse; text-align: center;"> <tr> <td style="width: 10%;"></td> <td style="width: 10%;"></td> <td style="width: 10%;"></td> <td style="width: 10%;"></td> <td style="width: 10%;"></td> <td style="width: 10%;"></td> <td style="width: 10%;"></td> <td style="width: 10%;"></td> <td style="width: 10%;"></td> <td style="width: 10%;"></td> </tr> <tr> <td></td> <td></td> <td colspan="8" style="text-align: center;"> <table border="1" style="width: 100%; border-collapse: collapse; text-align: center;"> <tr> <td style="width: 10%;"></td> <td style="width: 10%;"></td> <td style="width: 10%;"></td> <td style="width: 10%;"></td> <td style="width: 10%;"></td> <td style="width: 10%;"></td> <td style="width: 10%;"></td> <td style="width: 10%;"></td> <td style="width: 10%;"></td> <td style="width: 10%;"></td> </tr> <tr> <td></td> <td></td> <td colspan="8" style="text-align: center;"> <table border="1" style="width: 100%; border-collapse: collapse; text-align: center;"> <tr> <td style="width: 10%;"></td> <td style="width: 10%;"></td> <td style="width: 10%;"></td> <td style="width: 10%;"></td> <td style="width: 10%;"></td> <td style="width: 10%;"></td> <td style="width: 10%;"></td> <td style="width: 10%;"></td> <td style="width: 10%;"></td> <td style="width: 10%;"></td> </tr> <tr> <td></td> <td></td> <td colspan="8" style="text-align: center;"> <table border="1" style="width: 100%; border-collapse: collapse; text-align: center;"> <tr> <td style="width: 10%;"></td> <td style="width: 10%;"></td> <td style="width: 10%;"></td> <td style="width: 10%;"></td> <td style="width: 10%;"></td> <td style="width: 10%;"></td> <td style="width: 10%;"></td> <td style="width: 10%;"></td> <td style="width: 10%;"></td> <td style="width: 10%;"></td> </tr> <tr> <td></td> <td></td> <td colspan="8" style="text-align: center;"> <table border="1" style="width: 100%; border-collapse: collapse; text-align: center;"> <tr> <td style="width: 10%;"></td> <td style="width: 10%;"></td> <td style="width: 10%;"></td> <td style="width: 10%;"></td> <td style="width: 10%;"></td> <td style="width: 10%;"></td> <td style="width: 10%;"></td> <td style="width: 10%;"></td> <td style="width: 10%;"></td> <td style="width: 10%;"></td> </tr> <tr> <td></td> <td></td> <td colspan="8" style="text-align: center;"> <table border="1" style="width: 100%; border-collapse: collapse; text-align: center;"> <tr> <td style="width: 10%;"></td> <td style="width: 10%;"></td> <td style="width: 10%;"></td> <td style="width: 10%;"></td> <td style="width: 10%;"></td> <td style="width: 10%;"></td> <td style="width: 10%;"></td> <td style="width: 10%;"></td> <td style="width: 10%;"></td> <td style="width: 10%;"></td> </tr> <tr> <td></td> <td></td> <td colspan="8" style="text-align: center;"> <table border="1" style="width: 100%; border-collapse: collapse; text-align: center;"> <tr> <td style="width: 10%;"></td> <td style="width: 10%;"></td> <td style="width: 10%;"></td> <td style="width: 10%;"></td> <td style="width: 10%;"></td> <td style="width: 10%;"></td> <td style="width: 10%;"></td> <td style="width: 10%;"></td> <td style="width: 10%;"></td> <td style="width: 10%;"></td> </tr> <tr> <td></td> <td></td> <td colspan="8" style="text-align: center;"> <table border="1" style="width: 100%; border-collapse: collapse; text-align: center;"> <tr> <td style="width: 10%;"></td> <td style="width: 10%;"></td> <td style="width: 10%;"></td> <td style="width: 10%;"></td> <td style="width:
10%;"></td> <td style="width: 10%;"></td> <td style="width: 10%;"></td> <td style="width: 10%;"></td> <td style="width: 10%;"></td> <td style="width: 10%;"></td> </tr> <tr> <td></td> <td></td> <td colspan="8" style="text-align: center;"> <table border="1" style="width: 100%; border-collapse: collapse; text-align: center;"> <tr> <td style="width: 10%;"></td> <td style="width: 10%;"></td> <td style="width: 10%;"></td> <td style="width: 10%;"></td> <td style="width: 10%;"></td> <td style="width: 10%;"></td> <td style="width: 10%;"></td> <td style="width: 10%;"></td> <td style="width: 10%;"></td> <td style="width: 10%;"></td> </tr> <tr> <td></td> <td></td> <td colspan="8" style="text-align: center;"> <table border="1" style="width: 100%; border-collapse: collapse; text-align: center;"> <tr> <td style="width: 10%;"></td> <td style="width: 10%;"></td> <td style="width: 10%;"></td> <td style="width: 10%;"></td> <td style="width: 10%;"></td> <td style="width: 10%;"></td> <td style="width: 10%;"></td> <td style="width: 10%;"></td> <td style="width: 10%;"></td> <td style="width: 10%;"></td> </tr> <tr> <td></td> <td></td> <td colspan="8" style="text-align: center;"> <table border="1" style="width: 100%; border-collapse: collapse; text-align: center;"> <tr> <td style="width: 10%;"></td> <td style="width: 10%;"></td> <td style="width: 10%;"></td> <td style="width: 10%;"></td> <td style="width: 10%;"></td> <td style="width: 10%;"></td> <td style="width: 10%;"></td> <td style="width: 10%;"></td> <td style="width: 10%;"></td> <td style="width: 10%;"></td> </tr> <tr> <td></td> <td></td> <td colspan="8" style="text-align: center;"> <table border="1" style="width: 100%; border-collapse: collapse; text-align: center;"> <tr> <td style="width: 10%;"></td> <td style="width: 10%;"></td> <td style="width: 10%;"></td> <td style="width: 10%;"></td> <td style="width: 10%;"></td> <td style="width: 10%;"></td> <td style="width: 10%;"></td> <td style="width: 10%;"></td> <td style="width: 10%;"></td> <td style="width: 10%;"></td> </tr> <tr> <td></td> <td></td> <td colspan="8" style="text-align: center;"> <table border="1" style="width: 100%; border-collapse: collapse; text-align: center;"> <tr> <td style="width: 10%;"></td> <td style="width: 10%;"></td> <td style="width: 10%;"></td> <td style="width: 10%;"></td> <td style="width: 10%;"></td> <td style="width: 10%;"></td> <td style="width: 10%;"></td> <td style="width: 10%;"></td> <td style="width: 10%;"></td> <td style="width: 10%;"></td> </tr> <tr> <td></td> <td></td> <td colspan="8" style="text-align: center;"> <table border="1" style="width: 100%; border-collapse: collapse; text-align: center;"> <tr> <td style="width: 10%;"></td> <td style="width: 10%;"></td> <td style="width: 10%;"></td> <td style="width: 10%;"></td> <td style="width: 10%;"></td> <td style="width: 10%;"></td> <td style="width: 10%;"></td> <td style="width: 10%;"></td> <td style="width: 10%;"></td> <td style="width: 10%;"></td> </tr> <tr> <td></td> <td></td> <td colspan="8" style="text-align: center;"> <table border="1" style="width: 100%; border-collapse: collapse; text-align: center;"> <tr> <td style="width: 10%;"></td> <td style="width: 10%;"></td> <td style="width: 10%;"></td> <td style="width: 10%;"></td> <td style="width: 10%;"></td> <td style="width: 10%;"></td> <td style="width: 10%;"></td> <td style="width: 10%;"></td> <td style="width: 10%;"></td> <td style="width: 10%;"></td> </tr> <tr> <td></td> <td></td> <td colspan="8" style="text-align: center;"> <table border="1" style="width: 100%; border-collapse: collapse; text-align: center;"> <tr> <td style="width: 10%;"></td> <td style="width: 10%;"></td> <td style="width: 10%;"></td> <td style="width: 10%;"></td> <td style="width: 10%;"></td> <td style="width: 10%;"></td> <td style="width: 10%;"></td> <td style="width: 10%;"></td> <td style="width: 10%;"></td> <td style="width: 10%;"></td> </tr> <tr> <td></td> <td></td> <td colspan="8" style="text-align: center;"> <table border="1" style="width: 100%; border-collapse: collapse; text-align: center;"> <tr> <td style="width: 10%;"></td> <td style="width: 10%;"></td> <td style="width: 10%;"></td> <td style="width: 10%;"></td> <td style="width: 10%;"></td> <td style="width: 10%;"></td> <td style="width: 10%;"></td> <td style="width: 10%;"></td> <td style="width: 10%;"></td> <td style="width: 10%;"></td> </tr> <tr> <td></td> <td></td> <td colspan="8" style="text-align: center;"> <table border="1" style="width: 100%; border-collapse: collapse; text-align: center;"> <tr> <td style="width: 10%;"></td> <td style="width: 10%;"></td> <td style="width: 10%;"></td> <td style="width: 10%;"></td> <td style="width: 10%;"></td> <td style="width: 10%;"></td> <td style="width: 10%;"></td> <td style="width: 10%;"></td> <td style="width: 10%;"></td> <td style="width: 10%;"></td> </tr> <tr> <td></td> <td></td> <td colspan="8" style="text-align: center;"> <table border="1" style="width: 100%; border-collapse: collapse; text-align: center;"> <tr> <td style="width: 10%;"></td> <td style="width: 10%;"></td> <td style="width: 10%;"></td> <td style="width: 10%;"></td> <td style="width: 10%;"></td> <td style="width: 10%;"></td> <td style="width: 10%;"></td> <td style="width: 10%;"></td> <td style="width: 10%;"></td> <td style="width: 10%;"></td> </tr> <tr> <td></td> <td></td> <td colspan="8" style="text-align: center;"> <table border="1" style="width: 100%; border-collapse: collapse; text-align: center;"> <tr> <td style="width: 10%;"></td> <td style="width: 10%;"></td> <td style="width: 10%;"></td> <td style="width: 10%;"></td> <td style="width: 10%;"></td> <td style="width: 10%;"></td> <td style="width: 10%;"></td> <td style="width: 10%;"></td> <td style="width: 10%;"></td> <td style="width: 10%;"></td> </tr> <tr> <td></td> <td></td> <td colspan="8" style="text-align: center;"> <table border="1" style="width: 100%; border-collapse: collapse; text-align: center;"> <tr> <td style="width: 10%;"></td> <td style="width: 10%;"></td> <td style="width: 10%;"></td> <td style="width: 10%;"></td> <td style="width: 10%;"></td> <td style="width: 10%;"></td> <td style="width: 10%;"></td> <td style="width: 10%;"></td> <td style="width: 10%;"></td> <td style="width: 10%;"></td> </tr> <tr> <td></td> <td></td> <td colspan="8" style="text-align: center;"> <table border="1" style="width: 100%; border-collapse: collapse; text-align: center;"> <tr> <td style="width: 10%;"></td> <td style="width: 10%;"></td> <td style="width: 10%;"></td> <td style="width: 10%;"></td> <td style="width: 10%;"></td> <td style="width: 10%;"></td> <td style="width: 10%;"></td> <td style="width: 10%;"></td> <td style="width: 10%;"></td> <td style="width: 10%;"></td> </tr> <tr> <td></td> <td></td> <td colspan="8" style="text-align: center;"> <table border="1" style="width: 100%; border-collapse: collapse; text-align: center;"> <tr> <td style="width: 10%;"></td> <td style="width: 10%;"></td> <td style="width: 10%;"></td> <td style="width: 10%;"></td> <td style="width: 10%;"></td> <td style="width: 10%;"></td> <td style="width: 10%;"></td> <td style="width: 10%;"></td> <td style="width: 10%;"></td> <td style="width: 10%;"></td> </tr> <tr> <td></td> <td></td> <td colspan="8" style="text-align: center;"> <table border="1" style="width: 100%; border-collapse: collapse; text-align: center;"> <tr> <td style="width: 10%;"></td> <td style="width: 10%;"></td> <td style="width: 10%;"></td> <td style="width: 10%;"></td> <td style="width: 10%;"></td> <td style="width: 10%;"></td> <td style="width: 10%;"></td> <td style="width: 10%;"></td> <td style="width: 10%;"></td> <td style="width: 10%;"></td> </tr> <tr> <td></td> <td></td> <td colspan="8" style="text-align: center;"> <table border="1" style="width: 100%; border-collapse: collapse; text-align: center;"> <tr> <td style="width: 10%;"></td> <td style="width: 10%;"></td> <td style="width: 10%;"></td> <td style="width: 10%;"></td> <td style="width: 10%;"></td> <td style="width: 10%;"></td> <td style="width: 10%;"></td> <td style="width: 10%;"></td> <td style="width: 10%;"></td> <td style="width: 10%;"></td> </tr> <tr> <td></td> <td></td> <td colspan="8" style="text-align: center;"> <table border="1" style="width: 100%; border-collapse: collapse; text-align: center;"> <tr> <td style="width: 10%;"></td> <td style="width: 10%;"></td> <td style="width: 10%;"></td> <td style="width: 10%;"></td> <td style="width: 10%;"></td> <td style="width: 10%;"></td> <td style="width: 10%;"></td> <td style="width: 10%;"></td> <td style="width: 10%;"></td> <td style="width: 10%;"></td> </tr> <tr> <td></td> <td></td> <td colspan="8" style="text-align: center;"> <table border="1" style="width: 100%; border-collapse: collapse; text-align: center;"> <tr> <td style="width: 10%;"></td> <td style="width: 10%;"></td> <td style="width: 10%;"></td> <td style="width: 10%;"></td> <td style="width: 10%;"></td> <td style="width: 10%;"></td> <td style="width: 10%;"></td> <td style="width: 10%;"></td> <td style="width: 10%;"></td> <td style="width: 10%;"></td> </tr> <tr> <td></td> <td></td> <td colspan="8" style="text-align: center;"> <table border="1" style="width: 100%; border-collapse: collapse; text-align: center;"> <tr> </tr></table></td></tr></table></td></tr></table></td></tr></table></td></tr></table></td></tr></table></td></tr></table></td></tr></table></td></tr></table></td></tr></table></td></tr></table></td></tr></table></td></tr></table></td></tr></table></td></tr></table></td></tr></table></td></tr></table></td></tr></table></td></tr></table></td></tr></table></td></tr></table></td></tr></table></td></tr></table></td></tr></table></td></tr></table></td></tr></table></td></tr></table></td></tr></table></td></tr></table></td></tr></table></td></tr></table></td></tr></table></td></tr></table></td></tr></table></td></tr></table></td></tr></table></td></tr></table>

 | | | | | | | | | | | | | | | | | | | | <table border="1" style="width: 100%; border-collapse: collapse; text-align: center;"> <tr> <td style="width: 10%;"></td> <td style="width: 10%;"></td> <td style="width: 10%;"></td> <td style="width: 10%;"></td> <td style="width: 10%;"></td> <td style="width: 10%;"></td> <td style="width: 10%;"></td> <td style="width: 10%;"></td> <td style="width: 10%;"></td> <td style="width: 10%;"></td> </tr> <tr> <td></td> <td></td> <td colspan="8" style="text-align: center;"> <table border="1" style="width: 100%; border-collapse: collapse; text-align: center;"> <tr> <td style="width: 10%;"></td> <td style="width: 10%;"></td> <td style="width: 10%;"></td> <td style="width: 10%;"></td> <td style="width: 10%;"></td> <td style="width: 10%;"></td> <td style="width: 10%;"></td> <td style="width: 10%;"></td> <td style="width: 10%;"></td> <td style="width: 10%;"></td> </tr> <tr> <td></td> <td></td> <td colspan="8" style="text-align: center;"> <table border="1" style="width: 100%; border-collapse: collapse; text-align: center;"> <tr> <td style="width: 10%;"></td> <td style="width: 10%;"></td> <td style="width: 10%;"></td> <td style="width: 10%;"></td> <td style="width: 10%;"></td> <td style="width: 10%;"></td> <td style="width: 10%;"></td> <td style="width: 10%;"></td> <td style="width: 10%;"></td> <td style="width: 10%;"></td> </tr> <tr> <td></td> <td></td> <td colspan="8" style="text-align: center;"> <table border="1" style="width: 100%; border-collapse: collapse; text-align: center;"> <tr> <td style="width: 10%;"></td> <td style="width: 10%;"></td> <td style="width: 10%;"></td> <td style="width: 10%;"></td> <td style="width: 10%;"></td> <td style="width: 10%;"></td> <td style="width: 10%;"></td> <td style="width: 10%;"></td> <td style="width: 10%;"></td> <td style="width: 10%;"></td> </tr> <tr> <td></td> <td></td> <td colspan="8" style="text-align: center;"> <table border="1" style="width: 100%; border-collapse: collapse; text-align: center;"> <tr> <td style="width: 10%;"></td> <td style="width: 10%;"></td> <td style="width: 10%;"></td> <td style="width: 10%;"></td> <td style="width: 10%;"></td> <td style="width: 10%;"></td> <td style="width: 10%;"></td> <td style="width: 10%;"></td> <td style="width: 10%;"></td> <td style="width: 10%;"></td> </tr> <tr> <td></td> <td></td> <td colspan="8" style="text-align: center;"> <table border="1" style="width: 100%; border-collapse: collapse; text-align: center;"> <tr> <td style="width: 10%;"></td> <td style="width: 10%;"></td> <td style="width: 10%;"></td> <td style="width: 10%;"></td> <td style="width: 10%;"></td> <td style="width: 10%;"></td> <td style="width: 10%;"></td> <td style="width: 10%;"></td> <td style="width: 10%;"></td> <td style="width: 10%;"></td> </tr> <tr> <td></td> <td></td> <td colspan="8" style="text-align: center;"> <table border="1" style="width: 100%; border-collapse: collapse; text-align: center;"> <tr> <td style="width: 10%;"></td> <td style="width: 10%;"></td> <td style="width: 10%;"></td> <td style="width: 10%;"></td> <td style="width: 10%;"></td> <td style="width: 10%;"></td> <td style="width: 10%;"></td> <td style="width: 10%;"></td> <td style="width: 10%;"></td> <td style="width: 10%;"></td> </tr> <tr> <td></td> <td></td> <td colspan="8" style="text-align: center;"> <table border="1" style="width: 100%; border-collapse: collapse; text-align: center;"> <tr> <td style="width: 10%;"></td> <td style="width: 10%;"></td> <td style="width: 10%;"></td> <td style="width: 10%;"></td> <td style="width: 10%;"></td> <td style="width: 10%;"></td> <td style="width: 10%;"></td> <td style="width: 10%;"></td> <td style="width: 10%;"></td> <td style="width: 10%;"></td> </tr> <tr> <td></td> <td></td> <td colspan="8" style="text-align: center;"> <table border="1" style="width: 100%; border-collapse: collapse; text-align: center;"> <tr> <td style="width: 10%;"></td> <td style="width: 10%;"></td> <td style="width: 10%;"></td> <td style="width: 10%;"></td> <td style="width: 10%;"></td> <td style="width: 10%;"></td> <td style="width: 10%;"></td> <td style="width: 10%;"></td> <td style="width: 10%;"></td> <td style="width: 10%;"></td> </tr> <tr> <td></td> <td></td> <td colspan="8" style="text-align: center;"> <table border="1" style="width: 100%; border-collapse: collapse; text-align: center;"> <tr> <td style="width: 10%;"></td> <td style="width: 10%;"></td> <td style="width: 10%;"></td> <td style="width: 10%;"></td> <td style="width: 10%;"></td> <td style="width: 10%;"></td> <td style="width: 10%;"></td> <td style="width: 10%;"></td> <td style="width: 10%;"></td> <td style="width: 10%;"></td> </tr> <tr> <td></td> <td></td> <td colspan="8" style="text-align: center;"> <table border="1" style="width: 100%; border-collapse: collapse; text-align: center;"> <tr> <td style="width: 10%;"></td> <td style="width: 10%;"></td> <td style="width: 10%;"></td> <td style="width: 10%;"></td> <td style="width: 10%;"></td> <td style="width: 10%;"></td> <td style="width: 10%;"></td> <td style="width: 10%;"></td> <td style="width: 10%;"></td> <td style="width: 10%;"></td> </tr> <tr> <td></td> <td></td> <td colspan="8" style="text-align: center;"> <table border="1" style="width: 100%; border-collapse: collapse; text-align: center;"> <tr> <td style="width: 10%;"></td> <td style="width: 10%;"></td> <td style="width: 10%;"></td> <td style="width: 10%;"></td> <td style="width: 10%;"></td> <td style="width: 10%;"></td> <td style="width: 10%;"></td> <td style="width: 10%;"></td> <td style="width: 10%;"></td> <td style="width: 10%;"></td> </tr> <tr> <td></td> <td></td> <td colspan="8" style="text-align: center;"> <table border="1" style="width: 100%; border-collapse: collapse; text-align: center;"> <tr> <td style="width: 10%;"></td> <td style="width: 10%;"></td> <td style="width: 10%;"></td> <td style="width: 10%;"></td> <td style="width: 10%;"></td> <td style="width: 10%;"></td> <td style="width: 10%;"></td> <td style="width: 10%;"></td> <td style="width: 10%;"></td> <td style="width: 10%;"></td> </tr> <tr> <td></td> <td></td> <td colspan="8" style="text-align: center;"> <table border="1" style="width: 100%; border-collapse: collapse; text-align: center;"> <tr> <td style="width: 10%;"></td> <td style="width: 10%;"></td> <td style="width: 10%;"></td> <td style="width: 10%;"></td> <td style="width: 10%;"></td> <td style="width: 10%;"></td> <td style="width: 10%;"></td> <td style="width: 10%;"></td> <td style="width: 10%;"></td> <td style="width: 10%;"></td> </tr> <tr> <td></td> <td></td> <td colspan="8" style="text-align: center;"> <table border="1" style="width: 100%; border-collapse: collapse; text-align: center;"> <tr> <td style="width: 10%;"></td> <td style="width: 10%;"></td> <td style="width: 10%;"></td> <td style="width: 10%;"></td> <td style="width: 10%;"></td> <td style="width: 10%;"></td> <td style="width: 10%;"></td> <td style="width: 10%;"></td> <td style="width: 10%;"></td> <td style="width: 10%;"></td> </tr> <tr> <td></td> <td></td> <td colspan="8" style="text-align: center;"> <table border="1" style="width: 100%; border-collapse: collapse; text-align: center;"> <tr> <td style="width: 10%;"></td> <td style="width: 10%;"></td> <td style="width: 10%;"></td> <td style="width: 10%;"></td> <td style="width: 10%;"></td> <td style="width: 10%;"></td> <td style="width: 10%;"></td> <td style="width: 10%;"></td> <td style="width: 10%;"></td> <td style="width: 10%;"></td> </tr> <tr> <td></td> <td></td> <td colspan="8" style="text-align: center;"> <table border="1" style="width: 100%; border-collapse: collapse; text-align: center;"> <tr> <td style="width: 10%;"></td> <td style="width: 10%;"></td> <td style="width: 10%;"></td> <td style="width: 10%;"></td> <td style="width: 10%;"></td> <td style="width: 10%;"></td> <td style="width: 10%;"></td> <td style="width: 10%;"></td> <td style="width: 10%;"></td> <td style="width: 10%;"></td> </tr> <tr> <td></td> <td></td> <td colspan="8" style="text-align: center;"> <table border="1" style="width: 100%; border-collapse: collapse; text-align: center;"> <tr> <td style="width: 10%;"></td> <td style="width: 10%;"></td> <td style="width: 10%;"></td> <td style="width: 10%;"></td> <td style="width: 10%;"></td> <td style="width: 10%;"></td> <td style="width: 10%;"></td> <td style="width: 10%;"></td> <td style="width: 10%;"></td> <td style="width: 10%;"></td> </tr> <tr> <td></td> <td></td> <td colspan="8" style="text-align: center;"> <table border="1" style="width: 100%; border-collapse: collapse; text-align: center;"> <tr> <td style="width: 10%;"></td> <td style="width: 10%;"></td> <td style="width: 10%;"></td> <td style="width: 10%;"></td> <td style="width: 10%;"></td> <td style="width: 10%;"></td> <td style="width: 10%;"></td> <td style="width: 10%;"></td> <td style="width: 10%;"></td> <td style="width: 10%;"></td> </tr> <tr> <td></td> <td></td> <td colspan="8"
style="text-align: center;"> <table border="1" style="width: 100%; border-collapse: collapse; text-align: center;"> <tr> <td style="width: 10%;"></td> <td style="width: 10%;"></td> <td style="width: 10%;"></td> <td style="width: 10%;"></td> <td style="width: 10%;"></td> <td style="width: 10%;"></td> <td style="width: 10%;"></td> <td style="width: 10%;"></td> <td style="width: 10%;"></td> <td style="width: 10%;"></td> </tr> <tr> <td></td> <td></td> <td colspan="8" style="text-align: center;"> <table border="1" style="width: 100%; border-collapse: collapse; text-align: center;"> <tr> <td style="width: 10%;"></td> <td style="width: 10%;"></td> <td style="width: 10%;"></td> <td style="width: 10%;"></td> <td style="width: 10%;"></td> <td style="width: 10%;"></td> <td style="width: 10%;"></td> <td style="width: 10%;"></td> <td style="width: 10%;"></td> <td style="width: 10%;"></td> </tr> <tr> <td></td> <td></td> <td colspan="8" style="text-align: center;"> <table border="1" style="width: 100%; border-collapse: collapse; text-align: center;"> <tr> <td style="width: 10%;"></td> <td style="width: 10%;"></td> <td style="width: 10%;"></td> <td style="width: 10%;"></td> <td style="width: 10%;"></td> <td style="width: 10%;"></td> <td style="width: 10%;"></td> <td style="width: 10%;"></td> <td style="width: 10%;"></td> <td style="width: 10%;"></td> </tr> <tr> <td></td> <td></td> <td colspan="8" style="text-align: center;"> <table border="1" style="width: 100%; border-collapse: collapse; text-align: center;"> <tr> <td style="width: 10%;"></td> <td style="width: 10%;"></td> <td style="width: 10%;"></td> <td style="width: 10%;"></td> <td style="width: 10%;"></td> <td style="width: 10%;"></td> <td style="width: 10%;"></td> <td style="width: 10%;"></td> <td style="width: 10%;"></td> <td style="width: 10%;"></td> </tr> <tr> <td></td> <td></td> <td colspan="8" style="text-align: center;"> <table border="1" style="width: 100%; border-collapse: collapse; text-align: center;"> <tr> <td style="width: 10%;"></td> <td style="width: 10%;"></td> <td style="width: 10%;"></td> <td style="width: 10%;"></td> <td style="width: 10%;"></td> <td style="width: 10%;"></td> <td style="width: 10%;"></td> <td style="width: 10%;"></td> <td style="width: 10%;"></td> <td style="width: 10%;"></td> </tr> <tr> <td></td> <td></td> <td colspan="8" style="text-align: center;"> <table border="1" style="width: 100%; border-collapse: collapse; text-align: center;"> <tr> <td style="width: 10%;"></td> <td style="width: 10%;"></td> <td style="width: 10%;"></td> <td style="width: 10%;"></td> <td style="width: 10%;"></td> <td style="width: 10%;"></td> <td style="width: 10%;"></td> <td style="width: 10%;"></td> <td style="width: 10%;"></td> <td style="width: 10%;"></td> </tr> <tr> <td></td> <td></td> <td colspan="8" style="text-align: center;"> <table border="1" style="width: 100%; border-collapse: collapse; text-align: center;"> <tr> <td style="width: 10%;"></td> <td style="width: 10%;"></td> <td style="width: 10%;"></td> <td style="width: 10%;"></td> <td style="width: 10%;"></td> <td style="width: 10%;"></td> <td style="width: 10%;"></td> <td style="width: 10%;"></td> <td style="width: 10%;"></td> <td style="width: 10%;"></td> </tr> <tr> <td></td> <td></td> <td colspan="8" style="text-align: center;"> <table border="1" style="width: 100%; border-collapse: collapse; text-align: center;"> <tr> <td style="width: 10%;"></td> <td style="width: 10%;"></td> <td style="width: 10%;"></td> <td style="width: 10%;"></td> <td style="width: 10%;"></td> <td style="width: 10%;"></td> <td style="width: 10%;"></td> <td style="width: 10%;"></td> <td style="width: 10%;"></td> <td style="width: 10%;"></td> </tr> <tr> <td></td> <td></td> <td colspan="8" style="text-align: center;"> <table border="1" style="width: 100%; border-collapse: collapse; text-align: center;"> <tr> <td style="width: 10%;"></td> <td style="width: 10%;"></td> <td style="width: 10%;"></td> <td style="width: 10%;"></td> <td style="width: 10%;"></td> <td style="width: 10%;"></td> <td style="width: 10%;"></td> <td style="width: 10%;"></td> <td style="width: 10%;"></td> <td style="width: 10%;"></td> </tr> <tr> <td></td> <td></td> <td colspan="8" style="text-align: center;"> <table border="1" style="width: 100%; border-collapse: collapse; text-align: center;"> <tr> <td style="width: 10%;"></td> <td style="width: 10%;"></td> <td style="width: 10%;"></td> <td style="width: 10%;"></td> <td style="width: 10%;"></td> <td style="width: 10%;"></td> <td style="width: 10%;"></td> <td style="width: 10%;"></td> <td style="width: 10%;"></td> <td style="width: 10%;"></td> </tr> <tr> <td></td> <td></td> <td colspan="8" style="text-align: center;"> <table border="1" style="width: 100%; border-collapse: collapse; text-align: center;"> <tr> <td style="width: 10%;"></td> <td style="width: 10%;"></td> <td style="width: 10%;"></td> <td style="width: 10%;"></td> <td style="width: 10%;"></td> <td style="width: 10%;"></td> <td style="width: 10%;"></td> <td style="width: 10%;"></td> <td style="width: 10%;"></td> <td style="width: 10%;"></td> </tr> <tr> <td></td> <td></td> <td colspan="8" style="text-align: center;"> <table border="1" style="width: 100%; border-collapse: collapse; text-align: center;"> <tr> <td style="width: 10%;"></td> <td style="width: 10%;"></td> <td style="width: 10%;"></td> <td style="width: 10%;"></td> <td style="width: 10%;"></td> <td style="width: 10%;"></td> <td style="width: 10%;"></td> <td style="width: 10%;"></td> <td style="width: 10%;"></td> <td style="width: 10%;"></td> </tr> <tr> <td></td> <td></td> <td colspan="8" style="text-align: center;"> <table border="1" style="width: 100%; border-collapse: collapse; text-align: center;"> <tr> <td style="width: 10%;"></td> <td style="width: 10%;"></td> <td style="width: 10%;"></td> <td style="width: 10%;"></td> <td style="width: 10%;"></td> <td style="width: 10%;"></td> <td style="width: 10%;"></td> <td style="width: 10%;"></td> <td style="width: 10%;"></td> <td style="width: 10%;"></td> </tr> <tr> <td></td> <td></td> <td colspan="8" style="text-align: center;"> <table border="1" style="width: 100%; border-collapse: collapse; text-align: center;"> <tr> <td style="width: 10%;"></td> <td style="width: 10%;"></td> <td style="width: 10%;"></td> <td style="width: 10%;"></td> <td style="width: 10%;"></td> <td style="width: 10%;"></td> <td style="width: 10%;"></td> <td style="width: 10%;"></td> <td style="width: 10%;"></td> <td style="width: 10%;"></td> </tr> <tr> <td></td> <td></td> <td colspan="8" style="text-align: center;"> <table border="1" style="width: 100%; border-collapse: collapse; text-align: center;"> <tr> <td style="width: 10%;"></td> <td style="width: 10%;"></td> <td style="width: 10%;"></td> <td style="width: 10%;"></td> <td style="width: 10%;"></td> <td style="width: 10%;"></td> <td style="width: 10%;"></td> <td style="width: 10%;"></td> <td style="width: 10%;"></td> <td style="width: 10%;"></td> </tr> <tr> <td></td> <td></td> <td colspan="8" style="text-align: center;"> <table border="1" style="width: 100%; border-collapse: collapse; text-align: center;"> <tr> <td style="width: 10%;"></td> <td style="width: 10%;"></td> <td style="width: 10%;"></td> <td style="width: 10%;"></td> <td style="width: 10%;"></td> <td style="width: 10%;"></td> <td style="width: 10%;"></td> <td style="width: 10%;"></td> <td style="width: 10%;"></td> <td style="width: 10%;"></td> </tr> <tr> <td></td> <td></td> <td colspan="8" style="text-align: center;"> <table border="1" style="width: 100%; border-collapse: collapse; text-align: center;"> <tr> </tr></table></td></tr></table></td></tr></table></td></tr></table></td></tr></table></td></tr></table></td></tr></table></td></tr></table></td></tr></table></td></tr></table></td></tr></table></td></tr></table></td></tr></table></td></tr></table></td></tr></table></td></tr></table></td></tr></table></td></tr></table></td></tr></table></td></tr></table></td></tr></table></td></tr></table></td></tr></table></td></tr></table></td></tr></table></td></tr></table></td></tr></table></td></tr></table></td></tr></table></td></tr></table></td></tr></table></td></tr></table></td></tr></table></td></tr></table></td></tr></table></td></tr></table>
 | | | | | | | | | | | | | | | | | | | | <table border="1" style="width: 100%; border-collapse: collapse; text-align: center;"> <tr> <td style="width: 10%;"></td> <td style="width: 10%;"></td> <td style="width: 10%;"></td> <td style="width: 10%;"></td> <td style="width: 10%;"></td> <td style="width: 10%;"></td> <td style="width: 10%;"></td> <td style="width: 10%;"></td> <td style="width: 10%;"></td> <td style="width: 10%;"></td> </tr> <tr> <td></td> <td></td> <td colspan="8" style="text-align: center;"> <table border="1" style="width: 100%;
border-collapse: collapse; text-align: center;"> <tr> <td style="width: 10%;"></td> <td style="width: 10%;"></td> <td style="width: 10%;"></td> <td style="width: 10%;"></td> <td style="width: 10%;"></td> <td style="width: 10%;"></td> <td style="width: 10%;"></td> <td style="width: 10%;"></td> <td style="width: 10%;"></td> <td style="width: 10%;"></td> </tr> <tr> <td></td> <td></td> <td colspan="8" style="text-align: center;"> <table border="1" style="width: 100%; border-collapse: collapse; text-align: center;"> <tr> <td style="width: 10%;"></td> <td style="width: 10%;"></td> <td style="width: 10%;"></td> <td style="width: 10%;"></td> <td style="width: 10%;"></td> <td style="width: 10%;"></td> <td style="width: 10%;"></td> <td style="width: 10%;"></td> <td style="width: 10%;"></td> <td style="width: 10%;"></td> </tr> <tr> <td></td> <td></td> <td colspan="8" style="text-align: center;"> <table border="1" style="width: 100%; border-collapse: collapse; text-align: center;"> <tr> <td style="width: 10%;"></td> <td style="width: 10%;"></td> <td style="width: 10%;"></td> <td style="width: 10%;"></td> <td style="width: 10%;"></td> <td style="width: 10%;"></td> <td style="width: 10%;"></td> <td style="width: 10%;"></td> <td style="width: 10%;"></td> <td style="width: 10%;"></td> </tr> <tr> <td></td> <td></td> <td colspan="8" style="text-align: center;"> <table border="1" style="width: 100%; border-collapse: collapse; text-align: center;"> <tr> <td style="width: 10%;"></td> <td style="width: 10%;"></td> <td style="width: 10%;"></td> <td style="width: 10%;"></td> <td style="width: 10%;"></td> <td style="width: 10%;"></td> <td style="width: 10%;"></td> <td style="width: 10%;"></td> <td style="width: 10%;"></td> <td style="width: 10%;"></td> </tr> <tr> <td></td> <td></td> <td colspan="8" style="text-align: center;"> <table border="1" style="width: 100%; border-collapse: collapse; text-align: center;"> <tr> <td style="width: 10%;"></td> <td style="width: 10%;"></td> <td style="width: 10%;"></td> <td style="width: 10%;"></td> <td style="width: 10%;"></td> <td style="width: 10%;"></td> <td style="width: 10%;"></td> <td style="width: 10%;"></td> <td style="width: 10%;"></td> <td style="width: 10%;"></td> </tr> <tr> <td></td> <td></td> <td colspan="8" style="text-align: center;"> <table border="1" style="width: 100%; border-collapse: collapse; text-align: center;"> <tr> <td style="width: 10%;"></td> <td style="width: 10%;"></td> <td style="width: 10%;"></td> <td style="width: 10%;"></td> <td style="width: 10%;"></td> <td style="width: 10%;"></td> <td style="width: 10%;"></td> <td style="width: 10%;"></td> <td style="width: 10%;"></td> <td style="width: 10%;"></td> </tr> <tr> <td></td> <td></td> <td colspan="8" style="text-align: center;"> <table border="1" style="width: 100%; border-collapse: collapse; text-align: center;"> <tr> <td style="width: 10%;"></td> <td style="width: 10%;"></td> <td style="width: 10%;"></td> <td style="width: 10%;"></td> <td style="width: 10%;"></td> <td style="width: 10%;"></td> <td style="width: 10%;"></td> <td style="width: 10%;"></td> <td style="width: 10%;"></td> <td style="width: 10%;"></td> </tr> <tr> <td></td> <td></td> <td colspan="8" style="text-align: center;"> <table border="1" style="width: 100%; border-collapse: collapse; text-align: center;"> <tr> <td style="width: 10%;"></td> <td style="width: 10%;"></td> <td style="width: 10%;"></td> <td style="width: 10%;"></td> <td style="width: 10%;"></td> <td style="width: 10%;"></td> <td style="width: 10%;"></td> <td style="width: 10%;"></td> <td style="width: 10%;"></td> <td style="width: 10%;"></td> </tr> <tr> <td></td> <td></td> <td colspan="8" style="text-align: center;"> <table border="1" style="width: 100%; border-collapse: collapse; text-align: center;"> <tr> <td style="width: 10%;"></td> <td style="width: 10%;"></td> <td style="width: 10%;"></td> <td style="width: 10%;"></td> <td style="width: 10%;"></td> <td style="width: 10%;"></td> <td style="width: 10%;"></td> <td style="width: 10%;"></td> <td style="width: 10%;"></td> <td style="width: 10%;"></td> </tr> <tr> <td></td> <td></td> <td colspan="8" style="text-align: center;"> <table border="1" style="width: 100%; border-collapse: collapse; text-align: center;"> <tr> <td style="width: 10%;"></td> <td style="width: 10%;"></td> <td style="width: 10%;"></td> <td style="width: 10%;"></td> <td style="width: 10%;"></td> <td style="width: 10%;"></td> <td style="width: 10%;"></td> <td style="width: 10%;"></td> <td style="width: 10%;"></td> <td style="width: 10%;"></td> </tr> <tr> <td></td> <td></td> <td colspan="8" style="text-align: center;"> <table border="1" style="width: 100%; border-collapse: collapse; text-align: center;"> <tr> <td style="width: 10%;"></td> <td style="width: 10%;"></td> <td style="width: 10%;"></td> <td style="width: 10%;"></td> <td style="width: 10%;"></td> <td style="width: 10%;"></td> <td style="width: 10%;"></td> <td style="width: 10%;"></td> <td style="width: 10%;"></td> <td style="width: 10%;"></td> </tr> <tr> <td></td> <td></td> <td colspan="8" style="text-align: center;"> <table border="1" style="width: 100%; border-collapse: collapse; text-align: center;"> <tr> <td style="width: 10%;"></td> <td style="width: 10%;"></td> <td style="width: 10%;"></td> <td style="width: 10%;"></td> <td style="width: 10%;"></td> <td style="width: 10%;"></td> <td style="width: 10%;"></td> <td style="width: 10%;"></td> <td style="width: 10%;"></td> <td style="width: 10%;"></td> </tr> <tr> <td></td> <td></td> <td colspan="8" style="text-align: center;"> <table border="1" style="width: 100%; border-collapse: collapse; text-align: center;"> <tr> <td style="width: 10%;"></td> <td style="width: 10%;"></td> <td style="width: 10%;"></td> <td style="width: 10%;"></td> <td style="width: 10%;"></td> <td style="width: 10%;"></td> <td style="width: 10%;"></td> <td style="width: 10%;"></td> <td style="width: 10%;"></td> <td style="width: 10%;"></td> </tr> <tr> <td></td> <td></td> <td colspan="8" style="text-align: center;"> <table border="1" style="width: 100%; border-collapse: collapse; text-align: center;"> <tr> <td style="width: 10%;"></td> <td style="width: 10%;"></td> <td style="width: 10%;"></td> <td style="width: 10%;"></td> <td style="width: 10%;"></td> <td style="width: 10%;"></td> <td style="width: 10%;"></td> <td style="width: 10%;"></td> <td style="width: 10%;"></td> <td style="width: 10%;"></td> </tr> <tr> <td></td> <td></td> <td colspan="8" style="text-align: center;"> <table border="1" style="width: 100%; border-collapse: collapse; text-align: center;"> <tr> <td style="width: 10%;"></td> <td style="width: 10%;"></td> <td style="width: 10%;"></td> <td style="width: 10%;"></td> <td style="width: 10%;"></td> <td style="width: 10%;"></td> <td style="width: 10%;"></td> <td style="width: 10%;"></td> <td style="width: 10%;"></td> <td style="width: 10%;"></td> </tr> <tr> <td></td> <td></td> <td colspan="8" style="text-align: center;"> <table border="1" style="width: 100%; border-collapse: collapse; text-align: center;"> <tr> <td style="width: 10%;"></td> <td style="width: 10%;"></td> <td style="width: 10%;"></td> <td style="width: 10%;"></td> <td style="width: 10%;"></td> <td style="width: 10%;"></td> <td style="width: 10%;"></td> <td style="width: 10%;"></td> <td style="width: 10%;"></td> <td style="width: 10%;"></td> </tr> <tr> <td></td> <td></td> <td colspan="8" style="text-align: center;"> <table border="1" style="width: 100%; border-collapse: collapse; text-align: center;"> <tr> <td style="width: 10%;"></td> <td style="width: 10%;"></td> <td style="width: 10%;"></td> <td style="width: 10%;"></td> <td style="width: 10%;"></td> <td style="width: 10%;"></td> <td style="width: 10%;"></td> <td style="width: 10%;"></td> <td style="width: 10%;"></td> <td style="width: 10%;"></td> </tr> <tr> <td></td> <td></td> <td colspan="8" style="text-align: center;"> <table border="1" style="width: 100%; border-collapse: collapse; text-align: center;"> <tr> <td style="width: 10%;"></td> <td style="width: 10%;"></td> <td style="width: 10%;"></td> <td style="width: 10%;"></td> <td style="width: 10%;"></td> <td style="width: 10%;"></td> <td style="width: 10%;"></td> <td style="width: 10%;"></td> <td style="width: 10%;"></td> <td style="width: 10%;"></td> </tr> <tr> <td></td> <td></td> <td colspan="8" style="text-align: center;"> <table border="1" style="width: 100%; border-collapse: collapse; text-align: center;"> <tr> <td style="width: 10%;"></td> <td style="width: 10%;"></td> <td style="width: 10%;"></td> <td style="width: 10%;"></td> <td style="width: 10%;"></td> <td style="width: 10%;"></td> <td style="width: 10%;"></td> <td style="width: 10%;"></td> <td style="width: 10%;"></td> <td style="width: 10%;"></td> </tr> <tr> <td></td> <td></td> <td colspan="8" style="text-align: center;"> <table border="1" style="width: 100%; border-collapse: collapse; text-align: center;"> <tr> <td style="width: 10%;"></td> <td style="width: 10%;"></td> <td style="width: 10%;"></td> <td style="width: 10%;"></td> <td style="width: 10%;"></td> <td style="width: 10%;"></td> <td style="width: 10%;"></td> <td style="width: 10%;"></td> <td style="width: 10%;"></td> <td style="width: 10%;"></td> </tr> <tr> <td></td> <td></td> <td colspan="8" style="text-align: center;"> <table border="1" style="width: 100%; border-collapse: collapse; text-align: center;"> <tr> <td style="width: 10%;"></td> <td style="width: 10%;"></td> <td style="width: 10%;"></td> <td style="width: 10%;"></td> <td style="width: 10%;"></td> <td style="width: 10%;"></td> <td style="width: 10%;"></td> <td style="width: 10%;"></td> <td style="width: 10%;"></td> <td style="width: 10%;"></td> </tr> <tr> <td></td> <td></td> <td colspan="8" style="text-align: center;"> <table border="1" style="width: 100%; border-collapse: collapse; text-align: center;"> <tr> <td style="width: 10%;"></td> <td style="width: 10%;"></td> <td style="width: 10%;"></td> <td style="width:
10%;"></td> <td style="width: 10%;"></td> <td style="width: 10%;"></td> <td style="width: 10%;"></td> <td style="width: 10%;"></td> <td style="width: 10%;"></td> <td style="width: 10%;"></td> </tr> <tr> <td></td> <td></td> <td colspan="8" style="text-align: center;"> <table border="1" style="width: 100%; border-collapse: collapse; text-align: center;"> <tr> <td style="width: 10%;"></td> <td style="width: 10%;"></td> <td style="width: 10%;"></td> <td style="width: 10%;"></td> <td style="width: 10%;"></td> <td style="width: 10%;"></td> <td style="width: 10%;"></td> <td style="width: 10%;"></td> <td style="width: 10%;"></td> <td style="width: 10%;"></td> </tr> <tr> <td></td> <td></td> <td colspan="8" style="text-align: center;"> <table border="1" style="width: 100%; border-collapse: collapse; text-align: center;"> <tr> <td style="width: 10%;"></td> <td style="width: 10%;"></td> <td style="width: 10%;"></td> <td style="width: 10%;"></td> <td style="width: 10%;"></td> <td style="width: 10%;"></td> <td style="width: 10%;"></td> <td style="width: 10%;"></td> <td style="width: 10%;"></td> <td style="width: 10%;"></td> </tr> <tr> <td></td> <td></td> <td colspan="8" style="text-align: center;"> <table border="1" style="width: 100%; border-collapse: collapse; text-align: center;"> <tr> <td style="width: 10%;"></td> <td style="width: 10%;"></td> <td style="width: 10%;"></td> <td style="width: 10%;"></td> <td style="width: 10%;"></td> <td style="width: 10%;"></td> <td style="width: 10%;"></td> <td style="width: 10%;"></td> <td style="width: 10%;"></td> <td style="width: 10%;"></td> </tr> <tr> <td></td> <td></td> <td colspan="8" style="text-align: center;"> <table border="1" style="width: 100%; border-collapse: collapse; text-align: center;"> <tr> <td style="width: 10%;"></td> <td style="width: 10%;"></td> <td style="width: 10%;"></td> <td style="width: 10%;"></td> <td style="width: 10%;"></td> <td style="width: 10%;"></td> <td style="width: 10%;"></td> <td style="width: 10%;"></td> <td style="width: 10%;"></td> <td style="width: 10%;"></td> </tr> <tr> <td></td> <td></td> <td colspan="8" style="text-align: center;"> <table border="1" style="width: 100%; border-collapse: collapse; text-align: center;"> <tr> <td style="width: 10%;"></td> <td style="width: 10%;"></td> <td style="width: 10%;"></td> <td style="width: 10%;"></td> <td style="width: 10%;"></td> <td style="width: 10%;"></td> <td style="width: 10%;"></td> <td style="width: 10%;"></td> <td style="width: 10%;"></td> <td style="width: 10%;"></td> </tr> <tr> <td></td> <td></td> <td colspan="8" style="text-align: center;"> <table border="1" style="width: 100%; border-collapse: collapse; text-align: center;"> <tr> <td style="width: 10%;"></td> <td style="width: 10%;"></td> <td style="width: 10%;"></td> <td style="width: 10%;"></td> <td style="width: 10%;"></td> <td style="width: 10%;"></td> <td style="width: 10%;"></td> <td style="width: 10%;"></td> <td style="width: 10%;"></td> <td style="width: 10%;"></td> </tr> <tr> <td></td> <td></td> <td colspan="8" style="text-align: center;"> <table border="1" style="width: 100%; border-collapse: collapse; text-align: center;"> <tr> <td style="width: 10%;"></td> <td style="width: 10%;"></td> <td style="width: 10%;"></td> <td style="width: 10%;"></td> <td style="width: 10%;"></td> <td style="width: 10%;"></td> <td style="width: 10%;"></td> <td style="width: 10%;"></td> <td style="width: 10%;"></td> <td style="width: 10%;"></td> </tr> <tr> <td></td> <td></td> <td colspan="8" style="text-align: center;"> <table border="1" style="width: 100%; border-collapse: collapse; text-align: center;"> <tr> <td style="width: 10%;"></td> <td style="width: 10%;"></td> <td style="width: 10%;"></td> <td style="width: 10%;"></td> <td style="width: 10%;"></td> <td style="width: 10%;"></td> <td style="width: 10%;"></td> <td style="width: 10%;"></td> <td style="width: 10%;"></td> <td style="width: 10%;"></td> </tr> <tr> <td></td> <td></td> <td colspan="8" style="text-align: center;"> <table border="1" style="width: 100%; border-collapse: collapse; text-align: center;"> <tr> <td style="width: 10%;"></td> <td style="width: 10%;"></td> <td style="width: 10%;"></td> <td style="width: 10%;"></td> <td style="width: 10%;"></td> <td style="width: 10%;"></td> <td style="width: 10%;"></td> <td style="width: 10%;"></td> <td style="width: 10%;"></td> <td style="width: 10%;"></td> </tr> <tr> <td></td> <td></td> <td colspan="8" style="text-align: center;"> <table border="1" style="width: 100%; border-collapse: collapse; text-align: center;"> <tr> <td style="width: 10%;"></td> <td style="width: 10%;"></td> <td style="width: 10%;"></td> <td style="width: 10%;"></td> <td style="width: 10%;"></td> <td style="width: 10%;"></td> <td style="width: 10%;"></td> <td style="width: 10%;"></td> <td style="width: 10%;"></td> <td style="width: 10%;"></td> </tr> <tr> <td></td> <td></td> <td colspan="8" style="text-align: center;"> <table border="1" style="width: 100%; border-collapse: collapse; text-align: center;"> <tr> <td style="width: 10%;"></td> <td style="width: 10%;"></td> <td style="width: 10%;"></td> <td style="width: 10%;"></td> <td style="width: 10%;"></td> <td style="width: 10%;"></td> <td style="width: 10%;"></td> <td style="width: 10%;"></td> <td style="width: 10%;"></td> <td style="width: 10%;"></td> </tr> <tr> <td></td> <td></td> <td colspan="8" style="text-align: center;"> <table border="1" style="width: 100%; border-collapse: collapse; text-align: center;"> <tr> </tr></table></td></tr></table></td></tr></table></td></tr></table></td></tr></table></td></tr></table></td></tr></table></td></tr></table></td></tr></table></td></tr></table></td></tr></table></td></tr></table></td></tr></table></td></tr></table></td></tr></table></td></tr></table></td></tr></table></td></tr></table></td></tr></table></td></tr></table></td></tr></table></td></tr></table></td></tr></table></td></tr></table></td></tr></table></td></tr></table></td></tr></table></td></tr></table></td></tr></table></td></tr></table></td></tr></table></td></tr></table></td></tr></table></td></tr></table></td></tr></table>
 | | | | | | | | | | | | | | | | | | | | <table border="1" style="width: 100%; border-collapse: collapse; text-align: center;"> <tr> <td style="width: 10%;"></td> <td style="width: 10%;"></td> <td style="width: 10%;"></td> <td style="width: 10%;"></td> <td style="width: 10%;"></td> <td style="width: 10%;"></td> <td style="width: 10%;"></td> <td style="width: 10%;"></td> <td style="width: 10%;"></td> <td style="width: 10%;"></td> </tr> <tr> <td></td> <td></td> <td colspan="8" style="text-align: center;"> <table border="1" style="width: 100%; border-collapse: collapse; text-align: center;"> <tr> <td style="width: 10%;"></td> <td style="width: 10%;"></td> <td style="width: 10%;"></td> <td style="width: 10%;"></td> <td style="width: 10%;"></td> <td style="width: 10%;"></td> <td style="width: 10%;"></td> <td style="width: 10%;"></td> <td style="width: 10%;"></td> <td style="width: 10%;"></td> </tr> <tr> <td></td> <td></td> <td colspan="8" style="text-align: center;"> <table border="1" style="width: 100%; border-collapse: collapse; text-align: center;"> <tr> <td style="width: 10%;"></td> <td style="width: 10%;"></td> <td style="width: 10%;"></td> <td style="width: 10%;"></td> <td style="width: 10%;"></td> <td style="width: 10%;"></td> <td style="width: 10%;"></td> <td style="width: 10%;"></td> <td style="width: 10%;"></td> <td style="width: 10%;"></td> </tr> <tr> <td></td> <td></td> <td colspan="8" style="text-align: center;"> <table border="1" style="width: 100%; border-collapse: collapse; text-align: center;"> <tr> <td style="width: 10%;"></td> <td style="width: 10%;"></td> <td style="width: 10%;"></td> <td style="width: 10%;"></td> <td style="width: 10%;"></td> <td style="width: 10%;"></td> <td style="width: 10%;"></td> <td style="width: 10%;"></td> <td style="width: 10%;"></td> <td style="width: 10%;"></td> </tr> <tr> <td></td> <td></td> <td colspan="8" style="text-align: center;"> <table border="1" style="width: 100%; border-collapse: collapse; text-align: center;"> <tr> <td style="width: 10%;"></td> <td style="width: 10%;"></td> <td style="width: 10%;"></td> <td style="width: 10%;"></td> <td style="width: 10%;"></td> <td style="width: 10%;"></td> <td style="width: 10%;"></td> <td style="width: 10%;"></td> <td style="width: 10%;"></td> <td style="width: 10%;"></td> </tr> <tr> <td></td> <td></td> <td colspan="8" style="text-align: center;"> <table border="1" style="width: 100%; border-collapse: collapse; text-align: center;"> <tr> <td style="width: 10%;"></td> <td style="width: 10%;"></td> <td style="width: 10%;"></td> <td style="width: 10%;"></td> <td style="width: 10%;"></td> <td style="width: 10%;"></td> <td
style="width: 10%;"></td> <td style="width: 10%;"></td> <td style="width: 10%;"></td> <td style="width: 10%;"></td> </tr> <tr> <td></td> <td></td> <td colspan="8" style="text-align: center;"> <table border="1" style="width: 100%; border-collapse: collapse; text-align: center;"> <tr> <td style="width: 10%;"></td> <td style="width: 10%;"></td> <td style="width: 10%;"></td> <td style="width: 10%;"></td> <td style="width: 10%;"></td> <td style="width: 10%;"></td> <td style="width: 10%;"></td> <td style="width: 10%;"></td> <td style="width: 10%;"></td> <td style="width: 10%;"></td> </tr> <tr> <td></td> <td></td> <td colspan="8" style="text-align: center;"> <table border="1" style="width: 100%; border-collapse: collapse; text-align: center;"> <tr> <td style="width: 10%;"></td> <td style="width: 10%;"></td> <td style="width: 10%;"></td> <td style="width: 10%;"></td> <td style="width: 10%;"></td> <td style="width: 10%;"></td> <td style="width: 10%;"></td> <td style="width: 10%;"></td> <td style="width: 10%;"></td> <td style="width: 10%;"></td> </tr> <tr> <td></td> <td></td> <td colspan="8" style="text-align: center;"> <table border="1" style="width: 100%; border-collapse: collapse; text-align: center;"> <tr> <td style="width: 10%;"></td> <td style="width: 10%;"></td> <td style="width: 10%;"></td> <td style="width: 10%;"></td> <td style="width: 10%;"></td> <td style="width: 10%;"></td> <td style="width: 10%;"></td> <td style="width: 10%;"></td> <td style="width: 10%;"></td> <td style="width: 10%;"></td> </tr> <tr> <td></td> <td></td> <td colspan="8" style="text-align: center;"> <table border="1" style="width: 100%; border-collapse: collapse; text-align: center;"> <tr> <td style="width: 10%;"></td> <td style="width: 10%;"></td> <td style="width: 10%;"></td> <td style="width: 10%;"></td> <td style="width: 10%;"></td> <td style="width: 10%;"></td> <td style="width: 10%;"></td> <td style="width: 10%;"></td> <td style="width: 10%;"></td> <td style="width: 10%;"></td> </tr> <tr> <td></td> <td></td> <td colspan="8" style="text-align: center;"> <table border="1" style="width: 100%; border-collapse: collapse; text-align: center;"> <tr> <td style="width: 10%;"></td> <td style="width: 10%;"></td> <td style="width: 10%;"></td> <td style="width: 10%;"></td> <td style="width: 10%;"></td> <td style="width: 10%;"></td> <td style="width: 10%;"></td> <td style="width: 10%;"></td> <td style="width: 10%;"></td> <td style="width: 10%;"></td> </tr> <tr> <td></td> <td></td> <td colspan="8" style="text-align: center;"> <table border="1" style="width: 100%; border-collapse: collapse; text-align: center;"> <tr> <td style="width: 10%;"></td> <td style="width: 10%;"></td> <td style="width: 10%;"></td> <td style="width: 10%;"></td> <td style="width: 10%;"></td> <td style="width: 10%;"></td> <td style="width: 10%;"></td> <td style="width: 10%;"></td> <td style="width: 10%;"></td> <td style="width: 10%;"></td> </tr> <tr> <td></td> <td></td> <td colspan="8" style="text-align: center;"> <table border="1" style="width: 100%; border-collapse: collapse; text-align: center;"> <tr> <td style="width: 10%;"></td> <td style="width: 10%;"></td> <td style="width: 10%;"></td> <td style="width: 10%;"></td> <td style="width: 10%;"></td> <td style="width: 10%;"></td> <td style="width: 10%;"></td> <td style="width: 10%;"></td> <td style="width: 10%;"></td> <td style="width: 10%;"></td> </tr> <tr> <td></td> <td></td> <td colspan="8" style="text-align: center;"> <table border="1" style="width: 100%; border-collapse: collapse; text-align: center;"> <tr> <td style="width: 10%;"></td> <td style="width: 10%;"></td> <td style="width: 10%;"></td> <td style="width: 10%;"></td> <td style="width: 10%;"></td> <td style="width: 10%;"></td> <td style="width: 10%;"></td> <td style="width: 10%;"></td> <td style="width: 10%;"></td> <td style="width: 10%;"></td> </tr> <tr> <td></td> <td></td> <td colspan="8" style="text-align: center;"> <table border="1" style="width: 100%; border-collapse: collapse; text-align: center;"> <tr> <td style="width: 10%;"></td> <td style="width: 10%;"></td> <td style="width: 10%;"></td> <td style="width: 10%;"></td> <td style="width: 10%;"></td> <td style="width: 10%;"></td> <td style="width: 10%;"></td> <td style="width: 10%;"></td> <td style="width: 10%;"></td> <td style="width: 10%;"></td> </tr> <tr> <td></td> <td></td> <td colspan="8" style="text-align: center;"> <table border="1" style="width: 100%; border-collapse: collapse; text-align: center;"> <tr> <td style="width: 10%;"></td> <td style="width: 10%;"></td> <td style="width: 10%;"></td> <td style="width: 10%;"></td> <td style="width: 10%;"></td> <td style="width: 10%;"></td> <td style="width: 10%;"></td> <td style="width: 10%;"></td> <td style="width: 10%;"></td> <td style="width: 10%;"></td> </tr> <tr> <td></td> <td></td> <td colspan="8" style="text-align: center;"> <table border="1" style="width: 100%; border-collapse: collapse; text-align: center;"> <tr> <td style="width: 10%;"></td> <td style="width: 10%;"></td> <td style="width: 10%;"></td> <td style="width: 10%;"></td> <td style="width: 10%;"></td> <td style="width: 10%;"></td> <td style="width: 10%;"></td> <td style="width: 10%;"></td> <td style="width: 10%;"></td> <td style="width: 10%;"></td> </tr> <tr> <td></td> <td></td> <td colspan="8" style="text-align: center;"> <table border="1" style="width: 100%; border-collapse: collapse; text-align: center;"> <tr> <td style="width: 10%;"></td> <td style="width: 10%;"></td> <td style="width: 10%;"></td> <td style="width: 10%;"></td> <td style="width: 10%;"></td> <td style="width: 10%;"></td> <td style="width: 10%;"></td> <td style="width: 10%;"></td> <td style="width: 10%;"></td> <td style="width: 10%;"></td> </tr> <tr> <td></td> <td></td> <td colspan="8" style="text-align: center;"> <table border="1" style="width: 100%; border-collapse: collapse; text-align: center;"> <tr> <td style="width: 10%;"></td> <td style="width: 10%;"></td> <td style="width: 10%;"></td> <td style="width: 10%;"></td> <td style="width: 10%;"></td> <td style="width: 10%;"></td> <td style="width: 10%;"></td> <td style="width: 10%;"></td> <td style="width: 10%;"></td> <td style="width: 10%;"></td> </tr> <tr> <td></td> <td></td> <td colspan="8" style="text-align: center;"> <table border="1" style="width: 100%; border-collapse: collapse; text-align: center;"> <tr> <td style="width: 10%;"></td> <td style="width: 10%;"></td> <td style="width: 10%;"></td> <td style="width: 10%;"></td> <td style="width: 10%;"></td> <td style="width: 10%;"></td> <td style="width: 10%;"></td> <td style="width: 10%;"></td> <td style="width: 10%;"></td> <td style="width: 10%;"></td> </tr> <tr> <td></td> <td></td> <td colspan="8" style="text-align: center;"> <table border="1" style="width: 100%; border-collapse: collapse; text-align: center;"> <tr> <td style="width: 10%;"></td> <td style="width: 10%;"></td> <td style="width: 10%;"></td> <td style="width: 10%;"></td> <td style="width: 10%;"></td> <td style="width: 10%;"></td> <td style="width: 10%;"></td> <td style="width: 10%;"></td> <td style="width: 10%;"></td> <td style="width: 10%;"></td> </tr> <tr> <td></td> <td></td> <td colspan="8" style="text-align: center;"> <table border="1" style="width: 100%; border-collapse: collapse; text-align: center;"> <tr> <td style="width: 10%;"></td> <td style="width: 10%;"></td> <td style="width: 10%;"></td> <td style="width: 10%;"></td> <td style="width: 10%;"></td> <td style="width: 10%;"></td> <td style="width: 10%;"></td> <td style="width: 10%;"></td> <td style="width: 10%;"></td> <td style="width: 10%;"></td> </tr> <tr> <td></td> <td></td> <td colspan="8" style="text-align: center;"> <table border="1" style="width: 100%; border-collapse: collapse; text-align: center;"> <tr> <td style="width: 10%;"></td> <td style="width: 10%;"></td> <td style="width: 10%;"></td> <td style="width: 10%;"></td> <td style="width: 10%;"></td> <td style="width: 10%;"></td> <td style="width: 10%;"></td> <td style="width: 10%;"></td> <td style="width: 10%;"></td> <td style="width: 10%;"></td> </tr> <tr> <td></td> <td></td> <td colspan="8" style="text-align: center;"> <table border="1" style="width: 100%; border-collapse: collapse; text-align: center;"> <tr> <td style="width: 10%;"></td> <td style="width: 10%;"></td> <td style="width: 10%;"></td> <td style="width: 10%;"></td> <td style="width: 10%;"></td> <td style="width: 10%;"></td> <td style="width: 10%;"></td> <td style="width: 10%;"></td> <td style="width: 10%;"></td> <td style="width: 10%;"></td> </tr> <tr> <td></td> <td></td> <td colspan="8" style="text-align: center;"> <table border="1" style="width: 100%; border-collapse: collapse; text-align: center;"> <tr> <td style="width: 10%;"></td> <td style="width: 10%;"></td> <td style="width: 10%;"></td> <td style="width: 10%;"></td> <td style="width: 10%;"></td> <td style="width: 10%;"></td> <td style="width: 10%;"></td> <td style="width: 10%;"></td> <td style="width: 10%;"></td> <td style="width: 10%;"></td> </tr> <tr> <td></td> <td></td> <td colspan="8" style="text-align: center;"> <table border="1" style="width: 100%; border-collapse: collapse; text-align: center;"> <tr> <td style="width: 10%;"></td> <td style="width: 10%;"></td> <td style="width: 10%;"></td> <td style="width: 10%;"></td> <td style="width: 10%;"></td> <td style="width: 10%;"></td> <td style="width: 10%;"></td> <td style="width: 10%;"></td> <td style="width: 10%;"></td> <td style="width: 10%;"></td> </tr> <tr> <td></td> <td></td> <td colspan="8" style="text-align: center;"> <table border="1" style="width: 100%; border-collapse: collapse; text-align: center;"> <tr> <td style="width: 10%;"></td> <td style="width: 10%;"></td> <td style="width: 10%;"></td> <td style="width: 10%;"></td> <td style="width: 10%;"></td> <td style="width: 10%;"></td> <td style="width: 10%;"></td> <td style="width: 10%;"></td> <td style="width: 10%;"></td> <td style="width: 10%;"></td> </tr> <tr> <td></td> <td></td> <td colspan="8"
style="text-align: center;"> <table border="1" style="width: 100%; border-collapse: collapse; text-align: center;"> <tr> <td style="width: 10%;"></td> <td style="width: 10%;"></td> <td style="width: 10%;"></td> <td style="width: 10%;"></td> <td style="width: 10%;"></td> <td style="width: 10%;"></td> <td style="width: 10%;"></td> <td style="width: 10%;"></td> <td style="width: 10%;"></td> <td style="width: 10%;"></td> </tr> <tr> <td></td> <td></td> <td colspan="8" style="text-align: center;"> <table border="1" style="width: 100%; border-collapse: collapse; text-align: center;"> <tr> <td style="width: 10%;"></td> <td style="width: 10%;"></td> <td style="width: 10%;"></td> <td style="width: 10%;"></td> <td style="width: 10%;"></td> <td style="width: 10%;"></td> <td style="width: 10%;"></td> <td style="width: 10%;"></td> <td style="width: 10%;"></td> <td style="width: 10%;"></td> </tr> <tr> <td></td> <td></td> <td colspan="8" style="text-align: center;"> <table border="1" style="width: 100%; border-collapse: collapse; text-align: center;"> <tr> <td style="width: 10%;"></td> <td style="width: 10%;"></td> <td style="width: 10%;"></td> <td style="width: 10%;"></td> <td style="width: 10%;"></td> <td style="width: 10%;"></td> <td style="width: 10%;"></td> <td style="width: 10%;"></td> <td style="width: 10%;"></td> <td style="width: 10%;"></td> </tr> <tr> <td></td> <td></td> <td colspan="8" style="text-align: center;"> <table border="1" style="width: 100%; border-collapse: collapse; text-align: center;"> <tr> <td style="width: 10%;"></td> <td style="width: 10%;"></td> <td style="width: 10%;"></td> <td style="width: 10%;"></td> <td style="width: 10%;"></td> <td style="width: 10%;"></td> <td style="width: 10%;"></td> <td style="width: 10%;"></td> <td style="width: 10%;"></td> <td style="width: 10%;"></td> </tr> <tr> <td></td> <td></td> <td colspan="8" style="text-align: center;"> <table border="1" style="width: 100%; border-collapse: collapse; text-align: center;"> <tr> <td style="width: 10%;"></td> <td style="width: 10%;"></td> <td style="width: 10%;"></td> <td style="width: 10%;"></td> <td style="width: 10%;"></td> <td style="width: 10%;"></td> <td style="width: 10%;"></td> <td style="width: 10%;"></td> <td style="width: 10%;"></td> <td style="width: 10%;"></td> </tr> <tr> <td></td> <td></td> <td colspan="8" style="text-align: center;"> <table border="1" style="width: 100%; border-collapse: collapse; text-align: center;"> <tr> <td style="width: 10%;"></td> <td style="width: 10%;"></td> <td style="width: 10%;"></td> <td style="width: 10%;"></td> <td style="width: 10%;"></td> <td style="width: 10%;"></td> <td style="width: 10%;"></td> <td style="width: 10%;"></td> <td style="width: 10%;"></td> <td style="width: 10%;"></td> </tr> <tr> <td></td> <td></td> <td colspan="8" style="text-align: center;"> <table border="1" style="width: 100%; border-collapse: collapse; text-align: center;"> <tr> </tr></table></td></tr></table></td></tr></table></td></tr></table></td></tr></table></td></tr></table></td></tr></table></td></tr></table></td></tr></table></td></tr></table></td></tr></table></td></tr></table></td></tr></table></td></tr></table></td></tr></table></td></tr></table></td></tr></table></td></tr></table></td></tr></table></td></tr></table></td></tr></table></td></tr></table></td></tr></table></td></tr></table></td></tr></table></td></tr></table></td></tr></table></td></tr></table></td></tr></table></td></tr></table></td></tr></table></td></tr></table></td></tr></table></td></tr></table>
 | | | | | | | | | | | | | | | | | | | | <table border="1" style="width: 100%; border-collapse: collapse; text-align: center;"> <tr> <td style="width: 10%;"></td> <td style="width: 10%;"></td> <td style="width: 10%;"></td> <td style="width: 10%;"></td> <td style="width: 10%;"></td> <td style="width: 10%;"></td> <td style="width: 10%;"></td> <td style="width: 10%;"></td> <td style="width: 10%;"></td> <td style="width: 10%;"></td> </tr> <tr> <td></td> <td></td> <td colspan="8" style="text-align: center;"> <table border="1" style="width: 100%; border-collapse: collapse; text-align: center;"> <tr> <td style="width: 10%;"></td> <td style="width: 10%;"></td> <td style="width: 10%;"></td> <td style="width: 10%;"></td> <td style="width: 10%;"></td> <td style="width: 10%;"></td> <td style="width: 10%;"></td> <td style="width: 10%;"></td> <td style="width: 10%;"></td> <td style="width: 10%;"></td> </tr> <tr> <td></td> <td></td> <td colspan="8" style="text-align: center;"> <table border="1" style="width: 100%; border-collapse: collapse; text-align: center;"> <tr> <td style="width: 10%;"></td> <td style="width: 10%;"></td> <td style="width: 10%;"></td> <td style="width: 10%;"></td> <td style="width: 10%;"></td> <td style="width: 10%;"></td> <td style="width: 10%;"></td> <td style="width: 10%;"></td> <td style="width: 10%;"></td> <td style="width: 10%;"></td> </tr> <tr> <td></td> <td></td> <td colspan="8" style="text-align: center;"> <table border="1" style="width: 100%; border-collapse: collapse; text-align: center;"> <tr> <td style="width: 10%;"></td> <td style="width: 10%;"></td> <td style="width: 10%;"></td> <td style="width: 10%;"></td> <td style="width: 10%;"></td> <td style="width: 10%;"></td> <td style="width: 10%;"></td> <td style="width: 10%;"></td> <td style="width: 10%;"></td> <td style="width: 10%;"></td> </tr> <tr> <td></td> <td></td> <td colspan="8" style="text-align: center;"> <table border="1" style="width: 100%; border-collapse: collapse; text-align: center;"> <tr> <td style="width: 10%;"></td> <td style="width: 10%;"></td> <td style="width: 10%;"></td> <td style="width: 10%;"></td> <td style="width: 10%;"></td> <td style="width: 10%;"></td> <td style="width: 10%;"></td> <td style="width: 10%;"></td> <td style="width: 10%;"></td> <td style="width: 10%;"></td> </tr> <tr> <td></td> <td></td> <td colspan="8" style="text-align: center;"> <table border="1" style="width: 100%; border-collapse: collapse; text-align: center;"> <tr> <td style="width: 10%;"></td> <td style="width: 10%;"></td> <td style="width: 10%;"></td> <td style="width: 10%;"></td> <td style="width: 10%;"></td> <td style="width: 10%;"></td> <td style="width: 10%;"></td> <td style="width: 10%;"></td> <td style="width: 10%;"></td> <td style="width: 10%;"></td> </tr> <tr> <td></td> <td></td> <td colspan="8" style="text-align: center;"> <table border="1" style="width: 100%; border-collapse: collapse; text-align: center;"> <tr> <td style="width: 10%;"></td> <td style="width: 10%;"></td> <td style="width: 10%;"></td> <td style="width: 10%;"></td> <td style="width: 10%;"></td> <td style="width: 10%;"></td> <td style="width: 10%;"></td> <td style="width: 10%;"></td> <td style="width: 10%;"></td> <td style="width: 10%;"></td> </tr> <tr> <td></td> <td></td> <td colspan="8" style="text-align: center;"> <table border="1" style="width: 100%; border-collapse: collapse; text-align: center;"> <tr> <td style="width: 10%;"></td> <td style="width: 10%;"></td> <td style="width: 10%;"></td> <td style="width: 10%;"></td> <td style="width: 10%;"></td> <td style="width: 10%;"></td> <td style="width: 10%;"></td> <td style="width: 10%;"></td> <td style="width: 10%;"></td> <td style="width: 10%;"></td> </tr> <tr> <td></td> <td></td> <td colspan="8" style="text-align: center;"> <table border="1" style="width: 100%; border-collapse: collapse; text-align: center;"> <tr> <td style="width: 10%;"></td> <td style="width: 10%;"></td> <td style="width: 10%;"></td> <td style="width: 10%;"></td> <td style="width: 10%;"></td> <td style="width: 10%;"></td> <td style="width: 10%;"></td> <td style="width: 10%;"></td> <td style="width: 10%;"></td> <td style="width: 10%;"></td> </tr> <tr> <td></td> <td></td> <td colspan="8" style="text-align: center;"> <table border="1" style="width: 100%; border-collapse: collapse; text-align: center;"> <tr> <td style="width: 10%;"></td> <td style="width: 10%;"></td> <td style="width: 10%;"></td> <td style="width: 10%;"></td> <td style="width: 10%;"></td> <td style="width: 10%;"></td> <td style="width: 10%;"></td> <td style="width: 10%;"></td> <td style="width: 10%;"></td> <td style="width: 10%;"></td> </tr> <tr> <td></td> <td></td> <td colspan="8" style="text-align: center;"> <table border="1" style="width: 100%; border-collapse: collapse; text-align: center;"> <tr> <td style="width: 10%;"></td> <td style="width: 10%;"></td> <td style="width: 10%;"></td> <td style="width: 10%;"></td> <td style="width: 10%;"></td> <td style="width: 10%;"></td> <td style="width: 10%;"></td> <td style="width: 10%;"></td> <td style="width: 10%;"></td> <td style="width: 10%;"></td> </tr> <tr> <td></td> <td></td> <td colspan="8" style="text-align: center;"> <table border="1" style="width: 100%; border-collapse: collapse; text-align:
center;"> <tr> <td style="width: 10%;"></td> <td style="width: 10%;"></td> <td style="width: 10%;"></td> <td style="width: 10%;"></td> <td style="width: 10%;"></td> <td style="width: 10%;"></td> <td style="width: 10%;"></td> <td style="width: 10%;"></td> <td style="width: 10%;"></td> <td style="width: 10%;"></td> </tr> <tr> <td></td> <td></td> <td colspan="8" style="text-align: center;"> <table border="1" style="width: 100%; border-collapse: collapse; text-align: center;"> <tr> <td style="width: 10%;"></td> <td style="width: 10%;"></td> <td style="width: 10%;"></td> <td style="width: 10%;"></td> <td style="width: 10%;"></td> <td style="width: 10%;"></td> <td style="width: 10%;"></td> <td style="width: 10%;"></td> <td style="width: 10%;"></td> <td style="width: 10%;"></td> </tr> <tr> <td></td> <td></td> <td colspan="8" style="text-align: center;"> <table border="1" style="width: 100%; border-collapse: collapse; text-align: center;"> <tr> <td style="width: 10%;"></td> <td style="width: 10%;"></td> <td style="width: 10%;"></td> <td style="width: 10%;"></td> <td style="width: 10%;"></td> <td style="width: 10%;"></td> <td style="width: 10%;"></td> <td style="width: 10%;"></td> <td style="width: 10%;"></td> <td style="width: 10%;"></td> </tr> <tr> <td></td> <td></td> <td colspan="8" style="text-align: center;"> <table border="1" style="width: 100%; border-collapse: collapse; text-align: center;"> <tr> <td style="width: 10%;"></td> <td style="width: 10%;"></td> <td style="width: 10%;"></td> <td style="width: 10%;"></td> <td style="width: 10%;"></td> <td style="width: 10%;"></td> <td style="width: 10%;"></td> <td style="width: 10%;"></td> <td style="width: 10%;"></td> <td style="width: 10%;"></td> </tr> <tr> <td></td> <td></td> <td colspan="8" style="text-align: center;"> <table border="1" style="width: 100%; border-collapse: collapse; text-align: center;"> <tr> <td style="width: 10%;"></td> <td style="width: 10%;"></td> <td style="width: 10%;"></td> <td style="width: 10%;"></td> <td style="width: 10%;"></td> <td style="width: 10%;"></td> <td style="width: 10%;"></td> <td style="width: 10%;"></td> <td style="width: 10%;"></td> <td style="width: 10%;"></td> </tr> <tr> <td></td> <td></td> <td colspan="8" style="text-align: center;"> <table border="1" style="width: 100%; border-collapse: collapse; text-align: center;"> <tr> <td style="width: 10%;"></td> <td style="width: 10%;"></td> <td style="width: 10%;"></td> <td style="width: 10%;"></td> <td style="width: 10%;"></td> <td style="width: 10%;"></td> <td style="width: 10%;"></td> <td style="width: 10%;"></td> <td style="width: 10%;"></td> <td style="width: 10%;"></td> </tr> <tr> <td></td> <td></td> <td colspan="8" style="text-align: center;"> <table border="1" style="width: 100%; border-collapse: collapse; text-align: center;"> <tr> <td style="width: 10%;"></td> <td style="width: 10%;"></td> <td style="width: 10%;"></td> <td style="width: 10%;"></td> <td style="width: 10%;"></td> <td style="width: 10%;"></td> <td style="width: 10%;"></td> <td style="width: 10%;"></td> <td style="width: 10%;"></td> <td style="width: 10%;"></td> </tr> <tr> <td></td> <td></td> <td colspan="8" style="text-align: center;"> <table border="1" style="width: 100%; border-collapse: collapse; text-align: center;"> <tr> <td style="width: 10%;"></td> <td style="width: 10%;"></td> <td style="width: 10%;"></td> <td style="width: 10%;"></td> <td style="width: 10%;"></td> <td style="width: 10%;"></td> <td style="width: 10%;"></td> <td style="width: 10%;"></td> <td style="width: 10%;"></td> <td style="width: 10%;"></td> </tr> <tr> <td></td> <td></td> <td colspan="8" style="text-align: center;"> <table border="1" style="width: 100%; border-collapse: collapse; text-align: center;"> <tr> <td style="width: 10%;"></td> <td style="width: 10%;"></td> <td style="width: 10%;"></td> <td style="width: 10%;"></td> <td style="width: 10%;"></td> <td style="width: 10%;"></td> <td style="width: 10%;"></td> <td style="width: 10%;"></td> <td style="width: 10%;"></td> <td style="width: 10%;"></td> </tr> <tr> <td></td> <td></td> <td colspan="8" style="text-align: center;"> <table border="1" style="width: 100%; border-collapse: collapse; text-align: center;"> <tr> <td style="width: 10%;"></td> <td style="width: 10%;"></td> <td style="width: 10%;"></td> <td style="width: 10%;"></td> <td style="width: 10%;"></td> <td style="width: 10%;"></td> <td style="width: 10%;"></td> <td style="width: 10%;"></td> <td style="width: 10%;"></td> <td style="width: 10%;"></td> </tr> <tr> <td></td> <td></td> <td colspan="8" style="text-align: center;"> <table border="1" style="width: 100%; border-collapse: collapse; text-align: center;"> <tr> <td style="width: 10%;"></td> <td style="width: 10%;"></td> <td style="width: 10%;"></td> <td style="width: 10%;"></td> <td style="width: 10%;"></td> <td style="width: 10%;"></td> <td style="width: 10%;"></td> <td style="width: 10%;"></td> <td style="width: 10%;"></td> <td style="width: 10%;"></td> </tr> <tr> <td></td> <td></td> <td colspan="8" style="text-align: center;"> <table border="1" style="width: 100%; border-collapse: collapse; text-align: center;"> <tr> <td style="width: 10%;"></td> <td style="width: 10%;"></td> <td style="width: 10%;"></td> <td style="width: 10%;"></td> <td style="width: 10%;"></td> <td style="width: 10%;"></td> <td style="width: 10%;"></td> <td style="width: 10%;"></td> <td style="width: 10%;"></td> <td style="width: 10%;"></td> </tr> <tr> <td></td> <td></td> <td colspan="8" style="text-align: center;"> <table border="1" style="width: 100%; border-collapse: collapse; text-align: center;"> <tr> <td style="width: 10%;"></td> <td style="width: 10%;"></td> <td style="width: 10%;"></td> <td style="width: 10%;"></td> <td style="width: 10%;"></td> <td style="width: 10%;"></td> <td style="width: 10%;"></td> <td style="width: 10%;"></td> <td style="width: 10%;"></td> <td style="width: 10%;"></td> </tr> <tr> <td></td> <td></td> <td colspan="8" style="text-align: center;"> <table border="1" style="width: 100%; border-collapse: collapse; text-align: center;"> <tr> <td style="width: 10%;"></td> <td style="width: 10%;"></td> <td style="width: 10%;"></td> <td style="width: 10%;"></td> <td style="width: 10%;"></td> <td style="width: 10%;"></td> <td style="width: 10%;"></td> <td style="width: 10%;"></td> <td style="width: 10%;"></td> <td style="width: 10%;"></td> </tr> <tr> <td></td> <td></td> <td colspan="8" style="text-align: center;"> <table border="1" style="width: 100%; border-collapse: collapse; text-align: center;"> <tr> <td style="width: 10%;"></td> <td style="width: 10%;"></td> <td style="width: 10%;"></td> <td style="width: 10%;"></td> <td style="width: 10%;"></td> <td style="width: 10%;"></td> <td style="width: 10%;"></td> <td style="width: 10%;"></td> <td style="width: 10%;"></td> <td style="width: 10%;"></td> </tr> <tr> <td></td> <td></td> <td colspan="8" style="text-align: center;"> <table border="1" style="width: 100%; border-collapse: collapse; text-align: center;"> <tr> <td style="width: 10%;"></td> <td style="width: 10%;"></td> <td style="width: 10%;"></td> <td style="width: 10%;"></td> <td style="width: 10%;"></td> <td style="width: 10%;"></td> <td style="width: 10%;"></td> <td style="width: 10%;"></td> <td style="width: 10%;"></td> <td style="width: 10%;"></td> </tr> <tr> <td></td> <td></td> <td colspan="8" style="text-align: center;"> <table border="1" style="width: 100%; border-collapse: collapse; text-align: center;"> <tr> <td style="width: 10%;"></td> <td style="width: 10%;"></td> <td style="width: 10%;"></td> <td style="width: 10%;"></td> <td style="width: 10%;"></td> <td style="width: 10%;"></td> <td style="width: 10%;"></td> <td style="width: 10%;"></td> <td style="width: 10%;"></td> <td style="width: 10%;"></td> </tr> <tr> <td></td> <td></td> <td colspan="8" style="text-align: center;"> <table border="1" style="width: 100%; border-collapse: collapse; text-align: center;"> <tr> <td style="width: 10%;"></td> <td style="width: 10%;"></td> <td style="width: 10%;"></td> <td style="width: 10%;"></td> <td style="width: 10%;"></td> <td style="width: 10%;"></td> <td style="width: 10%;"></td> <td style="width: 10%;"></td> <td style="width: 10%;"></td> <td style="width: 10%;"></td> </tr> <tr> <td></td> <td></td> <td colspan="8" style="text-align: center;"> <table border="1" style="width: 100%; border-collapse: collapse; text-align: center;"> <tr> <td style="width: 10%;"></td> <td style="width: 10%;"></td> <td style="width: 10%;"></td> <td style="width: 10%;"></td> <td style="width: 10%;"></td> <td style="width: 10%;"></td> <td style="width: 10%;"></td> <td style="width: 10%;"></td> <td style="width: 10%;"></td> <td style="width: 10%;"></td> </tr> <tr> <td></td> <td></td> <td colspan="8" style="text-align: center;"> <table border="1" style="width: 100%; border-collapse: collapse; text-align: center;"> <tr> <td style="width: 10%;"></td> <td style="width: 10%;"></td> <td style="width: 10%;"></td> <td style="width: 10%;"></td> <td style="width: 10%;"></td> <td style="width: 10%;"></td> <td style="width: 10%;"></td> <td style="width: 10%;"></td> <td style="width: 10%;"></td> <td style="width: 10%;"></td> </tr> <tr> <td></td> <td></td> <td colspan="8" style="text-align: center;"> <table border="1" style="width: 100%; border-collapse: collapse; text-align: center;"> <tr> <td style="width: 10%;"></td> <td style="width: 10%;"></td> <td style="width: 10%;"></td> <td style="width: 10%;"></td> <td style="width: 10%;"></td> <td style="width: 10%;"></td> <td style="width: 10%;"></td> <td style="width: 10%;"></td> <td style="width: 10%;"></td> <td style="width: 10%;"></td> </tr> <tr> <td></td> <td></td> <td colspan="8" style="text-align: center;"> <table border="1" style="width: 100%; border-collapse: collapse; text-align: center;"> <tr>
</tr></table></td></tr></table></td></tr></table></td></tr></table></td></tr></table></td></tr></table></td></tr></table></td></tr></table></td></tr></table></td></tr></table></td></tr></table></td></tr></table></td></tr></table></td></tr></table></td></tr></table></td></tr></table></td></tr></table></td></tr></table></td></tr></table></td></tr></table></td></tr></table></td></tr></table></td></tr></table></td></tr></table></td></tr></table></td></tr></table></td></tr></table></td></tr></table></td></tr></table></td></tr></table></td></tr></table></td></tr></table></td></tr></table>
 | | | | | | | | | | | | | | | | | | | | <table border="1" style="width: 100%; border-collapse: collapse; text-align: center;"> <tr> <td style="width: 10%;"></td> <td style="width: 10%;"></td> <td style="width: 10%;"></td> <td style="width: 10%;"></td> <td style="width: 10%;"></td> <td style="width: 10%;"></td> <td style="width: 10%;"></td> <td style="width: 10%;"></td> <td style="width: 10%;"></td> <td style="width: 10%;"></td> </tr> <tr> <td></td> <td></td> <td colspan="8" style="text-align: center;"> <table border="1" style="width: 100%; border-collapse: collapse; text-align: center;"> <tr> <td style="width: 10%;"></td> <td style="width: 10%;"></td> <td style="width: 10%;"></td> <td style="width: 10%;"></td> <td style="width: 10%;"></td> <td style="width: 10%;"></td> <td style="width: 10%;"></td> <td style="width: 10%;"></td> <td style="width: 10%;"></td> <td style="width: 10%;"></td> </tr> <tr> <td></td> <td></td> <td colspan="8" style="text-align: center;"> <table border="1" style="width: 100%; border-collapse: collapse; text-align: center;"> <tr> <td style="width: 10%;"></td> <td style="width: 10%;"></td> <td style="width: 10%;"></td> <td style="width: 10%;"></td> <td style="width: 10%;"></td> <td style="width: 10%;"></td> <td style="width: 10%;"></td> <td style="width: 10%;"></td> <td style="width: 10%;"></td> <td style="width: 10%;"></td> </tr> <tr> <td></td> <td></td> <td colspan="8" style="text-align: center;"> <table border="1" style="width: 100%; border-collapse: collapse; text-align: center;"> <tr> <td style="width: 10%;"></td> <td style="width: 10%;"></td> <td style="width: 10%;"></td> <td style="width: 10%;"></td> <td style="width: 10%;"></td> <td style="width: 10%;"></td> <td style="width: 10%;"></td> <td style="width: 10%;"></td> <td style="width: 10%;"></td> <td style="width: 10%;"></td> </tr> <tr> <td></td> <td></td> <td colspan="8" style="text-align: center;"> <table border="1" style="width: 100%; border-collapse: collapse; text-align: center;"> <tr> <td style="width: 10%;"></td> <td style="width: 10%;"></td> <td style="width: 10%;"></td> <td style="width: 10%;"></td> <td style="width: 10%;"></td> <td style="width: 10%;"></td> <td style="width: 10%;"></td> <td style="width: 10%;"></td> <td style="width: 10%;"></td> <td style="width: 10%;"></td> </tr> <tr> <td></td> <td></td> <td colspan="8" style="text-align: center;"> <table border="1" style="width: 100%; border-collapse: collapse; text-align: center;"> <tr> <td style="width: 10%;"></td> <td style="width: 10%;"></td> <td style="width: 10%;"></td> <td style="width: 10%;"></td> <td style="width: 10%;"></td> <td style="width: 10%;"></td> <td style="width: 10%;"></td> <td style="width: 10%;"></td> <td style="width: 10%;"></td> <td style="width: 10%;"></td> </tr> <tr> <td></td> <td></td> <td colspan="8" style="text-align: center;"> <table border="1" style="width: 100%; border-collapse: collapse; text-align: center;"> <tr> <td style="width: 10%;"></td> <td style="width: 10%;"></td> <td style="width: 10%;"></td> <td style="width: 10%;"></td> <td style="width: 10%;"></td> <td style="width: 10%;"></td> <td style="width: 10%;"></td> <td style="width: 10%;"></td> <td style="width: 10%;"></td> <td style="width: 10%;"></td> </tr> <tr> <td></td> <td></td> <td colspan="8" style="text-align: center;"> <table border="1" style="width: 100%; border-collapse: collapse; text-align: center;"> <tr> <td style="width: 10%;"></td> <td style="width: 10%;"></td> <td style="width: 10%;"></td> <td style="width: 10%;"></td> <td style="width: 10%;"></td> <td style="width: 10%;"></td> <td style="width: 10%;"></td> <td style="width: 10%;"></td> <td style="width: 10%;"></td> <td style="width: 10%;"></td> </tr> <tr> <td></td> <td></td> <td colspan="8" style="text-align: center;"> <table border="1" style="width: 100%; border-collapse: collapse; text-align: center;"> <tr> <td style="width: 10%;"></td> <td style="width: 10%;"></td> <td style="width: 10%;"></td> <td style="width: 10%;"></td> <td style="width: 10%;"></td> <td style="width: 10%;"></td> <td style="width: 10%;"></td> <td style="width: 10%;"></td> <td style="width: 10%;"></td> <td style="width: 10%;"></td> </tr> <tr> <td></td> <td></td> <td colspan="8" style="text-align: center;"> <table border="1" style="width: 100%; border-collapse: collapse; text-align: center;"> <tr> <td style="width: 10%;"></td> <td style="width: 10%;"></td> <td style="width: 10%;"></td> <td style="width: 10%;"></td> <td style="width: 10%;"></td> <td style="width: 10%;"></td> <td style="width: 10%;"></td> <td style="width: 10%;"></td> <td style="width: 10%;"></td> <td style="width: 10%;"></td> </tr> <tr> <td></td> <td></td> <td colspan="8" style="text-align: center;"> <table border="1" style="width: 100%; border-collapse: collapse; text-align: center;"> <tr> <td style="width: 10%;"></td> <td style="width: 10%;"></td> <td style="width: 10%;"></td> <td style="width: 10%;"></td> <td style="width: 10%;"></td> <td style="width: 10%;"></td> <td style="width: 10%;"></td> <td style="width: 10%;"></td> <td style="width: 10%;"></td> <td style="width: 10%;"></td> </tr> <tr> <td></td> <td></td> <td colspan="8" style="text-align: center;"> <table border="1" style="width: 100%; border-collapse: collapse; text-align: center;"> <tr> <td style="width: 10%;"></td> <td style="width: 10%;"></td> <td style="width: 10%;"></td> <td style="width: 10%;"></td> <td style="width: 10%;"></td> <td style="width: 10%;"></td> <td style="width: 10%;"></td> <td style="width: 10%;"></td> <td style="width: 10%;"></td> <td style="width: 10%;"></td> </tr> <tr> <td></td> <td></td> <td colspan="8" style="text-align: center;"> <table border="1" style="width: 100%; border-collapse: collapse; text-align: center;"> <tr> <td style="width: 10%;"></td> <td style="width: 10%;"></td> <td style="width: 10%;"></td> <td style="width: 10%;"></td> <td style="width: 10%;"></td> <td style="width: 10%;"></td> <td style="width: 10%;"></td> <td style="width: 10%;"></td> <td style="width: 10%;"></td> <td style="width: 10%;"></td> </tr> <tr> <td></td> <td></td> <td colspan="8" style="text-align: center;"> <table border="1" style="width: 100%; border-collapse: collapse; text-align: center;"> <tr> <td style="width: 10%;"></td> <td style="width: 10%;"></td> <td style="width: 10%;"></td> <td style="width: 10%;"></td> <td style="width: 10%;"></td> <td style="width: 10%;"></td> <td style="width: 10%;"></td> <td style="width: 10%;"></td> <td style="width: 10%;"></td> <td style="width: 10%;"></td> </tr> <tr> <td></td> <td></td> <td colspan="8" style="text-align: center;"> <table border="1" style="width: 100%; border-collapse: collapse; text-align: center;"> <tr> <td style="width: 10%;"></td> <td style="width: 10%;"></td> <td style="width: 10%;"></td> <td style="width: 10%;"></td> <td style="width: 10%;"></td> <td style="width: 10%;"></td> <td style="width: 10%;"></td> <td style="width: 10%;"></td> <td style="width: 10%;"></td> <td style="width: 10%;"></td> </tr> <tr> <td></td> <td></td> <td colspan="8" style="text-align: center;"> <table border="1" style="width: 100%; border-collapse: collapse; text-align: center;"> <tr> <td style="width: 10%;"></td> <td style="width: 10%;"></td> <td style="width: 10%;"></td> <td style="width: 10%;"></td> <td style="width: 10%;"></td> <td style="width: 10%;"></td> <td style="width: 10%;"></td> <td style="width: 10%;"></td> <td style="width: 10%;"></td> <td style="width: 10%;"></td> </tr> <tr> <td></td> <td></td> <td colspan="8" style="text-align: center;"> <table border="1" style="width: 100%; border-collapse: collapse; text-align: center;"> <tr> <td style="width: 10%;"></td> <td style="width: 10%;"></td> <td style="width: 10%;"></td> <td style="width: 10%;"></td> <td style="width: 10%;"></td> <td style="width: 10%;"></td> <td style="width: 10%;"></td> <td style="width: 10%;"></td> <td style="width: 10%;"></td> <td style="width: 10%;"></td> </tr> <tr> <td></td> <td></td> <td colspan="8" style="text-align: center;"> <table border="1" style="width: 100%; border-collapse: collapse; text-align: center;"> <tr> <td style="width: 10%;"></td> <td style="width: 10%;"></td> <td style="width: 10%;"></td> <td style="width: 10%;"></td> <td
style="width: 10%;"></td> <td style="width: 10%;"></td> <td style="width: 10%;"></td> <td style="width: 10%;"></td> <td style="width: 10%;"></td> <td style="width: 10%;"></td> </tr> <tr> <td></td> <td></td> <td colspan="8" style="text-align: center;"> <table border="1" style="width: 100%; border-collapse: collapse; text-align: center;"> <tr> <td style="width: 10%;"></td> <td style="width: 10%;"></td> <td style="width: 10%;"></td> <td style="width: 10%;"></td> <td style="width: 10%;"></td> <td style="width: 10%;"></td> <td style="width: 10%;"></td> <td style="width: 10%;"></td> <td style="width: 10%;"></td> <td style="width: 10%;"></td> </tr> <tr> <td></td> <td></td> <td colspan="8" style="text-align: center;"> <table border="1" style="width: 100%; border-collapse: collapse; text-align: center;"> <tr> <td style="width: 10%;"></td> <td style="width: 10%;"></td> <td style="width: 10%;"></td> <td style="width: 10%;"></td> <td style="width: 10%;"></td> <td style="width: 10%;"></td> <td style="width: 10%;"></td> <td style="width: 10%;"></td> <td style="width: 10%;"></td> <td style="width: 10%;"></td> </tr> <tr> <td></td> <td></td> <td colspan="8" style="text-align: center;"> <table border="1" style="width: 100%; border-collapse: collapse; text-align: center;"> <tr> <td style="width: 10%;"></td> <td style="width: 10%;"></td> <td style="width: 10%;"></td> <td style="width: 10%;"></td> <td style="width: 10%;"></td> <td style="width: 10%;"></td> <td style="width: 10%;"></td> <td style="width: 10%;"></td> <td style="width: 10%;"></td> <td style="width: 10%;"></td> </tr> <tr> <td></td> <td></td> <td colspan="8" style="text-align: center;"> <table border="1" style="width: 100%; border-collapse: collapse; text-align: center;"> <tr> <td style="width: 10%;"></td> <td style="width: 10%;"></td> <td style="width: 10%;"></td> <td style="width: 10%;"></td> <td style="width: 10%;"></td> <td style="width: 10%;"></td> <td style="width: 10%;"></td> <td style="width: 10%;"></td> <td style="width: 10%;"></td> <td style="width: 10%;"></td> </tr> <tr> <td></td> <td></td> <td colspan="8" style="text-align: center;"> <table border="1" style="width: 100%; border-collapse: collapse; text-align: center;"> <tr> <td style="width: 10%;"></td> <td style="width: 10%;"></td> <td style="width: 10%;"></td> <td style="width: 10%;"></td> <td style="width: 10%;"></td> <td style="width: 10%;"></td> <td style="width: 10%;"></td> <td style="width: 10%;"></td> <td style="width: 10%;"></td> <td style="width: 10%;"></td> </tr> <tr> <td></td> <td></td> <td colspan="8" style="text-align: center;"> <table border="1" style="width: 100%; border-collapse: collapse; text-align: center;"> <tr> <td style="width: 10%;"></td> <td style="width: 10%;"></td> <td style="width: 10%;"></td> <td style="width: 10%;"></td> <td style="width: 10%;"></td> <td style="width: 10%;"></td> <td style="width: 10%;"></td> <td style="width: 10%;"></td> <td style="width: 10%;"></td> <td style="width: 10%;"></td> </tr> <tr> <td></td> <td></td> <td colspan="8" style="text-align: center;"> <table border="1" style="width: 100%; border-collapse: collapse; text-align: center;"> <tr> <td style="width: 10%;"></td> <td style="width: 10%;"></td> <td style="width: 10%;"></td> <td style="width: 10%;"></td> <td style="width: 10%;"></td> <td style="width: 10%;"></td> <td style="width: 10%;"></td> <td style="width: 10%;"></td> <td style="width: 10%;"></td> <td style="width: 10%;"></td> </tr> <tr> <td></td> <td></td> <td colspan="8" style="text-align: center;"> <table border="1" style="width: 100%; border-collapse: collapse; text-align: center;"> <tr> <td style="width: 10%;"></td> <td style="width: 10%;"></td> <td style="width: 10%;"></td> <td style="width: 10%;"></td> <td style="width: 10%;"></td> <td style="width: 10%;"></td> <td style="width: 10%;"></td> <td style="width: 10%;"></td> <td style="width: 10%;"></td> <td style="width: 10%;"></td> </tr> <tr> <td></td> <td></td> <td colspan="8" style="text-align: center;"> <table border="1" style="width: 100%; border-collapse: collapse; text-align: center;"> <tr> <td style="width: 10%;"></td> <td style="width: 10%;"></td> <td style="width: 10%;"></td> <td style="width: 10%;"></td> <td style="width: 10%;"></td> <td style="width: 10%;"></td> <td style="width: 10%;"></td> <td style="width: 10%;"></td> <td style="width: 10%;"></td> <td style="width: 10%;"></td> </tr> <tr> <td></td> <td></td> <td colspan="8" style="text-align: center;"> <table border="1" style="width: 100%; border-collapse: collapse; text-align: center;"> <tr> <td style="width: 10%;"></td> <td style="width: 10%;"></td> <td style="width: 10%;"></td> <td style="width: 10%;"></td> <td style="width: 10%;"></td> <td style="width: 10%;"></td> <td style="width: 10%;"></td> <td style="width: 10%;"></td> <td style="width: 10%;"></td> <td style="width: 10%;"></td> </tr> <tr> <td></td> <td></td> <td colspan="8" style="text-align: center;"> <table border="1" style="width: 100%; border-collapse: collapse; text-align: center;"> <tr> <td style="width: 10%;"></td> <td style="width: 10%;"></td> <td style="width: 10%;"></td> <td style="width: 10%;"></td> <td style="width: 10%;"></td> <td style="width: 10%;"></td> <td style="width: 10%;"></td> <td style="width: 10%;"></td> <td style="width: 10%;"></td> <td style="width: 10%;"></td> </tr> <tr> <td></td> <td></td> <td colspan="8" style="text-align: center;"> <table border="1" style="width: 100%; border-collapse: collapse; text-align: center;"> <tr> <td style="width: 10%;"></td> <td style="width: 10%;"></td> <td style="width: 10%;"></td> <td style="width: 10%;"></td> <td style="width: 10%;"></td> <td style="width: 10%;"></td> <td style="width: 10%;"></td> <td style="width: 10%;"></td> <td style="width: 10%;"></td> <td style="width: 10%;"></td> </tr> <tr> <td></td> <td></td> <td colspan="8" style="text-align: center;"> <table border="1" style="width: 100%; border-collapse: collapse; text-align: center;"> <tr> <td style="width: 10%;"></td> <td style="width: 10%;"></td> <td style="width: 10%;"></td> <td style="width: 10%;"></td> <td style="width: 10%;"></td> <td style="width: 10%;"></td> <td style="width: 10%;"></td> <td style="width: 10%;"></td> <td style="width: 10%;"></td> <td style="width: 10%;"></td> </tr> <tr> <td></td> <td></td> <td colspan="8" style="text-align: center;"> <table border="1" style="width: 100%; border-collapse: collapse; text-align: center;"> <tr> </tr></table></td></tr></table></td></tr></table></td></tr></table></td></tr></table></td></tr></table></td></tr></table></td></tr></table></td></tr></table></td></tr></table></td></tr></table></td></tr></table></td></tr></table></td></tr></table></td></tr></table></td></tr></table></td></tr></table></td></tr></table></td></tr></table></td></tr></table></td></tr></table></td></tr></table></td></tr></table></td></tr></table></td></tr></table></td></tr></table></td></tr></table></td></tr></table></td></tr></table></td></tr></table></td></tr></table></td></tr></table>
 | | | | | | | | | | | | | | | | | | | | <table border="1" style="width: 100%; border-collapse: collapse; text-align: center;"> <tr> <td style="width: 10%;"></td> <td style="width: 10%;"></td> <td style="width: 10%;"></td> <td style="width: 10%;"></td> <td style="width: 10%;"></td> <td style="width: 10%;"></td> <td style="width: 10%;"></td> <td style="width: 10%;"></td> <td style="width: 10%;"></td> <td style="width: 10%;"></td> </tr> <tr> <td></td> <td></td> <td colspan="8" style="text-align: center;"> <table border="1" style="width: 100%; border-collapse: collapse; text-align: center;"> <tr> <td style="width: 10%;"></td> <td style="width: 10%;"></td> <td style="width: 10%;"></td> <td style="width: 10%;"></td> <td style="width: 10%;"></td> <td style="width: 10%;"></td> <td style="width: 10%;"></td> <td style="width: 10%;"></td> <td style="width: 10%;"></td> <td style="width: 10%;"></td> </tr> <tr> <td></td> <td></td> <td colspan="8" style="text-align: center;"> <table border="1" style="width: 100%; border-collapse: collapse; text-align: center;"> <tr> <td style="width: 10%;"></td> <td style="width: 10%;"></td> <td style="width: 10%;"></td> <td style="width: 10%;"></td> <td style="width: 10%;"></td> <td style="width: 10%;"></td> <td style="width: 10%;"></td> <td style="width: 10%;"></td> <td style="width: 10%;"></td> <td style="width: 10%;"></td> </tr> <tr> <td></td> <td></td> <td colspan="8" style="text-align: center;"> <table border="1" style="width: 100%; border-collapse: collapse; text-align: center;"> <tr> <td style="width: 10%;"></td> <td style="width: 10%;"></td> <td style="width: 10%;"></td> <td style="width: 10%;"></td> <td style="width: 10%;"></td> <td style="width: 10%;"></td> <td style="width: 10%;"></td> <td style="width: 10%;"></td> <td style="width:
10%;"></td> <td style="width: 10%;"></td> </tr> <tr> <td></td> <td></td> <td colspan="8" style="text-align: center;"> <table border="1" style="width: 100%; border-collapse: collapse; text-align: center;"> <tr> <td style="width: 10%;"></td> <td style="width: 10%;"></td> <td style="width: 10%;"></td> <td style="width: 10%;"></td> <td style="width: 10%;"></td> <td style="width: 10%;"></td> <td style="width: 10%;"></td> <td style="width: 10%;"></td> <td style="width: 10%;"></td> <td style="width: 10%;"></td> </tr> <tr> <td></td> <td></td> <td colspan="8" style="text-align: center;"> <table border="1" style="width: 100%; border-collapse: collapse; text-align: center;"> <tr> <td style="width: 10%;"></td> <td style="width: 10%;"></td> <td style="width: 10%;"></td> <td style="width: 10%;"></td> <td style="width: 10%;"></td> <td style="width: 10%;"></td> <td style="width: 10%;"></td> <td style="width: 10%;"></td> <td style="width: 10%;"></td> <td style="width: 10%;"></td> </tr> <tr> <td></td> <td></td> <td colspan="8" style="text-align: center;"> <table border="1" style="width: 100%; border-collapse: collapse; text-align: center;"> <tr> <td style="width: 10%;"></td> <td style="width: 10%;"></td> <td style="width: 10%;"></td> <td style="width: 10%;"></td> <td style="width: 10%;"></td> <td style="width: 10%;"></td> <td style="width: 10%;"></td> <td style="width: 10%;"></td> <td style="width: 10%;"></td> <td style="width: 10%;"></td> </tr> <tr> <td></td> <td></td> <td colspan="8" style="text-align: center;"> <table border="1" style="width: 100%; border-collapse: collapse; text-align: center;"> <tr> <td style="width: 10%;"></td> <td style="width: 10%;"></td> <td style="width: 10%;"></td> <td style="width: 10%;"></td> <td style="width: 10%;"></td> <td style="width: 10%;"></td> <td style="width: 10%;"></td> <td style="width: 10%;"></td> <td style="width: 10%;"></td> <td style="width: 10%;"></td> </tr> <tr> <td></td> <td></td> <td colspan="8" style="text-align: center;"> <table border="1" style="width: 100%; border-collapse: collapse; text-align: center;"> <tr> <td style="width: 10%;"></td> <td style="width: 10%;"></td> <td style="width: 10%;"></td> <td style="width: 10%;"></td> <td style="width: 10%;"></td> <td style="width: 10%;"></td> <td style="width: 10%;"></td> <td style="width: 10%;"></td> <td style="width: 10%;"></td> <td style="width: 10%;"></td> </tr> <tr> <td></td> <td></td> <td colspan="8" style="text-align: center;"> <table border="1" style="width: 100%; border-collapse: collapse; text-align: center;"> <tr> <td style="width: 10%;"></td> <td style="width: 10%;"></td> <td style="width: 10%;"></td> <td style="width: 10%;"></td> <td style="width: 10%;"></td> <td style="width: 10%;"></td> <td style="width: 10%;"></td> <td style="width: 10%;"></td> <td style="width: 10%;"></td> <td style="width: 10%;"></td> </tr> <tr> <td></td> <td></td> <td colspan="8" style="text-align: center;"> <table border="1" style="width: 100%; border-collapse: collapse; text-align: center;"> <tr> <td style="width: 10%;"></td> <td style="width: 10%;"></td> <td style="width: 10%;"></td> <td style="width: 10%;"></td> <td style="width: 10%;"></td> <td style="width: 10%;"></td> <td style="width: 10%;"></td> <td style="width: 10%;"></td> <td style="width: 10%;"></td> <td style="width: 10%;"></td> </tr> <tr> <td></td> <td></td> <td colspan="8" style="text-align: center;"> <table border="1" style="width: 100%; border-collapse: collapse; text-align: center;"> <tr> <td style="width: 10%;"></td> <td style="width: 10%;"></td> <td style="width: 10%;"></td> <td style="width: 10%;"></td> <td style="width: 10%;"></td> <td style="width: 10%;"></td> <td style="width: 10%;"></td> <td style="width: 10%;"></td> <td style="width: 10%;"></td> <td style="width: 10%;"></td> </tr> <tr> <td></td> <td></td> <td colspan="8" style="text-align: center;"> <table border="1" style="width: 100%; border-collapse: collapse; text-align: center;"> <tr> <td style="width: 10%;"></td> <td style="width: 10%;"></td> <td style="width: 10%;"></td> <td style="width: 10%;"></td> <td style="width: 10%;"></td> <td style="width: 10%;"></td> <td style="width: 10%;"></td> <td style="width: 10%;"></td> <td style="width: 10%;"></td> <td style="width: 10%;"></td> </tr> <tr> <td></td> <td></td> <td colspan="8" style="text-align: center;"> <table border="1" style="width: 100%; border-collapse: collapse; text-align: center;"> <tr> <td style="width: 10%;"></td> <td style="width: 10%;"></td> <td style="width: 10%;"></td> <td style="width: 10%;"></td> <td style="width: 10%;"></td> <td style="width: 10%;"></td> <td style="width: 10%;"></td> <td style="width: 10%;"></td> <td style="width: 10%;"></td> <td style="width: 10%;"></td> </tr> <tr> <td></td> <td></td> <td colspan="8" style="text-align: center;"> <table border="1" style="width: 100%; border-collapse: collapse; text-align: center;"> <tr> <td style="width: 10%;"></td> <td style="width: 10%;"></td> <td style="width: 10%;"></td> <td style="width: 10%;"></td> <td style="width: 10%;"></td> <td style="width: 10%;"></td> <td style="width: 10%;"></td> <td style="width: 10%;"></td> <td style="width: 10%;"></td> <td style="width: 10%;"></td> </tr> <tr> <td></td> <td></td> <td colspan="8" style="text-align: center;"> <table border="1" style="width: 100%; border-collapse: collapse; text-align: center;"> <tr> <td style="width: 10%;"></td> <td style="width: 10%;"></td> <td style="width: 10%;"></td> <td style="width: 10%;"></td> <td style="width: 10%;"></td> <td style="width: 10%;"></td> <td style="width: 10%;"></td> <td style="width: 10%;"></td> <td style="width: 10%;"></td> <td style="width: 10%;"></td> </tr> <tr> <td></td> <td></td> <td colspan="8" style="text-align: center;"> <table border="1" style="width: 100%; border-collapse: collapse; text-align: center;"> <tr> <td style="width: 10%;"></td> <td style="width: 10%;"></td> <td style="width: 10%;"></td> <td style="width: 10%;"></td> <td style="width: 10%;"></td> <td style="width: 10%;"></td> <td style="width: 10%;"></td> <td style="width: 10%;"></td> <td style="width: 10%;"></td> <td style="width: 10%;"></td> </tr> <tr> <td></td> <td></td> <td colspan="8" style="text-align: center;"> <table border="1" style="width: 100%; border-collapse: collapse; text-align: center;"> <tr> <td style="width: 10%;"></td> <td style="width: 10%;"></td> <td style="width: 10%;"></td> <td style="width: 10%;"></td> <td style="width: 10%;"></td> <td style="width: 10%;"></td> <td style="width: 10%;"></td> <td style="width: 10%;"></td> <td style="width: 10%;"></td> <td style="width: 10%;"></td> </tr> <tr> <td></td> <td></td> <td colspan="8" style="text-align: center;"> <table border="1" style="width: 100%; border-collapse: collapse; text-align: center;"> <tr> <td style="width: 10%;"></td> <td style="width: 10%;"></td> <td style="width: 10%;"></td> <td style="width: 10%;"></td> <td style="width: 10%;"></td> <td style="width: 10%;"></td> <td style="width: 10%;"></td> <td style="width: 10%;"></td> <td style="width: 10%;"></td> <td style="width: 10%;"></td> </tr> <tr> <td></td> <td></td> <td colspan="8" style="text-align: center;"> <table border="1" style="width: 100%; border-collapse: collapse; text-align: center;"> <tr> <td style="width: 10%;"></td> <td style="width: 10%;"></td> <td style="width: 10%;"></td> <td style="width: 10%;"></td> <td style="width: 10%;"></td> <td style="width: 10%;"></td> <td style="width: 10%;"></td> <td style="width: 10%;"></td> <td style="width: 10%;"></td> <td style="width: 10%;"></td> </tr> <tr> <td></td> <td></td> <td colspan="8" style="text-align: center;"> <table border="1" style="width: 100%; border-collapse: collapse; text-align: center;"> <tr> <td style="width: 10%;"></td> <td style="width: 10%;"></td> <td style="width: 10%;"></td> <td style="width: 10%;"></td> <td style="width: 10%;"></td> <td style="width: 10%;"></td> <td style="width: 10%;"></td> <td style="width: 10%;"></td> <td style="width: 10%;"></td> <td style="width: 10%;"></td> </tr> <tr> <td></td> <td></td> <td colspan="8" style="text-align: center;"> <table border="1" style="width: 100%; border-collapse: collapse; text-align: center;"> <tr> <td style="width: 10%;"></td> <td style="width: 10%;"></td> <td style="width: 10%;"></td> <td style="width: 10%;"></td> <td style="width: 10%;"></td> <td style="width: 10%;"></td> <td style="width: 10%;"></td> <td style="width: 10%;"></td> <td style="width: 10%;"></td> <td style="width: 10%;"></td> </tr> <tr> <td></td> <td></td> <td colspan="8" style="text-align: center;"> <table border="1" style="width: 100%; border-collapse: collapse; text-align: center;"> <tr> <td style="width: 10%;"></td> <td style="width: 10%;"></td> <td style="width: 10%;"></td> <td style="width: 10%;"></td> <td style="width: 10%;"></td> <td style="width: 10%;"></td> <td style="width: 10%;"></td> <td style="width: 10%;"></td> <td style="width: 10%;"></td> <td style="width: 10%;"></td> </tr> <tr> <td></td> <td></td> <td colspan="8" style="text-align: center;"> <table border="1" style="width: 100%; border-collapse: collapse; text-align: center;"> <tr> <td style="width: 10%;"></td> <td style="width: 10%;"></td> <td style="width: 10%;"></td> <td style="width: 10%;"></td> <td style="width: 10%;"></td> <td style="width: 10%;"></td> <td style="width: 10%;"></td> <td style="width: 10%;"></td> <td style="width: 10%;"></td> <td style="width: 10%;"></td> </tr> <tr> <td></td> <td></td> <td colspan="8" style="text-align: center;"> <table border="1" style="width: 100%; border-collapse: collapse; text-align: center;"> <tr> <td style="width: 10%;"></td> <td style="width: 10%;"></td> <td style="width: 10%;"></td> <td style="width: 10%;"></td> <td style="width: 10%;"></td> <td style="width: 10%;"></td> <td style="width: 10%;"></td> <td style="width: 10%;"></td> <td style="width: 10%;"></td> <td style="width: 10%;"></td> </tr> <tr> <td></td> <td></td> <td colspan="8" style="text-align: center;"> <table border="1" style="width: 100%;
border-collapse: collapse; text-align: center;"> <tr> <td style="width: 10%;"></td> <td style="width: 10%;"></td> <td style="width: 10%;"></td> <td style="width: 10%;"></td> <td style="width: 10%;"></td> <td style="width: 10%;"></td> <td style="width: 10%;"></td> <td style="width: 10%;"></td> <td style="width: 10%;"></td> <td style="width: 10%;"></td> </tr> <tr> <td></td> <td></td> <td colspan="8" style="text-align: center;"> <table border="1" style="width: 100%; border-collapse: collapse; text-align: center;"> <tr> <td style="width: 10%;"></td> <td style="width: 10%;"></td> <td style="width: 10%;"></td> <td style="width: 10%;"></td> <td style="width: 10%;"></td> <td style="width: 10%;"></td> <td style="width: 10%;"></td> <td style="width: 10%;"></td> <td style="width: 10%;"></td> <td style="width: 10%;"></td> </tr> <tr> <td></td> <td></td> <td colspan="8" style="text-align: center;"> <table border="1" style="width: 100%; border-collapse: collapse; text-align: center;"> <tr> <td style="width: 10%;"></td> <td style="width: 10%;"></td> <td style="width: 10%;"></td> <td style="width: 10%;"></td> <td style="width: 10%;"></td> <td style="width: 10%;"></td> <td style="width: 10%;"></td> <td style="width: 10%;"></td> <td style="width: 10%;"></td> <td style="width: 10%;"></td> </tr> <tr> <td></td> <td></td> <td colspan="8" style="text-align: center;"> <table border="1" style="width: 100%; border-collapse: collapse; text-align: center;"> <tr> <td style="width: 10%;"></td> <td style="width: 10%;"></td> <td style="width: 10%;"></td> <td style="width: 10%;"></td> <td style="width: 10%;"></td> <td style="width: 10%;"></td> <td style="width: 10%;"></td> <td style="width: 10%;"></td> <td style="width: 10%;"></td> <td style="width: 10%;"></td> </tr> <tr> <td></td> <td></td> <td colspan="8" style="text-align: center;"> <table border="1" style="width: 100%; border-collapse: collapse; text-align: center;"> <tr> <td style="width: 10%;"></td> <td style="width: 10%;"></td> <td style="width: 10%;"></td> <td style="width: 10%;"></td> <td style="width: 10%;"></td> <td style="width: 10%;"></td> <td style="width: 10%;"></td> <td style="width: 10%;"></td> <td style="width: 10%;"></td> <td style="width: 10%;"></td> </tr> <tr> <td></td> <td></td> <td colspan="8" style="text-align: center;"> <table border="1" style="width: 100%; border-collapse: collapse; text-align: center;"> <tr> </tr></table></td></tr></table></td></tr></table></td></tr></table></td></tr></table></td></tr></table></td></tr></table></td></tr></table></td></tr></table></td></tr></table></td></tr></table></td></tr></table></td></tr></table></td></tr></table></td></tr></table></td></tr></table></td></tr></table></td></tr></table></td></tr></table></td></tr></table></td></tr></table></td></tr></table></td></tr></table></td></tr></table></td></tr></table></td></tr></table></td></tr></table></td></tr></table></td></tr></table></td></tr></table></td></tr></table>
 | | | | | | | | | | | | | | | | | | | | <table border="1" style="width: 100%; border-collapse: collapse; text-align: center;"> <tr> <td style="width: 10%;"></td> <td style="width: 10%;"></td> <td style="width: 10%;"></td> <td style="width: 10%;"></td> <td style="width: 10%;"></td> <td style="width: 10%;"></td> <td style="width: 10%;"></td> <td style="width: 10%;"></td> <td style="width: 10%;"></td> <td style="width: 10%;"></td> </tr> <tr> <td></td> <td></td> <td colspan="8" style="text-align: center;"> <table border="1" style="width: 100%; border-collapse: collapse; text-align: center;"> <tr> <td style="width: 10%;"></td> <td style="width: 10%;"></td> <td style="width: 10%;"></td> <td style="width: 10%;"></td> <td style="width: 10%;"></td> <td style="width: 10%;"></td> <td style="width: 10%;"></td> <td style="width: 10%;"></td> <td style="width: 10%;"></td> <td style="width: 10%;"></td> </tr> <tr> <td></td> <td></td> <td colspan="8" style="text-align: center;"> <table border="1" style="width: 100%; border-collapse: collapse; text-align: center;"> <tr> <td style="width: 10%;"></td> <td style="width: 10%;"></td> <td style="width: 10%;"></td> <td style="width: 10%;"></td> <td style="width: 10%;"></td> <td style="width: 10%;"></td> <td style="width: 10%;"></td> <td style="width: 10%;"></td> <td style="width: 10%;"></td> <td style="width: 10%;"></td> </tr> <tr> <td></td> <td></td> <td colspan="8" style="text-align: center;"> <table border="1" style="width: 100%; border-collapse: collapse; text-align: center;"> <tr> <td style="width: 10%;"></td> <td style="width: 10%;"></td> <td style="width: 10%;"></td> <td style="width: 10%;"></td> <td style="width: 10%;"></td> <td style="width: 10%;"></td> <td style="width: 10%;"></td> <td style="width: 10%;"></td> <td style="width: 10%;"></td> <td style="width: 10%;"></td> </tr> <tr> <td></td> <td></td> <td colspan="8" style="text-align: center;"> <table border="1" style="width: 100%; border-collapse: collapse; text-align: center;"> <tr> <td style="width: 10%;"></td> <td style="width: 10%;"></td> <td style="width: 10%;"></td> <td style="width: 10%;"></td> <td style="width: 10%;"></td> <td style="width: 10%;"></td> <td style="width: 10%;"></td> <td style="width: 10%;"></td> <td style="width: 10%;"></td> <td style="width: 10%;"></td> </tr> <tr> <td></td> <td></td> <td colspan="8" style="text-align: center;"> <table border="1" style="width: 100%; border-collapse: collapse; text-align: center;"> <tr> <td style="width: 10%;"></td> <td style="width: 10%;"></td> <td style="width: 10%;"></td> <td style="width: 10%;"></td> <td style="width: 10%;"></td> <td style="width: 10%;"></td> <td style="width: 10%;"></td> <td style="width: 10%;"></td> <td style="width: 10%;"></td> <td style="width: 10%;"></td> </tr> <tr> <td></td> <td></td> <td colspan="8" style="text-align: center;"> <table border="1" style="width: 100%; border-collapse: collapse; text-align: center;"> <tr> <td style="width: 10%;"></td> <td style="width: 10%;"></td> <td style="width: 10%;"></td> <td style="width: 10%;"></td> <td style="width: 10%;"></td> <td style="width: 10%;"></td> <td style="width: 10%;"></td> <td style="width: 10%;"></td> <td style="width: 10%;"></td> <td style="width: 10%;"></td> </tr> <tr> <td></td> <td></td> <td colspan="8" style="text-align: center;"> <table border="1" style="width: 100%; border-collapse: collapse; text-align: center;"> <tr> <td style="width: 10%;"></td> <td style="width: 10%;"></td> <td style="width: 10%;"></td> <td style="width: 10%;"></td> <td style="width: 10%;"></td> <td style="width: 10%;"></td> <td style="width: 10%;"></td> <td style="width: 10%;"></td> <td style="width: 10%;"></td> <td style="width: 10%;"></td> </tr> <tr> <td></td> <td></td> <td colspan="8" style="text-align: center;"> <table border="1" style="width: 100%; border-collapse: collapse; text-align: center;"> <tr> <td style="width: 10%;"></td> <td style="width: 10%;"></td> <td style="width: 10%;"></td> <td style="width: 10%;"></td> <td style="width: 10%;"></td> <td style="width: 10%;"></td> <td style="width: 10%;"></td> <td style="width: 10%;"></td> <td style="width: 10%;"></td> <td style="width: 10%;"></td> </tr> <tr> <td></td> <td></td> <td colspan="8" style="text-align: center;"> <table border="1" style="width: 100%; border-collapse: collapse; text-align: center;"> <tr> <td style="width: 10%;"></td> <td style="width: 10%;"></td> <td style="width: 10%;"></td> <td style="width: 10%;"></td> <td style="width: 10%;"></td> <td style="width: 10%;"></td> <td style="width: 10%;"></td> <td style="width: 10%;"></td> <td style="width: 10%;"></td> <td style="width: 10%;"></td> </tr> <tr> <td></td> <td></td> <td colspan="8" style="text-align: center;"> <table border="1" style="width: 100%; border-collapse: collapse; text-align: center;"> <tr> <td style="width: 10%;"></td> <td style="width: 10%;"></td> <td style="width: 10%;"></td> <td style="width: 10%;"></td> <td style="width: 10%;"></td> <td style="width: 10%;"></td> <td style="width: 10%;"></td> <td style="width: 10%;"></td> <td style="width: 10%;"></td> <td style="width: 10%;"></td> </tr> <tr> <td></td> <td></td> <td colspan="8" style="text-align: center;"> <table border="1" style="width: 100%; border-collapse: collapse; text-align: center;"> <tr> <td style="width: 10%;"></td> <td style="width: 10%;"></td> <td style="width: 10%;"></td> <td style="width: 10%;"></td> <td style="width: 10%;"></td> <td style="width: 10%;"></td> <td style="width: 10%;"></td> <td style="width: 10%;"></td> <td style="width: 10%;"></td> <td style="width: 10%;"></td> </tr> <tr> <td></td> <td></td> <td colspan="8" style="text-align: center;"> <table border="1" style="width: 100%; border-collapse: collapse; text-align: center;"> <tr> <td style="width: 10%;"></td> <td style="width: 10%;"></td> <td style="width: 10%;"></td> <td
style="width: 10%;"></td> <td style="width: 10%;"></td> <td style="width: 10%;"></td> <td style="width: 10%;"></td> <td style="width: 10%;"></td> <td style="width: 10%;"></td> <td style="width: 10%;"></td> </tr> <tr> <td></td> <td></td> <td colspan="8" style="text-align: center;"> <table border="1" style="width: 100%; border-collapse: collapse; text-align: center;"> <tr> <td style="width: 10%;"></td> <td style="width: 10%;"></td> <td style="width: 10%;"></td> <td style="width: 10%;"></td> <td style="width: 10%;"></td> <td style="width: 10%;"></td> <td style="width: 10%;"></td> <td style="width: 10%;"></td> <td style="width: 10%;"></td> <td style="width: 10%;"></td> </tr> <tr> <td></td> <td></td> <td colspan="8" style="text-align: center;"> <table border="1" style="width: 100%; border-collapse: collapse; text-align: center;"> <tr> <td style="width: 10%;"></td> <td style="width: 10%;"></td> <td style="width: 10%;"></td> <td style="width: 10%;"></td> <td style="width: 10%;"></td> <td style="width: 10%;"></td> <td style="width: 10%;"></td> <td style="width: 10%;"></td> <td style="width: 10%;"></td> <td style="width: 10%;"></td> </tr> <tr> <td></td> <td></td> <td colspan="8" style="text-align: center;"> <table border="1" style="width: 100%; border-collapse: collapse; text-align: center;"> <tr> <td style="width: 10%;"></td> <td style="width: 10%;"></td> <td style="width: 10%;"></td> <td style="width: 10%;"></td> <td style="width: 10%;"></td> <td style="width: 10%;"></td> <td style="width: 10%;"></td> <td style="width: 10%;"></td> <td style="width: 10%;"></td> <td style="width: 10%;"></td> </tr> <tr> <td></td> <td></td> <td colspan="8" style="text-align: center;"> <table border="1" style="width: 100%; border-collapse: collapse; text-align: center;"> <tr> <td style="width: 10%;"></td> <td style="width: 10%;"></td> <td style="width: 10%;"></td> <td style="width: 10%;"></td> <td style="width: 10%;"></td> <td style="width: 10%;"></td> <td style="width: 10%;"></td> <td style="width: 10%;"></td> <td style="width: 10%;"></td> <td style="width: 10%;"></td> </tr> <tr> <td></td> <td></td> <td colspan="8" style="text-align: center;"> <table border="1" style="width: 100%; border-collapse: collapse; text-align: center;"> <tr> <td style="width: 10%;"></td> <td style="width: 10%;"></td> <td style="width: 10%;"></td> <td style="width: 10%;"></td> <td style="width: 10%;"></td> <td style="width: 10%;"></td> <td style="width: 10%;"></td> <td style="width: 10%;"></td> <td style="width: 10%;"></td> <td style="width: 10%;"></td> </tr> <tr> <td></td> <td></td> <td colspan="8" style="text-align: center;"> <table border="1" style="width: 100%; border-collapse: collapse; text-align: center;"> <tr> <td style="width: 10%;"></td> <td style="width: 10%;"></td> <td style="width: 10%;"></td> <td style="width: 10%;"></td> <td style="width: 10%;"></td> <td style="width: 10%;"></td> <td style="width: 10%;"></td> <td style="width: 10%;"></td> <td style="width: 10%;"></td> <td style="width: 10%;"></td> </tr> <tr> <td></td> <td></td> <td colspan="8" style="text-align: center;"> <table border="1" style="width: 100%; border-collapse: collapse; text-align: center;"> <tr> <td style="width: 10%;"></td> <td style="width: 10%;"></td> <td style="width: 10%;"></td> <td style="width: 10%;"></td> <td style="width: 10%;"></td> <td style="width: 10%;"></td> <td style="width: 10%;"></td> <td style="width: 10%;"></td> <td style="width: 10%;"></td> <td style="width: 10%;"></td> </tr> <tr> <td></td> <td></td> <td colspan="8" style="text-align: center;"> <table border="1" style="width: 100%; border-collapse: collapse; text-align: center;"> <tr> <td style="width: 10%;"></td> <td style="width: 10%;"></td> <td style="width: 10%;"></td> <td style="width: 10%;"></td> <td style="width: 10%;"></td> <td style="width: 10%;"></td> <td style="width: 10%;"></td> <td style="width: 10%;"></td> <td style="width: 10%;"></td> <td style="width: 10%;"></td> </tr> <tr> <td></td> <td></td> <td colspan="8" style="text-align: center;"> <table border="1" style="width: 100%; border-collapse: collapse; text-align: center;"> <tr> <td style="width: 10%;"></td> <td style="width: 10%;"></td> <td style="width: 10%;"></td> <td style="width: 10%;"></td> <td style="width: 10%;"></td> <td style="width: 10%;"></td> <td style="width: 10%;"></td> <td style="width: 10%;"></td> <td style="width: 10%;"></td> <td style="width: 10%;"></td> </tr> <tr> <td></td> <td></td> <td colspan="8" style="text-align: center;"> <table border="1" style="width: 100%; border-collapse: collapse; text-align: center;"> <tr> <td style="width: 10%;"></td> <td style="width: 10%;"></td> <td style="width: 10%;"></td> <td style="width: 10%;"></td> <td style="width: 10%;"></td> <td style="width: 10%;"></td> <td style="width: 10%;"></td> <td style="width: 10%;"></td> <td style="width: 10%;"></td> <td style="width: 10%;"></td> </tr> <tr> <td></td> <td></td> <td colspan="8" style="text-align: center;"> <table border="1" style="width: 100%; border-collapse: collapse; text-align: center;"> <tr> <td style="width: 10%;"></td> <td style="width: 10%;"></td> <td style="width: 10%;"></td> <td style="width: 10%;"></td> <td style="width: 10%;"></td> <td style="width: 10%;"></td> <td style="width: 10%;"></td> <td style="width: 10%;"></td> <td style="width: 10%;"></td> <td style="width: 10%;"></td> </tr> <tr> <td></td> <td></td> <td colspan="8" style="text-align: center;"> <table border="1" style="width: 100%; border-collapse: collapse; text-align: center;"> <tr> <td style="width: 10%;"></td> <td style="width: 10%;"></td> <td style="width: 10%;"></td> <td style="width: 10%;"></td> <td style="width: 10%;"></td> <td style="width: 10%;"></td> <td style="width: 10%;"></td> <td style="width: 10%;"></td> <td style="width: 10%;"></td> <td style="width: 10%;"></td> </tr> <tr> <td></td> <td></td> <td colspan="8" style="text-align: center;"> <table border="1" style="width: 100%; border-collapse: collapse; text-align: center;"> <tr> <td style="width: 10%;"></td> <td style="width: 10%;"></td> <td style="width: 10%;"></td> <td style="width: 10%;"></td> <td style="width: 10%;"></td> <td style="width: 10%;"></td> <td style="width: 10%;"></td> <td style="width: 10%;"></td> <td style="width: 10%;"></td> <td style="width: 10%;"></td> </tr> <tr> <td></td> <td></td> <td colspan="8" style="text-align: center;"> <table border="1" style="width: 100%; border-collapse: collapse; text-align: center;"> <tr> <td style="width: 10%;"></td> <td style="width: 10%;"></td> <td style="width: 10%;"></td> <td style="width: 10%;"></td> <td style="width: 10%;"></td> <td style="width: 10%;"></td> <td style="width: 10%;"></td> <td style="width: 10%;"></td> <td style="width: 10%;"></td> <td style="width: 10%;"></td> </tr> <tr> <td></td> <td></td> <td colspan="8" style="text-align: center;"> <table border="1" style="width: 100%; border-collapse: collapse; text-align: center;"> <tr> <td style="width: 10%;"></td> <td style="width: 10%;"></td> <td style="width: 10%;"></td> <td style="width: 10%;"></td> <td style="width: 10%;"></td> <td style="width: 10%;"></td> <td style="width: 10%;"></td> <td style="width: 10%;"></td> <td style="width: 10%;"></td> <td style="width: 10%;"></td> </tr> <tr> <td></td> <td></td> <td colspan="8" style="text-align: center;"> <table border="1" style="width: 100%; border-collapse: collapse; text-align: center;"> <tr> <td style="width: 10%;"></td> <td style="width: 10%;"></td> <td style="width: 10%;"></td> <td style="width: 10%;"></td> <td style="width: 10%;"></td> <td style="width: 10%;"></td> <td style="width: 10%;"></td> <td style="width: 10%;"></td> <td style="width: 10%;"></td> <td style="width: 10%;"></td> </tr> <tr> <td></td> <td></td> <td colspan="8" style="text-align: center;"> <table border="1" style="width: 100%; border-collapse: collapse; text-align: center;"> <tr> </tr></table></td></tr></table></td></tr></table></td></tr></table></td></tr></table></td></tr></table></td></tr></table></td></tr></table></td></tr></table></td></tr></table></td></tr></table></td></tr></table></td></tr></table></td></tr></table></td></tr></table></td></tr></table></td></tr></table></td></tr></table></td></tr></table></td></tr></table></td></tr></table></td></tr></table></td></tr></table></td></tr></table></td></tr></table></td></tr></table></td></tr></table></td></tr></table></td></tr></table></td></tr></table>
 | | | | | | | | | | | | | | | | | | | | <table border="1" style="width: 100%; border-collapse: collapse; text-align: center;"> <tr> <td style="width: 10%;"></td> <td style="width: 10%;"></td> <td style="width: 10%;"></td> <td style="width: 10%;"></td> <td style="width: 10%;"></td> <td style="width: 10%;"></td> <td style="width: 10%;"></td> <td style="width: 10%;"></td> <td style="width: 10%;"></td>
<td style="width: 10%;"></td> </tr> <tr> <td></td> <td></td> <td colspan="8" style="text-align: center;"> <table border="1" style="width: 100%; border-collapse: collapse; text-align: center;"> <tr> <td style="width: 10%;"></td> <td style="width: 10%;"></td> <td style="width: 10%;"></td> <td style="width: 10%;"></td> <td style="width: 10%;"></td> <td style="width: 10%;"></td> <td style="width: 10%;"></td> <td style="width: 10%;"></td> <td style="width: 10%;"></td> <td style="width: 10%;"></td> </tr> <tr> <td></td> <td></td> <td colspan="8" style="text-align: center;"> <table border="1" style="width: 100%; border-collapse: collapse; text-align: center;"> <tr> <td style="width: 10%;"></td> <td style="width: 10%;"></td> <td style="width: 10%;"></td> <td style="width: 10%;"></td> <td style="width: 10%;"></td> <td style="width: 10%;"></td> <td style="width: 10%;"></td> <td style="width: 10%;"></td> <td style="width: 10%;"></td> <td style="width: 10%;"></td> </tr> <tr> <td></td> <td></td> <td colspan="8" style="text-align: center;"> <table border="1" style="width: 100%; border-collapse: collapse; text-align: center;"> <tr> <td style="width: 10%;"></td> <td style="width: 10%;"></td> <td style="width: 10%;"></td> <td style="width: 10%;"></td> <td style="width: 10%;"></td> <td style="width: 10%;"></td> <td style="width: 10%;"></td> <td style="width: 10%;"></td> <td style="width: 10%;"></td> <td style="width: 10%;"></td> </tr> <tr> <td></td> <td></td> <td colspan="8" style="text-align: center;"> <table border="1" style="width: 100%; border-collapse: collapse; text-align: center;"> <tr> <td style="width: 10%;"></td> <td style="width: 10%;"></td> <td style="width: 10%;"></td> <td style="width: 10%;"></td> <td style="width: 10%;"></td> <td style="width: 10%;"></td> <td style="width: 10%;"></td> <td style="width: 10%;"></td> <td style="width: 10%;"></td> <td style="width: 10%;"></td> </tr> <tr> <td></td> <td></td> <td colspan="8" style="text-align: center;"> <table border="1" style="width: 100%; border-collapse: collapse; text-align: center;"> <tr> <td style="width: 10%;"></td> <td style="width: 10%;"></td> <td style="width: 10%;"></td> <td style="width: 10%;"></td> <td style="width: 10%;"></td> <td style="width: 10%;"></td> <td style="width: 10%;"></td> <td style="width: 10%;"></td> <td style="width: 10%;"></td> <td style="width: 10%;"></td> </tr> <tr> <td></td> <td></td> <td colspan="8" style="text-align: center;"> <table border="1" style="width: 100%; border-collapse: collapse; text-align: center;"> <tr> <td style="width: 10%;"></td> <td style="width: 10%;"></td> <td style="width: 10%;"></td> <td style="width: 10%;"></td> <td style="width: 10%;"></td> <td style="width: 10%;"></td> <td style="width: 10%;"></td> <td style="width: 10%;"></td> <td style="width: 10%;"></td> <td style="width: 10%;"></td> </tr> <tr> <td></td> <td></td> <td colspan="8" style="text-align: center;"> <table border="1" style="width: 100%; border-collapse: collapse; text-align: center;"> <tr> <td style="width: 10%;"></td> <td style="width: 10%;"></td> <td style="width: 10%;"></td> <td style="width: 10%;"></td> <td style="width: 10%;"></td> <td style="width: 10%;"></td> <td style="width: 10%;"></td> <td style="width: 10%;"></td> <td style="width: 10%;"></td> <td style="width: 10%;"></td> </tr> <tr> <td></td> <td></td> <td colspan="8" style="text-align: center;"> <table border="1" style="width: 100%; border-collapse: collapse; text-align: center;"> <tr> <td style="width: 10%;"></td> <td style="width: 10%;"></td> <td style="width: 10%;"></td> <td style="width: 10%;"></td> <td style="width: 10%;"></td> <td style="width: 10%;"></td> <td style="width: 10%;"></td> <td style="width: 10%;"></td> <td style="width: 10%;"></td> <td style="width: 10%;"></td> </tr> <tr> <td></td> <td></td> <td colspan="8" style="text-align: center;"> <table border="1" style="width: 100%; border-collapse: collapse; text-align: center;"> <tr> <td style="width: 10%;"></td> <td style="width: 10%;"></td> <td style="width: 10%;"></td> <td style="width: 10%;"></td> <td style="width: 10%;"></td> <td style="width: 10%;"></td> <td style="width: 10%;"></td> <td style="width: 10%;"></td> <td style="width: 10%;"></td> <td style="width: 10%;"></td> </tr> <tr> <td></td> <td></td> <td colspan="8" style="text-align: center;"> <table border="1" style="width: 100%; border-collapse: collapse; text-align: center;"> <tr> <td style="width: 10%;"></td> <td style="width: 10%;"></td> <td style="width: 10%;"></td> <td style="width: 10%;"></td> <td style="width: 10%;"></td> <td style="width: 10%;"></td> <td style="width: 10%;"></td> <td style="width: 10%;"></td> <td style="width: 10%;"></td> <td style="width: 10%;"></td> </tr> <tr> <td></td> <td></td> <td colspan="8" style="text-align: center;"> <table border="1" style="width: 100%; border-collapse: collapse; text-align: center;"> <tr> <td style="width: 10%;"></td> <td style="width: 10%;"></td> <td style="width: 10%;"></td> <td style="width: 10%;"></td> <td style="width: 10%;"></td> <td style="width: 10%;"></td> <td style="width: 10%;"></td> <td style="width: 10%;"></td> <td style="width: 10%;"></td> <td style="width: 10%;"></td> </tr> <tr> <td></td> <td></td> <td colspan="8" style="text-align: center;"> <table border="1" style="width: 100%; border-collapse: collapse; text-align: center;"> <tr> <td style="width: 10%;"></td> <td style="width: 10%;"></td> <td style="width: 10%;"></td> <td style="width: 10%;"></td> <td style="width: 10%;"></td> <td style="width: 10%;"></td> <td style="width: 10%;"></td> <td style="width: 10%;"></td> <td style="width: 10%;"></td> <td style="width: 10%;"></td> </tr> <tr> <td></td> <td></td> <td colspan="8" style="text-align: center;"> <table border="1" style="width: 100%; border-collapse: collapse; text-align: center;"> <tr> <td style="width: 10%;"></td> <td style="width: 10%;"></td> <td style="width: 10%;"></td> <td style="width: 10%;"></td> <td style="width: 10%;"></td> <td style="width: 10%;"></td> <td style="width: 10%;"></td> <td style="width: 10%;"></td> <td style="width: 10%;"></td> <td style="width: 10%;"></td> </tr> <tr> <td></td> <td></td> <td colspan="8" style="text-align: center;"> <table border="1" style="width: 100%; border-collapse: collapse; text-align: center;"> <tr> <td style="width: 10%;"></td> <td style="width: 10%;"></td> <td style="width: 10%;"></td> <td style="width: 10%;"></td> <td style="width: 10%;"></td> <td style="width: 10%;"></td> <td style="width: 10%;"></td> <td style="width: 10%;"></td> <td style="width: 10%;"></td> <td style="width: 10%;"></td> </tr> <tr> <td></td> <td></td> <td colspan="8" style="text-align: center;"> <table border="1" style="width: 100%; border-collapse: collapse; text-align: center;"> <tr> <td style="width: 10%;"></td> <td style="width: 10%;"></td> <td style="width: 10%;"></td> <td style="width: 10%;"></td> <td style="width: 10%;"></td> <td style="width: 10%;"></td> <td style="width: 10%;"></td> <td style="width: 10%;"></td> <td style="width: 10%;"></td> <td style="width: 10%;"></td> </tr> <tr> <td></td> <td></td> <td colspan="8" style="text-align: center;"> <table border="1" style="width: 100%; border-collapse: collapse; text-align: center;"> <tr> <td style="width: 10%;"></td> <td style="width: 10%;"></td> <td style="width: 10%;"></td> <td style="width: 10%;"></td> <td style="width: 10%;"></td> <td style="width: 10%;"></td> <td style="width: 10%;"></td> <td style="width: 10%;"></td> <td style="width: 10%;"></td> <td style="width: 10%;"></td> </tr> <tr> <td></td> <td></td> <td colspan="8" style="text-align: center;"> <table border="1" style="width: 100%; border-collapse: collapse; text-align: center;"> <tr> <td style="width: 10%;"></td> <td style="width: 10%;"></td> <td style="width: 10%;"></td> <td style="width: 10%;"></td> <td style="width: 10%;"></td> <td style="width: 10%;"></td> <td style="width: 10%;"></td> <td style="width: 10%;"></td> <td style="width: 10%;"></td> <td style="width: 10%;"></td> </tr> <tr> <td></td> <td></td> <td colspan="8" style="text-align: center;"> <table border="1" style="width: 100%; border-collapse: collapse; text-align: center;"> <tr> <td style="width: 10%;"></td> <td style="width: 10%;"></td> <td style="width: 10%;"></td> <td style="width: 10%;"></td> <td style="width: 10%;"></td> <td style="width: 10%;"></td> <td style="width: 10%;"></td> <td style="width: 10%;"></td> <td style="width: 10%;"></td> <td style="width: 10%;"></td> </tr> <tr> <td></td> <td></td> <td colspan="8" style="text-align: center;"> <table border="1" style="width: 100%; border-collapse: collapse; text-align: center;"> <tr> <td style="width: 10%;"></td> <td style="width: 10%;"></td> <td style="width: 10%;"></td> <td style="width: 10%;"></td> <td style="width: 10%;"></td> <td style="width: 10%;"></td> <td style="width: 10%;"></td> <td style="width: 10%;"></td> <td style="width: 10%;"></td> <td style="width: 10%;"></td> </tr> <tr> <td></td> <td></td> <td colspan="8" style="text-align: center;"> <table border="1" style="width: 100%; border-collapse: collapse; text-align: center;"> <tr> <td style="width: 10%;"></td> <td style="width: 10%;"></td> <td style="width: 10%;"></td> <td style="width: 10%;"></td> <td style="width: 10%;"></td> <td style="width: 10%;"></td> <td style="width: 10%;"></td> <td style="width: 10%;"></td> <td style="width: 10%;"></td> <td style="width: 10%;"></td> </tr> <tr> <td></td> <td></td> <td colspan="8" style="text-align: center;"> <table border="1" style="width: 100%; border-collapse: collapse; text-align: center;"> <tr> <td style="width: 10%;"></td> <td style="width: 10%;"></td> <td style="width: 10%;"></td> <td style="width: 10%;"></td> <td style="width: 10%;"></td> <td style="width: 10%;"></td> <td style="width: 10%;"></td> <td style="width: 10%;"></td> <td style="width: 10%;"></td> <td style="width: 10%;"></td> </tr> <tr> <td></td> <td></td> <td colspan="8" style="text-align: center;"> <table border="1" style="width: 100%; border-collapse: collapse;
text-align: center;"> <tr> <td style="width: 10%;"></td> <td style="width: 10%;"></td> <td style="width: 10%;"></td> <td style="width: 10%;"></td> <td style="width: 10%;"></td> <td style="width: 10%;"></td> <td style="width: 10%;"></td> <td style="width: 10%;"></td> <td style="width: 10%;"></td> <td style="width: 10%;"></td> </tr> <tr> <td></td> <td></td> <td colspan="8" style="text-align: center;"> <table border="1" style="width: 100%; border-collapse: collapse; text-align: center;"> <tr> <td style="width: 10%;"></td> <td style="width: 10%;"></td> <td style="width: 10%;"></td> <td style="width: 10%;"></td> <td style="width: 10%;"></td> <td style="width: 10%;"></td> <td style="width: 10%;"></td> <td style="width: 10%;"></td> <td style="width: 10%;"></td> <td style="width: 10%;"></td> </tr> <tr> <td></td> <td></td> <td colspan="8" style="text-align: center;"> <table border="1" style="width: 100%; border-collapse: collapse; text-align: center;"> <tr> <td style="width: 10%;"></td> <td style="width: 10%;"></td> <td style="width: 10%;"></td> <td style="width: 10%;"></td> <td style="width: 10%;"></td> <td style="width: 10%;"></td> <td style="width: 10%;"></td> <td style="width: 10%;"></td> <td style="width: 10%;"></td> <td style="width: 10%;"></td> </tr> <tr> <td></td> <td></td> <td colspan="8" style="text-align: center;"> <table border="1" style="width: 100%; border-collapse: collapse; text-align: center;"> <tr> <td style="width: 10%;"></td> <td style="width: 10%;"></td> <td style="width: 10%;"></td> <td style="width: 10%;"></td> <td style="width: 10%;"></td> <td style="width: 10%;"></td> <td style="width: 10%;"></td> <td style="width: 10%;"></td> <td style="width: 10%;"></td> <td style="width: 10%;"></td> </tr> <tr> <td></td> <td></td> <td colspan="8" style="text-align: center;"> <table border="1" style="width: 100%; border-collapse: collapse; text-align: center;"> <tr> <td style="width: 10%;"></td> <td style="width: 10%;"></td> <td style="width: 10%;"></td> <td style="width: 10%;"></td> <td style="width: 10%;"></td> <td style="width: 10%;"></td> <td style="width: 10%;"></td> <td style="width: 10%;"></td> <td style="width: 10%;"></td> <td style="width: 10%;"></td> </tr> <tr> <td></td> <td></td> <td colspan="8" style="text-align: center;"> <table border="1" style="width: 100%; border-collapse: collapse; text-align: center;"> <tr> <td style="width: 10%;"></td> <td style="width: 10%;"></td> <td style="width: 10%;"></td> <td style="width: 10%;"></td> <td style="width: 10%;"></td> <td style="width: 10%;"></td> <td style="width: 10%;"></td> <td style="width: 10%;"></td> <td style="width: 10%;"></td> <td style="width: 10%;"></td> </tr> <tr> <td></td> <td></td> <td colspan="8" style="text-align: center;"> <table border="1" style="width: 100%; border-collapse: collapse; text-align: center;"> <tr> </tr></table></td></tr></table></td></tr></table></td></tr></table></td></tr></table></td></tr></table></td></tr></table></td></tr></table></td></tr></table></td></tr></table></td></tr></table></td></tr></table></td></tr></table></td></tr></table></td></tr></table></td></tr></table></td></tr></table></td></tr></table></td></tr></table></td></tr></table></td></tr></table></td></tr></table></td></tr></table></td></tr></table></td></tr></table></td></tr></table></td></tr></table></td></tr></table></td></tr></table>
 | | | | | | | | | | | | | | | | | | | | <table border="1" style="width: 100%; border-collapse: collapse; text-align: center;"> <tr> <td style="width: 10%;"></td> <td style="width: 10%;"></td> <td style="width: 10%;"></td> <td style="width: 10%;"></td> <td style="width: 10%;"></td> <td style="width: 10%;"></td> <td style="width: 10%;"></td> <td style="width: 10%;"></td> <td style="width: 10%;"></td> <td style="width: 10%;"></td> </tr> <tr> <td></td> <td></td> <td colspan="8" style="text-align: center;"> <table border="1" style="width: 100%; border-collapse: collapse; text-align: center;"> <tr> <td style="width: 10%;"></td> <td style="width: 10%;"></td> <td style="width: 10%;"></td> <td style="width: 10%;"></td> <td style="width: 10%;"></td> <td style="width: 10%;"></td> <td style="width: 10%;"></td> <td style="width: 10%;"></td> <td style="width: 10%;"></td> <td style="width: 10%;"></td> </tr> <tr> <td></td> <td></td> <td colspan="8" style="text-align: center;"> <table border="1" style="width: 100%; border-collapse: collapse; text-align: center;"> <tr> <td style="width: 10%;"></td> <td style="width: 10%;"></td> <td style="width: 10%;"></td> <td style="width: 10%;"></td> <td style="width: 10%;"></td> <td style="width: 10%;"></td> <td style="width: 10%;"></td> <td style="width: 10%;"></td> <td style="width: 10%;"></td> <td style="width: 10%;"></td> </tr> <tr> <td></td> <td></td> <td colspan="8" style="text-align: center;"> <table border="1" style="width: 100%; border-collapse: collapse; text-align: center;"> <tr> <td style="width: 10%;"></td> <td style="width: 10%;"></td> <td style="width: 10%;"></td> <td style="width: 10%;"></td> <td style="width: 10%;"></td> <td style="width: 10%;"></td> <td style="width: 10%;"></td> <td style="width: 10%;"></td> <td style="width: 10%;"></td> <td style="width: 10%;"></td> </tr> <tr> <td></td> <td></td> <td colspan="8" style="text-align: center;"> <table border="1" style="width: 100%; border-collapse: collapse; text-align: center;"> <tr> <td style="width: 10%;"></td> <td style="width: 10%;"></td> <td style="width: 10%;"></td> <td style="width: 10%;"></td> <td style="width: 10%;"></td> <td style="width: 10%;"></td> <td style="width: 10%;"></td> <td style="width: 10%;"></td> <td style="width: 10%;"></td> <td style="width: 10%;"></td> </tr> <tr> <td></td> <td></td> <td colspan="8" style="text-align: center;"> <table border="1" style="width: 100%; border-collapse: collapse; text-align: center;"> <tr> <td style="width: 10%;"></td> <td style="width: 10%;"></td> <td style="width: 10%;"></td> <td style="width: 10%;"></td> <td style="width: 10%;"></td> <td style="width: 10%;"></td> <td style="width: 10%;"></td> <td style="width: 10%;"></td> <td style="width: 10%;"></td> <td style="width: 10%;"></td> </tr> <tr> <td></td> <td></td> <td colspan="8" style="text-align: center;"> <table border="1" style="width: 100%; border-collapse: collapse; text-align: center;"> <tr> <td style="width: 10%;"></td> <td style="width: 10%;"></td> <td style="width: 10%;"></td> <td style="width: 10%;"></td> <td style="width: 10%;"></td> <td style="width: 10%;"></td> <td style="width: 10%;"></td> <td style="width: 10%;"></td> <td style="width: 10%;"></td> <td style="width: 10%;"></td> </tr> <tr> <td></td> <td></td> <td colspan="8" style="text-align: center;"> <table border="1" style="width: 100%; border-collapse: collapse; text-align: center;"> <tr> <td style="width: 10%;"></td> <td style="width: 10%;"></td> <td style="width: 10%;"></td> <td style="width: 10%;"></td> <td style="width: 10%;"></td> <td style="width: 10%;"></td> <td style="width: 10%;"></td> <td style="width: 10%;"></td> <td style="width: 10%;"></td> <td style="width: 10%;"></td> </tr> <tr> <td></td> <td></td> <td colspan="8" style="text-align: center;"> <table border="1" style="width: 100%; border-collapse: collapse; text-align: center;"> <tr> <td style="width: 10%;"></td> <td style="width: 10%;"></td> <td style="width: 10%;"></td> <td style="width: 10%;"></td> <td style="width: 10%;"></td> <td style="width: 10%;"></td> <td style="width: 10%;"></td> <td style="width: 10%;"></td> <td style="width: 10%;"></td> <td style="width: 10%;"></td> </tr> <tr> <td></td> <td></td> <td colspan="8" style="text-align: center;"> <table border="1" style="width: 100%; border-collapse: collapse; text-align: center;"> <tr> <td style="width: 10%;"></td> <td style="width: 10%;"></td> <td style="width: 10%;"></td> <td style="width: 10%;"></td> <td style="width: 10%;"></td> <td style="width: 10%;"></td> <td style="width: 10%;"></td> <td style="width: 10%;"></td> <td style="width: 10%;"></td> <td style="width: 10%;"></td> </tr> <tr> <td></td> <td></td> <td colspan="8" style="text-align: center;"> <table border="1" style="width: 100%; border-collapse: collapse; text-align: center;"> <tr> <td style="width: 10%;"></td> <td style="width: 10%;"></td> <td style="width: 10%;"></td> <td style="width: 10%;"></td> <td style="width: 10%;"></td> <td style="width: 10%;"></td> <td style="width: 10%;"></td> <td style="width: 10%;"></td> <td style="width: 10%;"></td> <td style="width: 10%;"></td> </tr> <tr> <td></td> <td></td> <td colspan="8" style="text-align: center;"> <table border="1" style="width: 100%; border-collapse: collapse; text-align: center;"> <tr> <td style="width: 10%;"></td> <td style="width: 10%;"></td> <td style="width: 10%;"></td> <td style="width: 10%;"></td> <td style="width: 10%;"></td> <td style="width:
10%;"></td> <td style="width: 10%;"></td> <td style="width: 10%;"></td> <td style="width: 10%;"></td> <td style="width: 10%;"></td> </tr> <tr> <td></td> <td></td> <td colspan="8" style="text-align: center;"> <table border="1" style="width: 100%; border-collapse: collapse; text-align: center;"> <tr> <td style="width: 10%;"></td> <td style="width: 10%;"></td> <td style="width: 10%;"></td> <td style="width: 10%;"></td> <td style="width: 10%;"></td> <td style="width: 10%;"></td> <td style="width: 10%;"></td> <td style="width: 10%;"></td> <td style="width: 10%;"></td> <td style="width: 10%;"></td> </tr> <tr> <td></td> <td></td> <td colspan="8" style="text-align: center;"> <table border="1" style="width: 100%; border-collapse: collapse; text-align: center;"> <tr> <td style="width: 10%;"></td> <td style="width: 10%;"></td> <td style="width: 10%;"></td> <td style="width: 10%;"></td> <td style="width: 10%;"></td> <td style="width: 10%;"></td> <td style="width: 10%;"></td> <td style="width: 10%;"></td> <td style="width: 10%;"></td> <td style="width: 10%;"></td> </tr> <tr> <td></td> <td></td> <td colspan="8" style="text-align: center;"> <table border="1" style="width: 100%; border-collapse: collapse; text-align: center;"> <tr> <td style="width: 10%;"></td> <td style="width: 10%;"></td> <td style="width: 10%;"></td> <td style="width: 10%;"></td> <td style="width: 10%;"></td> <td style="width: 10%;"></td> <td style="width: 10%;"></td> <td style="width: 10%;"></td> <td style="width: 10%;"></td> <td style="width: 10%;"></td> </tr> <tr> <td></td> <td></td> <td colspan="8" style="text-align: center;"> <table border="1" style="width: 100%; border-collapse: collapse; text-align: center;"> <tr> <td style="width: 10%;"></td> <td style="width: 10%;"></td> <td style="width: 10%;"></td> <td style="width: 10%;"></td> <td style="width: 10%;"></td> <td style="width: 10%;"></td> <td style="width: 10%;"></td> <td style="width: 10%;"></td> <td style="width: 10%;"></td> <td style="width: 10%;"></td> </tr> <tr> <td></td> <td></td> <td colspan="8" style="text-align: center;"> <table border="1" style="width: 100%; border-collapse: collapse; text-align: center;"> <tr> <td style="width: 10%;"></td> <td style="width: 10%;"></td> <td style="width: 10%;"></td> <td style="width: 10%;"></td> <td style="width: 10%;"></td> <td style="width: 10%;"></td> <td style="width: 10%;"></td> <td style="width: 10%;"></td> <td style="width: 10%;"></td> <td style="width: 10%;"></td> </tr> <tr> <td></td> <td></td> <td colspan="8" style="text-align: center;"> <table border="1" style="width: 100%; border-collapse: collapse; text-align: center;"> <tr> <td style="width: 10%;"></td> <td style="width: 10%;"></td> <td style="width: 10%;"></td> <td style="width: 10%;"></td> <td style="width: 10%;"></td> <td style="width: 10%;"></td> <td style="width: 10%;"></td> <td style="width: 10%;"></td> <td style="width: 10%;"></td> <td style="width: 10%;"></td> </tr> <tr> <td></td> <td></td> <td colspan="8" style="text-align: center;"> <table border="1" style="width: 100%; border-collapse: collapse; text-align: center;"> <tr> <td style="width: 10%;"></td> <td style="width: 10%;"></td> <td style="width: 10%;"></td> <td style="width: 10%;"></td> <td style="width: 10%;"></td> <td style="width: 10%;"></td> <td style="width: 10%;"></td> <td style="width: 10%;"></td> <td style="width: 10%;"></td> <td style="width: 10%;"></td> </tr> <tr> <td></td> <td></td> <td colspan="8" style="text-align: center;"> <table border="1" style="width: 100%; border-collapse: collapse; text-align: center;"> <tr> <td style="width: 10%;"></td> <td style="width: 10%;"></td> <td style="width: 10%;"></td> <td style="width: 10%;"></td> <td style="width: 10%;"></td> <td style="width: 10%;"></td> <td style="width: 10%;"></td> <td style="width: 10%;"></td> <td style="width: 10%;"></td> <td style="width: 10%;"></td> </tr> <tr> <td></td> <td></td> <td colspan="8" style="text-align: center;"> <table border="1" style="width: 100%; border-collapse: collapse; text-align: center;"> <tr> <td style="width: 10%;"></td> <td style="width: 10%;"></td> <td style="width: 10%;"></td> <td style="width: 10%;"></td> <td style="width: 10%;"></td> <td style="width: 10%;"></td> <td style="width: 10%;"></td> <td style="width: 10%;"></td> <td style="width: 10%;"></td> <td style="width: 10%;"></td> </tr> <tr> <td></td> <td></td> <td colspan="8" style="text-align: center;"> <table border="1" style="width: 100%; border-collapse: collapse; text-align: center;"> <tr> <td style="width: 10%;"></td> <td style="width: 10%;"></td> <td style="width: 10%;"></td> <td style="width: 10%;"></td> <td style="width: 10%;"></td> <td style="width: 10%;"></td> <td style="width: 10%;"></td> <td style="width: 10%;"></td> <td style="width: 10%;"></td> <td style="width: 10%;"></td> </tr> <tr> <td></td> <td></td> <td colspan="8" style="text-align: center;"> <table border="1" style="width: 100%; border-collapse: collapse; text-align: center;"> <tr> <td style="width: 10%;"></td> <td style="width: 10%;"></td> <td style="width: 10%;"></td> <td style="width: 10%;"></td> <td style="width: 10%;"></td> <td style="width: 10%;"></td> <td style="width: 10%;"></td> <td style="width: 10%;"></td> <td style="width: 10%;"></td> <td style="width: 10%;"></td> </tr> <tr> <td></td> <td></td> <td colspan="8" style="text-align: center;"> <table border="1" style="width: 100%; border-collapse: collapse; text-align: center;"> <tr> <td style="width: 10%;"></td> <td style="width: 10%;"></td> <td style="width: 10%;"></td> <td style="width: 10%;"></td> <td style="width: 10%;"></td> <td style="width: 10%;"></td> <td style="width: 10%;"></td> <td style="width: 10%;"></td> <td style="width: 10%;"></td> <td style="width: 10%;"></td> </tr> <tr> <td></td> <td></td> <td colspan="8" style="text-align: center;"> <table border="1" style="width: 100%; border-collapse: collapse; text-align: center;"> <tr> <td style="width: 10%;"></td> <td style="width: 10%;"></td> <td style="width: 10%;"></td> <td style="width: 10%;"></td> <td style="width: 10%;"></td> <td style="width: 10%;"></td> <td style="width: 10%;"></td> <td style="width: 10%;"></td> <td style="width: 10%;"></td> <td style="width: 10%;"></td> </tr> <tr> <td></td> <td></td> <td colspan="8" style="text-align: center;"> <table border="1" style="width: 100%; border-collapse: collapse; text-align: center;"> <tr> <td style="width: 10%;"></td> <td style="width: 10%;"></td> <td style="width: 10%;"></td> <td style="width: 10%;"></td> <td style="width: 10%;"></td> <td style="width: 10%;"></td> <td style="width: 10%;"></td> <td style="width: 10%;"></td> <td style="width: 10%;"></td> <td style="width: 10%;"></td> </tr> <tr> <td></td> <td></td> <td colspan="8" style="text-align: center;"> <table border="1" style="width: 100%; border-collapse: collapse; text-align: center;"> <tr> <td style="width: 10%;"></td> <td style="width: 10%;"></td> <td style="width: 10%;"></td> <td style="width: 10%;"></td> <td style="width: 10%;"></td> <td style="width: 10%;"></td> <td style="width: 10%;"></td> <td style="width: 10%;"></td> <td style="width: 10%;"></td> <td style="width: 10%;"></td> </tr> <tr> <td></td> <td></td> <td colspan="8" style="text-align: center;"> <table border="1" style="width: 100%; border-collapse: collapse; text-align: center;"> <tr> </tr></table></td></tr></table></td></tr></table></td></tr></table></td></tr></table></td></tr></table></td></tr></table></td></tr></table></td></tr></table></td></tr></table></td></tr></table></td></tr></table></td></tr></table></td></tr></table></td></tr></table></td></tr></table></td></tr></table></td></tr></table></td></tr></table></td></tr></table></td></tr></table></td></tr></table></td></tr></table></td></tr></table></td></tr></table></td></tr></table></td></tr></table></td></tr></table>
 | | | | | | | | | | | | | | | | | | | | <table border="1" style="width: 100%; border-collapse: collapse; text-align: center;"> <tr> <td style="width: 10%;"></td> <td style="width: 10%;"></td> <td style="width: 10%;"></td> <td style="width: 10%;"></td> <td style="width: 10%;"></td> <td style="width: 10%;"></td> <td style="width: 10%;"></td> <td style="width: 10%;"></td> <td style="width: 10%;"></td> <td style="width: 10%;"></td> </tr> <tr> <td></td> <td></td> <td colspan="8" style="text-align: center;"> <table border="1" style="width: 100%; border-collapse: collapse; text-align: center;"> <tr> <td style="width: 10%;"></td> <td style="width: 10%;"></td> <td style="width: 10%;"></td> <td style="width: 10%;"></td> <td style="width: 10%;"></td> <td style="width: 10%;"></td> <td style="width: 10%;"></td> <td style="width: 10%;"></td> <td style="width: 10%;"></td> <td style="width: 10%;"></td> </tr> <tr> <td></td> <td></td> <td colspan="8" style="text-align: center;"> <table
border="1" style="width: 100%; border-collapse: collapse; text-align: center;"> <tr> <td style="width: 10%;"></td> <td style="width: 10%;"></td> <td style="width: 10%;"></td> <td style="width: 10%;"></td> <td style="width: 10%;"></td> <td style="width: 10%;"></td> <td style="width: 10%;"></td> <td style="width: 10%;"></td> <td style="width: 10%;"></td> <td style="width: 10%;"></td> </tr> <tr> <td></td> <td></td> <td colspan="8" style="text-align: center;"> <table border="1" style="width: 100%; border-collapse: collapse; text-align: center;"> <tr> <td style="width: 10%;"></td> <td style="width: 10%;"></td> <td style="width: 10%;"></td> <td style="width: 10%;"></td> <td style="width: 10%;"></td> <td style="width: 10%;"></td> <td style="width: 10%;"></td> <td style="width: 10%;"></td> <td style="width: 10%;"></td> <td style="width: 10%;"></td> </tr> <tr> <td></td> <td></td> <td colspan="8" style="text-align: center;"> <table border="1" style="width: 100%; border-collapse: collapse; text-align: center;"> <tr> <td style="width: 10%;"></td> <td style="width: 10%;"></td> <td style="width: 10%;"></td> <td style="width: 10%;"></td> <td style="width: 10%;"></td> <td style="width: 10%;"></td> <td style="width: 10%;"></td> <td style="width: 10%;"></td> <td style="width: 10%;"></td> <td style="width: 10%;"></td> </tr> <tr> <td></td> <td></td> <td colspan="8" style="text-align: center;"> <table border="1" style="width: 100%; border-collapse: collapse; text-align: center;"> <tr> <td style="width: 10%;"></td> <td style="width: 10%;"></td> <td style="width: 10%;"></td> <td style="width: 10%;"></td> <td style="width: 10%;"></td> <td style="width: 10%;"></td> <td style="width: 10%;"></td> <td style="width: 10%;"></td> <td style="width: 10%;"></td> <td style="width: 10%;"></td> </tr> <tr> <td></td> <td></td> <td colspan="8" style="text-align: center;"> <table border="1" style="width: 100%; border-collapse: collapse; text-align: center;"> <tr> <td style="width: 10%;"></td> <td style="width: 10%;"></td> <td style="width: 10%;"></td> <td style="width: 10%;"></td> <td style="width: 10%;"></td> <td style="width: 10%;"></td> <td style="width: 10%;"></td> <td style="width: 10%;"></td> <td style="width: 10%;"></td> <td style="width: 10%;"></td> </tr> <tr> <td></td> <td></td> <td colspan="8" style="text-align: center;"> <table border="1" style="width: 100%; border-collapse: collapse; text-align: center;"> <tr> <td style="width: 10%;"></td> <td style="width: 10%;"></td> <td style="width: 10%;"></td> <td style="width: 10%;"></td> <td style="width: 10%;"></td> <td style="width: 10%;"></td> <td style="width: 10%;"></td> <td style="width: 10%;"></td> <td style="width: 10%;"></td> <td style="width: 10%;"></td> </tr> <tr> <td></td> <td></td> <td colspan="8" style="text-align: center;"> <table border="1" style="width: 100%; border-collapse: collapse; text-align: center;"> <tr> <td style="width: 10%;"></td> <td style="width: 10%;"></td> <td style="width: 10%;"></td> <td style="width: 10%;"></td> <td style="width: 10%;"></td> <td style="width: 10%;"></td> <td style="width: 10%;"></td> <td style="width: 10%;"></td> <td style="width: 10%;"></td> <td style="width: 10%;"></td> </tr> <tr> <td></td> <td></td> <td colspan="8" style="text-align: center;"> <table border="1" style="width: 100%; border-collapse: collapse; text-align: center;"> <tr> <td style="width: 10%;"></td> <td style="width: 10%;"></td> <td style="width: 10%;"></td> <td style="width: 10%;"></td> <td style="width: 10%;"></td> <td style="width: 10%;"></td> <td style="width: 10%;"></td> <td style="width: 10%;"></td> <td style="width: 10%;"></td> <td style="width: 10%;"></td> </tr> <tr> <td></td> <td></td> <td colspan="8" style="text-align: center;"> <table border="1" style="width: 100%; border-collapse: collapse; text-align: center;"> <tr> <td style="width: 10%;"></td> <td style="width: 10%;"></td> <td style="width: 10%;"></td> <td style="width: 10%;"></td> <td style="width: 10%;"></td> <td style="width: 10%;"></td> <td style="width: 10%;"></td> <td style="width: 10%;"></td> <td style="width: 10%;"></td> <td style="width: 10%;"></td> </tr> <tr> <td></td> <td></td> <td colspan="8" style="text-align: center;"> <table border="1" style="width: 100%; border-collapse: collapse; text-align: center;"> <tr> <td style="width: 10%;"></td> <td style="width: 10%;"></td> <td style="width: 10%;"></td> <td style="width: 10%;"></td> <td style="width: 10%;"></td> <td style="width: 10%;"></td> <td style="width: 10%;"></td> <td style="width: 10%;"></td> <td style="width: 10%;"></td> <td style="width: 10%;"></td> </tr> <tr> <td></td> <td></td> <td colspan="8" style="text-align: center;"> <table border="1" style="width: 100%; border-collapse: collapse; text-align: center;"> <tr> <td style="width: 10%;"></td> <td style="width: 10%;"></td> <td style="width: 10%;"></td> <td style="width: 10%;"></td> <td style="width: 10%;"></td> <td style="width: 10%;"></td> <td style="width: 10%;"></td> <td style="width: 10%;"></td> <td style="width: 10%;"></td> <td style="width: 10%;"></td> </tr> <tr> <td></td> <td></td> <td colspan="8" style="text-align: center;"> <table border="1" style="width: 100%; border-collapse: collapse; text-align: center;"> <tr> <td style="width: 10%;"></td> <td style="width: 10%;"></td> <td style="width: 10%;"></td> <td style="width: 10%;"></td> <td style="width: 10%;"></td> <td style="width: 10%;"></td> <td style="width: 10%;"></td> <td style="width: 10%;"></td> <td style="width: 10%;"></td> <td style="width: 10%;"></td> </tr> <tr> <td></td> <td></td> <td colspan="8" style="text-align: center;"> <table border="1" style="width: 100%; border-collapse: collapse; text-align: center;"> <tr> <td style="width: 10%;"></td> <td style="width: 10%;"></td> <td style="width: 10%;"></td> <td style="width: 10%;"></td> <td style="width: 10%;"></td> <td style="width: 10%;"></td> <td style="width: 10%;"></td> <td style="width: 10%;"></td> <td style="width: 10%;"></td> <td style="width: 10%;"></td> </tr> <tr> <td></td> <td></td> <td colspan="8" style="text-align: center;"> <table border="1" style="width: 100%; border-collapse: collapse; text-align: center;"> <tr> <td style="width: 10%;"></td> <td style="width: 10%;"></td> <td style="width: 10%;"></td> <td style="width: 10%;"></td> <td style="width: 10%;"></td> <td style="width: 10%;"></td> <td style="width: 10%;"></td> <td style="width: 10%;"></td> <td style="width: 10%;"></td> <td style="width: 10%;"></td> </tr> <tr> <td></td> <td></td> <td colspan="8" style="text-align: center;"> <table border="1" style="width: 100%; border-collapse: collapse; text-align: center;"> <tr> <td style="width: 10%;"></td> <td style="width: 10%;"></td> <td style="width: 10%;"></td> <td style="width: 10%;"></td> <td style="width: 10%;"></td> <td style="width: 10%;"></td> <td style="width: 10%;"></td> <td style="width: 10%;"></td> <td style="width: 10%;"></td> <td style="width: 10%;"></td> </tr> <tr> <td></td> <td></td> <td colspan="8" style="text-align: center;"> <table border="1" style="width: 100%; border-collapse: collapse; text-align: center;"> <tr> <td style="width: 10%;"></td> <td style="width: 10%;"></td> <td style="width: 10%;"></td> <td style="width: 10%;"></td> <td style="width: 10%;"></td> <td style="width: 10%;"></td> <td style="width: 10%;"></td> <td style="width: 10%;"></td> <td style="width: 10%;"></td> <td style="width: 10%;"></td> </tr> <tr> <td></td> <td></td> <td colspan="8" style="text-align: center;"> <table border="1" style="width: 100%; border-collapse: collapse; text-align: center;"> <tr> <td style="width: 10%;"></td> <td style="width: 10%;"></td> <td style="width: 10%;"></td> <td style="width: 10%;"></td> <td style="width: 10%;"></td> <td style="width: 10%;"></td> <td style="width: 10%;"></td> <td style="width: 10%;"></td> <td style="width: 10%;"></td> <td style="width: 10%;"></td> </tr> <tr> <td></td> <td></td> <td colspan="8" style="text-align: center;"> <table border="1" style="width: 100%; border-collapse: collapse; text-align: center;"> <tr> <td style="width: 10%;"></td> <td style="width: 10%;"></td> <td style="width: 10%;"></td> <td style="width: 10%;"></td> <td style="width: 10%;"></td> <td style="width: 10%;"></td> <td style="width: 10%;"></td> <td style="width: 10%;"></td> <td style="width: 10%;"></td> <td style="width: 10%;"></td> </tr> <tr> <td></td> <td></td> <td colspan="8" style="text-align: center;"> <table border="1" style="width: 100%; border-collapse: collapse; text-align: center;"> <tr> <td style="width: 10%;"></td> <td style="width: 10%;"></td> <td style="width: 10%;"></td> <td style="width: 10%;"></td> <td style="width: 10%;"></td> <td style="width: 10%;"></td> <td style="width: 10%;"></td> <td style="width: 10%;"></td> <td style="width: 10%;"></td> <td style="width: 10%;"></td> </tr> <tr> <td></td> <td></td> <td colspan="8" style="text-align: center;"> <table border="1" style="width: 100%; border-collapse: collapse; text-align: center;"> <tr> <td style="width: 10%;"></td> <td style="width: 10%;"></td> <td style="width: 10%;"></td> <td style="width: 10%;"></td> <td style="width: 10%;"></td> <td style="width: 10%;"></td> <td style="width: 10%;"></td> <td style="width: 10%;"></td> <td style="width: 10%;"></td> <td style="width: 10%;"></td> </tr> <tr> <td></td> <td></td> <td colspan="8" style="text-align: center;"> <table border="1" style="width: 100%; border-collapse: collapse; text-align: center;"> <tr> <td style="width: 10%;"></td> <td style="width: 10%;"></td> <td style="width: 10%;"></td> <td style="width: 10%;"></td> <td style="width: 10%;"></td> <td style="width: 10%;"></td> <td style="width: 10%;"></td> <td style="width: 10%;"></td> <td style="width: 10%;"></td> <td style="width: 10%;"></td> </tr> <tr> <td></td> <td></td> <td colspan="8" style="text-align: center;"> <table border="1" style="width: 100%; border-collapse: collapse; text-align: center;"> <tr> <td style="width: 10%;"></td> <td style="width: 10%;"></td> <td style="width:
10%;"></td> <td style="width: 10%;"></td> <td style="width: 10%;"></td> <td style="width: 10%;"></td> <td style="width: 10%;"></td> <td style="width: 10%;"></td> <td style="width: 10%;"></td> <td style="width: 10%;"></td> </tr> <tr> <td></td> <td></td> <td colspan="8" style="text-align: center;"> <table border="1" style="width: 100%; border-collapse: collapse; text-align: center;"> <tr> <td style="width: 10%;"></td> <td style="width: 10%;"></td> <td style="width: 10%;"></td> <td style="width: 10%;"></td> <td style="width: 10%;"></td> <td style="width: 10%;"></td> <td style="width: 10%;"></td> <td style="width: 10%;"></td> <td style="width: 10%;"></td> <td style="width: 10%;"></td> </tr> <tr> <td></td> <td></td> <td colspan="8" style="text-align: center;"> <table border="1" style="width: 100%; border-collapse: collapse; text-align: center;"> <tr> <td style="width: 10%;"></td> <td style="width: 10%;"></td> <td style="width: 10%;"></td> <td style="width: 10%;"></td> <td style="width: 10%;"></td> <td style="width: 10%;"></td> <td style="width: 10%;"></td> <td style="width: 10%;"></td> <td style="width: 10%;"></td> <td style="width: 10%;"></td> </tr> <tr> <td></td> <td></td> <td colspan="8" style="text-align: center;"> <table border="1" style="width: 100%; border-collapse: collapse; text-align: center;"> <tr> </tr></table></td></tr></table></td></tr></table></td></tr></table></td></tr></table></td></tr></table></td></tr></table></td></tr></table></td></tr></table></td></tr></table></td></tr></table></td></tr></table></td></tr></table></td></tr></table></td></tr></table></td></tr></table></td></tr></table></td></tr></table></td></tr></table></td></tr></table></td></tr></table></td></tr></table></td></tr></table></td></tr></table></td></tr></table></td></tr></table></td></tr></table>
 | | | | | | | | | | | | | | | | | | | | <table border="1" style="width: 100%; border-collapse: collapse; text-align: center;"> <tr> <td style="width: 10%;"></td> <td style="width: 10%;"></td> <td style="width: 10%;"></td> <td style="width: 10%;"></td> <td style="width: 10%;"></td> <td style="width: 10%;"></td> <td style="width: 10%;"></td> <td style="width: 10%;"></td> <td style="width: 10%;"></td> <td style="width: 10%;"></td> </tr> <tr> <td></td> <td></td> <td colspan="8" style="text-align: center;"> <table border="1" style="width: 100%; border-collapse: collapse; text-align: center;"> <tr> <td style="width: 10%;"></td> <td style="width: 10%;"></td> <td style="width: 10%;"></td> <td style="width: 10%;"></td> <td style="width: 10%;"></td> <td style="width: 10%;"></td> <td style="width: 10%;"></td> <td style="width: 10%;"></td> <td style="width: 10%;"></td> <td style="width: 10%;"></td> </tr> <tr> <td></td> <td></td> <td colspan="8" style="text-align: center;"> <table border="1" style="width: 100%; border-collapse: collapse; text-align: center;"> <tr> <td style="width: 10%;"></td> <td style="width: 10%;"></td> <td style="width: 10%;"></td> <td style="width: 10%;"></td> <td style="width: 10%;"></td> <td style="width: 10%;"></td> <td style="width: 10%;"></td> <td style="width: 10%;"></td> <td style="width: 10%;"></td> <td style="width: 10%;"></td> </tr> <tr> <td></td> <td></td> <td colspan="8" style="text-align: center;"> <table border="1" style="width: 100%; border-collapse: collapse; text-align: center;"> <tr> <td style="width: 10%;"></td> <td style="width: 10%;"></td> <td style="width: 10%;"></td> <td style="width: 10%;"></td> <td style="width: 10%;"></td> <td style="width: 10%;"></td> <td style="width: 10%;"></td> <td style="width: 10%;"></td> <td style="width: 10%;"></td> <td style="width: 10%;"></td> </tr> <tr> <td></td> <td></td> <td colspan="8" style="text-align: center;"> <table border="1" style="width: 100%; border-collapse: collapse; text-align: center;"> <tr> <td style="width: 10%;"></td> <td style="width: 10%;"></td> <td style="width: 10%;"></td> <td style="width: 10%;"></td> <td style="width: 10%;"></td> <td style="width: 10%;"></td> <td style="width: 10%;"></td> <td style="width: 10%;"></td> <td style="width: 10%;"></td> <td style="width: 10%;"></td> </tr> <tr> <td></td> <td></td> <td colspan="8" style="text-align: center;"> <table border="1" style="width: 100%; border-collapse: collapse; text-align: center;"> <tr> <td style="width: 10%;"></td> <td style="width: 10%;"></td> <td style="width: 10%;"></td> <td style="width: 10%;"></td> <td style="width: 10%;"></td> <td style="width: 10%;"></td> <td style="width: 10%;"></td> <td style="width: 10%;"></td> <td style="width: 10%;"></td> <td style="width: 10%;"></td> </tr> <tr> <td></td> <td></td> <td colspan="8" style="text-align: center;"> <table border="1" style="width: 100%; border-collapse: collapse; text-align: center;"> <tr> <td style="width: 10%;"></td> <td style="width: 10%;"></td> <td style="width: 10%;"></td> <td style="width: 10%;"></td> <td style="width: 10%;"></td> <td style="width: 10%;"></td> <td style="width: 10%;"></td> <td style="width: 10%;"></td> <td style="width: 10%;"></td> <td style="width: 10%;"></td> </tr> <tr> <td></td> <td></td> <td colspan="8" style="text-align: center;"> <table border="1" style="width: 100%; border-collapse: collapse; text-align: center;"> <tr> <td style="width: 10%;"></td> <td style="width: 10%;"></td> <td style="width: 10%;"></td> <td style="width: 10%;"></td> <td style="width: 10%;"></td> <td style="width: 10%;"></td> <td style="width: 10%;"></td> <td style="width: 10%;"></td> <td style="width: 10%;"></td> <td style="width: 10%;"></td> </tr> <tr> <td></td> <td></td> <td colspan="8" style="text-align: center;"> <table border="1" style="width: 100%; border-collapse: collapse; text-align: center;"> <tr> <td style="width: 10%;"></td> <td style="width: 10%;"></td> <td style="width: 10%;"></td> <td style="width: 10%;"></td> <td style="width: 10%;"></td> <td style="width: 10%;"></td> <td style="width: 10%;"></td> <td style="width: 10%;"></td> <td style="width: 10%;"></td> <td style="width: 10%;"></td> </tr> <tr> <td></td> <td></td> <td colspan="8" style="text-align: center;"> <table border="1" style="width: 100%; border-collapse: collapse; text-align: center;"> <tr> <td style="width: 10%;"></td> <td style="width: 10%;"></td> <td style="width: 10%;"></td> <td style="width: 10%;"></td> <td style="width: 10%;"></td> <td style="width: 10%;"></td> <td style="width: 10%;"></td> <td style="width: 10%;"></td> <td style="width: 10%;"></td> <td style="width: 10%;"></td> </tr> <tr> <td></td> <td></td> <td colspan="8" style="text-align: center;"> <table border="1" style="width: 100%; border-collapse: collapse; text-align: center;"> <tr> <td style="width: 10%;"></td> <td style="width: 10%;"></td> <td style="width: 10%;"></td> <td style="width: 10%;"></td> <td style="width: 10%;"></td> <td style="width: 10%;"></td> <td style="width: 10%;"></td> <td style="width: 10%;"></td> <td style="width: 10%;"></td> <td style="width: 10%;"></td> </tr> <tr> <td></td> <td></td> <td colspan="8" style="text-align: center;"> <table border="1" style="width: 100%; border-collapse: collapse; text-align: center;"> <tr> <td style="width: 10%;"></td> <td style="width: 10%;"></td> <td style="width: 10%;"></td> <td style="width: 10%;"></td> <td style="width: 10%;"></td> <td style="width: 10%;"></td> <td style="width: 10%;"></td> <td style="width: 10%;"></td> <td style="width: 10%;"></td> <td style="width: 10%;"></td> </tr> <tr> <td></td> <td></td> <td colspan="8" style="text-align: center;"> <table border="1" style="width: 100%; border-collapse: collapse; text-align: center;"> <tr> <td style="width: 10%;"></td> <td style="width: 10%;"></td> <td style="width: 10%;"></td> <td style="width: 10%;"></td> <td style="width: 10%;"></td> <td style="width: 10%;"></td> <td style="width: 10%;"></td> <td style="width: 10%;"></td> <td style="width: 10%;"></td> <td style="width: 10%;"></td> </tr> <tr> <td></td> <td></td> <td colspan="8" style="text-align: center;"> <table border="1" style="width: 100%; border-collapse: collapse; text-align: center;"> <tr> <td style="width: 10%;"></td> <td style="width: 10%;"></td> <td style="width: 10%;"></td> <td style="width: 10%;"></td> <td style="width: 10%;"></td> <td style="width: 10%;"></td> <td style="width: 10%;"></td> <td style="width: 10%;"></td> <td style="width: 10%;"></td> <td style="width: 10%;"></td> </tr> <tr> <td></td> <td></td> <td colspan="8" style="text-align: center;"> <table border="1" style="width: 100%; border-collapse: collapse; text-align: center;"> <tr> <td style="width: 10%;"></td> <td style="width: 10%;"></td> <td style="width: 10%;"></td> <td style="width: 10%;"></td> <td style="width: 10%;"></td> <td style="width: 10%;"></td> <td style="width: 10%;"></td> <td style="width: 10%;"></td> <td style="width: 10%;"></td> <td style="width: 10%;"></td> </tr> <tr>
<td></td> <td></td> <td colspan="8" style="text-align: center;"> <table border="1" style="width: 100%; border-collapse: collapse; text-align: center;"> <tr> <td style="width: 10%;"></td> <td style="width: 10%;"></td> <td style="width: 10%;"></td> <td style="width: 10%;"></td> <td style="width: 10%;"></td> <td style="width: 10%;"></td> <td style="width: 10%;"></td> <td style="width: 10%;"></td> <td style="width: 10%;"></td> <td style="width: 10%;"></td> </tr> <tr> <td></td> <td></td> <td colspan="8" style="text-align: center;"> <table border="1" style="width: 100%; border-collapse: collapse; text-align: center;"> <tr> <td style="width: 10%;"></td> <td style="width: 10%;"></td> <td style="width: 10%;"></td> <td style="width: 10%;"></td> <td style="width: 10%;"></td> <td style="width: 10%;"></td> <td style="width: 10%;"></td> <td style="width: 10%;"></td> <td style="width: 10%;"></td> <td style="width: 10%;"></td> </tr> <tr> <td></td> <td></td> <td colspan="8" style="text-align: center;"> <table border="1" style="width: 100%; border-collapse: collapse; text-align: center;"> <tr> <td style="width: 10%;"></td> <td style="width: 10%;"></td> <td style="width: 10%;"></td> <td style="width: 10%;"></td> <td style="width: 10%;"></td> <td style="width: 10%;"></td> <td style="width: 10%;"></td> <td style="width: 10%;"></td> <td style="width: 10%;"></td> <td style="width: 10%;"></td> </tr> <tr> <td></td> <td></td> <td colspan="8" style="text-align: center;"> <table border="1" style="width: 100%; border-collapse: collapse; text-align: center;"> <tr> <td style="width: 10%;"></td> <td style="width: 10%;"></td> <td style="width: 10%;"></td> <td style="width: 10%;"></td> <td style="width: 10%;"></td> <td style="width: 10%;"></td> <td style="width: 10%;"></td> <td style="width: 10%;"></td> <td style="width: 10%;"></td> <td style="width: 10%;"></td> </tr> <tr> <td></td> <td></td> <td colspan="8" style="text-align: center;"> <table border="1" style="width: 100%; border-collapse: collapse; text-align: center;"> <tr> <td style="width: 10%;"></td> <td style="width: 10%;"></td> <td style="width: 10%;"></td> <td style="width: 10%;"></td> <td style="width: 10%;"></td> <td style="width: 10%;"></td> <td style="width: 10%;"></td> <td style="width: 10%;"></td> <td style="width: 10%;"></td> <td style="width: 10%;"></td> </tr> <tr> <td></td> <td></td> <td colspan="8" style="text-align: center;"> <table border="1" style="width: 100%; border-collapse: collapse; text-align: center;"> <tr> <td style="width: 10%;"></td> <td style="width: 10%;"></td> <td style="width: 10%;"></td> <td style="width: 10%;"></td> <td style="width: 10%;"></td> <td style="width: 10%;"></td> <td style="width: 10%;"></td> <td style="width: 10%;"></td> <td style="width: 10%;"></td> <td style="width: 10%;"></td> </tr> <tr> <td></td> <td></td> <td colspan="8" style="text-align: center;"> <table border="1" style="width: 100%; border-collapse: collapse; text-align: center;"> <tr> <td style="width: 10%;"></td> <td style="width: 10%;"></td> <td style="width: 10%;"></td> <td style="width: 10%;"></td> <td style="width: 10%;"></td> <td style="width: 10%;"></td> <td style="width: 10%;"></td> <td style="width: 10%;"></td> <td style="width: 10%;"></td> <td style="width: 10%;"></td> </tr> <tr> <td></td> <td></td> <td colspan="8" style="text-align: center;"> <table border="1" style="width: 100%; border-collapse: collapse; text-align: center;"> <tr> <td style="width: 10%;"></td> <td style="width: 10%;"></td> <td style="width: 10%;"></td> <td style="width: 10%;"></td> <td style="width: 10%;"></td> <td style="width: 10%;"></td> <td style="width: 10%;"></td> <td style="width: 10%;"></td> <td style="width: 10%;"></td> <td style="width: 10%;"></td> </tr> <tr> <td></td> <td></td> <td colspan="8" style="text-align: center;"> <table border="1" style="width: 100%; border-collapse: collapse; text-align: center;"> <tr> <td style="width: 10%;"></td> <td style="width: 10%;"></td> <td style="width: 10%;"></td> <td style="width: 10%;"></td> <td style="width: 10%;"></td> <td style="width: 10%;"></td> <td style="width: 10%;"></td> <td style="width: 10%;"></td> <td style="width: 10%;"></td> <td style="width: 10%;"></td> </tr> <tr> <td></td> <td></td> <td colspan="8" style="text-align: center;"> <table border="1" style="width: 100%; border-collapse: collapse; text-align: center;"> <tr> <td style="width: 10%;"></td> <td style="width: 10%;"></td> <td style="width: 10%;"></td> <td style="width: 10%;"></td> <td style="width: 10%;"></td> <td style="width: 10%;"></td> <td style="width: 10%;"></td> <td style="width: 10%;"></td> <td style="width: 10%;"></td> <td style="width: 10%;"></td> </tr> <tr> <td></td> <td></td> <td colspan="8" style="text-align: center;"> <table border="1" style="width: 100%; border-collapse: collapse; text-align: center;"> <tr> </tr></table></td></tr></table></td></tr></table></td></tr></table></td></tr></table></td></tr></table></td></tr></table></td></tr></table></td></tr></table></td></tr></table></td></tr></table></td></tr></table></td></tr></table></td></tr></table></td></tr></table></td></tr></table></td></tr></table></td></tr></table></td></tr></table></td></tr></table></td></tr></table></td></tr></table></td></tr></table></td></tr></table></td></tr></table></td></tr></table>
 | | | | | | | | | | | | | | | | | | | | <table border="1" style="width: 100%; border-collapse: collapse; text-align: center;"> <tr> <td style="width: 10%;"></td> <td style="width: 10%;"></td> <td style="width: 10%;"></td> <td style="width: 10%;"></td> <td style="width: 10%;"></td> <td style="width: 10%;"></td> <td style="width: 10%;"></td> <td style="width: 10%;"></td> <td style="width: 10%;"></td> <td style="width: 10%;"></td> </tr> <tr> <td></td> <td></td> <td colspan="8" style="text-align: center;"> <table border="1" style="width: 100%; border-collapse: collapse; text-align: center;"> <tr> <td style="width: 10%;"></td> <td style="width: 10%;"></td> <td style="width: 10%;"></td> <td style="width: 10%;"></td> <td style="width: 10%;"></td> <td style="width: 10%;"></td> <td style="width: 10%;"></td> <td style="width: 10%;"></td> <td style="width: 10%;"></td> <td style="width: 10%;"></td> </tr> <tr> <td></td> <td></td> <td colspan="8" style="text-align: center;"> <table border="1" style="width: 100%; border-collapse: collapse; text-align: center;"> <tr> <td style="width: 10%;"></td> <td style="width: 10%;"></td> <td style="width: 10%;"></td> <td style="width: 10%;"></td> <td style="width: 10%;"></td> <td style="width: 10%;"></td> <td style="width: 10%;"></td> <td style="width: 10%;"></td> <td style="width: 10%;"></td> <td style="width: 10%;"></td> </tr> <tr> <td></td> <td></td> <td colspan="8" style="text-align: center;"> <table border="1" style="width: 100%; border-collapse: collapse; text-align: center;"> <tr> <td style="width: 10%;"></td> <td style="width: 10%;"></td> <td style="width: 10%;"></td> <td style="width: 10%;"></td> <td style="width: 10%;"></td> <td style="width: 10%;"></td> <td style="width: 10%;"></td> <td style="width: 10%;"></td> <td style="width: 10%;"></td> <td style="width: 10%;"></td> </tr> <tr> <td></td> <td></td> <td colspan="8" style="text-align: center;"> <table border="1" style="width: 100%; border-collapse: collapse; text-align: center;"> <tr> <td style="width: 10%;"></td> <td style="width: 10%;"></td> <td style="width: 10%;"></td> <td style="width: 10%;"></td> <td style="width: 10%;"></td> <td style="width: 10%;"></td> <td style="width: 10%;"></td> <td style="width: 10%;"></td> <td style="width: 10%;"></td> <td style="width: 10%;"></td> </tr> <tr> <td></td> <td></td> <td colspan="8" style="text-align: center;"> <table border="1" style="width: 100%; border-collapse: collapse; text-align: center;"> <tr> <td style="width: 10%;"></td> <td style="width: 10%;"></td> <td style="width: 10%;"></td> <td style="width: 10%;"></td> <td style="width: 10%;"></td> <td style="width: 10%;"></td> <td style="width: 10%;"></td> <td style="width: 10%;"></td> <td style="width: 10%;"></td> <td style="width: 10%;"></td> </tr> <tr> <td></td> <td></td> <td colspan="8" style="text-align: center;"> <table border="1" style="width: 100%; border-collapse: collapse; text-align: center;"> <tr> <td style="width: 10%;"></td> <td style="width: 10%;"></td> <td style="width: 10%;"></td> <td style="width: 10%;"></td> <td style="width: 10%;"></td> <td style="width: 10%;"></td> <td style="width: 10%;"></td> <td style="width: 10%;"></td> <td style="width: 10%;"></td> <td style="width: 10%;"></td> </tr> <tr> <td></td> <td></td> <td colspan="8" style="text-align: center;"> <table border="1" style="width: 100%; border-collapse: collapse; text-align: center;"> <tr> <td style="width: 10%;"></td> <td style="width: 10%;"></td> <td style="width: 10%;"></td> <td
style="width: 10%;"></td> <td style="width: 10%;"></td> <td style="width: 10%;"></td> <td style="width: 10%;"></td> <td style="width: 10%;"></td> <td style="width: 10%;"></td> <td style="width: 10%;"></td> </tr> <tr> <td></td> <td></td> <td colspan="8" style="text-align: center;"> <table border="1" style="width: 100%; border-collapse: collapse; text-align: center;"> <tr> <td style="width: 10%;"></td> <td style="width: 10%;"></td> <td style="width: 10%;"></td> <td style="width: 10%;"></td> <td style="width: 10%;"></td> <td style="width: 10%;"></td> <td style="width: 10%;"></td> <td style="width: 10%;"></td> <td style="width: 10%;"></td> <td style="width: 10%;"></td> </tr> <tr> <td></td> <td></td> <td colspan="8" style="text-align: center;"> <table border="1" style="width: 100%; border-collapse: collapse; text-align: center;"> <tr> <td style="width: 10%;"></td> <td style="width: 10%;"></td> <td style="width: 10%;"></td> <td style="width: 10%;"></td> <td style="width: 10%;"></td> <td style="width: 10%;"></td> <td style="width: 10%;"></td> <td style="width: 10%;"></td> <td style="width: 10%;"></td> <td style="width: 10%;"></td> </tr> <tr> <td></td> <td></td> <td colspan="8" style="text-align: center;"> <table border="1" style="width: 100%; border-collapse: collapse; text-align: center;"> <tr> <td style="width: 10%;"></td> <td style="width: 10%;"></td> <td style="width: 10%;"></td> <td style="width: 10%;"></td> <td style="width: 10%;"></td> <td style="width: 10%;"></td> <td style="width: 10%;"></td> <td style="width: 10%;"></td> <td style="width: 10%;"></td> <td style="width: 10%;"></td> </tr> <tr> <td></td> <td></td> <td colspan="8" style="text-align: center;"> <table border="1" style="width: 100%; border-collapse: collapse; text-align: center;"> <tr> <td style="width: 10%;"></td> <td style="width: 10%;"></td> <td style="width: 10%;"></td> <td style="width: 10%;"></td> <td style="width: 10%;"></td> <td style="width: 10%;"></td> <td style="width: 10%;"></td> <td style="width: 10%;"></td> <td style="width: 10%;"></td> <td style="width: 10%;"></td> </tr> <tr> <td></td> <td></td> <td colspan="8" style="text-align: center;"> <table border="1" style="width: 100%; border-collapse: collapse; text-align: center;"> <tr> <td style="width: 10%;"></td> <td style="width: 10%;"></td> <td style="width: 10%;"></td> <td style="width: 10%;"></td> <td style="width: 10%;"></td> <td style="width: 10%;"></td> <td style="width: 10%;"></td> <td style="width: 10%;"></td> <td style="width: 10%;"></td> <td style="width: 10%;"></td> </tr> <tr> <td></td> <td></td> <td colspan="8" style="text-align: center;"> <table border="1" style="width: 100%; border-collapse: collapse; text-align: center;"> <tr> <td style="width: 10%;"></td> <td style="width: 10%;"></td> <td style="width: 10%;"></td> <td style="width: 10%;"></td> <td style="width: 10%;"></td> <td style="width: 10%;"></td> <td style="width: 10%;"></td> <td style="width: 10%;"></td> <td style="width: 10%;"></td> <td style="width: 10%;"></td> </tr> <tr> <td></td> <td></td> <td colspan="8" style="text-align: center;"> <table border="1" style="width: 100%; border-collapse: collapse; text-align: center;"> <tr> <td style="width: 10%;"></td> <td style="width: 10%;"></td> <td style="width: 10%;"></td> <td style="width: 10%;"></td> <td style="width: 10%;"></td> <td style="width: 10%;"></td> <td style="width: 10%;"></td> <td style="width: 10%;"></td> <td style="width: 10%;"></td> <td style="width: 10%;"></td> </tr> <tr> <td></td> <td></td> <td colspan="8" style="text-align: center;"> <table border="1" style="width: 100%; border-collapse: collapse; text-align: center;"> <tr> <td style="width: 10%;"></td> <td style="width: 10%;"></td> <td style="width: 10%;"></td> <td style="width: 10%;"></td> <td style="width: 10%;"></td> <td style="width: 10%;"></td> <td style="width: 10%;"></td> <td style="width: 10%;"></td> <td style="width: 10%;"></td> <td style="width: 10%;"></td> </tr> <tr> <td></td> <td></td> <td colspan="8" style="text-align: center;"> <table border="1" style="width: 100%; border-collapse: collapse; text-align: center;"> <tr> <td style="width: 10%;"></td> <td style="width: 10%;"></td> <td style="width: 10%;"></td> <td style="width: 10%;"></td> <td style="width: 10%;"></td> <td style="width: 10%;"></td> <td style="width: 10%;"></td> <td style="width: 10%;"></td> <td style="width: 10%;"></td> <td style="width: 10%;"></td> </tr> <tr> <td></td> <td></td> <td colspan="8" style="text-align: center;"> <table border="1" style="width: 100%; border-collapse: collapse; text-align: center;"> <tr> <td style="width: 10%;"></td> <td style="width: 10%;"></td> <td style="width: 10%;"></td> <td style="width: 10%;"></td> <td style="width: 10%;"></td> <td style="width: 10%;"></td> <td style="width: 10%;"></td> <td style="width: 10%;"></td> <td style="width: 10%;"></td> <td style="width: 10%;"></td> </tr> <tr> <td></td> <td></td> <td colspan="8" style="text-align: center;"> <table border="1" style="width: 100%; border-collapse: collapse; text-align: center;"> <tr> <td style="width: 10%;"></td> <td style="width: 10%;"></td> <td style="width: 10%;"></td> <td style="width: 10%;"></td> <td style="width: 10%;"></td> <td style="width: 10%;"></td> <td style="width: 10%;"></td> <td style="width: 10%;"></td> <td style="width: 10%;"></td> <td style="width: 10%;"></td> </tr> <tr> <td></td> <td></td> <td colspan="8" style="text-align: center;"> <table border="1" style="width: 100%; border-collapse: collapse; text-align: center;"> <tr> <td style="width: 10%;"></td> <td style="width: 10%;"></td> <td style="width: 10%;"></td> <td style="width: 10%;"></td> <td style="width: 10%;"></td> <td style="width: 10%;"></td> <td style="width: 10%;"></td> <td style="width: 10%;"></td> <td style="width: 10%;"></td> <td style="width: 10%;"></td> </tr> <tr> <td></td> <td></td> <td colspan="8" style="text-align: center;"> <table border="1" style="width: 100%; border-collapse: collapse; text-align: center;"> <tr> <td style="width: 10%;"></td> <td style="width: 10%;"></td> <td style="width: 10%;"></td> <td style="width: 10%;"></td> <td style="width: 10%;"></td> <td style="width: 10%;"></td> <td style="width: 10%;"></td> <td style="width: 10%;"></td> <td style="width: 10%;"></td> <td style="width: 10%;"></td> </tr> <tr> <td></td> <td></td> <td colspan="8" style="text-align: center;"> <table border="1" style="width: 100%; border-collapse: collapse; text-align: center;"> <tr> <td style="width: 10%;"></td> <td style="width: 10%;"></td> <td style="width: 10%;"></td> <td style="width: 10%;"></td> <td style="width: 10%;"></td> <td style="width: 10%;"></td> <td style="width: 10%;"></td> <td style="width: 10%;"></td> <td style="width: 10%;"></td> <td style="width: 10%;"></td> </tr> <tr> <td></td> <td></td> <td colspan="8" style="text-align: center;"> <table border="1" style="width: 100%; border-collapse: collapse; text-align: center;"> <tr> <td style="width: 10%;"></td> <td style="width: 10%;"></td> <td style="width: 10%;"></td> <td style="width: 10%;"></td> <td style="width: 10%;"></td> <td style="width: 10%;"></td> <td style="width: 10%;"></td> <td style="width: 10%;"></td> <td style="width: 10%;"></td> <td style="width: 10%;"></td> </tr> <tr> <td></td> <td></td> <td colspan="8" style="text-align: center;"> <table border="1" style="width: 100%; border-collapse: collapse; text-align: center;"> <tr> <td style="width: 10%;"></td> <td style="width: 10%;"></td> <td style="width: 10%;"></td> <td style="width: 10%;"></td> <td style="width: 10%;"></td> <td style="width: 10%;"></td> <td style="width: 10%;"></td> <td style="width: 10%;"></td> <td style="width: 10%;"></td> <td style="width: 10%;"></td> </tr> <tr> <td></td> <td></td> <td colspan="8" style="text-align: center;"> <table border="1" style="width: 100%; border-collapse: collapse; text-align: center;"> <tr> </tr></table></td></tr></table></td></tr></table></td></tr></table></td></tr></table></td></tr></table></td></tr></table></td></tr></table></td></tr></table></td></tr></table></td></tr></table></td></tr></table></td></tr></table></td></tr></table></td></tr></table></td></tr></table></td></tr></table></td></tr></table></td></tr></table></td></tr></table></td></tr></table></td></tr></table></td></tr></table></td></tr></table></td></tr></table>
 | | | | | | | | | | | | | | | | | | | | <table border="1" style="width: 100%; border-collapse: collapse; text-align: center;"> <tr> <td style="width: 10%;"></td> <td style="width: 10%;"></td> <td style="width: 10%;"></td> <td style="width: 10%;"></td> <td style="width: 10%;"></td> <td style="width: 10%;"></td> <td style="width: 10%;"></td> <td style="width: 10%;"></td> <td style="width: 10%;"></td> <td style="width: 10%;"></td> </tr> <tr> <td></td> <td></td> <td colspan="8"
style="text-align: center;"> <table border="1" style="width: 100%; border-collapse: collapse; text-align: center;"> <tr> <td style="width: 10%;"></td> <td style="width: 10%;"></td> <td style="width: 10%;"></td> <td style="width: 10%;"></td> <td style="width: 10%;"></td> <td style="width: 10%;"></td> <td style="width: 10%;"></td> <td style="width: 10%;"></td> <td style="width: 10%;"></td> <td style="width: 10%;"></td> </tr> <tr> <td></td> <td></td> <td colspan="8" style="text-align: center;"> <table border="1" style="width: 100%; border-collapse: collapse; text-align: center;"> <tr> <td style="width: 10%;"></td> <td style="width: 10%;"></td> <td style="width: 10%;"></td> <td style="width: 10%;"></td> <td style="width: 10%;"></td> <td style="width: 10%;"></td> <td style="width: 10%;"></td> <td style="width: 10%;"></td> <td style="width: 10%;"></td> <td style="width: 10%;"></td> </tr> <tr> <td></td> <td></td> <td colspan="8" style="text-align: center;"> <table border="1" style="width: 100%; border-collapse: collapse; text-align: center;"> <tr> <td style="width: 10%;"></td> <td style="width: 10%;"></td> <td style="width: 10%;"></td> <td style="width: 10%;"></td> <td style="width: 10%;"></td> <td style="width: 10%;"></td> <td style="width: 10%;"></td> <td style="width: 10%;"></td> <td style="width: 10%;"></td> <td style="width: 10%;"></td> </tr> <tr> <td></td> <td></td> <td colspan="8" style="text-align: center;"> <table border="1" style="width: 100%; border-collapse: collapse; text-align: center;"> <tr> <td style="width: 10%;"></td> <td style="width: 10%;"></td> <td style="width: 10%;"></td> <td style="width: 10%;"></td> <td style="width: 10%;"></td> <td style="width: 10%;"></td> <td style="width: 10%;"></td> <td style="width: 10%;"></td> <td style="width: 10%;"></td> <td style="width: 10%;"></td> </tr> <tr> <td></td> <td></td> <td colspan="8" style="text-align: center;"> <table border="1" style="width: 100%; border-collapse: collapse; text-align: center;"> <tr> <td style="width: 10%;"></td> <td style="width: 10%;"></td> <td style="width: 10%;"></td> <td style="width: 10%;"></td> <td style="width: 10%;"></td> <td style="width: 10%;"></td> <td style="width: 10%;"></td> <td style="width: 10%;"></td> <td style="width: 10%;"></td> <td style="width: 10%;"></td> </tr> <tr> <td></td> <td></td> <td colspan="8" style="text-align: center;"> <table border="1" style="width: 100%; border-collapse: collapse; text-align: center;"> <tr> <td style="width: 10%;"></td> <td style="width: 10%;"></td> <td style="width: 10%;"></td> <td style="width: 10%;"></td> <td style="width: 10%;"></td> <td style="width: 10%;"></td> <td style="width: 10%;"></td> <td style="width: 10%;"></td> <td style="width: 10%;"></td> <td style="width: 10%;"></td> </tr> <tr> <td></td> <td></td> <td colspan="8" style="text-align: center;"> <table border="1" style="width: 100%; border-collapse: collapse; text-align: center;"> <tr> <td style="width: 10%;"></td> <td style="width: 10%;"></td> <td style="width: 10%;"></td> <td style="width: 10%;"></td> <td style="width: 10%;"></td> <td style="width: 10%;"></td> <td style="width: 10%;"></td> <td style="width: 10%;"></td> <td style="width: 10%;"></td> <td style="width: 10%;"></td> </tr> <tr> <td></td> <td></td> <td colspan="8" style="text-align: center;"> <table border="1" style="width: 100%; border-collapse: collapse; text-align: center;"> <tr> <td style="width: 10%;"></td> <td style="width: 10%;"></td> <td style="width: 10%;"></td> <td style="width: 10%;"></td> <td style="width: 10%;"></td> <td style="width: 10%;"></td> <td style="width: 10%;"></td> <td style="width: 10%;"></td> <td style="width: 10%;"></td> <td style="width: 10%;"></td> </tr> <tr> <td></td> <td></td> <td colspan="8" style="text-align: center;"> <table border="1" style="width: 100%; border-collapse: collapse; text-align: center;"> <tr> <td style="width: 10%;"></td> <td style="width: 10%;"></td> <td style="width: 10%;"></td> <td style="width: 10%;"></td> <td style="width: 10%;"></td> <td style="width: 10%;"></td> <td style="width: 10%;"></td> <td style="width: 10%;"></td> <td style="width: 10%;"></td> <td style="width: 10%;"></td> </tr> <tr> <td></td> <td></td> <td colspan="8" style="text-align: center;"> <table border="1" style="width: 100%; border-collapse: collapse; text-align: center;"> <tr> <td style="width: 10%;"></td> <td style="width: 10%;"></td> <td style="width: 10%;"></td> <td style="width: 10%;"></td> <td style="width: 10%;"></td> <td style="width: 10%;"></td> <td style="width: 10%;"></td> <td style="width: 10%;"></td> <td style="width: 10%;"></td> <td style="width: 10%;"></td> </tr> <tr> <td></td> <td></td> <td colspan="8" style="text-align: center;"> <table border="1" style="width: 100%; border-collapse: collapse; text-align: center;"> <tr> <td style="width: 10%;"></td> <td style="width: 10%;"></td> <td style="width: 10%;"></td> <td style="width: 10%;"></td> <td style="width: 10%;"></td> <td style="width: 10%;"></td> <td style="width: 10%;"></td> <td style="width: 10%;"></td> <td style="width: 10%;"></td> <td style="width: 10%;"></td> </tr> <tr> <td></td> <td></td> <td colspan="8" style="text-align: center;"> <table border="1" style="width: 100%; border-collapse: collapse; text-align: center;"> <tr> <td style="width: 10%;"></td> <td style="width: 10%;"></td> <td style="width: 10%;"></td> <td style="width: 10%;"></td> <td style="width: 10%;"></td> <td style="width: 10%;"></td> <td style="width: 10%;"></td> <td style="width: 10%;"></td> <td style="width: 10%;"></td> <td style="width: 10%;"></td> </tr> <tr> <td></td> <td></td> <td colspan="8" style="text-align: center;"> <table border="1" style="width: 100%; border-collapse: collapse; text-align: center;"> <tr> <td style="width: 10%;"></td> <td style="width: 10%;"></td> <td style="width: 10%;"></td> <td style="width: 10%;"></td> <td style="width: 10%;"></td> <td style="width: 10%;"></td> <td style="width: 10%;"></td> <td style="width: 10%;"></td> <td style="width: 10%;"></td> <td style="width: 10%;"></td> </tr> <tr> <td></td> <td></td> <td colspan="8" style="text-align: center;"> <table border="1" style="width: 100%; border-collapse: collapse; text-align: center;"> <tr> <td style="width: 10%;"></td> <td style="width: 10%;"></td> <td style="width: 10%;"></td> <td style="width: 10%;"></td> <td style="width: 10%;"></td> <td style="width: 10%;"></td> <td style="width: 10%;"></td> <td style="width: 10%;"></td> <td style="width: 10%;"></td> <td style="width: 10%;"></td> </tr> <tr> <td></td> <td></td> <td colspan="8" style="text-align: center;"> <table border="1" style="width: 100%; border-collapse: collapse; text-align: center;"> <tr> <td style="width: 10%;"></td> <td style="width: 10%;"></td> <td style="width: 10%;"></td> <td style="width: 10%;"></td> <td style="width: 10%;"></td> <td style="width: 10%;"></td> <td style="width: 10%;"></td> <td style="width: 10%;"></td> <td style="width: 10%;"></td> <td style="width: 10%;"></td> </tr> <tr> <td></td> <td></td> <td colspan="8" style="text-align: center;"> <table border="1" style="width: 100%; border-collapse: collapse; text-align: center;"> <tr> <td style="width: 10%;"></td> <td style="width: 10%;"></td> <td style="width: 10%;"></td> <td style="width: 10%;"></td> <td style="width: 10%;"></td> <td style="width: 10%;"></td> <td style="width: 10%;"></td> <td style="width: 10%;"></td> <td style="width: 10%;"></td> <td style="width: 10%;"></td> </tr> <tr> <td></td> <td></td> <td colspan="8" style="text-align: center;"> <table border="1" style="width: 100%; border-collapse: collapse; text-align: center;"> <tr> <td style="width: 10%;"></td> <td style="width: 10%;"></td> <td style="width: 10%;"></td> <td style="width: 10%;"></td> <td style="width: 10%;"></td> <td style="width: 10%;"></td> <td style="width: 10%;"></td> <td style="width: 10%;"></td> <td style="width: 10%;"></td> <td style="width: 10%;"></td> </tr> <tr> <td></td> <td></td> <td colspan="8" style="text-align: center;"> <table border="1" style="width: 100%; border-collapse: collapse; text-align: center;"> <tr> <td style="width: 10%;"></td> <td style="width: 10%;"></td> <td style="width: 10%;"></td> <td style="width: 10%;"></td> <td style="width: 10%;"></td> <td style="width: 10%;"></td> <td style="width: 10%;"></td> <td style="width: 10%;"></td> <td style="width: 10%;"></td> <td style="width: 10%;"></td> </tr> <tr> <td></td> <td></td> <td colspan="8" style="text-align: center;"> <table border="1" style="width: 100%; border-collapse: collapse; text-align: center;"> <tr> <td style="width: 10%;"></td> <td style="width: 10%;"></td> <td style="width: 10%;"></td> <td style="width: 10%;"></td> <td style="width: 10%;"></td> <td style="width: 10%;"></td> <td style="width: 10%;"></td> <td style="width: 10%;"></td> <td style="width: 10%;"></td> <td style="width: 10%;"></td> </tr> <tr> <td></td> <td></td> <td colspan="8" style="text-align: center;"> <table border="1" style="width: 100%; border-collapse: collapse; text-align: center;"> <tr> <td style="width: 10%;"></td> <td style="width: 10%;"></td> <td style="width: 10%;"></td> <td style="width: 10%;"></td> <td style="width: 10%;"></td> <td style="width: 10%;"></td> <td style="width: 10%;"></td> <td style="width: 10%;"></td> <td style="width: 10%;"></td> <td style="width: 10%;"></td> </tr> <tr> <td></td> <td></td> <td colspan="8" style="text-align: center;"> <table border="1" style="width: 100%; border-collapse: collapse; text-align: center;"> <tr> <td style="width: 10%;"></td> <td style="width: 10%;"></td> <td style="width: 10%;"></td> <td style="width: 10%;"></td> <td style="width: 10%;"></td> <td style="width: 10%;"></td> <td style="width: 10%;"></td> <td style="width: 10%;"></td> <td style="width: 10%;"></td> <td style="width: 10%;"></td> </tr> <tr> <td></td> <td></td> <td colspan="8" style="text-align: center;"> <table border="1" style="width: 100%; border-collapse: collapse; text-align: center;"> <tr> <td style="width: 10%;"></td> <td style="width:
10%;"></td> <td style="width: 10%;"></td> <td style="width: 10%;"></td> <td style="width: 10%;"></td> <td style="width: 10%;"></td> <td style="width: 10%;"></td> <td style="width: 10%;"></td> <td style="width: 10%;"></td> <td style="width: 10%;"></td> </tr> <tr> <td></td> <td></td> <td colspan="8" style="text-align: center;"> <table border="1" style="width: 100%; border-collapse: collapse; text-align: center;"> <tr> </tr></table></td></tr></table></td></tr></table></td></tr></table></td></tr></table></td></tr></table></td></tr></table></td></tr></table></td></tr></table></td></tr></table></td></tr></table></td></tr></table></td></tr></table></td></tr></table></td></tr></table></td></tr></table></td></tr></table></td></tr></table></td></tr></table></td></tr></table></td></tr></table></td></tr></table></td></tr></table></td></tr></table>
 | | | | | | | | | | | | | | | | | | | | <table border="1" style="width: 100%; border-collapse: collapse; text-align: center;"> <tr> <td style="width: 10%;"></td> <td style="width: 10%;"></td> <td style="width: 10%;"></td> <td style="width: 10%;"></td> <td style="width: 10%;"></td> <td style="width: 10%;"></td> <td style="width: 10%;"></td> <td style="width: 10%;"></td> <td style="width: 10%;"></td> <td style="width: 10%;"></td> </tr> <tr> <td></td> <td></td> <td colspan="8" style="text-align: center;"> <table border="1" style="width: 100%; border-collapse: collapse; text-align: center;"> <tr> <td style="width: 10%;"></td> <td style="width: 10%;"></td> <td style="width: 10%;"></td> <td style="width: 10%;"></td> <td style="width: 10%;"></td> <td style="width: 10%;"></td> <td style="width: 10%;"></td> <td style="width: 10%;"></td> <td style="width: 10%;"></td> <td style="width: 10%;"></td> </tr> <tr> <td></td> <td></td> <td colspan="8" style="text-align: center;"> <table border="1" style="width: 100%; border-collapse: collapse; text-align: center;"> <tr> <td style="width: 10%;"></td> <td style="width: 10%;"></td> <td style="width: 10%;"></td> <td style="width: 10%;"></td> <td style="width: 10%;"></td> <td style="width: 10%;"></td> <td style="width: 10%;"></td> <td style="width: 10%;"></td> <td style="width: 10%;"></td> <td style="width: 10%;"></td> </tr> <tr> <td></td> <td></td> <td colspan="8" style="text-align: center;"> <table border="1" style="width: 100%; border-collapse: collapse; text-align: center;"> <tr> <td style="width: 10%;"></td> <td style="width: 10%;"></td> <td style="width: 10%;"></td> <td style="width: 10%;"></td> <td style="width: 10%;"></td> <td style="width: 10%;"></td> <td style="width: 10%;"></td> <td style="width: 10%;"></td> <td style="width: 10%;"></td> <td style="width: 10%;"></td> </tr> <tr> <td></td> <td></td> <td colspan="8" style="text-align: center;"> <table border="1" style="width: 100%; border-collapse: collapse; text-align: center;"> <tr> <td style="width: 10%;"></td> <td style="width: 10%;"></td> <td style="width: 10%;"></td> <td style="width: 10%;"></td> <td style="width: 10%;"></td> <td style="width: 10%;"></td> <td style="width: 10%;"></td> <td style="width: 10%;"></td> <td style="width: 10%;"></td> <td style="width: 10%;"></td> </tr> <tr> <td></td> <td></td> <td colspan="8" style="text-align: center;"> <table border="1" style="width: 100%; border-collapse: collapse; text-align: center;"> <tr> <td style="width: 10%;"></td> <td style="width: 10%;"></td> <td style="width: 10%;"></td> <td style="width: 10%;"></td> <td style="width: 10%;"></td> <td style="width: 10%;"></td> <td style="width: 10%;"></td> <td style="width: 10%;"></td> <td style="width: 10%;"></td> <td style="width: 10%;"></td> </tr> <tr> <td></td> <td></td> <td colspan="8" style="text-align: center;"> <table border="1" style="width: 100%; border-collapse: collapse; text-align: center;"> <tr> <td style="width: 10%;"></td> <td style="width: 10%;"></td> <td style="width: 10%;"></td> <td style="width: 10%;"></td> <td style="width: 10%;"></td> <td style="width: 10%;"></td> <td style="width: 10%;"></td> <td style="width: 10%;"></td> <td style="width: 10%;"></td> <td style="width: 10%;"></td> </tr> <tr> <td></td> <td></td> <td colspan="8" style="text-align: center;"> <table border="1" style="width: 100%; border-collapse: collapse; text-align: center;"> <tr> <td style="width: 10%;"></td> <td style="width: 10%;"></td> <td style="width: 10%;"></td> <td style="width: 10%;"></td> <td style="width: 10%;"></td> <td style="width: 10%;"></td> <td style="width: 10%;"></td> <td style="width: 10%;"></td> <td style="width: 10%;"></td> <td style="width: 10%;"></td> </tr> <tr> <td></td> <td></td> <td colspan="8" style="text-align: center;"> <table border="1" style="width: 100%; border-collapse: collapse; text-align: center;"> <tr> <td style="width: 10%;"></td> <td style="width: 10%;"></td> <td style="width: 10%;"></td> <td style="width: 10%;"></td> <td style="width: 10%;"></td> <td style="width: 10%;"></td> <td style="width: 10%;"></td> <td style="width: 10%;"></td> <td style="width: 10%;"></td> <td style="width: 10%;"></td> </tr> <tr> <td></td> <td></td> <td colspan="8" style="text-align: center;"> <table border="1" style="width: 100%; border-collapse: collapse; text-align: center;"> <tr> <td style="width: 10%;"></td> <td style="width: 10%;"></td> <td style="width: 10%;"></td> <td style="width: 10%;"></td> <td style="width: 10%;"></td> <td style="width: 10%;"></td> <td style="width: 10%;"></td> <td style="width: 10%;"></td> <td style="width: 10%;"></td> <td style="width: 10%;"></td> </tr> <tr> <td></td> <td></td> <td colspan="8" style="text-align: center;"> <table border="1" style="width: 100%; border-collapse: collapse; text-align: center;"> <tr> <td style="width: 10%;"></td> <td style="width: 10%;"></td> <td style="width: 10%;"></td> <td style="width: 10%;"></td> <td style="width: 10%;"></td> <td style="width: 10%;"></td> <td style="width: 10%;"></td> <td style="width: 10%;"></td> <td style="width: 10%;"></td> <td style="width: 10%;"></td> </tr> <tr> <td></td> <td></td> <td colspan="8" style="text-align: center;"> <table border="1" style="width: 100%; border-collapse: collapse; text-align: center;"> <tr> <td style="width: 10%;"></td> <td style="width: 10%;"></td> <td style="width: 10%;"></td> <td style="width: 10%;"></td> <td style="width: 10%;"></td> <td style="width: 10%;"></td> <td style="width: 10%;"></td> <td style="width: 10%;"></td> <td style="width: 10%;"></td> <td style="width: 10%;"></td> </tr> <tr> <td></td> <td></td> <td colspan="8" style="text-align: center;"> <table border="1" style="width: 100%; border-collapse: collapse; text-align: center;"> <tr> <td style="width: 10%;"></td> <td style="width: 10%;"></td> <td style="width: 10%;"></td> <td style="width: 10%;"></td> <td style="width: 10%;"></td> <td style="width: 10%;"></td> <td style="width: 10%;"></td> <td style="width: 10%;"></td> <td style="width: 10%;"></td> <td style="width: 10%;"></td> </tr> <tr> <td></td> <td></td> <td colspan="8" style="text-align: center;"> <table border="1" style="width: 100%; border-collapse: collapse; text-align: center;"> <tr> <td style="width: 10%;"></td> <td style="width: 10%;"></td> <td style="width: 10%;"></td> <td style="width: 10%;"></td> <td style="width: 10%;"></td> <td style="width: 10%;"></td> <td style="width: 10%;"></td> <td style="width: 10%;"></td> <td style="width: 10%;"></td> <td style="width: 10%;"></td> </tr> <tr> <td></td> <td></td> <td colspan="8" style="text-align: center;"> <table border="1" style="width: 100%; border-collapse: collapse; text-align: center;"> <tr> <td style="width: 10%;"></td> <td style="width: 10%;"></td> <td style="width: 10%;"></td> <td style="width: 10%;"></td> <td style="width: 10%;"></td> <td style="width: 10%;"></td> <td style="width: 10%;"></td> <td style="width: 10%;"></td> <td style="width: 10%;"></td> <td style="width: 10%;"></td> </tr> <tr> <td></td> <td></td> <td colspan="8" style="text-align: center;"> <table border="1" style="width: 100%; border-collapse: collapse; text-align: center;"> <tr> <td style="width: 10%;"></td> <td style="width: 10%;"></td> <td style="width: 10%;"></td> <td style="width: 10%;"></td> <td style="width: 10%;"></td> <td style="width: 10%;"></td> <td style="width: 10%;"></td> <td style="width: 10%;"></td> <td style="width: 10%;"></td> <td style="width: 10%;"></td> </tr> <tr> <td></td> <td></td> <td colspan="8" style="text-align: center;"> <table border="1" style="width: 100%; border-collapse: collapse; text-align: center;"> <tr> <td style="width: 10%;"></td> <td style="width: 10%;"></td> <td style="width: 10%;"></td> <td style="width: 10%;"></td> <td style="width: 10%;"></td> <td style="width: 10%;"></td> <td style="width: 10%;"></td> <td style="width: 10%;"></td> <td style="width: 10%;"></td> <td style="width: 10%;"></td> </tr> <tr> <td></td> <td></td> <td
colspan="8" style="text-align: center;"> <table border="1" style="width: 100%; border-collapse: collapse; text-align: center;"> <tr> <td style="width: 10%;"></td> <td style="width: 10%;"></td> <td style="width: 10%;"></td> <td style="width: 10%;"></td> <td style="width: 10%;"></td> <td style="width: 10%;"></td> <td style="width: 10%;"></td> <td style="width: 10%;"></td> <td style="width: 10%;"></td> <td style="width: 10%;"></td> </tr> <tr> <td></td> <td></td> <td colspan="8" style="text-align: center;"> <table border="1" style="width: 100%; border-collapse: collapse; text-align: center;"> <tr> <td style="width: 10%;"></td> <td style="width: 10%;"></td> <td style="width: 10%;"></td> <td style="width: 10%;"></td> <td style="width: 10%;"></td> <td style="width: 10%;"></td> <td style="width: 10%;"></td> <td style="width: 10%;"></td> <td style="width: 10%;"></td> <td style="width: 10%;"></td> </tr> <tr> <td></td> <td></td> <td colspan="8" style="text-align: center;"> <table border="1" style="width: 100%; border-collapse: collapse; text-align: center;"> <tr> <td style="width: 10%;"></td> <td style="width: 10%;"></td> <td style="width: 10%;"></td> <td style="width: 10%;"></td> <td style="width: 10%;"></td> <td style="width: 10%;"></td> <td style="width: 10%;"></td> <td style="width: 10%;"></td> <td style="width: 10%;"></td> <td style="width: 10%;"></td> </tr> <tr> <td></td> <td></td> <td colspan="8" style="text-align: center;"> <table border="1" style="width: 100%; border-collapse: collapse; text-align: center;"> <tr> <td style="width: 10%;"></td> <td style="width: 10%;"></td> <td style="width: 10%;"></td> <td style="width: 10%;"></td> <td style="width: 10%;"></td> <td style="width: 10%;"></td> <td style="width: 10%;"></td> <td style="width: 10%;"></td> <td style="width: 10%;"></td> <td style="width: 10%;"></td> </tr> <tr> <td></td> <td></td> <td colspan="8" style="text-align: center;"> <table border="1" style="width: 100%; border-collapse: collapse; text-align: center;"> <tr> <td style="width: 10%;"></td> <td style="width: 10%;"></td> <td style="width: 10%;"></td> <td style="width: 10%;"></td> <td style="width: 10%;"></td> <td style="width: 10%;"></td> <td style="width: 10%;"></td> <td style="width: 10%;"></td> <td style="width: 10%;"></td> <td style="width: 10%;"></td> </tr> <tr> <td></td> <td></td> <td colspan="8" style="text-align: center;"> <table border="1" style="width: 100%; border-collapse: collapse; text-align: center;"> <tr> </tr></table></td></tr></table></td></tr></table></td></tr></table></td></tr></table></td></tr></table></td></tr></table></td></tr></table></td></tr></table></td></tr></table></td></tr></table></td></tr></table></td></tr></table></td></tr></table></td></tr></table></td></tr></table></td></tr></table></td></tr></table></td></tr></table></td></tr></table></td></tr></table></td></tr></table></td></tr></table>
 | | | | | | | | | | | | | | | | | | | | <table border="1" style="width: 100%; border-collapse: collapse; text-align: center;"> <tr> <td style="width: 10%;"></td> <td style="width: 10%;"></td> <td style="width: 10%;"></td> <td style="width: 10%;"></td> <td style="width: 10%;"></td> <td style="width: 10%;"></td> <td style="width: 10%;"></td> <td style="width: 10%;"></td> <td style="width: 10%;"></td> <td style="width: 10%;"></td> </tr> <tr> <td></td> <td></td> <td colspan="8" style="text-align: center;"> <table border="1" style="width: 100%; border-collapse: collapse; text-align: center;"> <tr> <td style="width: 10%;"></td> <td style="width: 10%;"></td> <td style="width: 10%;"></td> <td style="width: 10%;"></td> <td style="width: 10%;"></td> <td style="width: 10%;"></td> <td style="width: 10%;"></td> <td style="width: 10%;"></td> <td style="width: 10%;"></td> <td style="width: 10%;"></td> </tr> <tr> <td></td> <td></td> <td colspan="8" style="text-align: center;"> <table border="1" style="width: 100%; border-collapse: collapse; text-align: center;"> <tr> <td style="width: 10%;"></td> <td style="width: 10%;"></td> <td style="width: 10%;"></td> <td style="width: 10%;"></td> <td style="width: 10%;"></td> <td style="width: 10%;"></td> <td style="width: 10%;"></td> <td style="width: 10%;"></td> <td style="width: 10%;"></td> <td style="width: 10%;"></td> </tr> <tr> <td></td> <td></td> <td colspan="8" style="text-align: center;"> <table border="1" style="width: 100%; border-collapse: collapse; text-align: center;"> <tr> <td style="width: 10%;"></td> <td style="width: 10%;"></td> <td style="width: 10%;"></td> <td style="width: 10%;"></td> <td style="width: 10%;"></td> <td style="width: 10%;"></td> <td style="width: 10%;"></td> <td style="width: 10%;"></td> <td style="width: 10%;"></td> <td style="width: 10%;"></td> </tr> <tr> <td></td> <td></td> <td colspan="8" style="text-align: center;"> <table border="1" style="width: 100%; border-collapse: collapse; text-align: center;"> <tr> <td style="width: 10%;"></td> <td style="width: 10%;"></td> <td style="width: 10%;"></td> <td style="width: 10%;"></td> <td style="width: 10%;"></td> <td style="width: 10%;"></td> <td style="width: 10%;"></td> <td style="width: 10%;"></td> <td style="width: 10%;"></td> <td style="width: 10%;"></td> </tr> <tr> <td></td> <td></td> <td colspan="8" style="text-align: center;"> <table border="1" style="width: 100%; border-collapse: collapse; text-align: center;"> <tr> <td style="width: 10%;"></td> <td style="width: 10%;"></td> <td style="width: 10%;"></td> <td style="width: 10%;"></td> <td style="width: 10%;"></td> <td style="width: 10%;"></td> <td style="width: 10%;"></td> <td style="width: 10%;"></td> <td style="width: 10%;"></td> <td style="width: 10%;"></td> </tr> <tr> <td></td> <td></td> <td colspan="8" style="text-align: center;"> <table border="1" style="width: 100%; border-collapse: collapse; text-align: center;"> <tr> <td style="width: 10%;"></td> <td style="width: 10%;"></td> <td style="width: 10%;"></td> <td style="width: 10%;"></td> <td style="width: 10%;"></td> <td style="width: 10%;"></td> <td style="width: 10%;"></td> <td style="width: 10%;"></td> <td style="width: 10%;"></td> <td style="width: 10%;"></td> </tr> <tr> <td></td> <td></td> <td colspan="8" style="text-align: center;"> <table border="1" style="width: 100%; border-collapse: collapse; text-align: center;"> <tr> <td style="width: 10%;"></td> <td style="width: 10%;"></td> <td style="width: 10%;"></td> <td style="width: 10%;"></td> <td style="width: 10%;"></td> <td style="width: 10%;"></td> <td style="width: 10%;"></td> <td style="width: 10%;"></td> <td style="width: 10%;"></td> <td style="width: 10%;"></td> </tr> <tr> <td></td> <td></td> <td colspan="8" style="text-align: center;"> <table border="1" style="width: 100%; border-collapse: collapse; text-align: center;"> <tr> <td style="width: 10%;"></td> <td style="width: 10%;"></td> <td style="width: 10%;"></td> <td style="width: 10%;"></td> <td style="width: 10%;"></td> <td style="width: 10%;"></td> <td style="width: 10%;"></td> <td style="width: 10%;"></td> <td style="width: 10%;"></td> <td style="width: 10%;"></td> </tr> <tr> <td></td> <td></td> <td colspan="8" style="text-align: center;"> <table border="1" style="width: 100%; border-collapse: collapse; text-align: center;"> <tr> <td style="width: 10%;"></td> <td style="width: 10%;"></td> <td style="width: 10%;"></td> <td style="width: 10%;"></td> <td style="width: 10%;"></td> <td style="width: 10%;"></td> <td style="width: 10%;"></td> <td style="width: 10%;"></td> <td style="width: 10%;"></td> <td style="width: 10%;"></td> </tr> <tr> <td></td> <td></td> <td colspan="8" style="text-align: center;"> <table border="1" style="width: 100%; border-collapse: collapse; text-align: center;"> <tr> <td style="width: 10%;"></td> <td style="width: 10%;"></td> <td style="width: 10%;"></td> <td style="width: 10%;"></td> <td style="width: 10%;"></td> <td style="width: 10%;"></td> <td style="width: 10%;"></td> <td style="width: 10%;"></td> <td style="width: 10%;"></td> <td style="width: 10%;"></td> </tr> <tr> <td></td> <td></td> <td colspan="8" style="text-align: center;"> <table border="1" style="width: 100%; border-collapse: collapse; text-align: center;"> <tr> <td style="width: 10%;"></td> <td style="width: 10%;"></td> <td style="width: 10%;"></td> <td style="width: 10%;"></td> <td style="width: 10%;"></td> <td style="width: 10%;"></td> <td style="width: 10%;"></td> <td style="width: 10%;"></td> <td style="width: 10%;"></td> <td style="width: 10%;"></td> </tr> <tr> <td></td> <td></td> <td colspan="8" style="text-align: center;"> <table border="1" style="width: 100%; border-collapse: collapse; text-align: center;"> <tr> <td style="width: 10%;"></td> <td style="width: 10%;"></td> <td style="width: 10%;"></td> <td style="width: 10%;"></td> <td style="width: 10%;"></td> <td style="width:
10%;"></td> <td style="width: 10%;"></td> <td style="width: 10%;"></td> <td style="width: 10%;"></td> <td style="width: 10%;"></td> </tr> <tr> <td></td> <td></td> <td colspan="8" style="text-align: center;"> <table border="1" style="width: 100%; border-collapse: collapse; text-align: center;"> <tr> <td style="width: 10%;"></td> <td style="width: 10%;"></td> <td style="width: 10%;"></td> <td style="width: 10%;"></td> <td style="width: 10%;"></td> <td style="width: 10%;"></td> <td style="width: 10%;"></td> <td style="width: 10%;"></td> <td style="width: 10%;"></td> <td style="width: 10%;"></td> </tr> <tr> <td></td> <td></td> <td colspan="8" style="text-align: center;"> <table border="1" style="width: 100%; border-collapse: collapse; text-align: center;"> <tr> <td style="width: 10%;"></td> <td style="width: 10%;"></td> <td style="width: 10%;"></td> <td style="width: 10%;"></td> <td style="width: 10%;"></td> <td style="width: 10%;"></td> <td style="width: 10%;"></td> <td style="width: 10%;"></td> <td style="width: 10%;"></td> <td style="width: 10%;"></td> </tr> <tr> <td></td> <td></td> <td colspan="8" style="text-align: center;"> <table border="1" style="width: 100%; border-collapse: collapse; text-align: center;"> <tr> <td style="width: 10%;"></td> <td style="width: 10%;"></td> <td style="width: 10%;"></td> <td style="width: 10%;"></td> <td style="width: 10%;"></td> <td style="width: 10%;"></td> <td style="width: 10%;"></td> <td style="width: 10%;"></td> <td style="width: 10%;"></td> <td style="width: 10%;"></td> </tr> <tr> <td></td> <td></td> <td colspan="8" style="text-align: center;"> <table border="1" style="width: 100%; border-collapse: collapse; text-align: center;"> <tr> <td style="width: 10%;"></td> <td style="width: 10%;"></td> <td style="width: 10%;"></td> <td style="width: 10%;"></td> <td style="width: 10%;"></td> <td style="width: 10%;"></td> <td style="width: 10%;"></td> <td style="width: 10%;"></td> <td style="width: 10%;"></td> <td style="width: 10%;"></td> </tr> <tr> <td></td> <td></td> <td colspan="8" style="text-align: center;"> <table border="1" style="width: 100%; border-collapse: collapse; text-align: center;"> <tr> <td style="width: 10%;"></td> <td style="width: 10%;"></td> <td style="width: 10%;"></td> <td style="width: 10%;"></td> <td style="width: 10%;"></td> <td style="width: 10%;"></td> <td style="width: 10%;"></td> <td style="width: 10%;"></td> <td style="width: 10%;"></td> <td style="width: 10%;"></td> </tr> <tr> <td></td> <td></td> <td colspan="8" style="text-align: center;"> <table border="1" style="width: 100%; border-collapse: collapse; text-align: center;"> <tr> <td style="width: 10%;"></td> <td style="width: 10%;"></td> <td style="width: 10%;"></td> <td style="width: 10%;"></td> <td style="width: 10%;"></td> <td style="width: 10%;"></td> <td style="width: 10%;"></td> <td style="width: 10%;"></td> <td style="width: 10%;"></td> <td style="width: 10%;"></td> </tr> <tr> <td></td> <td></td> <td colspan="8" style="text-align: center;"> <table border="1" style="width: 100%; border-collapse: collapse; text-align: center;"> <tr> <td style="width: 10%;"></td> <td style="width: 10%;"></td> <td style="width: 10%;"></td> <td style="width: 10%;"></td> <td style="width: 10%;"></td> <td style="width: 10%;"></td> <td style="width: 10%;"></td> <td style="width: 10%;"></td> <td style="width: 10%;"></td> <td style="width: 10%;"></td> </tr> <tr> <td></td> <td></td> <td colspan="8" style="text-align: center;"> <table border="1" style="width: 100%; border-collapse: collapse; text-align: center;"> <tr> <td style="width: 10%;"></td> <td style="width: 10%;"></td> <td style="width: 10%;"></td> <td style="width: 10%;"></td> <td style="width: 10%;"></td> <td style="width: 10%;"></td> <td style="width: 10%;"></td> <td style="width: 10%;"></td> <td style="width: 10%;"></td> <td style="width: 10%;"></td> </tr> <tr> <td></td> <td></td> <td colspan="8" style="text-align: center;"> <table border="1" style="width: 100%; border-collapse: collapse; text-align: center;"> <tr> </tr></table></td></tr></table></td></tr></table></td></tr></table></td></tr></table></td></tr></table></td></tr></table></td></tr></table></td></tr></table></td></tr></table></td></tr></table></td></tr></table></td></tr></table></td></tr></table></td></tr></table></td></tr></table></td></tr></table></td></tr></table></td></tr></table></td></tr></table></td></tr></table></td></tr></table>
 | | | | | | | | | | | | | | | | | | | | <table border="1" style="width: 100%; border-collapse: collapse; text-align: center;"> <tr> <td style="width: 10%;"></td> <td style="width: 10%;"></td> <td style="width: 10%;"></td> <td style="width: 10%;"></td> <td style="width: 10%;"></td> <td style="width: 10%;"></td> <td style="width: 10%;"></td> <td style="width: 10%;"></td> <td style="width: 10%;"></td> <td style="width: 10%;"></td> </tr> <tr> <td></td> <td></td> <td colspan="8" style="text-align: center;"> <table border="1" style="width: 100%; border-collapse: collapse; text-align: center;"> <tr> <td style="width: 10%;"></td> <td style="width: 10%;"></td> <td style="width: 10%;"></td> <td style="width: 10%;"></td> <td style="width: 10%;"></td> <td style="width: 10%;"></td> <td style="width: 10%;"></td> <td style="width: 10%;"></td> <td style="width: 10%;"></td> <td style="width: 10%;"></td> </tr> <tr> <td></td> <td></td> <td colspan="8" style="text-align: center;"> <table border="1" style="width: 100%; border-collapse: collapse; text-align: center;"> <tr> <td style="width: 10%;"></td> <td style="width: 10%;"></td> <td style="width: 10%;"></td> <td style="width: 10%;"></td> <td style="width: 10%;"></td> <td style="width: 10%;"></td> <td style="width: 10%;"></td> <td style="width: 10%;"></td> <td style="width: 10%;"></td> <td style="width: 10%;"></td> </tr> <tr> <td></td> <td></td> <td colspan="8" style="text-align: center;"> <table border="1" style="width: 100%; border-collapse: collapse; text-align: center;"> <tr> <td style="width: 10%;"></td> <td style="width: 10%;"></td> <td style="width: 10%;"></td> <td style="width: 10%;"></td> <td style="width: 10%;"></td> <td style="width: 10%;"></td> <td style="width: 10%;"></td> <td style="width: 10%;"></td> <td style="width: 10%;"></td> <td style="width: 10%;"></td> </tr> <tr> <td></td> <td></td> <td colspan="8" style="text-align: center;"> <table border="1" style="width: 100%; border-collapse: collapse; text-align: center;"> <tr> <td style="width: 10%;"></td> <td style="width: 10%;"></td> <td style="width: 10%;"></td> <td style="width: 10%;"></td> <td style="width: 10%;"></td> <td style="width: 10%;"></td> <td style="width: 10%;"></td> <td style="width: 10%;"></td> <td style="width: 10%;"></td> <td style="width: 10%;"></td> </tr> <tr> <td></td> <td></td> <td colspan="8" style="text-align: center;"> <table border="1" style="width: 100%; border-collapse: collapse; text-align: center;"> <tr> <td style="width: 10%;"></td> <td style="width: 10%;"></td> <td style="width: 10%;"></td> <td style="width: 10%;"></td> <td style="width: 10%;"></td> <td style="width: 10%;"></td> <td style="width: 10%;"></td> <td style="width: 10%;"></td> <td style="width: 10%;"></td> <td style="width: 10%;"></td> </tr> <tr> <td></td> <td></td> <td colspan="8" style="text-align: center;"> <table border="1" style="width: 100%; border-collapse: collapse; text-align: center;"> <tr> <td style="width: 10%;"></td> <td style="width: 10%;"></td> <td style="width: 10%;"></td> <td style="width: 10%;"></td> <td style="width: 10%;"></td> <td style="width: 10%;"></td> <td style="width: 10%;"></td> <td style="width: 10%;"></td> <td style="width: 10%;"></td> <td style="width: 10%;"></td> </tr> <tr> <td></td> <td></td> <td colspan="8" style="text-align: center;"> <table border="1" style="width: 100%; border-collapse: collapse; text-align: center;"> <tr> <td style="width: 10%;"></td> <td style="width: 10%;"></td> <td style="width: 10%;"></td> <td style="width: 10%;"></td> <td style="width: 10%;"></td> <td style="width: 10%;"></td> <td style="width: 10%;"></td> <td style="width: 10%;"></td> <td style="width: 10%;"></td> <td style="width: 10%;"></td> </tr> <tr> <td></td> <td></td> <td colspan="8" style="text-align: center;"> <table border="1" style="width: 100%; border-collapse: collapse; text-align: center;"> <tr> <td style="width: 10%;"></td> <td style="width: 10%;"></td> <td style="width: 10%;"></td> <td style="width: 10%;"></td> <td style="width: 10%;"></td> <td style="width: 10%;"></td> <td style="width: 10%;"></td> <td style="width: 10%;"></td> <td style="width: 10%;"></td> <td style="width: 10%;"></td> </tr> <tr> <td></td> <td></td> <td colspan="8" style="text-align: center;"> <table border="1" style="width: 100%; border-collapse: collapse; text-align: center;"> <tr> <td style="width:
10%;"></td> <td style="width: 10%;"></td> <td style="width: 10%;"></td> <td style="width: 10%;"></td> <td style="width: 10%;"></td> <td style="width: 10%;"></td> <td style="width: 10%;"></td> <td style="width: 10%;"></td> <td style="width: 10%;"></td> <td style="width: 10%;"></td> </tr> <tr> <td></td> <td></td> <td colspan="8" style="text-align: center;"> <table border="1" style="width: 100%; border-collapse: collapse; text-align: center;"> <tr> <td style="width: 10%;"></td> <td style="width: 10%;"></td> <td style="width: 10%;"></td> <td style="width: 10%;"></td> <td style="width: 10%;"></td> <td style="width: 10%;"></td> <td style="width: 10%;"></td> <td style="width: 10%;"></td> <td style="width: 10%;"></td> <td style="width: 10%;"></td> </tr> <tr> <td></td> <td></td> <td colspan="8" style="text-align: center;"> <table border="1" style="width: 100%; border-collapse: collapse; text-align: center;"> <tr> <td style="width: 10%;"></td> <td style="width: 10%;"></td> <td style="width: 10%;"></td> <td style="width: 10%;"></td> <td style="width: 10%;"></td> <td style="width: 10%;"></td> <td style="width: 10%;"></td> <td style="width: 10%;"></td> <td style="width: 10%;"></td> <td style="width: 10%;"></td> </tr> <tr> <td></td> <td></td> <td colspan="8" style="text-align: center;"> <table border="1" style="width: 100%; border-collapse: collapse; text-align: center;"> <tr> <td style="width: 10%;"></td> <td style="width: 10%;"></td> <td style="width: 10%;"></td> <td style="width: 10%;"></td> <td style="width: 10%;"></td> <td style="width: 10%;"></td> <td style="width: 10%;"></td> <td style="width: 10%;"></td> <td style="width: 10%;"></td> <td style="width: 10%;"></td> </tr> <tr> <td></td> <td></td> <td colspan="8" style="text-align: center;"> <table border="1" style="width: 100%; border-collapse: collapse; text-align: center;"> <tr> <td style="width: 10%;"></td> <td style="width: 10%;"></td> <td style="width: 10%;"></td> <td style="width: 10%;"></td> <td style="width: 10%;"></td> <td style="width: 10%;"></td> <td style="width: 10%;"></td> <td style="width: 10%;"></td> <td style="width: 10%;"></td> <td style="width: 10%;"></td> </tr> <tr> <td></td> <td></td> <td colspan="8" style="text-align: center;"> <table border="1" style="width: 100%; border-collapse: collapse; text-align: center;"> <tr> <td style="width: 10%;"></td> <td style="width: 10%;"></td> <td style="width: 10%;"></td> <td style="width: 10%;"></td> <td style="width: 10%;"></td> <td style="width: 10%;"></td> <td style="width: 10%;"></td> <td style="width: 10%;"></td> <td style="width: 10%;"></td> <td style="width: 10%;"></td> </tr> <tr> <td></td> <td></td> <td colspan="8" style="text-align: center;"> <table border="1" style="width: 100%; border-collapse: collapse; text-align: center;"> <tr> <td style="width: 10%;"></td> <td style="width: 10%;"></td> <td style="width: 10%;"></td> <td style="width: 10%;"></td> <td style="width: 10%;"></td> <td style="width: 10%;"></td> <td style="width: 10%;"></td> <td style="width: 10%;"></td> <td style="width: 10%;"></td> <td style="width: 10%;"></td> </tr> <tr> <td></td> <td></td> <td colspan="8" style="text-align: center;"> <table border="1" style="width: 100%; border-collapse: collapse; text-align: center;"> <tr> <td style="width: 10%;"></td> <td style="width: 10%;"></td> <td style="width: 10%;"></td> <td style="width: 10%;"></td> <td style="width: 10%;"></td> <td style="width: 10%;"></td> <td style="width: 10%;"></td> <td style="width: 10%;"></td> <td style="width: 10%;"></td> <td style="width: 10%;"></td> </tr> <tr> <td></td> <td></td> <td colspan="8" style="text-align: center;"> <table border="1" style="width: 100%; border-collapse: collapse; text-align: center;"> <tr> <td style="width: 10%;"></td> <td style="width: 10%;"></td> <td style="width: 10%;"></td> <td style="width: 10%;"></td> <td style="width: 10%;"></td> <td style="width: 10%;"></td> <td style="width: 10%;"></td> <td style="width: 10%;"></td> <td style="width: 10%;"></td> <td style="width: 10%;"></td> </tr> <tr> <td></td> <td></td> <td colspan="8" style="text-align: center;"> <table border="1" style="width: 100%; border-collapse: collapse; text-align: center;"> <tr> <td style="width: 10%;"></td> <td style="width: 10%;"></td> <td style="width: 10%;"></td> <td style="width: 10%;"></td> <td style="width: 10%;"></td> <td style="width: 10%;"></td> <td style="width: 10%;"></td> <td style="width: 10%;"></td> <td style="width: 10%;"></td> <td style="width: 10%;"></td> </tr> <tr> <td></td> <td></td> <td colspan="8" style="text-align: center;"> <table border="1" style="width: 100%; border-collapse: collapse; text-align: center;"> <tr> <td style="width: 10%;"></td> <td style="width: 10%;"></td> <td style="width: 10%;"></td> <td style="width: 10%;"></td> <td style="width: 10%;"></td> <td style="width: 10%;"></td> <td style="width: 10%;"></td> <td style="width: 10%;"></td> <td style="width: 10%;"></td> <td style="width: 10%;"></td> </tr> <tr> <td></td> <td></td> <td colspan="8" style="text-align: center;"> <table border="1" style="width: 100%; border-collapse: collapse; text-align: center;"> <tr> </tr></table></td></tr></table></td></tr></table></td></tr></table></td></tr></table></td></tr></table></td></tr></table></td></tr></table></td></tr></table></td></tr></table></td></tr></table></td></tr></table></td></tr></table></td></tr></table></td></tr></table></td></tr></table></td></tr></table></td></tr></table></td></tr></table></td></tr></table></td></tr></table>
 | | | | | | | | | | | | | | | | | | | | <table border="1" style="width: 100%; border-collapse: collapse; text-align: center;"> <tr> <td style="width: 10%;"></td> <td style="width: 10%;"></td> <td style="width: 10%;"></td> <td style="width: 10%;"></td> <td style="width: 10%;"></td> <td style="width: 10%;"></td> <td style="width: 10%;"></td> <td style="width: 10%;"></td> <td style="width: 10%;"></td> <td style="width: 10%;"></td> </tr> <tr> <td></td> <td></td> <td colspan="8" style="text-align: center;"> <table border="1" style="width: 100%; border-collapse: collapse; text-align: center;"> <tr> <td style="width: 10%;"></td> <td style="width: 10%;"></td> <td style="width: 10%;"></td> <td style="width: 10%;"></td> <td style="width: 10%;"></td> <td style="width: 10%;"></td> <td style="width: 10%;"></td> <td style="width: 10%;"></td> <td style="width: 10%;"></td> <td style="width: 10%;"></td> </tr> <tr> <td></td> <td></td> <td colspan="8" style="text-align: center;"> <table border="1" style="width: 100%; border-collapse: collapse; text-align: center;"> <tr> <td style="width: 10%;"></td> <td style="width: 10%;"></td> <td style="width: 10%;"></td> <td style="width: 10%;"></td> <td style="width: 10%;"></td> <td style="width: 10%;"></td> <td style="width: 10%;"></td> <td style="width: 10%;"></td> <td style="width: 10%;"></td> <td style="width: 10%;"></td> </tr> <tr> <td></td> <td></td> <td colspan="8" style="text-align: center;"> <table border="1" style="width: 100%; border-collapse: collapse; text-align: center;"> <tr> <td style="width: 10%;"></td> <td style="width: 10%;"></td> <td style="width: 10%;"></td> <td style="width: 10%;"></td> <td style="width: 10%;"></td> <td style="width: 10%;"></td> <td style="width: 10%;"></td> <td style="width: 10%;"></td> <td style="width: 10%;"></td> <td style="width: 10%;"></td> </tr> <tr> <td></td> <td></td> <td colspan="8" style="text-align: center;"> <table border="1" style="width: 100%; border-collapse: collapse; text-align: center;"> <tr> <td style="width: 10%;"></td> <td style="width: 10%;"></td> <td style="width: 10%;"></td> <td style="width: 10%;"></td> <td style="width: 10%;"></td> <td style="width: 10%;"></td> <td style="width: 10%;"></td> <td style="width: 10%;"></td> <td style="width: 10%;"></td> <td style="width: 10%;"></td> </tr> <tr> <td></td> <td></td> <td colspan="8" style="text-align: center;"> <table border="1" style="width: 100%; border-collapse: collapse; text-align: center;"> <tr> <td style="width: 10%;"></td> <td style="width: 10%;"></td> <td style="width: 10%;"></td> <td style="width: 10%;"></td> <td style="width: 10%;"></td> <td style="width: 10%;"></td> <td style="width: 10%;"></td> <td style="width: 10%;"></td> <td style="width: 10%;"></td> <td style="width: 10%;"></td> </tr> <tr> <td></td> <td></td> <td colspan="8" style="text-align: center;"> <table border="1" style="width: 100%; border-collapse: collapse; text-align: center;"> <tr> <td style="width: 10%;"></td> <td style="width: 10%;"></td> <td style="width: 10%;"></td> <td style="width: 10%;"></td> <td style="width: 10%;"></td> <td style="width: 10%;"></td> <td style="width: 10%;"></td> <td style="width: 10%;"></td> <td style="width: 10%;"></td> <td style="width: 10%;"></td> </tr> <tr> <td></td> <td></td> <td colspan="8"
style="text-align: center;"> <table border="1" style="width: 100%; border-collapse: collapse; text-align: center;"> <tr> <td style="width: 10%;"></td> <td style="width: 10%;"></td> <td style="width: 10%;"></td> <td style="width: 10%;"></td> <td style="width: 10%;"></td> <td style="width: 10%;"></td> <td style="width: 10%;"></td> <td style="width: 10%;"></td> <td style="width: 10%;"></td> <td style="width: 10%;"></td> </tr> <tr> <td></td> <td></td> <td colspan="8" style="text-align: center;"> <table border="1" style="width: 100%; border-collapse: collapse; text-align: center;"> <tr> <td style="width: 10%;"></td> <td style="width: 10%;"></td> <td style="width: 10%;"></td> <td style="width: 10%;"></td> <td style="width: 10%;"></td> <td style="width: 10%;"></td> <td style="width: 10%;"></td> <td style="width: 10%;"></td> <td style="width: 10%;"></td> <td style="width: 10%;"></td> </tr> <tr> <td></td> <td></td> <td colspan="8" style="text-align: center;"> <table border="1" style="width: 100%; border-collapse: collapse; text-align: center;"> <tr> <td style="width: 10%;"></td> <td style="width: 10%;"></td> <td style="width: 10%;"></td> <td style="width: 10%;"></td> <td style="width: 10%;"></td> <td style="width: 10%;"></td> <td style="width: 10%;"></td> <td style="width: 10%;"></td> <td style="width: 10%;"></td> <td style="width: 10%;"></td> </tr> <tr> <td></td> <td></td> <td colspan="8" style="text-align: center;"> <table border="1" style="width: 100%; border-collapse: collapse; text-align: center;"> <tr> <td style="width: 10%;"></td> <td style="width: 10%;"></td> <td style="width: 10%;"></td> <td style="width: 10%;"></td> <td style="width: 10%;"></td> <td style="width: 10%;"></td> <td style="width: 10%;"></td> <td style="width: 10%;"></td> <td style="width: 10%;"></td> <td style="width: 10%;"></td> </tr> <tr> <td></td> <td></td> <td colspan="8" style="text-align: center;"> <table border="1" style="width: 100%; border-collapse: collapse; text-align: center;"> <tr> <td style="width: 10%;"></td> <td style="width: 10%;"></td> <td style="width: 10%;"></td> <td style="width: 10%;"></td> <td style="width: 10%;"></td> <td style="width: 10%;"></td> <td style="width: 10%;"></td> <td style="width: 10%;"></td> <td style="width: 10%;"></td> <td style="width: 10%;"></td> </tr> <tr> <td></td> <td></td> <td colspan="8" style="text-align: center;"> <table border="1" style="width: 100%; border-collapse: collapse; text-align: center;"> <tr> <td style="width: 10%;"></td> <td style="width: 10%;"></td> <td style="width: 10%;"></td> <td style="width: 10%;"></td> <td style="width: 10%;"></td> <td style="width: 10%;"></td> <td style="width: 10%;"></td> <td style="width: 10%;"></td> <td style="width: 10%;"></td> <td style="width: 10%;"></td> </tr> <tr> <td></td> <td></td> <td colspan="8" style="text-align: center;"> <table border="1" style="width: 100%; border-collapse: collapse; text-align: center;"> <tr> <td style="width: 10%;"></td> <td style="width: 10%;"></td> <td style="width: 10%;"></td> <td style="width: 10%;"></td> <td style="width: 10%;"></td> <td style="width: 10%;"></td> <td style="width: 10%;"></td> <td style="width: 10%;"></td> <td style="width: 10%;"></td> <td style="width: 10%;"></td> </tr> <tr> <td></td> <td></td> <td colspan="8" style="text-align: center;"> <table border="1" style="width: 100%; border-collapse: collapse; text-align: center;"> <tr> <td style="width: 10%;"></td> <td style="width: 10%;"></td> <td style="width: 10%;"></td> <td style="width: 10%;"></td> <td style="width: 10%;"></td> <td style="width: 10%;"></td> <td style="width: 10%;"></td> <td style="width: 10%;"></td> <td style="width: 10%;"></td> <td style="width: 10%;"></td> </tr> <tr> <td></td> <td></td> <td colspan="8" style="text-align: center;"> <table border="1" style="width: 100%; border-collapse: collapse; text-align: center;"> <tr> <td style="width: 10%;"></td> <td style="width: 10%;"></td> <td style="width: 10%;"></td> <td style="width: 10%;"></td> <td style="width: 10%;"></td> <td style="width: 10%;"></td> <td style="width: 10%;"></td> <td style="width: 10%;"></td> <td style="width: 10%;"></td> <td style="width: 10%;"></td> </tr> <tr> <td></td> <td></td> <td colspan="8" style="text-align: center;"> <table border="1" style="width: 100%; border-collapse: collapse; text-align: center;"> <tr> <td style="width: 10%;"></td> <td style="width: 10%;"></td> <td style="width: 10%;"></td> <td style="width: 10%;"></td> <td style="width: 10%;"></td> <td style="width: 10%;"></td> <td style="width: 10%;"></td> <td style="width: 10%;"></td> <td style="width: 10%;"></td> <td style="width: 10%;"></td> </tr> <tr> <td></td> <td></td> <td colspan="8" style="text-align: center;"> <table border="1" style="width: 100%; border-collapse: collapse; text-align: center;"> <tr> <td style="width: 10%;"></td> <td style="width: 10%;"></td> <td style="width: 10%;"></td> <td style="width: 10%;"></td> <td style="width: 10%;"></td> <td style="width: 10%;"></td> <td style="width: 10%;"></td> <td style="width: 10%;"></td> <td style="width: 10%;"></td> <td style="width: 10%;"></td> </tr> <tr> <td></td> <td></td> <td colspan="8" style="text-align: center;"> <table border="1" style="width: 100%; border-collapse: collapse; text-align: center;"> <tr> <td style="width: 10%;"></td> <td style="width: 10%;"></td> <td style="width: 10%;"></td> <td style="width: 10%;"></td> <td style="width: 10%;"></td> <td style="width: 10%;"></td> <td style="width: 10%;"></td> <td style="width: 10%;"></td> <td style="width: 10%;"></td> <td style="width: 10%;"></td> </tr> <tr> <td></td> <td></td> <td colspan="8" style="text-align: center;"> <table border="1" style="width: 100%; border-collapse: collapse; text-align: center;"> <tr> </tr></table></td></tr></table></td></tr></table></td></tr></table></td></tr></table></td></tr></table></td></tr></table></td></tr></table></td></tr></table></td></tr></table></td></tr></table></td></tr></table></td></tr></table></td></tr></table></td></tr></table></td></tr></table></td></tr></table></td></tr></table></td></tr></table></td></tr></table>
 | | | | | | | | | | | | | | | | | | | | <table border="1" style="width: 100%; border-collapse: collapse; text-align: center;"> <tr> <td style="width: 10%;"></td> <td style="width: 10%;"></td> <td style="width: 10%;"></td> <td style="width: 10%;"></td> <td style="width: 10%;"></td> <td style="width: 10%;"></td> <td style="width: 10%;"></td> <td style="width: 10%;"></td> <td style="width: 10%;"></td> <td style="width: 10%;"></td> </tr> <tr> <td></td> <td></td> <td colspan="8" style="text-align: center;"> <table border="1" style="width: 100%; border-collapse: collapse; text-align: center;"> <tr> <td style="width: 10%;"></td> <td style="width: 10%;"></td> <td style="width: 10%;"></td> <td style="width: 10%;"></td> <td style="width: 10%;"></td> <td style="width: 10%;"></td> <td style="width: 10%;"></td> <td style="width: 10%;"></td> <td style="width: 10%;"></td> <td style="width: 10%;"></td> </tr> <tr> <td></td> <td></td> <td colspan="8" style="text-align: center;"> <table border="1" style="width: 100%; border-collapse: collapse; text-align: center;"> <tr> <td style="width: 10%;"></td> <td style="width: 10%;"></td> <td style="width: 10%;"></td> <td style="width: 10%;"></td> <td style="width: 10%;"></td> <td style="width: 10%;"></td> <td style="width: 10%;"></td> <td style="width: 10%;"></td> <td style="width: 10%;"></td> <td style="width: 10%;"></td> </tr> <tr> <td></td> <td></td> <td colspan="8" style="text-align: center;"> <table border="1" style="width: 100%; border-collapse: collapse; text-align: center;"> <tr> <td style="width: 10%;"></td> <td style="width: 10%;"></td> <td style="width: 10%;"></td> <td style="width: 10%;"></td> <td style="width: 10%;"></td> <td style="width: 10%;"></td> <td style="width: 10%;"></td> <td style="width: 10%;"></td> <td style="width: 10%;"></td> <td style="width: 10%;"></td> </tr> <tr> <td></td> <td></td> <td colspan="8" style="text-align: center;"> <table border="1" style="width: 100%; border-collapse: collapse; text-align: center;"> <tr> <td style="width: 10%;"></td> <td style="width: 10%;"></td> <td style="width: 10%;"></td> <td style="width: 10%;"></td> <td style="width: 10%;"></td> <td style="width: 10%;"></td> <td style="width: 10%;"></td> <td style="width: 10%;"></td> <td style="width: 10%;"></td> <td style="width: 10%;"></td> </tr> <tr> <td></td> <td></td> <td colspan="8" style="text-align: center;"> <table border="1" style="width: 100%; border-collapse: collapse; text-align: center;"> <tr> <td style="width: 10%;"></td> <td style="width: 10%;"></td> <td style="width: 10%;"></td> <td style="width: 10%;"></td> <td style="width: 10%;"></td> <td style="width: 10%;"></td> <td style="width: 10%;"></td> <td style="width:
10%;"></td> <td style="width: 10%;"></td> <td style="width: 10%;"></td> </tr> <tr> <td></td> <td></td> <td colspan="8" style="text-align: center;"> <table border="1" style="width: 100%; border-collapse: collapse; text-align: center;"> <tr> <td style="width: 10%;"></td> <td style="width: 10%;"></td> <td style="width: 10%;"></td> <td style="width: 10%;"></td> <td style="width: 10%;"></td> <td style="width: 10%;"></td> <td style="width: 10%;"></td> <td style="width: 10%;"></td> <td style="width: 10%;"></td> <td style="width: 10%;"></td> </tr> <tr> <td></td> <td></td> <td colspan="8" style="text-align: center;"> <table border="1" style="width: 100%; border-collapse: collapse; text-align: center;"> <tr> <td style="width: 10%;"></td> <td style="width: 10%;"></td> <td style="width: 10%;"></td> <td style="width: 10%;"></td> <td style="width: 10%;"></td> <td style="width: 10%;"></td> <td style="width: 10%;"></td> <td style="width: 10%;"></td> <td style="width: 10%;"></td> <td style="width: 10%;"></td> </tr> <tr> <td></td> <td></td> <td colspan="8" style="text-align: center;"> <table border="1" style="width: 100%; border-collapse: collapse; text-align: center;"> <tr> <td style="width: 10%;"></td> <td style="width: 10%;"></td> <td style="width: 10%;"></td> <td style="width: 10%;"></td> <td style="width: 10%;"></td> <td style="width: 10%;"></td> <td style="width: 10%;"></td> <td style="width: 10%;"></td> <td style="width: 10%;"></td> <td style="width: 10%;"></td> </tr> <tr> <td></td> <td></td> <td colspan="8" style="text-align: center;"> <table border="1" style="width: 100%; border-collapse: collapse; text-align: center;"> <tr> <td style="width: 10%;"></td> <td style="width: 10%;"></td> <td style="width: 10%;"></td> <td style="width: 10%;"></td> <td style="width: 10%;"></td> <td style="width: 10%;"></td> <td style="width: 10%;"></td> <td style="width: 10%;"></td> <td style="width: 10%;"></td> <td style="width: 10%;"></td> </tr> <tr> <td></td> <td></td> <td colspan="8" style="text-align: center;"> <table border="1" style="width: 100%; border-collapse: collapse; text-align: center;"> <tr> <td style="width: 10%;"></td> <td style="width: 10%;"></td> <td style="width: 10%;"></td> <td style="width: 10%;"></td> <td style="width: 10%;"></td> <td style="width: 10%;"></td> <td style="width: 10%;"></td> <td style="width: 10%;"></td> <td style="width: 10%;"></td> <td style="width: 10%;"></td> </tr> <tr> <td></td> <td></td> <td colspan="8" style="text-align: center;"> <table border="1" style="width: 100%; border-collapse: collapse; text-align: center;"> <tr> <td style="width: 10%;"></td> <td style="width: 10%;"></td> <td style="width: 10%;"></td> <td style="width: 10%;"></td> <td style="width: 10%;"></td> <td style="width: 10%;"></td> <td style="width: 10%;"></td> <td style="width: 10%;"></td> <td style="width: 10%;"></td> <td style="width: 10%;"></td> </tr> <tr> <td></td> <td></td> <td colspan="8" style="text-align: center;"> <table border="1" style="width: 100%; border-collapse: collapse; text-align: center;"> <tr> <td style="width: 10%;"></td> <td style="width: 10%;"></td> <td style="width: 10%;"></td> <td style="width: 10%;"></td> <td style="width: 10%;"></td> <td style="width: 10%;"></td> <td style="width: 10%;"></td> <td style="width: 10%;"></td> <td style="width: 10%;"></td> <td style="width: 10%;"></td> </tr> <tr> <td></td> <td></td> <td colspan="8" style="text-align: center;"> <table border="1" style="width: 100%; border-collapse: collapse; text-align: center;"> <tr> <td style="width: 10%;"></td> <td style="width: 10%;"></td> <td style="width: 10%;"></td> <td style="width: 10%;"></td> <td style="width: 10%;"></td> <td style="width: 10%;"></td> <td style="width: 10%;"></td> <td style="width: 10%;"></td> <td style="width: 10%;"></td> <td style="width: 10%;"></td> </tr> <tr> <td></td> <td></td> <td colspan="8" style="text-align: center;"> <table border="1" style="width: 100%; border-collapse: collapse; text-align: center;"> <tr> <td style="width: 10%;"></td> <td style="width: 10%;"></td> <td style="width: 10%;"></td> <td style="width: 10%;"></td> <td style="width: 10%;"></td> <td style="width: 10%;"></td> <td style="width: 10%;"></td> <td style="width: 10%;"></td> <td style="width: 10%;"></td> <td style="width: 10%;"></td> </tr> <tr> <td></td> <td></td> <td colspan="8" style="text-align: center;"> <table border="1" style="width: 100%; border-collapse: collapse; text-align: center;"> <tr> <td style="width: 10%;"></td> <td style="width: 10%;"></td> <td style="width: 10%;"></td> <td style="width: 10%;"></td> <td style="width: 10%;"></td> <td style="width: 10%;"></td> <td style="width: 10%;"></td> <td style="width: 10%;"></td> <td style="width: 10%;"></td> <td style="width: 10%;"></td> </tr> <tr> <td></td> <td></td> <td colspan="8" style="text-align: center;"> <table border="1" style="width: 100%; border-collapse: collapse; text-align: center;"> <tr> <td style="width: 10%;"></td> <td style="width: 10%;"></td> <td style="width: 10%;"></td> <td style="width: 10%;"></td> <td style="width: 10%;"></td> <td style="width: 10%;"></td> <td style="width: 10%;"></td> <td style="width: 10%;"></td> <td style="width: 10%;"></td> <td style="width: 10%;"></td> </tr> <tr> <td></td> <td></td> <td colspan="8" style="text-align: center;"> <table border="1" style="width: 100%; border-collapse: collapse; text-align: center;"> <tr> <td style="width: 10%;"></td> <td style="width: 10%;"></td> <td style="width: 10%;"></td> <td style="width: 10%;"></td> <td style="width: 10%;"></td> <td style="width: 10%;"></td> <td style="width: 10%;"></td> <td style="width: 10%;"></td> <td style="width: 10%;"></td> <td style="width: 10%;"></td> </tr> <tr> <td></td> <td></td> <td colspan="8" style="text-align: center;"> <table border="1" style="width: 100%; border-collapse: collapse; text-align: center;"> <tr> </tr></table></td></tr></table></td></tr></table></td></tr></table></td></tr></table></td></tr></table></td></tr></table></td></tr></table></td></tr></table></td></tr></table></td></tr></table></td></tr></table></td></tr></table></td></tr></table></td></tr></table></td></tr></table></td></tr></table></td></tr></table></td></tr></table>
 | | | | | | | | | | | | | | | | | | | | <table border="1" style="width: 100%; border-collapse: collapse; text-align: center;"> <tr> <td style="width: 10%;"></td> <td style="width: 10%;"></td> <td style="width: 10%;"></td> <td style="width: 10%;"></td> <td style="width: 10%;"></td> <td style="width: 10%;"></td> <td style="width: 10%;"></td> <td style="width: 10%;"></td> <td style="width: 10%;"></td> <td style="width: 10%;"></td> </tr> <tr> <td></td> <td></td> <td colspan="8" style="text-align: center;"> <table border="1" style="width: 100%; border-collapse: collapse; text-align: center;"> <tr> <td style="width: 10%;"></td> <td style="width: 10%;"></td> <td style="width: 10%;"></td> <td style="width: 10%;"></td> <td style="width: 10%;"></td> <td style="width: 10%;"></td> <td style="width: 10%;"></td> <td style="width: 10%;"></td> <td style="width: 10%;"></td> <td style="width: 10%;"></td> </tr> <tr> <td></td> <td></td> <td colspan="8" style="text-align: center;"> <table border="1" style="width: 100%; border-collapse: collapse; text-align: center;"> <tr> <td style="width: 10%;"></td> <td style="width: 10%;"></td> <td style="width: 10%;"></td> <td style="width: 10%;"></td> <td style="width: 10%;"></td> <td style="width: 10%;"></td> <td style="width: 10%;"></td> <td style="width: 10%;"></td> <td style="width: 10%;"></td> <td style="width: 10%;"></td> </tr> <tr> <td></td> <td></td> <td colspan="8" style="text-align: center;"> <table border="1" style="width: 100%; border-collapse: collapse; text-align: center;"> <tr> <td style="width: 10%;"></td> <td style="width: 10%;"></td> <td style="width: 10%;"></td> <td style="width: 10%;"></td> <td style="width: 10%;"></td> <td style="width: 10%;"></td> <td style="width: 10%;"></td> <td style="width: 10%;"></td> <td style="width: 10%;"></td> <td style="width: 10%;"></td> </tr> <tr> <td></td> <td></td> <td colspan="8" style="text-align: center;"> <table border="1" style="width: 100%; border-collapse: collapse; text-align: center;"> <tr> <td style="width: 10%;"></td> <td style="width: 10%;"></td> <td style="width: 10%;"></td> <td style="width: 10%;"></td> <td style="width: 10%;"></td> <td style="width: 10%;"></td> <td style="width: 10%;"></td> <td style="width: 10%;"></td> <td style="width: 10%;"></td> <td style="width: 10%;"></td> </tr> <tr> <td></td> <td></td> <td colspan="8" style="text-align: center;"> <table border="1" style="width: 100%; border-collapse: collapse; text-align: center;"> <tr> <td style="width: 10%;"></td> <td style="width: 10%;"></td> <td style="width: 10%;"></td> <td style="width: 10%;"></td> <td
style="width: 10%;"></td> <td style="width: 10%;"></td> <td style="width: 10%;"></td> <td style="width: 10%;"></td> <td style="width: 10%;"></td> <td style="width: 10%;"></td> </tr> <tr> <td></td> <td></td> <td colspan="8" style="text-align: center;"> <table border="1" style="width: 100%; border-collapse: collapse; text-align: center;"> <tr> <td style="width: 10%;"></td> <td style="width: 10%;"></td> <td style="width: 10%;"></td> <td style="width: 10%;"></td> <td style="width: 10%;"></td> <td style="width: 10%;"></td> <td style="width: 10%;"></td> <td style="width: 10%;"></td> <td style="width: 10%;"></td> <td style="width: 10%;"></td> </tr> <tr> <td></td> <td></td> <td colspan="8" style="text-align: center;"> <table border="1" style="width: 100%; border-collapse: collapse; text-align: center;"> <tr> <td style="width: 10%;"></td> <td style="width: 10%;"></td> <td style="width: 10%;"></td> <td style="width: 10%;"></td> <td style="width: 10%;"></td> <td style="width: 10%;"></td> <td style="width: 10%;"></td> <td style="width: 10%;"></td> <td style="width: 10%;"></td> <td style="width: 10%;"></td> </tr> <tr> <td></td> <td></td> <td colspan="8" style="text-align: center;"> <table border="1" style="width: 100%; border-collapse: collapse; text-align: center;"> <tr> <td style="width: 10%;"></td> <td style="width: 10%;"></td> <td style="width: 10%;"></td> <td style="width: 10%;"></td> <td style="width: 10%;"></td> <td style="width: 10%;"></td> <td style="width: 10%;"></td> <td style="width: 10%;"></td> <td style="width: 10%;"></td> <td style="width: 10%;"></td> </tr> <tr> <td></td> <td></td> <td colspan="8" style="text-align: center;"> <table border="1" style="width: 100%; border-collapse: collapse; text-align: center;"> <tr> <td style="width: 10%;"></td> <td style="width: 10%;"></td> <td style="width: 10%;"></td> <td style="width: 10%;"></td> <td style="width: 10%;"></td> <td style="width: 10%;"></td> <td style="width: 10%;"></td> <td style="width: 10%;"></td> <td style="width: 10%;"></td> <td style="width: 10%;"></td> </tr> <tr> <td></td> <td></td> <td colspan="8" style="text-align: center;"> <table border="1" style="width: 100%; border-collapse: collapse; text-align: center;"> <tr> <td style="width: 10%;"></td> <td style="width: 10%;"></td> <td style="width: 10%;"></td> <td style="width: 10%;"></td> <td style="width: 10%;"></td> <td style="width: 10%;"></td> <td style="width: 10%;"></td> <td style="width: 10%;"></td> <td style="width: 10%;"></td> <td style="width: 10%;"></td> </tr> <tr> <td></td> <td></td> <td colspan="8" style="text-align: center;"> <table border="1" style="width: 100%; border-collapse: collapse; text-align: center;"> <tr> <td style="width: 10%;"></td> <td style="width: 10%;"></td> <td style="width: 10%;"></td> <td style="width: 10%;"></td> <td style="width: 10%;"></td> <td style="width: 10%;"></td> <td style="width: 10%;"></td> <td style="width: 10%;"></td> <td style="width: 10%;"></td> <td style="width: 10%;"></td> </tr> <tr> <td></td> <td></td> <td colspan="8" style="text-align: center;"> <table border="1" style="width: 100%; border-collapse: collapse; text-align: center;"> <tr> <td style="width: 10%;"></td> <td style="width: 10%;"></td> <td style="width: 10%;"></td> <td style="width: 10%;"></td> <td style="width: 10%;"></td> <td style="width: 10%;"></td> <td style="width: 10%;"></td> <td style="width: 10%;"></td> <td style="width: 10%;"></td> <td style="width: 10%;"></td> </tr> <tr> <td></td> <td></td> <td colspan="8" style="text-align: center;"> <table border="1" style="width: 100%; border-collapse: collapse; text-align: center;"> <tr> <td style="width: 10%;"></td> <td style="width: 10%;"></td> <td style="width: 10%;"></td> <td style="width: 10%;"></td> <td style="width: 10%;"></td> <td style="width: 10%;"></td> <td style="width: 10%;"></td> <td style="width: 10%;"></td> <td style="width: 10%;"></td> <td style="width: 10%;"></td> </tr> <tr> <td></td> <td></td> <td colspan="8" style="text-align: center;"> <table border="1" style="width: 100%; border-collapse: collapse; text-align: center;"> <tr> <td style="width: 10%;"></td> <td style="width: 10%;"></td> <td style="width: 10%;"></td> <td style="width: 10%;"></td> <td style="width: 10%;"></td> <td style="width: 10%;"></td> <td style="width: 10%;"></td> <td style="width: 10%;"></td> <td style="width: 10%;"></td> <td style="width: 10%;"></td> </tr> <tr> <td></td> <td></td> <td colspan="8" style="text-align: center;"> <table border="1" style="width: 100%; border-collapse: collapse; text-align: center;"> <tr> <td style="width: 10%;"></td> <td style="width: 10%;"></td> <td style="width: 10%;"></td> <td style="width: 10%;"></td> <td style="width: 10%;"></td> <td style="width: 10%;"></td> <td style="width: 10%;"></td> <td style="width: 10%;"></td> <td style="width: 10%;"></td> <td style="width: 10%;"></td> </tr> <tr> <td></td> <td></td> <td colspan="8" style="text-align: center;"> <table border="1" style="width: 100%; border-collapse: collapse; text-align: center;"> <tr> <td style="width: 10%;"></td> <td style="width: 10%;"></td> <td style="width: 10%;"></td> <td style="width: 10%;"></td> <td style="width: 10%;"></td> <td style="width: 10%;"></td> <td style="width: 10%;"></td> <td style="width: 10%;"></td> <td style="width: 10%;"></td> <td style="width: 10%;"></td> </tr> <tr> <td></td> <td></td> <td colspan="8" style="text-align: center;"> <table border="1" style="width: 100%; border-collapse: collapse; text-align: center;"> <tr> </tr></table></td></tr></table></td></tr></table></td></tr></table></td></tr></table></td></tr></table></td></tr></table></td></tr></table></td></tr></table></td></tr></table></td></tr></table></td></tr></table></td></tr></table></td></tr></table></td></tr></table></td></tr></table></td></tr></table></td></tr></table>
 | | | | | | | | | | | | | | | | | | | | <table border="1" style="width: 100%; border-collapse: collapse; text-align: center;"> <tr> <td style="width: 10%;"></td> <td style="width: 10%;"></td> <td style="width: 10%;"></td> <td style="width: 10%;"></td> <td style="width: 10%;"></td> <td style="width: 10%;"></td> <td style="width: 10%;"></td> <td style="width: 10%;"></td> <td style="width: 10%;"></td> <td style="width: 10%;"></td> </tr> <tr> <td></td> <td></td> <td colspan="8" style="text-align: center;"> <table border="1" style="width: 100%; border-collapse: collapse; text-align: center;"> <tr> <td style="width: 10%;"></td> <td style="width: 10%;"></td> <td style="width: 10%;"></td> <td style="width: 10%;"></td> <td style="width: 10%;"></td> <td style="width: 10%;"></td> <td style="width: 10%;"></td> <td style="width: 10%;"></td> <td style="width: 10%;"></td> <td style="width: 10%;"></td> </tr> <tr> <td></td> <td></td> <td colspan="8" style="text-align: center;"> <table border="1" style="width: 100%; border-collapse: collapse; text-align: center;"> <tr> <td style="width: 10%;"></td> <td style="width: 10%;"></td> <td style="width: 10%;"></td> <td style="width: 10%;"></td> <td style="width: 10%;"></td> <td style="width: 10%;"></td> <td style="width: 10%;"></td> <td style="width: 10%;"></td> <td style="width: 10%;"></td> <td style="width: 10%;"></td> </tr> <tr> <td></td> <td></td> <td colspan="8" style="text-align: center;"> <table border="1" style="width: 100%; border-collapse: collapse; text-align: center;"> <tr> <td style="width: 10%;"></td> <td style="width: 10%;"></td> <td style="width: 10%;"></td> <td style="width: 10%;"></td> <td style="width: 10%;"></td> <td style="width: 10%;"></td> <td style="width: 10%;"></td> <td style="width: 10%;"></td> <td style="width: 10%;"></td> <td style="width: 10%;"></td> </tr> <tr> <td></td> <td></td> <td colspan="8" style="text-align: center;"> <table border="1" style="width: 100%; border-collapse: collapse; text-align: center;"> <tr> <td style="width: 10%;"></td> <td style="width: 10%;"></td> <td style="width: 10%;"></td> <td style="width: 10%;"></td> <td style="width: 10%;"></td> <td style="width: 10%;"></td> <td style="width: 10%;"></td> <td style="width: 10%;"></td> <td style="width: 10%;"></td> <td style="width: 10%;"></td> </tr> <tr> <td></td> <td></td> <td colspan="8" style="text-align: center;"> <table border="1" style="width: 100%; border-collapse: collapse; text-align: center;"> <tr> <td style="width: 10%;"></td> <td style="width: 10%;"></td> <td style="width: 10%;"></td> <td style="width: 10%;"></td> <td style="width: 10%;"></td> <td style="width: 10%;"></td> <td style="width: 10%;"></td> <td style="width: 10%;"></td> <td style="width: 10%;"></td> <td style="width: 10%;"></td> </tr> <tr> <td></td> <td></td> <td colspan="8" style="text-align: center;"> <table border="1" style="width: 100%; border-collapse: collapse; text-align: center;"> <tr> <td style="width: 10%;"></td> <td style="width:
10%;"></td> <td style="width: 10%;"></td> <td style="width: 10%;"></td> <td style="width: 10%;"></td> <td style="width: 10%;"></td> <td style="width: 10%;"></td> <td style="width: 10%;"></td> <td style="width: 10%;"></td> <td style="width: 10%;"></td> </tr> <tr> <td></td> <td></td> <td colspan="8" style="text-align: center;"> <table border="1" style="width: 100%; border-collapse: collapse; text-align: center;"> <tr> <td style="width: 10%;"></td> <td style="width: 10%;"></td> <td style="width: 10%;"></td> <td style="width: 10%;"></td> <td style="width: 10%;"></td> <td style="width: 10%;"></td> <td style="width: 10%;"></td> <td style="width: 10%;"></td> <td style="width: 10%;"></td> <td style="width: 10%;"></td> </tr> <tr> <td></td> <td></td> <td colspan="8" style="text-align: center;"> <table border="1" style="width: 100%; border-collapse: collapse; text-align: center;"> <tr> <td style="width: 10%;"></td> <td style="width: 10%;"></td> <td style="width: 10%;"></td> <td style="width: 10%;"></td> <td style="width: 10%;"></td> <td style="width: 10%;"></td> <td style="width: 10%;"></td> <td style="width: 10%;"></td> <td style="width: 10%;"></td> <td style="width: 10%;"></td> </tr> <tr> <td></td> <td></td> <td colspan="8" style="text-align: center;"> <table border="1" style="width: 100%; border-collapse: collapse; text-align: center;"> <tr> <td style="width: 10%;"></td> <td style="width: 10%;"></td> <td style="width: 10%;"></td> <td style="width: 10%;"></td> <td style="width: 10%;"></td> <td style="width: 10%;"></td> <td style="width: 10%;"></td> <td style="width: 10%;"></td> <td style="width: 10%;"></td> <td style="width: 10%;"></td> </tr> <tr> <td></td> <td></td> <td colspan="8" style="text-align: center;"> <table border="1" style="width: 100%; border-collapse: collapse; text-align: center;"> <tr> <td style="width: 10%;"></td> <td style="width: 10%;"></td> <td style="width: 10%;"></td> <td style="width: 10%;"></td> <td style="width: 10%;"></td> <td style="width: 10%;"></td> <td style="width: 10%;"></td> <td style="width: 10%;"></td> <td style="width: 10%;"></td> <td style="width: 10%;"></td> </tr> <tr> <td></td> <td></td> <td colspan="8" style="text-align: center;"> <table border="1" style="width: 100%; border-collapse: collapse; text-align: center;"> <tr> <td style="width: 10%;"></td> <td style="width: 10%;"></td> <td style="width: 10%;"></td> <td style="width: 10%;"></td> <td style="width: 10%;"></td> <td style="width: 10%;"></td> <td style="width: 10%;"></td> <td style="width: 10%;"></td> <td style="width: 10%;"></td> <td style="width: 10%;"></td> </tr> <tr> <td></td> <td></td> <td colspan="8" style="text-align: center;"> <table border="1" style="width: 100%; border-collapse: collapse; text-align: center;"> <tr> <td style="width: 10%;"></td> <td style="width: 10%;"></td> <td style="width: 10%;"></td> <td style="width: 10%;"></td> <td style="width: 10%;"></td> <td style="width: 10%;"></td> <td style="width: 10%;"></td> <td style="width: 10%;"></td> <td style="width: 10%;"></td> <td style="width: 10%;"></td> </tr> <tr> <td></td> <td></td> <td colspan="8" style="text-align: center;"> <table border="1" style="width: 100%; border-collapse: collapse; text-align: center;"> <tr> <td style="width: 10%;"></td> <td style="width: 10%;"></td> <td style="width: 10%;"></td> <td style="width: 10%;"></td> <td style="width: 10%;"></td> <td style="width: 10%;"></td> <td style="width: 10%;"></td> <td style="width: 10%;"></td> <td style="width: 10%;"></td> <td style="width: 10%;"></td> </tr> <tr> <td></td> <td></td> <td colspan="8" style="text-align: center;"> <table border="1" style="width: 100%; border-collapse: collapse; text-align: center;"> <tr> <td style="width: 10%;"></td> <td style="width: 10%;"></td> <td style="width: 10%;"></td> <td style="width: 10%;"></td> <td style="width: 10%;"></td> <td style="width: 10%;"></td> <td style="width: 10%;"></td> <td style="width: 10%;"></td> <td style="width: 10%;"></td> <td style="width: 10%;"></td> </tr> <tr> <td></td> <td></td> <td colspan="8" style="text-align: center;"> <table border="1" style="width: 100%; border-collapse: collapse; text-align: center;"> <tr> <td style="width: 10%;"></td> <td style="width: 10%;"></td> <td style="width: 10%;"></td> <td style="width: 10%;"></td> <td style="width: 10%;"></td> <td style="width: 10%;"></td> <td style="width: 10%;"></td> <td style="width: 10%;"></td> <td style="width: 10%;"></td> <td style="width: 10%;"></td> </tr> <tr> <td></td> <td></td> <td colspan="8" style="text-align: center;"> <table border="1" style="width: 100%; border-collapse: collapse; text-align: center;"> <tr> </tr></table></td></tr></table></td></tr></table></td></tr></table></td></tr></table></td></tr></table></td></tr></table></td></tr></table></td></tr></table></td></tr></table></td></tr></table></td></tr></table></td></tr></table></td></tr></table></td></tr></table></td></tr></table></td></tr></table>
 | | | | | | | | | | | | | | | | | | | | <table border="1" style="width: 100%; border-collapse: collapse; text-align: center;"> <tr> <td style="width: 10%;"></td> <td style="width: 10%;"></td> <td style="width: 10%;"></td> <td style="width: 10%;"></td> <td style="width: 10%;"></td> <td style="width: 10%;"></td> <td style="width: 10%;"></td> <td style="width: 10%;"></td> <td style="width: 10%;"></td> <td style="width: 10%;"></td> </tr> <tr> <td></td> <td></td> <td colspan="8" style="text-align: center;"> <table border="1" style="width: 100%; border-collapse: collapse; text-align: center;"> <tr> <td style="width: 10%;"></td> <td style="width: 10%;"></td> <td style="width: 10%;"></td> <td style="width: 10%;"></td> <td style="width: 10%;"></td> <td style="width: 10%;"></td> <td style="width: 10%;"></td> <td style="width: 10%;"></td> <td style="width: 10%;"></td> <td style="width: 10%;"></td> </tr> <tr> <td></td> <td></td> <td colspan="8" style="text-align: center;"> <table border="1" style="width: 100%; border-collapse: collapse; text-align: center;"> <tr> <td style="width: 10%;"></td> <td style="width: 10%;"></td> <td style="width: 10%;"></td> <td style="width: 10%;"></td> <td style="width: 10%;"></td> <td style="width: 10%;"></td> <td style="width: 10%;"></td> <td style="width: 10%;"></td> <td style="width: 10%;"></td> <td style="width: 10%;"></td> </tr> <tr> <td></td> <td></td> <td colspan="8" style="text-align: center;"> <table border="1" style="width: 100%; border-collapse: collapse; text-align: center;"> <tr> <td style="width: 10%;"></td> <td style="width: 10%;"></td> <td style="width: 10%;"></td> <td style="width: 10%;"></td> <td style="width: 10%;"></td> <td style="width: 10%;"></td> <td style="width: 10%;"></td> <td style="width: 10%;"></td> <td style="width: 10%;"></td> <td style="width: 10%;"></td> </tr> <tr> <td></td> <td></td> <td colspan="8" style="text-align: center;"> <table border="1" style="width: 100%; border-collapse: collapse; text-align: center;"> <tr> <td style="width: 10%;"></td> <td style="width: 10%;"></td> <td style="width: 10%;"></td> <td style="width: 10%;"></td> <td style="width: 10%;"></td> <td style="width: 10%;"></td> <td style="width: 10%;"></td> <td style="width: 10%;"></td> <td style="width: 10%;"></td> <td style="width: 10%;"></td> </tr> <tr> <td></td> <td></td> <td colspan="8" style="text-align: center;"> <table border="1" style="width: 100%; border-collapse: collapse; text-align: center;"> <tr> <td style="width: 10%;"></td> <td style="width: 10%;"></td> <td style="width: 10%;"></td> <td style="width: 10%;"></td> <td style="width: 10%;"></td> <td style="width: 10%;"></td> <td style="width: 10%;"></td> <td style="width: 10%;"></td> <td style="width: 10%;"></td> <td style="width: 10%;"></td> </tr> <tr> <td></td> <td></td> <td colspan="8" style="text-align: center;"> <table border="1" style="width: 100%; border-collapse: collapse; text-align: center;"> <tr> <td style="width: 10%;"></td> <td style="width: 10%;"></td> <td style="width: 10%;"></td> <td style="width: 10%;"></td> <td style="width: 10%;"></td> <td style="width: 10%;"></td> <td style="width: 10%;"></td> <td style="width: 10%;"></td> <td style="width: 10%;"></td> <td style="width: 10%;"></td> </tr> <tr> <td></td> <td></td> <td colspan="8" style="text-align: center;"> <table border="1" style="width: 100%; border-collapse: collapse; text-align: center;"> <tr> <td style="width: 10%;"></td> <td style="width: 10%;"></td> <td style="width: 10%;"></td> <td style="width: 10%;"></td> <td style="width: 10%;"></td> <td style="width: 10%;"></td> <td style="width: 10%;"></td> <td style="width: 10%;"></td> <td style="width: 10%;"></td> <td style="width: 10%;"></td> </tr> <tr> <td></td> <td></td> <td colspan="8" style="text-align: center;"> <table border="1" style="width: 100%; border-collapse: collapse; text-align:
center;"> <tr> <td style="width: 10%;"></td> <td style="width: 10%;"></td> <td style="width: 10%;"></td> <td style="width: 10%;"></td> <td style="width: 10%;"></td> <td style="width: 10%;"></td> <td style="width: 10%;"></td> <td style="width: 10%;"></td> <td style="width: 10%;"></td> <td style="width: 10%;"></td> </tr> <tr> <td></td> <td></td> <td colspan="8" style="text-align: center;"> <table border="1" style="width: 100%; border-collapse: collapse; text-align: center;"> <tr> <td style="width: 10%;"></td> <td style="width: 10%;"></td> <td style="width: 10%;"></td> <td style="width: 10%;"></td> <td style="width: 10%;"></td> <td style="width: 10%;"></td> <td style="width: 10%;"></td> <td style="width: 10%;"></td> <td style="width: 10%;"></td> <td style="width: 10%;"></td> </tr> <tr> <td></td> <td></td> <td colspan="8" style="text-align: center;"> <table border="1" style="width: 100%; border-collapse: collapse; text-align: center;"> <tr> <td style="width: 10%;"></td> <td style="width: 10%;"></td> <td style="width: 10%;"></td> <td style="width: 10%;"></td> <td style="width: 10%;"></td> <td style="width: 10%;"></td> <td style="width: 10%;"></td> <td style="width: 10%;"></td> <td style="width: 10%;"></td> <td style="width: 10%;"></td> </tr> <tr> <td></td> <td></td> <td colspan="8" style="text-align: center;"> <table border="1" style="width: 100%; border-collapse: collapse; text-align: center;"> <tr> <td style="width: 10%;"></td> <td style="width: 10%;"></td> <td style="width: 10%;"></td> <td style="width: 10%;"></td> <td style="width: 10%;"></td> <td style="width: 10%;"></td> <td style="width: 10%;"></td> <td style="width: 10%;"></td> <td style="width: 10%;"></td> <td style="width: 10%;"></td> </tr> <tr> <td></td> <td></td> <td colspan="8" style="text-align: center;"> <table border="1" style="width: 100%; border-collapse: collapse; text-align: center;"> <tr> <td style="width: 10%;"></td> <td style="width: 10%;"></td> <td style="width: 10%;"></td> <td style="width: 10%;"></td> <td style="width: 10%;"></td> <td style="width: 10%;"></td> <td style="width: 10%;"></td> <td style="width: 10%;"></td> <td style="width: 10%;"></td> <td style="width: 10%;"></td> </tr> <tr> <td></td> <td></td> <td colspan="8" style="text-align: center;"> <table border="1" style="width: 100%; border-collapse: collapse; text-align: center;"> <tr> <td style="width: 10%;"></td> <td style="width: 10%;"></td> <td style="width: 10%;"></td> <td style="width: 10%;"></td> <td style="width: 10%;"></td> <td style="width: 10%;"></td> <td style="width: 10%;"></td> <td style="width: 10%;"></td> <td style="width: 10%;"></td> <td style="width: 10%;"></td> </tr> <tr> <td></td> <td></td> <td colspan="8" style="text-align: center;"> <table border="1" style="width: 100%; border-collapse: collapse; text-align: center;"> <tr> <td style="width: 10%;"></td> <td style="width: 10%;"></td> <td style="width: 10%;"></td> <td style="width: 10%;"></td> <td style="width: 10%;"></td> <td style="width: 10%;"></td> <td style="width: 10%;"></td> <td style="width: 10%;"></td> <td style="width: 10%;"></td> <td style="width: 10%;"></td> </tr> <tr> <td></td> <td></td> <td colspan="8" style="text-align: center;"> <table border="1" style="width: 100%; border-collapse: collapse; text-align: center;"> <tr> </tr></table></td></tr></table></td></tr></table></td></tr></table></td></tr></table></td></tr></table></td></tr></table></td></tr></table></td></tr></table></td></tr></table></td></tr></table></td></tr></table></td></tr></table></td></tr></table></td></tr></table></td></tr></table>
 | | | | | | | | | | | | | | | | | | | | <table border="1" style="width: 100%; border-collapse: collapse; text-align: center;"> <tr> <td style="width: 10%;"></td> <td style="width: 10%;"></td> <td style="width: 10%;"></td> <td style="width: 10%;"></td> <td style="width: 10%;"></td> <td style="width: 10%;"></td> <td style="width: 10%;"></td> <td style="width: 10%;"></td> <td style="width: 10%;"></td> <td style="width: 10%;"></td> </tr> <tr> <td></td> <td></td> <td colspan="8" style="text-align: center;"> <table border="1" style="width: 100%; border-collapse: collapse; text-align: center;"> <tr> <td style="width: 10%;"></td> <td style="width: 10%;"></td> <td style="width: 10%;"></td> <td style="width: 10%;"></td> <td style="width: 10%;"></td> <td style="width: 10%;"></td> <td style="width: 10%;"></td> <td style="width: 10%;"></td> <td style="width: 10%;"></td> <td style="width: 10%;"></td> </tr> <tr> <td></td> <td></td> <td colspan="8" style="text-align: center;"> <table border="1" style="width: 100%; border-collapse: collapse; text-align: center;"> <tr> <td style="width: 10%;"></td> <td style="width: 10%;"></td> <td style="width: 10%;"></td> <td style="width: 10%;"></td> <td style="width: 10%;"></td> <td style="width: 10%;"></td> <td style="width: 10%;"></td> <td style="width: 10%;"></td> <td style="width: 10%;"></td> <td style="width: 10%;"></td> </tr> <tr> <td></td> <td></td> <td colspan="8" style="text-align: center;"> <table border="1" style="width: 100%; border-collapse: collapse; text-align: center;"> <tr> <td style="width: 10%;"></td> <td style="width: 10%;"></td> <td style="width: 10%;"></td> <td style="width: 10%;"></td> <td style="width: 10%;"></td> <td style="width: 10%;"></td> <td style="width: 10%;"></td> <td style="width: 10%;"></td> <td style="width: 10%;"></td> <td style="width: 10%;"></td> </tr> <tr> <td></td> <td></td> <td colspan="8" style="text-align: center;"> <table border="1" style="width: 100%; border-collapse: collapse; text-align: center;"> <tr> <td style="width: 10%;"></td> <td style="width: 10%;"></td> <td style="width: 10%;"></td> <td style="width: 10%;"></td> <td style="width: 10%;"></td> <td style="width: 10%;"></td> <td style="width: 10%;"></td> <td style="width: 10%;"></td> <td style="width: 10%;"></td> <td style="width: 10%;"></td> </tr> <tr> <td></td> <td></td> <td colspan="8" style="text-align: center;"> <table border="1" style="width: 100%; border-collapse: collapse; text-align: center;"> <tr> <td style="width: 10%;"></td> <td style="width: 10%;"></td> <td style="width: 10%;"></td> <td style="width: 10%;"></td> <td style="width: 10%;"></td> <td style="width: 10%;"></td> <td style="width: 10%;"></td> <td style="width: 10%;"></td> <td style="width: 10%;"></td> <td style="width: 10%;"></td> </tr> <tr> <td></td> <td></td> <td colspan="8" style="text-align: center;"> <table border="1" style="width: 100%; border-collapse: collapse; text-align: center;"> <tr> <td style="width: 10%;"></td> <td style="width: 10%;"></td> <td style="width: 10%;"></td> <td style="width: 10%;"></td> <td style="width: 10%;"></td> <td style="width: 10%;"></td> <td style="width: 10%;"></td> <td style="width: 10%;"></td> <td style="width: 10%;"></td> <td style="width: 10%;"></td> </tr> <tr> <td></td> <td></td> <td colspan="8" style="text-align: center;"> <table border="1" style="width: 100%; border-collapse: collapse; text-align: center;"> <tr> <td style="width: 10%;"></td> <td style="width: 10%;"></td> <td style="width: 10%;"></td> <td style="width: 10%;"></td> <td style="width: 10%;"></td> <td style="width: 10%;"></td> <td style="width: 10%;"></td> <td style="width: 10%;"></td> <td style="width: 10%;"></td> <td style="width: 10%;"></td> </tr> <tr> <td></td> <td></td> <td colspan="8" style="text-align: center;"> <table border="1" style="width: 100%; border-collapse: collapse; text-align: center;"> <tr> <td style="width: 10%;"></td> <td style="width: 10%;"></td> <td style="width: 10%;"></td> <td style="width: 10%;"></td> <td style="width: 10%;"></td> <td style="width: 10%;"></td> <td style="width: 10%;"></td> <td style="width: 10%;"></td> <td style="width: 10%;"></td> <td style="width: 10%;"></td> </tr> <tr> <td></td> <td></td> <td colspan="8" style="text-align: center;"> <table border="1" style="width: 100%; border-collapse: collapse; text-align: center;"> <tr> <td style="width: 10%;"></td> <td style="width: 10%;"></td> <td style="width: 10%;"></td> <td style="width: 10%;"></td> <td style="width: 10%;"></td> <td style="width: 10%;"></td> <td style="width: 10%;"></td> <td style="width: 10%;"></td> <td style="width: 10%;"></td> <td style="width: 10%;"></td> </tr> <tr> <td></td> <td></td> <td colspan="8" style="text-align: center;"> <table border="1" style="width: 100%; border-collapse: collapse; text-align: center;"> <tr> <td style="width: 10%;"></td> <td style="width: 10%;"></td> <td style="width: 10%;"></td> <td style="width: 10%;"></td> <td style="width: 10%;"></td> <td style="width: 10%;"></td> <td style="width: 10%;"></td> <td style="width: 10%;"></td> <td style="width: 10%;"></td> <td style="width: 10%;"></td> </tr> <tr> <td></td> <td></td> <td colspan="8" style="text-align: center;"> <table border="1" style="width: 100%;
border-collapse: collapse; text-align: center;"> <tr> <td style="width: 10%;"></td> <td style="width: 10%;"></td> <td style="width: 10%;"></td> <td style="width: 10%;"></td> <td style="width: 10%;"></td> <td style="width: 10%;"></td> <td style="width: 10%;"></td> <td style="width: 10%;"></td> <td style="width: 10%;"></td> <td style="width: 10%;"></td> </tr> <tr> <td></td> <td></td> <td colspan="8" style="text-align: center;"> <table border="1" style="width: 100%; border-collapse: collapse; text-align: center;"> <tr> <td style="width: 10%;"></td> <td style="width: 10%;"></td> <td style="width: 10%;"></td> <td style="width: 10%;"></td> <td style="width: 10%;"></td> <td style="width: 10%;"></td> <td style="width: 10%;"></td> <td style="width: 10%;"></td> <td style="width: 10%;"></td> <td style="width: 10%;"></td> </tr> <tr> <td></td> <td></td> <td colspan="8" style="text-align: center;"> <table border="1" style="width: 100%; border-collapse: collapse; text-align: center;"> <tr> <td style="width: 10%;"></td> <td style="width: 10%;"></td> <td style="width: 10%;"></td> <td style="width: 10%;"></td> <td style="width: 10%;"></td> <td style="width: 10%;"></td> <td style="width: 10%;"></td> <td style="width: 10%;"></td> <td style="width: 10%;"></td> <td style="width: 10%;"></td> </tr> <tr> <td></td> <td></td> <td colspan="8" style="text-align: center;"> <table border="1" style="width: 100%; border-collapse: collapse; text-align: center;"> <tr> </tr></table></td></tr></table></td></tr></table></td></tr></table></td></tr></table></td></tr></table></td></tr></table></td></tr></table></td></tr></table></td></tr></table></td></tr></table></td></tr></table></td></tr></table></td></tr></table></td></tr></table>
 | | | | | | | | | | | | | | | | | | | | <table border="1" style="width: 100%; border-collapse: collapse; text-align: center;"> <tr> <td style="width: 10%;"></td> <td style="width: 10%;"></td> <td style="width: 10%;"></td> <td style="width: 10%;"></td> <td style="width: 10%;"></td> <td style="width: 10%;"></td> <td style="width: 10%;"></td> <td style="width: 10%;"></td> <td style="width: 10%;"></td> <td style="width: 10%;"></td> </tr> <tr> <td></td> <td></td> <td colspan="8" style="text-align: center;"> <table border="1" style="width: 100%; border-collapse: collapse; text-align: center;"> <tr> <td style="width: 10%;"></td> <td style="width: 10%;"></td> <td style="width: 10%;"></td> <td style="width: 10%;"></td> <td style="width: 10%;"></td> <td style="width: 10%;"></td> <td style="width: 10%;"></td> <td style="width: 10%;"></td> <td style="width: 10%;"></td> <td style="width: 10%;"></td> </tr> <tr> <td></td> <td></td> <td colspan="8" style="text-align: center;"> <table border="1" style="width: 100%; border-collapse: collapse; text-align: center;"> <tr> <td style="width: 10%;"></td> <td style="width: 10%;"></td> <td style="width: 10%;"></td> <td style="width: 10%;"></td> <td style="width: 10%;"></td> <td style="width: 10%;"></td> <td style="width: 10%;"></td> <td style="width: 10%;"></td> <td style="width: 10%;"></td> <td style="width: 10%;"></td> </tr> <tr> <td></td> <td></td> <td colspan="8" style="text-align: center;"> <table border="1" style="width: 100%; border-collapse: collapse; text-align: center;"> <tr> <td style="width: 10%;"></td> <td style="width: 10%;"></td> <td style="width: 10%;"></td> <td style="width: 10%;"></td> <td style="width: 10%;"></td> <td style="width: 10%;"></td> <td style="width: 10%;"></td> <td style="width: 10%;"></td> <td style="width: 10%;"></td> <td style="width: 10%;"></td> </tr> <tr> <td></td> <td></td> <td colspan="8" style="text-align: center;"> <table border="1" style="width: 100%; border-collapse: collapse; text-align: center;"> <tr> <td style="width: 10%;"></td> <td style="width: 10%;"></td> <td style="width: 10%;"></td> <td style="width: 10%;"></td> <td style="width: 10%;"></td> <td style="width: 10%;"></td> <td style="width: 10%;"></td> <td style="width: 10%;"></td> <td style="width: 10%;"></td> <td style="width: 10%;"></td> </tr> <tr> <td></td> <td></td> <td colspan="8" style="text-align: center;"> <table border="1" style="width: 100%; border-collapse: collapse; text-align: center;"> <tr> <td style="width: 10%;"></td> <td style="width: 10%;"></td> <td style="width: 10%;"></td> <td style="width: 10%;"></td> <td style="width: 10%;"></td> <td style="width: 10%;"></td> <td style="width: 10%;"></td> <td style="width: 10%;"></td> <td style="width: 10%;"></td> <td style="width: 10%;"></td> </tr> <tr> <td></td> <td></td> <td colspan="8" style="text-align: center;"> <table border="1" style="width: 100%; border-collapse: collapse; text-align: center;"> <tr> <td style="width: 10%;"></td> <td style="width: 10%;"></td> <td style="width: 10%;"></td> <td style="width: 10%;"></td> <td style="width: 10%;"></td> <td style="width: 10%;"></td> <td style="width: 10%;"></td> <td style="width: 10%;"></td> <td style="width: 10%;"></td> <td style="width: 10%;"></td> </tr> <tr> <td></td> <td></td> <td colspan="8" style="text-align: center;"> <table border="1" style="width: 100%; border-collapse: collapse; text-align: center;"> <tr> <td style="width: 10%;"></td> <td style="width: 10%;"></td> <td style="width: 10%;"></td> <td style="width: 10%;"></td> <td style="width: 10%;"></td> <td style="width: 10%;"></td> <td style="width: 10%;"></td> <td style="width: 10%;"></td> <td style="width: 10%;"></td> <td style="width: 10%;"></td> </tr> <tr> <td></td> <td></td> <td colspan="8" style="text-align: center;"> <table border="1" style="width: 100%; border-collapse: collapse; text-align: center;"> <tr> <td style="width: 10%;"></td> <td style="width: 10%;"></td> <td style="width: 10%;"></td> <td style="width: 10%;"></td> <td style="width: 10%;"></td> <td style="width: 10%;"></td> <td style="width: 10%;"></td> <td style="width: 10%;"></td> <td style="width: 10%;"></td> <td style="width: 10%;"></td> </tr> <tr> <td></td> <td></td> <td colspan="8" style="text-align: center;"> <table border="1" style="width: 100%; border-collapse: collapse; text-align: center;"> <tr> <td style="width: 10%;"></td> <td style="width: 10%;"></td> <td style="width: 10%;"></td> <td style="width: 10%;"></td> <td style="width: 10%;"></td> <td style="width: 10%;"></td> <td style="width: 10%;"></td> <td style="width: 10%;"></td> <td style="width: 10%;"></td> <td style="width: 10%;"></td> </tr> <tr> <td></td> <td></td> <td colspan="8" style="text-align: center;"> <table border="1" style="width: 100%; border-collapse: collapse; text-align: center;"> <tr> <td style="width: 10%;"></td> <td style="width: 10%;"></td> <td style="width: 10%;"></td> <td style="width: 10%;"></td> <td style="width: 10%;"></td> <td style="width: 10%;"></td> <td style="width: 10%;"></td> <td style="width: 10%;"></td> <td style="width: 10%;"></td> <td style="width: 10%;"></td> </tr> <tr> <td></td> <td></td> <td colspan="8" style="text-align: center;"> <table border="1" style="width: 100%; border-collapse: collapse; text-align: center;"> <tr> <td style="width: 10%;"></td> <td style="width: 10%;"></td> <td style="width: 10%;"></td> <td style="width: 10%;"></td> <td style="width: 10%;"></td> <td style="width: 10%;"></td> <td style="width: 10%;"></td> <td style="width: 10%;"></td> <td style="width: 10%;"></td> <td style="width: 10%;"></td> </tr> <tr> <td></td> <td></td> <td colspan="8" style="text-align: center;"> <table border="1" style="width: 100%; border-collapse: collapse; text-align: center;"> <tr> <td style="width: 10%;"></td> <td style="width: 10%;"></td> <td style="width: 10%;"></td> <td style="width: 10%;"></td> <td style="width: 10%;"></td> <td style="width: 10%;"></td> <td style="width: 10%;"></td> <td style="width: 10%;"></td> <td style="width: 10%;"></td> <td style="width: 10%;"></td> </tr> <tr> <td></td> <td></td> <td colspan="8" style="text-align: center;"> <table border="1" style="width: 100%; border-collapse: collapse; text-align: center;"> <tr> </tr></table></td></tr></table></td></tr></table></td></tr></table></td></tr></table></td></tr></table></td></tr></table></td></tr></table></td></tr></table></td></tr></table></td></tr></table></td></tr></table></td></tr></table></td></tr></table>

 | | | | | | | | | | | | | | | | | | | | <table border="1" style="width: 100%; border-collapse: collapse; text-align: center;"> <tr> <td style="width: 10%;"></td> <td style="width: 10%;"></td> <td style="width: 10%;"></td> <td style="width: 10%;"></td> <td style="width: 10%;"></td> <td style="width: 10%;"></td> <td style="width: 10%;"></td> <td style="width: 10%;"></td> <td style="width: 10%;"></td> <td style="width: 10%;"></td> </tr> <tr> <td></td> <td></td> <td colspan="8" style="text-align: center;"> <table border="1" style="width: 100%; border-collapse: collapse; text-align: center;"> <tr> <td style="width: 10%;"></td> <td style="width: 10%;"></td> <td style="width: 10%;"></td> <td style="width: 10%;"></td> <td style="width: 10%;"></td> <td style="width: 10%;"></td> <td style="width: 10%;"></td> <td style="width: 10%;"></td> <td style="width: 10%;"></td> <td style="width: 10%;"></td> </tr> <tr> <td></td> <td></td> <td colspan="8" style="text-align: center;"> <table border="1" style="width: 100%; border-collapse: collapse; text-align: center;"> <tr> <td style="width: 10%;"></td> <td style="width: 10%;"></td> <td style="width: 10%;"></td> <td style="width: 10%;"></td> <td style="width: 10%;"></td> <td style="width: 10%;"></td> <td style="width: 10%;"></td> <td style="width: 10%;"></td> <td style="width: 10%;"></td> <td style="width: 10%;"></td> </tr> <tr> <td></td> <td></td> <td colspan="8" style="text-align: center;"> <table border="1" style="width: 100%; border-collapse: collapse; text-align: center;"> <tr> <td style="width: 10%;"></td> <td style="width: 10%;"></td> <td style="width: 10%;"></td> <td style="width: 10%;"></td> <td style="width: 10%;"></td> <td style="width: 10%;"></td> <td style="width: 10%;"></td> <td style="width: 10%;"></td> <td style="width: 10%;"></td> <td style="width: 10%;"></td> </tr> <tr> <td></td> <td></td> <td colspan="8" style="text-align: center;"> <table border="1" style="width: 100%; border-collapse: collapse; text-align: center;"> <tr> <td style="width: 10%;"></td> <td style="width: 10%;"></td> <td style="width: 10%;"></td> <td style="width: 10%;"></td> <td style="width: 10%;"></td> <td style="width: 10%;"></td> <td style="width: 10%;"></td> <td style="width: 10%;"></td> <td style="width: 10%;"></td> <td style="width: 10%;"></td> </tr> <tr> <td></td> <td></td> <td colspan="8" style="text-align: center;"> <table border="1" style="width: 100%; border-collapse: collapse; text-align: center;"> <tr> <td style="width: 10%;"></td> <td style="width: 10%;"></td> <td style="width: 10%;"></td> <td style="width: 10%;"></td> <td style="width: 10%;"></td> <td style="width: 10%;"></td> <td style="width: 10%;"></td> <td style="width: 10%;"></td> <td style="width: 10%;"></td> <td style="width: 10%;"></td> </tr> <tr> <td></td> <td></td> <td colspan="8" style="text-align: center;"> <table border="1" style="width: 100%; border-collapse: collapse; text-align: center;"> <tr> <td style="width: 10%;"></td> <td style="width: 10%;"></td> <td style="width: 10%;"></td> <td style="width: 10%;"></td> <td style="width: 10%;"></td> <td style="width: 10%;"></td> <td style="width: 10%;"></td> <td style="width: 10%;"></td> <td style="width: 10%;"></td> <td style="width: 10%;"></td> </tr> <tr> <td></td> <td></td> <td colspan="8" style="text-align: center;"> <table border="1" style="width: 100%; border-collapse: collapse; text-align: center;"> <tr> <td style="width: 10%;"></td> <td style="width: 10%;"></td> <td style="width: 10%;"></td> <td style="width: 10%;"></td> <td style="width: 10%;"></td> <td style="width: 10%;"></td> <td style="width: 10%;"></td> <td style="width: 10%;"></td> <td style="width: 10%;"></td> <td style="width: 10%;"></td> </tr> <tr> <td></td> <td></td> <td colspan="8" style="text-align: center;"> <table border="1" style="width: 100%; border-collapse: collapse; text-align: center;"> <tr> <td style="width: 10%;"></td> <td style="width: 10%;"></td> <td style="width: 10%;"></td> <td style="width: 10%;"></td> <td style="width: 10%;"></td> <td style="width: 10%;"></td> <td style="width: 10%;"></td> <td style="width: 10%;"></td> <td style="width: 10%;"></td> <td style="width: 10%;"></td> </tr> <tr> <td></td> <td></td> <td colspan="8" style="text-align: center;"> <table border="1" style="width: 100%; border-collapse: collapse; text-align: center;"> <tr> <td style="width: 10%;"></td> <td style="width: 10%;"></td> <td style="width: 10%;"></td> <td style="width: 10%;"></td> <td style="width: 10%;"></td> <td style="width: 10%;"></td> <td style="width: 10%;"></td> <td style="width: 10%;"></td> <td style="width: 10%;"></td> <td style="width: 10%;"></td> </tr> <tr> <td></td> <td></td> <td colspan="8" style="text-align: center;"> <table border="1" style="width: 100%; border-collapse: collapse; text-align: center;"> <tr> <td style="width: 10%;"></td> <td style="width: 10%;"></td> <td style="width: 10%;"></td> <td style="width: 10%;"></td> <td style="width: 10%;"></td> <td style="width: 10%;"></td> <td style="width: 10%;"></td> <td style="width: 10%;"></td> <td style="width: 10%;"></td> <td style="width: 10%;"></td> </tr> <tr> <td></td> <td></td> <td colspan="8" style="text-align: center;"> <table border="1" style="width: 100%; border-collapse: collapse; text-align: center;"> <tr> <td style="width: 10%;"></td> <td style="width: 10%;"></td> <td style="width: 10%;"></td> <td style="width: 10%;"></td> <td style="width: 10%;"></td> <td style="width: 10%;"></td> <td style="width: 10%;"></td> <td style="width: 10%;"></td> <td style="width: 10%;"></td> <td style="width: 10%;"></td> </tr> <tr> <td></td> <td></td> <td colspan="8" style="text-align: center;"> <table border="1" style="width: 100%; border-collapse: collapse; text-align: center;"> <tr> </tr></table></td></tr></table></td></tr></table></td></tr></table></td></tr></table></td></tr></table></td></tr></table></td></tr></table></td></tr></table></td></tr></table></td></tr></table></td></tr></table></td></tr></table>
 | | | | | | | | | | | | | | | | | | | | <table border="1" style="width: 100%; border-collapse: collapse; text-align: center;"> <tr> <td style="width: 10%;"></td> <td style="width: 10%;"></td> <td style="width: 10%;"></td> <td style="width: 10%;"></td> <td style="width: 10%;"></td> <td style="width: 10%;"></td> <td style="width: 10%;"></td> <td style="width: 10%;"></td> <td style="width: 10%;"></td> <td style="width: 10%;"></td> </tr> <tr> <td></td> <td></td> <td colspan="8" style="text-align: center;"> <table border="1" style="width: 100%; border-collapse: collapse; text-align: center;"> <tr> <td style="width: 10%;"></td> <td style="width: 10%;"></td> <td style="width: 10%;"></td> <td style="width: 10%;"></td> <td style="width: 10%;"></td> <td style="width: 10%;"></td> <td style="width: 10%;"></td> <td style="width: 10%;"></td> <td style="width: 10%;"></td> <td style="width: 10%;"></td> </tr> <tr> <td></td> <td></td> <td colspan="8" style="text-align: center;"> <table border="1" style="width: 100%; border-collapse: collapse; text-align: center;"> <tr> <td style="width: 10%;"></td> <td style="width: 10%;"></td> <td style="width: 10%;"></td> <td style="width: 10%;"></td> <td style="width: 10%;"></td> <td style="width: 10%;"></td> <td style="width: 10%;"></td> <td style="width: 10%;"></td> <td style="width: 10%;"></td> <td style="width: 10%;"></td> </tr> <tr> <td></td> <td></td> <td colspan="8" style="text-align: center;"> <table border="1" style="width: 100%; border-collapse: collapse; text-align: center;"> <tr> <td style="width: 10%;"></td> <td style="width: 10%;"></td> <td style="width: 10%;"></td> <td style="width: 10%;"></td> <td style="width: 10%;"></td> <td style="width: 10%;"></td> <td style="width: 10%;"></td> <td style="width: 10%;"></td> <td style="width: 10%;"></td> <td style="width: 10%;"></td> </tr> <tr> <td></td> <td></td> <td colspan="8" style="text-align: center;"> <table border="1" style="width: 100%; border-collapse: collapse; text-align: center;"> <tr> <td style="width: 10%;"></td> <td style="width: 10%;"></td> <td style="width: 10%;"></td> <td style="width: 10%;"></td> <td style="width: 10%;"></td> <td style="width: 10%;"></td> <td style="width: 10%;"></td> <td style="width:
10%;"></td> <td style="width: 10%;"></td> <td style="width: 10%;"></td> </tr> <tr> <td></td> <td></td> <td colspan="8" style="text-align: center;"> <table border="1" style="width: 100%; border-collapse: collapse; text-align: center;"> <tr> <td style="width: 10%;"></td> <td style="width: 10%;"></td> <td style="width: 10%;"></td> <td style="width: 10%;"></td> <td style="width: 10%;"></td> <td style="width: 10%;"></td> <td style="width: 10%;"></td> <td style="width: 10%;"></td> <td style="width: 10%;"></td> <td style="width: 10%;"></td> </tr> <tr> <td></td> <td></td> <td colspan="8" style="text-align: center;"> <table border="1" style="width: 100%; border-collapse: collapse; text-align: center;"> <tr> <td style="width: 10%;"></td> <td style="width: 10%;"></td> <td style="width: 10%;"></td> <td style="width: 10%;"></td> <td style="width: 10%;"></td> <td style="width: 10%;"></td> <td style="width: 10%;"></td> <td style="width: 10%;"></td> <td style="width: 10%;"></td> <td style="width: 10%;"></td> </tr> <tr> <td></td> <td></td> <td colspan="8" style="text-align: center;"> <table border="1" style="width: 100%; border-collapse: collapse; text-align: center;"> <tr> <td style="width: 10%;"></td> <td style="width: 10%;"></td> <td style="width: 10%;"></td> <td style="width: 10%;"></td> <td style="width: 10%;"></td> <td style="width: 10%;"></td> <td style="width: 10%;"></td> <td style="width: 10%;"></td> <td style="width: 10%;"></td> <td style="width: 10%;"></td> </tr> <tr> <td></td> <td></td> <td colspan="8" style="text-align: center;"> <table border="1" style="width: 100%; border-collapse: collapse; text-align: center;"> <tr> <td style="width: 10%;"></td> <td style="width: 10%;"></td> <td style="width: 10%;"></td> <td style="width: 10%;"></td> <td style="width: 10%;"></td> <td style="width: 10%;"></td> <td style="width: 10%;"></td> <td style="width: 10%;"></td> <td style="width: 10%;"></td> <td style="width: 10%;"></td> </tr> <tr> <td></td> <td></td> <td colspan="8" style="text-align: center;"> <table border="1" style="width: 100%; border-collapse: collapse; text-align: center;"> <tr> <td style="width: 10%;"></td> <td style="width: 10%;"></td> <td style="width: 10%;"></td> <td style="width: 10%;"></td> <td style="width: 10%;"></td> <td style="width: 10%;"></td> <td style="width: 10%;"></td> <td style="width: 10%;"></td> <td style="width: 10%;"></td> <td style="width: 10%;"></td> </tr> <tr> <td></td> <td></td> <td colspan="8" style="text-align: center;"> <table border="1" style="width: 100%; border-collapse: collapse; text-align: center;"> <tr> <td style="width: 10%;"></td> <td style="width: 10%;"></td> <td style="width: 10%;"></td> <td style="width: 10%;"></td> <td style="width: 10%;"></td> <td style="width: 10%;"></td> <td style="width: 10%;"></td> <td style="width: 10%;"></td> <td style="width: 10%;"></td> <td style="width: 10%;"></td> </tr> <tr> <td></td> <td></td> <td colspan="8" style="text-align: center;"> <table border="1" style="width: 100%; border-collapse: collapse; text-align: center;"> <tr> </tr></table></td></tr></table></td></tr></table></td></tr></table></td></tr></table></td></tr></table></td></tr></table></td></tr></table></td></tr></table></td></tr></table></td></tr></table></td></tr></table>
 | | | | | | | | | | | | | | | | | | | | <table border="1" style="width: 100%; border-collapse: collapse; text-align: center;"> <tr> <td style="width: 10%;"></td> <td style="width: 10%;"></td> <td style="width: 10%;"></td> <td style="width: 10%;"></td> <td style="width: 10%;"></td> <td style="width: 10%;"></td> <td style="width: 10%;"></td> <td style="width: 10%;"></td> <td style="width: 10%;"></td> <td style="width: 10%;"></td> </tr> <tr> <td></td> <td></td> <td colspan="8" style="text-align: center;"> <table border="1" style="width: 100%; border-collapse: collapse; text-align: center;"> <tr> <td style="width: 10%;"></td> <td style="width: 10%;"></td> <td style="width: 10%;"></td> <td style="width: 10%;"></td> <td style="width: 10%;"></td> <td style="width: 10%;"></td> <td style="width: 10%;"></td> <td style="width: 10%;"></td> <td style="width: 10%;"></td> <td style="width: 10%;"></td> </tr> <tr> <td></td> <td></td> <td colspan="8" style="text-align: center;"> <table border="1" style="width: 100%; border-collapse: collapse; text-align: center;"> <tr> <td style="width: 10%;"></td> <td style="width: 10%;"></td> <td style="width: 10%;"></td> <td style="width: 10%;"></td> <td style="width: 10%;"></td> <td style="width: 10%;"></td> <td style="width: 10%;"></td> <td style="width: 10%;"></td> <td style="width: 10%;"></td> <td style="width: 10%;"></td> </tr> <tr> <td></td> <td></td> <td colspan="8" style="text-align: center;"> <table border="1" style="width: 100%; border-collapse: collapse; text-align: center;"> <tr> <td style="width: 10%;"></td> <td style="width: 10%;"></td> <td style="width: 10%;"></td> <td style="width: 10%;"></td> <td style="width: 10%;"></td> <td style="width: 10%;"></td> <td style="width: 10%;"></td> <td style="width: 10%;"></td> <td style="width: 10%;"></td> <td style="width: 10%;"></td> </tr> <tr> <td></td> <td></td> <td colspan="8" style="text-align: center;"> <table border="1" style="width: 100%; border-collapse: collapse; text-align: center;"> <tr> <td style="width: 10%;"></td> <td style="width: 10%;"></td> <td style="width: 10%;"></td> <td style="width: 10%;"></td> <td style="width: 10%;"></td> <td style="width: 10%;"></td> <td style="width: 10%;"></td> <td style="width: 10%;"></td> <td style="width: 10%;"></td> <td style="width: 10%;"></td> </tr> <tr> <td></td> <td></td> <td colspan="8" style="text-align: center;"> <table border="1" style="width: 100%; border-collapse: collapse; text-align: center;"> <tr> <td style="width: 10%;"></td> <td style="width: 10%;"></td> <td style="width: 10%;"></td> <td style="width: 10%;"></td> <td style="width: 10%;"></td> <td style="width: 10%;"></td> <td style="width: 10%;"></td> <td style="width: 10%;"></td> <td style="width: 10%;"></td> <td style="width: 10%;"></td> </tr> <tr> <td></td> <td></td> <td colspan="8" style="text-align: center;"> <table border="1" style="width: 100%; border-collapse: collapse; text-align: center;"> <tr> <td style="width: 10%;"></td> <td style="width: 10%;"></td> <td style="width: 10%;"></td> <td style="width: 10%;"></td> <td style="width: 10%;"></td> <td style="width: 10%;"></td> <td style="width: 10%;"></td> <td style="width: 10%;"></td> <td style="width: 10%;"></td> <td style="width: 10%;"></td> </tr> <tr> <td></td> <td></td> <td colspan="8" style="text-align: center;"> <table border="1" style="width: 100%; border-collapse: collapse; text-align: center;"> <tr> <td style="width: 10%;"></td> <td style="width: 10%;"></td> <td style="width: 10%;"></td> <td style="width: 10%;"></td> <td style="width: 10%;"></td> <td style="width: 10%;"></td> <td style="width: 10%;"></td> <td style="width: 10%;"></td> <td style="width: 10%;"></td> <td style="width: 10%;"></td> </tr> <tr> <td></td> <td></td> <td colspan="8" style="text-align: center;"> <table border="1" style="width: 100%; border-collapse: collapse; text-align: center;"> <tr> <td style="width: 10%;"></td> <td style="width: 10%;"></td> <td style="width: 10%;"></td> <td style="width: 10%;"></td> <td style="width: 10%;"></td> <td style="width: 10%;"></td> <td style="width: 10%;"></td> <td style="width: 10%;"></td> <td style="width: 10%;"></td> <td style="width: 10%;"></td> </tr> <tr> <td></td> <td></td> <td colspan="8" style="text-align: center;"> <table border="1" style="width: 100%; border-collapse: collapse; text-align: center;"> <tr> <td style="width: 10%;"></td> <td style="width: 10%;"></td> <td style="width: 10%;"></td> <td style="width: 10%;"></td> <td style="width: 10%;"></td> <td style="width: 10%;"></td> <td style="width: 10%;"></td> <td style="width: 10%;"></td> <td style="width: 10%;"></td> <td style="width: 10%;"></td> </tr> <tr> <td></td> <td></td> <td colspan="8" style="text-align: center;"> <table border="1" style="width: 100%; border-collapse: collapse; text-align: center;"> <tr> </tr></table></td></tr></table></td></tr></table></td></tr></table></td></tr></table></td></tr></table></td></tr></table></td></tr></table></td></tr></table></td></tr></table></td></tr></table>

 | | | | | | | | | | | | | | | | | | | | <table border="1" style="width: 100%; border-collapse: collapse; text-align: center;"> <tr> <td style="width: 10%;"></td> <td style="width: 10%;"></td> <td style="width: 10%;"></td> <td style="width: 10%;"></td> <td style="width: 10%;"></td> <td style="width: 10%;"></td> <td style="width: 10%;"></td> <td style="width: 10%;"></td> <td style="width: 10%;"></td> <td style="width: 10%;"></td> </tr> <tr> <td></td> <td></td> <td colspan="8" style="text-align: center;"> <table border="1" style="width: 100%; border-collapse: collapse; text-align: center;"> <tr> <td style="width: 10%;"></td> <td style="width: 10%;"></td> <td style="width: 10%;"></td> <td style="width: 10%;"></td> <td style="width: 10%;"></td> <td style="width: 10%;"></td> <td style="width: 10%;"></td> <td style="width: 10%;"></td> <td style="width: 10%;"></td> <td style="width: 10%;"></td> </tr> <tr> <td></td> <td></td> <td colspan="8" style="text-align: center;"> <table border="1" style="width: 100%; border-collapse: collapse; text-align: center;"> <tr> <td style="width: 10%;"></td> <td style="width: 10%;"></td> <td style="width: 10%;"></td> <td style="width: 10%;"></td> <td style="width: 10%;"></td> <td style="width: 10%;"></td> <td style="width: 10%;"></td> <td style="width: 10%;"></td> <td style="width: 10%;"></td> <td style="width: 10%;"></td> </tr> <tr> <td></td> <td></td> <td colspan="8" style="text-align: center;"> <table border="1" style="width: 100%; border-collapse: collapse; text-align: center;"> <tr> <td style="width: 10%;"></td> <td style="width: 10%;"></td> <td style="width: 10%;"></td> <td style="width: 10%;"></td> <td style="width: 10%;"></td> <td style="width: 10%;"></td> <td style="width: 10%;"></td> <td style="width: 10%;"></td> <td style="width: 10%;"></td> <td style="width: 10%;"></td> </tr> <tr> <td></td> <td></td> <td colspan="8" style="text-align: center;"> <table border="1" style="width: 100%; border-collapse: collapse; text-align: center;"> <tr> <td style="width: 10%;"></td> <td style="width: 10%;"></td> <td style="width: 10%;"></td> <td style="width: 10%;"></td> <td style="width: 10%;"></td> <td style="width: 10%;"></td> <td style="width: 10%;"></td> <td style="width: 10%;"></td> <td style="width: 10%;"></td> <td style="width: 10%;"></td> </tr> <tr> <td></td> <td></td> <td colspan="8" style="text-align: center;"> <table border="1" style="width: 100%; border-collapse: collapse; text-align: center;"> <tr> <td style="width: 10%;"></td> <td style="width: 10%;"></td> <td style="width: 10%;"></td> <td style="width: 10%;"></td> <td style="width: 10%;"></td> <td style="width: 10%;"></td> <td style="width: 10%;"></td> <td style="width: 10%;"></td> <td style="width: 10%;"></td> <td style="width: 10%;"></td> </tr> <tr> <td></td> <td></td> <td colspan="8" style="text-align: center;"> <table border="1" style="width: 100%; border-collapse: collapse; text-align: center;"> <tr> <td style="width: 10%;"></td> <td style="width: 10%;"></td> <td style="width: 10%;"></td> <td style="width: 10%;"></td> <td style="width: 10%;"></td> <td style="width: 10%;"></td> <td style="width: 10%;"></td> <td style="width: 10%;"></td> <td style="width: 10%;"></td> <td style="width: 10%;"></td> </tr> <tr> <td></td> <td></td> <td colspan="8" style="text-align: center;"> <table border="1" style="width: 100%; border-collapse: collapse; text-align: center;"> <tr> <td style="width: 10%;"></td> <td style="width: 10%;"></td> <td style="width: 10%;"></td> <td style="width: 10%;"></td> <td style="width: 10%;"></td> <td style="width: 10%;"></td> <td style="width: 10%;"></td> <td style="width: 10%;"></td> <td style="width: 10%;"></td> <td style="width: 10%;"></td> </tr> <tr> <td></td> <td></td> <td colspan="8" style="text-align: center;"> <table border="1" style="width: 100%; border-collapse: collapse; text-align: center;"> <tr> <td style="width: 10%;"></td> <td style="width: 10%;"></td> <td style="width: 10%;"></td> <td style="width: 10%;"></td> <td style="width: 10%;"></td> <td style="width: 10%;"></td> <td style="width: 10%;"></td> <td style="width: 10%;"></td> <td style="width: 10%;"></td> <td style="width: 10%;"></td> </tr> <tr> <td></td> <td></td> <td colspan="8" style="text-align: center;"> <table border="1" style="width: 100%; border-collapse: collapse; text-align: center;"> <tr> </tr></table></td></tr></table></td></tr></table></td></tr></table></td></tr></table></td></tr></table></td></tr></table></td></tr></table></td></tr></table></td></tr></table>
 | | | | | | | | | | | | | | | | | | | | <table border="1" style="width: 100%; border-collapse: collapse; text-align: center;"> <tr> <td style="width: 10%;"></td> <td style="width: 10%;"></td> <td style="width: 10%;"></td> <td style="width: 10%;"></td> <td style="width: 10%;"></td> <td style="width: 10%;"></td> <td style="width: 10%;"></td> <td style="width: 10%;"></td> <td style="width: 10%;"></td> <td style="width: 10%;"></td> </tr> <tr> <td></td> <td></td> <td colspan="8" style="text-align: center;"> <table border="1" style="width: 100%; border-collapse: collapse; text-align: center;"> <tr> <td style="width: 10%;"></td> <td style="width: 10%;"></td> <td style="width: 10%;"></td> <td style="width: 10%;"></td> <td style="width: 10%;"></td> <td style="width: 10%;"></td> <td style="width: 10%;"></td> <td style="width: 10%;"></td> <td style="width: 10%;"></td> <td style="width: 10%;"></td> </tr> <tr> <td></td> <td></td> <td colspan="8" style="text-align: center;"> <table border="1" style="width: 100%; border-collapse: collapse; text-align: center;"> <tr> <td style="width: 10%;"></td> <td style="width: 10%;"></td> <td style="width: 10%;"></td> <td style="width: 10%;"></td> <td style="width: 10%;"></td> <td style="width: 10%;"></td> <td style="width: 10%;"></td> <td style="width: 10%;"></td> <td style="width: 10%;"></td> <td style="width: 10%;"></td> </tr> <tr> <td></td> <td></td> <td colspan="8" style="text-align: center;"> <table border="1" style="width: 100%; border-collapse: collapse; text-align: center;"> <tr> <td style="width: 10%;"></td> <td style="width: 10%;"></td> <td style="width: 10%;"></td> <td style="width: 10%;"></td> <td style="width: 10%;"></td> <td style="width: 10%;"></td> <td style="width: 10%;"></td> <td style="width: 10%;"></td> <td style="width: 10%;"></td> <td style="width: 10%;"></td> </tr> <tr> <td></td> <td></td> <td colspan="8" style="text-align: center;"> <table border="1" style="width: 100%; border-collapse: collapse; text-align: center;"> <tr> <td style="width: 10%;"></td> <td style="width: 10%;"></td> <td style="width: 10%;"></td> <td style="width: 10%;"></td> <td style="width: 10%;"></td> <td style="width: 10%;"></td> <td style="width: 10%;"></td> <td style="width: 10%;"></td> <td style="width: 10%;"></td> <td style="width: 10%;"></td> </tr> <tr> <td></td> <td></td> <td colspan="8" style="text-align: center;"> <table border="1" style="width: 100%; border-collapse: collapse; text-align: center;"> <tr> <td style="width: 10%;"></td> <td style="width: 10%;"></td> <td style="width: 10%;"></td> <td style="width: 10%;"></td> <td style="width: 10%;"></td> <td style="width: 10%;"></td> <td style="width: 10%;"></td> <td style="width: 10%;"></td> <td style="width: 10%;"></td> <td style="width: 10%;"></td> </tr> <tr> <td></td> <td></td> <td colspan="8" style="text-align: center;"> <table border="1" style="width: 100%; border-collapse: collapse; text-align: center;"> <tr> <td style="width: 10%;"></td> <td style="width: 10%;"></td> <td style="width: 10%;"></td> <td style="width: 10%;"></td> <td style="width: 10%;"></td> <td style="width: 10%;"></td> <td style="width: 10%;"></td> <td style="width: 10%;"></td> <td style="width: 10%;"></td> <td style="width: 10%;"></td> </tr> <tr> <td></td> <td></td> <td colspan="8" style="text-align: center;"> <table border="1" style="width: 100%; border-collapse: collapse; text-align: center;"> <tr> <td style="width: 10%;"></td> <td style="width: 10%;"></td> <td style="width: 10%;"></td> <td style="width: 10%;"></td> <td style="width: 10%;"></td> <td style="width: 10%;"></td> <td style="width: 10%;"></td> <td
style="width: 10%;"></td> <td style="width: 10%;"></td> <td style="width: 10%;"></td> </tr> <tr> <td></td> <td></td> <td colspan="8" style="text-align: center;"> <table border="1" style="width: 100%; border-collapse: collapse; text-align: center;"> <tr> </tr></table></td></tr></table></td></tr></table></td></tr></table></td></tr></table></td></tr></table></td></tr></table></td></tr></table></td></tr></table>
 | | | | | | | | | | | | | | | | | | | | <table border="1" style="width: 100%; border-collapse: collapse; text-align: center;"> <tr> <td style="width: 10%;"></td> <td style="width: 10%;"></td> <td style="width: 10%;"></td> <td style="width: 10%;"></td> <td style="width: 10%;"></td> <td style="width: 10%;"></td> <td style="width: 10%;"></td> <td style="width: 10%;"></td> <td style="width: 10%;"></td> <td style="width: 10%;"></td> </tr> <tr> <td></td> <td></td> <td colspan="8" style="text-align: center;"> <table border="1" style="width: 100%; border-collapse: collapse; text-align: center;"> <tr> <td style="width: 10%;"></td> <td style="width: 10%;"></td> <td style="width: 10%;"></td> <td style="width: 10%;"></td> <td style="width: 10%;"></td> <td style="width: 10%;"></td> <td style="width: 10%;"></td> <td style="width: 10%;"></td> <td style="width: 10%;"></td> <td style="width: 10%;"></td> </tr> <tr> <td></td> <td></td> <td colspan="8" style="text-align: center;"> <table border="1" style="width: 100%; border-collapse: collapse; text-align: center;"> <tr> <td style="width: 10%;"></td> <td style="width: 10%;"></td> <td style="width: 10%;"></td> <td style="width: 10%;"></td> <td style="width: 10%;"></td> <td style="width: 10%;"></td> <td style="width: 10%;"></td> <td style="width: 10%;"></td> <td style="width: 10%;"></td> <td style="width: 10%;"></td> </tr> <tr> <td></td> <td></td> <td colspan="8" style="text-align: center;"> <table border="1" style="width: 100%; border-collapse: collapse; text-align: center;"> <tr> <td style="width: 10%;"></td> <td style="width: 10%;"></td> <td style="width: 10%;"></td> <td style="width: 10%;"></td> <td style="width: 10%;"></td> <td style="width: 10%;"></td> <td style="width: 10%;"></td> <td style="width: 10%;"></td> <td style="width: 10%;"></td> <td style="width: 10%;"></td> </tr> <tr> <td></td> <td></td> <td colspan="8" style="text-align: center;"> <table border="1" style="width: 100%; border-collapse: collapse; text-align: center;"> <tr> <td style="width: 10%;"></td> <td style="width: 10%;"></td> <td style="width: 10%;"></td> <td style="width: 10%;"></td> <td style="width: 10%;"></td> <td style="width: 10%;"></td> <td style="width: 10%;"></td> <td style="width: 10%;"></td> <td style="width: 10%;"></td> <td style="width: 10%;"></td> </tr> <tr> <td></td> <td></td> <td colspan="8" style="text-align: center;"> <table border="1" style="width: 100%; border-collapse: collapse; text-align: center;"> <tr> <td style="width: 10%;"></td> <td style="width: 10%;"></td> <td style="width: 10%;"></td> <td style="width: 10%;"></td> <td style="width: 10%;"></td> <td style="width: 10%;"></td> <td style="width: 10%;"></td> <td style="width: 10%;"></td> <td style="width: 10%;"></td> <td style="width: 10%;"></td> </tr> <tr> <td></td> <td></td> <td colspan="8" style="text-align: center;"> <table border="1" style="width: 100%; border-collapse: collapse; text-align: center;"> <tr> <td style="width: 10%;"></td> <td style="width: 10%;"></td> <td style="width: 10%;"></td> <td style="width: 10%;"></td> <td style="width: 10%;"></td> <td style="width: 10%;"></td> <td style="width: 10%;"></td> <td style="width: 10%;"></td> <td style="width: 10%;"></td> <td style="width: 10%;"></td> </tr> <tr> <td></td> <td></td> <td colspan="8" style="text-align: center;"> <table border="1" style="width: 100%; border-collapse: collapse; text-align: center;"> <tr> </tr></table></td></tr></table></td></tr></table></td></tr></table></td></tr></table></td></tr></table></td></tr></table></td></tr></table>
 | | | | | | | | | | | | | | | | | | | | <table border="1" style="width: 100%; border-collapse: collapse; text-align: center;"> <tr> <td style="width: 10%;"></td> <td style="width: 10%;"></td> <td style="width: 10%;"></td> <td style="width: 10%;"></td> <td style="width: 10%;"></td> <td style="width: 10%;"></td> <td style="width: 10%;"></td> <td style="width: 10%;"></td> <td style="width: 10%;"></td> <td style="width: 10%;"></td> </tr> <tr> <td></td> <td></td> <td colspan="8" style="text-align: center;"> <table border="1" style="width: 100%; border-collapse: collapse; text-align: center;"> <tr> <td style="width: 10%;"></td> <td style="width: 10%;"></td> <td style="width: 10%;"></td> <td style="width: 10%;"></td> <td style="width: 10%;"></td> <td style="width: 10%;"></td> <td style="width: 10%;"></td> <td style="width: 10%;"></td> <td style="width: 10%;"></td> <td style="width: 10%;"></td> </tr> <tr> <td></td> <td></td> <td colspan="8" style="text-align: center;"> <table border="1" style="width: 100%; border-collapse: collapse; text-align: center;"> <tr> <td style="width: 10%;"></td> <td style="width: 10%;"></td> <td style="width: 10%;"></td> <td style="width: 10%;"></td> <td style="width: 10%;"></td> <td style="width: 10%;"></td> <td style="width: 10%;"></td> <td style="width: 10%;"></td> <td style="width: 10%;"></td> <td style="width: 10%;"></td> </tr> <tr> <td></td> <td></td> <td colspan="8" style="text-align: center;"> <table border="1" style="width: 100%; border-collapse: collapse; text-align: center;"> <tr> <td style="width: 10%;"></td> <td style="width: 10%;"></td> <td style="width: 10%;"></td> <td style="width: 10%;"></td> <td style="width: 10%;"></td> <td style="width: 10%;"></td> <td style="width: 10%;"></td> <td style="width: 10%;"></td> <td style="width: 10%;"></td> <td style="width: 10%;"></td> </tr> <tr> <td></td> <td></td> <td colspan="8" style="text-align: center;"> <table border="1" style="width: 100%; border-collapse: collapse; text-align: center;"> <tr> <td style="width: 10%;"></td> <td style="width: 10%;"></td> <td style="width: 10%;"></td> <td style="width: 10%;"></td> <td style="width: 10%;"></td> <td style="width: 10%;"></td> <td style="width: 10%;"></td> <td style="width: 10%;"></td> <td style="width: 10%;"></td> <td style="width: 10%;"></td> </tr> <tr> <td></td> <td></td> <td colspan="8" style="text-align: center;"> <table border="1" style="width: 100%; border-collapse: collapse; text-align: center;"> <tr> <td style="width: 10%;"></td> <td style="width: 10%;"></td> <td style="width: 10%;"></td> <td style="width: 10%;"></td> <td style="width: 10%;"></td> <td style="width: 10%;"></td> <td style="width: 10%;"></td> <td style="width: 10%;"></td> <td style="width: 10%;"></td> <td style="width: 10%;"></td> </tr> <tr> <td></td> <td></td> <td colspan="8" style="text-align: center;"> <table border="1" style="width: 100%; border-collapse: collapse; text-align: center;"> <tr> </tr></table></td></tr></table></td></tr></table></td></tr></table></td></tr></table></td></tr></table></td></tr></table>

 | | | | | | | | | | | | | | | | | | | | <table border="1" style="width: 100%; border-collapse: collapse; text-align: center;"> <tr> <td style="width: 10%;"></td> <td style="width: 10%;"></td> <td style="width: 10%;"></td> <td style="width: 10%;"></td> <td style="width: 10%;"></td> <td style="width: 10%;"></td> <td style="width: 10%;"></td> <td style="width: 10%;"></td> <td style="width: 10%;"></td> <td style="width: 10%;"></td> </tr> <tr> <td></td> <td></td> <td colspan="8" style="text-align: center;"> <table border="1" style="width: 100%; border-collapse: collapse; text-align: center;"> <tr> <td style="width: 10%;"></td> <td style="width: 10%;"></td> <td style="width: 10%;"></td> <td style="width: 10%;"></td> <td style="width: 10%;"></td> <td style="width: 10%;"></td> <td style="width: 10%;"></td> <td style="width: 10%;"></td> <td style="width: 10%;"></td> <td style="width: 10%;"></td> </tr> <tr> <td></td> <td></td> <td colspan="8" style="text-align: center;"> <table border="1" style="width: 100%; border-collapse: collapse; text-align: center;"> <tr> <td style="width: 10%;"></td> <td style="width: 10%;"></td> <td style="width: 10%;"></td> <td style="width: 10%;"></td> <td style="width: 10%;"></td> <td style="width: 10%;"></td> <td style="width: 10%;"></td> <td style="width: 10%;"></td> <td style="width: 10%;"></td> <td style="width: 10%;"></td> </tr> <tr> <td></td> <td></td> <td colspan="8" style="text-align: center;"> <table border="1" style="width: 100%; border-collapse: collapse; text-align: center;"> <tr> <td style="width: 10%;"></td> <td style="width: 10%;"></td> <td style="width: 10%;"></td> <td style="width: 10%;"></td> <td style="width: 10%;"></td> <td style="width: 10%;"></td> <td style="width: 10%;"></td> <td style="width: 10%;"></td> <td style="width: 10%;"></td> <td style="width: 10%;"></td> </tr> <tr> <td></td> <td></td> <td colspan="8" style="text-align: center;"> <table border="1" style="width: 100%; border-collapse: collapse; text-align: center;"> <tr> <td style="width: 10%;"></td> <td style="width: 10%;"></td> <td style="width: 10%;"></td> <td style="width: 10%;"></td> <td style="width: 10%;"></td> <td style="width: 10%;"></td> <td style="width: 10%;"></td> <td style="width: 10%;"></td> <td style="width: 10%;"></td> <td style="width: 10%;"></td> </tr> <tr> <td></td> <td></td> <td colspan="8" style="text-align: center;"> <table border="1" style="width: 100%; border-collapse: collapse; text-align: center;"> <tr> </tr></table></td></tr></table></td></tr></table></td></tr></table></td></tr></table></td></tr></table>
 | | | | | | | | | | | | | | | | | | | | <table border="1" style="width: 100%; border-collapse: collapse; text-align: center;"> <tr> <td style="width: 10%;"></td> <td style="width: 10%;"></td> <td style="width: 10%;"></td> <td style="width: 10%;"></td> <td style="width: 10%;"></td> <td style="width: 10%;"></td> <td style="width: 10%;"></td> <td style="width: 10%;"></td> <td style="width: 10%;"></td> <td style="width: 10%;"></td> </tr> <tr> <td></td> <td></td> <td colspan="8" style="text-align: center;"> <table border="1" style="width: 100%; border-collapse: collapse; text-align: center;"> <tr> <td style="width: 10%;"></td> <td style="width: 10%;"></td> <td style="width: 10%;"></td> <td style="width: 10%;"></td> <td style="width: 10%;"></td> <td style="width: 10%;"></td> <td style="width: 10%;"></td> <td style="width: 10%;"></td> <td style="width: 10%;"></td> <td style="width: 10%;"></td> </tr> <tr> <td></td> <td></td> <td colspan="8" style="text-align: center;"> <table border="1" style="width: 100%; border-collapse: collapse; text-align: center;"> <tr> <td style="width: 10%;"></td> <td style="width: 10%;"></td> <td style="width: 10%;"></td> <td style="width: 10%;"></td> <td style="width: 10%;"></td> <td style="width: 10%;"></td> <td style="width: 10%;"></td> <td style="width: 10%;"></td> <td style="width: 10%;"></td> <td style="width: 10%;"></td> </tr> <tr> <td></td> <td></td> <td colspan="8" style="text-align: center;"> <table border="1" style="width: 100%; border-collapse: collapse; text-align: center;"> <tr> <td style="width: 10%;"></td> <td style="width: 10%;"></td> <td style="width: 10%;"></td> <td style="width: 10%;"></td> <td style="width: 10%;"></td> <td style="width: 10%;"></td> <td style="width: 10%;"></td> <td style="width: 10%;"></td> <td style="width: 10%;"></td> <td style="width: 10%;"></td> </tr> <tr> <td></td> <td></td> <td colspan="8" style="text-align: center;"> <table border="1" style="width: 100%; border-collapse: collapse; text-align: center;"> <tr> </tr></table></td></tr></table></td></tr></table></td></tr></table></td></tr></table>
 | | | | | | | | | | | | | | | | | | | | <table border="1" style="width: 100%; border-collapse: collapse; text-align: center;"> <tr> <td style="width: 10%;"></td> <td style="width: 10%;"></td> <td style="width: 10%;"></td> <td style="width: 10%;"></td> <td style="width: 10%;"></td> <td style="width: 10%;"></td> <td style="width: 10%;"></td> <td style="width: 10%;"></td> <td style="width: 10%;"></td> <td style="width: 10%;"></td> </tr> <tr> <td></td> <td></td> <td colspan="8" style="text-align: center;"> <table border="1" style="width: 100%; border-collapse: collapse; text-align: center;"> <tr> <td style="width: 10%;"></td> <td style="width: 10%;"></td> <td style="width: 10%;"></td> <td style="width: 10%;"></td> <td style="width: 10%;"></td> <td style="width: 10%;"></td> <td style="width: 10%;"></td> <td style="width: 10%;"></td> <td style="width: 10%;"></td> <td style="width: 10%;"></td> </tr> <tr> <td></td> <td></td> <td colspan="8" style="text-align: center;"> <table border="1" style="width: 100%; border-collapse: collapse; text-align: center;"> <tr> <td style="width: 10%;"></td> <td style="width: 10%;"></td> <td style="width: 10%;"></td> <td style="width: 10%;"></td> <td style="width: 10%;"></td> <td style="width: 10%;"></td> <td style="width: 10%;"></td> <td style="width: 10%;"></td> <td style="width: 10%;"></td> <td style="width: 10%;"></td> </tr> <tr> <td></td> <td></td> <td colspan="8" style="text-align: center;"> <table border="1" style="width: 100%; border-collapse: collapse; text-align: center;"> <tr> </tr></table></td></tr></table></td></tr></table></td></tr></table>

 | | | | | | | | | | | | | | | | | | | | <table border="1" style="width: 100%; border-collapse: collapse; text-align: center;"> <tr> <td style="width: 10%;"></td> <td style="width: 10%;"></td> <td style="width: 10%;"></td> <td style="width: 10%;"></td> <td style="width: 10%;"></td> <td style="width: 10%;"></td> <td style="width: 10%;"></td> <td style="width: 10%;"></td> <td style="width: 10%;"></td> <td style="width: 10%;"></td> </tr> <tr> <td></td> <td></td> <td colspan="8" style="text-align: center;"> <table border="1" style="width: 100%; border-collapse: collapse; text-align: center;"> <tr> <td style="width: 10%;"></td> <td style="width: 10%;"></td> <td style="width: 10%;"></td> <td style="width: 10%;"></td> <td style="width: 10%;"></td> <td style="width: 10%;"></td> <td style="width: 10%;"></td> <td style="width: 10%;"></td> <td style="width: 10%;"></td> <td style="width: 10%;"></td> </tr> <tr> <td></td> <td></td> <td colspan="8" style="text-align: center;"> <table border="1" style="width: 100%; border-collapse: collapse; text-align: center;"> <tr> </tr></table></td></tr></table></td></tr></table>
 | | | | | | | | | | | | | | | | | | | | <table border="1" style="width: 100%; border-collapse: collapse; text-align: center;"> <tr> <td style="width: 10%;"></td> <td style="width: 10%;"></td> <td style="width: 10%;"></td> <td style="width: 10%;"></td> <td style="width: 10%;"></td> <td style="width: 10%;"></td> <td style="width: 10%;"></td> <td style="width: 10%;"></td> <td style="width: 10%;"></td> <td style="width: 10%;"></td> </tr> <tr> <td></td> <td></td> <td colspan="8" style="text-align: center;"> <table border="1" style="width: 100%; border-collapse: collapse; text-align: center;"> <tr> </tr></table></td></tr></table>
 | | | | | | | | | | | | | | | | | | | | <table border="1" style="width: 100%; border-collapse: collapse; text-align: center;"> <tr> </tr></table>
 | | | | | | | | | | | | | | | | | | | | | | | | | | | | | | | | | | | | | | | | | | | | | | | | | | | | | | | | | | | | | | | | | | | | | | | | | | | | | | | |
 | | | | | | | | | | | | | | | | | | | |
 | | | | | | | | | | | | | | | | | | | |
 | | | | | | | | | | | | | | | | | | | |
 | | | | | | | | | | | | | | | | | | | |
 | | | | | | | | | | | | | | | | | | | |
 | | | | | | | | | | | | | | | | | | | |
 | | | | | | | | | | | | | | | | | | | | | | | | | | | | | | | | | | | | | | | |
 | | | | | | | | | | | | | | | | | | | |
 | | | | | | | | | | | | | | | | | | | | | | | | | | | | | | | | | | | | | | | |
 | | | | | | | | | | | | | | | | | | | | | | | | | | | | | | | | | | | | | | | |
 | | | | | | | | | | | | | | | | | | | | | | | | | | | | | | | | | | | | | | | |
 | | | | | | | | | | | | | | | | | | | | | | | | | | | | | | | | | | | | | | | | | | | | | | | | | | | | | | | | | | | | | | | | | | | | | | | | | | | | | | | |
 | | | | | | | | | | | | | | | | | | | | | | | | | | | | | | | | | | | | | | | | | | | | | | | | | | | | | | | | | | | | | | | | | | | |
| | |

 | | | | | | | | | | | | | | | | | | | |

 | | | | | | | | | | | | | | | | | | | |

 | | | | | | | | | | | | | | | | | | | |

 | | | | | | | | | | | | | | | | | | | |

 | | | | | | | | | | | | | | | | | | | |

 | | | | | | | | | | | | | | | | | | | |

 | | | | | | | | | | | | | | | | | | | |

 | | | | | | | | | | | | | | | | | | | |

 | | | | | | | | | | | | | | | | | | | |

 | | | | | | | | | | | | | | | | | | | |

 | | | | | | | | | | | | | | | | | | | |

 | | | | | | | | | | | | | | | | | | | |

 | | | | | | | | | | | | | | | | | | | |

 | | | | | | | | | | | | | | | | | | | |

 | | | | | | | | | | | | | | | | | | | |

 | | | | | | | | | | | | | | | | | | | |

 | | | | | | | | | | | | | | | | | | | |

 | | | | | | | | | | | | | | | | | | | |

 | | | | | | | | | | | | | | | | | | | |

 | | | | | | | | | | | | | | | | | | | |

 | | | | | | | | | | | | | | | | | | | |

 | | | | | | | | | | | | | | | | | | | |

 | | | | | | | | | | | | | | | | | | | |

 | | | | | | | | | | | | | | | | | | | |

 | | | | | | | | | | | | | | | | | | | |

 | | | | | | | | | | | | | | | | | | | |

 | | | | | | | | | | | | | | | | | | | |

 | | | | | | | | | | | | | | | | | | | |
 | | | | | | | | | | | | | | | | | | | |

 | | | | | | | | | | | | | | | | | | | |

 | | | | | | | | | | | | | | | | | | | |
 | | | | | | | | | | | | | | | | | | | |

 | | | | | | | | | | | | | | | | | | | |

 | | | | | | | | | | | | | | | | | | | |
 | | | | | | | | | | | | | | | | | | | |
 | | | | | | | | | | | | | | | | | | | |

 | | | | | | | | | | | | | | | | | | | |
 | | | | | | | | | | | | | | | | | | | |
 | | | | | | | | | | | | | | | | | | | |

 | | | | | | | | | | | | | | | | | | | | | | | | | | | | | | | | | | | | | | | | | | | | | | | | | | | | | | | | | | | | | | | | | | | | | | | | | | | | | | | | | | | | | | | | | | | | | | | | | | | |
 | | | | | | | | | | | | | | | | | | | |
 | | | | | | | | | | | | | | | | | | | |
 | | | | | | | | | | | | | | | | | | | |
 | | | | | | | | | | | | | | | | | | | |
 | | | | | | | | | | | | | | | | | | | |
 | | | | | | | | | | | | | | | | | | | |
 | | | | | | | | | | | | | | | | | | | |
 | | | | | | | | | | | | | | | | | | | |
 | | | | | | | | | | | | | | | | | | | | | | | | | | | | | | | | | | | | | | | |
 | | | | | | | | | | | | | | | | | | | |
 | | | | | | | | | | | | | | | | | | | | | | | | | | | | | | | | | | | | | | | |
 | | | | | | | | | | | | | | | | | | | | | | | | | | | | | | | | | | | | | | | |
 | | | | | | | | | | | | | | | | | | | | | | | | | | | | | | | | | | | | | | | |
 | | | | | | | | | | | | | | | | | | | | | | | | | | | | | | | | | | | | | | | | | | | | | | | | | | | | | | | | | | | | | | | | | | | | | | | | | | | | | | | | | | | | | | | | | | | | | | | | | | | |
 | | | | | | | | | | | | | | | | | | | | | | | | | | | | | | | | | | | | | | | | | | | | | | | |
| | | <table border="1" style="width: 100%; border-collapse: collapse; text-align: center;"> <tr> <td style="width: 10%;"></td> <td style="width: 10%;"></td> <td style="width: 10%;"></td> <td style="width: 10%;"></td> <td style="width: 10%;"></td> <td style="width: 10%;"></td> <td style="width: 10%;"></td> <td style="width: 10%;"></td> <td style="width: 10%;"></td> <td style="width: 10%;"></td> </tr> <tr> <td></td> <td></td> <td colspan="8" style="text-align: center;"> <table border="1" style="width: 100%; border-collapse: collapse; text-align: center;"> <tr> <td style="width: 10%;"></td> <td style="width: 10%;"></td> <td style="width: 10%;"></td> <td style="width: 10%;"></td> <td style="width: 10%;"></td> <td style="width: 10%;"></td> <td style="width: 10%;"></td> <td style="width: 10%;"></td> <td style="width: 10%;"></td> <td style="width: 10%;"></td> </tr> <tr> <td></td> <td></td> <td colspan="8" style="text-align: center;"> <table border="1" style="width: 100%; border-collapse: collapse; text-align: center;"> <tr> <td style="width: 10%;"></td> <td style="width: 10%;"></td> <td style="width: 10%;"></td> <td style="width: 10%;"></td> <td style="width: 10%;"></td> <td style="width: 10%;"></td> <td style="width: 10%;"></td> <td style="width: 10%;"></td> <td style="width: 10%;"></td> <td style="width: 10%;"></td> </tr> <tr> <td></td> <td></td> <td colspan="8" style="text-align: center;"> <table border="1" style="width: 100%; border-collapse: collapse; text-align: center;"> <tr> <td style="width: 10%;"></td> <td style="width: 10%;"></td> <td style="width: 10%;"></td> <td style="width: 10%;"></td> <td style="width: 10%;"></td> <td style="width: 10%;"></td> <td style="width: 10%;"></td> <td style="width: 10%;"></td> <td style="width: 10%;"></td> <td style="width: 10%;"></td> </tr> <tr> <td></td> <td></td> <td colspan="8" style="text-align: center;"> <table border="1" style="width: 100%; border-collapse: collapse; text-align: center;"> <tr> <td style="width: 10%;"></td> <td style="width: 10%;"></td> <td style="width: 10%;"></td> <td style="width: 10%;"></td> <td style="width: 10%;"></td> <td style="width: 10%;"></td> <td style="width: 10%;"></td> <td style="width: 10%;"></td> <td style="width: 10%;"></td> <td style="width: 10%;"></td> </tr> <tr> <td></td> <td></td> <td colspan="8" style="text-align: center;"> <table border="1" style="width: 100%; border-collapse: collapse; text-align: center;"> <tr> <td style="width: 10%;"></td> <td style="width: 10%;"></td> <td style="width: 10%;"></td> <td style="width: 10%;"></td> <td style="width: 10%;"></td> <td style="width: 10%;"></td> <td style="width: 10%;"></td> <td style="width: 10%;"></td> <td style="width: 10%;"></td> <td style="width: 10%;"></td> </tr> <tr> <td></td> <td></td> <td colspan="8" style="text-align: center;"> <table border="1" style="width: 100%; border-collapse: collapse; text-align: center;"> <tr> <td style="width: 10%;"></td> <td style="width: 10%;"></td> <td style="width: 10%;"></td> <td style="width: 10%;"></td> <td style="width: 10%;"></td> <td style="width: 10%;"></td> <td style="width: 10%;"></td> <td style="width: 10%;"></td> <td style="width: 10%;"></td> <td style="width: 10%;"></td> </tr> <tr> <td></td> <td></td> <td colspan="8" style="text-align: center;"> <table border="1" style="width: 100%; border-collapse: collapse; text-align: center;"> <tr> <td style="width: 10%;"></td> <td style="width: 10%;"></td> <td style="width: 10%;"></td> <td style="width: 10%;"></td> <td style="width: 10%;"></td> <td style="width: 10%;"></td> <td style="width: 10%;"></td> <td style="width: 10%;"></td> <td style="width: 10%;"></td> <td style="width: 10%;"></td> </tr> <tr> <td></td> <td></td> <td colspan="8" style="text-align: center;"> <table border="1" style="width: 100%; border-collapse: collapse; text-align: center;"> <tr> <td style="width: 10%;"></td> <td style="width: 10%;"></td> <td style="width: 10%;"></td> <td style="width: 10%;"></td> <td style="width: 10%;"></td> <td style="width: 10%;"></td> <td style="width: 10%;"></td> <td style="width: 10%;"></td> <td style="width: 10%;"></td> <td style="width: 10%;"></td> </tr> <tr> <td></td> <td></td> <td colspan="8" style="text-align: center;"> <table border="1" style="width: 100%; border-collapse: collapse; text-align: center;"> <tr> <td style="width: 10%;"></td> <td style="width: 10%;"></td> <td style="width: 10%;"></td> <td style="width: 10%;"></td> <td style="width: 10%;"></td> <td style="width: 10%;"></td> <td style="width: 10%;"></td> <td style="width: 10%;"></td> <td style="width: 10%;"></td> <td style="width: 10%;"></td> </tr> <tr> <td></td> <td></td> <td colspan="8" style="text-align: center;"> <table border="1" style="width: 100%; border-collapse: collapse; text-align: center;"> <tr> <td style="width: 10%;"></td> <td style="width: 10%;"></td> <td style="width: 10%;"></td> <td style="width: 10%;"></td> <td style="width: 10%;"></td> <td style="width: 10%;"></td> <td style="width: 10%;"></td> <td style="width: 10%;"></td> <td style="width: 10%;"></td> <td style="width: 10%;"></td> </tr> <tr> <td></td> <td></td> <td colspan="8" style="text-align: center;"> <table border="1" style="width: 100%; border-collapse: collapse; text-align: center;"> <tr> <td style="width: 10%;"></td> <td style="width: 10%;"></td> <td style="width: 10%;"></td> <td style="width: 10%;"></td> <td style="width: 10%;"></td> <td style="width: 10%;"></td> <td style="width: 10%;"></td> <td style="width: 10%;"></td> <td style="width: 10%;"></td> <td style="width: 10%;"></td> </tr> <tr> <td></td> <td></td> <td colspan="8" style="text-align: center;"> <table border="1" style="width: 100%; border-collapse: collapse; text-align: center;"> <tr> <td style="width: 10%;"></td> <td style="width: 10%;"></td> <td style="width: 10%;"></td> <td style="width: 10%;"></td> <td style="width: 10%;"></td> <td style="width: 10%;"></td> <td style="width: 10%;"></td> <td style="width: 10%;"></td> <td style="width: 10%;"></td> <td style="width: 10%;"></td> </tr> <tr> <td></td> <td></td> <td colspan="8" style="text-align: center;"> <table border="1" style="width: 100%; border-collapse: collapse; text-align: center;"> <tr> <td style="width: 10%;"></td> <td style="width: 10%;"></td> <td style="width: 10%;"></td> <td style="width: 10%;"></td> <td style="width: 10%;"></td> <td style="width: 10%;"></td> <td style="width: 10%;"></td> <td style="width: 10%;"></td> <td style="width: 10%;"></td> <td style="width: 10%;"></td> </tr> <tr> <td></td> <td></td> <td colspan="8" style="text-align: center;"> <table border="1" style="width: 100%; border-collapse: collapse; text-align: center;"> <tr> <td style="width: 10%;"></td> <td style="width: 10%;"></td> <td style="width: 10%;"></td> <td style="width: 10%;"></td> <td style="width: 10%;"></td> <td style="width: 10%;"></td> <td style="width: 10%;"></td> <td style="width: 10%;"></td> <td style="width: 10%;"></td> <td style="width: 10%;"></td> </tr> <tr> <td></td> <td></td> <td colspan="8" style="text-align: center;"> <table border="1" style="width: 100%; border-collapse: collapse; text-align: center;"> <tr> <td style="width: 10%;"></td> <td style="width: 10%;"></td> <td style="width: 10%;"></td> <td style="width: 10%;"></td> <td style="width: 10%;"></td> <td style="width: 10%;"></td> <td style="width: 10%;"></td> <td style="width: 10%;"></td> <td style="width: 10%;"></td> <td style="width: 10%;"></td> </tr> <tr> <td></td> <td></td> <td colspan="8" style="text-align: center;"> <table border="1" style="width: 100%; border-collapse: collapse; text-align: center;"> <tr> <td style="width: 10%;"></td> <td style="width: 10%;"></td> <td style="width: 10%;"></td> <td style="width: 10%;"></td> <td style="width: 10%;"></td> <td style="width: 10%;"></td> <td style="width: 10%;"></td> <td style="width: 10%;"></td> <td style="width: 10%;"></td> <td style="width: 10%;"></td> </tr> <tr> <td></td> <td></td> <td colspan="8" style="text-align: center;"> <table border="1" style="width: 100%; border-collapse: collapse; text-align: center;"> <tr> <td style="width: 10%;"></td> <td style="width: 10%;"></td> <td style="width: 10%;"></td> <td style="width: 10%;"></td> <td style="width: 10%;"></td> <td style="width: 10%;"></td> <td style="width: 10%;"></td> <td style="width: 10%;"></td> <td style="width: 10%;"></td> <td style="width: 10%;"></td> </tr> <tr> <td></td> <td></td> <td colspan="8" style="text-align: center;"> <table border="1" style="width: 100%; border-collapse: collapse; text-align: center;"> <tr> <td style="width: 10%;"></td> <td style="width: 10%;"></td> <td style="width: 10%;"></td> <td style="width: 10%;"></td> <td style="width: 10%;"></td> <td style="width: 10%;"></td> <td style="width: 10%;"></td> <td style="width: 10%;"></td> <td style="width: 10%;"></td> <td style="width: 10%;"></td> </tr> <tr> <td></td> <td></td> <td colspan="8" style="text-align: center;"> <table border="1" style="width: 100%; border-collapse: collapse; text-align: center;"> <tr> <td style="width: 10%;"></td> <td style="width: 10%;"></td> <td style="width: 10%;"></td> <td style="width: 10%;"></td> <td style="width: 10%;"></td> <td style="width: 10%;"></td> <td style="width: 10%;"></td> <td style="width: 10%;"></td> <td style="width: 10%;"></td> <td style="width: 10%;"></td> </tr> <tr> <td></td> <td></td> <td colspan="8" style="text-align: center;"> <table border="1" style="width: 100%; border-collapse: collapse; text-align: center;"> <tr> <td style="width: 10%;"></td> <td style="width: 10%;"></td> <td style="width: 10%;"></td> <td style="width: 10%;"></td> <td style="width: 10%;"></td> <td style="width: 10%;"></td> <td style="width: 10%;"></td> <td style="width: 10%;"></td> <td style="width: 10%;"></td> <td style="width: 10%;"></td> </tr> <tr> <td></td> <td></td> <td colspan="8" style="text-align: center;"> <table border="1" style="width: 100%; border-collapse: collapse; text-align: center;"> <tr> <td style="width: 10%;"></td> <td style="width: 10%;"></td> <td
style="width: 10%;"></td> <td style="width: 10%;"></td> <td style="width: 10%;"></td> <td style="width: 10%;"></td> <td style="width: 10%;"></td> <td style="width: 10%;"></td> <td style="width: 10%;"></td> <td style="width: 10%;"></td> </tr> <tr> <td></td> <td></td> <td colspan="8" style="text-align: center;"> <table border="1" style="width: 100%; border-collapse: collapse; text-align: center;"> <tr> <td style="width: 10%;"></td> <td style="width: 10%;"></td> <td style="width: 10%;"></td> <td style="width: 10%;"></td> <td style="width: 10%;"></td> <td style="width: 10%;"></td> <td style="width: 10%;"></td> <td style="width: 10%;"></td> <td style="width: 10%;"></td> <td style="width: 10%;"></td> </tr> <tr> <td></td> <td></td> <td colspan="8" style="text-align: center;"> <table border="1" style="width: 100%; border-collapse: collapse; text-align: center;"> <tr> <td style="width: 10%;"></td> <td style="width: 10%;"></td> <td style="width: 10%;"></td> <td style="width: 10%;"></td> <td style="width: 10%;"></td> <td style="width: 10%;"></td> <td style="width: 10%;"></td> <td style="width: 10%;"></td> <td style="width: 10%;"></td> <td style="width: 10%;"></td> </tr> <tr> <td></td> <td></td> <td colspan="8" style="text-align: center;"> <table border="1" style="width: 100%; border-collapse: collapse; text-align: center;"> <tr> <td style="width: 10%;"></td> <td style="width: 10%;"></td> <td style="width: 10%;"></td> <td style="width: 10%;"></td> <td style="width: 10%;"></td> <td style="width: 10%;"></td> <td style="width: 10%;"></td> <td style="width: 10%;"></td> <td style="width: 10%;"></td> <td style="width: 10%;"></td> </tr> <tr> <td></td> <td></td> <td colspan="8" style="text-align: center;"> <table border="1" style="width: 100%; border-collapse: collapse; text-align: center;"> <tr> <td style="width: 10%;"></td> <td style="width: 10%;"></td> <td style="width: 10%;"></td> <td style="width: 10%;"></td> <td style="width: 10%;"></td> <td style="width: 10%;"></td> <td style="width: 10%;"></td> <td style="width: 10%;"></td> <td style="width: 10%;"></td> <td style="width: 10%;"></td> </tr> <tr> <td></td> <td></td> <td colspan="8" style="text-align: center;"> <table border="1" style="width: 100%; border-collapse: collapse; text-align: center;"> <tr> <td style="width: 10%;"></td> <td style="width: 10%;"></td> <td style="width: 10%;"></td> <td style="width: 10%;"></td> <td style="width: 10%;"></td> <td style="width: 10%;"></td> <td style="width: 10%;"></td> <td style="width: 10%;"></td> <td style="width: 10%;"></td> <td style="width: 10%;"></td> </tr> <tr> <td></td> <td></td> <td colspan="8" style="text-align: center;"> <table border="1" style="width: 100%; border-collapse: collapse; text-align: center;"> <tr> <td style="width: 10%;"></td> <td style="width: 10%;"></td> <td style="width: 10%;"></td> <td style="width: 10%;"></td> <td style="width: 10%;"></td> <td style="width: 10%;"></td> <td style="width: 10%;"></td> <td style="width: 10%;"></td> <td style="width: 10%;"></td> <td style="width: 10%;"></td> </tr> <tr> <td></td> <td></td> <td colspan="8" style="text-align: center;"> <table border="1" style="width: 100%; border-collapse: collapse; text-align: center;"> <tr> <td style="width: 10%;"></td> <td style="width: 10%;"></td> <td style="width: 10%;"></td> <td style="width: 10%;"></td> <td style="width: 10%;"></td> <td style="width: 10%;"></td> <td style="width: 10%;"></td> <td style="width: 10%;"></td> <td style="width: 10%;"></td> <td style="width: 10%;"></td> </tr> <tr> <td></td> <td></td> <td colspan="8" style="text-align: center;"> <table border="1" style="width: 100%; border-collapse: collapse; text-align: center;"> <tr> <td style="width: 10%;"></td> <td style="width: 10%;"></td> <td style="width: 10%;"></td> <td style="width: 10%;"></td> <td style="width: 10%;"></td> <td style="width: 10%;"></td> <td style="width: 10%;"></td> <td style="width: 10%;"></td> <td style="width: 10%;"></td> <td style="width: 10%;"></td> </tr> <tr> <td></td> <td></td> <td colspan="8" style="text-align: center;"> <table border="1" style="width: 100%; border-collapse: collapse; text-align: center;"> <tr> <td style="width: 10%;"></td> <td style="width: 10%;"></td> <td style="width: 10%;"></td> <td style="width: 10%;"></td> <td style="width: 10%;"></td> <td style="width: 10%;"></td> <td style="width: 10%;"></td> <td style="width: 10%;"></td> <td style="width: 10%;"></td> <td style="width: 10%;"></td> </tr> <tr> <td></td> <td></td> <td colspan="8" style="text-align: center;"> <table border="1" style="width: 100%; border-collapse: collapse; text-align: center;"> <tr> <td style="width: 10%;"></td> <td style="width: 10%;"></td> <td style="width: 10%;"></td> <td style="width: 10%;"></td> <td style="width: 10%;"></td> <td style="width: 10%;"></td> <td style="width: 10%;"></td> <td style="width: 10%;"></td> <td style="width: 10%;"></td> <td style="width: 10%;"></td> </tr> <tr> <td></td> <td></td> <td colspan="8" style="text-align: center;"> <table border="1" style="width: 100%; border-collapse: collapse; text-align: center;"> <tr> <td style="width: 10%;"></td> <td style="width: 10%;"></td> <td style="width: 10%;"></td> <td style="width: 10%;"></td> <td style="width: 10%;"></td> <td style="width: 10%;"></td> <td style="width: 10%;"></td> <td style="width: 10%;"></td> <td style="width: 10%;"></td> <td style="width: 10%;"></td> </tr> <tr> <td></td> <td></td> <td colspan="8" style="text-align: center;"> <table border="1" style="width: 100%; border-collapse: collapse; text-align: center;"> <tr> <td style="width: 10%;"></td> <td style="width: 10%;"></td> <td style="width: 10%;"></td> <td style="width: 10%;"></td> <td style="width: 10%;"></td> <td style="width: 10%;"></td> <td style="width: 10%;"></td> <td style="width: 10%;"></td> <td style="width: 10%;"></td> <td style="width: 10%;"></td> </tr> <tr> <td></td> <td></td> <td colspan="8" style="text-align: center;"> <table border="1" style="width: 100%; border-collapse: collapse; text-align: center;"> <tr> <td style="width: 10%;"></td> <td style="width: 10%;"></td> <td style="width: 10%;"></td> <td style="width: 10%;"></td> <td style="width: 10%;"></td> <td style="width: 10%;"></td> <td style="width: 10%;"></td> <td style="width: 10%;"></td> <td style="width: 10%;"></td> <td style="width: 10%;"></td> </tr> <tr> <td></td> <td></td> <td colspan="8" style="text-align: center;"> <table border="1" style="width: 100%; border-collapse: collapse; text-align: center;"> <tr> <td style="width: 10%;"></td> <td style="width: 10%;"></td> <td style="width: 10%;"></td> <td style="width: 10%;"></td> <td style="width: 10%;"></td> <td style="width: 10%;"></td> <td style="width: 10%;"></td> <td style="width: 10%;"></td> <td style="width: 10%;"></td> <td style="width: 10%;"></td> </tr> <tr> <td></td> <td></td> <td colspan="8" style="text-align: center;"> <table border="1" style="width: 100%; border-collapse: collapse; text-align: center;"> <tr> <td style="width: 10%;"></td> <td style="width: 10%;"></td> <td style="width: 10%;"></td> <td style="width: 10%;"></td> <td style="width: 10%;"></td> <td style="width: 10%;"></td> <td style="width: 10%;"></td> <td style="width: 10%;"></td> <td style="width: 10%;"></td> <td style="width: 10%;"></td> </tr> <tr> <td></td> <td></td> <td colspan="8" style="text-align: center;"> <table border="1" style="width: 100%; border-collapse: collapse; text-align: center;"> <tr> <td style="width: 10%;"></td> <td style="width: 10%;"></td> <td style="width: 10%;"></td> <td style="width: 10%;"></td> <td style="width: 10%;"></td> <td style="width: 10%;"></td> <td style="width: 10%;"></td> <td style="width: 10%;"></td> <td style="width: 10%;"></td> <td style="width: 10%;"></td> </tr> <tr> <td></td> <td></td> <td colspan="8" style="text-align: center;"> <table border="1" style="width: 100%; border-collapse: collapse; text-align: center;"> <tr> <td style="width: 10%;"></td> <td style="width: 10%;"></td> <td style="width: 10%;"></td> <td style="width: 10%;"></td> <td style="width: 10%;"></td> <td style="width: 10%;"></td> <td style="width: 10%;"></td> <td style="width: 10%;"></td> <td style="width: 10%;"></td> <td style="width: 10%;"></td> </tr> <tr> <td></td> <td></td> <td colspan="8" style="text-align: center;"> <table border="1" style="width: 100%; border-collapse: collapse; text-align: center;"> <tr> <td style="width: 10%;"></td> <td style="width: 10%;"></td> <td style="width: 10%;"></td> <td style="width: 10%;"></td> <td style="width: 10%;"></td> <td style="width: 10%;"></td> <td style="width: 10%;"></td> <td style="width: 10%;"></td> <td style="width: 10%;"></td> <td style="width: 10%;"></td> </tr> <tr> <td></td> <td></td> <td colspan="8" style="text-align: center;"> <table border="1" style="width: 100%; border-collapse: collapse; text-align: center;"> <tr> </tr></table></td></tr></table></td></tr></table></td></tr></table></td></tr></table></td></tr></table></td></tr></table></td></tr></table></td></tr></table></td></tr></table></td></tr></table></td></tr></table></td></tr></table></td></tr></table></td></tr></table></td></tr></table></td></tr></table></td></tr></table></td></tr></table></td></tr></table></td></tr></table></td></tr></table></td></tr></table></td></tr></table></td></tr></table></td></tr></table></td></tr></table></td></tr></table></td></tr></table></td></tr></table></td></tr></table></td></tr></table></td></tr></table></td></tr></table></td></tr></table></td></tr></table></td></tr></table></td></tr></table></td></tr></table></td></tr></table></td></tr></table>

 | | | | | | | | | | | | | | | | | | | | <table border="1" style="width: 100%; border-collapse: collapse; text-align: center;"> <tr> <td style="width: 10%;"></td> <td style="width: 10%;"></td> <td style="width: 10%;"></td> <td style="width: 10%;"></td> <td style="width: 10%;"></td> <td style="width: 10%;"></td> <td style="width: 10%;"></td> <td style="width: 10%;"></td> <td style="width: 10%;"></td> <td style="width: 10%;"></td> </tr> <tr> <td></td> <td></td> <td colspan="8" style="text-align: center;"> <table border="1" style="width: 100%; border-collapse: collapse; text-align: center;"> <tr> <td style="width: 10%;"></td> <td style="width: 10%;"></td> <td style="width: 10%;"></td> <td style="width: 10%;"></td> <td style="width: 10%;"></td> <td style="width: 10%;"></td> <td style="width: 10%;"></td> <td style="width: 10%;"></td> <td style="width: 10%;"></td> <td style="width: 10%;"></td> </tr> <tr> <td></td> <td></td> <td colspan="8" style="text-align: center;"> <table border="1" style="width: 100%; border-collapse: collapse; text-align: center;"> <tr> <td style="width: 10%;"></td> <td style="width: 10%;"></td> <td style="width: 10%;"></td> <td style="width: 10%;"></td> <td style="width: 10%;"></td> <td style="width: 10%;"></td> <td style="width: 10%;"></td> <td style="width: 10%;"></td> <td style="width: 10%;"></td> <td style="width: 10%;"></td> </tr> <tr> <td></td> <td></td> <td colspan="8" style="text-align: center;"> <table border="1" style="width: 100%; border-collapse: collapse; text-align: center;"> <tr> <td style="width: 10%;"></td> <td style="width: 10%;"></td> <td style="width: 10%;"></td> <td style="width: 10%;"></td> <td style="width: 10%;"></td> <td style="width: 10%;"></td> <td style="width: 10%;"></td> <td style="width: 10%;"></td> <td style="width: 10%;"></td> <td style="width: 10%;"></td> </tr> <tr> <td></td> <td></td> <td colspan="8" style="text-align: center;"> <table border="1" style="width: 100%; border-collapse: collapse; text-align: center;"> <tr> <td style="width: 10%;"></td> <td style="width: 10%;"></td> <td style="width: 10%;"></td> <td style="width: 10%;"></td> <td style="width: 10%;"></td> <td style="width: 10%;"></td> <td style="width: 10%;"></td> <td style="width: 10%;"></td> <td style="width: 10%;"></td> <td style="width: 10%;"></td> </tr> <tr> <td></td> <td></td> <td colspan="8" style="text-align: center;"> <table border="1" style="width: 100%; border-collapse: collapse; text-align: center;"> <tr> <td style="width: 10%;"></td> <td style="width: 10%;"></td> <td style="width: 10%;"></td> <td style="width: 10%;"></td> <td style="width: 10%;"></td> <td style="width: 10%;"></td> <td style="width: 10%;"></td> <td style="width: 10%;"></td> <td style="width: 10%;"></td> <td style="width: 10%;"></td> </tr> <tr> <td></td> <td></td> <td colspan="8" style="text-align: center;"> <table border="1" style="width: 100%; border-collapse: collapse; text-align: center;"> <tr> <td style="width: 10%;"></td> <td style="width: 10%;"></td> <td style="width: 10%;"></td> <td style="width: 10%;"></td> <td style="width: 10%;"></td> <td style="width: 10%;"></td> <td style="width: 10%;"></td> <td style="width: 10%;"></td> <td style="width: 10%;"></td> <td style="width: 10%;"></td> </tr> <tr> <td></td> <td></td> <td colspan="8" style="text-align: center;"> <table border="1" style="width: 100%; border-collapse: collapse; text-align: center;"> <tr> <td style="width: 10%;"></td> <td style="width: 10%;"></td> <td style="width: 10%;"></td> <td style="width: 10%;"></td> <td style="width: 10%;"></td> <td style="width: 10%;"></td> <td style="width: 10%;"></td> <td style="width: 10%;"></td> <td style="width: 10%;"></td> <td style="width: 10%;"></td> </tr> <tr> <td></td> <td></td> <td colspan="8" style="text-align: center;"> <table border="1" style="width: 100%; border-collapse: collapse; text-align: center;"> <tr> <td style="width: 10%;"></td> <td style="width: 10%;"></td> <td style="width: 10%;"></td> <td style="width: 10%;"></td> <td style="width: 10%;"></td> <td style="width: 10%;"></td> <td style="width: 10%;"></td> <td style="width: 10%;"></td> <td style="width: 10%;"></td> <td style="width: 10%;"></td> </tr> <tr> <td></td> <td></td> <td colspan="8" style="text-align: center;"> <table border="1" style="width: 100%; border-collapse: collapse; text-align: center;"> <tr> <td style="width: 10%;"></td> <td style="width: 10%;"></td> <td style="width: 10%;"></td> <td style="width: 10%;"></td> <td style="width: 10%;"></td> <td style="width: 10%;"></td> <td style="width: 10%;"></td> <td style="width: 10%;"></td> <td style="width: 10%;"></td> <td style="width: 10%;"></td> </tr> <tr> <td></td> <td></td> <td colspan="8" style="text-align: center;"> <table border="1" style="width: 100%; border-collapse: collapse; text-align: center;"> <tr> <td style="width: 10%;"></td> <td style="width: 10%;"></td> <td style="width: 10%;"></td> <td style="width: 10%;"></td> <td style="width: 10%;"></td> <td style="width: 10%;"></td> <td style="width: 10%;"></td> <td style="width: 10%;"></td> <td style="width: 10%;"></td> <td style="width: 10%;"></td> </tr> <tr> <td></td> <td></td> <td colspan="8" style="text-align: center;"> <table border="1" style="width: 100%; border-collapse: collapse; text-align: center;"> <tr> <td style="width: 10%;"></td> <td style="width: 10%;"></td> <td style="width: 10%;"></td> <td style="width: 10%;"></td> <td style="width: 10%;"></td> <td style="width: 10%;"></td> <td style="width: 10%;"></td> <td style="width: 10%;"></td> <td style="width: 10%;"></td> <td style="width: 10%;"></td> </tr> <tr> <td></td> <td></td> <td colspan="8" style="text-align: center;"> <table border="1" style="width: 100%; border-collapse: collapse; text-align: center;"> <tr> <td style="width: 10%;"></td> <td style="width: 10%;"></td> <td style="width: 10%;"></td> <td style="width: 10%;"></td> <td style="width: 10%;"></td> <td style="width: 10%;"></td> <td style="width: 10%;"></td> <td style="width: 10%;"></td> <td style="width: 10%;"></td> <td style="width: 10%;"></td> </tr> <tr> <td></td> <td></td> <td colspan="8" style="text-align: center;"> <table border="1" style="width: 100%; border-collapse: collapse; text-align: center;"> <tr> <td style="width: 10%;"></td> <td style="width: 10%;"></td> <td style="width: 10%;"></td> <td style="width: 10%;"></td> <td style="width: 10%;"></td> <td style="width: 10%;"></td> <td style="width: 10%;"></td> <td style="width: 10%;"></td> <td style="width: 10%;"></td> <td style="width: 10%;"></td> </tr> <tr> <td></td> <td></td> <td colspan="8" style="text-align: center;"> <table border="1" style="width: 100%; border-collapse: collapse; text-align: center;"> <tr> <td style="width: 10%;"></td> <td style="width: 10%;"></td> <td style="width: 10%;"></td> <td style="width: 10%;"></td> <td style="width: 10%;"></td> <td style="width: 10%;"></td> <td style="width: 10%;"></td> <td style="width: 10%;"></td> <td style="width: 10%;"></td> <td style="width: 10%;"></td> </tr> <tr> <td></td> <td></td> <td colspan="8" style="text-align: center;"> <table border="1" style="width: 100%; border-collapse: collapse; text-align: center;"> <tr> <td style="width: 10%;"></td> <td style="width: 10%;"></td> <td style="width: 10%;"></td> <td style="width: 10%;"></td> <td style="width: 10%;"></td> <td style="width: 10%;"></td> <td style="width: 10%;"></td> <td style="width: 10%;"></td> <td style="width: 10%;"></td> <td style="width: 10%;"></td> </tr> <tr> <td></td> <td></td> <td colspan="8" style="text-align: center;"> <table border="1" style="width: 100%; border-collapse: collapse; text-align: center;"> <tr> <td style="width: 10%;"></td> <td style="width: 10%;"></td> <td style="width: 10%;"></td> <td style="width: 10%;"></td> <td style="width: 10%;"></td> <td style="width: 10%;"></td> <td style="width: 10%;"></td> <td style="width: 10%;"></td> <td style="width: 10%;"></td> <td style="width: 10%;"></td> </tr> <tr> <td></td> <td></td> <td colspan="8" style="text-align: center;"> <table border="1" style="width: 100%; border-collapse: collapse; text-align: center;"> <tr> <td style="width: 10%;"></td> <td style="width: 10%;"></td> <td style="width: 10%;"></td> <td style="width: 10%;"></td> <td style="width: 10%;"></td> <td style="width: 10%;"></td> <td style="width: 10%;"></td> <td style="width: 10%;"></td> <td style="width: 10%;"></td> <td style="width: 10%;"></td> </tr> <tr> <td></td> <td></td> <td colspan="8" style="text-align: center;"> <table border="1" style="width: 100%; border-collapse: collapse; text-align: center;"> <tr> <td style="width: 10%;"></td> <td style="width: 10%;"></td> <td style="width: 10%;"></td> <td style="width: 10%;"></td> <td style="width: 10%;"></td> <td style="width: 10%;"></td> <td
style="width: 10%;"></td> <td style="width: 10%;"></td> <td style="width: 10%;"></td> <td style="width: 10%;"></td> </tr> <tr> <td></td> <td></td> <td colspan="8" style="text-align: center;"> <table border="1" style="width: 100%; border-collapse: collapse; text-align: center;"> <tr> <td style="width: 10%;"></td> <td style="width: 10%;"></td> <td style="width: 10%;"></td> <td style="width: 10%;"></td> <td style="width: 10%;"></td> <td style="width: 10%;"></td> <td style="width: 10%;"></td> <td style="width: 10%;"></td> <td style="width: 10%;"></td> <td style="width: 10%;"></td> </tr> <tr> <td></td> <td></td> <td colspan="8" style="text-align: center;"> <table border="1" style="width: 100%; border-collapse: collapse; text-align: center;"> <tr> <td style="width: 10%;"></td> <td style="width: 10%;"></td> <td style="width: 10%;"></td> <td style="width: 10%;"></td> <td style="width: 10%;"></td> <td style="width: 10%;"></td> <td style="width: 10%;"></td> <td style="width: 10%;"></td> <td style="width: 10%;"></td> <td style="width: 10%;"></td> </tr> <tr> <td></td> <td></td> <td colspan="8" style="text-align: center;"> <table border="1" style="width: 100%; border-collapse: collapse; text-align: center;"> <tr> <td style="width: 10%;"></td> <td style="width: 10%;"></td> <td style="width: 10%;"></td> <td style="width: 10%;"></td> <td style="width: 10%;"></td> <td style="width: 10%;"></td> <td style="width: 10%;"></td> <td style="width: 10%;"></td> <td style="width: 10%;"></td> <td style="width: 10%;"></td> </tr> <tr> <td></td> <td></td> <td colspan="8" style="text-align: center;"> <table border="1" style="width: 100%; border-collapse: collapse; text-align: center;"> <tr> <td style="width: 10%;"></td> <td style="width: 10%;"></td> <td style="width: 10%;"></td> <td style="width: 10%;"></td> <td style="width: 10%;"></td> <td style="width: 10%;"></td> <td style="width: 10%;"></td> <td style="width: 10%;"></td> <td style="width: 10%;"></td> <td style="width: 10%;"></td> </tr> <tr> <td></td> <td></td> <td colspan="8" style="text-align: center;"> <table border="1" style="width: 100%; border-collapse: collapse; text-align: center;"> <tr> <td style="width: 10%;"></td> <td style="width: 10%;"></td> <td style="width: 10%;"></td> <td style="width: 10%;"></td> <td style="width: 10%;"></td> <td style="width: 10%;"></td> <td style="width: 10%;"></td> <td style="width: 10%;"></td> <td style="width: 10%;"></td> <td style="width: 10%;"></td> </tr> <tr> <td></td> <td></td> <td colspan="8" style="text-align: center;"> <table border="1" style="width: 100%; border-collapse: collapse; text-align: center;"> <tr> <td style="width: 10%;"></td> <td style="width: 10%;"></td> <td style="width: 10%;"></td> <td style="width: 10%;"></td> <td style="width: 10%;"></td> <td style="width: 10%;"></td> <td style="width: 10%;"></td> <td style="width: 10%;"></td> <td style="width: 10%;"></td> <td style="width: 10%;"></td> </tr> <tr> <td></td> <td></td> <td colspan="8" style="text-align: center;"> <table border="1" style="width: 100%; border-collapse: collapse; text-align: center;"> <tr> <td style="width: 10%;"></td> <td style="width: 10%;"></td> <td style="width: 10%;"></td> <td style="width: 10%;"></td> <td style="width: 10%;"></td> <td style="width: 10%;"></td> <td style="width: 10%;"></td> <td style="width: 10%;"></td> <td style="width: 10%;"></td> <td style="width: 10%;"></td> </tr> <tr> <td></td> <td></td> <td colspan="8" style="text-align: center;"> <table border="1" style="width: 100%; border-collapse: collapse; text-align: center;"> <tr> <td style="width: 10%;"></td> <td style="width: 10%;"></td> <td style="width: 10%;"></td> <td style="width: 10%;"></td> <td style="width: 10%;"></td> <td style="width: 10%;"></td> <td style="width: 10%;"></td> <td style="width: 10%;"></td> <td style="width: 10%;"></td> <td style="width: 10%;"></td> </tr> <tr> <td></td> <td></td> <td colspan="8" style="text-align: center;"> <table border="1" style="width: 100%; border-collapse: collapse; text-align: center;"> <tr> <td style="width: 10%;"></td> <td style="width: 10%;"></td> <td style="width: 10%;"></td> <td style="width: 10%;"></td> <td style="width: 10%;"></td> <td style="width: 10%;"></td> <td style="width: 10%;"></td> <td style="width: 10%;"></td> <td style="width: 10%;"></td> <td style="width: 10%;"></td> </tr> <tr> <td></td> <td></td> <td colspan="8" style="text-align: center;"> <table border="1" style="width: 100%; border-collapse: collapse; text-align: center;"> <tr> <td style="width: 10%;"></td> <td style="width: 10%;"></td> <td style="width: 10%;"></td> <td style="width: 10%;"></td> <td style="width: 10%;"></td> <td style="width: 10%;"></td> <td style="width: 10%;"></td> <td style="width: 10%;"></td> <td style="width: 10%;"></td> <td style="width: 10%;"></td> </tr> <tr> <td></td> <td></td> <td colspan="8" style="text-align: center;"> <table border="1" style="width: 100%; border-collapse: collapse; text-align: center;"> <tr> <td style="width: 10%;"></td> <td style="width: 10%;"></td> <td style="width: 10%;"></td> <td style="width: 10%;"></td> <td style="width: 10%;"></td> <td style="width: 10%;"></td> <td style="width: 10%;"></td> <td style="width: 10%;"></td> <td style="width: 10%;"></td> <td style="width: 10%;"></td> </tr> <tr> <td></td> <td></td> <td colspan="8" style="text-align: center;"> <table border="1" style="width: 100%; border-collapse: collapse; text-align: center;"> <tr> <td style="width: 10%;"></td> <td style="width: 10%;"></td> <td style="width: 10%;"></td> <td style="width: 10%;"></td> <td style="width: 10%;"></td> <td style="width: 10%;"></td> <td style="width: 10%;"></td> <td style="width: 10%;"></td> <td style="width: 10%;"></td> <td style="width: 10%;"></td> </tr> <tr> <td></td> <td></td> <td colspan="8" style="text-align: center;"> <table border="1" style="width: 100%; border-collapse: collapse; text-align: center;"> <tr> <td style="width: 10%;"></td> <td style="width: 10%;"></td> <td style="width: 10%;"></td> <td style="width: 10%;"></td> <td style="width: 10%;"></td> <td style="width: 10%;"></td> <td style="width: 10%;"></td> <td style="width: 10%;"></td> <td style="width: 10%;"></td> <td style="width: 10%;"></td> </tr> <tr> <td></td> <td></td> <td colspan="8" style="text-align: center;"> <table border="1" style="width: 100%; border-collapse: collapse; text-align: center;"> <tr> <td style="width: 10%;"></td> <td style="width: 10%;"></td> <td style="width: 10%;"></td> <td style="width: 10%;"></td> <td style="width: 10%;"></td> <td style="width: 10%;"></td> <td style="width: 10%;"></td> <td style="width: 10%;"></td> <td style="width: 10%;"></td> <td style="width: 10%;"></td> </tr> <tr> <td></td> <td></td> <td colspan="8" style="text-align: center;"> <table border="1" style="width: 100%; border-collapse: collapse; text-align: center;"> <tr> <td style="width: 10%;"></td> <td style="width: 10%;"></td> <td style="width: 10%;"></td> <td style="width: 10%;"></td> <td style="width: 10%;"></td> <td style="width: 10%;"></td> <td style="width: 10%;"></td> <td style="width: 10%;"></td> <td style="width: 10%;"></td> <td style="width: 10%;"></td> </tr> <tr> <td></td> <td></td> <td colspan="8" style="text-align: center;"> <table border="1" style="width: 100%; border-collapse: collapse; text-align: center;"> <tr> <td style="width: 10%;"></td> <td style="width: 10%;"></td> <td style="width: 10%;"></td> <td style="width: 10%;"></td> <td style="width: 10%;"></td> <td style="width: 10%;"></td> <td style="width: 10%;"></td> <td style="width: 10%;"></td> <td style="width: 10%;"></td> <td style="width: 10%;"></td> </tr> <tr> <td></td> <td></td> <td colspan="8" style="text-align: center;"> <table border="1" style="width: 100%; border-collapse: collapse; text-align: center;"> <tr> <td style="width: 10%;"></td> <td style="width: 10%;"></td> <td style="width: 10%;"></td> <td style="width: 10%;"></td> <td style="width: 10%;"></td> <td style="width: 10%;"></td> <td style="width: 10%;"></td> <td style="width: 10%;"></td> <td style="width: 10%;"></td> <td style="width: 10%;"></td> </tr> <tr> <td></td> <td></td> <td colspan="8" style="text-align: center;"> <table border="1" style="width: 100%; border-collapse: collapse; text-align: center;"> <tr> <td style="width: 10%;"></td> <td style="width: 10%;"></td> <td style="width: 10%;"></td> <td style="width: 10%;"></td> <td style="width: 10%;"></td> <td style="width: 10%;"></td> <td style="width: 10%;"></td> <td style="width: 10%;"></td> <td style="width: 10%;"></td> <td style="width: 10%;"></td> </tr> <tr> <td></td> <td></td> <td colspan="8" style="text-align: center;"> <table border="1" style="width: 100%; border-collapse: collapse; text-align: center;"> <tr> <td style="width: 10%;"></td> <td style="width: 10%;"></td> <td style="width: 10%;"></td> <td style="width: 10%;"></td> <td style="width: 10%;"></td> <td style="width: 10%;"></td> <td style="width: 10%;"></td> <td style="width: 10%;"></td> <td style="width: 10%;"></td> <td style="width: 10%;"></td> </tr> <tr> <td></td> <td></td> <td colspan="8" style="text-align: center;"> <table border="1" style="width: 100%; border-collapse: collapse; text-align: center;"> <tr> <td style="width: 10%;"></td> <td style="width: 10%;"></td> <td style="width: 10%;"></td> <td style="width: 10%;"></td> <td style="width: 10%;"></td> <td style="width: 10%;"></td> <td style="width: 10%;"></td> <td style="width: 10%;"></td> <td style="width: 10%;"></td> <td style="width: 10%;"></td> </tr> <tr> <td></td> <td></td> <td colspan="8" style="text-align: center;"> <table border="1" style="width: 100%; border-collapse: collapse; text-align: center;"> <tr>
</tr></table></td></tr></table></td></tr></table></td></tr></table></td></tr></table></td></tr></table></td></tr></table></td></tr></table></td></tr></table></td></tr></table></td></tr></table></td></tr></table></td></tr></table></td></tr></table></td></tr></table></td></tr></table></td></tr></table></td></tr></table></td></tr></table></td></tr></table></td></tr></table></td></tr></table></td></tr></table></td></tr></table></td></tr></table></td></tr></table></td></tr></table></td></tr></table></td></tr></table></td></tr></table></td></tr></table></td></tr></table></td></tr></table></td></tr></table></td></tr></table></td></tr></table></td></tr></table></td></tr></table></td></tr></table></td></tr></table>
 | | | | | | | | | | | | | | | | | | | | <table border="1" style="width: 100%; border-collapse: collapse; text-align: center;"> <tr> <td style="width: 10%;"></td> <td style="width: 10%;"></td> <td style="width: 10%;"></td> <td style="width: 10%;"></td> <td style="width: 10%;"></td> <td style="width: 10%;"></td> <td style="width: 10%;"></td> <td style="width: 10%;"></td> <td style="width: 10%;"></td> <td style="width: 10%;"></td> </tr> <tr> <td></td> <td></td> <td colspan="8" style="text-align: center;"> <table border="1" style="width: 100%; border-collapse: collapse; text-align: center;"> <tr> <td style="width: 10%;"></td> <td style="width: 10%;"></td> <td style="width: 10%;"></td> <td style="width: 10%;"></td> <td style="width: 10%;"></td> <td style="width: 10%;"></td> <td style="width: 10%;"></td> <td style="width: 10%;"></td> <td style="width: 10%;"></td> <td style="width: 10%;"></td> </tr> <tr> <td></td> <td></td> <td colspan="8" style="text-align: center;"> <table border="1" style="width: 100%; border-collapse: collapse; text-align: center;"> <tr> <td style="width: 10%;"></td> <td style="width: 10%;"></td> <td style="width: 10%;"></td> <td style="width: 10%;"></td> <td style="width: 10%;"></td> <td style="width: 10%;"></td> <td style="width: 10%;"></td> <td style="width: 10%;"></td> <td style="width: 10%;"></td> <td style="width: 10%;"></td> </tr> <tr> <td></td> <td></td> <td colspan="8" style="text-align: center;"> <table border="1" style="width: 100%; border-collapse: collapse; text-align: center;"> <tr> <td style="width: 10%;"></td> <td style="width: 10%;"></td> <td style="width: 10%;"></td> <td style="width: 10%;"></td> <td style="width: 10%;"></td> <td style="width: 10%;"></td> <td style="width: 10%;"></td> <td style="width: 10%;"></td> <td style="width: 10%;"></td> <td style="width: 10%;"></td> </tr> <tr> <td></td> <td></td> <td colspan="8" style="text-align: center;"> <table border="1" style="width: 100%; border-collapse: collapse; text-align: center;"> <tr> <td style="width: 10%;"></td> <td style="width: 10%;"></td> <td style="width: 10%;"></td> <td style="width: 10%;"></td> <td style="width: 10%;"></td> <td style="width: 10%;"></td> <td style="width: 10%;"></td> <td style="width: 10%;"></td> <td style="width: 10%;"></td> <td style="width: 10%;"></td> </tr> <tr> <td></td> <td></td> <td colspan="8" style="text-align: center;"> <table border="1" style="width: 100%; border-collapse: collapse; text-align: center;"> <tr> <td style="width: 10%;"></td> <td style="width: 10%;"></td> <td style="width: 10%;"></td> <td style="width: 10%;"></td> <td style="width: 10%;"></td> <td style="width: 10%;"></td> <td style="width: 10%;"></td> <td style="width: 10%;"></td> <td style="width: 10%;"></td> <td style="width: 10%;"></td> </tr> <tr> <td></td> <td></td> <td colspan="8" style="text-align: center;"> <table border="1" style="width: 100%; border-collapse: collapse; text-align: center;"> <tr> <td style="width: 10%;"></td> <td style="width: 10%;"></td> <td style="width: 10%;"></td> <td style="width: 10%;"></td> <td style="width: 10%;"></td> <td style="width: 10%;"></td> <td style="width: 10%;"></td> <td style="width: 10%;"></td> <td style="width: 10%;"></td> <td style="width: 10%;"></td> </tr> <tr> <td></td> <td></td> <td colspan="8" style="text-align: center;"> <table border="1" style="width: 100%; border-collapse: collapse; text-align: center;"> <tr> <td style="width: 10%;"></td> <td style="width: 10%;"></td> <td style="width: 10%;"></td> <td style="width: 10%;"></td> <td style="width: 10%;"></td> <td style="width: 10%;"></td> <td style="width: 10%;"></td> <td style="width: 10%;"></td> <td style="width: 10%;"></td> <td style="width: 10%;"></td> </tr> <tr> <td></td> <td></td> <td colspan="8" style="text-align: center;"> <table border="1" style="width: 100%; border-collapse: collapse; text-align: center;"> <tr> <td style="width: 10%;"></td> <td style="width: 10%;"></td> <td style="width: 10%;"></td> <td style="width: 10%;"></td> <td style="width: 10%;"></td> <td style="width: 10%;"></td> <td style="width: 10%;"></td> <td style="width: 10%;"></td> <td style="width: 10%;"></td> <td style="width: 10%;"></td> </tr> <tr> <td></td> <td></td> <td colspan="8" style="text-align: center;"> <table border="1" style="width: 100%; border-collapse: collapse; text-align: center;"> <tr> <td style="width: 10%;"></td> <td style="width: 10%;"></td> <td style="width: 10%;"></td> <td style="width: 10%;"></td> <td style="width: 10%;"></td> <td style="width: 10%;"></td> <td style="width: 10%;"></td> <td style="width: 10%;"></td> <td style="width: 10%;"></td> <td style="width: 10%;"></td> </tr> <tr> <td></td> <td></td> <td colspan="8" style="text-align: center;"> <table border="1" style="width: 100%; border-collapse: collapse; text-align: center;"> <tr> <td style="width: 10%;"></td> <td style="width: 10%;"></td> <td style="width: 10%;"></td> <td style="width: 10%;"></td> <td style="width: 10%;"></td> <td style="width: 10%;"></td> <td style="width: 10%;"></td> <td style="width: 10%;"></td> <td style="width: 10%;"></td> <td style="width: 10%;"></td> </tr> <tr> <td></td> <td></td> <td colspan="8" style="text-align: center;"> <table border="1" style="width: 100%; border-collapse: collapse; text-align: center;"> <tr> <td style="width: 10%;"></td> <td style="width: 10%;"></td> <td style="width: 10%;"></td> <td style="width: 10%;"></td> <td style="width: 10%;"></td> <td style="width: 10%;"></td> <td style="width: 10%;"></td> <td style="width: 10%;"></td> <td style="width: 10%;"></td> <td style="width: 10%;"></td> </tr> <tr> <td></td> <td></td> <td colspan="8" style="text-align: center;"> <table border="1" style="width: 100%; border-collapse: collapse; text-align: center;"> <tr> <td style="width: 10%;"></td> <td style="width: 10%;"></td> <td style="width: 10%;"></td> <td style="width: 10%;"></td> <td style="width: 10%;"></td> <td style="width: 10%;"></td> <td style="width: 10%;"></td> <td style="width: 10%;"></td> <td style="width: 10%;"></td> <td style="width: 10%;"></td> </tr> <tr> <td></td> <td></td> <td colspan="8" style="text-align: center;"> <table border="1" style="width: 100%; border-collapse: collapse; text-align: center;"> <tr> <td style="width: 10%;"></td> <td style="width: 10%;"></td> <td style="width: 10%;"></td> <td style="width: 10%;"></td> <td style="width: 10%;"></td> <td style="width: 10%;"></td> <td style="width: 10%;"></td> <td style="width: 10%;"></td> <td style="width: 10%;"></td> <td style="width: 10%;"></td> </tr> <tr> <td></td> <td></td> <td colspan="8" style="text-align: center;"> <table border="1" style="width: 100%; border-collapse: collapse; text-align: center;"> <tr> <td style="width: 10%;"></td> <td style="width: 10%;"></td> <td style="width: 10%;"></td> <td style="width: 10%;"></td> <td style="width: 10%;"></td> <td style="width: 10%;"></td> <td style="width: 10%;"></td> <td style="width: 10%;"></td> <td style="width: 10%;"></td> <td style="width: 10%;"></td> </tr> <tr> <td></td> <td></td> <td colspan="8" style="text-align: center;"> <table border="1" style="width: 100%; border-collapse: collapse; text-align: center;"> <tr> <td style="width: 10%;"></td> <td style="width: 10%;"></td> <td style="width: 10%;"></td> <td style="width: 10%;"></td> <td style="width: 10%;"></td> <td style="width: 10%;"></td> <td style="width: 10%;"></td> <td style="width: 10%;"></td> <td style="width: 10%;"></td> <td style="width: 10%;"></td> </tr> <tr> <td></td> <td></td> <td colspan="8" style="text-align: center;"> <table border="1" style="width: 100%; border-collapse: collapse;
text-align: center;"> <tr> <td style="width: 10%;"></td> <td style="width: 10%;"></td> <td style="width: 10%;"></td> <td style="width: 10%;"></td> <td style="width: 10%;"></td> <td style="width: 10%;"></td> <td style="width: 10%;"></td> <td style="width: 10%;"></td> <td style="width: 10%;"></td> <td style="width: 10%;"></td> </tr> <tr> <td></td> <td></td> <td colspan="8" style="text-align: center;"> <table border="1" style="width: 100%; border-collapse: collapse; text-align: center;"> <tr> <td style="width: 10%;"></td> <td style="width: 10%;"></td> <td style="width: 10%;"></td> <td style="width: 10%;"></td> <td style="width: 10%;"></td> <td style="width: 10%;"></td> <td style="width: 10%;"></td> <td style="width: 10%;"></td> <td style="width: 10%;"></td> <td style="width: 10%;"></td> </tr> <tr> <td></td> <td></td> <td colspan="8" style="text-align: center;"> <table border="1" style="width: 100%; border-collapse: collapse; text-align: center;"> <tr> <td style="width: 10%;"></td> <td style="width: 10%;"></td> <td style="width: 10%;"></td> <td style="width: 10%;"></td> <td style="width: 10%;"></td> <td style="width: 10%;"></td> <td style="width: 10%;"></td> <td style="width: 10%;"></td> <td style="width: 10%;"></td> <td style="width: 10%;"></td> </tr> <tr> <td></td> <td></td> <td colspan="8" style="text-align: center;"> <table border="1" style="width: 100%; border-collapse: collapse; text-align: center;"> <tr> <td style="width: 10%;"></td> <td style="width: 10%;"></td> <td style="width: 10%;"></td> <td style="width: 10%;"></td> <td style="width: 10%;"></td> <td style="width: 10%;"></td> <td style="width: 10%;"></td> <td style="width: 10%;"></td> <td style="width: 10%;"></td> <td style="width: 10%;"></td> </tr> <tr> <td></td> <td></td> <td colspan="8" style="text-align: center;"> <table border="1" style="width: 100%; border-collapse: collapse; text-align: center;"> <tr> <td style="width: 10%;"></td> <td style="width: 10%;"></td> <td style="width: 10%;"></td> <td style="width: 10%;"></td> <td style="width: 10%;"></td> <td style="width: 10%;"></td> <td style="width: 10%;"></td> <td style="width: 10%;"></td> <td style="width: 10%;"></td> <td style="width: 10%;"></td> </tr> <tr> <td></td> <td></td> <td colspan="8" style="text-align: center;"> <table border="1" style="width: 100%; border-collapse: collapse; text-align: center;"> <tr> <td style="width: 10%;"></td> <td style="width: 10%;"></td> <td style="width: 10%;"></td> <td style="width: 10%;"></td> <td style="width: 10%;"></td> <td style="width: 10%;"></td> <td style="width: 10%;"></td> <td style="width: 10%;"></td> <td style="width: 10%;"></td> <td style="width: 10%;"></td> </tr> <tr> <td></td> <td></td> <td colspan="8" style="text-align: center;"> <table border="1" style="width: 100%; border-collapse: collapse; text-align: center;"> <tr> <td style="width: 10%;"></td> <td style="width: 10%;"></td> <td style="width: 10%;"></td> <td style="width: 10%;"></td> <td style="width: 10%;"></td> <td style="width: 10%;"></td> <td style="width: 10%;"></td> <td style="width: 10%;"></td> <td style="width: 10%;"></td> <td style="width: 10%;"></td> </tr> <tr> <td></td> <td></td> <td colspan="8" style="text-align: center;"> <table border="1" style="width: 100%; border-collapse: collapse; text-align: center;"> <tr> <td style="width: 10%;"></td> <td style="width: 10%;"></td> <td style="width: 10%;"></td> <td style="width: 10%;"></td> <td style="width: 10%;"></td> <td style="width: 10%;"></td> <td style="width: 10%;"></td> <td style="width: 10%;"></td> <td style="width: 10%;"></td> <td style="width: 10%;"></td> </tr> <tr> <td></td> <td></td> <td colspan="8" style="text-align: center;"> <table border="1" style="width: 100%; border-collapse: collapse; text-align: center;"> <tr> <td style="width: 10%;"></td> <td style="width: 10%;"></td> <td style="width: 10%;"></td> <td style="width: 10%;"></td> <td style="width: 10%;"></td> <td style="width: 10%;"></td> <td style="width: 10%;"></td> <td style="width: 10%;"></td> <td style="width: 10%;"></td> <td style="width: 10%;"></td> </tr> <tr> <td></td> <td></td> <td colspan="8" style="text-align: center;"> <table border="1" style="width: 100%; border-collapse: collapse; text-align: center;"> <tr> <td style="width: 10%;"></td> <td style="width: 10%;"></td> <td style="width: 10%;"></td> <td style="width: 10%;"></td> <td style="width: 10%;"></td> <td style="width: 10%;"></td> <td style="width: 10%;"></td> <td style="width: 10%;"></td> <td style="width: 10%;"></td> <td style="width: 10%;"></td> </tr> <tr> <td></td> <td></td> <td colspan="8" style="text-align: center;"> <table border="1" style="width: 100%; border-collapse: collapse; text-align: center;"> <tr> <td style="width: 10%;"></td> <td style="width: 10%;"></td> <td style="width: 10%;"></td> <td style="width: 10%;"></td> <td style="width: 10%;"></td> <td style="width: 10%;"></td> <td style="width: 10%;"></td> <td style="width: 10%;"></td> <td style="width: 10%;"></td> <td style="width: 10%;"></td> </tr> <tr> <td></td> <td></td> <td colspan="8" style="text-align: center;"> <table border="1" style="width: 100%; border-collapse: collapse; text-align: center;"> <tr> <td style="width: 10%;"></td> <td style="width: 10%;"></td> <td style="width: 10%;"></td> <td style="width: 10%;"></td> <td style="width: 10%;"></td> <td style="width: 10%;"></td> <td style="width: 10%;"></td> <td style="width: 10%;"></td> <td style="width: 10%;"></td> <td style="width: 10%;"></td> </tr> <tr> <td></td> <td></td> <td colspan="8" style="text-align: center;"> <table border="1" style="width: 100%; border-collapse: collapse; text-align: center;"> <tr> <td style="width: 10%;"></td> <td style="width: 10%;"></td> <td style="width: 10%;"></td> <td style="width: 10%;"></td> <td style="width: 10%;"></td> <td style="width: 10%;"></td> <td style="width: 10%;"></td> <td style="width: 10%;"></td> <td style="width: 10%;"></td> <td style="width: 10%;"></td> </tr> <tr> <td></td> <td></td> <td colspan="8" style="text-align: center;"> <table border="1" style="width: 100%; border-collapse: collapse; text-align: center;"> <tr> <td style="width: 10%;"></td> <td style="width: 10%;"></td> <td style="width: 10%;"></td> <td style="width: 10%;"></td> <td style="width: 10%;"></td> <td style="width: 10%;"></td> <td style="width: 10%;"></td> <td style="width: 10%;"></td> <td style="width: 10%;"></td> <td style="width: 10%;"></td> </tr> <tr> <td></td> <td></td> <td colspan="8" style="text-align: center;"> <table border="1" style="width: 100%; border-collapse: collapse; text-align: center;"> <tr> <td style="width: 10%;"></td> <td style="width: 10%;"></td> <td style="width: 10%;"></td> <td style="width: 10%;"></td> <td style="width: 10%;"></td> <td style="width: 10%;"></td> <td style="width: 10%;"></td> <td style="width: 10%;"></td> <td style="width: 10%;"></td> <td style="width: 10%;"></td> </tr> <tr> <td></td> <td></td> <td colspan="8" style="text-align: center;"> <table border="1" style="width: 100%; border-collapse: collapse; text-align: center;"> <tr> <td style="width: 10%;"></td> <td style="width: 10%;"></td> <td style="width: 10%;"></td> <td style="width: 10%;"></td> <td style="width: 10%;"></td> <td style="width: 10%;"></td> <td style="width: 10%;"></td> <td style="width: 10%;"></td> <td style="width: 10%;"></td> <td style="width: 10%;"></td> </tr> <tr> <td></td> <td></td> <td colspan="8" style="text-align: center;"> <table border="1" style="width: 100%; border-collapse: collapse; text-align: center;"> <tr> <td style="width: 10%;"></td> <td style="width: 10%;"></td> <td style="width: 10%;"></td> <td style="width: 10%;"></td> <td style="width: 10%;"></td> <td style="width: 10%;"></td> <td style="width: 10%;"></td> <td style="width: 10%;"></td> <td style="width: 10%;"></td> <td style="width: 10%;"></td> </tr> <tr> <td></td> <td></td> <td colspan="8" style="text-align: center;"> <table border="1" style="width: 100%; border-collapse: collapse; text-align: center;"> <tr> <td style="width: 10%;"></td> <td style="width: 10%;"></td> <td style="width: 10%;"></td> <td style="width: 10%;"></td> <td style="width: 10%;"></td> <td style="width: 10%;"></td> <td style="width: 10%;"></td> <td style="width: 10%;"></td> <td style="width: 10%;"></td> <td style="width: 10%;"></td> </tr> <tr> <td></td> <td></td> <td colspan="8" style="text-align: center;"> <table border="1" style="width: 100%; border-collapse: collapse; text-align: center;"> <tr> <td style="width: 10%;"></td> <td style="width: 10%;"></td> <td style="width: 10%;"></td> <td style="width: 10%;"></td> <td style="width: 10%;"></td> <td style="width: 10%;"></td> <td style="width: 10%;"></td> <td style="width: 10%;"></td> <td style="width: 10%;"></td> <td style="width: 10%;"></td> </tr> <tr> <td></td> <td></td> <td colspan="8" style="text-align: center;"> <table border="1" style="width: 100%; border-collapse: collapse; text-align: center;"> <tr> <td style="width: 10%;"></td> <td style="width: 10%;"></td> <td style="width: 10%;"></td> <td style="width: 10%;"></td> <td style="width: 10%;"></td> <td style="width: 10%;"></td> <td style="width: 10%;"></td> <td style="width: 10%;"></td> <td style="width: 10%;"></td> <td style="width: 10%;"></td> </tr> <tr> <td></td> <td></td> <td colspan="8" style="text-align: center;"> <table border="1" style="width: 100%; border-collapse: collapse; text-align: center;"> <tr> <td style="width: 10%;"></td> <td style="width: 10%;"></td> <td style="width: 10%;"></td> <td style="width: 10%;"></td> <td style="width: 10%;"></td> <td style="width: 10%;"></td> <td style="width: 10%;"></td> <td style="width: 10%;"></td> <td style="width: 10%;"></td> <td style="width: 10%;"></td> </tr> <tr> <td></td> <td></td> <td colspan="8" style="text-align: center;"> <table border="1" style="width: 100%; border-collapse: collapse; text-align: center;"> <tr> <td style="width: 10%;"></td> <td style="width: 10%;"></td> <td style="width: 10%;"></td> <td style="width: 10%;"></td> <td style="width:
10%;"></td> <td style="width: 10%;"></td> <td style="width: 10%;"></td> <td style="width: 10%;"></td> <td style="width: 10%;"></td> <td style="width: 10%;"></td> </tr> <tr> <td></td> <td></td> <td colspan="8" style="text-align: center;"> <table border="1" style="width: 100%; border-collapse: collapse; text-align: center;"> <tr> </tr></table></td></tr></table></td></tr></table></td></tr></table></td></tr></table></td></tr></table></td></tr></table></td></tr></table></td></tr></table></td></tr></table></td></tr></table></td></tr></table></td></tr></table></td></tr></table></td></tr></table></td></tr></table></td></tr></table></td></tr></table></td></tr></table></td></tr></table></td></tr></table></td></tr></table></td></tr></table></td></tr></table></td></tr></table></td></tr></table></td></tr></table></td></tr></table></td></tr></table></td></tr></table></td></tr></table></td></tr></table></td></tr></table></td></tr></table></td></tr></table></td></tr></table></td></tr></table></td></tr></table></td></tr></table>
 | | | | | | | | | | | | | | | | | | | | <table border="1" style="width: 100%; border-collapse: collapse; text-align: center;"> <tr> <td style="width: 10%;"></td> <td style="width: 10%;"></td> <td style="width: 10%;"></td> <td style="width: 10%;"></td> <td style="width: 10%;"></td> <td style="width: 10%;"></td> <td style="width: 10%;"></td> <td style="width: 10%;"></td> <td style="width: 10%;"></td> <td style="width: 10%;"></td> </tr> <tr> <td></td> <td></td> <td colspan="8" style="text-align: center;"> <table border="1" style="width: 100%; border-collapse: collapse; text-align: center;"> <tr> <td style="width: 10%;"></td> <td style="width: 10%;"></td> <td style="width: 10%;"></td> <td style="width: 10%;"></td> <td style="width: 10%;"></td> <td style="width: 10%;"></td> <td style="width: 10%;"></td> <td style="width: 10%;"></td> <td style="width: 10%;"></td> <td style="width: 10%;"></td> </tr> <tr> <td></td> <td></td> <td colspan="8" style="text-align: center;"> <table border="1" style="width: 100%; border-collapse: collapse; text-align: center;"> <tr> <td style="width: 10%;"></td> <td style="width: 10%;"></td> <td style="width: 10%;"></td> <td style="width: 10%;"></td> <td style="width: 10%;"></td> <td style="width: 10%;"></td> <td style="width: 10%;"></td> <td style="width: 10%;"></td> <td style="width: 10%;"></td> <td style="width: 10%;"></td> </tr> <tr> <td></td> <td></td> <td colspan="8" style="text-align: center;"> <table border="1" style="width: 100%; border-collapse: collapse; text-align: center;"> <tr> <td style="width: 10%;"></td> <td style="width: 10%;"></td> <td style="width: 10%;"></td> <td style="width: 10%;"></td> <td style="width: 10%;"></td> <td style="width: 10%;"></td> <td style="width: 10%;"></td> <td style="width: 10%;"></td> <td style="width: 10%;"></td> <td style="width: 10%;"></td> </tr> <tr> <td></td> <td></td> <td colspan="8" style="text-align: center;"> <table border="1" style="width: 100%; border-collapse: collapse; text-align: center;"> <tr> <td style="width: 10%;"></td> <td style="width: 10%;"></td> <td style="width: 10%;"></td> <td style="width: 10%;"></td> <td style="width: 10%;"></td> <td style="width: 10%;"></td> <td style="width: 10%;"></td> <td style="width: 10%;"></td> <td style="width: 10%;"></td> <td style="width: 10%;"></td> </tr> <tr> <td></td> <td></td> <td colspan="8" style="text-align: center;"> <table border="1" style="width: 100%; border-collapse: collapse; text-align: center;"> <tr> <td style="width: 10%;"></td> <td style="width: 10%;"></td> <td style="width: 10%;"></td> <td style="width: 10%;"></td> <td style="width: 10%;"></td> <td style="width: 10%;"></td> <td style="width: 10%;"></td> <td style="width: 10%;"></td> <td style="width: 10%;"></td> <td style="width: 10%;"></td> </tr> <tr> <td></td> <td></td> <td colspan="8" style="text-align: center;"> <table border="1" style="width: 100%; border-collapse: collapse; text-align: center;"> <tr> <td style="width: 10%;"></td> <td style="width: 10%;"></td> <td style="width: 10%;"></td> <td style="width: 10%;"></td> <td style="width: 10%;"></td> <td style="width: 10%;"></td> <td style="width: 10%;"></td> <td style="width: 10%;"></td> <td style="width: 10%;"></td> <td style="width: 10%;"></td> </tr> <tr> <td></td> <td></td> <td colspan="8" style="text-align: center;"> <table border="1" style="width: 100%; border-collapse: collapse; text-align: center;"> <tr> <td style="width: 10%;"></td> <td style="width: 10%;"></td> <td style="width: 10%;"></td> <td style="width: 10%;"></td> <td style="width: 10%;"></td> <td style="width: 10%;"></td> <td style="width: 10%;"></td> <td style="width: 10%;"></td> <td style="width: 10%;"></td> <td style="width: 10%;"></td> </tr> <tr> <td></td> <td></td> <td colspan="8" style="text-align: center;"> <table border="1" style="width: 100%; border-collapse: collapse; text-align: center;"> <tr> <td style="width: 10%;"></td> <td style="width: 10%;"></td> <td style="width: 10%;"></td> <td style="width: 10%;"></td> <td style="width: 10%;"></td> <td style="width: 10%;"></td> <td style="width: 10%;"></td> <td style="width: 10%;"></td> <td style="width: 10%;"></td> <td style="width: 10%;"></td> </tr> <tr> <td></td> <td></td> <td colspan="8" style="text-align: center;"> <table border="1" style="width: 100%; border-collapse: collapse; text-align: center;"> <tr> <td style="width: 10%;"></td> <td style="width: 10%;"></td> <td style="width: 10%;"></td> <td style="width: 10%;"></td> <td style="width: 10%;"></td> <td style="width: 10%;"></td> <td style="width: 10%;"></td> <td style="width: 10%;"></td> <td style="width: 10%;"></td> <td style="width: 10%;"></td> </tr> <tr> <td></td> <td></td> <td colspan="8" style="text-align: center;"> <table border="1" style="width: 100%; border-collapse: collapse; text-align: center;"> <tr> <td style="width: 10%;"></td> <td style="width: 10%;"></td> <td style="width: 10%;"></td> <td style="width: 10%;"></td> <td style="width: 10%;"></td> <td style="width: 10%;"></td> <td style="width: 10%;"></td> <td style="width: 10%;"></td> <td style="width: 10%;"></td> <td style="width: 10%;"></td> </tr> <tr> <td></td> <td></td> <td colspan="8" style="text-align: center;"> <table border="1" style="width: 100%; border-collapse: collapse; text-align: center;"> <tr> <td style="width: 10%;"></td> <td style="width: 10%;"></td> <td style="width: 10%;"></td> <td style="width: 10%;"></td> <td style="width: 10%;"></td> <td style="width: 10%;"></td> <td style="width: 10%;"></td> <td style="width: 10%;"></td> <td style="width: 10%;"></td> <td style="width: 10%;"></td> </tr> <tr> <td></td> <td></td> <td colspan="8" style="text-align: center;"> <table border="1" style="width: 100%; border-collapse: collapse; text-align: center;"> <tr> <td style="width: 10%;"></td> <td style="width: 10%;"></td> <td style="width: 10%;"></td> <td style="width: 10%;"></td> <td style="width: 10%;"></td> <td style="width: 10%;"></td> <td style="width: 10%;"></td> <td style="width: 10%;"></td> <td style="width: 10%;"></td> <td style="width: 10%;"></td> </tr> <tr> <td></td> <td></td> <td colspan="8" style="text-align: center;"> <table border="1" style="width: 100%; border-collapse: collapse; text-align: center;"> <tr> <td style="width: 10%;"></td> <td style="width: 10%;"></td> <td style="width: 10%;"></td> <td style="width: 10%;"></td> <td style="width: 10%;"></td> <td style="width: 10%;"></td> <td style="width: 10%;"></td> <td style="width: 10%;"></td> <td style="width: 10%;"></td> <td style="width: 10%;"></td> </tr> <tr> <td></td> <td></td> <td colspan="8" style="text-align: center;"> <table border="1" style="width: 100%; border-collapse: collapse; text-align: center;"> <tr> <td style="width: 10%;"></td> <td style="width: 10%;"></td> <td style="width: 10%;"></td> <td style="width: 10%;"></td> <td style="width: 10%;"></td> <td style="width: 10%;"></td> <td style="width: 10%;"></td> <td style="width: 10%;"></td> <td style="width: 10%;"></td> <td style="width: 10%;"></td> </tr> <tr> <td></td> <td></td> <td colspan="8" style="text-align: center;"> <table border="1" style="width: 100%; border-collapse: collapse; text-align: center;"> <tr> <td style="width: 10%;"></td> <td style="width: 10%;"></td> <td style="width: 10%;"></td> <td style="width: 10%;"></td> <td
style="width: 10%;"></td> <td style="width: 10%;"></td> <td style="width: 10%;"></td> <td style="width: 10%;"></td> <td style="width: 10%;"></td> <td style="width: 10%;"></td> </tr> <tr> <td></td> <td></td> <td colspan="8" style="text-align: center;"> <table border="1" style="width: 100%; border-collapse: collapse; text-align: center;"> <tr> <td style="width: 10%;"></td> <td style="width: 10%;"></td> <td style="width: 10%;"></td> <td style="width: 10%;"></td> <td style="width: 10%;"></td> <td style="width: 10%;"></td> <td style="width: 10%;"></td> <td style="width: 10%;"></td> <td style="width: 10%;"></td> <td style="width: 10%;"></td> </tr> <tr> <td></td> <td></td> <td colspan="8" style="text-align: center;"> <table border="1" style="width: 100%; border-collapse: collapse; text-align: center;"> <tr> <td style="width: 10%;"></td> <td style="width: 10%;"></td> <td style="width: 10%;"></td> <td style="width: 10%;"></td> <td style="width: 10%;"></td> <td style="width: 10%;"></td> <td style="width: 10%;"></td> <td style="width: 10%;"></td> <td style="width: 10%;"></td> <td style="width: 10%;"></td> </tr> <tr> <td></td> <td></td> <td colspan="8" style="text-align: center;"> <table border="1" style="width: 100%; border-collapse: collapse; text-align: center;"> <tr> <td style="width: 10%;"></td> <td style="width: 10%;"></td> <td style="width: 10%;"></td> <td style="width: 10%;"></td> <td style="width: 10%;"></td> <td style="width: 10%;"></td> <td style="width: 10%;"></td> <td style="width: 10%;"></td> <td style="width: 10%;"></td> <td style="width: 10%;"></td> </tr> <tr> <td></td> <td></td> <td colspan="8" style="text-align: center;"> <table border="1" style="width: 100%; border-collapse: collapse; text-align: center;"> <tr> <td style="width: 10%;"></td> <td style="width: 10%;"></td> <td style="width: 10%;"></td> <td style="width: 10%;"></td> <td style="width: 10%;"></td> <td style="width: 10%;"></td> <td style="width: 10%;"></td> <td style="width: 10%;"></td> <td style="width: 10%;"></td> <td style="width: 10%;"></td> </tr> <tr> <td></td> <td></td> <td colspan="8" style="text-align: center;"> <table border="1" style="width: 100%; border-collapse: collapse; text-align: center;"> <tr> <td style="width: 10%;"></td> <td style="width: 10%;"></td> <td style="width: 10%;"></td> <td style="width: 10%;"></td> <td style="width: 10%;"></td> <td style="width: 10%;"></td> <td style="width: 10%;"></td> <td style="width: 10%;"></td> <td style="width: 10%;"></td> <td style="width: 10%;"></td> </tr> <tr> <td></td> <td></td> <td colspan="8" style="text-align: center;"> <table border="1" style="width: 100%; border-collapse: collapse; text-align: center;"> <tr> <td style="width: 10%;"></td> <td style="width: 10%;"></td> <td style="width: 10%;"></td> <td style="width: 10%;"></td> <td style="width: 10%;"></td> <td style="width: 10%;"></td> <td style="width: 10%;"></td> <td style="width: 10%;"></td> <td style="width: 10%;"></td> <td style="width: 10%;"></td> </tr> <tr> <td></td> <td></td> <td colspan="8" style="text-align: center;"> <table border="1" style="width: 100%; border-collapse: collapse; text-align: center;"> <tr> <td style="width: 10%;"></td> <td style="width: 10%;"></td> <td style="width: 10%;"></td> <td style="width: 10%;"></td> <td style="width: 10%;"></td> <td style="width: 10%;"></td> <td style="width: 10%;"></td> <td style="width: 10%;"></td> <td style="width: 10%;"></td> <td style="width: 10%;"></td> </tr> <tr> <td></td> <td></td> <td colspan="8" style="text-align: center;"> <table border="1" style="width: 100%; border-collapse: collapse; text-align: center;"> <tr> <td style="width: 10%;"></td> <td style="width: 10%;"></td> <td style="width: 10%;"></td> <td style="width: 10%;"></td> <td style="width: 10%;"></td> <td style="width: 10%;"></td> <td style="width: 10%;"></td> <td style="width: 10%;"></td> <td style="width: 10%;"></td> <td style="width: 10%;"></td> </tr> <tr> <td></td> <td></td> <td colspan="8" style="text-align: center;"> <table border="1" style="width: 100%; border-collapse: collapse; text-align: center;"> <tr> <td style="width: 10%;"></td> <td style="width: 10%;"></td> <td style="width: 10%;"></td> <td style="width: 10%;"></td> <td style="width: 10%;"></td> <td style="width: 10%;"></td> <td style="width: 10%;"></td> <td style="width: 10%;"></td> <td style="width: 10%;"></td> <td style="width: 10%;"></td> </tr> <tr> <td></td> <td></td> <td colspan="8" style="text-align: center;"> <table border="1" style="width: 100%; border-collapse: collapse; text-align: center;"> <tr> <td style="width: 10%;"></td> <td style="width: 10%;"></td> <td style="width: 10%;"></td> <td style="width: 10%;"></td> <td style="width: 10%;"></td> <td style="width: 10%;"></td> <td style="width: 10%;"></td> <td style="width: 10%;"></td> <td style="width: 10%;"></td> <td style="width: 10%;"></td> </tr> <tr> <td></td> <td></td> <td colspan="8" style="text-align: center;"> <table border="1" style="width: 100%; border-collapse: collapse; text-align: center;"> <tr> <td style="width: 10%;"></td> <td style="width: 10%;"></td> <td style="width: 10%;"></td> <td style="width: 10%;"></td> <td style="width: 10%;"></td> <td style="width: 10%;"></td> <td style="width: 10%;"></td> <td style="width: 10%;"></td> <td style="width: 10%;"></td> <td style="width: 10%;"></td> </tr> <tr> <td></td> <td></td> <td colspan="8" style="text-align: center;"> <table border="1" style="width: 100%; border-collapse: collapse; text-align: center;"> <tr> <td style="width: 10%;"></td> <td style="width: 10%;"></td> <td style="width: 10%;"></td> <td style="width: 10%;"></td> <td style="width: 10%;"></td> <td style="width: 10%;"></td> <td style="width: 10%;"></td> <td style="width: 10%;"></td> <td style="width: 10%;"></td> <td style="width: 10%;"></td> </tr> <tr> <td></td> <td></td> <td colspan="8" style="text-align: center;"> <table border="1" style="width: 100%; border-collapse: collapse; text-align: center;"> <tr> <td style="width: 10%;"></td> <td style="width: 10%;"></td> <td style="width: 10%;"></td> <td style="width: 10%;"></td> <td style="width: 10%;"></td> <td style="width: 10%;"></td> <td style="width: 10%;"></td> <td style="width: 10%;"></td> <td style="width: 10%;"></td> <td style="width: 10%;"></td> </tr> <tr> <td></td> <td></td> <td colspan="8" style="text-align: center;"> <table border="1" style="width: 100%; border-collapse: collapse; text-align: center;"> <tr> <td style="width: 10%;"></td> <td style="width: 10%;"></td> <td style="width: 10%;"></td> <td style="width: 10%;"></td> <td style="width: 10%;"></td> <td style="width: 10%;"></td> <td style="width: 10%;"></td> <td style="width: 10%;"></td> <td style="width: 10%;"></td> <td style="width: 10%;"></td> </tr> <tr> <td></td> <td></td> <td colspan="8" style="text-align: center;"> <table border="1" style="width: 100%; border-collapse: collapse; text-align: center;"> <tr> <td style="width: 10%;"></td> <td style="width: 10%;"></td> <td style="width: 10%;"></td> <td style="width: 10%;"></td> <td style="width: 10%;"></td> <td style="width: 10%;"></td> <td style="width: 10%;"></td> <td style="width: 10%;"></td> <td style="width: 10%;"></td> <td style="width: 10%;"></td> </tr> <tr> <td></td> <td></td> <td colspan="8" style="text-align: center;"> <table border="1" style="width: 100%; border-collapse: collapse; text-align: center;"> <tr> <td style="width: 10%;"></td> <td style="width: 10%;"></td> <td style="width: 10%;"></td> <td style="width: 10%;"></td> <td style="width: 10%;"></td> <td style="width: 10%;"></td> <td style="width: 10%;"></td> <td style="width: 10%;"></td> <td style="width: 10%;"></td> <td style="width: 10%;"></td> </tr> <tr> <td></td> <td></td> <td colspan="8" style="text-align: center;"> <table border="1" style="width: 100%; border-collapse: collapse; text-align: center;"> <tr> <td style="width: 10%;"></td> <td style="width: 10%;"></td> <td style="width: 10%;"></td> <td style="width: 10%;"></td> <td style="width: 10%;"></td> <td style="width: 10%;"></td> <td style="width: 10%;"></td> <td style="width: 10%;"></td> <td style="width: 10%;"></td> <td style="width: 10%;"></td> </tr> <tr> <td></td> <td></td> <td colspan="8" style="text-align: center;"> <table border="1" style="width: 100%; border-collapse: collapse; text-align: center;"> <tr> <td style="width: 10%;"></td> <td style="width: 10%;"></td> <td style="width: 10%;"></td> <td style="width: 10%;"></td> <td style="width: 10%;"></td> <td style="width: 10%;"></td> <td style="width: 10%;"></td> <td style="width: 10%;"></td> <td style="width: 10%;"></td> <td style="width: 10%;"></td> </tr> <tr> <td></td> <td></td> <td colspan="8" style="text-align: center;"> <table border="1" style="width: 100%; border-collapse: collapse; text-align: center;"> <tr> <td style="width: 10%;"></td> <td style="width: 10%;"></td> <td style="width: 10%;"></td> <td style="width: 10%;"></td> <td style="width: 10%;"></td> <td style="width: 10%;"></td> <td style="width: 10%;"></td> <td style="width: 10%;"></td> <td style="width: 10%;"></td> <td style="width: 10%;"></td> </tr> <tr> <td></td> <td></td> <td colspan="8" style="text-align: center;"> <table border="1" style="width: 100%; border-collapse: collapse; text-align: center;"> <tr> <td style="width: 10%;"></td> <td style="width: 10%;"></td> <td style="width: 10%;"></td> <td style="width: 10%;"></td> <td style="width: 10%;"></td> <td style="width: 10%;"></td> <td style="width: 10%;"></td> <td style="width: 10%;"></td> <td style="width: 10%;"></td> <td style="width: 10%;"></td> </tr> <tr> <td></td> <td></td> <td colspan="8" style="text-align: center;"> <table border="1" style="width: 100%; border-collapse: collapse; text-align: center;"> <tr> <td style="width: 10%;"></td> <td style="width: 10%;"></td> <td style="width: 10%;"></td> <td style="width: 10%;"></td> <td style="width: 10%;"></td> <td style="width: 10%;"></td> <td style="width: 10%;"></td> <td style="width: 10%;"></td> <td style="width: 10%;"></td> <td style="width:
10%;"></td> </tr> <tr> <td></td> <td></td> <td colspan="8" style="text-align: center;"> <table border="1" style="width: 100%; border-collapse: collapse; text-align: center;"> <tr> </tr></table></td></tr></table></td></tr></table></td></tr></table></td></tr></table></td></tr></table></td></tr></table></td></tr></table></td></tr></table></td></tr></table></td></tr></table></td></tr></table></td></tr></table></td></tr></table></td></tr></table></td></tr></table></td></tr></table></td></tr></table></td></tr></table></td></tr></table></td></tr></table></td></tr></table></td></tr></table></td></tr></table></td></tr></table></td></tr></table></td></tr></table></td></tr></table></td></tr></table></td></tr></table></td></tr></table></td></tr></table></td></tr></table></td></tr></table></td></tr></table></td></tr></table></td></tr></table></td></tr></table>
 | | | | | | | | | | | | | | | | | | | | <table border="1" style="width: 100%; border-collapse: collapse; text-align: center;"> <tr> <td style="width: 10%;"></td> <td style="width: 10%;"></td> <td style="width: 10%;"></td> <td style="width: 10%;"></td> <td style="width: 10%;"></td> <td style="width: 10%;"></td> <td style="width: 10%;"></td> <td style="width: 10%;"></td> <td style="width: 10%;"></td> <td style="width: 10%;"></td> </tr> <tr> <td></td> <td></td> <td colspan="8" style="text-align: center;"> <table border="1" style="width: 100%; border-collapse: collapse; text-align: center;"> <tr> <td style="width: 10%;"></td> <td style="width: 10%;"></td> <td style="width: 10%;"></td> <td style="width: 10%;"></td> <td style="width: 10%;"></td> <td style="width: 10%;"></td> <td style="width: 10%;"></td> <td style="width: 10%;"></td> <td style="width: 10%;"></td> <td style="width: 10%;"></td> </tr> <tr> <td></td> <td></td> <td colspan="8" style="text-align: center;"> <table border="1" style="width: 100%; border-collapse: collapse; text-align: center;"> <tr> <td style="width: 10%;"></td> <td style="width: 10%;"></td> <td style="width: 10%;"></td> <td style="width: 10%;"></td> <td style="width: 10%;"></td> <td style="width: 10%;"></td> <td style="width: 10%;"></td> <td style="width: 10%;"></td> <td style="width: 10%;"></td> <td style="width: 10%;"></td> </tr> <tr> <td></td> <td></td> <td colspan="8" style="text-align: center;"> <table border="1" style="width: 100%; border-collapse: collapse; text-align: center;"> <tr> <td style="width: 10%;"></td> <td style="width: 10%;"></td> <td style="width: 10%;"></td> <td style="width: 10%;"></td> <td style="width: 10%;"></td> <td style="width: 10%;"></td> <td style="width: 10%;"></td> <td style="width: 10%;"></td> <td style="width: 10%;"></td> <td style="width: 10%;"></td> </tr> <tr> <td></td> <td></td> <td colspan="8" style="text-align: center;"> <table border="1" style="width: 100%; border-collapse: collapse; text-align: center;"> <tr> <td style="width: 10%;"></td> <td style="width: 10%;"></td> <td style="width: 10%;"></td> <td style="width: 10%;"></td> <td style="width: 10%;"></td> <td style="width: 10%;"></td> <td style="width: 10%;"></td> <td style="width: 10%;"></td> <td style="width: 10%;"></td> <td style="width: 10%;"></td> </tr> <tr> <td></td> <td></td> <td colspan="8" style="text-align: center;"> <table border="1" style="width: 100%; border-collapse: collapse; text-align: center;"> <tr> <td style="width: 10%;"></td> <td style="width: 10%;"></td> <td style="width: 10%;"></td> <td style="width: 10%;"></td> <td style="width: 10%;"></td> <td style="width: 10%;"></td> <td style="width: 10%;"></td> <td style="width: 10%;"></td> <td style="width: 10%;"></td> <td style="width: 10%;"></td> </tr> <tr> <td></td> <td></td> <td colspan="8" style="text-align: center;"> <table border="1" style="width: 100%; border-collapse: collapse; text-align: center;"> <tr> <td style="width: 10%;"></td> <td style="width: 10%;"></td> <td style="width: 10%;"></td> <td style="width: 10%;"></td> <td style="width: 10%;"></td> <td style="width: 10%;"></td> <td style="width: 10%;"></td> <td style="width: 10%;"></td> <td style="width: 10%;"></td> <td style="width: 10%;"></td> </tr> <tr> <td></td> <td></td> <td colspan="8" style="text-align: center;"> <table border="1" style="width: 100%; border-collapse: collapse; text-align: center;"> <tr> <td style="width: 10%;"></td> <td style="width: 10%;"></td> <td style="width: 10%;"></td> <td style="width: 10%;"></td> <td style="width: 10%;"></td> <td style="width: 10%;"></td> <td style="width: 10%;"></td> <td style="width: 10%;"></td> <td style="width: 10%;"></td> <td style="width: 10%;"></td> </tr> <tr> <td></td> <td></td> <td colspan="8" style="text-align: center;"> <table border="1" style="width: 100%; border-collapse: collapse; text-align: center;"> <tr> <td style="width: 10%;"></td> <td style="width: 10%;"></td> <td style="width: 10%;"></td> <td style="width: 10%;"></td> <td style="width: 10%;"></td> <td style="width: 10%;"></td> <td style="width: 10%;"></td> <td style="width: 10%;"></td> <td style="width: 10%;"></td> <td style="width: 10%;"></td> </tr> <tr> <td></td> <td></td> <td colspan="8" style="text-align: center;"> <table border="1" style="width: 100%; border-collapse: collapse; text-align: center;"> <tr> <td style="width: 10%;"></td> <td style="width: 10%;"></td> <td style="width: 10%;"></td> <td style="width: 10%;"></td> <td style="width: 10%;"></td> <td style="width: 10%;"></td> <td style="width: 10%;"></td> <td style="width: 10%;"></td> <td style="width: 10%;"></td> <td style="width: 10%;"></td> </tr> <tr> <td></td> <td></td> <td colspan="8" style="text-align: center;"> <table border="1" style="width: 100%; border-collapse: collapse; text-align: center;"> <tr> <td style="width: 10%;"></td> <td style="width: 10%;"></td> <td style="width: 10%;"></td> <td style="width: 10%;"></td> <td style="width: 10%;"></td> <td style="width: 10%;"></td> <td style="width: 10%;"></td> <td style="width: 10%;"></td> <td style="width: 10%;"></td> <td style="width: 10%;"></td> </tr> <tr> <td></td> <td></td> <td colspan="8" style="text-align: center;"> <table border="1" style="width: 100%; border-collapse: collapse; text-align: center;"> <tr> <td style="width: 10%;"></td> <td style="width: 10%;"></td> <td style="width: 10%;"></td> <td style="width: 10%;"></td> <td style="width: 10%;"></td> <td style="width: 10%;"></td> <td style="width: 10%;"></td> <td style="width: 10%;"></td> <td style="width: 10%;"></td> <td style="width: 10%;"></td> </tr> <tr> <td></td> <td></td> <td colspan="8" style="text-align: center;"> <table border="1" style="width: 100%; border-collapse: collapse; text-align: center;"> <tr> <td style="width: 10%;"></td> <td style="width: 10%;"></td> <td style="width: 10%;"></td> <td style="width: 10%;"></td> <td style="width: 10%;"></td> <td style="width: 10%;"></td> <td style="width: 10%;"></td> <td style="width: 10%;"></td> <td style="width: 10%;"></td> <td style="width: 10%;"></td> </tr> <tr> <td></td> <td></td> <td colspan="8" style="text-align: center;"> <table border="1" style="width: 100%; border-collapse: collapse; text-align: center;"> <tr> <td style="width: 10%;"></td> <td style="width: 10%;"></td> <td style="width: 10%;"></td> <td style="width: 10%;"></td> <td style="width: 10%;"></td> <td style="width: 10%;"></td> <td style="width: 10%;"></td> <td style="width: 10%;"></td> <td style="width: 10%;"></td> <td style="width: 10%;"></td> </tr> <tr> <td></td> <td></td> <td colspan="8" style="text-align: center;"> <table border="1" style="width: 100%; border-collapse: collapse; text-align: center;"> <tr> <td style="width: 10%;"></td> <td style="width: 10%;"></td> <td style="width: 10%;"></td> <td style="width: 10%;"></td> <td style="width: 10%;"></td> <td style="width: 10%;"></td> <td style="width: 10%;"></td> <td style="width: 10%;"></td> <td style="width: 10%;"></td> <td style="width: 10%;"></td> </tr> <tr> <td></td> <td></td> <td colspan="8" style="text-align: center;"> <table border="1" style="width: 100%; border-collapse: collapse; text-align: center;"> <tr> <td style="width: 10%;"></td> <td style="width: 10%;"></td> <td style="width: 10%;"></td> <td style="width: 10%;"></td> <td style="width: 10%;"></td> <td style="width: 10%;"></td> <td style="width: 10%;"></td> <td style="width: 10%;"></td> <td style="width: 10%;"></td> <td style="width: 10%;"></td>
</tr> <tr> <td></td> <td></td> <td colspan="8" style="text-align: center;"> <table border="1" style="width: 100%; border-collapse: collapse; text-align: center;"> <tr> <td style="width: 10%;"></td> <td style="width: 10%;"></td> <td style="width: 10%;"></td> <td style="width: 10%;"></td> <td style="width: 10%;"></td> <td style="width: 10%;"></td> <td style="width: 10%;"></td> <td style="width: 10%;"></td> <td style="width: 10%;"></td> <td style="width: 10%;"></td> </tr> <tr> <td></td> <td></td> <td colspan="8" style="text-align: center;"> <table border="1" style="width: 100%; border-collapse: collapse; text-align: center;"> <tr> <td style="width: 10%;"></td> <td style="width: 10%;"></td> <td style="width: 10%;"></td> <td style="width: 10%;"></td> <td style="width: 10%;"></td> <td style="width: 10%;"></td> <td style="width: 10%;"></td> <td style="width: 10%;"></td> <td style="width: 10%;"></td> <td style="width: 10%;"></td> </tr> <tr> <td></td> <td></td> <td colspan="8" style="text-align: center;"> <table border="1" style="width: 100%; border-collapse: collapse; text-align: center;"> <tr> <td style="width: 10%;"></td> <td style="width: 10%;"></td> <td style="width: 10%;"></td> <td style="width: 10%;"></td> <td style="width: 10%;"></td> <td style="width: 10%;"></td> <td style="width: 10%;"></td> <td style="width: 10%;"></td> <td style="width: 10%;"></td> <td style="width: 10%;"></td> </tr> <tr> <td></td> <td></td> <td colspan="8" style="text-align: center;"> <table border="1" style="width: 100%; border-collapse: collapse; text-align: center;"> <tr> <td style="width: 10%;"></td> <td style="width: 10%;"></td> <td style="width: 10%;"></td> <td style="width: 10%;"></td> <td style="width: 10%;"></td> <td style="width: 10%;"></td> <td style="width: 10%;"></td> <td style="width: 10%;"></td> <td style="width: 10%;"></td> <td style="width: 10%;"></td> </tr> <tr> <td></td> <td></td> <td colspan="8" style="text-align: center;"> <table border="1" style="width: 100%; border-collapse: collapse; text-align: center;"> <tr> <td style="width: 10%;"></td> <td style="width: 10%;"></td> <td style="width: 10%;"></td> <td style="width: 10%;"></td> <td style="width: 10%;"></td> <td style="width: 10%;"></td> <td style="width: 10%;"></td> <td style="width: 10%;"></td> <td style="width: 10%;"></td> <td style="width: 10%;"></td> </tr> <tr> <td></td> <td></td> <td colspan="8" style="text-align: center;"> <table border="1" style="width: 100%; border-collapse: collapse; text-align: center;"> <tr> <td style="width: 10%;"></td> <td style="width: 10%;"></td> <td style="width: 10%;"></td> <td style="width: 10%;"></td> <td style="width: 10%;"></td> <td style="width: 10%;"></td> <td style="width: 10%;"></td> <td style="width: 10%;"></td> <td style="width: 10%;"></td> <td style="width: 10%;"></td> </tr> <tr> <td></td> <td></td> <td colspan="8" style="text-align: center;"> <table border="1" style="width: 100%; border-collapse: collapse; text-align: center;"> <tr> <td style="width: 10%;"></td> <td style="width: 10%;"></td> <td style="width: 10%;"></td> <td style="width: 10%;"></td> <td style="width: 10%;"></td> <td style="width: 10%;"></td> <td style="width: 10%;"></td> <td style="width: 10%;"></td> <td style="width: 10%;"></td> <td style="width: 10%;"></td> </tr> <tr> <td></td> <td></td> <td colspan="8" style="text-align: center;"> <table border="1" style="width: 100%; border-collapse: collapse; text-align: center;"> <tr> <td style="width: 10%;"></td> <td style="width: 10%;"></td> <td style="width: 10%;"></td> <td style="width: 10%;"></td> <td style="width: 10%;"></td> <td style="width: 10%;"></td> <td style="width: 10%;"></td> <td style="width: 10%;"></td> <td style="width: 10%;"></td> <td style="width: 10%;"></td> </tr> <tr> <td></td> <td></td> <td colspan="8" style="text-align: center;"> <table border="1" style="width: 100%; border-collapse: collapse; text-align: center;"> <tr> <td style="width: 10%;"></td> <td style="width: 10%;"></td> <td style="width: 10%;"></td> <td style="width: 10%;"></td> <td style="width: 10%;"></td> <td style="width: 10%;"></td> <td style="width: 10%;"></td> <td style="width: 10%;"></td> <td style="width: 10%;"></td> <td style="width: 10%;"></td> </tr> <tr> <td></td> <td></td> <td colspan="8" style="text-align: center;"> <table border="1" style="width: 100%; border-collapse: collapse; text-align: center;"> <tr> <td style="width: 10%;"></td> <td style="width: 10%;"></td> <td style="width: 10%;"></td> <td style="width: 10%;"></td> <td style="width: 10%;"></td> <td style="width: 10%;"></td> <td style="width: 10%;"></td> <td style="width: 10%;"></td> <td style="width: 10%;"></td> <td style="width: 10%;"></td> </tr> <tr> <td></td> <td></td> <td colspan="8" style="text-align: center;"> <table border="1" style="width: 100%; border-collapse: collapse; text-align: center;"> <tr> <td style="width: 10%;"></td> <td style="width: 10%;"></td> <td style="width: 10%;"></td> <td style="width: 10%;"></td> <td style="width: 10%;"></td> <td style="width: 10%;"></td> <td style="width: 10%;"></td> <td style="width: 10%;"></td> <td style="width: 10%;"></td> <td style="width: 10%;"></td> </tr> <tr> <td></td> <td></td> <td colspan="8" style="text-align: center;"> <table border="1" style="width: 100%; border-collapse: collapse; text-align: center;"> <tr> <td style="width: 10%;"></td> <td style="width: 10%;"></td> <td style="width: 10%;"></td> <td style="width: 10%;"></td> <td style="width: 10%;"></td> <td style="width: 10%;"></td> <td style="width: 10%;"></td> <td style="width: 10%;"></td> <td style="width: 10%;"></td> <td style="width: 10%;"></td> </tr> <tr> <td></td> <td></td> <td colspan="8" style="text-align: center;"> <table border="1" style="width: 100%; border-collapse: collapse; text-align: center;"> <tr> <td style="width: 10%;"></td> <td style="width: 10%;"></td> <td style="width: 10%;"></td> <td style="width: 10%;"></td> <td style="width: 10%;"></td> <td style="width: 10%;"></td> <td style="width: 10%;"></td> <td style="width: 10%;"></td> <td style="width: 10%;"></td> <td style="width: 10%;"></td> </tr> <tr> <td></td> <td></td> <td colspan="8" style="text-align: center;"> <table border="1" style="width: 100%; border-collapse: collapse; text-align: center;"> <tr> <td style="width: 10%;"></td> <td style="width: 10%;"></td> <td style="width: 10%;"></td> <td style="width: 10%;"></td> <td style="width: 10%;"></td> <td style="width: 10%;"></td> <td style="width: 10%;"></td> <td style="width: 10%;"></td> <td style="width: 10%;"></td> <td style="width: 10%;"></td> </tr> <tr> <td></td> <td></td> <td colspan="8" style="text-align: center;"> <table border="1" style="width: 100%; border-collapse: collapse; text-align: center;"> <tr> <td style="width: 10%;"></td> <td style="width: 10%;"></td> <td style="width: 10%;"></td> <td style="width: 10%;"></td> <td style="width: 10%;"></td> <td style="width: 10%;"></td> <td style="width: 10%;"></td> <td style="width: 10%;"></td> <td style="width: 10%;"></td> <td style="width: 10%;"></td> </tr> <tr> <td></td> <td></td> <td colspan="8" style="text-align: center;"> <table border="1" style="width: 100%; border-collapse: collapse; text-align: center;"> <tr> <td style="width: 10%;"></td> <td style="width: 10%;"></td> <td style="width: 10%;"></td> <td style="width: 10%;"></td> <td style="width: 10%;"></td> <td style="width: 10%;"></td> <td style="width: 10%;"></td> <td style="width: 10%;"></td> <td style="width: 10%;"></td> <td style="width: 10%;"></td> </tr> <tr> <td></td> <td></td> <td colspan="8" style="text-align: center;"> <table border="1" style="width: 100%; border-collapse: collapse; text-align: center;"> <tr> <td style="width: 10%;"></td> <td style="width: 10%;"></td> <td style="width: 10%;"></td> <td style="width: 10%;"></td> <td style="width: 10%;"></td> <td style="width: 10%;"></td> <td style="width: 10%;"></td> <td style="width: 10%;"></td> <td style="width: 10%;"></td> <td style="width: 10%;"></td> </tr> <tr> <td></td> <td></td> <td colspan="8" style="text-align: center;"> <table border="1" style="width: 100%; border-collapse: collapse; text-align: center;"> <tr> <td style="width: 10%;"></td> <td style="width: 10%;"></td> <td style="width: 10%;"></td> <td style="width: 10%;"></td> <td style="width: 10%;"></td> <td style="width: 10%;"></td> <td style="width: 10%;"></td> <td style="width: 10%;"></td> <td style="width: 10%;"></td> <td style="width: 10%;"></td> </tr> <tr> <td></td> <td></td> <td colspan="8" style="text-align: center;"> <table border="1" style="width: 100%; border-collapse: collapse; text-align: center;"> <tr> <td style="width: 10%;"></td> <td style="width: 10%;"></td> <td style="width: 10%;"></td> <td style="width: 10%;"></td> <td style="width: 10%;"></td> <td style="width: 10%;"></td> <td style="width: 10%;"></td> <td style="width: 10%;"></td> <td style="width: 10%;"></td> <td style="width: 10%;"></td> </tr> <tr> <td></td> <td></td> <td colspan="8" style="text-align: center;"> <table border="1" style="width: 100%; border-collapse: collapse; text-align: center;"> <tr> <td style="width: 10%;"></td> <td style="width: 10%;"></td> <td style="width: 10%;"></td> <td style="width: 10%;"></td> <td style="width: 10%;"></td> <td style="width: 10%;"></td> <td style="width: 10%;"></td> <td style="width: 10%;"></td> <td style="width: 10%;"></td> <td style="width: 10%;"></td> </tr> <tr> <td></td> <td></td> <td colspan="8" style="text-align: center;"> <table border="1" style="width: 100%; border-collapse: collapse; text-align: center;"> <tr>
</tr></table></td></tr></table></td></tr></table></td></tr></table></td></tr></table></td></tr></table></td></tr></table></td></tr></table></td></tr></table></td></tr></table></td></tr></table></td></tr></table></td></tr></table></td></tr></table></td></tr></table></td></tr></table></td></tr></table></td></tr></table></td></tr></table></td></tr></table></td></tr></table></td></tr></table></td></tr></table></td></tr></table></td></tr></table></td></tr></table></td></tr></table></td></tr></table></td></tr></table></td></tr></table></td></tr></table></td></tr></table></td></tr></table></td></tr></table></td></tr></table></td></tr></table></td></tr></table>
 | | | | | | | | | | | | | | | | | | | | <table border="1" style="width: 100%; border-collapse: collapse; text-align: center;"> <tr> <td style="width: 10%;"></td> <td style="width: 10%;"></td> <td style="width: 10%;"></td> <td style="width: 10%;"></td> <td style="width: 10%;"></td> <td style="width: 10%;"></td> <td style="width: 10%;"></td> <td style="width: 10%;"></td> <td style="width: 10%;"></td> <td style="width: 10%;"></td> </tr> <tr> <td></td> <td></td> <td colspan="8" style="text-align: center;"> <table border="1" style="width: 100%; border-collapse: collapse; text-align: center;"> <tr> <td style="width: 10%;"></td> <td style="width: 10%;"></td> <td style="width: 10%;"></td> <td style="width: 10%;"></td> <td style="width: 10%;"></td> <td style="width: 10%;"></td> <td style="width: 10%;"></td> <td style="width: 10%;"></td> <td style="width: 10%;"></td> <td style="width: 10%;"></td> </tr> <tr> <td></td> <td></td> <td colspan="8" style="text-align: center;"> <table border="1" style="width: 100%; border-collapse: collapse; text-align: center;"> <tr> <td style="width: 10%;"></td> <td style="width: 10%;"></td> <td style="width: 10%;"></td> <td style="width: 10%;"></td> <td style="width: 10%;"></td> <td style="width: 10%;"></td> <td style="width: 10%;"></td> <td style="width: 10%;"></td> <td style="width: 10%;"></td> <td style="width: 10%;"></td> </tr> <tr> <td></td> <td></td> <td colspan="8" style="text-align: center;"> <table border="1" style="width: 100%; border-collapse: collapse; text-align: center;"> <tr> <td style="width: 10%;"></td> <td style="width: 10%;"></td> <td style="width: 10%;"></td> <td style="width: 10%;"></td> <td style="width: 10%;"></td> <td style="width: 10%;"></td> <td style="width: 10%;"></td> <td style="width: 10%;"></td> <td style="width: 10%;"></td> <td style="width: 10%;"></td> </tr> <tr> <td></td> <td></td> <td colspan="8" style="text-align: center;"> <table border="1" style="width: 100%; border-collapse: collapse; text-align: center;"> <tr> <td style="width: 10%;"></td> <td style="width: 10%;"></td> <td style="width: 10%;"></td> <td style="width: 10%;"></td> <td style="width: 10%;"></td> <td style="width: 10%;"></td> <td style="width: 10%;"></td> <td style="width: 10%;"></td> <td style="width: 10%;"></td> <td style="width: 10%;"></td> </tr> <tr> <td></td> <td></td> <td colspan="8" style="text-align: center;"> <table border="1" style="width: 100%; border-collapse: collapse; text-align: center;"> <tr> <td style="width: 10%;"></td> <td style="width: 10%;"></td> <td style="width: 10%;"></td> <td style="width: 10%;"></td> <td style="width: 10%;"></td> <td style="width: 10%;"></td> <td style="width: 10%;"></td> <td style="width: 10%;"></td> <td style="width: 10%;"></td> <td style="width: 10%;"></td> </tr> <tr> <td></td> <td></td> <td colspan="8" style="text-align: center;"> <table border="1" style="width: 100%; border-collapse: collapse; text-align: center;"> <tr> <td style="width: 10%;"></td> <td style="width: 10%;"></td> <td style="width: 10%;"></td> <td style="width: 10%;"></td> <td style="width: 10%;"></td> <td style="width: 10%;"></td> <td style="width: 10%;"></td> <td style="width: 10%;"></td> <td style="width: 10%;"></td> <td style="width: 10%;"></td> </tr> <tr> <td></td> <td></td> <td colspan="8" style="text-align: center;"> <table border="1" style="width: 100%; border-collapse: collapse; text-align: center;"> <tr> <td style="width: 10%;"></td> <td style="width: 10%;"></td> <td style="width: 10%;"></td> <td style="width: 10%;"></td> <td style="width: 10%;"></td> <td style="width: 10%;"></td> <td style="width: 10%;"></td> <td style="width: 10%;"></td> <td style="width: 10%;"></td> <td style="width: 10%;"></td> </tr> <tr> <td></td> <td></td> <td colspan="8" style="text-align: center;"> <table border="1" style="width: 100%; border-collapse: collapse; text-align: center;"> <tr> <td style="width: 10%;"></td> <td style="width: 10%;"></td> <td style="width: 10%;"></td> <td style="width: 10%;"></td> <td style="width: 10%;"></td> <td style="width: 10%;"></td> <td style="width: 10%;"></td> <td style="width: 10%;"></td> <td style="width: 10%;"></td> <td style="width: 10%;"></td> </tr> <tr> <td></td> <td></td> <td colspan="8" style="text-align: center;"> <table border="1" style="width: 100%; border-collapse: collapse; text-align: center;"> <tr> <td style="width: 10%;"></td> <td style="width: 10%;"></td> <td style="width: 10%;"></td> <td style="width: 10%;"></td> <td style="width: 10%;"></td> <td style="width: 10%;"></td> <td style="width: 10%;"></td> <td style="width: 10%;"></td> <td style="width: 10%;"></td> <td style="width: 10%;"></td> </tr> <tr> <td></td> <td></td> <td colspan="8" style="text-align: center;"> <table border="1" style="width: 100%; border-collapse: collapse; text-align: center;"> <tr> <td style="width: 10%;"></td> <td style="width: 10%;"></td> <td style="width: 10%;"></td> <td style="width: 10%;"></td> <td style="width: 10%;"></td> <td style="width: 10%;"></td> <td style="width: 10%;"></td> <td style="width: 10%;"></td> <td style="width: 10%;"></td> <td style="width: 10%;"></td> </tr> <tr> <td></td> <td></td> <td colspan="8" style="text-align: center;"> <table border="1" style="width: 100%; border-collapse: collapse; text-align: center;"> <tr> <td style="width: 10%;"></td> <td style="width: 10%;"></td> <td style="width: 10%;"></td> <td style="width: 10%;"></td> <td style="width: 10%;"></td> <td style="width: 10%;"></td> <td style="width: 10%;"></td> <td style="width: 10%;"></td> <td style="width: 10%;"></td> <td style="width: 10%;"></td> </tr> <tr> <td></td> <td></td> <td colspan="8" style="text-align: center;"> <table border="1" style="width: 100%; border-collapse: collapse; text-align: center;"> <tr> <td style="width: 10%;"></td> <td style="width: 10%;"></td> <td style="width: 10%;"></td> <td style="width: 10%;"></td> <td style="width: 10%;"></td> <td style="width: 10%;"></td> <td style="width: 10%;"></td> <td style="width: 10%;"></td> <td style="width: 10%;"></td> <td style="width: 10%;"></td> </tr> <tr> <td></td> <td></td> <td colspan="8" style="text-align: center;"> <table border="1" style="width: 100%; border-collapse: collapse; text-align: center;"> <tr> <td style="width: 10%;"></td> <td style="width: 10%;"></td> <td style="width: 10%;"></td> <td style="width: 10%;"></td> <td style="width: 10%;"></td> <td style="width: 10%;"></td> <td style="width: 10%;"></td> <td style="width: 10%;"></td> <td style="width: 10%;"></td> <td style="width: 10%;"></td> </tr> <tr> <td></td> <td></td> <td colspan="8" style="text-align: center;"> <table border="1" style="width: 100%; border-collapse: collapse; text-align: center;"> <tr> <td style="width: 10%;"></td> <td style="width: 10%;"></td> <td style="width: 10%;"></td> <td style="width: 10%;"></td> <td style="width: 10%;"></td> <td style="width: 10%;"></td> <td style="width: 10%;"></td> <td style="width: 10%;"></td> <td style="width: 10%;"></td> <td style="width: 10%;"></td> </tr> <tr> <td></td> <td></td> <td colspan="8" style="text-align: center;"> <table border="1" style="width: 100%; border-collapse: collapse; text-align: center;"> <tr> <td style="width: 10%;"></td> <td style="width: 10%;"></td> <td style="width: 10%;"></td> <td style="width: 10%;"></td> <td style="width: 10%;"></td> <td style="width: 10%;"></td> <td style="width: 10%;"></td> <td style="width: 10%;"></td> <td style="width: 10%;"></td> <td style="width: 10%;"></td> </tr> <tr> <td></td> <td></td> <td colspan="8" style="text-align: center;"> <table border="1" style="width: 100%; border-collapse: collapse; text-align: center;"> <tr> <td style="width: 10%;"></td> <td
style="width: 10%;"></td> <td style="width: 10%;"></td> <td style="width: 10%;"></td> <td style="width: 10%;"></td> <td style="width: 10%;"></td> <td style="width: 10%;"></td> <td style="width: 10%;"></td> <td style="width: 10%;"></td> <td style="width: 10%;"></td> </tr> <tr> <td></td> <td></td> <td colspan="8" style="text-align: center;"> <table border="1" style="width: 100%; border-collapse: collapse; text-align: center;"> <tr> <td style="width: 10%;"></td> <td style="width: 10%;"></td> <td style="width: 10%;"></td> <td style="width: 10%;"></td> <td style="width: 10%;"></td> <td style="width: 10%;"></td> <td style="width: 10%;"></td> <td style="width: 10%;"></td> <td style="width: 10%;"></td> <td style="width: 10%;"></td> </tr> <tr> <td></td> <td></td> <td colspan="8" style="text-align: center;"> <table border="1" style="width: 100%; border-collapse: collapse; text-align: center;"> <tr> <td style="width: 10%;"></td> <td style="width: 10%;"></td> <td style="width: 10%;"></td> <td style="width: 10%;"></td> <td style="width: 10%;"></td> <td style="width: 10%;"></td> <td style="width: 10%;"></td> <td style="width: 10%;"></td> <td style="width: 10%;"></td> <td style="width: 10%;"></td> </tr> <tr> <td></td> <td></td> <td colspan="8" style="text-align: center;"> <table border="1" style="width: 100%; border-collapse: collapse; text-align: center;"> <tr> <td style="width: 10%;"></td> <td style="width: 10%;"></td> <td style="width: 10%;"></td> <td style="width: 10%;"></td> <td style="width: 10%;"></td> <td style="width: 10%;"></td> <td style="width: 10%;"></td> <td style="width: 10%;"></td> <td style="width: 10%;"></td> <td style="width: 10%;"></td> </tr> <tr> <td></td> <td></td> <td colspan="8" style="text-align: center;"> <table border="1" style="width: 100%; border-collapse: collapse; text-align: center;"> <tr> <td style="width: 10%;"></td> <td style="width: 10%;"></td> <td style="width: 10%;"></td> <td style="width: 10%;"></td> <td style="width: 10%;"></td> <td style="width: 10%;"></td> <td style="width: 10%;"></td> <td style="width: 10%;"></td> <td style="width: 10%;"></td> <td style="width: 10%;"></td> </tr> <tr> <td></td> <td></td> <td colspan="8" style="text-align: center;"> <table border="1" style="width: 100%; border-collapse: collapse; text-align: center;"> <tr> <td style="width: 10%;"></td> <td style="width: 10%;"></td> <td style="width: 10%;"></td> <td style="width: 10%;"></td> <td style="width: 10%;"></td> <td style="width: 10%;"></td> <td style="width: 10%;"></td> <td style="width: 10%;"></td> <td style="width: 10%;"></td> <td style="width: 10%;"></td> </tr> <tr> <td></td> <td></td> <td colspan="8" style="text-align: center;"> <table border="1" style="width: 100%; border-collapse: collapse; text-align: center;"> <tr> <td style="width: 10%;"></td> <td style="width: 10%;"></td> <td style="width: 10%;"></td> <td style="width: 10%;"></td> <td style="width: 10%;"></td> <td style="width: 10%;"></td> <td style="width: 10%;"></td> <td style="width: 10%;"></td> <td style="width: 10%;"></td> <td style="width: 10%;"></td> </tr> <tr> <td></td> <td></td> <td colspan="8" style="text-align: center;"> <table border="1" style="width: 100%; border-collapse: collapse; text-align: center;"> <tr> <td style="width: 10%;"></td> <td style="width: 10%;"></td> <td style="width: 10%;"></td> <td style="width: 10%;"></td> <td style="width: 10%;"></td> <td style="width: 10%;"></td> <td style="width: 10%;"></td> <td style="width: 10%;"></td> <td style="width: 10%;"></td> <td style="width: 10%;"></td> </tr> <tr> <td></td> <td></td> <td colspan="8" style="text-align: center;"> <table border="1" style="width: 100%; border-collapse: collapse; text-align: center;"> <tr> <td style="width: 10%;"></td> <td style="width: 10%;"></td> <td style="width: 10%;"></td> <td style="width: 10%;"></td> <td style="width: 10%;"></td> <td style="width: 10%;"></td> <td style="width: 10%;"></td> <td style="width: 10%;"></td> <td style="width: 10%;"></td> <td style="width: 10%;"></td> </tr> <tr> <td></td> <td></td> <td colspan="8" style="text-align: center;"> <table border="1" style="width: 100%; border-collapse: collapse; text-align: center;"> <tr> <td style="width: 10%;"></td> <td style="width: 10%;"></td> <td style="width: 10%;"></td> <td style="width: 10%;"></td> <td style="width: 10%;"></td> <td style="width: 10%;"></td> <td style="width: 10%;"></td> <td style="width: 10%;"></td> <td style="width: 10%;"></td> <td style="width: 10%;"></td> </tr> <tr> <td></td> <td></td> <td colspan="8" style="text-align: center;"> <table border="1" style="width: 100%; border-collapse: collapse; text-align: center;"> <tr> <td style="width: 10%;"></td> <td style="width: 10%;"></td> <td style="width: 10%;"></td> <td style="width: 10%;"></td> <td style="width: 10%;"></td> <td style="width: 10%;"></td> <td style="width: 10%;"></td> <td style="width: 10%;"></td> <td style="width: 10%;"></td> <td style="width: 10%;"></td> </tr> <tr> <td></td> <td></td> <td colspan="8" style="text-align: center;"> <table border="1" style="width: 100%; border-collapse: collapse; text-align: center;"> <tr> <td style="width: 10%;"></td> <td style="width: 10%;"></td> <td style="width: 10%;"></td> <td style="width: 10%;"></td> <td style="width: 10%;"></td> <td style="width: 10%;"></td> <td style="width: 10%;"></td> <td style="width: 10%;"></td> <td style="width: 10%;"></td> <td style="width: 10%;"></td> </tr> <tr> <td></td> <td></td> <td colspan="8" style="text-align: center;"> <table border="1" style="width: 100%; border-collapse: collapse; text-align: center;"> <tr> <td style="width: 10%;"></td> <td style="width: 10%;"></td> <td style="width: 10%;"></td> <td style="width: 10%;"></td> <td style="width: 10%;"></td> <td style="width: 10%;"></td> <td style="width: 10%;"></td> <td style="width: 10%;"></td> <td style="width: 10%;"></td> <td style="width: 10%;"></td> </tr> <tr> <td></td> <td></td> <td colspan="8" style="text-align: center;"> <table border="1" style="width: 100%; border-collapse: collapse; text-align: center;"> <tr> <td style="width: 10%;"></td> <td style="width: 10%;"></td> <td style="width: 10%;"></td> <td style="width: 10%;"></td> <td style="width: 10%;"></td> <td style="width: 10%;"></td> <td style="width: 10%;"></td> <td style="width: 10%;"></td> <td style="width: 10%;"></td> <td style="width: 10%;"></td> </tr> <tr> <td></td> <td></td> <td colspan="8" style="text-align: center;"> <table border="1" style="width: 100%; border-collapse: collapse; text-align: center;"> <tr> <td style="width: 10%;"></td> <td style="width: 10%;"></td> <td style="width: 10%;"></td> <td style="width: 10%;"></td> <td style="width: 10%;"></td> <td style="width: 10%;"></td> <td style="width: 10%;"></td> <td style="width: 10%;"></td> <td style="width: 10%;"></td> <td style="width: 10%;"></td> </tr> <tr> <td></td> <td></td> <td colspan="8" style="text-align: center;"> <table border="1" style="width: 100%; border-collapse: collapse; text-align: center;"> <tr> <td style="width: 10%;"></td> <td style="width: 10%;"></td> <td style="width: 10%;"></td> <td style="width: 10%;"></td> <td style="width: 10%;"></td> <td style="width: 10%;"></td> <td style="width: 10%;"></td> <td style="width: 10%;"></td> <td style="width: 10%;"></td> <td style="width: 10%;"></td> </tr> <tr> <td></td> <td></td> <td colspan="8" style="text-align: center;"> <table border="1" style="width: 100%; border-collapse: collapse; text-align: center;"> <tr> <td style="width: 10%;"></td> <td style="width: 10%;"></td> <td style="width: 10%;"></td> <td style="width: 10%;"></td> <td style="width: 10%;"></td> <td style="width: 10%;"></td> <td style="width: 10%;"></td> <td style="width: 10%;"></td> <td style="width: 10%;"></td> <td style="width: 10%;"></td> </tr> <tr> <td></td> <td></td> <td colspan="8" style="text-align: center;"> <table border="1" style="width: 100%; border-collapse: collapse; text-align: center;"> <tr> <td style="width: 10%;"></td> <td style="width: 10%;"></td> <td style="width: 10%;"></td> <td style="width: 10%;"></td> <td style="width: 10%;"></td> <td style="width: 10%;"></td> <td style="width: 10%;"></td> <td style="width: 10%;"></td> <td style="width: 10%;"></td> <td style="width: 10%;"></td> </tr> <tr> <td></td> <td></td> <td colspan="8" style="text-align: center;"> <table border="1" style="width: 100%; border-collapse: collapse; text-align: center;"> <tr> <td style="width: 10%;"></td> <td style="width: 10%;"></td> <td style="width: 10%;"></td> <td style="width: 10%;"></td> <td style="width: 10%;"></td> <td style="width: 10%;"></td> <td style="width: 10%;"></td> <td style="width: 10%;"></td> <td style="width: 10%;"></td> <td style="width: 10%;"></td> </tr> <tr> <td></td> <td></td> <td colspan="8" style="text-align: center;"> <table border="1" style="width: 100%; border-collapse: collapse; text-align: center;"> <tr> </tr></table></td></tr></table></td></tr></table></td></tr></table></td></tr></table></td></tr></table></td></tr></table></td></tr></table></td></tr></table></td></tr></table></td></tr></table></td></tr></table></td></tr></table></td></tr></table></td></tr></table></td></tr></table></td></tr></table></td></tr></table></td></tr></table></td></tr></table></td></tr></table></td></tr></table></td></tr></table></td></tr></table></td></tr></table></td></tr></table></td></tr></table></td></tr></table></td></tr></table></td></tr></table></td></tr></table></td></tr></table></td></tr></table></td></tr></table></td></tr></table></td></tr></table>

 | | | | | | | | | | | | | | | | | | | | <table border="1" style="width: 100%; border-collapse: collapse; text-align: center;"> <tr> <td style="width: 10%;"></td> <td style="width: 10%;"></td> <td style="width: 10%;"></td> <td style="width: 10%;"></td> <td style="width: 10%;"></td> <td style="width: 10%;"></td> <td style="width: 10%;"></td> <td style="width: 10%;"></td> <td style="width: 10%;"></td> <td style="width: 10%;"></td> </tr> <tr> <td></td> <td></td> <td colspan="8" style="text-align: center;"> <table border="1" style="width: 100%; border-collapse: collapse; text-align: center;"> <tr> <td style="width: 10%;"></td> <td style="width: 10%;"></td> <td style="width: 10%;"></td> <td style="width: 10%;"></td> <td style="width: 10%;"></td> <td style="width: 10%;"></td> <td style="width: 10%;"></td> <td style="width: 10%;"></td> <td style="width: 10%;"></td> <td style="width: 10%;"></td> </tr> <tr> <td></td> <td></td> <td colspan="8" style="text-align: center;"> <table border="1" style="width: 100%; border-collapse: collapse; text-align: center;"> <tr> <td style="width: 10%;"></td> <td style="width: 10%;"></td> <td style="width: 10%;"></td> <td style="width: 10%;"></td> <td style="width: 10%;"></td> <td style="width: 10%;"></td> <td style="width: 10%;"></td> <td style="width: 10%;"></td> <td style="width: 10%;"></td> <td style="width: 10%;"></td> </tr> <tr> <td></td> <td></td> <td colspan="8" style="text-align: center;"> <table border="1" style="width: 100%; border-collapse: collapse; text-align: center;"> <tr> <td style="width: 10%;"></td> <td style="width: 10%;"></td> <td style="width: 10%;"></td> <td style="width: 10%;"></td> <td style="width: 10%;"></td> <td style="width: 10%;"></td> <td style="width: 10%;"></td> <td style="width: 10%;"></td> <td style="width: 10%;"></td> <td style="width: 10%;"></td> </tr> <tr> <td></td> <td></td> <td colspan="8" style="text-align: center;"> <table border="1" style="width: 100%; border-collapse: collapse; text-align: center;"> <tr> <td style="width: 10%;"></td> <td style="width: 10%;"></td> <td style="width: 10%;"></td> <td style="width: 10%;"></td> <td style="width: 10%;"></td> <td style="width: 10%;"></td> <td style="width: 10%;"></td> <td style="width: 10%;"></td> <td style="width: 10%;"></td> <td style="width: 10%;"></td> </tr> <tr> <td></td> <td></td> <td colspan="8" style="text-align: center;"> <table border="1" style="width: 100%; border-collapse: collapse; text-align: center;"> <tr> <td style="width: 10%;"></td> <td style="width: 10%;"></td> <td style="width: 10%;"></td> <td style="width: 10%;"></td> <td style="width: 10%;"></td> <td style="width: 10%;"></td> <td style="width: 10%;"></td> <td style="width: 10%;"></td> <td style="width: 10%;"></td> <td style="width: 10%;"></td> </tr> <tr> <td></td> <td></td> <td colspan="8" style="text-align: center;"> <table border="1" style="width: 100%; border-collapse: collapse; text-align: center;"> <tr> <td style="width: 10%;"></td> <td style="width: 10%;"></td> <td style="width: 10%;"></td> <td style="width: 10%;"></td> <td style="width: 10%;"></td> <td style="width: 10%;"></td> <td style="width: 10%;"></td> <td style="width: 10%;"></td> <td style="width: 10%;"></td> <td style="width: 10%;"></td> </tr> <tr> <td></td> <td></td> <td colspan="8" style="text-align: center;"> <table border="1" style="width: 100%; border-collapse: collapse; text-align: center;"> <tr> <td style="width: 10%;"></td> <td style="width: 10%;"></td> <td style="width: 10%;"></td> <td style="width: 10%;"></td> <td style="width: 10%;"></td> <td style="width: 10%;"></td> <td style="width: 10%;"></td> <td style="width: 10%;"></td> <td style="width: 10%;"></td> <td style="width: 10%;"></td> </tr> <tr> <td></td> <td></td> <td colspan="8" style="text-align: center;"> <table border="1" style="width: 100%; border-collapse: collapse; text-align: center;"> <tr> <td style="width: 10%;"></td> <td style="width: 10%;"></td> <td style="width: 10%;"></td> <td style="width: 10%;"></td> <td style="width: 10%;"></td> <td style="width: 10%;"></td> <td style="width: 10%;"></td> <td style="width: 10%;"></td> <td style="width: 10%;"></td> <td style="width: 10%;"></td> </tr> <tr> <td></td> <td></td> <td colspan="8" style="text-align: center;"> <table border="1" style="width: 100%; border-collapse: collapse; text-align: center;"> <tr> <td style="width: 10%;"></td> <td style="width: 10%;"></td> <td style="width: 10%;"></td> <td style="width: 10%;"></td> <td style="width: 10%;"></td> <td style="width: 10%;"></td> <td style="width: 10%;"></td> <td style="width: 10%;"></td> <td style="width: 10%;"></td> <td style="width: 10%;"></td> </tr> <tr> <td></td> <td></td> <td colspan="8" style="text-align: center;"> <table border="1" style="width: 100%; border-collapse: collapse; text-align: center;"> <tr> <td style="width: 10%;"></td> <td style="width: 10%;"></td> <td style="width: 10%;"></td> <td style="width: 10%;"></td> <td style="width: 10%;"></td> <td style="width: 10%;"></td> <td style="width: 10%;"></td> <td style="width: 10%;"></td> <td style="width: 10%;"></td> <td style="width: 10%;"></td> </tr> <tr> <td></td> <td></td> <td colspan="8" style="text-align: center;"> <table border="1" style="width: 100%; border-collapse: collapse; text-align: center;"> <tr> <td style="width: 10%;"></td> <td style="width: 10%;"></td> <td style="width: 10%;"></td> <td style="width: 10%;"></td> <td style="width: 10%;"></td> <td style="width: 10%;"></td> <td style="width: 10%;"></td> <td style="width: 10%;"></td> <td style="width: 10%;"></td> <td style="width: 10%;"></td> </tr> <tr> <td></td> <td></td> <td colspan="8" style="text-align: center;"> <table border="1" style="width: 100%; border-collapse: collapse; text-align: center;"> <tr> <td style="width: 10%;"></td> <td style="width: 10%;"></td> <td style="width: 10%;"></td> <td style="width: 10%;"></td> <td style="width: 10%;"></td> <td style="width: 10%;"></td> <td style="width: 10%;"></td> <td style="width: 10%;"></td> <td style="width: 10%;"></td> <td style="width: 10%;"></td> </tr> <tr> <td></td> <td></td> <td colspan="8" style="text-align: center;"> <table border="1" style="width: 100%; border-collapse: collapse; text-align: center;"> <tr> <td style="width: 10%;"></td> <td style="width: 10%;"></td> <td style="width: 10%;"></td> <td style="width: 10%;"></td> <td style="width: 10%;"></td> <td style="width: 10%;"></td> <td style="width: 10%;"></td> <td style="width: 10%;"></td> <td style="width: 10%;"></td> <td style="width: 10%;"></td> </tr> <tr> <td></td> <td></td> <td colspan="8" style="text-align: center;"> <table border="1" style="width: 100%; border-collapse: collapse; text-align: center;"> <tr> <td style="width: 10%;"></td> <td style="width: 10%;"></td> <td style="width: 10%;"></td> <td style="width: 10%;"></td> <td style="width: 10%;"></td> <td style="width: 10%;"></td> <td style="width: 10%;"></td> <td style="width: 10%;"></td> <td style="width: 10%;"></td> <td style="width: 10%;"></td> </tr> <tr> <td></td> <td></td> <td colspan="8" style="text-align: center;"> <table border="1" style="width: 100%; border-collapse: collapse; text-align: center;"> <tr> <td style="width: 10%;"></td> <td style="width: 10%;"></td> <td style="width: 10%;"></td> <td style="width: 10%;"></td> <td style="width: 10%;"></td> <td style="width: 10%;"></td> <td style="width: 10%;"></td> <td style="width: 10%;"></td> <td style="width: 10%;"></td> <td style="width: 10%;"></td> </tr> <tr> <td></td> <td></td> <td colspan="8" style="text-align: center;"> <table border="1" style="width: 100%; border-collapse: collapse; text-align: center;"> <tr> <td style="width: 10%;"></td> <td style="width: 10%;"></td> <td style="width: 10%;"></td> <td style="width: 10%;"></td> <td style="width: 10%;"></td> <td style="width: 10%;"></td> <td style="width: 10%;"></td> <td style="width: 10%;"></td> <td style="width: 10%;"></td> <td style="width: 10%;"></td> </tr> <tr> <td></td> <td></td> <td colspan="8" style="text-align: center;"> <table border="1" style="width: 100%; border-collapse: collapse; text-align: center;"> <tr> <td style="width: 10%;"></td> <td style="width: 10%;"></td> <td style="width: 10%;"></td> <td style="width: 10%;"></td> <td style="width: 10%;"></td> <td style="width: 10%;"></td> <td style="width: 10%;"></td> <td style="width: 10%;"></td> <td style="width: 10%;"></td> <td style="width: 10%;"></td> </tr> <tr> <td></td> <td></td> <td colspan="8" style="text-align: center;"> <table border="1" style="width: 100%; border-collapse: collapse; text-align: center;"> <tr> <td style="width: 10%;"></td> <td style="width: 10%;"></td> <td style="width: 10%;"></td> <td style="width: 10%;"></td> <td style="width: 10%;"></td> <td style="width: 10%;"></td> <td style="width: 10%;"></td> <td style="width: 10%;"></td> <td style="width:
10%;"></td> <td style="width: 10%;"></td> </tr> <tr> <td></td> <td></td> <td colspan="8" style="text-align: center;"> <table border="1" style="width: 100%; border-collapse: collapse; text-align: center;"> <tr> <td style="width: 10%;"></td> <td style="width: 10%;"></td> <td style="width: 10%;"></td> <td style="width: 10%;"></td> <td style="width: 10%;"></td> <td style="width: 10%;"></td> <td style="width: 10%;"></td> <td style="width: 10%;"></td> <td style="width: 10%;"></td> <td style="width: 10%;"></td> </tr> <tr> <td></td> <td></td> <td colspan="8" style="text-align: center;"> <table border="1" style="width: 100%; border-collapse: collapse; text-align: center;"> <tr> <td style="width: 10%;"></td> <td style="width: 10%;"></td> <td style="width: 10%;"></td> <td style="width: 10%;"></td> <td style="width: 10%;"></td> <td style="width: 10%;"></td> <td style="width: 10%;"></td> <td style="width: 10%;"></td> <td style="width: 10%;"></td> <td style="width: 10%;"></td> </tr> <tr> <td></td> <td></td> <td colspan="8" style="text-align: center;"> <table border="1" style="width: 100%; border-collapse: collapse; text-align: center;"> <tr> <td style="width: 10%;"></td> <td style="width: 10%;"></td> <td style="width: 10%;"></td> <td style="width: 10%;"></td> <td style="width: 10%;"></td> <td style="width: 10%;"></td> <td style="width: 10%;"></td> <td style="width: 10%;"></td> <td style="width: 10%;"></td> <td style="width: 10%;"></td> </tr> <tr> <td></td> <td></td> <td colspan="8" style="text-align: center;"> <table border="1" style="width: 100%; border-collapse: collapse; text-align: center;"> <tr> <td style="width: 10%;"></td> <td style="width: 10%;"></td> <td style="width: 10%;"></td> <td style="width: 10%;"></td> <td style="width: 10%;"></td> <td style="width: 10%;"></td> <td style="width: 10%;"></td> <td style="width: 10%;"></td> <td style="width: 10%;"></td> <td style="width: 10%;"></td> </tr> <tr> <td></td> <td></td> <td colspan="8" style="text-align: center;"> <table border="1" style="width: 100%; border-collapse: collapse; text-align: center;"> <tr> <td style="width: 10%;"></td> <td style="width: 10%;"></td> <td style="width: 10%;"></td> <td style="width: 10%;"></td> <td style="width: 10%;"></td> <td style="width: 10%;"></td> <td style="width: 10%;"></td> <td style="width: 10%;"></td> <td style="width: 10%;"></td> <td style="width: 10%;"></td> </tr> <tr> <td></td> <td></td> <td colspan="8" style="text-align: center;"> <table border="1" style="width: 100%; border-collapse: collapse; text-align: center;"> <tr> <td style="width: 10%;"></td> <td style="width: 10%;"></td> <td style="width: 10%;"></td> <td style="width: 10%;"></td> <td style="width: 10%;"></td> <td style="width: 10%;"></td> <td style="width: 10%;"></td> <td style="width: 10%;"></td> <td style="width: 10%;"></td> <td style="width: 10%;"></td> </tr> <tr> <td></td> <td></td> <td colspan="8" style="text-align: center;"> <table border="1" style="width: 100%; border-collapse: collapse; text-align: center;"> <tr> <td style="width: 10%;"></td> <td style="width: 10%;"></td> <td style="width: 10%;"></td> <td style="width: 10%;"></td> <td style="width: 10%;"></td> <td style="width: 10%;"></td> <td style="width: 10%;"></td> <td style="width: 10%;"></td> <td style="width: 10%;"></td> <td style="width: 10%;"></td> </tr> <tr> <td></td> <td></td> <td colspan="8" style="text-align: center;"> <table border="1" style="width: 100%; border-collapse: collapse; text-align: center;"> <tr> <td style="width: 10%;"></td> <td style="width: 10%;"></td> <td style="width: 10%;"></td> <td style="width: 10%;"></td> <td style="width: 10%;"></td> <td style="width: 10%;"></td> <td style="width: 10%;"></td> <td style="width: 10%;"></td> <td style="width: 10%;"></td> <td style="width: 10%;"></td> </tr> <tr> <td></td> <td></td> <td colspan="8" style="text-align: center;"> <table border="1" style="width: 100%; border-collapse: collapse; text-align: center;"> <tr> <td style="width: 10%;"></td> <td style="width: 10%;"></td> <td style="width: 10%;"></td> <td style="width: 10%;"></td> <td style="width: 10%;"></td> <td style="width: 10%;"></td> <td style="width: 10%;"></td> <td style="width: 10%;"></td> <td style="width: 10%;"></td> <td style="width: 10%;"></td> </tr> <tr> <td></td> <td></td> <td colspan="8" style="text-align: center;"> <table border="1" style="width: 100%; border-collapse: collapse; text-align: center;"> <tr> <td style="width: 10%;"></td> <td style="width: 10%;"></td> <td style="width: 10%;"></td> <td style="width: 10%;"></td> <td style="width: 10%;"></td> <td style="width: 10%;"></td> <td style="width: 10%;"></td> <td style="width: 10%;"></td> <td style="width: 10%;"></td> <td style="width: 10%;"></td> </tr> <tr> <td></td> <td></td> <td colspan="8" style="text-align: center;"> <table border="1" style="width: 100%; border-collapse: collapse; text-align: center;"> <tr> <td style="width: 10%;"></td> <td style="width: 10%;"></td> <td style="width: 10%;"></td> <td style="width: 10%;"></td> <td style="width: 10%;"></td> <td style="width: 10%;"></td> <td style="width: 10%;"></td> <td style="width: 10%;"></td> <td style="width: 10%;"></td> <td style="width: 10%;"></td> </tr> <tr> <td></td> <td></td> <td colspan="8" style="text-align: center;"> <table border="1" style="width: 100%; border-collapse: collapse; text-align: center;"> <tr> <td style="width: 10%;"></td> <td style="width: 10%;"></td> <td style="width: 10%;"></td> <td style="width: 10%;"></td> <td style="width: 10%;"></td> <td style="width: 10%;"></td> <td style="width: 10%;"></td> <td style="width: 10%;"></td> <td style="width: 10%;"></td> <td style="width: 10%;"></td> </tr> <tr> <td></td> <td></td> <td colspan="8" style="text-align: center;"> <table border="1" style="width: 100%; border-collapse: collapse; text-align: center;"> <tr> <td style="width: 10%;"></td> <td style="width: 10%;"></td> <td style="width: 10%;"></td> <td style="width: 10%;"></td> <td style="width: 10%;"></td> <td style="width: 10%;"></td> <td style="width: 10%;"></td> <td style="width: 10%;"></td> <td style="width: 10%;"></td> <td style="width: 10%;"></td> </tr> <tr> <td></td> <td></td> <td colspan="8" style="text-align: center;"> <table border="1" style="width: 100%; border-collapse: collapse; text-align: center;"> <tr> <td style="width: 10%;"></td> <td style="width: 10%;"></td> <td style="width: 10%;"></td> <td style="width: 10%;"></td> <td style="width: 10%;"></td> <td style="width: 10%;"></td> <td style="width: 10%;"></td> <td style="width: 10%;"></td> <td style="width: 10%;"></td> <td style="width: 10%;"></td> </tr> <tr> <td></td> <td></td> <td colspan="8" style="text-align: center;"> <table border="1" style="width: 100%; border-collapse: collapse; text-align: center;"> <tr> <td style="width: 10%;"></td> <td style="width: 10%;"></td> <td style="width: 10%;"></td> <td style="width: 10%;"></td> <td style="width: 10%;"></td> <td style="width: 10%;"></td> <td style="width: 10%;"></td> <td style="width: 10%;"></td> <td style="width: 10%;"></td> <td style="width: 10%;"></td> </tr> <tr> <td></td> <td></td> <td colspan="8" style="text-align: center;"> <table border="1" style="width: 100%; border-collapse: collapse; text-align: center;"> <tr> </tr></table></td></tr></table></td></tr></table></td></tr></table></td></tr></table></td></tr></table></td></tr></table></td></tr></table></td></tr></table></td></tr></table></td></tr></table></td></tr></table></td></tr></table></td></tr></table></td></tr></table></td></tr></table></td></tr></table></td></tr></table></td></tr></table></td></tr></table></td></tr></table></td></tr></table></td></tr></table></td></tr></table></td></tr></table></td></tr></table></td></tr></table></td></tr></table></td></tr></table></td></tr></table></td></tr></table></td></tr></table></td></tr></table></td></tr></table></td></tr></table>
 | | | | | | | | | | | | | | | | | | | | <table border="1" style="width: 100%; border-collapse: collapse; text-align: center;"> <tr> <td style="width: 10%;"></td> <td style="width: 10%;"></td> <td style="width: 10%;"></td> <td style="width: 10%;"></td> <td style="width: 10%;"></td> <td style="width: 10%;"></td> <td style="width: 10%;"></td> <td style="width: 10%;"></td> <td style="width: 10%;"></td> <td style="width: 10%;"></td> </tr> <tr> <td></td>
<td></td> <td colspan="8" style="text-align: center;"> <table border="1" style="width: 100%; border-collapse: collapse; text-align: center;"> <tr> <td style="width: 10%;"></td> <td style="width: 10%;"></td> <td style="width: 10%;"></td> <td style="width: 10%;"></td> <td style="width: 10%;"></td> <td style="width: 10%;"></td> <td style="width: 10%;"></td> <td style="width: 10%;"></td> <td style="width: 10%;"></td> <td style="width: 10%;"></td> </tr> <tr> <td></td> <td></td> <td colspan="8" style="text-align: center;"> <table border="1" style="width: 100%; border-collapse: collapse; text-align: center;"> <tr> <td style="width: 10%;"></td> <td style="width: 10%;"></td> <td style="width: 10%;"></td> <td style="width: 10%;"></td> <td style="width: 10%;"></td> <td style="width: 10%;"></td> <td style="width: 10%;"></td> <td style="width: 10%;"></td> <td style="width: 10%;"></td> <td style="width: 10%;"></td> </tr> <tr> <td></td> <td></td> <td colspan="8" style="text-align: center;"> <table border="1" style="width: 100%; border-collapse: collapse; text-align: center;"> <tr> <td style="width: 10%;"></td> <td style="width: 10%;"></td> <td style="width: 10%;"></td> <td style="width: 10%;"></td> <td style="width: 10%;"></td> <td style="width: 10%;"></td> <td style="width: 10%;"></td> <td style="width: 10%;"></td> <td style="width: 10%;"></td> <td style="width: 10%;"></td> </tr> <tr> <td></td> <td></td> <td colspan="8" style="text-align: center;"> <table border="1" style="width: 100%; border-collapse: collapse; text-align: center;"> <tr> <td style="width: 10%;"></td> <td style="width: 10%;"></td> <td style="width: 10%;"></td> <td style="width: 10%;"></td> <td style="width: 10%;"></td> <td style="width: 10%;"></td> <td style="width: 10%;"></td> <td style="width: 10%;"></td> <td style="width: 10%;"></td> <td style="width: 10%;"></td> </tr> <tr> <td></td> <td></td> <td colspan="8" style="text-align: center;"> <table border="1" style="width: 100%; border-collapse: collapse; text-align: center;"> <tr> <td style="width: 10%;"></td> <td style="width: 10%;"></td> <td style="width: 10%;"></td> <td style="width: 10%;"></td> <td style="width: 10%;"></td> <td style="width: 10%;"></td> <td style="width: 10%;"></td> <td style="width: 10%;"></td> <td style="width: 10%;"></td> <td style="width: 10%;"></td> </tr> <tr> <td></td> <td></td> <td colspan="8" style="text-align: center;"> <table border="1" style="width: 100%; border-collapse: collapse; text-align: center;"> <tr> <td style="width: 10%;"></td> <td style="width: 10%;"></td> <td style="width: 10%;"></td> <td style="width: 10%;"></td> <td style="width: 10%;"></td> <td style="width: 10%;"></td> <td style="width: 10%;"></td> <td style="width: 10%;"></td> <td style="width: 10%;"></td> <td style="width: 10%;"></td> </tr> <tr> <td></td> <td></td> <td colspan="8" style="text-align: center;"> <table border="1" style="width: 100%; border-collapse: collapse; text-align: center;"> <tr> <td style="width: 10%;"></td> <td style="width: 10%;"></td> <td style="width: 10%;"></td> <td style="width: 10%;"></td> <td style="width: 10%;"></td> <td style="width: 10%;"></td> <td style="width: 10%;"></td> <td style="width: 10%;"></td> <td style="width: 10%;"></td> <td style="width: 10%;"></td> </tr> <tr> <td></td> <td></td> <td colspan="8" style="text-align: center;"> <table border="1" style="width: 100%; border-collapse: collapse; text-align: center;"> <tr> <td style="width: 10%;"></td> <td style="width: 10%;"></td> <td style="width: 10%;"></td> <td style="width: 10%;"></td> <td style="width: 10%;"></td> <td style="width: 10%;"></td> <td style="width: 10%;"></td> <td style="width: 10%;"></td> <td style="width: 10%;"></td> <td style="width: 10%;"></td> </tr> <tr> <td></td> <td></td> <td colspan="8" style="text-align: center;"> <table border="1" style="width: 100%; border-collapse: collapse; text-align: center;"> <tr> <td style="width: 10%;"></td> <td style="width: 10%;"></td> <td style="width: 10%;"></td> <td style="width: 10%;"></td> <td style="width: 10%;"></td> <td style="width: 10%;"></td> <td style="width: 10%;"></td> <td style="width: 10%;"></td> <td style="width: 10%;"></td> <td style="width: 10%;"></td> </tr> <tr> <td></td> <td></td> <td colspan="8" style="text-align: center;"> <table border="1" style="width: 100%; border-collapse: collapse; text-align: center;"> <tr> <td style="width: 10%;"></td> <td style="width: 10%;"></td> <td style="width: 10%;"></td> <td style="width: 10%;"></td> <td style="width: 10%;"></td> <td style="width: 10%;"></td> <td style="width: 10%;"></td> <td style="width: 10%;"></td> <td style="width: 10%;"></td> <td style="width: 10%;"></td> </tr> <tr> <td></td> <td></td> <td colspan="8" style="text-align: center;"> <table border="1" style="width: 100%; border-collapse: collapse; text-align: center;"> <tr> <td style="width: 10%;"></td> <td style="width: 10%;"></td> <td style="width: 10%;"></td> <td style="width: 10%;"></td> <td style="width: 10%;"></td> <td style="width: 10%;"></td> <td style="width: 10%;"></td> <td style="width: 10%;"></td> <td style="width: 10%;"></td> <td style="width: 10%;"></td> </tr> <tr> <td></td> <td></td> <td colspan="8" style="text-align: center;"> <table border="1" style="width: 100%; border-collapse: collapse; text-align: center;"> <tr> <td style="width: 10%;"></td> <td style="width: 10%;"></td> <td style="width: 10%;"></td> <td style="width: 10%;"></td> <td style="width: 10%;"></td> <td style="width: 10%;"></td> <td style="width: 10%;"></td> <td style="width: 10%;"></td> <td style="width: 10%;"></td> <td style="width: 10%;"></td> </tr> <tr> <td></td> <td></td> <td colspan="8" style="text-align: center;"> <table border="1" style="width: 100%; border-collapse: collapse; text-align: center;"> <tr> <td style="width: 10%;"></td> <td style="width: 10%;"></td> <td style="width: 10%;"></td> <td style="width: 10%;"></td> <td style="width: 10%;"></td> <td style="width: 10%;"></td> <td style="width: 10%;"></td> <td style="width: 10%;"></td> <td style="width: 10%;"></td> <td style="width: 10%;"></td> </tr> <tr> <td></td> <td></td> <td colspan="8" style="text-align: center;"> <table border="1" style="width: 100%; border-collapse: collapse; text-align: center;"> <tr> <td style="width: 10%;"></td> <td style="width: 10%;"></td> <td style="width: 10%;"></td> <td style="width: 10%;"></td> <td style="width: 10%;"></td> <td style="width: 10%;"></td> <td style="width: 10%;"></td> <td style="width: 10%;"></td> <td style="width: 10%;"></td> <td style="width: 10%;"></td> </tr> <tr> <td></td> <td></td> <td colspan="8" style="text-align: center;"> <table border="1" style="width: 100%; border-collapse: collapse; text-align: center;"> <tr> <td style="width: 10%;"></td> <td style="width: 10%;"></td> <td style="width: 10%;"></td> <td style="width: 10%;"></td> <td style="width: 10%;"></td> <td style="width: 10%;"></td> <td style="width: 10%;"></td> <td style="width: 10%;"></td> <td style="width: 10%;"></td> <td style="width: 10%;"></td> </tr> <tr> <td></td> <td></td> <td colspan="8" style="text-align: center;"> <table border="1" style="width: 100%; border-collapse: collapse; text-align: center;"> <tr> <td style="width: 10%;"></td> <td style="width: 10%;"></td> <td style="width: 10%;"></td> <td style="width: 10%;"></td> <td style="width: 10%;"></td> <td style="width: 10%;"></td> <td style="width: 10%;"></td> <td style="width: 10%;"></td> <td style="width: 10%;"></td> <td style="width: 10%;"></td> </tr> <tr> <td></td> <td></td> <td colspan="8" style="text-align: center;"> <table border="1" style="width: 100%; border-collapse: collapse; text-align: center;"> <tr> <td style="width: 10%;"></td> <td style="width: 10%;"></td> <td style="width: 10%;"></td> <td style="width: 10%;"></td> <td style="width: 10%;"></td> <td style="width: 10%;"></td> <td style="width: 10%;"></td> <td style="width: 10%;"></td> <td style="width: 10%;"></td> <td style="width: 10%;"></td> </tr> <tr> <td></td> <td></td> <td colspan="8" style="text-align: center;"> <table border="1" style="width: 100%; border-collapse: collapse; text-align: center;"> <tr> <td style="width: 10%;"></td> <td style="width: 10%;"></td> <td style="width: 10%;"></td> <td style="width: 10%;"></td> <td style="width: 10%;"></td> <td style="width: 10%;"></td> <td style="width: 10%;"></td> <td style="width: 10%;"></td> <td style="width: 10%;"></td> <td style="width: 10%;"></td> </tr> <tr> <td></td> <td></td> <td colspan="8" style="text-align: center;"> <table border="1" style="width: 100%; border-collapse: collapse; text-align: center;"> <tr> <td style="width: 10%;"></td> <td style="width: 10%;"></td> <td style="width: 10%;"></td> <td style="width: 10%;"></td> <td style="width: 10%;"></td> <td style="width: 10%;"></td> <td style="width: 10%;"></td> <td style="width: 10%;"></td> <td style="width: 10%;"></td> <td style="width: 10%;"></td> </tr> <tr> <td></td> <td></td> <td colspan="8" style="text-align: center;"> <table border="1" style="width: 100%; border-collapse: collapse; text-align: center;"> <tr> <td style="width: 10%;"></td> <td style="width: 10%;"></td> <td style="width: 10%;"></td> <td style="width: 10%;"></td> <td style="width: 10%;"></td> <td style="width: 10%;"></td> <td style="width: 10%;"></td> <td style="width: 10%;"></td> <td style="width: 10%;"></td> <td style="width: 10%;"></td> </tr> <tr> <td></td> <td></td> <td colspan="8" style="text-align: center;"> <table border="1" style="width: 100%; border-collapse: collapse; text-align: center;"> <tr> <td style="width: 10%;"></td> <td style="width: 10%;"></td> <td style="width: 10%;"></td> <td style="width: 10%;"></td> <td style="width: 10%;"></td> <td style="width: 10%;"></td> <td style="width: 10%;"></td> <td style="width: 10%;"></td> <td style="width: 10%;"></td> <td style="width: 10%;"></td> </tr> <tr> <td></td> <td></td> <td colspan="8" style="text-align: center;"> <table border="1" style="width: 100%; border-collapse: collapse; text-align: center;"> <tr> <td style="width:
10%;"></td> <td style="width: 10%;"></td> <td style="width: 10%;"></td> <td style="width: 10%;"></td> <td style="width: 10%;"></td> <td style="width: 10%;"></td> <td style="width: 10%;"></td> <td style="width: 10%;"></td> <td style="width: 10%;"></td> <td style="width: 10%;"></td> </tr> <tr> <td></td> <td></td> <td colspan="8" style="text-align: center;"> <table border="1" style="width: 100%; border-collapse: collapse; text-align: center;"> <tr> <td style="width: 10%;"></td> <td style="width: 10%;"></td> <td style="width: 10%;"></td> <td style="width: 10%;"></td> <td style="width: 10%;"></td> <td style="width: 10%;"></td> <td style="width: 10%;"></td> <td style="width: 10%;"></td> <td style="width: 10%;"></td> <td style="width: 10%;"></td> </tr> <tr> <td></td> <td></td> <td colspan="8" style="text-align: center;"> <table border="1" style="width: 100%; border-collapse: collapse; text-align: center;"> <tr> <td style="width: 10%;"></td> <td style="width: 10%;"></td> <td style="width: 10%;"></td> <td style="width: 10%;"></td> <td style="width: 10%;"></td> <td style="width: 10%;"></td> <td style="width: 10%;"></td> <td style="width: 10%;"></td> <td style="width: 10%;"></td> <td style="width: 10%;"></td> </tr> <tr> <td></td> <td></td> <td colspan="8" style="text-align: center;"> <table border="1" style="width: 100%; border-collapse: collapse; text-align: center;"> <tr> <td style="width: 10%;"></td> <td style="width: 10%;"></td> <td style="width: 10%;"></td> <td style="width: 10%;"></td> <td style="width: 10%;"></td> <td style="width: 10%;"></td> <td style="width: 10%;"></td> <td style="width: 10%;"></td> <td style="width: 10%;"></td> <td style="width: 10%;"></td> </tr> <tr> <td></td> <td></td> <td colspan="8" style="text-align: center;"> <table border="1" style="width: 100%; border-collapse: collapse; text-align: center;"> <tr> <td style="width: 10%;"></td> <td style="width: 10%;"></td> <td style="width: 10%;"></td> <td style="width: 10%;"></td> <td style="width: 10%;"></td> <td style="width: 10%;"></td> <td style="width: 10%;"></td> <td style="width: 10%;"></td> <td style="width: 10%;"></td> <td style="width: 10%;"></td> </tr> <tr> <td></td> <td></td> <td colspan="8" style="text-align: center;"> <table border="1" style="width: 100%; border-collapse: collapse; text-align: center;"> <tr> <td style="width: 10%;"></td> <td style="width: 10%;"></td> <td style="width: 10%;"></td> <td style="width: 10%;"></td> <td style="width: 10%;"></td> <td style="width: 10%;"></td> <td style="width: 10%;"></td> <td style="width: 10%;"></td> <td style="width: 10%;"></td> <td style="width: 10%;"></td> </tr> <tr> <td></td> <td></td> <td colspan="8" style="text-align: center;"> <table border="1" style="width: 100%; border-collapse: collapse; text-align: center;"> <tr> <td style="width: 10%;"></td> <td style="width: 10%;"></td> <td style="width: 10%;"></td> <td style="width: 10%;"></td> <td style="width: 10%;"></td> <td style="width: 10%;"></td> <td style="width: 10%;"></td> <td style="width: 10%;"></td> <td style="width: 10%;"></td> <td style="width: 10%;"></td> </tr> <tr> <td></td> <td></td> <td colspan="8" style="text-align: center;"> <table border="1" style="width: 100%; border-collapse: collapse; text-align: center;"> <tr> <td style="width: 10%;"></td> <td style="width: 10%;"></td> <td style="width: 10%;"></td> <td style="width: 10%;"></td> <td style="width: 10%;"></td> <td style="width: 10%;"></td> <td style="width: 10%;"></td> <td style="width: 10%;"></td> <td style="width: 10%;"></td> <td style="width: 10%;"></td> </tr> <tr> <td></td> <td></td> <td colspan="8" style="text-align: center;"> <table border="1" style="width: 100%; border-collapse: collapse; text-align: center;"> <tr> <td style="width: 10%;"></td> <td style="width: 10%;"></td> <td style="width: 10%;"></td> <td style="width: 10%;"></td> <td style="width: 10%;"></td> <td style="width: 10%;"></td> <td style="width: 10%;"></td> <td style="width: 10%;"></td> <td style="width: 10%;"></td> <td style="width: 10%;"></td> </tr> <tr> <td></td> <td></td> <td colspan="8" style="text-align: center;"> <table border="1" style="width: 100%; border-collapse: collapse; text-align: center;"> <tr> <td style="width: 10%;"></td> <td style="width: 10%;"></td> <td style="width: 10%;"></td> <td style="width: 10%;"></td> <td style="width: 10%;"></td> <td style="width: 10%;"></td> <td style="width: 10%;"></td> <td style="width: 10%;"></td> <td style="width: 10%;"></td> <td style="width: 10%;"></td> </tr> <tr> <td></td> <td></td> <td colspan="8" style="text-align: center;"> <table border="1" style="width: 100%; border-collapse: collapse; text-align: center;"> <tr> <td style="width: 10%;"></td> <td style="width: 10%;"></td> <td style="width: 10%;"></td> <td style="width: 10%;"></td> <td style="width: 10%;"></td> <td style="width: 10%;"></td> <td style="width: 10%;"></td> <td style="width: 10%;"></td> <td style="width: 10%;"></td> <td style="width: 10%;"></td> </tr> <tr> <td></td> <td></td> <td colspan="8" style="text-align: center;"> <table border="1" style="width: 100%; border-collapse: collapse; text-align: center;"> <tr> </tr></table></td></tr></table></td></tr></table></td></tr></table></td></tr></table></td></tr></table></td></tr></table></td></tr></table></td></tr></table></td></tr></table></td></tr></table></td></tr></table></td></tr></table></td></tr></table></td></tr></table></td></tr></table></td></tr></table></td></tr></table></td></tr></table></td></tr></table></td></tr></table></td></tr></table></td></tr></table></td></tr></table></td></tr></table></td></tr></table></td></tr></table></td></tr></table></td></tr></table></td></tr></table></td></tr></table></td></tr></table></td></tr></table></td></tr></table>
 | | | | | | | | | | | | | | | | | | | | <table border="1" style="width: 100%; border-collapse: collapse; text-align: center;"> <tr> <td style="width: 10%;"></td> <td style="width: 10%;"></td> <td style="width: 10%;"></td> <td style="width: 10%;"></td> <td style="width: 10%;"></td> <td style="width: 10%;"></td> <td style="width: 10%;"></td> <td style="width: 10%;"></td> <td style="width: 10%;"></td> <td style="width: 10%;"></td> </tr> <tr> <td></td> <td></td> <td colspan="8" style="text-align: center;"> <table border="1" style="width: 100%; border-collapse: collapse; text-align: center;"> <tr> <td style="width: 10%;"></td> <td style="width: 10%;"></td> <td style="width: 10%;"></td> <td style="width: 10%;"></td> <td style="width: 10%;"></td> <td style="width: 10%;"></td> <td style="width: 10%;"></td> <td style="width: 10%;"></td> <td style="width: 10%;"></td> <td style="width: 10%;"></td> </tr> <tr> <td></td> <td></td> <td colspan="8" style="text-align: center;"> <table border="1" style="width: 100%; border-collapse: collapse; text-align: center;"> <tr> <td style="width: 10%;"></td> <td style="width: 10%;"></td> <td style="width: 10%;"></td> <td style="width: 10%;"></td> <td style="width: 10%;"></td> <td style="width: 10%;"></td> <td style="width: 10%;"></td> <td style="width: 10%;"></td> <td style="width: 10%;"></td> <td style="width: 10%;"></td> </tr> <tr> <td></td> <td></td> <td colspan="8" style="text-align: center;"> <table border="1" style="width: 100%; border-collapse: collapse; text-align: center;"> <tr> <td style="width: 10%;"></td> <td style="width: 10%;"></td> <td style="width: 10%;"></td> <td style="width: 10%;"></td> <td style="width: 10%;"></td> <td style="width: 10%;"></td> <td style="width: 10%;"></td> <td style="width: 10%;"></td> <td style="width: 10%;"></td> <td style="width: 10%;"></td> </tr> <tr> <td></td> <td></td> <td colspan="8" style="text-align: center;"> <table border="1" style="width: 100%; border-collapse: collapse; text-align: center;"> <tr> <td style="width: 10%;"></td> <td style="width: 10%;"></td> <td style="width: 10%;"></td> <td style="width: 10%;"></td> <td style="width: 10%;"></td> <td style="width: 10%;"></td> <td style="width: 10%;"></td> <td style="width: 10%;"></td> <td style="width: 10%;"></td> <td style="width: 10%;"></td> </tr> <tr> <td></td> <td></td> <td colspan="8" style="text-align: center;"> <table border="1" style="width: 100%; border-collapse: collapse; text-align: center;"> <tr> <td style="width: 10%;"></td> <td style="width: 10%;"></td> <td style="width: 10%;"></td> <td
style="width: 10%;"></td> <td style="width: 10%;"></td> <td style="width: 10%;"></td> <td style="width: 10%;"></td> <td style="width: 10%;"></td> <td style="width: 10%;"></td> <td style="width: 10%;"></td> </tr> <tr> <td></td> <td></td> <td colspan="8" style="text-align: center;"> <table border="1" style="width: 100%; border-collapse: collapse; text-align: center;"> <tr> <td style="width: 10%;"></td> <td style="width: 10%;"></td> <td style="width: 10%;"></td> <td style="width: 10%;"></td> <td style="width: 10%;"></td> <td style="width: 10%;"></td> <td style="width: 10%;"></td> <td style="width: 10%;"></td> <td style="width: 10%;"></td> <td style="width: 10%;"></td> </tr> <tr> <td></td> <td></td> <td colspan="8" style="text-align: center;"> <table border="1" style="width: 100%; border-collapse: collapse; text-align: center;"> <tr> <td style="width: 10%;"></td> <td style="width: 10%;"></td> <td style="width: 10%;"></td> <td style="width: 10%;"></td> <td style="width: 10%;"></td> <td style="width: 10%;"></td> <td style="width: 10%;"></td> <td style="width: 10%;"></td> <td style="width: 10%;"></td> <td style="width: 10%;"></td> </tr> <tr> <td></td> <td></td> <td colspan="8" style="text-align: center;"> <table border="1" style="width: 100%; border-collapse: collapse; text-align: center;"> <tr> <td style="width: 10%;"></td> <td style="width: 10%;"></td> <td style="width: 10%;"></td> <td style="width: 10%;"></td> <td style="width: 10%;"></td> <td style="width: 10%;"></td> <td style="width: 10%;"></td> <td style="width: 10%;"></td> <td style="width: 10%;"></td> <td style="width: 10%;"></td> </tr> <tr> <td></td> <td></td> <td colspan="8" style="text-align: center;"> <table border="1" style="width: 100%; border-collapse: collapse; text-align: center;"> <tr> <td style="width: 10%;"></td> <td style="width: 10%;"></td> <td style="width: 10%;"></td> <td style="width: 10%;"></td> <td style="width: 10%;"></td> <td style="width: 10%;"></td> <td style="width: 10%;"></td> <td style="width: 10%;"></td> <td style="width: 10%;"></td> <td style="width: 10%;"></td> </tr> <tr> <td></td> <td></td> <td colspan="8" style="text-align: center;"> <table border="1" style="width: 100%; border-collapse: collapse; text-align: center;"> <tr> <td style="width: 10%;"></td> <td style="width: 10%;"></td> <td style="width: 10%;"></td> <td style="width: 10%;"></td> <td style="width: 10%;"></td> <td style="width: 10%;"></td> <td style="width: 10%;"></td> <td style="width: 10%;"></td> <td style="width: 10%;"></td> <td style="width: 10%;"></td> </tr> <tr> <td></td> <td></td> <td colspan="8" style="text-align: center;"> <table border="1" style="width: 100%; border-collapse: collapse; text-align: center;"> <tr> <td style="width: 10%;"></td> <td style="width: 10%;"></td> <td style="width: 10%;"></td> <td style="width: 10%;"></td> <td style="width: 10%;"></td> <td style="width: 10%;"></td> <td style="width: 10%;"></td> <td style="width: 10%;"></td> <td style="width: 10%;"></td> <td style="width: 10%;"></td> </tr> <tr> <td></td> <td></td> <td colspan="8" style="text-align: center;"> <table border="1" style="width: 100%; border-collapse: collapse; text-align: center;"> <tr> <td style="width: 10%;"></td> <td style="width: 10%;"></td> <td style="width: 10%;"></td> <td style="width: 10%;"></td> <td style="width: 10%;"></td> <td style="width: 10%;"></td> <td style="width: 10%;"></td> <td style="width: 10%;"></td> <td style="width: 10%;"></td> <td style="width: 10%;"></td> </tr> <tr> <td></td> <td></td> <td colspan="8" style="text-align: center;"> <table border="1" style="width: 100%; border-collapse: collapse; text-align: center;"> <tr> <td style="width: 10%;"></td> <td style="width: 10%;"></td> <td style="width: 10%;"></td> <td style="width: 10%;"></td> <td style="width: 10%;"></td> <td style="width: 10%;"></td> <td style="width: 10%;"></td> <td style="width: 10%;"></td> <td style="width: 10%;"></td> <td style="width: 10%;"></td> </tr> <tr> <td></td> <td></td> <td colspan="8" style="text-align: center;"> <table border="1" style="width: 100%; border-collapse: collapse; text-align: center;"> <tr> <td style="width: 10%;"></td> <td style="width: 10%;"></td> <td style="width: 10%;"></td> <td style="width: 10%;"></td> <td style="width: 10%;"></td> <td style="width: 10%;"></td> <td style="width: 10%;"></td> <td style="width: 10%;"></td> <td style="width: 10%;"></td> <td style="width: 10%;"></td> </tr> <tr> <td></td> <td></td> <td colspan="8" style="text-align: center;"> <table border="1" style="width: 100%; border-collapse: collapse; text-align: center;"> <tr> <td style="width: 10%;"></td> <td style="width: 10%;"></td> <td style="width: 10%;"></td> <td style="width: 10%;"></td> <td style="width: 10%;"></td> <td style="width: 10%;"></td> <td style="width: 10%;"></td> <td style="width: 10%;"></td> <td style="width: 10%;"></td> <td style="width: 10%;"></td> </tr> <tr> <td></td> <td></td> <td colspan="8" style="text-align: center;"> <table border="1" style="width: 100%; border-collapse: collapse; text-align: center;"> <tr> <td style="width: 10%;"></td> <td style="width: 10%;"></td> <td style="width: 10%;"></td> <td style="width: 10%;"></td> <td style="width: 10%;"></td> <td style="width: 10%;"></td> <td style="width: 10%;"></td> <td style="width: 10%;"></td> <td style="width: 10%;"></td> <td style="width: 10%;"></td> </tr> <tr> <td></td> <td></td> <td colspan="8" style="text-align: center;"> <table border="1" style="width: 100%; border-collapse: collapse; text-align: center;"> <tr> <td style="width: 10%;"></td> <td style="width: 10%;"></td> <td style="width: 10%;"></td> <td style="width: 10%;"></td> <td style="width: 10%;"></td> <td style="width: 10%;"></td> <td style="width: 10%;"></td> <td style="width: 10%;"></td> <td style="width: 10%;"></td> <td style="width: 10%;"></td> </tr> <tr> <td></td> <td></td> <td colspan="8" style="text-align: center;"> <table border="1" style="width: 100%; border-collapse: collapse; text-align: center;"> <tr> <td style="width: 10%;"></td> <td style="width: 10%;"></td> <td style="width: 10%;"></td> <td style="width: 10%;"></td> <td style="width: 10%;"></td> <td style="width: 10%;"></td> <td style="width: 10%;"></td> <td style="width: 10%;"></td> <td style="width: 10%;"></td> <td style="width: 10%;"></td> </tr> <tr> <td></td> <td></td> <td colspan="8" style="text-align: center;"> <table border="1" style="width: 100%; border-collapse: collapse; text-align: center;"> <tr> <td style="width: 10%;"></td> <td style="width: 10%;"></td> <td style="width: 10%;"></td> <td style="width: 10%;"></td> <td style="width: 10%;"></td> <td style="width: 10%;"></td> <td style="width: 10%;"></td> <td style="width: 10%;"></td> <td style="width: 10%;"></td> <td style="width: 10%;"></td> </tr> <tr> <td></td> <td></td> <td colspan="8" style="text-align: center;"> <table border="1" style="width: 100%; border-collapse: collapse; text-align: center;"> <tr> <td style="width: 10%;"></td> <td style="width: 10%;"></td> <td style="width: 10%;"></td> <td style="width: 10%;"></td> <td style="width: 10%;"></td> <td style="width: 10%;"></td> <td style="width: 10%;"></td> <td style="width: 10%;"></td> <td style="width: 10%;"></td> <td style="width: 10%;"></td> </tr> <tr> <td></td> <td></td> <td colspan="8" style="text-align: center;"> <table border="1" style="width: 100%; border-collapse: collapse; text-align: center;"> <tr> <td style="width: 10%;"></td> <td style="width: 10%;"></td> <td style="width: 10%;"></td> <td style="width: 10%;"></td> <td style="width: 10%;"></td> <td style="width: 10%;"></td> <td style="width: 10%;"></td> <td style="width: 10%;"></td> <td style="width: 10%;"></td> <td style="width: 10%;"></td> </tr> <tr> <td></td> <td></td> <td colspan="8" style="text-align: center;"> <table border="1" style="width: 100%; border-collapse: collapse; text-align: center;"> <tr> <td style="width: 10%;"></td> <td style="width: 10%;"></td> <td style="width: 10%;"></td> <td style="width: 10%;"></td> <td style="width: 10%;"></td> <td style="width: 10%;"></td> <td style="width: 10%;"></td> <td style="width: 10%;"></td> <td style="width: 10%;"></td> <td style="width: 10%;"></td> </tr> <tr> <td></td> <td></td> <td colspan="8" style="text-align: center;"> <table border="1" style="width: 100%; border-collapse: collapse; text-align: center;"> <tr> <td style="width: 10%;"></td> <td style="width: 10%;"></td> <td style="width: 10%;"></td> <td style="width: 10%;"></td> <td style="width: 10%;"></td> <td style="width: 10%;"></td> <td style="width: 10%;"></td> <td style="width: 10%;"></td> <td style="width: 10%;"></td> <td style="width: 10%;"></td> </tr> <tr> <td></td> <td></td> <td colspan="8" style="text-align: center;"> <table border="1" style="width: 100%; border-collapse: collapse; text-align: center;"> <tr> <td style="width: 10%;"></td> <td style="width: 10%;"></td> <td style="width: 10%;"></td> <td style="width: 10%;"></td> <td style="width: 10%;"></td> <td style="width: 10%;"></td> <td style="width: 10%;"></td> <td style="width: 10%;"></td> <td style="width: 10%;"></td> <td style="width: 10%;"></td> </tr> <tr> <td></td> <td></td> <td colspan="8" style="text-align: center;"> <table border="1" style="width: 100%; border-collapse: collapse; text-align: center;"> <tr> <td style="width: 10%;"></td> <td style="width: 10%;"></td> <td style="width: 10%;"></td> <td style="width: 10%;"></td> <td style="width: 10%;"></td> <td style="width: 10%;"></td> <td style="width: 10%;"></td> <td style="width: 10%;"></td> <td style="width: 10%;"></td> <td style="width: 10%;"></td> </tr> <tr> <td></td> <td></td> <td colspan="8" style="text-align: center;"> <table border="1" style="width: 100%; border-collapse: collapse; text-align: center;"> <tr> <td style="width: 10%;"></td> <td style="width: 10%;"></td> <td style="width: 10%;"></td> <td style="width: 10%;"></td> <td style="width: 10%;"></td> <td style="width: 10%;"></td> <td style="width: 10%;"></td> <td style="width: 10%;"></td> <td style="width:
10%;"></td> <td style="width: 10%;"></td> </tr> <tr> <td></td> <td></td> <td colspan="8" style="text-align: center;"> <table border="1" style="width: 100%; border-collapse: collapse; text-align: center;"> <tr> <td style="width: 10%;"></td> <td style="width: 10%;"></td> <td style="width: 10%;"></td> <td style="width: 10%;"></td> <td style="width: 10%;"></td> <td style="width: 10%;"></td> <td style="width: 10%;"></td> <td style="width: 10%;"></td> <td style="width: 10%;"></td> <td style="width: 10%;"></td> </tr> <tr> <td></td> <td></td> <td colspan="8" style="text-align: center;"> <table border="1" style="width: 100%; border-collapse: collapse; text-align: center;"> <tr> <td style="width: 10%;"></td> <td style="width: 10%;"></td> <td style="width: 10%;"></td> <td style="width: 10%;"></td> <td style="width: 10%;"></td> <td style="width: 10%;"></td> <td style="width: 10%;"></td> <td style="width: 10%;"></td> <td style="width: 10%;"></td> <td style="width: 10%;"></td> </tr> <tr> <td></td> <td></td> <td colspan="8" style="text-align: center;"> <table border="1" style="width: 100%; border-collapse: collapse; text-align: center;"> <tr> <td style="width: 10%;"></td> <td style="width: 10%;"></td> <td style="width: 10%;"></td> <td style="width: 10%;"></td> <td style="width: 10%;"></td> <td style="width: 10%;"></td> <td style="width: 10%;"></td> <td style="width: 10%;"></td> <td style="width: 10%;"></td> <td style="width: 10%;"></td> </tr> <tr> <td></td> <td></td> <td colspan="8" style="text-align: center;"> <table border="1" style="width: 100%; border-collapse: collapse; text-align: center;"> <tr> <td style="width: 10%;"></td> <td style="width: 10%;"></td> <td style="width: 10%;"></td> <td style="width: 10%;"></td> <td style="width: 10%;"></td> <td style="width: 10%;"></td> <td style="width: 10%;"></td> <td style="width: 10%;"></td> <td style="width: 10%;"></td> <td style="width: 10%;"></td> </tr> <tr> <td></td> <td></td> <td colspan="8" style="text-align: center;"> <table border="1" style="width: 100%; border-collapse: collapse; text-align: center;"> <tr> <td style="width: 10%;"></td> <td style="width: 10%;"></td> <td style="width: 10%;"></td> <td style="width: 10%;"></td> <td style="width: 10%;"></td> <td style="width: 10%;"></td> <td style="width: 10%;"></td> <td style="width: 10%;"></td> <td style="width: 10%;"></td> <td style="width: 10%;"></td> </tr> <tr> <td></td> <td></td> <td colspan="8" style="text-align: center;"> <table border="1" style="width: 100%; border-collapse: collapse; text-align: center;"> <tr> </tr></table></td></tr></table></td></tr></table></td></tr></table></td></tr></table></td></tr></table></td></tr></table></td></tr></table></td></tr></table></td></tr></table></td></tr></table></td></tr></table></td></tr></table></td></tr></table></td></tr></table></td></tr></table></td></tr></table></td></tr></table></td></tr></table></td></tr></table></td></tr></table></td></tr></table></td></tr></table></td></tr></table></td></tr></table></td></tr></table></td></tr></table></td></tr></table></td></tr></table></td></tr></table></td></tr></table></td></tr></table></td></tr></table>
 | | | | | | | | | | | | | | | | | | | | <table border="1" style="width: 100%; border-collapse: collapse; text-align: center;"> <tr> <td style="width: 10%;"></td> <td style="width: 10%;"></td> <td style="width: 10%;"></td> <td style="width: 10%;"></td> <td style="width: 10%;"></td> <td style="width: 10%;"></td> <td style="width: 10%;"></td> <td style="width: 10%;"></td> <td style="width: 10%;"></td> <td style="width: 10%;"></td> </tr> <tr> <td></td> <td></td> <td colspan="8" style="text-align: center;"> <table border="1" style="width: 100%; border-collapse: collapse; text-align: center;"> <tr> <td style="width: 10%;"></td> <td style="width: 10%;"></td> <td style="width: 10%;"></td> <td style="width: 10%;"></td> <td style="width: 10%;"></td> <td style="width: 10%;"></td> <td style="width: 10%;"></td> <td style="width: 10%;"></td> <td style="width: 10%;"></td> <td style="width: 10%;"></td> </tr> <tr> <td></td> <td></td> <td colspan="8" style="text-align: center;"> <table border="1" style="width: 100%; border-collapse: collapse; text-align: center;"> <tr> <td style="width: 10%;"></td> <td style="width: 10%;"></td> <td style="width: 10%;"></td> <td style="width: 10%;"></td> <td style="width: 10%;"></td> <td style="width: 10%;"></td> <td style="width: 10%;"></td> <td style="width: 10%;"></td> <td style="width: 10%;"></td> <td style="width: 10%;"></td> </tr> <tr> <td></td> <td></td> <td colspan="8" style="text-align: center;"> <table border="1" style="width: 100%; border-collapse: collapse; text-align: center;"> <tr> <td style="width: 10%;"></td> <td style="width: 10%;"></td> <td style="width: 10%;"></td> <td style="width: 10%;"></td> <td style="width: 10%;"></td> <td style="width: 10%;"></td> <td style="width: 10%;"></td> <td style="width: 10%;"></td> <td style="width: 10%;"></td> <td style="width: 10%;"></td> </tr> <tr> <td></td> <td></td> <td colspan="8" style="text-align: center;"> <table border="1" style="width: 100%; border-collapse: collapse; text-align: center;"> <tr> <td style="width: 10%;"></td> <td style="width: 10%;"></td> <td style="width: 10%;"></td> <td style="width: 10%;"></td> <td style="width: 10%;"></td> <td style="width: 10%;"></td> <td style="width: 10%;"></td> <td style="width: 10%;"></td> <td style="width: 10%;"></td> <td style="width: 10%;"></td> </tr> <tr> <td></td> <td></td> <td colspan="8" style="text-align: center;"> <table border="1" style="width: 100%; border-collapse: collapse; text-align: center;"> <tr> <td style="width: 10%;"></td> <td style="width: 10%;"></td> <td style="width: 10%;"></td> <td style="width: 10%;"></td> <td style="width: 10%;"></td> <td style="width: 10%;"></td> <td style="width: 10%;"></td> <td style="width: 10%;"></td> <td style="width: 10%;"></td> <td style="width: 10%;"></td> </tr> <tr> <td></td> <td></td> <td colspan="8" style="text-align: center;"> <table border="1" style="width: 100%; border-collapse: collapse; text-align: center;"> <tr> <td style="width: 10%;"></td> <td style="width: 10%;"></td> <td style="width: 10%;"></td> <td style="width: 10%;"></td> <td style="width: 10%;"></td> <td style="width: 10%;"></td> <td style="width: 10%;"></td> <td style="width: 10%;"></td> <td style="width: 10%;"></td> <td style="width: 10%;"></td> </tr> <tr> <td></td> <td></td> <td colspan="8" style="text-align: center;"> <table border="1" style="width: 100%; border-collapse: collapse; text-align: center;"> <tr> <td style="width: 10%;"></td> <td style="width: 10%;"></td> <td style="width: 10%;"></td> <td style="width: 10%;"></td> <td style="width: 10%;"></td> <td style="width: 10%;"></td> <td style="width: 10%;"></td> <td style="width: 10%;"></td> <td style="width: 10%;"></td> <td style="width: 10%;"></td> </tr> <tr> <td></td> <td></td> <td colspan="8" style="text-align: center;"> <table border="1" style="width: 100%; border-collapse: collapse; text-align: center;"> <tr> <td style="width: 10%;"></td> <td style="width: 10%;"></td> <td style="width: 10%;"></td> <td style="width: 10%;"></td> <td style="width: 10%;"></td> <td style="width: 10%;"></td> <td style="width: 10%;"></td> <td style="width: 10%;"></td> <td style="width: 10%;"></td> <td style="width: 10%;"></td> </tr> <tr> <td></td> <td></td> <td colspan="8" style="text-align: center;"> <table border="1" style="width: 100%; border-collapse: collapse; text-align: center;"> <tr> <td style="width: 10%;"></td> <td style="width: 10%;"></td> <td style="width: 10%;"></td> <td style="width: 10%;"></td> <td style="width: 10%;"></td> <td style="width: 10%;"></td> <td style="width: 10%;"></td> <td style="width: 10%;"></td> <td style="width: 10%;"></td> <td style="width: 10%;"></td> </tr> <tr> <td></td> <td></td> <td colspan="8" style="text-align: center;"> <table border="1" style="width: 100%; border-collapse: collapse; text-align: center;"> <tr> <td style="width: 10%;"></td> <td style="width: 10%;"></td> <td style="width: 10%;"></td> <td style="width: 10%;"></td> <td style="width: 10%;"></td> <td style="width: 10%;"></td> <td style="width: 10%;"></td> <td style="width: 10%;"></td> <td style="width: 10%;"></td> <td style="width: 10%;"></td> </tr> <tr> <td></td> <td></td> <td colspan="8"
style="text-align: center;"> <table border="1" style="width: 100%; border-collapse: collapse; text-align: center;"> <tr> <td style="width: 10%;"></td> <td style="width: 10%;"></td> <td style="width: 10%;"></td> <td style="width: 10%;"></td> <td style="width: 10%;"></td> <td style="width: 10%;"></td> <td style="width: 10%;"></td> <td style="width: 10%;"></td> <td style="width: 10%;"></td> <td style="width: 10%;"></td> </tr> <tr> <td></td> <td></td> <td colspan="8" style="text-align: center;"> <table border="1" style="width: 100%; border-collapse: collapse; text-align: center;"> <tr> <td style="width: 10%;"></td> <td style="width: 10%;"></td> <td style="width: 10%;"></td> <td style="width: 10%;"></td> <td style="width: 10%;"></td> <td style="width: 10%;"></td> <td style="width: 10%;"></td> <td style="width: 10%;"></td> <td style="width: 10%;"></td> <td style="width: 10%;"></td> </tr> <tr> <td></td> <td></td> <td colspan="8" style="text-align: center;"> <table border="1" style="width: 100%; border-collapse: collapse; text-align: center;"> <tr> <td style="width: 10%;"></td> <td style="width: 10%;"></td> <td style="width: 10%;"></td> <td style="width: 10%;"></td> <td style="width: 10%;"></td> <td style="width: 10%;"></td> <td style="width: 10%;"></td> <td style="width: 10%;"></td> <td style="width: 10%;"></td> <td style="width: 10%;"></td> </tr> <tr> <td></td> <td></td> <td colspan="8" style="text-align: center;"> <table border="1" style="width: 100%; border-collapse: collapse; text-align: center;"> <tr> <td style="width: 10%;"></td> <td style="width: 10%;"></td> <td style="width: 10%;"></td> <td style="width: 10%;"></td> <td style="width: 10%;"></td> <td style="width: 10%;"></td> <td style="width: 10%;"></td> <td style="width: 10%;"></td> <td style="width: 10%;"></td> <td style="width: 10%;"></td> </tr> <tr> <td></td> <td></td> <td colspan="8" style="text-align: center;"> <table border="1" style="width: 100%; border-collapse: collapse; text-align: center;"> <tr> <td style="width: 10%;"></td> <td style="width: 10%;"></td> <td style="width: 10%;"></td> <td style="width: 10%;"></td> <td style="width: 10%;"></td> <td style="width: 10%;"></td> <td style="width: 10%;"></td> <td style="width: 10%;"></td> <td style="width: 10%;"></td> <td style="width: 10%;"></td> </tr> <tr> <td></td> <td></td> <td colspan="8" style="text-align: center;"> <table border="1" style="width: 100%; border-collapse: collapse; text-align: center;"> <tr> <td style="width: 10%;"></td> <td style="width: 10%;"></td> <td style="width: 10%;"></td> <td style="width: 10%;"></td> <td style="width: 10%;"></td> <td style="width: 10%;"></td> <td style="width: 10%;"></td> <td style="width: 10%;"></td> <td style="width: 10%;"></td> <td style="width: 10%;"></td> </tr> <tr> <td></td> <td></td> <td colspan="8" style="text-align: center;"> <table border="1" style="width: 100%; border-collapse: collapse; text-align: center;"> <tr> <td style="width: 10%;"></td> <td style="width: 10%;"></td> <td style="width: 10%;"></td> <td style="width: 10%;"></td> <td style="width: 10%;"></td> <td style="width: 10%;"></td> <td style="width: 10%;"></td> <td style="width: 10%;"></td> <td style="width: 10%;"></td> <td style="width: 10%;"></td> </tr> <tr> <td></td> <td></td> <td colspan="8" style="text-align: center;"> <table border="1" style="width: 100%; border-collapse: collapse; text-align: center;"> <tr> <td style="width: 10%;"></td> <td style="width: 10%;"></td> <td style="width: 10%;"></td> <td style="width: 10%;"></td> <td style="width: 10%;"></td> <td style="width: 10%;"></td> <td style="width: 10%;"></td> <td style="width: 10%;"></td> <td style="width: 10%;"></td> <td style="width: 10%;"></td> </tr> <tr> <td></td> <td></td> <td colspan="8" style="text-align: center;"> <table border="1" style="width: 100%; border-collapse: collapse; text-align: center;"> <tr> <td style="width: 10%;"></td> <td style="width: 10%;"></td> <td style="width: 10%;"></td> <td style="width: 10%;"></td> <td style="width: 10%;"></td> <td style="width: 10%;"></td> <td style="width: 10%;"></td> <td style="width: 10%;"></td> <td style="width: 10%;"></td> <td style="width: 10%;"></td> </tr> <tr> <td></td> <td></td> <td colspan="8" style="text-align: center;"> <table border="1" style="width: 100%; border-collapse: collapse; text-align: center;"> <tr> <td style="width: 10%;"></td> <td style="width: 10%;"></td> <td style="width: 10%;"></td> <td style="width: 10%;"></td> <td style="width: 10%;"></td> <td style="width: 10%;"></td> <td style="width: 10%;"></td> <td style="width: 10%;"></td> <td style="width: 10%;"></td> <td style="width: 10%;"></td> </tr> <tr> <td></td> <td></td> <td colspan="8" style="text-align: center;"> <table border="1" style="width: 100%; border-collapse: collapse; text-align: center;"> <tr> <td style="width: 10%;"></td> <td style="width: 10%;"></td> <td style="width: 10%;"></td> <td style="width: 10%;"></td> <td style="width: 10%;"></td> <td style="width: 10%;"></td> <td style="width: 10%;"></td> <td style="width: 10%;"></td> <td style="width: 10%;"></td> <td style="width: 10%;"></td> </tr> <tr> <td></td> <td></td> <td colspan="8" style="text-align: center;"> <table border="1" style="width: 100%; border-collapse: collapse; text-align: center;"> <tr> <td style="width: 10%;"></td> <td style="width: 10%;"></td> <td style="width: 10%;"></td> <td style="width: 10%;"></td> <td style="width: 10%;"></td> <td style="width: 10%;"></td> <td style="width: 10%;"></td> <td style="width: 10%;"></td> <td style="width: 10%;"></td> <td style="width: 10%;"></td> </tr> <tr> <td></td> <td></td> <td colspan="8" style="text-align: center;"> <table border="1" style="width: 100%; border-collapse: collapse; text-align: center;"> <tr> <td style="width: 10%;"></td> <td style="width: 10%;"></td> <td style="width: 10%;"></td> <td style="width: 10%;"></td> <td style="width: 10%;"></td> <td style="width: 10%;"></td> <td style="width: 10%;"></td> <td style="width: 10%;"></td> <td style="width: 10%;"></td> <td style="width: 10%;"></td> </tr> <tr> <td></td> <td></td> <td colspan="8" style="text-align: center;"> <table border="1" style="width: 100%; border-collapse: collapse; text-align: center;"> <tr> <td style="width: 10%;"></td> <td style="width: 10%;"></td> <td style="width: 10%;"></td> <td style="width: 10%;"></td> <td style="width: 10%;"></td> <td style="width: 10%;"></td> <td style="width: 10%;"></td> <td style="width: 10%;"></td> <td style="width: 10%;"></td> <td style="width: 10%;"></td> </tr> <tr> <td></td> <td></td> <td colspan="8" style="text-align: center;"> <table border="1" style="width: 100%; border-collapse: collapse; text-align: center;"> <tr> <td style="width: 10%;"></td> <td style="width: 10%;"></td> <td style="width: 10%;"></td> <td style="width: 10%;"></td> <td style="width: 10%;"></td> <td style="width: 10%;"></td> <td style="width: 10%;"></td> <td style="width: 10%;"></td> <td style="width: 10%;"></td> <td style="width: 10%;"></td> </tr> <tr> <td></td> <td></td> <td colspan="8" style="text-align: center;"> <table border="1" style="width: 100%; border-collapse: collapse; text-align: center;"> <tr> <td style="width: 10%;"></td> <td style="width: 10%;"></td> <td style="width: 10%;"></td> <td style="width: 10%;"></td> <td style="width: 10%;"></td> <td style="width: 10%;"></td> <td style="width: 10%;"></td> <td style="width: 10%;"></td> <td style="width: 10%;"></td> <td style="width: 10%;"></td> </tr> <tr> <td></td> <td></td> <td colspan="8" style="text-align: center;"> <table border="1" style="width: 100%; border-collapse: collapse; text-align: center;"> <tr> <td style="width: 10%;"></td> <td style="width: 10%;"></td> <td style="width: 10%;"></td> <td style="width: 10%;"></td> <td style="width: 10%;"></td> <td style="width: 10%;"></td> <td style="width: 10%;"></td> <td style="width: 10%;"></td> <td style="width: 10%;"></td> <td style="width: 10%;"></td> </tr> <tr> <td></td> <td></td> <td colspan="8" style="text-align: center;"> <table border="1" style="width: 100%; border-collapse: collapse; text-align: center;"> <tr> <td style="width: 10%;"></td> <td style="width: 10%;"></td> <td style="width: 10%;"></td> <td style="width: 10%;"></td> <td style="width: 10%;"></td> <td style="width: 10%;"></td> <td style="width: 10%;"></td> <td style="width: 10%;"></td> <td style="width: 10%;"></td> <td style="width: 10%;"></td> </tr> <tr> <td></td> <td></td> <td colspan="8" style="text-align: center;"> <table border="1" style="width: 100%; border-collapse: collapse; text-align: center;"> <tr> <td style="width: 10%;"></td> <td style="width: 10%;"></td> <td style="width: 10%;"></td> <td style="width: 10%;"></td> <td style="width: 10%;"></td> <td style="width: 10%;"></td> <td style="width: 10%;"></td> <td style="width: 10%;"></td> <td style="width: 10%;"></td> <td style="width: 10%;"></td> </tr> <tr> <td></td> <td></td> <td colspan="8" style="text-align: center;"> <table border="1" style="width: 100%; border-collapse: collapse; text-align: center;"> <tr> <td style="width: 10%;"></td> <td style="width: 10%;"></td> <td style="width: 10%;"></td> <td style="width: 10%;"></td> <td style="width: 10%;"></td> <td style="width: 10%;"></td> <td style="width: 10%;"></td> <td style="width: 10%;"></td> <td style="width: 10%;"></td> <td style="width: 10%;"></td> </tr> <tr> <td></td> <td></td> <td colspan="8" style="text-align: center;"> <table border="1" style="width: 100%; border-collapse: collapse; text-align: center;"> <tr>
</tr></table></td></tr></table></td></tr></table></td></tr></table></td></tr></table></td></tr></table></td></tr></table></td></tr></table></td></tr></table></td></tr></table></td></tr></table></td></tr></table></td></tr></table></td></tr></table></td></tr></table></td></tr></table></td></tr></table></td></tr></table></td></tr></table></td></tr></table></td></tr></table></td></tr></table></td></tr></table></td></tr></table></td></tr></table></td></tr></table></td></tr></table></td></tr></table></td></tr></table></td></tr></table></td></tr></table></td></tr></table>
 | | | | | | | | | | | | | | | | | | | | <table border="1" style="width: 100%; border-collapse: collapse; text-align: center;"> <tr> <td style="width: 10%;"></td> <td style="width: 10%;"></td> <td style="width: 10%;"></td> <td style="width: 10%;"></td> <td style="width: 10%;"></td> <td style="width: 10%;"></td> <td style="width: 10%;"></td> <td style="width: 10%;"></td> <td style="width: 10%;"></td> <td style="width: 10%;"></td> </tr> <tr> <td></td> <td></td> <td colspan="8" style="text-align: center;"> <table border="1" style="width: 100%; border-collapse: collapse; text-align: center;"> <tr> <td style="width: 10%;"></td> <td style="width: 10%;"></td> <td style="width: 10%;"></td> <td style="width: 10%;"></td> <td style="width: 10%;"></td> <td style="width: 10%;"></td> <td style="width: 10%;"></td> <td style="width: 10%;"></td> <td style="width: 10%;"></td> <td style="width: 10%;"></td> </tr> <tr> <td></td> <td></td> <td colspan="8" style="text-align: center;"> <table border="1" style="width: 100%; border-collapse: collapse; text-align: center;"> <tr> <td style="width: 10%;"></td> <td style="width: 10%;"></td> <td style="width: 10%;"></td> <td style="width: 10%;"></td> <td style="width: 10%;"></td> <td style="width: 10%;"></td> <td style="width: 10%;"></td> <td style="width: 10%;"></td> <td style="width: 10%;"></td> <td style="width: 10%;"></td> </tr> <tr> <td></td> <td></td> <td colspan="8" style="text-align: center;"> <table border="1" style="width: 100%; border-collapse: collapse; text-align: center;"> <tr> <td style="width: 10%;"></td> <td style="width: 10%;"></td> <td style="width: 10%;"></td> <td style="width: 10%;"></td> <td style="width: 10%;"></td> <td style="width: 10%;"></td> <td style="width: 10%;"></td> <td style="width: 10%;"></td> <td style="width: 10%;"></td> <td style="width: 10%;"></td> </tr> <tr> <td></td> <td></td> <td colspan="8" style="text-align: center;"> <table border="1" style="width: 100%; border-collapse: collapse; text-align: center;"> <tr> <td style="width: 10%;"></td> <td style="width: 10%;"></td> <td style="width: 10%;"></td> <td style="width: 10%;"></td> <td style="width: 10%;"></td> <td style="width: 10%;"></td> <td style="width: 10%;"></td> <td style="width: 10%;"></td> <td style="width: 10%;"></td> <td style="width: 10%;"></td> </tr> <tr> <td></td> <td></td> <td colspan="8" style="text-align: center;"> <table border="1" style="width: 100%; border-collapse: collapse; text-align: center;"> <tr> <td style="width: 10%;"></td> <td style="width: 10%;"></td> <td style="width: 10%;"></td> <td style="width: 10%;"></td> <td style="width: 10%;"></td> <td style="width: 10%;"></td> <td style="width: 10%;"></td> <td style="width: 10%;"></td> <td style="width: 10%;"></td> <td style="width: 10%;"></td> </tr> <tr> <td></td> <td></td> <td colspan="8" style="text-align: center;"> <table border="1" style="width: 100%; border-collapse: collapse; text-align: center;"> <tr> <td style="width: 10%;"></td> <td style="width: 10%;"></td> <td style="width: 10%;"></td> <td style="width: 10%;"></td> <td style="width: 10%;"></td> <td style="width: 10%;"></td> <td style="width: 10%;"></td> <td style="width: 10%;"></td> <td style="width: 10%;"></td> <td style="width: 10%;"></td> </tr> <tr> <td></td> <td></td> <td colspan="8" style="text-align: center;"> <table border="1" style="width: 100%; border-collapse: collapse; text-align: center;"> <tr> <td style="width: 10%;"></td> <td style="width: 10%;"></td> <td style="width: 10%;"></td> <td style="width: 10%;"></td> <td style="width: 10%;"></td> <td style="width: 10%;"></td> <td style="width: 10%;"></td> <td style="width: 10%;"></td> <td style="width: 10%;"></td> <td style="width: 10%;"></td> </tr> <tr> <td></td> <td></td> <td colspan="8" style="text-align: center;"> <table border="1" style="width: 100%; border-collapse: collapse; text-align: center;"> <tr> <td style="width: 10%;"></td> <td style="width: 10%;"></td> <td style="width: 10%;"></td> <td style="width: 10%;"></td> <td style="width: 10%;"></td> <td style="width: 10%;"></td> <td style="width: 10%;"></td> <td style="width: 10%;"></td> <td style="width: 10%;"></td> <td style="width: 10%;"></td> </tr> <tr> <td></td> <td></td> <td colspan="8" style="text-align: center;"> <table border="1" style="width: 100%; border-collapse: collapse; text-align: center;"> <tr> <td style="width: 10%;"></td> <td style="width: 10%;"></td> <td style="width: 10%;"></td> <td style="width: 10%;"></td> <td style="width: 10%;"></td> <td style="width: 10%;"></td> <td style="width: 10%;"></td> <td style="width: 10%;"></td> <td style="width: 10%;"></td> <td style="width: 10%;"></td> </tr> <tr> <td></td> <td></td> <td colspan="8" style="text-align: center;"> <table border="1" style="width: 100%; border-collapse: collapse; text-align: center;"> <tr> <td style="width: 10%;"></td> <td style="width: 10%;"></td> <td style="width: 10%;"></td> <td style="width: 10%;"></td> <td style="width: 10%;"></td> <td style="width: 10%;"></td> <td style="width: 10%;"></td> <td style="width: 10%;"></td> <td style="width: 10%;"></td> <td style="width: 10%;"></td> </tr> <tr> <td></td> <td></td> <td colspan="8" style="text-align: center;"> <table border="1" style="width: 100%; border-collapse: collapse; text-align: center;"> <tr> <td style="width: 10%;"></td> <td style="width: 10%;"></td> <td style="width: 10%;"></td> <td style="width: 10%;"></td> <td style="width: 10%;"></td> <td style="width: 10%;"></td> <td style="width: 10%;"></td> <td style="width: 10%;"></td> <td style="width: 10%;"></td> <td style="width: 10%;"></td> </tr> <tr> <td></td> <td></td> <td colspan="8" style="text-align: center;"> <table border="1" style="width: 100%; border-collapse: collapse; text-align: center;"> <tr> <td style="width: 10%;"></td> <td style="width: 10%;"></td> <td style="width: 10%;"></td> <td style="width: 10%;"></td> <td style="width: 10%;"></td> <td style="width: 10%;"></td> <td style="width: 10%;"></td> <td style="width: 10%;"></td> <td style="width: 10%;"></td> <td style="width: 10%;"></td> </tr> <tr> <td></td> <td></td> <td colspan="8" style="text-align: center;"> <table border="1" style="width: 100%; border-collapse: collapse; text-align: center;"> <tr> <td style="width: 10%;"></td> <td style="width: 10%;"></td> <td style="width: 10%;"></td> <td style="width: 10%;"></td> <td style="width: 10%;"></td> <td style="width: 10%;"></td> <td style="width: 10%;"></td> <td style="width: 10%;"></td> <td style="width: 10%;"></td> <td style="width: 10%;"></td> </tr> <tr> <td></td> <td></td> <td colspan="8" style="text-align: center;"> <table border="1" style="width: 100%; border-collapse: collapse; text-align: center;"> <tr> <td style="width: 10%;"></td> <td style="width: 10%;"></td> <td style="width: 10%;"></td> <td style="width: 10%;"></td> <td style="width: 10%;"></td> <td style="width: 10%;"></td> <td style="width: 10%;"></td> <td style="width: 10%;"></td> <td style="width: 10%;"></td> <td style="width: 10%;"></td> </tr> <tr> <td></td> <td></td> <td colspan="8" style="text-align: center;"> <table border="1" style="width: 100%; border-collapse: collapse; text-align: center;"> <tr> <td style="width: 10%;"></td> <td style="width: 10%;"></td> <td style="width: 10%;"></td> <td style="width: 10%;"></td> <td style="width: 10%;"></td> <td style="width: 10%;"></td> <td style="width: 10%;"></td> <td style="width: 10%;"></td> <td style="width: 10%;"></td> <td style="width: 10%;"></td> </tr> <tr> <td></td> <td></td> <td colspan="8" style="text-align: center;"> <table border="1" style="width: 100%; border-collapse: collapse; text-align: center;"> <tr> <td style="width: 10%;"></td> <td style="width: 10%;"></td> <td style="width: 10%;"></td> <td style="width: 10%;"></td> <td
style="width: 10%;"></td> <td style="width: 10%;"></td> <td style="width: 10%;"></td> <td style="width: 10%;"></td> <td style="width: 10%;"></td> <td style="width: 10%;"></td> </tr> <tr> <td></td> <td></td> <td colspan="8" style="text-align: center;"> <table border="1" style="width: 100%; border-collapse: collapse; text-align: center;"> <tr> <td style="width: 10%;"></td> <td style="width: 10%;"></td> <td style="width: 10%;"></td> <td style="width: 10%;"></td> <td style="width: 10%;"></td> <td style="width: 10%;"></td> <td style="width: 10%;"></td> <td style="width: 10%;"></td> <td style="width: 10%;"></td> <td style="width: 10%;"></td> </tr> <tr> <td></td> <td></td> <td colspan="8" style="text-align: center;"> <table border="1" style="width: 100%; border-collapse: collapse; text-align: center;"> <tr> <td style="width: 10%;"></td> <td style="width: 10%;"></td> <td style="width: 10%;"></td> <td style="width: 10%;"></td> <td style="width: 10%;"></td> <td style="width: 10%;"></td> <td style="width: 10%;"></td> <td style="width: 10%;"></td> <td style="width: 10%;"></td> <td style="width: 10%;"></td> </tr> <tr> <td></td> <td></td> <td colspan="8" style="text-align: center;"> <table border="1" style="width: 100%; border-collapse: collapse; text-align: center;"> <tr> <td style="width: 10%;"></td> <td style="width: 10%;"></td> <td style="width: 10%;"></td> <td style="width: 10%;"></td> <td style="width: 10%;"></td> <td style="width: 10%;"></td> <td style="width: 10%;"></td> <td style="width: 10%;"></td> <td style="width: 10%;"></td> <td style="width: 10%;"></td> </tr> <tr> <td></td> <td></td> <td colspan="8" style="text-align: center;"> <table border="1" style="width: 100%; border-collapse: collapse; text-align: center;"> <tr> <td style="width: 10%;"></td> <td style="width: 10%;"></td> <td style="width: 10%;"></td> <td style="width: 10%;"></td> <td style="width: 10%;"></td> <td style="width: 10%;"></td> <td style="width: 10%;"></td> <td style="width: 10%;"></td> <td style="width: 10%;"></td> <td style="width: 10%;"></td> </tr> <tr> <td></td> <td></td> <td colspan="8" style="text-align: center;"> <table border="1" style="width: 100%; border-collapse: collapse; text-align: center;"> <tr> <td style="width: 10%;"></td> <td style="width: 10%;"></td> <td style="width: 10%;"></td> <td style="width: 10%;"></td> <td style="width: 10%;"></td> <td style="width: 10%;"></td> <td style="width: 10%;"></td> <td style="width: 10%;"></td> <td style="width: 10%;"></td> <td style="width: 10%;"></td> </tr> <tr> <td></td> <td></td> <td colspan="8" style="text-align: center;"> <table border="1" style="width: 100%; border-collapse: collapse; text-align: center;"> <tr> <td style="width: 10%;"></td> <td style="width: 10%;"></td> <td style="width: 10%;"></td> <td style="width: 10%;"></td> <td style="width: 10%;"></td> <td style="width: 10%;"></td> <td style="width: 10%;"></td> <td style="width: 10%;"></td> <td style="width: 10%;"></td> <td style="width: 10%;"></td> </tr> <tr> <td></td> <td></td> <td colspan="8" style="text-align: center;"> <table border="1" style="width: 100%; border-collapse: collapse; text-align: center;"> <tr> <td style="width: 10%;"></td> <td style="width: 10%;"></td> <td style="width: 10%;"></td> <td style="width: 10%;"></td> <td style="width: 10%;"></td> <td style="width: 10%;"></td> <td style="width: 10%;"></td> <td style="width: 10%;"></td> <td style="width: 10%;"></td> <td style="width: 10%;"></td> </tr> <tr> <td></td> <td></td> <td colspan="8" style="text-align: center;"> <table border="1" style="width: 100%; border-collapse: collapse; text-align: center;"> <tr> <td style="width: 10%;"></td> <td style="width: 10%;"></td> <td style="width: 10%;"></td> <td style="width: 10%;"></td> <td style="width: 10%;"></td> <td style="width: 10%;"></td> <td style="width: 10%;"></td> <td style="width: 10%;"></td> <td style="width: 10%;"></td> <td style="width: 10%;"></td> </tr> <tr> <td></td> <td></td> <td colspan="8" style="text-align: center;"> <table border="1" style="width: 100%; border-collapse: collapse; text-align: center;"> <tr> <td style="width: 10%;"></td> <td style="width: 10%;"></td> <td style="width: 10%;"></td> <td style="width: 10%;"></td> <td style="width: 10%;"></td> <td style="width: 10%;"></td> <td style="width: 10%;"></td> <td style="width: 10%;"></td> <td style="width: 10%;"></td> <td style="width: 10%;"></td> </tr> <tr> <td></td> <td></td> <td colspan="8" style="text-align: center;"> <table border="1" style="width: 100%; border-collapse: collapse; text-align: center;"> <tr> <td style="width: 10%;"></td> <td style="width: 10%;"></td> <td style="width: 10%;"></td> <td style="width: 10%;"></td> <td style="width: 10%;"></td> <td style="width: 10%;"></td> <td style="width: 10%;"></td> <td style="width: 10%;"></td> <td style="width: 10%;"></td> <td style="width: 10%;"></td> </tr> <tr> <td></td> <td></td> <td colspan="8" style="text-align: center;"> <table border="1" style="width: 100%; border-collapse: collapse; text-align: center;"> <tr> <td style="width: 10%;"></td> <td style="width: 10%;"></td> <td style="width: 10%;"></td> <td style="width: 10%;"></td> <td style="width: 10%;"></td> <td style="width: 10%;"></td> <td style="width: 10%;"></td> <td style="width: 10%;"></td> <td style="width: 10%;"></td> <td style="width: 10%;"></td> </tr> <tr> <td></td> <td></td> <td colspan="8" style="text-align: center;"> <table border="1" style="width: 100%; border-collapse: collapse; text-align: center;"> <tr> <td style="width: 10%;"></td> <td style="width: 10%;"></td> <td style="width: 10%;"></td> <td style="width: 10%;"></td> <td style="width: 10%;"></td> <td style="width: 10%;"></td> <td style="width: 10%;"></td> <td style="width: 10%;"></td> <td style="width: 10%;"></td> <td style="width: 10%;"></td> </tr> <tr> <td></td> <td></td> <td colspan="8" style="text-align: center;"> <table border="1" style="width: 100%; border-collapse: collapse; text-align: center;"> <tr> <td style="width: 10%;"></td> <td style="width: 10%;"></td> <td style="width: 10%;"></td> <td style="width: 10%;"></td> <td style="width: 10%;"></td> <td style="width: 10%;"></td> <td style="width: 10%;"></td> <td style="width: 10%;"></td> <td style="width: 10%;"></td> <td style="width: 10%;"></td> </tr> <tr> <td></td> <td></td> <td colspan="8" style="text-align: center;"> <table border="1" style="width: 100%; border-collapse: collapse; text-align: center;"> <tr> </tr></table></td></tr></table></td></tr></table></td></tr></table></td></tr></table></td></tr></table></td></tr></table></td></tr></table></td></tr></table></td></tr></table></td></tr></table></td></tr></table></td></tr></table></td></tr></table></td></tr></table></td></tr></table></td></tr></table></td></tr></table></td></tr></table></td></tr></table></td></tr></table></td></tr></table></td></tr></table></td></tr></table></td></tr></table></td></tr></table></td></tr></table></td></tr></table></td></tr></table></td></tr></table></td></tr></table>
 | | | | | | | | | | | | | | | | | | | | <table border="1" style="width: 100%; border-collapse: collapse; text-align: center;"> <tr> <td style="width: 10%;"></td> <td style="width: 10%;"></td> <td style="width: 10%;"></td> <td style="width: 10%;"></td> <td style="width: 10%;"></td> <td style="width: 10%;"></td> <td style="width: 10%;"></td> <td style="width: 10%;"></td> <td style="width: 10%;"></td> <td style="width: 10%;"></td> </tr> <tr> <td></td> <td></td> <td colspan="8" style="text-align: center;"> <table border="1" style="width: 100%; border-collapse: collapse; text-align: center;"> <tr> <td style="width: 10%;"></td> <td style="width: 10%;"></td> <td style="width: 10%;"></td> <td style="width: 10%;"></td> <td style="width: 10%;"></td> <td style="width: 10%;"></td> <td style="width: 10%;"></td> <td style="width: 10%;"></td> <td style="width: 10%;"></td> <td style="width: 10%;"></td> </tr> <tr> <td></td> <td></td> <td colspan="8" style="text-align: center;"> <table border="1" style="width: 100%; border-collapse: collapse; text-align: center;"> <tr> <td style="width: 10%;"></td> <td style="width: 10%;"></td> <td style="width: 10%;"></td> <td style="width: 10%;"></td> <td style="width: 10%;"></td> <td style="width: 10%;"></td> <td style="width: 10%;"></td> <td style="width: 10%;"></td> <td style="width:
10%;"></td> <td style="width: 10%;"></td> </tr> <tr> <td></td> <td></td> <td colspan="8" style="text-align: center;"> <table border="1" style="width: 100%; border-collapse: collapse; text-align: center;"> <tr> <td style="width: 10%;"></td> <td style="width: 10%;"></td> <td style="width: 10%;"></td> <td style="width: 10%;"></td> <td style="width: 10%;"></td> <td style="width: 10%;"></td> <td style="width: 10%;"></td> <td style="width: 10%;"></td> <td style="width: 10%;"></td> <td style="width: 10%;"></td> </tr> <tr> <td></td> <td></td> <td colspan="8" style="text-align: center;"> <table border="1" style="width: 100%; border-collapse: collapse; text-align: center;"> <tr> <td style="width: 10%;"></td> <td style="width: 10%;"></td> <td style="width: 10%;"></td> <td style="width: 10%;"></td> <td style="width: 10%;"></td> <td style="width: 10%;"></td> <td style="width: 10%;"></td> <td style="width: 10%;"></td> <td style="width: 10%;"></td> <td style="width: 10%;"></td> </tr> <tr> <td></td> <td></td> <td colspan="8" style="text-align: center;"> <table border="1" style="width: 100%; border-collapse: collapse; text-align: center;"> <tr> <td style="width: 10%;"></td> <td style="width: 10%;"></td> <td style="width: 10%;"></td> <td style="width: 10%;"></td> <td style="width: 10%;"></td> <td style="width: 10%;"></td> <td style="width: 10%;"></td> <td style="width: 10%;"></td> <td style="width: 10%;"></td> <td style="width: 10%;"></td> </tr> <tr> <td></td> <td></td> <td colspan="8" style="text-align: center;"> <table border="1" style="width: 100%; border-collapse: collapse; text-align: center;"> <tr> <td style="width: 10%;"></td> <td style="width: 10%;"></td> <td style="width: 10%;"></td> <td style="width: 10%;"></td> <td style="width: 10%;"></td> <td style="width: 10%;"></td> <td style="width: 10%;"></td> <td style="width: 10%;"></td> <td style="width: 10%;"></td> <td style="width: 10%;"></td> </tr> <tr> <td></td> <td></td> <td colspan="8" style="text-align: center;"> <table border="1" style="width: 100%; border-collapse: collapse; text-align: center;"> <tr> <td style="width: 10%;"></td> <td style="width: 10%;"></td> <td style="width: 10%;"></td> <td style="width: 10%;"></td> <td style="width: 10%;"></td> <td style="width: 10%;"></td> <td style="width: 10%;"></td> <td style="width: 10%;"></td> <td style="width: 10%;"></td> <td style="width: 10%;"></td> </tr> <tr> <td></td> <td></td> <td colspan="8" style="text-align: center;"> <table border="1" style="width: 100%; border-collapse: collapse; text-align: center;"> <tr> <td style="width: 10%;"></td> <td style="width: 10%;"></td> <td style="width: 10%;"></td> <td style="width: 10%;"></td> <td style="width: 10%;"></td> <td style="width: 10%;"></td> <td style="width: 10%;"></td> <td style="width: 10%;"></td> <td style="width: 10%;"></td> <td style="width: 10%;"></td> </tr> <tr> <td></td> <td></td> <td colspan="8" style="text-align: center;"> <table border="1" style="width: 100%; border-collapse: collapse; text-align: center;"> <tr> <td style="width: 10%;"></td> <td style="width: 10%;"></td> <td style="width: 10%;"></td> <td style="width: 10%;"></td> <td style="width: 10%;"></td> <td style="width: 10%;"></td> <td style="width: 10%;"></td> <td style="width: 10%;"></td> <td style="width: 10%;"></td> <td style="width: 10%;"></td> </tr> <tr> <td></td> <td></td> <td colspan="8" style="text-align: center;"> <table border="1" style="width: 100%; border-collapse: collapse; text-align: center;"> <tr> <td style="width: 10%;"></td> <td style="width: 10%;"></td> <td style="width: 10%;"></td> <td style="width: 10%;"></td> <td style="width: 10%;"></td> <td style="width: 10%;"></td> <td style="width: 10%;"></td> <td style="width: 10%;"></td> <td style="width: 10%;"></td> <td style="width: 10%;"></td> </tr> <tr> <td></td> <td></td> <td colspan="8" style="text-align: center;"> <table border="1" style="width: 100%; border-collapse: collapse; text-align: center;"> <tr> <td style="width: 10%;"></td> <td style="width: 10%;"></td> <td style="width: 10%;"></td> <td style="width: 10%;"></td> <td style="width: 10%;"></td> <td style="width: 10%;"></td> <td style="width: 10%;"></td> <td style="width: 10%;"></td> <td style="width: 10%;"></td> <td style="width: 10%;"></td> </tr> <tr> <td></td> <td></td> <td colspan="8" style="text-align: center;"> <table border="1" style="width: 100%; border-collapse: collapse; text-align: center;"> <tr> <td style="width: 10%;"></td> <td style="width: 10%;"></td> <td style="width: 10%;"></td> <td style="width: 10%;"></td> <td style="width: 10%;"></td> <td style="width: 10%;"></td> <td style="width: 10%;"></td> <td style="width: 10%;"></td> <td style="width: 10%;"></td> <td style="width: 10%;"></td> </tr> <tr> <td></td> <td></td> <td colspan="8" style="text-align: center;"> <table border="1" style="width: 100%; border-collapse: collapse; text-align: center;"> <tr> <td style="width: 10%;"></td> <td style="width: 10%;"></td> <td style="width: 10%;"></td> <td style="width: 10%;"></td> <td style="width: 10%;"></td> <td style="width: 10%;"></td> <td style="width: 10%;"></td> <td style="width: 10%;"></td> <td style="width: 10%;"></td> <td style="width: 10%;"></td> </tr> <tr> <td></td> <td></td> <td colspan="8" style="text-align: center;"> <table border="1" style="width: 100%; border-collapse: collapse; text-align: center;"> <tr> <td style="width: 10%;"></td> <td style="width: 10%;"></td> <td style="width: 10%;"></td> <td style="width: 10%;"></td> <td style="width: 10%;"></td> <td style="width: 10%;"></td> <td style="width: 10%;"></td> <td style="width: 10%;"></td> <td style="width: 10%;"></td> <td style="width: 10%;"></td> </tr> <tr> <td></td> <td></td> <td colspan="8" style="text-align: center;"> <table border="1" style="width: 100%; border-collapse: collapse; text-align: center;"> <tr> <td style="width: 10%;"></td> <td style="width: 10%;"></td> <td style="width: 10%;"></td> <td style="width: 10%;"></td> <td style="width: 10%;"></td> <td style="width: 10%;"></td> <td style="width: 10%;"></td> <td style="width: 10%;"></td> <td style="width: 10%;"></td> <td style="width: 10%;"></td> </tr> <tr> <td></td> <td></td> <td colspan="8" style="text-align: center;"> <table border="1" style="width: 100%; border-collapse: collapse; text-align: center;"> <tr> <td style="width: 10%;"></td> <td style="width: 10%;"></td> <td style="width: 10%;"></td> <td style="width: 10%;"></td> <td style="width: 10%;"></td> <td style="width: 10%;"></td> <td style="width: 10%;"></td> <td style="width: 10%;"></td> <td style="width: 10%;"></td> <td style="width: 10%;"></td> </tr> <tr> <td></td> <td></td> <td colspan="8" style="text-align: center;"> <table border="1" style="width: 100%; border-collapse: collapse; text-align: center;"> <tr> <td style="width: 10%;"></td> <td style="width: 10%;"></td> <td style="width: 10%;"></td> <td style="width: 10%;"></td> <td style="width: 10%;"></td> <td style="width: 10%;"></td> <td style="width: 10%;"></td> <td style="width: 10%;"></td> <td style="width: 10%;"></td> <td style="width: 10%;"></td> </tr> <tr> <td></td> <td></td> <td colspan="8" style="text-align: center;"> <table border="1" style="width: 100%; border-collapse: collapse; text-align: center;"> <tr> <td style="width: 10%;"></td> <td style="width: 10%;"></td> <td style="width: 10%;"></td> <td style="width: 10%;"></td> <td style="width: 10%;"></td> <td style="width: 10%;"></td> <td style="width: 10%;"></td> <td style="width: 10%;"></td> <td style="width: 10%;"></td> <td style="width: 10%;"></td> </tr> <tr> <td></td> <td></td> <td colspan="8" style="text-align: center;"> <table border="1" style="width: 100%; border-collapse: collapse; text-align: center;"> <tr> <td style="width: 10%;"></td> <td style="width: 10%;"></td> <td style="width: 10%;"></td> <td style="width: 10%;"></td> <td style="width: 10%;"></td> <td style="width: 10%;"></td> <td style="width: 10%;"></td> <td style="width: 10%;"></td> <td style="width: 10%;"></td> <td style="width: 10%;"></td> </tr> <tr> <td></td> <td></td> <td colspan="8" style="text-align: center;"> <table border="1" style="width: 100%; border-collapse: collapse; text-align: center;"> <tr> <td style="width: 10%;"></td> <td style="width: 10%;"></td> <td style="width: 10%;"></td> <td style="width: 10%;"></td> <td style="width: 10%;"></td> <td style="width: 10%;"></td> <td style="width: 10%;"></td> <td style="width: 10%;"></td> <td style="width: 10%;"></td> <td style="width: 10%;"></td> </tr> <tr> <td></td> <td></td> <td colspan="8" style="text-align: center;"> <table border="1" style="width: 100%; border-collapse: collapse; text-align: center;"> <tr> <td style="width: 10%;"></td> <td style="width: 10%;"></td> <td style="width: 10%;"></td> <td style="width: 10%;"></td> <td style="width: 10%;"></td> <td style="width: 10%;"></td> <td style="width: 10%;"></td> <td style="width: 10%;"></td> <td style="width: 10%;"></td> <td style="width: 10%;"></td> </tr> <tr> <td></td> <td></td> <td colspan="8" style="text-align: center;"> <table border="1" style="width: 100%; border-collapse: collapse; text-align: center;"> <tr> <td style="width: 10%;"></td> <td style="width: 10%;"></td> <td style="width: 10%;"></td> <td style="width: 10%;"></td> <td style="width: 10%;"></td> <td style="width: 10%;"></td> <td style="width: 10%;"></td> <td style="width: 10%;"></td> <td style="width: 10%;"></td> <td style="width: 10%;"></td> </tr> <tr> <td></td> <td></td> <td colspan="8" style="text-align: center;"> <table border="1" style="width: 100%; border-collapse: collapse; text-align: center;"> <tr> <td style="width: 10%;"></td> <td style="width: 10%;"></td> <td style="width: 10%;"></td> <td style="width: 10%;"></td> <td style="width: 10%;"></td> <td style="width: 10%;"></td> <td style="width: 10%;"></td> <td style="width: 10%;"></td> <td style="width: 10%;"></td> <td style="width: 10%;"></td> </tr> <tr> <td></td> <td></td> <td colspan="8" style="text-align: center;"> <table border="1" style="width: 100%;
border-collapse: collapse; text-align: center;"> <tr> <td style="width: 10%;"></td> <td style="width: 10%;"></td> <td style="width: 10%;"></td> <td style="width: 10%;"></td> <td style="width: 10%;"></td> <td style="width: 10%;"></td> <td style="width: 10%;"></td> <td style="width: 10%;"></td> <td style="width: 10%;"></td> <td style="width: 10%;"></td> </tr> <tr> <td></td> <td></td> <td colspan="8" style="text-align: center;"> <table border="1" style="width: 100%; border-collapse: collapse; text-align: center;"> <tr> <td style="width: 10%;"></td> <td style="width: 10%;"></td> <td style="width: 10%;"></td> <td style="width: 10%;"></td> <td style="width: 10%;"></td> <td style="width: 10%;"></td> <td style="width: 10%;"></td> <td style="width: 10%;"></td> <td style="width: 10%;"></td> <td style="width: 10%;"></td> </tr> <tr> <td></td> <td></td> <td colspan="8" style="text-align: center;"> <table border="1" style="width: 100%; border-collapse: collapse; text-align: center;"> <tr> <td style="width: 10%;"></td> <td style="width: 10%;"></td> <td style="width: 10%;"></td> <td style="width: 10%;"></td> <td style="width: 10%;"></td> <td style="width: 10%;"></td> <td style="width: 10%;"></td> <td style="width: 10%;"></td> <td style="width: 10%;"></td> <td style="width: 10%;"></td> </tr> <tr> <td></td> <td></td> <td colspan="8" style="text-align: center;"> <table border="1" style="width: 100%; border-collapse: collapse; text-align: center;"> <tr> <td style="width: 10%;"></td> <td style="width: 10%;"></td> <td style="width: 10%;"></td> <td style="width: 10%;"></td> <td style="width: 10%;"></td> <td style="width: 10%;"></td> <td style="width: 10%;"></td> <td style="width: 10%;"></td> <td style="width: 10%;"></td> <td style="width: 10%;"></td> </tr> <tr> <td></td> <td></td> <td colspan="8" style="text-align: center;"> <table border="1" style="width: 100%; border-collapse: collapse; text-align: center;"> <tr> <td style="width: 10%;"></td> <td style="width: 10%;"></td> <td style="width: 10%;"></td> <td style="width: 10%;"></td> <td style="width: 10%;"></td> <td style="width: 10%;"></td> <td style="width: 10%;"></td> <td style="width: 10%;"></td> <td style="width: 10%;"></td> <td style="width: 10%;"></td> </tr> <tr> <td></td> <td></td> <td colspan="8" style="text-align: center;"> <table border="1" style="width: 100%; border-collapse: collapse; text-align: center;"> <tr> </tr></table></td></tr></table></td></tr></table></td></tr></table></td></tr></table></td></tr></table></td></tr></table></td></tr></table></td></tr></table></td></tr></table></td></tr></table></td></tr></table></td></tr></table></td></tr></table></td></tr></table></td></tr></table></td></tr></table></td></tr></table></td></tr></table></td></tr></table></td></tr></table></td></tr></table></td></tr></table></td></tr></table></td></tr></table></td></tr></table></td></tr></table></td></tr></table></td></tr></table></td></tr></table>
 | | | | | | | | | | | | | | | | | | | | <table border="1" style="width: 100%; border-collapse: collapse; text-align: center;"> <tr> <td style="width: 10%;"></td> <td style="width: 10%;"></td> <td style="width: 10%;"></td> <td style="width: 10%;"></td> <td style="width: 10%;"></td> <td style="width: 10%;"></td> <td style="width: 10%;"></td> <td style="width: 10%;"></td> <td style="width: 10%;"></td> <td style="width: 10%;"></td> </tr> <tr> <td></td> <td></td> <td colspan="8" style="text-align: center;"> <table border="1" style="width: 100%; border-collapse: collapse; text-align: center;"> <tr> <td style="width: 10%;"></td> <td style="width: 10%;"></td> <td style="width: 10%;"></td> <td style="width: 10%;"></td> <td style="width: 10%;"></td> <td style="width: 10%;"></td> <td style="width: 10%;"></td> <td style="width: 10%;"></td> <td style="width: 10%;"></td> <td style="width: 10%;"></td> </tr> <tr> <td></td> <td></td> <td colspan="8" style="text-align: center;"> <table border="1" style="width: 100%; border-collapse: collapse; text-align: center;"> <tr> <td style="width: 10%;"></td> <td style="width: 10%;"></td> <td style="width: 10%;"></td> <td style="width: 10%;"></td> <td style="width: 10%;"></td> <td style="width: 10%;"></td> <td style="width: 10%;"></td> <td style="width: 10%;"></td> <td style="width: 10%;"></td> <td style="width: 10%;"></td> </tr> <tr> <td></td> <td></td> <td colspan="8" style="text-align: center;"> <table border="1" style="width: 100%; border-collapse: collapse; text-align: center;"> <tr> <td style="width: 10%;"></td> <td style="width: 10%;"></td> <td style="width: 10%;"></td> <td style="width: 10%;"></td> <td style="width: 10%;"></td> <td style="width: 10%;"></td> <td style="width: 10%;"></td> <td style="width: 10%;"></td> <td style="width: 10%;"></td> <td style="width: 10%;"></td> </tr> <tr> <td></td> <td></td> <td colspan="8" style="text-align: center;"> <table border="1" style="width: 100%; border-collapse: collapse; text-align: center;"> <tr> <td style="width: 10%;"></td> <td style="width: 10%;"></td> <td style="width: 10%;"></td> <td style="width: 10%;"></td> <td style="width: 10%;"></td> <td style="width: 10%;"></td> <td style="width: 10%;"></td> <td style="width: 10%;"></td> <td style="width: 10%;"></td> <td style="width: 10%;"></td> </tr> <tr> <td></td> <td></td> <td colspan="8" style="text-align: center;"> <table border="1" style="width: 100%; border-collapse: collapse; text-align: center;"> <tr> <td style="width: 10%;"></td> <td style="width: 10%;"></td> <td style="width: 10%;"></td> <td style="width: 10%;"></td> <td style="width: 10%;"></td> <td style="width: 10%;"></td> <td style="width: 10%;"></td> <td style="width: 10%;"></td> <td style="width: 10%;"></td> <td style="width: 10%;"></td> </tr> <tr> <td></td> <td></td> <td colspan="8" style="text-align: center;"> <table border="1" style="width: 100%; border-collapse: collapse; text-align: center;"> <tr> <td style="width: 10%;"></td> <td style="width: 10%;"></td> <td style="width: 10%;"></td> <td style="width: 10%;"></td> <td style="width: 10%;"></td> <td style="width: 10%;"></td> <td style="width: 10%;"></td> <td style="width: 10%;"></td> <td style="width: 10%;"></td> <td style="width: 10%;"></td> </tr> <tr> <td></td> <td></td> <td colspan="8" style="text-align: center;"> <table border="1" style="width: 100%; border-collapse: collapse; text-align: center;"> <tr> <td style="width: 10%;"></td> <td style="width: 10%;"></td> <td style="width: 10%;"></td> <td style="width: 10%;"></td> <td style="width: 10%;"></td> <td style="width: 10%;"></td> <td style="width: 10%;"></td> <td style="width: 10%;"></td> <td style="width: 10%;"></td> <td style="width: 10%;"></td> </tr> <tr> <td></td> <td></td> <td colspan="8" style="text-align: center;"> <table border="1" style="width: 100%; border-collapse: collapse; text-align: center;"> <tr> <td style="width: 10%;"></td> <td style="width: 10%;"></td> <td style="width: 10%;"></td> <td style="width: 10%;"></td> <td style="width: 10%;"></td> <td style="width: 10%;"></td> <td style="width: 10%;"></td> <td style="width: 10%;"></td> <td style="width: 10%;"></td> <td style="width: 10%;"></td> </tr> <tr> <td></td> <td></td> <td colspan="8" style="text-align: center;"> <table border="1" style="width: 100%; border-collapse: collapse; text-align: center;"> <tr> <td style="width: 10%;"></td> <td style="width: 10%;"></td> <td style="width: 10%;"></td> <td style="width: 10%;"></td> <td style="width: 10%;"></td> <td style="width: 10%;"></td> <td style="width: 10%;"></td> <td style="width: 10%;"></td> <td style="width: 10%;"></td> <td style="width: 10%;"></td> </tr> <tr> <td></td> <td></td> <td colspan="8" style="text-align: center;"> <table border="1" style="width: 100%; border-collapse: collapse; text-align: center;"> <tr> <td style="width: 10%;"></td> <td style="width: 10%;"></td> <td style="width: 10%;"></td> <td style="width: 10%;"></td> <td style="width: 10%;"></td> <td style="width: 10%;"></td> <td style="width: 10%;"></td> <td style="width: 10%;"></td> <td style="width: 10%;"></td> <td style="width: 10%;"></td> </tr> <tr> <td></td> <td></td> <td colspan="8" style="text-align: center;"> <table border="1" style="width: 100%; border-collapse: collapse; text-align: center;"> <tr> <td style="width: 10%;"></td> <td style="width: 10%;"></td> <td style="width: 10%;"></td> <td
style="width: 10%;"></td> <td style="width: 10%;"></td> <td style="width: 10%;"></td> <td style="width: 10%;"></td> <td style="width: 10%;"></td> <td style="width: 10%;"></td> <td style="width: 10%;"></td> </tr> <tr> <td></td> <td></td> <td colspan="8" style="text-align: center;"> <table border="1" style="width: 100%; border-collapse: collapse; text-align: center;"> <tr> <td style="width: 10%;"></td> <td style="width: 10%;"></td> <td style="width: 10%;"></td> <td style="width: 10%;"></td> <td style="width: 10%;"></td> <td style="width: 10%;"></td> <td style="width: 10%;"></td> <td style="width: 10%;"></td> <td style="width: 10%;"></td> <td style="width: 10%;"></td> </tr> <tr> <td></td> <td></td> <td colspan="8" style="text-align: center;"> <table border="1" style="width: 100%; border-collapse: collapse; text-align: center;"> <tr> <td style="width: 10%;"></td> <td style="width: 10%;"></td> <td style="width: 10%;"></td> <td style="width: 10%;"></td> <td style="width: 10%;"></td> <td style="width: 10%;"></td> <td style="width: 10%;"></td> <td style="width: 10%;"></td> <td style="width: 10%;"></td> <td style="width: 10%;"></td> </tr> <tr> <td></td> <td></td> <td colspan="8" style="text-align: center;"> <table border="1" style="width: 100%; border-collapse: collapse; text-align: center;"> <tr> <td style="width: 10%;"></td> <td style="width: 10%;"></td> <td style="width: 10%;"></td> <td style="width: 10%;"></td> <td style="width: 10%;"></td> <td style="width: 10%;"></td> <td style="width: 10%;"></td> <td style="width: 10%;"></td> <td style="width: 10%;"></td> <td style="width: 10%;"></td> </tr> <tr> <td></td> <td></td> <td colspan="8" style="text-align: center;"> <table border="1" style="width: 100%; border-collapse: collapse; text-align: center;"> <tr> <td style="width: 10%;"></td> <td style="width: 10%;"></td> <td style="width: 10%;"></td> <td style="width: 10%;"></td> <td style="width: 10%;"></td> <td style="width: 10%;"></td> <td style="width: 10%;"></td> <td style="width: 10%;"></td> <td style="width: 10%;"></td> <td style="width: 10%;"></td> </tr> <tr> <td></td> <td></td> <td colspan="8" style="text-align: center;"> <table border="1" style="width: 100%; border-collapse: collapse; text-align: center;"> <tr> <td style="width: 10%;"></td> <td style="width: 10%;"></td> <td style="width: 10%;"></td> <td style="width: 10%;"></td> <td style="width: 10%;"></td> <td style="width: 10%;"></td> <td style="width: 10%;"></td> <td style="width: 10%;"></td> <td style="width: 10%;"></td> <td style="width: 10%;"></td> </tr> <tr> <td></td> <td></td> <td colspan="8" style="text-align: center;"> <table border="1" style="width: 100%; border-collapse: collapse; text-align: center;"> <tr> <td style="width: 10%;"></td> <td style="width: 10%;"></td> <td style="width: 10%;"></td> <td style="width: 10%;"></td> <td style="width: 10%;"></td> <td style="width: 10%;"></td> <td style="width: 10%;"></td> <td style="width: 10%;"></td> <td style="width: 10%;"></td> <td style="width: 10%;"></td> </tr> <tr> <td></td> <td></td> <td colspan="8" style="text-align: center;"> <table border="1" style="width: 100%; border-collapse: collapse; text-align: center;"> <tr> <td style="width: 10%;"></td> <td style="width: 10%;"></td> <td style="width: 10%;"></td> <td style="width: 10%;"></td> <td style="width: 10%;"></td> <td style="width: 10%;"></td> <td style="width: 10%;"></td> <td style="width: 10%;"></td> <td style="width: 10%;"></td> <td style="width: 10%;"></td> </tr> <tr> <td></td> <td></td> <td colspan="8" style="text-align: center;"> <table border="1" style="width: 100%; border-collapse: collapse; text-align: center;"> <tr> <td style="width: 10%;"></td> <td style="width: 10%;"></td> <td style="width: 10%;"></td> <td style="width: 10%;"></td> <td style="width: 10%;"></td> <td style="width: 10%;"></td> <td style="width: 10%;"></td> <td style="width: 10%;"></td> <td style="width: 10%;"></td> <td style="width: 10%;"></td> </tr> <tr> <td></td> <td></td> <td colspan="8" style="text-align: center;"> <table border="1" style="width: 100%; border-collapse: collapse; text-align: center;"> <tr> <td style="width: 10%;"></td> <td style="width: 10%;"></td> <td style="width: 10%;"></td> <td style="width: 10%;"></td> <td style="width: 10%;"></td> <td style="width: 10%;"></td> <td style="width: 10%;"></td> <td style="width: 10%;"></td> <td style="width: 10%;"></td> <td style="width: 10%;"></td> </tr> <tr> <td></td> <td></td> <td colspan="8" style="text-align: center;"> <table border="1" style="width: 100%; border-collapse: collapse; text-align: center;"> <tr> <td style="width: 10%;"></td> <td style="width: 10%;"></td> <td style="width: 10%;"></td> <td style="width: 10%;"></td> <td style="width: 10%;"></td> <td style="width: 10%;"></td> <td style="width: 10%;"></td> <td style="width: 10%;"></td> <td style="width: 10%;"></td> <td style="width: 10%;"></td> </tr> <tr> <td></td> <td></td> <td colspan="8" style="text-align: center;"> <table border="1" style="width: 100%; border-collapse: collapse; text-align: center;"> <tr> <td style="width: 10%;"></td> <td style="width: 10%;"></td> <td style="width: 10%;"></td> <td style="width: 10%;"></td> <td style="width: 10%;"></td> <td style="width: 10%;"></td> <td style="width: 10%;"></td> <td style="width: 10%;"></td> <td style="width: 10%;"></td> <td style="width: 10%;"></td> </tr> <tr> <td></td> <td></td> <td colspan="8" style="text-align: center;"> <table border="1" style="width: 100%; border-collapse: collapse; text-align: center;"> <tr> <td style="width: 10%;"></td> <td style="width: 10%;"></td> <td style="width: 10%;"></td> <td style="width: 10%;"></td> <td style="width: 10%;"></td> <td style="width: 10%;"></td> <td style="width: 10%;"></td> <td style="width: 10%;"></td> <td style="width: 10%;"></td> <td style="width: 10%;"></td> </tr> <tr> <td></td> <td></td> <td colspan="8" style="text-align: center;"> <table border="1" style="width: 100%; border-collapse: collapse; text-align: center;"> <tr> <td style="width: 10%;"></td> <td style="width: 10%;"></td> <td style="width: 10%;"></td> <td style="width: 10%;"></td> <td style="width: 10%;"></td> <td style="width: 10%;"></td> <td style="width: 10%;"></td> <td style="width: 10%;"></td> <td style="width: 10%;"></td> <td style="width: 10%;"></td> </tr> <tr> <td></td> <td></td> <td colspan="8" style="text-align: center;"> <table border="1" style="width: 100%; border-collapse: collapse; text-align: center;"> <tr> <td style="width: 10%;"></td> <td style="width: 10%;"></td> <td style="width: 10%;"></td> <td style="width: 10%;"></td> <td style="width: 10%;"></td> <td style="width: 10%;"></td> <td style="width: 10%;"></td> <td style="width: 10%;"></td> <td style="width: 10%;"></td> <td style="width: 10%;"></td> </tr> <tr> <td></td> <td></td> <td colspan="8" style="text-align: center;"> <table border="1" style="width: 100%; border-collapse: collapse; text-align: center;"> <tr> <td style="width: 10%;"></td> <td style="width: 10%;"></td> <td style="width: 10%;"></td> <td style="width: 10%;"></td> <td style="width: 10%;"></td> <td style="width: 10%;"></td> <td style="width: 10%;"></td> <td style="width: 10%;"></td> <td style="width: 10%;"></td> <td style="width: 10%;"></td> </tr> <tr> <td></td> <td></td> <td colspan="8" style="text-align: center;"> <table border="1" style="width: 100%; border-collapse: collapse; text-align: center;"> <tr> <td style="width: 10%;"></td> <td style="width: 10%;"></td> <td style="width: 10%;"></td> <td style="width: 10%;"></td> <td style="width: 10%;"></td> <td style="width: 10%;"></td> <td style="width: 10%;"></td> <td style="width: 10%;"></td> <td style="width: 10%;"></td> <td style="width: 10%;"></td> </tr> <tr> <td></td> <td></td> <td colspan="8" style="text-align: center;"> <table border="1" style="width: 100%; border-collapse: collapse; text-align: center;"> <tr> </tr></table></td></tr></table></td></tr></table></td></tr></table></td></tr></table></td></tr></table></td></tr></table></td></tr></table></td></tr></table></td></tr></table></td></tr></table></td></tr></table></td></tr></table></td></tr></table></td></tr></table></td></tr></table></td></tr></table></td></tr></table></td></tr></table></td></tr></table></td></tr></table></td></tr></table></td></tr></table></td></tr></table></td></tr></table></td></tr></table></td></tr></table></td></tr></table></td></tr></table>

 | | | | | | | | | | | | | | | | | | | | <table border="1" style="width: 100%; border-collapse: collapse; text-align: center;"> <tr> <td style="width: 10%;"></td> <td style="width: 10%;"></td> <td style="width: 10%;"></td> <td style="width: 10%;"></td> <td style="width: 10%;"></td> <td style="width: 10%;"></td> <td style="width: 10%;"></td> <td style="width: 10%;"></td> <td style="width: 10%;"></td> <td style="width: 10%;"></td> </tr> <tr> <td></td> <td></td> <td colspan="8" style="text-align: center;"> <table border="1" style="width: 100%; border-collapse: collapse; text-align: center;"> <tr> <td style="width: 10%;"></td> <td style="width: 10%;"></td> <td style="width: 10%;"></td> <td style="width: 10%;"></td> <td style="width: 10%;"></td> <td style="width: 10%;"></td> <td style="width: 10%;"></td> <td style="width: 10%;"></td> <td style="width: 10%;"></td> <td style="width: 10%;"></td> </tr> <tr> <td></td> <td></td> <td colspan="8" style="text-align: center;"> <table border="1" style="width: 100%; border-collapse: collapse; text-align: center;"> <tr> <td style="width: 10%;"></td> <td style="width: 10%;"></td> <td style="width: 10%;"></td> <td style="width: 10%;"></td> <td style="width: 10%;"></td> <td style="width: 10%;"></td> <td style="width: 10%;"></td> <td style="width: 10%;"></td> <td style="width: 10%;"></td> <td style="width: 10%;"></td> </tr> <tr> <td></td> <td></td> <td colspan="8" style="text-align: center;"> <table border="1" style="width: 100%; border-collapse: collapse; text-align: center;"> <tr> <td style="width: 10%;"></td> <td style="width: 10%;"></td> <td style="width: 10%;"></td> <td style="width: 10%;"></td> <td style="width: 10%;"></td> <td style="width: 10%;"></td> <td style="width: 10%;"></td> <td style="width: 10%;"></td> <td style="width: 10%;"></td> <td style="width: 10%;"></td> </tr> <tr> <td></td> <td></td> <td colspan="8" style="text-align: center;"> <table border="1" style="width: 100%; border-collapse: collapse; text-align: center;"> <tr> <td style="width: 10%;"></td> <td style="width: 10%;"></td> <td style="width: 10%;"></td> <td style="width: 10%;"></td> <td style="width: 10%;"></td> <td style="width: 10%;"></td> <td style="width: 10%;"></td> <td style="width: 10%;"></td> <td style="width: 10%;"></td> <td style="width: 10%;"></td> </tr> <tr> <td></td> <td></td> <td colspan="8" style="text-align: center;"> <table border="1" style="width: 100%; border-collapse: collapse; text-align: center;"> <tr> <td style="width: 10%;"></td> <td style="width: 10%;"></td> <td style="width: 10%;"></td> <td style="width: 10%;"></td> <td style="width: 10%;"></td> <td style="width: 10%;"></td> <td style="width: 10%;"></td> <td style="width: 10%;"></td> <td style="width: 10%;"></td> <td style="width: 10%;"></td> </tr> <tr> <td></td> <td></td> <td colspan="8" style="text-align: center;"> <table border="1" style="width: 100%; border-collapse: collapse; text-align: center;"> <tr> <td style="width: 10%;"></td> <td style="width: 10%;"></td> <td style="width: 10%;"></td> <td style="width: 10%;"></td> <td style="width: 10%;"></td> <td style="width: 10%;"></td> <td style="width: 10%;"></td> <td style="width: 10%;"></td> <td style="width: 10%;"></td> <td style="width: 10%;"></td> </tr> <tr> <td></td> <td></td> <td colspan="8" style="text-align: center;"> <table border="1" style="width: 100%; border-collapse: collapse; text-align: center;"> <tr> <td style="width: 10%;"></td> <td style="width: 10%;"></td> <td style="width: 10%;"></td> <td style="width: 10%;"></td> <td style="width: 10%;"></td> <td style="width: 10%;"></td> <td style="width: 10%;"></td> <td style="width: 10%;"></td> <td style="width: 10%;"></td> <td style="width: 10%;"></td> </tr> <tr> <td></td> <td></td> <td colspan="8" style="text-align: center;"> <table border="1" style="width: 100%; border-collapse: collapse; text-align: center;"> <tr> <td style="width: 10%;"></td> <td style="width: 10%;"></td> <td style="width: 10%;"></td> <td style="width: 10%;"></td> <td style="width: 10%;"></td> <td style="width: 10%;"></td> <td style="width: 10%;"></td> <td style="width: 10%;"></td> <td style="width: 10%;"></td> <td style="width: 10%;"></td> </tr> <tr> <td></td> <td></td> <td colspan="8" style="text-align: center;"> <table border="1" style="width: 100%; border-collapse: collapse; text-align: center;"> <tr> <td style="width: 10%;"></td> <td style="width: 10%;"></td> <td style="width: 10%;"></td> <td style="width: 10%;"></td> <td style="width: 10%;"></td> <td style="width: 10%;"></td> <td style="width: 10%;"></td> <td style="width: 10%;"></td> <td style="width: 10%;"></td> <td style="width: 10%;"></td> </tr> <tr> <td></td> <td></td> <td colspan="8" style="text-align: center;"> <table border="1" style="width: 100%; border-collapse: collapse; text-align: center;"> <tr> <td style="width: 10%;"></td> <td style="width: 10%;"></td> <td style="width: 10%;"></td> <td style="width: 10%;"></td> <td style="width: 10%;"></td> <td style="width: 10%;"></td> <td style="width: 10%;"></td> <td style="width: 10%;"></td> <td style="width: 10%;"></td> <td style="width: 10%;"></td> </tr> <tr> <td></td> <td></td> <td colspan="8" style="text-align: center;"> <table border="1" style="width: 100%; border-collapse: collapse; text-align: center;"> <tr> <td style="width: 10%;"></td> <td style="width: 10%;"></td> <td style="width: 10%;"></td> <td style="width: 10%;"></td> <td style="width: 10%;"></td> <td style="width: 10%;"></td> <td style="width: 10%;"></td> <td style="width: 10%;"></td> <td style="width: 10%;"></td> <td style="width: 10%;"></td> </tr> <tr> <td></td> <td></td> <td colspan="8" style="text-align: center;"> <table border="1" style="width: 100%; border-collapse: collapse; text-align: center;"> <tr> <td style="width: 10%;"></td> <td style="width: 10%;"></td> <td style="width: 10%;"></td> <td style="width: 10%;"></td> <td style="width: 10%;"></td> <td style="width: 10%;"></td> <td style="width: 10%;"></td> <td style="width: 10%;"></td> <td style="width: 10%;"></td> <td style="width: 10%;"></td> </tr> <tr> <td></td> <td></td> <td colspan="8" style="text-align: center;"> <table border="1" style="width: 100%; border-collapse: collapse; text-align: center;"> <tr> <td style="width: 10%;"></td> <td style="width: 10%;"></td> <td style="width: 10%;"></td> <td style="width: 10%;"></td> <td style="width: 10%;"></td> <td style="width: 10%;"></td> <td style="width: 10%;"></td> <td style="width: 10%;"></td> <td style="width: 10%;"></td> <td style="width: 10%;"></td> </tr> <tr> <td></td> <td></td> <td colspan="8" style="text-align: center;"> <table border="1" style="width: 100%; border-collapse: collapse; text-align: center;"> <tr> <td style="width: 10%;"></td> <td style="width: 10%;"></td> <td style="width: 10%;"></td> <td style="width: 10%;"></td> <td style="width: 10%;"></td> <td style="width: 10%;"></td> <td style="width: 10%;"></td> <td style="width: 10%;"></td> <td style="width: 10%;"></td> <td style="width: 10%;"></td> </tr> <tr> <td></td> <td></td> <td colspan="8" style="text-align: center;"> <table border="1" style="width: 100%; border-collapse: collapse; text-align: center;"> <tr> <td style="width: 10%;"></td> <td style="width: 10%;"></td> <td style="width: 10%;"></td> <td style="width: 10%;"></td> <td style="width: 10%;"></td> <td style="width: 10%;"></td> <td style="width: 10%;"></td> <td style="width: 10%;"></td> <td style="width: 10%;"></td> <td style="width: 10%;"></td> </tr> <tr> <td></td> <td></td> <td colspan="8" style="text-align: center;"> <table border="1" style="width: 100%; border-collapse: collapse; text-align: center;"> <tr> <td style="width: 10%;"></td> <td style="width: 10%;"></td> <td style="width: 10%;"></td> <td style="width: 10%;"></td> <td style="width: 10%;"></td> <td style="width: 10%;"></td> <td style="width: 10%;"></td> <td style="width: 10%;"></td> <td style="width: 10%;"></td> <td style="width: 10%;"></td> </tr> <tr> <td></td> <td></td> <td colspan="8" style="text-align: center;"> <table border="1" style="width: 100%; border-collapse: collapse; text-align: center;"> <tr> <td style="width: 10%;"></td> <td style="width: 10%;"></td> <td style="width: 10%;"></td> <td style="width: 10%;"></td> <td style="width: 10%;"></td> <td style="width: 10%;"></td> <td style="width: 10%;"></td> <td style="width: 10%;"></td> <td style="width: 10%;"></td> <td style="width: 10%;"></td> </tr> <tr> <td></td> <td></td> <td colspan="8" style="text-align: center;"> <table border="1" style="width: 100%; border-collapse: collapse; text-align: center;"> <tr> <td style="width: 10%;"></td> <td style="width: 10%;"></td> <td style="width: 10%;"></td> <td style="width: 10%;"></td> <td style="width: 10%;"></td> <td style="width: 10%;"></td> <td style="width: 10%;"></td> <td style="width: 10%;"></td> <td style="width: 10%;"></td> <td style="width: 10%;"></td> </tr> <tr> <td></td> <td></td> <td colspan="8" style="text-align: center;"> <table border="1" style="width: 100%; border-collapse: collapse; text-align: center;"> <tr> <td style="width: 10%;"></td> <td style="width: 10%;"></td> <td style="width: 10%;"></td> <td style="width: 10%;"></td> <td style="width: 10%;"></td> <td style="width: 10%;"></td> <td style="width: 10%;"></td> <td style="width: 10%;"></td> <td style="width: 10%;"></td> <td style="width: 10%;"></td> </tr> <tr> <td></td> <td></td> <td colspan="8" style="text-align: center;"> <table border="1" style="width: 100%; border-collapse: collapse; text-align: center;"> <tr> <td style="width: 10%;"></td> <td style="width: 10%;"></td> <td style="width: 10%;"></td> <td style="width: 10%;"></td> <td style="width: 10%;"></td> <td style="width: 10%;"></td> <td style="width: 10%;"></td> <td style="width: 10%;"></td> <td style="width: 10%;"></td> <td style="width: 10%;"></td> </tr> <tr> <td></td> <td></td> <td colspan="8" style="text-align: center;"> <table border="1" style="width: 100%; border-collapse: collapse;
text-align: center;"> <tr> <td style="width: 10%;"></td> <td style="width: 10%;"></td> <td style="width: 10%;"></td> <td style="width: 10%;"></td> <td style="width: 10%;"></td> <td style="width: 10%;"></td> <td style="width: 10%;"></td> <td style="width: 10%;"></td> <td style="width: 10%;"></td> <td style="width: 10%;"></td> </tr> <tr> <td></td> <td></td> <td colspan="8" style="text-align: center;"> <table border="1" style="width: 100%; border-collapse: collapse; text-align: center;"> <tr> <td style="width: 10%;"></td> <td style="width: 10%;"></td> <td style="width: 10%;"></td> <td style="width: 10%;"></td> <td style="width: 10%;"></td> <td style="width: 10%;"></td> <td style="width: 10%;"></td> <td style="width: 10%;"></td> <td style="width: 10%;"></td> <td style="width: 10%;"></td> </tr> <tr> <td></td> <td></td> <td colspan="8" style="text-align: center;"> <table border="1" style="width: 100%; border-collapse: collapse; text-align: center;"> <tr> <td style="width: 10%;"></td> <td style="width: 10%;"></td> <td style="width: 10%;"></td> <td style="width: 10%;"></td> <td style="width: 10%;"></td> <td style="width: 10%;"></td> <td style="width: 10%;"></td> <td style="width: 10%;"></td> <td style="width: 10%;"></td> <td style="width: 10%;"></td> </tr> <tr> <td></td> <td></td> <td colspan="8" style="text-align: center;"> <table border="1" style="width: 100%; border-collapse: collapse; text-align: center;"> <tr> <td style="width: 10%;"></td> <td style="width: 10%;"></td> <td style="width: 10%;"></td> <td style="width: 10%;"></td> <td style="width: 10%;"></td> <td style="width: 10%;"></td> <td style="width: 10%;"></td> <td style="width: 10%;"></td> <td style="width: 10%;"></td> <td style="width: 10%;"></td> </tr> <tr> <td></td> <td></td> <td colspan="8" style="text-align: center;"> <table border="1" style="width: 100%; border-collapse: collapse; text-align: center;"> <tr> <td style="width: 10%;"></td> <td style="width: 10%;"></td> <td style="width: 10%;"></td> <td style="width: 10%;"></td> <td style="width: 10%;"></td> <td style="width: 10%;"></td> <td style="width: 10%;"></td> <td style="width: 10%;"></td> <td style="width: 10%;"></td> <td style="width: 10%;"></td> </tr> <tr> <td></td> <td></td> <td colspan="8" style="text-align: center;"> <table border="1" style="width: 100%; border-collapse: collapse; text-align: center;"> <tr> <td style="width: 10%;"></td> <td style="width: 10%;"></td> <td style="width: 10%;"></td> <td style="width: 10%;"></td> <td style="width: 10%;"></td> <td style="width: 10%;"></td> <td style="width: 10%;"></td> <td style="width: 10%;"></td> <td style="width: 10%;"></td> <td style="width: 10%;"></td> </tr> <tr> <td></td> <td></td> <td colspan="8" style="text-align: center;"> <table border="1" style="width: 100%; border-collapse: collapse; text-align: center;"> <tr> </tr></table></td></tr></table></td></tr></table></td></tr></table></td></tr></table></td></tr></table></td></tr></table></td></tr></table></td></tr></table></td></tr></table></td></tr></table></td></tr></table></td></tr></table></td></tr></table></td></tr></table></td></tr></table></td></tr></table></td></tr></table></td></tr></table></td></tr></table></td></tr></table></td></tr></table></td></tr></table></td></tr></table></td></tr></table></td></tr></table></td></tr></table></td></tr></table>
 | | | | | | | | | | | | | | | | | | | | <table border="1" style="width: 100%; border-collapse: collapse; text-align: center;"> <tr> <td style="width: 10%;"></td> <td style="width: 10%;"></td> <td style="width: 10%;"></td> <td style="width: 10%;"></td> <td style="width: 10%;"></td> <td style="width: 10%;"></td> <td style="width: 10%;"></td> <td style="width: 10%;"></td> <td style="width: 10%;"></td> <td style="width: 10%;"></td> </tr> <tr> <td></td> <td></td> <td colspan="8" style="text-align: center;"> <table border="1" style="width: 100%; border-collapse: collapse; text-align: center;"> <tr> <td style="width: 10%;"></td> <td style="width: 10%;"></td> <td style="width: 10%;"></td> <td style="width: 10%;"></td> <td style="width: 10%;"></td> <td style="width: 10%;"></td> <td style="width: 10%;"></td> <td style="width: 10%;"></td> <td style="width: 10%;"></td> <td style="width: 10%;"></td> </tr> <tr> <td></td> <td></td> <td colspan="8" style="text-align: center;"> <table border="1" style="width: 100%; border-collapse: collapse; text-align: center;"> <tr> <td style="width: 10%;"></td> <td style="width: 10%;"></td> <td style="width: 10%;"></td> <td style="width: 10%;"></td> <td style="width: 10%;"></td> <td style="width: 10%;"></td> <td style="width: 10%;"></td> <td style="width: 10%;"></td> <td style="width: 10%;"></td> <td style="width: 10%;"></td> </tr> <tr> <td></td> <td></td> <td colspan="8" style="text-align: center;"> <table border="1" style="width: 100%; border-collapse: collapse; text-align: center;"> <tr> <td style="width: 10%;"></td> <td style="width: 10%;"></td> <td style="width: 10%;"></td> <td style="width: 10%;"></td> <td style="width: 10%;"></td> <td style="width: 10%;"></td> <td style="width: 10%;"></td> <td style="width: 10%;"></td> <td style="width: 10%;"></td> <td style="width: 10%;"></td> </tr> <tr> <td></td> <td></td> <td colspan="8" style="text-align: center;"> <table border="1" style="width: 100%; border-collapse: collapse; text-align: center;"> <tr> <td style="width: 10%;"></td> <td style="width: 10%;"></td> <td style="width: 10%;"></td> <td style="width: 10%;"></td> <td style="width: 10%;"></td> <td style="width: 10%;"></td> <td style="width: 10%;"></td> <td style="width: 10%;"></td> <td style="width: 10%;"></td> <td style="width: 10%;"></td> </tr> <tr> <td></td> <td></td> <td colspan="8" style="text-align: center;"> <table border="1" style="width: 100%; border-collapse: collapse; text-align: center;"> <tr> <td style="width: 10%;"></td> <td style="width: 10%;"></td> <td style="width: 10%;"></td> <td style="width: 10%;"></td> <td style="width: 10%;"></td> <td style="width: 10%;"></td> <td style="width: 10%;"></td> <td style="width: 10%;"></td> <td style="width: 10%;"></td> <td style="width: 10%;"></td> </tr> <tr> <td></td> <td></td> <td colspan="8" style="text-align: center;"> <table border="1" style="width: 100%; border-collapse: collapse; text-align: center;"> <tr> <td style="width: 10%;"></td> <td style="width: 10%;"></td> <td style="width: 10%;"></td> <td style="width: 10%;"></td> <td style="width: 10%;"></td> <td style="width: 10%;"></td> <td style="width: 10%;"></td> <td style="width: 10%;"></td> <td style="width: 10%;"></td> <td style="width: 10%;"></td> </tr> <tr> <td></td> <td></td> <td colspan="8" style="text-align: center;"> <table border="1" style="width: 100%; border-collapse: collapse; text-align: center;"> <tr> <td style="width: 10%;"></td> <td style="width: 10%;"></td> <td style="width: 10%;"></td> <td style="width: 10%;"></td> <td style="width: 10%;"></td> <td style="width: 10%;"></td> <td style="width: 10%;"></td> <td style="width: 10%;"></td> <td style="width: 10%;"></td> <td style="width: 10%;"></td> </tr> <tr> <td></td> <td></td> <td colspan="8" style="text-align: center;"> <table border="1" style="width: 100%; border-collapse: collapse; text-align: center;"> <tr> <td style="width: 10%;"></td> <td style="width: 10%;"></td> <td style="width: 10%;"></td> <td style="width: 10%;"></td> <td style="width: 10%;"></td> <td style="width: 10%;"></td> <td style="width: 10%;"></td> <td style="width: 10%;"></td> <td style="width: 10%;"></td> <td style="width: 10%;"></td> </tr> <tr> <td></td> <td></td> <td colspan="8" style="text-align: center;"> <table border="1" style="width: 100%; border-collapse: collapse; text-align: center;"> <tr> <td style="width: 10%;"></td> <td style="width: 10%;"></td> <td style="width: 10%;"></td> <td style="width: 10%;"></td> <td style="width: 10%;"></td> <td style="width: 10%;"></td> <td style="width: 10%;"></td> <td style="width: 10%;"></td> <td style="width: 10%;"></td> <td style="width: 10%;"></td> </tr> <tr> <td></td> <td></td> <td colspan="8" style="text-align: center;"> <table border="1" style="width: 100%; border-collapse: collapse; text-align: center;"> <tr> <td style="width: 10%;"></td> <td style="width: 10%;"></td> <td style="width: 10%;"></td> <td style="width: 10%;"></td> <td style="width: 10%;"></td> <td style="width:
10%;"></td> <td style="width: 10%;"></td> <td style="width: 10%;"></td> <td style="width: 10%;"></td> <td style="width: 10%;"></td> </tr> <tr> <td></td> <td></td> <td colspan="8" style="text-align: center;"> <table border="1" style="width: 100%; border-collapse: collapse; text-align: center;"> <tr> <td style="width: 10%;"></td> <td style="width: 10%;"></td> <td style="width: 10%;"></td> <td style="width: 10%;"></td> <td style="width: 10%;"></td> <td style="width: 10%;"></td> <td style="width: 10%;"></td> <td style="width: 10%;"></td> <td style="width: 10%;"></td> <td style="width: 10%;"></td> </tr> <tr> <td></td> <td></td> <td colspan="8" style="text-align: center;"> <table border="1" style="width: 100%; border-collapse: collapse; text-align: center;"> <tr> <td style="width: 10%;"></td> <td style="width: 10%;"></td> <td style="width: 10%;"></td> <td style="width: 10%;"></td> <td style="width: 10%;"></td> <td style="width: 10%;"></td> <td style="width: 10%;"></td> <td style="width: 10%;"></td> <td style="width: 10%;"></td> <td style="width: 10%;"></td> </tr> <tr> <td></td> <td></td> <td colspan="8" style="text-align: center;"> <table border="1" style="width: 100%; border-collapse: collapse; text-align: center;"> <tr> <td style="width: 10%;"></td> <td style="width: 10%;"></td> <td style="width: 10%;"></td> <td style="width: 10%;"></td> <td style="width: 10%;"></td> <td style="width: 10%;"></td> <td style="width: 10%;"></td> <td style="width: 10%;"></td> <td style="width: 10%;"></td> <td style="width: 10%;"></td> </tr> <tr> <td></td> <td></td> <td colspan="8" style="text-align: center;"> <table border="1" style="width: 100%; border-collapse: collapse; text-align: center;"> <tr> <td style="width: 10%;"></td> <td style="width: 10%;"></td> <td style="width: 10%;"></td> <td style="width: 10%;"></td> <td style="width: 10%;"></td> <td style="width: 10%;"></td> <td style="width: 10%;"></td> <td style="width: 10%;"></td> <td style="width: 10%;"></td> <td style="width: 10%;"></td> </tr> <tr> <td></td> <td></td> <td colspan="8" style="text-align: center;"> <table border="1" style="width: 100%; border-collapse: collapse; text-align: center;"> <tr> <td style="width: 10%;"></td> <td style="width: 10%;"></td> <td style="width: 10%;"></td> <td style="width: 10%;"></td> <td style="width: 10%;"></td> <td style="width: 10%;"></td> <td style="width: 10%;"></td> <td style="width: 10%;"></td> <td style="width: 10%;"></td> <td style="width: 10%;"></td> </tr> <tr> <td></td> <td></td> <td colspan="8" style="text-align: center;"> <table border="1" style="width: 100%; border-collapse: collapse; text-align: center;"> <tr> <td style="width: 10%;"></td> <td style="width: 10%;"></td> <td style="width: 10%;"></td> <td style="width: 10%;"></td> <td style="width: 10%;"></td> <td style="width: 10%;"></td> <td style="width: 10%;"></td> <td style="width: 10%;"></td> <td style="width: 10%;"></td> <td style="width: 10%;"></td> </tr> <tr> <td></td> <td></td> <td colspan="8" style="text-align: center;"> <table border="1" style="width: 100%; border-collapse: collapse; text-align: center;"> <tr> <td style="width: 10%;"></td> <td style="width: 10%;"></td> <td style="width: 10%;"></td> <td style="width: 10%;"></td> <td style="width: 10%;"></td> <td style="width: 10%;"></td> <td style="width: 10%;"></td> <td style="width: 10%;"></td> <td style="width: 10%;"></td> <td style="width: 10%;"></td> </tr> <tr> <td></td> <td></td> <td colspan="8" style="text-align: center;"> <table border="1" style="width: 100%; border-collapse: collapse; text-align: center;"> <tr> <td style="width: 10%;"></td> <td style="width: 10%;"></td> <td style="width: 10%;"></td> <td style="width: 10%;"></td> <td style="width: 10%;"></td> <td style="width: 10%;"></td> <td style="width: 10%;"></td> <td style="width: 10%;"></td> <td style="width: 10%;"></td> <td style="width: 10%;"></td> </tr> <tr> <td></td> <td></td> <td colspan="8" style="text-align: center;"> <table border="1" style="width: 100%; border-collapse: collapse; text-align: center;"> <tr> <td style="width: 10%;"></td> <td style="width: 10%;"></td> <td style="width: 10%;"></td> <td style="width: 10%;"></td> <td style="width: 10%;"></td> <td style="width: 10%;"></td> <td style="width: 10%;"></td> <td style="width: 10%;"></td> <td style="width: 10%;"></td> <td style="width: 10%;"></td> </tr> <tr> <td></td> <td></td> <td colspan="8" style="text-align: center;"> <table border="1" style="width: 100%; border-collapse: collapse; text-align: center;"> <tr> <td style="width: 10%;"></td> <td style="width: 10%;"></td> <td style="width: 10%;"></td> <td style="width: 10%;"></td> <td style="width: 10%;"></td> <td style="width: 10%;"></td> <td style="width: 10%;"></td> <td style="width: 10%;"></td> <td style="width: 10%;"></td> <td style="width: 10%;"></td> </tr> <tr> <td></td> <td></td> <td colspan="8" style="text-align: center;"> <table border="1" style="width: 100%; border-collapse: collapse; text-align: center;"> <tr> <td style="width: 10%;"></td> <td style="width: 10%;"></td> <td style="width: 10%;"></td> <td style="width: 10%;"></td> <td style="width: 10%;"></td> <td style="width: 10%;"></td> <td style="width: 10%;"></td> <td style="width: 10%;"></td> <td style="width: 10%;"></td> <td style="width: 10%;"></td> </tr> <tr> <td></td> <td></td> <td colspan="8" style="text-align: center;"> <table border="1" style="width: 100%; border-collapse: collapse; text-align: center;"> <tr> <td style="width: 10%;"></td> <td style="width: 10%;"></td> <td style="width: 10%;"></td> <td style="width: 10%;"></td> <td style="width: 10%;"></td> <td style="width: 10%;"></td> <td style="width: 10%;"></td> <td style="width: 10%;"></td> <td style="width: 10%;"></td> <td style="width: 10%;"></td> </tr> <tr> <td></td> <td></td> <td colspan="8" style="text-align: center;"> <table border="1" style="width: 100%; border-collapse: collapse; text-align: center;"> <tr> <td style="width: 10%;"></td> <td style="width: 10%;"></td> <td style="width: 10%;"></td> <td style="width: 10%;"></td> <td style="width: 10%;"></td> <td style="width: 10%;"></td> <td style="width: 10%;"></td> <td style="width: 10%;"></td> <td style="width: 10%;"></td> <td style="width: 10%;"></td> </tr> <tr> <td></td> <td></td> <td colspan="8" style="text-align: center;"> <table border="1" style="width: 100%; border-collapse: collapse; text-align: center;"> <tr> <td style="width: 10%;"></td> <td style="width: 10%;"></td> <td style="width: 10%;"></td> <td style="width: 10%;"></td> <td style="width: 10%;"></td> <td style="width: 10%;"></td> <td style="width: 10%;"></td> <td style="width: 10%;"></td> <td style="width: 10%;"></td> <td style="width: 10%;"></td> </tr> <tr> <td></td> <td></td> <td colspan="8" style="text-align: center;"> <table border="1" style="width: 100%; border-collapse: collapse; text-align: center;"> <tr> <td style="width: 10%;"></td> <td style="width: 10%;"></td> <td style="width: 10%;"></td> <td style="width: 10%;"></td> <td style="width: 10%;"></td> <td style="width: 10%;"></td> <td style="width: 10%;"></td> <td style="width: 10%;"></td> <td style="width: 10%;"></td> <td style="width: 10%;"></td> </tr> <tr> <td></td> <td></td> <td colspan="8" style="text-align: center;"> <table border="1" style="width: 100%; border-collapse: collapse; text-align: center;"> <tr> </tr></table></td></tr></table></td></tr></table></td></tr></table></td></tr></table></td></tr></table></td></tr></table></td></tr></table></td></tr></table></td></tr></table></td></tr></table></td></tr></table></td></tr></table></td></tr></table></td></tr></table></td></tr></table></td></tr></table></td></tr></table></td></tr></table></td></tr></table></td></tr></table></td></tr></table></td></tr></table></td></tr></table></td></tr></table></td></tr></table></td></tr></table>
 | | | | | | | | | | | | | | | | | | | | <table border="1" style="width: 100%; border-collapse: collapse; text-align: center;"> <tr> <td style="width: 10%;"></td> <td style="width: 10%;"></td> <td style="width: 10%;"></td> <td style="width: 10%;"></td> <td style="width: 10%;"></td> <td style="width: 10%;"></td> <td style="width: 10%;"></td> <td style="width: 10%;"></td> <td style="width: 10%;"></td> <td style="width: 10%;"></td> </tr> <tr> <td></td> <td></td> <td colspan="8" style="text-align: center;"> <table
border="1" style="width: 100%; border-collapse: collapse; text-align: center;"> <tr> <td style="width: 10%;"></td> <td style="width: 10%;"></td> <td style="width: 10%;"></td> <td style="width: 10%;"></td> <td style="width: 10%;"></td> <td style="width: 10%;"></td> <td style="width: 10%;"></td> <td style="width: 10%;"></td> <td style="width: 10%;"></td> <td style="width: 10%;"></td> </tr> <tr> <td></td> <td></td> <td colspan="8" style="text-align: center;"> <table border="1" style="width: 100%; border-collapse: collapse; text-align: center;"> <tr> <td style="width: 10%;"></td> <td style="width: 10%;"></td> <td style="width: 10%;"></td> <td style="width: 10%;"></td> <td style="width: 10%;"></td> <td style="width: 10%;"></td> <td style="width: 10%;"></td> <td style="width: 10%;"></td> <td style="width: 10%;"></td> <td style="width: 10%;"></td> </tr> <tr> <td></td> <td></td> <td colspan="8" style="text-align: center;"> <table border="1" style="width: 100%; border-collapse: collapse; text-align: center;"> <tr> <td style="width: 10%;"></td> <td style="width: 10%;"></td> <td style="width: 10%;"></td> <td style="width: 10%;"></td> <td style="width: 10%;"></td> <td style="width: 10%;"></td> <td style="width: 10%;"></td> <td style="width: 10%;"></td> <td style="width: 10%;"></td> <td style="width: 10%;"></td> </tr> <tr> <td></td> <td></td> <td colspan="8" style="text-align: center;"> <table border="1" style="width: 100%; border-collapse: collapse; text-align: center;"> <tr> <td style="width: 10%;"></td> <td style="width: 10%;"></td> <td style="width: 10%;"></td> <td style="width: 10%;"></td> <td style="width: 10%;"></td> <td style="width: 10%;"></td> <td style="width: 10%;"></td> <td style="width: 10%;"></td> <td style="width: 10%;"></td> <td style="width: 10%;"></td> </tr> <tr> <td></td> <td></td> <td colspan="8" style="text-align: center;"> <table border="1" style="width: 100%; border-collapse: collapse; text-align: center;"> <tr> <td style="width: 10%;"></td> <td style="width: 10%;"></td> <td style="width: 10%;"></td> <td style="width: 10%;"></td> <td style="width: 10%;"></td> <td style="width: 10%;"></td> <td style="width: 10%;"></td> <td style="width: 10%;"></td> <td style="width: 10%;"></td> <td style="width: 10%;"></td> </tr> <tr> <td></td> <td></td> <td colspan="8" style="text-align: center;"> <table border="1" style="width: 100%; border-collapse: collapse; text-align: center;"> <tr> <td style="width: 10%;"></td> <td style="width: 10%;"></td> <td style="width: 10%;"></td> <td style="width: 10%;"></td> <td style="width: 10%;"></td> <td style="width: 10%;"></td> <td style="width: 10%;"></td> <td style="width: 10%;"></td> <td style="width: 10%;"></td> <td style="width: 10%;"></td> </tr> <tr> <td></td> <td></td> <td colspan="8" style="text-align: center;"> <table border="1" style="width: 100%; border-collapse: collapse; text-align: center;"> <tr> <td style="width: 10%;"></td> <td style="width: 10%;"></td> <td style="width: 10%;"></td> <td style="width: 10%;"></td> <td style="width: 10%;"></td> <td style="width: 10%;"></td> <td style="width: 10%;"></td> <td style="width: 10%;"></td> <td style="width: 10%;"></td> <td style="width: 10%;"></td> </tr> <tr> <td></td> <td></td> <td colspan="8" style="text-align: center;"> <table border="1" style="width: 100%; border-collapse: collapse; text-align: center;"> <tr> <td style="width: 10%;"></td> <td style="width: 10%;"></td> <td style="width: 10%;"></td> <td style="width: 10%;"></td> <td style="width: 10%;"></td> <td style="width: 10%;"></td> <td style="width: 10%;"></td> <td style="width: 10%;"></td> <td style="width: 10%;"></td> <td style="width: 10%;"></td> </tr> <tr> <td></td> <td></td> <td colspan="8" style="text-align: center;"> <table border="1" style="width: 100%; border-collapse: collapse; text-align: center;"> <tr> <td style="width: 10%;"></td> <td style="width: 10%;"></td> <td style="width: 10%;"></td> <td style="width: 10%;"></td> <td style="width: 10%;"></td> <td style="width: 10%;"></td> <td style="width: 10%;"></td> <td style="width: 10%;"></td> <td style="width: 10%;"></td> <td style="width: 10%;"></td> </tr> <tr> <td></td> <td></td> <td colspan="8" style="text-align: center;"> <table border="1" style="width: 100%; border-collapse: collapse; text-align: center;"> <tr> <td style="width: 10%;"></td> <td style="width: 10%;"></td> <td style="width: 10%;"></td> <td style="width: 10%;"></td> <td style="width: 10%;"></td> <td style="width: 10%;"></td> <td style="width: 10%;"></td> <td style="width: 10%;"></td> <td style="width: 10%;"></td> <td style="width: 10%;"></td> </tr> <tr> <td></td> <td></td> <td colspan="8" style="text-align: center;"> <table border="1" style="width: 100%; border-collapse: collapse; text-align: center;"> <tr> <td style="width: 10%;"></td> <td style="width: 10%;"></td> <td style="width: 10%;"></td> <td style="width: 10%;"></td> <td style="width: 10%;"></td> <td style="width: 10%;"></td> <td style="width: 10%;"></td> <td style="width: 10%;"></td> <td style="width: 10%;"></td> <td style="width: 10%;"></td> </tr> <tr> <td></td> <td></td> <td colspan="8" style="text-align: center;"> <table border="1" style="width: 100%; border-collapse: collapse; text-align: center;"> <tr> <td style="width: 10%;"></td> <td style="width: 10%;"></td> <td style="width: 10%;"></td> <td style="width: 10%;"></td> <td style="width: 10%;"></td> <td style="width: 10%;"></td> <td style="width: 10%;"></td> <td style="width: 10%;"></td> <td style="width: 10%;"></td> <td style="width: 10%;"></td> </tr> <tr> <td></td> <td></td> <td colspan="8" style="text-align: center;"> <table border="1" style="width: 100%; border-collapse: collapse; text-align: center;"> <tr> <td style="width: 10%;"></td> <td style="width: 10%;"></td> <td style="width: 10%;"></td> <td style="width: 10%;"></td> <td style="width: 10%;"></td> <td style="width: 10%;"></td> <td style="width: 10%;"></td> <td style="width: 10%;"></td> <td style="width: 10%;"></td> <td style="width: 10%;"></td> </tr> <tr> <td></td> <td></td> <td colspan="8" style="text-align: center;"> <table border="1" style="width: 100%; border-collapse: collapse; text-align: center;"> <tr> <td style="width: 10%;"></td> <td style="width: 10%;"></td> <td style="width: 10%;"></td> <td style="width: 10%;"></td> <td style="width: 10%;"></td> <td style="width: 10%;"></td> <td style="width: 10%;"></td> <td style="width: 10%;"></td> <td style="width: 10%;"></td> <td style="width: 10%;"></td> </tr> <tr> <td></td> <td></td> <td colspan="8" style="text-align: center;"> <table border="1" style="width: 100%; border-collapse: collapse; text-align: center;"> <tr> <td style="width: 10%;"></td> <td style="width: 10%;"></td> <td style="width: 10%;"></td> <td style="width: 10%;"></td> <td style="width: 10%;"></td> <td style="width: 10%;"></td> <td style="width: 10%;"></td> <td style="width: 10%;"></td> <td style="width: 10%;"></td> <td style="width: 10%;"></td> </tr> <tr> <td></td> <td></td> <td colspan="8" style="text-align: center;"> <table border="1" style="width: 100%; border-collapse: collapse; text-align: center;"> <tr> <td style="width: 10%;"></td> <td style="width: 10%;"></td> <td style="width: 10%;"></td> <td style="width: 10%;"></td> <td style="width: 10%;"></td> <td style="width: 10%;"></td> <td style="width: 10%;"></td> <td style="width: 10%;"></td> <td style="width: 10%;"></td> <td style="width: 10%;"></td> </tr> <tr> <td></td> <td></td> <td colspan="8" style="text-align: center;"> <table border="1" style="width: 100%; border-collapse: collapse; text-align: center;"> <tr> <td style="width: 10%;"></td> <td style="width: 10%;"></td> <td style="width: 10%;"></td> <td style="width: 10%;"></td> <td style="width: 10%;"></td> <td style="width: 10%;"></td> <td style="width: 10%;"></td> <td style="width: 10%;"></td> <td style="width: 10%;"></td> <td style="width: 10%;"></td> </tr> <tr> <td></td> <td></td> <td colspan="8" style="text-align: center;"> <table border="1" style="width: 100%; border-collapse: collapse; text-align: center;"> <tr> <td style="width: 10%;"></td> <td style="width: 10%;"></td> <td style="width: 10%;"></td> <td style="width: 10%;"></td> <td style="width: 10%;"></td> <td style="width: 10%;"></td> <td style="width: 10%;"></td> <td style="width: 10%;"></td> <td style="width: 10%;"></td> <td style="width: 10%;"></td> </tr> <tr> <td></td> <td></td> <td colspan="8" style="text-align: center;"> <table border="1" style="width: 100%; border-collapse: collapse; text-align: center;"> <tr> <td style="width: 10%;"></td> <td style="width: 10%;"></td> <td style="width: 10%;"></td> <td style="width: 10%;"></td> <td style="width: 10%;"></td> <td style="width: 10%;"></td> <td style="width: 10%;"></td> <td style="width: 10%;"></td> <td style="width: 10%;"></td> <td style="width: 10%;"></td> </tr> <tr> <td></td> <td></td> <td colspan="8" style="text-align: center;"> <table border="1" style="width: 100%; border-collapse: collapse; text-align: center;"> <tr> <td style="width: 10%;"></td> <td style="width: 10%;"></td> <td style="width: 10%;"></td> <td style="width: 10%;"></td> <td style="width: 10%;"></td> <td style="width: 10%;"></td> <td style="width: 10%;"></td> <td style="width: 10%;"></td> <td style="width: 10%;"></td> <td style="width: 10%;"></td> </tr> <tr> <td></td> <td></td> <td colspan="8" style="text-align: center;"> <table border="1" style="width: 100%; border-collapse: collapse; text-align: center;"> <tr> <td style="width: 10%;"></td> <td style="width: 10%;"></td> <td style="width: 10%;"></td> <td style="width: 10%;"></td> <td style="width: 10%;"></td> <td style="width: 10%;"></td> <td style="width: 10%;"></td> <td style="width: 10%;"></td> <td style="width: 10%;"></td> <td style="width: 10%;"></td> </tr> <tr> <td></td> <td></td> <td colspan="8" style="text-align: center;"> <table border="1" style="width: 100%; border-collapse: collapse; text-align: center;"> <tr> <td style="width: 10%;"></td> <td style="width: 10%;"></td> <td style="width:
10%;"></td> <td style="width: 10%;"></td> <td style="width: 10%;"></td> <td style="width: 10%;"></td> <td style="width: 10%;"></td> <td style="width: 10%;"></td> <td style="width: 10%;"></td> <td style="width: 10%;"></td> </tr> <tr> <td></td> <td></td> <td colspan="8" style="text-align: center;"> <table border="1" style="width: 100%; border-collapse: collapse; text-align: center;"> <tr> <td style="width: 10%;"></td> <td style="width: 10%;"></td> <td style="width: 10%;"></td> <td style="width: 10%;"></td> <td style="width: 10%;"></td> <td style="width: 10%;"></td> <td style="width: 10%;"></td> <td style="width: 10%;"></td> <td style="width: 10%;"></td> <td style="width: 10%;"></td> </tr> <tr> <td></td> <td></td> <td colspan="8" style="text-align: center;"> <table border="1" style="width: 100%; border-collapse: collapse; text-align: center;"> <tr> <td style="width: 10%;"></td> <td style="width: 10%;"></td> <td style="width: 10%;"></td> <td style="width: 10%;"></td> <td style="width: 10%;"></td> <td style="width: 10%;"></td> <td style="width: 10%;"></td> <td style="width: 10%;"></td> <td style="width: 10%;"></td> <td style="width: 10%;"></td> </tr> <tr> <td></td> <td></td> <td colspan="8" style="text-align: center;"> <table border="1" style="width: 100%; border-collapse: collapse; text-align: center;"> <tr> </tr></table></td></tr></table></td></tr></table></td></tr></table></td></tr></table></td></tr></table></td></tr></table></td></tr></table></td></tr></table></td></tr></table></td></tr></table></td></tr></table></td></tr></table></td></tr></table></td></tr></table></td></tr></table></td></tr></table></td></tr></table></td></tr></table></td></tr></table></td></tr></table></td></tr></table></td></tr></table></td></tr></table></td></tr></table></td></tr></table>
 | | | | | | | | | | | | | | | | | | | | <table border="1" style="width: 100%; border-collapse: collapse; text-align: center;"> <tr> <td style="width: 10%;"></td> <td style="width: 10%;"></td> <td style="width: 10%;"></td> <td style="width: 10%;"></td> <td style="width: 10%;"></td> <td style="width: 10%;"></td> <td style="width: 10%;"></td> <td style="width: 10%;"></td> <td style="width: 10%;"></td> <td style="width: 10%;"></td> </tr> <tr> <td></td> <td></td> <td colspan="8" style="text-align: center;"> <table border="1" style="width: 100%; border-collapse: collapse; text-align: center;"> <tr> <td style="width: 10%;"></td> <td style="width: 10%;"></td> <td style="width: 10%;"></td> <td style="width: 10%;"></td> <td style="width: 10%;"></td> <td style="width: 10%;"></td> <td style="width: 10%;"></td> <td style="width: 10%;"></td> <td style="width: 10%;"></td> <td style="width: 10%;"></td> </tr> <tr> <td></td> <td></td> <td colspan="8" style="text-align: center;"> <table border="1" style="width: 100%; border-collapse: collapse; text-align: center;"> <tr> <td style="width: 10%;"></td> <td style="width: 10%;"></td> <td style="width: 10%;"></td> <td style="width: 10%;"></td> <td style="width: 10%;"></td> <td style="width: 10%;"></td> <td style="width: 10%;"></td> <td style="width: 10%;"></td> <td style="width: 10%;"></td> <td style="width: 10%;"></td> </tr> <tr> <td></td> <td></td> <td colspan="8" style="text-align: center;"> <table border="1" style="width: 100%; border-collapse: collapse; text-align: center;"> <tr> <td style="width: 10%;"></td> <td style="width: 10%;"></td> <td style="width: 10%;"></td> <td style="width: 10%;"></td> <td style="width: 10%;"></td> <td style="width: 10%;"></td> <td style="width: 10%;"></td> <td style="width: 10%;"></td> <td style="width: 10%;"></td> <td style="width: 10%;"></td> </tr> <tr> <td></td> <td></td> <td colspan="8" style="text-align: center;"> <table border="1" style="width: 100%; border-collapse: collapse; text-align: center;"> <tr> <td style="width: 10%;"></td> <td style="width: 10%;"></td> <td style="width: 10%;"></td> <td style="width: 10%;"></td> <td style="width: 10%;"></td> <td style="width: 10%;"></td> <td style="width: 10%;"></td> <td style="width: 10%;"></td> <td style="width: 10%;"></td> <td style="width: 10%;"></td> </tr> <tr> <td></td> <td></td> <td colspan="8" style="text-align: center;"> <table border="1" style="width: 100%; border-collapse: collapse; text-align: center;"> <tr> <td style="width: 10%;"></td> <td style="width: 10%;"></td> <td style="width: 10%;"></td> <td style="width: 10%;"></td> <td style="width: 10%;"></td> <td style="width: 10%;"></td> <td style="width: 10%;"></td> <td style="width: 10%;"></td> <td style="width: 10%;"></td> <td style="width: 10%;"></td> </tr> <tr> <td></td> <td></td> <td colspan="8" style="text-align: center;"> <table border="1" style="width: 100%; border-collapse: collapse; text-align: center;"> <tr> <td style="width: 10%;"></td> <td style="width: 10%;"></td> <td style="width: 10%;"></td> <td style="width: 10%;"></td> <td style="width: 10%;"></td> <td style="width: 10%;"></td> <td style="width: 10%;"></td> <td style="width: 10%;"></td> <td style="width: 10%;"></td> <td style="width: 10%;"></td> </tr> <tr> <td></td> <td></td> <td colspan="8" style="text-align: center;"> <table border="1" style="width: 100%; border-collapse: collapse; text-align: center;"> <tr> <td style="width: 10%;"></td> <td style="width: 10%;"></td> <td style="width: 10%;"></td> <td style="width: 10%;"></td> <td style="width: 10%;"></td> <td style="width: 10%;"></td> <td style="width: 10%;"></td> <td style="width: 10%;"></td> <td style="width: 10%;"></td> <td style="width: 10%;"></td> </tr> <tr> <td></td> <td></td> <td colspan="8" style="text-align: center;"> <table border="1" style="width: 100%; border-collapse: collapse; text-align: center;"> <tr> <td style="width: 10%;"></td> <td style="width: 10%;"></td> <td style="width: 10%;"></td> <td style="width: 10%;"></td> <td style="width: 10%;"></td> <td style="width: 10%;"></td> <td style="width: 10%;"></td> <td style="width: 10%;"></td> <td style="width: 10%;"></td> <td style="width: 10%;"></td> </tr> <tr> <td></td> <td></td> <td colspan="8" style="text-align: center;"> <table border="1" style="width: 100%; border-collapse: collapse; text-align: center;"> <tr> <td style="width: 10%;"></td> <td style="width: 10%;"></td> <td style="width: 10%;"></td> <td style="width: 10%;"></td> <td style="width: 10%;"></td> <td style="width: 10%;"></td> <td style="width: 10%;"></td> <td style="width: 10%;"></td> <td style="width: 10%;"></td> <td style="width: 10%;"></td> </tr> <tr> <td></td> <td></td> <td colspan="8" style="text-align: center;"> <table border="1" style="width: 100%; border-collapse: collapse; text-align: center;"> <tr> <td style="width: 10%;"></td> <td style="width: 10%;"></td> <td style="width: 10%;"></td> <td style="width: 10%;"></td> <td style="width: 10%;"></td> <td style="width: 10%;"></td> <td style="width: 10%;"></td> <td style="width: 10%;"></td> <td style="width: 10%;"></td> <td style="width: 10%;"></td> </tr> <tr> <td></td> <td></td> <td colspan="8" style="text-align: center;"> <table border="1" style="width: 100%; border-collapse: collapse; text-align: center;"> <tr> <td style="width: 10%;"></td> <td style="width: 10%;"></td> <td style="width: 10%;"></td> <td style="width: 10%;"></td> <td style="width: 10%;"></td> <td style="width: 10%;"></td> <td style="width: 10%;"></td> <td style="width: 10%;"></td> <td style="width: 10%;"></td> <td style="width: 10%;"></td> </tr> <tr> <td></td> <td></td> <td colspan="8" style="text-align: center;"> <table border="1" style="width: 100%; border-collapse: collapse; text-align: center;"> <tr> <td style="width: 10%;"></td> <td style="width: 10%;"></td> <td style="width: 10%;"></td> <td style="width: 10%;"></td> <td style="width: 10%;"></td> <td style="width: 10%;"></td> <td style="width: 10%;"></td> <td style="width: 10%;"></td> <td style="width: 10%;"></td> <td style="width: 10%;"></td> </tr> <tr> <td></td> <td></td> <td colspan="8" style="text-align: center;"> <table border="1" style="width: 100%; border-collapse: collapse; text-align: center;"> <tr> <td style="width: 10%;"></td> <td style="width: 10%;"></td> <td style="width: 10%;"></td> <td style="width: 10%;"></td> <td style="width: 10%;"></td> <td style="width: 10%;"></td> <td style="width: 10%;"></td> <td style="width: 10%;"></td> <td style="width: 10%;"></td> <td style="width: 10%;"></td> </tr> <tr>
<td></td> <td></td> <td colspan="8" style="text-align: center;"> <table border="1" style="width: 100%; border-collapse: collapse; text-align: center;"> <tr> <td style="width: 10%;"></td> <td style="width: 10%;"></td> <td style="width: 10%;"></td> <td style="width: 10%;"></td> <td style="width: 10%;"></td> <td style="width: 10%;"></td> <td style="width: 10%;"></td> <td style="width: 10%;"></td> <td style="width: 10%;"></td> <td style="width: 10%;"></td> </tr> <tr> <td></td> <td></td> <td colspan="8" style="text-align: center;"> <table border="1" style="width: 100%; border-collapse: collapse; text-align: center;"> <tr> <td style="width: 10%;"></td> <td style="width: 10%;"></td> <td style="width: 10%;"></td> <td style="width: 10%;"></td> <td style="width: 10%;"></td> <td style="width: 10%;"></td> <td style="width: 10%;"></td> <td style="width: 10%;"></td> <td style="width: 10%;"></td> <td style="width: 10%;"></td> </tr> <tr> <td></td> <td></td> <td colspan="8" style="text-align: center;"> <table border="1" style="width: 100%; border-collapse: collapse; text-align: center;"> <tr> <td style="width: 10%;"></td> <td style="width: 10%;"></td> <td style="width: 10%;"></td> <td style="width: 10%;"></td> <td style="width: 10%;"></td> <td style="width: 10%;"></td> <td style="width: 10%;"></td> <td style="width: 10%;"></td> <td style="width: 10%;"></td> <td style="width: 10%;"></td> </tr> <tr> <td></td> <td></td> <td colspan="8" style="text-align: center;"> <table border="1" style="width: 100%; border-collapse: collapse; text-align: center;"> <tr> <td style="width: 10%;"></td> <td style="width: 10%;"></td> <td style="width: 10%;"></td> <td style="width: 10%;"></td> <td style="width: 10%;"></td> <td style="width: 10%;"></td> <td style="width: 10%;"></td> <td style="width: 10%;"></td> <td style="width: 10%;"></td> <td style="width: 10%;"></td> </tr> <tr> <td></td> <td></td> <td colspan="8" style="text-align: center;"> <table border="1" style="width: 100%; border-collapse: collapse; text-align: center;"> <tr> <td style="width: 10%;"></td> <td style="width: 10%;"></td> <td style="width: 10%;"></td> <td style="width: 10%;"></td> <td style="width: 10%;"></td> <td style="width: 10%;"></td> <td style="width: 10%;"></td> <td style="width: 10%;"></td> <td style="width: 10%;"></td> <td style="width: 10%;"></td> </tr> <tr> <td></td> <td></td> <td colspan="8" style="text-align: center;"> <table border="1" style="width: 100%; border-collapse: collapse; text-align: center;"> <tr> <td style="width: 10%;"></td> <td style="width: 10%;"></td> <td style="width: 10%;"></td> <td style="width: 10%;"></td> <td style="width: 10%;"></td> <td style="width: 10%;"></td> <td style="width: 10%;"></td> <td style="width: 10%;"></td> <td style="width: 10%;"></td> <td style="width: 10%;"></td> </tr> <tr> <td></td> <td></td> <td colspan="8" style="text-align: center;"> <table border="1" style="width: 100%; border-collapse: collapse; text-align: center;"> <tr> <td style="width: 10%;"></td> <td style="width: 10%;"></td> <td style="width: 10%;"></td> <td style="width: 10%;"></td> <td style="width: 10%;"></td> <td style="width: 10%;"></td> <td style="width: 10%;"></td> <td style="width: 10%;"></td> <td style="width: 10%;"></td> <td style="width: 10%;"></td> </tr> <tr> <td></td> <td></td> <td colspan="8" style="text-align: center;"> <table border="1" style="width: 100%; border-collapse: collapse; text-align: center;"> <tr> <td style="width: 10%;"></td> <td style="width: 10%;"></td> <td style="width: 10%;"></td> <td style="width: 10%;"></td> <td style="width: 10%;"></td> <td style="width: 10%;"></td> <td style="width: 10%;"></td> <td style="width: 10%;"></td> <td style="width: 10%;"></td> <td style="width: 10%;"></td> </tr> <tr> <td></td> <td></td> <td colspan="8" style="text-align: center;"> <table border="1" style="width: 100%; border-collapse: collapse; text-align: center;"> <tr> <td style="width: 10%;"></td> <td style="width: 10%;"></td> <td style="width: 10%;"></td> <td style="width: 10%;"></td> <td style="width: 10%;"></td> <td style="width: 10%;"></td> <td style="width: 10%;"></td> <td style="width: 10%;"></td> <td style="width: 10%;"></td> <td style="width: 10%;"></td> </tr> <tr> <td></td> <td></td> <td colspan="8" style="text-align: center;"> <table border="1" style="width: 100%; border-collapse: collapse; text-align: center;"> <tr> <td style="width: 10%;"></td> <td style="width: 10%;"></td> <td style="width: 10%;"></td> <td style="width: 10%;"></td> <td style="width: 10%;"></td> <td style="width: 10%;"></td> <td style="width: 10%;"></td> <td style="width: 10%;"></td> <td style="width: 10%;"></td> <td style="width: 10%;"></td> </tr> <tr> <td></td> <td></td> <td colspan="8" style="text-align: center;"> <table border="1" style="width: 100%; border-collapse: collapse; text-align: center;"> <tr> </tr></table></td></tr></table></td></tr></table></td></tr></table></td></tr></table></td></tr></table></td></tr></table></td></tr></table></td></tr></table></td></tr></table></td></tr></table></td></tr></table></td></tr></table></td></tr></table></td></tr></table></td></tr></table></td></tr></table></td></tr></table></td></tr></table></td></tr></table></td></tr></table></td></tr></table></td></tr></table></td></tr></table></td></tr></table>
 | | | | | | | | | | | | | | | | | | | | <table border="1" style="width: 100%; border-collapse: collapse; text-align: center;"> <tr> <td style="width: 10%;"></td> <td style="width: 10%;"></td> <td style="width: 10%;"></td> <td style="width: 10%;"></td> <td style="width: 10%;"></td> <td style="width: 10%;"></td> <td style="width: 10%;"></td> <td style="width: 10%;"></td> <td style="width: 10%;"></td> <td style="width: 10%;"></td> </tr> <tr> <td></td> <td></td> <td colspan="8" style="text-align: center;"> <table border="1" style="width: 100%; border-collapse: collapse; text-align: center;"> <tr> <td style="width: 10%;"></td> <td style="width: 10%;"></td> <td style="width: 10%;"></td> <td style="width: 10%;"></td> <td style="width: 10%;"></td> <td style="width: 10%;"></td> <td style="width: 10%;"></td> <td style="width: 10%;"></td> <td style="width: 10%;"></td> <td style="width: 10%;"></td> </tr> <tr> <td></td> <td></td> <td colspan="8" style="text-align: center;"> <table border="1" style="width: 100%; border-collapse: collapse; text-align: center;"> <tr> <td style="width: 10%;"></td> <td style="width: 10%;"></td> <td style="width: 10%;"></td> <td style="width: 10%;"></td> <td style="width: 10%;"></td> <td style="width: 10%;"></td> <td style="width: 10%;"></td> <td style="width: 10%;"></td> <td style="width: 10%;"></td> <td style="width: 10%;"></td> </tr> <tr> <td></td> <td></td> <td colspan="8" style="text-align: center;"> <table border="1" style="width: 100%; border-collapse: collapse; text-align: center;"> <tr> <td style="width: 10%;"></td> <td style="width: 10%;"></td> <td style="width: 10%;"></td> <td style="width: 10%;"></td> <td style="width: 10%;"></td> <td style="width: 10%;"></td> <td style="width: 10%;"></td> <td style="width: 10%;"></td> <td style="width: 10%;"></td> <td style="width: 10%;"></td> </tr> <tr> <td></td> <td></td> <td colspan="8" style="text-align: center;"> <table border="1" style="width: 100%; border-collapse: collapse; text-align: center;"> <tr> <td style="width: 10%;"></td> <td style="width: 10%;"></td> <td style="width: 10%;"></td> <td style="width: 10%;"></td> <td style="width: 10%;"></td> <td style="width: 10%;"></td> <td style="width: 10%;"></td> <td style="width: 10%;"></td> <td style="width: 10%;"></td> <td style="width: 10%;"></td> </tr> <tr> <td></td> <td></td> <td colspan="8" style="text-align: center;"> <table border="1" style="width: 100%; border-collapse: collapse; text-align: center;"> <tr> <td style="width: 10%;"></td> <td style="width: 10%;"></td> <td style="width: 10%;"></td> <td style="width: 10%;"></td> <td style="width: 10%;"></td> <td style="width: 10%;"></td> <td style="width: 10%;"></td> <td style="width: 10%;"></td> <td style="width: 10%;"></td> <td style="width: 10%;"></td> </tr> <tr> <td></td> <td></td> <td colspan="8" style="text-align: center;"> <table border="1" style="width: 100%; border-collapse: collapse; text-align: center;"> <tr> <td style="width: 10%;"></td> <td style="width: 10%;"></td> <td style="width: 10%;"></td> <td
style="width: 10%;"></td> <td style="width: 10%;"></td> <td style="width: 10%;"></td> <td style="width: 10%;"></td> <td style="width: 10%;"></td> <td style="width: 10%;"></td> <td style="width: 10%;"></td> </tr> <tr> <td></td> <td></td> <td colspan="8" style="text-align: center;"> <table border="1" style="width: 100%; border-collapse: collapse; text-align: center;"> <tr> <td style="width: 10%;"></td> <td style="width: 10%;"></td> <td style="width: 10%;"></td> <td style="width: 10%;"></td> <td style="width: 10%;"></td> <td style="width: 10%;"></td> <td style="width: 10%;"></td> <td style="width: 10%;"></td> <td style="width: 10%;"></td> <td style="width: 10%;"></td> </tr> <tr> <td></td> <td></td> <td colspan="8" style="text-align: center;"> <table border="1" style="width: 100%; border-collapse: collapse; text-align: center;"> <tr> <td style="width: 10%;"></td> <td style="width: 10%;"></td> <td style="width: 10%;"></td> <td style="width: 10%;"></td> <td style="width: 10%;"></td> <td style="width: 10%;"></td> <td style="width: 10%;"></td> <td style="width: 10%;"></td> <td style="width: 10%;"></td> <td style="width: 10%;"></td> </tr> <tr> <td></td> <td></td> <td colspan="8" style="text-align: center;"> <table border="1" style="width: 100%; border-collapse: collapse; text-align: center;"> <tr> <td style="width: 10%;"></td> <td style="width: 10%;"></td> <td style="width: 10%;"></td> <td style="width: 10%;"></td> <td style="width: 10%;"></td> <td style="width: 10%;"></td> <td style="width: 10%;"></td> <td style="width: 10%;"></td> <td style="width: 10%;"></td> <td style="width: 10%;"></td> </tr> <tr> <td></td> <td></td> <td colspan="8" style="text-align: center;"> <table border="1" style="width: 100%; border-collapse: collapse; text-align: center;"> <tr> <td style="width: 10%;"></td> <td style="width: 10%;"></td> <td style="width: 10%;"></td> <td style="width: 10%;"></td> <td style="width: 10%;"></td> <td style="width: 10%;"></td> <td style="width: 10%;"></td> <td style="width: 10%;"></td> <td style="width: 10%;"></td> <td style="width: 10%;"></td> </tr> <tr> <td></td> <td></td> <td colspan="8" style="text-align: center;"> <table border="1" style="width: 100%; border-collapse: collapse; text-align: center;"> <tr> <td style="width: 10%;"></td> <td style="width: 10%;"></td> <td style="width: 10%;"></td> <td style="width: 10%;"></td> <td style="width: 10%;"></td> <td style="width: 10%;"></td> <td style="width: 10%;"></td> <td style="width: 10%;"></td> <td style="width: 10%;"></td> <td style="width: 10%;"></td> </tr> <tr> <td></td> <td></td> <td colspan="8" style="text-align: center;"> <table border="1" style="width: 100%; border-collapse: collapse; text-align: center;"> <tr> <td style="width: 10%;"></td> <td style="width: 10%;"></td> <td style="width: 10%;"></td> <td style="width: 10%;"></td> <td style="width: 10%;"></td> <td style="width: 10%;"></td> <td style="width: 10%;"></td> <td style="width: 10%;"></td> <td style="width: 10%;"></td> <td style="width: 10%;"></td> </tr> <tr> <td></td> <td></td> <td colspan="8" style="text-align: center;"> <table border="1" style="width: 100%; border-collapse: collapse; text-align: center;"> <tr> <td style="width: 10%;"></td> <td style="width: 10%;"></td> <td style="width: 10%;"></td> <td style="width: 10%;"></td> <td style="width: 10%;"></td> <td style="width: 10%;"></td> <td style="width: 10%;"></td> <td style="width: 10%;"></td> <td style="width: 10%;"></td> <td style="width: 10%;"></td> </tr> <tr> <td></td> <td></td> <td colspan="8" style="text-align: center;"> <table border="1" style="width: 100%; border-collapse: collapse; text-align: center;"> <tr> <td style="width: 10%;"></td> <td style="width: 10%;"></td> <td style="width: 10%;"></td> <td style="width: 10%;"></td> <td style="width: 10%;"></td> <td style="width: 10%;"></td> <td style="width: 10%;"></td> <td style="width: 10%;"></td> <td style="width: 10%;"></td> <td style="width: 10%;"></td> </tr> <tr> <td></td> <td></td> <td colspan="8" style="text-align: center;"> <table border="1" style="width: 100%; border-collapse: collapse; text-align: center;"> <tr> <td style="width: 10%;"></td> <td style="width: 10%;"></td> <td style="width: 10%;"></td> <td style="width: 10%;"></td> <td style="width: 10%;"></td> <td style="width: 10%;"></td> <td style="width: 10%;"></td> <td style="width: 10%;"></td> <td style="width: 10%;"></td> <td style="width: 10%;"></td> </tr> <tr> <td></td> <td></td> <td colspan="8" style="text-align: center;"> <table border="1" style="width: 100%; border-collapse: collapse; text-align: center;"> <tr> <td style="width: 10%;"></td> <td style="width: 10%;"></td> <td style="width: 10%;"></td> <td style="width: 10%;"></td> <td style="width: 10%;"></td> <td style="width: 10%;"></td> <td style="width: 10%;"></td> <td style="width: 10%;"></td> <td style="width: 10%;"></td> <td style="width: 10%;"></td> </tr> <tr> <td></td> <td></td> <td colspan="8" style="text-align: center;"> <table border="1" style="width: 100%; border-collapse: collapse; text-align: center;"> <tr> <td style="width: 10%;"></td> <td style="width: 10%;"></td> <td style="width: 10%;"></td> <td style="width: 10%;"></td> <td style="width: 10%;"></td> <td style="width: 10%;"></td> <td style="width: 10%;"></td> <td style="width: 10%;"></td> <td style="width: 10%;"></td> <td style="width: 10%;"></td> </tr> <tr> <td></td> <td></td> <td colspan="8" style="text-align: center;"> <table border="1" style="width: 100%; border-collapse: collapse; text-align: center;"> <tr> <td style="width: 10%;"></td> <td style="width: 10%;"></td> <td style="width: 10%;"></td> <td style="width: 10%;"></td> <td style="width: 10%;"></td> <td style="width: 10%;"></td> <td style="width: 10%;"></td> <td style="width: 10%;"></td> <td style="width: 10%;"></td> <td style="width: 10%;"></td> </tr> <tr> <td></td> <td></td> <td colspan="8" style="text-align: center;"> <table border="1" style="width: 100%; border-collapse: collapse; text-align: center;"> <tr> <td style="width: 10%;"></td> <td style="width: 10%;"></td> <td style="width: 10%;"></td> <td style="width: 10%;"></td> <td style="width: 10%;"></td> <td style="width: 10%;"></td> <td style="width: 10%;"></td> <td style="width: 10%;"></td> <td style="width: 10%;"></td> <td style="width: 10%;"></td> </tr> <tr> <td></td> <td></td> <td colspan="8" style="text-align: center;"> <table border="1" style="width: 100%; border-collapse: collapse; text-align: center;"> <tr> <td style="width: 10%;"></td> <td style="width: 10%;"></td> <td style="width: 10%;"></td> <td style="width: 10%;"></td> <td style="width: 10%;"></td> <td style="width: 10%;"></td> <td style="width: 10%;"></td> <td style="width: 10%;"></td> <td style="width: 10%;"></td> <td style="width: 10%;"></td> </tr> <tr> <td></td> <td></td> <td colspan="8" style="text-align: center;"> <table border="1" style="width: 100%; border-collapse: collapse; text-align: center;"> <tr> <td style="width: 10%;"></td> <td style="width: 10%;"></td> <td style="width: 10%;"></td> <td style="width: 10%;"></td> <td style="width: 10%;"></td> <td style="width: 10%;"></td> <td style="width: 10%;"></td> <td style="width: 10%;"></td> <td style="width: 10%;"></td> <td style="width: 10%;"></td> </tr> <tr> <td></td> <td></td> <td colspan="8" style="text-align: center;"> <table border="1" style="width: 100%; border-collapse: collapse; text-align: center;"> <tr> <td style="width: 10%;"></td> <td style="width: 10%;"></td> <td style="width: 10%;"></td> <td style="width: 10%;"></td> <td style="width: 10%;"></td> <td style="width: 10%;"></td> <td style="width: 10%;"></td> <td style="width: 10%;"></td> <td style="width: 10%;"></td> <td style="width: 10%;"></td> </tr> <tr> <td></td> <td></td> <td colspan="8" style="text-align: center;"> <table border="1" style="width: 100%; border-collapse: collapse; text-align: center;"> <tr> </tr></table></td></tr></table></td></tr></table></td></tr></table></td></tr></table></td></tr></table></td></tr></table></td></tr></table></td></tr></table></td></tr></table></td></tr></table></td></tr></table></td></tr></table></td></tr></table></td></tr></table></td></tr></table></td></tr></table></td></tr></table></td></tr></table></td></tr></table></td></tr></table></td></tr></table></td></tr></table></td></tr></table>
 | | | | | | | | | | | | | | |
 | | | | <table border="1" style="width: 100%; border-collapse: collapse; text-align: center;"> <tr> <td style="width: 10%;"></td> <td style="width: 10%;"></td> <td style="width: 10%;"></td> <td style="width: 10%;"></td> <td style="width: 10%;"></td> <td style="width: 10%;"></td> <td style="width: 10%;"></td> <td style="width: 10%;"></td> <td style="width: 10%;"></td> <td style="width: 10%;"></td> </tr> <tr> <td></td> <td></td> <td colspan="8" style="text-align: center;"> <table border="1" style="width: 100%; border-collapse: collapse; text-align: center;"> <tr> <td style="width: 10%;"></td> <td style="width: 10%;"></td> <td style="width: 10%;"></td> <td style="width: 10%;"></td> <td style="width: 10%;"></td> <td style="width: 10%;"></td> <td style="width: 10%;"></td> <td style="width: 10%;"></td> <td style="width: 10%;"></td> <td style="width: 10%;"></td> </tr> <tr> <td></td> <td></td> <td colspan="8" style="text-align: center;"> <table border="1" style="width: 100%; border-collapse: collapse; text-align: center;"> <tr> <td style="width: 10%;"></td> <td style="width: 10%;"></td> <td style="width: 10%;"></td> <td style="width: 10%;"></td> <td style="width: 10%;"></td> <td style="width: 10%;"></td> <td style="width: 10%;"></td> <td style="width: 10%;"></td> <td style="width: 10%;"></td> <td style="width: 10%;"></td> </tr> <tr> <td></td> <td></td> <td colspan="8" style="text-align: center;"> <table border="1" style="width: 100%; border-collapse: collapse; text-align: center;"> <tr> <td style="width: 10%;"></td> <td style="width: 10%;"></td> <td style="width: 10%;"></td> <td style="width: 10%;"></td> <td style="width: 10%;"></td> <td style="width: 10%;"></td> <td style="width: 10%;"></td> <td style="width: 10%;"></td> <td style="width: 10%;"></td> <td style="width: 10%;"></td> </tr> <tr> <td></td> <td></td> <td colspan="8" style="text-align: center;"> <table border="1" style="width: 100%; border-collapse: collapse; text-align: center;"> <tr> <td style="width: 10%;"></td> <td style="width: 10%;"></td> <td style="width: 10%;"></td> <td style="width: 10%;"></td> <td style="width: 10%;"></td> <td style="width: 10%;"></td> <td style="width: 10%;"></td> <td style="width: 10%;"></td> <td style="width: 10%;"></td> <td style="width: 10%;"></td> </tr> <tr> <td></td> <td></td> <td colspan="8" style="text-align: center;"> <table border="1" style="width: 100%; border-collapse: collapse; text-align: center;"> <tr> <td style="width: 10%;"></td> <td style="width: 10%;"></td> <td style="width: 10%;"></td> <td style="width: 10%;"></td> <td style="width: 10%;"></td> <td style="width: 10%;"></td> <td style="width: 10%;"></td> <td style="width: 10%;"></td> <td style="width: 10%;"></td> <td style="width: 10%;"></td> </tr> <tr> <td></td> <td></td> <td colspan="8" style="text-align: center;"> <table border="1" style="width: 100%; border-collapse: collapse; text-align: center;"> <tr> <td style="width: 10%;"></td> <td style="width: 10%;"></td> <td style="width: 10%;"></td> <td style="width: 10%;"></td> <td style="width: 10%;"></td> <td style="width: 10%;"></td> <td style="width: 10%;"></td> <td style="width: 10%;"></td> <td style="width: 10%;"></td> <td style="width: 10%;"></td> </tr> <tr> <td></td> <td></td> <td colspan="8" style="text-align: center;"> <table border="1" style="width: 100%; border-collapse: collapse; text-align: center;"> <tr> <td style="width: 10%;"></td> <td style="width: 10%;"></td> <td style="width: 10%;"></td> <td style="width: 10%;"></td> <td style="width: 10%;"></td> <td style="width: 10%;"></td> <td style="width: 10%;"></td> <td style="width: 10%;"></td> <td style="width: 10%;"></td> <td style="width: 10%;"></td> </tr> <tr> <td></td> <td></td> <td colspan="8" style="text-align: center;"> <table border="1" style="width: 100%; border-collapse: collapse; text-align: center;"> <tr> <td style="width: 10%;"></td> <td style="width: 10%;"></td> <td style="width: 10%;"></td> <td style="width: 10%;"></td> <td style="width: 10%;"></td> <td style="width: 10%;"></td> <td style="width: 10%;"></td> <td style="width: 10%;"></td> <td style="width: 10%;"></td> <td style="width: 10%;"></td> </tr> <tr> <td></td> <td></td> <td colspan="8" style="text-align: center;"> <table border="1" style="width: 100%; border-collapse: collapse; text-align: center;"> <tr> <td style="width: 10%;"></td> <td style="width: 10%;"></td> <td style="width: 10%;"></td> <td style="width: 10%;"></td> <td style="width: 10%;"></td> <td style="width: 10%;"></td> <td style="width: 10%;"></td> <td style="width: 10%;"></td> <td style="width: 10%;"></td> <td style="width: 10%;"></td> </tr> <tr> <td></td> <td></td> <td colspan="8" style="text-align: center;"> <table border="1" style="width: 100%; border-collapse: collapse; text-align: center;"> <tr> <td style="width: 10%;"></td> <td style="width: 10%;"></td> <td style="width: 10%;"></td> <td style="width: 10%;"></td> <td style="width: 10%;"></td> <td style="width: 10%;"></td> <td style="width: 10%;"></td> <td style="width: 10%;"></td> <td style="width: 10%;"></td> <td style="width: 10%;"></td> </tr> <tr> <td></td> <td></td> <td colspan="8" style="text-align: center;"> <table border="1" style="width: 100%; border-collapse: collapse; text-align: center;"> <tr> <td style="width: 10%;"></td> <td style="width: 10%;"></td> <td style="width: 10%;"></td> <td style="width: 10%;"></td> <td style="width: 10%;"></td> <td style="width: 10%;"></td> <td style="width: 10%;"></td> <td style="width: 10%;"></td> <td style="width: 10%;"></td> <td style="width: 10%;"></td> </tr> <tr> <td></td> <td></td> <td colspan="8" style="text-align: center;"> <table border="1" style="width: 100%; border-collapse: collapse; text-align: center;"> <tr> <td style="width: 10%;"></td> <td style="width: 10%;"></td> <td style="width: 10%;"></td> <td style="width: 10%;"></td> <td style="width: 10%;"></td> <td style="width: 10%;"></td> <td style="width: 10%;"></td> <td style="width: 10%;"></td> <td style="width: 10%;"></td> <td style="width: 10%;"></td> </tr> <tr> <td></td> <td></td> <td colspan="8" style="text-align: center;"> <table border="1" style="width: 100%; border-collapse: collapse; text-align: center;"> <tr> <td style="width: 10%;"></td> <td style="width: 10%;"></td> <td style="width: 10%;"></td> <td style="width: 10%;"></td> <td style="width: 10%;"></td> <td style="width: 10%;"></td> <td style="width: 10%;"></td> <td style="width: 10%;"></td> <td style="width: 10%;"></td> <td style="width: 10%;"></td> </tr> <tr> <td></td> <td></td> <td colspan="8" style="text-align: center;"> <table border="1" style="width: 100%; border-collapse: collapse; text-align: center;"> <tr> <td style="width: 10%;"></td> <td style="width: 10%;"></td> <td style="width: 10%;"></td> <td style="width: 10%;"></td> <td style="width: 10%;"></td> <td style="width: 10%;"></td> <td style="width: 10%;"></td> <td style="width: 10%;"></td> <td style="width: 10%;"></td> <td style="width: 10%;"></td> </tr> <tr> <td></td> <td></td> <td colspan="8" style="text-align: center;"> <table border="1" style="width: 100%; border-collapse: collapse; text-align: center;"> <tr> <td style="width: 10%;"></td> <td style="width: 10%;"></td> <td style="width: 10%;"></td> <td style="width: 10%;"></td> <td style="width: 10%;"></td> <td style="width: 10%;"></td> <td style="width: 10%;"></td> <td style="width: 10%;"></td> <td style="width: 10%;"></td> <td style="width: 10%;"></td> </tr> <tr> <td></td> <td></td> <td colspan="8" style="text-align: center;"> <table border="1" style="width: 100%; border-collapse: collapse; text-align: center;"> <tr> <td style="width: 10%;"></td> <td style="width: 10%;"></td> <td style="width: 10%;"></td> <td style="width: 10%;"></td> <td style="width: 10%;"></td> <td style="width: 10%;"></td> <td style="width: 10%;"></td> <td style="width: 10%;"></td> <td style="width: 10%;"></td> <td style="width: 10%;"></td> </tr> <tr> <td></td> <td></td> <td colspan="8" style="text-align: center;"> <table border="1" style="width: 100%; border-collapse: collapse; text-align: center;"> <tr> <td style="width: 10%;"></td> <td style="width: 10%;"></td> <td style="width: 10%;"></td> <td style="width: 10%;"></td> <td style="width: 10%;"></td> <td style="width: 10%;"></td> <td style="width: 10%;"></td> <td style="width: 10%;"></td> <td style="width: 10%;"></td> <td style="width: 10%;"></td> </tr> <tr> <td></td> <td></td> <td colspan="8" style="text-align: center;"> <table border="1" style="width: 100%; border-collapse: collapse; text-align: center;"> <tr> <td style="width: 10%;"></td> <td style="width: 10%;"></td> <td style="width: 10%;"></td> <td style="width: 10%;"></td> <td style="width: 10%;"></td> <td style="width: 10%;"></td> <td style="width: 10%;"></td> <td style="width: 10%;"></td> <td style="width: 10%;"></td> <td style="width: 10%;"></td> </tr> <tr> <td></td> <td></td> <td colspan="8" style="text-align: center;"> <table border="1" style="width: 100%; border-collapse: collapse; text-align: center;"> <tr> <td style="width: 10%;"></td> <td style="width: 10%;"></td> <td style="width: 10%;"></td> <td style="width: 10%;"></td> <td style="width: 10%;"></td> <td style="width: 10%;"></td> <td style="width: 10%;"></td> <td style="width: 10%;"></td> <td style="width: 10%;"></td> <td style="width: 10%;"></td> </tr> <tr> <td></td> <td></td> <td colspan="8" style="text-align: center;"> <table border="1" style="width: 100%; border-collapse: collapse; text-align: center;"> <tr> <td style="width: 10%;"></td> <td style="width: 10%;"></td> <td style="width: 10%;"></td> <td style="width: 10%;"></td> <td style="width: 10%;"></td> <td style="width: 10%;"></td> <td style="width: 10%;"></td> <td style="width: 10%;"></td> <td style="width: 10%;"></td> <td style="width: 10%;"></td> </tr> <tr> <td></td> <td></td> <td colspan="8" style="text-align: center;"> <table border="1" style="width: 100%; border-collapse: collapse; text-align: center;"> <tr> <td style="width: 10%;"></td> <td style="width: 10%;"></td> <td
style="width: 10%;"></td> <td style="width: 10%;"></td> <td style="width: 10%;"></td> <td style="width: 10%;"></td> <td style="width: 10%;"></td> <td style="width: 10%;"></td> <td style="width: 10%;"></td> <td style="width: 10%;"></td> </tr> <tr> <td></td> <td></td> <td colspan="8" style="text-align: center;"> <table border="1" style="width: 100%; border-collapse: collapse; text-align: center;"> <tr> </tr></table></td></tr></table></td></tr></table></td></tr></table></td></tr></table></td></tr></table></td></tr></table></td></tr></table></td></tr></table></td></tr></table></td></tr></table></td></tr></table></td></tr></table></td></tr></table></td></tr></table></td></tr></table></td></tr></table></td></tr></table></td></tr></table></td></tr></table></td></tr></table></td></tr></table></td></tr></table>
 | | | | | | | | | | | | | | | | | | | | <table border="1" style="width: 100%; border-collapse: collapse; text-align: center;"> <tr> <td style="width: 10%;"></td> <td style="width: 10%;"></td> <td style="width: 10%;"></td> <td style="width: 10%;"></td> <td style="width: 10%;"></td> <td style="width: 10%;"></td> <td style="width: 10%;"></td> <td style="width: 10%;"></td> <td style="width: 10%;"></td> <td style="width: 10%;"></td> </tr> <tr> <td></td> <td></td> <td colspan="8" style="text-align: center;"> <table border="1" style="width: 100%; border-collapse: collapse; text-align: center;"> <tr> <td style="width: 10%;"></td> <td style="width: 10%;"></td> <td style="width: 10%;"></td> <td style="width: 10%;"></td> <td style="width: 10%;"></td> <td style="width: 10%;"></td> <td style="width: 10%;"></td> <td style="width: 10%;"></td> <td style="width: 10%;"></td> <td style="width: 10%;"></td> </tr> <tr> <td></td> <td></td> <td colspan="8" style="text-align: center;"> <table border="1" style="width: 100%; border-collapse: collapse; text-align: center;"> <tr> <td style="width: 10%;"></td> <td style="width: 10%;"></td> <td style="width: 10%;"></td> <td style="width: 10%;"></td> <td style="width: 10%;"></td> <td style="width: 10%;"></td> <td style="width: 10%;"></td> <td style="width: 10%;"></td> <td style="width: 10%;"></td> <td style="width: 10%;"></td> </tr> <tr> <td></td> <td></td> <td colspan="8" style="text-align: center;"> <table border="1" style="width: 100%; border-collapse: collapse; text-align: center;"> <tr> <td style="width: 10%;"></td> <td style="width: 10%;"></td> <td style="width: 10%;"></td> <td style="width: 10%;"></td> <td style="width: 10%;"></td> <td style="width: 10%;"></td> <td style="width: 10%;"></td> <td style="width: 10%;"></td> <td style="width: 10%;"></td> <td style="width: 10%;"></td> </tr> <tr> <td></td> <td></td> <td colspan="8" style="text-align: center;"> <table border="1" style="width: 100%; border-collapse: collapse; text-align: center;"> <tr> <td style="width: 10%;"></td> <td style="width: 10%;"></td> <td style="width: 10%;"></td> <td style="width: 10%;"></td> <td style="width: 10%;"></td> <td style="width: 10%;"></td> <td style="width: 10%;"></td> <td style="width: 10%;"></td> <td style="width: 10%;"></td> <td style="width: 10%;"></td> </tr> <tr> <td></td> <td></td> <td colspan="8" style="text-align: center;"> <table border="1" style="width: 100%; border-collapse: collapse; text-align: center;"> <tr> <td style="width: 10%;"></td> <td style="width: 10%;"></td> <td style="width: 10%;"></td> <td style="width: 10%;"></td> <td style="width: 10%;"></td> <td style="width: 10%;"></td> <td style="width: 10%;"></td> <td style="width: 10%;"></td> <td style="width: 10%;"></td> <td style="width: 10%;"></td> </tr> <tr> <td></td> <td></td> <td colspan="8" style="text-align: center;"> <table border="1" style="width: 100%; border-collapse: collapse; text-align: center;"> <tr> <td style="width: 10%;"></td> <td style="width: 10%;"></td> <td style="width: 10%;"></td> <td style="width: 10%;"></td> <td style="width: 10%;"></td> <td style="width: 10%;"></td> <td style="width: 10%;"></td> <td style="width: 10%;"></td> <td style="width: 10%;"></td> <td style="width: 10%;"></td> </tr> <tr> <td></td> <td></td> <td colspan="8" style="text-align: center;"> <table border="1" style="width: 100%; border-collapse: collapse; text-align: center;"> <tr> <td style="width: 10%;"></td> <td style="width: 10%;"></td> <td style="width: 10%;"></td> <td style="width: 10%;"></td> <td style="width: 10%;"></td> <td style="width: 10%;"></td> <td style="width: 10%;"></td> <td style="width: 10%;"></td> <td style="width: 10%;"></td> <td style="width: 10%;"></td> </tr> <tr> <td></td> <td></td> <td colspan="8" style="text-align: center;"> <table border="1" style="width: 100%; border-collapse: collapse; text-align: center;"> <tr> <td style="width: 10%;"></td> <td style="width: 10%;"></td> <td style="width: 10%;"></td> <td style="width: 10%;"></td> <td style="width: 10%;"></td> <td style="width: 10%;"></td> <td style="width: 10%;"></td> <td style="width: 10%;"></td> <td style="width: 10%;"></td> <td style="width: 10%;"></td> </tr> <tr> <td></td> <td></td> <td colspan="8" style="text-align: center;"> <table border="1" style="width: 100%; border-collapse: collapse; text-align: center;"> <tr> <td style="width: 10%;"></td> <td style="width: 10%;"></td> <td style="width: 10%;"></td> <td style="width: 10%;"></td> <td style="width: 10%;"></td> <td style="width: 10%;"></td> <td style="width: 10%;"></td> <td style="width: 10%;"></td> <td style="width: 10%;"></td> <td style="width: 10%;"></td> </tr> <tr> <td></td> <td></td> <td colspan="8" style="text-align: center;"> <table border="1" style="width: 100%; border-collapse: collapse; text-align: center;"> <tr> <td style="width: 10%;"></td> <td style="width: 10%;"></td> <td style="width: 10%;"></td> <td style="width: 10%;"></td> <td style="width: 10%;"></td> <td style="width: 10%;"></td> <td style="width: 10%;"></td> <td style="width: 10%;"></td> <td style="width: 10%;"></td> <td style="width: 10%;"></td> </tr> <tr> <td></td> <td></td> <td colspan="8" style="text-align: center;"> <table border="1" style="width: 100%; border-collapse: collapse; text-align: center;"> <tr> <td style="width: 10%;"></td> <td style="width: 10%;"></td> <td style="width: 10%;"></td> <td style="width: 10%;"></td> <td style="width: 10%;"></td> <td style="width: 10%;"></td> <td style="width: 10%;"></td> <td style="width: 10%;"></td> <td style="width: 10%;"></td> <td style="width: 10%;"></td> </tr> <tr> <td></td> <td></td> <td colspan="8" style="text-align: center;"> <table border="1" style="width: 100%; border-collapse: collapse; text-align: center;"> <tr> <td style="width: 10%;"></td> <td style="width: 10%;"></td> <td style="width: 10%;"></td> <td style="width: 10%;"></td> <td style="width: 10%;"></td> <td style="width: 10%;"></td> <td style="width: 10%;"></td> <td style="width: 10%;"></td> <td style="width: 10%;"></td> <td style="width: 10%;"></td> </tr> <tr> <td></td> <td></td> <td colspan="8" style="text-align: center;"> <table border="1" style="width: 100%; border-collapse: collapse; text-align: center;"> <tr> <td style="width: 10%;"></td> <td style="width: 10%;"></td> <td style="width: 10%;"></td> <td style="width: 10%;"></td> <td style="width: 10%;"></td> <td style="width: 10%;"></td> <td style="width: 10%;"></td> <td style="width: 10%;"></td> <td style="width: 10%;"></td> <td style="width: 10%;"></td> </tr> <tr> <td></td> <td></td> <td colspan="8" style="text-align: center;"> <table border="1" style="width: 100%; border-collapse: collapse; text-align: center;"> <tr> <td style="width: 10%;"></td> <td style="width: 10%;"></td> <td style="width: 10%;"></td> <td style="width: 10%;"></td> <td style="width: 10%;"></td> <td style="width: 10%;"></td> <td style="width: 10%;"></td> <td style="width: 10%;"></td> <td style="width: 10%;"></td> <td style="width: 10%;"></td> </tr> <tr> <td></td> <td></td> <td colspan="8" style="text-align: center;"> <table border="1" style="width: 100%; border-collapse: collapse; text-align: center;"> <tr> <td style="width: 10%;"></td> <td style="width: 10%;"></td> <td style="width: 10%;"></td> <td style="width: 10%;"></td> <td style="width: 10%;"></td> <td style="width: 10%;"></td> <td style="width: 10%;"></td> <td style="width: 10%;"></td> <td style="width: 10%;"></td> <td style="width: 10%;"></td> </tr> <tr> <td></td> <td></td> <td colspan="8"
style="text-align: center;"> <table border="1" style="width: 100%; border-collapse: collapse; text-align: center;"> <tr> <td style="width: 10%;"></td> <td style="width: 10%;"></td> <td style="width: 10%;"></td> <td style="width: 10%;"></td> <td style="width: 10%;"></td> <td style="width: 10%;"></td> <td style="width: 10%;"></td> <td style="width: 10%;"></td> <td style="width: 10%;"></td> <td style="width: 10%;"></td> </tr> <tr> <td></td> <td></td> <td colspan="8" style="text-align: center;"> <table border="1" style="width: 100%; border-collapse: collapse; text-align: center;"> <tr> <td style="width: 10%;"></td> <td style="width: 10%;"></td> <td style="width: 10%;"></td> <td style="width: 10%;"></td> <td style="width: 10%;"></td> <td style="width: 10%;"></td> <td style="width: 10%;"></td> <td style="width: 10%;"></td> <td style="width: 10%;"></td> <td style="width: 10%;"></td> </tr> <tr> <td></td> <td></td> <td colspan="8" style="text-align: center;"> <table border="1" style="width: 100%; border-collapse: collapse; text-align: center;"> <tr> <td style="width: 10%;"></td> <td style="width: 10%;"></td> <td style="width: 10%;"></td> <td style="width: 10%;"></td> <td style="width: 10%;"></td> <td style="width: 10%;"></td> <td style="width: 10%;"></td> <td style="width: 10%;"></td> <td style="width: 10%;"></td> <td style="width: 10%;"></td> </tr> <tr> <td></td> <td></td> <td colspan="8" style="text-align: center;"> <table border="1" style="width: 100%; border-collapse: collapse; text-align: center;"> <tr> <td style="width: 10%;"></td> <td style="width: 10%;"></td> <td style="width: 10%;"></td> <td style="width: 10%;"></td> <td style="width: 10%;"></td> <td style="width: 10%;"></td> <td style="width: 10%;"></td> <td style="width: 10%;"></td> <td style="width: 10%;"></td> <td style="width: 10%;"></td> </tr> <tr> <td></td> <td></td> <td colspan="8" style="text-align: center;"> <table border="1" style="width: 100%; border-collapse: collapse; text-align: center;"> <tr> <td style="width: 10%;"></td> <td style="width: 10%;"></td> <td style="width: 10%;"></td> <td style="width: 10%;"></td> <td style="width: 10%;"></td> <td style="width: 10%;"></td> <td style="width: 10%;"></td> <td style="width: 10%;"></td> <td style="width: 10%;"></td> <td style="width: 10%;"></td> </tr> <tr> <td></td> <td></td> <td colspan="8" style="text-align: center;"> <table border="1" style="width: 100%; border-collapse: collapse; text-align: center;"> <tr> </tr></table></td></tr></table></td></tr></table></td></tr></table></td></tr></table></td></tr></table></td></tr></table></td></tr></table></td></tr></table></td></tr></table></td></tr></table></td></tr></table></td></tr></table></td></tr></table></td></tr></table></td></tr></table></td></tr></table></td></tr></table></td></tr></table></td></tr></table></td></tr></table></td></tr></table>
 | | | | | | | | | | | | | | | | | | | | <table border="1" style="width: 100%; border-collapse: collapse; text-align: center;"> <tr> <td style="width: 10%;"></td> <td style="width: 10%;"></td> <td style="width: 10%;"></td> <td style="width: 10%;"></td> <td style="width: 10%;"></td> <td style="width: 10%;"></td> <td style="width: 10%;"></td> <td style="width: 10%;"></td> <td style="width: 10%;"></td> <td style="width: 10%;"></td> </tr> <tr> <td></td> <td></td> <td colspan="8" style="text-align: center;"> <table border="1" style="width: 100%; border-collapse: collapse; text-align: center;"> <tr> <td style="width: 10%;"></td> <td style="width: 10%;"></td> <td style="width: 10%;"></td> <td style="width: 10%;"></td> <td style="width: 10%;"></td> <td style="width: 10%;"></td> <td style="width: 10%;"></td> <td style="width: 10%;"></td> <td style="width: 10%;"></td> <td style="width: 10%;"></td> </tr> <tr> <td></td> <td></td> <td colspan="8" style="text-align: center;"> <table border="1" style="width: 100%; border-collapse: collapse; text-align: center;"> <tr> <td style="width: 10%;"></td> <td style="width: 10%;"></td> <td style="width: 10%;"></td> <td style="width: 10%;"></td> <td style="width: 10%;"></td> <td style="width: 10%;"></td> <td style="width: 10%;"></td> <td style="width: 10%;"></td> <td style="width: 10%;"></td> <td style="width: 10%;"></td> </tr> <tr> <td></td> <td></td> <td colspan="8" style="text-align: center;"> <table border="1" style="width: 100%; border-collapse: collapse; text-align: center;"> <tr> <td style="width: 10%;"></td> <td style="width: 10%;"></td> <td style="width: 10%;"></td> <td style="width: 10%;"></td> <td style="width: 10%;"></td> <td style="width: 10%;"></td> <td style="width: 10%;"></td> <td style="width: 10%;"></td> <td style="width: 10%;"></td> <td style="width: 10%;"></td> </tr> <tr> <td></td> <td></td> <td colspan="8" style="text-align: center;"> <table border="1" style="width: 100%; border-collapse: collapse; text-align: center;"> <tr> <td style="width: 10%;"></td> <td style="width: 10%;"></td> <td style="width: 10%;"></td> <td style="width: 10%;"></td> <td style="width: 10%;"></td> <td style="width: 10%;"></td> <td style="width: 10%;"></td> <td style="width: 10%;"></td> <td style="width: 10%;"></td> <td style="width: 10%;"></td> </tr> <tr> <td></td> <td></td> <td colspan="8" style="text-align: center;"> <table border="1" style="width: 100%; border-collapse: collapse; text-align: center;"> <tr> <td style="width: 10%;"></td> <td style="width: 10%;"></td> <td style="width: 10%;"></td> <td style="width: 10%;"></td> <td style="width: 10%;"></td> <td style="width: 10%;"></td> <td style="width: 10%;"></td> <td style="width: 10%;"></td> <td style="width: 10%;"></td> <td style="width: 10%;"></td> </tr> <tr> <td></td> <td></td> <td colspan="8" style="text-align: center;"> <table border="1" style="width: 100%; border-collapse: collapse; text-align: center;"> <tr> <td style="width: 10%;"></td> <td style="width: 10%;"></td> <td style="width: 10%;"></td> <td style="width: 10%;"></td> <td style="width: 10%;"></td> <td style="width: 10%;"></td> <td style="width: 10%;"></td> <td style="width: 10%;"></td> <td style="width: 10%;"></td> <td style="width: 10%;"></td> </tr> <tr> <td></td> <td></td> <td colspan="8" style="text-align: center;"> <table border="1" style="width: 100%; border-collapse: collapse; text-align: center;"> <tr> <td style="width: 10%;"></td> <td style="width: 10%;"></td> <td style="width: 10%;"></td> <td style="width: 10%;"></td> <td style="width: 10%;"></td> <td style="width: 10%;"></td> <td style="width: 10%;"></td> <td style="width: 10%;"></td> <td style="width: 10%;"></td> <td style="width: 10%;"></td> </tr> <tr> <td></td> <td></td> <td colspan="8" style="text-align: center;"> <table border="1" style="width: 100%; border-collapse: collapse; text-align: center;"> <tr> <td style="width: 10%;"></td> <td style="width: 10%;"></td> <td style="width: 10%;"></td> <td style="width: 10%;"></td> <td style="width: 10%;"></td> <td style="width: 10%;"></td> <td style="width: 10%;"></td> <td style="width: 10%;"></td> <td style="width: 10%;"></td> <td style="width: 10%;"></td> </tr> <tr> <td></td> <td></td> <td colspan="8" style="text-align: center;"> <table border="1" style="width: 100%; border-collapse: collapse; text-align: center;"> <tr> <td style="width: 10%;"></td> <td style="width: 10%;"></td> <td style="width: 10%;"></td> <td style="width: 10%;"></td> <td style="width: 10%;"></td> <td style="width: 10%;"></td> <td style="width: 10%;"></td> <td style="width: 10%;"></td> <td style="width: 10%;"></td> <td style="width: 10%;"></td> </tr> <tr> <td></td> <td></td> <td colspan="8" style="text-align: center;"> <table border="1" style="width: 100%; border-collapse: collapse; text-align: center;"> <tr> <td style="width: 10%;"></td> <td style="width: 10%;"></td> <td style="width: 10%;"></td> <td style="width: 10%;"></td> <td style="width: 10%;"></td> <td style="width: 10%;"></td> <td style="width: 10%;"></td> <td style="width: 10%;"></td> <td style="width: 10%;"></td> <td style="width: 10%;"></td> </tr> <tr> <td></td> <td></td> <td colspan="8" style="text-align: center;"> <table border="1" style="width: 100%; border-collapse: collapse; text-align: center;"> <tr> <td style="width: 10%;"></td> <td style="width: 10%;"></td> <td style="width: 10%;"></td> <td style="width: 10%;"></td> <td style="width: 10%;"></td> <td style="width: 10%;"></td> <td
style="width: 10%;"></td> <td style="width: 10%;"></td> <td style="width: 10%;"></td> <td style="width: 10%;"></td> </tr> <tr> <td></td> <td></td> <td colspan="8" style="text-align: center;"> <table border="1" style="width: 100%; border-collapse: collapse; text-align: center;"> <tr> <td style="width: 10%;"></td> <td style="width: 10%;"></td> <td style="width: 10%;"></td> <td style="width: 10%;"></td> <td style="width: 10%;"></td> <td style="width: 10%;"></td> <td style="width: 10%;"></td> <td style="width: 10%;"></td> <td style="width: 10%;"></td> <td style="width: 10%;"></td> </tr> <tr> <td></td> <td></td> <td colspan="8" style="text-align: center;"> <table border="1" style="width: 100%; border-collapse: collapse; text-align: center;"> <tr> <td style="width: 10%;"></td> <td style="width: 10%;"></td> <td style="width: 10%;"></td> <td style="width: 10%;"></td> <td style="width: 10%;"></td> <td style="width: 10%;"></td> <td style="width: 10%;"></td> <td style="width: 10%;"></td> <td style="width: 10%;"></td> <td style="width: 10%;"></td> </tr> <tr> <td></td> <td></td> <td colspan="8" style="text-align: center;"> <table border="1" style="width: 100%; border-collapse: collapse; text-align: center;"> <tr> <td style="width: 10%;"></td> <td style="width: 10%;"></td> <td style="width: 10%;"></td> <td style="width: 10%;"></td> <td style="width: 10%;"></td> <td style="width: 10%;"></td> <td style="width: 10%;"></td> <td style="width: 10%;"></td> <td style="width: 10%;"></td> <td style="width: 10%;"></td> </tr> <tr> <td></td> <td></td> <td colspan="8" style="text-align: center;"> <table border="1" style="width: 100%; border-collapse: collapse; text-align: center;"> <tr> <td style="width: 10%;"></td> <td style="width: 10%;"></td> <td style="width: 10%;"></td> <td style="width: 10%;"></td> <td style="width: 10%;"></td> <td style="width: 10%;"></td> <td style="width: 10%;"></td> <td style="width: 10%;"></td> <td style="width: 10%;"></td> <td style="width: 10%;"></td> </tr> <tr> <td></td> <td></td> <td colspan="8" style="text-align: center;"> <table border="1" style="width: 100%; border-collapse: collapse; text-align: center;"> <tr> <td style="width: 10%;"></td> <td style="width: 10%;"></td> <td style="width: 10%;"></td> <td style="width: 10%;"></td> <td style="width: 10%;"></td> <td style="width: 10%;"></td> <td style="width: 10%;"></td> <td style="width: 10%;"></td> <td style="width: 10%;"></td> <td style="width: 10%;"></td> </tr> <tr> <td></td> <td></td> <td colspan="8" style="text-align: center;"> <table border="1" style="width: 100%; border-collapse: collapse; text-align: center;"> <tr> <td style="width: 10%;"></td> <td style="width: 10%;"></td> <td style="width: 10%;"></td> <td style="width: 10%;"></td> <td style="width: 10%;"></td> <td style="width: 10%;"></td> <td style="width: 10%;"></td> <td style="width: 10%;"></td> <td style="width: 10%;"></td> <td style="width: 10%;"></td> </tr> <tr> <td></td> <td></td> <td colspan="8" style="text-align: center;"> <table border="1" style="width: 100%; border-collapse: collapse; text-align: center;"> <tr> <td style="width: 10%;"></td> <td style="width: 10%;"></td> <td style="width: 10%;"></td> <td style="width: 10%;"></td> <td style="width: 10%;"></td> <td style="width: 10%;"></td> <td style="width: 10%;"></td> <td style="width: 10%;"></td> <td style="width: 10%;"></td> <td style="width: 10%;"></td> </tr> <tr> <td></td> <td></td> <td colspan="8" style="text-align: center;"> <table border="1" style="width: 100%; border-collapse: collapse; text-align: center;"> <tr> <td style="width: 10%;"></td> <td style="width: 10%;"></td> <td style="width: 10%;"></td> <td style="width: 10%;"></td> <td style="width: 10%;"></td> <td style="width: 10%;"></td> <td style="width: 10%;"></td> <td style="width: 10%;"></td> <td style="width: 10%;"></td> <td style="width: 10%;"></td> </tr> <tr> <td></td> <td></td> <td colspan="8" style="text-align: center;"> <table border="1" style="width: 100%; border-collapse: collapse; text-align: center;"> <tr> </tr></table></td></tr></table></td></tr></table></td></tr></table></td></tr></table></td></tr></table></td></tr></table></td></tr></table></td></tr></table></td></tr></table></td></tr></table></td></tr></table></td></tr></table></td></tr></table></td></tr></table></td></tr></table></td></tr></table></td></tr></table></td></tr></table></td></tr></table></td></tr></table>
 | | | | | | | | | | | | | | | | | | | | <table border="1" style="width: 100%; border-collapse: collapse; text-align: center;"> <tr> <td style="width: 10%;"></td> <td style="width: 10%;"></td> <td style="width: 10%;"></td> <td style="width: 10%;"></td> <td style="width: 10%;"></td> <td style="width: 10%;"></td> <td style="width: 10%;"></td> <td style="width: 10%;"></td> <td style="width: 10%;"></td> <td style="width: 10%;"></td> </tr> <tr> <td></td> <td></td> <td colspan="8" style="text-align: center;"> <table border="1" style="width: 100%; border-collapse: collapse; text-align: center;"> <tr> <td style="width: 10%;"></td> <td style="width: 10%;"></td> <td style="width: 10%;"></td> <td style="width: 10%;"></td> <td style="width: 10%;"></td> <td style="width: 10%;"></td> <td style="width: 10%;"></td> <td style="width: 10%;"></td> <td style="width: 10%;"></td> <td style="width: 10%;"></td> </tr> <tr> <td></td> <td></td> <td colspan="8" style="text-align: center;"> <table border="1" style="width: 100%; border-collapse: collapse; text-align: center;"> <tr> <td style="width: 10%;"></td> <td style="width: 10%;"></td> <td style="width: 10%;"></td> <td style="width: 10%;"></td> <td style="width: 10%;"></td> <td style="width: 10%;"></td> <td style="width: 10%;"></td> <td style="width: 10%;"></td> <td style="width: 10%;"></td> <td style="width: 10%;"></td> </tr> <tr> <td></td> <td></td> <td colspan="8" style="text-align: center;"> <table border="1" style="width: 100%; border-collapse: collapse; text-align: center;"> <tr> <td style="width: 10%;"></td> <td style="width: 10%;"></td> <td style="width: 10%;"></td> <td style="width: 10%;"></td> <td style="width: 10%;"></td> <td style="width: 10%;"></td> <td style="width: 10%;"></td> <td style="width: 10%;"></td> <td style="width: 10%;"></td> <td style="width: 10%;"></td> </tr> <tr> <td></td> <td></td> <td colspan="8" style="text-align: center;"> <table border="1" style="width: 100%; border-collapse: collapse; text-align: center;"> <tr> <td style="width: 10%;"></td> <td style="width: 10%;"></td> <td style="width: 10%;"></td> <td style="width: 10%;"></td> <td style="width: 10%;"></td> <td style="width: 10%;"></td> <td style="width: 10%;"></td> <td style="width: 10%;"></td> <td style="width: 10%;"></td> <td style="width: 10%;"></td> </tr> <tr> <td></td> <td></td> <td colspan="8" style="text-align: center;"> <table border="1" style="width: 100%; border-collapse: collapse; text-align: center;"> <tr> <td style="width: 10%;"></td> <td style="width: 10%;"></td> <td style="width: 10%;"></td> <td style="width: 10%;"></td> <td style="width: 10%;"></td> <td style="width: 10%;"></td> <td style="width: 10%;"></td> <td style="width: 10%;"></td> <td style="width: 10%;"></td> <td style="width: 10%;"></td> </tr> <tr> <td></td> <td></td> <td colspan="8" style="text-align: center;"> <table border="1" style="width: 100%; border-collapse: collapse; text-align: center;"> <tr> <td style="width: 10%;"></td> <td style="width: 10%;"></td> <td style="width: 10%;"></td> <td style="width: 10%;"></td> <td style="width: 10%;"></td> <td style="width: 10%;"></td> <td style="width: 10%;"></td> <td style="width: 10%;"></td> <td style="width: 10%;"></td> <td style="width: 10%;"></td> </tr> <tr> <td></td> <td></td> <td colspan="8" style="text-align: center;"> <table border="1" style="width: 100%; border-collapse: collapse; text-align: center;"> <tr> <td style="width: 10%;"></td> <td style="width: 10%;"></td> <td style="width: 10%;"></td> <td style="width: 10%;"></td> <td style="width: 10%;"></td> <td style="width: 10%;"></td> <td style="width: 10%;"></td> <td style="width: 10%;"></td> <td style="width: 10%;"></td> <td style="width: 10%;"></td> </tr> <tr> <td></td> <td></td> <td colspan="8" style="text-align: center;"> <table border="1" style="width: 100%; border-collapse: collapse; text-align: center;"> <tr> <td style="width: 10%;"></td> <td
style="width: 10%;"></td> <td style="width: 10%;"></td> <td style="width: 10%;"></td> <td style="width: 10%;"></td> <td style="width: 10%;"></td> <td style="width: 10%;"></td> <td style="width: 10%;"></td> <td style="width: 10%;"></td> <td style="width: 10%;"></td> </tr> <tr> <td></td> <td></td> <td colspan="8" style="text-align: center;"> <table border="1" style="width: 100%; border-collapse: collapse; text-align: center;"> <tr> <td style="width: 10%;"></td> <td style="width: 10%;"></td> <td style="width: 10%;"></td> <td style="width: 10%;"></td> <td style="width: 10%;"></td> <td style="width: 10%;"></td> <td style="width: 10%;"></td> <td style="width: 10%;"></td> <td style="width: 10%;"></td> <td style="width: 10%;"></td> </tr> <tr> <td></td> <td></td> <td colspan="8" style="text-align: center;"> <table border="1" style="width: 100%; border-collapse: collapse; text-align: center;"> <tr> <td style="width: 10%;"></td> <td style="width: 10%;"></td> <td style="width: 10%;"></td> <td style="width: 10%;"></td> <td style="width: 10%;"></td> <td style="width: 10%;"></td> <td style="width: 10%;"></td> <td style="width: 10%;"></td> <td style="width: 10%;"></td> <td style="width: 10%;"></td> </tr> <tr> <td></td> <td></td> <td colspan="8" style="text-align: center;"> <table border="1" style="width: 100%; border-collapse: collapse; text-align: center;"> <tr> <td style="width: 10%;"></td> <td style="width: 10%;"></td> <td style="width: 10%;"></td> <td style="width: 10%;"></td> <td style="width: 10%;"></td> <td style="width: 10%;"></td> <td style="width: 10%;"></td> <td style="width: 10%;"></td> <td style="width: 10%;"></td> <td style="width: 10%;"></td> </tr> <tr> <td></td> <td></td> <td colspan="8" style="text-align: center;"> <table border="1" style="width: 100%; border-collapse: collapse; text-align: center;"> <tr> <td style="width: 10%;"></td> <td style="width: 10%;"></td> <td style="width: 10%;"></td> <td style="width: 10%;"></td> <td style="width: 10%;"></td> <td style="width: 10%;"></td> <td style="width: 10%;"></td> <td style="width: 10%;"></td> <td style="width: 10%;"></td> <td style="width: 10%;"></td> </tr> <tr> <td></td> <td></td> <td colspan="8" style="text-align: center;"> <table border="1" style="width: 100%; border-collapse: collapse; text-align: center;"> <tr> <td style="width: 10%;"></td> <td style="width: 10%;"></td> <td style="width: 10%;"></td> <td style="width: 10%;"></td> <td style="width: 10%;"></td> <td style="width: 10%;"></td> <td style="width: 10%;"></td> <td style="width: 10%;"></td> <td style="width: 10%;"></td> <td style="width: 10%;"></td> </tr> <tr> <td></td> <td></td> <td colspan="8" style="text-align: center;"> <table border="1" style="width: 100%; border-collapse: collapse; text-align: center;"> <tr> <td style="width: 10%;"></td> <td style="width: 10%;"></td> <td style="width: 10%;"></td> <td style="width: 10%;"></td> <td style="width: 10%;"></td> <td style="width: 10%;"></td> <td style="width: 10%;"></td> <td style="width: 10%;"></td> <td style="width: 10%;"></td> <td style="width: 10%;"></td> </tr> <tr> <td></td> <td></td> <td colspan="8" style="text-align: center;"> <table border="1" style="width: 100%; border-collapse: collapse; text-align: center;"> <tr> <td style="width: 10%;"></td> <td style="width: 10%;"></td> <td style="width: 10%;"></td> <td style="width: 10%;"></td> <td style="width: 10%;"></td> <td style="width: 10%;"></td> <td style="width: 10%;"></td> <td style="width: 10%;"></td> <td style="width: 10%;"></td> <td style="width: 10%;"></td> </tr> <tr> <td></td> <td></td> <td colspan="8" style="text-align: center;"> <table border="1" style="width: 100%; border-collapse: collapse; text-align: center;"> <tr> <td style="width: 10%;"></td> <td style="width: 10%;"></td> <td style="width: 10%;"></td> <td style="width: 10%;"></td> <td style="width: 10%;"></td> <td style="width: 10%;"></td> <td style="width: 10%;"></td> <td style="width: 10%;"></td> <td style="width: 10%;"></td> <td style="width: 10%;"></td> </tr> <tr> <td></td> <td></td> <td colspan="8" style="text-align: center;"> <table border="1" style="width: 100%; border-collapse: collapse; text-align: center;"> <tr> <td style="width: 10%;"></td> <td style="width: 10%;"></td> <td style="width: 10%;"></td> <td style="width: 10%;"></td> <td style="width: 10%;"></td> <td style="width: 10%;"></td> <td style="width: 10%;"></td> <td style="width: 10%;"></td> <td style="width: 10%;"></td> <td style="width: 10%;"></td> </tr> <tr> <td></td> <td></td> <td colspan="8" style="text-align: center;"> <table border="1" style="width: 100%; border-collapse: collapse; text-align: center;"> <tr> <td style="width: 10%;"></td> <td style="width: 10%;"></td> <td style="width: 10%;"></td> <td style="width: 10%;"></td> <td style="width: 10%;"></td> <td style="width: 10%;"></td> <td style="width: 10%;"></td> <td style="width: 10%;"></td> <td style="width: 10%;"></td> <td style="width: 10%;"></td> </tr> <tr> <td></td> <td></td> <td colspan="8" style="text-align: center;"> <table border="1" style="width: 100%; border-collapse: collapse; text-align: center;"> <tr> </tr></table></td></tr></table></td></tr></table></td></tr></table></td></tr></table></td></tr></table></td></tr></table></td></tr></table></td></tr></table></td></tr></table></td></tr></table></td></tr></table></td></tr></table></td></tr></table></td></tr></table></td></tr></table></td></tr></table></td></tr></table></td></tr></table></td></tr></table>
 | | | | | | | | | | | | | | | | | | | | <table border="1" style="width: 100%; border-collapse: collapse; text-align: center;"> <tr> <td style="width: 10%;"></td> <td style="width: 10%;"></td> <td style="width: 10%;"></td> <td style="width: 10%;"></td> <td style="width: 10%;"></td> <td style="width: 10%;"></td> <td style="width: 10%;"></td> <td style="width: 10%;"></td> <td style="width: 10%;"></td> <td style="width: 10%;"></td> </tr> <tr> <td></td> <td></td> <td colspan="8" style="text-align: center;"> <table border="1" style="width: 100%; border-collapse: collapse; text-align: center;"> <tr> <td style="width: 10%;"></td> <td style="width: 10%;"></td> <td style="width: 10%;"></td> <td style="width: 10%;"></td> <td style="width: 10%;"></td> <td style="width: 10%;"></td> <td style="width: 10%;"></td> <td style="width: 10%;"></td> <td style="width: 10%;"></td> <td style="width: 10%;"></td> </tr> <tr> <td></td> <td></td> <td colspan="8" style="text-align: center;"> <table border="1" style="width: 100%; border-collapse: collapse; text-align: center;"> <tr> <td style="width: 10%;"></td> <td style="width: 10%;"></td> <td style="width: 10%;"></td> <td style="width: 10%;"></td> <td style="width: 10%;"></td> <td style="width: 10%;"></td> <td style="width: 10%;"></td> <td style="width: 10%;"></td> <td style="width: 10%;"></td> <td style="width: 10%;"></td> </tr> <tr> <td></td> <td></td> <td colspan="8" style="text-align: center;"> <table border="1" style="width: 100%; border-collapse: collapse; text-align: center;"> <tr> <td style="width: 10%;"></td> <td style="width: 10%;"></td> <td style="width: 10%;"></td> <td style="width: 10%;"></td> <td style="width: 10%;"></td> <td style="width: 10%;"></td> <td style="width: 10%;"></td> <td style="width: 10%;"></td> <td style="width: 10%;"></td> <td style="width: 10%;"></td> </tr> <tr> <td></td> <td></td> <td colspan="8" style="text-align: center;"> <table border="1" style="width: 100%; border-collapse: collapse; text-align: center;"> <tr> <td style="width: 10%;"></td> <td style="width: 10%;"></td> <td style="width: 10%;"></td> <td style="width: 10%;"></td> <td style="width: 10%;"></td> <td style="width: 10%;"></td> <td style="width: 10%;"></td> <td style="width: 10%;"></td> <td style="width: 10%;"></td> <td style="width: 10%;"></td> </tr> <tr> <td></td> <td></td> <td colspan="8" style="text-align: center;"> <table border="1" style="width: 100%; border-collapse: collapse; text-align: center;"> <tr> <td style="width: 10%;"></td> <td style="width: 10%;"></td> <td style="width: 10%;"></td> <td style="width: 10%;"></td> <td style="width: 10%;"></td> <td style="width: 10%;"></td> <td style="width: 10%;"></td> <td style="width: 10%;"></td> <td style="width: 10%;"></td> <td style="width: 10%;"></td> </tr> <tr> <td></td> <td></td> <td colspan="8" style="text-align:
center;"> <table border="1" style="width: 100%; border-collapse: collapse; text-align: center;"> <tr> <td style="width: 10%;"></td> <td style="width: 10%;"></td> <td style="width: 10%;"></td> <td style="width: 10%;"></td> <td style="width: 10%;"></td> <td style="width: 10%;"></td> <td style="width: 10%;"></td> <td style="width: 10%;"></td> <td style="width: 10%;"></td> <td style="width: 10%;"></td> </tr> <tr> <td></td> <td></td> <td colspan="8" style="text-align: center;"> <table border="1" style="width: 100%; border-collapse: collapse; text-align: center;"> <tr> <td style="width: 10%;"></td> <td style="width: 10%;"></td> <td style="width: 10%;"></td> <td style="width: 10%;"></td> <td style="width: 10%;"></td> <td style="width: 10%;"></td> <td style="width: 10%;"></td> <td style="width: 10%;"></td> <td style="width: 10%;"></td> <td style="width: 10%;"></td> </tr> <tr> <td></td> <td></td> <td colspan="8" style="text-align: center;"> <table border="1" style="width: 100%; border-collapse: collapse; text-align: center;"> <tr> <td style="width: 10%;"></td> <td style="width: 10%;"></td> <td style="width: 10%;"></td> <td style="width: 10%;"></td> <td style="width: 10%;"></td> <td style="width: 10%;"></td> <td style="width: 10%;"></td> <td style="width: 10%;"></td> <td style="width: 10%;"></td> <td style="width: 10%;"></td> </tr> <tr> <td></td> <td></td> <td colspan="8" style="text-align: center;"> <table border="1" style="width: 100%; border-collapse: collapse; text-align: center;"> <tr> <td style="width: 10%;"></td> <td style="width: 10%;"></td> <td style="width: 10%;"></td> <td style="width: 10%;"></td> <td style="width: 10%;"></td> <td style="width: 10%;"></td> <td style="width: 10%;"></td> <td style="width: 10%;"></td> <td style="width: 10%;"></td> <td style="width: 10%;"></td> </tr> <tr> <td></td> <td></td> <td colspan="8" style="text-align: center;"> <table border="1" style="width: 100%; border-collapse: collapse; text-align: center;"> <tr> <td style="width: 10%;"></td> <td style="width: 10%;"></td> <td style="width: 10%;"></td> <td style="width: 10%;"></td> <td style="width: 10%;"></td> <td style="width: 10%;"></td> <td style="width: 10%;"></td> <td style="width: 10%;"></td> <td style="width: 10%;"></td> <td style="width: 10%;"></td> </tr> <tr> <td></td> <td></td> <td colspan="8" style="text-align: center;"> <table border="1" style="width: 100%; border-collapse: collapse; text-align: center;"> <tr> <td style="width: 10%;"></td> <td style="width: 10%;"></td> <td style="width: 10%;"></td> <td style="width: 10%;"></td> <td style="width: 10%;"></td> <td style="width: 10%;"></td> <td style="width: 10%;"></td> <td style="width: 10%;"></td> <td style="width: 10%;"></td> <td style="width: 10%;"></td> </tr> <tr> <td></td> <td></td> <td colspan="8" style="text-align: center;"> <table border="1" style="width: 100%; border-collapse: collapse; text-align: center;"> <tr> <td style="width: 10%;"></td> <td style="width: 10%;"></td> <td style="width: 10%;"></td> <td style="width: 10%;"></td> <td style="width: 10%;"></td> <td style="width: 10%;"></td> <td style="width: 10%;"></td> <td style="width: 10%;"></td> <td style="width: 10%;"></td> <td style="width: 10%;"></td> </tr> <tr> <td></td> <td></td> <td colspan="8" style="text-align: center;"> <table border="1" style="width: 100%; border-collapse: collapse; text-align: center;"> <tr> <td style="width: 10%;"></td> <td style="width: 10%;"></td> <td style="width: 10%;"></td> <td style="width: 10%;"></td> <td style="width: 10%;"></td> <td style="width: 10%;"></td> <td style="width: 10%;"></td> <td style="width: 10%;"></td> <td style="width: 10%;"></td> <td style="width: 10%;"></td> </tr> <tr> <td></td> <td></td> <td colspan="8" style="text-align: center;"> <table border="1" style="width: 100%; border-collapse: collapse; text-align: center;"> <tr> <td style="width: 10%;"></td> <td style="width: 10%;"></td> <td style="width: 10%;"></td> <td style="width: 10%;"></td> <td style="width: 10%;"></td> <td style="width: 10%;"></td> <td style="width: 10%;"></td> <td style="width: 10%;"></td> <td style="width: 10%;"></td> <td style="width: 10%;"></td> </tr> <tr> <td></td> <td></td> <td colspan="8" style="text-align: center;"> <table border="1" style="width: 100%; border-collapse: collapse; text-align: center;"> <tr> <td style="width: 10%;"></td> <td style="width: 10%;"></td> <td style="width: 10%;"></td> <td style="width: 10%;"></td> <td style="width: 10%;"></td> <td style="width: 10%;"></td> <td style="width: 10%;"></td> <td style="width: 10%;"></td> <td style="width: 10%;"></td> <td style="width: 10%;"></td> </tr> <tr> <td></td> <td></td> <td colspan="8" style="text-align: center;"> <table border="1" style="width: 100%; border-collapse: collapse; text-align: center;"> <tr> <td style="width: 10%;"></td> <td style="width: 10%;"></td> <td style="width: 10%;"></td> <td style="width: 10%;"></td> <td style="width: 10%;"></td> <td style="width: 10%;"></td> <td style="width: 10%;"></td> <td style="width: 10%;"></td> <td style="width: 10%;"></td> <td style="width: 10%;"></td> </tr> <tr> <td></td> <td></td> <td colspan="8" style="text-align: center;"> <table border="1" style="width: 100%; border-collapse: collapse; text-align: center;"> <tr> <td style="width: 10%;"></td> <td style="width: 10%;"></td> <td style="width: 10%;"></td> <td style="width: 10%;"></td> <td style="width: 10%;"></td> <td style="width: 10%;"></td> <td style="width: 10%;"></td> <td style="width: 10%;"></td> <td style="width: 10%;"></td> <td style="width: 10%;"></td> </tr> <tr> <td></td> <td></td> <td colspan="8" style="text-align: center;"> <table border="1" style="width: 100%; border-collapse: collapse; text-align: center;"> <tr> </tr></table></td></tr></table></td></tr></table></td></tr></table></td></tr></table></td></tr></table></td></tr></table></td></tr></table></td></tr></table></td></tr></table></td></tr></table></td></tr></table></td></tr></table></td></tr></table></td></tr></table></td></tr></table></td></tr></table></td></tr></table></td></tr></table>
 | | | | | | | | | | | | | | | | | | | | <table border="1" style="width: 100%; border-collapse: collapse; text-align: center;"> <tr> <td style="width: 10%;"></td> <td style="width: 10%;"></td> <td style="width: 10%;"></td> <td style="width: 10%;"></td> <td style="width: 10%;"></td> <td style="width: 10%;"></td> <td style="width: 10%;"></td> <td style="width: 10%;"></td> <td style="width: 10%;"></td> <td style="width: 10%;"></td> </tr> <tr> <td></td> <td></td> <td colspan="8" style="text-align: center;"> <table border="1" style="width: 100%; border-collapse: collapse; text-align: center;"> <tr> <td style="width: 10%;"></td> <td style="width: 10%;"></td> <td style="width: 10%;"></td> <td style="width: 10%;"></td> <td style="width: 10%;"></td> <td style="width: 10%;"></td> <td style="width: 10%;"></td> <td style="width: 10%;"></td> <td style="width: 10%;"></td> <td style="width: 10%;"></td> </tr> <tr> <td></td> <td></td> <td colspan="8" style="text-align: center;"> <table border="1" style="width: 100%; border-collapse: collapse; text-align: center;"> <tr> <td style="width: 10%;"></td> <td style="width: 10%;"></td> <td style="width: 10%;"></td> <td style="width: 10%;"></td> <td style="width: 10%;"></td> <td style="width: 10%;"></td> <td style="width: 10%;"></td> <td style="width: 10%;"></td> <td style="width: 10%;"></td> <td style="width: 10%;"></td> </tr> <tr> <td></td> <td></td> <td colspan="8" style="text-align: center;"> <table border="1" style="width: 100%; border-collapse: collapse; text-align: center;"> <tr> <td style="width: 10%;"></td> <td style="width: 10%;"></td> <td style="width: 10%;"></td> <td style="width: 10%;"></td> <td style="width: 10%;"></td> <td style="width: 10%;"></td> <td style="width: 10%;"></td> <td style="width: 10%;"></td> <td style="width: 10%;"></td> <td style="width: 10%;"></td> </tr> <tr> <td></td> <td></td> <td colspan="8" style="text-align: center;"> <table border="1" style="width: 100%; border-collapse: collapse; text-align: center;"> <tr> <td style="width: 10%;"></td> <td style="width: 10%;"></td> <td style="width: 10%;"></td> <td style="width: 10%;"></td> <td style="width: 10%;"></td> <td style="width: 10%;"></td> <td style="width: 10%;"></td> <td style="width: 10%;"></td> <td
style="width: 10%;"></td> <td style="width: 10%;"></td> </tr> <tr> <td></td> <td></td> <td colspan="8" style="text-align: center;"> <table border="1" style="width: 100%; border-collapse: collapse; text-align: center;"> <tr> <td style="width: 10%;"></td> <td style="width: 10%;"></td> <td style="width: 10%;"></td> <td style="width: 10%;"></td> <td style="width: 10%;"></td> <td style="width: 10%;"></td> <td style="width: 10%;"></td> <td style="width: 10%;"></td> <td style="width: 10%;"></td> <td style="width: 10%;"></td> </tr> <tr> <td></td> <td></td> <td colspan="8" style="text-align: center;"> <table border="1" style="width: 100%; border-collapse: collapse; text-align: center;"> <tr> <td style="width: 10%;"></td> <td style="width: 10%;"></td> <td style="width: 10%;"></td> <td style="width: 10%;"></td> <td style="width: 10%;"></td> <td style="width: 10%;"></td> <td style="width: 10%;"></td> <td style="width: 10%;"></td> <td style="width: 10%;"></td> <td style="width: 10%;"></td> </tr> <tr> <td></td> <td></td> <td colspan="8" style="text-align: center;"> <table border="1" style="width: 100%; border-collapse: collapse; text-align: center;"> <tr> <td style="width: 10%;"></td> <td style="width: 10%;"></td> <td style="width: 10%;"></td> <td style="width: 10%;"></td> <td style="width: 10%;"></td> <td style="width: 10%;"></td> <td style="width: 10%;"></td> <td style="width: 10%;"></td> <td style="width: 10%;"></td> <td style="width: 10%;"></td> </tr> <tr> <td></td> <td></td> <td colspan="8" style="text-align: center;"> <table border="1" style="width: 100%; border-collapse: collapse; text-align: center;"> <tr> <td style="width: 10%;"></td> <td style="width: 10%;"></td> <td style="width: 10%;"></td> <td style="width: 10%;"></td> <td style="width: 10%;"></td> <td style="width: 10%;"></td> <td style="width: 10%;"></td> <td style="width: 10%;"></td> <td style="width: 10%;"></td> <td style="width: 10%;"></td> </tr> <tr> <td></td> <td></td> <td colspan="8" style="text-align: center;"> <table border="1" style="width: 100%; border-collapse: collapse; text-align: center;"> <tr> <td style="width: 10%;"></td> <td style="width: 10%;"></td> <td style="width: 10%;"></td> <td style="width: 10%;"></td> <td style="width: 10%;"></td> <td style="width: 10%;"></td> <td style="width: 10%;"></td> <td style="width: 10%;"></td> <td style="width: 10%;"></td> <td style="width: 10%;"></td> </tr> <tr> <td></td> <td></td> <td colspan="8" style="text-align: center;"> <table border="1" style="width: 100%; border-collapse: collapse; text-align: center;"> <tr> <td style="width: 10%;"></td> <td style="width: 10%;"></td> <td style="width: 10%;"></td> <td style="width: 10%;"></td> <td style="width: 10%;"></td> <td style="width: 10%;"></td> <td style="width: 10%;"></td> <td style="width: 10%;"></td> <td style="width: 10%;"></td> <td style="width: 10%;"></td> </tr> <tr> <td></td> <td></td> <td colspan="8" style="text-align: center;"> <table border="1" style="width: 100%; border-collapse: collapse; text-align: center;"> <tr> <td style="width: 10%;"></td> <td style="width: 10%;"></td> <td style="width: 10%;"></td> <td style="width: 10%;"></td> <td style="width: 10%;"></td> <td style="width: 10%;"></td> <td style="width: 10%;"></td> <td style="width: 10%;"></td> <td style="width: 10%;"></td> <td style="width: 10%;"></td> </tr> <tr> <td></td> <td></td> <td colspan="8" style="text-align: center;"> <table border="1" style="width: 100%; border-collapse: collapse; text-align: center;"> <tr> <td style="width: 10%;"></td> <td style="width: 10%;"></td> <td style="width: 10%;"></td> <td style="width: 10%;"></td> <td style="width: 10%;"></td> <td style="width: 10%;"></td> <td style="width: 10%;"></td> <td style="width: 10%;"></td> <td style="width: 10%;"></td> <td style="width: 10%;"></td> </tr> <tr> <td></td> <td></td> <td colspan="8" style="text-align: center;"> <table border="1" style="width: 100%; border-collapse: collapse; text-align: center;"> <tr> <td style="width: 10%;"></td> <td style="width: 10%;"></td> <td style="width: 10%;"></td> <td style="width: 10%;"></td> <td style="width: 10%;"></td> <td style="width: 10%;"></td> <td style="width: 10%;"></td> <td style="width: 10%;"></td> <td style="width: 10%;"></td> <td style="width: 10%;"></td> </tr> <tr> <td></td> <td></td> <td colspan="8" style="text-align: center;"> <table border="1" style="width: 100%; border-collapse: collapse; text-align: center;"> <tr> <td style="width: 10%;"></td> <td style="width: 10%;"></td> <td style="width: 10%;"></td> <td style="width: 10%;"></td> <td style="width: 10%;"></td> <td style="width: 10%;"></td> <td style="width: 10%;"></td> <td style="width: 10%;"></td> <td style="width: 10%;"></td> <td style="width: 10%;"></td> </tr> <tr> <td></td> <td></td> <td colspan="8" style="text-align: center;"> <table border="1" style="width: 100%; border-collapse: collapse; text-align: center;"> <tr> <td style="width: 10%;"></td> <td style="width: 10%;"></td> <td style="width: 10%;"></td> <td style="width: 10%;"></td> <td style="width: 10%;"></td> <td style="width: 10%;"></td> <td style="width: 10%;"></td> <td style="width: 10%;"></td> <td style="width: 10%;"></td> <td style="width: 10%;"></td> </tr> <tr> <td></td> <td></td> <td colspan="8" style="text-align: center;"> <table border="1" style="width: 100%; border-collapse: collapse; text-align: center;"> <tr> <td style="width: 10%;"></td> <td style="width: 10%;"></td> <td style="width: 10%;"></td> <td style="width: 10%;"></td> <td style="width: 10%;"></td> <td style="width: 10%;"></td> <td style="width: 10%;"></td> <td style="width: 10%;"></td> <td style="width: 10%;"></td> <td style="width: 10%;"></td> </tr> <tr> <td></td> <td></td> <td colspan="8" style="text-align: center;"> <table border="1" style="width: 100%; border-collapse: collapse; text-align: center;"> <tr> </tr></table></td></tr></table></td></tr></table></td></tr></table></td></tr></table></td></tr></table></td></tr></table></td></tr></table></td></tr></table></td></tr></table></td></tr></table></td></tr></table></td></tr></table></td></tr></table></td></tr></table></td></tr></table></td></tr></table></td></tr></table>
 | | | | | | | | | | | | | | | | | | | | <table border="1" style="width: 100%; border-collapse: collapse; text-align: center;"> <tr> <td style="width: 10%;"></td> <td style="width: 10%;"></td> <td style="width: 10%;"></td> <td style="width: 10%;"></td> <td style="width: 10%;"></td> <td style="width: 10%;"></td> <td style="width: 10%;"></td> <td style="width: 10%;"></td> <td style="width: 10%;"></td> <td style="width: 10%;"></td> </tr> <tr> <td></td> <td></td> <td colspan="8" style="text-align: center;"> <table border="1" style="width: 100%; border-collapse: collapse; text-align: center;"> <tr> <td style="width: 10%;"></td> <td style="width: 10%;"></td> <td style="width: 10%;"></td> <td style="width: 10%;"></td> <td style="width: 10%;"></td> <td style="width: 10%;"></td> <td style="width: 10%;"></td> <td style="width: 10%;"></td> <td style="width: 10%;"></td> <td style="width: 10%;"></td> </tr> <tr> <td></td> <td></td> <td colspan="8" style="text-align: center;"> <table border="1" style="width: 100%; border-collapse: collapse; text-align: center;"> <tr> <td style="width: 10%;"></td> <td style="width: 10%;"></td> <td style="width: 10%;"></td> <td style="width: 10%;"></td> <td style="width: 10%;"></td> <td style="width: 10%;"></td> <td style="width: 10%;"></td> <td style="width: 10%;"></td> <td style="width: 10%;"></td> <td style="width: 10%;"></td> </tr> <tr> <td></td> <td></td> <td colspan="8" style="text-align: center;"> <table border="1" style="width: 100%; border-collapse: collapse; text-align: center;"> <tr> <td style="width: 10%;"></td> <td style="width: 10%;"></td> <td style="width: 10%;"></td> <td style="width: 10%;"></td> <td style="width: 10%;"></td> <td style="width: 10%;"></td> <td style="width: 10%;"></td> <td style="width: 10%;"></td> <td style="width: 10%;"></td> <td style="width: 10%;"></td> </tr> <tr> <td></td> <td></td> <td colspan="8" style="text-align: center;"> <table border="1" style="width: 100%; border-collapse: collapse; text-align: center;"> <tr> <td style="width: 10%;"></td> <td style="width: 10%;"></td> <td style="width: 10%;"></td> <td style="width: 10%;"></td> <td style="width: 10%;"></td>
<td style="width: 10%;"></td> <td style="width: 10%;"></td> <td style="width: 10%;"></td> <td style="width: 10%;"></td> <td style="width: 10%;"></td> </tr> <tr> <td></td> <td></td> <td colspan="8" style="text-align: center;"> <table border="1" style="width: 100%; border-collapse: collapse; text-align: center;"> <tr> <td style="width: 10%;"></td> <td style="width: 10%;"></td> <td style="width: 10%;"></td> <td style="width: 10%;"></td> <td style="width: 10%;"></td> <td style="width: 10%;"></td> <td style="width: 10%;"></td> <td style="width: 10%;"></td> <td style="width: 10%;"></td> <td style="width: 10%;"></td> </tr> <tr> <td></td> <td></td> <td colspan="8" style="text-align: center;"> <table border="1" style="width: 100%; border-collapse: collapse; text-align: center;"> <tr> <td style="width: 10%;"></td> <td style="width: 10%;"></td> <td style="width: 10%;"></td> <td style="width: 10%;"></td> <td style="width: 10%;"></td> <td style="width: 10%;"></td> <td style="width: 10%;"></td> <td style="width: 10%;"></td> <td style="width: 10%;"></td> <td style="width: 10%;"></td> </tr> <tr> <td></td> <td></td> <td colspan="8" style="text-align: center;"> <table border="1" style="width: 100%; border-collapse: collapse; text-align: center;"> <tr> <td style="width: 10%;"></td> <td style="width: 10%;"></td> <td style="width: 10%;"></td> <td style="width: 10%;"></td> <td style="width: 10%;"></td> <td style="width: 10%;"></td> <td style="width: 10%;"></td> <td style="width: 10%;"></td> <td style="width: 10%;"></td> <td style="width: 10%;"></td> </tr> <tr> <td></td> <td></td> <td colspan="8" style="text-align: center;"> <table border="1" style="width: 100%; border-collapse: collapse; text-align: center;"> <tr> <td style="width: 10%;"></td> <td style="width: 10%;"></td> <td style="width: 10%;"></td> <td style="width: 10%;"></td> <td style="width: 10%;"></td> <td style="width: 10%;"></td> <td style="width: 10%;"></td> <td style="width: 10%;"></td> <td style="width: 10%;"></td> <td style="width: 10%;"></td> </tr> <tr> <td></td> <td></td> <td colspan="8" style="text-align: center;"> <table border="1" style="width: 100%; border-collapse: collapse; text-align: center;"> <tr> <td style="width: 10%;"></td> <td style="width: 10%;"></td> <td style="width: 10%;"></td> <td style="width: 10%;"></td> <td style="width: 10%;"></td> <td style="width: 10%;"></td> <td style="width: 10%;"></td> <td style="width: 10%;"></td> <td style="width: 10%;"></td> <td style="width: 10%;"></td> </tr> <tr> <td></td> <td></td> <td colspan="8" style="text-align: center;"> <table border="1" style="width: 100%; border-collapse: collapse; text-align: center;"> <tr> <td style="width: 10%;"></td> <td style="width: 10%;"></td> <td style="width: 10%;"></td> <td style="width: 10%;"></td> <td style="width: 10%;"></td> <td style="width: 10%;"></td> <td style="width: 10%;"></td> <td style="width: 10%;"></td> <td style="width: 10%;"></td> <td style="width: 10%;"></td> </tr> <tr> <td></td> <td></td> <td colspan="8" style="text-align: center;"> <table border="1" style="width: 100%; border-collapse: collapse; text-align: center;"> <tr> <td style="width: 10%;"></td> <td style="width: 10%;"></td> <td style="width: 10%;"></td> <td style="width: 10%;"></td> <td style="width: 10%;"></td> <td style="width: 10%;"></td> <td style="width: 10%;"></td> <td style="width: 10%;"></td> <td style="width: 10%;"></td> <td style="width: 10%;"></td> </tr> <tr> <td></td> <td></td> <td colspan="8" style="text-align: center;"> <table border="1" style="width: 100%; border-collapse: collapse; text-align: center;"> <tr> <td style="width: 10%;"></td> <td style="width: 10%;"></td> <td style="width: 10%;"></td> <td style="width: 10%;"></td> <td style="width: 10%;"></td> <td style="width: 10%;"></td> <td style="width: 10%;"></td> <td style="width: 10%;"></td> <td style="width: 10%;"></td> <td style="width: 10%;"></td> </tr> <tr> <td></td> <td></td> <td colspan="8" style="text-align: center;"> <table border="1" style="width: 100%; border-collapse: collapse; text-align: center;"> <tr> <td style="width: 10%;"></td> <td style="width: 10%;"></td> <td style="width: 10%;"></td> <td style="width: 10%;"></td> <td style="width: 10%;"></td> <td style="width: 10%;"></td> <td style="width: 10%;"></td> <td style="width: 10%;"></td> <td style="width: 10%;"></td> <td style="width: 10%;"></td> </tr> <tr> <td></td> <td></td> <td colspan="8" style="text-align: center;"> <table border="1" style="width: 100%; border-collapse: collapse; text-align: center;"> <tr> <td style="width: 10%;"></td> <td style="width: 10%;"></td> <td style="width: 10%;"></td> <td style="width: 10%;"></td> <td style="width: 10%;"></td> <td style="width: 10%;"></td> <td style="width: 10%;"></td> <td style="width: 10%;"></td> <td style="width: 10%;"></td> <td style="width: 10%;"></td> </tr> <tr> <td></td> <td></td> <td colspan="8" style="text-align: center;"> <table border="1" style="width: 100%; border-collapse: collapse; text-align: center;"> <tr> <td style="width: 10%;"></td> <td style="width: 10%;"></td> <td style="width: 10%;"></td> <td style="width: 10%;"></td> <td style="width: 10%;"></td> <td style="width: 10%;"></td> <td style="width: 10%;"></td> <td style="width: 10%;"></td> <td style="width: 10%;"></td> <td style="width: 10%;"></td> </tr> <tr> <td></td> <td></td> <td colspan="8" style="text-align: center;"> <table border="1" style="width: 100%; border-collapse: collapse; text-align: center;"> <tr> </tr></table></td></tr></table></td></tr></table></td></tr></table></td></tr></table></td></tr></table></td></tr></table></td></tr></table></td></tr></table></td></tr></table></td></tr></table></td></tr></table></td></tr></table></td></tr></table></td></tr></table></td></tr></table></td></tr></table>
 | | | | | | | | | | | | | | | | | | | | <table border="1" style="width: 100%; border-collapse: collapse; text-align: center;"> <tr> <td style="width: 10%;"></td> <td style="width: 10%;"></td> <td style="width: 10%;"></td> <td style="width: 10%;"></td> <td style="width: 10%;"></td> <td style="width: 10%;"></td> <td style="width: 10%;"></td> <td style="width: 10%;"></td> <td style="width: 10%;"></td> <td style="width: 10%;"></td> </tr> <tr> <td></td> <td></td> <td colspan="8" style="text-align: center;"> <table border="1" style="width: 100%; border-collapse: collapse; text-align: center;"> <tr> <td style="width: 10%;"></td> <td style="width: 10%;"></td> <td style="width: 10%;"></td> <td style="width: 10%;"></td> <td style="width: 10%;"></td> <td style="width: 10%;"></td> <td style="width: 10%;"></td> <td style="width: 10%;"></td> <td style="width: 10%;"></td> <td style="width: 10%;"></td> </tr> <tr> <td></td> <td></td> <td colspan="8" style="text-align: center;"> <table border="1" style="width: 100%; border-collapse: collapse; text-align: center;"> <tr> <td style="width: 10%;"></td> <td style="width: 10%;"></td> <td style="width: 10%;"></td> <td style="width: 10%;"></td> <td style="width: 10%;"></td> <td style="width: 10%;"></td> <td style="width: 10%;"></td> <td style="width: 10%;"></td> <td style="width: 10%;"></td> <td style="width: 10%;"></td> </tr> <tr> <td></td> <td></td> <td colspan="8" style="text-align: center;"> <table border="1" style="width: 100%; border-collapse: collapse; text-align: center;"> <tr> <td style="width: 10%;"></td> <td style="width: 10%;"></td> <td style="width: 10%;"></td> <td style="width: 10%;"></td> <td style="width: 10%;"></td> <td style="width: 10%;"></td> <td style="width: 10%;"></td> <td style="width: 10%;"></td> <td style="width: 10%;"></td> <td style="width: 10%;"></td> </tr> <tr> <td></td> <td></td> <td colspan="8" style="text-align: center;"> <table border="1" style="width: 100%; border-collapse: collapse; text-align: center;"> <tr> <td style="width: 10%;"></td> <td style="width: 10%;"></td> <td style="width: 10%;"></td> <td style="width: 10%;"></td> <td style="width: 10%;"></td> <td style="width: 10%;"></td> <td style="width: 10%;"></td> <td style="width: 10%;"></td> <td style="width: 10%;"></td> <td style="width: 10%;"></td> </tr> <tr> <td></td> <td></td> <td colspan="8" style="text-align: center;"> <table border="1" style="width: 100%; border-collapse: collapse; text-align: center;"> <tr> <td style="width: 10%;"></td> <td style="width: 10%;"></td> <td
style="width: 10%;"></td> <td style="width: 10%;"></td> <td style="width: 10%;"></td> <td style="width: 10%;"></td> <td style="width: 10%;"></td> <td style="width: 10%;"></td> <td style="width: 10%;"></td> <td style="width: 10%;"></td> </tr> <tr> <td></td> <td></td> <td colspan="8" style="text-align: center;"> <table border="1" style="width: 100%; border-collapse: collapse; text-align: center;"> <tr> <td style="width: 10%;"></td> <td style="width: 10%;"></td> <td style="width: 10%;"></td> <td style="width: 10%;"></td> <td style="width: 10%;"></td> <td style="width: 10%;"></td> <td style="width: 10%;"></td> <td style="width: 10%;"></td> <td style="width: 10%;"></td> <td style="width: 10%;"></td> </tr> <tr> <td></td> <td></td> <td colspan="8" style="text-align: center;"> <table border="1" style="width: 100%; border-collapse: collapse; text-align: center;"> <tr> <td style="width: 10%;"></td> <td style="width: 10%;"></td> <td style="width: 10%;"></td> <td style="width: 10%;"></td> <td style="width: 10%;"></td> <td style="width: 10%;"></td> <td style="width: 10%;"></td> <td style="width: 10%;"></td> <td style="width: 10%;"></td> <td style="width: 10%;"></td> </tr> <tr> <td></td> <td></td> <td colspan="8" style="text-align: center;"> <table border="1" style="width: 100%; border-collapse: collapse; text-align: center;"> <tr> <td style="width: 10%;"></td> <td style="width: 10%;"></td> <td style="width: 10%;"></td> <td style="width: 10%;"></td> <td style="width: 10%;"></td> <td style="width: 10%;"></td> <td style="width: 10%;"></td> <td style="width: 10%;"></td> <td style="width: 10%;"></td> <td style="width: 10%;"></td> </tr> <tr> <td></td> <td></td> <td colspan="8" style="text-align: center;"> <table border="1" style="width: 100%; border-collapse: collapse; text-align: center;"> <tr> <td style="width: 10%;"></td> <td style="width: 10%;"></td> <td style="width: 10%;"></td> <td style="width: 10%;"></td> <td style="width: 10%;"></td> <td style="width: 10%;"></td> <td style="width: 10%;"></td> <td style="width: 10%;"></td> <td style="width: 10%;"></td> <td style="width: 10%;"></td> </tr> <tr> <td></td> <td></td> <td colspan="8" style="text-align: center;"> <table border="1" style="width: 100%; border-collapse: collapse; text-align: center;"> <tr> <td style="width: 10%;"></td> <td style="width: 10%;"></td> <td style="width: 10%;"></td> <td style="width: 10%;"></td> <td style="width: 10%;"></td> <td style="width: 10%;"></td> <td style="width: 10%;"></td> <td style="width: 10%;"></td> <td style="width: 10%;"></td> <td style="width: 10%;"></td> </tr> <tr> <td></td> <td></td> <td colspan="8" style="text-align: center;"> <table border="1" style="width: 100%; border-collapse: collapse; text-align: center;"> <tr> <td style="width: 10%;"></td> <td style="width: 10%;"></td> <td style="width: 10%;"></td> <td style="width: 10%;"></td> <td style="width: 10%;"></td> <td style="width: 10%;"></td> <td style="width: 10%;"></td> <td style="width: 10%;"></td> <td style="width: 10%;"></td> <td style="width: 10%;"></td> </tr> <tr> <td></td> <td></td> <td colspan="8" style="text-align: center;"> <table border="1" style="width: 100%; border-collapse: collapse; text-align: center;"> <tr> <td style="width: 10%;"></td> <td style="width: 10%;"></td> <td style="width: 10%;"></td> <td style="width: 10%;"></td> <td style="width: 10%;"></td> <td style="width: 10%;"></td> <td style="width: 10%;"></td> <td style="width: 10%;"></td> <td style="width: 10%;"></td> <td style="width: 10%;"></td> </tr> <tr> <td></td> <td></td> <td colspan="8" style="text-align: center;"> <table border="1" style="width: 100%; border-collapse: collapse; text-align: center;"> <tr> <td style="width: 10%;"></td> <td style="width: 10%;"></td> <td style="width: 10%;"></td> <td style="width: 10%;"></td> <td style="width: 10%;"></td> <td style="width: 10%;"></td> <td style="width: 10%;"></td> <td style="width: 10%;"></td> <td style="width: 10%;"></td> <td style="width: 10%;"></td> </tr> <tr> <td></td> <td></td> <td colspan="8" style="text-align: center;"> <table border="1" style="width: 100%; border-collapse: collapse; text-align: center;"> <tr> <td style="width: 10%;"></td> <td style="width: 10%;"></td> <td style="width: 10%;"></td> <td style="width: 10%;"></td> <td style="width: 10%;"></td> <td style="width: 10%;"></td> <td style="width: 10%;"></td> <td style="width: 10%;"></td> <td style="width: 10%;"></td> <td style="width: 10%;"></td> </tr> <tr> <td></td> <td></td> <td colspan="8" style="text-align: center;"> <table border="1" style="width: 100%; border-collapse: collapse; text-align: center;"> <tr> </tr></table></td></tr></table></td></tr></table></td></tr></table></td></tr></table></td></tr></table></td></tr></table></td></tr></table></td></tr></table></td></tr></table></td></tr></table></td></tr></table></td></tr></table></td></tr></table></td></tr></table></td></tr></table>
 | | | | | | | | | | | | | | | | | | | | <table border="1" style="width: 100%; border-collapse: collapse; text-align: center;"> <tr> <td style="width: 10%;"></td> <td style="width: 10%;"></td> <td style="width: 10%;"></td> <td style="width: 10%;"></td> <td style="width: 10%;"></td> <td style="width: 10%;"></td> <td style="width: 10%;"></td> <td style="width: 10%;"></td> <td style="width: 10%;"></td> <td style="width: 10%;"></td> </tr> <tr> <td></td> <td></td> <td colspan="8" style="text-align: center;"> <table border="1" style="width: 100%; border-collapse: collapse; text-align: center;"> <tr> <td style="width: 10%;"></td> <td style="width: 10%;"></td> <td style="width: 10%;"></td> <td style="width: 10%;"></td> <td style="width: 10%;"></td> <td style="width: 10%;"></td> <td style="width: 10%;"></td> <td style="width: 10%;"></td> <td style="width: 10%;"></td> <td style="width: 10%;"></td> </tr> <tr> <td></td> <td></td> <td colspan="8" style="text-align: center;"> <table border="1" style="width: 100%; border-collapse: collapse; text-align: center;"> <tr> <td style="width: 10%;"></td> <td style="width: 10%;"></td> <td style="width: 10%;"></td> <td style="width: 10%;"></td> <td style="width: 10%;"></td> <td style="width: 10%;"></td> <td style="width: 10%;"></td> <td style="width: 10%;"></td> <td style="width: 10%;"></td> <td style="width: 10%;"></td> </tr> <tr> <td></td> <td></td> <td colspan="8" style="text-align: center;"> <table border="1" style="width: 100%; border-collapse: collapse; text-align: center;"> <tr> <td style="width: 10%;"></td> <td style="width: 10%;"></td> <td style="width: 10%;"></td> <td style="width: 10%;"></td> <td style="width: 10%;"></td> <td style="width: 10%;"></td> <td style="width: 10%;"></td> <td style="width: 10%;"></td> <td style="width: 10%;"></td> <td style="width: 10%;"></td> </tr> <tr> <td></td> <td></td> <td colspan="8" style="text-align: center;"> <table border="1" style="width: 100%; border-collapse: collapse; text-align: center;"> <tr> <td style="width: 10%;"></td> <td style="width: 10%;"></td> <td style="width: 10%;"></td> <td style="width: 10%;"></td> <td style="width: 10%;"></td> <td style="width: 10%;"></td> <td style="width: 10%;"></td> <td style="width: 10%;"></td> <td style="width: 10%;"></td> <td style="width: 10%;"></td> </tr> <tr> <td></td> <td></td> <td colspan="8" style="text-align: center;"> <table border="1" style="width: 100%; border-collapse: collapse; text-align: center;"> <tr> <td style="width: 10%;"></td> <td style="width: 10%;"></td> <td style="width: 10%;"></td> <td style="width: 10%;"></td> <td style="width: 10%;"></td> <td style="width: 10%;"></td> <td style="width: 10%;"></td> <td style="width: 10%;"></td> <td style="width: 10%;"></td> <td style="width: 10%;"></td> </tr> <tr> <td></td> <td></td> <td colspan="8" style="text-align: center;"> <table border="1" style="width: 100%; border-collapse: collapse; text-align: center;"> <tr> <td style="width: 10%;"></td> <td style="width: 10%;"></td> <td style="width: 10%;"></td> <td style="width: 10%;"></td> <td style="width: 10%;"></td> <td style="width: 10%;"></td> <td style="width: 10%;"></td> <td style="width: 10%;"></td> <td style="width: 10%;"></td> <td style="width: 10%;"></td> </tr> <tr> <td></td> <td></td> <td colspan="8" style="text-align: center;"> <table border="1" style="width: 100%; border-collapse: collapse; text-align: center;"> <tr> <td
style="width: 10%;"></td> <td style="width: 10%;"></td> <td style="width: 10%;"></td> <td style="width: 10%;"></td> <td style="width: 10%;"></td> <td style="width: 10%;"></td> <td style="width: 10%;"></td> <td style="width: 10%;"></td> <td style="width: 10%;"></td> <td style="width: 10%;"></td> </tr> <tr> <td></td> <td></td> <td colspan="8" style="text-align: center;"> <table border="1" style="width: 100%; border-collapse: collapse; text-align: center;"> <tr> <td style="width: 10%;"></td> <td style="width: 10%;"></td> <td style="width: 10%;"></td> <td style="width: 10%;"></td> <td style="width: 10%;"></td> <td style="width: 10%;"></td> <td style="width: 10%;"></td> <td style="width: 10%;"></td> <td style="width: 10%;"></td> <td style="width: 10%;"></td> </tr> <tr> <td></td> <td></td> <td colspan="8" style="text-align: center;"> <table border="1" style="width: 100%; border-collapse: collapse; text-align: center;"> <tr> <td style="width: 10%;"></td> <td style="width: 10%;"></td> <td style="width: 10%;"></td> <td style="width: 10%;"></td> <td style="width: 10%;"></td> <td style="width: 10%;"></td> <td style="width: 10%;"></td> <td style="width: 10%;"></td> <td style="width: 10%;"></td> <td style="width: 10%;"></td> </tr> <tr> <td></td> <td></td> <td colspan="8" style="text-align: center;"> <table border="1" style="width: 100%; border-collapse: collapse; text-align: center;"> <tr> <td style="width: 10%;"></td> <td style="width: 10%;"></td> <td style="width: 10%;"></td> <td style="width: 10%;"></td> <td style="width: 10%;"></td> <td style="width: 10%;"></td> <td style="width: 10%;"></td> <td style="width: 10%;"></td> <td style="width: 10%;"></td> <td style="width: 10%;"></td> </tr> <tr> <td></td> <td></td> <td colspan="8" style="text-align: center;"> <table border="1" style="width: 100%; border-collapse: collapse; text-align: center;"> <tr> <td style="width: 10%;"></td> <td style="width: 10%;"></td> <td style="width: 10%;"></td> <td style="width: 10%;"></td> <td style="width: 10%;"></td> <td style="width: 10%;"></td> <td style="width: 10%;"></td> <td style="width: 10%;"></td> <td style="width: 10%;"></td> <td style="width: 10%;"></td> </tr> <tr> <td></td> <td></td> <td colspan="8" style="text-align: center;"> <table border="1" style="width: 100%; border-collapse: collapse; text-align: center;"> <tr> <td style="width: 10%;"></td> <td style="width: 10%;"></td> <td style="width: 10%;"></td> <td style="width: 10%;"></td> <td style="width: 10%;"></td> <td style="width: 10%;"></td> <td style="width: 10%;"></td> <td style="width: 10%;"></td> <td style="width: 10%;"></td> <td style="width: 10%;"></td> </tr> <tr> <td></td> <td></td> <td colspan="8" style="text-align: center;"> <table border="1" style="width: 100%; border-collapse: collapse; text-align: center;"> <tr> <td style="width: 10%;"></td> <td style="width: 10%;"></td> <td style="width: 10%;"></td> <td style="width: 10%;"></td> <td style="width: 10%;"></td> <td style="width: 10%;"></td> <td style="width: 10%;"></td> <td style="width: 10%;"></td> <td style="width: 10%;"></td> <td style="width: 10%;"></td> </tr> <tr> <td></td> <td></td> <td colspan="8" style="text-align: center;"> <table border="1" style="width: 100%; border-collapse: collapse; text-align: center;"> <tr> </tr></table></td></tr></table></td></tr></table></td></tr></table></td></tr></table></td></tr></table></td></tr></table></td></tr></table></td></tr></table></td></tr></table></td></tr></table></td></tr></table></td></tr></table></td></tr></table></td></tr></table>
 | | | | | | | | | | | | | | | | | | | | <table border="1" style="width: 100%; border-collapse: collapse; text-align: center;"> <tr> <td style="width: 10%;"></td> <td style="width: 10%;"></td> <td style="width: 10%;"></td> <td style="width: 10%;"></td> <td style="width: 10%;"></td> <td style="width: 10%;"></td> <td style="width: 10%;"></td> <td style="width: 10%;"></td> <td style="width: 10%;"></td> <td style="width: 10%;"></td> </tr> <tr> <td></td> <td></td> <td colspan="8" style="text-align: center;"> <table border="1" style="width: 100%; border-collapse: collapse; text-align: center;"> <tr> <td style="width: 10%;"></td> <td style="width: 10%;"></td> <td style="width: 10%;"></td> <td style="width: 10%;"></td> <td style="width: 10%;"></td> <td style="width: 10%;"></td> <td style="width: 10%;"></td> <td style="width: 10%;"></td> <td style="width: 10%;"></td> <td style="width: 10%;"></td> </tr> <tr> <td></td> <td></td> <td colspan="8" style="text-align: center;"> <table border="1" style="width: 100%; border-collapse: collapse; text-align: center;"> <tr> <td style="width: 10%;"></td> <td style="width: 10%;"></td> <td style="width: 10%;"></td> <td style="width: 10%;"></td> <td style="width: 10%;"></td> <td style="width: 10%;"></td> <td style="width: 10%;"></td> <td style="width: 10%;"></td> <td style="width: 10%;"></td> <td style="width: 10%;"></td> </tr> <tr> <td></td> <td></td> <td colspan="8" style="text-align: center;"> <table border="1" style="width: 100%; border-collapse: collapse; text-align: center;"> <tr> <td style="width: 10%;"></td> <td style="width: 10%;"></td> <td style="width: 10%;"></td> <td style="width: 10%;"></td> <td style="width: 10%;"></td> <td style="width: 10%;"></td> <td style="width: 10%;"></td> <td style="width: 10%;"></td> <td style="width: 10%;"></td> <td style="width: 10%;"></td> </tr> <tr> <td></td> <td></td> <td colspan="8" style="text-align: center;"> <table border="1" style="width: 100%; border-collapse: collapse; text-align: center;"> <tr> <td style="width: 10%;"></td> <td style="width: 10%;"></td> <td style="width: 10%;"></td> <td style="width: 10%;"></td> <td style="width: 10%;"></td> <td style="width: 10%;"></td> <td style="width: 10%;"></td> <td style="width: 10%;"></td> <td style="width: 10%;"></td> <td style="width: 10%;"></td> </tr> <tr> <td></td> <td></td> <td colspan="8" style="text-align: center;"> <table border="1" style="width: 100%; border-collapse: collapse; text-align: center;"> <tr> <td style="width: 10%;"></td> <td style="width: 10%;"></td> <td style="width: 10%;"></td> <td style="width: 10%;"></td> <td style="width: 10%;"></td> <td style="width: 10%;"></td> <td style="width: 10%;"></td> <td style="width: 10%;"></td> <td style="width: 10%;"></td> <td style="width: 10%;"></td> </tr> <tr> <td></td> <td></td> <td colspan="8" style="text-align: center;"> <table border="1" style="width: 100%; border-collapse: collapse; text-align: center;"> <tr> <td style="width: 10%;"></td> <td style="width: 10%;"></td> <td style="width: 10%;"></td> <td style="width: 10%;"></td> <td style="width: 10%;"></td> <td style="width: 10%;"></td> <td style="width: 10%;"></td> <td style="width: 10%;"></td> <td style="width: 10%;"></td> <td style="width: 10%;"></td> </tr> <tr> <td></td> <td></td> <td colspan="8" style="text-align: center;"> <table border="1" style="width: 100%; border-collapse: collapse; text-align: center;"> <tr> <td style="width: 10%;"></td> <td style="width: 10%;"></td> <td style="width: 10%;"></td> <td style="width: 10%;"></td> <td style="width: 10%;"></td> <td style="width: 10%;"></td> <td style="width: 10%;"></td> <td style="width: 10%;"></td> <td style="width: 10%;"></td> <td style="width: 10%;"></td> </tr> <tr> <td></td> <td></td> <td colspan="8" style="text-align: center;"> <table border="1" style="width: 100%; border-collapse: collapse; text-align: center;"> <tr> <td style="width: 10%;"></td> <td style="width: 10%;"></td> <td style="width: 10%;"></td> <td style="width: 10%;"></td> <td style="width: 10%;"></td> <td style="width: 10%;"></td> <td style="width: 10%;"></td> <td style="width: 10%;"></td> <td style="width: 10%;"></td> <td style="width: 10%;"></td> </tr> <tr> <td></td> <td></td> <td colspan="8" style="text-align: center;"> <table border="1" style="width: 100%; border-collapse: collapse; text-align: center;"> <tr> <td style="width: 10%;"></td> <td style="width: 10%;"></td> <td style="width: 10%;"></td> <td style="width: 10%;"></td> <td style="width: 10%;"></td> <td style="width: 10%;"></td> <td style="width: 10%;"></td> <td style="width: 10%;"></td> <td style="width: 10%;"></td> <td style="width: 10%;"></td> </tr> <tr> <td></td> <td></td> <td colspan="8" style="text-align: center;"> <table border="1" style="width: 100%; border-collapse:
collapse; text-align: center;"> <tr> <td style="width: 10%;"></td> <td style="width: 10%;"></td> <td style="width: 10%;"></td> <td style="width: 10%;"></td> <td style="width: 10%;"></td> <td style="width: 10%;"></td> <td style="width: 10%;"></td> <td style="width: 10%;"></td> <td style="width: 10%;"></td> <td style="width: 10%;"></td> </tr> <tr> <td></td> <td></td> <td colspan="8" style="text-align: center;"> <table border="1" style="width: 100%; border-collapse: collapse; text-align: center;"> <tr> <td style="width: 10%;"></td> <td style="width: 10%;"></td> <td style="width: 10%;"></td> <td style="width: 10%;"></td> <td style="width: 10%;"></td> <td style="width: 10%;"></td> <td style="width: 10%;"></td> <td style="width: 10%;"></td> <td style="width: 10%;"></td> <td style="width: 10%;"></td> </tr> <tr> <td></td> <td></td> <td colspan="8" style="text-align: center;"> <table border="1" style="width: 100%; border-collapse: collapse; text-align: center;"> <tr> <td style="width: 10%;"></td> <td style="width: 10%;"></td> <td style="width: 10%;"></td> <td style="width: 10%;"></td> <td style="width: 10%;"></td> <td style="width: 10%;"></td> <td style="width: 10%;"></td> <td style="width: 10%;"></td> <td style="width: 10%;"></td> <td style="width: 10%;"></td> </tr> <tr> <td></td> <td></td> <td colspan="8" style="text-align: center;"> <table border="1" style="width: 100%; border-collapse: collapse; text-align: center;"> <tr> </tr></table></td></tr></table></td></tr></table></td></tr></table></td></tr></table></td></tr></table></td></tr></table></td></tr></table></td></tr></table></td></tr></table></td></tr></table></td></tr></table></td></tr></table></td></tr></table>
 | | | | | | | | | | | | | | | | | | | | <table border="1" style="width: 100%; border-collapse: collapse; text-align: center;"> <tr> <td style="width: 10%;"></td> <td style="width: 10%;"></td> <td style="width: 10%;"></td> <td style="width: 10%;"></td> <td style="width: 10%;"></td> <td style="width: 10%;"></td> <td style="width: 10%;"></td> <td style="width: 10%;"></td> <td style="width: 10%;"></td> <td style="width: 10%;"></td> </tr> <tr> <td></td> <td></td> <td colspan="8" style="text-align: center;"> <table border="1" style="width: 100%; border-collapse: collapse; text-align: center;"> <tr> <td style="width: 10%;"></td> <td style="width: 10%;"></td> <td style="width: 10%;"></td> <td style="width: 10%;"></td> <td style="width: 10%;"></td> <td style="width: 10%;"></td> <td style="width: 10%;"></td> <td style="width: 10%;"></td> <td style="width: 10%;"></td> <td style="width: 10%;"></td> </tr> <tr> <td></td> <td></td> <td colspan="8" style="text-align: center;"> <table border="1" style="width: 100%; border-collapse: collapse; text-align: center;"> <tr> <td style="width: 10%;"></td> <td style="width: 10%;"></td> <td style="width: 10%;"></td> <td style="width: 10%;"></td> <td style="width: 10%;"></td> <td style="width: 10%;"></td> <td style="width: 10%;"></td> <td style="width: 10%;"></td> <td style="width: 10%;"></td> <td style="width: 10%;"></td> </tr> <tr> <td></td> <td></td> <td colspan="8" style="text-align: center;"> <table border="1" style="width: 100%; border-collapse: collapse; text-align: center;"> <tr> <td style="width: 10%;"></td> <td style="width: 10%;"></td> <td style="width: 10%;"></td> <td style="width: 10%;"></td> <td style="width: 10%;"></td> <td style="width: 10%;"></td> <td style="width: 10%;"></td> <td style="width: 10%;"></td> <td style="width: 10%;"></td> <td style="width: 10%;"></td> </tr> <tr> <td></td> <td></td> <td colspan="8" style="text-align: center;"> <table border="1" style="width: 100%; border-collapse: collapse; text-align: center;"> <tr> <td style="width: 10%;"></td> <td style="width: 10%;"></td> <td style="width: 10%;"></td> <td style="width: 10%;"></td> <td style="width: 10%;"></td> <td style="width: 10%;"></td> <td style="width: 10%;"></td> <td style="width: 10%;"></td> <td style="width: 10%;"></td> <td style="width: 10%;"></td> </tr> <tr> <td></td> <td></td> <td colspan="8" style="text-align: center;"> <table border="1" style="width: 100%; border-collapse: collapse; text-align: center;"> <tr> <td style="width: 10%;"></td> <td style="width: 10%;"></td> <td style="width: 10%;"></td> <td style="width: 10%;"></td> <td style="width: 10%;"></td> <td style="width: 10%;"></td> <td style="width: 10%;"></td> <td style="width: 10%;"></td> <td style="width: 10%;"></td> <td style="width: 10%;"></td> </tr> <tr> <td></td> <td></td> <td colspan="8" style="text-align: center;"> <table border="1" style="width: 100%; border-collapse: collapse; text-align: center;"> <tr> <td style="width: 10%;"></td> <td style="width: 10%;"></td> <td style="width: 10%;"></td> <td style="width: 10%;"></td> <td style="width: 10%;"></td> <td style="width: 10%;"></td> <td style="width: 10%;"></td> <td style="width: 10%;"></td> <td style="width: 10%;"></td> <td style="width: 10%;"></td> </tr> <tr> <td></td> <td></td> <td colspan="8" style="text-align: center;"> <table border="1" style="width: 100%; border-collapse: collapse; text-align: center;"> <tr> <td style="width: 10%;"></td> <td style="width: 10%;"></td> <td style="width: 10%;"></td> <td style="width: 10%;"></td> <td style="width: 10%;"></td> <td style="width: 10%;"></td> <td style="width: 10%;"></td> <td style="width: 10%;"></td> <td style="width: 10%;"></td> <td style="width: 10%;"></td> </tr> <tr> <td></td> <td></td> <td colspan="8" style="text-align: center;"> <table border="1" style="width: 100%; border-collapse: collapse; text-align: center;"> <tr> <td style="width: 10%;"></td> <td style="width: 10%;"></td> <td style="width: 10%;"></td> <td style="width: 10%;"></td> <td style="width: 10%;"></td> <td style="width: 10%;"></td> <td style="width: 10%;"></td> <td style="width: 10%;"></td> <td style="width: 10%;"></td> <td style="width: 10%;"></td> </tr> <tr> <td></td> <td></td> <td colspan="8" style="text-align: center;"> <table border="1" style="width: 100%; border-collapse: collapse; text-align: center;"> <tr> <td style="width: 10%;"></td> <td style="width: 10%;"></td> <td style="width: 10%;"></td> <td style="width: 10%;"></td> <td style="width: 10%;"></td> <td style="width: 10%;"></td> <td style="width: 10%;"></td> <td style="width: 10%;"></td> <td style="width: 10%;"></td> <td style="width: 10%;"></td> </tr> <tr> <td></td> <td></td> <td colspan="8" style="text-align: center;"> <table border="1" style="width: 100%; border-collapse: collapse; text-align: center;"> <tr> <td style="width: 10%;"></td> <td style="width: 10%;"></td> <td style="width: 10%;"></td> <td style="width: 10%;"></td> <td style="width: 10%;"></td> <td style="width: 10%;"></td> <td style="width: 10%;"></td> <td style="width: 10%;"></td> <td style="width: 10%;"></td> <td style="width: 10%;"></td> </tr> <tr> <td></td> <td></td> <td colspan="8" style="text-align: center;"> <table border="1" style="width: 100%; border-collapse: collapse; text-align: center;"> <tr> <td style="width: 10%;"></td> <td style="width: 10%;"></td> <td style="width: 10%;"></td> <td style="width: 10%;"></td> <td style="width: 10%;"></td> <td style="width: 10%;"></td> <td style="width: 10%;"></td> <td style="width: 10%;"></td> <td style="width: 10%;"></td> <td style="width: 10%;"></td> </tr> <tr> <td></td> <td></td> <td colspan="8" style="text-align: center;"> <table border="1" style="width: 100%; border-collapse: collapse; text-align: center;"> <tr> </tr></table></td></tr></table></td></tr></table></td></tr></table></td></tr></table></td></tr></table></td></tr></table></td></tr></table></td></tr></table></td></tr></table></td></tr></table></td></tr></table></td></tr></table>

 | | | | | | | | | | | | | | | | | | | | <table border="1" style="width: 100%; border-collapse: collapse; text-align: center;"> <tr> <td style="width: 10%;"></td> <td style="width: 10%;"></td> <td style="width: 10%;"></td> <td style="width: 10%;"></td> <td style="width: 10%;"></td> <td style="width: 10%;"></td> <td style="width: 10%;"></td> <td style="width: 10%;"></td> <td style="width: 10%;"></td> <td style="width: 10%;"></td> </tr> <tr> <td></td> <td></td> <td colspan="8" style="text-align: center;"> <table border="1" style="width: 100%; border-collapse: collapse; text-align: center;"> <tr> <td style="width: 10%;"></td> <td style="width: 10%;"></td> <td style="width: 10%;"></td> <td style="width: 10%;"></td> <td style="width: 10%;"></td> <td style="width: 10%;"></td> <td style="width: 10%;"></td> <td style="width: 10%;"></td> <td style="width: 10%;"></td> <td style="width: 10%;"></td> </tr> <tr> <td></td> <td></td> <td colspan="8" style="text-align: center;"> <table border="1" style="width: 100%; border-collapse: collapse; text-align: center;"> <tr> <td style="width: 10%;"></td> <td style="width: 10%;"></td> <td style="width: 10%;"></td> <td style="width: 10%;"></td> <td style="width: 10%;"></td> <td style="width: 10%;"></td> <td style="width: 10%;"></td> <td style="width: 10%;"></td> <td style="width: 10%;"></td> <td style="width: 10%;"></td> </tr> <tr> <td></td> <td></td> <td colspan="8" style="text-align: center;"> <table border="1" style="width: 100%; border-collapse: collapse; text-align: center;"> <tr> <td style="width: 10%;"></td> <td style="width: 10%;"></td> <td style="width: 10%;"></td> <td style="width: 10%;"></td> <td style="width: 10%;"></td> <td style="width: 10%;"></td> <td style="width: 10%;"></td> <td style="width: 10%;"></td> <td style="width: 10%;"></td> <td style="width: 10%;"></td> </tr> <tr> <td></td> <td></td> <td colspan="8" style="text-align: center;"> <table border="1" style="width: 100%; border-collapse: collapse; text-align: center;"> <tr> <td style="width: 10%;"></td> <td style="width: 10%;"></td> <td style="width: 10%;"></td> <td style="width: 10%;"></td> <td style="width: 10%;"></td> <td style="width: 10%;"></td> <td style="width: 10%;"></td> <td style="width: 10%;"></td> <td style="width: 10%;"></td> <td style="width: 10%;"></td> </tr> <tr> <td></td> <td></td> <td colspan="8" style="text-align: center;"> <table border="1" style="width: 100%; border-collapse: collapse; text-align: center;"> <tr> <td style="width: 10%;"></td> <td style="width: 10%;"></td> <td style="width: 10%;"></td> <td style="width: 10%;"></td> <td style="width: 10%;"></td> <td style="width: 10%;"></td> <td style="width: 10%;"></td> <td style="width: 10%;"></td> <td style="width: 10%;"></td> <td style="width: 10%;"></td> </tr> <tr> <td></td> <td></td> <td colspan="8" style="text-align: center;"> <table border="1" style="width: 100%; border-collapse: collapse; text-align: center;"> <tr> <td style="width: 10%;"></td> <td style="width: 10%;"></td> <td style="width: 10%;"></td> <td style="width: 10%;"></td> <td style="width: 10%;"></td> <td style="width: 10%;"></td> <td style="width: 10%;"></td> <td style="width: 10%;"></td> <td style="width: 10%;"></td> <td style="width: 10%;"></td> </tr> <tr> <td></td> <td></td> <td colspan="8" style="text-align: center;"> <table border="1" style="width: 100%; border-collapse: collapse; text-align: center;"> <tr> <td style="width: 10%;"></td> <td style="width: 10%;"></td> <td style="width: 10%;"></td> <td style="width: 10%;"></td> <td style="width: 10%;"></td> <td style="width: 10%;"></td> <td style="width: 10%;"></td> <td style="width: 10%;"></td> <td style="width: 10%;"></td> <td style="width: 10%;"></td> </tr> <tr> <td></td> <td></td> <td colspan="8" style="text-align: center;"> <table border="1" style="width: 100%; border-collapse: collapse; text-align: center;"> <tr> <td style="width: 10%;"></td> <td style="width: 10%;"></td> <td style="width: 10%;"></td> <td style="width: 10%;"></td> <td style="width: 10%;"></td> <td style="width: 10%;"></td> <td style="width: 10%;"></td> <td style="width: 10%;"></td> <td style="width: 10%;"></td> <td style="width: 10%;"></td> </tr> <tr> <td></td> <td></td> <td colspan="8" style="text-align: center;"> <table border="1" style="width: 100%; border-collapse: collapse; text-align: center;"> <tr> <td style="width: 10%;"></td> <td style="width: 10%;"></td> <td style="width: 10%;"></td> <td style="width: 10%;"></td> <td style="width: 10%;"></td> <td style="width: 10%;"></td> <td style="width: 10%;"></td> <td style="width: 10%;"></td> <td style="width: 10%;"></td> <td style="width: 10%;"></td> </tr> <tr> <td></td> <td></td> <td colspan="8" style="text-align: center;"> <table border="1" style="width: 100%; border-collapse: collapse; text-align: center;"> <tr> <td style="width: 10%;"></td> <td style="width: 10%;"></td> <td style="width: 10%;"></td> <td style="width: 10%;"></td> <td style="width: 10%;"></td> <td style="width: 10%;"></td> <td style="width: 10%;"></td> <td style="width: 10%;"></td> <td style="width: 10%;"></td> <td style="width: 10%;"></td> </tr> <tr> <td></td> <td></td> <td colspan="8" style="text-align: center;"> <table border="1" style="width: 100%; border-collapse: collapse; text-align: center;"> <tr> </tr></table></td></tr></table></td></tr></table></td></tr></table></td></tr></table></td></tr></table></td></tr></table></td></tr></table></td></tr></table></td></tr></table></td></tr></table></td></tr></table>
 | | | | | | | | | | | | | | | | | | | | <table border="1" style="width: 100%; border-collapse: collapse; text-align: center;"> <tr> <td style="width: 10%;"></td> <td style="width: 10%;"></td> <td style="width: 10%;"></td> <td style="width: 10%;"></td> <td style="width: 10%;"></td> <td style="width: 10%;"></td> <td style="width: 10%;"></td> <td style="width: 10%;"></td> <td style="width: 10%;"></td> <td style="width: 10%;"></td> </tr> <tr> <td></td> <td></td> <td colspan="8" style="text-align: center;"> <table border="1" style="width: 100%; border-collapse: collapse; text-align: center;"> <tr> <td style="width: 10%;"></td> <td style="width: 10%;"></td> <td style="width: 10%;"></td> <td style="width: 10%;"></td> <td style="width: 10%;"></td> <td style="width: 10%;"></td> <td style="width: 10%;"></td> <td style="width: 10%;"></td> <td style="width: 10%;"></td> <td style="width: 10%;"></td> </tr> <tr> <td></td> <td></td> <td colspan="8" style="text-align: center;"> <table border="1" style="width: 100%; border-collapse: collapse; text-align: center;"> <tr> <td style="width: 10%;"></td> <td style="width: 10%;"></td> <td style="width: 10%;"></td> <td style="width: 10%;"></td> <td style="width: 10%;"></td> <td style="width: 10%;"></td> <td style="width: 10%;"></td> <td style="width: 10%;"></td> <td style="width: 10%;"></td> <td style="width: 10%;"></td> </tr> <tr> <td></td> <td></td> <td colspan="8" style="text-align: center;"> <table border="1" style="width: 100%; border-collapse: collapse; text-align: center;"> <tr> <td style="width: 10%;"></td> <td style="width: 10%;"></td> <td style="width: 10%;"></td> <td style="width: 10%;"></td> <td style="width: 10%;"></td> <td style="width: 10%;"></td> <td style="width: 10%;"></td> <td style="width: 10%;"></td> <td
style="width: 10%;"></td> <td style="width: 10%;"></td> </tr> <tr> <td></td> <td></td> <td colspan="8" style="text-align: center;"> <table border="1" style="width: 100%; border-collapse: collapse; text-align: center;"> <tr> <td style="width: 10%;"></td> <td style="width: 10%;"></td> <td style="width: 10%;"></td> <td style="width: 10%;"></td> <td style="width: 10%;"></td> <td style="width: 10%;"></td> <td style="width: 10%;"></td> <td style="width: 10%;"></td> <td style="width: 10%;"></td> <td style="width: 10%;"></td> </tr> <tr> <td></td> <td></td> <td colspan="8" style="text-align: center;"> <table border="1" style="width: 100%; border-collapse: collapse; text-align: center;"> <tr> <td style="width: 10%;"></td> <td style="width: 10%;"></td> <td style="width: 10%;"></td> <td style="width: 10%;"></td> <td style="width: 10%;"></td> <td style="width: 10%;"></td> <td style="width: 10%;"></td> <td style="width: 10%;"></td> <td style="width: 10%;"></td> <td style="width: 10%;"></td> </tr> <tr> <td></td> <td></td> <td colspan="8" style="text-align: center;"> <table border="1" style="width: 100%; border-collapse: collapse; text-align: center;"> <tr> <td style="width: 10%;"></td> <td style="width: 10%;"></td> <td style="width: 10%;"></td> <td style="width: 10%;"></td> <td style="width: 10%;"></td> <td style="width: 10%;"></td> <td style="width: 10%;"></td> <td style="width: 10%;"></td> <td style="width: 10%;"></td> <td style="width: 10%;"></td> </tr> <tr> <td></td> <td></td> <td colspan="8" style="text-align: center;"> <table border="1" style="width: 100%; border-collapse: collapse; text-align: center;"> <tr> <td style="width: 10%;"></td> <td style="width: 10%;"></td> <td style="width: 10%;"></td> <td style="width: 10%;"></td> <td style="width: 10%;"></td> <td style="width: 10%;"></td> <td style="width: 10%;"></td> <td style="width: 10%;"></td> <td style="width: 10%;"></td> <td style="width: 10%;"></td> </tr> <tr> <td></td> <td></td> <td colspan="8" style="text-align: center;"> <table border="1" style="width: 100%; border-collapse: collapse; text-align: center;"> <tr> <td style="width: 10%;"></td> <td style="width: 10%;"></td> <td style="width: 10%;"></td> <td style="width: 10%;"></td> <td style="width: 10%;"></td> <td style="width: 10%;"></td> <td style="width: 10%;"></td> <td style="width: 10%;"></td> <td style="width: 10%;"></td> <td style="width: 10%;"></td> </tr> <tr> <td></td> <td></td> <td colspan="8" style="text-align: center;"> <table border="1" style="width: 100%; border-collapse: collapse; text-align: center;"> <tr> <td style="width: 10%;"></td> <td style="width: 10%;"></td> <td style="width: 10%;"></td> <td style="width: 10%;"></td> <td style="width: 10%;"></td> <td style="width: 10%;"></td> <td style="width: 10%;"></td> <td style="width: 10%;"></td> <td style="width: 10%;"></td> <td style="width: 10%;"></td> </tr> <tr> <td></td> <td></td> <td colspan="8" style="text-align: center;"> <table border="1" style="width: 100%; border-collapse: collapse; text-align: center;"> <tr> </tr></table></td></tr></table></td></tr></table></td></tr></table></td></tr></table></td></tr></table></td></tr></table></td></tr></table></td></tr></table></td></tr></table></td></tr></table>
 | | | | | | | | | | | | | | | | | | | | <table border="1" style="width: 100%; border-collapse: collapse; text-align: center;"> <tr> <td style="width: 10%;"></td> <td style="width: 10%;"></td> <td style="width: 10%;"></td> <td style="width: 10%;"></td> <td style="width: 10%;"></td> <td style="width: 10%;"></td> <td style="width: 10%;"></td> <td style="width: 10%;"></td> <td style="width: 10%;"></td> <td style="width: 10%;"></td> </tr> <tr> <td></td> <td></td> <td colspan="8" style="text-align: center;"> <table border="1" style="width: 100%; border-collapse: collapse; text-align: center;"> <tr> <td style="width: 10%;"></td> <td style="width: 10%;"></td> <td style="width: 10%;"></td> <td style="width: 10%;"></td> <td style="width: 10%;"></td> <td style="width: 10%;"></td> <td style="width: 10%;"></td> <td style="width: 10%;"></td> <td style="width: 10%;"></td> <td style="width: 10%;"></td> </tr> <tr> <td></td> <td></td> <td colspan="8" style="text-align: center;"> <table border="1" style="width: 100%; border-collapse: collapse; text-align: center;"> <tr> <td style="width: 10%;"></td> <td style="width: 10%;"></td> <td style="width: 10%;"></td> <td style="width: 10%;"></td> <td style="width: 10%;"></td> <td style="width: 10%;"></td> <td style="width: 10%;"></td> <td style="width: 10%;"></td> <td style="width: 10%;"></td> <td style="width: 10%;"></td> </tr> <tr> <td></td> <td></td> <td colspan="8" style="text-align: center;"> <table border="1" style="width: 100%; border-collapse: collapse; text-align: center;"> <tr> <td style="width: 10%;"></td> <td style="width: 10%;"></td> <td style="width: 10%;"></td> <td style="width: 10%;"></td> <td style="width: 10%;"></td> <td style="width: 10%;"></td> <td style="width: 10%;"></td> <td style="width: 10%;"></td> <td style="width: 10%;"></td> <td style="width: 10%;"></td> </tr> <tr> <td></td> <td></td> <td colspan="8" style="text-align: center;"> <table border="1" style="width: 100%; border-collapse: collapse; text-align: center;"> <tr> <td style="width: 10%;"></td> <td style="width: 10%;"></td> <td style="width: 10%;"></td> <td style="width: 10%;"></td> <td style="width: 10%;"></td> <td style="width: 10%;"></td> <td style="width: 10%;"></td> <td style="width: 10%;"></td> <td style="width: 10%;"></td> <td style="width: 10%;"></td> </tr> <tr> <td></td> <td></td> <td colspan="8" style="text-align: center;"> <table border="1" style="width: 100%; border-collapse: collapse; text-align: center;"> <tr> <td style="width: 10%;"></td> <td style="width: 10%;"></td> <td style="width: 10%;"></td> <td style="width: 10%;"></td> <td style="width: 10%;"></td> <td style="width: 10%;"></td> <td style="width: 10%;"></td> <td style="width: 10%;"></td> <td style="width: 10%;"></td> <td style="width: 10%;"></td> </tr> <tr> <td></td> <td></td> <td colspan="8" style="text-align: center;"> <table border="1" style="width: 100%; border-collapse: collapse; text-align: center;"> <tr> <td style="width: 10%;"></td> <td style="width: 10%;"></td> <td style="width: 10%;"></td> <td style="width: 10%;"></td> <td style="width: 10%;"></td> <td style="width: 10%;"></td> <td style="width: 10%;"></td> <td style="width: 10%;"></td> <td style="width: 10%;"></td> <td style="width: 10%;"></td> </tr> <tr> <td></td> <td></td> <td colspan="8" style="text-align: center;"> <table border="1" style="width: 100%; border-collapse: collapse; text-align: center;"> <tr> <td style="width: 10%;"></td> <td style="width: 10%;"></td> <td style="width: 10%;"></td> <td style="width: 10%;"></td> <td style="width: 10%;"></td> <td style="width: 10%;"></td> <td style="width: 10%;"></td> <td style="width: 10%;"></td> <td style="width: 10%;"></td> <td style="width: 10%;"></td> </tr> <tr> <td></td> <td></td> <td colspan="8" style="text-align: center;"> <table border="1" style="width: 100%; border-collapse: collapse; text-align: center;"> <tr> <td style="width: 10%;"></td> <td style="width: 10%;"></td> <td style="width: 10%;"></td> <td style="width: 10%;"></td> <td style="width: 10%;"></td> <td style="width: 10%;"></td> <td style="width: 10%;"></td> <td style="width: 10%;"></td> <td style="width: 10%;"></td> <td style="width: 10%;"></td> </tr> <tr> <td></td> <td></td> <td colspan="8" style="text-align: center;"> <table border="1" style="width: 100%; border-collapse: collapse; text-align: center;"> <tr> </tr></table></td></tr></table></td></tr></table></td></tr></table></td></tr></table></td></tr></table></td></tr></table></td></tr></table></td></tr></table></td></tr></table>

 | | | | | | | | | | | | | | | | | | | | <table border="1" style="width: 100%; border-collapse: collapse; text-align: center;"> <tr> <td style="width: 10%;"></td> <td style="width: 10%;"></td> <td style="width: 10%;"></td> <td style="width: 10%;"></td> <td style="width: 10%;"></td> <td style="width: 10%;"></td> <td style="width: 10%;"></td> <td style="width: 10%;"></td> <td style="width: 10%;"></td> <td style="width: 10%;"></td> </tr> <tr> <td></td> <td></td> <td colspan="8" style="text-align: center;"> <table border="1" style="width: 100%; border-collapse: collapse; text-align: center;"> <tr> <td style="width: 10%;"></td> <td style="width: 10%;"></td> <td style="width: 10%;"></td> <td style="width: 10%;"></td> <td style="width: 10%;"></td> <td style="width: 10%;"></td> <td style="width: 10%;"></td> <td style="width: 10%;"></td> <td style="width: 10%;"></td> <td style="width: 10%;"></td> </tr> <tr> <td></td> <td></td> <td colspan="8" style="text-align: center;"> <table border="1" style="width: 100%; border-collapse: collapse; text-align: center;"> <tr> <td style="width: 10%;"></td> <td style="width: 10%;"></td> <td style="width: 10%;"></td> <td style="width: 10%;"></td> <td style="width: 10%;"></td> <td style="width: 10%;"></td> <td style="width: 10%;"></td> <td style="width: 10%;"></td> <td style="width: 10%;"></td> <td style="width: 10%;"></td> </tr> <tr> <td></td> <td></td> <td colspan="8" style="text-align: center;"> <table border="1" style="width: 100%; border-collapse: collapse; text-align: center;"> <tr> <td style="width: 10%;"></td> <td style="width: 10%;"></td> <td style="width: 10%;"></td> <td style="width: 10%;"></td> <td style="width: 10%;"></td> <td style="width: 10%;"></td> <td style="width: 10%;"></td> <td style="width: 10%;"></td> <td style="width: 10%;"></td> <td style="width: 10%;"></td> </tr> <tr> <td></td> <td></td> <td colspan="8" style="text-align: center;"> <table border="1" style="width: 100%; border-collapse: collapse; text-align: center;"> <tr> <td style="width: 10%;"></td> <td style="width: 10%;"></td> <td style="width: 10%;"></td> <td style="width: 10%;"></td> <td style="width: 10%;"></td> <td style="width: 10%;"></td> <td style="width: 10%;"></td> <td style="width: 10%;"></td> <td style="width: 10%;"></td> <td style="width: 10%;"></td> </tr> <tr> <td></td> <td></td> <td colspan="8" style="text-align: center;"> <table border="1" style="width: 100%; border-collapse: collapse; text-align: center;"> <tr> <td style="width: 10%;"></td> <td style="width: 10%;"></td> <td style="width: 10%;"></td> <td style="width: 10%;"></td> <td style="width: 10%;"></td> <td style="width: 10%;"></td> <td style="width: 10%;"></td> <td style="width: 10%;"></td> <td style="width: 10%;"></td> <td style="width: 10%;"></td> </tr> <tr> <td></td> <td></td> <td colspan="8" style="text-align: center;"> <table border="1" style="width: 100%; border-collapse: collapse; text-align: center;"> <tr> <td style="width: 10%;"></td> <td style="width: 10%;"></td> <td style="width: 10%;"></td> <td style="width: 10%;"></td> <td style="width: 10%;"></td> <td style="width: 10%;"></td> <td style="width: 10%;"></td> <td style="width: 10%;"></td> <td style="width: 10%;"></td> <td style="width: 10%;"></td> </tr> <tr> <td></td> <td></td> <td colspan="8" style="text-align: center;"> <table border="1" style="width: 100%; border-collapse: collapse; text-align: center;"> <tr> <td style="width: 10%;"></td> <td style="width: 10%;"></td> <td style="width: 10%;"></td> <td style="width: 10%;"></td> <td style="width: 10%;"></td> <td style="width: 10%;"></td> <td style="width: 10%;"></td> <td style="width: 10%;"></td> <td style="width: 10%;"></td> <td style="width: 10%;"></td> </tr> <tr> <td></td> <td></td> <td colspan="8" style="text-align: center;"> <table border="1" style="width: 100%; border-collapse: collapse; text-align: center;"> <tr> </tr></table></td></tr></table></td></tr></table></td></tr></table></td></tr></table></td></tr></table></td></tr></table></td></tr></table></td></tr></table>
 | | | | | | | | | | | | | | | | | | | | <table border="1" style="width: 100%; border-collapse: collapse; text-align: center;"> <tr> <td style="width: 10%;"></td> <td style="width: 10%;"></td> <td style="width: 10%;"></td> <td style="width: 10%;"></td> <td style="width: 10%;"></td> <td style="width: 10%;"></td> <td style="width: 10%;"></td> <td style="width: 10%;"></td> <td style="width: 10%;"></td> <td style="width: 10%;"></td> </tr> <tr> <td></td> <td></td> <td colspan="8" style="text-align: center;"> <table border="1" style="width: 100%; border-collapse: collapse; text-align: center;"> <tr> <td style="width: 10%;"></td> <td style="width: 10%;"></td> <td style="width: 10%;"></td> <td style="width: 10%;"></td> <td style="width: 10%;"></td> <td style="width: 10%;"></td> <td style="width: 10%;"></td> <td style="width: 10%;"></td> <td style="width: 10%;"></td> <td style="width: 10%;"></td> </tr> <tr> <td></td> <td></td> <td colspan="8" style="text-align: center;"> <table border="1" style="width: 100%; border-collapse: collapse; text-align: center;"> <tr> <td style="width: 10%;"></td> <td style="width: 10%;"></td> <td style="width: 10%;"></td> <td style="width: 10%;"></td> <td style="width: 10%;"></td> <td style="width: 10%;"></td> <td style="width: 10%;"></td> <td style="width: 10%;"></td> <td style="width: 10%;"></td> <td style="width: 10%;"></td> </tr> <tr> <td></td> <td></td> <td colspan="8" style="text-align: center;"> <table border="1" style="width: 100%; border-collapse: collapse; text-align: center;"> <tr> <td style="width: 10%;"></td> <td style="width: 10%;"></td> <td style="width: 10%;"></td> <td style="width: 10%;"></td> <td style="width: 10%;"></td> <td style="width: 10%;"></td> <td style="width: 10%;"></td> <td style="width: 10%;"></td> <td style="width: 10%;"></td> <td style="width: 10%;"></td> </tr> <tr> <td></td> <td></td> <td colspan="8" style="text-align: center;"> <table border="1" style="width: 100%; border-collapse: collapse; text-align: center;"> <tr> <td style="width: 10%;"></td> <td style="width: 10%;"></td> <td style="width: 10%;"></td> <td style="width: 10%;"></td> <td style="width: 10%;"></td> <td style="width: 10%;"></td> <td style="width: 10%;"></td> <td style="width: 10%;"></td> <td style="width: 10%;"></td> <td style="width: 10%;"></td> </tr> <tr> <td></td> <td></td> <td colspan="8" style="text-align: center;"> <table border="1" style="width: 100%; border-collapse: collapse; text-align: center;"> <tr> <td style="width: 10%;"></td> <td style="width: 10%;"></td> <td style="width: 10%;"></td> <td style="width: 10%;"></td> <td style="width: 10%;"></td> <td style="width: 10%;"></td> <td style="width: 10%;"></td> <td style="width: 10%;"></td> <td style="width: 10%;"></td> <td style="width: 10%;"></td> </tr> <tr> <td></td> <td></td> <td colspan="8" style="text-align: center;"> <table border="1" style="width: 100%; border-collapse: collapse; text-align: center;"> <tr> <td style="width: 10%;"></td> <td style="width: 10%;"></td> <td style="width: 10%;"></td> <td style="width: 10%;"></td> <td style="width: 10%;"></td> <td style="width: 10%;"></td> <td style="width: 10%;"></td> <td style="width:
10%;"></td> <td style="width: 10%;"></td> <td style="width: 10%;"></td> </tr> <tr> <td></td> <td></td> <td colspan="8" style="text-align: center;"> <table border="1" style="width: 100%; border-collapse: collapse; text-align: center;"> <tr> </tr></table></td></tr></table></td></tr></table></td></tr></table></td></tr></table></td></tr></table></td></tr></table></td></tr></table>
 | | | | | | | | | | | | | | | | | | | | <table border="1" style="width: 100%; border-collapse: collapse; text-align: center;"> <tr> <td style="width: 10%;"></td> <td style="width: 10%;"></td> <td style="width: 10%;"></td> <td style="width: 10%;"></td> <td style="width: 10%;"></td> <td style="width: 10%;"></td> <td style="width: 10%;"></td> <td style="width: 10%;"></td> <td style="width: 10%;"></td> <td style="width: 10%;"></td> </tr> <tr> <td></td> <td></td> <td colspan="8" style="text-align: center;"> <table border="1" style="width: 100%; border-collapse: collapse; text-align: center;"> <tr> <td style="width: 10%;"></td> <td style="width: 10%;"></td> <td style="width: 10%;"></td> <td style="width: 10%;"></td> <td style="width: 10%;"></td> <td style="width: 10%;"></td> <td style="width: 10%;"></td> <td style="width: 10%;"></td> <td style="width: 10%;"></td> <td style="width: 10%;"></td> </tr> <tr> <td></td> <td></td> <td colspan="8" style="text-align: center;"> <table border="1" style="width: 100%; border-collapse: collapse; text-align: center;"> <tr> <td style="width: 10%;"></td> <td style="width: 10%;"></td> <td style="width: 10%;"></td> <td style="width: 10%;"></td> <td style="width: 10%;"></td> <td style="width: 10%;"></td> <td style="width: 10%;"></td> <td style="width: 10%;"></td> <td style="width: 10%;"></td> <td style="width: 10%;"></td> </tr> <tr> <td></td> <td></td> <td colspan="8" style="text-align: center;"> <table border="1" style="width: 100%; border-collapse: collapse; text-align: center;"> <tr> <td style="width: 10%;"></td> <td style="width: 10%;"></td> <td style="width: 10%;"></td> <td style="width: 10%;"></td> <td style="width: 10%;"></td> <td style="width: 10%;"></td> <td style="width: 10%;"></td> <td style="width: 10%;"></td> <td style="width: 10%;"></td> <td style="width: 10%;"></td> </tr> <tr> <td></td> <td></td> <td colspan="8" style="text-align: center;"> <table border="1" style="width: 100%; border-collapse: collapse; text-align: center;"> <tr> <td style="width: 10%;"></td> <td style="width: 10%;"></td> <td style="width: 10%;"></td> <td style="width: 10%;"></td> <td style="width: 10%;"></td> <td style="width: 10%;"></td> <td style="width: 10%;"></td> <td style="width: 10%;"></td> <td style="width: 10%;"></td> <td style="width: 10%;"></td> </tr> <tr> <td></td> <td></td> <td colspan="8" style="text-align: center;"> <table border="1" style="width: 100%; border-collapse: collapse; text-align: center;"> <tr> <td style="width: 10%;"></td> <td style="width: 10%;"></td> <td style="width: 10%;"></td> <td style="width: 10%;"></td> <td style="width: 10%;"></td> <td style="width: 10%;"></td> <td style="width: 10%;"></td> <td style="width: 10%;"></td> <td style="width: 10%;"></td> <td style="width: 10%;"></td> </tr> <tr> <td></td> <td></td> <td colspan="8" style="text-align: center;"> <table border="1" style="width: 100%; border-collapse: collapse; text-align: center;"> <tr> </tr></table></td></tr></table></td></tr></table></td></tr></table></td></tr></table></td></tr></table></td></tr></table>
 | | | | | | | | | | | | | | | | | | | | <table border="1" style="width: 100%; border-collapse: collapse; text-align: center;"> <tr> <td style="width: 10%;"></td> <td style="width: 10%;"></td> <td style="width: 10%;"></td> <td style="width: 10%;"></td> <td style="width: 10%;"></td> <td style="width: 10%;"></td> <td style="width: 10%;"></td> <td style="width: 10%;"></td> <td style="width: 10%;"></td> <td style="width: 10%;"></td> </tr> <tr> <td></td> <td></td> <td colspan="8" style="text-align: center;"> <table border="1" style="width: 100%; border-collapse: collapse; text-align: center;"> <tr> <td style="width: 10%;"></td> <td style="width: 10%;"></td> <td style="width: 10%;"></td> <td style="width: 10%;"></td> <td style="width: 10%;"></td> <td style="width: 10%;"></td> <td style="width: 10%;"></td> <td style="width: 10%;"></td> <td style="width: 10%;"></td> <td style="width: 10%;"></td> </tr> <tr> <td></td> <td></td> <td colspan="8" style="text-align: center;"> <table border="1" style="width: 100%; border-collapse: collapse; text-align: center;"> <tr> <td style="width: 10%;"></td> <td style="width: 10%;"></td> <td style="width: 10%;"></td> <td style="width: 10%;"></td> <td style="width: 10%;"></td> <td style="width: 10%;"></td> <td style="width: 10%;"></td> <td style="width: 10%;"></td> <td style="width: 10%;"></td> <td style="width: 10%;"></td> </tr> <tr> <td></td> <td></td> <td colspan="8" style="text-align: center;"> <table border="1" style="width: 100%; border-collapse: collapse; text-align: center;"> <tr> <td style="width: 10%;"></td> <td style="width: 10%;"></td> <td style="width: 10%;"></td> <td style="width: 10%;"></td> <td style="width: 10%;"></td> <td style="width: 10%;"></td> <td style="width: 10%;"></td> <td style="width: 10%;"></td> <td style="width: 10%;"></td> <td style="width: 10%;"></td> </tr> <tr> <td></td> <td></td> <td colspan="8" style="text-align: center;"> <table border="1" style="width: 100%; border-collapse: collapse; text-align: center;"> <tr> <td style="width: 10%;"></td> <td style="width: 10%;"></td> <td style="width: 10%;"></td> <td style="width: 10%;"></td> <td style="width: 10%;"></td> <td style="width: 10%;"></td> <td style="width: 10%;"></td> <td style="width: 10%;"></td> <td style="width: 10%;"></td> <td style="width: 10%;"></td> </tr> <tr> <td></td> <td></td> <td colspan="8" style="text-align: center;"> <table border="1" style="width: 100%; border-collapse: collapse; text-align: center;"> <tr> </tr></table></td></tr></table></td></tr></table></td></tr></table></td></tr></table></td></tr></table>

 | | | | | | | | | | | | | | | | | | | | <table border="1" style="width: 100%; border-collapse: collapse; text-align: center;"> <tr> <td style="width: 10%;"></td> <td style="width: 10%;"></td> <td style="width: 10%;"></td> <td style="width: 10%;"></td> <td style="width: 10%;"></td> <td style="width: 10%;"></td> <td style="width: 10%;"></td> <td style="width: 10%;"></td> <td style="width: 10%;"></td> <td style="width: 10%;"></td> </tr> <tr> <td></td> <td></td> <td colspan="8" style="text-align: center;"> <table border="1" style="width: 100%; border-collapse: collapse; text-align: center;"> <tr> <td style="width: 10%;"></td> <td style="width: 10%;"></td> <td style="width: 10%;"></td> <td style="width: 10%;"></td> <td style="width: 10%;"></td> <td style="width: 10%;"></td> <td style="width: 10%;"></td> <td style="width: 10%;"></td> <td style="width: 10%;"></td> <td style="width: 10%;"></td> </tr> <tr> <td></td> <td></td> <td colspan="8" style="text-align: center;"> <table border="1" style="width: 100%; border-collapse: collapse; text-align: center;"> <tr> <td style="width: 10%;"></td> <td style="width: 10%;"></td> <td style="width: 10%;"></td> <td style="width: 10%;"></td> <td style="width: 10%;"></td> <td style="width: 10%;"></td> <td style="width: 10%;"></td> <td style="width: 10%;"></td> <td style="width: 10%;"></td> <td style="width: 10%;"></td> </tr> <tr> <td></td> <td></td> <td colspan="8" style="text-align: center;"> <table border="1" style="width: 100%; border-collapse: collapse; text-align: center;"> <tr> <td style="width: 10%;"></td> <td style="width: 10%;"></td> <td style="width: 10%;"></td> <td style="width: 10%;"></td> <td style="width: 10%;"></td> <td style="width: 10%;"></td> <td style="width: 10%;"></td> <td style="width: 10%;"></td> <td style="width: 10%;"></td> <td style="width: 10%;"></td> </tr> <tr> <td></td> <td></td> <td colspan="8" style="text-align: center;"> <table border="1" style="width: 100%; border-collapse: collapse; text-align: center;"> <tr> </tr></table></td></tr></table></td></tr></table></td></tr></table></td></tr></table>
 | | | | | | | | | | | | | | | | | | | | <table border="1" style="width: 100%; border-collapse: collapse; text-align: center;"> <tr> <td style="width: 10%;"></td> <td style="width: 10%;"></td> <td style="width: 10%;"></td> <td style="width: 10%;"></td> <td style="width: 10%;"></td> <td style="width: 10%;"></td> <td style="width: 10%;"></td> <td style="width: 10%;"></td> <td style="width: 10%;"></td> <td style="width: 10%;"></td> </tr> <tr> <td></td> <td></td> <td colspan="8" style="text-align: center;"> <table border="1" style="width: 100%; border-collapse: collapse; text-align: center;"> <tr> <td style="width: 10%;"></td> <td style="width: 10%;"></td> <td style="width: 10%;"></td> <td style="width: 10%;"></td> <td style="width: 10%;"></td> <td style="width: 10%;"></td> <td style="width: 10%;"></td> <td style="width: 10%;"></td> <td style="width: 10%;"></td> <td style="width: 10%;"></td> </tr> <tr> <td></td> <td></td> <td colspan="8" style="text-align: center;"> <table border="1" style="width: 100%; border-collapse: collapse; text-align: center;"> <tr> <td style="width: 10%;"></td> <td style="width: 10%;"></td> <td style="width: 10%;"></td> <td style="width: 10%;"></td> <td style="width: 10%;"></td> <td style="width: 10%;"></td> <td style="width: 10%;"></td> <td style="width: 10%;"></td> <td style="width: 10%;"></td> <td style="width: 10%;"></td> </tr> <tr> <td></td> <td></td> <td colspan="8" style="text-align: center;"> <table border="1" style="width: 100%; border-collapse: collapse; text-align: center;"> <tr> </tr></table></td></tr></table></td></tr></table></td></tr></table>
 | | | | | | | | | | | | | | | | | | | | <table border="1" style="width: 100%; border-collapse: collapse; text-align: center;"> <tr> <td style="width: 10%;"></td> <td style="width: 10%;"></td> <td style="width: 10%;"></td> <td style="width: 10%;"></td> <td style="width: 10%;"></td> <td style="width: 10%;"></td> <td style="width: 10%;"></td> <td style="width: 10%;"></td> <td style="width: 10%;"></td> <td style="width: 10%;"></td> </tr> <tr> <td></td> <td></td> <td colspan="8" style="text-align: center;"> <table border="1" style="width: 100%; border-collapse: collapse; text-align: center;"> <tr> <td style="width: 10%;"></td> <td style="width: 10%;"></td> <td style="width: 10%;"></td> <td style="width: 10%;"></td> <td style="width: 10%;"></td> <td style="width: 10%;"></td> <td style="width: 10%;"></td> <td style="width: 10%;"></td> <td style="width: 10%;"></td> <td style="width: 10%;"></td> </tr> <tr> <td></td> <td></td> <td colspan="8" style="text-align: center;"> <table border="1" style="width: 100%; border-collapse: collapse; text-align: center;"> <tr> </tr></table></td></tr></table></td></tr></table>

 | | | | | | | | | | | | | | | | | | | | <table border="1" style="width: 100%; border-collapse: collapse; text-align: center;"> <tr> <td style="width: 10%;"></td> <td style="width: 10%;"></td> <td style="width: 10%;"></td> <td style="width: 10%;"></td> <td style="width: 10%;"></td> <td style="width: 10%;"></td> <td style="width: 10%;"></td> <td style="width: 10%;"></td> <td style="width: 10%;"></td> <td style="width: 10%;"></td> </tr> <tr> <td></td> <td></td> <td colspan="8" style="text-align: center;"> <table border="1" style="width: 100%; border-collapse: collapse; text-align: center;"> <tr> </tr></table></td></tr></table>
 | | | | | | | | | | | | | | | | | | | | <table border="1" style="width: 100%; border-collapse: collapse; text-align: center;"> <tr> </tr></table>
 | | | | | | | | | | | | | | | | | | | | | | | | | | | | | | | | | | | | | | | | | | | | | | | | | | | | | | | | | | | | | | | | | | | | | | | | | | | | | | | |
 | | | | | | | | | | | | | | | | | | | |
 | | | | | | | | | | | | | | | | | | | |
 | | | | | | | | | | | | | | | | | | | |
 | | | | | | | | | | | | | | | | | | | |
 | | | | | | | | | | | | | | | | | | | |
 | | | | | | | | | | | | | | | | | | | |
 | | | | | | | | | | | | | | | | | | | |
 | | | | | | | | | | | | | | | | | | | | | | | | | | | | | | | | | | | | | | | |
 | | | | | | | | | | | | | | | | | | | |
 | | | | | | | | | | | | | | | | | | | | | | | | | | | | | | | | | | | | | | | |
 | | | | | | | | | | | | | | | | | | | | | | | | | | | | | | | | | | | | | | | |
 | | | | | | | | | | | | | | | | | | | | | | | | | | | | | | | | | | | | | | | |
 | | | | | | | | | | | | | | | | | | | | | | | | | | | | | | | | | | | | | | | | | | | | | | | | | | | | | | | | | | | | | | | | | | | | | | | | | | | | | | | |
 | | | | | | | | | | | | | | | | | | | | | | | | | | | | | | | | | | | | | | | | | | | | | | | | | | | | | | | | | | | | | | | | | | | |
| | |

 | | | | | | | | | | | | | | | | | | | |

 | | | | | | | | | | | | | | | | | | | |

 | | | | | | | | | | | | | | | | | | | |

 | | | | | | | | | | | | | | | | | | | |

 | | | | | | | | | | | | | | | | | | | |

 | | | | | | | | | | | | | | | | | | | |

 | | | | | | | | | | | | | | | | | | | |

 | | | | | | | | | | | | | | | | | | | |

 | | | | | | | | | | | | | | | | | | | |

 | | | | | | | | | | | | | | | | | | | |

 | | | | | | | | | | | | | | | | | | | |

 | | | | | | | | | | | | | | | | | | | |

 | | | | | | | | | | | | | | | | | | | |

 | | | | | | | | | | | | | | | | | | | |

 | | | | | | | | | | | | | | | | | | | |

 | | | | | | | | | | | | | | | | | | | |

 | | | | | | | | | | | | | | | | | | | |

 | | | | | | | | | | | | | | | | | | | |

 | | | | | | | | | | | | | | | | | | | |

 | | | | | | | | | | | | | | | | | | | |

 | | | | | | | | | | | | | | | | | | | |

 | | | | | | | | | | | | | | | | | | | |

 | | | | | | | | | | | | | | | | | | | |

 | | | | | | | | | | | | | | | | | | | |

 | | | | | | | | | | | | | | | | | | | |

 | | | | | | | | | | | | | | | | | | | |

 | | | | | | | | | | | | | | | | | | | |

 | | | | | | | | | | | | | | | | | | | |
 | | | | | | | | | | | | | | | | | | | |

 | | | | | | | | | | | | | | | | | | | |

 | | | | | | | | | | | | | | | | | | | |
 | | | | | | | | | | | | | | | | | | | |

 | | | | | | | | | | | | | | | | | | | |

 | | | | | | | | | | | | | | | | | | | |
 | | | | | | | | | | | | | | | | | | | |
 | | | | | | | | | | | | | | | | | | | |

 | | | | | | | | | | | | | | | | | | | |
 | | | | | | | | | | | | | | | | | | | |
 | | | | | | | | | | | | | | | | | | | |

 | | | | | | | | | | | | | | | | | | | | | | | | | | | | | | | | | | | | | | | | | | | | | | | | | | | | | | | | | | | | | | | | | | | | | | | | | | | | | | | | | | | | | | | | | | | | | | | | | | | |
 | | | | | | | | | | | | | | | | | | | |
 | | | | | | | | | | | | | | | | | | | |
 | | | | | | | | | | | | | | | | | | | |
 | | | | | | | | | | | | | | | | | | | |
 | | | | | | | | | | | | | | | | | | | |
 | | | | | | | | | | | | | | | | | | | |
 | | | | | | | | | | | | | | | | | | | |
 | | | | | | | | | | | | | | | | | | | |
 | | | | | | | | | | | | | | | | | | | | | | | | | | | | | | | | | | | | | | | |
 | | | | | | | | | | | | | | | | | | | |
 | | | | | | | | | | | | | | | | | | | | | | | | | | | | | | | | | | | | | | | |
 | | | | | | | | | | | | | | | | | | | | | | | | | | | | | | | | | | | | | | | |
 | | | | | | | | | | | | | | | | | | | | | | | | | | | | | | | | | | | | | | | |
 | | | | | | | | | | | | | | | | | | | | | | | | | | | | | | | | | | | | | | | | | | | | | | | | | | | | | | | | | | | | | | | | | | | | | | | | | | | | | | | | | | | | | | | | | | | | | | | | | | | |
 | | | | | | | | | | | | | | | | | | | | | | | | | | | | | | | | | | | | | | | | | | | | | | | |
| | | <table border="1" style="width: 100%; border-collapse: collapse; text-align: center;"> <tr> <td style="width: 10%;"></td> <td style="width: 10%;"></td> <td style="width: 10%;"></td> <td style="width: 10%;"></td> <td style="width: 10%;"></td> <td style="width: 10%;"></td> <td style="width: 10%;"></td> <td style="width: 10%;"></td> <td style="width: 10%;"></td> <td style="width: 10%;"></td> </tr> <tr> <td></td> <td></td> <td colspan="8" style="text-align: center;"> <table border="1" style="width: 100%; border-collapse: collapse; text-align: center;"> <tr> <td style="width: 10%;"></td> <td style="width: 10%;"></td> <td style="width: 10%;"></td> <td style="width: 10%;"></td> <td style="width: 10%;"></td> <td style="width: 10%;"></td> <td style="width: 10%;"></td> <td style="width: 10%;"></td> <td style="width: 10%;"></td> <td style="width: 10%;"></td> </tr> <tr> <td></td> <td></td> <td colspan="8" style="text-align: center;"> <table border="1" style="width: 100%; border-collapse: collapse; text-align: center;"> <tr> <td style="width: 10%;"></td> <td style="width: 10%;"></td> <td style="width: 10%;"></td> <td style="width: 10%;"></td> <td style="width: 10%;"></td> <td style="width: 10%;"></td> <td style="width: 10%;"></td> <td style="width: 10%;"></td> <td style="width: 10%;"></td> <td style="width: 10%;"></td> </tr> <tr> <td></td> <td></td> <td colspan="8" style="text-align: center;"> <table border="1" style="width: 100%; border-collapse: collapse; text-align: center;"> <tr> <td style="width: 10%;"></td> <td style="width: 10%;"></td> <td style="width: 10%;"></td> <td style="width: 10%;"></td> <td style="width: 10%;"></td> <td style="width: 10%;"></td> <td style="width: 10%;"></td> <td style="width: 10%;"></td> <td style="width: 10%;"></td> <td style="width: 10%;"></td> </tr> <tr> <td></td> <td></td> <td colspan="8" style="text-align: center;"> <table border="1" style="width: 100%; border-collapse: collapse; text-align: center;"> <tr> <td style="width: 10%;"></td> <td style="width: 10%;"></td> <td style="width: 10%;"></td> <td style="width: 10%;"></td> <td style="width: 10%;"></td> <td style="width: 10%;"></td> <td style="width: 10%;"></td> <td style="width: 10%;"></td> <td style="width: 10%;"></td> <td style="width: 10%;"></td> </tr> <tr> <td></td> <td></td> <td colspan="8" style="text-align: center;"> <table border="1" style="width: 100%; border-collapse: collapse; text-align: center;"> <tr> <td style="width: 10%;"></td> <td style="width: 10%;"></td> <td style="width: 10%;"></td> <td style="width: 10%;"></td> <td style="width: 10%;"></td> <td style="width: 10%;"></td> <td style="width: 10%;"></td> <td style="width: 10%;"></td> <td style="width: 10%;"></td> <td style="width: 10%;"></td> </tr> <tr> <td></td> <td></td> <td colspan="8" style="text-align: center;"> <table border="1" style="width: 100%; border-collapse: collapse; text-align: center;"> <tr> <td style="width: 10%;"></td> <td style="width: 10%;"></td> <td style="width: 10%;"></td> <td style="width: 10%;"></td> <td style="width: 10%;"></td> <td style="width: 10%;"></td> <td style="width: 10%;"></td> <td style="width: 10%;"></td> <td style="width: 10%;"></td> <td style="width: 10%;"></td> </tr> <tr> <td></td> <td></td> <td colspan="8" style="text-align: center;"> <table border="1" style="width: 100%; border-collapse: collapse; text-align: center;"> <tr> <td style="width: 10%;"></td> <td style="width: 10%;"></td> <td style="width: 10%;"></td> <td style="width: 10%;"></td> <td style="width: 10%;"></td> <td style="width: 10%;"></td> <td style="width: 10%;"></td> <td style="width: 10%;"></td> <td style="width: 10%;"></td> <td style="width: 10%;"></td> </tr> <tr> <td></td> <td></td> <td colspan="8" style="text-align: center;"> <table border="1" style="width: 100%; border-collapse: collapse; text-align: center;"> <tr> <td style="width: 10%;"></td> <td style="width: 10%;"></td> <td style="width: 10%;"></td> <td style="width: 10%;"></td> <td style="width: 10%;"></td> <td style="width: 10%;"></td> <td style="width: 10%;"></td> <td style="width: 10%;"></td> <td style="width: 10%;"></td> <td style="width: 10%;"></td> </tr> <tr> <td></td> <td></td> <td colspan="8" style="text-align: center;"> <table border="1" style="width: 100%; border-collapse: collapse; text-align: center;"> <tr> <td style="width: 10%;"></td> <td style="width: 10%;"></td> <td style="width: 10%;"></td> <td style="width: 10%;"></td> <td style="width: 10%;"></td> <td style="width: 10%;"></td> <td style="width: 10%;"></td> <td style="width: 10%;"></td> <td style="width: 10%;"></td> <td style="width: 10%;"></td> </tr> <tr> <td></td> <td></td> <td colspan="8" style="text-align: center;"> <table border="1" style="width: 100%; border-collapse: collapse; text-align: center;"> <tr> <td style="width: 10%;"></td> <td style="width: 10%;"></td> <td style="width: 10%;"></td> <td style="width: 10%;"></td> <td style="width: 10%;"></td> <td style="width: 10%;"></td> <td style="width: 10%;"></td> <td style="width: 10%;"></td> <td style="width: 10%;"></td> <td style="width: 10%;"></td> </tr> <tr> <td></td> <td></td> <td colspan="8" style="text-align: center;"> <table border="1" style="width: 100%; border-collapse: collapse; text-align: center;"> <tr> <td style="width: 10%;"></td> <td style="width: 10%;"></td> <td style="width: 10%;"></td> <td style="width: 10%;"></td> <td style="width: 10%;"></td> <td style="width: 10%;"></td> <td style="width: 10%;"></td> <td style="width: 10%;"></td> <td style="width: 10%;"></td> <td style="width: 10%;"></td> </tr> <tr> <td></td> <td></td> <td colspan="8" style="text-align: center;"> <table border="1" style="width: 100%; border-collapse: collapse; text-align: center;"> <tr> <td style="width: 10%;"></td> <td style="width: 10%;"></td> <td style="width: 10%;"></td> <td style="width: 10%;"></td> <td style="width: 10%;"></td> <td style="width: 10%;"></td> <td style="width: 10%;"></td> <td style="width: 10%;"></td> <td style="width: 10%;"></td> <td style="width: 10%;"></td> </tr> <tr> <td></td> <td></td> <td colspan="8" style="text-align: center;"> <table border="1" style="width: 100%; border-collapse: collapse; text-align: center;"> <tr> <td style="width: 10%;"></td> <td style="width: 10%;"></td> <td style="width: 10%;"></td> <td style="width: 10%;"></td> <td style="width: 10%;"></td> <td style="width: 10%;"></td> <td style="width: 10%;"></td> <td style="width: 10%;"></td> <td style="width: 10%;"></td> <td style="width: 10%;"></td> </tr> <tr> <td></td> <td></td> <td colspan="8" style="text-align: center;"> <table border="1" style="width: 100%; border-collapse: collapse; text-align: center;"> <tr> <td style="width: 10%;"></td> <td style="width: 10%;"></td> <td style="width: 10%;"></td> <td style="width: 10%;"></td> <td style="width: 10%;"></td> <td style="width: 10%;"></td> <td style="width: 10%;"></td> <td style="width: 10%;"></td> <td style="width: 10%;"></td> <td style="width: 10%;"></td> </tr> <tr> <td></td> <td></td> <td colspan="8" style="text-align: center;"> <table border="1" style="width: 100%; border-collapse: collapse; text-align: center;"> <tr> <td style="width: 10%;"></td> <td style="width: 10%;"></td> <td style="width: 10%;"></td> <td style="width: 10%;"></td> <td style="width: 10%;"></td> <td style="width: 10%;"></td> <td style="width: 10%;"></td> <td style="width: 10%;"></td> <td style="width: 10%;"></td> <td style="width: 10%;"></td> </tr> <tr> <td></td> <td></td> <td colspan="8" style="text-align: center;"> <table border="1" style="width: 100%; border-collapse: collapse; text-align: center;"> <tr> <td style="width: 10%;"></td> <td style="width: 10%;"></td> <td style="width: 10%;"></td> <td style="width: 10%;"></td> <td style="width: 10%;"></td> <td style="width: 10%;"></td> <td style="width: 10%;"></td> <td style="width: 10%;"></td> <td style="width: 10%;"></td> <td style="width: 10%;"></td> </tr> <tr> <td></td> <td></td> <td colspan="8" style="text-align: center;"> <table border="1" style="width: 100%; border-collapse: collapse; text-align: center;"> <tr> <td style="width: 10%;"></td> <td style="width: 10%;"></td> <td style="width: 10%;"></td> <td style="width: 10%;"></td> <td style="width: 10%;"></td> <td style="width: 10%;"></td> <td style="width: 10%;"></td> <td style="width: 10%;"></td> <td style="width: 10%;"></td> <td style="width: 10%;"></td> </tr> <tr> <td></td> <td></td> <td colspan="8" style="text-align: center;"> <table border="1" style="width: 100%; border-collapse: collapse; text-align: center;"> <tr> <td style="width: 10%;"></td> <td style="width: 10%;"></td> <td style="width: 10%;"></td> <td style="width: 10%;"></td> <td style="width: 10%;"></td> <td style="width: 10%;"></td> <td style="width: 10%;"></td> <td style="width: 10%;"></td> <td style="width: 10%;"></td> <td style="width: 10%;"></td> </tr> <tr> <td></td> <td></td> <td colspan="8" style="text-align: center;"> <table border="1" style="width: 100%; border-collapse: collapse; text-align: center;"> <tr> <td style="width: 10%;"></td> <td style="width: 10%;"></td> <td style="width: 10%;"></td> <td style="width: 10%;"></td> <td style="width: 10%;"></td> <td style="width: 10%;"></td> <td style="width: 10%;"></td> <td style="width: 10%;"></td> <td style="width: 10%;"></td> <td style="width: 10%;"></td> </tr> <tr> <td></td> <td></td> <td colspan="8" style="text-align: center;"> <table border="1" style="width: 100%; border-collapse: collapse; text-align: center;"> <tr> <td style="width: 10%;"></td> <td style="width: 10%;"></td> <td style="width: 10%;"></td> <td style="width: 10%;"></td> <td style="width: 10%;"></td> <td style="width: 10%;"></td> <td style="width: 10%;"></td> <td style="width: 10%;"></td> <td style="width: 10%;"></td> <td style="width: 10%;"></td> </tr> <tr> <td></td> <td></td> <td colspan="8" style="text-align: center;"> <table border="1" style="width: 100%; border-collapse: collapse; text-align: center;"> <tr> <td style="width: 10%;"></td> <td style="width: 10%;"></td> <td
style="width: 10%;"></td> <td style="width: 10%;"></td> <td style="width: 10%;"></td> <td style="width: 10%;"></td> <td style="width: 10%;"></td> <td style="width: 10%;"></td> <td style="width: 10%;"></td> <td style="width: 10%;"></td> </tr> <tr> <td></td> <td></td> <td colspan="8" style="text-align: center;"> <table border="1" style="width: 100%; border-collapse: collapse; text-align: center;"> <tr> <td style="width: 10%;"></td> <td style="width: 10%;"></td> <td style="width: 10%;"></td> <td style="width: 10%;"></td> <td style="width: 10%;"></td> <td style="width: 10%;"></td> <td style="width: 10%;"></td> <td style="width: 10%;"></td> <td style="width: 10%;"></td> <td style="width: 10%;"></td> </tr> <tr> <td></td> <td></td> <td colspan="8" style="text-align: center;"> <table border="1" style="width: 100%; border-collapse: collapse; text-align: center;"> <tr> <td style="width: 10%;"></td> <td style="width: 10%;"></td> <td style="width: 10%;"></td> <td style="width: 10%;"></td> <td style="width: 10%;"></td> <td style="width: 10%;"></td> <td style="width: 10%;"></td> <td style="width: 10%;"></td> <td style="width: 10%;"></td> <td style="width: 10%;"></td> </tr> <tr> <td></td> <td></td> <td colspan="8" style="text-align: center;"> <table border="1" style="width: 100%; border-collapse: collapse; text-align: center;"> <tr> <td style="width: 10%;"></td> <td style="width: 10%;"></td> <td style="width: 10%;"></td> <td style="width: 10%;"></td> <td style="width: 10%;"></td> <td style="width: 10%;"></td> <td style="width: 10%;"></td> <td style="width: 10%;"></td> <td style="width: 10%;"></td> <td style="width: 10%;"></td> </tr> <tr> <td></td> <td></td> <td colspan="8" style="text-align: center;"> <table border="1" style="width: 100%; border-collapse: collapse; text-align: center;"> <tr> <td style="width: 10%;"></td> <td style="width: 10%;"></td> <td style="width: 10%;"></td> <td style="width: 10%;"></td> <td style="width: 10%;"></td> <td style="width: 10%;"></td> <td style="width: 10%;"></td> <td style="width: 10%;"></td> <td style="width: 10%;"></td> <td style="width: 10%;"></td> </tr> <tr> <td></td> <td></td> <td colspan="8" style="text-align: center;"> <table border="1" style="width: 100%; border-collapse: collapse; text-align: center;"> <tr> <td style="width: 10%;"></td> <td style="width: 10%;"></td> <td style="width: 10%;"></td> <td style="width: 10%;"></td> <td style="width: 10%;"></td> <td style="width: 10%;"></td> <td style="width: 10%;"></td> <td style="width: 10%;"></td> <td style="width: 10%;"></td> <td style="width: 10%;"></td> </tr> <tr> <td></td> <td></td> <td colspan="8" style="text-align: center;"> <table border="1" style="width: 100%; border-collapse: collapse; text-align: center;"> <tr> <td style="width: 10%;"></td> <td style="width: 10%;"></td> <td style="width: 10%;"></td> <td style="width: 10%;"></td> <td style="width: 10%;"></td> <td style="width: 10%;"></td> <td style="width: 10%;"></td> <td style="width: 10%;"></td> <td style="width: 10%;"></td> <td style="width: 10%;"></td> </tr> <tr> <td></td> <td></td> <td colspan="8" style="text-align: center;"> <table border="1" style="width: 100%; border-collapse: collapse; text-align: center;"> <tr> <td style="width: 10%;"></td> <td style="width: 10%;"></td> <td style="width: 10%;"></td> <td style="width: 10%;"></td> <td style="width: 10%;"></td> <td style="width: 10%;"></td> <td style="width: 10%;"></td> <td style="width: 10%;"></td> <td style="width: 10%;"></td> <td style="width: 10%;"></td> </tr> <tr> <td></td> <td></td> <td colspan="8" style="text-align: center;"> <table border="1" style="width: 100%; border-collapse: collapse; text-align: center;"> <tr> <td style="width: 10%;"></td> <td style="width: 10%;"></td> <td style="width: 10%;"></td> <td style="width: 10%;"></td> <td style="width: 10%;"></td> <td style="width: 10%;"></td> <td style="width: 10%;"></td> <td style="width: 10%;"></td> <td style="width: 10%;"></td> <td style="width: 10%;"></td> </tr> <tr> <td></td> <td></td> <td colspan="8" style="text-align: center;"> <table border="1" style="width: 100%; border-collapse: collapse; text-align: center;"> <tr> <td style="width: 10%;"></td> <td style="width: 10%;"></td> <td style="width: 10%;"></td> <td style="width: 10%;"></td> <td style="width: 10%;"></td> <td style="width: 10%;"></td> <td style="width: 10%;"></td> <td style="width: 10%;"></td> <td style="width: 10%;"></td> <td style="width: 10%;"></td> </tr> <tr> <td></td> <td></td> <td colspan="8" style="text-align: center;"> <table border="1" style="width: 100%; border-collapse: collapse; text-align: center;"> <tr> <td style="width: 10%;"></td> <td style="width: 10%;"></td> <td style="width: 10%;"></td> <td style="width: 10%;"></td> <td style="width: 10%;"></td> <td style="width: 10%;"></td> <td style="width: 10%;"></td> <td style="width: 10%;"></td> <td style="width: 10%;"></td> <td style="width: 10%;"></td> </tr> <tr> <td></td> <td></td> <td colspan="8" style="text-align: center;"> <table border="1" style="width: 100%; border-collapse: collapse; text-align: center;"> <tr> <td style="width: 10%;"></td> <td style="width: 10%;"></td> <td style="width: 10%;"></td> <td style="width: 10%;"></td> <td style="width: 10%;"></td> <td style="width: 10%;"></td> <td style="width: 10%;"></td> <td style="width: 10%;"></td> <td style="width: 10%;"></td> <td style="width: 10%;"></td> </tr> <tr> <td></td> <td></td> <td colspan="8" style="text-align: center;"> <table border="1" style="width: 100%; border-collapse: collapse; text-align: center;"> <tr> <td style="width: 10%;"></td> <td style="width: 10%;"></td> <td style="width: 10%;"></td> <td style="width: 10%;"></td> <td style="width: 10%;"></td> <td style="width: 10%;"></td> <td style="width: 10%;"></td> <td style="width: 10%;"></td> <td style="width: 10%;"></td> <td style="width: 10%;"></td> </tr> <tr> <td></td> <td></td> <td colspan="8" style="text-align: center;"> <table border="1" style="width: 100%; border-collapse: collapse; text-align: center;"> <tr> <td style="width: 10%;"></td> <td style="width: 10%;"></td> <td style="width: 10%;"></td> <td style="width: 10%;"></td> <td style="width: 10%;"></td> <td style="width: 10%;"></td> <td style="width: 10%;"></td> <td style="width: 10%;"></td> <td style="width: 10%;"></td> <td style="width: 10%;"></td> </tr> <tr> <td></td> <td></td> <td colspan="8" style="text-align: center;"> <table border="1" style="width: 100%; border-collapse: collapse; text-align: center;"> <tr> <td style="width: 10%;"></td> <td style="width: 10%;"></td> <td style="width: 10%;"></td> <td style="width: 10%;"></td> <td style="width: 10%;"></td> <td style="width: 10%;"></td> <td style="width: 10%;"></td> <td style="width: 10%;"></td> <td style="width: 10%;"></td> <td style="width: 10%;"></td> </tr> <tr> <td></td> <td></td> <td colspan="8" style="text-align: center;"> <table border="1" style="width: 100%; border-collapse: collapse; text-align: center;"> <tr> <td style="width: 10%;"></td> <td style="width: 10%;"></td> <td style="width: 10%;"></td> <td style="width: 10%;"></td> <td style="width: 10%;"></td> <td style="width: 10%;"></td> <td style="width: 10%;"></td> <td style="width: 10%;"></td> <td style="width: 10%;"></td> <td style="width: 10%;"></td> </tr> <tr> <td></td> <td></td> <td colspan="8" style="text-align: center;"> <table border="1" style="width: 100%; border-collapse: collapse; text-align: center;"> <tr> <td style="width: 10%;"></td> <td style="width: 10%;"></td> <td style="width: 10%;"></td> <td style="width: 10%;"></td> <td style="width: 10%;"></td> <td style="width: 10%;"></td> <td style="width: 10%;"></td> <td style="width: 10%;"></td> <td style="width: 10%;"></td> <td style="width: 10%;"></td> </tr> <tr> <td></td> <td></td> <td colspan="8" style="text-align: center;"> <table border="1" style="width: 100%; border-collapse: collapse; text-align: center;"> <tr> <td style="width: 10%;"></td> <td style="width: 10%;"></td> <td style="width: 10%;"></td> <td style="width: 10%;"></td> <td style="width: 10%;"></td> <td style="width: 10%;"></td> <td style="width: 10%;"></td> <td style="width: 10%;"></td> <td style="width: 10%;"></td> <td style="width: 10%;"></td> </tr> <tr> <td></td> <td></td> <td colspan="8" style="text-align: center;"> <table border="1" style="width: 100%; border-collapse: collapse; text-align: center;"> <tr> </tr></table></td></tr></table></td></tr></table></td></tr></table></td></tr></table></td></tr></table></td></tr></table></td></tr></table></td></tr></table></td></tr></table></td></tr></table></td></tr></table></td></tr></table></td></tr></table></td></tr></table></td></tr></table></td></tr></table></td></tr></table></td></tr></table></td></tr></table></td></tr></table></td></tr></table></td></tr></table></td></tr></table></td></tr></table></td></tr></table></td></tr></table></td></tr></table></td></tr></table></td></tr></table></td></tr></table></td></tr></table></td></tr></table></td></tr></table></td></tr></table></td></tr></table></td></tr></table></td></tr></table></td></tr></table></td></tr></table>

 | | | | | | | | | | | | | | | | | | | | <table border="1" style="width: 100%; border-collapse: collapse; text-align: center;"> <tr> <td style="width: 10%;"></td> <td style="width: 10%;"></td> <td style="width: 10%;"></td> <td style="width: 10%;"></td> <td style="width: 10%;"></td> <td style="width: 10%;"></td> <td style="width: 10%;"></td> <td style="width: 10%;"></td> <td style="width: 10%;"></td> <td style="width: 10%;"></td> </tr> <tr> <td></td> <td></td> <td colspan="8" style="text-align: center;"> <table border="1" style="width: 100%; border-collapse: collapse; text-align: center;"> <tr> <td style="width: 10%;"></td> <td style="width: 10%;"></td> <td style="width: 10%;"></td> <td style="width: 10%;"></td> <td style="width: 10%;"></td> <td style="width: 10%;"></td> <td style="width: 10%;"></td> <td style="width: 10%;"></td> <td style="width: 10%;"></td> <td style="width: 10%;"></td> </tr> <tr> <td></td> <td></td> <td colspan="8" style="text-align: center;"> <table border="1" style="width: 100%; border-collapse: collapse; text-align: center;"> <tr> <td style="width: 10%;"></td> <td style="width: 10%;"></td> <td style="width: 10%;"></td> <td style="width: 10%;"></td> <td style="width: 10%;"></td> <td style="width: 10%;"></td> <td style="width: 10%;"></td> <td style="width: 10%;"></td> <td style="width: 10%;"></td> <td style="width: 10%;"></td> </tr> <tr> <td></td> <td></td> <td colspan="8" style="text-align: center;"> <table border="1" style="width: 100%; border-collapse: collapse; text-align: center;"> <tr> <td style="width: 10%;"></td> <td style="width: 10%;"></td> <td style="width: 10%;"></td> <td style="width: 10%;"></td> <td style="width: 10%;"></td> <td style="width: 10%;"></td> <td style="width: 10%;"></td> <td style="width: 10%;"></td> <td style="width: 10%;"></td> <td style="width: 10%;"></td> </tr> <tr> <td></td> <td></td> <td colspan="8" style="text-align: center;"> <table border="1" style="width: 100%; border-collapse: collapse; text-align: center;"> <tr> <td style="width: 10%;"></td> <td style="width: 10%;"></td> <td style="width: 10%;"></td> <td style="width: 10%;"></td> <td style="width: 10%;"></td> <td style="width: 10%;"></td> <td style="width: 10%;"></td> <td style="width: 10%;"></td> <td style="width: 10%;"></td> <td style="width: 10%;"></td> </tr> <tr> <td></td> <td></td> <td colspan="8" style="text-align: center;"> <table border="1" style="width: 100%; border-collapse: collapse; text-align: center;"> <tr> <td style="width: 10%;"></td> <td style="width: 10%;"></td> <td style="width: 10%;"></td> <td style="width: 10%;"></td> <td style="width: 10%;"></td> <td style="width: 10%;"></td> <td style="width: 10%;"></td> <td style="width: 10%;"></td> <td style="width: 10%;"></td> <td style="width: 10%;"></td> </tr> <tr> <td></td> <td></td> <td colspan="8" style="text-align: center;"> <table border="1" style="width: 100%; border-collapse: collapse; text-align: center;"> <tr> <td style="width: 10%;"></td> <td style="width: 10%;"></td> <td style="width: 10%;"></td> <td style="width: 10%;"></td> <td style="width: 10%;"></td> <td style="width: 10%;"></td> <td style="width: 10%;"></td> <td style="width: 10%;"></td> <td style="width: 10%;"></td> <td style="width: 10%;"></td> </tr> <tr> <td></td> <td></td> <td colspan="8" style="text-align: center;"> <table border="1" style="width: 100%; border-collapse: collapse; text-align: center;"> <tr> <td style="width: 10%;"></td> <td style="width: 10%;"></td> <td style="width: 10%;"></td> <td style="width: 10%;"></td> <td style="width: 10%;"></td> <td style="width: 10%;"></td> <td style="width: 10%;"></td> <td style="width: 10%;"></td> <td style="width: 10%;"></td> <td style="width: 10%;"></td> </tr> <tr> <td></td> <td></td> <td colspan="8" style="text-align: center;"> <table border="1" style="width: 100%; border-collapse: collapse; text-align: center;"> <tr> <td style="width: 10%;"></td> <td style="width: 10%;"></td> <td style="width: 10%;"></td> <td style="width: 10%;"></td> <td style="width: 10%;"></td> <td style="width: 10%;"></td> <td style="width: 10%;"></td> <td style="width: 10%;"></td> <td style="width: 10%;"></td> <td style="width: 10%;"></td> </tr> <tr> <td></td> <td></td> <td colspan="8" style="text-align: center;"> <table border="1" style="width: 100%; border-collapse: collapse; text-align: center;"> <tr> <td style="width: 10%;"></td> <td style="width: 10%;"></td> <td style="width: 10%;"></td> <td style="width: 10%;"></td> <td style="width: 10%;"></td> <td style="width: 10%;"></td> <td style="width: 10%;"></td> <td style="width: 10%;"></td> <td style="width: 10%;"></td> <td style="width: 10%;"></td> </tr> <tr> <td></td> <td></td> <td colspan="8" style="text-align: center;"> <table border="1" style="width: 100%; border-collapse: collapse; text-align: center;"> <tr> <td style="width: 10%;"></td> <td style="width: 10%;"></td> <td style="width: 10%;"></td> <td style="width: 10%;"></td> <td style="width: 10%;"></td> <td style="width: 10%;"></td> <td style="width: 10%;"></td> <td style="width: 10%;"></td> <td style="width: 10%;"></td> <td style="width: 10%;"></td> </tr> <tr> <td></td> <td></td> <td colspan="8" style="text-align: center;"> <table border="1" style="width: 100%; border-collapse: collapse; text-align: center;"> <tr> <td style="width: 10%;"></td> <td style="width: 10%;"></td> <td style="width: 10%;"></td> <td style="width: 10%;"></td> <td style="width: 10%;"></td> <td style="width: 10%;"></td> <td style="width: 10%;"></td> <td style="width: 10%;"></td> <td style="width: 10%;"></td> <td style="width: 10%;"></td> </tr> <tr> <td></td> <td></td> <td colspan="8" style="text-align: center;"> <table border="1" style="width: 100%; border-collapse: collapse; text-align: center;"> <tr> <td style="width: 10%;"></td> <td style="width: 10%;"></td> <td style="width: 10%;"></td> <td style="width: 10%;"></td> <td style="width: 10%;"></td> <td style="width: 10%;"></td> <td style="width: 10%;"></td> <td style="width: 10%;"></td> <td style="width: 10%;"></td> <td style="width: 10%;"></td> </tr> <tr> <td></td> <td></td> <td colspan="8" style="text-align: center;"> <table border="1" style="width: 100%; border-collapse: collapse; text-align: center;"> <tr> <td style="width: 10%;"></td> <td style="width: 10%;"></td> <td style="width: 10%;"></td> <td style="width: 10%;"></td> <td style="width: 10%;"></td> <td style="width: 10%;"></td> <td style="width: 10%;"></td> <td style="width: 10%;"></td> <td style="width: 10%;"></td> <td style="width: 10%;"></td> </tr> <tr> <td></td> <td></td> <td colspan="8" style="text-align: center;"> <table border="1" style="width: 100%; border-collapse: collapse; text-align: center;"> <tr> <td style="width: 10%;"></td> <td style="width: 10%;"></td> <td style="width: 10%;"></td> <td style="width: 10%;"></td> <td style="width: 10%;"></td> <td style="width: 10%;"></td> <td style="width: 10%;"></td> <td style="width: 10%;"></td> <td style="width: 10%;"></td> <td style="width: 10%;"></td> </tr> <tr> <td></td> <td></td> <td colspan="8" style="text-align: center;"> <table border="1" style="width: 100%; border-collapse: collapse; text-align: center;"> <tr> <td style="width: 10%;"></td> <td style="width: 10%;"></td> <td style="width: 10%;"></td> <td style="width: 10%;"></td> <td style="width: 10%;"></td> <td style="width: 10%;"></td> <td style="width: 10%;"></td> <td style="width: 10%;"></td> <td style="width: 10%;"></td> <td style="width: 10%;"></td> </tr> <tr> <td></td> <td></td> <td colspan="8" style="text-align: center;"> <table border="1" style="width: 100%; border-collapse: collapse; text-align: center;"> <tr> <td style="width: 10%;"></td> <td style="width: 10%;"></td> <td style="width: 10%;"></td> <td style="width: 10%;"></td> <td style="width: 10%;"></td> <td style="width: 10%;"></td> <td style="width: 10%;"></td> <td style="width: 10%;"></td> <td style="width: 10%;"></td> <td style="width: 10%;"></td> </tr> <tr> <td></td> <td></td> <td colspan="8" style="text-align: center;"> <table border="1" style="width: 100%; border-collapse: collapse; text-align: center;"> <tr> <td style="width: 10%;"></td> <td style="width: 10%;"></td> <td style="width: 10%;"></td> <td style="width: 10%;"></td> <td style="width: 10%;"></td> <td style="width: 10%;"></td> <td style="width: 10%;"></td> <td style="width: 10%;"></td> <td style="width: 10%;"></td> <td style="width: 10%;"></td> </tr> <tr> <td></td> <td></td> <td colspan="8" style="text-align: center;"> <table border="1" style="width: 100%; border-collapse: collapse; text-align: center;"> <tr> <td style="width: 10%;"></td> <td style="width: 10%;"></td> <td style="width: 10%;"></td> <td style="width: 10%;"></td> <td style="width: 10%;"></td> <td style="width: 10%;"></td> <td
style="width: 10%;"></td> <td style="width: 10%;"></td> <td style="width: 10%;"></td> <td style="width: 10%;"></td> </tr> <tr> <td></td> <td></td> <td colspan="8" style="text-align: center;"> <table border="1" style="width: 100%; border-collapse: collapse; text-align: center;"> <tr> <td style="width: 10%;"></td> <td style="width: 10%;"></td> <td style="width: 10%;"></td> <td style="width: 10%;"></td> <td style="width: 10%;"></td> <td style="width: 10%;"></td> <td style="width: 10%;"></td> <td style="width: 10%;"></td> <td style="width: 10%;"></td> <td style="width: 10%;"></td> </tr> <tr> <td></td> <td></td> <td colspan="8" style="text-align: center;"> <table border="1" style="width: 100%; border-collapse: collapse; text-align: center;"> <tr> <td style="width: 10%;"></td> <td style="width: 10%;"></td> <td style="width: 10%;"></td> <td style="width: 10%;"></td> <td style="width: 10%;"></td> <td style="width: 10%;"></td> <td style="width: 10%;"></td> <td style="width: 10%;"></td> <td style="width: 10%;"></td> <td style="width: 10%;"></td> </tr> <tr> <td></td> <td></td> <td colspan="8" style="text-align: center;"> <table border="1" style="width: 100%; border-collapse: collapse; text-align: center;"> <tr> <td style="width: 10%;"></td> <td style="width: 10%;"></td> <td style="width: 10%;"></td> <td style="width: 10%;"></td> <td style="width: 10%;"></td> <td style="width: 10%;"></td> <td style="width: 10%;"></td> <td style="width: 10%;"></td> <td style="width: 10%;"></td> <td style="width: 10%;"></td> </tr> <tr> <td></td> <td></td> <td colspan="8" style="text-align: center;"> <table border="1" style="width: 100%; border-collapse: collapse; text-align: center;"> <tr> <td style="width: 10%;"></td> <td style="width: 10%;"></td> <td style="width: 10%;"></td> <td style="width: 10%;"></td> <td style="width: 10%;"></td> <td style="width: 10%;"></td> <td style="width: 10%;"></td> <td style="width: 10%;"></td> <td style="width: 10%;"></td> <td style="width: 10%;"></td> </tr> <tr> <td></td> <td></td> <td colspan="8" style="text-align: center;"> <table border="1" style="width: 100%; border-collapse: collapse; text-align: center;"> <tr> <td style="width: 10%;"></td> <td style="width: 10%;"></td> <td style="width: 10%;"></td> <td style="width: 10%;"></td> <td style="width: 10%;"></td> <td style="width: 10%;"></td> <td style="width: 10%;"></td> <td style="width: 10%;"></td> <td style="width: 10%;"></td> <td style="width: 10%;"></td> </tr> <tr> <td></td> <td></td> <td colspan="8" style="text-align: center;"> <table border="1" style="width: 100%; border-collapse: collapse; text-align: center;"> <tr> <td style="width: 10%;"></td> <td style="width: 10%;"></td> <td style="width: 10%;"></td> <td style="width: 10%;"></td> <td style="width: 10%;"></td> <td style="width: 10%;"></td> <td style="width: 10%;"></td> <td style="width: 10%;"></td> <td style="width: 10%;"></td> <td style="width: 10%;"></td> </tr> <tr> <td></td> <td></td> <td colspan="8" style="text-align: center;"> <table border="1" style="width: 100%; border-collapse: collapse; text-align: center;"> <tr> <td style="width: 10%;"></td> <td style="width: 10%;"></td> <td style="width: 10%;"></td> <td style="width: 10%;"></td> <td style="width: 10%;"></td> <td style="width: 10%;"></td> <td style="width: 10%;"></td> <td style="width: 10%;"></td> <td style="width: 10%;"></td> <td style="width: 10%;"></td> </tr> <tr> <td></td> <td></td> <td colspan="8" style="text-align: center;"> <table border="1" style="width: 100%; border-collapse: collapse; text-align: center;"> <tr> <td style="width: 10%;"></td> <td style="width: 10%;"></td> <td style="width: 10%;"></td> <td style="width: 10%;"></td> <td style="width: 10%;"></td> <td style="width: 10%;"></td> <td style="width: 10%;"></td> <td style="width: 10%;"></td> <td style="width: 10%;"></td> <td style="width: 10%;"></td> </tr> <tr> <td></td> <td></td> <td colspan="8" style="text-align: center;"> <table border="1" style="width: 100%; border-collapse: collapse; text-align: center;"> <tr> <td style="width: 10%;"></td> <td style="width: 10%;"></td> <td style="width: 10%;"></td> <td style="width: 10%;"></td> <td style="width: 10%;"></td> <td style="width: 10%;"></td> <td style="width: 10%;"></td> <td style="width: 10%;"></td> <td style="width: 10%;"></td> <td style="width: 10%;"></td> </tr> <tr> <td></td> <td></td> <td colspan="8" style="text-align: center;"> <table border="1" style="width: 100%; border-collapse: collapse; text-align: center;"> <tr> <td style="width: 10%;"></td> <td style="width: 10%;"></td> <td style="width: 10%;"></td> <td style="width: 10%;"></td> <td style="width: 10%;"></td> <td style="width: 10%;"></td> <td style="width: 10%;"></td> <td style="width: 10%;"></td> <td style="width: 10%;"></td> <td style="width: 10%;"></td> </tr> <tr> <td></td> <td></td> <td colspan="8" style="text-align: center;"> <table border="1" style="width: 100%; border-collapse: collapse; text-align: center;"> <tr> <td style="width: 10%;"></td> <td style="width: 10%;"></td> <td style="width: 10%;"></td> <td style="width: 10%;"></td> <td style="width: 10%;"></td> <td style="width: 10%;"></td> <td style="width: 10%;"></td> <td style="width: 10%;"></td> <td style="width: 10%;"></td> <td style="width: 10%;"></td> </tr> <tr> <td></td> <td></td> <td colspan="8" style="text-align: center;"> <table border="1" style="width: 100%; border-collapse: collapse; text-align: center;"> <tr> <td style="width: 10%;"></td> <td style="width: 10%;"></td> <td style="width: 10%;"></td> <td style="width: 10%;"></td> <td style="width: 10%;"></td> <td style="width: 10%;"></td> <td style="width: 10%;"></td> <td style="width: 10%;"></td> <td style="width: 10%;"></td> <td style="width: 10%;"></td> </tr> <tr> <td></td> <td></td> <td colspan="8" style="text-align: center;"> <table border="1" style="width: 100%; border-collapse: collapse; text-align: center;"> <tr> <td style="width: 10%;"></td> <td style="width: 10%;"></td> <td style="width: 10%;"></td> <td style="width: 10%;"></td> <td style="width: 10%;"></td> <td style="width: 10%;"></td> <td style="width: 10%;"></td> <td style="width: 10%;"></td> <td style="width: 10%;"></td> <td style="width: 10%;"></td> </tr> <tr> <td></td> <td></td> <td colspan="8" style="text-align: center;"> <table border="1" style="width: 100%; border-collapse: collapse; text-align: center;"> <tr> <td style="width: 10%;"></td> <td style="width: 10%;"></td> <td style="width: 10%;"></td> <td style="width: 10%;"></td> <td style="width: 10%;"></td> <td style="width: 10%;"></td> <td style="width: 10%;"></td> <td style="width: 10%;"></td> <td style="width: 10%;"></td> <td style="width: 10%;"></td> </tr> <tr> <td></td> <td></td> <td colspan="8" style="text-align: center;"> <table border="1" style="width: 100%; border-collapse: collapse; text-align: center;"> <tr> <td style="width: 10%;"></td> <td style="width: 10%;"></td> <td style="width: 10%;"></td> <td style="width: 10%;"></td> <td style="width: 10%;"></td> <td style="width: 10%;"></td> <td style="width: 10%;"></td> <td style="width: 10%;"></td> <td style="width: 10%;"></td> <td style="width: 10%;"></td> </tr> <tr> <td></td> <td></td> <td colspan="8" style="text-align: center;"> <table border="1" style="width: 100%; border-collapse: collapse; text-align: center;"> <tr> <td style="width: 10%;"></td> <td style="width: 10%;"></td> <td style="width: 10%;"></td> <td style="width: 10%;"></td> <td style="width: 10%;"></td> <td style="width: 10%;"></td> <td style="width: 10%;"></td> <td style="width: 10%;"></td> <td style="width: 10%;"></td> <td style="width: 10%;"></td> </tr> <tr> <td></td> <td></td> <td colspan="8" style="text-align: center;"> <table border="1" style="width: 100%; border-collapse: collapse; text-align: center;"> <tr> <td style="width: 10%;"></td> <td style="width: 10%;"></td> <td style="width: 10%;"></td> <td style="width: 10%;"></td> <td style="width: 10%;"></td> <td style="width: 10%;"></td> <td style="width: 10%;"></td> <td style="width: 10%;"></td> <td style="width: 10%;"></td> <td style="width: 10%;"></td> </tr> <tr> <td></td> <td></td> <td colspan="8" style="text-align: center;"> <table border="1" style="width: 100%; border-collapse: collapse; text-align: center;"> <tr> <td style="width: 10%;"></td> <td style="width: 10%;"></td> <td style="width: 10%;"></td> <td style="width: 10%;"></td> <td style="width: 10%;"></td> <td style="width: 10%;"></td> <td style="width: 10%;"></td> <td style="width: 10%;"></td> <td style="width: 10%;"></td> <td style="width: 10%;"></td> </tr> <tr> <td></td> <td></td> <td colspan="8" style="text-align: center;"> <table border="1" style="width: 100%; border-collapse: collapse; text-align: center;"> <tr> <td style="width: 10%;"></td> <td style="width: 10%;"></td> <td style="width: 10%;"></td> <td style="width: 10%;"></td> <td style="width: 10%;"></td> <td style="width: 10%;"></td> <td style="width: 10%;"></td> <td style="width: 10%;"></td> <td style="width: 10%;"></td> <td style="width: 10%;"></td> </tr> <tr> <td></td> <td></td> <td colspan="8" style="text-align: center;"> <table border="1" style="width: 100%; border-collapse: collapse; text-align: center;"> <tr> </tr></table></td></tr></table></td></tr></table></td></tr></table></td></tr></table></td></tr></table></td></tr></table></td></tr></table></td></tr></table></td></tr></table></td></tr></table></td></tr></table></td></tr></table></td></tr></table></td></tr></table></td></tr></table></td></tr></table></td></tr></table></td></tr></table></td></tr></table></td></tr></table></td></tr></table></td></tr></table></td></tr></table></td></tr></table></td></tr></table></td></tr></table></td></tr></table></td></tr></table></td></tr></table></td></tr></table></td></tr></table></td></tr></table></td></tr></table></td></tr></table></td></tr></table></td></tr></table></td></tr></table></td></tr></table>

 | | | | | | | | | | | | | | | | | | | | <table border="1" style="width: 100%; border-collapse: collapse; text-align: center;"> <tr> <td style="width: 10%;"></td> <td style="width: 10%;"></td> <td style="width: 10%;"></td> <td style="width: 10%;"></td> <td style="width: 10%;"></td> <td style="width: 10%;"></td> <td style="width: 10%;"></td> <td style="width: 10%;"></td> <td style="width: 10%;"></td> <td style="width: 10%;"></td> </tr> <tr> <td></td> <td></td> <td colspan="8" style="text-align: center;"> <table border="1" style="width: 100%; border-collapse: collapse; text-align: center;"> <tr> <td style="width: 10%;"></td> <td style="width: 10%;"></td> <td style="width: 10%;"></td> <td style="width: 10%;"></td> <td style="width: 10%;"></td> <td style="width: 10%;"></td> <td style="width: 10%;"></td> <td style="width: 10%;"></td> <td style="width: 10%;"></td> <td style="width: 10%;"></td> </tr> <tr> <td></td> <td></td> <td colspan="8" style="text-align: center;"> <table border="1" style="width: 100%; border-collapse: collapse; text-align: center;"> <tr> <td style="width: 10%;"></td> <td style="width: 10%;"></td> <td style="width: 10%;"></td> <td style="width: 10%;"></td> <td style="width: 10%;"></td> <td style="width: 10%;"></td> <td style="width: 10%;"></td> <td style="width: 10%;"></td> <td style="width: 10%;"></td> <td style="width: 10%;"></td> </tr> <tr> <td></td> <td></td> <td colspan="8" style="text-align: center;"> <table border="1" style="width: 100%; border-collapse: collapse; text-align: center;"> <tr> <td style="width: 10%;"></td> <td style="width: 10%;"></td> <td style="width: 10%;"></td> <td style="width: 10%;"></td> <td style="width: 10%;"></td> <td style="width: 10%;"></td> <td style="width: 10%;"></td> <td style="width: 10%;"></td> <td style="width: 10%;"></td> <td style="width: 10%;"></td> </tr> <tr> <td></td> <td></td> <td colspan="8" style="text-align: center;"> <table border="1" style="width: 100%; border-collapse: collapse; text-align: center;"> <tr> <td style="width: 10%;"></td> <td style="width: 10%;"></td> <td style="width: 10%;"></td> <td style="width: 10%;"></td> <td style="width: 10%;"></td> <td style="width: 10%;"></td> <td style="width: 10%;"></td> <td style="width: 10%;"></td> <td style="width: 10%;"></td> <td style="width: 10%;"></td> </tr> <tr> <td></td> <td></td> <td colspan="8" style="text-align: center;"> <table border="1" style="width: 100%; border-collapse: collapse; text-align: center;"> <tr> <td style="width: 10%;"></td> <td style="width: 10%;"></td> <td style="width: 10%;"></td> <td style="width: 10%;"></td> <td style="width: 10%;"></td> <td style="width: 10%;"></td> <td style="width: 10%;"></td> <td style="width: 10%;"></td> <td style="width: 10%;"></td> <td style="width: 10%;"></td> </tr> <tr> <td></td> <td></td> <td colspan="8" style="text-align: center;"> <table border="1" style="width: 100%; border-collapse: collapse; text-align: center;"> <tr> <td style="width: 10%;"></td> <td style="width: 10%;"></td> <td style="width: 10%;"></td> <td style="width: 10%;"></td> <td style="width: 10%;"></td> <td style="width: 10%;"></td> <td style="width: 10%;"></td> <td style="width: 10%;"></td> <td style="width: 10%;"></td> <td style="width: 10%;"></td> </tr> <tr> <td></td> <td></td> <td colspan="8" style="text-align: center;"> <table border="1" style="width: 100%; border-collapse: collapse; text-align: center;"> <tr> <td style="width: 10%;"></td> <td style="width: 10%;"></td> <td style="width: 10%;"></td> <td style="width: 10%;"></td> <td style="width: 10%;"></td> <td style="width: 10%;"></td> <td style="width: 10%;"></td> <td style="width: 10%;"></td> <td style="width: 10%;"></td> <td style="width: 10%;"></td> </tr> <tr> <td></td> <td></td> <td colspan="8" style="text-align: center;"> <table border="1" style="width: 100%; border-collapse: collapse; text-align: center;"> <tr> <td style="width: 10%;"></td> <td style="width: 10%;"></td> <td style="width: 10%;"></td> <td style="width: 10%;"></td> <td style="width: 10%;"></td> <td style="width: 10%;"></td> <td style="width: 10%;"></td> <td style="width: 10%;"></td> <td style="width: 10%;"></td> <td style="width: 10%;"></td> </tr> <tr> <td></td> <td></td> <td colspan="8" style="text-align: center;"> <table border="1" style="width: 100%; border-collapse: collapse; text-align: center;"> <tr> <td style="width: 10%;"></td> <td style="width: 10%;"></td> <td style="width: 10%;"></td> <td style="width: 10%;"></td> <td style="width: 10%;"></td> <td style="width: 10%;"></td> <td style="width: 10%;"></td> <td style="width: 10%;"></td> <td style="width: 10%;"></td> <td style="width: 10%;"></td> </tr> <tr> <td></td> <td></td> <td colspan="8" style="text-align: center;"> <table border="1" style="width: 100%; border-collapse: collapse; text-align: center;"> <tr> <td style="width: 10%;"></td> <td style="width: 10%;"></td> <td style="width: 10%;"></td> <td style="width: 10%;"></td> <td style="width: 10%;"></td> <td style="width: 10%;"></td> <td style="width: 10%;"></td> <td style="width: 10%;"></td> <td style="width: 10%;"></td> <td style="width: 10%;"></td> </tr> <tr> <td></td> <td></td> <td colspan="8" style="text-align: center;"> <table border="1" style="width: 100%; border-collapse: collapse; text-align: center;"> <tr> <td style="width: 10%;"></td> <td style="width: 10%;"></td> <td style="width: 10%;"></td> <td style="width: 10%;"></td> <td style="width: 10%;"></td> <td style="width: 10%;"></td> <td style="width: 10%;"></td> <td style="width: 10%;"></td> <td style="width: 10%;"></td> <td style="width: 10%;"></td> </tr> <tr> <td></td> <td></td> <td colspan="8" style="text-align: center;"> <table border="1" style="width: 100%; border-collapse: collapse; text-align: center;"> <tr> <td style="width: 10%;"></td> <td style="width: 10%;"></td> <td style="width: 10%;"></td> <td style="width: 10%;"></td> <td style="width: 10%;"></td> <td style="width: 10%;"></td> <td style="width: 10%;"></td> <td style="width: 10%;"></td> <td style="width: 10%;"></td> <td style="width: 10%;"></td> </tr> <tr> <td></td> <td></td> <td colspan="8" style="text-align: center;"> <table border="1" style="width: 100%; border-collapse: collapse; text-align: center;"> <tr> <td style="width: 10%;"></td> <td style="width: 10%;"></td> <td style="width: 10%;"></td> <td style="width: 10%;"></td> <td style="width: 10%;"></td> <td style="width: 10%;"></td> <td style="width: 10%;"></td> <td style="width: 10%;"></td> <td style="width: 10%;"></td> <td style="width: 10%;"></td> </tr> <tr> <td></td> <td></td> <td colspan="8" style="text-align: center;"> <table border="1" style="width: 100%; border-collapse: collapse; text-align: center;"> <tr> <td style="width: 10%;"></td> <td style="width: 10%;"></td> <td style="width: 10%;"></td> <td style="width: 10%;"></td> <td style="width: 10%;"></td> <td style="width: 10%;"></td> <td style="width: 10%;"></td> <td style="width: 10%;"></td> <td style="width: 10%;"></td> <td style="width: 10%;"></td> </tr> <tr> <td></td> <td></td> <td colspan="8" style="text-align: center;"> <table border="1" style="width: 100%; border-collapse: collapse; text-align: center;"> <tr> <td style="width: 10%;"></td> <td style="width: 10%;"></td> <td style="width: 10%;"></td> <td style="width: 10%;"></td> <td style="width: 10%;"></td> <td style="width: 10%;"></td> <td style="width: 10%;"></td> <td style="width: 10%;"></td> <td style="width: 10%;"></td> <td style="width: 10%;"></td> </tr> <tr> <td></td> <td></td> <td colspan="8" style="text-align: center;"> <table border="1" style="width: 100%; border-collapse: collapse; text-align: center;"> <tr> <td style="width: 10%;"></td> <td style="width: 10%;"></td> <td style="width: 10%;"></td> <td style="width: 10%;"></td> <td style="width: 10%;"></td> <td style="width: 10%;"></td> <td style="width: 10%;"></td> <td style="width: 10%;"></td> <td style="width: 10%;"></td> <td style="width: 10%;"></td> </tr> <tr> <td></td> <td></td> <td
colspan="8" style="text-align: center;"> <table border="1" style="width: 100%; border-collapse: collapse; text-align: center;"> <tr> <td style="width: 10%;"></td> <td style="width: 10%;"></td> <td style="width: 10%;"></td> <td style="width: 10%;"></td> <td style="width: 10%;"></td> <td style="width: 10%;"></td> <td style="width: 10%;"></td> <td style="width: 10%;"></td> <td style="width: 10%;"></td> <td style="width: 10%;"></td> </tr> <tr> <td></td> <td></td> <td colspan="8" style="text-align: center;"> <table border="1" style="width: 100%; border-collapse: collapse; text-align: center;"> <tr> <td style="width: 10%;"></td> <td style="width: 10%;"></td> <td style="width: 10%;"></td> <td style="width: 10%;"></td> <td style="width: 10%;"></td> <td style="width: 10%;"></td> <td style="width: 10%;"></td> <td style="width: 10%;"></td> <td style="width: 10%;"></td> <td style="width: 10%;"></td> </tr> <tr> <td></td> <td></td> <td colspan="8" style="text-align: center;"> <table border="1" style="width: 100%; border-collapse: collapse; text-align: center;"> <tr> <td style="width: 10%;"></td> <td style="width: 10%;"></td> <td style="width: 10%;"></td> <td style="width: 10%;"></td> <td style="width: 10%;"></td> <td style="width: 10%;"></td> <td style="width: 10%;"></td> <td style="width: 10%;"></td> <td style="width: 10%;"></td> <td style="width: 10%;"></td> </tr> <tr> <td></td> <td></td> <td colspan="8" style="text-align: center;"> <table border="1" style="width: 100%; border-collapse: collapse; text-align: center;"> <tr> <td style="width: 10%;"></td> <td style="width: 10%;"></td> <td style="width: 10%;"></td> <td style="width: 10%;"></td> <td style="width: 10%;"></td> <td style="width: 10%;"></td> <td style="width: 10%;"></td> <td style="width: 10%;"></td> <td style="width: 10%;"></td> <td style="width: 10%;"></td> </tr> <tr> <td></td> <td></td> <td colspan="8" style="text-align: center;"> <table border="1" style="width: 100%; border-collapse: collapse; text-align: center;"> <tr> <td style="width: 10%;"></td> <td style="width: 10%;"></td> <td style="width: 10%;"></td> <td style="width: 10%;"></td> <td style="width: 10%;"></td> <td style="width: 10%;"></td> <td style="width: 10%;"></td> <td style="width: 10%;"></td> <td style="width: 10%;"></td> <td style="width: 10%;"></td> </tr> <tr> <td></td> <td></td> <td colspan="8" style="text-align: center;"> <table border="1" style="width: 100%; border-collapse: collapse; text-align: center;"> <tr> <td style="width: 10%;"></td> <td style="width: 10%;"></td> <td style="width: 10%;"></td> <td style="width: 10%;"></td> <td style="width: 10%;"></td> <td style="width: 10%;"></td> <td style="width: 10%;"></td> <td style="width: 10%;"></td> <td style="width: 10%;"></td> <td style="width: 10%;"></td> </tr> <tr> <td></td> <td></td> <td colspan="8" style="text-align: center;"> <table border="1" style="width: 100%; border-collapse: collapse; text-align: center;"> <tr> <td style="width: 10%;"></td> <td style="width: 10%;"></td> <td style="width: 10%;"></td> <td style="width: 10%;"></td> <td style="width: 10%;"></td> <td style="width: 10%;"></td> <td style="width: 10%;"></td> <td style="width: 10%;"></td> <td style="width: 10%;"></td> <td style="width: 10%;"></td> </tr> <tr> <td></td> <td></td> <td colspan="8" style="text-align: center;"> <table border="1" style="width: 100%; border-collapse: collapse; text-align: center;"> <tr> <td style="width: 10%;"></td> <td style="width: 10%;"></td> <td style="width: 10%;"></td> <td style="width: 10%;"></td> <td style="width: 10%;"></td> <td style="width: 10%;"></td> <td style="width: 10%;"></td> <td style="width: 10%;"></td> <td style="width: 10%;"></td> <td style="width: 10%;"></td> </tr> <tr> <td></td> <td></td> <td colspan="8" style="text-align: center;"> <table border="1" style="width: 100%; border-collapse: collapse; text-align: center;"> <tr> <td style="width: 10%;"></td> <td style="width: 10%;"></td> <td style="width: 10%;"></td> <td style="width: 10%;"></td> <td style="width: 10%;"></td> <td style="width: 10%;"></td> <td style="width: 10%;"></td> <td style="width: 10%;"></td> <td style="width: 10%;"></td> <td style="width: 10%;"></td> </tr> <tr> <td></td> <td></td> <td colspan="8" style="text-align: center;"> <table border="1" style="width: 100%; border-collapse: collapse; text-align: center;"> <tr> <td style="width: 10%;"></td> <td style="width: 10%;"></td> <td style="width: 10%;"></td> <td style="width: 10%;"></td> <td style="width: 10%;"></td> <td style="width: 10%;"></td> <td style="width: 10%;"></td> <td style="width: 10%;"></td> <td style="width: 10%;"></td> <td style="width: 10%;"></td> </tr> <tr> <td></td> <td></td> <td colspan="8" style="text-align: center;"> <table border="1" style="width: 100%; border-collapse: collapse; text-align: center;"> <tr> <td style="width: 10%;"></td> <td style="width: 10%;"></td> <td style="width: 10%;"></td> <td style="width: 10%;"></td> <td style="width: 10%;"></td> <td style="width: 10%;"></td> <td style="width: 10%;"></td> <td style="width: 10%;"></td> <td style="width: 10%;"></td> <td style="width: 10%;"></td> </tr> <tr> <td></td> <td></td> <td colspan="8" style="text-align: center;"> <table border="1" style="width: 100%; border-collapse: collapse; text-align: center;"> <tr> <td style="width: 10%;"></td> <td style="width: 10%;"></td> <td style="width: 10%;"></td> <td style="width: 10%;"></td> <td style="width: 10%;"></td> <td style="width: 10%;"></td> <td style="width: 10%;"></td> <td style="width: 10%;"></td> <td style="width: 10%;"></td> <td style="width: 10%;"></td> </tr> <tr> <td></td> <td></td> <td colspan="8" style="text-align: center;"> <table border="1" style="width: 100%; border-collapse: collapse; text-align: center;"> <tr> <td style="width: 10%;"></td> <td style="width: 10%;"></td> <td style="width: 10%;"></td> <td style="width: 10%;"></td> <td style="width: 10%;"></td> <td style="width: 10%;"></td> <td style="width: 10%;"></td> <td style="width: 10%;"></td> <td style="width: 10%;"></td> <td style="width: 10%;"></td> </tr> <tr> <td></td> <td></td> <td colspan="8" style="text-align: center;"> <table border="1" style="width: 100%; border-collapse: collapse; text-align: center;"> <tr> <td style="width: 10%;"></td> <td style="width: 10%;"></td> <td style="width: 10%;"></td> <td style="width: 10%;"></td> <td style="width: 10%;"></td> <td style="width: 10%;"></td> <td style="width: 10%;"></td> <td style="width: 10%;"></td> <td style="width: 10%;"></td> <td style="width: 10%;"></td> </tr> <tr> <td></td> <td></td> <td colspan="8" style="text-align: center;"> <table border="1" style="width: 100%; border-collapse: collapse; text-align: center;"> <tr> <td style="width: 10%;"></td> <td style="width: 10%;"></td> <td style="width: 10%;"></td> <td style="width: 10%;"></td> <td style="width: 10%;"></td> <td style="width: 10%;"></td> <td style="width: 10%;"></td> <td style="width: 10%;"></td> <td style="width: 10%;"></td> <td style="width: 10%;"></td> </tr> <tr> <td></td> <td></td> <td colspan="8" style="text-align: center;"> <table border="1" style="width: 100%; border-collapse: collapse; text-align: center;"> <tr> <td style="width: 10%;"></td> <td style="width: 10%;"></td> <td style="width: 10%;"></td> <td style="width: 10%;"></td> <td style="width: 10%;"></td> <td style="width: 10%;"></td> <td style="width: 10%;"></td> <td style="width: 10%;"></td> <td style="width: 10%;"></td> <td style="width: 10%;"></td> </tr> <tr> <td></td> <td></td> <td colspan="8" style="text-align: center;"> <table border="1" style="width: 100%; border-collapse: collapse; text-align: center;"> <tr> <td style="width: 10%;"></td> <td style="width: 10%;"></td> <td style="width: 10%;"></td> <td style="width: 10%;"></td> <td style="width: 10%;"></td> <td style="width: 10%;"></td> <td style="width: 10%;"></td> <td style="width: 10%;"></td> <td style="width: 10%;"></td> <td style="width: 10%;"></td> </tr> <tr> <td></td> <td></td> <td colspan="8" style="text-align: center;"> <table border="1" style="width: 100%; border-collapse: collapse; text-align: center;"> <tr> <td style="width: 10%;"></td> <td style="width: 10%;"></td> <td style="width: 10%;"></td> <td style="width: 10%;"></td> <td style="width: 10%;"></td> <td style="width: 10%;"></td> <td style="width: 10%;"></td> <td style="width: 10%;"></td> <td style="width: 10%;"></td> <td style="width: 10%;"></td> </tr> <tr> <td></td> <td></td> <td colspan="8" style="text-align: center;"> <table border="1" style="width: 100%; border-collapse: collapse; text-align: center;"> <tr> <td style="width: 10%;"></td> <td style="width: 10%;"></td> <td style="width: 10%;"></td> <td style="width: 10%;"></td> <td style="width: 10%;"></td> <td style="width: 10%;"></td> <td style="width: 10%;"></td> <td style="width: 10%;"></td> <td style="width: 10%;"></td> <td style="width: 10%;"></td> </tr> <tr> <td></td> <td></td> <td colspan="8" style="text-align: center;"> <table border="1" style="width: 100%; border-collapse: collapse; text-align: center;"> <tr> <td style="width: 10%;"></td> <td style="width: 10%;"></td> <td style="width: 10%;"></td> <td style="width: 10%;"></td> <td style="width: 10%;"></td> <td style="width: 10%;"></td> <td style="width: 10%;"></td> <td style="width: 10%;"></td> <td style="width: 10%;"></td> <td style="width: 10%;"></td> </tr> <tr> <td></td> <td></td> <td colspan="8" style="text-align: center;"> <table border="1" style="width: 100%; border-collapse: collapse; text-align: center;"> <tr>
</tr></table></td></tr></table></td></tr></table></td></tr></table></td></tr></table></td></tr></table></td></tr></table></td></tr></table></td></tr></table></td></tr></table></td></tr></table></td></tr></table></td></tr></table></td></tr></table></td></tr></table></td></tr></table></td></tr></table></td></tr></table></td></tr></table></td></tr></table></td></tr></table></td></tr></table></td></tr></table></td></tr></table></td></tr></table></td></tr></table></td></tr></table></td></tr></table></td></tr></table></td></tr></table></td></tr></table></td></tr></table></td></tr></table></td></tr></table></td></tr></table></td></tr></table></td></tr></table></td></tr></table>
 | | | | | | | | | | | | | | | | | | | | <table border="1" style="width: 100%; border-collapse: collapse; text-align: center;"> <tr> <td style="width: 10%;"></td> <td style="width: 10%;"></td> <td style="width: 10%;"></td> <td style="width: 10%;"></td> <td style="width: 10%;"></td> <td style="width: 10%;"></td> <td style="width: 10%;"></td> <td style="width: 10%;"></td> <td style="width: 10%;"></td> <td style="width: 10%;"></td> </tr> <tr> <td></td> <td></td> <td colspan="8" style="text-align: center;"> <table border="1" style="width: 100%; border-collapse: collapse; text-align: center;"> <tr> <td style="width: 10%;"></td> <td style="width: 10%;"></td> <td style="width: 10%;"></td> <td style="width: 10%;"></td> <td style="width: 10%;"></td> <td style="width: 10%;"></td> <td style="width: 10%;"></td> <td style="width: 10%;"></td> <td style="width: 10%;"></td> <td style="width: 10%;"></td> </tr> <tr> <td></td> <td></td> <td colspan="8" style="text-align: center;"> <table border="1" style="width: 100%; border-collapse: collapse; text-align: center;"> <tr> <td style="width: 10%;"></td> <td style="width: 10%;"></td> <td style="width: 10%;"></td> <td style="width: 10%;"></td> <td style="width: 10%;"></td> <td style="width: 10%;"></td> <td style="width: 10%;"></td> <td style="width: 10%;"></td> <td style="width: 10%;"></td> <td style="width: 10%;"></td> </tr> <tr> <td></td> <td></td> <td colspan="8" style="text-align: center;"> <table border="1" style="width: 100%; border-collapse: collapse; text-align: center;"> <tr> <td style="width: 10%;"></td> <td style="width: 10%;"></td> <td style="width: 10%;"></td> <td style="width: 10%;"></td> <td style="width: 10%;"></td> <td style="width: 10%;"></td> <td style="width: 10%;"></td> <td style="width: 10%;"></td> <td style="width: 10%;"></td> <td style="width: 10%;"></td> </tr> <tr> <td></td> <td></td> <td colspan="8" style="text-align: center;"> <table border="1" style="width: 100%; border-collapse: collapse; text-align: center;"> <tr> <td style="width: 10%;"></td> <td style="width: 10%;"></td> <td style="width: 10%;"></td> <td style="width: 10%;"></td> <td style="width: 10%;"></td> <td style="width: 10%;"></td> <td style="width: 10%;"></td> <td style="width: 10%;"></td> <td style="width: 10%;"></td> <td style="width: 10%;"></td> </tr> <tr> <td></td> <td></td> <td colspan="8" style="text-align: center;"> <table border="1" style="width: 100%; border-collapse: collapse; text-align: center;"> <tr> <td style="width: 10%;"></td> <td style="width: 10%;"></td> <td style="width: 10%;"></td> <td style="width: 10%;"></td> <td style="width: 10%;"></td> <td style="width: 10%;"></td> <td style="width: 10%;"></td> <td style="width: 10%;"></td> <td style="width: 10%;"></td> <td style="width: 10%;"></td> </tr> <tr> <td></td> <td></td> <td colspan="8" style="text-align: center;"> <table border="1" style="width: 100%; border-collapse: collapse; text-align: center;"> <tr> <td style="width: 10%;"></td> <td style="width: 10%;"></td> <td style="width: 10%;"></td> <td style="width: 10%;"></td> <td style="width: 10%;"></td> <td style="width: 10%;"></td> <td style="width: 10%;"></td> <td style="width: 10%;"></td> <td style="width: 10%;"></td> <td style="width: 10%;"></td> </tr> <tr> <td></td> <td></td> <td colspan="8" style="text-align: center;"> <table border="1" style="width: 100%; border-collapse: collapse; text-align: center;"> <tr> <td style="width: 10%;"></td> <td style="width: 10%;"></td> <td style="width: 10%;"></td> <td style="width: 10%;"></td> <td style="width: 10%;"></td> <td style="width: 10%;"></td> <td style="width: 10%;"></td> <td style="width: 10%;"></td> <td style="width: 10%;"></td> <td style="width: 10%;"></td> </tr> <tr> <td></td> <td></td> <td colspan="8" style="text-align: center;"> <table border="1" style="width: 100%; border-collapse: collapse; text-align: center;"> <tr> <td style="width: 10%;"></td> <td style="width: 10%;"></td> <td style="width: 10%;"></td> <td style="width: 10%;"></td> <td style="width: 10%;"></td> <td style="width: 10%;"></td> <td style="width: 10%;"></td> <td style="width: 10%;"></td> <td style="width: 10%;"></td> <td style="width: 10%;"></td> </tr> <tr> <td></td> <td></td> <td colspan="8" style="text-align: center;"> <table border="1" style="width: 100%; border-collapse: collapse; text-align: center;"> <tr> <td style="width: 10%;"></td> <td style="width: 10%;"></td> <td style="width: 10%;"></td> <td style="width: 10%;"></td> <td style="width: 10%;"></td> <td style="width: 10%;"></td> <td style="width: 10%;"></td> <td style="width: 10%;"></td> <td style="width: 10%;"></td> <td style="width: 10%;"></td> </tr> <tr> <td></td> <td></td> <td colspan="8" style="text-align: center;"> <table border="1" style="width: 100%; border-collapse: collapse; text-align: center;"> <tr> <td style="width: 10%;"></td> <td style="width: 10%;"></td> <td style="width: 10%;"></td> <td style="width: 10%;"></td> <td style="width: 10%;"></td> <td style="width: 10%;"></td> <td style="width: 10%;"></td> <td style="width: 10%;"></td> <td style="width: 10%;"></td> <td style="width: 10%;"></td> </tr> <tr> <td></td> <td></td> <td colspan="8" style="text-align: center;"> <table border="1" style="width: 100%; border-collapse: collapse; text-align: center;"> <tr> <td style="width: 10%;"></td> <td style="width: 10%;"></td> <td style="width: 10%;"></td> <td style="width: 10%;"></td> <td style="width: 10%;"></td> <td style="width: 10%;"></td> <td style="width: 10%;"></td> <td style="width: 10%;"></td> <td style="width: 10%;"></td> <td style="width: 10%;"></td> </tr> <tr> <td></td> <td></td> <td colspan="8" style="text-align: center;"> <table border="1" style="width: 100%; border-collapse: collapse; text-align: center;"> <tr> <td style="width: 10%;"></td> <td style="width: 10%;"></td> <td style="width: 10%;"></td> <td style="width: 10%;"></td> <td style="width: 10%;"></td> <td style="width: 10%;"></td> <td style="width: 10%;"></td> <td style="width: 10%;"></td> <td style="width: 10%;"></td> <td style="width: 10%;"></td> </tr> <tr> <td></td> <td></td> <td colspan="8" style="text-align: center;"> <table border="1" style="width: 100%; border-collapse: collapse; text-align: center;"> <tr> <td style="width: 10%;"></td> <td style="width: 10%;"></td> <td style="width: 10%;"></td> <td style="width: 10%;"></td> <td style="width: 10%;"></td> <td style="width: 10%;"></td> <td style="width: 10%;"></td> <td style="width: 10%;"></td> <td style="width: 10%;"></td> <td style="width: 10%;"></td> </tr> <tr> <td></td> <td></td> <td colspan="8" style="text-align: center;"> <table border="1" style="width: 100%; border-collapse: collapse; text-align: center;"> <tr> <td style="width: 10%;"></td> <td style="width: 10%;"></td> <td style="width: 10%;"></td> <td style="width: 10%;"></td> <td style="width: 10%;"></td> <td style="width: 10%;"></td> <td style="width: 10%;"></td> <td style="width: 10%;"></td> <td style="width: 10%;"></td> <td style="width: 10%;"></td> </tr> <tr> <td></td> <td></td> <td colspan="8" style="text-align: center;"> <table border="1" style="width: 100%; border-collapse: collapse; text-align: center;">
<tr> <td style="width: 10%;"></td> <td style="width: 10%;"></td> <td style="width: 10%;"></td> <td style="width: 10%;"></td> <td style="width: 10%;"></td> <td style="width: 10%;"></td> <td style="width: 10%;"></td> <td style="width: 10%;"></td> <td style="width: 10%;"></td> <td style="width: 10%;"></td> </tr> <tr> <td></td> <td></td> <td colspan="8" style="text-align: center;"> <table border="1" style="width: 100%; border-collapse: collapse; text-align: center;"> <tr> <td style="width: 10%;"></td> <td style="width: 10%;"></td> <td style="width: 10%;"></td> <td style="width: 10%;"></td> <td style="width: 10%;"></td> <td style="width: 10%;"></td> <td style="width: 10%;"></td> <td style="width: 10%;"></td> <td style="width: 10%;"></td> <td style="width: 10%;"></td> </tr> <tr> <td></td> <td></td> <td colspan="8" style="text-align: center;"> <table border="1" style="width: 100%; border-collapse: collapse; text-align: center;"> <tr> <td style="width: 10%;"></td> <td style="width: 10%;"></td> <td style="width: 10%;"></td> <td style="width: 10%;"></td> <td style="width: 10%;"></td> <td style="width: 10%;"></td> <td style="width: 10%;"></td> <td style="width: 10%;"></td> <td style="width: 10%;"></td> <td style="width: 10%;"></td> </tr> <tr> <td></td> <td></td> <td colspan="8" style="text-align: center;"> <table border="1" style="width: 100%; border-collapse: collapse; text-align: center;"> <tr> <td style="width: 10%;"></td> <td style="width: 10%;"></td> <td style="width: 10%;"></td> <td style="width: 10%;"></td> <td style="width: 10%;"></td> <td style="width: 10%;"></td> <td style="width: 10%;"></td> <td style="width: 10%;"></td> <td style="width: 10%;"></td> <td style="width: 10%;"></td> </tr> <tr> <td></td> <td></td> <td colspan="8" style="text-align: center;"> <table border="1" style="width: 100%; border-collapse: collapse; text-align: center;"> <tr> <td style="width: 10%;"></td> <td style="width: 10%;"></td> <td style="width: 10%;"></td> <td style="width: 10%;"></td> <td style="width: 10%;"></td> <td style="width: 10%;"></td> <td style="width: 10%;"></td> <td style="width: 10%;"></td> <td style="width: 10%;"></td> <td style="width: 10%;"></td> </tr> <tr> <td></td> <td></td> <td colspan="8" style="text-align: center;"> <table border="1" style="width: 100%; border-collapse: collapse; text-align: center;"> <tr> <td style="width: 10%;"></td> <td style="width: 10%;"></td> <td style="width: 10%;"></td> <td style="width: 10%;"></td> <td style="width: 10%;"></td> <td style="width: 10%;"></td> <td style="width: 10%;"></td> <td style="width: 10%;"></td> <td style="width: 10%;"></td> <td style="width: 10%;"></td> </tr> <tr> <td></td> <td></td> <td colspan="8" style="text-align: center;"> <table border="1" style="width: 100%; border-collapse: collapse; text-align: center;"> <tr> <td style="width: 10%;"></td> <td style="width: 10%;"></td> <td style="width: 10%;"></td> <td style="width: 10%;"></td> <td style="width: 10%;"></td> <td style="width: 10%;"></td> <td style="width: 10%;"></td> <td style="width: 10%;"></td> <td style="width: 10%;"></td> <td style="width: 10%;"></td> </tr> <tr> <td></td> <td></td> <td colspan="8" style="text-align: center;"> <table border="1" style="width: 100%; border-collapse: collapse; text-align: center;"> <tr> <td style="width: 10%;"></td> <td style="width: 10%;"></td> <td style="width: 10%;"></td> <td style="width: 10%;"></td> <td style="width: 10%;"></td> <td style="width: 10%;"></td> <td style="width: 10%;"></td> <td style="width: 10%;"></td> <td style="width: 10%;"></td> <td style="width: 10%;"></td> </tr> <tr> <td></td> <td></td> <td colspan="8" style="text-align: center;"> <table border="1" style="width: 100%; border-collapse: collapse; text-align: center;"> <tr> <td style="width: 10%;"></td> <td style="width: 10%;"></td> <td style="width: 10%;"></td> <td style="width: 10%;"></td> <td style="width: 10%;"></td> <td style="width: 10%;"></td> <td style="width: 10%;"></td> <td style="width: 10%;"></td> <td style="width: 10%;"></td> <td style="width: 10%;"></td> </tr> <tr> <td></td> <td></td> <td colspan="8" style="text-align: center;"> <table border="1" style="width: 100%; border-collapse: collapse; text-align: center;"> <tr> <td style="width: 10%;"></td> <td style="width: 10%;"></td> <td style="width: 10%;"></td> <td style="width: 10%;"></td> <td style="width: 10%;"></td> <td style="width: 10%;"></td> <td style="width: 10%;"></td> <td style="width: 10%;"></td> <td style="width: 10%;"></td> <td style="width: 10%;"></td> </tr> <tr> <td></td> <td></td> <td colspan="8" style="text-align: center;"> <table border="1" style="width: 100%; border-collapse: collapse; text-align: center;"> <tr> <td style="width: 10%;"></td> <td style="width: 10%;"></td> <td style="width: 10%;"></td> <td style="width: 10%;"></td> <td style="width: 10%;"></td> <td style="width: 10%;"></td> <td style="width: 10%;"></td> <td style="width: 10%;"></td> <td style="width: 10%;"></td> <td style="width: 10%;"></td> </tr> <tr> <td></td> <td></td> <td colspan="8" style="text-align: center;"> <table border="1" style="width: 100%; border-collapse: collapse; text-align: center;"> <tr> <td style="width: 10%;"></td> <td style="width: 10%;"></td> <td style="width: 10%;"></td> <td style="width: 10%;"></td> <td style="width: 10%;"></td> <td style="width: 10%;"></td> <td style="width: 10%;"></td> <td style="width: 10%;"></td> <td style="width: 10%;"></td> <td style="width: 10%;"></td> </tr> <tr> <td></td> <td></td> <td colspan="8" style="text-align: center;"> <table border="1" style="width: 100%; border-collapse: collapse; text-align: center;"> <tr> <td style="width: 10%;"></td> <td style="width: 10%;"></td> <td style="width: 10%;"></td> <td style="width: 10%;"></td> <td style="width: 10%;"></td> <td style="width: 10%;"></td> <td style="width: 10%;"></td> <td style="width: 10%;"></td> <td style="width: 10%;"></td> <td style="width: 10%;"></td> </tr> <tr> <td></td> <td></td> <td colspan="8" style="text-align: center;"> <table border="1" style="width: 100%; border-collapse: collapse; text-align: center;"> <tr> <td style="width: 10%;"></td> <td style="width: 10%;"></td> <td style="width: 10%;"></td> <td style="width: 10%;"></td> <td style="width: 10%;"></td> <td style="width: 10%;"></td> <td style="width: 10%;"></td> <td style="width: 10%;"></td> <td style="width: 10%;"></td> <td style="width: 10%;"></td> </tr> <tr> <td></td> <td></td> <td colspan="8" style="text-align: center;"> <table border="1" style="width: 100%; border-collapse: collapse; text-align: center;"> <tr> <td style="width: 10%;"></td> <td style="width: 10%;"></td> <td style="width: 10%;"></td> <td style="width: 10%;"></td> <td style="width: 10%;"></td> <td style="width: 10%;"></td> <td style="width: 10%;"></td> <td style="width: 10%;"></td> <td style="width: 10%;"></td> <td style="width: 10%;"></td> </tr> <tr> <td></td> <td></td> <td colspan="8" style="text-align: center;"> <table border="1" style="width: 100%; border-collapse: collapse; text-align: center;"> <tr> <td style="width: 10%;"></td> <td style="width: 10%;"></td> <td style="width: 10%;"></td> <td style="width: 10%;"></td> <td style="width: 10%;"></td> <td style="width: 10%;"></td> <td style="width: 10%;"></td> <td style="width: 10%;"></td> <td style="width: 10%;"></td> <td style="width: 10%;"></td> </tr> <tr> <td></td> <td></td> <td colspan="8" style="text-align: center;"> <table border="1" style="width: 100%; border-collapse: collapse; text-align: center;"> <tr> <td style="width: 10%;"></td> <td style="width: 10%;"></td> <td style="width: 10%;"></td> <td style="width: 10%;"></td> <td style="width: 10%;"></td> <td style="width: 10%;"></td> <td style="width: 10%;"></td> <td style="width: 10%;"></td> <td style="width: 10%;"></td> <td style="width: 10%;"></td> </tr> <tr> <td></td> <td></td> <td colspan="8" style="text-align: center;"> <table border="1" style="width: 100%; border-collapse: collapse; text-align: center;"> <tr> <td style="width: 10%;"></td> <td style="width: 10%;"></td> <td style="width: 10%;"></td> <td style="width: 10%;"></td> <td style="width: 10%;"></td> <td style="width: 10%;"></td> <td style="width: 10%;"></td> <td style="width: 10%;"></td> <td style="width: 10%;"></td> <td style="width: 10%;"></td> </tr> <tr> <td></td> <td></td> <td colspan="8" style="text-align: center;"> <table border="1" style="width: 100%; border-collapse: collapse; text-align: center;"> <tr> <td style="width: 10%;"></td> <td style="width: 10%;"></td> <td style="width: 10%;"></td> <td style="width: 10%;"></td> <td style="width: 10%;"></td> <td style="width: 10%;"></td> <td style="width: 10%;"></td> <td style="width: 10%;"></td> <td style="width: 10%;"></td> <td style="width: 10%;"></td> </tr> <tr> <td></td> <td></td> <td colspan="8" style="text-align: center;"> <table border="1" style="width: 100%; border-collapse: collapse; text-align: center;"> <tr> <td style="width: 10%;"></td> <td style="width: 10%;"></td> <td style="width: 10%;"></td> <td style="width: 10%;"></td> <td style="width: 10%;"></td> <td style="width: 10%;"></td> <td style="width: 10%;"></td> <td style="width: 10%;"></td> <td style="width: 10%;"></td> <td style="width: 10%;"></td> </tr> <tr> <td></td> <td></td> <td colspan="8" style="text-align: center;"> <table border="1" style="width: 100%; border-collapse: collapse; text-align: center;"> <tr> <td style="width: 10%;"></td> <td style="width: 10%;"></td> <td style="width: 10%;"></td> <td style="width: 10%;"></td> <td style="width: 10%;"></td> <td style="width: 10%;"></td> <td style="width: 10%;"></td> <td style="width: 10%;"></td> <td style="width: 10%;"></td> <td style="width: 10%;"></td> </tr> <tr> <td></td> <td></td> <td colspan="8" style="text-align: center;"> <table border="1" style="width: 100%; border-collapse: collapse; text-align: center;"> <tr>
</tr></table></td></tr></table></td></tr></table></td></tr></table></td></tr></table></td></tr></table></td></tr></table></td></tr></table></td></tr></table></td></tr></table></td></tr></table></td></tr></table></td></tr></table></td></tr></table></td></tr></table></td></tr></table></td></tr></table></td></tr></table></td></tr></table></td></tr></table></td></tr></table></td></tr></table></td></tr></table></td></tr></table></td></tr></table></td></tr></table></td></tr></table></td></tr></table></td></tr></table></td></tr></table></td></tr></table></td></tr></table></td></tr></table></td></tr></table></td></tr></table></td></tr></table></td></tr></table>
 | | | | | | | | | | | | | | | | | | | | <table border="1" style="width: 100%; border-collapse: collapse; text-align: center;"> <tr> <td style="width: 10%;"></td> <td style="width: 10%;"></td> <td style="width: 10%;"></td> <td style="width: 10%;"></td> <td style="width: 10%;"></td> <td style="width: 10%;"></td> <td style="width: 10%;"></td> <td style="width: 10%;"></td> <td style="width: 10%;"></td> <td style="width: 10%;"></td> </tr> <tr> <td></td> <td></td> <td colspan="8" style="text-align: center;"> <table border="1" style="width: 100%; border-collapse: collapse; text-align: center;"> <tr> <td style="width: 10%;"></td> <td style="width: 10%;"></td> <td style="width: 10%;"></td> <td style="width: 10%;"></td> <td style="width: 10%;"></td> <td style="width: 10%;"></td> <td style="width: 10%;"></td> <td style="width: 10%;"></td> <td style="width: 10%;"></td> <td style="width: 10%;"></td> </tr> <tr> <td></td> <td></td> <td colspan="8" style="text-align: center;"> <table border="1" style="width: 100%; border-collapse: collapse; text-align: center;"> <tr> <td style="width: 10%;"></td> <td style="width: 10%;"></td> <td style="width: 10%;"></td> <td style="width: 10%;"></td> <td style="width: 10%;"></td> <td style="width: 10%;"></td> <td style="width: 10%;"></td> <td style="width: 10%;"></td> <td style="width: 10%;"></td> <td style="width: 10%;"></td> </tr> <tr> <td></td> <td></td> <td colspan="8" style="text-align: center;"> <table border="1" style="width: 100%; border-collapse: collapse; text-align: center;"> <tr> <td style="width: 10%;"></td> <td style="width: 10%;"></td> <td style="width: 10%;"></td> <td style="width: 10%;"></td> <td style="width: 10%;"></td> <td style="width: 10%;"></td> <td style="width: 10%;"></td> <td style="width: 10%;"></td> <td style="width: 10%;"></td> <td style="width: 10%;"></td> </tr> <tr> <td></td> <td></td> <td colspan="8" style="text-align: center;"> <table border="1" style="width: 100%; border-collapse: collapse; text-align: center;"> <tr> <td style="width: 10%;"></td> <td style="width: 10%;"></td> <td style="width: 10%;"></td> <td style="width: 10%;"></td> <td style="width: 10%;"></td> <td style="width: 10%;"></td> <td style="width: 10%;"></td> <td style="width: 10%;"></td> <td style="width: 10%;"></td> <td style="width: 10%;"></td> </tr> <tr> <td></td> <td></td> <td colspan="8" style="text-align: center;"> <table border="1" style="width: 100%; border-collapse: collapse; text-align: center;"> <tr> <td style="width: 10%;"></td> <td style="width: 10%;"></td> <td style="width: 10%;"></td> <td style="width: 10%;"></td> <td style="width: 10%;"></td> <td style="width: 10%;"></td> <td style="width: 10%;"></td> <td style="width: 10%;"></td> <td style="width: 10%;"></td> <td style="width: 10%;"></td> </tr> <tr> <td></td> <td></td> <td colspan="8" style="text-align: center;"> <table border="1" style="width: 100%; border-collapse: collapse; text-align: center;"> <tr> <td style="width: 10%;"></td> <td style="width: 10%;"></td> <td style="width: 10%;"></td> <td style="width: 10%;"></td> <td style="width: 10%;"></td> <td style="width: 10%;"></td> <td style="width: 10%;"></td> <td style="width: 10%;"></td> <td style="width: 10%;"></td> <td style="width: 10%;"></td> </tr> <tr> <td></td> <td></td> <td colspan="8" style="text-align: center;"> <table border="1" style="width: 100%; border-collapse: collapse; text-align: center;"> <tr> <td style="width: 10%;"></td> <td style="width: 10%;"></td> <td style="width: 10%;"></td> <td style="width: 10%;"></td> <td style="width: 10%;"></td> <td style="width: 10%;"></td> <td style="width: 10%;"></td> <td style="width: 10%;"></td> <td style="width: 10%;"></td> <td style="width: 10%;"></td> </tr> <tr> <td></td> <td></td> <td colspan="8" style="text-align: center;"> <table border="1" style="width: 100%; border-collapse: collapse; text-align: center;"> <tr> <td style="width: 10%;"></td> <td style="width: 10%;"></td> <td style="width: 10%;"></td> <td style="width: 10%;"></td> <td style="width: 10%;"></td> <td style="width: 10%;"></td> <td style="width: 10%;"></td> <td style="width: 10%;"></td> <td style="width: 10%;"></td> <td style="width: 10%;"></td> </tr> <tr> <td></td> <td></td> <td colspan="8" style="text-align: center;"> <table border="1" style="width: 100%; border-collapse: collapse; text-align: center;"> <tr> <td style="width: 10%;"></td> <td style="width: 10%;"></td> <td style="width: 10%;"></td> <td style="width: 10%;"></td> <td style="width: 10%;"></td> <td style="width: 10%;"></td> <td style="width: 10%;"></td> <td style="width: 10%;"></td> <td style="width: 10%;"></td> <td style="width: 10%;"></td> </tr> <tr> <td></td> <td></td> <td colspan="8" style="text-align: center;"> <table border="1" style="width: 100%; border-collapse: collapse; text-align: center;"> <tr> <td style="width: 10%;"></td> <td style="width: 10%;"></td> <td style="width: 10%;"></td> <td style="width: 10%;"></td> <td style="width: 10%;"></td> <td style="width: 10%;"></td> <td style="width: 10%;"></td> <td style="width: 10%;"></td> <td style="width: 10%;"></td> <td style="width: 10%;"></td> </tr> <tr> <td></td> <td></td> <td colspan="8" style="text-align: center;"> <table border="1" style="width: 100%; border-collapse: collapse; text-align: center;"> <tr> <td style="width: 10%;"></td> <td style="width: 10%;"></td> <td style="width: 10%;"></td> <td style="width: 10%;"></td> <td style="width: 10%;"></td> <td style="width: 10%;"></td> <td style="width: 10%;"></td> <td style="width: 10%;"></td> <td style="width: 10%;"></td> <td style="width: 10%;"></td> </tr> <tr> <td></td> <td></td> <td colspan="8" style="text-align: center;"> <table border="1" style="width: 100%; border-collapse: collapse; text-align: center;"> <tr> <td style="width: 10%;"></td> <td style="width: 10%;"></td> <td style="width: 10%;"></td> <td style="width: 10%;"></td> <td style="width: 10%;"></td> <td style="width: 10%;"></td> <td style="width: 10%;"></td> <td style="width: 10%;"></td> <td style="width: 10%;"></td> <td style="width: 10%;"></td> </tr> <tr> <td></td> <td></td> <td colspan="8" style="text-align: center;"> <table border="1" style="width: 100%; border-collapse: collapse; text-align: center;"> <tr> <td style="width: 10%;"></td> <td style="width: 10%;"></td> <td style="width: 10%;"></td> <td style="width: 10%;"></td> <td style="width: 10%;"></td> <td style="width: 10%;"></td> <td style="width: 10%;"></td> <td style="width: 10%;"></td> <td style="width: 10%;"></td> <td style="width: 10%;"></td> </tr> <tr> <td></td> <td></td> <td colspan="8" style="text-align: center;"> <table border="1" style="width: 100%; border-collapse: collapse; text-align: center;"> <tr> <td style="width: 10%;"></td> <td style="width: 10%;"></td> <td style="width: 10%;"></td> <td style="width: 10%;"></td> <td style="width: 10%;"></td> <td style="width: 10%;"></td> <td style="width: 10%;"></td> <td style="width: 10%;"></td> <td style="width: 10%;"></td> <td style="width: 10%;"></td> </tr> <tr> <td></td> <td></td> <td colspan="8" style="text-align: center;"> <table border="1" style="width: 100%; border-collapse: collapse; text-align: center;"> <tr> <td
style="width: 10%;"></td> <td style="width: 10%;"></td> <td style="width: 10%;"></td> <td style="width: 10%;"></td> <td style="width: 10%;"></td> <td style="width: 10%;"></td> <td style="width: 10%;"></td> <td style="width: 10%;"></td> <td style="width: 10%;"></td> <td style="width: 10%;"></td> </tr> <tr> <td></td> <td></td> <td colspan="8" style="text-align: center;"> <table border="1" style="width: 100%; border-collapse: collapse; text-align: center;"> <tr> <td style="width: 10%;"></td> <td style="width: 10%;"></td> <td style="width: 10%;"></td> <td style="width: 10%;"></td> <td style="width: 10%;"></td> <td style="width: 10%;"></td> <td style="width: 10%;"></td> <td style="width: 10%;"></td> <td style="width: 10%;"></td> <td style="width: 10%;"></td> </tr> <tr> <td></td> <td></td> <td colspan="8" style="text-align: center;"> <table border="1" style="width: 100%; border-collapse: collapse; text-align: center;"> <tr> <td style="width: 10%;"></td> <td style="width: 10%;"></td> <td style="width: 10%;"></td> <td style="width: 10%;"></td> <td style="width: 10%;"></td> <td style="width: 10%;"></td> <td style="width: 10%;"></td> <td style="width: 10%;"></td> <td style="width: 10%;"></td> <td style="width: 10%;"></td> </tr> <tr> <td></td> <td></td> <td colspan="8" style="text-align: center;"> <table border="1" style="width: 100%; border-collapse: collapse; text-align: center;"> <tr> <td style="width: 10%;"></td> <td style="width: 10%;"></td> <td style="width: 10%;"></td> <td style="width: 10%;"></td> <td style="width: 10%;"></td> <td style="width: 10%;"></td> <td style="width: 10%;"></td> <td style="width: 10%;"></td> <td style="width: 10%;"></td> <td style="width: 10%;"></td> </tr> <tr> <td></td> <td></td> <td colspan="8" style="text-align: center;"> <table border="1" style="width: 100%; border-collapse: collapse; text-align: center;"> <tr> <td style="width: 10%;"></td> <td style="width: 10%;"></td> <td style="width: 10%;"></td> <td style="width: 10%;"></td> <td style="width: 10%;"></td> <td style="width: 10%;"></td> <td style="width: 10%;"></td> <td style="width: 10%;"></td> <td style="width: 10%;"></td> <td style="width: 10%;"></td> </tr> <tr> <td></td> <td></td> <td colspan="8" style="text-align: center;"> <table border="1" style="width: 100%; border-collapse: collapse; text-align: center;"> <tr> <td style="width: 10%;"></td> <td style="width: 10%;"></td> <td style="width: 10%;"></td> <td style="width: 10%;"></td> <td style="width: 10%;"></td> <td style="width: 10%;"></td> <td style="width: 10%;"></td> <td style="width: 10%;"></td> <td style="width: 10%;"></td> <td style="width: 10%;"></td> </tr> <tr> <td></td> <td></td> <td colspan="8" style="text-align: center;"> <table border="1" style="width: 100%; border-collapse: collapse; text-align: center;"> <tr> <td style="width: 10%;"></td> <td style="width: 10%;"></td> <td style="width: 10%;"></td> <td style="width: 10%;"></td> <td style="width: 10%;"></td> <td style="width: 10%;"></td> <td style="width: 10%;"></td> <td style="width: 10%;"></td> <td style="width: 10%;"></td> <td style="width: 10%;"></td> </tr> <tr> <td></td> <td></td> <td colspan="8" style="text-align: center;"> <table border="1" style="width: 100%; border-collapse: collapse; text-align: center;"> <tr> <td style="width: 10%;"></td> <td style="width: 10%;"></td> <td style="width: 10%;"></td> <td style="width: 10%;"></td> <td style="width: 10%;"></td> <td style="width: 10%;"></td> <td style="width: 10%;"></td> <td style="width: 10%;"></td> <td style="width: 10%;"></td> <td style="width: 10%;"></td> </tr> <tr> <td></td> <td></td> <td colspan="8" style="text-align: center;"> <table border="1" style="width: 100%; border-collapse: collapse; text-align: center;"> <tr> <td style="width: 10%;"></td> <td style="width: 10%;"></td> <td style="width: 10%;"></td> <td style="width: 10%;"></td> <td style="width: 10%;"></td> <td style="width: 10%;"></td> <td style="width: 10%;"></td> <td style="width: 10%;"></td> <td style="width: 10%;"></td> <td style="width: 10%;"></td> </tr> <tr> <td></td> <td></td> <td colspan="8" style="text-align: center;"> <table border="1" style="width: 100%; border-collapse: collapse; text-align: center;"> <tr> <td style="width: 10%;"></td> <td style="width: 10%;"></td> <td style="width: 10%;"></td> <td style="width: 10%;"></td> <td style="width: 10%;"></td> <td style="width: 10%;"></td> <td style="width: 10%;"></td> <td style="width: 10%;"></td> <td style="width: 10%;"></td> <td style="width: 10%;"></td> </tr> <tr> <td></td> <td></td> <td colspan="8" style="text-align: center;"> <table border="1" style="width: 100%; border-collapse: collapse; text-align: center;"> <tr> <td style="width: 10%;"></td> <td style="width: 10%;"></td> <td style="width: 10%;"></td> <td style="width: 10%;"></td> <td style="width: 10%;"></td> <td style="width: 10%;"></td> <td style="width: 10%;"></td> <td style="width: 10%;"></td> <td style="width: 10%;"></td> <td style="width: 10%;"></td> </tr> <tr> <td></td> <td></td> <td colspan="8" style="text-align: center;"> <table border="1" style="width: 100%; border-collapse: collapse; text-align: center;"> <tr> <td style="width: 10%;"></td> <td style="width: 10%;"></td> <td style="width: 10%;"></td> <td style="width: 10%;"></td> <td style="width: 10%;"></td> <td style="width: 10%;"></td> <td style="width: 10%;"></td> <td style="width: 10%;"></td> <td style="width: 10%;"></td> <td style="width: 10%;"></td> </tr> <tr> <td></td> <td></td> <td colspan="8" style="text-align: center;"> <table border="1" style="width: 100%; border-collapse: collapse; text-align: center;"> <tr> <td style="width: 10%;"></td> <td style="width: 10%;"></td> <td style="width: 10%;"></td> <td style="width: 10%;"></td> <td style="width: 10%;"></td> <td style="width: 10%;"></td> <td style="width: 10%;"></td> <td style="width: 10%;"></td> <td style="width: 10%;"></td> <td style="width: 10%;"></td> </tr> <tr> <td></td> <td></td> <td colspan="8" style="text-align: center;"> <table border="1" style="width: 100%; border-collapse: collapse; text-align: center;"> <tr> <td style="width: 10%;"></td> <td style="width: 10%;"></td> <td style="width: 10%;"></td> <td style="width: 10%;"></td> <td style="width: 10%;"></td> <td style="width: 10%;"></td> <td style="width: 10%;"></td> <td style="width: 10%;"></td> <td style="width: 10%;"></td> <td style="width: 10%;"></td> </tr> <tr> <td></td> <td></td> <td colspan="8" style="text-align: center;"> <table border="1" style="width: 100%; border-collapse: collapse; text-align: center;"> <tr> <td style="width: 10%;"></td> <td style="width: 10%;"></td> <td style="width: 10%;"></td> <td style="width: 10%;"></td> <td style="width: 10%;"></td> <td style="width: 10%;"></td> <td style="width: 10%;"></td> <td style="width: 10%;"></td> <td style="width: 10%;"></td> <td style="width: 10%;"></td> </tr> <tr> <td></td> <td></td> <td colspan="8" style="text-align: center;"> <table border="1" style="width: 100%; border-collapse: collapse; text-align: center;"> <tr> <td style="width: 10%;"></td> <td style="width: 10%;"></td> <td style="width: 10%;"></td> <td style="width: 10%;"></td> <td style="width: 10%;"></td> <td style="width: 10%;"></td> <td style="width: 10%;"></td> <td style="width: 10%;"></td> <td style="width: 10%;"></td> <td style="width: 10%;"></td> </tr> <tr> <td></td> <td></td> <td colspan="8" style="text-align: center;"> <table border="1" style="width: 100%; border-collapse: collapse; text-align: center;"> <tr> <td style="width: 10%;"></td> <td style="width: 10%;"></td> <td style="width: 10%;"></td> <td style="width: 10%;"></td> <td style="width: 10%;"></td> <td style="width: 10%;"></td> <td style="width: 10%;"></td> <td style="width: 10%;"></td> <td style="width: 10%;"></td> <td style="width: 10%;"></td> </tr> <tr> <td></td> <td></td> <td colspan="8" style="text-align: center;"> <table border="1" style="width: 100%; border-collapse: collapse; text-align: center;"> <tr> <td style="width: 10%;"></td> <td style="width: 10%;"></td> <td style="width: 10%;"></td> <td style="width: 10%;"></td> <td style="width: 10%;"></td> <td style="width: 10%;"></td> <td style="width: 10%;"></td> <td style="width: 10%;"></td> <td style="width: 10%;"></td> <td style="width: 10%;"></td> </tr> <tr> <td></td> <td></td> <td colspan="8" style="text-align: center;"> <table border="1" style="width: 100%; border-collapse: collapse; text-align: center;"> <tr> <td style="width: 10%;"></td> <td style="width: 10%;"></td> <td style="width: 10%;"></td> <td style="width: 10%;"></td> <td style="width: 10%;"></td> <td style="width: 10%;"></td> <td style="width: 10%;"></td> <td style="width: 10%;"></td> <td style="width: 10%;"></td> <td style="width: 10%;"></td> </tr> <tr> <td></td> <td></td> <td colspan="8" style="text-align: center;"> <table border="1" style="width: 100%; border-collapse: collapse; text-align: center;"> <tr> <td style="width: 10%;"></td> <td style="width: 10%;"></td> <td style="width: 10%;"></td> <td style="width: 10%;"></td> <td style="width: 10%;"></td> <td style="width: 10%;"></td> <td style="width: 10%;"></td> <td style="width: 10%;"></td> <td style="width: 10%;"></td> <td style="width: 10%;"></td> </tr> <tr> <td></td> <td></td> <td colspan="8" style="text-align: center;"> <table border="1" style="width: 100%; border-collapse: collapse; text-align: center;"> <tr> </tr></table></td></tr></table></td></tr></table></td></tr></table></td></tr></table></td></tr></table></td></tr></table></td></tr></table></td></tr></table></td></tr></table></td></tr></table></td></tr></table></td></tr></table></td></tr></table></td></tr></table></td></tr></table></td></tr></table></td></tr></table></td></tr></table></td></tr></table></td></tr></table></td></tr></table></td></tr></table></td></tr></table></td></tr></table></td></tr></table></td></tr></table></td></tr></table></td></tr></table></td></tr></table></td></tr></table></td></tr></table></td></tr></table></td></tr></table></td></tr></table></td></tr></table>

 | | | | | | | | | | | | | | | | | | | | <table border="1" style="width: 100%; border-collapse: collapse; text-align: center;"> <tr> <td style="width: 10%;"></td> <td style="width: 10%;"></td> <td style="width: 10%;"></td> <td style="width: 10%;"></td> <td style="width: 10%;"></td> <td style="width: 10%;"></td> <td style="width: 10%;"></td> <td style="width: 10%;"></td> <td style="width: 10%;"></td> <td style="width: 10%;"></td> </tr> <tr> <td></td> <td></td> <td colspan="8" style="text-align: center;"> <table border="1" style="width: 100%; border-collapse: collapse; text-align: center;"> <tr> <td style="width: 10%;"></td> <td style="width: 10%;"></td> <td style="width: 10%;"></td> <td style="width: 10%;"></td> <td style="width: 10%;"></td> <td style="width: 10%;"></td> <td style="width: 10%;"></td> <td style="width: 10%;"></td> <td style="width: 10%;"></td> <td style="width: 10%;"></td> </tr> <tr> <td></td> <td></td> <td colspan="8" style="text-align: center;"> <table border="1" style="width: 100%; border-collapse: collapse; text-align: center;"> <tr> <td style="width: 10%;"></td> <td style="width: 10%;"></td> <td style="width: 10%;"></td> <td style="width: 10%;"></td> <td style="width: 10%;"></td> <td style="width: 10%;"></td> <td style="width: 10%;"></td> <td style="width: 10%;"></td> <td style="width: 10%;"></td> <td style="width: 10%;"></td> </tr> <tr> <td></td> <td></td> <td colspan="8" style="text-align: center;"> <table border="1" style="width: 100%; border-collapse: collapse; text-align: center;"> <tr> <td style="width: 10%;"></td> <td style="width: 10%;"></td> <td style="width: 10%;"></td> <td style="width: 10%;"></td> <td style="width: 10%;"></td> <td style="width: 10%;"></td> <td style="width: 10%;"></td> <td style="width: 10%;"></td> <td style="width: 10%;"></td> <td style="width: 10%;"></td> </tr> <tr> <td></td> <td></td> <td colspan="8" style="text-align: center;"> <table border="1" style="width: 100%; border-collapse: collapse; text-align: center;"> <tr> <td style="width: 10%;"></td> <td style="width: 10%;"></td> <td style="width: 10%;"></td> <td style="width: 10%;"></td> <td style="width: 10%;"></td> <td style="width: 10%;"></td> <td style="width: 10%;"></td> <td style="width: 10%;"></td> <td style="width: 10%;"></td> <td style="width: 10%;"></td> </tr> <tr> <td></td> <td></td> <td colspan="8" style="text-align: center;"> <table border="1" style="width: 100%; border-collapse: collapse; text-align: center;"> <tr> <td style="width: 10%;"></td> <td style="width: 10%;"></td> <td style="width: 10%;"></td> <td style="width: 10%;"></td> <td style="width: 10%;"></td> <td style="width: 10%;"></td> <td style="width: 10%;"></td> <td style="width: 10%;"></td> <td style="width: 10%;"></td> <td style="width: 10%;"></td> </tr> <tr> <td></td> <td></td> <td colspan="8" style="text-align: center;"> <table border="1" style="width: 100%; border-collapse: collapse; text-align: center;"> <tr> <td style="width: 10%;"></td> <td style="width: 10%;"></td> <td style="width: 10%;"></td> <td style="width: 10%;"></td> <td style="width: 10%;"></td> <td style="width: 10%;"></td> <td style="width: 10%;"></td> <td style="width: 10%;"></td> <td style="width: 10%;"></td> <td style="width: 10%;"></td> </tr> <tr> <td></td> <td></td> <td colspan="8" style="text-align: center;"> <table border="1" style="width: 100%; border-collapse: collapse; text-align: center;"> <tr> <td style="width: 10%;"></td> <td style="width: 10%;"></td> <td style="width: 10%;"></td> <td style="width: 10%;"></td> <td style="width: 10%;"></td> <td style="width: 10%;"></td> <td style="width: 10%;"></td> <td style="width: 10%;"></td> <td style="width: 10%;"></td> <td style="width: 10%;"></td> </tr> <tr> <td></td> <td></td> <td colspan="8" style="text-align: center;"> <table border="1" style="width: 100%; border-collapse: collapse; text-align: center;"> <tr> <td style="width: 10%;"></td> <td style="width: 10%;"></td> <td style="width: 10%;"></td> <td style="width: 10%;"></td> <td style="width: 10%;"></td> <td style="width: 10%;"></td> <td style="width: 10%;"></td> <td style="width: 10%;"></td> <td style="width: 10%;"></td> <td style="width: 10%;"></td> </tr> <tr> <td></td> <td></td> <td colspan="8" style="text-align: center;"> <table border="1" style="width: 100%; border-collapse: collapse; text-align: center;"> <tr> <td style="width: 10%;"></td> <td style="width: 10%;"></td> <td style="width: 10%;"></td> <td style="width: 10%;"></td> <td style="width: 10%;"></td> <td style="width: 10%;"></td> <td style="width: 10%;"></td> <td style="width: 10%;"></td> <td style="width: 10%;"></td> <td style="width: 10%;"></td> </tr> <tr> <td></td> <td></td> <td colspan="8" style="text-align: center;"> <table border="1" style="width: 100%; border-collapse: collapse; text-align: center;"> <tr> <td style="width: 10%;"></td> <td style="width: 10%;"></td> <td style="width: 10%;"></td> <td style="width: 10%;"></td> <td style="width: 10%;"></td> <td style="width: 10%;"></td> <td style="width: 10%;"></td> <td style="width: 10%;"></td> <td style="width: 10%;"></td> <td style="width: 10%;"></td> </tr> <tr> <td></td> <td></td> <td colspan="8" style="text-align: center;"> <table border="1" style="width: 100%; border-collapse: collapse; text-align: center;"> <tr> <td style="width: 10%;"></td> <td style="width: 10%;"></td> <td style="width: 10%;"></td> <td style="width: 10%;"></td> <td style="width: 10%;"></td> <td style="width: 10%;"></td> <td style="width: 10%;"></td> <td style="width: 10%;"></td> <td style="width: 10%;"></td> <td style="width: 10%;"></td> </tr> <tr> <td></td> <td></td> <td colspan="8" style="text-align: center;"> <table border="1" style="width: 100%; border-collapse: collapse; text-align: center;"> <tr> <td style="width: 10%;"></td> <td style="width: 10%;"></td> <td style="width: 10%;"></td> <td style="width: 10%;"></td> <td style="width: 10%;"></td> <td style="width: 10%;"></td> <td style="width: 10%;"></td> <td style="width: 10%;"></td> <td style="width: 10%;"></td> <td style="width: 10%;"></td> </tr> <tr> <td></td> <td></td> <td colspan="8" style="text-align: center;"> <table border="1" style="width: 100%; border-collapse: collapse; text-align: center;"> <tr> <td style="width: 10%;"></td> <td style="width: 10%;"></td> <td style="width: 10%;"></td> <td style="width: 10%;"></td> <td style="width: 10%;"></td> <td style="width: 10%;"></td> <td style="width: 10%;"></td> <td style="width: 10%;"></td> <td style="width: 10%;"></td> <td style="width: 10%;"></td> </tr> <tr> <td></td> <td></td> <td colspan="8" style="text-align: center;"> <table border="1" style="width: 100%; border-collapse: collapse; text-align: center;"> <tr> <td style="width: 10%;"></td> <td style="width: 10%;"></td> <td style="width: 10%;"></td> <td style="width: 10%;"></td> <td style="width: 10%;"></td> <td style="width: 10%;"></td> <td style="width: 10%;"></td> <td style="width: 10%;"></td> <td style="width: 10%;"></td> <td style="width: 10%;"></td> </tr> <tr> <td></td> <td></td> <td colspan="8" style="text-align: center;"> <table border="1" style="width: 100%; border-collapse: collapse; text-align: center;"> <tr> <td style="width: 10%;"></td> <td style="width: 10%;"></td> <td style="width: 10%;"></td> <td style="width: 10%;"></td> <td style="width: 10%;"></td> <td style="width: 10%;"></td> <td style="width: 10%;"></td> <td style="width: 10%;"></td> <td style="width: 10%;"></td> <td style="width: 10%;"></td> </tr> <tr> <td></td> <td></td> <td colspan="8" style="text-align: center;"> <table border="1" style="width: 100%; border-collapse: collapse; text-align: center;"> <tr> <td style="width: 10%;"></td> <td style="width: 10%;"></td> <td style="width: 10%;"></td> <td style="width: 10%;"></td> <td style="width: 10%;"></td> <td style="width: 10%;"></td> <td style="width: 10%;"></td>
<td style="width: 10%;"></td> <td style="width: 10%;"></td> <td style="width: 10%;"></td> </tr> <tr> <td></td> <td></td> <td colspan="8" style="text-align: center;"> <table border="1" style="width: 100%; border-collapse: collapse; text-align: center;"> <tr> <td style="width: 10%;"></td> <td style="width: 10%;"></td> <td style="width: 10%;"></td> <td style="width: 10%;"></td> <td style="width: 10%;"></td> <td style="width: 10%;"></td> <td style="width: 10%;"></td> <td style="width: 10%;"></td> <td style="width: 10%;"></td> <td style="width: 10%;"></td> </tr> <tr> <td></td> <td></td> <td colspan="8" style="text-align: center;"> <table border="1" style="width: 100%; border-collapse: collapse; text-align: center;"> <tr> <td style="width: 10%;"></td> <td style="width: 10%;"></td> <td style="width: 10%;"></td> <td style="width: 10%;"></td> <td style="width: 10%;"></td> <td style="width: 10%;"></td> <td style="width: 10%;"></td> <td style="width: 10%;"></td> <td style="width: 10%;"></td> <td style="width: 10%;"></td> </tr> <tr> <td></td> <td></td> <td colspan="8" style="text-align: center;"> <table border="1" style="width: 100%; border-collapse: collapse; text-align: center;"> <tr> <td style="width: 10%;"></td> <td style="width: 10%;"></td> <td style="width: 10%;"></td> <td style="width: 10%;"></td> <td style="width: 10%;"></td> <td style="width: 10%;"></td> <td style="width: 10%;"></td> <td style="width: 10%;"></td> <td style="width: 10%;"></td> <td style="width: 10%;"></td> </tr> <tr> <td></td> <td></td> <td colspan="8" style="text-align: center;"> <table border="1" style="width: 100%; border-collapse: collapse; text-align: center;"> <tr> <td style="width: 10%;"></td> <td style="width: 10%;"></td> <td style="width: 10%;"></td> <td style="width: 10%;"></td> <td style="width: 10%;"></td> <td style="width: 10%;"></td> <td style="width: 10%;"></td> <td style="width: 10%;"></td> <td style="width: 10%;"></td> <td style="width: 10%;"></td> </tr> <tr> <td></td> <td></td> <td colspan="8" style="text-align: center;"> <table border="1" style="width: 100%; border-collapse: collapse; text-align: center;"> <tr> <td style="width: 10%;"></td> <td style="width: 10%;"></td> <td style="width: 10%;"></td> <td style="width: 10%;"></td> <td style="width: 10%;"></td> <td style="width: 10%;"></td> <td style="width: 10%;"></td> <td style="width: 10%;"></td> <td style="width: 10%;"></td> <td style="width: 10%;"></td> </tr> <tr> <td></td> <td></td> <td colspan="8" style="text-align: center;"> <table border="1" style="width: 100%; border-collapse: collapse; text-align: center;"> <tr> <td style="width: 10%;"></td> <td style="width: 10%;"></td> <td style="width: 10%;"></td> <td style="width: 10%;"></td> <td style="width: 10%;"></td> <td style="width: 10%;"></td> <td style="width: 10%;"></td> <td style="width: 10%;"></td> <td style="width: 10%;"></td> <td style="width: 10%;"></td> </tr> <tr> <td></td> <td></td> <td colspan="8" style="text-align: center;"> <table border="1" style="width: 100%; border-collapse: collapse; text-align: center;"> <tr> <td style="width: 10%;"></td> <td style="width: 10%;"></td> <td style="width: 10%;"></td> <td style="width: 10%;"></td> <td style="width: 10%;"></td> <td style="width: 10%;"></td> <td style="width: 10%;"></td> <td style="width: 10%;"></td> <td style="width: 10%;"></td> <td style="width: 10%;"></td> </tr> <tr> <td></td> <td></td> <td colspan="8" style="text-align: center;"> <table border="1" style="width: 100%; border-collapse: collapse; text-align: center;"> <tr> <td style="width: 10%;"></td> <td style="width: 10%;"></td> <td style="width: 10%;"></td> <td style="width: 10%;"></td> <td style="width: 10%;"></td> <td style="width: 10%;"></td> <td style="width: 10%;"></td> <td style="width: 10%;"></td> <td style="width: 10%;"></td> <td style="width: 10%;"></td> </tr> <tr> <td></td> <td></td> <td colspan="8" style="text-align: center;"> <table border="1" style="width: 100%; border-collapse: collapse; text-align: center;"> <tr> <td style="width: 10%;"></td> <td style="width: 10%;"></td> <td style="width: 10%;"></td> <td style="width: 10%;"></td> <td style="width: 10%;"></td> <td style="width: 10%;"></td> <td style="width: 10%;"></td> <td style="width: 10%;"></td> <td style="width: 10%;"></td> <td style="width: 10%;"></td> </tr> <tr> <td></td> <td></td> <td colspan="8" style="text-align: center;"> <table border="1" style="width: 100%; border-collapse: collapse; text-align: center;"> <tr> <td style="width: 10%;"></td> <td style="width: 10%;"></td> <td style="width: 10%;"></td> <td style="width: 10%;"></td> <td style="width: 10%;"></td> <td style="width: 10%;"></td> <td style="width: 10%;"></td> <td style="width: 10%;"></td> <td style="width: 10%;"></td> <td style="width: 10%;"></td> </tr> <tr> <td></td> <td></td> <td colspan="8" style="text-align: center;"> <table border="1" style="width: 100%; border-collapse: collapse; text-align: center;"> <tr> <td style="width: 10%;"></td> <td style="width: 10%;"></td> <td style="width: 10%;"></td> <td style="width: 10%;"></td> <td style="width: 10%;"></td> <td style="width: 10%;"></td> <td style="width: 10%;"></td> <td style="width: 10%;"></td> <td style="width: 10%;"></td> <td style="width: 10%;"></td> </tr> <tr> <td></td> <td></td> <td colspan="8" style="text-align: center;"> <table border="1" style="width: 100%; border-collapse: collapse; text-align: center;"> <tr> <td style="width: 10%;"></td> <td style="width: 10%;"></td> <td style="width: 10%;"></td> <td style="width: 10%;"></td> <td style="width: 10%;"></td> <td style="width: 10%;"></td> <td style="width: 10%;"></td> <td style="width: 10%;"></td> <td style="width: 10%;"></td> <td style="width: 10%;"></td> </tr> <tr> <td></td> <td></td> <td colspan="8" style="text-align: center;"> <table border="1" style="width: 100%; border-collapse: collapse; text-align: center;"> <tr> <td style="width: 10%;"></td> <td style="width: 10%;"></td> <td style="width: 10%;"></td> <td style="width: 10%;"></td> <td style="width: 10%;"></td> <td style="width: 10%;"></td> <td style="width: 10%;"></td> <td style="width: 10%;"></td> <td style="width: 10%;"></td> <td style="width: 10%;"></td> </tr> <tr> <td></td> <td></td> <td colspan="8" style="text-align: center;"> <table border="1" style="width: 100%; border-collapse: collapse; text-align: center;"> <tr> <td style="width: 10%;"></td> <td style="width: 10%;"></td> <td style="width: 10%;"></td> <td style="width: 10%;"></td> <td style="width: 10%;"></td> <td style="width: 10%;"></td> <td style="width: 10%;"></td> <td style="width: 10%;"></td> <td style="width: 10%;"></td> <td style="width: 10%;"></td> </tr> <tr> <td></td> <td></td> <td colspan="8" style="text-align: center;"> <table border="1" style="width: 100%; border-collapse: collapse; text-align: center;"> <tr> <td style="width: 10%;"></td> <td style="width: 10%;"></td> <td style="width: 10%;"></td> <td style="width: 10%;"></td> <td style="width: 10%;"></td> <td style="width: 10%;"></td> <td style="width: 10%;"></td> <td style="width: 10%;"></td> <td style="width: 10%;"></td> <td style="width: 10%;"></td> </tr> <tr> <td></td> <td></td> <td colspan="8" style="text-align: center;"> <table border="1" style="width: 100%; border-collapse: collapse; text-align: center;"> <tr> <td style="width: 10%;"></td> <td style="width: 10%;"></td> <td style="width: 10%;"></td> <td style="width: 10%;"></td> <td style="width: 10%;"></td> <td style="width: 10%;"></td> <td style="width: 10%;"></td> <td style="width: 10%;"></td> <td style="width: 10%;"></td> <td style="width: 10%;"></td> </tr> <tr> <td></td> <td></td> <td colspan="8" style="text-align: center;"> <table border="1" style="width: 100%; border-collapse: collapse; text-align: center;"> <tr> <td style="width: 10%;"></td> <td style="width: 10%;"></td> <td style="width: 10%;"></td> <td style="width: 10%;"></td> <td style="width: 10%;"></td> <td style="width: 10%;"></td> <td style="width: 10%;"></td> <td style="width: 10%;"></td> <td style="width: 10%;"></td> <td style="width: 10%;"></td> </tr> <tr> <td></td> <td></td> <td colspan="8" style="text-align: center;"> <table border="1" style="width: 100%; border-collapse: collapse; text-align: center;"> <tr> </tr></table></td></tr></table></td></tr></table></td></tr></table></td></tr></table></td></tr></table></td></tr></table></td></tr></table></td></tr></table></td></tr></table></td></tr></table></td></tr></table></td></tr></table></td></tr></table></td></tr></table></td></tr></table></td></tr></table></td></tr></table></td></tr></table></td></tr></table></td></tr></table></td></tr></table></td></tr></table></td></tr></table></td></tr></table></td></tr></table></td></tr></table></td></tr></table></td></tr></table></td></tr></table></td></tr></table></td></tr></table></td></tr></table></td></tr></table></td></tr></table>

 | | | | | | | | | | | | | | | | | | | | <table border="1" style="width: 100%; border-collapse: collapse; text-align: center;"> <tr> <td style="width: 10%;"></td> <td style="width: 10%;"></td> <td style="width: 10%;"></td> <td style="width: 10%;"></td> <td style="width: 10%;"></td> <td style="width: 10%;"></td> <td style="width: 10%;"></td> <td style="width: 10%;"></td> <td style="width: 10%;"></td> <td style="width: 10%;"></td> </tr> <tr> <td></td> <td></td> <td colspan="8" style="text-align: center;"> <table border="1" style="width: 100%; border-collapse: collapse; text-align: center;"> <tr> <td style="width: 10%;"></td> <td style="width: 10%;"></td> <td style="width: 10%;"></td> <td style="width: 10%;"></td> <td style="width: 10%;"></td> <td style="width: 10%;"></td> <td style="width: 10%;"></td> <td style="width: 10%;"></td> <td style="width: 10%;"></td> <td style="width: 10%;"></td> </tr> <tr> <td></td> <td></td> <td colspan="8" style="text-align: center;"> <table border="1" style="width: 100%; border-collapse: collapse; text-align: center;"> <tr> <td style="width: 10%;"></td> <td style="width: 10%;"></td> <td style="width: 10%;"></td> <td style="width: 10%;"></td> <td style="width: 10%;"></td> <td style="width: 10%;"></td> <td style="width: 10%;"></td> <td style="width: 10%;"></td> <td style="width: 10%;"></td> <td style="width: 10%;"></td> </tr> <tr> <td></td> <td></td> <td colspan="8" style="text-align: center;"> <table border="1" style="width: 100%; border-collapse: collapse; text-align: center;"> <tr> <td style="width: 10%;"></td> <td style="width: 10%;"></td> <td style="width: 10%;"></td> <td style="width: 10%;"></td> <td style="width: 10%;"></td> <td style="width: 10%;"></td> <td style="width: 10%;"></td> <td style="width: 10%;"></td> <td style="width: 10%;"></td> <td style="width: 10%;"></td> </tr> <tr> <td></td> <td></td> <td colspan="8" style="text-align: center;"> <table border="1" style="width: 100%; border-collapse: collapse; text-align: center;"> <tr> <td style="width: 10%;"></td> <td style="width: 10%;"></td> <td style="width: 10%;"></td> <td style="width: 10%;"></td> <td style="width: 10%;"></td> <td style="width: 10%;"></td> <td style="width: 10%;"></td> <td style="width: 10%;"></td> <td style="width: 10%;"></td> <td style="width: 10%;"></td> </tr> <tr> <td></td> <td></td> <td colspan="8" style="text-align: center;"> <table border="1" style="width: 100%; border-collapse: collapse; text-align: center;"> <tr> <td style="width: 10%;"></td> <td style="width: 10%;"></td> <td style="width: 10%;"></td> <td style="width: 10%;"></td> <td style="width: 10%;"></td> <td style="width: 10%;"></td> <td style="width: 10%;"></td> <td style="width: 10%;"></td> <td style="width: 10%;"></td> <td style="width: 10%;"></td> </tr> <tr> <td></td> <td></td> <td colspan="8" style="text-align: center;"> <table border="1" style="width: 100%; border-collapse: collapse; text-align: center;"> <tr> <td style="width: 10%;"></td> <td style="width: 10%;"></td> <td style="width: 10%;"></td> <td style="width: 10%;"></td> <td style="width: 10%;"></td> <td style="width: 10%;"></td> <td style="width: 10%;"></td> <td style="width: 10%;"></td> <td style="width: 10%;"></td> <td style="width: 10%;"></td> </tr> <tr> <td></td> <td></td> <td colspan="8" style="text-align: center;"> <table border="1" style="width: 100%; border-collapse: collapse; text-align: center;"> <tr> <td style="width: 10%;"></td> <td style="width: 10%;"></td> <td style="width: 10%;"></td> <td style="width: 10%;"></td> <td style="width: 10%;"></td> <td style="width: 10%;"></td> <td style="width: 10%;"></td> <td style="width: 10%;"></td> <td style="width: 10%;"></td> <td style="width: 10%;"></td> </tr> <tr> <td></td> <td></td> <td colspan="8" style="text-align: center;"> <table border="1" style="width: 100%; border-collapse: collapse; text-align: center;"> <tr> <td style="width: 10%;"></td> <td style="width: 10%;"></td> <td style="width: 10%;"></td> <td style="width: 10%;"></td> <td style="width: 10%;"></td> <td style="width: 10%;"></td> <td style="width: 10%;"></td> <td style="width: 10%;"></td> <td style="width: 10%;"></td> <td style="width: 10%;"></td> </tr> <tr> <td></td> <td></td> <td colspan="8" style="text-align: center;"> <table border="1" style="width: 100%; border-collapse: collapse; text-align: center;"> <tr> <td style="width: 10%;"></td> <td style="width: 10%;"></td> <td style="width: 10%;"></td> <td style="width: 10%;"></td> <td style="width: 10%;"></td> <td style="width: 10%;"></td> <td style="width: 10%;"></td> <td style="width: 10%;"></td> <td style="width: 10%;"></td> <td style="width: 10%;"></td> </tr> <tr> <td></td> <td></td> <td colspan="8" style="text-align: center;"> <table border="1" style="width: 100%; border-collapse: collapse; text-align: center;"> <tr> <td style="width: 10%;"></td> <td style="width: 10%;"></td> <td style="width: 10%;"></td> <td style="width: 10%;"></td> <td style="width: 10%;"></td> <td style="width: 10%;"></td> <td style="width: 10%;"></td> <td style="width: 10%;"></td> <td style="width: 10%;"></td> <td style="width: 10%;"></td> </tr> <tr> <td></td> <td></td> <td colspan="8" style="text-align: center;"> <table border="1" style="width: 100%; border-collapse: collapse; text-align: center;"> <tr> <td style="width: 10%;"></td> <td style="width: 10%;"></td> <td style="width: 10%;"></td> <td style="width: 10%;"></td> <td style="width: 10%;"></td> <td style="width: 10%;"></td> <td style="width: 10%;"></td> <td style="width: 10%;"></td> <td style="width: 10%;"></td> <td style="width: 10%;"></td> </tr> <tr> <td></td> <td></td> <td colspan="8" style="text-align: center;"> <table border="1" style="width: 100%; border-collapse: collapse; text-align: center;"> <tr> <td style="width: 10%;"></td> <td style="width: 10%;"></td> <td style="width: 10%;"></td> <td style="width: 10%;"></td> <td style="width: 10%;"></td> <td style="width: 10%;"></td> <td style="width: 10%;"></td> <td style="width: 10%;"></td> <td style="width: 10%;"></td> <td style="width: 10%;"></td> </tr> <tr> <td></td> <td></td> <td colspan="8" style="text-align: center;"> <table border="1" style="width: 100%; border-collapse: collapse; text-align: center;"> <tr> <td style="width: 10%;"></td> <td style="width: 10%;"></td> <td style="width: 10%;"></td> <td style="width: 10%;"></td> <td style="width: 10%;"></td> <td style="width: 10%;"></td> <td style="width: 10%;"></td> <td style="width: 10%;"></td> <td style="width: 10%;"></td> <td style="width: 10%;"></td> </tr> <tr> <td></td> <td></td> <td colspan="8" style="text-align: center;"> <table border="1" style="width: 100%; border-collapse: collapse; text-align: center;"> <tr> <td style="width: 10%;"></td> <td style="width: 10%;"></td> <td style="width: 10%;"></td> <td style="width: 10%;"></td> <td style="width: 10%;"></td> <td style="width: 10%;"></td> <td style="width: 10%;"></td> <td style="width: 10%;"></td> <td style="width: 10%;"></td> <td style="width: 10%;"></td> </tr> <tr> <td></td> <td></td> <td colspan="8" style="text-align: center;"> <table border="1" style="width: 100%; border-collapse: collapse; text-align: center;"> <tr> <td style="width: 10%;"></td> <td style="width: 10%;"></td> <td style="width: 10%;"></td> <td style="width: 10%;"></td> <td style="width: 10%;"></td> <td style="width: 10%;"></td> <td style="width: 10%;"></td> <td style="width: 10%;"></td> <td style="width: 10%;"></td> <td style="width: 10%;"></td> </tr> <tr> <td></td> <td></td> <td colspan="8" style="text-align: center;"> <table border="1" style="width: 100%; border-collapse: collapse; text-align: center;"> <tr> <td style="width: 10%;"></td> <td style="width: 10%;"></td> <td style="width: 10%;"></td> <td style="width: 10%;"></td> <td style="width: 10%;"></td> <td style="width: 10%;"></td> <td style="width: 10%;"></td> <td style="width: 10%;"></td> <td style="width: 10%;"></td> <td style="width: 10%;"></td> </tr> <tr> <td></td> <td></td> <td colspan="8" style="text-align: center;"> <table border="1" style="width: 100%; border-collapse: collapse; text-align: center;"> <tr> <td style="width: 10%;"></td> <td style="width: 10%;"></td> <td style="width: 10%;"></td> <td style="width: 10%;"></td> <td style="width: 10%;"></td> <td style="width: 10%;"></td> <td style="width: 10%;"></td> <td style="width: 10%;"></td> <td style="width: 10%;"></td> <td style="width: 10%;"></td> </tr> <tr> <td></td> <td></td> <td colspan="8" style="text-align: center;"> <table border="1" style="width: 100%; border-collapse: collapse; text-align: center;"> <tr> <td style="width: 10%;"></td> <td style="width: 10%;"></td> <td style="width: 10%;"></td> <td style="width: 10%;"></td> <td style="width: 10%;"></td> <td style="width: 10%;"></td> <td style="width: 10%;"></td> <td style="width: 10%;"></td> <td style="width: 10%;"></td> <td style="width: 10%;"></td> </tr> <tr> <td></td> <td></td> <td colspan="8" style="text-align: center;"> <table border="1" style="width: 100%; border-collapse:
collapse; text-align: center;"> <tr> <td style="width: 10%;"></td> <td style="width: 10%;"></td> <td style="width: 10%;"></td> <td style="width: 10%;"></td> <td style="width: 10%;"></td> <td style="width: 10%;"></td> <td style="width: 10%;"></td> <td style="width: 10%;"></td> <td style="width: 10%;"></td> <td style="width: 10%;"></td> </tr> <tr> <td></td> <td></td> <td colspan="8" style="text-align: center;"> <table border="1" style="width: 100%; border-collapse: collapse; text-align: center;"> <tr> <td style="width: 10%;"></td> <td style="width: 10%;"></td> <td style="width: 10%;"></td> <td style="width: 10%;"></td> <td style="width: 10%;"></td> <td style="width: 10%;"></td> <td style="width: 10%;"></td> <td style="width: 10%;"></td> <td style="width: 10%;"></td> <td style="width: 10%;"></td> </tr> <tr> <td></td> <td></td> <td colspan="8" style="text-align: center;"> <table border="1" style="width: 100%; border-collapse: collapse; text-align: center;"> <tr> <td style="width: 10%;"></td> <td style="width: 10%;"></td> <td style="width: 10%;"></td> <td style="width: 10%;"></td> <td style="width: 10%;"></td> <td style="width: 10%;"></td> <td style="width: 10%;"></td> <td style="width: 10%;"></td> <td style="width: 10%;"></td> <td style="width: 10%;"></td> </tr> <tr> <td></td> <td></td> <td colspan="8" style="text-align: center;"> <table border="1" style="width: 100%; border-collapse: collapse; text-align: center;"> <tr> <td style="width: 10%;"></td> <td style="width: 10%;"></td> <td style="width: 10%;"></td> <td style="width: 10%;"></td> <td style="width: 10%;"></td> <td style="width: 10%;"></td> <td style="width: 10%;"></td> <td style="width: 10%;"></td> <td style="width: 10%;"></td> <td style="width: 10%;"></td> </tr> <tr> <td></td> <td></td> <td colspan="8" style="text-align: center;"> <table border="1" style="width: 100%; border-collapse: collapse; text-align: center;"> <tr> <td style="width: 10%;"></td> <td style="width: 10%;"></td> <td style="width: 10%;"></td> <td style="width: 10%;"></td> <td style="width: 10%;"></td> <td style="width: 10%;"></td> <td style="width: 10%;"></td> <td style="width: 10%;"></td> <td style="width: 10%;"></td> <td style="width: 10%;"></td> </tr> <tr> <td></td> <td></td> <td colspan="8" style="text-align: center;"> <table border="1" style="width: 100%; border-collapse: collapse; text-align: center;"> <tr> <td style="width: 10%;"></td> <td style="width: 10%;"></td> <td style="width: 10%;"></td> <td style="width: 10%;"></td> <td style="width: 10%;"></td> <td style="width: 10%;"></td> <td style="width: 10%;"></td> <td style="width: 10%;"></td> <td style="width: 10%;"></td> <td style="width: 10%;"></td> </tr> <tr> <td></td> <td></td> <td colspan="8" style="text-align: center;"> <table border="1" style="width: 100%; border-collapse: collapse; text-align: center;"> <tr> <td style="width: 10%;"></td> <td style="width: 10%;"></td> <td style="width: 10%;"></td> <td style="width: 10%;"></td> <td style="width: 10%;"></td> <td style="width: 10%;"></td> <td style="width: 10%;"></td> <td style="width: 10%;"></td> <td style="width: 10%;"></td> <td style="width: 10%;"></td> </tr> <tr> <td></td> <td></td> <td colspan="8" style="text-align: center;"> <table border="1" style="width: 100%; border-collapse: collapse; text-align: center;"> <tr> <td style="width: 10%;"></td> <td style="width: 10%;"></td> <td style="width: 10%;"></td> <td style="width: 10%;"></td> <td style="width: 10%;"></td> <td style="width: 10%;"></td> <td style="width: 10%;"></td> <td style="width: 10%;"></td> <td style="width: 10%;"></td> <td style="width: 10%;"></td> </tr> <tr> <td></td> <td></td> <td colspan="8" style="text-align: center;"> <table border="1" style="width: 100%; border-collapse: collapse; text-align: center;"> <tr> <td style="width: 10%;"></td> <td style="width: 10%;"></td> <td style="width: 10%;"></td> <td style="width: 10%;"></td> <td style="width: 10%;"></td> <td style="width: 10%;"></td> <td style="width: 10%;"></td> <td style="width: 10%;"></td> <td style="width: 10%;"></td> <td style="width: 10%;"></td> </tr> <tr> <td></td> <td></td> <td colspan="8" style="text-align: center;"> <table border="1" style="width: 100%; border-collapse: collapse; text-align: center;"> <tr> <td style="width: 10%;"></td> <td style="width: 10%;"></td> <td style="width: 10%;"></td> <td style="width: 10%;"></td> <td style="width: 10%;"></td> <td style="width: 10%;"></td> <td style="width: 10%;"></td> <td style="width: 10%;"></td> <td style="width: 10%;"></td> <td style="width: 10%;"></td> </tr> <tr> <td></td> <td></td> <td colspan="8" style="text-align: center;"> <table border="1" style="width: 100%; border-collapse: collapse; text-align: center;"> <tr> <td style="width: 10%;"></td> <td style="width: 10%;"></td> <td style="width: 10%;"></td> <td style="width: 10%;"></td> <td style="width: 10%;"></td> <td style="width: 10%;"></td> <td style="width: 10%;"></td> <td style="width: 10%;"></td> <td style="width: 10%;"></td> <td style="width: 10%;"></td> </tr> <tr> <td></td> <td></td> <td colspan="8" style="text-align: center;"> <table border="1" style="width: 100%; border-collapse: collapse; text-align: center;"> <tr> <td style="width: 10%;"></td> <td style="width: 10%;"></td> <td style="width: 10%;"></td> <td style="width: 10%;"></td> <td style="width: 10%;"></td> <td style="width: 10%;"></td> <td style="width: 10%;"></td> <td style="width: 10%;"></td> <td style="width: 10%;"></td> <td style="width: 10%;"></td> </tr> <tr> <td></td> <td></td> <td colspan="8" style="text-align: center;"> <table border="1" style="width: 100%; border-collapse: collapse; text-align: center;"> <tr> <td style="width: 10%;"></td> <td style="width: 10%;"></td> <td style="width: 10%;"></td> <td style="width: 10%;"></td> <td style="width: 10%;"></td> <td style="width: 10%;"></td> <td style="width: 10%;"></td> <td style="width: 10%;"></td> <td style="width: 10%;"></td> <td style="width: 10%;"></td> </tr> <tr> <td></td> <td></td> <td colspan="8" style="text-align: center;"> <table border="1" style="width: 100%; border-collapse: collapse; text-align: center;"> <tr> <td style="width: 10%;"></td> <td style="width: 10%;"></td> <td style="width: 10%;"></td> <td style="width: 10%;"></td> <td style="width: 10%;"></td> <td style="width: 10%;"></td> <td style="width: 10%;"></td> <td style="width: 10%;"></td> <td style="width: 10%;"></td> <td style="width: 10%;"></td> </tr> <tr> <td></td> <td></td> <td colspan="8" style="text-align: center;"> <table border="1" style="width: 100%; border-collapse: collapse; text-align: center;"> <tr> </tr></table></td></tr></table></td></tr></table></td></tr></table></td></tr></table></td></tr></table></td></tr></table></td></tr></table></td></tr></table></td></tr></table></td></tr></table></td></tr></table></td></tr></table></td></tr></table></td></tr></table></td></tr></table></td></tr></table></td></tr></table></td></tr></table></td></tr></table></td></tr></table></td></tr></table></td></tr></table></td></tr></table></td></tr></table></td></tr></table></td></tr></table></td></tr></table></td></tr></table></td></tr></table></td></tr></table></td></tr></table></td></tr></table></td></tr></table>
 | | | | | | | | | | | | | | | | | | | | <table border="1" style="width: 100%; border-collapse: collapse; text-align: center;"> <tr> <td style="width: 10%;"></td> <td style="width: 10%;"></td> <td style="width: 10%;"></td> <td style="width: 10%;"></td> <td style="width: 10%;"></td> <td style="width: 10%;"></td> <td style="width: 10%;"></td> <td style="width: 10%;"></td> <td style="width: 10%;"></td> <td style="width: 10%;"></td> </tr> <tr> <td></td> <td></td> <td colspan="8" style="text-align: center;"> <table border="1" style="width: 100%; border-collapse: collapse; text-align: center;"> <tr> <td style="width: 10%;"></td> <td
style="width: 10%;"></td> <td style="width: 10%;"></td> <td style="width: 10%;"></td> <td style="width: 10%;"></td> <td style="width: 10%;"></td> <td style="width: 10%;"></td> <td style="width: 10%;"></td> <td style="width: 10%;"></td> <td style="width: 10%;"></td> </tr> <tr> <td></td> <td></td> <td colspan="8" style="text-align: center;"> <table border="1" style="width: 100%; border-collapse: collapse; text-align: center;"> <tr> <td style="width: 10%;"></td> <td style="width: 10%;"></td> <td style="width: 10%;"></td> <td style="width: 10%;"></td> <td style="width: 10%;"></td> <td style="width: 10%;"></td> <td style="width: 10%;"></td> <td style="width: 10%;"></td> <td style="width: 10%;"></td> <td style="width: 10%;"></td> </tr> <tr> <td></td> <td></td> <td colspan="8" style="text-align: center;"> <table border="1" style="width: 100%; border-collapse: collapse; text-align: center;"> <tr> <td style="width: 10%;"></td> <td style="width: 10%;"></td> <td style="width: 10%;"></td> <td style="width: 10%;"></td> <td style="width: 10%;"></td> <td style="width: 10%;"></td> <td style="width: 10%;"></td> <td style="width: 10%;"></td> <td style="width: 10%;"></td> <td style="width: 10%;"></td> </tr> <tr> <td></td> <td></td> <td colspan="8" style="text-align: center;"> <table border="1" style="width: 100%; border-collapse: collapse; text-align: center;"> <tr> <td style="width: 10%;"></td> <td style="width: 10%;"></td> <td style="width: 10%;"></td> <td style="width: 10%;"></td> <td style="width: 10%;"></td> <td style="width: 10%;"></td> <td style="width: 10%;"></td> <td style="width: 10%;"></td> <td style="width: 10%;"></td> <td style="width: 10%;"></td> </tr> <tr> <td></td> <td></td> <td colspan="8" style="text-align: center;"> <table border="1" style="width: 100%; border-collapse: collapse; text-align: center;"> <tr> <td style="width: 10%;"></td> <td style="width: 10%;"></td> <td style="width: 10%;"></td> <td style="width: 10%;"></td> <td style="width: 10%;"></td> <td style="width: 10%;"></td> <td style="width: 10%;"></td> <td style="width: 10%;"></td> <td style="width: 10%;"></td> <td style="width: 10%;"></td> </tr> <tr> <td></td> <td></td> <td colspan="8" style="text-align: center;"> <table border="1" style="width: 100%; border-collapse: collapse; text-align: center;"> <tr> <td style="width: 10%;"></td> <td style="width: 10%;"></td> <td style="width: 10%;"></td> <td style="width: 10%;"></td> <td style="width: 10%;"></td> <td style="width: 10%;"></td> <td style="width: 10%;"></td> <td style="width: 10%;"></td> <td style="width: 10%;"></td> <td style="width: 10%;"></td> </tr> <tr> <td></td> <td></td> <td colspan="8" style="text-align: center;"> <table border="1" style="width: 100%; border-collapse: collapse; text-align: center;"> <tr> <td style="width: 10%;"></td> <td style="width: 10%;"></td> <td style="width: 10%;"></td> <td style="width: 10%;"></td> <td style="width: 10%;"></td> <td style="width: 10%;"></td> <td style="width: 10%;"></td> <td style="width: 10%;"></td> <td style="width: 10%;"></td> <td style="width: 10%;"></td> </tr> <tr> <td></td> <td></td> <td colspan="8" style="text-align: center;"> <table border="1" style="width: 100%; border-collapse: collapse; text-align: center;"> <tr> <td style="width: 10%;"></td> <td style="width: 10%;"></td> <td style="width: 10%;"></td> <td style="width: 10%;"></td> <td style="width: 10%;"></td> <td style="width: 10%;"></td> <td style="width: 10%;"></td> <td style="width: 10%;"></td> <td style="width: 10%;"></td> <td style="width: 10%;"></td> </tr> <tr> <td></td> <td></td> <td colspan="8" style="text-align: center;"> <table border="1" style="width: 100%; border-collapse: collapse; text-align: center;"> <tr> <td style="width: 10%;"></td> <td style="width: 10%;"></td> <td style="width: 10%;"></td> <td style="width: 10%;"></td> <td style="width: 10%;"></td> <td style="width: 10%;"></td> <td style="width: 10%;"></td> <td style="width: 10%;"></td> <td style="width: 10%;"></td> <td style="width: 10%;"></td> </tr> <tr> <td></td> <td></td> <td colspan="8" style="text-align: center;"> <table border="1" style="width: 100%; border-collapse: collapse; text-align: center;"> <tr> <td style="width: 10%;"></td> <td style="width: 10%;"></td> <td style="width: 10%;"></td> <td style="width: 10%;"></td> <td style="width: 10%;"></td> <td style="width: 10%;"></td> <td style="width: 10%;"></td> <td style="width: 10%;"></td> <td style="width: 10%;"></td> <td style="width: 10%;"></td> </tr> <tr> <td></td> <td></td> <td colspan="8" style="text-align: center;"> <table border="1" style="width: 100%; border-collapse: collapse; text-align: center;"> <tr> <td style="width: 10%;"></td> <td style="width: 10%;"></td> <td style="width: 10%;"></td> <td style="width: 10%;"></td> <td style="width: 10%;"></td> <td style="width: 10%;"></td> <td style="width: 10%;"></td> <td style="width: 10%;"></td> <td style="width: 10%;"></td> <td style="width: 10%;"></td> </tr> <tr> <td></td> <td></td> <td colspan="8" style="text-align: center;"> <table border="1" style="width: 100%; border-collapse: collapse; text-align: center;"> <tr> <td style="width: 10%;"></td> <td style="width: 10%;"></td> <td style="width: 10%;"></td> <td style="width: 10%;"></td> <td style="width: 10%;"></td> <td style="width: 10%;"></td> <td style="width: 10%;"></td> <td style="width: 10%;"></td> <td style="width: 10%;"></td> <td style="width: 10%;"></td> </tr> <tr> <td></td> <td></td> <td colspan="8" style="text-align: center;"> <table border="1" style="width: 100%; border-collapse: collapse; text-align: center;"> <tr> <td style="width: 10%;"></td> <td style="width: 10%;"></td> <td style="width: 10%;"></td> <td style="width: 10%;"></td> <td style="width: 10%;"></td> <td style="width: 10%;"></td> <td style="width: 10%;"></td> <td style="width: 10%;"></td> <td style="width: 10%;"></td> <td style="width: 10%;"></td> </tr> <tr> <td></td> <td></td> <td colspan="8" style="text-align: center;"> <table border="1" style="width: 100%; border-collapse: collapse; text-align: center;"> <tr> <td style="width: 10%;"></td> <td style="width: 10%;"></td> <td style="width: 10%;"></td> <td style="width: 10%;"></td> <td style="width: 10%;"></td> <td style="width: 10%;"></td> <td style="width: 10%;"></td> <td style="width: 10%;"></td> <td style="width: 10%;"></td> <td style="width: 10%;"></td> </tr> <tr> <td></td> <td></td> <td colspan="8" style="text-align: center;"> <table border="1" style="width: 100%; border-collapse: collapse; text-align: center;"> <tr> <td style="width: 10%;"></td> <td style="width: 10%;"></td> <td style="width: 10%;"></td> <td style="width: 10%;"></td> <td style="width: 10%;"></td> <td style="width: 10%;"></td> <td style="width: 10%;"></td> <td style="width: 10%;"></td> <td style="width: 10%;"></td> <td style="width: 10%;"></td> </tr> <tr> <td></td> <td></td> <td colspan="8" style="text-align: center;"> <table border="1" style="width: 100%; border-collapse: collapse; text-align: center;"> <tr> <td style="width: 10%;"></td> <td style="width: 10%;"></td> <td style="width: 10%;"></td> <td style="width: 10%;"></td> <td style="width: 10%;"></td> <td style="width: 10%;"></td> <td style="width: 10%;"></td> <td style="width: 10%;"></td> <td style="width: 10%;"></td> <td style="width: 10%;"></td> </tr> <tr> <td></td> <td></td> <td colspan="8" style="text-align: center;"> <table border="1" style="width: 100%; border-collapse: collapse; text-align: center;"> <tr> <td style="width: 10%;"></td> <td style="width: 10%;"></td> <td style="width: 10%;"></td> <td style="width: 10%;"></td> <td style="width: 10%;"></td> <td style="width: 10%;"></td> <td style="width: 10%;"></td> <td style="width: 10%;"></td> <td style="width: 10%;"></td> <td style="width: 10%;"></td> </tr> <tr> <td></td> <td></td> <td colspan="8" style="text-align: center;"> <table border="1" style="width: 100%; border-collapse: collapse; text-align: center;"> <tr> <td style="width: 10%;"></td> <td style="width: 10%;"></td> <td style="width: 10%;"></td> <td style="width: 10%;"></td> <td style="width: 10%;"></td> <td style="width: 10%;"></td> <td style="width: 10%;"></td> <td style="width: 10%;"></td> <td style="width: 10%;"></td> <td style="width: 10%;"></td> </tr> <tr> <td></td> <td></td> <td colspan="8" style="text-align: center;"> <table border="1" style="width: 100%; border-collapse: collapse; text-align: center;"> <tr> <td style="width: 10%;"></td> <td style="width: 10%;"></td> <td style="width: 10%;"></td> <td style="width: 10%;"></td> <td style="width: 10%;"></td> <td style="width: 10%;"></td> <td style="width: 10%;"></td> <td style="width: 10%;"></td> <td style="width: 10%;"></td> <td style="width: 10%;"></td> </tr> <tr> <td></td> <td></td> <td colspan="8" style="text-align: center;"> <table border="1" style="width: 100%; border-collapse: collapse; text-align: center;"> <tr> <td style="width: 10%;"></td> <td style="width: 10%;"></td> <td style="width: 10%;"></td> <td style="width: 10%;"></td> <td style="width: 10%;"></td> <td style="width: 10%;"></td> <td style="width: 10%;"></td> <td style="width: 10%;"></td> <td style="width: 10%;"></td> <td style="width: 10%;"></td> </tr> <tr> <td></td> <td></td> <td colspan="8" style="text-align: center;"> <table border="1" style="width: 100%; border-collapse: collapse; text-align: center;"> <tr> <td style="width: 10%;"></td> <td style="width: 10%;"></td> <td style="width: 10%;"></td> <td style="width: 10%;"></td> <td style="width: 10%;"></td> <td style="width: 10%;"></td> <td style="width: 10%;"></td> <td style="width: 10%;"></td> <td style="width: 10%;"></td> <td style="width: 10%;"></td> </tr> <tr> <td></td> <td></td> <td colspan="8" style="text-align: center;"> <table border="1" style="width: 100%; border-collapse: collapse; text-align: center;"> <tr> <td style="width: 10%;"></td> <td style="width: 10%;"></td> <td style="width: 10%;"></td> <td style="width: 10%;"></td> <td style="width: 10%;"></td> <td style="width: 10%;"></td> <td style="width:
10%;"></td> <td style="width: 10%;"></td> <td style="width: 10%;"></td> <td style="width: 10%;"></td> </tr> <tr> <td></td> <td></td> <td colspan="8" style="text-align: center;"> <table border="1" style="width: 100%; border-collapse: collapse; text-align: center;"> <tr> <td style="width: 10%;"></td> <td style="width: 10%;"></td> <td style="width: 10%;"></td> <td style="width: 10%;"></td> <td style="width: 10%;"></td> <td style="width: 10%;"></td> <td style="width: 10%;"></td> <td style="width: 10%;"></td> <td style="width: 10%;"></td> <td style="width: 10%;"></td> </tr> <tr> <td></td> <td></td> <td colspan="8" style="text-align: center;"> <table border="1" style="width: 100%; border-collapse: collapse; text-align: center;"> <tr> <td style="width: 10%;"></td> <td style="width: 10%;"></td> <td style="width: 10%;"></td> <td style="width: 10%;"></td> <td style="width: 10%;"></td> <td style="width: 10%;"></td> <td style="width: 10%;"></td> <td style="width: 10%;"></td> <td style="width: 10%;"></td> <td style="width: 10%;"></td> </tr> <tr> <td></td> <td></td> <td colspan="8" style="text-align: center;"> <table border="1" style="width: 100%; border-collapse: collapse; text-align: center;"> <tr> <td style="width: 10%;"></td> <td style="width: 10%;"></td> <td style="width: 10%;"></td> <td style="width: 10%;"></td> <td style="width: 10%;"></td> <td style="width: 10%;"></td> <td style="width: 10%;"></td> <td style="width: 10%;"></td> <td style="width: 10%;"></td> <td style="width: 10%;"></td> </tr> <tr> <td></td> <td></td> <td colspan="8" style="text-align: center;"> <table border="1" style="width: 100%; border-collapse: collapse; text-align: center;"> <tr> <td style="width: 10%;"></td> <td style="width: 10%;"></td> <td style="width: 10%;"></td> <td style="width: 10%;"></td> <td style="width: 10%;"></td> <td style="width: 10%;"></td> <td style="width: 10%;"></td> <td style="width: 10%;"></td> <td style="width: 10%;"></td> <td style="width: 10%;"></td> </tr> <tr> <td></td> <td></td> <td colspan="8" style="text-align: center;"> <table border="1" style="width: 100%; border-collapse: collapse; text-align: center;"> <tr> <td style="width: 10%;"></td> <td style="width: 10%;"></td> <td style="width: 10%;"></td> <td style="width: 10%;"></td> <td style="width: 10%;"></td> <td style="width: 10%;"></td> <td style="width: 10%;"></td> <td style="width: 10%;"></td> <td style="width: 10%;"></td> <td style="width: 10%;"></td> </tr> <tr> <td></td> <td></td> <td colspan="8" style="text-align: center;"> <table border="1" style="width: 100%; border-collapse: collapse; text-align: center;"> <tr> <td style="width: 10%;"></td> <td style="width: 10%;"></td> <td style="width: 10%;"></td> <td style="width: 10%;"></td> <td style="width: 10%;"></td> <td style="width: 10%;"></td> <td style="width: 10%;"></td> <td style="width: 10%;"></td> <td style="width: 10%;"></td> <td style="width: 10%;"></td> </tr> <tr> <td></td> <td></td> <td colspan="8" style="text-align: center;"> <table border="1" style="width: 100%; border-collapse: collapse; text-align: center;"> <tr> <td style="width: 10%;"></td> <td style="width: 10%;"></td> <td style="width: 10%;"></td> <td style="width: 10%;"></td> <td style="width: 10%;"></td> <td style="width: 10%;"></td> <td style="width: 10%;"></td> <td style="width: 10%;"></td> <td style="width: 10%;"></td> <td style="width: 10%;"></td> </tr> <tr> <td></td> <td></td> <td colspan="8" style="text-align: center;"> <table border="1" style="width: 100%; border-collapse: collapse; text-align: center;"> <tr> <td style="width: 10%;"></td> <td style="width: 10%;"></td> <td style="width: 10%;"></td> <td style="width: 10%;"></td> <td style="width: 10%;"></td> <td style="width: 10%;"></td> <td style="width: 10%;"></td> <td style="width: 10%;"></td> <td style="width: 10%;"></td> <td style="width: 10%;"></td> </tr> <tr> <td></td> <td></td> <td colspan="8" style="text-align: center;"> <table border="1" style="width: 100%; border-collapse: collapse; text-align: center;"> <tr> <td style="width: 10%;"></td> <td style="width: 10%;"></td> <td style="width: 10%;"></td> <td style="width: 10%;"></td> <td style="width: 10%;"></td> <td style="width: 10%;"></td> <td style="width: 10%;"></td> <td style="width: 10%;"></td> <td style="width: 10%;"></td> <td style="width: 10%;"></td> </tr> <tr> <td></td> <td></td> <td colspan="8" style="text-align: center;"> <table border="1" style="width: 100%; border-collapse: collapse; text-align: center;"> <tr> </tr></table></td></tr></table></td></tr></table></td></tr></table></td></tr></table></td></tr></table></td></tr></table></td></tr></table></td></tr></table></td></tr></table></td></tr></table></td></tr></table></td></tr></table></td></tr></table></td></tr></table></td></tr></table></td></tr></table></td></tr></table></td></tr></table></td></tr></table></td></tr></table></td></tr></table></td></tr></table></td></tr></table></td></tr></table></td></tr></table></td></tr></table></td></tr></table></td></tr></table></td></tr></table></td></tr></table></td></tr></table></td></tr></table>
 | | | | | | | | | | | | | | | | | | | | <table border="1" style="width: 100%; border-collapse: collapse; text-align: center;"> <tr> <td style="width: 10%;"></td> <td style="width: 10%;"></td> <td style="width: 10%;"></td> <td style="width: 10%;"></td> <td style="width: 10%;"></td> <td style="width: 10%;"></td> <td style="width: 10%;"></td> <td style="width: 10%;"></td> <td style="width: 10%;"></td> <td style="width: 10%;"></td> </tr> <tr> <td></td> <td></td> <td colspan="8" style="text-align: center;"> <table border="1" style="width: 100%; border-collapse: collapse; text-align: center;"> <tr> <td style="width: 10%;"></td> <td style="width: 10%;"></td> <td style="width: 10%;"></td> <td style="width: 10%;"></td> <td style="width: 10%;"></td> <td style="width: 10%;"></td> <td style="width: 10%;"></td> <td style="width: 10%;"></td> <td style="width: 10%;"></td> <td style="width: 10%;"></td> </tr> <tr> <td></td> <td></td> <td colspan="8" style="text-align: center;"> <table border="1" style="width: 100%; border-collapse: collapse; text-align: center;"> <tr> <td style="width: 10%;"></td> <td style="width: 10%;"></td> <td style="width: 10%;"></td> <td style="width: 10%;"></td> <td style="width: 10%;"></td> <td style="width: 10%;"></td> <td style="width: 10%;"></td> <td style="width: 10%;"></td> <td style="width: 10%;"></td> <td style="width: 10%;"></td> </tr> <tr> <td></td> <td></td> <td colspan="8" style="text-align: center;"> <table border="1" style="width: 100%; border-collapse: collapse; text-align: center;"> <tr> <td style="width: 10%;"></td> <td style="width: 10%;"></td> <td style="width: 10%;"></td> <td style="width: 10%;"></td> <td style="width: 10%;"></td> <td style="width: 10%;"></td> <td style="width: 10%;"></td> <td style="width: 10%;"></td> <td style="width: 10%;"></td> <td style="width: 10%;"></td> </tr> <tr> <td></td> <td></td> <td colspan="8" style="text-align: center;"> <table border="1" style="width: 100%; border-collapse: collapse; text-align: center;"> <tr> <td style="width: 10%;"></td> <td style="width: 10%;"></td> <td style="width: 10%;"></td> <td style="width: 10%;"></td> <td style="width: 10%;"></td> <td style="width: 10%;"></td> <td style="width: 10%;"></td> <td style="width: 10%;"></td> <td style="width: 10%;"></td> <td style="width: 10%;"></td> </tr> <tr> <td></td> <td></td> <td colspan="8" style="text-align: center;"> <table border="1" style="width: 100%; border-collapse: collapse; text-align: center;"> <tr> <td style="width: 10%;"></td> <td style="width: 10%;"></td> <td style="width: 10%;"></td> <td style="width: 10%;"></td> <td style="width: 10%;"></td> <td style="width: 10%;"></td> <td style="width: 10%;"></td> <td style="width: 10%;"></td> <td style="width: 10%;"></td> <td
style="width: 10%;"></td> </tr> <tr> <td></td> <td></td> <td colspan="8" style="text-align: center;"> <table border="1" style="width: 100%; border-collapse: collapse; text-align: center;"> <tr> <td style="width: 10%;"></td> <td style="width: 10%;"></td> <td style="width: 10%;"></td> <td style="width: 10%;"></td> <td style="width: 10%;"></td> <td style="width: 10%;"></td> <td style="width: 10%;"></td> <td style="width: 10%;"></td> <td style="width: 10%;"></td> <td style="width: 10%;"></td> </tr> <tr> <td></td> <td></td> <td colspan="8" style="text-align: center;"> <table border="1" style="width: 100%; border-collapse: collapse; text-align: center;"> <tr> <td style="width: 10%;"></td> <td style="width: 10%;"></td> <td style="width: 10%;"></td> <td style="width: 10%;"></td> <td style="width: 10%;"></td> <td style="width: 10%;"></td> <td style="width: 10%;"></td> <td style="width: 10%;"></td> <td style="width: 10%;"></td> <td style="width: 10%;"></td> </tr> <tr> <td></td> <td></td> <td colspan="8" style="text-align: center;"> <table border="1" style="width: 100%; border-collapse: collapse; text-align: center;"> <tr> <td style="width: 10%;"></td> <td style="width: 10%;"></td> <td style="width: 10%;"></td> <td style="width: 10%;"></td> <td style="width: 10%;"></td> <td style="width: 10%;"></td> <td style="width: 10%;"></td> <td style="width: 10%;"></td> <td style="width: 10%;"></td> <td style="width: 10%;"></td> </tr> <tr> <td></td> <td></td> <td colspan="8" style="text-align: center;"> <table border="1" style="width: 100%; border-collapse: collapse; text-align: center;"> <tr> <td style="width: 10%;"></td> <td style="width: 10%;"></td> <td style="width: 10%;"></td> <td style="width: 10%;"></td> <td style="width: 10%;"></td> <td style="width: 10%;"></td> <td style="width: 10%;"></td> <td style="width: 10%;"></td> <td style="width: 10%;"></td> <td style="width: 10%;"></td> </tr> <tr> <td></td> <td></td> <td colspan="8" style="text-align: center;"> <table border="1" style="width: 100%; border-collapse: collapse; text-align: center;"> <tr> <td style="width: 10%;"></td> <td style="width: 10%;"></td> <td style="width: 10%;"></td> <td style="width: 10%;"></td> <td style="width: 10%;"></td> <td style="width: 10%;"></td> <td style="width: 10%;"></td> <td style="width: 10%;"></td> <td style="width: 10%;"></td> <td style="width: 10%;"></td> </tr> <tr> <td></td> <td></td> <td colspan="8" style="text-align: center;"> <table border="1" style="width: 100%; border-collapse: collapse; text-align: center;"> <tr> <td style="width: 10%;"></td> <td style="width: 10%;"></td> <td style="width: 10%;"></td> <td style="width: 10%;"></td> <td style="width: 10%;"></td> <td style="width: 10%;"></td> <td style="width: 10%;"></td> <td style="width: 10%;"></td> <td style="width: 10%;"></td> <td style="width: 10%;"></td> </tr> <tr> <td></td> <td></td> <td colspan="8" style="text-align: center;"> <table border="1" style="width: 100%; border-collapse: collapse; text-align: center;"> <tr> <td style="width: 10%;"></td> <td style="width: 10%;"></td> <td style="width: 10%;"></td> <td style="width: 10%;"></td> <td style="width: 10%;"></td> <td style="width: 10%;"></td> <td style="width: 10%;"></td> <td style="width: 10%;"></td> <td style="width: 10%;"></td> <td style="width: 10%;"></td> </tr> <tr> <td></td> <td></td> <td colspan="8" style="text-align: center;"> <table border="1" style="width: 100%; border-collapse: collapse; text-align: center;"> <tr> <td style="width: 10%;"></td> <td style="width: 10%;"></td> <td style="width: 10%;"></td> <td style="width: 10%;"></td> <td style="width: 10%;"></td> <td style="width: 10%;"></td> <td style="width: 10%;"></td> <td style="width: 10%;"></td> <td style="width: 10%;"></td> <td style="width: 10%;"></td> </tr> <tr> <td></td> <td></td> <td colspan="8" style="text-align: center;"> <table border="1" style="width: 100%; border-collapse: collapse; text-align: center;"> <tr> <td style="width: 10%;"></td> <td style="width: 10%;"></td> <td style="width: 10%;"></td> <td style="width: 10%;"></td> <td style="width: 10%;"></td> <td style="width: 10%;"></td> <td style="width: 10%;"></td> <td style="width: 10%;"></td> <td style="width: 10%;"></td> <td style="width: 10%;"></td> </tr> <tr> <td></td> <td></td> <td colspan="8" style="text-align: center;"> <table border="1" style="width: 100%; border-collapse: collapse; text-align: center;"> <tr> <td style="width: 10%;"></td> <td style="width: 10%;"></td> <td style="width: 10%;"></td> <td style="width: 10%;"></td> <td style="width: 10%;"></td> <td style="width: 10%;"></td> <td style="width: 10%;"></td> <td style="width: 10%;"></td> <td style="width: 10%;"></td> <td style="width: 10%;"></td> </tr> <tr> <td></td> <td></td> <td colspan="8" style="text-align: center;"> <table border="1" style="width: 100%; border-collapse: collapse; text-align: center;"> <tr> <td style="width: 10%;"></td> <td style="width: 10%;"></td> <td style="width: 10%;"></td> <td style="width: 10%;"></td> <td style="width: 10%;"></td> <td style="width: 10%;"></td> <td style="width: 10%;"></td> <td style="width: 10%;"></td> <td style="width: 10%;"></td> <td style="width: 10%;"></td> </tr> <tr> <td></td> <td></td> <td colspan="8" style="text-align: center;"> <table border="1" style="width: 100%; border-collapse: collapse; text-align: center;"> <tr> <td style="width: 10%;"></td> <td style="width: 10%;"></td> <td style="width: 10%;"></td> <td style="width: 10%;"></td> <td style="width: 10%;"></td> <td style="width: 10%;"></td> <td style="width: 10%;"></td> <td style="width: 10%;"></td> <td style="width: 10%;"></td> <td style="width: 10%;"></td> </tr> <tr> <td></td> <td></td> <td colspan="8" style="text-align: center;"> <table border="1" style="width: 100%; border-collapse: collapse; text-align: center;"> <tr> <td style="width: 10%;"></td> <td style="width: 10%;"></td> <td style="width: 10%;"></td> <td style="width: 10%;"></td> <td style="width: 10%;"></td> <td style="width: 10%;"></td> <td style="width: 10%;"></td> <td style="width: 10%;"></td> <td style="width: 10%;"></td> <td style="width: 10%;"></td> </tr> <tr> <td></td> <td></td> <td colspan="8" style="text-align: center;"> <table border="1" style="width: 100%; border-collapse: collapse; text-align: center;"> <tr> <td style="width: 10%;"></td> <td style="width: 10%;"></td> <td style="width: 10%;"></td> <td style="width: 10%;"></td> <td style="width: 10%;"></td> <td style="width: 10%;"></td> <td style="width: 10%;"></td> <td style="width: 10%;"></td> <td style="width: 10%;"></td> <td style="width: 10%;"></td> </tr> <tr> <td></td> <td></td> <td colspan="8" style="text-align: center;"> <table border="1" style="width: 100%; border-collapse: collapse; text-align: center;"> <tr> <td style="width: 10%;"></td> <td style="width: 10%;"></td> <td style="width: 10%;"></td> <td style="width: 10%;"></td> <td style="width: 10%;"></td> <td style="width: 10%;"></td> <td style="width: 10%;"></td> <td style="width: 10%;"></td> <td style="width: 10%;"></td> <td style="width: 10%;"></td> </tr> <tr> <td></td> <td></td> <td colspan="8" style="text-align: center;"> <table border="1" style="width: 100%; border-collapse: collapse; text-align: center;"> <tr> <td style="width: 10%;"></td> <td style="width: 10%;"></td> <td style="width: 10%;"></td> <td style="width: 10%;"></td> <td style="width: 10%;"></td> <td style="width: 10%;"></td> <td style="width: 10%;"></td> <td style="width: 10%;"></td> <td style="width: 10%;"></td> <td style="width: 10%;"></td> </tr> <tr> <td></td> <td></td> <td colspan="8" style="text-align: center;"> <table border="1" style="width: 100%; border-collapse: collapse; text-align: center;"> <tr> <td style="width: 10%;"></td> <td style="width: 10%;"></td> <td style="width: 10%;"></td> <td style="width: 10%;"></td> <td style="width: 10%;"></td> <td style="width: 10%;"></td> <td style="width: 10%;"></td> <td style="width: 10%;"></td> <td style="width: 10%;"></td> <td style="width: 10%;"></td> </tr> <tr> <td></td> <td></td> <td colspan="8" style="text-align: center;"> <table border="1" style="width: 100%; border-collapse: collapse; text-align: center;"> <tr> <td style="width: 10%;"></td> <td style="width: 10%;"></td> <td style="width: 10%;"></td> <td style="width: 10%;"></td> <td style="width: 10%;"></td> <td style="width: 10%;"></td> <td style="width: 10%;"></td> <td style="width: 10%;"></td> <td style="width: 10%;"></td> <td style="width: 10%;"></td> </tr> <tr> <td></td> <td></td> <td colspan="8" style="text-align: center;"> <table border="1" style="width: 100%; border-collapse: collapse; text-align: center;"> <tr> <td style="width: 10%;"></td> <td style="width: 10%;"></td> <td style="width: 10%;"></td> <td style="width: 10%;"></td> <td style="width: 10%;"></td> <td style="width: 10%;"></td> <td style="width: 10%;"></td> <td style="width: 10%;"></td> <td style="width: 10%;"></td> <td style="width: 10%;"></td> </tr> <tr> <td></td> <td></td> <td colspan="8" style="text-align: center;"> <table border="1" style="width: 100%; border-collapse: collapse; text-align: center;"> <tr> <td style="width: 10%;"></td> <td style="width: 10%;"></td> <td style="width: 10%;"></td> <td style="width: 10%;"></td> <td style="width: 10%;"></td> <td style="width: 10%;"></td> <td style="width: 10%;"></td> <td style="width: 10%;"></td> <td style="width: 10%;"></td> <td style="width: 10%;"></td> </tr> <tr> <td></td> <td></td> <td colspan="8" style="text-align: center;"> <table border="1" style="width: 100%; border-collapse: collapse; text-align: center;"> <tr> <td style="width: 10%;"></td> <td style="width: 10%;"></td> <td style="width: 10%;"></td> <td style="width: 10%;"></td> <td style="width: 10%;"></td> <td style="width: 10%;"></td> <td style="width: 10%;"></td> <td style="width: 10%;"></td> <td style="width: 10%;"></td> <td style="width: 10%;"></td> </tr> <tr> <td></td> <td></td> <td colspan="8" style="text-align: center;"> <table border="1" style="width: 100%; border-collapse: collapse;
text-align: center;"> <tr> <td style="width: 10%;"></td> <td style="width: 10%;"></td> <td style="width: 10%;"></td> <td style="width: 10%;"></td> <td style="width: 10%;"></td> <td style="width: 10%;"></td> <td style="width: 10%;"></td> <td style="width: 10%;"></td> <td style="width: 10%;"></td> <td style="width: 10%;"></td> </tr> <tr> <td></td> <td></td> <td colspan="8" style="text-align: center;"> <table border="1" style="width: 100%; border-collapse: collapse; text-align: center;"> <tr> <td style="width: 10%;"></td> <td style="width: 10%;"></td> <td style="width: 10%;"></td> <td style="width: 10%;"></td> <td style="width: 10%;"></td> <td style="width: 10%;"></td> <td style="width: 10%;"></td> <td style="width: 10%;"></td> <td style="width: 10%;"></td> <td style="width: 10%;"></td> </tr> <tr> <td></td> <td></td> <td colspan="8" style="text-align: center;"> <table border="1" style="width: 100%; border-collapse: collapse; text-align: center;"> <tr> <td style="width: 10%;"></td> <td style="width: 10%;"></td> <td style="width: 10%;"></td> <td style="width: 10%;"></td> <td style="width: 10%;"></td> <td style="width: 10%;"></td> <td style="width: 10%;"></td> <td style="width: 10%;"></td> <td style="width: 10%;"></td> <td style="width: 10%;"></td> </tr> <tr> <td></td> <td></td> <td colspan="8" style="text-align: center;"> <table border="1" style="width: 100%; border-collapse: collapse; text-align: center;"> <tr> <td style="width: 10%;"></td> <td style="width: 10%;"></td> <td style="width: 10%;"></td> <td style="width: 10%;"></td> <td style="width: 10%;"></td> <td style="width: 10%;"></td> <td style="width: 10%;"></td> <td style="width: 10%;"></td> <td style="width: 10%;"></td> <td style="width: 10%;"></td> </tr> <tr> <td></td> <td></td> <td colspan="8" style="text-align: center;"> <table border="1" style="width: 100%; border-collapse: collapse; text-align: center;"> <tr> </tr></table></td></tr></table></td></tr></table></td></tr></table></td></tr></table></td></tr></table></td></tr></table></td></tr></table></td></tr></table></td></tr></table></td></tr></table></td></tr></table></td></tr></table></td></tr></table></td></tr></table></td></tr></table></td></tr></table></td></tr></table></td></tr></table></td></tr></table></td></tr></table></td></tr></table></td></tr></table></td></tr></table></td></tr></table></td></tr></table></td></tr></table></td></tr></table></td></tr></table></td></tr></table></td></tr></table></td></tr></table>
 | | | | | | | | | | | | | | | | | | | | <table border="1" style="width: 100%; border-collapse: collapse; text-align: center;"> <tr> <td style="width: 10%;"></td> <td style="width: 10%;"></td> <td style="width: 10%;"></td> <td style="width: 10%;"></td> <td style="width: 10%;"></td> <td style="width: 10%;"></td> <td style="width: 10%;"></td> <td style="width: 10%;"></td> <td style="width: 10%;"></td> <td style="width: 10%;"></td> </tr> <tr> <td></td> <td></td> <td colspan="8" style="text-align: center;"> <table border="1" style="width: 100%; border-collapse: collapse; text-align: center;"> <tr> <td style="width: 10%;"></td> <td style="width: 10%;"></td> <td style="width: 10%;"></td> <td style="width: 10%;"></td> <td style="width: 10%;"></td> <td style="width: 10%;"></td> <td style="width: 10%;"></td> <td style="width: 10%;"></td> <td style="width: 10%;"></td> <td style="width: 10%;"></td> </tr> <tr> <td></td> <td></td> <td colspan="8" style="text-align: center;"> <table border="1" style="width: 100%; border-collapse: collapse; text-align: center;"> <tr> <td style="width: 10%;"></td> <td style="width: 10%;"></td> <td style="width: 10%;"></td> <td style="width: 10%;"></td> <td style="width: 10%;"></td> <td style="width: 10%;"></td> <td style="width: 10%;"></td> <td style="width: 10%;"></td> <td style="width: 10%;"></td> <td style="width: 10%;"></td> </tr> <tr> <td></td> <td></td> <td colspan="8" style="text-align: center;"> <table border="1" style="width: 100%; border-collapse: collapse; text-align: center;"> <tr> <td style="width: 10%;"></td> <td style="width: 10%;"></td> <td style="width: 10%;"></td> <td style="width: 10%;"></td> <td style="width: 10%;"></td> <td style="width: 10%;"></td> <td style="width: 10%;"></td> <td style="width: 10%;"></td> <td style="width: 10%;"></td> <td style="width: 10%;"></td> </tr> <tr> <td></td> <td></td> <td colspan="8" style="text-align: center;"> <table border="1" style="width: 100%; border-collapse: collapse; text-align: center;"> <tr> <td style="width: 10%;"></td> <td style="width: 10%;"></td> <td style="width: 10%;"></td> <td style="width: 10%;"></td> <td style="width: 10%;"></td> <td style="width: 10%;"></td> <td style="width: 10%;"></td> <td style="width: 10%;"></td> <td style="width: 10%;"></td> <td style="width: 10%;"></td> </tr> <tr> <td></td> <td></td> <td colspan="8" style="text-align: center;"> <table border="1" style="width: 100%; border-collapse: collapse; text-align: center;"> <tr> <td style="width: 10%;"></td> <td style="width: 10%;"></td> <td style="width: 10%;"></td> <td style="width: 10%;"></td> <td style="width: 10%;"></td> <td style="width: 10%;"></td> <td style="width: 10%;"></td> <td style="width: 10%;"></td> <td style="width: 10%;"></td> <td style="width: 10%;"></td> </tr> <tr> <td></td> <td></td> <td colspan="8" style="text-align: center;"> <table border="1" style="width: 100%; border-collapse: collapse; text-align: center;"> <tr> <td style="width: 10%;"></td> <td style="width: 10%;"></td> <td style="width: 10%;"></td> <td style="width: 10%;"></td> <td style="width: 10%;"></td> <td style="width: 10%;"></td> <td style="width: 10%;"></td> <td style="width: 10%;"></td> <td style="width: 10%;"></td> <td style="width: 10%;"></td> </tr> <tr> <td></td> <td></td> <td colspan="8" style="text-align: center;"> <table border="1" style="width: 100%; border-collapse: collapse; text-align: center;"> <tr> <td style="width: 10%;"></td> <td style="width: 10%;"></td> <td style="width: 10%;"></td> <td style="width: 10%;"></td> <td style="width: 10%;"></td> <td style="width: 10%;"></td> <td style="width: 10%;"></td> <td style="width: 10%;"></td> <td style="width: 10%;"></td> <td style="width: 10%;"></td> </tr> <tr> <td></td> <td></td> <td colspan="8" style="text-align: center;"> <table border="1" style="width: 100%; border-collapse: collapse; text-align: center;"> <tr> <td style="width: 10%;"></td> <td style="width: 10%;"></td> <td style="width: 10%;"></td> <td style="width: 10%;"></td> <td style="width: 10%;"></td> <td style="width: 10%;"></td> <td style="width: 10%;"></td> <td style="width: 10%;"></td> <td style="width: 10%;"></td> <td style="width: 10%;"></td> </tr> <tr> <td></td> <td></td> <td colspan="8" style="text-align: center;"> <table border="1" style="width: 100%; border-collapse: collapse; text-align: center;"> <tr> <td style="width: 10%;"></td> <td style="width: 10%;"></td> <td style="width: 10%;"></td> <td style="width: 10%;"></td> <td style="width: 10%;"></td> <td style="width: 10%;"></td> <td style="width: 10%;"></td> <td style="width: 10%;"></td> <td style="width: 10%;"></td> <td style="width: 10%;"></td> </tr> <tr> <td></td> <td></td> <td colspan="8" style="text-align: center;"> <table border="1" style="width: 100%; border-collapse: collapse; text-align: center;"> <tr> <td style="width: 10%;"></td> <td style="width: 10%;"></td> <td style="width: 10%;"></td> <td style="width: 10%;"></td> <td style="width: 10%;"></td> <td style="width: 10%;"></td> <td style="width: 10%;"></td> <td style="width: 10%;"></td> <td style="width: 10%;"></td> <td style="width: 10%;"></td> </tr> <tr> <td></td> <td></td> <td colspan="8" style="text-align: center;"> <table border="1" style="width: 100%; border-collapse: collapse; text-align: center;"> <tr> <td style="width: 10%;"></td> <td style="width: 10%;"></td> <td style="width:
10%;"></td> <td style="width: 10%;"></td> <td style="width: 10%;"></td> <td style="width: 10%;"></td> <td style="width: 10%;"></td> <td style="width: 10%;"></td> <td style="width: 10%;"></td> <td style="width: 10%;"></td> </tr> <tr> <td></td> <td></td> <td colspan="8" style="text-align: center;"> <table border="1" style="width: 100%; border-collapse: collapse; text-align: center;"> <tr> <td style="width: 10%;"></td> <td style="width: 10%;"></td> <td style="width: 10%;"></td> <td style="width: 10%;"></td> <td style="width: 10%;"></td> <td style="width: 10%;"></td> <td style="width: 10%;"></td> <td style="width: 10%;"></td> <td style="width: 10%;"></td> <td style="width: 10%;"></td> </tr> <tr> <td></td> <td></td> <td colspan="8" style="text-align: center;"> <table border="1" style="width: 100%; border-collapse: collapse; text-align: center;"> <tr> <td style="width: 10%;"></td> <td style="width: 10%;"></td> <td style="width: 10%;"></td> <td style="width: 10%;"></td> <td style="width: 10%;"></td> <td style="width: 10%;"></td> <td style="width: 10%;"></td> <td style="width: 10%;"></td> <td style="width: 10%;"></td> <td style="width: 10%;"></td> </tr> <tr> <td></td> <td></td> <td colspan="8" style="text-align: center;"> <table border="1" style="width: 100%; border-collapse: collapse; text-align: center;"> <tr> <td style="width: 10%;"></td> <td style="width: 10%;"></td> <td style="width: 10%;"></td> <td style="width: 10%;"></td> <td style="width: 10%;"></td> <td style="width: 10%;"></td> <td style="width: 10%;"></td> <td style="width: 10%;"></td> <td style="width: 10%;"></td> <td style="width: 10%;"></td> </tr> <tr> <td></td> <td></td> <td colspan="8" style="text-align: center;"> <table border="1" style="width: 100%; border-collapse: collapse; text-align: center;"> <tr> <td style="width: 10%;"></td> <td style="width: 10%;"></td> <td style="width: 10%;"></td> <td style="width: 10%;"></td> <td style="width: 10%;"></td> <td style="width: 10%;"></td> <td style="width: 10%;"></td> <td style="width: 10%;"></td> <td style="width: 10%;"></td> <td style="width: 10%;"></td> </tr> <tr> <td></td> <td></td> <td colspan="8" style="text-align: center;"> <table border="1" style="width: 100%; border-collapse: collapse; text-align: center;"> <tr> <td style="width: 10%;"></td> <td style="width: 10%;"></td> <td style="width: 10%;"></td> <td style="width: 10%;"></td> <td style="width: 10%;"></td> <td style="width: 10%;"></td> <td style="width: 10%;"></td> <td style="width: 10%;"></td> <td style="width: 10%;"></td> <td style="width: 10%;"></td> </tr> <tr> <td></td> <td></td> <td colspan="8" style="text-align: center;"> <table border="1" style="width: 100%; border-collapse: collapse; text-align: center;"> <tr> <td style="width: 10%;"></td> <td style="width: 10%;"></td> <td style="width: 10%;"></td> <td style="width: 10%;"></td> <td style="width: 10%;"></td> <td style="width: 10%;"></td> <td style="width: 10%;"></td> <td style="width: 10%;"></td> <td style="width: 10%;"></td> <td style="width: 10%;"></td> </tr> <tr> <td></td> <td></td> <td colspan="8" style="text-align: center;"> <table border="1" style="width: 100%; border-collapse: collapse; text-align: center;"> <tr> <td style="width: 10%;"></td> <td style="width: 10%;"></td> <td style="width: 10%;"></td> <td style="width: 10%;"></td> <td style="width: 10%;"></td> <td style="width: 10%;"></td> <td style="width: 10%;"></td> <td style="width: 10%;"></td> <td style="width: 10%;"></td> <td style="width: 10%;"></td> </tr> <tr> <td></td> <td></td> <td colspan="8" style="text-align: center;"> <table border="1" style="width: 100%; border-collapse: collapse; text-align: center;"> <tr> <td style="width: 10%;"></td> <td style="width: 10%;"></td> <td style="width: 10%;"></td> <td style="width: 10%;"></td> <td style="width: 10%;"></td> <td style="width: 10%;"></td> <td style="width: 10%;"></td> <td style="width: 10%;"></td> <td style="width: 10%;"></td> <td style="width: 10%;"></td> </tr> <tr> <td></td> <td></td> <td colspan="8" style="text-align: center;"> <table border="1" style="width: 100%; border-collapse: collapse; text-align: center;"> <tr> <td style="width: 10%;"></td> <td style="width: 10%;"></td> <td style="width: 10%;"></td> <td style="width: 10%;"></td> <td style="width: 10%;"></td> <td style="width: 10%;"></td> <td style="width: 10%;"></td> <td style="width: 10%;"></td> <td style="width: 10%;"></td> <td style="width: 10%;"></td> </tr> <tr> <td></td> <td></td> <td colspan="8" style="text-align: center;"> <table border="1" style="width: 100%; border-collapse: collapse; text-align: center;"> <tr> <td style="width: 10%;"></td> <td style="width: 10%;"></td> <td style="width: 10%;"></td> <td style="width: 10%;"></td> <td style="width: 10%;"></td> <td style="width: 10%;"></td> <td style="width: 10%;"></td> <td style="width: 10%;"></td> <td style="width: 10%;"></td> <td style="width: 10%;"></td> </tr> <tr> <td></td> <td></td> <td colspan="8" style="text-align: center;"> <table border="1" style="width: 100%; border-collapse: collapse; text-align: center;"> <tr> <td style="width: 10%;"></td> <td style="width: 10%;"></td> <td style="width: 10%;"></td> <td style="width: 10%;"></td> <td style="width: 10%;"></td> <td style="width: 10%;"></td> <td style="width: 10%;"></td> <td style="width: 10%;"></td> <td style="width: 10%;"></td> <td style="width: 10%;"></td> </tr> <tr> <td></td> <td></td> <td colspan="8" style="text-align: center;"> <table border="1" style="width: 100%; border-collapse: collapse; text-align: center;"> <tr> <td style="width: 10%;"></td> <td style="width: 10%;"></td> <td style="width: 10%;"></td> <td style="width: 10%;"></td> <td style="width: 10%;"></td> <td style="width: 10%;"></td> <td style="width: 10%;"></td> <td style="width: 10%;"></td> <td style="width: 10%;"></td> <td style="width: 10%;"></td> </tr> <tr> <td></td> <td></td> <td colspan="8" style="text-align: center;"> <table border="1" style="width: 100%; border-collapse: collapse; text-align: center;"> <tr> <td style="width: 10%;"></td> <td style="width: 10%;"></td> <td style="width: 10%;"></td> <td style="width: 10%;"></td> <td style="width: 10%;"></td> <td style="width: 10%;"></td> <td style="width: 10%;"></td> <td style="width: 10%;"></td> <td style="width: 10%;"></td> <td style="width: 10%;"></td> </tr> <tr> <td></td> <td></td> <td colspan="8" style="text-align: center;"> <table border="1" style="width: 100%; border-collapse: collapse; text-align: center;"> <tr> <td style="width: 10%;"></td> <td style="width: 10%;"></td> <td style="width: 10%;"></td> <td style="width: 10%;"></td> <td style="width: 10%;"></td> <td style="width: 10%;"></td> <td style="width: 10%;"></td> <td style="width: 10%;"></td> <td style="width: 10%;"></td> <td style="width: 10%;"></td> </tr> <tr> <td></td> <td></td> <td colspan="8" style="text-align: center;"> <table border="1" style="width: 100%; border-collapse: collapse; text-align: center;"> <tr> <td style="width: 10%;"></td> <td style="width: 10%;"></td> <td style="width: 10%;"></td> <td style="width: 10%;"></td> <td style="width: 10%;"></td> <td style="width: 10%;"></td> <td style="width: 10%;"></td> <td style="width: 10%;"></td> <td style="width: 10%;"></td> <td style="width: 10%;"></td> </tr> <tr> <td></td> <td></td> <td colspan="8" style="text-align: center;"> <table border="1" style="width: 100%; border-collapse: collapse; text-align: center;"> <tr> <td style="width: 10%;"></td> <td style="width: 10%;"></td> <td style="width: 10%;"></td> <td style="width: 10%;"></td> <td style="width: 10%;"></td> <td style="width: 10%;"></td> <td style="width: 10%;"></td> <td style="width: 10%;"></td> <td style="width: 10%;"></td> <td style="width: 10%;"></td> </tr> <tr> <td></td> <td></td> <td colspan="8" style="text-align: center;"> <table border="1" style="width: 100%; border-collapse: collapse; text-align: center;"> <tr> <td style="width: 10%;"></td> <td style="width: 10%;"></td> <td style="width: 10%;"></td> <td style="width: 10%;"></td> <td style="width: 10%;"></td> <td style="width: 10%;"></td> <td style="width: 10%;"></td> <td style="width: 10%;"></td> <td style="width: 10%;"></td> <td style="width: 10%;"></td> </tr> <tr> <td></td> <td></td> <td colspan="8" style="text-align: center;"> <table border="1" style="width: 100%; border-collapse: collapse; text-align: center;"> <tr> <td style="width: 10%;"></td> <td style="width: 10%;"></td> <td style="width: 10%;"></td> <td style="width: 10%;"></td> <td style="width: 10%;"></td> <td style="width: 10%;"></td> <td style="width: 10%;"></td> <td style="width: 10%;"></td> <td style="width: 10%;"></td> <td style="width: 10%;"></td> </tr> <tr> <td></td> <td></td> <td colspan="8" style="text-align: center;"> <table border="1" style="width: 100%; border-collapse: collapse; text-align: center;"> <tr> </tr></table></td></tr></table></td></tr></table></td></tr></table></td></tr></table></td></tr></table></td></tr></table></td></tr></table></td></tr></table></td></tr></table></td></tr></table></td></tr></table></td></tr></table></td></tr></table></td></tr></table></td></tr></table></td></tr></table></td></tr></table></td></tr></table></td></tr></table></td></tr></table></td></tr></table></td></tr></table></td></tr></table></td></tr></table></td></tr></table></td></tr></table></td></tr></table></td></tr></table></td></tr></table></td></tr></table>

 | | | | | | | | | | | | | | | | | | | | <table border="1" style="width: 100%; border-collapse: collapse; text-align: center;"> <tr> <td style="width: 10%;"></td> <td style="width: 10%;"></td> <td style="width: 10%;"></td> <td style="width: 10%;"></td> <td style="width: 10%;"></td> <td style="width: 10%;"></td> <td style="width: 10%;"></td> <td style="width: 10%;"></td> <td style="width: 10%;"></td> <td style="width: 10%;"></td> </tr> <tr> <td></td> <td></td> <td colspan="8" style="text-align: center;"> <table border="1" style="width: 100%; border-collapse: collapse; text-align: center;"> <tr> <td style="width: 10%;"></td> <td style="width: 10%;"></td> <td style="width: 10%;"></td> <td style="width: 10%;"></td> <td style="width: 10%;"></td> <td style="width: 10%;"></td> <td style="width: 10%;"></td> <td style="width: 10%;"></td> <td style="width: 10%;"></td> <td style="width: 10%;"></td> </tr> <tr> <td></td> <td></td> <td colspan="8" style="text-align: center;"> <table border="1" style="width: 100%; border-collapse: collapse; text-align: center;"> <tr> <td style="width: 10%;"></td> <td style="width: 10%;"></td> <td style="width: 10%;"></td> <td style="width: 10%;"></td> <td style="width: 10%;"></td> <td style="width: 10%;"></td> <td style="width: 10%;"></td> <td style="width: 10%;"></td> <td style="width: 10%;"></td> <td style="width: 10%;"></td> </tr> <tr> <td></td> <td></td> <td colspan="8" style="text-align: center;"> <table border="1" style="width: 100%; border-collapse: collapse; text-align: center;"> <tr> <td style="width: 10%;"></td> <td style="width: 10%;"></td> <td style="width: 10%;"></td> <td style="width: 10%;"></td> <td style="width: 10%;"></td> <td style="width: 10%;"></td> <td style="width: 10%;"></td> <td style="width: 10%;"></td> <td style="width: 10%;"></td> <td style="width: 10%;"></td> </tr> <tr> <td></td> <td></td> <td colspan="8" style="text-align: center;"> <table border="1" style="width: 100%; border-collapse: collapse; text-align: center;"> <tr> <td style="width: 10%;"></td> <td style="width: 10%;"></td> <td style="width: 10%;"></td> <td style="width: 10%;"></td> <td style="width: 10%;"></td> <td style="width: 10%;"></td> <td style="width: 10%;"></td> <td style="width: 10%;"></td> <td style="width: 10%;"></td> <td style="width: 10%;"></td> </tr> <tr> <td></td> <td></td> <td colspan="8" style="text-align: center;"> <table border="1" style="width: 100%; border-collapse: collapse; text-align: center;"> <tr> <td style="width: 10%;"></td> <td style="width: 10%;"></td> <td style="width: 10%;"></td> <td style="width: 10%;"></td> <td style="width: 10%;"></td> <td style="width: 10%;"></td> <td style="width: 10%;"></td> <td style="width: 10%;"></td> <td style="width: 10%;"></td> <td style="width: 10%;"></td> </tr> <tr> <td></td> <td></td> <td colspan="8" style="text-align: center;"> <table border="1" style="width: 100%; border-collapse: collapse; text-align: center;"> <tr> <td style="width: 10%;"></td> <td style="width: 10%;"></td> <td style="width: 10%;"></td> <td style="width: 10%;"></td> <td style="width: 10%;"></td> <td style="width: 10%;"></td> <td style="width: 10%;"></td> <td style="width: 10%;"></td> <td style="width: 10%;"></td> <td style="width: 10%;"></td> </tr> <tr> <td></td> <td></td> <td colspan="8" style="text-align: center;"> <table border="1" style="width: 100%; border-collapse: collapse; text-align: center;"> <tr> <td style="width: 10%;"></td> <td style="width: 10%;"></td> <td style="width: 10%;"></td> <td style="width: 10%;"></td> <td style="width: 10%;"></td> <td style="width: 10%;"></td> <td style="width: 10%;"></td> <td style="width: 10%;"></td> <td style="width: 10%;"></td> <td style="width: 10%;"></td> </tr> <tr> <td></td> <td></td> <td colspan="8" style="text-align: center;"> <table border="1" style="width: 100%; border-collapse: collapse; text-align: center;"> <tr> <td style="width: 10%;"></td> <td style="width: 10%;"></td> <td style="width: 10%;"></td> <td style="width: 10%;"></td> <td style="width: 10%;"></td> <td style="width: 10%;"></td> <td style="width: 10%;"></td> <td style="width: 10%;"></td> <td style="width: 10%;"></td> <td style="width: 10%;"></td> </tr> <tr> <td></td> <td></td> <td colspan="8" style="text-align: center;"> <table border="1" style="width: 100%; border-collapse: collapse; text-align: center;"> <tr> <td style="width: 10%;"></td> <td style="width: 10%;"></td> <td style="width: 10%;"></td> <td style="width: 10%;"></td> <td style="width: 10%;"></td> <td style="width: 10%;"></td> <td style="width: 10%;"></td> <td style="width: 10%;"></td> <td style="width: 10%;"></td> <td style="width: 10%;"></td> </tr> <tr> <td></td> <td></td> <td colspan="8" style="text-align: center;"> <table border="1" style="width: 100%; border-collapse: collapse; text-align: center;"> <tr> <td style="width: 10%;"></td> <td style="width: 10%;"></td> <td style="width: 10%;"></td> <td style="width: 10%;"></td> <td style="width: 10%;"></td> <td style="width: 10%;"></td> <td style="width: 10%;"></td> <td style="width: 10%;"></td> <td style="width: 10%;"></td> <td style="width: 10%;"></td> </tr> <tr> <td></td> <td></td> <td colspan="8" style="text-align: center;"> <table border="1" style="width: 100%; border-collapse: collapse; text-align: center;"> <tr> <td style="width: 10%;"></td> <td style="width: 10%;"></td> <td style="width: 10%;"></td> <td style="width: 10%;"></td> <td style="width: 10%;"></td> <td style="width: 10%;"></td> <td style="width: 10%;"></td> <td style="width: 10%;"></td> <td style="width: 10%;"></td> <td style="width: 10%;"></td> </tr> <tr> <td></td> <td></td> <td colspan="8" style="text-align: center;"> <table border="1" style="width: 100%; border-collapse: collapse; text-align: center;"> <tr> <td style="width: 10%;"></td> <td style="width: 10%;"></td> <td style="width: 10%;"></td> <td style="width: 10%;"></td> <td style="width: 10%;"></td> <td style="width: 10%;"></td> <td style="width: 10%;"></td> <td style="width: 10%;"></td> <td style="width: 10%;"></td> <td style="width: 10%;"></td> </tr> <tr> <td></td> <td></td> <td colspan="8" style="text-align: center;"> <table border="1" style="width: 100%; border-collapse: collapse; text-align: center;"> <tr> <td style="width: 10%;"></td> <td style="width: 10%;"></td> <td style="width: 10%;"></td> <td style="width: 10%;"></td> <td style="width: 10%;"></td> <td style="width: 10%;"></td> <td style="width: 10%;"></td> <td style="width: 10%;"></td> <td style="width: 10%;"></td> <td style="width: 10%;"></td> </tr> <tr> <td></td> <td></td> <td colspan="8" style="text-align: center;"> <table border="1" style="width: 100%; border-collapse: collapse; text-align: center;"> <tr> <td style="width: 10%;"></td> <td style="width: 10%;"></td> <td style="width: 10%;"></td> <td style="width: 10%;"></td> <td style="width: 10%;"></td> <td style="width: 10%;"></td> <td style="width: 10%;"></td> <td style="width: 10%;"></td> <td style="width: 10%;"></td> <td style="width: 10%;"></td> </tr> <tr> <td></td> <td></td> <td colspan="8" style="text-align: center;"> <table border="1" style="width: 100%; border-collapse: collapse; text-align: center;"> <tr> <td style="width: 10%;"></td> <td style="width: 10%;"></td> <td style="width: 10%;"></td> <td style="width: 10%;"></td> <td style="width: 10%;"></td> <td style="width: 10%;"></td> <td style="width: 10%;"></td> <td style="width: 10%;"></td> <td style="width: 10%;"></td> <td style="width: 10%;"></td> </tr> <tr> <td></td> <td></td> <td colspan="8" style="text-align: center;"> <table border="1" style="width: 100%; border-collapse: collapse; text-align: center;"> <tr> <td style="width: 10%;"></td> <td style="width: 10%;"></td> <td style="width: 10%;"></td> <td style="width: 10%;"></td> <td style="width: 10%;"></td> <td style="width: 10%;"></td> <td style="width: 10%;"></td> <td style="width: 10%;"></td> <td style="width: 10%;"></td> <td style="width: 10%;"></td> </tr> <tr> <td></td> <td></td> <td colspan="8" style="text-align: center;"> <table border="1" style="width: 100%; border-collapse: collapse; text-align: center;"> <tr> <td style="width: 10%;"></td> <td style="width: 10%;"></td> <td style="width: 10%;"></td> <td style="width: 10%;"></td> <td style="width: 10%;"></td> <td style="width: 10%;"></td> <td style="width: 10%;"></td> <td style="width: 10%;"></td> <td style="width: 10%;"></td> <td style="width: 10%;"></td> </tr> <tr> <td></td> <td></td> <td colspan="8" style="text-align:
center;"> <table border="1" style="width: 100%; border-collapse: collapse; text-align: center;"> <tr> <td style="width: 10%;"></td> <td style="width: 10%;"></td> <td style="width: 10%;"></td> <td style="width: 10%;"></td> <td style="width: 10%;"></td> <td style="width: 10%;"></td> <td style="width: 10%;"></td> <td style="width: 10%;"></td> <td style="width: 10%;"></td> <td style="width: 10%;"></td> </tr> <tr> <td></td> <td></td> <td colspan="8" style="text-align: center;"> <table border="1" style="width: 100%; border-collapse: collapse; text-align: center;"> <tr> <td style="width: 10%;"></td> <td style="width: 10%;"></td> <td style="width: 10%;"></td> <td style="width: 10%;"></td> <td style="width: 10%;"></td> <td style="width: 10%;"></td> <td style="width: 10%;"></td> <td style="width: 10%;"></td> <td style="width: 10%;"></td> <td style="width: 10%;"></td> </tr> <tr> <td></td> <td></td> <td colspan="8" style="text-align: center;"> <table border="1" style="width: 100%; border-collapse: collapse; text-align: center;"> <tr> <td style="width: 10%;"></td> <td style="width: 10%;"></td> <td style="width: 10%;"></td> <td style="width: 10%;"></td> <td style="width: 10%;"></td> <td style="width: 10%;"></td> <td style="width: 10%;"></td> <td style="width: 10%;"></td> <td style="width: 10%;"></td> <td style="width: 10%;"></td> </tr> <tr> <td></td> <td></td> <td colspan="8" style="text-align: center;"> <table border="1" style="width: 100%; border-collapse: collapse; text-align: center;"> <tr> <td style="width: 10%;"></td> <td style="width: 10%;"></td> <td style="width: 10%;"></td> <td style="width: 10%;"></td> <td style="width: 10%;"></td> <td style="width: 10%;"></td> <td style="width: 10%;"></td> <td style="width: 10%;"></td> <td style="width: 10%;"></td> <td style="width: 10%;"></td> </tr> <tr> <td></td> <td></td> <td colspan="8" style="text-align: center;"> <table border="1" style="width: 100%; border-collapse: collapse; text-align: center;"> <tr> <td style="width: 10%;"></td> <td style="width: 10%;"></td> <td style="width: 10%;"></td> <td style="width: 10%;"></td> <td style="width: 10%;"></td> <td style="width: 10%;"></td> <td style="width: 10%;"></td> <td style="width: 10%;"></td> <td style="width: 10%;"></td> <td style="width: 10%;"></td> </tr> <tr> <td></td> <td></td> <td colspan="8" style="text-align: center;"> <table border="1" style="width: 100%; border-collapse: collapse; text-align: center;"> <tr> <td style="width: 10%;"></td> <td style="width: 10%;"></td> <td style="width: 10%;"></td> <td style="width: 10%;"></td> <td style="width: 10%;"></td> <td style="width: 10%;"></td> <td style="width: 10%;"></td> <td style="width: 10%;"></td> <td style="width: 10%;"></td> <td style="width: 10%;"></td> </tr> <tr> <td></td> <td></td> <td colspan="8" style="text-align: center;"> <table border="1" style="width: 100%; border-collapse: collapse; text-align: center;"> <tr> <td style="width: 10%;"></td> <td style="width: 10%;"></td> <td style="width: 10%;"></td> <td style="width: 10%;"></td> <td style="width: 10%;"></td> <td style="width: 10%;"></td> <td style="width: 10%;"></td> <td style="width: 10%;"></td> <td style="width: 10%;"></td> <td style="width: 10%;"></td> </tr> <tr> <td></td> <td></td> <td colspan="8" style="text-align: center;"> <table border="1" style="width: 100%; border-collapse: collapse; text-align: center;"> <tr> <td style="width: 10%;"></td> <td style="width: 10%;"></td> <td style="width: 10%;"></td> <td style="width: 10%;"></td> <td style="width: 10%;"></td> <td style="width: 10%;"></td> <td style="width: 10%;"></td> <td style="width: 10%;"></td> <td style="width: 10%;"></td> <td style="width: 10%;"></td> </tr> <tr> <td></td> <td></td> <td colspan="8" style="text-align: center;"> <table border="1" style="width: 100%; border-collapse: collapse; text-align: center;"> <tr> <td style="width: 10%;"></td> <td style="width: 10%;"></td> <td style="width: 10%;"></td> <td style="width: 10%;"></td> <td style="width: 10%;"></td> <td style="width: 10%;"></td> <td style="width: 10%;"></td> <td style="width: 10%;"></td> <td style="width: 10%;"></td> <td style="width: 10%;"></td> </tr> <tr> <td></td> <td></td> <td colspan="8" style="text-align: center;"> <table border="1" style="width: 100%; border-collapse: collapse; text-align: center;"> <tr> <td style="width: 10%;"></td> <td style="width: 10%;"></td> <td style="width: 10%;"></td> <td style="width: 10%;"></td> <td style="width: 10%;"></td> <td style="width: 10%;"></td> <td style="width: 10%;"></td> <td style="width: 10%;"></td> <td style="width: 10%;"></td> <td style="width: 10%;"></td> </tr> <tr> <td></td> <td></td> <td colspan="8" style="text-align: center;"> <table border="1" style="width: 100%; border-collapse: collapse; text-align: center;"> <tr> <td style="width: 10%;"></td> <td style="width: 10%;"></td> <td style="width: 10%;"></td> <td style="width: 10%;"></td> <td style="width: 10%;"></td> <td style="width: 10%;"></td> <td style="width: 10%;"></td> <td style="width: 10%;"></td> <td style="width: 10%;"></td> <td style="width: 10%;"></td> </tr> <tr> <td></td> <td></td> <td colspan="8" style="text-align: center;"> <table border="1" style="width: 100%; border-collapse: collapse; text-align: center;"> <tr> </tr></table></td></tr></table></td></tr></table></td></tr></table></td></tr></table></td></tr></table></td></tr></table></td></tr></table></td></tr></table></td></tr></table></td></tr></table></td></tr></table></td></tr></table></td></tr></table></td></tr></table></td></tr></table></td></tr></table></td></tr></table></td></tr></table></td></tr></table></td></tr></table></td></tr></table></td></tr></table></td></tr></table></td></tr></table></td></tr></table></td></tr></table></td></tr></table></td></tr></table></td></tr></table>
 | | | | | | | | | | | | | | | | | | | | <table border="1" style="width: 100%; border-collapse: collapse; text-align: center;"> <tr> <td style="width: 10%;"></td> <td style="width: 10%;"></td> <td style="width: 10%;"></td> <td style="width: 10%;"></td> <td style="width: 10%;"></td> <td style="width: 10%;"></td> <td style="width: 10%;"></td> <td style="width: 10%;"></td> <td style="width: 10%;"></td> <td style="width: 10%;"></td> </tr> <tr> <td></td> <td></td> <td colspan="8" style="text-align: center;"> <table border="1" style="width: 100%; border-collapse: collapse; text-align: center;"> <tr> <td style="width: 10%;"></td> <td style="width: 10%;"></td> <td style="width: 10%;"></td> <td style="width: 10%;"></td> <td style="width: 10%;"></td> <td style="width: 10%;"></td> <td style="width: 10%;"></td> <td style="width: 10%;"></td> <td style="width: 10%;"></td> <td style="width: 10%;"></td> </tr> <tr> <td></td> <td></td> <td colspan="8" style="text-align: center;"> <table border="1" style="width: 100%; border-collapse: collapse; text-align: center;"> <tr> <td style="width: 10%;"></td> <td style="width: 10%;"></td> <td style="width: 10%;"></td> <td style="width: 10%;"></td> <td style="width: 10%;"></td> <td style="width: 10%;"></td> <td style="width: 10%;"></td> <td style="width: 10%;"></td> <td style="width: 10%;"></td> <td style="width: 10%;"></td> </tr> <tr> <td></td> <td></td> <td colspan="8" style="text-align: center;"> <table border="1" style="width: 100%; border-collapse: collapse; text-align: center;"> <tr> <td style="width: 10%;"></td> <td style="width: 10%;"></td> <td style="width: 10%;"></td> <td style="width: 10%;"></td> <td style="width: 10%;"></td> <td style="width: 10%;"></td> <td style="width: 10%;"></td> <td style="width: 10%;"></td> <td style="width: 10%;"></td> <td style="width: 10%;"></td> </tr> <tr> <td></td> <td></td> <td colspan="8" style="text-align: center;"> <table border="1" style="width: 100%; border-collapse: collapse; text-align: center;"> <tr> <td style="width: 10%;"></td> <td
style="width: 10%;"></td> <td style="width: 10%;"></td> <td style="width: 10%;"></td> <td style="width: 10%;"></td> <td style="width: 10%;"></td> <td style="width: 10%;"></td> <td style="width: 10%;"></td> <td style="width: 10%;"></td> <td style="width: 10%;"></td> </tr> <tr> <td></td> <td></td> <td colspan="8" style="text-align: center;"> <table border="1" style="width: 100%; border-collapse: collapse; text-align: center;"> <tr> <td style="width: 10%;"></td> <td style="width: 10%;"></td> <td style="width: 10%;"></td> <td style="width: 10%;"></td> <td style="width: 10%;"></td> <td style="width: 10%;"></td> <td style="width: 10%;"></td> <td style="width: 10%;"></td> <td style="width: 10%;"></td> <td style="width: 10%;"></td> </tr> <tr> <td></td> <td></td> <td colspan="8" style="text-align: center;"> <table border="1" style="width: 100%; border-collapse: collapse; text-align: center;"> <tr> <td style="width: 10%;"></td> <td style="width: 10%;"></td> <td style="width: 10%;"></td> <td style="width: 10%;"></td> <td style="width: 10%;"></td> <td style="width: 10%;"></td> <td style="width: 10%;"></td> <td style="width: 10%;"></td> <td style="width: 10%;"></td> <td style="width: 10%;"></td> </tr> <tr> <td></td> <td></td> <td colspan="8" style="text-align: center;"> <table border="1" style="width: 100%; border-collapse: collapse; text-align: center;"> <tr> <td style="width: 10%;"></td> <td style="width: 10%;"></td> <td style="width: 10%;"></td> <td style="width: 10%;"></td> <td style="width: 10%;"></td> <td style="width: 10%;"></td> <td style="width: 10%;"></td> <td style="width: 10%;"></td> <td style="width: 10%;"></td> <td style="width: 10%;"></td> </tr> <tr> <td></td> <td></td> <td colspan="8" style="text-align: center;"> <table border="1" style="width: 100%; border-collapse: collapse; text-align: center;"> <tr> <td style="width: 10%;"></td> <td style="width: 10%;"></td> <td style="width: 10%;"></td> <td style="width: 10%;"></td> <td style="width: 10%;"></td> <td style="width: 10%;"></td> <td style="width: 10%;"></td> <td style="width: 10%;"></td> <td style="width: 10%;"></td> <td style="width: 10%;"></td> </tr> <tr> <td></td> <td></td> <td colspan="8" style="text-align: center;"> <table border="1" style="width: 100%; border-collapse: collapse; text-align: center;"> <tr> <td style="width: 10%;"></td> <td style="width: 10%;"></td> <td style="width: 10%;"></td> <td style="width: 10%;"></td> <td style="width: 10%;"></td> <td style="width: 10%;"></td> <td style="width: 10%;"></td> <td style="width: 10%;"></td> <td style="width: 10%;"></td> <td style="width: 10%;"></td> </tr> <tr> <td></td> <td></td> <td colspan="8" style="text-align: center;"> <table border="1" style="width: 100%; border-collapse: collapse; text-align: center;"> <tr> <td style="width: 10%;"></td> <td style="width: 10%;"></td> <td style="width: 10%;"></td> <td style="width: 10%;"></td> <td style="width: 10%;"></td> <td style="width: 10%;"></td> <td style="width: 10%;"></td> <td style="width: 10%;"></td> <td style="width: 10%;"></td> <td style="width: 10%;"></td> </tr> <tr> <td></td> <td></td> <td colspan="8" style="text-align: center;"> <table border="1" style="width: 100%; border-collapse: collapse; text-align: center;"> <tr> <td style="width: 10%;"></td> <td style="width: 10%;"></td> <td style="width: 10%;"></td> <td style="width: 10%;"></td> <td style="width: 10%;"></td> <td style="width: 10%;"></td> <td style="width: 10%;"></td> <td style="width: 10%;"></td> <td style="width: 10%;"></td> <td style="width: 10%;"></td> </tr> <tr> <td></td> <td></td> <td colspan="8" style="text-align: center;"> <table border="1" style="width: 100%; border-collapse: collapse; text-align: center;"> <tr> <td style="width: 10%;"></td> <td style="width: 10%;"></td> <td style="width: 10%;"></td> <td style="width: 10%;"></td> <td style="width: 10%;"></td> <td style="width: 10%;"></td> <td style="width: 10%;"></td> <td style="width: 10%;"></td> <td style="width: 10%;"></td> <td style="width: 10%;"></td> </tr> <tr> <td></td> <td></td> <td colspan="8" style="text-align: center;"> <table border="1" style="width: 100%; border-collapse: collapse; text-align: center;"> <tr> <td style="width: 10%;"></td> <td style="width: 10%;"></td> <td style="width: 10%;"></td> <td style="width: 10%;"></td> <td style="width: 10%;"></td> <td style="width: 10%;"></td> <td style="width: 10%;"></td> <td style="width: 10%;"></td> <td style="width: 10%;"></td> <td style="width: 10%;"></td> </tr> <tr> <td></td> <td></td> <td colspan="8" style="text-align: center;"> <table border="1" style="width: 100%; border-collapse: collapse; text-align: center;"> <tr> <td style="width: 10%;"></td> <td style="width: 10%;"></td> <td style="width: 10%;"></td> <td style="width: 10%;"></td> <td style="width: 10%;"></td> <td style="width: 10%;"></td> <td style="width: 10%;"></td> <td style="width: 10%;"></td> <td style="width: 10%;"></td> <td style="width: 10%;"></td> </tr> <tr> <td></td> <td></td> <td colspan="8" style="text-align: center;"> <table border="1" style="width: 100%; border-collapse: collapse; text-align: center;"> <tr> <td style="width: 10%;"></td> <td style="width: 10%;"></td> <td style="width: 10%;"></td> <td style="width: 10%;"></td> <td style="width: 10%;"></td> <td style="width: 10%;"></td> <td style="width: 10%;"></td> <td style="width: 10%;"></td> <td style="width: 10%;"></td> <td style="width: 10%;"></td> </tr> <tr> <td></td> <td></td> <td colspan="8" style="text-align: center;"> <table border="1" style="width: 100%; border-collapse: collapse; text-align: center;"> <tr> <td style="width: 10%;"></td> <td style="width: 10%;"></td> <td style="width: 10%;"></td> <td style="width: 10%;"></td> <td style="width: 10%;"></td> <td style="width: 10%;"></td> <td style="width: 10%;"></td> <td style="width: 10%;"></td> <td style="width: 10%;"></td> <td style="width: 10%;"></td> </tr> <tr> <td></td> <td></td> <td colspan="8" style="text-align: center;"> <table border="1" style="width: 100%; border-collapse: collapse; text-align: center;"> <tr> <td style="width: 10%;"></td> <td style="width: 10%;"></td> <td style="width: 10%;"></td> <td style="width: 10%;"></td> <td style="width: 10%;"></td> <td style="width: 10%;"></td> <td style="width: 10%;"></td> <td style="width: 10%;"></td> <td style="width: 10%;"></td> <td style="width: 10%;"></td> </tr> <tr> <td></td> <td></td> <td colspan="8" style="text-align: center;"> <table border="1" style="width: 100%; border-collapse: collapse; text-align: center;"> <tr> <td style="width: 10%;"></td> <td style="width: 10%;"></td> <td style="width: 10%;"></td> <td style="width: 10%;"></td> <td style="width: 10%;"></td> <td style="width: 10%;"></td> <td style="width: 10%;"></td> <td style="width: 10%;"></td> <td style="width: 10%;"></td> <td style="width: 10%;"></td> </tr> <tr> <td></td> <td></td> <td colspan="8" style="text-align: center;"> <table border="1" style="width: 100%; border-collapse: collapse; text-align: center;"> <tr> <td style="width: 10%;"></td> <td style="width: 10%;"></td> <td style="width: 10%;"></td> <td style="width: 10%;"></td> <td style="width: 10%;"></td> <td style="width: 10%;"></td> <td style="width: 10%;"></td> <td style="width: 10%;"></td> <td style="width: 10%;"></td> <td style="width: 10%;"></td> </tr> <tr> <td></td> <td></td> <td colspan="8" style="text-align: center;"> <table border="1" style="width: 100%; border-collapse: collapse; text-align: center;"> <tr> <td style="width: 10%;"></td> <td style="width: 10%;"></td> <td style="width: 10%;"></td> <td style="width: 10%;"></td> <td style="width: 10%;"></td> <td style="width: 10%;"></td> <td style="width: 10%;"></td> <td style="width: 10%;"></td> <td style="width: 10%;"></td> <td style="width: 10%;"></td> </tr> <tr> <td></td> <td></td> <td colspan="8" style="text-align: center;"> <table border="1" style="width: 100%; border-collapse: collapse; text-align: center;"> <tr> <td style="width: 10%;"></td> <td style="width: 10%;"></td> <td style="width: 10%;"></td> <td style="width: 10%;"></td> <td style="width: 10%;"></td> <td style="width: 10%;"></td> <td style="width: 10%;"></td> <td style="width: 10%;"></td> <td style="width: 10%;"></td> <td style="width: 10%;"></td> </tr> <tr> <td></td> <td></td> <td colspan="8" style="text-align: center;"> <table border="1" style="width: 100%; border-collapse: collapse; text-align: center;"> <tr> <td style="width: 10%;"></td> <td style="width: 10%;"></td> <td style="width: 10%;"></td> <td style="width: 10%;"></td> <td style="width: 10%;"></td> <td style="width: 10%;"></td> <td style="width: 10%;"></td> <td style="width: 10%;"></td> <td style="width: 10%;"></td> <td style="width: 10%;"></td> </tr> <tr> <td></td> <td></td> <td colspan="8" style="text-align: center;"> <table border="1" style="width: 100%; border-collapse: collapse; text-align: center;"> <tr> <td style="width: 10%;"></td> <td style="width: 10%;"></td> <td style="width: 10%;"></td> <td style="width: 10%;"></td> <td style="width: 10%;"></td> <td style="width: 10%;"></td> <td style="width: 10%;"></td> <td style="width: 10%;"></td> <td style="width: 10%;"></td> <td style="width: 10%;"></td> </tr> <tr> <td></td> <td></td> <td colspan="8" style="text-align: center;"> <table border="1" style="width: 100%; border-collapse: collapse; text-align: center;"> <tr> <td style="width: 10%;"></td> <td style="width: 10%;"></td> <td style="width: 10%;"></td> <td style="width: 10%;"></td> <td style="width: 10%;"></td> <td style="width: 10%;"></td> <td style="width: 10%;"></td> <td style="width: 10%;"></td> <td style="width: 10%;"></td> <td style="width: 10%;"></td> </tr> <tr> <td></td> <td></td> <td colspan="8" style="text-align: center;"> <table border="1" style="width: 100%; border-collapse: collapse; text-align: center;"> <tr> <td style="width: 10%;"></td> <td style="width: 10%;"></td> <td style="width: 10%;"></td> <td style="width: 10%;"></td> <td style="width: 10%;"></td> <td style="width: 10%;"></td> <td style="width:
10%;"></td> <td style="width: 10%;"></td> <td style="width: 10%;"></td> <td style="width: 10%;"></td> </tr> <tr> <td></td> <td></td> <td colspan="8" style="text-align: center;"> <table border="1" style="width: 100%; border-collapse: collapse; text-align: center;"> <tr> <td style="width: 10%;"></td> <td style="width: 10%;"></td> <td style="width: 10%;"></td> <td style="width: 10%;"></td> <td style="width: 10%;"></td> <td style="width: 10%;"></td> <td style="width: 10%;"></td> <td style="width: 10%;"></td> <td style="width: 10%;"></td> <td style="width: 10%;"></td> </tr> <tr> <td></td> <td></td> <td colspan="8" style="text-align: center;"> <table border="1" style="width: 100%; border-collapse: collapse; text-align: center;"> <tr> <td style="width: 10%;"></td> <td style="width: 10%;"></td> <td style="width: 10%;"></td> <td style="width: 10%;"></td> <td style="width: 10%;"></td> <td style="width: 10%;"></td> <td style="width: 10%;"></td> <td style="width: 10%;"></td> <td style="width: 10%;"></td> <td style="width: 10%;"></td> </tr> <tr> <td></td> <td></td> <td colspan="8" style="text-align: center;"> <table border="1" style="width: 100%; border-collapse: collapse; text-align: center;"> <tr> </tr></table></td></tr></table></td></tr></table></td></tr></table></td></tr></table></td></tr></table></td></tr></table></td></tr></table></td></tr></table></td></tr></table></td></tr></table></td></tr></table></td></tr></table></td></tr></table></td></tr></table></td></tr></table></td></tr></table></td></tr></table></td></tr></table></td></tr></table></td></tr></table></td></tr></table></td></tr></table></td></tr></table></td></tr></table></td></tr></table></td></tr></table></td></tr></table></td></tr></table>
 | | | | | | | | | | | | | | | | | | | | <table border="1" style="width: 100%; border-collapse: collapse; text-align: center;"> <tr> <td style="width: 10%;"></td> <td style="width: 10%;"></td> <td style="width: 10%;"></td> <td style="width: 10%;"></td> <td style="width: 10%;"></td> <td style="width: 10%;"></td> <td style="width: 10%;"></td> <td style="width: 10%;"></td> <td style="width: 10%;"></td> <td style="width: 10%;"></td> </tr> <tr> <td></td> <td></td> <td colspan="8" style="text-align: center;"> <table border="1" style="width: 100%; border-collapse: collapse; text-align: center;"> <tr> <td style="width: 10%;"></td> <td style="width: 10%;"></td> <td style="width: 10%;"></td> <td style="width: 10%;"></td> <td style="width: 10%;"></td> <td style="width: 10%;"></td> <td style="width: 10%;"></td> <td style="width: 10%;"></td> <td style="width: 10%;"></td> <td style="width: 10%;"></td> </tr> <tr> <td></td> <td></td> <td colspan="8" style="text-align: center;"> <table border="1" style="width: 100%; border-collapse: collapse; text-align: center;"> <tr> <td style="width: 10%;"></td> <td style="width: 10%;"></td> <td style="width: 10%;"></td> <td style="width: 10%;"></td> <td style="width: 10%;"></td> <td style="width: 10%;"></td> <td style="width: 10%;"></td> <td style="width: 10%;"></td> <td style="width: 10%;"></td> <td style="width: 10%;"></td> </tr> <tr> <td></td> <td></td> <td colspan="8" style="text-align: center;"> <table border="1" style="width: 100%; border-collapse: collapse; text-align: center;"> <tr> <td style="width: 10%;"></td> <td style="width: 10%;"></td> <td style="width: 10%;"></td> <td style="width: 10%;"></td> <td style="width: 10%;"></td> <td style="width: 10%;"></td> <td style="width: 10%;"></td> <td style="width: 10%;"></td> <td style="width: 10%;"></td> <td style="width: 10%;"></td> </tr> <tr> <td></td> <td></td> <td colspan="8" style="text-align: center;"> <table border="1" style="width: 100%; border-collapse: collapse; text-align: center;"> <tr> <td style="width: 10%;"></td> <td style="width: 10%;"></td> <td style="width: 10%;"></td> <td style="width: 10%;"></td> <td style="width: 10%;"></td> <td style="width: 10%;"></td> <td style="width: 10%;"></td> <td style="width: 10%;"></td> <td style="width: 10%;"></td> <td style="width: 10%;"></td> </tr> <tr> <td></td> <td></td> <td colspan="8" style="text-align: center;"> <table border="1" style="width: 100%; border-collapse: collapse; text-align: center;"> <tr> <td style="width: 10%;"></td> <td style="width: 10%;"></td> <td style="width: 10%;"></td> <td style="width: 10%;"></td> <td style="width: 10%;"></td> <td style="width: 10%;"></td> <td style="width: 10%;"></td> <td style="width: 10%;"></td> <td style="width: 10%;"></td> <td style="width: 10%;"></td> </tr> <tr> <td></td> <td></td> <td colspan="8" style="text-align: center;"> <table border="1" style="width: 100%; border-collapse: collapse; text-align: center;"> <tr> <td style="width: 10%;"></td> <td style="width: 10%;"></td> <td style="width: 10%;"></td> <td style="width: 10%;"></td> <td style="width: 10%;"></td> <td style="width: 10%;"></td> <td style="width: 10%;"></td> <td style="width: 10%;"></td> <td style="width: 10%;"></td> <td style="width: 10%;"></td> </tr> <tr> <td></td> <td></td> <td colspan="8" style="text-align: center;"> <table border="1" style="width: 100%; border-collapse: collapse; text-align: center;"> <tr> <td style="width: 10%;"></td> <td style="width: 10%;"></td> <td style="width: 10%;"></td> <td style="width: 10%;"></td> <td style="width: 10%;"></td> <td style="width: 10%;"></td> <td style="width: 10%;"></td> <td style="width: 10%;"></td> <td style="width: 10%;"></td> <td style="width: 10%;"></td> </tr> <tr> <td></td> <td></td> <td colspan="8" style="text-align: center;"> <table border="1" style="width: 100%; border-collapse: collapse; text-align: center;"> <tr> <td style="width: 10%;"></td> <td style="width: 10%;"></td> <td style="width: 10%;"></td> <td style="width: 10%;"></td> <td style="width: 10%;"></td> <td style="width: 10%;"></td> <td style="width: 10%;"></td> <td style="width: 10%;"></td> <td style="width: 10%;"></td> <td style="width: 10%;"></td> </tr> <tr> <td></td> <td></td> <td colspan="8" style="text-align: center;"> <table border="1" style="width: 100%; border-collapse: collapse; text-align: center;"> <tr> <td style="width: 10%;"></td> <td style="width: 10%;"></td> <td style="width: 10%;"></td> <td style="width: 10%;"></td> <td style="width: 10%;"></td> <td style="width: 10%;"></td> <td style="width: 10%;"></td> <td style="width: 10%;"></td> <td style="width: 10%;"></td> <td style="width: 10%;"></td> </tr> <tr> <td></td> <td></td> <td colspan="8" style="text-align: center;"> <table border="1" style="width: 100%; border-collapse: collapse; text-align: center;"> <tr> <td style="width: 10%;"></td> <td style="width: 10%;"></td> <td style="width: 10%;"></td> <td style="width: 10%;"></td> <td style="width: 10%;"></td> <td style="width: 10%;"></td> <td style="width: 10%;"></td> <td style="width: 10%;"></td> <td style="width: 10%;"></td> <td style="width: 10%;"></td> </tr> <tr> <td></td> <td></td> <td colspan="8" style="text-align: center;"> <table border="1" style="width: 100%; border-collapse: collapse; text-align: center;"> <tr> <td style="width: 10%;"></td> <td style="width: 10%;"></td> <td style="width: 10%;"></td> <td style="width: 10%;"></td> <td style="width: 10%;"></td> <td style="width: 10%;"></td> <td style="width: 10%;"></td> <td style="width: 10%;"></td> <td style="width: 10%;"></td> <td style="width: 10%;"></td> </tr> <tr> <td></td> <td></td> <td colspan="8" style="text-align: center;"> <table border="1" style="width: 100%; border-collapse: collapse; text-align: center;"> <tr> <td style="width: 10%;"></td> <td style="width: 10%;"></td> <td style="width: 10%;"></td> <td style="width: 10%;"></td> <td style="width: 10%;"></td> <td style="width: 10%;"></td> <td style="width: 10%;"></td> <td style="width: 10%;"></td> <td style="width: 10%;"></td> <td style="width: 10%;"></td> </tr> <tr> <td></td> <td></td> <td colspan="8"
style="text-align: center;"> <table border="1" style="width: 100%; border-collapse: collapse; text-align: center;"> <tr> <td style="width: 10%;"></td> <td style="width: 10%;"></td> <td style="width: 10%;"></td> <td style="width: 10%;"></td> <td style="width: 10%;"></td> <td style="width: 10%;"></td> <td style="width: 10%;"></td> <td style="width: 10%;"></td> <td style="width: 10%;"></td> <td style="width: 10%;"></td> </tr> <tr> <td></td> <td></td> <td colspan="8" style="text-align: center;"> <table border="1" style="width: 100%; border-collapse: collapse; text-align: center;"> <tr> <td style="width: 10%;"></td> <td style="width: 10%;"></td> <td style="width: 10%;"></td> <td style="width: 10%;"></td> <td style="width: 10%;"></td> <td style="width: 10%;"></td> <td style="width: 10%;"></td> <td style="width: 10%;"></td> <td style="width: 10%;"></td> <td style="width: 10%;"></td> </tr> <tr> <td></td> <td></td> <td colspan="8" style="text-align: center;"> <table border="1" style="width: 100%; border-collapse: collapse; text-align: center;"> <tr> <td style="width: 10%;"></td> <td style="width: 10%;"></td> <td style="width: 10%;"></td> <td style="width: 10%;"></td> <td style="width: 10%;"></td> <td style="width: 10%;"></td> <td style="width: 10%;"></td> <td style="width: 10%;"></td> <td style="width: 10%;"></td> <td style="width: 10%;"></td> </tr> <tr> <td></td> <td></td> <td colspan="8" style="text-align: center;"> <table border="1" style="width: 100%; border-collapse: collapse; text-align: center;"> <tr> <td style="width: 10%;"></td> <td style="width: 10%;"></td> <td style="width: 10%;"></td> <td style="width: 10%;"></td> <td style="width: 10%;"></td> <td style="width: 10%;"></td> <td style="width: 10%;"></td> <td style="width: 10%;"></td> <td style="width: 10%;"></td> <td style="width: 10%;"></td> </tr> <tr> <td></td> <td></td> <td colspan="8" style="text-align: center;"> <table border="1" style="width: 100%; border-collapse: collapse; text-align: center;"> <tr> <td style="width: 10%;"></td> <td style="width: 10%;"></td> <td style="width: 10%;"></td> <td style="width: 10%;"></td> <td style="width: 10%;"></td> <td style="width: 10%;"></td> <td style="width: 10%;"></td> <td style="width: 10%;"></td> <td style="width: 10%;"></td> <td style="width: 10%;"></td> </tr> <tr> <td></td> <td></td> <td colspan="8" style="text-align: center;"> <table border="1" style="width: 100%; border-collapse: collapse; text-align: center;"> <tr> <td style="width: 10%;"></td> <td style="width: 10%;"></td> <td style="width: 10%;"></td> <td style="width: 10%;"></td> <td style="width: 10%;"></td> <td style="width: 10%;"></td> <td style="width: 10%;"></td> <td style="width: 10%;"></td> <td style="width: 10%;"></td> <td style="width: 10%;"></td> </tr> <tr> <td></td> <td></td> <td colspan="8" style="text-align: center;"> <table border="1" style="width: 100%; border-collapse: collapse; text-align: center;"> <tr> <td style="width: 10%;"></td> <td style="width: 10%;"></td> <td style="width: 10%;"></td> <td style="width: 10%;"></td> <td style="width: 10%;"></td> <td style="width: 10%;"></td> <td style="width: 10%;"></td> <td style="width: 10%;"></td> <td style="width: 10%;"></td> <td style="width: 10%;"></td> </tr> <tr> <td></td> <td></td> <td colspan="8" style="text-align: center;"> <table border="1" style="width: 100%; border-collapse: collapse; text-align: center;"> <tr> <td style="width: 10%;"></td> <td style="width: 10%;"></td> <td style="width: 10%;"></td> <td style="width: 10%;"></td> <td style="width: 10%;"></td> <td style="width: 10%;"></td> <td style="width: 10%;"></td> <td style="width: 10%;"></td> <td style="width: 10%;"></td> <td style="width: 10%;"></td> </tr> <tr> <td></td> <td></td> <td colspan="8" style="text-align: center;"> <table border="1" style="width: 100%; border-collapse: collapse; text-align: center;"> <tr> <td style="width: 10%;"></td> <td style="width: 10%;"></td> <td style="width: 10%;"></td> <td style="width: 10%;"></td> <td style="width: 10%;"></td> <td style="width: 10%;"></td> <td style="width: 10%;"></td> <td style="width: 10%;"></td> <td style="width: 10%;"></td> <td style="width: 10%;"></td> </tr> <tr> <td></td> <td></td> <td colspan="8" style="text-align: center;"> <table border="1" style="width: 100%; border-collapse: collapse; text-align: center;"> <tr> <td style="width: 10%;"></td> <td style="width: 10%;"></td> <td style="width: 10%;"></td> <td style="width: 10%;"></td> <td style="width: 10%;"></td> <td style="width: 10%;"></td> <td style="width: 10%;"></td> <td style="width: 10%;"></td> <td style="width: 10%;"></td> <td style="width: 10%;"></td> </tr> <tr> <td></td> <td></td> <td colspan="8" style="text-align: center;"> <table border="1" style="width: 100%; border-collapse: collapse; text-align: center;"> <tr> <td style="width: 10%;"></td> <td style="width: 10%;"></td> <td style="width: 10%;"></td> <td style="width: 10%;"></td> <td style="width: 10%;"></td> <td style="width: 10%;"></td> <td style="width: 10%;"></td> <td style="width: 10%;"></td> <td style="width: 10%;"></td> <td style="width: 10%;"></td> </tr> <tr> <td></td> <td></td> <td colspan="8" style="text-align: center;"> <table border="1" style="width: 100%; border-collapse: collapse; text-align: center;"> <tr> <td style="width: 10%;"></td> <td style="width: 10%;"></td> <td style="width: 10%;"></td> <td style="width: 10%;"></td> <td style="width: 10%;"></td> <td style="width: 10%;"></td> <td style="width: 10%;"></td> <td style="width: 10%;"></td> <td style="width: 10%;"></td> <td style="width: 10%;"></td> </tr> <tr> <td></td> <td></td> <td colspan="8" style="text-align: center;"> <table border="1" style="width: 100%; border-collapse: collapse; text-align: center;"> <tr> <td style="width: 10%;"></td> <td style="width: 10%;"></td> <td style="width: 10%;"></td> <td style="width: 10%;"></td> <td style="width: 10%;"></td> <td style="width: 10%;"></td> <td style="width: 10%;"></td> <td style="width: 10%;"></td> <td style="width: 10%;"></td> <td style="width: 10%;"></td> </tr> <tr> <td></td> <td></td> <td colspan="8" style="text-align: center;"> <table border="1" style="width: 100%; border-collapse: collapse; text-align: center;"> <tr> <td style="width: 10%;"></td> <td style="width: 10%;"></td> <td style="width: 10%;"></td> <td style="width: 10%;"></td> <td style="width: 10%;"></td> <td style="width: 10%;"></td> <td style="width: 10%;"></td> <td style="width: 10%;"></td> <td style="width: 10%;"></td> <td style="width: 10%;"></td> </tr> <tr> <td></td> <td></td> <td colspan="8" style="text-align: center;"> <table border="1" style="width: 100%; border-collapse: collapse; text-align: center;"> <tr> </tr></table></td></tr></table></td></tr></table></td></tr></table></td></tr></table></td></tr></table></td></tr></table></td></tr></table></td></tr></table></td></tr></table></td></tr></table></td></tr></table></td></tr></table></td></tr></table></td></tr></table></td></tr></table></td></tr></table></td></tr></table></td></tr></table></td></tr></table></td></tr></table></td></tr></table></td></tr></table></td></tr></table></td></tr></table></td></tr></table></td></tr></table></td></tr></table>
 | | | | | | | | | | | | | | | | | | | | <table border="1" style="width: 100%; border-collapse: collapse; text-align: center;"> <tr> <td style="width: 10%;"></td> <td style="width: 10%;"></td> <td style="width: 10%;"></td> <td style="width: 10%;"></td> <td style="width: 10%;"></td> <td style="width: 10%;"></td> <td style="width: 10%;"></td> <td style="width: 10%;"></td> <td style="width: 10%;"></td> <td style="width: 10%;"></td> </tr> <tr> <td></td> <td></td> <td colspan="8" style="text-align: center;"> <table border="1" style="width: 100%; border-collapse: collapse; text-align: center;"> <tr> <td style="width: 10%;"></td> <td style="width:
10%;"></td> <td style="width: 10%;"></td> <td style="width: 10%;"></td> <td style="width: 10%;"></td> <td style="width: 10%;"></td> <td style="width: 10%;"></td> <td style="width: 10%;"></td> <td style="width: 10%;"></td> <td style="width: 10%;"></td> </tr> <tr> <td></td> <td></td> <td colspan="8" style="text-align: center;"> <table border="1" style="width: 100%; border-collapse: collapse; text-align: center;"> <tr> <td style="width: 10%;"></td> <td style="width: 10%;"></td> <td style="width: 10%;"></td> <td style="width: 10%;"></td> <td style="width: 10%;"></td> <td style="width: 10%;"></td> <td style="width: 10%;"></td> <td style="width: 10%;"></td> <td style="width: 10%;"></td> <td style="width: 10%;"></td> </tr> <tr> <td></td> <td></td> <td colspan="8" style="text-align: center;"> <table border="1" style="width: 100%; border-collapse: collapse; text-align: center;"> <tr> <td style="width: 10%;"></td> <td style="width: 10%;"></td> <td style="width: 10%;"></td> <td style="width: 10%;"></td> <td style="width: 10%;"></td> <td style="width: 10%;"></td> <td style="width: 10%;"></td> <td style="width: 10%;"></td> <td style="width: 10%;"></td> <td style="width: 10%;"></td> </tr> <tr> <td></td> <td></td> <td colspan="8" style="text-align: center;"> <table border="1" style="width: 100%; border-collapse: collapse; text-align: center;"> <tr> <td style="width: 10%;"></td> <td style="width: 10%;"></td> <td style="width: 10%;"></td> <td style="width: 10%;"></td> <td style="width: 10%;"></td> <td style="width: 10%;"></td> <td style="width: 10%;"></td> <td style="width: 10%;"></td> <td style="width: 10%;"></td> <td style="width: 10%;"></td> </tr> <tr> <td></td> <td></td> <td colspan="8" style="text-align: center;"> <table border="1" style="width: 100%; border-collapse: collapse; text-align: center;"> <tr> <td style="width: 10%;"></td> <td style="width: 10%;"></td> <td style="width: 10%;"></td> <td style="width: 10%;"></td> <td style="width: 10%;"></td> <td style="width: 10%;"></td> <td style="width: 10%;"></td> <td style="width: 10%;"></td> <td style="width: 10%;"></td> <td style="width: 10%;"></td> </tr> <tr> <td></td> <td></td> <td colspan="8" style="text-align: center;"> <table border="1" style="width: 100%; border-collapse: collapse; text-align: center;"> <tr> <td style="width: 10%;"></td> <td style="width: 10%;"></td> <td style="width: 10%;"></td> <td style="width: 10%;"></td> <td style="width: 10%;"></td> <td style="width: 10%;"></td> <td style="width: 10%;"></td> <td style="width: 10%;"></td> <td style="width: 10%;"></td> <td style="width: 10%;"></td> </tr> <tr> <td></td> <td></td> <td colspan="8" style="text-align: center;"> <table border="1" style="width: 100%; border-collapse: collapse; text-align: center;"> <tr> <td style="width: 10%;"></td> <td style="width: 10%;"></td> <td style="width: 10%;"></td> <td style="width: 10%;"></td> <td style="width: 10%;"></td> <td style="width: 10%;"></td> <td style="width: 10%;"></td> <td style="width: 10%;"></td> <td style="width: 10%;"></td> <td style="width: 10%;"></td> </tr> <tr> <td></td> <td></td> <td colspan="8" style="text-align: center;"> <table border="1" style="width: 100%; border-collapse: collapse; text-align: center;"> <tr> <td style="width: 10%;"></td> <td style="width: 10%;"></td> <td style="width: 10%;"></td> <td style="width: 10%;"></td> <td style="width: 10%;"></td> <td style="width: 10%;"></td> <td style="width: 10%;"></td> <td style="width: 10%;"></td> <td style="width: 10%;"></td> <td style="width: 10%;"></td> </tr> <tr> <td></td> <td></td> <td colspan="8" style="text-align: center;"> <table border="1" style="width: 100%; border-collapse: collapse; text-align: center;"> <tr> <td style="width: 10%;"></td> <td style="width: 10%;"></td> <td style="width: 10%;"></td> <td style="width: 10%;"></td> <td style="width: 10%;"></td> <td style="width: 10%;"></td> <td style="width: 10%;"></td> <td style="width: 10%;"></td> <td style="width: 10%;"></td> <td style="width: 10%;"></td> </tr> <tr> <td></td> <td></td> <td colspan="8" style="text-align: center;"> <table border="1" style="width: 100%; border-collapse: collapse; text-align: center;"> <tr> <td style="width: 10%;"></td> <td style="width: 10%;"></td> <td style="width: 10%;"></td> <td style="width: 10%;"></td> <td style="width: 10%;"></td> <td style="width: 10%;"></td> <td style="width: 10%;"></td> <td style="width: 10%;"></td> <td style="width: 10%;"></td> <td style="width: 10%;"></td> </tr> <tr> <td></td> <td></td> <td colspan="8" style="text-align: center;"> <table border="1" style="width: 100%; border-collapse: collapse; text-align: center;"> <tr> <td style="width: 10%;"></td> <td style="width: 10%;"></td> <td style="width: 10%;"></td> <td style="width: 10%;"></td> <td style="width: 10%;"></td> <td style="width: 10%;"></td> <td style="width: 10%;"></td> <td style="width: 10%;"></td> <td style="width: 10%;"></td> <td style="width: 10%;"></td> </tr> <tr> <td></td> <td></td> <td colspan="8" style="text-align: center;"> <table border="1" style="width: 100%; border-collapse: collapse; text-align: center;"> <tr> <td style="width: 10%;"></td> <td style="width: 10%;"></td> <td style="width: 10%;"></td> <td style="width: 10%;"></td> <td style="width: 10%;"></td> <td style="width: 10%;"></td> <td style="width: 10%;"></td> <td style="width: 10%;"></td> <td style="width: 10%;"></td> <td style="width: 10%;"></td> </tr> <tr> <td></td> <td></td> <td colspan="8" style="text-align: center;"> <table border="1" style="width: 100%; border-collapse: collapse; text-align: center;"> <tr> <td style="width: 10%;"></td> <td style="width: 10%;"></td> <td style="width: 10%;"></td> <td style="width: 10%;"></td> <td style="width: 10%;"></td> <td style="width: 10%;"></td> <td style="width: 10%;"></td> <td style="width: 10%;"></td> <td style="width: 10%;"></td> <td style="width: 10%;"></td> </tr> <tr> <td></td> <td></td> <td colspan="8" style="text-align: center;"> <table border="1" style="width: 100%; border-collapse: collapse; text-align: center;"> <tr> <td style="width: 10%;"></td> <td style="width: 10%;"></td> <td style="width: 10%;"></td> <td style="width: 10%;"></td> <td style="width: 10%;"></td> <td style="width: 10%;"></td> <td style="width: 10%;"></td> <td style="width: 10%;"></td> <td style="width: 10%;"></td> <td style="width: 10%;"></td> </tr> <tr> <td></td> <td></td> <td colspan="8" style="text-align: center;"> <table border="1" style="width: 100%; border-collapse: collapse; text-align: center;"> <tr> <td style="width: 10%;"></td> <td style="width: 10%;"></td> <td style="width: 10%;"></td> <td style="width: 10%;"></td> <td style="width: 10%;"></td> <td style="width: 10%;"></td> <td style="width: 10%;"></td> <td style="width: 10%;"></td> <td style="width: 10%;"></td> <td style="width: 10%;"></td> </tr> <tr> <td></td> <td></td> <td colspan="8" style="text-align: center;"> <table border="1" style="width: 100%; border-collapse: collapse; text-align: center;"> <tr> <td style="width: 10%;"></td> <td style="width: 10%;"></td> <td style="width: 10%;"></td> <td style="width: 10%;"></td> <td style="width: 10%;"></td> <td style="width: 10%;"></td> <td style="width: 10%;"></td> <td style="width: 10%;"></td> <td style="width: 10%;"></td> <td style="width: 10%;"></td> </tr> <tr> <td></td> <td></td> <td colspan="8" style="text-align: center;"> <table border="1" style="width: 100%; border-collapse: collapse; text-align: center;"> <tr> <td style="width: 10%;"></td> <td style="width: 10%;"></td> <td style="width: 10%;"></td> <td style="width: 10%;"></td> <td style="width: 10%;"></td> <td style="width: 10%;"></td> <td style="width: 10%;"></td> <td style="width: 10%;"></td> <td style="width: 10%;"></td> <td style="width: 10%;"></td> </tr> <tr> <td></td> <td></td> <td colspan="8" style="text-align: center;"> <table border="1" style="width: 100%; border-collapse: collapse; text-align: center;"> <tr> <td style="width: 10%;"></td> <td style="width: 10%;"></td> <td style="width: 10%;"></td> <td style="width: 10%;"></td> <td style="width: 10%;"></td> <td style="width: 10%;"></td> <td style="width: 10%;"></td> <td style="width: 10%;"></td> <td style="width: 10%;"></td> <td style="width: 10%;"></td> </tr> <tr> <td></td> <td></td> <td colspan="8" style="text-align: center;"> <table border="1" style="width: 100%; border-collapse: collapse; text-align: center;"> <tr> <td style="width: 10%;"></td> <td style="width: 10%;"></td> <td style="width: 10%;"></td> <td style="width: 10%;"></td> <td style="width: 10%;"></td> <td style="width: 10%;"></td> <td style="width: 10%;"></td> <td style="width: 10%;"></td> <td style="width: 10%;"></td> <td style="width: 10%;"></td> </tr> <tr> <td></td> <td></td> <td colspan="8" style="text-align: center;"> <table border="1" style="width: 100%; border-collapse: collapse; text-align: center;"> <tr> <td style="width: 10%;"></td> <td style="width: 10%;"></td> <td style="width: 10%;"></td> <td style="width: 10%;"></td> <td style="width: 10%;"></td> <td style="width: 10%;"></td> <td style="width: 10%;"></td> <td style="width: 10%;"></td> <td style="width: 10%;"></td> <td style="width: 10%;"></td> </tr> <tr> <td></td> <td></td> <td colspan="8" style="text-align: center;"> <table border="1" style="width: 100%; border-collapse: collapse; text-align: center;"> <tr> <td style="width: 10%;"></td> <td style="width: 10%;"></td> <td style="width: 10%;"></td> <td style="width: 10%;"></td> <td style="width: 10%;"></td> <td style="width: 10%;"></td> <td style="width: 10%;"></td> <td style="width: 10%;"></td> <td style="width: 10%;"></td> <td style="width: 10%;"></td> </tr> <tr> <td></td> <td></td> <td colspan="8" style="text-align: center;"> <table border="1" style="width: 100%; border-collapse: collapse; text-align: center;"> <tr> <td style="width: 10%;"></td> <td style="width: 10%;"></td> <td style="width: 10%;"></td> <td style="width: 10%;"></td> <td style="width: 10%;"></td> <td style="width: 10%;"></td> <td style="width: 10%;"></td> <td
style="width: 10%;"></td> <td style="width: 10%;"></td> <td style="width: 10%;"></td> </tr> <tr> <td></td> <td></td> <td colspan="8" style="text-align: center;"> <table border="1" style="width: 100%; border-collapse: collapse; text-align: center;"> <tr> <td style="width: 10%;"></td> <td style="width: 10%;"></td> <td style="width: 10%;"></td> <td style="width: 10%;"></td> <td style="width: 10%;"></td> <td style="width: 10%;"></td> <td style="width: 10%;"></td> <td style="width: 10%;"></td> <td style="width: 10%;"></td> <td style="width: 10%;"></td> </tr> <tr> <td></td> <td></td> <td colspan="8" style="text-align: center;"> <table border="1" style="width: 100%; border-collapse: collapse; text-align: center;"> <tr> <td style="width: 10%;"></td> <td style="width: 10%;"></td> <td style="width: 10%;"></td> <td style="width: 10%;"></td> <td style="width: 10%;"></td> <td style="width: 10%;"></td> <td style="width: 10%;"></td> <td style="width: 10%;"></td> <td style="width: 10%;"></td> <td style="width: 10%;"></td> </tr> <tr> <td></td> <td></td> <td colspan="8" style="text-align: center;"> <table border="1" style="width: 100%; border-collapse: collapse; text-align: center;"> <tr> <td style="width: 10%;"></td> <td style="width: 10%;"></td> <td style="width: 10%;"></td> <td style="width: 10%;"></td> <td style="width: 10%;"></td> <td style="width: 10%;"></td> <td style="width: 10%;"></td> <td style="width: 10%;"></td> <td style="width: 10%;"></td> <td style="width: 10%;"></td> </tr> <tr> <td></td> <td></td> <td colspan="8" style="text-align: center;"> <table border="1" style="width: 100%; border-collapse: collapse; text-align: center;"> <tr> </tr></table></td></tr></table></td></tr></table></td></tr></table></td></tr></table></td></tr></table></td></tr></table></td></tr></table></td></tr></table></td></tr></table></td></tr></table></td></tr></table></td></tr></table></td></tr></table></td></tr></table></td></tr></table></td></tr></table></td></tr></table></td></tr></table></td></tr></table></td></tr></table></td></tr></table></td></tr></table></td></tr></table></td></tr></table></td></tr></table></td></tr></table>
 | | | | | | | | | | | | | | | | | | | | <table border="1" style="width: 100%; border-collapse: collapse; text-align: center;"> <tr> <td style="width: 10%;"></td> <td style="width: 10%;"></td> <td style="width: 10%;"></td> <td style="width: 10%;"></td> <td style="width: 10%;"></td> <td style="width: 10%;"></td> <td style="width: 10%;"></td> <td style="width: 10%;"></td> <td style="width: 10%;"></td> <td style="width: 10%;"></td> </tr> <tr> <td></td> <td></td> <td colspan="8" style="text-align: center;"> <table border="1" style="width: 100%; border-collapse: collapse; text-align: center;"> <tr> <td style="width: 10%;"></td> <td style="width: 10%;"></td> <td style="width: 10%;"></td> <td style="width: 10%;"></td> <td style="width: 10%;"></td> <td style="width: 10%;"></td> <td style="width: 10%;"></td> <td style="width: 10%;"></td> <td style="width: 10%;"></td> <td style="width: 10%;"></td> </tr> <tr> <td></td> <td></td> <td colspan="8" style="text-align: center;"> <table border="1" style="width: 100%; border-collapse: collapse; text-align: center;"> <tr> <td style="width: 10%;"></td> <td style="width: 10%;"></td> <td style="width: 10%;"></td> <td style="width: 10%;"></td> <td style="width: 10%;"></td> <td style="width: 10%;"></td> <td style="width: 10%;"></td> <td style="width: 10%;"></td> <td style="width: 10%;"></td> <td style="width: 10%;"></td> </tr> <tr> <td></td> <td></td> <td colspan="8" style="text-align: center;"> <table border="1" style="width: 100%; border-collapse: collapse; text-align: center;"> <tr> <td style="width: 10%;"></td> <td style="width: 10%;"></td> <td style="width: 10%;"></td> <td style="width: 10%;"></td> <td style="width: 10%;"></td> <td style="width: 10%;"></td> <td style="width: 10%;"></td> <td style="width: 10%;"></td> <td style="width: 10%;"></td> <td style="width: 10%;"></td> </tr> <tr> <td></td> <td></td> <td colspan="8" style="text-align: center;"> <table border="1" style="width: 100%; border-collapse: collapse; text-align: center;"> <tr> <td style="width: 10%;"></td> <td style="width: 10%;"></td> <td style="width: 10%;"></td> <td style="width: 10%;"></td> <td style="width: 10%;"></td> <td style="width: 10%;"></td> <td style="width: 10%;"></td> <td style="width: 10%;"></td> <td style="width: 10%;"></td> <td style="width: 10%;"></td> </tr> <tr> <td></td> <td></td> <td colspan="8" style="text-align: center;"> <table border="1" style="width: 100%; border-collapse: collapse; text-align: center;"> <tr> <td style="width: 10%;"></td> <td style="width: 10%;"></td> <td style="width: 10%;"></td> <td style="width: 10%;"></td> <td style="width: 10%;"></td> <td style="width: 10%;"></td> <td style="width: 10%;"></td> <td style="width: 10%;"></td> <td style="width: 10%;"></td> <td style="width: 10%;"></td> </tr> <tr> <td></td> <td></td> <td colspan="8" style="text-align: center;"> <table border="1" style="width: 100%; border-collapse: collapse; text-align: center;"> <tr> <td style="width: 10%;"></td> <td style="width: 10%;"></td> <td style="width: 10%;"></td> <td style="width: 10%;"></td> <td style="width: 10%;"></td> <td style="width: 10%;"></td> <td style="width: 10%;"></td> <td style="width: 10%;"></td> <td style="width: 10%;"></td> <td style="width: 10%;"></td> </tr> <tr> <td></td> <td></td> <td colspan="8" style="text-align: center;"> <table border="1" style="width: 100%; border-collapse: collapse; text-align: center;"> <tr> <td style="width: 10%;"></td> <td style="width: 10%;"></td> <td style="width: 10%;"></td> <td style="width: 10%;"></td> <td style="width: 10%;"></td> <td style="width: 10%;"></td> <td style="width: 10%;"></td> <td style="width: 10%;"></td> <td style="width: 10%;"></td> <td style="width: 10%;"></td> </tr> <tr> <td></td> <td></td> <td colspan="8" style="text-align: center;"> <table border="1" style="width: 100%; border-collapse: collapse; text-align: center;"> <tr> <td style="width: 10%;"></td> <td style="width: 10%;"></td> <td style="width: 10%;"></td> <td style="width: 10%;"></td> <td style="width: 10%;"></td> <td style="width: 10%;"></td> <td style="width: 10%;"></td> <td style="width: 10%;"></td> <td style="width: 10%;"></td> <td style="width: 10%;"></td> </tr> <tr> <td></td> <td></td> <td colspan="8" style="text-align: center;"> <table border="1" style="width: 100%; border-collapse: collapse; text-align: center;"> <tr> <td style="width: 10%;"></td> <td style="width: 10%;"></td> <td style="width: 10%;"></td> <td style="width: 10%;"></td> <td style="width: 10%;"></td> <td style="width: 10%;"></td> <td style="width: 10%;"></td> <td style="width: 10%;"></td> <td style="width: 10%;"></td> <td style="width: 10%;"></td> </tr> <tr> <td></td> <td></td> <td colspan="8" style="text-align: center;"> <table border="1" style="width: 100%; border-collapse: collapse; text-align: center;"> <tr> <td style="width: 10%;"></td> <td style="width: 10%;"></td> <td style="width: 10%;"></td> <td style="width: 10%;"></td> <td style="width: 10%;"></td> <td style="width: 10%;"></td> <td style="width: 10%;"></td> <td style="width: 10%;"></td> <td style="width: 10%;"></td> <td style="width: 10%;"></td> </tr> <tr> <td></td> <td></td> <td colspan="8" style="text-align: center;"> <table border="1" style="width: 100%; border-collapse: collapse; text-align: center;"> <tr> <td style="width: 10%;"></td> <td style="width: 10%;"></td> <td style="width: 10%;"></td> <td style="width: 10%;"></td> <td style="width: 10%;"></td> <td style="width: 10%;"></td> <td style="width: 10%;"></td> <td style="width: 10%;"></td> <td style="width: 10%;"></td> <td style="width: 10%;"></td> </tr> <tr> <td></td> <td></td> <td colspan="8" style="text-align: center;"> <table border="1" style="width:
100%; border-collapse: collapse; text-align: center;"> <tr> <td style="width: 10%;"></td> <td style="width: 10%;"></td> <td style="width: 10%;"></td> <td style="width: 10%;"></td> <td style="width: 10%;"></td> <td style="width: 10%;"></td> <td style="width: 10%;"></td> <td style="width: 10%;"></td> <td style="width: 10%;"></td> <td style="width: 10%;"></td> </tr> <tr> <td></td> <td></td> <td colspan="8" style="text-align: center;"> <table border="1" style="width: 100%; border-collapse: collapse; text-align: center;"> <tr> <td style="width: 10%;"></td> <td style="width: 10%;"></td> <td style="width: 10%;"></td> <td style="width: 10%;"></td> <td style="width: 10%;"></td> <td style="width: 10%;"></td> <td style="width: 10%;"></td> <td style="width: 10%;"></td> <td style="width: 10%;"></td> <td style="width: 10%;"></td> </tr> <tr> <td></td> <td></td> <td colspan="8" style="text-align: center;"> <table border="1" style="width: 100%; border-collapse: collapse; text-align: center;"> <tr> <td style="width: 10%;"></td> <td style="width: 10%;"></td> <td style="width: 10%;"></td> <td style="width: 10%;"></td> <td style="width: 10%;"></td> <td style="width: 10%;"></td> <td style="width: 10%;"></td> <td style="width: 10%;"></td> <td style="width: 10%;"></td> <td style="width: 10%;"></td> </tr> <tr> <td></td> <td></td> <td colspan="8" style="text-align: center;"> <table border="1" style="width: 100%; border-collapse: collapse; text-align: center;"> <tr> <td style="width: 10%;"></td> <td style="width: 10%;"></td> <td style="width: 10%;"></td> <td style="width: 10%;"></td> <td style="width: 10%;"></td> <td style="width: 10%;"></td> <td style="width: 10%;"></td> <td style="width: 10%;"></td> <td style="width: 10%;"></td> <td style="width: 10%;"></td> </tr> <tr> <td></td> <td></td> <td colspan="8" style="text-align: center;"> <table border="1" style="width: 100%; border-collapse: collapse; text-align: center;"> <tr> <td style="width: 10%;"></td> <td style="width: 10%;"></td> <td style="width: 10%;"></td> <td style="width: 10%;"></td> <td style="width: 10%;"></td> <td style="width: 10%;"></td> <td style="width: 10%;"></td> <td style="width: 10%;"></td> <td style="width: 10%;"></td> <td style="width: 10%;"></td> </tr> <tr> <td></td> <td></td> <td colspan="8" style="text-align: center;"> <table border="1" style="width: 100%; border-collapse: collapse; text-align: center;"> <tr> <td style="width: 10%;"></td> <td style="width: 10%;"></td> <td style="width: 10%;"></td> <td style="width: 10%;"></td> <td style="width: 10%;"></td> <td style="width: 10%;"></td> <td style="width: 10%;"></td> <td style="width: 10%;"></td> <td style="width: 10%;"></td> <td style="width: 10%;"></td> </tr> <tr> <td></td> <td></td> <td colspan="8" style="text-align: center;"> <table border="1" style="width: 100%; border-collapse: collapse; text-align: center;"> <tr> <td style="width: 10%;"></td> <td style="width: 10%;"></td> <td style="width: 10%;"></td> <td style="width: 10%;"></td> <td style="width: 10%;"></td> <td style="width: 10%;"></td> <td style="width: 10%;"></td> <td style="width: 10%;"></td> <td style="width: 10%;"></td> <td style="width: 10%;"></td> </tr> <tr> <td></td> <td></td> <td colspan="8" style="text-align: center;"> <table border="1" style="width: 100%; border-collapse: collapse; text-align: center;"> <tr> <td style="width: 10%;"></td> <td style="width: 10%;"></td> <td style="width: 10%;"></td> <td style="width: 10%;"></td> <td style="width: 10%;"></td> <td style="width: 10%;"></td> <td style="width: 10%;"></td> <td style="width: 10%;"></td> <td style="width: 10%;"></td> <td style="width: 10%;"></td> </tr> <tr> <td></td> <td></td> <td colspan="8" style="text-align: center;"> <table border="1" style="width: 100%; border-collapse: collapse; text-align: center;"> <tr> <td style="width: 10%;"></td> <td style="width: 10%;"></td> <td style="width: 10%;"></td> <td style="width: 10%;"></td> <td style="width: 10%;"></td> <td style="width: 10%;"></td> <td style="width: 10%;"></td> <td style="width: 10%;"></td> <td style="width: 10%;"></td> <td style="width: 10%;"></td> </tr> <tr> <td></td> <td></td> <td colspan="8" style="text-align: center;"> <table border="1" style="width: 100%; border-collapse: collapse; text-align: center;"> <tr> <td style="width: 10%;"></td> <td style="width: 10%;"></td> <td style="width: 10%;"></td> <td style="width: 10%;"></td> <td style="width: 10%;"></td> <td style="width: 10%;"></td> <td style="width: 10%;"></td> <td style="width: 10%;"></td> <td style="width: 10%;"></td> <td style="width: 10%;"></td> </tr> <tr> <td></td> <td></td> <td colspan="8" style="text-align: center;"> <table border="1" style="width: 100%; border-collapse: collapse; text-align: center;"> <tr> <td style="width: 10%;"></td> <td style="width: 10%;"></td> <td style="width: 10%;"></td> <td style="width: 10%;"></td> <td style="width: 10%;"></td> <td style="width: 10%;"></td> <td style="width: 10%;"></td> <td style="width: 10%;"></td> <td style="width: 10%;"></td> <td style="width: 10%;"></td> </tr> <tr> <td></td> <td></td> <td colspan="8" style="text-align: center;"> <table border="1" style="width: 100%; border-collapse: collapse; text-align: center;"> <tr> <td style="width: 10%;"></td> <td style="width: 10%;"></td> <td style="width: 10%;"></td> <td style="width: 10%;"></td> <td style="width: 10%;"></td> <td style="width: 10%;"></td> <td style="width: 10%;"></td> <td style="width: 10%;"></td> <td style="width: 10%;"></td> <td style="width: 10%;"></td> </tr> <tr> <td></td> <td></td> <td colspan="8" style="text-align: center;"> <table border="1" style="width: 100%; border-collapse: collapse; text-align: center;"> <tr> <td style="width: 10%;"></td> <td style="width: 10%;"></td> <td style="width: 10%;"></td> <td style="width: 10%;"></td> <td style="width: 10%;"></td> <td style="width: 10%;"></td> <td style="width: 10%;"></td> <td style="width: 10%;"></td> <td style="width: 10%;"></td> <td style="width: 10%;"></td> </tr> <tr> <td></td> <td></td> <td colspan="8" style="text-align: center;"> <table border="1" style="width: 100%; border-collapse: collapse; text-align: center;"> <tr> </tr></table></td></tr></table></td></tr></table></td></tr></table></td></tr></table></td></tr></table></td></tr></table></td></tr></table></td></tr></table></td></tr></table></td></tr></table></td></tr></table></td></tr></table></td></tr></table></td></tr></table></td></tr></table></td></tr></table></td></tr></table></td></tr></table></td></tr></table></td></tr></table></td></tr></table></td></tr></table></td></tr></table></td></tr></table></td></tr></table>
 | | | | | | | | | | | | | | | | | | | | <table border="1" style="width: 100%; border-collapse: collapse; text-align: center;"> <tr> <td style="width: 10%;"></td> <td style="width: 10%;"></td> <td style="width: 10%;"></td> <td style="width: 10%;"></td> <td style="width: 10%;"></td> <td style="width: 10%;"></td> <td style="width: 10%;"></td> <td style="width: 10%;"></td> <td style="width: 10%;"></td> <td style="width: 10%;"></td> </tr> <tr> <td></td> <td></td> <td colspan="8" style="text-align: center;"> <table border="1" style="width: 100%; border-collapse: collapse; text-align: center;"> <tr> <td style="width: 10%;"></td> <td style="width: 10%;"></td> <td style="width: 10%;"></td> <td style="width: 10%;"></td> <td style="width: 10%;"></td> <td style="width: 10%;"></td> <td style="width: 10%;"></td> <td style="width: 10%;"></td> <td style="width: 10%;"></td> <td style="width: 10%;"></td> </tr> <tr> <td></td> <td></td> <td colspan="8" style="text-align: center;"> <table border="1" style="width: 100%; border-collapse: collapse; text-align: center;"> <tr> <td style="width: 10%;"></td> <td style="width: 10%;"></td> <td style="width: 10%;"></td> <td style="width: 10%;"></td> <td style="width: 10%;"></td> <td
style="width: 10%;"></td> <td style="width: 10%;"></td> <td style="width: 10%;"></td> <td style="width: 10%;"></td> <td style="width: 10%;"></td> </tr> <tr> <td></td> <td></td> <td colspan="8" style="text-align: center;"> <table border="1" style="width: 100%; border-collapse: collapse; text-align: center;"> <tr> <td style="width: 10%;"></td> <td style="width: 10%;"></td> <td style="width: 10%;"></td> <td style="width: 10%;"></td> <td style="width: 10%;"></td> <td style="width: 10%;"></td> <td style="width: 10%;"></td> <td style="width: 10%;"></td> <td style="width: 10%;"></td> <td style="width: 10%;"></td> </tr> <tr> <td></td> <td></td> <td colspan="8" style="text-align: center;"> <table border="1" style="width: 100%; border-collapse: collapse; text-align: center;"> <tr> <td style="width: 10%;"></td> <td style="width: 10%;"></td> <td style="width: 10%;"></td> <td style="width: 10%;"></td> <td style="width: 10%;"></td> <td style="width: 10%;"></td> <td style="width: 10%;"></td> <td style="width: 10%;"></td> <td style="width: 10%;"></td> <td style="width: 10%;"></td> </tr> <tr> <td></td> <td></td> <td colspan="8" style="text-align: center;"> <table border="1" style="width: 100%; border-collapse: collapse; text-align: center;"> <tr> <td style="width: 10%;"></td> <td style="width: 10%;"></td> <td style="width: 10%;"></td> <td style="width: 10%;"></td> <td style="width: 10%;"></td> <td style="width: 10%;"></td> <td style="width: 10%;"></td> <td style="width: 10%;"></td> <td style="width: 10%;"></td> <td style="width: 10%;"></td> </tr> <tr> <td></td> <td></td> <td colspan="8" style="text-align: center;"> <table border="1" style="width: 100%; border-collapse: collapse; text-align: center;"> <tr> <td style="width: 10%;"></td> <td style="width: 10%;"></td> <td style="width: 10%;"></td> <td style="width: 10%;"></td> <td style="width: 10%;"></td> <td style="width: 10%;"></td> <td style="width: 10%;"></td> <td style="width: 10%;"></td> <td style="width: 10%;"></td> <td style="width: 10%;"></td> </tr> <tr> <td></td> <td></td> <td colspan="8" style="text-align: center;"> <table border="1" style="width: 100%; border-collapse: collapse; text-align: center;"> <tr> <td style="width: 10%;"></td> <td style="width: 10%;"></td> <td style="width: 10%;"></td> <td style="width: 10%;"></td> <td style="width: 10%;"></td> <td style="width: 10%;"></td> <td style="width: 10%;"></td> <td style="width: 10%;"></td> <td style="width: 10%;"></td> <td style="width: 10%;"></td> </tr> <tr> <td></td> <td></td> <td colspan="8" style="text-align: center;"> <table border="1" style="width: 100%; border-collapse: collapse; text-align: center;"> <tr> <td style="width: 10%;"></td> <td style="width: 10%;"></td> <td style="width: 10%;"></td> <td style="width: 10%;"></td> <td style="width: 10%;"></td> <td style="width: 10%;"></td> <td style="width: 10%;"></td> <td style="width: 10%;"></td> <td style="width: 10%;"></td> <td style="width: 10%;"></td> </tr> <tr> <td></td> <td></td> <td colspan="8" style="text-align: center;"> <table border="1" style="width: 100%; border-collapse: collapse; text-align: center;"> <tr> <td style="width: 10%;"></td> <td style="width: 10%;"></td> <td style="width: 10%;"></td> <td style="width: 10%;"></td> <td style="width: 10%;"></td> <td style="width: 10%;"></td> <td style="width: 10%;"></td> <td style="width: 10%;"></td> <td style="width: 10%;"></td> <td style="width: 10%;"></td> </tr> <tr> <td></td> <td></td> <td colspan="8" style="text-align: center;"> <table border="1" style="width: 100%; border-collapse: collapse; text-align: center;"> <tr> <td style="width: 10%;"></td> <td style="width: 10%;"></td> <td style="width: 10%;"></td> <td style="width: 10%;"></td> <td style="width: 10%;"></td> <td style="width: 10%;"></td> <td style="width: 10%;"></td> <td style="width: 10%;"></td> <td style="width: 10%;"></td> <td style="width: 10%;"></td> </tr> <tr> <td></td> <td></td> <td colspan="8" style="text-align: center;"> <table border="1" style="width: 100%; border-collapse: collapse; text-align: center;"> <tr> <td style="width: 10%;"></td> <td style="width: 10%;"></td> <td style="width: 10%;"></td> <td style="width: 10%;"></td> <td style="width: 10%;"></td> <td style="width: 10%;"></td> <td style="width: 10%;"></td> <td style="width: 10%;"></td> <td style="width: 10%;"></td> <td style="width: 10%;"></td> </tr> <tr> <td></td> <td></td> <td colspan="8" style="text-align: center;"> <table border="1" style="width: 100%; border-collapse: collapse; text-align: center;"> <tr> <td style="width: 10%;"></td> <td style="width: 10%;"></td> <td style="width: 10%;"></td> <td style="width: 10%;"></td> <td style="width: 10%;"></td> <td style="width: 10%;"></td> <td style="width: 10%;"></td> <td style="width: 10%;"></td> <td style="width: 10%;"></td> <td style="width: 10%;"></td> </tr> <tr> <td></td> <td></td> <td colspan="8" style="text-align: center;"> <table border="1" style="width: 100%; border-collapse: collapse; text-align: center;"> <tr> <td style="width: 10%;"></td> <td style="width: 10%;"></td> <td style="width: 10%;"></td> <td style="width: 10%;"></td> <td style="width: 10%;"></td> <td style="width: 10%;"></td> <td style="width: 10%;"></td> <td style="width: 10%;"></td> <td style="width: 10%;"></td> <td style="width: 10%;"></td> </tr> <tr> <td></td> <td></td> <td colspan="8" style="text-align: center;"> <table border="1" style="width: 100%; border-collapse: collapse; text-align: center;"> <tr> <td style="width: 10%;"></td> <td style="width: 10%;"></td> <td style="width: 10%;"></td> <td style="width: 10%;"></td> <td style="width: 10%;"></td> <td style="width: 10%;"></td> <td style="width: 10%;"></td> <td style="width: 10%;"></td> <td style="width: 10%;"></td> <td style="width: 10%;"></td> </tr> <tr> <td></td> <td></td> <td colspan="8" style="text-align: center;"> <table border="1" style="width: 100%; border-collapse: collapse; text-align: center;"> <tr> <td style="width: 10%;"></td> <td style="width: 10%;"></td> <td style="width: 10%;"></td> <td style="width: 10%;"></td> <td style="width: 10%;"></td> <td style="width: 10%;"></td> <td style="width: 10%;"></td> <td style="width: 10%;"></td> <td style="width: 10%;"></td> <td style="width: 10%;"></td> </tr> <tr> <td></td> <td></td> <td colspan="8" style="text-align: center;"> <table border="1" style="width: 100%; border-collapse: collapse; text-align: center;"> <tr> <td style="width: 10%;"></td> <td style="width: 10%;"></td> <td style="width: 10%;"></td> <td style="width: 10%;"></td> <td style="width: 10%;"></td> <td style="width: 10%;"></td> <td style="width: 10%;"></td> <td style="width: 10%;"></td> <td style="width: 10%;"></td> <td style="width: 10%;"></td> </tr> <tr> <td></td> <td></td> <td colspan="8" style="text-align: center;"> <table border="1" style="width: 100%; border-collapse: collapse; text-align: center;"> <tr> <td style="width: 10%;"></td> <td style="width: 10%;"></td> <td style="width: 10%;"></td> <td style="width: 10%;"></td> <td style="width: 10%;"></td> <td style="width: 10%;"></td> <td style="width: 10%;"></td> <td style="width: 10%;"></td> <td style="width: 10%;"></td> <td style="width: 10%;"></td> </tr> <tr> <td></td> <td></td> <td colspan="8" style="text-align: center;"> <table border="1" style="width: 100%; border-collapse: collapse; text-align: center;"> <tr> <td style="width: 10%;"></td> <td style="width: 10%;"></td> <td style="width: 10%;"></td> <td style="width: 10%;"></td> <td style="width: 10%;"></td> <td style="width: 10%;"></td> <td style="width: 10%;"></td> <td style="width: 10%;"></td> <td style="width: 10%;"></td> <td style="width: 10%;"></td> </tr> <tr> <td></td> <td></td> <td colspan="8" style="text-align: center;"> <table border="1" style="width: 100%; border-collapse: collapse; text-align: center;"> <tr> <td style="width: 10%;"></td> <td style="width: 10%;"></td> <td style="width: 10%;"></td> <td style="width: 10%;"></td> <td style="width: 10%;"></td> <td style="width: 10%;"></td> <td style="width: 10%;"></td> <td style="width: 10%;"></td> <td style="width: 10%;"></td> <td style="width: 10%;"></td> </tr> <tr> <td></td> <td></td> <td colspan="8" style="text-align: center;"> <table border="1" style="width: 100%; border-collapse: collapse; text-align: center;"> <tr> <td style="width: 10%;"></td> <td style="width: 10%;"></td> <td style="width: 10%;"></td> <td style="width: 10%;"></td> <td style="width: 10%;"></td> <td style="width: 10%;"></td> <td style="width: 10%;"></td> <td style="width: 10%;"></td> <td style="width: 10%;"></td> <td style="width: 10%;"></td> </tr> <tr> <td></td> <td></td> <td colspan="8" style="text-align: center;"> <table border="1" style="width: 100%; border-collapse: collapse; text-align: center;"> <tr> <td style="width: 10%;"></td> <td style="width: 10%;"></td> <td style="width: 10%;"></td> <td style="width: 10%;"></td> <td style="width: 10%;"></td> <td style="width: 10%;"></td> <td style="width: 10%;"></td> <td style="width: 10%;"></td> <td style="width: 10%;"></td> <td style="width: 10%;"></td> </tr> <tr> <td></td> <td></td> <td colspan="8" style="text-align: center;"> <table border="1" style="width: 100%; border-collapse: collapse; text-align: center;"> <tr> <td style="width: 10%;"></td> <td style="width: 10%;"></td> <td style="width: 10%;"></td> <td style="width: 10%;"></td> <td style="width: 10%;"></td> <td style="width: 10%;"></td> <td style="width: 10%;"></td> <td style="width: 10%;"></td> <td style="width: 10%;"></td> <td style="width: 10%;"></td> </tr> <tr> <td></td> <td></td> <td colspan="8" style="text-align: center;"> <table border="1" style="width: 100%; border-collapse: collapse; text-align: center;"> <tr> <td style="width: 10%;"></td> <td style="width: 10%;"></td> <td style="width: 10%;"></td> <td style="width: 10%;"></td> <td style="width: 10%;"></td> <td style="width: 10%;"></td> <td style="width: 10%;"></td> <td style="width: 10%;"></td> <td style="width: 10%;"></td> <td style="width: 10%;"></td> </tr> <tr> <td></td>
<td></td> <td colspan="8" style="text-align: center;"> <table border="1" style="width: 100%; border-collapse: collapse; text-align: center;"> <tr> </tr></table></td></tr></table></td></tr></table></td></tr></table></td></tr></table></td></tr></table></td></tr></table></td></tr></table></td></tr></table></td></tr></table></td></tr></table></td></tr></table></td></tr></table></td></tr></table></td></tr></table></td></tr></table></td></tr></table></td></tr></table></td></tr></table></td></tr></table></td></tr></table></td></tr></table></td></tr></table></td></tr></table></td></tr></table>
 | | | | | | | | | | | | | | | | | | | | <table border="1" style="width: 100%; border-collapse: collapse; text-align: center;"> <tr> <td style="width: 10%;"></td> <td style="width: 10%;"></td> <td style="width: 10%;"></td> <td style="width: 10%;"></td> <td style="width: 10%;"></td> <td style="width: 10%;"></td> <td style="width: 10%;"></td> <td style="width: 10%;"></td> <td style="width: 10%;"></td> <td style="width: 10%;"></td> </tr> <tr> <td></td> <td></td> <td colspan="8" style="text-align: center;"> <table border="1" style="width: 100%; border-collapse: collapse; text-align: center;"> <tr> <td style="width: 10%;"></td> <td style="width: 10%;"></td> <td style="width: 10%;"></td> <td style="width: 10%;"></td> <td style="width: 10%;"></td> <td style="width: 10%;"></td> <td style="width: 10%;"></td> <td style="width: 10%;"></td> <td style="width: 10%;"></td> <td style="width: 10%;"></td> </tr> <tr> <td></td> <td></td> <td colspan="8" style="text-align: center;"> <table border="1" style="width: 100%; border-collapse: collapse; text-align: center;"> <tr> <td style="width: 10%;"></td> <td style="width: 10%;"></td> <td style="width: 10%;"></td> <td style="width: 10%;"></td> <td style="width: 10%;"></td> <td style="width: 10%;"></td> <td style="width: 10%;"></td> <td style="width: 10%;"></td> <td style="width: 10%;"></td> <td style="width: 10%;"></td> </tr> <tr> <td></td> <td></td> <td colspan="8" style="text-align: center;"> <table border="1" style="width: 100%; border-collapse: collapse; text-align: center;"> <tr> <td style="width: 10%;"></td> <td style="width: 10%;"></td> <td style="width: 10%;"></td> <td style="width: 10%;"></td> <td style="width: 10%;"></td> <td style="width: 10%;"></td> <td style="width: 10%;"></td> <td style="width: 10%;"></td> <td style="width: 10%;"></td> <td style="width: 10%;"></td> </tr> <tr> <td></td> <td></td> <td colspan="8" style="text-align: center;"> <table border="1" style="width: 100%; border-collapse: collapse; text-align: center;"> <tr> <td style="width: 10%;"></td> <td style="width: 10%;"></td> <td style="width: 10%;"></td> <td style="width: 10%;"></td> <td style="width: 10%;"></td> <td style="width: 10%;"></td> <td style="width: 10%;"></td> <td style="width: 10%;"></td> <td style="width: 10%;"></td> <td style="width: 10%;"></td> </tr> <tr> <td></td> <td></td> <td colspan="8" style="text-align: center;"> <table border="1" style="width: 100%; border-collapse: collapse; text-align: center;"> <tr> <td style="width: 10%;"></td> <td style="width: 10%;"></td> <td style="width: 10%;"></td> <td style="width: 10%;"></td> <td style="width: 10%;"></td> <td style="width: 10%;"></td> <td style="width: 10%;"></td> <td style="width: 10%;"></td> <td style="width: 10%;"></td> <td style="width: 10%;"></td> </tr> <tr> <td></td> <td></td> <td colspan="8" style="text-align: center;"> <table border="1" style="width: 100%; border-collapse: collapse; text-align: center;"> <tr> <td style="width: 10%;"></td> <td style="width: 10%;"></td> <td style="width: 10%;"></td> <td style="width: 10%;"></td> <td style="width: 10%;"></td> <td style="width: 10%;"></td> <td style="width: 10%;"></td> <td style="width: 10%;"></td> <td style="width: 10%;"></td> <td style="width: 10%;"></td> </tr> <tr> <td></td> <td></td> <td colspan="8" style="text-align: center;"> <table border="1" style="width: 100%; border-collapse: collapse; text-align: center;"> <tr> <td style="width: 10%;"></td> <td style="width: 10%;"></td> <td style="width: 10%;"></td> <td style="width: 10%;"></td> <td style="width: 10%;"></td> <td style="width: 10%;"></td> <td style="width: 10%;"></td> <td style="width: 10%;"></td> <td style="width: 10%;"></td> <td style="width: 10%;"></td> </tr> <tr> <td></td> <td></td> <td colspan="8" style="text-align: center;"> <table border="1" style="width: 100%; border-collapse: collapse; text-align: center;"> <tr> <td style="width: 10%;"></td> <td style="width: 10%;"></td> <td style="width: 10%;"></td> <td style="width: 10%;"></td> <td style="width: 10%;"></td> <td style="width: 10%;"></td> <td style="width: 10%;"></td> <td style="width: 10%;"></td> <td style="width: 10%;"></td> <td style="width: 10%;"></td> </tr> <tr> <td></td> <td></td> <td colspan="8" style="text-align: center;"> <table border="1" style="width: 100%; border-collapse: collapse; text-align: center;"> <tr> <td style="width: 10%;"></td> <td style="width: 10%;"></td> <td style="width: 10%;"></td> <td style="width: 10%;"></td> <td style="width: 10%;"></td> <td style="width: 10%;"></td> <td style="width: 10%;"></td> <td style="width: 10%;"></td> <td style="width: 10%;"></td> <td style="width: 10%;"></td> </tr> <tr> <td></td> <td></td> <td colspan="8" style="text-align: center;"> <table border="1" style="width: 100%; border-collapse: collapse; text-align: center;"> <tr> <td style="width: 10%;"></td> <td style="width: 10%;"></td> <td style="width: 10%;"></td> <td style="width: 10%;"></td> <td style="width: 10%;"></td> <td style="width: 10%;"></td> <td style="width: 10%;"></td> <td style="width: 10%;"></td> <td style="width: 10%;"></td> <td style="width: 10%;"></td> </tr> <tr> <td></td> <td></td> <td colspan="8" style="text-align: center;"> <table border="1" style="width: 100%; border-collapse: collapse; text-align: center;"> <tr> <td style="width: 10%;"></td> <td style="width: 10%;"></td> <td style="width: 10%;"></td> <td style="width: 10%;"></td> <td style="width: 10%;"></td> <td style="width: 10%;"></td> <td style="width: 10%;"></td> <td style="width: 10%;"></td> <td style="width: 10%;"></td> <td style="width: 10%;"></td> </tr> <tr> <td></td> <td></td> <td colspan="8" style="text-align: center;"> <table border="1" style="width: 100%; border-collapse: collapse; text-align: center;"> <tr> <td style="width: 10%;"></td> <td style="width: 10%;"></td> <td style="width: 10%;"></td> <td style="width: 10%;"></td> <td style="width: 10%;"></td> <td style="width: 10%;"></td> <td style="width: 10%;"></td> <td style="width: 10%;"></td> <td style="width: 10%;"></td> <td style="width: 10%;"></td> </tr> <tr> <td></td> <td></td> <td colspan="8" style="text-align: center;"> <table border="1" style="width: 100%; border-collapse: collapse; text-align: center;"> <tr> <td style="width: 10%;"></td> <td style="width: 10%;"></td> <td style="width: 10%;"></td> <td style="width: 10%;"></td> <td style="width: 10%;"></td> <td style="width: 10%;"></td> <td style="width: 10%;"></td> <td style="width: 10%;"></td> <td style="width: 10%;"></td> <td style="width: 10%;"></td> </tr> <tr> <td></td> <td></td> <td colspan="8" style="text-align: center;"> <table border="1" style="width: 100%; border-collapse: collapse; text-align: center;"> <tr> <td style="width: 10%;"></td> <td style="width: 10%;"></td> <td style="width: 10%;"></td> <td style="width: 10%;"></td> <td style="width: 10%;"></td> <td style="width: 10%;"></td> <td style="width: 10%;"></td> <td style="width: 10%;"></td> <td style="width: 10%;"></td> <td style="width: 10%;"></td> </tr> <tr> <td></td> <td></td> <td colspan="8" style="text-align: center;"> <table border="1" style="width: 100%; border-collapse: collapse; text-align: center;"> <tr> <td style="width: 10%;"></td> <td style="width: 10%;"></td> <td style="width:
10%;"></td> <td style="width: 10%;"></td> <td style="width: 10%;"></td> <td style="width: 10%;"></td> <td style="width: 10%;"></td> <td style="width: 10%;"></td> <td style="width: 10%;"></td> <td style="width: 10%;"></td> </tr> <tr> <td></td> <td></td> <td colspan="8" style="text-align: center;"> <table border="1" style="width: 100%; border-collapse: collapse; text-align: center;"> <tr> <td style="width: 10%;"></td> <td style="width: 10%;"></td> <td style="width: 10%;"></td> <td style="width: 10%;"></td> <td style="width: 10%;"></td> <td style="width: 10%;"></td> <td style="width: 10%;"></td> <td style="width: 10%;"></td> <td style="width: 10%;"></td> <td style="width: 10%;"></td> </tr> <tr> <td></td> <td></td> <td colspan="8" style="text-align: center;"> <table border="1" style="width: 100%; border-collapse: collapse; text-align: center;"> <tr> <td style="width: 10%;"></td> <td style="width: 10%;"></td> <td style="width: 10%;"></td> <td style="width: 10%;"></td> <td style="width: 10%;"></td> <td style="width: 10%;"></td> <td style="width: 10%;"></td> <td style="width: 10%;"></td> <td style="width: 10%;"></td> <td style="width: 10%;"></td> </tr> <tr> <td></td> <td></td> <td colspan="8" style="text-align: center;"> <table border="1" style="width: 100%; border-collapse: collapse; text-align: center;"> <tr> <td style="width: 10%;"></td> <td style="width: 10%;"></td> <td style="width: 10%;"></td> <td style="width: 10%;"></td> <td style="width: 10%;"></td> <td style="width: 10%;"></td> <td style="width: 10%;"></td> <td style="width: 10%;"></td> <td style="width: 10%;"></td> <td style="width: 10%;"></td> </tr> <tr> <td></td> <td></td> <td colspan="8" style="text-align: center;"> <table border="1" style="width: 100%; border-collapse: collapse; text-align: center;"> <tr> <td style="width: 10%;"></td> <td style="width: 10%;"></td> <td style="width: 10%;"></td> <td style="width: 10%;"></td> <td style="width: 10%;"></td> <td style="width: 10%;"></td> <td style="width: 10%;"></td> <td style="width: 10%;"></td> <td style="width: 10%;"></td> <td style="width: 10%;"></td> </tr> <tr> <td></td> <td></td> <td colspan="8" style="text-align: center;"> <table border="1" style="width: 100%; border-collapse: collapse; text-align: center;"> <tr> <td style="width: 10%;"></td> <td style="width: 10%;"></td> <td style="width: 10%;"></td> <td style="width: 10%;"></td> <td style="width: 10%;"></td> <td style="width: 10%;"></td> <td style="width: 10%;"></td> <td style="width: 10%;"></td> <td style="width: 10%;"></td> <td style="width: 10%;"></td> </tr> <tr> <td></td> <td></td> <td colspan="8" style="text-align: center;"> <table border="1" style="width: 100%; border-collapse: collapse; text-align: center;"> <tr> <td style="width: 10%;"></td> <td style="width: 10%;"></td> <td style="width: 10%;"></td> <td style="width: 10%;"></td> <td style="width: 10%;"></td> <td style="width: 10%;"></td> <td style="width: 10%;"></td> <td style="width: 10%;"></td> <td style="width: 10%;"></td> <td style="width: 10%;"></td> </tr> <tr> <td></td> <td></td> <td colspan="8" style="text-align: center;"> <table border="1" style="width: 100%; border-collapse: collapse; text-align: center;"> <tr> <td style="width: 10%;"></td> <td style="width: 10%;"></td> <td style="width: 10%;"></td> <td style="width: 10%;"></td> <td style="width: 10%;"></td> <td style="width: 10%;"></td> <td style="width: 10%;"></td> <td style="width: 10%;"></td> <td style="width: 10%;"></td> <td style="width: 10%;"></td> </tr> <tr> <td></td> <td></td> <td colspan="8" style="text-align: center;"> <table border="1" style="width: 100%; border-collapse: collapse; text-align: center;"> <tr> </tr></table></td></tr></table></td></tr></table></td></tr></table></td></tr></table></td></tr></table></td></tr></table></td></tr></table></td></tr></table></td></tr></table></td></tr></table></td></tr></table></td></tr></table></td></tr></table></td></tr></table></td></tr></table></td></tr></table></td></tr></table></td></tr></table></td></tr></table></td></tr></table></td></tr></table></td></tr></table></td></tr></table>
 | | | | | | | | | | | | | | | | | | | | <table border="1" style="width: 100%; border-collapse: collapse; text-align: center;"> <tr> <td style="width: 10%;"></td> <td style="width: 10%;"></td> <td style="width: 10%;"></td> <td style="width: 10%;"></td> <td style="width: 10%;"></td> <td style="width: 10%;"></td> <td style="width: 10%;"></td> <td style="width: 10%;"></td> <td style="width: 10%;"></td> <td style="width: 10%;"></td> </tr> <tr> <td></td> <td></td> <td colspan="8" style="text-align: center;"> <table border="1" style="width: 100%; border-collapse: collapse; text-align: center;"> <tr> <td style="width: 10%;"></td> <td style="width: 10%;"></td> <td style="width: 10%;"></td> <td style="width: 10%;"></td> <td style="width: 10%;"></td> <td style="width: 10%;"></td> <td style="width: 10%;"></td> <td style="width: 10%;"></td> <td style="width: 10%;"></td> <td style="width: 10%;"></td> </tr> <tr> <td></td> <td></td> <td colspan="8" style="text-align: center;"> <table border="1" style="width: 100%; border-collapse: collapse; text-align: center;"> <tr> <td style="width: 10%;"></td> <td style="width: 10%;"></td> <td style="width: 10%;"></td> <td style="width: 10%;"></td> <td style="width: 10%;"></td> <td style="width: 10%;"></td> <td style="width: 10%;"></td> <td style="width: 10%;"></td> <td style="width: 10%;"></td> <td style="width: 10%;"></td> </tr> <tr> <td></td> <td></td> <td colspan="8" style="text-align: center;"> <table border="1" style="width: 100%; border-collapse: collapse; text-align: center;"> <tr> <td style="width: 10%;"></td> <td style="width: 10%;"></td> <td style="width: 10%;"></td> <td style="width: 10%;"></td> <td style="width: 10%;"></td> <td style="width: 10%;"></td> <td style="width: 10%;"></td> <td style="width: 10%;"></td> <td style="width: 10%;"></td> <td style="width: 10%;"></td> </tr> <tr> <td></td> <td></td> <td colspan="8" style="text-align: center;"> <table border="1" style="width: 100%; border-collapse: collapse; text-align: center;"> <tr> <td style="width: 10%;"></td> <td style="width: 10%;"></td> <td style="width: 10%;"></td> <td style="width: 10%;"></td> <td style="width: 10%;"></td> <td style="width: 10%;"></td> <td style="width: 10%;"></td> <td style="width: 10%;"></td> <td style="width: 10%;"></td> <td style="width: 10%;"></td> </tr> <tr> <td></td> <td></td> <td colspan="8" style="text-align: center;"> <table border="1" style="width: 100%; border-collapse: collapse; text-align: center;"> <tr> <td style="width: 10%;"></td> <td style="width: 10%;"></td> <td style="width: 10%;"></td> <td style="width: 10%;"></td> <td style="width: 10%;"></td> <td style="width: 10%;"></td> <td style="width: 10%;"></td> <td style="width: 10%;"></td> <td style="width: 10%;"></td> <td style="width: 10%;"></td> </tr> <tr> <td></td> <td></td> <td colspan="8" style="text-align: center;"> <table border="1" style="width: 100%; border-collapse: collapse; text-align: center;"> <tr> <td style="width: 10%;"></td> <td style="width: 10%;"></td> <td style="width: 10%;"></td> <td style="width: 10%;"></td> <td style="width: 10%;"></td> <td style="width: 10%;"></td> <td style="width: 10%;"></td> <td style="width: 10%;"></td> <td style="width: 10%;"></td> <td style="width: 10%;"></td> </tr> <tr> <td></td> <td></td> <td colspan="8" style="text-align: center;"> <table border="1" style="width: 100%; border-collapse: collapse; text-align: center;"> <tr> <td style="width: 10%;"></td> <td style="width: 10%;"></td> <td style="width: 10%;"></td> <td style="width: 10%;"></td> <td style="width: 10%;"></td> <td style="width: 10%;"></td> <td style="width: 10%;"></td> <td style="width: 10%;"></td> <td style="width: 10%;"></td> <td style="width: 10%;"></td> </tr> <tr> <td></td>
<td></td> <td colspan="8" style="text-align: center;"> <table border="1" style="width: 100%; border-collapse: collapse; text-align: center;"> <tr> <td style="width: 10%;"></td> <td style="width: 10%;"></td> <td style="width: 10%;"></td> <td style="width: 10%;"></td> <td style="width: 10%;"></td> <td style="width: 10%;"></td> <td style="width: 10%;"></td> <td style="width: 10%;"></td> <td style="width: 10%;"></td> <td style="width: 10%;"></td> </tr> <tr> <td></td> <td></td> <td colspan="8" style="text-align: center;"> <table border="1" style="width: 100%; border-collapse: collapse; text-align: center;"> <tr> <td style="width: 10%;"></td> <td style="width: 10%;"></td> <td style="width: 10%;"></td> <td style="width: 10%;"></td> <td style="width: 10%;"></td> <td style="width: 10%;"></td> <td style="width: 10%;"></td> <td style="width: 10%;"></td> <td style="width: 10%;"></td> <td style="width: 10%;"></td> </tr> <tr> <td></td> <td></td> <td colspan="8" style="text-align: center;"> <table border="1" style="width: 100%; border-collapse: collapse; text-align: center;"> <tr> <td style="width: 10%;"></td> <td style="width: 10%;"></td> <td style="width: 10%;"></td> <td style="width: 10%;"></td> <td style="width: 10%;"></td> <td style="width: 10%;"></td> <td style="width: 10%;"></td> <td style="width: 10%;"></td> <td style="width: 10%;"></td> <td style="width: 10%;"></td> </tr> <tr> <td></td> <td></td> <td colspan="8" style="text-align: center;"> <table border="1" style="width: 100%; border-collapse: collapse; text-align: center;"> <tr> <td style="width: 10%;"></td> <td style="width: 10%;"></td> <td style="width: 10%;"></td> <td style="width: 10%;"></td> <td style="width: 10%;"></td> <td style="width: 10%;"></td> <td style="width: 10%;"></td> <td style="width: 10%;"></td> <td style="width: 10%;"></td> <td style="width: 10%;"></td> </tr> <tr> <td></td> <td></td> <td colspan="8" style="text-align: center;"> <table border="1" style="width: 100%; border-collapse: collapse; text-align: center;"> <tr> <td style="width: 10%;"></td> <td style="width: 10%;"></td> <td style="width: 10%;"></td> <td style="width: 10%;"></td> <td style="width: 10%;"></td> <td style="width: 10%;"></td> <td style="width: 10%;"></td> <td style="width: 10%;"></td> <td style="width: 10%;"></td> <td style="width: 10%;"></td> </tr> <tr> <td></td> <td></td> <td colspan="8" style="text-align: center;"> <table border="1" style="width: 100%; border-collapse: collapse; text-align: center;"> <tr> <td style="width: 10%;"></td> <td style="width: 10%;"></td> <td style="width: 10%;"></td> <td style="width: 10%;"></td> <td style="width: 10%;"></td> <td style="width: 10%;"></td> <td style="width: 10%;"></td> <td style="width: 10%;"></td> <td style="width: 10%;"></td> <td style="width: 10%;"></td> </tr> <tr> <td></td> <td></td> <td colspan="8" style="text-align: center;"> <table border="1" style="width: 100%; border-collapse: collapse; text-align: center;"> <tr> <td style="width: 10%;"></td> <td style="width: 10%;"></td> <td style="width: 10%;"></td> <td style="width: 10%;"></td> <td style="width: 10%;"></td> <td style="width: 10%;"></td> <td style="width: 10%;"></td> <td style="width: 10%;"></td> <td style="width: 10%;"></td> <td style="width: 10%;"></td> </tr> <tr> <td></td> <td></td> <td colspan="8" style="text-align: center;"> <table border="1" style="width: 100%; border-collapse: collapse; text-align: center;"> <tr> <td style="width: 10%;"></td> <td style="width: 10%;"></td> <td style="width: 10%;"></td> <td style="width: 10%;"></td> <td style="width: 10%;"></td> <td style="width: 10%;"></td> <td style="width: 10%;"></td> <td style="width: 10%;"></td> <td style="width: 10%;"></td> <td style="width: 10%;"></td> </tr> <tr> <td></td> <td></td> <td colspan="8" style="text-align: center;"> <table border="1" style="width: 100%; border-collapse: collapse; text-align: center;"> <tr> <td style="width: 10%;"></td> <td style="width: 10%;"></td> <td style="width: 10%;"></td> <td style="width: 10%;"></td> <td style="width: 10%;"></td> <td style="width: 10%;"></td> <td style="width: 10%;"></td> <td style="width: 10%;"></td> <td style="width: 10%;"></td> <td style="width: 10%;"></td> </tr> <tr> <td></td> <td></td> <td colspan="8" style="text-align: center;"> <table border="1" style="width: 100%; border-collapse: collapse; text-align: center;"> <tr> <td style="width: 10%;"></td> <td style="width: 10%;"></td> <td style="width: 10%;"></td> <td style="width: 10%;"></td> <td style="width: 10%;"></td> <td style="width: 10%;"></td> <td style="width: 10%;"></td> <td style="width: 10%;"></td> <td style="width: 10%;"></td> <td style="width: 10%;"></td> </tr> <tr> <td></td> <td></td> <td colspan="8" style="text-align: center;"> <table border="1" style="width: 100%; border-collapse: collapse; text-align: center;"> <tr> <td style="width: 10%;"></td> <td style="width: 10%;"></td> <td style="width: 10%;"></td> <td style="width: 10%;"></td> <td style="width: 10%;"></td> <td style="width: 10%;"></td> <td style="width: 10%;"></td> <td style="width: 10%;"></td> <td style="width: 10%;"></td> <td style="width: 10%;"></td> </tr> <tr> <td></td> <td></td> <td colspan="8" style="text-align: center;"> <table border="1" style="width: 100%; border-collapse: collapse; text-align: center;"> <tr> <td style="width: 10%;"></td> <td style="width: 10%;"></td> <td style="width: 10%;"></td> <td style="width: 10%;"></td> <td style="width: 10%;"></td> <td style="width: 10%;"></td> <td style="width: 10%;"></td> <td style="width: 10%;"></td> <td style="width: 10%;"></td> <td style="width: 10%;"></td> </tr> <tr> <td></td> <td></td> <td colspan="8" style="text-align: center;"> <table border="1" style="width: 100%; border-collapse: collapse; text-align: center;"> <tr> <td style="width: 10%;"></td> <td style="width: 10%;"></td> <td style="width: 10%;"></td> <td style="width: 10%;"></td> <td style="width: 10%;"></td> <td style="width: 10%;"></td> <td style="width: 10%;"></td> <td style="width: 10%;"></td> <td style="width: 10%;"></td> <td style="width: 10%;"></td> </tr> <tr> <td></td> <td></td> <td colspan="8" style="text-align: center;"> <table border="1" style="width: 100%; border-collapse: collapse; text-align: center;"> <tr> <td style="width: 10%;"></td> <td style="width: 10%;"></td> <td style="width: 10%;"></td> <td style="width: 10%;"></td> <td style="width: 10%;"></td> <td style="width: 10%;"></td> <td style="width: 10%;"></td> <td style="width: 10%;"></td> <td style="width: 10%;"></td> <td style="width: 10%;"></td> </tr> <tr> <td></td> <td></td> <td colspan="8" style="text-align: center;"> <table border="1" style="width: 100%; border-collapse: collapse; text-align: center;"> <tr> </tr></table></td></tr></table></td></tr></table></td></tr></table></td></tr></table></td></tr></table></td></tr></table></td></tr></table></td></tr></table></td></tr></table></td></tr></table></td></tr></table></td></tr></table></td></tr></table></td></tr></table></td></tr></table></td></tr></table></td></tr></table></td></tr></table></td></tr></table></td></tr></table></td></tr></table></td></tr></table>
 | | | | | | | | | | | | | | | | | | | | <table border="1" style="width: 100%; border-collapse: collapse; text-align: center;"> <tr> <td style="width: 10%;"></td> <td style="width: 10%;"></td> <td style="width: 10%;"></td> <td style="width: 10%;"></td> <td style="width: 10%;"></td> <td style="width: 10%;"></td> <td style="width: 10%;"></td> <td style="width: 10%;"></td> <td style="width: 10%;"></td> <td style="width: 10%;"></td> </tr> <tr> <td></td> <td></td> <td colspan="8" style="text-align: center;"> <table border="1" style="width: 100%; border-collapse: collapse; text-align: center;"> <tr> <td style="width: 10%;"></td> <td style="width: 10%;"></td> <td style="width: 10%;"></td> <td style="width: 10%;"></td>
<td style="width: 10%;"></td> <td style="width: 10%;"></td> <td style="width: 10%;"></td> <td style="width: 10%;"></td> <td style="width: 10%;"></td> <td style="width: 10%;"></td> </tr> <tr> <td></td> <td></td> <td colspan="8" style="text-align: center;"> <table border="1" style="width: 100%; border-collapse: collapse; text-align: center;"> <tr> <td style="width: 10%;"></td> <td style="width: 10%;"></td> <td style="width: 10%;"></td> <td style="width: 10%;"></td> <td style="width: 10%;"></td> <td style="width: 10%;"></td> <td style="width: 10%;"></td> <td style="width: 10%;"></td> <td style="width: 10%;"></td> <td style="width: 10%;"></td> </tr> <tr> <td></td> <td></td> <td colspan="8" style="text-align: center;"> <table border="1" style="width: 100%; border-collapse: collapse; text-align: center;"> <tr> <td style="width: 10%;"></td> <td style="width: 10%;"></td> <td style="width: 10%;"></td> <td style="width: 10%;"></td> <td style="width: 10%;"></td> <td style="width: 10%;"></td> <td style="width: 10%;"></td> <td style="width: 10%;"></td> <td style="width: 10%;"></td> <td style="width: 10%;"></td> </tr> <tr> <td></td> <td></td> <td colspan="8" style="text-align: center;"> <table border="1" style="width: 100%; border-collapse: collapse; text-align: center;"> <tr> <td style="width: 10%;"></td> <td style="width: 10%;"></td> <td style="width: 10%;"></td> <td style="width: 10%;"></td> <td style="width: 10%;"></td> <td style="width: 10%;"></td> <td style="width: 10%;"></td> <td style="width: 10%;"></td> <td style="width: 10%;"></td> <td style="width: 10%;"></td> </tr> <tr> <td></td> <td></td> <td colspan="8" style="text-align: center;"> <table border="1" style="width: 100%; border-collapse: collapse; text-align: center;"> <tr> <td style="width: 10%;"></td> <td style="width: 10%;"></td> <td style="width: 10%;"></td> <td style="width: 10%;"></td> <td style="width: 10%;"></td> <td style="width: 10%;"></td> <td style="width: 10%;"></td> <td style="width: 10%;"></td> <td style="width: 10%;"></td> <td style="width: 10%;"></td> </tr> <tr> <td></td> <td></td> <td colspan="8" style="text-align: center;"> <table border="1" style="width: 100%; border-collapse: collapse; text-align: center;"> <tr> <td style="width: 10%;"></td> <td style="width: 10%;"></td> <td style="width: 10%;"></td> <td style="width: 10%;"></td> <td style="width: 10%;"></td> <td style="width: 10%;"></td> <td style="width: 10%;"></td> <td style="width: 10%;"></td> <td style="width: 10%;"></td> <td style="width: 10%;"></td> </tr> <tr> <td></td> <td></td> <td colspan="8" style="text-align: center;"> <table border="1" style="width: 100%; border-collapse: collapse; text-align: center;"> <tr> <td style="width: 10%;"></td> <td style="width: 10%;"></td> <td style="width: 10%;"></td> <td style="width: 10%;"></td> <td style="width: 10%;"></td> <td style="width: 10%;"></td> <td style="width: 10%;"></td> <td style="width: 10%;"></td> <td style="width: 10%;"></td> <td style="width: 10%;"></td> </tr> <tr> <td></td> <td></td> <td colspan="8" style="text-align: center;"> <table border="1" style="width: 100%; border-collapse: collapse; text-align: center;"> <tr> <td style="width: 10%;"></td> <td style="width: 10%;"></td> <td style="width: 10%;"></td> <td style="width: 10%;"></td> <td style="width: 10%;"></td> <td style="width: 10%;"></td> <td style="width: 10%;"></td> <td style="width: 10%;"></td> <td style="width: 10%;"></td> <td style="width: 10%;"></td> </tr> <tr> <td></td> <td></td> <td colspan="8" style="text-align: center;"> <table border="1" style="width: 100%; border-collapse: collapse; text-align: center;"> <tr> <td style="width: 10%;"></td> <td style="width: 10%;"></td> <td style="width: 10%;"></td> <td style="width: 10%;"></td> <td style="width: 10%;"></td> <td style="width: 10%;"></td> <td style="width: 10%;"></td> <td style="width: 10%;"></td> <td style="width: 10%;"></td> <td style="width: 10%;"></td> </tr> <tr> <td></td> <td></td> <td colspan="8" style="text-align: center;"> <table border="1" style="width: 100%; border-collapse: collapse; text-align: center;"> <tr> <td style="width: 10%;"></td> <td style="width: 10%;"></td> <td style="width: 10%;"></td> <td style="width: 10%;"></td> <td style="width: 10%;"></td> <td style="width: 10%;"></td> <td style="width: 10%;"></td> <td style="width: 10%;"></td> <td style="width: 10%;"></td> <td style="width: 10%;"></td> </tr> <tr> <td></td> <td></td> <td colspan="8" style="text-align: center;"> <table border="1" style="width: 100%; border-collapse: collapse; text-align: center;"> <tr> <td style="width: 10%;"></td> <td style="width: 10%;"></td> <td style="width: 10%;"></td> <td style="width: 10%;"></td> <td style="width: 10%;"></td> <td style="width: 10%;"></td> <td style="width: 10%;"></td> <td style="width: 10%;"></td> <td style="width: 10%;"></td> <td style="width: 10%;"></td> </tr> <tr> <td></td> <td></td> <td colspan="8" style="text-align: center;"> <table border="1" style="width: 100%; border-collapse: collapse; text-align: center;"> <tr> <td style="width: 10%;"></td> <td style="width: 10%;"></td> <td style="width: 10%;"></td> <td style="width: 10%;"></td> <td style="width: 10%;"></td> <td style="width: 10%;"></td> <td style="width: 10%;"></td> <td style="width: 10%;"></td> <td style="width: 10%;"></td> <td style="width: 10%;"></td> </tr> <tr> <td></td> <td></td> <td colspan="8" style="text-align: center;"> <table border="1" style="width: 100%; border-collapse: collapse; text-align: center;"> <tr> <td style="width: 10%;"></td> <td style="width: 10%;"></td> <td style="width: 10%;"></td> <td style="width: 10%;"></td> <td style="width: 10%;"></td> <td style="width: 10%;"></td> <td style="width: 10%;"></td> <td style="width: 10%;"></td> <td style="width: 10%;"></td> <td style="width: 10%;"></td> </tr> <tr> <td></td> <td></td> <td colspan="8" style="text-align: center;"> <table border="1" style="width: 100%; border-collapse: collapse; text-align: center;"> <tr> <td style="width: 10%;"></td> <td style="width: 10%;"></td> <td style="width: 10%;"></td> <td style="width: 10%;"></td> <td style="width: 10%;"></td> <td style="width: 10%;"></td> <td style="width: 10%;"></td> <td style="width: 10%;"></td> <td style="width: 10%;"></td> <td style="width: 10%;"></td> </tr> <tr> <td></td> <td></td> <td colspan="8" style="text-align: center;"> <table border="1" style="width: 100%; border-collapse: collapse; text-align: center;"> <tr> <td style="width: 10%;"></td> <td style="width: 10%;"></td> <td style="width: 10%;"></td> <td style="width: 10%;"></td> <td style="width: 10%;"></td> <td style="width: 10%;"></td> <td style="width: 10%;"></td> <td style="width: 10%;"></td> <td style="width: 10%;"></td> <td style="width: 10%;"></td> </tr> <tr> <td></td> <td></td> <td colspan="8" style="text-align: center;"> <table border="1" style="width: 100%; border-collapse: collapse; text-align: center;"> <tr> <td style="width: 10%;"></td> <td style="width: 10%;"></td> <td style="width: 10%;"></td> <td style="width: 10%;"></td> <td style="width: 10%;"></td> <td style="width: 10%;"></td> <td style="width: 10%;"></td> <td style="width: 10%;"></td> <td style="width: 10%;"></td> <td style="width: 10%;"></td> </tr> <tr> <td></td> <td></td> <td colspan="8" style="text-align: center;"> <table border="1" style="width: 100%; border-collapse: collapse; text-align: center;"> <tr> <td style="width: 10%;"></td> <td style="width: 10%;"></td> <td style="width: 10%;"></td> <td style="width: 10%;"></td> <td style="width: 10%;"></td> <td style="width: 10%;"></td> <td style="width: 10%;"></td> <td style="width: 10%;"></td> <td style="width: 10%;"></td> <td style="width: 10%;"></td> </tr> <tr> <td></td> <td></td> <td colspan="8" style="text-align: center;"> <table border="1" style="width: 100%; border-collapse: collapse; text-align: center;"> <tr> <td style="width: 10%;"></td> <td style="width: 10%;"></td> <td style="width: 10%;"></td> <td style="width: 10%;"></td> <td style="width: 10%;"></td> <td style="width: 10%;"></td> <td style="width: 10%;"></td> <td style="width: 10%;"></td> <td style="width: 10%;"></td> <td style="width: 10%;"></td> </tr> <tr> <td></td> <td></td> <td colspan="8" style="text-align: center;"> <table border="1" style="width: 100%; border-collapse: collapse; text-align: center;"> <tr> <td style="width: 10%;"></td> <td style="width: 10%;"></td> <td style="width: 10%;"></td> <td style="width: 10%;"></td> <td style="width: 10%;"></td> <td style="width: 10%;"></td> <td style="width: 10%;"></td> <td style="width: 10%;"></td> <td style="width: 10%;"></td> <td style="width: 10%;"></td> </tr> <tr> <td></td> <td></td> <td colspan="8" style="text-align: center;"> <table border="1" style="width: 100%; border-collapse: collapse; text-align: center;"> <tr> <td style="width: 10%;"></td> <td style="width: 10%;"></td> <td style="width: 10%;"></td> <td style="width: 10%;"></td> <td style="width: 10%;"></td> <td style="width: 10%;"></td> <td style="width: 10%;"></td> <td style="width: 10%;"></td> <td style="width: 10%;"></td> <td style="width: 10%;"></td> </tr> <tr> <td></td> <td></td> <td colspan="8" style="text-align: center;"> <table border="1" style="width: 100%; border-collapse: collapse; text-align: center;"> <tr> </tr></table></td></tr></table></td></tr></table></td></tr></table></td></tr></table></td></tr></table></td></tr></table></td></tr></table></td></tr></table></td></tr></table></td></tr></table></td></tr></table></td></tr></table></td></tr></table></td></tr></table></td></tr></table></td></tr></table></td></tr></table></td></tr></table></td></tr></table></td></tr></table></td></tr></table>

 | | | | | | | | | | | | | | | | | | | | <table border="1" style="width: 100%; border-collapse: collapse; text-align: center;"> <tr> <td style="width: 10%;"></td> <td style="width: 10%;"></td> <td style="width: 10%;"></td> <td style="width: 10%;"></td> <td style="width: 10%;"></td> <td style="width: 10%;"></td> <td style="width: 10%;"></td> <td style="width: 10%;"></td> <td style="width: 10%;"></td> <td style="width: 10%;"></td> </tr> <tr> <td></td> <td></td> <td colspan="8" style="text-align: center;"> <table border="1" style="width: 100%; border-collapse: collapse; text-align: center;"> <tr> <td style="width: 10%;"></td> <td style="width: 10%;"></td> <td style="width: 10%;"></td> <td style="width: 10%;"></td> <td style="width: 10%;"></td> <td style="width: 10%;"></td> <td style="width: 10%;"></td> <td style="width: 10%;"></td> <td style="width: 10%;"></td> <td style="width: 10%;"></td> </tr> <tr> <td></td> <td></td> <td colspan="8" style="text-align: center;"> <table border="1" style="width: 100%; border-collapse: collapse; text-align: center;"> <tr> <td style="width: 10%;"></td> <td style="width: 10%;"></td> <td style="width: 10%;"></td> <td style="width: 10%;"></td> <td style="width: 10%;"></td> <td style="width: 10%;"></td> <td style="width: 10%;"></td> <td style="width: 10%;"></td> <td style="width: 10%;"></td> <td style="width: 10%;"></td> </tr> <tr> <td></td> <td></td> <td colspan="8" style="text-align: center;"> <table border="1" style="width: 100%; border-collapse: collapse; text-align: center;"> <tr> <td style="width: 10%;"></td> <td style="width: 10%;"></td> <td style="width: 10%;"></td> <td style="width: 10%;"></td> <td style="width: 10%;"></td> <td style="width: 10%;"></td> <td style="width: 10%;"></td> <td style="width: 10%;"></td> <td style="width: 10%;"></td> <td style="width: 10%;"></td> </tr> <tr> <td></td> <td></td> <td colspan="8" style="text-align: center;"> <table border="1" style="width: 100%; border-collapse: collapse; text-align: center;"> <tr> <td style="width: 10%;"></td> <td style="width: 10%;"></td> <td style="width: 10%;"></td> <td style="width: 10%;"></td> <td style="width: 10%;"></td> <td style="width: 10%;"></td> <td style="width: 10%;"></td> <td style="width: 10%;"></td> <td style="width: 10%;"></td> <td style="width: 10%;"></td> </tr> <tr> <td></td> <td></td> <td colspan="8" style="text-align: center;"> <table border="1" style="width: 100%; border-collapse: collapse; text-align: center;"> <tr> <td style="width: 10%;"></td> <td style="width: 10%;"></td> <td style="width: 10%;"></td> <td style="width: 10%;"></td> <td style="width: 10%;"></td> <td style="width: 10%;"></td> <td style="width: 10%;"></td> <td style="width: 10%;"></td> <td style="width: 10%;"></td> <td style="width: 10%;"></td> </tr> <tr> <td></td> <td></td> <td colspan="8" style="text-align: center;"> <table border="1" style="width: 100%; border-collapse: collapse; text-align: center;"> <tr> <td style="width: 10%;"></td> <td style="width: 10%;"></td> <td style="width: 10%;"></td> <td style="width: 10%;"></td> <td style="width: 10%;"></td> <td style="width: 10%;"></td> <td style="width: 10%;"></td> <td style="width: 10%;"></td> <td style="width: 10%;"></td> <td style="width: 10%;"></td> </tr> <tr> <td></td> <td></td> <td colspan="8" style="text-align: center;"> <table border="1" style="width: 100%; border-collapse: collapse; text-align: center;"> <tr> <td style="width: 10%;"></td> <td style="width: 10%;"></td> <td style="width: 10%;"></td> <td style="width: 10%;"></td> <td style="width: 10%;"></td> <td style="width: 10%;"></td> <td style="width: 10%;"></td> <td style="width: 10%;"></td> <td style="width: 10%;"></td> <td style="width: 10%;"></td> </tr> <tr> <td></td> <td></td> <td colspan="8" style="text-align: center;"> <table border="1" style="width: 100%; border-collapse: collapse; text-align: center;"> <tr> <td style="width: 10%;"></td> <td style="width: 10%;"></td> <td style="width: 10%;"></td> <td style="width: 10%;"></td> <td style="width: 10%;"></td> <td style="width: 10%;"></td> <td style="width: 10%;"></td> <td style="width: 10%;"></td> <td style="width: 10%;"></td> <td style="width: 10%;"></td> </tr> <tr> <td></td> <td></td> <td colspan="8" style="text-align: center;"> <table border="1" style="width: 100%; border-collapse: collapse; text-align: center;"> <tr> <td style="width: 10%;"></td> <td style="width: 10%;"></td> <td style="width: 10%;"></td> <td style="width: 10%;"></td> <td style="width: 10%;"></td> <td style="width: 10%;"></td> <td style="width: 10%;"></td> <td style="width: 10%;"></td> <td style="width: 10%;"></td> <td style="width: 10%;"></td> </tr> <tr> <td></td> <td></td> <td colspan="8" style="text-align: center;"> <table border="1" style="width: 100%; border-collapse: collapse; text-align: center;"> <tr> <td style="width: 10%;"></td> <td style="width: 10%;"></td> <td style="width: 10%;"></td> <td style="width: 10%;"></td> <td style="width: 10%;"></td> <td style="width: 10%;"></td> <td style="width: 10%;"></td> <td style="width: 10%;"></td> <td style="width: 10%;"></td> <td style="width: 10%;"></td> </tr> <tr> <td></td> <td></td> <td colspan="8" style="text-align: center;"> <table border="1" style="width: 100%; border-collapse: collapse; text-align: center;"> <tr> <td style="width: 10%;"></td> <td style="width: 10%;"></td> <td style="width: 10%;"></td> <td style="width: 10%;"></td> <td style="width: 10%;"></td> <td style="width: 10%;"></td> <td style="width: 10%;"></td> <td style="width: 10%;"></td> <td style="width: 10%;"></td> <td style="width: 10%;"></td> </tr> <tr> <td></td> <td></td> <td colspan="8" style="text-align: center;"> <table border="1" style="width: 100%; border-collapse: collapse; text-align: center;"> <tr> <td style="width: 10%;"></td> <td style="width: 10%;"></td> <td style="width: 10%;"></td> <td style="width: 10%;"></td> <td style="width: 10%;"></td> <td style="width: 10%;"></td> <td style="width: 10%;"></td> <td style="width: 10%;"></td> <td style="width: 10%;"></td> <td style="width: 10%;"></td> </tr> <tr> <td></td> <td></td> <td colspan="8" style="text-align: center;"> <table border="1" style="width: 100%; border-collapse: collapse; text-align: center;"> <tr> <td style="width: 10%;"></td> <td style="width: 10%;"></td> <td style="width: 10%;"></td> <td style="width: 10%;"></td> <td style="width: 10%;"></td> <td style="width: 10%;"></td> <td style="width: 10%;"></td> <td style="width: 10%;"></td> <td style="width: 10%;"></td> <td style="width: 10%;"></td> </tr> <tr> <td></td> <td></td> <td colspan="8" style="text-align: center;"> <table border="1" style="width: 100%; border-collapse: collapse; text-align: center;"> <tr> <td style="width: 10%;"></td> <td style="width: 10%;"></td> <td style="width: 10%;"></td> <td style="width: 10%;"></td> <td style="width: 10%;"></td> <td style="width: 10%;"></td> <td style="width: 10%;"></td> <td style="width: 10%;"></td> <td style="width: 10%;"></td> <td style="width: 10%;"></td> </tr> <tr> <td></td> <td></td> <td colspan="8" style="text-align: center;"> <table border="1" style="width: 100%; border-collapse: collapse; text-align: center;"> <tr> <td style="width: 10%;"></td> <td style="width: 10%;"></td> <td style="width: 10%;"></td> <td style="width: 10%;"></td> <td style="width: 10%;"></td> <td style="width: 10%;"></td> <td style="width: 10%;"></td> <td style="width: 10%;"></td> <td style="width: 10%;"></td> <td style="width: 10%;"></td> </tr> <tr> <td></td> <td></td> <td colspan="8" style="text-align: center;"> <table border="1" style="width: 100%; border-collapse: collapse; text-align: center;"> <tr> <td style="width: 10%;"></td> <td style="width: 10%;"></td> <td style="width: 10%;"></td> <td style="width: 10%;"></td> <td style="width: 10%;"></td> <td style="width: 10%;"></td> <td style="width: 10%;"></td> <td style="width: 10%;"></td> <td style="width: 10%;"></td> <td style="width: 10%;"></td> </tr> <tr> <td></td> <td></td> <td colspan="8" style="text-align: center;"> <table border="1" style="width: 100%; border-collapse: collapse; text-align: center;"> <tr> <td style="width: 10%;"></td> <td style="width: 10%;"></td> <td style="width: 10%;"></td> <td style="width:
10%;"></td> <td style="width: 10%;"></td> <td style="width: 10%;"></td> <td style="width: 10%;"></td> <td style="width: 10%;"></td> <td style="width: 10%;"></td> <td style="width: 10%;"></td> </tr> <tr> <td></td> <td></td> <td colspan="8" style="text-align: center;"> <table border="1" style="width: 100%; border-collapse: collapse; text-align: center;"> <tr> <td style="width: 10%;"></td> <td style="width: 10%;"></td> <td style="width: 10%;"></td> <td style="width: 10%;"></td> <td style="width: 10%;"></td> <td style="width: 10%;"></td> <td style="width: 10%;"></td> <td style="width: 10%;"></td> <td style="width: 10%;"></td> <td style="width: 10%;"></td> </tr> <tr> <td></td> <td></td> <td colspan="8" style="text-align: center;"> <table border="1" style="width: 100%; border-collapse: collapse; text-align: center;"> <tr> <td style="width: 10%;"></td> <td style="width: 10%;"></td> <td style="width: 10%;"></td> <td style="width: 10%;"></td> <td style="width: 10%;"></td> <td style="width: 10%;"></td> <td style="width: 10%;"></td> <td style="width: 10%;"></td> <td style="width: 10%;"></td> <td style="width: 10%;"></td> </tr> <tr> <td></td> <td></td> <td colspan="8" style="text-align: center;"> <table border="1" style="width: 100%; border-collapse: collapse; text-align: center;"> <tr> </tr></table></td></tr></table></td></tr></table></td></tr></table></td></tr></table></td></tr></table></td></tr></table></td></tr></table></td></tr></table></td></tr></table></td></tr></table></td></tr></table></td></tr></table></td></tr></table></td></tr></table></td></tr></table></td></tr></table></td></tr></table></td></tr></table></td></tr></table></td></tr></table>
 | | | | | | | | | | | | | | | | | | | | <table border="1" style="width: 100%; border-collapse: collapse; text-align: center;"> <tr> <td style="width: 10%;"></td> <td style="width: 10%;"></td> <td style="width: 10%;"></td> <td style="width: 10%;"></td> <td style="width: 10%;"></td> <td style="width: 10%;"></td> <td style="width: 10%;"></td> <td style="width: 10%;"></td> <td style="width: 10%;"></td> <td style="width: 10%;"></td> </tr> <tr> <td></td> <td></td> <td colspan="8" style="text-align: center;"> <table border="1" style="width: 100%; border-collapse: collapse; text-align: center;"> <tr> <td style="width: 10%;"></td> <td style="width: 10%;"></td> <td style="width: 10%;"></td> <td style="width: 10%;"></td> <td style="width: 10%;"></td> <td style="width: 10%;"></td> <td style="width: 10%;"></td> <td style="width: 10%;"></td> <td style="width: 10%;"></td> <td style="width: 10%;"></td> </tr> <tr> <td></td> <td></td> <td colspan="8" style="text-align: center;"> <table border="1" style="width: 100%; border-collapse: collapse; text-align: center;"> <tr> <td style="width: 10%;"></td> <td style="width: 10%;"></td> <td style="width: 10%;"></td> <td style="width: 10%;"></td> <td style="width: 10%;"></td> <td style="width: 10%;"></td> <td style="width: 10%;"></td> <td style="width: 10%;"></td> <td style="width: 10%;"></td> <td style="width: 10%;"></td> </tr> <tr> <td></td> <td></td> <td colspan="8" style="text-align: center;"> <table border="1" style="width: 100%; border-collapse: collapse; text-align: center;"> <tr> <td style="width: 10%;"></td> <td style="width: 10%;"></td> <td style="width: 10%;"></td> <td style="width: 10%;"></td> <td style="width: 10%;"></td> <td style="width: 10%;"></td> <td style="width: 10%;"></td> <td style="width: 10%;"></td> <td style="width: 10%;"></td> <td style="width: 10%;"></td> </tr> <tr> <td></td> <td></td> <td colspan="8" style="text-align: center;"> <table border="1" style="width: 100%; border-collapse: collapse; text-align: center;"> <tr> <td style="width: 10%;"></td> <td style="width: 10%;"></td> <td style="width: 10%;"></td> <td style="width: 10%;"></td> <td style="width: 10%;"></td> <td style="width: 10%;"></td> <td style="width: 10%;"></td> <td style="width: 10%;"></td> <td style="width: 10%;"></td> <td style="width: 10%;"></td> </tr> <tr> <td></td> <td></td> <td colspan="8" style="text-align: center;"> <table border="1" style="width: 100%; border-collapse: collapse; text-align: center;"> <tr> <td style="width: 10%;"></td> <td style="width: 10%;"></td> <td style="width: 10%;"></td> <td style="width: 10%;"></td> <td style="width: 10%;"></td> <td style="width: 10%;"></td> <td style="width: 10%;"></td> <td style="width: 10%;"></td> <td style="width: 10%;"></td> <td style="width: 10%;"></td> </tr> <tr> <td></td> <td></td> <td colspan="8" style="text-align: center;"> <table border="1" style="width: 100%; border-collapse: collapse; text-align: center;"> <tr> <td style="width: 10%;"></td> <td style="width: 10%;"></td> <td style="width: 10%;"></td> <td style="width: 10%;"></td> <td style="width: 10%;"></td> <td style="width: 10%;"></td> <td style="width: 10%;"></td> <td style="width: 10%;"></td> <td style="width: 10%;"></td> <td style="width: 10%;"></td> </tr> <tr> <td></td> <td></td> <td colspan="8" style="text-align: center;"> <table border="1" style="width: 100%; border-collapse: collapse; text-align: center;"> <tr> <td style="width: 10%;"></td> <td style="width: 10%;"></td> <td style="width: 10%;"></td> <td style="width: 10%;"></td> <td style="width: 10%;"></td> <td style="width: 10%;"></td> <td style="width: 10%;"></td> <td style="width: 10%;"></td> <td style="width: 10%;"></td> <td style="width: 10%;"></td> </tr> <tr> <td></td> <td></td> <td colspan="8" style="text-align: center;"> <table border="1" style="width: 100%; border-collapse: collapse; text-align: center;"> <tr> <td style="width: 10%;"></td> <td style="width: 10%;"></td> <td style="width: 10%;"></td> <td style="width: 10%;"></td> <td style="width: 10%;"></td> <td style="width: 10%;"></td> <td style="width: 10%;"></td> <td style="width: 10%;"></td> <td style="width: 10%;"></td> <td style="width: 10%;"></td> </tr> <tr> <td></td> <td></td> <td colspan="8" style="text-align: center;"> <table border="1" style="width: 100%; border-collapse: collapse; text-align: center;"> <tr> <td style="width: 10%;"></td> <td style="width: 10%;"></td> <td style="width: 10%;"></td> <td style="width: 10%;"></td> <td style="width: 10%;"></td> <td style="width: 10%;"></td> <td style="width: 10%;"></td> <td style="width: 10%;"></td> <td style="width: 10%;"></td> <td style="width: 10%;"></td> </tr> <tr> <td></td> <td></td> <td colspan="8" style="text-align: center;"> <table border="1" style="width: 100%; border-collapse: collapse; text-align: center;"> <tr> <td style="width: 10%;"></td> <td style="width: 10%;"></td> <td style="width: 10%;"></td> <td style="width: 10%;"></td> <td style="width: 10%;"></td> <td style="width: 10%;"></td> <td style="width: 10%;"></td> <td style="width: 10%;"></td> <td style="width: 10%;"></td> <td style="width: 10%;"></td> </tr> <tr> <td></td> <td></td> <td colspan="8" style="text-align: center;"> <table border="1" style="width: 100%; border-collapse: collapse; text-align: center;"> <tr> <td style="width: 10%;"></td> <td style="width: 10%;"></td> <td style="width: 10%;"></td> <td style="width: 10%;"></td> <td style="width: 10%;"></td> <td style="width: 10%;"></td> <td style="width: 10%;"></td> <td style="width: 10%;"></td> <td style="width: 10%;"></td> <td style="width: 10%;"></td> </tr> <tr> <td></td> <td></td> <td colspan="8" style="text-align: center;"> <table border="1" style="width: 100%; border-collapse: collapse; text-align: center;"> <tr> <td style="width: 10%;"></td> <td style="width: 10%;"></td> <td style="width: 10%;"></td> <td style="width: 10%;"></td> <td style="width: 10%;"></td> <td style="width: 10%;"></td> <td style="width: 10%;"></td> <td style="width: 10%;"></td> <td style="width: 10%;"></td> <td style="width: 10%;"></td> </tr> <tr> <td></td> <td></td> <td colspan="8" style="text-align: center;"> <table border="1" style="width:
100%; border-collapse: collapse; text-align: center;"> <tr> <td style="width: 10%;"></td> <td style="width: 10%;"></td> <td style="width: 10%;"></td> <td style="width: 10%;"></td> <td style="width: 10%;"></td> <td style="width: 10%;"></td> <td style="width: 10%;"></td> <td style="width: 10%;"></td> <td style="width: 10%;"></td> <td style="width: 10%;"></td> </tr> <tr> <td></td> <td></td> <td colspan="8" style="text-align: center;"> <table border="1" style="width: 100%; border-collapse: collapse; text-align: center;"> <tr> <td style="width: 10%;"></td> <td style="width: 10%;"></td> <td style="width: 10%;"></td> <td style="width: 10%;"></td> <td style="width: 10%;"></td> <td style="width: 10%;"></td> <td style="width: 10%;"></td> <td style="width: 10%;"></td> <td style="width: 10%;"></td> <td style="width: 10%;"></td> </tr> <tr> <td></td> <td></td> <td colspan="8" style="text-align: center;"> <table border="1" style="width: 100%; border-collapse: collapse; text-align: center;"> <tr> <td style="width: 10%;"></td> <td style="width: 10%;"></td> <td style="width: 10%;"></td> <td style="width: 10%;"></td> <td style="width: 10%;"></td> <td style="width: 10%;"></td> <td style="width: 10%;"></td> <td style="width: 10%;"></td> <td style="width: 10%;"></td> <td style="width: 10%;"></td> </tr> <tr> <td></td> <td></td> <td colspan="8" style="text-align: center;"> <table border="1" style="width: 100%; border-collapse: collapse; text-align: center;"> <tr> <td style="width: 10%;"></td> <td style="width: 10%;"></td> <td style="width: 10%;"></td> <td style="width: 10%;"></td> <td style="width: 10%;"></td> <td style="width: 10%;"></td> <td style="width: 10%;"></td> <td style="width: 10%;"></td> <td style="width: 10%;"></td> <td style="width: 10%;"></td> </tr> <tr> <td></td> <td></td> <td colspan="8" style="text-align: center;"> <table border="1" style="width: 100%; border-collapse: collapse; text-align: center;"> <tr> <td style="width: 10%;"></td> <td style="width: 10%;"></td> <td style="width: 10%;"></td> <td style="width: 10%;"></td> <td style="width: 10%;"></td> <td style="width: 10%;"></td> <td style="width: 10%;"></td> <td style="width: 10%;"></td> <td style="width: 10%;"></td> <td style="width: 10%;"></td> </tr> <tr> <td></td> <td></td> <td colspan="8" style="text-align: center;"> <table border="1" style="width: 100%; border-collapse: collapse; text-align: center;"> <tr> <td style="width: 10%;"></td> <td style="width: 10%;"></td> <td style="width: 10%;"></td> <td style="width: 10%;"></td> <td style="width: 10%;"></td> <td style="width: 10%;"></td> <td style="width: 10%;"></td> <td style="width: 10%;"></td> <td style="width: 10%;"></td> <td style="width: 10%;"></td> </tr> <tr> <td></td> <td></td> <td colspan="8" style="text-align: center;"> <table border="1" style="width: 100%; border-collapse: collapse; text-align: center;"> <tr> </tr></table></td></tr></table></td></tr></table></td></tr></table></td></tr></table></td></tr></table></td></tr></table></td></tr></table></td></tr></table></td></tr></table></td></tr></table></td></tr></table></td></tr></table></td></tr></table></td></tr></table></td></tr></table></td></tr></table></td></tr></table></td></tr></table></td></tr></table>
 | | | | | | | | | | | | | | | | | | | | <table border="1" style="width: 100%; border-collapse: collapse; text-align: center;"> <tr> <td style="width: 10%;"></td> <td style="width: 10%;"></td> <td style="width: 10%;"></td> <td style="width: 10%;"></td> <td style="width: 10%;"></td> <td style="width: 10%;"></td> <td style="width: 10%;"></td> <td style="width: 10%;"></td> <td style="width: 10%;"></td> <td style="width: 10%;"></td> </tr> <tr> <td></td> <td></td> <td colspan="8" style="text-align: center;"> <table border="1" style="width: 100%; border-collapse: collapse; text-align: center;"> <tr> <td style="width: 10%;"></td> <td style="width: 10%;"></td> <td style="width: 10%;"></td> <td style="width: 10%;"></td> <td style="width: 10%;"></td> <td style="width: 10%;"></td> <td style="width: 10%;"></td> <td style="width: 10%;"></td> <td style="width: 10%;"></td> <td style="width: 10%;"></td> </tr> <tr> <td></td> <td></td> <td colspan="8" style="text-align: center;"> <table border="1" style="width: 100%; border-collapse: collapse; text-align: center;"> <tr> <td style="width: 10%;"></td> <td style="width: 10%;"></td> <td style="width: 10%;"></td> <td style="width: 10%;"></td> <td style="width: 10%;"></td> <td style="width: 10%;"></td> <td style="width: 10%;"></td> <td style="width: 10%;"></td> <td style="width: 10%;"></td> <td style="width: 10%;"></td> </tr> <tr> <td></td> <td></td> <td colspan="8" style="text-align: center;"> <table border="1" style="width: 100%; border-collapse: collapse; text-align: center;"> <tr> <td style="width: 10%;"></td> <td style="width: 10%;"></td> <td style="width: 10%;"></td> <td style="width: 10%;"></td> <td style="width: 10%;"></td> <td style="width: 10%;"></td> <td style="width: 10%;"></td> <td style="width: 10%;"></td> <td style="width: 10%;"></td> <td style="width: 10%;"></td> </tr> <tr> <td></td> <td></td> <td colspan="8" style="text-align: center;"> <table border="1" style="width: 100%; border-collapse: collapse; text-align: center;"> <tr> <td style="width: 10%;"></td> <td style="width: 10%;"></td> <td style="width: 10%;"></td> <td style="width: 10%;"></td> <td style="width: 10%;"></td> <td style="width: 10%;"></td> <td style="width: 10%;"></td> <td style="width: 10%;"></td> <td style="width: 10%;"></td> <td style="width: 10%;"></td> </tr> <tr> <td></td> <td></td> <td colspan="8" style="text-align: center;"> <table border="1" style="width: 100%; border-collapse: collapse; text-align: center;"> <tr> <td style="width: 10%;"></td> <td style="width: 10%;"></td> <td style="width: 10%;"></td> <td style="width: 10%;"></td> <td style="width: 10%;"></td> <td style="width: 10%;"></td> <td style="width: 10%;"></td> <td style="width: 10%;"></td> <td style="width: 10%;"></td> <td style="width: 10%;"></td> </tr> <tr> <td></td> <td></td> <td colspan="8" style="text-align: center;"> <table border="1" style="width: 100%; border-collapse: collapse; text-align: center;"> <tr> <td style="width: 10%;"></td> <td style="width: 10%;"></td> <td style="width: 10%;"></td> <td style="width: 10%;"></td> <td style="width: 10%;"></td> <td style="width: 10%;"></td> <td style="width: 10%;"></td> <td style="width: 10%;"></td> <td style="width: 10%;"></td> <td style="width: 10%;"></td> </tr> <tr> <td></td> <td></td> <td colspan="8" style="text-align: center;"> <table border="1" style="width: 100%; border-collapse: collapse; text-align: center;"> <tr> <td style="width: 10%;"></td> <td style="width: 10%;"></td> <td style="width: 10%;"></td> <td style="width: 10%;"></td> <td style="width: 10%;"></td> <td style="width: 10%;"></td> <td style="width: 10%;"></td> <td style="width: 10%;"></td> <td style="width: 10%;"></td> <td style="width: 10%;"></td> </tr> <tr> <td></td> <td></td> <td colspan="8" style="text-align: center;"> <table border="1" style="width: 100%; border-collapse: collapse; text-align: center;"> <tr> <td style="width: 10%;"></td> <td style="width: 10%;"></td> <td style="width: 10%;"></td> <td style="width: 10%;"></td> <td style="width: 10%;"></td> <td style="width: 10%;"></td> <td style="width: 10%;"></td> <td style="width: 10%;"></td> <td style="width: 10%;"></td> <td style="width: 10%;"></td> </tr> <tr> <td></td> <td></td> <td colspan="8" style="text-align: center;"> <table border="1" style="width: 100%; border-collapse: collapse; text-align: center;"> <tr> <td style="width: 10%;"></td> <td style="width: 10%;"></td> <td style="width: 10%;"></td> <td style="width: 10%;"></td> <td style="width: 10%;"></td> <td style="width: 10%;"></td> <td style="width: 10%;"></td> <td style="width: 10%;"></td> <td style="width:
10%;"></td> <td style="width: 10%;"></td> </tr> <tr> <td></td> <td></td> <td colspan="8" style="text-align: center;"> <table border="1" style="width: 100%; border-collapse: collapse; text-align: center;"> <tr> <td style="width: 10%;"></td> <td style="width: 10%;"></td> <td style="width: 10%;"></td> <td style="width: 10%;"></td> <td style="width: 10%;"></td> <td style="width: 10%;"></td> <td style="width: 10%;"></td> <td style="width: 10%;"></td> <td style="width: 10%;"></td> <td style="width: 10%;"></td> </tr> <tr> <td></td> <td></td> <td colspan="8" style="text-align: center;"> <table border="1" style="width: 100%; border-collapse: collapse; text-align: center;"> <tr> <td style="width: 10%;"></td> <td style="width: 10%;"></td> <td style="width: 10%;"></td> <td style="width: 10%;"></td> <td style="width: 10%;"></td> <td style="width: 10%;"></td> <td style="width: 10%;"></td> <td style="width: 10%;"></td> <td style="width: 10%;"></td> <td style="width: 10%;"></td> </tr> <tr> <td></td> <td></td> <td colspan="8" style="text-align: center;"> <table border="1" style="width: 100%; border-collapse: collapse; text-align: center;"> <tr> <td style="width: 10%;"></td> <td style="width: 10%;"></td> <td style="width: 10%;"></td> <td style="width: 10%;"></td> <td style="width: 10%;"></td> <td style="width: 10%;"></td> <td style="width: 10%;"></td> <td style="width: 10%;"></td> <td style="width: 10%;"></td> <td style="width: 10%;"></td> </tr> <tr> <td></td> <td></td> <td colspan="8" style="text-align: center;"> <table border="1" style="width: 100%; border-collapse: collapse; text-align: center;"> <tr> <td style="width: 10%;"></td> <td style="width: 10%;"></td> <td style="width: 10%;"></td> <td style="width: 10%;"></td> <td style="width: 10%;"></td> <td style="width: 10%;"></td> <td style="width: 10%;"></td> <td style="width: 10%;"></td> <td style="width: 10%;"></td> <td style="width: 10%;"></td> </tr> <tr> <td></td> <td></td> <td colspan="8" style="text-align: center;"> <table border="1" style="width: 100%; border-collapse: collapse; text-align: center;"> <tr> <td style="width: 10%;"></td> <td style="width: 10%;"></td> <td style="width: 10%;"></td> <td style="width: 10%;"></td> <td style="width: 10%;"></td> <td style="width: 10%;"></td> <td style="width: 10%;"></td> <td style="width: 10%;"></td> <td style="width: 10%;"></td> <td style="width: 10%;"></td> </tr> <tr> <td></td> <td></td> <td colspan="8" style="text-align: center;"> <table border="1" style="width: 100%; border-collapse: collapse; text-align: center;"> <tr> <td style="width: 10%;"></td> <td style="width: 10%;"></td> <td style="width: 10%;"></td> <td style="width: 10%;"></td> <td style="width: 10%;"></td> <td style="width: 10%;"></td> <td style="width: 10%;"></td> <td style="width: 10%;"></td> <td style="width: 10%;"></td> <td style="width: 10%;"></td> </tr> <tr> <td></td> <td></td> <td colspan="8" style="text-align: center;"> <table border="1" style="width: 100%; border-collapse: collapse; text-align: center;"> <tr> <td style="width: 10%;"></td> <td style="width: 10%;"></td> <td style="width: 10%;"></td> <td style="width: 10%;"></td> <td style="width: 10%;"></td> <td style="width: 10%;"></td> <td style="width: 10%;"></td> <td style="width: 10%;"></td> <td style="width: 10%;"></td> <td style="width: 10%;"></td> </tr> <tr> <td></td> <td></td> <td colspan="8" style="text-align: center;"> <table border="1" style="width: 100%; border-collapse: collapse; text-align: center;"> <tr> <td style="width: 10%;"></td> <td style="width: 10%;"></td> <td style="width: 10%;"></td> <td style="width: 10%;"></td> <td style="width: 10%;"></td> <td style="width: 10%;"></td> <td style="width: 10%;"></td> <td style="width: 10%;"></td> <td style="width: 10%;"></td> <td style="width: 10%;"></td> </tr> <tr> <td></td> <td></td> <td colspan="8" style="text-align: center;"> <table border="1" style="width: 100%; border-collapse: collapse; text-align: center;"> <tr> </tr></table></td></tr></table></td></tr></table></td></tr></table></td></tr></table></td></tr></table></td></tr></table></td></tr></table></td></tr></table></td></tr></table></td></tr></table></td></tr></table></td></tr></table></td></tr></table></td></tr></table></td></tr></table></td></tr></table></td></tr></table></td></tr></table>
 | | | | | | | | | | | | | | | | | | | | <table border="1" style="width: 100%; border-collapse: collapse; text-align: center;"> <tr> <td style="width: 10%;"></td> <td style="width: 10%;"></td> <td style="width: 10%;"></td> <td style="width: 10%;"></td> <td style="width: 10%;"></td> <td style="width: 10%;"></td> <td style="width: 10%;"></td> <td style="width: 10%;"></td> <td style="width: 10%;"></td> <td style="width: 10%;"></td> </tr> <tr> <td></td> <td></td> <td colspan="8" style="text-align: center;"> <table border="1" style="width: 100%; border-collapse: collapse; text-align: center;"> <tr> <td style="width: 10%;"></td> <td style="width: 10%;"></td> <td style="width: 10%;"></td> <td style="width: 10%;"></td> <td style="width: 10%;"></td> <td style="width: 10%;"></td> <td style="width: 10%;"></td> <td style="width: 10%;"></td> <td style="width: 10%;"></td> <td style="width: 10%;"></td> </tr> <tr> <td></td> <td></td> <td colspan="8" style="text-align: center;"> <table border="1" style="width: 100%; border-collapse: collapse; text-align: center;"> <tr> <td style="width: 10%;"></td> <td style="width: 10%;"></td> <td style="width: 10%;"></td> <td style="width: 10%;"></td> <td style="width: 10%;"></td> <td style="width: 10%;"></td> <td style="width: 10%;"></td> <td style="width: 10%;"></td> <td style="width: 10%;"></td> <td style="width: 10%;"></td> </tr> <tr> <td></td> <td></td> <td colspan="8" style="text-align: center;"> <table border="1" style="width: 100%; border-collapse: collapse; text-align: center;"> <tr> <td style="width: 10%;"></td> <td style="width: 10%;"></td> <td style="width: 10%;"></td> <td style="width: 10%;"></td> <td style="width: 10%;"></td> <td style="width: 10%;"></td> <td style="width: 10%;"></td> <td style="width: 10%;"></td> <td style="width: 10%;"></td> <td style="width: 10%;"></td> </tr> <tr> <td></td> <td></td> <td colspan="8" style="text-align: center;"> <table border="1" style="width: 100%; border-collapse: collapse; text-align: center;"> <tr> <td style="width: 10%;"></td> <td style="width: 10%;"></td> <td style="width: 10%;"></td> <td style="width: 10%;"></td> <td style="width: 10%;"></td> <td style="width: 10%;"></td> <td style="width: 10%;"></td> <td style="width: 10%;"></td> <td style="width: 10%;"></td> <td style="width: 10%;"></td> </tr> <tr> <td></td> <td></td> <td colspan="8" style="text-align: center;"> <table border="1" style="width: 100%; border-collapse: collapse; text-align: center;"> <tr> <td style="width: 10%;"></td> <td style="width: 10%;"></td> <td style="width: 10%;"></td> <td style="width: 10%;"></td> <td style="width: 10%;"></td> <td style="width: 10%;"></td> <td style="width: 10%;"></td> <td style="width: 10%;"></td> <td style="width: 10%;"></td> <td style="width: 10%;"></td> </tr> <tr> <td></td> <td></td> <td colspan="8" style="text-align: center;"> <table border="1" style="width: 100%; border-collapse: collapse; text-align: center;"> <tr> <td style="width: 10%;"></td> <td style="width: 10%;"></td> <td style="width: 10%;"></td> <td style="width: 10%;"></td> <td style="width: 10%;"></td> <td style="width: 10%;"></td> <td style="width: 10%;"></td> <td style="width: 10%;"></td> <td style="width: 10%;"></td> <td style="width: 10%;"></td> </tr> <tr> <td></td> <td></td> <td colspan="8" style="text-align: center;"> <table border="1" style="width: 100%; border-collapse: collapse; text-align: center;"> <tr> <td style="width: 10%;"></td> <td style="width: 10%;"></td> <td style="width: 10%;"></td> <td style="width: 10%;"></td> <td
style="width: 10%;"></td> <td style="width: 10%;"></td> <td style="width: 10%;"></td> <td style="width: 10%;"></td> <td style="width: 10%;"></td> <td style="width: 10%;"></td> </tr> <tr> <td></td> <td></td> <td colspan="8" style="text-align: center;"> <table border="1" style="width: 100%; border-collapse: collapse; text-align: center;"> <tr> <td style="width: 10%;"></td> <td style="width: 10%;"></td> <td style="width: 10%;"></td> <td style="width: 10%;"></td> <td style="width: 10%;"></td> <td style="width: 10%;"></td> <td style="width: 10%;"></td> <td style="width: 10%;"></td> <td style="width: 10%;"></td> <td style="width: 10%;"></td> </tr> <tr> <td></td> <td></td> <td colspan="8" style="text-align: center;"> <table border="1" style="width: 100%; border-collapse: collapse; text-align: center;"> <tr> <td style="width: 10%;"></td> <td style="width: 10%;"></td> <td style="width: 10%;"></td> <td style="width: 10%;"></td> <td style="width: 10%;"></td> <td style="width: 10%;"></td> <td style="width: 10%;"></td> <td style="width: 10%;"></td> <td style="width: 10%;"></td> <td style="width: 10%;"></td> </tr> <tr> <td></td> <td></td> <td colspan="8" style="text-align: center;"> <table border="1" style="width: 100%; border-collapse: collapse; text-align: center;"> <tr> <td style="width: 10%;"></td> <td style="width: 10%;"></td> <td style="width: 10%;"></td> <td style="width: 10%;"></td> <td style="width: 10%;"></td> <td style="width: 10%;"></td> <td style="width: 10%;"></td> <td style="width: 10%;"></td> <td style="width: 10%;"></td> <td style="width: 10%;"></td> </tr> <tr> <td></td> <td></td> <td colspan="8" style="text-align: center;"> <table border="1" style="width: 100%; border-collapse: collapse; text-align: center;"> <tr> <td style="width: 10%;"></td> <td style="width: 10%;"></td> <td style="width: 10%;"></td> <td style="width: 10%;"></td> <td style="width: 10%;"></td> <td style="width: 10%;"></td> <td style="width: 10%;"></td> <td style="width: 10%;"></td> <td style="width: 10%;"></td> <td style="width: 10%;"></td> </tr> <tr> <td></td> <td></td> <td colspan="8" style="text-align: center;"> <table border="1" style="width: 100%; border-collapse: collapse; text-align: center;"> <tr> <td style="width: 10%;"></td> <td style="width: 10%;"></td> <td style="width: 10%;"></td> <td style="width: 10%;"></td> <td style="width: 10%;"></td> <td style="width: 10%;"></td> <td style="width: 10%;"></td> <td style="width: 10%;"></td> <td style="width: 10%;"></td> <td style="width: 10%;"></td> </tr> <tr> <td></td> <td></td> <td colspan="8" style="text-align: center;"> <table border="1" style="width: 100%; border-collapse: collapse; text-align: center;"> <tr> <td style="width: 10%;"></td> <td style="width: 10%;"></td> <td style="width: 10%;"></td> <td style="width: 10%;"></td> <td style="width: 10%;"></td> <td style="width: 10%;"></td> <td style="width: 10%;"></td> <td style="width: 10%;"></td> <td style="width: 10%;"></td> <td style="width: 10%;"></td> </tr> <tr> <td></td> <td></td> <td colspan="8" style="text-align: center;"> <table border="1" style="width: 100%; border-collapse: collapse; text-align: center;"> <tr> <td style="width: 10%;"></td> <td style="width: 10%;"></td> <td style="width: 10%;"></td> <td style="width: 10%;"></td> <td style="width: 10%;"></td> <td style="width: 10%;"></td> <td style="width: 10%;"></td> <td style="width: 10%;"></td> <td style="width: 10%;"></td> <td style="width: 10%;"></td> </tr> <tr> <td></td> <td></td> <td colspan="8" style="text-align: center;"> <table border="1" style="width: 100%; border-collapse: collapse; text-align: center;"> <tr> <td style="width: 10%;"></td> <td style="width: 10%;"></td> <td style="width: 10%;"></td> <td style="width: 10%;"></td> <td style="width: 10%;"></td> <td style="width: 10%;"></td> <td style="width: 10%;"></td> <td style="width: 10%;"></td> <td style="width: 10%;"></td> <td style="width: 10%;"></td> </tr> <tr> <td></td> <td></td> <td colspan="8" style="text-align: center;"> <table border="1" style="width: 100%; border-collapse: collapse; text-align: center;"> <tr> <td style="width: 10%;"></td> <td style="width: 10%;"></td> <td style="width: 10%;"></td> <td style="width: 10%;"></td> <td style="width: 10%;"></td> <td style="width: 10%;"></td> <td style="width: 10%;"></td> <td style="width: 10%;"></td> <td style="width: 10%;"></td> <td style="width: 10%;"></td> </tr> <tr> <td></td> <td></td> <td colspan="8" style="text-align: center;"> <table border="1" style="width: 100%; border-collapse: collapse; text-align: center;"> <tr> </tr></table></td></tr></table></td></tr></table></td></tr></table></td></tr></table></td></tr></table></td></tr></table></td></tr></table></td></tr></table></td></tr></table></td></tr></table></td></tr></table></td></tr></table></td></tr></table></td></tr></table></td></tr></table></td></tr></table></td></tr></table>
 | | | | | | | | | | | | | | | | | | | | <table border="1" style="width: 100%; border-collapse: collapse; text-align: center;"> <tr> <td style="width: 10%;"></td> <td style="width: 10%;"></td> <td style="width: 10%;"></td> <td style="width: 10%;"></td> <td style="width: 10%;"></td> <td style="width: 10%;"></td> <td style="width: 10%;"></td> <td style="width: 10%;"></td> <td style="width: 10%;"></td> <td style="width: 10%;"></td> </tr> <tr> <td></td> <td></td> <td colspan="8" style="text-align: center;"> <table border="1" style="width: 100%; border-collapse: collapse; text-align: center;"> <tr> <td style="width: 10%;"></td> <td style="width: 10%;"></td> <td style="width: 10%;"></td> <td style="width: 10%;"></td> <td style="width: 10%;"></td> <td style="width: 10%;"></td> <td style="width: 10%;"></td> <td style="width: 10%;"></td> <td style="width: 10%;"></td> <td style="width: 10%;"></td> </tr> <tr> <td></td> <td></td> <td colspan="8" style="text-align: center;"> <table border="1" style="width: 100%; border-collapse: collapse; text-align: center;"> <tr> <td style="width: 10%;"></td> <td style="width: 10%;"></td> <td style="width: 10%;"></td> <td style="width: 10%;"></td> <td style="width: 10%;"></td> <td style="width: 10%;"></td> <td style="width: 10%;"></td> <td style="width: 10%;"></td> <td style="width: 10%;"></td> <td style="width: 10%;"></td> </tr> <tr> <td></td> <td></td> <td colspan="8" style="text-align: center;"> <table border="1" style="width: 100%; border-collapse: collapse; text-align: center;"> <tr> <td style="width: 10%;"></td> <td style="width: 10%;"></td> <td style="width: 10%;"></td> <td style="width: 10%;"></td> <td style="width: 10%;"></td> <td style="width: 10%;"></td> <td style="width: 10%;"></td> <td style="width: 10%;"></td> <td style="width: 10%;"></td> <td style="width: 10%;"></td> </tr> <tr> <td></td> <td></td> <td colspan="8" style="text-align: center;"> <table border="1" style="width: 100%; border-collapse: collapse; text-align: center;"> <tr> <td style="width: 10%;"></td> <td style="width: 10%;"></td> <td style="width: 10%;"></td> <td style="width: 10%;"></td> <td style="width: 10%;"></td> <td style="width: 10%;"></td> <td style="width: 10%;"></td> <td style="width: 10%;"></td> <td style="width: 10%;"></td> <td style="width: 10%;"></td> </tr> <tr> <td></td> <td></td> <td colspan="8" style="text-align: center;"> <table border="1" style="width: 100%; border-collapse: collapse; text-align: center;"> <tr> <td style="width: 10%;"></td> <td style="width: 10%;"></td> <td style="width: 10%;"></td> <td style="width: 10%;"></td> <td style="width: 10%;"></td> <td style="width: 10%;"></td> <td style="width: 10%;"></td> <td style="width: 10%;"></td> <td style="width: 10%;"></td> <td style="width: 10%;"></td> </tr> <tr> <td></td> <td></td> <td colspan="8" style="text-align: center;"> <table border="1" style="width: 100%; border-collapse: collapse; text-align: center;"> <tr> <td
style="width: 10%;"></td> <td style="width: 10%;"></td> <td style="width: 10%;"></td> <td style="width: 10%;"></td> <td style="width: 10%;"></td> <td style="width: 10%;"></td> <td style="width: 10%;"></td> <td style="width: 10%;"></td> <td style="width: 10%;"></td> <td style="width: 10%;"></td> </tr> <tr> <td></td> <td></td> <td colspan="8" style="text-align: center;"> <table border="1" style="width: 100%; border-collapse: collapse; text-align: center;"> <tr> <td style="width: 10%;"></td> <td style="width: 10%;"></td> <td style="width: 10%;"></td> <td style="width: 10%;"></td> <td style="width: 10%;"></td> <td style="width: 10%;"></td> <td style="width: 10%;"></td> <td style="width: 10%;"></td> <td style="width: 10%;"></td> <td style="width: 10%;"></td> </tr> <tr> <td></td> <td></td> <td colspan="8" style="text-align: center;"> <table border="1" style="width: 100%; border-collapse: collapse; text-align: center;"> <tr> <td style="width: 10%;"></td> <td style="width: 10%;"></td> <td style="width: 10%;"></td> <td style="width: 10%;"></td> <td style="width: 10%;"></td> <td style="width: 10%;"></td> <td style="width: 10%;"></td> <td style="width: 10%;"></td> <td style="width: 10%;"></td> <td style="width: 10%;"></td> </tr> <tr> <td></td> <td></td> <td colspan="8" style="text-align: center;"> <table border="1" style="width: 100%; border-collapse: collapse; text-align: center;"> <tr> <td style="width: 10%;"></td> <td style="width: 10%;"></td> <td style="width: 10%;"></td> <td style="width: 10%;"></td> <td style="width: 10%;"></td> <td style="width: 10%;"></td> <td style="width: 10%;"></td> <td style="width: 10%;"></td> <td style="width: 10%;"></td> <td style="width: 10%;"></td> </tr> <tr> <td></td> <td></td> <td colspan="8" style="text-align: center;"> <table border="1" style="width: 100%; border-collapse: collapse; text-align: center;"> <tr> <td style="width: 10%;"></td> <td style="width: 10%;"></td> <td style="width: 10%;"></td> <td style="width: 10%;"></td> <td style="width: 10%;"></td> <td style="width: 10%;"></td> <td style="width: 10%;"></td> <td style="width: 10%;"></td> <td style="width: 10%;"></td> <td style="width: 10%;"></td> </tr> <tr> <td></td> <td></td> <td colspan="8" style="text-align: center;"> <table border="1" style="width: 100%; border-collapse: collapse; text-align: center;"> <tr> <td style="width: 10%;"></td> <td style="width: 10%;"></td> <td style="width: 10%;"></td> <td style="width: 10%;"></td> <td style="width: 10%;"></td> <td style="width: 10%;"></td> <td style="width: 10%;"></td> <td style="width: 10%;"></td> <td style="width: 10%;"></td> <td style="width: 10%;"></td> </tr> <tr> <td></td> <td></td> <td colspan="8" style="text-align: center;"> <table border="1" style="width: 100%; border-collapse: collapse; text-align: center;"> <tr> <td style="width: 10%;"></td> <td style="width: 10%;"></td> <td style="width: 10%;"></td> <td style="width: 10%;"></td> <td style="width: 10%;"></td> <td style="width: 10%;"></td> <td style="width: 10%;"></td> <td style="width: 10%;"></td> <td style="width: 10%;"></td> <td style="width: 10%;"></td> </tr> <tr> <td></td> <td></td> <td colspan="8" style="text-align: center;"> <table border="1" style="width: 100%; border-collapse: collapse; text-align: center;"> <tr> <td style="width: 10%;"></td> <td style="width: 10%;"></td> <td style="width: 10%;"></td> <td style="width: 10%;"></td> <td style="width: 10%;"></td> <td style="width: 10%;"></td> <td style="width: 10%;"></td> <td style="width: 10%;"></td> <td style="width: 10%;"></td> <td style="width: 10%;"></td> </tr> <tr> <td></td> <td></td> <td colspan="8" style="text-align: center;"> <table border="1" style="width: 100%; border-collapse: collapse; text-align: center;"> <tr> <td style="width: 10%;"></td> <td style="width: 10%;"></td> <td style="width: 10%;"></td> <td style="width: 10%;"></td> <td style="width: 10%;"></td> <td style="width: 10%;"></td> <td style="width: 10%;"></td> <td style="width: 10%;"></td> <td style="width: 10%;"></td> <td style="width: 10%;"></td> </tr> <tr> <td></td> <td></td> <td colspan="8" style="text-align: center;"> <table border="1" style="width: 100%; border-collapse: collapse; text-align: center;"> <tr> <td style="width: 10%;"></td> <td style="width: 10%;"></td> <td style="width: 10%;"></td> <td style="width: 10%;"></td> <td style="width: 10%;"></td> <td style="width: 10%;"></td> <td style="width: 10%;"></td> <td style="width: 10%;"></td> <td style="width: 10%;"></td> <td style="width: 10%;"></td> </tr> <tr> <td></td> <td></td> <td colspan="8" style="text-align: center;"> <table border="1" style="width: 100%; border-collapse: collapse; text-align: center;"> <tr> </tr></table></td></tr></table></td></tr></table></td></tr></table></td></tr></table></td></tr></table></td></tr></table></td></tr></table></td></tr></table></td></tr></table></td></tr></table></td></tr></table></td></tr></table></td></tr></table></td></tr></table></td></tr></table></td></tr></table>
 | | | | | | | | | | | | | | | | | | | | <table border="1" style="width: 100%; border-collapse: collapse; text-align: center;"> <tr> <td style="width: 10%;"></td> <td style="width: 10%;"></td> <td style="width: 10%;"></td> <td style="width: 10%;"></td> <td style="width: 10%;"></td> <td style="width: 10%;"></td> <td style="width: 10%;"></td> <td style="width: 10%;"></td> <td style="width: 10%;"></td> <td style="width: 10%;"></td> </tr> <tr> <td></td> <td></td> <td colspan="8" style="text-align: center;"> <table border="1" style="width: 100%; border-collapse: collapse; text-align: center;"> <tr> <td style="width: 10%;"></td> <td style="width: 10%;"></td> <td style="width: 10%;"></td> <td style="width: 10%;"></td> <td style="width: 10%;"></td> <td style="width: 10%;"></td> <td style="width: 10%;"></td> <td style="width: 10%;"></td> <td style="width: 10%;"></td> <td style="width: 10%;"></td> </tr> <tr> <td></td> <td></td> <td colspan="8" style="text-align: center;"> <table border="1" style="width: 100%; border-collapse: collapse; text-align: center;"> <tr> <td style="width: 10%;"></td> <td style="width: 10%;"></td> <td style="width: 10%;"></td> <td style="width: 10%;"></td> <td style="width: 10%;"></td> <td style="width: 10%;"></td> <td style="width: 10%;"></td> <td style="width: 10%;"></td> <td style="width: 10%;"></td> <td style="width: 10%;"></td> </tr> <tr> <td></td> <td></td> <td colspan="8" style="text-align: center;"> <table border="1" style="width: 100%; border-collapse: collapse; text-align: center;"> <tr> <td style="width: 10%;"></td> <td style="width: 10%;"></td> <td style="width: 10%;"></td> <td style="width: 10%;"></td> <td style="width: 10%;"></td> <td style="width: 10%;"></td> <td style="width: 10%;"></td> <td style="width: 10%;"></td> <td style="width: 10%;"></td> <td style="width: 10%;"></td> </tr> <tr> <td></td> <td></td> <td colspan="8" style="text-align: center;"> <table border="1" style="width: 100%; border-collapse: collapse; text-align: center;"> <tr> <td style="width: 10%;"></td> <td style="width: 10%;"></td> <td style="width: 10%;"></td> <td style="width: 10%;"></td> <td style="width: 10%;"></td> <td style="width: 10%;"></td> <td style="width: 10%;"></td> <td style="width: 10%;"></td> <td style="width: 10%;"></td> <td style="width: 10%;"></td> </tr> <tr> <td></td> <td></td> <td colspan="8" style="text-align: center;"> <table border="1" style="width: 100%; border-collapse: collapse; text-align: center;"> <tr> <td style="width: 10%;"></td> <td style="width: 10%;"></td> <td style="width: 10%;"></td> <td style="width: 10%;"></td> <td style="width: 10%;"></td> <td style="width: 10%;"></td> <td style="width: 10%;"></td> <td style="width: 10%;"></td> <td style="width: 10%;"></td> <td style="width: 10%;"></td> </tr> <tr> <td></td> <td></td> <td colspan="8" style="text-align: center;">
<table border="1" style="width: 100%; border-collapse: collapse; text-align: center;"> <tr> <td style="width: 10%;"></td> <td style="width: 10%;"></td> <td style="width: 10%;"></td> <td style="width: 10%;"></td> <td style="width: 10%;"></td> <td style="width: 10%;"></td> <td style="width: 10%;"></td> <td style="width: 10%;"></td> <td style="width: 10%;"></td> <td style="width: 10%;"></td> </tr> <tr> <td></td> <td></td> <td colspan="8" style="text-align: center;"> <table border="1" style="width: 100%; border-collapse: collapse; text-align: center;"> <tr> <td style="width: 10%;"></td> <td style="width: 10%;"></td> <td style="width: 10%;"></td> <td style="width: 10%;"></td> <td style="width: 10%;"></td> <td style="width: 10%;"></td> <td style="width: 10%;"></td> <td style="width: 10%;"></td> <td style="width: 10%;"></td> <td style="width: 10%;"></td> </tr> <tr> <td></td> <td></td> <td colspan="8" style="text-align: center;"> <table border="1" style="width: 100%; border-collapse: collapse; text-align: center;"> <tr> <td style="width: 10%;"></td> <td style="width: 10%;"></td> <td style="width: 10%;"></td> <td style="width: 10%;"></td> <td style="width: 10%;"></td> <td style="width: 10%;"></td> <td style="width: 10%;"></td> <td style="width: 10%;"></td> <td style="width: 10%;"></td> <td style="width: 10%;"></td> </tr> <tr> <td></td> <td></td> <td colspan="8" style="text-align: center;"> <table border="1" style="width: 100%; border-collapse: collapse; text-align: center;"> <tr> <td style="width: 10%;"></td> <td style="width: 10%;"></td> <td style="width: 10%;"></td> <td style="width: 10%;"></td> <td style="width: 10%;"></td> <td style="width: 10%;"></td> <td style="width: 10%;"></td> <td style="width: 10%;"></td> <td style="width: 10%;"></td> <td style="width: 10%;"></td> </tr> <tr> <td></td> <td></td> <td colspan="8" style="text-align: center;"> <table border="1" style="width: 100%; border-collapse: collapse; text-align: center;"> <tr> <td style="width: 10%;"></td> <td style="width: 10%;"></td> <td style="width: 10%;"></td> <td style="width: 10%;"></td> <td style="width: 10%;"></td> <td style="width: 10%;"></td> <td style="width: 10%;"></td> <td style="width: 10%;"></td> <td style="width: 10%;"></td> <td style="width: 10%;"></td> </tr> <tr> <td></td> <td></td> <td colspan="8" style="text-align: center;"> <table border="1" style="width: 100%; border-collapse: collapse; text-align: center;"> <tr> <td style="width: 10%;"></td> <td style="width: 10%;"></td> <td style="width: 10%;"></td> <td style="width: 10%;"></td> <td style="width: 10%;"></td> <td style="width: 10%;"></td> <td style="width: 10%;"></td> <td style="width: 10%;"></td> <td style="width: 10%;"></td> <td style="width: 10%;"></td> </tr> <tr> <td></td> <td></td> <td colspan="8" style="text-align: center;"> <table border="1" style="width: 100%; border-collapse: collapse; text-align: center;"> <tr> <td style="width: 10%;"></td> <td style="width: 10%;"></td> <td style="width: 10%;"></td> <td style="width: 10%;"></td> <td style="width: 10%;"></td> <td style="width: 10%;"></td> <td style="width: 10%;"></td> <td style="width: 10%;"></td> <td style="width: 10%;"></td> <td style="width: 10%;"></td> </tr> <tr> <td></td> <td></td> <td colspan="8" style="text-align: center;"> <table border="1" style="width: 100%; border-collapse: collapse; text-align: center;"> <tr> <td style="width: 10%;"></td> <td style="width: 10%;"></td> <td style="width: 10%;"></td> <td style="width: 10%;"></td> <td style="width: 10%;"></td> <td style="width: 10%;"></td> <td style="width: 10%;"></td> <td style="width: 10%;"></td> <td style="width: 10%;"></td> <td style="width: 10%;"></td> </tr> <tr> <td></td> <td></td> <td colspan="8" style="text-align: center;"> <table border="1" style="width: 100%; border-collapse: collapse; text-align: center;"> <tr> <td style="width: 10%;"></td> <td style="width: 10%;"></td> <td style="width: 10%;"></td> <td style="width: 10%;"></td> <td style="width: 10%;"></td> <td style="width: 10%;"></td> <td style="width: 10%;"></td> <td style="width: 10%;"></td> <td style="width: 10%;"></td> <td style="width: 10%;"></td> </tr> <tr> <td></td> <td></td> <td colspan="8" style="text-align: center;"> <table border="1" style="width: 100%; border-collapse: collapse; text-align: center;"> <tr> </tr></table></td></tr></table></td></tr></table></td></tr></table></td></tr></table></td></tr></table></td></tr></table></td></tr></table></td></tr></table></td></tr></table></td></tr></table></td></tr></table></td></tr></table></td></tr></table></td></tr></table></td></tr></table>
 | | | | | | | | | | | | | | | | | | | | <table border="1" style="width: 100%; border-collapse: collapse; text-align: center;"> <tr> <td style="width: 10%;"></td> <td style="width: 10%;"></td> <td style="width: 10%;"></td> <td style="width: 10%;"></td> <td style="width: 10%;"></td> <td style="width: 10%;"></td> <td style="width: 10%;"></td> <td style="width: 10%;"></td> <td style="width: 10%;"></td> <td style="width: 10%;"></td> </tr> <tr> <td></td> <td></td> <td colspan="8" style="text-align: center;"> <table border="1" style="width: 100%; border-collapse: collapse; text-align: center;"> <tr> <td style="width: 10%;"></td> <td style="width: 10%;"></td> <td style="width: 10%;"></td> <td style="width: 10%;"></td> <td style="width: 10%;"></td> <td style="width: 10%;"></td> <td style="width: 10%;"></td> <td style="width: 10%;"></td> <td style="width: 10%;"></td> <td style="width: 10%;"></td> </tr> <tr> <td></td> <td></td> <td colspan="8" style="text-align: center;"> <table border="1" style="width: 100%; border-collapse: collapse; text-align: center;"> <tr> <td style="width: 10%;"></td> <td style="width: 10%;"></td> <td style="width: 10%;"></td> <td style="width: 10%;"></td> <td style="width: 10%;"></td> <td style="width: 10%;"></td> <td style="width: 10%;"></td> <td style="width: 10%;"></td> <td style="width: 10%;"></td> <td style="width: 10%;"></td> </tr> <tr> <td></td> <td></td> <td colspan="8" style="text-align: center;"> <table border="1" style="width: 100%; border-collapse: collapse; text-align: center;"> <tr> <td style="width: 10%;"></td> <td style="width: 10%;"></td> <td style="width: 10%;"></td> <td style="width: 10%;"></td> <td style="width: 10%;"></td> <td style="width: 10%;"></td> <td style="width: 10%;"></td> <td style="width: 10%;"></td> <td style="width: 10%;"></td> <td style="width: 10%;"></td> </tr> <tr> <td></td> <td></td> <td colspan="8" style="text-align: center;"> <table border="1" style="width: 100%; border-collapse: collapse; text-align: center;"> <tr> <td style="width: 10%;"></td> <td style="width: 10%;"></td> <td style="width: 10%;"></td> <td style="width: 10%;"></td> <td style="width: 10%;"></td> <td style="width: 10%;"></td> <td style="width: 10%;"></td> <td style="width: 10%;"></td> <td style="width: 10%;"></td> <td style="width: 10%;"></td> </tr> <tr> <td></td> <td></td> <td colspan="8" style="text-align: center;"> <table border="1" style="width: 100%; border-collapse: collapse; text-align: center;"> <tr> <td style="width: 10%;"></td> <td style="width: 10%;"></td> <td style="width: 10%;"></td> <td style="width: 10%;"></td> <td style="width: 10%;"></td> <td style="width: 10%;"></td> <td style="width: 10%;"></td> <td style="width: 10%;"></td> <td style="width: 10%;"></td> <td style="width: 10%;"></td> </tr> <tr> <td></td> <td></td> <td colspan="8" style="text-align: center;"> <table border="1" style="width: 100%; border-collapse: collapse; text-align: center;"> <tr> <td style="width: 10%;"></td> <td style="width: 10%;"></td> <td style="width: 10%;"></td> <td style="width: 10%;"></td> <td style="width: 10%;"></td> <td style="width: 10%;"></td> <td style="width: 10%;"></td> <td style="width: 10%;"></td> <td style="width: 10%;"></td> <td style="width: 10%;"></td>
</tr> <tr> <td></td> <td></td> <td colspan="8" style="text-align: center;"> <table border="1" style="width: 100%; border-collapse: collapse; text-align: center;"> <tr> <td style="width: 10%;"></td> <td style="width: 10%;"></td> <td style="width: 10%;"></td> <td style="width: 10%;"></td> <td style="width: 10%;"></td> <td style="width: 10%;"></td> <td style="width: 10%;"></td> <td style="width: 10%;"></td> <td style="width: 10%;"></td> <td style="width: 10%;"></td> </tr> <tr> <td></td> <td></td> <td colspan="8" style="text-align: center;"> <table border="1" style="width: 100%; border-collapse: collapse; text-align: center;"> <tr> <td style="width: 10%;"></td> <td style="width: 10%;"></td> <td style="width: 10%;"></td> <td style="width: 10%;"></td> <td style="width: 10%;"></td> <td style="width: 10%;"></td> <td style="width: 10%;"></td> <td style="width: 10%;"></td> <td style="width: 10%;"></td> <td style="width: 10%;"></td> </tr> <tr> <td></td> <td></td> <td colspan="8" style="text-align: center;"> <table border="1" style="width: 100%; border-collapse: collapse; text-align: center;"> <tr> <td style="width: 10%;"></td> <td style="width: 10%;"></td> <td style="width: 10%;"></td> <td style="width: 10%;"></td> <td style="width: 10%;"></td> <td style="width: 10%;"></td> <td style="width: 10%;"></td> <td style="width: 10%;"></td> <td style="width: 10%;"></td> <td style="width: 10%;"></td> </tr> <tr> <td></td> <td></td> <td colspan="8" style="text-align: center;"> <table border="1" style="width: 100%; border-collapse: collapse; text-align: center;"> <tr> <td style="width: 10%;"></td> <td style="width: 10%;"></td> <td style="width: 10%;"></td> <td style="width: 10%;"></td> <td style="width: 10%;"></td> <td style="width: 10%;"></td> <td style="width: 10%;"></td> <td style="width: 10%;"></td> <td style="width: 10%;"></td> <td style="width: 10%;"></td> </tr> <tr> <td></td> <td></td> <td colspan="8" style="text-align: center;"> <table border="1" style="width: 100%; border-collapse: collapse; text-align: center;"> <tr> <td style="width: 10%;"></td> <td style="width: 10%;"></td> <td style="width: 10%;"></td> <td style="width: 10%;"></td> <td style="width: 10%;"></td> <td style="width: 10%;"></td> <td style="width: 10%;"></td> <td style="width: 10%;"></td> <td style="width: 10%;"></td> <td style="width: 10%;"></td> </tr> <tr> <td></td> <td></td> <td colspan="8" style="text-align: center;"> <table border="1" style="width: 100%; border-collapse: collapse; text-align: center;"> <tr> <td style="width: 10%;"></td> <td style="width: 10%;"></td> <td style="width: 10%;"></td> <td style="width: 10%;"></td> <td style="width: 10%;"></td> <td style="width: 10%;"></td> <td style="width: 10%;"></td> <td style="width: 10%;"></td> <td style="width: 10%;"></td> <td style="width: 10%;"></td> </tr> <tr> <td></td> <td></td> <td colspan="8" style="text-align: center;"> <table border="1" style="width: 100%; border-collapse: collapse; text-align: center;"> <tr> <td style="width: 10%;"></td> <td style="width: 10%;"></td> <td style="width: 10%;"></td> <td style="width: 10%;"></td> <td style="width: 10%;"></td> <td style="width: 10%;"></td> <td style="width: 10%;"></td> <td style="width: 10%;"></td> <td style="width: 10%;"></td> <td style="width: 10%;"></td> </tr> <tr> <td></td> <td></td> <td colspan="8" style="text-align: center;"> <table border="1" style="width: 100%; border-collapse: collapse; text-align: center;"> <tr> </tr></table></td></tr></table></td></tr></table></td></tr></table></td></tr></table></td></tr></table></td></tr></table></td></tr></table></td></tr></table></td></tr></table></td></tr></table></td></tr></table></td></tr></table></td></tr></table></td></tr></table>
 | | | | | | | | | | | | | | | | | | | | <table border="1" style="width: 100%; border-collapse: collapse; text-align: center;"> <tr> <td style="width: 10%;"></td> <td style="width: 10%;"></td> <td style="width: 10%;"></td> <td style="width: 10%;"></td> <td style="width: 10%;"></td> <td style="width: 10%;"></td> <td style="width: 10%;"></td> <td style="width: 10%;"></td> <td style="width: 10%;"></td> <td style="width: 10%;"></td> </tr> <tr> <td></td> <td></td> <td colspan="8" style="text-align: center;"> <table border="1" style="width: 100%; border-collapse: collapse; text-align: center;"> <tr> <td style="width: 10%;"></td> <td style="width: 10%;"></td> <td style="width: 10%;"></td> <td style="width: 10%;"></td> <td style="width: 10%;"></td> <td style="width: 10%;"></td> <td style="width: 10%;"></td> <td style="width: 10%;"></td> <td style="width: 10%;"></td> <td style="width: 10%;"></td> </tr> <tr> <td></td> <td></td> <td colspan="8" style="text-align: center;"> <table border="1" style="width: 100%; border-collapse: collapse; text-align: center;"> <tr> <td style="width: 10%;"></td> <td style="width: 10%;"></td> <td style="width: 10%;"></td> <td style="width: 10%;"></td> <td style="width: 10%;"></td> <td style="width: 10%;"></td> <td style="width: 10%;"></td> <td style="width: 10%;"></td> <td style="width: 10%;"></td> <td style="width: 10%;"></td> </tr> <tr> <td></td> <td></td> <td colspan="8" style="text-align: center;"> <table border="1" style="width: 100%; border-collapse: collapse; text-align: center;"> <tr> <td style="width: 10%;"></td> <td style="width: 10%;"></td> <td style="width: 10%;"></td> <td style="width: 10%;"></td> <td style="width: 10%;"></td> <td style="width: 10%;"></td> <td style="width: 10%;"></td> <td style="width: 10%;"></td> <td style="width: 10%;"></td> <td style="width: 10%;"></td> </tr> <tr> <td></td> <td></td> <td colspan="8" style="text-align: center;"> <table border="1" style="width: 100%; border-collapse: collapse; text-align: center;"> <tr> <td style="width: 10%;"></td> <td style="width: 10%;"></td> <td style="width: 10%;"></td> <td style="width: 10%;"></td> <td style="width: 10%;"></td> <td style="width: 10%;"></td> <td style="width: 10%;"></td> <td style="width: 10%;"></td> <td style="width: 10%;"></td> <td style="width: 10%;"></td> </tr> <tr> <td></td> <td></td> <td colspan="8" style="text-align: center;"> <table border="1" style="width: 100%; border-collapse: collapse; text-align: center;"> <tr> <td style="width: 10%;"></td> <td style="width: 10%;"></td> <td style="width: 10%;"></td> <td style="width: 10%;"></td> <td style="width: 10%;"></td> <td style="width: 10%;"></td> <td style="width: 10%;"></td> <td style="width: 10%;"></td> <td style="width: 10%;"></td> <td style="width: 10%;"></td> </tr> <tr> <td></td> <td></td> <td colspan="8" style="text-align: center;"> <table border="1" style="width: 100%; border-collapse: collapse; text-align: center;"> <tr> <td style="width: 10%;"></td> <td style="width: 10%;"></td> <td style="width: 10%;"></td> <td style="width: 10%;"></td> <td style="width: 10%;"></td> <td style="width: 10%;"></td> <td style="width: 10%;"></td> <td style="width: 10%;"></td> <td style="width: 10%;"></td> <td style="width: 10%;"></td> </tr> <tr> <td></td> <td></td> <td colspan="8" style="text-align: center;"> <table border="1" style="width: 100%; border-collapse: collapse; text-align: center;"> <tr> <td style="width: 10%;"></td> <td style="width: 10%;"></td> <td style="width: 10%;"></td> <td style="width: 10%;"></td> <td style="width: 10%;"></td> <td style="width: 10%;"></td> <td style="width: 10%;"></td> <td style="width: 10%;"></td> <td style="width: 10%;"></td> <td style="width: 10%;"></td> </tr> <tr> <td></td> <td></td> <td colspan="8" style="text-align: center;"> <table border="1" style="width: 100%; border-collapse: collapse; text-align: center;"> <tr> <td style="width: 10%;"></td> <td style="width: 10%;"></td> <td style="width: 10%;"></td> <td style="width: 10%;"></td> <td style="width: 10%;"></td> <td style="width: 10%;"></td> <td style="width: 10%;"></td> <td style="width: 10%;"></td> <td
style="width: 10%;"></td> <td style="width: 10%;"></td> </tr> <tr> <td></td> <td></td> <td colspan="8" style="text-align: center;"> <table border="1" style="width: 100%; border-collapse: collapse; text-align: center;"> <tr> <td style="width: 10%;"></td> <td style="width: 10%;"></td> <td style="width: 10%;"></td> <td style="width: 10%;"></td> <td style="width: 10%;"></td> <td style="width: 10%;"></td> <td style="width: 10%;"></td> <td style="width: 10%;"></td> <td style="width: 10%;"></td> <td style="width: 10%;"></td> </tr> <tr> <td></td> <td></td> <td colspan="8" style="text-align: center;"> <table border="1" style="width: 100%; border-collapse: collapse; text-align: center;"> <tr> <td style="width: 10%;"></td> <td style="width: 10%;"></td> <td style="width: 10%;"></td> <td style="width: 10%;"></td> <td style="width: 10%;"></td> <td style="width: 10%;"></td> <td style="width: 10%;"></td> <td style="width: 10%;"></td> <td style="width: 10%;"></td> <td style="width: 10%;"></td> </tr> <tr> <td></td> <td></td> <td colspan="8" style="text-align: center;"> <table border="1" style="width: 100%; border-collapse: collapse; text-align: center;"> <tr> <td style="width: 10%;"></td> <td style="width: 10%;"></td> <td style="width: 10%;"></td> <td style="width: 10%;"></td> <td style="width: 10%;"></td> <td style="width: 10%;"></td> <td style="width: 10%;"></td> <td style="width: 10%;"></td> <td style="width: 10%;"></td> <td style="width: 10%;"></td> </tr> <tr> <td></td> <td></td> <td colspan="8" style="text-align: center;"> <table border="1" style="width: 100%; border-collapse: collapse; text-align: center;"> <tr> <td style="width: 10%;"></td> <td style="width: 10%;"></td> <td style="width: 10%;"></td> <td style="width: 10%;"></td> <td style="width: 10%;"></td> <td style="width: 10%;"></td> <td style="width: 10%;"></td> <td style="width: 10%;"></td> <td style="width: 10%;"></td> <td style="width: 10%;"></td> </tr> <tr> <td></td> <td></td> <td colspan="8" style="text-align: center;"> <table border="1" style="width: 100%; border-collapse: collapse; text-align: center;"> <tr> </tr></table></td></tr></table></td></tr></table></td></tr></table></td></tr></table></td></tr></table></td></tr></table></td></tr></table></td></tr></table></td></tr></table></td></tr></table></td></tr></table></td></tr></table></td></tr></table>
 | | | | | | | | | | | | | | | | | | | | <table border="1" style="width: 100%; border-collapse: collapse; text-align: center;"> <tr> <td style="width: 10%;"></td> <td style="width: 10%;"></td> <td style="width: 10%;"></td> <td style="width: 10%;"></td> <td style="width: 10%;"></td> <td style="width: 10%;"></td> <td style="width: 10%;"></td> <td style="width: 10%;"></td> <td style="width: 10%;"></td> <td style="width: 10%;"></td> </tr> <tr> <td></td> <td></td> <td colspan="8" style="text-align: center;"> <table border="1" style="width: 100%; border-collapse: collapse; text-align: center;"> <tr> <td style="width: 10%;"></td> <td style="width: 10%;"></td> <td style="width: 10%;"></td> <td style="width: 10%;"></td> <td style="width: 10%;"></td> <td style="width: 10%;"></td> <td style="width: 10%;"></td> <td style="width: 10%;"></td> <td style="width: 10%;"></td> <td style="width: 10%;"></td> </tr> <tr> <td></td> <td></td> <td colspan="8" style="text-align: center;"> <table border="1" style="width: 100%; border-collapse: collapse; text-align: center;"> <tr> <td style="width: 10%;"></td> <td style="width: 10%;"></td> <td style="width: 10%;"></td> <td style="width: 10%;"></td> <td style="width: 10%;"></td> <td style="width: 10%;"></td> <td style="width: 10%;"></td> <td style="width: 10%;"></td> <td style="width: 10%;"></td> <td style="width: 10%;"></td> </tr> <tr> <td></td> <td></td> <td colspan="8" style="text-align: center;"> <table border="1" style="width: 100%; border-collapse: collapse; text-align: center;"> <tr> <td style="width: 10%;"></td> <td style="width: 10%;"></td> <td style="width: 10%;"></td> <td style="width: 10%;"></td> <td style="width: 10%;"></td> <td style="width: 10%;"></td> <td style="width: 10%;"></td> <td style="width: 10%;"></td> <td style="width: 10%;"></td> <td style="width: 10%;"></td> </tr> <tr> <td></td> <td></td> <td colspan="8" style="text-align: center;"> <table border="1" style="width: 100%; border-collapse: collapse; text-align: center;"> <tr> <td style="width: 10%;"></td> <td style="width: 10%;"></td> <td style="width: 10%;"></td> <td style="width: 10%;"></td> <td style="width: 10%;"></td> <td style="width: 10%;"></td> <td style="width: 10%;"></td> <td style="width: 10%;"></td> <td style="width: 10%;"></td> <td style="width: 10%;"></td> </tr> <tr> <td></td> <td></td> <td colspan="8" style="text-align: center;"> <table border="1" style="width: 100%; border-collapse: collapse; text-align: center;"> <tr> <td style="width: 10%;"></td> <td style="width: 10%;"></td> <td style="width: 10%;"></td> <td style="width: 10%;"></td> <td style="width: 10%;"></td> <td style="width: 10%;"></td> <td style="width: 10%;"></td> <td style="width: 10%;"></td> <td style="width: 10%;"></td> <td style="width: 10%;"></td> </tr> <tr> <td></td> <td></td> <td colspan="8" style="text-align: center;"> <table border="1" style="width: 100%; border-collapse: collapse; text-align: center;"> <tr> <td style="width: 10%;"></td> <td style="width: 10%;"></td> <td style="width: 10%;"></td> <td style="width: 10%;"></td> <td style="width: 10%;"></td> <td style="width: 10%;"></td> <td style="width: 10%;"></td> <td style="width: 10%;"></td> <td style="width: 10%;"></td> <td style="width: 10%;"></td> </tr> <tr> <td></td> <td></td> <td colspan="8" style="text-align: center;"> <table border="1" style="width: 100%; border-collapse: collapse; text-align: center;"> <tr> <td style="width: 10%;"></td> <td style="width: 10%;"></td> <td style="width: 10%;"></td> <td style="width: 10%;"></td> <td style="width: 10%;"></td> <td style="width: 10%;"></td> <td style="width: 10%;"></td> <td style="width: 10%;"></td> <td style="width: 10%;"></td> <td style="width: 10%;"></td> </tr> <tr> <td></td> <td></td> <td colspan="8" style="text-align: center;"> <table border="1" style="width: 100%; border-collapse: collapse; text-align: center;"> <tr> <td style="width: 10%;"></td> <td style="width: 10%;"></td> <td style="width: 10%;"></td> <td style="width: 10%;"></td> <td style="width: 10%;"></td> <td style="width: 10%;"></td> <td style="width: 10%;"></td> <td style="width: 10%;"></td> <td style="width: 10%;"></td> <td style="width: 10%;"></td> </tr> <tr> <td></td> <td></td> <td colspan="8" style="text-align: center;"> <table border="1" style="width: 100%; border-collapse: collapse; text-align: center;"> <tr> <td style="width: 10%;"></td> <td style="width: 10%;"></td> <td style="width: 10%;"></td> <td style="width: 10%;"></td> <td style="width: 10%;"></td> <td style="width: 10%;"></td> <td style="width: 10%;"></td> <td style="width: 10%;"></td> <td style="width: 10%;"></td> <td style="width: 10%;"></td> </tr> <tr> <td></td> <td></td> <td colspan="8" style="text-align: center;"> <table border="1" style="width: 100%; border-collapse: collapse; text-align: center;"> <tr> <td style="width: 10%;"></td> <td style="width: 10%;"></td> <td style="width: 10%;"></td> <td style="width: 10%;"></td> <td style="width: 10%;"></td> <td style="width: 10%;"></td> <td style="width: 10%;"></td> <td style="width: 10%;"></td> <td style="width: 10%;"></td> <td style="width: 10%;"></td> </tr> <tr> <td></td> <td></td> <td colspan="8" style="text-align: center;"> <table border="1" style="width: 100%; border-collapse: collapse; text-align: center;"> <tr> <td style="width: 10%;"></td> <td style="width: 10%;"></td> <td style="width: 10%;"></td> <td style="width: 10%;"></td> <td style="width: 10%;"></td> <td style="width: 10%;"></td> <td style="width:
10%;"></td> <td style="width: 10%;"></td> <td style="width: 10%;"></td> <td style="width: 10%;"></td> </tr> <tr> <td></td> <td></td> <td colspan="8" style="text-align: center;"> <table border="1" style="width: 100%; border-collapse: collapse; text-align: center;"> <tr> </tr></table></td></tr></table></td></tr></table></td></tr></table></td></tr></table></td></tr></table></td></tr></table></td></tr></table></td></tr></table></td></tr></table></td></tr></table></td></tr></table></td></tr></table>
 | | | | | | | | | | | | | | | | | | | | <table border="1" style="width: 100%; border-collapse: collapse; text-align: center;"> <tr> <td style="width: 10%;"></td> <td style="width: 10%;"></td> <td style="width: 10%;"></td> <td style="width: 10%;"></td> <td style="width: 10%;"></td> <td style="width: 10%;"></td> <td style="width: 10%;"></td> <td style="width: 10%;"></td> <td style="width: 10%;"></td> <td style="width: 10%;"></td> </tr> <tr> <td></td> <td></td> <td colspan="8" style="text-align: center;"> <table border="1" style="width: 100%; border-collapse: collapse; text-align: center;"> <tr> <td style="width: 10%;"></td> <td style="width: 10%;"></td> <td style="width: 10%;"></td> <td style="width: 10%;"></td> <td style="width: 10%;"></td> <td style="width: 10%;"></td> <td style="width: 10%;"></td> <td style="width: 10%;"></td> <td style="width: 10%;"></td> <td style="width: 10%;"></td> </tr> <tr> <td></td> <td></td> <td colspan="8" style="text-align: center;"> <table border="1" style="width: 100%; border-collapse: collapse; text-align: center;"> <tr> <td style="width: 10%;"></td> <td style="width: 10%;"></td> <td style="width: 10%;"></td> <td style="width: 10%;"></td> <td style="width: 10%;"></td> <td style="width: 10%;"></td> <td style="width: 10%;"></td> <td style="width: 10%;"></td> <td style="width: 10%;"></td> <td style="width: 10%;"></td> </tr> <tr> <td></td> <td></td> <td colspan="8" style="text-align: center;"> <table border="1" style="width: 100%; border-collapse: collapse; text-align: center;"> <tr> <td style="width: 10%;"></td> <td style="width: 10%;"></td> <td style="width: 10%;"></td> <td style="width: 10%;"></td> <td style="width: 10%;"></td> <td style="width: 10%;"></td> <td style="width: 10%;"></td> <td style="width: 10%;"></td> <td style="width: 10%;"></td> <td style="width: 10%;"></td> </tr> <tr> <td></td> <td></td> <td colspan="8" style="text-align: center;"> <table border="1" style="width: 100%; border-collapse: collapse; text-align: center;"> <tr> <td style="width: 10%;"></td> <td style="width: 10%;"></td> <td style="width: 10%;"></td> <td style="width: 10%;"></td> <td style="width: 10%;"></td> <td style="width: 10%;"></td> <td style="width: 10%;"></td> <td style="width: 10%;"></td> <td style="width: 10%;"></td> <td style="width: 10%;"></td> </tr> <tr> <td></td> <td></td> <td colspan="8" style="text-align: center;"> <table border="1" style="width: 100%; border-collapse: collapse; text-align: center;"> <tr> <td style="width: 10%;"></td> <td style="width: 10%;"></td> <td style="width: 10%;"></td> <td style="width: 10%;"></td> <td style="width: 10%;"></td> <td style="width: 10%;"></td> <td style="width: 10%;"></td> <td style="width: 10%;"></td> <td style="width: 10%;"></td> <td style="width: 10%;"></td> </tr> <tr> <td></td> <td></td> <td colspan="8" style="text-align: center;"> <table border="1" style="width: 100%; border-collapse: collapse; text-align: center;"> <tr> <td style="width: 10%;"></td> <td style="width: 10%;"></td> <td style="width: 10%;"></td> <td style="width: 10%;"></td> <td style="width: 10%;"></td> <td style="width: 10%;"></td> <td style="width: 10%;"></td> <td style="width: 10%;"></td> <td style="width: 10%;"></td> <td style="width: 10%;"></td> </tr> <tr> <td></td> <td></td> <td colspan="8" style="text-align: center;"> <table border="1" style="width: 100%; border-collapse: collapse; text-align: center;"> <tr> <td style="width: 10%;"></td> <td style="width: 10%;"></td> <td style="width: 10%;"></td> <td style="width: 10%;"></td> <td style="width: 10%;"></td> <td style="width: 10%;"></td> <td style="width: 10%;"></td> <td style="width: 10%;"></td> <td style="width: 10%;"></td> <td style="width: 10%;"></td> </tr> <tr> <td></td> <td></td> <td colspan="8" style="text-align: center;"> <table border="1" style="width: 100%; border-collapse: collapse; text-align: center;"> <tr> <td style="width: 10%;"></td> <td style="width: 10%;"></td> <td style="width: 10%;"></td> <td style="width: 10%;"></td> <td style="width: 10%;"></td> <td style="width: 10%;"></td> <td style="width: 10%;"></td> <td style="width: 10%;"></td> <td style="width: 10%;"></td> <td style="width: 10%;"></td> </tr> <tr> <td></td> <td></td> <td colspan="8" style="text-align: center;"> <table border="1" style="width: 100%; border-collapse: collapse; text-align: center;"> <tr> <td style="width: 10%;"></td> <td style="width: 10%;"></td> <td style="width: 10%;"></td> <td style="width: 10%;"></td> <td style="width: 10%;"></td> <td style="width: 10%;"></td> <td style="width: 10%;"></td> <td style="width: 10%;"></td> <td style="width: 10%;"></td> <td style="width: 10%;"></td> </tr> <tr> <td></td> <td></td> <td colspan="8" style="text-align: center;"> <table border="1" style="width: 100%; border-collapse: collapse; text-align: center;"> <tr> <td style="width: 10%;"></td> <td style="width: 10%;"></td> <td style="width: 10%;"></td> <td style="width: 10%;"></td> <td style="width: 10%;"></td> <td style="width: 10%;"></td> <td style="width: 10%;"></td> <td style="width: 10%;"></td> <td style="width: 10%;"></td> <td style="width: 10%;"></td> </tr> <tr> <td></td> <td></td> <td colspan="8" style="text-align: center;"> <table border="1" style="width: 100%; border-collapse: collapse; text-align: center;"> <tr> </tr></table></td></tr></table></td></tr></table></td></tr></table></td></tr></table></td></tr></table></td></tr></table></td></tr></table></td></tr></table></td></tr></table></td></tr></table></td></tr></table>

 | | | | | | | | | | | | | | | | | | | | <table border="1" style="width: 100%; border-collapse: collapse; text-align: center;"> <tr> <td style="width: 10%;"></td> <td style="width: 10%;"></td> <td style="width: 10%;"></td> <td style="width: 10%;"></td> <td style="width: 10%;"></td> <td style="width: 10%;"></td> <td style="width: 10%;"></td> <td style="width: 10%;"></td> <td style="width: 10%;"></td> <td style="width: 10%;"></td> </tr> <tr> <td></td> <td></td> <td colspan="8" style="text-align: center;"> <table border="1" style="width: 100%; border-collapse: collapse; text-align: center;"> <tr> <td style="width: 10%;"></td> <td style="width: 10%;"></td> <td style="width: 10%;"></td> <td style="width: 10%;"></td> <td style="width: 10%;"></td> <td style="width: 10%;"></td> <td style="width: 10%;"></td> <td style="width: 10%;"></td> <td style="width: 10%;"></td> <td style="width: 10%;"></td> </tr> <tr> <td></td> <td></td> <td colspan="8" style="text-align: center;"> <table border="1" style="width: 100%; border-collapse: collapse; text-align: center;"> <tr> <td style="width: 10%;"></td> <td style="width: 10%;"></td> <td style="width: 10%;"></td> <td style="width: 10%;"></td> <td style="width: 10%;"></td> <td style="width: 10%;"></td> <td style="width: 10%;"></td> <td style="width: 10%;"></td> <td style="width: 10%;"></td> <td style="width: 10%;"></td> </tr> <tr> <td></td> <td></td> <td colspan="8" style="text-align: center;"> <table border="1" style="width: 100%; border-collapse: collapse; text-align: center;"> <tr> <td style="width: 10%;"></td> <td style="width: 10%;"></td> <td style="width: 10%;"></td> <td style="width: 10%;"></td> <td style="width: 10%;"></td> <td style="width: 10%;"></td> <td style="width: 10%;"></td> <td style="width: 10%;"></td> <td style="width: 10%;"></td> <td style="width: 10%;"></td> </tr> <tr> <td></td> <td></td> <td colspan="8" style="text-align: center;"> <table border="1" style="width: 100%; border-collapse: collapse; text-align: center;"> <tr> <td style="width: 10%;"></td> <td style="width: 10%;"></td> <td style="width: 10%;"></td> <td style="width: 10%;"></td> <td style="width: 10%;"></td> <td style="width: 10%;"></td> <td style="width: 10%;"></td> <td style="width: 10%;"></td> <td style="width: 10%;"></td> <td style="width: 10%;"></td> </tr> <tr> <td></td> <td></td> <td colspan="8" style="text-align: center;"> <table border="1" style="width: 100%; border-collapse: collapse; text-align: center;"> <tr> <td style="width: 10%;"></td> <td style="width: 10%;"></td> <td style="width: 10%;"></td> <td style="width: 10%;"></td> <td style="width: 10%;"></td> <td style="width: 10%;"></td> <td style="width: 10%;"></td> <td style="width: 10%;"></td> <td style="width: 10%;"></td> <td style="width: 10%;"></td> </tr> <tr> <td></td> <td></td> <td colspan="8" style="text-align: center;"> <table border="1" style="width: 100%; border-collapse: collapse; text-align: center;"> <tr> <td style="width: 10%;"></td> <td style="width: 10%;"></td> <td style="width: 10%;"></td> <td style="width: 10%;"></td> <td style="width: 10%;"></td> <td style="width: 10%;"></td> <td style="width: 10%;"></td> <td style="width: 10%;"></td> <td style="width: 10%;"></td> <td style="width: 10%;"></td> </tr> <tr> <td></td> <td></td> <td colspan="8" style="text-align: center;"> <table border="1" style="width: 100%; border-collapse: collapse; text-align: center;"> <tr> <td style="width: 10%;"></td> <td style="width: 10%;"></td> <td style="width: 10%;"></td> <td style="width: 10%;"></td> <td style="width: 10%;"></td> <td style="width: 10%;"></td> <td style="width: 10%;"></td> <td style="width: 10%;"></td> <td style="width: 10%;"></td> <td style="width: 10%;"></td> </tr> <tr> <td></td> <td></td> <td colspan="8" style="text-align: center;"> <table border="1" style="width: 100%; border-collapse: collapse; text-align: center;"> <tr> <td style="width: 10%;"></td> <td style="width: 10%;"></td> <td style="width: 10%;"></td> <td style="width: 10%;"></td> <td style="width: 10%;"></td> <td style="width: 10%;"></td> <td style="width: 10%;"></td> <td style="width: 10%;"></td> <td style="width: 10%;"></td> <td style="width: 10%;"></td> </tr> <tr> <td></td> <td></td> <td colspan="8" style="text-align: center;"> <table border="1" style="width: 100%; border-collapse: collapse; text-align: center;"> <tr> <td style="width: 10%;"></td> <td style="width: 10%;"></td> <td style="width: 10%;"></td> <td style="width: 10%;"></td> <td style="width: 10%;"></td> <td style="width: 10%;"></td> <td style="width: 10%;"></td> <td style="width: 10%;"></td> <td style="width: 10%;"></td> <td style="width: 10%;"></td> </tr> <tr> <td></td> <td></td> <td colspan="8" style="text-align: center;"> <table border="1" style="width: 100%; border-collapse: collapse; text-align: center;"> <tr> </tr></table></td></tr></table></td></tr></table></td></tr></table></td></tr></table></td></tr></table></td></tr></table></td></tr></table></td></tr></table></td></tr></table></td></tr></table>
 | | | | | | | | | | | | | | | | | | | | <table border="1" style="width: 100%; border-collapse: collapse; text-align: center;"> <tr> <td style="width: 10%;"></td> <td style="width: 10%;"></td> <td style="width: 10%;"></td> <td style="width: 10%;"></td> <td style="width: 10%;"></td> <td style="width: 10%;"></td> <td style="width: 10%;"></td> <td style="width: 10%;"></td> <td style="width: 10%;"></td> <td style="width: 10%;"></td> </tr> <tr> <td></td> <td></td> <td colspan="8" style="text-align: center;"> <table border="1" style="width: 100%; border-collapse: collapse; text-align: center;"> <tr> <td style="width: 10%;"></td> <td style="width: 10%;"></td> <td style="width: 10%;"></td> <td style="width: 10%;"></td> <td style="width: 10%;"></td> <td style="width: 10%;"></td> <td style="width: 10%;"></td> <td style="width: 10%;"></td> <td style="width: 10%;"></td> <td style="width: 10%;"></td> </tr> <tr> <td></td> <td></td> <td colspan="8" style="text-align: center;"> <table border="1" style="width: 100%; border-collapse: collapse; text-align: center;"> <tr> <td style="width: 10%;"></td> <td style="width: 10%;"></td> <td style="width: 10%;"></td> <td style="width: 10%;"></td> <td style="width: 10%;"></td> <td style="width: 10%;"></td> <td style="width: 10%;"></td> <td style="width: 10%;"></td> <td style="width: 10%;"></td> <td style="width: 10%;"></td> </tr> <tr> <td></td> <td></td> <td colspan="8" style="text-align: center;"> <table border="1" style="width: 100%; border-collapse: collapse; text-align: center;"> <tr> <td style="width: 10%;"></td> <td style="width: 10%;"></td> <td style="width: 10%;"></td> <td style="width: 10%;"></td> <td style="width: 10%;"></td> <td style="width: 10%;"></td> <td style="width: 10%;"></td> <td style="width: 10%;"></td> <td style="width: 10%;"></td> <td style="width: 10%;"></td> </tr> <tr> <td></td> <td></td> <td colspan="8" style="text-align: center;"> <table border="1" style="width: 100%; border-collapse: collapse; text-align: center;"> <tr> <td style="width: 10%;"></td> <td style="width: 10%;"></td> <td style="width: 10%;"></td> <td style="width: 10%;"></td> <td style="width: 10%;"></td> <td style="width: 10%;"></td> <td style="width: 10%;"></td> <td style="width: 10%;"></td> <td style="width: 10%;"></td> <td style="width: 10%;"></td> </tr> <tr> <td></td> <td></td> <td colspan="8" style="text-align: center;"> <table border="1" style="width: 100%; border-collapse: collapse; text-align: center;"> <tr> <td style="width:
10%;"></td> <td style="width: 10%;"></td> <td style="width: 10%;"></td> <td style="width: 10%;"></td> <td style="width: 10%;"></td> <td style="width: 10%;"></td> <td style="width: 10%;"></td> <td style="width: 10%;"></td> <td style="width: 10%;"></td> <td style="width: 10%;"></td> </tr> <tr> <td></td> <td></td> <td colspan="8" style="text-align: center;"> <table border="1" style="width: 100%; border-collapse: collapse; text-align: center;"> <tr> <td style="width: 10%;"></td> <td style="width: 10%;"></td> <td style="width: 10%;"></td> <td style="width: 10%;"></td> <td style="width: 10%;"></td> <td style="width: 10%;"></td> <td style="width: 10%;"></td> <td style="width: 10%;"></td> <td style="width: 10%;"></td> <td style="width: 10%;"></td> </tr> <tr> <td></td> <td></td> <td colspan="8" style="text-align: center;"> <table border="1" style="width: 100%; border-collapse: collapse; text-align: center;"> <tr> <td style="width: 10%;"></td> <td style="width: 10%;"></td> <td style="width: 10%;"></td> <td style="width: 10%;"></td> <td style="width: 10%;"></td> <td style="width: 10%;"></td> <td style="width: 10%;"></td> <td style="width: 10%;"></td> <td style="width: 10%;"></td> <td style="width: 10%;"></td> </tr> <tr> <td></td> <td></td> <td colspan="8" style="text-align: center;"> <table border="1" style="width: 100%; border-collapse: collapse; text-align: center;"> <tr> <td style="width: 10%;"></td> <td style="width: 10%;"></td> <td style="width: 10%;"></td> <td style="width: 10%;"></td> <td style="width: 10%;"></td> <td style="width: 10%;"></td> <td style="width: 10%;"></td> <td style="width: 10%;"></td> <td style="width: 10%;"></td> <td style="width: 10%;"></td> </tr> <tr> <td></td> <td></td> <td colspan="8" style="text-align: center;"> <table border="1" style="width: 100%; border-collapse: collapse; text-align: center;"> <tr> </tr></table></td></tr></table></td></tr></table></td></tr></table></td></tr></table></td></tr></table></td></tr></table></td></tr></table></td></tr></table></td></tr></table>
 | | | | | | | | | | | | | | | | | | | | <table border="1" style="width: 100%; border-collapse: collapse; text-align: center;"> <tr> <td style="width: 10%;"></td> <td style="width: 10%;"></td> <td style="width: 10%;"></td> <td style="width: 10%;"></td> <td style="width: 10%;"></td> <td style="width: 10%;"></td> <td style="width: 10%;"></td> <td style="width: 10%;"></td> <td style="width: 10%;"></td> <td style="width: 10%;"></td> </tr> <tr> <td></td> <td></td> <td colspan="8" style="text-align: center;"> <table border="1" style="width: 100%; border-collapse: collapse; text-align: center;"> <tr> <td style="width: 10%;"></td> <td style="width: 10%;"></td> <td style="width: 10%;"></td> <td style="width: 10%;"></td> <td style="width: 10%;"></td> <td style="width: 10%;"></td> <td style="width: 10%;"></td> <td style="width: 10%;"></td> <td style="width: 10%;"></td> <td style="width: 10%;"></td> </tr> <tr> <td></td> <td></td> <td colspan="8" style="text-align: center;"> <table border="1" style="width: 100%; border-collapse: collapse; text-align: center;"> <tr> <td style="width: 10%;"></td> <td style="width: 10%;"></td> <td style="width: 10%;"></td> <td style="width: 10%;"></td> <td style="width: 10%;"></td> <td style="width: 10%;"></td> <td style="width: 10%;"></td> <td style="width: 10%;"></td> <td style="width: 10%;"></td> <td style="width: 10%;"></td> </tr> <tr> <td></td> <td></td> <td colspan="8" style="text-align: center;"> <table border="1" style="width: 100%; border-collapse: collapse; text-align: center;"> <tr> <td style="width: 10%;"></td> <td style="width: 10%;"></td> <td style="width: 10%;"></td> <td style="width: 10%;"></td> <td style="width: 10%;"></td> <td style="width: 10%;"></td> <td style="width: 10%;"></td> <td style="width: 10%;"></td> <td style="width: 10%;"></td> <td style="width: 10%;"></td> </tr> <tr> <td></td> <td></td> <td colspan="8" style="text-align: center;"> <table border="1" style="width: 100%; border-collapse: collapse; text-align: center;"> <tr> <td style="width: 10%;"></td> <td style="width: 10%;"></td> <td style="width: 10%;"></td> <td style="width: 10%;"></td> <td style="width: 10%;"></td> <td style="width: 10%;"></td> <td style="width: 10%;"></td> <td style="width: 10%;"></td> <td style="width: 10%;"></td> <td style="width: 10%;"></td> </tr> <tr> <td></td> <td></td> <td colspan="8" style="text-align: center;"> <table border="1" style="width: 100%; border-collapse: collapse; text-align: center;"> <tr> <td style="width: 10%;"></td> <td style="width: 10%;"></td> <td style="width: 10%;"></td> <td style="width: 10%;"></td> <td style="width: 10%;"></td> <td style="width: 10%;"></td> <td style="width: 10%;"></td> <td style="width: 10%;"></td> <td style="width: 10%;"></td> <td style="width: 10%;"></td> </tr> <tr> <td></td> <td></td> <td colspan="8" style="text-align: center;"> <table border="1" style="width: 100%; border-collapse: collapse; text-align: center;"> <tr> <td style="width: 10%;"></td> <td style="width: 10%;"></td> <td style="width: 10%;"></td> <td style="width: 10%;"></td> <td style="width: 10%;"></td> <td style="width: 10%;"></td> <td style="width: 10%;"></td> <td style="width: 10%;"></td> <td style="width: 10%;"></td> <td style="width: 10%;"></td> </tr> <tr> <td></td> <td></td> <td colspan="8" style="text-align: center;"> <table border="1" style="width: 100%; border-collapse: collapse; text-align: center;"> <tr> <td style="width: 10%;"></td> <td style="width: 10%;"></td> <td style="width: 10%;"></td> <td style="width: 10%;"></td> <td style="width: 10%;"></td> <td style="width: 10%;"></td> <td style="width: 10%;"></td> <td style="width: 10%;"></td> <td style="width: 10%;"></td> <td style="width: 10%;"></td> </tr> <tr> <td></td> <td></td> <td colspan="8" style="text-align: center;"> <table border="1" style="width: 100%; border-collapse: collapse; text-align: center;"> <tr> </tr></table></td></tr></table></td></tr></table></td></tr></table></td></tr></table></td></tr></table></td></tr></table></td></tr></table></td></tr></table>

 | | | | | | | | | | | | | | | | | | | | <table border="1" style="width: 100%; border-collapse: collapse; text-align: center;"> <tr> <td style="width: 10%;"></td> <td style="width: 10%;"></td> <td style="width: 10%;"></td> <td style="width: 10%;"></td> <td style="width: 10%;"></td> <td style="width: 10%;"></td> <td style="width: 10%;"></td> <td style="width: 10%;"></td> <td style="width: 10%;"></td> <td style="width: 10%;"></td> </tr> <tr> <td></td> <td></td> <td colspan="8" style="text-align: center;"> <table border="1" style="width: 100%; border-collapse: collapse; text-align: center;"> <tr> <td style="width: 10%;"></td> <td style="width: 10%;"></td> <td style="width: 10%;"></td> <td style="width: 10%;"></td> <td style="width: 10%;"></td> <td style="width: 10%;"></td> <td style="width: 10%;"></td> <td style="width: 10%;"></td> <td style="width: 10%;"></td> <td style="width: 10%;"></td> </tr> <tr> <td></td> <td></td> <td colspan="8" style="text-align: center;"> <table border="1" style="width: 100%; border-collapse: collapse; text-align: center;"> <tr> <td style="width: 10%;"></td> <td style="width: 10%;"></td> <td style="width: 10%;"></td> <td style="width: 10%;"></td> <td style="width: 10%;"></td> <td style="width: 10%;"></td> <td style="width: 10%;"></td> <td style="width: 10%;"></td> <td style="width: 10%;"></td> <td style="width: 10%;"></td> </tr> <tr> <td></td> <td></td> <td colspan="8" style="text-align: center;"> <table border="1" style="width: 100%; border-collapse: collapse; text-align: center;"> <tr> <td style="width: 10%;"></td> <td style="width: 10%;"></td> <td style="width: 10%;"></td> <td style="width: 10%;"></td> <td style="width: 10%;"></td> <td style="width: 10%;"></td> <td style="width: 10%;"></td> <td style="width: 10%;"></td> <td style="width: 10%;"></td> <td style="width: 10%;"></td> </tr> <tr> <td></td> <td></td> <td colspan="8" style="text-align: center;"> <table border="1" style="width: 100%; border-collapse: collapse; text-align: center;"> <tr> <td style="width: 10%;"></td> <td style="width: 10%;"></td> <td style="width: 10%;"></td> <td style="width: 10%;"></td> <td style="width: 10%;"></td> <td style="width: 10%;"></td> <td style="width: 10%;"></td> <td style="width: 10%;"></td> <td style="width: 10%;"></td> <td style="width: 10%;"></td> </tr> <tr> <td></td> <td></td> <td colspan="8" style="text-align: center;"> <table border="1" style="width: 100%; border-collapse: collapse; text-align: center;"> <tr> <td style="width: 10%;"></td> <td style="width: 10%;"></td> <td style="width: 10%;"></td> <td style="width: 10%;"></td> <td style="width: 10%;"></td> <td style="width: 10%;"></td> <td style="width: 10%;"></td> <td style="width: 10%;"></td> <td style="width: 10%;"></td> <td style="width: 10%;"></td> </tr> <tr> <td></td> <td></td> <td colspan="8" style="text-align: center;"> <table border="1" style="width: 100%; border-collapse: collapse; text-align: center;"> <tr> <td style="width: 10%;"></td> <td style="width: 10%;"></td> <td style="width: 10%;"></td> <td style="width: 10%;"></td> <td style="width: 10%;"></td> <td style="width: 10%;"></td> <td style="width: 10%;"></td> <td style="width: 10%;"></td> <td style="width: 10%;"></td> <td style="width: 10%;"></td> </tr> <tr> <td></td> <td></td> <td colspan="8" style="text-align: center;"> <table border="1" style="width: 100%; border-collapse: collapse; text-align: center;"> <tr> </tr></table></td></tr></table></td></tr></table></td></tr></table></td></tr></table></td></tr></table></td></tr></table></td></tr></table>
 | | | | | | | | | | | | | | | | | | | | <table border="1" style="width: 100%; border-collapse: collapse; text-align: center;"> <tr> <td style="width: 10%;"></td> <td style="width: 10%;"></td> <td style="width: 10%;"></td> <td style="width: 10%;"></td> <td style="width: 10%;"></td> <td style="width: 10%;"></td> <td style="width: 10%;"></td> <td style="width: 10%;"></td> <td style="width: 10%;"></td> <td style="width: 10%;"></td> </tr> <tr> <td></td> <td></td> <td colspan="8" style="text-align: center;"> <table border="1" style="width: 100%; border-collapse: collapse; text-align: center;"> <tr> <td style="width: 10%;"></td> <td style="width: 10%;"></td> <td style="width: 10%;"></td> <td style="width: 10%;"></td> <td style="width: 10%;"></td> <td style="width: 10%;"></td> <td style="width: 10%;"></td> <td style="width: 10%;"></td> <td style="width: 10%;"></td> <td style="width: 10%;"></td> </tr> <tr> <td></td> <td></td> <td colspan="8" style="text-align: center;"> <table border="1" style="width: 100%; border-collapse: collapse; text-align: center;"> <tr> <td style="width: 10%;"></td> <td style="width: 10%;"></td> <td style="width: 10%;"></td> <td style="width: 10%;"></td> <td style="width: 10%;"></td> <td style="width: 10%;"></td> <td style="width: 10%;"></td> <td style="width: 10%;"></td> <td style="width: 10%;"></td> <td style="width: 10%;"></td> </tr> <tr> <td></td> <td></td> <td colspan="8" style="text-align: center;"> <table border="1" style="width: 100%; border-collapse: collapse; text-align: center;"> <tr> <td style="width: 10%;"></td> <td style="width: 10%;"></td> <td style="width: 10%;"></td> <td style="width: 10%;"></td> <td style="width: 10%;"></td> <td style="width: 10%;"></td> <td style="width: 10%;"></td> <td style="width: 10%;"></td> <td style="width: 10%;"></td> <td style="width: 10%;"></td> </tr> <tr> <td></td> <td></td> <td colspan="8" style="text-align: center;"> <table border="1" style="width: 100%; border-collapse: collapse; text-align: center;"> <tr> <td style="width: 10%;"></td> <td style="width: 10%;"></td> <td style="width: 10%;"></td> <td style="width: 10%;"></td> <td style="width: 10%;"></td> <td style="width: 10%;"></td> <td style="width: 10%;"></td> <td style="width: 10%;"></td> <td style="width: 10%;"></td> <td style="width: 10%;"></td> </tr> <tr> <td></td> <td></td> <td colspan="8" style="text-align: center;"> <table border="1" style="width: 100%; border-collapse: collapse; text-align: center;"> <tr> <td style="width: 10%;"></td> <td style="width: 10%;"></td> <td style="width: 10%;"></td> <td style="width: 10%;"></td> <td style="width: 10%;"></td> <td style="width: 10%;"></td> <td style="width: 10%;"></td> <td style="width: 10%;"></td> <td style="width: 10%;"></td> <td style="width: 10%;"></td> </tr> <tr> <td></td> <td></td> <td colspan="8" style="text-align: center;"> <table border="1" style="width: 100%; border-collapse: collapse; text-align: center;"> <tr> </tr></table></td></tr></table></td></tr></table></td></tr></table></td></tr></table></td></tr></table></td></tr></table>

 | | | | | | | | | | | | | | | | | | | | <table border="1" style="width: 100%; border-collapse: collapse; text-align: center;"> <tr> <td style="width: 10%;"></td> <td style="width: 10%;"></td> <td style="width: 10%;"></td> <td style="width: 10%;"></td> <td style="width: 10%;"></td> <td style="width: 10%;"></td> <td style="width: 10%;"></td> <td style="width: 10%;"></td> <td style="width: 10%;"></td> <td style="width: 10%;"></td> </tr> <tr> <td></td> <td></td> <td colspan="8" style="text-align: center;"> <table border="1" style="width: 100%; border-collapse: collapse; text-align: center;"> <tr> <td style="width: 10%;"></td> <td style="width: 10%;"></td> <td style="width: 10%;"></td> <td style="width: 10%;"></td> <td style="width: 10%;"></td> <td style="width: 10%;"></td> <td style="width: 10%;"></td> <td style="width: 10%;"></td> <td style="width: 10%;"></td> <td style="width: 10%;"></td> </tr> <tr> <td></td> <td></td> <td colspan="8" style="text-align: center;"> <table border="1" style="width: 100%; border-collapse: collapse; text-align: center;"> <tr> <td style="width: 10%;"></td> <td style="width: 10%;"></td> <td style="width: 10%;"></td> <td style="width: 10%;"></td> <td style="width: 10%;"></td> <td style="width: 10%;"></td> <td style="width: 10%;"></td> <td style="width: 10%;"></td> <td style="width: 10%;"></td> <td style="width: 10%;"></td> </tr> <tr> <td></td> <td></td> <td colspan="8" style="text-align: center;"> <table border="1" style="width: 100%; border-collapse: collapse; text-align: center;"> <tr> <td style="width: 10%;"></td> <td style="width: 10%;"></td> <td style="width: 10%;"></td> <td style="width: 10%;"></td> <td style="width: 10%;"></td> <td style="width: 10%;"></td> <td style="width: 10%;"></td> <td style="width: 10%;"></td> <td style="width: 10%;"></td> <td style="width: 10%;"></td> </tr> <tr> <td></td> <td></td> <td colspan="8" style="text-align: center;"> <table border="1" style="width: 100%; border-collapse: collapse; text-align: center;"> <tr> <td style="width: 10%;"></td> <td style="width: 10%;"></td> <td style="width: 10%;"></td> <td style="width: 10%;"></td> <td style="width: 10%;"></td> <td style="width: 10%;"></td> <td style="width: 10%;"></td> <td style="width: 10%;"></td> <td style="width: 10%;"></td> <td style="width: 10%;"></td> </tr> <tr> <td></td> <td></td> <td colspan="8" style="text-align: center;"> <table border="1" style="width: 100%; border-collapse: collapse; text-align: center;"> <tr> </tr></table></td></tr></table></td></tr></table></td></tr></table></td></tr></table></td></tr></table>
 | | | | | | | | | | | | | | | | | | | | <table border="1" style="width: 100%; border-collapse: collapse; text-align: center;"> <tr> <td style="width: 10%;"></td> <td style="width: 10%;"></td> <td style="width: 10%;"></td> <td style="width: 10%;"></td> <td style="width: 10%;"></td> <td style="width: 10%;"></td> <td style="width: 10%;"></td> <td style="width: 10%;"></td> <td style="width: 10%;"></td> <td style="width: 10%;"></td> </tr> <tr> <td></td> <td></td> <td colspan="8" style="text-align: center;"> <table border="1" style="width: 100%; border-collapse: collapse; text-align: center;"> <tr> <td style="width: 10%;"></td> <td style="width: 10%;"></td> <td style="width: 10%;"></td> <td style="width: 10%;"></td> <td style="width: 10%;"></td> <td style="width: 10%;"></td> <td style="width: 10%;"></td> <td style="width: 10%;"></td> <td style="width: 10%;"></td> <td style="width: 10%;"></td> </tr> <tr> <td></td> <td></td> <td colspan="8" style="text-align: center;"> <table border="1" style="width: 100%; border-collapse: collapse; text-align: center;"> <tr> <td style="width: 10%;"></td> <td style="width: 10%;"></td> <td style="width: 10%;"></td> <td style="width: 10%;"></td> <td style="width: 10%;"></td> <td style="width: 10%;"></td> <td style="width: 10%;"></td> <td style="width: 10%;"></td> <td style="width: 10%;"></td> <td style="width: 10%;"></td> </tr> <tr> <td></td> <td></td> <td colspan="8" style="text-align: center;"> <table border="1" style="width: 100%; border-collapse: collapse; text-align: center;"> <tr> <td style="width: 10%;"></td> <td style="width: 10%;"></td> <td style="width: 10%;"></td> <td style="width: 10%;"></td> <td style="width: 10%;"></td> <td style="width: 10%;"></td> <td style="width: 10%;"></td> <td style="width: 10%;"></td> <td style="width: 10%;"></td> <td style="width: 10%;"></td> </tr> <tr> <td></td> <td></td> <td colspan="8" style="text-align: center;"> <table border="1" style="width: 100%; border-collapse: collapse; text-align: center;"> <tr> </tr></table></td></tr></table></td></tr></table></td></tr></table></td></tr></table>

 | | | | | | | | | | | | | | | | | | | | <table border="1" style="width: 100%; border-collapse: collapse; text-align: center;"> <tr> <td style="width: 10%;"></td> <td style="width: 10%;"></td> <td style="width: 10%;"></td> <td style="width: 10%;"></td> <td style="width: 10%;"></td> <td style="width: 10%;"></td> <td style="width: 10%;"></td> <td style="width: 10%;"></td> <td style="width: 10%;"></td> <td style="width: 10%;"></td> </tr> <tr> <td></td> <td></td> <td colspan="8" style="text-align: center;"> <table border="1" style="width: 100%; border-collapse: collapse; text-align: center;"> <tr> <td style="width: 10%;"></td> <td style="width: 10%;"></td> <td style="width: 10%;"></td> <td style="width: 10%;"></td> <td style="width: 10%;"></td> <td style="width: 10%;"></td> <td style="width: 10%;"></td> <td style="width: 10%;"></td> <td style="width: 10%;"></td> <td style="width: 10%;"></td> </tr> <tr> <td></td> <td></td> <td colspan="8" style="text-align: center;"> <table border="1" style="width: 100%; border-collapse: collapse; text-align: center;"> <tr> <td style="width: 10%;"></td> <td style="width: 10%;"></td> <td style="width: 10%;"></td> <td style="width: 10%;"></td> <td style="width: 10%;"></td> <td style="width: 10%;"></td> <td style="width: 10%;"></td> <td style="width: 10%;"></td> <td style="width: 10%;"></td> <td style="width: 10%;"></td> </tr> <tr> <td></td> <td></td> <td colspan="8" style="text-align: center;"> <table border="1" style="width: 100%; border-collapse: collapse; text-align: center;"> <tr> </tr></table></td></tr></table></td></tr></table></td></tr></table>
 | | | | | | | | | | | | | | | | | | | | <table border="1" style="width: 100%; border-collapse: collapse; text-align: center;"> <tr> <td style="width: 10%;"></td> <td style="width: 10%;"></td> <td style="width: 10%;"></td> <td style="width: 10%;"></td> <td style="width: 10%;"></td> <td style="width: 10%;"></td> <td style="width: 10%;"></td> <td style="width: 10%;"></td> <td style="width: 10%;"></td> <td style="width: 10%;"></td> </tr> <tr> <td></td> <td></td> <td colspan="8" style="text-align: center;"> <table border="1" style="width: 100%; border-collapse: collapse; text-align: center;"> <tr> <td style="width: 10%;"></td> <td style="width: 10%;"></td> <td style="width: 10%;"></td> <td style="width: 10%;"></td> <td style="width: 10%;"></td> <td style="width: 10%;"></td> <td style="width: 10%;"></td> <td style="width: 10%;"></td> <td style="width: 10%;"></td> <td style="width: 10%;"></td> </tr> <tr> <td></td> <td></td> <td colspan="8" style="text-align: center;"> <table border="1" style="width: 100%; border-collapse: collapse; text-align: center;"> <tr> </tr></table></td></tr></table></td></tr></table>
 | | | | | | | | | | | | | | | | | | | | <table border="1" style="width: 100%; border-collapse: collapse; text-align: center;"> <tr> <td style="width: 10%;"></td> <td style="width: 10%;"></td> <td style="width: 10%;"></td> <td style="width: 10%;"></td> <td style="width: 10%;"></td> <td style="width: 10%;"></td> <td style="width: 10%;"></td> <td style="width: 10%;"></td> <td style="width: 10%;"></td> <td style="width: 10%;"></td> </tr> <tr> <td></td> <td></td> <td colspan="8" style="text-align: center;"> <table border="1" style="width: 100%; border-collapse: collapse; text-align: center;"> <tr> </tr></table></td></tr></table>

 | | | | | | | | | | | | | | | | | | | | <table border="1" style="width: 100%; border-collapse: collapse; text-align: center;"> <tr> </tr></table>
 | | | | | | | | | | | | | | | | | | | | | | | | | | | | | | | | | | | | | | | | | | | | | | | | | | | | | | | | | | | | | | | | | | | | | | | | | | | | | | | |
 | | | | | | | | | | | | | | | | | | | |
 | | | | | | | | | | | | | | | | | | | |
 | | | | | | | | | | | | | | | | | | | |
 | | | | | | | | | | | | | | | | | | | |
 | | | | | | | | | | | | | | | | | | | |
 | | | | | | | | | | | | | | | | | | | |
 | | | | | | | | | | | | | | | | | | | |
 | | | | | | | | | | | | | | | | | | | |
 | | | | | | | | | | | | | | | | | | | | | | | | | | | | | | | | | | | | | | | |
 | | | | | | | | | | | | | | | | | | | |
 | | | | | | | | | | | | | | | | | | | | | | | | | | | | | | | | | | | | | | | |
 | | | | | | | | | | | | | | | | | | | | | | | | | | | | | | | | | | | | | | | |
 | | | | | | | | | | | | | | | | | | | | | | | | | | | | | | | | | | | | | | | |
 | | | | | | | | | | | | | | | | | | | | | | | | | | | | | | | | | | | | | | | | | | | | | | | | | | | | | | | | | | | | | | | | | | | | | | | | | | | | | | | |
 | | | | | | | | | | | | | | | | | | | | | | | | | | | | | | | | | | | | | | | | | | | | | | | | | | | | | | | | | | | | | | | | | | | |
| | |

 | | | | | | | | | | | | | | | | | | | |

 | | | | | | | | | | | | | | | | | | | |

 | | | | | | | | | | | | | | | | | | | |

 | | | | | | | | | | | | | | | | | | | |

 | | | | | | | | | | | | | | | | | | | |

 | | | | | | | | | | | | | | | | | | | |

 | | | | | | | | | | | | | | | | | | | |

 | | | | | | | | | | | | | | | | | | | |

 | | | | | | | | | | | | | | | | | | | |

 | | | | | | | | | | | | | | | | | | | |

 | | | | | | | | | | | | | | | | | | | |

 | | | | | | | | | | | | | | | | | | | |

 | | | | | | | | | | | | | | | | | | | |

 | | | | | | | | | | | | | | | | | | | |

 | | | | | | | | | | | | | | | | | | | |

 | | | | | | | | | | | | | | | | | | | |

 | | | | | | | | | | | | | | | | | | | |

 | | | | | | | | | | | | | | | | | | | |

 | | | | | | | | | | | | | | | | | | | |

 | | | | | | | | | | | | | | | | | | | |

 | | | | | | | | | | | | | | | | | | | |

 | | | | | | | | | | | | | | | | | | | |

 | | | | | | | | | | | | | | | | | | | |

 | | | | | | | | | | | | | | | | | | | |

 | | | | | | | | | | | | | | | | | | | |

 | | | | | | | | | | | | | | | | | | | |

 | | | | | | | | | | | | | | | | | | | |

 | | | | | | | | | | | | | | | | | | | |
 | | | | | | | | | | | | | | | | | | | |

 | | | | | | | | | | | | | | | | | | | |

 | | | | | | | | | | | | | | | | | | | |
 | | | | | | | | | | | | | | | | | | | |

 | | | | | | | | | | | | | | | | | | | |

 | | | | | | | | | | | | | | | | | | | |
 | | | | | | | | | | | | | | | | | | | |
 | | | | | | | | | | | | | | | | | | | |

 | | | | | | | | | | | | | | | | | | | |
 | | | | | | | | | | | | | | | | | | | |
 | | | | | | | | | | | | | | | | | | | |

 | | | | | | | | | | | | | | | | | | | | | | | | | | | | | | | | | | | | | | | | | | | | | | | | | | | | | | | | | | | | | | | | | | | | | | | | | | | | | | | | | | | | | | | | | | | | | | | | | | | |
 | | | | | | | | | | | | | | | | | | | |
 | | | | | | | | | | | | | | | | | | | |
 | | | | | | | | | | | | | | | | | | | |
 | | | | | | | | | | | | | | | | | | | |
 | | | | | | | | | | | | | | | | | | | |
 | | | | | | | | | | | | | | | | | | | |
 | | | | | | | | | | | | | | | | | | | |
 | | | | | | | | | | | | | | | | | | | |
 | | | | | | | | | | | | | | | | | | | | | | | | | | | | | | | | | | | | | | | |
 | | | | | | | | | | | | | | | | | | | |
 | | | | | | | | | | | | | | | | | | | | | | | | | | | | | | | | | | | | | | | |
 | | | | | | | | | | | | | | | | | | | | | | | | | | | | | | | | | | | | | | | |
 | | | | | | | | | | | | | | | | | | | | | | | | | | | | | | | | | | | | | | | |
 | | | | | | | | | | | | | | | | | | | | | | | | | | | | | | | | | | | | | | | | | | | | | | | | | | | | | | | | | | | | | | | | | | | | | | | | | | | | | | | | | | | | | | | | | | | | | | | | | | | |
 | | | | | | | | | | | | | | | | | | | | | | | | | | | | | | | | | | | | | | | | | | | | | | | |
| | | <table border="1" style="width: 100%; border-collapse: collapse; text-align: center;"> <tr> <td style="width: 10%;"></td> <td style="width: 10%;"></td> <td style="width: 10%;"></td> <td style="width: 10%;"></td> <td style="width: 10%;"></td> <td style="width: 10%;"></td> <td style="width: 10%;"></td> <td style="width: 10%;"></td> <td style="width: 10%;"></td> <td style="width: 10%;"></td> </tr> <tr> <td></td> <td></td> <td colspan="8" style="text-align: center;"> <table border="1" style="width: 100%; border-collapse: collapse; text-align: center;"> <tr> <td style="width: 10%;"></td> <td style="width: 10%;"></td> <td style="width: 10%;"></td> <td style="width: 10%;"></td> <td style="width: 10%;"></td> <td style="width: 10%;"></td> <td style="width: 10%;"></td> <td style="width: 10%;"></td> <td style="width: 10%;"></td> <td style="width: 10%;"></td> </tr> <tr> <td></td> <td></td> <td colspan="8" style="text-align: center;"> <table border="1" style="width: 100%; border-collapse: collapse; text-align: center;"> <tr> <td style="width: 10%;"></td> <td style="width: 10%;"></td> <td style="width: 10%;"></td> <td style="width: 10%;"></td> <td style="width: 10%;"></td> <td style="width: 10%;"></td> <td style="width: 10%;"></td> <td style="width: 10%;"></td> <td style="width: 10%;"></td> <td style="width: 10%;"></td> </tr> <tr> <td></td> <td></td> <td colspan="8" style="text-align: center;"> <table border="1" style="width: 100%; border-collapse: collapse; text-align: center;"> <tr> <td style="width: 10%;"></td> <td style="width: 10%;"></td> <td style="width: 10%;"></td> <td style="width: 10%;"></td> <td style="width: 10%;"></td> <td style="width: 10%;"></td> <td style="width: 10%;"></td> <td style="width: 10%;"></td> <td style="width: 10%;"></td> <td style="width: 10%;"></td> </tr> <tr> <td></td> <td></td> <td colspan="8" style="text-align: center;"> <table border="1" style="width: 100%; border-collapse: collapse; text-align: center;"> <tr> <td style="width: 10%;"></td> <td style="width: 10%;"></td> <td style="width: 10%;"></td> <td style="width: 10%;"></td> <td style="width: 10%;"></td> <td style="width: 10%;"></td> <td style="width: 10%;"></td> <td style="width: 10%;"></td> <td style="width: 10%;"></td> <td style="width: 10%;"></td> </tr> <tr> <td></td> <td></td> <td colspan="8" style="text-align: center;"> <table border="1" style="width: 100%; border-collapse: collapse; text-align: center;"> <tr> <td style="width: 10%;"></td> <td style="width: 10%;"></td> <td style="width: 10%;"></td> <td style="width: 10%;"></td> <td style="width: 10%;"></td> <td style="width: 10%;"></td> <td style="width: 10%;"></td> <td style="width: 10%;"></td> <td style="width: 10%;"></td> <td style="width: 10%;"></td> </tr> <tr> <td></td> <td></td> <td colspan="8" style="text-align: center;"> <table border="1" style="width: 100%; border-collapse: collapse; text-align: center;"> <tr> <td style="width: 10%;"></td> <td style="width: 10%;"></td> <td style="width: 10%;"></td> <td style="width: 10%;"></td> <td style="width: 10%;"></td> <td style="width: 10%;"></td> <td style="width: 10%;"></td> <td style="width: 10%;"></td> <td style="width: 10%;"></td> <td style="width: 10%;"></td> </tr> <tr> <td></td> <td></td> <td colspan="8" style="text-align: center;"> <table border="1" style="width: 100%; border-collapse: collapse; text-align: center;"> <tr> <td style="width: 10%;"></td> <td style="width: 10%;"></td> <td style="width: 10%;"></td> <td style="width: 10%;"></td> <td style="width: 10%;"></td> <td style="width: 10%;"></td> <td style="width: 10%;"></td> <td style="width: 10%;"></td> <td style="width: 10%;"></td> <td style="width: 10%;"></td> </tr> <tr> <td></td> <td></td> <td colspan="8" style="text-align: center;"> <table border="1" style="width: 100%; border-collapse: collapse; text-align: center;"> <tr> <td style="width: 10%;"></td> <td style="width: 10%;"></td> <td style="width: 10%;"></td> <td style="width: 10%;"></td> <td style="width: 10%;"></td> <td style="width: 10%;"></td> <td style="width: 10%;"></td> <td style="width: 10%;"></td> <td style="width: 10%;"></td> <td style="width: 10%;"></td> </tr> <tr> <td></td> <td></td> <td colspan="8" style="text-align: center;"> <table border="1" style="width: 100%; border-collapse: collapse; text-align: center;"> <tr> <td style="width: 10%;"></td> <td style="width: 10%;"></td> <td style="width: 10%;"></td> <td style="width: 10%;"></td> <td style="width: 10%;"></td> <td style="width: 10%;"></td> <td style="width: 10%;"></td> <td style="width: 10%;"></td> <td style="width: 10%;"></td> <td style="width: 10%;"></td> </tr> <tr> <td></td> <td></td> <td colspan="8" style="text-align: center;"> <table border="1" style="width: 100%; border-collapse: collapse; text-align: center;"> <tr> <td style="width: 10%;"></td> <td style="width: 10%;"></td> <td style="width: 10%;"></td> <td style="width: 10%;"></td> <td style="width: 10%;"></td> <td style="width: 10%;"></td> <td style="width: 10%;"></td> <td style="width: 10%;"></td> <td style="width: 10%;"></td> <td style="width: 10%;"></td> </tr> <tr> <td></td> <td></td> <td colspan="8" style="text-align: center;"> <table border="1" style="width: 100%; border-collapse: collapse; text-align: center;"> <tr> <td style="width: 10%;"></td> <td style="width: 10%;"></td> <td style="width: 10%;"></td> <td style="width: 10%;"></td> <td style="width: 10%;"></td> <td style="width: 10%;"></td> <td style="width: 10%;"></td> <td style="width: 10%;"></td> <td style="width: 10%;"></td> <td style="width: 10%;"></td> </tr> <tr> <td></td> <td></td> <td colspan="8" style="text-align: center;"> <table border="1" style="width: 100%; border-collapse: collapse; text-align: center;"> <tr> <td style="width: 10%;"></td> <td style="width: 10%;"></td> <td style="width: 10%;"></td> <td style="width: 10%;"></td> <td style="width: 10%;"></td> <td style="width: 10%;"></td> <td style="width: 10%;"></td> <td style="width: 10%;"></td> <td style="width: 10%;"></td> <td style="width: 10%;"></td> </tr> <tr> <td></td> <td></td> <td colspan="8" style="text-align: center;"> <table border="1" style="width: 100%; border-collapse: collapse; text-align: center;"> <tr> <td style="width: 10%;"></td> <td style="width: 10%;"></td> <td style="width: 10%;"></td> <td style="width: 10%;"></td> <td style="width: 10%;"></td> <td style="width: 10%;"></td> <td style="width: 10%;"></td> <td style="width: 10%;"></td> <td style="width: 10%;"></td> <td style="width: 10%;"></td> </tr> <tr> <td></td> <td></td> <td colspan="8" style="text-align: center;"> <table border="1" style="width: 100%; border-collapse: collapse; text-align: center;"> <tr> <td style="width: 10%;"></td> <td style="width: 10%;"></td> <td style="width: 10%;"></td> <td style="width: 10%;"></td> <td style="width: 10%;"></td> <td style="width: 10%;"></td> <td style="width: 10%;"></td> <td style="width: 10%;"></td> <td style="width: 10%;"></td> <td style="width: 10%;"></td> </tr> <tr> <td></td> <td></td> <td colspan="8" style="text-align: center;"> <table border="1" style="width: 100%; border-collapse: collapse; text-align: center;"> <tr> <td style="width: 10%;"></td> <td style="width: 10%;"></td> <td style="width: 10%;"></td> <td style="width: 10%;"></td> <td style="width: 10%;"></td> <td style="width: 10%;"></td> <td style="width: 10%;"></td> <td style="width: 10%;"></td> <td style="width: 10%;"></td> <td style="width: 10%;"></td> </tr> <tr> <td></td> <td></td> <td colspan="8" style="text-align: center;"> <table border="1" style="width: 100%; border-collapse: collapse; text-align: center;"> <tr> <td style="width: 10%;"></td> <td style="width: 10%;"></td> <td style="width: 10%;"></td> <td style="width: 10%;"></td> <td style="width: 10%;"></td> <td style="width: 10%;"></td> <td style="width: 10%;"></td> <td style="width: 10%;"></td> <td style="width: 10%;"></td> <td style="width: 10%;"></td> </tr> <tr> <td></td> <td></td> <td colspan="8" style="text-align: center;"> <table border="1" style="width: 100%; border-collapse: collapse; text-align: center;"> <tr> <td style="width: 10%;"></td> <td style="width: 10%;"></td> <td style="width: 10%;"></td> <td style="width: 10%;"></td> <td style="width: 10%;"></td> <td style="width: 10%;"></td> <td style="width: 10%;"></td> <td style="width: 10%;"></td> <td style="width: 10%;"></td> <td style="width: 10%;"></td> </tr> <tr> <td></td> <td></td> <td colspan="8" style="text-align: center;"> <table border="1" style="width: 100%; border-collapse: collapse; text-align: center;"> <tr> <td style="width: 10%;"></td> <td style="width: 10%;"></td> <td style="width: 10%;"></td> <td style="width: 10%;"></td> <td style="width: 10%;"></td> <td style="width: 10%;"></td> <td style="width: 10%;"></td> <td style="width: 10%;"></td> <td style="width: 10%;"></td> <td style="width: 10%;"></td> </tr> <tr> <td></td> <td></td> <td colspan="8" style="text-align: center;"> <table border="1" style="width: 100%; border-collapse: collapse; text-align: center;"> <tr> <td style="width: 10%;"></td> <td style="width: 10%;"></td> <td style="width: 10%;"></td> <td style="width: 10%;"></td> <td style="width: 10%;"></td> <td style="width: 10%;"></td> <td style="width: 10%;"></td> <td style="width: 10%;"></td> <td style="width: 10%;"></td> <td style="width: 10%;"></td> </tr> <tr> <td></td> <td></td> <td colspan="8" style="text-align: center;"> <table border="1" style="width: 100%; border-collapse: collapse; text-align: center;"> <tr> <td style="width: 10%;"></td> <td style="width: 10%;"></td> <td style="width: 10%;"></td> <td style="width: 10%;"></td> <td style="width: 10%;"></td> <td style="width: 10%;"></td> <td style="width: 10%;"></td> <td style="width: 10%;"></td> <td style="width: 10%;"></td> <td style="width: 10%;"></td> </tr> <tr> <td></td> <td></td> <td colspan="8" style="text-align: center;"> <table border="1" style="width: 100%; border-collapse: collapse; text-align: center;"> <tr> <td style="width: 10%;"></td> <td style="width: 10%;"></td> <td
style="width: 10%;"></td> <td style="width: 10%;"></td> <td style="width: 10%;"></td> <td style="width: 10%;"></td> <td style="width: 10%;"></td> <td style="width: 10%;"></td> <td style="width: 10%;"></td> <td style="width: 10%;"></td> </tr> <tr> <td></td> <td></td> <td colspan="8" style="text-align: center;"> <table border="1" style="width: 100%; border-collapse: collapse; text-align: center;"> <tr> <td style="width: 10%;"></td> <td style="width: 10%;"></td> <td style="width: 10%;"></td> <td style="width: 10%;"></td> <td style="width: 10%;"></td> <td style="width: 10%;"></td> <td style="width: 10%;"></td> <td style="width: 10%;"></td> <td style="width: 10%;"></td> <td style="width: 10%;"></td> </tr> <tr> <td></td> <td></td> <td colspan="8" style="text-align: center;"> <table border="1" style="width: 100%; border-collapse: collapse; text-align: center;"> <tr> <td style="width: 10%;"></td> <td style="width: 10%;"></td> <td style="width: 10%;"></td> <td style="width: 10%;"></td> <td style="width: 10%;"></td> <td style="width: 10%;"></td> <td style="width: 10%;"></td> <td style="width: 10%;"></td> <td style="width: 10%;"></td> <td style="width: 10%;"></td> </tr> <tr> <td></td> <td></td> <td colspan="8" style="text-align: center;"> <table border="1" style="width: 100%; border-collapse: collapse; text-align: center;"> <tr> <td style="width: 10%;"></td> <td style="width: 10%;"></td> <td style="width: 10%;"></td> <td style="width: 10%;"></td> <td style="width: 10%;"></td> <td style="width: 10%;"></td> <td style="width: 10%;"></td> <td style="width: 10%;"></td> <td style="width: 10%;"></td> <td style="width: 10%;"></td> </tr> <tr> <td></td> <td></td> <td colspan="8" style="text-align: center;"> <table border="1" style="width: 100%; border-collapse: collapse; text-align: center;"> <tr> <td style="width: 10%;"></td> <td style="width: 10%;"></td> <td style="width: 10%;"></td> <td style="width: 10%;"></td> <td style="width: 10%;"></td> <td style="width: 10%;"></td> <td style="width: 10%;"></td> <td style="width: 10%;"></td> <td style="width: 10%;"></td> <td style="width: 10%;"></td> </tr> <tr> <td></td> <td></td> <td colspan="8" style="text-align: center;"> <table border="1" style="width: 100%; border-collapse: collapse; text-align: center;"> <tr> <td style="width: 10%;"></td> <td style="width: 10%;"></td> <td style="width: 10%;"></td> <td style="width: 10%;"></td> <td style="width: 10%;"></td> <td style="width: 10%;"></td> <td style="width: 10%;"></td> <td style="width: 10%;"></td> <td style="width: 10%;"></td> <td style="width: 10%;"></td> </tr> <tr> <td></td> <td></td> <td colspan="8" style="text-align: center;"> <table border="1" style="width: 100%; border-collapse: collapse; text-align: center;"> <tr> <td style="width: 10%;"></td> <td style="width: 10%;"></td> <td style="width: 10%;"></td> <td style="width: 10%;"></td> <td style="width: 10%;"></td> <td style="width: 10%;"></td> <td style="width: 10%;"></td> <td style="width: 10%;"></td> <td style="width: 10%;"></td> <td style="width: 10%;"></td> </tr> <tr> <td></td> <td></td> <td colspan="8" style="text-align: center;"> <table border="1" style="width: 100%; border-collapse: collapse; text-align: center;"> <tr> <td style="width: 10%;"></td> <td style="width: 10%;"></td> <td style="width: 10%;"></td> <td style="width: 10%;"></td> <td style="width: 10%;"></td> <td style="width: 10%;"></td> <td style="width: 10%;"></td> <td style="width: 10%;"></td> <td style="width: 10%;"></td> <td style="width: 10%;"></td> </tr> <tr> <td></td> <td></td> <td colspan="8" style="text-align: center;"> <table border="1" style="width: 100%; border-collapse: collapse; text-align: center;"> <tr> <td style="width: 10%;"></td> <td style="width: 10%;"></td> <td style="width: 10%;"></td> <td style="width: 10%;"></td> <td style="width: 10%;"></td> <td style="width: 10%;"></td> <td style="width: 10%;"></td> <td style="width: 10%;"></td> <td style="width: 10%;"></td> <td style="width: 10%;"></td> </tr> <tr> <td></td> <td></td> <td colspan="8" style="text-align: center;"> <table border="1" style="width: 100%; border-collapse: collapse; text-align: center;"> <tr> <td style="width: 10%;"></td> <td style="width: 10%;"></td> <td style="width: 10%;"></td> <td style="width: 10%;"></td> <td style="width: 10%;"></td> <td style="width: 10%;"></td> <td style="width: 10%;"></td> <td style="width: 10%;"></td> <td style="width: 10%;"></td> <td style="width: 10%;"></td> </tr> <tr> <td></td> <td></td> <td colspan="8" style="text-align: center;"> <table border="1" style="width: 100%; border-collapse: collapse; text-align: center;"> <tr> <td style="width: 10%;"></td> <td style="width: 10%;"></td> <td style="width: 10%;"></td> <td style="width: 10%;"></td> <td style="width: 10%;"></td> <td style="width: 10%;"></td> <td style="width: 10%;"></td> <td style="width: 10%;"></td> <td style="width: 10%;"></td> <td style="width: 10%;"></td> </tr> <tr> <td></td> <td></td> <td colspan="8" style="text-align: center;"> <table border="1" style="width: 100%; border-collapse: collapse; text-align: center;"> <tr> <td style="width: 10%;"></td> <td style="width: 10%;"></td> <td style="width: 10%;"></td> <td style="width: 10%;"></td> <td style="width: 10%;"></td> <td style="width: 10%;"></td> <td style="width: 10%;"></td> <td style="width: 10%;"></td> <td style="width: 10%;"></td> <td style="width: 10%;"></td> </tr> <tr> <td></td> <td></td> <td colspan="8" style="text-align: center;"> <table border="1" style="width: 100%; border-collapse: collapse; text-align: center;"> <tr> <td style="width: 10%;"></td> <td style="width: 10%;"></td> <td style="width: 10%;"></td> <td style="width: 10%;"></td> <td style="width: 10%;"></td> <td style="width: 10%;"></td> <td style="width: 10%;"></td> <td style="width: 10%;"></td> <td style="width: 10%;"></td> <td style="width: 10%;"></td> </tr> <tr> <td></td> <td></td> <td colspan="8" style="text-align: center;"> <table border="1" style="width: 100%; border-collapse: collapse; text-align: center;"> <tr> <td style="width: 10%;"></td> <td style="width: 10%;"></td> <td style="width: 10%;"></td> <td style="width: 10%;"></td> <td style="width: 10%;"></td> <td style="width: 10%;"></td> <td style="width: 10%;"></td> <td style="width: 10%;"></td> <td style="width: 10%;"></td> <td style="width: 10%;"></td> </tr> <tr> <td></td> <td></td> <td colspan="8" style="text-align: center;"> <table border="1" style="width: 100%; border-collapse: collapse; text-align: center;"> <tr> <td style="width: 10%;"></td> <td style="width: 10%;"></td> <td style="width: 10%;"></td> <td style="width: 10%;"></td> <td style="width: 10%;"></td> <td style="width: 10%;"></td> <td style="width: 10%;"></td> <td style="width: 10%;"></td> <td style="width: 10%;"></td> <td style="width: 10%;"></td> </tr> <tr> <td></td> <td></td> <td colspan="8" style="text-align: center;"> <table border="1" style="width: 100%; border-collapse: collapse; text-align: center;"> <tr> <td style="width: 10%;"></td> <td style="width: 10%;"></td> <td style="width: 10%;"></td> <td style="width: 10%;"></td> <td style="width: 10%;"></td> <td style="width: 10%;"></td> <td style="width: 10%;"></td> <td style="width: 10%;"></td> <td style="width: 10%;"></td> <td style="width: 10%;"></td> </tr> <tr> <td></td> <td></td> <td colspan="8" style="text-align: center;"> <table border="1" style="width: 100%; border-collapse: collapse; text-align: center;"> <tr> <td style="width: 10%;"></td> <td style="width: 10%;"></td> <td style="width: 10%;"></td> <td style="width: 10%;"></td> <td style="width: 10%;"></td> <td style="width: 10%;"></td> <td style="width: 10%;"></td> <td style="width: 10%;"></td> <td style="width: 10%;"></td> <td style="width: 10%;"></td> </tr> <tr> <td></td> <td></td> <td colspan="8" style="text-align: center;"> <table border="1" style="width: 100%; border-collapse: collapse; text-align: center;"> <tr> </tr></table></td></tr></table></td></tr></table></td></tr></table></td></tr></table></td></tr></table></td></tr></table></td></tr></table></td></tr></table></td></tr></table></td></tr></table></td></tr></table></td></tr></table></td></tr></table></td></tr></table></td></tr></table></td></tr></table></td></tr></table></td></tr></table></td></tr></table></td></tr></table></td></tr></table></td></tr></table></td></tr></table></td></tr></table></td></tr></table></td></tr></table></td></tr></table></td></tr></table></td></tr></table></td></tr></table></td></tr></table></td></tr></table></td></tr></table></td></tr></table></td></tr></table></td></tr></table></td></tr></table></td></tr></table>

 | | | | | | | | | | | | | | | | | | | | <table border="1" style="width: 100%; border-collapse: collapse; text-align: center;"> <tr> <td style="width: 10%;"></td> <td style="width: 10%;"></td> <td style="width: 10%;"></td> <td style="width: 10%;"></td> <td style="width: 10%;"></td> <td style="width: 10%;"></td> <td style="width: 10%;"></td> <td style="width: 10%;"></td> <td style="width: 10%;"></td> <td style="width: 10%;"></td> </tr> <tr> <td></td> <td></td> <td colspan="8" style="text-align: center;"> <table border="1" style="width: 100%; border-collapse: collapse; text-align: center;"> <tr> <td style="width: 10%;"></td> <td style="width: 10%;"></td> <td style="width: 10%;"></td> <td style="width: 10%;"></td> <td style="width: 10%;"></td> <td style="width: 10%;"></td> <td style="width: 10%;"></td> <td style="width: 10%;"></td> <td style="width: 10%;"></td> <td style="width: 10%;"></td> </tr> <tr> <td></td> <td></td> <td colspan="8" style="text-align: center;"> <table border="1" style="width: 100%; border-collapse: collapse; text-align: center;"> <tr> <td style="width: 10%;"></td> <td style="width: 10%;"></td> <td style="width: 10%;"></td> <td style="width: 10%;"></td> <td style="width: 10%;"></td> <td style="width: 10%;"></td> <td style="width: 10%;"></td> <td style="width: 10%;"></td> <td style="width: 10%;"></td> <td style="width: 10%;"></td> </tr> <tr> <td></td> <td></td> <td colspan="8" style="text-align: center;"> <table border="1" style="width: 100%; border-collapse: collapse; text-align: center;"> <tr> <td style="width: 10%;"></td> <td style="width: 10%;"></td> <td style="width: 10%;"></td> <td style="width: 10%;"></td> <td style="width: 10%;"></td> <td style="width: 10%;"></td> <td style="width: 10%;"></td> <td style="width: 10%;"></td> <td style="width: 10%;"></td> <td style="width: 10%;"></td> </tr> <tr> <td></td> <td></td> <td colspan="8" style="text-align: center;"> <table border="1" style="width: 100%; border-collapse: collapse; text-align: center;"> <tr> <td style="width: 10%;"></td> <td style="width: 10%;"></td> <td style="width: 10%;"></td> <td style="width: 10%;"></td> <td style="width: 10%;"></td> <td style="width: 10%;"></td> <td style="width: 10%;"></td> <td style="width: 10%;"></td> <td style="width: 10%;"></td> <td style="width: 10%;"></td> </tr> <tr> <td></td> <td></td> <td colspan="8" style="text-align: center;"> <table border="1" style="width: 100%; border-collapse: collapse; text-align: center;"> <tr> <td style="width: 10%;"></td> <td style="width: 10%;"></td> <td style="width: 10%;"></td> <td style="width: 10%;"></td> <td style="width: 10%;"></td> <td style="width: 10%;"></td> <td style="width: 10%;"></td> <td style="width: 10%;"></td> <td style="width: 10%;"></td> <td style="width: 10%;"></td> </tr> <tr> <td></td> <td></td> <td colspan="8" style="text-align: center;"> <table border="1" style="width: 100%; border-collapse: collapse; text-align: center;"> <tr> <td style="width: 10%;"></td> <td style="width: 10%;"></td> <td style="width: 10%;"></td> <td style="width: 10%;"></td> <td style="width: 10%;"></td> <td style="width: 10%;"></td> <td style="width: 10%;"></td> <td style="width: 10%;"></td> <td style="width: 10%;"></td> <td style="width: 10%;"></td> </tr> <tr> <td></td> <td></td> <td colspan="8" style="text-align: center;"> <table border="1" style="width: 100%; border-collapse: collapse; text-align: center;"> <tr> <td style="width: 10%;"></td> <td style="width: 10%;"></td> <td style="width: 10%;"></td> <td style="width: 10%;"></td> <td style="width: 10%;"></td> <td style="width: 10%;"></td> <td style="width: 10%;"></td> <td style="width: 10%;"></td> <td style="width: 10%;"></td> <td style="width: 10%;"></td> </tr> <tr> <td></td> <td></td> <td colspan="8" style="text-align: center;"> <table border="1" style="width: 100%; border-collapse: collapse; text-align: center;"> <tr> <td style="width: 10%;"></td> <td style="width: 10%;"></td> <td style="width: 10%;"></td> <td style="width: 10%;"></td> <td style="width: 10%;"></td> <td style="width: 10%;"></td> <td style="width: 10%;"></td> <td style="width: 10%;"></td> <td style="width: 10%;"></td> <td style="width: 10%;"></td> </tr> <tr> <td></td> <td></td> <td colspan="8" style="text-align: center;"> <table border="1" style="width: 100%; border-collapse: collapse; text-align: center;"> <tr> <td style="width: 10%;"></td> <td style="width: 10%;"></td> <td style="width: 10%;"></td> <td style="width: 10%;"></td> <td style="width: 10%;"></td> <td style="width: 10%;"></td> <td style="width: 10%;"></td> <td style="width: 10%;"></td> <td style="width: 10%;"></td> <td style="width: 10%;"></td> </tr> <tr> <td></td> <td></td> <td colspan="8" style="text-align: center;"> <table border="1" style="width: 100%; border-collapse: collapse; text-align: center;"> <tr> <td style="width: 10%;"></td> <td style="width: 10%;"></td> <td style="width: 10%;"></td> <td style="width: 10%;"></td> <td style="width: 10%;"></td> <td style="width: 10%;"></td> <td style="width: 10%;"></td> <td style="width: 10%;"></td> <td style="width: 10%;"></td> <td style="width: 10%;"></td> </tr> <tr> <td></td> <td></td> <td colspan="8" style="text-align: center;"> <table border="1" style="width: 100%; border-collapse: collapse; text-align: center;"> <tr> <td style="width: 10%;"></td> <td style="width: 10%;"></td> <td style="width: 10%;"></td> <td style="width: 10%;"></td> <td style="width: 10%;"></td> <td style="width: 10%;"></td> <td style="width: 10%;"></td> <td style="width: 10%;"></td> <td style="width: 10%;"></td> <td style="width: 10%;"></td> </tr> <tr> <td></td> <td></td> <td colspan="8" style="text-align: center;"> <table border="1" style="width: 100%; border-collapse: collapse; text-align: center;"> <tr> <td style="width: 10%;"></td> <td style="width: 10%;"></td> <td style="width: 10%;"></td> <td style="width: 10%;"></td> <td style="width: 10%;"></td> <td style="width: 10%;"></td> <td style="width: 10%;"></td> <td style="width: 10%;"></td> <td style="width: 10%;"></td> <td style="width: 10%;"></td> </tr> <tr> <td></td> <td></td> <td colspan="8" style="text-align: center;"> <table border="1" style="width: 100%; border-collapse: collapse; text-align: center;"> <tr> <td style="width: 10%;"></td> <td style="width: 10%;"></td> <td style="width: 10%;"></td> <td style="width: 10%;"></td> <td style="width: 10%;"></td> <td style="width: 10%;"></td> <td style="width: 10%;"></td> <td style="width: 10%;"></td> <td style="width: 10%;"></td> <td style="width: 10%;"></td> </tr> <tr> <td></td> <td></td> <td colspan="8" style="text-align: center;"> <table border="1" style="width: 100%; border-collapse: collapse; text-align: center;"> <tr> <td style="width: 10%;"></td> <td style="width: 10%;"></td> <td style="width: 10%;"></td> <td style="width: 10%;"></td> <td style="width: 10%;"></td> <td style="width: 10%;"></td> <td style="width: 10%;"></td> <td style="width: 10%;"></td> <td style="width: 10%;"></td> <td style="width: 10%;"></td> </tr> <tr> <td></td> <td></td> <td colspan="8" style="text-align: center;"> <table border="1" style="width: 100%; border-collapse: collapse; text-align: center;"> <tr> <td style="width: 10%;"></td> <td style="width: 10%;"></td> <td style="width: 10%;"></td> <td style="width: 10%;"></td> <td style="width: 10%;"></td> <td style="width: 10%;"></td> <td style="width: 10%;"></td> <td style="width: 10%;"></td> <td style="width: 10%;"></td> <td style="width: 10%;"></td> </tr> <tr> <td></td> <td></td> <td colspan="8" style="text-align: center;"> <table border="1" style="width: 100%; border-collapse: collapse; text-align: center;"> <tr> <td style="width: 10%;"></td> <td style="width: 10%;"></td> <td style="width: 10%;"></td> <td style="width: 10%;"></td> <td style="width: 10%;"></td> <td style="width: 10%;"></td> <td style="width: 10%;"></td> <td style="width: 10%;"></td> <td style="width: 10%;"></td> <td style="width: 10%;"></td> </tr> <tr> <td></td> <td></td> <td colspan="8" style="text-align: center;"> <table border="1" style="width: 100%; border-collapse: collapse; text-align: center;"> <tr> <td style="width: 10%;"></td> <td style="width: 10%;"></td> <td style="width: 10%;"></td> <td style="width: 10%;"></td> <td style="width: 10%;"></td> <td style="width: 10%;"></td> <td style="width: 10%;"></td> <td style="width: 10%;"></td> <td style="width: 10%;"></td> <td style="width: 10%;"></td> </tr> <tr> <td></td> <td></td> <td colspan="8" style="text-align: center;"> <table border="1" style="width: 100%; border-collapse: collapse; text-align: center;"> <tr> <td style="width: 10%;"></td> <td style="width: 10%;"></td> <td style="width: 10%;"></td> <td style="width: 10%;"></td> <td style="width: 10%;"></td> <td style="width: 10%;"></td> <td
style="width: 10%;"></td> <td style="width: 10%;"></td> <td style="width: 10%;"></td> <td style="width: 10%;"></td> </tr> <tr> <td></td> <td></td> <td colspan="8" style="text-align: center;"> <table border="1" style="width: 100%; border-collapse: collapse; text-align: center;"> <tr> <td style="width: 10%;"></td> <td style="width: 10%;"></td> <td style="width: 10%;"></td> <td style="width: 10%;"></td> <td style="width: 10%;"></td> <td style="width: 10%;"></td> <td style="width: 10%;"></td> <td style="width: 10%;"></td> <td style="width: 10%;"></td> <td style="width: 10%;"></td> </tr> <tr> <td></td> <td></td> <td colspan="8" style="text-align: center;"> <table border="1" style="width: 100%; border-collapse: collapse; text-align: center;"> <tr> <td style="width: 10%;"></td> <td style="width: 10%;"></td> <td style="width: 10%;"></td> <td style="width: 10%;"></td> <td style="width: 10%;"></td> <td style="width: 10%;"></td> <td style="width: 10%;"></td> <td style="width: 10%;"></td> <td style="width: 10%;"></td> <td style="width: 10%;"></td> </tr> <tr> <td></td> <td></td> <td colspan="8" style="text-align: center;"> <table border="1" style="width: 100%; border-collapse: collapse; text-align: center;"> <tr> <td style="width: 10%;"></td> <td style="width: 10%;"></td> <td style="width: 10%;"></td> <td style="width: 10%;"></td> <td style="width: 10%;"></td> <td style="width: 10%;"></td> <td style="width: 10%;"></td> <td style="width: 10%;"></td> <td style="width: 10%;"></td> <td style="width: 10%;"></td> </tr> <tr> <td></td> <td></td> <td colspan="8" style="text-align: center;"> <table border="1" style="width: 100%; border-collapse: collapse; text-align: center;"> <tr> <td style="width: 10%;"></td> <td style="width: 10%;"></td> <td style="width: 10%;"></td> <td style="width: 10%;"></td> <td style="width: 10%;"></td> <td style="width: 10%;"></td> <td style="width: 10%;"></td> <td style="width: 10%;"></td> <td style="width: 10%;"></td> <td style="width: 10%;"></td> </tr> <tr> <td></td> <td></td> <td colspan="8" style="text-align: center;"> <table border="1" style="width: 100%; border-collapse: collapse; text-align: center;"> <tr> <td style="width: 10%;"></td> <td style="width: 10%;"></td> <td style="width: 10%;"></td> <td style="width: 10%;"></td> <td style="width: 10%;"></td> <td style="width: 10%;"></td> <td style="width: 10%;"></td> <td style="width: 10%;"></td> <td style="width: 10%;"></td> <td style="width: 10%;"></td> </tr> <tr> <td></td> <td></td> <td colspan="8" style="text-align: center;"> <table border="1" style="width: 100%; border-collapse: collapse; text-align: center;"> <tr> <td style="width: 10%;"></td> <td style="width: 10%;"></td> <td style="width: 10%;"></td> <td style="width: 10%;"></td> <td style="width: 10%;"></td> <td style="width: 10%;"></td> <td style="width: 10%;"></td> <td style="width: 10%;"></td> <td style="width: 10%;"></td> <td style="width: 10%;"></td> </tr> <tr> <td></td> <td></td> <td colspan="8" style="text-align: center;"> <table border="1" style="width: 100%; border-collapse: collapse; text-align: center;"> <tr> <td style="width: 10%;"></td> <td style="width: 10%;"></td> <td style="width: 10%;"></td> <td style="width: 10%;"></td> <td style="width: 10%;"></td> <td style="width: 10%;"></td> <td style="width: 10%;"></td> <td style="width: 10%;"></td> <td style="width: 10%;"></td> <td style="width: 10%;"></td> </tr> <tr> <td></td> <td></td> <td colspan="8" style="text-align: center;"> <table border="1" style="width: 100%; border-collapse: collapse; text-align: center;"> <tr> <td style="width: 10%;"></td> <td style="width: 10%;"></td> <td style="width: 10%;"></td> <td style="width: 10%;"></td> <td style="width: 10%;"></td> <td style="width: 10%;"></td> <td style="width: 10%;"></td> <td style="width: 10%;"></td> <td style="width: 10%;"></td> <td style="width: 10%;"></td> </tr> <tr> <td></td> <td></td> <td colspan="8" style="text-align: center;"> <table border="1" style="width: 100%; border-collapse: collapse; text-align: center;"> <tr> <td style="width: 10%;"></td> <td style="width: 10%;"></td> <td style="width: 10%;"></td> <td style="width: 10%;"></td> <td style="width: 10%;"></td> <td style="width: 10%;"></td> <td style="width: 10%;"></td> <td style="width: 10%;"></td> <td style="width: 10%;"></td> <td style="width: 10%;"></td> </tr> <tr> <td></td> <td></td> <td colspan="8" style="text-align: center;"> <table border="1" style="width: 100%; border-collapse: collapse; text-align: center;"> <tr> <td style="width: 10%;"></td> <td style="width: 10%;"></td> <td style="width: 10%;"></td> <td style="width: 10%;"></td> <td style="width: 10%;"></td> <td style="width: 10%;"></td> <td style="width: 10%;"></td> <td style="width: 10%;"></td> <td style="width: 10%;"></td> <td style="width: 10%;"></td> </tr> <tr> <td></td> <td></td> <td colspan="8" style="text-align: center;"> <table border="1" style="width: 100%; border-collapse: collapse; text-align: center;"> <tr> <td style="width: 10%;"></td> <td style="width: 10%;"></td> <td style="width: 10%;"></td> <td style="width: 10%;"></td> <td style="width: 10%;"></td> <td style="width: 10%;"></td> <td style="width: 10%;"></td> <td style="width: 10%;"></td> <td style="width: 10%;"></td> <td style="width: 10%;"></td> </tr> <tr> <td></td> <td></td> <td colspan="8" style="text-align: center;"> <table border="1" style="width: 100%; border-collapse: collapse; text-align: center;"> <tr> <td style="width: 10%;"></td> <td style="width: 10%;"></td> <td style="width: 10%;"></td> <td style="width: 10%;"></td> <td style="width: 10%;"></td> <td style="width: 10%;"></td> <td style="width: 10%;"></td> <td style="width: 10%;"></td> <td style="width: 10%;"></td> <td style="width: 10%;"></td> </tr> <tr> <td></td> <td></td> <td colspan="8" style="text-align: center;"> <table border="1" style="width: 100%; border-collapse: collapse; text-align: center;"> <tr> <td style="width: 10%;"></td> <td style="width: 10%;"></td> <td style="width: 10%;"></td> <td style="width: 10%;"></td> <td style="width: 10%;"></td> <td style="width: 10%;"></td> <td style="width: 10%;"></td> <td style="width: 10%;"></td> <td style="width: 10%;"></td> <td style="width: 10%;"></td> </tr> <tr> <td></td> <td></td> <td colspan="8" style="text-align: center;"> <table border="1" style="width: 100%; border-collapse: collapse; text-align: center;"> <tr> <td style="width: 10%;"></td> <td style="width: 10%;"></td> <td style="width: 10%;"></td> <td style="width: 10%;"></td> <td style="width: 10%;"></td> <td style="width: 10%;"></td> <td style="width: 10%;"></td> <td style="width: 10%;"></td> <td style="width: 10%;"></td> <td style="width: 10%;"></td> </tr> <tr> <td></td> <td></td> <td colspan="8" style="text-align: center;"> <table border="1" style="width: 100%; border-collapse: collapse; text-align: center;"> <tr> <td style="width: 10%;"></td> <td style="width: 10%;"></td> <td style="width: 10%;"></td> <td style="width: 10%;"></td> <td style="width: 10%;"></td> <td style="width: 10%;"></td> <td style="width: 10%;"></td> <td style="width: 10%;"></td> <td style="width: 10%;"></td> <td style="width: 10%;"></td> </tr> <tr> <td></td> <td></td> <td colspan="8" style="text-align: center;"> <table border="1" style="width: 100%; border-collapse: collapse; text-align: center;"> <tr> <td style="width: 10%;"></td> <td style="width: 10%;"></td> <td style="width: 10%;"></td> <td style="width: 10%;"></td> <td style="width: 10%;"></td> <td style="width: 10%;"></td> <td style="width: 10%;"></td> <td style="width: 10%;"></td> <td style="width: 10%;"></td> <td style="width: 10%;"></td> </tr> <tr> <td></td> <td></td> <td colspan="8" style="text-align: center;"> <table border="1" style="width: 100%; border-collapse: collapse; text-align: center;"> <tr> <td style="width: 10%;"></td> <td style="width: 10%;"></td> <td style="width: 10%;"></td> <td style="width: 10%;"></td> <td style="width: 10%;"></td> <td style="width: 10%;"></td> <td style="width: 10%;"></td> <td style="width: 10%;"></td> <td style="width: 10%;"></td> <td style="width: 10%;"></td> </tr> <tr> <td></td> <td></td> <td colspan="8" style="text-align: center;"> <table border="1" style="width: 100%; border-collapse: collapse; text-align: center;"> <tr> <td style="width: 10%;"></td> <td style="width: 10%;"></td> <td style="width: 10%;"></td> <td style="width: 10%;"></td> <td style="width: 10%;"></td> <td style="width: 10%;"></td> <td style="width: 10%;"></td> <td style="width: 10%;"></td> <td style="width: 10%;"></td> <td style="width: 10%;"></td> </tr> <tr> <td></td> <td></td> <td colspan="8" style="text-align: center;"> <table border="1" style="width: 100%; border-collapse: collapse; text-align: center;"> <tr> </tr></table></td></tr></table></td></tr></table></td></tr></table></td></tr></table></td></tr></table></td></tr></table></td></tr></table></td></tr></table></td></tr></table></td></tr></table></td></tr></table></td></tr></table></td></tr></table></td></tr></table></td></tr></table></td></tr></table></td></tr></table></td></tr></table></td></tr></table></td></tr></table></td></tr></table></td></tr></table></td></tr></table></td></tr></table></td></tr></table></td></tr></table></td></tr></table></td></tr></table></td></tr></table></td></tr></table></td></tr></table></td></tr></table></td></tr></table></td></tr></table></td></tr></table></td></tr></table></td></tr></table>

 | | | | | | | | | | | | | | | | | | | | <table border="1" style="width: 100%; border-collapse: collapse; text-align: center;"> <tr> <td style="width: 10%;"></td> <td style="width: 10%;"></td> <td style="width: 10%;"></td> <td style="width: 10%;"></td> <td style="width: 10%;"></td> <td style="width: 10%;"></td> <td style="width: 10%;"></td> <td style="width: 10%;"></td> <td style="width: 10%;"></td> <td style="width: 10%;"></td> </tr> <tr> <td></td> <td></td> <td colspan="8" style="text-align: center;"> <table border="1" style="width: 100%; border-collapse: collapse; text-align: center;"> <tr> <td style="width: 10%;"></td> <td style="width: 10%;"></td> <td style="width: 10%;"></td> <td style="width: 10%;"></td> <td style="width: 10%;"></td> <td style="width: 10%;"></td> <td style="width: 10%;"></td> <td style="width: 10%;"></td> <td style="width: 10%;"></td> <td style="width: 10%;"></td> </tr> <tr> <td></td> <td></td> <td colspan="8" style="text-align: center;"> <table border="1" style="width: 100%; border-collapse: collapse; text-align: center;"> <tr> <td style="width: 10%;"></td> <td style="width: 10%;"></td> <td style="width: 10%;"></td> <td style="width: 10%;"></td> <td style="width: 10%;"></td> <td style="width: 10%;"></td> <td style="width: 10%;"></td> <td style="width: 10%;"></td> <td style="width: 10%;"></td> <td style="width: 10%;"></td> </tr> <tr> <td></td> <td></td> <td colspan="8" style="text-align: center;"> <table border="1" style="width: 100%; border-collapse: collapse; text-align: center;"> <tr> <td style="width: 10%;"></td> <td style="width: 10%;"></td> <td style="width: 10%;"></td> <td style="width: 10%;"></td> <td style="width: 10%;"></td> <td style="width: 10%;"></td> <td style="width: 10%;"></td> <td style="width: 10%;"></td> <td style="width: 10%;"></td> <td style="width: 10%;"></td> </tr> <tr> <td></td> <td></td> <td colspan="8" style="text-align: center;"> <table border="1" style="width: 100%; border-collapse: collapse; text-align: center;"> <tr> <td style="width: 10%;"></td> <td style="width: 10%;"></td> <td style="width: 10%;"></td> <td style="width: 10%;"></td> <td style="width: 10%;"></td> <td style="width: 10%;"></td> <td style="width: 10%;"></td> <td style="width: 10%;"></td> <td style="width: 10%;"></td> <td style="width: 10%;"></td> </tr> <tr> <td></td> <td></td> <td colspan="8" style="text-align: center;"> <table border="1" style="width: 100%; border-collapse: collapse; text-align: center;"> <tr> <td style="width: 10%;"></td> <td style="width: 10%;"></td> <td style="width: 10%;"></td> <td style="width: 10%;"></td> <td style="width: 10%;"></td> <td style="width: 10%;"></td> <td style="width: 10%;"></td> <td style="width: 10%;"></td> <td style="width: 10%;"></td> <td style="width: 10%;"></td> </tr> <tr> <td></td> <td></td> <td colspan="8" style="text-align: center;"> <table border="1" style="width: 100%; border-collapse: collapse; text-align: center;"> <tr> <td style="width: 10%;"></td> <td style="width: 10%;"></td> <td style="width: 10%;"></td> <td style="width: 10%;"></td> <td style="width: 10%;"></td> <td style="width: 10%;"></td> <td style="width: 10%;"></td> <td style="width: 10%;"></td> <td style="width: 10%;"></td> <td style="width: 10%;"></td> </tr> <tr> <td></td> <td></td> <td colspan="8" style="text-align: center;"> <table border="1" style="width: 100%; border-collapse: collapse; text-align: center;"> <tr> <td style="width: 10%;"></td> <td style="width: 10%;"></td> <td style="width: 10%;"></td> <td style="width: 10%;"></td> <td style="width: 10%;"></td> <td style="width: 10%;"></td> <td style="width: 10%;"></td> <td style="width: 10%;"></td> <td style="width: 10%;"></td> <td style="width: 10%;"></td> </tr> <tr> <td></td> <td></td> <td colspan="8" style="text-align: center;"> <table border="1" style="width: 100%; border-collapse: collapse; text-align: center;"> <tr> <td style="width: 10%;"></td> <td style="width: 10%;"></td> <td style="width: 10%;"></td> <td style="width: 10%;"></td> <td style="width: 10%;"></td> <td style="width: 10%;"></td> <td style="width: 10%;"></td> <td style="width: 10%;"></td> <td style="width: 10%;"></td> <td style="width: 10%;"></td> </tr> <tr> <td></td> <td></td> <td colspan="8" style="text-align: center;"> <table border="1" style="width: 100%; border-collapse: collapse; text-align: center;"> <tr> <td style="width: 10%;"></td> <td style="width: 10%;"></td> <td style="width: 10%;"></td> <td style="width: 10%;"></td> <td style="width: 10%;"></td> <td style="width: 10%;"></td> <td style="width: 10%;"></td> <td style="width: 10%;"></td> <td style="width: 10%;"></td> <td style="width: 10%;"></td> </tr> <tr> <td></td> <td></td> <td colspan="8" style="text-align: center;"> <table border="1" style="width: 100%; border-collapse: collapse; text-align: center;"> <tr> <td style="width: 10%;"></td> <td style="width: 10%;"></td> <td style="width: 10%;"></td> <td style="width: 10%;"></td> <td style="width: 10%;"></td> <td style="width: 10%;"></td> <td style="width: 10%;"></td> <td style="width: 10%;"></td> <td style="width: 10%;"></td> <td style="width: 10%;"></td> </tr> <tr> <td></td> <td></td> <td colspan="8" style="text-align: center;"> <table border="1" style="width: 100%; border-collapse: collapse; text-align: center;"> <tr> <td style="width: 10%;"></td> <td style="width: 10%;"></td> <td style="width: 10%;"></td> <td style="width: 10%;"></td> <td style="width: 10%;"></td> <td style="width: 10%;"></td> <td style="width: 10%;"></td> <td style="width: 10%;"></td> <td style="width: 10%;"></td> <td style="width: 10%;"></td> </tr> <tr> <td></td> <td></td> <td colspan="8" style="text-align: center;"> <table border="1" style="width: 100%; border-collapse: collapse; text-align: center;"> <tr> <td style="width: 10%;"></td> <td style="width: 10%;"></td> <td style="width: 10%;"></td> <td style="width: 10%;"></td> <td style="width: 10%;"></td> <td style="width: 10%;"></td> <td style="width: 10%;"></td> <td style="width: 10%;"></td> <td style="width: 10%;"></td> <td style="width: 10%;"></td> </tr> <tr> <td></td> <td></td> <td colspan="8" style="text-align: center;"> <table border="1" style="width: 100%; border-collapse: collapse; text-align: center;"> <tr> <td style="width: 10%;"></td> <td style="width: 10%;"></td> <td style="width: 10%;"></td> <td style="width: 10%;"></td> <td style="width: 10%;"></td> <td style="width: 10%;"></td> <td style="width: 10%;"></td> <td style="width: 10%;"></td> <td style="width: 10%;"></td> <td style="width: 10%;"></td> </tr> <tr> <td></td> <td></td> <td colspan="8" style="text-align: center;"> <table border="1" style="width: 100%; border-collapse: collapse; text-align: center;"> <tr> <td style="width: 10%;"></td> <td style="width: 10%;"></td> <td style="width: 10%;"></td> <td style="width: 10%;"></td> <td style="width: 10%;"></td> <td style="width: 10%;"></td> <td style="width: 10%;"></td> <td style="width: 10%;"></td> <td style="width: 10%;"></td> <td style="width: 10%;"></td> </tr> <tr> <td></td> <td></td> <td colspan="8" style="text-align: center;"> <table border="1" style="width: 100%; border-collapse: collapse; text-align: center;"> <tr> <td style="width: 10%;"></td> <td style="width: 10%;"></td> <td style="width: 10%;"></td> <td style="width: 10%;"></td> <td style="width: 10%;"></td> <td style="width: 10%;"></td> <td style="width: 10%;"></td> <td style="width: 10%;"></td> <td style="width: 10%;"></td> <td style="width: 10%;"></td> </tr> <tr> <td></td> <td></td> <td colspan="8" style="text-align: center;"> <table border="1" style="width: 100%; border-collapse: collapse; text-align: center;"> <tr> <td style="width: 10%;"></td> <td style="width: 10%;"></td> <td style="width: 10%;"></td> <td style="width: 10%;"></td> <td style="width: 10%;"></td> <td style="width: 10%;"></td> <td style="width: 10%;"></td> <td style="width: 10%;"></td> <td style="width: 10%;"></td> <td style="width: 10%;"></td> </tr> <tr> <td></td> <td></td> <td
colspan="8" style="text-align: center;"> <table border="1" style="width: 100%; border-collapse: collapse; text-align: center;"> <tr> <td style="width: 10%;"></td> <td style="width: 10%;"></td> <td style="width: 10%;"></td> <td style="width: 10%;"></td> <td style="width: 10%;"></td> <td style="width: 10%;"></td> <td style="width: 10%;"></td> <td style="width: 10%;"></td> <td style="width: 10%;"></td> <td style="width: 10%;"></td> </tr> <tr> <td></td> <td></td> <td colspan="8" style="text-align: center;"> <table border="1" style="width: 100%; border-collapse: collapse; text-align: center;"> <tr> <td style="width: 10%;"></td> <td style="width: 10%;"></td> <td style="width: 10%;"></td> <td style="width: 10%;"></td> <td style="width: 10%;"></td> <td style="width: 10%;"></td> <td style="width: 10%;"></td> <td style="width: 10%;"></td> <td style="width: 10%;"></td> <td style="width: 10%;"></td> </tr> <tr> <td></td> <td></td> <td colspan="8" style="text-align: center;"> <table border="1" style="width: 100%; border-collapse: collapse; text-align: center;"> <tr> <td style="width: 10%;"></td> <td style="width: 10%;"></td> <td style="width: 10%;"></td> <td style="width: 10%;"></td> <td style="width: 10%;"></td> <td style="width: 10%;"></td> <td style="width: 10%;"></td> <td style="width: 10%;"></td> <td style="width: 10%;"></td> <td style="width: 10%;"></td> </tr> <tr> <td></td> <td></td> <td colspan="8" style="text-align: center;"> <table border="1" style="width: 100%; border-collapse: collapse; text-align: center;"> <tr> <td style="width: 10%;"></td> <td style="width: 10%;"></td> <td style="width: 10%;"></td> <td style="width: 10%;"></td> <td style="width: 10%;"></td> <td style="width: 10%;"></td> <td style="width: 10%;"></td> <td style="width: 10%;"></td> <td style="width: 10%;"></td> <td style="width: 10%;"></td> </tr> <tr> <td></td> <td></td> <td colspan="8" style="text-align: center;"> <table border="1" style="width: 100%; border-collapse: collapse; text-align: center;"> <tr> <td style="width: 10%;"></td> <td style="width: 10%;"></td> <td style="width: 10%;"></td> <td style="width: 10%;"></td> <td style="width: 10%;"></td> <td style="width: 10%;"></td> <td style="width: 10%;"></td> <td style="width: 10%;"></td> <td style="width: 10%;"></td> <td style="width: 10%;"></td> </tr> <tr> <td></td> <td></td> <td colspan="8" style="text-align: center;"> <table border="1" style="width: 100%; border-collapse: collapse; text-align: center;"> <tr> <td style="width: 10%;"></td> <td style="width: 10%;"></td> <td style="width: 10%;"></td> <td style="width: 10%;"></td> <td style="width: 10%;"></td> <td style="width: 10%;"></td> <td style="width: 10%;"></td> <td style="width: 10%;"></td> <td style="width: 10%;"></td> <td style="width: 10%;"></td> </tr> <tr> <td></td> <td></td> <td colspan="8" style="text-align: center;"> <table border="1" style="width: 100%; border-collapse: collapse; text-align: center;"> <tr> <td style="width: 10%;"></td> <td style="width: 10%;"></td> <td style="width: 10%;"></td> <td style="width: 10%;"></td> <td style="width: 10%;"></td> <td style="width: 10%;"></td> <td style="width: 10%;"></td> <td style="width: 10%;"></td> <td style="width: 10%;"></td> <td style="width: 10%;"></td> </tr> <tr> <td></td> <td></td> <td colspan="8" style="text-align: center;"> <table border="1" style="width: 100%; border-collapse: collapse; text-align: center;"> <tr> <td style="width: 10%;"></td> <td style="width: 10%;"></td> <td style="width: 10%;"></td> <td style="width: 10%;"></td> <td style="width: 10%;"></td> <td style="width: 10%;"></td> <td style="width: 10%;"></td> <td style="width: 10%;"></td> <td style="width: 10%;"></td> <td style="width: 10%;"></td> </tr> <tr> <td></td> <td></td> <td colspan="8" style="text-align: center;"> <table border="1" style="width: 100%; border-collapse: collapse; text-align: center;"> <tr> <td style="width: 10%;"></td> <td style="width: 10%;"></td> <td style="width: 10%;"></td> <td style="width: 10%;"></td> <td style="width: 10%;"></td> <td style="width: 10%;"></td> <td style="width: 10%;"></td> <td style="width: 10%;"></td> <td style="width: 10%;"></td> <td style="width: 10%;"></td> </tr> <tr> <td></td> <td></td> <td colspan="8" style="text-align: center;"> <table border="1" style="width: 100%; border-collapse: collapse; text-align: center;"> <tr> <td style="width: 10%;"></td> <td style="width: 10%;"></td> <td style="width: 10%;"></td> <td style="width: 10%;"></td> <td style="width: 10%;"></td> <td style="width: 10%;"></td> <td style="width: 10%;"></td> <td style="width: 10%;"></td> <td style="width: 10%;"></td> <td style="width: 10%;"></td> </tr> <tr> <td></td> <td></td> <td colspan="8" style="text-align: center;"> <table border="1" style="width: 100%; border-collapse: collapse; text-align: center;"> <tr> <td style="width: 10%;"></td> <td style="width: 10%;"></td> <td style="width: 10%;"></td> <td style="width: 10%;"></td> <td style="width: 10%;"></td> <td style="width: 10%;"></td> <td style="width: 10%;"></td> <td style="width: 10%;"></td> <td style="width: 10%;"></td> <td style="width: 10%;"></td> </tr> <tr> <td></td> <td></td> <td colspan="8" style="text-align: center;"> <table border="1" style="width: 100%; border-collapse: collapse; text-align: center;"> <tr> <td style="width: 10%;"></td> <td style="width: 10%;"></td> <td style="width: 10%;"></td> <td style="width: 10%;"></td> <td style="width: 10%;"></td> <td style="width: 10%;"></td> <td style="width: 10%;"></td> <td style="width: 10%;"></td> <td style="width: 10%;"></td> <td style="width: 10%;"></td> </tr> <tr> <td></td> <td></td> <td colspan="8" style="text-align: center;"> <table border="1" style="width: 100%; border-collapse: collapse; text-align: center;"> <tr> <td style="width: 10%;"></td> <td style="width: 10%;"></td> <td style="width: 10%;"></td> <td style="width: 10%;"></td> <td style="width: 10%;"></td> <td style="width: 10%;"></td> <td style="width: 10%;"></td> <td style="width: 10%;"></td> <td style="width: 10%;"></td> <td style="width: 10%;"></td> </tr> <tr> <td></td> <td></td> <td colspan="8" style="text-align: center;"> <table border="1" style="width: 100%; border-collapse: collapse; text-align: center;"> <tr> <td style="width: 10%;"></td> <td style="width: 10%;"></td> <td style="width: 10%;"></td> <td style="width: 10%;"></td> <td style="width: 10%;"></td> <td style="width: 10%;"></td> <td style="width: 10%;"></td> <td style="width: 10%;"></td> <td style="width: 10%;"></td> <td style="width: 10%;"></td> </tr> <tr> <td></td> <td></td> <td colspan="8" style="text-align: center;"> <table border="1" style="width: 100%; border-collapse: collapse; text-align: center;"> <tr> <td style="width: 10%;"></td> <td style="width: 10%;"></td> <td style="width: 10%;"></td> <td style="width: 10%;"></td> <td style="width: 10%;"></td> <td style="width: 10%;"></td> <td style="width: 10%;"></td> <td style="width: 10%;"></td> <td style="width: 10%;"></td> <td style="width: 10%;"></td> </tr> <tr> <td></td> <td></td> <td colspan="8" style="text-align: center;"> <table border="1" style="width: 100%; border-collapse: collapse; text-align: center;"> <tr> <td style="width: 10%;"></td> <td style="width: 10%;"></td> <td style="width: 10%;"></td> <td style="width: 10%;"></td> <td style="width: 10%;"></td> <td style="width: 10%;"></td> <td style="width: 10%;"></td> <td style="width: 10%;"></td> <td style="width: 10%;"></td> <td style="width: 10%;"></td> </tr> <tr> <td></td> <td></td> <td colspan="8" style="text-align: center;"> <table border="1" style="width: 100%; border-collapse: collapse; text-align: center;"> <tr> <td style="width: 10%;"></td> <td style="width: 10%;"></td> <td style="width: 10%;"></td> <td style="width: 10%;"></td> <td style="width: 10%;"></td> <td style="width: 10%;"></td> <td style="width: 10%;"></td> <td style="width: 10%;"></td> <td style="width: 10%;"></td> <td style="width: 10%;"></td> </tr> <tr> <td></td> <td></td> <td colspan="8" style="text-align: center;"> <table border="1" style="width: 100%; border-collapse: collapse; text-align: center;"> <tr> <td style="width: 10%;"></td> <td style="width: 10%;"></td> <td style="width: 10%;"></td> <td style="width: 10%;"></td> <td style="width: 10%;"></td> <td style="width: 10%;"></td> <td style="width: 10%;"></td> <td style="width: 10%;"></td> <td style="width: 10%;"></td> <td style="width: 10%;"></td> </tr> <tr> <td></td> <td></td> <td colspan="8" style="text-align: center;"> <table border="1" style="width: 100%; border-collapse: collapse; text-align: center;"> <tr> <td style="width: 10%;"></td> <td style="width: 10%;"></td> <td style="width: 10%;"></td> <td style="width: 10%;"></td> <td style="width: 10%;"></td> <td style="width: 10%;"></td> <td style="width: 10%;"></td> <td style="width: 10%;"></td> <td style="width: 10%;"></td> <td style="width: 10%;"></td> </tr> <tr> <td></td> <td></td> <td colspan="8" style="text-align: center;"> <table border="1" style="width: 100%; border-collapse: collapse; text-align: center;"> <tr> </tr></table></td></tr></table></td></tr></table></td></tr></table></td></tr></table></td></tr></table></td></tr></table></td></tr></table></td></tr></table></td></tr></table></td></tr></table></td></tr></table></td></tr></table></td></tr></table></td></tr></table></td></tr></table></td></tr></table></td></tr></table></td></tr></table></td></tr></table></td></tr></table></td></tr></table></td></tr></table></td></tr></table></td></tr></table></td></tr></table></td></tr></table></td></tr></table></td></tr></table></td></tr></table></td></tr></table></td></tr></table></td></tr></table></td></tr></table></td></tr></table></td></tr></table></td></tr></table>

 | | | | | | | | | | | | | | | | | | | | <table border="1" style="width: 100%; border-collapse: collapse; text-align: center;"> <tr> <td style="width: 10%;"></td> <td style="width: 10%;"></td> <td style="width: 10%;"></td> <td style="width: 10%;"></td> <td style="width: 10%;"></td> <td style="width: 10%;"></td> <td style="width: 10%;"></td> <td style="width: 10%;"></td> <td style="width: 10%;"></td> <td style="width: 10%;"></td> </tr> <tr> <td></td> <td></td> <td colspan="8" style="text-align: center;"> <table border="1" style="width: 100%; border-collapse: collapse; text-align: center;"> <tr> <td style="width: 10%;"></td> <td style="width: 10%;"></td> <td style="width: 10%;"></td> <td style="width: 10%;"></td> <td style="width: 10%;"></td> <td style="width: 10%;"></td> <td style="width: 10%;"></td> <td style="width: 10%;"></td> <td style="width: 10%;"></td> <td style="width: 10%;"></td> </tr> <tr> <td></td> <td></td> <td colspan="8" style="text-align: center;"> <table border="1" style="width: 100%; border-collapse: collapse; text-align: center;"> <tr> <td style="width: 10%;"></td> <td style="width: 10%;"></td> <td style="width: 10%;"></td> <td style="width: 10%;"></td> <td style="width: 10%;"></td> <td style="width: 10%;"></td> <td style="width: 10%;"></td> <td style="width: 10%;"></td> <td style="width: 10%;"></td> <td style="width: 10%;"></td> </tr> <tr> <td></td> <td></td> <td colspan="8" style="text-align: center;"> <table border="1" style="width: 100%; border-collapse: collapse; text-align: center;"> <tr> <td style="width: 10%;"></td> <td style="width: 10%;"></td> <td style="width: 10%;"></td> <td style="width: 10%;"></td> <td style="width: 10%;"></td> <td style="width: 10%;"></td> <td style="width: 10%;"></td> <td style="width: 10%;"></td> <td style="width: 10%;"></td> <td style="width: 10%;"></td> </tr> <tr> <td></td> <td></td> <td colspan="8" style="text-align: center;"> <table border="1" style="width: 100%; border-collapse: collapse; text-align: center;"> <tr> <td style="width: 10%;"></td> <td style="width: 10%;"></td> <td style="width: 10%;"></td> <td style="width: 10%;"></td> <td style="width: 10%;"></td> <td style="width: 10%;"></td> <td style="width: 10%;"></td> <td style="width: 10%;"></td> <td style="width: 10%;"></td> <td style="width: 10%;"></td> </tr> <tr> <td></td> <td></td> <td colspan="8" style="text-align: center;"> <table border="1" style="width: 100%; border-collapse: collapse; text-align: center;"> <tr> <td style="width: 10%;"></td> <td style="width: 10%;"></td> <td style="width: 10%;"></td> <td style="width: 10%;"></td> <td style="width: 10%;"></td> <td style="width: 10%;"></td> <td style="width: 10%;"></td> <td style="width: 10%;"></td> <td style="width: 10%;"></td> <td style="width: 10%;"></td> </tr> <tr> <td></td> <td></td> <td colspan="8" style="text-align: center;"> <table border="1" style="width: 100%; border-collapse: collapse; text-align: center;"> <tr> <td style="width: 10%;"></td> <td style="width: 10%;"></td> <td style="width: 10%;"></td> <td style="width: 10%;"></td> <td style="width: 10%;"></td> <td style="width: 10%;"></td> <td style="width: 10%;"></td> <td style="width: 10%;"></td> <td style="width: 10%;"></td> <td style="width: 10%;"></td> </tr> <tr> <td></td> <td></td> <td colspan="8" style="text-align: center;"> <table border="1" style="width: 100%; border-collapse: collapse; text-align: center;"> <tr> <td style="width: 10%;"></td> <td style="width: 10%;"></td> <td style="width: 10%;"></td> <td style="width: 10%;"></td> <td style="width: 10%;"></td> <td style="width: 10%;"></td> <td style="width: 10%;"></td> <td style="width: 10%;"></td> <td style="width: 10%;"></td> <td style="width: 10%;"></td> </tr> <tr> <td></td> <td></td> <td colspan="8" style="text-align: center;"> <table border="1" style="width: 100%; border-collapse: collapse; text-align: center;"> <tr> <td style="width: 10%;"></td> <td style="width: 10%;"></td> <td style="width: 10%;"></td> <td style="width: 10%;"></td> <td style="width: 10%;"></td> <td style="width: 10%;"></td> <td style="width: 10%;"></td> <td style="width: 10%;"></td> <td style="width: 10%;"></td> <td style="width: 10%;"></td> </tr> <tr> <td></td> <td></td> <td colspan="8" style="text-align: center;"> <table border="1" style="width: 100%; border-collapse: collapse; text-align: center;"> <tr> <td style="width: 10%;"></td> <td style="width: 10%;"></td> <td style="width: 10%;"></td> <td style="width: 10%;"></td> <td style="width: 10%;"></td> <td style="width: 10%;"></td> <td style="width: 10%;"></td> <td style="width: 10%;"></td> <td style="width: 10%;"></td> <td style="width: 10%;"></td> </tr> <tr> <td></td> <td></td> <td colspan="8" style="text-align: center;"> <table border="1" style="width: 100%; border-collapse: collapse; text-align: center;"> <tr> <td style="width: 10%;"></td> <td style="width: 10%;"></td> <td style="width: 10%;"></td> <td style="width: 10%;"></td> <td style="width: 10%;"></td> <td style="width: 10%;"></td> <td style="width: 10%;"></td> <td style="width: 10%;"></td> <td style="width: 10%;"></td> <td style="width: 10%;"></td> </tr> <tr> <td></td> <td></td> <td colspan="8" style="text-align: center;"> <table border="1" style="width: 100%; border-collapse: collapse; text-align: center;"> <tr> <td style="width: 10%;"></td> <td style="width: 10%;"></td> <td style="width: 10%;"></td> <td style="width: 10%;"></td> <td style="width: 10%;"></td> <td style="width: 10%;"></td> <td style="width: 10%;"></td> <td style="width: 10%;"></td> <td style="width: 10%;"></td> <td style="width: 10%;"></td> </tr> <tr> <td></td> <td></td> <td colspan="8" style="text-align: center;"> <table border="1" style="width: 100%; border-collapse: collapse; text-align: center;"> <tr> <td style="width: 10%;"></td> <td style="width: 10%;"></td> <td style="width: 10%;"></td> <td style="width: 10%;"></td> <td style="width: 10%;"></td> <td style="width: 10%;"></td> <td style="width: 10%;"></td> <td style="width: 10%;"></td> <td style="width: 10%;"></td> <td style="width: 10%;"></td> </tr> <tr> <td></td> <td></td> <td colspan="8" style="text-align: center;"> <table border="1" style="width: 100%; border-collapse: collapse; text-align: center;"> <tr> <td style="width: 10%;"></td> <td style="width: 10%;"></td> <td style="width: 10%;"></td> <td style="width: 10%;"></td> <td style="width: 10%;"></td> <td style="width: 10%;"></td> <td style="width: 10%;"></td> <td style="width: 10%;"></td> <td style="width: 10%;"></td> <td style="width: 10%;"></td> </tr> <tr> <td></td> <td></td> <td colspan="8" style="text-align: center;"> <table border="1" style="width: 100%; border-collapse: collapse; text-align: center;"> <tr> <td style="width: 10%;"></td> <td style="width: 10%;"></td> <td style="width: 10%;"></td> <td style="width: 10%;"></td> <td style="width: 10%;"></td> <td style="width: 10%;"></td> <td style="width: 10%;"></td> <td style="width: 10%;"></td> <td style="width: 10%;"></td> <td style="width: 10%;"></td> </tr> <tr> <td></td> <td></td> <td colspan="8" style="text-align: center;"> <table border="1" style="width: 100%; border-collapse: collapse; text-align: center;"> <tr> <td style="width: 10%;"></td> <td style="width: 10%;"></td> <td style="width: 10%;"></td> <td style="width: 10%;"></td> <td style="width: 10%;"></td> <td style="width: 10%;"></td> <td style="width: 10%;"></td> <td style="width: 10%;"></td> <td style="width: 10%;"></td> <td style="width: 10%;"></td> </tr> <tr> <td></td> <td></td> <td colspan="8" style="text-align: center;"> <table border="1" style="width: 100%; border-collapse: collapse; text-align: center;"> <tr> <td style="width: 10%;"></td> <td
style="width: 10%;"></td> <td style="width: 10%;"></td> <td style="width: 10%;"></td> <td style="width: 10%;"></td> <td style="width: 10%;"></td> <td style="width: 10%;"></td> <td style="width: 10%;"></td> <td style="width: 10%;"></td> <td style="width: 10%;"></td> </tr> <tr> <td></td> <td></td> <td colspan="8" style="text-align: center;"> <table border="1" style="width: 100%; border-collapse: collapse; text-align: center;"> <tr> <td style="width: 10%;"></td> <td style="width: 10%;"></td> <td style="width: 10%;"></td> <td style="width: 10%;"></td> <td style="width: 10%;"></td> <td style="width: 10%;"></td> <td style="width: 10%;"></td> <td style="width: 10%;"></td> <td style="width: 10%;"></td> <td style="width: 10%;"></td> </tr> <tr> <td></td> <td></td> <td colspan="8" style="text-align: center;"> <table border="1" style="width: 100%; border-collapse: collapse; text-align: center;"> <tr> <td style="width: 10%;"></td> <td style="width: 10%;"></td> <td style="width: 10%;"></td> <td style="width: 10%;"></td> <td style="width: 10%;"></td> <td style="width: 10%;"></td> <td style="width: 10%;"></td> <td style="width: 10%;"></td> <td style="width: 10%;"></td> <td style="width: 10%;"></td> </tr> <tr> <td></td> <td></td> <td colspan="8" style="text-align: center;"> <table border="1" style="width: 100%; border-collapse: collapse; text-align: center;"> <tr> <td style="width: 10%;"></td> <td style="width: 10%;"></td> <td style="width: 10%;"></td> <td style="width: 10%;"></td> <td style="width: 10%;"></td> <td style="width: 10%;"></td> <td style="width: 10%;"></td> <td style="width: 10%;"></td> <td style="width: 10%;"></td> <td style="width: 10%;"></td> </tr> <tr> <td></td> <td></td> <td colspan="8" style="text-align: center;"> <table border="1" style="width: 100%; border-collapse: collapse; text-align: center;"> <tr> <td style="width: 10%;"></td> <td style="width: 10%;"></td> <td style="width: 10%;"></td> <td style="width: 10%;"></td> <td style="width: 10%;"></td> <td style="width: 10%;"></td> <td style="width: 10%;"></td> <td style="width: 10%;"></td> <td style="width: 10%;"></td> <td style="width: 10%;"></td> </tr> <tr> <td></td> <td></td> <td colspan="8" style="text-align: center;"> <table border="1" style="width: 100%; border-collapse: collapse; text-align: center;"> <tr> <td style="width: 10%;"></td> <td style="width: 10%;"></td> <td style="width: 10%;"></td> <td style="width: 10%;"></td> <td style="width: 10%;"></td> <td style="width: 10%;"></td> <td style="width: 10%;"></td> <td style="width: 10%;"></td> <td style="width: 10%;"></td> <td style="width: 10%;"></td> </tr> <tr> <td></td> <td></td> <td colspan="8" style="text-align: center;"> <table border="1" style="width: 100%; border-collapse: collapse; text-align: center;"> <tr> <td style="width: 10%;"></td> <td style="width: 10%;"></td> <td style="width: 10%;"></td> <td style="width: 10%;"></td> <td style="width: 10%;"></td> <td style="width: 10%;"></td> <td style="width: 10%;"></td> <td style="width: 10%;"></td> <td style="width: 10%;"></td> <td style="width: 10%;"></td> </tr> <tr> <td></td> <td></td> <td colspan="8" style="text-align: center;"> <table border="1" style="width: 100%; border-collapse: collapse; text-align: center;"> <tr> <td style="width: 10%;"></td> <td style="width: 10%;"></td> <td style="width: 10%;"></td> <td style="width: 10%;"></td> <td style="width: 10%;"></td> <td style="width: 10%;"></td> <td style="width: 10%;"></td> <td style="width: 10%;"></td> <td style="width: 10%;"></td> <td style="width: 10%;"></td> </tr> <tr> <td></td> <td></td> <td colspan="8" style="text-align: center;"> <table border="1" style="width: 100%; border-collapse: collapse; text-align: center;"> <tr> <td style="width: 10%;"></td> <td style="width: 10%;"></td> <td style="width: 10%;"></td> <td style="width: 10%;"></td> <td style="width: 10%;"></td> <td style="width: 10%;"></td> <td style="width: 10%;"></td> <td style="width: 10%;"></td> <td style="width: 10%;"></td> <td style="width: 10%;"></td> </tr> <tr> <td></td> <td></td> <td colspan="8" style="text-align: center;"> <table border="1" style="width: 100%; border-collapse: collapse; text-align: center;"> <tr> <td style="width: 10%;"></td> <td style="width: 10%;"></td> <td style="width: 10%;"></td> <td style="width: 10%;"></td> <td style="width: 10%;"></td> <td style="width: 10%;"></td> <td style="width: 10%;"></td> <td style="width: 10%;"></td> <td style="width: 10%;"></td> <td style="width: 10%;"></td> </tr> <tr> <td></td> <td></td> <td colspan="8" style="text-align: center;"> <table border="1" style="width: 100%; border-collapse: collapse; text-align: center;"> <tr> <td style="width: 10%;"></td> <td style="width: 10%;"></td> <td style="width: 10%;"></td> <td style="width: 10%;"></td> <td style="width: 10%;"></td> <td style="width: 10%;"></td> <td style="width: 10%;"></td> <td style="width: 10%;"></td> <td style="width: 10%;"></td> <td style="width: 10%;"></td> </tr> <tr> <td></td> <td></td> <td colspan="8" style="text-align: center;"> <table border="1" style="width: 100%; border-collapse: collapse; text-align: center;"> <tr> <td style="width: 10%;"></td> <td style="width: 10%;"></td> <td style="width: 10%;"></td> <td style="width: 10%;"></td> <td style="width: 10%;"></td> <td style="width: 10%;"></td> <td style="width: 10%;"></td> <td style="width: 10%;"></td> <td style="width: 10%;"></td> <td style="width: 10%;"></td> </tr> <tr> <td></td> <td></td> <td colspan="8" style="text-align: center;"> <table border="1" style="width: 100%; border-collapse: collapse; text-align: center;"> <tr> <td style="width: 10%;"></td> <td style="width: 10%;"></td> <td style="width: 10%;"></td> <td style="width: 10%;"></td> <td style="width: 10%;"></td> <td style="width: 10%;"></td> <td style="width: 10%;"></td> <td style="width: 10%;"></td> <td style="width: 10%;"></td> <td style="width: 10%;"></td> </tr> <tr> <td></td> <td></td> <td colspan="8" style="text-align: center;"> <table border="1" style="width: 100%; border-collapse: collapse; text-align: center;"> <tr> <td style="width: 10%;"></td> <td style="width: 10%;"></td> <td style="width: 10%;"></td> <td style="width: 10%;"></td> <td style="width: 10%;"></td> <td style="width: 10%;"></td> <td style="width: 10%;"></td> <td style="width: 10%;"></td> <td style="width: 10%;"></td> <td style="width: 10%;"></td> </tr> <tr> <td></td> <td></td> <td colspan="8" style="text-align: center;"> <table border="1" style="width: 100%; border-collapse: collapse; text-align: center;"> <tr> <td style="width: 10%;"></td> <td style="width: 10%;"></td> <td style="width: 10%;"></td> <td style="width: 10%;"></td> <td style="width: 10%;"></td> <td style="width: 10%;"></td> <td style="width: 10%;"></td> <td style="width: 10%;"></td> <td style="width: 10%;"></td> <td style="width: 10%;"></td> </tr> <tr> <td></td> <td></td> <td colspan="8" style="text-align: center;"> <table border="1" style="width: 100%; border-collapse: collapse; text-align: center;"> <tr> <td style="width: 10%;"></td> <td style="width: 10%;"></td> <td style="width: 10%;"></td> <td style="width: 10%;"></td> <td style="width: 10%;"></td> <td style="width: 10%;"></td> <td style="width: 10%;"></td> <td style="width: 10%;"></td> <td style="width: 10%;"></td> <td style="width: 10%;"></td> </tr> <tr> <td></td> <td></td> <td colspan="8" style="text-align: center;"> <table border="1" style="width: 100%; border-collapse: collapse; text-align: center;"> <tr> <td style="width: 10%;"></td> <td style="width: 10%;"></td> <td style="width: 10%;"></td> <td style="width: 10%;"></td> <td style="width: 10%;"></td> <td style="width: 10%;"></td> <td style="width: 10%;"></td> <td style="width: 10%;"></td> <td style="width: 10%;"></td> <td style="width: 10%;"></td> </tr> <tr> <td></td> <td></td> <td colspan="8" style="text-align: center;"> <table border="1" style="width: 100%; border-collapse: collapse; text-align: center;"> <tr> <td style="width: 10%;"></td> <td style="width: 10%;"></td> <td style="width: 10%;"></td> <td style="width: 10%;"></td> <td style="width: 10%;"></td> <td style="width: 10%;"></td> <td style="width: 10%;"></td> <td style="width: 10%;"></td> <td style="width: 10%;"></td> <td style="width: 10%;"></td> </tr> <tr> <td></td> <td></td> <td colspan="8" style="text-align: center;"> <table border="1" style="width: 100%; border-collapse: collapse; text-align: center;"> <tr> <td style="width: 10%;"></td> <td style="width: 10%;"></td> <td style="width: 10%;"></td> <td style="width: 10%;"></td> <td style="width: 10%;"></td> <td style="width: 10%;"></td> <td style="width: 10%;"></td> <td style="width: 10%;"></td> <td style="width: 10%;"></td> <td style="width: 10%;"></td> </tr> <tr> <td></td> <td></td> <td colspan="8" style="text-align: center;"> <table border="1" style="width: 100%; border-collapse: collapse; text-align: center;"> <tr> </tr></table></td></tr></table></td></tr></table></td></tr></table></td></tr></table></td></tr></table></td></tr></table></td></tr></table></td></tr></table></td></tr></table></td></tr></table></td></tr></table></td></tr></table></td></tr></table></td></tr></table></td></tr></table></td></tr></table></td></tr></table></td></tr></table></td></tr></table></td></tr></table></td></tr></table></td></tr></table></td></tr></table></td></tr></table></td></tr></table></td></tr></table></td></tr></table></td></tr></table></td></tr></table></td></tr></table></td></tr></table></td></tr></table></td></tr></table></td></tr></table></td></tr></table>

 | | | | | | | | | | | | | | | | | | | | <table border="1" style="width: 100%; border-collapse: collapse; text-align: center;"> <tr> <td style="width: 10%;"></td> <td style="width: 10%;"></td> <td style="width: 10%;"></td> <td style="width: 10%;"></td> <td style="width: 10%;"></td> <td style="width: 10%;"></td> <td style="width: 10%;"></td> <td style="width: 10%;"></td> <td style="width: 10%;"></td> <td style="width: 10%;"></td> </tr> <tr> <td></td> <td></td> <td colspan="8" style="text-align: center;"> <table border="1" style="width: 100%; border-collapse: collapse; text-align: center;"> <tr> <td style="width: 10%;"></td> <td style="width: 10%;"></td> <td style="width: 10%;"></td> <td style="width: 10%;"></td> <td style="width: 10%;"></td> <td style="width: 10%;"></td> <td style="width: 10%;"></td> <td style="width: 10%;"></td> <td style="width: 10%;"></td> <td style="width: 10%;"></td> </tr> <tr> <td></td> <td></td> <td colspan="8" style="text-align: center;"> <table border="1" style="width: 100%; border-collapse: collapse; text-align: center;"> <tr> <td style="width: 10%;"></td> <td style="width: 10%;"></td> <td style="width: 10%;"></td> <td style="width: 10%;"></td> <td style="width: 10%;"></td> <td style="width: 10%;"></td> <td style="width: 10%;"></td> <td style="width: 10%;"></td> <td style="width: 10%;"></td> <td style="width: 10%;"></td> </tr> <tr> <td></td> <td></td> <td colspan="8" style="text-align: center;"> <table border="1" style="width: 100%; border-collapse: collapse; text-align: center;"> <tr> <td style="width: 10%;"></td> <td style="width: 10%;"></td> <td style="width: 10%;"></td> <td style="width: 10%;"></td> <td style="width: 10%;"></td> <td style="width: 10%;"></td> <td style="width: 10%;"></td> <td style="width: 10%;"></td> <td style="width: 10%;"></td> <td style="width: 10%;"></td> </tr> <tr> <td></td> <td></td> <td colspan="8" style="text-align: center;"> <table border="1" style="width: 100%; border-collapse: collapse; text-align: center;"> <tr> <td style="width: 10%;"></td> <td style="width: 10%;"></td> <td style="width: 10%;"></td> <td style="width: 10%;"></td> <td style="width: 10%;"></td> <td style="width: 10%;"></td> <td style="width: 10%;"></td> <td style="width: 10%;"></td> <td style="width: 10%;"></td> <td style="width: 10%;"></td> </tr> <tr> <td></td> <td></td> <td colspan="8" style="text-align: center;"> <table border="1" style="width: 100%; border-collapse: collapse; text-align: center;"> <tr> <td style="width: 10%;"></td> <td style="width: 10%;"></td> <td style="width: 10%;"></td> <td style="width: 10%;"></td> <td style="width: 10%;"></td> <td style="width: 10%;"></td> <td style="width: 10%;"></td> <td style="width: 10%;"></td> <td style="width: 10%;"></td> <td style="width: 10%;"></td> </tr> <tr> <td></td> <td></td> <td colspan="8" style="text-align: center;"> <table border="1" style="width: 100%; border-collapse: collapse; text-align: center;"> <tr> <td style="width: 10%;"></td> <td style="width: 10%;"></td> <td style="width: 10%;"></td> <td style="width: 10%;"></td> <td style="width: 10%;"></td> <td style="width: 10%;"></td> <td style="width: 10%;"></td> <td style="width: 10%;"></td> <td style="width: 10%;"></td> <td style="width: 10%;"></td> </tr> <tr> <td></td> <td></td> <td colspan="8" style="text-align: center;"> <table border="1" style="width: 100%; border-collapse: collapse; text-align: center;"> <tr> <td style="width: 10%;"></td> <td style="width: 10%;"></td> <td style="width: 10%;"></td> <td style="width: 10%;"></td> <td style="width: 10%;"></td> <td style="width: 10%;"></td> <td style="width: 10%;"></td> <td style="width: 10%;"></td> <td style="width: 10%;"></td> <td style="width: 10%;"></td> </tr> <tr> <td></td> <td></td> <td colspan="8" style="text-align: center;"> <table border="1" style="width: 100%; border-collapse: collapse; text-align: center;"> <tr> <td style="width: 10%;"></td> <td style="width: 10%;"></td> <td style="width: 10%;"></td> <td style="width: 10%;"></td> <td style="width: 10%;"></td> <td style="width: 10%;"></td> <td style="width: 10%;"></td> <td style="width: 10%;"></td> <td style="width: 10%;"></td> <td style="width: 10%;"></td> </tr> <tr> <td></td> <td></td> <td colspan="8" style="text-align: center;"> <table border="1" style="width: 100%; border-collapse: collapse; text-align: center;"> <tr> <td style="width: 10%;"></td> <td style="width: 10%;"></td> <td style="width: 10%;"></td> <td style="width: 10%;"></td> <td style="width: 10%;"></td> <td style="width: 10%;"></td> <td style="width: 10%;"></td> <td style="width: 10%;"></td> <td style="width: 10%;"></td> <td style="width: 10%;"></td> </tr> <tr> <td></td> <td></td> <td colspan="8" style="text-align: center;"> <table border="1" style="width: 100%; border-collapse: collapse; text-align: center;"> <tr> <td style="width: 10%;"></td> <td style="width: 10%;"></td> <td style="width: 10%;"></td> <td style="width: 10%;"></td> <td style="width: 10%;"></td> <td style="width: 10%;"></td> <td style="width: 10%;"></td> <td style="width: 10%;"></td> <td style="width: 10%;"></td> <td style="width: 10%;"></td> </tr> <tr> <td></td> <td></td> <td colspan="8" style="text-align: center;"> <table border="1" style="width: 100%; border-collapse: collapse; text-align: center;"> <tr> <td style="width: 10%;"></td> <td style="width: 10%;"></td> <td style="width: 10%;"></td> <td style="width: 10%;"></td> <td style="width: 10%;"></td> <td style="width: 10%;"></td> <td style="width: 10%;"></td> <td style="width: 10%;"></td> <td style="width: 10%;"></td> <td style="width: 10%;"></td> </tr> <tr> <td></td> <td></td> <td colspan="8" style="text-align: center;"> <table border="1" style="width: 100%; border-collapse: collapse; text-align: center;"> <tr> <td style="width: 10%;"></td> <td style="width: 10%;"></td> <td style="width: 10%;"></td> <td style="width: 10%;"></td> <td style="width: 10%;"></td> <td style="width: 10%;"></td> <td style="width: 10%;"></td> <td style="width: 10%;"></td> <td style="width: 10%;"></td> <td style="width: 10%;"></td> </tr> <tr> <td></td> <td></td> <td colspan="8" style="text-align: center;"> <table border="1" style="width: 100%; border-collapse: collapse; text-align: center;"> <tr> <td style="width: 10%;"></td> <td style="width: 10%;"></td> <td style="width: 10%;"></td> <td style="width: 10%;"></td> <td style="width: 10%;"></td> <td style="width: 10%;"></td> <td style="width: 10%;"></td> <td style="width: 10%;"></td> <td style="width: 10%;"></td> <td style="width: 10%;"></td> </tr> <tr> <td></td> <td></td> <td colspan="8" style="text-align: center;"> <table border="1" style="width: 100%; border-collapse: collapse; text-align: center;"> <tr> <td style="width: 10%;"></td> <td style="width: 10%;"></td> <td style="width: 10%;"></td> <td style="width: 10%;"></td> <td style="width: 10%;"></td> <td style="width: 10%;"></td> <td style="width: 10%;"></td> <td style="width: 10%;"></td> <td style="width: 10%;"></td> <td style="width: 10%;"></td> </tr> <tr> <td></td> <td></td> <td colspan="8" style="text-align: center;"> <table border="1" style="width: 100%; border-collapse: collapse; text-align: center;"> <tr> <td style="width: 10%;"></td> <td style="width: 10%;"></td> <td style="width: 10%;"></td> <td style="width: 10%;"></td> <td style="width: 10%;"></td> <td style="width: 10%;"></td> <td style="width: 10%;"></td> <td style="width: 10%;"></td> <td style="width: 10%;"></td> <td style="width: 10%;"></td> </tr> <tr> <td></td> <td></td> <td colspan="8" style="text-align: center;"> <table border="1" style="width: 100%; border-collapse: collapse; text-align: center;"> <tr> <td style="width: 10%;"></td> <td style="width: 10%;"></td> <td style="width: 10%;"></td> <td style="width: 10%;"></td> <td style="width: 10%;"></td> <td style="width: 10%;"></td> <td style="width: 10%;"></td> <td
style="width: 10%;"></td> <td style="width: 10%;"></td> <td style="width: 10%;"></td> </tr> <tr> <td></td> <td></td> <td colspan="8" style="text-align: center;"> <table border="1" style="width: 100%; border-collapse: collapse; text-align: center;"> <tr> <td style="width: 10%;"></td> <td style="width: 10%;"></td> <td style="width: 10%;"></td> <td style="width: 10%;"></td> <td style="width: 10%;"></td> <td style="width: 10%;"></td> <td style="width: 10%;"></td> <td style="width: 10%;"></td> <td style="width: 10%;"></td> <td style="width: 10%;"></td> </tr> <tr> <td></td> <td></td> <td colspan="8" style="text-align: center;"> <table border="1" style="width: 100%; border-collapse: collapse; text-align: center;"> <tr> <td style="width: 10%;"></td> <td style="width: 10%;"></td> <td style="width: 10%;"></td> <td style="width: 10%;"></td> <td style="width: 10%;"></td> <td style="width: 10%;"></td> <td style="width: 10%;"></td> <td style="width: 10%;"></td> <td style="width: 10%;"></td> <td style="width: 10%;"></td> </tr> <tr> <td></td> <td></td> <td colspan="8" style="text-align: center;"> <table border="1" style="width: 100%; border-collapse: collapse; text-align: center;"> <tr> <td style="width: 10%;"></td> <td style="width: 10%;"></td> <td style="width: 10%;"></td> <td style="width: 10%;"></td> <td style="width: 10%;"></td> <td style="width: 10%;"></td> <td style="width: 10%;"></td> <td style="width: 10%;"></td> <td style="width: 10%;"></td> <td style="width: 10%;"></td> </tr> <tr> <td></td> <td></td> <td colspan="8" style="text-align: center;"> <table border="1" style="width: 100%; border-collapse: collapse; text-align: center;"> <tr> <td style="width: 10%;"></td> <td style="width: 10%;"></td> <td style="width: 10%;"></td> <td style="width: 10%;"></td> <td style="width: 10%;"></td> <td style="width: 10%;"></td> <td style="width: 10%;"></td> <td style="width: 10%;"></td> <td style="width: 10%;"></td> <td style="width: 10%;"></td> </tr> <tr> <td></td> <td></td> <td colspan="8" style="text-align: center;"> <table border="1" style="width: 100%; border-collapse: collapse; text-align: center;"> <tr> <td style="width: 10%;"></td> <td style="width: 10%;"></td> <td style="width: 10%;"></td> <td style="width: 10%;"></td> <td style="width: 10%;"></td> <td style="width: 10%;"></td> <td style="width: 10%;"></td> <td style="width: 10%;"></td> <td style="width: 10%;"></td> <td style="width: 10%;"></td> </tr> <tr> <td></td> <td></td> <td colspan="8" style="text-align: center;"> <table border="1" style="width: 100%; border-collapse: collapse; text-align: center;"> <tr> <td style="width: 10%;"></td> <td style="width: 10%;"></td> <td style="width: 10%;"></td> <td style="width: 10%;"></td> <td style="width: 10%;"></td> <td style="width: 10%;"></td> <td style="width: 10%;"></td> <td style="width: 10%;"></td> <td style="width: 10%;"></td> <td style="width: 10%;"></td> </tr> <tr> <td></td> <td></td> <td colspan="8" style="text-align: center;"> <table border="1" style="width: 100%; border-collapse: collapse; text-align: center;"> <tr> <td style="width: 10%;"></td> <td style="width: 10%;"></td> <td style="width: 10%;"></td> <td style="width: 10%;"></td> <td style="width: 10%;"></td> <td style="width: 10%;"></td> <td style="width: 10%;"></td> <td style="width: 10%;"></td> <td style="width: 10%;"></td> <td style="width: 10%;"></td> </tr> <tr> <td></td> <td></td> <td colspan="8" style="text-align: center;"> <table border="1" style="width: 100%; border-collapse: collapse; text-align: center;"> <tr> <td style="width: 10%;"></td> <td style="width: 10%;"></td> <td style="width: 10%;"></td> <td style="width: 10%;"></td> <td style="width: 10%;"></td> <td style="width: 10%;"></td> <td style="width: 10%;"></td> <td style="width: 10%;"></td> <td style="width: 10%;"></td> <td style="width: 10%;"></td> </tr> <tr> <td></td> <td></td> <td colspan="8" style="text-align: center;"> <table border="1" style="width: 100%; border-collapse: collapse; text-align: center;"> <tr> <td style="width: 10%;"></td> <td style="width: 10%;"></td> <td style="width: 10%;"></td> <td style="width: 10%;"></td> <td style="width: 10%;"></td> <td style="width: 10%;"></td> <td style="width: 10%;"></td> <td style="width: 10%;"></td> <td style="width: 10%;"></td> <td style="width: 10%;"></td> </tr> <tr> <td></td> <td></td> <td colspan="8" style="text-align: center;"> <table border="1" style="width: 100%; border-collapse: collapse; text-align: center;"> <tr> <td style="width: 10%;"></td> <td style="width: 10%;"></td> <td style="width: 10%;"></td> <td style="width: 10%;"></td> <td style="width: 10%;"></td> <td style="width: 10%;"></td> <td style="width: 10%;"></td> <td style="width: 10%;"></td> <td style="width: 10%;"></td> <td style="width: 10%;"></td> </tr> <tr> <td></td> <td></td> <td colspan="8" style="text-align: center;"> <table border="1" style="width: 100%; border-collapse: collapse; text-align: center;"> <tr> <td style="width: 10%;"></td> <td style="width: 10%;"></td> <td style="width: 10%;"></td> <td style="width: 10%;"></td> <td style="width: 10%;"></td> <td style="width: 10%;"></td> <td style="width: 10%;"></td> <td style="width: 10%;"></td> <td style="width: 10%;"></td> <td style="width: 10%;"></td> </tr> <tr> <td></td> <td></td> <td colspan="8" style="text-align: center;"> <table border="1" style="width: 100%; border-collapse: collapse; text-align: center;"> <tr> <td style="width: 10%;"></td> <td style="width: 10%;"></td> <td style="width: 10%;"></td> <td style="width: 10%;"></td> <td style="width: 10%;"></td> <td style="width: 10%;"></td> <td style="width: 10%;"></td> <td style="width: 10%;"></td> <td style="width: 10%;"></td> <td style="width: 10%;"></td> </tr> <tr> <td></td> <td></td> <td colspan="8" style="text-align: center;"> <table border="1" style="width: 100%; border-collapse: collapse; text-align: center;"> <tr> <td style="width: 10%;"></td> <td style="width: 10%;"></td> <td style="width: 10%;"></td> <td style="width: 10%;"></td> <td style="width: 10%;"></td> <td style="width: 10%;"></td> <td style="width: 10%;"></td> <td style="width: 10%;"></td> <td style="width: 10%;"></td> <td style="width: 10%;"></td> </tr> <tr> <td></td> <td></td> <td colspan="8" style="text-align: center;"> <table border="1" style="width: 100%; border-collapse: collapse; text-align: center;"> <tr> <td style="width: 10%;"></td> <td style="width: 10%;"></td> <td style="width: 10%;"></td> <td style="width: 10%;"></td> <td style="width: 10%;"></td> <td style="width: 10%;"></td> <td style="width: 10%;"></td> <td style="width: 10%;"></td> <td style="width: 10%;"></td> <td style="width: 10%;"></td> </tr> <tr> <td></td> <td></td> <td colspan="8" style="text-align: center;"> <table border="1" style="width: 100%; border-collapse: collapse; text-align: center;"> <tr> <td style="width: 10%;"></td> <td style="width: 10%;"></td> <td style="width: 10%;"></td> <td style="width: 10%;"></td> <td style="width: 10%;"></td> <td style="width: 10%;"></td> <td style="width: 10%;"></td> <td style="width: 10%;"></td> <td style="width: 10%;"></td> <td style="width: 10%;"></td> </tr> <tr> <td></td> <td></td> <td colspan="8" style="text-align: center;"> <table border="1" style="width: 100%; border-collapse: collapse; text-align: center;"> <tr> <td style="width: 10%;"></td> <td style="width: 10%;"></td> <td style="width: 10%;"></td> <td style="width: 10%;"></td> <td style="width: 10%;"></td> <td style="width: 10%;"></td> <td style="width: 10%;"></td> <td style="width: 10%;"></td> <td style="width: 10%;"></td> <td style="width: 10%;"></td> </tr> <tr> <td></td> <td></td> <td colspan="8" style="text-align: center;"> <table border="1" style="width: 100%; border-collapse: collapse; text-align: center;"> <tr> <td style="width: 10%;"></td> <td style="width: 10%;"></td> <td style="width: 10%;"></td> <td style="width: 10%;"></td> <td style="width: 10%;"></td> <td style="width: 10%;"></td> <td style="width: 10%;"></td> <td style="width: 10%;"></td> <td style="width: 10%;"></td> <td style="width: 10%;"></td> </tr> <tr> <td></td> <td></td> <td colspan="8" style="text-align: center;"> <table border="1" style="width: 100%; border-collapse: collapse; text-align: center;"> <tr> </tr></table></td></tr></table></td></tr></table></td></tr></table></td></tr></table></td></tr></table></td></tr></table></td></tr></table></td></tr></table></td></tr></table></td></tr></table></td></tr></table></td></tr></table></td></tr></table></td></tr></table></td></tr></table></td></tr></table></td></tr></table></td></tr></table></td></tr></table></td></tr></table></td></tr></table></td></tr></table></td></tr></table></td></tr></table></td></tr></table></td></tr></table></td></tr></table></td></tr></table></td></tr></table></td></tr></table></td></tr></table></td></tr></table></td></tr></table></td></tr></table>

 | | | | | | | | | | | | | | | | | | | | <table border="1" style="width: 100%; border-collapse: collapse; text-align: center;"> <tr> <td style="width: 10%;"></td> <td style="width: 10%;"></td> <td style="width: 10%;"></td> <td style="width: 10%;"></td> <td style="width: 10%;"></td> <td style="width: 10%;"></td> <td style="width: 10%;"></td> <td style="width: 10%;"></td> <td style="width: 10%;"></td> <td style="width: 10%;"></td> </tr> <tr> <td></td> <td></td> <td colspan="8" style="text-align: center;"> <table border="1" style="width: 100%; border-collapse: collapse; text-align: center;"> <tr> <td style="width: 10%;"></td> <td style="width: 10%;"></td> <td style="width: 10%;"></td> <td style="width: 10%;"></td> <td style="width: 10%;"></td> <td style="width: 10%;"></td> <td style="width: 10%;"></td> <td style="width: 10%;"></td> <td style="width: 10%;"></td> <td style="width: 10%;"></td> </tr> <tr> <td></td> <td></td> <td colspan="8" style="text-align: center;"> <table border="1" style="width: 100%; border-collapse: collapse; text-align: center;"> <tr> <td style="width: 10%;"></td> <td style="width: 10%;"></td> <td style="width: 10%;"></td> <td style="width: 10%;"></td> <td style="width: 10%;"></td> <td style="width: 10%;"></td> <td style="width: 10%;"></td> <td style="width: 10%;"></td> <td style="width: 10%;"></td> <td style="width: 10%;"></td> </tr> <tr> <td></td> <td></td> <td colspan="8" style="text-align: center;"> <table border="1" style="width: 100%; border-collapse: collapse; text-align: center;"> <tr> <td style="width: 10%;"></td> <td style="width: 10%;"></td> <td style="width: 10%;"></td> <td style="width: 10%;"></td> <td style="width: 10%;"></td> <td style="width: 10%;"></td> <td style="width: 10%;"></td> <td style="width: 10%;"></td> <td style="width: 10%;"></td> <td style="width: 10%;"></td> </tr> <tr> <td></td> <td></td> <td colspan="8" style="text-align: center;"> <table border="1" style="width: 100%; border-collapse: collapse; text-align: center;"> <tr> <td style="width: 10%;"></td> <td style="width: 10%;"></td> <td style="width: 10%;"></td> <td style="width: 10%;"></td> <td style="width: 10%;"></td> <td style="width: 10%;"></td> <td style="width: 10%;"></td> <td style="width: 10%;"></td> <td style="width: 10%;"></td> <td style="width: 10%;"></td> </tr> <tr> <td></td> <td></td> <td colspan="8" style="text-align: center;"> <table border="1" style="width: 100%; border-collapse: collapse; text-align: center;"> <tr> <td style="width: 10%;"></td> <td style="width: 10%;"></td> <td style="width: 10%;"></td> <td style="width: 10%;"></td> <td style="width: 10%;"></td> <td style="width: 10%;"></td> <td style="width: 10%;"></td> <td style="width: 10%;"></td> <td style="width: 10%;"></td> <td style="width: 10%;"></td> </tr> <tr> <td></td> <td></td> <td colspan="8" style="text-align: center;"> <table border="1" style="width: 100%; border-collapse: collapse; text-align: center;"> <tr> <td style="width: 10%;"></td> <td style="width: 10%;"></td> <td style="width: 10%;"></td> <td style="width: 10%;"></td> <td style="width: 10%;"></td> <td style="width: 10%;"></td> <td style="width: 10%;"></td> <td style="width: 10%;"></td> <td style="width: 10%;"></td> <td style="width: 10%;"></td> </tr> <tr> <td></td> <td></td> <td colspan="8" style="text-align: center;"> <table border="1" style="width: 100%; border-collapse: collapse; text-align: center;"> <tr> <td style="width: 10%;"></td> <td style="width: 10%;"></td> <td style="width: 10%;"></td> <td style="width: 10%;"></td> <td style="width: 10%;"></td> <td style="width: 10%;"></td> <td style="width: 10%;"></td> <td style="width: 10%;"></td> <td style="width: 10%;"></td> <td style="width: 10%;"></td> </tr> <tr> <td></td> <td></td> <td colspan="8" style="text-align: center;"> <table border="1" style="width: 100%; border-collapse: collapse; text-align: center;"> <tr> <td style="width: 10%;"></td> <td style="width: 10%;"></td> <td style="width: 10%;"></td> <td style="width: 10%;"></td> <td style="width: 10%;"></td> <td style="width: 10%;"></td> <td style="width: 10%;"></td> <td style="width: 10%;"></td> <td style="width: 10%;"></td> <td style="width: 10%;"></td> </tr> <tr> <td></td> <td></td> <td colspan="8" style="text-align: center;"> <table border="1" style="width: 100%; border-collapse: collapse; text-align: center;"> <tr> <td style="width: 10%;"></td> <td style="width: 10%;"></td> <td style="width: 10%;"></td> <td style="width: 10%;"></td> <td style="width: 10%;"></td> <td style="width: 10%;"></td> <td style="width: 10%;"></td> <td style="width: 10%;"></td> <td style="width: 10%;"></td> <td style="width: 10%;"></td> </tr> <tr> <td></td> <td></td> <td colspan="8" style="text-align: center;"> <table border="1" style="width: 100%; border-collapse: collapse; text-align: center;"> <tr> <td style="width: 10%;"></td> <td style="width: 10%;"></td> <td style="width: 10%;"></td> <td style="width: 10%;"></td> <td style="width: 10%;"></td> <td style="width: 10%;"></td> <td style="width: 10%;"></td> <td style="width: 10%;"></td> <td style="width: 10%;"></td> <td style="width: 10%;"></td> </tr> <tr> <td></td> <td></td> <td colspan="8" style="text-align: center;"> <table border="1" style="width: 100%; border-collapse: collapse; text-align: center;"> <tr> <td style="width: 10%;"></td> <td style="width: 10%;"></td> <td style="width: 10%;"></td> <td style="width: 10%;"></td> <td style="width: 10%;"></td> <td style="width: 10%;"></td> <td style="width: 10%;"></td> <td style="width: 10%;"></td> <td style="width: 10%;"></td> <td style="width: 10%;"></td> </tr> <tr> <td></td> <td></td> <td colspan="8" style="text-align: center;"> <table border="1" style="width: 100%; border-collapse: collapse; text-align: center;"> <tr> <td style="width: 10%;"></td> <td style="width: 10%;"></td> <td style="width: 10%;"></td> <td style="width: 10%;"></td> <td style="width: 10%;"></td> <td style="width: 10%;"></td> <td style="width: 10%;"></td> <td style="width: 10%;"></td> <td style="width: 10%;"></td> <td style="width: 10%;"></td> </tr> <tr> <td></td> <td></td> <td colspan="8" style="text-align: center;"> <table border="1" style="width: 100%; border-collapse: collapse; text-align: center;"> <tr> <td style="width: 10%;"></td> <td style="width: 10%;"></td> <td style="width: 10%;"></td> <td style="width: 10%;"></td> <td style="width: 10%;"></td> <td style="width: 10%;"></td> <td style="width: 10%;"></td> <td style="width: 10%;"></td> <td style="width: 10%;"></td> <td style="width: 10%;"></td> </tr> <tr> <td></td> <td></td> <td colspan="8" style="text-align: center;"> <table border="1" style="width: 100%; border-collapse: collapse; text-align: center;"> <tr> <td style="width: 10%;"></td> <td style="width: 10%;"></td> <td style="width: 10%;"></td> <td style="width: 10%;"></td> <td style="width: 10%;"></td> <td style="width: 10%;"></td> <td style="width: 10%;"></td> <td style="width: 10%;"></td> <td style="width: 10%;"></td> <td style="width: 10%;"></td> </tr> <tr> <td></td> <td></td> <td colspan="8" style="text-align: center;"> <table border="1" style="width: 100%; border-collapse: collapse; text-align: center;"> <tr> <td style="width: 10%;"></td> <td style="width: 10%;"></td> <td style="width: 10%;"></td> <td style="width: 10%;"></td> <td style="width: 10%;"></td> <td style="width: 10%;"></td> <td style="width: 10%;"></td> <td style="width: 10%;"></td> <td style="width: 10%;"></td> <td style="width: 10%;"></td> </tr> <tr> <td></td> <td></td> <td colspan="8" style="text-align: center;"> <table border="1" style="width: 100%; border-collapse: collapse; text-align: center;"> <tr> <td style="width: 10%;"></td> <td style="width: 10%;"></td> <td style="width: 10%;"></td> <td style="width: 10%;"></td> <td style="width: 10%;"></td> <td style="width: 10%;"></td> <td style="width: 10%;"></td> <td style="width: 10%;"></td> <td style="width: 10%;"></td> <td style="width: 10%;"></td> </tr> <tr> <td></td> <td></td> <td colspan="8" style="text-align: center;"> <table border="1" style="width: 100%; border-collapse: collapse; text-align: center;"> <tr> <td style="width: 10%;"></td> <td style="width: 10%;"></td> <td style="width: 10%;"></td> <td style="width: 10%;"></td> <td style="width: 10%;"></td> <td style="width: 10%;"></td> <td style="width: 10%;"></td> <td style="width: 10%;"></td> <td style="width: 10%;"></td> <td style="width: 10%;"></td> </tr> <tr> <td></td> <td></td> <td colspan="8" style="text-align: center;"> <table border="1" style="width: 100%;
border-collapse: collapse; text-align: center;"> <tr> <td style="width: 10%;"></td> <td style="width: 10%;"></td> <td style="width: 10%;"></td> <td style="width: 10%;"></td> <td style="width: 10%;"></td> <td style="width: 10%;"></td> <td style="width: 10%;"></td> <td style="width: 10%;"></td> <td style="width: 10%;"></td> <td style="width: 10%;"></td> </tr> <tr> <td></td> <td></td> <td colspan="8" style="text-align: center;"> <table border="1" style="width: 100%; border-collapse: collapse; text-align: center;"> <tr> <td style="width: 10%;"></td> <td style="width: 10%;"></td> <td style="width: 10%;"></td> <td style="width: 10%;"></td> <td style="width: 10%;"></td> <td style="width: 10%;"></td> <td style="width: 10%;"></td> <td style="width: 10%;"></td> <td style="width: 10%;"></td> <td style="width: 10%;"></td> </tr> <tr> <td></td> <td></td> <td colspan="8" style="text-align: center;"> <table border="1" style="width: 100%; border-collapse: collapse; text-align: center;"> <tr> <td style="width: 10%;"></td> <td style="width: 10%;"></td> <td style="width: 10%;"></td> <td style="width: 10%;"></td> <td style="width: 10%;"></td> <td style="width: 10%;"></td> <td style="width: 10%;"></td> <td style="width: 10%;"></td> <td style="width: 10%;"></td> <td style="width: 10%;"></td> </tr> <tr> <td></td> <td></td> <td colspan="8" style="text-align: center;"> <table border="1" style="width: 100%; border-collapse: collapse; text-align: center;"> <tr> <td style="width: 10%;"></td> <td style="width: 10%;"></td> <td style="width: 10%;"></td> <td style="width: 10%;"></td> <td style="width: 10%;"></td> <td style="width: 10%;"></td> <td style="width: 10%;"></td> <td style="width: 10%;"></td> <td style="width: 10%;"></td> <td style="width: 10%;"></td> </tr> <tr> <td></td> <td></td> <td colspan="8" style="text-align: center;"> <table border="1" style="width: 100%; border-collapse: collapse; text-align: center;"> <tr> <td style="width: 10%;"></td> <td style="width: 10%;"></td> <td style="width: 10%;"></td> <td style="width: 10%;"></td> <td style="width: 10%;"></td> <td style="width: 10%;"></td> <td style="width: 10%;"></td> <td style="width: 10%;"></td> <td style="width: 10%;"></td> <td style="width: 10%;"></td> </tr> <tr> <td></td> <td></td> <td colspan="8" style="text-align: center;"> <table border="1" style="width: 100%; border-collapse: collapse; text-align: center;"> <tr> <td style="width: 10%;"></td> <td style="width: 10%;"></td> <td style="width: 10%;"></td> <td style="width: 10%;"></td> <td style="width: 10%;"></td> <td style="width: 10%;"></td> <td style="width: 10%;"></td> <td style="width: 10%;"></td> <td style="width: 10%;"></td> <td style="width: 10%;"></td> </tr> <tr> <td></td> <td></td> <td colspan="8" style="text-align: center;"> <table border="1" style="width: 100%; border-collapse: collapse; text-align: center;"> <tr> <td style="width: 10%;"></td> <td style="width: 10%;"></td> <td style="width: 10%;"></td> <td style="width: 10%;"></td> <td style="width: 10%;"></td> <td style="width: 10%;"></td> <td style="width: 10%;"></td> <td style="width: 10%;"></td> <td style="width: 10%;"></td> <td style="width: 10%;"></td> </tr> <tr> <td></td> <td></td> <td colspan="8" style="text-align: center;"> <table border="1" style="width: 100%; border-collapse: collapse; text-align: center;"> <tr> <td style="width: 10%;"></td> <td style="width: 10%;"></td> <td style="width: 10%;"></td> <td style="width: 10%;"></td> <td style="width: 10%;"></td> <td style="width: 10%;"></td> <td style="width: 10%;"></td> <td style="width: 10%;"></td> <td style="width: 10%;"></td> <td style="width: 10%;"></td> </tr> <tr> <td></td> <td></td> <td colspan="8" style="text-align: center;"> <table border="1" style="width: 100%; border-collapse: collapse; text-align: center;"> <tr> <td style="width: 10%;"></td> <td style="width: 10%;"></td> <td style="width: 10%;"></td> <td style="width: 10%;"></td> <td style="width: 10%;"></td> <td style="width: 10%;"></td> <td style="width: 10%;"></td> <td style="width: 10%;"></td> <td style="width: 10%;"></td> <td style="width: 10%;"></td> </tr> <tr> <td></td> <td></td> <td colspan="8" style="text-align: center;"> <table border="1" style="width: 100%; border-collapse: collapse; text-align: center;"> <tr> <td style="width: 10%;"></td> <td style="width: 10%;"></td> <td style="width: 10%;"></td> <td style="width: 10%;"></td> <td style="width: 10%;"></td> <td style="width: 10%;"></td> <td style="width: 10%;"></td> <td style="width: 10%;"></td> <td style="width: 10%;"></td> <td style="width: 10%;"></td> </tr> <tr> <td></td> <td></td> <td colspan="8" style="text-align: center;"> <table border="1" style="width: 100%; border-collapse: collapse; text-align: center;"> <tr> <td style="width: 10%;"></td> <td style="width: 10%;"></td> <td style="width: 10%;"></td> <td style="width: 10%;"></td> <td style="width: 10%;"></td> <td style="width: 10%;"></td> <td style="width: 10%;"></td> <td style="width: 10%;"></td> <td style="width: 10%;"></td> <td style="width: 10%;"></td> </tr> <tr> <td></td> <td></td> <td colspan="8" style="text-align: center;"> <table border="1" style="width: 100%; border-collapse: collapse; text-align: center;"> <tr> <td style="width: 10%;"></td> <td style="width: 10%;"></td> <td style="width: 10%;"></td> <td style="width: 10%;"></td> <td style="width: 10%;"></td> <td style="width: 10%;"></td> <td style="width: 10%;"></td> <td style="width: 10%;"></td> <td style="width: 10%;"></td> <td style="width: 10%;"></td> </tr> <tr> <td></td> <td></td> <td colspan="8" style="text-align: center;"> <table border="1" style="width: 100%; border-collapse: collapse; text-align: center;"> <tr> <td style="width: 10%;"></td> <td style="width: 10%;"></td> <td style="width: 10%;"></td> <td style="width: 10%;"></td> <td style="width: 10%;"></td> <td style="width: 10%;"></td> <td style="width: 10%;"></td> <td style="width: 10%;"></td> <td style="width: 10%;"></td> <td style="width: 10%;"></td> </tr> <tr> <td></td> <td></td> <td colspan="8" style="text-align: center;"> <table border="1" style="width: 100%; border-collapse: collapse; text-align: center;"> <tr> <td style="width: 10%;"></td> <td style="width: 10%;"></td> <td style="width: 10%;"></td> <td style="width: 10%;"></td> <td style="width: 10%;"></td> <td style="width: 10%;"></td> <td style="width: 10%;"></td> <td style="width: 10%;"></td> <td style="width: 10%;"></td> <td style="width: 10%;"></td> </tr> <tr> <td></td> <td></td> <td colspan="8" style="text-align: center;"> <table border="1" style="width: 100%; border-collapse: collapse; text-align: center;"> <tr> <td style="width: 10%;"></td> <td style="width: 10%;"></td> <td style="width: 10%;"></td> <td style="width: 10%;"></td> <td style="width: 10%;"></td> <td style="width: 10%;"></td> <td style="width: 10%;"></td> <td style="width: 10%;"></td> <td style="width: 10%;"></td> <td style="width: 10%;"></td> </tr> <tr> <td></td> <td></td> <td colspan="8" style="text-align: center;"> <table border="1" style="width: 100%; border-collapse: collapse; text-align: center;"> <tr> </tr></table></td></tr></table></td></tr></table></td></tr></table></td></tr></table></td></tr></table></td></tr></table></td></tr></table></td></tr></table></td></tr></table></td></tr></table></td></tr></table></td></tr></table></td></tr></table></td></tr></table></td></tr></table></td></tr></table></td></tr></table></td></tr></table></td></tr></table></td></tr></table></td></tr></table></td></tr></table></td></tr></table></td></tr></table></td></tr></table></td></tr></table></td></tr></table></td></tr></table></td></tr></table></td></tr></table></td></tr></table></td></tr></table></td></tr></table>

 | | | | | | | | | | | | | | | | | | | | <table border="1" style="width: 100%; border-collapse: collapse; text-align: center;"> <tr> <td style="width: 10%;"></td> <td style="width: 10%;"></td> <td style="width: 10%;"></td> <td style="width: 10%;"></td> <td style="width: 10%;"></td> <td style="width: 10%;"></td> <td style="width: 10%;"></td> <td style="width: 10%;"></td> <td style="width: 10%;"></td> <td style="width: 10%;"></td> </tr> <tr> <td></td> <td></td> <td colspan="8" style="text-align: center;"> <table border="1" style="width: 100%; border-collapse: collapse; text-align: center;"> <tr> <td style="width: 10%;"></td> <td style="width: 10%;"></td> <td style="width: 10%;"></td> <td style="width: 10%;"></td> <td style="width: 10%;"></td> <td style="width: 10%;"></td> <td style="width: 10%;"></td> <td style="width: 10%;"></td> <td style="width: 10%;"></td> <td style="width: 10%;"></td> </tr> <tr> <td></td> <td></td> <td colspan="8" style="text-align: center;"> <table border="1" style="width: 100%; border-collapse: collapse; text-align: center;"> <tr> <td style="width: 10%;"></td> <td style="width: 10%;"></td> <td style="width: 10%;"></td> <td style="width: 10%;"></td> <td style="width: 10%;"></td> <td style="width: 10%;"></td> <td style="width: 10%;"></td> <td style="width: 10%;"></td> <td style="width: 10%;"></td> <td style="width: 10%;"></td> </tr> <tr> <td></td> <td></td> <td colspan="8" style="text-align: center;"> <table border="1" style="width: 100%; border-collapse: collapse; text-align: center;"> <tr> <td style="width: 10%;"></td> <td style="width: 10%;"></td> <td style="width: 10%;"></td> <td style="width: 10%;"></td> <td style="width: 10%;"></td> <td style="width: 10%;"></td> <td style="width: 10%;"></td> <td style="width: 10%;"></td> <td style="width: 10%;"></td> <td style="width: 10%;"></td> </tr> <tr> <td></td> <td></td> <td colspan="8" style="text-align: center;"> <table border="1" style="width: 100%; border-collapse: collapse; text-align: center;"> <tr> <td style="width: 10%;"></td> <td style="width: 10%;"></td> <td style="width: 10%;"></td> <td style="width: 10%;"></td> <td style="width: 10%;"></td> <td style="width: 10%;"></td> <td style="width: 10%;"></td> <td style="width: 10%;"></td> <td style="width: 10%;"></td> <td style="width: 10%;"></td> </tr> <tr> <td></td> <td></td> <td colspan="8" style="text-align: center;"> <table border="1" style="width: 100%; border-collapse: collapse; text-align: center;"> <tr> <td style="width: 10%;"></td> <td style="width: 10%;"></td> <td style="width: 10%;"></td> <td style="width: 10%;"></td> <td style="width: 10%;"></td> <td style="width: 10%;"></td> <td style="width: 10%;"></td> <td style="width: 10%;"></td> <td style="width: 10%;"></td> <td style="width: 10%;"></td> </tr> <tr> <td></td> <td></td> <td colspan="8" style="text-align: center;"> <table border="1" style="width: 100%; border-collapse: collapse; text-align: center;"> <tr> <td style="width: 10%;"></td> <td style="width: 10%;"></td> <td style="width: 10%;"></td> <td style="width: 10%;"></td> <td style="width: 10%;"></td> <td style="width: 10%;"></td> <td style="width: 10%;"></td> <td style="width: 10%;"></td> <td style="width: 10%;"></td> <td style="width: 10%;"></td> </tr> <tr> <td></td> <td></td> <td colspan="8" style="text-align: center;"> <table border="1" style="width: 100%; border-collapse: collapse; text-align: center;"> <tr> <td style="width: 10%;"></td> <td style="width: 10%;"></td> <td style="width: 10%;"></td> <td style="width: 10%;"></td> <td style="width: 10%;"></td> <td style="width: 10%;"></td> <td style="width: 10%;"></td> <td style="width: 10%;"></td> <td style="width: 10%;"></td> <td style="width: 10%;"></td> </tr> <tr> <td></td> <td></td> <td colspan="8" style="text-align: center;"> <table border="1" style="width: 100%; border-collapse: collapse; text-align: center;"> <tr> <td style="width: 10%;"></td> <td style="width: 10%;"></td> <td style="width: 10%;"></td> <td style="width: 10%;"></td> <td style="width: 10%;"></td> <td style="width: 10%;"></td> <td style="width: 10%;"></td> <td style="width: 10%;"></td> <td style="width: 10%;"></td> <td style="width: 10%;"></td> </tr> <tr> <td></td> <td></td> <td colspan="8" style="text-align: center;"> <table border="1" style="width: 100%; border-collapse: collapse; text-align: center;"> <tr> <td style="width: 10%;"></td> <td style="width: 10%;"></td> <td style="width: 10%;"></td> <td style="width: 10%;"></td> <td style="width: 10%;"></td> <td style="width: 10%;"></td> <td style="width: 10%;"></td> <td style="width: 10%;"></td> <td style="width: 10%;"></td> <td style="width: 10%;"></td> </tr> <tr> <td></td> <td></td> <td colspan="8" style="text-align: center;"> <table border="1" style="width: 100%; border-collapse: collapse; text-align: center;"> <tr> <td style="width: 10%;"></td> <td style="width: 10%;"></td> <td style="width: 10%;"></td> <td style="width: 10%;"></td> <td style="width: 10%;"></td> <td style="width: 10%;"></td> <td style="width: 10%;"></td> <td style="width: 10%;"></td> <td style="width: 10%;"></td> <td style="width: 10%;"></td> </tr> <tr> <td></td> <td></td> <td colspan="8" style="text-align: center;"> <table border="1" style="width: 100%; border-collapse: collapse; text-align: center;"> <tr> <td style="width: 10%;"></td> <td style="width: 10%;"></td> <td style="width: 10%;"></td> <td style="width: 10%;"></td> <td style="width: 10%;"></td> <td style="width: 10%;"></td> <td style="width: 10%;"></td> <td style="width: 10%;"></td> <td style="width: 10%;"></td> <td style="width: 10%;"></td> </tr> <tr> <td></td> <td></td> <td colspan="8" style="text-align: center;"> <table border="1" style="width: 100%; border-collapse: collapse; text-align: center;"> <tr> <td style="width: 10%;"></td> <td style="width: 10%;"></td> <td style="width: 10%;"></td> <td style="width: 10%;"></td> <td style="width: 10%;"></td> <td style="width: 10%;"></td> <td style="width: 10%;"></td> <td style="width: 10%;"></td> <td style="width: 10%;"></td> <td style="width: 10%;"></td> </tr> <tr> <td></td> <td></td> <td colspan="8" style="text-align: center;"> <table border="1" style="width: 100%; border-collapse: collapse; text-align: center;"> <tr> <td style="width: 10%;"></td> <td style="width: 10%;"></td> <td style="width: 10%;"></td> <td style="width: 10%;"></td> <td style="width: 10%;"></td> <td style="width: 10%;"></td> <td style="width: 10%;"></td> <td style="width: 10%;"></td> <td style="width: 10%;"></td> <td style="width: 10%;"></td> </tr> <tr> <td></td> <td></td> <td colspan="8" style="text-align: center;"> <table border="1" style="width: 100%; border-collapse: collapse; text-align: center;"> <tr> <td style="width: 10%;"></td> <td style="width: 10%;"></td> <td style="width: 10%;"></td> <td style="width: 10%;"></td> <td style="width: 10%;"></td> <td style="width: 10%;"></td> <td style="width: 10%;"></td> <td style="width: 10%;"></td> <td style="width: 10%;"></td> <td style="width: 10%;"></td> </tr> <tr> <td></td> <td></td> <td colspan="8" style="text-align: center;"> <table border="1" style="width: 100%; border-collapse: collapse; text-align: center;"> <tr> <td style="width: 10%;"></td> <td style="width: 10%;"></td> <td style="width: 10%;"></td> <td style="width: 10%;"></td> <td style="width: 10%;"></td> <td style="width: 10%;"></td> <td style="width: 10%;"></td> <td style="width: 10%;"></td> <td style="width: 10%;"></td> <td style="width: 10%;"></td> </tr> <tr> <td></td> <td></td> <td colspan="8" style="text-align: center;"> <table border="1" style="width: 100%; border-collapse: collapse; text-align: center;"> <tr> <td style="width: 10%;"></td> <td style="width: 10%;"></td> <td style="width: 10%;"></td> <td style="width: 10%;"></td> <td style="width: 10%;"></td> <td style="width: 10%;"></td> <td style="width: 10%;"></td> <td style="width: 10%;"></td> <td style="width: 10%;"></td> <td style="width: 10%;"></td> </tr> <tr> <td></td> <td></td> <td colspan="8" style="text-align: center;"> <table border="1" style="width: 100%; border-collapse: collapse; text-align: center;"> <tr> <td style="width: 10%;"></td> <td style="width: 10%;"></td> <td style="width: 10%;"></td> <td style="width: 10%;"></td> <td style="width: 10%;"></td> <td style="width: 10%;"></td> <td style="width: 10%;"></td> <td style="width: 10%;"></td> <td style="width: 10%;"></td> <td style="width: 10%;"></td> </tr> <tr> <td></td> <td></td> <td colspan="8" style="text-align: center;"> <table border="1" style="width: 100%; border-collapse: collapse; text-align: center;"> <tr> <td style="width: 10%;"></td> <td style="width: 10%;"></td> <td style="width: 10%;"></td> <td style="width: 10%;"></td> <td style="width: 10%;"></td> <td style="width: 10%;"></td> <td style="width: 10%;"></td> <td style="width: 10%;"></td> <td style="width: 10%;"></td> <td style="width: 10%;"></td> </tr> <tr> <td></td> <td></td> <td colspan="8" style="text-align: center;"> <table border="1" style="width: 100%; border-collapse: collapse; text-align: center;"> <tr> <td style="width: 10%;"></td> <td style="width: 10%;"></td> <td style="width: 10%;"></td> <td style="width: 10%;"></td> <td style="width: 10%;"></td> <td style="width: 10%;"></td> <td style="width: 10%;"></td> <td style="width: 10%;"></td> <td style="width: 10%;"></td> <td style="width: 10%;"></td> </tr> <tr> <td></td> <td></td> <td colspan="8" style="text-align: center;"> <table border="1" style="width: 100%; border-collapse: collapse; text-align: center;"> <tr> <td style="width: 10%;"></td> <td style="width: 10%;"></td> <td style="width: 10%;"></td> <td style="width: 10%;"></td> <td style="width: 10%;"></td> <td style="width:
10%;"></td> <td style="width: 10%;"></td> <td style="width: 10%;"></td> <td style="width: 10%;"></td> <td style="width: 10%;"></td> </tr> <tr> <td></td> <td></td> <td colspan="8" style="text-align: center;"> <table border="1" style="width: 100%; border-collapse: collapse; text-align: center;"> <tr> <td style="width: 10%;"></td> <td style="width: 10%;"></td> <td style="width: 10%;"></td> <td style="width: 10%;"></td> <td style="width: 10%;"></td> <td style="width: 10%;"></td> <td style="width: 10%;"></td> <td style="width: 10%;"></td> <td style="width: 10%;"></td> <td style="width: 10%;"></td> </tr> <tr> <td></td> <td></td> <td colspan="8" style="text-align: center;"> <table border="1" style="width: 100%; border-collapse: collapse; text-align: center;"> <tr> <td style="width: 10%;"></td> <td style="width: 10%;"></td> <td style="width: 10%;"></td> <td style="width: 10%;"></td> <td style="width: 10%;"></td> <td style="width: 10%;"></td> <td style="width: 10%;"></td> <td style="width: 10%;"></td> <td style="width: 10%;"></td> <td style="width: 10%;"></td> </tr> <tr> <td></td> <td></td> <td colspan="8" style="text-align: center;"> <table border="1" style="width: 100%; border-collapse: collapse; text-align: center;"> <tr> <td style="width: 10%;"></td> <td style="width: 10%;"></td> <td style="width: 10%;"></td> <td style="width: 10%;"></td> <td style="width: 10%;"></td> <td style="width: 10%;"></td> <td style="width: 10%;"></td> <td style="width: 10%;"></td> <td style="width: 10%;"></td> <td style="width: 10%;"></td> </tr> <tr> <td></td> <td></td> <td colspan="8" style="text-align: center;"> <table border="1" style="width: 100%; border-collapse: collapse; text-align: center;"> <tr> <td style="width: 10%;"></td> <td style="width: 10%;"></td> <td style="width: 10%;"></td> <td style="width: 10%;"></td> <td style="width: 10%;"></td> <td style="width: 10%;"></td> <td style="width: 10%;"></td> <td style="width: 10%;"></td> <td style="width: 10%;"></td> <td style="width: 10%;"></td> </tr> <tr> <td></td> <td></td> <td colspan="8" style="text-align: center;"> <table border="1" style="width: 100%; border-collapse: collapse; text-align: center;"> <tr> <td style="width: 10%;"></td> <td style="width: 10%;"></td> <td style="width: 10%;"></td> <td style="width: 10%;"></td> <td style="width: 10%;"></td> <td style="width: 10%;"></td> <td style="width: 10%;"></td> <td style="width: 10%;"></td> <td style="width: 10%;"></td> <td style="width: 10%;"></td> </tr> <tr> <td></td> <td></td> <td colspan="8" style="text-align: center;"> <table border="1" style="width: 100%; border-collapse: collapse; text-align: center;"> <tr> <td style="width: 10%;"></td> <td style="width: 10%;"></td> <td style="width: 10%;"></td> <td style="width: 10%;"></td> <td style="width: 10%;"></td> <td style="width: 10%;"></td> <td style="width: 10%;"></td> <td style="width: 10%;"></td> <td style="width: 10%;"></td> <td style="width: 10%;"></td> </tr> <tr> <td></td> <td></td> <td colspan="8" style="text-align: center;"> <table border="1" style="width: 100%; border-collapse: collapse; text-align: center;"> <tr> <td style="width: 10%;"></td> <td style="width: 10%;"></td> <td style="width: 10%;"></td> <td style="width: 10%;"></td> <td style="width: 10%;"></td> <td style="width: 10%;"></td> <td style="width: 10%;"></td> <td style="width: 10%;"></td> <td style="width: 10%;"></td> <td style="width: 10%;"></td> </tr> <tr> <td></td> <td></td> <td colspan="8" style="text-align: center;"> <table border="1" style="width: 100%; border-collapse: collapse; text-align: center;"> <tr> <td style="width: 10%;"></td> <td style="width: 10%;"></td> <td style="width: 10%;"></td> <td style="width: 10%;"></td> <td style="width: 10%;"></td> <td style="width: 10%;"></td> <td style="width: 10%;"></td> <td style="width: 10%;"></td> <td style="width: 10%;"></td> <td style="width: 10%;"></td> </tr> <tr> <td></td> <td></td> <td colspan="8" style="text-align: center;"> <table border="1" style="width: 100%; border-collapse: collapse; text-align: center;"> <tr> <td style="width: 10%;"></td> <td style="width: 10%;"></td> <td style="width: 10%;"></td> <td style="width: 10%;"></td> <td style="width: 10%;"></td> <td style="width: 10%;"></td> <td style="width: 10%;"></td> <td style="width: 10%;"></td> <td style="width: 10%;"></td> <td style="width: 10%;"></td> </tr> <tr> <td></td> <td></td> <td colspan="8" style="text-align: center;"> <table border="1" style="width: 100%; border-collapse: collapse; text-align: center;"> <tr> <td style="width: 10%;"></td> <td style="width: 10%;"></td> <td style="width: 10%;"></td> <td style="width: 10%;"></td> <td style="width: 10%;"></td> <td style="width: 10%;"></td> <td style="width: 10%;"></td> <td style="width: 10%;"></td> <td style="width: 10%;"></td> <td style="width: 10%;"></td> </tr> <tr> <td></td> <td></td> <td colspan="8" style="text-align: center;"> <table border="1" style="width: 100%; border-collapse: collapse; text-align: center;"> <tr> <td style="width: 10%;"></td> <td style="width: 10%;"></td> <td style="width: 10%;"></td> <td style="width: 10%;"></td> <td style="width: 10%;"></td> <td style="width: 10%;"></td> <td style="width: 10%;"></td> <td style="width: 10%;"></td> <td style="width: 10%;"></td> <td style="width: 10%;"></td> </tr> <tr> <td></td> <td></td> <td colspan="8" style="text-align: center;"> <table border="1" style="width: 100%; border-collapse: collapse; text-align: center;"> <tr> </tr></table></td></tr></table></td></tr></table></td></tr></table></td></tr></table></td></tr></table></td></tr></table></td></tr></table></td></tr></table></td></tr></table></td></tr></table></td></tr></table></td></tr></table></td></tr></table></td></tr></table></td></tr></table></td></tr></table></td></tr></table></td></tr></table></td></tr></table></td></tr></table></td></tr></table></td></tr></table></td></tr></table></td></tr></table></td></tr></table></td></tr></table></td></tr></table></td></tr></table></td></tr></table></td></tr></table></td></tr></table></td></tr></table>
 | | | | | | | | | | | | | | | | | | | | <table border="1" style="width: 100%; border-collapse: collapse; text-align: center;"> <tr> <td style="width: 10%;"></td> <td style="width: 10%;"></td> <td style="width: 10%;"></td> <td style="width: 10%;"></td> <td style="width: 10%;"></td> <td style="width: 10%;"></td> <td style="width: 10%;"></td> <td style="width: 10%;"></td> <td style="width: 10%;"></td> <td style="width: 10%;"></td> </tr> <tr> <td></td> <td></td> <td colspan="8" style="text-align: center;"> <table border="1" style="width: 100%; border-collapse: collapse; text-align: center;"> <tr> <td style="width: 10%;"></td> <td style="width: 10%;"></td> <td style="width: 10%;"></td> <td style="width: 10%;"></td> <td style="width: 10%;"></td> <td style="width: 10%;"></td> <td style="width: 10%;"></td> <td style="width: 10%;"></td> <td style="width: 10%;"></td> <td style="width: 10%;"></td> </tr> <tr> <td></td> <td></td> <td colspan="8" style="text-align: center;"> <table border="1" style="width: 100%; border-collapse: collapse; text-align: center;"> <tr> <td style="width: 10%;"></td> <td style="width: 10%;"></td> <td style="width: 10%;"></td> <td style="width: 10%;"></td> <td style="width: 10%;"></td> <td style="width: 10%;"></td> <td style="width: 10%;"></td> <td style="width:
10%;"></td> <td style="width: 10%;"></td> <td style="width: 10%;"></td> </tr> <tr> <td></td> <td></td> <td colspan="8" style="text-align: center;"> <table border="1" style="width: 100%; border-collapse: collapse; text-align: center;"> <tr> <td style="width: 10%;"></td> <td style="width: 10%;"></td> <td style="width: 10%;"></td> <td style="width: 10%;"></td> <td style="width: 10%;"></td> <td style="width: 10%;"></td> <td style="width: 10%;"></td> <td style="width: 10%;"></td> <td style="width: 10%;"></td> <td style="width: 10%;"></td> </tr> <tr> <td></td> <td></td> <td colspan="8" style="text-align: center;"> <table border="1" style="width: 100%; border-collapse: collapse; text-align: center;"> <tr> <td style="width: 10%;"></td> <td style="width: 10%;"></td> <td style="width: 10%;"></td> <td style="width: 10%;"></td> <td style="width: 10%;"></td> <td style="width: 10%;"></td> <td style="width: 10%;"></td> <td style="width: 10%;"></td> <td style="width: 10%;"></td> <td style="width: 10%;"></td> </tr> <tr> <td></td> <td></td> <td colspan="8" style="text-align: center;"> <table border="1" style="width: 100%; border-collapse: collapse; text-align: center;"> <tr> <td style="width: 10%;"></td> <td style="width: 10%;"></td> <td style="width: 10%;"></td> <td style="width: 10%;"></td> <td style="width: 10%;"></td> <td style="width: 10%;"></td> <td style="width: 10%;"></td> <td style="width: 10%;"></td> <td style="width: 10%;"></td> <td style="width: 10%;"></td> </tr> <tr> <td></td> <td></td> <td colspan="8" style="text-align: center;"> <table border="1" style="width: 100%; border-collapse: collapse; text-align: center;"> <tr> <td style="width: 10%;"></td> <td style="width: 10%;"></td> <td style="width: 10%;"></td> <td style="width: 10%;"></td> <td style="width: 10%;"></td> <td style="width: 10%;"></td> <td style="width: 10%;"></td> <td style="width: 10%;"></td> <td style="width: 10%;"></td> <td style="width: 10%;"></td> </tr> <tr> <td></td> <td></td> <td colspan="8" style="text-align: center;"> <table border="1" style="width: 100%; border-collapse: collapse; text-align: center;"> <tr> <td style="width: 10%;"></td> <td style="width: 10%;"></td> <td style="width: 10%;"></td> <td style="width: 10%;"></td> <td style="width: 10%;"></td> <td style="width: 10%;"></td> <td style="width: 10%;"></td> <td style="width: 10%;"></td> <td style="width: 10%;"></td> <td style="width: 10%;"></td> </tr> <tr> <td></td> <td></td> <td colspan="8" style="text-align: center;"> <table border="1" style="width: 100%; border-collapse: collapse; text-align: center;"> <tr> <td style="width: 10%;"></td> <td style="width: 10%;"></td> <td style="width: 10%;"></td> <td style="width: 10%;"></td> <td style="width: 10%;"></td> <td style="width: 10%;"></td> <td style="width: 10%;"></td> <td style="width: 10%;"></td> <td style="width: 10%;"></td> <td style="width: 10%;"></td> </tr> <tr> <td></td> <td></td> <td colspan="8" style="text-align: center;"> <table border="1" style="width: 100%; border-collapse: collapse; text-align: center;"> <tr> <td style="width: 10%;"></td> <td style="width: 10%;"></td> <td style="width: 10%;"></td> <td style="width: 10%;"></td> <td style="width: 10%;"></td> <td style="width: 10%;"></td> <td style="width: 10%;"></td> <td style="width: 10%;"></td> <td style="width: 10%;"></td> <td style="width: 10%;"></td> </tr> <tr> <td></td> <td></td> <td colspan="8" style="text-align: center;"> <table border="1" style="width: 100%; border-collapse: collapse; text-align: center;"> <tr> <td style="width: 10%;"></td> <td style="width: 10%;"></td> <td style="width: 10%;"></td> <td style="width: 10%;"></td> <td style="width: 10%;"></td> <td style="width: 10%;"></td> <td style="width: 10%;"></td> <td style="width: 10%;"></td> <td style="width: 10%;"></td> <td style="width: 10%;"></td> </tr> <tr> <td></td> <td></td> <td colspan="8" style="text-align: center;"> <table border="1" style="width: 100%; border-collapse: collapse; text-align: center;"> <tr> <td style="width: 10%;"></td> <td style="width: 10%;"></td> <td style="width: 10%;"></td> <td style="width: 10%;"></td> <td style="width: 10%;"></td> <td style="width: 10%;"></td> <td style="width: 10%;"></td> <td style="width: 10%;"></td> <td style="width: 10%;"></td> <td style="width: 10%;"></td> </tr> <tr> <td></td> <td></td> <td colspan="8" style="text-align: center;"> <table border="1" style="width: 100%; border-collapse: collapse; text-align: center;"> <tr> <td style="width: 10%;"></td> <td style="width: 10%;"></td> <td style="width: 10%;"></td> <td style="width: 10%;"></td> <td style="width: 10%;"></td> <td style="width: 10%;"></td> <td style="width: 10%;"></td> <td style="width: 10%;"></td> <td style="width: 10%;"></td> <td style="width: 10%;"></td> </tr> <tr> <td></td> <td></td> <td colspan="8" style="text-align: center;"> <table border="1" style="width: 100%; border-collapse: collapse; text-align: center;"> <tr> <td style="width: 10%;"></td> <td style="width: 10%;"></td> <td style="width: 10%;"></td> <td style="width: 10%;"></td> <td style="width: 10%;"></td> <td style="width: 10%;"></td> <td style="width: 10%;"></td> <td style="width: 10%;"></td> <td style="width: 10%;"></td> <td style="width: 10%;"></td> </tr> <tr> <td></td> <td></td> <td colspan="8" style="text-align: center;"> <table border="1" style="width: 100%; border-collapse: collapse; text-align: center;"> <tr> <td style="width: 10%;"></td> <td style="width: 10%;"></td> <td style="width: 10%;"></td> <td style="width: 10%;"></td> <td style="width: 10%;"></td> <td style="width: 10%;"></td> <td style="width: 10%;"></td> <td style="width: 10%;"></td> <td style="width: 10%;"></td> <td style="width: 10%;"></td> </tr> <tr> <td></td> <td></td> <td colspan="8" style="text-align: center;"> <table border="1" style="width: 100%; border-collapse: collapse; text-align: center;"> <tr> <td style="width: 10%;"></td> <td style="width: 10%;"></td> <td style="width: 10%;"></td> <td style="width: 10%;"></td> <td style="width: 10%;"></td> <td style="width: 10%;"></td> <td style="width: 10%;"></td> <td style="width: 10%;"></td> <td style="width: 10%;"></td> <td style="width: 10%;"></td> </tr> <tr> <td></td> <td></td> <td colspan="8" style="text-align: center;"> <table border="1" style="width: 100%; border-collapse: collapse; text-align: center;"> <tr> <td style="width: 10%;"></td> <td style="width: 10%;"></td> <td style="width: 10%;"></td> <td style="width: 10%;"></td> <td style="width: 10%;"></td> <td style="width: 10%;"></td> <td style="width: 10%;"></td> <td style="width: 10%;"></td> <td style="width: 10%;"></td> <td style="width: 10%;"></td> </tr> <tr> <td></td> <td></td> <td colspan="8" style="text-align: center;"> <table border="1" style="width: 100%; border-collapse: collapse; text-align: center;"> <tr> <td style="width: 10%;"></td> <td style="width: 10%;"></td> <td style="width: 10%;"></td> <td style="width: 10%;"></td> <td style="width: 10%;"></td> <td style="width: 10%;"></td> <td style="width: 10%;"></td> <td style="width: 10%;"></td> <td style="width: 10%;"></td> <td style="width: 10%;"></td> </tr> <tr> <td></td> <td></td> <td colspan="8" style="text-align: center;"> <table border="1" style="width: 100%; border-collapse: collapse; text-align: center;"> <tr> <td style="width: 10%;"></td> <td style="width: 10%;"></td> <td style="width: 10%;"></td> <td style="width: 10%;"></td> <td style="width: 10%;"></td> <td style="width: 10%;"></td> <td style="width: 10%;"></td> <td style="width: 10%;"></td> <td style="width: 10%;"></td> <td style="width: 10%;"></td> </tr> <tr> <td></td> <td></td> <td colspan="8" style="text-align: center;"> <table border="1" style="width: 100%; border-collapse: collapse; text-align: center;"> <tr> <td style="width: 10%;"></td> <td style="width: 10%;"></td> <td style="width: 10%;"></td> <td style="width: 10%;"></td> <td style="width: 10%;"></td> <td style="width: 10%;"></td> <td style="width: 10%;"></td> <td style="width: 10%;"></td> <td style="width: 10%;"></td> <td style="width: 10%;"></td> </tr> <tr> <td></td> <td></td> <td colspan="8" style="text-align: center;"> <table border="1" style="width: 100%; border-collapse: collapse; text-align: center;"> <tr> <td style="width: 10%;"></td> <td style="width: 10%;"></td> <td style="width: 10%;"></td> <td style="width: 10%;"></td> <td style="width: 10%;"></td> <td style="width: 10%;"></td> <td style="width: 10%;"></td> <td style="width: 10%;"></td> <td style="width: 10%;"></td> <td style="width: 10%;"></td> </tr> <tr> <td></td> <td></td> <td colspan="8" style="text-align: center;"> <table border="1" style="width: 100%; border-collapse: collapse; text-align: center;"> <tr> <td style="width: 10%;"></td> <td style="width: 10%;"></td> <td style="width: 10%;"></td> <td style="width: 10%;"></td> <td style="width: 10%;"></td> <td style="width: 10%;"></td> <td style="width: 10%;"></td> <td style="width: 10%;"></td> <td style="width: 10%;"></td> <td style="width: 10%;"></td> </tr> <tr> <td></td> <td></td> <td colspan="8" style="text-align: center;"> <table border="1" style="width: 100%; border-collapse: collapse; text-align: center;"> <tr> <td style="width: 10%;"></td> <td style="width: 10%;"></td> <td style="width: 10%;"></td> <td style="width: 10%;"></td> <td style="width: 10%;"></td> <td style="width: 10%;"></td> <td style="width: 10%;"></td> <td style="width: 10%;"></td> <td style="width: 10%;"></td> <td style="width: 10%;"></td> </tr> <tr> <td></td> <td></td> <td colspan="8" style="text-align: center;"> <table border="1" style="width: 100%; border-collapse: collapse; text-align: center;"> <tr> <td style="width: 10%;"></td> <td style="width: 10%;"></td> <td style="width: 10%;"></td> <td style="width: 10%;"></td> <td style="width: 10%;"></td> <td style="width: 10%;"></td> <td style="width: 10%;"></td> <td style="width: 10%;"></td> <td style="width: 10%;"></td> <td style="width: 10%;"></td> </tr> <tr> <td></td> <td></td> <td colspan="8" style="text-align: center;"> <table border="1"
style="width: 100%; border-collapse: collapse; text-align: center;"> <tr> <td style="width: 10%;"></td> <td style="width: 10%;"></td> <td style="width: 10%;"></td> <td style="width: 10%;"></td> <td style="width: 10%;"></td> <td style="width: 10%;"></td> <td style="width: 10%;"></td> <td style="width: 10%;"></td> <td style="width: 10%;"></td> <td style="width: 10%;"></td> </tr> <tr> <td></td> <td></td> <td colspan="8" style="text-align: center;"> <table border="1" style="width: 100%; border-collapse: collapse; text-align: center;"> <tr> <td style="width: 10%;"></td> <td style="width: 10%;"></td> <td style="width: 10%;"></td> <td style="width: 10%;"></td> <td style="width: 10%;"></td> <td style="width: 10%;"></td> <td style="width: 10%;"></td> <td style="width: 10%;"></td> <td style="width: 10%;"></td> <td style="width: 10%;"></td> </tr> <tr> <td></td> <td></td> <td colspan="8" style="text-align: center;"> <table border="1" style="width: 100%; border-collapse: collapse; text-align: center;"> <tr> <td style="width: 10%;"></td> <td style="width: 10%;"></td> <td style="width: 10%;"></td> <td style="width: 10%;"></td> <td style="width: 10%;"></td> <td style="width: 10%;"></td> <td style="width: 10%;"></td> <td style="width: 10%;"></td> <td style="width: 10%;"></td> <td style="width: 10%;"></td> </tr> <tr> <td></td> <td></td> <td colspan="8" style="text-align: center;"> <table border="1" style="width: 100%; border-collapse: collapse; text-align: center;"> <tr> <td style="width: 10%;"></td> <td style="width: 10%;"></td> <td style="width: 10%;"></td> <td style="width: 10%;"></td> <td style="width: 10%;"></td> <td style="width: 10%;"></td> <td style="width: 10%;"></td> <td style="width: 10%;"></td> <td style="width: 10%;"></td> <td style="width: 10%;"></td> </tr> <tr> <td></td> <td></td> <td colspan="8" style="text-align: center;"> <table border="1" style="width: 100%; border-collapse: collapse; text-align: center;"> <tr> <td style="width: 10%;"></td> <td style="width: 10%;"></td> <td style="width: 10%;"></td> <td style="width: 10%;"></td> <td style="width: 10%;"></td> <td style="width: 10%;"></td> <td style="width: 10%;"></td> <td style="width: 10%;"></td> <td style="width: 10%;"></td> <td style="width: 10%;"></td> </tr> <tr> <td></td> <td></td> <td colspan="8" style="text-align: center;"> <table border="1" style="width: 100%; border-collapse: collapse; text-align: center;"> <tr> <td style="width: 10%;"></td> <td style="width: 10%;"></td> <td style="width: 10%;"></td> <td style="width: 10%;"></td> <td style="width: 10%;"></td> <td style="width: 10%;"></td> <td style="width: 10%;"></td> <td style="width: 10%;"></td> <td style="width: 10%;"></td> <td style="width: 10%;"></td> </tr> <tr> <td></td> <td></td> <td colspan="8" style="text-align: center;"> <table border="1" style="width: 100%; border-collapse: collapse; text-align: center;"> <tr> <td style="width: 10%;"></td> <td style="width: 10%;"></td> <td style="width: 10%;"></td> <td style="width: 10%;"></td> <td style="width: 10%;"></td> <td style="width: 10%;"></td> <td style="width: 10%;"></td> <td style="width: 10%;"></td> <td style="width: 10%;"></td> <td style="width: 10%;"></td> </tr> <tr> <td></td> <td></td> <td colspan="8" style="text-align: center;"> <table border="1" style="width: 100%; border-collapse: collapse; text-align: center;"> <tr> </tr></table></td></tr></table></td></tr></table></td></tr></table></td></tr></table></td></tr></table></td></tr></table></td></tr></table></td></tr></table></td></tr></table></td></tr></table></td></tr></table></td></tr></table></td></tr></table></td></tr></table></td></tr></table></td></tr></table></td></tr></table></td></tr></table></td></tr></table></td></tr></table></td></tr></table></td></tr></table></td></tr></table></td></tr></table></td></tr></table></td></tr></table></td></tr></table></td></tr></table></td></tr></table></td></tr></table></td></tr></table>
 | | | | | | | | | | | | | | | | | | | | <table border="1" style="width: 100%; border-collapse: collapse; text-align: center;"> <tr> <td style="width: 10%;"></td> <td style="width: 10%;"></td> <td style="width: 10%;"></td> <td style="width: 10%;"></td> <td style="width: 10%;"></td> <td style="width: 10%;"></td> <td style="width: 10%;"></td> <td style="width: 10%;"></td> <td style="width: 10%;"></td> <td style="width: 10%;"></td> </tr> <tr> <td></td> <td></td> <td colspan="8" style="text-align: center;"> <table border="1" style="width: 100%; border-collapse: collapse; text-align: center;"> <tr> <td style="width: 10%;"></td> <td style="width: 10%;"></td> <td style="width: 10%;"></td> <td style="width: 10%;"></td> <td style="width: 10%;"></td> <td style="width: 10%;"></td> <td style="width: 10%;"></td> <td style="width: 10%;"></td> <td style="width: 10%;"></td> <td style="width: 10%;"></td> </tr> <tr> <td></td> <td></td> <td colspan="8" style="text-align: center;"> <table border="1" style="width: 100%; border-collapse: collapse; text-align: center;"> <tr> <td style="width: 10%;"></td> <td style="width: 10%;"></td> <td style="width: 10%;"></td> <td style="width: 10%;"></td> <td style="width: 10%;"></td> <td style="width: 10%;"></td> <td style="width: 10%;"></td> <td style="width: 10%;"></td> <td style="width: 10%;"></td> <td style="width: 10%;"></td> </tr> <tr> <td></td> <td></td> <td colspan="8" style="text-align: center;"> <table border="1" style="width: 100%; border-collapse: collapse; text-align: center;"> <tr> <td style="width: 10%;"></td> <td style="width: 10%;"></td> <td style="width: 10%;"></td> <td style="width: 10%;"></td> <td style="width: 10%;"></td> <td style="width: 10%;"></td> <td style="width: 10%;"></td> <td style="width: 10%;"></td> <td style="width: 10%;"></td> <td style="width: 10%;"></td> </tr> <tr> <td></td> <td></td> <td colspan="8" style="text-align: center;"> <table border="1" style="width: 100%; border-collapse: collapse; text-align: center;"> <tr> <td style="width: 10%;"></td> <td style="width: 10%;"></td> <td style="width: 10%;"></td> <td style="width: 10%;"></td> <td style="width: 10%;"></td> <td style="width: 10%;"></td> <td style="width: 10%;"></td> <td style="width: 10%;"></td> <td style="width: 10%;"></td> <td style="width: 10%;"></td> </tr> <tr> <td></td> <td></td> <td colspan="8" style="text-align: center;"> <table border="1" style="width: 100%; border-collapse: collapse; text-align: center;"> <tr> <td style="width: 10%;"></td> <td style="width: 10%;"></td> <td style="width: 10%;"></td> <td style="width: 10%;"></td> <td style="width: 10%;"></td> <td style="width: 10%;"></td> <td style="width: 10%;"></td> <td style="width: 10%;"></td> <td style="width: 10%;"></td> <td style="width: 10%;"></td> </tr> <tr> <td></td> <td></td> <td colspan="8" style="text-align: center;"> <table border="1" style="width: 100%; border-collapse: collapse; text-align: center;"> <tr> <td style="width: 10%;"></td> <td style="width: 10%;"></td> <td style="width: 10%;"></td> <td style="width: 10%;"></td> <td style="width: 10%;"></td> <td style="width: 10%;"></td> <td style="width: 10%;"></td> <td style="width: 10%;"></td> <td style="width: 10%;"></td> <td style="width: 10%;"></td> </tr> <tr> <td></td> <td></td> <td colspan="8" style="text-align: center;"> <table border="1" style="width: 100%; border-collapse: collapse; text-align: center;"> <tr> <td
style="width: 10%;"></td> <td style="width: 10%;"></td> <td style="width: 10%;"></td> <td style="width: 10%;"></td> <td style="width: 10%;"></td> <td style="width: 10%;"></td> <td style="width: 10%;"></td> <td style="width: 10%;"></td> <td style="width: 10%;"></td> <td style="width: 10%;"></td> </tr> <tr> <td></td> <td></td> <td colspan="8" style="text-align: center;"> <table border="1" style="width: 100%; border-collapse: collapse; text-align: center;"> <tr> <td style="width: 10%;"></td> <td style="width: 10%;"></td> <td style="width: 10%;"></td> <td style="width: 10%;"></td> <td style="width: 10%;"></td> <td style="width: 10%;"></td> <td style="width: 10%;"></td> <td style="width: 10%;"></td> <td style="width: 10%;"></td> <td style="width: 10%;"></td> </tr> <tr> <td></td> <td></td> <td colspan="8" style="text-align: center;"> <table border="1" style="width: 100%; border-collapse: collapse; text-align: center;"> <tr> <td style="width: 10%;"></td> <td style="width: 10%;"></td> <td style="width: 10%;"></td> <td style="width: 10%;"></td> <td style="width: 10%;"></td> <td style="width: 10%;"></td> <td style="width: 10%;"></td> <td style="width: 10%;"></td> <td style="width: 10%;"></td> <td style="width: 10%;"></td> </tr> <tr> <td></td> <td></td> <td colspan="8" style="text-align: center;"> <table border="1" style="width: 100%; border-collapse: collapse; text-align: center;"> <tr> <td style="width: 10%;"></td> <td style="width: 10%;"></td> <td style="width: 10%;"></td> <td style="width: 10%;"></td> <td style="width: 10%;"></td> <td style="width: 10%;"></td> <td style="width: 10%;"></td> <td style="width: 10%;"></td> <td style="width: 10%;"></td> <td style="width: 10%;"></td> </tr> <tr> <td></td> <td></td> <td colspan="8" style="text-align: center;"> <table border="1" style="width: 100%; border-collapse: collapse; text-align: center;"> <tr> <td style="width: 10%;"></td> <td style="width: 10%;"></td> <td style="width: 10%;"></td> <td style="width: 10%;"></td> <td style="width: 10%;"></td> <td style="width: 10%;"></td> <td style="width: 10%;"></td> <td style="width: 10%;"></td> <td style="width: 10%;"></td> <td style="width: 10%;"></td> </tr> <tr> <td></td> <td></td> <td colspan="8" style="text-align: center;"> <table border="1" style="width: 100%; border-collapse: collapse; text-align: center;"> <tr> <td style="width: 10%;"></td> <td style="width: 10%;"></td> <td style="width: 10%;"></td> <td style="width: 10%;"></td> <td style="width: 10%;"></td> <td style="width: 10%;"></td> <td style="width: 10%;"></td> <td style="width: 10%;"></td> <td style="width: 10%;"></td> <td style="width: 10%;"></td> </tr> <tr> <td></td> <td></td> <td colspan="8" style="text-align: center;"> <table border="1" style="width: 100%; border-collapse: collapse; text-align: center;"> <tr> <td style="width: 10%;"></td> <td style="width: 10%;"></td> <td style="width: 10%;"></td> <td style="width: 10%;"></td> <td style="width: 10%;"></td> <td style="width: 10%;"></td> <td style="width: 10%;"></td> <td style="width: 10%;"></td> <td style="width: 10%;"></td> <td style="width: 10%;"></td> </tr> <tr> <td></td> <td></td> <td colspan="8" style="text-align: center;"> <table border="1" style="width: 100%; border-collapse: collapse; text-align: center;"> <tr> <td style="width: 10%;"></td> <td style="width: 10%;"></td> <td style="width: 10%;"></td> <td style="width: 10%;"></td> <td style="width: 10%;"></td> <td style="width: 10%;"></td> <td style="width: 10%;"></td> <td style="width: 10%;"></td> <td style="width: 10%;"></td> <td style="width: 10%;"></td> </tr> <tr> <td></td> <td></td> <td colspan="8" style="text-align: center;"> <table border="1" style="width: 100%; border-collapse: collapse; text-align: center;"> <tr> <td style="width: 10%;"></td> <td style="width: 10%;"></td> <td style="width: 10%;"></td> <td style="width: 10%;"></td> <td style="width: 10%;"></td> <td style="width: 10%;"></td> <td style="width: 10%;"></td> <td style="width: 10%;"></td> <td style="width: 10%;"></td> <td style="width: 10%;"></td> </tr> <tr> <td></td> <td></td> <td colspan="8" style="text-align: center;"> <table border="1" style="width: 100%; border-collapse: collapse; text-align: center;"> <tr> <td style="width: 10%;"></td> <td style="width: 10%;"></td> <td style="width: 10%;"></td> <td style="width: 10%;"></td> <td style="width: 10%;"></td> <td style="width: 10%;"></td> <td style="width: 10%;"></td> <td style="width: 10%;"></td> <td style="width: 10%;"></td> <td style="width: 10%;"></td> </tr> <tr> <td></td> <td></td> <td colspan="8" style="text-align: center;"> <table border="1" style="width: 100%; border-collapse: collapse; text-align: center;"> <tr> <td style="width: 10%;"></td> <td style="width: 10%;"></td> <td style="width: 10%;"></td> <td style="width: 10%;"></td> <td style="width: 10%;"></td> <td style="width: 10%;"></td> <td style="width: 10%;"></td> <td style="width: 10%;"></td> <td style="width: 10%;"></td> <td style="width: 10%;"></td> </tr> <tr> <td></td> <td></td> <td colspan="8" style="text-align: center;"> <table border="1" style="width: 100%; border-collapse: collapse; text-align: center;"> <tr> <td style="width: 10%;"></td> <td style="width: 10%;"></td> <td style="width: 10%;"></td> <td style="width: 10%;"></td> <td style="width: 10%;"></td> <td style="width: 10%;"></td> <td style="width: 10%;"></td> <td style="width: 10%;"></td> <td style="width: 10%;"></td> <td style="width: 10%;"></td> </tr> <tr> <td></td> <td></td> <td colspan="8" style="text-align: center;"> <table border="1" style="width: 100%; border-collapse: collapse; text-align: center;"> <tr> <td style="width: 10%;"></td> <td style="width: 10%;"></td> <td style="width: 10%;"></td> <td style="width: 10%;"></td> <td style="width: 10%;"></td> <td style="width: 10%;"></td> <td style="width: 10%;"></td> <td style="width: 10%;"></td> <td style="width: 10%;"></td> <td style="width: 10%;"></td> </tr> <tr> <td></td> <td></td> <td colspan="8" style="text-align: center;"> <table border="1" style="width: 100%; border-collapse: collapse; text-align: center;"> <tr> <td style="width: 10%;"></td> <td style="width: 10%;"></td> <td style="width: 10%;"></td> <td style="width: 10%;"></td> <td style="width: 10%;"></td> <td style="width: 10%;"></td> <td style="width: 10%;"></td> <td style="width: 10%;"></td> <td style="width: 10%;"></td> <td style="width: 10%;"></td> </tr> <tr> <td></td> <td></td> <td colspan="8" style="text-align: center;"> <table border="1" style="width: 100%; border-collapse: collapse; text-align: center;"> <tr> <td style="width: 10%;"></td> <td style="width: 10%;"></td> <td style="width: 10%;"></td> <td style="width: 10%;"></td> <td style="width: 10%;"></td> <td style="width: 10%;"></td> <td style="width: 10%;"></td> <td style="width: 10%;"></td> <td style="width: 10%;"></td> <td style="width: 10%;"></td> </tr> <tr> <td></td> <td></td> <td colspan="8" style="text-align: center;"> <table border="1" style="width: 100%; border-collapse: collapse; text-align: center;"> <tr> <td style="width: 10%;"></td> <td style="width: 10%;"></td> <td style="width: 10%;"></td> <td style="width: 10%;"></td> <td style="width: 10%;"></td> <td style="width: 10%;"></td> <td style="width: 10%;"></td> <td style="width: 10%;"></td> <td style="width: 10%;"></td> <td style="width: 10%;"></td> </tr> <tr> <td></td> <td></td> <td colspan="8" style="text-align: center;"> <table border="1" style="width: 100%; border-collapse: collapse; text-align: center;"> <tr> <td style="width: 10%;"></td> <td style="width: 10%;"></td> <td style="width: 10%;"></td> <td style="width: 10%;"></td> <td style="width: 10%;"></td> <td style="width: 10%;"></td> <td style="width: 10%;"></td> <td style="width: 10%;"></td> <td style="width: 10%;"></td> <td style="width: 10%;"></td> </tr> <tr> <td></td> <td></td> <td colspan="8" style="text-align: center;"> <table border="1" style="width: 100%; border-collapse: collapse; text-align: center;"> <tr> <td style="width: 10%;"></td> <td style="width: 10%;"></td> <td style="width: 10%;"></td> <td style="width: 10%;"></td> <td style="width: 10%;"></td> <td style="width: 10%;"></td> <td style="width: 10%;"></td> <td style="width: 10%;"></td> <td style="width: 10%;"></td> <td style="width: 10%;"></td> </tr> <tr> <td></td> <td></td> <td colspan="8" style="text-align: center;"> <table border="1" style="width: 100%; border-collapse: collapse; text-align: center;"> <tr> <td style="width: 10%;"></td> <td style="width: 10%;"></td> <td style="width: 10%;"></td> <td style="width: 10%;"></td> <td style="width: 10%;"></td> <td style="width: 10%;"></td> <td style="width: 10%;"></td> <td style="width: 10%;"></td> <td style="width: 10%;"></td> <td style="width: 10%;"></td> </tr> <tr> <td></td> <td></td> <td colspan="8" style="text-align: center;"> <table border="1" style="width: 100%; border-collapse: collapse; text-align: center;"> <tr> <td style="width: 10%;"></td> <td style="width: 10%;"></td> <td style="width: 10%;"></td> <td style="width: 10%;"></td> <td style="width: 10%;"></td> <td style="width: 10%;"></td> <td style="width: 10%;"></td> <td style="width: 10%;"></td> <td style="width: 10%;"></td> <td style="width: 10%;"></td> </tr> <tr> <td></td> <td></td> <td colspan="8" style="text-align: center;"> <table border="1" style="width: 100%; border-collapse: collapse; text-align: center;"> <tr> <td style="width: 10%;"></td> <td style="width: 10%;"></td> <td style="width: 10%;"></td> <td style="width: 10%;"></td> <td style="width: 10%;"></td> <td style="width: 10%;"></td> <td style="width: 10%;"></td> <td style="width: 10%;"></td> <td style="width: 10%;"></td> <td style="width: 10%;"></td> </tr> <tr> <td></td> <td></td> <td colspan="8" style="text-align: center;"> <table border="1" style="width: 100%; border-collapse: collapse; text-align: center;"> <tr> <td style="width: 10%;"></td> <td style="width: 10%;"></td> <td style="width: 10%;"></td> <td style="width: 10%;"></td> <td style="width: 10%;"></td> <td style="width:
10%;"></td> <td style="width: 10%;"></td> <td style="width: 10%;"></td> <td style="width: 10%;"></td> <td style="width: 10%;"></td> </tr> <tr> <td></td> <td></td> <td colspan="8" style="text-align: center;"> <table border="1" style="width: 100%; border-collapse: collapse; text-align: center;"> <tr> <td style="width: 10%;"></td> <td style="width: 10%;"></td> <td style="width: 10%;"></td> <td style="width: 10%;"></td> <td style="width: 10%;"></td> <td style="width: 10%;"></td> <td style="width: 10%;"></td> <td style="width: 10%;"></td> <td style="width: 10%;"></td> <td style="width: 10%;"></td> </tr> <tr> <td></td> <td></td> <td colspan="8" style="text-align: center;"> <table border="1" style="width: 100%; border-collapse: collapse; text-align: center;"> <tr> </tr></table></td></tr></table></td></tr></table></td></tr></table></td></tr></table></td></tr></table></td></tr></table></td></tr></table></td></tr></table></td></tr></table></td></tr></table></td></tr></table></td></tr></table></td></tr></table></td></tr></table></td></tr></table></td></tr></table></td></tr></table></td></tr></table></td></tr></table></td></tr></table></td></tr></table></td></tr></table></td></tr></table></td></tr></table></td></tr></table></td></tr></table></td></tr></table></td></tr></table></td></tr></table></td></tr></table>
 | | | | | | | | | | | | | | | | | | | | <table border="1" style="width: 100%; border-collapse: collapse; text-align: center;"> <tr> <td style="width: 10%;"></td> <td style="width: 10%;"></td> <td style="width: 10%;"></td> <td style="width: 10%;"></td> <td style="width: 10%;"></td> <td style="width: 10%;"></td> <td style="width: 10%;"></td> <td style="width: 10%;"></td> <td style="width: 10%;"></td> <td style="width: 10%;"></td> </tr> <tr> <td></td> <td></td> <td colspan="8" style="text-align: center;"> <table border="1" style="width: 100%; border-collapse: collapse; text-align: center;"> <tr> <td style="width: 10%;"></td> <td style="width: 10%;"></td> <td style="width: 10%;"></td> <td style="width: 10%;"></td> <td style="width: 10%;"></td> <td style="width: 10%;"></td> <td style="width: 10%;"></td> <td style="width: 10%;"></td> <td style="width: 10%;"></td> <td style="width: 10%;"></td> </tr> <tr> <td></td> <td></td> <td colspan="8" style="text-align: center;"> <table border="1" style="width: 100%; border-collapse: collapse; text-align: center;"> <tr> <td style="width: 10%;"></td> <td style="width: 10%;"></td> <td style="width: 10%;"></td> <td style="width: 10%;"></td> <td style="width: 10%;"></td> <td style="width: 10%;"></td> <td style="width: 10%;"></td> <td style="width: 10%;"></td> <td style="width: 10%;"></td> <td style="width: 10%;"></td> </tr> <tr> <td></td> <td></td> <td colspan="8" style="text-align: center;"> <table border="1" style="width: 100%; border-collapse: collapse; text-align: center;"> <tr> <td style="width: 10%;"></td> <td style="width: 10%;"></td> <td style="width: 10%;"></td> <td style="width: 10%;"></td> <td style="width: 10%;"></td> <td style="width: 10%;"></td> <td style="width: 10%;"></td> <td style="width: 10%;"></td> <td style="width: 10%;"></td> <td style="width: 10%;"></td> </tr> <tr> <td></td> <td></td> <td colspan="8" style="text-align: center;"> <table border="1" style="width: 100%; border-collapse: collapse; text-align: center;"> <tr> <td style="width: 10%;"></td> <td style="width: 10%;"></td> <td style="width: 10%;"></td> <td style="width: 10%;"></td> <td style="width: 10%;"></td> <td style="width: 10%;"></td> <td style="width: 10%;"></td> <td style="width: 10%;"></td> <td style="width: 10%;"></td> <td style="width: 10%;"></td> </tr> <tr> <td></td> <td></td> <td colspan="8" style="text-align: center;"> <table border="1" style="width: 100%; border-collapse: collapse; text-align: center;"> <tr> <td style="width: 10%;"></td> <td style="width: 10%;"></td> <td style="width: 10%;"></td> <td style="width: 10%;"></td> <td style="width: 10%;"></td> <td style="width: 10%;"></td> <td style="width: 10%;"></td> <td style="width: 10%;"></td> <td style="width: 10%;"></td> <td style="width: 10%;"></td> </tr> <tr> <td></td> <td></td> <td colspan="8" style="text-align: center;"> <table border="1" style="width: 100%; border-collapse: collapse; text-align: center;"> <tr> <td style="width: 10%;"></td> <td style="width: 10%;"></td> <td style="width: 10%;"></td> <td style="width: 10%;"></td> <td style="width: 10%;"></td> <td style="width: 10%;"></td> <td style="width: 10%;"></td> <td style="width: 10%;"></td> <td style="width: 10%;"></td> <td style="width: 10%;"></td> </tr> <tr> <td></td> <td></td> <td colspan="8" style="text-align: center;"> <table border="1" style="width: 100%; border-collapse: collapse; text-align: center;"> <tr> <td style="width: 10%;"></td> <td style="width: 10%;"></td> <td style="width: 10%;"></td> <td style="width: 10%;"></td> <td style="width: 10%;"></td> <td style="width: 10%;"></td> <td style="width: 10%;"></td> <td style="width: 10%;"></td> <td style="width: 10%;"></td> <td style="width: 10%;"></td> </tr> <tr> <td></td> <td></td> <td colspan="8" style="text-align: center;"> <table border="1" style="width: 100%; border-collapse: collapse; text-align: center;"> <tr> <td style="width: 10%;"></td> <td style="width: 10%;"></td> <td style="width: 10%;"></td> <td style="width: 10%;"></td> <td style="width: 10%;"></td> <td style="width: 10%;"></td> <td style="width: 10%;"></td> <td style="width: 10%;"></td> <td style="width: 10%;"></td> <td style="width: 10%;"></td> </tr> <tr> <td></td> <td></td> <td colspan="8" style="text-align: center;"> <table border="1" style="width: 100%; border-collapse: collapse; text-align: center;"> <tr> <td style="width: 10%;"></td> <td style="width: 10%;"></td> <td style="width: 10%;"></td> <td style="width: 10%;"></td> <td style="width: 10%;"></td> <td style="width: 10%;"></td> <td style="width: 10%;"></td> <td style="width: 10%;"></td> <td style="width: 10%;"></td> <td style="width: 10%;"></td> </tr> <tr> <td></td> <td></td> <td colspan="8" style="text-align: center;"> <table border="1" style="width: 100%; border-collapse: collapse; text-align: center;"> <tr> <td style="width: 10%;"></td> <td style="width: 10%;"></td> <td style="width: 10%;"></td> <td style="width: 10%;"></td> <td style="width: 10%;"></td> <td style="width: 10%;"></td> <td style="width: 10%;"></td> <td style="width: 10%;"></td> <td style="width: 10%;"></td> <td style="width: 10%;"></td> </tr> <tr> <td></td> <td></td> <td colspan="8" style="text-align: center;"> <table border="1" style="width: 100%; border-collapse: collapse; text-align: center;"> <tr> <td style="width: 10%;"></td> <td style="width: 10%;"></td> <td style="width: 10%;"></td> <td style="width: 10%;"></td> <td style="width: 10%;"></td> <td style="width: 10%;"></td> <td style="width: 10%;"></td> <td style="width: 10%;"></td> <td style="width: 10%;"></td> <td style="width: 10%;"></td> </tr> <tr> <td></td> <td></td> <td colspan="8" style="text-align: center;"> <table border="1" style="width: 100%; border-collapse: collapse; text-align: center;"> <tr> <td style="width: 10%;"></td> <td style="width: 10%;"></td> <td style="width: 10%;"></td> <td style="width: 10%;"></td> <td style="width: 10%;"></td> <td style="width: 10%;"></td> <td style="width: 10%;"></td> <td style="width: 10%;"></td> <td style="width: 10%;"></td> <td
style="width: 10%;"></td> </tr> <tr> <td></td> <td></td> <td colspan="8" style="text-align: center;"> <table border="1" style="width: 100%; border-collapse: collapse; text-align: center;"> <tr> <td style="width: 10%;"></td> <td style="width: 10%;"></td> <td style="width: 10%;"></td> <td style="width: 10%;"></td> <td style="width: 10%;"></td> <td style="width: 10%;"></td> <td style="width: 10%;"></td> <td style="width: 10%;"></td> <td style="width: 10%;"></td> <td style="width: 10%;"></td> </tr> <tr> <td></td> <td></td> <td colspan="8" style="text-align: center;"> <table border="1" style="width: 100%; border-collapse: collapse; text-align: center;"> <tr> <td style="width: 10%;"></td> <td style="width: 10%;"></td> <td style="width: 10%;"></td> <td style="width: 10%;"></td> <td style="width: 10%;"></td> <td style="width: 10%;"></td> <td style="width: 10%;"></td> <td style="width: 10%;"></td> <td style="width: 10%;"></td> <td style="width: 10%;"></td> </tr> <tr> <td></td> <td></td> <td colspan="8" style="text-align: center;"> <table border="1" style="width: 100%; border-collapse: collapse; text-align: center;"> <tr> <td style="width: 10%;"></td> <td style="width: 10%;"></td> <td style="width: 10%;"></td> <td style="width: 10%;"></td> <td style="width: 10%;"></td> <td style="width: 10%;"></td> <td style="width: 10%;"></td> <td style="width: 10%;"></td> <td style="width: 10%;"></td> <td style="width: 10%;"></td> </tr> <tr> <td></td> <td></td> <td colspan="8" style="text-align: center;"> <table border="1" style="width: 100%; border-collapse: collapse; text-align: center;"> <tr> <td style="width: 10%;"></td> <td style="width: 10%;"></td> <td style="width: 10%;"></td> <td style="width: 10%;"></td> <td style="width: 10%;"></td> <td style="width: 10%;"></td> <td style="width: 10%;"></td> <td style="width: 10%;"></td> <td style="width: 10%;"></td> <td style="width: 10%;"></td> </tr> <tr> <td></td> <td></td> <td colspan="8" style="text-align: center;"> <table border="1" style="width: 100%; border-collapse: collapse; text-align: center;"> <tr> <td style="width: 10%;"></td> <td style="width: 10%;"></td> <td style="width: 10%;"></td> <td style="width: 10%;"></td> <td style="width: 10%;"></td> <td style="width: 10%;"></td> <td style="width: 10%;"></td> <td style="width: 10%;"></td> <td style="width: 10%;"></td> <td style="width: 10%;"></td> </tr> <tr> <td></td> <td></td> <td colspan="8" style="text-align: center;"> <table border="1" style="width: 100%; border-collapse: collapse; text-align: center;"> <tr> <td style="width: 10%;"></td> <td style="width: 10%;"></td> <td style="width: 10%;"></td> <td style="width: 10%;"></td> <td style="width: 10%;"></td> <td style="width: 10%;"></td> <td style="width: 10%;"></td> <td style="width: 10%;"></td> <td style="width: 10%;"></td> <td style="width: 10%;"></td> </tr> <tr> <td></td> <td></td> <td colspan="8" style="text-align: center;"> <table border="1" style="width: 100%; border-collapse: collapse; text-align: center;"> <tr> <td style="width: 10%;"></td> <td style="width: 10%;"></td> <td style="width: 10%;"></td> <td style="width: 10%;"></td> <td style="width: 10%;"></td> <td style="width: 10%;"></td> <td style="width: 10%;"></td> <td style="width: 10%;"></td> <td style="width: 10%;"></td> <td style="width: 10%;"></td> </tr> <tr> <td></td> <td></td> <td colspan="8" style="text-align: center;"> <table border="1" style="width: 100%; border-collapse: collapse; text-align: center;"> <tr> <td style="width: 10%;"></td> <td style="width: 10%;"></td> <td style="width: 10%;"></td> <td style="width: 10%;"></td> <td style="width: 10%;"></td> <td style="width: 10%;"></td> <td style="width: 10%;"></td> <td style="width: 10%;"></td> <td style="width: 10%;"></td> <td style="width: 10%;"></td> </tr> <tr> <td></td> <td></td> <td colspan="8" style="text-align: center;"> <table border="1" style="width: 100%; border-collapse: collapse; text-align: center;"> <tr> <td style="width: 10%;"></td> <td style="width: 10%;"></td> <td style="width: 10%;"></td> <td style="width: 10%;"></td> <td style="width: 10%;"></td> <td style="width: 10%;"></td> <td style="width: 10%;"></td> <td style="width: 10%;"></td> <td style="width: 10%;"></td> <td style="width: 10%;"></td> </tr> <tr> <td></td> <td></td> <td colspan="8" style="text-align: center;"> <table border="1" style="width: 100%; border-collapse: collapse; text-align: center;"> <tr> <td style="width: 10%;"></td> <td style="width: 10%;"></td> <td style="width: 10%;"></td> <td style="width: 10%;"></td> <td style="width: 10%;"></td> <td style="width: 10%;"></td> <td style="width: 10%;"></td> <td style="width: 10%;"></td> <td style="width: 10%;"></td> <td style="width: 10%;"></td> </tr> <tr> <td></td> <td></td> <td colspan="8" style="text-align: center;"> <table border="1" style="width: 100%; border-collapse: collapse; text-align: center;"> <tr> <td style="width: 10%;"></td> <td style="width: 10%;"></td> <td style="width: 10%;"></td> <td style="width: 10%;"></td> <td style="width: 10%;"></td> <td style="width: 10%;"></td> <td style="width: 10%;"></td> <td style="width: 10%;"></td> <td style="width: 10%;"></td> <td style="width: 10%;"></td> </tr> <tr> <td></td> <td></td> <td colspan="8" style="text-align: center;"> <table border="1" style="width: 100%; border-collapse: collapse; text-align: center;"> <tr> <td style="width: 10%;"></td> <td style="width: 10%;"></td> <td style="width: 10%;"></td> <td style="width: 10%;"></td> <td style="width: 10%;"></td> <td style="width: 10%;"></td> <td style="width: 10%;"></td> <td style="width: 10%;"></td> <td style="width: 10%;"></td> <td style="width: 10%;"></td> </tr> <tr> <td></td> <td></td> <td colspan="8" style="text-align: center;"> <table border="1" style="width: 100%; border-collapse: collapse; text-align: center;"> <tr> <td style="width: 10%;"></td> <td style="width: 10%;"></td> <td style="width: 10%;"></td> <td style="width: 10%;"></td> <td style="width: 10%;"></td> <td style="width: 10%;"></td> <td style="width: 10%;"></td> <td style="width: 10%;"></td> <td style="width: 10%;"></td> <td style="width: 10%;"></td> </tr> <tr> <td></td> <td></td> <td colspan="8" style="text-align: center;"> <table border="1" style="width: 100%; border-collapse: collapse; text-align: center;"> <tr> <td style="width: 10%;"></td> <td style="width: 10%;"></td> <td style="width: 10%;"></td> <td style="width: 10%;"></td> <td style="width: 10%;"></td> <td style="width: 10%;"></td> <td style="width: 10%;"></td> <td style="width: 10%;"></td> <td style="width: 10%;"></td> <td style="width: 10%;"></td> </tr> <tr> <td></td> <td></td> <td colspan="8" style="text-align: center;"> <table border="1" style="width: 100%; border-collapse: collapse; text-align: center;"> <tr> <td style="width: 10%;"></td> <td style="width: 10%;"></td> <td style="width: 10%;"></td> <td style="width: 10%;"></td> <td style="width: 10%;"></td> <td style="width: 10%;"></td> <td style="width: 10%;"></td> <td style="width: 10%;"></td> <td style="width: 10%;"></td> <td style="width: 10%;"></td> </tr> <tr> <td></td> <td></td> <td colspan="8" style="text-align: center;"> <table border="1" style="width: 100%; border-collapse: collapse; text-align: center;"> <tr> <td style="width: 10%;"></td> <td style="width: 10%;"></td> <td style="width: 10%;"></td> <td style="width: 10%;"></td> <td style="width: 10%;"></td> <td style="width: 10%;"></td> <td style="width: 10%;"></td> <td style="width: 10%;"></td> <td style="width: 10%;"></td> <td style="width: 10%;"></td> </tr> <tr> <td></td> <td></td> <td colspan="8" style="text-align: center;"> <table border="1" style="width: 100%; border-collapse: collapse; text-align: center;"> <tr> </tr></table></td></tr></table></td></tr></table></td></tr></table></td></tr></table></td></tr></table></td></tr></table></td></tr></table></td></tr></table></td></tr></table></td></tr></table></td></tr></table></td></tr></table></td></tr></table></td></tr></table></td></tr></table></td></tr></table></td></tr></table></td></tr></table></td></tr></table></td></tr></table></td></tr></table></td></tr></table></td></tr></table></td></tr></table></td></tr></table></td></tr></table></td></tr></table></td></tr></table></td></tr></table>

 | | | | | | | | | | | | | | | | | | | | <table border="1" style="width: 100%; border-collapse: collapse; text-align: center;"> <tr> <td style="width: 10%;"></td> <td style="width: 10%;"></td> <td style="width: 10%;"></td> <td style="width: 10%;"></td> <td style="width: 10%;"></td> <td style="width: 10%;"></td> <td style="width: 10%;"></td> <td style="width: 10%;"></td> <td style="width: 10%;"></td> <td style="width: 10%;"></td> </tr> <tr> <td></td> <td></td> <td colspan="8" style="text-align: center;"> <table border="1" style="width: 100%; border-collapse: collapse; text-align: center;"> <tr> <td style="width: 10%;"></td> <td style="width: 10%;"></td> <td style="width: 10%;"></td> <td style="width: 10%;"></td> <td style="width: 10%;"></td> <td style="width: 10%;"></td> <td style="width: 10%;"></td> <td style="width: 10%;"></td> <td style="width: 10%;"></td> <td style="width: 10%;"></td> </tr> <tr> <td></td> <td></td> <td colspan="8" style="text-align: center;"> <table border="1" style="width: 100%; border-collapse: collapse; text-align: center;"> <tr> <td style="width: 10%;"></td> <td style="width: 10%;"></td> <td style="width: 10%;"></td> <td style="width: 10%;"></td> <td style="width: 10%;"></td> <td style="width: 10%;"></td> <td style="width: 10%;"></td> <td style="width: 10%;"></td> <td style="width: 10%;"></td> <td style="width: 10%;"></td> </tr> <tr> <td></td> <td></td> <td colspan="8" style="text-align: center;"> <table border="1" style="width: 100%; border-collapse: collapse; text-align: center;"> <tr> <td style="width: 10%;"></td> <td style="width: 10%;"></td> <td style="width: 10%;"></td> <td style="width: 10%;"></td> <td style="width: 10%;"></td> <td style="width: 10%;"></td> <td style="width: 10%;"></td> <td style="width: 10%;"></td> <td style="width: 10%;"></td> <td style="width: 10%;"></td> </tr> <tr> <td></td> <td></td> <td colspan="8" style="text-align: center;"> <table border="1" style="width: 100%; border-collapse: collapse; text-align: center;"> <tr> <td style="width: 10%;"></td> <td style="width: 10%;"></td> <td style="width: 10%;"></td> <td style="width: 10%;"></td> <td style="width: 10%;"></td> <td style="width: 10%;"></td> <td style="width: 10%;"></td> <td style="width: 10%;"></td> <td style="width: 10%;"></td> <td style="width: 10%;"></td> </tr> <tr> <td></td> <td></td> <td colspan="8" style="text-align: center;"> <table border="1" style="width: 100%; border-collapse: collapse; text-align: center;"> <tr> <td style="width: 10%;"></td> <td style="width: 10%;"></td> <td style="width: 10%;"></td> <td style="width: 10%;"></td> <td style="width: 10%;"></td> <td style="width: 10%;"></td> <td style="width: 10%;"></td> <td style="width: 10%;"></td> <td style="width: 10%;"></td> <td style="width: 10%;"></td> </tr> <tr> <td></td> <td></td> <td colspan="8" style="text-align: center;"> <table border="1" style="width: 100%; border-collapse: collapse; text-align: center;"> <tr> <td style="width: 10%;"></td> <td style="width: 10%;"></td> <td style="width: 10%;"></td> <td style="width: 10%;"></td> <td style="width: 10%;"></td> <td style="width: 10%;"></td> <td style="width: 10%;"></td> <td style="width: 10%;"></td> <td style="width: 10%;"></td> <td style="width: 10%;"></td> </tr> <tr> <td></td> <td></td> <td colspan="8" style="text-align: center;"> <table border="1" style="width: 100%; border-collapse: collapse; text-align: center;"> <tr> <td style="width: 10%;"></td> <td style="width: 10%;"></td> <td style="width: 10%;"></td> <td style="width: 10%;"></td> <td style="width: 10%;"></td> <td style="width: 10%;"></td> <td style="width: 10%;"></td> <td style="width: 10%;"></td> <td style="width: 10%;"></td> <td style="width: 10%;"></td> </tr> <tr> <td></td> <td></td> <td colspan="8" style="text-align: center;"> <table border="1" style="width: 100%; border-collapse: collapse; text-align: center;"> <tr> <td style="width: 10%;"></td> <td style="width: 10%;"></td> <td style="width: 10%;"></td> <td style="width: 10%;"></td> <td style="width: 10%;"></td> <td style="width: 10%;"></td> <td style="width: 10%;"></td> <td style="width: 10%;"></td> <td style="width: 10%;"></td> <td style="width: 10%;"></td> </tr> <tr> <td></td> <td></td> <td colspan="8" style="text-align: center;"> <table border="1" style="width: 100%; border-collapse: collapse; text-align: center;"> <tr> <td style="width: 10%;"></td> <td style="width: 10%;"></td> <td style="width: 10%;"></td> <td style="width: 10%;"></td> <td style="width: 10%;"></td> <td style="width: 10%;"></td> <td style="width: 10%;"></td> <td style="width: 10%;"></td> <td style="width: 10%;"></td> <td style="width: 10%;"></td> </tr> <tr> <td></td> <td></td> <td colspan="8" style="text-align: center;"> <table border="1" style="width: 100%; border-collapse: collapse; text-align: center;"> <tr> <td style="width: 10%;"></td> <td style="width: 10%;"></td> <td style="width: 10%;"></td> <td style="width: 10%;"></td> <td style="width: 10%;"></td> <td style="width: 10%;"></td> <td style="width: 10%;"></td> <td style="width: 10%;"></td> <td style="width: 10%;"></td> <td style="width: 10%;"></td> </tr> <tr> <td></td> <td></td> <td colspan="8" style="text-align: center;"> <table border="1" style="width: 100%; border-collapse: collapse; text-align: center;"> <tr> <td style="width: 10%;"></td> <td style="width: 10%;"></td> <td style="width: 10%;"></td> <td style="width: 10%;"></td> <td style="width: 10%;"></td> <td style="width: 10%;"></td> <td style="width: 10%;"></td> <td style="width: 10%;"></td> <td style="width: 10%;"></td> <td style="width: 10%;"></td> </tr> <tr> <td></td> <td></td> <td colspan="8" style="text-align: center;"> <table border="1" style="width: 100%; border-collapse: collapse; text-align: center;"> <tr> <td style="width: 10%;"></td> <td style="width: 10%;"></td> <td style="width: 10%;"></td> <td style="width: 10%;"></td> <td style="width: 10%;"></td> <td style="width: 10%;"></td> <td style="width: 10%;"></td> <td style="width: 10%;"></td> <td style="width: 10%;"></td> <td style="width: 10%;"></td> </tr> <tr> <td></td> <td></td> <td colspan="8" style="text-align: center;"> <table border="1" style="width: 100%; border-collapse: collapse; text-align: center;"> <tr> <td style="width: 10%;"></td> <td style="width: 10%;"></td> <td style="width: 10%;"></td> <td style="width: 10%;"></td> <td style="width: 10%;"></td> <td style="width: 10%;"></td> <td style="width: 10%;"></td> <td style="width: 10%;"></td> <td style="width: 10%;"></td> <td style="width: 10%;"></td> </tr> <tr> <td></td> <td></td> <td colspan="8" style="text-align: center;"> <table border="1" style="width: 100%; border-collapse: collapse; text-align: center;"> <tr> <td style="width: 10%;"></td> <td style="width: 10%;"></td> <td style="width: 10%;"></td> <td style="width: 10%;"></td> <td style="width: 10%;"></td> <td style="width: 10%;"></td> <td style="width: 10%;"></td> <td style="width: 10%;"></td> <td style="width: 10%;"></td> <td style="width: 10%;"></td> </tr> <tr> <td></td> <td></td> <td colspan="8" style="text-align: center;"> <table border="1" style="width: 100%; border-collapse: collapse; text-align: center;"> <tr> <td style="width: 10%;"></td> <td style="width: 10%;"></td> <td style="width: 10%;"></td> <td style="width: 10%;"></td> <td style="width: 10%;"></td> <td style="width: 10%;"></td> <td style="width: 10%;"></td> <td style="width: 10%;"></td> <td style="width: 10%;"></td> <td style="width: 10%;"></td> </tr> <tr> <td></td> <td></td> <td colspan="8" style="text-align: center;"> <table border="1" style="width: 100%; border-collapse: collapse; text-align: center;"> <tr> <td style="width: 10%;"></td> <td style="width: 10%;"></td> <td style="width: 10%;"></td> <td style="width: 10%;"></td> <td style="width: 10%;"></td> <td style="width: 10%;"></td> <td style="width: 10%;"></td> <td style="width: 10%;"></td> <td style="width: 10%;"></td> <td style="width: 10%;"></td> </tr> <tr> <td></td> <td></td> <td colspan="8" style="text-align: center;"> <table border="1" style="width: 100%; border-collapse: collapse; text-align: center;"> <tr> <td style="width: 10%;"></td> <td style="width: 10%;"></td> <td style="width: 10%;"></td> <td style="width: 10%;"></td> <td style="width: 10%;"></td> <td style="width: 10%;"></td> <td style="width: 10%;"></td> <td style="width: 10%;"></td> <td style="width: 10%;"></td> <td style="width: 10%;"></td> </tr> <tr> <td></td> <td></td> <td colspan="8" style="text-align: center;"> <table border="1" style="width: 100%; border-collapse: collapse; text-align: center;"> <tr> <td style="width: 10%;"></td> <td style="width: 10%;"></td> <td style="width: 10%;"></td> <td style="width: 10%;"></td> <td style="width: 10%;"></td> <td style="width: 10%;"></td> <td style="width: 10%;"></td> <td style="width: 10%;"></td> <td style="width: 10%;"></td> <td style="width: 10%;"></td> </tr> <tr> <td></td> <td></td> <td colspan="8" style="text-align: center;"> <table border="1" style="width: 100%; border-collapse: collapse; text-align: center;"> <tr> <td style="width: 10%;"></td> <td style="width: 10%;"></td> <td style="width: 10%;"></td> <td
style="width: 10%;"></td> <td style="width: 10%;"></td> <td style="width: 10%;"></td> <td style="width: 10%;"></td> <td style="width: 10%;"></td> <td style="width: 10%;"></td> <td style="width: 10%;"></td> </tr> <tr> <td></td> <td></td> <td colspan="8" style="text-align: center;"> <table border="1" style="width: 100%; border-collapse: collapse; text-align: center;"> <tr> <td style="width: 10%;"></td> <td style="width: 10%;"></td> <td style="width: 10%;"></td> <td style="width: 10%;"></td> <td style="width: 10%;"></td> <td style="width: 10%;"></td> <td style="width: 10%;"></td> <td style="width: 10%;"></td> <td style="width: 10%;"></td> <td style="width: 10%;"></td> </tr> <tr> <td></td> <td></td> <td colspan="8" style="text-align: center;"> <table border="1" style="width: 100%; border-collapse: collapse; text-align: center;"> <tr> <td style="width: 10%;"></td> <td style="width: 10%;"></td> <td style="width: 10%;"></td> <td style="width: 10%;"></td> <td style="width: 10%;"></td> <td style="width: 10%;"></td> <td style="width: 10%;"></td> <td style="width: 10%;"></td> <td style="width: 10%;"></td> <td style="width: 10%;"></td> </tr> <tr> <td></td> <td></td> <td colspan="8" style="text-align: center;"> <table border="1" style="width: 100%; border-collapse: collapse; text-align: center;"> <tr> <td style="width: 10%;"></td> <td style="width: 10%;"></td> <td style="width: 10%;"></td> <td style="width: 10%;"></td> <td style="width: 10%;"></td> <td style="width: 10%;"></td> <td style="width: 10%;"></td> <td style="width: 10%;"></td> <td style="width: 10%;"></td> <td style="width: 10%;"></td> </tr> <tr> <td></td> <td></td> <td colspan="8" style="text-align: center;"> <table border="1" style="width: 100%; border-collapse: collapse; text-align: center;"> <tr> <td style="width: 10%;"></td> <td style="width: 10%;"></td> <td style="width: 10%;"></td> <td style="width: 10%;"></td> <td style="width: 10%;"></td> <td style="width: 10%;"></td> <td style="width: 10%;"></td> <td style="width: 10%;"></td> <td style="width: 10%;"></td> <td style="width: 10%;"></td> </tr> <tr> <td></td> <td></td> <td colspan="8" style="text-align: center;"> <table border="1" style="width: 100%; border-collapse: collapse; text-align: center;"> <tr> <td style="width: 10%;"></td> <td style="width: 10%;"></td> <td style="width: 10%;"></td> <td style="width: 10%;"></td> <td style="width: 10%;"></td> <td style="width: 10%;"></td> <td style="width: 10%;"></td> <td style="width: 10%;"></td> <td style="width: 10%;"></td> <td style="width: 10%;"></td> </tr> <tr> <td></td> <td></td> <td colspan="8" style="text-align: center;"> <table border="1" style="width: 100%; border-collapse: collapse; text-align: center;"> <tr> <td style="width: 10%;"></td> <td style="width: 10%;"></td> <td style="width: 10%;"></td> <td style="width: 10%;"></td> <td style="width: 10%;"></td> <td style="width: 10%;"></td> <td style="width: 10%;"></td> <td style="width: 10%;"></td> <td style="width: 10%;"></td> <td style="width: 10%;"></td> </tr> <tr> <td></td> <td></td> <td colspan="8" style="text-align: center;"> <table border="1" style="width: 100%; border-collapse: collapse; text-align: center;"> <tr> <td style="width: 10%;"></td> <td style="width: 10%;"></td> <td style="width: 10%;"></td> <td style="width: 10%;"></td> <td style="width: 10%;"></td> <td style="width: 10%;"></td> <td style="width: 10%;"></td> <td style="width: 10%;"></td> <td style="width: 10%;"></td> <td style="width: 10%;"></td> </tr> <tr> <td></td> <td></td> <td colspan="8" style="text-align: center;"> <table border="1" style="width: 100%; border-collapse: collapse; text-align: center;"> <tr> <td style="width: 10%;"></td> <td style="width: 10%;"></td> <td style="width: 10%;"></td> <td style="width: 10%;"></td> <td style="width: 10%;"></td> <td style="width: 10%;"></td> <td style="width: 10%;"></td> <td style="width: 10%;"></td> <td style="width: 10%;"></td> <td style="width: 10%;"></td> </tr> <tr> <td></td> <td></td> <td colspan="8" style="text-align: center;"> <table border="1" style="width: 100%; border-collapse: collapse; text-align: center;"> <tr> </tr></table></td></tr></table></td></tr></table></td></tr></table></td></tr></table></td></tr></table></td></tr></table></td></tr></table></td></tr></table></td></tr></table></td></tr></table></td></tr></table></td></tr></table></td></tr></table></td></tr></table></td></tr></table></td></tr></table></td></tr></table></td></tr></table></td></tr></table></td></tr></table></td></tr></table></td></tr></table></td></tr></table></td></tr></table></td></tr></table></td></tr></table></td></tr></table></td></tr></table>
 | | | | | | | | | | | | | | | | | | | | <table border="1" style="width: 100%; border-collapse: collapse; text-align: center;"> <tr> <td style="width: 10%;"></td> <td style="width: 10%;"></td> <td style="width: 10%;"></td> <td style="width: 10%;"></td> <td style="width: 10%;"></td> <td style="width: 10%;"></td> <td style="width: 10%;"></td> <td style="width: 10%;"></td> <td style="width: 10%;"></td> <td style="width: 10%;"></td> </tr> <tr> <td></td> <td></td> <td colspan="8" style="text-align: center;"> <table border="1" style="width: 100%; border-collapse: collapse; text-align: center;"> <tr> <td style="width: 10%;"></td> <td style="width: 10%;"></td> <td style="width: 10%;"></td> <td style="width: 10%;"></td> <td style="width: 10%;"></td> <td style="width: 10%;"></td> <td style="width: 10%;"></td> <td style="width: 10%;"></td> <td style="width: 10%;"></td> <td style="width: 10%;"></td> </tr> <tr> <td></td> <td></td> <td colspan="8" style="text-align: center;"> <table border="1" style="width: 100%; border-collapse: collapse; text-align: center;"> <tr> <td style="width: 10%;"></td> <td style="width: 10%;"></td> <td style="width: 10%;"></td> <td style="width: 10%;"></td> <td style="width: 10%;"></td> <td style="width: 10%;"></td> <td style="width: 10%;"></td> <td style="width: 10%;"></td> <td style="width: 10%;"></td> <td style="width: 10%;"></td> </tr> <tr> <td></td> <td></td> <td colspan="8" style="text-align: center;"> <table border="1" style="width: 100%; border-collapse: collapse; text-align: center;"> <tr> <td style="width: 10%;"></td> <td style="width: 10%;"></td> <td style="width: 10%;"></td> <td style="width: 10%;"></td> <td style="width: 10%;"></td> <td style="width: 10%;"></td> <td style="width: 10%;"></td> <td style="width: 10%;"></td> <td style="width: 10%;"></td> <td style="width: 10%;"></td> </tr> <tr> <td></td> <td></td> <td colspan="8" style="text-align: center;"> <table border="1" style="width: 100%; border-collapse: collapse; text-align: center;"> <tr> <td style="width: 10%;"></td> <td style="width: 10%;"></td> <td style="width: 10%;"></td> <td style="width: 10%;"></td> <td style="width: 10%;"></td> <td style="width: 10%;"></td> <td style="width: 10%;"></td> <td style="width: 10%;"></td> <td style="width: 10%;"></td> <td style="width: 10%;"></td> </tr> <tr> <td></td> <td></td> <td colspan="8" style="text-align: center;"> <table border="1" style="width: 100%; border-collapse: collapse; text-align: center;"> <tr> <td style="width: 10%;"></td> <td style="width: 10%;"></td> <td style="width: 10%;"></td> <td style="width: 10%;"></td> <td style="width: 10%;"></td> <td style="width: 10%;"></td> <td style="width: 10%;"></td> <td style="width:
10%;"></td> <td style="width: 10%;"></td> <td style="width: 10%;"></td> </tr> <tr> <td></td> <td></td> <td colspan="8" style="text-align: center;"> <table border="1" style="width: 100%; border-collapse: collapse; text-align: center;"> <tr> <td style="width: 10%;"></td> <td style="width: 10%;"></td> <td style="width: 10%;"></td> <td style="width: 10%;"></td> <td style="width: 10%;"></td> <td style="width: 10%;"></td> <td style="width: 10%;"></td> <td style="width: 10%;"></td> <td style="width: 10%;"></td> <td style="width: 10%;"></td> </tr> <tr> <td></td> <td></td> <td colspan="8" style="text-align: center;"> <table border="1" style="width: 100%; border-collapse: collapse; text-align: center;"> <tr> <td style="width: 10%;"></td> <td style="width: 10%;"></td> <td style="width: 10%;"></td> <td style="width: 10%;"></td> <td style="width: 10%;"></td> <td style="width: 10%;"></td> <td style="width: 10%;"></td> <td style="width: 10%;"></td> <td style="width: 10%;"></td> <td style="width: 10%;"></td> </tr> <tr> <td></td> <td></td> <td colspan="8" style="text-align: center;"> <table border="1" style="width: 100%; border-collapse: collapse; text-align: center;"> <tr> <td style="width: 10%;"></td> <td style="width: 10%;"></td> <td style="width: 10%;"></td> <td style="width: 10%;"></td> <td style="width: 10%;"></td> <td style="width: 10%;"></td> <td style="width: 10%;"></td> <td style="width: 10%;"></td> <td style="width: 10%;"></td> <td style="width: 10%;"></td> </tr> <tr> <td></td> <td></td> <td colspan="8" style="text-align: center;"> <table border="1" style="width: 100%; border-collapse: collapse; text-align: center;"> <tr> <td style="width: 10%;"></td> <td style="width: 10%;"></td> <td style="width: 10%;"></td> <td style="width: 10%;"></td> <td style="width: 10%;"></td> <td style="width: 10%;"></td> <td style="width: 10%;"></td> <td style="width: 10%;"></td> <td style="width: 10%;"></td> <td style="width: 10%;"></td> </tr> <tr> <td></td> <td></td> <td colspan="8" style="text-align: center;"> <table border="1" style="width: 100%; border-collapse: collapse; text-align: center;"> <tr> <td style="width: 10%;"></td> <td style="width: 10%;"></td> <td style="width: 10%;"></td> <td style="width: 10%;"></td> <td style="width: 10%;"></td> <td style="width: 10%;"></td> <td style="width: 10%;"></td> <td style="width: 10%;"></td> <td style="width: 10%;"></td> <td style="width: 10%;"></td> </tr> <tr> <td></td> <td></td> <td colspan="8" style="text-align: center;"> <table border="1" style="width: 100%; border-collapse: collapse; text-align: center;"> <tr> <td style="width: 10%;"></td> <td style="width: 10%;"></td> <td style="width: 10%;"></td> <td style="width: 10%;"></td> <td style="width: 10%;"></td> <td style="width: 10%;"></td> <td style="width: 10%;"></td> <td style="width: 10%;"></td> <td style="width: 10%;"></td> <td style="width: 10%;"></td> </tr> <tr> <td></td> <td></td> <td colspan="8" style="text-align: center;"> <table border="1" style="width: 100%; border-collapse: collapse; text-align: center;"> <tr> <td style="width: 10%;"></td> <td style="width: 10%;"></td> <td style="width: 10%;"></td> <td style="width: 10%;"></td> <td style="width: 10%;"></td> <td style="width: 10%;"></td> <td style="width: 10%;"></td> <td style="width: 10%;"></td> <td style="width: 10%;"></td> <td style="width: 10%;"></td> </tr> <tr> <td></td> <td></td> <td colspan="8" style="text-align: center;"> <table border="1" style="width: 100%; border-collapse: collapse; text-align: center;"> <tr> <td style="width: 10%;"></td> <td style="width: 10%;"></td> <td style="width: 10%;"></td> <td style="width: 10%;"></td> <td style="width: 10%;"></td> <td style="width: 10%;"></td> <td style="width: 10%;"></td> <td style="width: 10%;"></td> <td style="width: 10%;"></td> <td style="width: 10%;"></td> </tr> <tr> <td></td> <td></td> <td colspan="8" style="text-align: center;"> <table border="1" style="width: 100%; border-collapse: collapse; text-align: center;"> <tr> <td style="width: 10%;"></td> <td style="width: 10%;"></td> <td style="width: 10%;"></td> <td style="width: 10%;"></td> <td style="width: 10%;"></td> <td style="width: 10%;"></td> <td style="width: 10%;"></td> <td style="width: 10%;"></td> <td style="width: 10%;"></td> <td style="width: 10%;"></td> </tr> <tr> <td></td> <td></td> <td colspan="8" style="text-align: center;"> <table border="1" style="width: 100%; border-collapse: collapse; text-align: center;"> <tr> <td style="width: 10%;"></td> <td style="width: 10%;"></td> <td style="width: 10%;"></td> <td style="width: 10%;"></td> <td style="width: 10%;"></td> <td style="width: 10%;"></td> <td style="width: 10%;"></td> <td style="width: 10%;"></td> <td style="width: 10%;"></td> <td style="width: 10%;"></td> </tr> <tr> <td></td> <td></td> <td colspan="8" style="text-align: center;"> <table border="1" style="width: 100%; border-collapse: collapse; text-align: center;"> <tr> <td style="width: 10%;"></td> <td style="width: 10%;"></td> <td style="width: 10%;"></td> <td style="width: 10%;"></td> <td style="width: 10%;"></td> <td style="width: 10%;"></td> <td style="width: 10%;"></td> <td style="width: 10%;"></td> <td style="width: 10%;"></td> <td style="width: 10%;"></td> </tr> <tr> <td></td> <td></td> <td colspan="8" style="text-align: center;"> <table border="1" style="width: 100%; border-collapse: collapse; text-align: center;"> <tr> <td style="width: 10%;"></td> <td style="width: 10%;"></td> <td style="width: 10%;"></td> <td style="width: 10%;"></td> <td style="width: 10%;"></td> <td style="width: 10%;"></td> <td style="width: 10%;"></td> <td style="width: 10%;"></td> <td style="width: 10%;"></td> <td style="width: 10%;"></td> </tr> <tr> <td></td> <td></td> <td colspan="8" style="text-align: center;"> <table border="1" style="width: 100%; border-collapse: collapse; text-align: center;"> <tr> <td style="width: 10%;"></td> <td style="width: 10%;"></td> <td style="width: 10%;"></td> <td style="width: 10%;"></td> <td style="width: 10%;"></td> <td style="width: 10%;"></td> <td style="width: 10%;"></td> <td style="width: 10%;"></td> <td style="width: 10%;"></td> <td style="width: 10%;"></td> </tr> <tr> <td></td> <td></td> <td colspan="8" style="text-align: center;"> <table border="1" style="width: 100%; border-collapse: collapse; text-align: center;"> <tr> <td style="width: 10%;"></td> <td style="width: 10%;"></td> <td style="width: 10%;"></td> <td style="width: 10%;"></td> <td style="width: 10%;"></td> <td style="width: 10%;"></td> <td style="width: 10%;"></td> <td style="width: 10%;"></td> <td style="width: 10%;"></td> <td style="width: 10%;"></td> </tr> <tr> <td></td> <td></td> <td colspan="8" style="text-align: center;"> <table border="1" style="width: 100%; border-collapse: collapse; text-align: center;"> <tr> <td style="width: 10%;"></td> <td style="width: 10%;"></td> <td style="width: 10%;"></td> <td style="width: 10%;"></td> <td style="width: 10%;"></td> <td style="width: 10%;"></td> <td style="width: 10%;"></td> <td style="width: 10%;"></td> <td style="width: 10%;"></td> <td style="width: 10%;"></td> </tr> <tr> <td></td> <td></td> <td colspan="8" style="text-align: center;"> <table border="1" style="width: 100%; border-collapse: collapse; text-align: center;"> <tr> <td style="width: 10%;"></td> <td style="width: 10%;"></td> <td style="width: 10%;"></td> <td style="width: 10%;"></td> <td style="width: 10%;"></td> <td style="width: 10%;"></td> <td style="width: 10%;"></td> <td style="width: 10%;"></td> <td style="width: 10%;"></td> <td style="width: 10%;"></td> </tr> <tr> <td></td> <td></td> <td colspan="8" style="text-align: center;"> <table border="1" style="width: 100%; border-collapse: collapse; text-align: center;"> <tr> <td style="width: 10%;"></td> <td style="width: 10%;"></td> <td style="width: 10%;"></td> <td style="width: 10%;"></td> <td style="width: 10%;"></td> <td style="width: 10%;"></td> <td style="width: 10%;"></td> <td style="width: 10%;"></td> <td style="width: 10%;"></td> <td style="width: 10%;"></td> </tr> <tr> <td></td> <td></td> <td colspan="8" style="text-align: center;"> <table border="1" style="width: 100%; border-collapse: collapse; text-align: center;"> <tr> <td style="width: 10%;"></td> <td style="width: 10%;"></td> <td style="width: 10%;"></td> <td style="width: 10%;"></td> <td style="width: 10%;"></td> <td style="width: 10%;"></td> <td style="width: 10%;"></td> <td style="width: 10%;"></td> <td style="width: 10%;"></td> <td style="width: 10%;"></td> </tr> <tr> <td></td> <td></td> <td colspan="8" style="text-align: center;"> <table border="1" style="width: 100%; border-collapse: collapse; text-align: center;"> <tr> <td style="width: 10%;"></td> <td style="width: 10%;"></td> <td style="width: 10%;"></td> <td style="width: 10%;"></td> <td style="width: 10%;"></td> <td style="width: 10%;"></td> <td style="width: 10%;"></td> <td style="width: 10%;"></td> <td style="width: 10%;"></td> <td style="width: 10%;"></td> </tr> <tr> <td></td> <td></td> <td colspan="8" style="text-align: center;"> <table border="1" style="width: 100%; border-collapse: collapse; text-align: center;"> <tr> <td style="width: 10%;"></td> <td style="width: 10%;"></td> <td style="width: 10%;"></td> <td style="width: 10%;"></td> <td style="width: 10%;"></td> <td style="width: 10%;"></td> <td style="width: 10%;"></td> <td style="width: 10%;"></td> <td style="width: 10%;"></td> <td style="width: 10%;"></td> </tr> <tr> <td></td> <td></td> <td colspan="8" style="text-align: center;"> <table border="1" style="width: 100%; border-collapse: collapse; text-align: center;"> <tr> <td style="width: 10%;"></td> <td style="width: 10%;"></td> <td style="width: 10%;"></td> <td style="width: 10%;"></td> <td style="width: 10%;"></td> <td style="width: 10%;"></td> <td style="width: 10%;"></td> <td style="width: 10%;"></td> <td style="width: 10%;"></td> <td style="width: 10%;"></td> </tr> <tr> <td></td> <td></td> <td colspan="8" style="text-align: center;"> <table border="1"
style="width: 100%; border-collapse: collapse; text-align: center;"> <tr> </tr></table></td></tr></table></td></tr></table></td></tr></table></td></tr></table></td></tr></table></td></tr></table></td></tr></table></td></tr></table></td></tr></table></td></tr></table></td></tr></table></td></tr></table></td></tr></table></td></tr></table></td></tr></table></td></tr></table></td></tr></table></td></tr></table></td></tr></table></td></tr></table></td></tr></table></td></tr></table></td></tr></table></td></tr></table></td></tr></table></td></tr></table></td></tr></table>
 | | | | | | | | | | | | | | | | | | | | <table border="1" style="width: 100%; border-collapse: collapse; text-align: center;"> <tr> <td style="width: 10%;"></td> <td style="width: 10%;"></td> <td style="width: 10%;"></td> <td style="width: 10%;"></td> <td style="width: 10%;"></td> <td style="width: 10%;"></td> <td style="width: 10%;"></td> <td style="width: 10%;"></td> <td style="width: 10%;"></td> <td style="width: 10%;"></td> </tr> <tr> <td></td> <td></td> <td colspan="8" style="text-align: center;"> <table border="1" style="width: 100%; border-collapse: collapse; text-align: center;"> <tr> <td style="width: 10%;"></td> <td style="width: 10%;"></td> <td style="width: 10%;"></td> <td style="width: 10%;"></td> <td style="width: 10%;"></td> <td style="width: 10%;"></td> <td style="width: 10%;"></td> <td style="width: 10%;"></td> <td style="width: 10%;"></td> <td style="width: 10%;"></td> </tr> <tr> <td></td> <td></td> <td colspan="8" style="text-align: center;"> <table border="1" style="width: 100%; border-collapse: collapse; text-align: center;"> <tr> <td style="width: 10%;"></td> <td style="width: 10%;"></td> <td style="width: 10%;"></td> <td style="width: 10%;"></td> <td style="width: 10%;"></td> <td style="width: 10%;"></td> <td style="width: 10%;"></td> <td style="width: 10%;"></td> <td style="width: 10%;"></td> <td style="width: 10%;"></td> </tr> <tr> <td></td> <td></td> <td colspan="8" style="text-align: center;"> <table border="1" style="width: 100%; border-collapse: collapse; text-align: center;"> <tr> <td style="width: 10%;"></td> <td style="width: 10%;"></td> <td style="width: 10%;"></td> <td style="width: 10%;"></td> <td style="width: 10%;"></td> <td style="width: 10%;"></td> <td style="width: 10%;"></td> <td style="width: 10%;"></td> <td style="width: 10%;"></td> <td style="width: 10%;"></td> </tr> <tr> <td></td> <td></td> <td colspan="8" style="text-align: center;"> <table border="1" style="width: 100%; border-collapse: collapse; text-align: center;"> <tr> <td style="width: 10%;"></td> <td style="width: 10%;"></td> <td style="width: 10%;"></td> <td style="width: 10%;"></td> <td style="width: 10%;"></td> <td style="width: 10%;"></td> <td style="width: 10%;"></td> <td style="width: 10%;"></td> <td style="width: 10%;"></td> <td style="width: 10%;"></td> </tr> <tr> <td></td> <td></td> <td colspan="8" style="text-align: center;"> <table border="1" style="width: 100%; border-collapse: collapse; text-align: center;"> <tr> <td style="width: 10%;"></td> <td style="width: 10%;"></td> <td style="width: 10%;"></td> <td style="width: 10%;"></td> <td style="width: 10%;"></td> <td style="width: 10%;"></td> <td style="width: 10%;"></td> <td style="width: 10%;"></td> <td style="width: 10%;"></td> <td style="width: 10%;"></td> </tr> <tr> <td></td> <td></td> <td colspan="8" style="text-align: center;"> <table border="1" style="width: 100%; border-collapse: collapse; text-align: center;"> <tr> <td style="width: 10%;"></td> <td style="width: 10%;"></td> <td style="width: 10%;"></td> <td style="width: 10%;"></td> <td style="width: 10%;"></td> <td style="width: 10%;"></td> <td style="width: 10%;"></td> <td style="width: 10%;"></td> <td style="width: 10%;"></td> <td style="width: 10%;"></td> </tr> <tr> <td></td> <td></td> <td colspan="8" style="text-align: center;"> <table border="1" style="width: 100%; border-collapse: collapse; text-align: center;"> <tr> <td style="width: 10%;"></td> <td style="width: 10%;"></td> <td style="width: 10%;"></td> <td style="width: 10%;"></td> <td style="width: 10%;"></td> <td style="width: 10%;"></td> <td style="width: 10%;"></td> <td style="width: 10%;"></td> <td style="width: 10%;"></td> <td style="width: 10%;"></td> </tr> <tr> <td></td> <td></td> <td colspan="8" style="text-align: center;"> <table border="1" style="width: 100%; border-collapse: collapse; text-align: center;"> <tr> <td style="width: 10%;"></td> <td style="width: 10%;"></td> <td style="width: 10%;"></td> <td style="width: 10%;"></td> <td style="width: 10%;"></td> <td style="width: 10%;"></td> <td style="width: 10%;"></td> <td style="width: 10%;"></td> <td style="width: 10%;"></td> <td style="width: 10%;"></td> </tr> <tr> <td></td> <td></td> <td colspan="8" style="text-align: center;"> <table border="1" style="width: 100%; border-collapse: collapse; text-align: center;"> <tr> <td style="width: 10%;"></td> <td style="width: 10%;"></td> <td style="width: 10%;"></td> <td style="width: 10%;"></td> <td style="width: 10%;"></td> <td style="width: 10%;"></td> <td style="width: 10%;"></td> <td style="width: 10%;"></td> <td style="width: 10%;"></td> <td style="width: 10%;"></td> </tr> <tr> <td></td> <td></td> <td colspan="8" style="text-align: center;"> <table border="1" style="width: 100%; border-collapse: collapse; text-align: center;"> <tr> <td style="width: 10%;"></td> <td style="width: 10%;"></td> <td style="width: 10%;"></td> <td style="width: 10%;"></td> <td style="width: 10%;"></td> <td style="width: 10%;"></td> <td style="width: 10%;"></td> <td style="width: 10%;"></td> <td style="width: 10%;"></td> <td style="width: 10%;"></td> </tr> <tr> <td></td> <td></td> <td colspan="8" style="text-align: center;"> <table border="1" style="width: 100%; border-collapse: collapse; text-align: center;"> <tr> <td style="width: 10%;"></td> <td style="width: 10%;"></td> <td style="width: 10%;"></td> <td style="width: 10%;"></td> <td style="width: 10%;"></td> <td style="width: 10%;"></td> <td style="width: 10%;"></td> <td style="width: 10%;"></td> <td style="width: 10%;"></td> <td style="width: 10%;"></td> </tr> <tr> <td></td> <td></td> <td colspan="8" style="text-align: center;"> <table border="1" style="width: 100%; border-collapse: collapse; text-align: center;"> <tr> <td style="width: 10%;"></td> <td style="width: 10%;"></td> <td style="width: 10%;"></td> <td style="width: 10%;"></td> <td style="width: 10%;"></td> <td style="width: 10%;"></td> <td style="width: 10%;"></td> <td style="width: 10%;"></td> <td style="width: 10%;"></td> <td style="width: 10%;"></td> </tr> <tr> <td></td> <td></td> <td colspan="8" style="text-align: center;"> <table border="1" style="width: 100%; border-collapse: collapse; text-align: center;"> <tr> <td style="width: 10%;"></td> <td style="width: 10%;"></td> <td style="width: 10%;"></td> <td style="width: 10%;"></td> <td style="width: 10%;"></td> <td style="width: 10%;"></td> <td style="width: 10%;"></td> <td style="width: 10%;"></td> <td style="width: 10%;"></td> <td style="width: 10%;"></td> </tr> <tr> <td></td> <td></td> <td colspan="8" style="text-align: center;"> <table border="1" style="width: 100%; border-collapse: collapse; text-align: center;"> <tr> <td style="width: 10%;"></td> <td style="width: 10%;"></td> <td style="width:
10%;"></td> <td style="width: 10%;"></td> <td style="width: 10%;"></td> <td style="width: 10%;"></td> <td style="width: 10%;"></td> <td style="width: 10%;"></td> <td style="width: 10%;"></td> <td style="width: 10%;"></td> </tr> <tr> <td></td> <td></td> <td colspan="8" style="text-align: center;"> <table border="1" style="width: 100%; border-collapse: collapse; text-align: center;"> <tr> <td style="width: 10%;"></td> <td style="width: 10%;"></td> <td style="width: 10%;"></td> <td style="width: 10%;"></td> <td style="width: 10%;"></td> <td style="width: 10%;"></td> <td style="width: 10%;"></td> <td style="width: 10%;"></td> <td style="width: 10%;"></td> <td style="width: 10%;"></td> </tr> <tr> <td></td> <td></td> <td colspan="8" style="text-align: center;"> <table border="1" style="width: 100%; border-collapse: collapse; text-align: center;"> <tr> <td style="width: 10%;"></td> <td style="width: 10%;"></td> <td style="width: 10%;"></td> <td style="width: 10%;"></td> <td style="width: 10%;"></td> <td style="width: 10%;"></td> <td style="width: 10%;"></td> <td style="width: 10%;"></td> <td style="width: 10%;"></td> <td style="width: 10%;"></td> </tr> <tr> <td></td> <td></td> <td colspan="8" style="text-align: center;"> <table border="1" style="width: 100%; border-collapse: collapse; text-align: center;"> <tr> <td style="width: 10%;"></td> <td style="width: 10%;"></td> <td style="width: 10%;"></td> <td style="width: 10%;"></td> <td style="width: 10%;"></td> <td style="width: 10%;"></td> <td style="width: 10%;"></td> <td style="width: 10%;"></td> <td style="width: 10%;"></td> <td style="width: 10%;"></td> </tr> <tr> <td></td> <td></td> <td colspan="8" style="text-align: center;"> <table border="1" style="width: 100%; border-collapse: collapse; text-align: center;"> <tr> <td style="width: 10%;"></td> <td style="width: 10%;"></td> <td style="width: 10%;"></td> <td style="width: 10%;"></td> <td style="width: 10%;"></td> <td style="width: 10%;"></td> <td style="width: 10%;"></td> <td style="width: 10%;"></td> <td style="width: 10%;"></td> <td style="width: 10%;"></td> </tr> <tr> <td></td> <td></td> <td colspan="8" style="text-align: center;"> <table border="1" style="width: 100%; border-collapse: collapse; text-align: center;"> <tr> <td style="width: 10%;"></td> <td style="width: 10%;"></td> <td style="width: 10%;"></td> <td style="width: 10%;"></td> <td style="width: 10%;"></td> <td style="width: 10%;"></td> <td style="width: 10%;"></td> <td style="width: 10%;"></td> <td style="width: 10%;"></td> <td style="width: 10%;"></td> </tr> <tr> <td></td> <td></td> <td colspan="8" style="text-align: center;"> <table border="1" style="width: 100%; border-collapse: collapse; text-align: center;"> <tr> <td style="width: 10%;"></td> <td style="width: 10%;"></td> <td style="width: 10%;"></td> <td style="width: 10%;"></td> <td style="width: 10%;"></td> <td style="width: 10%;"></td> <td style="width: 10%;"></td> <td style="width: 10%;"></td> <td style="width: 10%;"></td> <td style="width: 10%;"></td> </tr> <tr> <td></td> <td></td> <td colspan="8" style="text-align: center;"> <table border="1" style="width: 100%; border-collapse: collapse; text-align: center;"> <tr> <td style="width: 10%;"></td> <td style="width: 10%;"></td> <td style="width: 10%;"></td> <td style="width: 10%;"></td> <td style="width: 10%;"></td> <td style="width: 10%;"></td> <td style="width: 10%;"></td> <td style="width: 10%;"></td> <td style="width: 10%;"></td> <td style="width: 10%;"></td> </tr> <tr> <td></td> <td></td> <td colspan="8" style="text-align: center;"> <table border="1" style="width: 100%; border-collapse: collapse; text-align: center;"> <tr> <td style="width: 10%;"></td> <td style="width: 10%;"></td> <td style="width: 10%;"></td> <td style="width: 10%;"></td> <td style="width: 10%;"></td> <td style="width: 10%;"></td> <td style="width: 10%;"></td> <td style="width: 10%;"></td> <td style="width: 10%;"></td> <td style="width: 10%;"></td> </tr> <tr> <td></td> <td></td> <td colspan="8" style="text-align: center;"> <table border="1" style="width: 100%; border-collapse: collapse; text-align: center;"> <tr> <td style="width: 10%;"></td> <td style="width: 10%;"></td> <td style="width: 10%;"></td> <td style="width: 10%;"></td> <td style="width: 10%;"></td> <td style="width: 10%;"></td> <td style="width: 10%;"></td> <td style="width: 10%;"></td> <td style="width: 10%;"></td> <td style="width: 10%;"></td> </tr> <tr> <td></td> <td></td> <td colspan="8" style="text-align: center;"> <table border="1" style="width: 100%; border-collapse: collapse; text-align: center;"> <tr> <td style="width: 10%;"></td> <td style="width: 10%;"></td> <td style="width: 10%;"></td> <td style="width: 10%;"></td> <td style="width: 10%;"></td> <td style="width: 10%;"></td> <td style="width: 10%;"></td> <td style="width: 10%;"></td> <td style="width: 10%;"></td> <td style="width: 10%;"></td> </tr> <tr> <td></td> <td></td> <td colspan="8" style="text-align: center;"> <table border="1" style="width: 100%; border-collapse: collapse; text-align: center;"> <tr> <td style="width: 10%;"></td> <td style="width: 10%;"></td> <td style="width: 10%;"></td> <td style="width: 10%;"></td> <td style="width: 10%;"></td> <td style="width: 10%;"></td> <td style="width: 10%;"></td> <td style="width: 10%;"></td> <td style="width: 10%;"></td> <td style="width: 10%;"></td> </tr> <tr> <td></td> <td></td> <td colspan="8" style="text-align: center;"> <table border="1" style="width: 100%; border-collapse: collapse; text-align: center;"> <tr> </tr></table></td></tr></table></td></tr></table></td></tr></table></td></tr></table></td></tr></table></td></tr></table></td></tr></table></td></tr></table></td></tr></table></td></tr></table></td></tr></table></td></tr></table></td></tr></table></td></tr></table></td></tr></table></td></tr></table></td></tr></table></td></tr></table></td></tr></table></td></tr></table></td></tr></table></td></tr></table></td></tr></table></td></tr></table></td></tr></table></td></tr></table>
 | | | | | | | | | | | | | | | | | | | | <table border="1" style="width: 100%; border-collapse: collapse; text-align: center;"> <tr> <td style="width: 10%;"></td> <td style="width: 10%;"></td> <td style="width: 10%;"></td> <td style="width: 10%;"></td> <td style="width: 10%;"></td> <td style="width: 10%;"></td> <td style="width: 10%;"></td> <td style="width: 10%;"></td> <td style="width: 10%;"></td> <td style="width: 10%;"></td> </tr> <tr> <td></td> <td></td> <td colspan="8" style="text-align: center;"> <table border="1" style="width: 100%; border-collapse: collapse; text-align: center;"> <tr> <td style="width: 10%;"></td> <td style="width: 10%;"></td> <td style="width: 10%;"></td> <td style="width: 10%;"></td> <td style="width: 10%;"></td> <td style="width: 10%;"></td> <td style="width: 10%;"></td> <td style="width: 10%;"></td> <td style="width: 10%;"></td> <td style="width: 10%;"></td> </tr> <tr> <td></td> <td></td> <td colspan="8" style="text-align: center;"> <table border="1" style="width: 100%; border-collapse: collapse; text-align: center;"> <tr> <td style="width: 10%;"></td> <td style="width: 10%;"></td> <td style="width: 10%;"></td> <td style="width: 10%;"></td> <td style="width: 10%;"></td> <td style="width: 10%;"></td> <td style="width: 10%;"></td> <td style="width: 10%;"></td> <td
style="width: 10%;"></td> <td style="width: 10%;"></td> </tr> <tr> <td></td> <td></td> <td colspan="8" style="text-align: center;"> <table border="1" style="width: 100%; border-collapse: collapse; text-align: center;"> <tr> <td style="width: 10%;"></td> <td style="width: 10%;"></td> <td style="width: 10%;"></td> <td style="width: 10%;"></td> <td style="width: 10%;"></td> <td style="width: 10%;"></td> <td style="width: 10%;"></td> <td style="width: 10%;"></td> <td style="width: 10%;"></td> <td style="width: 10%;"></td> </tr> <tr> <td></td> <td></td> <td colspan="8" style="text-align: center;"> <table border="1" style="width: 100%; border-collapse: collapse; text-align: center;"> <tr> <td style="width: 10%;"></td> <td style="width: 10%;"></td> <td style="width: 10%;"></td> <td style="width: 10%;"></td> <td style="width: 10%;"></td> <td style="width: 10%;"></td> <td style="width: 10%;"></td> <td style="width: 10%;"></td> <td style="width: 10%;"></td> <td style="width: 10%;"></td> </tr> <tr> <td></td> <td></td> <td colspan="8" style="text-align: center;"> <table border="1" style="width: 100%; border-collapse: collapse; text-align: center;"> <tr> <td style="width: 10%;"></td> <td style="width: 10%;"></td> <td style="width: 10%;"></td> <td style="width: 10%;"></td> <td style="width: 10%;"></td> <td style="width: 10%;"></td> <td style="width: 10%;"></td> <td style="width: 10%;"></td> <td style="width: 10%;"></td> <td style="width: 10%;"></td> </tr> <tr> <td></td> <td></td> <td colspan="8" style="text-align: center;"> <table border="1" style="width: 100%; border-collapse: collapse; text-align: center;"> <tr> <td style="width: 10%;"></td> <td style="width: 10%;"></td> <td style="width: 10%;"></td> <td style="width: 10%;"></td> <td style="width: 10%;"></td> <td style="width: 10%;"></td> <td style="width: 10%;"></td> <td style="width: 10%;"></td> <td style="width: 10%;"></td> <td style="width: 10%;"></td> </tr> <tr> <td></td> <td></td> <td colspan="8" style="text-align: center;"> <table border="1" style="width: 100%; border-collapse: collapse; text-align: center;"> <tr> <td style="width: 10%;"></td> <td style="width: 10%;"></td> <td style="width: 10%;"></td> <td style="width: 10%;"></td> <td style="width: 10%;"></td> <td style="width: 10%;"></td> <td style="width: 10%;"></td> <td style="width: 10%;"></td> <td style="width: 10%;"></td> <td style="width: 10%;"></td> </tr> <tr> <td></td> <td></td> <td colspan="8" style="text-align: center;"> <table border="1" style="width: 100%; border-collapse: collapse; text-align: center;"> <tr> <td style="width: 10%;"></td> <td style="width: 10%;"></td> <td style="width: 10%;"></td> <td style="width: 10%;"></td> <td style="width: 10%;"></td> <td style="width: 10%;"></td> <td style="width: 10%;"></td> <td style="width: 10%;"></td> <td style="width: 10%;"></td> <td style="width: 10%;"></td> </tr> <tr> <td></td> <td></td> <td colspan="8" style="text-align: center;"> <table border="1" style="width: 100%; border-collapse: collapse; text-align: center;"> <tr> <td style="width: 10%;"></td> <td style="width: 10%;"></td> <td style="width: 10%;"></td> <td style="width: 10%;"></td> <td style="width: 10%;"></td> <td style="width: 10%;"></td> <td style="width: 10%;"></td> <td style="width: 10%;"></td> <td style="width: 10%;"></td> <td style="width: 10%;"></td> </tr> <tr> <td></td> <td></td> <td colspan="8" style="text-align: center;"> <table border="1" style="width: 100%; border-collapse: collapse; text-align: center;"> <tr> <td style="width: 10%;"></td> <td style="width: 10%;"></td> <td style="width: 10%;"></td> <td style="width: 10%;"></td> <td style="width: 10%;"></td> <td style="width: 10%;"></td> <td style="width: 10%;"></td> <td style="width: 10%;"></td> <td style="width: 10%;"></td> <td style="width: 10%;"></td> </tr> <tr> <td></td> <td></td> <td colspan="8" style="text-align: center;"> <table border="1" style="width: 100%; border-collapse: collapse; text-align: center;"> <tr> <td style="width: 10%;"></td> <td style="width: 10%;"></td> <td style="width: 10%;"></td> <td style="width: 10%;"></td> <td style="width: 10%;"></td> <td style="width: 10%;"></td> <td style="width: 10%;"></td> <td style="width: 10%;"></td> <td style="width: 10%;"></td> <td style="width: 10%;"></td> </tr> <tr> <td></td> <td></td> <td colspan="8" style="text-align: center;"> <table border="1" style="width: 100%; border-collapse: collapse; text-align: center;"> <tr> <td style="width: 10%;"></td> <td style="width: 10%;"></td> <td style="width: 10%;"></td> <td style="width: 10%;"></td> <td style="width: 10%;"></td> <td style="width: 10%;"></td> <td style="width: 10%;"></td> <td style="width: 10%;"></td> <td style="width: 10%;"></td> <td style="width: 10%;"></td> </tr> <tr> <td></td> <td></td> <td colspan="8" style="text-align: center;"> <table border="1" style="width: 100%; border-collapse: collapse; text-align: center;"> <tr> <td style="width: 10%;"></td> <td style="width: 10%;"></td> <td style="width: 10%;"></td> <td style="width: 10%;"></td> <td style="width: 10%;"></td> <td style="width: 10%;"></td> <td style="width: 10%;"></td> <td style="width: 10%;"></td> <td style="width: 10%;"></td> <td style="width: 10%;"></td> </tr> <tr> <td></td> <td></td> <td colspan="8" style="text-align: center;"> <table border="1" style="width: 100%; border-collapse: collapse; text-align: center;"> <tr> <td style="width: 10%;"></td> <td style="width: 10%;"></td> <td style="width: 10%;"></td> <td style="width: 10%;"></td> <td style="width: 10%;"></td> <td style="width: 10%;"></td> <td style="width: 10%;"></td> <td style="width: 10%;"></td> <td style="width: 10%;"></td> <td style="width: 10%;"></td> </tr> <tr> <td></td> <td></td> <td colspan="8" style="text-align: center;"> <table border="1" style="width: 100%; border-collapse: collapse; text-align: center;"> <tr> <td style="width: 10%;"></td> <td style="width: 10%;"></td> <td style="width: 10%;"></td> <td style="width: 10%;"></td> <td style="width: 10%;"></td> <td style="width: 10%;"></td> <td style="width: 10%;"></td> <td style="width: 10%;"></td> <td style="width: 10%;"></td> <td style="width: 10%;"></td> </tr> <tr> <td></td> <td></td> <td colspan="8" style="text-align: center;"> <table border="1" style="width: 100%; border-collapse: collapse; text-align: center;"> <tr> <td style="width: 10%;"></td> <td style="width: 10%;"></td> <td style="width: 10%;"></td> <td style="width: 10%;"></td> <td style="width: 10%;"></td> <td style="width: 10%;"></td> <td style="width: 10%;"></td> <td style="width: 10%;"></td> <td style="width: 10%;"></td> <td style="width: 10%;"></td> </tr> <tr> <td></td> <td></td> <td colspan="8" style="text-align: center;"> <table border="1" style="width: 100%; border-collapse: collapse; text-align: center;"> <tr> <td style="width: 10%;"></td> <td style="width: 10%;"></td> <td style="width: 10%;"></td> <td style="width: 10%;"></td> <td style="width: 10%;"></td> <td style="width: 10%;"></td> <td style="width: 10%;"></td> <td style="width: 10%;"></td> <td style="width: 10%;"></td> <td style="width: 10%;"></td> </tr> <tr> <td></td> <td></td> <td colspan="8" style="text-align: center;"> <table border="1" style="width: 100%; border-collapse: collapse; text-align: center;"> <tr> <td style="width: 10%;"></td> <td style="width: 10%;"></td> <td style="width: 10%;"></td> <td style="width: 10%;"></td> <td style="width: 10%;"></td> <td style="width: 10%;"></td> <td style="width: 10%;"></td> <td style="width: 10%;"></td> <td style="width: 10%;"></td> <td style="width: 10%;"></td> </tr> <tr> <td></td> <td></td> <td colspan="8" style="text-align: center;"> <table border="1" style="width: 100%; border-collapse: collapse; text-align: center;"> <tr> <td style="width: 10%;"></td> <td style="width: 10%;"></td> <td style="width: 10%;"></td> <td style="width: 10%;"></td> <td style="width: 10%;"></td> <td style="width: 10%;"></td> <td style="width: 10%;"></td> <td style="width: 10%;"></td> <td style="width: 10%;"></td> <td style="width: 10%;"></td> </tr> <tr> <td></td> <td></td> <td colspan="8" style="text-align: center;"> <table border="1" style="width: 100%; border-collapse: collapse; text-align: center;"> <tr> <td style="width: 10%;"></td> <td style="width: 10%;"></td> <td style="width: 10%;"></td> <td style="width: 10%;"></td> <td style="width: 10%;"></td> <td style="width: 10%;"></td> <td style="width: 10%;"></td> <td style="width: 10%;"></td> <td style="width: 10%;"></td> <td style="width: 10%;"></td> </tr> <tr> <td></td> <td></td> <td colspan="8" style="text-align: center;"> <table border="1" style="width: 100%; border-collapse: collapse; text-align: center;"> <tr> <td style="width: 10%;"></td> <td style="width: 10%;"></td> <td style="width: 10%;"></td> <td style="width: 10%;"></td> <td style="width: 10%;"></td> <td style="width: 10%;"></td> <td style="width: 10%;"></td> <td style="width: 10%;"></td> <td style="width: 10%;"></td> <td style="width: 10%;"></td> </tr> <tr> <td></td> <td></td> <td colspan="8" style="text-align: center;"> <table border="1" style="width: 100%; border-collapse: collapse; text-align: center;"> <tr> <td style="width: 10%;"></td> <td style="width: 10%;"></td> <td style="width: 10%;"></td> <td style="width: 10%;"></td> <td style="width: 10%;"></td> <td style="width: 10%;"></td> <td style="width: 10%;"></td> <td style="width: 10%;"></td> <td style="width: 10%;"></td> <td style="width: 10%;"></td> </tr> <tr> <td></td> <td></td> <td colspan="8" style="text-align: center;"> <table border="1" style="width: 100%; border-collapse: collapse; text-align: center;"> <tr> <td style="width: 10%;"></td> <td style="width: 10%;"></td> <td style="width: 10%;"></td> <td style="width: 10%;"></td> <td style="width: 10%;"></td> <td style="width: 10%;"></td> <td style="width: 10%;"></td> <td style="width: 10%;"></td> <td style="width: 10%;"></td> <td style="width: 10%;"></td> </tr> <tr> <td></td> <td></td> <td colspan="8" style="text-align: center;"> <table border="1" style="width: 100%;
border-collapse: collapse; text-align: center;"> <tr> <td style="width: 10%;"></td> <td style="width: 10%;"></td> <td style="width: 10%;"></td> <td style="width: 10%;"></td> <td style="width: 10%;"></td> <td style="width: 10%;"></td> <td style="width: 10%;"></td> <td style="width: 10%;"></td> <td style="width: 10%;"></td> <td style="width: 10%;"></td> </tr> <tr> <td></td> <td></td> <td colspan="8" style="text-align: center;"> <table border="1" style="width: 100%; border-collapse: collapse; text-align: center;"> <tr> </tr></table></td></tr></table></td></tr></table></td></tr></table></td></tr></table></td></tr></table></td></tr></table></td></tr></table></td></tr></table></td></tr></table></td></tr></table></td></tr></table></td></tr></table></td></tr></table></td></tr></table></td></tr></table></td></tr></table></td></tr></table></td></tr></table></td></tr></table></td></tr></table></td></tr></table></td></tr></table></td></tr></table></td></tr></table></td></tr></table>
 | | | | | | | | | | | | | | | | | | | | <table border="1" style="width: 100%; border-collapse: collapse; text-align: center;"> <tr> <td style="width: 10%;"></td> <td style="width: 10%;"></td> <td style="width: 10%;"></td> <td style="width: 10%;"></td> <td style="width: 10%;"></td> <td style="width: 10%;"></td> <td style="width: 10%;"></td> <td style="width: 10%;"></td> <td style="width: 10%;"></td> <td style="width: 10%;"></td> </tr> <tr> <td></td> <td></td> <td colspan="8" style="text-align: center;"> <table border="1" style="width: 100%; border-collapse: collapse; text-align: center;"> <tr> <td style="width: 10%;"></td> <td style="width: 10%;"></td> <td style="width: 10%;"></td> <td style="width: 10%;"></td> <td style="width: 10%;"></td> <td style="width: 10%;"></td> <td style="width: 10%;"></td> <td style="width: 10%;"></td> <td style="width: 10%;"></td> <td style="width: 10%;"></td> </tr> <tr> <td></td> <td></td> <td colspan="8" style="text-align: center;"> <table border="1" style="width: 100%; border-collapse: collapse; text-align: center;"> <tr> <td style="width: 10%;"></td> <td style="width: 10%;"></td> <td style="width: 10%;"></td> <td style="width: 10%;"></td> <td style="width: 10%;"></td> <td style="width: 10%;"></td> <td style="width: 10%;"></td> <td style="width: 10%;"></td> <td style="width: 10%;"></td> <td style="width: 10%;"></td> </tr> <tr> <td></td> <td></td> <td colspan="8" style="text-align: center;"> <table border="1" style="width: 100%; border-collapse: collapse; text-align: center;"> <tr> <td style="width: 10%;"></td> <td style="width: 10%;"></td> <td style="width: 10%;"></td> <td style="width: 10%;"></td> <td style="width: 10%;"></td> <td style="width: 10%;"></td> <td style="width: 10%;"></td> <td style="width: 10%;"></td> <td style="width: 10%;"></td> <td style="width: 10%;"></td> </tr> <tr> <td></td> <td></td> <td colspan="8" style="text-align: center;"> <table border="1" style="width: 100%; border-collapse: collapse; text-align: center;"> <tr> <td style="width: 10%;"></td> <td style="width: 10%;"></td> <td style="width: 10%;"></td> <td style="width: 10%;"></td> <td style="width: 10%;"></td> <td style="width: 10%;"></td> <td style="width: 10%;"></td> <td style="width: 10%;"></td> <td style="width: 10%;"></td> <td style="width: 10%;"></td> </tr> <tr> <td></td> <td></td> <td colspan="8" style="text-align: center;"> <table border="1" style="width: 100%; border-collapse: collapse; text-align: center;"> <tr> <td style="width: 10%;"></td> <td style="width: 10%;"></td> <td style="width: 10%;"></td> <td style="width: 10%;"></td> <td style="width: 10%;"></td> <td style="width: 10%;"></td> <td style="width: 10%;"></td> <td style="width: 10%;"></td> <td style="width: 10%;"></td> <td style="width: 10%;"></td> </tr> <tr> <td></td> <td></td> <td colspan="8" style="text-align: center;"> <table border="1" style="width: 100%; border-collapse: collapse; text-align: center;"> <tr> <td style="width: 10%;"></td> <td style="width: 10%;"></td> <td style="width: 10%;"></td> <td style="width: 10%;"></td> <td style="width: 10%;"></td> <td style="width: 10%;"></td> <td style="width: 10%;"></td> <td style="width: 10%;"></td> <td style="width: 10%;"></td> <td style="width: 10%;"></td> </tr> <tr> <td></td> <td></td> <td colspan="8" style="text-align: center;"> <table border="1" style="width: 100%; border-collapse: collapse; text-align: center;"> <tr> <td style="width: 10%;"></td> <td style="width: 10%;"></td> <td style="width: 10%;"></td> <td style="width: 10%;"></td> <td style="width: 10%;"></td> <td style="width: 10%;"></td> <td style="width: 10%;"></td> <td style="width: 10%;"></td> <td style="width: 10%;"></td> <td style="width: 10%;"></td> </tr> <tr> <td></td> <td></td> <td colspan="8" style="text-align: center;"> <table border="1" style="width: 100%; border-collapse: collapse; text-align: center;"> <tr> <td style="width: 10%;"></td> <td style="width: 10%;"></td> <td style="width: 10%;"></td> <td style="width: 10%;"></td> <td style="width: 10%;"></td> <td style="width: 10%;"></td> <td style="width: 10%;"></td> <td style="width: 10%;"></td> <td style="width: 10%;"></td> <td style="width: 10%;"></td> </tr> <tr> <td></td> <td></td> <td colspan="8" style="text-align: center;"> <table border="1" style="width: 100%; border-collapse: collapse; text-align: center;"> <tr> <td style="width: 10%;"></td> <td style="width: 10%;"></td> <td style="width: 10%;"></td> <td style="width: 10%;"></td> <td style="width: 10%;"></td> <td style="width: 10%;"></td> <td style="width: 10%;"></td> <td style="width: 10%;"></td> <td style="width: 10%;"></td> <td style="width: 10%;"></td> </tr> <tr> <td></td> <td></td> <td colspan="8" style="text-align: center;"> <table border="1" style="width: 100%; border-collapse: collapse; text-align: center;"> <tr> <td style="width: 10%;"></td> <td style="width: 10%;"></td> <td style="width: 10%;"></td> <td style="width: 10%;"></td> <td style="width: 10%;"></td> <td style="width: 10%;"></td> <td style="width: 10%;"></td> <td style="width: 10%;"></td> <td style="width: 10%;"></td> <td style="width: 10%;"></td> </tr> <tr> <td></td> <td></td> <td colspan="8" style="text-align: center;"> <table border="1" style="width: 100%; border-collapse: collapse; text-align: center;"> <tr> <td style="width: 10%;"></td> <td style="width: 10%;"></td> <td style="width: 10%;"></td> <td style="width: 10%;"></td> <td style="width: 10%;"></td> <td style="width: 10%;"></td> <td style="width: 10%;"></td> <td style="width: 10%;"></td> <td style="width: 10%;"></td> <td style="width: 10%;"></td> </tr> <tr> <td></td> <td></td> <td colspan="8" style="text-align: center;"> <table border="1" style="width: 100%; border-collapse: collapse; text-align: center;"> <tr> <td style="width: 10%;"></td> <td style="width: 10%;"></td> <td style="width: 10%;"></td> <td style="width: 10%;"></td> <td style="width: 10%;"></td> <td style="width: 10%;"></td> <td style="width: 10%;"></td> <td style="width: 10%;"></td> <td style="width: 10%;"></td> <td style="width: 10%;"></td> </tr> <tr> <td></td> <td></td> <td colspan="8" style="text-align: center;"> <table border="1" style="width: 100%; border-collapse: collapse; text-align: center;"> <tr> <td style="width: 10%;"></td> <td style="width: 10%;"></td> <td style="width: 10%;"></td> <td style="width: 10%;"></td> <td style="width:
10%;"></td> <td style="width: 10%;"></td> <td style="width: 10%;"></td> <td style="width: 10%;"></td> <td style="width: 10%;"></td> <td style="width: 10%;"></td> </tr> <tr> <td></td> <td></td> <td colspan="8" style="text-align: center;"> <table border="1" style="width: 100%; border-collapse: collapse; text-align: center;"> <tr> <td style="width: 10%;"></td> <td style="width: 10%;"></td> <td style="width: 10%;"></td> <td style="width: 10%;"></td> <td style="width: 10%;"></td> <td style="width: 10%;"></td> <td style="width: 10%;"></td> <td style="width: 10%;"></td> <td style="width: 10%;"></td> <td style="width: 10%;"></td> </tr> <tr> <td></td> <td></td> <td colspan="8" style="text-align: center;"> <table border="1" style="width: 100%; border-collapse: collapse; text-align: center;"> <tr> <td style="width: 10%;"></td> <td style="width: 10%;"></td> <td style="width: 10%;"></td> <td style="width: 10%;"></td> <td style="width: 10%;"></td> <td style="width: 10%;"></td> <td style="width: 10%;"></td> <td style="width: 10%;"></td> <td style="width: 10%;"></td> <td style="width: 10%;"></td> </tr> <tr> <td></td> <td></td> <td colspan="8" style="text-align: center;"> <table border="1" style="width: 100%; border-collapse: collapse; text-align: center;"> <tr> <td style="width: 10%;"></td> <td style="width: 10%;"></td> <td style="width: 10%;"></td> <td style="width: 10%;"></td> <td style="width: 10%;"></td> <td style="width: 10%;"></td> <td style="width: 10%;"></td> <td style="width: 10%;"></td> <td style="width: 10%;"></td> <td style="width: 10%;"></td> </tr> <tr> <td></td> <td></td> <td colspan="8" style="text-align: center;"> <table border="1" style="width: 100%; border-collapse: collapse; text-align: center;"> <tr> <td style="width: 10%;"></td> <td style="width: 10%;"></td> <td style="width: 10%;"></td> <td style="width: 10%;"></td> <td style="width: 10%;"></td> <td style="width: 10%;"></td> <td style="width: 10%;"></td> <td style="width: 10%;"></td> <td style="width: 10%;"></td> <td style="width: 10%;"></td> </tr> <tr> <td></td> <td></td> <td colspan="8" style="text-align: center;"> <table border="1" style="width: 100%; border-collapse: collapse; text-align: center;"> <tr> <td style="width: 10%;"></td> <td style="width: 10%;"></td> <td style="width: 10%;"></td> <td style="width: 10%;"></td> <td style="width: 10%;"></td> <td style="width: 10%;"></td> <td style="width: 10%;"></td> <td style="width: 10%;"></td> <td style="width: 10%;"></td> <td style="width: 10%;"></td> </tr> <tr> <td></td> <td></td> <td colspan="8" style="text-align: center;"> <table border="1" style="width: 100%; border-collapse: collapse; text-align: center;"> <tr> <td style="width: 10%;"></td> <td style="width: 10%;"></td> <td style="width: 10%;"></td> <td style="width: 10%;"></td> <td style="width: 10%;"></td> <td style="width: 10%;"></td> <td style="width: 10%;"></td> <td style="width: 10%;"></td> <td style="width: 10%;"></td> <td style="width: 10%;"></td> </tr> <tr> <td></td> <td></td> <td colspan="8" style="text-align: center;"> <table border="1" style="width: 100%; border-collapse: collapse; text-align: center;"> <tr> <td style="width: 10%;"></td> <td style="width: 10%;"></td> <td style="width: 10%;"></td> <td style="width: 10%;"></td> <td style="width: 10%;"></td> <td style="width: 10%;"></td> <td style="width: 10%;"></td> <td style="width: 10%;"></td> <td style="width: 10%;"></td> <td style="width: 10%;"></td> </tr> <tr> <td></td> <td></td> <td colspan="8" style="text-align: center;"> <table border="1" style="width: 100%; border-collapse: collapse; text-align: center;"> <tr> <td style="width: 10%;"></td> <td style="width: 10%;"></td> <td style="width: 10%;"></td> <td style="width: 10%;"></td> <td style="width: 10%;"></td> <td style="width: 10%;"></td> <td style="width: 10%;"></td> <td style="width: 10%;"></td> <td style="width: 10%;"></td> <td style="width: 10%;"></td> </tr> <tr> <td></td> <td></td> <td colspan="8" style="text-align: center;"> <table border="1" style="width: 100%; border-collapse: collapse; text-align: center;"> <tr> <td style="width: 10%;"></td> <td style="width: 10%;"></td> <td style="width: 10%;"></td> <td style="width: 10%;"></td> <td style="width: 10%;"></td> <td style="width: 10%;"></td> <td style="width: 10%;"></td> <td style="width: 10%;"></td> <td style="width: 10%;"></td> <td style="width: 10%;"></td> </tr> <tr> <td></td> <td></td> <td colspan="8" style="text-align: center;"> <table border="1" style="width: 100%; border-collapse: collapse; text-align: center;"> <tr> <td style="width: 10%;"></td> <td style="width: 10%;"></td> <td style="width: 10%;"></td> <td style="width: 10%;"></td> <td style="width: 10%;"></td> <td style="width: 10%;"></td> <td style="width: 10%;"></td> <td style="width: 10%;"></td> <td style="width: 10%;"></td> <td style="width: 10%;"></td> </tr> <tr> <td></td> <td></td> <td colspan="8" style="text-align: center;"> <table border="1" style="width: 100%; border-collapse: collapse; text-align: center;"> <tr> </tr></table></td></tr></table></td></tr></table></td></tr></table></td></tr></table></td></tr></table></td></tr></table></td></tr></table></td></tr></table></td></tr></table></td></tr></table></td></tr></table></td></tr></table></td></tr></table></td></tr></table></td></tr></table></td></tr></table></td></tr></table></td></tr></table></td></tr></table></td></tr></table></td></tr></table></td></tr></table></td></tr></table></td></tr></table>
 | | | | | | | | | | | | | | | | | | | | <table border="1" style="width: 100%; border-collapse: collapse; text-align: center;"> <tr> <td style="width: 10%;"></td> <td style="width: 10%;"></td> <td style="width: 10%;"></td> <td style="width: 10%;"></td> <td style="width: 10%;"></td> <td style="width: 10%;"></td> <td style="width: 10%;"></td> <td style="width: 10%;"></td> <td style="width: 10%;"></td> <td style="width: 10%;"></td> </tr> <tr> <td></td> <td></td> <td colspan="8" style="text-align: center;"> <table border="1" style="width: 100%; border-collapse: collapse; text-align: center;"> <tr> <td style="width: 10%;"></td> <td style="width: 10%;"></td> <td style="width: 10%;"></td> <td style="width: 10%;"></td> <td style="width: 10%;"></td> <td style="width: 10%;"></td> <td style="width: 10%;"></td> <td style="width: 10%;"></td> <td style="width: 10%;"></td> <td style="width: 10%;"></td> </tr> <tr> <td></td> <td></td> <td colspan="8" style="text-align: center;"> <table border="1" style="width: 100%; border-collapse: collapse; text-align: center;"> <tr> <td style="width: 10%;"></td> <td style="width: 10%;"></td> <td style="width: 10%;"></td> <td style="width: 10%;"></td> <td style="width: 10%;"></td> <td style="width: 10%;"></td> <td style="width: 10%;"></td> <td style="width: 10%;"></td> <td style="width: 10%;"></td> <td style="width: 10%;"></td> </tr> <tr> <td></td> <td></td> <td colspan="8" style="text-align: center;"> <table border="1" style="width: 100%; border-collapse: collapse; text-align: center;"> <tr> <td style="width: 10%;"></td> <td style="width: 10%;"></td> <td style="width: 10%;"></td> <td style="width: 10%;"></td> <td style="width: 10%;"></td> <td style="width: 10%;"></td> <td style="width: 10%;"></td> <td style="width: 10%;"></td> <td style="width: 10%;"></td> <td style="width: 10%;"></td> </tr> <tr> <td></td> <td></td> <td colspan="8"
style="text-align: center;"> <table border="1" style="width: 100%; border-collapse: collapse; text-align: center;"> <tr> <td style="width: 10%;"></td> <td style="width: 10%;"></td> <td style="width: 10%;"></td> <td style="width: 10%;"></td> <td style="width: 10%;"></td> <td style="width: 10%;"></td> <td style="width: 10%;"></td> <td style="width: 10%;"></td> <td style="width: 10%;"></td> <td style="width: 10%;"></td> </tr> <tr> <td></td> <td></td> <td colspan="8" style="text-align: center;"> <table border="1" style="width: 100%; border-collapse: collapse; text-align: center;"> <tr> <td style="width: 10%;"></td> <td style="width: 10%;"></td> <td style="width: 10%;"></td> <td style="width: 10%;"></td> <td style="width: 10%;"></td> <td style="width: 10%;"></td> <td style="width: 10%;"></td> <td style="width: 10%;"></td> <td style="width: 10%;"></td> <td style="width: 10%;"></td> </tr> <tr> <td></td> <td></td> <td colspan="8" style="text-align: center;"> <table border="1" style="width: 100%; border-collapse: collapse; text-align: center;"> <tr> <td style="width: 10%;"></td> <td style="width: 10%;"></td> <td style="width: 10%;"></td> <td style="width: 10%;"></td> <td style="width: 10%;"></td> <td style="width: 10%;"></td> <td style="width: 10%;"></td> <td style="width: 10%;"></td> <td style="width: 10%;"></td> <td style="width: 10%;"></td> </tr> <tr> <td></td> <td></td> <td colspan="8" style="text-align: center;"> <table border="1" style="width: 100%; border-collapse: collapse; text-align: center;"> <tr> <td style="width: 10%;"></td> <td style="width: 10%;"></td> <td style="width: 10%;"></td> <td style="width: 10%;"></td> <td style="width: 10%;"></td> <td style="width: 10%;"></td> <td style="width: 10%;"></td> <td style="width: 10%;"></td> <td style="width: 10%;"></td> <td style="width: 10%;"></td> </tr> <tr> <td></td> <td></td> <td colspan="8" style="text-align: center;"> <table border="1" style="width: 100%; border-collapse: collapse; text-align: center;"> <tr> <td style="width: 10%;"></td> <td style="width: 10%;"></td> <td style="width: 10%;"></td> <td style="width: 10%;"></td> <td style="width: 10%;"></td> <td style="width: 10%;"></td> <td style="width: 10%;"></td> <td style="width: 10%;"></td> <td style="width: 10%;"></td> <td style="width: 10%;"></td> </tr> <tr> <td></td> <td></td> <td colspan="8" style="text-align: center;"> <table border="1" style="width: 100%; border-collapse: collapse; text-align: center;"> <tr> <td style="width: 10%;"></td> <td style="width: 10%;"></td> <td style="width: 10%;"></td> <td style="width: 10%;"></td> <td style="width: 10%;"></td> <td style="width: 10%;"></td> <td style="width: 10%;"></td> <td style="width: 10%;"></td> <td style="width: 10%;"></td> <td style="width: 10%;"></td> </tr> <tr> <td></td> <td></td> <td colspan="8" style="text-align: center;"> <table border="1" style="width: 100%; border-collapse: collapse; text-align: center;"> <tr> <td style="width: 10%;"></td> <td style="width: 10%;"></td> <td style="width: 10%;"></td> <td style="width: 10%;"></td> <td style="width: 10%;"></td> <td style="width: 10%;"></td> <td style="width: 10%;"></td> <td style="width: 10%;"></td> <td style="width: 10%;"></td> <td style="width: 10%;"></td> </tr> <tr> <td></td> <td></td> <td colspan="8" style="text-align: center;"> <table border="1" style="width: 100%; border-collapse: collapse; text-align: center;"> <tr> <td style="width: 10%;"></td> <td style="width: 10%;"></td> <td style="width: 10%;"></td> <td style="width: 10%;"></td> <td style="width: 10%;"></td> <td style="width: 10%;"></td> <td style="width: 10%;"></td> <td style="width: 10%;"></td> <td style="width: 10%;"></td> <td style="width: 10%;"></td> </tr> <tr> <td></td> <td></td> <td colspan="8" style="text-align: center;"> <table border="1" style="width: 100%; border-collapse: collapse; text-align: center;"> <tr> <td style="width: 10%;"></td> <td style="width: 10%;"></td> <td style="width: 10%;"></td> <td style="width: 10%;"></td> <td style="width: 10%;"></td> <td style="width: 10%;"></td> <td style="width: 10%;"></td> <td style="width: 10%;"></td> <td style="width: 10%;"></td> <td style="width: 10%;"></td> </tr> <tr> <td></td> <td></td> <td colspan="8" style="text-align: center;"> <table border="1" style="width: 100%; border-collapse: collapse; text-align: center;"> <tr> <td style="width: 10%;"></td> <td style="width: 10%;"></td> <td style="width: 10%;"></td> <td style="width: 10%;"></td> <td style="width: 10%;"></td> <td style="width: 10%;"></td> <td style="width: 10%;"></td> <td style="width: 10%;"></td> <td style="width: 10%;"></td> <td style="width: 10%;"></td> </tr> <tr> <td></td> <td></td> <td colspan="8" style="text-align: center;"> <table border="1" style="width: 100%; border-collapse: collapse; text-align: center;"> <tr> <td style="width: 10%;"></td> <td style="width: 10%;"></td> <td style="width: 10%;"></td> <td style="width: 10%;"></td> <td style="width: 10%;"></td> <td style="width: 10%;"></td> <td style="width: 10%;"></td> <td style="width: 10%;"></td> <td style="width: 10%;"></td> <td style="width: 10%;"></td> </tr> <tr> <td></td> <td></td> <td colspan="8" style="text-align: center;"> <table border="1" style="width: 100%; border-collapse: collapse; text-align: center;"> <tr> <td style="width: 10%;"></td> <td style="width: 10%;"></td> <td style="width: 10%;"></td> <td style="width: 10%;"></td> <td style="width: 10%;"></td> <td style="width: 10%;"></td> <td style="width: 10%;"></td> <td style="width: 10%;"></td> <td style="width: 10%;"></td> <td style="width: 10%;"></td> </tr> <tr> <td></td> <td></td> <td colspan="8" style="text-align: center;"> <table border="1" style="width: 100%; border-collapse: collapse; text-align: center;"> <tr> <td style="width: 10%;"></td> <td style="width: 10%;"></td> <td style="width: 10%;"></td> <td style="width: 10%;"></td> <td style="width: 10%;"></td> <td style="width: 10%;"></td> <td style="width: 10%;"></td> <td style="width: 10%;"></td> <td style="width: 10%;"></td> <td style="width: 10%;"></td> </tr> <tr> <td></td> <td></td> <td colspan="8" style="text-align: center;"> <table border="1" style="width: 100%; border-collapse: collapse; text-align: center;"> <tr> <td style="width: 10%;"></td> <td style="width: 10%;"></td> <td style="width: 10%;"></td> <td style="width: 10%;"></td> <td style="width: 10%;"></td> <td style="width: 10%;"></td> <td style="width: 10%;"></td> <td style="width: 10%;"></td> <td style="width: 10%;"></td> <td style="width: 10%;"></td> </tr> <tr> <td></td> <td></td> <td colspan="8" style="text-align: center;"> <table border="1" style="width: 100%; border-collapse: collapse; text-align: center;"> <tr> <td style="width: 10%;"></td> <td style="width: 10%;"></td> <td style="width: 10%;"></td> <td style="width: 10%;"></td> <td style="width: 10%;"></td> <td style="width: 10%;"></td> <td style="width: 10%;"></td> <td style="width: 10%;"></td> <td style="width: 10%;"></td> <td style="width: 10%;"></td> </tr> <tr> <td></td> <td></td> <td colspan="8" style="text-align: center;"> <table border="1" style="width: 100%; border-collapse: collapse; text-align: center;"> <tr> <td style="width: 10%;"></td> <td style="width: 10%;"></td> <td style="width: 10%;"></td> <td style="width: 10%;"></td> <td style="width: 10%;"></td> <td style="width: 10%;"></td> <td style="width: 10%;"></td> <td style="width: 10%;"></td> <td style="width: 10%;"></td> <td style="width: 10%;"></td> </tr> <tr> <td></td> <td></td> <td colspan="8" style="text-align: center;"> <table border="1" style="width: 100%; border-collapse: collapse; text-align: center;"> <tr> <td style="width: 10%;"></td> <td style="width: 10%;"></td> <td style="width: 10%;"></td> <td style="width: 10%;"></td> <td style="width: 10%;"></td> <td style="width: 10%;"></td> <td style="width: 10%;"></td> <td style="width: 10%;"></td> <td style="width: 10%;"></td> <td style="width: 10%;"></td> </tr> <tr> <td></td> <td></td> <td colspan="8" style="text-align: center;"> <table border="1" style="width: 100%; border-collapse: collapse; text-align: center;"> <tr> <td style="width: 10%;"></td> <td style="width: 10%;"></td> <td style="width: 10%;"></td> <td style="width: 10%;"></td> <td style="width: 10%;"></td> <td style="width: 10%;"></td> <td style="width: 10%;"></td> <td style="width: 10%;"></td> <td style="width: 10%;"></td> <td style="width: 10%;"></td> </tr> <tr> <td></td> <td></td> <td colspan="8" style="text-align: center;"> <table border="1" style="width: 100%; border-collapse: collapse; text-align: center;"> <tr> <td style="width: 10%;"></td> <td style="width: 10%;"></td> <td style="width: 10%;"></td> <td style="width: 10%;"></td> <td style="width: 10%;"></td> <td style="width: 10%;"></td> <td style="width: 10%;"></td> <td style="width: 10%;"></td> <td style="width: 10%;"></td> <td style="width: 10%;"></td> </tr> <tr> <td></td> <td></td> <td colspan="8" style="text-align: center;"> <table border="1" style="width: 100%; border-collapse: collapse; text-align: center;"> <tr> </tr></table></td></tr></table></td></tr></table></td></tr></table></td></tr></table></td></tr></table></td></tr></table></td></tr></table></td></tr></table></td></tr></table></td></tr></table></td></tr></table></td></tr></table></td></tr></table></td></tr></table></td></tr></table></td></tr></table></td></tr></table></td></tr></table></td></tr></table></td></tr></table></td></tr></table></td></tr></table></td></tr></table>

 | | | | | | | | | | | | | | | | | | | | <table border="1" style="width: 100%; border-collapse: collapse; text-align: center;"> <tr> <td style="width: 10%;"></td> <td style="width: 10%;"></td> <td style="width: 10%;"></td> <td style="width: 10%;"></td> <td style="width: 10%;"></td> <td style="width: 10%;"></td> <td style="width: 10%;"></td> <td style="width: 10%;"></td> <td style="width: 10%;"></td> <td style="width: 10%;"></td> </tr> <tr> <td></td> <td></td> <td colspan="8" style="text-align: center;"> <table border="1" style="width: 100%; border-collapse: collapse; text-align: center;"> <tr> <td style="width: 10%;"></td> <td style="width: 10%;"></td> <td style="width: 10%;"></td> <td style="width: 10%;"></td> <td style="width: 10%;"></td> <td style="width: 10%;"></td> <td style="width: 10%;"></td> <td style="width: 10%;"></td> <td style="width: 10%;"></td> <td style="width: 10%;"></td> </tr> <tr> <td></td> <td></td> <td colspan="8" style="text-align: center;"> <table border="1" style="width: 100%; border-collapse: collapse; text-align: center;"> <tr> <td style="width: 10%;"></td> <td style="width: 10%;"></td> <td style="width: 10%;"></td> <td style="width: 10%;"></td> <td style="width: 10%;"></td> <td style="width: 10%;"></td> <td style="width: 10%;"></td> <td style="width: 10%;"></td> <td style="width: 10%;"></td> <td style="width: 10%;"></td> </tr> <tr> <td></td> <td></td> <td colspan="8" style="text-align: center;"> <table border="1" style="width: 100%; border-collapse: collapse; text-align: center;"> <tr> <td style="width: 10%;"></td> <td style="width: 10%;"></td> <td style="width: 10%;"></td> <td style="width: 10%;"></td> <td style="width: 10%;"></td> <td style="width: 10%;"></td> <td style="width: 10%;"></td> <td style="width: 10%;"></td> <td style="width: 10%;"></td> <td style="width: 10%;"></td> </tr> <tr> <td></td> <td></td> <td colspan="8" style="text-align: center;"> <table border="1" style="width: 100%; border-collapse: collapse; text-align: center;"> <tr> <td style="width: 10%;"></td> <td style="width: 10%;"></td> <td style="width: 10%;"></td> <td style="width: 10%;"></td> <td style="width: 10%;"></td> <td style="width: 10%;"></td> <td style="width: 10%;"></td> <td style="width: 10%;"></td> <td style="width: 10%;"></td> <td style="width: 10%;"></td> </tr> <tr> <td></td> <td></td> <td colspan="8" style="text-align: center;"> <table border="1" style="width: 100%; border-collapse: collapse; text-align: center;"> <tr> <td style="width: 10%;"></td> <td style="width: 10%;"></td> <td style="width: 10%;"></td> <td style="width: 10%;"></td> <td style="width: 10%;"></td> <td style="width: 10%;"></td> <td style="width: 10%;"></td> <td style="width: 10%;"></td> <td style="width: 10%;"></td> <td style="width: 10%;"></td> </tr> <tr> <td></td> <td></td> <td colspan="8" style="text-align: center;"> <table border="1" style="width: 100%; border-collapse: collapse; text-align: center;"> <tr> <td style="width: 10%;"></td> <td style="width: 10%;"></td> <td style="width: 10%;"></td> <td style="width: 10%;"></td> <td style="width: 10%;"></td> <td style="width: 10%;"></td> <td style="width: 10%;"></td> <td style="width: 10%;"></td> <td style="width: 10%;"></td> <td style="width: 10%;"></td> </tr> <tr> <td></td> <td></td> <td colspan="8" style="text-align: center;"> <table border="1" style="width: 100%; border-collapse: collapse; text-align: center;"> <tr> <td style="width: 10%;"></td> <td style="width: 10%;"></td> <td style="width: 10%;"></td> <td style="width: 10%;"></td> <td style="width: 10%;"></td> <td style="width: 10%;"></td> <td style="width: 10%;"></td> <td style="width: 10%;"></td> <td style="width: 10%;"></td> <td style="width: 10%;"></td> </tr> <tr> <td></td> <td></td> <td colspan="8" style="text-align: center;"> <table border="1" style="width: 100%; border-collapse: collapse; text-align: center;"> <tr> <td style="width: 10%;"></td> <td style="width: 10%;"></td> <td style="width: 10%;"></td> <td style="width: 10%;"></td> <td style="width: 10%;"></td> <td style="width: 10%;"></td> <td style="width: 10%;"></td> <td style="width: 10%;"></td> <td style="width: 10%;"></td> <td style="width: 10%;"></td> </tr> <tr> <td></td> <td></td> <td colspan="8" style="text-align: center;"> <table border="1" style="width: 100%; border-collapse: collapse; text-align: center;"> <tr> <td style="width: 10%;"></td> <td style="width: 10%;"></td> <td style="width: 10%;"></td> <td style="width: 10%;"></td> <td style="width: 10%;"></td> <td style="width: 10%;"></td> <td style="width: 10%;"></td> <td style="width: 10%;"></td> <td style="width: 10%;"></td> <td style="width: 10%;"></td> </tr> <tr> <td></td> <td></td> <td colspan="8" style="text-align: center;"> <table border="1" style="width: 100%; border-collapse: collapse; text-align: center;"> <tr> <td style="width: 10%;"></td> <td style="width: 10%;"></td> <td style="width: 10%;"></td> <td style="width: 10%;"></td> <td style="width: 10%;"></td> <td style="width: 10%;"></td> <td style="width: 10%;"></td> <td style="width: 10%;"></td> <td style="width: 10%;"></td> <td style="width: 10%;"></td> </tr> <tr> <td></td> <td></td> <td colspan="8" style="text-align: center;"> <table border="1" style="width: 100%; border-collapse: collapse; text-align: center;"> <tr> <td style="width: 10%;"></td> <td style="width: 10%;"></td> <td style="width: 10%;"></td> <td style="width: 10%;"></td> <td style="width: 10%;"></td> <td style="width: 10%;"></td> <td style="width: 10%;"></td> <td style="width: 10%;"></td> <td style="width: 10%;"></td> <td style="width: 10%;"></td> </tr> <tr> <td></td> <td></td> <td colspan="8" style="text-align: center;"> <table border="1" style="width: 100%; border-collapse: collapse; text-align: center;"> <tr> <td style="width: 10%;"></td> <td style="width: 10%;"></td> <td style="width: 10%;"></td> <td style="width: 10%;"></td> <td style="width: 10%;"></td> <td style="width: 10%;"></td> <td style="width: 10%;"></td> <td style="width: 10%;"></td> <td style="width: 10%;"></td> <td style="width: 10%;"></td> </tr> <tr> <td></td> <td></td> <td colspan="8" style="text-align: center;"> <table border="1" style="width: 100%; border-collapse: collapse; text-align: center;"> <tr> <td style="width: 10%;"></td> <td style="width: 10%;"></td> <td style="width: 10%;"></td> <td style="width: 10%;"></td> <td style="width: 10%;"></td> <td style="width: 10%;"></td> <td style="width: 10%;"></td> <td style="width: 10%;"></td> <td style="width: 10%;"></td> <td style="width: 10%;"></td> </tr> <tr> <td></td> <td></td> <td colspan="8" style="text-align: center;"> <table border="1" style="width: 100%; border-collapse: collapse; text-align: center;"> <tr> <td style="width: 10%;"></td> <td style="width: 10%;"></td> <td style="width: 10%;"></td> <td style="width: 10%;"></td> <td style="width: 10%;"></td> <td style="width: 10%;"></td> <td style="width: 10%;"></td> <td style="width: 10%;"></td> <td style="width: 10%;"></td> <td style="width: 10%;"></td> </tr> <tr> <td></td> <td></td> <td colspan="8" style="text-align: center;"> <table border="1" style="width: 100%; border-collapse: collapse; text-align: center;"> <tr> <td style="width: 10%;"></td> <td style="width: 10%;"></td> <td style="width: 10%;"></td> <td style="width: 10%;"></td> <td style="width: 10%;"></td> <td style="width: 10%;"></td> <td style="width: 10%;"></td> <td style="width: 10%;"></td> <td style="width: 10%;"></td> <td style="width: 10%;"></td> </tr> <tr> <td></td> <td></td> <td colspan="8" style="text-align: center;"> <table border="1" style="width: 100%; border-collapse: collapse; text-align: center;"> <tr> <td style="width: 10%;"></td> <td style="width: 10%;"></td> <td style="width: 10%;"></td> <td style="width: 10%;"></td> <td style="width: 10%;"></td> <td style="width: 10%;"></td> <td style="width: 10%;"></td> <td style="width: 10%;"></td> <td style="width: 10%;"></td> <td
style="width: 10%;"></td> </tr> <tr> <td></td> <td></td> <td colspan="8" style="text-align: center;"> <table border="1" style="width: 100%; border-collapse: collapse; text-align: center;"> <tr> <td style="width: 10%;"></td> <td style="width: 10%;"></td> <td style="width: 10%;"></td> <td style="width: 10%;"></td> <td style="width: 10%;"></td> <td style="width: 10%;"></td> <td style="width: 10%;"></td> <td style="width: 10%;"></td> <td style="width: 10%;"></td> <td style="width: 10%;"></td> </tr> <tr> <td></td> <td></td> <td colspan="8" style="text-align: center;"> <table border="1" style="width: 100%; border-collapse: collapse; text-align: center;"> <tr> <td style="width: 10%;"></td> <td style="width: 10%;"></td> <td style="width: 10%;"></td> <td style="width: 10%;"></td> <td style="width: 10%;"></td> <td style="width: 10%;"></td> <td style="width: 10%;"></td> <td style="width: 10%;"></td> <td style="width: 10%;"></td> <td style="width: 10%;"></td> </tr> <tr> <td></td> <td></td> <td colspan="8" style="text-align: center;"> <table border="1" style="width: 100%; border-collapse: collapse; text-align: center;"> <tr> <td style="width: 10%;"></td> <td style="width: 10%;"></td> <td style="width: 10%;"></td> <td style="width: 10%;"></td> <td style="width: 10%;"></td> <td style="width: 10%;"></td> <td style="width: 10%;"></td> <td style="width: 10%;"></td> <td style="width: 10%;"></td> <td style="width: 10%;"></td> </tr> <tr> <td></td> <td></td> <td colspan="8" style="text-align: center;"> <table border="1" style="width: 100%; border-collapse: collapse; text-align: center;"> <tr> <td style="width: 10%;"></td> <td style="width: 10%;"></td> <td style="width: 10%;"></td> <td style="width: 10%;"></td> <td style="width: 10%;"></td> <td style="width: 10%;"></td> <td style="width: 10%;"></td> <td style="width: 10%;"></td> <td style="width: 10%;"></td> <td style="width: 10%;"></td> </tr> <tr> <td></td> <td></td> <td colspan="8" style="text-align: center;"> <table border="1" style="width: 100%; border-collapse: collapse; text-align: center;"> <tr> <td style="width: 10%;"></td> <td style="width: 10%;"></td> <td style="width: 10%;"></td> <td style="width: 10%;"></td> <td style="width: 10%;"></td> <td style="width: 10%;"></td> <td style="width: 10%;"></td> <td style="width: 10%;"></td> <td style="width: 10%;"></td> <td style="width: 10%;"></td> </tr> <tr> <td></td> <td></td> <td colspan="8" style="text-align: center;"> <table border="1" style="width: 100%; border-collapse: collapse; text-align: center;"> <tr> </tr></table></td></tr></table></td></tr></table></td></tr></table></td></tr></table></td></tr></table></td></tr></table></td></tr></table></td></tr></table></td></tr></table></td></tr></table></td></tr></table></td></tr></table></td></tr></table></td></tr></table></td></tr></table></td></tr></table></td></tr></table></td></tr></table></td></tr></table></td></tr></table></td></tr></table></td></tr></table>
 | | | | | | | | | | | | | | | | | | | | <table border="1" style="width: 100%; border-collapse: collapse; text-align: center;"> <tr> <td style="width: 10%;"></td> <td style="width: 10%;"></td> <td style="width: 10%;"></td> <td style="width: 10%;"></td> <td style="width: 10%;"></td> <td style="width: 10%;"></td> <td style="width: 10%;"></td> <td style="width: 10%;"></td> <td style="width: 10%;"></td> <td style="width: 10%;"></td> </tr> <tr> <td></td> <td></td> <td colspan="8" style="text-align: center;"> <table border="1" style="width: 100%; border-collapse: collapse; text-align: center;"> <tr> <td style="width: 10%;"></td> <td style="width: 10%;"></td> <td style="width: 10%;"></td> <td style="width: 10%;"></td> <td style="width: 10%;"></td> <td style="width: 10%;"></td> <td style="width: 10%;"></td> <td style="width: 10%;"></td> <td style="width: 10%;"></td> <td style="width: 10%;"></td> </tr> <tr> <td></td> <td></td> <td colspan="8" style="text-align: center;"> <table border="1" style="width: 100%; border-collapse: collapse; text-align: center;"> <tr> <td style="width: 10%;"></td> <td style="width: 10%;"></td> <td style="width: 10%;"></td> <td style="width: 10%;"></td> <td style="width: 10%;"></td> <td style="width: 10%;"></td> <td style="width: 10%;"></td> <td style="width: 10%;"></td> <td style="width: 10%;"></td> <td style="width: 10%;"></td> </tr> <tr> <td></td> <td></td> <td colspan="8" style="text-align: center;"> <table border="1" style="width: 100%; border-collapse: collapse; text-align: center;"> <tr> <td style="width: 10%;"></td> <td style="width: 10%;"></td> <td style="width: 10%;"></td> <td style="width: 10%;"></td> <td style="width: 10%;"></td> <td style="width: 10%;"></td> <td style="width: 10%;"></td> <td style="width: 10%;"></td> <td style="width: 10%;"></td> <td style="width: 10%;"></td> </tr> <tr> <td></td> <td></td> <td colspan="8" style="text-align: center;"> <table border="1" style="width: 100%; border-collapse: collapse; text-align: center;"> <tr> <td style="width: 10%;"></td> <td style="width: 10%;"></td> <td style="width: 10%;"></td> <td style="width: 10%;"></td> <td style="width: 10%;"></td> <td style="width: 10%;"></td> <td style="width: 10%;"></td> <td style="width: 10%;"></td> <td style="width: 10%;"></td> <td style="width: 10%;"></td> </tr> <tr> <td></td> <td></td> <td colspan="8" style="text-align: center;"> <table border="1" style="width: 100%; border-collapse: collapse; text-align: center;"> <tr> <td style="width: 10%;"></td> <td style="width: 10%;"></td> <td style="width: 10%;"></td> <td style="width: 10%;"></td> <td style="width: 10%;"></td> <td style="width: 10%;"></td> <td style="width: 10%;"></td> <td style="width: 10%;"></td> <td style="width: 10%;"></td> <td style="width: 10%;"></td> </tr> <tr> <td></td> <td></td> <td colspan="8" style="text-align: center;"> <table border="1" style="width: 100%; border-collapse: collapse; text-align: center;"> <tr> <td style="width: 10%;"></td> <td style="width: 10%;"></td> <td style="width: 10%;"></td> <td style="width: 10%;"></td> <td style="width: 10%;"></td> <td style="width: 10%;"></td> <td style="width: 10%;"></td> <td style="width: 10%;"></td> <td style="width: 10%;"></td> <td style="width: 10%;"></td> </tr> <tr> <td></td> <td></td> <td colspan="8" style="text-align: center;"> <table border="1" style="width: 100%; border-collapse: collapse; text-align: center;"> <tr> <td style="width: 10%;"></td> <td style="width: 10%;"></td> <td style="width: 10%;"></td> <td style="width: 10%;"></td> <td style="width: 10%;"></td> <td style="width: 10%;"></td> <td style="width: 10%;"></td> <td style="width: 10%;"></td> <td style="width: 10%;"></td> <td style="width: 10%;"></td> </tr> <tr> <td></td> <td></td> <td colspan="8" style="text-align: center;"> <table border="1" style="width: 100%; border-collapse: collapse; text-align: center;"> <tr> <td style="width: 10%;"></td> <td style="width: 10%;"></td> <td style="width: 10%;"></td> <td style="width: 10%;"></td> <td style="width: 10%;"></td> <td style="width: 10%;"></td> <td style="width: 10%;"></td> <td style="width: 10%;"></td> <td style="width: 10%;"></td> <td style="width: 10%;"></td> </tr> <tr> <td></td> <td></td> <td colspan="8" style="text-align: center;"> <table border="1" style="width: 100%; border-collapse: collapse; text-align: center;"> <tr> <td style="width: 10%;"></td> <td style="width:
10%;"></td> <td style="width: 10%;"></td> <td style="width: 10%;"></td> <td style="width: 10%;"></td> <td style="width: 10%;"></td> <td style="width: 10%;"></td> <td style="width: 10%;"></td> <td style="width: 10%;"></td> <td style="width: 10%;"></td> </tr> <tr> <td></td> <td></td> <td colspan="8" style="text-align: center;"> <table border="1" style="width: 100%; border-collapse: collapse; text-align: center;"> <tr> <td style="width: 10%;"></td> <td style="width: 10%;"></td> <td style="width: 10%;"></td> <td style="width: 10%;"></td> <td style="width: 10%;"></td> <td style="width: 10%;"></td> <td style="width: 10%;"></td> <td style="width: 10%;"></td> <td style="width: 10%;"></td> <td style="width: 10%;"></td> </tr> <tr> <td></td> <td></td> <td colspan="8" style="text-align: center;"> <table border="1" style="width: 100%; border-collapse: collapse; text-align: center;"> <tr> <td style="width: 10%;"></td> <td style="width: 10%;"></td> <td style="width: 10%;"></td> <td style="width: 10%;"></td> <td style="width: 10%;"></td> <td style="width: 10%;"></td> <td style="width: 10%;"></td> <td style="width: 10%;"></td> <td style="width: 10%;"></td> <td style="width: 10%;"></td> </tr> <tr> <td></td> <td></td> <td colspan="8" style="text-align: center;"> <table border="1" style="width: 100%; border-collapse: collapse; text-align: center;"> <tr> <td style="width: 10%;"></td> <td style="width: 10%;"></td> <td style="width: 10%;"></td> <td style="width: 10%;"></td> <td style="width: 10%;"></td> <td style="width: 10%;"></td> <td style="width: 10%;"></td> <td style="width: 10%;"></td> <td style="width: 10%;"></td> <td style="width: 10%;"></td> </tr> <tr> <td></td> <td></td> <td colspan="8" style="text-align: center;"> <table border="1" style="width: 100%; border-collapse: collapse; text-align: center;"> <tr> <td style="width: 10%;"></td> <td style="width: 10%;"></td> <td style="width: 10%;"></td> <td style="width: 10%;"></td> <td style="width: 10%;"></td> <td style="width: 10%;"></td> <td style="width: 10%;"></td> <td style="width: 10%;"></td> <td style="width: 10%;"></td> <td style="width: 10%;"></td> </tr> <tr> <td></td> <td></td> <td colspan="8" style="text-align: center;"> <table border="1" style="width: 100%; border-collapse: collapse; text-align: center;"> <tr> <td style="width: 10%;"></td> <td style="width: 10%;"></td> <td style="width: 10%;"></td> <td style="width: 10%;"></td> <td style="width: 10%;"></td> <td style="width: 10%;"></td> <td style="width: 10%;"></td> <td style="width: 10%;"></td> <td style="width: 10%;"></td> <td style="width: 10%;"></td> </tr> <tr> <td></td> <td></td> <td colspan="8" style="text-align: center;"> <table border="1" style="width: 100%; border-collapse: collapse; text-align: center;"> <tr> <td style="width: 10%;"></td> <td style="width: 10%;"></td> <td style="width: 10%;"></td> <td style="width: 10%;"></td> <td style="width: 10%;"></td> <td style="width: 10%;"></td> <td style="width: 10%;"></td> <td style="width: 10%;"></td> <td style="width: 10%;"></td> <td style="width: 10%;"></td> </tr> <tr> <td></td> <td></td> <td colspan="8" style="text-align: center;"> <table border="1" style="width: 100%; border-collapse: collapse; text-align: center;"> <tr> <td style="width: 10%;"></td> <td style="width: 10%;"></td> <td style="width: 10%;"></td> <td style="width: 10%;"></td> <td style="width: 10%;"></td> <td style="width: 10%;"></td> <td style="width: 10%;"></td> <td style="width: 10%;"></td> <td style="width: 10%;"></td> <td style="width: 10%;"></td> </tr> <tr> <td></td> <td></td> <td colspan="8" style="text-align: center;"> <table border="1" style="width: 100%; border-collapse: collapse; text-align: center;"> <tr> <td style="width: 10%;"></td> <td style="width: 10%;"></td> <td style="width: 10%;"></td> <td style="width: 10%;"></td> <td style="width: 10%;"></td> <td style="width: 10%;"></td> <td style="width: 10%;"></td> <td style="width: 10%;"></td> <td style="width: 10%;"></td> <td style="width: 10%;"></td> </tr> <tr> <td></td> <td></td> <td colspan="8" style="text-align: center;"> <table border="1" style="width: 100%; border-collapse: collapse; text-align: center;"> <tr> <td style="width: 10%;"></td> <td style="width: 10%;"></td> <td style="width: 10%;"></td> <td style="width: 10%;"></td> <td style="width: 10%;"></td> <td style="width: 10%;"></td> <td style="width: 10%;"></td> <td style="width: 10%;"></td> <td style="width: 10%;"></td> <td style="width: 10%;"></td> </tr> <tr> <td></td> <td></td> <td colspan="8" style="text-align: center;"> <table border="1" style="width: 100%; border-collapse: collapse; text-align: center;"> <tr> <td style="width: 10%;"></td> <td style="width: 10%;"></td> <td style="width: 10%;"></td> <td style="width: 10%;"></td> <td style="width: 10%;"></td> <td style="width: 10%;"></td> <td style="width: 10%;"></td> <td style="width: 10%;"></td> <td style="width: 10%;"></td> <td style="width: 10%;"></td> </tr> <tr> <td></td> <td></td> <td colspan="8" style="text-align: center;"> <table border="1" style="width: 100%; border-collapse: collapse; text-align: center;"> <tr> <td style="width: 10%;"></td> <td style="width: 10%;"></td> <td style="width: 10%;"></td> <td style="width: 10%;"></td> <td style="width: 10%;"></td> <td style="width: 10%;"></td> <td style="width: 10%;"></td> <td style="width: 10%;"></td> <td style="width: 10%;"></td> <td style="width: 10%;"></td> </tr> <tr> <td></td> <td></td> <td colspan="8" style="text-align: center;"> <table border="1" style="width: 100%; border-collapse: collapse; text-align: center;"> <tr> </tr></table></td></tr></table></td></tr></table></td></tr></table></td></tr></table></td></tr></table></td></tr></table></td></tr></table></td></tr></table></td></tr></table></td></tr></table></td></tr></table></td></tr></table></td></tr></table></td></tr></table></td></tr></table></td></tr></table></td></tr></table></td></tr></table></td></tr></table></td></tr></table></td></tr></table>
 | | | | | | | | | | | | | | | | | | | | <table border="1" style="width: 100%; border-collapse: collapse; text-align: center;"> <tr> <td style="width: 10%;"></td> <td style="width: 10%;"></td> <td style="width: 10%;"></td> <td style="width: 10%;"></td> <td style="width: 10%;"></td> <td style="width: 10%;"></td> <td style="width: 10%;"></td> <td style="width: 10%;"></td> <td style="width: 10%;"></td> <td style="width: 10%;"></td> </tr> <tr> <td></td> <td></td> <td colspan="8" style="text-align: center;"> <table border="1" style="width: 100%; border-collapse: collapse; text-align: center;"> <tr> <td style="width: 10%;"></td> <td style="width: 10%;"></td> <td style="width: 10%;"></td> <td style="width: 10%;"></td> <td style="width: 10%;"></td> <td style="width: 10%;"></td> <td style="width: 10%;"></td> <td style="width: 10%;"></td> <td style="width: 10%;"></td> <td style="width: 10%;"></td> </tr> <tr> <td></td> <td></td> <td colspan="8" style="text-align: center;"> <table border="1" style="width: 100%; border-collapse: collapse; text-align: center;"> <tr> <td style="width: 10%;"></td> <td style="width: 10%;"></td> <td style="width: 10%;"></td> <td style="width: 10%;"></td> <td style="width: 10%;"></td> <td style="width: 10%;"></td> <td style="width: 10%;"></td> <td style="width: 10%;"></td> <td style="width: 10%;"></td> <td style="width: 10%;"></td> </tr> <tr>
<td></td> <td></td> <td colspan="8" style="text-align: center;"> <table border="1" style="width: 100%; border-collapse: collapse; text-align: center;"> <tr> <td style="width: 10%;"></td> <td style="width: 10%;"></td> <td style="width: 10%;"></td> <td style="width: 10%;"></td> <td style="width: 10%;"></td> <td style="width: 10%;"></td> <td style="width: 10%;"></td> <td style="width: 10%;"></td> <td style="width: 10%;"></td> <td style="width: 10%;"></td> </tr> <tr> <td></td> <td></td> <td colspan="8" style="text-align: center;"> <table border="1" style="width: 100%; border-collapse: collapse; text-align: center;"> <tr> <td style="width: 10%;"></td> <td style="width: 10%;"></td> <td style="width: 10%;"></td> <td style="width: 10%;"></td> <td style="width: 10%;"></td> <td style="width: 10%;"></td> <td style="width: 10%;"></td> <td style="width: 10%;"></td> <td style="width: 10%;"></td> <td style="width: 10%;"></td> </tr> <tr> <td></td> <td></td> <td colspan="8" style="text-align: center;"> <table border="1" style="width: 100%; border-collapse: collapse; text-align: center;"> <tr> <td style="width: 10%;"></td> <td style="width: 10%;"></td> <td style="width: 10%;"></td> <td style="width: 10%;"></td> <td style="width: 10%;"></td> <td style="width: 10%;"></td> <td style="width: 10%;"></td> <td style="width: 10%;"></td> <td style="width: 10%;"></td> <td style="width: 10%;"></td> </tr> <tr> <td></td> <td></td> <td colspan="8" style="text-align: center;"> <table border="1" style="width: 100%; border-collapse: collapse; text-align: center;"> <tr> <td style="width: 10%;"></td> <td style="width: 10%;"></td> <td style="width: 10%;"></td> <td style="width: 10%;"></td> <td style="width: 10%;"></td> <td style="width: 10%;"></td> <td style="width: 10%;"></td> <td style="width: 10%;"></td> <td style="width: 10%;"></td> <td style="width: 10%;"></td> </tr> <tr> <td></td> <td></td> <td colspan="8" style="text-align: center;"> <table border="1" style="width: 100%; border-collapse: collapse; text-align: center;"> <tr> <td style="width: 10%;"></td> <td style="width: 10%;"></td> <td style="width: 10%;"></td> <td style="width: 10%;"></td> <td style="width: 10%;"></td> <td style="width: 10%;"></td> <td style="width: 10%;"></td> <td style="width: 10%;"></td> <td style="width: 10%;"></td> <td style="width: 10%;"></td> </tr> <tr> <td></td> <td></td> <td colspan="8" style="text-align: center;"> <table border="1" style="width: 100%; border-collapse: collapse; text-align: center;"> <tr> <td style="width: 10%;"></td> <td style="width: 10%;"></td> <td style="width: 10%;"></td> <td style="width: 10%;"></td> <td style="width: 10%;"></td> <td style="width: 10%;"></td> <td style="width: 10%;"></td> <td style="width: 10%;"></td> <td style="width: 10%;"></td> <td style="width: 10%;"></td> </tr> <tr> <td></td> <td></td> <td colspan="8" style="text-align: center;"> <table border="1" style="width: 100%; border-collapse: collapse; text-align: center;"> <tr> <td style="width: 10%;"></td> <td style="width: 10%;"></td> <td style="width: 10%;"></td> <td style="width: 10%;"></td> <td style="width: 10%;"></td> <td style="width: 10%;"></td> <td style="width: 10%;"></td> <td style="width: 10%;"></td> <td style="width: 10%;"></td> <td style="width: 10%;"></td> </tr> <tr> <td></td> <td></td> <td colspan="8" style="text-align: center;"> <table border="1" style="width: 100%; border-collapse: collapse; text-align: center;"> <tr> <td style="width: 10%;"></td> <td style="width: 10%;"></td> <td style="width: 10%;"></td> <td style="width: 10%;"></td> <td style="width: 10%;"></td> <td style="width: 10%;"></td> <td style="width: 10%;"></td> <td style="width: 10%;"></td> <td style="width: 10%;"></td> <td style="width: 10%;"></td> </tr> <tr> <td></td> <td></td> <td colspan="8" style="text-align: center;"> <table border="1" style="width: 100%; border-collapse: collapse; text-align: center;"> <tr> <td style="width: 10%;"></td> <td style="width: 10%;"></td> <td style="width: 10%;"></td> <td style="width: 10%;"></td> <td style="width: 10%;"></td> <td style="width: 10%;"></td> <td style="width: 10%;"></td> <td style="width: 10%;"></td> <td style="width: 10%;"></td> <td style="width: 10%;"></td> </tr> <tr> <td></td> <td></td> <td colspan="8" style="text-align: center;"> <table border="1" style="width: 100%; border-collapse: collapse; text-align: center;"> <tr> <td style="width: 10%;"></td> <td style="width: 10%;"></td> <td style="width: 10%;"></td> <td style="width: 10%;"></td> <td style="width: 10%;"></td> <td style="width: 10%;"></td> <td style="width: 10%;"></td> <td style="width: 10%;"></td> <td style="width: 10%;"></td> <td style="width: 10%;"></td> </tr> <tr> <td></td> <td></td> <td colspan="8" style="text-align: center;"> <table border="1" style="width: 100%; border-collapse: collapse; text-align: center;"> <tr> <td style="width: 10%;"></td> <td style="width: 10%;"></td> <td style="width: 10%;"></td> <td style="width: 10%;"></td> <td style="width: 10%;"></td> <td style="width: 10%;"></td> <td style="width: 10%;"></td> <td style="width: 10%;"></td> <td style="width: 10%;"></td> <td style="width: 10%;"></td> </tr> <tr> <td></td> <td></td> <td colspan="8" style="text-align: center;"> <table border="1" style="width: 100%; border-collapse: collapse; text-align: center;"> <tr> <td style="width: 10%;"></td> <td style="width: 10%;"></td> <td style="width: 10%;"></td> <td style="width: 10%;"></td> <td style="width: 10%;"></td> <td style="width: 10%;"></td> <td style="width: 10%;"></td> <td style="width: 10%;"></td> <td style="width: 10%;"></td> <td style="width: 10%;"></td> </tr> <tr> <td></td> <td></td> <td colspan="8" style="text-align: center;"> <table border="1" style="width: 100%; border-collapse: collapse; text-align: center;"> <tr> <td style="width: 10%;"></td> <td style="width: 10%;"></td> <td style="width: 10%;"></td> <td style="width: 10%;"></td> <td style="width: 10%;"></td> <td style="width: 10%;"></td> <td style="width: 10%;"></td> <td style="width: 10%;"></td> <td style="width: 10%;"></td> <td style="width: 10%;"></td> </tr> <tr> <td></td> <td></td> <td colspan="8" style="text-align: center;"> <table border="1" style="width: 100%; border-collapse: collapse; text-align: center;"> <tr> <td style="width: 10%;"></td> <td style="width: 10%;"></td> <td style="width: 10%;"></td> <td style="width: 10%;"></td> <td style="width: 10%;"></td> <td style="width: 10%;"></td> <td style="width: 10%;"></td> <td style="width: 10%;"></td> <td style="width: 10%;"></td> <td style="width: 10%;"></td> </tr> <tr> <td></td> <td></td> <td colspan="8" style="text-align: center;"> <table border="1" style="width: 100%; border-collapse: collapse; text-align: center;"> <tr> <td style="width: 10%;"></td> <td style="width: 10%;"></td> <td style="width: 10%;"></td> <td style="width: 10%;"></td> <td style="width: 10%;"></td> <td style="width: 10%;"></td> <td style="width: 10%;"></td> <td style="width: 10%;"></td> <td style="width: 10%;"></td> <td style="width: 10%;"></td> </tr> <tr> <td></td> <td></td> <td colspan="8" style="text-align: center;"> <table border="1" style="width: 100%; border-collapse: collapse; text-align: center;"> <tr> <td style="width: 10%;"></td> <td style="width: 10%;"></td> <td style="width: 10%;"></td> <td style="width: 10%;"></td> <td style="width: 10%;"></td> <td style="width: 10%;"></td> <td style="width: 10%;"></td> <td style="width: 10%;"></td> <td style="width: 10%;"></td> <td style="width: 10%;"></td> </tr> <tr> <td></td> <td></td> <td colspan="8" style="text-align: center;"> <table border="1" style="width: 100%; border-collapse: collapse; text-align: center;"> <tr> <td style="width: 10%;"></td> <td style="width: 10%;"></td> <td style="width: 10%;"></td> <td style="width: 10%;"></td> <td style="width: 10%;"></td> <td style="width: 10%;"></td> <td style="width: 10%;"></td> <td style="width: 10%;"></td> <td style="width: 10%;"></td> <td style="width: 10%;"></td> </tr> <tr> <td></td> <td></td> <td colspan="8" style="text-align: center;"> <table border="1" style="width: 100%; border-collapse: collapse; text-align: center;"> <tr> </tr></table></td></tr></table></td></tr></table></td></tr></table></td></tr></table></td></tr></table></td></tr></table></td></tr></table></td></tr></table></td></tr></table></td></tr></table></td></tr></table></td></tr></table></td></tr></table></td></tr></table></td></tr></table></td></tr></table></td></tr></table></td></tr></table></td></tr></table></td></tr></table>

 | | | | | | | | | | | | | | | | | | | | <table border="1" style="width: 100%; border-collapse: collapse; text-align: center;"> <tr> <td style="width: 10%;"></td> <td style="width: 10%;"></td> <td style="width: 10%;"></td> <td style="width: 10%;"></td> <td style="width: 10%;"></td> <td style="width: 10%;"></td> <td style="width: 10%;"></td> <td style="width: 10%;"></td> <td style="width: 10%;"></td> <td style="width: 10%;"></td> </tr> <tr> <td></td> <td></td> <td colspan="8" style="text-align: center;"> <table border="1" style="width: 100%; border-collapse: collapse; text-align: center;"> <tr> <td style="width: 10%;"></td> <td style="width: 10%;"></td> <td style="width: 10%;"></td> <td style="width: 10%;"></td> <td style="width: 10%;"></td> <td style="width: 10%;"></td> <td style="width: 10%;"></td> <td style="width: 10%;"></td> <td style="width: 10%;"></td> <td style="width: 10%;"></td> </tr> <tr> <td></td> <td></td> <td colspan="8" style="text-align: center;"> <table border="1" style="width: 100%; border-collapse: collapse; text-align: center;"> <tr> <td style="width: 10%;"></td> <td style="width: 10%;"></td> <td style="width: 10%;"></td> <td style="width: 10%;"></td> <td style="width: 10%;"></td> <td style="width: 10%;"></td> <td style="width: 10%;"></td> <td style="width: 10%;"></td> <td style="width: 10%;"></td> <td style="width: 10%;"></td> </tr> <tr> <td></td> <td></td> <td colspan="8" style="text-align: center;"> <table border="1" style="width: 100%; border-collapse: collapse; text-align: center;"> <tr> <td style="width: 10%;"></td> <td style="width: 10%;"></td> <td style="width: 10%;"></td> <td style="width: 10%;"></td> <td style="width: 10%;"></td> <td style="width: 10%;"></td> <td style="width: 10%;"></td> <td style="width: 10%;"></td> <td style="width: 10%;"></td> <td style="width: 10%;"></td> </tr> <tr> <td></td> <td></td> <td colspan="8" style="text-align: center;"> <table border="1" style="width: 100%; border-collapse: collapse; text-align: center;"> <tr> <td style="width: 10%;"></td> <td style="width: 10%;"></td> <td style="width: 10%;"></td> <td style="width: 10%;"></td> <td style="width: 10%;"></td> <td style="width: 10%;"></td> <td style="width: 10%;"></td> <td style="width: 10%;"></td> <td style="width: 10%;"></td> <td style="width: 10%;"></td> </tr> <tr> <td></td> <td></td> <td colspan="8" style="text-align: center;"> <table border="1" style="width: 100%; border-collapse: collapse; text-align: center;"> <tr> <td style="width: 10%;"></td> <td style="width: 10%;"></td> <td style="width: 10%;"></td> <td style="width: 10%;"></td> <td style="width: 10%;"></td> <td style="width: 10%;"></td> <td style="width: 10%;"></td> <td style="width: 10%;"></td> <td style="width: 10%;"></td> <td style="width: 10%;"></td> </tr> <tr> <td></td> <td></td> <td colspan="8" style="text-align: center;"> <table border="1" style="width: 100%; border-collapse: collapse; text-align: center;"> <tr> <td style="width: 10%;"></td> <td style="width: 10%;"></td> <td style="width: 10%;"></td> <td style="width: 10%;"></td> <td style="width: 10%;"></td> <td style="width: 10%;"></td> <td style="width: 10%;"></td> <td style="width: 10%;"></td> <td style="width: 10%;"></td> <td style="width: 10%;"></td> </tr> <tr> <td></td> <td></td> <td colspan="8" style="text-align: center;"> <table border="1" style="width: 100%; border-collapse: collapse; text-align: center;"> <tr> <td style="width: 10%;"></td> <td style="width: 10%;"></td> <td style="width: 10%;"></td> <td style="width: 10%;"></td> <td style="width: 10%;"></td> <td style="width: 10%;"></td> <td style="width: 10%;"></td> <td style="width: 10%;"></td> <td style="width: 10%;"></td> <td style="width: 10%;"></td> </tr> <tr> <td></td> <td></td> <td colspan="8" style="text-align: center;"> <table border="1" style="width: 100%; border-collapse: collapse; text-align: center;"> <tr> <td style="width: 10%;"></td> <td style="width: 10%;"></td> <td style="width: 10%;"></td> <td style="width: 10%;"></td> <td style="width: 10%;"></td> <td style="width: 10%;"></td> <td style="width: 10%;"></td> <td style="width: 10%;"></td> <td style="width: 10%;"></td> <td style="width: 10%;"></td> </tr> <tr> <td></td> <td></td> <td colspan="8" style="text-align: center;"> <table border="1" style="width: 100%; border-collapse: collapse; text-align: center;"> <tr> <td style="width: 10%;"></td> <td style="width: 10%;"></td> <td style="width: 10%;"></td> <td style="width: 10%;"></td> <td style="width: 10%;"></td> <td style="width: 10%;"></td> <td style="width: 10%;"></td> <td style="width: 10%;"></td> <td style="width: 10%;"></td> <td style="width: 10%;"></td> </tr> <tr> <td></td> <td></td> <td colspan="8" style="text-align: center;"> <table border="1" style="width: 100%; border-collapse: collapse; text-align: center;"> <tr> <td style="width: 10%;"></td> <td style="width: 10%;"></td> <td style="width: 10%;"></td> <td style="width: 10%;"></td> <td style="width: 10%;"></td> <td style="width: 10%;"></td> <td style="width: 10%;"></td> <td style="width: 10%;"></td> <td style="width: 10%;"></td> <td style="width: 10%;"></td> </tr> <tr> <td></td> <td></td> <td colspan="8" style="text-align: center;"> <table border="1" style="width: 100%; border-collapse: collapse; text-align: center;"> <tr> <td style="width: 10%;"></td> <td style="width: 10%;"></td> <td style="width: 10%;"></td> <td style="width: 10%;"></td> <td style="width: 10%;"></td> <td style="width: 10%;"></td> <td style="width: 10%;"></td> <td style="width: 10%;"></td> <td style="width: 10%;"></td> <td style="width: 10%;"></td> </tr> <tr> <td></td> <td></td> <td colspan="8" style="text-align: center;"> <table border="1" style="width: 100%; border-collapse: collapse; text-align: center;"> <tr> <td style="width: 10%;"></td> <td style="width: 10%;"></td> <td style="width: 10%;"></td> <td style="width: 10%;"></td> <td style="width: 10%;"></td> <td style="width: 10%;"></td> <td style="width: 10%;"></td> <td style="width: 10%;"></td> <td style="width: 10%;"></td> <td style="width: 10%;"></td> </tr> <tr> <td></td> <td></td> <td colspan="8" style="text-align: center;"> <table border="1" style="width: 100%; border-collapse: collapse; text-align: center;"> <tr> <td style="width: 10%;"></td> <td style="width: 10%;"></td> <td style="width: 10%;"></td> <td style="width: 10%;"></td> <td style="width: 10%;"></td> <td style="width: 10%;"></td> <td style="width: 10%;"></td> <td style="width: 10%;"></td> <td style="width: 10%;"></td> <td style="width: 10%;"></td> </tr> <tr> <td></td> <td></td> <td colspan="8" style="text-align: center;"> <table border="1" style="width: 100%; border-collapse: collapse; text-align: center;"> <tr> <td style="width: 10%;"></td> <td style="width: 10%;"></td> <td style="width: 10%;"></td> <td style="width: 10%;"></td> <td style="width: 10%;"></td> <td style="width: 10%;"></td> <td style="width: 10%;"></td> <td style="width: 10%;"></td> <td style="width: 10%;"></td> <td style="width: 10%;"></td> </tr> <tr> <td></td> <td></td> <td colspan="8" style="text-align: center;"> <table border="1" style="width: 100%; border-collapse: collapse; text-align: center;"> <tr> <td style="width: 10%;"></td> <td style="width: 10%;"></td> <td style="width: 10%;"></td> <td style="width: 10%;"></td> <td style="width: 10%;"></td> <td style="width: 10%;"></td> <td style="width: 10%;"></td> <td style="width: 10%;"></td> <td style="width: 10%;"></td> <td style="width: 10%;"></td> </tr> <tr> <td></td> <td></td> <td colspan="8" style="text-align: center;"> <table border="1" style="width: 100%; border-collapse: collapse; text-align: center;"> <tr> <td style="width: 10%;"></td> <td style="width: 10%;"></td> <td style="width: 10%;"></td> <td style="width: 10%;"></td> <td style="width: 10%;"></td> <td style="width: 10%;"></td> <td style="width: 10%;"></td> <td style="width: 10%;"></td> <td style="width: 10%;"></td> <td style="width: 10%;"></td> </tr> <tr> <td></td> <td></td> <td colspan="8" style="text-align: center;"> <table border="1" style="width: 100%; border-collapse: collapse; text-align: center;"> <tr> <td style="width: 10%;"></td> <td style="width: 10%;"></td> <td style="width: 10%;"></td> <td style="width: 10%;"></td> <td style="width: 10%;"></td> <td style="width: 10%;"></td> <td style="width: 10%;"></td> <td style="width: 10%;"></td> <td style="width: 10%;"></td> <td style="width: 10%;"></td> </tr> <tr> <td></td> <td></td> <td colspan="8" style="text-align: center;"> <table border="1" style="width: 100%; border-collapse: collapse; text-align: center;"> <tr> <td style="width: 10%;"></td> <td style="width: 10%;"></td> <td style="width: 10%;"></td> <td style="width: 10%;"></td> <td style="width: 10%;"></td> <td style="width: 10%;"></td> <td style="width: 10%;"></td> <td style="width: 10%;"></td> <td style="width: 10%;"></td> <td style="width: 10%;"></td>
</tr> <tr> <td></td> <td></td> <td colspan="8" style="text-align: center;"> <table border="1" style="width: 100%; border-collapse: collapse; text-align: center;"> <tr> </tr></table></td></tr></table></td></tr></table></td></tr></table></td></tr></table></td></tr></table></td></tr></table></td></tr></table></td></tr></table></td></tr></table></td></tr></table></td></tr></table></td></tr></table></td></tr></table></td></tr></table></td></tr></table></td></tr></table></td></tr></table></td></tr></table></td></tr></table>
 | | | | | | | | | | | | | | | | | | | | <table border="1" style="width: 100%; border-collapse: collapse; text-align: center;"> <tr> <td style="width: 10%;"></td> <td style="width: 10%;"></td> <td style="width: 10%;"></td> <td style="width: 10%;"></td> <td style="width: 10%;"></td> <td style="width: 10%;"></td> <td style="width: 10%;"></td> <td style="width: 10%;"></td> <td style="width: 10%;"></td> <td style="width: 10%;"></td> </tr> <tr> <td></td> <td></td> <td colspan="8" style="text-align: center;"> <table border="1" style="width: 100%; border-collapse: collapse; text-align: center;"> <tr> <td style="width: 10%;"></td> <td style="width: 10%;"></td> <td style="width: 10%;"></td> <td style="width: 10%;"></td> <td style="width: 10%;"></td> <td style="width: 10%;"></td> <td style="width: 10%;"></td> <td style="width: 10%;"></td> <td style="width: 10%;"></td> <td style="width: 10%;"></td> </tr> <tr> <td></td> <td></td> <td colspan="8" style="text-align: center;"> <table border="1" style="width: 100%; border-collapse: collapse; text-align: center;"> <tr> <td style="width: 10%;"></td> <td style="width: 10%;"></td> <td style="width: 10%;"></td> <td style="width: 10%;"></td> <td style="width: 10%;"></td> <td style="width: 10%;"></td> <td style="width: 10%;"></td> <td style="width: 10%;"></td> <td style="width: 10%;"></td> <td style="width: 10%;"></td> </tr> <tr> <td></td> <td></td> <td colspan="8" style="text-align: center;"> <table border="1" style="width: 100%; border-collapse: collapse; text-align: center;"> <tr> <td style="width: 10%;"></td> <td style="width: 10%;"></td> <td style="width: 10%;"></td> <td style="width: 10%;"></td> <td style="width: 10%;"></td> <td style="width: 10%;"></td> <td style="width: 10%;"></td> <td style="width: 10%;"></td> <td style="width: 10%;"></td> <td style="width: 10%;"></td> </tr> <tr> <td></td> <td></td> <td colspan="8" style="text-align: center;"> <table border="1" style="width: 100%; border-collapse: collapse; text-align: center;"> <tr> <td style="width: 10%;"></td> <td style="width: 10%;"></td> <td style="width: 10%;"></td> <td style="width: 10%;"></td> <td style="width: 10%;"></td> <td style="width: 10%;"></td> <td style="width: 10%;"></td> <td style="width: 10%;"></td> <td style="width: 10%;"></td> <td style="width: 10%;"></td> </tr> <tr> <td></td> <td></td> <td colspan="8" style="text-align: center;"> <table border="1" style="width: 100%; border-collapse: collapse; text-align: center;"> <tr> <td style="width: 10%;"></td> <td style="width: 10%;"></td> <td style="width: 10%;"></td> <td style="width: 10%;"></td> <td style="width: 10%;"></td> <td style="width: 10%;"></td> <td style="width: 10%;"></td> <td style="width: 10%;"></td> <td style="width: 10%;"></td> <td style="width: 10%;"></td> </tr> <tr> <td></td> <td></td> <td colspan="8" style="text-align: center;"> <table border="1" style="width: 100%; border-collapse: collapse; text-align: center;"> <tr> <td style="width: 10%;"></td> <td style="width: 10%;"></td> <td style="width: 10%;"></td> <td style="width: 10%;"></td> <td style="width: 10%;"></td> <td style="width: 10%;"></td> <td style="width: 10%;"></td> <td style="width: 10%;"></td> <td style="width: 10%;"></td> <td style="width: 10%;"></td> </tr> <tr> <td></td> <td></td> <td colspan="8" style="text-align: center;"> <table border="1" style="width: 100%; border-collapse: collapse; text-align: center;"> <tr> <td style="width: 10%;"></td> <td style="width: 10%;"></td> <td style="width: 10%;"></td> <td style="width: 10%;"></td> <td style="width: 10%;"></td> <td style="width: 10%;"></td> <td style="width: 10%;"></td> <td style="width: 10%;"></td> <td style="width: 10%;"></td> <td style="width: 10%;"></td> </tr> <tr> <td></td> <td></td> <td colspan="8" style="text-align: center;"> <table border="1" style="width: 100%; border-collapse: collapse; text-align: center;"> <tr> <td style="width: 10%;"></td> <td style="width: 10%;"></td> <td style="width: 10%;"></td> <td style="width: 10%;"></td> <td style="width: 10%;"></td> <td style="width: 10%;"></td> <td style="width: 10%;"></td> <td style="width: 10%;"></td> <td style="width: 10%;"></td> <td style="width: 10%;"></td> </tr> <tr> <td></td> <td></td> <td colspan="8" style="text-align: center;"> <table border="1" style="width: 100%; border-collapse: collapse; text-align: center;"> <tr> <td style="width: 10%;"></td> <td style="width: 10%;"></td> <td style="width: 10%;"></td> <td style="width: 10%;"></td> <td style="width: 10%;"></td> <td style="width: 10%;"></td> <td style="width: 10%;"></td> <td style="width: 10%;"></td> <td style="width: 10%;"></td> <td style="width: 10%;"></td> </tr> <tr> <td></td> <td></td> <td colspan="8" style="text-align: center;"> <table border="1" style="width: 100%; border-collapse: collapse; text-align: center;"> <tr> <td style="width: 10%;"></td> <td style="width: 10%;"></td> <td style="width: 10%;"></td> <td style="width: 10%;"></td> <td style="width: 10%;"></td> <td style="width: 10%;"></td> <td style="width: 10%;"></td> <td style="width: 10%;"></td> <td style="width: 10%;"></td> <td style="width: 10%;"></td> </tr> <tr> <td></td> <td></td> <td colspan="8" style="text-align: center;"> <table border="1" style="width: 100%; border-collapse: collapse; text-align: center;"> <tr> <td style="width: 10%;"></td> <td style="width: 10%;"></td> <td style="width: 10%;"></td> <td style="width: 10%;"></td> <td style="width: 10%;"></td> <td style="width: 10%;"></td> <td style="width: 10%;"></td> <td style="width: 10%;"></td> <td style="width: 10%;"></td> <td style="width: 10%;"></td> </tr> <tr> <td></td> <td></td> <td colspan="8" style="text-align: center;"> <table border="1" style="width: 100%; border-collapse: collapse; text-align: center;"> <tr> <td style="width: 10%;"></td> <td style="width: 10%;"></td> <td style="width: 10%;"></td> <td style="width: 10%;"></td> <td style="width: 10%;"></td> <td style="width: 10%;"></td> <td style="width: 10%;"></td> <td style="width: 10%;"></td> <td style="width: 10%;"></td> <td style="width: 10%;"></td> </tr> <tr> <td></td> <td></td> <td colspan="8" style="text-align: center;"> <table border="1" style="width: 100%; border-collapse: collapse; text-align: center;"> <tr> <td style="width: 10%;"></td> <td style="width: 10%;"></td> <td style="width: 10%;"></td> <td style="width: 10%;"></td> <td style="width: 10%;"></td> <td style="width: 10%;"></td> <td style="width: 10%;"></td> <td style="width: 10%;"></td> <td style="width: 10%;"></td> <td style="width: 10%;"></td> </tr> <tr> <td></td> <td></td> <td colspan="8" style="text-align: center;"> <table border="1" style="width: 100%; border-collapse: collapse; text-align: center;"> <tr> <td style="width: 10%;"></td> <td style="width: 10%;"></td> <td style="width: 10%;"></td> <td style="width: 10%;"></td> <td
style="width: 10%;"></td> <td style="width: 10%;"></td> <td style="width: 10%;"></td> <td style="width: 10%;"></td> <td style="width: 10%;"></td> <td style="width: 10%;"></td> </tr> <tr> <td></td> <td></td> <td colspan="8" style="text-align: center;"> <table border="1" style="width: 100%; border-collapse: collapse; text-align: center;"> <tr> <td style="width: 10%;"></td> <td style="width: 10%;"></td> <td style="width: 10%;"></td> <td style="width: 10%;"></td> <td style="width: 10%;"></td> <td style="width: 10%;"></td> <td style="width: 10%;"></td> <td style="width: 10%;"></td> <td style="width: 10%;"></td> <td style="width: 10%;"></td> </tr> <tr> <td></td> <td></td> <td colspan="8" style="text-align: center;"> <table border="1" style="width: 100%; border-collapse: collapse; text-align: center;"> <tr> <td style="width: 10%;"></td> <td style="width: 10%;"></td> <td style="width: 10%;"></td> <td style="width: 10%;"></td> <td style="width: 10%;"></td> <td style="width: 10%;"></td> <td style="width: 10%;"></td> <td style="width: 10%;"></td> <td style="width: 10%;"></td> <td style="width: 10%;"></td> </tr> <tr> <td></td> <td></td> <td colspan="8" style="text-align: center;"> <table border="1" style="width: 100%; border-collapse: collapse; text-align: center;"> <tr> <td style="width: 10%;"></td> <td style="width: 10%;"></td> <td style="width: 10%;"></td> <td style="width: 10%;"></td> <td style="width: 10%;"></td> <td style="width: 10%;"></td> <td style="width: 10%;"></td> <td style="width: 10%;"></td> <td style="width: 10%;"></td> <td style="width: 10%;"></td> </tr> <tr> <td></td> <td></td> <td colspan="8" style="text-align: center;"> <table border="1" style="width: 100%; border-collapse: collapse; text-align: center;"> <tr> </tr></table></td></tr></table></td></tr></table></td></tr></table></td></tr></table></td></tr></table></td></tr></table></td></tr></table></td></tr></table></td></tr></table></td></tr></table></td></tr></table></td></tr></table></td></tr></table></td></tr></table></td></tr></table></td></tr></table></td></tr></table></td></tr></table>
 | | | | | | | | | | | | | | | | | | | | <table border="1" style="width: 100%; border-collapse: collapse; text-align: center;"> <tr> <td style="width: 10%;"></td> <td style="width: 10%;"></td> <td style="width: 10%;"></td> <td style="width: 10%;"></td> <td style="width: 10%;"></td> <td style="width: 10%;"></td> <td style="width: 10%;"></td> <td style="width: 10%;"></td> <td style="width: 10%;"></td> <td style="width: 10%;"></td> </tr> <tr> <td></td> <td></td> <td colspan="8" style="text-align: center;"> <table border="1" style="width: 100%; border-collapse: collapse; text-align: center;"> <tr> <td style="width: 10%;"></td> <td style="width: 10%;"></td> <td style="width: 10%;"></td> <td style="width: 10%;"></td> <td style="width: 10%;"></td> <td style="width: 10%;"></td> <td style="width: 10%;"></td> <td style="width: 10%;"></td> <td style="width: 10%;"></td> <td style="width: 10%;"></td> </tr> <tr> <td></td> <td></td> <td colspan="8" style="text-align: center;"> <table border="1" style="width: 100%; border-collapse: collapse; text-align: center;"> <tr> <td style="width: 10%;"></td> <td style="width: 10%;"></td> <td style="width: 10%;"></td> <td style="width: 10%;"></td> <td style="width: 10%;"></td> <td style="width: 10%;"></td> <td style="width: 10%;"></td> <td style="width: 10%;"></td> <td style="width: 10%;"></td> <td style="width: 10%;"></td> </tr> <tr> <td></td> <td></td> <td colspan="8" style="text-align: center;"> <table border="1" style="width: 100%; border-collapse: collapse; text-align: center;"> <tr> <td style="width: 10%;"></td> <td style="width: 10%;"></td> <td style="width: 10%;"></td> <td style="width: 10%;"></td> <td style="width: 10%;"></td> <td style="width: 10%;"></td> <td style="width: 10%;"></td> <td style="width: 10%;"></td> <td style="width: 10%;"></td> <td style="width: 10%;"></td> </tr> <tr> <td></td> <td></td> <td colspan="8" style="text-align: center;"> <table border="1" style="width: 100%; border-collapse: collapse; text-align: center;"> <tr> <td style="width: 10%;"></td> <td style="width: 10%;"></td> <td style="width: 10%;"></td> <td style="width: 10%;"></td> <td style="width: 10%;"></td> <td style="width: 10%;"></td> <td style="width: 10%;"></td> <td style="width: 10%;"></td> <td style="width: 10%;"></td> <td style="width: 10%;"></td> </tr> <tr> <td></td> <td></td> <td colspan="8" style="text-align: center;"> <table border="1" style="width: 100%; border-collapse: collapse; text-align: center;"> <tr> <td style="width: 10%;"></td> <td style="width: 10%;"></td> <td style="width: 10%;"></td> <td style="width: 10%;"></td> <td style="width: 10%;"></td> <td style="width: 10%;"></td> <td style="width: 10%;"></td> <td style="width: 10%;"></td> <td style="width: 10%;"></td> <td style="width: 10%;"></td> </tr> <tr> <td></td> <td></td> <td colspan="8" style="text-align: center;"> <table border="1" style="width: 100%; border-collapse: collapse; text-align: center;"> <tr> <td style="width: 10%;"></td> <td style="width: 10%;"></td> <td style="width: 10%;"></td> <td style="width: 10%;"></td> <td style="width: 10%;"></td> <td style="width: 10%;"></td> <td style="width: 10%;"></td> <td style="width: 10%;"></td> <td style="width: 10%;"></td> <td style="width: 10%;"></td> </tr> <tr> <td></td> <td></td> <td colspan="8" style="text-align: center;"> <table border="1" style="width: 100%; border-collapse: collapse; text-align: center;"> <tr> <td style="width: 10%;"></td> <td style="width: 10%;"></td> <td style="width: 10%;"></td> <td style="width: 10%;"></td> <td style="width: 10%;"></td> <td style="width: 10%;"></td> <td style="width: 10%;"></td> <td style="width: 10%;"></td> <td style="width: 10%;"></td> <td style="width: 10%;"></td> </tr> <tr> <td></td> <td></td> <td colspan="8" style="text-align: center;"> <table border="1" style="width: 100%; border-collapse: collapse; text-align: center;"> <tr> <td style="width: 10%;"></td> <td style="width: 10%;"></td> <td style="width: 10%;"></td> <td style="width: 10%;"></td> <td style="width: 10%;"></td> <td style="width: 10%;"></td> <td style="width: 10%;"></td> <td style="width: 10%;"></td> <td style="width: 10%;"></td> <td style="width: 10%;"></td> </tr> <tr> <td></td> <td></td> <td colspan="8" style="text-align: center;"> <table border="1" style="width: 100%; border-collapse: collapse; text-align: center;"> <tr> <td style="width: 10%;"></td> <td style="width: 10%;"></td> <td style="width: 10%;"></td> <td style="width: 10%;"></td> <td style="width: 10%;"></td> <td style="width: 10%;"></td> <td style="width: 10%;"></td> <td style="width: 10%;"></td> <td style="width: 10%;"></td> <td style="width: 10%;"></td> </tr> <tr> <td></td> <td></td> <td colspan="8" style="text-align: center;"> <table border="1" style="width: 100%; border-collapse: collapse; text-align: center;"> <tr> <td style="width: 10%;"></td> <td style="width: 10%;"></td> <td style="width: 10%;"></td> <td style="width: 10%;"></td> <td style="width: 10%;"></td> <td style="width: 10%;"></td> <td style="width: 10%;"></td> <td style="width: 10%;"></td> <td style="width: 10%;"></td> <td style="width: 10%;"></td> </tr> <tr> <td></td> <td></td> <td colspan="8" style="text-align: center;"> <table border="1" style="width: 100%; border-collapse: collapse;
text-align: center;"> <tr> <td style="width: 10%;"></td> <td style="width: 10%;"></td> <td style="width: 10%;"></td> <td style="width: 10%;"></td> <td style="width: 10%;"></td> <td style="width: 10%;"></td> <td style="width: 10%;"></td> <td style="width: 10%;"></td> <td style="width: 10%;"></td> <td style="width: 10%;"></td> </tr> <tr> <td></td> <td></td> <td colspan="8" style="text-align: center;"> <table border="1" style="width: 100%; border-collapse: collapse; text-align: center;"> <tr> <td style="width: 10%;"></td> <td style="width: 10%;"></td> <td style="width: 10%;"></td> <td style="width: 10%;"></td> <td style="width: 10%;"></td> <td style="width: 10%;"></td> <td style="width: 10%;"></td> <td style="width: 10%;"></td> <td style="width: 10%;"></td> <td style="width: 10%;"></td> </tr> <tr> <td></td> <td></td> <td colspan="8" style="text-align: center;"> <table border="1" style="width: 100%; border-collapse: collapse; text-align: center;"> <tr> <td style="width: 10%;"></td> <td style="width: 10%;"></td> <td style="width: 10%;"></td> <td style="width: 10%;"></td> <td style="width: 10%;"></td> <td style="width: 10%;"></td> <td style="width: 10%;"></td> <td style="width: 10%;"></td> <td style="width: 10%;"></td> <td style="width: 10%;"></td> </tr> <tr> <td></td> <td></td> <td colspan="8" style="text-align: center;"> <table border="1" style="width: 100%; border-collapse: collapse; text-align: center;"> <tr> <td style="width: 10%;"></td> <td style="width: 10%;"></td> <td style="width: 10%;"></td> <td style="width: 10%;"></td> <td style="width: 10%;"></td> <td style="width: 10%;"></td> <td style="width: 10%;"></td> <td style="width: 10%;"></td> <td style="width: 10%;"></td> <td style="width: 10%;"></td> </tr> <tr> <td></td> <td></td> <td colspan="8" style="text-align: center;"> <table border="1" style="width: 100%; border-collapse: collapse; text-align: center;"> <tr> <td style="width: 10%;"></td> <td style="width: 10%;"></td> <td style="width: 10%;"></td> <td style="width: 10%;"></td> <td style="width: 10%;"></td> <td style="width: 10%;"></td> <td style="width: 10%;"></td> <td style="width: 10%;"></td> <td style="width: 10%;"></td> <td style="width: 10%;"></td> </tr> <tr> <td></td> <td></td> <td colspan="8" style="text-align: center;"> <table border="1" style="width: 100%; border-collapse: collapse; text-align: center;"> <tr> <td style="width: 10%;"></td> <td style="width: 10%;"></td> <td style="width: 10%;"></td> <td style="width: 10%;"></td> <td style="width: 10%;"></td> <td style="width: 10%;"></td> <td style="width: 10%;"></td> <td style="width: 10%;"></td> <td style="width: 10%;"></td> <td style="width: 10%;"></td> </tr> <tr> <td></td> <td></td> <td colspan="8" style="text-align: center;"> <table border="1" style="width: 100%; border-collapse: collapse; text-align: center;"> <tr> </tr></table></td></tr></table></td></tr></table></td></tr></table></td></tr></table></td></tr></table></td></tr></table></td></tr></table></td></tr></table></td></tr></table></td></tr></table></td></tr></table></td></tr></table></td></tr></table></td></tr></table></td></tr></table></td></tr></table></td></tr></table>
 | | | | | | | | | | | | | | | | | | | | <table border="1" style="width: 100%; border-collapse: collapse; text-align: center;"> <tr> <td style="width: 10%;"></td> <td style="width: 10%;"></td> <td style="width: 10%;"></td> <td style="width: 10%;"></td> <td style="width: 10%;"></td> <td style="width: 10%;"></td> <td style="width: 10%;"></td> <td style="width: 10%;"></td> <td style="width: 10%;"></td> <td style="width: 10%;"></td> </tr> <tr> <td></td> <td></td> <td colspan="8" style="text-align: center;"> <table border="1" style="width: 100%; border-collapse: collapse; text-align: center;"> <tr> <td style="width: 10%;"></td> <td style="width: 10%;"></td> <td style="width: 10%;"></td> <td style="width: 10%;"></td> <td style="width: 10%;"></td> <td style="width: 10%;"></td> <td style="width: 10%;"></td> <td style="width: 10%;"></td> <td style="width: 10%;"></td> <td style="width: 10%;"></td> </tr> <tr> <td></td> <td></td> <td colspan="8" style="text-align: center;"> <table border="1" style="width: 100%; border-collapse: collapse; text-align: center;"> <tr> <td style="width: 10%;"></td> <td style="width: 10%;"></td> <td style="width: 10%;"></td> <td style="width: 10%;"></td> <td style="width: 10%;"></td> <td style="width: 10%;"></td> <td style="width: 10%;"></td> <td style="width: 10%;"></td> <td style="width: 10%;"></td> <td style="width: 10%;"></td> </tr> <tr> <td></td> <td></td> <td colspan="8" style="text-align: center;"> <table border="1" style="width: 100%; border-collapse: collapse; text-align: center;"> <tr> <td style="width: 10%;"></td> <td style="width: 10%;"></td> <td style="width: 10%;"></td> <td style="width: 10%;"></td> <td style="width: 10%;"></td> <td style="width: 10%;"></td> <td style="width: 10%;"></td> <td style="width: 10%;"></td> <td style="width: 10%;"></td> <td style="width: 10%;"></td> </tr> <tr> <td></td> <td></td> <td colspan="8" style="text-align: center;"> <table border="1" style="width: 100%; border-collapse: collapse; text-align: center;"> <tr> <td style="width: 10%;"></td> <td style="width: 10%;"></td> <td style="width: 10%;"></td> <td style="width: 10%;"></td> <td style="width: 10%;"></td> <td style="width: 10%;"></td> <td style="width: 10%;"></td> <td style="width: 10%;"></td> <td style="width: 10%;"></td> <td style="width: 10%;"></td> </tr> <tr> <td></td> <td></td> <td colspan="8" style="text-align: center;"> <table border="1" style="width: 100%; border-collapse: collapse; text-align: center;"> <tr> <td style="width: 10%;"></td> <td style="width: 10%;"></td> <td style="width: 10%;"></td> <td style="width: 10%;"></td> <td style="width: 10%;"></td> <td style="width: 10%;"></td> <td style="width: 10%;"></td> <td style="width: 10%;"></td> <td style="width: 10%;"></td> <td style="width: 10%;"></td> </tr> <tr> <td></td> <td></td> <td colspan="8" style="text-align: center;"> <table border="1" style="width: 100%; border-collapse: collapse; text-align: center;"> <tr> <td style="width: 10%;"></td> <td style="width: 10%;"></td> <td style="width: 10%;"></td> <td style="width: 10%;"></td> <td style="width: 10%;"></td> <td style="width: 10%;"></td> <td style="width: 10%;"></td> <td style="width: 10%;"></td> <td style="width: 10%;"></td> <td style="width: 10%;"></td> </tr> <tr> <td></td> <td></td> <td colspan="8" style="text-align: center;"> <table border="1" style="width: 100%; border-collapse: collapse; text-align: center;"> <tr> <td style="width: 10%;"></td> <td style="width: 10%;"></td> <td style="width: 10%;"></td> <td style="width: 10%;"></td> <td style="width: 10%;"></td> <td style="width: 10%;"></td> <td style="width: 10%;"></td> <td style="width: 10%;"></td> <td style="width: 10%;"></td> <td style="width: 10%;"></td> </tr> <tr> <td></td> <td></td> <td colspan="8" style="text-align: center;"> <table border="1" style="width: 100%; border-collapse: collapse; text-align: center;"> <tr> <td style="width: 10%;"></td> <td style="width: 10%;"></td> <td style="width: 10%;"></td> <td style="width: 10%;"></td> <td style="width: 10%;"></td> <td style="width: 10%;"></td> <td style="width: 10%;"></td> <td style="width: 10%;"></td> <td style="width: 10%;"></td> <td style="width: 10%;"></td> </tr> <tr>
<td></td> <td></td> <td colspan="8" style="text-align: center;"> <table border="1" style="width: 100%; border-collapse: collapse; text-align: center;"> <tr> <td style="width: 10%;"></td> <td style="width: 10%;"></td> <td style="width: 10%;"></td> <td style="width: 10%;"></td> <td style="width: 10%;"></td> <td style="width: 10%;"></td> <td style="width: 10%;"></td> <td style="width: 10%;"></td> <td style="width: 10%;"></td> <td style="width: 10%;"></td> </tr> <tr> <td></td> <td></td> <td colspan="8" style="text-align: center;"> <table border="1" style="width: 100%; border-collapse: collapse; text-align: center;"> <tr> <td style="width: 10%;"></td> <td style="width: 10%;"></td> <td style="width: 10%;"></td> <td style="width: 10%;"></td> <td style="width: 10%;"></td> <td style="width: 10%;"></td> <td style="width: 10%;"></td> <td style="width: 10%;"></td> <td style="width: 10%;"></td> <td style="width: 10%;"></td> </tr> <tr> <td></td> <td></td> <td colspan="8" style="text-align: center;"> <table border="1" style="width: 100%; border-collapse: collapse; text-align: center;"> <tr> <td style="width: 10%;"></td> <td style="width: 10%;"></td> <td style="width: 10%;"></td> <td style="width: 10%;"></td> <td style="width: 10%;"></td> <td style="width: 10%;"></td> <td style="width: 10%;"></td> <td style="width: 10%;"></td> <td style="width: 10%;"></td> <td style="width: 10%;"></td> </tr> <tr> <td></td> <td></td> <td colspan="8" style="text-align: center;"> <table border="1" style="width: 100%; border-collapse: collapse; text-align: center;"> <tr> <td style="width: 10%;"></td> <td style="width: 10%;"></td> <td style="width: 10%;"></td> <td style="width: 10%;"></td> <td style="width: 10%;"></td> <td style="width: 10%;"></td> <td style="width: 10%;"></td> <td style="width: 10%;"></td> <td style="width: 10%;"></td> <td style="width: 10%;"></td> </tr> <tr> <td></td> <td></td> <td colspan="8" style="text-align: center;"> <table border="1" style="width: 100%; border-collapse: collapse; text-align: center;"> <tr> <td style="width: 10%;"></td> <td style="width: 10%;"></td> <td style="width: 10%;"></td> <td style="width: 10%;"></td> <td style="width: 10%;"></td> <td style="width: 10%;"></td> <td style="width: 10%;"></td> <td style="width: 10%;"></td> <td style="width: 10%;"></td> <td style="width: 10%;"></td> </tr> <tr> <td></td> <td></td> <td colspan="8" style="text-align: center;"> <table border="1" style="width: 100%; border-collapse: collapse; text-align: center;"> <tr> <td style="width: 10%;"></td> <td style="width: 10%;"></td> <td style="width: 10%;"></td> <td style="width: 10%;"></td> <td style="width: 10%;"></td> <td style="width: 10%;"></td> <td style="width: 10%;"></td> <td style="width: 10%;"></td> <td style="width: 10%;"></td> <td style="width: 10%;"></td> </tr> <tr> <td></td> <td></td> <td colspan="8" style="text-align: center;"> <table border="1" style="width: 100%; border-collapse: collapse; text-align: center;"> <tr> <td style="width: 10%;"></td> <td style="width: 10%;"></td> <td style="width: 10%;"></td> <td style="width: 10%;"></td> <td style="width: 10%;"></td> <td style="width: 10%;"></td> <td style="width: 10%;"></td> <td style="width: 10%;"></td> <td style="width: 10%;"></td> <td style="width: 10%;"></td> </tr> <tr> <td></td> <td></td> <td colspan="8" style="text-align: center;"> <table border="1" style="width: 100%; border-collapse: collapse; text-align: center;"> <tr> </tr></table></td></tr></table></td></tr></table></td></tr></table></td></tr></table></td></tr></table></td></tr></table></td></tr></table></td></tr></table></td></tr></table></td></tr></table></td></tr></table></td></tr></table></td></tr></table></td></tr></table></td></tr></table></td></tr></table>
 | | | | | | | | | | | | | | | | | | | | <table border="1" style="width: 100%; border-collapse: collapse; text-align: center;"> <tr> <td style="width: 10%;"></td> <td style="width: 10%;"></td> <td style="width: 10%;"></td> <td style="width: 10%;"></td> <td style="width: 10%;"></td> <td style="width: 10%;"></td> <td style="width: 10%;"></td> <td style="width: 10%;"></td> <td style="width: 10%;"></td> <td style="width: 10%;"></td> </tr> <tr> <td></td> <td></td> <td colspan="8" style="text-align: center;"> <table border="1" style="width: 100%; border-collapse: collapse; text-align: center;"> <tr> <td style="width: 10%;"></td> <td style="width: 10%;"></td> <td style="width: 10%;"></td> <td style="width: 10%;"></td> <td style="width: 10%;"></td> <td style="width: 10%;"></td> <td style="width: 10%;"></td> <td style="width: 10%;"></td> <td style="width: 10%;"></td> <td style="width: 10%;"></td> </tr> <tr> <td></td> <td></td> <td colspan="8" style="text-align: center;"> <table border="1" style="width: 100%; border-collapse: collapse; text-align: center;"> <tr> <td style="width: 10%;"></td> <td style="width: 10%;"></td> <td style="width: 10%;"></td> <td style="width: 10%;"></td> <td style="width: 10%;"></td> <td style="width: 10%;"></td> <td style="width: 10%;"></td> <td style="width: 10%;"></td> <td style="width: 10%;"></td> <td style="width: 10%;"></td> </tr> <tr> <td></td> <td></td> <td colspan="8" style="text-align: center;"> <table border="1" style="width: 100%; border-collapse: collapse; text-align: center;"> <tr> <td style="width: 10%;"></td> <td style="width: 10%;"></td> <td style="width: 10%;"></td> <td style="width: 10%;"></td> <td style="width: 10%;"></td> <td style="width: 10%;"></td> <td style="width: 10%;"></td> <td style="width: 10%;"></td> <td style="width: 10%;"></td> <td style="width: 10%;"></td> </tr> <tr> <td></td> <td></td> <td colspan="8" style="text-align: center;"> <table border="1" style="width: 100%; border-collapse: collapse; text-align: center;"> <tr> <td style="width: 10%;"></td> <td style="width: 10%;"></td> <td style="width: 10%;"></td> <td style="width: 10%;"></td> <td style="width: 10%;"></td> <td style="width: 10%;"></td> <td style="width: 10%;"></td> <td style="width: 10%;"></td> <td style="width: 10%;"></td> <td style="width: 10%;"></td> </tr> <tr> <td></td> <td></td> <td colspan="8" style="text-align: center;"> <table border="1" style="width: 100%; border-collapse: collapse; text-align: center;"> <tr> <td style="width: 10%;"></td> <td style="width: 10%;"></td> <td style="width: 10%;"></td> <td style="width: 10%;"></td> <td style="width: 10%;"></td> <td style="width: 10%;"></td> <td style="width: 10%;"></td> <td style="width: 10%;"></td> <td style="width: 10%;"></td> <td style="width: 10%;"></td> </tr> <tr> <td></td> <td></td> <td colspan="8" style="text-align: center;"> <table border="1" style="width: 100%; border-collapse: collapse; text-align: center;"> <tr> <td style="width: 10%;"></td> <td style="width: 10%;"></td> <td style="width: 10%;"></td> <td style="width: 10%;"></td> <td style="width: 10%;"></td> <td style="width: 10%;"></td> <td style="width: 10%;"></td> <td style="width: 10%;"></td> <td style="width: 10%;"></td> <td style="width: 10%;"></td> </tr> <tr> <td></td> <td></td> <td colspan="8" style="text-align: center;"> <table border="1" style="width: 100%; border-collapse: collapse; text-align: center;"> <tr> <td style="width: 10%;"></td> <td style="width: 10%;"></td> <td style="width: 10%;"></td> <td style="width: 10%;"></td> <td style="width: 10%;"></td> <td style="width: 10%;"></td> <td style="width:
10%;"></td> <td style="width: 10%;"></td> <td style="width: 10%;"></td> <td style="width: 10%;"></td> </tr> <tr> <td></td> <td></td> <td colspan="8" style="text-align: center;"> <table border="1" style="width: 100%; border-collapse: collapse; text-align: center;"> <tr> <td style="width: 10%;"></td> <td style="width: 10%;"></td> <td style="width: 10%;"></td> <td style="width: 10%;"></td> <td style="width: 10%;"></td> <td style="width: 10%;"></td> <td style="width: 10%;"></td> <td style="width: 10%;"></td> <td style="width: 10%;"></td> <td style="width: 10%;"></td> </tr> <tr> <td></td> <td></td> <td colspan="8" style="text-align: center;"> <table border="1" style="width: 100%; border-collapse: collapse; text-align: center;"> <tr> <td style="width: 10%;"></td> <td style="width: 10%;"></td> <td style="width: 10%;"></td> <td style="width: 10%;"></td> <td style="width: 10%;"></td> <td style="width: 10%;"></td> <td style="width: 10%;"></td> <td style="width: 10%;"></td> <td style="width: 10%;"></td> <td style="width: 10%;"></td> </tr> <tr> <td></td> <td></td> <td colspan="8" style="text-align: center;"> <table border="1" style="width: 100%; border-collapse: collapse; text-align: center;"> <tr> <td style="width: 10%;"></td> <td style="width: 10%;"></td> <td style="width: 10%;"></td> <td style="width: 10%;"></td> <td style="width: 10%;"></td> <td style="width: 10%;"></td> <td style="width: 10%;"></td> <td style="width: 10%;"></td> <td style="width: 10%;"></td> <td style="width: 10%;"></td> </tr> <tr> <td></td> <td></td> <td colspan="8" style="text-align: center;"> <table border="1" style="width: 100%; border-collapse: collapse; text-align: center;"> <tr> <td style="width: 10%;"></td> <td style="width: 10%;"></td> <td style="width: 10%;"></td> <td style="width: 10%;"></td> <td style="width: 10%;"></td> <td style="width: 10%;"></td> <td style="width: 10%;"></td> <td style="width: 10%;"></td> <td style="width: 10%;"></td> <td style="width: 10%;"></td> </tr> <tr> <td></td> <td></td> <td colspan="8" style="text-align: center;"> <table border="1" style="width: 100%; border-collapse: collapse; text-align: center;"> <tr> <td style="width: 10%;"></td> <td style="width: 10%;"></td> <td style="width: 10%;"></td> <td style="width: 10%;"></td> <td style="width: 10%;"></td> <td style="width: 10%;"></td> <td style="width: 10%;"></td> <td style="width: 10%;"></td> <td style="width: 10%;"></td> <td style="width: 10%;"></td> </tr> <tr> <td></td> <td></td> <td colspan="8" style="text-align: center;"> <table border="1" style="width: 100%; border-collapse: collapse; text-align: center;"> <tr> <td style="width: 10%;"></td> <td style="width: 10%;"></td> <td style="width: 10%;"></td> <td style="width: 10%;"></td> <td style="width: 10%;"></td> <td style="width: 10%;"></td> <td style="width: 10%;"></td> <td style="width: 10%;"></td> <td style="width: 10%;"></td> <td style="width: 10%;"></td> </tr> <tr> <td></td> <td></td> <td colspan="8" style="text-align: center;"> <table border="1" style="width: 100%; border-collapse: collapse; text-align: center;"> <tr> <td style="width: 10%;"></td> <td style="width: 10%;"></td> <td style="width: 10%;"></td> <td style="width: 10%;"></td> <td style="width: 10%;"></td> <td style="width: 10%;"></td> <td style="width: 10%;"></td> <td style="width: 10%;"></td> <td style="width: 10%;"></td> <td style="width: 10%;"></td> </tr> <tr> <td></td> <td></td> <td colspan="8" style="text-align: center;"> <table border="1" style="width: 100%; border-collapse: collapse; text-align: center;"> <tr> </tr></table></td></tr></table></td></tr></table></td></tr></table></td></tr></table></td></tr></table></td></tr></table></td></tr></table></td></tr></table></td></tr></table></td></tr></table></td></tr></table></td></tr></table></td></tr></table></td></tr></table></td></tr></table>
 | | | | | | | | | | | | | | | | | | | | <table border="1" style="width: 100%; border-collapse: collapse; text-align: center;"> <tr> <td style="width: 10%;"></td> <td style="width: 10%;"></td> <td style="width: 10%;"></td> <td style="width: 10%;"></td> <td style="width: 10%;"></td> <td style="width: 10%;"></td> <td style="width: 10%;"></td> <td style="width: 10%;"></td> <td style="width: 10%;"></td> <td style="width: 10%;"></td> </tr> <tr> <td></td> <td></td> <td colspan="8" style="text-align: center;"> <table border="1" style="width: 100%; border-collapse: collapse; text-align: center;"> <tr> <td style="width: 10%;"></td> <td style="width: 10%;"></td> <td style="width: 10%;"></td> <td style="width: 10%;"></td> <td style="width: 10%;"></td> <td style="width: 10%;"></td> <td style="width: 10%;"></td> <td style="width: 10%;"></td> <td style="width: 10%;"></td> <td style="width: 10%;"></td> </tr> <tr> <td></td> <td></td> <td colspan="8" style="text-align: center;"> <table border="1" style="width: 100%; border-collapse: collapse; text-align: center;"> <tr> <td style="width: 10%;"></td> <td style="width: 10%;"></td> <td style="width: 10%;"></td> <td style="width: 10%;"></td> <td style="width: 10%;"></td> <td style="width: 10%;"></td> <td style="width: 10%;"></td> <td style="width: 10%;"></td> <td style="width: 10%;"></td> <td style="width: 10%;"></td> </tr> <tr> <td></td> <td></td> <td colspan="8" style="text-align: center;"> <table border="1" style="width: 100%; border-collapse: collapse; text-align: center;"> <tr> <td style="width: 10%;"></td> <td style="width: 10%;"></td> <td style="width: 10%;"></td> <td style="width: 10%;"></td> <td style="width: 10%;"></td> <td style="width: 10%;"></td> <td style="width: 10%;"></td> <td style="width: 10%;"></td> <td style="width: 10%;"></td> <td style="width: 10%;"></td> </tr> <tr> <td></td> <td></td> <td colspan="8" style="text-align: center;"> <table border="1" style="width: 100%; border-collapse: collapse; text-align: center;"> <tr> <td style="width: 10%;"></td> <td style="width: 10%;"></td> <td style="width: 10%;"></td> <td style="width: 10%;"></td> <td style="width: 10%;"></td> <td style="width: 10%;"></td> <td style="width: 10%;"></td> <td style="width: 10%;"></td> <td style="width: 10%;"></td> <td style="width: 10%;"></td> </tr> <tr> <td></td> <td></td> <td colspan="8" style="text-align: center;"> <table border="1" style="width: 100%; border-collapse: collapse; text-align: center;"> <tr> <td style="width: 10%;"></td> <td style="width: 10%;"></td> <td style="width: 10%;"></td> <td style="width: 10%;"></td> <td style="width: 10%;"></td> <td style="width: 10%;"></td> <td style="width: 10%;"></td> <td style="width: 10%;"></td> <td style="width: 10%;"></td> <td style="width: 10%;"></td> </tr> <tr> <td></td> <td></td> <td colspan="8" style="text-align: center;"> <table border="1" style="width: 100%; border-collapse: collapse; text-align: center;"> <tr> <td style="width: 10%;"></td> <td style="width: 10%;"></td> <td style="width: 10%;"></td> <td style="width: 10%;"></td> <td style="width: 10%;"></td> <td style="width: 10%;"></td> <td style="width: 10%;"></td> <td style="width: 10%;"></td> <td style="width: 10%;"></td> <td style="width: 10%;"></td> </tr> <tr> <td></td> <td></td> <td colspan="8" style="text-align: center;"> <table border="1" style="width: 100%; border-collapse: collapse; text-align: center;"> <tr> <td style="width: 10%;"></td> <td style="width: 10%;"></td> <td style="width: 10%;"></td> <td
style="width: 10%;"></td> <td style="width: 10%;"></td> <td style="width: 10%;"></td> <td style="width: 10%;"></td> <td style="width: 10%;"></td> <td style="width: 10%;"></td> <td style="width: 10%;"></td> </tr> <tr> <td></td> <td></td> <td colspan="8" style="text-align: center;"> <table border="1" style="width: 100%; border-collapse: collapse; text-align: center;"> <tr> <td style="width: 10%;"></td> <td style="width: 10%;"></td> <td style="width: 10%;"></td> <td style="width: 10%;"></td> <td style="width: 10%;"></td> <td style="width: 10%;"></td> <td style="width: 10%;"></td> <td style="width: 10%;"></td> <td style="width: 10%;"></td> <td style="width: 10%;"></td> </tr> <tr> <td></td> <td></td> <td colspan="8" style="text-align: center;"> <table border="1" style="width: 100%; border-collapse: collapse; text-align: center;"> <tr> <td style="width: 10%;"></td> <td style="width: 10%;"></td> <td style="width: 10%;"></td> <td style="width: 10%;"></td> <td style="width: 10%;"></td> <td style="width: 10%;"></td> <td style="width: 10%;"></td> <td style="width: 10%;"></td> <td style="width: 10%;"></td> <td style="width: 10%;"></td> </tr> <tr> <td></td> <td></td> <td colspan="8" style="text-align: center;"> <table border="1" style="width: 100%; border-collapse: collapse; text-align: center;"> <tr> <td style="width: 10%;"></td> <td style="width: 10%;"></td> <td style="width: 10%;"></td> <td style="width: 10%;"></td> <td style="width: 10%;"></td> <td style="width: 10%;"></td> <td style="width: 10%;"></td> <td style="width: 10%;"></td> <td style="width: 10%;"></td> <td style="width: 10%;"></td> </tr> <tr> <td></td> <td></td> <td colspan="8" style="text-align: center;"> <table border="1" style="width: 100%; border-collapse: collapse; text-align: center;"> <tr> <td style="width: 10%;"></td> <td style="width: 10%;"></td> <td style="width: 10%;"></td> <td style="width: 10%;"></td> <td style="width: 10%;"></td> <td style="width: 10%;"></td> <td style="width: 10%;"></td> <td style="width: 10%;"></td> <td style="width: 10%;"></td> <td style="width: 10%;"></td> </tr> <tr> <td></td> <td></td> <td colspan="8" style="text-align: center;"> <table border="1" style="width: 100%; border-collapse: collapse; text-align: center;"> <tr> <td style="width: 10%;"></td> <td style="width: 10%;"></td> <td style="width: 10%;"></td> <td style="width: 10%;"></td> <td style="width: 10%;"></td> <td style="width: 10%;"></td> <td style="width: 10%;"></td> <td style="width: 10%;"></td> <td style="width: 10%;"></td> <td style="width: 10%;"></td> </tr> <tr> <td></td> <td></td> <td colspan="8" style="text-align: center;"> <table border="1" style="width: 100%; border-collapse: collapse; text-align: center;"> <tr> <td style="width: 10%;"></td> <td style="width: 10%;"></td> <td style="width: 10%;"></td> <td style="width: 10%;"></td> <td style="width: 10%;"></td> <td style="width: 10%;"></td> <td style="width: 10%;"></td> <td style="width: 10%;"></td> <td style="width: 10%;"></td> <td style="width: 10%;"></td> </tr> <tr> <td></td> <td></td> <td colspan="8" style="text-align: center;"> <table border="1" style="width: 100%; border-collapse: collapse; text-align: center;"> <tr> </tr></table></td></tr></table></td></tr></table></td></tr></table></td></tr></table></td></tr></table></td></tr></table></td></tr></table></td></tr></table></td></tr></table></td></tr></table></td></tr></table></td></tr></table></td></tr></table></td></tr></table>
 | | | | | | | | | | | | | | | | | | | | <table border="1" style="width: 100%; border-collapse: collapse; text-align: center;"> <tr> <td style="width: 10%;"></td> <td style="width: 10%;"></td> <td style="width: 10%;"></td> <td style="width: 10%;"></td> <td style="width: 10%;"></td> <td style="width: 10%;"></td> <td style="width: 10%;"></td> <td style="width: 10%;"></td> <td style="width: 10%;"></td> <td style="width: 10%;"></td> </tr> <tr> <td></td> <td></td> <td colspan="8" style="text-align: center;"> <table border="1" style="width: 100%; border-collapse: collapse; text-align: center;"> <tr> <td style="width: 10%;"></td> <td style="width: 10%;"></td> <td style="width: 10%;"></td> <td style="width: 10%;"></td> <td style="width: 10%;"></td> <td style="width: 10%;"></td> <td style="width: 10%;"></td> <td style="width: 10%;"></td> <td style="width: 10%;"></td> <td style="width: 10%;"></td> </tr> <tr> <td></td> <td></td> <td colspan="8" style="text-align: center;"> <table border="1" style="width: 100%; border-collapse: collapse; text-align: center;"> <tr> <td style="width: 10%;"></td> <td style="width: 10%;"></td> <td style="width: 10%;"></td> <td style="width: 10%;"></td> <td style="width: 10%;"></td> <td style="width: 10%;"></td> <td style="width: 10%;"></td> <td style="width: 10%;"></td> <td style="width: 10%;"></td> <td style="width: 10%;"></td> </tr> <tr> <td></td> <td></td> <td colspan="8" style="text-align: center;"> <table border="1" style="width: 100%; border-collapse: collapse; text-align: center;"> <tr> <td style="width: 10%;"></td> <td style="width: 10%;"></td> <td style="width: 10%;"></td> <td style="width: 10%;"></td> <td style="width: 10%;"></td> <td style="width: 10%;"></td> <td style="width: 10%;"></td> <td style="width: 10%;"></td> <td style="width: 10%;"></td> <td style="width: 10%;"></td> </tr> <tr> <td></td> <td></td> <td colspan="8" style="text-align: center;"> <table border="1" style="width: 100%; border-collapse: collapse; text-align: center;"> <tr> <td style="width: 10%;"></td> <td style="width: 10%;"></td> <td style="width: 10%;"></td> <td style="width: 10%;"></td> <td style="width: 10%;"></td> <td style="width: 10%;"></td> <td style="width: 10%;"></td> <td style="width: 10%;"></td> <td style="width: 10%;"></td> <td style="width: 10%;"></td> </tr> <tr> <td></td> <td></td> <td colspan="8" style="text-align: center;"> <table border="1" style="width: 100%; border-collapse: collapse; text-align: center;"> <tr> <td style="width: 10%;"></td> <td style="width: 10%;"></td> <td style="width: 10%;"></td> <td style="width: 10%;"></td> <td style="width: 10%;"></td> <td style="width: 10%;"></td> <td style="width: 10%;"></td> <td style="width: 10%;"></td> <td style="width: 10%;"></td> <td style="width: 10%;"></td> </tr> <tr> <td></td> <td></td> <td colspan="8" style="text-align: center;"> <table border="1" style="width: 100%; border-collapse: collapse; text-align: center;"> <tr> <td style="width: 10%;"></td> <td style="width: 10%;"></td> <td style="width: 10%;"></td> <td style="width: 10%;"></td> <td style="width: 10%;"></td> <td style="width: 10%;"></td> <td style="width: 10%;"></td> <td style="width: 10%;"></td> <td style="width: 10%;"></td> <td style="width: 10%;"></td> </tr> <tr> <td></td> <td></td> <td colspan="8" style="text-align: center;"> <table border="1" style="width: 100%; border-collapse: collapse; text-align: center;"> <tr> <td style="width: 10%;"></td> <td style="width: 10%;"></td> <td style="width: 10%;"></td> <td style="width: 10%;"></td> <td style="width: 10%;"></td> <td style="width: 10%;"></td> <td style="width: 10%;"></td> <td style="width: 10%;"></td> <td style="width: 10%;"></td> <td style="width: 10%;"></td> </tr> <tr> <td></td> <td></td> <td colspan="8" style="text-align: center;"> <table border="1" style="width: 100%; border-collapse: collapse; text-align: center;"> <tr> <td style="width:
10%;"></td> <td style="width: 10%;"></td> <td style="width: 10%;"></td> <td style="width: 10%;"></td> <td style="width: 10%;"></td> <td style="width: 10%;"></td> <td style="width: 10%;"></td> <td style="width: 10%;"></td> <td style="width: 10%;"></td> <td style="width: 10%;"></td> </tr> <tr> <td></td> <td></td> <td colspan="8" style="text-align: center;"> <table border="1" style="width: 100%; border-collapse: collapse; text-align: center;"> <tr> <td style="width: 10%;"></td> <td style="width: 10%;"></td> <td style="width: 10%;"></td> <td style="width: 10%;"></td> <td style="width: 10%;"></td> <td style="width: 10%;"></td> <td style="width: 10%;"></td> <td style="width: 10%;"></td> <td style="width: 10%;"></td> <td style="width: 10%;"></td> </tr> <tr> <td></td> <td></td> <td colspan="8" style="text-align: center;"> <table border="1" style="width: 100%; border-collapse: collapse; text-align: center;"> <tr> <td style="width: 10%;"></td> <td style="width: 10%;"></td> <td style="width: 10%;"></td> <td style="width: 10%;"></td> <td style="width: 10%;"></td> <td style="width: 10%;"></td> <td style="width: 10%;"></td> <td style="width: 10%;"></td> <td style="width: 10%;"></td> <td style="width: 10%;"></td> </tr> <tr> <td></td> <td></td> <td colspan="8" style="text-align: center;"> <table border="1" style="width: 100%; border-collapse: collapse; text-align: center;"> <tr> <td style="width: 10%;"></td> <td style="width: 10%;"></td> <td style="width: 10%;"></td> <td style="width: 10%;"></td> <td style="width: 10%;"></td> <td style="width: 10%;"></td> <td style="width: 10%;"></td> <td style="width: 10%;"></td> <td style="width: 10%;"></td> <td style="width: 10%;"></td> </tr> <tr> <td></td> <td></td> <td colspan="8" style="text-align: center;"> <table border="1" style="width: 100%; border-collapse: collapse; text-align: center;"> <tr> <td style="width: 10%;"></td> <td style="width: 10%;"></td> <td style="width: 10%;"></td> <td style="width: 10%;"></td> <td style="width: 10%;"></td> <td style="width: 10%;"></td> <td style="width: 10%;"></td> <td style="width: 10%;"></td> <td style="width: 10%;"></td> <td style="width: 10%;"></td> </tr> <tr> <td></td> <td></td> <td colspan="8" style="text-align: center;"> <table border="1" style="width: 100%; border-collapse: collapse; text-align: center;"> <tr> </tr></table></td></tr></table></td></tr></table></td></tr></table></td></tr></table></td></tr></table></td></tr></table></td></tr></table></td></tr></table></td></tr></table></td></tr></table></td></tr></table></td></tr></table></td></tr></table>
 | | | | | | | | | | | | | | | | | | | | <table border="1" style="width: 100%; border-collapse: collapse; text-align: center;"> <tr> <td style="width: 10%;"></td> <td style="width: 10%;"></td> <td style="width: 10%;"></td> <td style="width: 10%;"></td> <td style="width: 10%;"></td> <td style="width: 10%;"></td> <td style="width: 10%;"></td> <td style="width: 10%;"></td> <td style="width: 10%;"></td> <td style="width: 10%;"></td> </tr> <tr> <td></td> <td></td> <td colspan="8" style="text-align: center;"> <table border="1" style="width: 100%; border-collapse: collapse; text-align: center;"> <tr> <td style="width: 10%;"></td> <td style="width: 10%;"></td> <td style="width: 10%;"></td> <td style="width: 10%;"></td> <td style="width: 10%;"></td> <td style="width: 10%;"></td> <td style="width: 10%;"></td> <td style="width: 10%;"></td> <td style="width: 10%;"></td> <td style="width: 10%;"></td> </tr> <tr> <td></td> <td></td> <td colspan="8" style="text-align: center;"> <table border="1" style="width: 100%; border-collapse: collapse; text-align: center;"> <tr> <td style="width: 10%;"></td> <td style="width: 10%;"></td> <td style="width: 10%;"></td> <td style="width: 10%;"></td> <td style="width: 10%;"></td> <td style="width: 10%;"></td> <td style="width: 10%;"></td> <td style="width: 10%;"></td> <td style="width: 10%;"></td> <td style="width: 10%;"></td> </tr> <tr> <td></td> <td></td> <td colspan="8" style="text-align: center;"> <table border="1" style="width: 100%; border-collapse: collapse; text-align: center;"> <tr> <td style="width: 10%;"></td> <td style="width: 10%;"></td> <td style="width: 10%;"></td> <td style="width: 10%;"></td> <td style="width: 10%;"></td> <td style="width: 10%;"></td> <td style="width: 10%;"></td> <td style="width: 10%;"></td> <td style="width: 10%;"></td> <td style="width: 10%;"></td> </tr> <tr> <td></td> <td></td> <td colspan="8" style="text-align: center;"> <table border="1" style="width: 100%; border-collapse: collapse; text-align: center;"> <tr> <td style="width: 10%;"></td> <td style="width: 10%;"></td> <td style="width: 10%;"></td> <td style="width: 10%;"></td> <td style="width: 10%;"></td> <td style="width: 10%;"></td> <td style="width: 10%;"></td> <td style="width: 10%;"></td> <td style="width: 10%;"></td> <td style="width: 10%;"></td> </tr> <tr> <td></td> <td></td> <td colspan="8" style="text-align: center;"> <table border="1" style="width: 100%; border-collapse: collapse; text-align: center;"> <tr> <td style="width: 10%;"></td> <td style="width: 10%;"></td> <td style="width: 10%;"></td> <td style="width: 10%;"></td> <td style="width: 10%;"></td> <td style="width: 10%;"></td> <td style="width: 10%;"></td> <td style="width: 10%;"></td> <td style="width: 10%;"></td> <td style="width: 10%;"></td> </tr> <tr> <td></td> <td></td> <td colspan="8" style="text-align: center;"> <table border="1" style="width: 100%; border-collapse: collapse; text-align: center;"> <tr> <td style="width: 10%;"></td> <td style="width: 10%;"></td> <td style="width: 10%;"></td> <td style="width: 10%;"></td> <td style="width: 10%;"></td> <td style="width: 10%;"></td> <td style="width: 10%;"></td> <td style="width: 10%;"></td> <td style="width: 10%;"></td> <td style="width: 10%;"></td> </tr> <tr> <td></td> <td></td> <td colspan="8" style="text-align: center;"> <table border="1" style="width: 100%; border-collapse: collapse; text-align: center;"> <tr> <td style="width: 10%;"></td> <td style="width: 10%;"></td> <td style="width: 10%;"></td> <td style="width: 10%;"></td> <td style="width: 10%;"></td> <td style="width: 10%;"></td> <td style="width: 10%;"></td> <td style="width: 10%;"></td> <td style="width: 10%;"></td> <td style="width: 10%;"></td> </tr> <tr> <td></td> <td></td> <td colspan="8" style="text-align: center;"> <table border="1" style="width: 100%; border-collapse: collapse; text-align: center;"> <tr> <td style="width: 10%;"></td> <td style="width: 10%;"></td> <td style="width: 10%;"></td> <td style="width: 10%;"></td> <td style="width: 10%;"></td> <td style="width: 10%;"></td> <td style="width: 10%;"></td> <td style="width: 10%;"></td> <td style="width: 10%;"></td> <td style="width: 10%;"></td> </tr> <tr> <td></td> <td></td> <td colspan="8" style="text-align: center;"> <table border="1" style="width: 100%; border-collapse: collapse; text-align: center;"> <tr> <td style="width: 10%;"></td> <td style="width: 10%;"></td> <td style="width: 10%;"></td> <td style="width: 10%;"></td> <td style="width: 10%;"></td> <td style="width: 10%;"></td> <td style="width: 10%;"></td> <td style="width: 10%;"></td> <td style="width: 10%;"></td> <td style="width: 10%;"></td> </tr> <tr> <td></td> <td></td> <td colspan="8" style="text-align: center;"> <table border="1" style="width: 100%; border-collapse:
collapse; text-align: center;"> <tr> <td style="width: 10%;"></td> <td style="width: 10%;"></td> <td style="width: 10%;"></td> <td style="width: 10%;"></td> <td style="width: 10%;"></td> <td style="width: 10%;"></td> <td style="width: 10%;"></td> <td style="width: 10%;"></td> <td style="width: 10%;"></td> <td style="width: 10%;"></td> </tr> <tr> <td></td> <td></td> <td colspan="8" style="text-align: center;"> <table border="1" style="width: 100%; border-collapse: collapse; text-align: center;"> <tr> <td style="width: 10%;"></td> <td style="width: 10%;"></td> <td style="width: 10%;"></td> <td style="width: 10%;"></td> <td style="width: 10%;"></td> <td style="width: 10%;"></td> <td style="width: 10%;"></td> <td style="width: 10%;"></td> <td style="width: 10%;"></td> <td style="width: 10%;"></td> </tr> <tr> <td></td> <td></td> <td colspan="8" style="text-align: center;"> <table border="1" style="width: 100%; border-collapse: collapse; text-align: center;"> <tr> </tr></table></td></tr></table></td></tr></table></td></tr></table></td></tr></table></td></tr></table></td></tr></table></td></tr></table></td></tr></table></td></tr></table></td></tr></table></td></tr></table></td></tr></table>
 | | | | | | | | | | | | | | | | | | | | <table border="1" style="width: 100%; border-collapse: collapse; text-align: center;"> <tr> <td style="width: 10%;"></td> <td style="width: 10%;"></td> <td style="width: 10%;"></td> <td style="width: 10%;"></td> <td style="width: 10%;"></td> <td style="width: 10%;"></td> <td style="width: 10%;"></td> <td style="width: 10%;"></td> <td style="width: 10%;"></td> <td style="width: 10%;"></td> </tr> <tr> <td></td> <td></td> <td colspan="8" style="text-align: center;"> <table border="1" style="width: 100%; border-collapse: collapse; text-align: center;"> <tr> <td style="width: 10%;"></td> <td style="width: 10%;"></td> <td style="width: 10%;"></td> <td style="width: 10%;"></td> <td style="width: 10%;"></td> <td style="width: 10%;"></td> <td style="width: 10%;"></td> <td style="width: 10%;"></td> <td style="width: 10%;"></td> <td style="width: 10%;"></td> </tr> <tr> <td></td> <td></td> <td colspan="8" style="text-align: center;"> <table border="1" style="width: 100%; border-collapse: collapse; text-align: center;"> <tr> <td style="width: 10%;"></td> <td style="width: 10%;"></td> <td style="width: 10%;"></td> <td style="width: 10%;"></td> <td style="width: 10%;"></td> <td style="width: 10%;"></td> <td style="width: 10%;"></td> <td style="width: 10%;"></td> <td style="width: 10%;"></td> <td style="width: 10%;"></td> </tr> <tr> <td></td> <td></td> <td colspan="8" style="text-align: center;"> <table border="1" style="width: 100%; border-collapse: collapse; text-align: center;"> <tr> <td style="width: 10%;"></td> <td style="width: 10%;"></td> <td style="width: 10%;"></td> <td style="width: 10%;"></td> <td style="width: 10%;"></td> <td style="width: 10%;"></td> <td style="width: 10%;"></td> <td style="width: 10%;"></td> <td style="width: 10%;"></td> <td style="width: 10%;"></td> </tr> <tr> <td></td> <td></td> <td colspan="8" style="text-align: center;"> <table border="1" style="width: 100%; border-collapse: collapse; text-align: center;"> <tr> <td style="width: 10%;"></td> <td style="width: 10%;"></td> <td style="width: 10%;"></td> <td style="width: 10%;"></td> <td style="width: 10%;"></td> <td style="width: 10%;"></td> <td style="width: 10%;"></td> <td style="width: 10%;"></td> <td style="width: 10%;"></td> <td style="width: 10%;"></td> </tr> <tr> <td></td> <td></td> <td colspan="8" style="text-align: center;"> <table border="1" style="width: 100%; border-collapse: collapse; text-align: center;"> <tr> <td style="width: 10%;"></td> <td style="width: 10%;"></td> <td style="width: 10%;"></td> <td style="width: 10%;"></td> <td style="width: 10%;"></td> <td style="width: 10%;"></td> <td style="width: 10%;"></td> <td style="width: 10%;"></td> <td style="width: 10%;"></td> <td style="width: 10%;"></td> </tr> <tr> <td></td> <td></td> <td colspan="8" style="text-align: center;"> <table border="1" style="width: 100%; border-collapse: collapse; text-align: center;"> <tr> <td style="width: 10%;"></td> <td style="width: 10%;"></td> <td style="width: 10%;"></td> <td style="width: 10%;"></td> <td style="width: 10%;"></td> <td style="width: 10%;"></td> <td style="width: 10%;"></td> <td style="width: 10%;"></td> <td style="width: 10%;"></td> <td style="width: 10%;"></td> </tr> <tr> <td></td> <td></td> <td colspan="8" style="text-align: center;"> <table border="1" style="width: 100%; border-collapse: collapse; text-align: center;"> <tr> <td style="width: 10%;"></td> <td style="width: 10%;"></td> <td style="width: 10%;"></td> <td style="width: 10%;"></td> <td style="width: 10%;"></td> <td style="width: 10%;"></td> <td style="width: 10%;"></td> <td style="width: 10%;"></td> <td style="width: 10%;"></td> <td style="width: 10%;"></td> </tr> <tr> <td></td> <td></td> <td colspan="8" style="text-align: center;"> <table border="1" style="width: 100%; border-collapse: collapse; text-align: center;"> <tr> <td style="width: 10%;"></td> <td style="width: 10%;"></td> <td style="width: 10%;"></td> <td style="width: 10%;"></td> <td style="width: 10%;"></td> <td style="width: 10%;"></td> <td style="width: 10%;"></td> <td style="width: 10%;"></td> <td style="width: 10%;"></td> <td style="width: 10%;"></td> </tr> <tr> <td></td> <td></td> <td colspan="8" style="text-align: center;"> <table border="1" style="width: 100%; border-collapse: collapse; text-align: center;"> <tr> <td style="width: 10%;"></td> <td style="width: 10%;"></td> <td style="width: 10%;"></td> <td style="width: 10%;"></td> <td style="width: 10%;"></td> <td style="width: 10%;"></td> <td style="width: 10%;"></td> <td style="width: 10%;"></td> <td style="width: 10%;"></td> <td style="width: 10%;"></td> </tr> <tr> <td></td> <td></td> <td colspan="8" style="text-align: center;"> <table border="1" style="width: 100%; border-collapse: collapse; text-align: center;"> <tr> <td style="width: 10%;"></td> <td style="width: 10%;"></td> <td style="width: 10%;"></td> <td style="width: 10%;"></td> <td style="width: 10%;"></td> <td style="width: 10%;"></td> <td style="width: 10%;"></td> <td style="width: 10%;"></td> <td style="width: 10%;"></td> <td style="width: 10%;"></td> </tr> <tr> <td></td> <td></td> <td colspan="8" style="text-align: center;"> <table border="1" style="width: 100%; border-collapse: collapse; text-align: center;"> <tr> </tr></table></td></tr></table></td></tr></table></td></tr></table></td></tr></table></td></tr></table></td></tr></table></td></tr></table></td></tr></table></td></tr></table></td></tr></table></td></tr></table>

 | | | | | | | | | | | | | | | | | | | | <table border="1" style="width: 100%; border-collapse: collapse; text-align: center;"> <tr> <td style="width: 10%;"></td> <td style="width: 10%;"></td> <td style="width: 10%;"></td> <td style="width: 10%;"></td> <td style="width: 10%;"></td> <td style="width: 10%;"></td> <td style="width: 10%;"></td> <td style="width: 10%;"></td> <td style="width: 10%;"></td> <td style="width: 10%;"></td> </tr> <tr> <td></td> <td></td> <td colspan="8" style="text-align: center;"> <table border="1" style="width: 100%; border-collapse: collapse; text-align: center;"> <tr> <td style="width: 10%;"></td> <td style="width: 10%;"></td> <td style="width: 10%;"></td> <td style="width: 10%;"></td> <td style="width: 10%;"></td> <td style="width: 10%;"></td> <td style="width: 10%;"></td> <td style="width: 10%;"></td> <td style="width: 10%;"></td> <td style="width: 10%;"></td> </tr> <tr> <td></td> <td></td> <td colspan="8" style="text-align: center;"> <table border="1" style="width: 100%; border-collapse: collapse; text-align: center;"> <tr> <td style="width: 10%;"></td> <td style="width: 10%;"></td> <td style="width: 10%;"></td> <td style="width: 10%;"></td> <td style="width: 10%;"></td> <td style="width: 10%;"></td> <td style="width: 10%;"></td> <td style="width: 10%;"></td> <td style="width: 10%;"></td> <td style="width: 10%;"></td> </tr> <tr> <td></td> <td></td> <td colspan="8" style="text-align: center;"> <table border="1" style="width: 100%; border-collapse: collapse; text-align: center;"> <tr> <td style="width: 10%;"></td> <td style="width: 10%;"></td> <td style="width: 10%;"></td> <td style="width: 10%;"></td> <td style="width: 10%;"></td> <td style="width: 10%;"></td> <td style="width: 10%;"></td> <td style="width: 10%;"></td> <td style="width: 10%;"></td> <td style="width: 10%;"></td> </tr> <tr> <td></td> <td></td> <td colspan="8" style="text-align: center;"> <table border="1" style="width: 100%; border-collapse: collapse; text-align: center;"> <tr> <td style="width: 10%;"></td> <td style="width: 10%;"></td> <td style="width: 10%;"></td> <td style="width: 10%;"></td> <td style="width: 10%;"></td> <td style="width: 10%;"></td> <td style="width: 10%;"></td> <td style="width: 10%;"></td> <td style="width: 10%;"></td> <td style="width: 10%;"></td> </tr> <tr> <td></td> <td></td> <td colspan="8" style="text-align: center;"> <table border="1" style="width: 100%; border-collapse: collapse; text-align: center;"> <tr> <td style="width: 10%;"></td> <td style="width: 10%;"></td> <td style="width: 10%;"></td> <td style="width: 10%;"></td> <td style="width: 10%;"></td> <td style="width: 10%;"></td> <td style="width: 10%;"></td> <td style="width: 10%;"></td> <td style="width: 10%;"></td> <td style="width: 10%;"></td> </tr> <tr> <td></td> <td></td> <td colspan="8" style="text-align: center;"> <table border="1" style="width: 100%; border-collapse: collapse; text-align: center;"> <tr> <td style="width: 10%;"></td> <td style="width: 10%;"></td> <td style="width: 10%;"></td> <td style="width: 10%;"></td> <td style="width: 10%;"></td> <td style="width: 10%;"></td> <td style="width: 10%;"></td> <td style="width: 10%;"></td> <td style="width: 10%;"></td> <td style="width: 10%;"></td> </tr> <tr> <td></td> <td></td> <td colspan="8" style="text-align: center;"> <table border="1" style="width: 100%; border-collapse: collapse; text-align: center;"> <tr> <td style="width: 10%;"></td> <td style="width: 10%;"></td> <td style="width: 10%;"></td> <td style="width: 10%;"></td> <td style="width: 10%;"></td> <td style="width: 10%;"></td> <td style="width: 10%;"></td> <td style="width: 10%;"></td> <td style="width: 10%;"></td> <td style="width: 10%;"></td> </tr> <tr> <td></td> <td></td> <td colspan="8" style="text-align: center;"> <table border="1" style="width: 100%; border-collapse: collapse; text-align: center;"> <tr> <td style="width: 10%;"></td> <td style="width: 10%;"></td> <td style="width: 10%;"></td> <td style="width: 10%;"></td> <td style="width: 10%;"></td> <td style="width: 10%;"></td> <td style="width: 10%;"></td> <td style="width: 10%;"></td> <td style="width: 10%;"></td> <td style="width: 10%;"></td> </tr> <tr> <td></td> <td></td> <td colspan="8" style="text-align: center;"> <table border="1" style="width: 100%; border-collapse: collapse; text-align: center;"> <tr> <td style="width: 10%;"></td> <td style="width: 10%;"></td> <td style="width: 10%;"></td> <td style="width: 10%;"></td> <td style="width: 10%;"></td> <td style="width: 10%;"></td> <td style="width: 10%;"></td> <td style="width: 10%;"></td> <td style="width: 10%;"></td> <td style="width: 10%;"></td> </tr> <tr> <td></td> <td></td> <td colspan="8" style="text-align: center;"> <table border="1" style="width: 100%; border-collapse: collapse; text-align: center;"> <tr> </tr></table></td></tr></table></td></tr></table></td></tr></table></td></tr></table></td></tr></table></td></tr></table></td></tr></table></td></tr></table></td></tr></table></td></tr></table>
 | | | | | | | | | | | | | | | | | | | | <table border="1" style="width: 100%; border-collapse: collapse; text-align: center;"> <tr> <td style="width: 10%;"></td> <td style="width: 10%;"></td> <td style="width: 10%;"></td> <td style="width: 10%;"></td> <td style="width: 10%;"></td> <td style="width: 10%;"></td> <td style="width:
10%;"></td> <td style="width: 10%;"></td> <td style="width: 10%;"></td> <td style="width: 10%;"></td> </tr> <tr> <td></td> <td></td> <td colspan="8" style="text-align: center;"> <table border="1" style="width: 100%; border-collapse: collapse; text-align: center;"> <tr> <td style="width: 10%;"></td> <td style="width: 10%;"></td> <td style="width: 10%;"></td> <td style="width: 10%;"></td> <td style="width: 10%;"></td> <td style="width: 10%;"></td> <td style="width: 10%;"></td> <td style="width: 10%;"></td> <td style="width: 10%;"></td> <td style="width: 10%;"></td> </tr> <tr> <td></td> <td></td> <td colspan="8" style="text-align: center;"> <table border="1" style="width: 100%; border-collapse: collapse; text-align: center;"> <tr> <td style="width: 10%;"></td> <td style="width: 10%;"></td> <td style="width: 10%;"></td> <td style="width: 10%;"></td> <td style="width: 10%;"></td> <td style="width: 10%;"></td> <td style="width: 10%;"></td> <td style="width: 10%;"></td> <td style="width: 10%;"></td> <td style="width: 10%;"></td> </tr> <tr> <td></td> <td></td> <td colspan="8" style="text-align: center;"> <table border="1" style="width: 100%; border-collapse: collapse; text-align: center;"> <tr> <td style="width: 10%;"></td> <td style="width: 10%;"></td> <td style="width: 10%;"></td> <td style="width: 10%;"></td> <td style="width: 10%;"></td> <td style="width: 10%;"></td> <td style="width: 10%;"></td> <td style="width: 10%;"></td> <td style="width: 10%;"></td> <td style="width: 10%;"></td> </tr> <tr> <td></td> <td></td> <td colspan="8" style="text-align: center;"> <table border="1" style="width: 100%; border-collapse: collapse; text-align: center;"> <tr> <td style="width: 10%;"></td> <td style="width: 10%;"></td> <td style="width: 10%;"></td> <td style="width: 10%;"></td> <td style="width: 10%;"></td> <td style="width: 10%;"></td> <td style="width: 10%;"></td> <td style="width: 10%;"></td> <td style="width: 10%;"></td> <td style="width: 10%;"></td> </tr> <tr> <td></td> <td></td> <td colspan="8" style="text-align: center;"> <table border="1" style="width: 100%; border-collapse: collapse; text-align: center;"> <tr> <td style="width: 10%;"></td> <td style="width: 10%;"></td> <td style="width: 10%;"></td> <td style="width: 10%;"></td> <td style="width: 10%;"></td> <td style="width: 10%;"></td> <td style="width: 10%;"></td> <td style="width: 10%;"></td> <td style="width: 10%;"></td> <td style="width: 10%;"></td> </tr> <tr> <td></td> <td></td> <td colspan="8" style="text-align: center;"> <table border="1" style="width: 100%; border-collapse: collapse; text-align: center;"> <tr> <td style="width: 10%;"></td> <td style="width: 10%;"></td> <td style="width: 10%;"></td> <td style="width: 10%;"></td> <td style="width: 10%;"></td> <td style="width: 10%;"></td> <td style="width: 10%;"></td> <td style="width: 10%;"></td> <td style="width: 10%;"></td> <td style="width: 10%;"></td> </tr> <tr> <td></td> <td></td> <td colspan="8" style="text-align: center;"> <table border="1" style="width: 100%; border-collapse: collapse; text-align: center;"> <tr> <td style="width: 10%;"></td> <td style="width: 10%;"></td> <td style="width: 10%;"></td> <td style="width: 10%;"></td> <td style="width: 10%;"></td> <td style="width: 10%;"></td> <td style="width: 10%;"></td> <td style="width: 10%;"></td> <td style="width: 10%;"></td> <td style="width: 10%;"></td> </tr> <tr> <td></td> <td></td> <td colspan="8" style="text-align: center;"> <table border="1" style="width: 100%; border-collapse: collapse; text-align: center;"> <tr> <td style="width: 10%;"></td> <td style="width: 10%;"></td> <td style="width: 10%;"></td> <td style="width: 10%;"></td> <td style="width: 10%;"></td> <td style="width: 10%;"></td> <td style="width: 10%;"></td> <td style="width: 10%;"></td> <td style="width: 10%;"></td> <td style="width: 10%;"></td> </tr> <tr> <td></td> <td></td> <td colspan="8" style="text-align: center;"> <table border="1" style="width: 100%; border-collapse: collapse; text-align: center;"> <tr> </tr></table></td></tr></table></td></tr></table></td></tr></table></td></tr></table></td></tr></table></td></tr></table></td></tr></table></td></tr></table></td></tr></table>
 | | | | | | | | | | | | | | | | | | | | <table border="1" style="width: 100%; border-collapse: collapse; text-align: center;"> <tr> <td style="width: 10%;"></td> <td style="width: 10%;"></td> <td style="width: 10%;"></td> <td style="width: 10%;"></td> <td style="width: 10%;"></td> <td style="width: 10%;"></td> <td style="width: 10%;"></td> <td style="width: 10%;"></td> <td style="width: 10%;"></td> <td style="width: 10%;"></td> </tr> <tr> <td></td> <td></td> <td colspan="8" style="text-align: center;"> <table border="1" style="width: 100%; border-collapse: collapse; text-align: center;"> <tr> <td style="width: 10%;"></td> <td style="width: 10%;"></td> <td style="width: 10%;"></td> <td style="width: 10%;"></td> <td style="width: 10%;"></td> <td style="width: 10%;"></td> <td style="width: 10%;"></td> <td style="width: 10%;"></td> <td style="width: 10%;"></td> <td style="width: 10%;"></td> </tr> <tr> <td></td> <td></td> <td colspan="8" style="text-align: center;"> <table border="1" style="width: 100%; border-collapse: collapse; text-align: center;"> <tr> <td style="width: 10%;"></td> <td style="width: 10%;"></td> <td style="width: 10%;"></td> <td style="width: 10%;"></td> <td style="width: 10%;"></td> <td style="width: 10%;"></td> <td style="width: 10%;"></td> <td style="width: 10%;"></td> <td style="width: 10%;"></td> <td style="width: 10%;"></td> </tr> <tr> <td></td> <td></td> <td colspan="8" style="text-align: center;"> <table border="1" style="width: 100%; border-collapse: collapse; text-align: center;"> <tr> <td style="width: 10%;"></td> <td style="width: 10%;"></td> <td style="width: 10%;"></td> <td style="width: 10%;"></td> <td style="width: 10%;"></td> <td style="width: 10%;"></td> <td style="width: 10%;"></td> <td style="width: 10%;"></td> <td style="width: 10%;"></td> <td style="width: 10%;"></td> </tr> <tr> <td></td> <td></td> <td colspan="8" style="text-align: center;"> <table border="1" style="width: 100%; border-collapse: collapse; text-align: center;"> <tr> <td style="width: 10%;"></td> <td style="width: 10%;"></td> <td style="width: 10%;"></td> <td style="width: 10%;"></td> <td style="width: 10%;"></td> <td style="width: 10%;"></td> <td style="width: 10%;"></td> <td style="width: 10%;"></td> <td style="width: 10%;"></td> <td style="width: 10%;"></td> </tr> <tr> <td></td> <td></td> <td colspan="8" style="text-align: center;"> <table border="1" style="width: 100%; border-collapse: collapse; text-align: center;"> <tr> <td style="width: 10%;"></td> <td style="width: 10%;"></td> <td style="width: 10%;"></td> <td style="width: 10%;"></td> <td style="width: 10%;"></td> <td style="width: 10%;"></td> <td style="width: 10%;"></td> <td style="width: 10%;"></td> <td style="width: 10%;"></td> <td style="width: 10%;"></td> </tr> <tr> <td></td> <td></td> <td colspan="8" style="text-align: center;"> <table border="1" style="width: 100%; border-collapse: collapse; text-align: center;"> <tr> <td style="width: 10%;"></td> <td style="width: 10%;"></td> <td style="width: 10%;"></td> <td style="width: 10%;"></td> <td style="width: 10%;"></td> <td style="width: 10%;"></td> <td style="width: 10%;"></td> <td
style="width: 10%;"></td> <td style="width: 10%;"></td> <td style="width: 10%;"></td> </tr> <tr> <td></td> <td></td> <td colspan="8" style="text-align: center;"> <table border="1" style="width: 100%; border-collapse: collapse; text-align: center;"> <tr> <td style="width: 10%;"></td> <td style="width: 10%;"></td> <td style="width: 10%;"></td> <td style="width: 10%;"></td> <td style="width: 10%;"></td> <td style="width: 10%;"></td> <td style="width: 10%;"></td> <td style="width: 10%;"></td> <td style="width: 10%;"></td> <td style="width: 10%;"></td> </tr> <tr> <td></td> <td></td> <td colspan="8" style="text-align: center;"> <table border="1" style="width: 100%; border-collapse: collapse; text-align: center;"> <tr> </tr></table></td></tr></table></td></tr></table></td></tr></table></td></tr></table></td></tr></table></td></tr></table></td></tr></table></td></tr></table>
 | | | | | | | | | | | | | | | | | | | | <table border="1" style="width: 100%; border-collapse: collapse; text-align: center;"> <tr> <td style="width: 10%;"></td> <td style="width: 10%;"></td> <td style="width: 10%;"></td> <td style="width: 10%;"></td> <td style="width: 10%;"></td> <td style="width: 10%;"></td> <td style="width: 10%;"></td> <td style="width: 10%;"></td> <td style="width: 10%;"></td> <td style="width: 10%;"></td> </tr> <tr> <td></td> <td></td> <td colspan="8" style="text-align: center;"> <table border="1" style="width: 100%; border-collapse: collapse; text-align: center;"> <tr> <td style="width: 10%;"></td> <td style="width: 10%;"></td> <td style="width: 10%;"></td> <td style="width: 10%;"></td> <td style="width: 10%;"></td> <td style="width: 10%;"></td> <td style="width: 10%;"></td> <td style="width: 10%;"></td> <td style="width: 10%;"></td> <td style="width: 10%;"></td> </tr> <tr> <td></td> <td></td> <td colspan="8" style="text-align: center;"> <table border="1" style="width: 100%; border-collapse: collapse; text-align: center;"> <tr> <td style="width: 10%;"></td> <td style="width: 10%;"></td> <td style="width: 10%;"></td> <td style="width: 10%;"></td> <td style="width: 10%;"></td> <td style="width: 10%;"></td> <td style="width: 10%;"></td> <td style="width: 10%;"></td> <td style="width: 10%;"></td> <td style="width: 10%;"></td> </tr> <tr> <td></td> <td></td> <td colspan="8" style="text-align: center;"> <table border="1" style="width: 100%; border-collapse: collapse; text-align: center;"> <tr> <td style="width: 10%;"></td> <td style="width: 10%;"></td> <td style="width: 10%;"></td> <td style="width: 10%;"></td> <td style="width: 10%;"></td> <td style="width: 10%;"></td> <td style="width: 10%;"></td> <td style="width: 10%;"></td> <td style="width: 10%;"></td> <td style="width: 10%;"></td> </tr> <tr> <td></td> <td></td> <td colspan="8" style="text-align: center;"> <table border="1" style="width: 100%; border-collapse: collapse; text-align: center;"> <tr> <td style="width: 10%;"></td> <td style="width: 10%;"></td> <td style="width: 10%;"></td> <td style="width: 10%;"></td> <td style="width: 10%;"></td> <td style="width: 10%;"></td> <td style="width: 10%;"></td> <td style="width: 10%;"></td> <td style="width: 10%;"></td> <td style="width: 10%;"></td> </tr> <tr> <td></td> <td></td> <td colspan="8" style="text-align: center;"> <table border="1" style="width: 100%; border-collapse: collapse; text-align: center;"> <tr> <td style="width: 10%;"></td> <td style="width: 10%;"></td> <td style="width: 10%;"></td> <td style="width: 10%;"></td> <td style="width: 10%;"></td> <td style="width: 10%;"></td> <td style="width: 10%;"></td> <td style="width: 10%;"></td> <td style="width: 10%;"></td> <td style="width: 10%;"></td> </tr> <tr> <td></td> <td></td> <td colspan="8" style="text-align: center;"> <table border="1" style="width: 100%; border-collapse: collapse; text-align: center;"> <tr> <td style="width: 10%;"></td> <td style="width: 10%;"></td> <td style="width: 10%;"></td> <td style="width: 10%;"></td> <td style="width: 10%;"></td> <td style="width: 10%;"></td> <td style="width: 10%;"></td> <td style="width: 10%;"></td> <td style="width: 10%;"></td> <td style="width: 10%;"></td> </tr> <tr> <td></td> <td></td> <td colspan="8" style="text-align: center;"> <table border="1" style="width: 100%; border-collapse: collapse; text-align: center;"> <tr> </tr></table></td></tr></table></td></tr></table></td></tr></table></td></tr></table></td></tr></table></td></tr></table></td></tr></table>
 | | | | | | | | | | | | | | | | | | | | <table border="1" style="width: 100%; border-collapse: collapse; text-align: center;"> <tr> <td style="width: 10%;"></td> <td style="width: 10%;"></td> <td style="width: 10%;"></td> <td style="width: 10%;"></td> <td
style="width: 10%;"></td> <td style="width: 10%;"></td> <td style="width: 10%;"></td> <td style="width: 10%;"></td> <td style="width: 10%;"></td> <td style="width: 10%;"></td> </tr> <tr> <td></td> <td></td> <td colspan="8" style="text-align: center;"> <table border="1" style="width: 100%; border-collapse: collapse; text-align: center;"> <tr> <td style="width: 10%;"></td> <td style="width: 10%;"></td> <td style="width: 10%;"></td> <td style="width: 10%;"></td> <td style="width: 10%;"></td> <td style="width: 10%;"></td> <td style="width: 10%;"></td> <td style="width: 10%;"></td> <td style="width: 10%;"></td> <td style="width: 10%;"></td> </tr> <tr> <td></td> <td></td> <td colspan="8" style="text-align: center;"> <table border="1" style="width: 100%; border-collapse: collapse; text-align: center;"> <tr> <td style="width: 10%;"></td> <td style="width: 10%;"></td> <td style="width: 10%;"></td> <td style="width: 10%;"></td> <td style="width: 10%;"></td> <td style="width: 10%;"></td> <td style="width: 10%;"></td> <td style="width: 10%;"></td> <td style="width: 10%;"></td> <td style="width: 10%;"></td> </tr> <tr> <td></td> <td></td> <td colspan="8" style="text-align: center;"> <table border="1" style="width: 100%; border-collapse: collapse; text-align: center;"> <tr> <td style="width: 10%;"></td> <td style="width: 10%;"></td> <td style="width: 10%;"></td> <td style="width: 10%;"></td> <td style="width: 10%;"></td> <td style="width: 10%;"></td> <td style="width: 10%;"></td> <td style="width: 10%;"></td> <td style="width: 10%;"></td> <td style="width: 10%;"></td> </tr> <tr> <td></td> <td></td> <td colspan="8" style="text-align: center;"> <table border="1" style="width: 100%; border-collapse: collapse; text-align: center;"> <tr> <td style="width: 10%;"></td> <td style="width: 10%;"></td> <td style="width: 10%;"></td> <td style="width: 10%;"></td> <td style="width: 10%;"></td> <td style="width: 10%;"></td> <td style="width: 10%;"></td> <td style="width: 10%;"></td> <td style="width: 10%;"></td> <td style="width: 10%;"></td> </tr> <tr> <td></td> <td></td> <td colspan="8" style="text-align: center;"> <table border="1" style="width: 100%; border-collapse: collapse; text-align: center;"> <tr> <td style="width: 10%;"></td> <td style="width: 10%;"></td> <td style="width: 10%;"></td> <td style="width: 10%;"></td> <td style="width: 10%;"></td> <td style="width: 10%;"></td> <td style="width: 10%;"></td> <td style="width: 10%;"></td> <td style="width: 10%;"></td> <td style="width: 10%;"></td> </tr> <tr> <td></td> <td></td> <td colspan="8" style="text-align: center;"> <table border="1" style="width: 100%; border-collapse: collapse; text-align: center;"> <tr> </tr></table></td></tr></table></td></tr></table></td></tr></table></td></tr></table></td></tr></table></td></tr></table>
 | | | | | | | | | | | | | | | | | | | | <table border="1" style="width: 100%; border-collapse: collapse; text-align: center;"> <tr> <td style="width: 10%;"></td> <td style="width: 10%;"></td> <td style="width: 10%;"></td> <td style="width: 10%;"></td> <td style="width: 10%;"></td> <td style="width: 10%;"></td> <td style="width: 10%;"></td> <td style="width: 10%;"></td> <td style="width: 10%;"></td> <td style="width: 10%;"></td> </tr> <tr> <td></td> <td></td> <td colspan="8" style="text-align: center;"> <table border="1" style="width: 100%; border-collapse: collapse; text-align: center;"> <tr> <td style="width: 10%;"></td> <td style="width: 10%;"></td> <td style="width: 10%;"></td> <td style="width: 10%;"></td> <td style="width: 10%;"></td> <td style="width: 10%;"></td> <td style="width: 10%;"></td> <td style="width: 10%;"></td> <td style="width: 10%;"></td> <td style="width: 10%;"></td> </tr> <tr> <td></td> <td></td> <td colspan="8" style="text-align: center;"> <table border="1" style="width: 100%; border-collapse: collapse; text-align: center;"> <tr> <td style="width: 10%;"></td> <td style="width: 10%;"></td> <td style="width: 10%;"></td> <td style="width: 10%;"></td> <td style="width: 10%;"></td> <td style="width: 10%;"></td> <td style="width: 10%;"></td> <td style="width: 10%;"></td> <td style="width: 10%;"></td> <td style="width: 10%;"></td> </tr> <tr> <td></td> <td></td> <td colspan="8" style="text-align: center;"> <table border="1" style="width: 100%; border-collapse: collapse; text-align: center;"> <tr> <td style="width: 10%;"></td> <td style="width: 10%;"></td> <td style="width: 10%;"></td> <td style="width: 10%;"></td> <td style="width: 10%;"></td> <td style="width: 10%;"></td> <td style="width: 10%;"></td> <td style="width: 10%;"></td> <td style="width: 10%;"></td> <td style="width: 10%;"></td> </tr> <tr> <td></td> <td></td> <td colspan="8" style="text-align: center;"> <table border="1" style="width: 100%; border-collapse: collapse; text-align: center;"> <tr> <td style="width: 10%;"></td> <td style="width: 10%;"></td> <td style="width: 10%;"></td> <td style="width: 10%;"></td> <td style="width: 10%;"></td> <td style="width: 10%;"></td> <td style="width: 10%;"></td> <td style="width: 10%;"></td> <td style="width: 10%;"></td> <td style="width: 10%;"></td> </tr> <tr> <td></td> <td></td> <td colspan="8" style="text-align: center;"> <table border="1" style="width: 100%; border-collapse: collapse; text-align: center;"> <tr> </tr></table></td></tr></table></td></tr></table></td></tr></table></td></tr></table></td></tr></table>

 | | | | | | | | | | | | | | | | | | | | <table border="1" style="width: 100%; border-collapse: collapse; text-align: center;"> <tr> <td style="width: 10%;"></td> <td style="width: 10%;"></td> <td style="width: 10%;"></td> <td style="width: 10%;"></td> <td style="width: 10%;"></td> <td style="width: 10%;"></td> <td style="width: 10%;"></td> <td style="width: 10%;"></td> <td style="width: 10%;"></td> <td style="width: 10%;"></td> </tr> <tr> <td></td> <td></td> <td colspan="8" style="text-align: center;"> <table border="1" style="width: 100%; border-collapse: collapse; text-align: center;"> <tr> <td style="width: 10%;"></td> <td style="width: 10%;"></td> <td style="width: 10%;"></td> <td style="width: 10%;"></td> <td style="width: 10%;"></td> <td style="width: 10%;"></td> <td style="width: 10%;"></td> <td style="width: 10%;"></td> <td style="width: 10%;"></td> <td style="width: 10%;"></td> </tr> <tr> <td></td> <td></td> <td colspan="8" style="text-align: center;"> <table border="1" style="width: 100%; border-collapse: collapse; text-align: center;"> <tr> <td style="width: 10%;"></td> <td style="width: 10%;"></td> <td style="width: 10%;"></td> <td style="width: 10%;"></td> <td style="width: 10%;"></td> <td style="width: 10%;"></td> <td style="width: 10%;"></td> <td style="width: 10%;"></td> <td style="width: 10%;"></td> <td style="width: 10%;"></td> </tr> <tr> <td></td> <td></td> <td colspan="8" style="text-align: center;"> <table border="1" style="width: 100%; border-collapse: collapse; text-align: center;"> <tr> <td style="width: 10%;"></td> <td style="width: 10%;"></td> <td style="width: 10%;"></td> <td style="width: 10%;"></td> <td style="width: 10%;"></td> <td style="width: 10%;"></td> <td style="width: 10%;"></td> <td style="width: 10%;"></td> <td style="width: 10%;"></td> <td style="width: 10%;"></td> </tr> <tr> <td></td> <td></td> <td colspan="8" style="text-align: center;"> <table border="1" style="width: 100%; border-collapse: collapse; text-align: center;"> <tr> </tr></table></td></tr></table></td></tr></table></td></tr></table></td></tr></table>
 | | | | | | | | | | | | | | | | | | | | <table border="1" style="width: 100%; border-collapse: collapse; text-align: center;"> <tr> <td style="width: 10%;"></td> <td style="width: 10%;"></td> <td style="width: 10%;"></td> <td style="width: 10%;"></td> <td style="width: 10%;"></td> <td style="width: 10%;"></td> <td style="width: 10%;"></td> <td style="width: 10%;"></td> <td style="width: 10%;"></td> <td style="width: 10%;"></td> </tr> <tr> <td></td> <td></td> <td colspan="8" style="text-align: center;"> <table border="1" style="width: 100%; border-collapse: collapse; text-align: center;"> <tr> <td style="width: 10%;"></td> <td style="width: 10%;"></td> <td style="width: 10%;"></td> <td style="width: 10%;"></td> <td style="width: 10%;"></td> <td style="width: 10%;"></td> <td style="width: 10%;"></td> <td style="width: 10%;"></td> <td style="width: 10%;"></td> <td style="width: 10%;"></td> </tr> <tr> <td></td> <td></td> <td colspan="8" style="text-align: center;"> <table border="1" style="width: 100%; border-collapse: collapse; text-align: center;"> <tr> <td style="width: 10%;"></td> <td style="width: 10%;"></td> <td style="width: 10%;"></td> <td style="width: 10%;"></td> <td style="width: 10%;"></td> <td style="width: 10%;"></td> <td style="width: 10%;"></td> <td style="width: 10%;"></td> <td style="width: 10%;"></td> <td style="width: 10%;"></td> </tr> <tr> <td></td> <td></td> <td colspan="8" style="text-align: center;"> <table border="1" style="width: 100%; border-collapse: collapse; text-align: center;"> <tr> </tr></table></td></tr></table></td></tr></table></td></tr></table>
 | | | | | | | | | | | | | | | | | | | | <table border="1" style="width: 100%; border-collapse: collapse; text-align: center;"> <tr> <td style="width: 10%;"></td> <td style="width: 10%;"></td> <td style="width: 10%;"></td> <td style="width: 10%;"></td> <td style="width: 10%;"></td> <td style="width:
10%;"></td> <td style="width: 10%;"></td> <td style="width: 10%;"></td> <td style="width: 10%;"></td> <td style="width: 10%;"></td> </tr> <tr> <td></td> <td></td> <td colspan="8" style="text-align: center;"> <table border="1" style="width: 100%; border-collapse: collapse; text-align: center;"> <tr> <td style="width: 10%;"></td> <td style="width: 10%;"></td> <td style="width: 10%;"></td> <td style="width: 10%;"></td> <td style="width: 10%;"></td> <td style="width: 10%;"></td> <td style="width: 10%;"></td> <td style="width: 10%;"></td> <td style="width: 10%;"></td> <td style="width: 10%;"></td> </tr> <tr> <td></td> <td></td> <td colspan="8" style="text-align: center;"> <table border="1" style="width: 100%; border-collapse: collapse; text-align: center;"> <tr> </tr></table></td></tr></table></td></tr></table>
 | | | | | | | | | | | | | | | | | | | | <table border="1" style="width: 100%; border-collapse: collapse; text-align: center;"> <tr> <td style="width: 10%;"></td> <td style="width: 10%;"></td> <td style="width: 10%;"></td> <td style="width: 10%;"></td> <td style="width: 10%;"></td> <td style="width: 10%;"></td> <td style="width: 10%;"></td> <td style="width: 10%;"></td> <td style="width: 10%;"></td> <td style="width: 10%;"></td> </tr> <tr> <td></td> <td></td> <td colspan="8" style="text-align: center;"> <table border="1" style="width: 100%; border-collapse: collapse; text-align: center;"> <tr> </tr></table></td></tr></table>
 | | | | | | | | | | | | | | | | | | | | <table border="1" style="width: 100%; border-collapse: collapse; text-align: center;"> <tr> </tr></table>
 | | | | | | | | | | | | | | | | | | | |

 | | | | | | | | | | | | | | | | | | | | | | | | | | | | | | | | | | | | | | | | | | | | | | | | | | | | | | | | | | | | | | | | | | | | | | | | | | | | | | | | | | | | | | | | | | | | | | | | | | | |
 | | | | | | | | | | | | | | | | | | | |
 | | | | | | | | | | | | | | | | | | | |
 | | | | | | | | | | | | | | | | | | | |
 | | | | | | | | | | | | | | | | | | | |
 | | | | | | | | | | | | | | | | | | | |
 | | | | | | | | | | | | | | | | | | | |
 | | | | | | | | | | | | | | | | | | | |
 | | | | | | | | | | | | | | | | | | | |
 | | | | | | | | | | | | | | | | | | | | | | | | | | | | | | | | | | | | | | | |
 | | | | | | | | | | | | | | | | | | | |
 | | | | | | | | | | | | | | | | | | | | | | | | | | | | | | | | | | | | | | | |
 | | | | | | | | | | | | | | | | | | | | | | | | | | | | | | | | | | | | | | | |
 | | | | | | | | | | | | | | | | | | | | | | | | | | | | | | | | | | | | | | | |
 | | | | | | | | | | | | | | | | | | | | | | | | | | | | | | | | | | | | | | | | | | | | | | | | | | | | | | | | | | | | | | | | | | | | | | | | | | | | | | | | | | | | | | | | | | | | | | | | | | | |
 | | | | | | | | | | | | | | | | | | | | | | | | | | | | | | | | | | | | | | | | | | | | | | | |
| | |

 | | | | | | | | | | | | | | | | | | | |

 | | | | | | | | | | | | | | | | | | | |

 | | | | | | | | | | | | | | | | | | | |

 | | | | | | | | | | | | | | | | | | | |

 | | | | | | | | | | | | | | | | | | | |

 | | | | | | | | | | | | | | | | | | | |

 | | | | | | | | | | | | | | | | | | | |

 | | | | | | | | | | | | | | | | | | | |

 | | | | | | | | | | | | | | | | | | | |

 | | | | | | | | | | | | | | | | | | | |

 | | | | | | | | | | | | | | | | | | | |

 | | | | | | | | | | | | | | | | | | | |

 | | | | | | | | | | | | | | | | | | | |

 | | | | | | | | | | | | | | | | | | | |

 | | | | | | | | | | | | | | | | | | | |

 | | | | | | | | | | | | | | | | | | | |

 | | | | | | | | | | | | | | | | | | | |

 | | | | | | | | | | | | | | | | | | | |

 | | | | | | | | | | | | | | | | | | | |

 | | | | | | | | | | | | | | | | | | | |

 | | | | | | | | | | | | | | | | | | | |

 | | | | | | | | | | | | | | | | | | | |

 | | | | | | | | | | | | | | | | | | | |

 | | | | | | | | | | | | | | | | | | | |

 | | | | | | | | | | | | | | | | | | | |

 | | | | | | | | | | | | | | | | | | | |

 | | | | | | | | | | | | | | | | | | | |

 | | | | | | | | | | | | | | | | | | | |
 | | | | | | | | | | | | | | | | | | | |

 | | | | | | | | | | | | | | | | | | | |

 | | | | | | | | | | | | | | | | | | | |
 | | | | | | | | | | | | | | | | | | | |

 | | | | | | | | | | | | | | | | | | | |

 | | | | | | | | | | | | | | | | | | | |
 | | | | | | | | | | | | | | | | | | | |
 | | | | | | | | | | | | | | | | | | | |

 | | | | | | | | | | | | | | | | | | | |
 | | | | | | | | | | | | | | | | | | | |
 | | | | | | | | | | | | | | | | | | | |

 | | | | | | | | | | | | | | | | | | | | | | | | | | | | | | | | | | | | | | | | | | | | | | | | | | | | | | | | | | | | | | | | | | | | | | | | | | | | | | | | | | | | | | | | | | | | | | | | | | | |
 | | | | | | | | | | | | | | | | | | | |
 | | | | | | | | | | | | | | | | | | | |
 | | | | | | | | | | | | | | | | | | | |
 | | | | | | | | | | | | | | | | | | | |
 | | | | | | | | | | | | | | | | | | | |
 | | | | | | | | | | | | | | | | | | | |
 | | | | | | | | | | | | | | | | | | | |
 | | | | | | | | | | | | | | | | | | | |
 | | | | | | | | | | | | | | | | | | | | | | | | | | | | | | | | | | | | | | | |
 | | | | | | | | | | | | | | | | | | | |
 | | | | | | | | | | | | | | | | | | | | | | | | | | | | | | | | | | | | | | | |
 | | | | | | | | | | | | | | | | | | | | | | | | | | | | | | | | | | | | | | | |
 | | | | | | | | | | | | | | | | | | | | | | | | | | | | | | | | | | | | | | | |
 | | | | | | | | | | | | | | | | | | | | | | | | | | | | | | | | | | | | | | | | | | | | | | | | | | | | | | | | | | | | | | | | | | | | | | | | | | | | | | | | | | | | | | | | | | | | | | | | | | | |
 | | | | | | | | | | | | | | | | | | | | | | | | | | | | | | | | | | | | | | | | | | | | | | | |
| | | <table border="1" style="width: 100%; border-collapse: collapse; text-align: center;"> <tr> <td style="width: 10%;"></td> <td style="width: 10%;"></td> <td style="width: 10%;"></td> <td style="width: 10%;"></td> <td style="width: 10%;"></td> <td style="width: 10%;"></td> <td style="width: 10%;"></td> <td style="width: 10%;"></td> <td style="width: 10%;"></td> <td style="width: 10%;"></td> </tr> <tr> <td></td> <td></td> <td colspan="8" style="text-align: center;"> <table border="1" style="width: 100%; border-collapse: collapse; text-align: center;"> <tr> <td style="width: 10%;"></td> <td style="width: 10%;"></td> <td style="width: 10%;"></td> <td style="width: 10%;"></td> <td style="width: 10%;"></td> <td style="width: 10%;"></td> <td style="width: 10%;"></td> <td style="width: 10%;"></td> <td style="width: 10%;"></td> <td style="width: 10%;"></td> </tr> <tr> <td></td> <td></td> <td colspan="8" style="text-align: center;"> <table border="1" style="width: 100%; border-collapse: collapse; text-align: center;"> <tr> <td style="width: 10%;"></td> <td style="width: 10%;"></td> <td style="width: 10%;"></td> <td style="width: 10%;"></td> <td style="width: 10%;"></td> <td style="width: 10%;"></td> <td style="width: 10%;"></td> <td style="width: 10%;"></td> <td style="width: 10%;"></td> <td style="width: 10%;"></td> </tr> <tr> <td></td> <td></td> <td colspan="8" style="text-align: center;"> <table border="1" style="width: 100%; border-collapse: collapse; text-align: center;"> <tr> <td style="width: 10%;"></td> <td style="width: 10%;"></td> <td style="width: 10%;"></td> <td style="width: 10%;"></td> <td style="width: 10%;"></td> <td style="width: 10%;"></td> <td style="width: 10%;"></td> <td style="width: 10%;"></td> <td style="width: 10%;"></td> <td style="width: 10%;"></td> </tr> <tr> <td></td> <td></td> <td colspan="8" style="text-align: center;"> <table border="1" style="width: 100%; border-collapse: collapse; text-align: center;"> <tr> <td style="width: 10%;"></td> <td style="width: 10%;"></td> <td style="width: 10%;"></td> <td style="width: 10%;"></td> <td style="width: 10%;"></td> <td style="width: 10%;"></td> <td style="width: 10%;"></td> <td style="width: 10%;"></td> <td style="width: 10%;"></td> <td style="width: 10%;"></td> </tr> <tr> <td></td> <td></td> <td colspan="8" style="text-align: center;"> <table border="1" style="width: 100%; border-collapse: collapse; text-align: center;"> <tr> <td style="width: 10%;"></td> <td style="width: 10%;"></td> <td style="width: 10%;"></td> <td style="width: 10%;"></td> <td style="width: 10%;"></td> <td style="width: 10%;"></td> <td style="width: 10%;"></td> <td style="width: 10%;"></td> <td style="width: 10%;"></td> <td style="width: 10%;"></td> </tr> <tr> <td></td> <td></td> <td colspan="8" style="text-align: center;"> <table border="1" style="width: 100%; border-collapse: collapse; text-align: center;"> <tr> <td style="width: 10%;"></td> <td style="width: 10%;"></td> <td style="width: 10%;"></td> <td style="width: 10%;"></td> <td style="width: 10%;"></td> <td style="width: 10%;"></td> <td style="width: 10%;"></td> <td style="width: 10%;"></td> <td style="width: 10%;"></td> <td style="width: 10%;"></td> </tr> <tr> <td></td> <td></td> <td colspan="8" style="text-align: center;"> <table border="1" style="width: 100%; border-collapse: collapse; text-align: center;"> <tr> <td style="width: 10%;"></td> <td style="width: 10%;"></td> <td style="width: 10%;"></td> <td style="width: 10%;"></td> <td style="width: 10%;"></td> <td style="width: 10%;"></td> <td style="width: 10%;"></td> <td style="width: 10%;"></td> <td style="width: 10%;"></td> <td style="width: 10%;"></td> </tr> <tr> <td></td> <td></td> <td colspan="8" style="text-align: center;"> <table border="1" style="width: 100%; border-collapse: collapse; text-align: center;"> <tr> <td style="width: 10%;"></td> <td style="width: 10%;"></td> <td style="width: 10%;"></td> <td style="width: 10%;"></td> <td style="width: 10%;"></td> <td style="width: 10%;"></td> <td style="width: 10%;"></td> <td style="width: 10%;"></td> <td style="width: 10%;"></td> <td style="width: 10%;"></td> </tr> <tr> <td></td> <td></td> <td colspan="8" style="text-align: center;"> <table border="1" style="width: 100%; border-collapse: collapse; text-align: center;"> <tr> <td style="width: 10%;"></td> <td style="width: 10%;"></td> <td style="width: 10%;"></td> <td style="width: 10%;"></td> <td style="width: 10%;"></td> <td style="width: 10%;"></td> <td style="width: 10%;"></td> <td style="width: 10%;"></td> <td style="width: 10%;"></td> <td style="width: 10%;"></td> </tr> <tr> <td></td> <td></td> <td colspan="8" style="text-align: center;"> <table border="1" style="width: 100%; border-collapse: collapse; text-align: center;"> <tr> <td style="width: 10%;"></td> <td style="width: 10%;"></td> <td style="width: 10%;"></td> <td style="width: 10%;"></td> <td style="width: 10%;"></td> <td style="width: 10%;"></td> <td style="width: 10%;"></td> <td style="width: 10%;"></td> <td style="width: 10%;"></td> <td style="width: 10%;"></td> </tr> <tr> <td></td> <td></td> <td colspan="8" style="text-align: center;"> <table border="1" style="width: 100%; border-collapse: collapse; text-align: center;"> <tr> <td style="width: 10%;"></td> <td style="width: 10%;"></td> <td style="width: 10%;"></td> <td style="width: 10%;"></td> <td style="width: 10%;"></td> <td style="width: 10%;"></td> <td style="width: 10%;"></td> <td style="width: 10%;"></td> <td style="width: 10%;"></td> <td style="width: 10%;"></td> </tr> <tr> <td></td> <td></td> <td colspan="8" style="text-align: center;"> <table border="1" style="width: 100%; border-collapse: collapse; text-align: center;"> <tr> <td style="width: 10%;"></td> <td style="width: 10%;"></td> <td style="width: 10%;"></td> <td style="width: 10%;"></td> <td style="width: 10%;"></td> <td style="width: 10%;"></td> <td style="width: 10%;"></td> <td style="width: 10%;"></td> <td style="width: 10%;"></td> <td style="width: 10%;"></td> </tr> <tr> <td></td> <td></td> <td colspan="8" style="text-align: center;"> <table border="1" style="width: 100%; border-collapse: collapse; text-align: center;"> <tr> <td style="width: 10%;"></td> <td style="width: 10%;"></td> <td style="width: 10%;"></td> <td style="width: 10%;"></td> <td style="width: 10%;"></td> <td style="width: 10%;"></td> <td style="width: 10%;"></td> <td style="width: 10%;"></td> <td style="width: 10%;"></td> <td style="width: 10%;"></td> </tr> <tr> <td></td> <td></td> <td colspan="8" style="text-align: center;"> <table border="1" style="width: 100%; border-collapse: collapse; text-align: center;"> <tr> <td style="width: 10%;"></td> <td style="width: 10%;"></td> <td style="width: 10%;"></td> <td style="width: 10%;"></td> <td style="width: 10%;"></td> <td style="width: 10%;"></td> <td style="width: 10%;"></td> <td style="width: 10%;"></td> <td style="width: 10%;"></td> <td style="width: 10%;"></td> </tr> <tr> <td></td> <td></td> <td colspan="8" style="text-align: center;"> <table border="1" style="width: 100%; border-collapse: collapse; text-align: center;"> <tr> <td style="width: 10%;"></td> <td style="width: 10%;"></td> <td style="width: 10%;"></td> <td style="width: 10%;"></td> <td style="width: 10%;"></td> <td style="width: 10%;"></td> <td style="width: 10%;"></td> <td style="width: 10%;"></td> <td style="width: 10%;"></td> <td style="width: 10%;"></td> </tr> <tr> <td></td> <td></td> <td colspan="8" style="text-align: center;"> <table border="1" style="width: 100%; border-collapse: collapse; text-align: center;"> <tr> <td style="width: 10%;"></td> <td style="width: 10%;"></td> <td style="width: 10%;"></td> <td style="width: 10%;"></td> <td style="width: 10%;"></td> <td style="width: 10%;"></td> <td style="width: 10%;"></td> <td style="width: 10%;"></td> <td style="width: 10%;"></td> <td style="width: 10%;"></td> </tr> <tr> <td></td> <td></td> <td colspan="8" style="text-align: center;"> <table border="1" style="width: 100%; border-collapse: collapse; text-align: center;"> <tr> <td style="width: 10%;"></td> <td style="width: 10%;"></td> <td style="width: 10%;"></td> <td style="width: 10%;"></td> <td style="width: 10%;"></td> <td style="width: 10%;"></td> <td style="width: 10%;"></td> <td style="width: 10%;"></td> <td style="width: 10%;"></td> <td style="width: 10%;"></td> </tr> <tr> <td></td> <td></td> <td colspan="8" style="text-align: center;"> <table border="1" style="width: 100%; border-collapse: collapse; text-align: center;"> <tr> <td style="width: 10%;"></td> <td style="width: 10%;"></td> <td style="width: 10%;"></td> <td style="width: 10%;"></td> <td style="width: 10%;"></td> <td style="width: 10%;"></td> <td style="width: 10%;"></td> <td style="width: 10%;"></td> <td style="width: 10%;"></td> <td style="width: 10%;"></td> </tr> <tr> <td></td> <td></td> <td colspan="8" style="text-align: center;"> <table border="1" style="width: 100%; border-collapse: collapse; text-align: center;"> <tr> <td style="width: 10%;"></td> <td style="width: 10%;"></td> <td style="width: 10%;"></td> <td style="width: 10%;"></td> <td style="width: 10%;"></td> <td style="width: 10%;"></td> <td style="width: 10%;"></td> <td style="width: 10%;"></td> <td style="width: 10%;"></td> <td style="width: 10%;"></td> </tr> <tr> <td></td> <td></td> <td colspan="8" style="text-align: center;"> <table border="1" style="width: 100%; border-collapse: collapse; text-align: center;"> <tr> <td style="width: 10%;"></td> <td style="width: 10%;"></td> <td style="width: 10%;"></td> <td style="width: 10%;"></td> <td style="width: 10%;"></td> <td style="width: 10%;"></td> <td style="width: 10%;"></td> <td style="width: 10%;"></td> <td style="width: 10%;"></td> <td style="width: 10%;"></td> </tr> <tr> <td></td> <td></td> <td colspan="8" style="text-align: center;"> <table border="1" style="width: 100%; border-collapse: collapse; text-align: center;"> <tr> <td style="width: 10%;"></td> <td style="width: 10%;"></td> <td
style="width: 10%;"></td> <td style="width: 10%;"></td> <td style="width: 10%;"></td> <td style="width: 10%;"></td> <td style="width: 10%;"></td> <td style="width: 10%;"></td> <td style="width: 10%;"></td> <td style="width: 10%;"></td> </tr> <tr> <td></td> <td></td> <td colspan="8" style="text-align: center;"> <table border="1" style="width: 100%; border-collapse: collapse; text-align: center;"> <tr> <td style="width: 10%;"></td> <td style="width: 10%;"></td> <td style="width: 10%;"></td> <td style="width: 10%;"></td> <td style="width: 10%;"></td> <td style="width: 10%;"></td> <td style="width: 10%;"></td> <td style="width: 10%;"></td> <td style="width: 10%;"></td> <td style="width: 10%;"></td> </tr> <tr> <td></td> <td></td> <td colspan="8" style="text-align: center;"> <table border="1" style="width: 100%; border-collapse: collapse; text-align: center;"> <tr> <td style="width: 10%;"></td> <td style="width: 10%;"></td> <td style="width: 10%;"></td> <td style="width: 10%;"></td> <td style="width: 10%;"></td> <td style="width: 10%;"></td> <td style="width: 10%;"></td> <td style="width: 10%;"></td> <td style="width: 10%;"></td> <td style="width: 10%;"></td> </tr> <tr> <td></td> <td></td> <td colspan="8" style="text-align: center;"> <table border="1" style="width: 100%; border-collapse: collapse; text-align: center;"> <tr> <td style="width: 10%;"></td> <td style="width: 10%;"></td> <td style="width: 10%;"></td> <td style="width: 10%;"></td> <td style="width: 10%;"></td> <td style="width: 10%;"></td> <td style="width: 10%;"></td> <td style="width: 10%;"></td> <td style="width: 10%;"></td> <td style="width: 10%;"></td> </tr> <tr> <td></td> <td></td> <td colspan="8" style="text-align: center;"> <table border="1" style="width: 100%; border-collapse: collapse; text-align: center;"> <tr> <td style="width: 10%;"></td> <td style="width: 10%;"></td> <td style="width: 10%;"></td> <td style="width: 10%;"></td> <td style="width: 10%;"></td> <td style="width: 10%;"></td> <td style="width: 10%;"></td> <td style="width: 10%;"></td> <td style="width: 10%;"></td> <td style="width: 10%;"></td> </tr> <tr> <td></td> <td></td> <td colspan="8" style="text-align: center;"> <table border="1" style="width: 100%; border-collapse: collapse; text-align: center;"> <tr> <td style="width: 10%;"></td> <td style="width: 10%;"></td> <td style="width: 10%;"></td> <td style="width: 10%;"></td> <td style="width: 10%;"></td> <td style="width: 10%;"></td> <td style="width: 10%;"></td> <td style="width: 10%;"></td> <td style="width: 10%;"></td> <td style="width: 10%;"></td> </tr> <tr> <td></td> <td></td> <td colspan="8" style="text-align: center;"> <table border="1" style="width: 100%; border-collapse: collapse; text-align: center;"> <tr> <td style="width: 10%;"></td> <td style="width: 10%;"></td> <td style="width: 10%;"></td> <td style="width: 10%;"></td> <td style="width: 10%;"></td> <td style="width: 10%;"></td> <td style="width: 10%;"></td> <td style="width: 10%;"></td> <td style="width: 10%;"></td> <td style="width: 10%;"></td> </tr> <tr> <td></td> <td></td> <td colspan="8" style="text-align: center;"> <table border="1" style="width: 100%; border-collapse: collapse; text-align: center;"> <tr> <td style="width: 10%;"></td> <td style="width: 10%;"></td> <td style="width: 10%;"></td> <td style="width: 10%;"></td> <td style="width: 10%;"></td> <td style="width: 10%;"></td> <td style="width: 10%;"></td> <td style="width: 10%;"></td> <td style="width: 10%;"></td> <td style="width: 10%;"></td> </tr> <tr> <td></td> <td></td> <td colspan="8" style="text-align: center;"> <table border="1" style="width: 100%; border-collapse: collapse; text-align: center;"> <tr> <td style="width: 10%;"></td> <td style="width: 10%;"></td> <td style="width: 10%;"></td> <td style="width: 10%;"></td> <td style="width: 10%;"></td> <td style="width: 10%;"></td> <td style="width: 10%;"></td> <td style="width: 10%;"></td> <td style="width: 10%;"></td> <td style="width: 10%;"></td> </tr> <tr> <td></td> <td></td> <td colspan="8" style="text-align: center;"> <table border="1" style="width: 100%; border-collapse: collapse; text-align: center;"> <tr> <td style="width: 10%;"></td> <td style="width: 10%;"></td> <td style="width: 10%;"></td> <td style="width: 10%;"></td> <td style="width: 10%;"></td> <td style="width: 10%;"></td> <td style="width: 10%;"></td> <td style="width: 10%;"></td> <td style="width: 10%;"></td> <td style="width: 10%;"></td> </tr> <tr> <td></td> <td></td> <td colspan="8" style="text-align: center;"> <table border="1" style="width: 100%; border-collapse: collapse; text-align: center;"> <tr> <td style="width: 10%;"></td> <td style="width: 10%;"></td> <td style="width: 10%;"></td> <td style="width: 10%;"></td> <td style="width: 10%;"></td> <td style="width: 10%;"></td> <td style="width: 10%;"></td> <td style="width: 10%;"></td> <td style="width: 10%;"></td> <td style="width: 10%;"></td> </tr> <tr> <td></td> <td></td> <td colspan="8" style="text-align: center;"> <table border="1" style="width: 100%; border-collapse: collapse; text-align: center;"> <tr> <td style="width: 10%;"></td> <td style="width: 10%;"></td> <td style="width: 10%;"></td> <td style="width: 10%;"></td> <td style="width: 10%;"></td> <td style="width: 10%;"></td> <td style="width: 10%;"></td> <td style="width: 10%;"></td> <td style="width: 10%;"></td> <td style="width: 10%;"></td> </tr> <tr> <td></td> <td></td> <td colspan="8" style="text-align: center;"> <table border="1" style="width: 100%; border-collapse: collapse; text-align: center;"> <tr> <td style="width: 10%;"></td> <td style="width: 10%;"></td> <td style="width: 10%;"></td> <td style="width: 10%;"></td> <td style="width: 10%;"></td> <td style="width: 10%;"></td> <td style="width: 10%;"></td> <td style="width: 10%;"></td> <td style="width: 10%;"></td> <td style="width: 10%;"></td> </tr> <tr> <td></td> <td></td> <td colspan="8" style="text-align: center;"> <table border="1" style="width: 100%; border-collapse: collapse; text-align: center;"> <tr> <td style="width: 10%;"></td> <td style="width: 10%;"></td> <td style="width: 10%;"></td> <td style="width: 10%;"></td> <td style="width: 10%;"></td> <td style="width: 10%;"></td> <td style="width: 10%;"></td> <td style="width: 10%;"></td> <td style="width: 10%;"></td> <td style="width: 10%;"></td> </tr> <tr> <td></td> <td></td> <td colspan="8" style="text-align: center;"> <table border="1" style="width: 100%; border-collapse: collapse; text-align: center;"> <tr> <td style="width: 10%;"></td> <td style="width: 10%;"></td> <td style="width: 10%;"></td> <td style="width: 10%;"></td> <td style="width: 10%;"></td> <td style="width: 10%;"></td> <td style="width: 10%;"></td> <td style="width: 10%;"></td> <td style="width: 10%;"></td> <td style="width: 10%;"></td> </tr> <tr> <td></td> <td></td> <td colspan="8" style="text-align: center;"> <table border="1" style="width: 100%; border-collapse: collapse; text-align: center;"> <tr> <td style="width: 10%;"></td> <td style="width: 10%;"></td> <td style="width: 10%;"></td> <td style="width: 10%;"></td> <td style="width: 10%;"></td> <td style="width: 10%;"></td> <td style="width: 10%;"></td> <td style="width: 10%;"></td> <td style="width: 10%;"></td> <td style="width: 10%;"></td> </tr> <tr> <td></td> <td></td> <td colspan="8" style="text-align: center;"> <table border="1" style="width: 100%; border-collapse: collapse; text-align: center;"> <tr> </tr></table></td></tr></table></td></tr></table></td></tr></table></td></tr></table></td></tr></table></td></tr></table></td></tr></table></td></tr></table></td></tr></table></td></tr></table></td></tr></table></td></tr></table></td></tr></table></td></tr></table></td></tr></table></td></tr></table></td></tr></table></td></tr></table></td></tr></table></td></tr></table></td></tr></table></td></tr></table></td></tr></table></td></tr></table></td></tr></table></td></tr></table></td></tr></table></td></tr></table></td></tr></table></td></tr></table></td></tr></table></td></tr></table></td></tr></table></td></tr></table></td></tr></table></td></tr></table></td></tr></table>

 | | | | | | | | | | | | | | | | | | | | <table border="1" style="width: 100%; border-collapse: collapse; text-align: center;"> <tr> <td style="width: 10%;"></td> <td style="width: 10%;"></td> <td style="width: 10%;"></td> <td style="width: 10%;"></td> <td style="width: 10%;"></td> <td style="width: 10%;"></td> <td style="width: 10%;"></td> <td style="width: 10%;"></td> <td style="width: 10%;"></td> <td style="width: 10%;"></td> </tr> <tr> <td></td> <td></td> <td colspan="8" style="text-align: center;"> <table border="1" style="width: 100%; border-collapse: collapse; text-align: center;"> <tr> <td style="width: 10%;"></td> <td style="width: 10%;"></td> <td style="width: 10%;"></td> <td style="width: 10%;"></td> <td style="width: 10%;"></td> <td style="width: 10%;"></td> <td style="width: 10%;"></td> <td style="width: 10%;"></td> <td style="width: 10%;"></td> <td style="width: 10%;"></td> </tr> <tr> <td></td> <td></td> <td colspan="8" style="text-align: center;"> <table border="1" style="width: 100%; border-collapse: collapse; text-align: center;"> <tr> <td style="width: 10%;"></td> <td style="width: 10%;"></td> <td style="width: 10%;"></td> <td style="width: 10%;"></td> <td style="width: 10%;"></td> <td style="width: 10%;"></td> <td style="width: 10%;"></td> <td style="width: 10%;"></td> <td style="width: 10%;"></td> <td style="width: 10%;"></td> </tr> <tr> <td></td> <td></td> <td colspan="8" style="text-align: center;"> <table border="1" style="width: 100%; border-collapse: collapse; text-align: center;"> <tr> <td style="width: 10%;"></td> <td style="width: 10%;"></td> <td style="width: 10%;"></td> <td style="width: 10%;"></td> <td style="width: 10%;"></td> <td style="width: 10%;"></td> <td style="width: 10%;"></td> <td style="width: 10%;"></td> <td style="width: 10%;"></td> <td style="width: 10%;"></td> </tr> <tr> <td></td> <td></td> <td colspan="8" style="text-align: center;"> <table border="1" style="width: 100%; border-collapse: collapse; text-align: center;"> <tr> <td style="width: 10%;"></td> <td style="width: 10%;"></td> <td style="width: 10%;"></td> <td style="width: 10%;"></td> <td style="width: 10%;"></td> <td style="width: 10%;"></td> <td style="width: 10%;"></td> <td style="width: 10%;"></td> <td style="width: 10%;"></td> <td style="width: 10%;"></td> </tr> <tr> <td></td> <td></td> <td colspan="8" style="text-align: center;"> <table border="1" style="width: 100%; border-collapse: collapse; text-align: center;"> <tr> <td style="width: 10%;"></td> <td style="width: 10%;"></td> <td style="width: 10%;"></td> <td style="width: 10%;"></td> <td style="width: 10%;"></td> <td style="width: 10%;"></td> <td style="width: 10%;"></td> <td style="width: 10%;"></td> <td style="width: 10%;"></td> <td style="width: 10%;"></td> </tr> <tr> <td></td> <td></td> <td colspan="8" style="text-align: center;"> <table border="1" style="width: 100%; border-collapse: collapse; text-align: center;"> <tr> <td style="width: 10%;"></td> <td style="width: 10%;"></td> <td style="width: 10%;"></td> <td style="width: 10%;"></td> <td style="width: 10%;"></td> <td style="width: 10%;"></td> <td style="width: 10%;"></td> <td style="width: 10%;"></td> <td style="width: 10%;"></td> <td style="width: 10%;"></td> </tr> <tr> <td></td> <td></td> <td colspan="8" style="text-align: center;"> <table border="1" style="width: 100%; border-collapse: collapse; text-align: center;"> <tr> <td style="width: 10%;"></td> <td style="width: 10%;"></td> <td style="width: 10%;"></td> <td style="width: 10%;"></td> <td style="width: 10%;"></td> <td style="width: 10%;"></td> <td style="width: 10%;"></td> <td style="width: 10%;"></td> <td style="width: 10%;"></td> <td style="width: 10%;"></td> </tr> <tr> <td></td> <td></td> <td colspan="8" style="text-align: center;"> <table border="1" style="width: 100%; border-collapse: collapse; text-align: center;"> <tr> <td style="width: 10%;"></td> <td style="width: 10%;"></td> <td style="width: 10%;"></td> <td style="width: 10%;"></td> <td style="width: 10%;"></td> <td style="width: 10%;"></td> <td style="width: 10%;"></td> <td style="width: 10%;"></td> <td style="width: 10%;"></td> <td style="width: 10%;"></td> </tr> <tr> <td></td> <td></td> <td colspan="8" style="text-align: center;"> <table border="1" style="width: 100%; border-collapse: collapse; text-align: center;"> <tr> <td style="width: 10%;"></td> <td style="width: 10%;"></td> <td style="width: 10%;"></td> <td style="width: 10%;"></td> <td style="width: 10%;"></td> <td style="width: 10%;"></td> <td style="width: 10%;"></td> <td style="width: 10%;"></td> <td style="width: 10%;"></td> <td style="width: 10%;"></td> </tr> <tr> <td></td> <td></td> <td colspan="8" style="text-align: center;"> <table border="1" style="width: 100%; border-collapse: collapse; text-align: center;"> <tr> <td style="width: 10%;"></td> <td style="width: 10%;"></td> <td style="width: 10%;"></td> <td style="width: 10%;"></td> <td style="width: 10%;"></td> <td style="width: 10%;"></td> <td style="width: 10%;"></td> <td style="width: 10%;"></td> <td style="width: 10%;"></td> <td style="width: 10%;"></td> </tr> <tr> <td></td> <td></td> <td colspan="8" style="text-align: center;"> <table border="1" style="width: 100%; border-collapse: collapse; text-align: center;"> <tr> <td style="width: 10%;"></td> <td style="width: 10%;"></td> <td style="width: 10%;"></td> <td style="width: 10%;"></td> <td style="width: 10%;"></td> <td style="width: 10%;"></td> <td style="width: 10%;"></td> <td style="width: 10%;"></td> <td style="width: 10%;"></td> <td style="width: 10%;"></td> </tr> <tr> <td></td> <td></td> <td colspan="8" style="text-align: center;"> <table border="1" style="width: 100%; border-collapse: collapse; text-align: center;"> <tr> <td style="width: 10%;"></td> <td style="width: 10%;"></td> <td style="width: 10%;"></td> <td style="width: 10%;"></td> <td style="width: 10%;"></td> <td style="width: 10%;"></td> <td style="width: 10%;"></td> <td style="width: 10%;"></td> <td style="width: 10%;"></td> <td style="width: 10%;"></td> </tr> <tr> <td></td> <td></td> <td colspan="8" style="text-align: center;"> <table border="1" style="width: 100%; border-collapse: collapse; text-align: center;"> <tr> <td style="width: 10%;"></td> <td style="width: 10%;"></td> <td style="width: 10%;"></td> <td style="width: 10%;"></td> <td style="width: 10%;"></td> <td style="width: 10%;"></td> <td style="width: 10%;"></td> <td style="width: 10%;"></td> <td style="width: 10%;"></td> <td style="width: 10%;"></td> </tr> <tr> <td></td> <td></td> <td colspan="8" style="text-align: center;"> <table border="1" style="width: 100%; border-collapse: collapse; text-align: center;"> <tr> <td style="width: 10%;"></td> <td style="width: 10%;"></td> <td style="width: 10%;"></td> <td style="width: 10%;"></td> <td style="width: 10%;"></td> <td style="width: 10%;"></td> <td style="width: 10%;"></td> <td style="width: 10%;"></td> <td style="width: 10%;"></td> <td style="width: 10%;"></td> </tr> <tr> <td></td> <td></td> <td colspan="8" style="text-align: center;"> <table border="1" style="width: 100%; border-collapse: collapse; text-align: center;"> <tr> <td style="width: 10%;"></td> <td style="width: 10%;"></td> <td style="width: 10%;"></td> <td style="width: 10%;"></td> <td style="width: 10%;"></td> <td style="width: 10%;"></td> <td style="width: 10%;"></td> <td style="width: 10%;"></td> <td style="width: 10%;"></td> <td style="width: 10%;"></td> </tr> <tr> <td></td> <td></td> <td colspan="8" style="text-align: center;"> <table border="1" style="width: 100%; border-collapse: collapse; text-align: center;"> <tr> <td style="width: 10%;"></td> <td style="width: 10%;"></td> <td style="width: 10%;"></td> <td style="width: 10%;"></td> <td style="width: 10%;"></td> <td style="width: 10%;"></td> <td style="width: 10%;"></td> <td style="width: 10%;"></td> <td style="width: 10%;"></td> <td style="width: 10%;"></td> </tr> <tr> <td></td> <td></td> <td colspan="8" style="text-align: center;"> <table border="1" style="width: 100%; border-collapse: collapse; text-align: center;"> <tr> <td style="width: 10%;"></td> <td style="width: 10%;"></td> <td style="width: 10%;"></td> <td style="width: 10%;"></td> <td style="width: 10%;"></td> <td style="width: 10%;"></td> <td style="width: 10%;"></td> <td style="width: 10%;"></td> <td style="width: 10%;"></td> <td style="width: 10%;"></td> </tr> <tr> <td></td> <td></td> <td colspan="8" style="text-align: center;"> <table border="1" style="width: 100%; border-collapse: collapse; text-align: center;"> <tr> <td style="width: 10%;"></td> <td style="width: 10%;"></td> <td style="width: 10%;"></td> <td style="width: 10%;"></td> <td style="width: 10%;"></td> <td style="width: 10%;"></td> <td
style="width: 10%;"></td> <td style="width: 10%;"></td> <td style="width: 10%;"></td> <td style="width: 10%;"></td> </tr> <tr> <td></td> <td></td> <td colspan="8" style="text-align: center;"> <table border="1" style="width: 100%; border-collapse: collapse; text-align: center;"> <tr> <td style="width: 10%;"></td> <td style="width: 10%;"></td> <td style="width: 10%;"></td> <td style="width: 10%;"></td> <td style="width: 10%;"></td> <td style="width: 10%;"></td> <td style="width: 10%;"></td> <td style="width: 10%;"></td> <td style="width: 10%;"></td> <td style="width: 10%;"></td> </tr> <tr> <td></td> <td></td> <td colspan="8" style="text-align: center;"> <table border="1" style="width: 100%; border-collapse: collapse; text-align: center;"> <tr> <td style="width: 10%;"></td> <td style="width: 10%;"></td> <td style="width: 10%;"></td> <td style="width: 10%;"></td> <td style="width: 10%;"></td> <td style="width: 10%;"></td> <td style="width: 10%;"></td> <td style="width: 10%;"></td> <td style="width: 10%;"></td> <td style="width: 10%;"></td> </tr> <tr> <td></td> <td></td> <td colspan="8" style="text-align: center;"> <table border="1" style="width: 100%; border-collapse: collapse; text-align: center;"> <tr> <td style="width: 10%;"></td> <td style="width: 10%;"></td> <td style="width: 10%;"></td> <td style="width: 10%;"></td> <td style="width: 10%;"></td> <td style="width: 10%;"></td> <td style="width: 10%;"></td> <td style="width: 10%;"></td> <td style="width: 10%;"></td> <td style="width: 10%;"></td> </tr> <tr> <td></td> <td></td> <td colspan="8" style="text-align: center;"> <table border="1" style="width: 100%; border-collapse: collapse; text-align: center;"> <tr> <td style="width: 10%;"></td> <td style="width: 10%;"></td> <td style="width: 10%;"></td> <td style="width: 10%;"></td> <td style="width: 10%;"></td> <td style="width: 10%;"></td> <td style="width: 10%;"></td> <td style="width: 10%;"></td> <td style="width: 10%;"></td> <td style="width: 10%;"></td> </tr> <tr> <td></td> <td></td> <td colspan="8" style="text-align: center;"> <table border="1" style="width: 100%; border-collapse: collapse; text-align: center;"> <tr> <td style="width: 10%;"></td> <td style="width: 10%;"></td> <td style="width: 10%;"></td> <td style="width: 10%;"></td> <td style="width: 10%;"></td> <td style="width: 10%;"></td> <td style="width: 10%;"></td> <td style="width: 10%;"></td> <td style="width: 10%;"></td> <td style="width: 10%;"></td> </tr> <tr> <td></td> <td></td> <td colspan="8" style="text-align: center;"> <table border="1" style="width: 100%; border-collapse: collapse; text-align: center;"> <tr> <td style="width: 10%;"></td> <td style="width: 10%;"></td> <td style="width: 10%;"></td> <td style="width: 10%;"></td> <td style="width: 10%;"></td> <td style="width: 10%;"></td> <td style="width: 10%;"></td> <td style="width: 10%;"></td> <td style="width: 10%;"></td> <td style="width: 10%;"></td> </tr> <tr> <td></td> <td></td> <td colspan="8" style="text-align: center;"> <table border="1" style="width: 100%; border-collapse: collapse; text-align: center;"> <tr> <td style="width: 10%;"></td> <td style="width: 10%;"></td> <td style="width: 10%;"></td> <td style="width: 10%;"></td> <td style="width: 10%;"></td> <td style="width: 10%;"></td> <td style="width: 10%;"></td> <td style="width: 10%;"></td> <td style="width: 10%;"></td> <td style="width: 10%;"></td> </tr> <tr> <td></td> <td></td> <td colspan="8" style="text-align: center;"> <table border="1" style="width: 100%; border-collapse: collapse; text-align: center;"> <tr> <td style="width: 10%;"></td> <td style="width: 10%;"></td> <td style="width: 10%;"></td> <td style="width: 10%;"></td> <td style="width: 10%;"></td> <td style="width: 10%;"></td> <td style="width: 10%;"></td> <td style="width: 10%;"></td> <td style="width: 10%;"></td> <td style="width: 10%;"></td> </tr> <tr> <td></td> <td></td> <td colspan="8" style="text-align: center;"> <table border="1" style="width: 100%; border-collapse: collapse; text-align: center;"> <tr> <td style="width: 10%;"></td> <td style="width: 10%;"></td> <td style="width: 10%;"></td> <td style="width: 10%;"></td> <td style="width: 10%;"></td> <td style="width: 10%;"></td> <td style="width: 10%;"></td> <td style="width: 10%;"></td> <td style="width: 10%;"></td> <td style="width: 10%;"></td> </tr> <tr> <td></td> <td></td> <td colspan="8" style="text-align: center;"> <table border="1" style="width: 100%; border-collapse: collapse; text-align: center;"> <tr> <td style="width: 10%;"></td> <td style="width: 10%;"></td> <td style="width: 10%;"></td> <td style="width: 10%;"></td> <td style="width: 10%;"></td> <td style="width: 10%;"></td> <td style="width: 10%;"></td> <td style="width: 10%;"></td> <td style="width: 10%;"></td> <td style="width: 10%;"></td> </tr> <tr> <td></td> <td></td> <td colspan="8" style="text-align: center;"> <table border="1" style="width: 100%; border-collapse: collapse; text-align: center;"> <tr> <td style="width: 10%;"></td> <td style="width: 10%;"></td> <td style="width: 10%;"></td> <td style="width: 10%;"></td> <td style="width: 10%;"></td> <td style="width: 10%;"></td> <td style="width: 10%;"></td> <td style="width: 10%;"></td> <td style="width: 10%;"></td> <td style="width: 10%;"></td> </tr> <tr> <td></td> <td></td> <td colspan="8" style="text-align: center;"> <table border="1" style="width: 100%; border-collapse: collapse; text-align: center;"> <tr> <td style="width: 10%;"></td> <td style="width: 10%;"></td> <td style="width: 10%;"></td> <td style="width: 10%;"></td> <td style="width: 10%;"></td> <td style="width: 10%;"></td> <td style="width: 10%;"></td> <td style="width: 10%;"></td> <td style="width: 10%;"></td> <td style="width: 10%;"></td> </tr> <tr> <td></td> <td></td> <td colspan="8" style="text-align: center;"> <table border="1" style="width: 100%; border-collapse: collapse; text-align: center;"> <tr> <td style="width: 10%;"></td> <td style="width: 10%;"></td> <td style="width: 10%;"></td> <td style="width: 10%;"></td> <td style="width: 10%;"></td> <td style="width: 10%;"></td> <td style="width: 10%;"></td> <td style="width: 10%;"></td> <td style="width: 10%;"></td> <td style="width: 10%;"></td> </tr> <tr> <td></td> <td></td> <td colspan="8" style="text-align: center;"> <table border="1" style="width: 100%; border-collapse: collapse; text-align: center;"> <tr> <td style="width: 10%;"></td> <td style="width: 10%;"></td> <td style="width: 10%;"></td> <td style="width: 10%;"></td> <td style="width: 10%;"></td> <td style="width: 10%;"></td> <td style="width: 10%;"></td> <td style="width: 10%;"></td> <td style="width: 10%;"></td> <td style="width: 10%;"></td> </tr> <tr> <td></td> <td></td> <td colspan="8" style="text-align: center;"> <table border="1" style="width: 100%; border-collapse: collapse; text-align: center;"> <tr> <td style="width: 10%;"></td> <td style="width: 10%;"></td> <td style="width: 10%;"></td> <td style="width: 10%;"></td> <td style="width: 10%;"></td> <td style="width: 10%;"></td> <td style="width: 10%;"></td> <td style="width: 10%;"></td> <td style="width: 10%;"></td> <td style="width: 10%;"></td> </tr> <tr> <td></td> <td></td> <td colspan="8" style="text-align: center;"> <table border="1" style="width: 100%; border-collapse: collapse; text-align: center;"> <tr> <td style="width: 10%;"></td> <td style="width: 10%;"></td> <td style="width: 10%;"></td> <td style="width: 10%;"></td> <td style="width: 10%;"></td> <td style="width: 10%;"></td> <td style="width: 10%;"></td> <td style="width: 10%;"></td> <td style="width: 10%;"></td> <td style="width: 10%;"></td> </tr> <tr> <td></td> <td></td> <td colspan="8" style="text-align: center;"> <table border="1" style="width: 100%; border-collapse: collapse; text-align: center;"> <tr> <td style="width: 10%;"></td> <td style="width: 10%;"></td> <td style="width: 10%;"></td> <td style="width: 10%;"></td> <td style="width: 10%;"></td> <td style="width: 10%;"></td> <td style="width: 10%;"></td> <td style="width: 10%;"></td> <td style="width: 10%;"></td> <td style="width: 10%;"></td> </tr> <tr> <td></td> <td></td> <td colspan="8" style="text-align: center;"> <table border="1" style="width: 100%; border-collapse: collapse; text-align: center;"> <tr> </tr></table></td></tr></table></td></tr></table></td></tr></table></td></tr></table></td></tr></table></td></tr></table></td></tr></table></td></tr></table></td></tr></table></td></tr></table></td></tr></table></td></tr></table></td></tr></table></td></tr></table></td></tr></table></td></tr></table></td></tr></table></td></tr></table></td></tr></table></td></tr></table></td></tr></table></td></tr></table></td></tr></table></td></tr></table></td></tr></table></td></tr></table></td></tr></table></td></tr></table></td></tr></table></td></tr></table></td></tr></table></td></tr></table></td></tr></table></td></tr></table></td></tr></table></td></tr></table>

 | | | | | | | | | | | | | | | | | | | | <table border="1" style="width: 100%; border-collapse: collapse; text-align: center;"> <tr> <td style="width: 10%;"></td> <td style="width: 10%;"></td> <td style="width: 10%;"></td> <td style="width: 10%;"></td> <td style="width: 10%;"></td> <td style="width: 10%;"></td> <td style="width: 10%;"></td> <td style="width: 10%;"></td> <td style="width: 10%;"></td> <td style="width: 10%;"></td> </tr> <tr> <td></td> <td></td> <td colspan="8" style="text-align: center;"> <table border="1" style="width: 100%; border-collapse: collapse; text-align: center;"> <tr> <td style="width: 10%;"></td> <td style="width: 10%;"></td> <td style="width: 10%;"></td> <td style="width: 10%;"></td> <td style="width: 10%;"></td> <td style="width: 10%;"></td> <td style="width: 10%;"></td> <td style="width: 10%;"></td> <td style="width: 10%;"></td> <td style="width: 10%;"></td> </tr> <tr> <td></td> <td></td> <td colspan="8" style="text-align: center;"> <table border="1" style="width: 100%; border-collapse: collapse; text-align: center;"> <tr> <td style="width: 10%;"></td> <td style="width: 10%;"></td> <td style="width: 10%;"></td> <td style="width: 10%;"></td> <td style="width: 10%;"></td> <td style="width: 10%;"></td> <td style="width: 10%;"></td> <td style="width: 10%;"></td> <td style="width: 10%;"></td> <td style="width: 10%;"></td> </tr> <tr> <td></td> <td></td> <td colspan="8" style="text-align: center;"> <table border="1" style="width: 100%; border-collapse: collapse; text-align: center;"> <tr> <td style="width: 10%;"></td> <td style="width: 10%;"></td> <td style="width: 10%;"></td> <td style="width: 10%;"></td> <td style="width: 10%;"></td> <td style="width: 10%;"></td> <td style="width: 10%;"></td> <td style="width: 10%;"></td> <td style="width: 10%;"></td> <td style="width: 10%;"></td> </tr> <tr> <td></td> <td></td> <td colspan="8" style="text-align: center;"> <table border="1" style="width: 100%; border-collapse: collapse; text-align: center;"> <tr> <td style="width: 10%;"></td> <td style="width: 10%;"></td> <td style="width: 10%;"></td> <td style="width: 10%;"></td> <td style="width: 10%;"></td> <td style="width: 10%;"></td> <td style="width: 10%;"></td> <td style="width: 10%;"></td> <td style="width: 10%;"></td> <td style="width: 10%;"></td> </tr> <tr> <td></td> <td></td> <td colspan="8" style="text-align: center;"> <table border="1" style="width: 100%; border-collapse: collapse; text-align: center;"> <tr> <td style="width: 10%;"></td> <td style="width: 10%;"></td> <td style="width: 10%;"></td> <td style="width: 10%;"></td> <td style="width: 10%;"></td> <td style="width: 10%;"></td> <td style="width: 10%;"></td> <td style="width: 10%;"></td> <td style="width: 10%;"></td> <td style="width: 10%;"></td> </tr> <tr> <td></td> <td></td> <td colspan="8" style="text-align: center;"> <table border="1" style="width: 100%; border-collapse: collapse; text-align: center;"> <tr> <td style="width: 10%;"></td> <td style="width: 10%;"></td> <td style="width: 10%;"></td> <td style="width: 10%;"></td> <td style="width: 10%;"></td> <td style="width: 10%;"></td> <td style="width: 10%;"></td> <td style="width: 10%;"></td> <td style="width: 10%;"></td> <td style="width: 10%;"></td> </tr> <tr> <td></td> <td></td> <td colspan="8" style="text-align: center;"> <table border="1" style="width: 100%; border-collapse: collapse; text-align: center;"> <tr> <td style="width: 10%;"></td> <td style="width: 10%;"></td> <td style="width: 10%;"></td> <td style="width: 10%;"></td> <td style="width: 10%;"></td> <td style="width: 10%;"></td> <td style="width: 10%;"></td> <td style="width: 10%;"></td> <td style="width: 10%;"></td> <td style="width: 10%;"></td> </tr> <tr> <td></td> <td></td> <td colspan="8" style="text-align: center;"> <table border="1" style="width: 100%; border-collapse: collapse; text-align: center;"> <tr> <td style="width: 10%;"></td> <td style="width: 10%;"></td> <td style="width: 10%;"></td> <td style="width: 10%;"></td> <td style="width: 10%;"></td> <td style="width: 10%;"></td> <td style="width: 10%;"></td> <td style="width: 10%;"></td> <td style="width: 10%;"></td> <td style="width: 10%;"></td> </tr> <tr> <td></td> <td></td> <td colspan="8" style="text-align: center;"> <table border="1" style="width: 100%; border-collapse: collapse; text-align: center;"> <tr> <td style="width: 10%;"></td> <td style="width: 10%;"></td> <td style="width: 10%;"></td> <td style="width: 10%;"></td> <td style="width: 10%;"></td> <td style="width: 10%;"></td> <td style="width: 10%;"></td> <td style="width: 10%;"></td> <td style="width: 10%;"></td> <td style="width: 10%;"></td> </tr> <tr> <td></td> <td></td> <td colspan="8" style="text-align: center;"> <table border="1" style="width: 100%; border-collapse: collapse; text-align: center;"> <tr> <td style="width: 10%;"></td> <td style="width: 10%;"></td> <td style="width: 10%;"></td> <td style="width: 10%;"></td> <td style="width: 10%;"></td> <td style="width: 10%;"></td> <td style="width: 10%;"></td> <td style="width: 10%;"></td> <td style="width: 10%;"></td> <td style="width: 10%;"></td> </tr> <tr> <td></td> <td></td> <td colspan="8" style="text-align: center;"> <table border="1" style="width: 100%; border-collapse: collapse; text-align: center;"> <tr> <td style="width: 10%;"></td> <td style="width: 10%;"></td> <td style="width: 10%;"></td> <td style="width: 10%;"></td> <td style="width: 10%;"></td> <td style="width: 10%;"></td> <td style="width: 10%;"></td> <td style="width: 10%;"></td> <td style="width: 10%;"></td> <td style="width: 10%;"></td> </tr> <tr> <td></td> <td></td> <td colspan="8" style="text-align: center;"> <table border="1" style="width: 100%; border-collapse: collapse; text-align: center;"> <tr> <td style="width: 10%;"></td> <td style="width: 10%;"></td> <td style="width: 10%;"></td> <td style="width: 10%;"></td> <td style="width: 10%;"></td> <td style="width: 10%;"></td> <td style="width: 10%;"></td> <td style="width: 10%;"></td> <td style="width: 10%;"></td> <td style="width: 10%;"></td> </tr> <tr> <td></td> <td></td> <td colspan="8" style="text-align: center;"> <table border="1" style="width: 100%; border-collapse: collapse; text-align: center;"> <tr> <td style="width: 10%;"></td> <td style="width: 10%;"></td> <td style="width: 10%;"></td> <td style="width: 10%;"></td> <td style="width: 10%;"></td> <td style="width: 10%;"></td> <td style="width: 10%;"></td> <td style="width: 10%;"></td> <td style="width: 10%;"></td> <td style="width: 10%;"></td> </tr> <tr> <td></td> <td></td> <td colspan="8" style="text-align: center;"> <table border="1" style="width: 100%; border-collapse: collapse; text-align: center;"> <tr> <td style="width: 10%;"></td> <td style="width: 10%;"></td> <td style="width: 10%;"></td> <td style="width: 10%;"></td> <td style="width: 10%;"></td> <td style="width: 10%;"></td> <td style="width: 10%;"></td> <td style="width: 10%;"></td> <td style="width: 10%;"></td> <td style="width: 10%;"></td> </tr> <tr> <td></td> <td></td> <td colspan="8" style="text-align: center;"> <table border="1" style="width: 100%; border-collapse: collapse; text-align: center;"> <tr> <td style="width: 10%;"></td> <td style="width: 10%;"></td> <td style="width: 10%;"></td> <td style="width: 10%;"></td> <td style="width: 10%;"></td> <td style="width: 10%;"></td> <td style="width: 10%;"></td> <td style="width: 10%;"></td> <td style="width: 10%;"></td> <td style="width: 10%;"></td> </tr> <tr> <td></td> <td></td> <td colspan="8" style="text-align: center;"> <table border="1" style="width: 100%; border-collapse: collapse; text-align: center;"> <tr> <td style="width: 10%;"></td> <td style="width: 10%;"></td> <td style="width: 10%;"></td> <td style="width: 10%;"></td> <td style="width: 10%;"></td> <td style="width: 10%;"></td> <td style="width: 10%;"></td> <td style="width: 10%;"></td> <td style="width: 10%;"></td> <td style="width: 10%;"></td> </tr> <tr> <td></td> <td></td> <td
colspan="8" style="text-align: center;"> <table border="1" style="width: 100%; border-collapse: collapse; text-align: center;"> <tr> <td style="width: 10%;"></td> <td style="width: 10%;"></td> <td style="width: 10%;"></td> <td style="width: 10%;"></td> <td style="width: 10%;"></td> <td style="width: 10%;"></td> <td style="width: 10%;"></td> <td style="width: 10%;"></td> <td style="width: 10%;"></td> <td style="width: 10%;"></td> </tr> <tr> <td></td> <td></td> <td colspan="8" style="text-align: center;"> <table border="1" style="width: 100%; border-collapse: collapse; text-align: center;"> <tr> <td style="width: 10%;"></td> <td style="width: 10%;"></td> <td style="width: 10%;"></td> <td style="width: 10%;"></td> <td style="width: 10%;"></td> <td style="width: 10%;"></td> <td style="width: 10%;"></td> <td style="width: 10%;"></td> <td style="width: 10%;"></td> <td style="width: 10%;"></td> </tr> <tr> <td></td> <td></td> <td colspan="8" style="text-align: center;"> <table border="1" style="width: 100%; border-collapse: collapse; text-align: center;"> <tr> <td style="width: 10%;"></td> <td style="width: 10%;"></td> <td style="width: 10%;"></td> <td style="width: 10%;"></td> <td style="width: 10%;"></td> <td style="width: 10%;"></td> <td style="width: 10%;"></td> <td style="width: 10%;"></td> <td style="width: 10%;"></td> <td style="width: 10%;"></td> </tr> <tr> <td></td> <td></td> <td colspan="8" style="text-align: center;"> <table border="1" style="width: 100%; border-collapse: collapse; text-align: center;"> <tr> <td style="width: 10%;"></td> <td style="width: 10%;"></td> <td style="width: 10%;"></td> <td style="width: 10%;"></td> <td style="width: 10%;"></td> <td style="width: 10%;"></td> <td style="width: 10%;"></td> <td style="width: 10%;"></td> <td style="width: 10%;"></td> <td style="width: 10%;"></td> </tr> <tr> <td></td> <td></td> <td colspan="8" style="text-align: center;"> <table border="1" style="width: 100%; border-collapse: collapse; text-align: center;"> <tr> <td style="width: 10%;"></td> <td style="width: 10%;"></td> <td style="width: 10%;"></td> <td style="width: 10%;"></td> <td style="width: 10%;"></td> <td style="width: 10%;"></td> <td style="width: 10%;"></td> <td style="width: 10%;"></td> <td style="width: 10%;"></td> <td style="width: 10%;"></td> </tr> <tr> <td></td> <td></td> <td colspan="8" style="text-align: center;"> <table border="1" style="width: 100%; border-collapse: collapse; text-align: center;"> <tr> <td style="width: 10%;"></td> <td style="width: 10%;"></td> <td style="width: 10%;"></td> <td style="width: 10%;"></td> <td style="width: 10%;"></td> <td style="width: 10%;"></td> <td style="width: 10%;"></td> <td style="width: 10%;"></td> <td style="width: 10%;"></td> <td style="width: 10%;"></td> </tr> <tr> <td></td> <td></td> <td colspan="8" style="text-align: center;"> <table border="1" style="width: 100%; border-collapse: collapse; text-align: center;"> <tr> <td style="width: 10%;"></td> <td style="width: 10%;"></td> <td style="width: 10%;"></td> <td style="width: 10%;"></td> <td style="width: 10%;"></td> <td style="width: 10%;"></td> <td style="width: 10%;"></td> <td style="width: 10%;"></td> <td style="width: 10%;"></td> <td style="width: 10%;"></td> </tr> <tr> <td></td> <td></td> <td colspan="8" style="text-align: center;"> <table border="1" style="width: 100%; border-collapse: collapse; text-align: center;"> <tr> <td style="width: 10%;"></td> <td style="width: 10%;"></td> <td style="width: 10%;"></td> <td style="width: 10%;"></td> <td style="width: 10%;"></td> <td style="width: 10%;"></td> <td style="width: 10%;"></td> <td style="width: 10%;"></td> <td style="width: 10%;"></td> <td style="width: 10%;"></td> </tr> <tr> <td></td> <td></td> <td colspan="8" style="text-align: center;"> <table border="1" style="width: 100%; border-collapse: collapse; text-align: center;"> <tr> <td style="width: 10%;"></td> <td style="width: 10%;"></td> <td style="width: 10%;"></td> <td style="width: 10%;"></td> <td style="width: 10%;"></td> <td style="width: 10%;"></td> <td style="width: 10%;"></td> <td style="width: 10%;"></td> <td style="width: 10%;"></td> <td style="width: 10%;"></td> </tr> <tr> <td></td> <td></td> <td colspan="8" style="text-align: center;"> <table border="1" style="width: 100%; border-collapse: collapse; text-align: center;"> <tr> <td style="width: 10%;"></td> <td style="width: 10%;"></td> <td style="width: 10%;"></td> <td style="width: 10%;"></td> <td style="width: 10%;"></td> <td style="width: 10%;"></td> <td style="width: 10%;"></td> <td style="width: 10%;"></td> <td style="width: 10%;"></td> <td style="width: 10%;"></td> </tr> <tr> <td></td> <td></td> <td colspan="8" style="text-align: center;"> <table border="1" style="width: 100%; border-collapse: collapse; text-align: center;"> <tr> <td style="width: 10%;"></td> <td style="width: 10%;"></td> <td style="width: 10%;"></td> <td style="width: 10%;"></td> <td style="width: 10%;"></td> <td style="width: 10%;"></td> <td style="width: 10%;"></td> <td style="width: 10%;"></td> <td style="width: 10%;"></td> <td style="width: 10%;"></td> </tr> <tr> <td></td> <td></td> <td colspan="8" style="text-align: center;"> <table border="1" style="width: 100%; border-collapse: collapse; text-align: center;"> <tr> <td style="width: 10%;"></td> <td style="width: 10%;"></td> <td style="width: 10%;"></td> <td style="width: 10%;"></td> <td style="width: 10%;"></td> <td style="width: 10%;"></td> <td style="width: 10%;"></td> <td style="width: 10%;"></td> <td style="width: 10%;"></td> <td style="width: 10%;"></td> </tr> <tr> <td></td> <td></td> <td colspan="8" style="text-align: center;"> <table border="1" style="width: 100%; border-collapse: collapse; text-align: center;"> <tr> <td style="width: 10%;"></td> <td style="width: 10%;"></td> <td style="width: 10%;"></td> <td style="width: 10%;"></td> <td style="width: 10%;"></td> <td style="width: 10%;"></td> <td style="width: 10%;"></td> <td style="width: 10%;"></td> <td style="width: 10%;"></td> <td style="width: 10%;"></td> </tr> <tr> <td></td> <td></td> <td colspan="8" style="text-align: center;"> <table border="1" style="width: 100%; border-collapse: collapse; text-align: center;"> <tr> <td style="width: 10%;"></td> <td style="width: 10%;"></td> <td style="width: 10%;"></td> <td style="width: 10%;"></td> <td style="width: 10%;"></td> <td style="width: 10%;"></td> <td style="width: 10%;"></td> <td style="width: 10%;"></td> <td style="width: 10%;"></td> <td style="width: 10%;"></td> </tr> <tr> <td></td> <td></td> <td colspan="8" style="text-align: center;"> <table border="1" style="width: 100%; border-collapse: collapse; text-align: center;"> <tr> <td style="width: 10%;"></td> <td style="width: 10%;"></td> <td style="width: 10%;"></td> <td style="width: 10%;"></td> <td style="width: 10%;"></td> <td style="width: 10%;"></td> <td style="width: 10%;"></td> <td style="width: 10%;"></td> <td style="width: 10%;"></td> <td style="width: 10%;"></td> </tr> <tr> <td></td> <td></td> <td colspan="8" style="text-align: center;"> <table border="1" style="width: 100%; border-collapse: collapse; text-align: center;"> <tr> <td style="width: 10%;"></td> <td style="width: 10%;"></td> <td style="width: 10%;"></td> <td style="width: 10%;"></td> <td style="width: 10%;"></td> <td style="width: 10%;"></td> <td style="width: 10%;"></td> <td style="width: 10%;"></td> <td style="width: 10%;"></td> <td style="width: 10%;"></td> </tr> <tr> <td></td> <td></td> <td colspan="8" style="text-align: center;"> <table border="1" style="width: 100%; border-collapse: collapse; text-align: center;"> <tr> <td style="width: 10%;"></td> <td style="width: 10%;"></td> <td style="width: 10%;"></td> <td style="width: 10%;"></td> <td style="width: 10%;"></td> <td style="width: 10%;"></td> <td style="width: 10%;"></td> <td style="width: 10%;"></td> <td style="width: 10%;"></td> <td style="width: 10%;"></td> </tr> <tr> <td></td> <td></td> <td colspan="8" style="text-align: center;"> <table border="1" style="width: 100%; border-collapse: collapse; text-align: center;"> <tr> <td style="width: 10%;"></td> <td style="width: 10%;"></td> <td style="width: 10%;"></td> <td style="width: 10%;"></td> <td style="width: 10%;"></td> <td style="width: 10%;"></td> <td style="width: 10%;"></td> <td style="width: 10%;"></td> <td style="width: 10%;"></td> <td style="width: 10%;"></td> </tr> <tr> <td></td> <td></td> <td colspan="8" style="text-align: center;"> <table border="1" style="width: 100%; border-collapse: collapse; text-align: center;"> <tr> </tr></table></td></tr></table></td></tr></table></td></tr></table></td></tr></table></td></tr></table></td></tr></table></td></tr></table></td></tr></table></td></tr></table></td></tr></table></td></tr></table></td></tr></table></td></tr></table></td></tr></table></td></tr></table></td></tr></table></td></tr></table></td></tr></table></td></tr></table></td></tr></table></td></tr></table></td></tr></table></td></tr></table></td></tr></table></td></tr></table></td></tr></table></td></tr></table></td></tr></table></td></tr></table></td></tr></table></td></tr></table></td></tr></table></td></tr></table></td></tr></table></td></tr></table>

 | | | | | | | | | | | | | | | | | | | | <table border="1" style="width: 100%; border-collapse: collapse; text-align: center;"> <tr> <td style="width: 10%;"></td> <td style="width: 10%;"></td> <td style="width: 10%;"></td> <td style="width: 10%;"></td> <td style="width: 10%;"></td> <td style="width: 10%;"></td> <td style="width: 10%;"></td> <td style="width: 10%;"></td> <td style="width: 10%;"></td> <td style="width: 10%;"></td> </tr> <tr> <td></td> <td></td> <td colspan="8" style="text-align: center;"> <table border="1" style="width: 100%; border-collapse: collapse; text-align: center;"> <tr> <td style="width: 10%;"></td> <td style="width: 10%;"></td> <td style="width: 10%;"></td> <td style="width: 10%;"></td> <td style="width: 10%;"></td> <td style="width: 10%;"></td> <td style="width: 10%;"></td> <td style="width: 10%;"></td> <td style="width: 10%;"></td> <td style="width: 10%;"></td> </tr> <tr> <td></td> <td></td> <td colspan="8" style="text-align: center;"> <table border="1" style="width: 100%; border-collapse: collapse; text-align: center;"> <tr> <td style="width: 10%;"></td> <td style="width: 10%;"></td> <td style="width: 10%;"></td> <td style="width: 10%;"></td> <td style="width: 10%;"></td> <td style="width: 10%;"></td> <td style="width: 10%;"></td> <td style="width: 10%;"></td> <td style="width: 10%;"></td> <td style="width: 10%;"></td> </tr> <tr> <td></td> <td></td> <td colspan="8" style="text-align: center;"> <table border="1" style="width: 100%; border-collapse: collapse; text-align: center;"> <tr> <td style="width: 10%;"></td> <td style="width: 10%;"></td> <td style="width: 10%;"></td> <td style="width: 10%;"></td> <td style="width: 10%;"></td> <td style="width: 10%;"></td> <td style="width: 10%;"></td> <td style="width: 10%;"></td> <td style="width: 10%;"></td> <td style="width: 10%;"></td> </tr> <tr> <td></td> <td></td> <td colspan="8" style="text-align: center;"> <table border="1" style="width: 100%; border-collapse: collapse; text-align: center;"> <tr> <td style="width: 10%;"></td> <td style="width: 10%;"></td> <td style="width: 10%;"></td> <td style="width: 10%;"></td> <td style="width: 10%;"></td> <td style="width: 10%;"></td> <td style="width: 10%;"></td> <td style="width: 10%;"></td> <td style="width: 10%;"></td> <td style="width: 10%;"></td> </tr> <tr> <td></td> <td></td> <td colspan="8" style="text-align: center;"> <table border="1" style="width: 100%; border-collapse: collapse; text-align: center;"> <tr> <td style="width: 10%;"></td> <td style="width: 10%;"></td> <td style="width: 10%;"></td> <td style="width: 10%;"></td> <td style="width: 10%;"></td> <td style="width: 10%;"></td> <td style="width: 10%;"></td> <td style="width: 10%;"></td> <td style="width: 10%;"></td> <td style="width: 10%;"></td> </tr> <tr> <td></td> <td></td> <td colspan="8" style="text-align: center;"> <table border="1" style="width: 100%; border-collapse: collapse; text-align: center;"> <tr> <td style="width: 10%;"></td> <td style="width: 10%;"></td> <td style="width: 10%;"></td> <td style="width: 10%;"></td> <td style="width: 10%;"></td> <td style="width: 10%;"></td> <td style="width: 10%;"></td> <td style="width: 10%;"></td> <td style="width: 10%;"></td> <td style="width: 10%;"></td> </tr> <tr> <td></td> <td></td> <td colspan="8" style="text-align: center;"> <table border="1" style="width: 100%; border-collapse: collapse; text-align: center;"> <tr> <td style="width: 10%;"></td> <td style="width: 10%;"></td> <td style="width: 10%;"></td> <td style="width: 10%;"></td> <td style="width: 10%;"></td> <td style="width: 10%;"></td> <td style="width: 10%;"></td> <td style="width: 10%;"></td> <td style="width: 10%;"></td> <td style="width: 10%;"></td> </tr> <tr> <td></td> <td></td> <td colspan="8" style="text-align: center;"> <table border="1" style="width: 100%; border-collapse: collapse; text-align: center;"> <tr> <td style="width: 10%;"></td> <td style="width: 10%;"></td> <td style="width: 10%;"></td> <td style="width: 10%;"></td> <td style="width: 10%;"></td> <td style="width: 10%;"></td> <td style="width: 10%;"></td> <td style="width: 10%;"></td> <td style="width: 10%;"></td> <td style="width: 10%;"></td> </tr> <tr> <td></td> <td></td> <td colspan="8" style="text-align: center;"> <table border="1" style="width: 100%; border-collapse: collapse; text-align: center;"> <tr> <td style="width: 10%;"></td> <td style="width: 10%;"></td> <td style="width: 10%;"></td> <td style="width: 10%;"></td> <td style="width: 10%;"></td> <td style="width: 10%;"></td> <td style="width: 10%;"></td> <td style="width: 10%;"></td> <td style="width: 10%;"></td> <td style="width: 10%;"></td> </tr> <tr> <td></td> <td></td> <td colspan="8" style="text-align: center;"> <table border="1" style="width: 100%; border-collapse: collapse; text-align: center;"> <tr> <td style="width: 10%;"></td> <td style="width: 10%;"></td> <td style="width: 10%;"></td> <td style="width: 10%;"></td> <td style="width: 10%;"></td> <td style="width: 10%;"></td> <td style="width: 10%;"></td> <td style="width: 10%;"></td> <td style="width: 10%;"></td> <td style="width: 10%;"></td> </tr> <tr> <td></td> <td></td> <td colspan="8" style="text-align: center;"> <table border="1" style="width: 100%; border-collapse: collapse; text-align: center;"> <tr> <td style="width: 10%;"></td> <td style="width: 10%;"></td> <td style="width: 10%;"></td> <td style="width: 10%;"></td> <td style="width: 10%;"></td> <td style="width: 10%;"></td> <td style="width: 10%;"></td> <td style="width: 10%;"></td> <td style="width: 10%;"></td> <td style="width: 10%;"></td> </tr> <tr> <td></td> <td></td> <td colspan="8" style="text-align: center;"> <table border="1" style="width: 100%; border-collapse: collapse; text-align: center;"> <tr> <td style="width: 10%;"></td> <td style="width: 10%;"></td> <td style="width: 10%;"></td> <td style="width: 10%;"></td> <td style="width: 10%;"></td> <td style="width: 10%;"></td> <td style="width: 10%;"></td> <td style="width: 10%;"></td> <td style="width: 10%;"></td> <td style="width: 10%;"></td> </tr> <tr> <td></td> <td></td> <td colspan="8" style="text-align: center;"> <table border="1" style="width: 100%; border-collapse: collapse; text-align: center;"> <tr> <td style="width: 10%;"></td> <td style="width: 10%;"></td> <td style="width: 10%;"></td> <td style="width: 10%;"></td> <td style="width: 10%;"></td> <td style="width: 10%;"></td> <td style="width: 10%;"></td> <td style="width: 10%;"></td> <td style="width: 10%;"></td> <td style="width: 10%;"></td> </tr> <tr> <td></td> <td></td> <td colspan="8" style="text-align: center;"> <table border="1" style="width: 100%; border-collapse: collapse; text-align: center;"> <tr> <td style="width: 10%;"></td> <td style="width: 10%;"></td> <td style="width: 10%;"></td> <td style="width: 10%;"></td> <td style="width: 10%;"></td> <td style="width: 10%;"></td> <td style="width: 10%;"></td> <td style="width: 10%;"></td> <td style="width: 10%;"></td> <td style="width: 10%;"></td> </tr> <tr> <td></td> <td></td> <td colspan="8" style="text-align: center;"> <table border="1" style="width: 100%; border-collapse: collapse; text-align: center;"> <tr> <td style="width: 10%;"></td> <td style="width: 10%;"></td> <td style="width: 10%;"></td> <td style="width: 10%;"></td> <td style="width: 10%;"></td> <td style="width: 10%;"></td> <td style="width: 10%;"></td> <td style="width: 10%;"></td> <td style="width: 10%;"></td> <td style="width: 10%;"></td> </tr> <tr> <td></td> <td></td> <td colspan="8" style="text-align: center;"> <table border="1" style="width: 100%; border-collapse: collapse; text-align: center;"> <tr> <td style="width: 10%;"></td> <td
style="width: 10%;"></td> <td style="width: 10%;"></td> <td style="width: 10%;"></td> <td style="width: 10%;"></td> <td style="width: 10%;"></td> <td style="width: 10%;"></td> <td style="width: 10%;"></td> <td style="width: 10%;"></td> <td style="width: 10%;"></td> </tr> <tr> <td></td> <td></td> <td colspan="8" style="text-align: center;"> <table border="1" style="width: 100%; border-collapse: collapse; text-align: center;"> <tr> <td style="width: 10%;"></td> <td style="width: 10%;"></td> <td style="width: 10%;"></td> <td style="width: 10%;"></td> <td style="width: 10%;"></td> <td style="width: 10%;"></td> <td style="width: 10%;"></td> <td style="width: 10%;"></td> <td style="width: 10%;"></td> <td style="width: 10%;"></td> </tr> <tr> <td></td> <td></td> <td colspan="8" style="text-align: center;"> <table border="1" style="width: 100%; border-collapse: collapse; text-align: center;"> <tr> <td style="width: 10%;"></td> <td style="width: 10%;"></td> <td style="width: 10%;"></td> <td style="width: 10%;"></td> <td style="width: 10%;"></td> <td style="width: 10%;"></td> <td style="width: 10%;"></td> <td style="width: 10%;"></td> <td style="width: 10%;"></td> <td style="width: 10%;"></td> </tr> <tr> <td></td> <td></td> <td colspan="8" style="text-align: center;"> <table border="1" style="width: 100%; border-collapse: collapse; text-align: center;"> <tr> <td style="width: 10%;"></td> <td style="width: 10%;"></td> <td style="width: 10%;"></td> <td style="width: 10%;"></td> <td style="width: 10%;"></td> <td style="width: 10%;"></td> <td style="width: 10%;"></td> <td style="width: 10%;"></td> <td style="width: 10%;"></td> <td style="width: 10%;"></td> </tr> <tr> <td></td> <td></td> <td colspan="8" style="text-align: center;"> <table border="1" style="width: 100%; border-collapse: collapse; text-align: center;"> <tr> <td style="width: 10%;"></td> <td style="width: 10%;"></td> <td style="width: 10%;"></td> <td style="width: 10%;"></td> <td style="width: 10%;"></td> <td style="width: 10%;"></td> <td style="width: 10%;"></td> <td style="width: 10%;"></td> <td style="width: 10%;"></td> <td style="width: 10%;"></td> </tr> <tr> <td></td> <td></td> <td colspan="8" style="text-align: center;"> <table border="1" style="width: 100%; border-collapse: collapse; text-align: center;"> <tr> <td style="width: 10%;"></td> <td style="width: 10%;"></td> <td style="width: 10%;"></td> <td style="width: 10%;"></td> <td style="width: 10%;"></td> <td style="width: 10%;"></td> <td style="width: 10%;"></td> <td style="width: 10%;"></td> <td style="width: 10%;"></td> <td style="width: 10%;"></td> </tr> <tr> <td></td> <td></td> <td colspan="8" style="text-align: center;"> <table border="1" style="width: 100%; border-collapse: collapse; text-align: center;"> <tr> <td style="width: 10%;"></td> <td style="width: 10%;"></td> <td style="width: 10%;"></td> <td style="width: 10%;"></td> <td style="width: 10%;"></td> <td style="width: 10%;"></td> <td style="width: 10%;"></td> <td style="width: 10%;"></td> <td style="width: 10%;"></td> <td style="width: 10%;"></td> </tr> <tr> <td></td> <td></td> <td colspan="8" style="text-align: center;"> <table border="1" style="width: 100%; border-collapse: collapse; text-align: center;"> <tr> <td style="width: 10%;"></td> <td style="width: 10%;"></td> <td style="width: 10%;"></td> <td style="width: 10%;"></td> <td style="width: 10%;"></td> <td style="width: 10%;"></td> <td style="width: 10%;"></td> <td style="width: 10%;"></td> <td style="width: 10%;"></td> <td style="width: 10%;"></td> </tr> <tr> <td></td> <td></td> <td colspan="8" style="text-align: center;"> <table border="1" style="width: 100%; border-collapse: collapse; text-align: center;"> <tr> <td style="width: 10%;"></td> <td style="width: 10%;"></td> <td style="width: 10%;"></td> <td style="width: 10%;"></td> <td style="width: 10%;"></td> <td style="width: 10%;"></td> <td style="width: 10%;"></td> <td style="width: 10%;"></td> <td style="width: 10%;"></td> <td style="width: 10%;"></td> </tr> <tr> <td></td> <td></td> <td colspan="8" style="text-align: center;"> <table border="1" style="width: 100%; border-collapse: collapse; text-align: center;"> <tr> <td style="width: 10%;"></td> <td style="width: 10%;"></td> <td style="width: 10%;"></td> <td style="width: 10%;"></td> <td style="width: 10%;"></td> <td style="width: 10%;"></td> <td style="width: 10%;"></td> <td style="width: 10%;"></td> <td style="width: 10%;"></td> <td style="width: 10%;"></td> </tr> <tr> <td></td> <td></td> <td colspan="8" style="text-align: center;"> <table border="1" style="width: 100%; border-collapse: collapse; text-align: center;"> <tr> <td style="width: 10%;"></td> <td style="width: 10%;"></td> <td style="width: 10%;"></td> <td style="width: 10%;"></td> <td style="width: 10%;"></td> <td style="width: 10%;"></td> <td style="width: 10%;"></td> <td style="width: 10%;"></td> <td style="width: 10%;"></td> <td style="width: 10%;"></td> </tr> <tr> <td></td> <td></td> <td colspan="8" style="text-align: center;"> <table border="1" style="width: 100%; border-collapse: collapse; text-align: center;"> <tr> <td style="width: 10%;"></td> <td style="width: 10%;"></td> <td style="width: 10%;"></td> <td style="width: 10%;"></td> <td style="width: 10%;"></td> <td style="width: 10%;"></td> <td style="width: 10%;"></td> <td style="width: 10%;"></td> <td style="width: 10%;"></td> <td style="width: 10%;"></td> </tr> <tr> <td></td> <td></td> <td colspan="8" style="text-align: center;"> <table border="1" style="width: 100%; border-collapse: collapse; text-align: center;"> <tr> <td style="width: 10%;"></td> <td style="width: 10%;"></td> <td style="width: 10%;"></td> <td style="width: 10%;"></td> <td style="width: 10%;"></td> <td style="width: 10%;"></td> <td style="width: 10%;"></td> <td style="width: 10%;"></td> <td style="width: 10%;"></td> <td style="width: 10%;"></td> </tr> <tr> <td></td> <td></td> <td colspan="8" style="text-align: center;"> <table border="1" style="width: 100%; border-collapse: collapse; text-align: center;"> <tr> <td style="width: 10%;"></td> <td style="width: 10%;"></td> <td style="width: 10%;"></td> <td style="width: 10%;"></td> <td style="width: 10%;"></td> <td style="width: 10%;"></td> <td style="width: 10%;"></td> <td style="width: 10%;"></td> <td style="width: 10%;"></td> <td style="width: 10%;"></td> </tr> <tr> <td></td> <td></td> <td colspan="8" style="text-align: center;"> <table border="1" style="width: 100%; border-collapse: collapse; text-align: center;"> <tr> <td style="width: 10%;"></td> <td style="width: 10%;"></td> <td style="width: 10%;"></td> <td style="width: 10%;"></td> <td style="width: 10%;"></td> <td style="width: 10%;"></td> <td style="width: 10%;"></td> <td style="width: 10%;"></td> <td style="width: 10%;"></td> <td style="width: 10%;"></td> </tr> <tr> <td></td> <td></td> <td colspan="8" style="text-align: center;"> <table border="1" style="width: 100%; border-collapse: collapse; text-align: center;"> <tr> <td style="width: 10%;"></td> <td style="width: 10%;"></td> <td style="width: 10%;"></td> <td style="width: 10%;"></td> <td style="width: 10%;"></td> <td style="width: 10%;"></td> <td style="width: 10%;"></td> <td style="width: 10%;"></td> <td style="width: 10%;"></td> <td style="width: 10%;"></td> </tr> <tr> <td></td> <td></td> <td colspan="8" style="text-align: center;"> <table border="1" style="width: 100%; border-collapse: collapse; text-align: center;"> <tr> <td style="width: 10%;"></td> <td style="width: 10%;"></td> <td style="width: 10%;"></td> <td style="width: 10%;"></td> <td style="width: 10%;"></td> <td style="width: 10%;"></td> <td style="width: 10%;"></td> <td style="width: 10%;"></td> <td style="width: 10%;"></td> <td style="width: 10%;"></td> </tr> <tr> <td></td> <td></td> <td colspan="8" style="text-align: center;"> <table border="1" style="width: 100%; border-collapse: collapse; text-align: center;"> <tr> <td style="width: 10%;"></td> <td style="width: 10%;"></td> <td style="width: 10%;"></td> <td style="width: 10%;"></td> <td style="width: 10%;"></td> <td style="width: 10%;"></td> <td style="width: 10%;"></td> <td style="width: 10%;"></td> <td style="width: 10%;"></td> <td style="width: 10%;"></td> </tr> <tr> <td></td> <td></td> <td colspan="8" style="text-align: center;"> <table border="1" style="width: 100%; border-collapse: collapse; text-align: center;"> <tr> </tr></table></td></tr></table></td></tr></table></td></tr></table></td></tr></table></td></tr></table></td></tr></table></td></tr></table></td></tr></table></td></tr></table></td></tr></table></td></tr></table></td></tr></table></td></tr></table></td></tr></table></td></tr></table></td></tr></table></td></tr></table></td></tr></table></td></tr></table></td></tr></table></td></tr></table></td></tr></table></td></tr></table></td></tr></table></td></tr></table></td></tr></table></td></tr></table></td></tr></table></td></tr></table></td></tr></table></td></tr></table></td></tr></table></td></tr></table></td></tr></table>

 | | | | | | | | | | | | | | | | | | | | <table border="1" style="width: 100%; border-collapse: collapse; text-align: center;"> <tr> <td style="width: 10%;"></td> <td style="width: 10%;"></td> <td style="width: 10%;"></td> <td style="width: 10%;"></td> <td style="width: 10%;"></td> <td style="width: 10%;"></td> <td style="width: 10%;"></td> <td style="width: 10%;"></td> <td style="width: 10%;"></td> <td style="width: 10%;"></td> </tr> <tr> <td></td> <td></td> <td colspan="8" style="text-align: center;"> <table border="1" style="width: 100%; border-collapse: collapse; text-align: center;"> <tr> <td style="width: 10%;"></td> <td style="width: 10%;"></td> <td style="width: 10%;"></td> <td style="width: 10%;"></td> <td style="width: 10%;"></td> <td style="width: 10%;"></td> <td style="width: 10%;"></td> <td style="width: 10%;"></td> <td style="width: 10%;"></td> <td style="width: 10%;"></td> </tr> <tr> <td></td> <td></td> <td colspan="8" style="text-align: center;"> <table border="1" style="width: 100%; border-collapse: collapse; text-align: center;"> <tr> <td style="width: 10%;"></td> <td style="width: 10%;"></td> <td style="width: 10%;"></td> <td style="width: 10%;"></td> <td style="width: 10%;"></td> <td style="width: 10%;"></td> <td style="width: 10%;"></td> <td style="width: 10%;"></td> <td style="width: 10%;"></td> <td style="width: 10%;"></td> </tr> <tr> <td></td> <td></td> <td colspan="8" style="text-align: center;"> <table border="1" style="width: 100%; border-collapse: collapse; text-align: center;"> <tr> <td style="width: 10%;"></td> <td style="width: 10%;"></td> <td style="width: 10%;"></td> <td style="width: 10%;"></td> <td style="width: 10%;"></td> <td style="width: 10%;"></td> <td style="width: 10%;"></td> <td style="width: 10%;"></td> <td style="width: 10%;"></td> <td style="width: 10%;"></td> </tr> <tr> <td></td> <td></td> <td colspan="8" style="text-align: center;"> <table border="1" style="width: 100%; border-collapse: collapse; text-align: center;"> <tr> <td style="width: 10%;"></td> <td style="width: 10%;"></td> <td style="width: 10%;"></td> <td style="width: 10%;"></td> <td style="width: 10%;"></td> <td style="width: 10%;"></td> <td style="width: 10%;"></td> <td style="width: 10%;"></td> <td style="width: 10%;"></td> <td style="width: 10%;"></td> </tr> <tr> <td></td> <td></td> <td colspan="8" style="text-align: center;"> <table border="1" style="width: 100%; border-collapse: collapse; text-align: center;"> <tr> <td style="width: 10%;"></td> <td style="width: 10%;"></td> <td style="width: 10%;"></td> <td style="width: 10%;"></td> <td style="width: 10%;"></td> <td style="width: 10%;"></td> <td style="width: 10%;"></td> <td style="width: 10%;"></td> <td style="width: 10%;"></td> <td style="width: 10%;"></td> </tr> <tr> <td></td> <td></td> <td colspan="8" style="text-align: center;"> <table border="1" style="width: 100%; border-collapse: collapse; text-align: center;"> <tr> <td style="width: 10%;"></td> <td style="width: 10%;"></td> <td style="width: 10%;"></td> <td style="width: 10%;"></td> <td style="width: 10%;"></td> <td style="width: 10%;"></td> <td style="width: 10%;"></td> <td style="width: 10%;"></td> <td style="width: 10%;"></td> <td style="width: 10%;"></td> </tr> <tr> <td></td> <td></td> <td colspan="8" style="text-align: center;"> <table border="1" style="width: 100%; border-collapse: collapse; text-align: center;"> <tr> <td style="width: 10%;"></td> <td style="width: 10%;"></td> <td style="width: 10%;"></td> <td style="width: 10%;"></td> <td style="width: 10%;"></td> <td style="width: 10%;"></td> <td style="width: 10%;"></td> <td style="width: 10%;"></td> <td style="width: 10%;"></td> <td style="width: 10%;"></td> </tr> <tr> <td></td> <td></td> <td colspan="8" style="text-align: center;"> <table border="1" style="width: 100%; border-collapse: collapse; text-align: center;"> <tr> <td style="width: 10%;"></td> <td style="width: 10%;"></td> <td style="width: 10%;"></td> <td style="width: 10%;"></td> <td style="width: 10%;"></td> <td style="width: 10%;"></td> <td style="width: 10%;"></td> <td style="width: 10%;"></td> <td style="width: 10%;"></td> <td style="width: 10%;"></td> </tr> <tr> <td></td> <td></td> <td colspan="8" style="text-align: center;"> <table border="1" style="width: 100%; border-collapse: collapse; text-align: center;"> <tr> <td style="width: 10%;"></td> <td style="width: 10%;"></td> <td style="width: 10%;"></td> <td style="width: 10%;"></td> <td style="width: 10%;"></td> <td style="width: 10%;"></td> <td style="width: 10%;"></td> <td style="width: 10%;"></td> <td style="width: 10%;"></td> <td style="width: 10%;"></td> </tr> <tr> <td></td> <td></td> <td colspan="8" style="text-align: center;"> <table border="1" style="width: 100%; border-collapse: collapse; text-align: center;"> <tr> <td style="width: 10%;"></td> <td style="width: 10%;"></td> <td style="width: 10%;"></td> <td style="width: 10%;"></td> <td style="width: 10%;"></td> <td style="width: 10%;"></td> <td style="width: 10%;"></td> <td style="width: 10%;"></td> <td style="width: 10%;"></td> <td style="width: 10%;"></td> </tr> <tr> <td></td> <td></td> <td colspan="8" style="text-align: center;"> <table border="1" style="width: 100%; border-collapse: collapse; text-align: center;"> <tr> <td style="width: 10%;"></td> <td style="width: 10%;"></td> <td style="width: 10%;"></td> <td style="width: 10%;"></td> <td style="width: 10%;"></td> <td style="width: 10%;"></td> <td style="width: 10%;"></td> <td style="width: 10%;"></td> <td style="width: 10%;"></td> <td style="width: 10%;"></td> </tr> <tr> <td></td> <td></td> <td colspan="8" style="text-align: center;"> <table border="1" style="width: 100%; border-collapse: collapse; text-align: center;"> <tr> <td style="width: 10%;"></td> <td style="width: 10%;"></td> <td style="width: 10%;"></td> <td style="width: 10%;"></td> <td style="width: 10%;"></td> <td style="width: 10%;"></td> <td style="width: 10%;"></td> <td style="width: 10%;"></td> <td style="width: 10%;"></td> <td style="width: 10%;"></td> </tr> <tr> <td></td> <td></td> <td colspan="8" style="text-align: center;"> <table border="1" style="width: 100%; border-collapse: collapse; text-align: center;"> <tr> <td style="width: 10%;"></td> <td style="width: 10%;"></td> <td style="width: 10%;"></td> <td style="width: 10%;"></td> <td style="width: 10%;"></td> <td style="width: 10%;"></td> <td style="width: 10%;"></td> <td style="width: 10%;"></td> <td style="width: 10%;"></td> <td style="width: 10%;"></td> </tr> <tr> <td></td> <td></td> <td colspan="8" style="text-align: center;"> <table border="1" style="width: 100%; border-collapse: collapse; text-align: center;"> <tr> <td style="width: 10%;"></td> <td style="width: 10%;"></td> <td style="width: 10%;"></td> <td style="width: 10%;"></td> <td style="width: 10%;"></td> <td style="width: 10%;"></td> <td style="width: 10%;"></td> <td style="width: 10%;"></td> <td style="width: 10%;"></td> <td style="width: 10%;"></td> </tr> <tr> <td></td> <td></td> <td colspan="8" style="text-align: center;"> <table border="1" style="width: 100%; border-collapse: collapse; text-align: center;"> <tr> <td style="width: 10%;"></td> <td style="width: 10%;"></td> <td style="width: 10%;"></td> <td style="width: 10%;"></td> <td style="width: 10%;"></td> <td style="width: 10%;"></td> <td style="width: 10%;"></td> <td style="width: 10%;"></td> <td style="width: 10%;"></td> <td style="width: 10%;"></td> </tr> <tr> <td></td> <td></td> <td colspan="8" style="text-align: center;"> <table border="1" style="width: 100%; border-collapse: collapse; text-align: center;"> <tr> <td style="width: 10%;"></td> <td style="width: 10%;"></td> <td style="width: 10%;"></td> <td style="width: 10%;"></td> <td style="width: 10%;"></td> <td style="width: 10%;"></td> <td style="width: 10%;"></td> <td
style="width: 10%;"></td> <td style="width: 10%;"></td> <td style="width: 10%;"></td> </tr> <tr> <td></td> <td></td> <td colspan="8" style="text-align: center;"> <table border="1" style="width: 100%; border-collapse: collapse; text-align: center;"> <tr> <td style="width: 10%;"></td> <td style="width: 10%;"></td> <td style="width: 10%;"></td> <td style="width: 10%;"></td> <td style="width: 10%;"></td> <td style="width: 10%;"></td> <td style="width: 10%;"></td> <td style="width: 10%;"></td> <td style="width: 10%;"></td> <td style="width: 10%;"></td> </tr> <tr> <td></td> <td></td> <td colspan="8" style="text-align: center;"> <table border="1" style="width: 100%; border-collapse: collapse; text-align: center;"> <tr> <td style="width: 10%;"></td> <td style="width: 10%;"></td> <td style="width: 10%;"></td> <td style="width: 10%;"></td> <td style="width: 10%;"></td> <td style="width: 10%;"></td> <td style="width: 10%;"></td> <td style="width: 10%;"></td> <td style="width: 10%;"></td> <td style="width: 10%;"></td> </tr> <tr> <td></td> <td></td> <td colspan="8" style="text-align: center;"> <table border="1" style="width: 100%; border-collapse: collapse; text-align: center;"> <tr> <td style="width: 10%;"></td> <td style="width: 10%;"></td> <td style="width: 10%;"></td> <td style="width: 10%;"></td> <td style="width: 10%;"></td> <td style="width: 10%;"></td> <td style="width: 10%;"></td> <td style="width: 10%;"></td> <td style="width: 10%;"></td> <td style="width: 10%;"></td> </tr> <tr> <td></td> <td></td> <td colspan="8" style="text-align: center;"> <table border="1" style="width: 100%; border-collapse: collapse; text-align: center;"> <tr> <td style="width: 10%;"></td> <td style="width: 10%;"></td> <td style="width: 10%;"></td> <td style="width: 10%;"></td> <td style="width: 10%;"></td> <td style="width: 10%;"></td> <td style="width: 10%;"></td> <td style="width: 10%;"></td> <td style="width: 10%;"></td> <td style="width: 10%;"></td> </tr> <tr> <td></td> <td></td> <td colspan="8" style="text-align: center;"> <table border="1" style="width: 100%; border-collapse: collapse; text-align: center;"> <tr> <td style="width: 10%;"></td> <td style="width: 10%;"></td> <td style="width: 10%;"></td> <td style="width: 10%;"></td> <td style="width: 10%;"></td> <td style="width: 10%;"></td> <td style="width: 10%;"></td> <td style="width: 10%;"></td> <td style="width: 10%;"></td> <td style="width: 10%;"></td> </tr> <tr> <td></td> <td></td> <td colspan="8" style="text-align: center;"> <table border="1" style="width: 100%; border-collapse: collapse; text-align: center;"> <tr> <td style="width: 10%;"></td> <td style="width: 10%;"></td> <td style="width: 10%;"></td> <td style="width: 10%;"></td> <td style="width: 10%;"></td> <td style="width: 10%;"></td> <td style="width: 10%;"></td> <td style="width: 10%;"></td> <td style="width: 10%;"></td> <td style="width: 10%;"></td> </tr> <tr> <td></td> <td></td> <td colspan="8" style="text-align: center;"> <table border="1" style="width: 100%; border-collapse: collapse; text-align: center;"> <tr> <td style="width: 10%;"></td> <td style="width: 10%;"></td> <td style="width: 10%;"></td> <td style="width: 10%;"></td> <td style="width: 10%;"></td> <td style="width: 10%;"></td> <td style="width: 10%;"></td> <td style="width: 10%;"></td> <td style="width: 10%;"></td> <td style="width: 10%;"></td> </tr> <tr> <td></td> <td></td> <td colspan="8" style="text-align: center;"> <table border="1" style="width: 100%; border-collapse: collapse; text-align: center;"> <tr> <td style="width: 10%;"></td> <td style="width: 10%;"></td> <td style="width: 10%;"></td> <td style="width: 10%;"></td> <td style="width: 10%;"></td> <td style="width: 10%;"></td> <td style="width: 10%;"></td> <td style="width: 10%;"></td> <td style="width: 10%;"></td> <td style="width: 10%;"></td> </tr> <tr> <td></td> <td></td> <td colspan="8" style="text-align: center;"> <table border="1" style="width: 100%; border-collapse: collapse; text-align: center;"> <tr> <td style="width: 10%;"></td> <td style="width: 10%;"></td> <td style="width: 10%;"></td> <td style="width: 10%;"></td> <td style="width: 10%;"></td> <td style="width: 10%;"></td> <td style="width: 10%;"></td> <td style="width: 10%;"></td> <td style="width: 10%;"></td> <td style="width: 10%;"></td> </tr> <tr> <td></td> <td></td> <td colspan="8" style="text-align: center;"> <table border="1" style="width: 100%; border-collapse: collapse; text-align: center;"> <tr> <td style="width: 10%;"></td> <td style="width: 10%;"></td> <td style="width: 10%;"></td> <td style="width: 10%;"></td> <td style="width: 10%;"></td> <td style="width: 10%;"></td> <td style="width: 10%;"></td> <td style="width: 10%;"></td> <td style="width: 10%;"></td> <td style="width: 10%;"></td> </tr> <tr> <td></td> <td></td> <td colspan="8" style="text-align: center;"> <table border="1" style="width: 100%; border-collapse: collapse; text-align: center;"> <tr> <td style="width: 10%;"></td> <td style="width: 10%;"></td> <td style="width: 10%;"></td> <td style="width: 10%;"></td> <td style="width: 10%;"></td> <td style="width: 10%;"></td> <td style="width: 10%;"></td> <td style="width: 10%;"></td> <td style="width: 10%;"></td> <td style="width: 10%;"></td> </tr> <tr> <td></td> <td></td> <td colspan="8" style="text-align: center;"> <table border="1" style="width: 100%; border-collapse: collapse; text-align: center;"> <tr> <td style="width: 10%;"></td> <td style="width: 10%;"></td> <td style="width: 10%;"></td> <td style="width: 10%;"></td> <td style="width: 10%;"></td> <td style="width: 10%;"></td> <td style="width: 10%;"></td> <td style="width: 10%;"></td> <td style="width: 10%;"></td> <td style="width: 10%;"></td> </tr> <tr> <td></td> <td></td> <td colspan="8" style="text-align: center;"> <table border="1" style="width: 100%; border-collapse: collapse; text-align: center;"> <tr> <td style="width: 10%;"></td> <td style="width: 10%;"></td> <td style="width: 10%;"></td> <td style="width: 10%;"></td> <td style="width: 10%;"></td> <td style="width: 10%;"></td> <td style="width: 10%;"></td> <td style="width: 10%;"></td> <td style="width: 10%;"></td> <td style="width: 10%;"></td> </tr> <tr> <td></td> <td></td> <td colspan="8" style="text-align: center;"> <table border="1" style="width: 100%; border-collapse: collapse; text-align: center;"> <tr> <td style="width: 10%;"></td> <td style="width: 10%;"></td> <td style="width: 10%;"></td> <td style="width: 10%;"></td> <td style="width: 10%;"></td> <td style="width: 10%;"></td> <td style="width: 10%;"></td> <td style="width: 10%;"></td> <td style="width: 10%;"></td> <td style="width: 10%;"></td> </tr> <tr> <td></td> <td></td> <td colspan="8" style="text-align: center;"> <table border="1" style="width: 100%; border-collapse: collapse; text-align: center;"> <tr> <td style="width: 10%;"></td> <td style="width: 10%;"></td> <td style="width: 10%;"></td> <td style="width: 10%;"></td> <td style="width: 10%;"></td> <td style="width: 10%;"></td> <td style="width: 10%;"></td> <td style="width: 10%;"></td> <td style="width: 10%;"></td> <td style="width: 10%;"></td> </tr> <tr> <td></td> <td></td> <td colspan="8" style="text-align: center;"> <table border="1" style="width: 100%; border-collapse: collapse; text-align: center;"> <tr> <td style="width: 10%;"></td> <td style="width: 10%;"></td> <td style="width: 10%;"></td> <td style="width: 10%;"></td> <td style="width: 10%;"></td> <td style="width: 10%;"></td> <td style="width: 10%;"></td> <td style="width: 10%;"></td> <td style="width: 10%;"></td> <td style="width: 10%;"></td> </tr> <tr> <td></td> <td></td> <td colspan="8" style="text-align: center;"> <table border="1" style="width: 100%; border-collapse: collapse; text-align: center;"> <tr> </tr></table></td></tr></table></td></tr></table></td></tr></table></td></tr></table></td></tr></table></td></tr></table></td></tr></table></td></tr></table></td></tr></table></td></tr></table></td></tr></table></td></tr></table></td></tr></table></td></tr></table></td></tr></table></td></tr></table></td></tr></table></td></tr></table></td></tr></table></td></tr></table></td></tr></table></td></tr></table></td></tr></table></td></tr></table></td></tr></table></td></tr></table></td></tr></table></td></tr></table></td></tr></table></td></tr></table></td></tr></table></td></tr></table></td></tr></table>

 | | | | | | | | | | | | | | | | | | | | <table border="1" style="width: 100%; border-collapse: collapse; text-align: center;"> <tr> <td style="width: 10%;"></td> <td style="width: 10%;"></td> <td style="width: 10%;"></td> <td style="width: 10%;"></td> <td style="width: 10%;"></td> <td style="width: 10%;"></td> <td style="width: 10%;"></td> <td style="width: 10%;"></td> <td style="width: 10%;"></td> <td style="width: 10%;"></td> </tr> <tr> <td></td> <td></td> <td colspan="8" style="text-align: center;"> <table border="1" style="width: 100%; border-collapse: collapse; text-align: center;"> <tr> <td style="width: 10%;"></td> <td style="width: 10%;"></td> <td style="width: 10%;"></td> <td style="width: 10%;"></td> <td style="width: 10%;"></td> <td style="width: 10%;"></td> <td style="width: 10%;"></td> <td style="width: 10%;"></td> <td style="width: 10%;"></td> <td style="width: 10%;"></td> </tr> <tr> <td></td> <td></td> <td colspan="8" style="text-align: center;"> <table border="1" style="width: 100%; border-collapse: collapse; text-align: center;"> <tr> <td style="width: 10%;"></td> <td style="width: 10%;"></td> <td style="width: 10%;"></td> <td style="width: 10%;"></td> <td style="width: 10%;"></td> <td style="width: 10%;"></td> <td style="width: 10%;"></td> <td style="width: 10%;"></td> <td style="width: 10%;"></td> <td style="width: 10%;"></td> </tr> <tr> <td></td> <td></td> <td colspan="8" style="text-align: center;"> <table border="1" style="width: 100%; border-collapse: collapse; text-align: center;"> <tr> <td style="width: 10%;"></td> <td style="width: 10%;"></td> <td style="width: 10%;"></td> <td style="width: 10%;"></td> <td style="width: 10%;"></td> <td style="width: 10%;"></td> <td style="width: 10%;"></td> <td style="width: 10%;"></td> <td style="width: 10%;"></td> <td style="width: 10%;"></td> </tr> <tr> <td></td> <td></td> <td colspan="8" style="text-align: center;"> <table border="1" style="width: 100%; border-collapse: collapse; text-align: center;"> <tr> <td style="width: 10%;"></td> <td style="width: 10%;"></td> <td style="width: 10%;"></td> <td style="width: 10%;"></td> <td style="width: 10%;"></td> <td style="width: 10%;"></td> <td style="width: 10%;"></td> <td style="width: 10%;"></td> <td style="width: 10%;"></td> <td style="width: 10%;"></td> </tr> <tr> <td></td> <td></td> <td colspan="8" style="text-align: center;"> <table border="1" style="width: 100%; border-collapse: collapse; text-align: center;"> <tr> <td style="width: 10%;"></td> <td style="width: 10%;"></td> <td style="width: 10%;"></td> <td style="width: 10%;"></td> <td style="width: 10%;"></td> <td style="width: 10%;"></td> <td style="width: 10%;"></td> <td style="width: 10%;"></td> <td style="width: 10%;"></td> <td style="width: 10%;"></td> </tr> <tr> <td></td> <td></td> <td colspan="8" style="text-align: center;"> <table border="1" style="width: 100%; border-collapse: collapse; text-align: center;"> <tr> <td style="width: 10%;"></td> <td style="width: 10%;"></td> <td style="width: 10%;"></td> <td style="width: 10%;"></td> <td style="width: 10%;"></td> <td style="width: 10%;"></td> <td style="width: 10%;"></td> <td style="width: 10%;"></td> <td style="width: 10%;"></td> <td style="width: 10%;"></td> </tr> <tr> <td></td> <td></td> <td colspan="8" style="text-align: center;"> <table border="1" style="width: 100%; border-collapse: collapse; text-align: center;"> <tr> <td style="width: 10%;"></td> <td style="width: 10%;"></td> <td style="width: 10%;"></td> <td style="width: 10%;"></td> <td style="width: 10%;"></td> <td style="width: 10%;"></td> <td style="width: 10%;"></td> <td style="width: 10%;"></td> <td style="width: 10%;"></td> <td style="width: 10%;"></td> </tr> <tr> <td></td> <td></td> <td colspan="8" style="text-align: center;"> <table border="1" style="width: 100%; border-collapse: collapse; text-align: center;"> <tr> <td style="width: 10%;"></td> <td style="width: 10%;"></td> <td style="width: 10%;"></td> <td style="width: 10%;"></td> <td style="width: 10%;"></td> <td style="width: 10%;"></td> <td style="width: 10%;"></td> <td style="width: 10%;"></td> <td style="width: 10%;"></td> <td style="width: 10%;"></td> </tr> <tr> <td></td> <td></td> <td colspan="8" style="text-align: center;"> <table border="1" style="width: 100%; border-collapse: collapse; text-align: center;"> <tr> <td style="width: 10%;"></td> <td style="width: 10%;"></td> <td style="width: 10%;"></td> <td style="width: 10%;"></td> <td style="width: 10%;"></td> <td style="width: 10%;"></td> <td style="width: 10%;"></td> <td style="width: 10%;"></td> <td style="width: 10%;"></td> <td style="width: 10%;"></td> </tr> <tr> <td></td> <td></td> <td colspan="8" style="text-align: center;"> <table border="1" style="width: 100%; border-collapse: collapse; text-align: center;"> <tr> <td style="width: 10%;"></td> <td style="width: 10%;"></td> <td style="width: 10%;"></td> <td style="width: 10%;"></td> <td style="width: 10%;"></td> <td style="width: 10%;"></td> <td style="width: 10%;"></td> <td style="width: 10%;"></td> <td style="width: 10%;"></td> <td style="width: 10%;"></td> </tr> <tr> <td></td> <td></td> <td colspan="8" style="text-align: center;"> <table border="1" style="width: 100%; border-collapse: collapse; text-align: center;"> <tr> <td style="width: 10%;"></td> <td style="width: 10%;"></td> <td style="width: 10%;"></td> <td style="width: 10%;"></td> <td style="width: 10%;"></td> <td style="width: 10%;"></td> <td style="width: 10%;"></td> <td style="width: 10%;"></td> <td style="width: 10%;"></td> <td style="width: 10%;"></td> </tr> <tr> <td></td> <td></td> <td colspan="8" style="text-align: center;"> <table border="1" style="width: 100%; border-collapse: collapse; text-align: center;"> <tr> <td style="width: 10%;"></td> <td style="width: 10%;"></td> <td style="width: 10%;"></td> <td style="width: 10%;"></td> <td style="width: 10%;"></td> <td style="width: 10%;"></td> <td style="width: 10%;"></td> <td style="width: 10%;"></td> <td style="width: 10%;"></td> <td style="width: 10%;"></td> </tr> <tr> <td></td> <td></td> <td colspan="8" style="text-align: center;"> <table border="1" style="width: 100%; border-collapse: collapse; text-align: center;"> <tr> <td style="width: 10%;"></td> <td style="width: 10%;"></td> <td style="width: 10%;"></td> <td style="width: 10%;"></td> <td style="width: 10%;"></td> <td style="width: 10%;"></td> <td style="width: 10%;"></td> <td style="width: 10%;"></td> <td style="width: 10%;"></td> <td style="width: 10%;"></td> </tr> <tr> <td></td> <td></td> <td colspan="8" style="text-align: center;"> <table border="1" style="width: 100%; border-collapse: collapse; text-align: center;"> <tr> <td style="width: 10%;"></td> <td style="width: 10%;"></td> <td style="width: 10%;"></td> <td style="width: 10%;"></td> <td style="width: 10%;"></td> <td style="width: 10%;"></td> <td style="width: 10%;"></td> <td style="width: 10%;"></td> <td style="width: 10%;"></td> <td style="width: 10%;"></td> </tr> <tr> <td></td> <td></td> <td colspan="8" style="text-align: center;"> <table border="1" style="width: 100%; border-collapse: collapse; text-align: center;"> <tr> <td style="width: 10%;"></td> <td style="width: 10%;"></td> <td style="width: 10%;"></td> <td style="width: 10%;"></td> <td style="width: 10%;"></td> <td style="width: 10%;"></td> <td style="width: 10%;"></td> <td style="width: 10%;"></td> <td style="width: 10%;"></td> <td style="width: 10%;"></td> </tr> <tr> <td></td> <td></td> <td colspan="8" style="text-align: center;"> <table border="1" style="width: 100%; border-collapse: collapse; text-align: center;"> <tr> <td style="width: 10%;"></td> <td style="width: 10%;"></td> <td style="width: 10%;"></td> <td style="width: 10%;"></td> <td style="width: 10%;"></td> <td style="width: 10%;"></td> <td style="width: 10%;"></td> <td style="width: 10%;"></td> <td style="width: 10%;"></td> <td style="width: 10%;"></td> </tr> <tr> <td></td> <td></td> <td colspan="8" style="text-align: center;"> <table border="1" style="width: 100%; border-collapse: collapse; text-align: center;"> <tr> <td style="width: 10%;"></td> <td style="width: 10%;"></td> <td style="width: 10%;"></td> <td style="width: 10%;"></td> <td style="width: 10%;"></td> <td style="width: 10%;"></td> <td style="width: 10%;"></td> <td style="width: 10%;"></td> <td style="width: 10%;"></td> <td style="width: 10%;"></td> </tr> <tr> <td></td> <td></td> <td colspan="8" style="text-align: center;"> <table border="1" style="width: 100%;
border-collapse: collapse; text-align: center;"> <tr> <td style="width: 10%;"></td> <td style="width: 10%;"></td> <td style="width: 10%;"></td> <td style="width: 10%;"></td> <td style="width: 10%;"></td> <td style="width: 10%;"></td> <td style="width: 10%;"></td> <td style="width: 10%;"></td> <td style="width: 10%;"></td> <td style="width: 10%;"></td> </tr> <tr> <td></td> <td></td> <td colspan="8" style="text-align: center;"> <table border="1" style="width: 100%; border-collapse: collapse; text-align: center;"> <tr> <td style="width: 10%;"></td> <td style="width: 10%;"></td> <td style="width: 10%;"></td> <td style="width: 10%;"></td> <td style="width: 10%;"></td> <td style="width: 10%;"></td> <td style="width: 10%;"></td> <td style="width: 10%;"></td> <td style="width: 10%;"></td> <td style="width: 10%;"></td> </tr> <tr> <td></td> <td></td> <td colspan="8" style="text-align: center;"> <table border="1" style="width: 100%; border-collapse: collapse; text-align: center;"> <tr> <td style="width: 10%;"></td> <td style="width: 10%;"></td> <td style="width: 10%;"></td> <td style="width: 10%;"></td> <td style="width: 10%;"></td> <td style="width: 10%;"></td> <td style="width: 10%;"></td> <td style="width: 10%;"></td> <td style="width: 10%;"></td> <td style="width: 10%;"></td> </tr> <tr> <td></td> <td></td> <td colspan="8" style="text-align: center;"> <table border="1" style="width: 100%; border-collapse: collapse; text-align: center;"> <tr> <td style="width: 10%;"></td> <td style="width: 10%;"></td> <td style="width: 10%;"></td> <td style="width: 10%;"></td> <td style="width: 10%;"></td> <td style="width: 10%;"></td> <td style="width: 10%;"></td> <td style="width: 10%;"></td> <td style="width: 10%;"></td> <td style="width: 10%;"></td> </tr> <tr> <td></td> <td></td> <td colspan="8" style="text-align: center;"> <table border="1" style="width: 100%; border-collapse: collapse; text-align: center;"> <tr> <td style="width: 10%;"></td> <td style="width: 10%;"></td> <td style="width: 10%;"></td> <td style="width: 10%;"></td> <td style="width: 10%;"></td> <td style="width: 10%;"></td> <td style="width: 10%;"></td> <td style="width: 10%;"></td> <td style="width: 10%;"></td> <td style="width: 10%;"></td> </tr> <tr> <td></td> <td></td> <td colspan="8" style="text-align: center;"> <table border="1" style="width: 100%; border-collapse: collapse; text-align: center;"> <tr> <td style="width: 10%;"></td> <td style="width: 10%;"></td> <td style="width: 10%;"></td> <td style="width: 10%;"></td> <td style="width: 10%;"></td> <td style="width: 10%;"></td> <td style="width: 10%;"></td> <td style="width: 10%;"></td> <td style="width: 10%;"></td> <td style="width: 10%;"></td> </tr> <tr> <td></td> <td></td> <td colspan="8" style="text-align: center;"> <table border="1" style="width: 100%; border-collapse: collapse; text-align: center;"> <tr> <td style="width: 10%;"></td> <td style="width: 10%;"></td> <td style="width: 10%;"></td> <td style="width: 10%;"></td> <td style="width: 10%;"></td> <td style="width: 10%;"></td> <td style="width: 10%;"></td> <td style="width: 10%;"></td> <td style="width: 10%;"></td> <td style="width: 10%;"></td> </tr> <tr> <td></td> <td></td> <td colspan="8" style="text-align: center;"> <table border="1" style="width: 100%; border-collapse: collapse; text-align: center;"> <tr> <td style="width: 10%;"></td> <td style="width: 10%;"></td> <td style="width: 10%;"></td> <td style="width: 10%;"></td> <td style="width: 10%;"></td> <td style="width: 10%;"></td> <td style="width: 10%;"></td> <td style="width: 10%;"></td> <td style="width: 10%;"></td> <td style="width: 10%;"></td> </tr> <tr> <td></td> <td></td> <td colspan="8" style="text-align: center;"> <table border="1" style="width: 100%; border-collapse: collapse; text-align: center;"> <tr> <td style="width: 10%;"></td> <td style="width: 10%;"></td> <td style="width: 10%;"></td> <td style="width: 10%;"></td> <td style="width: 10%;"></td> <td style="width: 10%;"></td> <td style="width: 10%;"></td> <td style="width: 10%;"></td> <td style="width: 10%;"></td> <td style="width: 10%;"></td> </tr> <tr> <td></td> <td></td> <td colspan="8" style="text-align: center;"> <table border="1" style="width: 100%; border-collapse: collapse; text-align: center;"> <tr> <td style="width: 10%;"></td> <td style="width: 10%;"></td> <td style="width: 10%;"></td> <td style="width: 10%;"></td> <td style="width: 10%;"></td> <td style="width: 10%;"></td> <td style="width: 10%;"></td> <td style="width: 10%;"></td> <td style="width: 10%;"></td> <td style="width: 10%;"></td> </tr> <tr> <td></td> <td></td> <td colspan="8" style="text-align: center;"> <table border="1" style="width: 100%; border-collapse: collapse; text-align: center;"> <tr> <td style="width: 10%;"></td> <td style="width: 10%;"></td> <td style="width: 10%;"></td> <td style="width: 10%;"></td> <td style="width: 10%;"></td> <td style="width: 10%;"></td> <td style="width: 10%;"></td> <td style="width: 10%;"></td> <td style="width: 10%;"></td> <td style="width: 10%;"></td> </tr> <tr> <td></td> <td></td> <td colspan="8" style="text-align: center;"> <table border="1" style="width: 100%; border-collapse: collapse; text-align: center;"> <tr> <td style="width: 10%;"></td> <td style="width: 10%;"></td> <td style="width: 10%;"></td> <td style="width: 10%;"></td> <td style="width: 10%;"></td> <td style="width: 10%;"></td> <td style="width: 10%;"></td> <td style="width: 10%;"></td> <td style="width: 10%;"></td> <td style="width: 10%;"></td> </tr> <tr> <td></td> <td></td> <td colspan="8" style="text-align: center;"> <table border="1" style="width: 100%; border-collapse: collapse; text-align: center;"> <tr> <td style="width: 10%;"></td> <td style="width: 10%;"></td> <td style="width: 10%;"></td> <td style="width: 10%;"></td> <td style="width: 10%;"></td> <td style="width: 10%;"></td> <td style="width: 10%;"></td> <td style="width: 10%;"></td> <td style="width: 10%;"></td> <td style="width: 10%;"></td> </tr> <tr> <td></td> <td></td> <td colspan="8" style="text-align: center;"> <table border="1" style="width: 100%; border-collapse: collapse; text-align: center;"> <tr> <td style="width: 10%;"></td> <td style="width: 10%;"></td> <td style="width: 10%;"></td> <td style="width: 10%;"></td> <td style="width: 10%;"></td> <td style="width: 10%;"></td> <td style="width: 10%;"></td> <td style="width: 10%;"></td> <td style="width: 10%;"></td> <td style="width: 10%;"></td> </tr> <tr> <td></td> <td></td> <td colspan="8" style="text-align: center;"> <table border="1" style="width: 100%; border-collapse: collapse; text-align: center;"> <tr> </tr></table></td></tr></table></td></tr></table></td></tr></table></td></tr></table></td></tr></table></td></tr></table></td></tr></table></td></tr></table></td></tr></table></td></tr></table></td></tr></table></td></tr></table></td></tr></table></td></tr></table></td></tr></table></td></tr></table></td></tr></table></td></tr></table></td></tr></table></td></tr></table></td></tr></table></td></tr></table></td></tr></table></td></tr></table></td></tr></table></td></tr></table></td></tr></table></td></tr></table></td></tr></table></td></tr></table></td></tr></table></td></tr></table>

 | | | | | | | | | | | | | | | | | | | | <table border="1" style="width: 100%; border-collapse: collapse; text-align: center;"> <tr> <td style="width: 10%;"></td> <td style="width: 10%;"></td> <td style="width: 10%;"></td> <td style="width: 10%;"></td> <td style="width: 10%;"></td> <td style="width: 10%;"></td> <td style="width: 10%;"></td> <td style="width: 10%;"></td> <td style="width: 10%;"></td> <td style="width: 10%;"></td> </tr> <tr> <td></td> <td></td> <td colspan="8" style="text-align: center;"> <table border="1" style="width: 100%; border-collapse: collapse; text-align: center;"> <tr> <td style="width: 10%;"></td> <td style="width: 10%;"></td> <td style="width: 10%;"></td> <td style="width: 10%;"></td> <td style="width: 10%;"></td> <td style="width: 10%;"></td> <td style="width: 10%;"></td> <td style="width: 10%;"></td> <td style="width: 10%;"></td> <td style="width: 10%;"></td> </tr> <tr> <td></td> <td></td> <td colspan="8" style="text-align: center;"> <table border="1" style="width: 100%; border-collapse: collapse; text-align: center;"> <tr> <td style="width: 10%;"></td> <td style="width: 10%;"></td> <td style="width: 10%;"></td> <td style="width: 10%;"></td> <td style="width: 10%;"></td> <td style="width: 10%;"></td> <td style="width: 10%;"></td> <td style="width: 10%;"></td> <td style="width: 10%;"></td> <td style="width: 10%;"></td> </tr> <tr> <td></td> <td></td> <td colspan="8" style="text-align: center;"> <table border="1" style="width: 100%; border-collapse: collapse; text-align: center;"> <tr> <td style="width: 10%;"></td> <td style="width: 10%;"></td> <td style="width: 10%;"></td> <td style="width: 10%;"></td> <td style="width: 10%;"></td> <td style="width: 10%;"></td> <td style="width: 10%;"></td> <td style="width: 10%;"></td> <td style="width: 10%;"></td> <td style="width: 10%;"></td> </tr> <tr> <td></td> <td></td> <td colspan="8" style="text-align: center;"> <table border="1" style="width: 100%; border-collapse: collapse; text-align: center;"> <tr> <td style="width: 10%;"></td> <td style="width: 10%;"></td> <td style="width: 10%;"></td> <td style="width: 10%;"></td> <td style="width: 10%;"></td> <td style="width: 10%;"></td> <td style="width: 10%;"></td> <td style="width: 10%;"></td> <td style="width: 10%;"></td> <td style="width: 10%;"></td> </tr> <tr> <td></td> <td></td> <td colspan="8" style="text-align: center;"> <table border="1" style="width: 100%; border-collapse: collapse; text-align: center;"> <tr> <td style="width: 10%;"></td> <td style="width: 10%;"></td> <td style="width: 10%;"></td> <td style="width: 10%;"></td> <td style="width: 10%;"></td> <td style="width: 10%;"></td> <td style="width: 10%;"></td> <td style="width: 10%;"></td> <td style="width: 10%;"></td> <td style="width: 10%;"></td> </tr> <tr> <td></td> <td></td> <td colspan="8" style="text-align: center;"> <table border="1" style="width: 100%; border-collapse: collapse; text-align: center;"> <tr> <td style="width: 10%;"></td> <td style="width: 10%;"></td> <td style="width: 10%;"></td> <td style="width: 10%;"></td> <td style="width: 10%;"></td> <td style="width: 10%;"></td> <td style="width: 10%;"></td> <td style="width: 10%;"></td> <td style="width: 10%;"></td> <td style="width: 10%;"></td> </tr> <tr> <td></td> <td></td> <td colspan="8" style="text-align: center;"> <table border="1" style="width: 100%; border-collapse: collapse; text-align: center;"> <tr> <td style="width: 10%;"></td> <td style="width: 10%;"></td> <td style="width: 10%;"></td> <td style="width: 10%;"></td> <td style="width: 10%;"></td> <td style="width: 10%;"></td> <td style="width: 10%;"></td> <td style="width: 10%;"></td> <td style="width: 10%;"></td> <td style="width: 10%;"></td> </tr> <tr> <td></td> <td></td> <td colspan="8" style="text-align: center;"> <table border="1" style="width: 100%; border-collapse: collapse; text-align: center;"> <tr> <td style="width: 10%;"></td> <td style="width: 10%;"></td> <td style="width: 10%;"></td> <td style="width: 10%;"></td> <td style="width: 10%;"></td> <td style="width: 10%;"></td> <td style="width: 10%;"></td> <td style="width: 10%;"></td> <td style="width: 10%;"></td> <td style="width: 10%;"></td> </tr> <tr> <td></td> <td></td> <td colspan="8" style="text-align: center;"> <table border="1" style="width: 100%; border-collapse: collapse; text-align: center;"> <tr> <td style="width: 10%;"></td> <td style="width: 10%;"></td> <td style="width: 10%;"></td> <td style="width: 10%;"></td> <td style="width: 10%;"></td> <td style="width: 10%;"></td> <td style="width: 10%;"></td> <td style="width: 10%;"></td> <td style="width: 10%;"></td> <td style="width: 10%;"></td> </tr> <tr> <td></td> <td></td> <td colspan="8" style="text-align: center;"> <table border="1" style="width: 100%; border-collapse: collapse; text-align: center;"> <tr> <td style="width: 10%;"></td> <td style="width: 10%;"></td> <td style="width: 10%;"></td> <td style="width: 10%;"></td> <td style="width: 10%;"></td> <td style="width: 10%;"></td> <td style="width: 10%;"></td> <td style="width: 10%;"></td> <td style="width: 10%;"></td> <td style="width: 10%;"></td> </tr> <tr> <td></td> <td></td> <td colspan="8" style="text-align: center;"> <table border="1" style="width: 100%; border-collapse: collapse; text-align: center;"> <tr> <td style="width: 10%;"></td> <td style="width: 10%;"></td> <td style="width: 10%;"></td> <td style="width: 10%;"></td> <td style="width: 10%;"></td> <td style="width: 10%;"></td> <td style="width: 10%;"></td> <td style="width: 10%;"></td> <td style="width: 10%;"></td> <td style="width: 10%;"></td> </tr> <tr> <td></td> <td></td> <td colspan="8" style="text-align: center;"> <table border="1" style="width: 100%; border-collapse: collapse; text-align: center;"> <tr> <td style="width: 10%;"></td> <td style="width: 10%;"></td> <td style="width: 10%;"></td> <td style="width: 10%;"></td> <td style="width: 10%;"></td> <td style="width: 10%;"></td> <td style="width: 10%;"></td> <td style="width: 10%;"></td> <td style="width: 10%;"></td> <td style="width: 10%;"></td> </tr> <tr> <td></td> <td></td> <td colspan="8" style="text-align: center;"> <table border="1" style="width: 100%; border-collapse: collapse; text-align: center;"> <tr> <td style="width: 10%;"></td> <td style="width: 10%;"></td> <td style="width: 10%;"></td> <td style="width: 10%;"></td> <td style="width: 10%;"></td> <td style="width: 10%;"></td> <td style="width: 10%;"></td> <td style="width: 10%;"></td> <td style="width: 10%;"></td> <td style="width: 10%;"></td> </tr> <tr> <td></td> <td></td> <td colspan="8" style="text-align: center;"> <table border="1" style="width: 100%; border-collapse: collapse; text-align: center;"> <tr> <td style="width: 10%;"></td> <td style="width: 10%;"></td> <td style="width: 10%;"></td> <td style="width: 10%;"></td> <td style="width: 10%;"></td> <td style="width: 10%;"></td> <td style="width: 10%;"></td> <td style="width: 10%;"></td> <td style="width: 10%;"></td> <td style="width: 10%;"></td> </tr> <tr> <td></td> <td></td> <td colspan="8" style="text-align: center;"> <table border="1" style="width: 100%; border-collapse: collapse; text-align: center;"> <tr> <td style="width: 10%;"></td> <td style="width: 10%;"></td> <td style="width: 10%;"></td> <td style="width: 10%;"></td> <td style="width: 10%;"></td> <td style="width: 10%;"></td> <td style="width: 10%;"></td> <td style="width: 10%;"></td> <td style="width: 10%;"></td> <td style="width: 10%;"></td> </tr> <tr> <td></td> <td></td> <td colspan="8" style="text-align: center;"> <table border="1" style="width: 100%; border-collapse: collapse; text-align: center;"> <tr> <td style="width: 10%;"></td> <td style="width: 10%;"></td> <td style="width: 10%;"></td> <td style="width: 10%;"></td> <td style="width: 10%;"></td> <td style="width: 10%;"></td> <td style="width: 10%;"></td> <td style="width: 10%;"></td> <td style="width: 10%;"></td> <td style="width: 10%;"></td> </tr> <tr> <td></td> <td></td> <td colspan="8" style="text-align: center;"> <table border="1" style="width: 100%; border-collapse: collapse; text-align: center;"> <tr> <td style="width: 10%;"></td> <td style="width: 10%;"></td> <td style="width: 10%;"></td> <td style="width: 10%;"></td> <td style="width: 10%;"></td> <td style="width: 10%;"></td> <td style="width: 10%;"></td> <td style="width: 10%;"></td> <td style="width: 10%;"></td> <td style="width: 10%;"></td> </tr> <tr> <td></td> <td></td> <td colspan="8" style="text-align: center;"> <table border="1" style="width: 100%; border-collapse: collapse; text-align: center;"> <tr> <td style="width: 10%;"></td> <td style="width: 10%;"></td> <td style="width: 10%;"></td> <td style="width: 10%;"></td> <td style="width: 10%;"></td> <td style="width: 10%;"></td> <td style="width: 10%;"></td> <td style="width: 10%;"></td> <td style="width: 10%;"></td> <td style="width: 10%;"></td> </tr> <tr> <td></td> <td></td> <td colspan="8" style="text-align: center;"> <table border="1" style="width: 100%; border-collapse: collapse; text-align: center;"> <tr> <td style="width: 10%;"></td> <td style="width: 10%;"></td> <td style="width: 10%;"></td> <td style="width: 10%;"></td> <td style="width: 10%;"></td> <td style="width: 10%;"></td> <td style="width: 10%;"></td> <td style="width: 10%;"></td> <td style="width: 10%;"></td> <td style="width: 10%;"></td> </tr> <tr> <td></td> <td></td> <td colspan="8" style="text-align: center;"> <table border="1" style="width: 100%; border-collapse: collapse; text-align: center;"> <tr> <td style="width: 10%;"></td> <td style="width: 10%;"></td> <td style="width: 10%;"></td> <td style="width: 10%;"></td> <td style="width: 10%;"></td> <td style="width:
10%;"></td> <td style="width: 10%;"></td> <td style="width: 10%;"></td> <td style="width: 10%;"></td> <td style="width: 10%;"></td> </tr> <tr> <td></td> <td></td> <td colspan="8" style="text-align: center;"> <table border="1" style="width: 100%; border-collapse: collapse; text-align: center;"> <tr> <td style="width: 10%;"></td> <td style="width: 10%;"></td> <td style="width: 10%;"></td> <td style="width: 10%;"></td> <td style="width: 10%;"></td> <td style="width: 10%;"></td> <td style="width: 10%;"></td> <td style="width: 10%;"></td> <td style="width: 10%;"></td> <td style="width: 10%;"></td> </tr> <tr> <td></td> <td></td> <td colspan="8" style="text-align: center;"> <table border="1" style="width: 100%; border-collapse: collapse; text-align: center;"> <tr> <td style="width: 10%;"></td> <td style="width: 10%;"></td> <td style="width: 10%;"></td> <td style="width: 10%;"></td> <td style="width: 10%;"></td> <td style="width: 10%;"></td> <td style="width: 10%;"></td> <td style="width: 10%;"></td> <td style="width: 10%;"></td> <td style="width: 10%;"></td> </tr> <tr> <td></td> <td></td> <td colspan="8" style="text-align: center;"> <table border="1" style="width: 100%; border-collapse: collapse; text-align: center;"> <tr> <td style="width: 10%;"></td> <td style="width: 10%;"></td> <td style="width: 10%;"></td> <td style="width: 10%;"></td> <td style="width: 10%;"></td> <td style="width: 10%;"></td> <td style="width: 10%;"></td> <td style="width: 10%;"></td> <td style="width: 10%;"></td> <td style="width: 10%;"></td> </tr> <tr> <td></td> <td></td> <td colspan="8" style="text-align: center;"> <table border="1" style="width: 100%; border-collapse: collapse; text-align: center;"> <tr> <td style="width: 10%;"></td> <td style="width: 10%;"></td> <td style="width: 10%;"></td> <td style="width: 10%;"></td> <td style="width: 10%;"></td> <td style="width: 10%;"></td> <td style="width: 10%;"></td> <td style="width: 10%;"></td> <td style="width: 10%;"></td> <td style="width: 10%;"></td> </tr> <tr> <td></td> <td></td> <td colspan="8" style="text-align: center;"> <table border="1" style="width: 100%; border-collapse: collapse; text-align: center;"> <tr> <td style="width: 10%;"></td> <td style="width: 10%;"></td> <td style="width: 10%;"></td> <td style="width: 10%;"></td> <td style="width: 10%;"></td> <td style="width: 10%;"></td> <td style="width: 10%;"></td> <td style="width: 10%;"></td> <td style="width: 10%;"></td> <td style="width: 10%;"></td> </tr> <tr> <td></td> <td></td> <td colspan="8" style="text-align: center;"> <table border="1" style="width: 100%; border-collapse: collapse; text-align: center;"> <tr> <td style="width: 10%;"></td> <td style="width: 10%;"></td> <td style="width: 10%;"></td> <td style="width: 10%;"></td> <td style="width: 10%;"></td> <td style="width: 10%;"></td> <td style="width: 10%;"></td> <td style="width: 10%;"></td> <td style="width: 10%;"></td> <td style="width: 10%;"></td> </tr> <tr> <td></td> <td></td> <td colspan="8" style="text-align: center;"> <table border="1" style="width: 100%; border-collapse: collapse; text-align: center;"> <tr> <td style="width: 10%;"></td> <td style="width: 10%;"></td> <td style="width: 10%;"></td> <td style="width: 10%;"></td> <td style="width: 10%;"></td> <td style="width: 10%;"></td> <td style="width: 10%;"></td> <td style="width: 10%;"></td> <td style="width: 10%;"></td> <td style="width: 10%;"></td> </tr> <tr> <td></td> <td></td> <td colspan="8" style="text-align: center;"> <table border="1" style="width: 100%; border-collapse: collapse; text-align: center;"> <tr> <td style="width: 10%;"></td> <td style="width: 10%;"></td> <td style="width: 10%;"></td> <td style="width: 10%;"></td> <td style="width: 10%;"></td> <td style="width: 10%;"></td> <td style="width: 10%;"></td> <td style="width: 10%;"></td> <td style="width: 10%;"></td> <td style="width: 10%;"></td> </tr> <tr> <td></td> <td></td> <td colspan="8" style="text-align: center;"> <table border="1" style="width: 100%; border-collapse: collapse; text-align: center;"> <tr> <td style="width: 10%;"></td> <td style="width: 10%;"></td> <td style="width: 10%;"></td> <td style="width: 10%;"></td> <td style="width: 10%;"></td> <td style="width: 10%;"></td> <td style="width: 10%;"></td> <td style="width: 10%;"></td> <td style="width: 10%;"></td> <td style="width: 10%;"></td> </tr> <tr> <td></td> <td></td> <td colspan="8" style="text-align: center;"> <table border="1" style="width: 100%; border-collapse: collapse; text-align: center;"> <tr> <td style="width: 10%;"></td> <td style="width: 10%;"></td> <td style="width: 10%;"></td> <td style="width: 10%;"></td> <td style="width: 10%;"></td> <td style="width: 10%;"></td> <td style="width: 10%;"></td> <td style="width: 10%;"></td> <td style="width: 10%;"></td> <td style="width: 10%;"></td> </tr> <tr> <td></td> <td></td> <td colspan="8" style="text-align: center;"> <table border="1" style="width: 100%; border-collapse: collapse; text-align: center;"> <tr> </tr></table></td></tr></table></td></tr></table></td></tr></table></td></tr></table></td></tr></table></td></tr></table></td></tr></table></td></tr></table></td></tr></table></td></tr></table></td></tr></table></td></tr></table></td></tr></table></td></tr></table></td></tr></table></td></tr></table></td></tr></table></td></tr></table></td></tr></table></td></tr></table></td></tr></table></td></tr></table></td></tr></table></td></tr></table></td></tr></table></td></tr></table></td></tr></table></td></tr></table></td></tr></table></td></tr></table></td></tr></table>
 | | | | | | | | | | | | | | | | | | | | <table border="1" style="width: 100%; border-collapse: collapse; text-align: center;"> <tr> <td style="width: 10%;"></td> <td style="width: 10%;"></td> <td style="width: 10%;"></td> <td style="width: 10%;"></td> <td style="width: 10%;"></td> <td style="width: 10%;"></td> <td style="width: 10%;"></td> <td style="width: 10%;"></td> <td style="width: 10%;"></td> <td style="width: 10%;"></td> </tr> <tr> <td></td> <td></td> <td colspan="8" style="text-align: center;"> <table border="1" style="width: 100%; border-collapse: collapse; text-align: center;"> <tr> <td style="width: 10%;"></td> <td style="width: 10%;"></td> <td style="width: 10%;"></td> <td style="width: 10%;"></td> <td style="width: 10%;"></td> <td style="width: 10%;"></td> <td style="width: 10%;"></td> <td style="width: 10%;"></td> <td style="width: 10%;"></td> <td style="width: 10%;"></td> </tr> <tr> <td></td> <td></td> <td colspan="8" style="text-align: center;"> <table border="1" style="width: 100%; border-collapse: collapse; text-align: center;"> <tr> <td style="width: 10%;"></td> <td style="width: 10%;"></td> <td style="width: 10%;"></td> <td style="width: 10%;"></td> <td style="width: 10%;"></td> <td style="width: 10%;"></td> <td style="width: 10%;"></td> <td style="width:
10%;"></td> <td style="width: 10%;"></td> <td style="width: 10%;"></td> </tr> <tr> <td></td> <td></td> <td colspan="8" style="text-align: center;"> <table border="1" style="width: 100%; border-collapse: collapse; text-align: center;"> <tr> <td style="width: 10%;"></td> <td style="width: 10%;"></td> <td style="width: 10%;"></td> <td style="width: 10%;"></td> <td style="width: 10%;"></td> <td style="width: 10%;"></td> <td style="width: 10%;"></td> <td style="width: 10%;"></td> <td style="width: 10%;"></td> <td style="width: 10%;"></td> </tr> <tr> <td></td> <td></td> <td colspan="8" style="text-align: center;"> <table border="1" style="width: 100%; border-collapse: collapse; text-align: center;"> <tr> <td style="width: 10%;"></td> <td style="width: 10%;"></td> <td style="width: 10%;"></td> <td style="width: 10%;"></td> <td style="width: 10%;"></td> <td style="width: 10%;"></td> <td style="width: 10%;"></td> <td style="width: 10%;"></td> <td style="width: 10%;"></td> <td style="width: 10%;"></td> </tr> <tr> <td></td> <td></td> <td colspan="8" style="text-align: center;"> <table border="1" style="width: 100%; border-collapse: collapse; text-align: center;"> <tr> <td style="width: 10%;"></td> <td style="width: 10%;"></td> <td style="width: 10%;"></td> <td style="width: 10%;"></td> <td style="width: 10%;"></td> <td style="width: 10%;"></td> <td style="width: 10%;"></td> <td style="width: 10%;"></td> <td style="width: 10%;"></td> <td style="width: 10%;"></td> </tr> <tr> <td></td> <td></td> <td colspan="8" style="text-align: center;"> <table border="1" style="width: 100%; border-collapse: collapse; text-align: center;"> <tr> <td style="width: 10%;"></td> <td style="width: 10%;"></td> <td style="width: 10%;"></td> <td style="width: 10%;"></td> <td style="width: 10%;"></td> <td style="width: 10%;"></td> <td style="width: 10%;"></td> <td style="width: 10%;"></td> <td style="width: 10%;"></td> <td style="width: 10%;"></td> </tr> <tr> <td></td> <td></td> <td colspan="8" style="text-align: center;"> <table border="1" style="width: 100%; border-collapse: collapse; text-align: center;"> <tr> <td style="width: 10%;"></td> <td style="width: 10%;"></td> <td style="width: 10%;"></td> <td style="width: 10%;"></td> <td style="width: 10%;"></td> <td style="width: 10%;"></td> <td style="width: 10%;"></td> <td style="width: 10%;"></td> <td style="width: 10%;"></td> <td style="width: 10%;"></td> </tr> <tr> <td></td> <td></td> <td colspan="8" style="text-align: center;"> <table border="1" style="width: 100%; border-collapse: collapse; text-align: center;"> <tr> <td style="width: 10%;"></td> <td style="width: 10%;"></td> <td style="width: 10%;"></td> <td style="width: 10%;"></td> <td style="width: 10%;"></td> <td style="width: 10%;"></td> <td style="width: 10%;"></td> <td style="width: 10%;"></td> <td style="width: 10%;"></td> <td style="width: 10%;"></td> </tr> <tr> <td></td> <td></td> <td colspan="8" style="text-align: center;"> <table border="1" style="width: 100%; border-collapse: collapse; text-align: center;"> <tr> <td style="width: 10%;"></td> <td style="width: 10%;"></td> <td style="width: 10%;"></td> <td style="width: 10%;"></td> <td style="width: 10%;"></td> <td style="width: 10%;"></td> <td style="width: 10%;"></td> <td style="width: 10%;"></td> <td style="width: 10%;"></td> <td style="width: 10%;"></td> </tr> <tr> <td></td> <td></td> <td colspan="8" style="text-align: center;"> <table border="1" style="width: 100%; border-collapse: collapse; text-align: center;"> <tr> <td style="width: 10%;"></td> <td style="width: 10%;"></td> <td style="width: 10%;"></td> <td style="width: 10%;"></td> <td style="width: 10%;"></td> <td style="width: 10%;"></td> <td style="width: 10%;"></td> <td style="width: 10%;"></td> <td style="width: 10%;"></td> <td style="width: 10%;"></td> </tr> <tr> <td></td> <td></td> <td colspan="8" style="text-align: center;"> <table border="1" style="width: 100%; border-collapse: collapse; text-align: center;"> <tr> <td style="width: 10%;"></td> <td style="width: 10%;"></td> <td style="width: 10%;"></td> <td style="width: 10%;"></td> <td style="width: 10%;"></td> <td style="width: 10%;"></td> <td style="width: 10%;"></td> <td style="width: 10%;"></td> <td style="width: 10%;"></td> <td style="width: 10%;"></td> </tr> <tr> <td></td> <td></td> <td colspan="8" style="text-align: center;"> <table border="1" style="width: 100%; border-collapse: collapse; text-align: center;"> <tr> <td style="width: 10%;"></td> <td style="width: 10%;"></td> <td style="width: 10%;"></td> <td style="width: 10%;"></td> <td style="width: 10%;"></td> <td style="width: 10%;"></td> <td style="width: 10%;"></td> <td style="width: 10%;"></td> <td style="width: 10%;"></td> <td style="width: 10%;"></td> </tr> <tr> <td></td> <td></td> <td colspan="8" style="text-align: center;"> <table border="1" style="width: 100%; border-collapse: collapse; text-align: center;"> <tr> <td style="width: 10%;"></td> <td style="width: 10%;"></td> <td style="width: 10%;"></td> <td style="width: 10%;"></td> <td style="width: 10%;"></td> <td style="width: 10%;"></td> <td style="width: 10%;"></td> <td style="width: 10%;"></td> <td style="width: 10%;"></td> <td style="width: 10%;"></td> </tr> <tr> <td></td> <td></td> <td colspan="8" style="text-align: center;"> <table border="1" style="width: 100%; border-collapse: collapse; text-align: center;"> <tr> <td style="width: 10%;"></td> <td style="width: 10%;"></td> <td style="width: 10%;"></td> <td style="width: 10%;"></td> <td style="width: 10%;"></td> <td style="width: 10%;"></td> <td style="width: 10%;"></td> <td style="width: 10%;"></td> <td style="width: 10%;"></td> <td style="width: 10%;"></td> </tr> <tr> <td></td> <td></td> <td colspan="8" style="text-align: center;"> <table border="1" style="width: 100%; border-collapse: collapse; text-align: center;"> <tr> <td style="width: 10%;"></td> <td style="width: 10%;"></td> <td style="width: 10%;"></td> <td style="width: 10%;"></td> <td style="width: 10%;"></td> <td style="width: 10%;"></td> <td style="width: 10%;"></td> <td style="width: 10%;"></td> <td style="width: 10%;"></td> <td style="width: 10%;"></td> </tr> <tr> <td></td> <td></td> <td colspan="8" style="text-align: center;"> <table border="1" style="width: 100%; border-collapse: collapse; text-align: center;"> <tr> <td style="width: 10%;"></td> <td style="width: 10%;"></td> <td style="width: 10%;"></td> <td style="width: 10%;"></td> <td style="width: 10%;"></td> <td style="width: 10%;"></td> <td style="width: 10%;"></td> <td style="width: 10%;"></td> <td style="width: 10%;"></td> <td style="width: 10%;"></td> </tr> <tr> <td></td> <td></td> <td colspan="8" style="text-align: center;"> <table border="1" style="width: 100%; border-collapse: collapse; text-align: center;"> <tr> <td style="width: 10%;"></td> <td style="width: 10%;"></td> <td style="width: 10%;"></td> <td style="width: 10%;"></td> <td style="width: 10%;"></td> <td style="width: 10%;"></td> <td style="width: 10%;"></td> <td style="width: 10%;"></td> <td style="width: 10%;"></td> <td style="width: 10%;"></td> </tr> <tr> <td></td> <td></td> <td colspan="8" style="text-align: center;"> <table border="1" style="width: 100%; border-collapse: collapse; text-align: center;"> <tr> <td style="width: 10%;"></td> <td style="width: 10%;"></td> <td style="width: 10%;"></td> <td style="width: 10%;"></td> <td style="width: 10%;"></td> <td style="width: 10%;"></td> <td style="width: 10%;"></td> <td style="width: 10%;"></td> <td style="width: 10%;"></td> <td style="width: 10%;"></td> </tr> <tr> <td></td> <td></td> <td colspan="8" style="text-align: center;"> <table border="1" style="width: 100%; border-collapse: collapse; text-align: center;"> <tr> <td style="width: 10%;"></td> <td style="width: 10%;"></td> <td style="width: 10%;"></td> <td style="width: 10%;"></td> <td style="width: 10%;"></td> <td style="width: 10%;"></td> <td style="width: 10%;"></td> <td style="width: 10%;"></td> <td style="width: 10%;"></td> <td style="width: 10%;"></td> </tr> <tr> <td></td> <td></td> <td colspan="8" style="text-align: center;"> <table border="1" style="width: 100%; border-collapse: collapse; text-align: center;"> <tr> <td style="width: 10%;"></td> <td style="width: 10%;"></td> <td style="width: 10%;"></td> <td style="width: 10%;"></td> <td style="width: 10%;"></td> <td style="width: 10%;"></td> <td style="width: 10%;"></td> <td style="width: 10%;"></td> <td style="width: 10%;"></td> <td style="width: 10%;"></td> </tr> <tr> <td></td> <td></td> <td colspan="8" style="text-align: center;"> <table border="1" style="width: 100%; border-collapse: collapse; text-align: center;"> <tr> <td style="width: 10%;"></td> <td style="width: 10%;"></td> <td style="width: 10%;"></td> <td style="width: 10%;"></td> <td style="width: 10%;"></td> <td style="width: 10%;"></td> <td style="width: 10%;"></td> <td style="width: 10%;"></td> <td style="width: 10%;"></td> <td style="width: 10%;"></td> </tr> <tr> <td></td> <td></td> <td colspan="8" style="text-align: center;"> <table border="1" style="width: 100%; border-collapse: collapse; text-align: center;"> <tr> <td style="width: 10%;"></td> <td style="width: 10%;"></td> <td style="width: 10%;"></td> <td style="width: 10%;"></td> <td style="width: 10%;"></td> <td style="width: 10%;"></td> <td style="width: 10%;"></td> <td style="width: 10%;"></td> <td style="width: 10%;"></td> <td style="width: 10%;"></td> </tr> <tr> <td></td> <td></td> <td colspan="8" style="text-align: center;"> <table border="1" style="width: 100%; border-collapse: collapse; text-align: center;"> <tr> <td style="width: 10%;"></td> <td style="width: 10%;"></td> <td style="width: 10%;"></td> <td style="width: 10%;"></td> <td style="width: 10%;"></td> <td style="width: 10%;"></td> <td style="width: 10%;"></td> <td style="width: 10%;"></td> <td style="width: 10%;"></td> <td style="width: 10%;"></td> </tr> <tr> <td></td> <td></td> <td colspan="8" style="text-align: center;"> <table border="1"
style="width: 100%; border-collapse: collapse; text-align: center;"> <tr> <td style="width: 10%;"></td> <td style="width: 10%;"></td> <td style="width: 10%;"></td> <td style="width: 10%;"></td> <td style="width: 10%;"></td> <td style="width: 10%;"></td> <td style="width: 10%;"></td> <td style="width: 10%;"></td> <td style="width: 10%;"></td> <td style="width: 10%;"></td> </tr> <tr> <td></td> <td></td> <td colspan="8" style="text-align: center;"> <table border="1" style="width: 100%; border-collapse: collapse; text-align: center;"> <tr> <td style="width: 10%;"></td> <td style="width: 10%;"></td> <td style="width: 10%;"></td> <td style="width: 10%;"></td> <td style="width: 10%;"></td> <td style="width: 10%;"></td> <td style="width: 10%;"></td> <td style="width: 10%;"></td> <td style="width: 10%;"></td> <td style="width: 10%;"></td> </tr> <tr> <td></td> <td></td> <td colspan="8" style="text-align: center;"> <table border="1" style="width: 100%; border-collapse: collapse; text-align: center;"> <tr> <td style="width: 10%;"></td> <td style="width: 10%;"></td> <td style="width: 10%;"></td> <td style="width: 10%;"></td> <td style="width: 10%;"></td> <td style="width: 10%;"></td> <td style="width: 10%;"></td> <td style="width: 10%;"></td> <td style="width: 10%;"></td> <td style="width: 10%;"></td> </tr> <tr> <td></td> <td></td> <td colspan="8" style="text-align: center;"> <table border="1" style="width: 100%; border-collapse: collapse; text-align: center;"> <tr> <td style="width: 10%;"></td> <td style="width: 10%;"></td> <td style="width: 10%;"></td> <td style="width: 10%;"></td> <td style="width: 10%;"></td> <td style="width: 10%;"></td> <td style="width: 10%;"></td> <td style="width: 10%;"></td> <td style="width: 10%;"></td> <td style="width: 10%;"></td> </tr> <tr> <td></td> <td></td> <td colspan="8" style="text-align: center;"> <table border="1" style="width: 100%; border-collapse: collapse; text-align: center;"> <tr> <td style="width: 10%;"></td> <td style="width: 10%;"></td> <td style="width: 10%;"></td> <td style="width: 10%;"></td> <td style="width: 10%;"></td> <td style="width: 10%;"></td> <td style="width: 10%;"></td> <td style="width: 10%;"></td> <td style="width: 10%;"></td> <td style="width: 10%;"></td> </tr> <tr> <td></td> <td></td> <td colspan="8" style="text-align: center;"> <table border="1" style="width: 100%; border-collapse: collapse; text-align: center;"> <tr> <td style="width: 10%;"></td> <td style="width: 10%;"></td> <td style="width: 10%;"></td> <td style="width: 10%;"></td> <td style="width: 10%;"></td> <td style="width: 10%;"></td> <td style="width: 10%;"></td> <td style="width: 10%;"></td> <td style="width: 10%;"></td> <td style="width: 10%;"></td> </tr> <tr> <td></td> <td></td> <td colspan="8" style="text-align: center;"> <table border="1" style="width: 100%; border-collapse: collapse; text-align: center;"> <tr> </tr></table></td></tr></table></td></tr></table></td></tr></table></td></tr></table></td></tr></table></td></tr></table></td></tr></table></td></tr></table></td></tr></table></td></tr></table></td></tr></table></td></tr></table></td></tr></table></td></tr></table></td></tr></table></td></tr></table></td></tr></table></td></tr></table></td></tr></table></td></tr></table></td></tr></table></td></tr></table></td></tr></table></td></tr></table></td></tr></table></td></tr></table></td></tr></table></td></tr></table></td></tr></table></td></tr></table>
 | | | | | | | | | | | | | | | | | | | | <table border="1" style="width: 100%; border-collapse: collapse; text-align: center;"> <tr> <td style="width: 10%;"></td> <td style="width: 10%;"></td> <td style="width: 10%;"></td> <td style="width: 10%;"></td> <td style="width: 10%;"></td> <td style="width: 10%;"></td> <td style="width: 10%;"></td> <td style="width: 10%;"></td> <td style="width: 10%;"></td> <td style="width: 10%;"></td> </tr> <tr> <td></td> <td></td> <td colspan="8" style="text-align: center;"> <table border="1" style="width: 100%; border-collapse: collapse; text-align: center;"> <tr> <td style="width: 10%;"></td> <td style="width: 10%;"></td> <td style="width: 10%;"></td> <td style="width: 10%;"></td> <td style="width: 10%;"></td> <td style="width: 10%;"></td> <td style="width: 10%;"></td> <td style="width: 10%;"></td> <td style="width: 10%;"></td> <td style="width: 10%;"></td> </tr> <tr> <td></td> <td></td> <td colspan="8" style="text-align: center;"> <table border="1" style="width: 100%; border-collapse: collapse; text-align: center;"> <tr> <td style="width: 10%;"></td> <td style="width: 10%;"></td> <td style="width: 10%;"></td> <td style="width: 10%;"></td> <td style="width: 10%;"></td> <td style="width: 10%;"></td> <td style="width: 10%;"></td> <td style="width: 10%;"></td> <td style="width: 10%;"></td> <td style="width: 10%;"></td> </tr> <tr> <td></td> <td></td> <td colspan="8" style="text-align: center;"> <table border="1" style="width: 100%; border-collapse: collapse; text-align: center;"> <tr> <td style="width: 10%;"></td> <td style="width: 10%;"></td> <td style="width: 10%;"></td> <td style="width: 10%;"></td> <td style="width: 10%;"></td> <td style="width: 10%;"></td> <td style="width: 10%;"></td> <td style="width: 10%;"></td> <td style="width: 10%;"></td> <td style="width: 10%;"></td> </tr> <tr> <td></td> <td></td> <td colspan="8" style="text-align: center;"> <table border="1" style="width: 100%; border-collapse: collapse; text-align: center;"> <tr> <td style="width: 10%;"></td> <td style="width: 10%;"></td> <td style="width: 10%;"></td> <td style="width: 10%;"></td> <td style="width: 10%;"></td> <td style="width: 10%;"></td> <td style="width: 10%;"></td> <td style="width: 10%;"></td> <td style="width: 10%;"></td> <td style="width: 10%;"></td> </tr> <tr> <td></td> <td></td> <td colspan="8" style="text-align: center;"> <table border="1" style="width: 100%; border-collapse: collapse; text-align: center;"> <tr> <td style="width: 10%;"></td> <td style="width: 10%;"></td> <td style="width: 10%;"></td> <td style="width: 10%;"></td> <td style="width: 10%;"></td> <td style="width: 10%;"></td> <td style="width: 10%;"></td> <td style="width: 10%;"></td> <td style="width: 10%;"></td> <td style="width: 10%;"></td> </tr> <tr> <td></td> <td></td> <td colspan="8" style="text-align: center;"> <table border="1" style="width: 100%; border-collapse: collapse; text-align: center;"> <tr> <td style="width: 10%;"></td> <td style="width: 10%;"></td> <td style="width: 10%;"></td> <td style="width: 10%;"></td> <td style="width: 10%;"></td> <td style="width: 10%;"></td> <td style="width: 10%;"></td> <td style="width: 10%;"></td> <td style="width: 10%;"></td> <td style="width: 10%;"></td> </tr> <tr> <td></td> <td></td> <td colspan="8" style="text-align: center;"> <table border="1" style="width: 100%; border-collapse: collapse; text-align: center;"> <tr> <td
style="width: 10%;"></td> <td style="width: 10%;"></td> <td style="width: 10%;"></td> <td style="width: 10%;"></td> <td style="width: 10%;"></td> <td style="width: 10%;"></td> <td style="width: 10%;"></td> <td style="width: 10%;"></td> <td style="width: 10%;"></td> <td style="width: 10%;"></td> </tr> <tr> <td></td> <td></td> <td colspan="8" style="text-align: center;"> <table border="1" style="width: 100%; border-collapse: collapse; text-align: center;"> <tr> <td style="width: 10%;"></td> <td style="width: 10%;"></td> <td style="width: 10%;"></td> <td style="width: 10%;"></td> <td style="width: 10%;"></td> <td style="width: 10%;"></td> <td style="width: 10%;"></td> <td style="width: 10%;"></td> <td style="width: 10%;"></td> <td style="width: 10%;"></td> </tr> <tr> <td></td> <td></td> <td colspan="8" style="text-align: center;"> <table border="1" style="width: 100%; border-collapse: collapse; text-align: center;"> <tr> <td style="width: 10%;"></td> <td style="width: 10%;"></td> <td style="width: 10%;"></td> <td style="width: 10%;"></td> <td style="width: 10%;"></td> <td style="width: 10%;"></td> <td style="width: 10%;"></td> <td style="width: 10%;"></td> <td style="width: 10%;"></td> <td style="width: 10%;"></td> </tr> <tr> <td></td> <td></td> <td colspan="8" style="text-align: center;"> <table border="1" style="width: 100%; border-collapse: collapse; text-align: center;"> <tr> <td style="width: 10%;"></td> <td style="width: 10%;"></td> <td style="width: 10%;"></td> <td style="width: 10%;"></td> <td style="width: 10%;"></td> <td style="width: 10%;"></td> <td style="width: 10%;"></td> <td style="width: 10%;"></td> <td style="width: 10%;"></td> <td style="width: 10%;"></td> </tr> <tr> <td></td> <td></td> <td colspan="8" style="text-align: center;"> <table border="1" style="width: 100%; border-collapse: collapse; text-align: center;"> <tr> <td style="width: 10%;"></td> <td style="width: 10%;"></td> <td style="width: 10%;"></td> <td style="width: 10%;"></td> <td style="width: 10%;"></td> <td style="width: 10%;"></td> <td style="width: 10%;"></td> <td style="width: 10%;"></td> <td style="width: 10%;"></td> <td style="width: 10%;"></td> </tr> <tr> <td></td> <td></td> <td colspan="8" style="text-align: center;"> <table border="1" style="width: 100%; border-collapse: collapse; text-align: center;"> <tr> <td style="width: 10%;"></td> <td style="width: 10%;"></td> <td style="width: 10%;"></td> <td style="width: 10%;"></td> <td style="width: 10%;"></td> <td style="width: 10%;"></td> <td style="width: 10%;"></td> <td style="width: 10%;"></td> <td style="width: 10%;"></td> <td style="width: 10%;"></td> </tr> <tr> <td></td> <td></td> <td colspan="8" style="text-align: center;"> <table border="1" style="width: 100%; border-collapse: collapse; text-align: center;"> <tr> <td style="width: 10%;"></td> <td style="width: 10%;"></td> <td style="width: 10%;"></td> <td style="width: 10%;"></td> <td style="width: 10%;"></td> <td style="width: 10%;"></td> <td style="width: 10%;"></td> <td style="width: 10%;"></td> <td style="width: 10%;"></td> <td style="width: 10%;"></td> </tr> <tr> <td></td> <td></td> <td colspan="8" style="text-align: center;"> <table border="1" style="width: 100%; border-collapse: collapse; text-align: center;"> <tr> <td style="width: 10%;"></td> <td style="width: 10%;"></td> <td style="width: 10%;"></td> <td style="width: 10%;"></td> <td style="width: 10%;"></td> <td style="width: 10%;"></td> <td style="width: 10%;"></td> <td style="width: 10%;"></td> <td style="width: 10%;"></td> <td style="width: 10%;"></td> </tr> <tr> <td></td> <td></td> <td colspan="8" style="text-align: center;"> <table border="1" style="width: 100%; border-collapse: collapse; text-align: center;"> <tr> <td style="width: 10%;"></td> <td style="width: 10%;"></td> <td style="width: 10%;"></td> <td style="width: 10%;"></td> <td style="width: 10%;"></td> <td style="width: 10%;"></td> <td style="width: 10%;"></td> <td style="width: 10%;"></td> <td style="width: 10%;"></td> <td style="width: 10%;"></td> </tr> <tr> <td></td> <td></td> <td colspan="8" style="text-align: center;"> <table border="1" style="width: 100%; border-collapse: collapse; text-align: center;"> <tr> <td style="width: 10%;"></td> <td style="width: 10%;"></td> <td style="width: 10%;"></td> <td style="width: 10%;"></td> <td style="width: 10%;"></td> <td style="width: 10%;"></td> <td style="width: 10%;"></td> <td style="width: 10%;"></td> <td style="width: 10%;"></td> <td style="width: 10%;"></td> </tr> <tr> <td></td> <td></td> <td colspan="8" style="text-align: center;"> <table border="1" style="width: 100%; border-collapse: collapse; text-align: center;"> <tr> <td style="width: 10%;"></td> <td style="width: 10%;"></td> <td style="width: 10%;"></td> <td style="width: 10%;"></td> <td style="width: 10%;"></td> <td style="width: 10%;"></td> <td style="width: 10%;"></td> <td style="width: 10%;"></td> <td style="width: 10%;"></td> <td style="width: 10%;"></td> </tr> <tr> <td></td> <td></td> <td colspan="8" style="text-align: center;"> <table border="1" style="width: 100%; border-collapse: collapse; text-align: center;"> <tr> <td style="width: 10%;"></td> <td style="width: 10%;"></td> <td style="width: 10%;"></td> <td style="width: 10%;"></td> <td style="width: 10%;"></td> <td style="width: 10%;"></td> <td style="width: 10%;"></td> <td style="width: 10%;"></td> <td style="width: 10%;"></td> <td style="width: 10%;"></td> </tr> <tr> <td></td> <td></td> <td colspan="8" style="text-align: center;"> <table border="1" style="width: 100%; border-collapse: collapse; text-align: center;"> <tr> <td style="width: 10%;"></td> <td style="width: 10%;"></td> <td style="width: 10%;"></td> <td style="width: 10%;"></td> <td style="width: 10%;"></td> <td style="width: 10%;"></td> <td style="width: 10%;"></td> <td style="width: 10%;"></td> <td style="width: 10%;"></td> <td style="width: 10%;"></td> </tr> <tr> <td></td> <td></td> <td colspan="8" style="text-align: center;"> <table border="1" style="width: 100%; border-collapse: collapse; text-align: center;"> <tr> <td style="width: 10%;"></td> <td style="width: 10%;"></td> <td style="width: 10%;"></td> <td style="width: 10%;"></td> <td style="width: 10%;"></td> <td style="width: 10%;"></td> <td style="width: 10%;"></td> <td style="width: 10%;"></td> <td style="width: 10%;"></td> <td style="width: 10%;"></td> </tr> <tr> <td></td> <td></td> <td colspan="8" style="text-align: center;"> <table border="1" style="width: 100%; border-collapse: collapse; text-align: center;"> <tr> <td style="width: 10%;"></td> <td style="width: 10%;"></td> <td style="width: 10%;"></td> <td style="width: 10%;"></td> <td style="width: 10%;"></td> <td style="width: 10%;"></td> <td style="width: 10%;"></td> <td style="width: 10%;"></td> <td style="width: 10%;"></td> <td style="width: 10%;"></td> </tr> <tr> <td></td> <td></td> <td colspan="8" style="text-align: center;"> <table border="1" style="width: 100%; border-collapse: collapse; text-align: center;"> <tr> <td style="width: 10%;"></td> <td style="width: 10%;"></td> <td style="width: 10%;"></td> <td style="width: 10%;"></td> <td style="width: 10%;"></td> <td style="width: 10%;"></td> <td style="width: 10%;"></td> <td style="width: 10%;"></td> <td style="width: 10%;"></td> <td style="width: 10%;"></td> </tr> <tr> <td></td> <td></td> <td colspan="8" style="text-align: center;"> <table border="1" style="width: 100%; border-collapse: collapse; text-align: center;"> <tr> <td style="width: 10%;"></td> <td style="width: 10%;"></td> <td style="width: 10%;"></td> <td style="width: 10%;"></td> <td style="width: 10%;"></td> <td style="width: 10%;"></td> <td style="width: 10%;"></td> <td style="width: 10%;"></td> <td style="width: 10%;"></td> <td style="width: 10%;"></td> </tr> <tr> <td></td> <td></td> <td colspan="8" style="text-align: center;"> <table border="1" style="width: 100%; border-collapse: collapse; text-align: center;"> <tr> <td style="width: 10%;"></td> <td style="width: 10%;"></td> <td style="width: 10%;"></td> <td style="width: 10%;"></td> <td style="width: 10%;"></td> <td style="width: 10%;"></td> <td style="width: 10%;"></td> <td style="width: 10%;"></td> <td style="width: 10%;"></td> <td style="width: 10%;"></td> </tr> <tr> <td></td> <td></td> <td colspan="8" style="text-align: center;"> <table border="1" style="width: 100%; border-collapse: collapse; text-align: center;"> <tr> <td style="width: 10%;"></td> <td style="width: 10%;"></td> <td style="width: 10%;"></td> <td style="width: 10%;"></td> <td style="width: 10%;"></td> <td style="width: 10%;"></td> <td style="width: 10%;"></td> <td style="width: 10%;"></td> <td style="width: 10%;"></td> <td style="width: 10%;"></td> </tr> <tr> <td></td> <td></td> <td colspan="8" style="text-align: center;"> <table border="1" style="width: 100%; border-collapse: collapse; text-align: center;"> <tr> <td style="width: 10%;"></td> <td style="width: 10%;"></td> <td style="width: 10%;"></td> <td style="width: 10%;"></td> <td style="width: 10%;"></td> <td style="width: 10%;"></td> <td style="width: 10%;"></td> <td style="width: 10%;"></td> <td style="width: 10%;"></td> <td style="width: 10%;"></td> </tr> <tr> <td></td> <td></td> <td colspan="8" style="text-align: center;"> <table border="1" style="width: 100%; border-collapse: collapse; text-align: center;"> <tr> <td style="width: 10%;"></td> <td style="width: 10%;"></td> <td style="width: 10%;"></td> <td style="width: 10%;"></td> <td style="width: 10%;"></td> <td style="width: 10%;"></td> <td style="width: 10%;"></td> <td style="width: 10%;"></td> <td style="width: 10%;"></td> <td style="width: 10%;"></td> </tr> <tr> <td></td> <td></td> <td colspan="8" style="text-align: center;"> <table border="1" style="width: 100%; border-collapse: collapse; text-align: center;"> <tr> <td style="width: 10%;"></td> <td style="width: 10%;"></td> <td style="width: 10%;"></td> <td style="width: 10%;"></td> <td style="width: 10%;"></td> <td style="width:
10%;"></td> <td style="width: 10%;"></td> <td style="width: 10%;"></td> <td style="width: 10%;"></td> <td style="width: 10%;"></td> </tr> <tr> <td></td> <td></td> <td colspan="8" style="text-align: center;"> <table border="1" style="width: 100%; border-collapse: collapse; text-align: center;"> <tr> </tr></table></td></tr></table></td></tr></table></td></tr></table></td></tr></table></td></tr></table></td></tr></table></td></tr></table></td></tr></table></td></tr></table></td></tr></table></td></tr></table></td></tr></table></td></tr></table></td></tr></table></td></tr></table></td></tr></table></td></tr></table></td></tr></table></td></tr></table></td></tr></table></td></tr></table></td></tr></table></td></tr></table></td></tr></table></td></tr></table></td></tr></table></td></tr></table></td></tr></table></td></tr></table>
 | | | | | | | | | | | | | | | | | | | | <table border="1" style="width: 100%; border-collapse: collapse; text-align: center;"> <tr> <td style="width: 10%;"></td> <td style="width: 10%;"></td> <td style="width: 10%;"></td> <td style="width: 10%;"></td> <td style="width: 10%;"></td> <td style="width: 10%;"></td> <td style="width: 10%;"></td> <td style="width: 10%;"></td> <td style="width: 10%;"></td> <td style="width: 10%;"></td> </tr> <tr> <td></td> <td></td> <td colspan="8" style="text-align: center;"> <table border="1" style="width: 100%; border-collapse: collapse; text-align: center;"> <tr> <td style="width: 10%;"></td> <td style="width: 10%;"></td> <td style="width: 10%;"></td> <td style="width: 10%;"></td> <td style="width: 10%;"></td> <td style="width: 10%;"></td> <td style="width: 10%;"></td> <td style="width: 10%;"></td> <td style="width: 10%;"></td> <td style="width: 10%;"></td> </tr> <tr> <td></td> <td></td> <td colspan="8" style="text-align: center;"> <table border="1" style="width: 100%; border-collapse: collapse; text-align: center;"> <tr> <td style="width: 10%;"></td> <td style="width: 10%;"></td> <td style="width: 10%;"></td> <td style="width: 10%;"></td> <td style="width: 10%;"></td> <td style="width: 10%;"></td> <td style="width: 10%;"></td> <td style="width: 10%;"></td> <td style="width: 10%;"></td> <td style="width: 10%;"></td> </tr> <tr> <td></td> <td></td> <td colspan="8" style="text-align: center;"> <table border="1" style="width: 100%; border-collapse: collapse; text-align: center;"> <tr> <td style="width: 10%;"></td> <td style="width: 10%;"></td> <td style="width: 10%;"></td> <td style="width: 10%;"></td> <td style="width: 10%;"></td> <td style="width: 10%;"></td> <td style="width: 10%;"></td> <td style="width: 10%;"></td> <td style="width: 10%;"></td> <td style="width: 10%;"></td> </tr> <tr> <td></td> <td></td> <td colspan="8" style="text-align: center;"> <table border="1" style="width: 100%; border-collapse: collapse; text-align: center;"> <tr> <td style="width: 10%;"></td> <td style="width: 10%;"></td> <td style="width: 10%;"></td> <td style="width: 10%;"></td> <td style="width: 10%;"></td> <td style="width: 10%;"></td> <td style="width: 10%;"></td> <td style="width: 10%;"></td> <td style="width: 10%;"></td> <td style="width: 10%;"></td> </tr> <tr> <td></td> <td></td> <td colspan="8" style="text-align: center;"> <table border="1" style="width: 100%; border-collapse: collapse; text-align: center;"> <tr> <td style="width: 10%;"></td> <td style="width: 10%;"></td> <td style="width: 10%;"></td> <td style="width: 10%;"></td> <td style="width: 10%;"></td> <td style="width: 10%;"></td> <td style="width: 10%;"></td> <td style="width: 10%;"></td> <td style="width: 10%;"></td> <td style="width: 10%;"></td> </tr> <tr> <td></td> <td></td> <td colspan="8" style="text-align: center;"> <table border="1" style="width: 100%; border-collapse: collapse; text-align: center;"> <tr> <td style="width: 10%;"></td> <td style="width: 10%;"></td> <td style="width: 10%;"></td> <td style="width: 10%;"></td> <td style="width: 10%;"></td> <td style="width: 10%;"></td> <td style="width: 10%;"></td> <td style="width: 10%;"></td> <td style="width: 10%;"></td> <td style="width: 10%;"></td> </tr> <tr> <td></td> <td></td> <td colspan="8" style="text-align: center;"> <table border="1" style="width: 100%; border-collapse: collapse; text-align: center;"> <tr> <td style="width: 10%;"></td> <td style="width: 10%;"></td> <td style="width: 10%;"></td> <td style="width: 10%;"></td> <td style="width: 10%;"></td> <td style="width: 10%;"></td> <td style="width: 10%;"></td> <td style="width: 10%;"></td> <td style="width: 10%;"></td> <td style="width: 10%;"></td> </tr> <tr> <td></td> <td></td> <td colspan="8" style="text-align: center;"> <table border="1" style="width: 100%; border-collapse: collapse; text-align: center;"> <tr> <td style="width: 10%;"></td> <td style="width: 10%;"></td> <td style="width: 10%;"></td> <td style="width: 10%;"></td> <td style="width: 10%;"></td> <td style="width: 10%;"></td> <td style="width: 10%;"></td> <td style="width: 10%;"></td> <td style="width: 10%;"></td> <td style="width: 10%;"></td> </tr> <tr> <td></td> <td></td> <td colspan="8" style="text-align: center;"> <table border="1" style="width: 100%; border-collapse: collapse; text-align: center;"> <tr> <td style="width: 10%;"></td> <td style="width: 10%;"></td> <td style="width: 10%;"></td> <td style="width: 10%;"></td> <td style="width: 10%;"></td> <td style="width: 10%;"></td> <td style="width: 10%;"></td> <td style="width: 10%;"></td> <td style="width: 10%;"></td> <td style="width: 10%;"></td> </tr> <tr> <td></td> <td></td> <td colspan="8" style="text-align: center;"> <table border="1" style="width: 100%; border-collapse: collapse; text-align: center;"> <tr> <td style="width: 10%;"></td> <td style="width: 10%;"></td> <td style="width: 10%;"></td> <td style="width: 10%;"></td> <td style="width: 10%;"></td> <td style="width: 10%;"></td> <td style="width: 10%;"></td> <td style="width: 10%;"></td> <td style="width: 10%;"></td> <td style="width: 10%;"></td> </tr> <tr> <td></td> <td></td> <td colspan="8" style="text-align: center;"> <table border="1" style="width: 100%; border-collapse: collapse; text-align: center;"> <tr> <td style="width: 10%;"></td> <td style="width: 10%;"></td> <td style="width: 10%;"></td> <td style="width: 10%;"></td> <td style="width: 10%;"></td> <td style="width: 10%;"></td> <td style="width: 10%;"></td> <td style="width: 10%;"></td> <td style="width: 10%;"></td> <td style="width: 10%;"></td> </tr> <tr> <td></td> <td></td> <td colspan="8" style="text-align: center;"> <table border="1" style="width: 100%; border-collapse: collapse; text-align: center;"> <tr> <td style="width: 10%;"></td> <td style="width: 10%;"></td> <td style="width: 10%;"></td> <td style="width: 10%;"></td> <td style="width: 10%;"></td> <td style="width: 10%;"></td> <td style="width: 10%;"></td> <td style="width: 10%;"></td> <td style="width: 10%;"></td> <td
style="width: 10%;"></td> </tr> <tr> <td></td> <td></td> <td colspan="8" style="text-align: center;"> <table border="1" style="width: 100%; border-collapse: collapse; text-align: center;"> <tr> <td style="width: 10%;"></td> <td style="width: 10%;"></td> <td style="width: 10%;"></td> <td style="width: 10%;"></td> <td style="width: 10%;"></td> <td style="width: 10%;"></td> <td style="width: 10%;"></td> <td style="width: 10%;"></td> <td style="width: 10%;"></td> <td style="width: 10%;"></td> </tr> <tr> <td></td> <td></td> <td colspan="8" style="text-align: center;"> <table border="1" style="width: 100%; border-collapse: collapse; text-align: center;"> <tr> <td style="width: 10%;"></td> <td style="width: 10%;"></td> <td style="width: 10%;"></td> <td style="width: 10%;"></td> <td style="width: 10%;"></td> <td style="width: 10%;"></td> <td style="width: 10%;"></td> <td style="width: 10%;"></td> <td style="width: 10%;"></td> <td style="width: 10%;"></td> </tr> <tr> <td></td> <td></td> <td colspan="8" style="text-align: center;"> <table border="1" style="width: 100%; border-collapse: collapse; text-align: center;"> <tr> <td style="width: 10%;"></td> <td style="width: 10%;"></td> <td style="width: 10%;"></td> <td style="width: 10%;"></td> <td style="width: 10%;"></td> <td style="width: 10%;"></td> <td style="width: 10%;"></td> <td style="width: 10%;"></td> <td style="width: 10%;"></td> <td style="width: 10%;"></td> </tr> <tr> <td></td> <td></td> <td colspan="8" style="text-align: center;"> <table border="1" style="width: 100%; border-collapse: collapse; text-align: center;"> <tr> <td style="width: 10%;"></td> <td style="width: 10%;"></td> <td style="width: 10%;"></td> <td style="width: 10%;"></td> <td style="width: 10%;"></td> <td style="width: 10%;"></td> <td style="width: 10%;"></td> <td style="width: 10%;"></td> <td style="width: 10%;"></td> <td style="width: 10%;"></td> </tr> <tr> <td></td> <td></td> <td colspan="8" style="text-align: center;"> <table border="1" style="width: 100%; border-collapse: collapse; text-align: center;"> <tr> <td style="width: 10%;"></td> <td style="width: 10%;"></td> <td style="width: 10%;"></td> <td style="width: 10%;"></td> <td style="width: 10%;"></td> <td style="width: 10%;"></td> <td style="width: 10%;"></td> <td style="width: 10%;"></td> <td style="width: 10%;"></td> <td style="width: 10%;"></td> </tr> <tr> <td></td> <td></td> <td colspan="8" style="text-align: center;"> <table border="1" style="width: 100%; border-collapse: collapse; text-align: center;"> <tr> <td style="width: 10%;"></td> <td style="width: 10%;"></td> <td style="width: 10%;"></td> <td style="width: 10%;"></td> <td style="width: 10%;"></td> <td style="width: 10%;"></td> <td style="width: 10%;"></td> <td style="width: 10%;"></td> <td style="width: 10%;"></td> <td style="width: 10%;"></td> </tr> <tr> <td></td> <td></td> <td colspan="8" style="text-align: center;"> <table border="1" style="width: 100%; border-collapse: collapse; text-align: center;"> <tr> <td style="width: 10%;"></td> <td style="width: 10%;"></td> <td style="width: 10%;"></td> <td style="width: 10%;"></td> <td style="width: 10%;"></td> <td style="width: 10%;"></td> <td style="width: 10%;"></td> <td style="width: 10%;"></td> <td style="width: 10%;"></td> <td style="width: 10%;"></td> </tr> <tr> <td></td> <td></td> <td colspan="8" style="text-align: center;"> <table border="1" style="width: 100%; border-collapse: collapse; text-align: center;"> <tr> <td style="width: 10%;"></td> <td style="width: 10%;"></td> <td style="width: 10%;"></td> <td style="width: 10%;"></td> <td style="width: 10%;"></td> <td style="width: 10%;"></td> <td style="width: 10%;"></td> <td style="width: 10%;"></td> <td style="width: 10%;"></td> <td style="width: 10%;"></td> </tr> <tr> <td></td> <td></td> <td colspan="8" style="text-align: center;"> <table border="1" style="width: 100%; border-collapse: collapse; text-align: center;"> <tr> <td style="width: 10%;"></td> <td style="width: 10%;"></td> <td style="width: 10%;"></td> <td style="width: 10%;"></td> <td style="width: 10%;"></td> <td style="width: 10%;"></td> <td style="width: 10%;"></td> <td style="width: 10%;"></td> <td style="width: 10%;"></td> <td style="width: 10%;"></td> </tr> <tr> <td></td> <td></td> <td colspan="8" style="text-align: center;"> <table border="1" style="width: 100%; border-collapse: collapse; text-align: center;"> <tr> <td style="width: 10%;"></td> <td style="width: 10%;"></td> <td style="width: 10%;"></td> <td style="width: 10%;"></td> <td style="width: 10%;"></td> <td style="width: 10%;"></td> <td style="width: 10%;"></td> <td style="width: 10%;"></td> <td style="width: 10%;"></td> <td style="width: 10%;"></td> </tr> <tr> <td></td> <td></td> <td colspan="8" style="text-align: center;"> <table border="1" style="width: 100%; border-collapse: collapse; text-align: center;"> <tr> <td style="width: 10%;"></td> <td style="width: 10%;"></td> <td style="width: 10%;"></td> <td style="width: 10%;"></td> <td style="width: 10%;"></td> <td style="width: 10%;"></td> <td style="width: 10%;"></td> <td style="width: 10%;"></td> <td style="width: 10%;"></td> <td style="width: 10%;"></td> </tr> <tr> <td></td> <td></td> <td colspan="8" style="text-align: center;"> <table border="1" style="width: 100%; border-collapse: collapse; text-align: center;"> <tr> <td style="width: 10%;"></td> <td style="width: 10%;"></td> <td style="width: 10%;"></td> <td style="width: 10%;"></td> <td style="width: 10%;"></td> <td style="width: 10%;"></td> <td style="width: 10%;"></td> <td style="width: 10%;"></td> <td style="width: 10%;"></td> <td style="width: 10%;"></td> </tr> <tr> <td></td> <td></td> <td colspan="8" style="text-align: center;"> <table border="1" style="width: 100%; border-collapse: collapse; text-align: center;"> <tr> <td style="width: 10%;"></td> <td style="width: 10%;"></td> <td style="width: 10%;"></td> <td style="width: 10%;"></td> <td style="width: 10%;"></td> <td style="width: 10%;"></td> <td style="width: 10%;"></td> <td style="width: 10%;"></td> <td style="width: 10%;"></td> <td style="width: 10%;"></td> </tr> <tr> <td></td> <td></td> <td colspan="8" style="text-align: center;"> <table border="1" style="width: 100%; border-collapse: collapse; text-align: center;"> <tr> <td style="width: 10%;"></td> <td style="width: 10%;"></td> <td style="width: 10%;"></td> <td style="width: 10%;"></td> <td style="width: 10%;"></td> <td style="width: 10%;"></td> <td style="width: 10%;"></td> <td style="width: 10%;"></td> <td style="width: 10%;"></td> <td style="width: 10%;"></td> </tr> <tr> <td></td> <td></td> <td colspan="8" style="text-align: center;"> <table border="1" style="width: 100%; border-collapse: collapse; text-align: center;"> <tr> <td style="width: 10%;"></td> <td style="width: 10%;"></td> <td style="width: 10%;"></td> <td style="width: 10%;"></td> <td style="width: 10%;"></td> <td style="width: 10%;"></td> <td style="width: 10%;"></td> <td style="width: 10%;"></td> <td style="width: 10%;"></td> <td style="width: 10%;"></td> </tr> <tr> <td></td> <td></td> <td colspan="8" style="text-align: center;"> <table border="1" style="width: 100%; border-collapse: collapse; text-align: center;"> <tr> </tr></table></td></tr></table></td></tr></table></td></tr></table></td></tr></table></td></tr></table></td></tr></table></td></tr></table></td></tr></table></td></tr></table></td></tr></table></td></tr></table></td></tr></table></td></tr></table></td></tr></table></td></tr></table></td></tr></table></td></tr></table></td></tr></table></td></tr></table></td></tr></table></td></tr></table></td></tr></table></td></tr></table></td></tr></table></td></tr></table></td></tr></table></td></tr></table></td></tr></table>

 | | | | | | | | | | | | | | | | | | | | <table border="1" style="width: 100%; border-collapse: collapse; text-align: center;"> <tr> <td style="width: 10%;"></td> <td style="width: 10%;"></td> <td style="width: 10%;"></td> <td style="width: 10%;"></td> <td style="width: 10%;"></td> <td style="width: 10%;"></td> <td style="width: 10%;"></td> <td style="width: 10%;"></td> <td style="width: 10%;"></td> <td style="width: 10%;"></td> </tr> <tr> <td></td> <td></td> <td colspan="8" style="text-align: center;"> <table border="1" style="width: 100%; border-collapse: collapse; text-align: center;"> <tr> <td style="width: 10%;"></td> <td style="width: 10%;"></td> <td style="width: 10%;"></td> <td style="width: 10%;"></td> <td style="width: 10%;"></td> <td style="width: 10%;"></td> <td style="width: 10%;"></td> <td style="width: 10%;"></td> <td style="width: 10%;"></td> <td style="width: 10%;"></td> </tr> <tr> <td></td> <td></td> <td colspan="8" style="text-align: center;"> <table border="1" style="width: 100%; border-collapse: collapse; text-align: center;"> <tr> <td style="width: 10%;"></td> <td style="width: 10%;"></td> <td style="width: 10%;"></td> <td style="width: 10%;"></td> <td style="width: 10%;"></td> <td style="width: 10%;"></td> <td style="width: 10%;"></td> <td style="width: 10%;"></td> <td style="width: 10%;"></td> <td style="width: 10%;"></td> </tr> <tr> <td></td> <td></td> <td colspan="8" style="text-align: center;"> <table border="1" style="width: 100%; border-collapse: collapse; text-align: center;"> <tr> <td style="width: 10%;"></td> <td style="width: 10%;"></td> <td style="width: 10%;"></td> <td style="width: 10%;"></td> <td style="width: 10%;"></td> <td style="width: 10%;"></td> <td style="width: 10%;"></td> <td style="width: 10%;"></td> <td style="width: 10%;"></td> <td style="width: 10%;"></td> </tr> <tr> <td></td> <td></td> <td colspan="8" style="text-align: center;"> <table border="1" style="width: 100%; border-collapse: collapse; text-align: center;"> <tr> <td style="width: 10%;"></td> <td style="width: 10%;"></td> <td style="width: 10%;"></td> <td style="width: 10%;"></td> <td style="width: 10%;"></td> <td style="width: 10%;"></td> <td style="width: 10%;"></td> <td style="width: 10%;"></td> <td style="width: 10%;"></td> <td style="width: 10%;"></td> </tr> <tr> <td></td> <td></td> <td colspan="8" style="text-align: center;"> <table border="1" style="width: 100%; border-collapse: collapse; text-align: center;"> <tr> <td style="width: 10%;"></td> <td style="width: 10%;"></td> <td style="width: 10%;"></td> <td style="width: 10%;"></td> <td style="width: 10%;"></td> <td style="width: 10%;"></td> <td style="width: 10%;"></td> <td style="width: 10%;"></td> <td style="width: 10%;"></td> <td style="width: 10%;"></td> </tr> <tr> <td></td> <td></td> <td colspan="8" style="text-align: center;"> <table border="1" style="width: 100%; border-collapse: collapse; text-align: center;"> <tr> <td style="width: 10%;"></td> <td style="width: 10%;"></td> <td style="width: 10%;"></td> <td style="width: 10%;"></td> <td style="width: 10%;"></td> <td style="width: 10%;"></td> <td style="width: 10%;"></td> <td style="width: 10%;"></td> <td style="width: 10%;"></td> <td style="width: 10%;"></td> </tr> <tr> <td></td> <td></td> <td colspan="8" style="text-align: center;"> <table border="1" style="width: 100%; border-collapse: collapse; text-align: center;"> <tr> <td style="width: 10%;"></td> <td style="width: 10%;"></td> <td style="width: 10%;"></td> <td style="width: 10%;"></td> <td style="width: 10%;"></td> <td style="width: 10%;"></td> <td style="width: 10%;"></td> <td style="width: 10%;"></td> <td style="width: 10%;"></td> <td style="width: 10%;"></td> </tr> <tr> <td></td> <td></td> <td colspan="8" style="text-align: center;"> <table border="1" style="width: 100%; border-collapse: collapse; text-align: center;"> <tr> <td style="width: 10%;"></td> <td style="width: 10%;"></td> <td style="width: 10%;"></td> <td style="width: 10%;"></td> <td style="width: 10%;"></td> <td style="width: 10%;"></td> <td style="width: 10%;"></td> <td style="width: 10%;"></td> <td style="width: 10%;"></td> <td style="width: 10%;"></td> </tr> <tr> <td></td> <td></td> <td colspan="8" style="text-align: center;"> <table border="1" style="width: 100%; border-collapse: collapse; text-align: center;"> <tr> <td style="width: 10%;"></td> <td style="width: 10%;"></td> <td style="width: 10%;"></td> <td style="width: 10%;"></td> <td style="width: 10%;"></td> <td style="width: 10%;"></td> <td style="width: 10%;"></td> <td style="width: 10%;"></td> <td style="width: 10%;"></td> <td style="width: 10%;"></td> </tr> <tr> <td></td> <td></td> <td colspan="8" style="text-align: center;"> <table border="1" style="width: 100%; border-collapse: collapse; text-align: center;"> <tr> <td style="width: 10%;"></td> <td style="width: 10%;"></td> <td style="width: 10%;"></td> <td style="width: 10%;"></td> <td style="width: 10%;"></td> <td style="width: 10%;"></td> <td style="width: 10%;"></td> <td style="width: 10%;"></td> <td style="width: 10%;"></td> <td style="width: 10%;"></td> </tr> <tr> <td></td> <td></td> <td colspan="8" style="text-align: center;"> <table border="1" style="width: 100%; border-collapse: collapse; text-align: center;"> <tr> <td style="width: 10%;"></td> <td style="width: 10%;"></td> <td style="width: 10%;"></td> <td style="width: 10%;"></td> <td style="width: 10%;"></td> <td style="width: 10%;"></td> <td style="width: 10%;"></td> <td style="width: 10%;"></td> <td style="width: 10%;"></td> <td style="width: 10%;"></td> </tr> <tr> <td></td> <td></td> <td colspan="8" style="text-align: center;"> <table border="1" style="width: 100%; border-collapse: collapse; text-align: center;"> <tr> <td style="width: 10%;"></td> <td style="width: 10%;"></td> <td style="width: 10%;"></td> <td style="width: 10%;"></td> <td style="width: 10%;"></td> <td style="width: 10%;"></td> <td style="width: 10%;"></td> <td style="width: 10%;"></td> <td style="width: 10%;"></td> <td style="width: 10%;"></td> </tr> <tr> <td></td> <td></td> <td colspan="8" style="text-align: center;"> <table border="1" style="width: 100%; border-collapse: collapse; text-align: center;"> <tr> <td style="width: 10%;"></td> <td style="width: 10%;"></td> <td style="width: 10%;"></td> <td style="width: 10%;"></td> <td style="width: 10%;"></td> <td style="width: 10%;"></td> <td style="width: 10%;"></td> <td style="width: 10%;"></td> <td style="width: 10%;"></td> <td style="width: 10%;"></td> </tr> <tr> <td></td> <td></td> <td colspan="8" style="text-align: center;"> <table border="1" style="width: 100%; border-collapse: collapse; text-align: center;"> <tr> <td style="width: 10%;"></td> <td style="width: 10%;"></td> <td style="width: 10%;"></td> <td style="width: 10%;"></td> <td style="width: 10%;"></td> <td style="width: 10%;"></td> <td style="width: 10%;"></td> <td style="width: 10%;"></td> <td style="width: 10%;"></td> <td style="width: 10%;"></td> </tr> <tr> <td></td> <td></td> <td colspan="8" style="text-align: center;"> <table border="1" style="width: 100%; border-collapse: collapse; text-align: center;"> <tr> <td style="width: 10%;"></td> <td style="width: 10%;"></td> <td style="width: 10%;"></td> <td style="width: 10%;"></td> <td style="width: 10%;"></td> <td style="width: 10%;"></td> <td style="width: 10%;"></td> <td style="width: 10%;"></td> <td style="width: 10%;"></td> <td style="width: 10%;"></td> </tr> <tr> <td></td> <td></td> <td colspan="8" style="text-align: center;"> <table border="1" style="width: 100%; border-collapse: collapse; text-align: center;"> <tr> <td style="width: 10%;"></td> <td style="width: 10%;"></td> <td style="width: 10%;"></td> <td style="width: 10%;"></td> <td style="width: 10%;"></td> <td style="width: 10%;"></td> <td style="width: 10%;"></td> <td style="width: 10%;"></td> <td style="width: 10%;"></td> <td style="width: 10%;"></td> </tr> <tr> <td></td> <td></td> <td colspan="8" style="text-align: center;"> <table border="1" style="width: 100%; border-collapse: collapse; text-align: center;"> <tr> <td style="width: 10%;"></td> <td style="width: 10%;"></td> <td style="width: 10%;"></td> <td style="width: 10%;"></td> <td style="width: 10%;"></td> <td style="width: 10%;"></td> <td style="width: 10%;"></td> <td style="width: 10%;"></td> <td style="width: 10%;"></td> <td style="width: 10%;"></td> </tr> <tr> <td></td> <td></td> <td colspan="8" style="text-align: center;"> <table border="1" style="width: 100%; border-collapse: collapse; text-align: center;"> <tr> <td style="width: 10%;"></td> <td style="width: 10%;"></td> <td style="width: 10%;"></td> <td style="width: 10%;"></td> <td style="width: 10%;"></td> <td style="width: 10%;"></td> <td style="width: 10%;"></td> <td style="width: 10%;"></td> <td style="width: 10%;"></td> <td style="width: 10%;"></td> </tr> <tr> <td></td> <td></td> <td colspan="8" style="text-align: center;"> <table border="1" style="width: 100%; border-collapse: collapse; text-align: center;"> <tr> <td style="width: 10%;"></td> <td style="width: 10%;"></td> <td style="width: 10%;"></td> <td
style="width: 10%;"></td> <td style="width: 10%;"></td> <td style="width: 10%;"></td> <td style="width: 10%;"></td> <td style="width: 10%;"></td> <td style="width: 10%;"></td> <td style="width: 10%;"></td> </tr> <tr> <td></td> <td></td> <td colspan="8" style="text-align: center;"> <table border="1" style="width: 100%; border-collapse: collapse; text-align: center;"> <tr> <td style="width: 10%;"></td> <td style="width: 10%;"></td> <td style="width: 10%;"></td> <td style="width: 10%;"></td> <td style="width: 10%;"></td> <td style="width: 10%;"></td> <td style="width: 10%;"></td> <td style="width: 10%;"></td> <td style="width: 10%;"></td> <td style="width: 10%;"></td> </tr> <tr> <td></td> <td></td> <td colspan="8" style="text-align: center;"> <table border="1" style="width: 100%; border-collapse: collapse; text-align: center;"> <tr> <td style="width: 10%;"></td> <td style="width: 10%;"></td> <td style="width: 10%;"></td> <td style="width: 10%;"></td> <td style="width: 10%;"></td> <td style="width: 10%;"></td> <td style="width: 10%;"></td> <td style="width: 10%;"></td> <td style="width: 10%;"></td> <td style="width: 10%;"></td> </tr> <tr> <td></td> <td></td> <td colspan="8" style="text-align: center;"> <table border="1" style="width: 100%; border-collapse: collapse; text-align: center;"> <tr> <td style="width: 10%;"></td> <td style="width: 10%;"></td> <td style="width: 10%;"></td> <td style="width: 10%;"></td> <td style="width: 10%;"></td> <td style="width: 10%;"></td> <td style="width: 10%;"></td> <td style="width: 10%;"></td> <td style="width: 10%;"></td> <td style="width: 10%;"></td> </tr> <tr> <td></td> <td></td> <td colspan="8" style="text-align: center;"> <table border="1" style="width: 100%; border-collapse: collapse; text-align: center;"> <tr> <td style="width: 10%;"></td> <td style="width: 10%;"></td> <td style="width: 10%;"></td> <td style="width: 10%;"></td> <td style="width: 10%;"></td> <td style="width: 10%;"></td> <td style="width: 10%;"></td> <td style="width: 10%;"></td> <td style="width: 10%;"></td> <td style="width: 10%;"></td> </tr> <tr> <td></td> <td></td> <td colspan="8" style="text-align: center;"> <table border="1" style="width: 100%; border-collapse: collapse; text-align: center;"> <tr> <td style="width: 10%;"></td> <td style="width: 10%;"></td> <td style="width: 10%;"></td> <td style="width: 10%;"></td> <td style="width: 10%;"></td> <td style="width: 10%;"></td> <td style="width: 10%;"></td> <td style="width: 10%;"></td> <td style="width: 10%;"></td> <td style="width: 10%;"></td> </tr> <tr> <td></td> <td></td> <td colspan="8" style="text-align: center;"> <table border="1" style="width: 100%; border-collapse: collapse; text-align: center;"> <tr> <td style="width: 10%;"></td> <td style="width: 10%;"></td> <td style="width: 10%;"></td> <td style="width: 10%;"></td> <td style="width: 10%;"></td> <td style="width: 10%;"></td> <td style="width: 10%;"></td> <td style="width: 10%;"></td> <td style="width: 10%;"></td> <td style="width: 10%;"></td> </tr> <tr> <td></td> <td></td> <td colspan="8" style="text-align: center;"> <table border="1" style="width: 100%; border-collapse: collapse; text-align: center;"> <tr> <td style="width: 10%;"></td> <td style="width: 10%;"></td> <td style="width: 10%;"></td> <td style="width: 10%;"></td> <td style="width: 10%;"></td> <td style="width: 10%;"></td> <td style="width: 10%;"></td> <td style="width: 10%;"></td> <td style="width: 10%;"></td> <td style="width: 10%;"></td> </tr> <tr> <td></td> <td></td> <td colspan="8" style="text-align: center;"> <table border="1" style="width: 100%; border-collapse: collapse; text-align: center;"> <tr> </tr></table></td></tr></table></td></tr></table></td></tr></table></td></tr></table></td></tr></table></td></tr></table></td></tr></table></td></tr></table></td></tr></table></td></tr></table></td></tr></table></td></tr></table></td></tr></table></td></tr></table></td></tr></table></td></tr></table></td></tr></table></td></tr></table></td></tr></table></td></tr></table></td></tr></table></td></tr></table></td></tr></table></td></tr></table></td></tr></table></td></tr></table></td></tr></table>
 | | | | | | | | | | | | | | | | | | | | <table border="1" style="width: 100%; border-collapse: collapse; text-align: center;"> <tr> <td style="width: 10%;"></td> <td style="width: 10%;"></td> <td style="width: 10%;"></td> <td style="width: 10%;"></td> <td style="width: 10%;"></td> <td style="width: 10%;"></td> <td style="width: 10%;"></td> <td style="width: 10%;"></td> <td style="width: 10%;"></td> <td style="width: 10%;"></td> </tr> <tr> <td></td> <td></td> <td colspan="8" style="text-align: center;"> <table border="1" style="width: 100%; border-collapse: collapse; text-align: center;"> <tr> <td style="width: 10%;"></td> <td style="width: 10%;"></td> <td style="width: 10%;"></td> <td style="width: 10%;"></td> <td style="width: 10%;"></td> <td style="width: 10%;"></td> <td style="width: 10%;"></td> <td style="width: 10%;"></td> <td style="width: 10%;"></td> <td style="width: 10%;"></td> </tr> <tr> <td></td> <td></td> <td colspan="8" style="text-align: center;"> <table border="1" style="width: 100%; border-collapse: collapse; text-align: center;"> <tr> <td style="width: 10%;"></td> <td style="width: 10%;"></td> <td style="width: 10%;"></td> <td style="width: 10%;"></td> <td style="width: 10%;"></td> <td style="width: 10%;"></td> <td style="width: 10%;"></td> <td style="width: 10%;"></td> <td style="width: 10%;"></td> <td style="width: 10%;"></td> </tr> <tr> <td></td> <td></td> <td colspan="8" style="text-align: center;"> <table border="1" style="width: 100%; border-collapse: collapse; text-align: center;"> <tr> <td style="width: 10%;"></td> <td style="width: 10%;"></td> <td style="width: 10%;"></td> <td style="width: 10%;"></td> <td style="width: 10%;"></td> <td style="width: 10%;"></td> <td style="width: 10%;"></td> <td style="width: 10%;"></td> <td style="width: 10%;"></td> <td style="width: 10%;"></td> </tr> <tr> <td></td> <td></td> <td colspan="8" style="text-align: center;"> <table border="1" style="width: 100%; border-collapse: collapse; text-align: center;"> <tr> <td style="width: 10%;"></td> <td style="width: 10%;"></td> <td style="width: 10%;"></td> <td style="width: 10%;"></td> <td style="width: 10%;"></td> <td style="width: 10%;"></td> <td style="width: 10%;"></td> <td style="width: 10%;"></td> <td style="width: 10%;"></td> <td style="width: 10%;"></td> </tr> <tr> <td></td> <td></td> <td colspan="8" style="text-align: center;"> <table border="1" style="width: 100%; border-collapse: collapse; text-align: center;"> <tr> <td style="width: 10%;"></td> <td style="width: 10%;"></td> <td style="width: 10%;"></td> <td style="width: 10%;"></td> <td style="width: 10%;"></td> <td style="width: 10%;"></td> <td style="width: 10%;"></td> <td style="width:
10%;"></td> <td style="width: 10%;"></td> <td style="width: 10%;"></td> </tr> <tr> <td></td> <td></td> <td colspan="8" style="text-align: center;"> <table border="1" style="width: 100%; border-collapse: collapse; text-align: center;"> <tr> <td style="width: 10%;"></td> <td style="width: 10%;"></td> <td style="width: 10%;"></td> <td style="width: 10%;"></td> <td style="width: 10%;"></td> <td style="width: 10%;"></td> <td style="width: 10%;"></td> <td style="width: 10%;"></td> <td style="width: 10%;"></td> <td style="width: 10%;"></td> </tr> <tr> <td></td> <td></td> <td colspan="8" style="text-align: center;"> <table border="1" style="width: 100%; border-collapse: collapse; text-align: center;"> <tr> <td style="width: 10%;"></td> <td style="width: 10%;"></td> <td style="width: 10%;"></td> <td style="width: 10%;"></td> <td style="width: 10%;"></td> <td style="width: 10%;"></td> <td style="width: 10%;"></td> <td style="width: 10%;"></td> <td style="width: 10%;"></td> <td style="width: 10%;"></td> </tr> <tr> <td></td> <td></td> <td colspan="8" style="text-align: center;"> <table border="1" style="width: 100%; border-collapse: collapse; text-align: center;"> <tr> <td style="width: 10%;"></td> <td style="width: 10%;"></td> <td style="width: 10%;"></td> <td style="width: 10%;"></td> <td style="width: 10%;"></td> <td style="width: 10%;"></td> <td style="width: 10%;"></td> <td style="width: 10%;"></td> <td style="width: 10%;"></td> <td style="width: 10%;"></td> </tr> <tr> <td></td> <td></td> <td colspan="8" style="text-align: center;"> <table border="1" style="width: 100%; border-collapse: collapse; text-align: center;"> <tr> <td style="width: 10%;"></td> <td style="width: 10%;"></td> <td style="width: 10%;"></td> <td style="width: 10%;"></td> <td style="width: 10%;"></td> <td style="width: 10%;"></td> <td style="width: 10%;"></td> <td style="width: 10%;"></td> <td style="width: 10%;"></td> <td style="width: 10%;"></td> </tr> <tr> <td></td> <td></td> <td colspan="8" style="text-align: center;"> <table border="1" style="width: 100%; border-collapse: collapse; text-align: center;"> <tr> <td style="width: 10%;"></td> <td style="width: 10%;"></td> <td style="width: 10%;"></td> <td style="width: 10%;"></td> <td style="width: 10%;"></td> <td style="width: 10%;"></td> <td style="width: 10%;"></td> <td style="width: 10%;"></td> <td style="width: 10%;"></td> <td style="width: 10%;"></td> </tr> <tr> <td></td> <td></td> <td colspan="8" style="text-align: center;"> <table border="1" style="width: 100%; border-collapse: collapse; text-align: center;"> <tr> <td style="width: 10%;"></td> <td style="width: 10%;"></td> <td style="width: 10%;"></td> <td style="width: 10%;"></td> <td style="width: 10%;"></td> <td style="width: 10%;"></td> <td style="width: 10%;"></td> <td style="width: 10%;"></td> <td style="width: 10%;"></td> <td style="width: 10%;"></td> </tr> <tr> <td></td> <td></td> <td colspan="8" style="text-align: center;"> <table border="1" style="width: 100%; border-collapse: collapse; text-align: center;"> <tr> <td style="width: 10%;"></td> <td style="width: 10%;"></td> <td style="width: 10%;"></td> <td style="width: 10%;"></td> <td style="width: 10%;"></td> <td style="width: 10%;"></td> <td style="width: 10%;"></td> <td style="width: 10%;"></td> <td style="width: 10%;"></td> <td style="width: 10%;"></td> </tr> <tr> <td></td> <td></td> <td colspan="8" style="text-align: center;"> <table border="1" style="width: 100%; border-collapse: collapse; text-align: center;"> <tr> <td style="width: 10%;"></td> <td style="width: 10%;"></td> <td style="width: 10%;"></td> <td style="width: 10%;"></td> <td style="width: 10%;"></td> <td style="width: 10%;"></td> <td style="width: 10%;"></td> <td style="width: 10%;"></td> <td style="width: 10%;"></td> <td style="width: 10%;"></td> </tr> <tr> <td></td> <td></td> <td colspan="8" style="text-align: center;"> <table border="1" style="width: 100%; border-collapse: collapse; text-align: center;"> <tr> <td style="width: 10%;"></td> <td style="width: 10%;"></td> <td style="width: 10%;"></td> <td style="width: 10%;"></td> <td style="width: 10%;"></td> <td style="width: 10%;"></td> <td style="width: 10%;"></td> <td style="width: 10%;"></td> <td style="width: 10%;"></td> <td style="width: 10%;"></td> </tr> <tr> <td></td> <td></td> <td colspan="8" style="text-align: center;"> <table border="1" style="width: 100%; border-collapse: collapse; text-align: center;"> <tr> <td style="width: 10%;"></td> <td style="width: 10%;"></td> <td style="width: 10%;"></td> <td style="width: 10%;"></td> <td style="width: 10%;"></td> <td style="width: 10%;"></td> <td style="width: 10%;"></td> <td style="width: 10%;"></td> <td style="width: 10%;"></td> <td style="width: 10%;"></td> </tr> <tr> <td></td> <td></td> <td colspan="8" style="text-align: center;"> <table border="1" style="width: 100%; border-collapse: collapse; text-align: center;"> <tr> <td style="width: 10%;"></td> <td style="width: 10%;"></td> <td style="width: 10%;"></td> <td style="width: 10%;"></td> <td style="width: 10%;"></td> <td style="width: 10%;"></td> <td style="width: 10%;"></td> <td style="width: 10%;"></td> <td style="width: 10%;"></td> <td style="width: 10%;"></td> </tr> <tr> <td></td> <td></td> <td colspan="8" style="text-align: center;"> <table border="1" style="width: 100%; border-collapse: collapse; text-align: center;"> <tr> <td style="width: 10%;"></td> <td style="width: 10%;"></td> <td style="width: 10%;"></td> <td style="width: 10%;"></td> <td style="width: 10%;"></td> <td style="width: 10%;"></td> <td style="width: 10%;"></td> <td style="width: 10%;"></td> <td style="width: 10%;"></td> <td style="width: 10%;"></td> </tr> <tr> <td></td> <td></td> <td colspan="8" style="text-align: center;"> <table border="1" style="width: 100%; border-collapse: collapse; text-align: center;"> <tr> <td style="width: 10%;"></td> <td style="width: 10%;"></td> <td style="width: 10%;"></td> <td style="width: 10%;"></td> <td style="width: 10%;"></td> <td style="width: 10%;"></td> <td style="width: 10%;"></td> <td style="width: 10%;"></td> <td style="width: 10%;"></td> <td style="width: 10%;"></td> </tr> <tr> <td></td> <td></td> <td colspan="8" style="text-align: center;"> <table border="1" style="width: 100%; border-collapse: collapse; text-align: center;"> <tr> <td style="width: 10%;"></td> <td style="width: 10%;"></td> <td style="width: 10%;"></td> <td style="width: 10%;"></td> <td style="width: 10%;"></td> <td style="width: 10%;"></td> <td style="width: 10%;"></td> <td style="width: 10%;"></td> <td style="width: 10%;"></td> <td style="width: 10%;"></td> </tr> <tr> <td></td> <td></td> <td colspan="8" style="text-align: center;"> <table border="1" style="width: 100%; border-collapse: collapse; text-align: center;"> <tr> <td style="width: 10%;"></td> <td style="width: 10%;"></td> <td style="width: 10%;"></td> <td style="width: 10%;"></td> <td style="width: 10%;"></td> <td style="width: 10%;"></td> <td style="width: 10%;"></td> <td style="width: 10%;"></td> <td style="width: 10%;"></td> <td style="width: 10%;"></td> </tr> <tr> <td></td> <td></td> <td colspan="8" style="text-align: center;"> <table border="1" style="width: 100%; border-collapse: collapse; text-align: center;"> <tr> <td style="width: 10%;"></td> <td style="width: 10%;"></td> <td style="width: 10%;"></td> <td style="width: 10%;"></td> <td style="width: 10%;"></td> <td style="width: 10%;"></td> <td style="width: 10%;"></td> <td style="width: 10%;"></td> <td style="width: 10%;"></td> <td style="width: 10%;"></td> </tr> <tr> <td></td> <td></td> <td colspan="8" style="text-align: center;"> <table border="1" style="width: 100%; border-collapse: collapse; text-align: center;"> <tr> <td style="width: 10%;"></td> <td style="width: 10%;"></td> <td style="width: 10%;"></td> <td style="width: 10%;"></td> <td style="width: 10%;"></td> <td style="width: 10%;"></td> <td style="width: 10%;"></td> <td style="width: 10%;"></td> <td style="width: 10%;"></td> <td style="width: 10%;"></td> </tr> <tr> <td></td> <td></td> <td colspan="8" style="text-align: center;"> <table border="1" style="width: 100%; border-collapse: collapse; text-align: center;"> <tr> <td style="width: 10%;"></td> <td style="width: 10%;"></td> <td style="width: 10%;"></td> <td style="width: 10%;"></td> <td style="width: 10%;"></td> <td style="width: 10%;"></td> <td style="width: 10%;"></td> <td style="width: 10%;"></td> <td style="width: 10%;"></td> <td style="width: 10%;"></td> </tr> <tr> <td></td> <td></td> <td colspan="8" style="text-align: center;"> <table border="1" style="width: 100%; border-collapse: collapse; text-align: center;"> <tr> <td style="width: 10%;"></td> <td style="width: 10%;"></td> <td style="width: 10%;"></td> <td style="width: 10%;"></td> <td style="width: 10%;"></td> <td style="width: 10%;"></td> <td style="width: 10%;"></td> <td style="width: 10%;"></td> <td style="width: 10%;"></td> <td style="width: 10%;"></td> </tr> <tr> <td></td> <td></td> <td colspan="8" style="text-align: center;"> <table border="1" style="width: 100%; border-collapse: collapse; text-align: center;"> <tr> <td style="width: 10%;"></td> <td style="width: 10%;"></td> <td style="width: 10%;"></td> <td style="width: 10%;"></td> <td style="width: 10%;"></td> <td style="width: 10%;"></td> <td style="width: 10%;"></td> <td style="width: 10%;"></td> <td style="width: 10%;"></td> <td style="width: 10%;"></td> </tr> <tr> <td></td> <td></td> <td colspan="8" style="text-align: center;"> <table border="1" style="width: 100%; border-collapse: collapse; text-align: center;"> <tr>
</tr></table></td></tr></table></td></tr></table></td></tr></table></td></tr></table></td></tr></table></td></tr></table></td></tr></table></td></tr></table></td></tr></table></td></tr></table></td></tr></table></td></tr></table></td></tr></table></td></tr></table></td></tr></table></td></tr></table></td></tr></table></td></tr></table></td></tr></table></td></tr></table></td></tr></table></td></tr></table></td></tr></table></td></tr></table></td></tr></table></td></tr></table>
 | | | | | | | | | | | | | | | | | | | | <table border="1" style="width: 100%; border-collapse: collapse; text-align: center;"> <tr> <td style="width: 10%;"></td> <td style="width: 10%;"></td> <td style="width: 10%;"></td> <td style="width: 10%;"></td> <td style="width: 10%;"></td> <td style="width: 10%;"></td> <td style="width: 10%;"></td> <td style="width: 10%;"></td> <td style="width: 10%;"></td> <td style="width: 10%;"></td> </tr> <tr> <td></td> <td></td> <td colspan="8" style="text-align: center;"> <table border="1" style="width: 100%; border-collapse: collapse; text-align: center;"> <tr> <td style="width: 10%;"></td> <td style="width: 10%;"></td> <td style="width: 10%;"></td> <td style="width: 10%;"></td> <td style="width: 10%;"></td> <td style="width: 10%;"></td> <td style="width: 10%;"></td> <td style="width: 10%;"></td> <td style="width: 10%;"></td> <td style="width: 10%;"></td> </tr> <tr> <td></td> <td></td> <td colspan="8" style="text-align: center;"> <table border="1" style="width: 100%; border-collapse: collapse; text-align: center;"> <tr> <td style="width: 10%;"></td> <td style="width: 10%;"></td> <td style="width: 10%;"></td> <td style="width: 10%;"></td> <td style="width: 10%;"></td> <td style="width: 10%;"></td> <td style="width: 10%;"></td> <td style="width: 10%;"></td> <td style="width: 10%;"></td> <td style="width: 10%;"></td> </tr> <tr> <td></td> <td></td> <td colspan="8" style="text-align: center;"> <table border="1" style="width: 100%; border-collapse: collapse; text-align: center;"> <tr> <td style="width: 10%;"></td> <td style="width: 10%;"></td> <td style="width: 10%;"></td> <td style="width: 10%;"></td> <td style="width: 10%;"></td> <td style="width: 10%;"></td> <td style="width: 10%;"></td> <td style="width: 10%;"></td> <td style="width: 10%;"></td> <td style="width: 10%;"></td> </tr> <tr> <td></td> <td></td> <td colspan="8" style="text-align: center;"> <table border="1" style="width: 100%; border-collapse: collapse; text-align: center;"> <tr> <td style="width: 10%;"></td> <td style="width: 10%;"></td> <td style="width: 10%;"></td> <td style="width: 10%;"></td> <td style="width: 10%;"></td> <td style="width: 10%;"></td> <td style="width: 10%;"></td> <td style="width: 10%;"></td> <td style="width: 10%;"></td> <td style="width: 10%;"></td> </tr> <tr> <td></td> <td></td> <td colspan="8" style="text-align: center;"> <table border="1" style="width: 100%; border-collapse: collapse; text-align: center;"> <tr> <td style="width: 10%;"></td> <td style="width: 10%;"></td> <td style="width: 10%;"></td> <td style="width: 10%;"></td> <td style="width: 10%;"></td> <td style="width: 10%;"></td> <td style="width: 10%;"></td> <td style="width: 10%;"></td> <td style="width: 10%;"></td> <td style="width: 10%;"></td> </tr> <tr> <td></td> <td></td> <td colspan="8" style="text-align: center;"> <table border="1" style="width: 100%; border-collapse: collapse; text-align: center;"> <tr> <td style="width: 10%;"></td> <td style="width: 10%;"></td> <td style="width: 10%;"></td> <td style="width: 10%;"></td> <td style="width: 10%;"></td> <td style="width: 10%;"></td> <td style="width: 10%;"></td> <td style="width: 10%;"></td> <td style="width: 10%;"></td> <td style="width: 10%;"></td> </tr> <tr> <td></td> <td></td> <td colspan="8" style="text-align: center;"> <table border="1" style="width: 100%; border-collapse: collapse; text-align: center;"> <tr> <td style="width: 10%;"></td> <td style="width: 10%;"></td> <td style="width: 10%;"></td> <td style="width: 10%;"></td> <td style="width: 10%;"></td> <td style="width: 10%;"></td> <td style="width: 10%;"></td> <td style="width: 10%;"></td> <td style="width: 10%;"></td> <td style="width: 10%;"></td> </tr> <tr> <td></td> <td></td> <td colspan="8" style="text-align: center;"> <table border="1" style="width: 100%; border-collapse: collapse; text-align: center;"> <tr> <td style="width: 10%;"></td> <td style="width: 10%;"></td> <td style="width: 10%;"></td> <td style="width: 10%;"></td> <td style="width: 10%;"></td> <td style="width: 10%;"></td> <td style="width: 10%;"></td> <td style="width: 10%;"></td> <td style="width: 10%;"></td> <td style="width: 10%;"></td> </tr> <tr> <td></td> <td></td> <td colspan="8" style="text-align: center;"> <table border="1" style="width: 100%; border-collapse: collapse; text-align: center;"> <tr> <td style="width: 10%;"></td> <td style="width: 10%;"></td> <td style="width: 10%;"></td> <td style="width: 10%;"></td> <td style="width: 10%;"></td> <td style="width: 10%;"></td> <td style="width: 10%;"></td> <td style="width: 10%;"></td> <td style="width: 10%;"></td> <td style="width: 10%;"></td> </tr> <tr> <td></td> <td></td> <td colspan="8" style="text-align: center;"> <table border="1" style="width: 100%; border-collapse: collapse; text-align: center;"> <tr> <td style="width: 10%;"></td> <td style="width: 10%;"></td> <td style="width: 10%;"></td> <td style="width: 10%;"></td> <td style="width: 10%;"></td> <td style="width: 10%;"></td> <td style="width: 10%;"></td> <td style="width: 10%;"></td> <td style="width: 10%;"></td> <td style="width: 10%;"></td> </tr> <tr> <td></td> <td></td> <td colspan="8" style="text-align: center;"> <table border="1" style="width: 100%; border-collapse: collapse; text-align: center;"> <tr> <td style="width: 10%;"></td> <td style="width: 10%;"></td> <td style="width: 10%;"></td> <td style="width: 10%;"></td> <td style="width: 10%;"></td> <td style="width: 10%;"></td> <td style="width: 10%;"></td> <td style="width: 10%;"></td> <td style="width: 10%;"></td> <td style="width: 10%;"></td> </tr> <tr> <td></td> <td></td> <td colspan="8" style="text-align: center;"> <table border="1" style="width: 100%; border-collapse: collapse; text-align: center;"> <tr> <td style="width: 10%;"></td> <td style="width: 10%;"></td> <td style="width: 10%;"></td> <td style="width: 10%;"></td> <td style="width: 10%;"></td> <td style="width: 10%;"></td> <td style="width: 10%;"></td> <td style="width: 10%;"></td> <td style="width: 10%;"></td> <td style="width: 10%;"></td> </tr> <tr> <td></td> <td></td> <td colspan="8" style="text-align: center;"> <table border="1" style="width: 100%; border-collapse: collapse; text-align: center;"> <tr> <td style="width: 10%;"></td> <td style="width: 10%;"></td> <td style="width: 10%;"></td> <td style="width: 10%;"></td> <td style="width: 10%;"></td> <td
style="width: 10%;"></td> <td style="width: 10%;"></td> <td style="width: 10%;"></td> <td style="width: 10%;"></td> <td style="width: 10%;"></td> </tr> <tr> <td></td> <td></td> <td colspan="8" style="text-align: center;"> <table border="1" style="width: 100%; border-collapse: collapse; text-align: center;"> <tr> <td style="width: 10%;"></td> <td style="width: 10%;"></td> <td style="width: 10%;"></td> <td style="width: 10%;"></td> <td style="width: 10%;"></td> <td style="width: 10%;"></td> <td style="width: 10%;"></td> <td style="width: 10%;"></td> <td style="width: 10%;"></td> <td style="width: 10%;"></td> </tr> <tr> <td></td> <td></td> <td colspan="8" style="text-align: center;"> <table border="1" style="width: 100%; border-collapse: collapse; text-align: center;"> <tr> <td style="width: 10%;"></td> <td style="width: 10%;"></td> <td style="width: 10%;"></td> <td style="width: 10%;"></td> <td style="width: 10%;"></td> <td style="width: 10%;"></td> <td style="width: 10%;"></td> <td style="width: 10%;"></td> <td style="width: 10%;"></td> <td style="width: 10%;"></td> </tr> <tr> <td></td> <td></td> <td colspan="8" style="text-align: center;"> <table border="1" style="width: 100%; border-collapse: collapse; text-align: center;"> <tr> <td style="width: 10%;"></td> <td style="width: 10%;"></td> <td style="width: 10%;"></td> <td style="width: 10%;"></td> <td style="width: 10%;"></td> <td style="width: 10%;"></td> <td style="width: 10%;"></td> <td style="width: 10%;"></td> <td style="width: 10%;"></td> <td style="width: 10%;"></td> </tr> <tr> <td></td> <td></td> <td colspan="8" style="text-align: center;"> <table border="1" style="width: 100%; border-collapse: collapse; text-align: center;"> <tr> <td style="width: 10%;"></td> <td style="width: 10%;"></td> <td style="width: 10%;"></td> <td style="width: 10%;"></td> <td style="width: 10%;"></td> <td style="width: 10%;"></td> <td style="width: 10%;"></td> <td style="width: 10%;"></td> <td style="width: 10%;"></td> <td style="width: 10%;"></td> </tr> <tr> <td></td> <td></td> <td colspan="8" style="text-align: center;"> <table border="1" style="width: 100%; border-collapse: collapse; text-align: center;"> <tr> <td style="width: 10%;"></td> <td style="width: 10%;"></td> <td style="width: 10%;"></td> <td style="width: 10%;"></td> <td style="width: 10%;"></td> <td style="width: 10%;"></td> <td style="width: 10%;"></td> <td style="width: 10%;"></td> <td style="width: 10%;"></td> <td style="width: 10%;"></td> </tr> <tr> <td></td> <td></td> <td colspan="8" style="text-align: center;"> <table border="1" style="width: 100%; border-collapse: collapse; text-align: center;"> <tr> <td style="width: 10%;"></td> <td style="width: 10%;"></td> <td style="width: 10%;"></td> <td style="width: 10%;"></td> <td style="width: 10%;"></td> <td style="width: 10%;"></td> <td style="width: 10%;"></td> <td style="width: 10%;"></td> <td style="width: 10%;"></td> <td style="width: 10%;"></td> </tr> <tr> <td></td> <td></td> <td colspan="8" style="text-align: center;"> <table border="1" style="width: 100%; border-collapse: collapse; text-align: center;"> <tr> <td style="width: 10%;"></td> <td style="width: 10%;"></td> <td style="width: 10%;"></td> <td style="width: 10%;"></td> <td style="width: 10%;"></td> <td style="width: 10%;"></td> <td style="width: 10%;"></td> <td style="width: 10%;"></td> <td style="width: 10%;"></td> <td style="width: 10%;"></td> </tr> <tr> <td></td> <td></td> <td colspan="8" style="text-align: center;"> <table border="1" style="width: 100%; border-collapse: collapse; text-align: center;"> <tr> <td style="width: 10%;"></td> <td style="width: 10%;"></td> <td style="width: 10%;"></td> <td style="width: 10%;"></td> <td style="width: 10%;"></td> <td style="width: 10%;"></td> <td style="width: 10%;"></td> <td style="width: 10%;"></td> <td style="width: 10%;"></td> <td style="width: 10%;"></td> </tr> <tr> <td></td> <td></td> <td colspan="8" style="text-align: center;"> <table border="1" style="width: 100%; border-collapse: collapse; text-align: center;"> <tr> <td style="width: 10%;"></td> <td style="width: 10%;"></td> <td style="width: 10%;"></td> <td style="width: 10%;"></td> <td style="width: 10%;"></td> <td style="width: 10%;"></td> <td style="width: 10%;"></td> <td style="width: 10%;"></td> <td style="width: 10%;"></td> <td style="width: 10%;"></td> </tr> <tr> <td></td> <td></td> <td colspan="8" style="text-align: center;"> <table border="1" style="width: 100%; border-collapse: collapse; text-align: center;"> <tr> <td style="width: 10%;"></td> <td style="width: 10%;"></td> <td style="width: 10%;"></td> <td style="width: 10%;"></td> <td style="width: 10%;"></td> <td style="width: 10%;"></td> <td style="width: 10%;"></td> <td style="width: 10%;"></td> <td style="width: 10%;"></td> <td style="width: 10%;"></td> </tr> <tr> <td></td> <td></td> <td colspan="8" style="text-align: center;"> <table border="1" style="width: 100%; border-collapse: collapse; text-align: center;"> <tr> <td style="width: 10%;"></td> <td style="width: 10%;"></td> <td style="width: 10%;"></td> <td style="width: 10%;"></td> <td style="width: 10%;"></td> <td style="width: 10%;"></td> <td style="width: 10%;"></td> <td style="width: 10%;"></td> <td style="width: 10%;"></td> <td style="width: 10%;"></td> </tr> <tr> <td></td> <td></td> <td colspan="8" style="text-align: center;"> <table border="1" style="width: 100%; border-collapse: collapse; text-align: center;"> <tr> </tr></table></td></tr></table></td></tr></table></td></tr></table></td></tr></table></td></tr></table></td></tr></table></td></tr></table></td></tr></table></td></tr></table></td></tr></table></td></tr></table></td></tr></table></td></tr></table></td></tr></table></td></tr></table></td></tr></table></td></tr></table></td></tr></table></td></tr></table></td></tr></table></td></tr></table></td></tr></table></td></tr></table></td></tr></table></td></tr></table>
 | | | | | | | | | | | | | | | | | | | | <table border="1" style="width: 100%; border-collapse: collapse; text-align: center;"> <tr> <td style="width: 10%;"></td> <td style="width: 10%;"></td> <td style="width: 10%;"></td> <td style="width: 10%;"></td> <td style="width: 10%;"></td> <td style="width: 10%;"></td> <td style="width: 10%;"></td> <td style="width: 10%;"></td> <td style="width: 10%;"></td> <td style="width: 10%;"></td> </tr> <tr> <td></td> <td></td> <td colspan="8" style="text-align: center;"> <table border="1" style="width: 100%; border-collapse: collapse; text-align: center;"> <tr> <td style="width: 10%;"></td> <td style="width: 10%;"></td> <td style="width: 10%;"></td> <td style="width: 10%;"></td> <td style="width: 10%;"></td> <td style="width: 10%;"></td> <td style="width: 10%;"></td> <td style="width: 10%;"></td> <td style="width: 10%;"></td> <td style="width: 10%;"></td> </tr> <tr> <td></td> <td></td>
<td colspan="8" style="text-align: center;"> <table border="1" style="width: 100%; border-collapse: collapse; text-align: center;"> <tr> <td style="width: 10%;"></td> <td style="width: 10%;"></td> <td style="width: 10%;"></td> <td style="width: 10%;"></td> <td style="width: 10%;"></td> <td style="width: 10%;"></td> <td style="width: 10%;"></td> <td style="width: 10%;"></td> <td style="width: 10%;"></td> <td style="width: 10%;"></td> </tr> <tr> <td></td> <td></td> <td colspan="8" style="text-align: center;"> <table border="1" style="width: 100%; border-collapse: collapse; text-align: center;"> <tr> <td style="width: 10%;"></td> <td style="width: 10%;"></td> <td style="width: 10%;"></td> <td style="width: 10%;"></td> <td style="width: 10%;"></td> <td style="width: 10%;"></td> <td style="width: 10%;"></td> <td style="width: 10%;"></td> <td style="width: 10%;"></td> <td style="width: 10%;"></td> </tr> <tr> <td></td> <td></td> <td colspan="8" style="text-align: center;"> <table border="1" style="width: 100%; border-collapse: collapse; text-align: center;"> <tr> <td style="width: 10%;"></td> <td style="width: 10%;"></td> <td style="width: 10%;"></td> <td style="width: 10%;"></td> <td style="width: 10%;"></td> <td style="width: 10%;"></td> <td style="width: 10%;"></td> <td style="width: 10%;"></td> <td style="width: 10%;"></td> <td style="width: 10%;"></td> </tr> <tr> <td></td> <td></td> <td colspan="8" style="text-align: center;"> <table border="1" style="width: 100%; border-collapse: collapse; text-align: center;"> <tr> <td style="width: 10%;"></td> <td style="width: 10%;"></td> <td style="width: 10%;"></td> <td style="width: 10%;"></td> <td style="width: 10%;"></td> <td style="width: 10%;"></td> <td style="width: 10%;"></td> <td style="width: 10%;"></td> <td style="width: 10%;"></td> <td style="width: 10%;"></td> </tr> <tr> <td></td> <td></td> <td colspan="8" style="text-align: center;"> <table border="1" style="width: 100%; border-collapse: collapse; text-align: center;"> <tr> <td style="width: 10%;"></td> <td style="width: 10%;"></td> <td style="width: 10%;"></td> <td style="width: 10%;"></td> <td style="width: 10%;"></td> <td style="width: 10%;"></td> <td style="width: 10%;"></td> <td style="width: 10%;"></td> <td style="width: 10%;"></td> <td style="width: 10%;"></td> </tr> <tr> <td></td> <td></td> <td colspan="8" style="text-align: center;"> <table border="1" style="width: 100%; border-collapse: collapse; text-align: center;"> <tr> <td style="width: 10%;"></td> <td style="width: 10%;"></td> <td style="width: 10%;"></td> <td style="width: 10%;"></td> <td style="width: 10%;"></td> <td style="width: 10%;"></td> <td style="width: 10%;"></td> <td style="width: 10%;"></td> <td style="width: 10%;"></td> <td style="width: 10%;"></td> </tr> <tr> <td></td> <td></td> <td colspan="8" style="text-align: center;"> <table border="1" style="width: 100%; border-collapse: collapse; text-align: center;"> <tr> <td style="width: 10%;"></td> <td style="width: 10%;"></td> <td style="width: 10%;"></td> <td style="width: 10%;"></td> <td style="width: 10%;"></td> <td style="width: 10%;"></td> <td style="width: 10%;"></td> <td style="width: 10%;"></td> <td style="width: 10%;"></td> <td style="width: 10%;"></td> </tr> <tr> <td></td> <td></td> <td colspan="8" style="text-align: center;"> <table border="1" style="width: 100%; border-collapse: collapse; text-align: center;"> <tr> <td style="width: 10%;"></td> <td style="width: 10%;"></td> <td style="width: 10%;"></td> <td style="width: 10%;"></td> <td style="width: 10%;"></td> <td style="width: 10%;"></td> <td style="width: 10%;"></td> <td style="width: 10%;"></td> <td style="width: 10%;"></td> <td style="width: 10%;"></td> </tr> <tr> <td></td> <td></td> <td colspan="8" style="text-align: center;"> <table border="1" style="width: 100%; border-collapse: collapse; text-align: center;"> <tr> <td style="width: 10%;"></td> <td style="width: 10%;"></td> <td style="width: 10%;"></td> <td style="width: 10%;"></td> <td style="width: 10%;"></td> <td style="width: 10%;"></td> <td style="width: 10%;"></td> <td style="width: 10%;"></td> <td style="width: 10%;"></td> <td style="width: 10%;"></td> </tr> <tr> <td></td> <td></td> <td colspan="8" style="text-align: center;"> <table border="1" style="width: 100%; border-collapse: collapse; text-align: center;"> <tr> <td style="width: 10%;"></td> <td style="width: 10%;"></td> <td style="width: 10%;"></td> <td style="width: 10%;"></td> <td style="width: 10%;"></td> <td style="width: 10%;"></td> <td style="width: 10%;"></td> <td style="width: 10%;"></td> <td style="width: 10%;"></td> <td style="width: 10%;"></td> </tr> <tr> <td></td> <td></td> <td colspan="8" style="text-align: center;"> <table border="1" style="width: 100%; border-collapse: collapse; text-align: center;"> <tr> <td style="width: 10%;"></td> <td style="width: 10%;"></td> <td style="width: 10%;"></td> <td style="width: 10%;"></td> <td style="width: 10%;"></td> <td style="width: 10%;"></td> <td style="width: 10%;"></td> <td style="width: 10%;"></td> <td style="width: 10%;"></td> <td style="width: 10%;"></td> </tr> <tr> <td></td> <td></td> <td colspan="8" style="text-align: center;"> <table border="1" style="width: 100%; border-collapse: collapse; text-align: center;"> <tr> <td style="width: 10%;"></td> <td style="width: 10%;"></td> <td style="width: 10%;"></td> <td style="width: 10%;"></td> <td style="width: 10%;"></td> <td style="width: 10%;"></td> <td style="width: 10%;"></td> <td style="width: 10%;"></td> <td style="width: 10%;"></td> <td style="width: 10%;"></td> </tr> <tr> <td></td> <td></td> <td colspan="8" style="text-align: center;"> <table border="1" style="width: 100%; border-collapse: collapse; text-align: center;"> <tr> <td style="width: 10%;"></td> <td style="width: 10%;"></td> <td style="width: 10%;"></td> <td style="width: 10%;"></td> <td style="width: 10%;"></td> <td style="width: 10%;"></td> <td style="width: 10%;"></td> <td style="width: 10%;"></td> <td style="width: 10%;"></td> <td style="width: 10%;"></td> </tr> <tr> <td></td> <td></td> <td colspan="8" style="text-align: center;"> <table border="1" style="width: 100%; border-collapse: collapse; text-align: center;"> <tr> <td style="width: 10%;"></td> <td style="width: 10%;"></td> <td style="width: 10%;"></td> <td style="width: 10%;"></td> <td style="width: 10%;"></td> <td style="width: 10%;"></td> <td style="width: 10%;"></td> <td style="width: 10%;"></td> <td style="width: 10%;"></td> <td style="width: 10%;"></td> </tr> <tr> <td></td> <td></td> <td colspan="8" style="text-align: center;"> <table border="1" style="width: 100%; border-collapse: collapse; text-align: center;"> <tr> <td style="width: 10%;"></td> <td style="width: 10%;"></td> <td style="width: 10%;"></td> <td style="width: 10%;"></td> <td style="width: 10%;"></td> <td style="width: 10%;"></td> <td style="width: 10%;"></td> <td style="width: 10%;"></td> <td style="width: 10%;"></td> <td style="width: 10%;"></td> </tr> <tr> <td></td> <td></td> <td colspan="8" style="text-align: center;"> <table border="1" style="width: 100%; border-collapse: collapse; text-align: center;"> <tr> <td style="width: 10%;"></td> <td style="width: 10%;"></td> <td style="width: 10%;"></td> <td style="width: 10%;"></td> <td style="width: 10%;"></td> <td style="width: 10%;"></td> <td style="width: 10%;"></td> <td style="width: 10%;"></td> <td style="width: 10%;"></td> <td style="width: 10%;"></td> </tr> <tr> <td></td> <td></td> <td colspan="8" style="text-align: center;"> <table border="1" style="width: 100%; border-collapse: collapse; text-align: center;"> <tr> <td style="width: 10%;"></td> <td style="width: 10%;"></td> <td style="width: 10%;"></td> <td style="width: 10%;"></td> <td style="width: 10%;"></td> <td style="width: 10%;"></td> <td style="width: 10%;"></td> <td style="width: 10%;"></td> <td style="width: 10%;"></td> <td style="width: 10%;"></td> </tr> <tr> <td></td> <td></td> <td colspan="8" style="text-align: center;"> <table border="1" style="width: 100%; border-collapse: collapse; text-align: center;"> <tr> <td style="width: 10%;"></td> <td style="width: 10%;"></td> <td style="width: 10%;"></td> <td style="width: 10%;"></td> <td style="width: 10%;"></td> <td style="width: 10%;"></td> <td style="width: 10%;"></td> <td style="width: 10%;"></td> <td style="width: 10%;"></td> <td style="width: 10%;"></td> </tr> <tr> <td></td> <td></td> <td colspan="8" style="text-align: center;"> <table border="1" style="width: 100%; border-collapse: collapse; text-align: center;"> <tr> <td style="width: 10%;"></td> <td style="width: 10%;"></td> <td style="width: 10%;"></td> <td style="width: 10%;"></td> <td style="width: 10%;"></td> <td style="width: 10%;"></td> <td style="width: 10%;"></td> <td style="width: 10%;"></td> <td style="width: 10%;"></td> <td style="width: 10%;"></td> </tr> <tr> <td></td> <td></td> <td colspan="8" style="text-align: center;"> <table border="1" style="width: 100%; border-collapse: collapse; text-align: center;"> <tr> <td style="width: 10%;"></td> <td style="width: 10%;"></td> <td style="width: 10%;"></td> <td style="width: 10%;"></td> <td style="width: 10%;"></td> <td style="width: 10%;"></td> <td style="width: 10%;"></td> <td style="width: 10%;"></td> <td style="width: 10%;"></td> <td style="width: 10%;"></td> </tr> <tr> <td></td> <td></td> <td colspan="8" style="text-align: center;"> <table border="1" style="width: 100%; border-collapse: collapse; text-align: center;"> <tr> <td style="width: 10%;"></td> <td style="width: 10%;"></td> <td style="width: 10%;"></td> <td style="width: 10%;"></td> <td style="width: 10%;"></td> <td style="width: 10%;"></td> <td style="width: 10%;"></td> <td style="width: 10%;"></td> <td style="width: 10%;"></td> <td style="width: 10%;"></td> </tr> <tr> <td></td> <td></td> <td colspan="8" style="text-align: center;"> <table border="1" style="width: 100%; border-collapse: collapse; text-align: center;"> <tr> <td style="width: 10%;"></td> <td
style="width: 10%;"></td> <td style="width: 10%;"></td> <td style="width: 10%;"></td> <td style="width: 10%;"></td> <td style="width: 10%;"></td> <td style="width: 10%;"></td> <td style="width: 10%;"></td> <td style="width: 10%;"></td> <td style="width: 10%;"></td> </tr> <tr> <td></td> <td></td> <td colspan="8" style="text-align: center;"> <table border="1" style="width: 100%; border-collapse: collapse; text-align: center;"> <tr> </tr></table></td></tr></table></td></tr></table></td></tr></table></td></tr></table></td></tr></table></td></tr></table></td></tr></table></td></tr></table></td></tr></table></td></tr></table></td></tr></table></td></tr></table></td></tr></table></td></tr></table></td></tr></table></td></tr></table></td></tr></table></td></tr></table></td></tr></table></td></tr></table></td></tr></table></td></tr></table></td></tr></table></td></tr></table>
 | | | | | | | | | | | | | | | | | | | | <table border="1" style="width: 100%; border-collapse: collapse; text-align: center;"> <tr> <td style="width: 10%;"></td> <td style="width: 10%;"></td> <td style="width: 10%;"></td> <td style="width: 10%;"></td> <td style="width: 10%;"></td> <td style="width: 10%;"></td> <td style="width: 10%;"></td> <td style="width: 10%;"></td> <td style="width: 10%;"></td> <td style="width: 10%;"></td> </tr> <tr> <td></td> <td></td> <td colspan="8" style="text-align: center;"> <table border="1" style="width: 100%; border-collapse: collapse; text-align: center;"> <tr> <td style="width: 10%;"></td> <td style="width: 10%;"></td> <td style="width: 10%;"></td> <td style="width: 10%;"></td> <td style="width: 10%;"></td> <td style="width: 10%;"></td> <td style="width: 10%;"></td> <td style="width: 10%;"></td> <td style="width: 10%;"></td> <td style="width: 10%;"></td> </tr> <tr> <td></td> <td></td> <td colspan="8" style="text-align: center;"> <table border="1" style="width: 100%; border-collapse: collapse; text-align: center;"> <tr> <td style="width: 10%;"></td> <td style="width: 10%;"></td> <td style="width: 10%;"></td> <td style="width: 10%;"></td> <td style="width: 10%;"></td> <td style="width: 10%;"></td> <td style="width: 10%;"></td> <td style="width: 10%;"></td> <td style="width: 10%;"></td> <td style="width: 10%;"></td> </tr> <tr> <td></td> <td></td> <td colspan="8" style="text-align: center;"> <table border="1" style="width: 100%; border-collapse: collapse; text-align: center;"> <tr> <td style="width: 10%;"></td> <td style="width: 10%;"></td> <td style="width: 10%;"></td> <td style="width: 10%;"></td> <td style="width: 10%;"></td> <td style="width: 10%;"></td> <td style="width: 10%;"></td> <td style="width: 10%;"></td> <td style="width: 10%;"></td> <td style="width: 10%;"></td> </tr> <tr> <td></td> <td></td> <td colspan="8" style="text-align: center;"> <table border="1" style="width: 100%; border-collapse: collapse; text-align: center;"> <tr> <td style="width: 10%;"></td> <td style="width: 10%;"></td> <td style="width: 10%;"></td> <td style="width: 10%;"></td> <td style="width: 10%;"></td> <td style="width: 10%;"></td> <td style="width: 10%;"></td> <td style="width: 10%;"></td> <td style="width: 10%;"></td> <td style="width: 10%;"></td> </tr> <tr> <td></td> <td></td> <td colspan="8" style="text-align: center;"> <table border="1" style="width: 100%; border-collapse: collapse; text-align: center;"> <tr> <td style="width: 10%;"></td> <td style="width: 10%;"></td> <td style="width: 10%;"></td> <td style="width: 10%;"></td> <td style="width: 10%;"></td> <td style="width: 10%;"></td> <td style="width: 10%;"></td> <td style="width: 10%;"></td> <td style="width: 10%;"></td> <td style="width: 10%;"></td> </tr> <tr> <td></td> <td></td> <td colspan="8" style="text-align: center;"> <table border="1" style="width: 100%; border-collapse: collapse; text-align: center;"> <tr> <td style="width: 10%;"></td> <td style="width: 10%;"></td> <td style="width: 10%;"></td> <td style="width: 10%;"></td> <td style="width: 10%;"></td> <td style="width: 10%;"></td> <td style="width: 10%;"></td> <td style="width: 10%;"></td> <td style="width: 10%;"></td> <td style="width: 10%;"></td> </tr> <tr> <td></td> <td></td> <td colspan="8" style="text-align: center;"> <table border="1" style="width: 100%; border-collapse: collapse; text-align: center;"> <tr> <td style="width: 10%;"></td> <td style="width: 10%;"></td> <td style="width: 10%;"></td> <td style="width: 10%;"></td> <td style="width: 10%;"></td> <td style="width: 10%;"></td> <td style="width: 10%;"></td> <td style="width: 10%;"></td> <td style="width: 10%;"></td> <td style="width: 10%;"></td> </tr> <tr> <td></td> <td></td> <td colspan="8" style="text-align: center;"> <table border="1" style="width: 100%; border-collapse: collapse; text-align: center;"> <tr> <td style="width: 10%;"></td> <td style="width: 10%;"></td> <td style="width: 10%;"></td> <td style="width: 10%;"></td> <td style="width: 10%;"></td> <td style="width: 10%;"></td> <td style="width: 10%;"></td> <td style="width: 10%;"></td> <td style="width: 10%;"></td> <td style="width: 10%;"></td> </tr> <tr> <td></td> <td></td> <td colspan="8" style="text-align: center;"> <table border="1" style="width: 100%; border-collapse: collapse; text-align: center;"> <tr> <td style="width: 10%;"></td> <td style="width: 10%;"></td> <td style="width: 10%;"></td> <td style="width: 10%;"></td> <td style="width: 10%;"></td> <td style="width: 10%;"></td> <td style="width: 10%;"></td> <td style="width: 10%;"></td> <td style="width: 10%;"></td> <td style="width: 10%;"></td> </tr> <tr> <td></td> <td></td> <td colspan="8" style="text-align: center;"> <table border="1" style="width: 100%; border-collapse: collapse; text-align: center;"> <tr> <td style="width: 10%;"></td> <td style="width: 10%;"></td> <td style="width: 10%;"></td> <td style="width: 10%;"></td> <td style="width: 10%;"></td> <td style="width: 10%;"></td> <td style="width: 10%;"></td> <td style="width: 10%;"></td> <td style="width: 10%;"></td> <td style="width: 10%;"></td> </tr> <tr> <td></td> <td></td> <td colspan="8" style="text-align: center;"> <table border="1" style="width: 100%; border-collapse: collapse; text-align: center;"> <tr> <td style="width: 10%;"></td> <td style="width: 10%;"></td> <td style="width: 10%;"></td> <td style="width: 10%;"></td> <td style="width: 10%;"></td> <td style="width: 10%;"></td> <td style="width: 10%;"></td> <td style="width: 10%;"></td> <td style="width: 10%;"></td> <td style="width: 10%;"></td> </tr> <tr> <td></td> <td></td> <td colspan="8" style="text-align: center;"> <table border="1" style="width: 100%; border-collapse: collapse; text-align: center;"> <tr> <td style="width: 10%;"></td> <td style="width: 10%;"></td> <td style="width: 10%;"></td> <td style="width: 10%;"></td> <td style="width: 10%;"></td> <td style="width: 10%;"></td> <td style="width: 10%;"></td> <td style="width:
10%;"></td> <td style="width: 10%;"></td> <td style="width: 10%;"></td> </tr> <tr> <td></td> <td></td> <td colspan="8" style="text-align: center;"> <table border="1" style="width: 100%; border-collapse: collapse; text-align: center;"> <tr> <td style="width: 10%;"></td> <td style="width: 10%;"></td> <td style="width: 10%;"></td> <td style="width: 10%;"></td> <td style="width: 10%;"></td> <td style="width: 10%;"></td> <td style="width: 10%;"></td> <td style="width: 10%;"></td> <td style="width: 10%;"></td> <td style="width: 10%;"></td> </tr> <tr> <td></td> <td></td> <td colspan="8" style="text-align: center;"> <table border="1" style="width: 100%; border-collapse: collapse; text-align: center;"> <tr> <td style="width: 10%;"></td> <td style="width: 10%;"></td> <td style="width: 10%;"></td> <td style="width: 10%;"></td> <td style="width: 10%;"></td> <td style="width: 10%;"></td> <td style="width: 10%;"></td> <td style="width: 10%;"></td> <td style="width: 10%;"></td> <td style="width: 10%;"></td> </tr> <tr> <td></td> <td></td> <td colspan="8" style="text-align: center;"> <table border="1" style="width: 100%; border-collapse: collapse; text-align: center;"> <tr> <td style="width: 10%;"></td> <td style="width: 10%;"></td> <td style="width: 10%;"></td> <td style="width: 10%;"></td> <td style="width: 10%;"></td> <td style="width: 10%;"></td> <td style="width: 10%;"></td> <td style="width: 10%;"></td> <td style="width: 10%;"></td> <td style="width: 10%;"></td> </tr> <tr> <td></td> <td></td> <td colspan="8" style="text-align: center;"> <table border="1" style="width: 100%; border-collapse: collapse; text-align: center;"> <tr> <td style="width: 10%;"></td> <td style="width: 10%;"></td> <td style="width: 10%;"></td> <td style="width: 10%;"></td> <td style="width: 10%;"></td> <td style="width: 10%;"></td> <td style="width: 10%;"></td> <td style="width: 10%;"></td> <td style="width: 10%;"></td> <td style="width: 10%;"></td> </tr> <tr> <td></td> <td></td> <td colspan="8" style="text-align: center;"> <table border="1" style="width: 100%; border-collapse: collapse; text-align: center;"> <tr> <td style="width: 10%;"></td> <td style="width: 10%;"></td> <td style="width: 10%;"></td> <td style="width: 10%;"></td> <td style="width: 10%;"></td> <td style="width: 10%;"></td> <td style="width: 10%;"></td> <td style="width: 10%;"></td> <td style="width: 10%;"></td> <td style="width: 10%;"></td> </tr> <tr> <td></td> <td></td> <td colspan="8" style="text-align: center;"> <table border="1" style="width: 100%; border-collapse: collapse; text-align: center;"> <tr> <td style="width: 10%;"></td> <td style="width: 10%;"></td> <td style="width: 10%;"></td> <td style="width: 10%;"></td> <td style="width: 10%;"></td> <td style="width: 10%;"></td> <td style="width: 10%;"></td> <td style="width: 10%;"></td> <td style="width: 10%;"></td> <td style="width: 10%;"></td> </tr> <tr> <td></td> <td></td> <td colspan="8" style="text-align: center;"> <table border="1" style="width: 100%; border-collapse: collapse; text-align: center;"> <tr> <td style="width: 10%;"></td> <td style="width: 10%;"></td> <td style="width: 10%;"></td> <td style="width: 10%;"></td> <td style="width: 10%;"></td> <td style="width: 10%;"></td> <td style="width: 10%;"></td> <td style="width: 10%;"></td> <td style="width: 10%;"></td> <td style="width: 10%;"></td> </tr> <tr> <td></td> <td></td> <td colspan="8" style="text-align: center;"> <table border="1" style="width: 100%; border-collapse: collapse; text-align: center;"> <tr> <td style="width: 10%;"></td> <td style="width: 10%;"></td> <td style="width: 10%;"></td> <td style="width: 10%;"></td> <td style="width: 10%;"></td> <td style="width: 10%;"></td> <td style="width: 10%;"></td> <td style="width: 10%;"></td> <td style="width: 10%;"></td> <td style="width: 10%;"></td> </tr> <tr> <td></td> <td></td> <td colspan="8" style="text-align: center;"> <table border="1" style="width: 100%; border-collapse: collapse; text-align: center;"> <tr> <td style="width: 10%;"></td> <td style="width: 10%;"></td> <td style="width: 10%;"></td> <td style="width: 10%;"></td> <td style="width: 10%;"></td> <td style="width: 10%;"></td> <td style="width: 10%;"></td> <td style="width: 10%;"></td> <td style="width: 10%;"></td> <td style="width: 10%;"></td> </tr> <tr> <td></td> <td></td> <td colspan="8" style="text-align: center;"> <table border="1" style="width: 100%; border-collapse: collapse; text-align: center;"> <tr> <td style="width: 10%;"></td> <td style="width: 10%;"></td> <td style="width: 10%;"></td> <td style="width: 10%;"></td> <td style="width: 10%;"></td> <td style="width: 10%;"></td> <td style="width: 10%;"></td> <td style="width: 10%;"></td> <td style="width: 10%;"></td> <td style="width: 10%;"></td> </tr> <tr> <td></td> <td></td> <td colspan="8" style="text-align: center;"> <table border="1" style="width: 100%; border-collapse: collapse; text-align: center;"> <tr> </tr></table></td></tr></table></td></tr></table></td></tr></table></td></tr></table></td></tr></table></td></tr></table></td></tr></table></td></tr></table></td></tr></table></td></tr></table></td></tr></table></td></tr></table></td></tr></table></td></tr></table></td></tr></table></td></tr></table></td></tr></table></td></tr></table></td></tr></table></td></tr></table></td></tr></table></td></tr></table></td></tr></table>
 | | | | | | | | | | | | | | | | | | | | <table border="1" style="width: 100%; border-collapse: collapse; text-align: center;"> <tr> <td style="width: 10%;"></td> <td style="width: 10%;"></td> <td style="width: 10%;"></td> <td style="width: 10%;"></td> <td style="width: 10%;"></td> <td style="width: 10%;"></td> <td style="width: 10%;"></td> <td style="width: 10%;"></td> <td style="width: 10%;"></td> <td style="width: 10%;"></td> </tr> <tr> <td></td> <td></td> <td colspan="8" style="text-align: center;"> <table border="1" style="width: 100%; border-collapse: collapse; text-align: center;"> <tr> <td style="width: 10%;"></td> <td style="width: 10%;"></td> <td style="width: 10%;"></td> <td style="width: 10%;"></td> <td style="width: 10%;"></td> <td style="width: 10%;"></td> <td style="width: 10%;"></td> <td style="width: 10%;"></td> <td style="width: 10%;"></td> <td style="width: 10%;"></td> </tr> <tr> <td></td> <td></td> <td colspan="8" style="text-align: center;"> <table border="1" style="width: 100%; border-collapse: collapse; text-align: center;"> <tr> <td style="width: 10%;"></td> <td style="width: 10%;"></td> <td style="width: 10%;"></td> <td style="width: 10%;"></td> <td style="width: 10%;"></td> <td style="width: 10%;"></td> <td style="width: 10%;"></td> <td style="width: 10%;"></td> <td style="width: 10%;"></td> <td style="width: 10%;"></td> </tr> <tr> <td></td> <td></td> <td colspan="8" style="text-align: center;"> <table border="1" style="width: 100%; border-collapse: collapse;
text-align: center;"> <tr> <td style="width: 10%;"></td> <td style="width: 10%;"></td> <td style="width: 10%;"></td> <td style="width: 10%;"></td> <td style="width: 10%;"></td> <td style="width: 10%;"></td> <td style="width: 10%;"></td> <td style="width: 10%;"></td> <td style="width: 10%;"></td> <td style="width: 10%;"></td> </tr> <tr> <td></td> <td></td> <td colspan="8" style="text-align: center;"> <table border="1" style="width: 100%; border-collapse: collapse; text-align: center;"> <tr> <td style="width: 10%;"></td> <td style="width: 10%;"></td> <td style="width: 10%;"></td> <td style="width: 10%;"></td> <td style="width: 10%;"></td> <td style="width: 10%;"></td> <td style="width: 10%;"></td> <td style="width: 10%;"></td> <td style="width: 10%;"></td> <td style="width: 10%;"></td> </tr> <tr> <td></td> <td></td> <td colspan="8" style="text-align: center;"> <table border="1" style="width: 100%; border-collapse: collapse; text-align: center;"> <tr> <td style="width: 10%;"></td> <td style="width: 10%;"></td> <td style="width: 10%;"></td> <td style="width: 10%;"></td> <td style="width: 10%;"></td> <td style="width: 10%;"></td> <td style="width: 10%;"></td> <td style="width: 10%;"></td> <td style="width: 10%;"></td> <td style="width: 10%;"></td> </tr> <tr> <td></td> <td></td> <td colspan="8" style="text-align: center;"> <table border="1" style="width: 100%; border-collapse: collapse; text-align: center;"> <tr> <td style="width: 10%;"></td> <td style="width: 10%;"></td> <td style="width: 10%;"></td> <td style="width: 10%;"></td> <td style="width: 10%;"></td> <td style="width: 10%;"></td> <td style="width: 10%;"></td> <td style="width: 10%;"></td> <td style="width: 10%;"></td> <td style="width: 10%;"></td> </tr> <tr> <td></td> <td></td> <td colspan="8" style="text-align: center;"> <table border="1" style="width: 100%; border-collapse: collapse; text-align: center;"> <tr> <td style="width: 10%;"></td> <td style="width: 10%;"></td> <td style="width: 10%;"></td> <td style="width: 10%;"></td> <td style="width: 10%;"></td> <td style="width: 10%;"></td> <td style="width: 10%;"></td> <td style="width: 10%;"></td> <td style="width: 10%;"></td> <td style="width: 10%;"></td> </tr> <tr> <td></td> <td></td> <td colspan="8" style="text-align: center;"> <table border="1" style="width: 100%; border-collapse: collapse; text-align: center;"> <tr> <td style="width: 10%;"></td> <td style="width: 10%;"></td> <td style="width: 10%;"></td> <td style="width: 10%;"></td> <td style="width: 10%;"></td> <td style="width: 10%;"></td> <td style="width: 10%;"></td> <td style="width: 10%;"></td> <td style="width: 10%;"></td> <td style="width: 10%;"></td> </tr> <tr> <td></td> <td></td> <td colspan="8" style="text-align: center;"> <table border="1" style="width: 100%; border-collapse: collapse; text-align: center;"> <tr> <td style="width: 10%;"></td> <td style="width: 10%;"></td> <td style="width: 10%;"></td> <td style="width: 10%;"></td> <td style="width: 10%;"></td> <td style="width: 10%;"></td> <td style="width: 10%;"></td> <td style="width: 10%;"></td> <td style="width: 10%;"></td> <td style="width: 10%;"></td> </tr> <tr> <td></td> <td></td> <td colspan="8" style="text-align: center;"> <table border="1" style="width: 100%; border-collapse: collapse; text-align: center;"> <tr> <td style="width: 10%;"></td> <td style="width: 10%;"></td> <td style="width: 10%;"></td> <td style="width: 10%;"></td> <td style="width: 10%;"></td> <td style="width: 10%;"></td> <td style="width: 10%;"></td> <td style="width: 10%;"></td> <td style="width: 10%;"></td> <td style="width: 10%;"></td> </tr> <tr> <td></td> <td></td> <td colspan="8" style="text-align: center;"> <table border="1" style="width: 100%; border-collapse: collapse; text-align: center;"> <tr> <td style="width: 10%;"></td> <td style="width: 10%;"></td> <td style="width: 10%;"></td> <td style="width: 10%;"></td> <td style="width: 10%;"></td> <td style="width: 10%;"></td> <td style="width: 10%;"></td> <td style="width: 10%;"></td> <td style="width: 10%;"></td> <td style="width: 10%;"></td> </tr> <tr> <td></td> <td></td> <td colspan="8" style="text-align: center;"> <table border="1" style="width: 100%; border-collapse: collapse; text-align: center;"> <tr> <td style="width: 10%;"></td> <td style="width: 10%;"></td> <td style="width: 10%;"></td> <td style="width: 10%;"></td> <td style="width: 10%;"></td> <td style="width: 10%;"></td> <td style="width: 10%;"></td> <td style="width: 10%;"></td> <td style="width: 10%;"></td> <td style="width: 10%;"></td> </tr> <tr> <td></td> <td></td> <td colspan="8" style="text-align: center;"> <table border="1" style="width: 100%; border-collapse: collapse; text-align: center;"> <tr> <td style="width: 10%;"></td> <td style="width: 10%;"></td> <td style="width: 10%;"></td> <td style="width: 10%;"></td> <td style="width: 10%;"></td> <td style="width: 10%;"></td> <td style="width: 10%;"></td> <td style="width: 10%;"></td> <td style="width: 10%;"></td> <td style="width: 10%;"></td> </tr> <tr> <td></td> <td></td> <td colspan="8" style="text-align: center;"> <table border="1" style="width: 100%; border-collapse: collapse; text-align: center;"> <tr> <td style="width: 10%;"></td> <td style="width: 10%;"></td> <td style="width: 10%;"></td> <td style="width: 10%;"></td> <td style="width: 10%;"></td> <td style="width: 10%;"></td> <td style="width: 10%;"></td> <td style="width: 10%;"></td> <td style="width: 10%;"></td> <td style="width: 10%;"></td> </tr> <tr> <td></td> <td></td> <td colspan="8" style="text-align: center;"> <table border="1" style="width: 100%; border-collapse: collapse; text-align: center;"> <tr> <td style="width: 10%;"></td> <td style="width: 10%;"></td> <td style="width: 10%;"></td> <td style="width: 10%;"></td> <td style="width: 10%;"></td> <td style="width: 10%;"></td> <td style="width: 10%;"></td> <td style="width: 10%;"></td> <td style="width: 10%;"></td> <td style="width: 10%;"></td> </tr> <tr> <td></td> <td></td> <td colspan="8" style="text-align: center;"> <table border="1" style="width: 100%; border-collapse: collapse; text-align: center;"> <tr> <td style="width: 10%;"></td> <td style="width: 10%;"></td> <td style="width: 10%;"></td> <td style="width: 10%;"></td> <td style="width: 10%;"></td> <td style="width: 10%;"></td> <td style="width: 10%;"></td> <td style="width: 10%;"></td> <td style="width: 10%;"></td> <td style="width: 10%;"></td> </tr> <tr> <td></td> <td></td> <td colspan="8" style="text-align: center;"> <table border="1" style="width: 100%; border-collapse: collapse; text-align: center;"> <tr> <td style="width: 10%;"></td> <td style="width: 10%;"></td> <td style="width: 10%;"></td> <td style="width: 10%;"></td> <td style="width: 10%;"></td> <td style="width: 10%;"></td> <td style="width: 10%;"></td> <td style="width: 10%;"></td> <td style="width: 10%;"></td> <td style="width: 10%;"></td> </tr> <tr> <td></td> <td></td> <td colspan="8" style="text-align: center;"> <table border="1" style="width: 100%; border-collapse: collapse; text-align: center;"> <tr> <td style="width: 10%;"></td> <td style="width: 10%;"></td> <td style="width: 10%;"></td> <td style="width: 10%;"></td> <td style="width: 10%;"></td> <td style="width: 10%;"></td> <td style="width: 10%;"></td> <td style="width: 10%;"></td> <td style="width: 10%;"></td> <td style="width: 10%;"></td> </tr> <tr> <td></td> <td></td> <td colspan="8" style="text-align: center;"> <table border="1" style="width: 100%; border-collapse: collapse; text-align: center;"> <tr> <td style="width: 10%;"></td> <td style="width: 10%;"></td> <td style="width: 10%;"></td> <td style="width: 10%;"></td> <td style="width: 10%;"></td> <td style="width: 10%;"></td> <td style="width: 10%;"></td> <td style="width: 10%;"></td> <td style="width: 10%;"></td> <td style="width: 10%;"></td> </tr> <tr> <td></td> <td></td> <td colspan="8" style="text-align: center;"> <table border="1" style="width: 100%; border-collapse: collapse; text-align: center;"> <tr> <td style="width: 10%;"></td> <td style="width: 10%;"></td> <td style="width: 10%;"></td> <td style="width: 10%;"></td> <td style="width: 10%;"></td> <td style="width: 10%;"></td> <td style="width: 10%;"></td> <td style="width: 10%;"></td> <td style="width: 10%;"></td> <td style="width: 10%;"></td> </tr> <tr> <td></td> <td></td> <td colspan="8" style="text-align: center;"> <table border="1" style="width: 100%; border-collapse: collapse; text-align: center;"> <tr> <td style="width: 10%;"></td> <td style="width: 10%;"></td> <td style="width: 10%;"></td> <td style="width: 10%;"></td> <td style="width: 10%;"></td> <td style="width: 10%;"></td> <td style="width: 10%;"></td> <td style="width: 10%;"></td> <td style="width: 10%;"></td> <td style="width: 10%;"></td> </tr> <tr> <td></td> <td></td> <td colspan="8" style="text-align: center;"> <table border="1" style="width: 100%; border-collapse: collapse; text-align: center;"> <tr> </tr></table></td></tr></table></td></tr></table></td></tr></table></td></tr></table></td></tr></table></td></tr></table></td></tr></table></td></tr></table></td></tr></table></td></tr></table></td></tr></table></td></tr></table></td></tr></table></td></tr></table></td></tr></table></td></tr></table></td></tr></table></td></tr></table></td></tr></table></td></tr></table></td></tr></table></td></tr></table>

 | | | | | | | | | | | | | | | | | | | | <table border="1" style="width: 100%; border-collapse: collapse; text-align: center;"> <tr> <td style="width: 10%;"></td> <td style="width: 10%;"></td> <td style="width: 10%;"></td> <td style="width: 10%;"></td> <td style="width: 10%;"></td> <td style="width: 10%;"></td> <td style="width: 10%;"></td> <td style="width: 10%;"></td> <td style="width: 10%;"></td> <td style="width: 10%;"></td> </tr> <tr> <td></td> <td></td> <td colspan="8" style="text-align: center;"> <table border="1" style="width: 100%; border-collapse: collapse; text-align: center;"> <tr> <td style="width: 10%;"></td> <td style="width: 10%;"></td> <td style="width: 10%;"></td> <td style="width: 10%;"></td> <td style="width: 10%;"></td> <td style="width: 10%;"></td> <td style="width: 10%;"></td> <td style="width: 10%;"></td> <td style="width: 10%;"></td> <td style="width: 10%;"></td> </tr> <tr> <td></td> <td></td> <td colspan="8" style="text-align: center;"> <table border="1" style="width: 100%; border-collapse: collapse; text-align: center;"> <tr> <td style="width: 10%;"></td> <td style="width: 10%;"></td> <td style="width: 10%;"></td> <td style="width: 10%;"></td> <td style="width: 10%;"></td> <td style="width: 10%;"></td> <td style="width: 10%;"></td> <td style="width: 10%;"></td> <td style="width: 10%;"></td> <td style="width: 10%;"></td> </tr> <tr> <td></td> <td></td> <td colspan="8" style="text-align: center;"> <table border="1" style="width: 100%; border-collapse: collapse; text-align: center;"> <tr> <td style="width: 10%;"></td> <td style="width: 10%;"></td> <td style="width: 10%;"></td> <td style="width: 10%;"></td> <td style="width: 10%;"></td> <td style="width: 10%;"></td> <td style="width: 10%;"></td> <td style="width: 10%;"></td> <td style="width: 10%;"></td> <td style="width: 10%;"></td> </tr> <tr> <td></td> <td></td> <td colspan="8" style="text-align: center;"> <table border="1" style="width: 100%; border-collapse: collapse; text-align: center;"> <tr> <td style="width: 10%;"></td> <td style="width: 10%;"></td> <td style="width: 10%;"></td> <td style="width: 10%;"></td> <td style="width: 10%;"></td> <td style="width: 10%;"></td> <td style="width: 10%;"></td> <td style="width: 10%;"></td> <td style="width: 10%;"></td> <td style="width: 10%;"></td> </tr> <tr> <td></td> <td></td> <td colspan="8" style="text-align: center;"> <table border="1" style="width: 100%; border-collapse: collapse; text-align: center;"> <tr> <td style="width: 10%;"></td> <td style="width: 10%;"></td> <td style="width: 10%;"></td> <td style="width: 10%;"></td> <td style="width: 10%;"></td> <td style="width: 10%;"></td> <td style="width: 10%;"></td> <td style="width: 10%;"></td> <td style="width: 10%;"></td> <td style="width: 10%;"></td> </tr> <tr> <td></td> <td></td> <td colspan="8" style="text-align: center;"> <table border="1" style="width: 100%; border-collapse: collapse; text-align: center;"> <tr> <td style="width: 10%;"></td> <td style="width: 10%;"></td> <td style="width: 10%;"></td> <td style="width: 10%;"></td> <td style="width: 10%;"></td> <td style="width: 10%;"></td> <td style="width: 10%;"></td> <td style="width: 10%;"></td> <td style="width: 10%;"></td> <td style="width: 10%;"></td> </tr> <tr> <td></td> <td></td> <td colspan="8" style="text-align: center;"> <table border="1" style="width: 100%; border-collapse: collapse; text-align: center;"> <tr> <td style="width: 10%;"></td> <td style="width: 10%;"></td> <td style="width: 10%;"></td> <td style="width: 10%;"></td> <td style="width: 10%;"></td> <td style="width: 10%;"></td> <td style="width: 10%;"></td> <td style="width: 10%;"></td> <td style="width: 10%;"></td> <td style="width: 10%;"></td> </tr> <tr> <td></td> <td></td> <td colspan="8" style="text-align: center;"> <table border="1" style="width: 100%; border-collapse: collapse; text-align: center;"> <tr> <td style="width: 10%;"></td> <td style="width: 10%;"></td> <td style="width: 10%;"></td> <td style="width: 10%;"></td> <td style="width: 10%;"></td> <td style="width: 10%;"></td> <td style="width: 10%;"></td> <td style="width: 10%;"></td> <td style="width: 10%;"></td> <td style="width: 10%;"></td> </tr> <tr> <td></td> <td></td> <td colspan="8" style="text-align: center;"> <table border="1" style="width: 100%; border-collapse: collapse; text-align: center;"> <tr> <td style="width: 10%;"></td> <td style="width: 10%;"></td> <td style="width: 10%;"></td> <td style="width: 10%;"></td> <td style="width: 10%;"></td> <td style="width: 10%;"></td> <td style="width: 10%;"></td> <td style="width: 10%;"></td> <td style="width: 10%;"></td> <td style="width: 10%;"></td> </tr> <tr> <td></td> <td></td> <td colspan="8" style="text-align: center;"> <table border="1" style="width: 100%; border-collapse: collapse; text-align: center;"> <tr> <td style="width: 10%;"></td> <td style="width: 10%;"></td> <td style="width: 10%;"></td> <td style="width: 10%;"></td> <td style="width: 10%;"></td> <td style="width: 10%;"></td> <td style="width: 10%;"></td> <td style="width: 10%;"></td> <td style="width: 10%;"></td> <td style="width: 10%;"></td> </tr> <tr> <td></td> <td></td> <td colspan="8" style="text-align: center;"> <table border="1" style="width: 100%; border-collapse: collapse; text-align: center;"> <tr> <td style="width: 10%;"></td> <td style="width: 10%;"></td> <td style="width: 10%;"></td> <td style="width: 10%;"></td> <td style="width: 10%;"></td> <td style="width: 10%;"></td> <td style="width: 10%;"></td> <td style="width: 10%;"></td> <td style="width: 10%;"></td> <td style="width: 10%;"></td> </tr> <tr> <td></td> <td></td> <td colspan="8" style="text-align: center;"> <table border="1" style="width: 100%; border-collapse: collapse; text-align: center;"> <tr> <td style="width: 10%;"></td> <td style="width: 10%;"></td> <td style="width: 10%;"></td> <td style="width: 10%;"></td> <td style="width: 10%;"></td> <td style="width: 10%;"></td> <td style="width: 10%;"></td> <td style="width: 10%;"></td> <td style="width: 10%;"></td> <td style="width: 10%;"></td> </tr> <tr> <td></td> <td></td> <td colspan="8" style="text-align: center;"> <table border="1" style="width: 100%; border-collapse: collapse; text-align: center;"> <tr> <td style="width: 10%;"></td> <td style="width: 10%;"></td> <td style="width: 10%;"></td> <td style="width: 10%;"></td> <td style="width: 10%;"></td> <td style="width: 10%;"></td> <td style="width: 10%;"></td> <td style="width: 10%;"></td> <td style="width: 10%;"></td> <td style="width: 10%;"></td> </tr> <tr> <td></td> <td></td> <td colspan="8" style="text-align: center;"> <table border="1" style="width: 100%; border-collapse: collapse; text-align: center;"> <tr> <td style="width: 10%;"></td> <td style="width: 10%;"></td> <td style="width: 10%;"></td> <td style="width: 10%;"></td> <td style="width: 10%;"></td> <td style="width: 10%;"></td> <td style="width: 10%;"></td> <td style="width: 10%;"></td> <td style="width: 10%;"></td> <td style="width: 10%;"></td> </tr> <tr> <td></td> <td></td> <td colspan="8" style="text-align: center;"> <table border="1" style="width: 100%; border-collapse: collapse; text-align: center;"> <tr> <td style="width: 10%;"></td> <td style="width: 10%;"></td> <td style="width: 10%;"></td> <td style="width: 10%;"></td> <td style="width: 10%;"></td> <td style="width: 10%;"></td> <td style="width: 10%;"></td> <td style="width: 10%;"></td> <td style="width: 10%;"></td> <td style="width: 10%;"></td> </tr> <tr> <td></td> <td></td> <td colspan="8" style="text-align: center;">
<table border="1" style="width: 100%; border-collapse: collapse; text-align: center;"> <tr> <td style="width: 10%;"></td> <td style="width: 10%;"></td> <td style="width: 10%;"></td> <td style="width: 10%;"></td> <td style="width: 10%;"></td> <td style="width: 10%;"></td> <td style="width: 10%;"></td> <td style="width: 10%;"></td> <td style="width: 10%;"></td> <td style="width: 10%;"></td> </tr> <tr> <td></td> <td></td> <td colspan="8" style="text-align: center;"> <table border="1" style="width: 100%; border-collapse: collapse; text-align: center;"> <tr> <td style="width: 10%;"></td> <td style="width: 10%;"></td> <td style="width: 10%;"></td> <td style="width: 10%;"></td> <td style="width: 10%;"></td> <td style="width: 10%;"></td> <td style="width: 10%;"></td> <td style="width: 10%;"></td> <td style="width: 10%;"></td> <td style="width: 10%;"></td> </tr> <tr> <td></td> <td></td> <td colspan="8" style="text-align: center;"> <table border="1" style="width: 100%; border-collapse: collapse; text-align: center;"> <tr> <td style="width: 10%;"></td> <td style="width: 10%;"></td> <td style="width: 10%;"></td> <td style="width: 10%;"></td> <td style="width: 10%;"></td> <td style="width: 10%;"></td> <td style="width: 10%;"></td> <td style="width: 10%;"></td> <td style="width: 10%;"></td> <td style="width: 10%;"></td> </tr> <tr> <td></td> <td></td> <td colspan="8" style="text-align: center;"> <table border="1" style="width: 100%; border-collapse: collapse; text-align: center;"> <tr> <td style="width: 10%;"></td> <td style="width: 10%;"></td> <td style="width: 10%;"></td> <td style="width: 10%;"></td> <td style="width: 10%;"></td> <td style="width: 10%;"></td> <td style="width: 10%;"></td> <td style="width: 10%;"></td> <td style="width: 10%;"></td> <td style="width: 10%;"></td> </tr> <tr> <td></td> <td></td> <td colspan="8" style="text-align: center;"> <table border="1" style="width: 100%; border-collapse: collapse; text-align: center;"> <tr> <td style="width: 10%;"></td> <td style="width: 10%;"></td> <td style="width: 10%;"></td> <td style="width: 10%;"></td> <td style="width: 10%;"></td> <td style="width: 10%;"></td> <td style="width: 10%;"></td> <td style="width: 10%;"></td> <td style="width: 10%;"></td> <td style="width: 10%;"></td> </tr> <tr> <td></td> <td></td> <td colspan="8" style="text-align: center;"> <table border="1" style="width: 100%; border-collapse: collapse; text-align: center;"> <tr> </tr></table></td></tr></table></td></tr></table></td></tr></table></td></tr></table></td></tr></table></td></tr></table></td></tr></table></td></tr></table></td></tr></table></td></tr></table></td></tr></table></td></tr></table></td></tr></table></td></tr></table></td></tr></table></td></tr></table></td></tr></table></td></tr></table></td></tr></table></td></tr></table></td></tr></table>
 | | | | | | | | | | | | | | | | | | | | <table border="1" style="width: 100%; border-collapse: collapse; text-align: center;"> <tr> <td style="width: 10%;"></td> <td style="width: 10%;"></td> <td style="width: 10%;"></td> <td style="width: 10%;"></td> <td style="width: 10%;"></td> <td style="width: 10%;"></td> <td style="width: 10%;"></td> <td style="width: 10%;"></td> <td style="width: 10%;"></td> <td style="width: 10%;"></td> </tr> <tr> <td></td> <td></td> <td colspan="8" style="text-align: center;"> <table border="1" style="width: 100%; border-collapse: collapse; text-align: center;"> <tr> <td style="width: 10%;"></td> <td style="width: 10%;"></td> <td style="width: 10%;"></td> <td style="width: 10%;"></td> <td style="width: 10%;"></td> <td style="width: 10%;"></td> <td style="width: 10%;"></td> <td style="width: 10%;"></td> <td style="width: 10%;"></td> <td style="width: 10%;"></td> </tr> <tr> <td></td> <td></td> <td colspan="8" style="text-align: center;"> <table border="1" style="width: 100%; border-collapse: collapse; text-align: center;"> <tr> <td style="width: 10%;"></td> <td style="width: 10%;"></td> <td style="width: 10%;"></td> <td style="width: 10%;"></td> <td style="width: 10%;"></td> <td style="width: 10%;"></td> <td style="width: 10%;"></td> <td style="width: 10%;"></td> <td style="width: 10%;"></td> <td style="width: 10%;"></td> </tr> <tr> <td></td> <td></td> <td colspan="8" style="text-align: center;"> <table border="1" style="width: 100%; border-collapse: collapse; text-align: center;"> <tr> <td style="width: 10%;"></td> <td style="width: 10%;"></td> <td style="width: 10%;"></td> <td style="width: 10%;"></td> <td style="width: 10%;"></td> <td style="width: 10%;"></td> <td style="width: 10%;"></td> <td style="width: 10%;"></td> <td style="width: 10%;"></td> <td style="width: 10%;"></td> </tr> <tr> <td></td> <td></td> <td colspan="8" style="text-align: center;"> <table border="1" style="width: 100%; border-collapse: collapse; text-align: center;"> <tr> <td style="width: 10%;"></td> <td style="width: 10%;"></td> <td style="width: 10%;"></td> <td style="width: 10%;"></td> <td style="width: 10%;"></td> <td style="width: 10%;"></td> <td style="width: 10%;"></td> <td style="width: 10%;"></td> <td style="width: 10%;"></td> <td style="width: 10%;"></td> </tr> <tr> <td></td> <td></td> <td colspan="8" style="text-align: center;"> <table border="1" style="width: 100%; border-collapse: collapse; text-align: center;"> <tr> <td style="width: 10%;"></td> <td style="width: 10%;"></td> <td style="width: 10%;"></td> <td style="width: 10%;"></td> <td style="width: 10%;"></td> <td style="width: 10%;"></td> <td style="width: 10%;"></td> <td style="width: 10%;"></td> <td style="width: 10%;"></td> <td style="width: 10%;"></td> </tr> <tr> <td></td> <td></td> <td colspan="8" style="text-align: center;"> <table border="1" style="width: 100%; border-collapse: collapse; text-align: center;"> <tr> <td style="width: 10%;"></td> <td style="width: 10%;"></td> <td style="width: 10%;"></td> <td style="width: 10%;"></td> <td style="width: 10%;"></td> <td style="width: 10%;"></td> <td style="width: 10%;"></td> <td style="width: 10%;"></td> <td style="width: 10%;"></td> <td style="width: 10%;"></td> </tr> <tr> <td></td> <td></td> <td colspan="8" style="text-align: center;"> <table border="1" style="width: 100%; border-collapse: collapse; text-align: center;"> <tr> <td style="width: 10%;"></td> <td style="width: 10%;"></td> <td style="width: 10%;"></td> <td style="width: 10%;"></td> <td style="width: 10%;"></td> <td style="width: 10%;"></td> <td style="width: 10%;"></td> <td style="width: 10%;"></td> <td style="width: 10%;"></td> <td style="width: 10%;"></td> </tr> <tr> <td></td> <td></td> <td colspan="8" style="text-align: center;"> <table border="1" style="width: 100%; border-collapse: collapse; text-align: center;"> <tr> <td style="width: 10%;"></td> <td style="width: 10%;"></td> <td style="width: 10%;"></td> <td style="width: 10%;"></td> <td style="width: 10%;"></td> <td
style="width: 10%;"></td> <td style="width: 10%;"></td> <td style="width: 10%;"></td> <td style="width: 10%;"></td> <td style="width: 10%;"></td> </tr> <tr> <td></td> <td></td> <td colspan="8" style="text-align: center;"> <table border="1" style="width: 100%; border-collapse: collapse; text-align: center;"> <tr> <td style="width: 10%;"></td> <td style="width: 10%;"></td> <td style="width: 10%;"></td> <td style="width: 10%;"></td> <td style="width: 10%;"></td> <td style="width: 10%;"></td> <td style="width: 10%;"></td> <td style="width: 10%;"></td> <td style="width: 10%;"></td> <td style="width: 10%;"></td> </tr> <tr> <td></td> <td></td> <td colspan="8" style="text-align: center;"> <table border="1" style="width: 100%; border-collapse: collapse; text-align: center;"> <tr> <td style="width: 10%;"></td> <td style="width: 10%;"></td> <td style="width: 10%;"></td> <td style="width: 10%;"></td> <td style="width: 10%;"></td> <td style="width: 10%;"></td> <td style="width: 10%;"></td> <td style="width: 10%;"></td> <td style="width: 10%;"></td> <td style="width: 10%;"></td> </tr> <tr> <td></td> <td></td> <td colspan="8" style="text-align: center;"> <table border="1" style="width: 100%; border-collapse: collapse; text-align: center;"> <tr> <td style="width: 10%;"></td> <td style="width: 10%;"></td> <td style="width: 10%;"></td> <td style="width: 10%;"></td> <td style="width: 10%;"></td> <td style="width: 10%;"></td> <td style="width: 10%;"></td> <td style="width: 10%;"></td> <td style="width: 10%;"></td> <td style="width: 10%;"></td> </tr> <tr> <td></td> <td></td> <td colspan="8" style="text-align: center;"> <table border="1" style="width: 100%; border-collapse: collapse; text-align: center;"> <tr> <td style="width: 10%;"></td> <td style="width: 10%;"></td> <td style="width: 10%;"></td> <td style="width: 10%;"></td> <td style="width: 10%;"></td> <td style="width: 10%;"></td> <td style="width: 10%;"></td> <td style="width: 10%;"></td> <td style="width: 10%;"></td> <td style="width: 10%;"></td> </tr> <tr> <td></td> <td></td> <td colspan="8" style="text-align: center;"> <table border="1" style="width: 100%; border-collapse: collapse; text-align: center;"> <tr> <td style="width: 10%;"></td> <td style="width: 10%;"></td> <td style="width: 10%;"></td> <td style="width: 10%;"></td> <td style="width: 10%;"></td> <td style="width: 10%;"></td> <td style="width: 10%;"></td> <td style="width: 10%;"></td> <td style="width: 10%;"></td> <td style="width: 10%;"></td> </tr> <tr> <td></td> <td></td> <td colspan="8" style="text-align: center;"> <table border="1" style="width: 100%; border-collapse: collapse; text-align: center;"> <tr> <td style="width: 10%;"></td> <td style="width: 10%;"></td> <td style="width: 10%;"></td> <td style="width: 10%;"></td> <td style="width: 10%;"></td> <td style="width: 10%;"></td> <td style="width: 10%;"></td> <td style="width: 10%;"></td> <td style="width: 10%;"></td> <td style="width: 10%;"></td> </tr> <tr> <td></td> <td></td> <td colspan="8" style="text-align: center;"> <table border="1" style="width: 100%; border-collapse: collapse; text-align: center;"> <tr> <td style="width: 10%;"></td> <td style="width: 10%;"></td> <td style="width: 10%;"></td> <td style="width: 10%;"></td> <td style="width: 10%;"></td> <td style="width: 10%;"></td> <td style="width: 10%;"></td> <td style="width: 10%;"></td> <td style="width: 10%;"></td> <td style="width: 10%;"></td> </tr> <tr> <td></td> <td></td> <td colspan="8" style="text-align: center;"> <table border="1" style="width: 100%; border-collapse: collapse; text-align: center;"> <tr> <td style="width: 10%;"></td> <td style="width: 10%;"></td> <td style="width: 10%;"></td> <td style="width: 10%;"></td> <td style="width: 10%;"></td> <td style="width: 10%;"></td> <td style="width: 10%;"></td> <td style="width: 10%;"></td> <td style="width: 10%;"></td> <td style="width: 10%;"></td> </tr> <tr> <td></td> <td></td> <td colspan="8" style="text-align: center;"> <table border="1" style="width: 100%; border-collapse: collapse; text-align: center;"> <tr> <td style="width: 10%;"></td> <td style="width: 10%;"></td> <td style="width: 10%;"></td> <td style="width: 10%;"></td> <td style="width: 10%;"></td> <td style="width: 10%;"></td> <td style="width: 10%;"></td> <td style="width: 10%;"></td> <td style="width: 10%;"></td> <td style="width: 10%;"></td> </tr> <tr> <td></td> <td></td> <td colspan="8" style="text-align: center;"> <table border="1" style="width: 100%; border-collapse: collapse; text-align: center;"> <tr> <td style="width: 10%;"></td> <td style="width: 10%;"></td> <td style="width: 10%;"></td> <td style="width: 10%;"></td> <td style="width: 10%;"></td> <td style="width: 10%;"></td> <td style="width: 10%;"></td> <td style="width: 10%;"></td> <td style="width: 10%;"></td> <td style="width: 10%;"></td> </tr> <tr> <td></td> <td></td> <td colspan="8" style="text-align: center;"> <table border="1" style="width: 100%; border-collapse: collapse; text-align: center;"> <tr> <td style="width: 10%;"></td> <td style="width: 10%;"></td> <td style="width: 10%;"></td> <td style="width: 10%;"></td> <td style="width: 10%;"></td> <td style="width: 10%;"></td> <td style="width: 10%;"></td> <td style="width: 10%;"></td> <td style="width: 10%;"></td> <td style="width: 10%;"></td> </tr> <tr> <td></td> <td></td> <td colspan="8" style="text-align: center;"> <table border="1" style="width: 100%; border-collapse: collapse; text-align: center;"> <tr> </tr></table></td></tr></table></td></tr></table></td></tr></table></td></tr></table></td></tr></table></td></tr></table></td></tr></table></td></tr></table></td></tr></table></td></tr></table></td></tr></table></td></tr></table></td></tr></table></td></tr></table></td></tr></table></td></tr></table></td></tr></table></td></tr></table></td></tr></table></td></tr></table>
 | | | | | | | | | | | | | | | | | | | | <table border="1" style="width: 100%; border-collapse: collapse; text-align: center;"> <tr> <td style="width: 10%;"></td> <td style="width: 10%;"></td> <td style="width: 10%;"></td> <td style="width: 10%;"></td> <td style="width: 10%;"></td> <td style="width: 10%;"></td> <td style="width: 10%;"></td> <td style="width: 10%;"></td> <td style="width: 10%;"></td> <td style="width: 10%;"></td> </tr> <tr> <td></td> <td></td> <td colspan="8" style="text-align: center;"> <table border="1" style="width: 100%; border-collapse: collapse; text-align: center;"> <tr> <td style="width: 10%;"></td> <td style="width: 10%;"></td> <td style="width: 10%;"></td> <td style="width: 10%;"></td> <td style="width: 10%;"></td> <td style="width: 10%;"></td> <td style="width: 10%;"></td> <td style="width: 10%;"></td> <td style="width: 10%;"></td> <td style="width: 10%;"></td> </tr> <tr> <td></td> <td></td> <td colspan="8" style="text-align: center;"> <table border="1" style="width: 100%;
border-collapse: collapse; text-align: center;"> <tr> <td style="width: 10%;"></td> <td style="width: 10%;"></td> <td style="width: 10%;"></td> <td style="width: 10%;"></td> <td style="width: 10%;"></td> <td style="width: 10%;"></td> <td style="width: 10%;"></td> <td style="width: 10%;"></td> <td style="width: 10%;"></td> <td style="width: 10%;"></td> </tr> <tr> <td></td> <td></td> <td colspan="8" style="text-align: center;"> <table border="1" style="width: 100%; border-collapse: collapse; text-align: center;"> <tr> <td style="width: 10%;"></td> <td style="width: 10%;"></td> <td style="width: 10%;"></td> <td style="width: 10%;"></td> <td style="width: 10%;"></td> <td style="width: 10%;"></td> <td style="width: 10%;"></td> <td style="width: 10%;"></td> <td style="width: 10%;"></td> <td style="width: 10%;"></td> </tr> <tr> <td></td> <td></td> <td colspan="8" style="text-align: center;"> <table border="1" style="width: 100%; border-collapse: collapse; text-align: center;"> <tr> <td style="width: 10%;"></td> <td style="width: 10%;"></td> <td style="width: 10%;"></td> <td style="width: 10%;"></td> <td style="width: 10%;"></td> <td style="width: 10%;"></td> <td style="width: 10%;"></td> <td style="width: 10%;"></td> <td style="width: 10%;"></td> <td style="width: 10%;"></td> </tr> <tr> <td></td> <td></td> <td colspan="8" style="text-align: center;"> <table border="1" style="width: 100%; border-collapse: collapse; text-align: center;"> <tr> <td style="width: 10%;"></td> <td style="width: 10%;"></td> <td style="width: 10%;"></td> <td style="width: 10%;"></td> <td style="width: 10%;"></td> <td style="width: 10%;"></td> <td style="width: 10%;"></td> <td style="width: 10%;"></td> <td style="width: 10%;"></td> <td style="width: 10%;"></td> </tr> <tr> <td></td> <td></td> <td colspan="8" style="text-align: center;"> <table border="1" style="width: 100%; border-collapse: collapse; text-align: center;"> <tr> <td style="width: 10%;"></td> <td style="width: 10%;"></td> <td style="width: 10%;"></td> <td style="width: 10%;"></td> <td style="width: 10%;"></td> <td style="width: 10%;"></td> <td style="width: 10%;"></td> <td style="width: 10%;"></td> <td style="width: 10%;"></td> <td style="width: 10%;"></td> </tr> <tr> <td></td> <td></td> <td colspan="8" style="text-align: center;"> <table border="1" style="width: 100%; border-collapse: collapse; text-align: center;"> <tr> <td style="width: 10%;"></td> <td style="width: 10%;"></td> <td style="width: 10%;"></td> <td style="width: 10%;"></td> <td style="width: 10%;"></td> <td style="width: 10%;"></td> <td style="width: 10%;"></td> <td style="width: 10%;"></td> <td style="width: 10%;"></td> <td style="width: 10%;"></td> </tr> <tr> <td></td> <td></td> <td colspan="8" style="text-align: center;"> <table border="1" style="width: 100%; border-collapse: collapse; text-align: center;"> <tr> <td style="width: 10%;"></td> <td style="width: 10%;"></td> <td style="width: 10%;"></td> <td style="width: 10%;"></td> <td style="width: 10%;"></td> <td style="width: 10%;"></td> <td style="width: 10%;"></td> <td style="width: 10%;"></td> <td style="width: 10%;"></td> <td style="width: 10%;"></td> </tr> <tr> <td></td> <td></td> <td colspan="8" style="text-align: center;"> <table border="1" style="width: 100%; border-collapse: collapse; text-align: center;"> <tr> <td style="width: 10%;"></td> <td style="width: 10%;"></td> <td style="width: 10%;"></td> <td style="width: 10%;"></td> <td style="width: 10%;"></td> <td style="width: 10%;"></td> <td style="width: 10%;"></td> <td style="width: 10%;"></td> <td style="width: 10%;"></td> <td style="width: 10%;"></td> </tr> <tr> <td></td> <td></td> <td colspan="8" style="text-align: center;"> <table border="1" style="width: 100%; border-collapse: collapse; text-align: center;"> <tr> <td style="width: 10%;"></td> <td style="width: 10%;"></td> <td style="width: 10%;"></td> <td style="width: 10%;"></td> <td style="width: 10%;"></td> <td style="width: 10%;"></td> <td style="width: 10%;"></td> <td style="width: 10%;"></td> <td style="width: 10%;"></td> <td style="width: 10%;"></td> </tr> <tr> <td></td> <td></td> <td colspan="8" style="text-align: center;"> <table border="1" style="width: 100%; border-collapse: collapse; text-align: center;"> <tr> <td style="width: 10%;"></td> <td style="width: 10%;"></td> <td style="width: 10%;"></td> <td style="width: 10%;"></td> <td style="width: 10%;"></td> <td style="width: 10%;"></td> <td style="width: 10%;"></td> <td style="width: 10%;"></td> <td style="width: 10%;"></td> <td style="width: 10%;"></td> </tr> <tr> <td></td> <td></td> <td colspan="8" style="text-align: center;"> <table border="1" style="width: 100%; border-collapse: collapse; text-align: center;"> <tr> <td style="width: 10%;"></td> <td style="width: 10%;"></td> <td style="width: 10%;"></td> <td style="width: 10%;"></td> <td style="width: 10%;"></td> <td style="width: 10%;"></td> <td style="width: 10%;"></td> <td style="width: 10%;"></td> <td style="width: 10%;"></td> <td style="width: 10%;"></td> </tr> <tr> <td></td> <td></td> <td colspan="8" style="text-align: center;"> <table border="1" style="width: 100%; border-collapse: collapse; text-align: center;"> <tr> <td style="width: 10%;"></td> <td style="width: 10%;"></td> <td style="width: 10%;"></td> <td style="width: 10%;"></td> <td style="width: 10%;"></td> <td style="width: 10%;"></td> <td style="width: 10%;"></td> <td style="width: 10%;"></td> <td style="width: 10%;"></td> <td style="width: 10%;"></td> </tr> <tr> <td></td> <td></td> <td colspan="8" style="text-align: center;"> <table border="1" style="width: 100%; border-collapse: collapse; text-align: center;"> <tr> <td style="width: 10%;"></td> <td style="width: 10%;"></td> <td style="width: 10%;"></td> <td style="width: 10%;"></td> <td style="width: 10%;"></td> <td style="width: 10%;"></td> <td style="width: 10%;"></td> <td style="width: 10%;"></td> <td style="width: 10%;"></td> <td style="width: 10%;"></td> </tr> <tr> <td></td> <td></td> <td colspan="8" style="text-align: center;"> <table border="1" style="width: 100%; border-collapse: collapse; text-align: center;"> <tr> <td style="width: 10%;"></td> <td style="width: 10%;"></td> <td style="width: 10%;"></td> <td style="width: 10%;"></td> <td style="width: 10%;"></td> <td style="width: 10%;"></td> <td style="width: 10%;"></td> <td style="width: 10%;"></td> <td style="width: 10%;"></td> <td style="width: 10%;"></td> </tr> <tr> <td></td> <td></td> <td colspan="8" style="text-align: center;"> <table border="1" style="width: 100%; border-collapse: collapse; text-align: center;"> <tr> <td style="width: 10%;"></td> <td style="width: 10%;"></td> <td style="width: 10%;"></td> <td style="width: 10%;"></td> <td style="width: 10%;"></td> <td style="width: 10%;"></td> <td style="width: 10%;"></td> <td style="width: 10%;"></td> <td style="width: 10%;"></td> <td style="width: 10%;"></td> </tr> <tr> <td></td> <td></td> <td colspan="8" style="text-align: center;"> <table border="1" style="width: 100%; border-collapse: collapse; text-align: center;"> <tr> <td style="width: 10%;"></td> <td style="width: 10%;"></td> <td style="width: 10%;"></td> <td style="width: 10%;"></td> <td style="width: 10%;"></td> <td style="width: 10%;"></td> <td style="width: 10%;"></td> <td style="width: 10%;"></td> <td style="width: 10%;"></td> <td style="width: 10%;"></td> </tr> <tr> <td></td> <td></td> <td colspan="8" style="text-align: center;"> <table border="1" style="width: 100%; border-collapse: collapse; text-align: center;"> <tr> <td style="width: 10%;"></td> <td style="width: 10%;"></td> <td style="width: 10%;"></td> <td style="width: 10%;"></td> <td style="width: 10%;"></td> <td style="width: 10%;"></td> <td style="width: 10%;"></td> <td style="width: 10%;"></td> <td style="width: 10%;"></td> <td style="width: 10%;"></td> </tr> <tr> <td></td> <td></td> <td colspan="8" style="text-align: center;"> <table border="1" style="width: 100%; border-collapse: collapse; text-align: center;"> <tr> </tr></table></td></tr></table></td></tr></table></td></tr></table></td></tr></table></td></tr></table></td></tr></table></td></tr></table></td></tr></table></td></tr></table></td></tr></table></td></tr></table></td></tr></table></td></tr></table></td></tr></table></td></tr></table></td></tr></table></td></tr></table></td></tr></table></td></tr></table>

 | | | | | | | | | | | | | | | | | | | | <table border="1" style="width: 100%; border-collapse: collapse; text-align: center;"> <tr> <td style="width: 10%;"></td> <td style="width: 10%;"></td> <td style="width: 10%;"></td> <td style="width: 10%;"></td> <td style="width: 10%;"></td> <td style="width: 10%;"></td> <td style="width: 10%;"></td> <td style="width: 10%;"></td> <td style="width: 10%;"></td> <td style="width: 10%;"></td> </tr> <tr> <td></td> <td></td> <td colspan="8" style="text-align: center;"> <table border="1" style="width: 100%; border-collapse: collapse; text-align: center;"> <tr> <td style="width: 10%;"></td> <td style="width: 10%;"></td> <td style="width: 10%;"></td> <td style="width: 10%;"></td> <td style="width: 10%;"></td> <td style="width: 10%;"></td> <td style="width: 10%;"></td> <td style="width: 10%;"></td> <td style="width: 10%;"></td> <td style="width: 10%;"></td> </tr> <tr> <td></td> <td></td> <td colspan="8" style="text-align: center;"> <table border="1" style="width: 100%; border-collapse: collapse; text-align: center;"> <tr> <td style="width: 10%;"></td> <td style="width: 10%;"></td> <td style="width: 10%;"></td> <td style="width: 10%;"></td> <td style="width: 10%;"></td> <td style="width: 10%;"></td> <td style="width: 10%;"></td> <td style="width: 10%;"></td> <td style="width: 10%;"></td> <td style="width: 10%;"></td> </tr> <tr> <td></td> <td></td> <td colspan="8" style="text-align: center;"> <table border="1" style="width: 100%; border-collapse: collapse; text-align: center;"> <tr> <td style="width: 10%;"></td> <td style="width: 10%;"></td> <td style="width: 10%;"></td> <td style="width: 10%;"></td> <td style="width: 10%;"></td> <td style="width: 10%;"></td> <td style="width: 10%;"></td> <td style="width: 10%;"></td> <td style="width: 10%;"></td> <td style="width: 10%;"></td> </tr> <tr> <td></td> <td></td> <td colspan="8" style="text-align: center;"> <table border="1" style="width: 100%; border-collapse: collapse; text-align: center;"> <tr> <td style="width: 10%;"></td> <td style="width: 10%;"></td> <td style="width: 10%;"></td> <td style="width: 10%;"></td> <td style="width: 10%;"></td> <td style="width: 10%;"></td> <td style="width: 10%;"></td> <td style="width: 10%;"></td> <td style="width: 10%;"></td> <td style="width: 10%;"></td> </tr> <tr> <td></td> <td></td> <td colspan="8" style="text-align: center;"> <table border="1" style="width: 100%; border-collapse: collapse; text-align: center;"> <tr> <td style="width: 10%;"></td> <td style="width: 10%;"></td> <td style="width: 10%;"></td> <td style="width: 10%;"></td> <td style="width: 10%;"></td> <td style="width: 10%;"></td> <td style="width: 10%;"></td> <td style="width: 10%;"></td> <td style="width: 10%;"></td> <td style="width: 10%;"></td> </tr> <tr> <td></td> <td></td> <td colspan="8" style="text-align: center;"> <table border="1" style="width: 100%; border-collapse: collapse; text-align: center;"> <tr> <td style="width: 10%;"></td> <td style="width: 10%;"></td> <td style="width: 10%;"></td> <td style="width: 10%;"></td> <td style="width: 10%;"></td> <td style="width: 10%;"></td> <td style="width: 10%;"></td> <td style="width: 10%;"></td> <td style="width: 10%;"></td> <td style="width: 10%;"></td> </tr> <tr> <td></td> <td></td> <td colspan="8" style="text-align: center;"> <table border="1" style="width: 100%; border-collapse: collapse; text-align: center;"> <tr> <td style="width: 10%;"></td> <td style="width: 10%;"></td> <td style="width: 10%;"></td> <td style="width: 10%;"></td> <td style="width: 10%;"></td> <td style="width: 10%;"></td> <td style="width: 10%;"></td> <td style="width: 10%;"></td> <td style="width: 10%;"></td> <td style="width: 10%;"></td> </tr> <tr> <td></td> <td></td> <td colspan="8" style="text-align: center;"> <table border="1" style="width: 100%; border-collapse: collapse; text-align: center;"> <tr> <td style="width: 10%;"></td> <td style="width: 10%;"></td> <td style="width: 10%;"></td> <td style="width: 10%;"></td> <td style="width: 10%;"></td> <td style="width: 10%;"></td> <td style="width: 10%;"></td> <td style="width: 10%;"></td> <td style="width: 10%;"></td> <td style="width: 10%;"></td> </tr> <tr> <td></td> <td></td> <td colspan="8" style="text-align: center;"> <table border="1" style="width: 100%; border-collapse: collapse; text-align: center;"> <tr> <td style="width: 10%;"></td> <td style="width: 10%;"></td> <td style="width: 10%;"></td> <td style="width: 10%;"></td> <td style="width: 10%;"></td> <td style="width: 10%;"></td> <td style="width: 10%;"></td> <td style="width: 10%;"></td> <td style="width: 10%;"></td> <td style="width: 10%;"></td> </tr> <tr> <td></td> <td></td> <td colspan="8" style="text-align: center;"> <table border="1" style="width: 100%; border-collapse: collapse; text-align: center;"> <tr> <td style="width: 10%;"></td> <td style="width: 10%;"></td> <td style="width: 10%;"></td> <td style="width: 10%;"></td> <td style="width: 10%;"></td> <td style="width: 10%;"></td> <td style="width: 10%;"></td> <td style="width: 10%;"></td> <td style="width: 10%;"></td> <td style="width: 10%;"></td> </tr> <tr> <td></td> <td></td> <td colspan="8" style="text-align: center;"> <table border="1" style="width: 100%; border-collapse: collapse; text-align: center;"> <tr> <td style="width: 10%;"></td> <td style="width: 10%;"></td> <td style="width: 10%;"></td> <td style="width: 10%;"></td> <td style="width: 10%;"></td> <td style="width: 10%;"></td> <td style="width: 10%;"></td> <td style="width: 10%;"></td> <td style="width: 10%;"></td> <td style="width: 10%;"></td> </tr> <tr> <td></td> <td></td> <td colspan="8" style="text-align: center;"> <table border="1" style="width: 100%; border-collapse: collapse; text-align: center;"> <tr> <td style="width: 10%;"></td> <td style="width: 10%;"></td> <td style="width: 10%;"></td> <td style="width: 10%;"></td> <td style="width: 10%;"></td> <td style="width: 10%;"></td> <td style="width: 10%;"></td> <td style="width: 10%;"></td> <td style="width: 10%;"></td> <td style="width: 10%;"></td> </tr> <tr> <td></td> <td></td> <td colspan="8" style="text-align: center;"> <table border="1" style="width: 100%; border-collapse: collapse; text-align: center;"> <tr> <td style="width: 10%;"></td> <td style="width: 10%;"></td> <td style="width: 10%;"></td> <td style="width: 10%;"></td> <td style="width: 10%;"></td> <td style="width: 10%;"></td> <td style="width: 10%;"></td> <td style="width: 10%;"></td> <td style="width: 10%;"></td> <td style="width: 10%;"></td> </tr> <tr> <td></td> <td></td> <td colspan="8" style="text-align: center;"> <table border="1" style="width: 100%; border-collapse: collapse; text-align: center;"> <tr> <td style="width: 10%;"></td> <td style="width: 10%;"></td> <td style="width: 10%;"></td> <td style="width: 10%;"></td> <td style="width: 10%;"></td> <td style="width: 10%;"></td> <td style="width: 10%;"></td> <td style="width: 10%;"></td> <td style="width: 10%;"></td> <td style="width: 10%;"></td> </tr> <tr> <td></td> <td></td> <td colspan="8" style="text-align: center;"> <table border="1" style="width: 100%; border-collapse: collapse; text-align: center;"> <tr> <td style="width: 10%;"></td> <td style="width: 10%;"></td> <td style="width: 10%;"></td> <td style="width: 10%;"></td> <td style="width: 10%;"></td> <td style="width: 10%;"></td> <td style="width: 10%;"></td> <td style="width: 10%;"></td> <td style="width: 10%;"></td> <td style="width: 10%;"></td> </tr> <tr> <td></td> <td></td> <td colspan="8" style="text-align: center;"> <table border="1" style="width: 100%; border-collapse: collapse; text-align: center;"> <tr> <td style="width: 10%;"></td> <td style="width: 10%;"></td> <td style="width: 10%;"></td> <td style="width: 10%;"></td> <td style="width: 10%;"></td> <td style="width: 10%;"></td> <td style="width: 10%;"></td> <td style="width: 10%;"></td> <td style="width: 10%;"></td> <td style="width: 10%;"></td> </tr> <tr> <td></td> <td></td> <td colspan="8" style="text-align: center;"> <table border="1" style="width: 100%; border-collapse: collapse; text-align: center;"> <tr> <td style="width: 10%;"></td> <td style="width: 10%;"></td> <td style="width: 10%;"></td> <td style="width: 10%;"></td> <td style="width: 10%;"></td> <td style="width: 10%;"></td> <td style="width: 10%;"></td> <td style="width: 10%;"></td> <td style="width: 10%;"></td> <td style="width: 10%;"></td> </tr> <tr> <td></td> <td></td> <td colspan="8" style="text-align: center;"> <table border="1"
style="width: 100%; border-collapse: collapse; text-align: center;"> <tr> </tr></table></td></tr></table></td></tr></table></td></tr></table></td></tr></table></td></tr></table></td></tr></table></td></tr></table></td></tr></table></td></tr></table></td></tr></table></td></tr></table></td></tr></table></td></tr></table></td></tr></table></td></tr></table></td></tr></table></td></tr></table></td></tr></table>
 | | | | | | | | | | | | | | | | | | | | <table border="1" style="width: 100%; border-collapse: collapse; text-align: center;"> <tr> <td style="width: 10%;"></td> <td style="width: 10%;"></td> <td style="width: 10%;"></td> <td style="width: 10%;"></td> <td style="width: 10%;"></td> <td style="width: 10%;"></td> <td style="width: 10%;"></td> <td style="width: 10%;"></td> <td style="width: 10%;"></td> <td style="width: 10%;"></td> </tr> <tr> <td></td> <td></td> <td colspan="8" style="text-align: center;"> <table border="1" style="width: 100%; border-collapse: collapse; text-align: center;"> <tr> <td style="width: 10%;"></td> <td style="width: 10%;"></td> <td style="width: 10%;"></td> <td style="width: 10%;"></td> <td style="width: 10%;"></td> <td style="width: 10%;"></td> <td style="width: 10%;"></td> <td style="width: 10%;"></td> <td style="width: 10%;"></td> <td style="width: 10%;"></td> </tr> <tr> <td></td> <td></td> <td colspan="8" style="text-align: center;"> <table border="1" style="width: 100%; border-collapse: collapse; text-align: center;"> <tr> <td style="width: 10%;"></td> <td style="width: 10%;"></td> <td style="width: 10%;"></td> <td style="width: 10%;"></td> <td style="width: 10%;"></td> <td style="width: 10%;"></td> <td style="width: 10%;"></td> <td style="width: 10%;"></td> <td style="width: 10%;"></td> <td style="width: 10%;"></td> </tr> <tr> <td></td> <td></td> <td colspan="8" style="text-align: center;"> <table border="1" style="width: 100%; border-collapse: collapse; text-align: center;"> <tr> <td style="width: 10%;"></td> <td style="width: 10%;"></td> <td style="width: 10%;"></td> <td style="width: 10%;"></td> <td style="width: 10%;"></td> <td style="width: 10%;"></td> <td style="width: 10%;"></td> <td style="width: 10%;"></td> <td style="width: 10%;"></td> <td style="width: 10%;"></td> </tr> <tr> <td></td> <td></td> <td colspan="8" style="text-align: center;"> <table border="1" style="width: 100%; border-collapse: collapse; text-align: center;"> <tr> <td style="width: 10%;"></td> <td style="width: 10%;"></td> <td style="width: 10%;"></td> <td style="width: 10%;"></td> <td style="width: 10%;"></td> <td style="width: 10%;"></td> <td style="width: 10%;"></td> <td style="width: 10%;"></td> <td style="width: 10%;"></td> <td style="width: 10%;"></td> </tr> <tr> <td></td> <td></td> <td colspan="8" style="text-align: center;"> <table border="1" style="width: 100%; border-collapse: collapse; text-align: center;"> <tr> <td style="width: 10%;"></td> <td style="width: 10%;"></td> <td style="width: 10%;"></td> <td style="width: 10%;"></td> <td style="width: 10%;"></td> <td style="width: 10%;"></td> <td style="width: 10%;"></td> <td style="width: 10%;"></td> <td style="width: 10%;"></td> <td style="width: 10%;"></td> </tr> <tr> <td></td> <td></td> <td colspan="8" style="text-align: center;"> <table border="1" style="width: 100%; border-collapse: collapse; text-align: center;"> <tr> <td style="width: 10%;"></td> <td style="width: 10%;"></td> <td style="width: 10%;"></td> <td style="width: 10%;"></td> <td style="width: 10%;"></td> <td style="width: 10%;"></td> <td style="width: 10%;"></td> <td style="width: 10%;"></td> <td style="width: 10%;"></td> <td style="width: 10%;"></td> </tr> <tr> <td></td> <td></td> <td colspan="8" style="text-align: center;"> <table border="1" style="width: 100%; border-collapse: collapse; text-align: center;"> <tr> <td style="width: 10%;"></td> <td style="width: 10%;"></td> <td style="width: 10%;"></td> <td style="width: 10%;"></td> <td style="width: 10%;"></td> <td style="width: 10%;"></td> <td style="width: 10%;"></td> <td style="width: 10%;"></td> <td style="width: 10%;"></td> <td style="width: 10%;"></td> </tr> <tr> <td></td> <td></td> <td colspan="8" style="text-align: center;"> <table border="1" style="width: 100%; border-collapse: collapse; text-align: center;"> <tr> <td style="width: 10%;"></td> <td style="width: 10%;"></td> <td style="width: 10%;"></td> <td style="width: 10%;"></td> <td style="width: 10%;"></td> <td style="width: 10%;"></td> <td style="width: 10%;"></td> <td style="width: 10%;"></td> <td style="width: 10%;"></td> <td style="width: 10%;"></td> </tr> <tr> <td></td> <td></td> <td colspan="8" style="text-align: center;"> <table border="1" style="width: 100%; border-collapse: collapse; text-align: center;"> <tr> <td style="width: 10%;"></td> <td style="width: 10%;"></td> <td style="width: 10%;"></td> <td style="width: 10%;"></td> <td style="width: 10%;"></td> <td style="width: 10%;"></td> <td style="width: 10%;"></td> <td style="width: 10%;"></td> <td style="width: 10%;"></td> <td style="width: 10%;"></td> </tr> <tr> <td></td> <td></td> <td colspan="8" style="text-align: center;"> <table border="1" style="width: 100%; border-collapse: collapse; text-align: center;"> <tr> <td style="width: 10%;"></td> <td style="width: 10%;"></td> <td style="width: 10%;"></td> <td style="width: 10%;"></td> <td style="width: 10%;"></td> <td style="width: 10%;"></td> <td style="width: 10%;"></td> <td style="width: 10%;"></td> <td style="width: 10%;"></td> <td style="width: 10%;"></td> </tr> <tr> <td></td> <td></td> <td colspan="8" style="text-align: center;"> <table border="1" style="width: 100%; border-collapse: collapse; text-align: center;"> <tr> <td style="width: 10%;"></td> <td style="width: 10%;"></td> <td style="width: 10%;"></td> <td style="width: 10%;"></td> <td style="width: 10%;"></td> <td style="width: 10%;"></td> <td style="width: 10%;"></td> <td style="width: 10%;"></td> <td style="width: 10%;"></td> <td style="width: 10%;"></td> </tr> <tr> <td></td> <td></td> <td colspan="8" style="text-align: center;"> <table border="1" style="width: 100%; border-collapse: collapse; text-align: center;"> <tr> <td style="width: 10%;"></td> <td style="width: 10%;"></td> <td style="width: 10%;"></td> <td style="width: 10%;"></td> <td style="width: 10%;"></td> <td style="width: 10%;"></td> <td style="width: 10%;"></td> <td style="width: 10%;"></td> <td style="width: 10%;"></td> <td style="width: 10%;"></td> </tr> <tr> <td></td> <td></td> <td colspan="8" style="text-align: center;"> <table border="1" style="width: 100%; border-collapse: collapse; text-align: center;"> <tr> <td style="width: 10%;"></td> <td style="width: 10%;"></td> <td style="width: 10%;"></td> <td style="width: 10%;"></td> <td style="width: 10%;"></td> <td style="width: 10%;"></td> <td style="width: 10%;"></td> <td style="width:
10%;"></td> <td style="width: 10%;"></td> <td style="width: 10%;"></td> </tr> <tr> <td></td> <td></td> <td colspan="8" style="text-align: center;"> <table border="1" style="width: 100%; border-collapse: collapse; text-align: center;"> <tr> <td style="width: 10%;"></td> <td style="width: 10%;"></td> <td style="width: 10%;"></td> <td style="width: 10%;"></td> <td style="width: 10%;"></td> <td style="width: 10%;"></td> <td style="width: 10%;"></td> <td style="width: 10%;"></td> <td style="width: 10%;"></td> <td style="width: 10%;"></td> </tr> <tr> <td></td> <td></td> <td colspan="8" style="text-align: center;"> <table border="1" style="width: 100%; border-collapse: collapse; text-align: center;"> <tr> <td style="width: 10%;"></td> <td style="width: 10%;"></td> <td style="width: 10%;"></td> <td style="width: 10%;"></td> <td style="width: 10%;"></td> <td style="width: 10%;"></td> <td style="width: 10%;"></td> <td style="width: 10%;"></td> <td style="width: 10%;"></td> <td style="width: 10%;"></td> </tr> <tr> <td></td> <td></td> <td colspan="8" style="text-align: center;"> <table border="1" style="width: 100%; border-collapse: collapse; text-align: center;"> <tr> <td style="width: 10%;"></td> <td style="width: 10%;"></td> <td style="width: 10%;"></td> <td style="width: 10%;"></td> <td style="width: 10%;"></td> <td style="width: 10%;"></td> <td style="width: 10%;"></td> <td style="width: 10%;"></td> <td style="width: 10%;"></td> <td style="width: 10%;"></td> </tr> <tr> <td></td> <td></td> <td colspan="8" style="text-align: center;"> <table border="1" style="width: 100%; border-collapse: collapse; text-align: center;"> <tr> </tr></table></td></tr></table></td></tr></table></td></tr></table></td></tr></table></td></tr></table></td></tr></table></td></tr></table></td></tr></table></td></tr></table></td></tr></table></td></tr></table></td></tr></table></td></tr></table></td></tr></table></td></tr></table></td></tr></table></td></tr></table>
 | | | | | | | | | | | | | | | | | | | | <table border="1" style="width: 100%; border-collapse: collapse; text-align: center;"> <tr> <td style="width: 10%;"></td> <td style="width: 10%;"></td> <td style="width: 10%;"></td> <td style="width: 10%;"></td> <td style="width: 10%;"></td> <td style="width: 10%;"></td> <td style="width: 10%;"></td> <td style="width: 10%;"></td> <td style="width: 10%;"></td> <td style="width: 10%;"></td> </tr> <tr> <td></td> <td></td> <td colspan="8" style="text-align: center;"> <table border="1" style="width: 100%; border-collapse: collapse; text-align: center;"> <tr> <td style="width: 10%;"></td> <td style="width: 10%;"></td> <td style="width: 10%;"></td> <td style="width: 10%;"></td> <td style="width: 10%;"></td> <td style="width: 10%;"></td> <td style="width: 10%;"></td> <td style="width: 10%;"></td> <td style="width: 10%;"></td> <td style="width: 10%;"></td> </tr> <tr> <td></td> <td></td> <td colspan="8" style="text-align: center;"> <table border="1" style="width: 100%; border-collapse: collapse; text-align: center;"> <tr> <td style="width: 10%;"></td> <td style="width: 10%;"></td> <td style="width: 10%;"></td> <td style="width: 10%;"></td> <td style="width: 10%;"></td> <td style="width: 10%;"></td> <td style="width: 10%;"></td> <td style="width: 10%;"></td> <td style="width: 10%;"></td> <td style="width: 10%;"></td> </tr> <tr> <td></td> <td></td> <td colspan="8" style="text-align: center;"> <table border="1" style="width: 100%; border-collapse: collapse; text-align: center;"> <tr> <td style="width: 10%;"></td> <td style="width: 10%;"></td> <td style="width: 10%;"></td> <td style="width: 10%;"></td> <td style="width: 10%;"></td> <td style="width: 10%;"></td> <td style="width: 10%;"></td> <td style="width: 10%;"></td> <td style="width: 10%;"></td> <td style="width: 10%;"></td> </tr> <tr> <td></td> <td></td> <td colspan="8" style="text-align: center;"> <table border="1" style="width: 100%; border-collapse: collapse; text-align: center;"> <tr> <td style="width: 10%;"></td> <td style="width: 10%;"></td> <td style="width: 10%;"></td> <td style="width: 10%;"></td> <td style="width: 10%;"></td> <td style="width: 10%;"></td> <td style="width: 10%;"></td> <td style="width: 10%;"></td> <td style="width: 10%;"></td> <td style="width: 10%;"></td> </tr> <tr> <td></td> <td></td> <td colspan="8" style="text-align: center;"> <table border="1" style="width: 100%; border-collapse: collapse; text-align: center;"> <tr> <td style="width: 10%;"></td> <td style="width: 10%;"></td> <td style="width: 10%;"></td> <td style="width: 10%;"></td> <td style="width: 10%;"></td> <td style="width: 10%;"></td> <td style="width: 10%;"></td> <td style="width: 10%;"></td> <td style="width: 10%;"></td> <td style="width: 10%;"></td> </tr> <tr> <td></td> <td></td> <td colspan="8" style="text-align: center;"> <table border="1" style="width: 100%; border-collapse: collapse; text-align: center;"> <tr> <td style="width: 10%;"></td> <td style="width: 10%;"></td> <td style="width: 10%;"></td> <td style="width: 10%;"></td> <td style="width: 10%;"></td> <td style="width: 10%;"></td> <td style="width: 10%;"></td> <td style="width: 10%;"></td> <td style="width: 10%;"></td> <td style="width: 10%;"></td> </tr> <tr> <td></td> <td></td> <td colspan="8" style="text-align: center;"> <table border="1" style="width: 100%; border-collapse: collapse; text-align: center;"> <tr> <td style="width: 10%;"></td> <td style="width: 10%;"></td> <td style="width: 10%;"></td> <td style="width: 10%;"></td> <td style="width: 10%;"></td> <td style="width: 10%;"></td> <td style="width: 10%;"></td> <td style="width: 10%;"></td> <td style="width: 10%;"></td> <td style="width: 10%;"></td> </tr> <tr> <td></td> <td></td> <td colspan="8" style="text-align: center;"> <table border="1" style="width: 100%; border-collapse: collapse; text-align: center;"> <tr> <td style="width: 10%;"></td> <td style="width: 10%;"></td> <td style="width: 10%;"></td> <td style="width: 10%;"></td> <td style="width: 10%;"></td> <td style="width: 10%;"></td> <td style="width: 10%;"></td> <td style="width: 10%;"></td> <td style="width: 10%;"></td> <td style="width: 10%;"></td> </tr> <tr> <td></td> <td></td> <td colspan="8" style="text-align: center;"> <table border="1" style="width: 100%; border-collapse: collapse; text-align: center;"> <tr> <td style="width: 10%;"></td> <td style="width: 10%;"></td> <td style="width: 10%;"></td> <td style="width: 10%;"></td> <td style="width: 10%;"></td> <td style="width: 10%;"></td> <td style="width: 10%;"></td> <td style="width: 10%;"></td> <td style="width: 10%;"></td> <td style="width: 10%;"></td> </tr> <tr> <td></td> <td></td> <td colspan="8" style="text-align: center;"> <table border="1" style="width: 100%; border-collapse: collapse; text-align: center;"> <tr> <td style="width: 10%;"></td> <td style="width: 10%;"></td> <td style="width:
10%;"></td> <td style="width: 10%;"></td> <td style="width: 10%;"></td> <td style="width: 10%;"></td> <td style="width: 10%;"></td> <td style="width: 10%;"></td> <td style="width: 10%;"></td> <td style="width: 10%;"></td> </tr> <tr> <td></td> <td></td> <td colspan="8" style="text-align: center;"> <table border="1" style="width: 100%; border-collapse: collapse; text-align: center;"> <tr> <td style="width: 10%;"></td> <td style="width: 10%;"></td> <td style="width: 10%;"></td> <td style="width: 10%;"></td> <td style="width: 10%;"></td> <td style="width: 10%;"></td> <td style="width: 10%;"></td> <td style="width: 10%;"></td> <td style="width: 10%;"></td> <td style="width: 10%;"></td> </tr> <tr> <td></td> <td></td> <td colspan="8" style="text-align: center;"> <table border="1" style="width: 100%; border-collapse: collapse; text-align: center;"> <tr> <td style="width: 10%;"></td> <td style="width: 10%;"></td> <td style="width: 10%;"></td> <td style="width: 10%;"></td> <td style="width: 10%;"></td> <td style="width: 10%;"></td> <td style="width: 10%;"></td> <td style="width: 10%;"></td> <td style="width: 10%;"></td> <td style="width: 10%;"></td> </tr> <tr> <td></td> <td></td> <td colspan="8" style="text-align: center;"> <table border="1" style="width: 100%; border-collapse: collapse; text-align: center;"> <tr> <td style="width: 10%;"></td> <td style="width: 10%;"></td> <td style="width: 10%;"></td> <td style="width: 10%;"></td> <td style="width: 10%;"></td> <td style="width: 10%;"></td> <td style="width: 10%;"></td> <td style="width: 10%;"></td> <td style="width: 10%;"></td> <td style="width: 10%;"></td> </tr> <tr> <td></td> <td></td> <td colspan="8" style="text-align: center;"> <table border="1" style="width: 100%; border-collapse: collapse; text-align: center;"> <tr> <td style="width: 10%;"></td> <td style="width: 10%;"></td> <td style="width: 10%;"></td> <td style="width: 10%;"></td> <td style="width: 10%;"></td> <td style="width: 10%;"></td> <td style="width: 10%;"></td> <td style="width: 10%;"></td> <td style="width: 10%;"></td> <td style="width: 10%;"></td> </tr> <tr> <td></td> <td></td> <td colspan="8" style="text-align: center;"> <table border="1" style="width: 100%; border-collapse: collapse; text-align: center;"> <tr> <td style="width: 10%;"></td> <td style="width: 10%;"></td> <td style="width: 10%;"></td> <td style="width: 10%;"></td> <td style="width: 10%;"></td> <td style="width: 10%;"></td> <td style="width: 10%;"></td> <td style="width: 10%;"></td> <td style="width: 10%;"></td> <td style="width: 10%;"></td> </tr> <tr> <td></td> <td></td> <td colspan="8" style="text-align: center;"> <table border="1" style="width: 100%; border-collapse: collapse; text-align: center;"> <tr> </tr></table></td></tr></table></td></tr></table></td></tr></table></td></tr></table></td></tr></table></td></tr></table></td></tr></table></td></tr></table></td></tr></table></td></tr></table></td></tr></table></td></tr></table></td></tr></table></td></tr></table></td></tr></table></td></tr></table>
 | | | | | | | | | | | | | | | | | | | | <table border="1" style="width: 100%; border-collapse: collapse; text-align: center;"> <tr> <td style="width: 10%;"></td> <td style="width: 10%;"></td> <td style="width: 10%;"></td> <td style="width: 10%;"></td> <td style="width: 10%;"></td> <td style="width: 10%;"></td> <td style="width: 10%;"></td> <td style="width: 10%;"></td> <td style="width: 10%;"></td> <td style="width: 10%;"></td> </tr> <tr> <td></td> <td></td> <td colspan="8" style="text-align: center;"> <table border="1" style="width: 100%; border-collapse: collapse; text-align: center;"> <tr> <td style="width: 10%;"></td> <td style="width: 10%;"></td> <td style="width: 10%;"></td> <td style="width: 10%;"></td> <td style="width: 10%;"></td> <td style="width: 10%;"></td> <td style="width: 10%;"></td> <td style="width: 10%;"></td> <td style="width: 10%;"></td> <td style="width: 10%;"></td> </tr> <tr> <td></td> <td></td> <td colspan="8" style="text-align: center;"> <table border="1" style="width: 100%; border-collapse: collapse; text-align: center;"> <tr> <td style="width: 10%;"></td> <td style="width: 10%;"></td> <td style="width: 10%;"></td> <td style="width: 10%;"></td> <td style="width: 10%;"></td> <td style="width: 10%;"></td> <td style="width: 10%;"></td> <td style="width: 10%;"></td> <td style="width: 10%;"></td> <td style="width: 10%;"></td> </tr> <tr> <td></td> <td></td> <td colspan="8" style="text-align: center;"> <table border="1" style="width: 100%; border-collapse: collapse; text-align: center;"> <tr> <td style="width: 10%;"></td> <td style="width: 10%;"></td> <td style="width: 10%;"></td> <td style="width: 10%;"></td> <td style="width: 10%;"></td> <td style="width: 10%;"></td> <td style="width: 10%;"></td> <td style="width: 10%;"></td> <td style="width: 10%;"></td> <td style="width: 10%;"></td> </tr> <tr> <td></td> <td></td> <td colspan="8" style="text-align: center;"> <table border="1" style="width: 100%; border-collapse: collapse; text-align: center;"> <tr> <td style="width: 10%;"></td> <td style="width: 10%;"></td> <td style="width: 10%;"></td> <td style="width: 10%;"></td> <td style="width: 10%;"></td> <td style="width: 10%;"></td> <td style="width: 10%;"></td> <td style="width: 10%;"></td> <td style="width: 10%;"></td> <td style="width: 10%;"></td> </tr> <tr> <td></td> <td></td> <td colspan="8" style="text-align: center;"> <table border="1" style="width: 100%; border-collapse: collapse; text-align: center;"> <tr> <td style="width: 10%;"></td> <td style="width: 10%;"></td> <td style="width: 10%;"></td> <td style="width: 10%;"></td> <td style="width: 10%;"></td> <td style="width: 10%;"></td> <td style="width: 10%;"></td> <td style="width: 10%;"></td> <td style="width: 10%;"></td> <td style="width: 10%;"></td> </tr> <tr> <td></td> <td></td> <td colspan="8" style="text-align: center;"> <table border="1" style="width: 100%; border-collapse: collapse; text-align: center;"> <tr> <td style="width: 10%;"></td> <td style="width: 10%;"></td> <td style="width: 10%;"></td> <td style="width: 10%;"></td> <td style="width: 10%;"></td> <td style="width: 10%;"></td> <td style="width: 10%;"></td> <td style="width: 10%;"></td> <td style="width: 10%;"></td> <td style="width: 10%;"></td> </tr> <tr> <td></td> <td></td> <td colspan="8" style="text-align: center;"> <table border="1" style="width: 100%; border-collapse: collapse; text-align: center;"> <tr> <td style="width: 10%;"></td> <td style="width: 10%;"></td> <td style="width: 10%;"></td> <td style="width: 10%;"></td> <td style="width: 10%;"></td> <td style="width: 10%;"></td> <td style="width: 10%;"></td> <td style="width: 10%;"></td> <td style="width: 10%;"></td> <td style="width: 10%;"></td> </tr> <tr> <td></td> <td></td> <td colspan="8" style="text-align: center;"> <table border="1" style="width: 100%;
border-collapse: collapse; text-align: center;"> <tr> <td style="width: 10%;"></td> <td style="width: 10%;"></td> <td style="width: 10%;"></td> <td style="width: 10%;"></td> <td style="width: 10%;"></td> <td style="width: 10%;"></td> <td style="width: 10%;"></td> <td style="width: 10%;"></td> <td style="width: 10%;"></td> <td style="width: 10%;"></td> </tr> <tr> <td></td> <td></td> <td colspan="8" style="text-align: center;"> <table border="1" style="width: 100%; border-collapse: collapse; text-align: center;"> <tr> <td style="width: 10%;"></td> <td style="width: 10%;"></td> <td style="width: 10%;"></td> <td style="width: 10%;"></td> <td style="width: 10%;"></td> <td style="width: 10%;"></td> <td style="width: 10%;"></td> <td style="width: 10%;"></td> <td style="width: 10%;"></td> <td style="width: 10%;"></td> </tr> <tr> <td></td> <td></td> <td colspan="8" style="text-align: center;"> <table border="1" style="width: 100%; border-collapse: collapse; text-align: center;"> <tr> <td style="width: 10%;"></td> <td style="width: 10%;"></td> <td style="width: 10%;"></td> <td style="width: 10%;"></td> <td style="width: 10%;"></td> <td style="width: 10%;"></td> <td style="width: 10%;"></td> <td style="width: 10%;"></td> <td style="width: 10%;"></td> <td style="width: 10%;"></td> </tr> <tr> <td></td> <td></td> <td colspan="8" style="text-align: center;"> <table border="1" style="width: 100%; border-collapse: collapse; text-align: center;"> <tr> <td style="width: 10%;"></td> <td style="width: 10%;"></td> <td style="width: 10%;"></td> <td style="width: 10%;"></td> <td style="width: 10%;"></td> <td style="width: 10%;"></td> <td style="width: 10%;"></td> <td style="width: 10%;"></td> <td style="width: 10%;"></td> <td style="width: 10%;"></td> </tr> <tr> <td></td> <td></td> <td colspan="8" style="text-align: center;"> <table border="1" style="width: 100%; border-collapse: collapse; text-align: center;"> <tr> <td style="width: 10%;"></td> <td style="width: 10%;"></td> <td style="width: 10%;"></td> <td style="width: 10%;"></td> <td style="width: 10%;"></td> <td style="width: 10%;"></td> <td style="width: 10%;"></td> <td style="width: 10%;"></td> <td style="width: 10%;"></td> <td style="width: 10%;"></td> </tr> <tr> <td></td> <td></td> <td colspan="8" style="text-align: center;"> <table border="1" style="width: 100%; border-collapse: collapse; text-align: center;"> <tr> <td style="width: 10%;"></td> <td style="width: 10%;"></td> <td style="width: 10%;"></td> <td style="width: 10%;"></td> <td style="width: 10%;"></td> <td style="width: 10%;"></td> <td style="width: 10%;"></td> <td style="width: 10%;"></td> <td style="width: 10%;"></td> <td style="width: 10%;"></td> </tr> <tr> <td></td> <td></td> <td colspan="8" style="text-align: center;"> <table border="1" style="width: 100%; border-collapse: collapse; text-align: center;"> <tr> <td style="width: 10%;"></td> <td style="width: 10%;"></td> <td style="width: 10%;"></td> <td style="width: 10%;"></td> <td style="width: 10%;"></td> <td style="width: 10%;"></td> <td style="width: 10%;"></td> <td style="width: 10%;"></td> <td style="width: 10%;"></td> <td style="width: 10%;"></td> </tr> <tr> <td></td> <td></td> <td colspan="8" style="text-align: center;"> <table border="1" style="width: 100%; border-collapse: collapse; text-align: center;"> <tr> </tr></table></td></tr></table></td></tr></table></td></tr></table></td></tr></table></td></tr></table></td></tr></table></td></tr></table></td></tr></table></td></tr></table></td></tr></table></td></tr></table></td></tr></table></td></tr></table></td></tr></table></td></tr></table>
 | | | | | | | | | | | | | | | | | | | | <table border="1" style="width: 100%; border-collapse: collapse; text-align: center;"> <tr> <td style="width: 10%;"></td> <td style="width: 10%;"></td> <td style="width: 10%;"></td> <td style="width: 10%;"></td> <td style="width: 10%;"></td> <td style="width: 10%;"></td> <td style="width: 10%;"></td> <td style="width: 10%;"></td> <td style="width: 10%;"></td> <td style="width: 10%;"></td> </tr> <tr> <td></td> <td></td> <td colspan="8" style="text-align: center;"> <table border="1" style="width: 100%; border-collapse: collapse; text-align: center;"> <tr> <td style="width: 10%;"></td> <td style="width: 10%;"></td> <td style="width: 10%;"></td> <td style="width: 10%;"></td> <td style="width: 10%;"></td> <td style="width: 10%;"></td> <td style="width: 10%;"></td> <td style="width: 10%;"></td> <td style="width: 10%;"></td> <td style="width: 10%;"></td> </tr> <tr> <td></td> <td></td> <td colspan="8" style="text-align: center;"> <table border="1" style="width: 100%; border-collapse: collapse; text-align: center;"> <tr> <td style="width: 10%;"></td> <td style="width: 10%;"></td> <td style="width: 10%;"></td> <td style="width: 10%;"></td> <td style="width: 10%;"></td> <td style="width: 10%;"></td> <td style="width: 10%;"></td> <td style="width: 10%;"></td> <td style="width: 10%;"></td> <td style="width: 10%;"></td> </tr> <tr> <td></td> <td></td> <td colspan="8" style="text-align: center;"> <table border="1" style="width: 100%; border-collapse: collapse; text-align: center;"> <tr> <td style="width: 10%;"></td> <td style="width: 10%;"></td> <td style="width: 10%;"></td> <td style="width: 10%;"></td> <td style="width: 10%;"></td> <td style="width: 10%;"></td> <td style="width: 10%;"></td> <td style="width: 10%;"></td> <td style="width: 10%;"></td> <td style="width: 10%;"></td> </tr> <tr> <td></td> <td></td> <td colspan="8" style="text-align: center;"> <table border="1" style="width: 100%; border-collapse: collapse; text-align: center;"> <tr> <td style="width: 10%;"></td> <td style="width: 10%;"></td> <td style="width: 10%;"></td> <td style="width: 10%;"></td> <td style="width: 10%;"></td> <td style="width: 10%;"></td> <td style="width: 10%;"></td> <td style="width: 10%;"></td> <td style="width: 10%;"></td> <td style="width: 10%;"></td> </tr> <tr> <td></td> <td></td> <td colspan="8" style="text-align: center;"> <table border="1" style="width: 100%; border-collapse: collapse; text-align: center;"> <tr> <td style="width: 10%;"></td> <td style="width: 10%;"></td> <td style="width: 10%;"></td> <td style="width: 10%;"></td> <td style="width: 10%;"></td> <td style="width: 10%;"></td> <td style="width: 10%;"></td> <td style="width: 10%;"></td> <td style="width: 10%;"></td> <td style="width: 10%;"></td> </tr> <tr> <td></td> <td></td> <td colspan="8" style="text-align: center;"> <table border="1" style="width: 100%; border-collapse: collapse; text-align: center;"> <tr> <td style="width: 10%;"></td> <td style="width: 10%;"></td> <td style="width: 10%;"></td> <td style="width: 10%;"></td> <td style="width: 10%;"></td> <td style="width: 10%;"></td> <td style="width: 10%;"></td> <td style="width: 10%;"></td> <td style="width: 10%;"></td> <td style="width: 10%;"></td>
</tr> <tr> <td></td> <td></td> <td colspan="8" style="text-align: center;"> <table border="1" style="width: 100%; border-collapse: collapse; text-align: center;"> <tr> <td style="width: 10%;"></td> <td style="width: 10%;"></td> <td style="width: 10%;"></td> <td style="width: 10%;"></td> <td style="width: 10%;"></td> <td style="width: 10%;"></td> <td style="width: 10%;"></td> <td style="width: 10%;"></td> <td style="width: 10%;"></td> <td style="width: 10%;"></td> </tr> <tr> <td></td> <td></td> <td colspan="8" style="text-align: center;"> <table border="1" style="width: 100%; border-collapse: collapse; text-align: center;"> <tr> <td style="width: 10%;"></td> <td style="width: 10%;"></td> <td style="width: 10%;"></td> <td style="width: 10%;"></td> <td style="width: 10%;"></td> <td style="width: 10%;"></td> <td style="width: 10%;"></td> <td style="width: 10%;"></td> <td style="width: 10%;"></td> <td style="width: 10%;"></td> </tr> <tr> <td></td> <td></td> <td colspan="8" style="text-align: center;"> <table border="1" style="width: 100%; border-collapse: collapse; text-align: center;"> <tr> <td style="width: 10%;"></td> <td style="width: 10%;"></td> <td style="width: 10%;"></td> <td style="width: 10%;"></td> <td style="width: 10%;"></td> <td style="width: 10%;"></td> <td style="width: 10%;"></td> <td style="width: 10%;"></td> <td style="width: 10%;"></td> <td style="width: 10%;"></td> </tr> <tr> <td></td> <td></td> <td colspan="8" style="text-align: center;"> <table border="1" style="width: 100%; border-collapse: collapse; text-align: center;"> <tr> <td style="width: 10%;"></td> <td style="width: 10%;"></td> <td style="width: 10%;"></td> <td style="width: 10%;"></td> <td style="width: 10%;"></td> <td style="width: 10%;"></td> <td style="width: 10%;"></td> <td style="width: 10%;"></td> <td style="width: 10%;"></td> <td style="width: 10%;"></td> </tr> <tr> <td></td> <td></td> <td colspan="8" style="text-align: center;"> <table border="1" style="width: 100%; border-collapse: collapse; text-align: center;"> <tr> <td style="width: 10%;"></td> <td style="width: 10%;"></td> <td style="width: 10%;"></td> <td style="width: 10%;"></td> <td style="width: 10%;"></td> <td style="width: 10%;"></td> <td style="width: 10%;"></td> <td style="width: 10%;"></td> <td style="width: 10%;"></td> <td style="width: 10%;"></td> </tr> <tr> <td></td> <td></td> <td colspan="8" style="text-align: center;"> <table border="1" style="width: 100%; border-collapse: collapse; text-align: center;"> <tr> <td style="width: 10%;"></td> <td style="width: 10%;"></td> <td style="width: 10%;"></td> <td style="width: 10%;"></td> <td style="width: 10%;"></td> <td style="width: 10%;"></td> <td style="width: 10%;"></td> <td style="width: 10%;"></td> <td style="width: 10%;"></td> <td style="width: 10%;"></td> </tr> <tr> <td></td> <td></td> <td colspan="8" style="text-align: center;"> <table border="1" style="width: 100%; border-collapse: collapse; text-align: center;"> <tr> <td style="width: 10%;"></td> <td style="width: 10%;"></td> <td style="width: 10%;"></td> <td style="width: 10%;"></td> <td style="width: 10%;"></td> <td style="width: 10%;"></td> <td style="width: 10%;"></td> <td style="width: 10%;"></td> <td style="width: 10%;"></td> <td style="width: 10%;"></td> </tr> <tr> <td></td> <td></td> <td colspan="8" style="text-align: center;"> <table border="1" style="width: 100%; border-collapse: collapse; text-align: center;"> <tr> </tr></table></td></tr></table></td></tr></table></td></tr></table></td></tr></table></td></tr></table></td></tr></table></td></tr></table></td></tr></table></td></tr></table></td></tr></table></td></tr></table></td></tr></table></td></tr></table></td></tr></table>
 | | | | | | | | | | | | | | | | | | | | <table border="1" style="width: 100%; border-collapse: collapse; text-align: center;"> <tr> <td style="width: 10%;"></td> <td style="width: 10%;"></td> <td style="width: 10%;"></td> <td style="width: 10%;"></td> <td style="width: 10%;"></td> <td style="width: 10%;"></td> <td style="width: 10%;"></td> <td style="width: 10%;"></td> <td style="width: 10%;"></td> <td style="width: 10%;"></td> </tr> <tr> <td></td> <td></td> <td colspan="8" style="text-align: center;"> <table border="1" style="width: 100%; border-collapse: collapse; text-align: center;"> <tr> <td style="width: 10%;"></td> <td style="width: 10%;"></td> <td style="width: 10%;"></td> <td style="width: 10%;"></td> <td style="width: 10%;"></td> <td style="width: 10%;"></td> <td style="width: 10%;"></td> <td style="width: 10%;"></td> <td style="width: 10%;"></td> <td style="width: 10%;"></td> </tr> <tr> <td></td> <td></td> <td colspan="8" style="text-align: center;"> <table border="1" style="width: 100%; border-collapse: collapse; text-align: center;"> <tr> <td style="width: 10%;"></td> <td style="width: 10%;"></td> <td style="width: 10%;"></td> <td style="width: 10%;"></td> <td style="width: 10%;"></td> <td style="width: 10%;"></td> <td style="width: 10%;"></td> <td style="width: 10%;"></td> <td style="width: 10%;"></td> <td style="width: 10%;"></td> </tr> <tr> <td></td> <td></td> <td colspan="8" style="text-align: center;"> <table border="1" style="width: 100%; border-collapse: collapse; text-align: center;"> <tr> <td style="width: 10%;"></td> <td style="width: 10%;"></td> <td style="width: 10%;"></td> <td style="width: 10%;"></td> <td style="width: 10%;"></td> <td style="width: 10%;"></td> <td style="width: 10%;"></td> <td style="width: 10%;"></td> <td style="width: 10%;"></td> <td style="width: 10%;"></td> </tr> <tr> <td></td> <td></td> <td colspan="8" style="text-align: center;"> <table border="1" style="width: 100%; border-collapse: collapse; text-align: center;"> <tr> <td style="width: 10%;"></td> <td style="width: 10%;"></td> <td style="width: 10%;"></td> <td style="width: 10%;"></td> <td style="width: 10%;"></td> <td style="width: 10%;"></td> <td style="width: 10%;"></td> <td style="width: 10%;"></td> <td style="width: 10%;"></td> <td style="width: 10%;"></td> </tr> <tr> <td></td> <td></td> <td colspan="8" style="text-align: center;"> <table border="1" style="width: 100%; border-collapse: collapse; text-align: center;"> <tr> <td style="width: 10%;"></td> <td style="width: 10%;"></td> <td style="width: 10%;"></td> <td style="width: 10%;"></td> <td style="width: 10%;"></td> <td style="width: 10%;"></td> <td style="width: 10%;"></td> <td style="width: 10%;"></td> <td style="width: 10%;"></td> <td style="width: 10%;"></td> </tr> <tr> <td></td> <td></td> <td colspan="8" style="text-align: center;"> <table border="1" style="width: 100%; border-collapse: collapse; text-align: center;"> <tr> <td style="width: 10%;"></td> <td style="width: 10%;"></td> <td style="width: 10%;"></td> <td style="width: 10%;"></td> <td style="width: 10%;"></td> <td style="width: 10%;"></td> <td style="width:
10%;"></td> <td style="width: 10%;"></td> <td style="width: 10%;"></td> <td style="width: 10%;"></td> </tr> <tr> <td></td> <td></td> <td colspan="8" style="text-align: center;"> <table border="1" style="width: 100%; border-collapse: collapse; text-align: center;"> <tr> <td style="width: 10%;"></td> <td style="width: 10%;"></td> <td style="width: 10%;"></td> <td style="width: 10%;"></td> <td style="width: 10%;"></td> <td style="width: 10%;"></td> <td style="width: 10%;"></td> <td style="width: 10%;"></td> <td style="width: 10%;"></td> <td style="width: 10%;"></td> </tr> <tr> <td></td> <td></td> <td colspan="8" style="text-align: center;"> <table border="1" style="width: 100%; border-collapse: collapse; text-align: center;"> <tr> <td style="width: 10%;"></td> <td style="width: 10%;"></td> <td style="width: 10%;"></td> <td style="width: 10%;"></td> <td style="width: 10%;"></td> <td style="width: 10%;"></td> <td style="width: 10%;"></td> <td style="width: 10%;"></td> <td style="width: 10%;"></td> <td style="width: 10%;"></td> </tr> <tr> <td></td> <td></td> <td colspan="8" style="text-align: center;"> <table border="1" style="width: 100%; border-collapse: collapse; text-align: center;"> <tr> <td style="width: 10%;"></td> <td style="width: 10%;"></td> <td style="width: 10%;"></td> <td style="width: 10%;"></td> <td style="width: 10%;"></td> <td style="width: 10%;"></td> <td style="width: 10%;"></td> <td style="width: 10%;"></td> <td style="width: 10%;"></td> <td style="width: 10%;"></td> </tr> <tr> <td></td> <td></td> <td colspan="8" style="text-align: center;"> <table border="1" style="width: 100%; border-collapse: collapse; text-align: center;"> <tr> <td style="width: 10%;"></td> <td style="width: 10%;"></td> <td style="width: 10%;"></td> <td style="width: 10%;"></td> <td style="width: 10%;"></td> <td style="width: 10%;"></td> <td style="width: 10%;"></td> <td style="width: 10%;"></td> <td style="width: 10%;"></td> <td style="width: 10%;"></td> </tr> <tr> <td></td> <td></td> <td colspan="8" style="text-align: center;"> <table border="1" style="width: 100%; border-collapse: collapse; text-align: center;"> <tr> <td style="width: 10%;"></td> <td style="width: 10%;"></td> <td style="width: 10%;"></td> <td style="width: 10%;"></td> <td style="width: 10%;"></td> <td style="width: 10%;"></td> <td style="width: 10%;"></td> <td style="width: 10%;"></td> <td style="width: 10%;"></td> <td style="width: 10%;"></td> </tr> <tr> <td></td> <td></td> <td colspan="8" style="text-align: center;"> <table border="1" style="width: 100%; border-collapse: collapse; text-align: center;"> <tr> <td style="width: 10%;"></td> <td style="width: 10%;"></td> <td style="width: 10%;"></td> <td style="width: 10%;"></td> <td style="width: 10%;"></td> <td style="width: 10%;"></td> <td style="width: 10%;"></td> <td style="width: 10%;"></td> <td style="width: 10%;"></td> <td style="width: 10%;"></td> </tr> <tr> <td></td> <td></td> <td colspan="8" style="text-align: center;"> <table border="1" style="width: 100%; border-collapse: collapse; text-align: center;"> <tr> </tr></table></td></tr></table></td></tr></table></td></tr></table></td></tr></table></td></tr></table></td></tr></table></td></tr></table></td></tr></table></td></tr></table></td></tr></table></td></tr></table></td></tr></table></td></tr></table>
 | | | | | | | | | | | | | | | | | | | | <table border="1" style="width: 100%; border-collapse: collapse; text-align: center;"> <tr> <td style="width: 10%;"></td> <td style="width: 10%;"></td> <td style="width: 10%;"></td> <td style="width: 10%;"></td> <td style="width: 10%;"></td> <td style="width: 10%;"></td> <td style="width: 10%;"></td> <td style="width: 10%;"></td> <td style="width: 10%;"></td> <td style="width: 10%;"></td> </tr> <tr> <td></td> <td></td> <td colspan="8" style="text-align: center;"> <table border="1" style="width: 100%; border-collapse: collapse; text-align: center;"> <tr> <td style="width: 10%;"></td> <td style="width: 10%;"></td> <td style="width: 10%;"></td> <td style="width: 10%;"></td> <td style="width: 10%;"></td> <td style="width: 10%;"></td> <td style="width: 10%;"></td> <td style="width: 10%;"></td> <td style="width: 10%;"></td> <td style="width: 10%;"></td> </tr> <tr> <td></td> <td></td> <td colspan="8" style="text-align: center;"> <table border="1" style="width: 100%; border-collapse: collapse; text-align: center;"> <tr> <td style="width: 10%;"></td> <td style="width: 10%;"></td> <td style="width: 10%;"></td> <td style="width: 10%;"></td> <td style="width: 10%;"></td> <td style="width: 10%;"></td> <td style="width: 10%;"></td> <td style="width: 10%;"></td> <td style="width: 10%;"></td> <td style="width: 10%;"></td> </tr> <tr> <td></td> <td></td> <td colspan="8" style="text-align: center;"> <table border="1" style="width: 100%; border-collapse: collapse; text-align: center;"> <tr> <td style="width: 10%;"></td> <td style="width: 10%;"></td> <td style="width: 10%;"></td> <td style="width: 10%;"></td> <td style="width: 10%;"></td> <td style="width: 10%;"></td> <td style="width: 10%;"></td> <td style="width: 10%;"></td> <td style="width: 10%;"></td> <td style="width: 10%;"></td> </tr> <tr> <td></td> <td></td> <td colspan="8" style="text-align: center;"> <table border="1" style="width: 100%; border-collapse: collapse; text-align: center;"> <tr> <td style="width: 10%;"></td> <td style="width: 10%;"></td> <td style="width: 10%;"></td> <td style="width: 10%;"></td> <td style="width: 10%;"></td> <td style="width: 10%;"></td> <td style="width: 10%;"></td> <td style="width: 10%;"></td> <td style="width: 10%;"></td> <td style="width: 10%;"></td> </tr> <tr> <td></td> <td></td> <td colspan="8" style="text-align: center;"> <table border="1" style="width: 100%; border-collapse: collapse; text-align: center;"> <tr> <td style="width: 10%;"></td> <td style="width: 10%;"></td> <td style="width: 10%;"></td> <td style="width: 10%;"></td> <td style="width: 10%;"></td> <td style="width: 10%;"></td> <td style="width: 10%;"></td> <td style="width: 10%;"></td> <td style="width: 10%;"></td> <td style="width: 10%;"></td> </tr> <tr> <td></td> <td></td> <td colspan="8" style="text-align: center;"> <table border="1" style="width: 100%; border-collapse: collapse; text-align: center;"> <tr> <td style="width: 10%;"></td> <td style="width: 10%;"></td> <td style="width: 10%;"></td> <td style="width: 10%;"></td> <td style="width: 10%;"></td> <td style="width: 10%;"></td> <td style="width: 10%;"></td> <td style="width: 10%;"></td> <td style="width: 10%;"></td> <td style="width: 10%;"></td> </tr> <tr> <td></td> <td></td> <td colspan="8" style="text-align: center;"> <table border="1" style="width: 100%; border-collapse: collapse; text-align: center;"> <tr> <td style="width: 10%;"></td> <td style="width: 10%;"></td> <td style="width: 10%;"></td> <td style="width: 10%;"></td> <td
style="width: 10%;"></td> <td style="width: 10%;"></td> <td style="width: 10%;"></td> <td style="width: 10%;"></td> <td style="width: 10%;"></td> <td style="width: 10%;"></td> </tr> <tr> <td></td> <td></td> <td colspan="8" style="text-align: center;"> <table border="1" style="width: 100%; border-collapse: collapse; text-align: center;"> <tr> <td style="width: 10%;"></td> <td style="width: 10%;"></td> <td style="width: 10%;"></td> <td style="width: 10%;"></td> <td style="width: 10%;"></td> <td style="width: 10%;"></td> <td style="width: 10%;"></td> <td style="width: 10%;"></td> <td style="width: 10%;"></td> <td style="width: 10%;"></td> </tr> <tr> <td></td> <td></td> <td colspan="8" style="text-align: center;"> <table border="1" style="width: 100%; border-collapse: collapse; text-align: center;"> <tr> <td style="width: 10%;"></td> <td style="width: 10%;"></td> <td style="width: 10%;"></td> <td style="width: 10%;"></td> <td style="width: 10%;"></td> <td style="width: 10%;"></td> <td style="width: 10%;"></td> <td style="width: 10%;"></td> <td style="width: 10%;"></td> <td style="width: 10%;"></td> </tr> <tr> <td></td> <td></td> <td colspan="8" style="text-align: center;"> <table border="1" style="width: 100%; border-collapse: collapse; text-align: center;"> <tr> <td style="width: 10%;"></td> <td style="width: 10%;"></td> <td style="width: 10%;"></td> <td style="width: 10%;"></td> <td style="width: 10%;"></td> <td style="width: 10%;"></td> <td style="width: 10%;"></td> <td style="width: 10%;"></td> <td style="width: 10%;"></td> <td style="width: 10%;"></td> </tr> <tr> <td></td> <td></td> <td colspan="8" style="text-align: center;"> <table border="1" style="width: 100%; border-collapse: collapse; text-align: center;"> <tr> <td style="width: 10%;"></td> <td style="width: 10%;"></td> <td style="width: 10%;"></td> <td style="width: 10%;"></td> <td style="width: 10%;"></td> <td style="width: 10%;"></td> <td style="width: 10%;"></td> <td style="width: 10%;"></td> <td style="width: 10%;"></td> <td style="width: 10%;"></td> </tr> <tr> <td></td> <td></td> <td colspan="8" style="text-align: center;"> <table border="1" style="width: 100%; border-collapse: collapse; text-align: center;"> <tr> </tr></table></td></tr></table></td></tr></table></td></tr></table></td></tr></table></td></tr></table></td></tr></table></td></tr></table></td></tr></table></td></tr></table></td></tr></table></td></tr></table></td></tr></table>
 | | | | | | | | | | | | | | | | | | | | <table border="1" style="width: 100%; border-collapse: collapse; text-align: center;"> <tr> <td style="width: 10%;"></td> <td style="width: 10%;"></td> <td style="width: 10%;"></td> <td style="width: 10%;"></td> <td style="width: 10%;"></td> <td style="width: 10%;"></td> <td style="width: 10%;"></td> <td style="width: 10%;"></td> <td style="width: 10%;"></td> <td style="width: 10%;"></td> </tr> <tr> <td></td> <td></td> <td colspan="8" style="text-align: center;"> <table border="1" style="width: 100%; border-collapse: collapse; text-align: center;"> <tr> <td style="width: 10%;"></td> <td style="width: 10%;"></td> <td style="width: 10%;"></td> <td style="width: 10%;"></td> <td style="width: 10%;"></td> <td style="width: 10%;"></td> <td style="width: 10%;"></td> <td style="width: 10%;"></td> <td style="width: 10%;"></td> <td style="width: 10%;"></td> </tr> <tr> <td></td> <td></td> <td colspan="8" style="text-align: center;"> <table border="1" style="width: 100%; border-collapse: collapse; text-align: center;"> <tr> <td style="width: 10%;"></td> <td style="width: 10%;"></td> <td style="width: 10%;"></td> <td style="width: 10%;"></td> <td style="width: 10%;"></td> <td style="width: 10%;"></td> <td style="width: 10%;"></td> <td style="width: 10%;"></td> <td style="width: 10%;"></td> <td style="width: 10%;"></td> </tr> <tr> <td></td> <td></td> <td colspan="8" style="text-align: center;"> <table border="1" style="width: 100%; border-collapse: collapse; text-align: center;"> <tr> <td style="width: 10%;"></td> <td style="width: 10%;"></td> <td style="width: 10%;"></td> <td style="width: 10%;"></td> <td style="width: 10%;"></td> <td style="width: 10%;"></td> <td style="width: 10%;"></td> <td style="width: 10%;"></td> <td style="width: 10%;"></td> <td style="width: 10%;"></td> </tr> <tr> <td></td> <td></td> <td colspan="8" style="text-align: center;"> <table border="1" style="width: 100%; border-collapse: collapse; text-align: center;"> <tr> <td style="width: 10%;"></td> <td style="width: 10%;"></td> <td style="width: 10%;"></td> <td style="width: 10%;"></td> <td style="width: 10%;"></td> <td style="width: 10%;"></td> <td style="width: 10%;"></td> <td style="width: 10%;"></td> <td style="width: 10%;"></td> <td style="width: 10%;"></td> </tr> <tr> <td></td> <td></td> <td colspan="8" style="text-align: center;"> <table border="1" style="width: 100%; border-collapse: collapse; text-align: center;"> <tr> <td style="width: 10%;"></td> <td style="width: 10%;"></td> <td style="width: 10%;"></td> <td style="width: 10%;"></td> <td style="width: 10%;"></td> <td style="width: 10%;"></td> <td style="width: 10%;"></td> <td style="width: 10%;"></td> <td style="width: 10%;"></td> <td style="width: 10%;"></td> </tr> <tr> <td></td> <td></td> <td colspan="8" style="text-align: center;"> <table border="1" style="width: 100%; border-collapse: collapse; text-align: center;"> <tr> <td style="width: 10%;"></td> <td style="width: 10%;"></td> <td style="width: 10%;"></td> <td style="width: 10%;"></td> <td style="width: 10%;"></td> <td style="width: 10%;"></td> <td style="width: 10%;"></td> <td style="width: 10%;"></td> <td style="width: 10%;"></td> <td style="width: 10%;"></td> </tr> <tr> <td></td> <td></td> <td colspan="8" style="text-align: center;"> <table border="1" style="width: 100%; border-collapse: collapse; text-align: center;"> <tr> <td style="width: 10%;"></td> <td style="width: 10%;"></td> <td style="width: 10%;"></td> <td style="width: 10%;"></td> <td style="width: 10%;"></td> <td style="width: 10%;"></td> <td style="width: 10%;"></td> <td style="width: 10%;"></td> <td style="width: 10%;"></td> <td style="width: 10%;"></td> </tr> <tr> <td></td> <td></td> <td colspan="8" style="text-align: center;"> <table border="1" style="width: 100%; border-collapse: collapse; text-align: center;"> <tr> <td style="width: 10%;"></td> <td style="width: 10%;"></td> <td style="width: 10%;"></td> <td style="width: 10%;"></td> <td style="width: 10%;"></td> <td style="width: 10%;"></td> <td style="width: 10%;"></td> <td style="width: 10%;"></td> <td style="width: 10%;"></td> <td style="width: 10%;"></td> </tr> <tr> <td></td> <td></td> <td colspan="8" style="text-align: center;"> <table border="1" style="width: 100%; border-collapse: collapse; text-align: center;"> <tr> <td style="width: 10%;"></td> <td style="width: 10%;"></td> <td
style="width: 10%;"></td> <td style="width: 10%;"></td> <td style="width: 10%;"></td> <td style="width: 10%;"></td> <td style="width: 10%;"></td> <td style="width: 10%;"></td> <td style="width: 10%;"></td> <td style="width: 10%;"></td> </tr> <tr> <td></td> <td></td> <td colspan="8" style="text-align: center;"> <table border="1" style="width: 100%; border-collapse: collapse; text-align: center;"> <tr> <td style="width: 10%;"></td> <td style="width: 10%;"></td> <td style="width: 10%;"></td> <td style="width: 10%;"></td> <td style="width: 10%;"></td> <td style="width: 10%;"></td> <td style="width: 10%;"></td> <td style="width: 10%;"></td> <td style="width: 10%;"></td> <td style="width: 10%;"></td> </tr> <tr> <td></td> <td></td> <td colspan="8" style="text-align: center;"> <table border="1" style="width: 100%; border-collapse: collapse; text-align: center;"> <tr> </tr></table></td></tr></table></td></tr></table></td></tr></table></td></tr></table></td></tr></table></td></tr></table></td></tr></table></td></tr></table></td></tr></table></td></tr></table></td></tr></table>
 | | | | | | | | | | | | | | | | | | | | <table border="1" style="width: 100%; border-collapse: collapse; text-align: center;"> <tr> <td style="width: 10%;"></td> <td style="width: 10%;"></td> <td style="width: 10%;"></td> <td style="width: 10%;"></td> <td style="width: 10%;"></td> <td style="width: 10%;"></td> <td style="width: 10%;"></td> <td style="width: 10%;"></td> <td style="width: 10%;"></td> <td style="width: 10%;"></td> </tr> <tr> <td></td> <td></td> <td colspan="8" style="text-align: center;"> <table border="1" style="width: 100%; border-collapse: collapse; text-align: center;"> <tr> <td style="width: 10%;"></td> <td style="width: 10%;"></td> <td style="width: 10%;"></td> <td style="width: 10%;"></td> <td style="width: 10%;"></td> <td style="width: 10%;"></td> <td style="width: 10%;"></td> <td style="width: 10%;"></td> <td style="width: 10%;"></td> <td style="width: 10%;"></td> </tr> <tr> <td></td> <td></td> <td colspan="8" style="text-align: center;"> <table border="1" style="width: 100%; border-collapse: collapse; text-align: center;"> <tr> <td style="width: 10%;"></td> <td style="width: 10%;"></td> <td style="width: 10%;"></td> <td style="width: 10%;"></td> <td style="width: 10%;"></td> <td style="width: 10%;"></td> <td style="width: 10%;"></td> <td style="width: 10%;"></td> <td style="width: 10%;"></td> <td style="width: 10%;"></td> </tr> <tr> <td></td> <td></td> <td colspan="8" style="text-align: center;"> <table border="1" style="width: 100%; border-collapse: collapse; text-align: center;"> <tr> <td style="width: 10%;"></td> <td style="width: 10%;"></td> <td style="width: 10%;"></td> <td style="width: 10%;"></td> <td style="width: 10%;"></td> <td style="width: 10%;"></td> <td style="width: 10%;"></td> <td style="width: 10%;"></td> <td style="width: 10%;"></td> <td style="width: 10%;"></td> </tr> <tr> <td></td> <td></td> <td colspan="8" style="text-align: center;"> <table border="1" style="width: 100%; border-collapse: collapse; text-align: center;"> <tr> <td style="width: 10%;"></td> <td style="width: 10%;"></td> <td style="width: 10%;"></td> <td style="width: 10%;"></td> <td style="width: 10%;"></td> <td style="width: 10%;"></td> <td style="width: 10%;"></td> <td style="width: 10%;"></td> <td style="width: 10%;"></td> <td style="width: 10%;"></td> </tr> <tr> <td></td> <td></td> <td colspan="8" style="text-align: center;"> <table border="1" style="width: 100%; border-collapse: collapse; text-align: center;"> <tr> <td style="width: 10%;"></td> <td style="width: 10%;"></td> <td style="width: 10%;"></td> <td style="width: 10%;"></td> <td style="width: 10%;"></td> <td style="width: 10%;"></td> <td style="width: 10%;"></td> <td style="width: 10%;"></td> <td style="width: 10%;"></td> <td style="width: 10%;"></td> </tr> <tr> <td></td> <td></td> <td colspan="8" style="text-align: center;"> <table border="1" style="width: 100%; border-collapse: collapse; text-align: center;"> <tr> <td style="width: 10%;"></td> <td style="width: 10%;"></td> <td style="width: 10%;"></td> <td style="width: 10%;"></td> <td style="width: 10%;"></td> <td style="width: 10%;"></td> <td style="width: 10%;"></td> <td style="width: 10%;"></td> <td style="width: 10%;"></td> <td style="width: 10%;"></td> </tr> <tr> <td></td> <td></td> <td colspan="8" style="text-align: center;"> <table border="1" style="width: 100%; border-collapse: collapse; text-align: center;"> <tr> <td style="width: 10%;"></td> <td style="width: 10%;"></td> <td style="width: 10%;"></td> <td style="width: 10%;"></td> <td style="width: 10%;"></td> <td style="width: 10%;"></td> <td style="width: 10%;"></td> <td style="width: 10%;"></td> <td style="width: 10%;"></td> <td style="width: 10%;"></td> </tr> <tr> <td></td> <td></td> <td colspan="8" style="text-align: center;"> <table border="1" style="width: 100%; border-collapse: collapse; text-align: center;"> <tr> <td style="width: 10%;"></td> <td style="width: 10%;"></td> <td style="width: 10%;"></td> <td style="width: 10%;"></td> <td style="width: 10%;"></td> <td style="width: 10%;"></td> <td style="width: 10%;"></td> <td style="width: 10%;"></td> <td style="width: 10%;"></td> <td style="width: 10%;"></td> </tr> <tr> <td></td> <td></td> <td colspan="8" style="text-align: center;"> <table border="1" style="width: 100%; border-collapse: collapse; text-align: center;"> <tr> <td style="width: 10%;"></td> <td style="width: 10%;"></td> <td style="width: 10%;"></td> <td style="width: 10%;"></td> <td style="width: 10%;"></td> <td style="width: 10%;"></td> <td style="width: 10%;"></td> <td style="width: 10%;"></td> <td style="width: 10%;"></td> <td style="width: 10%;"></td> </tr> <tr> <td></td> <td></td> <td colspan="8" style="text-align: center;"> <table border="1" style="width: 100%; border-collapse: collapse; text-align: center;"> <tr> </tr></table></td></tr></table></td></tr></table></td></tr></table></td></tr></table></td></tr></table></td></tr></table></td></tr></table></td></tr></table></td></tr></table></td></tr></table>

 | | | | | | | | | | | | | | | | | | | | <table border="1" style="width: 100%; border-collapse: collapse; text-align: center;"> <tr> <td style="width: 10%;"></td> <td style="width: 10%;"></td> <td style="width: 10%;"></td> <td style="width: 10%;"></td> <td style="width: 10%;"></td> <td style="width: 10%;"></td> <td style="width: 10%;"></td> <td style="width: 10%;"></td> <td style="width: 10%;"></td> <td style="width: 10%;"></td> </tr> <tr> <td></td> <td></td> <td colspan="8" style="text-align: center;"> <table border="1" style="width: 100%; border-collapse: collapse; text-align: center;"> <tr> <td style="width: 10%;"></td> <td style="width: 10%;"></td> <td style="width: 10%;"></td> <td style="width: 10%;"></td> <td style="width: 10%;"></td> <td style="width: 10%;"></td> <td style="width: 10%;"></td> <td style="width: 10%;"></td> <td style="width: 10%;"></td> <td style="width: 10%;"></td> </tr> <tr> <td></td> <td></td> <td colspan="8" style="text-align: center;"> <table border="1" style="width: 100%; border-collapse: collapse; text-align: center;"> <tr> <td style="width: 10%;"></td> <td style="width: 10%;"></td> <td style="width: 10%;"></td> <td style="width: 10%;"></td> <td style="width: 10%;"></td> <td style="width: 10%;"></td> <td style="width: 10%;"></td> <td style="width: 10%;"></td> <td style="width: 10%;"></td> <td style="width: 10%;"></td> </tr> <tr> <td></td> <td></td> <td colspan="8" style="text-align: center;"> <table border="1" style="width: 100%; border-collapse: collapse; text-align: center;"> <tr> <td style="width: 10%;"></td> <td style="width: 10%;"></td> <td style="width: 10%;"></td> <td style="width: 10%;"></td> <td style="width: 10%;"></td> <td style="width: 10%;"></td> <td style="width: 10%;"></td> <td style="width: 10%;"></td> <td style="width: 10%;"></td> <td style="width: 10%;"></td> </tr> <tr> <td></td> <td></td> <td colspan="8" style="text-align: center;"> <table border="1" style="width: 100%; border-collapse: collapse; text-align: center;"> <tr> <td style="width: 10%;"></td> <td style="width: 10%;"></td> <td style="width: 10%;"></td> <td style="width: 10%;"></td> <td style="width: 10%;"></td> <td style="width: 10%;"></td> <td style="width: 10%;"></td> <td style="width: 10%;"></td> <td style="width: 10%;"></td> <td style="width: 10%;"></td> </tr> <tr> <td></td> <td></td> <td colspan="8" style="text-align: center;"> <table border="1" style="width: 100%; border-collapse: collapse; text-align: center;"> <tr> <td style="width: 10%;"></td> <td style="width: 10%;"></td> <td style="width: 10%;"></td> <td style="width: 10%;"></td> <td style="width: 10%;"></td> <td style="width: 10%;"></td> <td style="width: 10%;"></td> <td style="width: 10%;"></td> <td style="width: 10%;"></td> <td style="width: 10%;"></td> </tr> <tr> <td></td> <td></td> <td colspan="8" style="text-align: center;"> <table border="1" style="width: 100%; border-collapse: collapse; text-align: center;"> <tr> <td style="width: 10%;"></td> <td style="width: 10%;"></td> <td style="width: 10%;"></td> <td style="width: 10%;"></td> <td style="width: 10%;"></td> <td style="width: 10%;"></td> <td style="width: 10%;"></td> <td style="width: 10%;"></td> <td style="width: 10%;"></td> <td style="width: 10%;"></td> </tr> <tr> <td></td> <td></td> <td colspan="8" style="text-align: center;"> <table border="1" style="width: 100%; border-collapse: collapse; text-align: center;"> <tr> <td style="width: 10%;"></td> <td style="width: 10%;"></td> <td style="width: 10%;"></td> <td style="width: 10%;"></td> <td style="width: 10%;"></td> <td style="width: 10%;"></td> <td style="width: 10%;"></td> <td style="width: 10%;"></td> <td style="width: 10%;"></td> <td style="width: 10%;"></td> </tr> <tr> <td></td> <td></td> <td colspan="8" style="text-align: center;"> <table border="1" style="width: 100%; border-collapse: collapse; text-align: center;"> <tr> <td style="width: 10%;"></td> <td style="width: 10%;"></td> <td style="width: 10%;"></td> <td style="width: 10%;"></td> <td style="width: 10%;"></td> <td style="width: 10%;"></td> <td style="width: 10%;"></td> <td style="width: 10%;"></td> <td style="width: 10%;"></td> <td style="width: 10%;"></td> </tr> <tr> <td></td> <td></td> <td colspan="8" style="text-align: center;"> <table border="1" style="width: 100%; border-collapse: collapse; text-align: center;"> <tr> </tr></table></td></tr></table></td></tr></table></td></tr></table></td></tr></table></td></tr></table></td></tr></table></td></tr></table></td></tr></table></td></tr></table>

 | | | | | | | | | | | | | | | | | | | | <table border="1" style="width: 100%; border-collapse: collapse; text-align: center;"> <tr> <td style="width: 10%;"></td> <td style="width: 10%;"></td> <td style="width: 10%;"></td> <td style="width: 10%;"></td> <td style="width: 10%;"></td> <td style="width: 10%;"></td> <td style="width: 10%;"></td> <td style="width: 10%;"></td> <td style="width: 10%;"></td> <td style="width: 10%;"></td> </tr> <tr> <td></td> <td></td> <td colspan="8" style="text-align: center;"> <table border="1" style="width: 100%; border-collapse: collapse; text-align: center;"> <tr> <td style="width: 10%;"></td> <td style="width: 10%;"></td> <td style="width: 10%;"></td> <td style="width: 10%;"></td> <td style="width: 10%;"></td> <td style="width: 10%;"></td> <td style="width: 10%;"></td> <td style="width: 10%;"></td> <td style="width: 10%;"></td> <td style="width: 10%;"></td> </tr> <tr> <td></td> <td></td> <td colspan="8" style="text-align: center;"> <table border="1" style="width: 100%; border-collapse: collapse; text-align: center;"> <tr> <td style="width: 10%;"></td> <td style="width: 10%;"></td> <td style="width: 10%;"></td> <td style="width: 10%;"></td> <td style="width: 10%;"></td> <td style="width: 10%;"></td> <td style="width: 10%;"></td> <td style="width: 10%;"></td> <td style="width: 10%;"></td> <td style="width: 10%;"></td> </tr> <tr> <td></td> <td></td> <td colspan="8" style="text-align: center;"> <table border="1" style="width: 100%; border-collapse: collapse; text-align: center;"> <tr> <td style="width: 10%;"></td> <td style="width: 10%;"></td> <td style="width: 10%;"></td> <td style="width: 10%;"></td> <td style="width: 10%;"></td> <td style="width: 10%;"></td> <td style="width: 10%;"></td> <td style="width: 10%;"></td> <td style="width: 10%;"></td> <td style="width: 10%;"></td> </tr> <tr> <td></td> <td></td> <td colspan="8" style="text-align: center;"> <table border="1" style="width: 100%; border-collapse: collapse; text-align: center;"> <tr> <td style="width: 10%;"></td> <td style="width: 10%;"></td> <td style="width: 10%;"></td> <td style="width: 10%;"></td> <td style="width: 10%;"></td> <td style="width: 10%;"></td> <td style="width: 10%;"></td> <td style="width: 10%;"></td> <td style="width: 10%;"></td> <td style="width: 10%;"></td> </tr> <tr> <td></td> <td></td> <td colspan="8" style="text-align: center;"> <table border="1" style="width: 100%; border-collapse: collapse; text-align: center;"> <tr> <td style="width: 10%;"></td> <td style="width: 10%;"></td> <td style="width: 10%;"></td> <td style="width: 10%;"></td> <td style="width: 10%;"></td> <td style="width: 10%;"></td> <td style="width: 10%;"></td> <td style="width: 10%;"></td> <td style="width: 10%;"></td> <td style="width: 10%;"></td> </tr> <tr> <td></td> <td></td> <td colspan="8" style="text-align: center;"> <table border="1" style="width: 100%; border-collapse: collapse; text-align: center;"> <tr> <td style="width: 10%;"></td> <td style="width: 10%;"></td> <td style="width: 10%;"></td> <td style="width: 10%;"></td> <td style="width: 10%;"></td> <td style="width: 10%;"></td> <td style="width: 10%;"></td> <td style="width: 10%;"></td> <td style="width: 10%;"></td> <td style="width: 10%;"></td> </tr> <tr> <td></td> <td></td> <td colspan="8" style="text-align: center;"> <table border="1" style="width: 100%; border-collapse: collapse; text-align: center;"> <tr> <td style="width: 10%;"></td> <td style="width: 10%;"></td> <td style="width: 10%;"></td> <td style="width: 10%;"></td> <td style="width: 10%;"></td> <td style="width: 10%;"></td> <td style="width: 10%;"></td> <td style="width: 10%;"></td> <td style="width: 10%;"></td> <td style="width: 10%;"></td> </tr> <tr> <td></td> <td></td> <td colspan="8" style="text-align: center;"> <table border="1" style="width: 100%; border-collapse: collapse; text-align: center;"> <tr> </tr></table></td></tr></table></td></tr></table></td></tr></table></td></tr></table></td></tr></table></td></tr></table></td></tr></table></td></tr></table>
 | | | | | | | | | | | | | | | | | | | | <table border="1" style="width: 100%; border-collapse: collapse; text-align: center;"> <tr> <td style="width: 10%;"></td> <td style="width: 10%;"></td> <td style="width: 10%;"></td> <td style="width: 10%;"></td> <td style="width: 10%;"></td> <td style="width: 10%;"></td> <td style="width: 10%;"></td> <td style="width: 10%;"></td> <td style="width: 10%;"></td> <td style="width: 10%;"></td> </tr> <tr> <td></td> <td></td> <td colspan="8" style="text-align: center;"> <table border="1" style="width: 100%; border-collapse: collapse; text-align: center;"> <tr> <td style="width: 10%;"></td> <td style="width: 10%;"></td> <td style="width: 10%;"></td> <td style="width: 10%;"></td> <td style="width: 10%;"></td> <td style="width: 10%;"></td> <td style="width: 10%;"></td> <td style="width: 10%;"></td> <td style="width: 10%;"></td> <td style="width: 10%;"></td> </tr> <tr> <td></td> <td></td> <td colspan="8" style="text-align: center;"> <table border="1" style="width: 100%; border-collapse: collapse; text-align: center;"> <tr> <td style="width: 10%;"></td> <td style="width: 10%;"></td> <td style="width: 10%;"></td> <td style="width: 10%;"></td> <td style="width: 10%;"></td> <td style="width: 10%;"></td> <td style="width: 10%;"></td> <td style="width: 10%;"></td> <td style="width: 10%;"></td> <td style="width: 10%;"></td> </tr> <tr> <td></td> <td></td> <td colspan="8" style="text-align: center;"> <table border="1" style="width: 100%; border-collapse: collapse; text-align: center;"> <tr> <td style="width: 10%;"></td> <td style="width: 10%;"></td> <td style="width: 10%;"></td> <td style="width: 10%;"></td> <td style="width: 10%;"></td> <td style="width: 10%;"></td> <td style="width: 10%;"></td> <td style="width: 10%;"></td> <td style="width: 10%;"></td> <td style="width: 10%;"></td> </tr> <tr> <td></td> <td></td> <td colspan="8" style="text-align: center;"> <table border="1" style="width: 100%; border-collapse: collapse; text-align: center;"> <tr> <td style="width: 10%;"></td> <td style="width: 10%;"></td> <td style="width: 10%;"></td> <td style="width: 10%;"></td> <td style="width: 10%;"></td> <td style="width: 10%;"></td> <td style="width: 10%;"></td> <td style="width: 10%;"></td> <td style="width: 10%;"></td> <td style="width: 10%;"></td> </tr> <tr> <td></td> <td></td> <td colspan="8" style="text-align: center;"> <table border="1" style="width: 100%; border-collapse: collapse; text-align: center;"> <tr> <td style="width: 10%;"></td> <td style="width: 10%;"></td> <td style="width: 10%;"></td> <td style="width: 10%;"></td> <td style="width: 10%;"></td> <td style="width: 10%;"></td> <td style="width: 10%;"></td> <td style="width: 10%;"></td> <td style="width: 10%;"></td> <td style="width: 10%;"></td> </tr> <tr>
<td></td> <td></td> <td colspan="8" style="text-align: center;"> <table border="1" style="width: 100%; border-collapse: collapse; text-align: center;"> <tr> <td style="width: 10%;"></td> <td style="width: 10%;"></td> <td style="width: 10%;"></td> <td style="width: 10%;"></td> <td style="width: 10%;"></td> <td style="width: 10%;"></td> <td style="width: 10%;"></td> <td style="width: 10%;"></td> <td style="width: 10%;"></td> <td style="width: 10%;"></td> </tr> <tr> <td></td> <td></td> <td colspan="8" style="text-align: center;"> <table border="1" style="width: 100%; border-collapse: collapse; text-align: center;"> <tr> </tr></table></td></tr></table></td></tr></table></td></tr></table></td></tr></table></td></tr></table></td></tr></table></td></tr></table>
 | | | | | | | | | | | | | | | | | | | | <table border="1" style="width: 100%; border-collapse: collapse; text-align: center;"> <tr> <td style="width: 10%;"></td> <td style="width: 10%;"></td> <td style="width: 10%;"></td> <td style="width: 10%;"></td> <td style="width: 10%;"></td> <td style="width: 10%;"></td> <td style="width: 10%;"></td> <td style="width: 10%;"></td> <td style="width: 10%;"></td> <td style="width: 10%;"></td> </tr> <tr> <td></td> <td></td> <td colspan="8" style="text-align: center;"> <table border="1" style="width: 100%; border-collapse: collapse; text-align: center;"> <tr> <td style="width: 10%;"></td> <td style="width: 10%;"></td> <td style="width: 10%;"></td> <td style="width: 10%;"></td> <td style="width: 10%;"></td> <td style="width: 10%;"></td> <td style="width: 10%;"></td> <td style="width: 10%;"></td> <td style="width: 10%;"></td> <td style="width: 10%;"></td> </tr> <tr> <td></td> <td></td> <td colspan="8" style="text-align: center;"> <table border="1" style="width: 100%; border-collapse: collapse; text-align: center;"> <tr> <td style="width: 10%;"></td> <td style="width: 10%;"></td> <td style="width: 10%;"></td> <td style="width: 10%;"></td> <td style="width: 10%;"></td> <td style="width: 10%;"></td> <td style="width: 10%;"></td> <td style="width: 10%;"></td> <td style="width: 10%;"></td> <td style="width: 10%;"></td> </tr> <tr> <td></td> <td></td> <td colspan="8" style="text-align: center;"> <table border="1" style="width: 100%; border-collapse: collapse; text-align: center;"> <tr> <td style="width: 10%;"></td> <td style="width: 10%;"></td> <td style="width: 10%;"></td> <td style="width: 10%;"></td> <td style="width: 10%;"></td> <td style="width: 10%;"></td> <td style="width: 10%;"></td> <td style="width: 10%;"></td> <td style="width: 10%;"></td> <td style="width: 10%;"></td> </tr> <tr> <td></td> <td></td> <td colspan="8" style="text-align: center;"> <table border="1" style="width: 100%; border-collapse: collapse; text-align: center;"> <tr> <td style="width: 10%;"></td> <td style="width: 10%;"></td> <td style="width: 10%;"></td> <td style="width: 10%;"></td> <td style="width: 10%;"></td> <td style="width: 10%;"></td> <td style="width: 10%;"></td> <td style="width: 10%;"></td> <td style="width: 10%;"></td> <td style="width: 10%;"></td> </tr> <tr> <td></td> <td></td> <td colspan="8" style="text-align: center;"> <table border="1" style="width: 100%; border-collapse: collapse; text-align: center;"> <tr> <td style="width: 10%;"></td> <td style="width: 10%;"></td> <td style="width: 10%;"></td> <td style="width: 10%;"></td> <td style="width: 10%;"></td> <td style="width: 10%;"></td> <td style="width: 10%;"></td> <td style="width: 10%;"></td> <td style="width: 10%;"></td> <td style="width: 10%;"></td> </tr> <tr> <td></td> <td></td> <td colspan="8" style="text-align: center;"> <table border="1" style="width: 100%; border-collapse: collapse; text-align: center;"> <tr> </tr></table></td></tr></table></td></tr></table></td></tr></table></td></tr></table></td></tr></table></td></tr></table>

 | | | | | | | | | | | | | | | | | | | | <table border="1" style="width: 100%; border-collapse: collapse; text-align: center;"> <tr> <td style="width: 10%;"></td> <td style="width: 10%;"></td> <td style="width: 10%;"></td> <td style="width: 10%;"></td> <td style="width: 10%;"></td> <td style="width: 10%;"></td> <td style="width: 10%;"></td> <td style="width: 10%;"></td> <td style="width: 10%;"></td> <td style="width: 10%;"></td> </tr> <tr> <td></td> <td></td> <td colspan="8" style="text-align: center;"> <table border="1" style="width: 100%; border-collapse: collapse; text-align: center;"> <tr> <td style="width: 10%;"></td> <td style="width: 10%;"></td> <td style="width: 10%;"></td> <td style="width: 10%;"></td> <td style="width: 10%;"></td> <td style="width: 10%;"></td> <td style="width: 10%;"></td> <td style="width: 10%;"></td> <td style="width: 10%;"></td> <td style="width: 10%;"></td> </tr> <tr> <td></td> <td></td> <td colspan="8" style="text-align: center;"> <table border="1" style="width: 100%; border-collapse: collapse; text-align: center;"> <tr> <td style="width: 10%;"></td> <td style="width: 10%;"></td> <td style="width: 10%;"></td> <td style="width: 10%;"></td> <td style="width: 10%;"></td> <td style="width: 10%;"></td> <td style="width: 10%;"></td> <td style="width: 10%;"></td> <td style="width: 10%;"></td> <td style="width: 10%;"></td> </tr> <tr> <td></td> <td></td> <td colspan="8" style="text-align: center;"> <table border="1" style="width: 100%; border-collapse: collapse; text-align: center;"> <tr> <td style="width: 10%;"></td> <td style="width: 10%;"></td> <td style="width: 10%;"></td> <td style="width: 10%;"></td> <td style="width: 10%;"></td> <td style="width: 10%;"></td> <td style="width: 10%;"></td> <td style="width: 10%;"></td> <td style="width: 10%;"></td> <td style="width: 10%;"></td> </tr> <tr> <td></td> <td></td> <td colspan="8" style="text-align: center;"> <table border="1" style="width: 100%; border-collapse: collapse; text-align: center;"> <tr> <td style="width: 10%;"></td> <td style="width: 10%;"></td> <td style="width: 10%;"></td> <td style="width: 10%;"></td> <td style="width: 10%;"></td> <td style="width: 10%;"></td> <td style="width: 10%;"></td> <td style="width: 10%;"></td> <td style="width: 10%;"></td> <td style="width: 10%;"></td> </tr> <tr> <td></td> <td></td> <td colspan="8" style="text-align: center;"> <table border="1" style="width: 100%; border-collapse: collapse; text-align: center;"> <tr> </tr></table></td></tr></table></td></tr></table></td></tr></table></td></tr></table></td></tr></table>
 | | | | | | | | | | | | | | | | | | | | <table border="1" style="width: 100%; border-collapse: collapse; text-align: center;"> <tr> <td style="width: 10%;"></td> <td style="width: 10%;"></td> <td style="width: 10%;"></td> <td style="width: 10%;"></td> <td style="width: 10%;"></td> <td style="width: 10%;"></td> <td style="width: 10%;"></td> <td style="width: 10%;"></td> <td style="width: 10%;"></td> <td style="width: 10%;"></td> </tr> <tr> <td></td> <td></td> <td colspan="8" style="text-align: center;"> <table border="1" style="width: 100%; border-collapse: collapse; text-align: center;"> <tr> <td style="width: 10%;"></td> <td style="width: 10%;"></td> <td style="width: 10%;"></td> <td style="width: 10%;"></td> <td style="width: 10%;"></td> <td style="width: 10%;"></td> <td style="width: 10%;"></td> <td style="width: 10%;"></td> <td style="width: 10%;"></td> <td style="width: 10%;"></td> </tr> <tr> <td></td> <td></td> <td colspan="8" style="text-align: center;"> <table border="1" style="width: 100%; border-collapse: collapse; text-align: center;"> <tr> <td style="width: 10%;"></td> <td style="width: 10%;"></td> <td style="width: 10%;"></td> <td style="width: 10%;"></td> <td style="width: 10%;"></td> <td style="width: 10%;"></td> <td style="width: 10%;"></td> <td style="width: 10%;"></td> <td style="width: 10%;"></td> <td style="width: 10%;"></td> </tr> <tr> <td></td> <td></td> <td colspan="8" style="text-align: center;"> <table border="1" style="width: 100%; border-collapse: collapse; text-align: center;"> <tr> <td style="width: 10%;"></td> <td style="width: 10%;"></td> <td style="width: 10%;"></td> <td style="width: 10%;"></td> <td style="width: 10%;"></td> <td style="width: 10%;"></td> <td style="width: 10%;"></td> <td style="width: 10%;"></td> <td style="width: 10%;"></td> <td style="width: 10%;"></td> </tr> <tr> <td></td> <td></td> <td colspan="8" style="text-align: center;"> <table border="1" style="width: 100%; border-collapse: collapse; text-align: center;"> <tr> </tr></table></td></tr></table></td></tr></table></td></tr></table></td></tr></table>

 | | | | | | | | | | | | | | | | | | | | <table border="1" style="width: 100%; border-collapse: collapse; text-align: center;"> <tr> <td style="width: 10%;"></td> <td style="width: 10%;"></td> <td style="width: 10%;"></td> <td style="width: 10%;"></td> <td style="width: 10%;"></td> <td style="width: 10%;"></td> <td style="width: 10%;"></td> <td style="width: 10%;"></td> <td style="width: 10%;"></td> <td style="width: 10%;"></td> </tr> <tr> <td></td> <td></td> <td colspan="8" style="text-align: center;"> <table border="1" style="width: 100%; border-collapse: collapse; text-align: center;"> <tr> <td style="width: 10%;"></td> <td style="width: 10%;"></td> <td style="width: 10%;"></td> <td style="width: 10%;"></td> <td style="width: 10%;"></td> <td style="width: 10%;"></td> <td style="width: 10%;"></td> <td style="width: 10%;"></td> <td style="width: 10%;"></td> <td style="width: 10%;"></td> </tr> <tr> <td></td> <td></td> <td colspan="8" style="text-align: center;"> <table border="1" style="width: 100%; border-collapse: collapse; text-align: center;"> <tr> <td style="width: 10%;"></td> <td style="width: 10%;"></td> <td style="width: 10%;"></td> <td style="width: 10%;"></td> <td style="width: 10%;"></td> <td style="width: 10%;"></td> <td style="width: 10%;"></td> <td style="width: 10%;"></td> <td style="width: 10%;"></td> <td style="width: 10%;"></td> </tr> <tr> <td></td> <td></td> <td colspan="8" style="text-align: center;"> <table border="1" style="width: 100%; border-collapse: collapse; text-align: center;"> <tr> </tr></table></td></tr></table></td></tr></table></td></tr></table>
 | | | | | | | | | | | | | | | | | | | | <table border="1" style="width: 100%; border-collapse: collapse; text-align: center;"> <tr> <td style="width: 10%;"></td> <td style="width: 10%;"></td> <td style="width: 10%;"></td> <td style="width: 10%;"></td> <td style="width: 10%;"></td> <td style="width: 10%;"></td> <td style="width: 10%;"></td> <td style="width: 10%;"></td> <td style="width: 10%;"></td> <td style="width: 10%;"></td> </tr> <tr> <td></td> <td></td> <td colspan="8" style="text-align: center;"> <table border="1" style="width: 100%; border-collapse: collapse; text-align: center;"> <tr> <td style="width: 10%;"></td> <td style="width: 10%;"></td> <td style="width: 10%;"></td> <td style="width: 10%;"></td> <td style="width: 10%;"></td> <td style="width: 10%;"></td> <td style="width: 10%;"></td> <td style="width: 10%;"></td> <td style="width: 10%;"></td> <td style="width: 10%;"></td> </tr> <tr> <td></td> <td></td> <td colspan="8" style="text-align: center;"> <table border="1" style="width: 100%; border-collapse: collapse; text-align: center;"> <tr> </tr></table></td></tr></table></td></tr></table>

 | | | | | | | | | | | | | | | | | | | | <table border="1" style="width: 100%; border-collapse: collapse; text-align: center;"> <tr> <td style="width: 10%;"></td> <td style="width: 10%;"></td> <td style="width: 10%;"></td> <td style="width: 10%;"></td> <td style="width: 10%;"></td> <td style="width: 10%;"></td> <td style="width: 10%;"></td> <td style="width: 10%;"></td> <td style="width: 10%;"></td> <td style="width: 10%;"></td> </tr> <tr> <td></td> <td></td> <td colspan="8" style="text-align: center;"> <table border="1" style="width: 100%; border-collapse: collapse; text-align: center;"> <tr> </tr></table></td></tr></table>
 | | | | | | | | | | | | | | | | | | | | <table border="1" style="width: 100%; border-collapse: collapse; text-align: center;"> <tr> </tr></table>
 | | | | | | | | | | | | | | | | | | | |
 | | | | | | | | | | | | | | | | | | | |

 | | | | | | | | | | | | | | | | | | | | | | | | | | | | | | | | | | | | | | | | | | | | | | | | | | | | | | | | | | | | | | | | | | | | | | | | | | | | | | | |
 | | | | | | | | | | | | | | | | | | | |
 | | | | | | | | | | | | | | | | | | | |
 | | | | | | | | | | | | | | | | | | | |
 | | | | | | | | | | | | | | | | | | | |
 | | | | | | | | | | | | | | | | | | | |
 | | | | | | | | | | | | | | | | | | | |
 | | | | | | | | | | | | | | | | | | | |
 | | | | | | | | | | | | | | | | | | | |
 | | | | | | | | | | | | | | | | | | | | | | | | | | | | | | | | | | | | | | | |
 | | | | | | | | | | | | | | | | | | | |
 | | | | | | | | | | | | | | | | | | | | | | | | | | | | | | | | | | | | | | | |
 | | | | | | | | | | | | | | | | | | | | | | | | | | | | | | | | | | | | | | | |
 | | | | | | | | | | | | | | | | | | | | | | | | | | | | | | | | | | | | | | | |
 | | | | | | | | | | | | | | | | | | | | | | | | | | | | | | | | | | | | | | | | | | | | | | | | | | | | | | | | | | | | | | | | | | | | | | | | | | | | | | | |
 | | | | | | | | | | | | | | | | | | | | | | | | | | | | | | | | | | | | | | | | | | | | | | | | | | | | | | | | | | | | | | | | | | | |
| | |

 | | | | | | | | | | | | | | | | | | | |

 | | | | | | | | | | | | | | | | | | | |

 | | | | | | | | | | | | | | | | | | | |

 | | | | | | | | | | | | | | | | | | | |

 | | | | | | | | | | | | | | | | | | | |

 | | | | | | | | | | | | | | | | | | | |

 | | | | | | | | | | | | | | | | | | | |

 | | | | | | | | | | | | | | | | | | | |

 | | | | | | | | | | | | | | | | | | | |

 | | | | | | | | | | | | | | | | | | | |

 | | | | | | | | | | | | | | | | | | | |

 | | | | | | | | | | | | | | | | | | | |

 | | | | | | | | | | | | | | | | | | | |

 | | | | | | | | | | | | | | | | | | | |

 | | | | | | | | | | | | | | | | | | | |

 | | | | | | | | | | | | | | | | | | | |

 | | | | | | | | | | | | | | | | | | | |

 | | | | | | | | | | | | | | | | | | | |

 | | | | | | | | | | | | | | | | | | | |

 | | | | | | | | | | | | | | | | | | | |

 | | | | | | | | | | | | | | | | | | | |

 | | | | | | | | | | | | | | | | | | | |

 | | | | | | | | | | | | | | | | | | | |

 | | | | | | | | | | | | | | | | | | | |

 | | | | | | | | | | | | | | | | | | | |

 | | | | | | | | | | | | | | | | | | | |

 | | | | | | | | | | | | | | | | | | | |

 | | | | | | | | | | | | | | | | | | | |
 | | | | | | | | | | | | | | | | | | | |

 | | | | | | | | | | | | | | | | | | | |

 | | | | | | | | | | | | | | | | | | | |
 | | | | | | | | | | | | | | | | | | | |

 | | | | | | | | | | | | | | | | | | | |

 | | | | | | | | | | | | | | | | | | | |
 | | | | | | | | | | | | | | | | | | | |
 | | | | | | | | | | | | | | | | | | | |

 | | | | | | | | | | | | | | | | | | | |
 | | | | | | | | | | | | | | | | | | | |
 | | | | | | | | | | | | | | | | | | | |

 | | | | | | | | | | | | | | | | | | | | | | | | | | | | | | | | | | | | | | | | | | | | | | | | | | | | | | | | | | | | | | | | | | | | | | | | | | | | | | | | | | | | | | | | | | | | | | | | | | | |
 | | | | | | | | | | | | | | | | | | | |
 | | | | | | | | | | | | | | | | | | | |
 | | | | | | | | | | | | | | | | | | | |
 | | | | | | | | | | | | | | | | | | | |
 | | | | | | | | | | | | | | | | | | | |
 | | | | | | | | | | | | | | | | | | | |
 | | | | | | | | | | | | | | | | | | | |
 | | | | | | | | | | | | | | | | | | | |
 | | | | | | | | | | | | | | | | | | | | | | | | | | | | | | | | | | | | | | | |
 | | | | | | | | | | | | | | | | | | | |
 | | | | | | | | | | | | | | | | | | | | | | | | | | | | | | | | | | | | | | | |
 | | | | | | | | | | | | | | | | | | | | | | | | | | | | | | | | | | | | | | | |
 | | | | | | | | | | | | | | | | | | | | | | | | | | | | | | | | | | | | | | | |
 | | | | | | | | | | | | | | | | | | | | | | | | | | | | | | | | | | | | | | | | | | | | | | | | | | | | | | | | | | | | | | | | | | | | | | | | | | | | | | | | | | | | | | | | | | | | | | | | | | | |
 | | | | | | | | | | | | | | | | | | | | | | | | | | | | | | | | | | | | | | | | | | | | | | | |
| | | <table border="1" style="width: 100%; border-collapse: collapse; text-align: center;"> <tr> <td style="width: 10%;"></td> <td style="width: 10%;"></td> <td style="width: 10%;"></td> <td style="width: 10%;"></td> <td style="width: 10%;"></td> <td style="width: 10%;"></td> <td style="width: 10%;"></td> <td style="width: 10%;"></td> <td style="width: 10%;"></td> <td style="width: 10%;"></td> </tr> <tr> <td></td> <td></td> <td colspan="8" style="text-align: center;"> <table border="1" style="width: 100%; border-collapse: collapse; text-align: center;"> <tr> <td style="width: 10%;"></td> <td style="width: 10%;"></td> <td style="width: 10%;"></td> <td style="width: 10%;"></td> <td style="width: 10%;"></td> <td style="width: 10%;"></td> <td style="width: 10%;"></td> <td style="width: 10%;"></td> <td style="width: 10%;"></td> <td style="width: 10%;"></td> </tr> <tr> <td></td> <td></td> <td colspan="8" style="text-align: center;"> <table border="1" style="width: 100%; border-collapse: collapse; text-align: center;"> <tr> <td style="width: 10%;"></td> <td style="width: 10%;"></td> <td style="width: 10%;"></td> <td style="width: 10%;"></td> <td style="width: 10%;"></td> <td style="width: 10%;"></td> <td style="width: 10%;"></td> <td style="width: 10%;"></td> <td style="width: 10%;"></td> <td style="width: 10%;"></td> </tr> <tr> <td></td> <td></td> <td colspan="8" style="text-align: center;"> <table border="1" style="width: 100%; border-collapse: collapse; text-align: center;"> <tr> <td style="width: 10%;"></td> <td style="width: 10%;"></td> <td style="width: 10%;"></td> <td style="width: 10%;"></td> <td style="width: 10%;"></td> <td style="width: 10%;"></td> <td style="width: 10%;"></td> <td style="width: 10%;"></td> <td style="width: 10%;"></td> <td style="width: 10%;"></td> </tr> <tr> <td></td> <td></td> <td colspan="8" style="text-align: center;"> <table border="1" style="width: 100%; border-collapse: collapse; text-align: center;"> <tr> <td style="width: 10%;"></td> <td style="width: 10%;"></td> <td style="width: 10%;"></td> <td style="width: 10%;"></td> <td style="width: 10%;"></td> <td style="width: 10%;"></td> <td style="width: 10%;"></td> <td style="width: 10%;"></td> <td style="width: 10%;"></td> <td style="width: 10%;"></td> </tr> <tr> <td></td> <td></td> <td colspan="8" style="text-align: center;"> <table border="1" style="width: 100%; border-collapse: collapse; text-align: center;"> <tr> <td style="width: 10%;"></td> <td style="width: 10%;"></td> <td style="width: 10%;"></td> <td style="width: 10%;"></td> <td style="width: 10%;"></td> <td style="width: 10%;"></td> <td style="width: 10%;"></td> <td style="width: 10%;"></td> <td style="width: 10%;"></td> <td style="width: 10%;"></td> </tr> <tr> <td></td> <td></td> <td colspan="8" style="text-align: center;"> <table border="1" style="width: 100%; border-collapse: collapse; text-align: center;"> <tr> <td style="width: 10%;"></td> <td style="width: 10%;"></td> <td style="width: 10%;"></td> <td style="width: 10%;"></td> <td style="width: 10%;"></td> <td style="width: 10%;"></td> <td style="width: 10%;"></td> <td style="width: 10%;"></td> <td style="width: 10%;"></td> <td style="width: 10%;"></td> </tr> <tr> <td></td> <td></td> <td colspan="8" style="text-align: center;"> <table border="1" style="width: 100%; border-collapse: collapse; text-align: center;"> <tr> <td style="width: 10%;"></td> <td style="width: 10%;"></td> <td style="width: 10%;"></td> <td style="width: 10%;"></td> <td style="width: 10%;"></td> <td style="width: 10%;"></td> <td style="width: 10%;"></td> <td style="width: 10%;"></td> <td style="width: 10%;"></td> <td style="width: 10%;"></td> </tr> <tr> <td></td> <td></td> <td colspan="8" style="text-align: center;"> <table border="1" style="width: 100%; border-collapse: collapse; text-align: center;"> <tr> <td style="width: 10%;"></td> <td style="width: 10%;"></td> <td style="width: 10%;"></td> <td style="width: 10%;"></td> <td style="width: 10%;"></td> <td style="width: 10%;"></td> <td style="width: 10%;"></td> <td style="width: 10%;"></td> <td style="width: 10%;"></td> <td style="width: 10%;"></td> </tr> <tr> <td></td> <td></td> <td colspan="8" style="text-align: center;"> <table border="1" style="width: 100%; border-collapse: collapse; text-align: center;"> <tr> <td style="width: 10%;"></td> <td style="width: 10%;"></td> <td style="width: 10%;"></td> <td style="width: 10%;"></td> <td style="width: 10%;"></td> <td style="width: 10%;"></td> <td style="width: 10%;"></td> <td style="width: 10%;"></td> <td style="width: 10%;"></td> <td style="width: 10%;"></td> </tr> <tr> <td></td> <td></td> <td colspan="8" style="text-align: center;"> <table border="1" style="width: 100%; border-collapse: collapse; text-align: center;"> <tr> <td style="width: 10%;"></td> <td style="width: 10%;"></td> <td style="width: 10%;"></td> <td style="width: 10%;"></td> <td style="width: 10%;"></td> <td style="width: 10%;"></td> <td style="width: 10%;"></td> <td style="width: 10%;"></td> <td style="width: 10%;"></td> <td style="width: 10%;"></td> </tr> <tr> <td></td> <td></td> <td colspan="8" style="text-align: center;"> <table border="1" style="width: 100%; border-collapse: collapse; text-align: center;"> <tr> <td style="width: 10%;"></td> <td style="width: 10%;"></td> <td style="width: 10%;"></td> <td style="width: 10%;"></td> <td style="width: 10%;"></td> <td style="width: 10%;"></td> <td style="width: 10%;"></td> <td style="width: 10%;"></td> <td style="width: 10%;"></td> <td style="width: 10%;"></td> </tr> <tr> <td></td> <td></td> <td colspan="8" style="text-align: center;"> <table border="1" style="width: 100%; border-collapse: collapse; text-align: center;"> <tr> <td style="width: 10%;"></td> <td style="width: 10%;"></td> <td style="width: 10%;"></td> <td style="width: 10%;"></td> <td style="width: 10%;"></td> <td style="width: 10%;"></td> <td style="width: 10%;"></td> <td style="width: 10%;"></td> <td style="width: 10%;"></td> <td style="width: 10%;"></td> </tr> <tr> <td></td> <td></td> <td colspan="8" style="text-align: center;"> <table border="1" style="width: 100%; border-collapse: collapse; text-align: center;"> <tr> <td style="width: 10%;"></td> <td style="width: 10%;"></td> <td style="width: 10%;"></td> <td style="width: 10%;"></td> <td style="width: 10%;"></td> <td style="width: 10%;"></td> <td style="width: 10%;"></td> <td style="width: 10%;"></td> <td style="width: 10%;"></td> <td style="width: 10%;"></td> </tr> <tr> <td></td> <td></td> <td colspan="8" style="text-align: center;"> <table border="1" style="width: 100%; border-collapse: collapse; text-align: center;"> <tr> <td style="width: 10%;"></td> <td style="width: 10%;"></td> <td style="width: 10%;"></td> <td style="width: 10%;"></td> <td style="width: 10%;"></td> <td style="width: 10%;"></td> <td style="width: 10%;"></td> <td style="width: 10%;"></td> <td style="width: 10%;"></td> <td style="width: 10%;"></td> </tr> <tr> <td></td> <td></td> <td colspan="8" style="text-align: center;"> <table border="1" style="width: 100%; border-collapse: collapse; text-align: center;"> <tr> <td style="width: 10%;"></td> <td style="width: 10%;"></td> <td style="width: 10%;"></td> <td style="width: 10%;"></td> <td style="width: 10%;"></td> <td style="width: 10%;"></td> <td style="width: 10%;"></td> <td style="width: 10%;"></td> <td style="width: 10%;"></td> <td style="width: 10%;"></td> </tr> <tr> <td></td> <td></td> <td colspan="8" style="text-align: center;"> <table border="1" style="width: 100%; border-collapse: collapse; text-align: center;"> <tr> <td style="width: 10%;"></td> <td style="width: 10%;"></td> <td style="width: 10%;"></td> <td style="width: 10%;"></td> <td style="width: 10%;"></td> <td style="width: 10%;"></td> <td style="width: 10%;"></td> <td style="width: 10%;"></td> <td style="width: 10%;"></td> <td style="width: 10%;"></td> </tr> <tr> <td></td> <td></td> <td colspan="8" style="text-align: center;"> <table border="1" style="width: 100%; border-collapse: collapse; text-align: center;"> <tr> <td style="width: 10%;"></td> <td style="width: 10%;"></td> <td style="width: 10%;"></td> <td style="width: 10%;"></td> <td style="width: 10%;"></td> <td style="width: 10%;"></td> <td style="width: 10%;"></td> <td style="width: 10%;"></td> <td style="width: 10%;"></td> <td style="width: 10%;"></td> </tr> <tr> <td></td> <td></td> <td colspan="8" style="text-align: center;"> <table border="1" style="width: 100%; border-collapse: collapse; text-align: center;"> <tr> <td style="width: 10%;"></td> <td style="width: 10%;"></td> <td style="width: 10%;"></td> <td style="width: 10%;"></td> <td style="width: 10%;"></td> <td style="width: 10%;"></td> <td style="width: 10%;"></td> <td style="width: 10%;"></td> <td style="width: 10%;"></td> <td style="width: 10%;"></td> </tr> <tr> <td></td> <td></td> <td colspan="8" style="text-align: center;"> <table border="1" style="width: 100%; border-collapse: collapse; text-align: center;"> <tr> <td style="width: 10%;"></td> <td style="width: 10%;"></td> <td style="width: 10%;"></td> <td style="width: 10%;"></td> <td style="width: 10%;"></td> <td style="width: 10%;"></td> <td style="width: 10%;"></td> <td style="width: 10%;"></td> <td style="width: 10%;"></td> <td style="width: 10%;"></td> </tr> <tr> <td></td> <td></td> <td colspan="8" style="text-align: center;"> <table border="1" style="width: 100%; border-collapse: collapse; text-align: center;"> <tr> <td style="width: 10%;"></td> <td style="width: 10%;"></td> <td style="width: 10%;"></td> <td style="width: 10%;"></td> <td style="width: 10%;"></td> <td style="width: 10%;"></td> <td style="width: 10%;"></td> <td style="width: 10%;"></td> <td style="width: 10%;"></td> <td style="width: 10%;"></td> </tr> <tr> <td></td> <td></td> <td colspan="8" style="text-align: center;"> <table border="1" style="width: 100%; border-collapse: collapse; text-align: center;"> <tr> <td style="width: 10%;"></td> <td style="width: 10%;"></td> <td
style="width: 10%;"></td> <td style="width: 10%;"></td> <td style="width: 10%;"></td> <td style="width: 10%;"></td> <td style="width: 10%;"></td> <td style="width: 10%;"></td> <td style="width: 10%;"></td> <td style="width: 10%;"></td> </tr> <tr> <td></td> <td></td> <td colspan="8" style="text-align: center;"> <table border="1" style="width: 100%; border-collapse: collapse; text-align: center;"> <tr> <td style="width: 10%;"></td> <td style="width: 10%;"></td> <td style="width: 10%;"></td> <td style="width: 10%;"></td> <td style="width: 10%;"></td> <td style="width: 10%;"></td> <td style="width: 10%;"></td> <td style="width: 10%;"></td> <td style="width: 10%;"></td> <td style="width: 10%;"></td> </tr> <tr> <td></td> <td></td> <td colspan="8" style="text-align: center;"> <table border="1" style="width: 100%; border-collapse: collapse; text-align: center;"> <tr> <td style="width: 10%;"></td> <td style="width: 10%;"></td> <td style="width: 10%;"></td> <td style="width: 10%;"></td> <td style="width: 10%;"></td> <td style="width: 10%;"></td> <td style="width: 10%;"></td> <td style="width: 10%;"></td> <td style="width: 10%;"></td> <td style="width: 10%;"></td> </tr> <tr> <td></td> <td></td> <td colspan="8" style="text-align: center;"> <table border="1" style="width: 100%; border-collapse: collapse; text-align: center;"> <tr> <td style="width: 10%;"></td> <td style="width: 10%;"></td> <td style="width: 10%;"></td> <td style="width: 10%;"></td> <td style="width: 10%;"></td> <td style="width: 10%;"></td> <td style="width: 10%;"></td> <td style="width: 10%;"></td> <td style="width: 10%;"></td> <td style="width: 10%;"></td> </tr> <tr> <td></td> <td></td> <td colspan="8" style="text-align: center;"> <table border="1" style="width: 100%; border-collapse: collapse; text-align: center;"> <tr> <td style="width: 10%;"></td> <td style="width: 10%;"></td> <td style="width: 10%;"></td> <td style="width: 10%;"></td> <td style="width: 10%;"></td> <td style="width: 10%;"></td> <td style="width: 10%;"></td> <td style="width: 10%;"></td> <td style="width: 10%;"></td> <td style="width: 10%;"></td> </tr> <tr> <td></td> <td></td> <td colspan="8" style="text-align: center;"> <table border="1" style="width: 100%; border-collapse: collapse; text-align: center;"> <tr> <td style="width: 10%;"></td> <td style="width: 10%;"></td> <td style="width: 10%;"></td> <td style="width: 10%;"></td> <td style="width: 10%;"></td> <td style="width: 10%;"></td> <td style="width: 10%;"></td> <td style="width: 10%;"></td> <td style="width: 10%;"></td> <td style="width: 10%;"></td> </tr> <tr> <td></td> <td></td> <td colspan="8" style="text-align: center;"> <table border="1" style="width: 100%; border-collapse: collapse; text-align: center;"> <tr> <td style="width: 10%;"></td> <td style="width: 10%;"></td> <td style="width: 10%;"></td> <td style="width: 10%;"></td> <td style="width: 10%;"></td> <td style="width: 10%;"></td> <td style="width: 10%;"></td> <td style="width: 10%;"></td> <td style="width: 10%;"></td> <td style="width: 10%;"></td> </tr> <tr> <td></td> <td></td> <td colspan="8" style="text-align: center;"> <table border="1" style="width: 100%; border-collapse: collapse; text-align: center;"> <tr> <td style="width: 10%;"></td> <td style="width: 10%;"></td> <td style="width: 10%;"></td> <td style="width: 10%;"></td> <td style="width: 10%;"></td> <td style="width: 10%;"></td> <td style="width: 10%;"></td> <td style="width: 10%;"></td> <td style="width: 10%;"></td> <td style="width: 10%;"></td> </tr> <tr> <td></td> <td></td> <td colspan="8" style="text-align: center;"> <table border="1" style="width: 100%; border-collapse: collapse; text-align: center;"> <tr> <td style="width: 10%;"></td> <td style="width: 10%;"></td> <td style="width: 10%;"></td> <td style="width: 10%;"></td> <td style="width: 10%;"></td> <td style="width: 10%;"></td> <td style="width: 10%;"></td> <td style="width: 10%;"></td> <td style="width: 10%;"></td> <td style="width: 10%;"></td> </tr> <tr> <td></td> <td></td> <td colspan="8" style="text-align: center;"> <table border="1" style="width: 100%; border-collapse: collapse; text-align: center;"> <tr> <td style="width: 10%;"></td> <td style="width: 10%;"></td> <td style="width: 10%;"></td> <td style="width: 10%;"></td> <td style="width: 10%;"></td> <td style="width: 10%;"></td> <td style="width: 10%;"></td> <td style="width: 10%;"></td> <td style="width: 10%;"></td> <td style="width: 10%;"></td> </tr> <tr> <td></td> <td></td> <td colspan="8" style="text-align: center;"> <table border="1" style="width: 100%; border-collapse: collapse; text-align: center;"> <tr> <td style="width: 10%;"></td> <td style="width: 10%;"></td> <td style="width: 10%;"></td> <td style="width: 10%;"></td> <td style="width: 10%;"></td> <td style="width: 10%;"></td> <td style="width: 10%;"></td> <td style="width: 10%;"></td> <td style="width: 10%;"></td> <td style="width: 10%;"></td> </tr> <tr> <td></td> <td></td> <td colspan="8" style="text-align: center;"> <table border="1" style="width: 100%; border-collapse: collapse; text-align: center;"> <tr> <td style="width: 10%;"></td> <td style="width: 10%;"></td> <td style="width: 10%;"></td> <td style="width: 10%;"></td> <td style="width: 10%;"></td> <td style="width: 10%;"></td> <td style="width: 10%;"></td> <td style="width: 10%;"></td> <td style="width: 10%;"></td> <td style="width: 10%;"></td> </tr> <tr> <td></td> <td></td> <td colspan="8" style="text-align: center;"> <table border="1" style="width: 100%; border-collapse: collapse; text-align: center;"> <tr> <td style="width: 10%;"></td> <td style="width: 10%;"></td> <td style="width: 10%;"></td> <td style="width: 10%;"></td> <td style="width: 10%;"></td> <td style="width: 10%;"></td> <td style="width: 10%;"></td> <td style="width: 10%;"></td> <td style="width: 10%;"></td> <td style="width: 10%;"></td> </tr> <tr> <td></td> <td></td> <td colspan="8" style="text-align: center;"> <table border="1" style="width: 100%; border-collapse: collapse; text-align: center;"> <tr> <td style="width: 10%;"></td> <td style="width: 10%;"></td> <td style="width: 10%;"></td> <td style="width: 10%;"></td> <td style="width: 10%;"></td> <td style="width: 10%;"></td> <td style="width: 10%;"></td> <td style="width: 10%;"></td> <td style="width: 10%;"></td> <td style="width: 10%;"></td> </tr> <tr> <td></td> <td></td> <td colspan="8" style="text-align: center;"> <table border="1" style="width: 100%; border-collapse: collapse; text-align: center;"> <tr> <td style="width: 10%;"></td> <td style="width: 10%;"></td> <td style="width: 10%;"></td> <td style="width: 10%;"></td> <td style="width: 10%;"></td> <td style="width: 10%;"></td> <td style="width: 10%;"></td> <td style="width: 10%;"></td> <td style="width: 10%;"></td> <td style="width: 10%;"></td> </tr> <tr> <td></td> <td></td> <td colspan="8" style="text-align: center;"> <table border="1" style="width: 100%; border-collapse: collapse; text-align: center;"> <tr> </tr></table></td></tr></table></td></tr></table></td></tr></table></td></tr></table></td></tr></table></td></tr></table></td></tr></table></td></tr></table></td></tr></table></td></tr></table></td></tr></table></td></tr></table></td></tr></table></td></tr></table></td></tr></table></td></tr></table></td></tr></table></td></tr></table></td></tr></table></td></tr></table></td></tr></table></td></tr></table></td></tr></table></td></tr></table></td></tr></table></td></tr></table></td></tr></table></td></tr></table></td></tr></table></td></tr></table></td></tr></table></td></tr></table></td></tr></table></td></tr></table></td></tr></table></td></tr></table>

 | | | | | | | | | | | | | | | | | | | | <table border="1" style="width: 100%; border-collapse: collapse; text-align: center;"> <tr> <td style="width: 10%;"></td> <td style="width: 10%;"></td> <td style="width: 10%;"></td> <td style="width: 10%;"></td> <td style="width: 10%;"></td> <td style="width: 10%;"></td> <td style="width: 10%;"></td> <td style="width: 10%;"></td> <td style="width: 10%;"></td> <td style="width: 10%;"></td> </tr> <tr> <td></td> <td></td> <td colspan="8" style="text-align: center;"> <table border="1" style="width: 100%; border-collapse: collapse; text-align: center;"> <tr> <td style="width: 10%;"></td> <td style="width: 10%;"></td> <td style="width: 10%;"></td> <td style="width: 10%;"></td> <td style="width: 10%;"></td> <td style="width: 10%;"></td> <td style="width: 10%;"></td> <td style="width: 10%;"></td> <td style="width: 10%;"></td> <td style="width: 10%;"></td> </tr> <tr> <td></td> <td></td> <td colspan="8" style="text-align: center;"> <table border="1" style="width: 100%; border-collapse: collapse; text-align: center;"> <tr> <td style="width: 10%;"></td> <td style="width: 10%;"></td> <td style="width: 10%;"></td> <td style="width: 10%;"></td> <td style="width: 10%;"></td> <td style="width: 10%;"></td> <td style="width: 10%;"></td> <td style="width: 10%;"></td> <td style="width: 10%;"></td> <td style="width: 10%;"></td> </tr> <tr> <td></td> <td></td> <td colspan="8" style="text-align: center;"> <table border="1" style="width: 100%; border-collapse: collapse; text-align: center;"> <tr> <td style="width: 10%;"></td> <td style="width: 10%;"></td> <td style="width: 10%;"></td> <td style="width: 10%;"></td> <td style="width: 10%;"></td> <td style="width: 10%;"></td> <td style="width: 10%;"></td> <td style="width: 10%;"></td> <td style="width: 10%;"></td> <td style="width: 10%;"></td> </tr> <tr> <td></td> <td></td> <td colspan="8" style="text-align: center;"> <table border="1" style="width: 100%; border-collapse: collapse; text-align: center;"> <tr> <td style="width: 10%;"></td> <td style="width: 10%;"></td> <td style="width: 10%;"></td> <td style="width: 10%;"></td> <td style="width: 10%;"></td> <td style="width: 10%;"></td> <td style="width: 10%;"></td> <td style="width: 10%;"></td> <td style="width: 10%;"></td> <td style="width: 10%;"></td> </tr> <tr> <td></td> <td></td> <td colspan="8" style="text-align: center;"> <table border="1" style="width: 100%; border-collapse: collapse; text-align: center;"> <tr> <td style="width: 10%;"></td> <td style="width: 10%;"></td> <td style="width: 10%;"></td> <td style="width: 10%;"></td> <td style="width: 10%;"></td> <td style="width: 10%;"></td> <td style="width: 10%;"></td> <td style="width: 10%;"></td> <td style="width: 10%;"></td> <td style="width: 10%;"></td> </tr> <tr> <td></td> <td></td> <td colspan="8" style="text-align: center;"> <table border="1" style="width: 100%; border-collapse: collapse; text-align: center;"> <tr> <td style="width: 10%;"></td> <td style="width: 10%;"></td> <td style="width: 10%;"></td> <td style="width: 10%;"></td> <td style="width: 10%;"></td> <td style="width: 10%;"></td> <td style="width: 10%;"></td> <td style="width: 10%;"></td> <td style="width: 10%;"></td> <td style="width: 10%;"></td> </tr> <tr> <td></td> <td></td> <td colspan="8" style="text-align: center;"> <table border="1" style="width: 100%; border-collapse: collapse; text-align: center;"> <tr> <td style="width: 10%;"></td> <td style="width: 10%;"></td> <td style="width: 10%;"></td> <td style="width: 10%;"></td> <td style="width: 10%;"></td> <td style="width: 10%;"></td> <td style="width: 10%;"></td> <td style="width: 10%;"></td> <td style="width: 10%;"></td> <td style="width: 10%;"></td> </tr> <tr> <td></td> <td></td> <td colspan="8" style="text-align: center;"> <table border="1" style="width: 100%; border-collapse: collapse; text-align: center;"> <tr> <td style="width: 10%;"></td> <td style="width: 10%;"></td> <td style="width: 10%;"></td> <td style="width: 10%;"></td> <td style="width: 10%;"></td> <td style="width: 10%;"></td> <td style="width: 10%;"></td> <td style="width: 10%;"></td> <td style="width: 10%;"></td> <td style="width: 10%;"></td> </tr> <tr> <td></td> <td></td> <td colspan="8" style="text-align: center;"> <table border="1" style="width: 100%; border-collapse: collapse; text-align: center;"> <tr> <td style="width: 10%;"></td> <td style="width: 10%;"></td> <td style="width: 10%;"></td> <td style="width: 10%;"></td> <td style="width: 10%;"></td> <td style="width: 10%;"></td> <td style="width: 10%;"></td> <td style="width: 10%;"></td> <td style="width: 10%;"></td> <td style="width: 10%;"></td> </tr> <tr> <td></td> <td></td> <td colspan="8" style="text-align: center;"> <table border="1" style="width: 100%; border-collapse: collapse; text-align: center;"> <tr> <td style="width: 10%;"></td> <td style="width: 10%;"></td> <td style="width: 10%;"></td> <td style="width: 10%;"></td> <td style="width: 10%;"></td> <td style="width: 10%;"></td> <td style="width: 10%;"></td> <td style="width: 10%;"></td> <td style="width: 10%;"></td> <td style="width: 10%;"></td> </tr> <tr> <td></td> <td></td> <td colspan="8" style="text-align: center;"> <table border="1" style="width: 100%; border-collapse: collapse; text-align: center;"> <tr> <td style="width: 10%;"></td> <td style="width: 10%;"></td> <td style="width: 10%;"></td> <td style="width: 10%;"></td> <td style="width: 10%;"></td> <td style="width: 10%;"></td> <td style="width: 10%;"></td> <td style="width: 10%;"></td> <td style="width: 10%;"></td> <td style="width: 10%;"></td> </tr> <tr> <td></td> <td></td> <td colspan="8" style="text-align: center;"> <table border="1" style="width: 100%; border-collapse: collapse; text-align: center;"> <tr> <td style="width: 10%;"></td> <td style="width: 10%;"></td> <td style="width: 10%;"></td> <td style="width: 10%;"></td> <td style="width: 10%;"></td> <td style="width: 10%;"></td> <td style="width: 10%;"></td> <td style="width: 10%;"></td> <td style="width: 10%;"></td> <td style="width: 10%;"></td> </tr> <tr> <td></td> <td></td> <td colspan="8" style="text-align: center;"> <table border="1" style="width: 100%; border-collapse: collapse; text-align: center;"> <tr> <td style="width: 10%;"></td> <td style="width: 10%;"></td> <td style="width: 10%;"></td> <td style="width: 10%;"></td> <td style="width: 10%;"></td> <td style="width: 10%;"></td> <td style="width: 10%;"></td> <td style="width: 10%;"></td> <td style="width: 10%;"></td> <td style="width: 10%;"></td> </tr> <tr> <td></td> <td></td> <td colspan="8" style="text-align: center;"> <table border="1" style="width: 100%; border-collapse: collapse; text-align: center;"> <tr> <td style="width: 10%;"></td> <td style="width: 10%;"></td> <td style="width: 10%;"></td> <td style="width: 10%;"></td> <td style="width: 10%;"></td> <td style="width: 10%;"></td> <td style="width: 10%;"></td> <td style="width: 10%;"></td> <td style="width: 10%;"></td> <td style="width: 10%;"></td> </tr> <tr> <td></td> <td></td> <td colspan="8" style="text-align: center;"> <table border="1" style="width: 100%; border-collapse: collapse; text-align: center;"> <tr> <td style="width: 10%;"></td> <td style="width: 10%;"></td> <td style="width: 10%;"></td> <td style="width: 10%;"></td> <td style="width: 10%;"></td> <td style="width: 10%;"></td> <td style="width: 10%;"></td> <td style="width: 10%;"></td> <td style="width: 10%;"></td> <td style="width: 10%;"></td> </tr> <tr> <td></td> <td></td> <td colspan="8" style="text-align: center;"> <table border="1" style="width: 100%; border-collapse: collapse; text-align: center;"> <tr> <td style="width: 10%;"></td> <td style="width: 10%;"></td> <td style="width: 10%;"></td> <td style="width: 10%;"></td> <td style="width: 10%;"></td> <td style="width: 10%;"></td> <td style="width: 10%;"></td> <td style="width: 10%;"></td> <td style="width: 10%;"></td> <td style="width: 10%;"></td> </tr> <tr> <td></td> <td></td> <td colspan="8" style="text-align: center;"> <table border="1" style="width: 100%; border-collapse: collapse; text-align: center;"> <tr> <td style="width: 10%;"></td> <td style="width: 10%;"></td> <td style="width: 10%;"></td> <td style="width: 10%;"></td> <td style="width: 10%;"></td> <td style="width: 10%;"></td> <td style="width: 10%;"></td> <td style="width: 10%;"></td> <td style="width: 10%;"></td> <td style="width: 10%;"></td> </tr> <tr> <td></td> <td></td> <td colspan="8" style="text-align: center;"> <table border="1" style="width: 100%; border-collapse: collapse; text-align: center;"> <tr> <td style="width: 10%;"></td> <td style="width: 10%;"></td> <td style="width: 10%;"></td> <td style="width: 10%;"></td> <td style="width: 10%;"></td> <td style="width: 10%;"></td> <td
style="width: 10%;"></td> <td style="width: 10%;"></td> <td style="width: 10%;"></td> <td style="width: 10%;"></td> </tr> <tr> <td></td> <td></td> <td colspan="8" style="text-align: center;"> <table border="1" style="width: 100%; border-collapse: collapse; text-align: center;"> <tr> <td style="width: 10%;"></td> <td style="width: 10%;"></td> <td style="width: 10%;"></td> <td style="width: 10%;"></td> <td style="width: 10%;"></td> <td style="width: 10%;"></td> <td style="width: 10%;"></td> <td style="width: 10%;"></td> <td style="width: 10%;"></td> <td style="width: 10%;"></td> </tr> <tr> <td></td> <td></td> <td colspan="8" style="text-align: center;"> <table border="1" style="width: 100%; border-collapse: collapse; text-align: center;"> <tr> <td style="width: 10%;"></td> <td style="width: 10%;"></td> <td style="width: 10%;"></td> <td style="width: 10%;"></td> <td style="width: 10%;"></td> <td style="width: 10%;"></td> <td style="width: 10%;"></td> <td style="width: 10%;"></td> <td style="width: 10%;"></td> <td style="width: 10%;"></td> </tr> <tr> <td></td> <td></td> <td colspan="8" style="text-align: center;"> <table border="1" style="width: 100%; border-collapse: collapse; text-align: center;"> <tr> <td style="width: 10%;"></td> <td style="width: 10%;"></td> <td style="width: 10%;"></td> <td style="width: 10%;"></td> <td style="width: 10%;"></td> <td style="width: 10%;"></td> <td style="width: 10%;"></td> <td style="width: 10%;"></td> <td style="width: 10%;"></td> <td style="width: 10%;"></td> </tr> <tr> <td></td> <td></td> <td colspan="8" style="text-align: center;"> <table border="1" style="width: 100%; border-collapse: collapse; text-align: center;"> <tr> <td style="width: 10%;"></td> <td style="width: 10%;"></td> <td style="width: 10%;"></td> <td style="width: 10%;"></td> <td style="width: 10%;"></td> <td style="width: 10%;"></td> <td style="width: 10%;"></td> <td style="width: 10%;"></td> <td style="width: 10%;"></td> <td style="width: 10%;"></td> </tr> <tr> <td></td> <td></td> <td colspan="8" style="text-align: center;"> <table border="1" style="width: 100%; border-collapse: collapse; text-align: center;"> <tr> <td style="width: 10%;"></td> <td style="width: 10%;"></td> <td style="width: 10%;"></td> <td style="width: 10%;"></td> <td style="width: 10%;"></td> <td style="width: 10%;"></td> <td style="width: 10%;"></td> <td style="width: 10%;"></td> <td style="width: 10%;"></td> <td style="width: 10%;"></td> </tr> <tr> <td></td> <td></td> <td colspan="8" style="text-align: center;"> <table border="1" style="width: 100%; border-collapse: collapse; text-align: center;"> <tr> <td style="width: 10%;"></td> <td style="width: 10%;"></td> <td style="width: 10%;"></td> <td style="width: 10%;"></td> <td style="width: 10%;"></td> <td style="width: 10%;"></td> <td style="width: 10%;"></td> <td style="width: 10%;"></td> <td style="width: 10%;"></td> <td style="width: 10%;"></td> </tr> <tr> <td></td> <td></td> <td colspan="8" style="text-align: center;"> <table border="1" style="width: 100%; border-collapse: collapse; text-align: center;"> <tr> <td style="width: 10%;"></td> <td style="width: 10%;"></td> <td style="width: 10%;"></td> <td style="width: 10%;"></td> <td style="width: 10%;"></td> <td style="width: 10%;"></td> <td style="width: 10%;"></td> <td style="width: 10%;"></td> <td style="width: 10%;"></td> <td style="width: 10%;"></td> </tr> <tr> <td></td> <td></td> <td colspan="8" style="text-align: center;"> <table border="1" style="width: 100%; border-collapse: collapse; text-align: center;"> <tr> <td style="width: 10%;"></td> <td style="width: 10%;"></td> <td style="width: 10%;"></td> <td style="width: 10%;"></td> <td style="width: 10%;"></td> <td style="width: 10%;"></td> <td style="width: 10%;"></td> <td style="width: 10%;"></td> <td style="width: 10%;"></td> <td style="width: 10%;"></td> </tr> <tr> <td></td> <td></td> <td colspan="8" style="text-align: center;"> <table border="1" style="width: 100%; border-collapse: collapse; text-align: center;"> <tr> <td style="width: 10%;"></td> <td style="width: 10%;"></td> <td style="width: 10%;"></td> <td style="width: 10%;"></td> <td style="width: 10%;"></td> <td style="width: 10%;"></td> <td style="width: 10%;"></td> <td style="width: 10%;"></td> <td style="width: 10%;"></td> <td style="width: 10%;"></td> </tr> <tr> <td></td> <td></td> <td colspan="8" style="text-align: center;"> <table border="1" style="width: 100%; border-collapse: collapse; text-align: center;"> <tr> <td style="width: 10%;"></td> <td style="width: 10%;"></td> <td style="width: 10%;"></td> <td style="width: 10%;"></td> <td style="width: 10%;"></td> <td style="width: 10%;"></td> <td style="width: 10%;"></td> <td style="width: 10%;"></td> <td style="width: 10%;"></td> <td style="width: 10%;"></td> </tr> <tr> <td></td> <td></td> <td colspan="8" style="text-align: center;"> <table border="1" style="width: 100%; border-collapse: collapse; text-align: center;"> <tr> <td style="width: 10%;"></td> <td style="width: 10%;"></td> <td style="width: 10%;"></td> <td style="width: 10%;"></td> <td style="width: 10%;"></td> <td style="width: 10%;"></td> <td style="width: 10%;"></td> <td style="width: 10%;"></td> <td style="width: 10%;"></td> <td style="width: 10%;"></td> </tr> <tr> <td></td> <td></td> <td colspan="8" style="text-align: center;"> <table border="1" style="width: 100%; border-collapse: collapse; text-align: center;"> <tr> <td style="width: 10%;"></td> <td style="width: 10%;"></td> <td style="width: 10%;"></td> <td style="width: 10%;"></td> <td style="width: 10%;"></td> <td style="width: 10%;"></td> <td style="width: 10%;"></td> <td style="width: 10%;"></td> <td style="width: 10%;"></td> <td style="width: 10%;"></td> </tr> <tr> <td></td> <td></td> <td colspan="8" style="text-align: center;"> <table border="1" style="width: 100%; border-collapse: collapse; text-align: center;"> <tr> <td style="width: 10%;"></td> <td style="width: 10%;"></td> <td style="width: 10%;"></td> <td style="width: 10%;"></td> <td style="width: 10%;"></td> <td style="width: 10%;"></td> <td style="width: 10%;"></td> <td style="width: 10%;"></td> <td style="width: 10%;"></td> <td style="width: 10%;"></td> </tr> <tr> <td></td> <td></td> <td colspan="8" style="text-align: center;"> <table border="1" style="width: 100%; border-collapse: collapse; text-align: center;"> <tr> <td style="width: 10%;"></td> <td style="width: 10%;"></td> <td style="width: 10%;"></td> <td style="width: 10%;"></td> <td style="width: 10%;"></td> <td style="width: 10%;"></td> <td style="width: 10%;"></td> <td style="width: 10%;"></td> <td style="width: 10%;"></td> <td style="width: 10%;"></td> </tr> <tr> <td></td> <td></td> <td colspan="8" style="text-align: center;"> <table border="1" style="width: 100%; border-collapse: collapse; text-align: center;"> <tr> <td style="width: 10%;"></td> <td style="width: 10%;"></td> <td style="width: 10%;"></td> <td style="width: 10%;"></td> <td style="width: 10%;"></td> <td style="width: 10%;"></td> <td style="width: 10%;"></td> <td style="width: 10%;"></td> <td style="width: 10%;"></td> <td style="width: 10%;"></td> </tr> <tr> <td></td> <td></td> <td colspan="8" style="text-align: center;"> <table border="1" style="width: 100%; border-collapse: collapse; text-align: center;"> <tr> <td style="width: 10%;"></td> <td style="width: 10%;"></td> <td style="width: 10%;"></td> <td style="width: 10%;"></td> <td style="width: 10%;"></td> <td style="width: 10%;"></td> <td style="width: 10%;"></td> <td style="width: 10%;"></td> <td style="width: 10%;"></td> <td style="width: 10%;"></td> </tr> <tr> <td></td> <td></td> <td colspan="8" style="text-align: center;"> <table border="1" style="width: 100%; border-collapse: collapse; text-align: center;"> <tr> </tr></table></td></tr></table></td></tr></table></td></tr></table></td></tr></table></td></tr></table></td></tr></table></td></tr></table></td></tr></table></td></tr></table></td></tr></table></td></tr></table></td></tr></table></td></tr></table></td></tr></table></td></tr></table></td></tr></table></td></tr></table></td></tr></table></td></tr></table></td></tr></table></td></tr></table></td></tr></table></td></tr></table></td></tr></table></td></tr></table></td></tr></table></td></tr></table></td></tr></table></td></tr></table></td></tr></table></td></tr></table></td></tr></table></td></tr></table></td></tr></table></td></tr></table>

 | | | | | | | | | | | | | | | | | | | | <table border="1" style="width: 100%; border-collapse: collapse; text-align: center;"> <tr> <td style="width: 10%;"></td> <td style="width: 10%;"></td> <td style="width: 10%;"></td> <td style="width: 10%;"></td> <td style="width: 10%;"></td> <td style="width: 10%;"></td> <td style="width: 10%;"></td> <td style="width: 10%;"></td> <td style="width: 10%;"></td> <td style="width: 10%;"></td> </tr> <tr> <td></td> <td></td> <td colspan="8" style="text-align: center;"> <table border="1" style="width: 100%; border-collapse: collapse; text-align: center;"> <tr> <td style="width: 10%;"></td> <td style="width: 10%;"></td> <td style="width: 10%;"></td> <td style="width: 10%;"></td> <td style="width: 10%;"></td> <td style="width: 10%;"></td> <td style="width: 10%;"></td> <td style="width: 10%;"></td> <td style="width: 10%;"></td> <td style="width: 10%;"></td> </tr> <tr> <td></td> <td></td> <td colspan="8" style="text-align: center;"> <table border="1" style="width: 100%; border-collapse: collapse; text-align: center;"> <tr> <td style="width: 10%;"></td> <td style="width: 10%;"></td> <td style="width: 10%;"></td> <td style="width: 10%;"></td> <td style="width: 10%;"></td> <td style="width: 10%;"></td> <td style="width: 10%;"></td> <td style="width: 10%;"></td> <td style="width: 10%;"></td> <td style="width: 10%;"></td> </tr> <tr> <td></td> <td></td> <td colspan="8" style="text-align: center;"> <table border="1" style="width: 100%; border-collapse: collapse; text-align: center;"> <tr> <td style="width: 10%;"></td> <td style="width: 10%;"></td> <td style="width: 10%;"></td> <td style="width: 10%;"></td> <td style="width: 10%;"></td> <td style="width: 10%;"></td> <td style="width: 10%;"></td> <td style="width: 10%;"></td> <td style="width: 10%;"></td> <td style="width: 10%;"></td> </tr> <tr> <td></td> <td></td> <td colspan="8" style="text-align: center;"> <table border="1" style="width: 100%; border-collapse: collapse; text-align: center;"> <tr> <td style="width: 10%;"></td> <td style="width: 10%;"></td> <td style="width: 10%;"></td> <td style="width: 10%;"></td> <td style="width: 10%;"></td> <td style="width: 10%;"></td> <td style="width: 10%;"></td> <td style="width: 10%;"></td> <td style="width: 10%;"></td> <td style="width: 10%;"></td> </tr> <tr> <td></td> <td></td> <td colspan="8" style="text-align: center;"> <table border="1" style="width: 100%; border-collapse: collapse; text-align: center;"> <tr> <td style="width: 10%;"></td> <td style="width: 10%;"></td> <td style="width: 10%;"></td> <td style="width: 10%;"></td> <td style="width: 10%;"></td> <td style="width: 10%;"></td> <td style="width: 10%;"></td> <td style="width: 10%;"></td> <td style="width: 10%;"></td> <td style="width: 10%;"></td> </tr> <tr> <td></td> <td></td> <td colspan="8" style="text-align: center;"> <table border="1" style="width: 100%; border-collapse: collapse; text-align: center;"> <tr> <td style="width: 10%;"></td> <td style="width: 10%;"></td> <td style="width: 10%;"></td> <td style="width: 10%;"></td> <td style="width: 10%;"></td> <td style="width: 10%;"></td> <td style="width: 10%;"></td> <td style="width: 10%;"></td> <td style="width: 10%;"></td> <td style="width: 10%;"></td> </tr> <tr> <td></td> <td></td> <td colspan="8" style="text-align: center;"> <table border="1" style="width: 100%; border-collapse: collapse; text-align: center;"> <tr> <td style="width: 10%;"></td> <td style="width: 10%;"></td> <td style="width: 10%;"></td> <td style="width: 10%;"></td> <td style="width: 10%;"></td> <td style="width: 10%;"></td> <td style="width: 10%;"></td> <td style="width: 10%;"></td> <td style="width: 10%;"></td> <td style="width: 10%;"></td> </tr> <tr> <td></td> <td></td> <td colspan="8" style="text-align: center;"> <table border="1" style="width: 100%; border-collapse: collapse; text-align: center;"> <tr> <td style="width: 10%;"></td> <td style="width: 10%;"></td> <td style="width: 10%;"></td> <td style="width: 10%;"></td> <td style="width: 10%;"></td> <td style="width: 10%;"></td> <td style="width: 10%;"></td> <td style="width: 10%;"></td> <td style="width: 10%;"></td> <td style="width: 10%;"></td> </tr> <tr> <td></td> <td></td> <td colspan="8" style="text-align: center;"> <table border="1" style="width: 100%; border-collapse: collapse; text-align: center;"> <tr> <td style="width: 10%;"></td> <td style="width: 10%;"></td> <td style="width: 10%;"></td> <td style="width: 10%;"></td> <td style="width: 10%;"></td> <td style="width: 10%;"></td> <td style="width: 10%;"></td> <td style="width: 10%;"></td> <td style="width: 10%;"></td> <td style="width: 10%;"></td> </tr> <tr> <td></td> <td></td> <td colspan="8" style="text-align: center;"> <table border="1" style="width: 100%; border-collapse: collapse; text-align: center;"> <tr> <td style="width: 10%;"></td> <td style="width: 10%;"></td> <td style="width: 10%;"></td> <td style="width: 10%;"></td> <td style="width: 10%;"></td> <td style="width: 10%;"></td> <td style="width: 10%;"></td> <td style="width: 10%;"></td> <td style="width: 10%;"></td> <td style="width: 10%;"></td> </tr> <tr> <td></td> <td></td> <td colspan="8" style="text-align: center;"> <table border="1" style="width: 100%; border-collapse: collapse; text-align: center;"> <tr> <td style="width: 10%;"></td> <td style="width: 10%;"></td> <td style="width: 10%;"></td> <td style="width: 10%;"></td> <td style="width: 10%;"></td> <td style="width: 10%;"></td> <td style="width: 10%;"></td> <td style="width: 10%;"></td> <td style="width: 10%;"></td> <td style="width: 10%;"></td> </tr> <tr> <td></td> <td></td> <td colspan="8" style="text-align: center;"> <table border="1" style="width: 100%; border-collapse: collapse; text-align: center;"> <tr> <td style="width: 10%;"></td> <td style="width: 10%;"></td> <td style="width: 10%;"></td> <td style="width: 10%;"></td> <td style="width: 10%;"></td> <td style="width: 10%;"></td> <td style="width: 10%;"></td> <td style="width: 10%;"></td> <td style="width: 10%;"></td> <td style="width: 10%;"></td> </tr> <tr> <td></td> <td></td> <td colspan="8" style="text-align: center;"> <table border="1" style="width: 100%; border-collapse: collapse; text-align: center;"> <tr> <td style="width: 10%;"></td> <td style="width: 10%;"></td> <td style="width: 10%;"></td> <td style="width: 10%;"></td> <td style="width: 10%;"></td> <td style="width: 10%;"></td> <td style="width: 10%;"></td> <td style="width: 10%;"></td> <td style="width: 10%;"></td> <td style="width: 10%;"></td> </tr> <tr> <td></td> <td></td> <td colspan="8" style="text-align: center;"> <table border="1" style="width: 100%; border-collapse: collapse; text-align: center;"> <tr> <td style="width: 10%;"></td> <td style="width: 10%;"></td> <td style="width: 10%;"></td> <td style="width: 10%;"></td> <td style="width: 10%;"></td> <td style="width: 10%;"></td> <td style="width: 10%;"></td> <td style="width: 10%;"></td> <td style="width: 10%;"></td> <td style="width: 10%;"></td> </tr> <tr> <td></td> <td></td> <td colspan="8" style="text-align: center;"> <table border="1" style="width: 100%; border-collapse: collapse; text-align: center;"> <tr> <td style="width: 10%;"></td> <td style="width: 10%;"></td> <td style="width: 10%;"></td> <td style="width: 10%;"></td> <td style="width: 10%;"></td> <td style="width: 10%;"></td> <td style="width: 10%;"></td> <td style="width: 10%;"></td> <td style="width: 10%;"></td> <td style="width: 10%;"></td> </tr> <tr> <td></td> <td></td> <td colspan="8" style="text-align: center;"> <table border="1" style="width: 100%; border-collapse: collapse; text-align: center;"> <tr> <td style="width: 10%;"></td> <td style="width: 10%;"></td> <td style="width: 10%;"></td> <td style="width: 10%;"></td> <td style="width: 10%;"></td> <td style="width: 10%;"></td> <td style="width: 10%;"></td> <td style="width: 10%;"></td> <td style="width: 10%;"></td> <td style="width: 10%;"></td> </tr> <tr> <td></td> <td></td> <td
colspan="8" style="text-align: center;"> <table border="1" style="width: 100%; border-collapse: collapse; text-align: center;"> <tr> <td style="width: 10%;"></td> <td style="width: 10%;"></td> <td style="width: 10%;"></td> <td style="width: 10%;"></td> <td style="width: 10%;"></td> <td style="width: 10%;"></td> <td style="width: 10%;"></td> <td style="width: 10%;"></td> <td style="width: 10%;"></td> <td style="width: 10%;"></td> </tr> <tr> <td></td> <td></td> <td colspan="8" style="text-align: center;"> <table border="1" style="width: 100%; border-collapse: collapse; text-align: center;"> <tr> <td style="width: 10%;"></td> <td style="width: 10%;"></td> <td style="width: 10%;"></td> <td style="width: 10%;"></td> <td style="width: 10%;"></td> <td style="width: 10%;"></td> <td style="width: 10%;"></td> <td style="width: 10%;"></td> <td style="width: 10%;"></td> <td style="width: 10%;"></td> </tr> <tr> <td></td> <td></td> <td colspan="8" style="text-align: center;"> <table border="1" style="width: 100%; border-collapse: collapse; text-align: center;"> <tr> <td style="width: 10%;"></td> <td style="width: 10%;"></td> <td style="width: 10%;"></td> <td style="width: 10%;"></td> <td style="width: 10%;"></td> <td style="width: 10%;"></td> <td style="width: 10%;"></td> <td style="width: 10%;"></td> <td style="width: 10%;"></td> <td style="width: 10%;"></td> </tr> <tr> <td></td> <td></td> <td colspan="8" style="text-align: center;"> <table border="1" style="width: 100%; border-collapse: collapse; text-align: center;"> <tr> <td style="width: 10%;"></td> <td style="width: 10%;"></td> <td style="width: 10%;"></td> <td style="width: 10%;"></td> <td style="width: 10%;"></td> <td style="width: 10%;"></td> <td style="width: 10%;"></td> <td style="width: 10%;"></td> <td style="width: 10%;"></td> <td style="width: 10%;"></td> </tr> <tr> <td></td> <td></td> <td colspan="8" style="text-align: center;"> <table border="1" style="width: 100%; border-collapse: collapse; text-align: center;"> <tr> <td style="width: 10%;"></td> <td style="width: 10%;"></td> <td style="width: 10%;"></td> <td style="width: 10%;"></td> <td style="width: 10%;"></td> <td style="width: 10%;"></td> <td style="width: 10%;"></td> <td style="width: 10%;"></td> <td style="width: 10%;"></td> <td style="width: 10%;"></td> </tr> <tr> <td></td> <td></td> <td colspan="8" style="text-align: center;"> <table border="1" style="width: 100%; border-collapse: collapse; text-align: center;"> <tr> <td style="width: 10%;"></td> <td style="width: 10%;"></td> <td style="width: 10%;"></td> <td style="width: 10%;"></td> <td style="width: 10%;"></td> <td style="width: 10%;"></td> <td style="width: 10%;"></td> <td style="width: 10%;"></td> <td style="width: 10%;"></td> <td style="width: 10%;"></td> </tr> <tr> <td></td> <td></td> <td colspan="8" style="text-align: center;"> <table border="1" style="width: 100%; border-collapse: collapse; text-align: center;"> <tr> <td style="width: 10%;"></td> <td style="width: 10%;"></td> <td style="width: 10%;"></td> <td style="width: 10%;"></td> <td style="width: 10%;"></td> <td style="width: 10%;"></td> <td style="width: 10%;"></td> <td style="width: 10%;"></td> <td style="width: 10%;"></td> <td style="width: 10%;"></td> </tr> <tr> <td></td> <td></td> <td colspan="8" style="text-align: center;"> <table border="1" style="width: 100%; border-collapse: collapse; text-align: center;"> <tr> <td style="width: 10%;"></td> <td style="width: 10%;"></td> <td style="width: 10%;"></td> <td style="width: 10%;"></td> <td style="width: 10%;"></td> <td style="width: 10%;"></td> <td style="width: 10%;"></td> <td style="width: 10%;"></td> <td style="width: 10%;"></td> <td style="width: 10%;"></td> </tr> <tr> <td></td> <td></td> <td colspan="8" style="text-align: center;"> <table border="1" style="width: 100%; border-collapse: collapse; text-align: center;"> <tr> <td style="width: 10%;"></td> <td style="width: 10%;"></td> <td style="width: 10%;"></td> <td style="width: 10%;"></td> <td style="width: 10%;"></td> <td style="width: 10%;"></td> <td style="width: 10%;"></td> <td style="width: 10%;"></td> <td style="width: 10%;"></td> <td style="width: 10%;"></td> </tr> <tr> <td></td> <td></td> <td colspan="8" style="text-align: center;"> <table border="1" style="width: 100%; border-collapse: collapse; text-align: center;"> <tr> <td style="width: 10%;"></td> <td style="width: 10%;"></td> <td style="width: 10%;"></td> <td style="width: 10%;"></td> <td style="width: 10%;"></td> <td style="width: 10%;"></td> <td style="width: 10%;"></td> <td style="width: 10%;"></td> <td style="width: 10%;"></td> <td style="width: 10%;"></td> </tr> <tr> <td></td> <td></td> <td colspan="8" style="text-align: center;"> <table border="1" style="width: 100%; border-collapse: collapse; text-align: center;"> <tr> <td style="width: 10%;"></td> <td style="width: 10%;"></td> <td style="width: 10%;"></td> <td style="width: 10%;"></td> <td style="width: 10%;"></td> <td style="width: 10%;"></td> <td style="width: 10%;"></td> <td style="width: 10%;"></td> <td style="width: 10%;"></td> <td style="width: 10%;"></td> </tr> <tr> <td></td> <td></td> <td colspan="8" style="text-align: center;"> <table border="1" style="width: 100%; border-collapse: collapse; text-align: center;"> <tr> <td style="width: 10%;"></td> <td style="width: 10%;"></td> <td style="width: 10%;"></td> <td style="width: 10%;"></td> <td style="width: 10%;"></td> <td style="width: 10%;"></td> <td style="width: 10%;"></td> <td style="width: 10%;"></td> <td style="width: 10%;"></td> <td style="width: 10%;"></td> </tr> <tr> <td></td> <td></td> <td colspan="8" style="text-align: center;"> <table border="1" style="width: 100%; border-collapse: collapse; text-align: center;"> <tr> <td style="width: 10%;"></td> <td style="width: 10%;"></td> <td style="width: 10%;"></td> <td style="width: 10%;"></td> <td style="width: 10%;"></td> <td style="width: 10%;"></td> <td style="width: 10%;"></td> <td style="width: 10%;"></td> <td style="width: 10%;"></td> <td style="width: 10%;"></td> </tr> <tr> <td></td> <td></td> <td colspan="8" style="text-align: center;"> <table border="1" style="width: 100%; border-collapse: collapse; text-align: center;"> <tr> <td style="width: 10%;"></td> <td style="width: 10%;"></td> <td style="width: 10%;"></td> <td style="width: 10%;"></td> <td style="width: 10%;"></td> <td style="width: 10%;"></td> <td style="width: 10%;"></td> <td style="width: 10%;"></td> <td style="width: 10%;"></td> <td style="width: 10%;"></td> </tr> <tr> <td></td> <td></td> <td colspan="8" style="text-align: center;"> <table border="1" style="width: 100%; border-collapse: collapse; text-align: center;"> <tr> <td style="width: 10%;"></td> <td style="width: 10%;"></td> <td style="width: 10%;"></td> <td style="width: 10%;"></td> <td style="width: 10%;"></td> <td style="width: 10%;"></td> <td style="width: 10%;"></td> <td style="width: 10%;"></td> <td style="width: 10%;"></td> <td style="width: 10%;"></td> </tr> <tr> <td></td> <td></td> <td colspan="8" style="text-align: center;"> <table border="1" style="width: 100%; border-collapse: collapse; text-align: center;"> <tr> <td style="width: 10%;"></td> <td style="width: 10%;"></td> <td style="width: 10%;"></td> <td style="width: 10%;"></td> <td style="width: 10%;"></td> <td style="width: 10%;"></td> <td style="width: 10%;"></td> <td style="width: 10%;"></td> <td style="width: 10%;"></td> <td style="width: 10%;"></td> </tr> <tr> <td></td> <td></td> <td colspan="8" style="text-align: center;"> <table border="1" style="width: 100%; border-collapse: collapse; text-align: center;"> <tr> <td style="width: 10%;"></td> <td style="width: 10%;"></td> <td style="width: 10%;"></td> <td style="width: 10%;"></td> <td style="width: 10%;"></td> <td style="width: 10%;"></td> <td style="width: 10%;"></td> <td style="width: 10%;"></td> <td style="width: 10%;"></td> <td style="width: 10%;"></td> </tr> <tr> <td></td> <td></td> <td colspan="8" style="text-align: center;"> <table border="1" style="width: 100%; border-collapse: collapse; text-align: center;"> <tr> </tr></table></td></tr></table></td></tr></table></td></tr></table></td></tr></table></td></tr></table></td></tr></table></td></tr></table></td></tr></table></td></tr></table></td></tr></table></td></tr></table></td></tr></table></td></tr></table></td></tr></table></td></tr></table></td></tr></table></td></tr></table></td></tr></table></td></tr></table></td></tr></table></td></tr></table></td></tr></table></td></tr></table></td></tr></table></td></tr></table></td></tr></table></td></tr></table></td></tr></table></td></tr></table></td></tr></table></td></tr></table></td></tr></table></td></tr></table></td></tr></table>

 | | | | | | | | | | | | | | | | | | | | <table border="1" style="width: 100%; border-collapse: collapse; text-align: center;"> <tr> <td style="width: 10%;"></td> <td style="width: 10%;"></td> <td style="width: 10%;"></td> <td style="width: 10%;"></td> <td style="width: 10%;"></td> <td style="width: 10%;"></td> <td style="width: 10%;"></td> <td style="width: 10%;"></td> <td style="width: 10%;"></td> <td style="width: 10%;"></td> </tr> <tr> <td></td> <td></td> <td colspan="8" style="text-align: center;"> <table border="1" style="width: 100%; border-collapse: collapse; text-align: center;"> <tr> <td style="width: 10%;"></td> <td style="width: 10%;"></td> <td style="width: 10%;"></td> <td style="width: 10%;"></td> <td style="width: 10%;"></td> <td style="width: 10%;"></td> <td style="width: 10%;"></td> <td style="width: 10%;"></td> <td style="width: 10%;"></td> <td style="width: 10%;"></td> </tr> <tr> <td></td> <td></td> <td colspan="8" style="text-align: center;"> <table border="1" style="width: 100%; border-collapse: collapse; text-align: center;"> <tr> <td style="width: 10%;"></td> <td style="width: 10%;"></td> <td style="width: 10%;"></td> <td style="width: 10%;"></td> <td style="width: 10%;"></td> <td style="width: 10%;"></td> <td style="width: 10%;"></td> <td style="width: 10%;"></td> <td style="width: 10%;"></td> <td style="width: 10%;"></td> </tr> <tr> <td></td> <td></td> <td colspan="8" style="text-align: center;"> <table border="1" style="width: 100%; border-collapse: collapse; text-align: center;"> <tr> <td style="width: 10%;"></td> <td style="width: 10%;"></td> <td style="width: 10%;"></td> <td style="width: 10%;"></td> <td style="width: 10%;"></td> <td style="width: 10%;"></td> <td style="width: 10%;"></td> <td style="width: 10%;"></td> <td style="width: 10%;"></td> <td style="width: 10%;"></td> </tr> <tr> <td></td> <td></td> <td colspan="8" style="text-align: center;"> <table border="1" style="width: 100%; border-collapse: collapse; text-align: center;"> <tr> <td style="width: 10%;"></td> <td style="width: 10%;"></td> <td style="width: 10%;"></td> <td style="width: 10%;"></td> <td style="width: 10%;"></td> <td style="width: 10%;"></td> <td style="width: 10%;"></td> <td style="width: 10%;"></td> <td style="width: 10%;"></td> <td style="width: 10%;"></td> </tr> <tr> <td></td> <td></td> <td colspan="8" style="text-align: center;"> <table border="1" style="width: 100%; border-collapse: collapse; text-align: center;"> <tr> <td style="width: 10%;"></td> <td style="width: 10%;"></td> <td style="width: 10%;"></td> <td style="width: 10%;"></td> <td style="width: 10%;"></td> <td style="width: 10%;"></td> <td style="width: 10%;"></td> <td style="width: 10%;"></td> <td style="width: 10%;"></td> <td style="width: 10%;"></td> </tr> <tr> <td></td> <td></td> <td colspan="8" style="text-align: center;"> <table border="1" style="width: 100%; border-collapse: collapse; text-align: center;"> <tr> <td style="width: 10%;"></td> <td style="width: 10%;"></td> <td style="width: 10%;"></td> <td style="width: 10%;"></td> <td style="width: 10%;"></td> <td style="width: 10%;"></td> <td style="width: 10%;"></td> <td style="width: 10%;"></td> <td style="width: 10%;"></td> <td style="width: 10%;"></td> </tr> <tr> <td></td> <td></td> <td colspan="8" style="text-align: center;"> <table border="1" style="width: 100%; border-collapse: collapse; text-align: center;"> <tr> <td style="width: 10%;"></td> <td style="width: 10%;"></td> <td style="width: 10%;"></td> <td style="width: 10%;"></td> <td style="width: 10%;"></td> <td style="width: 10%;"></td> <td style="width: 10%;"></td> <td style="width: 10%;"></td> <td style="width: 10%;"></td> <td style="width: 10%;"></td> </tr> <tr> <td></td> <td></td> <td colspan="8" style="text-align: center;"> <table border="1" style="width: 100%; border-collapse: collapse; text-align: center;"> <tr> <td style="width: 10%;"></td> <td style="width: 10%;"></td> <td style="width: 10%;"></td> <td style="width: 10%;"></td> <td style="width: 10%;"></td> <td style="width: 10%;"></td> <td style="width: 10%;"></td> <td style="width: 10%;"></td> <td style="width: 10%;"></td> <td style="width: 10%;"></td> </tr> <tr> <td></td> <td></td> <td colspan="8" style="text-align: center;"> <table border="1" style="width: 100%; border-collapse: collapse; text-align: center;"> <tr> <td style="width: 10%;"></td> <td style="width: 10%;"></td> <td style="width: 10%;"></td> <td style="width: 10%;"></td> <td style="width: 10%;"></td> <td style="width: 10%;"></td> <td style="width: 10%;"></td> <td style="width: 10%;"></td> <td style="width: 10%;"></td> <td style="width: 10%;"></td> </tr> <tr> <td></td> <td></td> <td colspan="8" style="text-align: center;"> <table border="1" style="width: 100%; border-collapse: collapse; text-align: center;"> <tr> <td style="width: 10%;"></td> <td style="width: 10%;"></td> <td style="width: 10%;"></td> <td style="width: 10%;"></td> <td style="width: 10%;"></td> <td style="width: 10%;"></td> <td style="width: 10%;"></td> <td style="width: 10%;"></td> <td style="width: 10%;"></td> <td style="width: 10%;"></td> </tr> <tr> <td></td> <td></td> <td colspan="8" style="text-align: center;"> <table border="1" style="width: 100%; border-collapse: collapse; text-align: center;"> <tr> <td style="width: 10%;"></td> <td style="width: 10%;"></td> <td style="width: 10%;"></td> <td style="width: 10%;"></td> <td style="width: 10%;"></td> <td style="width: 10%;"></td> <td style="width: 10%;"></td> <td style="width: 10%;"></td> <td style="width: 10%;"></td> <td style="width: 10%;"></td> </tr> <tr> <td></td> <td></td> <td colspan="8" style="text-align: center;"> <table border="1" style="width: 100%; border-collapse: collapse; text-align: center;"> <tr> <td style="width: 10%;"></td> <td style="width: 10%;"></td> <td style="width: 10%;"></td> <td style="width: 10%;"></td> <td style="width: 10%;"></td> <td style="width: 10%;"></td> <td style="width: 10%;"></td> <td style="width: 10%;"></td> <td style="width: 10%;"></td> <td style="width: 10%;"></td> </tr> <tr> <td></td> <td></td> <td colspan="8" style="text-align: center;"> <table border="1" style="width: 100%; border-collapse: collapse; text-align: center;"> <tr> <td style="width: 10%;"></td> <td style="width: 10%;"></td> <td style="width: 10%;"></td> <td style="width: 10%;"></td> <td style="width: 10%;"></td> <td style="width: 10%;"></td> <td style="width: 10%;"></td> <td style="width: 10%;"></td> <td style="width: 10%;"></td> <td style="width: 10%;"></td> </tr> <tr> <td></td> <td></td> <td colspan="8" style="text-align: center;"> <table border="1" style="width: 100%; border-collapse: collapse; text-align: center;"> <tr> <td style="width: 10%;"></td> <td style="width: 10%;"></td> <td style="width: 10%;"></td> <td style="width: 10%;"></td> <td style="width: 10%;"></td> <td style="width: 10%;"></td> <td style="width: 10%;"></td> <td style="width: 10%;"></td> <td style="width: 10%;"></td> <td style="width: 10%;"></td> </tr> <tr> <td></td> <td></td> <td colspan="8" style="text-align: center;"> <table border="1" style="width: 100%; border-collapse: collapse; text-align: center;"> <tr> <td style="width: 10%;"></td> <td style="width: 10%;"></td> <td style="width: 10%;"></td> <td style="width: 10%;"></td> <td style="width: 10%;"></td> <td style="width: 10%;"></td> <td style="width: 10%;"></td> <td style="width: 10%;"></td> <td style="width: 10%;"></td> <td style="width: 10%;"></td> </tr> <tr> <td></td> <td></td> <td colspan="8" style="text-align: center;"> <table border="1" style="width: 100%; border-collapse: collapse; text-align: center;"> <tr> <td style="width: 10%;"></td> <td
style="width: 10%;"></td> <td style="width: 10%;"></td> <td style="width: 10%;"></td> <td style="width: 10%;"></td> <td style="width: 10%;"></td> <td style="width: 10%;"></td> <td style="width: 10%;"></td> <td style="width: 10%;"></td> <td style="width: 10%;"></td> </tr> <tr> <td></td> <td></td> <td colspan="8" style="text-align: center;"> <table border="1" style="width: 100%; border-collapse: collapse; text-align: center;"> <tr> <td style="width: 10%;"></td> <td style="width: 10%;"></td> <td style="width: 10%;"></td> <td style="width: 10%;"></td> <td style="width: 10%;"></td> <td style="width: 10%;"></td> <td style="width: 10%;"></td> <td style="width: 10%;"></td> <td style="width: 10%;"></td> <td style="width: 10%;"></td> </tr> <tr> <td></td> <td></td> <td colspan="8" style="text-align: center;"> <table border="1" style="width: 100%; border-collapse: collapse; text-align: center;"> <tr> <td style="width: 10%;"></td> <td style="width: 10%;"></td> <td style="width: 10%;"></td> <td style="width: 10%;"></td> <td style="width: 10%;"></td> <td style="width: 10%;"></td> <td style="width: 10%;"></td> <td style="width: 10%;"></td> <td style="width: 10%;"></td> <td style="width: 10%;"></td> </tr> <tr> <td></td> <td></td> <td colspan="8" style="text-align: center;"> <table border="1" style="width: 100%; border-collapse: collapse; text-align: center;"> <tr> <td style="width: 10%;"></td> <td style="width: 10%;"></td> <td style="width: 10%;"></td> <td style="width: 10%;"></td> <td style="width: 10%;"></td> <td style="width: 10%;"></td> <td style="width: 10%;"></td> <td style="width: 10%;"></td> <td style="width: 10%;"></td> <td style="width: 10%;"></td> </tr> <tr> <td></td> <td></td> <td colspan="8" style="text-align: center;"> <table border="1" style="width: 100%; border-collapse: collapse; text-align: center;"> <tr> <td style="width: 10%;"></td> <td style="width: 10%;"></td> <td style="width: 10%;"></td> <td style="width: 10%;"></td> <td style="width: 10%;"></td> <td style="width: 10%;"></td> <td style="width: 10%;"></td> <td style="width: 10%;"></td> <td style="width: 10%;"></td> <td style="width: 10%;"></td> </tr> <tr> <td></td> <td></td> <td colspan="8" style="text-align: center;"> <table border="1" style="width: 100%; border-collapse: collapse; text-align: center;"> <tr> <td style="width: 10%;"></td> <td style="width: 10%;"></td> <td style="width: 10%;"></td> <td style="width: 10%;"></td> <td style="width: 10%;"></td> <td style="width: 10%;"></td> <td style="width: 10%;"></td> <td style="width: 10%;"></td> <td style="width: 10%;"></td> <td style="width: 10%;"></td> </tr> <tr> <td></td> <td></td> <td colspan="8" style="text-align: center;"> <table border="1" style="width: 100%; border-collapse: collapse; text-align: center;"> <tr> <td style="width: 10%;"></td> <td style="width: 10%;"></td> <td style="width: 10%;"></td> <td style="width: 10%;"></td> <td style="width: 10%;"></td> <td style="width: 10%;"></td> <td style="width: 10%;"></td> <td style="width: 10%;"></td> <td style="width: 10%;"></td> <td style="width: 10%;"></td> </tr> <tr> <td></td> <td></td> <td colspan="8" style="text-align: center;"> <table border="1" style="width: 100%; border-collapse: collapse; text-align: center;"> <tr> <td style="width: 10%;"></td> <td style="width: 10%;"></td> <td style="width: 10%;"></td> <td style="width: 10%;"></td> <td style="width: 10%;"></td> <td style="width: 10%;"></td> <td style="width: 10%;"></td> <td style="width: 10%;"></td> <td style="width: 10%;"></td> <td style="width: 10%;"></td> </tr> <tr> <td></td> <td></td> <td colspan="8" style="text-align: center;"> <table border="1" style="width: 100%; border-collapse: collapse; text-align: center;"> <tr> <td style="width: 10%;"></td> <td style="width: 10%;"></td> <td style="width: 10%;"></td> <td style="width: 10%;"></td> <td style="width: 10%;"></td> <td style="width: 10%;"></td> <td style="width: 10%;"></td> <td style="width: 10%;"></td> <td style="width: 10%;"></td> <td style="width: 10%;"></td> </tr> <tr> <td></td> <td></td> <td colspan="8" style="text-align: center;"> <table border="1" style="width: 100%; border-collapse: collapse; text-align: center;"> <tr> <td style="width: 10%;"></td> <td style="width: 10%;"></td> <td style="width: 10%;"></td> <td style="width: 10%;"></td> <td style="width: 10%;"></td> <td style="width: 10%;"></td> <td style="width: 10%;"></td> <td style="width: 10%;"></td> <td style="width: 10%;"></td> <td style="width: 10%;"></td> </tr> <tr> <td></td> <td></td> <td colspan="8" style="text-align: center;"> <table border="1" style="width: 100%; border-collapse: collapse; text-align: center;"> <tr> <td style="width: 10%;"></td> <td style="width: 10%;"></td> <td style="width: 10%;"></td> <td style="width: 10%;"></td> <td style="width: 10%;"></td> <td style="width: 10%;"></td> <td style="width: 10%;"></td> <td style="width: 10%;"></td> <td style="width: 10%;"></td> <td style="width: 10%;"></td> </tr> <tr> <td></td> <td></td> <td colspan="8" style="text-align: center;"> <table border="1" style="width: 100%; border-collapse: collapse; text-align: center;"> <tr> <td style="width: 10%;"></td> <td style="width: 10%;"></td> <td style="width: 10%;"></td> <td style="width: 10%;"></td> <td style="width: 10%;"></td> <td style="width: 10%;"></td> <td style="width: 10%;"></td> <td style="width: 10%;"></td> <td style="width: 10%;"></td> <td style="width: 10%;"></td> </tr> <tr> <td></td> <td></td> <td colspan="8" style="text-align: center;"> <table border="1" style="width: 100%; border-collapse: collapse; text-align: center;"> <tr> <td style="width: 10%;"></td> <td style="width: 10%;"></td> <td style="width: 10%;"></td> <td style="width: 10%;"></td> <td style="width: 10%;"></td> <td style="width: 10%;"></td> <td style="width: 10%;"></td> <td style="width: 10%;"></td> <td style="width: 10%;"></td> <td style="width: 10%;"></td> </tr> <tr> <td></td> <td></td> <td colspan="8" style="text-align: center;"> <table border="1" style="width: 100%; border-collapse: collapse; text-align: center;"> <tr> <td style="width: 10%;"></td> <td style="width: 10%;"></td> <td style="width: 10%;"></td> <td style="width: 10%;"></td> <td style="width: 10%;"></td> <td style="width: 10%;"></td> <td style="width: 10%;"></td> <td style="width: 10%;"></td> <td style="width: 10%;"></td> <td style="width: 10%;"></td> </tr> <tr> <td></td> <td></td> <td colspan="8" style="text-align: center;"> <table border="1" style="width: 100%; border-collapse: collapse; text-align: center;"> <tr> <td style="width: 10%;"></td> <td style="width: 10%;"></td> <td style="width: 10%;"></td> <td style="width: 10%;"></td> <td style="width: 10%;"></td> <td style="width: 10%;"></td> <td style="width: 10%;"></td> <td style="width: 10%;"></td> <td style="width: 10%;"></td> <td style="width: 10%;"></td> </tr> <tr> <td></td> <td></td> <td colspan="8" style="text-align: center;"> <table border="1" style="width: 100%; border-collapse: collapse; text-align: center;"> <tr> <td style="width: 10%;"></td> <td style="width: 10%;"></td> <td style="width: 10%;"></td> <td style="width: 10%;"></td> <td style="width: 10%;"></td> <td style="width: 10%;"></td> <td style="width: 10%;"></td> <td style="width: 10%;"></td> <td style="width: 10%;"></td> <td style="width: 10%;"></td> </tr> <tr> <td></td> <td></td> <td colspan="8" style="text-align: center;"> <table border="1" style="width: 100%; border-collapse: collapse; text-align: center;"> <tr> <td style="width: 10%;"></td> <td style="width: 10%;"></td> <td style="width: 10%;"></td> <td style="width: 10%;"></td> <td style="width: 10%;"></td> <td style="width: 10%;"></td> <td style="width: 10%;"></td> <td style="width: 10%;"></td> <td style="width: 10%;"></td> <td style="width: 10%;"></td> </tr> <tr> <td></td> <td></td> <td colspan="8" style="text-align: center;"> <table border="1" style="width: 100%; border-collapse: collapse; text-align: center;"> <tr> </tr></table></td></tr></table></td></tr></table></td></tr></table></td></tr></table></td></tr></table></td></tr></table></td></tr></table></td></tr></table></td></tr></table></td></tr></table></td></tr></table></td></tr></table></td></tr></table></td></tr></table></td></tr></table></td></tr></table></td></tr></table></td></tr></table></td></tr></table></td></tr></table></td></tr></table></td></tr></table></td></tr></table></td></tr></table></td></tr></table></td></tr></table></td></tr></table></td></tr></table></td></tr></table></td></tr></table></td></tr></table></td></tr></table></td></tr></table>

 | | | | | | | | | | | | | | | | | | | | <table border="1" style="width: 100%; border-collapse: collapse; text-align: center;"> <tr> <td style="width: 10%;"></td> <td style="width: 10%;"></td> <td style="width: 10%;"></td> <td style="width: 10%;"></td> <td style="width: 10%;"></td> <td style="width: 10%;"></td> <td style="width: 10%;"></td> <td style="width: 10%;"></td> <td style="width: 10%;"></td> <td style="width: 10%;"></td> </tr> <tr> <td></td> <td></td> <td colspan="8" style="text-align: center;"> <table border="1" style="width: 100%; border-collapse: collapse; text-align: center;"> <tr> <td style="width: 10%;"></td> <td style="width: 10%;"></td> <td style="width: 10%;"></td> <td style="width: 10%;"></td> <td style="width: 10%;"></td> <td style="width: 10%;"></td> <td style="width: 10%;"></td> <td style="width: 10%;"></td> <td style="width: 10%;"></td> <td style="width: 10%;"></td> </tr> <tr> <td></td> <td></td> <td colspan="8" style="text-align: center;"> <table border="1" style="width: 100%; border-collapse: collapse; text-align: center;"> <tr> <td style="width: 10%;"></td> <td style="width: 10%;"></td> <td style="width: 10%;"></td> <td style="width: 10%;"></td> <td style="width: 10%;"></td> <td style="width: 10%;"></td> <td style="width: 10%;"></td> <td style="width: 10%;"></td> <td style="width: 10%;"></td> <td style="width: 10%;"></td> </tr> <tr> <td></td> <td></td> <td colspan="8" style="text-align: center;"> <table border="1" style="width: 100%; border-collapse: collapse; text-align: center;"> <tr> <td style="width: 10%;"></td> <td style="width: 10%;"></td> <td style="width: 10%;"></td> <td style="width: 10%;"></td> <td style="width: 10%;"></td> <td style="width: 10%;"></td> <td style="width: 10%;"></td> <td style="width: 10%;"></td> <td style="width: 10%;"></td> <td style="width: 10%;"></td> </tr> <tr> <td></td> <td></td> <td colspan="8" style="text-align: center;"> <table border="1" style="width: 100%; border-collapse: collapse; text-align: center;"> <tr> <td style="width: 10%;"></td> <td style="width: 10%;"></td> <td style="width: 10%;"></td> <td style="width: 10%;"></td> <td style="width: 10%;"></td> <td style="width: 10%;"></td> <td style="width: 10%;"></td> <td style="width: 10%;"></td> <td style="width: 10%;"></td> <td style="width: 10%;"></td> </tr> <tr> <td></td> <td></td> <td colspan="8" style="text-align: center;"> <table border="1" style="width: 100%; border-collapse: collapse; text-align: center;"> <tr> <td style="width: 10%;"></td> <td style="width: 10%;"></td> <td style="width: 10%;"></td> <td style="width: 10%;"></td> <td style="width: 10%;"></td> <td style="width: 10%;"></td> <td style="width: 10%;"></td> <td style="width: 10%;"></td> <td style="width: 10%;"></td> <td style="width: 10%;"></td> </tr> <tr> <td></td> <td></td> <td colspan="8" style="text-align: center;"> <table border="1" style="width: 100%; border-collapse: collapse; text-align: center;"> <tr> <td style="width: 10%;"></td> <td style="width: 10%;"></td> <td style="width: 10%;"></td> <td style="width: 10%;"></td> <td style="width: 10%;"></td> <td style="width: 10%;"></td> <td style="width: 10%;"></td> <td style="width: 10%;"></td> <td style="width: 10%;"></td> <td style="width: 10%;"></td> </tr> <tr> <td></td> <td></td> <td colspan="8" style="text-align: center;"> <table border="1" style="width: 100%; border-collapse: collapse; text-align: center;"> <tr> <td style="width: 10%;"></td> <td style="width: 10%;"></td> <td style="width: 10%;"></td> <td style="width: 10%;"></td> <td style="width: 10%;"></td> <td style="width: 10%;"></td> <td style="width: 10%;"></td> <td style="width: 10%;"></td> <td style="width: 10%;"></td> <td style="width: 10%;"></td> </tr> <tr> <td></td> <td></td> <td colspan="8" style="text-align: center;"> <table border="1" style="width: 100%; border-collapse: collapse; text-align: center;"> <tr> <td style="width: 10%;"></td> <td style="width: 10%;"></td> <td style="width: 10%;"></td> <td style="width: 10%;"></td> <td style="width: 10%;"></td> <td style="width: 10%;"></td> <td style="width: 10%;"></td> <td style="width: 10%;"></td> <td style="width: 10%;"></td> <td style="width: 10%;"></td> </tr> <tr> <td></td> <td></td> <td colspan="8" style="text-align: center;"> <table border="1" style="width: 100%; border-collapse: collapse; text-align: center;"> <tr> <td style="width: 10%;"></td> <td style="width: 10%;"></td> <td style="width: 10%;"></td> <td style="width: 10%;"></td> <td style="width: 10%;"></td> <td style="width: 10%;"></td> <td style="width: 10%;"></td> <td style="width: 10%;"></td> <td style="width: 10%;"></td> <td style="width: 10%;"></td> </tr> <tr> <td></td> <td></td> <td colspan="8" style="text-align: center;"> <table border="1" style="width: 100%; border-collapse: collapse; text-align: center;"> <tr> <td style="width: 10%;"></td> <td style="width: 10%;"></td> <td style="width: 10%;"></td> <td style="width: 10%;"></td> <td style="width: 10%;"></td> <td style="width: 10%;"></td> <td style="width: 10%;"></td> <td style="width: 10%;"></td> <td style="width: 10%;"></td> <td style="width: 10%;"></td> </tr> <tr> <td></td> <td></td> <td colspan="8" style="text-align: center;"> <table border="1" style="width: 100%; border-collapse: collapse; text-align: center;"> <tr> <td style="width: 10%;"></td> <td style="width: 10%;"></td> <td style="width: 10%;"></td> <td style="width: 10%;"></td> <td style="width: 10%;"></td> <td style="width: 10%;"></td> <td style="width: 10%;"></td> <td style="width: 10%;"></td> <td style="width: 10%;"></td> <td style="width: 10%;"></td> </tr> <tr> <td></td> <td></td> <td colspan="8" style="text-align: center;"> <table border="1" style="width: 100%; border-collapse: collapse; text-align: center;"> <tr> <td style="width: 10%;"></td> <td style="width: 10%;"></td> <td style="width: 10%;"></td> <td style="width: 10%;"></td> <td style="width: 10%;"></td> <td style="width: 10%;"></td> <td style="width: 10%;"></td> <td style="width: 10%;"></td> <td style="width: 10%;"></td> <td style="width: 10%;"></td> </tr> <tr> <td></td> <td></td> <td colspan="8" style="text-align: center;"> <table border="1" style="width: 100%; border-collapse: collapse; text-align: center;"> <tr> <td style="width: 10%;"></td> <td style="width: 10%;"></td> <td style="width: 10%;"></td> <td style="width: 10%;"></td> <td style="width: 10%;"></td> <td style="width: 10%;"></td> <td style="width: 10%;"></td> <td style="width: 10%;"></td> <td style="width: 10%;"></td> <td style="width: 10%;"></td> </tr> <tr> <td></td> <td></td> <td colspan="8" style="text-align: center;"> <table border="1" style="width: 100%; border-collapse: collapse; text-align: center;"> <tr> <td style="width: 10%;"></td> <td style="width: 10%;"></td> <td style="width: 10%;"></td> <td style="width: 10%;"></td> <td style="width: 10%;"></td> <td style="width: 10%;"></td> <td style="width: 10%;"></td> <td style="width: 10%;"></td> <td style="width: 10%;"></td> <td style="width: 10%;"></td> </tr> <tr> <td></td> <td></td> <td colspan="8" style="text-align: center;"> <table border="1" style="width: 100%; border-collapse: collapse; text-align: center;"> <tr> <td style="width: 10%;"></td> <td style="width: 10%;"></td> <td style="width: 10%;"></td> <td style="width: 10%;"></td> <td style="width: 10%;"></td> <td style="width: 10%;"></td> <td style="width: 10%;"></td> <td style="width: 10%;"></td> <td style="width: 10%;"></td> <td style="width: 10%;"></td> </tr> <tr> <td></td> <td></td> <td colspan="8" style="text-align: center;"> <table border="1" style="width: 100%; border-collapse: collapse; text-align: center;"> <tr> <td style="width: 10%;"></td> <td style="width: 10%;"></td> <td style="width: 10%;"></td> <td style="width: 10%;"></td> <td style="width: 10%;"></td> <td style="width: 10%;"></td> <td style="width: 10%;"></td> <td
style="width: 10%;"></td> <td style="width: 10%;"></td> <td style="width: 10%;"></td> </tr> <tr> <td></td> <td></td> <td colspan="8" style="text-align: center;"> <table border="1" style="width: 100%; border-collapse: collapse; text-align: center;"> <tr> <td style="width: 10%;"></td> <td style="width: 10%;"></td> <td style="width: 10%;"></td> <td style="width: 10%;"></td> <td style="width: 10%;"></td> <td style="width: 10%;"></td> <td style="width: 10%;"></td> <td style="width: 10%;"></td> <td style="width: 10%;"></td> <td style="width: 10%;"></td> </tr> <tr> <td></td> <td></td> <td colspan="8" style="text-align: center;"> <table border="1" style="width: 100%; border-collapse: collapse; text-align: center;"> <tr> <td style="width: 10%;"></td> <td style="width: 10%;"></td> <td style="width: 10%;"></td> <td style="width: 10%;"></td> <td style="width: 10%;"></td> <td style="width: 10%;"></td> <td style="width: 10%;"></td> <td style="width: 10%;"></td> <td style="width: 10%;"></td> <td style="width: 10%;"></td> </tr> <tr> <td></td> <td></td> <td colspan="8" style="text-align: center;"> <table border="1" style="width: 100%; border-collapse: collapse; text-align: center;"> <tr> <td style="width: 10%;"></td> <td style="width: 10%;"></td> <td style="width: 10%;"></td> <td style="width: 10%;"></td> <td style="width: 10%;"></td> <td style="width: 10%;"></td> <td style="width: 10%;"></td> <td style="width: 10%;"></td> <td style="width: 10%;"></td> <td style="width: 10%;"></td> </tr> <tr> <td></td> <td></td> <td colspan="8" style="text-align: center;"> <table border="1" style="width: 100%; border-collapse: collapse; text-align: center;"> <tr> <td style="width: 10%;"></td> <td style="width: 10%;"></td> <td style="width: 10%;"></td> <td style="width: 10%;"></td> <td style="width: 10%;"></td> <td style="width: 10%;"></td> <td style="width: 10%;"></td> <td style="width: 10%;"></td> <td style="width: 10%;"></td> <td style="width: 10%;"></td> </tr> <tr> <td></td> <td></td> <td colspan="8" style="text-align: center;"> <table border="1" style="width: 100%; border-collapse: collapse; text-align: center;"> <tr> <td style="width: 10%;"></td> <td style="width: 10%;"></td> <td style="width: 10%;"></td> <td style="width: 10%;"></td> <td style="width: 10%;"></td> <td style="width: 10%;"></td> <td style="width: 10%;"></td> <td style="width: 10%;"></td> <td style="width: 10%;"></td> <td style="width: 10%;"></td> </tr> <tr> <td></td> <td></td> <td colspan="8" style="text-align: center;"> <table border="1" style="width: 100%; border-collapse: collapse; text-align: center;"> <tr> <td style="width: 10%;"></td> <td style="width: 10%;"></td> <td style="width: 10%;"></td> <td style="width: 10%;"></td> <td style="width: 10%;"></td> <td style="width: 10%;"></td> <td style="width: 10%;"></td> <td style="width: 10%;"></td> <td style="width: 10%;"></td> <td style="width: 10%;"></td> </tr> <tr> <td></td> <td></td> <td colspan="8" style="text-align: center;"> <table border="1" style="width: 100%; border-collapse: collapse; text-align: center;"> <tr> <td style="width: 10%;"></td> <td style="width: 10%;"></td> <td style="width: 10%;"></td> <td style="width: 10%;"></td> <td style="width: 10%;"></td> <td style="width: 10%;"></td> <td style="width: 10%;"></td> <td style="width: 10%;"></td> <td style="width: 10%;"></td> <td style="width: 10%;"></td> </tr> <tr> <td></td> <td></td> <td colspan="8" style="text-align: center;"> <table border="1" style="width: 100%; border-collapse: collapse; text-align: center;"> <tr> <td style="width: 10%;"></td> <td style="width: 10%;"></td> <td style="width: 10%;"></td> <td style="width: 10%;"></td> <td style="width: 10%;"></td> <td style="width: 10%;"></td> <td style="width: 10%;"></td> <td style="width: 10%;"></td> <td style="width: 10%;"></td> <td style="width: 10%;"></td> </tr> <tr> <td></td> <td></td> <td colspan="8" style="text-align: center;"> <table border="1" style="width: 100%; border-collapse: collapse; text-align: center;"> <tr> <td style="width: 10%;"></td> <td style="width: 10%;"></td> <td style="width: 10%;"></td> <td style="width: 10%;"></td> <td style="width: 10%;"></td> <td style="width: 10%;"></td> <td style="width: 10%;"></td> <td style="width: 10%;"></td> <td style="width: 10%;"></td> <td style="width: 10%;"></td> </tr> <tr> <td></td> <td></td> <td colspan="8" style="text-align: center;"> <table border="1" style="width: 100%; border-collapse: collapse; text-align: center;"> <tr> <td style="width: 10%;"></td> <td style="width: 10%;"></td> <td style="width: 10%;"></td> <td style="width: 10%;"></td> <td style="width: 10%;"></td> <td style="width: 10%;"></td> <td style="width: 10%;"></td> <td style="width: 10%;"></td> <td style="width: 10%;"></td> <td style="width: 10%;"></td> </tr> <tr> <td></td> <td></td> <td colspan="8" style="text-align: center;"> <table border="1" style="width: 100%; border-collapse: collapse; text-align: center;"> <tr> <td style="width: 10%;"></td> <td style="width: 10%;"></td> <td style="width: 10%;"></td> <td style="width: 10%;"></td> <td style="width: 10%;"></td> <td style="width: 10%;"></td> <td style="width: 10%;"></td> <td style="width: 10%;"></td> <td style="width: 10%;"></td> <td style="width: 10%;"></td> </tr> <tr> <td></td> <td></td> <td colspan="8" style="text-align: center;"> <table border="1" style="width: 100%; border-collapse: collapse; text-align: center;"> <tr> <td style="width: 10%;"></td> <td style="width: 10%;"></td> <td style="width: 10%;"></td> <td style="width: 10%;"></td> <td style="width: 10%;"></td> <td style="width: 10%;"></td> <td style="width: 10%;"></td> <td style="width: 10%;"></td> <td style="width: 10%;"></td> <td style="width: 10%;"></td> </tr> <tr> <td></td> <td></td> <td colspan="8" style="text-align: center;"> <table border="1" style="width: 100%; border-collapse: collapse; text-align: center;"> <tr> <td style="width: 10%;"></td> <td style="width: 10%;"></td> <td style="width: 10%;"></td> <td style="width: 10%;"></td> <td style="width: 10%;"></td> <td style="width: 10%;"></td> <td style="width: 10%;"></td> <td style="width: 10%;"></td> <td style="width: 10%;"></td> <td style="width: 10%;"></td> </tr> <tr> <td></td> <td></td> <td colspan="8" style="text-align: center;"> <table border="1" style="width: 100%; border-collapse: collapse; text-align: center;"> <tr> <td style="width: 10%;"></td> <td style="width: 10%;"></td> <td style="width: 10%;"></td> <td style="width: 10%;"></td> <td style="width: 10%;"></td> <td style="width: 10%;"></td> <td style="width: 10%;"></td> <td style="width: 10%;"></td> <td style="width: 10%;"></td> <td style="width: 10%;"></td> </tr> <tr> <td></td> <td></td> <td colspan="8" style="text-align: center;"> <table border="1" style="width: 100%; border-collapse: collapse; text-align: center;"> <tr> <td style="width: 10%;"></td> <td style="width: 10%;"></td> <td style="width: 10%;"></td> <td style="width: 10%;"></td> <td style="width: 10%;"></td> <td style="width: 10%;"></td> <td style="width: 10%;"></td> <td style="width: 10%;"></td> <td style="width: 10%;"></td> <td style="width: 10%;"></td> </tr> <tr> <td></td> <td></td> <td colspan="8" style="text-align: center;"> <table border="1" style="width: 100%; border-collapse: collapse; text-align: center;"> <tr> </tr></table></td></tr></table></td></tr></table></td></tr></table></td></tr></table></td></tr></table></td></tr></table></td></tr></table></td></tr></table></td></tr></table></td></tr></table></td></tr></table></td></tr></table></td></tr></table></td></tr></table></td></tr></table></td></tr></table></td></tr></table></td></tr></table></td></tr></table></td></tr></table></td></tr></table></td></tr></table></td></tr></table></td></tr></table></td></tr></table></td></tr></table></td></tr></table></td></tr></table></td></tr></table></td></tr></table></td></tr></table></td></tr></table>

 | | | | | | | | | | | | | | | | | | | | <table border="1" style="width: 100%; border-collapse: collapse; text-align: center;"> <tr> <td style="width: 10%;"></td> <td style="width: 10%;"></td> <td style="width: 10%;"></td> <td style="width: 10%;"></td> <td style="width: 10%;"></td> <td style="width: 10%;"></td> <td style="width: 10%;"></td> <td style="width: 10%;"></td> <td style="width: 10%;"></td> <td style="width: 10%;"></td> </tr> <tr> <td></td> <td></td> <td colspan="8" style="text-align: center;"> <table border="1" style="width: 100%; border-collapse: collapse; text-align: center;"> <tr> <td style="width: 10%;"></td> <td style="width: 10%;"></td> <td style="width: 10%;"></td> <td style="width: 10%;"></td> <td style="width: 10%;"></td> <td style="width: 10%;"></td> <td style="width: 10%;"></td> <td style="width: 10%;"></td> <td style="width: 10%;"></td> <td style="width: 10%;"></td> </tr> <tr> <td></td> <td></td> <td colspan="8" style="text-align: center;"> <table border="1" style="width: 100%; border-collapse: collapse; text-align: center;"> <tr> <td style="width: 10%;"></td> <td style="width: 10%;"></td> <td style="width: 10%;"></td> <td style="width: 10%;"></td> <td style="width: 10%;"></td> <td style="width: 10%;"></td> <td style="width: 10%;"></td> <td style="width: 10%;"></td> <td style="width: 10%;"></td> <td style="width: 10%;"></td> </tr> <tr> <td></td> <td></td> <td colspan="8" style="text-align: center;"> <table border="1" style="width: 100%; border-collapse: collapse; text-align: center;"> <tr> <td style="width: 10%;"></td> <td style="width: 10%;"></td> <td style="width: 10%;"></td> <td style="width: 10%;"></td> <td style="width: 10%;"></td> <td style="width: 10%;"></td> <td style="width: 10%;"></td> <td style="width: 10%;"></td> <td style="width: 10%;"></td> <td style="width: 10%;"></td> </tr> <tr> <td></td> <td></td> <td colspan="8" style="text-align: center;"> <table border="1" style="width: 100%; border-collapse: collapse; text-align: center;"> <tr> <td style="width: 10%;"></td> <td style="width: 10%;"></td> <td style="width: 10%;"></td> <td style="width: 10%;"></td> <td style="width: 10%;"></td> <td style="width: 10%;"></td> <td style="width: 10%;"></td> <td style="width: 10%;"></td> <td style="width: 10%;"></td> <td style="width: 10%;"></td> </tr> <tr> <td></td> <td></td> <td colspan="8" style="text-align: center;"> <table border="1" style="width: 100%; border-collapse: collapse; text-align: center;"> <tr> <td style="width: 10%;"></td> <td style="width: 10%;"></td> <td style="width: 10%;"></td> <td style="width: 10%;"></td> <td style="width: 10%;"></td> <td style="width: 10%;"></td> <td style="width: 10%;"></td> <td style="width: 10%;"></td> <td style="width: 10%;"></td> <td style="width: 10%;"></td> </tr> <tr> <td></td> <td></td> <td colspan="8" style="text-align: center;"> <table border="1" style="width: 100%; border-collapse: collapse; text-align: center;"> <tr> <td style="width: 10%;"></td> <td style="width: 10%;"></td> <td style="width: 10%;"></td> <td style="width: 10%;"></td> <td style="width: 10%;"></td> <td style="width: 10%;"></td> <td style="width: 10%;"></td> <td style="width: 10%;"></td> <td style="width: 10%;"></td> <td style="width: 10%;"></td> </tr> <tr> <td></td> <td></td> <td colspan="8" style="text-align: center;"> <table border="1" style="width: 100%; border-collapse: collapse; text-align: center;"> <tr> <td style="width: 10%;"></td> <td style="width: 10%;"></td> <td style="width: 10%;"></td> <td style="width: 10%;"></td> <td style="width: 10%;"></td> <td style="width: 10%;"></td> <td style="width: 10%;"></td> <td style="width: 10%;"></td> <td style="width: 10%;"></td> <td style="width: 10%;"></td> </tr> <tr> <td></td> <td></td> <td colspan="8" style="text-align: center;"> <table border="1" style="width: 100%; border-collapse: collapse; text-align: center;"> <tr> <td style="width: 10%;"></td> <td style="width: 10%;"></td> <td style="width: 10%;"></td> <td style="width: 10%;"></td> <td style="width: 10%;"></td> <td style="width: 10%;"></td> <td style="width: 10%;"></td> <td style="width: 10%;"></td> <td style="width: 10%;"></td> <td style="width: 10%;"></td> </tr> <tr> <td></td> <td></td> <td colspan="8" style="text-align: center;"> <table border="1" style="width: 100%; border-collapse: collapse; text-align: center;"> <tr> <td style="width: 10%;"></td> <td style="width: 10%;"></td> <td style="width: 10%;"></td> <td style="width: 10%;"></td> <td style="width: 10%;"></td> <td style="width: 10%;"></td> <td style="width: 10%;"></td> <td style="width: 10%;"></td> <td style="width: 10%;"></td> <td style="width: 10%;"></td> </tr> <tr> <td></td> <td></td> <td colspan="8" style="text-align: center;"> <table border="1" style="width: 100%; border-collapse: collapse; text-align: center;"> <tr> <td style="width: 10%;"></td> <td style="width: 10%;"></td> <td style="width: 10%;"></td> <td style="width: 10%;"></td> <td style="width: 10%;"></td> <td style="width: 10%;"></td> <td style="width: 10%;"></td> <td style="width: 10%;"></td> <td style="width: 10%;"></td> <td style="width: 10%;"></td> </tr> <tr> <td></td> <td></td> <td colspan="8" style="text-align: center;"> <table border="1" style="width: 100%; border-collapse: collapse; text-align: center;"> <tr> <td style="width: 10%;"></td> <td style="width: 10%;"></td> <td style="width: 10%;"></td> <td style="width: 10%;"></td> <td style="width: 10%;"></td> <td style="width: 10%;"></td> <td style="width: 10%;"></td> <td style="width: 10%;"></td> <td style="width: 10%;"></td> <td style="width: 10%;"></td> </tr> <tr> <td></td> <td></td> <td colspan="8" style="text-align: center;"> <table border="1" style="width: 100%; border-collapse: collapse; text-align: center;"> <tr> <td style="width: 10%;"></td> <td style="width: 10%;"></td> <td style="width: 10%;"></td> <td style="width: 10%;"></td> <td style="width: 10%;"></td> <td style="width: 10%;"></td> <td style="width: 10%;"></td> <td style="width: 10%;"></td> <td style="width: 10%;"></td> <td style="width: 10%;"></td> </tr> <tr> <td></td> <td></td> <td colspan="8" style="text-align: center;"> <table border="1" style="width: 100%; border-collapse: collapse; text-align: center;"> <tr> <td style="width: 10%;"></td> <td style="width: 10%;"></td> <td style="width: 10%;"></td> <td style="width: 10%;"></td> <td style="width: 10%;"></td> <td style="width: 10%;"></td> <td style="width: 10%;"></td> <td style="width: 10%;"></td> <td style="width: 10%;"></td> <td style="width: 10%;"></td> </tr> <tr> <td></td> <td></td> <td colspan="8" style="text-align: center;"> <table border="1" style="width: 100%; border-collapse: collapse; text-align: center;"> <tr> <td style="width: 10%;"></td> <td style="width: 10%;"></td> <td style="width: 10%;"></td> <td style="width: 10%;"></td> <td style="width: 10%;"></td> <td style="width: 10%;"></td> <td style="width: 10%;"></td> <td style="width: 10%;"></td> <td style="width: 10%;"></td> <td style="width: 10%;"></td> </tr> <tr> <td></td> <td></td> <td colspan="8" style="text-align: center;"> <table border="1" style="width: 100%; border-collapse: collapse; text-align: center;"> <tr> <td style="width: 10%;"></td> <td style="width: 10%;"></td> <td style="width: 10%;"></td> <td style="width: 10%;"></td> <td style="width: 10%;"></td> <td style="width: 10%;"></td> <td style="width: 10%;"></td> <td style="width: 10%;"></td> <td style="width: 10%;"></td> <td style="width: 10%;"></td> </tr> <tr> <td></td> <td></td> <td colspan="8" style="text-align: center;"> <table border="1" style="width: 100%; border-collapse: collapse; text-align: center;"> <tr> <td style="width: 10%;"></td> <td style="width: 10%;"></td> <td style="width: 10%;"></td> <td style="width: 10%;"></td> <td style="width: 10%;"></td> <td style="width: 10%;"></td> <td style="width: 10%;"></td> <td style="width: 10%;"></td> <td style="width: 10%;"></td> <td style="width: 10%;"></td> </tr> <tr> <td></td> <td></td> <td colspan="8" style="text-align: center;"> <table border="1" style="width: 100%; border-collapse: collapse; text-align: center;"> <tr> <td style="width: 10%;"></td> <td style="width: 10%;"></td> <td style="width: 10%;"></td> <td style="width: 10%;"></td> <td style="width: 10%;"></td> <td style="width: 10%;"></td> <td style="width: 10%;"></td> <td style="width: 10%;"></td> <td style="width: 10%;"></td> <td style="width: 10%;"></td> </tr> <tr> <td></td> <td></td> <td colspan="8" style="text-align: center;"> <table border="1" style="width: 100%;
border-collapse: collapse; text-align: center;"> <tr> <td style="width: 10%;"></td> <td style="width: 10%;"></td> <td style="width: 10%;"></td> <td style="width: 10%;"></td> <td style="width: 10%;"></td> <td style="width: 10%;"></td> <td style="width: 10%;"></td> <td style="width: 10%;"></td> <td style="width: 10%;"></td> <td style="width: 10%;"></td> </tr> <tr> <td></td> <td></td> <td colspan="8" style="text-align: center;"> <table border="1" style="width: 100%; border-collapse: collapse; text-align: center;"> <tr> <td style="width: 10%;"></td> <td style="width: 10%;"></td> <td style="width: 10%;"></td> <td style="width: 10%;"></td> <td style="width: 10%;"></td> <td style="width: 10%;"></td> <td style="width: 10%;"></td> <td style="width: 10%;"></td> <td style="width: 10%;"></td> <td style="width: 10%;"></td> </tr> <tr> <td></td> <td></td> <td colspan="8" style="text-align: center;"> <table border="1" style="width: 100%; border-collapse: collapse; text-align: center;"> <tr> <td style="width: 10%;"></td> <td style="width: 10%;"></td> <td style="width: 10%;"></td> <td style="width: 10%;"></td> <td style="width: 10%;"></td> <td style="width: 10%;"></td> <td style="width: 10%;"></td> <td style="width: 10%;"></td> <td style="width: 10%;"></td> <td style="width: 10%;"></td> </tr> <tr> <td></td> <td></td> <td colspan="8" style="text-align: center;"> <table border="1" style="width: 100%; border-collapse: collapse; text-align: center;"> <tr> <td style="width: 10%;"></td> <td style="width: 10%;"></td> <td style="width: 10%;"></td> <td style="width: 10%;"></td> <td style="width: 10%;"></td> <td style="width: 10%;"></td> <td style="width: 10%;"></td> <td style="width: 10%;"></td> <td style="width: 10%;"></td> <td style="width: 10%;"></td> </tr> <tr> <td></td> <td></td> <td colspan="8" style="text-align: center;"> <table border="1" style="width: 100%; border-collapse: collapse; text-align: center;"> <tr> <td style="width: 10%;"></td> <td style="width: 10%;"></td> <td style="width: 10%;"></td> <td style="width: 10%;"></td> <td style="width: 10%;"></td> <td style="width: 10%;"></td> <td style="width: 10%;"></td> <td style="width: 10%;"></td> <td style="width: 10%;"></td> <td style="width: 10%;"></td> </tr> <tr> <td></td> <td></td> <td colspan="8" style="text-align: center;"> <table border="1" style="width: 100%; border-collapse: collapse; text-align: center;"> <tr> <td style="width: 10%;"></td> <td style="width: 10%;"></td> <td style="width: 10%;"></td> <td style="width: 10%;"></td> <td style="width: 10%;"></td> <td style="width: 10%;"></td> <td style="width: 10%;"></td> <td style="width: 10%;"></td> <td style="width: 10%;"></td> <td style="width: 10%;"></td> </tr> <tr> <td></td> <td></td> <td colspan="8" style="text-align: center;"> <table border="1" style="width: 100%; border-collapse: collapse; text-align: center;"> <tr> <td style="width: 10%;"></td> <td style="width: 10%;"></td> <td style="width: 10%;"></td> <td style="width: 10%;"></td> <td style="width: 10%;"></td> <td style="width: 10%;"></td> <td style="width: 10%;"></td> <td style="width: 10%;"></td> <td style="width: 10%;"></td> <td style="width: 10%;"></td> </tr> <tr> <td></td> <td></td> <td colspan="8" style="text-align: center;"> <table border="1" style="width: 100%; border-collapse: collapse; text-align: center;"> <tr> <td style="width: 10%;"></td> <td style="width: 10%;"></td> <td style="width: 10%;"></td> <td style="width: 10%;"></td> <td style="width: 10%;"></td> <td style="width: 10%;"></td> <td style="width: 10%;"></td> <td style="width: 10%;"></td> <td style="width: 10%;"></td> <td style="width: 10%;"></td> </tr> <tr> <td></td> <td></td> <td colspan="8" style="text-align: center;"> <table border="1" style="width: 100%; border-collapse: collapse; text-align: center;"> <tr> <td style="width: 10%;"></td> <td style="width: 10%;"></td> <td style="width: 10%;"></td> <td style="width: 10%;"></td> <td style="width: 10%;"></td> <td style="width: 10%;"></td> <td style="width: 10%;"></td> <td style="width: 10%;"></td> <td style="width: 10%;"></td> <td style="width: 10%;"></td> </tr> <tr> <td></td> <td></td> <td colspan="8" style="text-align: center;"> <table border="1" style="width: 100%; border-collapse: collapse; text-align: center;"> <tr> <td style="width: 10%;"></td> <td style="width: 10%;"></td> <td style="width: 10%;"></td> <td style="width: 10%;"></td> <td style="width: 10%;"></td> <td style="width: 10%;"></td> <td style="width: 10%;"></td> <td style="width: 10%;"></td> <td style="width: 10%;"></td> <td style="width: 10%;"></td> </tr> <tr> <td></td> <td></td> <td colspan="8" style="text-align: center;"> <table border="1" style="width: 100%; border-collapse: collapse; text-align: center;"> <tr> <td style="width: 10%;"></td> <td style="width: 10%;"></td> <td style="width: 10%;"></td> <td style="width: 10%;"></td> <td style="width: 10%;"></td> <td style="width: 10%;"></td> <td style="width: 10%;"></td> <td style="width: 10%;"></td> <td style="width: 10%;"></td> <td style="width: 10%;"></td> </tr> <tr> <td></td> <td></td> <td colspan="8" style="text-align: center;"> <table border="1" style="width: 100%; border-collapse: collapse; text-align: center;"> <tr> <td style="width: 10%;"></td> <td style="width: 10%;"></td> <td style="width: 10%;"></td> <td style="width: 10%;"></td> <td style="width: 10%;"></td> <td style="width: 10%;"></td> <td style="width: 10%;"></td> <td style="width: 10%;"></td> <td style="width: 10%;"></td> <td style="width: 10%;"></td> </tr> <tr> <td></td> <td></td> <td colspan="8" style="text-align: center;"> <table border="1" style="width: 100%; border-collapse: collapse; text-align: center;"> <tr> <td style="width: 10%;"></td> <td style="width: 10%;"></td> <td style="width: 10%;"></td> <td style="width: 10%;"></td> <td style="width: 10%;"></td> <td style="width: 10%;"></td> <td style="width: 10%;"></td> <td style="width: 10%;"></td> <td style="width: 10%;"></td> <td style="width: 10%;"></td> </tr> <tr> <td></td> <td></td> <td colspan="8" style="text-align: center;"> <table border="1" style="width: 100%; border-collapse: collapse; text-align: center;"> <tr> </tr></table></td></tr></table></td></tr></table></td></tr></table></td></tr></table></td></tr></table></td></tr></table></td></tr></table></td></tr></table></td></tr></table></td></tr></table></td></tr></table></td></tr></table></td></tr></table></td></tr></table></td></tr></table></td></tr></table></td></tr></table></td></tr></table></td></tr></table></td></tr></table></td></tr></table></td></tr></table></td></tr></table></td></tr></table></td></tr></table></td></tr></table></td></tr></table></td></tr></table></td></tr></table></td></tr></table></td></tr></table>

 | | | | | | | | | | | | | | | | | | | | <table border="1" style="width: 100%; border-collapse: collapse; text-align: center;"> <tr> <td style="width: 10%;"></td> <td style="width: 10%;"></td> <td style="width: 10%;"></td> <td style="width: 10%;"></td> <td style="width: 10%;"></td> <td style="width: 10%;"></td> <td style="width: 10%;"></td> <td style="width: 10%;"></td> <td style="width: 10%;"></td> <td style="width: 10%;"></td> </tr> <tr> <td></td> <td></td> <td colspan="8" style="text-align: center;"> <table border="1" style="width: 100%; border-collapse: collapse; text-align: center;"> <tr> <td style="width: 10%;"></td> <td style="width: 10%;"></td> <td style="width: 10%;"></td> <td style="width: 10%;"></td> <td style="width: 10%;"></td> <td style="width: 10%;"></td> <td style="width: 10%;"></td> <td style="width: 10%;"></td> <td style="width: 10%;"></td> <td style="width: 10%;"></td> </tr> <tr> <td></td> <td></td> <td colspan="8" style="text-align: center;"> <table border="1" style="width: 100%; border-collapse: collapse; text-align: center;"> <tr> <td style="width: 10%;"></td> <td style="width: 10%;"></td> <td style="width: 10%;"></td> <td style="width: 10%;"></td> <td style="width: 10%;"></td> <td style="width: 10%;"></td> <td style="width: 10%;"></td> <td style="width: 10%;"></td> <td style="width: 10%;"></td> <td style="width: 10%;"></td> </tr> <tr> <td></td> <td></td> <td colspan="8" style="text-align: center;"> <table border="1" style="width: 100%; border-collapse: collapse; text-align: center;"> <tr> <td style="width: 10%;"></td> <td style="width: 10%;"></td> <td style="width: 10%;"></td> <td style="width: 10%;"></td> <td style="width: 10%;"></td> <td style="width: 10%;"></td> <td style="width: 10%;"></td> <td style="width: 10%;"></td> <td style="width: 10%;"></td> <td style="width: 10%;"></td> </tr> <tr> <td></td> <td></td> <td colspan="8" style="text-align: center;"> <table border="1" style="width: 100%; border-collapse: collapse; text-align: center;"> <tr> <td style="width: 10%;"></td> <td style="width: 10%;"></td> <td style="width: 10%;"></td> <td style="width: 10%;"></td> <td style="width: 10%;"></td> <td style="width: 10%;"></td> <td style="width: 10%;"></td> <td style="width: 10%;"></td> <td style="width: 10%;"></td> <td style="width: 10%;"></td> </tr> <tr> <td></td> <td></td> <td colspan="8" style="text-align: center;"> <table border="1" style="width: 100%; border-collapse: collapse; text-align: center;"> <tr> <td style="width: 10%;"></td> <td style="width: 10%;"></td> <td style="width: 10%;"></td> <td style="width: 10%;"></td> <td style="width: 10%;"></td> <td style="width: 10%;"></td> <td style="width: 10%;"></td> <td style="width: 10%;"></td> <td style="width: 10%;"></td> <td style="width: 10%;"></td> </tr> <tr> <td></td> <td></td> <td colspan="8" style="text-align: center;"> <table border="1" style="width: 100%; border-collapse: collapse; text-align: center;"> <tr> <td style="width: 10%;"></td> <td style="width: 10%;"></td> <td style="width: 10%;"></td> <td style="width: 10%;"></td> <td style="width: 10%;"></td> <td style="width: 10%;"></td> <td style="width: 10%;"></td> <td style="width: 10%;"></td> <td style="width: 10%;"></td> <td style="width: 10%;"></td> </tr> <tr> <td></td> <td></td> <td colspan="8" style="text-align: center;"> <table border="1" style="width: 100%; border-collapse: collapse; text-align: center;"> <tr> <td style="width: 10%;"></td> <td style="width: 10%;"></td> <td style="width: 10%;"></td> <td style="width: 10%;"></td> <td style="width: 10%;"></td> <td style="width: 10%;"></td> <td style="width: 10%;"></td> <td style="width: 10%;"></td> <td style="width: 10%;"></td> <td style="width: 10%;"></td> </tr> <tr> <td></td> <td></td> <td colspan="8" style="text-align: center;"> <table border="1" style="width: 100%; border-collapse: collapse; text-align: center;"> <tr> <td style="width: 10%;"></td> <td style="width: 10%;"></td> <td style="width: 10%;"></td> <td style="width: 10%;"></td> <td style="width: 10%;"></td> <td style="width: 10%;"></td> <td style="width: 10%;"></td> <td style="width: 10%;"></td> <td style="width: 10%;"></td> <td style="width: 10%;"></td> </tr> <tr> <td></td> <td></td> <td colspan="8" style="text-align: center;"> <table border="1" style="width: 100%; border-collapse: collapse; text-align: center;"> <tr> <td style="width: 10%;"></td> <td style="width: 10%;"></td> <td style="width: 10%;"></td> <td style="width: 10%;"></td> <td style="width: 10%;"></td> <td style="width: 10%;"></td> <td style="width: 10%;"></td> <td style="width: 10%;"></td> <td style="width: 10%;"></td> <td style="width: 10%;"></td> </tr> <tr> <td></td> <td></td> <td colspan="8" style="text-align: center;"> <table border="1" style="width: 100%; border-collapse: collapse; text-align: center;"> <tr> <td style="width: 10%;"></td> <td style="width: 10%;"></td> <td style="width: 10%;"></td> <td style="width: 10%;"></td> <td style="width: 10%;"></td> <td style="width: 10%;"></td> <td style="width: 10%;"></td> <td style="width: 10%;"></td> <td style="width: 10%;"></td> <td style="width: 10%;"></td> </tr> <tr> <td></td> <td></td> <td colspan="8" style="text-align: center;"> <table border="1" style="width: 100%; border-collapse: collapse; text-align: center;"> <tr> <td style="width: 10%;"></td> <td style="width: 10%;"></td> <td style="width: 10%;"></td> <td style="width: 10%;"></td> <td style="width: 10%;"></td> <td style="width: 10%;"></td> <td style="width: 10%;"></td> <td style="width: 10%;"></td> <td style="width: 10%;"></td> <td style="width: 10%;"></td> </tr> <tr> <td></td> <td></td> <td colspan="8" style="text-align: center;"> <table border="1" style="width: 100%; border-collapse: collapse; text-align: center;"> <tr> <td style="width: 10%;"></td> <td style="width: 10%;"></td> <td style="width: 10%;"></td> <td style="width: 10%;"></td> <td style="width: 10%;"></td> <td style="width: 10%;"></td> <td style="width: 10%;"></td> <td style="width: 10%;"></td> <td style="width: 10%;"></td> <td style="width: 10%;"></td> </tr> <tr> <td></td> <td></td> <td colspan="8" style="text-align: center;"> <table border="1" style="width: 100%; border-collapse: collapse; text-align: center;"> <tr> <td style="width: 10%;"></td> <td style="width: 10%;"></td> <td style="width: 10%;"></td> <td style="width: 10%;"></td> <td style="width: 10%;"></td> <td style="width: 10%;"></td> <td style="width: 10%;"></td> <td style="width: 10%;"></td> <td style="width: 10%;"></td> <td style="width: 10%;"></td> </tr> <tr> <td></td> <td></td> <td colspan="8" style="text-align: center;"> <table border="1" style="width: 100%; border-collapse: collapse; text-align: center;"> <tr> <td style="width: 10%;"></td> <td style="width: 10%;"></td> <td style="width: 10%;"></td> <td style="width: 10%;"></td> <td style="width: 10%;"></td> <td style="width: 10%;"></td> <td style="width: 10%;"></td> <td style="width: 10%;"></td> <td style="width: 10%;"></td> <td style="width: 10%;"></td> </tr> <tr> <td></td> <td></td> <td colspan="8" style="text-align: center;"> <table border="1" style="width: 100%; border-collapse: collapse; text-align: center;"> <tr> <td style="width: 10%;"></td> <td style="width: 10%;"></td> <td style="width: 10%;"></td> <td style="width: 10%;"></td> <td style="width: 10%;"></td> <td style="width: 10%;"></td> <td style="width: 10%;"></td> <td style="width: 10%;"></td> <td style="width: 10%;"></td> <td style="width: 10%;"></td> </tr> <tr> <td></td> <td></td> <td colspan="8" style="text-align: center;"> <table border="1" style="width: 100%; border-collapse: collapse; text-align: center;"> <tr> <td style="width: 10%;"></td> <td style="width: 10%;"></td> <td style="width: 10%;"></td> <td style="width: 10%;"></td> <td style="width: 10%;"></td> <td style="width: 10%;"></td> <td style="width: 10%;"></td> <td style="width: 10%;"></td> <td style="width: 10%;"></td> <td style="width: 10%;"></td> </tr> <tr> <td></td> <td></td> <td colspan="8" style="text-align: center;"> <table border="1" style="width: 100%; border-collapse: collapse; text-align: center;"> <tr> <td style="width: 10%;"></td> <td style="width: 10%;"></td> <td style="width: 10%;"></td> <td style="width: 10%;"></td> <td style="width: 10%;"></td> <td style="width: 10%;"></td> <td style="width: 10%;"></td> <td style="width: 10%;"></td> <td style="width: 10%;"></td> <td style="width: 10%;"></td> </tr> <tr> <td></td> <td></td> <td colspan="8" style="text-align: center;"> <table border="1" style="width: 100%; border-collapse: collapse; text-align: center;"> <tr> <td style="width: 10%;"></td> <td style="width: 10%;"></td> <td style="width: 10%;"></td> <td style="width: 10%;"></td> <td style="width: 10%;"></td> <td style="width: 10%;"></td> <td style="width: 10%;"></td> <td style="width: 10%;"></td> <td style="width: 10%;"></td> <td style="width: 10%;"></td> </tr> <tr> <td></td> <td></td> <td colspan="8" style="text-align: center;"> <table border="1" style="width: 100%; border-collapse: collapse; text-align: center;"> <tr> <td style="width: 10%;"></td> <td style="width: 10%;"></td> <td style="width: 10%;"></td> <td style="width: 10%;"></td> <td style="width: 10%;"></td> <td style="width: 10%;"></td> <td style="width: 10%;"></td> <td style="width: 10%;"></td> <td style="width: 10%;"></td> <td style="width: 10%;"></td> </tr> <tr> <td></td> <td></td> <td colspan="8" style="text-align: center;"> <table border="1" style="width: 100%; border-collapse: collapse; text-align: center;"> <tr> <td style="width: 10%;"></td> <td style="width: 10%;"></td> <td style="width: 10%;"></td> <td style="width: 10%;"></td> <td style="width: 10%;"></td> <td style="width:
10%;"></td> <td style="width: 10%;"></td> <td style="width: 10%;"></td> <td style="width: 10%;"></td> <td style="width: 10%;"></td> </tr> <tr> <td></td> <td></td> <td colspan="8" style="text-align: center;"> <table border="1" style="width: 100%; border-collapse: collapse; text-align: center;"> <tr> <td style="width: 10%;"></td> <td style="width: 10%;"></td> <td style="width: 10%;"></td> <td style="width: 10%;"></td> <td style="width: 10%;"></td> <td style="width: 10%;"></td> <td style="width: 10%;"></td> <td style="width: 10%;"></td> <td style="width: 10%;"></td> <td style="width: 10%;"></td> </tr> <tr> <td></td> <td></td> <td colspan="8" style="text-align: center;"> <table border="1" style="width: 100%; border-collapse: collapse; text-align: center;"> <tr> <td style="width: 10%;"></td> <td style="width: 10%;"></td> <td style="width: 10%;"></td> <td style="width: 10%;"></td> <td style="width: 10%;"></td> <td style="width: 10%;"></td> <td style="width: 10%;"></td> <td style="width: 10%;"></td> <td style="width: 10%;"></td> <td style="width: 10%;"></td> </tr> <tr> <td></td> <td></td> <td colspan="8" style="text-align: center;"> <table border="1" style="width: 100%; border-collapse: collapse; text-align: center;"> <tr> <td style="width: 10%;"></td> <td style="width: 10%;"></td> <td style="width: 10%;"></td> <td style="width: 10%;"></td> <td style="width: 10%;"></td> <td style="width: 10%;"></td> <td style="width: 10%;"></td> <td style="width: 10%;"></td> <td style="width: 10%;"></td> <td style="width: 10%;"></td> </tr> <tr> <td></td> <td></td> <td colspan="8" style="text-align: center;"> <table border="1" style="width: 100%; border-collapse: collapse; text-align: center;"> <tr> <td style="width: 10%;"></td> <td style="width: 10%;"></td> <td style="width: 10%;"></td> <td style="width: 10%;"></td> <td style="width: 10%;"></td> <td style="width: 10%;"></td> <td style="width: 10%;"></td> <td style="width: 10%;"></td> <td style="width: 10%;"></td> <td style="width: 10%;"></td> </tr> <tr> <td></td> <td></td> <td colspan="8" style="text-align: center;"> <table border="1" style="width: 100%; border-collapse: collapse; text-align: center;"> <tr> <td style="width: 10%;"></td> <td style="width: 10%;"></td> <td style="width: 10%;"></td> <td style="width: 10%;"></td> <td style="width: 10%;"></td> <td style="width: 10%;"></td> <td style="width: 10%;"></td> <td style="width: 10%;"></td> <td style="width: 10%;"></td> <td style="width: 10%;"></td> </tr> <tr> <td></td> <td></td> <td colspan="8" style="text-align: center;"> <table border="1" style="width: 100%; border-collapse: collapse; text-align: center;"> <tr> <td style="width: 10%;"></td> <td style="width: 10%;"></td> <td style="width: 10%;"></td> <td style="width: 10%;"></td> <td style="width: 10%;"></td> <td style="width: 10%;"></td> <td style="width: 10%;"></td> <td style="width: 10%;"></td> <td style="width: 10%;"></td> <td style="width: 10%;"></td> </tr> <tr> <td></td> <td></td> <td colspan="8" style="text-align: center;"> <table border="1" style="width: 100%; border-collapse: collapse; text-align: center;"> <tr> <td style="width: 10%;"></td> <td style="width: 10%;"></td> <td style="width: 10%;"></td> <td style="width: 10%;"></td> <td style="width: 10%;"></td> <td style="width: 10%;"></td> <td style="width: 10%;"></td> <td style="width: 10%;"></td> <td style="width: 10%;"></td> <td style="width: 10%;"></td> </tr> <tr> <td></td> <td></td> <td colspan="8" style="text-align: center;"> <table border="1" style="width: 100%; border-collapse: collapse; text-align: center;"> <tr> <td style="width: 10%;"></td> <td style="width: 10%;"></td> <td style="width: 10%;"></td> <td style="width: 10%;"></td> <td style="width: 10%;"></td> <td style="width: 10%;"></td> <td style="width: 10%;"></td> <td style="width: 10%;"></td> <td style="width: 10%;"></td> <td style="width: 10%;"></td> </tr> <tr> <td></td> <td></td> <td colspan="8" style="text-align: center;"> <table border="1" style="width: 100%; border-collapse: collapse; text-align: center;"> <tr> <td style="width: 10%;"></td> <td style="width: 10%;"></td> <td style="width: 10%;"></td> <td style="width: 10%;"></td> <td style="width: 10%;"></td> <td style="width: 10%;"></td> <td style="width: 10%;"></td> <td style="width: 10%;"></td> <td style="width: 10%;"></td> <td style="width: 10%;"></td> </tr> <tr> <td></td> <td></td> <td colspan="8" style="text-align: center;"> <table border="1" style="width: 100%; border-collapse: collapse; text-align: center;"> <tr> </tr></table></td></tr></table></td></tr></table></td></tr></table></td></tr></table></td></tr></table></td></tr></table></td></tr></table></td></tr></table></td></tr></table></td></tr></table></td></tr></table></td></tr></table></td></tr></table></td></tr></table></td></tr></table></td></tr></table></td></tr></table></td></tr></table></td></tr></table></td></tr></table></td></tr></table></td></tr></table></td></tr></table></td></tr></table></td></tr></table></td></tr></table></td></tr></table></td></tr></table></td></tr></table></td></tr></table>
 | | | | | | | | | | | | | | | | | | | | <table border="1" style="width: 100%; border-collapse: collapse; text-align: center;"> <tr> <td style="width: 10%;"></td> <td style="width: 10%;"></td> <td style="width: 10%;"></td> <td style="width: 10%;"></td> <td style="width: 10%;"></td> <td style="width: 10%;"></td> <td style="width: 10%;"></td> <td style="width: 10%;"></td> <td style="width: 10%;"></td> <td style="width: 10%;"></td> </tr> <tr> <td></td> <td></td> <td colspan="8" style="text-align: center;"> <table border="1" style="width: 100%; border-collapse: collapse; text-align: center;"> <tr> <td style="width: 10%;"></td> <td style="width: 10%;"></td> <td style="width: 10%;"></td> <td style="width: 10%;"></td> <td style="width: 10%;"></td> <td style="width: 10%;"></td> <td style="width: 10%;"></td> <td style="width: 10%;"></td> <td style="width: 10%;"></td> <td style="width: 10%;"></td> </tr> <tr> <td></td> <td></td> <td colspan="8" style="text-align: center;"> <table border="1" style="width: 100%; border-collapse: collapse; text-align: center;"> <tr> <td style="width: 10%;"></td> <td style="width: 10%;"></td> <td style="width: 10%;"></td> <td style="width: 10%;"></td> <td style="width: 10%;"></td> <td style="width: 10%;"></td> <td style="width: 10%;"></td> <td style="width:
10%;"></td> <td style="width: 10%;"></td> <td style="width: 10%;"></td> </tr> <tr> <td></td> <td></td> <td colspan="8" style="text-align: center;"> <table border="1" style="width: 100%; border-collapse: collapse; text-align: center;"> <tr> <td style="width: 10%;"></td> <td style="width: 10%;"></td> <td style="width: 10%;"></td> <td style="width: 10%;"></td> <td style="width: 10%;"></td> <td style="width: 10%;"></td> <td style="width: 10%;"></td> <td style="width: 10%;"></td> <td style="width: 10%;"></td> <td style="width: 10%;"></td> </tr> <tr> <td></td> <td></td> <td colspan="8" style="text-align: center;"> <table border="1" style="width: 100%; border-collapse: collapse; text-align: center;"> <tr> <td style="width: 10%;"></td> <td style="width: 10%;"></td> <td style="width: 10%;"></td> <td style="width: 10%;"></td> <td style="width: 10%;"></td> <td style="width: 10%;"></td> <td style="width: 10%;"></td> <td style="width: 10%;"></td> <td style="width: 10%;"></td> <td style="width: 10%;"></td> </tr> <tr> <td></td> <td></td> <td colspan="8" style="text-align: center;"> <table border="1" style="width: 100%; border-collapse: collapse; text-align: center;"> <tr> <td style="width: 10%;"></td> <td style="width: 10%;"></td> <td style="width: 10%;"></td> <td style="width: 10%;"></td> <td style="width: 10%;"></td> <td style="width: 10%;"></td> <td style="width: 10%;"></td> <td style="width: 10%;"></td> <td style="width: 10%;"></td> <td style="width: 10%;"></td> </tr> <tr> <td></td> <td></td> <td colspan="8" style="text-align: center;"> <table border="1" style="width: 100%; border-collapse: collapse; text-align: center;"> <tr> <td style="width: 10%;"></td> <td style="width: 10%;"></td> <td style="width: 10%;"></td> <td style="width: 10%;"></td> <td style="width: 10%;"></td> <td style="width: 10%;"></td> <td style="width: 10%;"></td> <td style="width: 10%;"></td> <td style="width: 10%;"></td> <td style="width: 10%;"></td> </tr> <tr> <td></td> <td></td> <td colspan="8" style="text-align: center;"> <table border="1" style="width: 100%; border-collapse: collapse; text-align: center;"> <tr> <td style="width: 10%;"></td> <td style="width: 10%;"></td> <td style="width: 10%;"></td> <td style="width: 10%;"></td> <td style="width: 10%;"></td> <td style="width: 10%;"></td> <td style="width: 10%;"></td> <td style="width: 10%;"></td> <td style="width: 10%;"></td> <td style="width: 10%;"></td> </tr> <tr> <td></td> <td></td> <td colspan="8" style="text-align: center;"> <table border="1" style="width: 100%; border-collapse: collapse; text-align: center;"> <tr> <td style="width: 10%;"></td> <td style="width: 10%;"></td> <td style="width: 10%;"></td> <td style="width: 10%;"></td> <td style="width: 10%;"></td> <td style="width: 10%;"></td> <td style="width: 10%;"></td> <td style="width: 10%;"></td> <td style="width: 10%;"></td> <td style="width: 10%;"></td> </tr> <tr> <td></td> <td></td> <td colspan="8" style="text-align: center;"> <table border="1" style="width: 100%; border-collapse: collapse; text-align: center;"> <tr> <td style="width: 10%;"></td> <td style="width: 10%;"></td> <td style="width: 10%;"></td> <td style="width: 10%;"></td> <td style="width: 10%;"></td> <td style="width: 10%;"></td> <td style="width: 10%;"></td> <td style="width: 10%;"></td> <td style="width: 10%;"></td> <td style="width: 10%;"></td> </tr> <tr> <td></td> <td></td> <td colspan="8" style="text-align: center;"> <table border="1" style="width: 100%; border-collapse: collapse; text-align: center;"> <tr> <td style="width: 10%;"></td> <td style="width: 10%;"></td> <td style="width: 10%;"></td> <td style="width: 10%;"></td> <td style="width: 10%;"></td> <td style="width: 10%;"></td> <td style="width: 10%;"></td> <td style="width: 10%;"></td> <td style="width: 10%;"></td> <td style="width: 10%;"></td> </tr> <tr> <td></td> <td></td> <td colspan="8" style="text-align: center;"> <table border="1" style="width: 100%; border-collapse: collapse; text-align: center;"> <tr> <td style="width: 10%;"></td> <td style="width: 10%;"></td> <td style="width: 10%;"></td> <td style="width: 10%;"></td> <td style="width: 10%;"></td> <td style="width: 10%;"></td> <td style="width: 10%;"></td> <td style="width: 10%;"></td> <td style="width: 10%;"></td> <td style="width: 10%;"></td> </tr> <tr> <td></td> <td></td> <td colspan="8" style="text-align: center;"> <table border="1" style="width: 100%; border-collapse: collapse; text-align: center;"> <tr> <td style="width: 10%;"></td> <td style="width: 10%;"></td> <td style="width: 10%;"></td> <td style="width: 10%;"></td> <td style="width: 10%;"></td> <td style="width: 10%;"></td> <td style="width: 10%;"></td> <td style="width: 10%;"></td> <td style="width: 10%;"></td> <td style="width: 10%;"></td> </tr> <tr> <td></td> <td></td> <td colspan="8" style="text-align: center;"> <table border="1" style="width: 100%; border-collapse: collapse; text-align: center;"> <tr> <td style="width: 10%;"></td> <td style="width: 10%;"></td> <td style="width: 10%;"></td> <td style="width: 10%;"></td> <td style="width: 10%;"></td> <td style="width: 10%;"></td> <td style="width: 10%;"></td> <td style="width: 10%;"></td> <td style="width: 10%;"></td> <td style="width: 10%;"></td> </tr> <tr> <td></td> <td></td> <td colspan="8" style="text-align: center;"> <table border="1" style="width: 100%; border-collapse: collapse; text-align: center;"> <tr> <td style="width: 10%;"></td> <td style="width: 10%;"></td> <td style="width: 10%;"></td> <td style="width: 10%;"></td> <td style="width: 10%;"></td> <td style="width: 10%;"></td> <td style="width: 10%;"></td> <td style="width: 10%;"></td> <td style="width: 10%;"></td> <td style="width: 10%;"></td> </tr> <tr> <td></td> <td></td> <td colspan="8" style="text-align: center;"> <table border="1" style="width: 100%; border-collapse: collapse; text-align: center;"> <tr> <td style="width: 10%;"></td> <td style="width: 10%;"></td> <td style="width: 10%;"></td> <td style="width: 10%;"></td> <td style="width: 10%;"></td> <td style="width: 10%;"></td> <td style="width: 10%;"></td> <td style="width: 10%;"></td> <td style="width: 10%;"></td> <td style="width: 10%;"></td> </tr> <tr> <td></td> <td></td> <td colspan="8" style="text-align: center;"> <table border="1" style="width: 100%; border-collapse: collapse; text-align: center;"> <tr> <td style="width: 10%;"></td> <td style="width: 10%;"></td> <td style="width: 10%;"></td> <td style="width: 10%;"></td> <td style="width: 10%;"></td> <td style="width: 10%;"></td> <td style="width: 10%;"></td> <td style="width: 10%;"></td> <td style="width: 10%;"></td> <td style="width: 10%;"></td> </tr> <tr> <td></td> <td></td> <td colspan="8" style="text-align: center;"> <table border="1" style="width: 100%; border-collapse: collapse; text-align: center;"> <tr> <td style="width: 10%;"></td> <td style="width: 10%;"></td> <td style="width: 10%;"></td> <td style="width: 10%;"></td> <td style="width: 10%;"></td> <td style="width: 10%;"></td> <td style="width: 10%;"></td> <td style="width: 10%;"></td> <td style="width: 10%;"></td> <td style="width: 10%;"></td> </tr> <tr> <td></td> <td></td> <td colspan="8" style="text-align: center;"> <table border="1" style="width: 100%; border-collapse: collapse; text-align: center;"> <tr> <td style="width: 10%;"></td> <td style="width: 10%;"></td> <td style="width: 10%;"></td> <td style="width: 10%;"></td> <td style="width: 10%;"></td> <td style="width: 10%;"></td> <td style="width: 10%;"></td> <td style="width: 10%;"></td> <td style="width: 10%;"></td> <td style="width: 10%;"></td> </tr> <tr> <td></td> <td></td> <td colspan="8" style="text-align: center;"> <table border="1" style="width: 100%; border-collapse: collapse; text-align: center;"> <tr> <td style="width: 10%;"></td> <td style="width: 10%;"></td> <td style="width: 10%;"></td> <td style="width: 10%;"></td> <td style="width: 10%;"></td> <td style="width: 10%;"></td> <td style="width: 10%;"></td> <td style="width: 10%;"></td> <td style="width: 10%;"></td> <td style="width: 10%;"></td> </tr> <tr> <td></td> <td></td> <td colspan="8" style="text-align: center;"> <table border="1" style="width: 100%; border-collapse: collapse; text-align: center;"> <tr> <td style="width: 10%;"></td> <td style="width: 10%;"></td> <td style="width: 10%;"></td> <td style="width: 10%;"></td> <td style="width: 10%;"></td> <td style="width: 10%;"></td> <td style="width: 10%;"></td> <td style="width: 10%;"></td> <td style="width: 10%;"></td> <td style="width: 10%;"></td> </tr> <tr> <td></td> <td></td> <td colspan="8" style="text-align: center;"> <table border="1" style="width: 100%; border-collapse: collapse; text-align: center;"> <tr> <td style="width: 10%;"></td> <td style="width: 10%;"></td> <td style="width: 10%;"></td> <td style="width: 10%;"></td> <td style="width: 10%;"></td> <td style="width: 10%;"></td> <td style="width: 10%;"></td> <td style="width: 10%;"></td> <td style="width: 10%;"></td> <td style="width: 10%;"></td> </tr> <tr> <td></td> <td></td> <td colspan="8" style="text-align: center;"> <table border="1" style="width: 100%; border-collapse: collapse; text-align: center;"> <tr> <td style="width: 10%;"></td> <td style="width: 10%;"></td> <td style="width: 10%;"></td> <td style="width: 10%;"></td> <td style="width: 10%;"></td> <td style="width: 10%;"></td> <td style="width: 10%;"></td> <td style="width: 10%;"></td> <td style="width: 10%;"></td> <td style="width: 10%;"></td> </tr> <tr> <td></td> <td></td> <td colspan="8" style="text-align: center;"> <table border="1" style="width: 100%; border-collapse: collapse; text-align: center;"> <tr> <td style="width: 10%;"></td> <td style="width: 10%;"></td> <td style="width: 10%;"></td> <td style="width: 10%;"></td> <td style="width: 10%;"></td> <td style="width: 10%;"></td> <td style="width: 10%;"></td> <td style="width: 10%;"></td> <td style="width: 10%;"></td> <td style="width: 10%;"></td> </tr> <tr> <td></td> <td></td> <td colspan="8" style="text-align: center;"> <table border="1"
style="width: 100%; border-collapse: collapse; text-align: center;"> <tr> <td style="width: 10%;"></td> <td style="width: 10%;"></td> <td style="width: 10%;"></td> <td style="width: 10%;"></td> <td style="width: 10%;"></td> <td style="width: 10%;"></td> <td style="width: 10%;"></td> <td style="width: 10%;"></td> <td style="width: 10%;"></td> <td style="width: 10%;"></td> </tr> <tr> <td></td> <td></td> <td colspan="8" style="text-align: center;"> <table border="1" style="width: 100%; border-collapse: collapse; text-align: center;"> <tr> <td style="width: 10%;"></td> <td style="width: 10%;"></td> <td style="width: 10%;"></td> <td style="width: 10%;"></td> <td style="width: 10%;"></td> <td style="width: 10%;"></td> <td style="width: 10%;"></td> <td style="width: 10%;"></td> <td style="width: 10%;"></td> <td style="width: 10%;"></td> </tr> <tr> <td></td> <td></td> <td colspan="8" style="text-align: center;"> <table border="1" style="width: 100%; border-collapse: collapse; text-align: center;"> <tr> <td style="width: 10%;"></td> <td style="width: 10%;"></td> <td style="width: 10%;"></td> <td style="width: 10%;"></td> <td style="width: 10%;"></td> <td style="width: 10%;"></td> <td style="width: 10%;"></td> <td style="width: 10%;"></td> <td style="width: 10%;"></td> <td style="width: 10%;"></td> </tr> <tr> <td></td> <td></td> <td colspan="8" style="text-align: center;"> <table border="1" style="width: 100%; border-collapse: collapse; text-align: center;"> <tr> <td style="width: 10%;"></td> <td style="width: 10%;"></td> <td style="width: 10%;"></td> <td style="width: 10%;"></td> <td style="width: 10%;"></td> <td style="width: 10%;"></td> <td style="width: 10%;"></td> <td style="width: 10%;"></td> <td style="width: 10%;"></td> <td style="width: 10%;"></td> </tr> <tr> <td></td> <td></td> <td colspan="8" style="text-align: center;"> <table border="1" style="width: 100%; border-collapse: collapse; text-align: center;"> <tr> <td style="width: 10%;"></td> <td style="width: 10%;"></td> <td style="width: 10%;"></td> <td style="width: 10%;"></td> <td style="width: 10%;"></td> <td style="width: 10%;"></td> <td style="width: 10%;"></td> <td style="width: 10%;"></td> <td style="width: 10%;"></td> <td style="width: 10%;"></td> </tr> <tr> <td></td> <td></td> <td colspan="8" style="text-align: center;"> <table border="1" style="width: 100%; border-collapse: collapse; text-align: center;"> <tr> </tr></table></td></tr></table></td></tr></table></td></tr></table></td></tr></table></td></tr></table></td></tr></table></td></tr></table></td></tr></table></td></tr></table></td></tr></table></td></tr></table></td></tr></table></td></tr></table></td></tr></table></td></tr></table></td></tr></table></td></tr></table></td></tr></table></td></tr></table></td></tr></table></td></tr></table></td></tr></table></td></tr></table></td></tr></table></td></tr></table></td></tr></table></td></tr></table></td></tr></table></td></tr></table>
 | | | | | | | | | | | | | | | | | | | | <table border="1" style="width: 100%; border-collapse: collapse; text-align: center;"> <tr> <td style="width: 10%;"></td> <td style="width: 10%;"></td> <td style="width: 10%;"></td> <td style="width: 10%;"></td> <td style="width: 10%;"></td> <td style="width: 10%;"></td> <td style="width: 10%;"></td> <td style="width: 10%;"></td> <td style="width: 10%;"></td> <td style="width: 10%;"></td> </tr> <tr> <td></td> <td></td> <td colspan="8" style="text-align: center;"> <table border="1" style="width: 100%; border-collapse: collapse; text-align: center;"> <tr> <td style="width: 10%;"></td> <td style="width: 10%;"></td> <td style="width: 10%;"></td> <td style="width: 10%;"></td> <td style="width: 10%;"></td> <td style="width: 10%;"></td> <td style="width: 10%;"></td> <td style="width: 10%;"></td> <td style="width: 10%;"></td> <td style="width: 10%;"></td> </tr> <tr> <td></td> <td></td> <td colspan="8" style="text-align: center;"> <table border="1" style="width: 100%; border-collapse: collapse; text-align: center;"> <tr> <td style="width: 10%;"></td> <td style="width: 10%;"></td> <td style="width: 10%;"></td> <td style="width: 10%;"></td> <td style="width: 10%;"></td> <td style="width: 10%;"></td> <td style="width: 10%;"></td> <td style="width: 10%;"></td> <td style="width: 10%;"></td> <td style="width: 10%;"></td> </tr> <tr> <td></td> <td></td> <td colspan="8" style="text-align: center;"> <table border="1" style="width: 100%; border-collapse: collapse; text-align: center;"> <tr> <td style="width: 10%;"></td> <td style="width: 10%;"></td> <td style="width: 10%;"></td> <td style="width: 10%;"></td> <td style="width: 10%;"></td> <td style="width: 10%;"></td> <td style="width: 10%;"></td> <td style="width: 10%;"></td> <td style="width: 10%;"></td> <td style="width: 10%;"></td> </tr> <tr> <td></td> <td></td> <td colspan="8" style="text-align: center;"> <table border="1" style="width: 100%; border-collapse: collapse; text-align: center;"> <tr> <td style="width: 10%;"></td> <td style="width: 10%;"></td> <td style="width: 10%;"></td> <td style="width: 10%;"></td> <td style="width: 10%;"></td> <td style="width: 10%;"></td> <td style="width: 10%;"></td> <td style="width: 10%;"></td> <td style="width: 10%;"></td> <td style="width: 10%;"></td> </tr> <tr> <td></td> <td></td> <td colspan="8" style="text-align: center;"> <table border="1" style="width: 100%; border-collapse: collapse; text-align: center;"> <tr> <td style="width: 10%;"></td> <td style="width: 10%;"></td> <td style="width: 10%;"></td> <td style="width: 10%;"></td> <td style="width: 10%;"></td> <td style="width: 10%;"></td> <td style="width: 10%;"></td> <td style="width: 10%;"></td> <td style="width: 10%;"></td> <td style="width: 10%;"></td> </tr> <tr> <td></td> <td></td> <td colspan="8" style="text-align: center;"> <table border="1" style="width: 100%; border-collapse: collapse; text-align: center;"> <tr> <td style="width: 10%;"></td> <td style="width: 10%;"></td> <td style="width: 10%;"></td> <td style="width: 10%;"></td> <td style="width: 10%;"></td> <td style="width: 10%;"></td> <td style="width: 10%;"></td> <td style="width: 10%;"></td> <td style="width: 10%;"></td> <td style="width: 10%;"></td> </tr> <tr> <td></td> <td></td> <td colspan="8" style="text-align: center;"> <table border="1" style="width: 100%; border-collapse: collapse; text-align: center;"> <tr> <td
style="width: 10%;"></td> <td style="width: 10%;"></td> <td style="width: 10%;"></td> <td style="width: 10%;"></td> <td style="width: 10%;"></td> <td style="width: 10%;"></td> <td style="width: 10%;"></td> <td style="width: 10%;"></td> <td style="width: 10%;"></td> <td style="width: 10%;"></td> </tr> <tr> <td></td> <td></td> <td colspan="8" style="text-align: center;"> <table border="1" style="width: 100%; border-collapse: collapse; text-align: center;"> <tr> <td style="width: 10%;"></td> <td style="width: 10%;"></td> <td style="width: 10%;"></td> <td style="width: 10%;"></td> <td style="width: 10%;"></td> <td style="width: 10%;"></td> <td style="width: 10%;"></td> <td style="width: 10%;"></td> <td style="width: 10%;"></td> <td style="width: 10%;"></td> </tr> <tr> <td></td> <td></td> <td colspan="8" style="text-align: center;"> <table border="1" style="width: 100%; border-collapse: collapse; text-align: center;"> <tr> <td style="width: 10%;"></td> <td style="width: 10%;"></td> <td style="width: 10%;"></td> <td style="width: 10%;"></td> <td style="width: 10%;"></td> <td style="width: 10%;"></td> <td style="width: 10%;"></td> <td style="width: 10%;"></td> <td style="width: 10%;"></td> <td style="width: 10%;"></td> </tr> <tr> <td></td> <td></td> <td colspan="8" style="text-align: center;"> <table border="1" style="width: 100%; border-collapse: collapse; text-align: center;"> <tr> <td style="width: 10%;"></td> <td style="width: 10%;"></td> <td style="width: 10%;"></td> <td style="width: 10%;"></td> <td style="width: 10%;"></td> <td style="width: 10%;"></td> <td style="width: 10%;"></td> <td style="width: 10%;"></td> <td style="width: 10%;"></td> <td style="width: 10%;"></td> </tr> <tr> <td></td> <td></td> <td colspan="8" style="text-align: center;"> <table border="1" style="width: 100%; border-collapse: collapse; text-align: center;"> <tr> <td style="width: 10%;"></td> <td style="width: 10%;"></td> <td style="width: 10%;"></td> <td style="width: 10%;"></td> <td style="width: 10%;"></td> <td style="width: 10%;"></td> <td style="width: 10%;"></td> <td style="width: 10%;"></td> <td style="width: 10%;"></td> <td style="width: 10%;"></td> </tr> <tr> <td></td> <td></td> <td colspan="8" style="text-align: center;"> <table border="1" style="width: 100%; border-collapse: collapse; text-align: center;"> <tr> <td style="width: 10%;"></td> <td style="width: 10%;"></td> <td style="width: 10%;"></td> <td style="width: 10%;"></td> <td style="width: 10%;"></td> <td style="width: 10%;"></td> <td style="width: 10%;"></td> <td style="width: 10%;"></td> <td style="width: 10%;"></td> <td style="width: 10%;"></td> </tr> <tr> <td></td> <td></td> <td colspan="8" style="text-align: center;"> <table border="1" style="width: 100%; border-collapse: collapse; text-align: center;"> <tr> <td style="width: 10%;"></td> <td style="width: 10%;"></td> <td style="width: 10%;"></td> <td style="width: 10%;"></td> <td style="width: 10%;"></td> <td style="width: 10%;"></td> <td style="width: 10%;"></td> <td style="width: 10%;"></td> <td style="width: 10%;"></td> <td style="width: 10%;"></td> </tr> <tr> <td></td> <td></td> <td colspan="8" style="text-align: center;"> <table border="1" style="width: 100%; border-collapse: collapse; text-align: center;"> <tr> <td style="width: 10%;"></td> <td style="width: 10%;"></td> <td style="width: 10%;"></td> <td style="width: 10%;"></td> <td style="width: 10%;"></td> <td style="width: 10%;"></td> <td style="width: 10%;"></td> <td style="width: 10%;"></td> <td style="width: 10%;"></td> <td style="width: 10%;"></td> </tr> <tr> <td></td> <td></td> <td colspan="8" style="text-align: center;"> <table border="1" style="width: 100%; border-collapse: collapse; text-align: center;"> <tr> <td style="width: 10%;"></td> <td style="width: 10%;"></td> <td style="width: 10%;"></td> <td style="width: 10%;"></td> <td style="width: 10%;"></td> <td style="width: 10%;"></td> <td style="width: 10%;"></td> <td style="width: 10%;"></td> <td style="width: 10%;"></td> <td style="width: 10%;"></td> </tr> <tr> <td></td> <td></td> <td colspan="8" style="text-align: center;"> <table border="1" style="width: 100%; border-collapse: collapse; text-align: center;"> <tr> <td style="width: 10%;"></td> <td style="width: 10%;"></td> <td style="width: 10%;"></td> <td style="width: 10%;"></td> <td style="width: 10%;"></td> <td style="width: 10%;"></td> <td style="width: 10%;"></td> <td style="width: 10%;"></td> <td style="width: 10%;"></td> <td style="width: 10%;"></td> </tr> <tr> <td></td> <td></td> <td colspan="8" style="text-align: center;"> <table border="1" style="width: 100%; border-collapse: collapse; text-align: center;"> <tr> <td style="width: 10%;"></td> <td style="width: 10%;"></td> <td style="width: 10%;"></td> <td style="width: 10%;"></td> <td style="width: 10%;"></td> <td style="width: 10%;"></td> <td style="width: 10%;"></td> <td style="width: 10%;"></td> <td style="width: 10%;"></td> <td style="width: 10%;"></td> </tr> <tr> <td></td> <td></td> <td colspan="8" style="text-align: center;"> <table border="1" style="width: 100%; border-collapse: collapse; text-align: center;"> <tr> <td style="width: 10%;"></td> <td style="width: 10%;"></td> <td style="width: 10%;"></td> <td style="width: 10%;"></td> <td style="width: 10%;"></td> <td style="width: 10%;"></td> <td style="width: 10%;"></td> <td style="width: 10%;"></td> <td style="width: 10%;"></td> <td style="width: 10%;"></td> </tr> <tr> <td></td> <td></td> <td colspan="8" style="text-align: center;"> <table border="1" style="width: 100%; border-collapse: collapse; text-align: center;"> <tr> <td style="width: 10%;"></td> <td style="width: 10%;"></td> <td style="width: 10%;"></td> <td style="width: 10%;"></td> <td style="width: 10%;"></td> <td style="width: 10%;"></td> <td style="width: 10%;"></td> <td style="width: 10%;"></td> <td style="width: 10%;"></td> <td style="width: 10%;"></td> </tr> <tr> <td></td> <td></td> <td colspan="8" style="text-align: center;"> <table border="1" style="width: 100%; border-collapse: collapse; text-align: center;"> <tr> <td style="width: 10%;"></td> <td style="width: 10%;"></td> <td style="width: 10%;"></td> <td style="width: 10%;"></td> <td style="width: 10%;"></td> <td style="width: 10%;"></td> <td style="width: 10%;"></td> <td style="width: 10%;"></td> <td style="width: 10%;"></td> <td style="width: 10%;"></td> </tr> <tr> <td></td> <td></td> <td colspan="8" style="text-align: center;"> <table border="1" style="width: 100%; border-collapse: collapse; text-align: center;"> <tr> <td style="width: 10%;"></td> <td style="width: 10%;"></td> <td style="width: 10%;"></td> <td style="width: 10%;"></td> <td style="width: 10%;"></td> <td style="width: 10%;"></td> <td style="width: 10%;"></td> <td style="width: 10%;"></td> <td style="width: 10%;"></td> <td style="width: 10%;"></td> </tr> <tr> <td></td> <td></td> <td colspan="8" style="text-align: center;"> <table border="1" style="width: 100%; border-collapse: collapse; text-align: center;"> <tr> <td style="width: 10%;"></td> <td style="width: 10%;"></td> <td style="width: 10%;"></td> <td style="width: 10%;"></td> <td style="width: 10%;"></td> <td style="width: 10%;"></td> <td style="width: 10%;"></td> <td style="width: 10%;"></td> <td style="width: 10%;"></td> <td style="width: 10%;"></td> </tr> <tr> <td></td> <td></td> <td colspan="8" style="text-align: center;"> <table border="1" style="width: 100%; border-collapse: collapse; text-align: center;"> <tr> <td style="width: 10%;"></td> <td style="width: 10%;"></td> <td style="width: 10%;"></td> <td style="width: 10%;"></td> <td style="width: 10%;"></td> <td style="width: 10%;"></td> <td style="width: 10%;"></td> <td style="width: 10%;"></td> <td style="width: 10%;"></td> <td style="width: 10%;"></td> </tr> <tr> <td></td> <td></td> <td colspan="8" style="text-align: center;"> <table border="1" style="width: 100%; border-collapse: collapse; text-align: center;"> <tr> <td style="width: 10%;"></td> <td style="width: 10%;"></td> <td style="width: 10%;"></td> <td style="width: 10%;"></td> <td style="width: 10%;"></td> <td style="width: 10%;"></td> <td style="width: 10%;"></td> <td style="width: 10%;"></td> <td style="width: 10%;"></td> <td style="width: 10%;"></td> </tr> <tr> <td></td> <td></td> <td colspan="8" style="text-align: center;"> <table border="1" style="width: 100%; border-collapse: collapse; text-align: center;"> <tr> <td style="width: 10%;"></td> <td style="width: 10%;"></td> <td style="width: 10%;"></td> <td style="width: 10%;"></td> <td style="width: 10%;"></td> <td style="width: 10%;"></td> <td style="width: 10%;"></td> <td style="width: 10%;"></td> <td style="width: 10%;"></td> <td style="width: 10%;"></td> </tr> <tr> <td></td> <td></td> <td colspan="8" style="text-align: center;"> <table border="1" style="width: 100%; border-collapse: collapse; text-align: center;"> <tr> <td style="width: 10%;"></td> <td style="width: 10%;"></td> <td style="width: 10%;"></td> <td style="width: 10%;"></td> <td style="width: 10%;"></td> <td style="width: 10%;"></td> <td style="width: 10%;"></td> <td style="width: 10%;"></td> <td style="width: 10%;"></td> <td style="width: 10%;"></td> </tr> <tr> <td></td> <td></td> <td colspan="8" style="text-align: center;"> <table border="1" style="width: 100%; border-collapse: collapse; text-align: center;"> <tr> <td style="width: 10%;"></td> <td style="width: 10%;"></td> <td style="width: 10%;"></td> <td style="width: 10%;"></td> <td style="width: 10%;"></td> <td style="width: 10%;"></td> <td style="width: 10%;"></td> <td style="width: 10%;"></td> <td style="width: 10%;"></td> <td style="width: 10%;"></td> </tr> <tr> <td></td> <td></td> <td colspan="8" style="text-align: center;"> <table border="1" style="width: 100%; border-collapse: collapse; text-align: center;"> <tr>
</tr></table></td></tr></table></td></tr></table></td></tr></table></td></tr></table></td></tr></table></td></tr></table></td></tr></table></td></tr></table></td></tr></table></td></tr></table></td></tr></table></td></tr></table></td></tr></table></td></tr></table></td></tr></table></td></tr></table></td></tr></table></td></tr></table></td></tr></table></td></tr></table></td></tr></table></td></tr></table></td></tr></table></td></tr></table></td></tr></table></td></tr></table></td></tr></table></td></tr></table>
 | | | | | | | | | | | | | | | | | | | | <table border="1" style="width: 100%; border-collapse: collapse; text-align: center;"> <tr> <td style="width: 10%;"></td> <td style="width: 10%;"></td> <td style="width: 10%;"></td> <td style="width: 10%;"></td> <td style="width: 10%;"></td> <td style="width: 10%;"></td> <td style="width: 10%;"></td> <td style="width: 10%;"></td> <td style="width: 10%;"></td> <td style="width: 10%;"></td> </tr> <tr> <td></td> <td></td> <td colspan="8" style="text-align: center;"> <table border="1" style="width: 100%; border-collapse: collapse; text-align: center;"> <tr> <td style="width: 10%;"></td> <td style="width: 10%;"></td> <td style="width: 10%;"></td> <td style="width: 10%;"></td> <td style="width: 10%;"></td> <td style="width: 10%;"></td> <td style="width: 10%;"></td> <td style="width: 10%;"></td> <td style="width: 10%;"></td> <td style="width: 10%;"></td> </tr> <tr> <td></td> <td></td> <td colspan="8" style="text-align: center;"> <table border="1" style="width: 100%; border-collapse: collapse; text-align: center;"> <tr> <td style="width: 10%;"></td> <td style="width: 10%;"></td> <td style="width: 10%;"></td> <td style="width: 10%;"></td> <td style="width: 10%;"></td> <td style="width: 10%;"></td> <td style="width: 10%;"></td> <td style="width: 10%;"></td> <td style="width: 10%;"></td> <td style="width: 10%;"></td> </tr> <tr> <td></td> <td></td> <td colspan="8" style="text-align: center;"> <table border="1" style="width: 100%; border-collapse: collapse; text-align: center;"> <tr> <td style="width: 10%;"></td> <td style="width: 10%;"></td> <td style="width: 10%;"></td> <td style="width: 10%;"></td> <td style="width: 10%;"></td> <td style="width: 10%;"></td> <td style="width: 10%;"></td> <td style="width: 10%;"></td> <td style="width: 10%;"></td> <td style="width: 10%;"></td> </tr> <tr> <td></td> <td></td> <td colspan="8" style="text-align: center;"> <table border="1" style="width: 100%; border-collapse: collapse; text-align: center;"> <tr> <td style="width: 10%;"></td> <td style="width: 10%;"></td> <td style="width: 10%;"></td> <td style="width: 10%;"></td> <td style="width: 10%;"></td> <td style="width: 10%;"></td> <td style="width: 10%;"></td> <td style="width: 10%;"></td> <td style="width: 10%;"></td> <td style="width: 10%;"></td> </tr> <tr> <td></td> <td></td> <td colspan="8" style="text-align: center;"> <table border="1" style="width: 100%; border-collapse: collapse; text-align: center;"> <tr> <td style="width: 10%;"></td> <td style="width: 10%;"></td> <td style="width: 10%;"></td> <td style="width: 10%;"></td> <td style="width: 10%;"></td> <td style="width: 10%;"></td> <td style="width: 10%;"></td> <td style="width: 10%;"></td> <td style="width: 10%;"></td> <td style="width: 10%;"></td> </tr> <tr> <td></td> <td></td> <td colspan="8" style="text-align: center;"> <table border="1" style="width: 100%; border-collapse: collapse; text-align: center;"> <tr> <td style="width: 10%;"></td> <td style="width: 10%;"></td> <td style="width: 10%;"></td> <td style="width: 10%;"></td> <td style="width: 10%;"></td> <td style="width: 10%;"></td> <td style="width: 10%;"></td> <td style="width: 10%;"></td> <td style="width: 10%;"></td> <td style="width: 10%;"></td> </tr> <tr> <td></td> <td></td> <td colspan="8" style="text-align: center;"> <table border="1" style="width: 100%; border-collapse: collapse; text-align: center;"> <tr> <td style="width: 10%;"></td> <td style="width: 10%;"></td> <td style="width: 10%;"></td> <td style="width: 10%;"></td> <td style="width: 10%;"></td> <td style="width: 10%;"></td> <td style="width: 10%;"></td> <td style="width: 10%;"></td> <td style="width: 10%;"></td> <td style="width: 10%;"></td> </tr> <tr> <td></td> <td></td> <td colspan="8" style="text-align: center;"> <table border="1" style="width: 100%; border-collapse: collapse; text-align: center;"> <tr> <td style="width: 10%;"></td> <td style="width: 10%;"></td> <td style="width: 10%;"></td> <td style="width: 10%;"></td> <td style="width: 10%;"></td> <td style="width: 10%;"></td> <td style="width: 10%;"></td> <td style="width: 10%;"></td> <td style="width: 10%;"></td> <td style="width: 10%;"></td> </tr> <tr> <td></td> <td></td> <td colspan="8" style="text-align: center;"> <table border="1" style="width: 100%; border-collapse: collapse; text-align: center;"> <tr> <td style="width: 10%;"></td> <td style="width: 10%;"></td> <td style="width: 10%;"></td> <td style="width: 10%;"></td> <td style="width: 10%;"></td> <td style="width: 10%;"></td> <td style="width: 10%;"></td> <td style="width: 10%;"></td> <td style="width: 10%;"></td> <td style="width: 10%;"></td> </tr> <tr> <td></td> <td></td> <td colspan="8" style="text-align: center;"> <table border="1" style="width: 100%; border-collapse: collapse; text-align: center;"> <tr> <td style="width: 10%;"></td> <td style="width: 10%;"></td> <td style="width: 10%;"></td> <td style="width: 10%;"></td> <td style="width: 10%;"></td> <td style="width: 10%;"></td> <td style="width: 10%;"></td> <td style="width: 10%;"></td> <td style="width: 10%;"></td> <td style="width: 10%;"></td> </tr> <tr> <td></td> <td></td> <td colspan="8" style="text-align: center;"> <table border="1" style="width: 100%; border-collapse: collapse; text-align: center;"> <tr> <td style="width: 10%;"></td> <td style="width: 10%;"></td> <td style="width: 10%;"></td> <td style="width: 10%;"></td> <td style="width: 10%;"></td> <td style="width: 10%;"></td> <td style="width: 10%;"></td> <td style="width: 10%;"></td> <td style="width: 10%;"></td> <td style="width: 10%;"></td> </tr> <tr> <td></td> <td></td> <td colspan="8" style="text-align: center;"> <table border="1" style="width: 100%; border-collapse: collapse; text-align: center;"> <tr> <td style="width: 10%;"></td> <td style="width: 10%;"></td> <td style="width: 10%;"></td> <td
style="width: 10%;"></td> <td style="width: 10%;"></td> <td style="width: 10%;"></td> <td style="width: 10%;"></td> <td style="width: 10%;"></td> <td style="width: 10%;"></td> <td style="width: 10%;"></td> </tr> <tr> <td></td> <td></td> <td colspan="8" style="text-align: center;"> <table border="1" style="width: 100%; border-collapse: collapse; text-align: center;"> <tr> <td style="width: 10%;"></td> <td style="width: 10%;"></td> <td style="width: 10%;"></td> <td style="width: 10%;"></td> <td style="width: 10%;"></td> <td style="width: 10%;"></td> <td style="width: 10%;"></td> <td style="width: 10%;"></td> <td style="width: 10%;"></td> <td style="width: 10%;"></td> </tr> <tr> <td></td> <td></td> <td colspan="8" style="text-align: center;"> <table border="1" style="width: 100%; border-collapse: collapse; text-align: center;"> <tr> <td style="width: 10%;"></td> <td style="width: 10%;"></td> <td style="width: 10%;"></td> <td style="width: 10%;"></td> <td style="width: 10%;"></td> <td style="width: 10%;"></td> <td style="width: 10%;"></td> <td style="width: 10%;"></td> <td style="width: 10%;"></td> <td style="width: 10%;"></td> </tr> <tr> <td></td> <td></td> <td colspan="8" style="text-align: center;"> <table border="1" style="width: 100%; border-collapse: collapse; text-align: center;"> <tr> <td style="width: 10%;"></td> <td style="width: 10%;"></td> <td style="width: 10%;"></td> <td style="width: 10%;"></td> <td style="width: 10%;"></td> <td style="width: 10%;"></td> <td style="width: 10%;"></td> <td style="width: 10%;"></td> <td style="width: 10%;"></td> <td style="width: 10%;"></td> </tr> <tr> <td></td> <td></td> <td colspan="8" style="text-align: center;"> <table border="1" style="width: 100%; border-collapse: collapse; text-align: center;"> <tr> <td style="width: 10%;"></td> <td style="width: 10%;"></td> <td style="width: 10%;"></td> <td style="width: 10%;"></td> <td style="width: 10%;"></td> <td style="width: 10%;"></td> <td style="width: 10%;"></td> <td style="width: 10%;"></td> <td style="width: 10%;"></td> <td style="width: 10%;"></td> </tr> <tr> <td></td> <td></td> <td colspan="8" style="text-align: center;"> <table border="1" style="width: 100%; border-collapse: collapse; text-align: center;"> <tr> <td style="width: 10%;"></td> <td style="width: 10%;"></td> <td style="width: 10%;"></td> <td style="width: 10%;"></td> <td style="width: 10%;"></td> <td style="width: 10%;"></td> <td style="width: 10%;"></td> <td style="width: 10%;"></td> <td style="width: 10%;"></td> <td style="width: 10%;"></td> </tr> <tr> <td></td> <td></td> <td colspan="8" style="text-align: center;"> <table border="1" style="width: 100%; border-collapse: collapse; text-align: center;"> <tr> <td style="width: 10%;"></td> <td style="width: 10%;"></td> <td style="width: 10%;"></td> <td style="width: 10%;"></td> <td style="width: 10%;"></td> <td style="width: 10%;"></td> <td style="width: 10%;"></td> <td style="width: 10%;"></td> <td style="width: 10%;"></td> <td style="width: 10%;"></td> </tr> <tr> <td></td> <td></td> <td colspan="8" style="text-align: center;"> <table border="1" style="width: 100%; border-collapse: collapse; text-align: center;"> <tr> <td style="width: 10%;"></td> <td style="width: 10%;"></td> <td style="width: 10%;"></td> <td style="width: 10%;"></td> <td style="width: 10%;"></td> <td style="width: 10%;"></td> <td style="width: 10%;"></td> <td style="width: 10%;"></td> <td style="width: 10%;"></td> <td style="width: 10%;"></td> </tr> <tr> <td></td> <td></td> <td colspan="8" style="text-align: center;"> <table border="1" style="width: 100%; border-collapse: collapse; text-align: center;"> <tr> <td style="width: 10%;"></td> <td style="width: 10%;"></td> <td style="width: 10%;"></td> <td style="width: 10%;"></td> <td style="width: 10%;"></td> <td style="width: 10%;"></td> <td style="width: 10%;"></td> <td style="width: 10%;"></td> <td style="width: 10%;"></td> <td style="width: 10%;"></td> </tr> <tr> <td></td> <td></td> <td colspan="8" style="text-align: center;"> <table border="1" style="width: 100%; border-collapse: collapse; text-align: center;"> <tr> <td style="width: 10%;"></td> <td style="width: 10%;"></td> <td style="width: 10%;"></td> <td style="width: 10%;"></td> <td style="width: 10%;"></td> <td style="width: 10%;"></td> <td style="width: 10%;"></td> <td style="width: 10%;"></td> <td style="width: 10%;"></td> <td style="width: 10%;"></td> </tr> <tr> <td></td> <td></td> <td colspan="8" style="text-align: center;"> <table border="1" style="width: 100%; border-collapse: collapse; text-align: center;"> <tr> <td style="width: 10%;"></td> <td style="width: 10%;"></td> <td style="width: 10%;"></td> <td style="width: 10%;"></td> <td style="width: 10%;"></td> <td style="width: 10%;"></td> <td style="width: 10%;"></td> <td style="width: 10%;"></td> <td style="width: 10%;"></td> <td style="width: 10%;"></td> </tr> <tr> <td></td> <td></td> <td colspan="8" style="text-align: center;"> <table border="1" style="width: 100%; border-collapse: collapse; text-align: center;"> <tr> <td style="width: 10%;"></td> <td style="width: 10%;"></td> <td style="width: 10%;"></td> <td style="width: 10%;"></td> <td style="width: 10%;"></td> <td style="width: 10%;"></td> <td style="width: 10%;"></td> <td style="width: 10%;"></td> <td style="width: 10%;"></td> <td style="width: 10%;"></td> </tr> <tr> <td></td> <td></td> <td colspan="8" style="text-align: center;"> <table border="1" style="width: 100%; border-collapse: collapse; text-align: center;"> <tr> <td style="width: 10%;"></td> <td style="width: 10%;"></td> <td style="width: 10%;"></td> <td style="width: 10%;"></td> <td style="width: 10%;"></td> <td style="width: 10%;"></td> <td style="width: 10%;"></td> <td style="width: 10%;"></td> <td style="width: 10%;"></td> <td style="width: 10%;"></td> </tr> <tr> <td></td> <td></td> <td colspan="8" style="text-align: center;"> <table border="1" style="width: 100%; border-collapse: collapse; text-align: center;"> <tr> <td style="width: 10%;"></td> <td style="width: 10%;"></td> <td style="width: 10%;"></td> <td style="width: 10%;"></td> <td style="width: 10%;"></td> <td style="width: 10%;"></td> <td style="width: 10%;"></td> <td style="width: 10%;"></td> <td style="width: 10%;"></td> <td style="width: 10%;"></td> </tr> <tr> <td></td> <td></td> <td colspan="8" style="text-align: center;"> <table border="1" style="width: 100%; border-collapse: collapse; text-align: center;"> <tr> <td style="width: 10%;"></td> <td style="width: 10%;"></td> <td style="width: 10%;"></td> <td style="width: 10%;"></td> <td style="width: 10%;"></td> <td style="width: 10%;"></td> <td style="width: 10%;"></td> <td style="width: 10%;"></td> <td style="width: 10%;"></td> <td style="width: 10%;"></td> </tr> <tr> <td></td> <td></td> <td colspan="8" style="text-align: center;"> <table border="1" style="width: 100%; border-collapse: collapse; text-align: center;"> <tr> </tr></table></td></tr></table></td></tr></table></td></tr></table></td></tr></table></td></tr></table></td></tr></table></td></tr></table></td></tr></table></td></tr></table></td></tr></table></td></tr></table></td></tr></table></td></tr></table></td></tr></table></td></tr></table></td></tr></table></td></tr></table></td></tr></table></td></tr></table></td></tr></table></td></tr></table></td></tr></table></td></tr></table></td></tr></table></td></tr></table></td></tr></table></td></tr></table>

 | | | | | | | | | | | | | | | | | | | | <table border="1" style="width: 100%; border-collapse: collapse; text-align: center;"> <tr> <td style="width: 10%;"></td> <td style="width: 10%;"></td> <td style="width: 10%;"></td> <td style="width: 10%;"></td> <td style="width: 10%;"></td> <td style="width: 10%;"></td> <td style="width: 10%;"></td> <td style="width: 10%;"></td> <td style="width: 10%;"></td> <td style="width: 10%;"></td> </tr> <tr> <td></td> <td></td> <td colspan="8" style="text-align: center;"> <table border="1" style="width: 100%; border-collapse: collapse; text-align: center;"> <tr> <td style="width: 10%;"></td> <td style="width: 10%;"></td> <td style="width: 10%;"></td> <td style="width: 10%;"></td> <td style="width: 10%;"></td> <td style="width: 10%;"></td> <td style="width: 10%;"></td> <td style="width: 10%;"></td> <td style="width: 10%;"></td> <td style="width: 10%;"></td> </tr> <tr> <td></td> <td></td> <td colspan="8" style="text-align: center;"> <table border="1" style="width: 100%; border-collapse: collapse; text-align: center;"> <tr> <td style="width: 10%;"></td> <td style="width: 10%;"></td> <td style="width: 10%;"></td> <td style="width: 10%;"></td> <td style="width: 10%;"></td> <td style="width: 10%;"></td> <td style="width: 10%;"></td> <td style="width: 10%;"></td> <td style="width: 10%;"></td> <td style="width: 10%;"></td> </tr> <tr> <td></td> <td></td> <td colspan="8" style="text-align: center;"> <table border="1" style="width: 100%; border-collapse: collapse; text-align: center;"> <tr> <td style="width: 10%;"></td> <td style="width: 10%;"></td> <td style="width: 10%;"></td> <td style="width: 10%;"></td> <td style="width: 10%;"></td> <td style="width: 10%;"></td> <td style="width: 10%;"></td> <td style="width: 10%;"></td> <td style="width: 10%;"></td> <td style="width: 10%;"></td> </tr> <tr> <td></td> <td></td> <td colspan="8" style="text-align: center;"> <table border="1" style="width: 100%; border-collapse: collapse; text-align: center;"> <tr> <td style="width: 10%;"></td> <td style="width: 10%;"></td> <td style="width: 10%;"></td> <td style="width: 10%;"></td> <td style="width: 10%;"></td> <td style="width: 10%;"></td> <td style="width: 10%;"></td> <td style="width: 10%;"></td> <td style="width: 10%;"></td> <td style="width: 10%;"></td> </tr> <tr> <td></td> <td></td> <td colspan="8" style="text-align: center;"> <table border="1" style="width: 100%; border-collapse: collapse; text-align: center;"> <tr> <td style="width: 10%;"></td> <td style="width: 10%;"></td> <td style="width: 10%;"></td> <td style="width: 10%;"></td> <td style="width: 10%;"></td> <td style="width: 10%;"></td> <td style="width: 10%;"></td> <td style="width: 10%;"></td> <td style="width: 10%;"></td> <td style="width: 10%;"></td> </tr> <tr> <td></td> <td></td> <td colspan="8" style="text-align: center;"> <table border="1" style="width: 100%; border-collapse: collapse; text-align: center;"> <tr> <td style="width: 10%;"></td> <td style="width: 10%;"></td> <td style="width: 10%;"></td> <td style="width: 10%;"></td> <td style="width: 10%;"></td> <td style="width: 10%;"></td> <td style="width: 10%;"></td> <td style="width: 10%;"></td> <td style="width: 10%;"></td> <td style="width: 10%;"></td> </tr> <tr> <td></td> <td></td> <td colspan="8" style="text-align: center;"> <table border="1" style="width: 100%; border-collapse: collapse; text-align: center;"> <tr> <td style="width: 10%;"></td> <td style="width: 10%;"></td> <td style="width: 10%;"></td> <td style="width: 10%;"></td> <td style="width: 10%;"></td> <td style="width: 10%;"></td> <td style="width: 10%;"></td> <td style="width: 10%;"></td> <td style="width: 10%;"></td> <td style="width: 10%;"></td> </tr> <tr> <td></td> <td></td> <td colspan="8" style="text-align: center;"> <table border="1" style="width: 100%; border-collapse: collapse; text-align: center;"> <tr> <td style="width: 10%;"></td> <td style="width: 10%;"></td> <td style="width: 10%;"></td> <td style="width: 10%;"></td> <td style="width: 10%;"></td> <td style="width: 10%;"></td> <td style="width: 10%;"></td> <td style="width: 10%;"></td> <td style="width: 10%;"></td> <td style="width: 10%;"></td> </tr> <tr> <td></td> <td></td> <td colspan="8" style="text-align: center;"> <table border="1" style="width: 100%; border-collapse: collapse; text-align: center;"> <tr> <td style="width: 10%;"></td> <td style="width: 10%;"></td> <td style="width: 10%;"></td> <td style="width: 10%;"></td> <td style="width: 10%;"></td> <td style="width: 10%;"></td> <td style="width: 10%;"></td> <td style="width: 10%;"></td> <td style="width: 10%;"></td> <td style="width: 10%;"></td> </tr> <tr> <td></td> <td></td> <td colspan="8" style="text-align: center;"> <table border="1" style="width: 100%; border-collapse: collapse; text-align: center;"> <tr> <td style="width: 10%;"></td> <td style="width: 10%;"></td> <td style="width: 10%;"></td> <td style="width: 10%;"></td> <td style="width: 10%;"></td> <td style="width: 10%;"></td> <td style="width: 10%;"></td> <td style="width: 10%;"></td> <td style="width: 10%;"></td> <td style="width: 10%;"></td> </tr> <tr> <td></td> <td></td> <td colspan="8" style="text-align: center;"> <table border="1" style="width: 100%; border-collapse: collapse; text-align: center;"> <tr> <td style="width: 10%;"></td> <td style="width: 10%;"></td> <td style="width: 10%;"></td> <td style="width: 10%;"></td> <td style="width: 10%;"></td> <td style="width: 10%;"></td> <td style="width: 10%;"></td> <td style="width: 10%;"></td> <td style="width: 10%;"></td> <td style="width: 10%;"></td> </tr> <tr> <td></td> <td></td> <td colspan="8" style="text-align: center;"> <table border="1" style="width: 100%; border-collapse: collapse; text-align: center;"> <tr> <td style="width: 10%;"></td> <td style="width: 10%;"></td> <td style="width: 10%;"></td> <td style="width: 10%;"></td> <td style="width: 10%;"></td> <td style="width: 10%;"></td> <td style="width: 10%;"></td> <td style="width: 10%;"></td> <td style="width: 10%;"></td> <td style="width: 10%;"></td> </tr> <tr> <td></td> <td></td> <td colspan="8" style="text-align: center;"> <table border="1" style="width: 100%; border-collapse: collapse; text-align: center;"> <tr> <td style="width: 10%;"></td> <td style="width: 10%;"></td> <td style="width: 10%;"></td> <td style="width: 10%;"></td> <td style="width: 10%;"></td> <td style="width: 10%;"></td> <td style="width: 10%;"></td> <td style="width: 10%;"></td> <td style="width: 10%;"></td> <td style="width: 10%;"></td> </tr> <tr> <td></td> <td></td> <td colspan="8" style="text-align: center;"> <table border="1" style="width: 100%; border-collapse: collapse; text-align: center;"> <tr> <td style="width: 10%;"></td> <td style="width: 10%;"></td> <td style="width: 10%;"></td> <td style="width: 10%;"></td> <td style="width: 10%;"></td> <td style="width: 10%;"></td> <td style="width: 10%;"></td> <td style="width: 10%;"></td> <td style="width: 10%;"></td> <td style="width: 10%;"></td> </tr> <tr> <td></td> <td></td> <td colspan="8" style="text-align: center;"> <table border="1" style="width: 100%; border-collapse: collapse; text-align: center;"> <tr> <td style="width: 10%;"></td> <td style="width: 10%;"></td> <td style="width: 10%;"></td> <td style="width: 10%;"></td> <td style="width: 10%;"></td> <td style="width: 10%;"></td> <td style="width: 10%;"></td> <td style="width: 10%;"></td> <td style="width: 10%;"></td> <td style="width: 10%;"></td> </tr> <tr> <td></td> <td></td> <td colspan="8" style="text-align: center;"> <table border="1" style="width: 100%; border-collapse: collapse; text-align: center;"> <tr> <td style="width: 10%;"></td> <td style="width: 10%;"></td> <td style="width: 10%;"></td> <td style="width: 10%;"></td> <td style="width: 10%;"></td> <td style="width: 10%;"></td> <td style="width: 10%;"></td> <td style="width: 10%;"></td> <td style="width: 10%;"></td> <td style="width: 10%;"></td> </tr> <tr> <td></td> <td></td> <td colspan="8" style="text-align: center;"> <table border="1" style="width: 100%; border-collapse: collapse; text-align: center;"> <tr> <td style="width: 10%;"></td> <td style="width: 10%;"></td> <td style="width: 10%;"></td> <td style="width: 10%;"></td> <td style="width: 10%;"></td> <td style="width: 10%;"></td> <td style="width: 10%;"></td> <td style="width: 10%;"></td> <td style="width: 10%;"></td> <td style="width: 10%;"></td> </tr> <tr> <td></td> <td></td> <td colspan="8" style="text-align: center;"> <table border="1" style="width: 100%; border-collapse: collapse; text-align: center;"> <tr> <td style="width: 10%;"></td> <td style="width: 10%;"></td> <td style="width: 10%;"></td> <td style="width: 10%;"></td> <td style="width: 10%;"></td> <td style="width: 10%;"></td> <td style="width: 10%;"></td> <td style="width: 10%;"></td> <td style="width: 10%;"></td> <td style="width: 10%;"></td> </tr> <tr> <td></td> <td></td> <td colspan="8" style="text-align: center;"> <table
border="1" style="width: 100%; border-collapse: collapse; text-align: center;"> <tr> <td style="width: 10%;"></td> <td style="width: 10%;"></td> <td style="width: 10%;"></td> <td style="width: 10%;"></td> <td style="width: 10%;"></td> <td style="width: 10%;"></td> <td style="width: 10%;"></td> <td style="width: 10%;"></td> <td style="width: 10%;"></td> <td style="width: 10%;"></td> </tr> <tr> <td></td> <td></td> <td colspan="8" style="text-align: center;"> <table border="1" style="width: 100%; border-collapse: collapse; text-align: center;"> <tr> <td style="width: 10%;"></td> <td style="width: 10%;"></td> <td style="width: 10%;"></td> <td style="width: 10%;"></td> <td style="width: 10%;"></td> <td style="width: 10%;"></td> <td style="width: 10%;"></td> <td style="width: 10%;"></td> <td style="width: 10%;"></td> <td style="width: 10%;"></td> </tr> <tr> <td></td> <td></td> <td colspan="8" style="text-align: center;"> <table border="1" style="width: 100%; border-collapse: collapse; text-align: center;"> <tr> <td style="width: 10%;"></td> <td style="width: 10%;"></td> <td style="width: 10%;"></td> <td style="width: 10%;"></td> <td style="width: 10%;"></td> <td style="width: 10%;"></td> <td style="width: 10%;"></td> <td style="width: 10%;"></td> <td style="width: 10%;"></td> <td style="width: 10%;"></td> </tr> <tr> <td></td> <td></td> <td colspan="8" style="text-align: center;"> <table border="1" style="width: 100%; border-collapse: collapse; text-align: center;"> <tr> <td style="width: 10%;"></td> <td style="width: 10%;"></td> <td style="width: 10%;"></td> <td style="width: 10%;"></td> <td style="width: 10%;"></td> <td style="width: 10%;"></td> <td style="width: 10%;"></td> <td style="width: 10%;"></td> <td style="width: 10%;"></td> <td style="width: 10%;"></td> </tr> <tr> <td></td> <td></td> <td colspan="8" style="text-align: center;"> <table border="1" style="width: 100%; border-collapse: collapse; text-align: center;"> <tr> <td style="width: 10%;"></td> <td style="width: 10%;"></td> <td style="width: 10%;"></td> <td style="width: 10%;"></td> <td style="width: 10%;"></td> <td style="width: 10%;"></td> <td style="width: 10%;"></td> <td style="width: 10%;"></td> <td style="width: 10%;"></td> <td style="width: 10%;"></td> </tr> <tr> <td></td> <td></td> <td colspan="8" style="text-align: center;"> <table border="1" style="width: 100%; border-collapse: collapse; text-align: center;"> <tr> <td style="width: 10%;"></td> <td style="width: 10%;"></td> <td style="width: 10%;"></td> <td style="width: 10%;"></td> <td style="width: 10%;"></td> <td style="width: 10%;"></td> <td style="width: 10%;"></td> <td style="width: 10%;"></td> <td style="width: 10%;"></td> <td style="width: 10%;"></td> </tr> <tr> <td></td> <td></td> <td colspan="8" style="text-align: center;"> <table border="1" style="width: 100%; border-collapse: collapse; text-align: center;"> <tr> <td style="width: 10%;"></td> <td style="width: 10%;"></td> <td style="width: 10%;"></td> <td style="width: 10%;"></td> <td style="width: 10%;"></td> <td style="width: 10%;"></td> <td style="width: 10%;"></td> <td style="width: 10%;"></td> <td style="width: 10%;"></td> <td style="width: 10%;"></td> </tr> <tr> <td></td> <td></td> <td colspan="8" style="text-align: center;"> <table border="1" style="width: 100%; border-collapse: collapse; text-align: center;"> <tr> </tr></table></td></tr></table></td></tr></table></td></tr></table></td></tr></table></td></tr></table></td></tr></table></td></tr></table></td></tr></table></td></tr></table></td></tr></table></td></tr></table></td></tr></table></td></tr></table></td></tr></table></td></tr></table></td></tr></table></td></tr></table></td></tr></table></td></tr></table></td></tr></table></td></tr></table></td></tr></table></td></tr></table></td></tr></table></td></tr></table></td></tr></table>
 | | | | | | | | | | | | | | | | | | | | <table border="1" style="width: 100%; border-collapse: collapse; text-align: center;"> <tr> <td style="width: 10%;"></td> <td style="width: 10%;"></td> <td style="width: 10%;"></td> <td style="width: 10%;"></td> <td style="width: 10%;"></td> <td style="width: 10%;"></td> <td style="width: 10%;"></td> <td style="width: 10%;"></td> <td style="width: 10%;"></td> <td style="width: 10%;"></td> </tr> <tr> <td></td> <td></td> <td colspan="8" style="text-align: center;"> <table border="1" style="width: 100%; border-collapse: collapse; text-align: center;"> <tr> <td style="width: 10%;"></td> <td style="width: 10%;"></td> <td style="width: 10%;"></td> <td style="width: 10%;"></td> <td style="width: 10%;"></td> <td style="width: 10%;"></td> <td style="width: 10%;"></td> <td style="width: 10%;"></td> <td style="width: 10%;"></td> <td style="width: 10%;"></td> </tr> <tr> <td></td> <td></td> <td colspan="8" style="text-align: center;"> <table border="1" style="width: 100%; border-collapse: collapse; text-align: center;"> <tr> <td style="width: 10%;"></td> <td style="width: 10%;"></td> <td style="width: 10%;"></td> <td style="width: 10%;"></td> <td style="width: 10%;"></td> <td style="width: 10%;"></td> <td style="width: 10%;"></td> <td style="width: 10%;"></td> <td style="width: 10%;"></td> <td style="width: 10%;"></td> </tr> <tr> <td></td> <td></td> <td colspan="8" style="text-align: center;"> <table border="1" style="width: 100%; border-collapse: collapse; text-align: center;"> <tr> <td style="width: 10%;"></td> <td style="width: 10%;"></td> <td style="width: 10%;"></td> <td style="width: 10%;"></td> <td style="width: 10%;"></td> <td style="width: 10%;"></td> <td style="width: 10%;"></td> <td style="width: 10%;"></td> <td style="width: 10%;"></td> <td style="width: 10%;"></td> </tr> <tr> <td></td> <td></td> <td colspan="8" style="text-align: center;"> <table border="1" style="width: 100%; border-collapse: collapse; text-align: center;"> <tr> <td style="width: 10%;"></td> <td style="width: 10%;"></td> <td style="width: 10%;"></td> <td style="width: 10%;"></td> <td style="width: 10%;"></td> <td style="width: 10%;"></td> <td style="width: 10%;"></td> <td style="width: 10%;"></td> <td style="width: 10%;"></td> <td style="width: 10%;"></td> </tr> <tr> <td></td> <td></td> <td colspan="8" style="text-align: center;"> <table border="1" style="width: 100%; border-collapse: collapse; text-align: center;"> <tr> <td style="width: 10%;"></td> <td style="width:
10%;"></td> <td style="width: 10%;"></td> <td style="width: 10%;"></td> <td style="width: 10%;"></td> <td style="width: 10%;"></td> <td style="width: 10%;"></td> <td style="width: 10%;"></td> <td style="width: 10%;"></td> <td style="width: 10%;"></td> </tr> <tr> <td></td> <td></td> <td colspan="8" style="text-align: center;"> <table border="1" style="width: 100%; border-collapse: collapse; text-align: center;"> <tr> <td style="width: 10%;"></td> <td style="width: 10%;"></td> <td style="width: 10%;"></td> <td style="width: 10%;"></td> <td style="width: 10%;"></td> <td style="width: 10%;"></td> <td style="width: 10%;"></td> <td style="width: 10%;"></td> <td style="width: 10%;"></td> <td style="width: 10%;"></td> </tr> <tr> <td></td> <td></td> <td colspan="8" style="text-align: center;"> <table border="1" style="width: 100%; border-collapse: collapse; text-align: center;"> <tr> <td style="width: 10%;"></td> <td style="width: 10%;"></td> <td style="width: 10%;"></td> <td style="width: 10%;"></td> <td style="width: 10%;"></td> <td style="width: 10%;"></td> <td style="width: 10%;"></td> <td style="width: 10%;"></td> <td style="width: 10%;"></td> <td style="width: 10%;"></td> </tr> <tr> <td></td> <td></td> <td colspan="8" style="text-align: center;"> <table border="1" style="width: 100%; border-collapse: collapse; text-align: center;"> <tr> <td style="width: 10%;"></td> <td style="width: 10%;"></td> <td style="width: 10%;"></td> <td style="width: 10%;"></td> <td style="width: 10%;"></td> <td style="width: 10%;"></td> <td style="width: 10%;"></td> <td style="width: 10%;"></td> <td style="width: 10%;"></td> <td style="width: 10%;"></td> </tr> <tr> <td></td> <td></td> <td colspan="8" style="text-align: center;"> <table border="1" style="width: 100%; border-collapse: collapse; text-align: center;"> <tr> <td style="width: 10%;"></td> <td style="width: 10%;"></td> <td style="width: 10%;"></td> <td style="width: 10%;"></td> <td style="width: 10%;"></td> <td style="width: 10%;"></td> <td style="width: 10%;"></td> <td style="width: 10%;"></td> <td style="width: 10%;"></td> <td style="width: 10%;"></td> </tr> <tr> <td></td> <td></td> <td colspan="8" style="text-align: center;"> <table border="1" style="width: 100%; border-collapse: collapse; text-align: center;"> <tr> <td style="width: 10%;"></td> <td style="width: 10%;"></td> <td style="width: 10%;"></td> <td style="width: 10%;"></td> <td style="width: 10%;"></td> <td style="width: 10%;"></td> <td style="width: 10%;"></td> <td style="width: 10%;"></td> <td style="width: 10%;"></td> <td style="width: 10%;"></td> </tr> <tr> <td></td> <td></td> <td colspan="8" style="text-align: center;"> <table border="1" style="width: 100%; border-collapse: collapse; text-align: center;"> <tr> <td style="width: 10%;"></td> <td style="width: 10%;"></td> <td style="width: 10%;"></td> <td style="width: 10%;"></td> <td style="width: 10%;"></td> <td style="width: 10%;"></td> <td style="width: 10%;"></td> <td style="width: 10%;"></td> <td style="width: 10%;"></td> <td style="width: 10%;"></td> </tr> <tr> <td></td> <td></td> <td colspan="8" style="text-align: center;"> <table border="1" style="width: 100%; border-collapse: collapse; text-align: center;"> <tr> <td style="width: 10%;"></td> <td style="width: 10%;"></td> <td style="width: 10%;"></td> <td style="width: 10%;"></td> <td style="width: 10%;"></td> <td style="width: 10%;"></td> <td style="width: 10%;"></td> <td style="width: 10%;"></td> <td style="width: 10%;"></td> <td style="width: 10%;"></td> </tr> <tr> <td></td> <td></td> <td colspan="8" style="text-align: center;"> <table border="1" style="width: 100%; border-collapse: collapse; text-align: center;"> <tr> <td style="width: 10%;"></td> <td style="width: 10%;"></td> <td style="width: 10%;"></td> <td style="width: 10%;"></td> <td style="width: 10%;"></td> <td style="width: 10%;"></td> <td style="width: 10%;"></td> <td style="width: 10%;"></td> <td style="width: 10%;"></td> <td style="width: 10%;"></td> </tr> <tr> <td></td> <td></td> <td colspan="8" style="text-align: center;"> <table border="1" style="width: 100%; border-collapse: collapse; text-align: center;"> <tr> <td style="width: 10%;"></td> <td style="width: 10%;"></td> <td style="width: 10%;"></td> <td style="width: 10%;"></td> <td style="width: 10%;"></td> <td style="width: 10%;"></td> <td style="width: 10%;"></td> <td style="width: 10%;"></td> <td style="width: 10%;"></td> <td style="width: 10%;"></td> </tr> <tr> <td></td> <td></td> <td colspan="8" style="text-align: center;"> <table border="1" style="width: 100%; border-collapse: collapse; text-align: center;"> <tr> <td style="width: 10%;"></td> <td style="width: 10%;"></td> <td style="width: 10%;"></td> <td style="width: 10%;"></td> <td style="width: 10%;"></td> <td style="width: 10%;"></td> <td style="width: 10%;"></td> <td style="width: 10%;"></td> <td style="width: 10%;"></td> <td style="width: 10%;"></td> </tr> <tr> <td></td> <td></td> <td colspan="8" style="text-align: center;"> <table border="1" style="width: 100%; border-collapse: collapse; text-align: center;"> <tr> <td style="width: 10%;"></td> <td style="width: 10%;"></td> <td style="width: 10%;"></td> <td style="width: 10%;"></td> <td style="width: 10%;"></td> <td style="width: 10%;"></td> <td style="width: 10%;"></td> <td style="width: 10%;"></td> <td style="width: 10%;"></td> <td style="width: 10%;"></td> </tr> <tr> <td></td> <td></td> <td colspan="8" style="text-align: center;"> <table border="1" style="width: 100%; border-collapse: collapse; text-align: center;"> <tr> <td style="width: 10%;"></td> <td style="width: 10%;"></td> <td style="width: 10%;"></td> <td style="width: 10%;"></td> <td style="width: 10%;"></td> <td style="width: 10%;"></td> <td style="width: 10%;"></td> <td style="width: 10%;"></td> <td style="width: 10%;"></td> <td style="width: 10%;"></td> </tr> <tr> <td></td> <td></td> <td colspan="8" style="text-align: center;"> <table border="1" style="width: 100%; border-collapse: collapse; text-align: center;"> <tr> <td style="width: 10%;"></td> <td style="width: 10%;"></td> <td style="width: 10%;"></td> <td style="width: 10%;"></td> <td style="width: 10%;"></td> <td style="width: 10%;"></td> <td style="width: 10%;"></td> <td style="width: 10%;"></td> <td style="width: 10%;"></td> <td style="width: 10%;"></td> </tr> <tr> <td></td> <td></td> <td colspan="8" style="text-align: center;"> <table border="1" style="width: 100%; border-collapse: collapse; text-align: center;"> <tr> <td style="width: 10%;"></td> <td style="width: 10%;"></td> <td style="width: 10%;"></td> <td style="width: 10%;"></td> <td style="width: 10%;"></td> <td style="width: 10%;"></td> <td style="width: 10%;"></td> <td style="width: 10%;"></td> <td style="width: 10%;"></td> <td style="width: 10%;"></td> </tr> <tr> <td></td> <td></td> <td colspan="8" style="text-align: center;"> <table border="1" style="width: 100%; border-collapse: collapse; text-align: center;"> <tr> <td style="width: 10%;"></td> <td style="width: 10%;"></td> <td style="width: 10%;"></td> <td style="width: 10%;"></td> <td style="width: 10%;"></td> <td style="width: 10%;"></td> <td style="width: 10%;"></td> <td style="width: 10%;"></td> <td style="width: 10%;"></td> <td style="width: 10%;"></td> </tr> <tr> <td></td> <td></td> <td colspan="8" style="text-align: center;"> <table border="1" style="width: 100%; border-collapse: collapse; text-align: center;"> <tr> <td style="width: 10%;"></td> <td style="width: 10%;"></td> <td style="width: 10%;"></td> <td style="width: 10%;"></td> <td style="width: 10%;"></td> <td style="width: 10%;"></td> <td style="width: 10%;"></td> <td style="width: 10%;"></td> <td style="width: 10%;"></td> <td style="width: 10%;"></td> </tr> <tr> <td></td> <td></td> <td colspan="8" style="text-align: center;"> <table border="1" style="width: 100%; border-collapse: collapse; text-align: center;"> <tr> <td style="width: 10%;"></td> <td style="width: 10%;"></td> <td style="width: 10%;"></td> <td style="width: 10%;"></td> <td style="width: 10%;"></td> <td style="width: 10%;"></td> <td style="width: 10%;"></td> <td style="width: 10%;"></td> <td style="width: 10%;"></td> <td style="width: 10%;"></td> </tr> <tr> <td></td> <td></td> <td colspan="8" style="text-align: center;"> <table border="1" style="width: 100%; border-collapse: collapse; text-align: center;"> <tr> <td style="width: 10%;"></td> <td style="width: 10%;"></td> <td style="width: 10%;"></td> <td style="width: 10%;"></td> <td style="width: 10%;"></td> <td style="width: 10%;"></td> <td style="width: 10%;"></td> <td style="width: 10%;"></td> <td style="width: 10%;"></td> <td style="width: 10%;"></td> </tr> <tr> <td></td> <td></td> <td colspan="8" style="text-align: center;"> <table border="1" style="width: 100%; border-collapse: collapse; text-align: center;"> <tr> <td style="width: 10%;"></td> <td style="width: 10%;"></td> <td style="width: 10%;"></td> <td style="width: 10%;"></td> <td style="width: 10%;"></td> <td style="width: 10%;"></td> <td style="width: 10%;"></td> <td style="width: 10%;"></td> <td style="width: 10%;"></td> <td style="width: 10%;"></td> </tr> <tr> <td></td> <td></td> <td colspan="8" style="text-align: center;"> <table border="1" style="width: 100%; border-collapse: collapse; text-align: center;"> <tr> </tr></table></td></tr></table></td></tr></table></td></tr></table></td></tr></table></td></tr></table></td></tr></table></td></tr></table></td></tr></table></td></tr></table></td></tr></table></td></tr></table></td></tr></table></td></tr></table></td></tr></table></td></tr></table></td></tr></table></td></tr></table></td></tr></table></td></tr></table></td></tr></table></td></tr></table></td></tr></table></td></tr></table></td></tr></table></td></tr></table>

 | | | | | | | | | | | | | | | | | | | | <table border="1" style="width: 100%; border-collapse: collapse; text-align: center;"> <tr> <td style="width: 10%;"></td> <td style="width: 10%;"></td> <td style="width: 10%;"></td> <td style="width: 10%;"></td> <td style="width: 10%;"></td> <td style="width: 10%;"></td> <td style="width: 10%;"></td> <td style="width: 10%;"></td> <td style="width: 10%;"></td> <td style="width: 10%;"></td> </tr> <tr> <td></td> <td></td> <td colspan="8" style="text-align: center;"> <table border="1" style="width: 100%; border-collapse: collapse; text-align: center;"> <tr> <td style="width: 10%;"></td> <td style="width: 10%;"></td> <td style="width: 10%;"></td> <td style="width: 10%;"></td> <td style="width: 10%;"></td> <td style="width: 10%;"></td> <td style="width: 10%;"></td> <td style="width: 10%;"></td> <td style="width: 10%;"></td> <td style="width: 10%;"></td> </tr> <tr> <td></td> <td></td> <td colspan="8" style="text-align: center;"> <table border="1" style="width: 100%; border-collapse: collapse; text-align: center;"> <tr> <td style="width: 10%;"></td> <td style="width: 10%;"></td> <td style="width: 10%;"></td> <td style="width: 10%;"></td> <td style="width: 10%;"></td> <td style="width: 10%;"></td> <td style="width: 10%;"></td> <td style="width: 10%;"></td> <td style="width: 10%;"></td> <td style="width: 10%;"></td> </tr> <tr> <td></td> <td></td> <td colspan="8" style="text-align: center;"> <table border="1" style="width: 100%; border-collapse: collapse; text-align: center;"> <tr> <td style="width: 10%;"></td> <td style="width: 10%;"></td> <td style="width: 10%;"></td> <td style="width: 10%;"></td> <td style="width: 10%;"></td> <td style="width: 10%;"></td> <td style="width: 10%;"></td> <td style="width: 10%;"></td> <td style="width: 10%;"></td> <td style="width: 10%;"></td> </tr> <tr> <td></td> <td></td> <td colspan="8" style="text-align: center;"> <table border="1" style="width: 100%; border-collapse: collapse; text-align: center;"> <tr> <td style="width: 10%;"></td> <td style="width: 10%;"></td> <td style="width: 10%;"></td> <td style="width: 10%;"></td> <td style="width: 10%;"></td> <td style="width: 10%;"></td> <td style="width: 10%;"></td> <td style="width: 10%;"></td> <td style="width: 10%;"></td> <td style="width: 10%;"></td> </tr> <tr> <td></td> <td></td> <td colspan="8" style="text-align: center;"> <table border="1" style="width: 100%; border-collapse: collapse; text-align: center;"> <tr> <td style="width: 10%;"></td> <td style="width: 10%;"></td> <td style="width: 10%;"></td> <td style="width: 10%;"></td> <td style="width: 10%;"></td> <td style="width: 10%;"></td> <td style="width: 10%;"></td> <td style="width: 10%;"></td> <td style="width: 10%;"></td> <td style="width: 10%;"></td> </tr> <tr> <td></td> <td></td> <td colspan="8" style="text-align: center;"> <table border="1" style="width: 100%; border-collapse: collapse; text-align: center;"> <tr> <td style="width: 10%;"></td> <td style="width: 10%;"></td> <td style="width: 10%;"></td> <td style="width: 10%;"></td> <td style="width: 10%;"></td> <td style="width: 10%;"></td> <td style="width: 10%;"></td> <td style="width: 10%;"></td> <td style="width: 10%;"></td> <td style="width: 10%;"></td> </tr> <tr> <td></td> <td></td> <td colspan="8" style="text-align: center;"> <table border="1" style="width: 100%; border-collapse: collapse; text-align: center;"> <tr> <td style="width: 10%;"></td> <td style="width: 10%;"></td> <td style="width: 10%;"></td> <td style="width: 10%;"></td> <td style="width: 10%;"></td> <td style="width: 10%;"></td> <td style="width: 10%;"></td> <td style="width: 10%;"></td> <td style="width: 10%;"></td> <td style="width: 10%;"></td> </tr> <tr> <td></td> <td></td> <td colspan="8" style="text-align: center;"> <table border="1" style="width: 100%; border-collapse: collapse; text-align: center;"> <tr> <td style="width: 10%;"></td> <td style="width: 10%;"></td> <td style="width: 10%;"></td> <td style="width: 10%;"></td> <td style="width: 10%;"></td> <td style="width: 10%;"></td> <td style="width: 10%;"></td> <td style="width: 10%;"></td> <td style="width: 10%;"></td> <td style="width: 10%;"></td> </tr> <tr> <td></td> <td></td> <td colspan="8" style="text-align: center;"> <table border="1" style="width: 100%; border-collapse: collapse; text-align: center;"> <tr> <td style="width: 10%;"></td> <td style="width: 10%;"></td> <td style="width: 10%;"></td> <td style="width: 10%;"></td> <td style="width: 10%;"></td> <td style="width: 10%;"></td> <td style="width: 10%;"></td> <td style="width: 10%;"></td> <td style="width: 10%;"></td> <td style="width: 10%;"></td> </tr> <tr> <td></td> <td></td> <td colspan="8" style="text-align: center;"> <table border="1" style="width: 100%; border-collapse: collapse; text-align: center;"> <tr> <td style="width: 10%;"></td> <td style="width: 10%;"></td> <td style="width: 10%;"></td> <td style="width: 10%;"></td> <td style="width: 10%;"></td> <td style="width: 10%;"></td> <td style="width: 10%;"></td> <td style="width: 10%;"></td> <td style="width: 10%;"></td> <td style="width: 10%;"></td> </tr> <tr> <td></td> <td></td> <td colspan="8" style="text-align: center;"> <table border="1" style="width: 100%; border-collapse: collapse; text-align: center;"> <tr> <td style="width: 10%;"></td> <td style="width: 10%;"></td> <td style="width: 10%;"></td> <td style="width: 10%;"></td> <td style="width: 10%;"></td> <td style="width: 10%;"></td> <td style="width: 10%;"></td> <td style="width: 10%;"></td> <td style="width: 10%;"></td> <td style="width: 10%;"></td> </tr> <tr> <td></td> <td></td> <td colspan="8" style="text-align: center;"> <table border="1" style="width: 100%; border-collapse: collapse; text-align: center;"> <tr> <td style="width: 10%;"></td> <td style="width: 10%;"></td> <td style="width: 10%;"></td> <td style="width: 10%;"></td> <td style="width: 10%;"></td> <td style="width: 10%;"></td> <td style="width: 10%;"></td> <td style="width: 10%;"></td> <td style="width: 10%;"></td> <td style="width: 10%;"></td> </tr> <tr> <td></td> <td></td> <td colspan="8" style="text-align: center;"> <table border="1" style="width: 100%; border-collapse: collapse; text-align: center;"> <tr> <td style="width: 10%;"></td> <td style="width: 10%;"></td> <td style="width: 10%;"></td> <td style="width: 10%;"></td> <td style="width: 10%;"></td> <td style="width: 10%;"></td> <td style="width: 10%;"></td> <td style="width: 10%;"></td> <td style="width: 10%;"></td> <td style="width: 10%;"></td> </tr> <tr> <td></td> <td></td> <td colspan="8" style="text-align: center;">
<table border="1" style="width: 100%; border-collapse: collapse; text-align: center;"> <tr> <td style="width: 10%;"></td> <td style="width: 10%;"></td> <td style="width: 10%;"></td> <td style="width: 10%;"></td> <td style="width: 10%;"></td> <td style="width: 10%;"></td> <td style="width: 10%;"></td> <td style="width: 10%;"></td> <td style="width: 10%;"></td> <td style="width: 10%;"></td> </tr> <tr> <td></td> <td></td> <td colspan="8" style="text-align: center;"> <table border="1" style="width: 100%; border-collapse: collapse; text-align: center;"> <tr> <td style="width: 10%;"></td> <td style="width: 10%;"></td> <td style="width: 10%;"></td> <td style="width: 10%;"></td> <td style="width: 10%;"></td> <td style="width: 10%;"></td> <td style="width: 10%;"></td> <td style="width: 10%;"></td> <td style="width: 10%;"></td> <td style="width: 10%;"></td> </tr> <tr> <td></td> <td></td> <td colspan="8" style="text-align: center;"> <table border="1" style="width: 100%; border-collapse: collapse; text-align: center;"> <tr> <td style="width: 10%;"></td> <td style="width: 10%;"></td> <td style="width: 10%;"></td> <td style="width: 10%;"></td> <td style="width: 10%;"></td> <td style="width: 10%;"></td> <td style="width: 10%;"></td> <td style="width: 10%;"></td> <td style="width: 10%;"></td> <td style="width: 10%;"></td> </tr> <tr> <td></td> <td></td> <td colspan="8" style="text-align: center;"> <table border="1" style="width: 100%; border-collapse: collapse; text-align: center;"> <tr> <td style="width: 10%;"></td> <td style="width: 10%;"></td> <td style="width: 10%;"></td> <td style="width: 10%;"></td> <td style="width: 10%;"></td> <td style="width: 10%;"></td> <td style="width: 10%;"></td> <td style="width: 10%;"></td> <td style="width: 10%;"></td> <td style="width: 10%;"></td> </tr> <tr> <td></td> <td></td> <td colspan="8" style="text-align: center;"> <table border="1" style="width: 100%; border-collapse: collapse; text-align: center;"> <tr> <td style="width: 10%;"></td> <td style="width: 10%;"></td> <td style="width: 10%;"></td> <td style="width: 10%;"></td> <td style="width: 10%;"></td> <td style="width: 10%;"></td> <td style="width: 10%;"></td> <td style="width: 10%;"></td> <td style="width: 10%;"></td> <td style="width: 10%;"></td> </tr> <tr> <td></td> <td></td> <td colspan="8" style="text-align: center;"> <table border="1" style="width: 100%; border-collapse: collapse; text-align: center;"> <tr> <td style="width: 10%;"></td> <td style="width: 10%;"></td> <td style="width: 10%;"></td> <td style="width: 10%;"></td> <td style="width: 10%;"></td> <td style="width: 10%;"></td> <td style="width: 10%;"></td> <td style="width: 10%;"></td> <td style="width: 10%;"></td> <td style="width: 10%;"></td> </tr> <tr> <td></td> <td></td> <td colspan="8" style="text-align: center;"> <table border="1" style="width: 100%; border-collapse: collapse; text-align: center;"> <tr> <td style="width: 10%;"></td> <td style="width: 10%;"></td> <td style="width: 10%;"></td> <td style="width: 10%;"></td> <td style="width: 10%;"></td> <td style="width: 10%;"></td> <td style="width: 10%;"></td> <td style="width: 10%;"></td> <td style="width: 10%;"></td> <td style="width: 10%;"></td> </tr> <tr> <td></td> <td></td> <td colspan="8" style="text-align: center;"> <table border="1" style="width: 100%; border-collapse: collapse; text-align: center;"> <tr> <td style="width: 10%;"></td> <td style="width: 10%;"></td> <td style="width: 10%;"></td> <td style="width: 10%;"></td> <td style="width: 10%;"></td> <td style="width: 10%;"></td> <td style="width: 10%;"></td> <td style="width: 10%;"></td> <td style="width: 10%;"></td> <td style="width: 10%;"></td> </tr> <tr> <td></td> <td></td> <td colspan="8" style="text-align: center;"> <table border="1" style="width: 100%; border-collapse: collapse; text-align: center;"> <tr> <td style="width: 10%;"></td> <td style="width: 10%;"></td> <td style="width: 10%;"></td> <td style="width: 10%;"></td> <td style="width: 10%;"></td> <td style="width: 10%;"></td> <td style="width: 10%;"></td> <td style="width: 10%;"></td> <td style="width: 10%;"></td> <td style="width: 10%;"></td> </tr> <tr> <td></td> <td></td> <td colspan="8" style="text-align: center;"> <table border="1" style="width: 100%; border-collapse: collapse; text-align: center;"> <tr> <td style="width: 10%;"></td> <td style="width: 10%;"></td> <td style="width: 10%;"></td> <td style="width: 10%;"></td> <td style="width: 10%;"></td> <td style="width: 10%;"></td> <td style="width: 10%;"></td> <td style="width: 10%;"></td> <td style="width: 10%;"></td> <td style="width: 10%;"></td> </tr> <tr> <td></td> <td></td> <td colspan="8" style="text-align: center;"> <table border="1" style="width: 100%; border-collapse: collapse; text-align: center;"> <tr> </tr></table></td></tr></table></td></tr></table></td></tr></table></td></tr></table></td></tr></table></td></tr></table></td></tr></table></td></tr></table></td></tr></table></td></tr></table></td></tr></table></td></tr></table></td></tr></table></td></tr></table></td></tr></table></td></tr></table></td></tr></table></td></tr></table></td></tr></table></td></tr></table></td></tr></table></td></tr></table></td></tr></table></td></tr></table>
 | | | | | | | | | | | | | | | | | | | | <table border="1" style="width: 100%; border-collapse: collapse; text-align: center;"> <tr> <td style="width: 10%;"></td> <td style="width: 10%;"></td> <td style="width: 10%;"></td> <td style="width: 10%;"></td> <td style="width: 10%;"></td> <td style="width: 10%;"></td> <td style="width: 10%;"></td> <td style="width: 10%;"></td> <td style="width: 10%;"></td> <td style="width: 10%;"></td> </tr> <tr> <td></td> <td></td> <td colspan="8" style="text-align: center;"> <table border="1" style="width: 100%; border-collapse: collapse; text-align: center;"> <tr> <td style="width: 10%;"></td> <td style="width: 10%;"></td> <td style="width: 10%;"></td> <td style="width: 10%;"></td> <td style="width: 10%;"></td> <td style="width: 10%;"></td> <td style="width: 10%;"></td> <td style="width: 10%;"></td> <td style="width: 10%;"></td> <td style="width: 10%;"></td> </tr> <tr> <td></td> <td></td> <td colspan="8" style="text-align: center;"> <table border="1" style="width: 100%; border-collapse: collapse; text-align: center;"> <tr> <td style="width: 10%;"></td> <td style="width: 10%;"></td> <td style="width:
10%;"></td> <td style="width: 10%;"></td> <td style="width: 10%;"></td> <td style="width: 10%;"></td> <td style="width: 10%;"></td> <td style="width: 10%;"></td> <td style="width: 10%;"></td> <td style="width: 10%;"></td> </tr> <tr> <td></td> <td></td> <td colspan="8" style="text-align: center;"> <table border="1" style="width: 100%; border-collapse: collapse; text-align: center;"> <tr> <td style="width: 10%;"></td> <td style="width: 10%;"></td> <td style="width: 10%;"></td> <td style="width: 10%;"></td> <td style="width: 10%;"></td> <td style="width: 10%;"></td> <td style="width: 10%;"></td> <td style="width: 10%;"></td> <td style="width: 10%;"></td> <td style="width: 10%;"></td> </tr> <tr> <td></td> <td></td> <td colspan="8" style="text-align: center;"> <table border="1" style="width: 100%; border-collapse: collapse; text-align: center;"> <tr> <td style="width: 10%;"></td> <td style="width: 10%;"></td> <td style="width: 10%;"></td> <td style="width: 10%;"></td> <td style="width: 10%;"></td> <td style="width: 10%;"></td> <td style="width: 10%;"></td> <td style="width: 10%;"></td> <td style="width: 10%;"></td> <td style="width: 10%;"></td> </tr> <tr> <td></td> <td></td> <td colspan="8" style="text-align: center;"> <table border="1" style="width: 100%; border-collapse: collapse; text-align: center;"> <tr> <td style="width: 10%;"></td> <td style="width: 10%;"></td> <td style="width: 10%;"></td> <td style="width: 10%;"></td> <td style="width: 10%;"></td> <td style="width: 10%;"></td> <td style="width: 10%;"></td> <td style="width: 10%;"></td> <td style="width: 10%;"></td> <td style="width: 10%;"></td> </tr> <tr> <td></td> <td></td> <td colspan="8" style="text-align: center;"> <table border="1" style="width: 100%; border-collapse: collapse; text-align: center;"> <tr> <td style="width: 10%;"></td> <td style="width: 10%;"></td> <td style="width: 10%;"></td> <td style="width: 10%;"></td> <td style="width: 10%;"></td> <td style="width: 10%;"></td> <td style="width: 10%;"></td> <td style="width: 10%;"></td> <td style="width: 10%;"></td> <td style="width: 10%;"></td> </tr> <tr> <td></td> <td></td> <td colspan="8" style="text-align: center;"> <table border="1" style="width: 100%; border-collapse: collapse; text-align: center;"> <tr> <td style="width: 10%;"></td> <td style="width: 10%;"></td> <td style="width: 10%;"></td> <td style="width: 10%;"></td> <td style="width: 10%;"></td> <td style="width: 10%;"></td> <td style="width: 10%;"></td> <td style="width: 10%;"></td> <td style="width: 10%;"></td> <td style="width: 10%;"></td> </tr> <tr> <td></td> <td></td> <td colspan="8" style="text-align: center;"> <table border="1" style="width: 100%; border-collapse: collapse; text-align: center;"> <tr> <td style="width: 10%;"></td> <td style="width: 10%;"></td> <td style="width: 10%;"></td> <td style="width: 10%;"></td> <td style="width: 10%;"></td> <td style="width: 10%;"></td> <td style="width: 10%;"></td> <td style="width: 10%;"></td> <td style="width: 10%;"></td> <td style="width: 10%;"></td> </tr> <tr> <td></td> <td></td> <td colspan="8" style="text-align: center;"> <table border="1" style="width: 100%; border-collapse: collapse; text-align: center;"> <tr> <td style="width: 10%;"></td> <td style="width: 10%;"></td> <td style="width: 10%;"></td> <td style="width: 10%;"></td> <td style="width: 10%;"></td> <td style="width: 10%;"></td> <td style="width: 10%;"></td> <td style="width: 10%;"></td> <td style="width: 10%;"></td> <td style="width: 10%;"></td> </tr> <tr> <td></td> <td></td> <td colspan="8" style="text-align: center;"> <table border="1" style="width: 100%; border-collapse: collapse; text-align: center;"> <tr> <td style="width: 10%;"></td> <td style="width: 10%;"></td> <td style="width: 10%;"></td> <td style="width: 10%;"></td> <td style="width: 10%;"></td> <td style="width: 10%;"></td> <td style="width: 10%;"></td> <td style="width: 10%;"></td> <td style="width: 10%;"></td> <td style="width: 10%;"></td> </tr> <tr> <td></td> <td></td> <td colspan="8" style="text-align: center;"> <table border="1" style="width: 100%; border-collapse: collapse; text-align: center;"> <tr> <td style="width: 10%;"></td> <td style="width: 10%;"></td> <td style="width: 10%;"></td> <td style="width: 10%;"></td> <td style="width: 10%;"></td> <td style="width: 10%;"></td> <td style="width: 10%;"></td> <td style="width: 10%;"></td> <td style="width: 10%;"></td> <td style="width: 10%;"></td> </tr> <tr> <td></td> <td></td> <td colspan="8" style="text-align: center;"> <table border="1" style="width: 100%; border-collapse: collapse; text-align: center;"> <tr> <td style="width: 10%;"></td> <td style="width: 10%;"></td> <td style="width: 10%;"></td> <td style="width: 10%;"></td> <td style="width: 10%;"></td> <td style="width: 10%;"></td> <td style="width: 10%;"></td> <td style="width: 10%;"></td> <td style="width: 10%;"></td> <td style="width: 10%;"></td> </tr> <tr> <td></td> <td></td> <td colspan="8" style="text-align: center;"> <table border="1" style="width: 100%; border-collapse: collapse; text-align: center;"> <tr> <td style="width: 10%;"></td> <td style="width: 10%;"></td> <td style="width: 10%;"></td> <td style="width: 10%;"></td> <td style="width: 10%;"></td> <td style="width: 10%;"></td> <td style="width: 10%;"></td> <td style="width: 10%;"></td> <td style="width: 10%;"></td> <td style="width: 10%;"></td> </tr> <tr> <td></td> <td></td> <td colspan="8" style="text-align: center;"> <table border="1" style="width: 100%; border-collapse: collapse; text-align: center;"> <tr> <td style="width: 10%;"></td> <td style="width: 10%;"></td> <td style="width: 10%;"></td> <td style="width: 10%;"></td> <td style="width: 10%;"></td> <td style="width: 10%;"></td> <td style="width: 10%;"></td> <td style="width: 10%;"></td> <td style="width: 10%;"></td> <td style="width: 10%;"></td> </tr> <tr> <td></td> <td></td> <td colspan="8" style="text-align: center;"> <table border="1" style="width: 100%; border-collapse: collapse; text-align: center;"> <tr> <td style="width: 10%;"></td> <td style="width: 10%;"></td> <td style="width: 10%;"></td> <td style="width: 10%;"></td> <td style="width: 10%;"></td> <td style="width: 10%;"></td> <td style="width: 10%;"></td> <td style="width: 10%;"></td> <td style="width: 10%;"></td> <td style="width: 10%;"></td> </tr> <tr> <td></td> <td></td> <td colspan="8" style="text-align: center;"> <table border="1" style="width: 100%; border-collapse: collapse; text-align: center;"> <tr> <td style="width: 10%;"></td> <td style="width: 10%;"></td> <td style="width: 10%;"></td> <td style="width: 10%;"></td> <td style="width: 10%;"></td> <td style="width: 10%;"></td> <td style="width: 10%;"></td> <td style="width: 10%;"></td> <td style="width: 10%;"></td> <td style="width: 10%;"></td> </tr> <tr> <td></td> <td></td> <td colspan="8" style="text-align: center;"> <table border="1" style="width: 100%; border-collapse: collapse; text-align: center;"> <tr> <td style="width: 10%;"></td> <td style="width: 10%;"></td> <td style="width: 10%;"></td> <td style="width: 10%;"></td> <td style="width: 10%;"></td> <td style="width: 10%;"></td> <td style="width: 10%;"></td> <td style="width: 10%;"></td> <td style="width: 10%;"></td> <td style="width: 10%;"></td> </tr> <tr> <td></td> <td></td> <td colspan="8" style="text-align: center;"> <table border="1" style="width: 100%; border-collapse: collapse; text-align: center;"> <tr> <td style="width: 10%;"></td> <td style="width: 10%;"></td> <td style="width: 10%;"></td> <td style="width: 10%;"></td> <td style="width: 10%;"></td> <td style="width: 10%;"></td> <td style="width: 10%;"></td> <td style="width: 10%;"></td> <td style="width: 10%;"></td> <td style="width: 10%;"></td> </tr> <tr> <td></td> <td></td> <td colspan="8" style="text-align: center;"> <table border="1" style="width: 100%; border-collapse: collapse; text-align: center;"> <tr> <td style="width: 10%;"></td> <td style="width: 10%;"></td> <td style="width: 10%;"></td> <td style="width: 10%;"></td> <td style="width: 10%;"></td> <td style="width: 10%;"></td> <td style="width: 10%;"></td> <td style="width: 10%;"></td> <td style="width: 10%;"></td> <td style="width: 10%;"></td> </tr> <tr> <td></td> <td></td> <td colspan="8" style="text-align: center;"> <table border="1" style="width: 100%; border-collapse: collapse; text-align: center;"> <tr> <td style="width: 10%;"></td> <td style="width: 10%;"></td> <td style="width: 10%;"></td> <td style="width: 10%;"></td> <td style="width: 10%;"></td> <td style="width: 10%;"></td> <td style="width: 10%;"></td> <td style="width: 10%;"></td> <td style="width: 10%;"></td> <td style="width: 10%;"></td> </tr> <tr> <td></td> <td></td> <td colspan="8" style="text-align: center;"> <table border="1" style="width: 100%; border-collapse: collapse; text-align: center;"> <tr> <td style="width: 10%;"></td> <td style="width: 10%;"></td> <td style="width: 10%;"></td> <td style="width: 10%;"></td> <td style="width: 10%;"></td> <td style="width: 10%;"></td> <td style="width: 10%;"></td> <td style="width: 10%;"></td> <td style="width: 10%;"></td> <td style="width: 10%;"></td> </tr> <tr> <td></td> <td></td> <td colspan="8" style="text-align: center;"> <table border="1" style="width: 100%; border-collapse: collapse; text-align: center;"> <tr> <td style="width: 10%;"></td> <td style="width: 10%;"></td> <td style="width: 10%;"></td> <td style="width: 10%;"></td> <td style="width: 10%;"></td> <td style="width: 10%;"></td> <td style="width: 10%;"></td> <td style="width: 10%;"></td> <td style="width: 10%;"></td> <td style="width: 10%;"></td> </tr> <tr> <td></td> <td></td> <td colspan="8" style="text-align: center;"> <table border="1" style="width: 100%; border-collapse: collapse; text-align: center;"> <tr>
</tr></table></td></tr></table></td></tr></table></td></tr></table></td></tr></table></td></tr></table></td></tr></table></td></tr></table></td></tr></table></td></tr></table></td></tr></table></td></tr></table></td></tr></table></td></tr></table></td></tr></table></td></tr></table></td></tr></table></td></tr></table></td></tr></table></td></tr></table></td></tr></table></td></tr></table></td></tr></table></td></tr></table>
 | | | | | | | | | | | | | | | | | | | | <table border="1" style="width: 100%; border-collapse: collapse; text-align: center;"> <tr> <td style="width: 10%;"></td> <td style="width: 10%;"></td> <td style="width: 10%;"></td> <td style="width: 10%;"></td> <td style="width: 10%;"></td> <td style="width: 10%;"></td> <td style="width: 10%;"></td> <td style="width: 10%;"></td> <td style="width: 10%;"></td> <td style="width: 10%;"></td> </tr> <tr> <td></td> <td></td> <td colspan="8" style="text-align: center;"> <table border="1" style="width: 100%; border-collapse: collapse; text-align: center;"> <tr> <td style="width: 10%;"></td> <td style="width: 10%;"></td> <td style="width: 10%;"></td> <td style="width: 10%;"></td> <td style="width: 10%;"></td> <td style="width: 10%;"></td> <td style="width: 10%;"></td> <td style="width: 10%;"></td> <td style="width: 10%;"></td> <td style="width: 10%;"></td> </tr> <tr> <td></td> <td></td> <td colspan="8" style="text-align: center;"> <table border="1" style="width: 100%; border-collapse: collapse; text-align: center;"> <tr> <td style="width: 10%;"></td> <td style="width: 10%;"></td> <td style="width: 10%;"></td> <td style="width: 10%;"></td> <td style="width: 10%;"></td> <td style="width: 10%;"></td> <td style="width: 10%;"></td> <td style="width: 10%;"></td> <td style="width: 10%;"></td> <td style="width: 10%;"></td> </tr> <tr> <td></td> <td></td> <td colspan="8" style="text-align: center;"> <table border="1" style="width: 100%; border-collapse: collapse; text-align: center;"> <tr> <td style="width: 10%;"></td> <td style="width: 10%;"></td> <td style="width: 10%;"></td> <td style="width: 10%;"></td> <td style="width: 10%;"></td> <td style="width: 10%;"></td> <td style="width: 10%;"></td> <td style="width: 10%;"></td> <td style="width: 10%;"></td> <td style="width: 10%;"></td> </tr> <tr> <td></td> <td></td> <td colspan="8" style="text-align: center;"> <table border="1" style="width: 100%; border-collapse: collapse; text-align: center;"> <tr> <td style="width: 10%;"></td> <td style="width: 10%;"></td> <td style="width: 10%;"></td> <td style="width: 10%;"></td> <td style="width: 10%;"></td> <td style="width: 10%;"></td> <td style="width: 10%;"></td> <td style="width: 10%;"></td> <td style="width: 10%;"></td> <td style="width: 10%;"></td> </tr> <tr> <td></td> <td></td> <td colspan="8" style="text-align: center;"> <table border="1" style="width: 100%; border-collapse: collapse; text-align: center;"> <tr> <td style="width: 10%;"></td> <td style="width: 10%;"></td> <td style="width: 10%;"></td> <td style="width: 10%;"></td> <td style="width: 10%;"></td> <td style="width: 10%;"></td> <td style="width: 10%;"></td> <td style="width: 10%;"></td> <td style="width: 10%;"></td> <td style="width: 10%;"></td> </tr> <tr> <td></td> <td></td> <td colspan="8" style="text-align: center;"> <table border="1" style="width: 100%; border-collapse: collapse; text-align: center;"> <tr> <td style="width: 10%;"></td> <td style="width: 10%;"></td> <td style="width: 10%;"></td> <td style="width: 10%;"></td> <td style="width: 10%;"></td> <td style="width: 10%;"></td> <td style="width: 10%;"></td> <td style="width: 10%;"></td> <td style="width: 10%;"></td> <td style="width: 10%;"></td> </tr> <tr> <td></td> <td></td> <td colspan="8" style="text-align: center;"> <table border="1" style="width: 100%; border-collapse: collapse; text-align: center;"> <tr> <td style="width: 10%;"></td> <td style="width: 10%;"></td> <td style="width: 10%;"></td> <td style="width: 10%;"></td> <td style="width: 10%;"></td> <td style="width: 10%;"></td> <td style="width: 10%;"></td> <td style="width: 10%;"></td> <td style="width: 10%;"></td> <td style="width: 10%;"></td> </tr> <tr> <td></td> <td></td> <td colspan="8" style="text-align: center;"> <table border="1" style="width: 100%; border-collapse: collapse; text-align: center;"> <tr> <td style="width: 10%;"></td> <td style="width: 10%;"></td> <td style="width: 10%;"></td> <td style="width: 10%;"></td> <td style="width: 10%;"></td> <td style="width: 10%;"></td> <td style="width: 10%;"></td> <td style="width: 10%;"></td> <td style="width: 10%;"></td> <td style="width: 10%;"></td> </tr> <tr> <td></td> <td></td> <td colspan="8" style="text-align: center;"> <table border="1" style="width: 100%; border-collapse: collapse; text-align: center;"> <tr> <td style="width: 10%;"></td> <td style="width: 10%;"></td> <td style="width: 10%;"></td> <td style="width: 10%;"></td> <td style="width: 10%;"></td> <td style="width: 10%;"></td> <td style="width: 10%;"></td> <td style="width: 10%;"></td> <td style="width: 10%;"></td> <td style="width: 10%;"></td> </tr> <tr> <td></td> <td></td> <td colspan="8" style="text-align: center;"> <table border="1" style="width: 100%; border-collapse: collapse; text-align: center;"> <tr> <td style="width: 10%;"></td> <td style="width: 10%;"></td> <td style="width: 10%;"></td> <td style="width: 10%;"></td> <td style="width: 10%;"></td> <td style="width: 10%;"></td> <td style="width: 10%;"></td> <td style="width: 10%;"></td> <td style="width: 10%;"></td> <td style="width: 10%;"></td> </tr> <tr> <td></td> <td></td> <td colspan="8" style="text-align: center;"> <table border="1" style="width: 100%; border-collapse: collapse; text-align: center;"> <tr> <td style="width: 10%;"></td> <td style="width: 10%;"></td> <td style="width: 10%;"></td> <td style="width: 10%;"></td> <td style="width: 10%;"></td> <td style="width: 10%;"></td> <td style="width: 10%;"></td> <td style="width: 10%;"></td> <td style="width: 10%;"></td> <td style="width: 10%;"></td> </tr> <tr> <td></td> <td></td> <td colspan="8" style="text-align: center;"> <table border="1" style="width: 100%; border-collapse: collapse; text-align: center;"> <tr> <td style="width: 10%;"></td> <td style="width: 10%;"></td> <td style="width: 10%;"></td> <td style="width: 10%;"></td> <td style="width: 10%;"></td> <td style="width: 10%;"></td> <td
style="width: 10%;"></td> <td style="width: 10%;"></td> <td style="width: 10%;"></td> <td style="width: 10%;"></td> </tr> <tr> <td></td> <td></td> <td colspan="8" style="text-align: center;"> <table border="1" style="width: 100%; border-collapse: collapse; text-align: center;"> <tr> <td style="width: 10%;"></td> <td style="width: 10%;"></td> <td style="width: 10%;"></td> <td style="width: 10%;"></td> <td style="width: 10%;"></td> <td style="width: 10%;"></td> <td style="width: 10%;"></td> <td style="width: 10%;"></td> <td style="width: 10%;"></td> <td style="width: 10%;"></td> </tr> <tr> <td></td> <td></td> <td colspan="8" style="text-align: center;"> <table border="1" style="width: 100%; border-collapse: collapse; text-align: center;"> <tr> <td style="width: 10%;"></td> <td style="width: 10%;"></td> <td style="width: 10%;"></td> <td style="width: 10%;"></td> <td style="width: 10%;"></td> <td style="width: 10%;"></td> <td style="width: 10%;"></td> <td style="width: 10%;"></td> <td style="width: 10%;"></td> <td style="width: 10%;"></td> </tr> <tr> <td></td> <td></td> <td colspan="8" style="text-align: center;"> <table border="1" style="width: 100%; border-collapse: collapse; text-align: center;"> <tr> <td style="width: 10%;"></td> <td style="width: 10%;"></td> <td style="width: 10%;"></td> <td style="width: 10%;"></td> <td style="width: 10%;"></td> <td style="width: 10%;"></td> <td style="width: 10%;"></td> <td style="width: 10%;"></td> <td style="width: 10%;"></td> <td style="width: 10%;"></td> </tr> <tr> <td></td> <td></td> <td colspan="8" style="text-align: center;"> <table border="1" style="width: 100%; border-collapse: collapse; text-align: center;"> <tr> <td style="width: 10%;"></td> <td style="width: 10%;"></td> <td style="width: 10%;"></td> <td style="width: 10%;"></td> <td style="width: 10%;"></td> <td style="width: 10%;"></td> <td style="width: 10%;"></td> <td style="width: 10%;"></td> <td style="width: 10%;"></td> <td style="width: 10%;"></td> </tr> <tr> <td></td> <td></td> <td colspan="8" style="text-align: center;"> <table border="1" style="width: 100%; border-collapse: collapse; text-align: center;"> <tr> <td style="width: 10%;"></td> <td style="width: 10%;"></td> <td style="width: 10%;"></td> <td style="width: 10%;"></td> <td style="width: 10%;"></td> <td style="width: 10%;"></td> <td style="width: 10%;"></td> <td style="width: 10%;"></td> <td style="width: 10%;"></td> <td style="width: 10%;"></td> </tr> <tr> <td></td> <td></td> <td colspan="8" style="text-align: center;"> <table border="1" style="width: 100%; border-collapse: collapse; text-align: center;"> <tr> <td style="width: 10%;"></td> <td style="width: 10%;"></td> <td style="width: 10%;"></td> <td style="width: 10%;"></td> <td style="width: 10%;"></td> <td style="width: 10%;"></td> <td style="width: 10%;"></td> <td style="width: 10%;"></td> <td style="width: 10%;"></td> <td style="width: 10%;"></td> </tr> <tr> <td></td> <td></td> <td colspan="8" style="text-align: center;"> <table border="1" style="width: 100%; border-collapse: collapse; text-align: center;"> <tr> <td style="width: 10%;"></td> <td style="width: 10%;"></td> <td style="width: 10%;"></td> <td style="width: 10%;"></td> <td style="width: 10%;"></td> <td style="width: 10%;"></td> <td style="width: 10%;"></td> <td style="width: 10%;"></td> <td style="width: 10%;"></td> <td style="width: 10%;"></td> </tr> <tr> <td></td> <td></td> <td colspan="8" style="text-align: center;"> <table border="1" style="width: 100%; border-collapse: collapse; text-align: center;"> <tr> <td style="width: 10%;"></td> <td style="width: 10%;"></td> <td style="width: 10%;"></td> <td style="width: 10%;"></td> <td style="width: 10%;"></td> <td style="width: 10%;"></td> <td style="width: 10%;"></td> <td style="width: 10%;"></td> <td style="width: 10%;"></td> <td style="width: 10%;"></td> </tr> <tr> <td></td> <td></td> <td colspan="8" style="text-align: center;"> <table border="1" style="width: 100%; border-collapse: collapse; text-align: center;"> <tr> <td style="width: 10%;"></td> <td style="width: 10%;"></td> <td style="width: 10%;"></td> <td style="width: 10%;"></td> <td style="width: 10%;"></td> <td style="width: 10%;"></td> <td style="width: 10%;"></td> <td style="width: 10%;"></td> <td style="width: 10%;"></td> <td style="width: 10%;"></td> </tr> <tr> <td></td> <td></td> <td colspan="8" style="text-align: center;"> <table border="1" style="width: 100%; border-collapse: collapse; text-align: center;"> <tr> </tr></table></td></tr></table></td></tr></table></td></tr></table></td></tr></table></td></tr></table></td></tr></table></td></tr></table></td></tr></table></td></tr></table></td></tr></table></td></tr></table></td></tr></table></td></tr></table></td></tr></table></td></tr></table></td></tr></table></td></tr></table></td></tr></table></td></tr></table></td></tr></table></td></tr></table></td></tr></table>
 | | | | | | | | | | | | | | | | | | | | <table border="1" style="width: 100%; border-collapse: collapse; text-align: center;"> <tr> <td style="width: 10%;"></td> <td style="width: 10%;"></td> <td style="width: 10%;"></td> <td style="width: 10%;"></td> <td style="width: 10%;"></td> <td style="width: 10%;"></td> <td style="width: 10%;"></td> <td style="width: 10%;"></td> <td style="width: 10%;"></td> <td style="width: 10%;"></td> </tr> <tr> <td></td> <td></td> <td colspan="8" style="text-align: center;"> <table border="1" style="width: 100%; border-collapse: collapse; text-align: center;"> <tr> <td style="width: 10%;"></td> <td style="width: 10%;"></td> <td style="width: 10%;"></td> <td style="width: 10%;"></td> <td style="width: 10%;"></td> <td style="width: 10%;"></td> <td style="width: 10%;"></td> <td style="width: 10%;"></td> <td style="width: 10%;"></td> <td style="width: 10%;"></td> </tr> <tr> <td></td> <td></td> <td colspan="8" style="text-align: center;"> <table border="1" style="width: 100%; border-collapse: collapse; text-align: center;"> <tr> <td style="width: 10%;"></td> <td style="width: 10%;"></td> <td style="width: 10%;"></td> <td style="width: 10%;"></td> <td style="width: 10%;"></td> <td style="width: 10%;"></td> <td style="width: 10%;"></td> <td style="width: 10%;"></td> <td style="width: 10%;"></td> <td style="width: 10%;"></td> </tr> <tr> <td></td> <td></td> <td colspan="8" style="text-align: center;"> <table border="1"
style="width: 100%; border-collapse: collapse; text-align: center;"> <tr> <td style="width: 10%;"></td> <td style="width: 10%;"></td> <td style="width: 10%;"></td> <td style="width: 10%;"></td> <td style="width: 10%;"></td> <td style="width: 10%;"></td> <td style="width: 10%;"></td> <td style="width: 10%;"></td> <td style="width: 10%;"></td> <td style="width: 10%;"></td> </tr> <tr> <td></td> <td></td> <td colspan="8" style="text-align: center;"> <table border="1" style="width: 100%; border-collapse: collapse; text-align: center;"> <tr> <td style="width: 10%;"></td> <td style="width: 10%;"></td> <td style="width: 10%;"></td> <td style="width: 10%;"></td> <td style="width: 10%;"></td> <td style="width: 10%;"></td> <td style="width: 10%;"></td> <td style="width: 10%;"></td> <td style="width: 10%;"></td> <td style="width: 10%;"></td> </tr> <tr> <td></td> <td></td> <td colspan="8" style="text-align: center;"> <table border="1" style="width: 100%; border-collapse: collapse; text-align: center;"> <tr> <td style="width: 10%;"></td> <td style="width: 10%;"></td> <td style="width: 10%;"></td> <td style="width: 10%;"></td> <td style="width: 10%;"></td> <td style="width: 10%;"></td> <td style="width: 10%;"></td> <td style="width: 10%;"></td> <td style="width: 10%;"></td> <td style="width: 10%;"></td> </tr> <tr> <td></td> <td></td> <td colspan="8" style="text-align: center;"> <table border="1" style="width: 100%; border-collapse: collapse; text-align: center;"> <tr> <td style="width: 10%;"></td> <td style="width: 10%;"></td> <td style="width: 10%;"></td> <td style="width: 10%;"></td> <td style="width: 10%;"></td> <td style="width: 10%;"></td> <td style="width: 10%;"></td> <td style="width: 10%;"></td> <td style="width: 10%;"></td> <td style="width: 10%;"></td> </tr> <tr> <td></td> <td></td> <td colspan="8" style="text-align: center;"> <table border="1" style="width: 100%; border-collapse: collapse; text-align: center;"> <tr> <td style="width: 10%;"></td> <td style="width: 10%;"></td> <td style="width: 10%;"></td> <td style="width: 10%;"></td> <td style="width: 10%;"></td> <td style="width: 10%;"></td> <td style="width: 10%;"></td> <td style="width: 10%;"></td> <td style="width: 10%;"></td> <td style="width: 10%;"></td> </tr> <tr> <td></td> <td></td> <td colspan="8" style="text-align: center;"> <table border="1" style="width: 100%; border-collapse: collapse; text-align: center;"> <tr> <td style="width: 10%;"></td> <td style="width: 10%;"></td> <td style="width: 10%;"></td> <td style="width: 10%;"></td> <td style="width: 10%;"></td> <td style="width: 10%;"></td> <td style="width: 10%;"></td> <td style="width: 10%;"></td> <td style="width: 10%;"></td> <td style="width: 10%;"></td> </tr> <tr> <td></td> <td></td> <td colspan="8" style="text-align: center;"> <table border="1" style="width: 100%; border-collapse: collapse; text-align: center;"> <tr> <td style="width: 10%;"></td> <td style="width: 10%;"></td> <td style="width: 10%;"></td> <td style="width: 10%;"></td> <td style="width: 10%;"></td> <td style="width: 10%;"></td> <td style="width: 10%;"></td> <td style="width: 10%;"></td> <td style="width: 10%;"></td> <td style="width: 10%;"></td> </tr> <tr> <td></td> <td></td> <td colspan="8" style="text-align: center;"> <table border="1" style="width: 100%; border-collapse: collapse; text-align: center;"> <tr> <td style="width: 10%;"></td> <td style="width: 10%;"></td> <td style="width: 10%;"></td> <td style="width: 10%;"></td> <td style="width: 10%;"></td> <td style="width: 10%;"></td> <td style="width: 10%;"></td> <td style="width: 10%;"></td> <td style="width: 10%;"></td> <td style="width: 10%;"></td> </tr> <tr> <td></td> <td></td> <td colspan="8" style="text-align: center;"> <table border="1" style="width: 100%; border-collapse: collapse; text-align: center;"> <tr> <td style="width: 10%;"></td> <td style="width: 10%;"></td> <td style="width: 10%;"></td> <td style="width: 10%;"></td> <td style="width: 10%;"></td> <td style="width: 10%;"></td> <td style="width: 10%;"></td> <td style="width: 10%;"></td> <td style="width: 10%;"></td> <td style="width: 10%;"></td> </tr> <tr> <td></td> <td></td> <td colspan="8" style="text-align: center;"> <table border="1" style="width: 100%; border-collapse: collapse; text-align: center;"> <tr> <td style="width: 10%;"></td> <td style="width: 10%;"></td> <td style="width: 10%;"></td> <td style="width: 10%;"></td> <td style="width: 10%;"></td> <td style="width: 10%;"></td> <td style="width: 10%;"></td> <td style="width: 10%;"></td> <td style="width: 10%;"></td> <td style="width: 10%;"></td> </tr> <tr> <td></td> <td></td> <td colspan="8" style="text-align: center;"> <table border="1" style="width: 100%; border-collapse: collapse; text-align: center;"> <tr> <td style="width: 10%;"></td> <td style="width: 10%;"></td> <td style="width: 10%;"></td> <td style="width: 10%;"></td> <td style="width: 10%;"></td> <td style="width: 10%;"></td> <td style="width: 10%;"></td> <td style="width: 10%;"></td> <td style="width: 10%;"></td> <td style="width: 10%;"></td> </tr> <tr> <td></td> <td></td> <td colspan="8" style="text-align: center;"> <table border="1" style="width: 100%; border-collapse: collapse; text-align: center;"> <tr> <td style="width: 10%;"></td> <td style="width: 10%;"></td> <td style="width: 10%;"></td> <td style="width: 10%;"></td> <td style="width: 10%;"></td> <td style="width: 10%;"></td> <td style="width: 10%;"></td> <td style="width: 10%;"></td> <td style="width: 10%;"></td> <td style="width: 10%;"></td> </tr> <tr> <td></td> <td></td> <td colspan="8" style="text-align: center;"> <table border="1" style="width: 100%; border-collapse: collapse; text-align: center;"> <tr> <td style="width: 10%;"></td> <td style="width: 10%;"></td> <td style="width: 10%;"></td> <td style="width: 10%;"></td> <td style="width: 10%;"></td> <td style="width: 10%;"></td> <td style="width: 10%;"></td> <td style="width: 10%;"></td> <td style="width: 10%;"></td> <td style="width: 10%;"></td> </tr> <tr> <td></td> <td></td> <td colspan="8" style="text-align: center;"> <table border="1" style="width: 100%; border-collapse: collapse; text-align: center;"> <tr> <td style="width: 10%;"></td> <td style="width: 10%;"></td> <td style="width: 10%;"></td> <td style="width: 10%;"></td> <td style="width: 10%;"></td> <td style="width: 10%;"></td> <td style="width: 10%;"></td> <td style="width: 10%;"></td> <td style="width: 10%;"></td> <td style="width: 10%;"></td> </tr> <tr> <td></td> <td></td> <td colspan="8" style="text-align: center;"> <table border="1" style="width: 100%; border-collapse: collapse; text-align: center;"> <tr> <td style="width: 10%;"></td> <td style="width: 10%;"></td> <td style="width: 10%;"></td> <td style="width: 10%;"></td> <td style="width: 10%;"></td> <td style="width: 10%;"></td> <td style="width: 10%;"></td> <td style="width: 10%;"></td> <td style="width: 10%;"></td> <td style="width: 10%;"></td> </tr> <tr> <td></td> <td></td> <td colspan="8" style="text-align: center;"> <table border="1" style="width: 100%; border-collapse: collapse; text-align: center;"> <tr> <td style="width: 10%;"></td> <td style="width: 10%;"></td> <td style="width: 10%;"></td> <td style="width: 10%;"></td> <td style="width: 10%;"></td> <td style="width: 10%;"></td> <td style="width: 10%;"></td> <td style="width: 10%;"></td> <td style="width: 10%;"></td> <td style="width: 10%;"></td> </tr> <tr> <td></td> <td></td> <td colspan="8" style="text-align: center;"> <table border="1" style="width: 100%; border-collapse: collapse; text-align: center;"> <tr> <td style="width: 10%;"></td> <td style="width: 10%;"></td> <td style="width: 10%;"></td> <td style="width: 10%;"></td> <td style="width: 10%;"></td> <td style="width: 10%;"></td> <td style="width: 10%;"></td> <td style="width: 10%;"></td> <td style="width: 10%;"></td> <td style="width: 10%;"></td> </tr> <tr> <td></td> <td></td> <td colspan="8" style="text-align: center;"> <table border="1" style="width: 100%; border-collapse: collapse; text-align: center;"> <tr> <td style="width: 10%;"></td> <td style="width: 10%;"></td> <td style="width: 10%;"></td> <td style="width: 10%;"></td> <td style="width: 10%;"></td> <td style="width: 10%;"></td> <td style="width: 10%;"></td> <td style="width: 10%;"></td> <td style="width: 10%;"></td> <td style="width: 10%;"></td> </tr> <tr> <td></td> <td></td> <td colspan="8" style="text-align: center;"> <table border="1" style="width: 100%; border-collapse: collapse; text-align: center;"> <tr> </tr></table></td></tr></table></td></tr></table></td></tr></table></td></tr></table></td></tr></table></td></tr></table></td></tr></table></td></tr></table></td></tr></table></td></tr></table></td></tr></table></td></tr></table></td></tr></table></td></tr></table></td></tr></table></td></tr></table></td></tr></table></td></tr></table></td></tr></table></td></tr></table></td></tr></table>

 | | | | | | | | | | | | | | | | | | | | <table border="1" style="width: 100%; border-collapse: collapse; text-align: center;"> <tr> <td style="width: 10%;"></td> <td style="width: 10%;"></td> <td style="width: 10%;"></td> <td style="width: 10%;"></td> <td style="width: 10%;"></td> <td style="width: 10%;"></td> <td style="width: 10%;"></td> <td style="width: 10%;"></td> <td style="width: 10%;"></td> <td style="width: 10%;"></td> </tr> <tr> <td></td> <td></td> <td colspan="8" style="text-align: center;"> <table border="1" style="width: 100%; border-collapse: collapse; text-align: center;"> <tr> <td style="width: 10%;"></td> <td style="width: 10%;"></td> <td style="width: 10%;"></td> <td style="width: 10%;"></td> <td style="width: 10%;"></td> <td style="width: 10%;"></td> <td style="width: 10%;"></td> <td style="width: 10%;"></td> <td style="width: 10%;"></td> <td style="width: 10%;"></td> </tr> <tr> <td></td> <td></td> <td colspan="8" style="text-align: center;"> <table border="1" style="width: 100%; border-collapse: collapse; text-align: center;"> <tr> <td style="width: 10%;"></td> <td style="width: 10%;"></td> <td style="width: 10%;"></td> <td style="width: 10%;"></td> <td style="width: 10%;"></td> <td style="width: 10%;"></td> <td style="width: 10%;"></td> <td style="width: 10%;"></td> <td style="width: 10%;"></td> <td style="width: 10%;"></td> </tr> <tr> <td></td> <td></td> <td colspan="8" style="text-align: center;"> <table border="1" style="width: 100%; border-collapse: collapse; text-align: center;"> <tr> <td style="width: 10%;"></td> <td style="width: 10%;"></td> <td style="width: 10%;"></td> <td style="width: 10%;"></td> <td style="width: 10%;"></td> <td style="width: 10%;"></td> <td style="width: 10%;"></td> <td style="width: 10%;"></td> <td style="width: 10%;"></td> <td style="width: 10%;"></td> </tr> <tr> <td></td> <td></td> <td colspan="8" style="text-align: center;"> <table border="1" style="width: 100%; border-collapse: collapse; text-align: center;"> <tr> <td style="width: 10%;"></td> <td style="width: 10%;"></td> <td style="width: 10%;"></td> <td style="width: 10%;"></td> <td style="width: 10%;"></td> <td style="width: 10%;"></td> <td style="width: 10%;"></td> <td style="width: 10%;"></td> <td style="width: 10%;"></td> <td style="width: 10%;"></td> </tr> <tr> <td></td> <td></td> <td colspan="8" style="text-align: center;"> <table border="1" style="width: 100%; border-collapse: collapse; text-align: center;"> <tr> <td style="width: 10%;"></td> <td style="width: 10%;"></td> <td style="width: 10%;"></td> <td style="width: 10%;"></td> <td style="width: 10%;"></td> <td style="width: 10%;"></td> <td style="width: 10%;"></td> <td style="width: 10%;"></td> <td style="width: 10%;"></td> <td style="width: 10%;"></td> </tr> <tr> <td></td> <td></td> <td colspan="8" style="text-align: center;"> <table border="1" style="width: 100%; border-collapse: collapse; text-align: center;"> <tr> <td style="width: 10%;"></td> <td style="width: 10%;"></td> <td style="width: 10%;"></td> <td style="width: 10%;"></td> <td style="width: 10%;"></td> <td style="width: 10%;"></td> <td style="width: 10%;"></td> <td style="width: 10%;"></td> <td style="width: 10%;"></td> <td style="width: 10%;"></td> </tr> <tr> <td></td> <td></td> <td colspan="8" style="text-align: center;"> <table border="1" style="width: 100%; border-collapse: collapse; text-align: center;"> <tr> <td style="width: 10%;"></td> <td style="width: 10%;"></td> <td style="width: 10%;"></td> <td style="width: 10%;"></td> <td style="width: 10%;"></td> <td style="width: 10%;"></td> <td style="width: 10%;"></td> <td style="width: 10%;"></td> <td style="width: 10%;"></td> <td style="width: 10%;"></td> </tr> <tr> <td></td> <td></td> <td colspan="8" style="text-align: center;"> <table border="1" style="width: 100%; border-collapse: collapse; text-align: center;"> <tr> <td style="width: 10%;"></td> <td style="width: 10%;"></td> <td style="width: 10%;"></td> <td style="width: 10%;"></td> <td style="width: 10%;"></td> <td style="width: 10%;"></td> <td style="width: 10%;"></td> <td style="width: 10%;"></td> <td style="width: 10%;"></td> <td style="width: 10%;"></td> </tr> <tr> <td></td> <td></td> <td colspan="8" style="text-align: center;"> <table border="1" style="width: 100%; border-collapse: collapse; text-align: center;"> <tr> <td style="width: 10%;"></td> <td style="width: 10%;"></td> <td style="width: 10%;"></td> <td style="width: 10%;"></td> <td style="width: 10%;"></td> <td style="width: 10%;"></td> <td style="width: 10%;"></td> <td style="width: 10%;"></td> <td style="width: 10%;"></td> <td style="width: 10%;"></td> </tr> <tr> <td></td> <td></td> <td colspan="8" style="text-align: center;"> <table border="1" style="width: 100%; border-collapse: collapse; text-align: center;"> <tr> <td style="width: 10%;"></td> <td style="width: 10%;"></td> <td style="width: 10%;"></td> <td style="width: 10%;"></td> <td style="width: 10%;"></td> <td style="width: 10%;"></td> <td style="width: 10%;"></td> <td style="width: 10%;"></td> <td style="width: 10%;"></td> <td style="width: 10%;"></td> </tr> <tr> <td></td> <td></td> <td colspan="8" style="text-align: center;"> <table border="1" style="width: 100%; border-collapse: collapse; text-align: center;"> <tr> <td style="width: 10%;"></td> <td style="width: 10%;"></td> <td style="width: 10%;"></td> <td style="width: 10%;"></td> <td style="width: 10%;"></td> <td style="width: 10%;"></td> <td style="width: 10%;"></td> <td style="width: 10%;"></td> <td style="width: 10%;"></td> <td style="width: 10%;"></td> </tr> <tr> <td></td> <td></td> <td colspan="8" style="text-align: center;"> <table border="1" style="width: 100%; border-collapse: collapse; text-align: center;"> <tr> <td style="width: 10%;"></td> <td style="width: 10%;"></td> <td style="width: 10%;"></td> <td style="width: 10%;"></td> <td style="width: 10%;"></td> <td style="width: 10%;"></td> <td style="width: 10%;"></td> <td style="width: 10%;"></td> <td style="width: 10%;"></td> <td style="width: 10%;"></td> </tr> <tr> <td></td> <td></td> <td colspan="8" style="text-align: center;"> <table border="1" style="width: 100%; border-collapse: collapse; text-align: center;"> <tr> <td style="width: 10%;"></td> <td style="width: 10%;"></td> <td style="width: 10%;"></td> <td style="width: 10%;"></td> <td style="width: 10%;"></td> <td style="width: 10%;"></td> <td style="width: 10%;"></td> <td style="width: 10%;"></td> <td style="width: 10%;"></td> <td style="width: 10%;"></td> </tr> <tr> <td></td> <td></td> <td colspan="8" style="text-align: center;"> <table border="1" style="width: 100%; border-collapse: collapse; text-align: center;"> <tr> <td style="width: 10%;"></td> <td style="width: 10%;"></td> <td style="width: 10%;"></td> <td style="width: 10%;"></td> <td style="width: 10%;"></td> <td style="width: 10%;"></td> <td style="width: 10%;"></td> <td style="width: 10%;"></td> <td style="width: 10%;"></td> <td style="width: 10%;"></td> </tr> <tr> <td></td> <td></td> <td colspan="8" style="text-align: center;"> <table border="1" style="width: 100%; border-collapse: collapse; text-align: center;"> <tr> <td style="width: 10%;"></td> <td style="width: 10%;"></td> <td style="width: 10%;"></td> <td style="width: 10%;"></td> <td style="width: 10%;"></td> <td style="width: 10%;"></td> <td style="width: 10%;"></td> <td style="width: 10%;"></td> <td style="width: 10%;"></td> <td style="width: 10%;"></td> </tr> <tr> <td></td> <td></td>
<td colspan="8" style="text-align: center;"> <table border="1" style="width: 100%; border-collapse: collapse; text-align: center;"> <tr> <td style="width: 10%;"></td> <td style="width: 10%;"></td> <td style="width: 10%;"></td> <td style="width: 10%;"></td> <td style="width: 10%;"></td> <td style="width: 10%;"></td> <td style="width: 10%;"></td> <td style="width: 10%;"></td> <td style="width: 10%;"></td> <td style="width: 10%;"></td> </tr> <tr> <td></td> <td></td> <td colspan="8" style="text-align: center;"> <table border="1" style="width: 100%; border-collapse: collapse; text-align: center;"> <tr> <td style="width: 10%;"></td> <td style="width: 10%;"></td> <td style="width: 10%;"></td> <td style="width: 10%;"></td> <td style="width: 10%;"></td> <td style="width: 10%;"></td> <td style="width: 10%;"></td> <td style="width: 10%;"></td> <td style="width: 10%;"></td> <td style="width: 10%;"></td> </tr> <tr> <td></td> <td></td> <td colspan="8" style="text-align: center;"> <table border="1" style="width: 100%; border-collapse: collapse; text-align: center;"> <tr> <td style="width: 10%;"></td> <td style="width: 10%;"></td> <td style="width: 10%;"></td> <td style="width: 10%;"></td> <td style="width: 10%;"></td> <td style="width: 10%;"></td> <td style="width: 10%;"></td> <td style="width: 10%;"></td> <td style="width: 10%;"></td> <td style="width: 10%;"></td> </tr> <tr> <td></td> <td></td> <td colspan="8" style="text-align: center;"> <table border="1" style="width: 100%; border-collapse: collapse; text-align: center;"> <tr> <td style="width: 10%;"></td> <td style="width: 10%;"></td> <td style="width: 10%;"></td> <td style="width: 10%;"></td> <td style="width: 10%;"></td> <td style="width: 10%;"></td> <td style="width: 10%;"></td> <td style="width: 10%;"></td> <td style="width: 10%;"></td> <td style="width: 10%;"></td> </tr> <tr> <td></td> <td></td> <td colspan="8" style="text-align: center;"> <table border="1" style="width: 100%; border-collapse: collapse; text-align: center;"> <tr> </tr></table></td></tr></table></td></tr></table></td></tr></table></td></tr></table></td></tr></table></td></tr></table></td></tr></table></td></tr></table></td></tr></table></td></tr></table></td></tr></table></td></tr></table></td></tr></table></td></tr></table></td></tr></table></td></tr></table></td></tr></table></td></tr></table></td></tr></table></td></tr></table>
 | | | | | | | | | | | | | | | | | | | | <table border="1" style="width: 100%; border-collapse: collapse; text-align: center;"> <tr> <td style="width: 10%;"></td> <td style="width: 10%;"></td> <td style="width: 10%;"></td> <td style="width: 10%;"></td> <td style="width: 10%;"></td> <td style="width: 10%;"></td> <td style="width: 10%;"></td> <td style="width: 10%;"></td> <td style="width: 10%;"></td> <td style="width: 10%;"></td> </tr> <tr> <td></td> <td></td> <td colspan="8" style="text-align: center;"> <table border="1" style="width: 100%; border-collapse: collapse; text-align: center;"> <tr> <td style="width: 10%;"></td> <td style="width: 10%;"></td> <td style="width: 10%;"></td> <td style="width: 10%;"></td> <td style="width: 10%;"></td> <td style="width: 10%;"></td> <td style="width: 10%;"></td> <td style="width: 10%;"></td> <td style="width: 10%;"></td> <td style="width: 10%;"></td> </tr> <tr> <td></td> <td></td> <td colspan="8" style="text-align: center;"> <table border="1" style="width: 100%; border-collapse: collapse; text-align: center;"> <tr> <td style="width: 10%;"></td> <td style="width: 10%;"></td> <td style="width: 10%;"></td> <td style="width: 10%;"></td> <td style="width: 10%;"></td> <td style="width: 10%;"></td> <td style="width: 10%;"></td> <td style="width: 10%;"></td> <td style="width: 10%;"></td> <td style="width: 10%;"></td> </tr> <tr> <td></td> <td></td> <td colspan="8" style="text-align: center;"> <table border="1" style="width: 100%; border-collapse: collapse; text-align: center;"> <tr> <td style="width: 10%;"></td> <td style="width: 10%;"></td> <td style="width: 10%;"></td> <td style="width: 10%;"></td> <td style="width: 10%;"></td> <td style="width: 10%;"></td> <td style="width: 10%;"></td> <td style="width: 10%;"></td> <td style="width: 10%;"></td> <td style="width: 10%;"></td> </tr> <tr> <td></td> <td></td> <td colspan="8" style="text-align: center;"> <table border="1" style="width: 100%; border-collapse: collapse; text-align: center;"> <tr> <td style="width: 10%;"></td> <td style="width: 10%;"></td> <td style="width: 10%;"></td> <td style="width: 10%;"></td> <td style="width: 10%;"></td> <td style="width: 10%;"></td> <td style="width: 10%;"></td> <td style="width: 10%;"></td> <td style="width: 10%;"></td> <td style="width: 10%;"></td> </tr> <tr> <td></td> <td></td> <td colspan="8" style="text-align: center;"> <table border="1" style="width: 100%; border-collapse: collapse; text-align: center;"> <tr> <td style="width: 10%;"></td> <td style="width: 10%;"></td> <td style="width: 10%;"></td> <td style="width: 10%;"></td> <td style="width: 10%;"></td> <td style="width: 10%;"></td> <td style="width: 10%;"></td> <td style="width: 10%;"></td> <td style="width: 10%;"></td> <td style="width: 10%;"></td> </tr> <tr> <td></td> <td></td> <td colspan="8" style="text-align: center;"> <table border="1" style="width: 100%; border-collapse: collapse; text-align: center;"> <tr> <td style="width: 10%;"></td> <td style="width: 10%;"></td> <td style="width: 10%;"></td> <td style="width: 10%;"></td> <td style="width: 10%;"></td> <td style="width: 10%;"></td> <td style="width: 10%;"></td> <td style="width: 10%;"></td> <td style="width: 10%;"></td> <td style="width: 10%;"></td> </tr> <tr> <td></td> <td></td> <td colspan="8" style="text-align: center;"> <table border="1" style="width: 100%; border-collapse: collapse; text-align: center;"> <tr> <td style="width: 10%;"></td> <td style="width: 10%;"></td> <td style="width: 10%;"></td> <td style="width: 10%;"></td> <td style="width: 10%;"></td> <td style="width: 10%;"></td> <td style="width: 10%;"></td> <td style="width: 10%;"></td> <td style="width: 10%;"></td> <td style="width: 10%;"></td> </tr> <tr> <td></td> <td></td> <td colspan="8" style="text-align: center;"> <table border="1" style="width: 100%; border-collapse: collapse; text-align: center;"> <tr> <td style="width: 10%;"></td> <td style="width: 10%;"></td> <td style="width: 10%;"></td> <td style="width:
10%;"></td> <td style="width: 10%;"></td> <td style="width: 10%;"></td> <td style="width: 10%;"></td> <td style="width: 10%;"></td> <td style="width: 10%;"></td> <td style="width: 10%;"></td> </tr> <tr> <td></td> <td></td> <td colspan="8" style="text-align: center;"> <table border="1" style="width: 100%; border-collapse: collapse; text-align: center;"> <tr> <td style="width: 10%;"></td> <td style="width: 10%;"></td> <td style="width: 10%;"></td> <td style="width: 10%;"></td> <td style="width: 10%;"></td> <td style="width: 10%;"></td> <td style="width: 10%;"></td> <td style="width: 10%;"></td> <td style="width: 10%;"></td> <td style="width: 10%;"></td> </tr> <tr> <td></td> <td></td> <td colspan="8" style="text-align: center;"> <table border="1" style="width: 100%; border-collapse: collapse; text-align: center;"> <tr> <td style="width: 10%;"></td> <td style="width: 10%;"></td> <td style="width: 10%;"></td> <td style="width: 10%;"></td> <td style="width: 10%;"></td> <td style="width: 10%;"></td> <td style="width: 10%;"></td> <td style="width: 10%;"></td> <td style="width: 10%;"></td> <td style="width: 10%;"></td> </tr> <tr> <td></td> <td></td> <td colspan="8" style="text-align: center;"> <table border="1" style="width: 100%; border-collapse: collapse; text-align: center;"> <tr> <td style="width: 10%;"></td> <td style="width: 10%;"></td> <td style="width: 10%;"></td> <td style="width: 10%;"></td> <td style="width: 10%;"></td> <td style="width: 10%;"></td> <td style="width: 10%;"></td> <td style="width: 10%;"></td> <td style="width: 10%;"></td> <td style="width: 10%;"></td> </tr> <tr> <td></td> <td></td> <td colspan="8" style="text-align: center;"> <table border="1" style="width: 100%; border-collapse: collapse; text-align: center;"> <tr> <td style="width: 10%;"></td> <td style="width: 10%;"></td> <td style="width: 10%;"></td> <td style="width: 10%;"></td> <td style="width: 10%;"></td> <td style="width: 10%;"></td> <td style="width: 10%;"></td> <td style="width: 10%;"></td> <td style="width: 10%;"></td> <td style="width: 10%;"></td> </tr> <tr> <td></td> <td></td> <td colspan="8" style="text-align: center;"> <table border="1" style="width: 100%; border-collapse: collapse; text-align: center;"> <tr> <td style="width: 10%;"></td> <td style="width: 10%;"></td> <td style="width: 10%;"></td> <td style="width: 10%;"></td> <td style="width: 10%;"></td> <td style="width: 10%;"></td> <td style="width: 10%;"></td> <td style="width: 10%;"></td> <td style="width: 10%;"></td> <td style="width: 10%;"></td> </tr> <tr> <td></td> <td></td> <td colspan="8" style="text-align: center;"> <table border="1" style="width: 100%; border-collapse: collapse; text-align: center;"> <tr> <td style="width: 10%;"></td> <td style="width: 10%;"></td> <td style="width: 10%;"></td> <td style="width: 10%;"></td> <td style="width: 10%;"></td> <td style="width: 10%;"></td> <td style="width: 10%;"></td> <td style="width: 10%;"></td> <td style="width: 10%;"></td> <td style="width: 10%;"></td> </tr> <tr> <td></td> <td></td> <td colspan="8" style="text-align: center;"> <table border="1" style="width: 100%; border-collapse: collapse; text-align: center;"> <tr> <td style="width: 10%;"></td> <td style="width: 10%;"></td> <td style="width: 10%;"></td> <td style="width: 10%;"></td> <td style="width: 10%;"></td> <td style="width: 10%;"></td> <td style="width: 10%;"></td> <td style="width: 10%;"></td> <td style="width: 10%;"></td> <td style="width: 10%;"></td> </tr> <tr> <td></td> <td></td> <td colspan="8" style="text-align: center;"> <table border="1" style="width: 100%; border-collapse: collapse; text-align: center;"> <tr> <td style="width: 10%;"></td> <td style="width: 10%;"></td> <td style="width: 10%;"></td> <td style="width: 10%;"></td> <td style="width: 10%;"></td> <td style="width: 10%;"></td> <td style="width: 10%;"></td> <td style="width: 10%;"></td> <td style="width: 10%;"></td> <td style="width: 10%;"></td> </tr> <tr> <td></td> <td></td> <td colspan="8" style="text-align: center;"> <table border="1" style="width: 100%; border-collapse: collapse; text-align: center;"> <tr> <td style="width: 10%;"></td> <td style="width: 10%;"></td> <td style="width: 10%;"></td> <td style="width: 10%;"></td> <td style="width: 10%;"></td> <td style="width: 10%;"></td> <td style="width: 10%;"></td> <td style="width: 10%;"></td> <td style="width: 10%;"></td> <td style="width: 10%;"></td> </tr> <tr> <td></td> <td></td> <td colspan="8" style="text-align: center;"> <table border="1" style="width: 100%; border-collapse: collapse; text-align: center;"> <tr> <td style="width: 10%;"></td> <td style="width: 10%;"></td> <td style="width: 10%;"></td> <td style="width: 10%;"></td> <td style="width: 10%;"></td> <td style="width: 10%;"></td> <td style="width: 10%;"></td> <td style="width: 10%;"></td> <td style="width: 10%;"></td> <td style="width: 10%;"></td> </tr> <tr> <td></td> <td></td> <td colspan="8" style="text-align: center;"> <table border="1" style="width: 100%; border-collapse: collapse; text-align: center;"> <tr> </tr></table></td></tr></table></td></tr></table></td></tr></table></td></tr></table></td></tr></table></td></tr></table></td></tr></table></td></tr></table></td></tr></table></td></tr></table></td></tr></table></td></tr></table></td></tr></table></td></tr></table></td></tr></table></td></tr></table></td></tr></table></td></tr></table></td></tr></table>
 | | | | | | | | | | | | | | | | | | | | <table border="1" style="width: 100%; border-collapse: collapse; text-align: center;"> <tr> <td style="width: 10%;"></td> <td style="width: 10%;"></td> <td style="width: 10%;"></td> <td style="width: 10%;"></td> <td style="width: 10%;"></td> <td style="width: 10%;"></td> <td style="width: 10%;"></td> <td style="width: 10%;"></td> <td style="width: 10%;"></td> <td style="width: 10%;"></td> </tr> <tr> <td></td> <td></td> <td colspan="8" style="text-align: center;"> <table border="1" style="width: 100%; border-collapse: collapse; text-align: center;"> <tr> <td style="width: 10%;"></td> <td style="width: 10%;"></td> <td style="width: 10%;"></td> <td style="width: 10%;"></td> <td style="width: 10%;"></td> <td style="width: 10%;"></td> <td style="width: 10%;"></td> <td style="width: 10%;"></td> <td style="width: 10%;"></td> <td style="width: 10%;"></td> </tr> <tr> <td></td> <td></td> <td colspan="8" style="text-align: center;">
<table border="1" style="width: 100%; border-collapse: collapse; text-align: center;"> <tr> <td style="width: 10%;"></td> <td style="width: 10%;"></td> <td style="width: 10%;"></td> <td style="width: 10%;"></td> <td style="width: 10%;"></td> <td style="width: 10%;"></td> <td style="width: 10%;"></td> <td style="width: 10%;"></td> <td style="width: 10%;"></td> <td style="width: 10%;"></td> </tr> <tr> <td></td> <td></td> <td colspan="8" style="text-align: center;"> <table border="1" style="width: 100%; border-collapse: collapse; text-align: center;"> <tr> <td style="width: 10%;"></td> <td style="width: 10%;"></td> <td style="width: 10%;"></td> <td style="width: 10%;"></td> <td style="width: 10%;"></td> <td style="width: 10%;"></td> <td style="width: 10%;"></td> <td style="width: 10%;"></td> <td style="width: 10%;"></td> <td style="width: 10%;"></td> </tr> <tr> <td></td> <td></td> <td colspan="8" style="text-align: center;"> <table border="1" style="width: 100%; border-collapse: collapse; text-align: center;"> <tr> <td style="width: 10%;"></td> <td style="width: 10%;"></td> <td style="width: 10%;"></td> <td style="width: 10%;"></td> <td style="width: 10%;"></td> <td style="width: 10%;"></td> <td style="width: 10%;"></td> <td style="width: 10%;"></td> <td style="width: 10%;"></td> <td style="width: 10%;"></td> </tr> <tr> <td></td> <td></td> <td colspan="8" style="text-align: center;"> <table border="1" style="width: 100%; border-collapse: collapse; text-align: center;"> <tr> <td style="width: 10%;"></td> <td style="width: 10%;"></td> <td style="width: 10%;"></td> <td style="width: 10%;"></td> <td style="width: 10%;"></td> <td style="width: 10%;"></td> <td style="width: 10%;"></td> <td style="width: 10%;"></td> <td style="width: 10%;"></td> <td style="width: 10%;"></td> </tr> <tr> <td></td> <td></td> <td colspan="8" style="text-align: center;"> <table border="1" style="width: 100%; border-collapse: collapse; text-align: center;"> <tr> <td style="width: 10%;"></td> <td style="width: 10%;"></td> <td style="width: 10%;"></td> <td style="width: 10%;"></td> <td style="width: 10%;"></td> <td style="width: 10%;"></td> <td style="width: 10%;"></td> <td style="width: 10%;"></td> <td style="width: 10%;"></td> <td style="width: 10%;"></td> </tr> <tr> <td></td> <td></td> <td colspan="8" style="text-align: center;"> <table border="1" style="width: 100%; border-collapse: collapse; text-align: center;"> <tr> <td style="width: 10%;"></td> <td style="width: 10%;"></td> <td style="width: 10%;"></td> <td style="width: 10%;"></td> <td style="width: 10%;"></td> <td style="width: 10%;"></td> <td style="width: 10%;"></td> <td style="width: 10%;"></td> <td style="width: 10%;"></td> <td style="width: 10%;"></td> </tr> <tr> <td></td> <td></td> <td colspan="8" style="text-align: center;"> <table border="1" style="width: 100%; border-collapse: collapse; text-align: center;"> <tr> <td style="width: 10%;"></td> <td style="width: 10%;"></td> <td style="width: 10%;"></td> <td style="width: 10%;"></td> <td style="width: 10%;"></td> <td style="width: 10%;"></td> <td style="width: 10%;"></td> <td style="width: 10%;"></td> <td style="width: 10%;"></td> <td style="width: 10%;"></td> </tr> <tr> <td></td> <td></td> <td colspan="8" style="text-align: center;"> <table border="1" style="width: 100%; border-collapse: collapse; text-align: center;"> <tr> <td style="width: 10%;"></td> <td style="width: 10%;"></td> <td style="width: 10%;"></td> <td style="width: 10%;"></td> <td style="width: 10%;"></td> <td style="width: 10%;"></td> <td style="width: 10%;"></td> <td style="width: 10%;"></td> <td style="width: 10%;"></td> <td style="width: 10%;"></td> </tr> <tr> <td></td> <td></td> <td colspan="8" style="text-align: center;"> <table border="1" style="width: 100%; border-collapse: collapse; text-align: center;"> <tr> <td style="width: 10%;"></td> <td style="width: 10%;"></td> <td style="width: 10%;"></td> <td style="width: 10%;"></td> <td style="width: 10%;"></td> <td style="width: 10%;"></td> <td style="width: 10%;"></td> <td style="width: 10%;"></td> <td style="width: 10%;"></td> <td style="width: 10%;"></td> </tr> <tr> <td></td> <td></td> <td colspan="8" style="text-align: center;"> <table border="1" style="width: 100%; border-collapse: collapse; text-align: center;"> <tr> <td style="width: 10%;"></td> <td style="width: 10%;"></td> <td style="width: 10%;"></td> <td style="width: 10%;"></td> <td style="width: 10%;"></td> <td style="width: 10%;"></td> <td style="width: 10%;"></td> <td style="width: 10%;"></td> <td style="width: 10%;"></td> <td style="width: 10%;"></td> </tr> <tr> <td></td> <td></td> <td colspan="8" style="text-align: center;"> <table border="1" style="width: 100%; border-collapse: collapse; text-align: center;"> <tr> <td style="width: 10%;"></td> <td style="width: 10%;"></td> <td style="width: 10%;"></td> <td style="width: 10%;"></td> <td style="width: 10%;"></td> <td style="width: 10%;"></td> <td style="width: 10%;"></td> <td style="width: 10%;"></td> <td style="width: 10%;"></td> <td style="width: 10%;"></td> </tr> <tr> <td></td> <td></td> <td colspan="8" style="text-align: center;"> <table border="1" style="width: 100%; border-collapse: collapse; text-align: center;"> <tr> <td style="width: 10%;"></td> <td style="width: 10%;"></td> <td style="width: 10%;"></td> <td style="width: 10%;"></td> <td style="width: 10%;"></td> <td style="width: 10%;"></td> <td style="width: 10%;"></td> <td style="width: 10%;"></td> <td style="width: 10%;"></td> <td style="width: 10%;"></td> </tr> <tr> <td></td> <td></td> <td colspan="8" style="text-align: center;"> <table border="1" style="width: 100%; border-collapse: collapse; text-align: center;"> <tr> <td style="width: 10%;"></td> <td style="width: 10%;"></td> <td style="width: 10%;"></td> <td style="width: 10%;"></td> <td style="width: 10%;"></td> <td style="width: 10%;"></td> <td style="width: 10%;"></td> <td style="width: 10%;"></td> <td style="width: 10%;"></td> <td style="width: 10%;"></td> </tr> <tr> <td></td> <td></td> <td colspan="8" style="text-align: center;"> <table border="1" style="width: 100%; border-collapse: collapse; text-align: center;"> <tr> <td style="width: 10%;"></td> <td style="width: 10%;"></td> <td style="width: 10%;"></td> <td style="width: 10%;"></td> <td style="width: 10%;"></td> <td style="width: 10%;"></td> <td style="width: 10%;"></td> <td style="width: 10%;"></td> <td style="width: 10%;"></td> <td style="width: 10%;"></td> </tr> <tr> <td></td> <td></td> <td colspan="8" style="text-align: center;"> <table border="1" style="width: 100%; border-collapse: collapse; text-align: center;"> <tr> <td style="width: 10%;"></td> <td style="width: 10%;"></td> <td style="width: 10%;"></td> <td style="width: 10%;"></td> <td style="width: 10%;"></td> <td style="width: 10%;"></td> <td style="width: 10%;"></td> <td style="width: 10%;"></td> <td style="width: 10%;"></td> <td style="width: 10%;"></td> </tr> <tr> <td></td> <td></td> <td colspan="8" style="text-align: center;"> <table border="1" style="width: 100%; border-collapse: collapse; text-align: center;"> <tr> <td style="width: 10%;"></td> <td style="width: 10%;"></td> <td style="width: 10%;"></td> <td style="width: 10%;"></td> <td style="width: 10%;"></td> <td style="width: 10%;"></td> <td style="width: 10%;"></td> <td style="width: 10%;"></td> <td style="width: 10%;"></td> <td style="width: 10%;"></td> </tr> <tr> <td></td> <td></td> <td colspan="8" style="text-align: center;"> <table border="1" style="width: 100%; border-collapse: collapse; text-align: center;"> <tr> </tr></table></td></tr></table></td></tr></table></td></tr></table></td></tr></table></td></tr></table></td></tr></table></td></tr></table></td></tr></table></td></tr></table></td></tr></table></td></tr></table></td></tr></table></td></tr></table></td></tr></table></td></tr></table></td></tr></table></td></tr></table></td></tr></table>

 | | | | | | | | | | | | | | | | | | | | <table border="1" style="width: 100%; border-collapse: collapse; text-align: center;"> <tr> <td style="width: 10%;"></td> <td style="width: 10%;"></td> <td style="width: 10%;"></td> <td style="width: 10%;"></td> <td style="width: 10%;"></td> <td style="width: 10%;"></td> <td style="width: 10%;"></td> <td style="width: 10%;"></td> <td style="width: 10%;"></td> <td style="width: 10%;"></td> </tr> <tr> <td></td> <td></td> <td colspan="8" style="text-align: center;"> <table border="1" style="width: 100%; border-collapse: collapse; text-align: center;"> <tr> <td style="width: 10%;"></td> <td style="width: 10%;"></td> <td style="width: 10%;"></td> <td style="width: 10%;"></td> <td style="width: 10%;"></td> <td style="width: 10%;"></td> <td style="width: 10%;"></td> <td style="width: 10%;"></td> <td style="width: 10%;"></td> <td style="width: 10%;"></td> </tr> <tr> <td></td> <td></td> <td colspan="8" style="text-align: center;"> <table border="1" style="width: 100%; border-collapse: collapse; text-align: center;"> <tr> <td style="width: 10%;"></td> <td style="width: 10%;"></td> <td style="width: 10%;"></td> <td style="width: 10%;"></td> <td style="width: 10%;"></td> <td style="width: 10%;"></td> <td style="width: 10%;"></td> <td style="width: 10%;"></td> <td style="width: 10%;"></td> <td style="width: 10%;"></td> </tr> <tr> <td></td> <td></td> <td colspan="8" style="text-align: center;"> <table border="1" style="width: 100%; border-collapse: collapse; text-align: center;"> <tr> <td style="width: 10%;"></td> <td style="width: 10%;"></td> <td style="width: 10%;"></td> <td style="width: 10%;"></td> <td style="width: 10%;"></td> <td style="width: 10%;"></td> <td style="width: 10%;"></td> <td style="width: 10%;"></td> <td style="width: 10%;"></td> <td style="width: 10%;"></td> </tr> <tr> <td></td> <td></td> <td colspan="8" style="text-align: center;"> <table border="1" style="width: 100%; border-collapse: collapse; text-align: center;"> <tr> <td style="width: 10%;"></td> <td style="width: 10%;"></td> <td style="width: 10%;"></td> <td style="width: 10%;"></td> <td style="width: 10%;"></td> <td style="width: 10%;"></td> <td style="width: 10%;"></td> <td style="width: 10%;"></td> <td style="width: 10%;"></td> <td style="width: 10%;"></td> </tr> <tr> <td></td> <td></td> <td colspan="8" style="text-align: center;"> <table border="1" style="width: 100%; border-collapse: collapse; text-align: center;"> <tr> <td style="width: 10%;"></td> <td style="width: 10%;"></td> <td style="width: 10%;"></td> <td style="width: 10%;"></td> <td style="width: 10%;"></td> <td style="width: 10%;"></td> <td style="width: 10%;"></td> <td style="width: 10%;"></td> <td style="width: 10%;"></td> <td style="width: 10%;"></td> </tr> <tr> <td></td> <td></td> <td colspan="8" style="text-align: center;"> <table border="1" style="width: 100%; border-collapse: collapse; text-align: center;"> <tr> <td style="width: 10%;"></td> <td style="width: 10%;"></td> <td style="width: 10%;"></td> <td style="width: 10%;"></td> <td style="width: 10%;"></td> <td style="width: 10%;"></td> <td style="width: 10%;"></td> <td style="width: 10%;"></td> <td style="width: 10%;"></td> <td style="width: 10%;"></td> </tr> <tr> <td></td> <td></td> <td colspan="8" style="text-align: center;"> <table border="1" style="width: 100%; border-collapse: collapse; text-align: center;"> <tr> <td style="width: 10%;"></td> <td style="width: 10%;"></td> <td style="width: 10%;"></td> <td style="width: 10%;"></td> <td style="width: 10%;"></td> <td style="width: 10%;"></td> <td style="width: 10%;"></td> <td style="width: 10%;"></td> <td style="width: 10%;"></td> <td style="width: 10%;"></td> </tr> <tr> <td></td> <td></td> <td colspan="8" style="text-align: center;"> <table border="1" style="width: 100%; border-collapse: collapse; text-align: center;"> <tr> <td style="width: 10%;"></td> <td style="width: 10%;"></td> <td style="width: 10%;"></td> <td style="width: 10%;"></td> <td style="width: 10%;"></td> <td style="width: 10%;"></td> <td style="width: 10%;"></td> <td style="width: 10%;"></td> <td style="width: 10%;"></td> <td style="width: 10%;"></td> </tr> <tr> <td></td> <td></td> <td colspan="8" style="text-align: center;"> <table border="1" style="width: 100%; border-collapse: collapse; text-align: center;"> <tr> <td style="width: 10%;"></td> <td style="width: 10%;"></td> <td style="width: 10%;"></td> <td style="width: 10%;"></td> <td style="width: 10%;"></td> <td style="width: 10%;"></td> <td style="width: 10%;"></td> <td style="width: 10%;"></td> <td style="width: 10%;"></td> <td style="width: 10%;"></td> </tr> <tr> <td></td> <td></td> <td colspan="8" style="text-align: center;"> <table border="1" style="width: 100%; border-collapse: collapse; text-align: center;"> <tr> <td style="width: 10%;"></td> <td style="width: 10%;"></td> <td style="width: 10%;"></td> <td style="width: 10%;"></td> <td style="width: 10%;"></td> <td style="width: 10%;"></td> <td style="width: 10%;"></td> <td style="width: 10%;"></td> <td style="width: 10%;"></td> <td style="width: 10%;"></td> </tr> <tr> <td></td> <td></td> <td colspan="8" style="text-align: center;"> <table border="1" style="width: 100%; border-collapse: collapse; text-align: center;"> <tr> <td style="width: 10%;"></td> <td style="width: 10%;"></td> <td style="width: 10%;"></td> <td style="width: 10%;"></td> <td style="width: 10%;"></td> <td style="width: 10%;"></td> <td style="width: 10%;"></td> <td style="width: 10%;"></td> <td style="width: 10%;"></td> <td style="width: 10%;"></td> </tr> <tr> <td></td> <td></td> <td colspan="8" style="text-align: center;"> <table border="1" style="width: 100%; border-collapse: collapse; text-align: center;"> <tr> <td style="width: 10%;"></td> <td style="width: 10%;"></td> <td style="width: 10%;"></td> <td style="width: 10%;"></td> <td style="width: 10%;"></td> <td style="width: 10%;"></td> <td style="width: 10%;"></td> <td style="width: 10%;"></td> <td style="width: 10%;"></td> <td style="width: 10%;"></td> </tr> <tr> <td></td> <td></td> <td colspan="8" style="text-align: center;"> <table border="1" style="width: 100%; border-collapse: collapse; text-align: center;"> <tr> <td style="width: 10%;"></td> <td style="width: 10%;"></td> <td style="width: 10%;"></td> <td style="width: 10%;"></td> <td style="width: 10%;"></td> <td style="width: 10%;"></td> <td style="width: 10%;"></td> <td style="width: 10%;"></td> <td style="width: 10%;"></td> <td style="width: 10%;"></td> </tr> <tr> <td></td> <td></td> <td colspan="8" style="text-align: center;"> <table border="1" style="width: 100%; border-collapse: collapse; text-align: center;"> <tr> <td style="width: 10%;"></td> <td style="width: 10%;"></td> <td style="width: 10%;"></td> <td style="width: 10%;"></td> <td style="width: 10%;"></td> <td style="width: 10%;"></td> <td style="width: 10%;"></td> <td style="width: 10%;"></td> <td style="width: 10%;"></td> <td style="width: 10%;"></td> </tr> <tr> <td></td> <td></td> <td colspan="8" style="text-align: center;"> <table border="1" style="width: 100%; border-collapse: collapse; text-align: center;"> <tr> <td style="width: 10%;"></td> <td style="width: 10%;"></td> <td style="width: 10%;"></td> <td style="width: 10%;"></td> <td style="width: 10%;"></td> <td style="width: 10%;"></td> <td style="width: 10%;"></td> <td style="width: 10%;"></td> <td style="width: 10%;"></td> <td style="width: 10%;"></td> </tr> <tr> <td></td> <td></td> <td colspan="8" style="text-align: center;"> <table border="1" style="width: 100%; border-collapse: collapse; text-align: center;"> <tr> <td style="width: 10%;"></td> <td style="width: 10%;"></td> <td style="width: 10%;"></td> <td style="width: 10%;"></td> <td style="width: 10%;"></td> <td style="width: 10%;"></td> <td style="width: 10%;"></td> <td style="width: 10%;"></td> <td style="width: 10%;"></td> <td style="width: 10%;"></td> </tr> <tr> <td></td> <td></td> <td colspan="8" style="text-align: center;"> <table border="1" style="width: 100%; border-collapse: collapse; text-align: center;"> <tr> </tr></table></td></tr></table></td></tr></table></td></tr></table></td></tr></table></td></tr></table></td></tr></table></td></tr></table></td></tr></table></td></tr></table></td></tr></table></td></tr></table></td></tr></table></td></tr></table></td></tr></table></td></tr></table></td></tr></table></td></tr></table>

 | | | | | | | | | | | | | | | | | | | | <table border="1" style="width: 100%; border-collapse: collapse; text-align: center;"> <tr> <td style="width: 10%;"></td> <td style="width: 10%;"></td> <td style="width: 10%;"></td> <td style="width: 10%;"></td> <td style="width: 10%;"></td> <td style="width: 10%;"></td> <td style="width: 10%;"></td> <td style="width: 10%;"></td> <td style="width: 10%;"></td> <td style="width: 10%;"></td> </tr> <tr> <td></td> <td></td> <td colspan="8" style="text-align: center;"> <table border="1" style="width: 100%; border-collapse: collapse; text-align: center;"> <tr> <td style="width: 10%;"></td> <td style="width: 10%;"></td> <td style="width: 10%;"></td> <td style="width: 10%;"></td> <td style="width: 10%;"></td> <td style="width: 10%;"></td> <td style="width: 10%;"></td> <td style="width: 10%;"></td> <td style="width: 10%;"></td> <td style="width: 10%;"></td> </tr> <tr> <td></td> <td></td> <td colspan="8" style="text-align: center;"> <table border="1" style="width: 100%; border-collapse: collapse; text-align: center;"> <tr> <td style="width: 10%;"></td> <td style="width: 10%;"></td> <td style="width: 10%;"></td> <td style="width: 10%;"></td> <td style="width: 10%;"></td> <td style="width: 10%;"></td> <td style="width: 10%;"></td> <td style="width: 10%;"></td> <td style="width: 10%;"></td> <td style="width: 10%;"></td> </tr> <tr> <td></td> <td></td> <td colspan="8" style="text-align: center;"> <table border="1" style="width: 100%; border-collapse: collapse; text-align: center;"> <tr> <td style="width: 10%;"></td> <td style="width: 10%;"></td> <td style="width: 10%;"></td> <td style="width: 10%;"></td> <td style="width: 10%;"></td> <td style="width: 10%;"></td> <td style="width: 10%;"></td> <td style="width: 10%;"></td> <td style="width: 10%;"></td> <td style="width: 10%;"></td> </tr> <tr> <td></td> <td></td> <td colspan="8" style="text-align: center;"> <table border="1" style="width: 100%; border-collapse: collapse; text-align: center;"> <tr> <td style="width: 10%;"></td> <td style="width: 10%;"></td> <td style="width: 10%;"></td> <td style="width: 10%;"></td> <td style="width: 10%;"></td> <td style="width: 10%;"></td> <td style="width: 10%;"></td> <td style="width: 10%;"></td> <td style="width: 10%;"></td> <td style="width: 10%;"></td> </tr> <tr> <td></td> <td></td> <td colspan="8" style="text-align: center;"> <table border="1" style="width: 100%; border-collapse: collapse; text-align: center;"> <tr> <td style="width: 10%;"></td> <td style="width: 10%;"></td> <td style="width: 10%;"></td> <td style="width: 10%;"></td> <td style="width: 10%;"></td> <td style="width: 10%;"></td> <td style="width: 10%;"></td> <td style="width: 10%;"></td> <td style="width: 10%;"></td> <td style="width: 10%;"></td> </tr> <tr> <td></td> <td></td> <td colspan="8" style="text-align: center;"> <table border="1" style="width: 100%; border-collapse: collapse; text-align: center;"> <tr> <td style="width: 10%;"></td> <td style="width: 10%;"></td> <td style="width: 10%;"></td> <td style="width: 10%;"></td> <td style="width: 10%;"></td> <td style="width: 10%;"></td> <td style="width: 10%;"></td> <td style="width: 10%;"></td> <td style="width: 10%;"></td> <td style="width: 10%;"></td> </tr> <tr> <td></td> <td></td> <td colspan="8" style="text-align: center;"> <table border="1" style="width: 100%; border-collapse: collapse; text-align: center;"> <tr> <td style="width: 10%;"></td> <td style="width: 10%;"></td> <td style="width: 10%;"></td> <td style="width: 10%;"></td> <td style="width: 10%;"></td> <td style="width: 10%;"></td> <td style="width: 10%;"></td> <td style="width: 10%;"></td> <td style="width: 10%;"></td> <td style="width: 10%;"></td> </tr> <tr> <td></td> <td></td> <td colspan="8" style="text-align: center;"> <table border="1" style="width: 100%; border-collapse: collapse; text-align: center;"> <tr> <td style="width: 10%;"></td> <td style="width: 10%;"></td> <td style="width: 10%;"></td> <td style="width: 10%;"></td> <td style="width: 10%;"></td> <td style="width: 10%;"></td> <td style="width: 10%;"></td> <td style="width: 10%;"></td> <td style="width: 10%;"></td> <td style="width: 10%;"></td> </tr> <tr> <td></td> <td></td> <td colspan="8" style="text-align: center;"> <table border="1" style="width: 100%; border-collapse: collapse; text-align: center;"> <tr> <td style="width: 10%;"></td> <td style="width: 10%;"></td> <td style="width: 10%;"></td> <td style="width: 10%;"></td> <td style="width: 10%;"></td> <td style="width: 10%;"></td> <td style="width: 10%;"></td> <td style="width: 10%;"></td> <td style="width: 10%;"></td> <td style="width: 10%;"></td> </tr> <tr> <td></td> <td></td> <td colspan="8" style="text-align: center;"> <table border="1" style="width: 100%; border-collapse: collapse; text-align: center;"> <tr> <td style="width: 10%;"></td> <td style="width: 10%;"></td> <td style="width: 10%;"></td> <td style="width: 10%;"></td> <td style="width: 10%;"></td> <td style="width: 10%;"></td> <td style="width: 10%;"></td> <td style="width: 10%;"></td> <td style="width: 10%;"></td> <td style="width: 10%;"></td> </tr> <tr> <td></td> <td></td> <td colspan="8" style="text-align: center;"> <table border="1" style="width: 100%; border-collapse: collapse; text-align: center;"> <tr> <td style="width: 10%;"></td> <td style="width: 10%;"></td> <td style="width: 10%;"></td> <td style="width: 10%;"></td> <td style="width: 10%;"></td> <td style="width: 10%;"></td> <td style="width: 10%;"></td> <td style="width: 10%;"></td> <td style="width: 10%;"></td> <td style="width: 10%;"></td> </tr> <tr> <td></td> <td></td> <td colspan="8" style="text-align: center;"> <table border="1" style="width: 100%; border-collapse: collapse; text-align: center;"> <tr> <td style="width: 10%;"></td> <td style="width: 10%;"></td> <td style="width: 10%;"></td> <td style="width: 10%;"></td> <td style="width: 10%;"></td> <td style="width: 10%;"></td> <td style="width: 10%;"></td> <td style="width: 10%;"></td> <td style="width: 10%;"></td> <td style="width: 10%;"></td> </tr> <tr> <td></td> <td></td> <td colspan="8" style="text-align: center;"> <table border="1" style="width: 100%; border-collapse: collapse; text-align: center;"> <tr> <td style="width: 10%;"></td> <td style="width: 10%;"></td> <td style="width: 10%;"></td> <td style="width: 10%;"></td> <td style="width: 10%;"></td> <td style="width: 10%;"></td> <td style="width:
10%;"></td> <td style="width: 10%;"></td> <td style="width: 10%;"></td> <td style="width: 10%;"></td> </tr> <tr> <td></td> <td></td> <td colspan="8" style="text-align: center;"> <table border="1" style="width: 100%; border-collapse: collapse; text-align: center;"> <tr> <td style="width: 10%;"></td> <td style="width: 10%;"></td> <td style="width: 10%;"></td> <td style="width: 10%;"></td> <td style="width: 10%;"></td> <td style="width: 10%;"></td> <td style="width: 10%;"></td> <td style="width: 10%;"></td> <td style="width: 10%;"></td> <td style="width: 10%;"></td> </tr> <tr> <td></td> <td></td> <td colspan="8" style="text-align: center;"> <table border="1" style="width: 100%; border-collapse: collapse; text-align: center;"> <tr> <td style="width: 10%;"></td> <td style="width: 10%;"></td> <td style="width: 10%;"></td> <td style="width: 10%;"></td> <td style="width: 10%;"></td> <td style="width: 10%;"></td> <td style="width: 10%;"></td> <td style="width: 10%;"></td> <td style="width: 10%;"></td> <td style="width: 10%;"></td> </tr> <tr> <td></td> <td></td> <td colspan="8" style="text-align: center;"> <table border="1" style="width: 100%; border-collapse: collapse; text-align: center;"> <tr> </tr></table></td></tr></table></td></tr></table></td></tr></table></td></tr></table></td></tr></table></td></tr></table></td></tr></table></td></tr></table></td></tr></table></td></tr></table></td></tr></table></td></tr></table></td></tr></table></td></tr></table></td></tr></table></td></tr></table>
 | | | | | | | | | | | | | | | | | | | | <table border="1" style="width: 100%; border-collapse: collapse; text-align: center;"> <tr> <td style="width: 10%;"></td> <td style="width: 10%;"></td> <td style="width: 10%;"></td> <td style="width: 10%;"></td> <td style="width: 10%;"></td> <td style="width: 10%;"></td> <td style="width: 10%;"></td> <td style="width: 10%;"></td> <td style="width: 10%;"></td> <td style="width: 10%;"></td> </tr> <tr> <td></td> <td></td> <td colspan="8" style="text-align: center;"> <table border="1" style="width: 100%; border-collapse: collapse; text-align: center;"> <tr> <td style="width: 10%;"></td> <td style="width: 10%;"></td> <td style="width: 10%;"></td> <td style="width: 10%;"></td> <td style="width: 10%;"></td> <td style="width: 10%;"></td> <td style="width: 10%;"></td> <td style="width: 10%;"></td> <td style="width: 10%;"></td> <td style="width: 10%;"></td> </tr> <tr> <td></td> <td></td> <td colspan="8" style="text-align: center;"> <table border="1" style="width: 100%; border-collapse: collapse; text-align: center;"> <tr> <td style="width: 10%;"></td> <td style="width: 10%;"></td> <td style="width: 10%;"></td> <td style="width: 10%;"></td> <td style="width: 10%;"></td> <td style="width: 10%;"></td> <td style="width: 10%;"></td> <td style="width: 10%;"></td> <td style="width: 10%;"></td> <td style="width: 10%;"></td> </tr> <tr> <td></td> <td></td> <td colspan="8" style="text-align: center;"> <table border="1" style="width: 100%; border-collapse: collapse; text-align: center;"> <tr> <td style="width: 10%;"></td> <td style="width: 10%;"></td> <td style="width: 10%;"></td> <td style="width: 10%;"></td> <td style="width: 10%;"></td> <td style="width: 10%;"></td> <td style="width: 10%;"></td> <td style="width: 10%;"></td> <td style="width: 10%;"></td> <td style="width: 10%;"></td> </tr> <tr> <td></td> <td></td> <td colspan="8" style="text-align: center;"> <table border="1" style="width: 100%; border-collapse: collapse; text-align: center;"> <tr> <td style="width: 10%;"></td> <td style="width: 10%;"></td> <td style="width: 10%;"></td> <td style="width: 10%;"></td> <td style="width: 10%;"></td> <td style="width: 10%;"></td> <td style="width: 10%;"></td> <td style="width: 10%;"></td> <td style="width: 10%;"></td> <td style="width: 10%;"></td> </tr> <tr> <td></td> <td></td> <td colspan="8" style="text-align: center;"> <table border="1" style="width: 100%; border-collapse: collapse; text-align: center;"> <tr> <td style="width: 10%;"></td> <td style="width: 10%;"></td> <td style="width: 10%;"></td> <td style="width: 10%;"></td> <td style="width: 10%;"></td> <td style="width: 10%;"></td> <td style="width: 10%;"></td> <td style="width: 10%;"></td> <td style="width: 10%;"></td> <td style="width: 10%;"></td> </tr> <tr> <td></td> <td></td> <td colspan="8" style="text-align: center;"> <table border="1" style="width: 100%; border-collapse: collapse; text-align: center;"> <tr> <td style="width: 10%;"></td> <td style="width: 10%;"></td> <td style="width: 10%;"></td> <td style="width: 10%;"></td> <td style="width: 10%;"></td> <td style="width: 10%;"></td> <td style="width: 10%;"></td> <td style="width: 10%;"></td> <td style="width: 10%;"></td> <td style="width: 10%;"></td> </tr> <tr> <td></td> <td></td> <td colspan="8" style="text-align: center;"> <table border="1" style="width: 100%; border-collapse: collapse; text-align: center;"> <tr> <td style="width: 10%;"></td> <td style="width: 10%;"></td> <td style="width: 10%;"></td> <td style="width: 10%;"></td> <td style="width: 10%;"></td> <td style="width: 10%;"></td> <td style="width: 10%;"></td> <td style="width: 10%;"></td> <td style="width: 10%;"></td> <td style="width: 10%;"></td> </tr> <tr> <td></td> <td></td> <td colspan="8" style="text-align: center;"> <table border="1" style="width: 100%; border-collapse: collapse; text-align: center;"> <tr> <td style="width: 10%;"></td> <td style="width: 10%;"></td> <td style="width: 10%;"></td> <td style="width: 10%;"></td> <td style="width: 10%;"></td> <td style="width: 10%;"></td> <td style="width: 10%;"></td> <td style="width: 10%;"></td> <td style="width: 10%;"></td> <td style="width: 10%;"></td> </tr> <tr> <td></td> <td></td> <td colspan="8" style="text-align: center;"> <table border="1" style="width: 100%; border-collapse: collapse; text-align: center;"> <tr> <td style="width: 10%;"></td> <td style="width: 10%;"></td> <td style="width: 10%;"></td> <td style="width: 10%;"></td> <td style="width: 10%;"></td> <td style="width: 10%;"></td> <td style="width: 10%;"></td> <td style="width: 10%;"></td> <td style="width: 10%;"></td> <td style="width: 10%;"></td> </tr> <tr> <td></td> <td></td> <td colspan="8" style="text-align: center;"> <table border="1" style="width: 100%; border-collapse: collapse; text-align: center;"> <tr> <td style="width: 10%;"></td> <td style="width:
10%;"></td> <td style="width: 10%;"></td> <td style="width: 10%;"></td> <td style="width: 10%;"></td> <td style="width: 10%;"></td> <td style="width: 10%;"></td> <td style="width: 10%;"></td> <td style="width: 10%;"></td> <td style="width: 10%;"></td> </tr> <tr> <td></td> <td></td> <td colspan="8" style="text-align: center;"> <table border="1" style="width: 100%; border-collapse: collapse; text-align: center;"> <tr> <td style="width: 10%;"></td> <td style="width: 10%;"></td> <td style="width: 10%;"></td> <td style="width: 10%;"></td> <td style="width: 10%;"></td> <td style="width: 10%;"></td> <td style="width: 10%;"></td> <td style="width: 10%;"></td> <td style="width: 10%;"></td> <td style="width: 10%;"></td> </tr> <tr> <td></td> <td></td> <td colspan="8" style="text-align: center;"> <table border="1" style="width: 100%; border-collapse: collapse; text-align: center;"> <tr> <td style="width: 10%;"></td> <td style="width: 10%;"></td> <td style="width: 10%;"></td> <td style="width: 10%;"></td> <td style="width: 10%;"></td> <td style="width: 10%;"></td> <td style="width: 10%;"></td> <td style="width: 10%;"></td> <td style="width: 10%;"></td> <td style="width: 10%;"></td> </tr> <tr> <td></td> <td></td> <td colspan="8" style="text-align: center;"> <table border="1" style="width: 100%; border-collapse: collapse; text-align: center;"> <tr> <td style="width: 10%;"></td> <td style="width: 10%;"></td> <td style="width: 10%;"></td> <td style="width: 10%;"></td> <td style="width: 10%;"></td> <td style="width: 10%;"></td> <td style="width: 10%;"></td> <td style="width: 10%;"></td> <td style="width: 10%;"></td> <td style="width: 10%;"></td> </tr> <tr> <td></td> <td></td> <td colspan="8" style="text-align: center;"> <table border="1" style="width: 100%; border-collapse: collapse; text-align: center;"> <tr> <td style="width: 10%;"></td> <td style="width: 10%;"></td> <td style="width: 10%;"></td> <td style="width: 10%;"></td> <td style="width: 10%;"></td> <td style="width: 10%;"></td> <td style="width: 10%;"></td> <td style="width: 10%;"></td> <td style="width: 10%;"></td> <td style="width: 10%;"></td> </tr> <tr> <td></td> <td></td> <td colspan="8" style="text-align: center;"> <table border="1" style="width: 100%; border-collapse: collapse; text-align: center;"> <tr> </tr></table></td></tr></table></td></tr></table></td></tr></table></td></tr></table></td></tr></table></td></tr></table></td></tr></table></td></tr></table></td></tr></table></td></tr></table></td></tr></table></td></tr></table></td></tr></table></td></tr></table></td></tr></table>
 | | | | | | | | | | | | | | | | | | | | <table border="1" style="width: 100%; border-collapse: collapse; text-align: center;"> <tr> <td style="width: 10%;"></td> <td style="width: 10%;"></td> <td style="width: 10%;"></td> <td style="width: 10%;"></td> <td style="width: 10%;"></td> <td style="width: 10%;"></td> <td style="width: 10%;"></td> <td style="width: 10%;"></td> <td style="width: 10%;"></td> <td style="width: 10%;"></td> </tr> <tr> <td></td> <td></td> <td colspan="8" style="text-align: center;"> <table border="1" style="width: 100%; border-collapse: collapse; text-align: center;"> <tr> <td style="width: 10%;"></td> <td style="width: 10%;"></td> <td style="width: 10%;"></td> <td style="width: 10%;"></td> <td style="width: 10%;"></td> <td style="width: 10%;"></td> <td style="width: 10%;"></td> <td style="width: 10%;"></td> <td style="width: 10%;"></td> <td style="width: 10%;"></td> </tr> <tr> <td></td> <td></td> <td colspan="8" style="text-align: center;"> <table border="1" style="width: 100%; border-collapse: collapse; text-align: center;"> <tr> <td style="width: 10%;"></td> <td style="width: 10%;"></td> <td style="width: 10%;"></td> <td style="width: 10%;"></td> <td style="width: 10%;"></td> <td style="width: 10%;"></td> <td style="width: 10%;"></td> <td style="width: 10%;"></td> <td style="width: 10%;"></td> <td style="width: 10%;"></td> </tr> <tr> <td></td> <td></td> <td colspan="8" style="text-align: center;"> <table border="1" style="width: 100%; border-collapse: collapse; text-align: center;"> <tr> <td style="width: 10%;"></td> <td style="width: 10%;"></td> <td style="width: 10%;"></td> <td style="width: 10%;"></td> <td style="width: 10%;"></td> <td style="width: 10%;"></td> <td style="width: 10%;"></td> <td style="width: 10%;"></td> <td style="width: 10%;"></td> <td style="width: 10%;"></td> </tr> <tr> <td></td> <td></td> <td colspan="8" style="text-align: center;"> <table border="1" style="width: 100%; border-collapse: collapse; text-align: center;"> <tr> <td style="width: 10%;"></td> <td style="width: 10%;"></td> <td style="width: 10%;"></td> <td style="width: 10%;"></td> <td style="width: 10%;"></td> <td style="width: 10%;"></td> <td style="width: 10%;"></td> <td style="width: 10%;"></td> <td style="width: 10%;"></td> <td style="width: 10%;"></td> </tr> <tr> <td></td> <td></td> <td colspan="8" style="text-align: center;"> <table border="1" style="width: 100%; border-collapse: collapse; text-align: center;"> <tr> <td style="width: 10%;"></td> <td style="width: 10%;"></td> <td style="width: 10%;"></td> <td style="width: 10%;"></td> <td style="width: 10%;"></td> <td style="width: 10%;"></td> <td style="width: 10%;"></td> <td style="width: 10%;"></td> <td style="width: 10%;"></td> <td style="width: 10%;"></td> </tr> <tr> <td></td> <td></td> <td colspan="8" style="text-align: center;"> <table border="1" style="width: 100%; border-collapse: collapse; text-align: center;"> <tr> <td style="width: 10%;"></td> <td style="width: 10%;"></td> <td style="width: 10%;"></td> <td style="width: 10%;"></td> <td style="width: 10%;"></td> <td style="width: 10%;"></td> <td style="width: 10%;"></td> <td style="width: 10%;"></td> <td style="width: 10%;"></td> <td style="width: 10%;"></td> </tr> <tr> <td></td> <td></td> <td colspan="8" style="text-align: center;"> <table border="1" style="width: 100%; border-collapse: collapse; text-align: center;"> <tr> <td style="width: 10%;"></td> <td style="width: 10%;"></td> <td style="width: 10%;"></td> <td style="width: 10%;"></td> <td style="width: 10%;"></td> <td style="width: 10%;"></td> <td style="width: 10%;"></td> <td style="width: 10%;"></td> <td style="width: 10%;"></td> <td style="width: 10%;"></td> </tr> <tr> <td></td> <td></td> <td colspan="8" style="text-align: center;"> <table
border="1" style="width: 100%; border-collapse: collapse; text-align: center;"> <tr> <td style="width: 10%;"></td> <td style="width: 10%;"></td> <td style="width: 10%;"></td> <td style="width: 10%;"></td> <td style="width: 10%;"></td> <td style="width: 10%;"></td> <td style="width: 10%;"></td> <td style="width: 10%;"></td> <td style="width: 10%;"></td> <td style="width: 10%;"></td> </tr> <tr> <td></td> <td></td> <td colspan="8" style="text-align: center;"> <table border="1" style="width: 100%; border-collapse: collapse; text-align: center;"> <tr> <td style="width: 10%;"></td> <td style="width: 10%;"></td> <td style="width: 10%;"></td> <td style="width: 10%;"></td> <td style="width: 10%;"></td> <td style="width: 10%;"></td> <td style="width: 10%;"></td> <td style="width: 10%;"></td> <td style="width: 10%;"></td> <td style="width: 10%;"></td> </tr> <tr> <td></td> <td></td> <td colspan="8" style="text-align: center;"> <table border="1" style="width: 100%; border-collapse: collapse; text-align: center;"> <tr> <td style="width: 10%;"></td> <td style="width: 10%;"></td> <td style="width: 10%;"></td> <td style="width: 10%;"></td> <td style="width: 10%;"></td> <td style="width: 10%;"></td> <td style="width: 10%;"></td> <td style="width: 10%;"></td> <td style="width: 10%;"></td> <td style="width: 10%;"></td> </tr> <tr> <td></td> <td></td> <td colspan="8" style="text-align: center;"> <table border="1" style="width: 100%; border-collapse: collapse; text-align: center;"> <tr> <td style="width: 10%;"></td> <td style="width: 10%;"></td> <td style="width: 10%;"></td> <td style="width: 10%;"></td> <td style="width: 10%;"></td> <td style="width: 10%;"></td> <td style="width: 10%;"></td> <td style="width: 10%;"></td> <td style="width: 10%;"></td> <td style="width: 10%;"></td> </tr> <tr> <td></td> <td></td> <td colspan="8" style="text-align: center;"> <table border="1" style="width: 100%; border-collapse: collapse; text-align: center;"> <tr> <td style="width: 10%;"></td> <td style="width: 10%;"></td> <td style="width: 10%;"></td> <td style="width: 10%;"></td> <td style="width: 10%;"></td> <td style="width: 10%;"></td> <td style="width: 10%;"></td> <td style="width: 10%;"></td> <td style="width: 10%;"></td> <td style="width: 10%;"></td> </tr> <tr> <td></td> <td></td> <td colspan="8" style="text-align: center;"> <table border="1" style="width: 100%; border-collapse: collapse; text-align: center;"> <tr> <td style="width: 10%;"></td> <td style="width: 10%;"></td> <td style="width: 10%;"></td> <td style="width: 10%;"></td> <td style="width: 10%;"></td> <td style="width: 10%;"></td> <td style="width: 10%;"></td> <td style="width: 10%;"></td> <td style="width: 10%;"></td> <td style="width: 10%;"></td> </tr> <tr> <td></td> <td></td> <td colspan="8" style="text-align: center;"> <table border="1" style="width: 100%; border-collapse: collapse; text-align: center;"> <tr> </tr></table></td></tr></table></td></tr></table></td></tr></table></td></tr></table></td></tr></table></td></tr></table></td></tr></table></td></tr></table></td></tr></table></td></tr></table></td></tr></table></td></tr></table></td></tr></table></td></tr></table>
 | | | | | | | | | | | | | | | | | | | | <table border="1" style="width: 100%; border-collapse: collapse; text-align: center;"> <tr> <td style="width: 10%;"></td> <td style="width: 10%;"></td> <td style="width: 10%;"></td> <td style="width: 10%;"></td> <td style="width: 10%;"></td> <td style="width: 10%;"></td> <td style="width: 10%;"></td> <td style="width: 10%;"></td> <td style="width: 10%;"></td> <td style="width: 10%;"></td> </tr> <tr> <td></td> <td></td> <td colspan="8" style="text-align: center;"> <table border="1" style="width: 100%; border-collapse: collapse; text-align: center;"> <tr> <td style="width: 10%;"></td> <td style="width: 10%;"></td> <td style="width: 10%;"></td> <td style="width: 10%;"></td> <td style="width: 10%;"></td> <td style="width: 10%;"></td> <td style="width: 10%;"></td> <td style="width: 10%;"></td> <td style="width: 10%;"></td> <td style="width: 10%;"></td> </tr> <tr> <td></td> <td></td> <td colspan="8" style="text-align: center;"> <table border="1" style="width: 100%; border-collapse: collapse; text-align: center;"> <tr> <td style="width: 10%;"></td> <td style="width: 10%;"></td> <td style="width: 10%;"></td> <td style="width: 10%;"></td> <td style="width: 10%;"></td> <td style="width: 10%;"></td> <td style="width: 10%;"></td> <td style="width: 10%;"></td> <td style="width: 10%;"></td> <td style="width: 10%;"></td> </tr> <tr> <td></td> <td></td> <td colspan="8" style="text-align: center;"> <table border="1" style="width: 100%; border-collapse: collapse; text-align: center;"> <tr> <td style="width: 10%;"></td> <td style="width: 10%;"></td> <td style="width: 10%;"></td> <td style="width: 10%;"></td> <td style="width: 10%;"></td> <td style="width: 10%;"></td> <td style="width: 10%;"></td> <td style="width: 10%;"></td> <td style="width: 10%;"></td> <td style="width: 10%;"></td> </tr> <tr> <td></td> <td></td> <td colspan="8" style="text-align: center;"> <table border="1" style="width: 100%; border-collapse: collapse; text-align: center;"> <tr> <td style="width: 10%;"></td> <td style="width: 10%;"></td> <td style="width: 10%;"></td> <td style="width: 10%;"></td> <td style="width: 10%;"></td> <td style="width: 10%;"></td> <td style="width: 10%;"></td> <td style="width: 10%;"></td> <td style="width: 10%;"></td> <td style="width: 10%;"></td> </tr> <tr> <td></td> <td></td> <td colspan="8" style="text-align: center;"> <table border="1" style="width: 100%; border-collapse: collapse; text-align: center;"> <tr> <td style="width: 10%;"></td> <td style="width: 10%;"></td> <td style="width: 10%;"></td> <td style="width: 10%;"></td> <td style="width: 10%;"></td> <td style="width: 10%;"></td> <td style="width: 10%;"></td> <td style="width: 10%;"></td> <td style="width: 10%;"></td> <td style="width: 10%;"></td> </tr> <tr> <td></td> <td></td> <td colspan="8" style="text-align: center;"> <table border="1" style="width: 100%; border-collapse: collapse; text-align: center;"> <tr> <td style="width: 10%;"></td> <td style="width: 10%;"></td> <td style="width: 10%;"></td> <td style="width: 10%;"></td> <td style="width: 10%;"></td> <td style="width: 10%;"></td> <td style="width: 10%;"></td> <td style="width: 10%;"></td> <td style="width: 10%;"></td> <td
style="width: 10%;"></td> </tr> <tr> <td></td> <td></td> <td colspan="8" style="text-align: center;"> <table border="1" style="width: 100%; border-collapse: collapse; text-align: center;"> <tr> <td style="width: 10%;"></td> <td style="width: 10%;"></td> <td style="width: 10%;"></td> <td style="width: 10%;"></td> <td style="width: 10%;"></td> <td style="width: 10%;"></td> <td style="width: 10%;"></td> <td style="width: 10%;"></td> <td style="width: 10%;"></td> <td style="width: 10%;"></td> </tr> <tr> <td></td> <td></td> <td colspan="8" style="text-align: center;"> <table border="1" style="width: 100%; border-collapse: collapse; text-align: center;"> <tr> <td style="width: 10%;"></td> <td style="width: 10%;"></td> <td style="width: 10%;"></td> <td style="width: 10%;"></td> <td style="width: 10%;"></td> <td style="width: 10%;"></td> <td style="width: 10%;"></td> <td style="width: 10%;"></td> <td style="width: 10%;"></td> <td style="width: 10%;"></td> </tr> <tr> <td></td> <td></td> <td colspan="8" style="text-align: center;"> <table border="1" style="width: 100%; border-collapse: collapse; text-align: center;"> <tr> <td style="width: 10%;"></td> <td style="width: 10%;"></td> <td style="width: 10%;"></td> <td style="width: 10%;"></td> <td style="width: 10%;"></td> <td style="width: 10%;"></td> <td style="width: 10%;"></td> <td style="width: 10%;"></td> <td style="width: 10%;"></td> <td style="width: 10%;"></td> </tr> <tr> <td></td> <td></td> <td colspan="8" style="text-align: center;"> <table border="1" style="width: 100%; border-collapse: collapse; text-align: center;"> <tr> <td style="width: 10%;"></td> <td style="width: 10%;"></td> <td style="width: 10%;"></td> <td style="width: 10%;"></td> <td style="width: 10%;"></td> <td style="width: 10%;"></td> <td style="width: 10%;"></td> <td style="width: 10%;"></td> <td style="width: 10%;"></td> <td style="width: 10%;"></td> </tr> <tr> <td></td> <td></td> <td colspan="8" style="text-align: center;"> <table border="1" style="width: 100%; border-collapse: collapse; text-align: center;"> <tr> <td style="width: 10%;"></td> <td style="width: 10%;"></td> <td style="width: 10%;"></td> <td style="width: 10%;"></td> <td style="width: 10%;"></td> <td style="width: 10%;"></td> <td style="width: 10%;"></td> <td style="width: 10%;"></td> <td style="width: 10%;"></td> <td style="width: 10%;"></td> </tr> <tr> <td></td> <td></td> <td colspan="8" style="text-align: center;"> <table border="1" style="width: 100%; border-collapse: collapse; text-align: center;"> <tr> <td style="width: 10%;"></td> <td style="width: 10%;"></td> <td style="width: 10%;"></td> <td style="width: 10%;"></td> <td style="width: 10%;"></td> <td style="width: 10%;"></td> <td style="width: 10%;"></td> <td style="width: 10%;"></td> <td style="width: 10%;"></td> <td style="width: 10%;"></td> </tr> <tr> <td></td> <td></td> <td colspan="8" style="text-align: center;"> <table border="1" style="width: 100%; border-collapse: collapse; text-align: center;"> <tr> </tr></table></td></tr></table></td></tr></table></td></tr></table></td></tr></table></td></tr></table></td></tr></table></td></tr></table></td></tr></table></td></tr></table></td></tr></table></td></tr></table></td></tr></table></td></tr></table>
 | | | | | | | | | | | | | | | | | | | | <table border="1" style="width: 100%; border-collapse: collapse; text-align: center;"> <tr> <td style="width: 10%;"></td> <td style="width: 10%;"></td> <td style="width: 10%;"></td> <td style="width: 10%;"></td> <td style="width: 10%;"></td> <td style="width: 10%;"></td> <td style="width: 10%;"></td> <td style="width: 10%;"></td> <td style="width: 10%;"></td> <td style="width: 10%;"></td> </tr> <tr> <td></td> <td></td> <td colspan="8" style="text-align: center;"> <table border="1" style="width: 100%; border-collapse: collapse; text-align: center;"> <tr> <td style="width: 10%;"></td> <td style="width: 10%;"></td> <td style="width: 10%;"></td> <td style="width: 10%;"></td> <td style="width: 10%;"></td> <td style="width: 10%;"></td> <td style="width: 10%;"></td> <td style="width: 10%;"></td> <td style="width: 10%;"></td> <td style="width: 10%;"></td> </tr> <tr> <td></td> <td></td> <td colspan="8" style="text-align: center;"> <table border="1" style="width: 100%; border-collapse: collapse; text-align: center;"> <tr> <td style="width: 10%;"></td> <td style="width: 10%;"></td> <td style="width: 10%;"></td> <td style="width: 10%;"></td> <td style="width: 10%;"></td> <td style="width: 10%;"></td> <td style="width: 10%;"></td> <td style="width: 10%;"></td> <td style="width: 10%;"></td> <td style="width: 10%;"></td> </tr> <tr> <td></td> <td></td> <td colspan="8" style="text-align: center;"> <table border="1" style="width: 100%; border-collapse: collapse; text-align: center;"> <tr> <td style="width: 10%;"></td> <td style="width: 10%;"></td> <td style="width: 10%;"></td> <td style="width: 10%;"></td> <td style="width: 10%;"></td> <td style="width: 10%;"></td> <td style="width: 10%;"></td> <td style="width: 10%;"></td> <td style="width: 10%;"></td> <td style="width: 10%;"></td> </tr> <tr> <td></td> <td></td> <td colspan="8" style="text-align: center;"> <table border="1" style="width: 100%; border-collapse: collapse; text-align: center;"> <tr> <td style="width: 10%;"></td> <td style="width: 10%;"></td> <td style="width: 10%;"></td> <td style="width: 10%;"></td> <td style="width: 10%;"></td> <td style="width: 10%;"></td> <td style="width: 10%;"></td> <td style="width: 10%;"></td> <td style="width: 10%;"></td> <td style="width: 10%;"></td> </tr> <tr> <td></td> <td></td> <td colspan="8" style="text-align: center;"> <table border="1" style="width: 100%; border-collapse: collapse; text-align: center;"> <tr> <td style="width: 10%;"></td> <td style="width: 10%;"></td> <td style="width: 10%;"></td> <td style="width: 10%;"></td> <td style="width: 10%;"></td> <td style="width: 10%;"></td> <td style="width: 10%;"></td> <td style="width: 10%;"></td> <td style="width: 10%;"></td> <td style="width: 10%;"></td> </tr> <tr> <td></td> <td></td> <td colspan="8" style="text-align: center;"> <table border="1" style="width: 100%; border-collapse: collapse; text-align: center;"> <tr> <td style="width: 10%;"></td> <td style="width: 10%;"></td> <td style="width: 10%;"></td> <td style="width: 10%;"></td> <td style="width: 10%;"></td> <td style="width: 10%;"></td>
<td style="width: 10%;"></td> <td style="width: 10%;"></td> <td style="width: 10%;"></td> <td style="width: 10%;"></td> </tr> <tr> <td></td> <td></td> <td colspan="8" style="text-align: center;"> <table border="1" style="width: 100%; border-collapse: collapse; text-align: center;"> <tr> <td style="width: 10%;"></td> <td style="width: 10%;"></td> <td style="width: 10%;"></td> <td style="width: 10%;"></td> <td style="width: 10%;"></td> <td style="width: 10%;"></td> <td style="width: 10%;"></td> <td style="width: 10%;"></td> <td style="width: 10%;"></td> <td style="width: 10%;"></td> </tr> <tr> <td></td> <td></td> <td colspan="8" style="text-align: center;"> <table border="1" style="width: 100%; border-collapse: collapse; text-align: center;"> <tr> <td style="width: 10%;"></td> <td style="width: 10%;"></td> <td style="width: 10%;"></td> <td style="width: 10%;"></td> <td style="width: 10%;"></td> <td style="width: 10%;"></td> <td style="width: 10%;"></td> <td style="width: 10%;"></td> <td style="width: 10%;"></td> <td style="width: 10%;"></td> </tr> <tr> <td></td> <td></td> <td colspan="8" style="text-align: center;"> <table border="1" style="width: 100%; border-collapse: collapse; text-align: center;"> <tr> <td style="width: 10%;"></td> <td style="width: 10%;"></td> <td style="width: 10%;"></td> <td style="width: 10%;"></td> <td style="width: 10%;"></td> <td style="width: 10%;"></td> <td style="width: 10%;"></td> <td style="width: 10%;"></td> <td style="width: 10%;"></td> <td style="width: 10%;"></td> </tr> <tr> <td></td> <td></td> <td colspan="8" style="text-align: center;"> <table border="1" style="width: 100%; border-collapse: collapse; text-align: center;"> <tr> <td style="width: 10%;"></td> <td style="width: 10%;"></td> <td style="width: 10%;"></td> <td style="width: 10%;"></td> <td style="width: 10%;"></td> <td style="width: 10%;"></td> <td style="width: 10%;"></td> <td style="width: 10%;"></td> <td style="width: 10%;"></td> <td style="width: 10%;"></td> </tr> <tr> <td></td> <td></td> <td colspan="8" style="text-align: center;"> <table border="1" style="width: 100%; border-collapse: collapse; text-align: center;"> <tr> <td style="width: 10%;"></td> <td style="width: 10%;"></td> <td style="width: 10%;"></td> <td style="width: 10%;"></td> <td style="width: 10%;"></td> <td style="width: 10%;"></td> <td style="width: 10%;"></td> <td style="width: 10%;"></td> <td style="width: 10%;"></td> <td style="width: 10%;"></td> </tr> <tr> <td></td> <td></td> <td colspan="8" style="text-align: center;"> <table border="1" style="width: 100%; border-collapse: collapse; text-align: center;"> <tr> </tr></table></td></tr></table></td></tr></table></td></tr></table></td></tr></table></td></tr></table></td></tr></table></td></tr></table></td></tr></table></td></tr></table></td></tr></table></td></tr></table></td></tr></table>
 | | | | | | | | | | | | | | | | | | | | <table border="1" style="width: 100%; border-collapse: collapse; text-align: center;"> <tr> <td style="width: 10%;"></td> <td style="width: 10%;"></td> <td style="width: 10%;"></td> <td style="width: 10%;"></td> <td style="width: 10%;"></td> <td style="width: 10%;"></td> <td style="width: 10%;"></td> <td style="width: 10%;"></td> <td style="width: 10%;"></td> <td style="width: 10%;"></td> </tr> <tr> <td></td> <td></td> <td colspan="8" style="text-align: center;"> <table border="1" style="width: 100%; border-collapse: collapse; text-align: center;"> <tr> <td style="width: 10%;"></td> <td style="width: 10%;"></td> <td style="width: 10%;"></td> <td style="width: 10%;"></td> <td style="width: 10%;"></td> <td style="width: 10%;"></td> <td style="width: 10%;"></td> <td style="width: 10%;"></td> <td style="width: 10%;"></td> <td style="width: 10%;"></td> </tr> <tr> <td></td> <td></td> <td colspan="8" style="text-align: center;"> <table border="1" style="width: 100%; border-collapse: collapse; text-align: center;"> <tr> <td style="width: 10%;"></td> <td style="width: 10%;"></td> <td style="width: 10%;"></td> <td style="width: 10%;"></td> <td style="width: 10%;"></td> <td style="width: 10%;"></td> <td style="width: 10%;"></td> <td style="width: 10%;"></td> <td style="width: 10%;"></td> <td style="width: 10%;"></td> </tr> <tr> <td></td> <td></td> <td colspan="8" style="text-align: center;"> <table border="1" style="width: 100%; border-collapse: collapse; text-align: center;"> <tr> <td style="width: 10%;"></td> <td style="width: 10%;"></td> <td style="width: 10%;"></td> <td style="width: 10%;"></td> <td style="width: 10%;"></td> <td style="width: 10%;"></td> <td style="width: 10%;"></td> <td style="width: 10%;"></td> <td style="width: 10%;"></td> <td style="width: 10%;"></td> </tr> <tr> <td></td> <td></td> <td colspan="8" style="text-align: center;"> <table border="1" style="width: 100%; border-collapse: collapse; text-align: center;"> <tr> <td style="width: 10%;"></td> <td style="width: 10%;"></td> <td style="width: 10%;"></td> <td style="width: 10%;"></td> <td style="width: 10%;"></td> <td style="width: 10%;"></td> <td style="width: 10%;"></td> <td style="width: 10%;"></td> <td style="width: 10%;"></td> <td style="width: 10%;"></td> </tr> <tr> <td></td> <td></td> <td colspan="8" style="text-align: center;"> <table border="1" style="width: 100%; border-collapse: collapse; text-align: center;"> <tr> <td style="width: 10%;"></td> <td style="width: 10%;"></td> <td style="width: 10%;"></td> <td style="width: 10%;"></td> <td style="width: 10%;"></td> <td style="width: 10%;"></td> <td style="width: 10%;"></td> <td style="width: 10%;"></td> <td style="width: 10%;"></td> <td style="width: 10%;"></td> </tr> <tr> <td></td> <td></td> <td colspan="8" style="text-align: center;"> <table border="1" style="width: 100%; border-collapse: collapse; text-align: center;"> <tr> <td style="width: 10%;"></td> <td style="width: 10%;"></td> <td style="width: 10%;"></td> <td style="width: 10%;"></td> <td style="width: 10%;"></td> <td style="width: 10%;"></td> <td style="width: 10%;"></td> <td style="width: 10%;"></td> <td style="width: 10%;"></td> <td style="width: 10%;"></td> </tr> <tr> <td></td> <td></td> <td colspan="8" style="text-align: center;"> <table border="1" style="width: 100%; border-collapse: collapse; text-align: center;"> <tr> <td style="width: 10%;"></td> <td style="width: 10%;"></td> <td style="width: 10%;"></td> <td
style="width: 10%;"></td> <td style="width: 10%;"></td> <td style="width: 10%;"></td> <td style="width: 10%;"></td> <td style="width: 10%;"></td> <td style="width: 10%;"></td> <td style="width: 10%;"></td> </tr> <tr> <td></td> <td></td> <td colspan="8" style="text-align: center;"> <table border="1" style="width: 100%; border-collapse: collapse; text-align: center;"> <tr> <td style="width: 10%;"></td> <td style="width: 10%;"></td> <td style="width: 10%;"></td> <td style="width: 10%;"></td> <td style="width: 10%;"></td> <td style="width: 10%;"></td> <td style="width: 10%;"></td> <td style="width: 10%;"></td> <td style="width: 10%;"></td> <td style="width: 10%;"></td> </tr> <tr> <td></td> <td></td> <td colspan="8" style="text-align: center;"> <table border="1" style="width: 100%; border-collapse: collapse; text-align: center;"> <tr> <td style="width: 10%;"></td> <td style="width: 10%;"></td> <td style="width: 10%;"></td> <td style="width: 10%;"></td> <td style="width: 10%;"></td> <td style="width: 10%;"></td> <td style="width: 10%;"></td> <td style="width: 10%;"></td> <td style="width: 10%;"></td> <td style="width: 10%;"></td> </tr> <tr> <td></td> <td></td> <td colspan="8" style="text-align: center;"> <table border="1" style="width: 100%; border-collapse: collapse; text-align: center;"> <tr> <td style="width: 10%;"></td> <td style="width: 10%;"></td> <td style="width: 10%;"></td> <td style="width: 10%;"></td> <td style="width: 10%;"></td> <td style="width: 10%;"></td> <td style="width: 10%;"></td> <td style="width: 10%;"></td> <td style="width: 10%;"></td> <td style="width: 10%;"></td> </tr> <tr> <td></td> <td></td> <td colspan="8" style="text-align: center;"> <table border="1" style="width: 100%; border-collapse: collapse; text-align: center;"> <tr> </tr></table></td></tr></table></td></tr></table></td></tr></table></td></tr></table></td></tr></table></td></tr></table></td></tr></table></td></tr></table></td></tr></table></td></tr></table></td></tr></table>
 | | | | | | | | | | | | | | | | | | | | <table border="1" style="width: 100%; border-collapse: collapse; text-align: center;"> <tr> <td style="width: 10%;"></td> <td style="width: 10%;"></td> <td style="width: 10%;"></td> <td style="width: 10%;"></td> <td style="width: 10%;"></td> <td style="width: 10%;"></td> <td style="width: 10%;"></td> <td style="width: 10%;"></td> <td style="width: 10%;"></td> <td style="width: 10%;"></td> </tr> <tr> <td></td> <td></td> <td colspan="8" style="text-align: center;"> <table border="1" style="width: 100%; border-collapse: collapse; text-align: center;"> <tr> <td style="width: 10%;"></td> <td style="width: 10%;"></td> <td style="width: 10%;"></td> <td style="width: 10%;"></td> <td style="width: 10%;"></td> <td style="width: 10%;"></td> <td style="width: 10%;"></td> <td style="width: 10%;"></td> <td style="width: 10%;"></td> <td style="width: 10%;"></td> </tr> <tr> <td></td> <td></td> <td colspan="8" style="text-align: center;"> <table border="1" style="width: 100%; border-collapse: collapse; text-align: center;"> <tr> <td style="width: 10%;"></td> <td style="width: 10%;"></td> <td style="width: 10%;"></td> <td style="width: 10%;"></td> <td style="width: 10%;"></td> <td style="width: 10%;"></td> <td style="width: 10%;"></td> <td style="width: 10%;"></td> <td style="width: 10%;"></td> <td style="width: 10%;"></td> </tr> <tr> <td></td> <td></td> <td colspan="8" style="text-align: center;"> <table border="1" style="width: 100%; border-collapse: collapse; text-align: center;"> <tr> <td style="width: 10%;"></td> <td style="width: 10%;"></td> <td style="width: 10%;"></td> <td style="width: 10%;"></td> <td style="width: 10%;"></td> <td style="width: 10%;"></td> <td style="width: 10%;"></td> <td style="width: 10%;"></td> <td style="width: 10%;"></td> <td style="width: 10%;"></td> </tr> <tr> <td></td> <td></td> <td colspan="8" style="text-align: center;"> <table border="1" style="width: 100%; border-collapse: collapse; text-align: center;"> <tr> <td style="width: 10%;"></td> <td style="width: 10%;"></td> <td style="width: 10%;"></td> <td style="width: 10%;"></td> <td style="width: 10%;"></td> <td style="width: 10%;"></td> <td style="width: 10%;"></td> <td style="width: 10%;"></td> <td style="width: 10%;"></td> <td style="width: 10%;"></td> </tr> <tr> <td></td> <td></td> <td colspan="8" style="text-align: center;"> <table border="1" style="width: 100%; border-collapse: collapse; text-align: center;"> <tr> <td style="width: 10%;"></td> <td style="width: 10%;"></td> <td style="width: 10%;"></td> <td style="width: 10%;"></td> <td style="width: 10%;"></td> <td style="width: 10%;"></td> <td style="width: 10%;"></td> <td style="width: 10%;"></td> <td style="width: 10%;"></td> <td style="width: 10%;"></td> </tr> <tr> <td></td> <td></td> <td colspan="8" style="text-align: center;"> <table border="1" style="width: 100%; border-collapse: collapse; text-align: center;"> <tr> <td style="width: 10%;"></td> <td style="width: 10%;"></td> <td style="width: 10%;"></td> <td style="width: 10%;"></td> <td style="width: 10%;"></td> <td style="width: 10%;"></td> <td style="width: 10%;"></td> <td style="width: 10%;"></td> <td style="width: 10%;"></td> <td style="width: 10%;"></td> </tr> <tr> <td></td> <td></td> <td colspan="8" style="text-align: center;"> <table border="1" style="width: 100%; border-collapse: collapse; text-align: center;"> <tr> <td style="width: 10%;"></td> <td style="width: 10%;"></td> <td style="width: 10%;"></td> <td style="width: 10%;"></td> <td style="width: 10%;"></td> <td style="width: 10%;"></td> <td style="width: 10%;"></td> <td style="width: 10%;"></td> <td style="width: 10%;"></td> <td style="width: 10%;"></td> </tr> <tr> <td></td> <td></td> <td colspan="8" style="text-align: center;"> <table border="1" style="width: 100%; border-collapse: collapse; text-align: center;"> <tr> <td style="width: 10%;"></td> <td style="width: 10%;"></td> <td style="width: 10%;"></td> <td style="width: 10%;"></td> <td style="width: 10%;"></td> <td style="width: 10%;"></td> <td style="width: 10%;"></td> <td style="width: 10%;"></td> <td style="width: 10%;"></td> <td style="width: 10%;"></td> </tr> <tr> <td></td> <td></td> <td colspan="8" style="text-align: center;"> <table border="1" style="width: 100%; border-collapse: collapse; text-align: center;"> <tr> <td style="width: 10%;"></td> <td
style="width: 10%;"></td> <td style="width: 10%;"></td> <td style="width: 10%;"></td> <td style="width: 10%;"></td> <td style="width: 10%;"></td> <td style="width: 10%;"></td> <td style="width: 10%;"></td> <td style="width: 10%;"></td> <td style="width: 10%;"></td> </tr> <tr> <td></td> <td></td> <td colspan="8" style="text-align: center;"> <table border="1" style="width: 100%; border-collapse: collapse; text-align: center;"> <tr> </tr></table></td></tr></table></td></tr></table></td></tr></table></td></tr></table></td></tr></table></td></tr></table></td></tr></table></td></tr></table></td></tr></table></td></tr></table>
 | | | | | | | | | | | | | | | | | | | | <table border="1" style="width: 100%; border-collapse: collapse; text-align: center;"> <tr> <td style="width: 10%;"></td> <td style="width: 10%;"></td> <td style="width: 10%;"></td> <td style="width: 10%;"></td> <td style="width: 10%;"></td> <td style="width: 10%;"></td> <td style="width: 10%;"></td> <td style="width: 10%;"></td> <td style="width: 10%;"></td> <td style="width: 10%;"></td> </tr> <tr> <td></td> <td></td> <td colspan="8" style="text-align: center;"> <table border="1" style="width: 100%; border-collapse: collapse; text-align: center;"> <tr> <td style="width: 10%;"></td> <td style="width: 10%;"></td> <td style="width: 10%;"></td> <td style="width: 10%;"></td> <td style="width: 10%;"></td> <td style="width: 10%;"></td> <td style="width: 10%;"></td> <td style="width: 10%;"></td> <td style="width: 10%;"></td> <td style="width: 10%;"></td> </tr> <tr> <td></td> <td></td> <td colspan="8" style="text-align: center;"> <table border="1" style="width: 100%; border-collapse: collapse; text-align: center;"> <tr> <td style="width: 10%;"></td> <td style="width: 10%;"></td> <td style="width: 10%;"></td> <td style="width: 10%;"></td> <td style="width: 10%;"></td> <td style="width: 10%;"></td> <td style="width: 10%;"></td> <td style="width: 10%;"></td> <td style="width: 10%;"></td> <td style="width: 10%;"></td> </tr> <tr> <td></td> <td></td> <td colspan="8" style="text-align: center;"> <table border="1" style="width: 100%; border-collapse: collapse; text-align: center;"> <tr> <td style="width: 10%;"></td> <td style="width: 10%;"></td> <td style="width: 10%;"></td> <td style="width: 10%;"></td> <td style="width: 10%;"></td> <td style="width: 10%;"></td> <td style="width: 10%;"></td> <td style="width: 10%;"></td> <td style="width: 10%;"></td> <td style="width: 10%;"></td> </tr> <tr> <td></td> <td></td> <td colspan="8" style="text-align: center;"> <table border="1" style="width: 100%; border-collapse: collapse; text-align: center;"> <tr> <td style="width: 10%;"></td> <td style="width: 10%;"></td> <td style="width: 10%;"></td> <td style="width: 10%;"></td> <td style="width: 10%;"></td> <td style="width: 10%;"></td> <td style="width: 10%;"></td> <td style="width: 10%;"></td> <td style="width: 10%;"></td> <td style="width: 10%;"></td> </tr> <tr> <td></td> <td></td> <td colspan="8" style="text-align: center;"> <table border="1" style="width: 100%; border-collapse: collapse; text-align: center;"> <tr> <td style="width: 10%;"></td> <td style="width: 10%;"></td> <td style="width: 10%;"></td> <td style="width: 10%;"></td> <td style="width: 10%;"></td> <td style="width: 10%;"></td> <td style="width: 10%;"></td> <td style="width: 10%;"></td> <td style="width: 10%;"></td> <td style="width: 10%;"></td> </tr> <tr> <td></td> <td></td> <td colspan="8" style="text-align: center;"> <table border="1" style="width: 100%; border-collapse: collapse; text-align: center;"> <tr> <td style="width: 10%;"></td> <td style="width: 10%;"></td> <td style="width: 10%;"></td> <td style="width: 10%;"></td> <td style="width: 10%;"></td> <td style="width: 10%;"></td> <td style="width: 10%;"></td> <td style="width: 10%;"></td> <td style="width: 10%;"></td> <td style="width: 10%;"></td> </tr> <tr> <td></td> <td></td> <td colspan="8" style="text-align: center;"> <table border="1" style="width: 100%; border-collapse: collapse; text-align: center;"> <tr> <td style="width: 10%;"></td> <td style="width: 10%;"></td> <td style="width: 10%;"></td> <td style="width: 10%;"></td> <td style="width: 10%;"></td> <td style="width: 10%;"></td> <td style="width: 10%;"></td> <td style="width: 10%;"></td> <td style="width: 10%;"></td> <td style="width: 10%;"></td> </tr> <tr> <td></td> <td></td> <td colspan="8" style="text-align: center;"> <table border="1" style="width: 100%; border-collapse: collapse; text-align: center;"> <tr> <td style="width: 10%;"></td> <td style="width: 10%;"></td> <td style="width: 10%;"></td> <td style="width: 10%;"></td> <td style="width: 10%;"></td> <td style="width: 10%;"></td> <td style="width: 10%;"></td> <td style="width: 10%;"></td> <td style="width: 10%;"></td> <td style="width: 10%;"></td> </tr> <tr> <td></td> <td></td> <td colspan="8" style="text-align: center;"> <table border="1" style="width: 100%; border-collapse: collapse; text-align: center;"> <tr> </tr></table></td></tr></table></td></tr></table></td></tr></table></td></tr></table></td></tr></table></td></tr></table></td></tr></table></td></tr></table></td></tr></table>

 | | | | | | | | | | | | | | | | | | | | <table border="1" style="width: 100%; border-collapse: collapse; text-align: center;"> <tr> <td style="width: 10%;"></td> <td style="width: 10%;"></td> <td style="width: 10%;"></td> <td style="width: 10%;"></td> <td style="width: 10%;"></td> <td style="width: 10%;"></td> <td style="width: 10%;"></td> <td style="width: 10%;"></td> <td style="width: 10%;"></td> <td style="width: 10%;"></td> </tr> <tr> <td></td> <td></td> <td colspan="8" style="text-align: center;"> <table border="1" style="width: 100%; border-collapse: collapse; text-align: center;"> <tr> <td style="width: 10%;"></td> <td style="width: 10%;"></td> <td style="width: 10%;"></td> <td style="width: 10%;"></td> <td style="width: 10%;"></td> <td style="width: 10%;"></td> <td style="width: 10%;"></td> <td style="width: 10%;"></td> <td style="width: 10%;"></td> <td style="width: 10%;"></td> </tr> <tr> <td></td> <td></td> <td colspan="8" style="text-align: center;"> <table border="1" style="width: 100%; border-collapse: collapse; text-align: center;"> <tr> <td style="width: 10%;"></td> <td style="width: 10%;"></td> <td style="width: 10%;"></td> <td style="width: 10%;"></td> <td style="width: 10%;"></td> <td style="width: 10%;"></td> <td style="width: 10%;"></td> <td style="width: 10%;"></td> <td style="width: 10%;"></td> <td style="width: 10%;"></td> </tr> <tr> <td></td> <td></td> <td colspan="8" style="text-align: center;"> <table border="1" style="width: 100%; border-collapse: collapse; text-align: center;"> <tr> <td style="width: 10%;"></td> <td style="width: 10%;"></td> <td style="width: 10%;"></td> <td style="width: 10%;"></td> <td style="width: 10%;"></td> <td style="width: 10%;"></td> <td style="width: 10%;"></td> <td style="width: 10%;"></td> <td style="width: 10%;"></td> <td style="width: 10%;"></td> </tr> <tr> <td></td> <td></td> <td colspan="8" style="text-align: center;"> <table border="1" style="width: 100%; border-collapse: collapse; text-align: center;"> <tr> <td style="width: 10%;"></td> <td style="width: 10%;"></td> <td style="width: 10%;"></td> <td style="width: 10%;"></td> <td style="width: 10%;"></td> <td style="width: 10%;"></td> <td style="width: 10%;"></td> <td style="width: 10%;"></td> <td style="width: 10%;"></td> <td style="width: 10%;"></td> </tr> <tr> <td></td> <td></td> <td colspan="8" style="text-align: center;"> <table border="1" style="width: 100%; border-collapse: collapse; text-align: center;"> <tr> <td style="width: 10%;"></td> <td style="width: 10%;"></td> <td style="width: 10%;"></td> <td style="width: 10%;"></td> <td style="width: 10%;"></td> <td style="width: 10%;"></td> <td style="width: 10%;"></td> <td style="width: 10%;"></td> <td style="width: 10%;"></td> <td style="width: 10%;"></td> </tr> <tr> <td></td> <td></td> <td colspan="8" style="text-align: center;"> <table border="1" style="width: 100%; border-collapse: collapse; text-align: center;"> <tr> <td style="width: 10%;"></td> <td style="width: 10%;"></td> <td style="width: 10%;"></td> <td style="width: 10%;"></td> <td style="width: 10%;"></td> <td style="width: 10%;"></td> <td style="width: 10%;"></td> <td style="width: 10%;"></td> <td style="width: 10%;"></td> <td style="width: 10%;"></td> </tr> <tr> <td></td> <td></td> <td colspan="8" style="text-align: center;"> <table border="1" style="width: 100%; border-collapse: collapse; text-align: center;"> <tr> <td style="width: 10%;"></td> <td style="width: 10%;"></td> <td style="width: 10%;"></td> <td style="width: 10%;"></td> <td style="width: 10%;"></td> <td style="width: 10%;"></td> <td style="width: 10%;"></td> <td style="width: 10%;"></td> <td style="width: 10%;"></td> <td style="width: 10%;"></td> </tr> <tr> <td></td> <td></td> <td colspan="8" style="text-align: center;"> <table border="1" style="width: 100%; border-collapse: collapse; text-align: center;"> <tr> </tr></table></td></tr></table></td></tr></table></td></tr></table></td></tr></table></td></tr></table></td></tr></table></td></tr></table></td></tr></table>

 | | | | | | | | | | | | | | | | | | | | <table border="1" style="width: 100%; border-collapse: collapse; text-align: center;"> <tr> <td style="width: 10%;"></td> <td style="width: 10%;"></td> <td style="width: 10%;"></td> <td style="width: 10%;"></td> <td style="width: 10%;"></td> <td style="width: 10%;"></td> <td style="width: 10%;"></td> <td style="width: 10%;"></td> <td style="width: 10%;"></td> <td style="width: 10%;"></td> </tr> <tr> <td></td> <td></td> <td colspan="8" style="text-align: center;"> <table border="1" style="width: 100%; border-collapse: collapse; text-align: center;"> <tr> <td style="width: 10%;"></td> <td style="width: 10%;"></td> <td style="width: 10%;"></td> <td style="width: 10%;"></td> <td style="width: 10%;"></td> <td style="width: 10%;"></td> <td style="width: 10%;"></td> <td style="width: 10%;"></td> <td style="width: 10%;"></td> <td style="width: 10%;"></td> </tr> <tr> <td></td> <td></td> <td colspan="8" style="text-align: center;"> <table border="1" style="width: 100%; border-collapse: collapse; text-align: center;"> <tr> <td style="width: 10%;"></td> <td style="width: 10%;"></td> <td style="width: 10%;"></td> <td style="width: 10%;"></td> <td style="width: 10%;"></td> <td style="width: 10%;"></td> <td style="width: 10%;"></td> <td style="width: 10%;"></td> <td style="width: 10%;"></td> <td style="width: 10%;"></td> </tr> <tr> <td></td> <td></td> <td colspan="8" style="text-align: center;"> <table border="1" style="width: 100%; border-collapse: collapse; text-align: center;"> <tr> <td style="width: 10%;"></td> <td style="width: 10%;"></td> <td style="width: 10%;"></td> <td style="width: 10%;"></td> <td style="width: 10%;"></td> <td style="width: 10%;"></td> <td style="width: 10%;"></td> <td style="width: 10%;"></td> <td style="width: 10%;"></td> <td style="width: 10%;"></td> </tr> <tr> <td></td> <td></td> <td colspan="8" style="text-align: center;"> <table border="1" style="width: 100%; border-collapse: collapse; text-align: center;"> <tr> <td style="width: 10%;"></td> <td style="width: 10%;"></td> <td style="width: 10%;"></td> <td style="width: 10%;"></td> <td style="width: 10%;"></td> <td style="width: 10%;"></td> <td style="width: 10%;"></td> <td style="width: 10%;"></td> <td style="width: 10%;"></td> <td style="width: 10%;"></td> </tr> <tr> <td></td> <td></td> <td colspan="8" style="text-align: center;"> <table border="1" style="width: 100%; border-collapse: collapse; text-align: center;"> <tr> <td style="width: 10%;"></td> <td style="width: 10%;"></td> <td style="width: 10%;"></td> <td style="width: 10%;"></td> <td style="width: 10%;"></td> <td style="width: 10%;"></td> <td style="width: 10%;"></td> <td style="width: 10%;"></td> <td style="width: 10%;"></td> <td style="width: 10%;"></td> </tr> <tr> <td></td> <td></td> <td colspan="8" style="text-align: center;"> <table border="1" style="width: 100%; border-collapse: collapse; text-align: center;"> <tr> <td style="width: 10%;"></td> <td style="width: 10%;"></td> <td style="width: 10%;"></td> <td style="width: 10%;"></td> <td style="width: 10%;"></td> <td style="width: 10%;"></td> <td style="width: 10%;"></td> <td style="width: 10%;"></td> <td style="width: 10%;"></td> <td style="width: 10%;"></td> </tr> <tr> <td></td> <td></td> <td colspan="8" style="text-align: center;"> <table border="1" style="width: 100%; border-collapse: collapse; text-align: center;"> <tr> </tr></table></td></tr></table></td></tr></table></td></tr></table></td></tr></table></td></tr></table></td></tr></table></td></tr></table>
 | | | | | | | | | | | | | | | | | | | | <table border="1" style="width: 100%; border-collapse: collapse; text-align: center;"> <tr> <td style="width: 10%;"></td> <td style="width: 10%;"></td> <td style="width: 10%;"></td> <td style="width: 10%;"></td> <td style="width: 10%;"></td> <td style="width: 10%;"></td> <td style="width: 10%;"></td> <td style="width: 10%;"></td> <td style="width: 10%;"></td> <td style="width: 10%;"></td> </tr> <tr> <td></td> <td></td> <td colspan="8" style="text-align: center;"> <table border="1" style="width: 100%; border-collapse: collapse; text-align: center;"> <tr> <td style="width: 10%;"></td> <td style="width: 10%;"></td> <td style="width: 10%;"></td> <td style="width: 10%;"></td> <td style="width: 10%;"></td> <td style="width: 10%;"></td> <td style="width: 10%;"></td> <td style="width: 10%;"></td> <td style="width: 10%;"></td> <td style="width: 10%;"></td> </tr> <tr> <td></td> <td></td> <td colspan="8" style="text-align: center;"> <table border="1" style="width: 100%; border-collapse: collapse; text-align: center;"> <tr> <td style="width: 10%;"></td> <td style="width: 10%;"></td> <td style="width: 10%;"></td> <td style="width: 10%;"></td> <td style="width: 10%;"></td> <td style="width: 10%;"></td> <td style="width: 10%;"></td> <td style="width: 10%;"></td> <td style="width: 10%;"></td> <td style="width: 10%;"></td> </tr> <tr> <td></td> <td></td> <td colspan="8" style="text-align: center;"> <table border="1" style="width: 100%; border-collapse: collapse; text-align: center;"> <tr> <td style="width: 10%;"></td> <td style="width: 10%;"></td> <td style="width: 10%;"></td> <td style="width: 10%;"></td> <td style="width: 10%;"></td> <td style="width: 10%;"></td> <td style="width: 10%;"></td> <td style="width: 10%;"></td> <td style="width: 10%;"></td> <td style="width: 10%;"></td> </tr> <tr> <td></td> <td></td> <td colspan="8" style="text-align: center;"> <table border="1" style="width: 100%; border-collapse: collapse; text-align: center;"> <tr> <td style="width: 10%;"></td> <td style="width: 10%;"></td> <td style="width: 10%;"></td> <td style="width: 10%;"></td> <td style="width: 10%;"></td> <td style="width: 10%;"></td> <td style="width: 10%;"></td> <td style="width: 10%;"></td> <td style="width: 10%;"></td> <td style="width: 10%;"></td> </tr> <tr> <td></td> <td></td> <td colspan="8" style="text-align: center;"> <table border="1" style="width: 100%; border-collapse: collapse; text-align: center;"> <tr> <td style="width: 10%;"></td> <td style="width: 10%;"></td> <td style="width: 10%;"></td> <td style="width: 10%;"></td> <td style="width: 10%;"></td> <td style="width: 10%;"></td> <td style="width: 10%;"></td> <td style="width: 10%;"></td> <td style="width: 10%;"></td> <td style="width:
10%;"></td> </tr> <tr> <td></td> <td></td> <td colspan="8" style="text-align: center;"> <table border="1" style="width: 100%; border-collapse: collapse; text-align: center;"> <tr> </tr></table></td></tr></table></td></tr></table></td></tr></table></td></tr></table></td></tr></table></td></tr></table>
 | | | | | | | | | | | | | | | | | | | | <table border="1" style="width: 100%; border-collapse: collapse; text-align: center;"> <tr> <td style="width: 10%;"></td> <td style="width: 10%;"></td> <td style="width: 10%;"></td> <td style="width: 10%;"></td> <td style="width: 10%;"></td> <td style="width: 10%;"></td> <td style="width: 10%;"></td> <td style="width: 10%;"></td> <td style="width: 10%;"></td> <td style="width: 10%;"></td> </tr> <tr> <td></td> <td></td> <td colspan="8" style="text-align: center;"> <table border="1" style="width: 100%; border-collapse: collapse; text-align: center;"> <tr> <td style="width: 10%;"></td> <td style="width: 10%;"></td> <td style="width: 10%;"></td> <td style="width: 10%;"></td> <td style="width: 10%;"></td> <td style="width: 10%;"></td> <td style="width: 10%;"></td> <td style="width: 10%;"></td> <td style="width: 10%;"></td> <td style="width: 10%;"></td> </tr> <tr> <td></td> <td></td> <td colspan="8" style="text-align: center;"> <table border="1" style="width: 100%; border-collapse: collapse; text-align: center;"> <tr> <td style="width: 10%;"></td> <td style="width: 10%;"></td> <td style="width: 10%;"></td> <td style="width: 10%;"></td> <td style="width: 10%;"></td> <td style="width: 10%;"></td> <td style="width: 10%;"></td> <td style="width: 10%;"></td> <td style="width: 10%;"></td> <td style="width: 10%;"></td> </tr> <tr> <td></td> <td></td> <td colspan="8" style="text-align: center;"> <table border="1" style="width: 100%; border-collapse: collapse; text-align: center;"> <tr> <td style="width: 10%;"></td> <td style="width: 10%;"></td> <td style="width: 10%;"></td> <td style="width: 10%;"></td> <td style="width: 10%;"></td> <td style="width: 10%;"></td> <td style="width: 10%;"></td> <td style="width: 10%;"></td> <td style="width: 10%;"></td> <td style="width: 10%;"></td> </tr> <tr> <td></td> <td></td> <td colspan="8" style="text-align: center;"> <table border="1" style="width: 100%; border-collapse: collapse; text-align: center;"> <tr> <td style="width: 10%;"></td> <td style="width: 10%;"></td> <td style="width: 10%;"></td> <td style="width: 10%;"></td> <td style="width: 10%;"></td> <td style="width: 10%;"></td> <td style="width: 10%;"></td> <td style="width: 10%;"></td> <td style="width: 10%;"></td> <td style="width: 10%;"></td> </tr> <tr> <td></td> <td></td> <td colspan="8" style="text-align: center;"> <table border="1" style="width: 100%; border-collapse: collapse; text-align: center;"> <tr> </tr></table></td></tr></table></td></tr></table></td></tr></table></td></tr></table></td></tr></table>

 | | | | | | | | | | | | | | | | | | | | <table border="1" style="width: 100%; border-collapse: collapse; text-align: center;"> <tr> <td style="width: 10%;"></td> <td style="width: 10%;"></td> <td style="width: 10%;"></td> <td style="width: 10%;"></td> <td style="width: 10%;"></td> <td style="width: 10%;"></td> <td style="width: 10%;"></td> <td style="width: 10%;"></td> <td style="width: 10%;"></td> <td style="width: 10%;"></td> </tr> <tr> <td></td> <td></td> <td colspan="8" style="text-align: center;"> <table border="1" style="width: 100%; border-collapse: collapse; text-align: center;"> <tr> <td style="width: 10%;"></td> <td style="width: 10%;"></td> <td style="width: 10%;"></td> <td style="width: 10%;"></td> <td style="width: 10%;"></td> <td style="width: 10%;"></td> <td style="width: 10%;"></td> <td style="width: 10%;"></td> <td style="width: 10%;"></td> <td style="width: 10%;"></td> </tr> <tr> <td></td> <td></td> <td colspan="8" style="text-align: center;"> <table border="1" style="width: 100%; border-collapse: collapse; text-align: center;"> <tr> <td style="width: 10%;"></td> <td style="width: 10%;"></td> <td style="width: 10%;"></td> <td style="width: 10%;"></td> <td style="width: 10%;"></td> <td style="width: 10%;"></td> <td style="width: 10%;"></td> <td style="width: 10%;"></td> <td style="width: 10%;"></td> <td style="width: 10%;"></td> </tr> <tr> <td></td> <td></td> <td colspan="8" style="text-align: center;"> <table border="1" style="width: 100%; border-collapse: collapse; text-align: center;"> <tr> <td style="width: 10%;"></td> <td style="width: 10%;"></td> <td style="width: 10%;"></td> <td style="width: 10%;"></td> <td style="width: 10%;"></td> <td style="width: 10%;"></td> <td style="width: 10%;"></td> <td style="width: 10%;"></td> <td style="width: 10%;"></td> <td style="width: 10%;"></td> </tr> <tr> <td></td> <td></td> <td colspan="8" style="text-align: center;"> <table border="1" style="width: 100%; border-collapse: collapse; text-align: center;"> <tr> </tr></table></td></tr></table></td></tr></table></td></tr></table></td></tr></table>
 | | | | | | | | | | | | | | | | | | | | <table border="1" style="width: 100%; border-collapse: collapse; text-align: center;"> <tr> <td style="width: 10%;"></td> <td style="width: 10%;"></td> <td style="width: 10%;"></td> <td style="width: 10%;"></td> <td style="width: 10%;"></td> <td style="width: 10%;"></td> <td style="width: 10%;"></td> <td style="width: 10%;"></td> <td style="width: 10%;"></td> <td style="width: 10%;"></td> </tr> <tr> <td></td> <td></td> <td colspan="8" style="text-align: center;"> <table border="1" style="width: 100%; border-collapse: collapse; text-align: center;"> <tr> <td style="width: 10%;"></td> <td style="width: 10%;"></td> <td style="width: 10%;"></td> <td style="width: 10%;"></td> <td style="width: 10%;"></td> <td style="width: 10%;"></td> <td style="width: 10%;"></td> <td style="width: 10%;"></td> <td style="width: 10%;"></td> <td style="width: 10%;"></td> </tr> <tr> <td></td> <td></td> <td colspan="8" style="text-align: center;"> <table border="1" style="width: 100%; border-collapse: collapse; text-align: center;"> <tr> <td style="width: 10%;"></td> <td style="width: 10%;"></td> <td style="width: 10%;"></td> <td style="width: 10%;"></td> <td style="width: 10%;"></td> <td style="width: 10%;"></td> <td style="width: 10%;"></td> <td style="width: 10%;"></td> <td style="width: 10%;"></td> <td style="width: 10%;"></td> </tr> <tr> <td></td> <td></td> <td colspan="8" style="text-align: center;"> <table border="1" style="width: 100%; border-collapse: collapse; text-align: center;"> <tr> </tr></table></td></tr></table></td></tr></table></td></tr></table>

 | | | | | | | | | | | | | | | | | | | | <table border="1" style="width: 100%; border-collapse: collapse; text-align: center;"> <tr> <td style="width: 10%;"></td> <td style="width: 10%;"></td> <td style="width: 10%;"></td> <td style="width: 10%;"></td> <td style="width: 10%;"></td> <td style="width: 10%;"></td> <td style="width: 10%;"></td> <td style="width: 10%;"></td> <td style="width: 10%;"></td> <td style="width: 10%;"></td> </tr> <tr> <td></td> <td></td> <td colspan="8" style="text-align: center;"> <table border="1" style="width: 100%; border-collapse: collapse; text-align: center;"> <tr> <td style="width: 10%;"></td> <td style="width: 10%;"></td> <td style="width: 10%;"></td> <td style="width: 10%;"></td> <td style="width: 10%;"></td> <td style="width: 10%;"></td> <td style="width: 10%;"></td> <td style="width: 10%;"></td> <td style="width: 10%;"></td> <td style="width: 10%;"></td> </tr> <tr> <td></td> <td></td> <td colspan="8" style="text-align: center;"> <table border="1" style="width: 100%; border-collapse: collapse; text-align: center;"> <tr> </tr></table></td></tr></table></td></tr></table>
 | | | | | | | | | | | | | | | | | | | | <table border="1" style="width: 100%; border-collapse: collapse; text-align: center;"> <tr> <td style="width: 10%;"></td> <td style="width: 10%;"></td> <td style="width: 10%;"></td> <td style="width: 10%;"></td> <td style="width: 10%;"></td> <td style="width: 10%;"></td> <td style="width: 10%;"></td> <td style="width: 10%;"></td> <td style="width: 10%;"></td> <td style="width: 10%;"></td> </tr> <tr> <td></td> <td></td> <td colspan="8" style="text-align: center;"> <table border="1" style="width: 100%; border-collapse: collapse; text-align: center;"> <tr> </tr></table></td></tr></table>

 | | | | | | | | | | | | | | | | | | | | <table border="1" style="width: 100%; border-collapse: collapse; text-align: center;"> <tr> </tr></table>
 | | | | | | | | | | | | | | | | | | | |
 | | | | | | | | | | | | | | | | | | | |
 | | | | | | | | | | | | | | | | | | | |

 | | | | | | | | | | | | | | | | | | | | | | | | | | | | | | | | | | | | | | | | | | | | | | | | | | | | | | | | | | | | | | | | | | | | | | | | | | | | | | | |
 | | | | | | | | | | | | | | | | | | | |
 | | | | | | | | | | | | | | | | | | | |
 | | | | | | | | | | | | | | | | | | | |
 | | | | | | | | | | | | | | | | | | | |
 | | | | | | | | | | | | | | | | | | | |
 | | | | | | | | | | | | | | | | | | | |
 | | | | | | | | | | | | | | | | | | | |
 | | | | | | | | | | | | | | | | | | | |
 | | | | | | | | | | | | | | | | | | | | | | | | | | | | | | | | | | | | | | | |
 | | | | | | | | | | | | | | | | | | | |
 | | | | | | | | | | | | | | | | | | | | | | | | | | | | | | | | | | | | | | | |
 | | | | | | | | | | | | | | | | | | | | | | | | | | | | | | | | | | | | | | | |
 | | | | | | | | | | | | | | | | | | | | | | | | | | | | | | | | | | | | | | | |
 | | | | | | | | | | | | | | | | | | | | | | | | | | | | | | | | | | | | | | | | | | | | | | | | | | | | | | | | | | | | | | | | | | | | | | | | | | | | | | | |
 | | | | | | | | | | | | | | | | | | | | | | | | | | | | | | | | | | | | | | | | | | | | | | | | | | | | | | | | | | | | | | | | | | | |
| | |

 | | | | | | | | | | | | | | | | | | | |

 | | | | | | | | | | | | | | | | | | | |

 | | | | | | | | | | | | | | | | | | | |

 | | | | | | | | | | | | | | | | | | | |

 | | | | | | | | | | | | | | | | | | | |

 | | | | | | | | | | | | | | | | | | | |

 | | | | | | | | | | | | | | | | | | | |

 | | | | | | | | | | | | | | | | | | | |

 | | | | | | | | | | | | | | | | | | | |

 | | | | | | | | | | | | | | | | | | | |

 | | | | | | | | | | | | | | | | | | | |

 | | | | | | | | | | | | | | | | | | | |

 | | | | | | | | | | | | | | | | | | | |

 | | | | | | | | | | | | | | | | | | | |

 | | | | | | | | | | | | | | | | | | | |

 | | | | | | | | | | | | | | | | | | | |

 | | | | | | | | | | | | | | | | | | | |

 | | | | | | | | | | | | | | | | | | | |

 | | | | | | | | | | | | | | | | | | | |

 | | | | | | | | | | | | | | | | | | | |

 | | | | | | | | | | | | | | | | | | | |

 | | | | | | | | | | | | | | | | | | | |

 | | | | | | | | | | | | | | | | | | | |

 | | | | | | | | | | | | | | | | | | | |

 | | | | | | | | | | | | | | | | | | | |

 | | | | | | | | | | | | | | | | | | | |

 | | | | | | | | | | | | | | | | | | | |

 | | | | | | | | | | | | | | | | | | | |
 | | | | | | | | | | | | | | | | | | | |

 | | | | | | | | | | | | | | | | | | | |

 | | | | | | | | | | | | | | | | | | | |
 | | | | | | | | | | | | | | | | | | | |

 | | | | | | | | | | | | | | | | | | | |

 | | | | | | | | | | | | | | | | | | | |
 | | | | | | | | | | | | | | | | | | | |
 | | | | | | | | | | | | | | | | | | | |

 | | | | | | | | | | | | | | | | | | | |
 | | | | | | | | | | | | | | | | | | | |
 | | | | | | | | | | | | | | | | | | | |

 | | | | | | | | | | | | | | | | | | | | | | | | | | | | | | | | | | | | | | | | | | | | | | | | | | | | | | | | | | | | | | | | | | | | | | | | | | | | | | | | | | | | | | | | | | | | | | | | | | | |
 | | | | | | | | | | | | | | | | | | | |
 | | | | | | | | | | | | | | | | | | | |
 | | | | | | | | | | | | | | | | | | | |
 | | | | | | | | | | | | | | | | | | | |
 | | | | | | | | | | | | | | | | | | | |
 | | | | | | | | | | | | | | | | | | | |
 | | | | | | | | | | | | | | | | | | | |
 | | | | | | | | | | | | | | | | | | | |
 | | | | | | | | | | | | | | | | | | | | | | | | | | | | | | | | | | | | | | | |
 | | | | | | | | | | | | | | | | | | | |
 | | | | | | | | | | | | | | | | | | | | | | | | | | | | | | | | | | | | | | | |
 | | | | | | | | | | | | | | | | | | | | | | | | | | | | | | | | | | | | | | | |
 | | | | | | | | | | | | | | | | | | | | | | | | | | | | | | | | | | | | | | | |
 | | | | | | | | | | | | | | | | | | | | | | | | | | | | | | | | | | | | | | | | | | | | | | | | | | | | | | | | | | | | | | | | | | | | | | | | | | | | | | | | | | | | | | | | | | | | | | | | | | | |
 | | | | | | | | | | | | | | | | | | | | | | | | | | | | | | | | | | | | | | | | | | | | | | | |
| | | <table border="1" style="width: 100%; border-collapse: collapse; text-align: center;"> <tr> <td style="width: 10%;"></td> <td style="width: 10%;"></td> <td style="width: 10%;"></td> <td style="width: 10%;"></td> <td style="width: 10%;"></td> <td style="width: 10%;"></td> <td style="width: 10%;"></td> <td style="width: 10%;"></td> <td style="width: 10%;"></td> <td style="width: 10%;"></td> </tr> <tr> <td></td> <td></td> <td colspan="8" style="text-align: center;"> <table border="1" style="width: 100%; border-collapse: collapse; text-align: center;"> <tr> <td style="width: 10%;"></td> <td style="width: 10%;"></td> <td style="width: 10%;"></td> <td style="width: 10%;"></td> <td style="width: 10%;"></td> <td style="width: 10%;"></td> <td style="width: 10%;"></td> <td style="width: 10%;"></td> <td style="width: 10%;"></td> <td style="width: 10%;"></td> </tr> <tr> <td></td> <td></td> <td colspan="8" style="text-align: center;"> <table border="1" style="width: 100%; border-collapse: collapse; text-align: center;"> <tr> <td style="width: 10%;"></td> <td style="width: 10%;"></td> <td style="width: 10%;"></td> <td style="width: 10%;"></td> <td style="width: 10%;"></td> <td style="width: 10%;"></td> <td style="width: 10%;"></td> <td style="width: 10%;"></td> <td style="width: 10%;"></td> <td style="width: 10%;"></td> </tr> <tr> <td></td> <td></td> <td colspan="8" style="text-align: center;"> <table border="1" style="width: 100%; border-collapse: collapse; text-align: center;"> <tr> <td style="width: 10%;"></td> <td style="width: 10%;"></td> <td style="width: 10%;"></td> <td style="width: 10%;"></td> <td style="width: 10%;"></td> <td style="width: 10%;"></td> <td style="width: 10%;"></td> <td style="width: 10%;"></td> <td style="width: 10%;"></td> <td style="width: 10%;"></td> </tr> <tr> <td></td> <td></td> <td colspan="8" style="text-align: center;"> <table border="1" style="width: 100%; border-collapse: collapse; text-align: center;"> <tr> <td style="width: 10%;"></td> <td style="width: 10%;"></td> <td style="width: 10%;"></td> <td style="width: 10%;"></td> <td style="width: 10%;"></td> <td style="width: 10%;"></td> <td style="width: 10%;"></td> <td style="width: 10%;"></td> <td style="width: 10%;"></td> <td style="width: 10%;"></td> </tr> <tr> <td></td> <td></td> <td colspan="8" style="text-align: center;"> <table border="1" style="width: 100%; border-collapse: collapse; text-align: center;"> <tr> <td style="width: 10%;"></td> <td style="width: 10%;"></td> <td style="width: 10%;"></td> <td style="width: 10%;"></td> <td style="width: 10%;"></td> <td style="width: 10%;"></td> <td style="width: 10%;"></td> <td style="width: 10%;"></td> <td style="width: 10%;"></td> <td style="width: 10%;"></td> </tr> <tr> <td></td> <td></td> <td colspan="8" style="text-align: center;"> <table border="1" style="width: 100%; border-collapse: collapse; text-align: center;"> <tr> <td style="width: 10%;"></td> <td style="width: 10%;"></td> <td style="width: 10%;"></td> <td style="width: 10%;"></td> <td style="width: 10%;"></td> <td style="width: 10%;"></td> <td style="width: 10%;"></td> <td style="width: 10%;"></td> <td style="width: 10%;"></td> <td style="width: 10%;"></td> </tr> <tr> <td></td> <td></td> <td colspan="8" style="text-align: center;"> <table border="1" style="width: 100%; border-collapse: collapse; text-align: center;"> <tr> <td style="width: 10%;"></td> <td style="width: 10%;"></td> <td style="width: 10%;"></td> <td style="width: 10%;"></td> <td style="width: 10%;"></td> <td style="width: 10%;"></td> <td style="width: 10%;"></td> <td style="width: 10%;"></td> <td style="width: 10%;"></td> <td style="width: 10%;"></td> </tr> <tr> <td></td> <td></td> <td colspan="8" style="text-align: center;"> <table border="1" style="width: 100%; border-collapse: collapse; text-align: center;"> <tr> <td style="width: 10%;"></td> <td style="width: 10%;"></td> <td style="width: 10%;"></td> <td style="width: 10%;"></td> <td style="width: 10%;"></td> <td style="width: 10%;"></td> <td style="width: 10%;"></td> <td style="width: 10%;"></td> <td style="width: 10%;"></td> <td style="width: 10%;"></td> </tr> <tr> <td></td> <td></td> <td colspan="8" style="text-align: center;"> <table border="1" style="width: 100%; border-collapse: collapse; text-align: center;"> <tr> <td style="width: 10%;"></td> <td style="width: 10%;"></td> <td style="width: 10%;"></td> <td style="width: 10%;"></td> <td style="width: 10%;"></td> <td style="width: 10%;"></td> <td style="width: 10%;"></td> <td style="width: 10%;"></td> <td style="width: 10%;"></td> <td style="width: 10%;"></td> </tr> <tr> <td></td> <td></td> <td colspan="8" style="text-align: center;"> <table border="1" style="width: 100%; border-collapse: collapse; text-align: center;"> <tr> <td style="width: 10%;"></td> <td style="width: 10%;"></td> <td style="width: 10%;"></td> <td style="width: 10%;"></td> <td style="width: 10%;"></td> <td style="width: 10%;"></td> <td style="width: 10%;"></td> <td style="width: 10%;"></td> <td style="width: 10%;"></td> <td style="width: 10%;"></td> </tr> <tr> <td></td> <td></td> <td colspan="8" style="text-align: center;"> <table border="1" style="width: 100%; border-collapse: collapse; text-align: center;"> <tr> <td style="width: 10%;"></td> <td style="width: 10%;"></td> <td style="width: 10%;"></td> <td style="width: 10%;"></td> <td style="width: 10%;"></td> <td style="width: 10%;"></td> <td style="width: 10%;"></td> <td style="width: 10%;"></td> <td style="width: 10%;"></td> <td style="width: 10%;"></td> </tr> <tr> <td></td> <td></td> <td colspan="8" style="text-align: center;"> <table border="1" style="width: 100%; border-collapse: collapse; text-align: center;"> <tr> <td style="width: 10%;"></td> <td style="width: 10%;"></td> <td style="width: 10%;"></td> <td style="width: 10%;"></td> <td style="width: 10%;"></td> <td style="width: 10%;"></td> <td style="width: 10%;"></td> <td style="width: 10%;"></td> <td style="width: 10%;"></td> <td style="width: 10%;"></td> </tr> <tr> <td></td> <td></td> <td colspan="8" style="text-align: center;"> <table border="1" style="width: 100%; border-collapse: collapse; text-align: center;"> <tr> <td style="width: 10%;"></td> <td style="width: 10%;"></td> <td style="width: 10%;"></td> <td style="width: 10%;"></td> <td style="width: 10%;"></td> <td style="width: 10%;"></td> <td style="width: 10%;"></td> <td style="width: 10%;"></td> <td style="width: 10%;"></td> <td style="width: 10%;"></td> </tr> <tr> <td></td> <td></td> <td colspan="8" style="text-align: center;"> <table border="1" style="width: 100%; border-collapse: collapse; text-align: center;"> <tr> <td style="width: 10%;"></td> <td style="width: 10%;"></td> <td style="width: 10%;"></td> <td style="width: 10%;"></td> <td style="width: 10%;"></td> <td style="width: 10%;"></td> <td style="width: 10%;"></td> <td style="width: 10%;"></td> <td style="width: 10%;"></td> <td style="width: 10%;"></td> </tr> <tr> <td></td> <td></td> <td colspan="8" style="text-align: center;"> <table border="1" style="width: 100%; border-collapse: collapse; text-align: center;"> <tr> <td style="width: 10%;"></td> <td style="width: 10%;"></td> <td style="width: 10%;"></td> <td style="width: 10%;"></td> <td style="width: 10%;"></td> <td style="width: 10%;"></td> <td style="width: 10%;"></td> <td style="width: 10%;"></td> <td style="width: 10%;"></td> <td style="width: 10%;"></td> </tr> <tr> <td></td> <td></td> <td colspan="8" style="text-align: center;"> <table border="1" style="width: 100%; border-collapse: collapse; text-align: center;"> <tr> <td style="width: 10%;"></td> <td style="width: 10%;"></td> <td style="width: 10%;"></td> <td style="width: 10%;"></td> <td style="width: 10%;"></td> <td style="width: 10%;"></td> <td style="width: 10%;"></td> <td style="width: 10%;"></td> <td style="width: 10%;"></td> <td style="width: 10%;"></td> </tr> <tr> <td></td> <td></td> <td colspan="8" style="text-align: center;"> <table border="1" style="width: 100%; border-collapse: collapse; text-align: center;"> <tr> <td style="width: 10%;"></td> <td style="width: 10%;"></td> <td style="width: 10%;"></td> <td style="width: 10%;"></td> <td style="width: 10%;"></td> <td style="width: 10%;"></td> <td style="width: 10%;"></td> <td style="width: 10%;"></td> <td style="width: 10%;"></td> <td style="width: 10%;"></td> </tr> <tr> <td></td> <td></td> <td colspan="8" style="text-align: center;"> <table border="1" style="width: 100%; border-collapse: collapse; text-align: center;"> <tr> <td style="width: 10%;"></td> <td style="width: 10%;"></td> <td style="width: 10%;"></td> <td style="width: 10%;"></td> <td style="width: 10%;"></td> <td style="width: 10%;"></td> <td style="width: 10%;"></td> <td style="width: 10%;"></td> <td style="width: 10%;"></td> <td style="width: 10%;"></td> </tr> <tr> <td></td> <td></td> <td colspan="8" style="text-align: center;"> <table border="1" style="width: 100%; border-collapse: collapse; text-align: center;"> <tr> <td style="width: 10%;"></td> <td style="width: 10%;"></td> <td style="width: 10%;"></td> <td style="width: 10%;"></td> <td style="width: 10%;"></td> <td style="width: 10%;"></td> <td style="width: 10%;"></td> <td style="width: 10%;"></td> <td style="width: 10%;"></td> <td style="width: 10%;"></td> </tr> <tr> <td></td> <td></td> <td colspan="8" style="text-align: center;"> <table border="1" style="width: 100%; border-collapse: collapse; text-align: center;"> <tr> <td style="width: 10%;"></td> <td style="width: 10%;"></td> <td style="width: 10%;"></td> <td style="width: 10%;"></td> <td style="width: 10%;"></td> <td style="width: 10%;"></td> <td style="width: 10%;"></td> <td style="width: 10%;"></td> <td style="width: 10%;"></td> <td style="width: 10%;"></td> </tr> <tr> <td></td> <td></td> <td colspan="8" style="text-align: center;"> <table border="1" style="width: 100%; border-collapse: collapse; text-align: center;"> <tr> <td style="width: 10%;"></td> <td style="width: 10%;"></td> <td
style="width: 10%;"></td> <td style="width: 10%;"></td> <td style="width: 10%;"></td> <td style="width: 10%;"></td> <td style="width: 10%;"></td> <td style="width: 10%;"></td> <td style="width: 10%;"></td> <td style="width: 10%;"></td> </tr> <tr> <td></td> <td></td> <td colspan="8" style="text-align: center;"> <table border="1" style="width: 100%; border-collapse: collapse; text-align: center;"> <tr> <td style="width: 10%;"></td> <td style="width: 10%;"></td> <td style="width: 10%;"></td> <td style="width: 10%;"></td> <td style="width: 10%;"></td> <td style="width: 10%;"></td> <td style="width: 10%;"></td> <td style="width: 10%;"></td> <td style="width: 10%;"></td> <td style="width: 10%;"></td> </tr> <tr> <td></td> <td></td> <td colspan="8" style="text-align: center;"> <table border="1" style="width: 100%; border-collapse: collapse; text-align: center;"> <tr> <td style="width: 10%;"></td> <td style="width: 10%;"></td> <td style="width: 10%;"></td> <td style="width: 10%;"></td> <td style="width: 10%;"></td> <td style="width: 10%;"></td> <td style="width: 10%;"></td> <td style="width: 10%;"></td> <td style="width: 10%;"></td> <td style="width: 10%;"></td> </tr> <tr> <td></td> <td></td> <td colspan="8" style="text-align: center;"> <table border="1" style="width: 100%; border-collapse: collapse; text-align: center;"> <tr> <td style="width: 10%;"></td> <td style="width: 10%;"></td> <td style="width: 10%;"></td> <td style="width: 10%;"></td> <td style="width: 10%;"></td> <td style="width: 10%;"></td> <td style="width: 10%;"></td> <td style="width: 10%;"></td> <td style="width: 10%;"></td> <td style="width: 10%;"></td> </tr> <tr> <td></td> <td></td> <td colspan="8" style="text-align: center;"> <table border="1" style="width: 100%; border-collapse: collapse; text-align: center;"> <tr> <td style="width: 10%;"></td> <td style="width: 10%;"></td> <td style="width: 10%;"></td> <td style="width: 10%;"></td> <td style="width: 10%;"></td> <td style="width: 10%;"></td> <td style="width: 10%;"></td> <td style="width: 10%;"></td> <td style="width: 10%;"></td> <td style="width: 10%;"></td> </tr> <tr> <td></td> <td></td> <td colspan="8" style="text-align: center;"> <table border="1" style="width: 100%; border-collapse: collapse; text-align: center;"> <tr> <td style="width: 10%;"></td> <td style="width: 10%;"></td> <td style="width: 10%;"></td> <td style="width: 10%;"></td> <td style="width: 10%;"></td> <td style="width: 10%;"></td> <td style="width: 10%;"></td> <td style="width: 10%;"></td> <td style="width: 10%;"></td> <td style="width: 10%;"></td> </tr> <tr> <td></td> <td></td> <td colspan="8" style="text-align: center;"> <table border="1" style="width: 100%; border-collapse: collapse; text-align: center;"> <tr> <td style="width: 10%;"></td> <td style="width: 10%;"></td> <td style="width: 10%;"></td> <td style="width: 10%;"></td> <td style="width: 10%;"></td> <td style="width: 10%;"></td> <td style="width: 10%;"></td> <td style="width: 10%;"></td> <td style="width: 10%;"></td> <td style="width: 10%;"></td> </tr> <tr> <td></td> <td></td> <td colspan="8" style="text-align: center;"> <table border="1" style="width: 100%; border-collapse: collapse; text-align: center;"> <tr> <td style="width: 10%;"></td> <td style="width: 10%;"></td> <td style="width: 10%;"></td> <td style="width: 10%;"></td> <td style="width: 10%;"></td> <td style="width: 10%;"></td> <td style="width: 10%;"></td> <td style="width: 10%;"></td> <td style="width: 10%;"></td> <td style="width: 10%;"></td> </tr> <tr> <td></td> <td></td> <td colspan="8" style="text-align: center;"> <table border="1" style="width: 100%; border-collapse: collapse; text-align: center;"> <tr> <td style="width: 10%;"></td> <td style="width: 10%;"></td> <td style="width: 10%;"></td> <td style="width: 10%;"></td> <td style="width: 10%;"></td> <td style="width: 10%;"></td> <td style="width: 10%;"></td> <td style="width: 10%;"></td> <td style="width: 10%;"></td> <td style="width: 10%;"></td> </tr> <tr> <td></td> <td></td> <td colspan="8" style="text-align: center;"> <table border="1" style="width: 100%; border-collapse: collapse; text-align: center;"> <tr> <td style="width: 10%;"></td> <td style="width: 10%;"></td> <td style="width: 10%;"></td> <td style="width: 10%;"></td> <td style="width: 10%;"></td> <td style="width: 10%;"></td> <td style="width: 10%;"></td> <td style="width: 10%;"></td> <td style="width: 10%;"></td> <td style="width: 10%;"></td> </tr> <tr> <td></td> <td></td> <td colspan="8" style="text-align: center;"> <table border="1" style="width: 100%; border-collapse: collapse; text-align: center;"> <tr> <td style="width: 10%;"></td> <td style="width: 10%;"></td> <td style="width: 10%;"></td> <td style="width: 10%;"></td> <td style="width: 10%;"></td> <td style="width: 10%;"></td> <td style="width: 10%;"></td> <td style="width: 10%;"></td> <td style="width: 10%;"></td> <td style="width: 10%;"></td> </tr> <tr> <td></td> <td></td> <td colspan="8" style="text-align: center;"> <table border="1" style="width: 100%; border-collapse: collapse; text-align: center;"> <tr> <td style="width: 10%;"></td> <td style="width: 10%;"></td> <td style="width: 10%;"></td> <td style="width: 10%;"></td> <td style="width: 10%;"></td> <td style="width: 10%;"></td> <td style="width: 10%;"></td> <td style="width: 10%;"></td> <td style="width: 10%;"></td> <td style="width: 10%;"></td> </tr> <tr> <td></td> <td></td> <td colspan="8" style="text-align: center;"> <table border="1" style="width: 100%; border-collapse: collapse; text-align: center;"> <tr> <td style="width: 10%;"></td> <td style="width: 10%;"></td> <td style="width: 10%;"></td> <td style="width: 10%;"></td> <td style="width: 10%;"></td> <td style="width: 10%;"></td> <td style="width: 10%;"></td> <td style="width: 10%;"></td> <td style="width: 10%;"></td> <td style="width: 10%;"></td> </tr> <tr> <td></td> <td></td> <td colspan="8" style="text-align: center;"> <table border="1" style="width: 100%; border-collapse: collapse; text-align: center;"> <tr> <td style="width: 10%;"></td> <td style="width: 10%;"></td> <td style="width: 10%;"></td> <td style="width: 10%;"></td> <td style="width: 10%;"></td> <td style="width: 10%;"></td> <td style="width: 10%;"></td> <td style="width: 10%;"></td> <td style="width: 10%;"></td> <td style="width: 10%;"></td> </tr> <tr> <td></td> <td></td> <td colspan="8" style="text-align: center;"> <table border="1" style="width: 100%; border-collapse: collapse; text-align: center;"> <tr> </tr></table></td></tr></table></td></tr></table></td></tr></table></td></tr></table></td></tr></table></td></tr></table></td></tr></table></td></tr></table></td></tr></table></td></tr></table></td></tr></table></td></tr></table></td></tr></table></td></tr></table></td></tr></table></td></tr></table></td></tr></table></td></tr></table></td></tr></table></td></tr></table></td></tr></table></td></tr></table></td></tr></table></td></tr></table></td></tr></table></td></tr></table></td></tr></table></td></tr></table></td></tr></table></td></tr></table></td></tr></table></td></tr></table></td></tr></table></td></tr></table></td></tr></table>

 | | | | | | | | | | | | | | | | | | | | <table border="1" style="width: 100%; border-collapse: collapse; text-align: center;"> <tr> <td style="width: 10%;"></td> <td style="width: 10%;"></td> <td style="width: 10%;"></td> <td style="width: 10%;"></td> <td style="width: 10%;"></td> <td style="width: 10%;"></td> <td style="width: 10%;"></td> <td style="width: 10%;"></td> <td style="width: 10%;"></td> <td style="width: 10%;"></td> </tr> <tr> <td></td> <td></td> <td colspan="8" style="text-align: center;"> <table border="1" style="width: 100%; border-collapse: collapse; text-align: center;"> <tr> <td style="width: 10%;"></td> <td style="width: 10%;"></td> <td style="width: 10%;"></td> <td style="width: 10%;"></td> <td style="width: 10%;"></td> <td style="width: 10%;"></td> <td style="width: 10%;"></td> <td style="width: 10%;"></td> <td style="width: 10%;"></td> <td style="width: 10%;"></td> </tr> <tr> <td></td> <td></td> <td colspan="8" style="text-align: center;"> <table border="1" style="width: 100%; border-collapse: collapse; text-align: center;"> <tr> <td style="width: 10%;"></td> <td style="width: 10%;"></td> <td style="width: 10%;"></td> <td style="width: 10%;"></td> <td style="width: 10%;"></td> <td style="width: 10%;"></td> <td style="width: 10%;"></td> <td style="width: 10%;"></td> <td style="width: 10%;"></td> <td style="width: 10%;"></td> </tr> <tr> <td></td> <td></td> <td colspan="8" style="text-align: center;"> <table border="1" style="width: 100%; border-collapse: collapse; text-align: center;"> <tr> <td style="width: 10%;"></td> <td style="width: 10%;"></td> <td style="width: 10%;"></td> <td style="width: 10%;"></td> <td style="width: 10%;"></td> <td style="width: 10%;"></td> <td style="width: 10%;"></td> <td style="width: 10%;"></td> <td style="width: 10%;"></td> <td style="width: 10%;"></td> </tr> <tr> <td></td> <td></td> <td colspan="8" style="text-align: center;"> <table border="1" style="width: 100%; border-collapse: collapse; text-align: center;"> <tr> <td style="width: 10%;"></td> <td style="width: 10%;"></td> <td style="width: 10%;"></td> <td style="width: 10%;"></td> <td style="width: 10%;"></td> <td style="width: 10%;"></td> <td style="width: 10%;"></td> <td style="width: 10%;"></td> <td style="width: 10%;"></td> <td style="width: 10%;"></td> </tr> <tr> <td></td> <td></td> <td colspan="8" style="text-align: center;"> <table border="1" style="width: 100%; border-collapse: collapse; text-align: center;"> <tr> <td style="width: 10%;"></td> <td style="width: 10%;"></td> <td style="width: 10%;"></td> <td style="width: 10%;"></td> <td style="width: 10%;"></td> <td style="width: 10%;"></td> <td style="width: 10%;"></td> <td style="width: 10%;"></td> <td style="width: 10%;"></td> <td style="width: 10%;"></td> </tr> <tr> <td></td> <td></td> <td colspan="8" style="text-align: center;"> <table border="1" style="width: 100%; border-collapse: collapse; text-align: center;"> <tr> <td style="width: 10%;"></td> <td style="width: 10%;"></td> <td style="width: 10%;"></td> <td style="width: 10%;"></td> <td style="width: 10%;"></td> <td style="width: 10%;"></td> <td style="width: 10%;"></td> <td style="width: 10%;"></td> <td style="width: 10%;"></td> <td style="width: 10%;"></td> </tr> <tr> <td></td> <td></td> <td colspan="8" style="text-align: center;"> <table border="1" style="width: 100%; border-collapse: collapse; text-align: center;"> <tr> <td style="width: 10%;"></td> <td style="width: 10%;"></td> <td style="width: 10%;"></td> <td style="width: 10%;"></td> <td style="width: 10%;"></td> <td style="width: 10%;"></td> <td style="width: 10%;"></td> <td style="width: 10%;"></td> <td style="width: 10%;"></td> <td style="width: 10%;"></td> </tr> <tr> <td></td> <td></td> <td colspan="8" style="text-align: center;"> <table border="1" style="width: 100%; border-collapse: collapse; text-align: center;"> <tr> <td style="width: 10%;"></td> <td style="width: 10%;"></td> <td style="width: 10%;"></td> <td style="width: 10%;"></td> <td style="width: 10%;"></td> <td style="width: 10%;"></td> <td style="width: 10%;"></td> <td style="width: 10%;"></td> <td style="width: 10%;"></td> <td style="width: 10%;"></td> </tr> <tr> <td></td> <td></td> <td colspan="8" style="text-align: center;"> <table border="1" style="width: 100%; border-collapse: collapse; text-align: center;"> <tr> <td style="width: 10%;"></td> <td style="width: 10%;"></td> <td style="width: 10%;"></td> <td style="width: 10%;"></td> <td style="width: 10%;"></td> <td style="width: 10%;"></td> <td style="width: 10%;"></td> <td style="width: 10%;"></td> <td style="width: 10%;"></td> <td style="width: 10%;"></td> </tr> <tr> <td></td> <td></td> <td colspan="8" style="text-align: center;"> <table border="1" style="width: 100%; border-collapse: collapse; text-align: center;"> <tr> <td style="width: 10%;"></td> <td style="width: 10%;"></td> <td style="width: 10%;"></td> <td style="width: 10%;"></td> <td style="width: 10%;"></td> <td style="width: 10%;"></td> <td style="width: 10%;"></td> <td style="width: 10%;"></td> <td style="width: 10%;"></td> <td style="width: 10%;"></td> </tr> <tr> <td></td> <td></td> <td colspan="8" style="text-align: center;"> <table border="1" style="width: 100%; border-collapse: collapse; text-align: center;"> <tr> <td style="width: 10%;"></td> <td style="width: 10%;"></td> <td style="width: 10%;"></td> <td style="width: 10%;"></td> <td style="width: 10%;"></td> <td style="width: 10%;"></td> <td style="width: 10%;"></td> <td style="width: 10%;"></td> <td style="width: 10%;"></td> <td style="width: 10%;"></td> </tr> <tr> <td></td> <td></td> <td colspan="8" style="text-align: center;"> <table border="1" style="width: 100%; border-collapse: collapse; text-align: center;"> <tr> <td style="width: 10%;"></td> <td style="width: 10%;"></td> <td style="width: 10%;"></td> <td style="width: 10%;"></td> <td style="width: 10%;"></td> <td style="width: 10%;"></td> <td style="width: 10%;"></td> <td style="width: 10%;"></td> <td style="width: 10%;"></td> <td style="width: 10%;"></td> </tr> <tr> <td></td> <td></td> <td colspan="8" style="text-align: center;"> <table border="1" style="width: 100%; border-collapse: collapse; text-align: center;"> <tr> <td style="width: 10%;"></td> <td style="width: 10%;"></td> <td style="width: 10%;"></td> <td style="width: 10%;"></td> <td style="width: 10%;"></td> <td style="width: 10%;"></td> <td style="width: 10%;"></td> <td style="width: 10%;"></td> <td style="width: 10%;"></td> <td style="width: 10%;"></td> </tr> <tr> <td></td> <td></td> <td colspan="8" style="text-align: center;"> <table border="1" style="width: 100%; border-collapse: collapse; text-align: center;"> <tr> <td style="width: 10%;"></td> <td style="width: 10%;"></td> <td style="width: 10%;"></td> <td style="width: 10%;"></td> <td style="width: 10%;"></td> <td style="width: 10%;"></td> <td style="width: 10%;"></td> <td style="width: 10%;"></td> <td style="width: 10%;"></td> <td style="width: 10%;"></td> </tr> <tr> <td></td> <td></td> <td colspan="8" style="text-align: center;"> <table border="1" style="width: 100%; border-collapse: collapse; text-align: center;"> <tr> <td style="width: 10%;"></td> <td style="width: 10%;"></td> <td style="width: 10%;"></td> <td style="width: 10%;"></td> <td style="width: 10%;"></td> <td style="width: 10%;"></td> <td style="width: 10%;"></td> <td style="width: 10%;"></td> <td style="width: 10%;"></td> <td style="width: 10%;"></td> </tr> <tr> <td></td> <td></td> <td colspan="8" style="text-align: center;"> <table border="1" style="width: 100%; border-collapse: collapse; text-align: center;"> <tr> <td style="width: 10%;"></td> <td style="width: 10%;"></td> <td style="width: 10%;"></td> <td style="width: 10%;"></td> <td style="width: 10%;"></td> <td style="width: 10%;"></td> <td style="width: 10%;"></td> <td style="width: 10%;"></td> <td style="width: 10%;"></td> <td style="width: 10%;"></td> </tr> <tr> <td></td> <td></td> <td colspan="8" style="text-align: center;"> <table border="1" style="width: 100%; border-collapse: collapse; text-align: center;"> <tr> <td style="width: 10%;"></td> <td style="width: 10%;"></td> <td style="width: 10%;"></td> <td style="width: 10%;"></td> <td style="width: 10%;"></td> <td style="width: 10%;"></td> <td style="width: 10%;"></td> <td style="width: 10%;"></td> <td style="width: 10%;"></td> <td style="width: 10%;"></td> </tr> <tr> <td></td> <td></td> <td colspan="8" style="text-align: center;"> <table border="1" style="width: 100%; border-collapse: collapse; text-align: center;"> <tr> <td style="width: 10%;"></td> <td style="width: 10%;"></td> <td style="width: 10%;"></td> <td style="width: 10%;"></td> <td style="width: 10%;"></td> <td style="width: 10%;"></td> <td
style="width: 10%;"></td> <td style="width: 10%;"></td> <td style="width: 10%;"></td> <td style="width: 10%;"></td> </tr> <tr> <td></td> <td></td> <td colspan="8" style="text-align: center;"> <table border="1" style="width: 100%; border-collapse: collapse; text-align: center;"> <tr> <td style="width: 10%;"></td> <td style="width: 10%;"></td> <td style="width: 10%;"></td> <td style="width: 10%;"></td> <td style="width: 10%;"></td> <td style="width: 10%;"></td> <td style="width: 10%;"></td> <td style="width: 10%;"></td> <td style="width: 10%;"></td> <td style="width: 10%;"></td> </tr> <tr> <td></td> <td></td> <td colspan="8" style="text-align: center;"> <table border="1" style="width: 100%; border-collapse: collapse; text-align: center;"> <tr> <td style="width: 10%;"></td> <td style="width: 10%;"></td> <td style="width: 10%;"></td> <td style="width: 10%;"></td> <td style="width: 10%;"></td> <td style="width: 10%;"></td> <td style="width: 10%;"></td> <td style="width: 10%;"></td> <td style="width: 10%;"></td> <td style="width: 10%;"></td> </tr> <tr> <td></td> <td></td> <td colspan="8" style="text-align: center;"> <table border="1" style="width: 100%; border-collapse: collapse; text-align: center;"> <tr> <td style="width: 10%;"></td> <td style="width: 10%;"></td> <td style="width: 10%;"></td> <td style="width: 10%;"></td> <td style="width: 10%;"></td> <td style="width: 10%;"></td> <td style="width: 10%;"></td> <td style="width: 10%;"></td> <td style="width: 10%;"></td> <td style="width: 10%;"></td> </tr> <tr> <td></td> <td></td> <td colspan="8" style="text-align: center;"> <table border="1" style="width: 100%; border-collapse: collapse; text-align: center;"> <tr> <td style="width: 10%;"></td> <td style="width: 10%;"></td> <td style="width: 10%;"></td> <td style="width: 10%;"></td> <td style="width: 10%;"></td> <td style="width: 10%;"></td> <td style="width: 10%;"></td> <td style="width: 10%;"></td> <td style="width: 10%;"></td> <td style="width: 10%;"></td> </tr> <tr> <td></td> <td></td> <td colspan="8" style="text-align: center;"> <table border="1" style="width: 100%; border-collapse: collapse; text-align: center;"> <tr> <td style="width: 10%;"></td> <td style="width: 10%;"></td> <td style="width: 10%;"></td> <td style="width: 10%;"></td> <td style="width: 10%;"></td> <td style="width: 10%;"></td> <td style="width: 10%;"></td> <td style="width: 10%;"></td> <td style="width: 10%;"></td> <td style="width: 10%;"></td> </tr> <tr> <td></td> <td></td> <td colspan="8" style="text-align: center;"> <table border="1" style="width: 100%; border-collapse: collapse; text-align: center;"> <tr> <td style="width: 10%;"></td> <td style="width: 10%;"></td> <td style="width: 10%;"></td> <td style="width: 10%;"></td> <td style="width: 10%;"></td> <td style="width: 10%;"></td> <td style="width: 10%;"></td> <td style="width: 10%;"></td> <td style="width: 10%;"></td> <td style="width: 10%;"></td> </tr> <tr> <td></td> <td></td> <td colspan="8" style="text-align: center;"> <table border="1" style="width: 100%; border-collapse: collapse; text-align: center;"> <tr> <td style="width: 10%;"></td> <td style="width: 10%;"></td> <td style="width: 10%;"></td> <td style="width: 10%;"></td> <td style="width: 10%;"></td> <td style="width: 10%;"></td> <td style="width: 10%;"></td> <td style="width: 10%;"></td> <td style="width: 10%;"></td> <td style="width: 10%;"></td> </tr> <tr> <td></td> <td></td> <td colspan="8" style="text-align: center;"> <table border="1" style="width: 100%; border-collapse: collapse; text-align: center;"> <tr> <td style="width: 10%;"></td> <td style="width: 10%;"></td> <td style="width: 10%;"></td> <td style="width: 10%;"></td> <td style="width: 10%;"></td> <td style="width: 10%;"></td> <td style="width: 10%;"></td> <td style="width: 10%;"></td> <td style="width: 10%;"></td> <td style="width: 10%;"></td> </tr> <tr> <td></td> <td></td> <td colspan="8" style="text-align: center;"> <table border="1" style="width: 100%; border-collapse: collapse; text-align: center;"> <tr> <td style="width: 10%;"></td> <td style="width: 10%;"></td> <td style="width: 10%;"></td> <td style="width: 10%;"></td> <td style="width: 10%;"></td> <td style="width: 10%;"></td> <td style="width: 10%;"></td> <td style="width: 10%;"></td> <td style="width: 10%;"></td> <td style="width: 10%;"></td> </tr> <tr> <td></td> <td></td> <td colspan="8" style="text-align: center;"> <table border="1" style="width: 100%; border-collapse: collapse; text-align: center;"> <tr> <td style="width: 10%;"></td> <td style="width: 10%;"></td> <td style="width: 10%;"></td> <td style="width: 10%;"></td> <td style="width: 10%;"></td> <td style="width: 10%;"></td> <td style="width: 10%;"></td> <td style="width: 10%;"></td> <td style="width: 10%;"></td> <td style="width: 10%;"></td> </tr> <tr> <td></td> <td></td> <td colspan="8" style="text-align: center;"> <table border="1" style="width: 100%; border-collapse: collapse; text-align: center;"> <tr> <td style="width: 10%;"></td> <td style="width: 10%;"></td> <td style="width: 10%;"></td> <td style="width: 10%;"></td> <td style="width: 10%;"></td> <td style="width: 10%;"></td> <td style="width: 10%;"></td> <td style="width: 10%;"></td> <td style="width: 10%;"></td> <td style="width: 10%;"></td> </tr> <tr> <td></td> <td></td> <td colspan="8" style="text-align: center;"> <table border="1" style="width: 100%; border-collapse: collapse; text-align: center;"> <tr> <td style="width: 10%;"></td> <td style="width: 10%;"></td> <td style="width: 10%;"></td> <td style="width: 10%;"></td> <td style="width: 10%;"></td> <td style="width: 10%;"></td> <td style="width: 10%;"></td> <td style="width: 10%;"></td> <td style="width: 10%;"></td> <td style="width: 10%;"></td> </tr> <tr> <td></td> <td></td> <td colspan="8" style="text-align: center;"> <table border="1" style="width: 100%; border-collapse: collapse; text-align: center;"> <tr> <td style="width: 10%;"></td> <td style="width: 10%;"></td> <td style="width: 10%;"></td> <td style="width: 10%;"></td> <td style="width: 10%;"></td> <td style="width: 10%;"></td> <td style="width: 10%;"></td> <td style="width: 10%;"></td> <td style="width: 10%;"></td> <td style="width: 10%;"></td> </tr> <tr> <td></td> <td></td> <td colspan="8" style="text-align: center;"> <table border="1" style="width: 100%; border-collapse: collapse; text-align: center;"> <tr> <td style="width: 10%;"></td> <td style="width: 10%;"></td> <td style="width: 10%;"></td> <td style="width: 10%;"></td> <td style="width: 10%;"></td> <td style="width: 10%;"></td> <td style="width: 10%;"></td> <td style="width: 10%;"></td> <td style="width: 10%;"></td> <td style="width: 10%;"></td> </tr> <tr> <td></td> <td></td> <td colspan="8" style="text-align: center;"> <table border="1" style="width: 100%; border-collapse: collapse; text-align: center;"> <tr> <td style="width: 10%;"></td> <td style="width: 10%;"></td> <td style="width: 10%;"></td> <td style="width: 10%;"></td> <td style="width: 10%;"></td> <td style="width: 10%;"></td> <td style="width: 10%;"></td> <td style="width: 10%;"></td> <td style="width: 10%;"></td> <td style="width: 10%;"></td> </tr> <tr> <td></td> <td></td> <td colspan="8" style="text-align: center;"> <table border="1" style="width: 100%; border-collapse: collapse; text-align: center;"> <tr> </tr></table></td></tr></table></td></tr></table></td></tr></table></td></tr></table></td></tr></table></td></tr></table></td></tr></table></td></tr></table></td></tr></table></td></tr></table></td></tr></table></td></tr></table></td></tr></table></td></tr></table></td></tr></table></td></tr></table></td></tr></table></td></tr></table></td></tr></table></td></tr></table></td></tr></table></td></tr></table></td></tr></table></td></tr></table></td></tr></table></td></tr></table></td></tr></table></td></tr></table></td></tr></table></td></tr></table></td></tr></table></td></tr></table></td></tr></table></td></tr></table>

 | | | | | | | | | | | | | | | | | | | | <table border="1" style="width: 100%; border-collapse: collapse; text-align: center;"> <tr> <td style="width: 10%;"></td> <td style="width: 10%;"></td> <td style="width: 10%;"></td> <td style="width: 10%;"></td> <td style="width: 10%;"></td> <td style="width: 10%;"></td> <td style="width: 10%;"></td> <td style="width: 10%;"></td> <td style="width: 10%;"></td> <td style="width: 10%;"></td> </tr> <tr> <td></td> <td></td> <td colspan="8" style="text-align: center;"> <table border="1" style="width: 100%; border-collapse: collapse; text-align: center;"> <tr> <td style="width: 10%;"></td> <td style="width: 10%;"></td> <td style="width: 10%;"></td> <td style="width: 10%;"></td> <td style="width: 10%;"></td> <td style="width: 10%;"></td> <td style="width: 10%;"></td> <td style="width: 10%;"></td> <td style="width: 10%;"></td> <td style="width: 10%;"></td> </tr> <tr> <td></td> <td></td> <td colspan="8" style="text-align: center;"> <table border="1" style="width: 100%; border-collapse: collapse; text-align: center;"> <tr> <td style="width: 10%;"></td> <td style="width: 10%;"></td> <td style="width: 10%;"></td> <td style="width: 10%;"></td> <td style="width: 10%;"></td> <td style="width: 10%;"></td> <td style="width: 10%;"></td> <td style="width: 10%;"></td> <td style="width: 10%;"></td> <td style="width: 10%;"></td> </tr> <tr> <td></td> <td></td> <td colspan="8" style="text-align: center;"> <table border="1" style="width: 100%; border-collapse: collapse; text-align: center;"> <tr> <td style="width: 10%;"></td> <td style="width: 10%;"></td> <td style="width: 10%;"></td> <td style="width: 10%;"></td> <td style="width: 10%;"></td> <td style="width: 10%;"></td> <td style="width: 10%;"></td> <td style="width: 10%;"></td> <td style="width: 10%;"></td> <td style="width: 10%;"></td> </tr> <tr> <td></td> <td></td> <td colspan="8" style="text-align: center;"> <table border="1" style="width: 100%; border-collapse: collapse; text-align: center;"> <tr> <td style="width: 10%;"></td> <td style="width: 10%;"></td> <td style="width: 10%;"></td> <td style="width: 10%;"></td> <td style="width: 10%;"></td> <td style="width: 10%;"></td> <td style="width: 10%;"></td> <td style="width: 10%;"></td> <td style="width: 10%;"></td> <td style="width: 10%;"></td> </tr> <tr> <td></td> <td></td> <td colspan="8" style="text-align: center;"> <table border="1" style="width: 100%; border-collapse: collapse; text-align: center;"> <tr> <td style="width: 10%;"></td> <td style="width: 10%;"></td> <td style="width: 10%;"></td> <td style="width: 10%;"></td> <td style="width: 10%;"></td> <td style="width: 10%;"></td> <td style="width: 10%;"></td> <td style="width: 10%;"></td> <td style="width: 10%;"></td> <td style="width: 10%;"></td> </tr> <tr> <td></td> <td></td> <td colspan="8" style="text-align: center;"> <table border="1" style="width: 100%; border-collapse: collapse; text-align: center;"> <tr> <td style="width: 10%;"></td> <td style="width: 10%;"></td> <td style="width: 10%;"></td> <td style="width: 10%;"></td> <td style="width: 10%;"></td> <td style="width: 10%;"></td> <td style="width: 10%;"></td> <td style="width: 10%;"></td> <td style="width: 10%;"></td> <td style="width: 10%;"></td> </tr> <tr> <td></td> <td></td> <td colspan="8" style="text-align: center;"> <table border="1" style="width: 100%; border-collapse: collapse; text-align: center;"> <tr> <td style="width: 10%;"></td> <td style="width: 10%;"></td> <td style="width: 10%;"></td> <td style="width: 10%;"></td> <td style="width: 10%;"></td> <td style="width: 10%;"></td> <td style="width: 10%;"></td> <td style="width: 10%;"></td> <td style="width: 10%;"></td> <td style="width: 10%;"></td> </tr> <tr> <td></td> <td></td> <td colspan="8" style="text-align: center;"> <table border="1" style="width: 100%; border-collapse: collapse; text-align: center;"> <tr> <td style="width: 10%;"></td> <td style="width: 10%;"></td> <td style="width: 10%;"></td> <td style="width: 10%;"></td> <td style="width: 10%;"></td> <td style="width: 10%;"></td> <td style="width: 10%;"></td> <td style="width: 10%;"></td> <td style="width: 10%;"></td> <td style="width: 10%;"></td> </tr> <tr> <td></td> <td></td> <td colspan="8" style="text-align: center;"> <table border="1" style="width: 100%; border-collapse: collapse; text-align: center;"> <tr> <td style="width: 10%;"></td> <td style="width: 10%;"></td> <td style="width: 10%;"></td> <td style="width: 10%;"></td> <td style="width: 10%;"></td> <td style="width: 10%;"></td> <td style="width: 10%;"></td> <td style="width: 10%;"></td> <td style="width: 10%;"></td> <td style="width: 10%;"></td> </tr> <tr> <td></td> <td></td> <td colspan="8" style="text-align: center;"> <table border="1" style="width: 100%; border-collapse: collapse; text-align: center;"> <tr> <td style="width: 10%;"></td> <td style="width: 10%;"></td> <td style="width: 10%;"></td> <td style="width: 10%;"></td> <td style="width: 10%;"></td> <td style="width: 10%;"></td> <td style="width: 10%;"></td> <td style="width: 10%;"></td> <td style="width: 10%;"></td> <td style="width: 10%;"></td> </tr> <tr> <td></td> <td></td> <td colspan="8" style="text-align: center;"> <table border="1" style="width: 100%; border-collapse: collapse; text-align: center;"> <tr> <td style="width: 10%;"></td> <td style="width: 10%;"></td> <td style="width: 10%;"></td> <td style="width: 10%;"></td> <td style="width: 10%;"></td> <td style="width: 10%;"></td> <td style="width: 10%;"></td> <td style="width: 10%;"></td> <td style="width: 10%;"></td> <td style="width: 10%;"></td> </tr> <tr> <td></td> <td></td> <td colspan="8" style="text-align: center;"> <table border="1" style="width: 100%; border-collapse: collapse; text-align: center;"> <tr> <td style="width: 10%;"></td> <td style="width: 10%;"></td> <td style="width: 10%;"></td> <td style="width: 10%;"></td> <td style="width: 10%;"></td> <td style="width: 10%;"></td> <td style="width: 10%;"></td> <td style="width: 10%;"></td> <td style="width: 10%;"></td> <td style="width: 10%;"></td> </tr> <tr> <td></td> <td></td> <td colspan="8" style="text-align: center;"> <table border="1" style="width: 100%; border-collapse: collapse; text-align: center;"> <tr> <td style="width: 10%;"></td> <td style="width: 10%;"></td> <td style="width: 10%;"></td> <td style="width: 10%;"></td> <td style="width: 10%;"></td> <td style="width: 10%;"></td> <td style="width: 10%;"></td> <td style="width: 10%;"></td> <td style="width: 10%;"></td> <td style="width: 10%;"></td> </tr> <tr> <td></td> <td></td> <td colspan="8" style="text-align: center;"> <table border="1" style="width: 100%; border-collapse: collapse; text-align: center;"> <tr> <td style="width: 10%;"></td> <td style="width: 10%;"></td> <td style="width: 10%;"></td> <td style="width: 10%;"></td> <td style="width: 10%;"></td> <td style="width: 10%;"></td> <td style="width: 10%;"></td> <td style="width: 10%;"></td> <td style="width: 10%;"></td> <td style="width: 10%;"></td> </tr> <tr> <td></td> <td></td> <td colspan="8" style="text-align: center;"> <table border="1" style="width: 100%; border-collapse: collapse; text-align: center;"> <tr> <td style="width: 10%;"></td> <td style="width: 10%;"></td> <td style="width: 10%;"></td> <td style="width: 10%;"></td> <td style="width: 10%;"></td> <td style="width: 10%;"></td> <td style="width: 10%;"></td> <td style="width: 10%;"></td> <td style="width: 10%;"></td> <td style="width: 10%;"></td> </tr> <tr> <td></td> <td></td> <td colspan="8" style="text-align: center;"> <table border="1" style="width: 100%; border-collapse: collapse; text-align: center;"> <tr> <td style="width: 10%;"></td> <td style="width: 10%;"></td> <td style="width: 10%;"></td> <td style="width: 10%;"></td> <td style="width: 10%;"></td> <td style="width: 10%;"></td> <td style="width: 10%;"></td> <td style="width: 10%;"></td> <td style="width: 10%;"></td> <td style="width: 10%;"></td> </tr> <tr> <td></td> <td></td> <td
colspan="8" style="text-align: center;"> <table border="1" style="width: 100%; border-collapse: collapse; text-align: center;"> <tr> <td style="width: 10%;"></td> <td style="width: 10%;"></td> <td style="width: 10%;"></td> <td style="width: 10%;"></td> <td style="width: 10%;"></td> <td style="width: 10%;"></td> <td style="width: 10%;"></td> <td style="width: 10%;"></td> <td style="width: 10%;"></td> <td style="width: 10%;"></td> </tr> <tr> <td></td> <td></td> <td colspan="8" style="text-align: center;"> <table border="1" style="width: 100%; border-collapse: collapse; text-align: center;"> <tr> <td style="width: 10%;"></td> <td style="width: 10%;"></td> <td style="width: 10%;"></td> <td style="width: 10%;"></td> <td style="width: 10%;"></td> <td style="width: 10%;"></td> <td style="width: 10%;"></td> <td style="width: 10%;"></td> <td style="width: 10%;"></td> <td style="width: 10%;"></td> </tr> <tr> <td></td> <td></td> <td colspan="8" style="text-align: center;"> <table border="1" style="width: 100%; border-collapse: collapse; text-align: center;"> <tr> <td style="width: 10%;"></td> <td style="width: 10%;"></td> <td style="width: 10%;"></td> <td style="width: 10%;"></td> <td style="width: 10%;"></td> <td style="width: 10%;"></td> <td style="width: 10%;"></td> <td style="width: 10%;"></td> <td style="width: 10%;"></td> <td style="width: 10%;"></td> </tr> <tr> <td></td> <td></td> <td colspan="8" style="text-align: center;"> <table border="1" style="width: 100%; border-collapse: collapse; text-align: center;"> <tr> <td style="width: 10%;"></td> <td style="width: 10%;"></td> <td style="width: 10%;"></td> <td style="width: 10%;"></td> <td style="width: 10%;"></td> <td style="width: 10%;"></td> <td style="width: 10%;"></td> <td style="width: 10%;"></td> <td style="width: 10%;"></td> <td style="width: 10%;"></td> </tr> <tr> <td></td> <td></td> <td colspan="8" style="text-align: center;"> <table border="1" style="width: 100%; border-collapse: collapse; text-align: center;"> <tr> <td style="width: 10%;"></td> <td style="width: 10%;"></td> <td style="width: 10%;"></td> <td style="width: 10%;"></td> <td style="width: 10%;"></td> <td style="width: 10%;"></td> <td style="width: 10%;"></td> <td style="width: 10%;"></td> <td style="width: 10%;"></td> <td style="width: 10%;"></td> </tr> <tr> <td></td> <td></td> <td colspan="8" style="text-align: center;"> <table border="1" style="width: 100%; border-collapse: collapse; text-align: center;"> <tr> <td style="width: 10%;"></td> <td style="width: 10%;"></td> <td style="width: 10%;"></td> <td style="width: 10%;"></td> <td style="width: 10%;"></td> <td style="width: 10%;"></td> <td style="width: 10%;"></td> <td style="width: 10%;"></td> <td style="width: 10%;"></td> <td style="width: 10%;"></td> </tr> <tr> <td></td> <td></td> <td colspan="8" style="text-align: center;"> <table border="1" style="width: 100%; border-collapse: collapse; text-align: center;"> <tr> <td style="width: 10%;"></td> <td style="width: 10%;"></td> <td style="width: 10%;"></td> <td style="width: 10%;"></td> <td style="width: 10%;"></td> <td style="width: 10%;"></td> <td style="width: 10%;"></td> <td style="width: 10%;"></td> <td style="width: 10%;"></td> <td style="width: 10%;"></td> </tr> <tr> <td></td> <td></td> <td colspan="8" style="text-align: center;"> <table border="1" style="width: 100%; border-collapse: collapse; text-align: center;"> <tr> <td style="width: 10%;"></td> <td style="width: 10%;"></td> <td style="width: 10%;"></td> <td style="width: 10%;"></td> <td style="width: 10%;"></td> <td style="width: 10%;"></td> <td style="width: 10%;"></td> <td style="width: 10%;"></td> <td style="width: 10%;"></td> <td style="width: 10%;"></td> </tr> <tr> <td></td> <td></td> <td colspan="8" style="text-align: center;"> <table border="1" style="width: 100%; border-collapse: collapse; text-align: center;"> <tr> <td style="width: 10%;"></td> <td style="width: 10%;"></td> <td style="width: 10%;"></td> <td style="width: 10%;"></td> <td style="width: 10%;"></td> <td style="width: 10%;"></td> <td style="width: 10%;"></td> <td style="width: 10%;"></td> <td style="width: 10%;"></td> <td style="width: 10%;"></td> </tr> <tr> <td></td> <td></td> <td colspan="8" style="text-align: center;"> <table border="1" style="width: 100%; border-collapse: collapse; text-align: center;"> <tr> <td style="width: 10%;"></td> <td style="width: 10%;"></td> <td style="width: 10%;"></td> <td style="width: 10%;"></td> <td style="width: 10%;"></td> <td style="width: 10%;"></td> <td style="width: 10%;"></td> <td style="width: 10%;"></td> <td style="width: 10%;"></td> <td style="width: 10%;"></td> </tr> <tr> <td></td> <td></td> <td colspan="8" style="text-align: center;"> <table border="1" style="width: 100%; border-collapse: collapse; text-align: center;"> <tr> <td style="width: 10%;"></td> <td style="width: 10%;"></td> <td style="width: 10%;"></td> <td style="width: 10%;"></td> <td style="width: 10%;"></td> <td style="width: 10%;"></td> <td style="width: 10%;"></td> <td style="width: 10%;"></td> <td style="width: 10%;"></td> <td style="width: 10%;"></td> </tr> <tr> <td></td> <td></td> <td colspan="8" style="text-align: center;"> <table border="1" style="width: 100%; border-collapse: collapse; text-align: center;"> <tr> <td style="width: 10%;"></td> <td style="width: 10%;"></td> <td style="width: 10%;"></td> <td style="width: 10%;"></td> <td style="width: 10%;"></td> <td style="width: 10%;"></td> <td style="width: 10%;"></td> <td style="width: 10%;"></td> <td style="width: 10%;"></td> <td style="width: 10%;"></td> </tr> <tr> <td></td> <td></td> <td colspan="8" style="text-align: center;"> <table border="1" style="width: 100%; border-collapse: collapse; text-align: center;"> <tr> <td style="width: 10%;"></td> <td style="width: 10%;"></td> <td style="width: 10%;"></td> <td style="width: 10%;"></td> <td style="width: 10%;"></td> <td style="width: 10%;"></td> <td style="width: 10%;"></td> <td style="width: 10%;"></td> <td style="width: 10%;"></td> <td style="width: 10%;"></td> </tr> <tr> <td></td> <td></td> <td colspan="8" style="text-align: center;"> <table border="1" style="width: 100%; border-collapse: collapse; text-align: center;"> <tr> <td style="width: 10%;"></td> <td style="width: 10%;"></td> <td style="width: 10%;"></td> <td style="width: 10%;"></td> <td style="width: 10%;"></td> <td style="width: 10%;"></td> <td style="width: 10%;"></td> <td style="width: 10%;"></td> <td style="width: 10%;"></td> <td style="width: 10%;"></td> </tr> <tr> <td></td> <td></td> <td colspan="8" style="text-align: center;"> <table border="1" style="width: 100%; border-collapse: collapse; text-align: center;"> <tr> <td style="width: 10%;"></td> <td style="width: 10%;"></td> <td style="width: 10%;"></td> <td style="width: 10%;"></td> <td style="width: 10%;"></td> <td style="width: 10%;"></td> <td style="width: 10%;"></td> <td style="width: 10%;"></td> <td style="width: 10%;"></td> <td style="width: 10%;"></td> </tr> <tr> <td></td> <td></td> <td colspan="8" style="text-align: center;"> <table border="1" style="width: 100%; border-collapse: collapse; text-align: center;"> <tr> <td style="width: 10%;"></td> <td style="width: 10%;"></td> <td style="width: 10%;"></td> <td style="width: 10%;"></td> <td style="width: 10%;"></td> <td style="width: 10%;"></td> <td style="width: 10%;"></td> <td style="width: 10%;"></td> <td style="width: 10%;"></td> <td style="width: 10%;"></td> </tr> <tr> <td></td> <td></td> <td colspan="8" style="text-align: center;"> <table border="1" style="width: 100%; border-collapse: collapse; text-align: center;"> <tr> </tr></table></td></tr></table></td></tr></table></td></tr></table></td></tr></table></td></tr></table></td></tr></table></td></tr></table></td></tr></table></td></tr></table></td></tr></table></td></tr></table></td></tr></table></td></tr></table></td></tr></table></td></tr></table></td></tr></table></td></tr></table></td></tr></table></td></tr></table></td></tr></table></td></tr></table></td></tr></table></td></tr></table></td></tr></table></td></tr></table></td></tr></table></td></tr></table></td></tr></table></td></tr></table></td></tr></table></td></tr></table></td></tr></table></td></tr></table>

 | | | | | | | | | | | | | | | | | | | | <table border="1" style="width: 100%; border-collapse: collapse; text-align: center;"> <tr> <td style="width: 10%;"></td> <td style="width: 10%;"></td> <td style="width: 10%;"></td> <td style="width: 10%;"></td> <td style="width: 10%;"></td> <td style="width: 10%;"></td> <td style="width: 10%;"></td> <td style="width: 10%;"></td> <td style="width: 10%;"></td> <td style="width: 10%;"></td> </tr> <tr> <td></td> <td></td> <td colspan="8" style="text-align: center;"> <table border="1" style="width: 100%; border-collapse: collapse; text-align: center;"> <tr> <td style="width: 10%;"></td> <td style="width: 10%;"></td> <td style="width: 10%;"></td> <td style="width: 10%;"></td> <td style="width: 10%;"></td> <td style="width: 10%;"></td> <td style="width: 10%;"></td> <td style="width: 10%;"></td> <td style="width: 10%;"></td> <td style="width: 10%;"></td> </tr> <tr> <td></td> <td></td> <td colspan="8" style="text-align: center;"> <table border="1" style="width: 100%; border-collapse: collapse; text-align: center;"> <tr> <td style="width: 10%;"></td> <td style="width: 10%;"></td> <td style="width: 10%;"></td> <td style="width: 10%;"></td> <td style="width: 10%;"></td> <td style="width: 10%;"></td> <td style="width: 10%;"></td> <td style="width: 10%;"></td> <td style="width: 10%;"></td> <td style="width: 10%;"></td> </tr> <tr> <td></td> <td></td> <td colspan="8" style="text-align: center;"> <table border="1" style="width: 100%; border-collapse: collapse; text-align: center;"> <tr> <td style="width: 10%;"></td> <td style="width: 10%;"></td> <td style="width: 10%;"></td> <td style="width: 10%;"></td> <td style="width: 10%;"></td> <td style="width: 10%;"></td> <td style="width: 10%;"></td> <td style="width: 10%;"></td> <td style="width: 10%;"></td> <td style="width: 10%;"></td> </tr> <tr> <td></td> <td></td> <td colspan="8" style="text-align: center;"> <table border="1" style="width: 100%; border-collapse: collapse; text-align: center;"> <tr> <td style="width: 10%;"></td> <td style="width: 10%;"></td> <td style="width: 10%;"></td> <td style="width: 10%;"></td> <td style="width: 10%;"></td> <td style="width: 10%;"></td> <td style="width: 10%;"></td> <td style="width: 10%;"></td> <td style="width: 10%;"></td> <td style="width: 10%;"></td> </tr> <tr> <td></td> <td></td> <td colspan="8" style="text-align: center;"> <table border="1" style="width: 100%; border-collapse: collapse; text-align: center;"> <tr> <td style="width: 10%;"></td> <td style="width: 10%;"></td> <td style="width: 10%;"></td> <td style="width: 10%;"></td> <td style="width: 10%;"></td> <td style="width: 10%;"></td> <td style="width: 10%;"></td> <td style="width: 10%;"></td> <td style="width: 10%;"></td> <td style="width: 10%;"></td> </tr> <tr> <td></td> <td></td> <td colspan="8" style="text-align: center;"> <table border="1" style="width: 100%; border-collapse: collapse; text-align: center;"> <tr> <td style="width: 10%;"></td> <td style="width: 10%;"></td> <td style="width: 10%;"></td> <td style="width: 10%;"></td> <td style="width: 10%;"></td> <td style="width: 10%;"></td> <td style="width: 10%;"></td> <td style="width: 10%;"></td> <td style="width: 10%;"></td> <td style="width: 10%;"></td> </tr> <tr> <td></td> <td></td> <td colspan="8" style="text-align: center;"> <table border="1" style="width: 100%; border-collapse: collapse; text-align: center;"> <tr> <td style="width: 10%;"></td> <td style="width: 10%;"></td> <td style="width: 10%;"></td> <td style="width: 10%;"></td> <td style="width: 10%;"></td> <td style="width: 10%;"></td> <td style="width: 10%;"></td> <td style="width: 10%;"></td> <td style="width: 10%;"></td> <td style="width: 10%;"></td> </tr> <tr> <td></td> <td></td> <td colspan="8" style="text-align: center;"> <table border="1" style="width: 100%; border-collapse: collapse; text-align: center;"> <tr> <td style="width: 10%;"></td> <td style="width: 10%;"></td> <td style="width: 10%;"></td> <td style="width: 10%;"></td> <td style="width: 10%;"></td> <td style="width: 10%;"></td> <td style="width: 10%;"></td> <td style="width: 10%;"></td> <td style="width: 10%;"></td> <td style="width: 10%;"></td> </tr> <tr> <td></td> <td></td> <td colspan="8" style="text-align: center;"> <table border="1" style="width: 100%; border-collapse: collapse; text-align: center;"> <tr> <td style="width: 10%;"></td> <td style="width: 10%;"></td> <td style="width: 10%;"></td> <td style="width: 10%;"></td> <td style="width: 10%;"></td> <td style="width: 10%;"></td> <td style="width: 10%;"></td> <td style="width: 10%;"></td> <td style="width: 10%;"></td> <td style="width: 10%;"></td> </tr> <tr> <td></td> <td></td> <td colspan="8" style="text-align: center;"> <table border="1" style="width: 100%; border-collapse: collapse; text-align: center;"> <tr> <td style="width: 10%;"></td> <td style="width: 10%;"></td> <td style="width: 10%;"></td> <td style="width: 10%;"></td> <td style="width: 10%;"></td> <td style="width: 10%;"></td> <td style="width: 10%;"></td> <td style="width: 10%;"></td> <td style="width: 10%;"></td> <td style="width: 10%;"></td> </tr> <tr> <td></td> <td></td> <td colspan="8" style="text-align: center;"> <table border="1" style="width: 100%; border-collapse: collapse; text-align: center;"> <tr> <td style="width: 10%;"></td> <td style="width: 10%;"></td> <td style="width: 10%;"></td> <td style="width: 10%;"></td> <td style="width: 10%;"></td> <td style="width: 10%;"></td> <td style="width: 10%;"></td> <td style="width: 10%;"></td> <td style="width: 10%;"></td> <td style="width: 10%;"></td> </tr> <tr> <td></td> <td></td> <td colspan="8" style="text-align: center;"> <table border="1" style="width: 100%; border-collapse: collapse; text-align: center;"> <tr> <td style="width: 10%;"></td> <td style="width: 10%;"></td> <td style="width: 10%;"></td> <td style="width: 10%;"></td> <td style="width: 10%;"></td> <td style="width: 10%;"></td> <td style="width: 10%;"></td> <td style="width: 10%;"></td> <td style="width: 10%;"></td> <td style="width: 10%;"></td> </tr> <tr> <td></td> <td></td> <td colspan="8" style="text-align: center;"> <table border="1" style="width: 100%; border-collapse: collapse; text-align: center;"> <tr> <td style="width: 10%;"></td> <td style="width: 10%;"></td> <td style="width: 10%;"></td> <td style="width: 10%;"></td> <td style="width: 10%;"></td> <td style="width: 10%;"></td> <td style="width: 10%;"></td> <td style="width: 10%;"></td> <td style="width: 10%;"></td> <td style="width: 10%;"></td> </tr> <tr> <td></td> <td></td> <td colspan="8" style="text-align: center;"> <table border="1" style="width: 100%; border-collapse: collapse; text-align: center;"> <tr> <td style="width: 10%;"></td> <td style="width: 10%;"></td> <td style="width: 10%;"></td> <td style="width: 10%;"></td> <td style="width: 10%;"></td> <td style="width: 10%;"></td> <td style="width: 10%;"></td> <td style="width: 10%;"></td> <td style="width: 10%;"></td> <td style="width: 10%;"></td> </tr> <tr> <td></td> <td></td> <td colspan="8" style="text-align: center;"> <table border="1" style="width: 100%; border-collapse: collapse; text-align: center;"> <tr> <td style="width: 10%;"></td> <td style="width: 10%;"></td> <td style="width: 10%;"></td> <td style="width: 10%;"></td> <td style="width: 10%;"></td> <td style="width: 10%;"></td> <td style="width: 10%;"></td> <td style="width: 10%;"></td> <td style="width: 10%;"></td> <td style="width: 10%;"></td> </tr> <tr> <td></td> <td></td> <td colspan="8" style="text-align: center;"> <table border="1" style="width: 100%; border-collapse: collapse; text-align: center;"> <tr> <td style="width: 10%;"></td> <td
style="width: 10%;"></td> <td style="width: 10%;"></td> <td style="width: 10%;"></td> <td style="width: 10%;"></td> <td style="width: 10%;"></td> <td style="width: 10%;"></td> <td style="width: 10%;"></td> <td style="width: 10%;"></td> <td style="width: 10%;"></td> </tr> <tr> <td></td> <td></td> <td colspan="8" style="text-align: center;"> <table border="1" style="width: 100%; border-collapse: collapse; text-align: center;"> <tr> <td style="width: 10%;"></td> <td style="width: 10%;"></td> <td style="width: 10%;"></td> <td style="width: 10%;"></td> <td style="width: 10%;"></td> <td style="width: 10%;"></td> <td style="width: 10%;"></td> <td style="width: 10%;"></td> <td style="width: 10%;"></td> <td style="width: 10%;"></td> </tr> <tr> <td></td> <td></td> <td colspan="8" style="text-align: center;"> <table border="1" style="width: 100%; border-collapse: collapse; text-align: center;"> <tr> <td style="width: 10%;"></td> <td style="width: 10%;"></td> <td style="width: 10%;"></td> <td style="width: 10%;"></td> <td style="width: 10%;"></td> <td style="width: 10%;"></td> <td style="width: 10%;"></td> <td style="width: 10%;"></td> <td style="width: 10%;"></td> <td style="width: 10%;"></td> </tr> <tr> <td></td> <td></td> <td colspan="8" style="text-align: center;"> <table border="1" style="width: 100%; border-collapse: collapse; text-align: center;"> <tr> <td style="width: 10%;"></td> <td style="width: 10%;"></td> <td style="width: 10%;"></td> <td style="width: 10%;"></td> <td style="width: 10%;"></td> <td style="width: 10%;"></td> <td style="width: 10%;"></td> <td style="width: 10%;"></td> <td style="width: 10%;"></td> <td style="width: 10%;"></td> </tr> <tr> <td></td> <td></td> <td colspan="8" style="text-align: center;"> <table border="1" style="width: 100%; border-collapse: collapse; text-align: center;"> <tr> <td style="width: 10%;"></td> <td style="width: 10%;"></td> <td style="width: 10%;"></td> <td style="width: 10%;"></td> <td style="width: 10%;"></td> <td style="width: 10%;"></td> <td style="width: 10%;"></td> <td style="width: 10%;"></td> <td style="width: 10%;"></td> <td style="width: 10%;"></td> </tr> <tr> <td></td> <td></td> <td colspan="8" style="text-align: center;"> <table border="1" style="width: 100%; border-collapse: collapse; text-align: center;"> <tr> <td style="width: 10%;"></td> <td style="width: 10%;"></td> <td style="width: 10%;"></td> <td style="width: 10%;"></td> <td style="width: 10%;"></td> <td style="width: 10%;"></td> <td style="width: 10%;"></td> <td style="width: 10%;"></td> <td style="width: 10%;"></td> <td style="width: 10%;"></td> </tr> <tr> <td></td> <td></td> <td colspan="8" style="text-align: center;"> <table border="1" style="width: 100%; border-collapse: collapse; text-align: center;"> <tr> <td style="width: 10%;"></td> <td style="width: 10%;"></td> <td style="width: 10%;"></td> <td style="width: 10%;"></td> <td style="width: 10%;"></td> <td style="width: 10%;"></td> <td style="width: 10%;"></td> <td style="width: 10%;"></td> <td style="width: 10%;"></td> <td style="width: 10%;"></td> </tr> <tr> <td></td> <td></td> <td colspan="8" style="text-align: center;"> <table border="1" style="width: 100%; border-collapse: collapse; text-align: center;"> <tr> <td style="width: 10%;"></td> <td style="width: 10%;"></td> <td style="width: 10%;"></td> <td style="width: 10%;"></td> <td style="width: 10%;"></td> <td style="width: 10%;"></td> <td style="width: 10%;"></td> <td style="width: 10%;"></td> <td style="width: 10%;"></td> <td style="width: 10%;"></td> </tr> <tr> <td></td> <td></td> <td colspan="8" style="text-align: center;"> <table border="1" style="width: 100%; border-collapse: collapse; text-align: center;"> <tr> <td style="width: 10%;"></td> <td style="width: 10%;"></td> <td style="width: 10%;"></td> <td style="width: 10%;"></td> <td style="width: 10%;"></td> <td style="width: 10%;"></td> <td style="width: 10%;"></td> <td style="width: 10%;"></td> <td style="width: 10%;"></td> <td style="width: 10%;"></td> </tr> <tr> <td></td> <td></td> <td colspan="8" style="text-align: center;"> <table border="1" style="width: 100%; border-collapse: collapse; text-align: center;"> <tr> <td style="width: 10%;"></td> <td style="width: 10%;"></td> <td style="width: 10%;"></td> <td style="width: 10%;"></td> <td style="width: 10%;"></td> <td style="width: 10%;"></td> <td style="width: 10%;"></td> <td style="width: 10%;"></td> <td style="width: 10%;"></td> <td style="width: 10%;"></td> </tr> <tr> <td></td> <td></td> <td colspan="8" style="text-align: center;"> <table border="1" style="width: 100%; border-collapse: collapse; text-align: center;"> <tr> <td style="width: 10%;"></td> <td style="width: 10%;"></td> <td style="width: 10%;"></td> <td style="width: 10%;"></td> <td style="width: 10%;"></td> <td style="width: 10%;"></td> <td style="width: 10%;"></td> <td style="width: 10%;"></td> <td style="width: 10%;"></td> <td style="width: 10%;"></td> </tr> <tr> <td></td> <td></td> <td colspan="8" style="text-align: center;"> <table border="1" style="width: 100%; border-collapse: collapse; text-align: center;"> <tr> <td style="width: 10%;"></td> <td style="width: 10%;"></td> <td style="width: 10%;"></td> <td style="width: 10%;"></td> <td style="width: 10%;"></td> <td style="width: 10%;"></td> <td style="width: 10%;"></td> <td style="width: 10%;"></td> <td style="width: 10%;"></td> <td style="width: 10%;"></td> </tr> <tr> <td></td> <td></td> <td colspan="8" style="text-align: center;"> <table border="1" style="width: 100%; border-collapse: collapse; text-align: center;"> <tr> <td style="width: 10%;"></td> <td style="width: 10%;"></td> <td style="width: 10%;"></td> <td style="width: 10%;"></td> <td style="width: 10%;"></td> <td style="width: 10%;"></td> <td style="width: 10%;"></td> <td style="width: 10%;"></td> <td style="width: 10%;"></td> <td style="width: 10%;"></td> </tr> <tr> <td></td> <td></td> <td colspan="8" style="text-align: center;"> <table border="1" style="width: 100%; border-collapse: collapse; text-align: center;"> <tr> <td style="width: 10%;"></td> <td style="width: 10%;"></td> <td style="width: 10%;"></td> <td style="width: 10%;"></td> <td style="width: 10%;"></td> <td style="width: 10%;"></td> <td style="width: 10%;"></td> <td style="width: 10%;"></td> <td style="width: 10%;"></td> <td style="width: 10%;"></td> </tr> <tr> <td></td> <td></td> <td colspan="8" style="text-align: center;"> <table border="1" style="width: 100%; border-collapse: collapse; text-align: center;"> <tr> <td style="width: 10%;"></td> <td style="width: 10%;"></td> <td style="width: 10%;"></td> <td style="width: 10%;"></td> <td style="width: 10%;"></td> <td style="width: 10%;"></td> <td style="width: 10%;"></td> <td style="width: 10%;"></td> <td style="width: 10%;"></td> <td style="width: 10%;"></td> </tr> <tr> <td></td> <td></td> <td colspan="8" style="text-align: center;"> <table border="1" style="width: 100%; border-collapse: collapse; text-align: center;"> <tr> <td style="width: 10%;"></td> <td style="width: 10%;"></td> <td style="width: 10%;"></td> <td style="width: 10%;"></td> <td style="width: 10%;"></td> <td style="width: 10%;"></td> <td style="width: 10%;"></td> <td style="width: 10%;"></td> <td style="width: 10%;"></td> <td style="width: 10%;"></td> </tr> <tr> <td></td> <td></td> <td colspan="8" style="text-align: center;"> <table border="1" style="width: 100%; border-collapse: collapse; text-align: center;"> <tr> </tr></table></td></tr></table></td></tr></table></td></tr></table></td></tr></table></td></tr></table></td></tr></table></td></tr></table></td></tr></table></td></tr></table></td></tr></table></td></tr></table></td></tr></table></td></tr></table></td></tr></table></td></tr></table></td></tr></table></td></tr></table></td></tr></table></td></tr></table></td></tr></table></td></tr></table></td></tr></table></td></tr></table></td></tr></table></td></tr></table></td></tr></table></td></tr></table></td></tr></table></td></tr></table></td></tr></table></td></tr></table></td></tr></table>

 | | | | | | | | | | | | | | | | | | | | <table border="1" style="width: 100%; border-collapse: collapse; text-align: center;"> <tr> <td style="width: 10%;"></td> <td style="width: 10%;"></td> <td style="width: 10%;"></td> <td style="width: 10%;"></td> <td style="width: 10%;"></td> <td style="width: 10%;"></td> <td style="width: 10%;"></td> <td style="width: 10%;"></td> <td style="width: 10%;"></td> <td style="width: 10%;"></td> </tr> <tr> <td></td> <td></td> <td colspan="8" style="text-align: center;"> <table border="1" style="width: 100%; border-collapse: collapse; text-align: center;"> <tr> <td style="width: 10%;"></td> <td style="width: 10%;"></td> <td style="width: 10%;"></td> <td style="width: 10%;"></td> <td style="width: 10%;"></td> <td style="width: 10%;"></td> <td style="width: 10%;"></td> <td style="width: 10%;"></td> <td style="width: 10%;"></td> <td style="width: 10%;"></td> </tr> <tr> <td></td> <td></td> <td colspan="8" style="text-align: center;"> <table border="1" style="width: 100%; border-collapse: collapse; text-align: center;"> <tr> <td style="width: 10%;"></td> <td style="width: 10%;"></td> <td style="width: 10%;"></td> <td style="width: 10%;"></td> <td style="width: 10%;"></td> <td style="width: 10%;"></td> <td style="width: 10%;"></td> <td style="width: 10%;"></td> <td style="width: 10%;"></td> <td style="width: 10%;"></td> </tr> <tr> <td></td> <td></td> <td colspan="8" style="text-align: center;"> <table border="1" style="width: 100%; border-collapse: collapse; text-align: center;"> <tr> <td style="width: 10%;"></td> <td style="width: 10%;"></td> <td style="width: 10%;"></td> <td style="width: 10%;"></td> <td style="width: 10%;"></td> <td style="width: 10%;"></td> <td style="width: 10%;"></td> <td style="width: 10%;"></td> <td style="width: 10%;"></td> <td style="width: 10%;"></td> </tr> <tr> <td></td> <td></td> <td colspan="8" style="text-align: center;"> <table border="1" style="width: 100%; border-collapse: collapse; text-align: center;"> <tr> <td style="width: 10%;"></td> <td style="width: 10%;"></td> <td style="width: 10%;"></td> <td style="width: 10%;"></td> <td style="width: 10%;"></td> <td style="width: 10%;"></td> <td style="width: 10%;"></td> <td style="width: 10%;"></td> <td style="width: 10%;"></td> <td style="width: 10%;"></td> </tr> <tr> <td></td> <td></td> <td colspan="8" style="text-align: center;"> <table border="1" style="width: 100%; border-collapse: collapse; text-align: center;"> <tr> <td style="width: 10%;"></td> <td style="width: 10%;"></td> <td style="width: 10%;"></td> <td style="width: 10%;"></td> <td style="width: 10%;"></td> <td style="width: 10%;"></td> <td style="width: 10%;"></td> <td style="width: 10%;"></td> <td style="width: 10%;"></td> <td style="width: 10%;"></td> </tr> <tr> <td></td> <td></td> <td colspan="8" style="text-align: center;"> <table border="1" style="width: 100%; border-collapse: collapse; text-align: center;"> <tr> <td style="width: 10%;"></td> <td style="width: 10%;"></td> <td style="width: 10%;"></td> <td style="width: 10%;"></td> <td style="width: 10%;"></td> <td style="width: 10%;"></td> <td style="width: 10%;"></td> <td style="width: 10%;"></td> <td style="width: 10%;"></td> <td style="width: 10%;"></td> </tr> <tr> <td></td> <td></td> <td colspan="8" style="text-align: center;"> <table border="1" style="width: 100%; border-collapse: collapse; text-align: center;"> <tr> <td style="width: 10%;"></td> <td style="width: 10%;"></td> <td style="width: 10%;"></td> <td style="width: 10%;"></td> <td style="width: 10%;"></td> <td style="width: 10%;"></td> <td style="width: 10%;"></td> <td style="width: 10%;"></td> <td style="width: 10%;"></td> <td style="width: 10%;"></td> </tr> <tr> <td></td> <td></td> <td colspan="8" style="text-align: center;"> <table border="1" style="width: 100%; border-collapse: collapse; text-align: center;"> <tr> <td style="width: 10%;"></td> <td style="width: 10%;"></td> <td style="width: 10%;"></td> <td style="width: 10%;"></td> <td style="width: 10%;"></td> <td style="width: 10%;"></td> <td style="width: 10%;"></td> <td style="width: 10%;"></td> <td style="width: 10%;"></td> <td style="width: 10%;"></td> </tr> <tr> <td></td> <td></td> <td colspan="8" style="text-align: center;"> <table border="1" style="width: 100%; border-collapse: collapse; text-align: center;"> <tr> <td style="width: 10%;"></td> <td style="width: 10%;"></td> <td style="width: 10%;"></td> <td style="width: 10%;"></td> <td style="width: 10%;"></td> <td style="width: 10%;"></td> <td style="width: 10%;"></td> <td style="width: 10%;"></td> <td style="width: 10%;"></td> <td style="width: 10%;"></td> </tr> <tr> <td></td> <td></td> <td colspan="8" style="text-align: center;"> <table border="1" style="width: 100%; border-collapse: collapse; text-align: center;"> <tr> <td style="width: 10%;"></td> <td style="width: 10%;"></td> <td style="width: 10%;"></td> <td style="width: 10%;"></td> <td style="width: 10%;"></td> <td style="width: 10%;"></td> <td style="width: 10%;"></td> <td style="width: 10%;"></td> <td style="width: 10%;"></td> <td style="width: 10%;"></td> </tr> <tr> <td></td> <td></td> <td colspan="8" style="text-align: center;"> <table border="1" style="width: 100%; border-collapse: collapse; text-align: center;"> <tr> <td style="width: 10%;"></td> <td style="width: 10%;"></td> <td style="width: 10%;"></td> <td style="width: 10%;"></td> <td style="width: 10%;"></td> <td style="width: 10%;"></td> <td style="width: 10%;"></td> <td style="width: 10%;"></td> <td style="width: 10%;"></td> <td style="width: 10%;"></td> </tr> <tr> <td></td> <td></td> <td colspan="8" style="text-align: center;"> <table border="1" style="width: 100%; border-collapse: collapse; text-align: center;"> <tr> <td style="width: 10%;"></td> <td style="width: 10%;"></td> <td style="width: 10%;"></td> <td style="width: 10%;"></td> <td style="width: 10%;"></td> <td style="width: 10%;"></td> <td style="width: 10%;"></td> <td style="width: 10%;"></td> <td style="width: 10%;"></td> <td style="width: 10%;"></td> </tr> <tr> <td></td> <td></td> <td colspan="8" style="text-align: center;"> <table border="1" style="width: 100%; border-collapse: collapse; text-align: center;"> <tr> <td style="width: 10%;"></td> <td style="width: 10%;"></td> <td style="width: 10%;"></td> <td style="width: 10%;"></td> <td style="width: 10%;"></td> <td style="width: 10%;"></td> <td style="width: 10%;"></td> <td style="width: 10%;"></td> <td style="width: 10%;"></td> <td style="width: 10%;"></td> </tr> <tr> <td></td> <td></td> <td colspan="8" style="text-align: center;"> <table border="1" style="width: 100%; border-collapse: collapse; text-align: center;"> <tr> <td style="width: 10%;"></td> <td style="width: 10%;"></td> <td style="width: 10%;"></td> <td style="width: 10%;"></td> <td style="width: 10%;"></td> <td style="width: 10%;"></td> <td style="width: 10%;"></td> <td style="width: 10%;"></td> <td style="width: 10%;"></td> <td style="width: 10%;"></td> </tr> <tr> <td></td> <td></td> <td colspan="8" style="text-align: center;"> <table border="1" style="width: 100%; border-collapse: collapse; text-align: center;"> <tr> <td style="width: 10%;"></td> <td style="width: 10%;"></td> <td style="width: 10%;"></td> <td style="width: 10%;"></td> <td style="width: 10%;"></td> <td style="width: 10%;"></td> <td style="width: 10%;"></td> <td style="width: 10%;"></td> <td style="width: 10%;"></td> <td style="width: 10%;"></td> </tr> <tr> <td></td> <td></td> <td colspan="8" style="text-align: center;"> <table border="1" style="width: 100%; border-collapse: collapse; text-align: center;"> <tr> <td style="width: 10%;"></td> <td style="width: 10%;"></td> <td style="width: 10%;"></td> <td style="width: 10%;"></td> <td style="width: 10%;"></td> <td style="width: 10%;"></td> <td style="width: 10%;"></td> <td
style="width: 10%;"></td> <td style="width: 10%;"></td> <td style="width: 10%;"></td> </tr> <tr> <td></td> <td></td> <td colspan="8" style="text-align: center;"> <table border="1" style="width: 100%; border-collapse: collapse; text-align: center;"> <tr> <td style="width: 10%;"></td> <td style="width: 10%;"></td> <td style="width: 10%;"></td> <td style="width: 10%;"></td> <td style="width: 10%;"></td> <td style="width: 10%;"></td> <td style="width: 10%;"></td> <td style="width: 10%;"></td> <td style="width: 10%;"></td> <td style="width: 10%;"></td> </tr> <tr> <td></td> <td></td> <td colspan="8" style="text-align: center;"> <table border="1" style="width: 100%; border-collapse: collapse; text-align: center;"> <tr> <td style="width: 10%;"></td> <td style="width: 10%;"></td> <td style="width: 10%;"></td> <td style="width: 10%;"></td> <td style="width: 10%;"></td> <td style="width: 10%;"></td> <td style="width: 10%;"></td> <td style="width: 10%;"></td> <td style="width: 10%;"></td> <td style="width: 10%;"></td> </tr> <tr> <td></td> <td></td> <td colspan="8" style="text-align: center;"> <table border="1" style="width: 100%; border-collapse: collapse; text-align: center;"> <tr> <td style="width: 10%;"></td> <td style="width: 10%;"></td> <td style="width: 10%;"></td> <td style="width: 10%;"></td> <td style="width: 10%;"></td> <td style="width: 10%;"></td> <td style="width: 10%;"></td> <td style="width: 10%;"></td> <td style="width: 10%;"></td> <td style="width: 10%;"></td> </tr> <tr> <td></td> <td></td> <td colspan="8" style="text-align: center;"> <table border="1" style="width: 100%; border-collapse: collapse; text-align: center;"> <tr> <td style="width: 10%;"></td> <td style="width: 10%;"></td> <td style="width: 10%;"></td> <td style="width: 10%;"></td> <td style="width: 10%;"></td> <td style="width: 10%;"></td> <td style="width: 10%;"></td> <td style="width: 10%;"></td> <td style="width: 10%;"></td> <td style="width: 10%;"></td> </tr> <tr> <td></td> <td></td> <td colspan="8" style="text-align: center;"> <table border="1" style="width: 100%; border-collapse: collapse; text-align: center;"> <tr> <td style="width: 10%;"></td> <td style="width: 10%;"></td> <td style="width: 10%;"></td> <td style="width: 10%;"></td> <td style="width: 10%;"></td> <td style="width: 10%;"></td> <td style="width: 10%;"></td> <td style="width: 10%;"></td> <td style="width: 10%;"></td> <td style="width: 10%;"></td> </tr> <tr> <td></td> <td></td> <td colspan="8" style="text-align: center;"> <table border="1" style="width: 100%; border-collapse: collapse; text-align: center;"> <tr> <td style="width: 10%;"></td> <td style="width: 10%;"></td> <td style="width: 10%;"></td> <td style="width: 10%;"></td> <td style="width: 10%;"></td> <td style="width: 10%;"></td> <td style="width: 10%;"></td> <td style="width: 10%;"></td> <td style="width: 10%;"></td> <td style="width: 10%;"></td> </tr> <tr> <td></td> <td></td> <td colspan="8" style="text-align: center;"> <table border="1" style="width: 100%; border-collapse: collapse; text-align: center;"> <tr> <td style="width: 10%;"></td> <td style="width: 10%;"></td> <td style="width: 10%;"></td> <td style="width: 10%;"></td> <td style="width: 10%;"></td> <td style="width: 10%;"></td> <td style="width: 10%;"></td> <td style="width: 10%;"></td> <td style="width: 10%;"></td> <td style="width: 10%;"></td> </tr> <tr> <td></td> <td></td> <td colspan="8" style="text-align: center;"> <table border="1" style="width: 100%; border-collapse: collapse; text-align: center;"> <tr> <td style="width: 10%;"></td> <td style="width: 10%;"></td> <td style="width: 10%;"></td> <td style="width: 10%;"></td> <td style="width: 10%;"></td> <td style="width: 10%;"></td> <td style="width: 10%;"></td> <td style="width: 10%;"></td> <td style="width: 10%;"></td> <td style="width: 10%;"></td> </tr> <tr> <td></td> <td></td> <td colspan="8" style="text-align: center;"> <table border="1" style="width: 100%; border-collapse: collapse; text-align: center;"> <tr> <td style="width: 10%;"></td> <td style="width: 10%;"></td> <td style="width: 10%;"></td> <td style="width: 10%;"></td> <td style="width: 10%;"></td> <td style="width: 10%;"></td> <td style="width: 10%;"></td> <td style="width: 10%;"></td> <td style="width: 10%;"></td> <td style="width: 10%;"></td> </tr> <tr> <td></td> <td></td> <td colspan="8" style="text-align: center;"> <table border="1" style="width: 100%; border-collapse: collapse; text-align: center;"> <tr> <td style="width: 10%;"></td> <td style="width: 10%;"></td> <td style="width: 10%;"></td> <td style="width: 10%;"></td> <td style="width: 10%;"></td> <td style="width: 10%;"></td> <td style="width: 10%;"></td> <td style="width: 10%;"></td> <td style="width: 10%;"></td> <td style="width: 10%;"></td> </tr> <tr> <td></td> <td></td> <td colspan="8" style="text-align: center;"> <table border="1" style="width: 100%; border-collapse: collapse; text-align: center;"> <tr> <td style="width: 10%;"></td> <td style="width: 10%;"></td> <td style="width: 10%;"></td> <td style="width: 10%;"></td> <td style="width: 10%;"></td> <td style="width: 10%;"></td> <td style="width: 10%;"></td> <td style="width: 10%;"></td> <td style="width: 10%;"></td> <td style="width: 10%;"></td> </tr> <tr> <td></td> <td></td> <td colspan="8" style="text-align: center;"> <table border="1" style="width: 100%; border-collapse: collapse; text-align: center;"> <tr> <td style="width: 10%;"></td> <td style="width: 10%;"></td> <td style="width: 10%;"></td> <td style="width: 10%;"></td> <td style="width: 10%;"></td> <td style="width: 10%;"></td> <td style="width: 10%;"></td> <td style="width: 10%;"></td> <td style="width: 10%;"></td> <td style="width: 10%;"></td> </tr> <tr> <td></td> <td></td> <td colspan="8" style="text-align: center;"> <table border="1" style="width: 100%; border-collapse: collapse; text-align: center;"> <tr> <td style="width: 10%;"></td> <td style="width: 10%;"></td> <td style="width: 10%;"></td> <td style="width: 10%;"></td> <td style="width: 10%;"></td> <td style="width: 10%;"></td> <td style="width: 10%;"></td> <td style="width: 10%;"></td> <td style="width: 10%;"></td> <td style="width: 10%;"></td> </tr> <tr> <td></td> <td></td> <td colspan="8" style="text-align: center;"> <table border="1" style="width: 100%; border-collapse: collapse; text-align: center;"> <tr> <td style="width: 10%;"></td> <td style="width: 10%;"></td> <td style="width: 10%;"></td> <td style="width: 10%;"></td> <td style="width: 10%;"></td> <td style="width: 10%;"></td> <td style="width: 10%;"></td> <td style="width: 10%;"></td> <td style="width: 10%;"></td> <td style="width: 10%;"></td> </tr> <tr> <td></td> <td></td> <td colspan="8" style="text-align: center;"> <table border="1" style="width: 100%; border-collapse: collapse; text-align: center;"> <tr> </tr></table></td></tr></table></td></tr></table></td></tr></table></td></tr></table></td></tr></table></td></tr></table></td></tr></table></td></tr></table></td></tr></table></td></tr></table></td></tr></table></td></tr></table></td></tr></table></td></tr></table></td></tr></table></td></tr></table></td></tr></table></td></tr></table></td></tr></table></td></tr></table></td></tr></table></td></tr></table></td></tr></table></td></tr></table></td></tr></table></td></tr></table></td></tr></table></td></tr></table></td></tr></table></td></tr></table></td></tr></table>

 | | | | | | | | | | | | | | | | | | | | <table border="1" style="width: 100%; border-collapse: collapse; text-align: center;"> <tr> <td style="width: 10%;"></td> <td style="width: 10%;"></td> <td style="width: 10%;"></td> <td style="width: 10%;"></td> <td style="width: 10%;"></td> <td style="width: 10%;"></td> <td style="width: 10%;"></td> <td style="width: 10%;"></td> <td style="width: 10%;"></td> <td style="width: 10%;"></td> </tr> <tr> <td></td> <td></td> <td colspan="8" style="text-align: center;"> <table border="1" style="width: 100%; border-collapse: collapse; text-align: center;"> <tr> <td style="width: 10%;"></td> <td style="width: 10%;"></td> <td style="width: 10%;"></td> <td style="width: 10%;"></td> <td style="width: 10%;"></td> <td style="width: 10%;"></td> <td style="width: 10%;"></td> <td style="width: 10%;"></td> <td style="width: 10%;"></td> <td style="width: 10%;"></td> </tr> <tr> <td></td> <td></td> <td colspan="8" style="text-align: center;"> <table border="1" style="width: 100%; border-collapse: collapse; text-align: center;"> <tr> <td style="width: 10%;"></td> <td style="width: 10%;"></td> <td style="width: 10%;"></td> <td style="width: 10%;"></td> <td style="width: 10%;"></td> <td style="width: 10%;"></td> <td style="width: 10%;"></td> <td style="width: 10%;"></td> <td style="width: 10%;"></td> <td style="width: 10%;"></td> </tr> <tr> <td></td> <td></td> <td colspan="8" style="text-align: center;"> <table border="1" style="width: 100%; border-collapse: collapse; text-align: center;"> <tr> <td style="width: 10%;"></td> <td style="width: 10%;"></td> <td style="width: 10%;"></td> <td style="width: 10%;"></td> <td style="width: 10%;"></td> <td style="width: 10%;"></td> <td style="width: 10%;"></td> <td style="width: 10%;"></td> <td style="width: 10%;"></td> <td style="width: 10%;"></td> </tr> <tr> <td></td> <td></td> <td colspan="8" style="text-align: center;"> <table border="1" style="width: 100%; border-collapse: collapse; text-align: center;"> <tr> <td style="width: 10%;"></td> <td style="width: 10%;"></td> <td style="width: 10%;"></td> <td style="width: 10%;"></td> <td style="width: 10%;"></td> <td style="width: 10%;"></td> <td style="width: 10%;"></td> <td style="width: 10%;"></td> <td style="width: 10%;"></td> <td style="width: 10%;"></td> </tr> <tr> <td></td> <td></td> <td colspan="8" style="text-align: center;"> <table border="1" style="width: 100%; border-collapse: collapse; text-align: center;"> <tr> <td style="width: 10%;"></td> <td style="width: 10%;"></td> <td style="width: 10%;"></td> <td style="width: 10%;"></td> <td style="width: 10%;"></td> <td style="width: 10%;"></td> <td style="width: 10%;"></td> <td style="width: 10%;"></td> <td style="width: 10%;"></td> <td style="width: 10%;"></td> </tr> <tr> <td></td> <td></td> <td colspan="8" style="text-align: center;"> <table border="1" style="width: 100%; border-collapse: collapse; text-align: center;"> <tr> <td style="width: 10%;"></td> <td style="width: 10%;"></td> <td style="width: 10%;"></td> <td style="width: 10%;"></td> <td style="width: 10%;"></td> <td style="width: 10%;"></td> <td style="width: 10%;"></td> <td style="width: 10%;"></td> <td style="width: 10%;"></td> <td style="width: 10%;"></td> </tr> <tr> <td></td> <td></td> <td colspan="8" style="text-align: center;"> <table border="1" style="width: 100%; border-collapse: collapse; text-align: center;"> <tr> <td style="width: 10%;"></td> <td style="width: 10%;"></td> <td style="width: 10%;"></td> <td style="width: 10%;"></td> <td style="width: 10%;"></td> <td style="width: 10%;"></td> <td style="width: 10%;"></td> <td style="width: 10%;"></td> <td style="width: 10%;"></td> <td style="width: 10%;"></td> </tr> <tr> <td></td> <td></td> <td colspan="8" style="text-align: center;"> <table border="1" style="width: 100%; border-collapse: collapse; text-align: center;"> <tr> <td style="width: 10%;"></td> <td style="width: 10%;"></td> <td style="width: 10%;"></td> <td style="width: 10%;"></td> <td style="width: 10%;"></td> <td style="width: 10%;"></td> <td style="width: 10%;"></td> <td style="width: 10%;"></td> <td style="width: 10%;"></td> <td style="width: 10%;"></td> </tr> <tr> <td></td> <td></td> <td colspan="8" style="text-align: center;"> <table border="1" style="width: 100%; border-collapse: collapse; text-align: center;"> <tr> <td style="width: 10%;"></td> <td style="width: 10%;"></td> <td style="width: 10%;"></td> <td style="width: 10%;"></td> <td style="width: 10%;"></td> <td style="width: 10%;"></td> <td style="width: 10%;"></td> <td style="width: 10%;"></td> <td style="width: 10%;"></td> <td style="width: 10%;"></td> </tr> <tr> <td></td> <td></td> <td colspan="8" style="text-align: center;"> <table border="1" style="width: 100%; border-collapse: collapse; text-align: center;"> <tr> <td style="width: 10%;"></td> <td style="width: 10%;"></td> <td style="width: 10%;"></td> <td style="width: 10%;"></td> <td style="width: 10%;"></td> <td style="width: 10%;"></td> <td style="width: 10%;"></td> <td style="width: 10%;"></td> <td style="width: 10%;"></td> <td style="width: 10%;"></td> </tr> <tr> <td></td> <td></td> <td colspan="8" style="text-align: center;"> <table border="1" style="width: 100%; border-collapse: collapse; text-align: center;"> <tr> <td style="width: 10%;"></td> <td style="width: 10%;"></td> <td style="width: 10%;"></td> <td style="width: 10%;"></td> <td style="width: 10%;"></td> <td style="width: 10%;"></td> <td style="width: 10%;"></td> <td style="width: 10%;"></td> <td style="width: 10%;"></td> <td style="width: 10%;"></td> </tr> <tr> <td></td> <td></td> <td colspan="8" style="text-align: center;"> <table border="1" style="width: 100%; border-collapse: collapse; text-align: center;"> <tr> <td style="width: 10%;"></td> <td style="width: 10%;"></td> <td style="width: 10%;"></td> <td style="width: 10%;"></td> <td style="width: 10%;"></td> <td style="width: 10%;"></td> <td style="width: 10%;"></td> <td style="width: 10%;"></td> <td style="width: 10%;"></td> <td style="width: 10%;"></td> </tr> <tr> <td></td> <td></td> <td colspan="8" style="text-align: center;"> <table border="1" style="width: 100%; border-collapse: collapse; text-align: center;"> <tr> <td style="width: 10%;"></td> <td style="width: 10%;"></td> <td style="width: 10%;"></td> <td style="width: 10%;"></td> <td style="width: 10%;"></td> <td style="width: 10%;"></td> <td style="width: 10%;"></td> <td style="width: 10%;"></td> <td style="width: 10%;"></td> <td style="width: 10%;"></td> </tr> <tr> <td></td> <td></td> <td colspan="8" style="text-align: center;"> <table border="1" style="width: 100%; border-collapse: collapse; text-align: center;"> <tr> <td style="width: 10%;"></td> <td style="width: 10%;"></td> <td style="width: 10%;"></td> <td style="width: 10%;"></td> <td style="width: 10%;"></td> <td style="width: 10%;"></td> <td style="width: 10%;"></td> <td style="width: 10%;"></td> <td style="width: 10%;"></td> <td style="width: 10%;"></td> </tr> <tr> <td></td> <td></td> <td colspan="8" style="text-align: center;"> <table border="1" style="width: 100%; border-collapse: collapse; text-align: center;"> <tr> <td style="width: 10%;"></td> <td style="width: 10%;"></td> <td style="width: 10%;"></td> <td style="width: 10%;"></td> <td style="width: 10%;"></td> <td style="width: 10%;"></td> <td style="width: 10%;"></td> <td style="width: 10%;"></td> <td style="width: 10%;"></td> <td style="width: 10%;"></td> </tr> <tr> <td></td> <td></td> <td colspan="8" style="text-align: center;"> <table border="1" style="width: 100%; border-collapse: collapse; text-align: center;"> <tr> <td style="width: 10%;"></td> <td style="width: 10%;"></td> <td style="width: 10%;"></td> <td style="width: 10%;"></td> <td style="width: 10%;"></td> <td style="width: 10%;"></td> <td style="width: 10%;"></td> <td style="width: 10%;"></td> <td style="width: 10%;"></td> <td style="width: 10%;"></td> </tr> <tr> <td></td> <td></td> <td colspan="8" style="text-align: center;"> <table border="1" style="width: 100%; border-collapse: collapse; text-align: center;"> <tr> <td style="width: 10%;"></td> <td style="width: 10%;"></td> <td style="width: 10%;"></td> <td style="width: 10%;"></td> <td style="width: 10%;"></td> <td style="width: 10%;"></td> <td style="width: 10%;"></td> <td style="width: 10%;"></td> <td style="width: 10%;"></td> <td style="width: 10%;"></td> </tr> <tr> <td></td> <td></td> <td colspan="8" style="text-align: center;"> <table border="1" style="width: 100%;
border-collapse: collapse; text-align: center;"> <tr> <td style="width: 10%;"></td> <td style="width: 10%;"></td> <td style="width: 10%;"></td> <td style="width: 10%;"></td> <td style="width: 10%;"></td> <td style="width: 10%;"></td> <td style="width: 10%;"></td> <td style="width: 10%;"></td> <td style="width: 10%;"></td> <td style="width: 10%;"></td> </tr> <tr> <td></td> <td></td> <td colspan="8" style="text-align: center;"> <table border="1" style="width: 100%; border-collapse: collapse; text-align: center;"> <tr> <td style="width: 10%;"></td> <td style="width: 10%;"></td> <td style="width: 10%;"></td> <td style="width: 10%;"></td> <td style="width: 10%;"></td> <td style="width: 10%;"></td> <td style="width: 10%;"></td> <td style="width: 10%;"></td> <td style="width: 10%;"></td> <td style="width: 10%;"></td> </tr> <tr> <td></td> <td></td> <td colspan="8" style="text-align: center;"> <table border="1" style="width: 100%; border-collapse: collapse; text-align: center;"> <tr> <td style="width: 10%;"></td> <td style="width: 10%;"></td> <td style="width: 10%;"></td> <td style="width: 10%;"></td> <td style="width: 10%;"></td> <td style="width: 10%;"></td> <td style="width: 10%;"></td> <td style="width: 10%;"></td> <td style="width: 10%;"></td> <td style="width: 10%;"></td> </tr> <tr> <td></td> <td></td> <td colspan="8" style="text-align: center;"> <table border="1" style="width: 100%; border-collapse: collapse; text-align: center;"> <tr> <td style="width: 10%;"></td> <td style="width: 10%;"></td> <td style="width: 10%;"></td> <td style="width: 10%;"></td> <td style="width: 10%;"></td> <td style="width: 10%;"></td> <td style="width: 10%;"></td> <td style="width: 10%;"></td> <td style="width: 10%;"></td> <td style="width: 10%;"></td> </tr> <tr> <td></td> <td></td> <td colspan="8" style="text-align: center;"> <table border="1" style="width: 100%; border-collapse: collapse; text-align: center;"> <tr> <td style="width: 10%;"></td> <td style="width: 10%;"></td> <td style="width: 10%;"></td> <td style="width: 10%;"></td> <td style="width: 10%;"></td> <td style="width: 10%;"></td> <td style="width: 10%;"></td> <td style="width: 10%;"></td> <td style="width: 10%;"></td> <td style="width: 10%;"></td> </tr> <tr> <td></td> <td></td> <td colspan="8" style="text-align: center;"> <table border="1" style="width: 100%; border-collapse: collapse; text-align: center;"> <tr> <td style="width: 10%;"></td> <td style="width: 10%;"></td> <td style="width: 10%;"></td> <td style="width: 10%;"></td> <td style="width: 10%;"></td> <td style="width: 10%;"></td> <td style="width: 10%;"></td> <td style="width: 10%;"></td> <td style="width: 10%;"></td> <td style="width: 10%;"></td> </tr> <tr> <td></td> <td></td> <td colspan="8" style="text-align: center;"> <table border="1" style="width: 100%; border-collapse: collapse; text-align: center;"> <tr> <td style="width: 10%;"></td> <td style="width: 10%;"></td> <td style="width: 10%;"></td> <td style="width: 10%;"></td> <td style="width: 10%;"></td> <td style="width: 10%;"></td> <td style="width: 10%;"></td> <td style="width: 10%;"></td> <td style="width: 10%;"></td> <td style="width: 10%;"></td> </tr> <tr> <td></td> <td></td> <td colspan="8" style="text-align: center;"> <table border="1" style="width: 100%; border-collapse: collapse; text-align: center;"> <tr> <td style="width: 10%;"></td> <td style="width: 10%;"></td> <td style="width: 10%;"></td> <td style="width: 10%;"></td> <td style="width: 10%;"></td> <td style="width: 10%;"></td> <td style="width: 10%;"></td> <td style="width: 10%;"></td> <td style="width: 10%;"></td> <td style="width: 10%;"></td> </tr> <tr> <td></td> <td></td> <td colspan="8" style="text-align: center;"> <table border="1" style="width: 100%; border-collapse: collapse; text-align: center;"> <tr> <td style="width: 10%;"></td> <td style="width: 10%;"></td> <td style="width: 10%;"></td> <td style="width: 10%;"></td> <td style="width: 10%;"></td> <td style="width: 10%;"></td> <td style="width: 10%;"></td> <td style="width: 10%;"></td> <td style="width: 10%;"></td> <td style="width: 10%;"></td> </tr> <tr> <td></td> <td></td> <td colspan="8" style="text-align: center;"> <table border="1" style="width: 100%; border-collapse: collapse; text-align: center;"> <tr> <td style="width: 10%;"></td> <td style="width: 10%;"></td> <td style="width: 10%;"></td> <td style="width: 10%;"></td> <td style="width: 10%;"></td> <td style="width: 10%;"></td> <td style="width: 10%;"></td> <td style="width: 10%;"></td> <td style="width: 10%;"></td> <td style="width: 10%;"></td> </tr> <tr> <td></td> <td></td> <td colspan="8" style="text-align: center;"> <table border="1" style="width: 100%; border-collapse: collapse; text-align: center;"> <tr> <td style="width: 10%;"></td> <td style="width: 10%;"></td> <td style="width: 10%;"></td> <td style="width: 10%;"></td> <td style="width: 10%;"></td> <td style="width: 10%;"></td> <td style="width: 10%;"></td> <td style="width: 10%;"></td> <td style="width: 10%;"></td> <td style="width: 10%;"></td> </tr> <tr> <td></td> <td></td> <td colspan="8" style="text-align: center;"> <table border="1" style="width: 100%; border-collapse: collapse; text-align: center;"> <tr> <td style="width: 10%;"></td> <td style="width: 10%;"></td> <td style="width: 10%;"></td> <td style="width: 10%;"></td> <td style="width: 10%;"></td> <td style="width: 10%;"></td> <td style="width: 10%;"></td> <td style="width: 10%;"></td> <td style="width: 10%;"></td> <td style="width: 10%;"></td> </tr> <tr> <td></td> <td></td> <td colspan="8" style="text-align: center;"> <table border="1" style="width: 100%; border-collapse: collapse; text-align: center;"> <tr> </tr></table></td></tr></table></td></tr></table></td></tr></table></td></tr></table></td></tr></table></td></tr></table></td></tr></table></td></tr></table></td></tr></table></td></tr></table></td></tr></table></td></tr></table></td></tr></table></td></tr></table></td></tr></table></td></tr></table></td></tr></table></td></tr></table></td></tr></table></td></tr></table></td></tr></table></td></tr></table></td></tr></table></td></tr></table></td></tr></table></td></tr></table></td></tr></table></td></tr></table></td></tr></table></td></tr></table>

 | | | | | | | | | | | | | | | | | | | | <table border="1" style="width: 100%; border-collapse: collapse; text-align: center;"> <tr> <td style="width: 10%;"></td> <td style="width: 10%;"></td> <td style="width: 10%;"></td> <td style="width: 10%;"></td> <td style="width: 10%;"></td> <td style="width: 10%;"></td> <td style="width: 10%;"></td> <td style="width: 10%;"></td> <td style="width: 10%;"></td> <td style="width: 10%;"></td> </tr> <tr> <td></td> <td></td> <td colspan="8" style="text-align: center;"> <table border="1" style="width: 100%; border-collapse: collapse; text-align: center;"> <tr> <td style="width: 10%;"></td> <td style="width: 10%;"></td> <td style="width: 10%;"></td> <td style="width: 10%;"></td> <td style="width: 10%;"></td> <td style="width: 10%;"></td> <td style="width: 10%;"></td> <td style="width: 10%;"></td> <td style="width: 10%;"></td> <td style="width: 10%;"></td> </tr> <tr> <td></td> <td></td> <td colspan="8" style="text-align: center;"> <table border="1" style="width: 100%; border-collapse: collapse; text-align: center;"> <tr> <td style="width: 10%;"></td> <td style="width: 10%;"></td> <td style="width: 10%;"></td> <td style="width: 10%;"></td> <td style="width: 10%;"></td> <td style="width: 10%;"></td> <td style="width: 10%;"></td> <td style="width: 10%;"></td> <td style="width: 10%;"></td> <td style="width: 10%;"></td> </tr> <tr> <td></td> <td></td> <td colspan="8" style="text-align: center;"> <table border="1" style="width: 100%; border-collapse: collapse; text-align: center;"> <tr> <td style="width: 10%;"></td> <td style="width: 10%;"></td> <td style="width: 10%;"></td> <td style="width: 10%;"></td> <td style="width: 10%;"></td> <td style="width: 10%;"></td> <td style="width: 10%;"></td> <td style="width: 10%;"></td> <td style="width: 10%;"></td> <td style="width: 10%;"></td> </tr> <tr> <td></td> <td></td> <td colspan="8" style="text-align: center;"> <table border="1" style="width: 100%; border-collapse: collapse; text-align: center;"> <tr> <td style="width: 10%;"></td> <td style="width: 10%;"></td> <td style="width: 10%;"></td> <td style="width: 10%;"></td> <td style="width: 10%;"></td> <td style="width: 10%;"></td> <td style="width: 10%;"></td> <td style="width: 10%;"></td> <td style="width: 10%;"></td> <td style="width: 10%;"></td> </tr> <tr> <td></td> <td></td> <td colspan="8" style="text-align: center;"> <table border="1" style="width: 100%; border-collapse: collapse; text-align: center;"> <tr> <td style="width: 10%;"></td> <td style="width: 10%;"></td> <td style="width: 10%;"></td> <td style="width: 10%;"></td> <td style="width: 10%;"></td> <td style="width: 10%;"></td> <td style="width: 10%;"></td> <td style="width: 10%;"></td> <td style="width: 10%;"></td> <td style="width: 10%;"></td> </tr> <tr> <td></td> <td></td> <td colspan="8" style="text-align: center;"> <table border="1" style="width: 100%; border-collapse: collapse; text-align: center;"> <tr> <td style="width: 10%;"></td> <td style="width: 10%;"></td> <td style="width: 10%;"></td> <td style="width: 10%;"></td> <td style="width: 10%;"></td> <td style="width: 10%;"></td> <td style="width: 10%;"></td> <td style="width: 10%;"></td> <td style="width: 10%;"></td> <td style="width: 10%;"></td> </tr> <tr> <td></td> <td></td> <td colspan="8" style="text-align: center;"> <table border="1" style="width: 100%; border-collapse: collapse; text-align: center;"> <tr> <td style="width: 10%;"></td> <td style="width: 10%;"></td> <td style="width: 10%;"></td> <td style="width: 10%;"></td> <td style="width: 10%;"></td> <td style="width: 10%;"></td> <td style="width: 10%;"></td> <td style="width: 10%;"></td> <td style="width: 10%;"></td> <td style="width: 10%;"></td> </tr> <tr> <td></td> <td></td> <td colspan="8" style="text-align: center;"> <table border="1" style="width: 100%; border-collapse: collapse; text-align: center;"> <tr> <td style="width: 10%;"></td> <td style="width: 10%;"></td> <td style="width: 10%;"></td> <td style="width: 10%;"></td> <td style="width: 10%;"></td> <td style="width: 10%;"></td> <td style="width: 10%;"></td> <td style="width: 10%;"></td> <td style="width: 10%;"></td> <td style="width: 10%;"></td> </tr> <tr> <td></td> <td></td> <td colspan="8" style="text-align: center;"> <table border="1" style="width: 100%; border-collapse: collapse; text-align: center;"> <tr> <td style="width: 10%;"></td> <td style="width: 10%;"></td> <td style="width: 10%;"></td> <td style="width: 10%;"></td> <td style="width: 10%;"></td> <td style="width: 10%;"></td> <td style="width: 10%;"></td> <td style="width: 10%;"></td> <td style="width: 10%;"></td> <td style="width: 10%;"></td> </tr> <tr> <td></td> <td></td> <td colspan="8" style="text-align: center;"> <table border="1" style="width: 100%; border-collapse: collapse; text-align: center;"> <tr> <td style="width: 10%;"></td> <td style="width: 10%;"></td> <td style="width: 10%;"></td> <td style="width: 10%;"></td> <td style="width: 10%;"></td> <td style="width: 10%;"></td> <td style="width: 10%;"></td> <td style="width: 10%;"></td> <td style="width: 10%;"></td> <td style="width: 10%;"></td> </tr> <tr> <td></td> <td></td> <td colspan="8" style="text-align: center;"> <table border="1" style="width: 100%; border-collapse: collapse; text-align: center;"> <tr> <td style="width: 10%;"></td> <td style="width: 10%;"></td> <td style="width: 10%;"></td> <td style="width: 10%;"></td> <td style="width: 10%;"></td> <td style="width: 10%;"></td> <td style="width: 10%;"></td> <td style="width: 10%;"></td> <td style="width: 10%;"></td> <td style="width: 10%;"></td> </tr> <tr> <td></td> <td></td> <td colspan="8" style="text-align: center;"> <table border="1" style="width: 100%; border-collapse: collapse; text-align: center;"> <tr> <td style="width: 10%;"></td> <td style="width: 10%;"></td> <td style="width: 10%;"></td> <td style="width: 10%;"></td> <td style="width: 10%;"></td> <td style="width: 10%;"></td> <td style="width: 10%;"></td> <td style="width: 10%;"></td> <td style="width: 10%;"></td> <td style="width: 10%;"></td> </tr> <tr> <td></td> <td></td> <td colspan="8" style="text-align: center;"> <table border="1" style="width: 100%; border-collapse: collapse; text-align: center;"> <tr> <td style="width: 10%;"></td> <td style="width: 10%;"></td> <td style="width: 10%;"></td> <td style="width: 10%;"></td> <td style="width: 10%;"></td> <td style="width: 10%;"></td> <td style="width: 10%;"></td> <td style="width: 10%;"></td> <td style="width: 10%;"></td> <td style="width: 10%;"></td> </tr> <tr> <td></td> <td></td> <td colspan="8" style="text-align: center;"> <table border="1" style="width: 100%; border-collapse: collapse; text-align: center;"> <tr> <td style="width: 10%;"></td> <td style="width: 10%;"></td> <td style="width: 10%;"></td> <td style="width: 10%;"></td> <td style="width: 10%;"></td> <td style="width: 10%;"></td> <td style="width: 10%;"></td> <td style="width: 10%;"></td> <td style="width: 10%;"></td> <td style="width: 10%;"></td> </tr> <tr> <td></td> <td></td> <td colspan="8" style="text-align: center;"> <table border="1" style="width: 100%; border-collapse: collapse; text-align: center;"> <tr> <td style="width: 10%;"></td> <td style="width: 10%;"></td> <td style="width: 10%;"></td> <td style="width: 10%;"></td> <td style="width: 10%;"></td> <td style="width: 10%;"></td> <td style="width: 10%;"></td> <td style="width: 10%;"></td> <td style="width: 10%;"></td> <td style="width: 10%;"></td> </tr> <tr> <td></td> <td></td> <td colspan="8" style="text-align: center;"> <table border="1" style="width: 100%; border-collapse: collapse; text-align: center;"> <tr> <td style="width: 10%;"></td> <td style="width: 10%;"></td> <td style="width: 10%;"></td> <td style="width: 10%;"></td> <td style="width: 10%;"></td> <td style="width: 10%;"></td> <td style="width: 10%;"></td> <td style="width: 10%;"></td> <td style="width: 10%;"></td> <td style="width: 10%;"></td> </tr> <tr> <td></td> <td></td> <td colspan="8" style="text-align: center;"> <table border="1" style="width: 100%; border-collapse: collapse; text-align: center;"> <tr> <td style="width: 10%;"></td> <td style="width: 10%;"></td> <td style="width: 10%;"></td> <td style="width: 10%;"></td> <td style="width: 10%;"></td> <td style="width: 10%;"></td> <td style="width: 10%;"></td> <td style="width: 10%;"></td> <td style="width: 10%;"></td> <td style="width: 10%;"></td> </tr> <tr> <td></td> <td></td> <td colspan="8" style="text-align: center;"> <table border="1" style="width: 100%; border-collapse: collapse; text-align: center;"> <tr> <td style="width: 10%;"></td> <td style="width: 10%;"></td> <td style="width: 10%;"></td> <td style="width: 10%;"></td> <td style="width: 10%;"></td> <td style="width: 10%;"></td> <td style="width: 10%;"></td> <td style="width: 10%;"></td> <td style="width: 10%;"></td> <td style="width: 10%;"></td> </tr> <tr> <td></td> <td></td> <td colspan="8" style="text-align: center;"> <table border="1" style="width: 100%; border-collapse: collapse; text-align: center;"> <tr> <td style="width: 10%;"></td> <td style="width: 10%;"></td> <td style="width: 10%;"></td> <td style="width: 10%;"></td> <td style="width: 10%;"></td> <td style="width: 10%;"></td> <td style="width: 10%;"></td> <td style="width: 10%;"></td> <td style="width: 10%;"></td> <td style="width: 10%;"></td> </tr> <tr> <td></td> <td></td> <td colspan="8" style="text-align: center;"> <table border="1" style="width: 100%; border-collapse: collapse; text-align: center;"> <tr> <td style="width: 10%;"></td> <td style="width: 10%;"></td> <td style="width: 10%;"></td> <td style="width: 10%;"></td> <td style="width: 10%;"></td> <td style="width:
10%;"></td> <td style="width: 10%;"></td> <td style="width: 10%;"></td> <td style="width: 10%;"></td> <td style="width: 10%;"></td> </tr> <tr> <td></td> <td></td> <td colspan="8" style="text-align: center;"> <table border="1" style="width: 100%; border-collapse: collapse; text-align: center;"> <tr> <td style="width: 10%;"></td> <td style="width: 10%;"></td> <td style="width: 10%;"></td> <td style="width: 10%;"></td> <td style="width: 10%;"></td> <td style="width: 10%;"></td> <td style="width: 10%;"></td> <td style="width: 10%;"></td> <td style="width: 10%;"></td> <td style="width: 10%;"></td> </tr> <tr> <td></td> <td></td> <td colspan="8" style="text-align: center;"> <table border="1" style="width: 100%; border-collapse: collapse; text-align: center;"> <tr> <td style="width: 10%;"></td> <td style="width: 10%;"></td> <td style="width: 10%;"></td> <td style="width: 10%;"></td> <td style="width: 10%;"></td> <td style="width: 10%;"></td> <td style="width: 10%;"></td> <td style="width: 10%;"></td> <td style="width: 10%;"></td> <td style="width: 10%;"></td> </tr> <tr> <td></td> <td></td> <td colspan="8" style="text-align: center;"> <table border="1" style="width: 100%; border-collapse: collapse; text-align: center;"> <tr> <td style="width: 10%;"></td> <td style="width: 10%;"></td> <td style="width: 10%;"></td> <td style="width: 10%;"></td> <td style="width: 10%;"></td> <td style="width: 10%;"></td> <td style="width: 10%;"></td> <td style="width: 10%;"></td> <td style="width: 10%;"></td> <td style="width: 10%;"></td> </tr> <tr> <td></td> <td></td> <td colspan="8" style="text-align: center;"> <table border="1" style="width: 100%; border-collapse: collapse; text-align: center;"> <tr> <td style="width: 10%;"></td> <td style="width: 10%;"></td> <td style="width: 10%;"></td> <td style="width: 10%;"></td> <td style="width: 10%;"></td> <td style="width: 10%;"></td> <td style="width: 10%;"></td> <td style="width: 10%;"></td> <td style="width: 10%;"></td> <td style="width: 10%;"></td> </tr> <tr> <td></td> <td></td> <td colspan="8" style="text-align: center;"> <table border="1" style="width: 100%; border-collapse: collapse; text-align: center;"> <tr> <td style="width: 10%;"></td> <td style="width: 10%;"></td> <td style="width: 10%;"></td> <td style="width: 10%;"></td> <td style="width: 10%;"></td> <td style="width: 10%;"></td> <td style="width: 10%;"></td> <td style="width: 10%;"></td> <td style="width: 10%;"></td> <td style="width: 10%;"></td> </tr> <tr> <td></td> <td></td> <td colspan="8" style="text-align: center;"> <table border="1" style="width: 100%; border-collapse: collapse; text-align: center;"> <tr> <td style="width: 10%;"></td> <td style="width: 10%;"></td> <td style="width: 10%;"></td> <td style="width: 10%;"></td> <td style="width: 10%;"></td> <td style="width: 10%;"></td> <td style="width: 10%;"></td> <td style="width: 10%;"></td> <td style="width: 10%;"></td> <td style="width: 10%;"></td> </tr> <tr> <td></td> <td></td> <td colspan="8" style="text-align: center;"> <table border="1" style="width: 100%; border-collapse: collapse; text-align: center;"> <tr> <td style="width: 10%;"></td> <td style="width: 10%;"></td> <td style="width: 10%;"></td> <td style="width: 10%;"></td> <td style="width: 10%;"></td> <td style="width: 10%;"></td> <td style="width: 10%;"></td> <td style="width: 10%;"></td> <td style="width: 10%;"></td> <td style="width: 10%;"></td> </tr> <tr> <td></td> <td></td> <td colspan="8" style="text-align: center;"> <table border="1" style="width: 100%; border-collapse: collapse; text-align: center;"> <tr> <td style="width: 10%;"></td> <td style="width: 10%;"></td> <td style="width: 10%;"></td> <td style="width: 10%;"></td> <td style="width: 10%;"></td> <td style="width: 10%;"></td> <td style="width: 10%;"></td> <td style="width: 10%;"></td> <td style="width: 10%;"></td> <td style="width: 10%;"></td> </tr> <tr> <td></td> <td></td> <td colspan="8" style="text-align: center;"> <table border="1" style="width: 100%; border-collapse: collapse; text-align: center;"> <tr> </tr></table></td></tr></table></td></tr></table></td></tr></table></td></tr></table></td></tr></table></td></tr></table></td></tr></table></td></tr></table></td></tr></table></td></tr></table></td></tr></table></td></tr></table></td></tr></table></td></tr></table></td></tr></table></td></tr></table></td></tr></table></td></tr></table></td></tr></table></td></tr></table></td></tr></table></td></tr></table></td></tr></table></td></tr></table></td></tr></table></td></tr></table></td></tr></table></td></tr></table></td></tr></table>
 | | | | | | | | | | | | | | | | | | | | <table border="1" style="width: 100%; border-collapse: collapse; text-align: center;"> <tr> <td style="width: 10%;"></td> <td style="width: 10%;"></td> <td style="width: 10%;"></td> <td style="width: 10%;"></td> <td style="width: 10%;"></td> <td style="width: 10%;"></td> <td style="width: 10%;"></td> <td style="width: 10%;"></td> <td style="width: 10%;"></td> <td style="width: 10%;"></td> </tr> <tr> <td></td> <td></td> <td colspan="8" style="text-align: center;"> <table border="1" style="width: 100%; border-collapse: collapse; text-align: center;"> <tr> <td style="width: 10%;"></td> <td style="width: 10%;"></td> <td style="width: 10%;"></td> <td style="width: 10%;"></td> <td style="width: 10%;"></td> <td style="width: 10%;"></td> <td style="width: 10%;"></td> <td style="width: 10%;"></td> <td style="width: 10%;"></td> <td style="width: 10%;"></td> </tr> <tr> <td></td> <td></td> <td colspan="8" style="text-align: center;"> <table border="1" style="width: 100%; border-collapse: collapse; text-align: center;"> <tr> <td style="width: 10%;"></td> <td style="width: 10%;"></td> <td style="width: 10%;"></td> <td style="width: 10%;"></td> <td style="width: 10%;"></td> <td style="width: 10%;"></td> <td style="width: 10%;"></td> <td style="width:
10%;"></td> <td style="width: 10%;"></td> <td style="width: 10%;"></td> </tr> <tr> <td></td> <td></td> <td colspan="8" style="text-align: center;"> <table border="1" style="width: 100%; border-collapse: collapse; text-align: center;"> <tr> <td style="width: 10%;"></td> <td style="width: 10%;"></td> <td style="width: 10%;"></td> <td style="width: 10%;"></td> <td style="width: 10%;"></td> <td style="width: 10%;"></td> <td style="width: 10%;"></td> <td style="width: 10%;"></td> <td style="width: 10%;"></td> <td style="width: 10%;"></td> </tr> <tr> <td></td> <td></td> <td colspan="8" style="text-align: center;"> <table border="1" style="width: 100%; border-collapse: collapse; text-align: center;"> <tr> <td style="width: 10%;"></td> <td style="width: 10%;"></td> <td style="width: 10%;"></td> <td style="width: 10%;"></td> <td style="width: 10%;"></td> <td style="width: 10%;"></td> <td style="width: 10%;"></td> <td style="width: 10%;"></td> <td style="width: 10%;"></td> <td style="width: 10%;"></td> </tr> <tr> <td></td> <td></td> <td colspan="8" style="text-align: center;"> <table border="1" style="width: 100%; border-collapse: collapse; text-align: center;"> <tr> <td style="width: 10%;"></td> <td style="width: 10%;"></td> <td style="width: 10%;"></td> <td style="width: 10%;"></td> <td style="width: 10%;"></td> <td style="width: 10%;"></td> <td style="width: 10%;"></td> <td style="width: 10%;"></td> <td style="width: 10%;"></td> <td style="width: 10%;"></td> </tr> <tr> <td></td> <td></td> <td colspan="8" style="text-align: center;"> <table border="1" style="width: 100%; border-collapse: collapse; text-align: center;"> <tr> <td style="width: 10%;"></td> <td style="width: 10%;"></td> <td style="width: 10%;"></td> <td style="width: 10%;"></td> <td style="width: 10%;"></td> <td style="width: 10%;"></td> <td style="width: 10%;"></td> <td style="width: 10%;"></td> <td style="width: 10%;"></td> <td style="width: 10%;"></td> </tr> <tr> <td></td> <td></td> <td colspan="8" style="text-align: center;"> <table border="1" style="width: 100%; border-collapse: collapse; text-align: center;"> <tr> <td style="width: 10%;"></td> <td style="width: 10%;"></td> <td style="width: 10%;"></td> <td style="width: 10%;"></td> <td style="width: 10%;"></td> <td style="width: 10%;"></td> <td style="width: 10%;"></td> <td style="width: 10%;"></td> <td style="width: 10%;"></td> <td style="width: 10%;"></td> </tr> <tr> <td></td> <td></td> <td colspan="8" style="text-align: center;"> <table border="1" style="width: 100%; border-collapse: collapse; text-align: center;"> <tr> <td style="width: 10%;"></td> <td style="width: 10%;"></td> <td style="width: 10%;"></td> <td style="width: 10%;"></td> <td style="width: 10%;"></td> <td style="width: 10%;"></td> <td style="width: 10%;"></td> <td style="width: 10%;"></td> <td style="width: 10%;"></td> <td style="width: 10%;"></td> </tr> <tr> <td></td> <td></td> <td colspan="8" style="text-align: center;"> <table border="1" style="width: 100%; border-collapse: collapse; text-align: center;"> <tr> <td style="width: 10%;"></td> <td style="width: 10%;"></td> <td style="width: 10%;"></td> <td style="width: 10%;"></td> <td style="width: 10%;"></td> <td style="width: 10%;"></td> <td style="width: 10%;"></td> <td style="width: 10%;"></td> <td style="width: 10%;"></td> <td style="width: 10%;"></td> </tr> <tr> <td></td> <td></td> <td colspan="8" style="text-align: center;"> <table border="1" style="width: 100%; border-collapse: collapse; text-align: center;"> <tr> <td style="width: 10%;"></td> <td style="width: 10%;"></td> <td style="width: 10%;"></td> <td style="width: 10%;"></td> <td style="width: 10%;"></td> <td style="width: 10%;"></td> <td style="width: 10%;"></td> <td style="width: 10%;"></td> <td style="width: 10%;"></td> <td style="width: 10%;"></td> </tr> <tr> <td></td> <td></td> <td colspan="8" style="text-align: center;"> <table border="1" style="width: 100%; border-collapse: collapse; text-align: center;"> <tr> <td style="width: 10%;"></td> <td style="width: 10%;"></td> <td style="width: 10%;"></td> <td style="width: 10%;"></td> <td style="width: 10%;"></td> <td style="width: 10%;"></td> <td style="width: 10%;"></td> <td style="width: 10%;"></td> <td style="width: 10%;"></td> <td style="width: 10%;"></td> </tr> <tr> <td></td> <td></td> <td colspan="8" style="text-align: center;"> <table border="1" style="width: 100%; border-collapse: collapse; text-align: center;"> <tr> <td style="width: 10%;"></td> <td style="width: 10%;"></td> <td style="width: 10%;"></td> <td style="width: 10%;"></td> <td style="width: 10%;"></td> <td style="width: 10%;"></td> <td style="width: 10%;"></td> <td style="width: 10%;"></td> <td style="width: 10%;"></td> <td style="width: 10%;"></td> </tr> <tr> <td></td> <td></td> <td colspan="8" style="text-align: center;"> <table border="1" style="width: 100%; border-collapse: collapse; text-align: center;"> <tr> <td style="width: 10%;"></td> <td style="width: 10%;"></td> <td style="width: 10%;"></td> <td style="width: 10%;"></td> <td style="width: 10%;"></td> <td style="width: 10%;"></td> <td style="width: 10%;"></td> <td style="width: 10%;"></td> <td style="width: 10%;"></td> <td style="width: 10%;"></td> </tr> <tr> <td></td> <td></td> <td colspan="8" style="text-align: center;"> <table border="1" style="width: 100%; border-collapse: collapse; text-align: center;"> <tr> <td style="width: 10%;"></td> <td style="width: 10%;"></td> <td style="width: 10%;"></td> <td style="width: 10%;"></td> <td style="width: 10%;"></td> <td style="width: 10%;"></td> <td style="width: 10%;"></td> <td style="width: 10%;"></td> <td style="width: 10%;"></td> <td style="width: 10%;"></td> </tr> <tr> <td></td> <td></td> <td colspan="8" style="text-align: center;"> <table border="1" style="width: 100%; border-collapse: collapse; text-align: center;"> <tr> <td style="width: 10%;"></td> <td style="width: 10%;"></td> <td style="width: 10%;"></td> <td style="width: 10%;"></td> <td style="width: 10%;"></td> <td style="width: 10%;"></td> <td style="width: 10%;"></td> <td style="width: 10%;"></td> <td style="width: 10%;"></td> <td style="width: 10%;"></td> </tr> <tr> <td></td> <td></td> <td colspan="8" style="text-align: center;"> <table border="1" style="width: 100%; border-collapse: collapse; text-align: center;"> <tr> <td style="width: 10%;"></td> <td style="width: 10%;"></td> <td style="width: 10%;"></td> <td style="width: 10%;"></td> <td style="width: 10%;"></td> <td style="width: 10%;"></td> <td style="width: 10%;"></td> <td style="width: 10%;"></td> <td style="width: 10%;"></td> <td style="width: 10%;"></td> </tr> <tr> <td></td> <td></td> <td colspan="8" style="text-align: center;"> <table border="1" style="width: 100%; border-collapse: collapse; text-align: center;"> <tr> <td style="width: 10%;"></td> <td style="width: 10%;"></td> <td style="width: 10%;"></td> <td style="width: 10%;"></td> <td style="width: 10%;"></td> <td style="width: 10%;"></td> <td style="width: 10%;"></td> <td style="width: 10%;"></td> <td style="width: 10%;"></td> <td style="width: 10%;"></td> </tr> <tr> <td></td> <td></td> <td colspan="8" style="text-align: center;"> <table border="1" style="width: 100%; border-collapse: collapse; text-align: center;"> <tr> <td style="width: 10%;"></td> <td style="width: 10%;"></td> <td style="width: 10%;"></td> <td style="width: 10%;"></td> <td style="width: 10%;"></td> <td style="width: 10%;"></td> <td style="width: 10%;"></td> <td style="width: 10%;"></td> <td style="width: 10%;"></td> <td style="width: 10%;"></td> </tr> <tr> <td></td> <td></td> <td colspan="8" style="text-align: center;"> <table border="1" style="width: 100%; border-collapse: collapse; text-align: center;"> <tr> <td style="width: 10%;"></td> <td style="width: 10%;"></td> <td style="width: 10%;"></td> <td style="width: 10%;"></td> <td style="width: 10%;"></td> <td style="width: 10%;"></td> <td style="width: 10%;"></td> <td style="width: 10%;"></td> <td style="width: 10%;"></td> <td style="width: 10%;"></td> </tr> <tr> <td></td> <td></td> <td colspan="8" style="text-align: center;"> <table border="1" style="width: 100%; border-collapse: collapse; text-align: center;"> <tr> <td style="width: 10%;"></td> <td style="width: 10%;"></td> <td style="width: 10%;"></td> <td style="width: 10%;"></td> <td style="width: 10%;"></td> <td style="width: 10%;"></td> <td style="width: 10%;"></td> <td style="width: 10%;"></td> <td style="width: 10%;"></td> <td style="width: 10%;"></td> </tr> <tr> <td></td> <td></td> <td colspan="8" style="text-align: center;"> <table border="1" style="width: 100%; border-collapse: collapse; text-align: center;"> <tr> <td style="width: 10%;"></td> <td style="width: 10%;"></td> <td style="width: 10%;"></td> <td style="width: 10%;"></td> <td style="width: 10%;"></td> <td style="width: 10%;"></td> <td style="width: 10%;"></td> <td style="width: 10%;"></td> <td style="width: 10%;"></td> <td style="width: 10%;"></td> </tr> <tr> <td></td> <td></td> <td colspan="8" style="text-align: center;"> <table border="1" style="width: 100%; border-collapse: collapse; text-align: center;"> <tr> <td style="width: 10%;"></td> <td style="width: 10%;"></td> <td style="width: 10%;"></td> <td style="width: 10%;"></td> <td style="width: 10%;"></td> <td style="width: 10%;"></td> <td style="width: 10%;"></td> <td style="width: 10%;"></td> <td style="width: 10%;"></td> <td style="width: 10%;"></td> </tr> <tr> <td></td> <td></td> <td colspan="8" style="text-align: center;"> <table border="1" style="width: 100%; border-collapse: collapse; text-align: center;"> <tr> <td style="width: 10%;"></td> <td style="width: 10%;"></td> <td style="width: 10%;"></td> <td style="width: 10%;"></td> <td style="width: 10%;"></td> <td style="width: 10%;"></td> <td style="width: 10%;"></td> <td style="width: 10%;"></td> <td style="width: 10%;"></td> <td style="width: 10%;"></td> </tr> <tr> <td></td> <td></td> <td colspan="8" style="text-align: center;"> <table border="1"
style="width: 100%; border-collapse: collapse; text-align: center;"> <tr> <td style="width: 10%;"></td> <td style="width: 10%;"></td> <td style="width: 10%;"></td> <td style="width: 10%;"></td> <td style="width: 10%;"></td> <td style="width: 10%;"></td> <td style="width: 10%;"></td> <td style="width: 10%;"></td> <td style="width: 10%;"></td> <td style="width: 10%;"></td> </tr> <tr> <td></td> <td></td> <td colspan="8" style="text-align: center;"> <table border="1" style="width: 100%; border-collapse: collapse; text-align: center;"> <tr> <td style="width: 10%;"></td> <td style="width: 10%;"></td> <td style="width: 10%;"></td> <td style="width: 10%;"></td> <td style="width: 10%;"></td> <td style="width: 10%;"></td> <td style="width: 10%;"></td> <td style="width: 10%;"></td> <td style="width: 10%;"></td> <td style="width: 10%;"></td> </tr> <tr> <td></td> <td></td> <td colspan="8" style="text-align: center;"> <table border="1" style="width: 100%; border-collapse: collapse; text-align: center;"> <tr> <td style="width: 10%;"></td> <td style="width: 10%;"></td> <td style="width: 10%;"></td> <td style="width: 10%;"></td> <td style="width: 10%;"></td> <td style="width: 10%;"></td> <td style="width: 10%;"></td> <td style="width: 10%;"></td> <td style="width: 10%;"></td> <td style="width: 10%;"></td> </tr> <tr> <td></td> <td></td> <td colspan="8" style="text-align: center;"> <table border="1" style="width: 100%; border-collapse: collapse; text-align: center;"> <tr> <td style="width: 10%;"></td> <td style="width: 10%;"></td> <td style="width: 10%;"></td> <td style="width: 10%;"></td> <td style="width: 10%;"></td> <td style="width: 10%;"></td> <td style="width: 10%;"></td> <td style="width: 10%;"></td> <td style="width: 10%;"></td> <td style="width: 10%;"></td> </tr> <tr> <td></td> <td></td> <td colspan="8" style="text-align: center;"> <table border="1" style="width: 100%; border-collapse: collapse; text-align: center;"> <tr> </tr></table></td></tr></table></td></tr></table></td></tr></table></td></tr></table></td></tr></table></td></tr></table></td></tr></table></td></tr></table></td></tr></table></td></tr></table></td></tr></table></td></tr></table></td></tr></table></td></tr></table></td></tr></table></td></tr></table></td></tr></table></td></tr></table></td></tr></table></td></tr></table></td></tr></table></td></tr></table></td></tr></table></td></tr></table></td></tr></table></td></tr></table></td></tr></table></td></tr></table>
 | | | | | | | | | | | | | | | | | | | | <table border="1" style="width: 100%; border-collapse: collapse; text-align: center;"> <tr> <td style="width: 10%;"></td> <td style="width: 10%;"></td> <td style="width: 10%;"></td> <td style="width: 10%;"></td> <td style="width: 10%;"></td> <td style="width: 10%;"></td> <td style="width: 10%;"></td> <td style="width: 10%;"></td> <td style="width: 10%;"></td> <td style="width: 10%;"></td> </tr> <tr> <td></td> <td></td> <td colspan="8" style="text-align: center;"> <table border="1" style="width: 100%; border-collapse: collapse; text-align: center;"> <tr> <td style="width: 10%;"></td> <td style="width: 10%;"></td> <td style="width: 10%;"></td> <td style="width: 10%;"></td> <td style="width: 10%;"></td> <td style="width: 10%;"></td> <td style="width: 10%;"></td> <td style="width: 10%;"></td> <td style="width: 10%;"></td> <td style="width: 10%;"></td> </tr> <tr> <td></td> <td></td> <td colspan="8" style="text-align: center;"> <table border="1" style="width: 100%; border-collapse: collapse; text-align: center;"> <tr> <td style="width: 10%;"></td> <td style="width: 10%;"></td> <td style="width: 10%;"></td> <td style="width: 10%;"></td> <td style="width: 10%;"></td> <td style="width: 10%;"></td> <td style="width: 10%;"></td> <td style="width: 10%;"></td> <td style="width: 10%;"></td> <td style="width: 10%;"></td> </tr> <tr> <td></td> <td></td> <td colspan="8" style="text-align: center;"> <table border="1" style="width: 100%; border-collapse: collapse; text-align: center;"> <tr> <td style="width: 10%;"></td> <td style="width: 10%;"></td> <td style="width: 10%;"></td> <td style="width: 10%;"></td> <td style="width: 10%;"></td> <td style="width: 10%;"></td> <td style="width: 10%;"></td> <td style="width: 10%;"></td> <td style="width: 10%;"></td> <td style="width: 10%;"></td> </tr> <tr> <td></td> <td></td> <td colspan="8" style="text-align: center;"> <table border="1" style="width: 100%; border-collapse: collapse; text-align: center;"> <tr> <td style="width: 10%;"></td> <td style="width: 10%;"></td> <td style="width: 10%;"></td> <td style="width: 10%;"></td> <td style="width: 10%;"></td> <td style="width: 10%;"></td> <td style="width: 10%;"></td> <td style="width: 10%;"></td> <td style="width: 10%;"></td> <td style="width: 10%;"></td> </tr> <tr> <td></td> <td></td> <td colspan="8" style="text-align: center;"> <table border="1" style="width: 100%; border-collapse: collapse; text-align: center;"> <tr> <td style="width: 10%;"></td> <td style="width: 10%;"></td> <td style="width: 10%;"></td> <td style="width: 10%;"></td> <td style="width: 10%;"></td> <td style="width: 10%;"></td> <td style="width: 10%;"></td> <td style="width: 10%;"></td> <td style="width: 10%;"></td> <td style="width: 10%;"></td> </tr> <tr> <td></td> <td></td> <td colspan="8" style="text-align: center;"> <table border="1" style="width: 100%; border-collapse: collapse; text-align: center;"> <tr> <td style="width: 10%;"></td> <td style="width: 10%;"></td> <td style="width: 10%;"></td> <td style="width: 10%;"></td> <td style="width: 10%;"></td> <td style="width: 10%;"></td> <td style="width: 10%;"></td> <td style="width: 10%;"></td> <td style="width: 10%;"></td> <td style="width: 10%;"></td> </tr> <tr> <td></td> <td></td> <td colspan="8" style="text-align: center;"> <table border="1" style="width: 100%; border-collapse: collapse; text-align: center;"> <tr> <td
style="width: 10%;"></td> <td style="width: 10%;"></td> <td style="width: 10%;"></td> <td style="width: 10%;"></td> <td style="width: 10%;"></td> <td style="width: 10%;"></td> <td style="width: 10%;"></td> <td style="width: 10%;"></td> <td style="width: 10%;"></td> <td style="width: 10%;"></td> </tr> <tr> <td></td> <td></td> <td colspan="8" style="text-align: center;"> <table border="1" style="width: 100%; border-collapse: collapse; text-align: center;"> <tr> <td style="width: 10%;"></td> <td style="width: 10%;"></td> <td style="width: 10%;"></td> <td style="width: 10%;"></td> <td style="width: 10%;"></td> <td style="width: 10%;"></td> <td style="width: 10%;"></td> <td style="width: 10%;"></td> <td style="width: 10%;"></td> <td style="width: 10%;"></td> </tr> <tr> <td></td> <td></td> <td colspan="8" style="text-align: center;"> <table border="1" style="width: 100%; border-collapse: collapse; text-align: center;"> <tr> <td style="width: 10%;"></td> <td style="width: 10%;"></td> <td style="width: 10%;"></td> <td style="width: 10%;"></td> <td style="width: 10%;"></td> <td style="width: 10%;"></td> <td style="width: 10%;"></td> <td style="width: 10%;"></td> <td style="width: 10%;"></td> <td style="width: 10%;"></td> </tr> <tr> <td></td> <td></td> <td colspan="8" style="text-align: center;"> <table border="1" style="width: 100%; border-collapse: collapse; text-align: center;"> <tr> <td style="width: 10%;"></td> <td style="width: 10%;"></td> <td style="width: 10%;"></td> <td style="width: 10%;"></td> <td style="width: 10%;"></td> <td style="width: 10%;"></td> <td style="width: 10%;"></td> <td style="width: 10%;"></td> <td style="width: 10%;"></td> <td style="width: 10%;"></td> </tr> <tr> <td></td> <td></td> <td colspan="8" style="text-align: center;"> <table border="1" style="width: 100%; border-collapse: collapse; text-align: center;"> <tr> <td style="width: 10%;"></td> <td style="width: 10%;"></td> <td style="width: 10%;"></td> <td style="width: 10%;"></td> <td style="width: 10%;"></td> <td style="width: 10%;"></td> <td style="width: 10%;"></td> <td style="width: 10%;"></td> <td style="width: 10%;"></td> <td style="width: 10%;"></td> </tr> <tr> <td></td> <td></td> <td colspan="8" style="text-align: center;"> <table border="1" style="width: 100%; border-collapse: collapse; text-align: center;"> <tr> <td style="width: 10%;"></td> <td style="width: 10%;"></td> <td style="width: 10%;"></td> <td style="width: 10%;"></td> <td style="width: 10%;"></td> <td style="width: 10%;"></td> <td style="width: 10%;"></td> <td style="width: 10%;"></td> <td style="width: 10%;"></td> <td style="width: 10%;"></td> </tr> <tr> <td></td> <td></td> <td colspan="8" style="text-align: center;"> <table border="1" style="width: 100%; border-collapse: collapse; text-align: center;"> <tr> <td style="width: 10%;"></td> <td style="width: 10%;"></td> <td style="width: 10%;"></td> <td style="width: 10%;"></td> <td style="width: 10%;"></td> <td style="width: 10%;"></td> <td style="width: 10%;"></td> <td style="width: 10%;"></td> <td style="width: 10%;"></td> <td style="width: 10%;"></td> </tr> <tr> <td></td> <td></td> <td colspan="8" style="text-align: center;"> <table border="1" style="width: 100%; border-collapse: collapse; text-align: center;"> <tr> <td style="width: 10%;"></td> <td style="width: 10%;"></td> <td style="width: 10%;"></td> <td style="width: 10%;"></td> <td style="width: 10%;"></td> <td style="width: 10%;"></td> <td style="width: 10%;"></td> <td style="width: 10%;"></td> <td style="width: 10%;"></td> <td style="width: 10%;"></td> </tr> <tr> <td></td> <td></td> <td colspan="8" style="text-align: center;"> <table border="1" style="width: 100%; border-collapse: collapse; text-align: center;"> <tr> <td style="width: 10%;"></td> <td style="width: 10%;"></td> <td style="width: 10%;"></td> <td style="width: 10%;"></td> <td style="width: 10%;"></td> <td style="width: 10%;"></td> <td style="width: 10%;"></td> <td style="width: 10%;"></td> <td style="width: 10%;"></td> <td style="width: 10%;"></td> </tr> <tr> <td></td> <td></td> <td colspan="8" style="text-align: center;"> <table border="1" style="width: 100%; border-collapse: collapse; text-align: center;"> <tr> <td style="width: 10%;"></td> <td style="width: 10%;"></td> <td style="width: 10%;"></td> <td style="width: 10%;"></td> <td style="width: 10%;"></td> <td style="width: 10%;"></td> <td style="width: 10%;"></td> <td style="width: 10%;"></td> <td style="width: 10%;"></td> <td style="width: 10%;"></td> </tr> <tr> <td></td> <td></td> <td colspan="8" style="text-align: center;"> <table border="1" style="width: 100%; border-collapse: collapse; text-align: center;"> <tr> <td style="width: 10%;"></td> <td style="width: 10%;"></td> <td style="width: 10%;"></td> <td style="width: 10%;"></td> <td style="width: 10%;"></td> <td style="width: 10%;"></td> <td style="width: 10%;"></td> <td style="width: 10%;"></td> <td style="width: 10%;"></td> <td style="width: 10%;"></td> </tr> <tr> <td></td> <td></td> <td colspan="8" style="text-align: center;"> <table border="1" style="width: 100%; border-collapse: collapse; text-align: center;"> <tr> <td style="width: 10%;"></td> <td style="width: 10%;"></td> <td style="width: 10%;"></td> <td style="width: 10%;"></td> <td style="width: 10%;"></td> <td style="width: 10%;"></td> <td style="width: 10%;"></td> <td style="width: 10%;"></td> <td style="width: 10%;"></td> <td style="width: 10%;"></td> </tr> <tr> <td></td> <td></td> <td colspan="8" style="text-align: center;"> <table border="1" style="width: 100%; border-collapse: collapse; text-align: center;"> <tr> <td style="width: 10%;"></td> <td style="width: 10%;"></td> <td style="width: 10%;"></td> <td style="width: 10%;"></td> <td style="width: 10%;"></td> <td style="width: 10%;"></td> <td style="width: 10%;"></td> <td style="width: 10%;"></td> <td style="width: 10%;"></td> <td style="width: 10%;"></td> </tr> <tr> <td></td> <td></td> <td colspan="8" style="text-align: center;"> <table border="1" style="width: 100%; border-collapse: collapse; text-align: center;"> <tr> <td style="width: 10%;"></td> <td style="width: 10%;"></td> <td style="width: 10%;"></td> <td style="width: 10%;"></td> <td style="width: 10%;"></td> <td style="width: 10%;"></td> <td style="width: 10%;"></td> <td style="width: 10%;"></td> <td style="width: 10%;"></td> <td style="width: 10%;"></td> </tr> <tr> <td></td> <td></td> <td colspan="8" style="text-align: center;"> <table border="1" style="width: 100%; border-collapse: collapse; text-align: center;"> <tr> <td style="width: 10%;"></td> <td style="width: 10%;"></td> <td style="width: 10%;"></td> <td style="width: 10%;"></td> <td style="width: 10%;"></td> <td style="width: 10%;"></td> <td style="width: 10%;"></td> <td style="width: 10%;"></td> <td style="width: 10%;"></td> <td style="width: 10%;"></td> </tr> <tr> <td></td> <td></td> <td colspan="8" style="text-align: center;"> <table border="1" style="width: 100%; border-collapse: collapse; text-align: center;"> <tr> <td style="width: 10%;"></td> <td style="width: 10%;"></td> <td style="width: 10%;"></td> <td style="width: 10%;"></td> <td style="width: 10%;"></td> <td style="width: 10%;"></td> <td style="width: 10%;"></td> <td style="width: 10%;"></td> <td style="width: 10%;"></td> <td style="width: 10%;"></td> </tr> <tr> <td></td> <td></td> <td colspan="8" style="text-align: center;"> <table border="1" style="width: 100%; border-collapse: collapse; text-align: center;"> <tr> <td style="width: 10%;"></td> <td style="width: 10%;"></td> <td style="width: 10%;"></td> <td style="width: 10%;"></td> <td style="width: 10%;"></td> <td style="width: 10%;"></td> <td style="width: 10%;"></td> <td style="width: 10%;"></td> <td style="width: 10%;"></td> <td style="width: 10%;"></td> </tr> <tr> <td></td> <td></td> <td colspan="8" style="text-align: center;"> <table border="1" style="width: 100%; border-collapse: collapse; text-align: center;"> <tr> <td style="width: 10%;"></td> <td style="width: 10%;"></td> <td style="width: 10%;"></td> <td style="width: 10%;"></td> <td style="width: 10%;"></td> <td style="width: 10%;"></td> <td style="width: 10%;"></td> <td style="width: 10%;"></td> <td style="width: 10%;"></td> <td style="width: 10%;"></td> </tr> <tr> <td></td> <td></td> <td colspan="8" style="text-align: center;"> <table border="1" style="width: 100%; border-collapse: collapse; text-align: center;"> <tr> <td style="width: 10%;"></td> <td style="width: 10%;"></td> <td style="width: 10%;"></td> <td style="width: 10%;"></td> <td style="width: 10%;"></td> <td style="width: 10%;"></td> <td style="width: 10%;"></td> <td style="width: 10%;"></td> <td style="width: 10%;"></td> <td style="width: 10%;"></td> </tr> <tr> <td></td> <td></td> <td colspan="8" style="text-align: center;"> <table border="1" style="width: 100%; border-collapse: collapse; text-align: center;"> <tr> <td style="width: 10%;"></td> <td style="width: 10%;"></td> <td style="width: 10%;"></td> <td style="width: 10%;"></td> <td style="width: 10%;"></td> <td style="width: 10%;"></td> <td style="width: 10%;"></td> <td style="width: 10%;"></td> <td style="width: 10%;"></td> <td style="width: 10%;"></td> </tr> <tr> <td></td> <td></td> <td colspan="8" style="text-align: center;"> <table border="1" style="width: 100%; border-collapse: collapse; text-align: center;"> <tr> </tr></table></td></tr></table></td></tr></table></td></tr></table></td></tr></table></td></tr></table></td></tr></table></td></tr></table></td></tr></table></td></tr></table></td></tr></table></td></tr></table></td></tr></table></td></tr></table></td></tr></table></td></tr></table></td></tr></table></td></tr></table></td></tr></table></td></tr></table></td></tr></table></td></tr></table></td></tr></table></td></tr></table></td></tr></table></td></tr></table></td></tr></table></td></tr></table>

 | | | | | | | | | | | | | | | | | | | | <table border="1" style="width: 100%; border-collapse: collapse; text-align: center;"> <tr> <td style="width: 10%;"></td> <td style="width: 10%;"></td> <td style="width: 10%;"></td> <td style="width: 10%;"></td> <td style="width: 10%;"></td> <td style="width: 10%;"></td> <td style="width: 10%;"></td> <td style="width: 10%;"></td> <td style="width: 10%;"></td> <td style="width: 10%;"></td> </tr> <tr> <td></td> <td></td> <td colspan="8" style="text-align: center;"> <table border="1" style="width: 100%; border-collapse: collapse; text-align: center;"> <tr> <td style="width: 10%;"></td> <td style="width: 10%;"></td> <td style="width: 10%;"></td> <td style="width: 10%;"></td> <td style="width: 10%;"></td> <td style="width: 10%;"></td> <td style="width: 10%;"></td> <td style="width: 10%;"></td> <td style="width: 10%;"></td> <td style="width: 10%;"></td> </tr> <tr> <td></td> <td></td> <td colspan="8" style="text-align: center;"> <table border="1" style="width: 100%; border-collapse: collapse; text-align: center;"> <tr> <td style="width: 10%;"></td> <td style="width: 10%;"></td> <td style="width: 10%;"></td> <td style="width: 10%;"></td> <td style="width: 10%;"></td> <td style="width: 10%;"></td> <td style="width: 10%;"></td> <td style="width: 10%;"></td> <td style="width: 10%;"></td> <td style="width: 10%;"></td> </tr> <tr> <td></td> <td></td> <td colspan="8" style="text-align: center;"> <table border="1" style="width: 100%; border-collapse: collapse; text-align: center;"> <tr> <td style="width: 10%;"></td> <td style="width: 10%;"></td> <td style="width: 10%;"></td> <td style="width: 10%;"></td> <td style="width: 10%;"></td> <td style="width: 10%;"></td> <td style="width: 10%;"></td> <td style="width: 10%;"></td> <td style="width: 10%;"></td> <td style="width: 10%;"></td> </tr> <tr> <td></td> <td></td> <td colspan="8" style="text-align: center;"> <table border="1" style="width: 100%; border-collapse: collapse; text-align: center;"> <tr> <td style="width: 10%;"></td> <td style="width: 10%;"></td> <td style="width: 10%;"></td> <td style="width: 10%;"></td> <td style="width: 10%;"></td> <td style="width: 10%;"></td> <td style="width: 10%;"></td> <td style="width: 10%;"></td> <td style="width: 10%;"></td> <td style="width: 10%;"></td> </tr> <tr> <td></td> <td></td> <td colspan="8" style="text-align: center;"> <table border="1" style="width: 100%; border-collapse: collapse; text-align: center;"> <tr> <td style="width: 10%;"></td> <td style="width: 10%;"></td> <td style="width: 10%;"></td> <td style="width: 10%;"></td> <td style="width: 10%;"></td> <td style="width: 10%;"></td> <td style="width: 10%;"></td> <td style="width: 10%;"></td> <td style="width: 10%;"></td> <td style="width: 10%;"></td> </tr> <tr> <td></td> <td></td> <td colspan="8" style="text-align: center;"> <table border="1" style="width: 100%; border-collapse: collapse; text-align: center;"> <tr> <td style="width: 10%;"></td> <td style="width: 10%;"></td> <td style="width: 10%;"></td> <td style="width: 10%;"></td> <td style="width: 10%;"></td> <td style="width: 10%;"></td> <td style="width: 10%;"></td> <td style="width: 10%;"></td> <td style="width: 10%;"></td> <td style="width: 10%;"></td> </tr> <tr> <td></td> <td></td> <td colspan="8" style="text-align: center;"> <table border="1" style="width: 100%; border-collapse: collapse; text-align: center;"> <tr> <td style="width: 10%;"></td> <td style="width: 10%;"></td> <td style="width: 10%;"></td> <td style="width: 10%;"></td> <td style="width: 10%;"></td> <td style="width: 10%;"></td> <td style="width: 10%;"></td> <td style="width: 10%;"></td> <td style="width: 10%;"></td> <td style="width: 10%;"></td> </tr> <tr> <td></td> <td></td> <td colspan="8" style="text-align: center;"> <table border="1" style="width: 100%; border-collapse: collapse; text-align: center;"> <tr> <td style="width: 10%;"></td> <td style="width: 10%;"></td> <td style="width: 10%;"></td> <td style="width: 10%;"></td> <td style="width: 10%;"></td> <td style="width: 10%;"></td> <td style="width: 10%;"></td> <td style="width: 10%;"></td> <td style="width: 10%;"></td> <td style="width: 10%;"></td> </tr> <tr> <td></td> <td></td> <td colspan="8" style="text-align: center;"> <table border="1" style="width: 100%; border-collapse: collapse; text-align: center;"> <tr> <td style="width: 10%;"></td> <td style="width: 10%;"></td> <td style="width: 10%;"></td> <td style="width: 10%;"></td> <td style="width: 10%;"></td> <td style="width: 10%;"></td> <td style="width: 10%;"></td> <td style="width: 10%;"></td> <td style="width: 10%;"></td> <td style="width: 10%;"></td> </tr> <tr> <td></td> <td></td> <td colspan="8" style="text-align: center;"> <table border="1" style="width: 100%; border-collapse: collapse; text-align: center;"> <tr> <td style="width: 10%;"></td> <td style="width: 10%;"></td> <td style="width: 10%;"></td> <td style="width: 10%;"></td> <td style="width: 10%;"></td> <td style="width: 10%;"></td> <td style="width: 10%;"></td> <td style="width: 10%;"></td> <td style="width: 10%;"></td> <td style="width: 10%;"></td> </tr> <tr> <td></td> <td></td> <td colspan="8" style="text-align: center;"> <table border="1" style="width: 100%; border-collapse: collapse; text-align: center;"> <tr> <td style="width: 10%;"></td> <td style="width: 10%;"></td> <td style="width: 10%;"></td> <td style="width: 10%;"></td> <td style="width: 10%;"></td> <td style="width: 10%;"></td> <td style="width: 10%;"></td> <td style="width: 10%;"></td> <td style="width: 10%;"></td> <td style="width: 10%;"></td> </tr> <tr> <td></td> <td></td> <td colspan="8" style="text-align: center;"> <table border="1" style="width: 100%; border-collapse: collapse; text-align: center;"> <tr> <td style="width: 10%;"></td> <td style="width: 10%;"></td> <td style="width: 10%;"></td> <td style="width: 10%;"></td> <td style="width: 10%;"></td> <td style="width: 10%;"></td> <td style="width: 10%;"></td> <td style="width: 10%;"></td> <td style="width: 10%;"></td> <td
style="width: 10%;"></td> </tr> <tr> <td></td> <td></td> <td colspan="8" style="text-align: center;"> <table border="1" style="width: 100%; border-collapse: collapse; text-align: center;"> <tr> <td style="width: 10%;"></td> <td style="width: 10%;"></td> <td style="width: 10%;"></td> <td style="width: 10%;"></td> <td style="width: 10%;"></td> <td style="width: 10%;"></td> <td style="width: 10%;"></td> <td style="width: 10%;"></td> <td style="width: 10%;"></td> <td style="width: 10%;"></td> </tr> <tr> <td></td> <td></td> <td colspan="8" style="text-align: center;"> <table border="1" style="width: 100%; border-collapse: collapse; text-align: center;"> <tr> <td style="width: 10%;"></td> <td style="width: 10%;"></td> <td style="width: 10%;"></td> <td style="width: 10%;"></td> <td style="width: 10%;"></td> <td style="width: 10%;"></td> <td style="width: 10%;"></td> <td style="width: 10%;"></td> <td style="width: 10%;"></td> <td style="width: 10%;"></td> </tr> <tr> <td></td> <td></td> <td colspan="8" style="text-align: center;"> <table border="1" style="width: 100%; border-collapse: collapse; text-align: center;"> <tr> <td style="width: 10%;"></td> <td style="width: 10%;"></td> <td style="width: 10%;"></td> <td style="width: 10%;"></td> <td style="width: 10%;"></td> <td style="width: 10%;"></td> <td style="width: 10%;"></td> <td style="width: 10%;"></td> <td style="width: 10%;"></td> <td style="width: 10%;"></td> </tr> <tr> <td></td> <td></td> <td colspan="8" style="text-align: center;"> <table border="1" style="width: 100%; border-collapse: collapse; text-align: center;"> <tr> <td style="width: 10%;"></td> <td style="width: 10%;"></td> <td style="width: 10%;"></td> <td style="width: 10%;"></td> <td style="width: 10%;"></td> <td style="width: 10%;"></td> <td style="width: 10%;"></td> <td style="width: 10%;"></td> <td style="width: 10%;"></td> <td style="width: 10%;"></td> </tr> <tr> <td></td> <td></td> <td colspan="8" style="text-align: center;"> <table border="1" style="width: 100%; border-collapse: collapse; text-align: center;"> <tr> <td style="width: 10%;"></td> <td style="width: 10%;"></td> <td style="width: 10%;"></td> <td style="width: 10%;"></td> <td style="width: 10%;"></td> <td style="width: 10%;"></td> <td style="width: 10%;"></td> <td style="width: 10%;"></td> <td style="width: 10%;"></td> <td style="width: 10%;"></td> </tr> <tr> <td></td> <td></td> <td colspan="8" style="text-align: center;"> <table border="1" style="width: 100%; border-collapse: collapse; text-align: center;"> <tr> <td style="width: 10%;"></td> <td style="width: 10%;"></td> <td style="width: 10%;"></td> <td style="width: 10%;"></td> <td style="width: 10%;"></td> <td style="width: 10%;"></td> <td style="width: 10%;"></td> <td style="width: 10%;"></td> <td style="width: 10%;"></td> <td style="width: 10%;"></td> </tr> <tr> <td></td> <td></td> <td colspan="8" style="text-align: center;"> <table border="1" style="width: 100%; border-collapse: collapse; text-align: center;"> <tr> <td style="width: 10%;"></td> <td style="width: 10%;"></td> <td style="width: 10%;"></td> <td style="width: 10%;"></td> <td style="width: 10%;"></td> <td style="width: 10%;"></td> <td style="width: 10%;"></td> <td style="width: 10%;"></td> <td style="width: 10%;"></td> <td style="width: 10%;"></td> </tr> <tr> <td></td> <td></td> <td colspan="8" style="text-align: center;"> <table border="1" style="width: 100%; border-collapse: collapse; text-align: center;"> <tr> <td style="width: 10%;"></td> <td style="width: 10%;"></td> <td style="width: 10%;"></td> <td style="width: 10%;"></td> <td style="width: 10%;"></td> <td style="width: 10%;"></td> <td style="width: 10%;"></td> <td style="width: 10%;"></td> <td style="width: 10%;"></td> <td style="width: 10%;"></td> </tr> <tr> <td></td> <td></td> <td colspan="8" style="text-align: center;"> <table border="1" style="width: 100%; border-collapse: collapse; text-align: center;"> <tr> <td style="width: 10%;"></td> <td style="width: 10%;"></td> <td style="width: 10%;"></td> <td style="width: 10%;"></td> <td style="width: 10%;"></td> <td style="width: 10%;"></td> <td style="width: 10%;"></td> <td style="width: 10%;"></td> <td style="width: 10%;"></td> <td style="width: 10%;"></td> </tr> <tr> <td></td> <td></td> <td colspan="8" style="text-align: center;"> <table border="1" style="width: 100%; border-collapse: collapse; text-align: center;"> <tr> <td style="width: 10%;"></td> <td style="width: 10%;"></td> <td style="width: 10%;"></td> <td style="width: 10%;"></td> <td style="width: 10%;"></td> <td style="width: 10%;"></td> <td style="width: 10%;"></td> <td style="width: 10%;"></td> <td style="width: 10%;"></td> <td style="width: 10%;"></td> </tr> <tr> <td></td> <td></td> <td colspan="8" style="text-align: center;"> <table border="1" style="width: 100%; border-collapse: collapse; text-align: center;"> <tr> <td style="width: 10%;"></td> <td style="width: 10%;"></td> <td style="width: 10%;"></td> <td style="width: 10%;"></td> <td style="width: 10%;"></td> <td style="width: 10%;"></td> <td style="width: 10%;"></td> <td style="width: 10%;"></td> <td style="width: 10%;"></td> <td style="width: 10%;"></td> </tr> <tr> <td></td> <td></td> <td colspan="8" style="text-align: center;"> <table border="1" style="width: 100%; border-collapse: collapse; text-align: center;"> <tr> <td style="width: 10%;"></td> <td style="width: 10%;"></td> <td style="width: 10%;"></td> <td style="width: 10%;"></td> <td style="width: 10%;"></td> <td style="width: 10%;"></td> <td style="width: 10%;"></td> <td style="width: 10%;"></td> <td style="width: 10%;"></td> <td style="width: 10%;"></td> </tr> <tr> <td></td> <td></td> <td colspan="8" style="text-align: center;"> <table border="1" style="width: 100%; border-collapse: collapse; text-align: center;"> <tr> <td style="width: 10%;"></td> <td style="width: 10%;"></td> <td style="width: 10%;"></td> <td style="width: 10%;"></td> <td style="width: 10%;"></td> <td style="width: 10%;"></td> <td style="width: 10%;"></td> <td style="width: 10%;"></td> <td style="width: 10%;"></td> <td style="width: 10%;"></td> </tr> <tr> <td></td> <td></td> <td colspan="8" style="text-align: center;"> <table border="1" style="width: 100%; border-collapse: collapse; text-align: center;"> <tr> </tr></table></td></tr></table></td></tr></table></td></tr></table></td></tr></table></td></tr></table></td></tr></table></td></tr></table></td></tr></table></td></tr></table></td></tr></table></td></tr></table></td></tr></table></td></tr></table></td></tr></table></td></tr></table></td></tr></table></td></tr></table></td></tr></table></td></tr></table></td></tr></table></td></tr></table></td></tr></table></td></tr></table></td></tr></table></td></tr></table></td></tr></table>

 | | | | | | | | | | | | | | | | | | | | <table border="1" style="width: 100%; border-collapse: collapse; text-align: center;"> <tr> <td style="width: 10%;"></td> <td style="width: 10%;"></td> <td style="width: 10%;"></td> <td style="width: 10%;"></td> <td style="width: 10%;"></td> <td style="width: 10%;"></td> <td style="width: 10%;"></td> <td style="width: 10%;"></td> <td style="width: 10%;"></td> <td style="width: 10%;"></td> </tr> <tr> <td></td> <td></td> <td colspan="8" style="text-align: center;"> <table border="1" style="width: 100%; border-collapse: collapse; text-align: center;"> <tr> <td style="width: 10%;"></td> <td style="width: 10%;"></td> <td style="width: 10%;"></td> <td style="width: 10%;"></td> <td style="width: 10%;"></td> <td style="width: 10%;"></td> <td style="width: 10%;"></td> <td style="width: 10%;"></td> <td style="width: 10%;"></td> <td style="width: 10%;"></td> </tr> <tr> <td></td> <td></td> <td colspan="8" style="text-align: center;"> <table border="1" style="width: 100%; border-collapse: collapse; text-align: center;"> <tr> <td style="width: 10%;"></td> <td style="width: 10%;"></td> <td style="width: 10%;"></td> <td style="width: 10%;"></td> <td style="width: 10%;"></td> <td style="width: 10%;"></td> <td style="width: 10%;"></td> <td style="width: 10%;"></td> <td style="width: 10%;"></td> <td style="width: 10%;"></td> </tr> <tr> <td></td> <td></td> <td colspan="8" style="text-align: center;"> <table border="1" style="width: 100%; border-collapse: collapse; text-align: center;"> <tr> <td style="width: 10%;"></td> <td style="width: 10%;"></td> <td style="width: 10%;"></td> <td style="width: 10%;"></td> <td style="width: 10%;"></td> <td style="width: 10%;"></td> <td style="width: 10%;"></td> <td style="width: 10%;"></td> <td style="width: 10%;"></td> <td style="width: 10%;"></td> </tr> <tr> <td></td> <td></td> <td colspan="8" style="text-align: center;"> <table border="1" style="width: 100%; border-collapse: collapse; text-align: center;"> <tr> <td style="width: 10%;"></td> <td style="width: 10%;"></td> <td style="width: 10%;"></td> <td style="width: 10%;"></td> <td style="width: 10%;"></td> <td style="width: 10%;"></td> <td style="width: 10%;"></td> <td style="width: 10%;"></td> <td style="width: 10%;"></td> <td style="width: 10%;"></td> </tr> <tr> <td></td> <td></td> <td colspan="8" style="text-align: center;"> <table border="1" style="width: 100%; border-collapse: collapse; text-align: center;"> <tr> <td style="width: 10%;"></td> <td style="width: 10%;"></td> <td style="width: 10%;"></td> <td style="width: 10%;"></td> <td style="width: 10%;"></td> <td style="width: 10%;"></td> <td style="width: 10%;"></td> <td style="width: 10%;"></td> <td style="width: 10%;"></td> <td style="width: 10%;"></td> </tr> <tr> <td></td> <td></td> <td colspan="8" style="text-align: center;"> <table border="1" style="width: 100%; border-collapse: collapse; text-align: center;"> <tr> <td style="width: 10%;"></td> <td style="width: 10%;"></td> <td style="width: 10%;"></td> <td style="width: 10%;"></td> <td style="width: 10%;"></td> <td style="width: 10%;"></td> <td style="width: 10%;"></td> <td style="width: 10%;"></td> <td style="width: 10%;"></td> <td style="width: 10%;"></td> </tr> <tr> <td></td> <td></td> <td colspan="8" style="text-align: center;"> <table border="1" style="width: 100%; border-collapse: collapse; text-align: center;"> <tr> <td style="width: 10%;"></td> <td style="width: 10%;"></td> <td style="width: 10%;"></td> <td style="width: 10%;"></td> <td style="width: 10%;"></td> <td style="width: 10%;"></td> <td style="width: 10%;"></td> <td style="width: 10%;"></td> <td style="width: 10%;"></td> <td style="width: 10%;"></td> </tr> <tr> <td></td> <td></td> <td colspan="8" style="text-align: center;"> <table border="1" style="width: 100%; border-collapse: collapse; text-align: center;"> <tr> <td style="width: 10%;"></td> <td style="width: 10%;"></td> <td style="width: 10%;"></td> <td style="width: 10%;"></td> <td style="width: 10%;"></td> <td style="width: 10%;"></td> <td style="width: 10%;"></td> <td style="width: 10%;"></td> <td style="width: 10%;"></td> <td style="width: 10%;"></td> </tr> <tr> <td></td> <td></td> <td colspan="8" style="text-align: center;"> <table border="1" style="width: 100%; border-collapse: collapse; text-align: center;"> <tr> <td style="width: 10%;"></td> <td style="width: 10%;"></td> <td style="width: 10%;"></td> <td style="width: 10%;"></td> <td style="width: 10%;"></td> <td style="width: 10%;"></td> <td style="width: 10%;"></td> <td style="width: 10%;"></td> <td style="width: 10%;"></td> <td style="width: 10%;"></td> </tr> <tr> <td></td> <td></td> <td colspan="8" style="text-align: center;"> <table border="1" style="width: 100%; border-collapse: collapse; text-align: center;"> <tr> <td style="width: 10%;"></td> <td style="width: 10%;"></td> <td style="width: 10%;"></td> <td style="width: 10%;"></td> <td style="width: 10%;"></td> <td style="width: 10%;"></td> <td style="width: 10%;"></td> <td style="width: 10%;"></td> <td style="width: 10%;"></td> <td style="width: 10%;"></td> </tr> <tr> <td></td> <td></td> <td colspan="8" style="text-align: center;"> <table border="1" style="width: 100%; border-collapse: collapse; text-align: center;"> <tr> <td style="width: 10%;"></td> <td style="width: 10%;"></td> <td style="width: 10%;"></td> <td style="width: 10%;"></td> <td style="width: 10%;"></td> <td style="width: 10%;"></td> <td style="width: 10%;"></td> <td style="width: 10%;"></td> <td style="width: 10%;"></td> <td style="width: 10%;"></td> </tr> <tr> <td></td> <td></td> <td colspan="8" style="text-align: center;"> <table border="1" style="width: 100%; border-collapse: collapse; text-align: center;"> <tr> <td style="width: 10%;"></td> <td style="width: 10%;"></td> <td style="width: 10%;"></td> <td style="width: 10%;"></td> <td style="width: 10%;"></td> <td style="width: 10%;"></td> <td style="width: 10%;"></td> <td style="width: 10%;"></td> <td style="width: 10%;"></td> <td style="width: 10%;"></td> </tr> <tr> <td></td> <td></td> <td colspan="8" style="text-align: center;"> <table border="1" style="width: 100%; border-collapse: collapse; text-align: center;"> <tr> <td style="width: 10%;"></td> <td style="width: 10%;"></td> <td style="width: 10%;"></td> <td style="width: 10%;"></td> <td style="width: 10%;"></td> <td style="width: 10%;"></td> <td style="width: 10%;"></td> <td style="width: 10%;"></td> <td style="width: 10%;"></td> <td style="width: 10%;"></td> </tr> <tr> <td></td> <td></td> <td colspan="8" style="text-align: center;"> <table border="1" style="width: 100%; border-collapse: collapse; text-align: center;"> <tr> <td style="width: 10%;"></td> <td style="width: 10%;"></td> <td style="width: 10%;"></td> <td style="width: 10%;"></td> <td style="width: 10%;"></td> <td style="width: 10%;"></td> <td style="width: 10%;"></td> <td style="width: 10%;"></td> <td style="width: 10%;"></td> <td style="width: 10%;"></td> </tr> <tr> <td></td> <td></td> <td colspan="8" style="text-align: center;"> <table border="1" style="width: 100%; border-collapse: collapse; text-align: center;"> <tr> <td style="width: 10%;"></td> <td style="width: 10%;"></td> <td style="width: 10%;"></td> <td style="width: 10%;"></td> <td style="width: 10%;"></td> <td style="width: 10%;"></td> <td style="width: 10%;"></td> <td style="width: 10%;"></td> <td style="width: 10%;"></td> <td style="width: 10%;"></td> </tr> <tr> <td></td> <td></td> <td colspan="8" style="text-align: center;"> <table border="1" style="width: 100%; border-collapse: collapse; text-align: center;"> <tr> <td style="width: 10%;"></td> <td style="width: 10%;"></td> <td style="width: 10%;"></td> <td style="width: 10%;"></td> <td style="width: 10%;"></td> <td style="width: 10%;"></td> <td style="width: 10%;"></td> <td style="width: 10%;"></td> <td style="width: 10%;"></td> <td style="width: 10%;"></td> </tr> <tr> <td></td> <td></td> <td colspan="8" style="text-align: center;"> <table border="1" style="width: 100%; border-collapse: collapse; text-align: center;"> <tr> <td style="width: 10%;"></td> <td style="width: 10%;"></td> <td style="width: 10%;"></td> <td style="width: 10%;"></td> <td style="width: 10%;"></td> <td style="width: 10%;"></td> <td style="width: 10%;"></td> <td style="width: 10%;"></td> <td style="width: 10%;"></td> <td style="width: 10%;"></td> </tr> <tr> <td></td> <td></td> <td colspan="8" style="text-align: center;"> <table border="1" style="width: 100%; border-collapse: collapse; text-align: center;"> <tr> <td style="width: 10%;"></td> <td style="width: 10%;"></td> <td style="width: 10%;"></td> <td style="width: 10%;"></td> <td style="width: 10%;"></td> <td style="width: 10%;"></td> <td style="width: 10%;"></td> <td style="width: 10%;"></td> <td style="width: 10%;"></td> <td style="width: 10%;"></td> </tr> <tr> <td></td> <td></td> <td colspan="8" style="text-align: center;"> <table border="1" style="width: 100%; border-collapse: collapse; text-align: center;"> <tr> <td style="width: 10%;"></td> <td style="width: 10%;"></td> <td style="width: 10%;"></td> <td
style="width: 10%;"></td> <td style="width: 10%;"></td> <td style="width: 10%;"></td> <td style="width: 10%;"></td> <td style="width: 10%;"></td> <td style="width: 10%;"></td> <td style="width: 10%;"></td> </tr> <tr> <td></td> <td></td> <td colspan="8" style="text-align: center;"> <table border="1" style="width: 100%; border-collapse: collapse; text-align: center;"> <tr> <td style="width: 10%;"></td> <td style="width: 10%;"></td> <td style="width: 10%;"></td> <td style="width: 10%;"></td> <td style="width: 10%;"></td> <td style="width: 10%;"></td> <td style="width: 10%;"></td> <td style="width: 10%;"></td> <td style="width: 10%;"></td> <td style="width: 10%;"></td> </tr> <tr> <td></td> <td></td> <td colspan="8" style="text-align: center;"> <table border="1" style="width: 100%; border-collapse: collapse; text-align: center;"> <tr> <td style="width: 10%;"></td> <td style="width: 10%;"></td> <td style="width: 10%;"></td> <td style="width: 10%;"></td> <td style="width: 10%;"></td> <td style="width: 10%;"></td> <td style="width: 10%;"></td> <td style="width: 10%;"></td> <td style="width: 10%;"></td> <td style="width: 10%;"></td> </tr> <tr> <td></td> <td></td> <td colspan="8" style="text-align: center;"> <table border="1" style="width: 100%; border-collapse: collapse; text-align: center;"> <tr> <td style="width: 10%;"></td> <td style="width: 10%;"></td> <td style="width: 10%;"></td> <td style="width: 10%;"></td> <td style="width: 10%;"></td> <td style="width: 10%;"></td> <td style="width: 10%;"></td> <td style="width: 10%;"></td> <td style="width: 10%;"></td> <td style="width: 10%;"></td> </tr> <tr> <td></td> <td></td> <td colspan="8" style="text-align: center;"> <table border="1" style="width: 100%; border-collapse: collapse; text-align: center;"> <tr> <td style="width: 10%;"></td> <td style="width: 10%;"></td> <td style="width: 10%;"></td> <td style="width: 10%;"></td> <td style="width: 10%;"></td> <td style="width: 10%;"></td> <td style="width: 10%;"></td> <td style="width: 10%;"></td> <td style="width: 10%;"></td> <td style="width: 10%;"></td> </tr> <tr> <td></td> <td></td> <td colspan="8" style="text-align: center;"> <table border="1" style="width: 100%; border-collapse: collapse; text-align: center;"> <tr> <td style="width: 10%;"></td> <td style="width: 10%;"></td> <td style="width: 10%;"></td> <td style="width: 10%;"></td> <td style="width: 10%;"></td> <td style="width: 10%;"></td> <td style="width: 10%;"></td> <td style="width: 10%;"></td> <td style="width: 10%;"></td> <td style="width: 10%;"></td> </tr> <tr> <td></td> <td></td> <td colspan="8" style="text-align: center;"> <table border="1" style="width: 100%; border-collapse: collapse; text-align: center;"> <tr> </tr></table></td></tr></table></td></tr></table></td></tr></table></td></tr></table></td></tr></table></td></tr></table></td></tr></table></td></tr></table></td></tr></table></td></tr></table></td></tr></table></td></tr></table></td></tr></table></td></tr></table></td></tr></table></td></tr></table></td></tr></table></td></tr></table></td></tr></table></td></tr></table></td></tr></table></td></tr></table></td></tr></table></td></tr></table></td></tr></table>
 | | | | | | | | | | | | | | | | | | | | <table border="1" style="width: 100%; border-collapse: collapse; text-align: center;"> <tr> <td style="width: 10%;"></td> <td style="width: 10%;"></td> <td style="width: 10%;"></td> <td style="width: 10%;"></td> <td style="width: 10%;"></td> <td style="width: 10%;"></td> <td style="width: 10%;"></td> <td style="width: 10%;"></td> <td style="width: 10%;"></td> <td style="width: 10%;"></td> </tr> <tr> <td></td> <td></td> <td colspan="8" style="text-align: center;"> <table border="1" style="width: 100%; border-collapse: collapse; text-align: center;"> <tr> <td style="width: 10%;"></td> <td style="width: 10%;"></td> <td style="width: 10%;"></td> <td style="width: 10%;"></td> <td style="width: 10%;"></td> <td style="width: 10%;"></td> <td style="width: 10%;"></td> <td style="width: 10%;"></td> <td style="width: 10%;"></td> <td style="width: 10%;"></td> </tr> <tr> <td></td> <td></td> <td colspan="8" style="text-align: center;"> <table border="1" style="width: 100%; border-collapse: collapse; text-align: center;"> <tr> <td style="width: 10%;"></td> <td style="width: 10%;"></td> <td style="width: 10%;"></td> <td style="width: 10%;"></td> <td style="width: 10%;"></td> <td style="width: 10%;"></td> <td style="width: 10%;"></td> <td style="width: 10%;"></td> <td style="width: 10%;"></td> <td style="width: 10%;"></td> </tr> <tr> <td></td> <td></td> <td colspan="8" style="text-align: center;"> <table border="1" style="width: 100%; border-collapse: collapse; text-align: center;"> <tr> <td style="width: 10%;"></td> <td style="width: 10%;"></td> <td style="width: 10%;"></td> <td style="width: 10%;"></td> <td style="width: 10%;"></td> <td style="width: 10%;"></td> <td style="width: 10%;"></td> <td style="width: 10%;"></td> <td style="width: 10%;"></td> <td style="width: 10%;"></td> </tr> <tr> <td></td> <td></td> <td colspan="8" style="text-align: center;"> <table border="1" style="width: 100%; border-collapse: collapse; text-align: center;"> <tr> <td style="width: 10%;"></td> <td style="width: 10%;"></td> <td style="width: 10%;"></td> <td style="width: 10%;"></td> <td style="width: 10%;"></td> <td style="width: 10%;"></td> <td style="width: 10%;"></td> <td style="width: 10%;"></td> <td style="width: 10%;"></td> <td style="width: 10%;"></td> </tr> <tr> <td></td> <td></td> <td colspan="8" style="text-align: center;"> <table border="1" style="width: 100%; border-collapse: collapse; text-align: center;"> <tr> <td style="width: 10%;"></td> <td style="width: 10%;"></td> <td style="width: 10%;"></td> <td style="width: 10%;"></td> <td style="width: 10%;"></td> <td style="width: 10%;"></td> <td style="width: 10%;"></td> <td style="width:
10%;"></td> <td style="width: 10%;"></td> <td style="width: 10%;"></td> </tr> <tr> <td></td> <td></td> <td colspan="8" style="text-align: center;"> <table border="1" style="width: 100%; border-collapse: collapse; text-align: center;"> <tr> <td style="width: 10%;"></td> <td style="width: 10%;"></td> <td style="width: 10%;"></td> <td style="width: 10%;"></td> <td style="width: 10%;"></td> <td style="width: 10%;"></td> <td style="width: 10%;"></td> <td style="width: 10%;"></td> <td style="width: 10%;"></td> <td style="width: 10%;"></td> </tr> <tr> <td></td> <td></td> <td colspan="8" style="text-align: center;"> <table border="1" style="width: 100%; border-collapse: collapse; text-align: center;"> <tr> <td style="width: 10%;"></td> <td style="width: 10%;"></td> <td style="width: 10%;"></td> <td style="width: 10%;"></td> <td style="width: 10%;"></td> <td style="width: 10%;"></td> <td style="width: 10%;"></td> <td style="width: 10%;"></td> <td style="width: 10%;"></td> <td style="width: 10%;"></td> </tr> <tr> <td></td> <td></td> <td colspan="8" style="text-align: center;"> <table border="1" style="width: 100%; border-collapse: collapse; text-align: center;"> <tr> <td style="width: 10%;"></td> <td style="width: 10%;"></td> <td style="width: 10%;"></td> <td style="width: 10%;"></td> <td style="width: 10%;"></td> <td style="width: 10%;"></td> <td style="width: 10%;"></td> <td style="width: 10%;"></td> <td style="width: 10%;"></td> <td style="width: 10%;"></td> </tr> <tr> <td></td> <td></td> <td colspan="8" style="text-align: center;"> <table border="1" style="width: 100%; border-collapse: collapse; text-align: center;"> <tr> <td style="width: 10%;"></td> <td style="width: 10%;"></td> <td style="width: 10%;"></td> <td style="width: 10%;"></td> <td style="width: 10%;"></td> <td style="width: 10%;"></td> <td style="width: 10%;"></td> <td style="width: 10%;"></td> <td style="width: 10%;"></td> <td style="width: 10%;"></td> </tr> <tr> <td></td> <td></td> <td colspan="8" style="text-align: center;"> <table border="1" style="width: 100%; border-collapse: collapse; text-align: center;"> <tr> <td style="width: 10%;"></td> <td style="width: 10%;"></td> <td style="width: 10%;"></td> <td style="width: 10%;"></td> <td style="width: 10%;"></td> <td style="width: 10%;"></td> <td style="width: 10%;"></td> <td style="width: 10%;"></td> <td style="width: 10%;"></td> <td style="width: 10%;"></td> </tr> <tr> <td></td> <td></td> <td colspan="8" style="text-align: center;"> <table border="1" style="width: 100%; border-collapse: collapse; text-align: center;"> <tr> <td style="width: 10%;"></td> <td style="width: 10%;"></td> <td style="width: 10%;"></td> <td style="width: 10%;"></td> <td style="width: 10%;"></td> <td style="width: 10%;"></td> <td style="width: 10%;"></td> <td style="width: 10%;"></td> <td style="width: 10%;"></td> <td style="width: 10%;"></td> </tr> <tr> <td></td> <td></td> <td colspan="8" style="text-align: center;"> <table border="1" style="width: 100%; border-collapse: collapse; text-align: center;"> <tr> <td style="width: 10%;"></td> <td style="width: 10%;"></td> <td style="width: 10%;"></td> <td style="width: 10%;"></td> <td style="width: 10%;"></td> <td style="width: 10%;"></td> <td style="width: 10%;"></td> <td style="width: 10%;"></td> <td style="width: 10%;"></td> <td style="width: 10%;"></td> </tr> <tr> <td></td> <td></td> <td colspan="8" style="text-align: center;"> <table border="1" style="width: 100%; border-collapse: collapse; text-align: center;"> <tr> <td style="width: 10%;"></td> <td style="width: 10%;"></td> <td style="width: 10%;"></td> <td style="width: 10%;"></td> <td style="width: 10%;"></td> <td style="width: 10%;"></td> <td style="width: 10%;"></td> <td style="width: 10%;"></td> <td style="width: 10%;"></td> <td style="width: 10%;"></td> </tr> <tr> <td></td> <td></td> <td colspan="8" style="text-align: center;"> <table border="1" style="width: 100%; border-collapse: collapse; text-align: center;"> <tr> <td style="width: 10%;"></td> <td style="width: 10%;"></td> <td style="width: 10%;"></td> <td style="width: 10%;"></td> <td style="width: 10%;"></td> <td style="width: 10%;"></td> <td style="width: 10%;"></td> <td style="width: 10%;"></td> <td style="width: 10%;"></td> <td style="width: 10%;"></td> </tr> <tr> <td></td> <td></td> <td colspan="8" style="text-align: center;"> <table border="1" style="width: 100%; border-collapse: collapse; text-align: center;"> <tr> <td style="width: 10%;"></td> <td style="width: 10%;"></td> <td style="width: 10%;"></td> <td style="width: 10%;"></td> <td style="width: 10%;"></td> <td style="width: 10%;"></td> <td style="width: 10%;"></td> <td style="width: 10%;"></td> <td style="width: 10%;"></td> <td style="width: 10%;"></td> </tr> <tr> <td></td> <td></td> <td colspan="8" style="text-align: center;"> <table border="1" style="width: 100%; border-collapse: collapse; text-align: center;"> <tr> <td style="width: 10%;"></td> <td style="width: 10%;"></td> <td style="width: 10%;"></td> <td style="width: 10%;"></td> <td style="width: 10%;"></td> <td style="width: 10%;"></td> <td style="width: 10%;"></td> <td style="width: 10%;"></td> <td style="width: 10%;"></td> <td style="width: 10%;"></td> </tr> <tr> <td></td> <td></td> <td colspan="8" style="text-align: center;"> <table border="1" style="width: 100%; border-collapse: collapse; text-align: center;"> <tr> <td style="width: 10%;"></td> <td style="width: 10%;"></td> <td style="width: 10%;"></td> <td style="width: 10%;"></td> <td style="width: 10%;"></td> <td style="width: 10%;"></td> <td style="width: 10%;"></td> <td style="width: 10%;"></td> <td style="width: 10%;"></td> <td style="width: 10%;"></td> </tr> <tr> <td></td> <td></td> <td colspan="8" style="text-align: center;"> <table border="1" style="width: 100%; border-collapse: collapse; text-align: center;"> <tr> <td style="width: 10%;"></td> <td style="width: 10%;"></td> <td style="width: 10%;"></td> <td style="width: 10%;"></td> <td style="width: 10%;"></td> <td style="width: 10%;"></td> <td style="width: 10%;"></td> <td style="width: 10%;"></td> <td style="width: 10%;"></td> <td style="width: 10%;"></td> </tr> <tr> <td></td> <td></td> <td colspan="8" style="text-align: center;"> <table border="1" style="width: 100%; border-collapse: collapse; text-align: center;"> <tr> <td style="width: 10%;"></td> <td style="width: 10%;"></td> <td style="width: 10%;"></td> <td style="width: 10%;"></td> <td style="width: 10%;"></td> <td style="width: 10%;"></td> <td style="width: 10%;"></td> <td style="width: 10%;"></td> <td style="width: 10%;"></td> <td style="width: 10%;"></td> </tr> <tr> <td></td> <td></td> <td colspan="8" style="text-align: center;"> <table border="1" style="width: 100%; border-collapse: collapse; text-align: center;"> <tr> <td style="width: 10%;"></td> <td style="width: 10%;"></td> <td style="width: 10%;"></td> <td style="width: 10%;"></td> <td style="width: 10%;"></td> <td style="width: 10%;"></td> <td style="width: 10%;"></td> <td style="width: 10%;"></td> <td style="width: 10%;"></td> <td style="width: 10%;"></td> </tr> <tr> <td></td> <td></td> <td colspan="8" style="text-align: center;"> <table border="1" style="width: 100%; border-collapse: collapse; text-align: center;"> <tr> <td style="width: 10%;"></td> <td style="width: 10%;"></td> <td style="width: 10%;"></td> <td style="width: 10%;"></td> <td style="width: 10%;"></td> <td style="width: 10%;"></td> <td style="width: 10%;"></td> <td style="width: 10%;"></td> <td style="width: 10%;"></td> <td style="width: 10%;"></td> </tr> <tr> <td></td> <td></td> <td colspan="8" style="text-align: center;"> <table border="1" style="width: 100%; border-collapse: collapse; text-align: center;"> <tr> <td style="width: 10%;"></td> <td style="width: 10%;"></td> <td style="width: 10%;"></td> <td style="width: 10%;"></td> <td style="width: 10%;"></td> <td style="width: 10%;"></td> <td style="width: 10%;"></td> <td style="width: 10%;"></td> <td style="width: 10%;"></td> <td style="width: 10%;"></td> </tr> <tr> <td></td> <td></td> <td colspan="8" style="text-align: center;"> <table border="1" style="width: 100%; border-collapse: collapse; text-align: center;"> <tr> <td style="width: 10%;"></td> <td style="width: 10%;"></td> <td style="width: 10%;"></td> <td style="width: 10%;"></td> <td style="width: 10%;"></td> <td style="width: 10%;"></td> <td style="width: 10%;"></td> <td style="width: 10%;"></td> <td style="width: 10%;"></td> <td style="width: 10%;"></td> </tr> <tr> <td></td> <td></td> <td colspan="8" style="text-align: center;"> <table border="1" style="width: 100%; border-collapse: collapse; text-align: center;"> <tr> </tr></table></td></tr></table></td></tr></table></td></tr></table></td></tr></table></td></tr></table></td></tr></table></td></tr></table></td></tr></table></td></tr></table></td></tr></table></td></tr></table></td></tr></table></td></tr></table></td></tr></table></td></tr></table></td></tr></table></td></tr></table></td></tr></table></td></tr></table></td></tr></table></td></tr></table></td></tr></table></td></tr></table></td></tr></table>

 | | | | | | | | | | | | | | | | | | | | <table border="1" style="width: 100%; border-collapse: collapse; text-align: center;"> <tr> <td style="width: 10%;"></td> <td style="width: 10%;"></td> <td style="width: 10%;"></td> <td style="width: 10%;"></td> <td style="width: 10%;"></td> <td style="width: 10%;"></td> <td style="width: 10%;"></td> <td style="width: 10%;"></td> <td style="width: 10%;"></td> <td style="width: 10%;"></td> </tr> <tr> <td></td> <td></td> <td colspan="8" style="text-align: center;"> <table border="1" style="width: 100%; border-collapse: collapse; text-align: center;"> <tr> <td style="width: 10%;"></td> <td style="width: 10%;"></td> <td style="width: 10%;"></td> <td style="width: 10%;"></td> <td style="width: 10%;"></td> <td style="width: 10%;"></td> <td style="width: 10%;"></td> <td style="width: 10%;"></td> <td style="width: 10%;"></td> <td style="width: 10%;"></td> </tr> <tr> <td></td> <td></td> <td colspan="8" style="text-align: center;"> <table border="1" style="width: 100%; border-collapse: collapse; text-align: center;"> <tr> <td style="width: 10%;"></td> <td style="width: 10%;"></td> <td style="width: 10%;"></td> <td style="width: 10%;"></td> <td style="width: 10%;"></td> <td style="width: 10%;"></td> <td style="width: 10%;"></td> <td style="width: 10%;"></td> <td style="width: 10%;"></td> <td style="width: 10%;"></td> </tr> <tr> <td></td> <td></td> <td colspan="8" style="text-align: center;"> <table border="1" style="width: 100%; border-collapse: collapse; text-align: center;"> <tr> <td style="width: 10%;"></td> <td style="width: 10%;"></td> <td style="width: 10%;"></td> <td style="width: 10%;"></td> <td style="width: 10%;"></td> <td style="width: 10%;"></td> <td style="width: 10%;"></td> <td style="width: 10%;"></td> <td style="width: 10%;"></td> <td style="width: 10%;"></td> </tr> <tr> <td></td> <td></td> <td colspan="8" style="text-align: center;"> <table border="1" style="width: 100%; border-collapse: collapse; text-align: center;"> <tr> <td style="width: 10%;"></td> <td style="width: 10%;"></td> <td style="width: 10%;"></td> <td style="width: 10%;"></td> <td style="width: 10%;"></td> <td style="width: 10%;"></td> <td style="width: 10%;"></td> <td style="width: 10%;"></td> <td style="width: 10%;"></td> <td style="width: 10%;"></td> </tr> <tr> <td></td> <td></td> <td colspan="8" style="text-align: center;"> <table border="1" style="width: 100%; border-collapse: collapse; text-align: center;"> <tr> <td style="width: 10%;"></td> <td style="width: 10%;"></td> <td style="width: 10%;"></td> <td style="width: 10%;"></td> <td style="width: 10%;"></td> <td style="width: 10%;"></td> <td style="width: 10%;"></td> <td style="width: 10%;"></td> <td style="width: 10%;"></td> <td style="width: 10%;"></td> </tr> <tr> <td></td> <td></td> <td colspan="8" style="text-align: center;"> <table border="1" style="width: 100%; border-collapse: collapse; text-align: center;"> <tr> <td style="width: 10%;"></td> <td style="width: 10%;"></td> <td style="width: 10%;"></td> <td style="width: 10%;"></td> <td style="width: 10%;"></td> <td style="width: 10%;"></td> <td style="width: 10%;"></td> <td style="width: 10%;"></td> <td style="width: 10%;"></td> <td style="width: 10%;"></td> </tr> <tr> <td></td> <td></td> <td colspan="8" style="text-align: center;"> <table border="1" style="width: 100%; border-collapse: collapse; text-align: center;"> <tr> <td style="width: 10%;"></td> <td style="width: 10%;"></td> <td style="width: 10%;"></td> <td style="width: 10%;"></td> <td style="width: 10%;"></td> <td style="width: 10%;"></td> <td style="width: 10%;"></td> <td style="width: 10%;"></td> <td style="width: 10%;"></td> <td style="width: 10%;"></td> </tr> <tr> <td></td> <td></td> <td colspan="8" style="text-align: center;"> <table border="1" style="width: 100%; border-collapse: collapse; text-align: center;"> <tr> <td style="width: 10%;"></td> <td style="width: 10%;"></td> <td style="width: 10%;"></td> <td style="width: 10%;"></td> <td style="width: 10%;"></td> <td style="width: 10%;"></td> <td style="width: 10%;"></td> <td style="width: 10%;"></td> <td style="width: 10%;"></td> <td style="width: 10%;"></td> </tr> <tr> <td></td> <td></td> <td colspan="8" style="text-align: center;"> <table border="1" style="width: 100%; border-collapse: collapse; text-align: center;"> <tr> <td style="width: 10%;"></td> <td style="width: 10%;"></td> <td style="width: 10%;"></td> <td style="width: 10%;"></td> <td style="width: 10%;"></td> <td style="width: 10%;"></td> <td style="width: 10%;"></td> <td style="width: 10%;"></td> <td style="width: 10%;"></td> <td style="width: 10%;"></td> </tr> <tr> <td></td> <td></td> <td colspan="8" style="text-align: center;"> <table border="1" style="width: 100%; border-collapse: collapse; text-align: center;"> <tr> <td style="width: 10%;"></td> <td style="width: 10%;"></td> <td style="width: 10%;"></td> <td style="width: 10%;"></td> <td style="width: 10%;"></td> <td style="width: 10%;"></td> <td style="width: 10%;"></td> <td style="width: 10%;"></td> <td style="width: 10%;"></td> <td style="width: 10%;"></td> </tr> <tr> <td></td> <td></td> <td colspan="8" style="text-align: center;"> <table border="1" style="width: 100%; border-collapse: collapse; text-align: center;"> <tr> <td style="width: 10%;"></td> <td style="width: 10%;"></td> <td style="width: 10%;"></td> <td style="width: 10%;"></td> <td style="width: 10%;"></td> <td style="width: 10%;"></td> <td style="width: 10%;"></td> <td style="width: 10%;"></td> <td style="width: 10%;"></td> <td style="width: 10%;"></td> </tr> <tr> <td></td> <td></td> <td colspan="8" style="text-align: center;"> <table border="1" style="width: 100%; border-collapse: collapse; text-align: center;"> <tr> <td style="width: 10%;"></td> <td style="width: 10%;"></td> <td style="width: 10%;"></td> <td style="width: 10%;"></td> <td style="width: 10%;"></td> <td style="width: 10%;"></td> <td style="width: 10%;"></td> <td style="width: 10%;"></td> <td style="width: 10%;"></td> <td style="width: 10%;"></td> </tr> <tr> <td></td> <td></td> <td colspan="8" style="text-align: center;"> <table border="1" style="width: 100%; border-collapse: collapse; text-align: center;"> <tr> <td style="width: 10%;"></td> <td style="width: 10%;"></td> <td style="width: 10%;"></td> <td style="width: 10%;"></td> <td style="width: 10%;"></td> <td style="width: 10%;"></td> <td style="width: 10%;"></td> <td style="width: 10%;"></td> <td style="width: 10%;"></td> <td style="width: 10%;"></td> </tr> <tr> <td></td> <td></td> <td colspan="8" style="text-align: center;"> <table border="1" style="width: 100%; border-collapse: collapse; text-align: center;"> <tr> <td style="width: 10%;"></td> <td style="width: 10%;"></td> <td style="width: 10%;"></td>
<td style="width: 10%;"></td> <td style="width: 10%;"></td> <td style="width: 10%;"></td> <td style="width: 10%;"></td> <td style="width: 10%;"></td> <td style="width: 10%;"></td> <td style="width: 10%;"></td> </tr> <tr> <td></td> <td></td> <td colspan="8" style="text-align: center;"> <table border="1" style="width: 100%; border-collapse: collapse; text-align: center;"> <tr> <td style="width: 10%;"></td> <td style="width: 10%;"></td> <td style="width: 10%;"></td> <td style="width: 10%;"></td> <td style="width: 10%;"></td> <td style="width: 10%;"></td> <td style="width: 10%;"></td> <td style="width: 10%;"></td> <td style="width: 10%;"></td> <td style="width: 10%;"></td> </tr> <tr> <td></td> <td></td> <td colspan="8" style="text-align: center;"> <table border="1" style="width: 100%; border-collapse: collapse; text-align: center;"> <tr> <td style="width: 10%;"></td> <td style="width: 10%;"></td> <td style="width: 10%;"></td> <td style="width: 10%;"></td> <td style="width: 10%;"></td> <td style="width: 10%;"></td> <td style="width: 10%;"></td> <td style="width: 10%;"></td> <td style="width: 10%;"></td> <td style="width: 10%;"></td> </tr> <tr> <td></td> <td></td> <td colspan="8" style="text-align: center;"> <table border="1" style="width: 100%; border-collapse: collapse; text-align: center;"> <tr> <td style="width: 10%;"></td> <td style="width: 10%;"></td> <td style="width: 10%;"></td> <td style="width: 10%;"></td> <td style="width: 10%;"></td> <td style="width: 10%;"></td> <td style="width: 10%;"></td> <td style="width: 10%;"></td> <td style="width: 10%;"></td> <td style="width: 10%;"></td> </tr> <tr> <td></td> <td></td> <td colspan="8" style="text-align: center;"> <table border="1" style="width: 100%; border-collapse: collapse; text-align: center;"> <tr> <td style="width: 10%;"></td> <td style="width: 10%;"></td> <td style="width: 10%;"></td> <td style="width: 10%;"></td> <td style="width: 10%;"></td> <td style="width: 10%;"></td> <td style="width: 10%;"></td> <td style="width: 10%;"></td> <td style="width: 10%;"></td> <td style="width: 10%;"></td> </tr> <tr> <td></td> <td></td> <td colspan="8" style="text-align: center;"> <table border="1" style="width: 100%; border-collapse: collapse; text-align: center;"> <tr> <td style="width: 10%;"></td> <td style="width: 10%;"></td> <td style="width: 10%;"></td> <td style="width: 10%;"></td> <td style="width: 10%;"></td> <td style="width: 10%;"></td> <td style="width: 10%;"></td> <td style="width: 10%;"></td> <td style="width: 10%;"></td> <td style="width: 10%;"></td> </tr> <tr> <td></td> <td></td> <td colspan="8" style="text-align: center;"> <table border="1" style="width: 100%; border-collapse: collapse; text-align: center;"> <tr> <td style="width: 10%;"></td> <td style="width: 10%;"></td> <td style="width: 10%;"></td> <td style="width: 10%;"></td> <td style="width: 10%;"></td> <td style="width: 10%;"></td> <td style="width: 10%;"></td> <td style="width: 10%;"></td> <td style="width: 10%;"></td> <td style="width: 10%;"></td> </tr> <tr> <td></td> <td></td> <td colspan="8" style="text-align: center;"> <table border="1" style="width: 100%; border-collapse: collapse; text-align: center;"> <tr> <td style="width: 10%;"></td> <td style="width: 10%;"></td> <td style="width: 10%;"></td> <td style="width: 10%;"></td> <td style="width: 10%;"></td> <td style="width: 10%;"></td> <td style="width: 10%;"></td> <td style="width: 10%;"></td> <td style="width: 10%;"></td> <td style="width: 10%;"></td> </tr> <tr> <td></td> <td></td> <td colspan="8" style="text-align: center;"> <table border="1" style="width: 100%; border-collapse: collapse; text-align: center;"> <tr> <td style="width: 10%;"></td> <td style="width: 10%;"></td> <td style="width: 10%;"></td> <td style="width: 10%;"></td> <td style="width: 10%;"></td> <td style="width: 10%;"></td> <td style="width: 10%;"></td> <td style="width: 10%;"></td> <td style="width: 10%;"></td> <td style="width: 10%;"></td> </tr> <tr> <td></td> <td></td> <td colspan="8" style="text-align: center;"> <table border="1" style="width: 100%; border-collapse: collapse; text-align: center;"> <tr> </tr></table></td></tr></table></td></tr></table></td></tr></table></td></tr></table></td></tr></table></td></tr></table></td></tr></table></td></tr></table></td></tr></table></td></tr></table></td></tr></table></td></tr></table></td></tr></table></td></tr></table></td></tr></table></td></tr></table></td></tr></table></td></tr></table></td></tr></table></td></tr></table></td></tr></table></td></tr></table></td></tr></table>
 | | | | | | | | | | | | | | | | | | | | <table border="1" style="width: 100%; border-collapse: collapse; text-align: center;"> <tr> <td style="width: 10%;"></td> <td style="width: 10%;"></td> <td style="width: 10%;"></td> <td style="width: 10%;"></td> <td style="width: 10%;"></td> <td style="width: 10%;"></td> <td style="width: 10%;"></td> <td style="width: 10%;"></td> <td style="width: 10%;"></td> <td style="width: 10%;"></td> </tr> <tr> <td></td> <td></td> <td colspan="8" style="text-align: center;"> <table border="1" style="width: 100%; border-collapse: collapse; text-align: center;"> <tr> <td style="width: 10%;"></td> <td style="width: 10%;"></td> <td style="width: 10%;"></td> <td style="width: 10%;"></td> <td style="width: 10%;"></td> <td style="width: 10%;"></td> <td style="width: 10%;"></td> <td style="width: 10%;"></td> <td style="width: 10%;"></td> <td style="width: 10%;"></td> </tr> <tr> <td></td> <td></td> <td colspan="8" style="text-align: center;"> <table border="1" style="width: 100%; border-collapse: collapse; text-align: center;"> <tr> <td style="width: 10%;"></td> <td style="width: 10%;"></td> <td style="width: 10%;"></td> <td style="width: 10%;"></td> <td style="width: 10%;"></td> <td style="width: 10%;"></td> <td style="width: 10%;"></td> <td style="width: 10%;"></td> <td style="width:
10%;"></td> <td style="width: 10%;"></td> </tr> <tr> <td></td> <td></td> <td colspan="8" style="text-align: center;"> <table border="1" style="width: 100%; border-collapse: collapse; text-align: center;"> <tr> <td style="width: 10%;"></td> <td style="width: 10%;"></td> <td style="width: 10%;"></td> <td style="width: 10%;"></td> <td style="width: 10%;"></td> <td style="width: 10%;"></td> <td style="width: 10%;"></td> <td style="width: 10%;"></td> <td style="width: 10%;"></td> <td style="width: 10%;"></td> </tr> <tr> <td></td> <td></td> <td colspan="8" style="text-align: center;"> <table border="1" style="width: 100%; border-collapse: collapse; text-align: center;"> <tr> <td style="width: 10%;"></td> <td style="width: 10%;"></td> <td style="width: 10%;"></td> <td style="width: 10%;"></td> <td style="width: 10%;"></td> <td style="width: 10%;"></td> <td style="width: 10%;"></td> <td style="width: 10%;"></td> <td style="width: 10%;"></td> <td style="width: 10%;"></td> </tr> <tr> <td></td> <td></td> <td colspan="8" style="text-align: center;"> <table border="1" style="width: 100%; border-collapse: collapse; text-align: center;"> <tr> <td style="width: 10%;"></td> <td style="width: 10%;"></td> <td style="width: 10%;"></td> <td style="width: 10%;"></td> <td style="width: 10%;"></td> <td style="width: 10%;"></td> <td style="width: 10%;"></td> <td style="width: 10%;"></td> <td style="width: 10%;"></td> <td style="width: 10%;"></td> </tr> <tr> <td></td> <td></td> <td colspan="8" style="text-align: center;"> <table border="1" style="width: 100%; border-collapse: collapse; text-align: center;"> <tr> <td style="width: 10%;"></td> <td style="width: 10%;"></td> <td style="width: 10%;"></td> <td style="width: 10%;"></td> <td style="width: 10%;"></td> <td style="width: 10%;"></td> <td style="width: 10%;"></td> <td style="width: 10%;"></td> <td style="width: 10%;"></td> <td style="width: 10%;"></td> </tr> <tr> <td></td> <td></td> <td colspan="8" style="text-align: center;"> <table border="1" style="width: 100%; border-collapse: collapse; text-align: center;"> <tr> <td style="width: 10%;"></td> <td style="width: 10%;"></td> <td style="width: 10%;"></td> <td style="width: 10%;"></td> <td style="width: 10%;"></td> <td style="width: 10%;"></td> <td style="width: 10%;"></td> <td style="width: 10%;"></td> <td style="width: 10%;"></td> <td style="width: 10%;"></td> </tr> <tr> <td></td> <td></td> <td colspan="8" style="text-align: center;"> <table border="1" style="width: 100%; border-collapse: collapse; text-align: center;"> <tr> <td style="width: 10%;"></td> <td style="width: 10%;"></td> <td style="width: 10%;"></td> <td style="width: 10%;"></td> <td style="width: 10%;"></td> <td style="width: 10%;"></td> <td style="width: 10%;"></td> <td style="width: 10%;"></td> <td style="width: 10%;"></td> <td style="width: 10%;"></td> </tr> <tr> <td></td> <td></td> <td colspan="8" style="text-align: center;"> <table border="1" style="width: 100%; border-collapse: collapse; text-align: center;"> <tr> <td style="width: 10%;"></td> <td style="width: 10%;"></td> <td style="width: 10%;"></td> <td style="width: 10%;"></td> <td style="width: 10%;"></td> <td style="width: 10%;"></td> <td style="width: 10%;"></td> <td style="width: 10%;"></td> <td style="width: 10%;"></td> <td style="width: 10%;"></td> </tr> <tr> <td></td> <td></td> <td colspan="8" style="text-align: center;"> <table border="1" style="width: 100%; border-collapse: collapse; text-align: center;"> <tr> <td style="width: 10%;"></td> <td style="width: 10%;"></td> <td style="width: 10%;"></td> <td style="width: 10%;"></td> <td style="width: 10%;"></td> <td style="width: 10%;"></td> <td style="width: 10%;"></td> <td style="width: 10%;"></td> <td style="width: 10%;"></td> <td style="width: 10%;"></td> </tr> <tr> <td></td> <td></td> <td colspan="8" style="text-align: center;"> <table border="1" style="width: 100%; border-collapse: collapse; text-align: center;"> <tr> <td style="width: 10%;"></td> <td style="width: 10%;"></td> <td style="width: 10%;"></td> <td style="width: 10%;"></td> <td style="width: 10%;"></td> <td style="width: 10%;"></td> <td style="width: 10%;"></td> <td style="width: 10%;"></td> <td style="width: 10%;"></td> <td style="width: 10%;"></td> </tr> <tr> <td></td> <td></td> <td colspan="8" style="text-align: center;"> <table border="1" style="width: 100%; border-collapse: collapse; text-align: center;"> <tr> <td style="width: 10%;"></td> <td style="width: 10%;"></td> <td style="width: 10%;"></td> <td style="width: 10%;"></td> <td style="width: 10%;"></td> <td style="width: 10%;"></td> <td style="width: 10%;"></td> <td style="width: 10%;"></td> <td style="width: 10%;"></td> <td style="width: 10%;"></td> </tr> <tr> <td></td> <td></td> <td colspan="8" style="text-align: center;"> <table border="1" style="width: 100%; border-collapse: collapse; text-align: center;"> <tr> <td style="width: 10%;"></td> <td style="width: 10%;"></td> <td style="width: 10%;"></td> <td style="width: 10%;"></td> <td style="width: 10%;"></td> <td style="width: 10%;"></td> <td style="width: 10%;"></td> <td style="width: 10%;"></td> <td style="width: 10%;"></td> <td style="width: 10%;"></td> </tr> <tr> <td></td> <td></td> <td colspan="8" style="text-align: center;"> <table border="1" style="width: 100%; border-collapse: collapse; text-align: center;"> <tr> <td style="width: 10%;"></td> <td style="width: 10%;"></td> <td style="width: 10%;"></td> <td style="width: 10%;"></td> <td style="width: 10%;"></td> <td style="width: 10%;"></td> <td style="width: 10%;"></td> <td style="width: 10%;"></td> <td style="width: 10%;"></td> <td style="width: 10%;"></td> </tr> <tr> <td></td> <td></td> <td colspan="8" style="text-align: center;"> <table border="1" style="width: 100%; border-collapse: collapse; text-align: center;"> <tr> <td style="width: 10%;"></td> <td style="width: 10%;"></td> <td style="width: 10%;"></td> <td style="width: 10%;"></td> <td style="width: 10%;"></td> <td style="width: 10%;"></td> <td style="width: 10%;"></td> <td style="width: 10%;"></td> <td style="width: 10%;"></td> <td style="width: 10%;"></td> </tr> <tr> <td></td> <td></td> <td colspan="8" style="text-align: center;"> <table border="1" style="width: 100%; border-collapse: collapse; text-align: center;"> <tr> <td style="width: 10%;"></td> <td style="width: 10%;"></td> <td style="width: 10%;"></td> <td style="width: 10%;"></td> <td style="width: 10%;"></td> <td style="width: 10%;"></td> <td style="width: 10%;"></td> <td style="width: 10%;"></td> <td style="width: 10%;"></td> <td style="width: 10%;"></td> </tr> <tr> <td></td> <td></td> <td colspan="8" style="text-align: center;"> <table border="1" style="width: 100%; border-collapse: collapse; text-align: center;"> <tr> <td style="width: 10%;"></td> <td style="width: 10%;"></td> <td style="width: 10%;"></td> <td style="width: 10%;"></td> <td style="width: 10%;"></td> <td style="width: 10%;"></td> <td style="width: 10%;"></td> <td style="width: 10%;"></td> <td style="width: 10%;"></td> <td style="width: 10%;"></td> </tr> <tr> <td></td> <td></td> <td colspan="8" style="text-align: center;"> <table border="1" style="width: 100%; border-collapse: collapse; text-align: center;"> <tr> <td style="width: 10%;"></td> <td style="width: 10%;"></td> <td style="width: 10%;"></td> <td style="width: 10%;"></td> <td style="width: 10%;"></td> <td style="width: 10%;"></td> <td style="width: 10%;"></td> <td style="width: 10%;"></td> <td style="width: 10%;"></td> <td style="width: 10%;"></td> </tr> <tr> <td></td> <td></td> <td colspan="8" style="text-align: center;"> <table border="1" style="width: 100%; border-collapse: collapse; text-align: center;"> <tr> <td style="width: 10%;"></td> <td style="width: 10%;"></td> <td style="width: 10%;"></td> <td style="width: 10%;"></td> <td style="width: 10%;"></td> <td style="width: 10%;"></td> <td style="width: 10%;"></td> <td style="width: 10%;"></td> <td style="width: 10%;"></td> <td style="width: 10%;"></td> </tr> <tr> <td></td> <td></td> <td colspan="8" style="text-align: center;"> <table border="1" style="width: 100%; border-collapse: collapse; text-align: center;"> <tr> <td style="width: 10%;"></td> <td style="width: 10%;"></td> <td style="width: 10%;"></td> <td style="width: 10%;"></td> <td style="width: 10%;"></td> <td style="width: 10%;"></td> <td style="width: 10%;"></td> <td style="width: 10%;"></td> <td style="width: 10%;"></td> <td style="width: 10%;"></td> </tr> <tr> <td></td> <td></td> <td colspan="8" style="text-align: center;"> <table border="1" style="width: 100%; border-collapse: collapse; text-align: center;"> <tr> <td style="width: 10%;"></td> <td style="width: 10%;"></td> <td style="width: 10%;"></td> <td style="width: 10%;"></td> <td style="width: 10%;"></td> <td style="width: 10%;"></td> <td style="width: 10%;"></td> <td style="width: 10%;"></td> <td style="width: 10%;"></td> <td style="width: 10%;"></td> </tr> <tr> <td></td> <td></td> <td colspan="8" style="text-align: center;"> <table border="1" style="width: 100%; border-collapse: collapse; text-align: center;"> <tr> </tr></table></td></tr></table></td></tr></table></td></tr></table></td></tr></table></td></tr></table></td></tr></table></td></tr></table></td></tr></table></td></tr></table></td></tr></table></td></tr></table></td></tr></table></td></tr></table></td></tr></table></td></tr></table></td></tr></table></td></tr></table></td></tr></table></td></tr></table></td></tr></table></td></tr></table></td></tr></table>

 | | | | | | | | | | | | | | | | | | | | <table border="1" style="width: 100%; border-collapse: collapse; text-align: center;"> <tr> <td style="width: 10%;"></td> <td style="width: 10%;"></td> <td style="width: 10%;"></td> <td style="width: 10%;"></td> <td style="width: 10%;"></td> <td style="width: 10%;"></td> <td style="width: 10%;"></td> <td style="width: 10%;"></td> <td style="width: 10%;"></td> <td style="width: 10%;"></td> </tr> <tr> <td></td> <td></td> <td colspan="8" style="text-align: center;"> <table border="1" style="width: 100%; border-collapse: collapse; text-align: center;"> <tr> <td style="width: 10%;"></td> <td style="width: 10%;"></td> <td style="width: 10%;"></td> <td style="width: 10%;"></td> <td style="width: 10%;"></td> <td style="width: 10%;"></td> <td style="width: 10%;"></td> <td style="width: 10%;"></td> <td style="width: 10%;"></td> <td style="width: 10%;"></td> </tr> <tr> <td></td> <td></td> <td colspan="8" style="text-align: center;"> <table border="1" style="width: 100%; border-collapse: collapse; text-align: center;"> <tr> <td style="width: 10%;"></td> <td style="width: 10%;"></td> <td style="width: 10%;"></td> <td style="width: 10%;"></td> <td style="width: 10%;"></td> <td style="width: 10%;"></td> <td style="width: 10%;"></td> <td style="width: 10%;"></td> <td style="width: 10%;"></td> <td style="width: 10%;"></td> </tr> <tr> <td></td> <td></td> <td colspan="8" style="text-align: center;"> <table border="1" style="width: 100%; border-collapse: collapse; text-align: center;"> <tr> <td style="width: 10%;"></td> <td style="width: 10%;"></td> <td style="width: 10%;"></td> <td style="width: 10%;"></td> <td style="width: 10%;"></td> <td style="width: 10%;"></td> <td style="width: 10%;"></td> <td style="width: 10%;"></td> <td style="width: 10%;"></td> <td style="width: 10%;"></td> </tr> <tr> <td></td> <td></td> <td colspan="8" style="text-align: center;"> <table border="1" style="width: 100%; border-collapse: collapse; text-align: center;"> <tr> <td style="width: 10%;"></td> <td style="width: 10%;"></td> <td style="width: 10%;"></td> <td style="width: 10%;"></td> <td style="width: 10%;"></td> <td style="width: 10%;"></td> <td style="width: 10%;"></td> <td style="width: 10%;"></td> <td style="width: 10%;"></td> <td style="width: 10%;"></td> </tr> <tr> <td></td> <td></td> <td colspan="8" style="text-align: center;"> <table border="1" style="width: 100%; border-collapse: collapse; text-align: center;"> <tr> <td style="width: 10%;"></td> <td style="width: 10%;"></td> <td style="width: 10%;"></td> <td style="width: 10%;"></td> <td style="width: 10%;"></td> <td style="width: 10%;"></td> <td style="width: 10%;"></td> <td style="width: 10%;"></td> <td style="width: 10%;"></td> <td style="width: 10%;"></td> </tr> <tr> <td></td> <td></td> <td colspan="8" style="text-align: center;"> <table border="1" style="width: 100%; border-collapse: collapse; text-align: center;"> <tr> <td style="width: 10%;"></td> <td style="width: 10%;"></td> <td style="width: 10%;"></td> <td style="width: 10%;"></td> <td style="width: 10%;"></td> <td style="width: 10%;"></td> <td style="width: 10%;"></td> <td style="width: 10%;"></td> <td style="width: 10%;"></td> <td style="width: 10%;"></td> </tr> <tr> <td></td> <td></td> <td colspan="8" style="text-align: center;"> <table border="1" style="width: 100%; border-collapse: collapse; text-align: center;"> <tr> <td style="width: 10%;"></td> <td style="width: 10%;"></td> <td style="width: 10%;"></td> <td style="width: 10%;"></td> <td style="width: 10%;"></td> <td style="width: 10%;"></td> <td style="width: 10%;"></td> <td style="width: 10%;"></td> <td style="width: 10%;"></td> <td style="width: 10%;"></td> </tr> <tr> <td></td> <td></td> <td colspan="8" style="text-align: center;"> <table border="1" style="width: 100%; border-collapse: collapse; text-align: center;"> <tr> <td style="width: 10%;"></td> <td style="width: 10%;"></td> <td style="width: 10%;"></td> <td style="width: 10%;"></td> <td style="width: 10%;"></td> <td style="width: 10%;"></td> <td style="width: 10%;"></td> <td style="width: 10%;"></td> <td style="width: 10%;"></td> <td style="width: 10%;"></td> </tr> <tr> <td></td> <td></td> <td colspan="8" style="text-align: center;"> <table border="1" style="width: 100%; border-collapse: collapse; text-align: center;"> <tr> <td style="width: 10%;"></td> <td style="width: 10%;"></td> <td style="width: 10%;"></td> <td style="width: 10%;"></td> <td style="width: 10%;"></td> <td style="width: 10%;"></td> <td style="width: 10%;"></td> <td style="width: 10%;"></td> <td style="width: 10%;"></td> <td style="width: 10%;"></td> </tr> <tr> <td></td> <td></td> <td colspan="8" style="text-align: center;"> <table border="1" style="width: 100%; border-collapse: collapse; text-align: center;"> <tr> <td style="width: 10%;"></td> <td style="width: 10%;"></td> <td style="width: 10%;"></td> <td style="width: 10%;"></td> <td style="width: 10%;"></td> <td style="width: 10%;"></td> <td style="width: 10%;"></td> <td style="width: 10%;"></td> <td style="width: 10%;"></td> <td style="width: 10%;"></td> </tr> <tr> <td></td> <td></td> <td colspan="8" style="text-align: center;"> <table border="1" style="width: 100%; border-collapse: collapse; text-align: center;"> <tr> <td style="width: 10%;"></td> <td style="width: 10%;"></td> <td style="width: 10%;"></td> <td style="width: 10%;"></td> <td style="width: 10%;"></td> <td style="width: 10%;"></td> <td style="width: 10%;"></td> <td style="width: 10%;"></td> <td style="width: 10%;"></td> <td style="width: 10%;"></td> </tr> <tr> <td></td> <td></td> <td colspan="8" style="text-align: center;"> <table border="1" style="width: 100%; border-collapse: collapse; text-align: center;"> <tr> <td style="width: 10%;"></td> <td style="width: 10%;"></td> <td style="width: 10%;"></td> <td style="width: 10%;"></td> <td style="width: 10%;"></td> <td style="width: 10%;"></td> <td style="width: 10%;"></td> <td style="width: 10%;"></td> <td style="width: 10%;"></td> <td style="width: 10%;"></td> </tr> <tr> <td></td> <td></td> <td colspan="8" style="text-align: center;"> <table border="1" style="width: 100%; border-collapse: collapse; text-align: center;"> <tr> <td style="width: 10%;"></td> <td style="width: 10%;"></td> <td style="width: 10%;"></td> <td style="width: 10%;"></td> <td style="width: 10%;"></td> <td
style="width: 10%;"></td> <td style="width: 10%;"></td> <td style="width: 10%;"></td> <td style="width: 10%;"></td> <td style="width: 10%;"></td> </tr> <tr> <td></td> <td></td> <td colspan="8" style="text-align: center;"> <table border="1" style="width: 100%; border-collapse: collapse; text-align: center;"> <tr> <td style="width: 10%;"></td> <td style="width: 10%;"></td> <td style="width: 10%;"></td> <td style="width: 10%;"></td> <td style="width: 10%;"></td> <td style="width: 10%;"></td> <td style="width: 10%;"></td> <td style="width: 10%;"></td> <td style="width: 10%;"></td> <td style="width: 10%;"></td> </tr> <tr> <td></td> <td></td> <td colspan="8" style="text-align: center;"> <table border="1" style="width: 100%; border-collapse: collapse; text-align: center;"> <tr> <td style="width: 10%;"></td> <td style="width: 10%;"></td> <td style="width: 10%;"></td> <td style="width: 10%;"></td> <td style="width: 10%;"></td> <td style="width: 10%;"></td> <td style="width: 10%;"></td> <td style="width: 10%;"></td> <td style="width: 10%;"></td> <td style="width: 10%;"></td> </tr> <tr> <td></td> <td></td> <td colspan="8" style="text-align: center;"> <table border="1" style="width: 100%; border-collapse: collapse; text-align: center;"> <tr> <td style="width: 10%;"></td> <td style="width: 10%;"></td> <td style="width: 10%;"></td> <td style="width: 10%;"></td> <td style="width: 10%;"></td> <td style="width: 10%;"></td> <td style="width: 10%;"></td> <td style="width: 10%;"></td> <td style="width: 10%;"></td> <td style="width: 10%;"></td> </tr> <tr> <td></td> <td></td> <td colspan="8" style="text-align: center;"> <table border="1" style="width: 100%; border-collapse: collapse; text-align: center;"> <tr> <td style="width: 10%;"></td> <td style="width: 10%;"></td> <td style="width: 10%;"></td> <td style="width: 10%;"></td> <td style="width: 10%;"></td> <td style="width: 10%;"></td> <td style="width: 10%;"></td> <td style="width: 10%;"></td> <td style="width: 10%;"></td> <td style="width: 10%;"></td> </tr> <tr> <td></td> <td></td> <td colspan="8" style="text-align: center;"> <table border="1" style="width: 100%; border-collapse: collapse; text-align: center;"> <tr> <td style="width: 10%;"></td> <td style="width: 10%;"></td> <td style="width: 10%;"></td> <td style="width: 10%;"></td> <td style="width: 10%;"></td> <td style="width: 10%;"></td> <td style="width: 10%;"></td> <td style="width: 10%;"></td> <td style="width: 10%;"></td> <td style="width: 10%;"></td> </tr> <tr> <td></td> <td></td> <td colspan="8" style="text-align: center;"> <table border="1" style="width: 100%; border-collapse: collapse; text-align: center;"> <tr> <td style="width: 10%;"></td> <td style="width: 10%;"></td> <td style="width: 10%;"></td> <td style="width: 10%;"></td> <td style="width: 10%;"></td> <td style="width: 10%;"></td> <td style="width: 10%;"></td> <td style="width: 10%;"></td> <td style="width: 10%;"></td> <td style="width: 10%;"></td> </tr> <tr> <td></td> <td></td> <td colspan="8" style="text-align: center;"> <table border="1" style="width: 100%; border-collapse: collapse; text-align: center;"> <tr> <td style="width: 10%;"></td> <td style="width: 10%;"></td> <td style="width: 10%;"></td> <td style="width: 10%;"></td> <td style="width: 10%;"></td> <td style="width: 10%;"></td> <td style="width: 10%;"></td> <td style="width: 10%;"></td> <td style="width: 10%;"></td> <td style="width: 10%;"></td> </tr> <tr> <td></td> <td></td> <td colspan="8" style="text-align: center;"> <table border="1" style="width: 100%; border-collapse: collapse; text-align: center;"> <tr> </tr></table></td></tr></table></td></tr></table></td></tr></table></td></tr></table></td></tr></table></td></tr></table></td></tr></table></td></tr></table></td></tr></table></td></tr></table></td></tr></table></td></tr></table></td></tr></table></td></tr></table></td></tr></table></td></tr></table></td></tr></table></td></tr></table></td></tr></table></td></tr></table></td></tr></table>
 | | | | | | | | | | | | | | | | | | | | <table border="1" style="width: 100%; border-collapse: collapse; text-align: center;"> <tr> <td style="width: 10%;"></td> <td style="width: 10%;"></td> <td style="width: 10%;"></td> <td style="width: 10%;"></td> <td style="width: 10%;"></td> <td style="width: 10%;"></td> <td style="width: 10%;"></td> <td style="width: 10%;"></td> <td style="width: 10%;"></td> <td style="width: 10%;"></td> </tr> <tr> <td></td> <td></td> <td colspan="8" style="text-align: center;"> <table border="1" style="width: 100%; border-collapse: collapse; text-align: center;"> <tr> <td style="width: 10%;"></td> <td style="width: 10%;"></td> <td style="width: 10%;"></td> <td style="width: 10%;"></td> <td style="width: 10%;"></td> <td style="width: 10%;"></td> <td style="width: 10%;"></td> <td style="width: 10%;"></td> <td style="width: 10%;"></td> <td style="width: 10%;"></td> </tr> <tr> <td></td> <td></td> <td colspan="8" style="text-align: center;"> <table border="1" style="width: 100%; border-collapse: collapse; text-align: center;"> <tr> <td style="width: 10%;"></td> <td style="width: 10%;"></td> <td style="width: 10%;"></td> <td style="width: 10%;"></td> <td style="width: 10%;"></td> <td style="width: 10%;"></td> <td style="width: 10%;"></td> <td style="width: 10%;"></td> <td style="width: 10%;"></td> <td style="width: 10%;"></td> </tr> <tr> <td></td> <td></td> <td colspan="8" style="text-align: center;"> <table border="1" style="width: 100%; border-collapse: collapse; text-align: center;"> <tr> <td style="width: 10%;"></td> <td style="width: 10%;"></td> <td style="width: 10%;"></td> <td style="width: 10%;"></td> <td style="width: 10%;"></td> <td style="width: 10%;"></td> <td style="width: 10%;"></td> <td style="width: 10%;"></td> <td style="width: 10%;"></td> <td style="width: 10%;"></td> </tr> <tr> <td></td> <td></td> <td colspan="8" style="text-align:
center;"> <table border="1" style="width: 100%; border-collapse: collapse; text-align: center;"> <tr> <td style="width: 10%;"></td> <td style="width: 10%;"></td> <td style="width: 10%;"></td> <td style="width: 10%;"></td> <td style="width: 10%;"></td> <td style="width: 10%;"></td> <td style="width: 10%;"></td> <td style="width: 10%;"></td> <td style="width: 10%;"></td> <td style="width: 10%;"></td> </tr> <tr> <td></td> <td></td> <td colspan="8" style="text-align: center;"> <table border="1" style="width: 100%; border-collapse: collapse; text-align: center;"> <tr> <td style="width: 10%;"></td> <td style="width: 10%;"></td> <td style="width: 10%;"></td> <td style="width: 10%;"></td> <td style="width: 10%;"></td> <td style="width: 10%;"></td> <td style="width: 10%;"></td> <td style="width: 10%;"></td> <td style="width: 10%;"></td> <td style="width: 10%;"></td> </tr> <tr> <td></td> <td></td> <td colspan="8" style="text-align: center;"> <table border="1" style="width: 100%; border-collapse: collapse; text-align: center;"> <tr> <td style="width: 10%;"></td> <td style="width: 10%;"></td> <td style="width: 10%;"></td> <td style="width: 10%;"></td> <td style="width: 10%;"></td> <td style="width: 10%;"></td> <td style="width: 10%;"></td> <td style="width: 10%;"></td> <td style="width: 10%;"></td> <td style="width: 10%;"></td> </tr> <tr> <td></td> <td></td> <td colspan="8" style="text-align: center;"> <table border="1" style="width: 100%; border-collapse: collapse; text-align: center;"> <tr> <td style="width: 10%;"></td> <td style="width: 10%;"></td> <td style="width: 10%;"></td> <td style="width: 10%;"></td> <td style="width: 10%;"></td> <td style="width: 10%;"></td> <td style="width: 10%;"></td> <td style="width: 10%;"></td> <td style="width: 10%;"></td> <td style="width: 10%;"></td> </tr> <tr> <td></td> <td></td> <td colspan="8" style="text-align: center;"> <table border="1" style="width: 100%; border-collapse: collapse; text-align: center;"> <tr> <td style="width: 10%;"></td> <td style="width: 10%;"></td> <td style="width: 10%;"></td> <td style="width: 10%;"></td> <td style="width: 10%;"></td> <td style="width: 10%;"></td> <td style="width: 10%;"></td> <td style="width: 10%;"></td> <td style="width: 10%;"></td> <td style="width: 10%;"></td> </tr> <tr> <td></td> <td></td> <td colspan="8" style="text-align: center;"> <table border="1" style="width: 100%; border-collapse: collapse; text-align: center;"> <tr> <td style="width: 10%;"></td> <td style="width: 10%;"></td> <td style="width: 10%;"></td> <td style="width: 10%;"></td> <td style="width: 10%;"></td> <td style="width: 10%;"></td> <td style="width: 10%;"></td> <td style="width: 10%;"></td> <td style="width: 10%;"></td> <td style="width: 10%;"></td> </tr> <tr> <td></td> <td></td> <td colspan="8" style="text-align: center;"> <table border="1" style="width: 100%; border-collapse: collapse; text-align: center;"> <tr> <td style="width: 10%;"></td> <td style="width: 10%;"></td> <td style="width: 10%;"></td> <td style="width: 10%;"></td> <td style="width: 10%;"></td> <td style="width: 10%;"></td> <td style="width: 10%;"></td> <td style="width: 10%;"></td> <td style="width: 10%;"></td> <td style="width: 10%;"></td> </tr> <tr> <td></td> <td></td> <td colspan="8" style="text-align: center;"> <table border="1" style="width: 100%; border-collapse: collapse; text-align: center;"> <tr> <td style="width: 10%;"></td> <td style="width: 10%;"></td> <td style="width: 10%;"></td> <td style="width: 10%;"></td> <td style="width: 10%;"></td> <td style="width: 10%;"></td> <td style="width: 10%;"></td> <td style="width: 10%;"></td> <td style="width: 10%;"></td> <td style="width: 10%;"></td> </tr> <tr> <td></td> <td></td> <td colspan="8" style="text-align: center;"> <table border="1" style="width: 100%; border-collapse: collapse; text-align: center;"> <tr> <td style="width: 10%;"></td> <td style="width: 10%;"></td> <td style="width: 10%;"></td> <td style="width: 10%;"></td> <td style="width: 10%;"></td> <td style="width: 10%;"></td> <td style="width: 10%;"></td> <td style="width: 10%;"></td> <td style="width: 10%;"></td> <td style="width: 10%;"></td> </tr> <tr> <td></td> <td></td> <td colspan="8" style="text-align: center;"> <table border="1" style="width: 100%; border-collapse: collapse; text-align: center;"> <tr> <td style="width: 10%;"></td> <td style="width: 10%;"></td> <td style="width: 10%;"></td> <td style="width: 10%;"></td> <td style="width: 10%;"></td> <td style="width: 10%;"></td> <td style="width: 10%;"></td> <td style="width: 10%;"></td> <td style="width: 10%;"></td> <td style="width: 10%;"></td> </tr> <tr> <td></td> <td></td> <td colspan="8" style="text-align: center;"> <table border="1" style="width: 100%; border-collapse: collapse; text-align: center;"> <tr> <td style="width: 10%;"></td> <td style="width: 10%;"></td> <td style="width: 10%;"></td> <td style="width: 10%;"></td> <td style="width: 10%;"></td> <td style="width: 10%;"></td> <td style="width: 10%;"></td> <td style="width: 10%;"></td> <td style="width: 10%;"></td> <td style="width: 10%;"></td> </tr> <tr> <td></td> <td></td> <td colspan="8" style="text-align: center;"> <table border="1" style="width: 100%; border-collapse: collapse; text-align: center;"> <tr> <td style="width: 10%;"></td> <td style="width: 10%;"></td> <td style="width: 10%;"></td> <td style="width: 10%;"></td> <td style="width: 10%;"></td> <td style="width: 10%;"></td> <td style="width: 10%;"></td> <td style="width: 10%;"></td> <td style="width: 10%;"></td> <td style="width: 10%;"></td> </tr> <tr> <td></td> <td></td> <td colspan="8" style="text-align: center;"> <table border="1" style="width: 100%; border-collapse: collapse; text-align: center;"> <tr> <td style="width: 10%;"></td> <td style="width: 10%;"></td> <td style="width: 10%;"></td> <td style="width: 10%;"></td> <td style="width: 10%;"></td> <td style="width: 10%;"></td> <td style="width: 10%;"></td> <td style="width: 10%;"></td> <td style="width: 10%;"></td> <td style="width: 10%;"></td> </tr> <tr> <td></td> <td></td> <td colspan="8" style="text-align: center;"> <table border="1" style="width: 100%; border-collapse: collapse; text-align: center;"> <tr> <td style="width: 10%;"></td> <td style="width: 10%;"></td> <td style="width: 10%;"></td> <td style="width: 10%;"></td> <td style="width: 10%;"></td> <td style="width: 10%;"></td> <td style="width: 10%;"></td> <td style="width: 10%;"></td> <td style="width: 10%;"></td> <td style="width: 10%;"></td> </tr> <tr> <td></td> <td></td> <td colspan="8" style="text-align: center;"> <table border="1" style="width: 100%; border-collapse: collapse; text-align: center;"> <tr> <td style="width: 10%;"></td> <td style="width: 10%;"></td> <td style="width: 10%;"></td> <td style="width: 10%;"></td> <td style="width: 10%;"></td> <td style="width: 10%;"></td> <td style="width: 10%;"></td> <td style="width: 10%;"></td> <td style="width: 10%;"></td> <td style="width: 10%;"></td> </tr> <tr> <td></td> <td></td> <td colspan="8" style="text-align: center;"> <table border="1" style="width: 100%; border-collapse: collapse; text-align: center;"> <tr> <td style="width: 10%;"></td> <td style="width: 10%;"></td> <td style="width: 10%;"></td> <td style="width: 10%;"></td> <td style="width: 10%;"></td> <td style="width: 10%;"></td> <td style="width: 10%;"></td> <td style="width: 10%;"></td> <td style="width: 10%;"></td> <td style="width: 10%;"></td> </tr> <tr> <td></td> <td></td> <td colspan="8" style="text-align: center;"> <table border="1" style="width: 100%; border-collapse: collapse; text-align: center;"> <tr> </tr></table></td></tr></table></td></tr></table></td></tr></table></td></tr></table></td></tr></table></td></tr></table></td></tr></table></td></tr></table></td></tr></table></td></tr></table></td></tr></table></td></tr></table></td></tr></table></td></tr></table></td></tr></table></td></tr></table></td></tr></table></td></tr></table></td></tr></table></td></tr></table>

 | | | | | | | | | | | | | | | | | | | | <table border="1" style="width: 100%; border-collapse: collapse; text-align: center;"> <tr> <td style="width: 10%;"></td> <td style="width: 10%;"></td> <td style="width: 10%;"></td> <td style="width: 10%;"></td> <td style="width: 10%;"></td> <td style="width: 10%;"></td> <td style="width: 10%;"></td> <td style="width: 10%;"></td> <td style="width: 10%;"></td> <td style="width: 10%;"></td> </tr> <tr> <td></td> <td></td> <td colspan="8" style="text-align: center;"> <table border="1" style="width: 100%; border-collapse: collapse; text-align: center;"> <tr> <td style="width: 10%;"></td> <td style="width: 10%;"></td> <td style="width: 10%;"></td> <td style="width: 10%;"></td> <td style="width: 10%;"></td> <td style="width: 10%;"></td> <td style="width: 10%;"></td> <td style="width: 10%;"></td> <td style="width: 10%;"></td> <td style="width: 10%;"></td> </tr> <tr> <td></td> <td></td> <td colspan="8" style="text-align: center;"> <table border="1" style="width: 100%; border-collapse: collapse; text-align: center;"> <tr> <td style="width: 10%;"></td> <td style="width: 10%;"></td> <td style="width: 10%;"></td> <td style="width: 10%;"></td> <td style="width: 10%;"></td> <td style="width: 10%;"></td> <td style="width: 10%;"></td> <td style="width: 10%;"></td> <td style="width: 10%;"></td> <td style="width: 10%;"></td> </tr> <tr> <td></td> <td></td> <td colspan="8" style="text-align: center;"> <table border="1" style="width: 100%; border-collapse: collapse; text-align: center;"> <tr> <td style="width: 10%;"></td> <td style="width: 10%;"></td> <td style="width: 10%;"></td> <td style="width: 10%;"></td> <td style="width: 10%;"></td> <td style="width: 10%;"></td> <td style="width: 10%;"></td> <td style="width: 10%;"></td> <td style="width: 10%;"></td> <td style="width: 10%;"></td> </tr> <tr> <td></td> <td></td> <td colspan="8" style="text-align: center;"> <table border="1" style="width: 100%; border-collapse: collapse; text-align: center;"> <tr> <td style="width: 10%;"></td> <td style="width: 10%;"></td> <td style="width: 10%;"></td> <td style="width: 10%;"></td> <td style="width: 10%;"></td> <td style="width: 10%;"></td> <td style="width: 10%;"></td> <td style="width: 10%;"></td> <td style="width: 10%;"></td> <td style="width: 10%;"></td> </tr> <tr> <td></td> <td></td> <td colspan="8" style="text-align: center;"> <table border="1" style="width: 100%; border-collapse: collapse; text-align: center;"> <tr> <td style="width: 10%;"></td> <td style="width: 10%;"></td> <td style="width: 10%;"></td> <td style="width: 10%;"></td> <td style="width: 10%;"></td> <td style="width: 10%;"></td> <td style="width: 10%;"></td> <td style="width: 10%;"></td> <td style="width: 10%;"></td> <td style="width: 10%;"></td> </tr> <tr> <td></td> <td></td> <td colspan="8" style="text-align: center;"> <table border="1" style="width: 100%; border-collapse: collapse; text-align: center;"> <tr> <td style="width: 10%;"></td> <td style="width: 10%;"></td> <td style="width: 10%;"></td> <td style="width: 10%;"></td> <td style="width: 10%;"></td> <td style="width: 10%;"></td> <td style="width: 10%;"></td> <td style="width: 10%;"></td> <td style="width: 10%;"></td> <td style="width: 10%;"></td> </tr> <tr> <td></td> <td></td> <td colspan="8" style="text-align: center;"> <table border="1" style="width: 100%; border-collapse: collapse; text-align: center;"> <tr> <td style="width: 10%;"></td> <td style="width: 10%;"></td> <td style="width: 10%;"></td> <td style="width: 10%;"></td> <td style="width: 10%;"></td> <td style="width: 10%;"></td> <td style="width: 10%;"></td> <td style="width: 10%;"></td> <td style="width: 10%;"></td> <td style="width: 10%;"></td> </tr> <tr> <td></td> <td></td> <td colspan="8" style="text-align: center;"> <table border="1" style="width: 100%; border-collapse: collapse; text-align: center;"> <tr> <td style="width: 10%;"></td> <td style="width: 10%;"></td> <td style="width: 10%;"></td> <td style="width: 10%;"></td> <td style="width: 10%;"></td> <td style="width: 10%;"></td> <td style="width: 10%;"></td> <td style="width: 10%;"></td> <td style="width: 10%;"></td> <td style="width: 10%;"></td> </tr> <tr> <td></td> <td></td> <td colspan="8" style="text-align: center;"> <table border="1" style="width: 100%; border-collapse: collapse; text-align: center;"> <tr> <td style="width: 10%;"></td> <td style="width: 10%;"></td> <td style="width: 10%;"></td> <td style="width: 10%;"></td> <td style="width: 10%;"></td> <td style="width: 10%;"></td> <td style="width: 10%;"></td> <td style="width: 10%;"></td> <td style="width: 10%;"></td> <td style="width: 10%;"></td> </tr> <tr> <td></td> <td></td> <td colspan="8" style="text-align: center;"> <table border="1" style="width: 100%; border-collapse: collapse; text-align: center;"> <tr> <td style="width: 10%;"></td> <td style="width: 10%;"></td> <td style="width: 10%;"></td> <td style="width: 10%;"></td> <td style="width: 10%;"></td> <td style="width: 10%;"></td> <td style="width: 10%;"></td> <td style="width: 10%;"></td> <td style="width: 10%;"></td> <td style="width: 10%;"></td> </tr> <tr> <td></td> <td></td> <td colspan="8" style="text-align: center;"> <table border="1" style="width: 100%; border-collapse: collapse; text-align: center;"> <tr> <td style="width: 10%;"></td> <td style="width: 10%;"></td> <td style="width: 10%;"></td> <td style="width: 10%;"></td> <td style="width: 10%;"></td> <td style="width: 10%;"></td> <td style="width: 10%;"></td> <td style="width: 10%;"></td> <td style="width: 10%;"></td> <td style="width: 10%;"></td> </tr> <tr> <td></td> <td></td> <td colspan="8" style="text-align: center;"> <table border="1" style="width: 100%; border-collapse: collapse; text-align: center;"> <tr> <td style="width: 10%;"></td> <td style="width: 10%;"></td> <td style="width: 10%;"></td> <td style="width: 10%;"></td> <td style="width: 10%;"></td> <td style="width: 10%;"></td> <td style="width: 10%;"></td> <td style="width: 10%;"></td> <td style="width: 10%;"></td> <td style="width: 10%;"></td> </tr> <tr> <td></td> <td></td> <td colspan="8" style="text-align: center;"> <table border="1" style="width: 100%; border-collapse: collapse; text-align: center;"> <tr> <td style="width: 10%;"></td> <td style="width: 10%;"></td> <td style="width: 10%;"></td> <td style="width: 10%;"></td> <td style="width: 10%;"></td> <td style="width: 10%;"></td> <td style="width: 10%;"></td> <td style="width: 10%;"></td> <td style="width: 10%;"></td> <td style="width: 10%;"></td> </tr> <tr> <td></td> <td></td> <td colspan="8" style="text-align: center;"> <table border="1" style="width: 100%; border-collapse: collapse; text-align: center;"> <tr> <td style="width: 10%;"></td> <td style="width: 10%;"></td> <td style="width: 10%;"></td> <td style="width: 10%;"></td> <td style="width: 10%;"></td> <td style="width: 10%;"></td> <td style="width: 10%;"></td> <td style="width: 10%;"></td> <td style="width: 10%;"></td> <td style="width: 10%;"></td> </tr> <tr> <td></td> <td></td> <td colspan="8" style="text-align: center;"> <table border="1" style="width: 100%; border-collapse: collapse; text-align: center;"> <tr> <td style="width: 10%;"></td> <td style="width: 10%;"></td> <td style="width: 10%;"></td> <td style="width: 10%;"></td> <td style="width: 10%;"></td> <td style="width: 10%;"></td> <td style="width: 10%;"></td> <td style="width: 10%;"></td> <td style="width: 10%;"></td> <td style="width: 10%;"></td> </tr> <tr> <td></td> <td></td> <td colspan="8" style="text-align: center;"> <table border="1" style="width: 100%; border-collapse: collapse; text-align: center;"> <tr> <td style="width: 10%;"></td> <td style="width: 10%;"></td> <td style="width: 10%;"></td> <td style="width: 10%;"></td> <td style="width: 10%;"></td> <td style="width: 10%;"></td> <td style="width: 10%;"></td> <td style="width: 10%;"></td> <td style="width: 10%;"></td> <td style="width: 10%;"></td>
</tr> <tr> <td></td> <td></td> <td colspan="8" style="text-align: center;"> <table border="1" style="width: 100%; border-collapse: collapse; text-align: center;"> <tr> <td style="width: 10%;"></td> <td style="width: 10%;"></td> <td style="width: 10%;"></td> <td style="width: 10%;"></td> <td style="width: 10%;"></td> <td style="width: 10%;"></td> <td style="width: 10%;"></td> <td style="width: 10%;"></td> <td style="width: 10%;"></td> <td style="width: 10%;"></td> </tr> <tr> <td></td> <td></td> <td colspan="8" style="text-align: center;"> <table border="1" style="width: 100%; border-collapse: collapse; text-align: center;"> <tr> <td style="width: 10%;"></td> <td style="width: 10%;"></td> <td style="width: 10%;"></td> <td style="width: 10%;"></td> <td style="width: 10%;"></td> <td style="width: 10%;"></td> <td style="width: 10%;"></td> <td style="width: 10%;"></td> <td style="width: 10%;"></td> <td style="width: 10%;"></td> </tr> <tr> <td></td> <td></td> <td colspan="8" style="text-align: center;"> <table border="1" style="width: 100%; border-collapse: collapse; text-align: center;"> <tr> </tr></table></td></tr></table></td></tr></table></td></tr></table></td></tr></table></td></tr></table></td></tr></table></td></tr></table></td></tr></table></td></tr></table></td></tr></table></td></tr></table></td></tr></table></td></tr></table></td></tr></table></td></tr></table></td></tr></table></td></tr></table></td></tr></table></td></tr></table>
 | | | | | | | | | | | | | | | | | | | | <table border="1" style="width: 100%; border-collapse: collapse; text-align: center;"> <tr> <td style="width: 10%;"></td> <td style="width: 10%;"></td> <td style="width: 10%;"></td> <td style="width: 10%;"></td> <td style="width: 10%;"></td> <td style="width: 10%;"></td> <td style="width: 10%;"></td> <td style="width: 10%;"></td> <td style="width: 10%;"></td> <td style="width: 10%;"></td> </tr> <tr> <td></td> <td></td> <td colspan="8" style="text-align: center;"> <table border="1" style="width: 100%; border-collapse: collapse; text-align: center;"> <tr> <td style="width: 10%;"></td> <td style="width: 10%;"></td> <td style="width: 10%;"></td> <td style="width: 10%;"></td> <td style="width: 10%;"></td> <td style="width: 10%;"></td> <td style="width: 10%;"></td> <td style="width: 10%;"></td> <td style="width: 10%;"></td> <td style="width: 10%;"></td> </tr> <tr> <td></td> <td></td> <td colspan="8" style="text-align: center;"> <table border="1" style="width: 100%; border-collapse: collapse; text-align: center;"> <tr> <td style="width: 10%;"></td> <td style="width: 10%;"></td> <td style="width: 10%;"></td> <td style="width: 10%;"></td> <td style="width: 10%;"></td> <td style="width: 10%;"></td> <td style="width: 10%;"></td> <td style="width: 10%;"></td> <td style="width: 10%;"></td> <td style="width: 10%;"></td> </tr> <tr> <td></td> <td></td> <td colspan="8" style="text-align: center;"> <table border="1" style="width: 100%; border-collapse: collapse; text-align: center;"> <tr> <td style="width: 10%;"></td> <td style="width: 10%;"></td> <td style="width: 10%;"></td> <td style="width: 10%;"></td> <td style="width: 10%;"></td> <td style="width: 10%;"></td> <td style="width: 10%;"></td> <td style="width: 10%;"></td> <td style="width: 10%;"></td> <td style="width: 10%;"></td> </tr> <tr> <td></td> <td></td> <td colspan="8" style="text-align: center;"> <table border="1" style="width: 100%; border-collapse: collapse; text-align: center;"> <tr> <td style="width: 10%;"></td> <td style="width: 10%;"></td> <td style="width: 10%;"></td> <td style="width: 10%;"></td> <td style="width: 10%;"></td> <td style="width: 10%;"></td> <td style="width: 10%;"></td> <td style="width: 10%;"></td> <td style="width: 10%;"></td> <td style="width: 10%;"></td> </tr> <tr> <td></td> <td></td> <td colspan="8" style="text-align: center;"> <table border="1" style="width: 100%; border-collapse: collapse; text-align: center;"> <tr> <td style="width: 10%;"></td> <td style="width: 10%;"></td> <td style="width: 10%;"></td> <td style="width: 10%;"></td> <td style="width: 10%;"></td> <td style="width: 10%;"></td> <td style="width: 10%;"></td> <td style="width: 10%;"></td> <td style="width: 10%;"></td> <td style="width: 10%;"></td> </tr> <tr> <td></td> <td></td> <td colspan="8" style="text-align: center;"> <table border="1" style="width: 100%; border-collapse: collapse; text-align: center;"> <tr> <td style="width: 10%;"></td> <td style="width: 10%;"></td> <td style="width: 10%;"></td> <td style="width: 10%;"></td> <td style="width: 10%;"></td> <td style="width: 10%;"></td> <td style="width: 10%;"></td> <td style="width: 10%;"></td> <td style="width: 10%;"></td> <td style="width: 10%;"></td> </tr> <tr> <td></td> <td></td> <td colspan="8" style="text-align: center;"> <table border="1" style="width: 100%; border-collapse: collapse; text-align: center;"> <tr> <td style="width: 10%;"></td> <td style="width: 10%;"></td> <td style="width: 10%;"></td> <td style="width: 10%;"></td> <td style="width: 10%;"></td> <td style="width: 10%;"></td> <td style="width: 10%;"></td> <td style="width: 10%;"></td> <td style="width: 10%;"></td> <td style="width: 10%;"></td> </tr> <tr> <td></td> <td></td> <td colspan="8" style="text-align: center;"> <table border="1" style="width: 100%; border-collapse: collapse; text-align: center;"> <tr> <td style="width: 10%;"></td> <td style="width: 10%;"></td> <td style="width: 10%;"></td> <td style="width: 10%;"></td> <td style="width: 10%;"></td> <td style="width: 10%;"></td> <td style="width: 10%;"></td> <td style="width: 10%;"></td> <td style="width: 10%;"></td> <td style="width: 10%;"></td> </tr> <tr> <td></td> <td></td> <td colspan="8" style="text-align: center;"> <table border="1" style="width: 100%; border-collapse: collapse; text-align: center;"> <tr> <td style="width: 10%;"></td> <td style="width: 10%;"></td> <td style="width:
10%;"></td> <td style="width: 10%;"></td> <td style="width: 10%;"></td> <td style="width: 10%;"></td> <td style="width: 10%;"></td> <td style="width: 10%;"></td> <td style="width: 10%;"></td> <td style="width: 10%;"></td> </tr> <tr> <td></td> <td></td> <td colspan="8" style="text-align: center;"> <table border="1" style="width: 100%; border-collapse: collapse; text-align: center;"> <tr> <td style="width: 10%;"></td> <td style="width: 10%;"></td> <td style="width: 10%;"></td> <td style="width: 10%;"></td> <td style="width: 10%;"></td> <td style="width: 10%;"></td> <td style="width: 10%;"></td> <td style="width: 10%;"></td> <td style="width: 10%;"></td> <td style="width: 10%;"></td> </tr> <tr> <td></td> <td></td> <td colspan="8" style="text-align: center;"> <table border="1" style="width: 100%; border-collapse: collapse; text-align: center;"> <tr> <td style="width: 10%;"></td> <td style="width: 10%;"></td> <td style="width: 10%;"></td> <td style="width: 10%;"></td> <td style="width: 10%;"></td> <td style="width: 10%;"></td> <td style="width: 10%;"></td> <td style="width: 10%;"></td> <td style="width: 10%;"></td> <td style="width: 10%;"></td> </tr> <tr> <td></td> <td></td> <td colspan="8" style="text-align: center;"> <table border="1" style="width: 100%; border-collapse: collapse; text-align: center;"> <tr> <td style="width: 10%;"></td> <td style="width: 10%;"></td> <td style="width: 10%;"></td> <td style="width: 10%;"></td> <td style="width: 10%;"></td> <td style="width: 10%;"></td> <td style="width: 10%;"></td> <td style="width: 10%;"></td> <td style="width: 10%;"></td> <td style="width: 10%;"></td> </tr> <tr> <td></td> <td></td> <td colspan="8" style="text-align: center;"> <table border="1" style="width: 100%; border-collapse: collapse; text-align: center;"> <tr> <td style="width: 10%;"></td> <td style="width: 10%;"></td> <td style="width: 10%;"></td> <td style="width: 10%;"></td> <td style="width: 10%;"></td> <td style="width: 10%;"></td> <td style="width: 10%;"></td> <td style="width: 10%;"></td> <td style="width: 10%;"></td> <td style="width: 10%;"></td> </tr> <tr> <td></td> <td></td> <td colspan="8" style="text-align: center;"> <table border="1" style="width: 100%; border-collapse: collapse; text-align: center;"> <tr> <td style="width: 10%;"></td> <td style="width: 10%;"></td> <td style="width: 10%;"></td> <td style="width: 10%;"></td> <td style="width: 10%;"></td> <td style="width: 10%;"></td> <td style="width: 10%;"></td> <td style="width: 10%;"></td> <td style="width: 10%;"></td> <td style="width: 10%;"></td> </tr> <tr> <td></td> <td></td> <td colspan="8" style="text-align: center;"> <table border="1" style="width: 100%; border-collapse: collapse; text-align: center;"> <tr> <td style="width: 10%;"></td> <td style="width: 10%;"></td> <td style="width: 10%;"></td> <td style="width: 10%;"></td> <td style="width: 10%;"></td> <td style="width: 10%;"></td> <td style="width: 10%;"></td> <td style="width: 10%;"></td> <td style="width: 10%;"></td> <td style="width: 10%;"></td> </tr> <tr> <td></td> <td></td> <td colspan="8" style="text-align: center;"> <table border="1" style="width: 100%; border-collapse: collapse; text-align: center;"> <tr> <td style="width: 10%;"></td> <td style="width: 10%;"></td> <td style="width: 10%;"></td> <td style="width: 10%;"></td> <td style="width: 10%;"></td> <td style="width: 10%;"></td> <td style="width: 10%;"></td> <td style="width: 10%;"></td> <td style="width: 10%;"></td> <td style="width: 10%;"></td> </tr> <tr> <td></td> <td></td> <td colspan="8" style="text-align: center;"> <table border="1" style="width: 100%; border-collapse: collapse; text-align: center;"> <tr> <td style="width: 10%;"></td> <td style="width: 10%;"></td> <td style="width: 10%;"></td> <td style="width: 10%;"></td> <td style="width: 10%;"></td> <td style="width: 10%;"></td> <td style="width: 10%;"></td> <td style="width: 10%;"></td> <td style="width: 10%;"></td> <td style="width: 10%;"></td> </tr> <tr> <td></td> <td></td> <td colspan="8" style="text-align: center;"> <table border="1" style="width: 100%; border-collapse: collapse; text-align: center;"> <tr> </tr></table></td></tr></table></td></tr></table></td></tr></table></td></tr></table></td></tr></table></td></tr></table></td></tr></table></td></tr></table></td></tr></table></td></tr></table></td></tr></table></td></tr></table></td></tr></table></td></tr></table></td></tr></table></td></tr></table></td></tr></table></td></tr></table>
 | | | | | | | | | | | | | | | | | | | | <table border="1" style="width: 100%; border-collapse: collapse; text-align: center;"> <tr> <td style="width: 10%;"></td> <td style="width: 10%;"></td> <td style="width: 10%;"></td> <td style="width: 10%;"></td> <td style="width: 10%;"></td> <td style="width: 10%;"></td> <td style="width: 10%;"></td> <td style="width: 10%;"></td> <td style="width: 10%;"></td> <td style="width: 10%;"></td> </tr> <tr> <td></td> <td></td> <td colspan="8" style="text-align: center;"> <table border="1" style="width: 100%; border-collapse: collapse; text-align: center;"> <tr> <td style="width: 10%;"></td> <td style="width: 10%;"></td> <td style="width: 10%;"></td> <td style="width: 10%;"></td> <td style="width: 10%;"></td> <td style="width: 10%;"></td> <td style="width: 10%;"></td> <td style="width: 10%;"></td> <td style="width: 10%;"></td> <td style="width: 10%;"></td> </tr> <tr> <td></td> <td></td> <td colspan="8" style="text-align: center;"> <table border="1" style="width: 100%; border-collapse: collapse; text-align: center;"> <tr> <td style="width: 10%;"></td> <td style="width: 10%;"></td> <td style="width: 10%;"></td> <td style="width: 10%;"></td> <td style="width: 10%;"></td> <td style="width: 10%;"></td> <td style="width: 10%;"></td> <td style="width: 10%;"></td> <td style="width: 10%;"></td> <td style="width: 10%;"></td> </tr> <tr> <td></td> <td></td> <td colspan="8"
style="text-align: center;"> <table border="1" style="width: 100%; border-collapse: collapse; text-align: center;"> <tr> <td style="width: 10%;"></td> <td style="width: 10%;"></td> <td style="width: 10%;"></td> <td style="width: 10%;"></td> <td style="width: 10%;"></td> <td style="width: 10%;"></td> <td style="width: 10%;"></td> <td style="width: 10%;"></td> <td style="width: 10%;"></td> <td style="width: 10%;"></td> </tr> <tr> <td></td> <td></td> <td colspan="8" style="text-align: center;"> <table border="1" style="width: 100%; border-collapse: collapse; text-align: center;"> <tr> <td style="width: 10%;"></td> <td style="width: 10%;"></td> <td style="width: 10%;"></td> <td style="width: 10%;"></td> <td style="width: 10%;"></td> <td style="width: 10%;"></td> <td style="width: 10%;"></td> <td style="width: 10%;"></td> <td style="width: 10%;"></td> <td style="width: 10%;"></td> </tr> <tr> <td></td> <td></td> <td colspan="8" style="text-align: center;"> <table border="1" style="width: 100%; border-collapse: collapse; text-align: center;"> <tr> <td style="width: 10%;"></td> <td style="width: 10%;"></td> <td style="width: 10%;"></td> <td style="width: 10%;"></td> <td style="width: 10%;"></td> <td style="width: 10%;"></td> <td style="width: 10%;"></td> <td style="width: 10%;"></td> <td style="width: 10%;"></td> <td style="width: 10%;"></td> </tr> <tr> <td></td> <td></td> <td colspan="8" style="text-align: center;"> <table border="1" style="width: 100%; border-collapse: collapse; text-align: center;"> <tr> <td style="width: 10%;"></td> <td style="width: 10%;"></td> <td style="width: 10%;"></td> <td style="width: 10%;"></td> <td style="width: 10%;"></td> <td style="width: 10%;"></td> <td style="width: 10%;"></td> <td style="width: 10%;"></td> <td style="width: 10%;"></td> <td style="width: 10%;"></td> </tr> <tr> <td></td> <td></td> <td colspan="8" style="text-align: center;"> <table border="1" style="width: 100%; border-collapse: collapse; text-align: center;"> <tr> <td style="width: 10%;"></td> <td style="width: 10%;"></td> <td style="width: 10%;"></td> <td style="width: 10%;"></td> <td style="width: 10%;"></td> <td style="width: 10%;"></td> <td style="width: 10%;"></td> <td style="width: 10%;"></td> <td style="width: 10%;"></td> <td style="width: 10%;"></td> </tr> <tr> <td></td> <td></td> <td colspan="8" style="text-align: center;"> <table border="1" style="width: 100%; border-collapse: collapse; text-align: center;"> <tr> <td style="width: 10%;"></td> <td style="width: 10%;"></td> <td style="width: 10%;"></td> <td style="width: 10%;"></td> <td style="width: 10%;"></td> <td style="width: 10%;"></td> <td style="width: 10%;"></td> <td style="width: 10%;"></td> <td style="width: 10%;"></td> <td style="width: 10%;"></td> </tr> <tr> <td></td> <td></td> <td colspan="8" style="text-align: center;"> <table border="1" style="width: 100%; border-collapse: collapse; text-align: center;"> <tr> <td style="width: 10%;"></td> <td style="width: 10%;"></td> <td style="width: 10%;"></td> <td style="width: 10%;"></td> <td style="width: 10%;"></td> <td style="width: 10%;"></td> <td style="width: 10%;"></td> <td style="width: 10%;"></td> <td style="width: 10%;"></td> <td style="width: 10%;"></td> </tr> <tr> <td></td> <td></td> <td colspan="8" style="text-align: center;"> <table border="1" style="width: 100%; border-collapse: collapse; text-align: center;"> <tr> <td style="width: 10%;"></td> <td style="width: 10%;"></td> <td style="width: 10%;"></td> <td style="width: 10%;"></td> <td style="width: 10%;"></td> <td style="width: 10%;"></td> <td style="width: 10%;"></td> <td style="width: 10%;"></td> <td style="width: 10%;"></td> <td style="width: 10%;"></td> </tr> <tr> <td></td> <td></td> <td colspan="8" style="text-align: center;"> <table border="1" style="width: 100%; border-collapse: collapse; text-align: center;"> <tr> <td style="width: 10%;"></td> <td style="width: 10%;"></td> <td style="width: 10%;"></td> <td style="width: 10%;"></td> <td style="width: 10%;"></td> <td style="width: 10%;"></td> <td style="width: 10%;"></td> <td style="width: 10%;"></td> <td style="width: 10%;"></td> <td style="width: 10%;"></td> </tr> <tr> <td></td> <td></td> <td colspan="8" style="text-align: center;"> <table border="1" style="width: 100%; border-collapse: collapse; text-align: center;"> <tr> <td style="width: 10%;"></td> <td style="width: 10%;"></td> <td style="width: 10%;"></td> <td style="width: 10%;"></td> <td style="width: 10%;"></td> <td style="width: 10%;"></td> <td style="width: 10%;"></td> <td style="width: 10%;"></td> <td style="width: 10%;"></td> <td style="width: 10%;"></td> </tr> <tr> <td></td> <td></td> <td colspan="8" style="text-align: center;"> <table border="1" style="width: 100%; border-collapse: collapse; text-align: center;"> <tr> <td style="width: 10%;"></td> <td style="width: 10%;"></td> <td style="width: 10%;"></td> <td style="width: 10%;"></td> <td style="width: 10%;"></td> <td style="width: 10%;"></td> <td style="width: 10%;"></td> <td style="width: 10%;"></td> <td style="width: 10%;"></td> <td style="width: 10%;"></td> </tr> <tr> <td></td> <td></td> <td colspan="8" style="text-align: center;"> <table border="1" style="width: 100%; border-collapse: collapse; text-align: center;"> <tr> <td style="width: 10%;"></td> <td style="width: 10%;"></td> <td style="width: 10%;"></td> <td style="width: 10%;"></td> <td style="width: 10%;"></td> <td style="width: 10%;"></td> <td style="width: 10%;"></td> <td style="width: 10%;"></td> <td style="width: 10%;"></td> <td style="width: 10%;"></td> </tr> <tr> <td></td> <td></td> <td colspan="8" style="text-align: center;"> <table border="1" style="width: 100%; border-collapse: collapse; text-align: center;"> <tr> <td style="width: 10%;"></td> <td style="width: 10%;"></td> <td style="width: 10%;"></td> <td style="width: 10%;"></td> <td style="width: 10%;"></td> <td style="width: 10%;"></td> <td style="width: 10%;"></td> <td style="width: 10%;"></td> <td style="width: 10%;"></td> <td style="width: 10%;"></td> </tr> <tr> <td></td> <td></td> <td colspan="8" style="text-align: center;"> <table border="1" style="width: 100%; border-collapse: collapse; text-align: center;"> <tr> <td style="width: 10%;"></td> <td style="width: 10%;"></td> <td style="width: 10%;"></td> <td style="width: 10%;"></td> <td style="width: 10%;"></td> <td style="width: 10%;"></td> <td style="width: 10%;"></td> <td style="width: 10%;"></td> <td style="width: 10%;"></td> <td style="width: 10%;"></td> </tr> <tr> <td></td> <td></td> <td colspan="8" style="text-align: center;"> <table border="1" style="width: 100%; border-collapse: collapse; text-align: center;"> <tr> </tr></table></td></tr></table></td></tr></table></td></tr></table></td></tr></table></td></tr></table></td></tr></table></td></tr></table></td></tr></table></td></tr></table></td></tr></table></td></tr></table></td></tr></table></td></tr></table></td></tr></table></td></tr></table></td></tr></table></td></tr></table>

 | | | | | | | | | | | | | | | | | | | | <table border="1" style="width: 100%; border-collapse: collapse; text-align: center;"> <tr> <td style="width: 10%;"></td> <td style="width: 10%;"></td> <td style="width: 10%;"></td> <td style="width: 10%;"></td> <td style="width: 10%;"></td> <td style="width: 10%;"></td> <td style="width: 10%;"></td> <td style="width: 10%;"></td> <td style="width: 10%;"></td> <td style="width: 10%;"></td> </tr> <tr> <td></td> <td></td> <td colspan="8" style="text-align: center;"> <table border="1" style="width: 100%; border-collapse: collapse; text-align: center;"> <tr> <td style="width: 10%;"></td> <td style="width: 10%;"></td> <td style="width: 10%;"></td> <td style="width: 10%;"></td> <td style="width: 10%;"></td> <td style="width: 10%;"></td> <td style="width: 10%;"></td> <td style="width: 10%;"></td> <td style="width: 10%;"></td> <td style="width: 10%;"></td> </tr> <tr> <td></td> <td></td> <td colspan="8" style="text-align: center;"> <table border="1" style="width: 100%; border-collapse: collapse; text-align: center;"> <tr> <td style="width: 10%;"></td> <td style="width: 10%;"></td> <td style="width: 10%;"></td> <td style="width: 10%;"></td> <td style="width: 10%;"></td> <td style="width: 10%;"></td> <td style="width: 10%;"></td> <td style="width: 10%;"></td> <td style="width: 10%;"></td> <td style="width: 10%;"></td> </tr> <tr> <td></td> <td></td> <td colspan="8" style="text-align: center;"> <table border="1" style="width: 100%; border-collapse: collapse; text-align: center;"> <tr> <td style="width: 10%;"></td> <td style="width: 10%;"></td> <td style="width: 10%;"></td> <td style="width: 10%;"></td> <td style="width: 10%;"></td> <td style="width: 10%;"></td> <td style="width: 10%;"></td> <td style="width: 10%;"></td> <td style="width: 10%;"></td> <td style="width: 10%;"></td> </tr> <tr> <td></td> <td></td> <td colspan="8" style="text-align: center;"> <table border="1" style="width: 100%; border-collapse: collapse; text-align: center;"> <tr> <td style="width: 10%;"></td> <td style="width: 10%;"></td> <td style="width: 10%;"></td> <td style="width: 10%;"></td> <td style="width: 10%;"></td> <td style="width: 10%;"></td> <td style="width: 10%;"></td> <td style="width: 10%;"></td> <td style="width: 10%;"></td> <td style="width: 10%;"></td> </tr> <tr> <td></td> <td></td> <td colspan="8" style="text-align: center;"> <table border="1" style="width: 100%; border-collapse: collapse; text-align: center;"> <tr> <td style="width: 10%;"></td> <td style="width: 10%;"></td> <td style="width: 10%;"></td> <td style="width: 10%;"></td> <td style="width: 10%;"></td> <td style="width: 10%;"></td> <td style="width: 10%;"></td> <td style="width: 10%;"></td> <td style="width: 10%;"></td> <td style="width: 10%;"></td> </tr> <tr> <td></td> <td></td> <td colspan="8" style="text-align: center;"> <table border="1" style="width: 100%; border-collapse: collapse; text-align: center;"> <tr> <td style="width: 10%;"></td> <td style="width: 10%;"></td> <td style="width: 10%;"></td> <td style="width: 10%;"></td> <td style="width: 10%;"></td> <td style="width: 10%;"></td> <td style="width: 10%;"></td> <td style="width: 10%;"></td> <td style="width: 10%;"></td> <td style="width: 10%;"></td> </tr> <tr> <td></td> <td></td> <td colspan="8" style="text-align: center;"> <table border="1" style="width: 100%; border-collapse: collapse; text-align: center;"> <tr> <td style="width: 10%;"></td> <td style="width: 10%;"></td> <td style="width: 10%;"></td> <td style="width: 10%;"></td> <td style="width: 10%;"></td> <td style="width: 10%;"></td> <td style="width: 10%;"></td> <td style="width: 10%;"></td> <td style="width: 10%;"></td> <td style="width: 10%;"></td> </tr> <tr> <td></td> <td></td> <td colspan="8" style="text-align: center;"> <table border="1" style="width: 100%; border-collapse: collapse; text-align: center;"> <tr> <td style="width: 10%;"></td> <td style="width: 10%;"></td> <td style="width: 10%;"></td> <td style="width: 10%;"></td> <td style="width: 10%;"></td> <td style="width: 10%;"></td> <td style="width: 10%;"></td> <td style="width: 10%;"></td> <td style="width: 10%;"></td> <td style="width: 10%;"></td> </tr> <tr> <td></td> <td></td> <td colspan="8" style="text-align: center;"> <table border="1" style="width: 100%; border-collapse: collapse; text-align: center;"> <tr> <td style="width: 10%;"></td> <td style="width: 10%;"></td> <td style="width: 10%;"></td> <td style="width: 10%;"></td> <td style="width: 10%;"></td> <td style="width: 10%;"></td> <td style="width: 10%;"></td> <td style="width: 10%;"></td> <td style="width: 10%;"></td> <td style="width: 10%;"></td> </tr> <tr> <td></td> <td></td> <td colspan="8" style="text-align: center;"> <table border="1" style="width: 100%; border-collapse: collapse; text-align: center;"> <tr> <td style="width: 10%;"></td> <td style="width: 10%;"></td> <td style="width: 10%;"></td> <td style="width: 10%;"></td> <td style="width: 10%;"></td> <td style="width: 10%;"></td> <td style="width: 10%;"></td> <td style="width: 10%;"></td> <td style="width: 10%;"></td> <td style="width: 10%;"></td> </tr> <tr> <td></td> <td></td> <td colspan="8" style="text-align: center;"> <table border="1" style="width: 100%; border-collapse: collapse; text-align: center;"> <tr> <td style="width: 10%;"></td> <td style="width: 10%;"></td> <td style="width: 10%;"></td> <td style="width: 10%;"></td> <td style="width: 10%;"></td> <td style="width: 10%;"></td> <td style="width: 10%;"></td> <td style="width: 10%;"></td> <td style="width: 10%;"></td> <td style="width: 10%;"></td> </tr> <tr> <td></td> <td></td> <td colspan="8" style="text-align: center;"> <table border="1" style="width: 100%; border-collapse: collapse; text-align: center;"> <tr> <td style="width: 10%;"></td> <td style="width: 10%;"></td> <td style="width: 10%;"></td> <td style="width: 10%;"></td> <td style="width: 10%;"></td> <td style="width: 10%;"></td> <td style="width: 10%;"></td> <td style="width: 10%;"></td> <td style="width: 10%;"></td> <td style="width: 10%;"></td> </tr> <tr> <td></td> <td></td> <td colspan="8" style="text-align: center;"> <table border="1" style="width: 100%; border-collapse: collapse; text-align: center;"> <tr> <td style="width: 10%;"></td> <td style="width: 10%;"></td> <td style="width: 10%;"></td> <td style="width: 10%;"></td> <td style="width: 10%;"></td> <td style="width: 10%;"></td> <td style="width: 10%;"></td> <td style="width: 10%;"></td> <td style="width: 10%;"></td> <td style="width: 10%;"></td> </tr> <tr> <td></td> <td></td> <td colspan="8" style="text-align: center;"> <table border="1" style="width: 100%; border-collapse: collapse; text-align: center;"> <tr> <td style="width: 10%;"></td> <td style="width: 10%;"></td> <td style="width: 10%;"></td> <td style="width: 10%;"></td> <td style="width: 10%;"></td> <td style="width: 10%;"></td> <td style="width: 10%;"></td> <td style="width: 10%;"></td> <td style="width: 10%;"></td> <td style="width: 10%;"></td> </tr> <tr> <td></td> <td></td> <td colspan="8" style="text-align: center;"> <table border="1" style="width: 100%; border-collapse: collapse; text-align: center;"> <tr> <td style="width: 10%;"></td> <td style="width: 10%;"></td> <td style="width: 10%;"></td> <td style="width: 10%;"></td> <td style="width: 10%;"></td> <td style="width: 10%;"></td> <td style="width: 10%;"></td> <td style="width: 10%;"></td> <td style="width: 10%;"></td> <td style="width: 10%;"></td> </tr> <tr> <td></td> <td></td> <td colspan="8" style="text-align: center;"> <table border="1" style="width: 100%; border-collapse: collapse; text-align: center;"> <tr> </tr></table></td></tr></table></td></tr></table></td></tr></table></td></tr></table></td></tr></table></td></tr></table></td></tr></table></td></tr></table></td></tr></table></td></tr></table></td></tr></table></td></tr></table></td></tr></table></td></tr></table></td></tr></table></td></tr></table>

 | | | | | | | | | | | | | | | | | | | | <table border="1" style="width: 100%; border-collapse: collapse; text-align: center;"> <tr> <td style="width: 10%;"></td> <td style="width: 10%;"></td> <td style="width: 10%;"></td> <td style="width: 10%;"></td> <td style="width: 10%;"></td> <td style="width: 10%;"></td> <td style="width: 10%;"></td> <td style="width: 10%;"></td> <td style="width: 10%;"></td> <td style="width: 10%;"></td> </tr> <tr> <td></td> <td></td> <td colspan="8" style="text-align: center;"> <table border="1" style="width: 100%; border-collapse: collapse; text-align: center;"> <tr> <td style="width: 10%;"></td> <td style="width: 10%;"></td> <td style="width: 10%;"></td> <td style="width: 10%;"></td> <td style="width: 10%;"></td> <td style="width: 10%;"></td> <td style="width: 10%;"></td> <td style="width: 10%;"></td> <td style="width: 10%;"></td> <td style="width: 10%;"></td> </tr> <tr> <td></td> <td></td> <td colspan="8" style="text-align: center;"> <table border="1" style="width: 100%; border-collapse: collapse; text-align: center;"> <tr> <td style="width: 10%;"></td> <td style="width: 10%;"></td> <td style="width: 10%;"></td> <td style="width: 10%;"></td> <td style="width: 10%;"></td> <td style="width: 10%;"></td> <td style="width: 10%;"></td> <td style="width: 10%;"></td> <td style="width: 10%;"></td> <td style="width: 10%;"></td> </tr> <tr> <td></td> <td></td> <td colspan="8" style="text-align: center;"> <table border="1" style="width: 100%; border-collapse: collapse; text-align: center;"> <tr> <td style="width: 10%;"></td> <td style="width: 10%;"></td> <td style="width: 10%;"></td> <td style="width: 10%;"></td> <td style="width: 10%;"></td> <td style="width: 10%;"></td> <td style="width: 10%;"></td> <td style="width: 10%;"></td> <td style="width: 10%;"></td> <td style="width: 10%;"></td> </tr> <tr> <td></td> <td></td> <td colspan="8" style="text-align: center;"> <table border="1" style="width: 100%; border-collapse: collapse; text-align: center;"> <tr> <td style="width: 10%;"></td> <td style="width: 10%;"></td> <td style="width: 10%;"></td> <td style="width: 10%;"></td> <td style="width: 10%;"></td> <td style="width: 10%;"></td> <td style="width: 10%;"></td> <td style="width: 10%;"></td> <td style="width: 10%;"></td> <td style="width: 10%;"></td> </tr> <tr> <td></td> <td></td> <td colspan="8" style="text-align: center;"> <table border="1" style="width: 100%; border-collapse: collapse; text-align: center;"> <tr> <td style="width: 10%;"></td> <td style="width: 10%;"></td> <td style="width: 10%;"></td> <td style="width: 10%;"></td> <td style="width: 10%;"></td> <td style="width: 10%;"></td> <td style="width: 10%;"></td> <td style="width: 10%;"></td> <td style="width: 10%;"></td> <td style="width: 10%;"></td> </tr> <tr> <td></td> <td></td> <td colspan="8" style="text-align: center;"> <table border="1" style="width: 100%; border-collapse: collapse; text-align: center;"> <tr> <td style="width: 10%;"></td> <td style="width: 10%;"></td> <td style="width: 10%;"></td> <td style="width: 10%;"></td> <td style="width: 10%;"></td> <td style="width: 10%;"></td> <td style="width: 10%;"></td> <td style="width: 10%;"></td> <td style="width: 10%;"></td> <td style="width: 10%;"></td> </tr> <tr> <td></td> <td></td> <td colspan="8" style="text-align: center;"> <table border="1" style="width: 100%; border-collapse: collapse; text-align: center;"> <tr> <td style="width: 10%;"></td> <td style="width: 10%;"></td> <td style="width: 10%;"></td> <td style="width: 10%;"></td> <td style="width: 10%;"></td> <td style="width: 10%;"></td> <td style="width: 10%;"></td> <td style="width: 10%;"></td> <td style="width: 10%;"></td> <td style="width: 10%;"></td> </tr> <tr> <td></td> <td></td> <td colspan="8" style="text-align: center;"> <table border="1" style="width: 100%; border-collapse: collapse; text-align: center;"> <tr> <td style="width: 10%;"></td> <td style="width: 10%;"></td> <td style="width: 10%;"></td> <td style="width: 10%;"></td> <td style="width: 10%;"></td> <td style="width: 10%;"></td> <td style="width: 10%;"></td> <td style="width: 10%;"></td> <td style="width: 10%;"></td> <td style="width: 10%;"></td> </tr> <tr> <td></td> <td></td> <td colspan="8" style="text-align: center;"> <table border="1" style="width: 100%; border-collapse: collapse; text-align: center;"> <tr> <td style="width: 10%;"></td> <td style="width: 10%;"></td> <td style="width: 10%;"></td> <td style="width: 10%;"></td> <td style="width: 10%;"></td> <td style="width: 10%;"></td> <td style="width: 10%;"></td> <td style="width: 10%;"></td> <td style="width: 10%;"></td> <td style="width: 10%;"></td> </tr> <tr> <td></td> <td></td> <td colspan="8" style="text-align: center;"> <table border="1" style="width: 100%; border-collapse: collapse; text-align: center;"> <tr> <td style="width: 10%;"></td> <td style="width: 10%;"></td> <td style="width: 10%;"></td> <td style="width: 10%;"></td> <td style="width: 10%;"></td> <td style="width: 10%;"></td> <td style="width: 10%;"></td> <td style="width: 10%;"></td> <td style="width: 10%;"></td> <td style="width: 10%;"></td> </tr> <tr> <td></td> <td></td> <td colspan="8" style="text-align: center;"> <table border="1" style="width: 100%; border-collapse: collapse; text-align: center;"> <tr> <td style="width: 10%;"></td> <td style="width: 10%;"></td> <td style="width: 10%;"></td> <td style="width: 10%;"></td> <td style="width: 10%;"></td> <td style="width: 10%;"></td> <td style="width: 10%;"></td> <td style="width: 10%;"></td> <td style="width: 10%;"></td> <td style="width: 10%;"></td> </tr> <tr> <td></td> <td></td> <td colspan="8" style="text-align: center;"> <table border="1" style="width: 100%; border-collapse: collapse; text-align: center;"> <tr> <td style="width: 10%;"></td> <td style="width: 10%;"></td> <td style="width: 10%;"></td> <td style="width: 10%;"></td> <td style="width: 10%;"></td> <td style="width: 10%;"></td> <td style="width: 10%;"></td> <td style="width: 10%;"></td> <td style="width: 10%;"></td> <td style="width: 10%;"></td> </tr> <tr> <td></td> <td></td> <td colspan="8" style="text-align: center;"> <table border="1" style="width: 100%; border-collapse: collapse; text-align: center;"> <tr> <td style="width: 10%;"></td> <td style="width: 10%;"></td> <td style="width: 10%;"></td> <td style="width: 10%;"></td> <td style="width: 10%;"></td> <td style="width: 10%;"></td> <td style="width: 10%;"></td> <td style="width: 10%;"></td> <td style="width: 10%;"></td> <td style="width: 10%;"></td> </tr> <tr> <td></td> <td></td> <td colspan="8" style="text-align: center;"> <table border="1" style="width: 100%; border-collapse: collapse; text-align: center;"> <tr> <td style="width: 10%;"></td> <td style="width: 10%;"></td> <td style="width: 10%;"></td> <td style="width: 10%;"></td> <td style="width: 10%;"></td> <td style="width:
10%;"></td> <td style="width: 10%;"></td> <td style="width: 10%;"></td> <td style="width: 10%;"></td> <td style="width: 10%;"></td> </tr> <tr> <td></td> <td></td> <td colspan="8" style="text-align: center;"> <table border="1" style="width: 100%; border-collapse: collapse; text-align: center;"> <tr> </tr></table></td></tr></table></td></tr></table></td></tr></table></td></tr></table></td></tr></table></td></tr></table></td></tr></table></td></tr></table></td></tr></table></td></tr></table></td></tr></table></td></tr></table></td></tr></table></td></tr></table></td></tr></table>
 | | | | | | | | | | | | | | | | | | | | <table border="1" style="width: 100%; border-collapse: collapse; text-align: center;"> <tr> <td style="width: 10%;"></td> <td style="width: 10%;"></td> <td style="width: 10%;"></td> <td style="width: 10%;"></td> <td style="width: 10%;"></td> <td style="width: 10%;"></td> <td style="width: 10%;"></td> <td style="width: 10%;"></td> <td style="width: 10%;"></td> <td style="width: 10%;"></td> </tr> <tr> <td></td> <td></td> <td colspan="8" style="text-align: center;"> <table border="1" style="width: 100%; border-collapse: collapse; text-align: center;"> <tr> <td style="width: 10%;"></td> <td style="width: 10%;"></td> <td style="width: 10%;"></td> <td style="width: 10%;"></td> <td style="width: 10%;"></td> <td style="width: 10%;"></td> <td style="width: 10%;"></td> <td style="width: 10%;"></td> <td style="width: 10%;"></td> <td style="width: 10%;"></td> </tr> <tr> <td></td> <td></td> <td colspan="8" style="text-align: center;"> <table border="1" style="width: 100%; border-collapse: collapse; text-align: center;"> <tr> <td style="width: 10%;"></td> <td style="width: 10%;"></td> <td style="width: 10%;"></td> <td style="width: 10%;"></td> <td style="width: 10%;"></td> <td style="width: 10%;"></td> <td style="width: 10%;"></td> <td style="width: 10%;"></td> <td style="width: 10%;"></td> <td style="width: 10%;"></td> </tr> <tr> <td></td> <td></td> <td colspan="8" style="text-align: center;"> <table border="1" style="width: 100%; border-collapse: collapse; text-align: center;"> <tr> <td style="width: 10%;"></td> <td style="width: 10%;"></td> <td style="width: 10%;"></td> <td style="width: 10%;"></td> <td style="width: 10%;"></td> <td style="width: 10%;"></td> <td style="width: 10%;"></td> <td style="width: 10%;"></td> <td style="width: 10%;"></td> <td style="width: 10%;"></td> </tr> <tr> <td></td> <td></td> <td colspan="8" style="text-align: center;"> <table border="1" style="width: 100%; border-collapse: collapse; text-align: center;"> <tr> <td style="width: 10%;"></td> <td style="width: 10%;"></td> <td style="width: 10%;"></td> <td style="width: 10%;"></td> <td style="width: 10%;"></td> <td style="width: 10%;"></td> <td style="width: 10%;"></td> <td style="width: 10%;"></td> <td style="width: 10%;"></td> <td style="width: 10%;"></td> </tr> <tr> <td></td> <td></td> <td colspan="8" style="text-align: center;"> <table border="1" style="width: 100%; border-collapse: collapse; text-align: center;"> <tr> <td style="width: 10%;"></td> <td style="width: 10%;"></td> <td style="width: 10%;"></td> <td style="width: 10%;"></td> <td style="width: 10%;"></td> <td style="width: 10%;"></td> <td style="width: 10%;"></td> <td style="width: 10%;"></td> <td style="width: 10%;"></td> <td style="width: 10%;"></td> </tr> <tr> <td></td> <td></td> <td colspan="8" style="text-align: center;"> <table border="1" style="width: 100%; border-collapse: collapse; text-align: center;"> <tr> <td style="width: 10%;"></td> <td style="width: 10%;"></td> <td style="width: 10%;"></td> <td style="width: 10%;"></td> <td style="width: 10%;"></td> <td style="width: 10%;"></td> <td style="width: 10%;"></td> <td style="width: 10%;"></td> <td style="width: 10%;"></td> <td style="width: 10%;"></td> </tr> <tr> <td></td> <td></td> <td colspan="8" style="text-align: center;"> <table border="1" style="width: 100%; border-collapse: collapse; text-align: center;"> <tr> <td style="width: 10%;"></td> <td style="width: 10%;"></td> <td style="width: 10%;"></td> <td style="width: 10%;"></td> <td style="width: 10%;"></td> <td style="width: 10%;"></td> <td style="width: 10%;"></td> <td style="width: 10%;"></td> <td style="width: 10%;"></td> <td style="width: 10%;"></td> </tr> <tr> <td></td> <td></td> <td colspan="8" style="text-align: center;"> <table border="1" style="width: 100%; border-collapse: collapse; text-align: center;"> <tr> <td style="width: 10%;"></td> <td style="width: 10%;"></td> <td style="width: 10%;"></td> <td style="width: 10%;"></td> <td style="width: 10%;"></td> <td style="width: 10%;"></td> <td style="width: 10%;"></td> <td style="width: 10%;"></td> <td style="width: 10%;"></td> <td style="width: 10%;"></td> </tr> <tr> <td></td> <td></td> <td colspan="8" style="text-align: center;"> <table border="1" style="width: 100%; border-collapse: collapse; text-align: center;"> <tr> <td style="width: 10%;"></td> <td style="width: 10%;"></td> <td style="width: 10%;"></td> <td style="width: 10%;"></td> <td style="width: 10%;"></td> <td style="width: 10%;"></td> <td style="width: 10%;"></td> <td style="width: 10%;"></td> <td style="width: 10%;"></td> <td style="width: 10%;"></td> </tr> <tr> <td></td> <td></td> <td colspan="8" style="text-align: center;"> <table border="1" style="width: 100%; border-collapse: collapse; text-align: center;"> <tr> <td style="width: 10%;"></td> <td style="width: 10%;"></td> <td style="width: 10%;"></td> <td style="width: 10%;"></td> <td style="width: 10%;"></td> <td style="width: 10%;"></td> <td style="width: 10%;"></td> <td style="width: 10%;"></td> <td style="width: 10%;"></td> <td style="width: 10%;"></td> </tr> <tr> <td></td> <td></td> <td colspan="8" style="text-align: center;"> <table border="1" style="width: 100%; border-collapse: collapse; text-align: center;"> <tr> <td style="width:
10%;"></td> <td style="width: 10%;"></td> <td style="width: 10%;"></td> <td style="width: 10%;"></td> <td style="width: 10%;"></td> <td style="width: 10%;"></td> <td style="width: 10%;"></td> <td style="width: 10%;"></td> <td style="width: 10%;"></td> <td style="width: 10%;"></td> </tr> <tr> <td></td> <td></td> <td colspan="8" style="text-align: center;"> <table border="1" style="width: 100%; border-collapse: collapse; text-align: center;"> <tr> <td style="width: 10%;"></td> <td style="width: 10%;"></td> <td style="width: 10%;"></td> <td style="width: 10%;"></td> <td style="width: 10%;"></td> <td style="width: 10%;"></td> <td style="width: 10%;"></td> <td style="width: 10%;"></td> <td style="width: 10%;"></td> <td style="width: 10%;"></td> </tr> <tr> <td></td> <td></td> <td colspan="8" style="text-align: center;"> <table border="1" style="width: 100%; border-collapse: collapse; text-align: center;"> <tr> <td style="width: 10%;"></td> <td style="width: 10%;"></td> <td style="width: 10%;"></td> <td style="width: 10%;"></td> <td style="width: 10%;"></td> <td style="width: 10%;"></td> <td style="width: 10%;"></td> <td style="width: 10%;"></td> <td style="width: 10%;"></td> <td style="width: 10%;"></td> </tr> <tr> <td></td> <td></td> <td colspan="8" style="text-align: center;"> <table border="1" style="width: 100%; border-collapse: collapse; text-align: center;"> <tr> </tr></table></td></tr></table></td></tr></table></td></tr></table></td></tr></table></td></tr></table></td></tr></table></td></tr></table></td></tr></table></td></tr></table></td></tr></table></td></tr></table></td></tr></table></td></tr></table></td></tr></table>
 | | | | | | | | | | | | | | | | | | | | <table border="1" style="width: 100%; border-collapse: collapse; text-align: center;"> <tr> <td style="width: 10%;"></td> <td style="width: 10%;"></td> <td style="width: 10%;"></td> <td style="width: 10%;"></td> <td style="width: 10%;"></td> <td style="width: 10%;"></td> <td style="width: 10%;"></td> <td style="width: 10%;"></td> <td style="width: 10%;"></td> <td style="width: 10%;"></td> </tr> <tr> <td></td> <td></td> <td colspan="8" style="text-align: center;"> <table border="1" style="width: 100%; border-collapse: collapse; text-align: center;"> <tr> <td style="width: 10%;"></td> <td style="width: 10%;"></td> <td style="width: 10%;"></td> <td style="width: 10%;"></td> <td style="width: 10%;"></td> <td style="width: 10%;"></td> <td style="width: 10%;"></td> <td style="width: 10%;"></td> <td style="width: 10%;"></td> <td style="width: 10%;"></td> </tr> <tr> <td></td> <td></td> <td colspan="8" style="text-align: center;"> <table border="1" style="width: 100%; border-collapse: collapse; text-align: center;"> <tr> <td style="width: 10%;"></td> <td style="width: 10%;"></td> <td style="width: 10%;"></td> <td style="width: 10%;"></td> <td style="width: 10%;"></td> <td style="width: 10%;"></td> <td style="width: 10%;"></td> <td style="width: 10%;"></td> <td style="width: 10%;"></td> <td style="width: 10%;"></td> </tr> <tr> <td></td> <td></td> <td colspan="8" style="text-align: center;"> <table border="1" style="width: 100%; border-collapse: collapse; text-align: center;"> <tr> <td style="width: 10%;"></td> <td style="width: 10%;"></td> <td style="width: 10%;"></td> <td style="width: 10%;"></td> <td style="width: 10%;"></td> <td style="width: 10%;"></td> <td style="width: 10%;"></td> <td style="width: 10%;"></td> <td style="width: 10%;"></td> <td style="width: 10%;"></td> </tr> <tr> <td></td> <td></td> <td colspan="8" style="text-align: center;"> <table border="1" style="width: 100%; border-collapse: collapse; text-align: center;"> <tr> <td style="width: 10%;"></td> <td style="width: 10%;"></td> <td style="width: 10%;"></td> <td style="width: 10%;"></td> <td style="width: 10%;"></td> <td style="width: 10%;"></td> <td style="width: 10%;"></td> <td style="width: 10%;"></td> <td style="width: 10%;"></td> <td style="width: 10%;"></td> </tr> <tr> <td></td> <td></td> <td colspan="8" style="text-align: center;"> <table border="1" style="width: 100%; border-collapse: collapse; text-align: center;"> <tr> <td style="width: 10%;"></td> <td style="width: 10%;"></td> <td style="width: 10%;"></td> <td style="width: 10%;"></td> <td style="width: 10%;"></td> <td style="width: 10%;"></td> <td style="width: 10%;"></td> <td style="width: 10%;"></td> <td style="width: 10%;"></td> <td style="width: 10%;"></td> </tr> <tr> <td></td> <td></td> <td colspan="8" style="text-align: center;"> <table border="1" style="width: 100%; border-collapse: collapse; text-align: center;"> <tr> <td style="width: 10%;"></td> <td style="width: 10%;"></td> <td style="width: 10%;"></td> <td style="width: 10%;"></td> <td style="width: 10%;"></td> <td style="width: 10%;"></td> <td style="width: 10%;"></td> <td style="width: 10%;"></td> <td style="width: 10%;"></td> <td style="width: 10%;"></td> </tr> <tr> <td></td> <td></td> <td colspan="8" style="text-align: center;"> <table border="1" style="width: 100%; border-collapse: collapse; text-align: center;"> <tr> <td style="width: 10%;"></td> <td style="width: 10%;"></td> <td style="width: 10%;"></td> <td style="width: 10%;"></td> <td style="width: 10%;"></td> <td style="width: 10%;"></td> <td style="width: 10%;"></td> <td style="width: 10%;"></td> <td style="width: 10%;"></td> <td style="width: 10%;"></td> </tr> <tr> <td></td> <td></td> <td colspan="8" style="text-align: center;"> <table border="1" style="width: 100%; border-collapse: collapse; text-align: center;"> <tr> <td style="width: 10%;"></td> <td style="width: 10%;"></td> <td style="width: 10%;"></td> <td style="width: 10%;"></td> <td style="width: 10%;"></td> <td style="width: 10%;"></td> <td style="width: 10%;"></td> <td style="width: 10%;"></td> <td style="width: 10%;"></td> <td style="width: 10%;"></td> </tr> <tr> <td></td> <td></td> <td colspan="8"
style="text-align: center;"> <table border="1" style="width: 100%; border-collapse: collapse; text-align: center;"> <tr> <td style="width: 10%;"></td> <td style="width: 10%;"></td> <td style="width: 10%;"></td> <td style="width: 10%;"></td> <td style="width: 10%;"></td> <td style="width: 10%;"></td> <td style="width: 10%;"></td> <td style="width: 10%;"></td> <td style="width: 10%;"></td> <td style="width: 10%;"></td> </tr> <tr> <td></td> <td></td> <td colspan="8" style="text-align: center;"> <table border="1" style="width: 100%; border-collapse: collapse; text-align: center;"> <tr> <td style="width: 10%;"></td> <td style="width: 10%;"></td> <td style="width: 10%;"></td> <td style="width: 10%;"></td> <td style="width: 10%;"></td> <td style="width: 10%;"></td> <td style="width: 10%;"></td> <td style="width: 10%;"></td> <td style="width: 10%;"></td> <td style="width: 10%;"></td> </tr> <tr> <td></td> <td></td> <td colspan="8" style="text-align: center;"> <table border="1" style="width: 100%; border-collapse: collapse; text-align: center;"> <tr> <td style="width: 10%;"></td> <td style="width: 10%;"></td> <td style="width: 10%;"></td> <td style="width: 10%;"></td> <td style="width: 10%;"></td> <td style="width: 10%;"></td> <td style="width: 10%;"></td> <td style="width: 10%;"></td> <td style="width: 10%;"></td> <td style="width: 10%;"></td> </tr> <tr> <td></td> <td></td> <td colspan="8" style="text-align: center;"> <table border="1" style="width: 100%; border-collapse: collapse; text-align: center;"> <tr> <td style="width: 10%;"></td> <td style="width: 10%;"></td> <td style="width: 10%;"></td> <td style="width: 10%;"></td> <td style="width: 10%;"></td> <td style="width: 10%;"></td> <td style="width: 10%;"></td> <td style="width: 10%;"></td> <td style="width: 10%;"></td> <td style="width: 10%;"></td> </tr> <tr> <td></td> <td></td> <td colspan="8" style="text-align: center;"> <table border="1" style="width: 100%; border-collapse: collapse; text-align: center;"> <tr> </tr></table></td></tr></table></td></tr></table></td></tr></table></td></tr></table></td></tr></table></td></tr></table></td></tr></table></td></tr></table></td></tr></table></td></tr></table></td></tr></table></td></tr></table></td></tr></table>
 | | | | | | | | | | | | | | | | | | | | <table border="1" style="width: 100%; border-collapse: collapse; text-align: center;"> <tr> <td style="width: 10%;"></td> <td style="width: 10%;"></td> <td style="width: 10%;"></td> <td style="width: 10%;"></td> <td style="width: 10%;"></td> <td style="width: 10%;"></td> <td style="width: 10%;"></td> <td style="width: 10%;"></td> <td style="width: 10%;"></td> <td style="width: 10%;"></td> </tr> <tr> <td></td> <td></td> <td colspan="8" style="text-align: center;"> <table border="1" style="width: 100%; border-collapse: collapse; text-align: center;"> <tr> <td style="width: 10%;"></td> <td style="width: 10%;"></td> <td style="width: 10%;"></td> <td style="width: 10%;"></td> <td style="width: 10%;"></td> <td style="width: 10%;"></td> <td style="width: 10%;"></td> <td style="width: 10%;"></td> <td style="width: 10%;"></td> <td style="width: 10%;"></td> </tr> <tr> <td></td> <td></td> <td colspan="8" style="text-align: center;"> <table border="1" style="width: 100%; border-collapse: collapse; text-align: center;"> <tr> <td style="width: 10%;"></td> <td style="width: 10%;"></td> <td style="width: 10%;"></td> <td style="width: 10%;"></td> <td style="width: 10%;"></td> <td style="width: 10%;"></td> <td style="width: 10%;"></td> <td style="width: 10%;"></td> <td style="width: 10%;"></td> <td style="width: 10%;"></td> </tr> <tr> <td></td> <td></td> <td colspan="8" style="text-align: center;"> <table border="1" style="width: 100%; border-collapse: collapse; text-align: center;"> <tr> <td style="width: 10%;"></td> <td style="width: 10%;"></td> <td style="width: 10%;"></td> <td style="width: 10%;"></td> <td style="width: 10%;"></td> <td style="width: 10%;"></td> <td style="width: 10%;"></td> <td style="width: 10%;"></td> <td style="width: 10%;"></td> <td style="width: 10%;"></td> </tr> <tr> <td></td> <td></td> <td colspan="8" style="text-align: center;"> <table border="1" style="width: 100%; border-collapse: collapse; text-align: center;"> <tr> <td style="width: 10%;"></td> <td style="width: 10%;"></td> <td style="width: 10%;"></td> <td style="width: 10%;"></td> <td style="width: 10%;"></td> <td style="width: 10%;"></td> <td style="width: 10%;"></td> <td style="width: 10%;"></td> <td style="width: 10%;"></td> <td style="width: 10%;"></td> </tr> <tr> <td></td> <td></td> <td colspan="8" style="text-align: center;"> <table border="1" style="width: 100%; border-collapse: collapse; text-align: center;"> <tr> <td style="width: 10%;"></td> <td style="width: 10%;"></td> <td style="width: 10%;"></td> <td style="width: 10%;"></td> <td style="width: 10%;"></td> <td style="width: 10%;"></td> <td style="width: 10%;"></td> <td style="width: 10%;"></td> <td style="width: 10%;"></td> <td style="width: 10%;"></td> </tr> <tr> <td></td> <td></td> <td colspan="8" style="text-align: center;"> <table border="1" style="width: 100%; border-collapse: collapse; text-align: center;"> <tr> <td style="width: 10%;"></td> <td style="width: 10%;"></td> <td style="width: 10%;"></td> <td style="width: 10%;"></td> <td style="width: 10%;"></td> <td style="width: 10%;"></td> <td style="width: 10%;"></td> <td style="width: 10%;"></td> <td style="width: 10%;"></td> <td style="width: 10%;"></td> </tr> <tr> <td></td> <td></td> <td colspan="8" style="text-align: center;"> <table border="1" style="width: 100%; border-collapse: collapse; text-align: center;"> <tr> <td style="width: 10%;"></td> <td style="width: 10%;"></td> <td style="width: 10%;"></td> <td style="width: 10%;"></td> <td style="width: 10%;"></td> <td style="width: 10%;"></td> <td style="width: 10%;"></td> <td style="width:
10%;"></td> <td style="width: 10%;"></td> <td style="width: 10%;"></td> </tr> <tr> <td></td> <td></td> <td colspan="8" style="text-align: center;"> <table border="1" style="width: 100%; border-collapse: collapse; text-align: center;"> <tr> <td style="width: 10%;"></td> <td style="width: 10%;"></td> <td style="width: 10%;"></td> <td style="width: 10%;"></td> <td style="width: 10%;"></td> <td style="width: 10%;"></td> <td style="width: 10%;"></td> <td style="width: 10%;"></td> <td style="width: 10%;"></td> <td style="width: 10%;"></td> </tr> <tr> <td></td> <td></td> <td colspan="8" style="text-align: center;"> <table border="1" style="width: 100%; border-collapse: collapse; text-align: center;"> <tr> <td style="width: 10%;"></td> <td style="width: 10%;"></td> <td style="width: 10%;"></td> <td style="width: 10%;"></td> <td style="width: 10%;"></td> <td style="width: 10%;"></td> <td style="width: 10%;"></td> <td style="width: 10%;"></td> <td style="width: 10%;"></td> <td style="width: 10%;"></td> </tr> <tr> <td></td> <td></td> <td colspan="8" style="text-align: center;"> <table border="1" style="width: 100%; border-collapse: collapse; text-align: center;"> <tr> <td style="width: 10%;"></td> <td style="width: 10%;"></td> <td style="width: 10%;"></td> <td style="width: 10%;"></td> <td style="width: 10%;"></td> <td style="width: 10%;"></td> <td style="width: 10%;"></td> <td style="width: 10%;"></td> <td style="width: 10%;"></td> <td style="width: 10%;"></td> </tr> <tr> <td></td> <td></td> <td colspan="8" style="text-align: center;"> <table border="1" style="width: 100%; border-collapse: collapse; text-align: center;"> <tr> <td style="width: 10%;"></td> <td style="width: 10%;"></td> <td style="width: 10%;"></td> <td style="width: 10%;"></td> <td style="width: 10%;"></td> <td style="width: 10%;"></td> <td style="width: 10%;"></td> <td style="width: 10%;"></td> <td style="width: 10%;"></td> <td style="width: 10%;"></td> </tr> <tr> <td></td> <td></td> <td colspan="8" style="text-align: center;"> <table border="1" style="width: 100%; border-collapse: collapse; text-align: center;"> <tr> </tr></table></td></tr></table></td></tr></table></td></tr></table></td></tr></table></td></tr></table></td></tr></table></td></tr></table></td></tr></table></td></tr></table></td></tr></table></td></tr></table></td></tr></table>
 | | | | | | | | | | | | | | | | | | | | <table border="1" style="width: 100%; border-collapse: collapse; text-align: center;"> <tr> <td style="width: 10%;"></td> <td style="width: 10%;"></td> <td style="width: 10%;"></td> <td style="width: 10%;"></td> <td style="width: 10%;"></td> <td style="width: 10%;"></td> <td style="width: 10%;"></td> <td style="width: 10%;"></td> <td style="width: 10%;"></td> <td style="width: 10%;"></td> </tr> <tr> <td></td> <td></td> <td colspan="8" style="text-align: center;"> <table border="1" style="width: 100%; border-collapse: collapse; text-align: center;"> <tr> <td style="width: 10%;"></td> <td style="width: 10%;"></td> <td style="width: 10%;"></td> <td style="width: 10%;"></td> <td style="width: 10%;"></td> <td style="width: 10%;"></td> <td style="width: 10%;"></td> <td style="width: 10%;"></td> <td style="width: 10%;"></td> <td style="width: 10%;"></td> </tr> <tr> <td></td> <td></td> <td colspan="8" style="text-align: center;"> <table border="1" style="width: 100%; border-collapse: collapse; text-align: center;"> <tr> <td style="width: 10%;"></td> <td style="width: 10%;"></td> <td style="width: 10%;"></td> <td style="width: 10%;"></td> <td style="width: 10%;"></td> <td style="width: 10%;"></td> <td style="width: 10%;"></td> <td style="width: 10%;"></td> <td style="width: 10%;"></td> <td style="width: 10%;"></td> </tr> <tr> <td></td> <td></td> <td colspan="8" style="text-align: center;"> <table border="1" style="width: 100%; border-collapse: collapse; text-align: center;"> <tr> <td style="width: 10%;"></td> <td style="width: 10%;"></td> <td style="width: 10%;"></td> <td style="width: 10%;"></td> <td style="width: 10%;"></td> <td style="width: 10%;"></td> <td style="width: 10%;"></td> <td style="width: 10%;"></td> <td style="width: 10%;"></td> <td style="width: 10%;"></td> </tr> <tr> <td></td> <td></td> <td colspan="8" style="text-align: center;"> <table border="1" style="width: 100%; border-collapse: collapse; text-align: center;"> <tr> <td style="width: 10%;"></td> <td style="width: 10%;"></td> <td style="width: 10%;"></td> <td style="width: 10%;"></td> <td style="width: 10%;"></td> <td style="width: 10%;"></td> <td style="width: 10%;"></td> <td style="width: 10%;"></td> <td style="width: 10%;"></td> <td style="width: 10%;"></td> </tr> <tr> <td></td> <td></td> <td colspan="8" style="text-align: center;"> <table border="1" style="width: 100%; border-collapse: collapse; text-align: center;"> <tr> <td style="width: 10%;"></td> <td style="width: 10%;"></td> <td style="width: 10%;"></td> <td style="width: 10%;"></td> <td style="width: 10%;"></td> <td style="width: 10%;"></td> <td style="width: 10%;"></td> <td style="width: 10%;"></td> <td style="width: 10%;"></td> <td style="width: 10%;"></td> </tr> <tr> <td></td> <td></td> <td colspan="8" style="text-align: center;"> <table border="1" style="width: 100%; border-collapse: collapse; text-align: center;"> <tr> <td style="width: 10%;"></td> <td style="width: 10%;"></td> <td style="width: 10%;"></td> <td style="width: 10%;"></td> <td style="width: 10%;"></td> <td style="width: 10%;"></td> <td style="width: 10%;"></td> <td style="width: 10%;"></td> <td style="width: 10%;"></td> <td style="width: 10%;"></td> </tr> <tr> <td></td> <td></td> <td colspan="8" style="text-align: center;"> <table border="1" style="width: 100%; border-collapse: collapse; text-align: center;"> <tr> <td style="width: 10%;"></td> <td style="width: 10%;"></td> <td style="width: 10%;"></td> <td style="width: 10%;"></td> <td
style="width: 10%;"></td> <td style="width: 10%;"></td> <td style="width: 10%;"></td> <td style="width: 10%;"></td> <td style="width: 10%;"></td> <td style="width: 10%;"></td> </tr> <tr> <td></td> <td></td> <td colspan="8" style="text-align: center;"> <table border="1" style="width: 100%; border-collapse: collapse; text-align: center;"> <tr> <td style="width: 10%;"></td> <td style="width: 10%;"></td> <td style="width: 10%;"></td> <td style="width: 10%;"></td> <td style="width: 10%;"></td> <td style="width: 10%;"></td> <td style="width: 10%;"></td> <td style="width: 10%;"></td> <td style="width: 10%;"></td> <td style="width: 10%;"></td> </tr> <tr> <td></td> <td></td> <td colspan="8" style="text-align: center;"> <table border="1" style="width: 100%; border-collapse: collapse; text-align: center;"> <tr> <td style="width: 10%;"></td> <td style="width: 10%;"></td> <td style="width: 10%;"></td> <td style="width: 10%;"></td> <td style="width: 10%;"></td> <td style="width: 10%;"></td> <td style="width: 10%;"></td> <td style="width: 10%;"></td> <td style="width: 10%;"></td> <td style="width: 10%;"></td> </tr> <tr> <td></td> <td></td> <td colspan="8" style="text-align: center;"> <table border="1" style="width: 100%; border-collapse: collapse; text-align: center;"> <tr> <td style="width: 10%;"></td> <td style="width: 10%;"></td> <td style="width: 10%;"></td> <td style="width: 10%;"></td> <td style="width: 10%;"></td> <td style="width: 10%;"></td> <td style="width: 10%;"></td> <td style="width: 10%;"></td> <td style="width: 10%;"></td> <td style="width: 10%;"></td> </tr> <tr> <td></td> <td></td> <td colspan="8" style="text-align: center;"> <table border="1" style="width: 100%; border-collapse: collapse; text-align: center;"> <tr> </tr></table></td></tr></table></td></tr></table></td></tr></table></td></tr></table></td></tr></table></td></tr></table></td></tr></table></td></tr></table></td></tr></table></td></tr></table></td></tr></table>
 | | | | | | | | | | | | | | | | | | | | <table border="1" style="width: 100%; border-collapse: collapse; text-align: center;"> <tr> <td style="width: 10%;"></td> <td style="width: 10%;"></td> <td style="width: 10%;"></td> <td style="width: 10%;"></td> <td style="width: 10%;"></td> <td style="width: 10%;"></td> <td style="width: 10%;"></td> <td style="width: 10%;"></td> <td style="width: 10%;"></td> <td style="width: 10%;"></td> </tr> <tr> <td></td> <td></td> <td colspan="8" style="text-align: center;"> <table border="1" style="width: 100%; border-collapse: collapse; text-align: center;"> <tr> <td style="width: 10%;"></td> <td style="width: 10%;"></td> <td style="width: 10%;"></td> <td style="width: 10%;"></td> <td style="width: 10%;"></td> <td style="width: 10%;"></td> <td style="width: 10%;"></td> <td style="width: 10%;"></td> <td style="width: 10%;"></td> <td style="width: 10%;"></td> </tr> <tr> <td></td> <td></td> <td colspan="8" style="text-align: center;"> <table border="1" style="width: 100%; border-collapse: collapse; text-align: center;"> <tr> <td style="width: 10%;"></td> <td style="width: 10%;"></td> <td style="width: 10%;"></td> <td style="width: 10%;"></td> <td style="width: 10%;"></td> <td style="width: 10%;"></td> <td style="width: 10%;"></td> <td style="width: 10%;"></td> <td style="width: 10%;"></td> <td style="width: 10%;"></td> </tr> <tr> <td></td> <td></td> <td colspan="8" style="text-align: center;"> <table border="1" style="width: 100%; border-collapse: collapse; text-align: center;"> <tr> <td style="width: 10%;"></td> <td style="width: 10%;"></td> <td style="width: 10%;"></td> <td style="width: 10%;"></td> <td style="width: 10%;"></td> <td style="width: 10%;"></td> <td style="width: 10%;"></td> <td style="width: 10%;"></td> <td style="width: 10%;"></td> <td style="width: 10%;"></td> </tr> <tr> <td></td> <td></td> <td colspan="8" style="text-align: center;"> <table border="1" style="width: 100%; border-collapse: collapse; text-align: center;"> <tr> <td style="width: 10%;"></td> <td style="width: 10%;"></td> <td style="width: 10%;"></td> <td style="width: 10%;"></td> <td style="width: 10%;"></td> <td style="width: 10%;"></td> <td style="width: 10%;"></td> <td style="width: 10%;"></td> <td style="width: 10%;"></td> <td style="width: 10%;"></td> </tr> <tr> <td></td> <td></td> <td colspan="8" style="text-align: center;"> <table border="1" style="width: 100%; border-collapse: collapse; text-align: center;"> <tr> <td style="width: 10%;"></td> <td style="width: 10%;"></td> <td style="width: 10%;"></td> <td style="width: 10%;"></td> <td style="width: 10%;"></td> <td style="width: 10%;"></td> <td style="width: 10%;"></td> <td style="width: 10%;"></td> <td style="width: 10%;"></td> <td style="width: 10%;"></td> </tr> <tr> <td></td> <td></td> <td colspan="8" style="text-align: center;"> <table border="1" style="width: 100%; border-collapse: collapse; text-align: center;"> <tr> <td style="width: 10%;"></td> <td style="width: 10%;"></td> <td style="width: 10%;"></td> <td style="width: 10%;"></td> <td style="width: 10%;"></td> <td style="width: 10%;"></td> <td style="width: 10%;"></td> <td style="width: 10%;"></td> <td style="width: 10%;"></td> <td style="width: 10%;"></td> </tr> <tr> <td></td> <td></td> <td colspan="8" style="text-align: center;"> <table border="1" style="width: 100%; border-collapse: collapse; text-align: center;"> <tr> <td style="width: 10%;"></td> <td style="width: 10%;"></td> <td style="width: 10%;"></td> <td style="width: 10%;"></td> <td style="width: 10%;"></td> <td style="width: 10%;"></td> <td style="width: 10%;"></td> <td style="width: 10%;"></td> <td style="width: 10%;"></td> <td style="width: 10%;"></td> </tr> <tr> <td></td> <td></td> <td colspan="8" style="text-align: center;"> <table border="1" style="width: 100%; border-collapse: collapse; text-align: center;"> <tr> <td style="width: 10%;"></td> <td style="width:
10%;"></td> <td style="width: 10%;"></td> <td style="width: 10%;"></td> <td style="width: 10%;"></td> <td style="width: 10%;"></td> <td style="width: 10%;"></td> <td style="width: 10%;"></td> <td style="width: 10%;"></td> <td style="width: 10%;"></td> </tr> <tr> <td></td> <td></td> <td colspan="8" style="text-align: center;"> <table border="1" style="width: 100%; border-collapse: collapse; text-align: center;"> <tr> <td style="width: 10%;"></td> <td style="width: 10%;"></td> <td style="width: 10%;"></td> <td style="width: 10%;"></td> <td style="width: 10%;"></td> <td style="width: 10%;"></td> <td style="width: 10%;"></td> <td style="width: 10%;"></td> <td style="width: 10%;"></td> <td style="width: 10%;"></td> </tr> <tr> <td></td> <td></td> <td colspan="8" style="text-align: center;"> <table border="1" style="width: 100%; border-collapse: collapse; text-align: center;"> <tr> </tr></table></td></tr></table></td></tr></table></td></tr></table></td></tr></table></td></tr></table></td></tr></table></td></tr></table></td></tr></table></td></tr></table></td></tr></table>
 | | | | | | | | | | | | | | | | | | | | <table border="1" style="width: 100%; border-collapse: collapse; text-align: center;"> <tr> <td style="width: 10%;"></td> <td style="width: 10%;"></td> <td style="width: 10%;"></td> <td style="width: 10%;"></td> <td style="width: 10%;"></td> <td style="width: 10%;"></td> <td style="width: 10%;"></td> <td style="width: 10%;"></td> <td style="width: 10%;"></td> <td style="width: 10%;"></td> </tr> <tr> <td></td> <td></td> <td colspan="8" style="text-align: center;"> <table border="1" style="width: 100%; border-collapse: collapse; text-align: center;"> <tr> <td style="width: 10%;"></td> <td style="width: 10%;"></td> <td style="width: 10%;"></td> <td style="width: 10%;"></td> <td style="width: 10%;"></td> <td style="width: 10%;"></td> <td style="width: 10%;"></td> <td style="width: 10%;"></td> <td style="width: 10%;"></td> <td style="width: 10%;"></td> </tr> <tr> <td></td> <td></td> <td colspan="8" style="text-align: center;"> <table border="1" style="width: 100%; border-collapse: collapse; text-align: center;"> <tr> <td style="width: 10%;"></td> <td style="width: 10%;"></td> <td style="width: 10%;"></td> <td style="width: 10%;"></td> <td style="width: 10%;"></td> <td style="width: 10%;"></td> <td style="width: 10%;"></td> <td style="width: 10%;"></td> <td style="width: 10%;"></td> <td style="width: 10%;"></td> </tr> <tr> <td></td> <td></td> <td colspan="8" style="text-align: center;"> <table border="1" style="width: 100%; border-collapse: collapse; text-align: center;"> <tr> <td style="width: 10%;"></td> <td style="width: 10%;"></td> <td style="width: 10%;"></td> <td style="width: 10%;"></td> <td style="width: 10%;"></td> <td style="width: 10%;"></td> <td style="width: 10%;"></td> <td style="width: 10%;"></td> <td style="width: 10%;"></td> <td style="width: 10%;"></td> </tr> <tr> <td></td> <td></td> <td colspan="8" style="text-align: center;"> <table border="1" style="width: 100%; border-collapse: collapse; text-align: center;"> <tr> <td style="width: 10%;"></td> <td style="width: 10%;"></td> <td style="width: 10%;"></td> <td style="width: 10%;"></td> <td style="width: 10%;"></td> <td style="width: 10%;"></td> <td style="width: 10%;"></td> <td style="width: 10%;"></td> <td style="width: 10%;"></td> <td style="width: 10%;"></td> </tr> <tr> <td></td> <td></td> <td colspan="8" style="text-align: center;"> <table border="1" style="width: 100%; border-collapse: collapse; text-align: center;"> <tr> <td style="width: 10%;"></td> <td style="width: 10%;"></td> <td style="width: 10%;"></td> <td style="width: 10%;"></td> <td style="width: 10%;"></td> <td style="width: 10%;"></td> <td style="width: 10%;"></td> <td style="width: 10%;"></td> <td style="width: 10%;"></td> <td style="width: 10%;"></td> </tr> <tr> <td></td> <td></td> <td colspan="8" style="text-align: center;"> <table border="1" style="width: 100%; border-collapse: collapse; text-align: center;"> <tr> <td style="width: 10%;"></td> <td style="width: 10%;"></td> <td style="width: 10%;"></td> <td style="width: 10%;"></td> <td style="width: 10%;"></td> <td style="width: 10%;"></td> <td style="width: 10%;"></td> <td style="width: 10%;"></td> <td style="width: 10%;"></td> <td style="width: 10%;"></td> </tr> <tr> <td></td> <td></td> <td colspan="8" style="text-align: center;"> <table border="1" style="width: 100%; border-collapse: collapse; text-align: center;"> <tr> <td style="width: 10%;"></td> <td style="width: 10%;"></td> <td style="width: 10%;"></td> <td style="width: 10%;"></td> <td style="width: 10%;"></td> <td style="width: 10%;"></td> <td style="width: 10%;"></td> <td style="width: 10%;"></td> <td style="width: 10%;"></td> <td style="width: 10%;"></td> </tr> <tr> <td></td> <td></td> <td colspan="8" style="text-align: center;"> <table border="1" style="width: 100%; border-collapse: collapse; text-align: center;"> <tr> <td style="width: 10%;"></td> <td style="width: 10%;"></td> <td style="width: 10%;"></td> <td style="width: 10%;"></td> <td style="width: 10%;"></td> <td style="width: 10%;"></td> <td style="width: 10%;"></td> <td style="width: 10%;"></td> <td style="width: 10%;"></td> <td style="width: 10%;"></td> </tr> <tr> <td></td> <td></td> <td colspan="8" style="text-align: center;"> <table border="1" style="width: 100%; border-collapse: collapse; text-align: center;"> <tr> </tr></table></td></tr></table></td></tr></table></td></tr></table></td></tr></table></td></tr></table></td></tr></table></td></tr></table></td></tr></table></td></tr></table>

 | | | | | | | | | | | | | | | | | | | | <table border="1" style="width: 100%; border-collapse: collapse; text-align: center;"> <tr> <td style="width: 10%;"></td> <td style="width: 10%;"></td> <td style="width: 10%;"></td> <td style="width: 10%;"></td> <td style="width: 10%;"></td> <td style="width: 10%;"></td> <td style="width: 10%;"></td> <td style="width: 10%;"></td> <td style="width: 10%;"></td> <td style="width: 10%;"></td> </tr> <tr> <td></td> <td></td> <td colspan="8" style="text-align: center;"> <table border="1" style="width: 100%; border-collapse: collapse; text-align: center;"> <tr> <td style="width: 10%;"></td> <td style="width: 10%;"></td> <td style="width: 10%;"></td> <td style="width: 10%;"></td> <td style="width: 10%;"></td> <td style="width: 10%;"></td> <td style="width: 10%;"></td> <td style="width: 10%;"></td> <td style="width: 10%;"></td> <td style="width: 10%;"></td> </tr> <tr> <td></td> <td></td> <td colspan="8" style="text-align: center;"> <table border="1" style="width: 100%; border-collapse: collapse; text-align: center;"> <tr> <td style="width: 10%;"></td> <td style="width: 10%;"></td> <td style="width: 10%;"></td> <td style="width: 10%;"></td> <td style="width: 10%;"></td> <td style="width: 10%;"></td> <td style="width: 10%;"></td> <td style="width: 10%;"></td> <td style="width: 10%;"></td> <td style="width: 10%;"></td> </tr> <tr> <td></td> <td></td> <td colspan="8" style="text-align: center;"> <table border="1" style="width: 100%; border-collapse: collapse; text-align: center;"> <tr> <td style="width: 10%;"></td> <td style="width: 10%;"></td> <td style="width: 10%;"></td> <td style="width: 10%;"></td> <td style="width: 10%;"></td> <td style="width: 10%;"></td> <td style="width: 10%;"></td> <td style="width: 10%;"></td> <td style="width: 10%;"></td> <td style="width: 10%;"></td> </tr> <tr> <td></td> <td></td> <td colspan="8" style="text-align: center;"> <table border="1" style="width: 100%; border-collapse: collapse; text-align: center;"> <tr> <td style="width: 10%;"></td> <td style="width: 10%;"></td> <td style="width: 10%;"></td> <td style="width: 10%;"></td> <td style="width: 10%;"></td> <td style="width: 10%;"></td> <td style="width: 10%;"></td> <td style="width: 10%;"></td> <td style="width: 10%;"></td> <td style="width: 10%;"></td> </tr> <tr> <td></td> <td></td> <td colspan="8" style="text-align: center;"> <table border="1" style="width: 100%; border-collapse: collapse; text-align: center;"> <tr> <td style="width: 10%;"></td> <td style="width: 10%;"></td> <td style="width: 10%;"></td> <td style="width: 10%;"></td> <td style="width: 10%;"></td> <td style="width: 10%;"></td> <td style="width: 10%;"></td> <td style="width: 10%;"></td> <td style="width: 10%;"></td> <td style="width: 10%;"></td> </tr> <tr> <td></td> <td></td> <td colspan="8" style="text-align: center;"> <table border="1" style="width: 100%; border-collapse: collapse; text-align: center;"> <tr> <td style="width: 10%;"></td> <td style="width: 10%;"></td> <td style="width: 10%;"></td> <td style="width: 10%;"></td> <td style="width: 10%;"></td> <td style="width: 10%;"></td> <td style="width: 10%;"></td> <td style="width: 10%;"></td> <td style="width: 10%;"></td> <td style="width: 10%;"></td> </tr> <tr> <td></td> <td></td> <td colspan="8" style="text-align: center;"> <table border="1" style="width: 100%; border-collapse: collapse; text-align: center;"> <tr> <td style="width: 10%;"></td> <td style="width: 10%;"></td> <td style="width: 10%;"></td> <td style="width: 10%;"></td> <td style="width: 10%;"></td> <td style="width: 10%;"></td> <td style="width: 10%;"></td> <td style="width: 10%;"></td> <td style="width: 10%;"></td> <td style="width: 10%;"></td> </tr> <tr> <td></td> <td></td> <td colspan="8" style="text-align: center;"> <table border="1" style="width: 100%; border-collapse: collapse; text-align: center;"> <tr> </tr></table></td></tr></table></td></tr></table></td></tr></table></td></tr></table></td></tr></table></td></tr></table></td></tr></table></td></tr></table>

 | | | | | | | | | | | | | | | | | | | | <table border="1" style="width: 100%; border-collapse: collapse; text-align: center;"> <tr> <td style="width: 10%;"></td> <td style="width: 10%;"></td> <td style="width: 10%;"></td> <td style="width: 10%;"></td> <td style="width: 10%;"></td> <td style="width: 10%;"></td> <td style="width: 10%;"></td> <td style="width: 10%;"></td> <td style="width: 10%;"></td> <td style="width: 10%;"></td> </tr> <tr> <td></td> <td></td> <td colspan="8" style="text-align: center;"> <table border="1" style="width: 100%; border-collapse: collapse; text-align: center;"> <tr> <td style="width: 10%;"></td> <td style="width: 10%;"></td> <td style="width: 10%;"></td> <td style="width: 10%;"></td> <td style="width: 10%;"></td> <td style="width: 10%;"></td> <td style="width: 10%;"></td> <td style="width: 10%;"></td> <td style="width: 10%;"></td> <td style="width: 10%;"></td> </tr> <tr> <td></td> <td></td> <td colspan="8" style="text-align: center;"> <table border="1" style="width: 100%; border-collapse: collapse; text-align: center;"> <tr> <td style="width: 10%;"></td> <td style="width: 10%;"></td> <td style="width: 10%;"></td> <td style="width: 10%;"></td> <td style="width: 10%;"></td> <td style="width: 10%;"></td> <td style="width: 10%;"></td> <td style="width: 10%;"></td> <td style="width: 10%;"></td> <td style="width: 10%;"></td> </tr> <tr> <td></td> <td></td> <td colspan="8" style="text-align: center;"> <table border="1" style="width: 100%; border-collapse: collapse; text-align: center;"> <tr> <td style="width: 10%;"></td> <td style="width: 10%;"></td> <td style="width: 10%;"></td> <td style="width: 10%;"></td> <td style="width: 10%;"></td> <td style="width: 10%;"></td> <td style="width: 10%;"></td> <td style="width: 10%;"></td> <td style="width: 10%;"></td> <td style="width: 10%;"></td> </tr> <tr> <td></td> <td></td> <td colspan="8" style="text-align: center;"> <table border="1" style="width: 100%; border-collapse: collapse; text-align: center;"> <tr> <td style="width: 10%;"></td> <td style="width: 10%;"></td> <td style="width: 10%;"></td> <td style="width: 10%;"></td> <td style="width: 10%;"></td> <td style="width: 10%;"></td> <td style="width: 10%;"></td> <td style="width: 10%;"></td> <td style="width: 10%;"></td> <td style="width: 10%;"></td> </tr> <tr> <td></td> <td></td> <td colspan="8" style="text-align: center;"> <table border="1" style="width: 100%; border-collapse: collapse; text-align: center;"> <tr> <td style="width: 10%;"></td> <td style="width: 10%;"></td> <td style="width: 10%;"></td> <td style="width: 10%;"></td> <td style="width: 10%;"></td> <td style="width: 10%;"></td> <td style="width: 10%;"></td> <td style="width: 10%;"></td> <td style="width: 10%;"></td> <td style="width: 10%;"></td> </tr> <tr> <td></td> <td></td> <td colspan="8" style="text-align: center;"> <table border="1" style="width: 100%; border-collapse: collapse; text-align: center;"> <tr> <td style="width: 10%;"></td> <td style="width: 10%;"></td> <td style="width: 10%;"></td> <td style="width: 10%;"></td> <td style="width: 10%;"></td> <td style="width: 10%;"></td> <td style="width: 10%;"></td> <td style="width: 10%;"></td> <td style="width: 10%;"></td> <td style="width: 10%;"></td> </tr> <tr> <td></td> <td></td> <td colspan="8" style="text-align: center;"> <table border="1" style="width: 100%; border-collapse: collapse; text-align: center;"> <tr> </tr></table></td></tr></table></td></tr></table></td></tr></table></td></tr></table></td></tr></table></td></tr></table></td></tr></table>
 | | | | | | | | | | | | | | | | | | | | <table border="1" style="width: 100%; border-collapse: collapse; text-align: center;"> <tr> <td style="width: 10%;"></td> <td style="width: 10%;"></td> <td style="width: 10%;"></td> <td style="width: 10%;"></td> <td style="width: 10%;"></td> <td style="width: 10%;"></td> <td style="width: 10%;"></td> <td style="width:
10%;"></td> <td style="width: 10%;"></td> <td style="width: 10%;"></td> </tr> <tr> <td></td> <td></td> <td colspan="8" style="text-align: center;"> <table border="1" style="width: 100%; border-collapse: collapse; text-align: center;"> <tr> <td style="width: 10%;"></td> <td style="width: 10%;"></td> <td style="width: 10%;"></td> <td style="width: 10%;"></td> <td style="width: 10%;"></td> <td style="width: 10%;"></td> <td style="width: 10%;"></td> <td style="width: 10%;"></td> <td style="width: 10%;"></td> <td style="width: 10%;"></td> </tr> <tr> <td></td> <td></td> <td colspan="8" style="text-align: center;"> <table border="1" style="width: 100%; border-collapse: collapse; text-align: center;"> <tr> <td style="width: 10%;"></td> <td style="width: 10%;"></td> <td style="width: 10%;"></td> <td style="width: 10%;"></td> <td style="width: 10%;"></td> <td style="width: 10%;"></td> <td style="width: 10%;"></td> <td style="width: 10%;"></td> <td style="width: 10%;"></td> <td style="width: 10%;"></td> </tr> <tr> <td></td> <td></td> <td colspan="8" style="text-align: center;"> <table border="1" style="width: 100%; border-collapse: collapse; text-align: center;"> <tr> <td style="width: 10%;"></td> <td style="width: 10%;"></td> <td style="width: 10%;"></td> <td style="width: 10%;"></td> <td style="width: 10%;"></td> <td style="width: 10%;"></td> <td style="width: 10%;"></td> <td style="width: 10%;"></td> <td style="width: 10%;"></td> <td style="width: 10%;"></td> </tr> <tr> <td></td> <td></td> <td colspan="8" style="text-align: center;"> <table border="1" style="width: 100%; border-collapse: collapse; text-align: center;"> <tr> <td style="width: 10%;"></td> <td style="width: 10%;"></td> <td style="width: 10%;"></td> <td style="width: 10%;"></td> <td style="width: 10%;"></td> <td style="width: 10%;"></td> <td style="width: 10%;"></td> <td style="width: 10%;"></td> <td style="width: 10%;"></td> <td style="width: 10%;"></td> </tr> <tr> <td></td> <td></td> <td colspan="8" style="text-align: center;"> <table border="1" style="width: 100%; border-collapse: collapse; text-align: center;"> <tr> <td style="width: 10%;"></td> <td style="width: 10%;"></td> <td style="width: 10%;"></td> <td style="width: 10%;"></td> <td style="width: 10%;"></td> <td style="width: 10%;"></td> <td style="width: 10%;"></td> <td style="width: 10%;"></td> <td style="width: 10%;"></td> <td style="width: 10%;"></td> </tr> <tr> <td></td> <td></td> <td colspan="8" style="text-align: center;"> <table border="1" style="width: 100%; border-collapse: collapse; text-align: center;"> <tr> </tr></table></td></tr></table></td></tr></table></td></tr></table></td></tr></table></td></tr></table></td></tr></table>
 | | | | | | | | | | | | | | | | | | | | <table border="1" style="width: 100%; border-collapse: collapse; text-align: center;"> <tr> <td style="width: 10%;"></td> <td style="width: 10%;"></td> <td style="width: 10%;"></td> <td style="width: 10%;"></td> <td style="width: 10%;"></td> <td style="width: 10%;"></td> <td style="width: 10%;"></td> <td style="width: 10%;"></td> <td style="width: 10%;"></td> <td style="width: 10%;"></td> </tr> <tr> <td></td> <td></td> <td colspan="8" style="text-align: center;"> <table border="1" style="width: 100%; border-collapse: collapse; text-align: center;"> <tr> <td style="width: 10%;"></td> <td style="width: 10%;"></td> <td style="width: 10%;"></td> <td style="width: 10%;"></td> <td style="width: 10%;"></td> <td style="width: 10%;"></td> <td style="width: 10%;"></td> <td style="width: 10%;"></td> <td style="width: 10%;"></td> <td style="width: 10%;"></td> </tr> <tr> <td></td> <td></td> <td colspan="8" style="text-align: center;"> <table border="1" style="width: 100%; border-collapse: collapse; text-align: center;"> <tr> <td style="width: 10%;"></td> <td style="width: 10%;"></td> <td style="width: 10%;"></td> <td style="width: 10%;"></td> <td style="width: 10%;"></td> <td style="width: 10%;"></td> <td style="width: 10%;"></td> <td style="width: 10%;"></td> <td style="width: 10%;"></td> <td style="width: 10%;"></td> </tr> <tr> <td></td> <td></td> <td colspan="8" style="text-align: center;"> <table border="1" style="width: 100%; border-collapse: collapse; text-align: center;"> <tr> <td style="width: 10%;"></td> <td style="width: 10%;"></td> <td style="width: 10%;"></td> <td style="width: 10%;"></td> <td style="width: 10%;"></td> <td style="width: 10%;"></td> <td style="width: 10%;"></td> <td style="width: 10%;"></td> <td style="width: 10%;"></td> <td style="width: 10%;"></td> </tr> <tr> <td></td> <td></td> <td colspan="8" style="text-align: center;"> <table border="1" style="width: 100%; border-collapse: collapse; text-align: center;"> <tr> <td style="width: 10%;"></td> <td style="width: 10%;"></td> <td style="width: 10%;"></td> <td style="width: 10%;"></td> <td style="width: 10%;"></td> <td style="width: 10%;"></td> <td style="width: 10%;"></td> <td style="width: 10%;"></td> <td style="width: 10%;"></td> <td style="width: 10%;"></td> </tr> <tr> <td></td> <td></td> <td colspan="8" style="text-align: center;"> <table border="1" style="width: 100%; border-collapse: collapse; text-align: center;"> <tr> </tr></table></td></tr></table></td></tr></table></td></tr></table></td></tr></table></td></tr></table>

 | | | | | | | | | | | | | | | | | | | | <table border="1" style="width: 100%; border-collapse: collapse; text-align: center;"> <tr> <td style="width: 10%;"></td> <td style="width: 10%;"></td> <td style="width: 10%;"></td> <td style="width: 10%;"></td> <td style="width: 10%;"></td> <td style="width: 10%;"></td> <td style="width: 10%;"></td> <td style="width: 10%;"></td> <td style="width: 10%;"></td> <td style="width: 10%;"></td> </tr> <tr> <td></td> <td></td> <td colspan="8" style="text-align: center;"> <table border="1" style="width: 100%; border-collapse: collapse; text-align: center;"> <tr> <td style="width: 10%;"></td> <td style="width: 10%;"></td> <td style="width: 10%;"></td> <td style="width: 10%;"></td> <td style="width: 10%;"></td> <td style="width: 10%;"></td> <td style="width: 10%;"></td> <td style="width: 10%;"></td> <td style="width: 10%;"></td> <td style="width: 10%;"></td> </tr> <tr> <td></td> <td></td> <td colspan="8" style="text-align: center;"> <table border="1" style="width: 100%; border-collapse: collapse; text-align: center;"> <tr> <td style="width: 10%;"></td> <td style="width: 10%;"></td> <td style="width: 10%;"></td> <td style="width: 10%;"></td> <td style="width: 10%;"></td> <td style="width: 10%;"></td> <td style="width: 10%;"></td> <td style="width: 10%;"></td> <td style="width: 10%;"></td> <td style="width: 10%;"></td> </tr> <tr> <td></td> <td></td> <td colspan="8" style="text-align: center;"> <table border="1" style="width: 100%; border-collapse: collapse; text-align: center;"> <tr> <td style="width: 10%;"></td> <td style="width: 10%;"></td> <td style="width: 10%;"></td> <td style="width: 10%;"></td> <td style="width: 10%;"></td> <td style="width: 10%;"></td> <td style="width: 10%;"></td> <td style="width: 10%;"></td> <td style="width: 10%;"></td> <td style="width: 10%;"></td> </tr> <tr> <td></td> <td></td> <td colspan="8" style="text-align: center;"> <table border="1" style="width: 100%; border-collapse: collapse; text-align: center;"> <tr> </tr></table></td></tr></table></td></tr></table></td></tr></table></td></tr></table>
 | | | | | | | | | | | | | | | | | | | | <table border="1" style="width: 100%; border-collapse: collapse; text-align: center;"> <tr> <td style="width: 10%;"></td> <td style="width: 10%;"></td> <td style="width: 10%;"></td> <td style="width: 10%;"></td> <td style="width: 10%;"></td> <td
style="width: 10%;"></td> <td style="width: 10%;"></td> <td style="width: 10%;"></td> <td style="width: 10%;"></td> <td style="width: 10%;"></td> </tr> <tr> <td></td> <td></td> <td colspan="8" style="text-align: center;"> <table border="1" style="width: 100%; border-collapse: collapse; text-align: center;"> <tr> <td style="width: 10%;"></td> <td style="width: 10%;"></td> <td style="width: 10%;"></td> <td style="width: 10%;"></td> <td style="width: 10%;"></td> <td style="width: 10%;"></td> <td style="width: 10%;"></td> <td style="width: 10%;"></td> <td style="width: 10%;"></td> <td style="width: 10%;"></td> </tr> <tr> <td></td> <td></td> <td colspan="8" style="text-align: center;"> <table border="1" style="width: 100%; border-collapse: collapse; text-align: center;"> <tr> <td style="width: 10%;"></td> <td style="width: 10%;"></td> <td style="width: 10%;"></td> <td style="width: 10%;"></td> <td style="width: 10%;"></td> <td style="width: 10%;"></td> <td style="width: 10%;"></td> <td style="width: 10%;"></td> <td style="width: 10%;"></td> <td style="width: 10%;"></td> </tr> <tr> <td></td> <td></td> <td colspan="8" style="text-align: center;"> <table border="1" style="width: 100%; border-collapse: collapse; text-align: center;"> <tr> </tr></table></td></tr></table></td></tr></table></td></tr></table>
 | | | | | | | | | | | | | | | | | | | | <table border="1" style="width: 100%; border-collapse: collapse; text-align: center;"> <tr> <td style="width: 10%;"></td> <td style="width: 10%;"></td> <td style="width: 10%;"></td> <td style="width: 10%;"></td> <td style="width: 10%;"></td> <td style="width: 10%;"></td> <td style="width: 10%;"></td> <td style="width: 10%;"></td> <td style="width: 10%;"></td> <td style="width: 10%;"></td> </tr> <tr> <td></td> <td></td> <td colspan="8" style="text-align: center;"> <table border="1" style="width: 100%; border-collapse: collapse; text-align: center;"> <tr> <td style="width: 10%;"></td> <td style="width: 10%;"></td> <td style="width: 10%;"></td> <td style="width: 10%;"></td> <td style="width: 10%;"></td> <td style="width: 10%;"></td> <td style="width: 10%;"></td> <td style="width: 10%;"></td> <td style="width: 10%;"></td> <td style="width: 10%;"></td> </tr> <tr> <td></td> <td></td> <td colspan="8" style="text-align: center;"> <table border="1" style="width: 100%; border-collapse: collapse; text-align: center;"> <tr> </tr></table></td></tr></table></td></tr></table>

 | | | | | | | | | | | | | | | | | | | | <table border="1" style="width: 100%; border-collapse: collapse; text-align: center;"> <tr> <td style="width: 10%;"></td> <td style="width: 10%;"></td> <td style="width: 10%;"></td> <td style="width: 10%;"></td> <td style="width: 10%;"></td> <td style="width: 10%;"></td> <td style="width: 10%;"></td> <td style="width: 10%;"></td> <td style="width: 10%;"></td> <td style="width: 10%;"></td> </tr> <tr> <td></td> <td></td> <td colspan="8" style="text-align: center;"> <table border="1" style="width: 100%; border-collapse: collapse; text-align: center;"> <tr> </tr></table></td></tr></table>
 | | | | | | | | | | | | | | | | | | | | <table border="1" style="width: 100%; border-collapse: collapse; text-align: center;"> <tr> </tr></table>
 | | | | | | | | | | | | | | | | | | | |

 | | | | | | | | | | | | | | | | | | | |
 | | | | | | | | | | | | | | | | | | | |
 | | | | | | | | | | | | | | | | | | | |

 | | | | | | | | | | | | | | | | | | | | | | | | | | | | | | | | | | | | | | | | | | | | | | | | | | | | | | | | | | | | | | | | | | | | | | | | | | | | | | | | | | | | | | | | | | | | | | | | | | | |
 | | | | | | | | | | | | | | | | | | | |
 | | | | | | | | | | | | | | | | | | | |
 | | | | | | | | | | | | | | | | | | | |
 | | | | | | | | | | | | | | | | | | | |
 | | | | | | | | | | | | | | | | | | | |
 | | | | | | | | | | | | | | | | | | | |
 | | | | | | | | | | | | | | | | | | | |
 | | | | | | | | | | | | | | | | | | | |
 | | | | | | | | | | | | | | | | | | | | | | | | | | | | | | | | | | | | | | | |
 | | | | | | | | | | | | | | | | | | | |
 | | | | | | | | | | | | | | | | | | | | | | | | | | | | | | | | | | | | | | | |
 | | | | | | | | | | | | | | | | | | | | | | | | | | | | | | | | | | | | | | | |
 | | | | | | | | | | | | | | | | | | | | | | | | | | | | | | | | | | | | | | | |
 | | | | | | | | | | | | | | | | | | | | | | | | | | | | | | | | | | | | | | | | | | | | | | | | | | | | | | | | | | | | | | | | | | | | | | | | | | | | | | | | | | | | | | | | | | | | | | | | | | | |
 | | | | | | | | | | | | | | | | | | | | | | | | | | | | | | | | | | | | | | | | | | | | | | | |
| | |

 | | | | | | | | | | | | | | | | | | | |

 | | | | | | | | | | | | | | | | | | | |

 | | | | | | | | | | | | | | | | | | | |

 | | | | | | | | | | | | | | | | | | | |

 | | | | | | | | | | | | | | | | | | | |

 | | | | | | | | | | | | | | | | | | | |

 | | | | | | | | | | | | | | | | | | | |

 | | | | | | | | | | | | | | | | | | | |

 | | | | | | | | | | | | | | | | | | | |

 | | | | | | | | | | | | | | | | | | | |

 | | | | | | | | | | | | | | | | | | | |

 | | | | | | | | | | | | | | | | | | | |

 | | | | | | | | | | | | | | | | | | | |

 | | | | | | | | | | | | | | | | | | | |

 | | | | | | | | | | | | | | | | | | | |

 | | | | | | | | | | | | | | | | | | | |

 | | | | | | | | | | | | | | | | | | | |

 | | | | | | | | | | | | | | | | | | | |

 | | | | | | | | | | | | | | | | | | | |

 | | | | | | | | | | | | | | | | | | | |

 | | | | | | | | | | | | | | | | | | | |

 | | | | | | | | | | | | | | | | | | | |

 | | | | | | | | | | | | | | | | | | | |

 | | | | | | | | | | | | | | | | | | | |

 | | | | | | | | | | | | | | | | | | | |

 | | | | | | | | | | | | | | | | | | | |

 | | | | | | | | | | | | | | | | | | | |

 | | | | | | | | | | | | | | | | | | | |
 | | | | | | | | | | | | | | | | | | | |

 | | | | | | | | | | | | | | | | | | | |

 | | | | | | | | | | | | | | | | | | | |
 | | | | | | | | | | | | | | | | | | | |

 | | | | | | | | | | | | | | | | | | | |

 | | | | | | | | | | | | | | | | | | | |
 | | | | | | | | | | | | | | | | | | | |
 | | | | | | | | | | | | | | | | | | | |

 | | | | | | | | | | | | | | | | | | | |
 | | | | | | | | | | | | | | | | | | | |
 | | | | | | | | | | | | | | | | | | | |

 | | | | | | | | | | | | | | | | | | | | | | | | | | | | | | | | | | | | | | | | | | | | | | | | | | | | | | | | | | | | | | | | | | | | | | | | | | | | | | | | | | | | | | | | | | | | | | | | | | | |
 | | | | | | | | | | | | | | | | | | | |
 | | | | | | | | | | | | | | | | | | | |
 | | | | | | | | | | | | | | | | | | | |
 | | | | | | | | | | | | | | | | | | | |
 | | | | | | | | | | | | | | | | | | | |
 | | | | | | | | | | | | | | | | | | | |
 | | | | | | | | | | | | | | | | | | | |
 | | | | | | | | | | | | | | | | | | | |
 | | | | | | | | | | | | | | | | | | | | | | | | | | | | | | | | | | | | | | | |
 | | | | | | | | | | | | | | | | | | | |
 | | | | | | | | | | | | | | | | | | | | | | | | | | | | | | | | | | | | | | | |
 | | | | | | | | | | | | | | | | | | | | | | | | | | | | | | | | | | | | | | | |
 | | | | | | | | | | | | | | | | | | | | | | | | | | | | | | | | | | | | | | | |
 | | | | | | | | | | | | | | | | | | | | | | | | | | | | | | | | | | | | | | | | | | | | | | | | | | | | | | | | | | | | | | | | | | | | | | | | | | | | | | | | | | | | | | | | | | | | | | | | | | | |
 | | | | | | | | | | | | | | | | | | | | | | | | | | | | | | | | | | | | | | | | | | | | | | | |
| | | <table border="1" style="width: 100%; border-collapse: collapse; text-align: center;"> <tr> <td style="width: 10%;"></td> <td style="width: 10%;"></td> <td style="width: 10%;"></td> <td style="width: 10%;"></td> <td style="width: 10%;"></td> <td style="width: 10%;"></td> <td style="width: 10%;"></td> <td style="width: 10%;"></td> <td style="width: 10%;"></td> <td style="width: 10%;"></td> </tr> <tr> <td></td> <td></td> <td colspan="8" style="text-align: center;"> <table border="1" style="width: 100%; border-collapse: collapse; text-align: center;"> <tr> <td style="width: 10%;"></td> <td style="width: 10%;"></td> <td style="width: 10%;"></td> <td style="width: 10%;"></td> <td style="width: 10%;"></td> <td style="width: 10%;"></td> <td style="width: 10%;"></td> <td style="width: 10%;"></td> <td style="width: 10%;"></td> <td style="width: 10%;"></td> </tr> <tr> <td></td> <td></td> <td colspan="8" style="text-align: center;"> <table border="1" style="width: 100%; border-collapse: collapse; text-align: center;"> <tr> <td style="width: 10%;"></td> <td style="width: 10%;"></td> <td style="width: 10%;"></td> <td style="width: 10%;"></td> <td style="width: 10%;"></td> <td style="width: 10%;"></td> <td style="width: 10%;"></td> <td style="width: 10%;"></td> <td style="width: 10%;"></td> <td style="width: 10%;"></td> </tr> <tr> <td></td> <td></td> <td colspan="8" style="text-align: center;"> <table border="1" style="width: 100%; border-collapse: collapse; text-align: center;"> <tr> <td style="width: 10%;"></td> <td style="width: 10%;"></td> <td style="width: 10%;"></td> <td style="width: 10%;"></td> <td style="width: 10%;"></td> <td style="width: 10%;"></td> <td style="width: 10%;"></td> <td style="width: 10%;"></td> <td style="width: 10%;"></td> <td style="width: 10%;"></td> </tr> <tr> <td></td> <td></td> <td colspan="8" style="text-align: center;"> <table border="1" style="width: 100%; border-collapse: collapse; text-align: center;"> <tr> <td style="width: 10%;"></td> <td style="width: 10%;"></td> <td style="width: 10%;"></td> <td style="width: 10%;"></td> <td style="width: 10%;"></td> <td style="width: 10%;"></td> <td style="width: 10%;"></td> <td style="width: 10%;"></td> <td style="width: 10%;"></td> <td style="width: 10%;"></td> </tr> <tr> <td></td> <td></td> <td colspan="8" style="text-align: center;"> <table border="1" style="width: 100%; border-collapse: collapse; text-align: center;"> <tr> <td style="width: 10%;"></td> <td style="width: 10%;"></td> <td style="width: 10%;"></td> <td style="width: 10%;"></td> <td style="width: 10%;"></td> <td style="width: 10%;"></td> <td style="width: 10%;"></td> <td style="width: 10%;"></td> <td style="width: 10%;"></td> <td style="width: 10%;"></td> </tr> <tr> <td></td> <td></td> <td colspan="8" style="text-align: center;"> <table border="1" style="width: 100%; border-collapse: collapse; text-align: center;"> <tr> <td style="width: 10%;"></td> <td style="width: 10%;"></td> <td style="width: 10%;"></td> <td style="width: 10%;"></td> <td style="width: 10%;"></td> <td style="width: 10%;"></td> <td style="width: 10%;"></td> <td style="width: 10%;"></td> <td style="width: 10%;"></td> <td style="width: 10%;"></td> </tr> <tr> <td></td> <td></td> <td colspan="8" style="text-align: center;"> <table border="1" style="width: 100%; border-collapse: collapse; text-align: center;"> <tr> <td style="width: 10%;"></td> <td style="width: 10%;"></td> <td style="width: 10%;"></td> <td style="width: 10%;"></td> <td style="width: 10%;"></td> <td style="width: 10%;"></td> <td style="width: 10%;"></td> <td style="width: 10%;"></td> <td style="width: 10%;"></td> <td style="width: 10%;"></td> </tr> <tr> <td></td> <td></td> <td colspan="8" style="text-align: center;"> <table border="1" style="width: 100%; border-collapse: collapse; text-align: center;"> <tr> <td style="width: 10%;"></td> <td style="width: 10%;"></td> <td style="width: 10%;"></td> <td style="width: 10%;"></td> <td style="width: 10%;"></td> <td style="width: 10%;"></td> <td style="width: 10%;"></td> <td style="width: 10%;"></td> <td style="width: 10%;"></td> <td style="width: 10%;"></td> </tr> <tr> <td></td> <td></td> <td colspan="8" style="text-align: center;"> <table border="1" style="width: 100%; border-collapse: collapse; text-align: center;"> <tr> <td style="width: 10%;"></td> <td style="width: 10%;"></td> <td style="width: 10%;"></td> <td style="width: 10%;"></td> <td style="width: 10%;"></td> <td style="width: 10%;"></td> <td style="width: 10%;"></td> <td style="width: 10%;"></td> <td style="width: 10%;"></td> <td style="width: 10%;"></td> </tr> <tr> <td></td> <td></td> <td colspan="8" style="text-align: center;"> <table border="1" style="width: 100%; border-collapse: collapse; text-align: center;"> <tr> <td style="width: 10%;"></td> <td style="width: 10%;"></td> <td style="width: 10%;"></td> <td style="width: 10%;"></td> <td style="width: 10%;"></td> <td style="width: 10%;"></td> <td style="width: 10%;"></td> <td style="width: 10%;"></td> <td style="width: 10%;"></td> <td style="width: 10%;"></td> </tr> <tr> <td></td> <td></td> <td colspan="8" style="text-align: center;"> <table border="1" style="width: 100%; border-collapse: collapse; text-align: center;"> <tr> <td style="width: 10%;"></td> <td style="width: 10%;"></td> <td style="width: 10%;"></td> <td style="width: 10%;"></td> <td style="width: 10%;"></td> <td style="width: 10%;"></td> <td style="width: 10%;"></td> <td style="width: 10%;"></td> <td style="width: 10%;"></td> <td style="width: 10%;"></td> </tr> <tr> <td></td> <td></td> <td colspan="8" style="text-align: center;"> <table border="1" style="width: 100%; border-collapse: collapse; text-align: center;"> <tr> <td style="width: 10%;"></td> <td style="width: 10%;"></td> <td style="width: 10%;"></td> <td style="width: 10%;"></td> <td style="width: 10%;"></td> <td style="width: 10%;"></td> <td style="width: 10%;"></td> <td style="width: 10%;"></td> <td style="width: 10%;"></td> <td style="width: 10%;"></td> </tr> <tr> <td></td> <td></td> <td colspan="8" style="text-align: center;"> <table border="1" style="width: 100%; border-collapse: collapse; text-align: center;"> <tr> <td style="width: 10%;"></td> <td style="width: 10%;"></td> <td style="width: 10%;"></td> <td style="width: 10%;"></td> <td style="width: 10%;"></td> <td style="width: 10%;"></td> <td style="width: 10%;"></td> <td style="width: 10%;"></td> <td style="width: 10%;"></td> <td style="width: 10%;"></td> </tr> <tr> <td></td> <td></td> <td colspan="8" style="text-align: center;"> <table border="1" style="width: 100%; border-collapse: collapse; text-align: center;"> <tr> <td style="width: 10%;"></td> <td style="width: 10%;"></td> <td style="width: 10%;"></td> <td style="width: 10%;"></td> <td style="width: 10%;"></td> <td style="width: 10%;"></td> <td style="width: 10%;"></td> <td style="width: 10%;"></td> <td style="width: 10%;"></td> <td style="width: 10%;"></td> </tr> <tr> <td></td> <td></td> <td colspan="8" style="text-align: center;"> <table border="1" style="width: 100%; border-collapse: collapse; text-align: center;"> <tr> <td style="width: 10%;"></td> <td style="width: 10%;"></td> <td style="width: 10%;"></td> <td style="width: 10%;"></td> <td style="width: 10%;"></td> <td style="width: 10%;"></td> <td style="width: 10%;"></td> <td style="width: 10%;"></td> <td style="width: 10%;"></td> <td style="width: 10%;"></td> </tr> <tr> <td></td> <td></td> <td colspan="8" style="text-align: center;"> <table border="1" style="width: 100%; border-collapse: collapse; text-align: center;"> <tr> <td style="width: 10%;"></td> <td style="width: 10%;"></td> <td style="width: 10%;"></td> <td style="width: 10%;"></td> <td style="width: 10%;"></td> <td style="width: 10%;"></td> <td style="width: 10%;"></td> <td style="width: 10%;"></td> <td style="width: 10%;"></td> <td style="width: 10%;"></td> </tr> <tr> <td></td> <td></td> <td colspan="8" style="text-align: center;"> <table border="1" style="width: 100%; border-collapse: collapse; text-align: center;"> <tr> <td style="width: 10%;"></td> <td style="width: 10%;"></td> <td style="width: 10%;"></td> <td style="width: 10%;"></td> <td style="width: 10%;"></td> <td style="width: 10%;"></td> <td style="width: 10%;"></td> <td style="width: 10%;"></td> <td style="width: 10%;"></td> <td style="width: 10%;"></td> </tr> <tr> <td></td> <td></td> <td colspan="8" style="text-align: center;"> <table border="1" style="width: 100%; border-collapse: collapse; text-align: center;"> <tr> <td style="width: 10%;"></td> <td style="width: 10%;"></td> <td style="width: 10%;"></td> <td style="width: 10%;"></td> <td style="width: 10%;"></td> <td style="width: 10%;"></td> <td style="width: 10%;"></td> <td style="width: 10%;"></td> <td style="width: 10%;"></td> <td style="width: 10%;"></td> </tr> <tr> <td></td> <td></td> <td colspan="8" style="text-align: center;"> <table border="1" style="width: 100%; border-collapse: collapse; text-align: center;"> <tr> <td style="width: 10%;"></td> <td style="width: 10%;"></td> <td style="width: 10%;"></td> <td style="width: 10%;"></td> <td style="width: 10%;"></td> <td style="width: 10%;"></td> <td style="width: 10%;"></td> <td style="width: 10%;"></td> <td style="width: 10%;"></td> <td style="width: 10%;"></td> </tr> <tr> <td></td> <td></td> <td colspan="8" style="text-align: center;"> <table border="1" style="width: 100%; border-collapse: collapse; text-align: center;"> <tr> <td style="width: 10%;"></td> <td style="width: 10%;"></td> <td style="width: 10%;"></td> <td style="width: 10%;"></td> <td style="width: 10%;"></td> <td style="width: 10%;"></td> <td style="width: 10%;"></td> <td style="width: 10%;"></td> <td style="width: 10%;"></td> <td style="width: 10%;"></td> </tr> <tr> <td></td> <td></td> <td colspan="8" style="text-align: center;"> <table border="1" style="width: 100%; border-collapse: collapse; text-align: center;"> <tr> <td style="width: 10%;"></td> <td style="width: 10%;"></td> <td
style="width: 10%;"></td> <td style="width: 10%;"></td> <td style="width: 10%;"></td> <td style="width: 10%;"></td> <td style="width: 10%;"></td> <td style="width: 10%;"></td> <td style="width: 10%;"></td> <td style="width: 10%;"></td> </tr> <tr> <td></td> <td></td> <td colspan="8" style="text-align: center;"> <table border="1" style="width: 100%; border-collapse: collapse; text-align: center;"> <tr> <td style="width: 10%;"></td> <td style="width: 10%;"></td> <td style="width: 10%;"></td> <td style="width: 10%;"></td> <td style="width: 10%;"></td> <td style="width: 10%;"></td> <td style="width: 10%;"></td> <td style="width: 10%;"></td> <td style="width: 10%;"></td> <td style="width: 10%;"></td> </tr> <tr> <td></td> <td></td> <td colspan="8" style="text-align: center;"> <table border="1" style="width: 100%; border-collapse: collapse; text-align: center;"> <tr> <td style="width: 10%;"></td> <td style="width: 10%;"></td> <td style="width: 10%;"></td> <td style="width: 10%;"></td> <td style="width: 10%;"></td> <td style="width: 10%;"></td> <td style="width: 10%;"></td> <td style="width: 10%;"></td> <td style="width: 10%;"></td> <td style="width: 10%;"></td> </tr> <tr> <td></td> <td></td> <td colspan="8" style="text-align: center;"> <table border="1" style="width: 100%; border-collapse: collapse; text-align: center;"> <tr> <td style="width: 10%;"></td> <td style="width: 10%;"></td> <td style="width: 10%;"></td> <td style="width: 10%;"></td> <td style="width: 10%;"></td> <td style="width: 10%;"></td> <td style="width: 10%;"></td> <td style="width: 10%;"></td> <td style="width: 10%;"></td> <td style="width: 10%;"></td> </tr> <tr> <td></td> <td></td> <td colspan="8" style="text-align: center;"> <table border="1" style="width: 100%; border-collapse: collapse; text-align: center;"> <tr> <td style="width: 10%;"></td> <td style="width: 10%;"></td> <td style="width: 10%;"></td> <td style="width: 10%;"></td> <td style="width: 10%;"></td> <td style="width: 10%;"></td> <td style="width: 10%;"></td> <td style="width: 10%;"></td> <td style="width: 10%;"></td> <td style="width: 10%;"></td> </tr> <tr> <td></td> <td></td> <td colspan="8" style="text-align: center;"> <table border="1" style="width: 100%; border-collapse: collapse; text-align: center;"> <tr> <td style="width: 10%;"></td> <td style="width: 10%;"></td> <td style="width: 10%;"></td> <td style="width: 10%;"></td> <td style="width: 10%;"></td> <td style="width: 10%;"></td> <td style="width: 10%;"></td> <td style="width: 10%;"></td> <td style="width: 10%;"></td> <td style="width: 10%;"></td> </tr> <tr> <td></td> <td></td> <td colspan="8" style="text-align: center;"> <table border="1" style="width: 100%; border-collapse: collapse; text-align: center;"> <tr> <td style="width: 10%;"></td> <td style="width: 10%;"></td> <td style="width: 10%;"></td> <td style="width: 10%;"></td> <td style="width: 10%;"></td> <td style="width: 10%;"></td> <td style="width: 10%;"></td> <td style="width: 10%;"></td> <td style="width: 10%;"></td> <td style="width: 10%;"></td> </tr> <tr> <td></td> <td></td> <td colspan="8" style="text-align: center;"> <table border="1" style="width: 100%; border-collapse: collapse; text-align: center;"> <tr> <td style="width: 10%;"></td> <td style="width: 10%;"></td> <td style="width: 10%;"></td> <td style="width: 10%;"></td> <td style="width: 10%;"></td> <td style="width: 10%;"></td> <td style="width: 10%;"></td> <td style="width: 10%;"></td> <td style="width: 10%;"></td> <td style="width: 10%;"></td> </tr> <tr> <td></td> <td></td> <td colspan="8" style="text-align: center;"> <table border="1" style="width: 100%; border-collapse: collapse; text-align: center;"> <tr> <td style="width: 10%;"></td> <td style="width: 10%;"></td> <td style="width: 10%;"></td> <td style="width: 10%;"></td> <td style="width: 10%;"></td> <td style="width: 10%;"></td> <td style="width: 10%;"></td> <td style="width: 10%;"></td> <td style="width: 10%;"></td> <td style="width: 10%;"></td> </tr> <tr> <td></td> <td></td> <td colspan="8" style="text-align: center;"> <table border="1" style="width: 100%; border-collapse: collapse; text-align: center;"> <tr> <td style="width: 10%;"></td> <td style="width: 10%;"></td> <td style="width: 10%;"></td> <td style="width: 10%;"></td> <td style="width: 10%;"></td> <td style="width: 10%;"></td> <td style="width: 10%;"></td> <td style="width: 10%;"></td> <td style="width: 10%;"></td> <td style="width: 10%;"></td> </tr> <tr> <td></td> <td></td> <td colspan="8" style="text-align: center;"> <table border="1" style="width: 100%; border-collapse: collapse; text-align: center;"> <tr> <td style="width: 10%;"></td> <td style="width: 10%;"></td> <td style="width: 10%;"></td> <td style="width: 10%;"></td> <td style="width: 10%;"></td> <td style="width: 10%;"></td> <td style="width: 10%;"></td> <td style="width: 10%;"></td> <td style="width: 10%;"></td> <td style="width: 10%;"></td> </tr> <tr> <td></td> <td></td> <td colspan="8" style="text-align: center;"> <table border="1" style="width: 100%; border-collapse: collapse; text-align: center;"> <tr> <td style="width: 10%;"></td> <td style="width: 10%;"></td> <td style="width: 10%;"></td> <td style="width: 10%;"></td> <td style="width: 10%;"></td> <td style="width: 10%;"></td> <td style="width: 10%;"></td> <td style="width: 10%;"></td> <td style="width: 10%;"></td> <td style="width: 10%;"></td> </tr> <tr> <td></td> <td></td> <td colspan="8" style="text-align: center;"> <table border="1" style="width: 100%; border-collapse: collapse; text-align: center;"> <tr> <td style="width: 10%;"></td> <td style="width: 10%;"></td> <td style="width: 10%;"></td> <td style="width: 10%;"></td> <td style="width: 10%;"></td> <td style="width: 10%;"></td> <td style="width: 10%;"></td> <td style="width: 10%;"></td> <td style="width: 10%;"></td> <td style="width: 10%;"></td> </tr> <tr> <td></td> <td></td> <td colspan="8" style="text-align: center;"> <table border="1" style="width: 100%; border-collapse: collapse; text-align: center;"> <tr> </tr></table></td></tr></table></td></tr></table></td></tr></table></td></tr></table></td></tr></table></td></tr></table></td></tr></table></td></tr></table></td></tr></table></td></tr></table></td></tr></table></td></tr></table></td></tr></table></td></tr></table></td></tr></table></td></tr></table></td></tr></table></td></tr></table></td></tr></table></td></tr></table></td></tr></table></td></tr></table></td></tr></table></td></tr></table></td></tr></table></td></tr></table></td></tr></table></td></tr></table></td></tr></table></td></tr></table></td></tr></table></td></tr></table></td></tr></table></td></tr></table>

 | | | | | | | | | | | | | | | | | | | | <table border="1" style="width: 100%; border-collapse: collapse; text-align: center;"> <tr> <td style="width: 10%;"></td> <td style="width: 10%;"></td> <td style="width: 10%;"></td> <td style="width: 10%;"></td> <td style="width: 10%;"></td> <td style="width: 10%;"></td> <td style="width: 10%;"></td> <td style="width: 10%;"></td> <td style="width: 10%;"></td> <td style="width: 10%;"></td> </tr> <tr> <td></td> <td></td> <td colspan="8" style="text-align: center;"> <table border="1" style="width: 100%; border-collapse: collapse; text-align: center;"> <tr> <td style="width: 10%;"></td> <td style="width: 10%;"></td> <td style="width: 10%;"></td> <td style="width: 10%;"></td> <td style="width: 10%;"></td> <td style="width: 10%;"></td> <td style="width: 10%;"></td> <td style="width: 10%;"></td> <td style="width: 10%;"></td> <td style="width: 10%;"></td> </tr> <tr> <td></td> <td></td> <td colspan="8" style="text-align: center;"> <table border="1" style="width: 100%; border-collapse: collapse; text-align: center;"> <tr> <td style="width: 10%;"></td> <td style="width: 10%;"></td> <td style="width: 10%;"></td> <td style="width: 10%;"></td> <td style="width: 10%;"></td> <td style="width: 10%;"></td> <td style="width: 10%;"></td> <td style="width: 10%;"></td> <td style="width: 10%;"></td> <td style="width: 10%;"></td> </tr> <tr> <td></td> <td></td> <td colspan="8" style="text-align: center;"> <table border="1" style="width: 100%; border-collapse: collapse; text-align: center;"> <tr> <td style="width: 10%;"></td> <td style="width: 10%;"></td> <td style="width: 10%;"></td> <td style="width: 10%;"></td> <td style="width: 10%;"></td> <td style="width: 10%;"></td> <td style="width: 10%;"></td> <td style="width: 10%;"></td> <td style="width: 10%;"></td> <td style="width: 10%;"></td> </tr> <tr> <td></td> <td></td> <td colspan="8" style="text-align: center;"> <table border="1" style="width: 100%; border-collapse: collapse; text-align: center;"> <tr> <td style="width: 10%;"></td> <td style="width: 10%;"></td> <td style="width: 10%;"></td> <td style="width: 10%;"></td> <td style="width: 10%;"></td> <td style="width: 10%;"></td> <td style="width: 10%;"></td> <td style="width: 10%;"></td> <td style="width: 10%;"></td> <td style="width: 10%;"></td> </tr> <tr> <td></td> <td></td> <td colspan="8" style="text-align: center;"> <table border="1" style="width: 100%; border-collapse: collapse; text-align: center;"> <tr> <td style="width: 10%;"></td> <td style="width: 10%;"></td> <td style="width: 10%;"></td> <td style="width: 10%;"></td> <td style="width: 10%;"></td> <td style="width: 10%;"></td> <td style="width: 10%;"></td> <td style="width: 10%;"></td> <td style="width: 10%;"></td> <td style="width: 10%;"></td> </tr> <tr> <td></td> <td></td> <td colspan="8" style="text-align: center;"> <table border="1" style="width: 100%; border-collapse: collapse; text-align: center;"> <tr> <td style="width: 10%;"></td> <td style="width: 10%;"></td> <td style="width: 10%;"></td> <td style="width: 10%;"></td> <td style="width: 10%;"></td> <td style="width: 10%;"></td> <td style="width: 10%;"></td> <td style="width: 10%;"></td> <td style="width: 10%;"></td> <td style="width: 10%;"></td> </tr> <tr> <td></td> <td></td> <td colspan="8" style="text-align: center;"> <table border="1" style="width: 100%; border-collapse: collapse; text-align: center;"> <tr> <td style="width: 10%;"></td> <td style="width: 10%;"></td> <td style="width: 10%;"></td> <td style="width: 10%;"></td> <td style="width: 10%;"></td> <td style="width: 10%;"></td> <td style="width: 10%;"></td> <td style="width: 10%;"></td> <td style="width: 10%;"></td> <td style="width: 10%;"></td> </tr> <tr> <td></td> <td></td> <td colspan="8" style="text-align: center;"> <table border="1" style="width: 100%; border-collapse: collapse; text-align: center;"> <tr> <td style="width: 10%;"></td> <td style="width: 10%;"></td> <td style="width: 10%;"></td> <td style="width: 10%;"></td> <td style="width: 10%;"></td> <td style="width: 10%;"></td> <td style="width: 10%;"></td> <td style="width: 10%;"></td> <td style="width: 10%;"></td> <td style="width: 10%;"></td> </tr> <tr> <td></td> <td></td> <td colspan="8" style="text-align: center;"> <table border="1" style="width: 100%; border-collapse: collapse; text-align: center;"> <tr> <td style="width: 10%;"></td> <td style="width: 10%;"></td> <td style="width: 10%;"></td> <td style="width: 10%;"></td> <td style="width: 10%;"></td> <td style="width: 10%;"></td> <td style="width: 10%;"></td> <td style="width: 10%;"></td> <td style="width: 10%;"></td> <td style="width: 10%;"></td> </tr> <tr> <td></td> <td></td> <td colspan="8" style="text-align: center;"> <table border="1" style="width: 100%; border-collapse: collapse; text-align: center;"> <tr> <td style="width: 10%;"></td> <td style="width: 10%;"></td> <td style="width: 10%;"></td> <td style="width: 10%;"></td> <td style="width: 10%;"></td> <td style="width: 10%;"></td> <td style="width: 10%;"></td> <td style="width: 10%;"></td> <td style="width: 10%;"></td> <td style="width: 10%;"></td> </tr> <tr> <td></td> <td></td> <td colspan="8" style="text-align: center;"> <table border="1" style="width: 100%; border-collapse: collapse; text-align: center;"> <tr> <td style="width: 10%;"></td> <td style="width: 10%;"></td> <td style="width: 10%;"></td> <td style="width: 10%;"></td> <td style="width: 10%;"></td> <td style="width: 10%;"></td> <td style="width: 10%;"></td> <td style="width: 10%;"></td> <td style="width: 10%;"></td> <td style="width: 10%;"></td> </tr> <tr> <td></td> <td></td> <td colspan="8" style="text-align: center;"> <table border="1" style="width: 100%; border-collapse: collapse; text-align: center;"> <tr> <td style="width: 10%;"></td> <td style="width: 10%;"></td> <td style="width: 10%;"></td> <td style="width: 10%;"></td> <td style="width: 10%;"></td> <td style="width: 10%;"></td> <td style="width: 10%;"></td> <td style="width: 10%;"></td> <td style="width: 10%;"></td> <td style="width: 10%;"></td> </tr> <tr> <td></td> <td></td> <td colspan="8" style="text-align: center;"> <table border="1" style="width: 100%; border-collapse: collapse; text-align: center;"> <tr> <td style="width: 10%;"></td> <td style="width: 10%;"></td> <td style="width: 10%;"></td> <td style="width: 10%;"></td> <td style="width: 10%;"></td> <td style="width: 10%;"></td> <td style="width: 10%;"></td> <td style="width: 10%;"></td> <td style="width: 10%;"></td> <td style="width: 10%;"></td> </tr> <tr> <td></td> <td></td> <td colspan="8" style="text-align: center;"> <table border="1" style="width: 100%; border-collapse: collapse; text-align: center;"> <tr> <td style="width: 10%;"></td> <td style="width: 10%;"></td> <td style="width: 10%;"></td> <td style="width: 10%;"></td> <td style="width: 10%;"></td> <td style="width: 10%;"></td> <td style="width: 10%;"></td> <td style="width: 10%;"></td> <td style="width: 10%;"></td> <td style="width: 10%;"></td> </tr> <tr> <td></td> <td></td> <td colspan="8" style="text-align: center;"> <table border="1" style="width: 100%; border-collapse: collapse; text-align: center;"> <tr> <td style="width: 10%;"></td> <td style="width: 10%;"></td> <td style="width: 10%;"></td> <td style="width: 10%;"></td> <td style="width: 10%;"></td> <td style="width: 10%;"></td> <td style="width: 10%;"></td> <td style="width: 10%;"></td> <td style="width: 10%;"></td> <td style="width: 10%;"></td> </tr> <tr> <td></td> <td></td> <td colspan="8" style="text-align: center;"> <table border="1" style="width: 100%; border-collapse: collapse; text-align: center;"> <tr> <td style="width: 10%;"></td> <td style="width: 10%;"></td> <td style="width: 10%;"></td> <td style="width: 10%;"></td> <td style="width: 10%;"></td> <td style="width: 10%;"></td> <td style="width: 10%;"></td> <td style="width: 10%;"></td> <td style="width: 10%;"></td> <td style="width: 10%;"></td> </tr> <tr> <td></td> <td></td> <td colspan="8" style="text-align: center;"> <table border="1" style="width: 100%; border-collapse: collapse; text-align: center;"> <tr> <td style="width: 10%;"></td> <td style="width: 10%;"></td> <td style="width: 10%;"></td> <td style="width: 10%;"></td> <td style="width: 10%;"></td> <td style="width: 10%;"></td> <td style="width: 10%;"></td> <td style="width: 10%;"></td> <td style="width: 10%;"></td> <td style="width: 10%;"></td> </tr> <tr> <td></td> <td></td> <td colspan="8" style="text-align: center;"> <table border="1" style="width: 100%; border-collapse: collapse; text-align: center;"> <tr> <td style="width: 10%;"></td> <td style="width: 10%;"></td> <td style="width: 10%;"></td> <td style="width: 10%;"></td> <td style="width: 10%;"></td> <td style="width: 10%;"></td> <td
style="width: 10%;"></td> <td style="width: 10%;"></td> <td style="width: 10%;"></td> <td style="width: 10%;"></td> </tr> <tr> <td></td> <td></td> <td colspan="8" style="text-align: center;"> <table border="1" style="width: 100%; border-collapse: collapse; text-align: center;"> <tr> <td style="width: 10%;"></td> <td style="width: 10%;"></td> <td style="width: 10%;"></td> <td style="width: 10%;"></td> <td style="width: 10%;"></td> <td style="width: 10%;"></td> <td style="width: 10%;"></td> <td style="width: 10%;"></td> <td style="width: 10%;"></td> <td style="width: 10%;"></td> </tr> <tr> <td></td> <td></td> <td colspan="8" style="text-align: center;"> <table border="1" style="width: 100%; border-collapse: collapse; text-align: center;"> <tr> <td style="width: 10%;"></td> <td style="width: 10%;"></td> <td style="width: 10%;"></td> <td style="width: 10%;"></td> <td style="width: 10%;"></td> <td style="width: 10%;"></td> <td style="width: 10%;"></td> <td style="width: 10%;"></td> <td style="width: 10%;"></td> <td style="width: 10%;"></td> </tr> <tr> <td></td> <td></td> <td colspan="8" style="text-align: center;"> <table border="1" style="width: 100%; border-collapse: collapse; text-align: center;"> <tr> <td style="width: 10%;"></td> <td style="width: 10%;"></td> <td style="width: 10%;"></td> <td style="width: 10%;"></td> <td style="width: 10%;"></td> <td style="width: 10%;"></td> <td style="width: 10%;"></td> <td style="width: 10%;"></td> <td style="width: 10%;"></td> <td style="width: 10%;"></td> </tr> <tr> <td></td> <td></td> <td colspan="8" style="text-align: center;"> <table border="1" style="width: 100%; border-collapse: collapse; text-align: center;"> <tr> <td style="width: 10%;"></td> <td style="width: 10%;"></td> <td style="width: 10%;"></td> <td style="width: 10%;"></td> <td style="width: 10%;"></td> <td style="width: 10%;"></td> <td style="width: 10%;"></td> <td style="width: 10%;"></td> <td style="width: 10%;"></td> <td style="width: 10%;"></td> </tr> <tr> <td></td> <td></td> <td colspan="8" style="text-align: center;"> <table border="1" style="width: 100%; border-collapse: collapse; text-align: center;"> <tr> <td style="width: 10%;"></td> <td style="width: 10%;"></td> <td style="width: 10%;"></td> <td style="width: 10%;"></td> <td style="width: 10%;"></td> <td style="width: 10%;"></td> <td style="width: 10%;"></td> <td style="width: 10%;"></td> <td style="width: 10%;"></td> <td style="width: 10%;"></td> </tr> <tr> <td></td> <td></td> <td colspan="8" style="text-align: center;"> <table border="1" style="width: 100%; border-collapse: collapse; text-align: center;"> <tr> <td style="width: 10%;"></td> <td style="width: 10%;"></td> <td style="width: 10%;"></td> <td style="width: 10%;"></td> <td style="width: 10%;"></td> <td style="width: 10%;"></td> <td style="width: 10%;"></td> <td style="width: 10%;"></td> <td style="width: 10%;"></td> <td style="width: 10%;"></td> </tr> <tr> <td></td> <td></td> <td colspan="8" style="text-align: center;"> <table border="1" style="width: 100%; border-collapse: collapse; text-align: center;"> <tr> <td style="width: 10%;"></td> <td style="width: 10%;"></td> <td style="width: 10%;"></td> <td style="width: 10%;"></td> <td style="width: 10%;"></td> <td style="width: 10%;"></td> <td style="width: 10%;"></td> <td style="width: 10%;"></td> <td style="width: 10%;"></td> <td style="width: 10%;"></td> </tr> <tr> <td></td> <td></td> <td colspan="8" style="text-align: center;"> <table border="1" style="width: 100%; border-collapse: collapse; text-align: center;"> <tr> <td style="width: 10%;"></td> <td style="width: 10%;"></td> <td style="width: 10%;"></td> <td style="width: 10%;"></td> <td style="width: 10%;"></td> <td style="width: 10%;"></td> <td style="width: 10%;"></td> <td style="width: 10%;"></td> <td style="width: 10%;"></td> <td style="width: 10%;"></td> </tr> <tr> <td></td> <td></td> <td colspan="8" style="text-align: center;"> <table border="1" style="width: 100%; border-collapse: collapse; text-align: center;"> <tr> <td style="width: 10%;"></td> <td style="width: 10%;"></td> <td style="width: 10%;"></td> <td style="width: 10%;"></td> <td style="width: 10%;"></td> <td style="width: 10%;"></td> <td style="width: 10%;"></td> <td style="width: 10%;"></td> <td style="width: 10%;"></td> <td style="width: 10%;"></td> </tr> <tr> <td></td> <td></td> <td colspan="8" style="text-align: center;"> <table border="1" style="width: 100%; border-collapse: collapse; text-align: center;"> <tr> <td style="width: 10%;"></td> <td style="width: 10%;"></td> <td style="width: 10%;"></td> <td style="width: 10%;"></td> <td style="width: 10%;"></td> <td style="width: 10%;"></td> <td style="width: 10%;"></td> <td style="width: 10%;"></td> <td style="width: 10%;"></td> <td style="width: 10%;"></td> </tr> <tr> <td></td> <td></td> <td colspan="8" style="text-align: center;"> <table border="1" style="width: 100%; border-collapse: collapse; text-align: center;"> <tr> <td style="width: 10%;"></td> <td style="width: 10%;"></td> <td style="width: 10%;"></td> <td style="width: 10%;"></td> <td style="width: 10%;"></td> <td style="width: 10%;"></td> <td style="width: 10%;"></td> <td style="width: 10%;"></td> <td style="width: 10%;"></td> <td style="width: 10%;"></td> </tr> <tr> <td></td> <td></td> <td colspan="8" style="text-align: center;"> <table border="1" style="width: 100%; border-collapse: collapse; text-align: center;"> <tr> <td style="width: 10%;"></td> <td style="width: 10%;"></td> <td style="width: 10%;"></td> <td style="width: 10%;"></td> <td style="width: 10%;"></td> <td style="width: 10%;"></td> <td style="width: 10%;"></td> <td style="width: 10%;"></td> <td style="width: 10%;"></td> <td style="width: 10%;"></td> </tr> <tr> <td></td> <td></td> <td colspan="8" style="text-align: center;"> <table border="1" style="width: 100%; border-collapse: collapse; text-align: center;"> <tr> <td style="width: 10%;"></td> <td style="width: 10%;"></td> <td style="width: 10%;"></td> <td style="width: 10%;"></td> <td style="width: 10%;"></td> <td style="width: 10%;"></td> <td style="width: 10%;"></td> <td style="width: 10%;"></td> <td style="width: 10%;"></td> <td style="width: 10%;"></td> </tr> <tr> <td></td> <td></td> <td colspan="8" style="text-align: center;"> <table border="1" style="width: 100%; border-collapse: collapse; text-align: center;"> <tr> <td style="width: 10%;"></td> <td style="width: 10%;"></td> <td style="width: 10%;"></td> <td style="width: 10%;"></td> <td style="width: 10%;"></td> <td style="width: 10%;"></td> <td style="width: 10%;"></td> <td style="width: 10%;"></td> <td style="width: 10%;"></td> <td style="width: 10%;"></td> </tr> <tr> <td></td> <td></td> <td colspan="8" style="text-align: center;"> <table border="1" style="width: 100%; border-collapse: collapse; text-align: center;"> <tr> </tr></table></td></tr></table></td></tr></table></td></tr></table></td></tr></table></td></tr></table></td></tr></table></td></tr></table></td></tr></table></td></tr></table></td></tr></table></td></tr></table></td></tr></table></td></tr></table></td></tr></table></td></tr></table></td></tr></table></td></tr></table></td></tr></table></td></tr></table></td></tr></table></td></tr></table></td></tr></table></td></tr></table></td></tr></table></td></tr></table></td></tr></table></td></tr></table></td></tr></table></td></tr></table></td></tr></table></td></tr></table></td></tr></table></td></tr></table>

 | | | | | | | | | | | | | | | | | | | | <table border="1" style="width: 100%; border-collapse: collapse; text-align: center;"> <tr> <td style="width: 10%;"></td> <td style="width: 10%;"></td> <td style="width: 10%;"></td> <td style="width: 10%;"></td> <td style="width: 10%;"></td> <td style="width: 10%;"></td> <td style="width: 10%;"></td> <td style="width: 10%;"></td> <td style="width: 10%;"></td> <td style="width: 10%;"></td> </tr> <tr> <td></td> <td></td> <td colspan="8" style="text-align: center;"> <table border="1" style="width: 100%; border-collapse: collapse; text-align: center;"> <tr> <td style="width: 10%;"></td> <td style="width: 10%;"></td> <td style="width: 10%;"></td> <td style="width: 10%;"></td> <td style="width: 10%;"></td> <td style="width: 10%;"></td> <td style="width: 10%;"></td> <td style="width: 10%;"></td> <td style="width: 10%;"></td> <td style="width: 10%;"></td> </tr> <tr> <td></td> <td></td> <td colspan="8" style="text-align: center;"> <table border="1" style="width: 100%; border-collapse: collapse; text-align: center;"> <tr> <td style="width: 10%;"></td> <td style="width: 10%;"></td> <td style="width: 10%;"></td> <td style="width: 10%;"></td> <td style="width: 10%;"></td> <td style="width: 10%;"></td> <td style="width: 10%;"></td> <td style="width: 10%;"></td> <td style="width: 10%;"></td> <td style="width: 10%;"></td> </tr> <tr> <td></td> <td></td> <td colspan="8" style="text-align: center;"> <table border="1" style="width: 100%; border-collapse: collapse; text-align: center;"> <tr> <td style="width: 10%;"></td> <td style="width: 10%;"></td> <td style="width: 10%;"></td> <td style="width: 10%;"></td> <td style="width: 10%;"></td> <td style="width: 10%;"></td> <td style="width: 10%;"></td> <td style="width: 10%;"></td> <td style="width: 10%;"></td> <td style="width: 10%;"></td> </tr> <tr> <td></td> <td></td> <td colspan="8" style="text-align: center;"> <table border="1" style="width: 100%; border-collapse: collapse; text-align: center;"> <tr> <td style="width: 10%;"></td> <td style="width: 10%;"></td> <td style="width: 10%;"></td> <td style="width: 10%;"></td> <td style="width: 10%;"></td> <td style="width: 10%;"></td> <td style="width: 10%;"></td> <td style="width: 10%;"></td> <td style="width: 10%;"></td> <td style="width: 10%;"></td> </tr> <tr> <td></td> <td></td> <td colspan="8" style="text-align: center;"> <table border="1" style="width: 100%; border-collapse: collapse; text-align: center;"> <tr> <td style="width: 10%;"></td> <td style="width: 10%;"></td> <td style="width: 10%;"></td> <td style="width: 10%;"></td> <td style="width: 10%;"></td> <td style="width: 10%;"></td> <td style="width: 10%;"></td> <td style="width: 10%;"></td> <td style="width: 10%;"></td> <td style="width: 10%;"></td> </tr> <tr> <td></td> <td></td> <td colspan="8" style="text-align: center;"> <table border="1" style="width: 100%; border-collapse: collapse; text-align: center;"> <tr> <td style="width: 10%;"></td> <td style="width: 10%;"></td> <td style="width: 10%;"></td> <td style="width: 10%;"></td> <td style="width: 10%;"></td> <td style="width: 10%;"></td> <td style="width: 10%;"></td> <td style="width: 10%;"></td> <td style="width: 10%;"></td> <td style="width: 10%;"></td> </tr> <tr> <td></td> <td></td> <td colspan="8" style="text-align: center;"> <table border="1" style="width: 100%; border-collapse: collapse; text-align: center;"> <tr> <td style="width: 10%;"></td> <td style="width: 10%;"></td> <td style="width: 10%;"></td> <td style="width: 10%;"></td> <td style="width: 10%;"></td> <td style="width: 10%;"></td> <td style="width: 10%;"></td> <td style="width: 10%;"></td> <td style="width: 10%;"></td> <td style="width: 10%;"></td> </tr> <tr> <td></td> <td></td> <td colspan="8" style="text-align: center;"> <table border="1" style="width: 100%; border-collapse: collapse; text-align: center;"> <tr> <td style="width: 10%;"></td> <td style="width: 10%;"></td> <td style="width: 10%;"></td> <td style="width: 10%;"></td> <td style="width: 10%;"></td> <td style="width: 10%;"></td> <td style="width: 10%;"></td> <td style="width: 10%;"></td> <td style="width: 10%;"></td> <td style="width: 10%;"></td> </tr> <tr> <td></td> <td></td> <td colspan="8" style="text-align: center;"> <table border="1" style="width: 100%; border-collapse: collapse; text-align: center;"> <tr> <td style="width: 10%;"></td> <td style="width: 10%;"></td> <td style="width: 10%;"></td> <td style="width: 10%;"></td> <td style="width: 10%;"></td> <td style="width: 10%;"></td> <td style="width: 10%;"></td> <td style="width: 10%;"></td> <td style="width: 10%;"></td> <td style="width: 10%;"></td> </tr> <tr> <td></td> <td></td> <td colspan="8" style="text-align: center;"> <table border="1" style="width: 100%; border-collapse: collapse; text-align: center;"> <tr> <td style="width: 10%;"></td> <td style="width: 10%;"></td> <td style="width: 10%;"></td> <td style="width: 10%;"></td> <td style="width: 10%;"></td> <td style="width: 10%;"></td> <td style="width: 10%;"></td> <td style="width: 10%;"></td> <td style="width: 10%;"></td> <td style="width: 10%;"></td> </tr> <tr> <td></td> <td></td> <td colspan="8" style="text-align: center;"> <table border="1" style="width: 100%; border-collapse: collapse; text-align: center;"> <tr> <td style="width: 10%;"></td> <td style="width: 10%;"></td> <td style="width: 10%;"></td> <td style="width: 10%;"></td> <td style="width: 10%;"></td> <td style="width: 10%;"></td> <td style="width: 10%;"></td> <td style="width: 10%;"></td> <td style="width: 10%;"></td> <td style="width: 10%;"></td> </tr> <tr> <td></td> <td></td> <td colspan="8" style="text-align: center;"> <table border="1" style="width: 100%; border-collapse: collapse; text-align: center;"> <tr> <td style="width: 10%;"></td> <td style="width: 10%;"></td> <td style="width: 10%;"></td> <td style="width: 10%;"></td> <td style="width: 10%;"></td> <td style="width: 10%;"></td> <td style="width: 10%;"></td> <td style="width: 10%;"></td> <td style="width: 10%;"></td> <td style="width: 10%;"></td> </tr> <tr> <td></td> <td></td> <td colspan="8" style="text-align: center;"> <table border="1" style="width: 100%; border-collapse: collapse; text-align: center;"> <tr> <td style="width: 10%;"></td> <td style="width: 10%;"></td> <td style="width: 10%;"></td> <td style="width: 10%;"></td> <td style="width: 10%;"></td> <td style="width: 10%;"></td> <td style="width: 10%;"></td> <td style="width: 10%;"></td> <td style="width: 10%;"></td> <td style="width: 10%;"></td> </tr> <tr> <td></td> <td></td> <td colspan="8" style="text-align: center;"> <table border="1" style="width: 100%; border-collapse: collapse; text-align: center;"> <tr> <td style="width: 10%;"></td> <td style="width: 10%;"></td> <td style="width: 10%;"></td> <td style="width: 10%;"></td> <td style="width: 10%;"></td> <td style="width: 10%;"></td> <td style="width: 10%;"></td> <td style="width: 10%;"></td> <td style="width: 10%;"></td> <td style="width: 10%;"></td> </tr> <tr> <td></td> <td></td> <td colspan="8" style="text-align: center;"> <table border="1" style="width: 100%; border-collapse: collapse; text-align: center;"> <tr> <td style="width: 10%;"></td> <td style="width: 10%;"></td> <td style="width: 10%;"></td> <td style="width: 10%;"></td> <td style="width: 10%;"></td> <td style="width: 10%;"></td> <td style="width: 10%;"></td> <td style="width: 10%;"></td> <td style="width: 10%;"></td> <td style="width: 10%;"></td> </tr> <tr> <td></td> <td></td> <td colspan="8" style="text-align: center;"> <table border="1" style="width: 100%; border-collapse: collapse; text-align: center;"> <tr> <td style="width: 10%;"></td> <td style="width: 10%;"></td> <td style="width: 10%;"></td> <td style="width: 10%;"></td> <td style="width: 10%;"></td> <td style="width: 10%;"></td> <td style="width: 10%;"></td> <td style="width: 10%;"></td> <td style="width: 10%;"></td> <td style="width: 10%;"></td> </tr> <tr> <td></td> <td></td> <td
colspan="8" style="text-align: center;"> <table border="1" style="width: 100%; border-collapse: collapse; text-align: center;"> <tr> <td style="width: 10%;"></td> <td style="width: 10%;"></td> <td style="width: 10%;"></td> <td style="width: 10%;"></td> <td style="width: 10%;"></td> <td style="width: 10%;"></td> <td style="width: 10%;"></td> <td style="width: 10%;"></td> <td style="width: 10%;"></td> <td style="width: 10%;"></td> </tr> <tr> <td></td> <td></td> <td colspan="8" style="text-align: center;"> <table border="1" style="width: 100%; border-collapse: collapse; text-align: center;"> <tr> <td style="width: 10%;"></td> <td style="width: 10%;"></td> <td style="width: 10%;"></td> <td style="width: 10%;"></td> <td style="width: 10%;"></td> <td style="width: 10%;"></td> <td style="width: 10%;"></td> <td style="width: 10%;"></td> <td style="width: 10%;"></td> <td style="width: 10%;"></td> </tr> <tr> <td></td> <td></td> <td colspan="8" style="text-align: center;"> <table border="1" style="width: 100%; border-collapse: collapse; text-align: center;"> <tr> <td style="width: 10%;"></td> <td style="width: 10%;"></td> <td style="width: 10%;"></td> <td style="width: 10%;"></td> <td style="width: 10%;"></td> <td style="width: 10%;"></td> <td style="width: 10%;"></td> <td style="width: 10%;"></td> <td style="width: 10%;"></td> <td style="width: 10%;"></td> </tr> <tr> <td></td> <td></td> <td colspan="8" style="text-align: center;"> <table border="1" style="width: 100%; border-collapse: collapse; text-align: center;"> <tr> <td style="width: 10%;"></td> <td style="width: 10%;"></td> <td style="width: 10%;"></td> <td style="width: 10%;"></td> <td style="width: 10%;"></td> <td style="width: 10%;"></td> <td style="width: 10%;"></td> <td style="width: 10%;"></td> <td style="width: 10%;"></td> <td style="width: 10%;"></td> </tr> <tr> <td></td> <td></td> <td colspan="8" style="text-align: center;"> <table border="1" style="width: 100%; border-collapse: collapse; text-align: center;"> <tr> <td style="width: 10%;"></td> <td style="width: 10%;"></td> <td style="width: 10%;"></td> <td style="width: 10%;"></td> <td style="width: 10%;"></td> <td style="width: 10%;"></td> <td style="width: 10%;"></td> <td style="width: 10%;"></td> <td style="width: 10%;"></td> <td style="width: 10%;"></td> </tr> <tr> <td></td> <td></td> <td colspan="8" style="text-align: center;"> <table border="1" style="width: 100%; border-collapse: collapse; text-align: center;"> <tr> <td style="width: 10%;"></td> <td style="width: 10%;"></td> <td style="width: 10%;"></td> <td style="width: 10%;"></td> <td style="width: 10%;"></td> <td style="width: 10%;"></td> <td style="width: 10%;"></td> <td style="width: 10%;"></td> <td style="width: 10%;"></td> <td style="width: 10%;"></td> </tr> <tr> <td></td> <td></td> <td colspan="8" style="text-align: center;"> <table border="1" style="width: 100%; border-collapse: collapse; text-align: center;"> <tr> <td style="width: 10%;"></td> <td style="width: 10%;"></td> <td style="width: 10%;"></td> <td style="width: 10%;"></td> <td style="width: 10%;"></td> <td style="width: 10%;"></td> <td style="width: 10%;"></td> <td style="width: 10%;"></td> <td style="width: 10%;"></td> <td style="width: 10%;"></td> </tr> <tr> <td></td> <td></td> <td colspan="8" style="text-align: center;"> <table border="1" style="width: 100%; border-collapse: collapse; text-align: center;"> <tr> <td style="width: 10%;"></td> <td style="width: 10%;"></td> <td style="width: 10%;"></td> <td style="width: 10%;"></td> <td style="width: 10%;"></td> <td style="width: 10%;"></td> <td style="width: 10%;"></td> <td style="width: 10%;"></td> <td style="width: 10%;"></td> <td style="width: 10%;"></td> </tr> <tr> <td></td> <td></td> <td colspan="8" style="text-align: center;"> <table border="1" style="width: 100%; border-collapse: collapse; text-align: center;"> <tr> <td style="width: 10%;"></td> <td style="width: 10%;"></td> <td style="width: 10%;"></td> <td style="width: 10%;"></td> <td style="width: 10%;"></td> <td style="width: 10%;"></td> <td style="width: 10%;"></td> <td style="width: 10%;"></td> <td style="width: 10%;"></td> <td style="width: 10%;"></td> </tr> <tr> <td></td> <td></td> <td colspan="8" style="text-align: center;"> <table border="1" style="width: 100%; border-collapse: collapse; text-align: center;"> <tr> <td style="width: 10%;"></td> <td style="width: 10%;"></td> <td style="width: 10%;"></td> <td style="width: 10%;"></td> <td style="width: 10%;"></td> <td style="width: 10%;"></td> <td style="width: 10%;"></td> <td style="width: 10%;"></td> <td style="width: 10%;"></td> <td style="width: 10%;"></td> </tr> <tr> <td></td> <td></td> <td colspan="8" style="text-align: center;"> <table border="1" style="width: 100%; border-collapse: collapse; text-align: center;"> <tr> <td style="width: 10%;"></td> <td style="width: 10%;"></td> <td style="width: 10%;"></td> <td style="width: 10%;"></td> <td style="width: 10%;"></td> <td style="width: 10%;"></td> <td style="width: 10%;"></td> <td style="width: 10%;"></td> <td style="width: 10%;"></td> <td style="width: 10%;"></td> </tr> <tr> <td></td> <td></td> <td colspan="8" style="text-align: center;"> <table border="1" style="width: 100%; border-collapse: collapse; text-align: center;"> <tr> <td style="width: 10%;"></td> <td style="width: 10%;"></td> <td style="width: 10%;"></td> <td style="width: 10%;"></td> <td style="width: 10%;"></td> <td style="width: 10%;"></td> <td style="width: 10%;"></td> <td style="width: 10%;"></td> <td style="width: 10%;"></td> <td style="width: 10%;"></td> </tr> <tr> <td></td> <td></td> <td colspan="8" style="text-align: center;"> <table border="1" style="width: 100%; border-collapse: collapse; text-align: center;"> <tr> <td style="width: 10%;"></td> <td style="width: 10%;"></td> <td style="width: 10%;"></td> <td style="width: 10%;"></td> <td style="width: 10%;"></td> <td style="width: 10%;"></td> <td style="width: 10%;"></td> <td style="width: 10%;"></td> <td style="width: 10%;"></td> <td style="width: 10%;"></td> </tr> <tr> <td></td> <td></td> <td colspan="8" style="text-align: center;"> <table border="1" style="width: 100%; border-collapse: collapse; text-align: center;"> <tr> <td style="width: 10%;"></td> <td style="width: 10%;"></td> <td style="width: 10%;"></td> <td style="width: 10%;"></td> <td style="width: 10%;"></td> <td style="width: 10%;"></td> <td style="width: 10%;"></td> <td style="width: 10%;"></td> <td style="width: 10%;"></td> <td style="width: 10%;"></td> </tr> <tr> <td></td> <td></td> <td colspan="8" style="text-align: center;"> <table border="1" style="width: 100%; border-collapse: collapse; text-align: center;"> <tr> <td style="width: 10%;"></td> <td style="width: 10%;"></td> <td style="width: 10%;"></td> <td style="width: 10%;"></td> <td style="width: 10%;"></td> <td style="width: 10%;"></td> <td style="width: 10%;"></td> <td style="width: 10%;"></td> <td style="width: 10%;"></td> <td style="width: 10%;"></td> </tr> <tr> <td></td> <td></td> <td colspan="8" style="text-align: center;"> <table border="1" style="width: 100%; border-collapse: collapse; text-align: center;"> <tr> </tr></table></td></tr></table></td></tr></table></td></tr></table></td></tr></table></td></tr></table></td></tr></table></td></tr></table></td></tr></table></td></tr></table></td></tr></table></td></tr></table></td></tr></table></td></tr></table></td></tr></table></td></tr></table></td></tr></table></td></tr></table></td></tr></table></td></tr></table></td></tr></table></td></tr></table></td></tr></table></td></tr></table></td></tr></table></td></tr></table></td></tr></table></td></tr></table></td></tr></table></td></tr></table></td></tr></table></td></tr></table></td></tr></table>

 | | | | | | | | | | | | | | | | | | | | <table border="1" style="width: 100%; border-collapse: collapse; text-align: center;"> <tr> <td style="width: 10%;"></td> <td style="width: 10%;"></td> <td style="width: 10%;"></td> <td style="width: 10%;"></td> <td style="width: 10%;"></td> <td style="width: 10%;"></td> <td style="width: 10%;"></td> <td style="width: 10%;"></td> <td style="width: 10%;"></td> <td style="width: 10%;"></td> </tr> <tr> <td></td> <td></td> <td colspan="8" style="text-align: center;"> <table border="1" style="width: 100%; border-collapse: collapse; text-align: center;"> <tr> <td style="width: 10%;"></td> <td style="width: 10%;"></td> <td style="width: 10%;"></td> <td style="width: 10%;"></td> <td style="width: 10%;"></td> <td style="width: 10%;"></td> <td style="width: 10%;"></td> <td style="width: 10%;"></td> <td style="width: 10%;"></td> <td style="width: 10%;"></td> </tr> <tr> <td></td> <td></td> <td colspan="8" style="text-align: center;"> <table border="1" style="width: 100%; border-collapse: collapse; text-align: center;"> <tr> <td style="width: 10%;"></td> <td style="width: 10%;"></td> <td style="width: 10%;"></td> <td style="width: 10%;"></td> <td style="width: 10%;"></td> <td style="width: 10%;"></td> <td style="width: 10%;"></td> <td style="width: 10%;"></td> <td style="width: 10%;"></td> <td style="width: 10%;"></td> </tr> <tr> <td></td> <td></td> <td colspan="8" style="text-align: center;"> <table border="1" style="width: 100%; border-collapse: collapse; text-align: center;"> <tr> <td style="width: 10%;"></td> <td style="width: 10%;"></td> <td style="width: 10%;"></td> <td style="width: 10%;"></td> <td style="width: 10%;"></td> <td style="width: 10%;"></td> <td style="width: 10%;"></td> <td style="width: 10%;"></td> <td style="width: 10%;"></td> <td style="width: 10%;"></td> </tr> <tr> <td></td> <td></td> <td colspan="8" style="text-align: center;"> <table border="1" style="width: 100%; border-collapse: collapse; text-align: center;"> <tr> <td style="width: 10%;"></td> <td style="width: 10%;"></td> <td style="width: 10%;"></td> <td style="width: 10%;"></td> <td style="width: 10%;"></td> <td style="width: 10%;"></td> <td style="width: 10%;"></td> <td style="width: 10%;"></td> <td style="width: 10%;"></td> <td style="width: 10%;"></td> </tr> <tr> <td></td> <td></td> <td colspan="8" style="text-align: center;"> <table border="1" style="width: 100%; border-collapse: collapse; text-align: center;"> <tr> <td style="width: 10%;"></td> <td style="width: 10%;"></td> <td style="width: 10%;"></td> <td style="width: 10%;"></td> <td style="width: 10%;"></td> <td style="width: 10%;"></td> <td style="width: 10%;"></td> <td style="width: 10%;"></td> <td style="width: 10%;"></td> <td style="width: 10%;"></td> </tr> <tr> <td></td> <td></td> <td colspan="8" style="text-align: center;"> <table border="1" style="width: 100%; border-collapse: collapse; text-align: center;"> <tr> <td style="width: 10%;"></td> <td style="width: 10%;"></td> <td style="width: 10%;"></td> <td style="width: 10%;"></td> <td style="width: 10%;"></td> <td style="width: 10%;"></td> <td style="width: 10%;"></td> <td style="width: 10%;"></td> <td style="width: 10%;"></td> <td style="width: 10%;"></td> </tr> <tr> <td></td> <td></td> <td colspan="8" style="text-align: center;"> <table border="1" style="width: 100%; border-collapse: collapse; text-align: center;"> <tr> <td style="width: 10%;"></td> <td style="width: 10%;"></td> <td style="width: 10%;"></td> <td style="width: 10%;"></td> <td style="width: 10%;"></td> <td style="width: 10%;"></td> <td style="width: 10%;"></td> <td style="width: 10%;"></td> <td style="width: 10%;"></td> <td style="width: 10%;"></td> </tr> <tr> <td></td> <td></td> <td colspan="8" style="text-align: center;"> <table border="1" style="width: 100%; border-collapse: collapse; text-align: center;"> <tr> <td style="width: 10%;"></td> <td style="width: 10%;"></td> <td style="width: 10%;"></td> <td style="width: 10%;"></td> <td style="width: 10%;"></td> <td style="width: 10%;"></td> <td style="width: 10%;"></td> <td style="width: 10%;"></td> <td style="width: 10%;"></td> <td style="width: 10%;"></td> </tr> <tr> <td></td> <td></td> <td colspan="8" style="text-align: center;"> <table border="1" style="width: 100%; border-collapse: collapse; text-align: center;"> <tr> <td style="width: 10%;"></td> <td style="width: 10%;"></td> <td style="width: 10%;"></td> <td style="width: 10%;"></td> <td style="width: 10%;"></td> <td style="width: 10%;"></td> <td style="width: 10%;"></td> <td style="width: 10%;"></td> <td style="width: 10%;"></td> <td style="width: 10%;"></td> </tr> <tr> <td></td> <td></td> <td colspan="8" style="text-align: center;"> <table border="1" style="width: 100%; border-collapse: collapse; text-align: center;"> <tr> <td style="width: 10%;"></td> <td style="width: 10%;"></td> <td style="width: 10%;"></td> <td style="width: 10%;"></td> <td style="width: 10%;"></td> <td style="width: 10%;"></td> <td style="width: 10%;"></td> <td style="width: 10%;"></td> <td style="width: 10%;"></td> <td style="width: 10%;"></td> </tr> <tr> <td></td> <td></td> <td colspan="8" style="text-align: center;"> <table border="1" style="width: 100%; border-collapse: collapse; text-align: center;"> <tr> <td style="width: 10%;"></td> <td style="width: 10%;"></td> <td style="width: 10%;"></td> <td style="width: 10%;"></td> <td style="width: 10%;"></td> <td style="width: 10%;"></td> <td style="width: 10%;"></td> <td style="width: 10%;"></td> <td style="width: 10%;"></td> <td style="width: 10%;"></td> </tr> <tr> <td></td> <td></td> <td colspan="8" style="text-align: center;"> <table border="1" style="width: 100%; border-collapse: collapse; text-align: center;"> <tr> <td style="width: 10%;"></td> <td style="width: 10%;"></td> <td style="width: 10%;"></td> <td style="width: 10%;"></td> <td style="width: 10%;"></td> <td style="width: 10%;"></td> <td style="width: 10%;"></td> <td style="width: 10%;"></td> <td style="width: 10%;"></td> <td style="width: 10%;"></td> </tr> <tr> <td></td> <td></td> <td colspan="8" style="text-align: center;"> <table border="1" style="width: 100%; border-collapse: collapse; text-align: center;"> <tr> <td style="width: 10%;"></td> <td style="width: 10%;"></td> <td style="width: 10%;"></td> <td style="width: 10%;"></td> <td style="width: 10%;"></td> <td style="width: 10%;"></td> <td style="width: 10%;"></td> <td style="width: 10%;"></td> <td style="width: 10%;"></td> <td style="width: 10%;"></td> </tr> <tr> <td></td> <td></td> <td colspan="8" style="text-align: center;"> <table border="1" style="width: 100%; border-collapse: collapse; text-align: center;"> <tr> <td style="width: 10%;"></td> <td style="width: 10%;"></td> <td style="width: 10%;"></td> <td style="width: 10%;"></td> <td style="width: 10%;"></td> <td style="width: 10%;"></td> <td style="width: 10%;"></td> <td style="width: 10%;"></td> <td style="width: 10%;"></td> <td style="width: 10%;"></td> </tr> <tr> <td></td> <td></td> <td colspan="8" style="text-align: center;"> <table border="1" style="width: 100%; border-collapse: collapse; text-align: center;"> <tr> <td style="width: 10%;"></td> <td style="width: 10%;"></td> <td style="width: 10%;"></td> <td style="width: 10%;"></td> <td style="width: 10%;"></td> <td style="width: 10%;"></td> <td style="width: 10%;"></td> <td style="width: 10%;"></td> <td style="width: 10%;"></td> <td style="width: 10%;"></td> </tr> <tr> <td></td> <td></td> <td colspan="8" style="text-align: center;"> <table border="1" style="width: 100%; border-collapse: collapse; text-align: center;"> <tr> <td style="width: 10%;"></td> <td
style="width: 10%;"></td> <td style="width: 10%;"></td> <td style="width: 10%;"></td> <td style="width: 10%;"></td> <td style="width: 10%;"></td> <td style="width: 10%;"></td> <td style="width: 10%;"></td> <td style="width: 10%;"></td> <td style="width: 10%;"></td> </tr> <tr> <td></td> <td></td> <td colspan="8" style="text-align: center;"> <table border="1" style="width: 100%; border-collapse: collapse; text-align: center;"> <tr> <td style="width: 10%;"></td> <td style="width: 10%;"></td> <td style="width: 10%;"></td> <td style="width: 10%;"></td> <td style="width: 10%;"></td> <td style="width: 10%;"></td> <td style="width: 10%;"></td> <td style="width: 10%;"></td> <td style="width: 10%;"></td> <td style="width: 10%;"></td> </tr> <tr> <td></td> <td></td> <td colspan="8" style="text-align: center;"> <table border="1" style="width: 100%; border-collapse: collapse; text-align: center;"> <tr> <td style="width: 10%;"></td> <td style="width: 10%;"></td> <td style="width: 10%;"></td> <td style="width: 10%;"></td> <td style="width: 10%;"></td> <td style="width: 10%;"></td> <td style="width: 10%;"></td> <td style="width: 10%;"></td> <td style="width: 10%;"></td> <td style="width: 10%;"></td> </tr> <tr> <td></td> <td></td> <td colspan="8" style="text-align: center;"> <table border="1" style="width: 100%; border-collapse: collapse; text-align: center;"> <tr> <td style="width: 10%;"></td> <td style="width: 10%;"></td> <td style="width: 10%;"></td> <td style="width: 10%;"></td> <td style="width: 10%;"></td> <td style="width: 10%;"></td> <td style="width: 10%;"></td> <td style="width: 10%;"></td> <td style="width: 10%;"></td> <td style="width: 10%;"></td> </tr> <tr> <td></td> <td></td> <td colspan="8" style="text-align: center;"> <table border="1" style="width: 100%; border-collapse: collapse; text-align: center;"> <tr> <td style="width: 10%;"></td> <td style="width: 10%;"></td> <td style="width: 10%;"></td> <td style="width: 10%;"></td> <td style="width: 10%;"></td> <td style="width: 10%;"></td> <td style="width: 10%;"></td> <td style="width: 10%;"></td> <td style="width: 10%;"></td> <td style="width: 10%;"></td> </tr> <tr> <td></td> <td></td> <td colspan="8" style="text-align: center;"> <table border="1" style="width: 100%; border-collapse: collapse; text-align: center;"> <tr> <td style="width: 10%;"></td> <td style="width: 10%;"></td> <td style="width: 10%;"></td> <td style="width: 10%;"></td> <td style="width: 10%;"></td> <td style="width: 10%;"></td> <td style="width: 10%;"></td> <td style="width: 10%;"></td> <td style="width: 10%;"></td> <td style="width: 10%;"></td> </tr> <tr> <td></td> <td></td> <td colspan="8" style="text-align: center;"> <table border="1" style="width: 100%; border-collapse: collapse; text-align: center;"> <tr> <td style="width: 10%;"></td> <td style="width: 10%;"></td> <td style="width: 10%;"></td> <td style="width: 10%;"></td> <td style="width: 10%;"></td> <td style="width: 10%;"></td> <td style="width: 10%;"></td> <td style="width: 10%;"></td> <td style="width: 10%;"></td> <td style="width: 10%;"></td> </tr> <tr> <td></td> <td></td> <td colspan="8" style="text-align: center;"> <table border="1" style="width: 100%; border-collapse: collapse; text-align: center;"> <tr> <td style="width: 10%;"></td> <td style="width: 10%;"></td> <td style="width: 10%;"></td> <td style="width: 10%;"></td> <td style="width: 10%;"></td> <td style="width: 10%;"></td> <td style="width: 10%;"></td> <td style="width: 10%;"></td> <td style="width: 10%;"></td> <td style="width: 10%;"></td> </tr> <tr> <td></td> <td></td> <td colspan="8" style="text-align: center;"> <table border="1" style="width: 100%; border-collapse: collapse; text-align: center;"> <tr> <td style="width: 10%;"></td> <td style="width: 10%;"></td> <td style="width: 10%;"></td> <td style="width: 10%;"></td> <td style="width: 10%;"></td> <td style="width: 10%;"></td> <td style="width: 10%;"></td> <td style="width: 10%;"></td> <td style="width: 10%;"></td> <td style="width: 10%;"></td> </tr> <tr> <td></td> <td></td> <td colspan="8" style="text-align: center;"> <table border="1" style="width: 100%; border-collapse: collapse; text-align: center;"> <tr> <td style="width: 10%;"></td> <td style="width: 10%;"></td> <td style="width: 10%;"></td> <td style="width: 10%;"></td> <td style="width: 10%;"></td> <td style="width: 10%;"></td> <td style="width: 10%;"></td> <td style="width: 10%;"></td> <td style="width: 10%;"></td> <td style="width: 10%;"></td> </tr> <tr> <td></td> <td></td> <td colspan="8" style="text-align: center;"> <table border="1" style="width: 100%; border-collapse: collapse; text-align: center;"> <tr> <td style="width: 10%;"></td> <td style="width: 10%;"></td> <td style="width: 10%;"></td> <td style="width: 10%;"></td> <td style="width: 10%;"></td> <td style="width: 10%;"></td> <td style="width: 10%;"></td> <td style="width: 10%;"></td> <td style="width: 10%;"></td> <td style="width: 10%;"></td> </tr> <tr> <td></td> <td></td> <td colspan="8" style="text-align: center;"> <table border="1" style="width: 100%; border-collapse: collapse; text-align: center;"> <tr> <td style="width: 10%;"></td> <td style="width: 10%;"></td> <td style="width: 10%;"></td> <td style="width: 10%;"></td> <td style="width: 10%;"></td> <td style="width: 10%;"></td> <td style="width: 10%;"></td> <td style="width: 10%;"></td> <td style="width: 10%;"></td> <td style="width: 10%;"></td> </tr> <tr> <td></td> <td></td> <td colspan="8" style="text-align: center;"> <table border="1" style="width: 100%; border-collapse: collapse; text-align: center;"> <tr> <td style="width: 10%;"></td> <td style="width: 10%;"></td> <td style="width: 10%;"></td> <td style="width: 10%;"></td> <td style="width: 10%;"></td> <td style="width: 10%;"></td> <td style="width: 10%;"></td> <td style="width: 10%;"></td> <td style="width: 10%;"></td> <td style="width: 10%;"></td> </tr> <tr> <td></td> <td></td> <td colspan="8" style="text-align: center;"> <table border="1" style="width: 100%; border-collapse: collapse; text-align: center;"> <tr> <td style="width: 10%;"></td> <td style="width: 10%;"></td> <td style="width: 10%;"></td> <td style="width: 10%;"></td> <td style="width: 10%;"></td> <td style="width: 10%;"></td> <td style="width: 10%;"></td> <td style="width: 10%;"></td> <td style="width: 10%;"></td> <td style="width: 10%;"></td> </tr> <tr> <td></td> <td></td> <td colspan="8" style="text-align: center;"> <table border="1" style="width: 100%; border-collapse: collapse; text-align: center;"> <tr> <td style="width: 10%;"></td> <td style="width: 10%;"></td> <td style="width: 10%;"></td> <td style="width: 10%;"></td> <td style="width: 10%;"></td> <td style="width: 10%;"></td> <td style="width: 10%;"></td> <td style="width: 10%;"></td> <td style="width: 10%;"></td> <td style="width: 10%;"></td> </tr> <tr> <td></td> <td></td> <td colspan="8" style="text-align: center;"> <table border="1" style="width: 100%; border-collapse: collapse; text-align: center;"> <tr> </tr></table></td></tr></table></td></tr></table></td></tr></table></td></tr></table></td></tr></table></td></tr></table></td></tr></table></td></tr></table></td></tr></table></td></tr></table></td></tr></table></td></tr></table></td></tr></table></td></tr></table></td></tr></table></td></tr></table></td></tr></table></td></tr></table></td></tr></table></td></tr></table></td></tr></table></td></tr></table></td></tr></table></td></tr></table></td></tr></table></td></tr></table></td></tr></table></td></tr></table></td></tr></table></td></tr></table></td></tr></table>

 | | | | | | | | | | | | | | | | | | | | <table border="1" style="width: 100%; border-collapse: collapse; text-align: center;"> <tr> <td style="width: 10%;"></td> <td style="width: 10%;"></td> <td style="width: 10%;"></td> <td style="width: 10%;"></td> <td style="width: 10%;"></td> <td style="width: 10%;"></td> <td style="width: 10%;"></td> <td style="width: 10%;"></td> <td style="width: 10%;"></td> <td style="width: 10%;"></td> </tr> <tr> <td></td> <td></td> <td colspan="8" style="text-align: center;"> <table border="1" style="width: 100%; border-collapse: collapse; text-align: center;"> <tr> <td style="width: 10%;"></td> <td style="width: 10%;"></td> <td style="width: 10%;"></td> <td style="width: 10%;"></td> <td style="width: 10%;"></td> <td style="width: 10%;"></td> <td style="width: 10%;"></td> <td style="width: 10%;"></td> <td style="width: 10%;"></td> <td style="width: 10%;"></td> </tr> <tr> <td></td> <td></td> <td colspan="8" style="text-align: center;"> <table border="1" style="width: 100%; border-collapse: collapse; text-align: center;"> <tr> <td style="width: 10%;"></td> <td style="width: 10%;"></td> <td style="width: 10%;"></td> <td style="width: 10%;"></td> <td style="width: 10%;"></td> <td style="width: 10%;"></td> <td style="width: 10%;"></td> <td style="width: 10%;"></td> <td style="width: 10%;"></td> <td style="width: 10%;"></td> </tr> <tr> <td></td> <td></td> <td colspan="8" style="text-align: center;"> <table border="1" style="width: 100%; border-collapse: collapse; text-align: center;"> <tr> <td style="width: 10%;"></td> <td style="width: 10%;"></td> <td style="width: 10%;"></td> <td style="width: 10%;"></td> <td style="width: 10%;"></td> <td style="width: 10%;"></td> <td style="width: 10%;"></td> <td style="width: 10%;"></td> <td style="width: 10%;"></td> <td style="width: 10%;"></td> </tr> <tr> <td></td> <td></td> <td colspan="8" style="text-align: center;"> <table border="1" style="width: 100%; border-collapse: collapse; text-align: center;"> <tr> <td style="width: 10%;"></td> <td style="width: 10%;"></td> <td style="width: 10%;"></td> <td style="width: 10%;"></td> <td style="width: 10%;"></td> <td style="width: 10%;"></td> <td style="width: 10%;"></td> <td style="width: 10%;"></td> <td style="width: 10%;"></td> <td style="width: 10%;"></td> </tr> <tr> <td></td> <td></td> <td colspan="8" style="text-align: center;"> <table border="1" style="width: 100%; border-collapse: collapse; text-align: center;"> <tr> <td style="width: 10%;"></td> <td style="width: 10%;"></td> <td style="width: 10%;"></td> <td style="width: 10%;"></td> <td style="width: 10%;"></td> <td style="width: 10%;"></td> <td style="width: 10%;"></td> <td style="width: 10%;"></td> <td style="width: 10%;"></td> <td style="width: 10%;"></td> </tr> <tr> <td></td> <td></td> <td colspan="8" style="text-align: center;"> <table border="1" style="width: 100%; border-collapse: collapse; text-align: center;"> <tr> <td style="width: 10%;"></td> <td style="width: 10%;"></td> <td style="width: 10%;"></td> <td style="width: 10%;"></td> <td style="width: 10%;"></td> <td style="width: 10%;"></td> <td style="width: 10%;"></td> <td style="width: 10%;"></td> <td style="width: 10%;"></td> <td style="width: 10%;"></td> </tr> <tr> <td></td> <td></td> <td colspan="8" style="text-align: center;"> <table border="1" style="width: 100%; border-collapse: collapse; text-align: center;"> <tr> <td style="width: 10%;"></td> <td style="width: 10%;"></td> <td style="width: 10%;"></td> <td style="width: 10%;"></td> <td style="width: 10%;"></td> <td style="width: 10%;"></td> <td style="width: 10%;"></td> <td style="width: 10%;"></td> <td style="width: 10%;"></td> <td style="width: 10%;"></td> </tr> <tr> <td></td> <td></td> <td colspan="8" style="text-align: center;"> <table border="1" style="width: 100%; border-collapse: collapse; text-align: center;"> <tr> <td style="width: 10%;"></td> <td style="width: 10%;"></td> <td style="width: 10%;"></td> <td style="width: 10%;"></td> <td style="width: 10%;"></td> <td style="width: 10%;"></td> <td style="width: 10%;"></td> <td style="width: 10%;"></td> <td style="width: 10%;"></td> <td style="width: 10%;"></td> </tr> <tr> <td></td> <td></td> <td colspan="8" style="text-align: center;"> <table border="1" style="width: 100%; border-collapse: collapse; text-align: center;"> <tr> <td style="width: 10%;"></td> <td style="width: 10%;"></td> <td style="width: 10%;"></td> <td style="width: 10%;"></td> <td style="width: 10%;"></td> <td style="width: 10%;"></td> <td style="width: 10%;"></td> <td style="width: 10%;"></td> <td style="width: 10%;"></td> <td style="width: 10%;"></td> </tr> <tr> <td></td> <td></td> <td colspan="8" style="text-align: center;"> <table border="1" style="width: 100%; border-collapse: collapse; text-align: center;"> <tr> <td style="width: 10%;"></td> <td style="width: 10%;"></td> <td style="width: 10%;"></td> <td style="width: 10%;"></td> <td style="width: 10%;"></td> <td style="width: 10%;"></td> <td style="width: 10%;"></td> <td style="width: 10%;"></td> <td style="width: 10%;"></td> <td style="width: 10%;"></td> </tr> <tr> <td></td> <td></td> <td colspan="8" style="text-align: center;"> <table border="1" style="width: 100%; border-collapse: collapse; text-align: center;"> <tr> <td style="width: 10%;"></td> <td style="width: 10%;"></td> <td style="width: 10%;"></td> <td style="width: 10%;"></td> <td style="width: 10%;"></td> <td style="width: 10%;"></td> <td style="width: 10%;"></td> <td style="width: 10%;"></td> <td style="width: 10%;"></td> <td style="width: 10%;"></td> </tr> <tr> <td></td> <td></td> <td colspan="8" style="text-align: center;"> <table border="1" style="width: 100%; border-collapse: collapse; text-align: center;"> <tr> <td style="width: 10%;"></td> <td style="width: 10%;"></td> <td style="width: 10%;"></td> <td style="width: 10%;"></td> <td style="width: 10%;"></td> <td style="width: 10%;"></td> <td style="width: 10%;"></td> <td style="width: 10%;"></td> <td style="width: 10%;"></td> <td style="width: 10%;"></td> </tr> <tr> <td></td> <td></td> <td colspan="8" style="text-align: center;"> <table border="1" style="width: 100%; border-collapse: collapse; text-align: center;"> <tr> <td style="width: 10%;"></td> <td style="width: 10%;"></td> <td style="width: 10%;"></td> <td style="width: 10%;"></td> <td style="width: 10%;"></td> <td style="width: 10%;"></td> <td style="width: 10%;"></td> <td style="width: 10%;"></td> <td style="width: 10%;"></td> <td style="width: 10%;"></td> </tr> <tr> <td></td> <td></td> <td colspan="8" style="text-align: center;"> <table border="1" style="width: 100%; border-collapse: collapse; text-align: center;"> <tr> <td style="width: 10%;"></td> <td style="width: 10%;"></td> <td style="width: 10%;"></td> <td style="width: 10%;"></td> <td style="width: 10%;"></td> <td style="width: 10%;"></td> <td style="width: 10%;"></td> <td style="width: 10%;"></td> <td style="width: 10%;"></td> <td style="width: 10%;"></td> </tr> <tr> <td></td> <td></td> <td colspan="8" style="text-align: center;"> <table border="1" style="width: 100%; border-collapse: collapse; text-align: center;"> <tr> <td style="width: 10%;"></td> <td style="width: 10%;"></td> <td style="width: 10%;"></td> <td style="width: 10%;"></td> <td style="width: 10%;"></td> <td style="width: 10%;"></td> <td style="width: 10%;"></td> <td style="width: 10%;"></td> <td style="width: 10%;"></td> <td style="width: 10%;"></td> </tr> <tr> <td></td> <td></td> <td colspan="8" style="text-align: center;"> <table border="1" style="width: 100%; border-collapse: collapse; text-align: center;"> <tr> <td style="width: 10%;"></td> <td style="width: 10%;"></td> <td style="width: 10%;"></td> <td style="width: 10%;"></td> <td style="width: 10%;"></td> <td style="width: 10%;"></td> <td style="width: 10%;"></td> <td
style="width: 10%;"></td> <td style="width: 10%;"></td> <td style="width: 10%;"></td> </tr> <tr> <td></td> <td></td> <td colspan="8" style="text-align: center;"> <table border="1" style="width: 100%; border-collapse: collapse; text-align: center;"> <tr> <td style="width: 10%;"></td> <td style="width: 10%;"></td> <td style="width: 10%;"></td> <td style="width: 10%;"></td> <td style="width: 10%;"></td> <td style="width: 10%;"></td> <td style="width: 10%;"></td> <td style="width: 10%;"></td> <td style="width: 10%;"></td> <td style="width: 10%;"></td> </tr> <tr> <td></td> <td></td> <td colspan="8" style="text-align: center;"> <table border="1" style="width: 100%; border-collapse: collapse; text-align: center;"> <tr> <td style="width: 10%;"></td> <td style="width: 10%;"></td> <td style="width: 10%;"></td> <td style="width: 10%;"></td> <td style="width: 10%;"></td> <td style="width: 10%;"></td> <td style="width: 10%;"></td> <td style="width: 10%;"></td> <td style="width: 10%;"></td> <td style="width: 10%;"></td> </tr> <tr> <td></td> <td></td> <td colspan="8" style="text-align: center;"> <table border="1" style="width: 100%; border-collapse: collapse; text-align: center;"> <tr> <td style="width: 10%;"></td> <td style="width: 10%;"></td> <td style="width: 10%;"></td> <td style="width: 10%;"></td> <td style="width: 10%;"></td> <td style="width: 10%;"></td> <td style="width: 10%;"></td> <td style="width: 10%;"></td> <td style="width: 10%;"></td> <td style="width: 10%;"></td> </tr> <tr> <td></td> <td></td> <td colspan="8" style="text-align: center;"> <table border="1" style="width: 100%; border-collapse: collapse; text-align: center;"> <tr> <td style="width: 10%;"></td> <td style="width: 10%;"></td> <td style="width: 10%;"></td> <td style="width: 10%;"></td> <td style="width: 10%;"></td> <td style="width: 10%;"></td> <td style="width: 10%;"></td> <td style="width: 10%;"></td> <td style="width: 10%;"></td> <td style="width: 10%;"></td> </tr> <tr> <td></td> <td></td> <td colspan="8" style="text-align: center;"> <table border="1" style="width: 100%; border-collapse: collapse; text-align: center;"> <tr> <td style="width: 10%;"></td> <td style="width: 10%;"></td> <td style="width: 10%;"></td> <td style="width: 10%;"></td> <td style="width: 10%;"></td> <td style="width: 10%;"></td> <td style="width: 10%;"></td> <td style="width: 10%;"></td> <td style="width: 10%;"></td> <td style="width: 10%;"></td> </tr> <tr> <td></td> <td></td> <td colspan="8" style="text-align: center;"> <table border="1" style="width: 100%; border-collapse: collapse; text-align: center;"> <tr> <td style="width: 10%;"></td> <td style="width: 10%;"></td> <td style="width: 10%;"></td> <td style="width: 10%;"></td> <td style="width: 10%;"></td> <td style="width: 10%;"></td> <td style="width: 10%;"></td> <td style="width: 10%;"></td> <td style="width: 10%;"></td> <td style="width: 10%;"></td> </tr> <tr> <td></td> <td></td> <td colspan="8" style="text-align: center;"> <table border="1" style="width: 100%; border-collapse: collapse; text-align: center;"> <tr> <td style="width: 10%;"></td> <td style="width: 10%;"></td> <td style="width: 10%;"></td> <td style="width: 10%;"></td> <td style="width: 10%;"></td> <td style="width: 10%;"></td> <td style="width: 10%;"></td> <td style="width: 10%;"></td> <td style="width: 10%;"></td> <td style="width: 10%;"></td> </tr> <tr> <td></td> <td></td> <td colspan="8" style="text-align: center;"> <table border="1" style="width: 100%; border-collapse: collapse; text-align: center;"> <tr> <td style="width: 10%;"></td> <td style="width: 10%;"></td> <td style="width: 10%;"></td> <td style="width: 10%;"></td> <td style="width: 10%;"></td> <td style="width: 10%;"></td> <td style="width: 10%;"></td> <td style="width: 10%;"></td> <td style="width: 10%;"></td> <td style="width: 10%;"></td> </tr> <tr> <td></td> <td></td> <td colspan="8" style="text-align: center;"> <table border="1" style="width: 100%; border-collapse: collapse; text-align: center;"> <tr> <td style="width: 10%;"></td> <td style="width: 10%;"></td> <td style="width: 10%;"></td> <td style="width: 10%;"></td> <td style="width: 10%;"></td> <td style="width: 10%;"></td> <td style="width: 10%;"></td> <td style="width: 10%;"></td> <td style="width: 10%;"></td> <td style="width: 10%;"></td> </tr> <tr> <td></td> <td></td> <td colspan="8" style="text-align: center;"> <table border="1" style="width: 100%; border-collapse: collapse; text-align: center;"> <tr> <td style="width: 10%;"></td> <td style="width: 10%;"></td> <td style="width: 10%;"></td> <td style="width: 10%;"></td> <td style="width: 10%;"></td> <td style="width: 10%;"></td> <td style="width: 10%;"></td> <td style="width: 10%;"></td> <td style="width: 10%;"></td> <td style="width: 10%;"></td> </tr> <tr> <td></td> <td></td> <td colspan="8" style="text-align: center;"> <table border="1" style="width: 100%; border-collapse: collapse; text-align: center;"> <tr> <td style="width: 10%;"></td> <td style="width: 10%;"></td> <td style="width: 10%;"></td> <td style="width: 10%;"></td> <td style="width: 10%;"></td> <td style="width: 10%;"></td> <td style="width: 10%;"></td> <td style="width: 10%;"></td> <td style="width: 10%;"></td> <td style="width: 10%;"></td> </tr> <tr> <td></td> <td></td> <td colspan="8" style="text-align: center;"> <table border="1" style="width: 100%; border-collapse: collapse; text-align: center;"> <tr> <td style="width: 10%;"></td> <td style="width: 10%;"></td> <td style="width: 10%;"></td> <td style="width: 10%;"></td> <td style="width: 10%;"></td> <td style="width: 10%;"></td> <td style="width: 10%;"></td> <td style="width: 10%;"></td> <td style="width: 10%;"></td> <td style="width: 10%;"></td> </tr> <tr> <td></td> <td></td> <td colspan="8" style="text-align: center;"> <table border="1" style="width: 100%; border-collapse: collapse; text-align: center;"> <tr> <td style="width: 10%;"></td> <td style="width: 10%;"></td> <td style="width: 10%;"></td> <td style="width: 10%;"></td> <td style="width: 10%;"></td> <td style="width: 10%;"></td> <td style="width: 10%;"></td> <td style="width: 10%;"></td> <td style="width: 10%;"></td> <td style="width: 10%;"></td> </tr> <tr> <td></td> <td></td> <td colspan="8" style="text-align: center;"> <table border="1" style="width: 100%; border-collapse: collapse; text-align: center;"> <tr> </tr></table></td></tr></table></td></tr></table></td></tr></table></td></tr></table></td></tr></table></td></tr></table></td></tr></table></td></tr></table></td></tr></table></td></tr></table></td></tr></table></td></tr></table></td></tr></table></td></tr></table></td></tr></table></td></tr></table></td></tr></table></td></tr></table></td></tr></table></td></tr></table></td></tr></table></td></tr></table></td></tr></table></td></tr></table></td></tr></table></td></tr></table></td></tr></table></td></tr></table></td></tr></table></td></tr></table>

 | | | | | | | | | | | | | | | | | | | | <table border="1" style="width: 100%; border-collapse: collapse; text-align: center;"> <tr> <td style="width: 10%;"></td> <td style="width: 10%;"></td> <td style="width: 10%;"></td> <td style="width: 10%;"></td> <td style="width: 10%;"></td> <td style="width: 10%;"></td> <td style="width: 10%;"></td> <td style="width: 10%;"></td> <td style="width: 10%;"></td> <td style="width: 10%;"></td> </tr> <tr> <td></td> <td></td> <td colspan="8" style="text-align: center;"> <table border="1" style="width: 100%; border-collapse: collapse; text-align: center;"> <tr> <td style="width: 10%;"></td> <td style="width: 10%;"></td> <td style="width: 10%;"></td> <td style="width: 10%;"></td> <td style="width: 10%;"></td> <td style="width: 10%;"></td> <td style="width: 10%;"></td> <td style="width: 10%;"></td> <td style="width: 10%;"></td> <td style="width: 10%;"></td> </tr> <tr> <td></td> <td></td> <td colspan="8" style="text-align: center;"> <table border="1" style="width: 100%; border-collapse: collapse; text-align: center;"> <tr> <td style="width: 10%;"></td> <td style="width: 10%;"></td> <td style="width: 10%;"></td> <td style="width: 10%;"></td> <td style="width: 10%;"></td> <td style="width: 10%;"></td> <td style="width: 10%;"></td> <td style="width: 10%;"></td> <td style="width: 10%;"></td> <td style="width: 10%;"></td> </tr> <tr> <td></td> <td></td> <td colspan="8" style="text-align: center;"> <table border="1" style="width: 100%; border-collapse: collapse; text-align: center;"> <tr> <td style="width: 10%;"></td> <td style="width: 10%;"></td> <td style="width: 10%;"></td> <td style="width: 10%;"></td> <td style="width: 10%;"></td> <td style="width: 10%;"></td> <td style="width: 10%;"></td> <td style="width: 10%;"></td> <td style="width: 10%;"></td> <td style="width: 10%;"></td> </tr> <tr> <td></td> <td></td> <td colspan="8" style="text-align: center;"> <table border="1" style="width: 100%; border-collapse: collapse; text-align: center;"> <tr> <td style="width: 10%;"></td> <td style="width: 10%;"></td> <td style="width: 10%;"></td> <td style="width: 10%;"></td> <td style="width: 10%;"></td> <td style="width: 10%;"></td> <td style="width: 10%;"></td> <td style="width: 10%;"></td> <td style="width: 10%;"></td> <td style="width: 10%;"></td> </tr> <tr> <td></td> <td></td> <td colspan="8" style="text-align: center;"> <table border="1" style="width: 100%; border-collapse: collapse; text-align: center;"> <tr> <td style="width: 10%;"></td> <td style="width: 10%;"></td> <td style="width: 10%;"></td> <td style="width: 10%;"></td> <td style="width: 10%;"></td> <td style="width: 10%;"></td> <td style="width: 10%;"></td> <td style="width: 10%;"></td> <td style="width: 10%;"></td> <td style="width: 10%;"></td> </tr> <tr> <td></td> <td></td> <td colspan="8" style="text-align: center;"> <table border="1" style="width: 100%; border-collapse: collapse; text-align: center;"> <tr> <td style="width: 10%;"></td> <td style="width: 10%;"></td> <td style="width: 10%;"></td> <td style="width: 10%;"></td> <td style="width: 10%;"></td> <td style="width: 10%;"></td> <td style="width: 10%;"></td> <td style="width: 10%;"></td> <td style="width: 10%;"></td> <td style="width: 10%;"></td> </tr> <tr> <td></td> <td></td> <td colspan="8" style="text-align: center;"> <table border="1" style="width: 100%; border-collapse: collapse; text-align: center;"> <tr> <td style="width: 10%;"></td> <td style="width: 10%;"></td> <td style="width: 10%;"></td> <td style="width: 10%;"></td> <td style="width: 10%;"></td> <td style="width: 10%;"></td> <td style="width: 10%;"></td> <td style="width: 10%;"></td> <td style="width: 10%;"></td> <td style="width: 10%;"></td> </tr> <tr> <td></td> <td></td> <td colspan="8" style="text-align: center;"> <table border="1" style="width: 100%; border-collapse: collapse; text-align: center;"> <tr> <td style="width: 10%;"></td> <td style="width: 10%;"></td> <td style="width: 10%;"></td> <td style="width: 10%;"></td> <td style="width: 10%;"></td> <td style="width: 10%;"></td> <td style="width: 10%;"></td> <td style="width: 10%;"></td> <td style="width: 10%;"></td> <td style="width: 10%;"></td> </tr> <tr> <td></td> <td></td> <td colspan="8" style="text-align: center;"> <table border="1" style="width: 100%; border-collapse: collapse; text-align: center;"> <tr> <td style="width: 10%;"></td> <td style="width: 10%;"></td> <td style="width: 10%;"></td> <td style="width: 10%;"></td> <td style="width: 10%;"></td> <td style="width: 10%;"></td> <td style="width: 10%;"></td> <td style="width: 10%;"></td> <td style="width: 10%;"></td> <td style="width: 10%;"></td> </tr> <tr> <td></td> <td></td> <td colspan="8" style="text-align: center;"> <table border="1" style="width: 100%; border-collapse: collapse; text-align: center;"> <tr> <td style="width: 10%;"></td> <td style="width: 10%;"></td> <td style="width: 10%;"></td> <td style="width: 10%;"></td> <td style="width: 10%;"></td> <td style="width: 10%;"></td> <td style="width: 10%;"></td> <td style="width: 10%;"></td> <td style="width: 10%;"></td> <td style="width: 10%;"></td> </tr> <tr> <td></td> <td></td> <td colspan="8" style="text-align: center;"> <table border="1" style="width: 100%; border-collapse: collapse; text-align: center;"> <tr> <td style="width: 10%;"></td> <td style="width: 10%;"></td> <td style="width: 10%;"></td> <td style="width: 10%;"></td> <td style="width: 10%;"></td> <td style="width: 10%;"></td> <td style="width: 10%;"></td> <td style="width: 10%;"></td> <td style="width: 10%;"></td> <td style="width: 10%;"></td> </tr> <tr> <td></td> <td></td> <td colspan="8" style="text-align: center;"> <table border="1" style="width: 100%; border-collapse: collapse; text-align: center;"> <tr> <td style="width: 10%;"></td> <td style="width: 10%;"></td> <td style="width: 10%;"></td> <td style="width: 10%;"></td> <td style="width: 10%;"></td> <td style="width: 10%;"></td> <td style="width: 10%;"></td> <td style="width: 10%;"></td> <td style="width: 10%;"></td> <td style="width: 10%;"></td> </tr> <tr> <td></td> <td></td> <td colspan="8" style="text-align: center;"> <table border="1" style="width: 100%; border-collapse: collapse; text-align: center;"> <tr> <td style="width: 10%;"></td> <td style="width: 10%;"></td> <td style="width: 10%;"></td> <td style="width: 10%;"></td> <td style="width: 10%;"></td> <td style="width: 10%;"></td> <td style="width: 10%;"></td> <td style="width: 10%;"></td> <td style="width: 10%;"></td> <td style="width: 10%;"></td> </tr> <tr> <td></td> <td></td> <td colspan="8" style="text-align: center;"> <table border="1" style="width: 100%; border-collapse: collapse; text-align: center;"> <tr> <td style="width: 10%;"></td> <td style="width: 10%;"></td> <td style="width: 10%;"></td> <td style="width: 10%;"></td> <td style="width: 10%;"></td> <td style="width: 10%;"></td> <td style="width: 10%;"></td> <td style="width: 10%;"></td> <td style="width: 10%;"></td> <td style="width: 10%;"></td> </tr> <tr> <td></td> <td></td> <td colspan="8" style="text-align: center;"> <table border="1" style="width: 100%; border-collapse: collapse; text-align: center;"> <tr> <td style="width: 10%;"></td> <td style="width: 10%;"></td> <td style="width: 10%;"></td> <td style="width: 10%;"></td> <td style="width: 10%;"></td> <td style="width: 10%;"></td> <td style="width: 10%;"></td> <td style="width: 10%;"></td> <td style="width: 10%;"></td> <td style="width: 10%;"></td> </tr> <tr> <td></td> <td></td> <td colspan="8" style="text-align: center;"> <table border="1" style="width: 100%; border-collapse: collapse; text-align: center;"> <tr> <td style="width: 10%;"></td> <td style="width: 10%;"></td> <td style="width: 10%;"></td> <td style="width: 10%;"></td> <td style="width: 10%;"></td> <td style="width: 10%;"></td> <td style="width: 10%;"></td> <td style="width: 10%;"></td> <td style="width: 10%;"></td> <td style="width: 10%;"></td> </tr> <tr> <td></td> <td></td> <td colspan="8" style="text-align: center;"> <table border="1" style="width: 100%; border-collapse: collapse; text-align: center;"> <tr> <td style="width: 10%;"></td> <td style="width: 10%;"></td> <td style="width: 10%;"></td> <td style="width: 10%;"></td> <td style="width: 10%;"></td> <td style="width: 10%;"></td> <td style="width: 10%;"></td> <td style="width: 10%;"></td> <td style="width: 10%;"></td> <td style="width: 10%;"></td> </tr> <tr> <td></td> <td></td> <td colspan="8" style="text-align: center;"> <table border="1" style="width: 100%;
border-collapse: collapse; text-align: center;"> <tr> <td style="width: 10%;"></td> <td style="width: 10%;"></td> <td style="width: 10%;"></td> <td style="width: 10%;"></td> <td style="width: 10%;"></td> <td style="width: 10%;"></td> <td style="width: 10%;"></td> <td style="width: 10%;"></td> <td style="width: 10%;"></td> <td style="width: 10%;"></td> </tr> <tr> <td></td> <td></td> <td colspan="8" style="text-align: center;"> <table border="1" style="width: 100%; border-collapse: collapse; text-align: center;"> <tr> <td style="width: 10%;"></td> <td style="width: 10%;"></td> <td style="width: 10%;"></td> <td style="width: 10%;"></td> <td style="width: 10%;"></td> <td style="width: 10%;"></td> <td style="width: 10%;"></td> <td style="width: 10%;"></td> <td style="width: 10%;"></td> <td style="width: 10%;"></td> </tr> <tr> <td></td> <td></td> <td colspan="8" style="text-align: center;"> <table border="1" style="width: 100%; border-collapse: collapse; text-align: center;"> <tr> <td style="width: 10%;"></td> <td style="width: 10%;"></td> <td style="width: 10%;"></td> <td style="width: 10%;"></td> <td style="width: 10%;"></td> <td style="width: 10%;"></td> <td style="width: 10%;"></td> <td style="width: 10%;"></td> <td style="width: 10%;"></td> <td style="width: 10%;"></td> </tr> <tr> <td></td> <td></td> <td colspan="8" style="text-align: center;"> <table border="1" style="width: 100%; border-collapse: collapse; text-align: center;"> <tr> <td style="width: 10%;"></td> <td style="width: 10%;"></td> <td style="width: 10%;"></td> <td style="width: 10%;"></td> <td style="width: 10%;"></td> <td style="width: 10%;"></td> <td style="width: 10%;"></td> <td style="width: 10%;"></td> <td style="width: 10%;"></td> <td style="width: 10%;"></td> </tr> <tr> <td></td> <td></td> <td colspan="8" style="text-align: center;"> <table border="1" style="width: 100%; border-collapse: collapse; text-align: center;"> <tr> <td style="width: 10%;"></td> <td style="width: 10%;"></td> <td style="width: 10%;"></td> <td style="width: 10%;"></td> <td style="width: 10%;"></td> <td style="width: 10%;"></td> <td style="width: 10%;"></td> <td style="width: 10%;"></td> <td style="width: 10%;"></td> <td style="width: 10%;"></td> </tr> <tr> <td></td> <td></td> <td colspan="8" style="text-align: center;"> <table border="1" style="width: 100%; border-collapse: collapse; text-align: center;"> <tr> <td style="width: 10%;"></td> <td style="width: 10%;"></td> <td style="width: 10%;"></td> <td style="width: 10%;"></td> <td style="width: 10%;"></td> <td style="width: 10%;"></td> <td style="width: 10%;"></td> <td style="width: 10%;"></td> <td style="width: 10%;"></td> <td style="width: 10%;"></td> </tr> <tr> <td></td> <td></td> <td colspan="8" style="text-align: center;"> <table border="1" style="width: 100%; border-collapse: collapse; text-align: center;"> <tr> <td style="width: 10%;"></td> <td style="width: 10%;"></td> <td style="width: 10%;"></td> <td style="width: 10%;"></td> <td style="width: 10%;"></td> <td style="width: 10%;"></td> <td style="width: 10%;"></td> <td style="width: 10%;"></td> <td style="width: 10%;"></td> <td style="width: 10%;"></td> </tr> <tr> <td></td> <td></td> <td colspan="8" style="text-align: center;"> <table border="1" style="width: 100%; border-collapse: collapse; text-align: center;"> <tr> <td style="width: 10%;"></td> <td style="width: 10%;"></td> <td style="width: 10%;"></td> <td style="width: 10%;"></td> <td style="width: 10%;"></td> <td style="width: 10%;"></td> <td style="width: 10%;"></td> <td style="width: 10%;"></td> <td style="width: 10%;"></td> <td style="width: 10%;"></td> </tr> <tr> <td></td> <td></td> <td colspan="8" style="text-align: center;"> <table border="1" style="width: 100%; border-collapse: collapse; text-align: center;"> <tr> <td style="width: 10%;"></td> <td style="width: 10%;"></td> <td style="width: 10%;"></td> <td style="width: 10%;"></td> <td style="width: 10%;"></td> <td style="width: 10%;"></td> <td style="width: 10%;"></td> <td style="width: 10%;"></td> <td style="width: 10%;"></td> <td style="width: 10%;"></td> </tr> <tr> <td></td> <td></td> <td colspan="8" style="text-align: center;"> <table border="1" style="width: 100%; border-collapse: collapse; text-align: center;"> <tr> <td style="width: 10%;"></td> <td style="width: 10%;"></td> <td style="width: 10%;"></td> <td style="width: 10%;"></td> <td style="width: 10%;"></td> <td style="width: 10%;"></td> <td style="width: 10%;"></td> <td style="width: 10%;"></td> <td style="width: 10%;"></td> <td style="width: 10%;"></td> </tr> <tr> <td></td> <td></td> <td colspan="8" style="text-align: center;"> <table border="1" style="width: 100%; border-collapse: collapse; text-align: center;"> <tr> <td style="width: 10%;"></td> <td style="width: 10%;"></td> <td style="width: 10%;"></td> <td style="width: 10%;"></td> <td style="width: 10%;"></td> <td style="width: 10%;"></td> <td style="width: 10%;"></td> <td style="width: 10%;"></td> <td style="width: 10%;"></td> <td style="width: 10%;"></td> </tr> <tr> <td></td> <td></td> <td colspan="8" style="text-align: center;"> <table border="1" style="width: 100%; border-collapse: collapse; text-align: center;"> <tr> </tr></table></td></tr></table></td></tr></table></td></tr></table></td></tr></table></td></tr></table></td></tr></table></td></tr></table></td></tr></table></td></tr></table></td></tr></table></td></tr></table></td></tr></table></td></tr></table></td></tr></table></td></tr></table></td></tr></table></td></tr></table></td></tr></table></td></tr></table></td></tr></table></td></tr></table></td></tr></table></td></tr></table></td></tr></table></td></tr></table></td></tr></table></td></tr></table></td></tr></table></td></tr></table>

 | | | | | | | | | | | | | | | | | | | | <table border="1" style="width: 100%; border-collapse: collapse; text-align: center;"> <tr> <td style="width: 10%;"></td> <td style="width: 10%;"></td> <td style="width: 10%;"></td> <td style="width: 10%;"></td> <td style="width: 10%;"></td> <td style="width: 10%;"></td> <td style="width: 10%;"></td> <td style="width: 10%;"></td> <td style="width: 10%;"></td> <td style="width: 10%;"></td> </tr> <tr> <td></td> <td></td> <td colspan="8" style="text-align: center;"> <table border="1" style="width: 100%; border-collapse: collapse; text-align: center;"> <tr> <td style="width: 10%;"></td> <td style="width: 10%;"></td> <td style="width: 10%;"></td> <td style="width: 10%;"></td> <td style="width: 10%;"></td> <td style="width: 10%;"></td> <td style="width: 10%;"></td> <td style="width: 10%;"></td> <td style="width: 10%;"></td> <td style="width: 10%;"></td> </tr> <tr> <td></td> <td></td> <td colspan="8" style="text-align: center;"> <table border="1" style="width: 100%; border-collapse: collapse; text-align: center;"> <tr> <td style="width: 10%;"></td> <td style="width: 10%;"></td> <td style="width: 10%;"></td> <td style="width: 10%;"></td> <td style="width: 10%;"></td> <td style="width: 10%;"></td> <td style="width: 10%;"></td> <td style="width: 10%;"></td> <td style="width: 10%;"></td> <td style="width: 10%;"></td> </tr> <tr> <td></td> <td></td> <td colspan="8" style="text-align: center;"> <table border="1" style="width: 100%; border-collapse: collapse; text-align: center;"> <tr> <td style="width: 10%;"></td> <td style="width: 10%;"></td> <td style="width: 10%;"></td> <td style="width: 10%;"></td> <td style="width: 10%;"></td> <td style="width: 10%;"></td> <td style="width: 10%;"></td> <td style="width: 10%;"></td> <td style="width: 10%;"></td> <td style="width: 10%;"></td> </tr> <tr> <td></td> <td></td> <td colspan="8" style="text-align: center;"> <table border="1" style="width: 100%; border-collapse: collapse; text-align: center;"> <tr> <td style="width: 10%;"></td> <td style="width: 10%;"></td> <td style="width: 10%;"></td> <td style="width: 10%;"></td> <td style="width: 10%;"></td> <td style="width: 10%;"></td> <td style="width: 10%;"></td> <td style="width: 10%;"></td> <td style="width: 10%;"></td> <td style="width: 10%;"></td> </tr> <tr> <td></td> <td></td> <td colspan="8" style="text-align: center;"> <table border="1" style="width: 100%; border-collapse: collapse; text-align: center;"> <tr> <td style="width: 10%;"></td> <td style="width: 10%;"></td> <td style="width: 10%;"></td> <td style="width: 10%;"></td> <td style="width: 10%;"></td> <td style="width: 10%;"></td> <td style="width: 10%;"></td> <td style="width: 10%;"></td> <td style="width: 10%;"></td> <td style="width: 10%;"></td> </tr> <tr> <td></td> <td></td> <td colspan="8" style="text-align: center;"> <table border="1" style="width: 100%; border-collapse: collapse; text-align: center;"> <tr> <td style="width: 10%;"></td> <td style="width: 10%;"></td> <td style="width: 10%;"></td> <td style="width: 10%;"></td> <td style="width: 10%;"></td> <td style="width: 10%;"></td> <td style="width: 10%;"></td> <td style="width: 10%;"></td> <td style="width: 10%;"></td> <td style="width: 10%;"></td> </tr> <tr> <td></td> <td></td> <td colspan="8" style="text-align: center;"> <table border="1" style="width: 100%; border-collapse: collapse; text-align: center;"> <tr> <td style="width: 10%;"></td> <td style="width: 10%;"></td> <td style="width: 10%;"></td> <td style="width: 10%;"></td> <td style="width: 10%;"></td> <td style="width: 10%;"></td> <td style="width: 10%;"></td> <td style="width: 10%;"></td> <td style="width: 10%;"></td> <td style="width: 10%;"></td> </tr> <tr> <td></td> <td></td> <td colspan="8" style="text-align: center;"> <table border="1" style="width: 100%; border-collapse: collapse; text-align: center;"> <tr> <td style="width: 10%;"></td> <td style="width: 10%;"></td> <td style="width: 10%;"></td> <td style="width: 10%;"></td> <td style="width: 10%;"></td> <td style="width: 10%;"></td> <td style="width: 10%;"></td> <td style="width: 10%;"></td> <td style="width: 10%;"></td> <td style="width: 10%;"></td> </tr> <tr> <td></td> <td></td> <td colspan="8" style="text-align: center;"> <table border="1" style="width: 100%; border-collapse: collapse; text-align: center;"> <tr> <td style="width: 10%;"></td> <td style="width: 10%;"></td> <td style="width: 10%;"></td> <td style="width: 10%;"></td> <td style="width: 10%;"></td> <td style="width: 10%;"></td> <td style="width: 10%;"></td> <td style="width: 10%;"></td> <td style="width: 10%;"></td> <td style="width: 10%;"></td> </tr> <tr> <td></td> <td></td> <td colspan="8" style="text-align: center;"> <table border="1" style="width: 100%; border-collapse: collapse; text-align: center;"> <tr> <td style="width: 10%;"></td> <td style="width: 10%;"></td> <td style="width: 10%;"></td> <td style="width: 10%;"></td> <td style="width: 10%;"></td> <td style="width: 10%;"></td> <td style="width: 10%;"></td> <td style="width: 10%;"></td> <td style="width: 10%;"></td> <td style="width: 10%;"></td> </tr> <tr> <td></td> <td></td> <td colspan="8" style="text-align: center;"> <table border="1" style="width: 100%; border-collapse: collapse; text-align: center;"> <tr> <td style="width: 10%;"></td> <td style="width: 10%;"></td> <td style="width: 10%;"></td> <td style="width: 10%;"></td> <td style="width: 10%;"></td> <td style="width: 10%;"></td> <td style="width: 10%;"></td> <td style="width: 10%;"></td> <td style="width: 10%;"></td> <td style="width: 10%;"></td> </tr> <tr> <td></td> <td></td> <td colspan="8" style="text-align: center;"> <table border="1" style="width: 100%; border-collapse: collapse; text-align: center;"> <tr> <td style="width: 10%;"></td> <td style="width: 10%;"></td> <td style="width: 10%;"></td> <td style="width: 10%;"></td> <td style="width: 10%;"></td> <td style="width: 10%;"></td> <td style="width: 10%;"></td> <td style="width: 10%;"></td> <td style="width: 10%;"></td> <td style="width: 10%;"></td> </tr> <tr> <td></td> <td></td> <td colspan="8" style="text-align: center;"> <table border="1" style="width: 100%; border-collapse: collapse; text-align: center;"> <tr> <td style="width: 10%;"></td> <td style="width: 10%;"></td> <td style="width: 10%;"></td> <td style="width: 10%;"></td> <td style="width: 10%;"></td> <td style="width: 10%;"></td> <td style="width: 10%;"></td> <td style="width: 10%;"></td> <td style="width: 10%;"></td> <td style="width: 10%;"></td> </tr> <tr> <td></td> <td></td> <td colspan="8" style="text-align: center;"> <table border="1" style="width: 100%; border-collapse: collapse; text-align: center;"> <tr> <td style="width: 10%;"></td> <td style="width: 10%;"></td> <td style="width: 10%;"></td> <td style="width: 10%;"></td> <td style="width: 10%;"></td> <td style="width: 10%;"></td> <td style="width: 10%;"></td> <td style="width: 10%;"></td> <td style="width: 10%;"></td> <td style="width: 10%;"></td> </tr> <tr> <td></td> <td></td> <td colspan="8" style="text-align: center;"> <table border="1" style="width: 100%; border-collapse: collapse; text-align: center;"> <tr> <td style="width: 10%;"></td> <td style="width: 10%;"></td> <td style="width: 10%;"></td> <td style="width: 10%;"></td> <td style="width: 10%;"></td> <td style="width: 10%;"></td> <td style="width: 10%;"></td> <td style="width: 10%;"></td> <td style="width: 10%;"></td> <td style="width: 10%;"></td> </tr> <tr> <td></td> <td></td> <td colspan="8" style="text-align: center;"> <table border="1" style="width: 100%; border-collapse: collapse; text-align: center;"> <tr> <td style="width: 10%;"></td> <td style="width: 10%;"></td> <td style="width: 10%;"></td> <td style="width: 10%;"></td> <td style="width: 10%;"></td> <td style="width: 10%;"></td> <td style="width: 10%;"></td> <td style="width: 10%;"></td> <td style="width: 10%;"></td> <td style="width: 10%;"></td> </tr> <tr> <td></td> <td></td> <td colspan="8" style="text-align: center;"> <table border="1" style="width: 100%; border-collapse: collapse; text-align: center;"> <tr> <td style="width: 10%;"></td> <td style="width: 10%;"></td> <td style="width: 10%;"></td> <td style="width: 10%;"></td> <td style="width: 10%;"></td> <td style="width: 10%;"></td> <td style="width: 10%;"></td> <td style="width: 10%;"></td> <td style="width: 10%;"></td> <td style="width: 10%;"></td> </tr> <tr> <td></td> <td></td> <td colspan="8" style="text-align: center;"> <table border="1" style="width: 100%; border-collapse: collapse; text-align: center;"> <tr> <td style="width: 10%;"></td> <td style="width: 10%;"></td> <td style="width: 10%;"></td> <td style="width: 10%;"></td> <td style="width: 10%;"></td> <td style="width: 10%;"></td> <td style="width: 10%;"></td> <td style="width: 10%;"></td> <td style="width: 10%;"></td> <td style="width: 10%;"></td> </tr> <tr> <td></td> <td></td> <td colspan="8" style="text-align: center;"> <table border="1" style="width: 100%; border-collapse: collapse; text-align: center;"> <tr> <td style="width: 10%;"></td> <td style="width: 10%;"></td> <td style="width: 10%;"></td> <td style="width: 10%;"></td> <td style="width: 10%;"></td> <td style="width: 10%;"></td> <td style="width: 10%;"></td> <td style="width: 10%;"></td> <td style="width: 10%;"></td> <td style="width: 10%;"></td> </tr> <tr> <td></td> <td></td> <td colspan="8" style="text-align: center;"> <table border="1" style="width: 100%; border-collapse: collapse; text-align: center;"> <tr> <td style="width: 10%;"></td> <td style="width: 10%;"></td> <td style="width: 10%;"></td> <td style="width: 10%;"></td> <td style="width: 10%;"></td> <td style="width:
10%;"></td> <td style="width: 10%;"></td> <td style="width: 10%;"></td> <td style="width: 10%;"></td> <td style="width: 10%;"></td> </tr> <tr> <td></td> <td></td> <td colspan="8" style="text-align: center;"> <table border="1" style="width: 100%; border-collapse: collapse; text-align: center;"> <tr> <td style="width: 10%;"></td> <td style="width: 10%;"></td> <td style="width: 10%;"></td> <td style="width: 10%;"></td> <td style="width: 10%;"></td> <td style="width: 10%;"></td> <td style="width: 10%;"></td> <td style="width: 10%;"></td> <td style="width: 10%;"></td> <td style="width: 10%;"></td> </tr> <tr> <td></td> <td></td> <td colspan="8" style="text-align: center;"> <table border="1" style="width: 100%; border-collapse: collapse; text-align: center;"> <tr> <td style="width: 10%;"></td> <td style="width: 10%;"></td> <td style="width: 10%;"></td> <td style="width: 10%;"></td> <td style="width: 10%;"></td> <td style="width: 10%;"></td> <td style="width: 10%;"></td> <td style="width: 10%;"></td> <td style="width: 10%;"></td> <td style="width: 10%;"></td> </tr> <tr> <td></td> <td></td> <td colspan="8" style="text-align: center;"> <table border="1" style="width: 100%; border-collapse: collapse; text-align: center;"> <tr> <td style="width: 10%;"></td> <td style="width: 10%;"></td> <td style="width: 10%;"></td> <td style="width: 10%;"></td> <td style="width: 10%;"></td> <td style="width: 10%;"></td> <td style="width: 10%;"></td> <td style="width: 10%;"></td> <td style="width: 10%;"></td> <td style="width: 10%;"></td> </tr> <tr> <td></td> <td></td> <td colspan="8" style="text-align: center;"> <table border="1" style="width: 100%; border-collapse: collapse; text-align: center;"> <tr> <td style="width: 10%;"></td> <td style="width: 10%;"></td> <td style="width: 10%;"></td> <td style="width: 10%;"></td> <td style="width: 10%;"></td> <td style="width: 10%;"></td> <td style="width: 10%;"></td> <td style="width: 10%;"></td> <td style="width: 10%;"></td> <td style="width: 10%;"></td> </tr> <tr> <td></td> <td></td> <td colspan="8" style="text-align: center;"> <table border="1" style="width: 100%; border-collapse: collapse; text-align: center;"> <tr> <td style="width: 10%;"></td> <td style="width: 10%;"></td> <td style="width: 10%;"></td> <td style="width: 10%;"></td> <td style="width: 10%;"></td> <td style="width: 10%;"></td> <td style="width: 10%;"></td> <td style="width: 10%;"></td> <td style="width: 10%;"></td> <td style="width: 10%;"></td> </tr> <tr> <td></td> <td></td> <td colspan="8" style="text-align: center;"> <table border="1" style="width: 100%; border-collapse: collapse; text-align: center;"> <tr> <td style="width: 10%;"></td> <td style="width: 10%;"></td> <td style="width: 10%;"></td> <td style="width: 10%;"></td> <td style="width: 10%;"></td> <td style="width: 10%;"></td> <td style="width: 10%;"></td> <td style="width: 10%;"></td> <td style="width: 10%;"></td> <td style="width: 10%;"></td> </tr> <tr> <td></td> <td></td> <td colspan="8" style="text-align: center;"> <table border="1" style="width: 100%; border-collapse: collapse; text-align: center;"> <tr> <td style="width: 10%;"></td> <td style="width: 10%;"></td> <td style="width: 10%;"></td> <td style="width: 10%;"></td> <td style="width: 10%;"></td> <td style="width: 10%;"></td> <td style="width: 10%;"></td> <td style="width: 10%;"></td> <td style="width: 10%;"></td> <td style="width: 10%;"></td> </tr> <tr> <td></td> <td></td> <td colspan="8" style="text-align: center;"> <table border="1" style="width: 100%; border-collapse: collapse; text-align: center;"> <tr> </tr></table></td></tr></table></td></tr></table></td></tr></table></td></tr></table></td></tr></table></td></tr></table></td></tr></table></td></tr></table></td></tr></table></td></tr></table></td></tr></table></td></tr></table></td></tr></table></td></tr></table></td></tr></table></td></tr></table></td></tr></table></td></tr></table></td></tr></table></td></tr></table></td></tr></table></td></tr></table></td></tr></table></td></tr></table></td></tr></table></td></tr></table></td></tr></table></td></tr></table>
 | | | | | | | | | | | | | | | | | | | | <table border="1" style="width: 100%; border-collapse: collapse; text-align: center;"> <tr> <td style="width: 10%;"></td> <td style="width: 10%;"></td> <td style="width: 10%;"></td> <td style="width: 10%;"></td> <td style="width: 10%;"></td> <td style="width: 10%;"></td> <td style="width: 10%;"></td> <td style="width: 10%;"></td> <td style="width: 10%;"></td> <td style="width: 10%;"></td> </tr> <tr> <td></td> <td></td> <td colspan="8" style="text-align: center;"> <table border="1" style="width: 100%; border-collapse: collapse; text-align: center;"> <tr> <td style="width: 10%;"></td> <td style="width: 10%;"></td> <td style="width: 10%;"></td> <td style="width: 10%;"></td> <td style="width: 10%;"></td> <td style="width: 10%;"></td> <td style="width: 10%;"></td> <td style="width: 10%;"></td> <td style="width: 10%;"></td> <td style="width: 10%;"></td> </tr> <tr> <td></td> <td></td> <td colspan="8" style="text-align: center;"> <table border="1" style="width: 100%; border-collapse: collapse; text-align: center;"> <tr> <td style="width: 10%;"></td> <td style="width: 10%;"></td> <td style="width: 10%;"></td> <td style="width: 10%;"></td> <td style="width: 10%;"></td> <td style="width: 10%;"></td> <td style="width: 10%;"></td> <td style="width:
10%;"></td> <td style="width: 10%;"></td> <td style="width: 10%;"></td> </tr> <tr> <td></td> <td></td> <td colspan="8" style="text-align: center;"> <table border="1" style="width: 100%; border-collapse: collapse; text-align: center;"> <tr> <td style="width: 10%;"></td> <td style="width: 10%;"></td> <td style="width: 10%;"></td> <td style="width: 10%;"></td> <td style="width: 10%;"></td> <td style="width: 10%;"></td> <td style="width: 10%;"></td> <td style="width: 10%;"></td> <td style="width: 10%;"></td> <td style="width: 10%;"></td> </tr> <tr> <td></td> <td></td> <td colspan="8" style="text-align: center;"> <table border="1" style="width: 100%; border-collapse: collapse; text-align: center;"> <tr> <td style="width: 10%;"></td> <td style="width: 10%;"></td> <td style="width: 10%;"></td> <td style="width: 10%;"></td> <td style="width: 10%;"></td> <td style="width: 10%;"></td> <td style="width: 10%;"></td> <td style="width: 10%;"></td> <td style="width: 10%;"></td> <td style="width: 10%;"></td> </tr> <tr> <td></td> <td></td> <td colspan="8" style="text-align: center;"> <table border="1" style="width: 100%; border-collapse: collapse; text-align: center;"> <tr> <td style="width: 10%;"></td> <td style="width: 10%;"></td> <td style="width: 10%;"></td> <td style="width: 10%;"></td> <td style="width: 10%;"></td> <td style="width: 10%;"></td> <td style="width: 10%;"></td> <td style="width: 10%;"></td> <td style="width: 10%;"></td> <td style="width: 10%;"></td> </tr> <tr> <td></td> <td></td> <td colspan="8" style="text-align: center;"> <table border="1" style="width: 100%; border-collapse: collapse; text-align: center;"> <tr> <td style="width: 10%;"></td> <td style="width: 10%;"></td> <td style="width: 10%;"></td> <td style="width: 10%;"></td> <td style="width: 10%;"></td> <td style="width: 10%;"></td> <td style="width: 10%;"></td> <td style="width: 10%;"></td> <td style="width: 10%;"></td> <td style="width: 10%;"></td> </tr> <tr> <td></td> <td></td> <td colspan="8" style="text-align: center;"> <table border="1" style="width: 100%; border-collapse: collapse; text-align: center;"> <tr> <td style="width: 10%;"></td> <td style="width: 10%;"></td> <td style="width: 10%;"></td> <td style="width: 10%;"></td> <td style="width: 10%;"></td> <td style="width: 10%;"></td> <td style="width: 10%;"></td> <td style="width: 10%;"></td> <td style="width: 10%;"></td> <td style="width: 10%;"></td> </tr> <tr> <td></td> <td></td> <td colspan="8" style="text-align: center;"> <table border="1" style="width: 100%; border-collapse: collapse; text-align: center;"> <tr> <td style="width: 10%;"></td> <td style="width: 10%;"></td> <td style="width: 10%;"></td> <td style="width: 10%;"></td> <td style="width: 10%;"></td> <td style="width: 10%;"></td> <td style="width: 10%;"></td> <td style="width: 10%;"></td> <td style="width: 10%;"></td> <td style="width: 10%;"></td> </tr> <tr> <td></td> <td></td> <td colspan="8" style="text-align: center;"> <table border="1" style="width: 100%; border-collapse: collapse; text-align: center;"> <tr> <td style="width: 10%;"></td> <td style="width: 10%;"></td> <td style="width: 10%;"></td> <td style="width: 10%;"></td> <td style="width: 10%;"></td> <td style="width: 10%;"></td> <td style="width: 10%;"></td> <td style="width: 10%;"></td> <td style="width: 10%;"></td> <td style="width: 10%;"></td> </tr> <tr> <td></td> <td></td> <td colspan="8" style="text-align: center;"> <table border="1" style="width: 100%; border-collapse: collapse; text-align: center;"> <tr> <td style="width: 10%;"></td> <td style="width: 10%;"></td> <td style="width: 10%;"></td> <td style="width: 10%;"></td> <td style="width: 10%;"></td> <td style="width: 10%;"></td> <td style="width: 10%;"></td> <td style="width: 10%;"></td> <td style="width: 10%;"></td> <td style="width: 10%;"></td> </tr> <tr> <td></td> <td></td> <td colspan="8" style="text-align: center;"> <table border="1" style="width: 100%; border-collapse: collapse; text-align: center;"> <tr> <td style="width: 10%;"></td> <td style="width: 10%;"></td> <td style="width: 10%;"></td> <td style="width: 10%;"></td> <td style="width: 10%;"></td> <td style="width: 10%;"></td> <td style="width: 10%;"></td> <td style="width: 10%;"></td> <td style="width: 10%;"></td> <td style="width: 10%;"></td> </tr> <tr> <td></td> <td></td> <td colspan="8" style="text-align: center;"> <table border="1" style="width: 100%; border-collapse: collapse; text-align: center;"> <tr> <td style="width: 10%;"></td> <td style="width: 10%;"></td> <td style="width: 10%;"></td> <td style="width: 10%;"></td> <td style="width: 10%;"></td> <td style="width: 10%;"></td> <td style="width: 10%;"></td> <td style="width: 10%;"></td> <td style="width: 10%;"></td> <td style="width: 10%;"></td> </tr> <tr> <td></td> <td></td> <td colspan="8" style="text-align: center;"> <table border="1" style="width: 100%; border-collapse: collapse; text-align: center;"> <tr> <td style="width: 10%;"></td> <td style="width: 10%;"></td> <td style="width: 10%;"></td> <td style="width: 10%;"></td> <td style="width: 10%;"></td> <td style="width: 10%;"></td> <td style="width: 10%;"></td> <td style="width: 10%;"></td> <td style="width: 10%;"></td> <td style="width: 10%;"></td> </tr> <tr> <td></td> <td></td> <td colspan="8" style="text-align: center;"> <table border="1" style="width: 100%; border-collapse: collapse; text-align: center;"> <tr> <td style="width: 10%;"></td> <td style="width: 10%;"></td> <td style="width: 10%;"></td> <td style="width: 10%;"></td> <td style="width: 10%;"></td> <td style="width: 10%;"></td> <td style="width: 10%;"></td> <td style="width: 10%;"></td> <td style="width: 10%;"></td> <td style="width: 10%;"></td> </tr> <tr> <td></td> <td></td> <td colspan="8" style="text-align: center;"> <table border="1" style="width: 100%; border-collapse: collapse; text-align: center;"> <tr> <td style="width: 10%;"></td> <td style="width: 10%;"></td> <td style="width: 10%;"></td> <td style="width: 10%;"></td> <td style="width: 10%;"></td> <td style="width: 10%;"></td> <td style="width: 10%;"></td> <td style="width: 10%;"></td> <td style="width: 10%;"></td> <td style="width: 10%;"></td> </tr> <tr> <td></td> <td></td> <td colspan="8" style="text-align: center;"> <table border="1" style="width: 100%; border-collapse: collapse; text-align: center;"> <tr> <td style="width: 10%;"></td> <td style="width: 10%;"></td> <td style="width: 10%;"></td> <td style="width: 10%;"></td> <td style="width: 10%;"></td> <td style="width: 10%;"></td> <td style="width: 10%;"></td> <td style="width: 10%;"></td> <td style="width: 10%;"></td> <td style="width: 10%;"></td> </tr> <tr> <td></td> <td></td> <td colspan="8" style="text-align: center;"> <table border="1" style="width: 100%; border-collapse: collapse; text-align: center;"> <tr> <td style="width: 10%;"></td> <td style="width: 10%;"></td> <td style="width: 10%;"></td> <td style="width: 10%;"></td> <td style="width: 10%;"></td> <td style="width: 10%;"></td> <td style="width: 10%;"></td> <td style="width: 10%;"></td> <td style="width: 10%;"></td> <td style="width: 10%;"></td> </tr> <tr> <td></td> <td></td> <td colspan="8" style="text-align: center;"> <table border="1" style="width: 100%; border-collapse: collapse; text-align: center;"> <tr> <td style="width: 10%;"></td> <td style="width: 10%;"></td> <td style="width: 10%;"></td> <td style="width: 10%;"></td> <td style="width: 10%;"></td> <td style="width: 10%;"></td> <td style="width: 10%;"></td> <td style="width: 10%;"></td> <td style="width: 10%;"></td> <td style="width: 10%;"></td> </tr> <tr> <td></td> <td></td> <td colspan="8" style="text-align: center;"> <table border="1" style="width: 100%; border-collapse: collapse; text-align: center;"> <tr> <td style="width: 10%;"></td> <td style="width: 10%;"></td> <td style="width: 10%;"></td> <td style="width: 10%;"></td> <td style="width: 10%;"></td> <td style="width: 10%;"></td> <td style="width: 10%;"></td> <td style="width: 10%;"></td> <td style="width: 10%;"></td> <td style="width: 10%;"></td> </tr> <tr> <td></td> <td></td> <td colspan="8" style="text-align: center;"> <table border="1" style="width: 100%; border-collapse: collapse; text-align: center;"> <tr> <td style="width: 10%;"></td> <td style="width: 10%;"></td> <td style="width: 10%;"></td> <td style="width: 10%;"></td> <td style="width: 10%;"></td> <td style="width: 10%;"></td> <td style="width: 10%;"></td> <td style="width: 10%;"></td> <td style="width: 10%;"></td> <td style="width: 10%;"></td> </tr> <tr> <td></td> <td></td> <td colspan="8" style="text-align: center;"> <table border="1" style="width: 100%; border-collapse: collapse; text-align: center;"> <tr> <td style="width: 10%;"></td> <td style="width: 10%;"></td> <td style="width: 10%;"></td> <td style="width: 10%;"></td> <td style="width: 10%;"></td> <td style="width: 10%;"></td> <td style="width: 10%;"></td> <td style="width: 10%;"></td> <td style="width: 10%;"></td> <td style="width: 10%;"></td> </tr> <tr> <td></td> <td></td> <td colspan="8" style="text-align: center;"> <table border="1" style="width: 100%; border-collapse: collapse; text-align: center;"> <tr> <td style="width: 10%;"></td> <td style="width: 10%;"></td> <td style="width: 10%;"></td> <td style="width: 10%;"></td> <td style="width: 10%;"></td> <td style="width: 10%;"></td> <td style="width: 10%;"></td> <td style="width: 10%;"></td> <td style="width: 10%;"></td> <td style="width: 10%;"></td> </tr> <tr> <td></td> <td></td> <td colspan="8" style="text-align: center;"> <table border="1" style="width: 100%; border-collapse: collapse; text-align: center;"> <tr> <td style="width: 10%;"></td> <td style="width: 10%;"></td> <td style="width: 10%;"></td> <td style="width: 10%;"></td> <td style="width: 10%;"></td> <td style="width: 10%;"></td> <td style="width: 10%;"></td> <td style="width: 10%;"></td> <td style="width: 10%;"></td> <td style="width: 10%;"></td> </tr> <tr> <td></td> <td></td> <td colspan="8" style="text-align: center;"> <table border="1"
style="width: 100%; border-collapse: collapse; text-align: center;"> <tr> <td style="width: 10%;"></td> <td style="width: 10%;"></td> <td style="width: 10%;"></td> <td style="width: 10%;"></td> <td style="width: 10%;"></td> <td style="width: 10%;"></td> <td style="width: 10%;"></td> <td style="width: 10%;"></td> <td style="width: 10%;"></td> <td style="width: 10%;"></td> </tr> <tr> <td></td> <td></td> <td colspan="8" style="text-align: center;"> <table border="1" style="width: 100%; border-collapse: collapse; text-align: center;"> <tr> <td style="width: 10%;"></td> <td style="width: 10%;"></td> <td style="width: 10%;"></td> <td style="width: 10%;"></td> <td style="width: 10%;"></td> <td style="width: 10%;"></td> <td style="width: 10%;"></td> <td style="width: 10%;"></td> <td style="width: 10%;"></td> <td style="width: 10%;"></td> </tr> <tr> <td></td> <td></td> <td colspan="8" style="text-align: center;"> <table border="1" style="width: 100%; border-collapse: collapse; text-align: center;"> <tr> <td style="width: 10%;"></td> <td style="width: 10%;"></td> <td style="width: 10%;"></td> <td style="width: 10%;"></td> <td style="width: 10%;"></td> <td style="width: 10%;"></td> <td style="width: 10%;"></td> <td style="width: 10%;"></td> <td style="width: 10%;"></td> <td style="width: 10%;"></td> </tr> <tr> <td></td> <td></td> <td colspan="8" style="text-align: center;"> <table border="1" style="width: 100%; border-collapse: collapse; text-align: center;"> <tr> </tr></table></td></tr></table></td></tr></table></td></tr></table></td></tr></table></td></tr></table></td></tr></table></td></tr></table></td></tr></table></td></tr></table></td></tr></table></td></tr></table></td></tr></table></td></tr></table></td></tr></table></td></tr></table></td></tr></table></td></tr></table></td></tr></table></td></tr></table></td></tr></table></td></tr></table></td></tr></table></td></tr></table></td></tr></table></td></tr></table></td></tr></table></td></tr></table>
 | | | | | | | | | | | | | | | | | | | | <table border="1" style="width: 100%; border-collapse: collapse; text-align: center;"> <tr> <td style="width: 10%;"></td> <td style="width: 10%;"></td> <td style="width: 10%;"></td> <td style="width: 10%;"></td> <td style="width: 10%;"></td> <td style="width: 10%;"></td> <td style="width: 10%;"></td> <td style="width: 10%;"></td> <td style="width: 10%;"></td> <td style="width: 10%;"></td> </tr> <tr> <td></td> <td></td> <td colspan="8" style="text-align: center;"> <table border="1" style="width: 100%; border-collapse: collapse; text-align: center;"> <tr> <td style="width: 10%;"></td> <td style="width: 10%;"></td> <td style="width: 10%;"></td> <td style="width: 10%;"></td> <td style="width: 10%;"></td> <td style="width: 10%;"></td> <td style="width: 10%;"></td> <td style="width: 10%;"></td> <td style="width: 10%;"></td> <td style="width: 10%;"></td> </tr> <tr> <td></td> <td></td> <td colspan="8" style="text-align: center;"> <table border="1" style="width: 100%; border-collapse: collapse; text-align: center;"> <tr> <td style="width: 10%;"></td> <td style="width: 10%;"></td> <td style="width: 10%;"></td> <td style="width: 10%;"></td> <td style="width: 10%;"></td> <td style="width: 10%;"></td> <td style="width: 10%;"></td> <td style="width: 10%;"></td> <td style="width: 10%;"></td> <td style="width: 10%;"></td> </tr> <tr> <td></td> <td></td> <td colspan="8" style="text-align: center;"> <table border="1" style="width: 100%; border-collapse: collapse; text-align: center;"> <tr> <td style="width: 10%;"></td> <td style="width: 10%;"></td> <td style="width: 10%;"></td> <td style="width: 10%;"></td> <td style="width: 10%;"></td> <td style="width: 10%;"></td> <td style="width: 10%;"></td> <td style="width: 10%;"></td> <td style="width: 10%;"></td> <td style="width: 10%;"></td> </tr> <tr> <td></td> <td></td> <td colspan="8" style="text-align: center;"> <table border="1" style="width: 100%; border-collapse: collapse; text-align: center;"> <tr> <td style="width: 10%;"></td> <td style="width: 10%;"></td> <td style="width: 10%;"></td> <td style="width: 10%;"></td> <td style="width: 10%;"></td> <td style="width: 10%;"></td> <td style="width: 10%;"></td> <td style="width: 10%;"></td> <td style="width: 10%;"></td> <td style="width: 10%;"></td> </tr> <tr> <td></td> <td></td> <td colspan="8" style="text-align: center;"> <table border="1" style="width: 100%; border-collapse: collapse; text-align: center;"> <tr> <td style="width: 10%;"></td> <td style="width: 10%;"></td> <td style="width: 10%;"></td> <td style="width: 10%;"></td> <td style="width: 10%;"></td> <td style="width: 10%;"></td> <td style="width: 10%;"></td> <td style="width: 10%;"></td> <td style="width: 10%;"></td> <td style="width: 10%;"></td> </tr> <tr> <td></td> <td></td> <td colspan="8" style="text-align: center;"> <table border="1" style="width: 100%; border-collapse: collapse; text-align: center;"> <tr> <td style="width: 10%;"></td> <td style="width: 10%;"></td> <td style="width: 10%;"></td> <td style="width: 10%;"></td> <td style="width: 10%;"></td> <td style="width: 10%;"></td> <td style="width: 10%;"></td> <td style="width: 10%;"></td> <td style="width: 10%;"></td> <td style="width: 10%;"></td> </tr> <tr> <td></td> <td></td> <td colspan="8" style="text-align: center;"> <table border="1" style="width: 100%; border-collapse: collapse; text-align: center;"> <tr> <td
style="width: 10%;"></td> <td style="width: 10%;"></td> <td style="width: 10%;"></td> <td style="width: 10%;"></td> <td style="width: 10%;"></td> <td style="width: 10%;"></td> <td style="width: 10%;"></td> <td style="width: 10%;"></td> <td style="width: 10%;"></td> <td style="width: 10%;"></td> </tr> <tr> <td></td> <td></td> <td colspan="8" style="text-align: center;"> <table border="1" style="width: 100%; border-collapse: collapse; text-align: center;"> <tr> <td style="width: 10%;"></td> <td style="width: 10%;"></td> <td style="width: 10%;"></td> <td style="width: 10%;"></td> <td style="width: 10%;"></td> <td style="width: 10%;"></td> <td style="width: 10%;"></td> <td style="width: 10%;"></td> <td style="width: 10%;"></td> <td style="width: 10%;"></td> </tr> <tr> <td></td> <td></td> <td colspan="8" style="text-align: center;"> <table border="1" style="width: 100%; border-collapse: collapse; text-align: center;"> <tr> <td style="width: 10%;"></td> <td style="width: 10%;"></td> <td style="width: 10%;"></td> <td style="width: 10%;"></td> <td style="width: 10%;"></td> <td style="width: 10%;"></td> <td style="width: 10%;"></td> <td style="width: 10%;"></td> <td style="width: 10%;"></td> <td style="width: 10%;"></td> </tr> <tr> <td></td> <td></td> <td colspan="8" style="text-align: center;"> <table border="1" style="width: 100%; border-collapse: collapse; text-align: center;"> <tr> <td style="width: 10%;"></td> <td style="width: 10%;"></td> <td style="width: 10%;"></td> <td style="width: 10%;"></td> <td style="width: 10%;"></td> <td style="width: 10%;"></td> <td style="width: 10%;"></td> <td style="width: 10%;"></td> <td style="width: 10%;"></td> <td style="width: 10%;"></td> </tr> <tr> <td></td> <td></td> <td colspan="8" style="text-align: center;"> <table border="1" style="width: 100%; border-collapse: collapse; text-align: center;"> <tr> <td style="width: 10%;"></td> <td style="width: 10%;"></td> <td style="width: 10%;"></td> <td style="width: 10%;"></td> <td style="width: 10%;"></td> <td style="width: 10%;"></td> <td style="width: 10%;"></td> <td style="width: 10%;"></td> <td style="width: 10%;"></td> <td style="width: 10%;"></td> </tr> <tr> <td></td> <td></td> <td colspan="8" style="text-align: center;"> <table border="1" style="width: 100%; border-collapse: collapse; text-align: center;"> <tr> <td style="width: 10%;"></td> <td style="width: 10%;"></td> <td style="width: 10%;"></td> <td style="width: 10%;"></td> <td style="width: 10%;"></td> <td style="width: 10%;"></td> <td style="width: 10%;"></td> <td style="width: 10%;"></td> <td style="width: 10%;"></td> <td style="width: 10%;"></td> </tr> <tr> <td></td> <td></td> <td colspan="8" style="text-align: center;"> <table border="1" style="width: 100%; border-collapse: collapse; text-align: center;"> <tr> <td style="width: 10%;"></td> <td style="width: 10%;"></td> <td style="width: 10%;"></td> <td style="width: 10%;"></td> <td style="width: 10%;"></td> <td style="width: 10%;"></td> <td style="width: 10%;"></td> <td style="width: 10%;"></td> <td style="width: 10%;"></td> <td style="width: 10%;"></td> </tr> <tr> <td></td> <td></td> <td colspan="8" style="text-align: center;"> <table border="1" style="width: 100%; border-collapse: collapse; text-align: center;"> <tr> <td style="width: 10%;"></td> <td style="width: 10%;"></td> <td style="width: 10%;"></td> <td style="width: 10%;"></td> <td style="width: 10%;"></td> <td style="width: 10%;"></td> <td style="width: 10%;"></td> <td style="width: 10%;"></td> <td style="width: 10%;"></td> <td style="width: 10%;"></td> </tr> <tr> <td></td> <td></td> <td colspan="8" style="text-align: center;"> <table border="1" style="width: 100%; border-collapse: collapse; text-align: center;"> <tr> <td style="width: 10%;"></td> <td style="width: 10%;"></td> <td style="width: 10%;"></td> <td style="width: 10%;"></td> <td style="width: 10%;"></td> <td style="width: 10%;"></td> <td style="width: 10%;"></td> <td style="width: 10%;"></td> <td style="width: 10%;"></td> <td style="width: 10%;"></td> </tr> <tr> <td></td> <td></td> <td colspan="8" style="text-align: center;"> <table border="1" style="width: 100%; border-collapse: collapse; text-align: center;"> <tr> <td style="width: 10%;"></td> <td style="width: 10%;"></td> <td style="width: 10%;"></td> <td style="width: 10%;"></td> <td style="width: 10%;"></td> <td style="width: 10%;"></td> <td style="width: 10%;"></td> <td style="width: 10%;"></td> <td style="width: 10%;"></td> <td style="width: 10%;"></td> </tr> <tr> <td></td> <td></td> <td colspan="8" style="text-align: center;"> <table border="1" style="width: 100%; border-collapse: collapse; text-align: center;"> <tr> <td style="width: 10%;"></td> <td style="width: 10%;"></td> <td style="width: 10%;"></td> <td style="width: 10%;"></td> <td style="width: 10%;"></td> <td style="width: 10%;"></td> <td style="width: 10%;"></td> <td style="width: 10%;"></td> <td style="width: 10%;"></td> <td style="width: 10%;"></td> </tr> <tr> <td></td> <td></td> <td colspan="8" style="text-align: center;"> <table border="1" style="width: 100%; border-collapse: collapse; text-align: center;"> <tr> <td style="width: 10%;"></td> <td style="width: 10%;"></td> <td style="width: 10%;"></td> <td style="width: 10%;"></td> <td style="width: 10%;"></td> <td style="width: 10%;"></td> <td style="width: 10%;"></td> <td style="width: 10%;"></td> <td style="width: 10%;"></td> <td style="width: 10%;"></td> </tr> <tr> <td></td> <td></td> <td colspan="8" style="text-align: center;"> <table border="1" style="width: 100%; border-collapse: collapse; text-align: center;"> <tr> <td style="width: 10%;"></td> <td style="width: 10%;"></td> <td style="width: 10%;"></td> <td style="width: 10%;"></td> <td style="width: 10%;"></td> <td style="width: 10%;"></td> <td style="width: 10%;"></td> <td style="width: 10%;"></td> <td style="width: 10%;"></td> <td style="width: 10%;"></td> </tr> <tr> <td></td> <td></td> <td colspan="8" style="text-align: center;"> <table border="1" style="width: 100%; border-collapse: collapse; text-align: center;"> <tr> <td style="width: 10%;"></td> <td style="width: 10%;"></td> <td style="width: 10%;"></td> <td style="width: 10%;"></td> <td style="width: 10%;"></td> <td style="width: 10%;"></td> <td style="width: 10%;"></td> <td style="width: 10%;"></td> <td style="width: 10%;"></td> <td style="width: 10%;"></td> </tr> <tr> <td></td> <td></td> <td colspan="8" style="text-align: center;"> <table border="1" style="width: 100%; border-collapse: collapse; text-align: center;"> <tr> <td style="width: 10%;"></td> <td style="width: 10%;"></td> <td style="width: 10%;"></td> <td style="width: 10%;"></td> <td style="width: 10%;"></td> <td style="width: 10%;"></td> <td style="width: 10%;"></td> <td style="width: 10%;"></td> <td style="width: 10%;"></td> <td style="width: 10%;"></td> </tr> <tr> <td></td> <td></td> <td colspan="8" style="text-align: center;"> <table border="1" style="width: 100%; border-collapse: collapse; text-align: center;"> <tr> <td style="width: 10%;"></td> <td style="width: 10%;"></td> <td style="width: 10%;"></td> <td style="width: 10%;"></td> <td style="width: 10%;"></td> <td style="width: 10%;"></td> <td style="width: 10%;"></td> <td style="width: 10%;"></td> <td style="width: 10%;"></td> <td style="width: 10%;"></td> </tr> <tr> <td></td> <td></td> <td colspan="8" style="text-align: center;"> <table border="1" style="width: 100%; border-collapse: collapse; text-align: center;"> <tr> <td style="width: 10%;"></td> <td style="width: 10%;"></td> <td style="width: 10%;"></td> <td style="width: 10%;"></td> <td style="width: 10%;"></td> <td style="width: 10%;"></td> <td style="width: 10%;"></td> <td style="width: 10%;"></td> <td style="width: 10%;"></td> <td style="width: 10%;"></td> </tr> <tr> <td></td> <td></td> <td colspan="8" style="text-align: center;"> <table border="1" style="width: 100%; border-collapse: collapse; text-align: center;"> <tr> <td style="width: 10%;"></td> <td style="width: 10%;"></td> <td style="width: 10%;"></td> <td style="width: 10%;"></td> <td style="width: 10%;"></td> <td style="width: 10%;"></td> <td style="width: 10%;"></td> <td style="width: 10%;"></td> <td style="width: 10%;"></td> <td style="width: 10%;"></td> </tr> <tr> <td></td> <td></td> <td colspan="8" style="text-align: center;"> <table border="1" style="width: 100%; border-collapse: collapse; text-align: center;"> <tr> <td style="width: 10%;"></td> <td style="width: 10%;"></td> <td style="width: 10%;"></td> <td style="width: 10%;"></td> <td style="width: 10%;"></td> <td style="width: 10%;"></td> <td style="width: 10%;"></td> <td style="width: 10%;"></td> <td style="width: 10%;"></td> <td style="width: 10%;"></td> </tr> <tr> <td></td> <td></td> <td colspan="8" style="text-align: center;"> <table border="1" style="width: 100%; border-collapse: collapse; text-align: center;"> <tr> </tr></table></td></tr></table></td></tr></table></td></tr></table></td></tr></table></td></tr></table></td></tr></table></td></tr></table></td></tr></table></td></tr></table></td></tr></table></td></tr></table></td></tr></table></td></tr></table></td></tr></table></td></tr></table></td></tr></table></td></tr></table></td></tr></table></td></tr></table></td></tr></table></td></tr></table></td></tr></table></td></tr></table></td></tr></table></td></tr></table></td></tr></table>

 | | | | | | | | | | | | | | | | | | | | <table border="1" style="width: 100%; border-collapse: collapse; text-align: center;"> <tr> <td style="width: 10%;"></td> <td style="width: 10%;"></td> <td style="width: 10%;"></td> <td style="width: 10%;"></td> <td style="width: 10%;"></td> <td style="width: 10%;"></td> <td style="width: 10%;"></td> <td style="width: 10%;"></td> <td style="width: 10%;"></td> <td style="width: 10%;"></td> </tr> <tr> <td></td> <td></td> <td colspan="8" style="text-align: center;"> <table border="1" style="width: 100%; border-collapse: collapse; text-align: center;"> <tr> <td style="width: 10%;"></td> <td style="width: 10%;"></td> <td style="width: 10%;"></td> <td style="width: 10%;"></td> <td style="width: 10%;"></td> <td style="width: 10%;"></td> <td style="width: 10%;"></td> <td style="width: 10%;"></td> <td style="width: 10%;"></td> <td style="width: 10%;"></td> </tr> <tr> <td></td> <td></td> <td colspan="8" style="text-align: center;"> <table border="1" style="width: 100%; border-collapse: collapse; text-align: center;"> <tr> <td style="width: 10%;"></td> <td style="width: 10%;"></td> <td style="width: 10%;"></td> <td style="width: 10%;"></td> <td style="width: 10%;"></td> <td style="width: 10%;"></td> <td style="width: 10%;"></td> <td style="width: 10%;"></td> <td style="width: 10%;"></td> <td style="width: 10%;"></td> </tr> <tr> <td></td> <td></td> <td colspan="8" style="text-align: center;"> <table border="1" style="width: 100%; border-collapse: collapse; text-align: center;"> <tr> <td style="width: 10%;"></td> <td style="width: 10%;"></td> <td style="width: 10%;"></td> <td style="width: 10%;"></td> <td style="width: 10%;"></td> <td style="width: 10%;"></td> <td style="width: 10%;"></td> <td style="width: 10%;"></td> <td style="width: 10%;"></td> <td style="width: 10%;"></td> </tr> <tr> <td></td> <td></td> <td colspan="8" style="text-align: center;"> <table border="1" style="width: 100%; border-collapse: collapse; text-align: center;"> <tr> <td style="width: 10%;"></td> <td style="width: 10%;"></td> <td style="width: 10%;"></td> <td style="width: 10%;"></td> <td style="width: 10%;"></td> <td style="width: 10%;"></td> <td style="width: 10%;"></td> <td style="width: 10%;"></td> <td style="width: 10%;"></td> <td style="width: 10%;"></td> </tr> <tr> <td></td> <td></td> <td colspan="8" style="text-align: center;"> <table border="1" style="width: 100%; border-collapse: collapse; text-align: center;"> <tr> <td style="width: 10%;"></td> <td style="width: 10%;"></td> <td style="width: 10%;"></td> <td style="width: 10%;"></td> <td style="width: 10%;"></td> <td style="width: 10%;"></td> <td style="width: 10%;"></td> <td style="width: 10%;"></td> <td style="width: 10%;"></td> <td style="width: 10%;"></td> </tr> <tr> <td></td> <td></td> <td colspan="8" style="text-align: center;"> <table border="1" style="width: 100%; border-collapse: collapse; text-align: center;"> <tr> <td style="width: 10%;"></td> <td style="width: 10%;"></td> <td style="width: 10%;"></td> <td style="width: 10%;"></td> <td style="width: 10%;"></td> <td style="width: 10%;"></td> <td style="width: 10%;"></td> <td style="width: 10%;"></td> <td style="width: 10%;"></td> <td style="width: 10%;"></td> </tr> <tr> <td></td> <td></td> <td colspan="8" style="text-align: center;"> <table border="1" style="width: 100%; border-collapse: collapse; text-align: center;"> <tr> <td style="width: 10%;"></td> <td style="width: 10%;"></td> <td style="width: 10%;"></td> <td style="width: 10%;"></td> <td style="width: 10%;"></td> <td style="width: 10%;"></td> <td style="width: 10%;"></td> <td style="width: 10%;"></td> <td style="width: 10%;"></td> <td style="width: 10%;"></td> </tr> <tr> <td></td> <td></td> <td colspan="8" style="text-align: center;"> <table border="1" style="width: 100%; border-collapse: collapse; text-align: center;"> <tr> <td style="width: 10%;"></td> <td style="width: 10%;"></td> <td style="width: 10%;"></td> <td style="width: 10%;"></td> <td style="width: 10%;"></td> <td style="width: 10%;"></td> <td style="width: 10%;"></td> <td style="width: 10%;"></td> <td style="width: 10%;"></td> <td style="width: 10%;"></td> </tr> <tr> <td></td> <td></td> <td colspan="8" style="text-align: center;"> <table border="1" style="width: 100%; border-collapse: collapse; text-align: center;"> <tr> <td style="width: 10%;"></td> <td style="width: 10%;"></td> <td style="width: 10%;"></td> <td style="width: 10%;"></td> <td style="width: 10%;"></td> <td style="width: 10%;"></td> <td style="width: 10%;"></td> <td style="width: 10%;"></td> <td style="width: 10%;"></td> <td style="width: 10%;"></td> </tr> <tr> <td></td> <td></td> <td colspan="8" style="text-align: center;"> <table border="1" style="width: 100%; border-collapse: collapse; text-align: center;"> <tr> <td style="width: 10%;"></td> <td style="width: 10%;"></td> <td style="width: 10%;"></td> <td style="width: 10%;"></td> <td style="width: 10%;"></td> <td style="width: 10%;"></td> <td style="width: 10%;"></td> <td style="width: 10%;"></td> <td style="width: 10%;"></td> <td style="width: 10%;"></td> </tr> <tr> <td></td> <td></td> <td colspan="8" style="text-align: center;"> <table border="1" style="width: 100%; border-collapse: collapse; text-align: center;"> <tr> <td style="width: 10%;"></td> <td style="width: 10%;"></td> <td style="width: 10%;"></td> <td style="width: 10%;"></td> <td style="width: 10%;"></td> <td style="width: 10%;"></td> <td style="width: 10%;"></td> <td style="width: 10%;"></td> <td style="width: 10%;"></td> <td style="width: 10%;"></td> </tr> <tr> <td></td> <td></td> <td colspan="8" style="text-align: center;"> <table border="1" style="width: 100%; border-collapse: collapse; text-align: center;"> <tr> <td style="width: 10%;"></td> <td style="width: 10%;"></td> <td style="width: 10%;"></td> <td style="width: 10%;"></td> <td style="width: 10%;"></td> <td style="width: 10%;"></td> <td style="width: 10%;"></td> <td style="width: 10%;"></td> <td style="width: 10%;"></td> <td
style="width: 10%;"></td> </tr> <tr> <td></td> <td></td> <td colspan="8" style="text-align: center;"> <table border="1" style="width: 100%; border-collapse: collapse; text-align: center;"> <tr> <td style="width: 10%;"></td> <td style="width: 10%;"></td> <td style="width: 10%;"></td> <td style="width: 10%;"></td> <td style="width: 10%;"></td> <td style="width: 10%;"></td> <td style="width: 10%;"></td> <td style="width: 10%;"></td> <td style="width: 10%;"></td> <td style="width: 10%;"></td> </tr> <tr> <td></td> <td></td> <td colspan="8" style="text-align: center;"> <table border="1" style="width: 100%; border-collapse: collapse; text-align: center;"> <tr> <td style="width: 10%;"></td> <td style="width: 10%;"></td> <td style="width: 10%;"></td> <td style="width: 10%;"></td> <td style="width: 10%;"></td> <td style="width: 10%;"></td> <td style="width: 10%;"></td> <td style="width: 10%;"></td> <td style="width: 10%;"></td> <td style="width: 10%;"></td> </tr> <tr> <td></td> <td></td> <td colspan="8" style="text-align: center;"> <table border="1" style="width: 100%; border-collapse: collapse; text-align: center;"> <tr> <td style="width: 10%;"></td> <td style="width: 10%;"></td> <td style="width: 10%;"></td> <td style="width: 10%;"></td> <td style="width: 10%;"></td> <td style="width: 10%;"></td> <td style="width: 10%;"></td> <td style="width: 10%;"></td> <td style="width: 10%;"></td> <td style="width: 10%;"></td> </tr> <tr> <td></td> <td></td> <td colspan="8" style="text-align: center;"> <table border="1" style="width: 100%; border-collapse: collapse; text-align: center;"> <tr> <td style="width: 10%;"></td> <td style="width: 10%;"></td> <td style="width: 10%;"></td> <td style="width: 10%;"></td> <td style="width: 10%;"></td> <td style="width: 10%;"></td> <td style="width: 10%;"></td> <td style="width: 10%;"></td> <td style="width: 10%;"></td> <td style="width: 10%;"></td> </tr> <tr> <td></td> <td></td> <td colspan="8" style="text-align: center;"> <table border="1" style="width: 100%; border-collapse: collapse; text-align: center;"> <tr> <td style="width: 10%;"></td> <td style="width: 10%;"></td> <td style="width: 10%;"></td> <td style="width: 10%;"></td> <td style="width: 10%;"></td> <td style="width: 10%;"></td> <td style="width: 10%;"></td> <td style="width: 10%;"></td> <td style="width: 10%;"></td> <td style="width: 10%;"></td> </tr> <tr> <td></td> <td></td> <td colspan="8" style="text-align: center;"> <table border="1" style="width: 100%; border-collapse: collapse; text-align: center;"> <tr> <td style="width: 10%;"></td> <td style="width: 10%;"></td> <td style="width: 10%;"></td> <td style="width: 10%;"></td> <td style="width: 10%;"></td> <td style="width: 10%;"></td> <td style="width: 10%;"></td> <td style="width: 10%;"></td> <td style="width: 10%;"></td> <td style="width: 10%;"></td> </tr> <tr> <td></td> <td></td> <td colspan="8" style="text-align: center;"> <table border="1" style="width: 100%; border-collapse: collapse; text-align: center;"> <tr> <td style="width: 10%;"></td> <td style="width: 10%;"></td> <td style="width: 10%;"></td> <td style="width: 10%;"></td> <td style="width: 10%;"></td> <td style="width: 10%;"></td> <td style="width: 10%;"></td> <td style="width: 10%;"></td> <td style="width: 10%;"></td> <td style="width: 10%;"></td> </tr> <tr> <td></td> <td></td> <td colspan="8" style="text-align: center;"> <table border="1" style="width: 100%; border-collapse: collapse; text-align: center;"> <tr> <td style="width: 10%;"></td> <td style="width: 10%;"></td> <td style="width: 10%;"></td> <td style="width: 10%;"></td> <td style="width: 10%;"></td> <td style="width: 10%;"></td> <td style="width: 10%;"></td> <td style="width: 10%;"></td> <td style="width: 10%;"></td> <td style="width: 10%;"></td> </tr> <tr> <td></td> <td></td> <td colspan="8" style="text-align: center;"> <table border="1" style="width: 100%; border-collapse: collapse; text-align: center;"> <tr> <td style="width: 10%;"></td> <td style="width: 10%;"></td> <td style="width: 10%;"></td> <td style="width: 10%;"></td> <td style="width: 10%;"></td> <td style="width: 10%;"></td> <td style="width: 10%;"></td> <td style="width: 10%;"></td> <td style="width: 10%;"></td> <td style="width: 10%;"></td> </tr> <tr> <td></td> <td></td> <td colspan="8" style="text-align: center;"> <table border="1" style="width: 100%; border-collapse: collapse; text-align: center;"> <tr> <td style="width: 10%;"></td> <td style="width: 10%;"></td> <td style="width: 10%;"></td> <td style="width: 10%;"></td> <td style="width: 10%;"></td> <td style="width: 10%;"></td> <td style="width: 10%;"></td> <td style="width: 10%;"></td> <td style="width: 10%;"></td> <td style="width: 10%;"></td> </tr> <tr> <td></td> <td></td> <td colspan="8" style="text-align: center;"> <table border="1" style="width: 100%; border-collapse: collapse; text-align: center;"> <tr> <td style="width: 10%;"></td> <td style="width: 10%;"></td> <td style="width: 10%;"></td> <td style="width: 10%;"></td> <td style="width: 10%;"></td> <td style="width: 10%;"></td> <td style="width: 10%;"></td> <td style="width: 10%;"></td> <td style="width: 10%;"></td> <td style="width: 10%;"></td> </tr> <tr> <td></td> <td></td> <td colspan="8" style="text-align: center;"> <table border="1" style="width: 100%; border-collapse: collapse; text-align: center;"> <tr> <td style="width: 10%;"></td> <td style="width: 10%;"></td> <td style="width: 10%;"></td> <td style="width: 10%;"></td> <td style="width: 10%;"></td> <td style="width: 10%;"></td> <td style="width: 10%;"></td> <td style="width: 10%;"></td> <td style="width: 10%;"></td> <td style="width: 10%;"></td> </tr> <tr> <td></td> <td></td> <td colspan="8" style="text-align: center;"> <table border="1" style="width: 100%; border-collapse: collapse; text-align: center;"> <tr> </tr></table></td></tr></table></td></tr></table></td></tr></table></td></tr></table></td></tr></table></td></tr></table></td></tr></table></td></tr></table></td></tr></table></td></tr></table></td></tr></table></td></tr></table></td></tr></table></td></tr></table></td></tr></table></td></tr></table></td></tr></table></td></tr></table></td></tr></table></td></tr></table></td></tr></table></td></tr></table></td></tr></table></td></tr></table></td></tr></table>

 | | | | | | | | | | | | | | | | | | | | <table border="1" style="width: 100%; border-collapse: collapse; text-align: center;"> <tr> <td style="width: 10%;"></td> <td style="width: 10%;"></td> <td style="width: 10%;"></td> <td style="width: 10%;"></td> <td style="width: 10%;"></td> <td style="width: 10%;"></td> <td style="width: 10%;"></td> <td style="width: 10%;"></td> <td style="width: 10%;"></td> <td style="width: 10%;"></td> </tr> <tr> <td></td> <td></td> <td colspan="8" style="text-align: center;"> <table border="1" style="width: 100%; border-collapse: collapse; text-align: center;"> <tr> <td style="width: 10%;"></td> <td style="width: 10%;"></td> <td style="width: 10%;"></td> <td style="width: 10%;"></td> <td style="width: 10%;"></td> <td style="width: 10%;"></td> <td style="width: 10%;"></td> <td style="width: 10%;"></td> <td style="width: 10%;"></td> <td style="width: 10%;"></td> </tr> <tr> <td></td> <td></td> <td colspan="8" style="text-align: center;"> <table border="1" style="width: 100%; border-collapse: collapse; text-align: center;"> <tr> <td style="width: 10%;"></td> <td style="width: 10%;"></td> <td style="width: 10%;"></td> <td style="width: 10%;"></td> <td style="width: 10%;"></td> <td style="width: 10%;"></td> <td style="width: 10%;"></td> <td style="width: 10%;"></td> <td style="width: 10%;"></td> <td style="width: 10%;"></td> </tr> <tr> <td></td> <td></td> <td colspan="8" style="text-align: center;"> <table border="1" style="width: 100%; border-collapse: collapse; text-align: center;"> <tr> <td style="width: 10%;"></td> <td style="width: 10%;"></td> <td style="width: 10%;"></td> <td style="width: 10%;"></td> <td style="width: 10%;"></td> <td style="width: 10%;"></td> <td style="width: 10%;"></td> <td style="width: 10%;"></td> <td style="width: 10%;"></td> <td style="width: 10%;"></td> </tr> <tr> <td></td> <td></td> <td colspan="8" style="text-align: center;"> <table border="1" style="width: 100%; border-collapse: collapse; text-align: center;"> <tr> <td style="width: 10%;"></td> <td style="width: 10%;"></td> <td style="width: 10%;"></td> <td style="width: 10%;"></td> <td style="width: 10%;"></td> <td style="width: 10%;"></td> <td style="width: 10%;"></td> <td style="width: 10%;"></td> <td style="width: 10%;"></td> <td style="width: 10%;"></td> </tr> <tr> <td></td> <td></td> <td colspan="8" style="text-align: center;"> <table border="1" style="width: 100%; border-collapse: collapse; text-align: center;"> <tr> <td style="width: 10%;"></td> <td style="width: 10%;"></td> <td style="width: 10%;"></td> <td style="width: 10%;"></td> <td style="width: 10%;"></td> <td style="width: 10%;"></td> <td style="width: 10%;"></td> <td style="width: 10%;"></td> <td style="width: 10%;"></td> <td style="width: 10%;"></td> </tr> <tr> <td></td> <td></td> <td colspan="8" style="text-align: center;"> <table border="1" style="width: 100%; border-collapse: collapse; text-align: center;"> <tr> <td style="width: 10%;"></td> <td style="width: 10%;"></td> <td style="width: 10%;"></td> <td style="width: 10%;"></td> <td style="width: 10%;"></td> <td style="width: 10%;"></td> <td style="width: 10%;"></td> <td style="width: 10%;"></td> <td style="width: 10%;"></td> <td style="width: 10%;"></td> </tr> <tr> <td></td> <td></td> <td colspan="8" style="text-align: center;"> <table border="1" style="width: 100%; border-collapse: collapse; text-align: center;"> <tr> <td style="width: 10%;"></td> <td style="width: 10%;"></td> <td style="width: 10%;"></td> <td style="width: 10%;"></td> <td style="width: 10%;"></td> <td style="width: 10%;"></td> <td style="width: 10%;"></td> <td style="width: 10%;"></td> <td style="width: 10%;"></td> <td style="width: 10%;"></td> </tr> <tr> <td></td> <td></td> <td colspan="8" style="text-align: center;"> <table border="1" style="width: 100%; border-collapse: collapse; text-align: center;"> <tr> <td style="width: 10%;"></td> <td style="width: 10%;"></td> <td style="width: 10%;"></td> <td style="width: 10%;"></td> <td style="width: 10%;"></td> <td style="width: 10%;"></td> <td style="width: 10%;"></td> <td style="width: 10%;"></td> <td style="width: 10%;"></td> <td style="width: 10%;"></td> </tr> <tr> <td></td> <td></td> <td colspan="8" style="text-align: center;"> <table border="1" style="width: 100%; border-collapse: collapse; text-align: center;"> <tr> <td style="width: 10%;"></td> <td style="width: 10%;"></td> <td style="width: 10%;"></td> <td style="width: 10%;"></td> <td style="width: 10%;"></td> <td style="width: 10%;"></td> <td style="width: 10%;"></td> <td style="width: 10%;"></td> <td style="width: 10%;"></td> <td style="width: 10%;"></td> </tr> <tr> <td></td> <td></td> <td colspan="8" style="text-align: center;"> <table border="1" style="width: 100%; border-collapse: collapse; text-align: center;"> <tr> <td style="width: 10%;"></td> <td style="width: 10%;"></td> <td style="width: 10%;"></td> <td style="width: 10%;"></td> <td style="width: 10%;"></td> <td style="width: 10%;"></td> <td style="width: 10%;"></td> <td style="width: 10%;"></td> <td style="width: 10%;"></td> <td style="width: 10%;"></td> </tr> <tr> <td></td> <td></td> <td colspan="8" style="text-align: center;"> <table border="1" style="width: 100%; border-collapse: collapse; text-align: center;"> <tr> <td style="width: 10%;"></td> <td style="width: 10%;"></td> <td style="width: 10%;"></td> <td style="width: 10%;"></td> <td style="width: 10%;"></td> <td style="width: 10%;"></td> <td style="width: 10%;"></td> <td style="width: 10%;"></td> <td style="width: 10%;"></td> <td style="width: 10%;"></td> </tr> <tr> <td></td> <td></td> <td colspan="8" style="text-align: center;"> <table border="1" style="width: 100%; border-collapse: collapse; text-align: center;"> <tr> <td style="width: 10%;"></td> <td style="width: 10%;"></td> <td style="width: 10%;"></td> <td style="width: 10%;"></td> <td style="width: 10%;"></td> <td style="width: 10%;"></td> <td style="width: 10%;"></td> <td style="width: 10%;"></td> <td style="width: 10%;"></td> <td style="width: 10%;"></td> </tr> <tr> <td></td> <td></td> <td colspan="8" style="text-align: center;"> <table border="1" style="width: 100%; border-collapse: collapse; text-align: center;"> <tr> <td style="width: 10%;"></td> <td style="width: 10%;"></td> <td style="width: 10%;"></td> <td style="width: 10%;"></td> <td style="width: 10%;"></td> <td style="width: 10%;"></td> <td style="width: 10%;"></td> <td style="width: 10%;"></td> <td style="width: 10%;"></td> <td style="width: 10%;"></td> </tr> <tr> <td></td> <td></td> <td colspan="8" style="text-align: center;"> <table border="1" style="width: 100%; border-collapse: collapse; text-align: center;"> <tr> <td style="width: 10%;"></td> <td style="width: 10%;"></td> <td style="width: 10%;"></td> <td style="width: 10%;"></td> <td style="width: 10%;"></td> <td style="width: 10%;"></td> <td style="width: 10%;"></td> <td style="width: 10%;"></td> <td style="width: 10%;"></td> <td style="width: 10%;"></td> </tr> <tr> <td></td> <td></td> <td colspan="8" style="text-align: center;"> <table border="1" style="width: 100%; border-collapse: collapse; text-align: center;"> <tr> <td style="width: 10%;"></td> <td style="width: 10%;"></td> <td style="width: 10%;"></td> <td style="width: 10%;"></td> <td style="width: 10%;"></td> <td style="width: 10%;"></td> <td style="width: 10%;"></td> <td style="width: 10%;"></td> <td style="width: 10%;"></td> <td style="width: 10%;"></td> </tr> <tr> <td></td> <td></td> <td colspan="8" style="text-align: center;"> <table border="1" style="width: 100%; border-collapse: collapse; text-align: center;"> <tr> <td style="width: 10%;"></td> <td style="width: 10%;"></td> <td style="width: 10%;"></td> <td style="width: 10%;"></td> <td style="width: 10%;"></td> <td style="width: 10%;"></td> <td style="width: 10%;"></td> <td style="width: 10%;"></td> <td style="width: 10%;"></td> <td style="width: 10%;"></td> </tr> <tr> <td></td> <td></td> <td colspan="8" style="text-align: center;"> <table border="1" style="width: 100%; border-collapse: collapse; text-align: center;"> <tr> <td style="width: 10%;"></td> <td style="width: 10%;"></td> <td style="width: 10%;"></td> <td style="width: 10%;"></td> <td style="width: 10%;"></td> <td style="width: 10%;"></td> <td style="width: 10%;"></td> <td style="width: 10%;"></td> <td style="width: 10%;"></td> <td style="width: 10%;"></td> </tr> <tr> <td></td> <td></td> <td colspan="8" style="text-align: center;"> <table border="1" style="width: 100%; border-collapse: collapse; text-align: center;"> <tr> <td style="width: 10%;"></td> <td style="width: 10%;"></td> <td style="width: 10%;"></td> <td style="width: 10%;"></td> <td style="width: 10%;"></td> <td style="width: 10%;"></td> <td style="width: 10%;"></td> <td style="width: 10%;"></td> <td style="width: 10%;"></td> <td style="width: 10%;"></td> </tr> <tr> <td></td> <td></td> <td colspan="8" style="text-align: center;"> <table border="1" style="width: 100%; border-collapse: collapse; text-align: center;"> <tr> <td style="width: 10%;"></td> <td style="width: 10%;"></td> <td style="width: 10%;"></td> <td
style="width: 10%;"></td> <td style="width: 10%;"></td> <td style="width: 10%;"></td> <td style="width: 10%;"></td> <td style="width: 10%;"></td> <td style="width: 10%;"></td> <td style="width: 10%;"></td> </tr> <tr> <td></td> <td></td> <td colspan="8" style="text-align: center;"> <table border="1" style="width: 100%; border-collapse: collapse; text-align: center;"> <tr> <td style="width: 10%;"></td> <td style="width: 10%;"></td> <td style="width: 10%;"></td> <td style="width: 10%;"></td> <td style="width: 10%;"></td> <td style="width: 10%;"></td> <td style="width: 10%;"></td> <td style="width: 10%;"></td> <td style="width: 10%;"></td> <td style="width: 10%;"></td> </tr> <tr> <td></td> <td></td> <td colspan="8" style="text-align: center;"> <table border="1" style="width: 100%; border-collapse: collapse; text-align: center;"> <tr> <td style="width: 10%;"></td> <td style="width: 10%;"></td> <td style="width: 10%;"></td> <td style="width: 10%;"></td> <td style="width: 10%;"></td> <td style="width: 10%;"></td> <td style="width: 10%;"></td> <td style="width: 10%;"></td> <td style="width: 10%;"></td> <td style="width: 10%;"></td> </tr> <tr> <td></td> <td></td> <td colspan="8" style="text-align: center;"> <table border="1" style="width: 100%; border-collapse: collapse; text-align: center;"> <tr> <td style="width: 10%;"></td> <td style="width: 10%;"></td> <td style="width: 10%;"></td> <td style="width: 10%;"></td> <td style="width: 10%;"></td> <td style="width: 10%;"></td> <td style="width: 10%;"></td> <td style="width: 10%;"></td> <td style="width: 10%;"></td> <td style="width: 10%;"></td> </tr> <tr> <td></td> <td></td> <td colspan="8" style="text-align: center;"> <table border="1" style="width: 100%; border-collapse: collapse; text-align: center;"> <tr> <td style="width: 10%;"></td> <td style="width: 10%;"></td> <td style="width: 10%;"></td> <td style="width: 10%;"></td> <td style="width: 10%;"></td> <td style="width: 10%;"></td> <td style="width: 10%;"></td> <td style="width: 10%;"></td> <td style="width: 10%;"></td> <td style="width: 10%;"></td> </tr> <tr> <td></td> <td></td> <td colspan="8" style="text-align: center;"> <table border="1" style="width: 100%; border-collapse: collapse; text-align: center;"> <tr> </tr></table></td></tr></table></td></tr></table></td></tr></table></td></tr></table></td></tr></table></td></tr></table></td></tr></table></td></tr></table></td></tr></table></td></tr></table></td></tr></table></td></tr></table></td></tr></table></td></tr></table></td></tr></table></td></tr></table></td></tr></table></td></tr></table></td></tr></table></td></tr></table></td></tr></table></td></tr></table></td></tr></table></td></tr></table>
 | | | | | | | | | | | | | | | | | | | | <table border="1" style="width: 100%; border-collapse: collapse; text-align: center;"> <tr> <td style="width: 10%;"></td> <td style="width: 10%;"></td> <td style="width: 10%;"></td> <td style="width: 10%;"></td> <td style="width: 10%;"></td> <td style="width: 10%;"></td> <td style="width: 10%;"></td> <td style="width: 10%;"></td> <td style="width: 10%;"></td> <td style="width: 10%;"></td> </tr> <tr> <td></td> <td></td> <td colspan="8" style="text-align: center;"> <table border="1" style="width: 100%; border-collapse: collapse; text-align: center;"> <tr> <td style="width: 10%;"></td> <td style="width: 10%;"></td> <td style="width: 10%;"></td> <td style="width: 10%;"></td> <td style="width: 10%;"></td> <td style="width: 10%;"></td> <td style="width: 10%;"></td> <td style="width: 10%;"></td> <td style="width: 10%;"></td> <td style="width: 10%;"></td> </tr> <tr> <td></td> <td></td> <td colspan="8" style="text-align: center;"> <table border="1" style="width: 100%; border-collapse: collapse; text-align: center;"> <tr> <td style="width: 10%;"></td> <td style="width: 10%;"></td> <td style="width: 10%;"></td> <td style="width: 10%;"></td> <td style="width: 10%;"></td> <td style="width: 10%;"></td> <td style="width: 10%;"></td> <td style="width: 10%;"></td> <td style="width: 10%;"></td> <td style="width: 10%;"></td> </tr> <tr> <td></td> <td></td> <td colspan="8" style="text-align: center;"> <table border="1" style="width: 100%; border-collapse: collapse; text-align: center;"> <tr> <td style="width: 10%;"></td> <td style="width: 10%;"></td> <td style="width: 10%;"></td> <td style="width: 10%;"></td> <td style="width: 10%;"></td> <td style="width: 10%;"></td> <td style="width: 10%;"></td> <td style="width: 10%;"></td> <td style="width: 10%;"></td> <td style="width: 10%;"></td> </tr> <tr> <td></td> <td></td> <td colspan="8" style="text-align: center;"> <table border="1" style="width: 100%; border-collapse: collapse; text-align: center;"> <tr> <td style="width: 10%;"></td> <td style="width: 10%;"></td> <td style="width: 10%;"></td> <td style="width: 10%;"></td> <td style="width: 10%;"></td> <td style="width: 10%;"></td> <td style="width: 10%;"></td> <td style="width: 10%;"></td> <td style="width: 10%;"></td> <td style="width: 10%;"></td> </tr> <tr> <td></td> <td></td> <td colspan="8" style="text-align: center;"> <table border="1" style="width: 100%; border-collapse: collapse; text-align: center;"> <tr> <td style="width: 10%;"></td> <td style="width: 10%;"></td> <td style="width: 10%;"></td> <td style="width: 10%;"></td> <td style="width: 10%;"></td> <td style="width: 10%;"></td> <td style="width: 10%;"></td> <td style="width:
10%;"></td> <td style="width: 10%;"></td> <td style="width: 10%;"></td> </tr> <tr> <td></td> <td></td> <td colspan="8" style="text-align: center;"> <table border="1" style="width: 100%; border-collapse: collapse; text-align: center;"> <tr> <td style="width: 10%;"></td> <td style="width: 10%;"></td> <td style="width: 10%;"></td> <td style="width: 10%;"></td> <td style="width: 10%;"></td> <td style="width: 10%;"></td> <td style="width: 10%;"></td> <td style="width: 10%;"></td> <td style="width: 10%;"></td> <td style="width: 10%;"></td> </tr> <tr> <td></td> <td></td> <td colspan="8" style="text-align: center;"> <table border="1" style="width: 100%; border-collapse: collapse; text-align: center;"> <tr> <td style="width: 10%;"></td> <td style="width: 10%;"></td> <td style="width: 10%;"></td> <td style="width: 10%;"></td> <td style="width: 10%;"></td> <td style="width: 10%;"></td> <td style="width: 10%;"></td> <td style="width: 10%;"></td> <td style="width: 10%;"></td> <td style="width: 10%;"></td> </tr> <tr> <td></td> <td></td> <td colspan="8" style="text-align: center;"> <table border="1" style="width: 100%; border-collapse: collapse; text-align: center;"> <tr> <td style="width: 10%;"></td> <td style="width: 10%;"></td> <td style="width: 10%;"></td> <td style="width: 10%;"></td> <td style="width: 10%;"></td> <td style="width: 10%;"></td> <td style="width: 10%;"></td> <td style="width: 10%;"></td> <td style="width: 10%;"></td> <td style="width: 10%;"></td> </tr> <tr> <td></td> <td></td> <td colspan="8" style="text-align: center;"> <table border="1" style="width: 100%; border-collapse: collapse; text-align: center;"> <tr> <td style="width: 10%;"></td> <td style="width: 10%;"></td> <td style="width: 10%;"></td> <td style="width: 10%;"></td> <td style="width: 10%;"></td> <td style="width: 10%;"></td> <td style="width: 10%;"></td> <td style="width: 10%;"></td> <td style="width: 10%;"></td> <td style="width: 10%;"></td> </tr> <tr> <td></td> <td></td> <td colspan="8" style="text-align: center;"> <table border="1" style="width: 100%; border-collapse: collapse; text-align: center;"> <tr> <td style="width: 10%;"></td> <td style="width: 10%;"></td> <td style="width: 10%;"></td> <td style="width: 10%;"></td> <td style="width: 10%;"></td> <td style="width: 10%;"></td> <td style="width: 10%;"></td> <td style="width: 10%;"></td> <td style="width: 10%;"></td> <td style="width: 10%;"></td> </tr> <tr> <td></td> <td></td> <td colspan="8" style="text-align: center;"> <table border="1" style="width: 100%; border-collapse: collapse; text-align: center;"> <tr> <td style="width: 10%;"></td> <td style="width: 10%;"></td> <td style="width: 10%;"></td> <td style="width: 10%;"></td> <td style="width: 10%;"></td> <td style="width: 10%;"></td> <td style="width: 10%;"></td> <td style="width: 10%;"></td> <td style="width: 10%;"></td> <td style="width: 10%;"></td> </tr> <tr> <td></td> <td></td> <td colspan="8" style="text-align: center;"> <table border="1" style="width: 100%; border-collapse: collapse; text-align: center;"> <tr> <td style="width: 10%;"></td> <td style="width: 10%;"></td> <td style="width: 10%;"></td> <td style="width: 10%;"></td> <td style="width: 10%;"></td> <td style="width: 10%;"></td> <td style="width: 10%;"></td> <td style="width: 10%;"></td> <td style="width: 10%;"></td> <td style="width: 10%;"></td> </tr> <tr> <td></td> <td></td> <td colspan="8" style="text-align: center;"> <table border="1" style="width: 100%; border-collapse: collapse; text-align: center;"> <tr> <td style="width: 10%;"></td> <td style="width: 10%;"></td> <td style="width: 10%;"></td> <td style="width: 10%;"></td> <td style="width: 10%;"></td> <td style="width: 10%;"></td> <td style="width: 10%;"></td> <td style="width: 10%;"></td> <td style="width: 10%;"></td> <td style="width: 10%;"></td> </tr> <tr> <td></td> <td></td> <td colspan="8" style="text-align: center;"> <table border="1" style="width: 100%; border-collapse: collapse; text-align: center;"> <tr> <td style="width: 10%;"></td> <td style="width: 10%;"></td> <td style="width: 10%;"></td> <td style="width: 10%;"></td> <td style="width: 10%;"></td> <td style="width: 10%;"></td> <td style="width: 10%;"></td> <td style="width: 10%;"></td> <td style="width: 10%;"></td> <td style="width: 10%;"></td> </tr> <tr> <td></td> <td></td> <td colspan="8" style="text-align: center;"> <table border="1" style="width: 100%; border-collapse: collapse; text-align: center;"> <tr> <td style="width: 10%;"></td> <td style="width: 10%;"></td> <td style="width: 10%;"></td> <td style="width: 10%;"></td> <td style="width: 10%;"></td> <td style="width: 10%;"></td> <td style="width: 10%;"></td> <td style="width: 10%;"></td> <td style="width: 10%;"></td> <td style="width: 10%;"></td> </tr> <tr> <td></td> <td></td> <td colspan="8" style="text-align: center;"> <table border="1" style="width: 100%; border-collapse: collapse; text-align: center;"> <tr> <td style="width: 10%;"></td> <td style="width: 10%;"></td> <td style="width: 10%;"></td> <td style="width: 10%;"></td> <td style="width: 10%;"></td> <td style="width: 10%;"></td> <td style="width: 10%;"></td> <td style="width: 10%;"></td> <td style="width: 10%;"></td> <td style="width: 10%;"></td> </tr> <tr> <td></td> <td></td> <td colspan="8" style="text-align: center;"> <table border="1" style="width: 100%; border-collapse: collapse; text-align: center;"> <tr> <td style="width: 10%;"></td> <td style="width: 10%;"></td> <td style="width: 10%;"></td> <td style="width: 10%;"></td> <td style="width: 10%;"></td> <td style="width: 10%;"></td> <td style="width: 10%;"></td> <td style="width: 10%;"></td> <td style="width: 10%;"></td> <td style="width: 10%;"></td> </tr> <tr> <td></td> <td></td> <td colspan="8" style="text-align: center;"> <table border="1" style="width: 100%; border-collapse: collapse; text-align: center;"> <tr> <td style="width: 10%;"></td> <td style="width: 10%;"></td> <td style="width: 10%;"></td> <td style="width: 10%;"></td> <td style="width: 10%;"></td> <td style="width: 10%;"></td> <td style="width: 10%;"></td> <td style="width: 10%;"></td> <td style="width: 10%;"></td> <td style="width: 10%;"></td> </tr> <tr> <td></td> <td></td> <td colspan="8" style="text-align: center;"> <table border="1" style="width: 100%; border-collapse: collapse; text-align: center;"> <tr> <td style="width: 10%;"></td> <td style="width: 10%;"></td> <td style="width: 10%;"></td> <td style="width: 10%;"></td> <td style="width: 10%;"></td> <td style="width: 10%;"></td> <td style="width: 10%;"></td> <td style="width: 10%;"></td> <td style="width: 10%;"></td> <td style="width: 10%;"></td> </tr> <tr> <td></td> <td></td> <td colspan="8" style="text-align: center;"> <table border="1" style="width: 100%; border-collapse: collapse; text-align: center;"> <tr> <td style="width: 10%;"></td> <td style="width: 10%;"></td> <td style="width: 10%;"></td> <td style="width: 10%;"></td> <td style="width: 10%;"></td> <td style="width: 10%;"></td> <td style="width: 10%;"></td> <td style="width: 10%;"></td> <td style="width: 10%;"></td> <td style="width: 10%;"></td> </tr> <tr> <td></td> <td></td> <td colspan="8" style="text-align: center;"> <table border="1" style="width: 100%; border-collapse: collapse; text-align: center;"> <tr> <td style="width: 10%;"></td> <td style="width: 10%;"></td> <td style="width: 10%;"></td> <td style="width: 10%;"></td> <td style="width: 10%;"></td> <td style="width: 10%;"></td> <td style="width: 10%;"></td> <td style="width: 10%;"></td> <td style="width: 10%;"></td> <td style="width: 10%;"></td> </tr> <tr> <td></td> <td></td> <td colspan="8" style="text-align: center;"> <table border="1" style="width: 100%; border-collapse: collapse; text-align: center;"> <tr> <td style="width: 10%;"></td> <td style="width: 10%;"></td> <td style="width: 10%;"></td> <td style="width: 10%;"></td> <td style="width: 10%;"></td> <td style="width: 10%;"></td> <td style="width: 10%;"></td> <td style="width: 10%;"></td> <td style="width: 10%;"></td> <td style="width: 10%;"></td> </tr> <tr> <td></td> <td></td> <td colspan="8" style="text-align: center;"> <table border="1" style="width: 100%; border-collapse: collapse; text-align: center;"> <tr> </tr></table></td></tr></table></td></tr></table></td></tr></table></td></tr></table></td></tr></table></td></tr></table></td></tr></table></td></tr></table></td></tr></table></td></tr></table></td></tr></table></td></tr></table></td></tr></table></td></tr></table></td></tr></table></td></tr></table></td></tr></table></td></tr></table></td></tr></table></td></tr></table></td></tr></table></td></tr></table></td></tr></table>

 | | | | | | | | | | | | | | | | | | | | <table border="1" style="width: 100%; border-collapse: collapse; text-align: center;"> <tr> <td style="width: 10%;"></td> <td style="width: 10%;"></td> <td style="width: 10%;"></td> <td style="width: 10%;"></td> <td style="width: 10%;"></td> <td style="width: 10%;"></td> <td style="width: 10%;"></td> <td style="width: 10%;"></td> <td style="width: 10%;"></td> <td style="width: 10%;"></td> </tr> <tr> <td></td> <td></td> <td colspan="8" style="text-align: center;"> <table border="1" style="width: 100%; border-collapse: collapse; text-align: center;"> <tr> <td style="width: 10%;"></td> <td style="width: 10%;"></td> <td style="width: 10%;"></td> <td style="width: 10%;"></td> <td style="width: 10%;"></td> <td style="width: 10%;"></td> <td style="width: 10%;"></td> <td style="width: 10%;"></td> <td style="width: 10%;"></td> <td style="width: 10%;"></td> </tr> <tr> <td></td> <td></td> <td colspan="8" style="text-align: center;"> <table border="1" style="width: 100%; border-collapse: collapse; text-align: center;"> <tr> <td style="width: 10%;"></td> <td style="width: 10%;"></td> <td style="width: 10%;"></td> <td style="width: 10%;"></td> <td style="width: 10%;"></td> <td style="width: 10%;"></td> <td style="width: 10%;"></td> <td style="width: 10%;"></td> <td style="width: 10%;"></td> <td style="width: 10%;"></td> </tr> <tr> <td></td> <td></td> <td colspan="8" style="text-align: center;"> <table border="1" style="width: 100%; border-collapse: collapse; text-align: center;"> <tr> <td style="width: 10%;"></td> <td style="width: 10%;"></td> <td style="width: 10%;"></td> <td style="width: 10%;"></td> <td style="width: 10%;"></td> <td style="width: 10%;"></td> <td style="width: 10%;"></td> <td style="width: 10%;"></td> <td style="width: 10%;"></td> <td style="width: 10%;"></td> </tr> <tr> <td></td> <td></td> <td colspan="8" style="text-align: center;"> <table border="1" style="width: 100%; border-collapse: collapse; text-align: center;"> <tr> <td style="width: 10%;"></td> <td style="width: 10%;"></td> <td style="width: 10%;"></td> <td style="width: 10%;"></td> <td style="width: 10%;"></td> <td style="width: 10%;"></td> <td style="width: 10%;"></td> <td style="width: 10%;"></td> <td style="width: 10%;"></td> <td style="width: 10%;"></td> </tr> <tr> <td></td> <td></td> <td colspan="8" style="text-align: center;"> <table border="1" style="width: 100%; border-collapse: collapse; text-align: center;"> <tr> <td style="width: 10%;"></td> <td style="width: 10%;"></td> <td style="width: 10%;"></td> <td style="width: 10%;"></td> <td style="width: 10%;"></td> <td style="width: 10%;"></td> <td style="width: 10%;"></td> <td style="width: 10%;"></td> <td style="width: 10%;"></td> <td style="width: 10%;"></td> </tr> <tr> <td></td> <td></td> <td colspan="8" style="text-align: center;"> <table border="1" style="width: 100%; border-collapse: collapse; text-align: center;"> <tr> <td style="width: 10%;"></td> <td style="width: 10%;"></td> <td style="width: 10%;"></td> <td style="width: 10%;"></td> <td style="width: 10%;"></td> <td style="width: 10%;"></td> <td style="width: 10%;"></td> <td style="width: 10%;"></td> <td style="width: 10%;"></td> <td style="width: 10%;"></td> </tr> <tr> <td></td> <td></td> <td colspan="8" style="text-align: center;"> <table border="1" style="width: 100%; border-collapse: collapse; text-align: center;"> <tr> <td style="width: 10%;"></td> <td style="width: 10%;"></td> <td style="width: 10%;"></td> <td style="width: 10%;"></td> <td style="width: 10%;"></td> <td style="width: 10%;"></td> <td style="width: 10%;"></td> <td style="width: 10%;"></td> <td style="width: 10%;"></td> <td style="width: 10%;"></td> </tr> <tr> <td></td> <td></td> <td colspan="8" style="text-align: center;"> <table border="1" style="width: 100%; border-collapse: collapse; text-align: center;"> <tr> <td style="width: 10%;"></td> <td style="width: 10%;"></td> <td style="width: 10%;"></td> <td style="width: 10%;"></td> <td style="width: 10%;"></td> <td style="width: 10%;"></td> <td style="width: 10%;"></td> <td style="width: 10%;"></td> <td style="width: 10%;"></td> <td style="width: 10%;"></td> </tr> <tr> <td></td> <td></td> <td colspan="8" style="text-align: center;"> <table border="1" style="width: 100%; border-collapse: collapse; text-align: center;"> <tr> <td style="width: 10%;"></td> <td style="width: 10%;"></td> <td style="width: 10%;"></td> <td style="width: 10%;"></td> <td style="width: 10%;"></td> <td style="width: 10%;"></td> <td style="width: 10%;"></td> <td style="width: 10%;"></td> <td style="width: 10%;"></td> <td style="width: 10%;"></td> </tr> <tr> <td></td> <td></td> <td colspan="8" style="text-align: center;"> <table border="1" style="width: 100%; border-collapse: collapse; text-align: center;"> <tr> <td style="width: 10%;"></td> <td style="width: 10%;"></td> <td style="width: 10%;"></td> <td style="width: 10%;"></td> <td style="width: 10%;"></td> <td style="width: 10%;"></td> <td style="width: 10%;"></td> <td style="width: 10%;"></td> <td style="width: 10%;"></td> <td style="width: 10%;"></td> </tr> <tr> <td></td> <td></td> <td colspan="8" style="text-align: center;"> <table border="1" style="width: 100%; border-collapse: collapse; text-align: center;"> <tr> <td style="width: 10%;"></td> <td style="width: 10%;"></td> <td style="width: 10%;"></td> <td style="width: 10%;"></td> <td style="width: 10%;"></td> <td style="width: 10%;"></td> <td style="width: 10%;"></td> <td style="width: 10%;"></td> <td style="width: 10%;"></td> <td style="width: 10%;"></td> </tr> <tr> <td></td> <td></td> <td colspan="8" style="text-align: center;"> <table border="1" style="width: 100%; border-collapse: collapse; text-align: center;"> <tr> <td style="width: 10%;"></td> <td style="width: 10%;"></td> <td style="width: 10%;"></td> <td style="width: 10%;"></td> <td style="width: 10%;"></td> <td style="width: 10%;"></td> <td style="width: 10%;"></td> <td style="width: 10%;"></td> <td style="width: 10%;"></td> <td style="width: 10%;"></td> </tr> <tr> <td></td> <td></td> <td colspan="8" style="text-align: center;"> <table border="1" style="width: 100%; border-collapse: collapse; text-align: center;"> <tr> <td style="width: 10%;"></td> <td style="width: 10%;"></td> <td style="width: 10%;"></td> <td style="width: 10%;"></td> <td style="width: 10%;"></td> <td style="width: 10%;"></td> <td style="width: 10%;"></td> <td style="width: 10%;"></td> <td style="width: 10%;"></td> <td style="width: 10%;"></td> </tr> <tr> <td></td> <td></td> <td colspan="8" style="text-align: center;"> <table border="1" style="width: 100%; border-collapse: collapse; text-align: center;"> <tr> <td style="width: 10%;"></td> <td style="width: 10%;"></td> <td style="width: 10%;"></td>
<td style="width: 10%;"></td> <td style="width: 10%;"></td> <td style="width: 10%;"></td> <td style="width: 10%;"></td> <td style="width: 10%;"></td> <td style="width: 10%;"></td> <td style="width: 10%;"></td> </tr> <tr> <td></td> <td></td> <td colspan="8" style="text-align: center;"> <table border="1" style="width: 100%; border-collapse: collapse; text-align: center;"> <tr> <td style="width: 10%;"></td> <td style="width: 10%;"></td> <td style="width: 10%;"></td> <td style="width: 10%;"></td> <td style="width: 10%;"></td> <td style="width: 10%;"></td> <td style="width: 10%;"></td> <td style="width: 10%;"></td> <td style="width: 10%;"></td> <td style="width: 10%;"></td> </tr> <tr> <td></td> <td></td> <td colspan="8" style="text-align: center;"> <table border="1" style="width: 100%; border-collapse: collapse; text-align: center;"> <tr> <td style="width: 10%;"></td> <td style="width: 10%;"></td> <td style="width: 10%;"></td> <td style="width: 10%;"></td> <td style="width: 10%;"></td> <td style="width: 10%;"></td> <td style="width: 10%;"></td> <td style="width: 10%;"></td> <td style="width: 10%;"></td> <td style="width: 10%;"></td> </tr> <tr> <td></td> <td></td> <td colspan="8" style="text-align: center;"> <table border="1" style="width: 100%; border-collapse: collapse; text-align: center;"> <tr> <td style="width: 10%;"></td> <td style="width: 10%;"></td> <td style="width: 10%;"></td> <td style="width: 10%;"></td> <td style="width: 10%;"></td> <td style="width: 10%;"></td> <td style="width: 10%;"></td> <td style="width: 10%;"></td> <td style="width: 10%;"></td> <td style="width: 10%;"></td> </tr> <tr> <td></td> <td></td> <td colspan="8" style="text-align: center;"> <table border="1" style="width: 100%; border-collapse: collapse; text-align: center;"> <tr> <td style="width: 10%;"></td> <td style="width: 10%;"></td> <td style="width: 10%;"></td> <td style="width: 10%;"></td> <td style="width: 10%;"></td> <td style="width: 10%;"></td> <td style="width: 10%;"></td> <td style="width: 10%;"></td> <td style="width: 10%;"></td> <td style="width: 10%;"></td> </tr> <tr> <td></td> <td></td> <td colspan="8" style="text-align: center;"> <table border="1" style="width: 100%; border-collapse: collapse; text-align: center;"> <tr> <td style="width: 10%;"></td> <td style="width: 10%;"></td> <td style="width: 10%;"></td> <td style="width: 10%;"></td> <td style="width: 10%;"></td> <td style="width: 10%;"></td> <td style="width: 10%;"></td> <td style="width: 10%;"></td> <td style="width: 10%;"></td> <td style="width: 10%;"></td> </tr> <tr> <td></td> <td></td> <td colspan="8" style="text-align: center;"> <table border="1" style="width: 100%; border-collapse: collapse; text-align: center;"> <tr> <td style="width: 10%;"></td> <td style="width: 10%;"></td> <td style="width: 10%;"></td> <td style="width: 10%;"></td> <td style="width: 10%;"></td> <td style="width: 10%;"></td> <td style="width: 10%;"></td> <td style="width: 10%;"></td> <td style="width: 10%;"></td> <td style="width: 10%;"></td> </tr> <tr> <td></td> <td></td> <td colspan="8" style="text-align: center;"> <table border="1" style="width: 100%; border-collapse: collapse; text-align: center;"> <tr> <td style="width: 10%;"></td> <td style="width: 10%;"></td> <td style="width: 10%;"></td> <td style="width: 10%;"></td> <td style="width: 10%;"></td> <td style="width: 10%;"></td> <td style="width: 10%;"></td> <td style="width: 10%;"></td> <td style="width: 10%;"></td> <td style="width: 10%;"></td> </tr> <tr> <td></td> <td></td> <td colspan="8" style="text-align: center;"> <table border="1" style="width: 100%; border-collapse: collapse; text-align: center;"> <tr> </tr></table></td></tr></table></td></tr></table></td></tr></table></td></tr></table></td></tr></table></td></tr></table></td></tr></table></td></tr></table></td></tr></table></td></tr></table></td></tr></table></td></tr></table></td></tr></table></td></tr></table></td></tr></table></td></tr></table></td></tr></table></td></tr></table></td></tr></table></td></tr></table></td></tr></table></td></tr></table>
 | | | | | | | | | | | | | | | | | | | | <table border="1" style="width: 100%; border-collapse: collapse; text-align: center;"> <tr> <td style="width: 10%;"></td> <td style="width: 10%;"></td> <td style="width: 10%;"></td> <td style="width: 10%;"></td> <td style="width: 10%;"></td> <td style="width: 10%;"></td> <td style="width: 10%;"></td> <td style="width: 10%;"></td> <td style="width: 10%;"></td> <td style="width: 10%;"></td> </tr> <tr> <td></td> <td></td> <td colspan="8" style="text-align: center;"> <table border="1" style="width: 100%; border-collapse: collapse; text-align: center;"> <tr> <td style="width: 10%;"></td> <td style="width: 10%;"></td> <td style="width: 10%;"></td> <td style="width: 10%;"></td> <td style="width: 10%;"></td> <td style="width: 10%;"></td> <td style="width: 10%;"></td> <td style="width: 10%;"></td> <td style="width: 10%;"></td> <td style="width: 10%;"></td> </tr> <tr> <td></td> <td></td> <td colspan="8" style="text-align: center;"> <table border="1" style="width: 100%; border-collapse: collapse; text-align: center;"> <tr> <td style="width: 10%;"></td> <td style="width: 10%;"></td> <td style="width: 10%;"></td> <td style="width: 10%;"></td> <td style="width: 10%;"></td> <td style="width: 10%;"></td> <td style="width: 10%;"></td> <td style="width: 10%;"></td> <td style="width:
10%;"></td> <td style="width: 10%;"></td> </tr> <tr> <td></td> <td></td> <td colspan="8" style="text-align: center;"> <table border="1" style="width: 100%; border-collapse: collapse; text-align: center;"> <tr> <td style="width: 10%;"></td> <td style="width: 10%;"></td> <td style="width: 10%;"></td> <td style="width: 10%;"></td> <td style="width: 10%;"></td> <td style="width: 10%;"></td> <td style="width: 10%;"></td> <td style="width: 10%;"></td> <td style="width: 10%;"></td> <td style="width: 10%;"></td> </tr> <tr> <td></td> <td></td> <td colspan="8" style="text-align: center;"> <table border="1" style="width: 100%; border-collapse: collapse; text-align: center;"> <tr> <td style="width: 10%;"></td> <td style="width: 10%;"></td> <td style="width: 10%;"></td> <td style="width: 10%;"></td> <td style="width: 10%;"></td> <td style="width: 10%;"></td> <td style="width: 10%;"></td> <td style="width: 10%;"></td> <td style="width: 10%;"></td> <td style="width: 10%;"></td> </tr> <tr> <td></td> <td></td> <td colspan="8" style="text-align: center;"> <table border="1" style="width: 100%; border-collapse: collapse; text-align: center;"> <tr> <td style="width: 10%;"></td> <td style="width: 10%;"></td> <td style="width: 10%;"></td> <td style="width: 10%;"></td> <td style="width: 10%;"></td> <td style="width: 10%;"></td> <td style="width: 10%;"></td> <td style="width: 10%;"></td> <td style="width: 10%;"></td> <td style="width: 10%;"></td> </tr> <tr> <td></td> <td></td> <td colspan="8" style="text-align: center;"> <table border="1" style="width: 100%; border-collapse: collapse; text-align: center;"> <tr> <td style="width: 10%;"></td> <td style="width: 10%;"></td> <td style="width: 10%;"></td> <td style="width: 10%;"></td> <td style="width: 10%;"></td> <td style="width: 10%;"></td> <td style="width: 10%;"></td> <td style="width: 10%;"></td> <td style="width: 10%;"></td> <td style="width: 10%;"></td> </tr> <tr> <td></td> <td></td> <td colspan="8" style="text-align: center;"> <table border="1" style="width: 100%; border-collapse: collapse; text-align: center;"> <tr> <td style="width: 10%;"></td> <td style="width: 10%;"></td> <td style="width: 10%;"></td> <td style="width: 10%;"></td> <td style="width: 10%;"></td> <td style="width: 10%;"></td> <td style="width: 10%;"></td> <td style="width: 10%;"></td> <td style="width: 10%;"></td> <td style="width: 10%;"></td> </tr> <tr> <td></td> <td></td> <td colspan="8" style="text-align: center;"> <table border="1" style="width: 100%; border-collapse: collapse; text-align: center;"> <tr> <td style="width: 10%;"></td> <td style="width: 10%;"></td> <td style="width: 10%;"></td> <td style="width: 10%;"></td> <td style="width: 10%;"></td> <td style="width: 10%;"></td> <td style="width: 10%;"></td> <td style="width: 10%;"></td> <td style="width: 10%;"></td> <td style="width: 10%;"></td> </tr> <tr> <td></td> <td></td> <td colspan="8" style="text-align: center;"> <table border="1" style="width: 100%; border-collapse: collapse; text-align: center;"> <tr> <td style="width: 10%;"></td> <td style="width: 10%;"></td> <td style="width: 10%;"></td> <td style="width: 10%;"></td> <td style="width: 10%;"></td> <td style="width: 10%;"></td> <td style="width: 10%;"></td> <td style="width: 10%;"></td> <td style="width: 10%;"></td> <td style="width: 10%;"></td> </tr> <tr> <td></td> <td></td> <td colspan="8" style="text-align: center;"> <table border="1" style="width: 100%; border-collapse: collapse; text-align: center;"> <tr> <td style="width: 10%;"></td> <td style="width: 10%;"></td> <td style="width: 10%;"></td> <td style="width: 10%;"></td> <td style="width: 10%;"></td> <td style="width: 10%;"></td> <td style="width: 10%;"></td> <td style="width: 10%;"></td> <td style="width: 10%;"></td> <td style="width: 10%;"></td> </tr> <tr> <td></td> <td></td> <td colspan="8" style="text-align: center;"> <table border="1" style="width: 100%; border-collapse: collapse; text-align: center;"> <tr> <td style="width: 10%;"></td> <td style="width: 10%;"></td> <td style="width: 10%;"></td> <td style="width: 10%;"></td> <td style="width: 10%;"></td> <td style="width: 10%;"></td> <td style="width: 10%;"></td> <td style="width: 10%;"></td> <td style="width: 10%;"></td> <td style="width: 10%;"></td> </tr> <tr> <td></td> <td></td> <td colspan="8" style="text-align: center;"> <table border="1" style="width: 100%; border-collapse: collapse; text-align: center;"> <tr> <td style="width: 10%;"></td> <td style="width: 10%;"></td> <td style="width: 10%;"></td> <td style="width: 10%;"></td> <td style="width: 10%;"></td> <td style="width: 10%;"></td> <td style="width: 10%;"></td> <td style="width: 10%;"></td> <td style="width: 10%;"></td> <td style="width: 10%;"></td> </tr> <tr> <td></td> <td></td> <td colspan="8" style="text-align: center;"> <table border="1" style="width: 100%; border-collapse: collapse; text-align: center;"> <tr> <td style="width: 10%;"></td> <td style="width: 10%;"></td> <td style="width: 10%;"></td> <td style="width: 10%;"></td> <td style="width: 10%;"></td> <td style="width: 10%;"></td> <td style="width: 10%;"></td> <td style="width: 10%;"></td> <td style="width: 10%;"></td> <td style="width: 10%;"></td> </tr> <tr> <td></td> <td></td> <td colspan="8" style="text-align: center;"> <table border="1" style="width: 100%; border-collapse: collapse; text-align: center;"> <tr> <td style="width: 10%;"></td> <td style="width: 10%;"></td> <td style="width: 10%;"></td> <td style="width: 10%;"></td> <td style="width: 10%;"></td> <td style="width: 10%;"></td> <td style="width: 10%;"></td> <td style="width: 10%;"></td> <td style="width: 10%;"></td> <td style="width: 10%;"></td> </tr> <tr> <td></td> <td></td> <td colspan="8" style="text-align: center;"> <table border="1" style="width: 100%; border-collapse: collapse; text-align: center;"> <tr> <td style="width: 10%;"></td> <td style="width: 10%;"></td> <td style="width: 10%;"></td> <td style="width: 10%;"></td> <td style="width: 10%;"></td> <td style="width: 10%;"></td> <td style="width: 10%;"></td> <td style="width: 10%;"></td> <td style="width: 10%;"></td> <td style="width: 10%;"></td> </tr> <tr> <td></td> <td></td> <td colspan="8" style="text-align: center;"> <table border="1" style="width: 100%; border-collapse: collapse; text-align: center;"> <tr> <td style="width: 10%;"></td> <td style="width: 10%;"></td> <td style="width: 10%;"></td> <td style="width: 10%;"></td> <td style="width: 10%;"></td> <td style="width: 10%;"></td> <td style="width: 10%;"></td> <td style="width: 10%;"></td> <td style="width: 10%;"></td> <td style="width: 10%;"></td> </tr> <tr> <td></td> <td></td> <td colspan="8" style="text-align: center;"> <table border="1" style="width: 100%; border-collapse: collapse; text-align: center;"> <tr> <td style="width: 10%;"></td> <td style="width: 10%;"></td> <td style="width: 10%;"></td> <td style="width: 10%;"></td> <td style="width: 10%;"></td> <td style="width: 10%;"></td> <td style="width: 10%;"></td> <td style="width: 10%;"></td> <td style="width: 10%;"></td> <td style="width: 10%;"></td> </tr> <tr> <td></td> <td></td> <td colspan="8" style="text-align: center;"> <table border="1" style="width: 100%; border-collapse: collapse; text-align: center;"> <tr> <td style="width: 10%;"></td> <td style="width: 10%;"></td> <td style="width: 10%;"></td> <td style="width: 10%;"></td> <td style="width: 10%;"></td> <td style="width: 10%;"></td> <td style="width: 10%;"></td> <td style="width: 10%;"></td> <td style="width: 10%;"></td> <td style="width: 10%;"></td> </tr> <tr> <td></td> <td></td> <td colspan="8" style="text-align: center;"> <table border="1" style="width: 100%; border-collapse: collapse; text-align: center;"> <tr> <td style="width: 10%;"></td> <td style="width: 10%;"></td> <td style="width: 10%;"></td> <td style="width: 10%;"></td> <td style="width: 10%;"></td> <td style="width: 10%;"></td> <td style="width: 10%;"></td> <td style="width: 10%;"></td> <td style="width: 10%;"></td> <td style="width: 10%;"></td> </tr> <tr> <td></td> <td></td> <td colspan="8" style="text-align: center;"> <table border="1" style="width: 100%; border-collapse: collapse; text-align: center;"> <tr> <td style="width: 10%;"></td> <td style="width: 10%;"></td> <td style="width: 10%;"></td> <td style="width: 10%;"></td> <td style="width: 10%;"></td> <td style="width: 10%;"></td> <td style="width: 10%;"></td> <td style="width: 10%;"></td> <td style="width: 10%;"></td> <td style="width: 10%;"></td> </tr> <tr> <td></td> <td></td> <td colspan="8" style="text-align: center;"> <table border="1" style="width: 100%; border-collapse: collapse; text-align: center;"> <tr> </tr></table></td></tr></table></td></tr></table></td></tr></table></td></tr></table></td></tr></table></td></tr></table></td></tr></table></td></tr></table></td></tr></table></td></tr></table></td></tr></table></td></tr></table></td></tr></table></td></tr></table></td></tr></table></td></tr></table></td></tr></table></td></tr></table></td></tr></table></td></tr></table></td></tr></table>

 | | | | | | | | | | | | | | | | | | | | <table border="1" style="width: 100%; border-collapse: collapse; text-align: center;"> <tr> <td style="width: 10%;"></td> <td style="width: 10%;"></td> <td style="width: 10%;"></td> <td style="width: 10%;"></td> <td style="width: 10%;"></td> <td style="width: 10%;"></td> <td style="width: 10%;"></td> <td style="width: 10%;"></td> <td style="width: 10%;"></td> <td style="width: 10%;"></td> </tr> <tr> <td></td> <td></td> <td colspan="8" style="text-align: center;"> <table border="1" style="width: 100%; border-collapse: collapse; text-align: center;"> <tr> <td style="width: 10%;"></td> <td style="width: 10%;"></td> <td style="width: 10%;"></td> <td style="width: 10%;"></td> <td style="width: 10%;"></td> <td style="width: 10%;"></td> <td style="width: 10%;"></td> <td style="width: 10%;"></td> <td style="width: 10%;"></td> <td style="width: 10%;"></td> </tr> <tr> <td></td> <td></td> <td colspan="8" style="text-align: center;"> <table border="1" style="width: 100%; border-collapse: collapse; text-align: center;"> <tr> <td style="width: 10%;"></td> <td style="width: 10%;"></td> <td style="width: 10%;"></td> <td style="width: 10%;"></td> <td style="width: 10%;"></td> <td style="width: 10%;"></td> <td style="width: 10%;"></td> <td style="width: 10%;"></td> <td style="width: 10%;"></td> <td style="width: 10%;"></td> </tr> <tr> <td></td> <td></td> <td colspan="8" style="text-align: center;"> <table border="1" style="width: 100%; border-collapse: collapse; text-align: center;"> <tr> <td style="width: 10%;"></td> <td style="width: 10%;"></td> <td style="width: 10%;"></td> <td style="width: 10%;"></td> <td style="width: 10%;"></td> <td style="width: 10%;"></td> <td style="width: 10%;"></td> <td style="width: 10%;"></td> <td style="width: 10%;"></td> <td style="width: 10%;"></td> </tr> <tr> <td></td> <td></td> <td colspan="8" style="text-align: center;"> <table border="1" style="width: 100%; border-collapse: collapse; text-align: center;"> <tr> <td style="width: 10%;"></td> <td style="width: 10%;"></td> <td style="width: 10%;"></td> <td style="width: 10%;"></td> <td style="width: 10%;"></td> <td style="width: 10%;"></td> <td style="width: 10%;"></td> <td style="width: 10%;"></td> <td style="width: 10%;"></td> <td style="width: 10%;"></td> </tr> <tr> <td></td> <td></td> <td colspan="8" style="text-align: center;"> <table border="1" style="width: 100%; border-collapse: collapse; text-align: center;"> <tr> <td style="width: 10%;"></td> <td style="width: 10%;"></td> <td style="width: 10%;"></td> <td style="width: 10%;"></td> <td style="width: 10%;"></td> <td style="width: 10%;"></td> <td style="width: 10%;"></td> <td style="width: 10%;"></td> <td style="width: 10%;"></td> <td style="width: 10%;"></td> </tr> <tr> <td></td> <td></td> <td colspan="8" style="text-align: center;"> <table border="1" style="width: 100%; border-collapse: collapse; text-align: center;"> <tr> <td style="width: 10%;"></td> <td style="width: 10%;"></td> <td style="width: 10%;"></td> <td style="width: 10%;"></td> <td style="width: 10%;"></td> <td style="width: 10%;"></td> <td style="width: 10%;"></td> <td style="width: 10%;"></td> <td style="width: 10%;"></td> <td style="width: 10%;"></td> </tr> <tr> <td></td> <td></td> <td colspan="8" style="text-align: center;"> <table border="1" style="width: 100%; border-collapse: collapse; text-align: center;"> <tr> <td style="width: 10%;"></td> <td style="width: 10%;"></td> <td style="width: 10%;"></td> <td style="width: 10%;"></td> <td style="width: 10%;"></td> <td style="width: 10%;"></td> <td style="width: 10%;"></td> <td style="width: 10%;"></td> <td style="width: 10%;"></td> <td style="width: 10%;"></td> </tr> <tr> <td></td> <td></td> <td colspan="8" style="text-align: center;"> <table border="1" style="width: 100%; border-collapse: collapse; text-align: center;"> <tr> <td style="width: 10%;"></td> <td style="width: 10%;"></td> <td style="width: 10%;"></td> <td style="width: 10%;"></td> <td style="width: 10%;"></td> <td style="width: 10%;"></td> <td style="width: 10%;"></td> <td style="width: 10%;"></td> <td style="width: 10%;"></td> <td style="width: 10%;"></td> </tr> <tr> <td></td> <td></td> <td colspan="8" style="text-align: center;"> <table border="1" style="width: 100%; border-collapse: collapse; text-align: center;"> <tr> <td style="width: 10%;"></td> <td style="width: 10%;"></td> <td style="width: 10%;"></td> <td style="width: 10%;"></td> <td style="width: 10%;"></td> <td style="width: 10%;"></td> <td style="width: 10%;"></td> <td style="width: 10%;"></td> <td style="width: 10%;"></td> <td style="width: 10%;"></td> </tr> <tr> <td></td> <td></td> <td colspan="8" style="text-align: center;"> <table border="1" style="width: 100%; border-collapse: collapse; text-align: center;"> <tr> <td style="width: 10%;"></td> <td style="width: 10%;"></td> <td style="width: 10%;"></td> <td style="width: 10%;"></td> <td style="width: 10%;"></td> <td style="width: 10%;"></td> <td style="width: 10%;"></td> <td style="width: 10%;"></td> <td style="width: 10%;"></td> <td style="width: 10%;"></td> </tr> <tr> <td></td> <td></td> <td colspan="8" style="text-align: center;"> <table border="1" style="width: 100%; border-collapse: collapse; text-align: center;"> <tr> <td style="width: 10%;"></td> <td style="width: 10%;"></td> <td style="width: 10%;"></td> <td style="width: 10%;"></td> <td style="width: 10%;"></td> <td style="width: 10%;"></td> <td style="width: 10%;"></td> <td style="width: 10%;"></td> <td style="width: 10%;"></td> <td style="width: 10%;"></td> </tr> <tr> <td></td> <td></td> <td colspan="8" style="text-align: center;"> <table border="1" style="width: 100%; border-collapse: collapse; text-align: center;"> <tr> <td style="width: 10%;"></td> <td style="width: 10%;"></td> <td style="width: 10%;"></td> <td style="width: 10%;"></td> <td style="width: 10%;"></td> <td style="width: 10%;"></td> <td style="width: 10%;"></td> <td style="width: 10%;"></td> <td style="width: 10%;"></td> <td style="width: 10%;"></td> </tr> <tr> <td></td> <td></td> <td colspan="8" style="text-align: center;"> <table border="1" style="width: 100%; border-collapse: collapse; text-align: center;"> <tr> <td style="width: 10%;"></td> <td style="width: 10%;"></td> <td style="width: 10%;"></td> <td style="width: 10%;"></td> <td style="width: 10%;"></td> <td
style="width: 10%;"></td> <td style="width: 10%;"></td> <td style="width: 10%;"></td> <td style="width: 10%;"></td> <td style="width: 10%;"></td> </tr> <tr> <td></td> <td></td> <td colspan="8" style="text-align: center;"> <table border="1" style="width: 100%; border-collapse: collapse; text-align: center;"> <tr> <td style="width: 10%;"></td> <td style="width: 10%;"></td> <td style="width: 10%;"></td> <td style="width: 10%;"></td> <td style="width: 10%;"></td> <td style="width: 10%;"></td> <td style="width: 10%;"></td> <td style="width: 10%;"></td> <td style="width: 10%;"></td> <td style="width: 10%;"></td> </tr> <tr> <td></td> <td></td> <td colspan="8" style="text-align: center;"> <table border="1" style="width: 100%; border-collapse: collapse; text-align: center;"> <tr> <td style="width: 10%;"></td> <td style="width: 10%;"></td> <td style="width: 10%;"></td> <td style="width: 10%;"></td> <td style="width: 10%;"></td> <td style="width: 10%;"></td> <td style="width: 10%;"></td> <td style="width: 10%;"></td> <td style="width: 10%;"></td> <td style="width: 10%;"></td> </tr> <tr> <td></td> <td></td> <td colspan="8" style="text-align: center;"> <table border="1" style="width: 100%; border-collapse: collapse; text-align: center;"> <tr> <td style="width: 10%;"></td> <td style="width: 10%;"></td> <td style="width: 10%;"></td> <td style="width: 10%;"></td> <td style="width: 10%;"></td> <td style="width: 10%;"></td> <td style="width: 10%;"></td> <td style="width: 10%;"></td> <td style="width: 10%;"></td> <td style="width: 10%;"></td> </tr> <tr> <td></td> <td></td> <td colspan="8" style="text-align: center;"> <table border="1" style="width: 100%; border-collapse: collapse; text-align: center;"> <tr> <td style="width: 10%;"></td> <td style="width: 10%;"></td> <td style="width: 10%;"></td> <td style="width: 10%;"></td> <td style="width: 10%;"></td> <td style="width: 10%;"></td> <td style="width: 10%;"></td> <td style="width: 10%;"></td> <td style="width: 10%;"></td> <td style="width: 10%;"></td> </tr> <tr> <td></td> <td></td> <td colspan="8" style="text-align: center;"> <table border="1" style="width: 100%; border-collapse: collapse; text-align: center;"> <tr> <td style="width: 10%;"></td> <td style="width: 10%;"></td> <td style="width: 10%;"></td> <td style="width: 10%;"></td> <td style="width: 10%;"></td> <td style="width: 10%;"></td> <td style="width: 10%;"></td> <td style="width: 10%;"></td> <td style="width: 10%;"></td> <td style="width: 10%;"></td> </tr> <tr> <td></td> <td></td> <td colspan="8" style="text-align: center;"> <table border="1" style="width: 100%; border-collapse: collapse; text-align: center;"> <tr> <td style="width: 10%;"></td> <td style="width: 10%;"></td> <td style="width: 10%;"></td> <td style="width: 10%;"></td> <td style="width: 10%;"></td> <td style="width: 10%;"></td> <td style="width: 10%;"></td> <td style="width: 10%;"></td> <td style="width: 10%;"></td> <td style="width: 10%;"></td> </tr> <tr> <td></td> <td></td> <td colspan="8" style="text-align: center;"> <table border="1" style="width: 100%; border-collapse: collapse; text-align: center;"> <tr> </tr></table></td></tr></table></td></tr></table></td></tr></table></td></tr></table></td></tr></table></td></tr></table></td></tr></table></td></tr></table></td></tr></table></td></tr></table></td></tr></table></td></tr></table></td></tr></table></td></tr></table></td></tr></table></td></tr></table></td></tr></table></td></tr></table></td></tr></table></td></tr></table>
 | | | | | | | | | | | | | | | | | | | | <table border="1" style="width: 100%; border-collapse: collapse; text-align: center;"> <tr> <td style="width: 10%;"></td> <td style="width: 10%;"></td> <td style="width: 10%;"></td> <td style="width: 10%;"></td> <td style="width: 10%;"></td> <td style="width: 10%;"></td> <td style="width: 10%;"></td> <td style="width: 10%;"></td> <td style="width: 10%;"></td> <td style="width: 10%;"></td> </tr> <tr> <td></td> <td></td> <td colspan="8" style="text-align: center;"> <table border="1" style="width: 100%; border-collapse: collapse; text-align: center;"> <tr> <td style="width: 10%;"></td> <td style="width: 10%;"></td> <td style="width: 10%;"></td> <td style="width: 10%;"></td> <td style="width: 10%;"></td> <td style="width: 10%;"></td> <td style="width: 10%;"></td> <td style="width: 10%;"></td> <td style="width: 10%;"></td> <td style="width: 10%;"></td> </tr> <tr> <td></td> <td></td> <td colspan="8" style="text-align: center;"> <table border="1" style="width: 100%; border-collapse: collapse; text-align: center;"> <tr> <td style="width: 10%;"></td> <td style="width: 10%;"></td> <td style="width: 10%;"></td> <td style="width: 10%;"></td> <td style="width: 10%;"></td> <td style="width: 10%;"></td> <td style="width: 10%;"></td> <td style="width: 10%;"></td> <td style="width: 10%;"></td> <td style="width: 10%;"></td> </tr> <tr> <td></td> <td></td> <td colspan="8" style="text-align: center;"> <table border="1" style="width: 100%; border-collapse: collapse; text-align: center;"> <tr> <td style="width: 10%;"></td> <td style="width: 10%;"></td> <td style="width: 10%;"></td> <td style="width: 10%;"></td> <td style="width: 10%;"></td> <td style="width: 10%;"></td> <td style="width: 10%;"></td> <td style="width: 10%;"></td> <td style="width: 10%;"></td> <td style="width: 10%;"></td> </tr> <tr> <td></td> <td></td> <td colspan="8" style="text-align:
center;"> <table border="1" style="width: 100%; border-collapse: collapse; text-align: center;"> <tr> <td style="width: 10%;"></td> <td style="width: 10%;"></td> <td style="width: 10%;"></td> <td style="width: 10%;"></td> <td style="width: 10%;"></td> <td style="width: 10%;"></td> <td style="width: 10%;"></td> <td style="width: 10%;"></td> <td style="width: 10%;"></td> <td style="width: 10%;"></td> </tr> <tr> <td></td> <td></td> <td colspan="8" style="text-align: center;"> <table border="1" style="width: 100%; border-collapse: collapse; text-align: center;"> <tr> <td style="width: 10%;"></td> <td style="width: 10%;"></td> <td style="width: 10%;"></td> <td style="width: 10%;"></td> <td style="width: 10%;"></td> <td style="width: 10%;"></td> <td style="width: 10%;"></td> <td style="width: 10%;"></td> <td style="width: 10%;"></td> <td style="width: 10%;"></td> </tr> <tr> <td></td> <td></td> <td colspan="8" style="text-align: center;"> <table border="1" style="width: 100%; border-collapse: collapse; text-align: center;"> <tr> <td style="width: 10%;"></td> <td style="width: 10%;"></td> <td style="width: 10%;"></td> <td style="width: 10%;"></td> <td style="width: 10%;"></td> <td style="width: 10%;"></td> <td style="width: 10%;"></td> <td style="width: 10%;"></td> <td style="width: 10%;"></td> <td style="width: 10%;"></td> </tr> <tr> <td></td> <td></td> <td colspan="8" style="text-align: center;"> <table border="1" style="width: 100%; border-collapse: collapse; text-align: center;"> <tr> <td style="width: 10%;"></td> <td style="width: 10%;"></td> <td style="width: 10%;"></td> <td style="width: 10%;"></td> <td style="width: 10%;"></td> <td style="width: 10%;"></td> <td style="width: 10%;"></td> <td style="width: 10%;"></td> <td style="width: 10%;"></td> <td style="width: 10%;"></td> </tr> <tr> <td></td> <td></td> <td colspan="8" style="text-align: center;"> <table border="1" style="width: 100%; border-collapse: collapse; text-align: center;"> <tr> <td style="width: 10%;"></td> <td style="width: 10%;"></td> <td style="width: 10%;"></td> <td style="width: 10%;"></td> <td style="width: 10%;"></td> <td style="width: 10%;"></td> <td style="width: 10%;"></td> <td style="width: 10%;"></td> <td style="width: 10%;"></td> <td style="width: 10%;"></td> </tr> <tr> <td></td> <td></td> <td colspan="8" style="text-align: center;"> <table border="1" style="width: 100%; border-collapse: collapse; text-align: center;"> <tr> <td style="width: 10%;"></td> <td style="width: 10%;"></td> <td style="width: 10%;"></td> <td style="width: 10%;"></td> <td style="width: 10%;"></td> <td style="width: 10%;"></td> <td style="width: 10%;"></td> <td style="width: 10%;"></td> <td style="width: 10%;"></td> <td style="width: 10%;"></td> </tr> <tr> <td></td> <td></td> <td colspan="8" style="text-align: center;"> <table border="1" style="width: 100%; border-collapse: collapse; text-align: center;"> <tr> <td style="width: 10%;"></td> <td style="width: 10%;"></td> <td style="width: 10%;"></td> <td style="width: 10%;"></td> <td style="width: 10%;"></td> <td style="width: 10%;"></td> <td style="width: 10%;"></td> <td style="width: 10%;"></td> <td style="width: 10%;"></td> <td style="width: 10%;"></td> </tr> <tr> <td></td> <td></td> <td colspan="8" style="text-align: center;"> <table border="1" style="width: 100%; border-collapse: collapse; text-align: center;"> <tr> <td style="width: 10%;"></td> <td style="width: 10%;"></td> <td style="width: 10%;"></td> <td style="width: 10%;"></td> <td style="width: 10%;"></td> <td style="width: 10%;"></td> <td style="width: 10%;"></td> <td style="width: 10%;"></td> <td style="width: 10%;"></td> <td style="width: 10%;"></td> </tr> <tr> <td></td> <td></td> <td colspan="8" style="text-align: center;"> <table border="1" style="width: 100%; border-collapse: collapse; text-align: center;"> <tr> <td style="width: 10%;"></td> <td style="width: 10%;"></td> <td style="width: 10%;"></td> <td style="width: 10%;"></td> <td style="width: 10%;"></td> <td style="width: 10%;"></td> <td style="width: 10%;"></td> <td style="width: 10%;"></td> <td style="width: 10%;"></td> <td style="width: 10%;"></td> </tr> <tr> <td></td> <td></td> <td colspan="8" style="text-align: center;"> <table border="1" style="width: 100%; border-collapse: collapse; text-align: center;"> <tr> <td style="width: 10%;"></td> <td style="width: 10%;"></td> <td style="width: 10%;"></td> <td style="width: 10%;"></td> <td style="width: 10%;"></td> <td style="width: 10%;"></td> <td style="width: 10%;"></td> <td style="width: 10%;"></td> <td style="width: 10%;"></td> <td style="width: 10%;"></td> </tr> <tr> <td></td> <td></td> <td colspan="8" style="text-align: center;"> <table border="1" style="width: 100%; border-collapse: collapse; text-align: center;"> <tr> <td style="width: 10%;"></td> <td style="width: 10%;"></td> <td style="width: 10%;"></td> <td style="width: 10%;"></td> <td style="width: 10%;"></td> <td style="width: 10%;"></td> <td style="width: 10%;"></td> <td style="width: 10%;"></td> <td style="width: 10%;"></td> <td style="width: 10%;"></td> </tr> <tr> <td></td> <td></td> <td colspan="8" style="text-align: center;"> <table border="1" style="width: 100%; border-collapse: collapse; text-align: center;"> <tr> <td style="width: 10%;"></td> <td style="width: 10%;"></td> <td style="width: 10%;"></td> <td style="width: 10%;"></td> <td style="width: 10%;"></td> <td style="width: 10%;"></td> <td style="width: 10%;"></td> <td style="width: 10%;"></td> <td style="width: 10%;"></td> <td style="width: 10%;"></td> </tr> <tr> <td></td> <td></td> <td colspan="8" style="text-align: center;"> <table border="1" style="width: 100%; border-collapse: collapse; text-align: center;"> <tr> <td style="width: 10%;"></td> <td style="width: 10%;"></td> <td style="width: 10%;"></td> <td style="width: 10%;"></td> <td style="width: 10%;"></td> <td style="width: 10%;"></td> <td style="width: 10%;"></td> <td style="width: 10%;"></td> <td style="width: 10%;"></td> <td style="width: 10%;"></td> </tr> <tr> <td></td> <td></td> <td colspan="8" style="text-align: center;"> <table border="1" style="width: 100%; border-collapse: collapse; text-align: center;"> <tr> <td style="width: 10%;"></td> <td style="width: 10%;"></td> <td style="width: 10%;"></td> <td style="width: 10%;"></td> <td style="width: 10%;"></td> <td style="width: 10%;"></td> <td style="width: 10%;"></td> <td style="width: 10%;"></td> <td style="width: 10%;"></td> <td style="width: 10%;"></td> </tr> <tr> <td></td> <td></td> <td colspan="8" style="text-align: center;"> <table border="1" style="width: 100%; border-collapse: collapse; text-align: center;"> <tr> <td style="width: 10%;"></td> <td style="width: 10%;"></td> <td style="width: 10%;"></td> <td style="width: 10%;"></td> <td style="width: 10%;"></td> <td style="width: 10%;"></td> <td style="width: 10%;"></td> <td style="width: 10%;"></td> <td style="width: 10%;"></td> <td style="width: 10%;"></td> </tr> <tr> <td></td> <td></td> <td colspan="8" style="text-align: center;"> <table border="1" style="width: 100%; border-collapse: collapse; text-align: center;"> <tr> </tr></table></td></tr></table></td></tr></table></td></tr></table></td></tr></table></td></tr></table></td></tr></table></td></tr></table></td></tr></table></td></tr></table></td></tr></table></td></tr></table></td></tr></table></td></tr></table></td></tr></table></td></tr></table></td></tr></table></td></tr></table></td></tr></table></td></tr></table>

 | | | | | | | | | | | | | | | | | | | | <table border="1" style="width: 100%; border-collapse: collapse; text-align: center;"> <tr> <td style="width: 10%;"></td> <td style="width: 10%;"></td> <td style="width: 10%;"></td> <td style="width: 10%;"></td> <td style="width: 10%;"></td> <td style="width: 10%;"></td> <td style="width: 10%;"></td> <td style="width: 10%;"></td> <td style="width: 10%;"></td> <td style="width: 10%;"></td> </tr> <tr> <td></td> <td></td> <td colspan="8" style="text-align: center;"> <table border="1" style="width: 100%; border-collapse: collapse; text-align: center;"> <tr> <td style="width: 10%;"></td> <td style="width: 10%;"></td> <td style="width: 10%;"></td> <td style="width: 10%;"></td> <td style="width: 10%;"></td> <td style="width: 10%;"></td> <td style="width: 10%;"></td> <td style="width: 10%;"></td> <td style="width: 10%;"></td> <td style="width: 10%;"></td> </tr> <tr> <td></td> <td></td> <td colspan="8" style="text-align: center;"> <table border="1" style="width: 100%; border-collapse: collapse; text-align: center;"> <tr> <td style="width: 10%;"></td> <td style="width: 10%;"></td> <td style="width: 10%;"></td> <td style="width: 10%;"></td> <td style="width: 10%;"></td> <td style="width: 10%;"></td> <td style="width: 10%;"></td> <td style="width: 10%;"></td> <td style="width: 10%;"></td> <td style="width: 10%;"></td> </tr> <tr> <td></td> <td></td> <td colspan="8" style="text-align: center;"> <table border="1" style="width: 100%; border-collapse: collapse; text-align: center;"> <tr> <td style="width: 10%;"></td> <td style="width: 10%;"></td> <td style="width: 10%;"></td> <td style="width: 10%;"></td> <td style="width: 10%;"></td> <td style="width: 10%;"></td> <td style="width: 10%;"></td> <td style="width: 10%;"></td> <td style="width: 10%;"></td> <td style="width: 10%;"></td> </tr> <tr> <td></td> <td></td> <td colspan="8" style="text-align: center;"> <table border="1" style="width: 100%; border-collapse: collapse; text-align: center;"> <tr> <td style="width: 10%;"></td> <td style="width: 10%;"></td> <td style="width: 10%;"></td> <td style="width: 10%;"></td> <td style="width: 10%;"></td> <td style="width: 10%;"></td> <td style="width: 10%;"></td> <td style="width: 10%;"></td> <td style="width: 10%;"></td> <td style="width: 10%;"></td> </tr> <tr> <td></td> <td></td> <td colspan="8" style="text-align: center;"> <table border="1" style="width: 100%; border-collapse: collapse; text-align: center;"> <tr> <td style="width: 10%;"></td> <td style="width: 10%;"></td> <td style="width: 10%;"></td> <td style="width: 10%;"></td> <td style="width: 10%;"></td> <td style="width: 10%;"></td> <td style="width: 10%;"></td> <td style="width: 10%;"></td> <td style="width: 10%;"></td> <td style="width: 10%;"></td> </tr> <tr> <td></td> <td></td> <td colspan="8" style="text-align: center;"> <table border="1" style="width: 100%; border-collapse: collapse; text-align: center;"> <tr> <td style="width: 10%;"></td> <td style="width: 10%;"></td> <td style="width: 10%;"></td> <td style="width: 10%;"></td> <td style="width: 10%;"></td> <td style="width: 10%;"></td> <td style="width: 10%;"></td> <td style="width: 10%;"></td> <td style="width: 10%;"></td> <td style="width: 10%;"></td> </tr> <tr> <td></td> <td></td> <td colspan="8" style="text-align: center;"> <table border="1" style="width: 100%; border-collapse: collapse; text-align: center;"> <tr> <td style="width: 10%;"></td> <td style="width: 10%;"></td> <td style="width: 10%;"></td> <td style="width: 10%;"></td> <td style="width: 10%;"></td> <td style="width: 10%;"></td> <td style="width: 10%;"></td> <td style="width: 10%;"></td> <td style="width: 10%;"></td> <td style="width: 10%;"></td> </tr> <tr> <td></td> <td></td> <td colspan="8" style="text-align: center;"> <table border="1" style="width: 100%; border-collapse: collapse; text-align: center;"> <tr> <td style="width: 10%;"></td> <td style="width: 10%;"></td> <td style="width: 10%;"></td> <td style="width: 10%;"></td> <td style="width: 10%;"></td> <td style="width: 10%;"></td> <td style="width: 10%;"></td> <td style="width: 10%;"></td> <td style="width: 10%;"></td> <td style="width: 10%;"></td> </tr> <tr> <td></td> <td></td> <td colspan="8" style="text-align: center;"> <table border="1" style="width: 100%; border-collapse: collapse; text-align: center;"> <tr> <td style="width: 10%;"></td> <td style="width: 10%;"></td> <td style="width: 10%;"></td> <td style="width: 10%;"></td> <td style="width: 10%;"></td> <td style="width: 10%;"></td> <td style="width: 10%;"></td> <td style="width: 10%;"></td> <td style="width: 10%;"></td> <td style="width: 10%;"></td> </tr> <tr> <td></td> <td></td> <td colspan="8" style="text-align: center;"> <table border="1" style="width: 100%; border-collapse: collapse; text-align: center;"> <tr> <td style="width: 10%;"></td> <td style="width: 10%;"></td> <td style="width: 10%;"></td> <td style="width: 10%;"></td> <td style="width: 10%;"></td> <td style="width: 10%;"></td> <td style="width: 10%;"></td> <td style="width: 10%;"></td> <td style="width: 10%;"></td> <td style="width: 10%;"></td> </tr> <tr> <td></td> <td></td> <td colspan="8" style="text-align: center;"> <table border="1" style="width: 100%; border-collapse: collapse; text-align: center;"> <tr> <td style="width: 10%;"></td> <td style="width: 10%;"></td> <td style="width: 10%;"></td> <td style="width: 10%;"></td> <td style="width: 10%;"></td> <td style="width: 10%;"></td> <td style="width: 10%;"></td> <td style="width: 10%;"></td> <td style="width: 10%;"></td> <td style="width: 10%;"></td> </tr> <tr> <td></td> <td></td> <td colspan="8" style="text-align: center;"> <table border="1" style="width: 100%; border-collapse: collapse; text-align: center;"> <tr> <td style="width: 10%;"></td> <td style="width: 10%;"></td> <td style="width: 10%;"></td> <td style="width: 10%;"></td> <td style="width: 10%;"></td> <td style="width: 10%;"></td> <td style="width: 10%;"></td> <td style="width: 10%;"></td> <td style="width: 10%;"></td> <td style="width: 10%;"></td> </tr> <tr> <td></td> <td></td> <td colspan="8" style="text-align: center;"> <table border="1" style="width: 100%; border-collapse: collapse; text-align: center;"> <tr> <td style="width: 10%;"></td> <td style="width: 10%;"></td> <td style="width: 10%;"></td> <td style="width: 10%;"></td> <td style="width: 10%;"></td> <td style="width: 10%;"></td> <td style="width: 10%;"></td> <td style="width: 10%;"></td> <td style="width: 10%;"></td> <td style="width: 10%;"></td> </tr> <tr> <td></td> <td></td> <td colspan="8" style="text-align: center;"> <table border="1" style="width: 100%; border-collapse: collapse; text-align: center;"> <tr> <td style="width: 10%;"></td> <td style="width: 10%;"></td> <td style="width: 10%;"></td> <td style="width: 10%;"></td> <td style="width: 10%;"></td> <td style="width: 10%;"></td> <td style="width: 10%;"></td> <td style="width: 10%;"></td> <td style="width: 10%;"></td> <td style="width: 10%;"></td> </tr> <tr> <td></td> <td></td> <td colspan="8" style="text-align: center;"> <table border="1" style="width: 100%; border-collapse: collapse; text-align: center;"> <tr> <td style="width: 10%;"></td> <td style="width: 10%;"></td> <td style="width: 10%;"></td> <td style="width: 10%;"></td> <td style="width: 10%;"></td> <td style="width: 10%;"></td> <td style="width: 10%;"></td> <td style="width: 10%;"></td> <td style="width: 10%;"></td> <td style="width: 10%;"></td> </tr> <tr> <td></td> <td></td> <td colspan="8" style="text-align: center;"> <table border="1" style="width: 100%; border-collapse: collapse; text-align: center;"> <tr> <td style="width: 10%;"></td> <td style="width: 10%;"></td> <td style="width: 10%;"></td> <td style="width: 10%;"></td> <td style="width: 10%;"></td> <td style="width: 10%;"></td> <td style="width: 10%;"></td> <td style="width: 10%;"></td> <td style="width: 10%;"></td> <td style="width: 10%;"></td>
</tr> <tr> <td></td> <td></td> <td colspan="8" style="text-align: center;"> <table border="1" style="width: 100%; border-collapse: collapse; text-align: center;"> <tr> <td style="width: 10%;"></td> <td style="width: 10%;"></td> <td style="width: 10%;"></td> <td style="width: 10%;"></td> <td style="width: 10%;"></td> <td style="width: 10%;"></td> <td style="width: 10%;"></td> <td style="width: 10%;"></td> <td style="width: 10%;"></td> <td style="width: 10%;"></td> </tr> <tr> <td></td> <td></td> <td colspan="8" style="text-align: center;"> <table border="1" style="width: 100%; border-collapse: collapse; text-align: center;"> <tr> </tr></table></td></tr></table></td></tr></table></td></tr></table></td></tr></table></td></tr></table></td></tr></table></td></tr></table></td></tr></table></td></tr></table></td></tr></table></td></tr></table></td></tr></table></td></tr></table></td></tr></table></td></tr></table></td></tr></table></td></tr></table></td></tr></table>
 | | | | | | | | | | | | | | | | | | | | <table border="1" style="width: 100%; border-collapse: collapse; text-align: center;"> <tr> <td style="width: 10%;"></td> <td style="width: 10%;"></td> <td style="width: 10%;"></td> <td style="width: 10%;"></td> <td style="width: 10%;"></td> <td style="width: 10%;"></td> <td style="width: 10%;"></td> <td style="width: 10%;"></td> <td style="width: 10%;"></td> <td style="width: 10%;"></td> </tr> <tr> <td></td> <td></td> <td colspan="8" style="text-align: center;"> <table border="1" style="width: 100%; border-collapse: collapse; text-align: center;"> <tr> <td style="width: 10%;"></td> <td style="width: 10%;"></td> <td style="width: 10%;"></td> <td style="width: 10%;"></td> <td style="width: 10%;"></td> <td style="width: 10%;"></td> <td style="width: 10%;"></td> <td style="width: 10%;"></td> <td style="width: 10%;"></td> <td style="width: 10%;"></td> </tr> <tr> <td></td> <td></td> <td colspan="8" style="text-align: center;"> <table border="1" style="width: 100%; border-collapse: collapse; text-align: center;"> <tr> <td style="width: 10%;"></td> <td style="width: 10%;"></td> <td style="width: 10%;"></td> <td style="width: 10%;"></td> <td style="width: 10%;"></td> <td style="width: 10%;"></td> <td style="width: 10%;"></td> <td style="width: 10%;"></td> <td style="width: 10%;"></td> <td style="width: 10%;"></td> </tr> <tr> <td></td> <td></td> <td colspan="8" style="text-align: center;"> <table border="1" style="width: 100%; border-collapse: collapse; text-align: center;"> <tr> <td style="width: 10%;"></td> <td style="width: 10%;"></td> <td style="width: 10%;"></td> <td style="width: 10%;"></td> <td style="width: 10%;"></td> <td style="width: 10%;"></td> <td style="width: 10%;"></td> <td style="width: 10%;"></td> <td style="width: 10%;"></td> <td style="width: 10%;"></td> </tr> <tr> <td></td> <td></td> <td colspan="8" style="text-align: center;"> <table border="1" style="width: 100%; border-collapse: collapse; text-align: center;"> <tr> <td style="width: 10%;"></td> <td style="width: 10%;"></td> <td style="width: 10%;"></td> <td style="width: 10%;"></td> <td style="width: 10%;"></td> <td style="width: 10%;"></td> <td style="width: 10%;"></td> <td style="width: 10%;"></td> <td style="width: 10%;"></td> <td style="width: 10%;"></td> </tr> <tr> <td></td> <td></td> <td colspan="8" style="text-align: center;"> <table border="1" style="width: 100%; border-collapse: collapse; text-align: center;"> <tr> <td style="width: 10%;"></td> <td style="width: 10%;"></td> <td style="width: 10%;"></td> <td style="width: 10%;"></td> <td style="width: 10%;"></td> <td style="width: 10%;"></td> <td style="width: 10%;"></td> <td style="width: 10%;"></td> <td style="width: 10%;"></td> <td style="width: 10%;"></td> </tr> <tr> <td></td> <td></td> <td colspan="8" style="text-align: center;"> <table border="1" style="width: 100%; border-collapse: collapse; text-align: center;"> <tr> <td style="width: 10%;"></td> <td style="width: 10%;"></td> <td style="width: 10%;"></td> <td style="width: 10%;"></td> <td style="width: 10%;"></td> <td style="width: 10%;"></td> <td style="width: 10%;"></td> <td style="width: 10%;"></td> <td style="width: 10%;"></td> <td style="width: 10%;"></td> </tr> <tr> <td></td> <td></td> <td colspan="8" style="text-align: center;"> <table border="1" style="width: 100%; border-collapse: collapse; text-align: center;"> <tr> <td style="width: 10%;"></td> <td style="width: 10%;"></td> <td style="width: 10%;"></td> <td style="width: 10%;"></td> <td style="width: 10%;"></td> <td style="width: 10%;"></td> <td style="width: 10%;"></td> <td style="width: 10%;"></td> <td style="width: 10%;"></td> <td style="width: 10%;"></td> </tr> <tr> <td></td> <td></td> <td colspan="8" style="text-align: center;"> <table border="1" style="width: 100%; border-collapse: collapse; text-align: center;"> <tr> <td style="width: 10%;"></td> <td style="width: 10%;"></td> <td style="width: 10%;"></td> <td style="width: 10%;"></td> <td style="width: 10%;"></td> <td style="width: 10%;"></td> <td style="width: 10%;"></td> <td style="width: 10%;"></td> <td style="width: 10%;"></td> <td style="width: 10%;"></td> </tr> <tr> <td></td> <td></td> <td colspan="8" style="text-align: center;"> <table border="1" style="width: 100%; border-collapse: collapse; text-align: center;"> <tr> <td style="width: 10%;"></td> <td style="width: 10%;"></td> <td style="width:
10%;"></td> <td style="width: 10%;"></td> <td style="width: 10%;"></td> <td style="width: 10%;"></td> <td style="width: 10%;"></td> <td style="width: 10%;"></td> <td style="width: 10%;"></td> <td style="width: 10%;"></td> </tr> <tr> <td></td> <td></td> <td colspan="8" style="text-align: center;"> <table border="1" style="width: 100%; border-collapse: collapse; text-align: center;"> <tr> <td style="width: 10%;"></td> <td style="width: 10%;"></td> <td style="width: 10%;"></td> <td style="width: 10%;"></td> <td style="width: 10%;"></td> <td style="width: 10%;"></td> <td style="width: 10%;"></td> <td style="width: 10%;"></td> <td style="width: 10%;"></td> <td style="width: 10%;"></td> </tr> <tr> <td></td> <td></td> <td colspan="8" style="text-align: center;"> <table border="1" style="width: 100%; border-collapse: collapse; text-align: center;"> <tr> <td style="width: 10%;"></td> <td style="width: 10%;"></td> <td style="width: 10%;"></td> <td style="width: 10%;"></td> <td style="width: 10%;"></td> <td style="width: 10%;"></td> <td style="width: 10%;"></td> <td style="width: 10%;"></td> <td style="width: 10%;"></td> <td style="width: 10%;"></td> </tr> <tr> <td></td> <td></td> <td colspan="8" style="text-align: center;"> <table border="1" style="width: 100%; border-collapse: collapse; text-align: center;"> <tr> <td style="width: 10%;"></td> <td style="width: 10%;"></td> <td style="width: 10%;"></td> <td style="width: 10%;"></td> <td style="width: 10%;"></td> <td style="width: 10%;"></td> <td style="width: 10%;"></td> <td style="width: 10%;"></td> <td style="width: 10%;"></td> <td style="width: 10%;"></td> </tr> <tr> <td></td> <td></td> <td colspan="8" style="text-align: center;"> <table border="1" style="width: 100%; border-collapse: collapse; text-align: center;"> <tr> <td style="width: 10%;"></td> <td style="width: 10%;"></td> <td style="width: 10%;"></td> <td style="width: 10%;"></td> <td style="width: 10%;"></td> <td style="width: 10%;"></td> <td style="width: 10%;"></td> <td style="width: 10%;"></td> <td style="width: 10%;"></td> <td style="width: 10%;"></td> </tr> <tr> <td></td> <td></td> <td colspan="8" style="text-align: center;"> <table border="1" style="width: 100%; border-collapse: collapse; text-align: center;"> <tr> <td style="width: 10%;"></td> <td style="width: 10%;"></td> <td style="width: 10%;"></td> <td style="width: 10%;"></td> <td style="width: 10%;"></td> <td style="width: 10%;"></td> <td style="width: 10%;"></td> <td style="width: 10%;"></td> <td style="width: 10%;"></td> <td style="width: 10%;"></td> </tr> <tr> <td></td> <td></td> <td colspan="8" style="text-align: center;"> <table border="1" style="width: 100%; border-collapse: collapse; text-align: center;"> <tr> <td style="width: 10%;"></td> <td style="width: 10%;"></td> <td style="width: 10%;"></td> <td style="width: 10%;"></td> <td style="width: 10%;"></td> <td style="width: 10%;"></td> <td style="width: 10%;"></td> <td style="width: 10%;"></td> <td style="width: 10%;"></td> <td style="width: 10%;"></td> </tr> <tr> <td></td> <td></td> <td colspan="8" style="text-align: center;"> <table border="1" style="width: 100%; border-collapse: collapse; text-align: center;"> <tr> <td style="width: 10%;"></td> <td style="width: 10%;"></td> <td style="width: 10%;"></td> <td style="width: 10%;"></td> <td style="width: 10%;"></td> <td style="width: 10%;"></td> <td style="width: 10%;"></td> <td style="width: 10%;"></td> <td style="width: 10%;"></td> <td style="width: 10%;"></td> </tr> <tr> <td></td> <td></td> <td colspan="8" style="text-align: center;"> <table border="1" style="width: 100%; border-collapse: collapse; text-align: center;"> <tr> </tr></table></td></tr></table></td></tr></table></td></tr></table></td></tr></table></td></tr></table></td></tr></table></td></tr></table></td></tr></table></td></tr></table></td></tr></table></td></tr></table></td></tr></table></td></tr></table></td></tr></table></td></tr></table></td></tr></table></td></tr></table>
 | | | | | | | | | | | | | | | | | | | | <table border="1" style="width: 100%; border-collapse: collapse; text-align: center;"> <tr> <td style="width: 10%;"></td> <td style="width: 10%;"></td> <td style="width: 10%;"></td> <td style="width: 10%;"></td> <td style="width: 10%;"></td> <td style="width: 10%;"></td> <td style="width: 10%;"></td> <td style="width: 10%;"></td> <td style="width: 10%;"></td> <td style="width: 10%;"></td> </tr> <tr> <td></td> <td></td> <td colspan="8" style="text-align: center;"> <table border="1" style="width: 100%; border-collapse: collapse; text-align: center;"> <tr> <td style="width: 10%;"></td> <td style="width: 10%;"></td> <td style="width: 10%;"></td> <td style="width: 10%;"></td> <td style="width: 10%;"></td> <td style="width: 10%;"></td> <td style="width: 10%;"></td> <td style="width: 10%;"></td> <td style="width: 10%;"></td> <td style="width: 10%;"></td> </tr> <tr> <td></td> <td></td> <td colspan="8" style="text-align: center;"> <table border="1" style="width: 100%; border-collapse: collapse; text-align: center;"> <tr> <td style="width: 10%;"></td> <td style="width: 10%;"></td> <td style="width: 10%;"></td> <td style="width: 10%;"></td> <td style="width: 10%;"></td> <td style="width: 10%;"></td> <td style="width: 10%;"></td> <td style="width: 10%;"></td> <td style="width: 10%;"></td> <td style="width: 10%;"></td> </tr> <tr> <td></td> <td></td> <td colspan="8"
style="text-align: center;"> <table border="1" style="width: 100%; border-collapse: collapse; text-align: center;"> <tr> <td style="width: 10%;"></td> <td style="width: 10%;"></td> <td style="width: 10%;"></td> <td style="width: 10%;"></td> <td style="width: 10%;"></td> <td style="width: 10%;"></td> <td style="width: 10%;"></td> <td style="width: 10%;"></td> <td style="width: 10%;"></td> <td style="width: 10%;"></td> </tr> <tr> <td></td> <td></td> <td colspan="8" style="text-align: center;"> <table border="1" style="width: 100%; border-collapse: collapse; text-align: center;"> <tr> <td style="width: 10%;"></td> <td style="width: 10%;"></td> <td style="width: 10%;"></td> <td style="width: 10%;"></td> <td style="width: 10%;"></td> <td style="width: 10%;"></td> <td style="width: 10%;"></td> <td style="width: 10%;"></td> <td style="width: 10%;"></td> <td style="width: 10%;"></td> </tr> <tr> <td></td> <td></td> <td colspan="8" style="text-align: center;"> <table border="1" style="width: 100%; border-collapse: collapse; text-align: center;"> <tr> <td style="width: 10%;"></td> <td style="width: 10%;"></td> <td style="width: 10%;"></td> <td style="width: 10%;"></td> <td style="width: 10%;"></td> <td style="width: 10%;"></td> <td style="width: 10%;"></td> <td style="width: 10%;"></td> <td style="width: 10%;"></td> <td style="width: 10%;"></td> </tr> <tr> <td></td> <td></td> <td colspan="8" style="text-align: center;"> <table border="1" style="width: 100%; border-collapse: collapse; text-align: center;"> <tr> <td style="width: 10%;"></td> <td style="width: 10%;"></td> <td style="width: 10%;"></td> <td style="width: 10%;"></td> <td style="width: 10%;"></td> <td style="width: 10%;"></td> <td style="width: 10%;"></td> <td style="width: 10%;"></td> <td style="width: 10%;"></td> <td style="width: 10%;"></td> </tr> <tr> <td></td> <td></td> <td colspan="8" style="text-align: center;"> <table border="1" style="width: 100%; border-collapse: collapse; text-align: center;"> <tr> <td style="width: 10%;"></td> <td style="width: 10%;"></td> <td style="width: 10%;"></td> <td style="width: 10%;"></td> <td style="width: 10%;"></td> <td style="width: 10%;"></td> <td style="width: 10%;"></td> <td style="width: 10%;"></td> <td style="width: 10%;"></td> <td style="width: 10%;"></td> </tr> <tr> <td></td> <td></td> <td colspan="8" style="text-align: center;"> <table border="1" style="width: 100%; border-collapse: collapse; text-align: center;"> <tr> <td style="width: 10%;"></td> <td style="width: 10%;"></td> <td style="width: 10%;"></td> <td style="width: 10%;"></td> <td style="width: 10%;"></td> <td style="width: 10%;"></td> <td style="width: 10%;"></td> <td style="width: 10%;"></td> <td style="width: 10%;"></td> <td style="width: 10%;"></td> </tr> <tr> <td></td> <td></td> <td colspan="8" style="text-align: center;"> <table border="1" style="width: 100%; border-collapse: collapse; text-align: center;"> <tr> <td style="width: 10%;"></td> <td style="width: 10%;"></td> <td style="width: 10%;"></td> <td style="width: 10%;"></td> <td style="width: 10%;"></td> <td style="width: 10%;"></td> <td style="width: 10%;"></td> <td style="width: 10%;"></td> <td style="width: 10%;"></td> <td style="width: 10%;"></td> </tr> <tr> <td></td> <td></td> <td colspan="8" style="text-align: center;"> <table border="1" style="width: 100%; border-collapse: collapse; text-align: center;"> <tr> <td style="width: 10%;"></td> <td style="width: 10%;"></td> <td style="width: 10%;"></td> <td style="width: 10%;"></td> <td style="width: 10%;"></td> <td style="width: 10%;"></td> <td style="width: 10%;"></td> <td style="width: 10%;"></td> <td style="width: 10%;"></td> <td style="width: 10%;"></td> </tr> <tr> <td></td> <td></td> <td colspan="8" style="text-align: center;"> <table border="1" style="width: 100%; border-collapse: collapse; text-align: center;"> <tr> <td style="width: 10%;"></td> <td style="width: 10%;"></td> <td style="width: 10%;"></td> <td style="width: 10%;"></td> <td style="width: 10%;"></td> <td style="width: 10%;"></td> <td style="width: 10%;"></td> <td style="width: 10%;"></td> <td style="width: 10%;"></td> <td style="width: 10%;"></td> </tr> <tr> <td></td> <td></td> <td colspan="8" style="text-align: center;"> <table border="1" style="width: 100%; border-collapse: collapse; text-align: center;"> <tr> <td style="width: 10%;"></td> <td style="width: 10%;"></td> <td style="width: 10%;"></td> <td style="width: 10%;"></td> <td style="width: 10%;"></td> <td style="width: 10%;"></td> <td style="width: 10%;"></td> <td style="width: 10%;"></td> <td style="width: 10%;"></td> <td style="width: 10%;"></td> </tr> <tr> <td></td> <td></td> <td colspan="8" style="text-align: center;"> <table border="1" style="width: 100%; border-collapse: collapse; text-align: center;"> <tr> <td style="width: 10%;"></td> <td style="width: 10%;"></td> <td style="width: 10%;"></td> <td style="width: 10%;"></td> <td style="width: 10%;"></td> <td style="width: 10%;"></td> <td style="width: 10%;"></td> <td style="width: 10%;"></td> <td style="width: 10%;"></td> <td style="width: 10%;"></td> </tr> <tr> <td></td> <td></td> <td colspan="8" style="text-align: center;"> <table border="1" style="width: 100%; border-collapse: collapse; text-align: center;"> <tr> <td style="width: 10%;"></td> <td style="width: 10%;"></td> <td style="width: 10%;"></td> <td style="width: 10%;"></td> <td style="width: 10%;"></td> <td style="width: 10%;"></td> <td style="width: 10%;"></td> <td style="width: 10%;"></td> <td style="width: 10%;"></td> <td style="width: 10%;"></td> </tr> <tr> <td></td> <td></td> <td colspan="8" style="text-align: center;"> <table border="1" style="width: 100%; border-collapse: collapse; text-align: center;"> <tr> <td style="width: 10%;"></td> <td style="width: 10%;"></td> <td style="width: 10%;"></td> <td style="width: 10%;"></td> <td style="width: 10%;"></td> <td style="width: 10%;"></td> <td style="width: 10%;"></td> <td style="width: 10%;"></td> <td style="width: 10%;"></td> <td style="width: 10%;"></td> </tr> <tr> <td></td> <td></td> <td colspan="8" style="text-align: center;"> <table border="1" style="width: 100%; border-collapse: collapse; text-align: center;"> <tr> </tr></table></td></tr></table></td></tr></table></td></tr></table></td></tr></table></td></tr></table></td></tr></table></td></tr></table></td></tr></table></td></tr></table></td></tr></table></td></tr></table></td></tr></table></td></tr></table></td></tr></table></td></tr></table></td></tr></table>

 | | | | | | | | | | | | | | | | | | | | <table border="1" style="width: 100%; border-collapse: collapse; text-align: center;"> <tr> <td style="width: 10%;"></td> <td style="width: 10%;"></td> <td style="width: 10%;"></td> <td style="width: 10%;"></td> <td style="width: 10%;"></td> <td style="width: 10%;"></td> <td style="width: 10%;"></td> <td style="width: 10%;"></td> <td style="width: 10%;"></td> <td style="width: 10%;"></td> </tr> <tr> <td></td> <td></td> <td colspan="8" style="text-align: center;"> <table border="1" style="width: 100%; border-collapse: collapse; text-align: center;"> <tr> <td style="width: 10%;"></td> <td style="width: 10%;"></td> <td style="width: 10%;"></td> <td style="width: 10%;"></td> <td style="width: 10%;"></td> <td style="width: 10%;"></td> <td style="width: 10%;"></td> <td style="width: 10%;"></td> <td style="width: 10%;"></td> <td style="width: 10%;"></td> </tr> <tr> <td></td> <td></td> <td colspan="8" style="text-align: center;"> <table border="1" style="width: 100%; border-collapse: collapse; text-align: center;"> <tr> <td style="width: 10%;"></td> <td style="width: 10%;"></td> <td style="width: 10%;"></td> <td style="width: 10%;"></td> <td style="width: 10%;"></td> <td style="width: 10%;"></td> <td style="width: 10%;"></td> <td style="width: 10%;"></td> <td style="width: 10%;"></td> <td style="width: 10%;"></td> </tr> <tr> <td></td> <td></td> <td colspan="8" style="text-align: center;"> <table border="1" style="width: 100%; border-collapse: collapse; text-align: center;"> <tr> <td style="width: 10%;"></td> <td style="width: 10%;"></td> <td style="width: 10%;"></td> <td style="width: 10%;"></td> <td style="width: 10%;"></td> <td style="width: 10%;"></td> <td style="width: 10%;"></td> <td style="width: 10%;"></td> <td style="width: 10%;"></td> <td style="width: 10%;"></td> </tr> <tr> <td></td> <td></td> <td colspan="8" style="text-align: center;"> <table border="1" style="width: 100%; border-collapse: collapse; text-align: center;"> <tr> <td style="width: 10%;"></td> <td style="width: 10%;"></td> <td style="width: 10%;"></td> <td style="width: 10%;"></td> <td style="width: 10%;"></td> <td style="width: 10%;"></td> <td style="width: 10%;"></td> <td style="width: 10%;"></td> <td style="width: 10%;"></td> <td style="width: 10%;"></td> </tr> <tr> <td></td> <td></td> <td colspan="8" style="text-align: center;"> <table border="1" style="width: 100%; border-collapse: collapse; text-align: center;"> <tr> <td style="width: 10%;"></td> <td style="width: 10%;"></td> <td style="width: 10%;"></td> <td style="width: 10%;"></td> <td style="width: 10%;"></td> <td style="width: 10%;"></td> <td style="width: 10%;"></td> <td style="width: 10%;"></td> <td style="width: 10%;"></td> <td style="width: 10%;"></td> </tr> <tr> <td></td> <td></td> <td colspan="8" style="text-align: center;"> <table border="1" style="width: 100%; border-collapse: collapse; text-align: center;"> <tr> <td style="width: 10%;"></td> <td style="width: 10%;"></td> <td style="width: 10%;"></td> <td style="width: 10%;"></td> <td style="width: 10%;"></td> <td style="width: 10%;"></td> <td style="width: 10%;"></td> <td style="width: 10%;"></td> <td style="width: 10%;"></td> <td style="width: 10%;"></td> </tr> <tr> <td></td> <td></td> <td colspan="8" style="text-align: center;"> <table border="1" style="width: 100%; border-collapse: collapse; text-align: center;"> <tr> <td style="width: 10%;"></td> <td style="width: 10%;"></td> <td style="width: 10%;"></td> <td style="width: 10%;"></td> <td style="width: 10%;"></td> <td style="width: 10%;"></td> <td style="width: 10%;"></td> <td style="width: 10%;"></td> <td style="width: 10%;"></td> <td style="width: 10%;"></td> </tr> <tr> <td></td> <td></td> <td colspan="8" style="text-align: center;"> <table border="1" style="width: 100%; border-collapse: collapse; text-align: center;"> <tr> <td style="width: 10%;"></td> <td style="width: 10%;"></td> <td style="width: 10%;"></td> <td style="width: 10%;"></td> <td style="width: 10%;"></td> <td style="width: 10%;"></td> <td style="width: 10%;"></td> <td style="width: 10%;"></td> <td style="width: 10%;"></td> <td style="width: 10%;"></td> </tr> <tr> <td></td> <td></td> <td colspan="8" style="text-align: center;"> <table border="1" style="width: 100%; border-collapse: collapse; text-align: center;"> <tr> <td style="width: 10%;"></td> <td style="width: 10%;"></td> <td style="width: 10%;"></td> <td style="width: 10%;"></td> <td style="width: 10%;"></td> <td style="width: 10%;"></td> <td style="width: 10%;"></td> <td style="width: 10%;"></td> <td style="width: 10%;"></td> <td style="width: 10%;"></td> </tr> <tr> <td></td> <td></td> <td colspan="8" style="text-align: center;"> <table border="1" style="width: 100%; border-collapse: collapse; text-align: center;"> <tr> <td style="width: 10%;"></td> <td style="width: 10%;"></td> <td style="width: 10%;"></td> <td style="width: 10%;"></td> <td style="width: 10%;"></td> <td style="width: 10%;"></td> <td style="width: 10%;"></td> <td style="width: 10%;"></td> <td style="width: 10%;"></td> <td style="width: 10%;"></td> </tr> <tr> <td></td> <td></td> <td colspan="8" style="text-align: center;"> <table border="1" style="width: 100%; border-collapse: collapse; text-align: center;"> <tr> <td style="width: 10%;"></td> <td style="width: 10%;"></td> <td style="width: 10%;"></td> <td style="width: 10%;"></td> <td style="width: 10%;"></td> <td style="width: 10%;"></td> <td style="width: 10%;"></td> <td style="width: 10%;"></td> <td style="width: 10%;"></td> <td style="width: 10%;"></td> </tr> <tr> <td></td> <td></td> <td colspan="8" style="text-align: center;"> <table border="1" style="width: 100%; border-collapse: collapse; text-align: center;"> <tr> <td style="width: 10%;"></td> <td style="width: 10%;"></td> <td style="width: 10%;"></td> <td style="width: 10%;"></td> <td style="width: 10%;"></td> <td style="width: 10%;"></td> <td style="width: 10%;"></td> <td style="width: 10%;"></td> <td style="width: 10%;"></td> <td style="width: 10%;"></td> </tr> <tr> <td></td> <td></td> <td colspan="8" style="text-align: center;"> <table border="1" style="width: 100%; border-collapse: collapse; text-align: center;"> <tr> <td style="width: 10%;"></td> <td style="width: 10%;"></td> <td style="width: 10%;"></td> <td style="width: 10%;"></td> <td style="width: 10%;"></td> <td style="width: 10%;"></td> <td style="width: 10%;"></td> <td style="width: 10%;"></td> <td style="width: 10%;"></td> <td style="width: 10%;"></td> </tr> <tr> <td></td> <td></td> <td colspan="8" style="text-align: center;"> <table border="1" style="width: 100%; border-collapse: collapse; text-align: center;"> <tr> <td style="width: 10%;"></td> <td style="width: 10%;"></td> <td style="width: 10%;"></td> <td style="width: 10%;"></td> <td style="width: 10%;"></td> <td style="width: 10%;"></td> <td style="width: 10%;"></td> <td style="width: 10%;"></td> <td style="width: 10%;"></td> <td style="width: 10%;"></td> </tr> <tr> <td></td> <td></td> <td colspan="8" style="text-align: center;"> <table border="1" style="width: 100%; border-collapse: collapse; text-align: center;"> <tr> </tr></table></td></tr></table></td></tr></table></td></tr></table></td></tr></table></td></tr></table></td></tr></table></td></tr></table></td></tr></table></td></tr></table></td></tr></table></td></tr></table></td></tr></table></td></tr></table></td></tr></table></td></tr></table>

 | | | | | | | | | | | | | | | | | | | | <table border="1" style="width: 100%; border-collapse: collapse; text-align: center;"> <tr> <td style="width: 10%;"></td> <td style="width: 10%;"></td> <td style="width: 10%;"></td> <td style="width: 10%;"></td> <td style="width: 10%;"></td> <td style="width: 10%;"></td> <td style="width: 10%;"></td> <td style="width: 10%;"></td> <td style="width: 10%;"></td> <td style="width: 10%;"></td> </tr> <tr> <td></td> <td></td> <td colspan="8" style="text-align: center;"> <table border="1" style="width: 100%; border-collapse: collapse; text-align: center;"> <tr> <td style="width: 10%;"></td> <td style="width: 10%;"></td> <td style="width: 10%;"></td> <td style="width: 10%;"></td> <td style="width: 10%;"></td> <td style="width: 10%;"></td> <td style="width: 10%;"></td> <td style="width: 10%;"></td> <td style="width: 10%;"></td> <td style="width: 10%;"></td> </tr> <tr> <td></td> <td></td> <td colspan="8" style="text-align: center;"> <table border="1" style="width: 100%; border-collapse: collapse; text-align: center;"> <tr> <td style="width: 10%;"></td> <td style="width: 10%;"></td> <td style="width: 10%;"></td> <td style="width: 10%;"></td> <td style="width: 10%;"></td> <td style="width: 10%;"></td> <td style="width: 10%;"></td> <td style="width: 10%;"></td> <td style="width: 10%;"></td> <td style="width: 10%;"></td> </tr> <tr> <td></td> <td></td> <td colspan="8" style="text-align: center;"> <table border="1" style="width: 100%; border-collapse: collapse; text-align: center;"> <tr> <td style="width: 10%;"></td> <td style="width: 10%;"></td> <td style="width: 10%;"></td> <td style="width: 10%;"></td> <td style="width: 10%;"></td> <td style="width: 10%;"></td> <td style="width: 10%;"></td> <td style="width: 10%;"></td> <td style="width: 10%;"></td> <td style="width: 10%;"></td> </tr> <tr> <td></td> <td></td> <td colspan="8" style="text-align: center;"> <table border="1" style="width: 100%; border-collapse: collapse; text-align: center;"> <tr> <td style="width: 10%;"></td> <td style="width: 10%;"></td> <td style="width: 10%;"></td> <td style="width: 10%;"></td> <td style="width: 10%;"></td> <td style="width: 10%;"></td> <td style="width: 10%;"></td> <td style="width: 10%;"></td> <td style="width: 10%;"></td> <td style="width: 10%;"></td> </tr> <tr> <td></td> <td></td> <td colspan="8" style="text-align: center;"> <table border="1" style="width: 100%; border-collapse: collapse; text-align: center;"> <tr> <td style="width: 10%;"></td> <td style="width: 10%;"></td> <td style="width: 10%;"></td> <td style="width: 10%;"></td> <td style="width: 10%;"></td> <td style="width: 10%;"></td> <td style="width: 10%;"></td> <td style="width: 10%;"></td> <td style="width: 10%;"></td> <td style="width: 10%;"></td> </tr> <tr> <td></td> <td></td> <td colspan="8" style="text-align: center;"> <table border="1" style="width: 100%; border-collapse: collapse; text-align: center;"> <tr> <td style="width: 10%;"></td> <td style="width: 10%;"></td> <td style="width: 10%;"></td> <td style="width: 10%;"></td> <td style="width: 10%;"></td> <td style="width: 10%;"></td> <td style="width: 10%;"></td> <td style="width: 10%;"></td> <td style="width: 10%;"></td> <td style="width: 10%;"></td> </tr> <tr> <td></td> <td></td> <td colspan="8" style="text-align: center;"> <table border="1" style="width: 100%; border-collapse: collapse; text-align: center;"> <tr> <td style="width: 10%;"></td> <td style="width: 10%;"></td> <td style="width: 10%;"></td> <td style="width: 10%;"></td> <td style="width: 10%;"></td> <td style="width: 10%;"></td> <td style="width: 10%;"></td> <td style="width: 10%;"></td> <td style="width: 10%;"></td> <td style="width: 10%;"></td> </tr> <tr> <td></td> <td></td> <td colspan="8" style="text-align: center;"> <table border="1" style="width: 100%; border-collapse: collapse; text-align: center;"> <tr> <td style="width: 10%;"></td> <td style="width: 10%;"></td> <td style="width: 10%;"></td> <td style="width: 10%;"></td> <td style="width: 10%;"></td> <td style="width: 10%;"></td> <td style="width: 10%;"></td> <td style="width: 10%;"></td> <td style="width: 10%;"></td> <td style="width: 10%;"></td> </tr> <tr> <td></td> <td></td> <td colspan="8" style="text-align: center;"> <table border="1" style="width: 100%; border-collapse: collapse; text-align: center;"> <tr> <td style="width: 10%;"></td> <td style="width: 10%;"></td> <td style="width: 10%;"></td> <td style="width: 10%;"></td> <td style="width: 10%;"></td> <td style="width: 10%;"></td> <td style="width: 10%;"></td> <td style="width: 10%;"></td> <td style="width: 10%;"></td> <td style="width: 10%;"></td> </tr> <tr> <td></td> <td></td> <td colspan="8" style="text-align: center;"> <table border="1" style="width: 100%; border-collapse: collapse; text-align: center;"> <tr> <td style="width: 10%;"></td> <td style="width: 10%;"></td> <td style="width: 10%;"></td> <td style="width: 10%;"></td> <td style="width: 10%;"></td> <td style="width: 10%;"></td> <td style="width: 10%;"></td> <td style="width: 10%;"></td> <td style="width: 10%;"></td> <td style="width: 10%;"></td> </tr> <tr> <td></td> <td></td> <td colspan="8" style="text-align: center;"> <table border="1" style="width: 100%; border-collapse: collapse; text-align: center;"> <tr> <td style="width: 10%;"></td> <td style="width: 10%;"></td> <td style="width: 10%;"></td> <td style="width: 10%;"></td> <td style="width: 10%;"></td> <td style="width: 10%;"></td> <td style="width: 10%;"></td> <td style="width: 10%;"></td> <td style="width: 10%;"></td> <td style="width: 10%;"></td> </tr> <tr> <td></td> <td></td> <td colspan="8" style="text-align: center;"> <table border="1" style="width: 100%; border-collapse: collapse; text-align: center;"> <tr> <td style="width: 10%;"></td> <td style="width: 10%;"></td> <td style="width: 10%;"></td> <td style="width: 10%;"></td> <td style="width: 10%;"></td> <td style="width: 10%;"></td> <td style="width: 10%;"></td> <td style="width: 10%;"></td> <td style="width: 10%;"></td> <td style="width: 10%;"></td> </tr> <tr> <td></td> <td></td> <td colspan="8" style="text-align: center;"> <table border="1" style="width: 100%; border-collapse: collapse; text-align: center;"> <tr> <td style="width: 10%;"></td> <td style="width: 10%;"></td> <td style="width: 10%;"></td> <td style="width: 10%;"></td> <td style="width: 10%;"></td> <td style="width: 10%;"></td> <td style="width: 10%;"></td> <td style="width: 10%;"></td> <td style="width: 10%;"></td> <td style="width: 10%;"></td> </tr> <tr> <td></td> <td></td> <td colspan="8" style="text-align: center;"> <table border="1" style="width: 100%; border-collapse: collapse; text-align: center;"> <tr>
</tr></table></td></tr></table></td></tr></table></td></tr></table></td></tr></table></td></tr></table></td></tr></table></td></tr></table></td></tr></table></td></tr></table></td></tr></table></td></tr></table></td></tr></table></td></tr></table></td></tr></table>
 | | | | | | | | | | | | | | | | | | | | <table border="1" style="width: 100%; border-collapse: collapse; text-align: center;"> <tr> <td style="width: 10%;"></td> <td style="width: 10%;"></td> <td style="width: 10%;"></td> <td style="width: 10%;"></td> <td style="width: 10%;"></td> <td style="width: 10%;"></td> <td style="width: 10%;"></td> <td style="width: 10%;"></td> <td style="width: 10%;"></td> <td style="width: 10%;"></td> </tr> <tr> <td></td> <td></td> <td colspan="8" style="text-align: center;"> <table border="1" style="width: 100%; border-collapse: collapse; text-align: center;"> <tr> <td style="width: 10%;"></td> <td style="width: 10%;"></td> <td style="width: 10%;"></td> <td style="width: 10%;"></td> <td style="width: 10%;"></td> <td style="width: 10%;"></td> <td style="width: 10%;"></td> <td style="width: 10%;"></td> <td style="width: 10%;"></td> <td style="width: 10%;"></td> </tr> <tr> <td></td> <td></td> <td colspan="8" style="text-align: center;"> <table border="1" style="width: 100%; border-collapse: collapse; text-align: center;"> <tr> <td style="width: 10%;"></td> <td style="width: 10%;"></td> <td style="width: 10%;"></td> <td style="width: 10%;"></td> <td style="width: 10%;"></td> <td style="width: 10%;"></td> <td style="width: 10%;"></td> <td style="width: 10%;"></td> <td style="width: 10%;"></td> <td style="width: 10%;"></td> </tr> <tr> <td></td> <td></td> <td colspan="8" style="text-align: center;"> <table border="1" style="width: 100%; border-collapse: collapse; text-align: center;"> <tr> <td style="width: 10%;"></td> <td style="width: 10%;"></td> <td style="width: 10%;"></td> <td style="width: 10%;"></td> <td style="width: 10%;"></td> <td style="width: 10%;"></td> <td style="width: 10%;"></td> <td style="width: 10%;"></td> <td style="width: 10%;"></td> <td style="width: 10%;"></td> </tr> <tr> <td></td> <td></td> <td colspan="8" style="text-align: center;"> <table border="1" style="width: 100%; border-collapse: collapse; text-align: center;"> <tr> <td style="width: 10%;"></td> <td style="width: 10%;"></td> <td style="width: 10%;"></td> <td style="width: 10%;"></td> <td style="width: 10%;"></td> <td style="width: 10%;"></td> <td style="width: 10%;"></td> <td style="width: 10%;"></td> <td style="width: 10%;"></td> <td style="width: 10%;"></td> </tr> <tr> <td></td> <td></td> <td colspan="8" style="text-align: center;"> <table border="1" style="width: 100%; border-collapse: collapse; text-align: center;"> <tr> <td style="width: 10%;"></td> <td style="width: 10%;"></td> <td style="width: 10%;"></td> <td style="width: 10%;"></td> <td style="width: 10%;"></td> <td style="width: 10%;"></td> <td style="width: 10%;"></td> <td style="width: 10%;"></td> <td style="width: 10%;"></td> <td style="width: 10%;"></td> </tr> <tr> <td></td> <td></td> <td colspan="8" style="text-align: center;"> <table border="1" style="width: 100%; border-collapse: collapse; text-align: center;"> <tr> <td style="width: 10%;"></td> <td style="width: 10%;"></td> <td style="width: 10%;"></td> <td style="width: 10%;"></td> <td style="width: 10%;"></td> <td style="width: 10%;"></td> <td style="width: 10%;"></td> <td style="width: 10%;"></td> <td style="width: 10%;"></td> <td style="width: 10%;"></td> </tr> <tr> <td></td> <td></td> <td colspan="8" style="text-align: center;"> <table border="1" style="width: 100%; border-collapse: collapse; text-align: center;"> <tr> <td style="width: 10%;"></td> <td style="width: 10%;"></td> <td style="width: 10%;"></td> <td style="width: 10%;"></td> <td style="width: 10%;"></td> <td style="width: 10%;"></td> <td style="width: 10%;"></td> <td style="width: 10%;"></td> <td style="width: 10%;"></td> <td style="width: 10%;"></td> </tr> <tr> <td></td> <td></td> <td colspan="8" style="text-align: center;"> <table border="1" style="width: 100%; border-collapse: collapse; text-align: center;"> <tr> <td style="width: 10%;"></td> <td style="width: 10%;"></td> <td style="width: 10%;"></td> <td style="width: 10%;"></td> <td style="width: 10%;"></td> <td style="width: 10%;"></td> <td style="width: 10%;"></td> <td style="width: 10%;"></td> <td style="width: 10%;"></td> <td style="width: 10%;"></td> </tr> <tr> <td></td> <td></td> <td colspan="8" style="text-align: center;"> <table border="1" style="width: 100%; border-collapse: collapse; text-align: center;"> <tr> <td style="width: 10%;"></td> <td style="width: 10%;"></td> <td style="width: 10%;"></td> <td style="width: 10%;"></td> <td style="width: 10%;"></td> <td style="width: 10%;"></td> <td style="width: 10%;"></td> <td style="width: 10%;"></td> <td style="width: 10%;"></td> <td style="width: 10%;"></td> </tr> <tr> <td></td> <td></td> <td colspan="8" style="text-align: center;"> <table border="1" style="width: 100%; border-collapse: collapse; text-align: center;"> <tr> <td style="width: 10%;"></td> <td style="width: 10%;"></td> <td style="width: 10%;"></td> <td style="width: 10%;"></td> <td style="width: 10%;"></td> <td style="width: 10%;"></td> <td style="width: 10%;"></td> <td style="width: 10%;"></td> <td style="width: 10%;"></td> <td style="width: 10%;"></td> </tr> <tr> <td></td>
<td></td> <td colspan="8" style="text-align: center;"> <table border="1" style="width: 100%; border-collapse: collapse; text-align: center;"> <tr> <td style="width: 10%;"></td> <td style="width: 10%;"></td> <td style="width: 10%;"></td> <td style="width: 10%;"></td> <td style="width: 10%;"></td> <td style="width: 10%;"></td> <td style="width: 10%;"></td> <td style="width: 10%;"></td> <td style="width: 10%;"></td> <td style="width: 10%;"></td> </tr> <tr> <td></td> <td></td> <td colspan="8" style="text-align: center;"> <table border="1" style="width: 100%; border-collapse: collapse; text-align: center;"> <tr> <td style="width: 10%;"></td> <td style="width: 10%;"></td> <td style="width: 10%;"></td> <td style="width: 10%;"></td> <td style="width: 10%;"></td> <td style="width: 10%;"></td> <td style="width: 10%;"></td> <td style="width: 10%;"></td> <td style="width: 10%;"></td> <td style="width: 10%;"></td> </tr> <tr> <td></td> <td></td> <td colspan="8" style="text-align: center;"> <table border="1" style="width: 100%; border-collapse: collapse; text-align: center;"> <tr> </tr></table></td></tr></table></td></tr></table></td></tr></table></td></tr></table></td></tr></table></td></tr></table></td></tr></table></td></tr></table></td></tr></table></td></tr></table></td></tr></table></td></tr></table></td></tr></table>
 | | | | | | | | | | | | | | | | | | | | <table border="1" style="width: 100%; border-collapse: collapse; text-align: center;"> <tr> <td style="width: 10%;"></td> <td style="width: 10%;"></td> <td style="width: 10%;"></td> <td style="width: 10%;"></td> <td style="width: 10%;"></td> <td style="width: 10%;"></td> <td style="width: 10%;"></td> <td style="width: 10%;"></td> <td style="width: 10%;"></td> <td style="width: 10%;"></td> </tr> <tr> <td></td> <td></td> <td colspan="8" style="text-align: center;"> <table border="1" style="width: 100%; border-collapse: collapse; text-align: center;"> <tr> <td style="width: 10%;"></td> <td style="width: 10%;"></td> <td style="width: 10%;"></td> <td style="width: 10%;"></td> <td style="width: 10%;"></td> <td style="width: 10%;"></td> <td style="width: 10%;"></td> <td style="width: 10%;"></td> <td style="width: 10%;"></td> <td style="width: 10%;"></td> </tr> <tr> <td></td> <td></td> <td colspan="8" style="text-align: center;"> <table border="1" style="width: 100%; border-collapse: collapse; text-align: center;"> <tr> <td style="width: 10%;"></td> <td style="width: 10%;"></td> <td style="width: 10%;"></td> <td style="width: 10%;"></td> <td style="width: 10%;"></td> <td style="width: 10%;"></td> <td style="width: 10%;"></td> <td style="width: 10%;"></td> <td style="width: 10%;"></td> <td style="width: 10%;"></td> </tr> <tr> <td></td> <td></td> <td colspan="8" style="text-align: center;"> <table border="1" style="width: 100%; border-collapse: collapse; text-align: center;"> <tr> <td style="width: 10%;"></td> <td style="width: 10%;"></td> <td style="width: 10%;"></td> <td style="width: 10%;"></td> <td style="width: 10%;"></td> <td style="width: 10%;"></td> <td style="width: 10%;"></td> <td style="width: 10%;"></td> <td style="width: 10%;"></td> <td style="width: 10%;"></td> </tr> <tr> <td></td> <td></td> <td colspan="8" style="text-align: center;"> <table border="1" style="width: 100%; border-collapse: collapse; text-align: center;"> <tr> <td style="width: 10%;"></td> <td style="width: 10%;"></td> <td style="width: 10%;"></td> <td style="width: 10%;"></td> <td style="width: 10%;"></td> <td style="width: 10%;"></td> <td style="width: 10%;"></td> <td style="width: 10%;"></td> <td style="width: 10%;"></td> <td style="width: 10%;"></td> </tr> <tr> <td></td> <td></td> <td colspan="8" style="text-align: center;"> <table border="1" style="width: 100%; border-collapse: collapse; text-align: center;"> <tr> <td style="width: 10%;"></td> <td style="width: 10%;"></td> <td style="width: 10%;"></td> <td style="width: 10%;"></td> <td style="width: 10%;"></td> <td style="width: 10%;"></td> <td style="width: 10%;"></td> <td style="width: 10%;"></td> <td style="width: 10%;"></td> <td style="width: 10%;"></td> </tr> <tr> <td></td> <td></td> <td colspan="8" style="text-align: center;"> <table border="1" style="width: 100%; border-collapse: collapse; text-align: center;"> <tr> <td style="width: 10%;"></td> <td style="width: 10%;"></td> <td style="width: 10%;"></td> <td style="width: 10%;"></td> <td style="width: 10%;"></td> <td style="width: 10%;"></td> <td style="width: 10%;"></td> <td style="width: 10%;"></td> <td style="width: 10%;"></td> <td style="width: 10%;"></td> </tr> <tr> <td></td> <td></td> <td colspan="8" style="text-align: center;"> <table border="1" style="width: 100%; border-collapse: collapse; text-align: center;"> <tr> <td style="width: 10%;"></td> <td style="width: 10%;"></td> <td style="width: 10%;"></td> <td style="width: 10%;"></td> <td style="width: 10%;"></td> <td style="width: 10%;"></td> <td style="width: 10%;"></td> <td style="width: 10%;"></td> <td style="width: 10%;"></td> <td style="width: 10%;"></td> </tr> <tr> <td></td> <td></td> <td colspan="8" style="text-align: center;"> <table border="1" style="width: 100%; border-collapse: collapse; text-align: center;"> <tr> <td style="width: 10%;"></td> <td style="width: 10%;"></td> <td style="width: 10%;"></td> <td style="width: 10%;"></td> <td style="width: 10%;"></td> <td style="width: 10%;"></td> <td
style="width: 10%;"></td> <td style="width: 10%;"></td> <td style="width: 10%;"></td> <td style="width: 10%;"></td> </tr> <tr> <td></td> <td></td> <td colspan="8" style="text-align: center;"> <table border="1" style="width: 100%; border-collapse: collapse; text-align: center;"> <tr> <td style="width: 10%;"></td> <td style="width: 10%;"></td> <td style="width: 10%;"></td> <td style="width: 10%;"></td> <td style="width: 10%;"></td> <td style="width: 10%;"></td> <td style="width: 10%;"></td> <td style="width: 10%;"></td> <td style="width: 10%;"></td> <td style="width: 10%;"></td> </tr> <tr> <td></td> <td></td> <td colspan="8" style="text-align: center;"> <table border="1" style="width: 100%; border-collapse: collapse; text-align: center;"> <tr> <td style="width: 10%;"></td> <td style="width: 10%;"></td> <td style="width: 10%;"></td> <td style="width: 10%;"></td> <td style="width: 10%;"></td> <td style="width: 10%;"></td> <td style="width: 10%;"></td> <td style="width: 10%;"></td> <td style="width: 10%;"></td> <td style="width: 10%;"></td> </tr> <tr> <td></td> <td></td> <td colspan="8" style="text-align: center;"> <table border="1" style="width: 100%; border-collapse: collapse; text-align: center;"> <tr> <td style="width: 10%;"></td> <td style="width: 10%;"></td> <td style="width: 10%;"></td> <td style="width: 10%;"></td> <td style="width: 10%;"></td> <td style="width: 10%;"></td> <td style="width: 10%;"></td> <td style="width: 10%;"></td> <td style="width: 10%;"></td> <td style="width: 10%;"></td> </tr> <tr> <td></td> <td></td> <td colspan="8" style="text-align: center;"> <table border="1" style="width: 100%; border-collapse: collapse; text-align: center;"> <tr> </tr></table></td></tr></table></td></tr></table></td></tr></table></td></tr></table></td></tr></table></td></tr></table></td></tr></table></td></tr></table></td></tr></table></td></tr></table></td></tr></table></td></tr></table>
 | | | | | | | | | | | | | | | | | | | | <table border="1" style="width: 100%; border-collapse: collapse; text-align: center;"> <tr> <td style="width: 10%;"></td> <td style="width: 10%;"></td> <td style="width: 10%;"></td> <td style="width: 10%;"></td> <td style="width: 10%;"></td> <td style="width: 10%;"></td> <td style="width: 10%;"></td> <td style="width: 10%;"></td> <td style="width: 10%;"></td> <td style="width: 10%;"></td> </tr> <tr> <td></td> <td></td> <td colspan="8" style="text-align: center;"> <table border="1" style="width: 100%; border-collapse: collapse; text-align: center;"> <tr> <td style="width: 10%;"></td> <td style="width: 10%;"></td> <td style="width: 10%;"></td> <td style="width: 10%;"></td> <td style="width: 10%;"></td> <td style="width: 10%;"></td> <td style="width: 10%;"></td> <td style="width: 10%;"></td> <td style="width: 10%;"></td> <td style="width: 10%;"></td> </tr> <tr> <td></td> <td></td> <td colspan="8" style="text-align: center;"> <table border="1" style="width: 100%; border-collapse: collapse; text-align: center;"> <tr> <td style="width: 10%;"></td> <td style="width: 10%;"></td> <td style="width: 10%;"></td> <td style="width: 10%;"></td> <td style="width: 10%;"></td> <td style="width: 10%;"></td> <td style="width: 10%;"></td> <td style="width: 10%;"></td> <td style="width: 10%;"></td> <td style="width: 10%;"></td> </tr> <tr> <td></td> <td></td> <td colspan="8" style="text-align: center;"> <table border="1" style="width: 100%; border-collapse: collapse; text-align: center;"> <tr> <td style="width: 10%;"></td> <td style="width: 10%;"></td> <td style="width: 10%;"></td> <td style="width: 10%;"></td> <td style="width: 10%;"></td> <td style="width: 10%;"></td> <td style="width: 10%;"></td> <td style="width: 10%;"></td> <td style="width: 10%;"></td> <td style="width: 10%;"></td> </tr> <tr> <td></td> <td></td> <td colspan="8" style="text-align: center;"> <table border="1" style="width: 100%; border-collapse: collapse; text-align: center;"> <tr> <td style="width: 10%;"></td> <td style="width: 10%;"></td> <td style="width: 10%;"></td> <td style="width: 10%;"></td> <td style="width: 10%;"></td> <td style="width: 10%;"></td> <td style="width: 10%;"></td> <td style="width: 10%;"></td> <td style="width: 10%;"></td> <td style="width: 10%;"></td> </tr> <tr> <td></td> <td></td> <td colspan="8" style="text-align: center;"> <table border="1" style="width: 100%; border-collapse: collapse; text-align: center;"> <tr> <td style="width: 10%;"></td> <td style="width: 10%;"></td> <td style="width: 10%;"></td> <td style="width: 10%;"></td> <td style="width: 10%;"></td> <td style="width: 10%;"></td> <td style="width: 10%;"></td> <td style="width: 10%;"></td> <td style="width: 10%;"></td> <td style="width: 10%;"></td> </tr> <tr> <td></td> <td></td> <td colspan="8" style="text-align: center;"> <table border="1" style="width: 100%; border-collapse: collapse; text-align: center;"> <tr> <td style="width: 10%;"></td> <td style="width: 10%;"></td> <td style="width: 10%;"></td> <td style="width: 10%;"></td> <td style="width: 10%;"></td> <td style="width: 10%;"></td> <td style="width: 10%;"></td> <td style="width: 10%;"></td> <td style="width: 10%;"></td> <td style="width: 10%;"></td> </tr> <tr> <td></td> <td></td> <td colspan="8" style="text-align: center;"> <table border="1" style="width: 100%; border-collapse: collapse; text-align: center;"> <tr> <td style="width: 10%;"></td> <td style="width: 10%;"></td> <td
style="width: 10%;"></td> <td style="width: 10%;"></td> <td style="width: 10%;"></td> <td style="width: 10%;"></td> <td style="width: 10%;"></td> <td style="width: 10%;"></td> <td style="width: 10%;"></td> <td style="width: 10%;"></td> </tr> <tr> <td></td> <td></td> <td colspan="8" style="text-align: center;"> <table border="1" style="width: 100%; border-collapse: collapse; text-align: center;"> <tr> <td style="width: 10%;"></td> <td style="width: 10%;"></td> <td style="width: 10%;"></td> <td style="width: 10%;"></td> <td style="width: 10%;"></td> <td style="width: 10%;"></td> <td style="width: 10%;"></td> <td style="width: 10%;"></td> <td style="width: 10%;"></td> <td style="width: 10%;"></td> </tr> <tr> <td></td> <td></td> <td colspan="8" style="text-align: center;"> <table border="1" style="width: 100%; border-collapse: collapse; text-align: center;"> <tr> <td style="width: 10%;"></td> <td style="width: 10%;"></td> <td style="width: 10%;"></td> <td style="width: 10%;"></td> <td style="width: 10%;"></td> <td style="width: 10%;"></td> <td style="width: 10%;"></td> <td style="width: 10%;"></td> <td style="width: 10%;"></td> <td style="width: 10%;"></td> </tr> <tr> <td></td> <td></td> <td colspan="8" style="text-align: center;"> <table border="1" style="width: 100%; border-collapse: collapse; text-align: center;"> <tr> <td style="width: 10%;"></td> <td style="width: 10%;"></td> <td style="width: 10%;"></td> <td style="width: 10%;"></td> <td style="width: 10%;"></td> <td style="width: 10%;"></td> <td style="width: 10%;"></td> <td style="width: 10%;"></td> <td style="width: 10%;"></td> <td style="width: 10%;"></td> </tr> <tr> <td></td> <td></td> <td colspan="8" style="text-align: center;"> <table border="1" style="width: 100%; border-collapse: collapse; text-align: center;"> <tr> </tr></table></td></tr></table></td></tr></table></td></tr></table></td></tr></table></td></tr></table></td></tr></table></td></tr></table></td></tr></table></td></tr></table></td></tr></table></td></tr></table>
 | | | | | | | | | | | | | | | | | | | | <table border="1" style="width: 100%; border-collapse: collapse; text-align: center;"> <tr> <td style="width: 10%;"></td> <td style="width: 10%;"></td> <td style="width: 10%;"></td> <td style="width: 10%;"></td> <td style="width: 10%;"></td> <td style="width: 10%;"></td> <td style="width: 10%;"></td> <td style="width: 10%;"></td> <td style="width: 10%;"></td> <td style="width: 10%;"></td> </tr> <tr> <td></td> <td></td> <td colspan="8" style="text-align: center;"> <table border="1" style="width: 100%; border-collapse: collapse; text-align: center;"> <tr> <td style="width: 10%;"></td> <td style="width: 10%;"></td> <td style="width: 10%;"></td> <td style="width: 10%;"></td> <td style="width: 10%;"></td> <td style="width: 10%;"></td> <td style="width: 10%;"></td> <td style="width: 10%;"></td> <td style="width: 10%;"></td> <td style="width: 10%;"></td> </tr> <tr> <td></td> <td></td> <td colspan="8" style="text-align: center;"> <table border="1" style="width: 100%; border-collapse: collapse; text-align: center;"> <tr> <td style="width: 10%;"></td> <td style="width: 10%;"></td> <td style="width: 10%;"></td> <td style="width: 10%;"></td> <td style="width: 10%;"></td> <td style="width: 10%;"></td> <td style="width: 10%;"></td> <td style="width: 10%;"></td> <td style="width: 10%;"></td> <td style="width: 10%;"></td> </tr> <tr> <td></td> <td></td> <td colspan="8" style="text-align: center;"> <table border="1" style="width: 100%; border-collapse: collapse; text-align: center;"> <tr> <td style="width: 10%;"></td> <td style="width: 10%;"></td> <td style="width: 10%;"></td> <td style="width: 10%;"></td> <td style="width: 10%;"></td> <td style="width: 10%;"></td> <td style="width: 10%;"></td> <td style="width: 10%;"></td> <td style="width: 10%;"></td> <td style="width: 10%;"></td> </tr> <tr> <td></td> <td></td> <td colspan="8" style="text-align: center;"> <table border="1" style="width: 100%; border-collapse: collapse; text-align: center;"> <tr> <td style="width: 10%;"></td> <td style="width: 10%;"></td> <td style="width: 10%;"></td> <td style="width: 10%;"></td> <td style="width: 10%;"></td> <td style="width: 10%;"></td> <td style="width: 10%;"></td> <td style="width: 10%;"></td> <td style="width: 10%;"></td> <td style="width: 10%;"></td> </tr> <tr> <td></td> <td></td> <td colspan="8" style="text-align: center;"> <table border="1" style="width: 100%; border-collapse: collapse; text-align: center;"> <tr> <td style="width: 10%;"></td> <td style="width: 10%;"></td> <td style="width: 10%;"></td> <td style="width: 10%;"></td> <td style="width: 10%;"></td> <td style="width: 10%;"></td> <td style="width: 10%;"></td> <td style="width: 10%;"></td> <td style="width: 10%;"></td> <td style="width: 10%;"></td> </tr> <tr> <td></td> <td></td> <td colspan="8" style="text-align: center;"> <table border="1" style="width: 100%; border-collapse: collapse; text-align: center;"> <tr> <td style="width: 10%;"></td> <td style="width: 10%;"></td> <td style="width: 10%;"></td> <td style="width: 10%;"></td> <td style="width: 10%;"></td> <td style="width: 10%;"></td> <td style="width: 10%;"></td> <td style="width: 10%;"></td> <td style="width: 10%;"></td> <td style="width: 10%;"></td> </tr> <tr> <td></td> <td></td> <td colspan="8" style="text-align: center;"> <table border="1" style="width: 100%; border-collapse: collapse;
text-align: center;"> <tr> <td style="width: 10%;"></td> <td style="width: 10%;"></td> <td style="width: 10%;"></td> <td style="width: 10%;"></td> <td style="width: 10%;"></td> <td style="width: 10%;"></td> <td style="width: 10%;"></td> <td style="width: 10%;"></td> <td style="width: 10%;"></td> <td style="width: 10%;"></td> </tr> <tr> <td></td> <td></td> <td colspan="8" style="text-align: center;"> <table border="1" style="width: 100%; border-collapse: collapse; text-align: center;"> <tr> <td style="width: 10%;"></td> <td style="width: 10%;"></td> <td style="width: 10%;"></td> <td style="width: 10%;"></td> <td style="width: 10%;"></td> <td style="width: 10%;"></td> <td style="width: 10%;"></td> <td style="width: 10%;"></td> <td style="width: 10%;"></td> <td style="width: 10%;"></td> </tr> <tr> <td></td> <td></td> <td colspan="8" style="text-align: center;"> <table border="1" style="width: 100%; border-collapse: collapse; text-align: center;"> <tr> <td style="width: 10%;"></td> <td style="width: 10%;"></td> <td style="width: 10%;"></td> <td style="width: 10%;"></td> <td style="width: 10%;"></td> <td style="width: 10%;"></td> <td style="width: 10%;"></td> <td style="width: 10%;"></td> <td style="width: 10%;"></td> <td style="width: 10%;"></td> </tr> <tr> <td></td> <td></td> <td colspan="8" style="text-align: center;"> <table border="1" style="width: 100%; border-collapse: collapse; text-align: center;"> <tr> </tr></table></td></tr></table></td></tr></table></td></tr></table></td></tr></table></td></tr></table></td></tr></table></td></tr></table></td></tr></table></td></tr></table></td></tr></table>
 | | | | | | | | | | | | | | | | | | | | <table border="1" style="width: 100%; border-collapse: collapse; text-align: center;"> <tr> <td style="width: 10%;"></td> <td style="width: 10%;"></td> <td style="width: 10%;"></td> <td style="width: 10%;"></td> <td style="width: 10%;"></td> <td style="width: 10%;"></td> <td style="width: 10%;"></td> <td style="width: 10%;"></td> <td style="width: 10%;"></td> <td style="width: 10%;"></td> </tr> <tr> <td></td> <td></td> <td colspan="8" style="text-align: center;"> <table border="1" style="width: 100%; border-collapse: collapse; text-align: center;"> <tr> <td style="width: 10%;"></td> <td style="width: 10%;"></td> <td style="width: 10%;"></td> <td style="width: 10%;"></td> <td style="width: 10%;"></td> <td style="width: 10%;"></td> <td style="width: 10%;"></td> <td style="width: 10%;"></td> <td style="width: 10%;"></td> <td style="width: 10%;"></td> </tr> <tr> <td></td> <td></td> <td colspan="8" style="text-align: center;"> <table border="1" style="width: 100%; border-collapse: collapse; text-align: center;"> <tr> <td style="width: 10%;"></td> <td style="width: 10%;"></td> <td style="width: 10%;"></td> <td style="width: 10%;"></td> <td style="width: 10%;"></td> <td style="width: 10%;"></td> <td style="width: 10%;"></td> <td style="width: 10%;"></td> <td style="width: 10%;"></td> <td style="width: 10%;"></td> </tr> <tr> <td></td> <td></td> <td colspan="8" style="text-align: center;"> <table border="1" style="width: 100%; border-collapse: collapse; text-align: center;"> <tr> <td style="width: 10%;"></td> <td style="width: 10%;"></td> <td style="width: 10%;"></td> <td style="width: 10%;"></td> <td style="width: 10%;"></td> <td style="width: 10%;"></td> <td style="width: 10%;"></td> <td style="width: 10%;"></td> <td style="width: 10%;"></td> <td style="width: 10%;"></td> </tr> <tr> <td></td> <td></td> <td colspan="8" style="text-align: center;"> <table border="1" style="width: 100%; border-collapse: collapse; text-align: center;"> <tr> <td style="width: 10%;"></td> <td style="width: 10%;"></td> <td style="width: 10%;"></td> <td style="width: 10%;"></td> <td style="width: 10%;"></td> <td style="width: 10%;"></td> <td style="width: 10%;"></td> <td style="width: 10%;"></td> <td style="width: 10%;"></td> <td style="width: 10%;"></td> </tr> <tr> <td></td> <td></td> <td colspan="8" style="text-align: center;"> <table border="1" style="width: 100%; border-collapse: collapse; text-align: center;"> <tr> <td style="width: 10%;"></td> <td style="width: 10%;"></td> <td style="width: 10%;"></td> <td style="width: 10%;"></td> <td style="width: 10%;"></td> <td style="width: 10%;"></td> <td style="width: 10%;"></td> <td style="width: 10%;"></td> <td style="width: 10%;"></td> <td style="width: 10%;"></td> </tr> <tr> <td></td> <td></td> <td colspan="8" style="text-align: center;"> <table border="1" style="width: 100%; border-collapse: collapse; text-align: center;"> <tr> <td style="width: 10%;"></td> <td style="width: 10%;"></td> <td style="width: 10%;"></td> <td style="width: 10%;"></td> <td style="width: 10%;"></td> <td style="width: 10%;"></td> <td style="width: 10%;"></td> <td style="width: 10%;"></td> <td style="width: 10%;"></td> <td style="width: 10%;"></td> </tr> <tr> <td></td> <td></td> <td colspan="8" style="text-align: center;"> <table border="1" style="width: 100%; border-collapse: collapse; text-align: center;"> <tr> <td style="width: 10%;"></td> <td style="width: 10%;"></td> <td style="width: 10%;"></td> <td style="width: 10%;"></td> <td style="width: 10%;"></td> <td style="width: 10%;"></td> <td style="width: 10%;"></td> <td style="width: 10%;"></td> <td style="width: 10%;"></td> <td style="width: 10%;"></td> </tr> <tr> <td></td> <td></td> <td colspan="8" style="text-align:
center;"> <table border="1" style="width: 100%; border-collapse: collapse; text-align: center;"> <tr> <td style="width: 10%;"></td> <td style="width: 10%;"></td> <td style="width: 10%;"></td> <td style="width: 10%;"></td> <td style="width: 10%;"></td> <td style="width: 10%;"></td> <td style="width: 10%;"></td> <td style="width: 10%;"></td> <td style="width: 10%;"></td> <td style="width: 10%;"></td> </tr> <tr> <td></td> <td></td> <td colspan="8" style="text-align: center;"> <table border="1" style="width: 100%; border-collapse: collapse; text-align: center;"> <tr> </tr></table></td></tr></table></td></tr></table></td></tr></table></td></tr></table></td></tr></table></td></tr></table></td></tr></table></td></tr></table></td></tr></table>
 | | | | | | | | | | | | | | | | | | | | <table border="1" style="width: 100%; border-collapse: collapse; text-align: center;"> <tr> <td style="width: 10%;"></td> <td style="width: 10%;"></td> <td style="width: 10%;"></td> <td style="width: 10%;"></td> <td style="width: 10%;"></td> <td style="width: 10%;"></td> <td style="width: 10%;"></td> <td style="width: 10%;"></td> <td style="width: 10%;"></td> <td style="width: 10%;"></td> </tr> <tr> <td></td> <td></td> <td colspan="8" style="text-align: center;"> <table border="1" style="width: 100%; border-collapse: collapse; text-align: center;"> <tr> <td style="width: 10%;"></td> <td style="width: 10%;"></td> <td style="width: 10%;"></td> <td style="width: 10%;"></td> <td style="width: 10%;"></td> <td style="width: 10%;"></td> <td style="width: 10%;"></td> <td style="width: 10%;"></td> <td style="width: 10%;"></td> <td style="width: 10%;"></td> </tr> <tr> <td></td> <td></td> <td colspan="8" style="text-align: center;"> <table border="1" style="width: 100%; border-collapse: collapse; text-align: center;"> <tr> <td style="width: 10%;"></td> <td style="width: 10%;"></td> <td style="width: 10%;"></td> <td style="width: 10%;"></td> <td style="width: 10%;"></td> <td style="width: 10%;"></td> <td style="width: 10%;"></td> <td style="width: 10%;"></td> <td style="width: 10%;"></td> <td style="width: 10%;"></td> </tr> <tr> <td></td> <td></td> <td colspan="8" style="text-align: center;"> <table border="1" style="width: 100%; border-collapse: collapse; text-align: center;"> <tr> <td style="width: 10%;"></td> <td style="width: 10%;"></td> <td style="width: 10%;"></td> <td style="width: 10%;"></td> <td style="width: 10%;"></td> <td style="width: 10%;"></td> <td style="width: 10%;"></td> <td style="width: 10%;"></td> <td style="width: 10%;"></td> <td style="width: 10%;"></td> </tr> <tr> <td></td> <td></td> <td colspan="8" style="text-align: center;"> <table border="1" style="width: 100%; border-collapse: collapse; text-align: center;"> <tr> <td style="width: 10%;"></td> <td style="width: 10%;"></td> <td style="width: 10%;"></td> <td style="width: 10%;"></td> <td style="width: 10%;"></td> <td style="width: 10%;"></td> <td style="width: 10%;"></td> <td style="width: 10%;"></td> <td style="width: 10%;"></td> <td style="width: 10%;"></td> </tr> <tr> <td></td> <td></td> <td colspan="8" style="text-align: center;"> <table border="1" style="width: 100%; border-collapse: collapse; text-align: center;"> <tr> <td style="width: 10%;"></td> <td style="width: 10%;"></td> <td style="width: 10%;"></td> <td style="width: 10%;"></td> <td style="width: 10%;"></td> <td style="width: 10%;"></td> <td style="width: 10%;"></td> <td style="width: 10%;"></td> <td style="width: 10%;"></td> <td style="width: 10%;"></td> </tr> <tr> <td></td> <td></td> <td colspan="8" style="text-align: center;"> <table border="1" style="width: 100%; border-collapse: collapse; text-align: center;"> <tr> <td style="width: 10%;"></td> <td style="width: 10%;"></td> <td style="width: 10%;"></td> <td style="width: 10%;"></td> <td style="width: 10%;"></td> <td style="width: 10%;"></td> <td style="width: 10%;"></td> <td style="width: 10%;"></td> <td style="width: 10%;"></td> <td style="width: 10%;"></td> </tr> <tr> <td></td> <td></td> <td colspan="8" style="text-align: center;"> <table border="1" style="width: 100%; border-collapse: collapse; text-align: center;"> <tr> <td style="width: 10%;"></td> <td style="width: 10%;"></td> <td style="width: 10%;"></td> <td style="width: 10%;"></td> <td style="width: 10%;"></td> <td style="width: 10%;"></td> <td style="width: 10%;"></td> <td style="width: 10%;"></td> <td style="width: 10%;"></td> <td style="width: 10%;"></td> </tr> <tr> <td></td> <td></td> <td colspan="8" style="text-align: center;"> <table border="1" style="width: 100%; border-collapse: collapse; text-align: center;"> <tr> </tr></table></td></tr></table></td></tr></table></td></tr></table></td></tr></table></td></tr></table></td></tr></table></td></tr></table></td></tr></table>

 | | | | | | | | | | | | | | | | | | | | <table border="1" style="width: 100%; border-collapse: collapse; text-align: center;"> <tr> <td style="width: 10%;"></td> <td style="width: 10%;"></td> <td style="width: 10%;"></td> <td style="width: 10%;"></td> <td style="width: 10%;"></td> <td style="width: 10%;"></td> <td style="width: 10%;"></td> <td style="width: 10%;"></td> <td style="width: 10%;"></td> <td style="width: 10%;"></td> </tr> <tr> <td></td> <td></td> <td colspan="8" style="text-align: center;"> <table border="1" style="width: 100%; border-collapse: collapse; text-align: center;"> <tr> <td style="width: 10%;"></td> <td style="width: 10%;"></td> <td style="width: 10%;"></td> <td style="width: 10%;"></td> <td style="width: 10%;"></td> <td style="width: 10%;"></td> <td style="width: 10%;"></td> <td style="width: 10%;"></td> <td style="width: 10%;"></td> <td style="width: 10%;"></td> </tr> <tr> <td></td> <td></td> <td colspan="8" style="text-align: center;"> <table border="1" style="width: 100%; border-collapse: collapse; text-align: center;"> <tr> <td style="width: 10%;"></td> <td style="width: 10%;"></td> <td style="width: 10%;"></td> <td style="width: 10%;"></td> <td style="width: 10%;"></td> <td style="width: 10%;"></td> <td style="width: 10%;"></td> <td style="width: 10%;"></td> <td style="width: 10%;"></td> <td style="width: 10%;"></td> </tr> <tr> <td></td> <td></td> <td colspan="8" style="text-align: center;"> <table border="1" style="width: 100%; border-collapse: collapse; text-align: center;"> <tr> <td style="width: 10%;"></td> <td style="width: 10%;"></td> <td style="width: 10%;"></td> <td style="width: 10%;"></td> <td style="width: 10%;"></td> <td style="width: 10%;"></td> <td style="width: 10%;"></td> <td style="width: 10%;"></td> <td style="width: 10%;"></td> <td style="width: 10%;"></td> </tr> <tr> <td></td> <td></td> <td colspan="8" style="text-align: center;"> <table border="1" style="width: 100%; border-collapse: collapse; text-align: center;"> <tr> <td style="width: 10%;"></td> <td style="width: 10%;"></td> <td style="width: 10%;"></td> <td style="width: 10%;"></td> <td style="width: 10%;"></td> <td style="width: 10%;"></td> <td style="width: 10%;"></td> <td style="width: 10%;"></td> <td style="width: 10%;"></td> <td style="width: 10%;"></td> </tr> <tr> <td></td> <td></td> <td colspan="8" style="text-align: center;"> <table border="1" style="width: 100%; border-collapse: collapse; text-align: center;"> <tr> <td style="width: 10%;"></td> <td style="width: 10%;"></td> <td style="width: 10%;"></td> <td style="width: 10%;"></td> <td style="width: 10%;"></td> <td style="width: 10%;"></td> <td style="width: 10%;"></td> <td style="width: 10%;"></td> <td style="width: 10%;"></td> <td style="width: 10%;"></td> </tr> <tr> <td></td> <td></td> <td colspan="8" style="text-align: center;"> <table border="1" style="width: 100%; border-collapse: collapse; text-align: center;"> <tr> <td style="width: 10%;"></td> <td style="width: 10%;"></td> <td style="width: 10%;"></td> <td style="width: 10%;"></td> <td style="width: 10%;"></td> <td style="width: 10%;"></td> <td style="width: 10%;"></td> <td style="width: 10%;"></td> <td style="width: 10%;"></td> <td style="width: 10%;"></td> </tr> <tr> <td></td> <td></td> <td colspan="8" style="text-align: center;"> <table border="1" style="width: 100%; border-collapse: collapse; text-align: center;"> <tr> </tr></table></td></tr></table></td></tr></table></td></tr></table></td></tr></table></td></tr></table></td></tr></table></td></tr></table>

 | | | | | | | | | | | | | | | | | | | | <table border="1" style="width: 100%; border-collapse: collapse; text-align: center;"> <tr> <td style="width: 10%;"></td> <td style="width: 10%;"></td> <td style="width: 10%;"></td> <td style="width: 10%;"></td> <td style="width: 10%;"></td> <td style="width: 10%;"></td> <td style="width: 10%;"></td> <td style="width: 10%;"></td> <td style="width: 10%;"></td> <td style="width: 10%;"></td> </tr> <tr> <td></td> <td></td> <td colspan="8" style="text-align: center;"> <table border="1" style="width: 100%; border-collapse: collapse; text-align: center;"> <tr> <td style="width: 10%;"></td> <td style="width: 10%;"></td> <td style="width: 10%;"></td> <td style="width: 10%;"></td> <td style="width: 10%;"></td> <td style="width: 10%;"></td> <td style="width: 10%;"></td> <td style="width: 10%;"></td> <td style="width: 10%;"></td> <td style="width: 10%;"></td> </tr> <tr> <td></td> <td></td> <td colspan="8" style="text-align: center;"> <table border="1" style="width: 100%; border-collapse: collapse; text-align: center;"> <tr> <td style="width: 10%;"></td> <td style="width: 10%;"></td> <td style="width: 10%;"></td> <td style="width: 10%;"></td> <td style="width: 10%;"></td> <td style="width: 10%;"></td> <td style="width: 10%;"></td> <td style="width: 10%;"></td> <td style="width: 10%;"></td> <td style="width: 10%;"></td> </tr> <tr> <td></td> <td></td> <td colspan="8" style="text-align: center;"> <table border="1" style="width: 100%; border-collapse: collapse; text-align: center;"> <tr> <td style="width: 10%;"></td> <td style="width: 10%;"></td> <td style="width: 10%;"></td> <td style="width: 10%;"></td> <td style="width: 10%;"></td> <td style="width: 10%;"></td> <td style="width: 10%;"></td> <td style="width: 10%;"></td> <td style="width: 10%;"></td> <td style="width: 10%;"></td> </tr> <tr> <td></td> <td></td> <td colspan="8" style="text-align: center;"> <table border="1" style="width: 100%; border-collapse: collapse; text-align: center;"> <tr> <td style="width: 10%;"></td> <td style="width: 10%;"></td> <td style="width: 10%;"></td> <td style="width: 10%;"></td> <td style="width: 10%;"></td> <td style="width: 10%;"></td> <td style="width: 10%;"></td> <td style="width: 10%;"></td> <td style="width: 10%;"></td> <td style="width: 10%;"></td> </tr> <tr> <td></td> <td></td> <td colspan="8" style="text-align: center;"> <table border="1" style="width: 100%; border-collapse: collapse; text-align: center;"> <tr> <td style="width: 10%;"></td> <td style="width: 10%;"></td> <td style="width: 10%;"></td> <td style="width: 10%;"></td> <td style="width: 10%;"></td> <td style="width: 10%;"></td> <td style="width: 10%;"></td> <td style="width: 10%;"></td> <td style="width: 10%;"></td> <td style="width: 10%;"></td> </tr> <tr> <td></td> <td></td> <td colspan="8" style="text-align: center;"> <table border="1" style="width: 100%; border-collapse: collapse; text-align: center;"> <tr> </tr></table></td></tr></table></td></tr></table></td></tr></table></td></tr></table></td></tr></table></td></tr></table>
 | | | | | | | | | | | | | | | | | | | | <table border="1" style="width: 100%; border-collapse: collapse; text-align: center;"> <tr> <td style="width: 10%;"></td> <td style="width: 10%;"></td> <td style="width:
10%;"></td> <td style="width: 10%;"></td> <td style="width: 10%;"></td> <td style="width: 10%;"></td> <td style="width: 10%;"></td> <td style="width: 10%;"></td> <td style="width: 10%;"></td> <td style="width: 10%;"></td> </tr> <tr> <td></td> <td></td> <td colspan="8" style="text-align: center;"> <table border="1" style="width: 100%; border-collapse: collapse; text-align: center;"> <tr> <td style="width: 10%;"></td> <td style="width: 10%;"></td> <td style="width: 10%;"></td> <td style="width: 10%;"></td> <td style="width: 10%;"></td> <td style="width: 10%;"></td> <td style="width: 10%;"></td> <td style="width: 10%;"></td> <td style="width: 10%;"></td> <td style="width: 10%;"></td> </tr> <tr> <td></td> <td></td> <td colspan="8" style="text-align: center;"> <table border="1" style="width: 100%; border-collapse: collapse; text-align: center;"> <tr> <td style="width: 10%;"></td> <td style="width: 10%;"></td> <td style="width: 10%;"></td> <td style="width: 10%;"></td> <td style="width: 10%;"></td> <td style="width: 10%;"></td> <td style="width: 10%;"></td> <td style="width: 10%;"></td> <td style="width: 10%;"></td> <td style="width: 10%;"></td> </tr> <tr> <td></td> <td></td> <td colspan="8" style="text-align: center;"> <table border="1" style="width: 100%; border-collapse: collapse; text-align: center;"> <tr> <td style="width: 10%;"></td> <td style="width: 10%;"></td> <td style="width: 10%;"></td> <td style="width: 10%;"></td> <td style="width: 10%;"></td> <td style="width: 10%;"></td> <td style="width: 10%;"></td> <td style="width: 10%;"></td> <td style="width: 10%;"></td> <td style="width: 10%;"></td> </tr> <tr> <td></td> <td></td> <td colspan="8" style="text-align: center;"> <table border="1" style="width: 100%; border-collapse: collapse; text-align: center;"> <tr> <td style="width: 10%;"></td> <td style="width: 10%;"></td> <td style="width: 10%;"></td> <td style="width: 10%;"></td> <td style="width: 10%;"></td> <td style="width: 10%;"></td> <td style="width: 10%;"></td> <td style="width: 10%;"></td> <td style="width: 10%;"></td> <td style="width: 10%;"></td> </tr> <tr> <td></td> <td></td> <td colspan="8" style="text-align: center;"> <table border="1" style="width: 100%; border-collapse: collapse; text-align: center;"> <tr> </tr></table></td></tr></table></td></tr></table></td></tr></table></td></tr></table></td></tr></table>
 | | | | | | | | | | | | | | | | | | | | <table border="1" style="width: 100%; border-collapse: collapse; text-align: center;"> <tr> <td style="width: 10%;"></td> <td style="width: 10%;"></td> <td style="width: 10%;"></td> <td style="width: 10%;"></td> <td style="width: 10%;"></td> <td style="width: 10%;"></td> <td style="width: 10%;"></td> <td style="width: 10%;"></td> <td style="width: 10%;"></td> <td style="width: 10%;"></td> </tr> <tr> <td></td> <td></td> <td colspan="8" style="text-align: center;"> <table border="1" style="width: 100%; border-collapse: collapse; text-align: center;"> <tr> <td style="width: 10%;"></td> <td style="width: 10%;"></td> <td style="width: 10%;"></td> <td style="width: 10%;"></td> <td style="width: 10%;"></td> <td style="width: 10%;"></td> <td style="width: 10%;"></td> <td style="width: 10%;"></td> <td style="width: 10%;"></td> <td style="width: 10%;"></td> </tr> <tr> <td></td> <td></td> <td colspan="8" style="text-align: center;"> <table border="1" style="width: 100%; border-collapse: collapse; text-align: center;"> <tr> <td style="width: 10%;"></td> <td style="width: 10%;"></td> <td style="width: 10%;"></td> <td style="width: 10%;"></td> <td style="width: 10%;"></td> <td style="width: 10%;"></td> <td style="width: 10%;"></td> <td style="width: 10%;"></td> <td style="width: 10%;"></td> <td style="width: 10%;"></td> </tr> <tr> <td></td> <td></td> <td colspan="8" style="text-align: center;"> <table border="1" style="width: 100%; border-collapse: collapse; text-align: center;"> <tr> <td style="width: 10%;"></td> <td style="width: 10%;"></td> <td style="width: 10%;"></td> <td style="width: 10%;"></td> <td style="width: 10%;"></td> <td style="width: 10%;"></td> <td style="width: 10%;"></td> <td style="width: 10%;"></td> <td style="width: 10%;"></td> <td style="width: 10%;"></td> </tr> <tr> <td></td> <td></td> <td colspan="8" style="text-align: center;"> <table border="1" style="width: 100%; border-collapse: collapse; text-align: center;"> <tr> </tr></table></td></tr></table></td></tr></table></td></tr></table></td></tr></table>

 | | | | | | | | | | | | | | | | | | | | <table border="1" style="width: 100%; border-collapse: collapse; text-align: center;"> <tr> <td style="width: 10%;"></td> <td style="width: 10%;"></td> <td style="width: 10%;"></td> <td style="width: 10%;"></td> <td style="width: 10%;"></td> <td style="width: 10%;"></td> <td style="width: 10%;"></td> <td style="width: 10%;"></td> <td style="width: 10%;"></td> <td style="width: 10%;"></td> </tr> <tr> <td></td> <td></td> <td colspan="8" style="text-align: center;"> <table border="1" style="width: 100%; border-collapse: collapse; text-align: center;"> <tr> <td style="width: 10%;"></td> <td style="width: 10%;"></td> <td style="width: 10%;"></td> <td style="width: 10%;"></td> <td style="width: 10%;"></td> <td style="width: 10%;"></td> <td style="width: 10%;"></td> <td style="width: 10%;"></td> <td style="width: 10%;"></td> <td style="width: 10%;"></td> </tr> <tr> <td></td> <td></td> <td colspan="8" style="text-align: center;"> <table border="1" style="width: 100%; border-collapse: collapse; text-align: center;"> <tr> <td style="width: 10%;"></td> <td style="width: 10%;"></td> <td style="width: 10%;"></td> <td style="width: 10%;"></td> <td style="width: 10%;"></td> <td style="width: 10%;"></td> <td style="width: 10%;"></td> <td style="width: 10%;"></td> <td style="width: 10%;"></td> <td style="width: 10%;"></td> </tr> <tr> <td></td> <td></td> <td colspan="8" style="text-align: center;"> <table border="1" style="width: 100%; border-collapse: collapse; text-align: center;"> <tr> </tr></table></td></tr></table></td></tr></table></td></tr></table>
 | | | | | | | | | | | | | | | | | | | | <table border="1" style="width: 100%; border-collapse: collapse; text-align: center;"> <tr> <td
style="width: 10%;"></td> <td style="width: 10%;"></td> <td style="width: 10%;"></td> <td style="width: 10%;"></td> <td style="width: 10%;"></td> <td style="width: 10%;"></td> <td style="width: 10%;"></td> <td style="width: 10%;"></td> <td style="width: 10%;"></td> <td style="width: 10%;"></td> </tr> <tr> <td></td> <td></td> <td colspan="8" style="text-align: center;"> <table border="1" style="width: 100%; border-collapse: collapse; text-align: center;"> <tr> <td style="width: 10%;"></td> <td style="width: 10%;"></td> <td style="width: 10%;"></td> <td style="width: 10%;"></td> <td style="width: 10%;"></td> <td style="width: 10%;"></td> <td style="width: 10%;"></td> <td style="width: 10%;"></td> <td style="width: 10%;"></td> <td style="width: 10%;"></td> </tr> <tr> <td></td> <td></td> <td colspan="8" style="text-align: center;"> <table border="1" style="width: 100%; border-collapse: collapse; text-align: center;"> <tr> </tr></table></td></tr></table></td></tr></table>
 | | | | | | | | | | | | | | | | | | | | <table border="1" style="width: 100%; border-collapse: collapse; text-align: center;"> <tr> <td style="width: 10%;"></td> <td style="width: 10%;"></td> <td style="width: 10%;"></td> <td style="width: 10%;"></td> <td style="width: 10%;"></td> <td style="width: 10%;"></td> <td style="width: 10%;"></td> <td style="width: 10%;"></td> <td style="width: 10%;"></td> <td style="width: 10%;"></td> </tr> <tr> <td></td> <td></td> <td colspan="8" style="text-align: center;"> <table border="1" style="width: 100%; border-collapse: collapse; text-align: center;"> <tr> </tr></table></td></tr></table>

 | | | | | | | | | | | | | | | | | | | | <table border="1" style="width: 100%; border-collapse: collapse; text-align: center;"> <tr> </tr></table>
 | | | | | | | | | | | | | | | | | | | |
 | | | | | | | | | | | | | | | | | | | |

 | | | | | | | | | | | | | | | | | | | |
 | | | | | | | | | | | | | | | | | | | |
 | | | | | | | | | | | | | | | | | | | |

 | | | | | | | | | | | | | | | | | | | | | | | | | | | | | | | | | | | | | | | | | | | | | | | | | | | | | | | | | | | | | | | | | | | | | | | | | | | | | | | | | | | | | | | | | | | | | | | | | |
 | | | | | | | | | | | | | | | | | | | |
 | | | | | | | | | | | | | | | | | | | |
 | | | | | | | | | | | | | | | | | | | |
 | | | | | | | | | | | | | | | | | | | |
 | | | | | | | | | | | | | | | | | | | |
 | | | | | | | | | | | | | | | | | | | |
 | | | | | | | | | | | | | | | | | | | |
 | | | | | | | | | | | | | | | | | | | |
 | | | | | | | | | | | | | | | | | | | | | | | | | | | | | | | | | | | | | | | |
 | | | | | | | | | | | | | | | | | | | |
 | | | | | | | | | | | | | | | | | | | | | | | | | | | | | | | | | | | | | | | |
 | | | | | | | | | | | | | | | | | | | | | | | | | | | | | | | | | | | | | | | |
 | | | | | | | | | | | | | | | | | | | | | | | | | | | | | | | | | | | | | | | |
 | | | | | | | | | | | | | | | | | | | | | | | | | | | | | | | | | | | | | | | | | | | | | | | | | | | | | | | | | | | | | | | | | | | | | | | | | | | | | | | | | | | | | | | | | | | | | | | | | |
 | | | | | | | | | | | | | | | | | | | | | | | | | | | | | | | | | | | | | | | | | | | | | | | | |
| | |

 | | | | | | | | | | | | | | | | | | | |

 | | | | | | | | | | | | | | | | | | | |

 | | | | | | | | | | | | | | | | | | | |

 | | | | | | | | | | | | | | | | | | | |

 | | | | | | | | | | | | | | | | | | | |

 | | | | | | | | | | | | | | | | | | | |

 | | | | | | | | | | | | | | | | | | | |

 | | | | | | | | | | | | | | | | | | | |

 | | | | | | | | | | | | | | | | | | | |

 | | | | | | | | | | | | | | | | | | | |

 | | | | | | | | | | | | | | | | | | | |

 | | | | | | | | | | | | | | | | | | | |

 | | | | | | | | | | | | | | | | | | | |

 | | | | | | | | | | | | | | | | | | | |

 | | | | | | | | | | | | | | | | | | | |

 | | | | | | | | | | | | | | | | | | | |

 | | | | | | | | | | | | | | | | | | | |

 | | | | | | | | | | | | | | | | | | | |

 | | | | | | | | | | | | | | | | | | | |

 | | | | | | | | | | | | | | | | | | | |

 | | | | | | | | | | | | | | | | | | | |

 | | | | | | | | | | | | | | | | | | | |

 | | | | | | | | | | | | | | | | | | | |

 | | | | | | | | | | | | | | | | | | | |

 | | | | | | | | | | | | | | | | | | | |

 | | | | | | | | | | | | | | | | | | | |

 | | | | | | | | | | | | | | | | | | | |

 | | | | | | | | | | | | | | | | | | | |
 | | | | | | | | | | | | | | | | | | | |

 | | | | | | | | | | | | | | | | | | | |

 | | | | | | | | | | | | | | | | | | | |
 | | | | | | | | | | | | | | | | | | | |

 | | | | | | | | | | | | | | | | | | | |

 | | | | | | | | | | | | | | | | | | | |
 | | | | | | | | | | | | | | | | | | | |
 | | | | | | | | | | | | | | | | | | | |

 | | | | | | | | | | | | | | | | | | | |
 | | | | | | | | | | | | | | | | | | | |
 | | | | | | | | | | | | | | | | | | | |

 | | | | | | | | | | | | | | | | | | | | | | | | | | | | | | | | | | | | | | | | | | | | | | | | | | | | | | | | | | | | | | | | | | | | | | | | | | | | | | | | | | | | | | | | | | | | | | | | | | | |
 | | | | | | | | | | | | | | | | | | | |
 | | | | | | | | | | | | | | | | | | | |
 | | | | | | | | | | | | | | | | | | | |
 | | | | | | | | | | | | | | | | | | | |
 | | | | | | | | | | | | | | | | | | | |
 | | | | | | | | | | | | | | | | | | | |
 | | | | | | | | | | | | | | | | | | | |
 | | | | | | | | | | | | | | | | | | | |
 | | | | | | | | | | | | | | | | | | | | | | | | | | | | | | | | | | | | | | | |
 | | | | | | | | | | | | | | | | | | | |
 | | | | | | | | | | | | | | | | | | | | | | | | | | | | | | | | | | | | | | | |
 | | | | | | | | | | | | | | | | | | | | | | | | | | | | | | | | | | | | | | | |
 | | | | | | | | | | | | | | | | | | | | | | | | | | | | | | | | | | | | | | | |
 | | | | | | | | | | | | | | | | | | | | | | | | | | | | | | | | | | | | | | | | | | | | | | | | | | | | | | | | | | | | | | | | | | | | | | | | | | | | | | | | | | | | | | | | | | | | | | | | | | | |
 | | | | | | | | | | | | | | | | | | | | | | | | | | | | | | | | | | | | | | | | | | | | | | | |
| | | <table border="1" style="width: 100%; border-collapse: collapse; text-align: center;"> <tr> <td style="width: 10%;"></td> <td style="width: 10%;"></td> <td style="width: 10%;"></td> <td style="width: 10%;"></td> <td style="width: 10%;"></td> <td style="width: 10%;"></td> <td style="width: 10%;"></td> <td style="width: 10%;"></td> <td style="width: 10%;"></td> <td style="width: 10%;"></td> </tr> <tr> <td></td> <td></td> <td colspan="8" style="text-align: center;"> <table border="1" style="width: 100%; border-collapse: collapse; text-align: center;"> <tr> <td style="width: 10%;"></td> <td style="width: 10%;"></td> <td style="width: 10%;"></td> <td style="width: 10%;"></td> <td style="width: 10%;"></td> <td style="width: 10%;"></td> <td style="width: 10%;"></td> <td style="width: 10%;"></td> <td style="width: 10%;"></td> <td style="width: 10%;"></td> </tr> <tr> <td></td> <td></td> <td colspan="8" style="text-align: center;"> <table border="1" style="width: 100%; border-collapse: collapse; text-align: center;"> <tr> <td style="width: 10%;"></td> <td style="width: 10%;"></td> <td style="width: 10%;"></td> <td style="width: 10%;"></td> <td style="width: 10%;"></td> <td style="width: 10%;"></td> <td style="width: 10%;"></td> <td style="width: 10%;"></td> <td style="width: 10%;"></td> <td style="width: 10%;"></td> </tr> <tr> <td></td> <td></td> <td colspan="8" style="text-align: center;"> <table border="1" style="width: 100%; border-collapse: collapse; text-align: center;"> <tr> <td style="width: 10%;"></td> <td style="width: 10%;"></td> <td style="width: 10%;"></td> <td style="width: 10%;"></td> <td style="width: 10%;"></td> <td style="width: 10%;"></td> <td style="width: 10%;"></td> <td style="width: 10%;"></td> <td style="width: 10%;"></td> <td style="width: 10%;"></td> </tr> <tr> <td></td> <td></td> <td colspan="8" style="text-align: center;"> <table border="1" style="width: 100%; border-collapse: collapse; text-align: center;"> <tr> <td style="width: 10%;"></td> <td style="width: 10%;"></td> <td style="width: 10%;"></td> <td style="width: 10%;"></td> <td style="width: 10%;"></td> <td style="width: 10%;"></td> <td style="width: 10%;"></td> <td style="width: 10%;"></td> <td style="width: 10%;"></td> <td style="width: 10%;"></td> </tr> <tr> <td></td> <td></td> <td colspan="8" style="text-align: center;"> <table border="1" style="width: 100%; border-collapse: collapse; text-align: center;"> <tr> <td style="width: 10%;"></td> <td style="width: 10%;"></td> <td style="width: 10%;"></td> <td style="width: 10%;"></td> <td style="width: 10%;"></td> <td style="width: 10%;"></td> <td style="width: 10%;"></td> <td style="width: 10%;"></td> <td style="width: 10%;"></td> <td style="width: 10%;"></td> </tr> <tr> <td></td> <td></td> <td colspan="8" style="text-align: center;"> <table border="1" style="width: 100%; border-collapse: collapse; text-align: center;"> <tr> <td style="width: 10%;"></td> <td style="width: 10%;"></td> <td style="width: 10%;"></td> <td style="width: 10%;"></td> <td style="width: 10%;"></td> <td style="width: 10%;"></td> <td style="width: 10%;"></td> <td style="width: 10%;"></td> <td style="width: 10%;"></td> <td style="width: 10%;"></td> </tr> <tr> <td></td> <td></td> <td colspan="8" style="text-align: center;"> <table border="1" style="width: 100%; border-collapse: collapse; text-align: center;"> <tr> <td style="width: 10%;"></td> <td style="width: 10%;"></td> <td style="width: 10%;"></td> <td style="width: 10%;"></td> <td style="width: 10%;"></td> <td style="width: 10%;"></td> <td style="width: 10%;"></td> <td style="width: 10%;"></td> <td style="width: 10%;"></td> <td style="width: 10%;"></td> </tr> <tr> <td></td> <td></td> <td colspan="8" style="text-align: center;"> <table border="1" style="width: 100%; border-collapse: collapse; text-align: center;"> <tr> <td style="width: 10%;"></td> <td style="width: 10%;"></td> <td style="width: 10%;"></td> <td style="width: 10%;"></td> <td style="width: 10%;"></td> <td style="width: 10%;"></td> <td style="width: 10%;"></td> <td style="width: 10%;"></td> <td style="width: 10%;"></td> <td style="width: 10%;"></td> </tr> <tr> <td></td> <td></td> <td colspan="8" style="text-align: center;"> <table border="1" style="width: 100%; border-collapse: collapse; text-align: center;"> <tr> <td style="width: 10%;"></td> <td style="width: 10%;"></td> <td style="width: 10%;"></td> <td style="width: 10%;"></td> <td style="width: 10%;"></td> <td style="width: 10%;"></td> <td style="width: 10%;"></td> <td style="width: 10%;"></td> <td style="width: 10%;"></td> <td style="width: 10%;"></td> </tr> <tr> <td></td> <td></td> <td colspan="8" style="text-align: center;"> <table border="1" style="width: 100%; border-collapse: collapse; text-align: center;"> <tr> <td style="width: 10%;"></td> <td style="width: 10%;"></td> <td style="width: 10%;"></td> <td style="width: 10%;"></td> <td style="width: 10%;"></td> <td style="width: 10%;"></td> <td style="width: 10%;"></td> <td style="width: 10%;"></td> <td style="width: 10%;"></td> <td style="width: 10%;"></td> </tr> <tr> <td></td> <td></td> <td colspan="8" style="text-align: center;"> <table border="1" style="width: 100%; border-collapse: collapse; text-align: center;"> <tr> <td style="width: 10%;"></td> <td style="width: 10%;"></td> <td style="width: 10%;"></td> <td style="width: 10%;"></td> <td style="width: 10%;"></td> <td style="width: 10%;"></td> <td style="width: 10%;"></td> <td style="width: 10%;"></td> <td style="width: 10%;"></td> <td style="width: 10%;"></td> </tr> <tr> <td></td> <td></td> <td colspan="8" style="text-align: center;"> <table border="1" style="width: 100%; border-collapse: collapse; text-align: center;"> <tr> <td style="width: 10%;"></td> <td style="width: 10%;"></td> <td style="width: 10%;"></td> <td style="width: 10%;"></td> <td style="width: 10%;"></td> <td style="width: 10%;"></td> <td style="width: 10%;"></td> <td style="width: 10%;"></td> <td style="width: 10%;"></td> <td style="width: 10%;"></td> </tr> <tr> <td></td> <td></td> <td colspan="8" style="text-align: center;"> <table border="1" style="width: 100%; border-collapse: collapse; text-align: center;"> <tr> <td style="width: 10%;"></td> <td style="width: 10%;"></td> <td style="width: 10%;"></td> <td style="width: 10%;"></td> <td style="width: 10%;"></td> <td style="width: 10%;"></td> <td style="width: 10%;"></td> <td style="width: 10%;"></td> <td style="width: 10%;"></td> <td style="width: 10%;"></td> </tr> <tr> <td></td> <td></td> <td colspan="8" style="text-align: center;"> <table border="1" style="width: 100%; border-collapse: collapse; text-align: center;"> <tr> <td style="width: 10%;"></td> <td style="width: 10%;"></td> <td style="width: 10%;"></td> <td style="width: 10%;"></td> <td style="width: 10%;"></td> <td style="width: 10%;"></td> <td style="width: 10%;"></td> <td style="width: 10%;"></td> <td style="width: 10%;"></td> <td style="width: 10%;"></td> </tr> <tr> <td></td> <td></td> <td colspan="8" style="text-align: center;"> <table border="1" style="width: 100%; border-collapse: collapse; text-align: center;"> <tr> <td style="width: 10%;"></td> <td style="width: 10%;"></td> <td style="width: 10%;"></td> <td style="width: 10%;"></td> <td style="width: 10%;"></td> <td style="width: 10%;"></td> <td style="width: 10%;"></td> <td style="width: 10%;"></td> <td style="width: 10%;"></td> <td style="width: 10%;"></td> </tr> <tr> <td></td> <td></td> <td colspan="8" style="text-align: center;"> <table border="1" style="width: 100%; border-collapse: collapse; text-align: center;"> <tr> <td style="width: 10%;"></td> <td style="width: 10%;"></td> <td style="width: 10%;"></td> <td style="width: 10%;"></td> <td style="width: 10%;"></td> <td style="width: 10%;"></td> <td style="width: 10%;"></td> <td style="width: 10%;"></td> <td style="width: 10%;"></td> <td style="width: 10%;"></td> </tr> <tr> <td></td> <td></td> <td colspan="8" style="text-align: center;"> <table border="1" style="width: 100%; border-collapse: collapse; text-align: center;"> <tr> <td style="width: 10%;"></td> <td style="width: 10%;"></td> <td style="width: 10%;"></td> <td style="width: 10%;"></td> <td style="width: 10%;"></td> <td style="width: 10%;"></td> <td style="width: 10%;"></td> <td style="width: 10%;"></td> <td style="width: 10%;"></td> <td style="width: 10%;"></td> </tr> <tr> <td></td> <td></td> <td colspan="8" style="text-align: center;"> <table border="1" style="width: 100%; border-collapse: collapse; text-align: center;"> <tr> <td style="width: 10%;"></td> <td style="width: 10%;"></td> <td style="width: 10%;"></td> <td style="width: 10%;"></td> <td style="width: 10%;"></td> <td style="width: 10%;"></td> <td style="width: 10%;"></td> <td style="width: 10%;"></td> <td style="width: 10%;"></td> <td style="width: 10%;"></td> </tr> <tr> <td></td> <td></td> <td colspan="8" style="text-align: center;"> <table border="1" style="width: 100%; border-collapse: collapse; text-align: center;"> <tr> <td style="width: 10%;"></td> <td style="width: 10%;"></td> <td style="width: 10%;"></td> <td style="width: 10%;"></td> <td style="width: 10%;"></td> <td style="width: 10%;"></td> <td style="width: 10%;"></td> <td style="width: 10%;"></td> <td style="width: 10%;"></td> <td style="width: 10%;"></td> </tr> <tr> <td></td> <td></td> <td colspan="8" style="text-align: center;"> <table border="1" style="width: 100%; border-collapse: collapse; text-align: center;"> <tr> <td style="width: 10%;"></td> <td style="width: 10%;"></td> <td style="width: 10%;"></td> <td style="width: 10%;"></td> <td style="width: 10%;"></td> <td style="width: 10%;"></td> <td style="width: 10%;"></td> <td style="width: 10%;"></td> <td style="width: 10%;"></td> <td style="width: 10%;"></td> </tr> <tr> <td></td> <td></td> <td colspan="8" style="text-align: center;"> <table border="1" style="width: 100%; border-collapse: collapse; text-align: center;"> <tr> <td style="width: 10%;"></td> <td style="width: 10%;"></td> <td
style="width: 10%;"></td> <td style="width: 10%;"></td> <td style="width: 10%;"></td> <td style="width: 10%;"></td> <td style="width: 10%;"></td> <td style="width: 10%;"></td> <td style="width: 10%;"></td> <td style="width: 10%;"></td> </tr> <tr> <td></td> <td></td> <td colspan="8" style="text-align: center;"> <table border="1" style="width: 100%; border-collapse: collapse; text-align: center;"> <tr> <td style="width: 10%;"></td> <td style="width: 10%;"></td> <td style="width: 10%;"></td> <td style="width: 10%;"></td> <td style="width: 10%;"></td> <td style="width: 10%;"></td> <td style="width: 10%;"></td> <td style="width: 10%;"></td> <td style="width: 10%;"></td> <td style="width: 10%;"></td> </tr> <tr> <td></td> <td></td> <td colspan="8" style="text-align: center;"> <table border="1" style="width: 100%; border-collapse: collapse; text-align: center;"> <tr> <td style="width: 10%;"></td> <td style="width: 10%;"></td> <td style="width: 10%;"></td> <td style="width: 10%;"></td> <td style="width: 10%;"></td> <td style="width: 10%;"></td> <td style="width: 10%;"></td> <td style="width: 10%;"></td> <td style="width: 10%;"></td> <td style="width: 10%;"></td> </tr> <tr> <td></td> <td></td> <td colspan="8" style="text-align: center;"> <table border="1" style="width: 100%; border-collapse: collapse; text-align: center;"> <tr> <td style="width: 10%;"></td> <td style="width: 10%;"></td> <td style="width: 10%;"></td> <td style="width: 10%;"></td> <td style="width: 10%;"></td> <td style="width: 10%;"></td> <td style="width: 10%;"></td> <td style="width: 10%;"></td> <td style="width: 10%;"></td> <td style="width: 10%;"></td> </tr> <tr> <td></td> <td></td> <td colspan="8" style="text-align: center;"> <table border="1" style="width: 100%; border-collapse: collapse; text-align: center;"> <tr> <td style="width: 10%;"></td> <td style="width: 10%;"></td> <td style="width: 10%;"></td> <td style="width: 10%;"></td> <td style="width: 10%;"></td> <td style="width: 10%;"></td> <td style="width: 10%;"></td> <td style="width: 10%;"></td> <td style="width: 10%;"></td> <td style="width: 10%;"></td> </tr> <tr> <td></td> <td></td> <td colspan="8" style="text-align: center;"> <table border="1" style="width: 100%; border-collapse: collapse; text-align: center;"> <tr> <td style="width: 10%;"></td> <td style="width: 10%;"></td> <td style="width: 10%;"></td> <td style="width: 10%;"></td> <td style="width: 10%;"></td> <td style="width: 10%;"></td> <td style="width: 10%;"></td> <td style="width: 10%;"></td> <td style="width: 10%;"></td> <td style="width: 10%;"></td> </tr> <tr> <td></td> <td></td> <td colspan="8" style="text-align: center;"> <table border="1" style="width: 100%; border-collapse: collapse; text-align: center;"> <tr> <td style="width: 10%;"></td> <td style="width: 10%;"></td> <td style="width: 10%;"></td> <td style="width: 10%;"></td> <td style="width: 10%;"></td> <td style="width: 10%;"></td> <td style="width: 10%;"></td> <td style="width: 10%;"></td> <td style="width: 10%;"></td> <td style="width: 10%;"></td> </tr> <tr> <td></td> <td></td> <td colspan="8" style="text-align: center;"> <table border="1" style="width: 100%; border-collapse: collapse; text-align: center;"> <tr> <td style="width: 10%;"></td> <td style="width: 10%;"></td> <td style="width: 10%;"></td> <td style="width: 10%;"></td> <td style="width: 10%;"></td> <td style="width: 10%;"></td> <td style="width: 10%;"></td> <td style="width: 10%;"></td> <td style="width: 10%;"></td> <td style="width: 10%;"></td> </tr> <tr> <td></td> <td></td> <td colspan="8" style="text-align: center;"> <table border="1" style="width: 100%; border-collapse: collapse; text-align: center;"> <tr> <td style="width: 10%;"></td> <td style="width: 10%;"></td> <td style="width: 10%;"></td> <td style="width: 10%;"></td> <td style="width: 10%;"></td> <td style="width: 10%;"></td> <td style="width: 10%;"></td> <td style="width: 10%;"></td> <td style="width: 10%;"></td> <td style="width: 10%;"></td> </tr> <tr> <td></td> <td></td> <td colspan="8" style="text-align: center;"> <table border="1" style="width: 100%; border-collapse: collapse; text-align: center;"> <tr> <td style="width: 10%;"></td> <td style="width: 10%;"></td> <td style="width: 10%;"></td> <td style="width: 10%;"></td> <td style="width: 10%;"></td> <td style="width: 10%;"></td> <td style="width: 10%;"></td> <td style="width: 10%;"></td> <td style="width: 10%;"></td> <td style="width: 10%;"></td> </tr> <tr> <td></td> <td></td> <td colspan="8" style="text-align: center;"> <table border="1" style="width: 100%; border-collapse: collapse; text-align: center;"> <tr> <td style="width: 10%;"></td> <td style="width: 10%;"></td> <td style="width: 10%;"></td> <td style="width: 10%;"></td> <td style="width: 10%;"></td> <td style="width: 10%;"></td> <td style="width: 10%;"></td> <td style="width: 10%;"></td> <td style="width: 10%;"></td> <td style="width: 10%;"></td> </tr> <tr> <td></td> <td></td> <td colspan="8" style="text-align: center;"> <table border="1" style="width: 100%; border-collapse: collapse; text-align: center;"> <tr> <td style="width: 10%;"></td> <td style="width: 10%;"></td> <td style="width: 10%;"></td> <td style="width: 10%;"></td> <td style="width: 10%;"></td> <td style="width: 10%;"></td> <td style="width: 10%;"></td> <td style="width: 10%;"></td> <td style="width: 10%;"></td> <td style="width: 10%;"></td> </tr> <tr> <td></td> <td></td> <td colspan="8" style="text-align: center;"> <table border="1" style="width: 100%; border-collapse: collapse; text-align: center;"> <tr> </tr></table></td></tr></table></td></tr></table></td></tr></table></td></tr></table></td></tr></table></td></tr></table></td></tr></table></td></tr></table></td></tr></table></td></tr></table></td></tr></table></td></tr></table></td></tr></table></td></tr></table></td></tr></table></td></tr></table></td></tr></table></td></tr></table></td></tr></table></td></tr></table></td></tr></table></td></tr></table></td></tr></table></td></tr></table></td></tr></table></td></tr></table></td></tr></table></td></tr></table></td></tr></table></td></tr></table></td></tr></table></td></tr></table></td></tr></table>

 | | | | | | | | | | | | | | | | | | | | <table border="1" style="width: 100%; border-collapse: collapse; text-align: center;"> <tr> <td style="width: 10%;"></td> <td style="width: 10%;"></td> <td style="width: 10%;"></td> <td style="width: 10%;"></td> <td style="width: 10%;"></td> <td style="width: 10%;"></td> <td style="width: 10%;"></td> <td style="width: 10%;"></td> <td style="width: 10%;"></td> <td style="width: 10%;"></td> </tr> <tr> <td></td> <td></td> <td colspan="8" style="text-align: center;"> <table border="1" style="width: 100%; border-collapse: collapse; text-align: center;"> <tr> <td style="width: 10%;"></td> <td style="width: 10%;"></td> <td style="width: 10%;"></td> <td style="width: 10%;"></td> <td style="width: 10%;"></td> <td style="width: 10%;"></td> <td style="width: 10%;"></td> <td style="width: 10%;"></td> <td style="width: 10%;"></td> <td style="width: 10%;"></td> </tr> <tr> <td></td> <td></td> <td colspan="8" style="text-align: center;"> <table border="1" style="width: 100%; border-collapse: collapse; text-align: center;"> <tr> <td style="width: 10%;"></td> <td style="width: 10%;"></td> <td style="width: 10%;"></td> <td style="width: 10%;"></td> <td style="width: 10%;"></td> <td style="width: 10%;"></td> <td style="width: 10%;"></td> <td style="width: 10%;"></td> <td style="width: 10%;"></td> <td style="width: 10%;"></td> </tr> <tr> <td></td> <td></td> <td colspan="8" style="text-align: center;"> <table border="1" style="width: 100%; border-collapse: collapse; text-align: center;"> <tr> <td style="width: 10%;"></td> <td style="width: 10%;"></td> <td style="width: 10%;"></td> <td style="width: 10%;"></td> <td style="width: 10%;"></td> <td style="width: 10%;"></td> <td style="width: 10%;"></td> <td style="width: 10%;"></td> <td style="width: 10%;"></td> <td style="width: 10%;"></td> </tr> <tr> <td></td> <td></td> <td colspan="8" style="text-align: center;"> <table border="1" style="width: 100%; border-collapse: collapse; text-align: center;"> <tr> <td style="width: 10%;"></td> <td style="width: 10%;"></td> <td style="width: 10%;"></td> <td style="width: 10%;"></td> <td style="width: 10%;"></td> <td style="width: 10%;"></td> <td style="width: 10%;"></td> <td style="width: 10%;"></td> <td style="width: 10%;"></td> <td style="width: 10%;"></td> </tr> <tr> <td></td> <td></td> <td colspan="8" style="text-align: center;"> <table border="1" style="width: 100%; border-collapse: collapse; text-align: center;"> <tr> <td style="width: 10%;"></td> <td style="width: 10%;"></td> <td style="width: 10%;"></td> <td style="width: 10%;"></td> <td style="width: 10%;"></td> <td style="width: 10%;"></td> <td style="width: 10%;"></td> <td style="width: 10%;"></td> <td style="width: 10%;"></td> <td style="width: 10%;"></td> </tr> <tr> <td></td> <td></td> <td colspan="8" style="text-align: center;"> <table border="1" style="width: 100%; border-collapse: collapse; text-align: center;"> <tr> <td style="width: 10%;"></td> <td style="width: 10%;"></td> <td style="width: 10%;"></td> <td style="width: 10%;"></td> <td style="width: 10%;"></td> <td style="width: 10%;"></td> <td style="width: 10%;"></td> <td style="width: 10%;"></td> <td style="width: 10%;"></td> <td style="width: 10%;"></td> </tr> <tr> <td></td> <td></td> <td colspan="8" style="text-align: center;"> <table border="1" style="width: 100%; border-collapse: collapse; text-align: center;"> <tr> <td style="width: 10%;"></td> <td style="width: 10%;"></td> <td style="width: 10%;"></td> <td style="width: 10%;"></td> <td style="width: 10%;"></td> <td style="width: 10%;"></td> <td style="width: 10%;"></td> <td style="width: 10%;"></td> <td style="width: 10%;"></td> <td style="width: 10%;"></td> </tr> <tr> <td></td> <td></td> <td colspan="8" style="text-align: center;"> <table border="1" style="width: 100%; border-collapse: collapse; text-align: center;"> <tr> <td style="width: 10%;"></td> <td style="width: 10%;"></td> <td style="width: 10%;"></td> <td style="width: 10%;"></td> <td style="width: 10%;"></td> <td style="width: 10%;"></td> <td style="width: 10%;"></td> <td style="width: 10%;"></td> <td style="width: 10%;"></td> <td style="width: 10%;"></td> </tr> <tr> <td></td> <td></td> <td colspan="8" style="text-align: center;"> <table border="1" style="width: 100%; border-collapse: collapse; text-align: center;"> <tr> <td style="width: 10%;"></td> <td style="width: 10%;"></td> <td style="width: 10%;"></td> <td style="width: 10%;"></td> <td style="width: 10%;"></td> <td style="width: 10%;"></td> <td style="width: 10%;"></td> <td style="width: 10%;"></td> <td style="width: 10%;"></td> <td style="width: 10%;"></td> </tr> <tr> <td></td> <td></td> <td colspan="8" style="text-align: center;"> <table border="1" style="width: 100%; border-collapse: collapse; text-align: center;"> <tr> <td style="width: 10%;"></td> <td style="width: 10%;"></td> <td style="width: 10%;"></td> <td style="width: 10%;"></td> <td style="width: 10%;"></td> <td style="width: 10%;"></td> <td style="width: 10%;"></td> <td style="width: 10%;"></td> <td style="width: 10%;"></td> <td style="width: 10%;"></td> </tr> <tr> <td></td> <td></td> <td colspan="8" style="text-align: center;"> <table border="1" style="width: 100%; border-collapse: collapse; text-align: center;"> <tr> <td style="width: 10%;"></td> <td style="width: 10%;"></td> <td style="width: 10%;"></td> <td style="width: 10%;"></td> <td style="width: 10%;"></td> <td style="width: 10%;"></td> <td style="width: 10%;"></td> <td style="width: 10%;"></td> <td style="width: 10%;"></td> <td style="width: 10%;"></td> </tr> <tr> <td></td> <td></td> <td colspan="8" style="text-align: center;"> <table border="1" style="width: 100%; border-collapse: collapse; text-align: center;"> <tr> <td style="width: 10%;"></td> <td style="width: 10%;"></td> <td style="width: 10%;"></td> <td style="width: 10%;"></td> <td style="width: 10%;"></td> <td style="width: 10%;"></td> <td style="width: 10%;"></td> <td style="width: 10%;"></td> <td style="width: 10%;"></td> <td style="width: 10%;"></td> </tr> <tr> <td></td> <td></td> <td colspan="8" style="text-align: center;"> <table border="1" style="width: 100%; border-collapse: collapse; text-align: center;"> <tr> <td style="width: 10%;"></td> <td style="width: 10%;"></td> <td style="width: 10%;"></td> <td style="width: 10%;"></td> <td style="width: 10%;"></td> <td style="width: 10%;"></td> <td style="width: 10%;"></td> <td style="width: 10%;"></td> <td style="width: 10%;"></td> <td style="width: 10%;"></td> </tr> <tr> <td></td> <td></td> <td colspan="8" style="text-align: center;"> <table border="1" style="width: 100%; border-collapse: collapse; text-align: center;"> <tr> <td style="width: 10%;"></td> <td style="width: 10%;"></td> <td style="width: 10%;"></td> <td style="width: 10%;"></td> <td style="width: 10%;"></td> <td style="width: 10%;"></td> <td style="width: 10%;"></td> <td style="width: 10%;"></td> <td style="width: 10%;"></td> <td style="width: 10%;"></td> </tr> <tr> <td></td> <td></td> <td colspan="8" style="text-align: center;"> <table border="1" style="width: 100%; border-collapse: collapse; text-align: center;"> <tr> <td style="width: 10%;"></td> <td style="width: 10%;"></td> <td style="width: 10%;"></td> <td style="width: 10%;"></td> <td style="width: 10%;"></td> <td style="width: 10%;"></td> <td style="width: 10%;"></td> <td style="width: 10%;"></td> <td style="width: 10%;"></td> <td style="width: 10%;"></td> </tr> <tr> <td></td> <td></td> <td colspan="8" style="text-align: center;"> <table border="1" style="width: 100%; border-collapse: collapse; text-align: center;"> <tr> <td style="width: 10%;"></td> <td style="width: 10%;"></td> <td style="width: 10%;"></td> <td style="width: 10%;"></td> <td style="width: 10%;"></td> <td style="width: 10%;"></td> <td style="width: 10%;"></td> <td style="width: 10%;"></td> <td style="width: 10%;"></td> <td style="width: 10%;"></td> </tr> <tr> <td></td> <td></td> <td colspan="8" style="text-align: center;"> <table border="1" style="width: 100%; border-collapse: collapse; text-align: center;"> <tr> <td style="width: 10%;"></td> <td style="width: 10%;"></td> <td style="width: 10%;"></td> <td style="width: 10%;"></td> <td style="width: 10%;"></td> <td style="width: 10%;"></td> <td style="width: 10%;"></td> <td style="width: 10%;"></td> <td style="width: 10%;"></td> <td style="width: 10%;"></td> </tr> <tr> <td></td> <td></td> <td colspan="8" style="text-align: center;"> <table border="1" style="width: 100%; border-collapse: collapse; text-align: center;"> <tr> <td style="width: 10%;"></td> <td style="width: 10%;"></td> <td style="width: 10%;"></td> <td style="width: 10%;"></td> <td style="width: 10%;"></td> <td style="width: 10%;"></td> <td
style="width: 10%;"></td> <td style="width: 10%;"></td> <td style="width: 10%;"></td> <td style="width: 10%;"></td> </tr> <tr> <td></td> <td></td> <td colspan="8" style="text-align: center;"> <table border="1" style="width: 100%; border-collapse: collapse; text-align: center;"> <tr> <td style="width: 10%;"></td> <td style="width: 10%;"></td> <td style="width: 10%;"></td> <td style="width: 10%;"></td> <td style="width: 10%;"></td> <td style="width: 10%;"></td> <td style="width: 10%;"></td> <td style="width: 10%;"></td> <td style="width: 10%;"></td> <td style="width: 10%;"></td> </tr> <tr> <td></td> <td></td> <td colspan="8" style="text-align: center;"> <table border="1" style="width: 100%; border-collapse: collapse; text-align: center;"> <tr> <td style="width: 10%;"></td> <td style="width: 10%;"></td> <td style="width: 10%;"></td> <td style="width: 10%;"></td> <td style="width: 10%;"></td> <td style="width: 10%;"></td> <td style="width: 10%;"></td> <td style="width: 10%;"></td> <td style="width: 10%;"></td> <td style="width: 10%;"></td> </tr> <tr> <td></td> <td></td> <td colspan="8" style="text-align: center;"> <table border="1" style="width: 100%; border-collapse: collapse; text-align: center;"> <tr> <td style="width: 10%;"></td> <td style="width: 10%;"></td> <td style="width: 10%;"></td> <td style="width: 10%;"></td> <td style="width: 10%;"></td> <td style="width: 10%;"></td> <td style="width: 10%;"></td> <td style="width: 10%;"></td> <td style="width: 10%;"></td> <td style="width: 10%;"></td> </tr> <tr> <td></td> <td></td> <td colspan="8" style="text-align: center;"> <table border="1" style="width: 100%; border-collapse: collapse; text-align: center;"> <tr> <td style="width: 10%;"></td> <td style="width: 10%;"></td> <td style="width: 10%;"></td> <td style="width: 10%;"></td> <td style="width: 10%;"></td> <td style="width: 10%;"></td> <td style="width: 10%;"></td> <td style="width: 10%;"></td> <td style="width: 10%;"></td> <td style="width: 10%;"></td> </tr> <tr> <td></td> <td></td> <td colspan="8" style="text-align: center;"> <table border="1" style="width: 100%; border-collapse: collapse; text-align: center;"> <tr> <td style="width: 10%;"></td> <td style="width: 10%;"></td> <td style="width: 10%;"></td> <td style="width: 10%;"></td> <td style="width: 10%;"></td> <td style="width: 10%;"></td> <td style="width: 10%;"></td> <td style="width: 10%;"></td> <td style="width: 10%;"></td> <td style="width: 10%;"></td> </tr> <tr> <td></td> <td></td> <td colspan="8" style="text-align: center;"> <table border="1" style="width: 100%; border-collapse: collapse; text-align: center;"> <tr> <td style="width: 10%;"></td> <td style="width: 10%;"></td> <td style="width: 10%;"></td> <td style="width: 10%;"></td> <td style="width: 10%;"></td> <td style="width: 10%;"></td> <td style="width: 10%;"></td> <td style="width: 10%;"></td> <td style="width: 10%;"></td> <td style="width: 10%;"></td> </tr> <tr> <td></td> <td></td> <td colspan="8" style="text-align: center;"> <table border="1" style="width: 100%; border-collapse: collapse; text-align: center;"> <tr> <td style="width: 10%;"></td> <td style="width: 10%;"></td> <td style="width: 10%;"></td> <td style="width: 10%;"></td> <td style="width: 10%;"></td> <td style="width: 10%;"></td> <td style="width: 10%;"></td> <td style="width: 10%;"></td> <td style="width: 10%;"></td> <td style="width: 10%;"></td> </tr> <tr> <td></td> <td></td> <td colspan="8" style="text-align: center;"> <table border="1" style="width: 100%; border-collapse: collapse; text-align: center;"> <tr> <td style="width: 10%;"></td> <td style="width: 10%;"></td> <td style="width: 10%;"></td> <td style="width: 10%;"></td> <td style="width: 10%;"></td> <td style="width: 10%;"></td> <td style="width: 10%;"></td> <td style="width: 10%;"></td> <td style="width: 10%;"></td> <td style="width: 10%;"></td> </tr> <tr> <td></td> <td></td> <td colspan="8" style="text-align: center;"> <table border="1" style="width: 100%; border-collapse: collapse; text-align: center;"> <tr> <td style="width: 10%;"></td> <td style="width: 10%;"></td> <td style="width: 10%;"></td> <td style="width: 10%;"></td> <td style="width: 10%;"></td> <td style="width: 10%;"></td> <td style="width: 10%;"></td> <td style="width: 10%;"></td> <td style="width: 10%;"></td> <td style="width: 10%;"></td> </tr> <tr> <td></td> <td></td> <td colspan="8" style="text-align: center;"> <table border="1" style="width: 100%; border-collapse: collapse; text-align: center;"> <tr> <td style="width: 10%;"></td> <td style="width: 10%;"></td> <td style="width: 10%;"></td> <td style="width: 10%;"></td> <td style="width: 10%;"></td> <td style="width: 10%;"></td> <td style="width: 10%;"></td> <td style="width: 10%;"></td> <td style="width: 10%;"></td> <td style="width: 10%;"></td> </tr> <tr> <td></td> <td></td> <td colspan="8" style="text-align: center;"> <table border="1" style="width: 100%; border-collapse: collapse; text-align: center;"> <tr> <td style="width: 10%;"></td> <td style="width: 10%;"></td> <td style="width: 10%;"></td> <td style="width: 10%;"></td> <td style="width: 10%;"></td> <td style="width: 10%;"></td> <td style="width: 10%;"></td> <td style="width: 10%;"></td> <td style="width: 10%;"></td> <td style="width: 10%;"></td> </tr> <tr> <td></td> <td></td> <td colspan="8" style="text-align: center;"> <table border="1" style="width: 100%; border-collapse: collapse; text-align: center;"> <tr> <td style="width: 10%;"></td> <td style="width: 10%;"></td> <td style="width: 10%;"></td> <td style="width: 10%;"></td> <td style="width: 10%;"></td> <td style="width: 10%;"></td> <td style="width: 10%;"></td> <td style="width: 10%;"></td> <td style="width: 10%;"></td> <td style="width: 10%;"></td> </tr> <tr> <td></td> <td></td> <td colspan="8" style="text-align: center;"> <table border="1" style="width: 100%; border-collapse: collapse; text-align: center;"> <tr> <td style="width: 10%;"></td> <td style="width: 10%;"></td> <td style="width: 10%;"></td> <td style="width: 10%;"></td> <td style="width: 10%;"></td> <td style="width: 10%;"></td> <td style="width: 10%;"></td> <td style="width: 10%;"></td> <td style="width: 10%;"></td> <td style="width: 10%;"></td> </tr> <tr> <td></td> <td></td> <td colspan="8" style="text-align: center;"> <table border="1" style="width: 100%; border-collapse: collapse; text-align: center;"> <tr> </tr></table></td></tr></table></td></tr></table></td></tr></table></td></tr></table></td></tr></table></td></tr></table></td></tr></table></td></tr></table></td></tr></table></td></tr></table></td></tr></table></td></tr></table></td></tr></table></td></tr></table></td></tr></table></td></tr></table></td></tr></table></td></tr></table></td></tr></table></td></tr></table></td></tr></table></td></tr></table></td></tr></table></td></tr></table></td></tr></table></td></tr></table></td></tr></table></td></tr></table></td></tr></table></td></tr></table></td></tr></table></td></tr></table>

 | | | | | | | | | | | | | | | | | | | | <table border="1" style="width: 100%; border-collapse: collapse; text-align: center;"> <tr> <td style="width: 10%;"></td> <td style="width: 10%;"></td> <td style="width: 10%;"></td> <td style="width: 10%;"></td> <td style="width: 10%;"></td> <td style="width: 10%;"></td> <td style="width: 10%;"></td> <td style="width: 10%;"></td> <td style="width: 10%;"></td> <td style="width: 10%;"></td> </tr> <tr> <td></td> <td></td> <td colspan="8" style="text-align: center;"> <table border="1" style="width: 100%; border-collapse: collapse; text-align: center;"> <tr> <td style="width: 10%;"></td> <td style="width: 10%;"></td> <td style="width: 10%;"></td> <td style="width: 10%;"></td> <td style="width: 10%;"></td> <td style="width: 10%;"></td> <td style="width: 10%;"></td> <td style="width: 10%;"></td> <td style="width: 10%;"></td> <td style="width: 10%;"></td> </tr> <tr> <td></td> <td></td> <td colspan="8" style="text-align: center;"> <table border="1" style="width: 100%; border-collapse: collapse; text-align: center;"> <tr> <td style="width: 10%;"></td> <td style="width: 10%;"></td> <td style="width: 10%;"></td> <td style="width: 10%;"></td> <td style="width: 10%;"></td> <td style="width: 10%;"></td> <td style="width: 10%;"></td> <td style="width: 10%;"></td> <td style="width: 10%;"></td> <td style="width: 10%;"></td> </tr> <tr> <td></td> <td></td> <td colspan="8" style="text-align: center;"> <table border="1" style="width: 100%; border-collapse: collapse; text-align: center;"> <tr> <td style="width: 10%;"></td> <td style="width: 10%;"></td> <td style="width: 10%;"></td> <td style="width: 10%;"></td> <td style="width: 10%;"></td> <td style="width: 10%;"></td> <td style="width: 10%;"></td> <td style="width: 10%;"></td> <td style="width: 10%;"></td> <td style="width: 10%;"></td> </tr> <tr> <td></td> <td></td> <td colspan="8" style="text-align: center;"> <table border="1" style="width: 100%; border-collapse: collapse; text-align: center;"> <tr> <td style="width: 10%;"></td> <td style="width: 10%;"></td> <td style="width: 10%;"></td> <td style="width: 10%;"></td> <td style="width: 10%;"></td> <td style="width: 10%;"></td> <td style="width: 10%;"></td> <td style="width: 10%;"></td> <td style="width: 10%;"></td> <td style="width: 10%;"></td> </tr> <tr> <td></td> <td></td> <td colspan="8" style="text-align: center;"> <table border="1" style="width: 100%; border-collapse: collapse; text-align: center;"> <tr> <td style="width: 10%;"></td> <td style="width: 10%;"></td> <td style="width: 10%;"></td> <td style="width: 10%;"></td> <td style="width: 10%;"></td> <td style="width: 10%;"></td> <td style="width: 10%;"></td> <td style="width: 10%;"></td> <td style="width: 10%;"></td> <td style="width: 10%;"></td> </tr> <tr> <td></td> <td></td> <td colspan="8" style="text-align: center;"> <table border="1" style="width: 100%; border-collapse: collapse; text-align: center;"> <tr> <td style="width: 10%;"></td> <td style="width: 10%;"></td> <td style="width: 10%;"></td> <td style="width: 10%;"></td> <td style="width: 10%;"></td> <td style="width: 10%;"></td> <td style="width: 10%;"></td> <td style="width: 10%;"></td> <td style="width: 10%;"></td> <td style="width: 10%;"></td> </tr> <tr> <td></td> <td></td> <td colspan="8" style="text-align: center;"> <table border="1" style="width: 100%; border-collapse: collapse; text-align: center;"> <tr> <td style="width: 10%;"></td> <td style="width: 10%;"></td> <td style="width: 10%;"></td> <td style="width: 10%;"></td> <td style="width: 10%;"></td> <td style="width: 10%;"></td> <td style="width: 10%;"></td> <td style="width: 10%;"></td> <td style="width: 10%;"></td> <td style="width: 10%;"></td> </tr> <tr> <td></td> <td></td> <td colspan="8" style="text-align: center;"> <table border="1" style="width: 100%; border-collapse: collapse; text-align: center;"> <tr> <td style="width: 10%;"></td> <td style="width: 10%;"></td> <td style="width: 10%;"></td> <td style="width: 10%;"></td> <td style="width: 10%;"></td> <td style="width: 10%;"></td> <td style="width: 10%;"></td> <td style="width: 10%;"></td> <td style="width: 10%;"></td> <td style="width: 10%;"></td> </tr> <tr> <td></td> <td></td> <td colspan="8" style="text-align: center;"> <table border="1" style="width: 100%; border-collapse: collapse; text-align: center;"> <tr> <td style="width: 10%;"></td> <td style="width: 10%;"></td> <td style="width: 10%;"></td> <td style="width: 10%;"></td> <td style="width: 10%;"></td> <td style="width: 10%;"></td> <td style="width: 10%;"></td> <td style="width: 10%;"></td> <td style="width: 10%;"></td> <td style="width: 10%;"></td> </tr> <tr> <td></td> <td></td> <td colspan="8" style="text-align: center;"> <table border="1" style="width: 100%; border-collapse: collapse; text-align: center;"> <tr> <td style="width: 10%;"></td> <td style="width: 10%;"></td> <td style="width: 10%;"></td> <td style="width: 10%;"></td> <td style="width: 10%;"></td> <td style="width: 10%;"></td> <td style="width: 10%;"></td> <td style="width: 10%;"></td> <td style="width: 10%;"></td> <td style="width: 10%;"></td> </tr> <tr> <td></td> <td></td> <td colspan="8" style="text-align: center;"> <table border="1" style="width: 100%; border-collapse: collapse; text-align: center;"> <tr> <td style="width: 10%;"></td> <td style="width: 10%;"></td> <td style="width: 10%;"></td> <td style="width: 10%;"></td> <td style="width: 10%;"></td> <td style="width: 10%;"></td> <td style="width: 10%;"></td> <td style="width: 10%;"></td> <td style="width: 10%;"></td> <td style="width: 10%;"></td> </tr> <tr> <td></td> <td></td> <td colspan="8" style="text-align: center;"> <table border="1" style="width: 100%; border-collapse: collapse; text-align: center;"> <tr> <td style="width: 10%;"></td> <td style="width: 10%;"></td> <td style="width: 10%;"></td> <td style="width: 10%;"></td> <td style="width: 10%;"></td> <td style="width: 10%;"></td> <td style="width: 10%;"></td> <td style="width: 10%;"></td> <td style="width: 10%;"></td> <td style="width: 10%;"></td> </tr> <tr> <td></td> <td></td> <td colspan="8" style="text-align: center;"> <table border="1" style="width: 100%; border-collapse: collapse; text-align: center;"> <tr> <td style="width: 10%;"></td> <td style="width: 10%;"></td> <td style="width: 10%;"></td> <td style="width: 10%;"></td> <td style="width: 10%;"></td> <td style="width: 10%;"></td> <td style="width: 10%;"></td> <td style="width: 10%;"></td> <td style="width: 10%;"></td> <td style="width: 10%;"></td> </tr> <tr> <td></td> <td></td> <td colspan="8" style="text-align: center;"> <table border="1" style="width: 100%; border-collapse: collapse; text-align: center;"> <tr> <td style="width: 10%;"></td> <td style="width: 10%;"></td> <td style="width: 10%;"></td> <td style="width: 10%;"></td> <td style="width: 10%;"></td> <td style="width: 10%;"></td> <td style="width: 10%;"></td> <td style="width: 10%;"></td> <td style="width: 10%;"></td> <td style="width: 10%;"></td> </tr> <tr> <td></td> <td></td> <td colspan="8" style="text-align: center;"> <table border="1" style="width: 100%; border-collapse: collapse; text-align: center;"> <tr> <td style="width: 10%;"></td> <td style="width: 10%;"></td> <td style="width: 10%;"></td> <td style="width: 10%;"></td> <td style="width: 10%;"></td> <td style="width: 10%;"></td> <td style="width: 10%;"></td> <td style="width: 10%;"></td> <td style="width: 10%;"></td> <td style="width: 10%;"></td> </tr> <tr> <td></td> <td></td> <td colspan="8" style="text-align: center;"> <table border="1" style="width: 100%; border-collapse: collapse; text-align: center;"> <tr> <td style="width: 10%;"></td> <td style="width: 10%;"></td> <td style="width: 10%;"></td> <td style="width: 10%;"></td> <td style="width: 10%;"></td> <td style="width: 10%;"></td> <td style="width: 10%;"></td> <td style="width: 10%;"></td> <td style="width: 10%;"></td> <td style="width: 10%;"></td> </tr> <tr> <td></td> <td></td> <td
colspan="8" style="text-align: center;"> <table border="1" style="width: 100%; border-collapse: collapse; text-align: center;"> <tr> <td style="width: 10%;"></td> <td style="width: 10%;"></td> <td style="width: 10%;"></td> <td style="width: 10%;"></td> <td style="width: 10%;"></td> <td style="width: 10%;"></td> <td style="width: 10%;"></td> <td style="width: 10%;"></td> <td style="width: 10%;"></td> <td style="width: 10%;"></td> </tr> <tr> <td></td> <td></td> <td colspan="8" style="text-align: center;"> <table border="1" style="width: 100%; border-collapse: collapse; text-align: center;"> <tr> <td style="width: 10%;"></td> <td style="width: 10%;"></td> <td style="width: 10%;"></td> <td style="width: 10%;"></td> <td style="width: 10%;"></td> <td style="width: 10%;"></td> <td style="width: 10%;"></td> <td style="width: 10%;"></td> <td style="width: 10%;"></td> <td style="width: 10%;"></td> </tr> <tr> <td></td> <td></td> <td colspan="8" style="text-align: center;"> <table border="1" style="width: 100%; border-collapse: collapse; text-align: center;"> <tr> <td style="width: 10%;"></td> <td style="width: 10%;"></td> <td style="width: 10%;"></td> <td style="width: 10%;"></td> <td style="width: 10%;"></td> <td style="width: 10%;"></td> <td style="width: 10%;"></td> <td style="width: 10%;"></td> <td style="width: 10%;"></td> <td style="width: 10%;"></td> </tr> <tr> <td></td> <td></td> <td colspan="8" style="text-align: center;"> <table border="1" style="width: 100%; border-collapse: collapse; text-align: center;"> <tr> <td style="width: 10%;"></td> <td style="width: 10%;"></td> <td style="width: 10%;"></td> <td style="width: 10%;"></td> <td style="width: 10%;"></td> <td style="width: 10%;"></td> <td style="width: 10%;"></td> <td style="width: 10%;"></td> <td style="width: 10%;"></td> <td style="width: 10%;"></td> </tr> <tr> <td></td> <td></td> <td colspan="8" style="text-align: center;"> <table border="1" style="width: 100%; border-collapse: collapse; text-align: center;"> <tr> <td style="width: 10%;"></td> <td style="width: 10%;"></td> <td style="width: 10%;"></td> <td style="width: 10%;"></td> <td style="width: 10%;"></td> <td style="width: 10%;"></td> <td style="width: 10%;"></td> <td style="width: 10%;"></td> <td style="width: 10%;"></td> <td style="width: 10%;"></td> </tr> <tr> <td></td> <td></td> <td colspan="8" style="text-align: center;"> <table border="1" style="width: 100%; border-collapse: collapse; text-align: center;"> <tr> <td style="width: 10%;"></td> <td style="width: 10%;"></td> <td style="width: 10%;"></td> <td style="width: 10%;"></td> <td style="width: 10%;"></td> <td style="width: 10%;"></td> <td style="width: 10%;"></td> <td style="width: 10%;"></td> <td style="width: 10%;"></td> <td style="width: 10%;"></td> </tr> <tr> <td></td> <td></td> <td colspan="8" style="text-align: center;"> <table border="1" style="width: 100%; border-collapse: collapse; text-align: center;"> <tr> <td style="width: 10%;"></td> <td style="width: 10%;"></td> <td style="width: 10%;"></td> <td style="width: 10%;"></td> <td style="width: 10%;"></td> <td style="width: 10%;"></td> <td style="width: 10%;"></td> <td style="width: 10%;"></td> <td style="width: 10%;"></td> <td style="width: 10%;"></td> </tr> <tr> <td></td> <td></td> <td colspan="8" style="text-align: center;"> <table border="1" style="width: 100%; border-collapse: collapse; text-align: center;"> <tr> <td style="width: 10%;"></td> <td style="width: 10%;"></td> <td style="width: 10%;"></td> <td style="width: 10%;"></td> <td style="width: 10%;"></td> <td style="width: 10%;"></td> <td style="width: 10%;"></td> <td style="width: 10%;"></td> <td style="width: 10%;"></td> <td style="width: 10%;"></td> </tr> <tr> <td></td> <td></td> <td colspan="8" style="text-align: center;"> <table border="1" style="width: 100%; border-collapse: collapse; text-align: center;"> <tr> <td style="width: 10%;"></td> <td style="width: 10%;"></td> <td style="width: 10%;"></td> <td style="width: 10%;"></td> <td style="width: 10%;"></td> <td style="width: 10%;"></td> <td style="width: 10%;"></td> <td style="width: 10%;"></td> <td style="width: 10%;"></td> <td style="width: 10%;"></td> </tr> <tr> <td></td> <td></td> <td colspan="8" style="text-align: center;"> <table border="1" style="width: 100%; border-collapse: collapse; text-align: center;"> <tr> <td style="width: 10%;"></td> <td style="width: 10%;"></td> <td style="width: 10%;"></td> <td style="width: 10%;"></td> <td style="width: 10%;"></td> <td style="width: 10%;"></td> <td style="width: 10%;"></td> <td style="width: 10%;"></td> <td style="width: 10%;"></td> <td style="width: 10%;"></td> </tr> <tr> <td></td> <td></td> <td colspan="8" style="text-align: center;"> <table border="1" style="width: 100%; border-collapse: collapse; text-align: center;"> <tr> <td style="width: 10%;"></td> <td style="width: 10%;"></td> <td style="width: 10%;"></td> <td style="width: 10%;"></td> <td style="width: 10%;"></td> <td style="width: 10%;"></td> <td style="width: 10%;"></td> <td style="width: 10%;"></td> <td style="width: 10%;"></td> <td style="width: 10%;"></td> </tr> <tr> <td></td> <td></td> <td colspan="8" style="text-align: center;"> <table border="1" style="width: 100%; border-collapse: collapse; text-align: center;"> <tr> <td style="width: 10%;"></td> <td style="width: 10%;"></td> <td style="width: 10%;"></td> <td style="width: 10%;"></td> <td style="width: 10%;"></td> <td style="width: 10%;"></td> <td style="width: 10%;"></td> <td style="width: 10%;"></td> <td style="width: 10%;"></td> <td style="width: 10%;"></td> </tr> <tr> <td></td> <td></td> <td colspan="8" style="text-align: center;"> <table border="1" style="width: 100%; border-collapse: collapse; text-align: center;"> <tr> <td style="width: 10%;"></td> <td style="width: 10%;"></td> <td style="width: 10%;"></td> <td style="width: 10%;"></td> <td style="width: 10%;"></td> <td style="width: 10%;"></td> <td style="width: 10%;"></td> <td style="width: 10%;"></td> <td style="width: 10%;"></td> <td style="width: 10%;"></td> </tr> <tr> <td></td> <td></td> <td colspan="8" style="text-align: center;"> <table border="1" style="width: 100%; border-collapse: collapse; text-align: center;"> <tr> <td style="width: 10%;"></td> <td style="width: 10%;"></td> <td style="width: 10%;"></td> <td style="width: 10%;"></td> <td style="width: 10%;"></td> <td style="width: 10%;"></td> <td style="width: 10%;"></td> <td style="width: 10%;"></td> <td style="width: 10%;"></td> <td style="width: 10%;"></td> </tr> <tr> <td></td> <td></td> <td colspan="8" style="text-align: center;"> <table border="1" style="width: 100%; border-collapse: collapse; text-align: center;"> <tr> </tr></table></td></tr></table></td></tr></table></td></tr></table></td></tr></table></td></tr></table></td></tr></table></td></tr></table></td></tr></table></td></tr></table></td></tr></table></td></tr></table></td></tr></table></td></tr></table></td></tr></table></td></tr></table></td></tr></table></td></tr></table></td></tr></table></td></tr></table></td></tr></table></td></tr></table></td></tr></table></td></tr></table></td></tr></table></td></tr></table></td></tr></table></td></tr></table></td></tr></table></td></tr></table></td></tr></table></td></tr></table>

 | | | | | | | | | | | | | | | | | | | | <table border="1" style="width: 100%; border-collapse: collapse; text-align: center;"> <tr> <td style="width: 10%;"></td> <td style="width: 10%;"></td> <td style="width: 10%;"></td> <td style="width: 10%;"></td> <td style="width: 10%;"></td> <td style="width: 10%;"></td> <td style="width: 10%;"></td> <td style="width: 10%;"></td> <td style="width: 10%;"></td> <td style="width: 10%;"></td> </tr> <tr> <td></td> <td></td> <td colspan="8" style="text-align: center;"> <table border="1" style="width: 100%; border-collapse: collapse; text-align: center;"> <tr> <td style="width: 10%;"></td> <td style="width: 10%;"></td> <td style="width: 10%;"></td> <td style="width: 10%;"></td> <td style="width: 10%;"></td> <td style="width: 10%;"></td> <td style="width: 10%;"></td> <td style="width: 10%;"></td> <td style="width: 10%;"></td> <td style="width: 10%;"></td> </tr> <tr> <td></td> <td></td> <td colspan="8" style="text-align: center;"> <table border="1" style="width: 100%; border-collapse: collapse; text-align: center;"> <tr> <td style="width: 10%;"></td> <td style="width: 10%;"></td> <td style="width: 10%;"></td> <td style="width: 10%;"></td> <td style="width: 10%;"></td> <td style="width: 10%;"></td> <td style="width: 10%;"></td> <td style="width: 10%;"></td> <td style="width: 10%;"></td> <td style="width: 10%;"></td> </tr> <tr> <td></td> <td></td> <td colspan="8" style="text-align: center;"> <table border="1" style="width: 100%; border-collapse: collapse; text-align: center;"> <tr> <td style="width: 10%;"></td> <td style="width: 10%;"></td> <td style="width: 10%;"></td> <td style="width: 10%;"></td> <td style="width: 10%;"></td> <td style="width: 10%;"></td> <td style="width: 10%;"></td> <td style="width: 10%;"></td> <td style="width: 10%;"></td> <td style="width: 10%;"></td> </tr> <tr> <td></td> <td></td> <td colspan="8" style="text-align: center;"> <table border="1" style="width: 100%; border-collapse: collapse; text-align: center;"> <tr> <td style="width: 10%;"></td> <td style="width: 10%;"></td> <td style="width: 10%;"></td> <td style="width: 10%;"></td> <td style="width: 10%;"></td> <td style="width: 10%;"></td> <td style="width: 10%;"></td> <td style="width: 10%;"></td> <td style="width: 10%;"></td> <td style="width: 10%;"></td> </tr> <tr> <td></td> <td></td> <td colspan="8" style="text-align: center;"> <table border="1" style="width: 100%; border-collapse: collapse; text-align: center;"> <tr> <td style="width: 10%;"></td> <td style="width: 10%;"></td> <td style="width: 10%;"></td> <td style="width: 10%;"></td> <td style="width: 10%;"></td> <td style="width: 10%;"></td> <td style="width: 10%;"></td> <td style="width: 10%;"></td> <td style="width: 10%;"></td> <td style="width: 10%;"></td> </tr> <tr> <td></td> <td></td> <td colspan="8" style="text-align: center;"> <table border="1" style="width: 100%; border-collapse: collapse; text-align: center;"> <tr> <td style="width: 10%;"></td> <td style="width: 10%;"></td> <td style="width: 10%;"></td> <td style="width: 10%;"></td> <td style="width: 10%;"></td> <td style="width: 10%;"></td> <td style="width: 10%;"></td> <td style="width: 10%;"></td> <td style="width: 10%;"></td> <td style="width: 10%;"></td> </tr> <tr> <td></td> <td></td> <td colspan="8" style="text-align: center;"> <table border="1" style="width: 100%; border-collapse: collapse; text-align: center;"> <tr> <td style="width: 10%;"></td> <td style="width: 10%;"></td> <td style="width: 10%;"></td> <td style="width: 10%;"></td> <td style="width: 10%;"></td> <td style="width: 10%;"></td> <td style="width: 10%;"></td> <td style="width: 10%;"></td> <td style="width: 10%;"></td> <td style="width: 10%;"></td> </tr> <tr> <td></td> <td></td> <td colspan="8" style="text-align: center;"> <table border="1" style="width: 100%; border-collapse: collapse; text-align: center;"> <tr> <td style="width: 10%;"></td> <td style="width: 10%;"></td> <td style="width: 10%;"></td> <td style="width: 10%;"></td> <td style="width: 10%;"></td> <td style="width: 10%;"></td> <td style="width: 10%;"></td> <td style="width: 10%;"></td> <td style="width: 10%;"></td> <td style="width: 10%;"></td> </tr> <tr> <td></td> <td></td> <td colspan="8" style="text-align: center;"> <table border="1" style="width: 100%; border-collapse: collapse; text-align: center;"> <tr> <td style="width: 10%;"></td> <td style="width: 10%;"></td> <td style="width: 10%;"></td> <td style="width: 10%;"></td> <td style="width: 10%;"></td> <td style="width: 10%;"></td> <td style="width: 10%;"></td> <td style="width: 10%;"></td> <td style="width: 10%;"></td> <td style="width: 10%;"></td> </tr> <tr> <td></td> <td></td> <td colspan="8" style="text-align: center;"> <table border="1" style="width: 100%; border-collapse: collapse; text-align: center;"> <tr> <td style="width: 10%;"></td> <td style="width: 10%;"></td> <td style="width: 10%;"></td> <td style="width: 10%;"></td> <td style="width: 10%;"></td> <td style="width: 10%;"></td> <td style="width: 10%;"></td> <td style="width: 10%;"></td> <td style="width: 10%;"></td> <td style="width: 10%;"></td> </tr> <tr> <td></td> <td></td> <td colspan="8" style="text-align: center;"> <table border="1" style="width: 100%; border-collapse: collapse; text-align: center;"> <tr> <td style="width: 10%;"></td> <td style="width: 10%;"></td> <td style="width: 10%;"></td> <td style="width: 10%;"></td> <td style="width: 10%;"></td> <td style="width: 10%;"></td> <td style="width: 10%;"></td> <td style="width: 10%;"></td> <td style="width: 10%;"></td> <td style="width: 10%;"></td> </tr> <tr> <td></td> <td></td> <td colspan="8" style="text-align: center;"> <table border="1" style="width: 100%; border-collapse: collapse; text-align: center;"> <tr> <td style="width: 10%;"></td> <td style="width: 10%;"></td> <td style="width: 10%;"></td> <td style="width: 10%;"></td> <td style="width: 10%;"></td> <td style="width: 10%;"></td> <td style="width: 10%;"></td> <td style="width: 10%;"></td> <td style="width: 10%;"></td> <td style="width: 10%;"></td> </tr> <tr> <td></td> <td></td> <td colspan="8" style="text-align: center;"> <table border="1" style="width: 100%; border-collapse: collapse; text-align: center;"> <tr> <td style="width: 10%;"></td> <td style="width: 10%;"></td> <td style="width: 10%;"></td> <td style="width: 10%;"></td> <td style="width: 10%;"></td> <td style="width: 10%;"></td> <td style="width: 10%;"></td> <td style="width: 10%;"></td> <td style="width: 10%;"></td> <td style="width: 10%;"></td> </tr> <tr> <td></td> <td></td> <td colspan="8" style="text-align: center;"> <table border="1" style="width: 100%; border-collapse: collapse; text-align: center;"> <tr> <td style="width: 10%;"></td> <td style="width: 10%;"></td> <td style="width: 10%;"></td> <td style="width: 10%;"></td> <td style="width: 10%;"></td> <td style="width: 10%;"></td> <td style="width: 10%;"></td> <td style="width: 10%;"></td> <td style="width: 10%;"></td> <td style="width: 10%;"></td> </tr> <tr> <td></td> <td></td> <td colspan="8" style="text-align: center;"> <table border="1" style="width: 100%; border-collapse: collapse; text-align: center;"> <tr> <td style="width: 10%;"></td> <td style="width: 10%;"></td> <td style="width: 10%;"></td> <td style="width: 10%;"></td> <td style="width: 10%;"></td> <td style="width: 10%;"></td> <td style="width: 10%;"></td> <td style="width: 10%;"></td> <td style="width: 10%;"></td> <td style="width: 10%;"></td> </tr> <tr> <td></td> <td></td> <td colspan="8" style="text-align: center;"> <table border="1" style="width: 100%; border-collapse: collapse; text-align: center;"> <tr> <td style="width: 10%;"></td> <td
style="width: 10%;"></td> <td style="width: 10%;"></td> <td style="width: 10%;"></td> <td style="width: 10%;"></td> <td style="width: 10%;"></td> <td style="width: 10%;"></td> <td style="width: 10%;"></td> <td style="width: 10%;"></td> <td style="width: 10%;"></td> </tr> <tr> <td></td> <td></td> <td colspan="8" style="text-align: center;"> <table border="1" style="width: 100%; border-collapse: collapse; text-align: center;"> <tr> <td style="width: 10%;"></td> <td style="width: 10%;"></td> <td style="width: 10%;"></td> <td style="width: 10%;"></td> <td style="width: 10%;"></td> <td style="width: 10%;"></td> <td style="width: 10%;"></td> <td style="width: 10%;"></td> <td style="width: 10%;"></td> <td style="width: 10%;"></td> </tr> <tr> <td></td> <td></td> <td colspan="8" style="text-align: center;"> <table border="1" style="width: 100%; border-collapse: collapse; text-align: center;"> <tr> <td style="width: 10%;"></td> <td style="width: 10%;"></td> <td style="width: 10%;"></td> <td style="width: 10%;"></td> <td style="width: 10%;"></td> <td style="width: 10%;"></td> <td style="width: 10%;"></td> <td style="width: 10%;"></td> <td style="width: 10%;"></td> <td style="width: 10%;"></td> </tr> <tr> <td></td> <td></td> <td colspan="8" style="text-align: center;"> <table border="1" style="width: 100%; border-collapse: collapse; text-align: center;"> <tr> <td style="width: 10%;"></td> <td style="width: 10%;"></td> <td style="width: 10%;"></td> <td style="width: 10%;"></td> <td style="width: 10%;"></td> <td style="width: 10%;"></td> <td style="width: 10%;"></td> <td style="width: 10%;"></td> <td style="width: 10%;"></td> <td style="width: 10%;"></td> </tr> <tr> <td></td> <td></td> <td colspan="8" style="text-align: center;"> <table border="1" style="width: 100%; border-collapse: collapse; text-align: center;"> <tr> <td style="width: 10%;"></td> <td style="width: 10%;"></td> <td style="width: 10%;"></td> <td style="width: 10%;"></td> <td style="width: 10%;"></td> <td style="width: 10%;"></td> <td style="width: 10%;"></td> <td style="width: 10%;"></td> <td style="width: 10%;"></td> <td style="width: 10%;"></td> </tr> <tr> <td></td> <td></td> <td colspan="8" style="text-align: center;"> <table border="1" style="width: 100%; border-collapse: collapse; text-align: center;"> <tr> <td style="width: 10%;"></td> <td style="width: 10%;"></td> <td style="width: 10%;"></td> <td style="width: 10%;"></td> <td style="width: 10%;"></td> <td style="width: 10%;"></td> <td style="width: 10%;"></td> <td style="width: 10%;"></td> <td style="width: 10%;"></td> <td style="width: 10%;"></td> </tr> <tr> <td></td> <td></td> <td colspan="8" style="text-align: center;"> <table border="1" style="width: 100%; border-collapse: collapse; text-align: center;"> <tr> <td style="width: 10%;"></td> <td style="width: 10%;"></td> <td style="width: 10%;"></td> <td style="width: 10%;"></td> <td style="width: 10%;"></td> <td style="width: 10%;"></td> <td style="width: 10%;"></td> <td style="width: 10%;"></td> <td style="width: 10%;"></td> <td style="width: 10%;"></td> </tr> <tr> <td></td> <td></td> <td colspan="8" style="text-align: center;"> <table border="1" style="width: 100%; border-collapse: collapse; text-align: center;"> <tr> <td style="width: 10%;"></td> <td style="width: 10%;"></td> <td style="width: 10%;"></td> <td style="width: 10%;"></td> <td style="width: 10%;"></td> <td style="width: 10%;"></td> <td style="width: 10%;"></td> <td style="width: 10%;"></td> <td style="width: 10%;"></td> <td style="width: 10%;"></td> </tr> <tr> <td></td> <td></td> <td colspan="8" style="text-align: center;"> <table border="1" style="width: 100%; border-collapse: collapse; text-align: center;"> <tr> <td style="width: 10%;"></td> <td style="width: 10%;"></td> <td style="width: 10%;"></td> <td style="width: 10%;"></td> <td style="width: 10%;"></td> <td style="width: 10%;"></td> <td style="width: 10%;"></td> <td style="width: 10%;"></td> <td style="width: 10%;"></td> <td style="width: 10%;"></td> </tr> <tr> <td></td> <td></td> <td colspan="8" style="text-align: center;"> <table border="1" style="width: 100%; border-collapse: collapse; text-align: center;"> <tr> <td style="width: 10%;"></td> <td style="width: 10%;"></td> <td style="width: 10%;"></td> <td style="width: 10%;"></td> <td style="width: 10%;"></td> <td style="width: 10%;"></td> <td style="width: 10%;"></td> <td style="width: 10%;"></td> <td style="width: 10%;"></td> <td style="width: 10%;"></td> </tr> <tr> <td></td> <td></td> <td colspan="8" style="text-align: center;"> <table border="1" style="width: 100%; border-collapse: collapse; text-align: center;"> <tr> <td style="width: 10%;"></td> <td style="width: 10%;"></td> <td style="width: 10%;"></td> <td style="width: 10%;"></td> <td style="width: 10%;"></td> <td style="width: 10%;"></td> <td style="width: 10%;"></td> <td style="width: 10%;"></td> <td style="width: 10%;"></td> <td style="width: 10%;"></td> </tr> <tr> <td></td> <td></td> <td colspan="8" style="text-align: center;"> <table border="1" style="width: 100%; border-collapse: collapse; text-align: center;"> <tr> <td style="width: 10%;"></td> <td style="width: 10%;"></td> <td style="width: 10%;"></td> <td style="width: 10%;"></td> <td style="width: 10%;"></td> <td style="width: 10%;"></td> <td style="width: 10%;"></td> <td style="width: 10%;"></td> <td style="width: 10%;"></td> <td style="width: 10%;"></td> </tr> <tr> <td></td> <td></td> <td colspan="8" style="text-align: center;"> <table border="1" style="width: 100%; border-collapse: collapse; text-align: center;"> <tr> <td style="width: 10%;"></td> <td style="width: 10%;"></td> <td style="width: 10%;"></td> <td style="width: 10%;"></td> <td style="width: 10%;"></td> <td style="width: 10%;"></td> <td style="width: 10%;"></td> <td style="width: 10%;"></td> <td style="width: 10%;"></td> <td style="width: 10%;"></td> </tr> <tr> <td></td> <td></td> <td colspan="8" style="text-align: center;"> <table border="1" style="width: 100%; border-collapse: collapse; text-align: center;"> <tr> <td style="width: 10%;"></td> <td style="width: 10%;"></td> <td style="width: 10%;"></td> <td style="width: 10%;"></td> <td style="width: 10%;"></td> <td style="width: 10%;"></td> <td style="width: 10%;"></td> <td style="width: 10%;"></td> <td style="width: 10%;"></td> <td style="width: 10%;"></td> </tr> <tr> <td></td> <td></td> <td colspan="8" style="text-align: center;"> <table border="1" style="width: 100%; border-collapse: collapse; text-align: center;"> <tr> </tr></table></td></tr></table></td></tr></table></td></tr></table></td></tr></table></td></tr></table></td></tr></table></td></tr></table></td></tr></table></td></tr></table></td></tr></table></td></tr></table></td></tr></table></td></tr></table></td></tr></table></td></tr></table></td></tr></table></td></tr></table></td></tr></table></td></tr></table></td></tr></table></td></tr></table></td></tr></table></td></tr></table></td></tr></table></td></tr></table></td></tr></table></td></tr></table></td></tr></table></td></tr></table></td></tr></table>

 | | | | | | | | | | | | | | | | | | | | <table border="1" style="width: 100%; border-collapse: collapse; text-align: center;"> <tr> <td style="width: 10%;"></td> <td style="width: 10%;"></td> <td style="width: 10%;"></td> <td style="width: 10%;"></td> <td style="width: 10%;"></td> <td style="width: 10%;"></td> <td style="width: 10%;"></td> <td style="width: 10%;"></td> <td style="width: 10%;"></td> <td style="width: 10%;"></td> </tr> <tr> <td></td> <td></td> <td colspan="8" style="text-align: center;"> <table border="1" style="width: 100%; border-collapse: collapse; text-align: center;"> <tr> <td style="width: 10%;"></td> <td style="width: 10%;"></td> <td style="width: 10%;"></td> <td style="width: 10%;"></td> <td style="width: 10%;"></td> <td style="width: 10%;"></td> <td style="width: 10%;"></td> <td style="width: 10%;"></td> <td style="width: 10%;"></td> <td style="width: 10%;"></td> </tr> <tr> <td></td> <td></td> <td colspan="8" style="text-align: center;"> <table border="1" style="width: 100%; border-collapse: collapse; text-align: center;"> <tr> <td style="width: 10%;"></td> <td style="width: 10%;"></td> <td style="width: 10%;"></td> <td style="width: 10%;"></td> <td style="width: 10%;"></td> <td style="width: 10%;"></td> <td style="width: 10%;"></td> <td style="width: 10%;"></td> <td style="width: 10%;"></td> <td style="width: 10%;"></td> </tr> <tr> <td></td> <td></td> <td colspan="8" style="text-align: center;"> <table border="1" style="width: 100%; border-collapse: collapse; text-align: center;"> <tr> <td style="width: 10%;"></td> <td style="width: 10%;"></td> <td style="width: 10%;"></td> <td style="width: 10%;"></td> <td style="width: 10%;"></td> <td style="width: 10%;"></td> <td style="width: 10%;"></td> <td style="width: 10%;"></td> <td style="width: 10%;"></td> <td style="width: 10%;"></td> </tr> <tr> <td></td> <td></td> <td colspan="8" style="text-align: center;"> <table border="1" style="width: 100%; border-collapse: collapse; text-align: center;"> <tr> <td style="width: 10%;"></td> <td style="width: 10%;"></td> <td style="width: 10%;"></td> <td style="width: 10%;"></td> <td style="width: 10%;"></td> <td style="width: 10%;"></td> <td style="width: 10%;"></td> <td style="width: 10%;"></td> <td style="width: 10%;"></td> <td style="width: 10%;"></td> </tr> <tr> <td></td> <td></td> <td colspan="8" style="text-align: center;"> <table border="1" style="width: 100%; border-collapse: collapse; text-align: center;"> <tr> <td style="width: 10%;"></td> <td style="width: 10%;"></td> <td style="width: 10%;"></td> <td style="width: 10%;"></td> <td style="width: 10%;"></td> <td style="width: 10%;"></td> <td style="width: 10%;"></td> <td style="width: 10%;"></td> <td style="width: 10%;"></td> <td style="width: 10%;"></td> </tr> <tr> <td></td> <td></td> <td colspan="8" style="text-align: center;"> <table border="1" style="width: 100%; border-collapse: collapse; text-align: center;"> <tr> <td style="width: 10%;"></td> <td style="width: 10%;"></td> <td style="width: 10%;"></td> <td style="width: 10%;"></td> <td style="width: 10%;"></td> <td style="width: 10%;"></td> <td style="width: 10%;"></td> <td style="width: 10%;"></td> <td style="width: 10%;"></td> <td style="width: 10%;"></td> </tr> <tr> <td></td> <td></td> <td colspan="8" style="text-align: center;"> <table border="1" style="width: 100%; border-collapse: collapse; text-align: center;"> <tr> <td style="width: 10%;"></td> <td style="width: 10%;"></td> <td style="width: 10%;"></td> <td style="width: 10%;"></td> <td style="width: 10%;"></td> <td style="width: 10%;"></td> <td style="width: 10%;"></td> <td style="width: 10%;"></td> <td style="width: 10%;"></td> <td style="width: 10%;"></td> </tr> <tr> <td></td> <td></td> <td colspan="8" style="text-align: center;"> <table border="1" style="width: 100%; border-collapse: collapse; text-align: center;"> <tr> <td style="width: 10%;"></td> <td style="width: 10%;"></td> <td style="width: 10%;"></td> <td style="width: 10%;"></td> <td style="width: 10%;"></td> <td style="width: 10%;"></td> <td style="width: 10%;"></td> <td style="width: 10%;"></td> <td style="width: 10%;"></td> <td style="width: 10%;"></td> </tr> <tr> <td></td> <td></td> <td colspan="8" style="text-align: center;"> <table border="1" style="width: 100%; border-collapse: collapse; text-align: center;"> <tr> <td style="width: 10%;"></td> <td style="width: 10%;"></td> <td style="width: 10%;"></td> <td style="width: 10%;"></td> <td style="width: 10%;"></td> <td style="width: 10%;"></td> <td style="width: 10%;"></td> <td style="width: 10%;"></td> <td style="width: 10%;"></td> <td style="width: 10%;"></td> </tr> <tr> <td></td> <td></td> <td colspan="8" style="text-align: center;"> <table border="1" style="width: 100%; border-collapse: collapse; text-align: center;"> <tr> <td style="width: 10%;"></td> <td style="width: 10%;"></td> <td style="width: 10%;"></td> <td style="width: 10%;"></td> <td style="width: 10%;"></td> <td style="width: 10%;"></td> <td style="width: 10%;"></td> <td style="width: 10%;"></td> <td style="width: 10%;"></td> <td style="width: 10%;"></td> </tr> <tr> <td></td> <td></td> <td colspan="8" style="text-align: center;"> <table border="1" style="width: 100%; border-collapse: collapse; text-align: center;"> <tr> <td style="width: 10%;"></td> <td style="width: 10%;"></td> <td style="width: 10%;"></td> <td style="width: 10%;"></td> <td style="width: 10%;"></td> <td style="width: 10%;"></td> <td style="width: 10%;"></td> <td style="width: 10%;"></td> <td style="width: 10%;"></td> <td style="width: 10%;"></td> </tr> <tr> <td></td> <td></td> <td colspan="8" style="text-align: center;"> <table border="1" style="width: 100%; border-collapse: collapse; text-align: center;"> <tr> <td style="width: 10%;"></td> <td style="width: 10%;"></td> <td style="width: 10%;"></td> <td style="width: 10%;"></td> <td style="width: 10%;"></td> <td style="width: 10%;"></td> <td style="width: 10%;"></td> <td style="width: 10%;"></td> <td style="width: 10%;"></td> <td style="width: 10%;"></td> </tr> <tr> <td></td> <td></td> <td colspan="8" style="text-align: center;"> <table border="1" style="width: 100%; border-collapse: collapse; text-align: center;"> <tr> <td style="width: 10%;"></td> <td style="width: 10%;"></td> <td style="width: 10%;"></td> <td style="width: 10%;"></td> <td style="width: 10%;"></td> <td style="width: 10%;"></td> <td style="width: 10%;"></td> <td style="width: 10%;"></td> <td style="width: 10%;"></td> <td style="width: 10%;"></td> </tr> <tr> <td></td> <td></td> <td colspan="8" style="text-align: center;"> <table border="1" style="width: 100%; border-collapse: collapse; text-align: center;"> <tr> <td style="width: 10%;"></td> <td style="width: 10%;"></td> <td style="width: 10%;"></td> <td style="width: 10%;"></td> <td style="width: 10%;"></td> <td style="width: 10%;"></td> <td style="width: 10%;"></td> <td style="width: 10%;"></td> <td style="width: 10%;"></td> <td style="width: 10%;"></td> </tr> <tr> <td></td> <td></td> <td colspan="8" style="text-align: center;"> <table border="1" style="width: 100%; border-collapse: collapse; text-align: center;"> <tr> <td style="width: 10%;"></td> <td style="width: 10%;"></td> <td style="width: 10%;"></td> <td style="width: 10%;"></td> <td style="width: 10%;"></td> <td style="width: 10%;"></td> <td style="width: 10%;"></td> <td style="width: 10%;"></td> <td style="width: 10%;"></td> <td style="width: 10%;"></td> </tr> <tr> <td></td> <td></td> <td colspan="8" style="text-align: center;"> <table border="1" style="width: 100%; border-collapse: collapse; text-align: center;"> <tr> <td style="width: 10%;"></td> <td style="width: 10%;"></td> <td style="width: 10%;"></td> <td style="width: 10%;"></td> <td style="width: 10%;"></td> <td style="width: 10%;"></td> <td style="width: 10%;"></td> <td
style="width: 10%;"></td> <td style="width: 10%;"></td> <td style="width: 10%;"></td> </tr> <tr> <td></td> <td></td> <td colspan="8" style="text-align: center;"> <table border="1" style="width: 100%; border-collapse: collapse; text-align: center;"> <tr> <td style="width: 10%;"></td> <td style="width: 10%;"></td> <td style="width: 10%;"></td> <td style="width: 10%;"></td> <td style="width: 10%;"></td> <td style="width: 10%;"></td> <td style="width: 10%;"></td> <td style="width: 10%;"></td> <td style="width: 10%;"></td> <td style="width: 10%;"></td> </tr> <tr> <td></td> <td></td> <td colspan="8" style="text-align: center;"> <table border="1" style="width: 100%; border-collapse: collapse; text-align: center;"> <tr> <td style="width: 10%;"></td> <td style="width: 10%;"></td> <td style="width: 10%;"></td> <td style="width: 10%;"></td> <td style="width: 10%;"></td> <td style="width: 10%;"></td> <td style="width: 10%;"></td> <td style="width: 10%;"></td> <td style="width: 10%;"></td> <td style="width: 10%;"></td> </tr> <tr> <td></td> <td></td> <td colspan="8" style="text-align: center;"> <table border="1" style="width: 100%; border-collapse: collapse; text-align: center;"> <tr> <td style="width: 10%;"></td> <td style="width: 10%;"></td> <td style="width: 10%;"></td> <td style="width: 10%;"></td> <td style="width: 10%;"></td> <td style="width: 10%;"></td> <td style="width: 10%;"></td> <td style="width: 10%;"></td> <td style="width: 10%;"></td> <td style="width: 10%;"></td> </tr> <tr> <td></td> <td></td> <td colspan="8" style="text-align: center;"> <table border="1" style="width: 100%; border-collapse: collapse; text-align: center;"> <tr> <td style="width: 10%;"></td> <td style="width: 10%;"></td> <td style="width: 10%;"></td> <td style="width: 10%;"></td> <td style="width: 10%;"></td> <td style="width: 10%;"></td> <td style="width: 10%;"></td> <td style="width: 10%;"></td> <td style="width: 10%;"></td> <td style="width: 10%;"></td> </tr> <tr> <td></td> <td></td> <td colspan="8" style="text-align: center;"> <table border="1" style="width: 100%; border-collapse: collapse; text-align: center;"> <tr> <td style="width: 10%;"></td> <td style="width: 10%;"></td> <td style="width: 10%;"></td> <td style="width: 10%;"></td> <td style="width: 10%;"></td> <td style="width: 10%;"></td> <td style="width: 10%;"></td> <td style="width: 10%;"></td> <td style="width: 10%;"></td> <td style="width: 10%;"></td> </tr> <tr> <td></td> <td></td> <td colspan="8" style="text-align: center;"> <table border="1" style="width: 100%; border-collapse: collapse; text-align: center;"> <tr> <td style="width: 10%;"></td> <td style="width: 10%;"></td> <td style="width: 10%;"></td> <td style="width: 10%;"></td> <td style="width: 10%;"></td> <td style="width: 10%;"></td> <td style="width: 10%;"></td> <td style="width: 10%;"></td> <td style="width: 10%;"></td> <td style="width: 10%;"></td> </tr> <tr> <td></td> <td></td> <td colspan="8" style="text-align: center;"> <table border="1" style="width: 100%; border-collapse: collapse; text-align: center;"> <tr> <td style="width: 10%;"></td> <td style="width: 10%;"></td> <td style="width: 10%;"></td> <td style="width: 10%;"></td> <td style="width: 10%;"></td> <td style="width: 10%;"></td> <td style="width: 10%;"></td> <td style="width: 10%;"></td> <td style="width: 10%;"></td> <td style="width: 10%;"></td> </tr> <tr> <td></td> <td></td> <td colspan="8" style="text-align: center;"> <table border="1" style="width: 100%; border-collapse: collapse; text-align: center;"> <tr> <td style="width: 10%;"></td> <td style="width: 10%;"></td> <td style="width: 10%;"></td> <td style="width: 10%;"></td> <td style="width: 10%;"></td> <td style="width: 10%;"></td> <td style="width: 10%;"></td> <td style="width: 10%;"></td> <td style="width: 10%;"></td> <td style="width: 10%;"></td> </tr> <tr> <td></td> <td></td> <td colspan="8" style="text-align: center;"> <table border="1" style="width: 100%; border-collapse: collapse; text-align: center;"> <tr> <td style="width: 10%;"></td> <td style="width: 10%;"></td> <td style="width: 10%;"></td> <td style="width: 10%;"></td> <td style="width: 10%;"></td> <td style="width: 10%;"></td> <td style="width: 10%;"></td> <td style="width: 10%;"></td> <td style="width: 10%;"></td> <td style="width: 10%;"></td> </tr> <tr> <td></td> <td></td> <td colspan="8" style="text-align: center;"> <table border="1" style="width: 100%; border-collapse: collapse; text-align: center;"> <tr> <td style="width: 10%;"></td> <td style="width: 10%;"></td> <td style="width: 10%;"></td> <td style="width: 10%;"></td> <td style="width: 10%;"></td> <td style="width: 10%;"></td> <td style="width: 10%;"></td> <td style="width: 10%;"></td> <td style="width: 10%;"></td> <td style="width: 10%;"></td> </tr> <tr> <td></td> <td></td> <td colspan="8" style="text-align: center;"> <table border="1" style="width: 100%; border-collapse: collapse; text-align: center;"> <tr> <td style="width: 10%;"></td> <td style="width: 10%;"></td> <td style="width: 10%;"></td> <td style="width: 10%;"></td> <td style="width: 10%;"></td> <td style="width: 10%;"></td> <td style="width: 10%;"></td> <td style="width: 10%;"></td> <td style="width: 10%;"></td> <td style="width: 10%;"></td> </tr> <tr> <td></td> <td></td> <td colspan="8" style="text-align: center;"> <table border="1" style="width: 100%; border-collapse: collapse; text-align: center;"> <tr> <td style="width: 10%;"></td> <td style="width: 10%;"></td> <td style="width: 10%;"></td> <td style="width: 10%;"></td> <td style="width: 10%;"></td> <td style="width: 10%;"></td> <td style="width: 10%;"></td> <td style="width: 10%;"></td> <td style="width: 10%;"></td> <td style="width: 10%;"></td> </tr> <tr> <td></td> <td></td> <td colspan="8" style="text-align: center;"> <table border="1" style="width: 100%; border-collapse: collapse; text-align: center;"> <tr> </tr></table></td></tr></table></td></tr></table></td></tr></table></td></tr></table></td></tr></table></td></tr></table></td></tr></table></td></tr></table></td></tr></table></td></tr></table></td></tr></table></td></tr></table></td></tr></table></td></tr></table></td></tr></table></td></tr></table></td></tr></table></td></tr></table></td></tr></table></td></tr></table></td></tr></table></td></tr></table></td></tr></table></td></tr></table></td></tr></table></td></tr></table></td></tr></table></td></tr></table></td></tr></table>

 | | | | | | | | | | | | | | | | | | | | <table border="1" style="width: 100%; border-collapse: collapse; text-align: center;"> <tr> <td style="width: 10%;"></td> <td style="width: 10%;"></td> <td style="width: 10%;"></td> <td style="width: 10%;"></td> <td style="width: 10%;"></td> <td style="width: 10%;"></td> <td style="width: 10%;"></td> <td style="width: 10%;"></td> <td style="width: 10%;"></td> <td style="width: 10%;"></td> </tr> <tr> <td></td> <td></td> <td colspan="8" style="text-align: center;"> <table border="1" style="width: 100%; border-collapse: collapse; text-align: center;"> <tr> <td style="width: 10%;"></td> <td style="width: 10%;"></td> <td style="width: 10%;"></td> <td style="width: 10%;"></td> <td style="width: 10%;"></td> <td style="width: 10%;"></td> <td style="width: 10%;"></td> <td style="width: 10%;"></td> <td style="width: 10%;"></td> <td style="width: 10%;"></td> </tr> <tr> <td></td> <td></td> <td colspan="8" style="text-align: center;"> <table border="1" style="width: 100%; border-collapse: collapse; text-align: center;"> <tr> <td style="width: 10%;"></td> <td style="width: 10%;"></td> <td style="width: 10%;"></td> <td style="width: 10%;"></td> <td style="width: 10%;"></td> <td style="width: 10%;"></td> <td style="width: 10%;"></td> <td style="width: 10%;"></td> <td style="width: 10%;"></td> <td style="width: 10%;"></td> </tr> <tr> <td></td> <td></td> <td colspan="8" style="text-align: center;"> <table border="1" style="width: 100%; border-collapse: collapse; text-align: center;"> <tr> <td style="width: 10%;"></td> <td style="width: 10%;"></td> <td style="width: 10%;"></td> <td style="width: 10%;"></td> <td style="width: 10%;"></td> <td style="width: 10%;"></td> <td style="width: 10%;"></td> <td style="width: 10%;"></td> <td style="width: 10%;"></td> <td style="width: 10%;"></td> </tr> <tr> <td></td> <td></td> <td colspan="8" style="text-align: center;"> <table border="1" style="width: 100%; border-collapse: collapse; text-align: center;"> <tr> <td style="width: 10%;"></td> <td style="width: 10%;"></td> <td style="width: 10%;"></td> <td style="width: 10%;"></td> <td style="width: 10%;"></td> <td style="width: 10%;"></td> <td style="width: 10%;"></td> <td style="width: 10%;"></td> <td style="width: 10%;"></td> <td style="width: 10%;"></td> </tr> <tr> <td></td> <td></td> <td colspan="8" style="text-align: center;"> <table border="1" style="width: 100%; border-collapse: collapse; text-align: center;"> <tr> <td style="width: 10%;"></td> <td style="width: 10%;"></td> <td style="width: 10%;"></td> <td style="width: 10%;"></td> <td style="width: 10%;"></td> <td style="width: 10%;"></td> <td style="width: 10%;"></td> <td style="width: 10%;"></td> <td style="width: 10%;"></td> <td style="width: 10%;"></td> </tr> <tr> <td></td> <td></td> <td colspan="8" style="text-align: center;"> <table border="1" style="width: 100%; border-collapse: collapse; text-align: center;"> <tr> <td style="width: 10%;"></td> <td style="width: 10%;"></td> <td style="width: 10%;"></td> <td style="width: 10%;"></td> <td style="width: 10%;"></td> <td style="width: 10%;"></td> <td style="width: 10%;"></td> <td style="width: 10%;"></td> <td style="width: 10%;"></td> <td style="width: 10%;"></td> </tr> <tr> <td></td> <td></td> <td colspan="8" style="text-align: center;"> <table border="1" style="width: 100%; border-collapse: collapse; text-align: center;"> <tr> <td style="width: 10%;"></td> <td style="width: 10%;"></td> <td style="width: 10%;"></td> <td style="width: 10%;"></td> <td style="width: 10%;"></td> <td style="width: 10%;"></td> <td style="width: 10%;"></td> <td style="width: 10%;"></td> <td style="width: 10%;"></td> <td style="width: 10%;"></td> </tr> <tr> <td></td> <td></td> <td colspan="8" style="text-align: center;"> <table border="1" style="width: 100%; border-collapse: collapse; text-align: center;"> <tr> <td style="width: 10%;"></td> <td style="width: 10%;"></td> <td style="width: 10%;"></td> <td style="width: 10%;"></td> <td style="width: 10%;"></td> <td style="width: 10%;"></td> <td style="width: 10%;"></td> <td style="width: 10%;"></td> <td style="width: 10%;"></td> <td style="width: 10%;"></td> </tr> <tr> <td></td> <td></td> <td colspan="8" style="text-align: center;"> <table border="1" style="width: 100%; border-collapse: collapse; text-align: center;"> <tr> <td style="width: 10%;"></td> <td style="width: 10%;"></td> <td style="width: 10%;"></td> <td style="width: 10%;"></td> <td style="width: 10%;"></td> <td style="width: 10%;"></td> <td style="width: 10%;"></td> <td style="width: 10%;"></td> <td style="width: 10%;"></td> <td style="width: 10%;"></td> </tr> <tr> <td></td> <td></td> <td colspan="8" style="text-align: center;"> <table border="1" style="width: 100%; border-collapse: collapse; text-align: center;"> <tr> <td style="width: 10%;"></td> <td style="width: 10%;"></td> <td style="width: 10%;"></td> <td style="width: 10%;"></td> <td style="width: 10%;"></td> <td style="width: 10%;"></td> <td style="width: 10%;"></td> <td style="width: 10%;"></td> <td style="width: 10%;"></td> <td style="width: 10%;"></td> </tr> <tr> <td></td> <td></td> <td colspan="8" style="text-align: center;"> <table border="1" style="width: 100%; border-collapse: collapse; text-align: center;"> <tr> <td style="width: 10%;"></td> <td style="width: 10%;"></td> <td style="width: 10%;"></td> <td style="width: 10%;"></td> <td style="width: 10%;"></td> <td style="width: 10%;"></td> <td style="width: 10%;"></td> <td style="width: 10%;"></td> <td style="width: 10%;"></td> <td style="width: 10%;"></td> </tr> <tr> <td></td> <td></td> <td colspan="8" style="text-align: center;"> <table border="1" style="width: 100%; border-collapse: collapse; text-align: center;"> <tr> <td style="width: 10%;"></td> <td style="width: 10%;"></td> <td style="width: 10%;"></td> <td style="width: 10%;"></td> <td style="width: 10%;"></td> <td style="width: 10%;"></td> <td style="width: 10%;"></td> <td style="width: 10%;"></td> <td style="width: 10%;"></td> <td style="width: 10%;"></td> </tr> <tr> <td></td> <td></td> <td colspan="8" style="text-align: center;"> <table border="1" style="width: 100%; border-collapse: collapse; text-align: center;"> <tr> <td style="width: 10%;"></td> <td style="width: 10%;"></td> <td style="width: 10%;"></td> <td style="width: 10%;"></td> <td style="width: 10%;"></td> <td style="width: 10%;"></td> <td style="width: 10%;"></td> <td style="width: 10%;"></td> <td style="width: 10%;"></td> <td style="width: 10%;"></td> </tr> <tr> <td></td> <td></td> <td colspan="8" style="text-align: center;"> <table border="1" style="width: 100%; border-collapse: collapse; text-align: center;"> <tr> <td style="width: 10%;"></td> <td style="width: 10%;"></td> <td style="width: 10%;"></td> <td style="width: 10%;"></td> <td style="width: 10%;"></td> <td style="width: 10%;"></td> <td style="width: 10%;"></td> <td style="width: 10%;"></td> <td style="width: 10%;"></td> <td style="width: 10%;"></td> </tr> <tr> <td></td> <td></td> <td colspan="8" style="text-align: center;"> <table border="1" style="width: 100%; border-collapse: collapse; text-align: center;"> <tr> <td style="width: 10%;"></td> <td style="width: 10%;"></td> <td style="width: 10%;"></td> <td style="width: 10%;"></td> <td style="width: 10%;"></td> <td style="width: 10%;"></td> <td style="width: 10%;"></td> <td style="width: 10%;"></td> <td style="width: 10%;"></td> <td style="width: 10%;"></td> </tr> <tr> <td></td> <td></td> <td colspan="8" style="text-align: center;"> <table border="1" style="width: 100%; border-collapse: collapse; text-align: center;"> <tr> <td style="width: 10%;"></td> <td style="width: 10%;"></td> <td style="width: 10%;"></td> <td style="width: 10%;"></td> <td style="width: 10%;"></td> <td style="width: 10%;"></td> <td style="width: 10%;"></td> <td style="width: 10%;"></td> <td style="width: 10%;"></td> <td style="width: 10%;"></td> </tr> <tr> <td></td> <td></td> <td colspan="8" style="text-align: center;"> <table border="1" style="width: 100%; border-collapse: collapse; text-align: center;"> <tr> <td style="width: 10%;"></td> <td style="width: 10%;"></td> <td style="width: 10%;"></td> <td style="width: 10%;"></td> <td style="width: 10%;"></td> <td style="width: 10%;"></td> <td style="width: 10%;"></td> <td style="width: 10%;"></td> <td style="width: 10%;"></td> <td style="width: 10%;"></td> </tr> <tr> <td></td> <td></td> <td colspan="8" style="text-align: center;"> <table border="1" style="width: 100%;
border-collapse: collapse; text-align: center;"> <tr> <td style="width: 10%;"></td> <td style="width: 10%;"></td> <td style="width: 10%;"></td> <td style="width: 10%;"></td> <td style="width: 10%;"></td> <td style="width: 10%;"></td> <td style="width: 10%;"></td> <td style="width: 10%;"></td> <td style="width: 10%;"></td> <td style="width: 10%;"></td> </tr> <tr> <td></td> <td></td> <td colspan="8" style="text-align: center;"> <table border="1" style="width: 100%; border-collapse: collapse; text-align: center;"> <tr> <td style="width: 10%;"></td> <td style="width: 10%;"></td> <td style="width: 10%;"></td> <td style="width: 10%;"></td> <td style="width: 10%;"></td> <td style="width: 10%;"></td> <td style="width: 10%;"></td> <td style="width: 10%;"></td> <td style="width: 10%;"></td> <td style="width: 10%;"></td> </tr> <tr> <td></td> <td></td> <td colspan="8" style="text-align: center;"> <table border="1" style="width: 100%; border-collapse: collapse; text-align: center;"> <tr> <td style="width: 10%;"></td> <td style="width: 10%;"></td> <td style="width: 10%;"></td> <td style="width: 10%;"></td> <td style="width: 10%;"></td> <td style="width: 10%;"></td> <td style="width: 10%;"></td> <td style="width: 10%;"></td> <td style="width: 10%;"></td> <td style="width: 10%;"></td> </tr> <tr> <td></td> <td></td> <td colspan="8" style="text-align: center;"> <table border="1" style="width: 100%; border-collapse: collapse; text-align: center;"> <tr> <td style="width: 10%;"></td> <td style="width: 10%;"></td> <td style="width: 10%;"></td> <td style="width: 10%;"></td> <td style="width: 10%;"></td> <td style="width: 10%;"></td> <td style="width: 10%;"></td> <td style="width: 10%;"></td> <td style="width: 10%;"></td> <td style="width: 10%;"></td> </tr> <tr> <td></td> <td></td> <td colspan="8" style="text-align: center;"> <table border="1" style="width: 100%; border-collapse: collapse; text-align: center;"> <tr> <td style="width: 10%;"></td> <td style="width: 10%;"></td> <td style="width: 10%;"></td> <td style="width: 10%;"></td> <td style="width: 10%;"></td> <td style="width: 10%;"></td> <td style="width: 10%;"></td> <td style="width: 10%;"></td> <td style="width: 10%;"></td> <td style="width: 10%;"></td> </tr> <tr> <td></td> <td></td> <td colspan="8" style="text-align: center;"> <table border="1" style="width: 100%; border-collapse: collapse; text-align: center;"> <tr> <td style="width: 10%;"></td> <td style="width: 10%;"></td> <td style="width: 10%;"></td> <td style="width: 10%;"></td> <td style="width: 10%;"></td> <td style="width: 10%;"></td> <td style="width: 10%;"></td> <td style="width: 10%;"></td> <td style="width: 10%;"></td> <td style="width: 10%;"></td> </tr> <tr> <td></td> <td></td> <td colspan="8" style="text-align: center;"> <table border="1" style="width: 100%; border-collapse: collapse; text-align: center;"> <tr> <td style="width: 10%;"></td> <td style="width: 10%;"></td> <td style="width: 10%;"></td> <td style="width: 10%;"></td> <td style="width: 10%;"></td> <td style="width: 10%;"></td> <td style="width: 10%;"></td> <td style="width: 10%;"></td> <td style="width: 10%;"></td> <td style="width: 10%;"></td> </tr> <tr> <td></td> <td></td> <td colspan="8" style="text-align: center;"> <table border="1" style="width: 100%; border-collapse: collapse; text-align: center;"> <tr> <td style="width: 10%;"></td> <td style="width: 10%;"></td> <td style="width: 10%;"></td> <td style="width: 10%;"></td> <td style="width: 10%;"></td> <td style="width: 10%;"></td> <td style="width: 10%;"></td> <td style="width: 10%;"></td> <td style="width: 10%;"></td> <td style="width: 10%;"></td> </tr> <tr> <td></td> <td></td> <td colspan="8" style="text-align: center;"> <table border="1" style="width: 100%; border-collapse: collapse; text-align: center;"> <tr> <td style="width: 10%;"></td> <td style="width: 10%;"></td> <td style="width: 10%;"></td> <td style="width: 10%;"></td> <td style="width: 10%;"></td> <td style="width: 10%;"></td> <td style="width: 10%;"></td> <td style="width: 10%;"></td> <td style="width: 10%;"></td> <td style="width: 10%;"></td> </tr> <tr> <td></td> <td></td> <td colspan="8" style="text-align: center;"> <table border="1" style="width: 100%; border-collapse: collapse; text-align: center;"> <tr> <td style="width: 10%;"></td> <td style="width: 10%;"></td> <td style="width: 10%;"></td> <td style="width: 10%;"></td> <td style="width: 10%;"></td> <td style="width: 10%;"></td> <td style="width: 10%;"></td> <td style="width: 10%;"></td> <td style="width: 10%;"></td> <td style="width: 10%;"></td> </tr> <tr> <td></td> <td></td> <td colspan="8" style="text-align: center;"> <table border="1" style="width: 100%; border-collapse: collapse; text-align: center;"> <tr> </tr></table></td></tr></table></td></tr></table></td></tr></table></td></tr></table></td></tr></table></td></tr></table></td></tr></table></td></tr></table></td></tr></table></td></tr></table></td></tr></table></td></tr></table></td></tr></table></td></tr></table></td></tr></table></td></tr></table></td></tr></table></td></tr></table></td></tr></table></td></tr></table></td></tr></table></td></tr></table></td></tr></table></td></tr></table></td></tr></table></td></tr></table></td></tr></table></td></tr></table>

 | | | | | | | | | | | | | | | | | | | | <table border="1" style="width: 100%; border-collapse: collapse; text-align: center;"> <tr> <td style="width: 10%;"></td> <td style="width: 10%;"></td> <td style="width: 10%;"></td> <td style="width: 10%;"></td> <td style="width: 10%;"></td> <td style="width: 10%;"></td> <td style="width: 10%;"></td> <td style="width: 10%;"></td> <td style="width: 10%;"></td> <td style="width: 10%;"></td> </tr> <tr> <td></td> <td></td> <td colspan="8" style="text-align: center;"> <table border="1" style="width: 100%; border-collapse: collapse; text-align: center;"> <tr> <td style="width: 10%;"></td> <td style="width: 10%;"></td> <td style="width: 10%;"></td> <td style="width: 10%;"></td> <td style="width: 10%;"></td> <td style="width: 10%;"></td> <td style="width: 10%;"></td> <td style="width: 10%;"></td> <td style="width: 10%;"></td> <td style="width: 10%;"></td> </tr> <tr> <td></td> <td></td> <td colspan="8" style="text-align: center;"> <table border="1" style="width: 100%; border-collapse: collapse; text-align: center;"> <tr> <td style="width: 10%;"></td> <td style="width: 10%;"></td> <td style="width: 10%;"></td> <td style="width: 10%;"></td> <td style="width: 10%;"></td> <td style="width: 10%;"></td> <td style="width: 10%;"></td> <td style="width: 10%;"></td> <td style="width: 10%;"></td> <td style="width: 10%;"></td> </tr> <tr> <td></td> <td></td> <td colspan="8" style="text-align: center;"> <table border="1" style="width: 100%; border-collapse: collapse; text-align: center;"> <tr> <td style="width: 10%;"></td> <td style="width: 10%;"></td> <td style="width: 10%;"></td> <td style="width: 10%;"></td> <td style="width: 10%;"></td> <td style="width: 10%;"></td> <td style="width: 10%;"></td> <td style="width: 10%;"></td> <td style="width: 10%;"></td> <td style="width: 10%;"></td> </tr> <tr> <td></td> <td></td> <td colspan="8" style="text-align: center;"> <table border="1" style="width: 100%; border-collapse: collapse; text-align: center;"> <tr> <td style="width: 10%;"></td> <td style="width: 10%;"></td> <td style="width: 10%;"></td> <td style="width: 10%;"></td> <td style="width: 10%;"></td> <td style="width: 10%;"></td> <td style="width: 10%;"></td> <td style="width: 10%;"></td> <td style="width: 10%;"></td> <td style="width: 10%;"></td> </tr> <tr> <td></td> <td></td> <td colspan="8" style="text-align: center;"> <table border="1" style="width: 100%; border-collapse: collapse; text-align: center;"> <tr> <td style="width: 10%;"></td> <td style="width: 10%;"></td> <td style="width: 10%;"></td> <td style="width: 10%;"></td> <td style="width: 10%;"></td> <td style="width: 10%;"></td> <td style="width: 10%;"></td> <td style="width: 10%;"></td> <td style="width: 10%;"></td> <td style="width: 10%;"></td> </tr> <tr> <td></td> <td></td> <td colspan="8" style="text-align: center;"> <table border="1" style="width: 100%; border-collapse: collapse; text-align: center;"> <tr> <td style="width: 10%;"></td> <td style="width: 10%;"></td> <td style="width: 10%;"></td> <td style="width: 10%;"></td> <td style="width: 10%;"></td> <td style="width: 10%;"></td> <td style="width: 10%;"></td> <td style="width: 10%;"></td> <td style="width: 10%;"></td> <td style="width: 10%;"></td> </tr> <tr> <td></td> <td></td> <td colspan="8" style="text-align: center;"> <table border="1" style="width: 100%; border-collapse: collapse; text-align: center;"> <tr> <td style="width: 10%;"></td> <td style="width: 10%;"></td> <td style="width: 10%;"></td> <td style="width: 10%;"></td> <td style="width: 10%;"></td> <td style="width: 10%;"></td> <td style="width: 10%;"></td> <td style="width: 10%;"></td> <td style="width: 10%;"></td> <td style="width: 10%;"></td> </tr> <tr> <td></td> <td></td> <td colspan="8" style="text-align: center;"> <table border="1" style="width: 100%; border-collapse: collapse; text-align: center;"> <tr> <td style="width: 10%;"></td> <td style="width: 10%;"></td> <td style="width: 10%;"></td> <td style="width: 10%;"></td> <td style="width: 10%;"></td> <td style="width: 10%;"></td> <td style="width: 10%;"></td> <td style="width: 10%;"></td> <td style="width: 10%;"></td> <td style="width: 10%;"></td> </tr> <tr> <td></td> <td></td> <td colspan="8" style="text-align: center;"> <table border="1" style="width: 100%; border-collapse: collapse; text-align: center;"> <tr> <td style="width: 10%;"></td> <td style="width: 10%;"></td> <td style="width: 10%;"></td> <td style="width: 10%;"></td> <td style="width: 10%;"></td> <td style="width: 10%;"></td> <td style="width: 10%;"></td> <td style="width: 10%;"></td> <td style="width: 10%;"></td> <td style="width: 10%;"></td> </tr> <tr> <td></td> <td></td> <td colspan="8" style="text-align: center;"> <table border="1" style="width: 100%; border-collapse: collapse; text-align: center;"> <tr> <td style="width: 10%;"></td> <td style="width: 10%;"></td> <td style="width: 10%;"></td> <td style="width: 10%;"></td> <td style="width: 10%;"></td> <td style="width: 10%;"></td> <td style="width: 10%;"></td> <td style="width: 10%;"></td> <td style="width: 10%;"></td> <td style="width: 10%;"></td> </tr> <tr> <td></td> <td></td> <td colspan="8" style="text-align: center;"> <table border="1" style="width: 100%; border-collapse: collapse; text-align: center;"> <tr> <td style="width: 10%;"></td> <td style="width: 10%;"></td> <td style="width: 10%;"></td> <td style="width: 10%;"></td> <td style="width: 10%;"></td> <td style="width: 10%;"></td> <td style="width: 10%;"></td> <td style="width: 10%;"></td> <td style="width: 10%;"></td> <td style="width: 10%;"></td> </tr> <tr> <td></td> <td></td> <td colspan="8" style="text-align: center;"> <table border="1" style="width: 100%; border-collapse: collapse; text-align: center;"> <tr> <td style="width: 10%;"></td> <td style="width: 10%;"></td> <td style="width: 10%;"></td> <td style="width: 10%;"></td> <td style="width: 10%;"></td> <td style="width: 10%;"></td> <td style="width: 10%;"></td> <td style="width: 10%;"></td> <td style="width: 10%;"></td> <td style="width: 10%;"></td> </tr> <tr> <td></td> <td></td> <td colspan="8" style="text-align: center;"> <table border="1" style="width: 100%; border-collapse: collapse; text-align: center;"> <tr> <td style="width: 10%;"></td> <td style="width: 10%;"></td> <td style="width: 10%;"></td> <td style="width: 10%;"></td> <td style="width: 10%;"></td> <td style="width: 10%;"></td> <td style="width: 10%;"></td> <td style="width: 10%;"></td> <td style="width: 10%;"></td> <td style="width: 10%;"></td> </tr> <tr> <td></td> <td></td> <td colspan="8" style="text-align: center;"> <table border="1" style="width: 100%; border-collapse: collapse; text-align: center;"> <tr> <td style="width: 10%;"></td> <td style="width: 10%;"></td> <td style="width: 10%;"></td> <td style="width: 10%;"></td> <td style="width: 10%;"></td> <td style="width: 10%;"></td> <td style="width: 10%;"></td> <td style="width: 10%;"></td> <td style="width: 10%;"></td> <td style="width: 10%;"></td> </tr> <tr> <td></td> <td></td> <td colspan="8" style="text-align: center;"> <table border="1" style="width: 100%; border-collapse: collapse; text-align: center;"> <tr> <td style="width: 10%;"></td> <td style="width: 10%;"></td> <td style="width: 10%;"></td> <td style="width: 10%;"></td> <td style="width: 10%;"></td> <td style="width: 10%;"></td> <td style="width: 10%;"></td> <td style="width: 10%;"></td> <td style="width: 10%;"></td> <td style="width: 10%;"></td> </tr> <tr> <td></td> <td></td> <td colspan="8" style="text-align: center;"> <table border="1" style="width: 100%; border-collapse: collapse; text-align: center;"> <tr> <td style="width: 10%;"></td> <td style="width: 10%;"></td> <td style="width: 10%;"></td> <td style="width: 10%;"></td> <td style="width: 10%;"></td> <td style="width: 10%;"></td> <td style="width: 10%;"></td> <td style="width: 10%;"></td> <td style="width: 10%;"></td> <td style="width: 10%;"></td> </tr> <tr> <td></td> <td></td> <td colspan="8" style="text-align: center;"> <table border="1" style="width: 100%; border-collapse: collapse; text-align: center;"> <tr> <td style="width: 10%;"></td> <td style="width: 10%;"></td> <td style="width: 10%;"></td> <td style="width: 10%;"></td> <td style="width: 10%;"></td> <td style="width: 10%;"></td> <td style="width: 10%;"></td> <td style="width: 10%;"></td> <td style="width: 10%;"></td> <td style="width: 10%;"></td> </tr> <tr> <td></td> <td></td> <td colspan="8" style="text-align: center;"> <table border="1" style="width: 100%; border-collapse: collapse; text-align: center;"> <tr> <td style="width: 10%;"></td> <td style="width: 10%;"></td> <td style="width: 10%;"></td> <td style="width: 10%;"></td> <td style="width: 10%;"></td> <td style="width: 10%;"></td> <td style="width: 10%;"></td> <td style="width: 10%;"></td> <td style="width: 10%;"></td> <td style="width: 10%;"></td> </tr> <tr> <td></td> <td></td> <td colspan="8" style="text-align: center;"> <table border="1" style="width: 100%; border-collapse: collapse; text-align: center;"> <tr> <td style="width: 10%;"></td> <td style="width: 10%;"></td> <td style="width: 10%;"></td> <td style="width: 10%;"></td> <td style="width: 10%;"></td> <td style="width: 10%;"></td> <td style="width: 10%;"></td> <td style="width: 10%;"></td> <td style="width: 10%;"></td> <td style="width: 10%;"></td> </tr> <tr> <td></td> <td></td> <td colspan="8" style="text-align: center;"> <table border="1" style="width: 100%; border-collapse: collapse; text-align: center;"> <tr> <td style="width: 10%;"></td> <td style="width: 10%;"></td> <td style="width: 10%;"></td> <td style="width: 10%;"></td> <td style="width: 10%;"></td> <td style="width:
10%;"></td> <td style="width: 10%;"></td> <td style="width: 10%;"></td> <td style="width: 10%;"></td> <td style="width: 10%;"></td> </tr> <tr> <td></td> <td></td> <td colspan="8" style="text-align: center;"> <table border="1" style="width: 100%; border-collapse: collapse; text-align: center;"> <tr> <td style="width: 10%;"></td> <td style="width: 10%;"></td> <td style="width: 10%;"></td> <td style="width: 10%;"></td> <td style="width: 10%;"></td> <td style="width: 10%;"></td> <td style="width: 10%;"></td> <td style="width: 10%;"></td> <td style="width: 10%;"></td> <td style="width: 10%;"></td> </tr> <tr> <td></td> <td></td> <td colspan="8" style="text-align: center;"> <table border="1" style="width: 100%; border-collapse: collapse; text-align: center;"> <tr> <td style="width: 10%;"></td> <td style="width: 10%;"></td> <td style="width: 10%;"></td> <td style="width: 10%;"></td> <td style="width: 10%;"></td> <td style="width: 10%;"></td> <td style="width: 10%;"></td> <td style="width: 10%;"></td> <td style="width: 10%;"></td> <td style="width: 10%;"></td> </tr> <tr> <td></td> <td></td> <td colspan="8" style="text-align: center;"> <table border="1" style="width: 100%; border-collapse: collapse; text-align: center;"> <tr> <td style="width: 10%;"></td> <td style="width: 10%;"></td> <td style="width: 10%;"></td> <td style="width: 10%;"></td> <td style="width: 10%;"></td> <td style="width: 10%;"></td> <td style="width: 10%;"></td> <td style="width: 10%;"></td> <td style="width: 10%;"></td> <td style="width: 10%;"></td> </tr> <tr> <td></td> <td></td> <td colspan="8" style="text-align: center;"> <table border="1" style="width: 100%; border-collapse: collapse; text-align: center;"> <tr> <td style="width: 10%;"></td> <td style="width: 10%;"></td> <td style="width: 10%;"></td> <td style="width: 10%;"></td> <td style="width: 10%;"></td> <td style="width: 10%;"></td> <td style="width: 10%;"></td> <td style="width: 10%;"></td> <td style="width: 10%;"></td> <td style="width: 10%;"></td> </tr> <tr> <td></td> <td></td> <td colspan="8" style="text-align: center;"> <table border="1" style="width: 100%; border-collapse: collapse; text-align: center;"> <tr> <td style="width: 10%;"></td> <td style="width: 10%;"></td> <td style="width: 10%;"></td> <td style="width: 10%;"></td> <td style="width: 10%;"></td> <td style="width: 10%;"></td> <td style="width: 10%;"></td> <td style="width: 10%;"></td> <td style="width: 10%;"></td> <td style="width: 10%;"></td> </tr> <tr> <td></td> <td></td> <td colspan="8" style="text-align: center;"> <table border="1" style="width: 100%; border-collapse: collapse; text-align: center;"> <tr> <td style="width: 10%;"></td> <td style="width: 10%;"></td> <td style="width: 10%;"></td> <td style="width: 10%;"></td> <td style="width: 10%;"></td> <td style="width: 10%;"></td> <td style="width: 10%;"></td> <td style="width: 10%;"></td> <td style="width: 10%;"></td> <td style="width: 10%;"></td> </tr> <tr> <td></td> <td></td> <td colspan="8" style="text-align: center;"> <table border="1" style="width: 100%; border-collapse: collapse; text-align: center;"> <tr> </tr></table></td></tr></table></td></tr></table></td></tr></table></td></tr></table></td></tr></table></td></tr></table></td></tr></table></td></tr></table></td></tr></table></td></tr></table></td></tr></table></td></tr></table></td></tr></table></td></tr></table></td></tr></table></td></tr></table></td></tr></table></td></tr></table></td></tr></table></td></tr></table></td></tr></table></td></tr></table></td></tr></table></td></tr></table></td></tr></table></td></tr></table></td></tr></table>
 | | | | | | | | | | | | | | | | | | | | <table border="1" style="width: 100%; border-collapse: collapse; text-align: center;"> <tr> <td style="width: 10%;"></td> <td style="width: 10%;"></td> <td style="width: 10%;"></td> <td style="width: 10%;"></td> <td style="width: 10%;"></td> <td style="width: 10%;"></td> <td style="width: 10%;"></td> <td style="width: 10%;"></td> <td style="width: 10%;"></td> <td style="width: 10%;"></td> </tr> <tr> <td></td> <td></td> <td colspan="8" style="text-align: center;"> <table border="1" style="width: 100%; border-collapse: collapse; text-align: center;"> <tr> <td style="width: 10%;"></td> <td style="width: 10%;"></td> <td style="width: 10%;"></td> <td style="width: 10%;"></td> <td style="width: 10%;"></td> <td style="width: 10%;"></td> <td style="width: 10%;"></td> <td style="width: 10%;"></td> <td style="width: 10%;"></td> <td style="width: 10%;"></td> </tr> <tr> <td></td> <td></td> <td colspan="8" style="text-align: center;"> <table border="1" style="width: 100%; border-collapse: collapse; text-align: center;"> <tr> <td style="width: 10%;"></td> <td style="width: 10%;"></td> <td style="width: 10%;"></td> <td style="width: 10%;"></td> <td style="width: 10%;"></td> <td style="width: 10%;"></td> <td style="width: 10%;"></td> <td style="width:
10%;"></td> <td style="width: 10%;"></td> <td style="width: 10%;"></td> </tr> <tr> <td></td> <td></td> <td colspan="8" style="text-align: center;"> <table border="1" style="width: 100%; border-collapse: collapse; text-align: center;"> <tr> <td style="width: 10%;"></td> <td style="width: 10%;"></td> <td style="width: 10%;"></td> <td style="width: 10%;"></td> <td style="width: 10%;"></td> <td style="width: 10%;"></td> <td style="width: 10%;"></td> <td style="width: 10%;"></td> <td style="width: 10%;"></td> <td style="width: 10%;"></td> </tr> <tr> <td></td> <td></td> <td colspan="8" style="text-align: center;"> <table border="1" style="width: 100%; border-collapse: collapse; text-align: center;"> <tr> <td style="width: 10%;"></td> <td style="width: 10%;"></td> <td style="width: 10%;"></td> <td style="width: 10%;"></td> <td style="width: 10%;"></td> <td style="width: 10%;"></td> <td style="width: 10%;"></td> <td style="width: 10%;"></td> <td style="width: 10%;"></td> <td style="width: 10%;"></td> </tr> <tr> <td></td> <td></td> <td colspan="8" style="text-align: center;"> <table border="1" style="width: 100%; border-collapse: collapse; text-align: center;"> <tr> <td style="width: 10%;"></td> <td style="width: 10%;"></td> <td style="width: 10%;"></td> <td style="width: 10%;"></td> <td style="width: 10%;"></td> <td style="width: 10%;"></td> <td style="width: 10%;"></td> <td style="width: 10%;"></td> <td style="width: 10%;"></td> <td style="width: 10%;"></td> </tr> <tr> <td></td> <td></td> <td colspan="8" style="text-align: center;"> <table border="1" style="width: 100%; border-collapse: collapse; text-align: center;"> <tr> <td style="width: 10%;"></td> <td style="width: 10%;"></td> <td style="width: 10%;"></td> <td style="width: 10%;"></td> <td style="width: 10%;"></td> <td style="width: 10%;"></td> <td style="width: 10%;"></td> <td style="width: 10%;"></td> <td style="width: 10%;"></td> <td style="width: 10%;"></td> </tr> <tr> <td></td> <td></td> <td colspan="8" style="text-align: center;"> <table border="1" style="width: 100%; border-collapse: collapse; text-align: center;"> <tr> <td style="width: 10%;"></td> <td style="width: 10%;"></td> <td style="width: 10%;"></td> <td style="width: 10%;"></td> <td style="width: 10%;"></td> <td style="width: 10%;"></td> <td style="width: 10%;"></td> <td style="width: 10%;"></td> <td style="width: 10%;"></td> <td style="width: 10%;"></td> </tr> <tr> <td></td> <td></td> <td colspan="8" style="text-align: center;"> <table border="1" style="width: 100%; border-collapse: collapse; text-align: center;"> <tr> <td style="width: 10%;"></td> <td style="width: 10%;"></td> <td style="width: 10%;"></td> <td style="width: 10%;"></td> <td style="width: 10%;"></td> <td style="width: 10%;"></td> <td style="width: 10%;"></td> <td style="width: 10%;"></td> <td style="width: 10%;"></td> <td style="width: 10%;"></td> </tr> <tr> <td></td> <td></td> <td colspan="8" style="text-align: center;"> <table border="1" style="width: 100%; border-collapse: collapse; text-align: center;"> <tr> <td style="width: 10%;"></td> <td style="width: 10%;"></td> <td style="width: 10%;"></td> <td style="width: 10%;"></td> <td style="width: 10%;"></td> <td style="width: 10%;"></td> <td style="width: 10%;"></td> <td style="width: 10%;"></td> <td style="width: 10%;"></td> <td style="width: 10%;"></td> </tr> <tr> <td></td> <td></td> <td colspan="8" style="text-align: center;"> <table border="1" style="width: 100%; border-collapse: collapse; text-align: center;"> <tr> <td style="width: 10%;"></td> <td style="width: 10%;"></td> <td style="width: 10%;"></td> <td style="width: 10%;"></td> <td style="width: 10%;"></td> <td style="width: 10%;"></td> <td style="width: 10%;"></td> <td style="width: 10%;"></td> <td style="width: 10%;"></td> <td style="width: 10%;"></td> </tr> <tr> <td></td> <td></td> <td colspan="8" style="text-align: center;"> <table border="1" style="width: 100%; border-collapse: collapse; text-align: center;"> <tr> <td style="width: 10%;"></td> <td style="width: 10%;"></td> <td style="width: 10%;"></td> <td style="width: 10%;"></td> <td style="width: 10%;"></td> <td style="width: 10%;"></td> <td style="width: 10%;"></td> <td style="width: 10%;"></td> <td style="width: 10%;"></td> <td style="width: 10%;"></td> </tr> <tr> <td></td> <td></td> <td colspan="8" style="text-align: center;"> <table border="1" style="width: 100%; border-collapse: collapse; text-align: center;"> <tr> <td style="width: 10%;"></td> <td style="width: 10%;"></td> <td style="width: 10%;"></td> <td style="width: 10%;"></td> <td style="width: 10%;"></td> <td style="width: 10%;"></td> <td style="width: 10%;"></td> <td style="width: 10%;"></td> <td style="width: 10%;"></td> <td style="width: 10%;"></td> </tr> <tr> <td></td> <td></td> <td colspan="8" style="text-align: center;"> <table border="1" style="width: 100%; border-collapse: collapse; text-align: center;"> <tr> <td style="width: 10%;"></td> <td style="width: 10%;"></td> <td style="width: 10%;"></td> <td style="width: 10%;"></td> <td style="width: 10%;"></td> <td style="width: 10%;"></td> <td style="width: 10%;"></td> <td style="width: 10%;"></td> <td style="width: 10%;"></td> <td style="width: 10%;"></td> </tr> <tr> <td></td> <td></td> <td colspan="8" style="text-align: center;"> <table border="1" style="width: 100%; border-collapse: collapse; text-align: center;"> <tr> <td style="width: 10%;"></td> <td style="width: 10%;"></td> <td style="width: 10%;"></td> <td style="width: 10%;"></td> <td style="width: 10%;"></td> <td style="width: 10%;"></td> <td style="width: 10%;"></td> <td style="width: 10%;"></td> <td style="width: 10%;"></td> <td style="width: 10%;"></td> </tr> <tr> <td></td> <td></td> <td colspan="8" style="text-align: center;"> <table border="1" style="width: 100%; border-collapse: collapse; text-align: center;"> <tr> <td style="width: 10%;"></td> <td style="width: 10%;"></td> <td style="width: 10%;"></td> <td style="width: 10%;"></td> <td style="width: 10%;"></td> <td style="width: 10%;"></td> <td style="width: 10%;"></td> <td style="width: 10%;"></td> <td style="width: 10%;"></td> <td style="width: 10%;"></td> </tr> <tr> <td></td> <td></td> <td colspan="8" style="text-align: center;"> <table border="1" style="width: 100%; border-collapse: collapse; text-align: center;"> <tr> <td style="width: 10%;"></td> <td style="width: 10%;"></td> <td style="width: 10%;"></td> <td style="width: 10%;"></td> <td style="width: 10%;"></td> <td style="width: 10%;"></td> <td style="width: 10%;"></td> <td style="width: 10%;"></td> <td style="width: 10%;"></td> <td style="width: 10%;"></td> </tr> <tr> <td></td> <td></td> <td colspan="8" style="text-align: center;"> <table border="1" style="width: 100%; border-collapse: collapse; text-align: center;"> <tr> <td style="width: 10%;"></td> <td style="width: 10%;"></td> <td style="width: 10%;"></td> <td style="width: 10%;"></td> <td style="width: 10%;"></td> <td style="width: 10%;"></td> <td style="width: 10%;"></td> <td style="width: 10%;"></td> <td style="width: 10%;"></td> <td style="width: 10%;"></td> </tr> <tr> <td></td> <td></td> <td colspan="8" style="text-align: center;"> <table border="1" style="width: 100%; border-collapse: collapse; text-align: center;"> <tr> <td style="width: 10%;"></td> <td style="width: 10%;"></td> <td style="width: 10%;"></td> <td style="width: 10%;"></td> <td style="width: 10%;"></td> <td style="width: 10%;"></td> <td style="width: 10%;"></td> <td style="width: 10%;"></td> <td style="width: 10%;"></td> <td style="width: 10%;"></td> </tr> <tr> <td></td> <td></td> <td colspan="8" style="text-align: center;"> <table border="1" style="width: 100%; border-collapse: collapse; text-align: center;"> <tr> <td style="width: 10%;"></td> <td style="width: 10%;"></td> <td style="width: 10%;"></td> <td style="width: 10%;"></td> <td style="width: 10%;"></td> <td style="width: 10%;"></td> <td style="width: 10%;"></td> <td style="width: 10%;"></td> <td style="width: 10%;"></td> <td style="width: 10%;"></td> </tr> <tr> <td></td> <td></td> <td colspan="8" style="text-align: center;"> <table border="1" style="width: 100%; border-collapse: collapse; text-align: center;"> <tr> <td style="width: 10%;"></td> <td style="width: 10%;"></td> <td style="width: 10%;"></td> <td style="width: 10%;"></td> <td style="width: 10%;"></td> <td style="width: 10%;"></td> <td style="width: 10%;"></td> <td style="width: 10%;"></td> <td style="width: 10%;"></td> <td style="width: 10%;"></td> </tr> <tr> <td></td> <td></td> <td colspan="8" style="text-align: center;"> <table border="1" style="width: 100%; border-collapse: collapse; text-align: center;"> <tr> <td style="width: 10%;"></td> <td style="width: 10%;"></td> <td style="width: 10%;"></td> <td style="width: 10%;"></td> <td style="width: 10%;"></td> <td style="width: 10%;"></td> <td style="width: 10%;"></td> <td style="width: 10%;"></td> <td style="width: 10%;"></td> <td style="width: 10%;"></td> </tr> <tr> <td></td> <td></td> <td colspan="8" style="text-align: center;"> <table border="1" style="width: 100%; border-collapse: collapse; text-align: center;"> <tr> <td style="width: 10%;"></td> <td style="width: 10%;"></td> <td style="width: 10%;"></td> <td style="width: 10%;"></td> <td style="width: 10%;"></td> <td style="width: 10%;"></td> <td style="width: 10%;"></td> <td style="width: 10%;"></td> <td style="width: 10%;"></td> <td style="width: 10%;"></td> </tr> <tr> <td></td> <td></td> <td colspan="8" style="text-align: center;"> <table border="1" style="width: 100%; border-collapse: collapse; text-align: center;"> <tr> <td style="width: 10%;"></td> <td style="width: 10%;"></td> <td style="width: 10%;"></td> <td style="width: 10%;"></td> <td style="width: 10%;"></td> <td style="width: 10%;"></td> <td style="width: 10%;"></td> <td style="width: 10%;"></td> <td style="width: 10%;"></td> <td style="width: 10%;"></td> </tr> <tr> <td></td> <td></td> <td colspan="8" style="text-align: center;"> <table border="1"
style="width: 100%; border-collapse: collapse; text-align: center;"> <tr> <td style="width: 10%;"></td> <td style="width: 10%;"></td> <td style="width: 10%;"></td> <td style="width: 10%;"></td> <td style="width: 10%;"></td> <td style="width: 10%;"></td> <td style="width: 10%;"></td> <td style="width: 10%;"></td> <td style="width: 10%;"></td> <td style="width: 10%;"></td> </tr> <tr> <td></td> <td></td> <td colspan="8" style="text-align: center;"> <table border="1" style="width: 100%; border-collapse: collapse; text-align: center;"> <tr> <td style="width: 10%;"></td> <td style="width: 10%;"></td> <td style="width: 10%;"></td> <td style="width: 10%;"></td> <td style="width: 10%;"></td> <td style="width: 10%;"></td> <td style="width: 10%;"></td> <td style="width: 10%;"></td> <td style="width: 10%;"></td> <td style="width: 10%;"></td> </tr> <tr> <td></td> <td></td> <td colspan="8" style="text-align: center;"> <table border="1" style="width: 100%; border-collapse: collapse; text-align: center;"> <tr> </tr></table></td></tr></table></td></tr></table></td></tr></table></td></tr></table></td></tr></table></td></tr></table></td></tr></table></td></tr></table></td></tr></table></td></tr></table></td></tr></table></td></tr></table></td></tr></table></td></tr></table></td></tr></table></td></tr></table></td></tr></table></td></tr></table></td></tr></table></td></tr></table></td></tr></table></td></tr></table></td></tr></table></td></tr></table></td></tr></table></td></tr></table>
 | | | | | | | | | | | | | | | | | | | | <table border="1" style="width: 100%; border-collapse: collapse; text-align: center;"> <tr> <td style="width: 10%;"></td> <td style="width: 10%;"></td> <td style="width: 10%;"></td> <td style="width: 10%;"></td> <td style="width: 10%;"></td> <td style="width: 10%;"></td> <td style="width: 10%;"></td> <td style="width: 10%;"></td> <td style="width: 10%;"></td> <td style="width: 10%;"></td> </tr> <tr> <td></td> <td></td> <td colspan="8" style="text-align: center;"> <table border="1" style="width: 100%; border-collapse: collapse; text-align: center;"> <tr> <td style="width: 10%;"></td> <td style="width: 10%;"></td> <td style="width: 10%;"></td> <td style="width: 10%;"></td> <td style="width: 10%;"></td> <td style="width: 10%;"></td> <td style="width: 10%;"></td> <td style="width: 10%;"></td> <td style="width: 10%;"></td> <td style="width: 10%;"></td> </tr> <tr> <td></td> <td></td> <td colspan="8" style="text-align: center;"> <table border="1" style="width: 100%; border-collapse: collapse; text-align: center;"> <tr> <td style="width: 10%;"></td> <td style="width: 10%;"></td> <td style="width: 10%;"></td> <td style="width: 10%;"></td> <td style="width: 10%;"></td> <td style="width: 10%;"></td> <td style="width: 10%;"></td> <td style="width: 10%;"></td> <td style="width: 10%;"></td> <td style="width: 10%;"></td> </tr> <tr> <td></td> <td></td> <td colspan="8" style="text-align: center;"> <table border="1" style="width: 100%; border-collapse: collapse; text-align: center;"> <tr> <td style="width: 10%;"></td> <td style="width: 10%;"></td> <td style="width: 10%;"></td> <td style="width: 10%;"></td> <td style="width: 10%;"></td> <td style="width: 10%;"></td> <td style="width: 10%;"></td> <td style="width: 10%;"></td> <td style="width: 10%;"></td> <td style="width: 10%;"></td> </tr> <tr> <td></td> <td></td> <td colspan="8" style="text-align: center;"> <table border="1" style="width: 100%; border-collapse: collapse; text-align: center;"> <tr> <td style="width: 10%;"></td> <td style="width: 10%;"></td> <td style="width: 10%;"></td> <td style="width: 10%;"></td> <td style="width: 10%;"></td> <td style="width: 10%;"></td> <td style="width: 10%;"></td> <td style="width: 10%;"></td> <td style="width: 10%;"></td> <td style="width: 10%;"></td> </tr> <tr> <td></td> <td></td> <td colspan="8" style="text-align: center;"> <table border="1" style="width: 100%; border-collapse: collapse; text-align: center;"> <tr> <td style="width: 10%;"></td> <td style="width: 10%;"></td> <td style="width: 10%;"></td> <td style="width: 10%;"></td> <td style="width: 10%;"></td> <td style="width: 10%;"></td> <td style="width: 10%;"></td> <td style="width: 10%;"></td> <td style="width: 10%;"></td> <td style="width: 10%;"></td> </tr> <tr> <td></td> <td></td> <td colspan="8" style="text-align: center;"> <table border="1" style="width: 100%; border-collapse: collapse; text-align: center;"> <tr> <td style="width: 10%;"></td> <td style="width: 10%;"></td> <td style="width: 10%;"></td> <td style="width: 10%;"></td> <td style="width: 10%;"></td> <td style="width: 10%;"></td> <td style="width: 10%;"></td> <td style="width: 10%;"></td> <td style="width: 10%;"></td> <td style="width: 10%;"></td> </tr> <tr> <td></td> <td></td> <td colspan="8" style="text-align: center;"> <table border="1" style="width: 100%; border-collapse: collapse; text-align: center;"> <tr> <td
style="width: 10%;"></td> <td style="width: 10%;"></td> <td style="width: 10%;"></td> <td style="width: 10%;"></td> <td style="width: 10%;"></td> <td style="width: 10%;"></td> <td style="width: 10%;"></td> <td style="width: 10%;"></td> <td style="width: 10%;"></td> <td style="width: 10%;"></td> </tr> <tr> <td></td> <td></td> <td colspan="8" style="text-align: center;"> <table border="1" style="width: 100%; border-collapse: collapse; text-align: center;"> <tr> <td style="width: 10%;"></td> <td style="width: 10%;"></td> <td style="width: 10%;"></td> <td style="width: 10%;"></td> <td style="width: 10%;"></td> <td style="width: 10%;"></td> <td style="width: 10%;"></td> <td style="width: 10%;"></td> <td style="width: 10%;"></td> <td style="width: 10%;"></td> </tr> <tr> <td></td> <td></td> <td colspan="8" style="text-align: center;"> <table border="1" style="width: 100%; border-collapse: collapse; text-align: center;"> <tr> <td style="width: 10%;"></td> <td style="width: 10%;"></td> <td style="width: 10%;"></td> <td style="width: 10%;"></td> <td style="width: 10%;"></td> <td style="width: 10%;"></td> <td style="width: 10%;"></td> <td style="width: 10%;"></td> <td style="width: 10%;"></td> <td style="width: 10%;"></td> </tr> <tr> <td></td> <td></td> <td colspan="8" style="text-align: center;"> <table border="1" style="width: 100%; border-collapse: collapse; text-align: center;"> <tr> <td style="width: 10%;"></td> <td style="width: 10%;"></td> <td style="width: 10%;"></td> <td style="width: 10%;"></td> <td style="width: 10%;"></td> <td style="width: 10%;"></td> <td style="width: 10%;"></td> <td style="width: 10%;"></td> <td style="width: 10%;"></td> <td style="width: 10%;"></td> </tr> <tr> <td></td> <td></td> <td colspan="8" style="text-align: center;"> <table border="1" style="width: 100%; border-collapse: collapse; text-align: center;"> <tr> <td style="width: 10%;"></td> <td style="width: 10%;"></td> <td style="width: 10%;"></td> <td style="width: 10%;"></td> <td style="width: 10%;"></td> <td style="width: 10%;"></td> <td style="width: 10%;"></td> <td style="width: 10%;"></td> <td style="width: 10%;"></td> <td style="width: 10%;"></td> </tr> <tr> <td></td> <td></td> <td colspan="8" style="text-align: center;"> <table border="1" style="width: 100%; border-collapse: collapse; text-align: center;"> <tr> <td style="width: 10%;"></td> <td style="width: 10%;"></td> <td style="width: 10%;"></td> <td style="width: 10%;"></td> <td style="width: 10%;"></td> <td style="width: 10%;"></td> <td style="width: 10%;"></td> <td style="width: 10%;"></td> <td style="width: 10%;"></td> <td style="width: 10%;"></td> </tr> <tr> <td></td> <td></td> <td colspan="8" style="text-align: center;"> <table border="1" style="width: 100%; border-collapse: collapse; text-align: center;"> <tr> <td style="width: 10%;"></td> <td style="width: 10%;"></td> <td style="width: 10%;"></td> <td style="width: 10%;"></td> <td style="width: 10%;"></td> <td style="width: 10%;"></td> <td style="width: 10%;"></td> <td style="width: 10%;"></td> <td style="width: 10%;"></td> <td style="width: 10%;"></td> </tr> <tr> <td></td> <td></td> <td colspan="8" style="text-align: center;"> <table border="1" style="width: 100%; border-collapse: collapse; text-align: center;"> <tr> <td style="width: 10%;"></td> <td style="width: 10%;"></td> <td style="width: 10%;"></td> <td style="width: 10%;"></td> <td style="width: 10%;"></td> <td style="width: 10%;"></td> <td style="width: 10%;"></td> <td style="width: 10%;"></td> <td style="width: 10%;"></td> <td style="width: 10%;"></td> </tr> <tr> <td></td> <td></td> <td colspan="8" style="text-align: center;"> <table border="1" style="width: 100%; border-collapse: collapse; text-align: center;"> <tr> <td style="width: 10%;"></td> <td style="width: 10%;"></td> <td style="width: 10%;"></td> <td style="width: 10%;"></td> <td style="width: 10%;"></td> <td style="width: 10%;"></td> <td style="width: 10%;"></td> <td style="width: 10%;"></td> <td style="width: 10%;"></td> <td style="width: 10%;"></td> </tr> <tr> <td></td> <td></td> <td colspan="8" style="text-align: center;"> <table border="1" style="width: 100%; border-collapse: collapse; text-align: center;"> <tr> <td style="width: 10%;"></td> <td style="width: 10%;"></td> <td style="width: 10%;"></td> <td style="width: 10%;"></td> <td style="width: 10%;"></td> <td style="width: 10%;"></td> <td style="width: 10%;"></td> <td style="width: 10%;"></td> <td style="width: 10%;"></td> <td style="width: 10%;"></td> </tr> <tr> <td></td> <td></td> <td colspan="8" style="text-align: center;"> <table border="1" style="width: 100%; border-collapse: collapse; text-align: center;"> <tr> <td style="width: 10%;"></td> <td style="width: 10%;"></td> <td style="width: 10%;"></td> <td style="width: 10%;"></td> <td style="width: 10%;"></td> <td style="width: 10%;"></td> <td style="width: 10%;"></td> <td style="width: 10%;"></td> <td style="width: 10%;"></td> <td style="width: 10%;"></td> </tr> <tr> <td></td> <td></td> <td colspan="8" style="text-align: center;"> <table border="1" style="width: 100%; border-collapse: collapse; text-align: center;"> <tr> <td style="width: 10%;"></td> <td style="width: 10%;"></td> <td style="width: 10%;"></td> <td style="width: 10%;"></td> <td style="width: 10%;"></td> <td style="width: 10%;"></td> <td style="width: 10%;"></td> <td style="width: 10%;"></td> <td style="width: 10%;"></td> <td style="width: 10%;"></td> </tr> <tr> <td></td> <td></td> <td colspan="8" style="text-align: center;"> <table border="1" style="width: 100%; border-collapse: collapse; text-align: center;"> <tr> <td style="width: 10%;"></td> <td style="width: 10%;"></td> <td style="width: 10%;"></td> <td style="width: 10%;"></td> <td style="width: 10%;"></td> <td style="width: 10%;"></td> <td style="width: 10%;"></td> <td style="width: 10%;"></td> <td style="width: 10%;"></td> <td style="width: 10%;"></td> </tr> <tr> <td></td> <td></td> <td colspan="8" style="text-align: center;"> <table border="1" style="width: 100%; border-collapse: collapse; text-align: center;"> <tr> <td style="width: 10%;"></td> <td style="width: 10%;"></td> <td style="width: 10%;"></td> <td style="width: 10%;"></td> <td style="width: 10%;"></td> <td style="width: 10%;"></td> <td style="width: 10%;"></td> <td style="width: 10%;"></td> <td style="width: 10%;"></td> <td style="width: 10%;"></td> </tr> <tr> <td></td> <td></td> <td colspan="8" style="text-align: center;"> <table border="1" style="width: 100%; border-collapse: collapse; text-align: center;"> <tr> <td style="width: 10%;"></td> <td style="width: 10%;"></td> <td style="width: 10%;"></td> <td style="width: 10%;"></td> <td style="width: 10%;"></td> <td style="width: 10%;"></td> <td style="width: 10%;"></td> <td style="width: 10%;"></td> <td style="width: 10%;"></td> <td style="width: 10%;"></td> </tr> <tr> <td></td> <td></td> <td colspan="8" style="text-align: center;"> <table border="1" style="width: 100%; border-collapse: collapse; text-align: center;"> <tr> <td style="width: 10%;"></td> <td style="width: 10%;"></td> <td style="width: 10%;"></td> <td style="width: 10%;"></td> <td style="width: 10%;"></td> <td style="width: 10%;"></td> <td style="width: 10%;"></td> <td style="width: 10%;"></td> <td style="width: 10%;"></td> <td style="width: 10%;"></td> </tr> <tr> <td></td> <td></td> <td colspan="8" style="text-align: center;"> <table border="1" style="width: 100%; border-collapse: collapse; text-align: center;"> <tr> <td style="width: 10%;"></td> <td style="width: 10%;"></td> <td style="width: 10%;"></td> <td style="width: 10%;"></td> <td style="width: 10%;"></td> <td style="width: 10%;"></td> <td style="width: 10%;"></td> <td style="width: 10%;"></td> <td style="width: 10%;"></td> <td style="width: 10%;"></td> </tr> <tr> <td></td> <td></td> <td colspan="8" style="text-align: center;"> <table border="1" style="width: 100%; border-collapse: collapse; text-align: center;"> <tr> <td style="width: 10%;"></td> <td style="width: 10%;"></td> <td style="width: 10%;"></td> <td style="width: 10%;"></td> <td style="width: 10%;"></td> <td style="width: 10%;"></td> <td style="width: 10%;"></td> <td style="width: 10%;"></td> <td style="width: 10%;"></td> <td style="width: 10%;"></td> </tr> <tr> <td></td> <td></td> <td colspan="8" style="text-align: center;"> <table border="1" style="width: 100%; border-collapse: collapse; text-align: center;"> <tr> </tr></table></td></tr></table></td></tr></table></td></tr></table></td></tr></table></td></tr></table></td></tr></table></td></tr></table></td></tr></table></td></tr></table></td></tr></table></td></tr></table></td></tr></table></td></tr></table></td></tr></table></td></tr></table></td></tr></table></td></tr></table></td></tr></table></td></tr></table></td></tr></table></td></tr></table></td></tr></table></td></tr></table></td></tr></table></td></tr></table>

 | | | | | | | | | | | | | | | | | | | | <table border="1" style="width: 100%; border-collapse: collapse; text-align: center;"> <tr> <td style="width: 10%;"></td> <td style="width: 10%;"></td> <td style="width: 10%;"></td> <td style="width: 10%;"></td> <td style="width: 10%;"></td> <td style="width: 10%;"></td> <td style="width: 10%;"></td> <td style="width: 10%;"></td> <td style="width: 10%;"></td> <td style="width: 10%;"></td> </tr> <tr> <td></td> <td></td> <td colspan="8" style="text-align: center;"> <table border="1" style="width: 100%; border-collapse: collapse; text-align: center;"> <tr> <td style="width: 10%;"></td> <td style="width: 10%;"></td> <td style="width: 10%;"></td> <td style="width: 10%;"></td> <td style="width: 10%;"></td> <td style="width: 10%;"></td> <td style="width: 10%;"></td> <td style="width: 10%;"></td> <td style="width: 10%;"></td> <td style="width: 10%;"></td> </tr> <tr> <td></td> <td></td> <td colspan="8" style="text-align: center;"> <table border="1" style="width: 100%; border-collapse: collapse; text-align: center;"> <tr> <td style="width: 10%;"></td> <td style="width: 10%;"></td> <td style="width: 10%;"></td> <td style="width: 10%;"></td> <td style="width: 10%;"></td> <td style="width: 10%;"></td> <td style="width: 10%;"></td> <td style="width: 10%;"></td> <td style="width: 10%;"></td> <td style="width: 10%;"></td> </tr> <tr> <td></td> <td></td> <td colspan="8" style="text-align: center;"> <table border="1" style="width: 100%; border-collapse: collapse; text-align: center;"> <tr> <td style="width: 10%;"></td> <td style="width: 10%;"></td> <td style="width: 10%;"></td> <td style="width: 10%;"></td> <td style="width: 10%;"></td> <td style="width: 10%;"></td> <td style="width: 10%;"></td> <td style="width: 10%;"></td> <td style="width: 10%;"></td> <td style="width: 10%;"></td> </tr> <tr> <td></td> <td></td> <td colspan="8" style="text-align: center;"> <table border="1" style="width: 100%; border-collapse: collapse; text-align: center;"> <tr> <td style="width: 10%;"></td> <td style="width: 10%;"></td> <td style="width: 10%;"></td> <td style="width: 10%;"></td> <td style="width: 10%;"></td> <td style="width: 10%;"></td> <td style="width: 10%;"></td> <td style="width: 10%;"></td> <td style="width: 10%;"></td> <td style="width: 10%;"></td> </tr> <tr> <td></td> <td></td> <td colspan="8" style="text-align: center;"> <table border="1" style="width: 100%; border-collapse: collapse; text-align: center;"> <tr> <td style="width: 10%;"></td> <td style="width: 10%;"></td> <td style="width: 10%;"></td> <td style="width: 10%;"></td> <td style="width: 10%;"></td> <td style="width: 10%;"></td> <td style="width: 10%;"></td> <td style="width: 10%;"></td> <td style="width: 10%;"></td> <td style="width: 10%;"></td> </tr> <tr> <td></td> <td></td> <td colspan="8" style="text-align: center;"> <table border="1" style="width: 100%; border-collapse: collapse; text-align: center;"> <tr> <td style="width: 10%;"></td> <td style="width: 10%;"></td> <td style="width: 10%;"></td> <td style="width: 10%;"></td> <td style="width: 10%;"></td> <td style="width: 10%;"></td> <td style="width: 10%;"></td> <td style="width: 10%;"></td> <td style="width: 10%;"></td> <td style="width: 10%;"></td> </tr> <tr> <td></td> <td></td> <td colspan="8" style="text-align: center;"> <table border="1" style="width: 100%; border-collapse: collapse; text-align: center;"> <tr> <td style="width: 10%;"></td> <td style="width: 10%;"></td> <td style="width: 10%;"></td> <td style="width: 10%;"></td> <td style="width: 10%;"></td> <td style="width: 10%;"></td> <td style="width: 10%;"></td> <td style="width: 10%;"></td> <td style="width: 10%;"></td> <td style="width: 10%;"></td> </tr> <tr> <td></td> <td></td> <td colspan="8" style="text-align: center;"> <table border="1" style="width: 100%; border-collapse: collapse; text-align: center;"> <tr> <td style="width: 10%;"></td> <td style="width: 10%;"></td> <td style="width: 10%;"></td> <td style="width: 10%;"></td> <td style="width: 10%;"></td> <td style="width: 10%;"></td> <td style="width: 10%;"></td> <td style="width: 10%;"></td> <td style="width: 10%;"></td> <td style="width: 10%;"></td> </tr> <tr> <td></td> <td></td> <td colspan="8" style="text-align: center;"> <table border="1" style="width: 100%; border-collapse: collapse; text-align: center;"> <tr> <td style="width: 10%;"></td> <td style="width: 10%;"></td> <td style="width: 10%;"></td> <td style="width: 10%;"></td> <td style="width: 10%;"></td> <td style="width: 10%;"></td> <td style="width: 10%;"></td> <td style="width: 10%;"></td> <td style="width: 10%;"></td> <td style="width: 10%;"></td> </tr> <tr> <td></td> <td></td> <td colspan="8" style="text-align: center;"> <table border="1" style="width: 100%; border-collapse: collapse; text-align: center;"> <tr> <td style="width: 10%;"></td> <td style="width: 10%;"></td> <td style="width: 10%;"></td> <td style="width: 10%;"></td> <td style="width: 10%;"></td> <td style="width: 10%;"></td> <td style="width: 10%;"></td> <td style="width: 10%;"></td> <td style="width: 10%;"></td> <td style="width: 10%;"></td> </tr> <tr> <td></td> <td></td> <td colspan="8" style="text-align: center;"> <table border="1" style="width: 100%; border-collapse: collapse; text-align: center;"> <tr> <td style="width: 10%;"></td> <td style="width: 10%;"></td> <td style="width: 10%;"></td> <td style="width: 10%;"></td> <td style="width: 10%;"></td> <td style="width: 10%;"></td> <td style="width: 10%;"></td> <td style="width: 10%;"></td> <td style="width: 10%;"></td> <td style="width: 10%;"></td> </tr> <tr> <td></td> <td></td> <td colspan="8" style="text-align: center;"> <table border="1" style="width: 100%; border-collapse: collapse; text-align: center;"> <tr> <td style="width: 10%;"></td> <td style="width: 10%;"></td> <td style="width: 10%;"></td> <td style="width: 10%;"></td> <td style="width: 10%;"></td> <td style="width: 10%;"></td> <td style="width: 10%;"></td> <td style="width: 10%;"></td> <td style="width: 10%;"></td> <td
style="width: 10%;"></td> </tr> <tr> <td></td> <td></td> <td colspan="8" style="text-align: center;"> <table border="1" style="width: 100%; border-collapse: collapse; text-align: center;"> <tr> <td style="width: 10%;"></td> <td style="width: 10%;"></td> <td style="width: 10%;"></td> <td style="width: 10%;"></td> <td style="width: 10%;"></td> <td style="width: 10%;"></td> <td style="width: 10%;"></td> <td style="width: 10%;"></td> <td style="width: 10%;"></td> <td style="width: 10%;"></td> </tr> <tr> <td></td> <td></td> <td colspan="8" style="text-align: center;"> <table border="1" style="width: 100%; border-collapse: collapse; text-align: center;"> <tr> <td style="width: 10%;"></td> <td style="width: 10%;"></td> <td style="width: 10%;"></td> <td style="width: 10%;"></td> <td style="width: 10%;"></td> <td style="width: 10%;"></td> <td style="width: 10%;"></td> <td style="width: 10%;"></td> <td style="width: 10%;"></td> <td style="width: 10%;"></td> </tr> <tr> <td></td> <td></td> <td colspan="8" style="text-align: center;"> <table border="1" style="width: 100%; border-collapse: collapse; text-align: center;"> <tr> <td style="width: 10%;"></td> <td style="width: 10%;"></td> <td style="width: 10%;"></td> <td style="width: 10%;"></td> <td style="width: 10%;"></td> <td style="width: 10%;"></td> <td style="width: 10%;"></td> <td style="width: 10%;"></td> <td style="width: 10%;"></td> <td style="width: 10%;"></td> </tr> <tr> <td></td> <td></td> <td colspan="8" style="text-align: center;"> <table border="1" style="width: 100%; border-collapse: collapse; text-align: center;"> <tr> <td style="width: 10%;"></td> <td style="width: 10%;"></td> <td style="width: 10%;"></td> <td style="width: 10%;"></td> <td style="width: 10%;"></td> <td style="width: 10%;"></td> <td style="width: 10%;"></td> <td style="width: 10%;"></td> <td style="width: 10%;"></td> <td style="width: 10%;"></td> </tr> <tr> <td></td> <td></td> <td colspan="8" style="text-align: center;"> <table border="1" style="width: 100%; border-collapse: collapse; text-align: center;"> <tr> <td style="width: 10%;"></td> <td style="width: 10%;"></td> <td style="width: 10%;"></td> <td style="width: 10%;"></td> <td style="width: 10%;"></td> <td style="width: 10%;"></td> <td style="width: 10%;"></td> <td style="width: 10%;"></td> <td style="width: 10%;"></td> <td style="width: 10%;"></td> </tr> <tr> <td></td> <td></td> <td colspan="8" style="text-align: center;"> <table border="1" style="width: 100%; border-collapse: collapse; text-align: center;"> <tr> <td style="width: 10%;"></td> <td style="width: 10%;"></td> <td style="width: 10%;"></td> <td style="width: 10%;"></td> <td style="width: 10%;"></td> <td style="width: 10%;"></td> <td style="width: 10%;"></td> <td style="width: 10%;"></td> <td style="width: 10%;"></td> <td style="width: 10%;"></td> </tr> <tr> <td></td> <td></td> <td colspan="8" style="text-align: center;"> <table border="1" style="width: 100%; border-collapse: collapse; text-align: center;"> <tr> <td style="width: 10%;"></td> <td style="width: 10%;"></td> <td style="width: 10%;"></td> <td style="width: 10%;"></td> <td style="width: 10%;"></td> <td style="width: 10%;"></td> <td style="width: 10%;"></td> <td style="width: 10%;"></td> <td style="width: 10%;"></td> <td style="width: 10%;"></td> </tr> <tr> <td></td> <td></td> <td colspan="8" style="text-align: center;"> <table border="1" style="width: 100%; border-collapse: collapse; text-align: center;"> <tr> <td style="width: 10%;"></td> <td style="width: 10%;"></td> <td style="width: 10%;"></td> <td style="width: 10%;"></td> <td style="width: 10%;"></td> <td style="width: 10%;"></td> <td style="width: 10%;"></td> <td style="width: 10%;"></td> <td style="width: 10%;"></td> <td style="width: 10%;"></td> </tr> <tr> <td></td> <td></td> <td colspan="8" style="text-align: center;"> <table border="1" style="width: 100%; border-collapse: collapse; text-align: center;"> <tr> <td style="width: 10%;"></td> <td style="width: 10%;"></td> <td style="width: 10%;"></td> <td style="width: 10%;"></td> <td style="width: 10%;"></td> <td style="width: 10%;"></td> <td style="width: 10%;"></td> <td style="width: 10%;"></td> <td style="width: 10%;"></td> <td style="width: 10%;"></td> </tr> <tr> <td></td> <td></td> <td colspan="8" style="text-align: center;"> <table border="1" style="width: 100%; border-collapse: collapse; text-align: center;"> <tr> <td style="width: 10%;"></td> <td style="width: 10%;"></td> <td style="width: 10%;"></td> <td style="width: 10%;"></td> <td style="width: 10%;"></td> <td style="width: 10%;"></td> <td style="width: 10%;"></td> <td style="width: 10%;"></td> <td style="width: 10%;"></td> <td style="width: 10%;"></td> </tr> <tr> <td></td> <td></td> <td colspan="8" style="text-align: center;"> <table border="1" style="width: 100%; border-collapse: collapse; text-align: center;"> <tr> <td style="width: 10%;"></td> <td style="width: 10%;"></td> <td style="width: 10%;"></td> <td style="width: 10%;"></td> <td style="width: 10%;"></td> <td style="width: 10%;"></td> <td style="width: 10%;"></td> <td style="width: 10%;"></td> <td style="width: 10%;"></td> <td style="width: 10%;"></td> </tr> <tr> <td></td> <td></td> <td colspan="8" style="text-align: center;"> <table border="1" style="width: 100%; border-collapse: collapse; text-align: center;"> <tr> </tr></table></td></tr></table></td></tr></table></td></tr></table></td></tr></table></td></tr></table></td></tr></table></td></tr></table></td></tr></table></td></tr></table></td></tr></table></td></tr></table></td></tr></table></td></tr></table></td></tr></table></td></tr></table></td></tr></table></td></tr></table></td></tr></table></td></tr></table></td></tr></table></td></tr></table></td></tr></table></td></tr></table></td></tr></table>

 | | | | | | | | | | | | | | | | | | | | <table border="1" style="width: 100%; border-collapse: collapse; text-align: center;"> <tr> <td style="width: 10%;"></td> <td style="width: 10%;"></td> <td style="width: 10%;"></td> <td style="width: 10%;"></td> <td style="width: 10%;"></td> <td style="width: 10%;"></td> <td style="width: 10%;"></td> <td style="width: 10%;"></td> <td style="width: 10%;"></td> <td style="width: 10%;"></td> </tr> <tr> <td></td> <td></td> <td colspan="8" style="text-align: center;"> <table border="1" style="width: 100%; border-collapse: collapse; text-align: center;"> <tr> <td style="width: 10%;"></td> <td style="width: 10%;"></td> <td style="width: 10%;"></td> <td style="width: 10%;"></td> <td style="width: 10%;"></td> <td style="width: 10%;"></td> <td style="width: 10%;"></td> <td style="width: 10%;"></td> <td style="width: 10%;"></td> <td style="width: 10%;"></td> </tr> <tr> <td></td> <td></td> <td colspan="8" style="text-align: center;"> <table border="1" style="width: 100%; border-collapse: collapse; text-align: center;"> <tr> <td style="width: 10%;"></td> <td style="width: 10%;"></td> <td style="width: 10%;"></td> <td style="width: 10%;"></td> <td style="width: 10%;"></td> <td style="width: 10%;"></td> <td style="width: 10%;"></td> <td style="width: 10%;"></td> <td style="width: 10%;"></td> <td style="width: 10%;"></td> </tr> <tr> <td></td> <td></td> <td colspan="8" style="text-align: center;"> <table border="1" style="width: 100%; border-collapse: collapse; text-align: center;"> <tr> <td style="width: 10%;"></td> <td style="width: 10%;"></td> <td style="width: 10%;"></td> <td style="width: 10%;"></td> <td style="width: 10%;"></td> <td style="width: 10%;"></td> <td style="width: 10%;"></td> <td style="width: 10%;"></td> <td style="width: 10%;"></td> <td style="width: 10%;"></td> </tr> <tr> <td></td> <td></td> <td colspan="8" style="text-align: center;"> <table border="1" style="width: 100%; border-collapse: collapse; text-align: center;"> <tr> <td style="width: 10%;"></td> <td style="width: 10%;"></td> <td style="width: 10%;"></td> <td style="width: 10%;"></td> <td style="width: 10%;"></td> <td style="width: 10%;"></td> <td style="width: 10%;"></td> <td style="width: 10%;"></td> <td style="width: 10%;"></td> <td style="width: 10%;"></td> </tr> <tr> <td></td> <td></td> <td colspan="8" style="text-align: center;"> <table border="1" style="width: 100%; border-collapse: collapse; text-align: center;"> <tr> <td style="width: 10%;"></td> <td style="width: 10%;"></td> <td style="width: 10%;"></td> <td style="width: 10%;"></td> <td style="width: 10%;"></td> <td style="width: 10%;"></td> <td style="width: 10%;"></td> <td style="width: 10%;"></td> <td style="width: 10%;"></td> <td style="width: 10%;"></td> </tr> <tr> <td></td> <td></td> <td colspan="8" style="text-align: center;"> <table border="1" style="width: 100%; border-collapse: collapse; text-align: center;"> <tr> <td style="width: 10%;"></td> <td style="width: 10%;"></td> <td style="width: 10%;"></td> <td style="width: 10%;"></td> <td style="width: 10%;"></td> <td style="width: 10%;"></td> <td style="width: 10%;"></td> <td style="width: 10%;"></td> <td style="width: 10%;"></td> <td style="width: 10%;"></td> </tr> <tr> <td></td> <td></td> <td colspan="8" style="text-align: center;"> <table border="1" style="width: 100%; border-collapse: collapse; text-align: center;"> <tr> <td style="width: 10%;"></td> <td style="width: 10%;"></td> <td style="width: 10%;"></td> <td style="width: 10%;"></td> <td style="width: 10%;"></td> <td style="width: 10%;"></td> <td style="width: 10%;"></td> <td style="width: 10%;"></td> <td style="width: 10%;"></td> <td style="width: 10%;"></td> </tr> <tr> <td></td> <td></td> <td colspan="8" style="text-align: center;"> <table border="1" style="width: 100%; border-collapse: collapse; text-align: center;"> <tr> <td style="width: 10%;"></td> <td style="width: 10%;"></td> <td style="width: 10%;"></td> <td style="width: 10%;"></td> <td style="width: 10%;"></td> <td style="width: 10%;"></td> <td style="width: 10%;"></td> <td style="width: 10%;"></td> <td style="width: 10%;"></td> <td style="width: 10%;"></td> </tr> <tr> <td></td> <td></td> <td colspan="8" style="text-align: center;"> <table border="1" style="width: 100%; border-collapse: collapse; text-align: center;"> <tr> <td style="width: 10%;"></td> <td style="width: 10%;"></td> <td style="width: 10%;"></td> <td style="width: 10%;"></td> <td style="width: 10%;"></td> <td style="width: 10%;"></td> <td style="width: 10%;"></td> <td style="width: 10%;"></td> <td style="width: 10%;"></td> <td style="width: 10%;"></td> </tr> <tr> <td></td> <td></td> <td colspan="8" style="text-align: center;"> <table border="1" style="width: 100%; border-collapse: collapse; text-align: center;"> <tr> <td style="width: 10%;"></td> <td style="width: 10%;"></td> <td style="width: 10%;"></td> <td style="width: 10%;"></td> <td style="width: 10%;"></td> <td style="width: 10%;"></td> <td style="width: 10%;"></td> <td style="width: 10%;"></td> <td style="width: 10%;"></td> <td style="width: 10%;"></td> </tr> <tr> <td></td> <td></td> <td colspan="8" style="text-align: center;"> <table border="1" style="width: 100%; border-collapse: collapse; text-align: center;"> <tr> <td style="width: 10%;"></td> <td style="width: 10%;"></td> <td style="width: 10%;"></td> <td style="width: 10%;"></td> <td style="width: 10%;"></td> <td style="width: 10%;"></td> <td style="width: 10%;"></td> <td style="width: 10%;"></td> <td style="width: 10%;"></td> <td style="width: 10%;"></td> </tr> <tr> <td></td> <td></td> <td colspan="8" style="text-align: center;"> <table border="1" style="width: 100%; border-collapse: collapse; text-align: center;"> <tr> <td style="width: 10%;"></td> <td style="width: 10%;"></td> <td style="width: 10%;"></td> <td style="width: 10%;"></td> <td style="width: 10%;"></td> <td style="width: 10%;"></td> <td style="width: 10%;"></td> <td style="width: 10%;"></td> <td style="width: 10%;"></td> <td style="width: 10%;"></td> </tr> <tr> <td></td> <td></td> <td colspan="8" style="text-align: center;"> <table border="1" style="width: 100%; border-collapse: collapse; text-align: center;"> <tr> <td style="width: 10%;"></td> <td style="width: 10%;"></td> <td style="width: 10%;"></td> <td style="width: 10%;"></td> <td style="width: 10%;"></td> <td style="width: 10%;"></td> <td style="width: 10%;"></td> <td style="width: 10%;"></td> <td style="width: 10%;"></td> <td style="width: 10%;"></td> </tr> <tr> <td></td> <td></td> <td colspan="8" style="text-align: center;"> <table border="1" style="width: 100%; border-collapse: collapse; text-align: center;"> <tr> <td style="width: 10%;"></td> <td style="width: 10%;"></td> <td style="width: 10%;"></td> <td style="width: 10%;"></td> <td style="width: 10%;"></td> <td style="width: 10%;"></td> <td style="width: 10%;"></td> <td style="width: 10%;"></td> <td style="width: 10%;"></td> <td style="width: 10%;"></td> </tr> <tr> <td></td> <td></td> <td colspan="8" style="text-align: center;"> <table border="1" style="width: 100%; border-collapse: collapse; text-align: center;"> <tr> <td style="width: 10%;"></td> <td style="width: 10%;"></td> <td style="width: 10%;"></td> <td style="width: 10%;"></td> <td style="width: 10%;"></td> <td style="width: 10%;"></td> <td style="width: 10%;"></td> <td style="width: 10%;"></td> <td style="width: 10%;"></td> <td style="width: 10%;"></td> </tr> <tr> <td></td> <td></td> <td colspan="8" style="text-align: center;"> <table border="1" style="width: 100%; border-collapse: collapse; text-align: center;"> <tr> <td style="width: 10%;"></td> <td style="width: 10%;"></td> <td style="width: 10%;"></td> <td style="width: 10%;"></td> <td style="width: 10%;"></td> <td style="width: 10%;"></td> <td style="width: 10%;"></td> <td style="width: 10%;"></td> <td style="width: 10%;"></td> <td style="width: 10%;"></td> </tr> <tr> <td></td> <td></td> <td colspan="8" style="text-align: center;"> <table border="1" style="width: 100%; border-collapse: collapse; text-align: center;"> <tr> <td style="width: 10%;"></td> <td style="width: 10%;"></td> <td style="width: 10%;"></td> <td style="width: 10%;"></td> <td style="width: 10%;"></td> <td style="width: 10%;"></td> <td style="width: 10%;"></td> <td style="width: 10%;"></td> <td style="width: 10%;"></td> <td style="width: 10%;"></td> </tr> <tr> <td></td> <td></td> <td colspan="8" style="text-align: center;"> <table border="1" style="width: 100%; border-collapse: collapse; text-align: center;"> <tr> <td style="width: 10%;"></td> <td style="width: 10%;"></td> <td style="width: 10%;"></td> <td style="width: 10%;"></td> <td style="width: 10%;"></td> <td style="width: 10%;"></td> <td style="width: 10%;"></td> <td style="width: 10%;"></td> <td style="width: 10%;"></td> <td style="width: 10%;"></td> </tr> <tr> <td></td> <td></td> <td colspan="8" style="text-align: center;"> <table border="1" style="width: 100%; border-collapse: collapse; text-align: center;"> <tr> <td style="width: 10%;"></td> <td style="width: 10%;"></td> <td style="width: 10%;"></td> <td
style="width: 10%;"></td> <td style="width: 10%;"></td> <td style="width: 10%;"></td> <td style="width: 10%;"></td> <td style="width: 10%;"></td> <td style="width: 10%;"></td> <td style="width: 10%;"></td> </tr> <tr> <td></td> <td></td> <td colspan="8" style="text-align: center;"> <table border="1" style="width: 100%; border-collapse: collapse; text-align: center;"> <tr> <td style="width: 10%;"></td> <td style="width: 10%;"></td> <td style="width: 10%;"></td> <td style="width: 10%;"></td> <td style="width: 10%;"></td> <td style="width: 10%;"></td> <td style="width: 10%;"></td> <td style="width: 10%;"></td> <td style="width: 10%;"></td> <td style="width: 10%;"></td> </tr> <tr> <td></td> <td></td> <td colspan="8" style="text-align: center;"> <table border="1" style="width: 100%; border-collapse: collapse; text-align: center;"> <tr> <td style="width: 10%;"></td> <td style="width: 10%;"></td> <td style="width: 10%;"></td> <td style="width: 10%;"></td> <td style="width: 10%;"></td> <td style="width: 10%;"></td> <td style="width: 10%;"></td> <td style="width: 10%;"></td> <td style="width: 10%;"></td> <td style="width: 10%;"></td> </tr> <tr> <td></td> <td></td> <td colspan="8" style="text-align: center;"> <table border="1" style="width: 100%; border-collapse: collapse; text-align: center;"> <tr> <td style="width: 10%;"></td> <td style="width: 10%;"></td> <td style="width: 10%;"></td> <td style="width: 10%;"></td> <td style="width: 10%;"></td> <td style="width: 10%;"></td> <td style="width: 10%;"></td> <td style="width: 10%;"></td> <td style="width: 10%;"></td> <td style="width: 10%;"></td> </tr> <tr> <td></td> <td></td> <td colspan="8" style="text-align: center;"> <table border="1" style="width: 100%; border-collapse: collapse; text-align: center;"> <tr> </tr></table></td></tr></table></td></tr></table></td></tr></table></td></tr></table></td></tr></table></td></tr></table></td></tr></table></td></tr></table></td></tr></table></td></tr></table></td></tr></table></td></tr></table></td></tr></table></td></tr></table></td></tr></table></td></tr></table></td></tr></table></td></tr></table></td></tr></table></td></tr></table></td></tr></table></td></tr></table></td></tr></table>
 | | | | | | | | | | | | | | | | | | | | <table border="1" style="width: 100%; border-collapse: collapse; text-align: center;"> <tr> <td style="width: 10%;"></td> <td style="width: 10%;"></td> <td style="width: 10%;"></td> <td style="width: 10%;"></td> <td style="width: 10%;"></td> <td style="width: 10%;"></td> <td style="width: 10%;"></td> <td style="width: 10%;"></td> <td style="width: 10%;"></td> <td style="width: 10%;"></td> </tr> <tr> <td></td> <td></td> <td colspan="8" style="text-align: center;"> <table border="1" style="width: 100%; border-collapse: collapse; text-align: center;"> <tr> <td style="width: 10%;"></td> <td style="width: 10%;"></td> <td style="width: 10%;"></td> <td style="width: 10%;"></td> <td style="width: 10%;"></td> <td style="width: 10%;"></td> <td style="width: 10%;"></td> <td style="width: 10%;"></td> <td style="width: 10%;"></td> <td style="width: 10%;"></td> </tr> <tr> <td></td> <td></td> <td colspan="8" style="text-align: center;"> <table border="1" style="width: 100%; border-collapse: collapse; text-align: center;"> <tr> <td style="width: 10%;"></td> <td style="width: 10%;"></td> <td style="width: 10%;"></td> <td style="width: 10%;"></td> <td style="width: 10%;"></td> <td style="width: 10%;"></td> <td style="width: 10%;"></td> <td style="width: 10%;"></td> <td style="width: 10%;"></td> <td style="width: 10%;"></td> </tr> <tr> <td></td> <td></td> <td colspan="8" style="text-align: center;"> <table border="1" style="width: 100%; border-collapse: collapse; text-align: center;"> <tr> <td style="width: 10%;"></td> <td style="width: 10%;"></td> <td style="width: 10%;"></td> <td style="width: 10%;"></td> <td style="width: 10%;"></td> <td style="width: 10%;"></td> <td style="width: 10%;"></td> <td style="width: 10%;"></td> <td style="width: 10%;"></td> <td style="width: 10%;"></td> </tr> <tr> <td></td> <td></td> <td colspan="8" style="text-align: center;"> <table border="1" style="width: 100%; border-collapse: collapse; text-align: center;"> <tr> <td style="width: 10%;"></td> <td style="width: 10%;"></td> <td style="width: 10%;"></td> <td style="width: 10%;"></td> <td style="width: 10%;"></td> <td style="width: 10%;"></td> <td style="width: 10%;"></td> <td style="width: 10%;"></td> <td style="width: 10%;"></td> <td style="width: 10%;"></td> </tr> <tr> <td></td> <td></td> <td colspan="8" style="text-align: center;"> <table border="1" style="width: 100%; border-collapse: collapse; text-align: center;"> <tr> <td style="width: 10%;"></td> <td style="width: 10%;"></td> <td style="width: 10%;"></td> <td style="width: 10%;"></td> <td style="width: 10%;"></td> <td style="width: 10%;"></td> <td style="width: 10%;"></td> <td style="width:
10%;"></td> <td style="width: 10%;"></td> <td style="width: 10%;"></td> </tr> <tr> <td></td> <td></td> <td colspan="8" style="text-align: center;"> <table border="1" style="width: 100%; border-collapse: collapse; text-align: center;"> <tr> <td style="width: 10%;"></td> <td style="width: 10%;"></td> <td style="width: 10%;"></td> <td style="width: 10%;"></td> <td style="width: 10%;"></td> <td style="width: 10%;"></td> <td style="width: 10%;"></td> <td style="width: 10%;"></td> <td style="width: 10%;"></td> <td style="width: 10%;"></td> </tr> <tr> <td></td> <td></td> <td colspan="8" style="text-align: center;"> <table border="1" style="width: 100%; border-collapse: collapse; text-align: center;"> <tr> <td style="width: 10%;"></td> <td style="width: 10%;"></td> <td style="width: 10%;"></td> <td style="width: 10%;"></td> <td style="width: 10%;"></td> <td style="width: 10%;"></td> <td style="width: 10%;"></td> <td style="width: 10%;"></td> <td style="width: 10%;"></td> <td style="width: 10%;"></td> </tr> <tr> <td></td> <td></td> <td colspan="8" style="text-align: center;"> <table border="1" style="width: 100%; border-collapse: collapse; text-align: center;"> <tr> <td style="width: 10%;"></td> <td style="width: 10%;"></td> <td style="width: 10%;"></td> <td style="width: 10%;"></td> <td style="width: 10%;"></td> <td style="width: 10%;"></td> <td style="width: 10%;"></td> <td style="width: 10%;"></td> <td style="width: 10%;"></td> <td style="width: 10%;"></td> </tr> <tr> <td></td> <td></td> <td colspan="8" style="text-align: center;"> <table border="1" style="width: 100%; border-collapse: collapse; text-align: center;"> <tr> <td style="width: 10%;"></td> <td style="width: 10%;"></td> <td style="width: 10%;"></td> <td style="width: 10%;"></td> <td style="width: 10%;"></td> <td style="width: 10%;"></td> <td style="width: 10%;"></td> <td style="width: 10%;"></td> <td style="width: 10%;"></td> <td style="width: 10%;"></td> </tr> <tr> <td></td> <td></td> <td colspan="8" style="text-align: center;"> <table border="1" style="width: 100%; border-collapse: collapse; text-align: center;"> <tr> <td style="width: 10%;"></td> <td style="width: 10%;"></td> <td style="width: 10%;"></td> <td style="width: 10%;"></td> <td style="width: 10%;"></td> <td style="width: 10%;"></td> <td style="width: 10%;"></td> <td style="width: 10%;"></td> <td style="width: 10%;"></td> <td style="width: 10%;"></td> </tr> <tr> <td></td> <td></td> <td colspan="8" style="text-align: center;"> <table border="1" style="width: 100%; border-collapse: collapse; text-align: center;"> <tr> <td style="width: 10%;"></td> <td style="width: 10%;"></td> <td style="width: 10%;"></td> <td style="width: 10%;"></td> <td style="width: 10%;"></td> <td style="width: 10%;"></td> <td style="width: 10%;"></td> <td style="width: 10%;"></td> <td style="width: 10%;"></td> <td style="width: 10%;"></td> </tr> <tr> <td></td> <td></td> <td colspan="8" style="text-align: center;"> <table border="1" style="width: 100%; border-collapse: collapse; text-align: center;"> <tr> <td style="width: 10%;"></td> <td style="width: 10%;"></td> <td style="width: 10%;"></td> <td style="width: 10%;"></td> <td style="width: 10%;"></td> <td style="width: 10%;"></td> <td style="width: 10%;"></td> <td style="width: 10%;"></td> <td style="width: 10%;"></td> <td style="width: 10%;"></td> </tr> <tr> <td></td> <td></td> <td colspan="8" style="text-align: center;"> <table border="1" style="width: 100%; border-collapse: collapse; text-align: center;"> <tr> <td style="width: 10%;"></td> <td style="width: 10%;"></td> <td style="width: 10%;"></td> <td style="width: 10%;"></td> <td style="width: 10%;"></td> <td style="width: 10%;"></td> <td style="width: 10%;"></td> <td style="width: 10%;"></td> <td style="width: 10%;"></td> <td style="width: 10%;"></td> </tr> <tr> <td></td> <td></td> <td colspan="8" style="text-align: center;"> <table border="1" style="width: 100%; border-collapse: collapse; text-align: center;"> <tr> <td style="width: 10%;"></td> <td style="width: 10%;"></td> <td style="width: 10%;"></td> <td style="width: 10%;"></td> <td style="width: 10%;"></td> <td style="width: 10%;"></td> <td style="width: 10%;"></td> <td style="width: 10%;"></td> <td style="width: 10%;"></td> <td style="width: 10%;"></td> </tr> <tr> <td></td> <td></td> <td colspan="8" style="text-align: center;"> <table border="1" style="width: 100%; border-collapse: collapse; text-align: center;"> <tr> <td style="width: 10%;"></td> <td style="width: 10%;"></td> <td style="width: 10%;"></td> <td style="width: 10%;"></td> <td style="width: 10%;"></td> <td style="width: 10%;"></td> <td style="width: 10%;"></td> <td style="width: 10%;"></td> <td style="width: 10%;"></td> <td style="width: 10%;"></td> </tr> <tr> <td></td> <td></td> <td colspan="8" style="text-align: center;"> <table border="1" style="width: 100%; border-collapse: collapse; text-align: center;"> <tr> <td style="width: 10%;"></td> <td style="width: 10%;"></td> <td style="width: 10%;"></td> <td style="width: 10%;"></td> <td style="width: 10%;"></td> <td style="width: 10%;"></td> <td style="width: 10%;"></td> <td style="width: 10%;"></td> <td style="width: 10%;"></td> <td style="width: 10%;"></td> </tr> <tr> <td></td> <td></td> <td colspan="8" style="text-align: center;"> <table border="1" style="width: 100%; border-collapse: collapse; text-align: center;"> <tr> <td style="width: 10%;"></td> <td style="width: 10%;"></td> <td style="width: 10%;"></td> <td style="width: 10%;"></td> <td style="width: 10%;"></td> <td style="width: 10%;"></td> <td style="width: 10%;"></td> <td style="width: 10%;"></td> <td style="width: 10%;"></td> <td style="width: 10%;"></td> </tr> <tr> <td></td> <td></td> <td colspan="8" style="text-align: center;"> <table border="1" style="width: 100%; border-collapse: collapse; text-align: center;"> <tr> <td style="width: 10%;"></td> <td style="width: 10%;"></td> <td style="width: 10%;"></td> <td style="width: 10%;"></td> <td style="width: 10%;"></td> <td style="width: 10%;"></td> <td style="width: 10%;"></td> <td style="width: 10%;"></td> <td style="width: 10%;"></td> <td style="width: 10%;"></td> </tr> <tr> <td></td> <td></td> <td colspan="8" style="text-align: center;"> <table border="1" style="width: 100%; border-collapse: collapse; text-align: center;"> <tr> <td style="width: 10%;"></td> <td style="width: 10%;"></td> <td style="width: 10%;"></td> <td style="width: 10%;"></td> <td style="width: 10%;"></td> <td style="width: 10%;"></td> <td style="width: 10%;"></td> <td style="width: 10%;"></td> <td style="width: 10%;"></td> <td style="width: 10%;"></td> </tr> <tr> <td></td> <td></td> <td colspan="8" style="text-align: center;"> <table border="1" style="width: 100%; border-collapse: collapse; text-align: center;"> <tr> <td style="width: 10%;"></td> <td style="width: 10%;"></td> <td style="width: 10%;"></td> <td style="width: 10%;"></td> <td style="width: 10%;"></td> <td style="width: 10%;"></td> <td style="width: 10%;"></td> <td style="width: 10%;"></td> <td style="width: 10%;"></td> <td style="width: 10%;"></td> </tr> <tr> <td></td> <td></td> <td colspan="8" style="text-align: center;"> <table border="1" style="width: 100%; border-collapse: collapse; text-align: center;"> <tr> <td style="width: 10%;"></td> <td style="width: 10%;"></td> <td style="width: 10%;"></td> <td style="width: 10%;"></td> <td style="width: 10%;"></td> <td style="width: 10%;"></td> <td style="width: 10%;"></td> <td style="width: 10%;"></td> <td style="width: 10%;"></td> <td style="width: 10%;"></td> </tr> <tr> <td></td> <td></td> <td colspan="8" style="text-align: center;"> <table border="1" style="width: 100%; border-collapse: collapse; text-align: center;"> <tr> </tr></table></td></tr></table></td></tr></table></td></tr></table></td></tr></table></td></tr></table></td></tr></table></td></tr></table></td></tr></table></td></tr></table></td></tr></table></td></tr></table></td></tr></table></td></tr></table></td></tr></table></td></tr></table></td></tr></table></td></tr></table></td></tr></table></td></tr></table></td></tr></table></td></tr></table></td></tr></table>

 | | | | | | | | | | | | | | | | | | | | <table border="1" style="width: 100%; border-collapse: collapse; text-align: center;"> <tr> <td style="width: 10%;"></td> <td style="width: 10%;"></td> <td style="width: 10%;"></td> <td style="width: 10%;"></td> <td style="width: 10%;"></td> <td style="width: 10%;"></td> <td style="width: 10%;"></td> <td style="width: 10%;"></td> <td style="width: 10%;"></td> <td style="width: 10%;"></td> </tr> <tr> <td></td> <td></td> <td colspan="8" style="text-align: center;"> <table border="1" style="width: 100%; border-collapse: collapse; text-align: center;"> <tr> <td style="width: 10%;"></td> <td style="width: 10%;"></td> <td style="width: 10%;"></td> <td style="width: 10%;"></td> <td style="width: 10%;"></td> <td style="width: 10%;"></td> <td style="width: 10%;"></td> <td style="width: 10%;"></td> <td style="width: 10%;"></td> <td style="width: 10%;"></td> </tr> <tr> <td></td> <td></td> <td colspan="8" style="text-align: center;"> <table border="1" style="width: 100%; border-collapse: collapse; text-align: center;"> <tr> <td style="width: 10%;"></td> <td style="width: 10%;"></td> <td style="width: 10%;"></td> <td style="width: 10%;"></td> <td style="width: 10%;"></td> <td style="width: 10%;"></td> <td style="width: 10%;"></td> <td style="width: 10%;"></td> <td style="width: 10%;"></td> <td style="width: 10%;"></td> </tr> <tr> <td></td> <td></td> <td colspan="8" style="text-align: center;"> <table border="1" style="width: 100%; border-collapse: collapse; text-align: center;"> <tr> <td style="width: 10%;"></td> <td style="width: 10%;"></td> <td style="width: 10%;"></td> <td style="width: 10%;"></td> <td style="width: 10%;"></td> <td style="width: 10%;"></td> <td style="width: 10%;"></td> <td style="width: 10%;"></td> <td style="width: 10%;"></td> <td style="width: 10%;"></td> </tr> <tr> <td></td> <td></td> <td colspan="8" style="text-align: center;"> <table border="1" style="width: 100%; border-collapse: collapse; text-align: center;"> <tr> <td style="width: 10%;"></td> <td style="width: 10%;"></td> <td style="width: 10%;"></td> <td style="width: 10%;"></td> <td style="width: 10%;"></td> <td style="width: 10%;"></td> <td style="width: 10%;"></td> <td style="width: 10%;"></td> <td style="width: 10%;"></td> <td style="width: 10%;"></td> </tr> <tr> <td></td> <td></td> <td colspan="8" style="text-align: center;"> <table border="1" style="width: 100%; border-collapse: collapse; text-align: center;"> <tr> <td style="width: 10%;"></td> <td style="width: 10%;"></td> <td style="width: 10%;"></td> <td style="width: 10%;"></td> <td style="width: 10%;"></td> <td style="width: 10%;"></td> <td style="width: 10%;"></td> <td style="width: 10%;"></td> <td style="width: 10%;"></td> <td style="width: 10%;"></td> </tr> <tr> <td></td> <td></td> <td colspan="8" style="text-align: center;"> <table border="1" style="width: 100%; border-collapse: collapse; text-align: center;"> <tr> <td style="width: 10%;"></td> <td style="width: 10%;"></td> <td style="width: 10%;"></td> <td style="width: 10%;"></td> <td style="width: 10%;"></td> <td style="width: 10%;"></td> <td style="width: 10%;"></td> <td style="width: 10%;"></td> <td style="width: 10%;"></td> <td style="width: 10%;"></td> </tr> <tr> <td></td> <td></td> <td colspan="8" style="text-align: center;"> <table border="1" style="width: 100%; border-collapse: collapse; text-align: center;"> <tr> <td style="width: 10%;"></td> <td style="width: 10%;"></td> <td style="width: 10%;"></td> <td style="width: 10%;"></td> <td style="width: 10%;"></td> <td style="width: 10%;"></td> <td style="width: 10%;"></td> <td style="width: 10%;"></td> <td style="width: 10%;"></td> <td style="width: 10%;"></td> </tr> <tr> <td></td> <td></td> <td colspan="8" style="text-align: center;"> <table border="1" style="width: 100%; border-collapse: collapse; text-align: center;"> <tr> <td style="width: 10%;"></td> <td style="width: 10%;"></td> <td style="width: 10%;"></td> <td style="width: 10%;"></td> <td style="width: 10%;"></td> <td style="width: 10%;"></td> <td style="width: 10%;"></td> <td style="width: 10%;"></td> <td style="width: 10%;"></td> <td style="width: 10%;"></td> </tr> <tr> <td></td> <td></td> <td colspan="8" style="text-align: center;"> <table border="1" style="width: 100%; border-collapse: collapse; text-align: center;"> <tr> <td style="width: 10%;"></td> <td style="width: 10%;"></td> <td style="width: 10%;"></td> <td style="width: 10%;"></td> <td style="width: 10%;"></td> <td style="width: 10%;"></td> <td style="width: 10%;"></td> <td style="width: 10%;"></td> <td style="width: 10%;"></td> <td style="width: 10%;"></td> </tr> <tr> <td></td> <td></td> <td colspan="8" style="text-align: center;"> <table border="1" style="width: 100%; border-collapse: collapse; text-align: center;"> <tr> <td style="width: 10%;"></td> <td style="width: 10%;"></td> <td style="width: 10%;"></td> <td style="width: 10%;"></td> <td style="width: 10%;"></td> <td style="width: 10%;"></td> <td style="width: 10%;"></td> <td style="width: 10%;"></td> <td style="width: 10%;"></td> <td style="width: 10%;"></td> </tr> <tr> <td></td> <td></td> <td colspan="8" style="text-align: center;"> <table border="1" style="width: 100%; border-collapse: collapse; text-align: center;"> <tr> <td style="width: 10%;"></td> <td style="width: 10%;"></td> <td style="width: 10%;"></td> <td style="width: 10%;"></td> <td style="width: 10%;"></td> <td style="width: 10%;"></td> <td style="width: 10%;"></td> <td style="width: 10%;"></td> <td style="width: 10%;"></td> <td style="width: 10%;"></td> </tr> <tr> <td></td> <td></td> <td colspan="8" style="text-align: center;"> <table border="1" style="width: 100%; border-collapse: collapse; text-align: center;"> <tr> <td style="width: 10%;"></td> <td style="width: 10%;"></td> <td style="width: 10%;"></td> <td style="width: 10%;"></td> <td style="width: 10%;"></td> <td style="width: 10%;"></td> <td style="width: 10%;"></td> <td style="width: 10%;"></td> <td style="width: 10%;"></td> <td style="width: 10%;"></td> </tr> <tr> <td></td> <td></td> <td colspan="8" style="text-align: center;"> <table border="1" style="width: 100%; border-collapse: collapse; text-align: center;"> <tr> <td style="width: 10%;"></td> <td style="width: 10%;"></td> <td style="width: 10%;"></td> <td style="width: 10%;"></td> <td style="width: 10%;"></td> <td style="width: 10%;"></td> <td style="width: 10%;"></td> <td style="width: 10%;"></td> <td style="width: 10%;"></td> <td style="width: 10%;"></td> </tr> <tr> <td></td> <td></td> <td colspan="8" style="text-align: center;"> <table border="1" style="width: 100%; border-collapse: collapse; text-align: center;"> <tr> <td style="width: 10%;"></td> <td style="width: 10%;"></td> <td style="width: 10%;"></td>
<td style="width: 10%;"></td> <td style="width: 10%;"></td> <td style="width: 10%;"></td> <td style="width: 10%;"></td> <td style="width: 10%;"></td> <td style="width: 10%;"></td> <td style="width: 10%;"></td> </tr> <tr> <td></td> <td></td> <td colspan="8" style="text-align: center;"> <table border="1" style="width: 100%; border-collapse: collapse; text-align: center;"> <tr> <td style="width: 10%;"></td> <td style="width: 10%;"></td> <td style="width: 10%;"></td> <td style="width: 10%;"></td> <td style="width: 10%;"></td> <td style="width: 10%;"></td> <td style="width: 10%;"></td> <td style="width: 10%;"></td> <td style="width: 10%;"></td> <td style="width: 10%;"></td> </tr> <tr> <td></td> <td></td> <td colspan="8" style="text-align: center;"> <table border="1" style="width: 100%; border-collapse: collapse; text-align: center;"> <tr> <td style="width: 10%;"></td> <td style="width: 10%;"></td> <td style="width: 10%;"></td> <td style="width: 10%;"></td> <td style="width: 10%;"></td> <td style="width: 10%;"></td> <td style="width: 10%;"></td> <td style="width: 10%;"></td> <td style="width: 10%;"></td> <td style="width: 10%;"></td> </tr> <tr> <td></td> <td></td> <td colspan="8" style="text-align: center;"> <table border="1" style="width: 100%; border-collapse: collapse; text-align: center;"> <tr> <td style="width: 10%;"></td> <td style="width: 10%;"></td> <td style="width: 10%;"></td> <td style="width: 10%;"></td> <td style="width: 10%;"></td> <td style="width: 10%;"></td> <td style="width: 10%;"></td> <td style="width: 10%;"></td> <td style="width: 10%;"></td> <td style="width: 10%;"></td> </tr> <tr> <td></td> <td></td> <td colspan="8" style="text-align: center;"> <table border="1" style="width: 100%; border-collapse: collapse; text-align: center;"> <tr> <td style="width: 10%;"></td> <td style="width: 10%;"></td> <td style="width: 10%;"></td> <td style="width: 10%;"></td> <td style="width: 10%;"></td> <td style="width: 10%;"></td> <td style="width: 10%;"></td> <td style="width: 10%;"></td> <td style="width: 10%;"></td> <td style="width: 10%;"></td> </tr> <tr> <td></td> <td></td> <td colspan="8" style="text-align: center;"> <table border="1" style="width: 100%; border-collapse: collapse; text-align: center;"> <tr> <td style="width: 10%;"></td> <td style="width: 10%;"></td> <td style="width: 10%;"></td> <td style="width: 10%;"></td> <td style="width: 10%;"></td> <td style="width: 10%;"></td> <td style="width: 10%;"></td> <td style="width: 10%;"></td> <td style="width: 10%;"></td> <td style="width: 10%;"></td> </tr> <tr> <td></td> <td></td> <td colspan="8" style="text-align: center;"> <table border="1" style="width: 100%; border-collapse: collapse; text-align: center;"> <tr> <td style="width: 10%;"></td> <td style="width: 10%;"></td> <td style="width: 10%;"></td> <td style="width: 10%;"></td> <td style="width: 10%;"></td> <td style="width: 10%;"></td> <td style="width: 10%;"></td> <td style="width: 10%;"></td> <td style="width: 10%;"></td> <td style="width: 10%;"></td> </tr> <tr> <td></td> <td></td> <td colspan="8" style="text-align: center;"> <table border="1" style="width: 100%; border-collapse: collapse; text-align: center;"> <tr> </tr></table></td></tr></table></td></tr></table></td></tr></table></td></tr></table></td></tr></table></td></tr></table></td></tr></table></td></tr></table></td></tr></table></td></tr></table></td></tr></table></td></tr></table></td></tr></table></td></tr></table></td></tr></table></td></tr></table></td></tr></table></td></tr></table></td></tr></table></td></tr></table></td></tr></table>
 | | | | | | | | | | | | | | | | | | | | <table border="1" style="width: 100%; border-collapse: collapse; text-align: center;"> <tr> <td style="width: 10%;"></td> <td style="width: 10%;"></td> <td style="width: 10%;"></td> <td style="width: 10%;"></td> <td style="width: 10%;"></td> <td style="width: 10%;"></td> <td style="width: 10%;"></td> <td style="width: 10%;"></td> <td style="width: 10%;"></td> <td style="width: 10%;"></td> </tr> <tr> <td></td> <td></td> <td colspan="8" style="text-align: center;"> <table border="1" style="width: 100%; border-collapse: collapse; text-align: center;"> <tr> <td style="width: 10%;"></td> <td style="width: 10%;"></td> <td style="width: 10%;"></td> <td style="width: 10%;"></td> <td style="width: 10%;"></td> <td style="width: 10%;"></td> <td style="width: 10%;"></td> <td style="width: 10%;"></td> <td style="width: 10%;"></td> <td style="width: 10%;"></td> </tr> <tr> <td></td> <td></td> <td colspan="8" style="text-align: center;"> <table border="1" style="width: 100%; border-collapse: collapse; text-align: center;"> <tr> <td style="width: 10%;"></td> <td style="width: 10%;"></td> <td style="width: 10%;"></td> <td style="width: 10%;"></td> <td style="width: 10%;"></td> <td style="width: 10%;"></td> <td style="width: 10%;"></td> <td style="width: 10%;"></td> <td style="width:
10%;"></td> <td style="width: 10%;"></td> </tr> <tr> <td></td> <td></td> <td colspan="8" style="text-align: center;"> <table border="1" style="width: 100%; border-collapse: collapse; text-align: center;"> <tr> <td style="width: 10%;"></td> <td style="width: 10%;"></td> <td style="width: 10%;"></td> <td style="width: 10%;"></td> <td style="width: 10%;"></td> <td style="width: 10%;"></td> <td style="width: 10%;"></td> <td style="width: 10%;"></td> <td style="width: 10%;"></td> <td style="width: 10%;"></td> </tr> <tr> <td></td> <td></td> <td colspan="8" style="text-align: center;"> <table border="1" style="width: 100%; border-collapse: collapse; text-align: center;"> <tr> <td style="width: 10%;"></td> <td style="width: 10%;"></td> <td style="width: 10%;"></td> <td style="width: 10%;"></td> <td style="width: 10%;"></td> <td style="width: 10%;"></td> <td style="width: 10%;"></td> <td style="width: 10%;"></td> <td style="width: 10%;"></td> <td style="width: 10%;"></td> </tr> <tr> <td></td> <td></td> <td colspan="8" style="text-align: center;"> <table border="1" style="width: 100%; border-collapse: collapse; text-align: center;"> <tr> <td style="width: 10%;"></td> <td style="width: 10%;"></td> <td style="width: 10%;"></td> <td style="width: 10%;"></td> <td style="width: 10%;"></td> <td style="width: 10%;"></td> <td style="width: 10%;"></td> <td style="width: 10%;"></td> <td style="width: 10%;"></td> <td style="width: 10%;"></td> </tr> <tr> <td></td> <td></td> <td colspan="8" style="text-align: center;"> <table border="1" style="width: 100%; border-collapse: collapse; text-align: center;"> <tr> <td style="width: 10%;"></td> <td style="width: 10%;"></td> <td style="width: 10%;"></td> <td style="width: 10%;"></td> <td style="width: 10%;"></td> <td style="width: 10%;"></td> <td style="width: 10%;"></td> <td style="width: 10%;"></td> <td style="width: 10%;"></td> <td style="width: 10%;"></td> </tr> <tr> <td></td> <td></td> <td colspan="8" style="text-align: center;"> <table border="1" style="width: 100%; border-collapse: collapse; text-align: center;"> <tr> <td style="width: 10%;"></td> <td style="width: 10%;"></td> <td style="width: 10%;"></td> <td style="width: 10%;"></td> <td style="width: 10%;"></td> <td style="width: 10%;"></td> <td style="width: 10%;"></td> <td style="width: 10%;"></td> <td style="width: 10%;"></td> <td style="width: 10%;"></td> </tr> <tr> <td></td> <td></td> <td colspan="8" style="text-align: center;"> <table border="1" style="width: 100%; border-collapse: collapse; text-align: center;"> <tr> <td style="width: 10%;"></td> <td style="width: 10%;"></td> <td style="width: 10%;"></td> <td style="width: 10%;"></td> <td style="width: 10%;"></td> <td style="width: 10%;"></td> <td style="width: 10%;"></td> <td style="width: 10%;"></td> <td style="width: 10%;"></td> <td style="width: 10%;"></td> </tr> <tr> <td></td> <td></td> <td colspan="8" style="text-align: center;"> <table border="1" style="width: 100%; border-collapse: collapse; text-align: center;"> <tr> <td style="width: 10%;"></td> <td style="width: 10%;"></td> <td style="width: 10%;"></td> <td style="width: 10%;"></td> <td style="width: 10%;"></td> <td style="width: 10%;"></td> <td style="width: 10%;"></td> <td style="width: 10%;"></td> <td style="width: 10%;"></td> <td style="width: 10%;"></td> </tr> <tr> <td></td> <td></td> <td colspan="8" style="text-align: center;"> <table border="1" style="width: 100%; border-collapse: collapse; text-align: center;"> <tr> <td style="width: 10%;"></td> <td style="width: 10%;"></td> <td style="width: 10%;"></td> <td style="width: 10%;"></td> <td style="width: 10%;"></td> <td style="width: 10%;"></td> <td style="width: 10%;"></td> <td style="width: 10%;"></td> <td style="width: 10%;"></td> <td style="width: 10%;"></td> </tr> <tr> <td></td> <td></td> <td colspan="8" style="text-align: center;"> <table border="1" style="width: 100%; border-collapse: collapse; text-align: center;"> <tr> <td style="width: 10%;"></td> <td style="width: 10%;"></td> <td style="width: 10%;"></td> <td style="width: 10%;"></td> <td style="width: 10%;"></td> <td style="width: 10%;"></td> <td style="width: 10%;"></td> <td style="width: 10%;"></td> <td style="width: 10%;"></td> <td style="width: 10%;"></td> </tr> <tr> <td></td> <td></td> <td colspan="8" style="text-align: center;"> <table border="1" style="width: 100%; border-collapse: collapse; text-align: center;"> <tr> <td style="width: 10%;"></td> <td style="width: 10%;"></td> <td style="width: 10%;"></td> <td style="width: 10%;"></td> <td style="width: 10%;"></td> <td style="width: 10%;"></td> <td style="width: 10%;"></td> <td style="width: 10%;"></td> <td style="width: 10%;"></td> <td style="width: 10%;"></td> </tr> <tr> <td></td> <td></td> <td colspan="8" style="text-align: center;"> <table border="1" style="width: 100%; border-collapse: collapse; text-align: center;"> <tr> <td style="width: 10%;"></td> <td style="width: 10%;"></td> <td style="width: 10%;"></td> <td style="width: 10%;"></td> <td style="width: 10%;"></td> <td style="width: 10%;"></td> <td style="width: 10%;"></td> <td style="width: 10%;"></td> <td style="width: 10%;"></td> <td style="width: 10%;"></td> </tr> <tr> <td></td> <td></td> <td colspan="8" style="text-align: center;"> <table border="1" style="width: 100%; border-collapse: collapse; text-align: center;"> <tr> <td style="width: 10%;"></td> <td style="width: 10%;"></td> <td style="width: 10%;"></td> <td style="width: 10%;"></td> <td style="width: 10%;"></td> <td style="width: 10%;"></td> <td style="width: 10%;"></td> <td style="width: 10%;"></td> <td style="width: 10%;"></td> <td style="width: 10%;"></td> </tr> <tr> <td></td> <td></td> <td colspan="8" style="text-align: center;"> <table border="1" style="width: 100%; border-collapse: collapse; text-align: center;"> <tr> <td style="width: 10%;"></td> <td style="width: 10%;"></td> <td style="width: 10%;"></td> <td style="width: 10%;"></td> <td style="width: 10%;"></td> <td style="width: 10%;"></td> <td style="width: 10%;"></td> <td style="width: 10%;"></td> <td style="width: 10%;"></td> <td style="width: 10%;"></td> </tr> <tr> <td></td> <td></td> <td colspan="8" style="text-align: center;"> <table border="1" style="width: 100%; border-collapse: collapse; text-align: center;"> <tr> <td style="width: 10%;"></td> <td style="width: 10%;"></td> <td style="width: 10%;"></td> <td style="width: 10%;"></td> <td style="width: 10%;"></td> <td style="width: 10%;"></td> <td style="width: 10%;"></td> <td style="width: 10%;"></td> <td style="width: 10%;"></td> <td style="width: 10%;"></td> </tr> <tr> <td></td> <td></td> <td colspan="8" style="text-align: center;"> <table border="1" style="width: 100%; border-collapse: collapse; text-align: center;"> <tr> <td style="width: 10%;"></td> <td style="width: 10%;"></td> <td style="width: 10%;"></td> <td style="width: 10%;"></td> <td style="width: 10%;"></td> <td style="width: 10%;"></td> <td style="width: 10%;"></td> <td style="width: 10%;"></td> <td style="width: 10%;"></td> <td style="width: 10%;"></td> </tr> <tr> <td></td> <td></td> <td colspan="8" style="text-align: center;"> <table border="1" style="width: 100%; border-collapse: collapse; text-align: center;"> <tr> <td style="width: 10%;"></td> <td style="width: 10%;"></td> <td style="width: 10%;"></td> <td style="width: 10%;"></td> <td style="width: 10%;"></td> <td style="width: 10%;"></td> <td style="width: 10%;"></td> <td style="width: 10%;"></td> <td style="width: 10%;"></td> <td style="width: 10%;"></td> </tr> <tr> <td></td> <td></td> <td colspan="8" style="text-align: center;"> <table border="1" style="width: 100%; border-collapse: collapse; text-align: center;"> <tr> <td style="width: 10%;"></td> <td style="width: 10%;"></td> <td style="width: 10%;"></td> <td style="width: 10%;"></td> <td style="width: 10%;"></td> <td style="width: 10%;"></td> <td style="width: 10%;"></td> <td style="width: 10%;"></td> <td style="width: 10%;"></td> <td style="width: 10%;"></td> </tr> <tr> <td></td> <td></td> <td colspan="8" style="text-align: center;"> <table border="1" style="width: 100%; border-collapse: collapse; text-align: center;"> <tr> </tr></table></td></tr></table></td></tr></table></td></tr></table></td></tr></table></td></tr></table></td></tr></table></td></tr></table></td></tr></table></td></tr></table></td></tr></table></td></tr></table></td></tr></table></td></tr></table></td></tr></table></td></tr></table></td></tr></table></td></tr></table></td></tr></table></td></tr></table></td></tr></table>

 | | | | | | | | | | | | | | | | | | | | <table border="1" style="width: 100%; border-collapse: collapse; text-align: center;"> <tr> <td style="width: 10%;"></td> <td style="width: 10%;"></td> <td style="width: 10%;"></td> <td style="width: 10%;"></td> <td style="width: 10%;"></td> <td style="width: 10%;"></td> <td style="width: 10%;"></td> <td style="width: 10%;"></td> <td style="width: 10%;"></td> <td style="width: 10%;"></td> </tr> <tr> <td></td> <td></td> <td colspan="8" style="text-align: center;"> <table border="1" style="width: 100%; border-collapse: collapse; text-align: center;"> <tr> <td style="width: 10%;"></td> <td style="width: 10%;"></td> <td style="width: 10%;"></td> <td style="width: 10%;"></td> <td style="width: 10%;"></td> <td style="width: 10%;"></td> <td style="width: 10%;"></td> <td style="width: 10%;"></td> <td style="width: 10%;"></td> <td style="width: 10%;"></td> </tr> <tr> <td></td> <td></td> <td colspan="8" style="text-align: center;"> <table border="1" style="width: 100%; border-collapse: collapse; text-align: center;"> <tr> <td style="width: 10%;"></td> <td style="width: 10%;"></td> <td style="width: 10%;"></td> <td style="width: 10%;"></td> <td style="width: 10%;"></td> <td style="width: 10%;"></td> <td style="width: 10%;"></td> <td style="width: 10%;"></td> <td style="width: 10%;"></td> <td style="width: 10%;"></td> </tr> <tr> <td></td> <td></td> <td colspan="8" style="text-align: center;"> <table border="1" style="width: 100%; border-collapse: collapse; text-align: center;"> <tr> <td style="width: 10%;"></td> <td style="width: 10%;"></td> <td style="width: 10%;"></td> <td style="width: 10%;"></td> <td style="width: 10%;"></td> <td style="width: 10%;"></td> <td style="width: 10%;"></td> <td style="width: 10%;"></td> <td style="width: 10%;"></td> <td style="width: 10%;"></td> </tr> <tr> <td></td> <td></td> <td colspan="8" style="text-align: center;"> <table border="1" style="width: 100%; border-collapse: collapse; text-align: center;"> <tr> <td style="width: 10%;"></td> <td style="width: 10%;"></td> <td style="width: 10%;"></td> <td style="width: 10%;"></td> <td style="width: 10%;"></td> <td style="width: 10%;"></td> <td style="width: 10%;"></td> <td style="width: 10%;"></td> <td style="width: 10%;"></td> <td style="width: 10%;"></td> </tr> <tr> <td></td> <td></td> <td colspan="8" style="text-align: center;"> <table border="1" style="width: 100%; border-collapse: collapse; text-align: center;"> <tr> <td style="width: 10%;"></td> <td style="width: 10%;"></td> <td style="width: 10%;"></td> <td style="width: 10%;"></td> <td style="width: 10%;"></td> <td style="width: 10%;"></td> <td style="width: 10%;"></td> <td style="width: 10%;"></td> <td style="width: 10%;"></td> <td style="width: 10%;"></td> </tr> <tr> <td></td> <td></td> <td colspan="8" style="text-align: center;"> <table border="1" style="width: 100%; border-collapse: collapse; text-align: center;"> <tr> <td style="width: 10%;"></td> <td style="width: 10%;"></td> <td style="width: 10%;"></td> <td style="width: 10%;"></td> <td style="width: 10%;"></td> <td style="width: 10%;"></td> <td style="width: 10%;"></td> <td style="width: 10%;"></td> <td style="width: 10%;"></td> <td style="width: 10%;"></td> </tr> <tr> <td></td> <td></td> <td colspan="8" style="text-align: center;"> <table border="1" style="width: 100%; border-collapse: collapse; text-align: center;"> <tr> <td style="width: 10%;"></td> <td style="width: 10%;"></td> <td style="width: 10%;"></td> <td style="width: 10%;"></td> <td style="width: 10%;"></td> <td style="width: 10%;"></td> <td style="width: 10%;"></td> <td style="width: 10%;"></td> <td style="width: 10%;"></td> <td style="width: 10%;"></td> </tr> <tr> <td></td> <td></td> <td colspan="8" style="text-align: center;"> <table border="1" style="width: 100%; border-collapse: collapse; text-align: center;"> <tr> <td style="width: 10%;"></td> <td style="width: 10%;"></td> <td style="width: 10%;"></td> <td style="width: 10%;"></td> <td style="width: 10%;"></td> <td style="width: 10%;"></td> <td style="width: 10%;"></td> <td style="width: 10%;"></td> <td style="width: 10%;"></td> <td style="width: 10%;"></td> </tr> <tr> <td></td> <td></td> <td colspan="8" style="text-align: center;"> <table border="1" style="width: 100%; border-collapse: collapse; text-align: center;"> <tr> <td style="width: 10%;"></td> <td style="width: 10%;"></td> <td style="width: 10%;"></td> <td style="width: 10%;"></td> <td style="width: 10%;"></td> <td style="width: 10%;"></td> <td style="width: 10%;"></td> <td style="width: 10%;"></td> <td style="width: 10%;"></td> <td style="width: 10%;"></td> </tr> <tr> <td></td> <td></td> <td colspan="8" style="text-align: center;"> <table border="1" style="width: 100%; border-collapse: collapse; text-align: center;"> <tr> <td style="width: 10%;"></td> <td style="width: 10%;"></td> <td style="width: 10%;"></td> <td style="width: 10%;"></td> <td style="width: 10%;"></td> <td style="width: 10%;"></td> <td style="width: 10%;"></td> <td style="width: 10%;"></td> <td style="width: 10%;"></td> <td style="width: 10%;"></td> </tr> <tr> <td></td> <td></td> <td colspan="8" style="text-align: center;"> <table border="1" style="width: 100%; border-collapse: collapse; text-align: center;"> <tr> <td style="width: 10%;"></td> <td style="width: 10%;"></td> <td style="width: 10%;"></td> <td style="width: 10%;"></td> <td style="width: 10%;"></td> <td style="width: 10%;"></td> <td style="width: 10%;"></td> <td style="width: 10%;"></td> <td style="width: 10%;"></td> <td style="width: 10%;"></td> </tr> <tr> <td></td> <td></td> <td colspan="8" style="text-align: center;"> <table border="1" style="width: 100%; border-collapse: collapse; text-align: center;"> <tr> <td style="width: 10%;"></td> <td style="width: 10%;"></td> <td style="width: 10%;"></td> <td style="width: 10%;"></td> <td style="width: 10%;"></td> <td style="width: 10%;"></td> <td style="width: 10%;"></td> <td style="width: 10%;"></td> <td style="width: 10%;"></td> <td style="width: 10%;"></td> </tr> <tr> <td></td> <td></td> <td colspan="8" style="text-align: center;"> <table border="1" style="width: 100%; border-collapse: collapse; text-align: center;"> <tr> <td style="width: 10%;"></td> <td style="width: 10%;"></td> <td style="width: 10%;"></td> <td style="width: 10%;"></td> <td style="width: 10%;"></td> <td
style="width: 10%;"></td> <td style="width: 10%;"></td> <td style="width: 10%;"></td> <td style="width: 10%;"></td> <td style="width: 10%;"></td> </tr> <tr> <td></td> <td></td> <td colspan="8" style="text-align: center;"> <table border="1" style="width: 100%; border-collapse: collapse; text-align: center;"> <tr> <td style="width: 10%;"></td> <td style="width: 10%;"></td> <td style="width: 10%;"></td> <td style="width: 10%;"></td> <td style="width: 10%;"></td> <td style="width: 10%;"></td> <td style="width: 10%;"></td> <td style="width: 10%;"></td> <td style="width: 10%;"></td> <td style="width: 10%;"></td> </tr> <tr> <td></td> <td></td> <td colspan="8" style="text-align: center;"> <table border="1" style="width: 100%; border-collapse: collapse; text-align: center;"> <tr> <td style="width: 10%;"></td> <td style="width: 10%;"></td> <td style="width: 10%;"></td> <td style="width: 10%;"></td> <td style="width: 10%;"></td> <td style="width: 10%;"></td> <td style="width: 10%;"></td> <td style="width: 10%;"></td> <td style="width: 10%;"></td> <td style="width: 10%;"></td> </tr> <tr> <td></td> <td></td> <td colspan="8" style="text-align: center;"> <table border="1" style="width: 100%; border-collapse: collapse; text-align: center;"> <tr> <td style="width: 10%;"></td> <td style="width: 10%;"></td> <td style="width: 10%;"></td> <td style="width: 10%;"></td> <td style="width: 10%;"></td> <td style="width: 10%;"></td> <td style="width: 10%;"></td> <td style="width: 10%;"></td> <td style="width: 10%;"></td> <td style="width: 10%;"></td> </tr> <tr> <td></td> <td></td> <td colspan="8" style="text-align: center;"> <table border="1" style="width: 100%; border-collapse: collapse; text-align: center;"> <tr> <td style="width: 10%;"></td> <td style="width: 10%;"></td> <td style="width: 10%;"></td> <td style="width: 10%;"></td> <td style="width: 10%;"></td> <td style="width: 10%;"></td> <td style="width: 10%;"></td> <td style="width: 10%;"></td> <td style="width: 10%;"></td> <td style="width: 10%;"></td> </tr> <tr> <td></td> <td></td> <td colspan="8" style="text-align: center;"> <table border="1" style="width: 100%; border-collapse: collapse; text-align: center;"> <tr> <td style="width: 10%;"></td> <td style="width: 10%;"></td> <td style="width: 10%;"></td> <td style="width: 10%;"></td> <td style="width: 10%;"></td> <td style="width: 10%;"></td> <td style="width: 10%;"></td> <td style="width: 10%;"></td> <td style="width: 10%;"></td> <td style="width: 10%;"></td> </tr> <tr> <td></td> <td></td> <td colspan="8" style="text-align: center;"> <table border="1" style="width: 100%; border-collapse: collapse; text-align: center;"> <tr> </tr></table></td></tr></table></td></tr></table></td></tr></table></td></tr></table></td></tr></table></td></tr></table></td></tr></table></td></tr></table></td></tr></table></td></tr></table></td></tr></table></td></tr></table></td></tr></table></td></tr></table></td></tr></table></td></tr></table></td></tr></table></td></tr></table></td></tr></table>
 | | | | | | | | | | | | | | | | | | | | <table border="1" style="width: 100%; border-collapse: collapse; text-align: center;"> <tr> <td style="width: 10%;"></td> <td style="width: 10%;"></td> <td style="width: 10%;"></td> <td style="width: 10%;"></td> <td style="width: 10%;"></td> <td style="width: 10%;"></td> <td style="width: 10%;"></td> <td style="width: 10%;"></td> <td style="width: 10%;"></td> <td style="width: 10%;"></td> </tr> <tr> <td></td> <td></td> <td colspan="8" style="text-align: center;"> <table border="1" style="width: 100%; border-collapse: collapse; text-align: center;"> <tr> <td style="width: 10%;"></td> <td style="width: 10%;"></td> <td style="width: 10%;"></td> <td style="width: 10%;"></td> <td style="width: 10%;"></td> <td style="width: 10%;"></td> <td style="width: 10%;"></td> <td style="width: 10%;"></td> <td style="width: 10%;"></td> <td style="width: 10%;"></td> </tr> <tr> <td></td> <td></td> <td colspan="8" style="text-align: center;"> <table border="1" style="width: 100%; border-collapse: collapse; text-align: center;"> <tr> <td style="width: 10%;"></td> <td style="width: 10%;"></td> <td style="width: 10%;"></td> <td style="width: 10%;"></td> <td style="width: 10%;"></td> <td style="width: 10%;"></td> <td style="width: 10%;"></td> <td style="width: 10%;"></td> <td style="width: 10%;"></td> <td style="width: 10%;"></td> </tr> <tr> <td></td> <td></td> <td colspan="8" style="text-align: center;"> <table border="1" style="width: 100%; border-collapse: collapse; text-align: center;"> <tr> <td style="width: 10%;"></td> <td style="width: 10%;"></td> <td style="width: 10%;"></td> <td style="width: 10%;"></td> <td style="width: 10%;"></td> <td style="width: 10%;"></td> <td style="width: 10%;"></td> <td style="width: 10%;"></td> <td style="width: 10%;"></td> <td style="width: 10%;"></td> </tr> <tr> <td></td> <td></td> <td colspan="8" style="text-align:
center;"> <table border="1" style="width: 100%; border-collapse: collapse; text-align: center;"> <tr> <td style="width: 10%;"></td> <td style="width: 10%;"></td> <td style="width: 10%;"></td> <td style="width: 10%;"></td> <td style="width: 10%;"></td> <td style="width: 10%;"></td> <td style="width: 10%;"></td> <td style="width: 10%;"></td> <td style="width: 10%;"></td> <td style="width: 10%;"></td> </tr> <tr> <td></td> <td></td> <td colspan="8" style="text-align: center;"> <table border="1" style="width: 100%; border-collapse: collapse; text-align: center;"> <tr> <td style="width: 10%;"></td> <td style="width: 10%;"></td> <td style="width: 10%;"></td> <td style="width: 10%;"></td> <td style="width: 10%;"></td> <td style="width: 10%;"></td> <td style="width: 10%;"></td> <td style="width: 10%;"></td> <td style="width: 10%;"></td> <td style="width: 10%;"></td> </tr> <tr> <td></td> <td></td> <td colspan="8" style="text-align: center;"> <table border="1" style="width: 100%; border-collapse: collapse; text-align: center;"> <tr> <td style="width: 10%;"></td> <td style="width: 10%;"></td> <td style="width: 10%;"></td> <td style="width: 10%;"></td> <td style="width: 10%;"></td> <td style="width: 10%;"></td> <td style="width: 10%;"></td> <td style="width: 10%;"></td> <td style="width: 10%;"></td> <td style="width: 10%;"></td> </tr> <tr> <td></td> <td></td> <td colspan="8" style="text-align: center;"> <table border="1" style="width: 100%; border-collapse: collapse; text-align: center;"> <tr> <td style="width: 10%;"></td> <td style="width: 10%;"></td> <td style="width: 10%;"></td> <td style="width: 10%;"></td> <td style="width: 10%;"></td> <td style="width: 10%;"></td> <td style="width: 10%;"></td> <td style="width: 10%;"></td> <td style="width: 10%;"></td> <td style="width: 10%;"></td> </tr> <tr> <td></td> <td></td> <td colspan="8" style="text-align: center;"> <table border="1" style="width: 100%; border-collapse: collapse; text-align: center;"> <tr> <td style="width: 10%;"></td> <td style="width: 10%;"></td> <td style="width: 10%;"></td> <td style="width: 10%;"></td> <td style="width: 10%;"></td> <td style="width: 10%;"></td> <td style="width: 10%;"></td> <td style="width: 10%;"></td> <td style="width: 10%;"></td> <td style="width: 10%;"></td> </tr> <tr> <td></td> <td></td> <td colspan="8" style="text-align: center;"> <table border="1" style="width: 100%; border-collapse: collapse; text-align: center;"> <tr> <td style="width: 10%;"></td> <td style="width: 10%;"></td> <td style="width: 10%;"></td> <td style="width: 10%;"></td> <td style="width: 10%;"></td> <td style="width: 10%;"></td> <td style="width: 10%;"></td> <td style="width: 10%;"></td> <td style="width: 10%;"></td> <td style="width: 10%;"></td> </tr> <tr> <td></td> <td></td> <td colspan="8" style="text-align: center;"> <table border="1" style="width: 100%; border-collapse: collapse; text-align: center;"> <tr> <td style="width: 10%;"></td> <td style="width: 10%;"></td> <td style="width: 10%;"></td> <td style="width: 10%;"></td> <td style="width: 10%;"></td> <td style="width: 10%;"></td> <td style="width: 10%;"></td> <td style="width: 10%;"></td> <td style="width: 10%;"></td> <td style="width: 10%;"></td> </tr> <tr> <td></td> <td></td> <td colspan="8" style="text-align: center;"> <table border="1" style="width: 100%; border-collapse: collapse; text-align: center;"> <tr> <td style="width: 10%;"></td> <td style="width: 10%;"></td> <td style="width: 10%;"></td> <td style="width: 10%;"></td> <td style="width: 10%;"></td> <td style="width: 10%;"></td> <td style="width: 10%;"></td> <td style="width: 10%;"></td> <td style="width: 10%;"></td> <td style="width: 10%;"></td> </tr> <tr> <td></td> <td></td> <td colspan="8" style="text-align: center;"> <table border="1" style="width: 100%; border-collapse: collapse; text-align: center;"> <tr> <td style="width: 10%;"></td> <td style="width: 10%;"></td> <td style="width: 10%;"></td> <td style="width: 10%;"></td> <td style="width: 10%;"></td> <td style="width: 10%;"></td> <td style="width: 10%;"></td> <td style="width: 10%;"></td> <td style="width: 10%;"></td> <td style="width: 10%;"></td> </tr> <tr> <td></td> <td></td> <td colspan="8" style="text-align: center;"> <table border="1" style="width: 100%; border-collapse: collapse; text-align: center;"> <tr> <td style="width: 10%;"></td> <td style="width: 10%;"></td> <td style="width: 10%;"></td> <td style="width: 10%;"></td> <td style="width: 10%;"></td> <td style="width: 10%;"></td> <td style="width: 10%;"></td> <td style="width: 10%;"></td> <td style="width: 10%;"></td> <td style="width: 10%;"></td> </tr> <tr> <td></td> <td></td> <td colspan="8" style="text-align: center;"> <table border="1" style="width: 100%; border-collapse: collapse; text-align: center;"> <tr> <td style="width: 10%;"></td> <td style="width: 10%;"></td> <td style="width: 10%;"></td> <td style="width: 10%;"></td> <td style="width: 10%;"></td> <td style="width: 10%;"></td> <td style="width: 10%;"></td> <td style="width: 10%;"></td> <td style="width: 10%;"></td> <td style="width: 10%;"></td> </tr> <tr> <td></td> <td></td> <td colspan="8" style="text-align: center;"> <table border="1" style="width: 100%; border-collapse: collapse; text-align: center;"> <tr> <td style="width: 10%;"></td> <td style="width: 10%;"></td> <td style="width: 10%;"></td> <td style="width: 10%;"></td> <td style="width: 10%;"></td> <td style="width: 10%;"></td> <td style="width: 10%;"></td> <td style="width: 10%;"></td> <td style="width: 10%;"></td> <td style="width: 10%;"></td> </tr> <tr> <td></td> <td></td> <td colspan="8" style="text-align: center;"> <table border="1" style="width: 100%; border-collapse: collapse; text-align: center;"> <tr> <td style="width: 10%;"></td> <td style="width: 10%;"></td> <td style="width: 10%;"></td> <td style="width: 10%;"></td> <td style="width: 10%;"></td> <td style="width: 10%;"></td> <td style="width: 10%;"></td> <td style="width: 10%;"></td> <td style="width: 10%;"></td> <td style="width: 10%;"></td> </tr> <tr> <td></td> <td></td> <td colspan="8" style="text-align: center;"> <table border="1" style="width: 100%; border-collapse: collapse; text-align: center;"> <tr> <td style="width: 10%;"></td> <td style="width: 10%;"></td> <td style="width: 10%;"></td> <td style="width: 10%;"></td> <td style="width: 10%;"></td> <td style="width: 10%;"></td> <td style="width: 10%;"></td> <td style="width: 10%;"></td> <td style="width: 10%;"></td> <td style="width: 10%;"></td> </tr> <tr> <td></td> <td></td> <td colspan="8" style="text-align: center;"> <table border="1" style="width: 100%; border-collapse: collapse; text-align: center;"> <tr> </tr></table></td></tr></table></td></tr></table></td></tr></table></td></tr></table></td></tr></table></td></tr></table></td></tr></table></td></tr></table></td></tr></table></td></tr></table></td></tr></table></td></tr></table></td></tr></table></td></tr></table></td></tr></table></td></tr></table></td></tr></table></td></tr></table>

 | | | | | | | | | | | | | | | | | | | | <table border="1" style="width: 100%; border-collapse: collapse; text-align: center;"> <tr> <td style="width: 10%;"></td> <td style="width: 10%;"></td> <td style="width: 10%;"></td> <td style="width: 10%;"></td> <td style="width: 10%;"></td> <td style="width: 10%;"></td> <td style="width: 10%;"></td> <td style="width: 10%;"></td> <td style="width: 10%;"></td> <td style="width: 10%;"></td> </tr> <tr> <td></td> <td></td> <td colspan="8" style="text-align: center;"> <table border="1" style="width: 100%; border-collapse: collapse; text-align: center;"> <tr> <td style="width: 10%;"></td> <td style="width: 10%;"></td> <td style="width: 10%;"></td> <td style="width: 10%;"></td> <td style="width: 10%;"></td> <td style="width: 10%;"></td> <td style="width: 10%;"></td> <td style="width: 10%;"></td> <td style="width: 10%;"></td> <td style="width: 10%;"></td> </tr> <tr> <td></td> <td></td> <td colspan="8" style="text-align: center;"> <table border="1" style="width: 100%; border-collapse: collapse; text-align: center;"> <tr> <td style="width: 10%;"></td> <td style="width: 10%;"></td> <td style="width: 10%;"></td> <td style="width: 10%;"></td> <td style="width: 10%;"></td> <td style="width: 10%;"></td> <td style="width: 10%;"></td> <td style="width: 10%;"></td> <td style="width: 10%;"></td> <td style="width: 10%;"></td> </tr> <tr> <td></td> <td></td> <td colspan="8" style="text-align: center;"> <table border="1" style="width: 100%; border-collapse: collapse; text-align: center;"> <tr> <td style="width: 10%;"></td> <td style="width: 10%;"></td> <td style="width: 10%;"></td> <td style="width: 10%;"></td> <td style="width: 10%;"></td> <td style="width: 10%;"></td> <td style="width: 10%;"></td> <td style="width: 10%;"></td> <td style="width: 10%;"></td> <td style="width: 10%;"></td> </tr> <tr> <td></td> <td></td> <td colspan="8" style="text-align: center;"> <table border="1" style="width: 100%; border-collapse: collapse; text-align: center;"> <tr> <td style="width: 10%;"></td> <td style="width: 10%;"></td> <td style="width: 10%;"></td> <td style="width: 10%;"></td> <td style="width: 10%;"></td> <td style="width: 10%;"></td> <td style="width: 10%;"></td> <td style="width: 10%;"></td> <td style="width: 10%;"></td> <td style="width: 10%;"></td> </tr> <tr> <td></td> <td></td> <td colspan="8" style="text-align: center;"> <table border="1" style="width: 100%; border-collapse: collapse; text-align: center;"> <tr> <td style="width: 10%;"></td> <td style="width: 10%;"></td> <td style="width: 10%;"></td> <td style="width: 10%;"></td> <td style="width: 10%;"></td> <td style="width: 10%;"></td> <td style="width: 10%;"></td> <td style="width: 10%;"></td> <td style="width: 10%;"></td> <td style="width: 10%;"></td> </tr> <tr> <td></td> <td></td> <td colspan="8" style="text-align: center;"> <table border="1" style="width: 100%; border-collapse: collapse; text-align: center;"> <tr> <td style="width: 10%;"></td> <td style="width: 10%;"></td> <td style="width: 10%;"></td> <td style="width: 10%;"></td> <td style="width: 10%;"></td> <td style="width: 10%;"></td> <td style="width: 10%;"></td> <td style="width: 10%;"></td> <td style="width: 10%;"></td> <td style="width: 10%;"></td> </tr> <tr> <td></td> <td></td> <td colspan="8" style="text-align: center;"> <table border="1" style="width: 100%; border-collapse: collapse; text-align: center;"> <tr> <td style="width: 10%;"></td> <td style="width: 10%;"></td> <td style="width: 10%;"></td> <td style="width: 10%;"></td> <td style="width: 10%;"></td> <td style="width: 10%;"></td> <td style="width: 10%;"></td> <td style="width: 10%;"></td> <td style="width: 10%;"></td> <td style="width: 10%;"></td> </tr> <tr> <td></td> <td></td> <td colspan="8" style="text-align: center;"> <table border="1" style="width: 100%; border-collapse: collapse; text-align: center;"> <tr> <td style="width: 10%;"></td> <td style="width: 10%;"></td> <td style="width: 10%;"></td> <td style="width: 10%;"></td> <td style="width: 10%;"></td> <td style="width: 10%;"></td> <td style="width: 10%;"></td> <td style="width: 10%;"></td> <td style="width: 10%;"></td> <td style="width: 10%;"></td> </tr> <tr> <td></td> <td></td> <td colspan="8" style="text-align: center;"> <table border="1" style="width: 100%; border-collapse: collapse; text-align: center;"> <tr> <td style="width: 10%;"></td> <td style="width: 10%;"></td> <td style="width: 10%;"></td> <td style="width: 10%;"></td> <td style="width: 10%;"></td> <td style="width: 10%;"></td> <td style="width: 10%;"></td> <td style="width: 10%;"></td> <td style="width: 10%;"></td> <td style="width: 10%;"></td> </tr> <tr> <td></td> <td></td> <td colspan="8" style="text-align: center;"> <table border="1" style="width: 100%; border-collapse: collapse; text-align: center;"> <tr> <td style="width: 10%;"></td> <td style="width: 10%;"></td> <td style="width: 10%;"></td> <td style="width: 10%;"></td> <td style="width: 10%;"></td> <td style="width: 10%;"></td> <td style="width: 10%;"></td> <td style="width: 10%;"></td> <td style="width: 10%;"></td> <td style="width: 10%;"></td> </tr> <tr> <td></td> <td></td> <td colspan="8" style="text-align: center;"> <table border="1" style="width: 100%; border-collapse: collapse; text-align: center;"> <tr> <td style="width: 10%;"></td> <td style="width: 10%;"></td> <td style="width: 10%;"></td> <td style="width: 10%;"></td> <td style="width: 10%;"></td> <td style="width: 10%;"></td> <td style="width: 10%;"></td> <td style="width: 10%;"></td> <td style="width: 10%;"></td> <td style="width: 10%;"></td> </tr> <tr> <td></td> <td></td> <td colspan="8" style="text-align: center;"> <table border="1" style="width: 100%; border-collapse: collapse; text-align: center;"> <tr> <td style="width: 10%;"></td> <td style="width: 10%;"></td> <td style="width: 10%;"></td> <td style="width: 10%;"></td> <td style="width: 10%;"></td> <td style="width: 10%;"></td> <td style="width: 10%;"></td> <td style="width: 10%;"></td> <td style="width: 10%;"></td> <td style="width: 10%;"></td> </tr> <tr> <td></td> <td></td> <td colspan="8" style="text-align: center;"> <table border="1" style="width: 100%; border-collapse: collapse; text-align: center;"> <tr> <td style="width: 10%;"></td> <td style="width: 10%;"></td> <td style="width: 10%;"></td> <td style="width: 10%;"></td> <td style="width: 10%;"></td> <td style="width: 10%;"></td> <td style="width: 10%;"></td> <td style="width: 10%;"></td> <td style="width: 10%;"></td> <td style="width: 10%;"></td> </tr> <tr> <td></td> <td></td> <td colspan="8" style="text-align: center;"> <table border="1" style="width: 100%; border-collapse: collapse; text-align: center;"> <tr> <td style="width: 10%;"></td> <td style="width: 10%;"></td> <td style="width: 10%;"></td> <td style="width: 10%;"></td> <td style="width: 10%;"></td> <td style="width: 10%;"></td> <td style="width: 10%;"></td> <td style="width: 10%;"></td> <td style="width: 10%;"></td> <td style="width: 10%;"></td> </tr> <tr> <td></td> <td></td> <td colspan="8" style="text-align: center;"> <table border="1" style="width: 100%; border-collapse: collapse; text-align: center;"> <tr> <td style="width: 10%;"></td> <td style="width: 10%;"></td> <td style="width: 10%;"></td> <td style="width: 10%;"></td> <td style="width: 10%;"></td> <td style="width: 10%;"></td> <td style="width: 10%;"></td> <td style="width: 10%;"></td> <td style="width: 10%;"></td> <td style="width: 10%;"></td> </tr> <tr> <td></td> <td></td> <td colspan="8" style="text-align: center;"> <table border="1" style="width: 100%; border-collapse: collapse; text-align: center;"> <tr> <td style="width: 10%;"></td> <td style="width: 10%;"></td> <td style="width: 10%;"></td> <td style="width: 10%;"></td> <td style="width: 10%;"></td> <td style="width: 10%;"></td> <td style="width: 10%;"></td> <td style="width: 10%;"></td> <td style="width: 10%;"></td> <td style="width: 10%;"></td>
</tr> <tr> <td></td> <td></td> <td colspan="8" style="text-align: center;"> <table border="1" style="width: 100%; border-collapse: collapse; text-align: center;"> <tr> </tr></table></td></tr></table></td></tr></table></td></tr></table></td></tr></table></td></tr></table></td></tr></table></td></tr></table></td></tr></table></td></tr></table></td></tr></table></td></tr></table></td></tr></table></td></tr></table></td></tr></table></td></tr></table></td></tr></table></td></tr></table>
 | | | | | | | | | | | | | | | | | | | | <table border="1" style="width: 100%; border-collapse: collapse; text-align: center;"> <tr> <td style="width: 10%;"></td> <td style="width: 10%;"></td> <td style="width: 10%;"></td> <td style="width: 10%;"></td> <td style="width: 10%;"></td> <td style="width: 10%;"></td> <td style="width: 10%;"></td> <td style="width: 10%;"></td> <td style="width: 10%;"></td> <td style="width: 10%;"></td> </tr> <tr> <td></td> <td></td> <td colspan="8" style="text-align: center;"> <table border="1" style="width: 100%; border-collapse: collapse; text-align: center;"> <tr> <td style="width: 10%;"></td> <td style="width: 10%;"></td> <td style="width: 10%;"></td> <td style="width: 10%;"></td> <td style="width: 10%;"></td> <td style="width: 10%;"></td> <td style="width: 10%;"></td> <td style="width: 10%;"></td> <td style="width: 10%;"></td> <td style="width: 10%;"></td> </tr> <tr> <td></td> <td></td> <td colspan="8" style="text-align: center;"> <table border="1" style="width: 100%; border-collapse: collapse; text-align: center;"> <tr> <td style="width: 10%;"></td> <td style="width: 10%;"></td> <td style="width: 10%;"></td> <td style="width: 10%;"></td> <td style="width: 10%;"></td> <td style="width: 10%;"></td> <td style="width: 10%;"></td> <td style="width: 10%;"></td> <td style="width: 10%;"></td> <td style="width: 10%;"></td> </tr> <tr> <td></td> <td></td> <td colspan="8" style="text-align: center;"> <table border="1" style="width: 100%; border-collapse: collapse; text-align: center;"> <tr> <td style="width: 10%;"></td> <td style="width: 10%;"></td> <td style="width: 10%;"></td> <td style="width: 10%;"></td> <td style="width: 10%;"></td> <td style="width: 10%;"></td> <td style="width: 10%;"></td> <td style="width: 10%;"></td> <td style="width: 10%;"></td> <td style="width: 10%;"></td> </tr> <tr> <td></td> <td></td> <td colspan="8" style="text-align: center;"> <table border="1" style="width: 100%; border-collapse: collapse; text-align: center;"> <tr> <td style="width: 10%;"></td> <td style="width: 10%;"></td> <td style="width: 10%;"></td> <td style="width: 10%;"></td> <td style="width: 10%;"></td> <td style="width: 10%;"></td> <td style="width: 10%;"></td> <td style="width: 10%;"></td> <td style="width: 10%;"></td> <td style="width: 10%;"></td> </tr> <tr> <td></td> <td></td> <td colspan="8" style="text-align: center;"> <table border="1" style="width: 100%; border-collapse: collapse; text-align: center;"> <tr> <td style="width: 10%;"></td> <td style="width: 10%;"></td> <td style="width: 10%;"></td> <td style="width: 10%;"></td> <td style="width: 10%;"></td> <td style="width: 10%;"></td> <td style="width: 10%;"></td> <td style="width: 10%;"></td> <td style="width: 10%;"></td> <td style="width: 10%;"></td> </tr> <tr> <td></td> <td></td> <td colspan="8" style="text-align: center;"> <table border="1" style="width: 100%; border-collapse: collapse; text-align: center;"> <tr> <td style="width: 10%;"></td> <td style="width: 10%;"></td> <td style="width: 10%;"></td> <td style="width: 10%;"></td> <td style="width: 10%;"></td> <td style="width: 10%;"></td> <td style="width: 10%;"></td> <td style="width: 10%;"></td> <td style="width: 10%;"></td> <td style="width: 10%;"></td> </tr> <tr> <td></td> <td></td> <td colspan="8" style="text-align: center;"> <table border="1" style="width: 100%; border-collapse: collapse; text-align: center;"> <tr> <td style="width: 10%;"></td> <td style="width: 10%;"></td> <td style="width: 10%;"></td> <td style="width: 10%;"></td> <td style="width: 10%;"></td> <td style="width: 10%;"></td> <td style="width: 10%;"></td> <td style="width: 10%;"></td> <td style="width: 10%;"></td> <td style="width: 10%;"></td> </tr> <tr> <td></td> <td></td> <td colspan="8" style="text-align: center;"> <table border="1" style="width: 100%; border-collapse: collapse; text-align: center;"> <tr> <td style="width: 10%;"></td> <td style="width: 10%;"></td> <td style="width: 10%;"></td> <td style="width: 10%;"></td> <td style="width: 10%;"></td> <td style="width: 10%;"></td> <td style="width: 10%;"></td> <td style="width: 10%;"></td> <td style="width: 10%;"></td> <td style="width: 10%;"></td> </tr> <tr> <td></td> <td></td> <td colspan="8" style="text-align: center;"> <table border="1" style="width: 100%; border-collapse: collapse; text-align: center;"> <tr> <td style="width: 10%;"></td> <td style="width: 10%;"></td> <td style="width:
10%;"></td> <td style="width: 10%;"></td> <td style="width: 10%;"></td> <td style="width: 10%;"></td> <td style="width: 10%;"></td> <td style="width: 10%;"></td> <td style="width: 10%;"></td> <td style="width: 10%;"></td> </tr> <tr> <td></td> <td></td> <td colspan="8" style="text-align: center;"> <table border="1" style="width: 100%; border-collapse: collapse; text-align: center;"> <tr> <td style="width: 10%;"></td> <td style="width: 10%;"></td> <td style="width: 10%;"></td> <td style="width: 10%;"></td> <td style="width: 10%;"></td> <td style="width: 10%;"></td> <td style="width: 10%;"></td> <td style="width: 10%;"></td> <td style="width: 10%;"></td> <td style="width: 10%;"></td> </tr> <tr> <td></td> <td></td> <td colspan="8" style="text-align: center;"> <table border="1" style="width: 100%; border-collapse: collapse; text-align: center;"> <tr> <td style="width: 10%;"></td> <td style="width: 10%;"></td> <td style="width: 10%;"></td> <td style="width: 10%;"></td> <td style="width: 10%;"></td> <td style="width: 10%;"></td> <td style="width: 10%;"></td> <td style="width: 10%;"></td> <td style="width: 10%;"></td> <td style="width: 10%;"></td> </tr> <tr> <td></td> <td></td> <td colspan="8" style="text-align: center;"> <table border="1" style="width: 100%; border-collapse: collapse; text-align: center;"> <tr> <td style="width: 10%;"></td> <td style="width: 10%;"></td> <td style="width: 10%;"></td> <td style="width: 10%;"></td> <td style="width: 10%;"></td> <td style="width: 10%;"></td> <td style="width: 10%;"></td> <td style="width: 10%;"></td> <td style="width: 10%;"></td> <td style="width: 10%;"></td> </tr> <tr> <td></td> <td></td> <td colspan="8" style="text-align: center;"> <table border="1" style="width: 100%; border-collapse: collapse; text-align: center;"> <tr> <td style="width: 10%;"></td> <td style="width: 10%;"></td> <td style="width: 10%;"></td> <td style="width: 10%;"></td> <td style="width: 10%;"></td> <td style="width: 10%;"></td> <td style="width: 10%;"></td> <td style="width: 10%;"></td> <td style="width: 10%;"></td> <td style="width: 10%;"></td> </tr> <tr> <td></td> <td></td> <td colspan="8" style="text-align: center;"> <table border="1" style="width: 100%; border-collapse: collapse; text-align: center;"> <tr> <td style="width: 10%;"></td> <td style="width: 10%;"></td> <td style="width: 10%;"></td> <td style="width: 10%;"></td> <td style="width: 10%;"></td> <td style="width: 10%;"></td> <td style="width: 10%;"></td> <td style="width: 10%;"></td> <td style="width: 10%;"></td> <td style="width: 10%;"></td> </tr> <tr> <td></td> <td></td> <td colspan="8" style="text-align: center;"> <table border="1" style="width: 100%; border-collapse: collapse; text-align: center;"> <tr> <td style="width: 10%;"></td> <td style="width: 10%;"></td> <td style="width: 10%;"></td> <td style="width: 10%;"></td> <td style="width: 10%;"></td> <td style="width: 10%;"></td> <td style="width: 10%;"></td> <td style="width: 10%;"></td> <td style="width: 10%;"></td> <td style="width: 10%;"></td> </tr> <tr> <td></td> <td></td> <td colspan="8" style="text-align: center;"> <table border="1" style="width: 100%; border-collapse: collapse; text-align: center;"> <tr> </tr></table></td></tr></table></td></tr></table></td></tr></table></td></tr></table></td></tr></table></td></tr></table></td></tr></table></td></tr></table></td></tr></table></td></tr></table></td></tr></table></td></tr></table></td></tr></table></td></tr></table></td></tr></table></td></tr></table>
 | | | | | | | | | | | | | | | | | | | | <table border="1" style="width: 100%; border-collapse: collapse; text-align: center;"> <tr> <td style="width: 10%;"></td> <td style="width: 10%;"></td> <td style="width: 10%;"></td> <td style="width: 10%;"></td> <td style="width: 10%;"></td> <td style="width: 10%;"></td> <td style="width: 10%;"></td> <td style="width: 10%;"></td> <td style="width: 10%;"></td> <td style="width: 10%;"></td> </tr> <tr> <td></td> <td></td> <td colspan="8" style="text-align: center;"> <table border="1" style="width: 100%; border-collapse: collapse; text-align: center;"> <tr> <td style="width: 10%;"></td> <td style="width: 10%;"></td> <td style="width: 10%;"></td> <td style="width: 10%;"></td> <td style="width: 10%;"></td> <td style="width: 10%;"></td> <td style="width: 10%;"></td> <td style="width: 10%;"></td> <td style="width: 10%;"></td> <td style="width: 10%;"></td> </tr> <tr> <td></td> <td></td> <td colspan="8" style="text-align: center;"> <table border="1" style="width: 100%; border-collapse: collapse; text-align: center;"> <tr> <td style="width: 10%;"></td> <td style="width: 10%;"></td> <td style="width: 10%;"></td> <td style="width: 10%;"></td> <td style="width: 10%;"></td> <td style="width: 10%;"></td> <td style="width: 10%;"></td> <td style="width: 10%;"></td> <td style="width: 10%;"></td> <td style="width: 10%;"></td> </tr> <tr> <td></td> <td></td> <td colspan="8"
style="text-align: center;"> <table border="1" style="width: 100%; border-collapse: collapse; text-align: center;"> <tr> <td style="width: 10%;"></td> <td style="width: 10%;"></td> <td style="width: 10%;"></td> <td style="width: 10%;"></td> <td style="width: 10%;"></td> <td style="width: 10%;"></td> <td style="width: 10%;"></td> <td style="width: 10%;"></td> <td style="width: 10%;"></td> <td style="width: 10%;"></td> </tr> <tr> <td></td> <td></td> <td colspan="8" style="text-align: center;"> <table border="1" style="width: 100%; border-collapse: collapse; text-align: center;"> <tr> <td style="width: 10%;"></td> <td style="width: 10%;"></td> <td style="width: 10%;"></td> <td style="width: 10%;"></td> <td style="width: 10%;"></td> <td style="width: 10%;"></td> <td style="width: 10%;"></td> <td style="width: 10%;"></td> <td style="width: 10%;"></td> <td style="width: 10%;"></td> </tr> <tr> <td></td> <td></td> <td colspan="8" style="text-align: center;"> <table border="1" style="width: 100%; border-collapse: collapse; text-align: center;"> <tr> <td style="width: 10%;"></td> <td style="width: 10%;"></td> <td style="width: 10%;"></td> <td style="width: 10%;"></td> <td style="width: 10%;"></td> <td style="width: 10%;"></td> <td style="width: 10%;"></td> <td style="width: 10%;"></td> <td style="width: 10%;"></td> <td style="width: 10%;"></td> </tr> <tr> <td></td> <td></td> <td colspan="8" style="text-align: center;"> <table border="1" style="width: 100%; border-collapse: collapse; text-align: center;"> <tr> <td style="width: 10%;"></td> <td style="width: 10%;"></td> <td style="width: 10%;"></td> <td style="width: 10%;"></td> <td style="width: 10%;"></td> <td style="width: 10%;"></td> <td style="width: 10%;"></td> <td style="width: 10%;"></td> <td style="width: 10%;"></td> <td style="width: 10%;"></td> </tr> <tr> <td></td> <td></td> <td colspan="8" style="text-align: center;"> <table border="1" style="width: 100%; border-collapse: collapse; text-align: center;"> <tr> <td style="width: 10%;"></td> <td style="width: 10%;"></td> <td style="width: 10%;"></td> <td style="width: 10%;"></td> <td style="width: 10%;"></td> <td style="width: 10%;"></td> <td style="width: 10%;"></td> <td style="width: 10%;"></td> <td style="width: 10%;"></td> <td style="width: 10%;"></td> </tr> <tr> <td></td> <td></td> <td colspan="8" style="text-align: center;"> <table border="1" style="width: 100%; border-collapse: collapse; text-align: center;"> <tr> <td style="width: 10%;"></td> <td style="width: 10%;"></td> <td style="width: 10%;"></td> <td style="width: 10%;"></td> <td style="width: 10%;"></td> <td style="width: 10%;"></td> <td style="width: 10%;"></td> <td style="width: 10%;"></td> <td style="width: 10%;"></td> <td style="width: 10%;"></td> </tr> <tr> <td></td> <td></td> <td colspan="8" style="text-align: center;"> <table border="1" style="width: 100%; border-collapse: collapse; text-align: center;"> <tr> <td style="width: 10%;"></td> <td style="width: 10%;"></td> <td style="width: 10%;"></td> <td style="width: 10%;"></td> <td style="width: 10%;"></td> <td style="width: 10%;"></td> <td style="width: 10%;"></td> <td style="width: 10%;"></td> <td style="width: 10%;"></td> <td style="width: 10%;"></td> </tr> <tr> <td></td> <td></td> <td colspan="8" style="text-align: center;"> <table border="1" style="width: 100%; border-collapse: collapse; text-align: center;"> <tr> <td style="width: 10%;"></td> <td style="width: 10%;"></td> <td style="width: 10%;"></td> <td style="width: 10%;"></td> <td style="width: 10%;"></td> <td style="width: 10%;"></td> <td style="width: 10%;"></td> <td style="width: 10%;"></td> <td style="width: 10%;"></td> <td style="width: 10%;"></td> </tr> <tr> <td></td> <td></td> <td colspan="8" style="text-align: center;"> <table border="1" style="width: 100%; border-collapse: collapse; text-align: center;"> <tr> <td style="width: 10%;"></td> <td style="width: 10%;"></td> <td style="width: 10%;"></td> <td style="width: 10%;"></td> <td style="width: 10%;"></td> <td style="width: 10%;"></td> <td style="width: 10%;"></td> <td style="width: 10%;"></td> <td style="width: 10%;"></td> <td style="width: 10%;"></td> </tr> <tr> <td></td> <td></td> <td colspan="8" style="text-align: center;"> <table border="1" style="width: 100%; border-collapse: collapse; text-align: center;"> <tr> <td style="width: 10%;"></td> <td style="width: 10%;"></td> <td style="width: 10%;"></td> <td style="width: 10%;"></td> <td style="width: 10%;"></td> <td style="width: 10%;"></td> <td style="width: 10%;"></td> <td style="width: 10%;"></td> <td style="width: 10%;"></td> <td style="width: 10%;"></td> </tr> <tr> <td></td> <td></td> <td colspan="8" style="text-align: center;"> <table border="1" style="width: 100%; border-collapse: collapse; text-align: center;"> <tr> <td style="width: 10%;"></td> <td style="width: 10%;"></td> <td style="width: 10%;"></td> <td style="width: 10%;"></td> <td style="width: 10%;"></td> <td style="width: 10%;"></td> <td style="width: 10%;"></td> <td style="width: 10%;"></td> <td style="width: 10%;"></td> <td style="width: 10%;"></td> </tr> <tr> <td></td> <td></td> <td colspan="8" style="text-align: center;"> <table border="1" style="width: 100%; border-collapse: collapse; text-align: center;"> <tr> <td style="width: 10%;"></td> <td style="width: 10%;"></td> <td style="width: 10%;"></td> <td style="width: 10%;"></td> <td style="width: 10%;"></td> <td style="width: 10%;"></td> <td style="width: 10%;"></td> <td style="width: 10%;"></td> <td style="width: 10%;"></td> <td style="width: 10%;"></td> </tr> <tr> <td></td> <td></td> <td colspan="8" style="text-align: center;"> <table border="1" style="width: 100%; border-collapse: collapse; text-align: center;"> <tr> </tr></table></td></tr></table></td></tr></table></td></tr></table></td></tr></table></td></tr></table></td></tr></table></td></tr></table></td></tr></table></td></tr></table></td></tr></table></td></tr></table></td></tr></table></td></tr></table></td></tr></table></td></tr></table>

 | | | | | | | | | | | | | | | | | | | | <table border="1" style="width: 100%; border-collapse: collapse; text-align: center;"> <tr> <td style="width: 10%;"></td> <td style="width: 10%;"></td> <td style="width: 10%;"></td> <td style="width: 10%;"></td> <td style="width: 10%;"></td> <td style="width: 10%;"></td> <td style="width: 10%;"></td> <td style="width: 10%;"></td> <td style="width: 10%;"></td> <td style="width: 10%;"></td> </tr> <tr> <td></td> <td></td> <td colspan="8" style="text-align: center;"> <table border="1" style="width: 100%; border-collapse: collapse; text-align: center;"> <tr> <td style="width: 10%;"></td> <td style="width: 10%;"></td> <td style="width: 10%;"></td> <td style="width: 10%;"></td> <td style="width: 10%;"></td> <td style="width: 10%;"></td> <td style="width: 10%;"></td> <td style="width: 10%;"></td> <td style="width: 10%;"></td> <td style="width: 10%;"></td> </tr> <tr> <td></td> <td></td> <td colspan="8" style="text-align: center;"> <table border="1" style="width: 100%; border-collapse: collapse; text-align: center;"> <tr> <td style="width: 10%;"></td> <td style="width: 10%;"></td> <td style="width: 10%;"></td> <td style="width: 10%;"></td> <td style="width: 10%;"></td> <td style="width: 10%;"></td> <td style="width: 10%;"></td> <td style="width: 10%;"></td> <td style="width: 10%;"></td> <td style="width: 10%;"></td> </tr> <tr> <td></td> <td></td> <td colspan="8" style="text-align: center;"> <table border="1" style="width: 100%; border-collapse: collapse; text-align: center;"> <tr> <td style="width: 10%;"></td> <td style="width: 10%;"></td> <td style="width: 10%;"></td> <td style="width: 10%;"></td> <td style="width: 10%;"></td> <td style="width: 10%;"></td> <td style="width: 10%;"></td> <td style="width: 10%;"></td> <td style="width: 10%;"></td> <td style="width: 10%;"></td> </tr> <tr> <td></td> <td></td> <td colspan="8" style="text-align: center;"> <table border="1" style="width: 100%; border-collapse: collapse; text-align: center;"> <tr> <td style="width: 10%;"></td> <td style="width: 10%;"></td> <td style="width: 10%;"></td> <td style="width: 10%;"></td> <td style="width: 10%;"></td> <td style="width: 10%;"></td> <td style="width: 10%;"></td> <td style="width: 10%;"></td> <td style="width: 10%;"></td> <td style="width: 10%;"></td> </tr> <tr> <td></td> <td></td> <td colspan="8" style="text-align: center;"> <table border="1" style="width: 100%; border-collapse: collapse; text-align: center;"> <tr> <td style="width: 10%;"></td> <td style="width: 10%;"></td> <td style="width: 10%;"></td> <td style="width: 10%;"></td> <td style="width: 10%;"></td> <td style="width: 10%;"></td> <td style="width: 10%;"></td> <td style="width: 10%;"></td> <td style="width: 10%;"></td> <td style="width: 10%;"></td> </tr> <tr> <td></td> <td></td> <td colspan="8" style="text-align: center;"> <table border="1" style="width: 100%; border-collapse: collapse; text-align: center;"> <tr> <td style="width: 10%;"></td> <td style="width: 10%;"></td> <td style="width: 10%;"></td> <td style="width: 10%;"></td> <td style="width: 10%;"></td> <td style="width: 10%;"></td> <td style="width: 10%;"></td> <td style="width: 10%;"></td> <td style="width: 10%;"></td> <td style="width: 10%;"></td> </tr> <tr> <td></td> <td></td> <td colspan="8" style="text-align: center;"> <table border="1" style="width: 100%; border-collapse: collapse; text-align: center;"> <tr> <td style="width: 10%;"></td> <td style="width: 10%;"></td> <td style="width: 10%;"></td> <td style="width: 10%;"></td> <td style="width: 10%;"></td> <td style="width: 10%;"></td> <td style="width: 10%;"></td> <td style="width: 10%;"></td> <td style="width: 10%;"></td> <td style="width: 10%;"></td> </tr> <tr> <td></td> <td></td> <td colspan="8" style="text-align: center;"> <table border="1" style="width: 100%; border-collapse: collapse; text-align: center;"> <tr> <td style="width: 10%;"></td> <td style="width: 10%;"></td> <td style="width: 10%;"></td> <td style="width: 10%;"></td> <td style="width: 10%;"></td> <td style="width: 10%;"></td> <td style="width: 10%;"></td> <td style="width: 10%;"></td> <td style="width: 10%;"></td> <td style="width: 10%;"></td> </tr> <tr> <td></td> <td></td> <td colspan="8" style="text-align: center;"> <table border="1" style="width: 100%; border-collapse: collapse; text-align: center;"> <tr> <td style="width: 10%;"></td> <td style="width: 10%;"></td> <td style="width: 10%;"></td> <td style="width: 10%;"></td> <td style="width: 10%;"></td> <td style="width: 10%;"></td> <td style="width: 10%;"></td> <td style="width: 10%;"></td> <td style="width: 10%;"></td> <td style="width: 10%;"></td> </tr> <tr> <td></td> <td></td> <td colspan="8" style="text-align: center;"> <table border="1" style="width: 100%; border-collapse: collapse; text-align: center;"> <tr> <td style="width: 10%;"></td> <td style="width: 10%;"></td> <td style="width: 10%;"></td> <td style="width: 10%;"></td> <td style="width: 10%;"></td> <td style="width: 10%;"></td> <td style="width: 10%;"></td> <td style="width: 10%;"></td> <td style="width: 10%;"></td> <td style="width: 10%;"></td> </tr> <tr> <td></td> <td></td> <td colspan="8" style="text-align: center;"> <table border="1" style="width: 100%; border-collapse: collapse; text-align: center;"> <tr> <td style="width: 10%;"></td> <td style="width: 10%;"></td> <td style="width: 10%;"></td> <td style="width: 10%;"></td> <td style="width: 10%;"></td> <td style="width: 10%;"></td> <td style="width: 10%;"></td> <td style="width: 10%;"></td> <td style="width: 10%;"></td> <td style="width: 10%;"></td> </tr> <tr> <td></td> <td></td> <td colspan="8" style="text-align: center;"> <table border="1" style="width: 100%; border-collapse: collapse; text-align: center;"> <tr> <td style="width: 10%;"></td> <td style="width: 10%;"></td> <td style="width: 10%;"></td> <td style="width: 10%;"></td> <td style="width: 10%;"></td> <td style="width: 10%;"></td> <td style="width: 10%;"></td> <td style="width: 10%;"></td> <td style="width: 10%;"></td> <td style="width: 10%;"></td> </tr> <tr> <td></td> <td></td> <td colspan="8" style="text-align: center;"> <table border="1" style="width: 100%; border-collapse: collapse; text-align: center;"> <tr> <td style="width: 10%;"></td> <td style="width: 10%;"></td> <td style="width: 10%;"></td> <td style="width: 10%;"></td> <td style="width: 10%;"></td> <td style="width: 10%;"></td> <td style="width: 10%;"></td> <td style="width: 10%;"></td> <td style="width: 10%;"></td> <td style="width: 10%;"></td> </tr> <tr> <td></td> <td></td> <td colspan="8" style="text-align: center;"> <table border="1" style="width: 100%; border-collapse: collapse; text-align: center;"> <tr> </tr></table></td></tr></table></td></tr></table></td></tr></table></td></tr></table></td></tr></table></td></tr></table></td></tr></table></td></tr></table></td></tr></table></td></tr></table></td></tr></table></td></tr></table></td></tr></table></td></tr></table>

 | | | | | | | | | | | | | | | | | | | | <table border="1" style="width: 100%; border-collapse: collapse; text-align: center;"> <tr> <td style="width: 10%;"></td> <td style="width: 10%;"></td> <td style="width: 10%;"></td> <td style="width: 10%;"></td> <td style="width: 10%;"></td> <td style="width: 10%;"></td> <td style="width: 10%;"></td> <td style="width: 10%;"></td> <td style="width: 10%;"></td> <td style="width: 10%;"></td> </tr> <tr> <td></td> <td></td> <td colspan="8" style="text-align: center;"> <table border="1" style="width: 100%; border-collapse: collapse; text-align: center;"> <tr> <td style="width: 10%;"></td> <td style="width: 10%;"></td> <td style="width: 10%;"></td> <td style="width: 10%;"></td> <td style="width: 10%;"></td> <td style="width: 10%;"></td> <td style="width: 10%;"></td> <td style="width: 10%;"></td> <td style="width: 10%;"></td> <td style="width: 10%;"></td> </tr> <tr> <td></td> <td></td> <td colspan="8" style="text-align: center;"> <table border="1" style="width: 100%; border-collapse: collapse; text-align: center;"> <tr> <td style="width: 10%;"></td> <td style="width: 10%;"></td> <td style="width: 10%;"></td> <td style="width: 10%;"></td> <td style="width: 10%;"></td> <td style="width: 10%;"></td> <td style="width: 10%;"></td> <td style="width: 10%;"></td> <td style="width: 10%;"></td> <td style="width: 10%;"></td> </tr> <tr> <td></td> <td></td> <td colspan="8" style="text-align: center;"> <table border="1" style="width: 100%; border-collapse: collapse; text-align: center;"> <tr> <td style="width: 10%;"></td> <td style="width: 10%;"></td> <td style="width: 10%;"></td> <td style="width: 10%;"></td> <td style="width: 10%;"></td> <td style="width: 10%;"></td> <td style="width: 10%;"></td> <td style="width: 10%;"></td> <td style="width: 10%;"></td> <td style="width: 10%;"></td> </tr> <tr> <td></td> <td></td> <td colspan="8" style="text-align: center;"> <table border="1" style="width: 100%; border-collapse: collapse; text-align: center;"> <tr> <td style="width: 10%;"></td> <td style="width: 10%;"></td> <td style="width: 10%;"></td> <td style="width: 10%;"></td> <td style="width: 10%;"></td> <td style="width: 10%;"></td> <td style="width: 10%;"></td> <td style="width: 10%;"></td> <td style="width: 10%;"></td> <td style="width: 10%;"></td> </tr> <tr> <td></td> <td></td> <td colspan="8" style="text-align: center;"> <table border="1" style="width: 100%; border-collapse: collapse; text-align: center;"> <tr> <td style="width: 10%;"></td> <td style="width: 10%;"></td> <td style="width: 10%;"></td> <td style="width: 10%;"></td> <td style="width: 10%;"></td> <td style="width: 10%;"></td> <td style="width: 10%;"></td> <td style="width: 10%;"></td> <td style="width: 10%;"></td> <td style="width: 10%;"></td> </tr> <tr> <td></td> <td></td> <td colspan="8" style="text-align: center;"> <table border="1" style="width: 100%; border-collapse: collapse; text-align: center;"> <tr> <td style="width: 10%;"></td> <td style="width: 10%;"></td> <td style="width: 10%;"></td> <td style="width: 10%;"></td> <td style="width: 10%;"></td> <td style="width: 10%;"></td> <td style="width: 10%;"></td> <td style="width: 10%;"></td> <td style="width: 10%;"></td> <td style="width: 10%;"></td> </tr> <tr> <td></td> <td></td> <td colspan="8" style="text-align: center;"> <table border="1" style="width: 100%; border-collapse: collapse; text-align: center;"> <tr> <td style="width: 10%;"></td> <td style="width: 10%;"></td> <td style="width: 10%;"></td> <td style="width: 10%;"></td> <td style="width: 10%;"></td> <td style="width: 10%;"></td> <td style="width: 10%;"></td> <td style="width: 10%;"></td> <td style="width: 10%;"></td> <td style="width: 10%;"></td> </tr> <tr> <td></td> <td></td> <td colspan="8" style="text-align: center;"> <table border="1" style="width: 100%; border-collapse: collapse; text-align: center;"> <tr> <td style="width: 10%;"></td> <td style="width: 10%;"></td> <td style="width: 10%;"></td> <td style="width: 10%;"></td> <td style="width: 10%;"></td> <td style="width: 10%;"></td> <td style="width: 10%;"></td> <td style="width: 10%;"></td> <td style="width: 10%;"></td> <td style="width: 10%;"></td> </tr> <tr> <td></td> <td></td> <td colspan="8" style="text-align: center;"> <table border="1" style="width: 100%; border-collapse: collapse; text-align: center;"> <tr> <td style="width: 10%;"></td> <td style="width: 10%;"></td> <td style="width: 10%;"></td> <td style="width: 10%;"></td> <td style="width: 10%;"></td> <td style="width: 10%;"></td> <td style="width: 10%;"></td> <td style="width: 10%;"></td> <td style="width: 10%;"></td> <td style="width: 10%;"></td> </tr> <tr> <td></td> <td></td> <td colspan="8" style="text-align: center;"> <table border="1" style="width: 100%; border-collapse: collapse; text-align: center;"> <tr> <td style="width: 10%;"></td> <td style="width: 10%;"></td> <td style="width: 10%;"></td> <td style="width: 10%;"></td> <td style="width: 10%;"></td> <td style="width: 10%;"></td> <td style="width: 10%;"></td> <td style="width: 10%;"></td> <td style="width: 10%;"></td> <td style="width: 10%;"></td> </tr> <tr> <td></td> <td></td> <td colspan="8" style="text-align: center;"> <table border="1" style="width: 100%; border-collapse: collapse; text-align: center;"> <tr> <td style="width: 10%;"></td> <td style="width: 10%;"></td> <td style="width: 10%;"></td> <td style="width: 10%;"></td> <td style="width: 10%;"></td> <td style="width: 10%;"></td> <td style="width: 10%;"></td> <td style="width: 10%;"></td> <td style="width: 10%;"></td> <td style="width: 10%;"></td> </tr> <tr> <td></td> <td></td> <td colspan="8" style="text-align: center;"> <table border="1" style="width: 100%; border-collapse: collapse; text-align: center;"> <tr> <td style="width: 10%;"></td> <td style="width: 10%;"></td> <td style="width: 10%;"></td> <td style="width: 10%;"></td> <td style="width: 10%;"></td> <td style="width: 10%;"></td> <td style="width: 10%;"></td> <td style="width: 10%;"></td> <td style="width: 10%;"></td> <td style="width: 10%;"></td> </tr> <tr> <td></td> <td></td> <td colspan="8" style="text-align: center;"> <table border="1" style="width: 100%; border-collapse: collapse; text-align: center;"> <tr> </tr></table></td></tr></table></td></tr></table></td></tr></table></td></tr></table></td></tr></table></td></tr></table></td></tr></table></td></tr></table></td></tr></table></td></tr></table></td></tr></table></td></tr></table></td></tr></table>

 | | | | | | | | | | | | | | | | | | | | <table border="1" style="width: 100%; border-collapse: collapse; text-align: center;"> <tr> <td style="width: 10%;"></td> <td style="width: 10%;"></td> <td style="width: 10%;"></td> <td style="width: 10%;"></td> <td style="width: 10%;"></td> <td style="width: 10%;"></td> <td style="width: 10%;"></td> <td style="width: 10%;"></td> <td style="width: 10%;"></td> <td style="width: 10%;"></td> </tr> <tr> <td></td> <td></td> <td colspan="8" style="text-align: center;"> <table border="1" style="width: 100%; border-collapse: collapse; text-align: center;"> <tr> <td style="width: 10%;"></td> <td style="width: 10%;"></td> <td style="width: 10%;"></td> <td style="width: 10%;"></td> <td style="width: 10%;"></td> <td style="width: 10%;"></td> <td style="width: 10%;"></td> <td style="width: 10%;"></td> <td style="width: 10%;"></td> <td style="width: 10%;"></td> </tr> <tr> <td></td> <td></td> <td colspan="8" style="text-align: center;"> <table border="1" style="width: 100%; border-collapse: collapse; text-align: center;"> <tr> <td style="width: 10%;"></td> <td style="width: 10%;"></td> <td style="width: 10%;"></td> <td style="width: 10%;"></td> <td style="width: 10%;"></td> <td style="width: 10%;"></td> <td style="width: 10%;"></td> <td style="width: 10%;"></td> <td style="width: 10%;"></td> <td style="width: 10%;"></td> </tr> <tr> <td></td> <td></td> <td colspan="8" style="text-align: center;"> <table border="1" style="width: 100%; border-collapse: collapse; text-align: center;"> <tr> <td style="width: 10%;"></td> <td style="width: 10%;"></td> <td style="width: 10%;"></td> <td style="width: 10%;"></td> <td style="width: 10%;"></td> <td style="width: 10%;"></td> <td style="width: 10%;"></td> <td style="width: 10%;"></td> <td style="width: 10%;"></td> <td style="width: 10%;"></td> </tr> <tr> <td></td> <td></td> <td colspan="8" style="text-align: center;"> <table border="1" style="width: 100%; border-collapse: collapse; text-align: center;"> <tr> <td style="width: 10%;"></td> <td style="width: 10%;"></td> <td style="width: 10%;"></td> <td style="width: 10%;"></td> <td style="width: 10%;"></td> <td style="width: 10%;"></td> <td style="width: 10%;"></td> <td style="width: 10%;"></td> <td style="width: 10%;"></td> <td style="width: 10%;"></td> </tr> <tr> <td></td> <td></td> <td colspan="8" style="text-align: center;"> <table border="1" style="width: 100%; border-collapse: collapse; text-align: center;"> <tr> <td style="width: 10%;"></td> <td style="width: 10%;"></td> <td style="width: 10%;"></td> <td style="width: 10%;"></td> <td style="width: 10%;"></td> <td style="width: 10%;"></td> <td style="width: 10%;"></td> <td style="width: 10%;"></td> <td style="width: 10%;"></td> <td style="width: 10%;"></td> </tr> <tr> <td></td> <td></td> <td colspan="8" style="text-align: center;"> <table border="1" style="width: 100%; border-collapse: collapse; text-align: center;"> <tr> <td style="width: 10%;"></td> <td style="width: 10%;"></td> <td style="width: 10%;"></td> <td style="width: 10%;"></td> <td style="width: 10%;"></td> <td style="width: 10%;"></td> <td style="width: 10%;"></td> <td style="width: 10%;"></td> <td style="width: 10%;"></td> <td style="width: 10%;"></td> </tr> <tr> <td></td> <td></td> <td colspan="8" style="text-align: center;"> <table border="1" style="width: 100%; border-collapse: collapse; text-align: center;"> <tr> <td style="width: 10%;"></td> <td style="width: 10%;"></td> <td style="width: 10%;"></td> <td style="width: 10%;"></td> <td style="width: 10%;"></td> <td style="width: 10%;"></td> <td style="width: 10%;"></td> <td style="width: 10%;"></td> <td style="width: 10%;"></td> <td style="width: 10%;"></td> </tr> <tr> <td></td> <td></td> <td colspan="8" style="text-align: center;"> <table border="1" style="width: 100%; border-collapse: collapse; text-align: center;"> <tr> <td style="width: 10%;"></td> <td style="width: 10%;"></td> <td style="width: 10%;"></td> <td style="width: 10%;"></td> <td style="width: 10%;"></td> <td style="width: 10%;"></td> <td style="width: 10%;"></td> <td style="width: 10%;"></td> <td style="width: 10%;"></td> <td style="width: 10%;"></td> </tr> <tr> <td></td> <td></td> <td colspan="8" style="text-align: center;"> <table border="1" style="width: 100%; border-collapse: collapse; text-align: center;"> <tr> <td style="width: 10%;"></td> <td style="width: 10%;"></td> <td style="width: 10%;"></td> <td style="width: 10%;"></td> <td style="width: 10%;"></td> <td style="width: 10%;"></td> <td style="width: 10%;"></td> <td style="width: 10%;"></td> <td style="width: 10%;"></td> <td style="width: 10%;"></td> </tr> <tr> <td></td> <td></td> <td colspan="8" style="text-align: center;"> <table border="1" style="width: 100%; border-collapse: collapse; text-align: center;"> <tr> <td style="width: 10%;"></td> <td style="width: 10%;"></td> <td style="width: 10%;"></td> <td style="width: 10%;"></td> <td style="width: 10%;"></td> <td style="width: 10%;"></td> <td style="width: 10%;"></td> <td style="width: 10%;"></td> <td style="width: 10%;"></td> <td style="width: 10%;"></td> </tr> <tr> <td></td> <td></td> <td colspan="8" style="text-align: center;"> <table border="1" style="width: 100%; border-collapse: collapse; text-align: center;"> <tr> <td style="width: 10%;"></td>
<td style="width: 10%;"></td> <td style="width: 10%;"></td> <td style="width: 10%;"></td> <td style="width: 10%;"></td> <td style="width: 10%;"></td> <td style="width: 10%;"></td> <td style="width: 10%;"></td> <td style="width: 10%;"></td> <td style="width: 10%;"></td> </tr> <tr> <td></td> <td></td> <td colspan="8" style="text-align: center;"> <table border="1" style="width: 100%; border-collapse: collapse; text-align: center;"> <tr> </tr></table></td></tr></table></td></tr></table></td></tr></table></td></tr></table></td></tr></table></td></tr></table></td></tr></table></td></tr></table></td></tr></table></td></tr></table></td></tr></table></td></tr></table>
 | | | | | | | | | | | | | | | | | | | | <table border="1" style="width: 100%; border-collapse: collapse; text-align: center;"> <tr> <td style="width: 10%;"></td> <td style="width: 10%;"></td> <td style="width: 10%;"></td> <td style="width: 10%;"></td> <td style="width: 10%;"></td> <td style="width: 10%;"></td> <td style="width: 10%;"></td> <td style="width: 10%;"></td> <td style="width: 10%;"></td> <td style="width: 10%;"></td> </tr> <tr> <td></td> <td></td> <td colspan="8" style="text-align: center;"> <table border="1" style="width: 100%; border-collapse: collapse; text-align: center;"> <tr> <td style="width: 10%;"></td> <td style="width: 10%;"></td> <td style="width: 10%;"></td> <td style="width: 10%;"></td> <td style="width: 10%;"></td> <td style="width: 10%;"></td> <td style="width: 10%;"></td> <td style="width: 10%;"></td> <td style="width: 10%;"></td> <td style="width: 10%;"></td> </tr> <tr> <td></td> <td></td> <td colspan="8" style="text-align: center;"> <table border="1" style="width: 100%; border-collapse: collapse; text-align: center;"> <tr> <td style="width: 10%;"></td> <td style="width: 10%;"></td> <td style="width: 10%;"></td> <td style="width: 10%;"></td> <td style="width: 10%;"></td> <td style="width: 10%;"></td> <td style="width: 10%;"></td> <td style="width: 10%;"></td> <td style="width: 10%;"></td> <td style="width: 10%;"></td> </tr> <tr> <td></td> <td></td> <td colspan="8" style="text-align: center;"> <table border="1" style="width: 100%; border-collapse: collapse; text-align: center;"> <tr> <td style="width: 10%;"></td> <td style="width: 10%;"></td> <td style="width: 10%;"></td> <td style="width: 10%;"></td> <td style="width: 10%;"></td> <td style="width: 10%;"></td> <td style="width: 10%;"></td> <td style="width: 10%;"></td> <td style="width: 10%;"></td> <td style="width: 10%;"></td> </tr> <tr> <td></td> <td></td> <td colspan="8" style="text-align: center;"> <table border="1" style="width: 100%; border-collapse: collapse; text-align: center;"> <tr> <td style="width: 10%;"></td> <td style="width: 10%;"></td> <td style="width: 10%;"></td> <td style="width: 10%;"></td> <td style="width: 10%;"></td> <td style="width: 10%;"></td> <td style="width: 10%;"></td> <td style="width: 10%;"></td> <td style="width: 10%;"></td> <td style="width: 10%;"></td> </tr> <tr> <td></td> <td></td> <td colspan="8" style="text-align: center;"> <table border="1" style="width: 100%; border-collapse: collapse; text-align: center;"> <tr> <td style="width: 10%;"></td> <td style="width: 10%;"></td> <td style="width: 10%;"></td> <td style="width: 10%;"></td> <td style="width: 10%;"></td> <td style="width: 10%;"></td> <td style="width: 10%;"></td> <td style="width: 10%;"></td> <td style="width: 10%;"></td> <td style="width: 10%;"></td> </tr> <tr> <td></td> <td></td> <td colspan="8" style="text-align: center;"> <table border="1" style="width: 100%; border-collapse: collapse; text-align: center;"> <tr> <td style="width: 10%;"></td> <td style="width: 10%;"></td> <td style="width: 10%;"></td> <td style="width: 10%;"></td> <td style="width: 10%;"></td> <td style="width: 10%;"></td> <td style="width: 10%;"></td> <td style="width: 10%;"></td> <td style="width: 10%;"></td> <td style="width: 10%;"></td> </tr> <tr> <td></td> <td></td> <td colspan="8" style="text-align: center;"> <table border="1" style="width: 100%; border-collapse: collapse; text-align: center;"> <tr> <td style="width: 10%;"></td> <td style="width: 10%;"></td> <td style="width: 10%;"></td> <td style="width: 10%;"></td> <td style="width: 10%;"></td> <td style="width: 10%;"></td> <td style="width: 10%;"></td> <td style="width: 10%;"></td> <td style="width: 10%;"></td> <td style="width: 10%;"></td> </tr> <tr> <td></td> <td></td> <td colspan="8" style="text-align: center;"> <table border="1" style="width: 100%; border-collapse: collapse; text-align: center;"> <tr> <td style="width: 10%;"></td> <td style="width: 10%;"></td> <td style="width: 10%;"></td> <td style="width: 10%;"></td> <td style="width: 10%;"></td> <td style="width: 10%;"></td> <td style="width: 10%;"></td> <td style="width: 10%;"></td> <td style="width: 10%;"></td> <td style="width: 10%;"></td> </tr> <tr> <td></td> <td></td> <td colspan="8" style="text-align:
center;"> <table border="1" style="width: 100%; border-collapse: collapse; text-align: center;"> <tr> <td style="width: 10%;"></td> <td style="width: 10%;"></td> <td style="width: 10%;"></td> <td style="width: 10%;"></td> <td style="width: 10%;"></td> <td style="width: 10%;"></td> <td style="width: 10%;"></td> <td style="width: 10%;"></td> <td style="width: 10%;"></td> <td style="width: 10%;"></td> </tr> <tr> <td></td> <td></td> <td colspan="8" style="text-align: center;"> <table border="1" style="width: 100%; border-collapse: collapse; text-align: center;"> <tr> <td style="width: 10%;"></td> <td style="width: 10%;"></td> <td style="width: 10%;"></td> <td style="width: 10%;"></td> <td style="width: 10%;"></td> <td style="width: 10%;"></td> <td style="width: 10%;"></td> <td style="width: 10%;"></td> <td style="width: 10%;"></td> <td style="width: 10%;"></td> </tr> <tr> <td></td> <td></td> <td colspan="8" style="text-align: center;"> <table border="1" style="width: 100%; border-collapse: collapse; text-align: center;"> <tr> </tr></table></td></tr></table></td></tr></table></td></tr></table></td></tr></table></td></tr></table></td></tr></table></td></tr></table></td></tr></table></td></tr></table></td></tr></table></td></tr></table>
 | | | | | | | | | | | | | | | | | | | | <table border="1" style="width: 100%; border-collapse: collapse; text-align: center;"> <tr> <td style="width: 10%;"></td> <td style="width: 10%;"></td> <td style="width: 10%;"></td> <td style="width: 10%;"></td> <td style="width: 10%;"></td> <td style="width: 10%;"></td> <td style="width: 10%;"></td> <td style="width: 10%;"></td> <td style="width: 10%;"></td> <td style="width: 10%;"></td> </tr> <tr> <td></td> <td></td> <td colspan="8" style="text-align: center;"> <table border="1" style="width: 100%; border-collapse: collapse; text-align: center;"> <tr> <td style="width: 10%;"></td> <td style="width: 10%;"></td> <td style="width: 10%;"></td> <td style="width: 10%;"></td> <td style="width: 10%;"></td> <td style="width: 10%;"></td> <td style="width: 10%;"></td> <td style="width: 10%;"></td> <td style="width: 10%;"></td> <td style="width: 10%;"></td> </tr> <tr> <td></td> <td></td> <td colspan="8" style="text-align: center;"> <table border="1" style="width: 100%; border-collapse: collapse; text-align: center;"> <tr> <td style="width: 10%;"></td> <td style="width: 10%;"></td> <td style="width: 10%;"></td> <td style="width: 10%;"></td> <td style="width: 10%;"></td> <td style="width: 10%;"></td> <td style="width: 10%;"></td> <td style="width: 10%;"></td> <td style="width: 10%;"></td> <td style="width: 10%;"></td> </tr> <tr> <td></td> <td></td> <td colspan="8" style="text-align: center;"> <table border="1" style="width: 100%; border-collapse: collapse; text-align: center;"> <tr> <td style="width: 10%;"></td> <td style="width: 10%;"></td> <td style="width: 10%;"></td> <td style="width: 10%;"></td> <td style="width: 10%;"></td> <td style="width: 10%;"></td> <td style="width: 10%;"></td> <td style="width: 10%;"></td> <td style="width: 10%;"></td> <td style="width: 10%;"></td> </tr> <tr> <td></td> <td></td> <td colspan="8" style="text-align: center;"> <table border="1" style="width: 100%; border-collapse: collapse; text-align: center;"> <tr> <td style="width: 10%;"></td> <td style="width: 10%;"></td> <td style="width: 10%;"></td> <td style="width: 10%;"></td> <td style="width: 10%;"></td> <td style="width: 10%;"></td> <td style="width: 10%;"></td> <td style="width: 10%;"></td> <td style="width: 10%;"></td> <td style="width: 10%;"></td> </tr> <tr> <td></td> <td></td> <td colspan="8" style="text-align: center;"> <table border="1" style="width: 100%; border-collapse: collapse; text-align: center;"> <tr> <td style="width: 10%;"></td> <td style="width: 10%;"></td> <td style="width: 10%;"></td> <td style="width: 10%;"></td> <td style="width: 10%;"></td> <td style="width: 10%;"></td> <td style="width: 10%;"></td> <td style="width: 10%;"></td> <td style="width: 10%;"></td> <td style="width: 10%;"></td> </tr> <tr> <td></td> <td></td> <td colspan="8" style="text-align: center;"> <table border="1" style="width: 100%; border-collapse: collapse; text-align: center;"> <tr> <td style="width: 10%;"></td> <td style="width: 10%;"></td> <td style="width: 10%;"></td> <td style="width: 10%;"></td> <td style="width: 10%;"></td> <td style="width: 10%;"></td> <td style="width: 10%;"></td> <td style="width: 10%;"></td> <td style="width: 10%;"></td> <td style="width: 10%;"></td> </tr> <tr> <td></td> <td></td> <td colspan="8" style="text-align: center;"> <table border="1" style="width: 100%; border-collapse: collapse; text-align: center;"> <tr> <td style="width: 10%;"></td> <td style="width: 10%;"></td> <td style="width: 10%;"></td> <td style="width: 10%;"></td> <td style="width: 10%;"></td> <td style="width: 10%;"></td> <td style="width: 10%;"></td> <td style="width: 10%;"></td> <td
style="width: 10%;"></td> <td style="width: 10%;"></td> </tr> <tr> <td></td> <td></td> <td colspan="8" style="text-align: center;"> <table border="1" style="width: 100%; border-collapse: collapse; text-align: center;"> <tr> <td style="width: 10%;"></td> <td style="width: 10%;"></td> <td style="width: 10%;"></td> <td style="width: 10%;"></td> <td style="width: 10%;"></td> <td style="width: 10%;"></td> <td style="width: 10%;"></td> <td style="width: 10%;"></td> <td style="width: 10%;"></td> <td style="width: 10%;"></td> </tr> <tr> <td></td> <td></td> <td colspan="8" style="text-align: center;"> <table border="1" style="width: 100%; border-collapse: collapse; text-align: center;"> <tr> <td style="width: 10%;"></td> <td style="width: 10%;"></td> <td style="width: 10%;"></td> <td style="width: 10%;"></td> <td style="width: 10%;"></td> <td style="width: 10%;"></td> <td style="width: 10%;"></td> <td style="width: 10%;"></td> <td style="width: 10%;"></td> <td style="width: 10%;"></td> </tr> <tr> <td></td> <td></td> <td colspan="8" style="text-align: center;"> <table border="1" style="width: 100%; border-collapse: collapse; text-align: center;"> <tr> </tr></table></td></tr></table></td></tr></table></td></tr></table></td></tr></table></td></tr></table></td></tr></table></td></tr></table></td></tr></table></td></tr></table></td></tr></table>
 | | | | | | | | | | | | | | | | | | | | <table border="1" style="width: 100%; border-collapse: collapse; text-align: center;"> <tr> <td style="width: 10%;"></td> <td style="width: 10%;"></td> <td style="width: 10%;"></td> <td style="width: 10%;"></td> <td style="width: 10%;"></td> <td style="width: 10%;"></td> <td style="width: 10%;"></td> <td style="width: 10%;"></td> <td style="width: 10%;"></td> <td style="width: 10%;"></td> </tr> <tr> <td></td> <td></td> <td colspan="8" style="text-align: center;"> <table border="1" style="width: 100%; border-collapse: collapse; text-align: center;"> <tr> <td style="width: 10%;"></td> <td style="width: 10%;"></td> <td style="width: 10%;"></td> <td style="width: 10%;"></td> <td style="width: 10%;"></td> <td style="width: 10%;"></td> <td style="width: 10%;"></td> <td style="width: 10%;"></td> <td style="width: 10%;"></td> <td style="width: 10%;"></td> </tr> <tr> <td></td> <td></td> <td colspan="8" style="text-align: center;"> <table border="1" style="width: 100%; border-collapse: collapse; text-align: center;"> <tr> <td style="width: 10%;"></td> <td style="width: 10%;"></td> <td style="width: 10%;"></td> <td style="width: 10%;"></td> <td style="width: 10%;"></td> <td style="width: 10%;"></td> <td style="width: 10%;"></td> <td style="width: 10%;"></td> <td style="width: 10%;"></td> <td style="width: 10%;"></td> </tr> <tr> <td></td> <td></td> <td colspan="8" style="text-align: center;"> <table border="1" style="width: 100%; border-collapse: collapse; text-align: center;"> <tr> <td style="width: 10%;"></td> <td style="width: 10%;"></td> <td style="width: 10%;"></td> <td style="width: 10%;"></td> <td style="width: 10%;"></td> <td style="width: 10%;"></td> <td style="width: 10%;"></td> <td style="width: 10%;"></td> <td style="width: 10%;"></td> <td style="width: 10%;"></td> </tr> <tr> <td></td> <td></td> <td colspan="8" style="text-align: center;"> <table border="1" style="width: 100%; border-collapse: collapse; text-align: center;"> <tr> <td style="width: 10%;"></td> <td style="width: 10%;"></td> <td style="width: 10%;"></td> <td style="width: 10%;"></td> <td style="width: 10%;"></td> <td style="width: 10%;"></td> <td style="width: 10%;"></td> <td style="width: 10%;"></td> <td style="width: 10%;"></td> <td style="width: 10%;"></td> </tr> <tr> <td></td> <td></td> <td colspan="8" style="text-align: center;"> <table border="1" style="width: 100%; border-collapse: collapse; text-align: center;"> <tr> <td style="width: 10%;"></td> <td style="width: 10%;"></td> <td style="width: 10%;"></td> <td style="width: 10%;"></td> <td style="width: 10%;"></td> <td style="width: 10%;"></td> <td style="width: 10%;"></td> <td style="width: 10%;"></td> <td style="width: 10%;"></td> <td style="width: 10%;"></td> </tr> <tr> <td></td> <td></td> <td colspan="8" style="text-align: center;"> <table border="1" style="width: 100%; border-collapse: collapse; text-align: center;"> <tr> <td style="width: 10%;"></td> <td style="width: 10%;"></td> <td style="width: 10%;"></td> <td style="width: 10%;"></td> <td style="width: 10%;"></td> <td style="width: 10%;"></td> <td style="width: 10%;"></td> <td style="width: 10%;"></td> <td style="width: 10%;"></td> <td style="width: 10%;"></td> </tr> <tr> <td></td> <td></td> <td colspan="8" style="text-align: center;"> <table border="1" style="width: 100%; border-collapse: collapse; text-align: center;"> <tr> <td style="width: 10%;"></td> <td style="width: 10%;"></td> <td style="width: 10%;"></td> <td style="width: 10%;"></td> <td style="width: 10%;"></td>
<td style="width: 10%;"></td> <td style="width: 10%;"></td> <td style="width: 10%;"></td> <td style="width: 10%;"></td> <td style="width: 10%;"></td> </tr> <tr> <td></td> <td></td> <td colspan="8" style="text-align: center;"> <table border="1" style="width: 100%; border-collapse: collapse; text-align: center;"> <tr> <td style="width: 10%;"></td> <td style="width: 10%;"></td> <td style="width: 10%;"></td> <td style="width: 10%;"></td> <td style="width: 10%;"></td> <td style="width: 10%;"></td> <td style="width: 10%;"></td> <td style="width: 10%;"></td> <td style="width: 10%;"></td> <td style="width: 10%;"></td> </tr> <tr> <td></td> <td></td> <td colspan="8" style="text-align: center;"> <table border="1" style="width: 100%; border-collapse: collapse; text-align: center;"> <tr> </tr></table></td></tr></table></td></tr></table></td></tr></table></td></tr></table></td></tr></table></td></tr></table></td></tr></table></td></tr></table></td></tr></table>
 | | | | | | | | | | | | | | | | | | | | <table border="1" style="width: 100%; border-collapse: collapse; text-align: center;"> <tr> <td style="width: 10%;"></td> <td style="width: 10%;"></td> <td style="width: 10%;"></td> <td style="width: 10%;"></td> <td style="width: 10%;"></td> <td style="width: 10%;"></td> <td style="width: 10%;"></td> <td style="width: 10%;"></td> <td style="width: 10%;"></td> <td style="width: 10%;"></td> </tr> <tr> <td></td> <td></td> <td colspan="8" style="text-align: center;"> <table border="1" style="width: 100%; border-collapse: collapse; text-align: center;"> <tr> <td style="width: 10%;"></td> <td style="width: 10%;"></td> <td style="width: 10%;"></td> <td style="width: 10%;"></td> <td style="width: 10%;"></td> <td style="width: 10%;"></td> <td style="width: 10%;"></td> <td style="width: 10%;"></td> <td style="width: 10%;"></td> <td style="width: 10%;"></td> </tr> <tr> <td></td> <td></td> <td colspan="8" style="text-align: center;"> <table border="1" style="width: 100%; border-collapse: collapse; text-align: center;"> <tr> <td style="width: 10%;"></td> <td style="width: 10%;"></td> <td style="width: 10%;"></td> <td style="width: 10%;"></td> <td style="width: 10%;"></td> <td style="width: 10%;"></td> <td style="width: 10%;"></td> <td style="width: 10%;"></td> <td style="width: 10%;"></td> <td style="width: 10%;"></td> </tr> <tr> <td></td> <td></td> <td colspan="8" style="text-align: center;"> <table border="1" style="width: 100%; border-collapse: collapse; text-align: center;"> <tr> <td style="width: 10%;"></td> <td style="width: 10%;"></td> <td style="width: 10%;"></td> <td style="width: 10%;"></td> <td style="width: 10%;"></td> <td style="width: 10%;"></td> <td style="width: 10%;"></td> <td style="width: 10%;"></td> <td style="width: 10%;"></td> <td style="width: 10%;"></td> </tr> <tr> <td></td> <td></td> <td colspan="8" style="text-align: center;"> <table border="1" style="width: 100%; border-collapse: collapse; text-align: center;"> <tr> <td style="width: 10%;"></td> <td style="width: 10%;"></td> <td style="width: 10%;"></td> <td style="width: 10%;"></td> <td style="width: 10%;"></td> <td style="width: 10%;"></td> <td style="width: 10%;"></td> <td style="width: 10%;"></td> <td style="width: 10%;"></td> <td style="width: 10%;"></td> </tr> <tr> <td></td> <td></td> <td colspan="8" style="text-align: center;"> <table border="1" style="width: 100%; border-collapse: collapse; text-align: center;"> <tr> <td style="width: 10%;"></td> <td style="width: 10%;"></td> <td style="width: 10%;"></td> <td style="width: 10%;"></td> <td style="width: 10%;"></td> <td style="width: 10%;"></td> <td style="width: 10%;"></td> <td style="width: 10%;"></td> <td style="width: 10%;"></td> <td style="width: 10%;"></td> </tr> <tr> <td></td> <td></td> <td colspan="8" style="text-align: center;"> <table border="1" style="width: 100%; border-collapse: collapse; text-align: center;"> <tr> <td style="width: 10%;"></td> <td style="width: 10%;"></td> <td style="width: 10%;"></td> <td style="width: 10%;"></td> <td style="width: 10%;"></td> <td style="width: 10%;"></td> <td style="width: 10%;"></td> <td style="width: 10%;"></td> <td style="width: 10%;"></td> <td style="width: 10%;"></td> </tr> <tr> <td></td> <td></td> <td colspan="8" style="text-align: center;"> <table border="1" style="width: 100%; border-collapse: collapse; text-align: center;"> <tr> <td style="width: 10%;"></td> <td style="width: 10%;"></td> <td style="width: 10%;"></td> <td style="width: 10%;"></td> <td style="width: 10%;"></td> <td style="width: 10%;"></td> <td style="width: 10%;"></td> <td style="width: 10%;"></td> <td style="width: 10%;"></td> <td style="width: 10%;"></td> </tr> <tr> <td></td> <td></td> <td colspan="8" style="text-align: center;"> <table border="1" style="width: 100%; border-collapse: collapse; text-align: center;"> <tr>
</tr></table></td></tr></table></td></tr></table></td></tr></table></td></tr></table></td></tr></table></td></tr></table></td></tr></table></td></tr></table>
 | | | | | | | | | | | | | | | | | | | | <table border="1" style="width: 100%; border-collapse: collapse; text-align: center;"> <tr> <td style="width: 10%;"></td> <td style="width: 10%;"></td> <td style="width: 10%;"></td> <td style="width: 10%;"></td> <td style="width: 10%;"></td> <td style="width: 10%;"></td> <td style="width: 10%;"></td> <td style="width: 10%;"></td> <td style="width: 10%;"></td> <td style="width: 10%;"></td> </tr> <tr> <td></td> <td></td> <td colspan="8" style="text-align: center;"> <table border="1" style="width: 100%; border-collapse: collapse; text-align: center;"> <tr> <td style="width: 10%;"></td> <td style="width: 10%;"></td> <td style="width: 10%;"></td> <td style="width: 10%;"></td> <td style="width: 10%;"></td> <td style="width: 10%;"></td> <td style="width: 10%;"></td> <td style="width: 10%;"></td> <td style="width: 10%;"></td> <td style="width: 10%;"></td> </tr> <tr> <td></td> <td></td> <td colspan="8" style="text-align: center;"> <table border="1" style="width: 100%; border-collapse: collapse; text-align: center;"> <tr> <td style="width: 10%;"></td> <td style="width: 10%;"></td> <td style="width: 10%;"></td> <td style="width: 10%;"></td> <td style="width: 10%;"></td> <td style="width: 10%;"></td> <td style="width: 10%;"></td> <td style="width: 10%;"></td> <td style="width: 10%;"></td> <td style="width: 10%;"></td> </tr> <tr> <td></td> <td></td> <td colspan="8" style="text-align: center;"> <table border="1" style="width: 100%; border-collapse: collapse; text-align: center;"> <tr> <td style="width: 10%;"></td> <td style="width: 10%;"></td> <td style="width: 10%;"></td> <td style="width: 10%;"></td> <td style="width: 10%;"></td> <td style="width: 10%;"></td> <td style="width: 10%;"></td> <td style="width: 10%;"></td> <td style="width: 10%;"></td> <td style="width: 10%;"></td> </tr> <tr> <td></td> <td></td> <td colspan="8" style="text-align: center;"> <table border="1" style="width: 100%; border-collapse: collapse; text-align: center;"> <tr> <td style="width: 10%;"></td> <td style="width: 10%;"></td> <td style="width: 10%;"></td> <td style="width: 10%;"></td> <td style="width: 10%;"></td> <td style="width: 10%;"></td> <td style="width: 10%;"></td> <td style="width: 10%;"></td> <td style="width: 10%;"></td> <td style="width: 10%;"></td> </tr> <tr> <td></td> <td></td> <td colspan="8" style="text-align: center;"> <table border="1" style="width: 100%; border-collapse: collapse; text-align: center;"> <tr> <td style="width: 10%;"></td> <td style="width: 10%;"></td> <td style="width: 10%;"></td> <td style="width: 10%;"></td> <td style="width: 10%;"></td> <td style="width: 10%;"></td> <td style="width: 10%;"></td> <td style="width: 10%;"></td> <td style="width: 10%;"></td> <td style="width: 10%;"></td> </tr> <tr> <td></td> <td></td> <td colspan="8" style="text-align: center;"> <table border="1" style="width: 100%; border-collapse: collapse; text-align: center;"> <tr> <td style="width: 10%;"></td> <td style="width: 10%;"></td> <td style="width: 10%;"></td> <td style="width: 10%;"></td> <td style="width: 10%;"></td> <td style="width: 10%;"></td> <td style="width: 10%;"></td> <td style="width: 10%;"></td> <td style="width: 10%;"></td> <td style="width: 10%;"></td> </tr> <tr> <td></td> <td></td> <td colspan="8" style="text-align: center;"> <table border="1" style="width: 100%; border-collapse: collapse; text-align: center;"> <tr> </tr></table></td></tr></table></td></tr></table></td></tr></table></td></tr></table></td></tr></table></td></tr></table></td></tr></table>

 | | | | | | | | | | | | | | | | | | | | <table border="1" style="width: 100%; border-collapse: collapse; text-align: center;"> <tr> <td style="width: 10%;"></td> <td style="width: 10%;"></td> <td style="width: 10%;"></td> <td style="width: 10%;"></td> <td style="width: 10%;"></td> <td style="width: 10%;"></td> <td style="width: 10%;"></td> <td style="width: 10%;"></td> <td style="width: 10%;"></td> <td style="width: 10%;"></td> </tr> <tr> <td></td> <td></td> <td colspan="8" style="text-align: center;"> <table border="1" style="width: 100%; border-collapse: collapse; text-align: center;"> <tr> <td style="width: 10%;"></td> <td style="width: 10%;"></td> <td style="width: 10%;"></td> <td style="width: 10%;"></td> <td style="width: 10%;"></td> <td style="width: 10%;"></td> <td style="width: 10%;"></td> <td style="width: 10%;"></td> <td style="width: 10%;"></td> <td style="width: 10%;"></td> </tr> <tr> <td></td> <td></td> <td colspan="8" style="text-align: center;"> <table border="1" style="width: 100%; border-collapse: collapse; text-align: center;"> <tr> <td style="width: 10%;"></td> <td style="width: 10%;"></td> <td style="width: 10%;"></td> <td style="width: 10%;"></td> <td style="width: 10%;"></td> <td style="width: 10%;"></td> <td style="width: 10%;"></td> <td style="width: 10%;"></td> <td style="width: 10%;"></td> <td style="width: 10%;"></td> </tr> <tr> <td></td> <td></td> <td colspan="8" style="text-align: center;"> <table border="1" style="width: 100%; border-collapse: collapse; text-align: center;"> <tr> <td style="width: 10%;"></td> <td style="width: 10%;"></td> <td style="width: 10%;"></td> <td style="width: 10%;"></td> <td style="width: 10%;"></td> <td style="width: 10%;"></td> <td style="width: 10%;"></td> <td style="width: 10%;"></td> <td style="width: 10%;"></td> <td style="width: 10%;"></td> </tr> <tr> <td></td> <td></td> <td colspan="8" style="text-align: center;"> <table border="1" style="width: 100%; border-collapse: collapse; text-align: center;"> <tr> <td style="width: 10%;"></td> <td style="width: 10%;"></td> <td style="width: 10%;"></td> <td style="width: 10%;"></td> <td style="width: 10%;"></td> <td style="width: 10%;"></td> <td style="width: 10%;"></td> <td style="width: 10%;"></td> <td style="width: 10%;"></td> <td style="width: 10%;"></td> </tr> <tr> <td></td> <td></td> <td colspan="8" style="text-align: center;"> <table border="1" style="width: 100%; border-collapse: collapse; text-align: center;"> <tr> <td style="width: 10%;"></td> <td style="width: 10%;"></td> <td style="width: 10%;"></td> <td style="width: 10%;"></td> <td style="width: 10%;"></td> <td style="width: 10%;"></td> <td style="width: 10%;"></td> <td style="width: 10%;"></td> <td style="width: 10%;"></td> <td style="width: 10%;"></td> </tr> <tr> <td></td> <td></td> <td colspan="8" style="text-align: center;"> <table border="1" style="width: 100%; border-collapse: collapse; text-align: center;"> <tr> </tr></table></td></tr></table></td></tr></table></td></tr></table></td></tr></table></td></tr></table></td></tr></table>

 | | | | | | | | | | | | | | | | | | | | <table border="1" style="width: 100%; border-collapse: collapse; text-align: center;"> <tr> <td style="width: 10%;"></td> <td style="width: 10%;"></td> <td style="width: 10%;"></td> <td style="width: 10%;"></td> <td style="width: 10%;"></td> <td style="width: 10%;"></td> <td style="width: 10%;"></td> <td style="width: 10%;"></td> <td style="width: 10%;"></td> <td style="width: 10%;"></td> </tr> <tr> <td></td> <td></td> <td colspan="8" style="text-align: center;"> <table border="1" style="width: 100%; border-collapse: collapse; text-align: center;"> <tr> <td style="width: 10%;"></td> <td style="width: 10%;"></td> <td style="width: 10%;"></td> <td style="width: 10%;"></td> <td style="width: 10%;"></td> <td style="width: 10%;"></td> <td style="width: 10%;"></td> <td style="width: 10%;"></td> <td style="width: 10%;"></td> <td style="width: 10%;"></td> </tr> <tr> <td></td> <td></td> <td colspan="8" style="text-align: center;"> <table border="1" style="width: 100%; border-collapse: collapse; text-align: center;"> <tr> <td style="width: 10%;"></td> <td style="width: 10%;"></td> <td style="width: 10%;"></td> <td style="width: 10%;"></td> <td style="width: 10%;"></td> <td style="width: 10%;"></td> <td style="width: 10%;"></td> <td style="width: 10%;"></td> <td style="width: 10%;"></td> <td style="width: 10%;"></td> </tr> <tr> <td></td> <td></td> <td colspan="8" style="text-align: center;"> <table border="1" style="width: 100%; border-collapse: collapse; text-align: center;"> <tr> <td style="width: 10%;"></td> <td style="width: 10%;"></td> <td style="width: 10%;"></td> <td style="width: 10%;"></td> <td style="width: 10%;"></td> <td style="width: 10%;"></td> <td style="width: 10%;"></td> <td style="width: 10%;"></td> <td style="width: 10%;"></td> <td style="width: 10%;"></td> </tr> <tr> <td></td> <td></td> <td colspan="8" style="text-align: center;"> <table border="1" style="width: 100%; border-collapse: collapse; text-align: center;"> <tr> <td style="width: 10%;"></td> <td style="width: 10%;"></td> <td style="width: 10%;"></td> <td style="width: 10%;"></td> <td style="width: 10%;"></td> <td style="width: 10%;"></td> <td style="width: 10%;"></td> <td style="width: 10%;"></td> <td style="width: 10%;"></td> <td style="width: 10%;"></td> </tr> <tr> <td></td> <td></td> <td colspan="8" style="text-align: center;"> <table border="1" style="width: 100%; border-collapse: collapse; text-align: center;"> <tr> </tr></table></td></tr></table></td></tr></table></td></tr></table></td></tr></table></td></tr></table>
 | | | | | | | | | | | | | | | | | | | | <table border="1" style="width: 100%; border-collapse: collapse; text-align: center;"> <tr> <td style="width: 10%;"></td> <td style="width: 10%;"></td> <td style="width: 10%;"></td> <td style="width: 10%;"></td> <td style="width: 10%;"></td> <td style="width: 10%;"></td> <td
style="width: 10%;"></td> <td style="width: 10%;"></td> <td style="width: 10%;"></td> <td style="width: 10%;"></td> </tr> <tr> <td></td> <td></td> <td colspan="8" style="text-align: center;"> <table border="1" style="width: 100%; border-collapse: collapse; text-align: center;"> <tr> <td style="width: 10%;"></td> <td style="width: 10%;"></td> <td style="width: 10%;"></td> <td style="width: 10%;"></td> <td style="width: 10%;"></td> <td style="width: 10%;"></td> <td style="width: 10%;"></td> <td style="width: 10%;"></td> <td style="width: 10%;"></td> <td style="width: 10%;"></td> </tr> <tr> <td></td> <td></td> <td colspan="8" style="text-align: center;"> <table border="1" style="width: 100%; border-collapse: collapse; text-align: center;"> <tr> <td style="width: 10%;"></td> <td style="width: 10%;"></td> <td style="width: 10%;"></td> <td style="width: 10%;"></td> <td style="width: 10%;"></td> <td style="width: 10%;"></td> <td style="width: 10%;"></td> <td style="width: 10%;"></td> <td style="width: 10%;"></td> <td style="width: 10%;"></td> </tr> <tr> <td></td> <td></td> <td colspan="8" style="text-align: center;"> <table border="1" style="width: 100%; border-collapse: collapse; text-align: center;"> <tr> <td style="width: 10%;"></td> <td style="width: 10%;"></td> <td style="width: 10%;"></td> <td style="width: 10%;"></td> <td style="width: 10%;"></td> <td style="width: 10%;"></td> <td style="width: 10%;"></td> <td style="width: 10%;"></td> <td style="width: 10%;"></td> <td style="width: 10%;"></td> </tr> <tr> <td></td> <td></td> <td colspan="8" style="text-align: center;"> <table border="1" style="width: 100%; border-collapse: collapse; text-align: center;"> <tr> </tr></table></td></tr></table></td></tr></table></td></tr></table></td></tr></table>
 | | | | | | | | | | | | | | | | | | | | <table border="1" style="width: 100%; border-collapse: collapse; text-align: center;"> <tr> <td style="width: 10%;"></td> <td style="width: 10%;"></td> <td style="width: 10%;"></td> <td style="width: 10%;"></td> <td style="width: 10%;"></td> <td style="width: 10%;"></td> <td style="width: 10%;"></td> <td style="width: 10%;"></td> <td style="width: 10%;"></td> <td style="width: 10%;"></td> </tr> <tr> <td></td> <td></td> <td colspan="8" style="text-align: center;"> <table border="1" style="width: 100%; border-collapse: collapse; text-align: center;"> <tr> <td style="width: 10%;"></td> <td style="width: 10%;"></td> <td style="width: 10%;"></td> <td style="width: 10%;"></td> <td style="width: 10%;"></td> <td style="width: 10%;"></td> <td style="width: 10%;"></td> <td style="width: 10%;"></td> <td style="width: 10%;"></td> <td style="width: 10%;"></td> </tr> <tr> <td></td> <td></td> <td colspan="8" style="text-align: center;"> <table border="1" style="width: 100%; border-collapse: collapse; text-align: center;"> <tr> <td style="width: 10%;"></td> <td style="width: 10%;"></td> <td style="width: 10%;"></td> <td style="width: 10%;"></td> <td style="width: 10%;"></td> <td style="width: 10%;"></td> <td style="width: 10%;"></td> <td style="width: 10%;"></td> <td style="width: 10%;"></td> <td style="width: 10%;"></td> </tr> <tr> <td></td> <td></td> <td colspan="8" style="text-align: center;"> <table border="1" style="width: 100%; border-collapse: collapse; text-align: center;"> <tr> </tr></table></td></tr></table></td></tr></table></td></tr></table>

 | | | | | | | | | | | | | | | | | | | | <table border="1" style="width: 100%; border-collapse: collapse; text-align: center;"> <tr> <td style="width: 10%;"></td> <td style="width: 10%;"></td> <td style="width: 10%;"></td> <td style="width: 10%;"></td> <td style="width: 10%;"></td> <td style="width: 10%;"></td> <td style="width: 10%;"></td> <td style="width: 10%;"></td> <td style="width: 10%;"></td> <td style="width: 10%;"></td> </tr> <tr> <td></td> <td></td> <td colspan="8" style="text-align: center;"> <table border="1" style="width: 100%; border-collapse: collapse; text-align: center;"> <tr> <td style="width: 10%;"></td> <td style="width: 10%;"></td> <td style="width: 10%;"></td> <td style="width: 10%;"></td> <td style="width: 10%;"></td> <td style="width: 10%;"></td> <td style="width: 10%;"></td> <td style="width: 10%;"></td> <td style="width: 10%;"></td> <td style="width: 10%;"></td> </tr> <tr> <td></td> <td></td> <td colspan="8" style="text-align: center;"> <table border="1" style="width: 100%; border-collapse: collapse; text-align: center;"> <tr> </tr></table></td></tr></table></td></tr></table>
 | | | | | | | | | | | | | | | | | | | | <table border="1" style="width: 100%; border-collapse: collapse; text-align: center;"> <tr> <td style="width: 10%;"></td> <td style="width: 10%;"></td> <td style="width: 10%;"></td> <td style="width:
10%;"></td> <td style="width: 10%;"></td> <td style="width: 10%;"></td> <td style="width: 10%;"></td> <td style="width: 10%;"></td> <td style="width: 10%;"></td> <td style="width: 10%;"></td> </tr> <tr> <td></td> <td></td> <td colspan="8" style="text-align: center;"> <table border="1" style="width: 100%; border-collapse: collapse; text-align: center;"> <tr> </tr></table></td></tr></table>
 | | | | | | | | | | | | | | | | | | | | <table border="1" style="width: 100%; border-collapse: collapse; text-align: center;"> <tr> </tr></table>

 | | | | | | | | | | | | | | | | | | | |
 | | | | | | | | | | | | | | | | | | | |
 | | | | | | | | | | | | | | | | | | | |

 | | | | | | | | | | | | | | | | | | | |
 | | | | | | | | | | | | | | | | | | | |
 | | | | | | | | | | | | | | | | | | | |

 | | | | | | | | | | | | | | | | | | | | | | | | | | | | | | | | | | | | | | | | | | | | | | | | | | | | | | | | | | | | | | | | | | | | | | | | | | | | | | | | | | | | | | | | | | | | | | | | | | | |
 | | | | | | | | | | | | | | | | | | | |
 | | | | | | | | | | | | | | | | | | | |
 | | | | | | | | | | | | | | | | | | | |
 | | | | | | | | | | | | | | | | | | | |
 | | | | | | | | | | | | | | | | | | | |
 | | | | | | | | | | | | | | | | | | | |
 | | | | | | | | | | | | | | | | | | | |
 | | | | | | | | | | | | | | | | | | | |
 | | | | | | | | | | | | | | | | | | | | | | | | | | | | | | | | | | | | | | | |
 | | | | | | | | | | | | | | | | | | | |
 | | | | | | | | | | | | | | | | | | | | | | | | | | | | | | | | | | | | | | | |
 | | | | | | | | | | | | | | | | | | | | | | | | | | | | | | | | | | | | | | | |
 | | | | | | | | | | | | | | | | | | | | | | | | | | | | | | | | | | | | | | | |
 | | | | | | | | | | | | | | | | | | | | | | | | | | | | | | | | | | | | | | | | | | | | | | | | | | | | | | | | | | | | | | | | | | | | | | | | | | | | | | | | | | | | | | | | | | | | | | | | | | | |
 | | | | | | | | | | | | | | | | | | | | | | | | | | | | | | | | | | | | | | | | | | | | | | | |
| | |

 | | | | | | | | | | | | | | | | | | | |

 | | | | | | | | | | | | | | | | | | | |

 | | | | | | | | | | | | | | | | | | | |

 | | | | | | | | | | | | | | | | | | | |

 | | | | | | | | | | | | | | | | | | | |

 | | | | | | | | | | | | | | | | | | | |

 | | | | | | | | | | | | | | | | | | | |

 | | | | | | | | | | | | | | | | | | | |

 | | | | | | | | | | | | | | | | | | | |

 | | | | | | | | | | | | | | | | | | | |

 | | | | | | | | | | | | | | | | | | | |

 | | | | | | | | | | | | | | | | | | | |

 | | | | | | | | | | | | | | | | | | | |

 | | | | | | | | | | | | | | | | | | | |

 | | | | | | | | | | | | | | | | | | | |

 | | | | | | | | | | | | | | | | | | | |

 | | | | | | | | | | | | | | | | | | | |

 | | | | | | | | | | | | | | | | | | | |

 | | | | | | | | | | | | | | | | | | | |

 | | | | | | | | | | | | | | | | | | | |

 | | | | | | | | | | | | | | | | | | | |

 | | | | | | | | | | | | | | | | | | | |

 | | | | | | | | | | | | | | | | | | | |

 | | | | | | | | | | | | | | | | | | | |

 | | | | | | | | | | | | | | | | | | | |

 | | | | | | | | | | | | | | | | | | | |

 | | | | | | | | | | | | | | | | | | | |

 | | | | | | | | | | | | | | | | | | | |
 | | | | | | | | | | | | | | | | | | | |

 | | | | | | | | | | | | | | | | | | | |

 | | | | | | | | | | | | | | | | | | | |
 | | | | | | | | | | | | | | | | | | | |

 | | | | | | | | | | | | | | | | | | | |

 | | | | | | | | | | | | | | | | | | | |
 | | | | | | | | | | | | | | | | | | | |
 | | | | | | | | | | | | | | | | | | | |

 | | | | | | | | | | | | | | | | | | | |
 | | | | | | | | | | | | | | | | | | | |
 | | | | | | | | | | | | | | | | | | | |

 | | | | | | | | | | | | | | | | | | | | | | | | | | | | | | | | | | | | | | | | | | | | | | | | | | | | | | | | | | | | | | | | | | | | | | | | | | | | | | | | | | | | | | | | | | | | | | | | | | | |
 | | | | | | | | | | | | | | | | | | | |
 | | | | | | | | | | | | | | | | | | | |
 | | | | | | | | | | | | | | | | | | | |
 | | | | | | | | | | | | | | | | | | | |
 | | | | | | | | | | | | | | | | | | | |
 | | | | | | | | | | | | | | | | | | | |
 | | | | | | | | | | | | | | | | | | | |
 | | | | | | | | | | | | | | | | | | | |
 | | | | | | | | | | | | | | | | | | | | | | | | | | | | | | | | | | | | | | | |
 | | | | | | | | | | | | | | | | | | | |
 | | | | | | | | | | | | | | | | | | | | | | | | | | | | | | | | | | | | | | | |
 | | | | | | | | | | | | | | | | | | | | | | | | | | | | | | | | | | | | | | | |
 | | | | | | | | | | | | | | | | | | | | | | | | | | | | | | | | | | | | | | | |
 | | | | | | | | | | | | | | | | | | | | | | | | | | | | | | | | | | | | | | | | | | | | | | | | | | | | | | | | | | | | | | | | | | | | | | | | | | | | | | | | | | | | | | | | | | | | | | | | | | | |
 | | | | | | | | | | | | | | | | | | | | | | | | | | | | | | | | | | | | | | | | | | | | | | | |
| | | <table border="1" style="width: 100%; border-collapse: collapse; text-align: center;"> <tr> <td style="width: 10%;"></td> <td style="width: 10%;"></td> <td style="width: 10%;"></td> <td style="width: 10%;"></td> <td style="width: 10%;"></td> <td style="width: 10%;"></td> <td style="width: 10%;"></td> <td style="width: 10%;"></td> <td style="width: 10%;"></td> <td style="width: 10%;"></td> </tr> <tr> <td></td> <td></td> <td colspan="8" style="text-align: center;"> <table border="1" style="width: 100%; border-collapse: collapse; text-align: center;"> <tr> <td style="width: 10%;"></td> <td style="width: 10%;"></td> <td style="width: 10%;"></td> <td style="width: 10%;"></td> <td style="width: 10%;"></td> <td style="width: 10%;"></td> <td style="width: 10%;"></td> <td style="width: 10%;"></td> <td style="width: 10%;"></td> <td style="width: 10%;"></td> </tr> <tr> <td></td> <td></td> <td colspan="8" style="text-align: center;"> <table border="1" style="width: 100%; border-collapse: collapse; text-align: center;"> <tr> <td style="width: 10%;"></td> <td style="width: 10%;"></td> <td style="width: 10%;"></td> <td style="width: 10%;"></td> <td style="width: 10%;"></td> <td style="width: 10%;"></td> <td style="width: 10%;"></td> <td style="width: 10%;"></td> <td style="width: 10%;"></td> <td style="width: 10%;"></td> </tr> <tr> <td></td> <td></td> <td colspan="8" style="text-align: center;"> <table border="1" style="width: 100%; border-collapse: collapse; text-align: center;"> <tr> <td style="width: 10%;"></td> <td style="width: 10%;"></td> <td style="width: 10%;"></td> <td style="width: 10%;"></td> <td style="width: 10%;"></td> <td style="width: 10%;"></td> <td style="width: 10%;"></td> <td style="width: 10%;"></td> <td style="width: 10%;"></td> <td style="width: 10%;"></td> </tr> <tr> <td></td> <td></td> <td colspan="8" style="text-align: center;"> <table border="1" style="width: 100%; border-collapse: collapse; text-align: center;"> <tr> <td style="width: 10%;"></td> <td style="width: 10%;"></td> <td style="width: 10%;"></td> <td style="width: 10%;"></td> <td style="width: 10%;"></td> <td style="width: 10%;"></td> <td style="width: 10%;"></td> <td style="width: 10%;"></td> <td style="width: 10%;"></td> <td style="width: 10%;"></td> </tr> <tr> <td></td> <td></td> <td colspan="8" style="text-align: center;"> <table border="1" style="width: 100%; border-collapse: collapse; text-align: center;"> <tr> <td style="width: 10%;"></td> <td style="width: 10%;"></td> <td style="width: 10%;"></td> <td style="width: 10%;"></td> <td style="width: 10%;"></td> <td style="width: 10%;"></td> <td style="width: 10%;"></td> <td style="width: 10%;"></td> <td style="width: 10%;"></td> <td style="width: 10%;"></td> </tr> <tr> <td></td> <td></td> <td colspan="8" style="text-align: center;"> <table border="1" style="width: 100%; border-collapse: collapse; text-align: center;"> <tr> <td style="width: 10%;"></td> <td style="width: 10%;"></td> <td style="width: 10%;"></td> <td style="width: 10%;"></td> <td style="width: 10%;"></td> <td style="width: 10%;"></td> <td style="width: 10%;"></td> <td style="width: 10%;"></td> <td style="width: 10%;"></td> <td style="width: 10%;"></td> </tr> <tr> <td></td> <td></td> <td colspan="8" style="text-align: center;"> <table border="1" style="width: 100%; border-collapse: collapse; text-align: center;"> <tr> <td style="width: 10%;"></td> <td style="width: 10%;"></td> <td style="width: 10%;"></td> <td style="width: 10%;"></td> <td style="width: 10%;"></td> <td style="width: 10%;"></td> <td style="width: 10%;"></td> <td style="width: 10%;"></td> <td style="width: 10%;"></td> <td style="width: 10%;"></td> </tr> <tr> <td></td> <td></td> <td colspan="8" style="text-align: center;"> <table border="1" style="width: 100%; border-collapse: collapse; text-align: center;"> <tr> <td style="width: 10%;"></td> <td style="width: 10%;"></td> <td style="width: 10%;"></td> <td style="width: 10%;"></td> <td style="width: 10%;"></td> <td style="width: 10%;"></td> <td style="width: 10%;"></td> <td style="width: 10%;"></td> <td style="width: 10%;"></td> <td style="width: 10%;"></td> </tr> <tr> <td></td> <td></td> <td colspan="8" style="text-align: center;"> <table border="1" style="width: 100%; border-collapse: collapse; text-align: center;"> <tr> <td style="width: 10%;"></td> <td style="width: 10%;"></td> <td style="width: 10%;"></td> <td style="width: 10%;"></td> <td style="width: 10%;"></td> <td style="width: 10%;"></td> <td style="width: 10%;"></td> <td style="width: 10%;"></td> <td style="width: 10%;"></td> <td style="width: 10%;"></td> </tr> <tr> <td></td> <td></td> <td colspan="8" style="text-align: center;"> <table border="1" style="width: 100%; border-collapse: collapse; text-align: center;"> <tr> <td style="width: 10%;"></td> <td style="width: 10%;"></td> <td style="width: 10%;"></td> <td style="width: 10%;"></td> <td style="width: 10%;"></td> <td style="width: 10%;"></td> <td style="width: 10%;"></td> <td style="width: 10%;"></td> <td style="width: 10%;"></td> <td style="width: 10%;"></td> </tr> <tr> <td></td> <td></td> <td colspan="8" style="text-align: center;"> <table border="1" style="width: 100%; border-collapse: collapse; text-align: center;"> <tr> <td style="width: 10%;"></td> <td style="width: 10%;"></td> <td style="width: 10%;"></td> <td style="width: 10%;"></td> <td style="width: 10%;"></td> <td style="width: 10%;"></td> <td style="width: 10%;"></td> <td style="width: 10%;"></td> <td style="width: 10%;"></td> <td style="width: 10%;"></td> </tr> <tr> <td></td> <td></td> <td colspan="8" style="text-align: center;"> <table border="1" style="width: 100%; border-collapse: collapse; text-align: center;"> <tr> <td style="width: 10%;"></td> <td style="width: 10%;"></td> <td style="width: 10%;"></td> <td style="width: 10%;"></td> <td style="width: 10%;"></td> <td style="width: 10%;"></td> <td style="width: 10%;"></td> <td style="width: 10%;"></td> <td style="width: 10%;"></td> <td style="width: 10%;"></td> </tr> <tr> <td></td> <td></td> <td colspan="8" style="text-align: center;"> <table border="1" style="width: 100%; border-collapse: collapse; text-align: center;"> <tr> <td style="width: 10%;"></td> <td style="width: 10%;"></td> <td style="width: 10%;"></td> <td style="width: 10%;"></td> <td style="width: 10%;"></td> <td style="width: 10%;"></td> <td style="width: 10%;"></td> <td style="width: 10%;"></td> <td style="width: 10%;"></td> <td style="width: 10%;"></td> </tr> <tr> <td></td> <td></td> <td colspan="8" style="text-align: center;"> <table border="1" style="width: 100%; border-collapse: collapse; text-align: center;"> <tr> <td style="width: 10%;"></td> <td style="width: 10%;"></td> <td style="width: 10%;"></td> <td style="width: 10%;"></td> <td style="width: 10%;"></td> <td style="width: 10%;"></td> <td style="width: 10%;"></td> <td style="width: 10%;"></td> <td style="width: 10%;"></td> <td style="width: 10%;"></td> </tr> <tr> <td></td> <td></td> <td colspan="8" style="text-align: center;"> <table border="1" style="width: 100%; border-collapse: collapse; text-align: center;"> <tr> <td style="width: 10%;"></td> <td style="width: 10%;"></td> <td style="width: 10%;"></td> <td style="width: 10%;"></td> <td style="width: 10%;"></td> <td style="width: 10%;"></td> <td style="width: 10%;"></td> <td style="width: 10%;"></td> <td style="width: 10%;"></td> <td style="width: 10%;"></td> </tr> <tr> <td></td> <td></td> <td colspan="8" style="text-align: center;"> <table border="1" style="width: 100%; border-collapse: collapse; text-align: center;"> <tr> <td style="width: 10%;"></td> <td style="width: 10%;"></td> <td style="width: 10%;"></td> <td style="width: 10%;"></td> <td style="width: 10%;"></td> <td style="width: 10%;"></td> <td style="width: 10%;"></td> <td style="width: 10%;"></td> <td style="width: 10%;"></td> <td style="width: 10%;"></td> </tr> <tr> <td></td> <td></td> <td colspan="8" style="text-align: center;"> <table border="1" style="width: 100%; border-collapse: collapse; text-align: center;"> <tr> <td style="width: 10%;"></td> <td style="width: 10%;"></td> <td style="width: 10%;"></td> <td style="width: 10%;"></td> <td style="width: 10%;"></td> <td style="width: 10%;"></td> <td style="width: 10%;"></td> <td style="width: 10%;"></td> <td style="width: 10%;"></td> <td style="width: 10%;"></td> </tr> <tr> <td></td> <td></td> <td colspan="8" style="text-align: center;"> <table border="1" style="width: 100%; border-collapse: collapse; text-align: center;"> <tr> <td style="width: 10%;"></td> <td style="width: 10%;"></td> <td style="width: 10%;"></td> <td style="width: 10%;"></td> <td style="width: 10%;"></td> <td style="width: 10%;"></td> <td style="width: 10%;"></td> <td style="width: 10%;"></td> <td style="width: 10%;"></td> <td style="width: 10%;"></td> </tr> <tr> <td></td> <td></td> <td colspan="8" style="text-align: center;"> <table border="1" style="width: 100%; border-collapse: collapse; text-align: center;"> <tr> <td style="width: 10%;"></td> <td style="width: 10%;"></td> <td style="width: 10%;"></td> <td style="width: 10%;"></td> <td style="width: 10%;"></td> <td style="width: 10%;"></td> <td style="width: 10%;"></td> <td style="width: 10%;"></td> <td style="width: 10%;"></td> <td style="width: 10%;"></td> </tr> <tr> <td></td> <td></td> <td colspan="8" style="text-align: center;"> <table border="1" style="width: 100%; border-collapse: collapse; text-align: center;"> <tr> <td style="width: 10%;"></td> <td style="width: 10%;"></td> <td style="width: 10%;"></td> <td style="width: 10%;"></td> <td style="width: 10%;"></td> <td style="width: 10%;"></td> <td style="width: 10%;"></td> <td style="width: 10%;"></td> <td style="width: 10%;"></td> <td style="width: 10%;"></td> </tr> <tr> <td></td> <td></td> <td colspan="8" style="text-align: center;"> <table border="1" style="width: 100%; border-collapse: collapse; text-align: center;"> <tr> <td style="width: 10%;"></td> <td style="width: 10%;"></td> <td
style="width: 10%;"></td> <td style="width: 10%;"></td> <td style="width: 10%;"></td> <td style="width: 10%;"></td> <td style="width: 10%;"></td> <td style="width: 10%;"></td> <td style="width: 10%;"></td> <td style="width: 10%;"></td> </tr> <tr> <td></td> <td></td> <td colspan="8" style="text-align: center;"> <table border="1" style="width: 100%; border-collapse: collapse; text-align: center;"> <tr> <td style="width: 10%;"></td> <td style="width: 10%;"></td> <td style="width: 10%;"></td> <td style="width: 10%;"></td> <td style="width: 10%;"></td> <td style="width: 10%;"></td> <td style="width: 10%;"></td> <td style="width: 10%;"></td> <td style="width: 10%;"></td> <td style="width: 10%;"></td> </tr> <tr> <td></td> <td></td> <td colspan="8" style="text-align: center;"> <table border="1" style="width: 100%; border-collapse: collapse; text-align: center;"> <tr> <td style="width: 10%;"></td> <td style="width: 10%;"></td> <td style="width: 10%;"></td> <td style="width: 10%;"></td> <td style="width: 10%;"></td> <td style="width: 10%;"></td> <td style="width: 10%;"></td> <td style="width: 10%;"></td> <td style="width: 10%;"></td> <td style="width: 10%;"></td> </tr> <tr> <td></td> <td></td> <td colspan="8" style="text-align: center;"> <table border="1" style="width: 100%; border-collapse: collapse; text-align: center;"> <tr> <td style="width: 10%;"></td> <td style="width: 10%;"></td> <td style="width: 10%;"></td> <td style="width: 10%;"></td> <td style="width: 10%;"></td> <td style="width: 10%;"></td> <td style="width: 10%;"></td> <td style="width: 10%;"></td> <td style="width: 10%;"></td> <td style="width: 10%;"></td> </tr> <tr> <td></td> <td></td> <td colspan="8" style="text-align: center;"> <table border="1" style="width: 100%; border-collapse: collapse; text-align: center;"> <tr> <td style="width: 10%;"></td> <td style="width: 10%;"></td> <td style="width: 10%;"></td> <td style="width: 10%;"></td> <td style="width: 10%;"></td> <td style="width: 10%;"></td> <td style="width: 10%;"></td> <td style="width: 10%;"></td> <td style="width: 10%;"></td> <td style="width: 10%;"></td> </tr> <tr> <td></td> <td></td> <td colspan="8" style="text-align: center;"> <table border="1" style="width: 100%; border-collapse: collapse; text-align: center;"> <tr> <td style="width: 10%;"></td> <td style="width: 10%;"></td> <td style="width: 10%;"></td> <td style="width: 10%;"></td> <td style="width: 10%;"></td> <td style="width: 10%;"></td> <td style="width: 10%;"></td> <td style="width: 10%;"></td> <td style="width: 10%;"></td> <td style="width: 10%;"></td> </tr> <tr> <td></td> <td></td> <td colspan="8" style="text-align: center;"> <table border="1" style="width: 100%; border-collapse: collapse; text-align: center;"> <tr> <td style="width: 10%;"></td> <td style="width: 10%;"></td> <td style="width: 10%;"></td> <td style="width: 10%;"></td> <td style="width: 10%;"></td> <td style="width: 10%;"></td> <td style="width: 10%;"></td> <td style="width: 10%;"></td> <td style="width: 10%;"></td> <td style="width: 10%;"></td> </tr> <tr> <td></td> <td></td> <td colspan="8" style="text-align: center;"> <table border="1" style="width: 100%; border-collapse: collapse; text-align: center;"> <tr> <td style="width: 10%;"></td> <td style="width: 10%;"></td> <td style="width: 10%;"></td> <td style="width: 10%;"></td> <td style="width: 10%;"></td> <td style="width: 10%;"></td> <td style="width: 10%;"></td> <td style="width: 10%;"></td> <td style="width: 10%;"></td> <td style="width: 10%;"></td> </tr> <tr> <td></td> <td></td> <td colspan="8" style="text-align: center;"> <table border="1" style="width: 100%; border-collapse: collapse; text-align: center;"> <tr> <td style="width: 10%;"></td> <td style="width: 10%;"></td> <td style="width: 10%;"></td> <td style="width: 10%;"></td> <td style="width: 10%;"></td> <td style="width: 10%;"></td> <td style="width: 10%;"></td> <td style="width: 10%;"></td> <td style="width: 10%;"></td> <td style="width: 10%;"></td> </tr> <tr> <td></td> <td></td> <td colspan="8" style="text-align: center;"> <table border="1" style="width: 100%; border-collapse: collapse; text-align: center;"> <tr> <td style="width: 10%;"></td> <td style="width: 10%;"></td> <td style="width: 10%;"></td> <td style="width: 10%;"></td> <td style="width: 10%;"></td> <td style="width: 10%;"></td> <td style="width: 10%;"></td> <td style="width: 10%;"></td> <td style="width: 10%;"></td> <td style="width: 10%;"></td> </tr> <tr> <td></td> <td></td> <td colspan="8" style="text-align: center;"> <table border="1" style="width: 100%; border-collapse: collapse; text-align: center;"> <tr> <td style="width: 10%;"></td> <td style="width: 10%;"></td> <td style="width: 10%;"></td> <td style="width: 10%;"></td> <td style="width: 10%;"></td> <td style="width: 10%;"></td> <td style="width: 10%;"></td> <td style="width: 10%;"></td> <td style="width: 10%;"></td> <td style="width: 10%;"></td> </tr> <tr> <td></td> <td></td> <td colspan="8" style="text-align: center;"> <table border="1" style="width: 100%; border-collapse: collapse; text-align: center;"> <tr> </tr></table></td></tr></table></td></tr></table></td></tr></table></td></tr></table></td></tr></table></td></tr></table></td></tr></table></td></tr></table></td></tr></table></td></tr></table></td></tr></table></td></tr></table></td></tr></table></td></tr></table></td></tr></table></td></tr></table></td></tr></table></td></tr></table></td></tr></table></td></tr></table></td></tr></table></td></tr></table></td></tr></table></td></tr></table></td></tr></table></td></tr></table></td></tr></table></td></tr></table></td></tr></table></td></tr></table></td></tr></table></td></tr></table>

 | | | | | | | | | | | | | | | | | | | | <table border="1" style="width: 100%; border-collapse: collapse; text-align: center;"> <tr> <td style="width: 10%;"></td> <td style="width: 10%;"></td> <td style="width: 10%;"></td> <td style="width: 10%;"></td> <td style="width: 10%;"></td> <td style="width: 10%;"></td> <td style="width: 10%;"></td> <td style="width: 10%;"></td> <td style="width: 10%;"></td> <td style="width: 10%;"></td> </tr> <tr> <td></td> <td></td> <td colspan="8" style="text-align: center;"> <table border="1" style="width: 100%; border-collapse: collapse; text-align: center;"> <tr> <td style="width: 10%;"></td> <td style="width: 10%;"></td> <td style="width: 10%;"></td> <td style="width: 10%;"></td> <td style="width: 10%;"></td> <td style="width: 10%;"></td> <td style="width: 10%;"></td> <td style="width: 10%;"></td> <td style="width: 10%;"></td> <td style="width: 10%;"></td> </tr> <tr> <td></td> <td></td> <td colspan="8" style="text-align: center;"> <table border="1" style="width: 100%; border-collapse: collapse; text-align: center;"> <tr> <td style="width: 10%;"></td> <td style="width: 10%;"></td> <td style="width: 10%;"></td> <td style="width: 10%;"></td> <td style="width: 10%;"></td> <td style="width: 10%;"></td> <td style="width: 10%;"></td> <td style="width: 10%;"></td> <td style="width: 10%;"></td> <td style="width: 10%;"></td> </tr> <tr> <td></td> <td></td> <td colspan="8" style="text-align: center;"> <table border="1" style="width: 100%; border-collapse: collapse; text-align: center;"> <tr> <td style="width: 10%;"></td> <td style="width: 10%;"></td> <td style="width: 10%;"></td> <td style="width: 10%;"></td> <td style="width: 10%;"></td> <td style="width: 10%;"></td> <td style="width: 10%;"></td> <td style="width: 10%;"></td> <td style="width: 10%;"></td> <td style="width: 10%;"></td> </tr> <tr> <td></td> <td></td> <td colspan="8" style="text-align: center;"> <table border="1" style="width: 100%; border-collapse: collapse; text-align: center;"> <tr> <td style="width: 10%;"></td> <td style="width: 10%;"></td> <td style="width: 10%;"></td> <td style="width: 10%;"></td> <td style="width: 10%;"></td> <td style="width: 10%;"></td> <td style="width: 10%;"></td> <td style="width: 10%;"></td> <td style="width: 10%;"></td> <td style="width: 10%;"></td> </tr> <tr> <td></td> <td></td> <td colspan="8" style="text-align: center;"> <table border="1" style="width: 100%; border-collapse: collapse; text-align: center;"> <tr> <td style="width: 10%;"></td> <td style="width: 10%;"></td> <td style="width: 10%;"></td> <td style="width: 10%;"></td> <td style="width: 10%;"></td> <td style="width: 10%;"></td> <td style="width: 10%;"></td> <td style="width: 10%;"></td> <td style="width: 10%;"></td> <td style="width: 10%;"></td> </tr> <tr> <td></td> <td></td> <td colspan="8" style="text-align: center;"> <table border="1" style="width: 100%; border-collapse: collapse; text-align: center;"> <tr> <td style="width: 10%;"></td> <td style="width: 10%;"></td> <td style="width: 10%;"></td> <td style="width: 10%;"></td> <td style="width: 10%;"></td> <td style="width: 10%;"></td> <td style="width: 10%;"></td> <td style="width: 10%;"></td> <td style="width: 10%;"></td> <td style="width: 10%;"></td> </tr> <tr> <td></td> <td></td> <td colspan="8" style="text-align: center;"> <table border="1" style="width: 100%; border-collapse: collapse; text-align: center;"> <tr> <td style="width: 10%;"></td> <td style="width: 10%;"></td> <td style="width: 10%;"></td> <td style="width: 10%;"></td> <td style="width: 10%;"></td> <td style="width: 10%;"></td> <td style="width: 10%;"></td> <td style="width: 10%;"></td> <td style="width: 10%;"></td> <td style="width: 10%;"></td> </tr> <tr> <td></td> <td></td> <td colspan="8" style="text-align: center;"> <table border="1" style="width: 100%; border-collapse: collapse; text-align: center;"> <tr> <td style="width: 10%;"></td> <td style="width: 10%;"></td> <td style="width: 10%;"></td> <td style="width: 10%;"></td> <td style="width: 10%;"></td> <td style="width: 10%;"></td> <td style="width: 10%;"></td> <td style="width: 10%;"></td> <td style="width: 10%;"></td> <td style="width: 10%;"></td> </tr> <tr> <td></td> <td></td> <td colspan="8" style="text-align: center;"> <table border="1" style="width: 100%; border-collapse: collapse; text-align: center;"> <tr> <td style="width: 10%;"></td> <td style="width: 10%;"></td> <td style="width: 10%;"></td> <td style="width: 10%;"></td> <td style="width: 10%;"></td> <td style="width: 10%;"></td> <td style="width: 10%;"></td> <td style="width: 10%;"></td> <td style="width: 10%;"></td> <td style="width: 10%;"></td> </tr> <tr> <td></td> <td></td> <td colspan="8" style="text-align: center;"> <table border="1" style="width: 100%; border-collapse: collapse; text-align: center;"> <tr> <td style="width: 10%;"></td> <td style="width: 10%;"></td> <td style="width: 10%;"></td> <td style="width: 10%;"></td> <td style="width: 10%;"></td> <td style="width: 10%;"></td> <td style="width: 10%;"></td> <td style="width: 10%;"></td> <td style="width: 10%;"></td> <td style="width: 10%;"></td> </tr> <tr> <td></td> <td></td> <td colspan="8" style="text-align: center;"> <table border="1" style="width: 100%; border-collapse: collapse; text-align: center;"> <tr> <td style="width: 10%;"></td> <td style="width: 10%;"></td> <td style="width: 10%;"></td> <td style="width: 10%;"></td> <td style="width: 10%;"></td> <td style="width: 10%;"></td> <td style="width: 10%;"></td> <td style="width: 10%;"></td> <td style="width: 10%;"></td> <td style="width: 10%;"></td> </tr> <tr> <td></td> <td></td> <td colspan="8" style="text-align: center;"> <table border="1" style="width: 100%; border-collapse: collapse; text-align: center;"> <tr> <td style="width: 10%;"></td> <td style="width: 10%;"></td> <td style="width: 10%;"></td> <td style="width: 10%;"></td> <td style="width: 10%;"></td> <td style="width: 10%;"></td> <td style="width: 10%;"></td> <td style="width: 10%;"></td> <td style="width: 10%;"></td> <td style="width: 10%;"></td> </tr> <tr> <td></td> <td></td> <td colspan="8" style="text-align: center;"> <table border="1" style="width: 100%; border-collapse: collapse; text-align: center;"> <tr> <td style="width: 10%;"></td> <td style="width: 10%;"></td> <td style="width: 10%;"></td> <td style="width: 10%;"></td> <td style="width: 10%;"></td> <td style="width: 10%;"></td> <td style="width: 10%;"></td> <td style="width: 10%;"></td> <td style="width: 10%;"></td> <td style="width: 10%;"></td> </tr> <tr> <td></td> <td></td> <td colspan="8" style="text-align: center;"> <table border="1" style="width: 100%; border-collapse: collapse; text-align: center;"> <tr> <td style="width: 10%;"></td> <td style="width: 10%;"></td> <td style="width: 10%;"></td> <td style="width: 10%;"></td> <td style="width: 10%;"></td> <td style="width: 10%;"></td> <td style="width: 10%;"></td> <td style="width: 10%;"></td> <td style="width: 10%;"></td> <td style="width: 10%;"></td> </tr> <tr> <td></td> <td></td> <td colspan="8" style="text-align: center;"> <table border="1" style="width: 100%; border-collapse: collapse; text-align: center;"> <tr> <td style="width: 10%;"></td> <td style="width: 10%;"></td> <td style="width: 10%;"></td> <td style="width: 10%;"></td> <td style="width: 10%;"></td> <td style="width: 10%;"></td> <td style="width: 10%;"></td> <td style="width: 10%;"></td> <td style="width: 10%;"></td> <td style="width: 10%;"></td> </tr> <tr> <td></td> <td></td> <td colspan="8" style="text-align: center;"> <table border="1" style="width: 100%; border-collapse: collapse; text-align: center;"> <tr> <td style="width: 10%;"></td> <td style="width: 10%;"></td> <td style="width: 10%;"></td> <td style="width: 10%;"></td> <td style="width: 10%;"></td> <td style="width: 10%;"></td> <td style="width: 10%;"></td> <td style="width: 10%;"></td> <td style="width: 10%;"></td> <td style="width: 10%;"></td> </tr> <tr> <td></td> <td></td> <td colspan="8" style="text-align: center;"> <table border="1" style="width: 100%; border-collapse: collapse; text-align: center;"> <tr> <td style="width: 10%;"></td> <td style="width: 10%;"></td> <td style="width: 10%;"></td> <td style="width: 10%;"></td> <td style="width: 10%;"></td> <td style="width: 10%;"></td> <td style="width: 10%;"></td> <td style="width: 10%;"></td> <td style="width: 10%;"></td> <td style="width: 10%;"></td> </tr> <tr> <td></td> <td></td> <td colspan="8" style="text-align: center;"> <table border="1" style="width: 100%; border-collapse: collapse; text-align: center;"> <tr> <td style="width: 10%;"></td> <td style="width: 10%;"></td> <td style="width: 10%;"></td> <td style="width: 10%;"></td> <td style="width: 10%;"></td> <td style="width: 10%;"></td> <td
style="width: 10%;"></td> <td style="width: 10%;"></td> <td style="width: 10%;"></td> <td style="width: 10%;"></td> </tr> <tr> <td></td> <td></td> <td colspan="8" style="text-align: center;"> <table border="1" style="width: 100%; border-collapse: collapse; text-align: center;"> <tr> <td style="width: 10%;"></td> <td style="width: 10%;"></td> <td style="width: 10%;"></td> <td style="width: 10%;"></td> <td style="width: 10%;"></td> <td style="width: 10%;"></td> <td style="width: 10%;"></td> <td style="width: 10%;"></td> <td style="width: 10%;"></td> <td style="width: 10%;"></td> </tr> <tr> <td></td> <td></td> <td colspan="8" style="text-align: center;"> <table border="1" style="width: 100%; border-collapse: collapse; text-align: center;"> <tr> <td style="width: 10%;"></td> <td style="width: 10%;"></td> <td style="width: 10%;"></td> <td style="width: 10%;"></td> <td style="width: 10%;"></td> <td style="width: 10%;"></td> <td style="width: 10%;"></td> <td style="width: 10%;"></td> <td style="width: 10%;"></td> <td style="width: 10%;"></td> </tr> <tr> <td></td> <td></td> <td colspan="8" style="text-align: center;"> <table border="1" style="width: 100%; border-collapse: collapse; text-align: center;"> <tr> <td style="width: 10%;"></td> <td style="width: 10%;"></td> <td style="width: 10%;"></td> <td style="width: 10%;"></td> <td style="width: 10%;"></td> <td style="width: 10%;"></td> <td style="width: 10%;"></td> <td style="width: 10%;"></td> <td style="width: 10%;"></td> <td style="width: 10%;"></td> </tr> <tr> <td></td> <td></td> <td colspan="8" style="text-align: center;"> <table border="1" style="width: 100%; border-collapse: collapse; text-align: center;"> <tr> <td style="width: 10%;"></td> <td style="width: 10%;"></td> <td style="width: 10%;"></td> <td style="width: 10%;"></td> <td style="width: 10%;"></td> <td style="width: 10%;"></td> <td style="width: 10%;"></td> <td style="width: 10%;"></td> <td style="width: 10%;"></td> <td style="width: 10%;"></td> </tr> <tr> <td></td> <td></td> <td colspan="8" style="text-align: center;"> <table border="1" style="width: 100%; border-collapse: collapse; text-align: center;"> <tr> <td style="width: 10%;"></td> <td style="width: 10%;"></td> <td style="width: 10%;"></td> <td style="width: 10%;"></td> <td style="width: 10%;"></td> <td style="width: 10%;"></td> <td style="width: 10%;"></td> <td style="width: 10%;"></td> <td style="width: 10%;"></td> <td style="width: 10%;"></td> </tr> <tr> <td></td> <td></td> <td colspan="8" style="text-align: center;"> <table border="1" style="width: 100%; border-collapse: collapse; text-align: center;"> <tr> <td style="width: 10%;"></td> <td style="width: 10%;"></td> <td style="width: 10%;"></td> <td style="width: 10%;"></td> <td style="width: 10%;"></td> <td style="width: 10%;"></td> <td style="width: 10%;"></td> <td style="width: 10%;"></td> <td style="width: 10%;"></td> <td style="width: 10%;"></td> </tr> <tr> <td></td> <td></td> <td colspan="8" style="text-align: center;"> <table border="1" style="width: 100%; border-collapse: collapse; text-align: center;"> <tr> <td style="width: 10%;"></td> <td style="width: 10%;"></td> <td style="width: 10%;"></td> <td style="width: 10%;"></td> <td style="width: 10%;"></td> <td style="width: 10%;"></td> <td style="width: 10%;"></td> <td style="width: 10%;"></td> <td style="width: 10%;"></td> <td style="width: 10%;"></td> </tr> <tr> <td></td> <td></td> <td colspan="8" style="text-align: center;"> <table border="1" style="width: 100%; border-collapse: collapse; text-align: center;"> <tr> <td style="width: 10%;"></td> <td style="width: 10%;"></td> <td style="width: 10%;"></td> <td style="width: 10%;"></td> <td style="width: 10%;"></td> <td style="width: 10%;"></td> <td style="width: 10%;"></td> <td style="width: 10%;"></td> <td style="width: 10%;"></td> <td style="width: 10%;"></td> </tr> <tr> <td></td> <td></td> <td colspan="8" style="text-align: center;"> <table border="1" style="width: 100%; border-collapse: collapse; text-align: center;"> <tr> <td style="width: 10%;"></td> <td style="width: 10%;"></td> <td style="width: 10%;"></td> <td style="width: 10%;"></td> <td style="width: 10%;"></td> <td style="width: 10%;"></td> <td style="width: 10%;"></td> <td style="width: 10%;"></td> <td style="width: 10%;"></td> <td style="width: 10%;"></td> </tr> <tr> <td></td> <td></td> <td colspan="8" style="text-align: center;"> <table border="1" style="width: 100%; border-collapse: collapse; text-align: center;"> <tr> <td style="width: 10%;"></td> <td style="width: 10%;"></td> <td style="width: 10%;"></td> <td style="width: 10%;"></td> <td style="width: 10%;"></td> <td style="width: 10%;"></td> <td style="width: 10%;"></td> <td style="width: 10%;"></td> <td style="width: 10%;"></td> <td style="width: 10%;"></td> </tr> <tr> <td></td> <td></td> <td colspan="8" style="text-align: center;"> <table border="1" style="width: 100%; border-collapse: collapse; text-align: center;"> <tr> <td style="width: 10%;"></td> <td style="width: 10%;"></td> <td style="width: 10%;"></td> <td style="width: 10%;"></td> <td style="width: 10%;"></td> <td style="width: 10%;"></td> <td style="width: 10%;"></td> <td style="width: 10%;"></td> <td style="width: 10%;"></td> <td style="width: 10%;"></td> </tr> <tr> <td></td> <td></td> <td colspan="8" style="text-align: center;"> <table border="1" style="width: 100%; border-collapse: collapse; text-align: center;"> <tr> <td style="width: 10%;"></td> <td style="width: 10%;"></td> <td style="width: 10%;"></td> <td style="width: 10%;"></td> <td style="width: 10%;"></td> <td style="width: 10%;"></td> <td style="width: 10%;"></td> <td style="width: 10%;"></td> <td style="width: 10%;"></td> <td style="width: 10%;"></td> </tr> <tr> <td></td> <td></td> <td colspan="8" style="text-align: center;"> <table border="1" style="width: 100%; border-collapse: collapse; text-align: center;"> <tr> </tr></table></td></tr></table></td></tr></table></td></tr></table></td></tr></table></td></tr></table></td></tr></table></td></tr></table></td></tr></table></td></tr></table></td></tr></table></td></tr></table></td></tr></table></td></tr></table></td></tr></table></td></tr></table></td></tr></table></td></tr></table></td></tr></table></td></tr></table></td></tr></table></td></tr></table></td></tr></table></td></tr></table></td></tr></table></td></tr></table></td></tr></table></td></tr></table></td></tr></table></td></tr></table></td></tr></table></td></tr></table>

 | | | | | | | | | | | | | | | | | | | | <table border="1" style="width: 100%; border-collapse: collapse; text-align: center;"> <tr> <td style="width: 10%;"></td> <td style="width: 10%;"></td> <td style="width: 10%;"></td> <td style="width: 10%;"></td> <td style="width: 10%;"></td> <td style="width: 10%;"></td> <td style="width: 10%;"></td> <td style="width: 10%;"></td> <td style="width: 10%;"></td> <td style="width: 10%;"></td> </tr> <tr> <td></td> <td></td> <td colspan="8" style="text-align: center;"> <table border="1" style="width: 100%; border-collapse: collapse; text-align: center;"> <tr> <td style="width: 10%;"></td> <td style="width: 10%;"></td> <td style="width: 10%;"></td> <td style="width: 10%;"></td> <td style="width: 10%;"></td> <td style="width: 10%;"></td> <td style="width: 10%;"></td> <td style="width: 10%;"></td> <td style="width: 10%;"></td> <td style="width: 10%;"></td> </tr> <tr> <td></td> <td></td> <td colspan="8" style="text-align: center;"> <table border="1" style="width: 100%; border-collapse: collapse; text-align: center;"> <tr> <td style="width: 10%;"></td> <td style="width: 10%;"></td> <td style="width: 10%;"></td> <td style="width: 10%;"></td> <td style="width: 10%;"></td> <td style="width: 10%;"></td> <td style="width: 10%;"></td> <td style="width: 10%;"></td> <td style="width: 10%;"></td> <td style="width: 10%;"></td> </tr> <tr> <td></td> <td></td> <td colspan="8" style="text-align: center;"> <table border="1" style="width: 100%; border-collapse: collapse; text-align: center;"> <tr> <td style="width: 10%;"></td> <td style="width: 10%;"></td> <td style="width: 10%;"></td> <td style="width: 10%;"></td> <td style="width: 10%;"></td> <td style="width: 10%;"></td> <td style="width: 10%;"></td> <td style="width: 10%;"></td> <td style="width: 10%;"></td> <td style="width: 10%;"></td> </tr> <tr> <td></td> <td></td> <td colspan="8" style="text-align: center;"> <table border="1" style="width: 100%; border-collapse: collapse; text-align: center;"> <tr> <td style="width: 10%;"></td> <td style="width: 10%;"></td> <td style="width: 10%;"></td> <td style="width: 10%;"></td> <td style="width: 10%;"></td> <td style="width: 10%;"></td> <td style="width: 10%;"></td> <td style="width: 10%;"></td> <td style="width: 10%;"></td> <td style="width: 10%;"></td> </tr> <tr> <td></td> <td></td> <td colspan="8" style="text-align: center;"> <table border="1" style="width: 100%; border-collapse: collapse; text-align: center;"> <tr> <td style="width: 10%;"></td> <td style="width: 10%;"></td> <td style="width: 10%;"></td> <td style="width: 10%;"></td> <td style="width: 10%;"></td> <td style="width: 10%;"></td> <td style="width: 10%;"></td> <td style="width: 10%;"></td> <td style="width: 10%;"></td> <td style="width: 10%;"></td> </tr> <tr> <td></td> <td></td> <td colspan="8" style="text-align: center;"> <table border="1" style="width: 100%; border-collapse: collapse; text-align: center;"> <tr> <td style="width: 10%;"></td> <td style="width: 10%;"></td> <td style="width: 10%;"></td> <td style="width: 10%;"></td> <td style="width: 10%;"></td> <td style="width: 10%;"></td> <td style="width: 10%;"></td> <td style="width: 10%;"></td> <td style="width: 10%;"></td> <td style="width: 10%;"></td> </tr> <tr> <td></td> <td></td> <td colspan="8" style="text-align: center;"> <table border="1" style="width: 100%; border-collapse: collapse; text-align: center;"> <tr> <td style="width: 10%;"></td> <td style="width: 10%;"></td> <td style="width: 10%;"></td> <td style="width: 10%;"></td> <td style="width: 10%;"></td> <td style="width: 10%;"></td> <td style="width: 10%;"></td> <td style="width: 10%;"></td> <td style="width: 10%;"></td> <td style="width: 10%;"></td> </tr> <tr> <td></td> <td></td> <td colspan="8" style="text-align: center;"> <table border="1" style="width: 100%; border-collapse: collapse; text-align: center;"> <tr> <td style="width: 10%;"></td> <td style="width: 10%;"></td> <td style="width: 10%;"></td> <td style="width: 10%;"></td> <td style="width: 10%;"></td> <td style="width: 10%;"></td> <td style="width: 10%;"></td> <td style="width: 10%;"></td> <td style="width: 10%;"></td> <td style="width: 10%;"></td> </tr> <tr> <td></td> <td></td> <td colspan="8" style="text-align: center;"> <table border="1" style="width: 100%; border-collapse: collapse; text-align: center;"> <tr> <td style="width: 10%;"></td> <td style="width: 10%;"></td> <td style="width: 10%;"></td> <td style="width: 10%;"></td> <td style="width: 10%;"></td> <td style="width: 10%;"></td> <td style="width: 10%;"></td> <td style="width: 10%;"></td> <td style="width: 10%;"></td> <td style="width: 10%;"></td> </tr> <tr> <td></td> <td></td> <td colspan="8" style="text-align: center;"> <table border="1" style="width: 100%; border-collapse: collapse; text-align: center;"> <tr> <td style="width: 10%;"></td> <td style="width: 10%;"></td> <td style="width: 10%;"></td> <td style="width: 10%;"></td> <td style="width: 10%;"></td> <td style="width: 10%;"></td> <td style="width: 10%;"></td> <td style="width: 10%;"></td> <td style="width: 10%;"></td> <td style="width: 10%;"></td> </tr> <tr> <td></td> <td></td> <td colspan="8" style="text-align: center;"> <table border="1" style="width: 100%; border-collapse: collapse; text-align: center;"> <tr> <td style="width: 10%;"></td> <td style="width: 10%;"></td> <td style="width: 10%;"></td> <td style="width: 10%;"></td> <td style="width: 10%;"></td> <td style="width: 10%;"></td> <td style="width: 10%;"></td> <td style="width: 10%;"></td> <td style="width: 10%;"></td> <td style="width: 10%;"></td> </tr> <tr> <td></td> <td></td> <td colspan="8" style="text-align: center;"> <table border="1" style="width: 100%; border-collapse: collapse; text-align: center;"> <tr> <td style="width: 10%;"></td> <td style="width: 10%;"></td> <td style="width: 10%;"></td> <td style="width: 10%;"></td> <td style="width: 10%;"></td> <td style="width: 10%;"></td> <td style="width: 10%;"></td> <td style="width: 10%;"></td> <td style="width: 10%;"></td> <td style="width: 10%;"></td> </tr> <tr> <td></td> <td></td> <td colspan="8" style="text-align: center;"> <table border="1" style="width: 100%; border-collapse: collapse; text-align: center;"> <tr> <td style="width: 10%;"></td> <td style="width: 10%;"></td> <td style="width: 10%;"></td> <td style="width: 10%;"></td> <td style="width: 10%;"></td> <td style="width: 10%;"></td> <td style="width: 10%;"></td> <td style="width: 10%;"></td> <td style="width: 10%;"></td> <td style="width: 10%;"></td> </tr> <tr> <td></td> <td></td> <td colspan="8" style="text-align: center;"> <table border="1" style="width: 100%; border-collapse: collapse; text-align: center;"> <tr> <td style="width: 10%;"></td> <td style="width: 10%;"></td> <td style="width: 10%;"></td> <td style="width: 10%;"></td> <td style="width: 10%;"></td> <td style="width: 10%;"></td> <td style="width: 10%;"></td> <td style="width: 10%;"></td> <td style="width: 10%;"></td> <td style="width: 10%;"></td> </tr> <tr> <td></td> <td></td> <td colspan="8" style="text-align: center;"> <table border="1" style="width: 100%; border-collapse: collapse; text-align: center;"> <tr> <td style="width: 10%;"></td> <td style="width: 10%;"></td> <td style="width: 10%;"></td> <td style="width: 10%;"></td> <td style="width: 10%;"></td> <td style="width: 10%;"></td> <td style="width: 10%;"></td> <td style="width: 10%;"></td> <td style="width: 10%;"></td> <td style="width: 10%;"></td> </tr> <tr> <td></td> <td></td> <td colspan="8" style="text-align: center;"> <table border="1" style="width: 100%; border-collapse: collapse; text-align: center;"> <tr> <td style="width: 10%;"></td> <td style="width: 10%;"></td> <td style="width: 10%;"></td> <td style="width: 10%;"></td> <td style="width: 10%;"></td> <td style="width: 10%;"></td> <td style="width: 10%;"></td> <td style="width: 10%;"></td> <td style="width: 10%;"></td> <td style="width: 10%;"></td> </tr> <tr> <td></td> <td></td> <td
colspan="8" style="text-align: center;"> <table border="1" style="width: 100%; border-collapse: collapse; text-align: center;"> <tr> <td style="width: 10%;"></td> <td style="width: 10%;"></td> <td style="width: 10%;"></td> <td style="width: 10%;"></td> <td style="width: 10%;"></td> <td style="width: 10%;"></td> <td style="width: 10%;"></td> <td style="width: 10%;"></td> <td style="width: 10%;"></td> <td style="width: 10%;"></td> </tr> <tr> <td></td> <td></td> <td colspan="8" style="text-align: center;"> <table border="1" style="width: 100%; border-collapse: collapse; text-align: center;"> <tr> <td style="width: 10%;"></td> <td style="width: 10%;"></td> <td style="width: 10%;"></td> <td style="width: 10%;"></td> <td style="width: 10%;"></td> <td style="width: 10%;"></td> <td style="width: 10%;"></td> <td style="width: 10%;"></td> <td style="width: 10%;"></td> <td style="width: 10%;"></td> </tr> <tr> <td></td> <td></td> <td colspan="8" style="text-align: center;"> <table border="1" style="width: 100%; border-collapse: collapse; text-align: center;"> <tr> <td style="width: 10%;"></td> <td style="width: 10%;"></td> <td style="width: 10%;"></td> <td style="width: 10%;"></td> <td style="width: 10%;"></td> <td style="width: 10%;"></td> <td style="width: 10%;"></td> <td style="width: 10%;"></td> <td style="width: 10%;"></td> <td style="width: 10%;"></td> </tr> <tr> <td></td> <td></td> <td colspan="8" style="text-align: center;"> <table border="1" style="width: 100%; border-collapse: collapse; text-align: center;"> <tr> <td style="width: 10%;"></td> <td style="width: 10%;"></td> <td style="width: 10%;"></td> <td style="width: 10%;"></td> <td style="width: 10%;"></td> <td style="width: 10%;"></td> <td style="width: 10%;"></td> <td style="width: 10%;"></td> <td style="width: 10%;"></td> <td style="width: 10%;"></td> </tr> <tr> <td></td> <td></td> <td colspan="8" style="text-align: center;"> <table border="1" style="width: 100%; border-collapse: collapse; text-align: center;"> <tr> <td style="width: 10%;"></td> <td style="width: 10%;"></td> <td style="width: 10%;"></td> <td style="width: 10%;"></td> <td style="width: 10%;"></td> <td style="width: 10%;"></td> <td style="width: 10%;"></td> <td style="width: 10%;"></td> <td style="width: 10%;"></td> <td style="width: 10%;"></td> </tr> <tr> <td></td> <td></td> <td colspan="8" style="text-align: center;"> <table border="1" style="width: 100%; border-collapse: collapse; text-align: center;"> <tr> <td style="width: 10%;"></td> <td style="width: 10%;"></td> <td style="width: 10%;"></td> <td style="width: 10%;"></td> <td style="width: 10%;"></td> <td style="width: 10%;"></td> <td style="width: 10%;"></td> <td style="width: 10%;"></td> <td style="width: 10%;"></td> <td style="width: 10%;"></td> </tr> <tr> <td></td> <td></td> <td colspan="8" style="text-align: center;"> <table border="1" style="width: 100%; border-collapse: collapse; text-align: center;"> <tr> <td style="width: 10%;"></td> <td style="width: 10%;"></td> <td style="width: 10%;"></td> <td style="width: 10%;"></td> <td style="width: 10%;"></td> <td style="width: 10%;"></td> <td style="width: 10%;"></td> <td style="width: 10%;"></td> <td style="width: 10%;"></td> <td style="width: 10%;"></td> </tr> <tr> <td></td> <td></td> <td colspan="8" style="text-align: center;"> <table border="1" style="width: 100%; border-collapse: collapse; text-align: center;"> <tr> <td style="width: 10%;"></td> <td style="width: 10%;"></td> <td style="width: 10%;"></td> <td style="width: 10%;"></td> <td style="width: 10%;"></td> <td style="width: 10%;"></td> <td style="width: 10%;"></td> <td style="width: 10%;"></td> <td style="width: 10%;"></td> <td style="width: 10%;"></td> </tr> <tr> <td></td> <td></td> <td colspan="8" style="text-align: center;"> <table border="1" style="width: 100%; border-collapse: collapse; text-align: center;"> <tr> <td style="width: 10%;"></td> <td style="width: 10%;"></td> <td style="width: 10%;"></td> <td style="width: 10%;"></td> <td style="width: 10%;"></td> <td style="width: 10%;"></td> <td style="width: 10%;"></td> <td style="width: 10%;"></td> <td style="width: 10%;"></td> <td style="width: 10%;"></td> </tr> <tr> <td></td> <td></td> <td colspan="8" style="text-align: center;"> <table border="1" style="width: 100%; border-collapse: collapse; text-align: center;"> <tr> <td style="width: 10%;"></td> <td style="width: 10%;"></td> <td style="width: 10%;"></td> <td style="width: 10%;"></td> <td style="width: 10%;"></td> <td style="width: 10%;"></td> <td style="width: 10%;"></td> <td style="width: 10%;"></td> <td style="width: 10%;"></td> <td style="width: 10%;"></td> </tr> <tr> <td></td> <td></td> <td colspan="8" style="text-align: center;"> <table border="1" style="width: 100%; border-collapse: collapse; text-align: center;"> <tr> <td style="width: 10%;"></td> <td style="width: 10%;"></td> <td style="width: 10%;"></td> <td style="width: 10%;"></td> <td style="width: 10%;"></td> <td style="width: 10%;"></td> <td style="width: 10%;"></td> <td style="width: 10%;"></td> <td style="width: 10%;"></td> <td style="width: 10%;"></td> </tr> <tr> <td></td> <td></td> <td colspan="8" style="text-align: center;"> <table border="1" style="width: 100%; border-collapse: collapse; text-align: center;"> <tr> <td style="width: 10%;"></td> <td style="width: 10%;"></td> <td style="width: 10%;"></td> <td style="width: 10%;"></td> <td style="width: 10%;"></td> <td style="width: 10%;"></td> <td style="width: 10%;"></td> <td style="width: 10%;"></td> <td style="width: 10%;"></td> <td style="width: 10%;"></td> </tr> <tr> <td></td> <td></td> <td colspan="8" style="text-align: center;"> <table border="1" style="width: 100%; border-collapse: collapse; text-align: center;"> <tr> <td style="width: 10%;"></td> <td style="width: 10%;"></td> <td style="width: 10%;"></td> <td style="width: 10%;"></td> <td style="width: 10%;"></td> <td style="width: 10%;"></td> <td style="width: 10%;"></td> <td style="width: 10%;"></td> <td style="width: 10%;"></td> <td style="width: 10%;"></td> </tr> <tr> <td></td> <td></td> <td colspan="8" style="text-align: center;"> <table border="1" style="width: 100%; border-collapse: collapse; text-align: center;"> <tr> </tr></table></td></tr></table></td></tr></table></td></tr></table></td></tr></table></td></tr></table></td></tr></table></td></tr></table></td></tr></table></td></tr></table></td></tr></table></td></tr></table></td></tr></table></td></tr></table></td></tr></table></td></tr></table></td></tr></table></td></tr></table></td></tr></table></td></tr></table></td></tr></table></td></tr></table></td></tr></table></td></tr></table></td></tr></table></td></tr></table></td></tr></table></td></tr></table></td></tr></table></td></tr></table></td></tr></table>

 | | | | | | | | | | | | | | | | | | | | <table border="1" style="width: 100%; border-collapse: collapse; text-align: center;"> <tr> <td style="width: 10%;"></td> <td style="width: 10%;"></td> <td style="width: 10%;"></td> <td style="width: 10%;"></td> <td style="width: 10%;"></td> <td style="width: 10%;"></td> <td style="width: 10%;"></td> <td style="width: 10%;"></td> <td style="width: 10%;"></td> <td style="width: 10%;"></td> </tr> <tr> <td></td> <td></td> <td colspan="8" style="text-align: center;"> <table border="1" style="width: 100%; border-collapse: collapse; text-align: center;"> <tr> <td style="width: 10%;"></td> <td style="width: 10%;"></td> <td style="width: 10%;"></td> <td style="width: 10%;"></td> <td style="width: 10%;"></td> <td style="width: 10%;"></td> <td style="width: 10%;"></td> <td style="width: 10%;"></td> <td style="width: 10%;"></td> <td style="width: 10%;"></td> </tr> <tr> <td></td> <td></td> <td colspan="8" style="text-align: center;"> <table border="1" style="width: 100%; border-collapse: collapse; text-align: center;"> <tr> <td style="width: 10%;"></td> <td style="width: 10%;"></td> <td style="width: 10%;"></td> <td style="width: 10%;"></td> <td style="width: 10%;"></td> <td style="width: 10%;"></td> <td style="width: 10%;"></td> <td style="width: 10%;"></td> <td style="width: 10%;"></td> <td style="width: 10%;"></td> </tr> <tr> <td></td> <td></td> <td colspan="8" style="text-align: center;"> <table border="1" style="width: 100%; border-collapse: collapse; text-align: center;"> <tr> <td style="width: 10%;"></td> <td style="width: 10%;"></td> <td style="width: 10%;"></td> <td style="width: 10%;"></td> <td style="width: 10%;"></td> <td style="width: 10%;"></td> <td style="width: 10%;"></td> <td style="width: 10%;"></td> <td style="width: 10%;"></td> <td style="width: 10%;"></td> </tr> <tr> <td></td> <td></td> <td colspan="8" style="text-align: center;"> <table border="1" style="width: 100%; border-collapse: collapse; text-align: center;"> <tr> <td style="width: 10%;"></td> <td style="width: 10%;"></td> <td style="width: 10%;"></td> <td style="width: 10%;"></td> <td style="width: 10%;"></td> <td style="width: 10%;"></td> <td style="width: 10%;"></td> <td style="width: 10%;"></td> <td style="width: 10%;"></td> <td style="width: 10%;"></td> </tr> <tr> <td></td> <td></td> <td colspan="8" style="text-align: center;"> <table border="1" style="width: 100%; border-collapse: collapse; text-align: center;"> <tr> <td style="width: 10%;"></td> <td style="width: 10%;"></td> <td style="width: 10%;"></td> <td style="width: 10%;"></td> <td style="width: 10%;"></td> <td style="width: 10%;"></td> <td style="width: 10%;"></td> <td style="width: 10%;"></td> <td style="width: 10%;"></td> <td style="width: 10%;"></td> </tr> <tr> <td></td> <td></td> <td colspan="8" style="text-align: center;"> <table border="1" style="width: 100%; border-collapse: collapse; text-align: center;"> <tr> <td style="width: 10%;"></td> <td style="width: 10%;"></td> <td style="width: 10%;"></td> <td style="width: 10%;"></td> <td style="width: 10%;"></td> <td style="width: 10%;"></td> <td style="width: 10%;"></td> <td style="width: 10%;"></td> <td style="width: 10%;"></td> <td style="width: 10%;"></td> </tr> <tr> <td></td> <td></td> <td colspan="8" style="text-align: center;"> <table border="1" style="width: 100%; border-collapse: collapse; text-align: center;"> <tr> <td style="width: 10%;"></td> <td style="width: 10%;"></td> <td style="width: 10%;"></td> <td style="width: 10%;"></td> <td style="width: 10%;"></td> <td style="width: 10%;"></td> <td style="width: 10%;"></td> <td style="width: 10%;"></td> <td style="width: 10%;"></td> <td style="width: 10%;"></td> </tr> <tr> <td></td> <td></td> <td colspan="8" style="text-align: center;"> <table border="1" style="width: 100%; border-collapse: collapse; text-align: center;"> <tr> <td style="width: 10%;"></td> <td style="width: 10%;"></td> <td style="width: 10%;"></td> <td style="width: 10%;"></td> <td style="width: 10%;"></td> <td style="width: 10%;"></td> <td style="width: 10%;"></td> <td style="width: 10%;"></td> <td style="width: 10%;"></td> <td style="width: 10%;"></td> </tr> <tr> <td></td> <td></td> <td colspan="8" style="text-align: center;"> <table border="1" style="width: 100%; border-collapse: collapse; text-align: center;"> <tr> <td style="width: 10%;"></td> <td style="width: 10%;"></td> <td style="width: 10%;"></td> <td style="width: 10%;"></td> <td style="width: 10%;"></td> <td style="width: 10%;"></td> <td style="width: 10%;"></td> <td style="width: 10%;"></td> <td style="width: 10%;"></td> <td style="width: 10%;"></td> </tr> <tr> <td></td> <td></td> <td colspan="8" style="text-align: center;"> <table border="1" style="width: 100%; border-collapse: collapse; text-align: center;"> <tr> <td style="width: 10%;"></td> <td style="width: 10%;"></td> <td style="width: 10%;"></td> <td style="width: 10%;"></td> <td style="width: 10%;"></td> <td style="width: 10%;"></td> <td style="width: 10%;"></td> <td style="width: 10%;"></td> <td style="width: 10%;"></td> <td style="width: 10%;"></td> </tr> <tr> <td></td> <td></td> <td colspan="8" style="text-align: center;"> <table border="1" style="width: 100%; border-collapse: collapse; text-align: center;"> <tr> <td style="width: 10%;"></td> <td style="width: 10%;"></td> <td style="width: 10%;"></td> <td style="width: 10%;"></td> <td style="width: 10%;"></td> <td style="width: 10%;"></td> <td style="width: 10%;"></td> <td style="width: 10%;"></td> <td style="width: 10%;"></td> <td style="width: 10%;"></td> </tr> <tr> <td></td> <td></td> <td colspan="8" style="text-align: center;"> <table border="1" style="width: 100%; border-collapse: collapse; text-align: center;"> <tr> <td style="width: 10%;"></td> <td style="width: 10%;"></td> <td style="width: 10%;"></td> <td style="width: 10%;"></td> <td style="width: 10%;"></td> <td style="width: 10%;"></td> <td style="width: 10%;"></td> <td style="width: 10%;"></td> <td style="width: 10%;"></td> <td style="width: 10%;"></td> </tr> <tr> <td></td> <td></td> <td colspan="8" style="text-align: center;"> <table border="1" style="width: 100%; border-collapse: collapse; text-align: center;"> <tr> <td style="width: 10%;"></td> <td style="width: 10%;"></td> <td style="width: 10%;"></td> <td style="width: 10%;"></td> <td style="width: 10%;"></td> <td style="width: 10%;"></td> <td style="width: 10%;"></td> <td style="width: 10%;"></td> <td style="width: 10%;"></td> <td style="width: 10%;"></td> </tr> <tr> <td></td> <td></td> <td colspan="8" style="text-align: center;"> <table border="1" style="width: 100%; border-collapse: collapse; text-align: center;"> <tr> <td style="width: 10%;"></td> <td style="width: 10%;"></td> <td style="width: 10%;"></td> <td style="width: 10%;"></td> <td style="width: 10%;"></td> <td style="width: 10%;"></td> <td style="width: 10%;"></td> <td style="width: 10%;"></td> <td style="width: 10%;"></td> <td style="width: 10%;"></td> </tr> <tr> <td></td> <td></td> <td colspan="8" style="text-align: center;"> <table border="1" style="width: 100%; border-collapse: collapse; text-align: center;"> <tr> <td style="width: 10%;"></td> <td style="width: 10%;"></td> <td style="width: 10%;"></td> <td style="width: 10%;"></td> <td style="width: 10%;"></td> <td style="width: 10%;"></td> <td style="width: 10%;"></td> <td style="width: 10%;"></td> <td style="width: 10%;"></td> <td style="width: 10%;"></td> </tr> <tr> <td></td> <td></td> <td colspan="8" style="text-align: center;"> <table border="1" style="width: 100%; border-collapse: collapse; text-align: center;"> <tr> <td style="width: 10%;"></td> <td
style="width: 10%;"></td> <td style="width: 10%;"></td> <td style="width: 10%;"></td> <td style="width: 10%;"></td> <td style="width: 10%;"></td> <td style="width: 10%;"></td> <td style="width: 10%;"></td> <td style="width: 10%;"></td> <td style="width: 10%;"></td> </tr> <tr> <td></td> <td></td> <td colspan="8" style="text-align: center;"> <table border="1" style="width: 100%; border-collapse: collapse; text-align: center;"> <tr> <td style="width: 10%;"></td> <td style="width: 10%;"></td> <td style="width: 10%;"></td> <td style="width: 10%;"></td> <td style="width: 10%;"></td> <td style="width: 10%;"></td> <td style="width: 10%;"></td> <td style="width: 10%;"></td> <td style="width: 10%;"></td> <td style="width: 10%;"></td> </tr> <tr> <td></td> <td></td> <td colspan="8" style="text-align: center;"> <table border="1" style="width: 100%; border-collapse: collapse; text-align: center;"> <tr> <td style="width: 10%;"></td> <td style="width: 10%;"></td> <td style="width: 10%;"></td> <td style="width: 10%;"></td> <td style="width: 10%;"></td> <td style="width: 10%;"></td> <td style="width: 10%;"></td> <td style="width: 10%;"></td> <td style="width: 10%;"></td> <td style="width: 10%;"></td> </tr> <tr> <td></td> <td></td> <td colspan="8" style="text-align: center;"> <table border="1" style="width: 100%; border-collapse: collapse; text-align: center;"> <tr> <td style="width: 10%;"></td> <td style="width: 10%;"></td> <td style="width: 10%;"></td> <td style="width: 10%;"></td> <td style="width: 10%;"></td> <td style="width: 10%;"></td> <td style="width: 10%;"></td> <td style="width: 10%;"></td> <td style="width: 10%;"></td> <td style="width: 10%;"></td> </tr> <tr> <td></td> <td></td> <td colspan="8" style="text-align: center;"> <table border="1" style="width: 100%; border-collapse: collapse; text-align: center;"> <tr> <td style="width: 10%;"></td> <td style="width: 10%;"></td> <td style="width: 10%;"></td> <td style="width: 10%;"></td> <td style="width: 10%;"></td> <td style="width: 10%;"></td> <td style="width: 10%;"></td> <td style="width: 10%;"></td> <td style="width: 10%;"></td> <td style="width: 10%;"></td> </tr> <tr> <td></td> <td></td> <td colspan="8" style="text-align: center;"> <table border="1" style="width: 100%; border-collapse: collapse; text-align: center;"> <tr> <td style="width: 10%;"></td> <td style="width: 10%;"></td> <td style="width: 10%;"></td> <td style="width: 10%;"></td> <td style="width: 10%;"></td> <td style="width: 10%;"></td> <td style="width: 10%;"></td> <td style="width: 10%;"></td> <td style="width: 10%;"></td> <td style="width: 10%;"></td> </tr> <tr> <td></td> <td></td> <td colspan="8" style="text-align: center;"> <table border="1" style="width: 100%; border-collapse: collapse; text-align: center;"> <tr> <td style="width: 10%;"></td> <td style="width: 10%;"></td> <td style="width: 10%;"></td> <td style="width: 10%;"></td> <td style="width: 10%;"></td> <td style="width: 10%;"></td> <td style="width: 10%;"></td> <td style="width: 10%;"></td> <td style="width: 10%;"></td> <td style="width: 10%;"></td> </tr> <tr> <td></td> <td></td> <td colspan="8" style="text-align: center;"> <table border="1" style="width: 100%; border-collapse: collapse; text-align: center;"> <tr> <td style="width: 10%;"></td> <td style="width: 10%;"></td> <td style="width: 10%;"></td> <td style="width: 10%;"></td> <td style="width: 10%;"></td> <td style="width: 10%;"></td> <td style="width: 10%;"></td> <td style="width: 10%;"></td> <td style="width: 10%;"></td> <td style="width: 10%;"></td> </tr> <tr> <td></td> <td></td> <td colspan="8" style="text-align: center;"> <table border="1" style="width: 100%; border-collapse: collapse; text-align: center;"> <tr> <td style="width: 10%;"></td> <td style="width: 10%;"></td> <td style="width: 10%;"></td> <td style="width: 10%;"></td> <td style="width: 10%;"></td> <td style="width: 10%;"></td> <td style="width: 10%;"></td> <td style="width: 10%;"></td> <td style="width: 10%;"></td> <td style="width: 10%;"></td> </tr> <tr> <td></td> <td></td> <td colspan="8" style="text-align: center;"> <table border="1" style="width: 100%; border-collapse: collapse; text-align: center;"> <tr> <td style="width: 10%;"></td> <td style="width: 10%;"></td> <td style="width: 10%;"></td> <td style="width: 10%;"></td> <td style="width: 10%;"></td> <td style="width: 10%;"></td> <td style="width: 10%;"></td> <td style="width: 10%;"></td> <td style="width: 10%;"></td> <td style="width: 10%;"></td> </tr> <tr> <td></td> <td></td> <td colspan="8" style="text-align: center;"> <table border="1" style="width: 100%; border-collapse: collapse; text-align: center;"> <tr> <td style="width: 10%;"></td> <td style="width: 10%;"></td> <td style="width: 10%;"></td> <td style="width: 10%;"></td> <td style="width: 10%;"></td> <td style="width: 10%;"></td> <td style="width: 10%;"></td> <td style="width: 10%;"></td> <td style="width: 10%;"></td> <td style="width: 10%;"></td> </tr> <tr> <td></td> <td></td> <td colspan="8" style="text-align: center;"> <table border="1" style="width: 100%; border-collapse: collapse; text-align: center;"> <tr> <td style="width: 10%;"></td> <td style="width: 10%;"></td> <td style="width: 10%;"></td> <td style="width: 10%;"></td> <td style="width: 10%;"></td> <td style="width: 10%;"></td> <td style="width: 10%;"></td> <td style="width: 10%;"></td> <td style="width: 10%;"></td> <td style="width: 10%;"></td> </tr> <tr> <td></td> <td></td> <td colspan="8" style="text-align: center;"> <table border="1" style="width: 100%; border-collapse: collapse; text-align: center;"> <tr> <td style="width: 10%;"></td> <td style="width: 10%;"></td> <td style="width: 10%;"></td> <td style="width: 10%;"></td> <td style="width: 10%;"></td> <td style="width: 10%;"></td> <td style="width: 10%;"></td> <td style="width: 10%;"></td> <td style="width: 10%;"></td> <td style="width: 10%;"></td> </tr> <tr> <td></td> <td></td> <td colspan="8" style="text-align: center;"> <table border="1" style="width: 100%; border-collapse: collapse; text-align: center;"> <tr> </tr></table></td></tr></table></td></tr></table></td></tr></table></td></tr></table></td></tr></table></td></tr></table></td></tr></table></td></tr></table></td></tr></table></td></tr></table></td></tr></table></td></tr></table></td></tr></table></td></tr></table></td></tr></table></td></tr></table></td></tr></table></td></tr></table></td></tr></table></td></tr></table></td></tr></table></td></tr></table></td></tr></table></td></tr></table></td></tr></table></td></tr></table></td></tr></table></td></tr></table></td></tr></table>

 | | | | | | | | | | | | | | | | | | | | <table border="1" style="width: 100%; border-collapse: collapse; text-align: center;"> <tr> <td style="width: 10%;"></td> <td style="width: 10%;"></td> <td style="width: 10%;"></td> <td style="width: 10%;"></td> <td style="width: 10%;"></td> <td style="width: 10%;"></td> <td style="width: 10%;"></td> <td style="width: 10%;"></td> <td style="width: 10%;"></td> <td style="width: 10%;"></td> </tr> <tr> <td></td> <td></td> <td colspan="8" style="text-align: center;"> <table border="1" style="width: 100%; border-collapse: collapse; text-align: center;"> <tr> <td style="width: 10%;"></td> <td style="width: 10%;"></td> <td style="width: 10%;"></td> <td style="width: 10%;"></td> <td style="width: 10%;"></td> <td style="width: 10%;"></td> <td style="width: 10%;"></td> <td style="width: 10%;"></td> <td style="width: 10%;"></td> <td style="width: 10%;"></td> </tr> <tr> <td></td> <td></td> <td colspan="8" style="text-align: center;"> <table border="1" style="width: 100%; border-collapse: collapse; text-align: center;"> <tr> <td style="width: 10%;"></td> <td style="width: 10%;"></td> <td style="width: 10%;"></td> <td style="width: 10%;"></td> <td style="width: 10%;"></td> <td style="width: 10%;"></td> <td style="width: 10%;"></td> <td style="width: 10%;"></td> <td style="width: 10%;"></td> <td style="width: 10%;"></td> </tr> <tr> <td></td> <td></td> <td colspan="8" style="text-align: center;"> <table border="1" style="width: 100%; border-collapse: collapse; text-align: center;"> <tr> <td style="width: 10%;"></td> <td style="width: 10%;"></td> <td style="width: 10%;"></td> <td style="width: 10%;"></td> <td style="width: 10%;"></td> <td style="width: 10%;"></td> <td style="width: 10%;"></td> <td style="width: 10%;"></td> <td style="width: 10%;"></td> <td style="width: 10%;"></td> </tr> <tr> <td></td> <td></td> <td colspan="8" style="text-align: center;"> <table border="1" style="width: 100%; border-collapse: collapse; text-align: center;"> <tr> <td style="width: 10%;"></td> <td style="width: 10%;"></td> <td style="width: 10%;"></td> <td style="width: 10%;"></td> <td style="width: 10%;"></td> <td style="width: 10%;"></td> <td style="width: 10%;"></td> <td style="width: 10%;"></td> <td style="width: 10%;"></td> <td style="width: 10%;"></td> </tr> <tr> <td></td> <td></td> <td colspan="8" style="text-align: center;"> <table border="1" style="width: 100%; border-collapse: collapse; text-align: center;"> <tr> <td style="width: 10%;"></td> <td style="width: 10%;"></td> <td style="width: 10%;"></td> <td style="width: 10%;"></td> <td style="width: 10%;"></td> <td style="width: 10%;"></td> <td style="width: 10%;"></td> <td style="width: 10%;"></td> <td style="width: 10%;"></td> <td style="width: 10%;"></td> </tr> <tr> <td></td> <td></td> <td colspan="8" style="text-align: center;"> <table border="1" style="width: 100%; border-collapse: collapse; text-align: center;"> <tr> <td style="width: 10%;"></td> <td style="width: 10%;"></td> <td style="width: 10%;"></td> <td style="width: 10%;"></td> <td style="width: 10%;"></td> <td style="width: 10%;"></td> <td style="width: 10%;"></td> <td style="width: 10%;"></td> <td style="width: 10%;"></td> <td style="width: 10%;"></td> </tr> <tr> <td></td> <td></td> <td colspan="8" style="text-align: center;"> <table border="1" style="width: 100%; border-collapse: collapse; text-align: center;"> <tr> <td style="width: 10%;"></td> <td style="width: 10%;"></td> <td style="width: 10%;"></td> <td style="width: 10%;"></td> <td style="width: 10%;"></td> <td style="width: 10%;"></td> <td style="width: 10%;"></td> <td style="width: 10%;"></td> <td style="width: 10%;"></td> <td style="width: 10%;"></td> </tr> <tr> <td></td> <td></td> <td colspan="8" style="text-align: center;"> <table border="1" style="width: 100%; border-collapse: collapse; text-align: center;"> <tr> <td style="width: 10%;"></td> <td style="width: 10%;"></td> <td style="width: 10%;"></td> <td style="width: 10%;"></td> <td style="width: 10%;"></td> <td style="width: 10%;"></td> <td style="width: 10%;"></td> <td style="width: 10%;"></td> <td style="width: 10%;"></td> <td style="width: 10%;"></td> </tr> <tr> <td></td> <td></td> <td colspan="8" style="text-align: center;"> <table border="1" style="width: 100%; border-collapse: collapse; text-align: center;"> <tr> <td style="width: 10%;"></td> <td style="width: 10%;"></td> <td style="width: 10%;"></td> <td style="width: 10%;"></td> <td style="width: 10%;"></td> <td style="width: 10%;"></td> <td style="width: 10%;"></td> <td style="width: 10%;"></td> <td style="width: 10%;"></td> <td style="width: 10%;"></td> </tr> <tr> <td></td> <td></td> <td colspan="8" style="text-align: center;"> <table border="1" style="width: 100%; border-collapse: collapse; text-align: center;"> <tr> <td style="width: 10%;"></td> <td style="width: 10%;"></td> <td style="width: 10%;"></td> <td style="width: 10%;"></td> <td style="width: 10%;"></td> <td style="width: 10%;"></td> <td style="width: 10%;"></td> <td style="width: 10%;"></td> <td style="width: 10%;"></td> <td style="width: 10%;"></td> </tr> <tr> <td></td> <td></td> <td colspan="8" style="text-align: center;"> <table border="1" style="width: 100%; border-collapse: collapse; text-align: center;"> <tr> <td style="width: 10%;"></td> <td style="width: 10%;"></td> <td style="width: 10%;"></td> <td style="width: 10%;"></td> <td style="width: 10%;"></td> <td style="width: 10%;"></td> <td style="width: 10%;"></td> <td style="width: 10%;"></td> <td style="width: 10%;"></td> <td style="width: 10%;"></td> </tr> <tr> <td></td> <td></td> <td colspan="8" style="text-align: center;"> <table border="1" style="width: 100%; border-collapse: collapse; text-align: center;"> <tr> <td style="width: 10%;"></td> <td style="width: 10%;"></td> <td style="width: 10%;"></td> <td style="width: 10%;"></td> <td style="width: 10%;"></td> <td style="width: 10%;"></td> <td style="width: 10%;"></td> <td style="width: 10%;"></td> <td style="width: 10%;"></td> <td style="width: 10%;"></td> </tr> <tr> <td></td> <td></td> <td colspan="8" style="text-align: center;"> <table border="1" style="width: 100%; border-collapse: collapse; text-align: center;"> <tr> <td style="width: 10%;"></td> <td style="width: 10%;"></td> <td style="width: 10%;"></td> <td style="width: 10%;"></td> <td style="width: 10%;"></td> <td style="width: 10%;"></td> <td style="width: 10%;"></td> <td style="width: 10%;"></td> <td style="width: 10%;"></td> <td style="width: 10%;"></td> </tr> <tr> <td></td> <td></td> <td colspan="8" style="text-align: center;"> <table border="1" style="width: 100%; border-collapse: collapse; text-align: center;"> <tr> <td style="width: 10%;"></td> <td style="width: 10%;"></td> <td style="width: 10%;"></td> <td style="width: 10%;"></td> <td style="width: 10%;"></td> <td style="width: 10%;"></td> <td style="width: 10%;"></td> <td style="width: 10%;"></td> <td style="width: 10%;"></td> <td style="width: 10%;"></td> </tr> <tr> <td></td> <td></td> <td colspan="8" style="text-align: center;"> <table border="1" style="width: 100%; border-collapse: collapse; text-align: center;"> <tr> <td style="width: 10%;"></td> <td style="width: 10%;"></td> <td style="width: 10%;"></td> <td style="width: 10%;"></td> <td style="width: 10%;"></td> <td style="width: 10%;"></td> <td style="width: 10%;"></td> <td style="width: 10%;"></td> <td style="width: 10%;"></td> <td style="width: 10%;"></td> </tr> <tr> <td></td> <td></td> <td colspan="8" style="text-align: center;"> <table border="1" style="width: 100%; border-collapse: collapse; text-align: center;"> <tr> <td style="width: 10%;"></td> <td style="width: 10%;"></td> <td style="width: 10%;"></td> <td style="width: 10%;"></td> <td style="width: 10%;"></td> <td style="width: 10%;"></td> <td style="width: 10%;"></td> <td
style="width: 10%;"></td> <td style="width: 10%;"></td> <td style="width: 10%;"></td> </tr> <tr> <td></td> <td></td> <td colspan="8" style="text-align: center;"> <table border="1" style="width: 100%; border-collapse: collapse; text-align: center;"> <tr> <td style="width: 10%;"></td> <td style="width: 10%;"></td> <td style="width: 10%;"></td> <td style="width: 10%;"></td> <td style="width: 10%;"></td> <td style="width: 10%;"></td> <td style="width: 10%;"></td> <td style="width: 10%;"></td> <td style="width: 10%;"></td> <td style="width: 10%;"></td> </tr> <tr> <td></td> <td></td> <td colspan="8" style="text-align: center;"> <table border="1" style="width: 100%; border-collapse: collapse; text-align: center;"> <tr> <td style="width: 10%;"></td> <td style="width: 10%;"></td> <td style="width: 10%;"></td> <td style="width: 10%;"></td> <td style="width: 10%;"></td> <td style="width: 10%;"></td> <td style="width: 10%;"></td> <td style="width: 10%;"></td> <td style="width: 10%;"></td> <td style="width: 10%;"></td> </tr> <tr> <td></td> <td></td> <td colspan="8" style="text-align: center;"> <table border="1" style="width: 100%; border-collapse: collapse; text-align: center;"> <tr> <td style="width: 10%;"></td> <td style="width: 10%;"></td> <td style="width: 10%;"></td> <td style="width: 10%;"></td> <td style="width: 10%;"></td> <td style="width: 10%;"></td> <td style="width: 10%;"></td> <td style="width: 10%;"></td> <td style="width: 10%;"></td> <td style="width: 10%;"></td> </tr> <tr> <td></td> <td></td> <td colspan="8" style="text-align: center;"> <table border="1" style="width: 100%; border-collapse: collapse; text-align: center;"> <tr> <td style="width: 10%;"></td> <td style="width: 10%;"></td> <td style="width: 10%;"></td> <td style="width: 10%;"></td> <td style="width: 10%;"></td> <td style="width: 10%;"></td> <td style="width: 10%;"></td> <td style="width: 10%;"></td> <td style="width: 10%;"></td> <td style="width: 10%;"></td> </tr> <tr> <td></td> <td></td> <td colspan="8" style="text-align: center;"> <table border="1" style="width: 100%; border-collapse: collapse; text-align: center;"> <tr> <td style="width: 10%;"></td> <td style="width: 10%;"></td> <td style="width: 10%;"></td> <td style="width: 10%;"></td> <td style="width: 10%;"></td> <td style="width: 10%;"></td> <td style="width: 10%;"></td> <td style="width: 10%;"></td> <td style="width: 10%;"></td> <td style="width: 10%;"></td> </tr> <tr> <td></td> <td></td> <td colspan="8" style="text-align: center;"> <table border="1" style="width: 100%; border-collapse: collapse; text-align: center;"> <tr> <td style="width: 10%;"></td> <td style="width: 10%;"></td> <td style="width: 10%;"></td> <td style="width: 10%;"></td> <td style="width: 10%;"></td> <td style="width: 10%;"></td> <td style="width: 10%;"></td> <td style="width: 10%;"></td> <td style="width: 10%;"></td> <td style="width: 10%;"></td> </tr> <tr> <td></td> <td></td> <td colspan="8" style="text-align: center;"> <table border="1" style="width: 100%; border-collapse: collapse; text-align: center;"> <tr> <td style="width: 10%;"></td> <td style="width: 10%;"></td> <td style="width: 10%;"></td> <td style="width: 10%;"></td> <td style="width: 10%;"></td> <td style="width: 10%;"></td> <td style="width: 10%;"></td> <td style="width: 10%;"></td> <td style="width: 10%;"></td> <td style="width: 10%;"></td> </tr> <tr> <td></td> <td></td> <td colspan="8" style="text-align: center;"> <table border="1" style="width: 100%; border-collapse: collapse; text-align: center;"> <tr> <td style="width: 10%;"></td> <td style="width: 10%;"></td> <td style="width: 10%;"></td> <td style="width: 10%;"></td> <td style="width: 10%;"></td> <td style="width: 10%;"></td> <td style="width: 10%;"></td> <td style="width: 10%;"></td> <td style="width: 10%;"></td> <td style="width: 10%;"></td> </tr> <tr> <td></td> <td></td> <td colspan="8" style="text-align: center;"> <table border="1" style="width: 100%; border-collapse: collapse; text-align: center;"> <tr> <td style="width: 10%;"></td> <td style="width: 10%;"></td> <td style="width: 10%;"></td> <td style="width: 10%;"></td> <td style="width: 10%;"></td> <td style="width: 10%;"></td> <td style="width: 10%;"></td> <td style="width: 10%;"></td> <td style="width: 10%;"></td> <td style="width: 10%;"></td> </tr> <tr> <td></td> <td></td> <td colspan="8" style="text-align: center;"> <table border="1" style="width: 100%; border-collapse: collapse; text-align: center;"> <tr> <td style="width: 10%;"></td> <td style="width: 10%;"></td> <td style="width: 10%;"></td> <td style="width: 10%;"></td> <td style="width: 10%;"></td> <td style="width: 10%;"></td> <td style="width: 10%;"></td> <td style="width: 10%;"></td> <td style="width: 10%;"></td> <td style="width: 10%;"></td> </tr> <tr> <td></td> <td></td> <td colspan="8" style="text-align: center;"> <table border="1" style="width: 100%; border-collapse: collapse; text-align: center;"> <tr> <td style="width: 10%;"></td> <td style="width: 10%;"></td> <td style="width: 10%;"></td> <td style="width: 10%;"></td> <td style="width: 10%;"></td> <td style="width: 10%;"></td> <td style="width: 10%;"></td> <td style="width: 10%;"></td> <td style="width: 10%;"></td> <td style="width: 10%;"></td> </tr> <tr> <td></td> <td></td> <td colspan="8" style="text-align: center;"> <table border="1" style="width: 100%; border-collapse: collapse; text-align: center;"> <tr> </tr></table></td></tr></table></td></tr></table></td></tr></table></td></tr></table></td></tr></table></td></tr></table></td></tr></table></td></tr></table></td></tr></table></td></tr></table></td></tr></table></td></tr></table></td></tr></table></td></tr></table></td></tr></table></td></tr></table></td></tr></table></td></tr></table></td></tr></table></td></tr></table></td></tr></table></td></tr></table></td></tr></table></td></tr></table></td></tr></table></td></tr></table></td></tr></table></td></tr></table>

 | | | | | | | | | | | | | | | | | | | | <table border="1" style="width: 100%; border-collapse: collapse; text-align: center;"> <tr> <td style="width: 10%;"></td> <td style="width: 10%;"></td> <td style="width: 10%;"></td> <td style="width: 10%;"></td> <td style="width: 10%;"></td> <td style="width: 10%;"></td> <td style="width: 10%;"></td> <td style="width: 10%;"></td> <td style="width: 10%;"></td> <td style="width: 10%;"></td> </tr> <tr> <td></td> <td></td> <td colspan="8" style="text-align: center;"> <table border="1" style="width: 100%; border-collapse: collapse; text-align: center;"> <tr> <td style="width: 10%;"></td> <td style="width: 10%;"></td> <td style="width: 10%;"></td> <td style="width: 10%;"></td> <td style="width: 10%;"></td> <td style="width: 10%;"></td> <td style="width: 10%;"></td> <td style="width: 10%;"></td> <td style="width: 10%;"></td> <td style="width: 10%;"></td> </tr> <tr> <td></td> <td></td> <td colspan="8" style="text-align: center;"> <table border="1" style="width: 100%; border-collapse: collapse; text-align: center;"> <tr> <td style="width: 10%;"></td> <td style="width: 10%;"></td> <td style="width: 10%;"></td> <td style="width: 10%;"></td> <td style="width: 10%;"></td> <td style="width: 10%;"></td> <td style="width: 10%;"></td> <td style="width: 10%;"></td> <td style="width: 10%;"></td> <td style="width: 10%;"></td> </tr> <tr> <td></td> <td></td> <td colspan="8" style="text-align: center;"> <table border="1" style="width: 100%; border-collapse: collapse; text-align: center;"> <tr> <td style="width: 10%;"></td> <td style="width: 10%;"></td> <td style="width: 10%;"></td> <td style="width: 10%;"></td> <td style="width: 10%;"></td> <td style="width: 10%;"></td> <td style="width: 10%;"></td> <td style="width: 10%;"></td> <td style="width: 10%;"></td> <td style="width: 10%;"></td> </tr> <tr> <td></td> <td></td> <td colspan="8" style="text-align: center;"> <table border="1" style="width: 100%; border-collapse: collapse; text-align: center;"> <tr> <td style="width: 10%;"></td> <td style="width: 10%;"></td> <td style="width: 10%;"></td> <td style="width: 10%;"></td> <td style="width: 10%;"></td> <td style="width: 10%;"></td> <td style="width: 10%;"></td> <td style="width: 10%;"></td> <td style="width: 10%;"></td> <td style="width: 10%;"></td> </tr> <tr> <td></td> <td></td> <td colspan="8" style="text-align: center;"> <table border="1" style="width: 100%; border-collapse: collapse; text-align: center;"> <tr> <td style="width: 10%;"></td> <td style="width: 10%;"></td> <td style="width: 10%;"></td> <td style="width: 10%;"></td> <td style="width: 10%;"></td> <td style="width: 10%;"></td> <td style="width: 10%;"></td> <td style="width: 10%;"></td> <td style="width: 10%;"></td> <td style="width: 10%;"></td> </tr> <tr> <td></td> <td></td> <td colspan="8" style="text-align: center;"> <table border="1" style="width: 100%; border-collapse: collapse; text-align: center;"> <tr> <td style="width: 10%;"></td> <td style="width: 10%;"></td> <td style="width: 10%;"></td> <td style="width: 10%;"></td> <td style="width: 10%;"></td> <td style="width: 10%;"></td> <td style="width: 10%;"></td> <td style="width: 10%;"></td> <td style="width: 10%;"></td> <td style="width: 10%;"></td> </tr> <tr> <td></td> <td></td> <td colspan="8" style="text-align: center;"> <table border="1" style="width: 100%; border-collapse: collapse; text-align: center;"> <tr> <td style="width: 10%;"></td> <td style="width: 10%;"></td> <td style="width: 10%;"></td> <td style="width: 10%;"></td> <td style="width: 10%;"></td> <td style="width: 10%;"></td> <td style="width: 10%;"></td> <td style="width: 10%;"></td> <td style="width: 10%;"></td> <td style="width: 10%;"></td> </tr> <tr> <td></td> <td></td> <td colspan="8" style="text-align: center;"> <table border="1" style="width: 100%; border-collapse: collapse; text-align: center;"> <tr> <td style="width: 10%;"></td> <td style="width: 10%;"></td> <td style="width: 10%;"></td> <td style="width: 10%;"></td> <td style="width: 10%;"></td> <td style="width: 10%;"></td> <td style="width: 10%;"></td> <td style="width: 10%;"></td> <td style="width: 10%;"></td> <td style="width: 10%;"></td> </tr> <tr> <td></td> <td></td> <td colspan="8" style="text-align: center;"> <table border="1" style="width: 100%; border-collapse: collapse; text-align: center;"> <tr> <td style="width: 10%;"></td> <td style="width: 10%;"></td> <td style="width: 10%;"></td> <td style="width: 10%;"></td> <td style="width: 10%;"></td> <td style="width: 10%;"></td> <td style="width: 10%;"></td> <td style="width: 10%;"></td> <td style="width: 10%;"></td> <td style="width: 10%;"></td> </tr> <tr> <td></td> <td></td> <td colspan="8" style="text-align: center;"> <table border="1" style="width: 100%; border-collapse: collapse; text-align: center;"> <tr> <td style="width: 10%;"></td> <td style="width: 10%;"></td> <td style="width: 10%;"></td> <td style="width: 10%;"></td> <td style="width: 10%;"></td> <td style="width: 10%;"></td> <td style="width: 10%;"></td> <td style="width: 10%;"></td> <td style="width: 10%;"></td> <td style="width: 10%;"></td> </tr> <tr> <td></td> <td></td> <td colspan="8" style="text-align: center;"> <table border="1" style="width: 100%; border-collapse: collapse; text-align: center;"> <tr> <td style="width: 10%;"></td> <td style="width: 10%;"></td> <td style="width: 10%;"></td> <td style="width: 10%;"></td> <td style="width: 10%;"></td> <td style="width: 10%;"></td> <td style="width: 10%;"></td> <td style="width: 10%;"></td> <td style="width: 10%;"></td> <td style="width: 10%;"></td> </tr> <tr> <td></td> <td></td> <td colspan="8" style="text-align: center;"> <table border="1" style="width: 100%; border-collapse: collapse; text-align: center;"> <tr> <td style="width: 10%;"></td> <td style="width: 10%;"></td> <td style="width: 10%;"></td> <td style="width: 10%;"></td> <td style="width: 10%;"></td> <td style="width: 10%;"></td> <td style="width: 10%;"></td> <td style="width: 10%;"></td> <td style="width: 10%;"></td> <td style="width: 10%;"></td> </tr> <tr> <td></td> <td></td> <td colspan="8" style="text-align: center;"> <table border="1" style="width: 100%; border-collapse: collapse; text-align: center;"> <tr> <td style="width: 10%;"></td> <td style="width: 10%;"></td> <td style="width: 10%;"></td> <td style="width: 10%;"></td> <td style="width: 10%;"></td> <td style="width: 10%;"></td> <td style="width: 10%;"></td> <td style="width: 10%;"></td> <td style="width: 10%;"></td> <td style="width: 10%;"></td> </tr> <tr> <td></td> <td></td> <td colspan="8" style="text-align: center;"> <table border="1" style="width: 100%; border-collapse: collapse; text-align: center;"> <tr> <td style="width: 10%;"></td> <td style="width: 10%;"></td> <td style="width: 10%;"></td> <td style="width: 10%;"></td> <td style="width: 10%;"></td> <td style="width: 10%;"></td> <td style="width: 10%;"></td> <td style="width: 10%;"></td> <td style="width: 10%;"></td> <td style="width: 10%;"></td> </tr> <tr> <td></td> <td></td> <td colspan="8" style="text-align: center;"> <table border="1" style="width: 100%; border-collapse: collapse; text-align: center;"> <tr> <td style="width: 10%;"></td> <td style="width: 10%;"></td> <td style="width: 10%;"></td> <td style="width: 10%;"></td> <td style="width: 10%;"></td> <td style="width: 10%;"></td> <td style="width: 10%;"></td> <td style="width: 10%;"></td> <td style="width: 10%;"></td> <td style="width: 10%;"></td> </tr> <tr> <td></td> <td></td> <td colspan="8" style="text-align: center;"> <table border="1" style="width: 100%; border-collapse: collapse; text-align: center;"> <tr> <td style="width: 10%;"></td> <td style="width: 10%;"></td> <td style="width: 10%;"></td> <td style="width: 10%;"></td> <td style="width: 10%;"></td> <td style="width: 10%;"></td> <td style="width: 10%;"></td> <td style="width: 10%;"></td> <td style="width: 10%;"></td> <td style="width: 10%;"></td> </tr> <tr> <td></td> <td></td> <td colspan="8" style="text-align: center;"> <table border="1" style="width: 100%; border-collapse: collapse; text-align: center;"> <tr> <td style="width: 10%;"></td> <td style="width: 10%;"></td> <td style="width: 10%;"></td> <td style="width: 10%;"></td> <td style="width: 10%;"></td> <td style="width: 10%;"></td> <td style="width: 10%;"></td> <td style="width: 10%;"></td> <td style="width: 10%;"></td> <td style="width: 10%;"></td> </tr> <tr> <td></td> <td></td> <td colspan="8" style="text-align: center;"> <table border="1" style="width: 100%;
border-collapse: collapse; text-align: center;"> <tr> <td style="width: 10%;"></td> <td style="width: 10%;"></td> <td style="width: 10%;"></td> <td style="width: 10%;"></td> <td style="width: 10%;"></td> <td style="width: 10%;"></td> <td style="width: 10%;"></td> <td style="width: 10%;"></td> <td style="width: 10%;"></td> <td style="width: 10%;"></td> </tr> <tr> <td></td> <td></td> <td colspan="8" style="text-align: center;"> <table border="1" style="width: 100%; border-collapse: collapse; text-align: center;"> <tr> <td style="width: 10%;"></td> <td style="width: 10%;"></td> <td style="width: 10%;"></td> <td style="width: 10%;"></td> <td style="width: 10%;"></td> <td style="width: 10%;"></td> <td style="width: 10%;"></td> <td style="width: 10%;"></td> <td style="width: 10%;"></td> <td style="width: 10%;"></td> </tr> <tr> <td></td> <td></td> <td colspan="8" style="text-align: center;"> <table border="1" style="width: 100%; border-collapse: collapse; text-align: center;"> <tr> <td style="width: 10%;"></td> <td style="width: 10%;"></td> <td style="width: 10%;"></td> <td style="width: 10%;"></td> <td style="width: 10%;"></td> <td style="width: 10%;"></td> <td style="width: 10%;"></td> <td style="width: 10%;"></td> <td style="width: 10%;"></td> <td style="width: 10%;"></td> </tr> <tr> <td></td> <td></td> <td colspan="8" style="text-align: center;"> <table border="1" style="width: 100%; border-collapse: collapse; text-align: center;"> <tr> <td style="width: 10%;"></td> <td style="width: 10%;"></td> <td style="width: 10%;"></td> <td style="width: 10%;"></td> <td style="width: 10%;"></td> <td style="width: 10%;"></td> <td style="width: 10%;"></td> <td style="width: 10%;"></td> <td style="width: 10%;"></td> <td style="width: 10%;"></td> </tr> <tr> <td></td> <td></td> <td colspan="8" style="text-align: center;"> <table border="1" style="width: 100%; border-collapse: collapse; text-align: center;"> <tr> <td style="width: 10%;"></td> <td style="width: 10%;"></td> <td style="width: 10%;"></td> <td style="width: 10%;"></td> <td style="width: 10%;"></td> <td style="width: 10%;"></td> <td style="width: 10%;"></td> <td style="width: 10%;"></td> <td style="width: 10%;"></td> <td style="width: 10%;"></td> </tr> <tr> <td></td> <td></td> <td colspan="8" style="text-align: center;"> <table border="1" style="width: 100%; border-collapse: collapse; text-align: center;"> <tr> <td style="width: 10%;"></td> <td style="width: 10%;"></td> <td style="width: 10%;"></td> <td style="width: 10%;"></td> <td style="width: 10%;"></td> <td style="width: 10%;"></td> <td style="width: 10%;"></td> <td style="width: 10%;"></td> <td style="width: 10%;"></td> <td style="width: 10%;"></td> </tr> <tr> <td></td> <td></td> <td colspan="8" style="text-align: center;"> <table border="1" style="width: 100%; border-collapse: collapse; text-align: center;"> <tr> <td style="width: 10%;"></td> <td style="width: 10%;"></td> <td style="width: 10%;"></td> <td style="width: 10%;"></td> <td style="width: 10%;"></td> <td style="width: 10%;"></td> <td style="width: 10%;"></td> <td style="width: 10%;"></td> <td style="width: 10%;"></td> <td style="width: 10%;"></td> </tr> <tr> <td></td> <td></td> <td colspan="8" style="text-align: center;"> <table border="1" style="width: 100%; border-collapse: collapse; text-align: center;"> <tr> <td style="width: 10%;"></td> <td style="width: 10%;"></td> <td style="width: 10%;"></td> <td style="width: 10%;"></td> <td style="width: 10%;"></td> <td style="width: 10%;"></td> <td style="width: 10%;"></td> <td style="width: 10%;"></td> <td style="width: 10%;"></td> <td style="width: 10%;"></td> </tr> <tr> <td></td> <td></td> <td colspan="8" style="text-align: center;"> <table border="1" style="width: 100%; border-collapse: collapse; text-align: center;"> <tr> <td style="width: 10%;"></td> <td style="width: 10%;"></td> <td style="width: 10%;"></td> <td style="width: 10%;"></td> <td style="width: 10%;"></td> <td style="width: 10%;"></td> <td style="width: 10%;"></td> <td style="width: 10%;"></td> <td style="width: 10%;"></td> <td style="width: 10%;"></td> </tr> <tr> <td></td> <td></td> <td colspan="8" style="text-align: center;"> <table border="1" style="width: 100%; border-collapse: collapse; text-align: center;"> <tr> </tr></table></td></tr></table></td></tr></table></td></tr></table></td></tr></table></td></tr></table></td></tr></table></td></tr></table></td></tr></table></td></tr></table></td></tr></table></td></tr></table></td></tr></table></td></tr></table></td></tr></table></td></tr></table></td></tr></table></td></tr></table></td></tr></table></td></tr></table></td></tr></table></td></tr></table></td></tr></table></td></tr></table></td></tr></table></td></tr></table></td></tr></table></td></tr></table>

 | | | | | | | | | | | | | | | | | | | | <table border="1" style="width: 100%; border-collapse: collapse; text-align: center;"> <tr> <td style="width: 10%;"></td> <td style="width: 10%;"></td> <td style="width: 10%;"></td> <td style="width: 10%;"></td> <td style="width: 10%;"></td> <td style="width: 10%;"></td> <td style="width: 10%;"></td> <td style="width: 10%;"></td> <td style="width: 10%;"></td> <td style="width: 10%;"></td> </tr> <tr> <td></td> <td></td> <td colspan="8" style="text-align: center;"> <table border="1" style="width: 100%; border-collapse: collapse; text-align: center;"> <tr> <td style="width: 10%;"></td> <td style="width: 10%;"></td> <td style="width: 10%;"></td> <td style="width: 10%;"></td> <td style="width: 10%;"></td> <td style="width: 10%;"></td> <td style="width: 10%;"></td> <td style="width: 10%;"></td> <td style="width: 10%;"></td> <td style="width: 10%;"></td> </tr> <tr> <td></td> <td></td> <td colspan="8" style="text-align: center;"> <table border="1" style="width: 100%; border-collapse: collapse; text-align: center;"> <tr> <td style="width: 10%;"></td> <td style="width: 10%;"></td> <td style="width: 10%;"></td> <td style="width: 10%;"></td> <td style="width: 10%;"></td> <td style="width: 10%;"></td> <td style="width: 10%;"></td> <td style="width: 10%;"></td> <td style="width: 10%;"></td> <td style="width: 10%;"></td> </tr> <tr> <td></td> <td></td> <td colspan="8" style="text-align: center;"> <table border="1" style="width: 100%; border-collapse: collapse; text-align: center;"> <tr> <td style="width: 10%;"></td> <td style="width: 10%;"></td> <td style="width: 10%;"></td> <td style="width: 10%;"></td> <td style="width: 10%;"></td> <td style="width: 10%;"></td> <td style="width: 10%;"></td> <td style="width: 10%;"></td> <td style="width: 10%;"></td> <td style="width: 10%;"></td> </tr> <tr> <td></td> <td></td> <td colspan="8" style="text-align: center;"> <table border="1" style="width: 100%; border-collapse: collapse; text-align: center;"> <tr> <td style="width: 10%;"></td> <td style="width: 10%;"></td> <td style="width: 10%;"></td> <td style="width: 10%;"></td> <td style="width: 10%;"></td> <td style="width: 10%;"></td> <td style="width: 10%;"></td> <td style="width: 10%;"></td> <td style="width: 10%;"></td> <td style="width: 10%;"></td> </tr> <tr> <td></td> <td></td> <td colspan="8" style="text-align: center;"> <table border="1" style="width: 100%; border-collapse: collapse; text-align: center;"> <tr> <td style="width: 10%;"></td> <td style="width: 10%;"></td> <td style="width: 10%;"></td> <td style="width: 10%;"></td> <td style="width: 10%;"></td> <td style="width: 10%;"></td> <td style="width: 10%;"></td> <td style="width: 10%;"></td> <td style="width: 10%;"></td> <td style="width: 10%;"></td> </tr> <tr> <td></td> <td></td> <td colspan="8" style="text-align: center;"> <table border="1" style="width: 100%; border-collapse: collapse; text-align: center;"> <tr> <td style="width: 10%;"></td> <td style="width: 10%;"></td> <td style="width: 10%;"></td> <td style="width: 10%;"></td> <td style="width: 10%;"></td> <td style="width: 10%;"></td> <td style="width: 10%;"></td> <td style="width: 10%;"></td> <td style="width: 10%;"></td> <td style="width: 10%;"></td> </tr> <tr> <td></td> <td></td> <td colspan="8" style="text-align: center;"> <table border="1" style="width: 100%; border-collapse: collapse; text-align: center;"> <tr> <td style="width: 10%;"></td> <td style="width: 10%;"></td> <td style="width: 10%;"></td> <td style="width: 10%;"></td> <td style="width: 10%;"></td> <td style="width: 10%;"></td> <td style="width: 10%;"></td> <td style="width: 10%;"></td> <td style="width: 10%;"></td> <td style="width: 10%;"></td> </tr> <tr> <td></td> <td></td> <td colspan="8" style="text-align: center;"> <table border="1" style="width: 100%; border-collapse: collapse; text-align: center;"> <tr> <td style="width: 10%;"></td> <td style="width: 10%;"></td> <td style="width: 10%;"></td> <td style="width: 10%;"></td> <td style="width: 10%;"></td> <td style="width: 10%;"></td> <td style="width: 10%;"></td> <td style="width: 10%;"></td> <td style="width: 10%;"></td> <td style="width: 10%;"></td> </tr> <tr> <td></td> <td></td> <td colspan="8" style="text-align: center;"> <table border="1" style="width: 100%; border-collapse: collapse; text-align: center;"> <tr> <td style="width: 10%;"></td> <td style="width: 10%;"></td> <td style="width: 10%;"></td> <td style="width: 10%;"></td> <td style="width: 10%;"></td> <td style="width: 10%;"></td> <td style="width: 10%;"></td> <td style="width: 10%;"></td> <td style="width: 10%;"></td> <td style="width: 10%;"></td> </tr> <tr> <td></td> <td></td> <td colspan="8" style="text-align: center;"> <table border="1" style="width: 100%; border-collapse: collapse; text-align: center;"> <tr> <td style="width: 10%;"></td> <td style="width: 10%;"></td> <td style="width: 10%;"></td> <td style="width: 10%;"></td> <td style="width: 10%;"></td> <td style="width: 10%;"></td> <td style="width: 10%;"></td> <td style="width: 10%;"></td> <td style="width: 10%;"></td> <td style="width: 10%;"></td> </tr> <tr> <td></td> <td></td> <td colspan="8" style="text-align: center;"> <table border="1" style="width: 100%; border-collapse: collapse; text-align: center;"> <tr> <td style="width: 10%;"></td> <td style="width: 10%;"></td> <td style="width: 10%;"></td> <td style="width: 10%;"></td> <td style="width: 10%;"></td> <td style="width: 10%;"></td> <td style="width: 10%;"></td> <td style="width: 10%;"></td> <td style="width: 10%;"></td> <td style="width: 10%;"></td> </tr> <tr> <td></td> <td></td> <td colspan="8" style="text-align: center;"> <table border="1" style="width: 100%; border-collapse: collapse; text-align: center;"> <tr> <td style="width: 10%;"></td> <td style="width: 10%;"></td> <td style="width: 10%;"></td> <td style="width: 10%;"></td> <td style="width: 10%;"></td> <td style="width: 10%;"></td> <td style="width: 10%;"></td> <td style="width: 10%;"></td> <td style="width: 10%;"></td> <td style="width: 10%;"></td> </tr> <tr> <td></td> <td></td> <td colspan="8" style="text-align: center;"> <table border="1" style="width: 100%; border-collapse: collapse; text-align: center;"> <tr> <td style="width: 10%;"></td> <td style="width: 10%;"></td> <td style="width: 10%;"></td> <td style="width: 10%;"></td> <td style="width: 10%;"></td> <td style="width: 10%;"></td> <td style="width: 10%;"></td> <td style="width: 10%;"></td> <td style="width: 10%;"></td> <td style="width: 10%;"></td> </tr> <tr> <td></td> <td></td> <td colspan="8" style="text-align: center;"> <table border="1" style="width: 100%; border-collapse: collapse; text-align: center;"> <tr> <td style="width: 10%;"></td> <td style="width: 10%;"></td> <td style="width: 10%;"></td> <td style="width: 10%;"></td> <td style="width: 10%;"></td> <td style="width: 10%;"></td> <td style="width: 10%;"></td> <td style="width: 10%;"></td> <td style="width: 10%;"></td> <td style="width: 10%;"></td> </tr> <tr> <td></td> <td></td> <td colspan="8" style="text-align: center;"> <table border="1" style="width: 100%; border-collapse: collapse; text-align: center;"> <tr> <td style="width: 10%;"></td> <td style="width: 10%;"></td> <td style="width: 10%;"></td> <td style="width: 10%;"></td> <td style="width: 10%;"></td> <td style="width: 10%;"></td> <td style="width: 10%;"></td> <td style="width: 10%;"></td> <td style="width: 10%;"></td> <td style="width: 10%;"></td> </tr> <tr> <td></td> <td></td> <td colspan="8" style="text-align: center;"> <table border="1" style="width: 100%; border-collapse: collapse; text-align: center;"> <tr> <td style="width: 10%;"></td> <td style="width: 10%;"></td> <td style="width: 10%;"></td> <td style="width: 10%;"></td> <td style="width: 10%;"></td> <td style="width: 10%;"></td> <td style="width: 10%;"></td> <td style="width: 10%;"></td> <td style="width: 10%;"></td> <td style="width: 10%;"></td> </tr> <tr> <td></td> <td></td> <td colspan="8" style="text-align: center;"> <table border="1" style="width: 100%; border-collapse: collapse; text-align: center;"> <tr> <td style="width: 10%;"></td> <td style="width: 10%;"></td> <td style="width: 10%;"></td> <td style="width: 10%;"></td> <td style="width: 10%;"></td> <td style="width: 10%;"></td> <td style="width: 10%;"></td> <td style="width: 10%;"></td> <td style="width: 10%;"></td> <td style="width: 10%;"></td> </tr> <tr> <td></td> <td></td> <td colspan="8" style="text-align: center;"> <table border="1" style="width: 100%; border-collapse: collapse; text-align: center;"> <tr> <td style="width: 10%;"></td> <td style="width: 10%;"></td> <td style="width: 10%;"></td> <td style="width: 10%;"></td> <td style="width: 10%;"></td> <td style="width: 10%;"></td> <td style="width: 10%;"></td> <td style="width: 10%;"></td> <td style="width: 10%;"></td> <td style="width: 10%;"></td> </tr> <tr> <td></td> <td></td> <td colspan="8" style="text-align: center;"> <table border="1" style="width: 100%; border-collapse: collapse; text-align: center;"> <tr> <td style="width: 10%;"></td> <td style="width: 10%;"></td> <td style="width: 10%;"></td> <td style="width: 10%;"></td> <td style="width: 10%;"></td> <td style="width: 10%;"></td> <td style="width: 10%;"></td> <td style="width: 10%;"></td> <td style="width: 10%;"></td> <td style="width: 10%;"></td> </tr> <tr> <td></td> <td></td> <td colspan="8" style="text-align: center;"> <table border="1" style="width: 100%; border-collapse: collapse; text-align: center;"> <tr> <td style="width: 10%;"></td> <td style="width: 10%;"></td> <td style="width: 10%;"></td> <td style="width: 10%;"></td> <td style="width: 10%;"></td> <td style="width:
10%;"></td> <td style="width: 10%;"></td> <td style="width: 10%;"></td> <td style="width: 10%;"></td> <td style="width: 10%;"></td> </tr> <tr> <td></td> <td></td> <td colspan="8" style="text-align: center;"> <table border="1" style="width: 100%; border-collapse: collapse; text-align: center;"> <tr> <td style="width: 10%;"></td> <td style="width: 10%;"></td> <td style="width: 10%;"></td> <td style="width: 10%;"></td> <td style="width: 10%;"></td> <td style="width: 10%;"></td> <td style="width: 10%;"></td> <td style="width: 10%;"></td> <td style="width: 10%;"></td> <td style="width: 10%;"></td> </tr> <tr> <td></td> <td></td> <td colspan="8" style="text-align: center;"> <table border="1" style="width: 100%; border-collapse: collapse; text-align: center;"> <tr> <td style="width: 10%;"></td> <td style="width: 10%;"></td> <td style="width: 10%;"></td> <td style="width: 10%;"></td> <td style="width: 10%;"></td> <td style="width: 10%;"></td> <td style="width: 10%;"></td> <td style="width: 10%;"></td> <td style="width: 10%;"></td> <td style="width: 10%;"></td> </tr> <tr> <td></td> <td></td> <td colspan="8" style="text-align: center;"> <table border="1" style="width: 100%; border-collapse: collapse; text-align: center;"> <tr> <td style="width: 10%;"></td> <td style="width: 10%;"></td> <td style="width: 10%;"></td> <td style="width: 10%;"></td> <td style="width: 10%;"></td> <td style="width: 10%;"></td> <td style="width: 10%;"></td> <td style="width: 10%;"></td> <td style="width: 10%;"></td> <td style="width: 10%;"></td> </tr> <tr> <td></td> <td></td> <td colspan="8" style="text-align: center;"> <table border="1" style="width: 100%; border-collapse: collapse; text-align: center;"> <tr> <td style="width: 10%;"></td> <td style="width: 10%;"></td> <td style="width: 10%;"></td> <td style="width: 10%;"></td> <td style="width: 10%;"></td> <td style="width: 10%;"></td> <td style="width: 10%;"></td> <td style="width: 10%;"></td> <td style="width: 10%;"></td> <td style="width: 10%;"></td> </tr> <tr> <td></td> <td></td> <td colspan="8" style="text-align: center;"> <table border="1" style="width: 100%; border-collapse: collapse; text-align: center;"> <tr> <td style="width: 10%;"></td> <td style="width: 10%;"></td> <td style="width: 10%;"></td> <td style="width: 10%;"></td> <td style="width: 10%;"></td> <td style="width: 10%;"></td> <td style="width: 10%;"></td> <td style="width: 10%;"></td> <td style="width: 10%;"></td> <td style="width: 10%;"></td> </tr> <tr> <td></td> <td></td> <td colspan="8" style="text-align: center;"> <table border="1" style="width: 100%; border-collapse: collapse; text-align: center;"> <tr> </tr></table></td></tr></table></td></tr></table></td></tr></table></td></tr></table></td></tr></table></td></tr></table></td></tr></table></td></tr></table></td></tr></table></td></tr></table></td></tr></table></td></tr></table></td></tr></table></td></tr></table></td></tr></table></td></tr></table></td></tr></table></td></tr></table></td></tr></table></td></tr></table></td></tr></table></td></tr></table></td></tr></table></td></tr></table></td></tr></table></td></tr></table>
 | | | | | | | | | | | | | | | | | | | | <table border="1" style="width: 100%; border-collapse: collapse; text-align: center;"> <tr> <td style="width: 10%;"></td> <td style="width: 10%;"></td> <td style="width: 10%;"></td> <td style="width: 10%;"></td> <td style="width: 10%;"></td> <td style="width: 10%;"></td> <td style="width: 10%;"></td> <td style="width: 10%;"></td> <td style="width: 10%;"></td> <td style="width: 10%;"></td> </tr> <tr> <td></td> <td></td> <td colspan="8" style="text-align: center;"> <table border="1" style="width: 100%; border-collapse: collapse; text-align: center;"> <tr> <td style="width: 10%;"></td> <td style="width: 10%;"></td> <td style="width: 10%;"></td> <td style="width: 10%;"></td> <td style="width: 10%;"></td> <td style="width: 10%;"></td> <td style="width: 10%;"></td> <td style="width: 10%;"></td> <td style="width: 10%;"></td> <td style="width: 10%;"></td> </tr> <tr> <td></td> <td></td> <td colspan="8" style="text-align: center;"> <table border="1" style="width: 100%; border-collapse: collapse; text-align: center;"> <tr> <td style="width: 10%;"></td> <td style="width: 10%;"></td> <td style="width: 10%;"></td> <td style="width: 10%;"></td> <td style="width: 10%;"></td> <td style="width: 10%;"></td> <td style="width: 10%;"></td> <td style="width:
10%;"></td> <td style="width: 10%;"></td> <td style="width: 10%;"></td> </tr> <tr> <td></td> <td></td> <td colspan="8" style="text-align: center;"> <table border="1" style="width: 100%; border-collapse: collapse; text-align: center;"> <tr> <td style="width: 10%;"></td> <td style="width: 10%;"></td> <td style="width: 10%;"></td> <td style="width: 10%;"></td> <td style="width: 10%;"></td> <td style="width: 10%;"></td> <td style="width: 10%;"></td> <td style="width: 10%;"></td> <td style="width: 10%;"></td> <td style="width: 10%;"></td> </tr> <tr> <td></td> <td></td> <td colspan="8" style="text-align: center;"> <table border="1" style="width: 100%; border-collapse: collapse; text-align: center;"> <tr> <td style="width: 10%;"></td> <td style="width: 10%;"></td> <td style="width: 10%;"></td> <td style="width: 10%;"></td> <td style="width: 10%;"></td> <td style="width: 10%;"></td> <td style="width: 10%;"></td> <td style="width: 10%;"></td> <td style="width: 10%;"></td> <td style="width: 10%;"></td> </tr> <tr> <td></td> <td></td> <td colspan="8" style="text-align: center;"> <table border="1" style="width: 100%; border-collapse: collapse; text-align: center;"> <tr> <td style="width: 10%;"></td> <td style="width: 10%;"></td> <td style="width: 10%;"></td> <td style="width: 10%;"></td> <td style="width: 10%;"></td> <td style="width: 10%;"></td> <td style="width: 10%;"></td> <td style="width: 10%;"></td> <td style="width: 10%;"></td> <td style="width: 10%;"></td> </tr> <tr> <td></td> <td></td> <td colspan="8" style="text-align: center;"> <table border="1" style="width: 100%; border-collapse: collapse; text-align: center;"> <tr> <td style="width: 10%;"></td> <td style="width: 10%;"></td> <td style="width: 10%;"></td> <td style="width: 10%;"></td> <td style="width: 10%;"></td> <td style="width: 10%;"></td> <td style="width: 10%;"></td> <td style="width: 10%;"></td> <td style="width: 10%;"></td> <td style="width: 10%;"></td> </tr> <tr> <td></td> <td></td> <td colspan="8" style="text-align: center;"> <table border="1" style="width: 100%; border-collapse: collapse; text-align: center;"> <tr> <td style="width: 10%;"></td> <td style="width: 10%;"></td> <td style="width: 10%;"></td> <td style="width: 10%;"></td> <td style="width: 10%;"></td> <td style="width: 10%;"></td> <td style="width: 10%;"></td> <td style="width: 10%;"></td> <td style="width: 10%;"></td> <td style="width: 10%;"></td> </tr> <tr> <td></td> <td></td> <td colspan="8" style="text-align: center;"> <table border="1" style="width: 100%; border-collapse: collapse; text-align: center;"> <tr> <td style="width: 10%;"></td> <td style="width: 10%;"></td> <td style="width: 10%;"></td> <td style="width: 10%;"></td> <td style="width: 10%;"></td> <td style="width: 10%;"></td> <td style="width: 10%;"></td> <td style="width: 10%;"></td> <td style="width: 10%;"></td> <td style="width: 10%;"></td> </tr> <tr> <td></td> <td></td> <td colspan="8" style="text-align: center;"> <table border="1" style="width: 100%; border-collapse: collapse; text-align: center;"> <tr> <td style="width: 10%;"></td> <td style="width: 10%;"></td> <td style="width: 10%;"></td> <td style="width: 10%;"></td> <td style="width: 10%;"></td> <td style="width: 10%;"></td> <td style="width: 10%;"></td> <td style="width: 10%;"></td> <td style="width: 10%;"></td> <td style="width: 10%;"></td> </tr> <tr> <td></td> <td></td> <td colspan="8" style="text-align: center;"> <table border="1" style="width: 100%; border-collapse: collapse; text-align: center;"> <tr> <td style="width: 10%;"></td> <td style="width: 10%;"></td> <td style="width: 10%;"></td> <td style="width: 10%;"></td> <td style="width: 10%;"></td> <td style="width: 10%;"></td> <td style="width: 10%;"></td> <td style="width: 10%;"></td> <td style="width: 10%;"></td> <td style="width: 10%;"></td> </tr> <tr> <td></td> <td></td> <td colspan="8" style="text-align: center;"> <table border="1" style="width: 100%; border-collapse: collapse; text-align: center;"> <tr> <td style="width: 10%;"></td> <td style="width: 10%;"></td> <td style="width: 10%;"></td> <td style="width: 10%;"></td> <td style="width: 10%;"></td> <td style="width: 10%;"></td> <td style="width: 10%;"></td> <td style="width: 10%;"></td> <td style="width: 10%;"></td> <td style="width: 10%;"></td> </tr> <tr> <td></td> <td></td> <td colspan="8" style="text-align: center;"> <table border="1" style="width: 100%; border-collapse: collapse; text-align: center;"> <tr> <td style="width: 10%;"></td> <td style="width: 10%;"></td> <td style="width: 10%;"></td> <td style="width: 10%;"></td> <td style="width: 10%;"></td> <td style="width: 10%;"></td> <td style="width: 10%;"></td> <td style="width: 10%;"></td> <td style="width: 10%;"></td> <td style="width: 10%;"></td> </tr> <tr> <td></td> <td></td> <td colspan="8" style="text-align: center;"> <table border="1" style="width: 100%; border-collapse: collapse; text-align: center;"> <tr> <td style="width: 10%;"></td> <td style="width: 10%;"></td> <td style="width: 10%;"></td> <td style="width: 10%;"></td> <td style="width: 10%;"></td> <td style="width: 10%;"></td> <td style="width: 10%;"></td> <td style="width: 10%;"></td> <td style="width: 10%;"></td> <td style="width: 10%;"></td> </tr> <tr> <td></td> <td></td> <td colspan="8" style="text-align: center;"> <table border="1" style="width: 100%; border-collapse: collapse; text-align: center;"> <tr> <td style="width: 10%;"></td> <td style="width: 10%;"></td> <td style="width: 10%;"></td> <td style="width: 10%;"></td> <td style="width: 10%;"></td> <td style="width: 10%;"></td> <td style="width: 10%;"></td> <td style="width: 10%;"></td> <td style="width: 10%;"></td> <td style="width: 10%;"></td> </tr> <tr> <td></td> <td></td> <td colspan="8" style="text-align: center;"> <table border="1" style="width: 100%; border-collapse: collapse; text-align: center;"> <tr> <td style="width: 10%;"></td> <td style="width: 10%;"></td> <td style="width: 10%;"></td> <td style="width: 10%;"></td> <td style="width: 10%;"></td> <td style="width: 10%;"></td> <td style="width: 10%;"></td> <td style="width: 10%;"></td> <td style="width: 10%;"></td> <td style="width: 10%;"></td> </tr> <tr> <td></td> <td></td> <td colspan="8" style="text-align: center;"> <table border="1" style="width: 100%; border-collapse: collapse; text-align: center;"> <tr> <td style="width: 10%;"></td> <td style="width: 10%;"></td> <td style="width: 10%;"></td> <td style="width: 10%;"></td> <td style="width: 10%;"></td> <td style="width: 10%;"></td> <td style="width: 10%;"></td> <td style="width: 10%;"></td> <td style="width: 10%;"></td> <td style="width: 10%;"></td> </tr> <tr> <td></td> <td></td> <td colspan="8" style="text-align: center;"> <table border="1" style="width: 100%; border-collapse: collapse; text-align: center;"> <tr> <td style="width: 10%;"></td> <td style="width: 10%;"></td> <td style="width: 10%;"></td> <td style="width: 10%;"></td> <td style="width: 10%;"></td> <td style="width: 10%;"></td> <td style="width: 10%;"></td> <td style="width: 10%;"></td> <td style="width: 10%;"></td> <td style="width: 10%;"></td> </tr> <tr> <td></td> <td></td> <td colspan="8" style="text-align: center;"> <table border="1" style="width: 100%; border-collapse: collapse; text-align: center;"> <tr> <td style="width: 10%;"></td> <td style="width: 10%;"></td> <td style="width: 10%;"></td> <td style="width: 10%;"></td> <td style="width: 10%;"></td> <td style="width: 10%;"></td> <td style="width: 10%;"></td> <td style="width: 10%;"></td> <td style="width: 10%;"></td> <td style="width: 10%;"></td> </tr> <tr> <td></td> <td></td> <td colspan="8" style="text-align: center;"> <table border="1" style="width: 100%; border-collapse: collapse; text-align: center;"> <tr> <td style="width: 10%;"></td> <td style="width: 10%;"></td> <td style="width: 10%;"></td> <td style="width: 10%;"></td> <td style="width: 10%;"></td> <td style="width: 10%;"></td> <td style="width: 10%;"></td> <td style="width: 10%;"></td> <td style="width: 10%;"></td> <td style="width: 10%;"></td> </tr> <tr> <td></td> <td></td> <td colspan="8" style="text-align: center;"> <table border="1" style="width: 100%; border-collapse: collapse; text-align: center;"> <tr> <td style="width: 10%;"></td> <td style="width: 10%;"></td> <td style="width: 10%;"></td> <td style="width: 10%;"></td> <td style="width: 10%;"></td> <td style="width: 10%;"></td> <td style="width: 10%;"></td> <td style="width: 10%;"></td> <td style="width: 10%;"></td> <td style="width: 10%;"></td> </tr> <tr> <td></td> <td></td> <td colspan="8" style="text-align: center;"> <table border="1" style="width: 100%; border-collapse: collapse; text-align: center;"> <tr> <td style="width: 10%;"></td> <td style="width: 10%;"></td> <td style="width: 10%;"></td> <td style="width: 10%;"></td> <td style="width: 10%;"></td> <td style="width: 10%;"></td> <td style="width: 10%;"></td> <td style="width: 10%;"></td> <td style="width: 10%;"></td> <td style="width: 10%;"></td> </tr> <tr> <td></td> <td></td> <td colspan="8" style="text-align: center;"> <table border="1" style="width: 100%; border-collapse: collapse; text-align: center;"> <tr> <td style="width: 10%;"></td> <td style="width: 10%;"></td> <td style="width: 10%;"></td> <td style="width: 10%;"></td> <td style="width: 10%;"></td> <td style="width: 10%;"></td> <td style="width: 10%;"></td> <td style="width: 10%;"></td> <td style="width: 10%;"></td> <td style="width: 10%;"></td> </tr> <tr> <td></td> <td></td> <td colspan="8" style="text-align: center;"> <table border="1" style="width: 100%; border-collapse: collapse; text-align: center;"> <tr> <td style="width: 10%;"></td> <td style="width: 10%;"></td> <td style="width: 10%;"></td> <td style="width: 10%;"></td> <td style="width: 10%;"></td> <td style="width: 10%;"></td> <td style="width: 10%;"></td> <td style="width: 10%;"></td> <td style="width: 10%;"></td> <td style="width: 10%;"></td> </tr> <tr> <td></td> <td></td> <td colspan="8" style="text-align: center;"> <table border="1"
style="width: 100%; border-collapse: collapse; text-align: center;"> <tr> <td style="width: 10%;"></td> <td style="width: 10%;"></td> <td style="width: 10%;"></td> <td style="width: 10%;"></td> <td style="width: 10%;"></td> <td style="width: 10%;"></td> <td style="width: 10%;"></td> <td style="width: 10%;"></td> <td style="width: 10%;"></td> <td style="width: 10%;"></td> </tr> <tr> <td></td> <td></td> <td colspan="8" style="text-align: center;"> <table border="1" style="width: 100%; border-collapse: collapse; text-align: center;"> <tr> </tr></table></td></tr></table></td></tr></table></td></tr></table></td></tr></table></td></tr></table></td></tr></table></td></tr></table></td></tr></table></td></tr></table></td></tr></table></td></tr></table></td></tr></table></td></tr></table></td></tr></table></td></tr></table></td></tr></table></td></tr></table></td></tr></table></td></tr></table></td></tr></table></td></tr></table></td></tr></table></td></tr></table></td></tr></table></td></tr></table>
 | | | | | | | | | | | | | | | | | | | | <table border="1" style="width: 100%; border-collapse: collapse; text-align: center;"> <tr> <td style="width: 10%;"></td> <td style="width: 10%;"></td> <td style="width: 10%;"></td> <td style="width: 10%;"></td> <td style="width: 10%;"></td> <td style="width: 10%;"></td> <td style="width: 10%;"></td> <td style="width: 10%;"></td> <td style="width: 10%;"></td> <td style="width: 10%;"></td> </tr> <tr> <td></td> <td></td> <td colspan="8" style="text-align: center;"> <table border="1" style="width: 100%; border-collapse: collapse; text-align: center;"> <tr> <td style="width: 10%;"></td> <td style="width: 10%;"></td> <td style="width: 10%;"></td> <td style="width: 10%;"></td> <td style="width: 10%;"></td> <td style="width: 10%;"></td> <td style="width: 10%;"></td> <td style="width: 10%;"></td> <td style="width: 10%;"></td> <td style="width: 10%;"></td> </tr> <tr> <td></td> <td></td> <td colspan="8" style="text-align: center;"> <table border="1" style="width: 100%; border-collapse: collapse; text-align: center;"> <tr> <td style="width: 10%;"></td> <td style="width: 10%;"></td> <td style="width: 10%;"></td> <td style="width: 10%;"></td> <td style="width: 10%;"></td> <td style="width: 10%;"></td> <td style="width: 10%;"></td> <td style="width: 10%;"></td> <td style="width: 10%;"></td> <td style="width: 10%;"></td> </tr> <tr> <td></td> <td></td> <td colspan="8" style="text-align: center;"> <table border="1" style="width: 100%; border-collapse: collapse; text-align: center;"> <tr> <td style="width: 10%;"></td> <td style="width: 10%;"></td> <td style="width: 10%;"></td> <td style="width: 10%;"></td> <td style="width: 10%;"></td> <td style="width: 10%;"></td> <td style="width: 10%;"></td> <td style="width: 10%;"></td> <td style="width: 10%;"></td> <td style="width: 10%;"></td> </tr> <tr> <td></td> <td></td> <td colspan="8" style="text-align: center;"> <table border="1" style="width: 100%; border-collapse: collapse; text-align: center;"> <tr> <td style="width: 10%;"></td> <td style="width: 10%;"></td> <td style="width: 10%;"></td> <td style="width: 10%;"></td> <td style="width: 10%;"></td> <td style="width: 10%;"></td> <td style="width: 10%;"></td> <td style="width: 10%;"></td> <td style="width: 10%;"></td> <td style="width: 10%;"></td> </tr> <tr> <td></td> <td></td> <td colspan="8" style="text-align: center;"> <table border="1" style="width: 100%; border-collapse: collapse; text-align: center;"> <tr> <td style="width: 10%;"></td> <td style="width: 10%;"></td> <td style="width: 10%;"></td> <td style="width: 10%;"></td> <td style="width: 10%;"></td> <td style="width: 10%;"></td> <td style="width: 10%;"></td> <td style="width: 10%;"></td> <td style="width: 10%;"></td> <td style="width: 10%;"></td> </tr> <tr> <td></td> <td></td> <td colspan="8" style="text-align: center;"> <table border="1" style="width: 100%; border-collapse: collapse; text-align: center;"> <tr> <td style="width: 10%;"></td> <td style="width: 10%;"></td> <td style="width: 10%;"></td> <td style="width: 10%;"></td> <td style="width: 10%;"></td> <td style="width: 10%;"></td> <td style="width: 10%;"></td> <td style="width: 10%;"></td> <td style="width: 10%;"></td> <td style="width: 10%;"></td> </tr> <tr> <td></td> <td></td> <td colspan="8" style="text-align: center;"> <table border="1" style="width: 100%; border-collapse: collapse; text-align: center;"> <tr> <td
style="width: 10%;"></td> <td style="width: 10%;"></td> <td style="width: 10%;"></td> <td style="width: 10%;"></td> <td style="width: 10%;"></td> <td style="width: 10%;"></td> <td style="width: 10%;"></td> <td style="width: 10%;"></td> <td style="width: 10%;"></td> <td style="width: 10%;"></td> </tr> <tr> <td></td> <td></td> <td colspan="8" style="text-align: center;"> <table border="1" style="width: 100%; border-collapse: collapse; text-align: center;"> <tr> <td style="width: 10%;"></td> <td style="width: 10%;"></td> <td style="width: 10%;"></td> <td style="width: 10%;"></td> <td style="width: 10%;"></td> <td style="width: 10%;"></td> <td style="width: 10%;"></td> <td style="width: 10%;"></td> <td style="width: 10%;"></td> <td style="width: 10%;"></td> </tr> <tr> <td></td> <td></td> <td colspan="8" style="text-align: center;"> <table border="1" style="width: 100%; border-collapse: collapse; text-align: center;"> <tr> <td style="width: 10%;"></td> <td style="width: 10%;"></td> <td style="width: 10%;"></td> <td style="width: 10%;"></td> <td style="width: 10%;"></td> <td style="width: 10%;"></td> <td style="width: 10%;"></td> <td style="width: 10%;"></td> <td style="width: 10%;"></td> <td style="width: 10%;"></td> </tr> <tr> <td></td> <td></td> <td colspan="8" style="text-align: center;"> <table border="1" style="width: 100%; border-collapse: collapse; text-align: center;"> <tr> <td style="width: 10%;"></td> <td style="width: 10%;"></td> <td style="width: 10%;"></td> <td style="width: 10%;"></td> <td style="width: 10%;"></td> <td style="width: 10%;"></td> <td style="width: 10%;"></td> <td style="width: 10%;"></td> <td style="width: 10%;"></td> <td style="width: 10%;"></td> </tr> <tr> <td></td> <td></td> <td colspan="8" style="text-align: center;"> <table border="1" style="width: 100%; border-collapse: collapse; text-align: center;"> <tr> <td style="width: 10%;"></td> <td style="width: 10%;"></td> <td style="width: 10%;"></td> <td style="width: 10%;"></td> <td style="width: 10%;"></td> <td style="width: 10%;"></td> <td style="width: 10%;"></td> <td style="width: 10%;"></td> <td style="width: 10%;"></td> <td style="width: 10%;"></td> </tr> <tr> <td></td> <td></td> <td colspan="8" style="text-align: center;"> <table border="1" style="width: 100%; border-collapse: collapse; text-align: center;"> <tr> <td style="width: 10%;"></td> <td style="width: 10%;"></td> <td style="width: 10%;"></td> <td style="width: 10%;"></td> <td style="width: 10%;"></td> <td style="width: 10%;"></td> <td style="width: 10%;"></td> <td style="width: 10%;"></td> <td style="width: 10%;"></td> <td style="width: 10%;"></td> </tr> <tr> <td></td> <td></td> <td colspan="8" style="text-align: center;"> <table border="1" style="width: 100%; border-collapse: collapse; text-align: center;"> <tr> <td style="width: 10%;"></td> <td style="width: 10%;"></td> <td style="width: 10%;"></td> <td style="width: 10%;"></td> <td style="width: 10%;"></td> <td style="width: 10%;"></td> <td style="width: 10%;"></td> <td style="width: 10%;"></td> <td style="width: 10%;"></td> <td style="width: 10%;"></td> </tr> <tr> <td></td> <td></td> <td colspan="8" style="text-align: center;"> <table border="1" style="width: 100%; border-collapse: collapse; text-align: center;"> <tr> <td style="width: 10%;"></td> <td style="width: 10%;"></td> <td style="width: 10%;"></td> <td style="width: 10%;"></td> <td style="width: 10%;"></td> <td style="width: 10%;"></td> <td style="width: 10%;"></td> <td style="width: 10%;"></td> <td style="width: 10%;"></td> <td style="width: 10%;"></td> </tr> <tr> <td></td> <td></td> <td colspan="8" style="text-align: center;"> <table border="1" style="width: 100%; border-collapse: collapse; text-align: center;"> <tr> <td style="width: 10%;"></td> <td style="width: 10%;"></td> <td style="width: 10%;"></td> <td style="width: 10%;"></td> <td style="width: 10%;"></td> <td style="width: 10%;"></td> <td style="width: 10%;"></td> <td style="width: 10%;"></td> <td style="width: 10%;"></td> <td style="width: 10%;"></td> </tr> <tr> <td></td> <td></td> <td colspan="8" style="text-align: center;"> <table border="1" style="width: 100%; border-collapse: collapse; text-align: center;"> <tr> <td style="width: 10%;"></td> <td style="width: 10%;"></td> <td style="width: 10%;"></td> <td style="width: 10%;"></td> <td style="width: 10%;"></td> <td style="width: 10%;"></td> <td style="width: 10%;"></td> <td style="width: 10%;"></td> <td style="width: 10%;"></td> <td style="width: 10%;"></td> </tr> <tr> <td></td> <td></td> <td colspan="8" style="text-align: center;"> <table border="1" style="width: 100%; border-collapse: collapse; text-align: center;"> <tr> <td style="width: 10%;"></td> <td style="width: 10%;"></td> <td style="width: 10%;"></td> <td style="width: 10%;"></td> <td style="width: 10%;"></td> <td style="width: 10%;"></td> <td style="width: 10%;"></td> <td style="width: 10%;"></td> <td style="width: 10%;"></td> <td style="width: 10%;"></td> </tr> <tr> <td></td> <td></td> <td colspan="8" style="text-align: center;"> <table border="1" style="width: 100%; border-collapse: collapse; text-align: center;"> <tr> <td style="width: 10%;"></td> <td style="width: 10%;"></td> <td style="width: 10%;"></td> <td style="width: 10%;"></td> <td style="width: 10%;"></td> <td style="width: 10%;"></td> <td style="width: 10%;"></td> <td style="width: 10%;"></td> <td style="width: 10%;"></td> <td style="width: 10%;"></td> </tr> <tr> <td></td> <td></td> <td colspan="8" style="text-align: center;"> <table border="1" style="width: 100%; border-collapse: collapse; text-align: center;"> <tr> <td style="width: 10%;"></td> <td style="width: 10%;"></td> <td style="width: 10%;"></td> <td style="width: 10%;"></td> <td style="width: 10%;"></td> <td style="width: 10%;"></td> <td style="width: 10%;"></td> <td style="width: 10%;"></td> <td style="width: 10%;"></td> <td style="width: 10%;"></td> </tr> <tr> <td></td> <td></td> <td colspan="8" style="text-align: center;"> <table border="1" style="width: 100%; border-collapse: collapse; text-align: center;"> <tr> <td style="width: 10%;"></td> <td style="width: 10%;"></td> <td style="width: 10%;"></td> <td style="width: 10%;"></td> <td style="width: 10%;"></td> <td style="width: 10%;"></td> <td style="width: 10%;"></td> <td style="width: 10%;"></td> <td style="width: 10%;"></td> <td style="width: 10%;"></td> </tr> <tr> <td></td> <td></td> <td colspan="8" style="text-align: center;"> <table border="1" style="width: 100%; border-collapse: collapse; text-align: center;"> <tr> <td style="width: 10%;"></td> <td style="width: 10%;"></td> <td style="width: 10%;"></td> <td style="width: 10%;"></td> <td style="width: 10%;"></td> <td style="width: 10%;"></td> <td style="width: 10%;"></td> <td style="width: 10%;"></td> <td style="width: 10%;"></td> <td style="width: 10%;"></td> </tr> <tr> <td></td> <td></td> <td colspan="8" style="text-align: center;"> <table border="1" style="width: 100%; border-collapse: collapse; text-align: center;"> <tr> <td style="width: 10%;"></td> <td style="width: 10%;"></td> <td style="width: 10%;"></td> <td style="width: 10%;"></td> <td style="width: 10%;"></td> <td style="width: 10%;"></td> <td style="width: 10%;"></td> <td style="width: 10%;"></td> <td style="width: 10%;"></td> <td style="width: 10%;"></td> </tr> <tr> <td></td> <td></td> <td colspan="8" style="text-align: center;"> <table border="1" style="width: 100%; border-collapse: collapse; text-align: center;"> <tr> <td style="width: 10%;"></td> <td style="width: 10%;"></td> <td style="width: 10%;"></td> <td style="width: 10%;"></td> <td style="width: 10%;"></td> <td style="width: 10%;"></td> <td style="width: 10%;"></td> <td style="width: 10%;"></td> <td style="width: 10%;"></td> <td style="width: 10%;"></td> </tr> <tr> <td></td> <td></td> <td colspan="8" style="text-align: center;"> <table border="1" style="width: 100%; border-collapse: collapse; text-align: center;"> <tr> </tr></table></td></tr></table></td></tr></table></td></tr></table></td></tr></table></td></tr></table></td></tr></table></td></tr></table></td></tr></table></td></tr></table></td></tr></table></td></tr></table></td></tr></table></td></tr></table></td></tr></table></td></tr></table></td></tr></table></td></tr></table></td></tr></table></td></tr></table></td></tr></table></td></tr></table></td></tr></table></td></tr></table></td></tr></table>

 | | | | | | | | | | | | | | | | | | | | <table border="1" style="width: 100%; border-collapse: collapse; text-align: center;"> <tr> <td style="width: 10%;"></td> <td style="width: 10%;"></td> <td style="width: 10%;"></td> <td style="width: 10%;"></td> <td style="width: 10%;"></td> <td style="width: 10%;"></td> <td style="width: 10%;"></td> <td style="width: 10%;"></td> <td style="width: 10%;"></td> <td style="width: 10%;"></td> </tr> <tr> <td></td> <td></td> <td colspan="8" style="text-align: center;"> <table border="1" style="width: 100%; border-collapse: collapse; text-align: center;"> <tr> <td style="width: 10%;"></td> <td style="width: 10%;"></td> <td style="width: 10%;"></td> <td style="width: 10%;"></td> <td style="width: 10%;"></td> <td style="width: 10%;"></td> <td style="width: 10%;"></td> <td style="width: 10%;"></td> <td style="width: 10%;"></td> <td style="width: 10%;"></td> </tr> <tr> <td></td> <td></td> <td colspan="8" style="text-align: center;"> <table border="1" style="width: 100%; border-collapse: collapse; text-align: center;"> <tr> <td style="width: 10%;"></td> <td style="width: 10%;"></td> <td style="width: 10%;"></td> <td style="width: 10%;"></td> <td style="width: 10%;"></td> <td style="width: 10%;"></td> <td style="width: 10%;"></td> <td style="width: 10%;"></td> <td style="width: 10%;"></td> <td style="width: 10%;"></td> </tr> <tr> <td></td> <td></td> <td colspan="8" style="text-align: center;"> <table border="1" style="width: 100%; border-collapse: collapse; text-align: center;"> <tr> <td style="width: 10%;"></td> <td style="width: 10%;"></td> <td style="width: 10%;"></td> <td style="width: 10%;"></td> <td style="width: 10%;"></td> <td style="width: 10%;"></td> <td style="width: 10%;"></td> <td style="width: 10%;"></td> <td style="width: 10%;"></td> <td style="width: 10%;"></td> </tr> <tr> <td></td> <td></td> <td colspan="8" style="text-align: center;"> <table border="1" style="width: 100%; border-collapse: collapse; text-align: center;"> <tr> <td style="width: 10%;"></td> <td style="width: 10%;"></td> <td style="width: 10%;"></td> <td style="width: 10%;"></td> <td style="width: 10%;"></td> <td style="width: 10%;"></td> <td style="width: 10%;"></td> <td style="width: 10%;"></td> <td style="width: 10%;"></td> <td style="width: 10%;"></td> </tr> <tr> <td></td> <td></td> <td colspan="8" style="text-align: center;"> <table border="1" style="width: 100%; border-collapse: collapse; text-align: center;"> <tr> <td style="width: 10%;"></td> <td style="width: 10%;"></td> <td style="width: 10%;"></td> <td style="width: 10%;"></td> <td style="width: 10%;"></td> <td style="width: 10%;"></td> <td style="width: 10%;"></td> <td style="width: 10%;"></td> <td style="width: 10%;"></td> <td style="width: 10%;"></td> </tr> <tr> <td></td> <td></td> <td colspan="8" style="text-align: center;"> <table border="1" style="width: 100%; border-collapse: collapse; text-align: center;"> <tr> <td style="width: 10%;"></td> <td style="width: 10%;"></td> <td style="width: 10%;"></td> <td style="width: 10%;"></td> <td style="width: 10%;"></td> <td style="width: 10%;"></td> <td style="width: 10%;"></td> <td style="width: 10%;"></td> <td style="width: 10%;"></td> <td style="width: 10%;"></td> </tr> <tr> <td></td> <td></td> <td colspan="8" style="text-align: center;"> <table border="1" style="width: 100%; border-collapse: collapse; text-align: center;"> <tr> <td style="width: 10%;"></td> <td style="width: 10%;"></td> <td style="width: 10%;"></td> <td style="width: 10%;"></td> <td style="width: 10%;"></td> <td style="width: 10%;"></td> <td style="width: 10%;"></td> <td style="width: 10%;"></td> <td style="width: 10%;"></td> <td style="width: 10%;"></td> </tr> <tr> <td></td> <td></td> <td colspan="8" style="text-align: center;"> <table border="1" style="width: 100%; border-collapse: collapse; text-align: center;"> <tr> <td style="width: 10%;"></td> <td style="width: 10%;"></td> <td style="width: 10%;"></td> <td style="width: 10%;"></td> <td style="width: 10%;"></td> <td style="width: 10%;"></td> <td style="width: 10%;"></td> <td style="width: 10%;"></td> <td style="width: 10%;"></td> <td style="width: 10%;"></td> </tr> <tr> <td></td> <td></td> <td colspan="8" style="text-align: center;"> <table border="1" style="width: 100%; border-collapse: collapse; text-align: center;"> <tr> <td style="width: 10%;"></td> <td style="width: 10%;"></td> <td style="width: 10%;"></td> <td style="width: 10%;"></td> <td style="width: 10%;"></td> <td style="width: 10%;"></td> <td style="width: 10%;"></td> <td style="width: 10%;"></td> <td style="width: 10%;"></td> <td style="width: 10%;"></td> </tr> <tr> <td></td> <td></td> <td colspan="8" style="text-align: center;"> <table border="1" style="width: 100%; border-collapse: collapse; text-align: center;"> <tr> <td style="width: 10%;"></td> <td style="width: 10%;"></td> <td style="width: 10%;"></td> <td style="width: 10%;"></td> <td style="width: 10%;"></td> <td style="width: 10%;"></td> <td style="width: 10%;"></td> <td style="width: 10%;"></td> <td style="width: 10%;"></td> <td style="width: 10%;"></td> </tr> <tr> <td></td> <td></td> <td colspan="8" style="text-align: center;"> <table border="1" style="width: 100%; border-collapse: collapse; text-align: center;"> <tr> <td style="width: 10%;"></td> <td style="width: 10%;"></td> <td style="width: 10%;"></td> <td style="width: 10%;"></td> <td style="width: 10%;"></td> <td style="width: 10%;"></td> <td style="width: 10%;"></td> <td style="width: 10%;"></td> <td style="width: 10%;"></td> <td style="width: 10%;"></td> </tr> <tr> <td></td> <td></td> <td colspan="8" style="text-align: center;"> <table border="1" style="width: 100%; border-collapse: collapse; text-align: center;"> <tr> <td style="width: 10%;"></td> <td style="width: 10%;"></td> <td style="width: 10%;"></td> <td style="width: 10%;"></td> <td style="width: 10%;"></td> <td style="width: 10%;"></td> <td style="width: 10%;"></td> <td style="width: 10%;"></td> <td style="width: 10%;"></td> <td
style="width: 10%;"></td> </tr> <tr> <td></td> <td></td> <td colspan="8" style="text-align: center;"> <table border="1" style="width: 100%; border-collapse: collapse; text-align: center;"> <tr> <td style="width: 10%;"></td> <td style="width: 10%;"></td> <td style="width: 10%;"></td> <td style="width: 10%;"></td> <td style="width: 10%;"></td> <td style="width: 10%;"></td> <td style="width: 10%;"></td> <td style="width: 10%;"></td> <td style="width: 10%;"></td> <td style="width: 10%;"></td> </tr> <tr> <td></td> <td></td> <td colspan="8" style="text-align: center;"> <table border="1" style="width: 100%; border-collapse: collapse; text-align: center;"> <tr> <td style="width: 10%;"></td> <td style="width: 10%;"></td> <td style="width: 10%;"></td> <td style="width: 10%;"></td> <td style="width: 10%;"></td> <td style="width: 10%;"></td> <td style="width: 10%;"></td> <td style="width: 10%;"></td> <td style="width: 10%;"></td> <td style="width: 10%;"></td> </tr> <tr> <td></td> <td></td> <td colspan="8" style="text-align: center;"> <table border="1" style="width: 100%; border-collapse: collapse; text-align: center;"> <tr> <td style="width: 10%;"></td> <td style="width: 10%;"></td> <td style="width: 10%;"></td> <td style="width: 10%;"></td> <td style="width: 10%;"></td> <td style="width: 10%;"></td> <td style="width: 10%;"></td> <td style="width: 10%;"></td> <td style="width: 10%;"></td> <td style="width: 10%;"></td> </tr> <tr> <td></td> <td></td> <td colspan="8" style="text-align: center;"> <table border="1" style="width: 100%; border-collapse: collapse; text-align: center;"> <tr> <td style="width: 10%;"></td> <td style="width: 10%;"></td> <td style="width: 10%;"></td> <td style="width: 10%;"></td> <td style="width: 10%;"></td> <td style="width: 10%;"></td> <td style="width: 10%;"></td> <td style="width: 10%;"></td> <td style="width: 10%;"></td> <td style="width: 10%;"></td> </tr> <tr> <td></td> <td></td> <td colspan="8" style="text-align: center;"> <table border="1" style="width: 100%; border-collapse: collapse; text-align: center;"> <tr> <td style="width: 10%;"></td> <td style="width: 10%;"></td> <td style="width: 10%;"></td> <td style="width: 10%;"></td> <td style="width: 10%;"></td> <td style="width: 10%;"></td> <td style="width: 10%;"></td> <td style="width: 10%;"></td> <td style="width: 10%;"></td> <td style="width: 10%;"></td> </tr> <tr> <td></td> <td></td> <td colspan="8" style="text-align: center;"> <table border="1" style="width: 100%; border-collapse: collapse; text-align: center;"> <tr> <td style="width: 10%;"></td> <td style="width: 10%;"></td> <td style="width: 10%;"></td> <td style="width: 10%;"></td> <td style="width: 10%;"></td> <td style="width: 10%;"></td> <td style="width: 10%;"></td> <td style="width: 10%;"></td> <td style="width: 10%;"></td> <td style="width: 10%;"></td> </tr> <tr> <td></td> <td></td> <td colspan="8" style="text-align: center;"> <table border="1" style="width: 100%; border-collapse: collapse; text-align: center;"> <tr> <td style="width: 10%;"></td> <td style="width: 10%;"></td> <td style="width: 10%;"></td> <td style="width: 10%;"></td> <td style="width: 10%;"></td> <td style="width: 10%;"></td> <td style="width: 10%;"></td> <td style="width: 10%;"></td> <td style="width: 10%;"></td> <td style="width: 10%;"></td> </tr> <tr> <td></td> <td></td> <td colspan="8" style="text-align: center;"> <table border="1" style="width: 100%; border-collapse: collapse; text-align: center;"> <tr> <td style="width: 10%;"></td> <td style="width: 10%;"></td> <td style="width: 10%;"></td> <td style="width: 10%;"></td> <td style="width: 10%;"></td> <td style="width: 10%;"></td> <td style="width: 10%;"></td> <td style="width: 10%;"></td> <td style="width: 10%;"></td> <td style="width: 10%;"></td> </tr> <tr> <td></td> <td></td> <td colspan="8" style="text-align: center;"> <table border="1" style="width: 100%; border-collapse: collapse; text-align: center;"> <tr> <td style="width: 10%;"></td> <td style="width: 10%;"></td> <td style="width: 10%;"></td> <td style="width: 10%;"></td> <td style="width: 10%;"></td> <td style="width: 10%;"></td> <td style="width: 10%;"></td> <td style="width: 10%;"></td> <td style="width: 10%;"></td> <td style="width: 10%;"></td> </tr> <tr> <td></td> <td></td> <td colspan="8" style="text-align: center;"> <table border="1" style="width: 100%; border-collapse: collapse; text-align: center;"> <tr> <td style="width: 10%;"></td> <td style="width: 10%;"></td> <td style="width: 10%;"></td> <td style="width: 10%;"></td> <td style="width: 10%;"></td> <td style="width: 10%;"></td> <td style="width: 10%;"></td> <td style="width: 10%;"></td> <td style="width: 10%;"></td> <td style="width: 10%;"></td> </tr> <tr> <td></td> <td></td> <td colspan="8" style="text-align: center;"> <table border="1" style="width: 100%; border-collapse: collapse; text-align: center;"> <tr> </tr></table></td></tr></table></td></tr></table></td></tr></table></td></tr></table></td></tr></table></td></tr></table></td></tr></table></td></tr></table></td></tr></table></td></tr></table></td></tr></table></td></tr></table></td></tr></table></td></tr></table></td></tr></table></td></tr></table></td></tr></table></td></tr></table></td></tr></table></td></tr></table></td></tr></table></td></tr></table></td></tr></table>

 | | | | | | | | | | | | | | | | | | | | <table border="1" style="width: 100%; border-collapse: collapse; text-align: center;"> <tr> <td style="width: 10%;"></td> <td style="width: 10%;"></td> <td style="width: 10%;"></td> <td style="width: 10%;"></td> <td style="width: 10%;"></td> <td style="width: 10%;"></td> <td style="width: 10%;"></td> <td style="width: 10%;"></td> <td style="width: 10%;"></td> <td style="width: 10%;"></td> </tr> <tr> <td></td> <td></td> <td colspan="8" style="text-align: center;"> <table border="1" style="width: 100%; border-collapse: collapse; text-align: center;"> <tr> <td style="width: 10%;"></td> <td style="width: 10%;"></td> <td style="width: 10%;"></td> <td style="width: 10%;"></td> <td style="width: 10%;"></td> <td style="width: 10%;"></td> <td style="width: 10%;"></td> <td style="width: 10%;"></td> <td style="width: 10%;"></td> <td style="width: 10%;"></td> </tr> <tr> <td></td> <td></td> <td colspan="8" style="text-align: center;"> <table border="1" style="width: 100%; border-collapse: collapse; text-align: center;"> <tr> <td style="width: 10%;"></td> <td style="width: 10%;"></td> <td style="width: 10%;"></td> <td style="width: 10%;"></td> <td style="width: 10%;"></td> <td style="width: 10%;"></td> <td style="width: 10%;"></td> <td style="width: 10%;"></td> <td style="width: 10%;"></td> <td style="width: 10%;"></td> </tr> <tr> <td></td> <td></td> <td colspan="8" style="text-align: center;"> <table border="1" style="width: 100%; border-collapse: collapse; text-align: center;"> <tr> <td style="width: 10%;"></td> <td style="width: 10%;"></td> <td style="width: 10%;"></td> <td style="width: 10%;"></td> <td style="width: 10%;"></td> <td style="width: 10%;"></td> <td style="width: 10%;"></td> <td style="width: 10%;"></td> <td style="width: 10%;"></td> <td style="width: 10%;"></td> </tr> <tr> <td></td> <td></td> <td colspan="8" style="text-align: center;"> <table border="1" style="width: 100%; border-collapse: collapse; text-align: center;"> <tr> <td style="width: 10%;"></td> <td style="width: 10%;"></td> <td style="width: 10%;"></td> <td style="width: 10%;"></td> <td style="width: 10%;"></td> <td style="width: 10%;"></td> <td style="width: 10%;"></td> <td style="width: 10%;"></td> <td style="width: 10%;"></td> <td style="width: 10%;"></td> </tr> <tr> <td></td> <td></td> <td colspan="8" style="text-align: center;"> <table border="1" style="width: 100%; border-collapse: collapse; text-align: center;"> <tr> <td style="width: 10%;"></td> <td style="width: 10%;"></td> <td style="width: 10%;"></td> <td style="width: 10%;"></td> <td style="width: 10%;"></td> <td style="width: 10%;"></td> <td style="width: 10%;"></td> <td style="width: 10%;"></td> <td style="width: 10%;"></td> <td style="width: 10%;"></td> </tr> <tr> <td></td> <td></td> <td colspan="8" style="text-align: center;"> <table border="1" style="width: 100%; border-collapse: collapse; text-align: center;"> <tr> <td style="width: 10%;"></td> <td style="width: 10%;"></td> <td style="width: 10%;"></td> <td style="width: 10%;"></td> <td style="width: 10%;"></td> <td style="width: 10%;"></td> <td style="width: 10%;"></td> <td style="width: 10%;"></td> <td style="width: 10%;"></td> <td style="width: 10%;"></td> </tr> <tr> <td></td> <td></td> <td colspan="8" style="text-align: center;"> <table border="1" style="width: 100%; border-collapse: collapse; text-align: center;"> <tr> <td style="width: 10%;"></td> <td style="width: 10%;"></td> <td style="width: 10%;"></td> <td style="width: 10%;"></td> <td style="width: 10%;"></td> <td style="width: 10%;"></td> <td style="width: 10%;"></td> <td style="width: 10%;"></td> <td style="width: 10%;"></td> <td style="width: 10%;"></td> </tr> <tr> <td></td> <td></td> <td colspan="8" style="text-align: center;"> <table border="1" style="width: 100%; border-collapse: collapse; text-align: center;"> <tr> <td style="width: 10%;"></td> <td style="width: 10%;"></td> <td style="width: 10%;"></td> <td style="width: 10%;"></td> <td style="width: 10%;"></td> <td style="width: 10%;"></td> <td style="width: 10%;"></td> <td style="width: 10%;"></td> <td style="width: 10%;"></td> <td style="width: 10%;"></td> </tr> <tr> <td></td> <td></td> <td colspan="8" style="text-align: center;"> <table border="1" style="width: 100%; border-collapse: collapse; text-align: center;"> <tr> <td style="width: 10%;"></td> <td style="width: 10%;"></td> <td style="width: 10%;"></td> <td style="width: 10%;"></td> <td style="width: 10%;"></td> <td style="width: 10%;"></td> <td style="width: 10%;"></td> <td style="width: 10%;"></td> <td style="width: 10%;"></td> <td style="width: 10%;"></td> </tr> <tr> <td></td> <td></td> <td colspan="8" style="text-align: center;"> <table border="1" style="width: 100%; border-collapse: collapse; text-align: center;"> <tr> <td style="width: 10%;"></td> <td style="width: 10%;"></td> <td style="width: 10%;"></td> <td style="width: 10%;"></td> <td style="width: 10%;"></td> <td style="width: 10%;"></td> <td style="width: 10%;"></td> <td style="width: 10%;"></td> <td style="width: 10%;"></td> <td style="width: 10%;"></td> </tr> <tr> <td></td> <td></td> <td colspan="8" style="text-align: center;"> <table border="1" style="width: 100%; border-collapse: collapse; text-align: center;"> <tr> <td style="width: 10%;"></td> <td style="width: 10%;"></td> <td style="width: 10%;"></td> <td style="width: 10%;"></td> <td style="width: 10%;"></td> <td style="width: 10%;"></td> <td style="width: 10%;"></td> <td style="width: 10%;"></td> <td style="width: 10%;"></td> <td style="width: 10%;"></td> </tr> <tr> <td></td> <td></td> <td colspan="8" style="text-align: center;"> <table border="1" style="width: 100%; border-collapse: collapse; text-align: center;"> <tr> <td style="width: 10%;"></td> <td style="width: 10%;"></td> <td style="width: 10%;"></td> <td style="width: 10%;"></td> <td style="width: 10%;"></td> <td style="width: 10%;"></td> <td style="width: 10%;"></td> <td style="width: 10%;"></td> <td style="width: 10%;"></td> <td style="width: 10%;"></td> </tr> <tr> <td></td> <td></td> <td colspan="8" style="text-align: center;"> <table border="1" style="width: 100%; border-collapse: collapse; text-align: center;"> <tr> <td style="width: 10%;"></td> <td style="width: 10%;"></td> <td style="width: 10%;"></td> <td style="width: 10%;"></td> <td style="width: 10%;"></td> <td style="width: 10%;"></td> <td style="width: 10%;"></td> <td style="width: 10%;"></td> <td style="width: 10%;"></td> <td style="width: 10%;"></td> </tr> <tr> <td></td> <td></td> <td colspan="8" style="text-align: center;"> <table border="1" style="width: 100%; border-collapse: collapse; text-align: center;"> <tr> <td style="width: 10%;"></td> <td style="width: 10%;"></td> <td style="width: 10%;"></td> <td style="width: 10%;"></td> <td style="width: 10%;"></td> <td style="width: 10%;"></td> <td style="width: 10%;"></td> <td style="width: 10%;"></td> <td style="width: 10%;"></td> <td style="width: 10%;"></td> </tr> <tr> <td></td> <td></td> <td colspan="8" style="text-align: center;"> <table border="1" style="width: 100%; border-collapse: collapse; text-align: center;"> <tr> <td style="width: 10%;"></td> <td style="width: 10%;"></td> <td style="width: 10%;"></td> <td style="width: 10%;"></td> <td style="width: 10%;"></td> <td style="width: 10%;"></td> <td style="width: 10%;"></td> <td style="width: 10%;"></td> <td style="width: 10%;"></td> <td style="width: 10%;"></td> </tr> <tr> <td></td> <td></td> <td colspan="8" style="text-align: center;"> <table border="1" style="width: 100%; border-collapse: collapse; text-align: center;"> <tr> <td style="width: 10%;"></td> <td style="width: 10%;"></td> <td style="width: 10%;"></td> <td style="width: 10%;"></td> <td style="width: 10%;"></td> <td style="width: 10%;"></td> <td style="width: 10%;"></td> <td style="width: 10%;"></td> <td style="width: 10%;"></td> <td style="width: 10%;"></td> </tr> <tr> <td></td> <td></td> <td colspan="8" style="text-align: center;"> <table border="1" style="width: 100%; border-collapse: collapse; text-align: center;"> <tr> <td style="width: 10%;"></td> <td style="width: 10%;"></td> <td style="width: 10%;"></td> <td style="width: 10%;"></td> <td style="width: 10%;"></td> <td style="width: 10%;"></td> <td style="width: 10%;"></td> <td style="width: 10%;"></td> <td style="width: 10%;"></td> <td style="width: 10%;"></td> </tr> <tr> <td></td> <td></td> <td colspan="8" style="text-align: center;"> <table border="1" style="width: 100%; border-collapse: collapse; text-align: center;"> <tr> <td style="width: 10%;"></td> <td style="width: 10%;"></td> <td style="width: 10%;"></td> <td style="width: 10%;"></td> <td style="width: 10%;"></td> <td style="width: 10%;"></td> <td style="width: 10%;"></td> <td style="width: 10%;"></td> <td style="width: 10%;"></td> <td style="width: 10%;"></td> </tr> <tr> <td></td> <td></td> <td colspan="8" style="text-align: center;"> <table border="1" style="width: 100%; border-collapse: collapse; text-align: center;"> <tr> <td style="width: 10%;"></td> <td style="width: 10%;"></td> <td style="width: 10%;"></td> <td
style="width: 10%;"></td> <td style="width: 10%;"></td> <td style="width: 10%;"></td> <td style="width: 10%;"></td> <td style="width: 10%;"></td> <td style="width: 10%;"></td> <td style="width: 10%;"></td> </tr> <tr> <td></td> <td></td> <td colspan="8" style="text-align: center;"> <table border="1" style="width: 100%; border-collapse: collapse; text-align: center;"> <tr> <td style="width: 10%;"></td> <td style="width: 10%;"></td> <td style="width: 10%;"></td> <td style="width: 10%;"></td> <td style="width: 10%;"></td> <td style="width: 10%;"></td> <td style="width: 10%;"></td> <td style="width: 10%;"></td> <td style="width: 10%;"></td> <td style="width: 10%;"></td> </tr> <tr> <td></td> <td></td> <td colspan="8" style="text-align: center;"> <table border="1" style="width: 100%; border-collapse: collapse; text-align: center;"> <tr> <td style="width: 10%;"></td> <td style="width: 10%;"></td> <td style="width: 10%;"></td> <td style="width: 10%;"></td> <td style="width: 10%;"></td> <td style="width: 10%;"></td> <td style="width: 10%;"></td> <td style="width: 10%;"></td> <td style="width: 10%;"></td> <td style="width: 10%;"></td> </tr> <tr> <td></td> <td></td> <td colspan="8" style="text-align: center;"> <table border="1" style="width: 100%; border-collapse: collapse; text-align: center;"> <tr> </tr></table></td></tr></table></td></tr></table></td></tr></table></td></tr></table></td></tr></table></td></tr></table></td></tr></table></td></tr></table></td></tr></table></td></tr></table></td></tr></table></td></tr></table></td></tr></table></td></tr></table></td></tr></table></td></tr></table></td></tr></table></td></tr></table></td></tr></table></td></tr></table></td></tr></table></td></tr></table>
 | | | | | | | | | | | | | | | | | | | | <table border="1" style="width: 100%; border-collapse: collapse; text-align: center;"> <tr> <td style="width: 10%;"></td> <td style="width: 10%;"></td> <td style="width: 10%;"></td> <td style="width: 10%;"></td> <td style="width: 10%;"></td> <td style="width: 10%;"></td> <td style="width: 10%;"></td> <td style="width: 10%;"></td> <td style="width: 10%;"></td> <td style="width: 10%;"></td> </tr> <tr> <td></td> <td></td> <td colspan="8" style="text-align: center;"> <table border="1" style="width: 100%; border-collapse: collapse; text-align: center;"> <tr> <td style="width: 10%;"></td> <td style="width: 10%;"></td> <td style="width: 10%;"></td> <td style="width: 10%;"></td> <td style="width: 10%;"></td> <td style="width: 10%;"></td> <td style="width: 10%;"></td> <td style="width: 10%;"></td> <td style="width: 10%;"></td> <td style="width: 10%;"></td> </tr> <tr> <td></td> <td></td> <td colspan="8" style="text-align: center;"> <table border="1" style="width: 100%; border-collapse: collapse; text-align: center;"> <tr> <td style="width: 10%;"></td> <td style="width: 10%;"></td> <td style="width: 10%;"></td> <td style="width: 10%;"></td> <td style="width: 10%;"></td> <td style="width: 10%;"></td> <td style="width: 10%;"></td> <td style="width: 10%;"></td> <td style="width: 10%;"></td> <td style="width: 10%;"></td> </tr> <tr> <td></td> <td></td> <td colspan="8" style="text-align: center;"> <table border="1" style="width: 100%; border-collapse: collapse; text-align: center;"> <tr> <td style="width: 10%;"></td> <td style="width: 10%;"></td> <td style="width: 10%;"></td> <td style="width: 10%;"></td> <td style="width: 10%;"></td> <td style="width: 10%;"></td> <td style="width: 10%;"></td> <td style="width: 10%;"></td> <td style="width: 10%;"></td> <td style="width: 10%;"></td> </tr> <tr> <td></td> <td></td> <td colspan="8" style="text-align: center;"> <table border="1" style="width: 100%; border-collapse: collapse; text-align: center;"> <tr> <td style="width: 10%;"></td> <td style="width: 10%;"></td> <td style="width: 10%;"></td> <td style="width: 10%;"></td> <td style="width: 10%;"></td> <td style="width: 10%;"></td> <td style="width: 10%;"></td> <td style="width: 10%;"></td> <td style="width: 10%;"></td> <td style="width: 10%;"></td> </tr> <tr> <td></td> <td></td> <td colspan="8" style="text-align: center;"> <table border="1" style="width: 100%; border-collapse: collapse; text-align: center;"> <tr> <td style="width: 10%;"></td> <td style="width: 10%;"></td> <td style="width: 10%;"></td> <td style="width: 10%;"></td> <td style="width: 10%;"></td> <td style="width: 10%;"></td> <td style="width: 10%;"></td> <td style="width:
10%;"></td> <td style="width: 10%;"></td> <td style="width: 10%;"></td> </tr> <tr> <td></td> <td></td> <td colspan="8" style="text-align: center;"> <table border="1" style="width: 100%; border-collapse: collapse; text-align: center;"> <tr> <td style="width: 10%;"></td> <td style="width: 10%;"></td> <td style="width: 10%;"></td> <td style="width: 10%;"></td> <td style="width: 10%;"></td> <td style="width: 10%;"></td> <td style="width: 10%;"></td> <td style="width: 10%;"></td> <td style="width: 10%;"></td> <td style="width: 10%;"></td> </tr> <tr> <td></td> <td></td> <td colspan="8" style="text-align: center;"> <table border="1" style="width: 100%; border-collapse: collapse; text-align: center;"> <tr> <td style="width: 10%;"></td> <td style="width: 10%;"></td> <td style="width: 10%;"></td> <td style="width: 10%;"></td> <td style="width: 10%;"></td> <td style="width: 10%;"></td> <td style="width: 10%;"></td> <td style="width: 10%;"></td> <td style="width: 10%;"></td> <td style="width: 10%;"></td> </tr> <tr> <td></td> <td></td> <td colspan="8" style="text-align: center;"> <table border="1" style="width: 100%; border-collapse: collapse; text-align: center;"> <tr> <td style="width: 10%;"></td> <td style="width: 10%;"></td> <td style="width: 10%;"></td> <td style="width: 10%;"></td> <td style="width: 10%;"></td> <td style="width: 10%;"></td> <td style="width: 10%;"></td> <td style="width: 10%;"></td> <td style="width: 10%;"></td> <td style="width: 10%;"></td> </tr> <tr> <td></td> <td></td> <td colspan="8" style="text-align: center;"> <table border="1" style="width: 100%; border-collapse: collapse; text-align: center;"> <tr> <td style="width: 10%;"></td> <td style="width: 10%;"></td> <td style="width: 10%;"></td> <td style="width: 10%;"></td> <td style="width: 10%;"></td> <td style="width: 10%;"></td> <td style="width: 10%;"></td> <td style="width: 10%;"></td> <td style="width: 10%;"></td> <td style="width: 10%;"></td> </tr> <tr> <td></td> <td></td> <td colspan="8" style="text-align: center;"> <table border="1" style="width: 100%; border-collapse: collapse; text-align: center;"> <tr> <td style="width: 10%;"></td> <td style="width: 10%;"></td> <td style="width: 10%;"></td> <td style="width: 10%;"></td> <td style="width: 10%;"></td> <td style="width: 10%;"></td> <td style="width: 10%;"></td> <td style="width: 10%;"></td> <td style="width: 10%;"></td> <td style="width: 10%;"></td> </tr> <tr> <td></td> <td></td> <td colspan="8" style="text-align: center;"> <table border="1" style="width: 100%; border-collapse: collapse; text-align: center;"> <tr> <td style="width: 10%;"></td> <td style="width: 10%;"></td> <td style="width: 10%;"></td> <td style="width: 10%;"></td> <td style="width: 10%;"></td> <td style="width: 10%;"></td> <td style="width: 10%;"></td> <td style="width: 10%;"></td> <td style="width: 10%;"></td> <td style="width: 10%;"></td> </tr> <tr> <td></td> <td></td> <td colspan="8" style="text-align: center;"> <table border="1" style="width: 100%; border-collapse: collapse; text-align: center;"> <tr> <td style="width: 10%;"></td> <td style="width: 10%;"></td> <td style="width: 10%;"></td> <td style="width: 10%;"></td> <td style="width: 10%;"></td> <td style="width: 10%;"></td> <td style="width: 10%;"></td> <td style="width: 10%;"></td> <td style="width: 10%;"></td> <td style="width: 10%;"></td> </tr> <tr> <td></td> <td></td> <td colspan="8" style="text-align: center;"> <table border="1" style="width: 100%; border-collapse: collapse; text-align: center;"> <tr> <td style="width: 10%;"></td> <td style="width: 10%;"></td> <td style="width: 10%;"></td> <td style="width: 10%;"></td> <td style="width: 10%;"></td> <td style="width: 10%;"></td> <td style="width: 10%;"></td> <td style="width: 10%;"></td> <td style="width: 10%;"></td> <td style="width: 10%;"></td> </tr> <tr> <td></td> <td></td> <td colspan="8" style="text-align: center;"> <table border="1" style="width: 100%; border-collapse: collapse; text-align: center;"> <tr> <td style="width: 10%;"></td> <td style="width: 10%;"></td> <td style="width: 10%;"></td> <td style="width: 10%;"></td> <td style="width: 10%;"></td> <td style="width: 10%;"></td> <td style="width: 10%;"></td> <td style="width: 10%;"></td> <td style="width: 10%;"></td> <td style="width: 10%;"></td> </tr> <tr> <td></td> <td></td> <td colspan="8" style="text-align: center;"> <table border="1" style="width: 100%; border-collapse: collapse; text-align: center;"> <tr> <td style="width: 10%;"></td> <td style="width: 10%;"></td> <td style="width: 10%;"></td> <td style="width: 10%;"></td> <td style="width: 10%;"></td> <td style="width: 10%;"></td> <td style="width: 10%;"></td> <td style="width: 10%;"></td> <td style="width: 10%;"></td> <td style="width: 10%;"></td> </tr> <tr> <td></td> <td></td> <td colspan="8" style="text-align: center;"> <table border="1" style="width: 100%; border-collapse: collapse; text-align: center;"> <tr> <td style="width: 10%;"></td> <td style="width: 10%;"></td> <td style="width: 10%;"></td> <td style="width: 10%;"></td> <td style="width: 10%;"></td> <td style="width: 10%;"></td> <td style="width: 10%;"></td> <td style="width: 10%;"></td> <td style="width: 10%;"></td> <td style="width: 10%;"></td> </tr> <tr> <td></td> <td></td> <td colspan="8" style="text-align: center;"> <table border="1" style="width: 100%; border-collapse: collapse; text-align: center;"> <tr> <td style="width: 10%;"></td> <td style="width: 10%;"></td> <td style="width: 10%;"></td> <td style="width: 10%;"></td> <td style="width: 10%;"></td> <td style="width: 10%;"></td> <td style="width: 10%;"></td> <td style="width: 10%;"></td> <td style="width: 10%;"></td> <td style="width: 10%;"></td> </tr> <tr> <td></td> <td></td> <td colspan="8" style="text-align: center;"> <table border="1" style="width: 100%; border-collapse: collapse; text-align: center;"> <tr> <td style="width: 10%;"></td> <td style="width: 10%;"></td> <td style="width: 10%;"></td> <td style="width: 10%;"></td> <td style="width: 10%;"></td> <td style="width: 10%;"></td> <td style="width: 10%;"></td> <td style="width: 10%;"></td> <td style="width: 10%;"></td> <td style="width: 10%;"></td> </tr> <tr> <td></td> <td></td> <td colspan="8" style="text-align: center;"> <table border="1" style="width: 100%; border-collapse: collapse; text-align: center;"> <tr> <td style="width: 10%;"></td> <td style="width: 10%;"></td> <td style="width: 10%;"></td> <td style="width: 10%;"></td> <td style="width: 10%;"></td> <td style="width: 10%;"></td> <td style="width: 10%;"></td> <td style="width: 10%;"></td> <td style="width: 10%;"></td> <td style="width: 10%;"></td> </tr> <tr> <td></td> <td></td> <td colspan="8" style="text-align: center;"> <table border="1" style="width: 100%; border-collapse: collapse; text-align: center;"> <tr> <td style="width: 10%;"></td> <td style="width: 10%;"></td> <td style="width: 10%;"></td> <td style="width: 10%;"></td> <td style="width: 10%;"></td> <td style="width: 10%;"></td> <td style="width: 10%;"></td> <td style="width: 10%;"></td> <td style="width: 10%;"></td> <td style="width: 10%;"></td> </tr> <tr> <td></td> <td></td> <td colspan="8" style="text-align: center;"> <table border="1" style="width: 100%; border-collapse: collapse; text-align: center;"> <tr> </tr></table></td></tr></table></td></tr></table></td></tr></table></td></tr></table></td></tr></table></td></tr></table></td></tr></table></td></tr></table></td></tr></table></td></tr></table></td></tr></table></td></tr></table></td></tr></table></td></tr></table></td></tr></table></td></tr></table></td></tr></table></td></tr></table></td></tr></table></td></tr></table></td></tr></table>

 | | | | | | | | | | | | | | | | | | | | <table border="1" style="width: 100%; border-collapse: collapse; text-align: center;"> <tr> <td style="width: 10%;"></td> <td style="width: 10%;"></td> <td style="width: 10%;"></td> <td style="width: 10%;"></td> <td style="width: 10%;"></td> <td style="width: 10%;"></td> <td style="width: 10%;"></td> <td style="width: 10%;"></td> <td style="width: 10%;"></td> <td style="width: 10%;"></td> </tr> <tr> <td></td> <td></td> <td colspan="8" style="text-align: center;"> <table border="1" style="width: 100%; border-collapse: collapse; text-align: center;"> <tr> <td style="width: 10%;"></td> <td style="width: 10%;"></td> <td style="width: 10%;"></td> <td style="width: 10%;"></td> <td style="width: 10%;"></td> <td style="width: 10%;"></td> <td style="width: 10%;"></td> <td style="width: 10%;"></td> <td style="width: 10%;"></td> <td style="width: 10%;"></td> </tr> <tr> <td></td> <td></td> <td colspan="8" style="text-align: center;"> <table border="1" style="width: 100%; border-collapse: collapse; text-align: center;"> <tr> <td style="width: 10%;"></td> <td style="width: 10%;"></td> <td style="width: 10%;"></td> <td style="width: 10%;"></td> <td style="width: 10%;"></td> <td style="width: 10%;"></td> <td style="width: 10%;"></td> <td style="width: 10%;"></td> <td style="width: 10%;"></td> <td style="width: 10%;"></td> </tr> <tr> <td></td> <td></td> <td colspan="8" style="text-align: center;"> <table border="1" style="width: 100%; border-collapse: collapse; text-align: center;"> <tr> <td style="width: 10%;"></td> <td style="width: 10%;"></td> <td style="width: 10%;"></td> <td style="width: 10%;"></td> <td style="width: 10%;"></td> <td style="width: 10%;"></td> <td style="width: 10%;"></td> <td style="width: 10%;"></td> <td style="width: 10%;"></td> <td style="width: 10%;"></td> </tr> <tr> <td></td> <td></td> <td colspan="8" style="text-align: center;"> <table border="1" style="width: 100%; border-collapse: collapse; text-align: center;"> <tr> <td style="width: 10%;"></td> <td style="width: 10%;"></td> <td style="width: 10%;"></td> <td style="width: 10%;"></td> <td style="width: 10%;"></td> <td style="width: 10%;"></td> <td style="width: 10%;"></td> <td style="width: 10%;"></td> <td style="width: 10%;"></td> <td style="width: 10%;"></td> </tr> <tr> <td></td> <td></td> <td colspan="8" style="text-align: center;"> <table border="1" style="width: 100%; border-collapse: collapse; text-align: center;"> <tr> <td style="width: 10%;"></td> <td style="width: 10%;"></td> <td style="width: 10%;"></td> <td style="width: 10%;"></td> <td style="width: 10%;"></td> <td style="width: 10%;"></td> <td style="width: 10%;"></td> <td style="width: 10%;"></td> <td style="width: 10%;"></td> <td style="width: 10%;"></td> </tr> <tr> <td></td> <td></td> <td colspan="8" style="text-align: center;"> <table border="1" style="width: 100%; border-collapse: collapse; text-align: center;"> <tr> <td style="width: 10%;"></td> <td style="width: 10%;"></td> <td style="width: 10%;"></td> <td style="width: 10%;"></td> <td style="width: 10%;"></td> <td style="width: 10%;"></td> <td style="width: 10%;"></td> <td style="width: 10%;"></td> <td style="width: 10%;"></td> <td style="width: 10%;"></td> </tr> <tr> <td></td> <td></td> <td colspan="8" style="text-align: center;"> <table border="1" style="width: 100%; border-collapse: collapse; text-align: center;"> <tr> <td style="width: 10%;"></td> <td style="width: 10%;"></td> <td style="width: 10%;"></td> <td style="width: 10%;"></td> <td style="width: 10%;"></td> <td style="width: 10%;"></td> <td style="width: 10%;"></td> <td style="width: 10%;"></td> <td style="width: 10%;"></td> <td style="width: 10%;"></td> </tr> <tr> <td></td> <td></td> <td colspan="8" style="text-align: center;"> <table border="1" style="width: 100%; border-collapse: collapse; text-align: center;"> <tr> <td style="width: 10%;"></td> <td style="width: 10%;"></td> <td style="width: 10%;"></td> <td style="width: 10%;"></td> <td style="width: 10%;"></td> <td style="width: 10%;"></td> <td style="width: 10%;"></td> <td style="width: 10%;"></td> <td style="width: 10%;"></td> <td style="width: 10%;"></td> </tr> <tr> <td></td> <td></td> <td colspan="8" style="text-align: center;"> <table border="1" style="width: 100%; border-collapse: collapse; text-align: center;"> <tr> <td style="width: 10%;"></td> <td style="width: 10%;"></td> <td style="width: 10%;"></td> <td style="width: 10%;"></td> <td style="width: 10%;"></td> <td style="width: 10%;"></td> <td style="width: 10%;"></td> <td style="width: 10%;"></td> <td style="width: 10%;"></td> <td style="width: 10%;"></td> </tr> <tr> <td></td> <td></td> <td colspan="8" style="text-align: center;"> <table border="1" style="width: 100%; border-collapse: collapse; text-align: center;"> <tr> <td style="width: 10%;"></td> <td style="width: 10%;"></td> <td style="width: 10%;"></td> <td style="width: 10%;"></td> <td style="width: 10%;"></td> <td style="width: 10%;"></td> <td style="width: 10%;"></td> <td style="width: 10%;"></td> <td style="width: 10%;"></td> <td style="width: 10%;"></td> </tr> <tr> <td></td> <td></td> <td colspan="8" style="text-align: center;"> <table border="1" style="width: 100%; border-collapse: collapse; text-align: center;"> <tr> <td style="width: 10%;"></td> <td style="width: 10%;"></td> <td style="width: 10%;"></td> <td style="width: 10%;"></td> <td style="width: 10%;"></td> <td style="width: 10%;"></td> <td style="width: 10%;"></td> <td style="width: 10%;"></td> <td style="width: 10%;"></td> <td style="width: 10%;"></td> </tr> <tr> <td></td> <td></td> <td colspan="8" style="text-align: center;"> <table border="1" style="width: 100%; border-collapse: collapse; text-align: center;"> <tr> <td style="width: 10%;"></td> <td style="width: 10%;"></td> <td style="width: 10%;"></td> <td style="width: 10%;"></td> <td style="width: 10%;"></td> <td style="width: 10%;"></td> <td style="width: 10%;"></td> <td style="width: 10%;"></td> <td style="width: 10%;"></td> <td style="width: 10%;"></td> </tr> <tr> <td></td> <td></td> <td colspan="8" style="text-align: center;"> <table border="1" style="width: 100%; border-collapse: collapse; text-align: center;"> <tr> <td style="width: 10%;"></td> <td style="width: 10%;"></td> <td style="width: 10%;"></td> <td style="width: 10%;"></td> <td style="width: 10%;"></td> <td style="width: 10%;"></td> <td style="width: 10%;"></td> <td style="width: 10%;"></td> <td style="width: 10%;"></td> <td style="width: 10%;"></td> </tr> <tr> <td></td> <td></td> <td colspan="8" style="text-align: center;"> <table border="1" style="width: 100%; border-collapse: collapse; text-align: center;"> <tr> <td style="width: 10%;"></td> <td style="width: 10%;"></td> <td style="width: 10%;"></td>
<td style="width: 10%;"></td> <td style="width: 10%;"></td> <td style="width: 10%;"></td> <td style="width: 10%;"></td> <td style="width: 10%;"></td> <td style="width: 10%;"></td> <td style="width: 10%;"></td> </tr> <tr> <td></td> <td></td> <td colspan="8" style="text-align: center;"> <table border="1" style="width: 100%; border-collapse: collapse; text-align: center;"> <tr> <td style="width: 10%;"></td> <td style="width: 10%;"></td> <td style="width: 10%;"></td> <td style="width: 10%;"></td> <td style="width: 10%;"></td> <td style="width: 10%;"></td> <td style="width: 10%;"></td> <td style="width: 10%;"></td> <td style="width: 10%;"></td> <td style="width: 10%;"></td> </tr> <tr> <td></td> <td></td> <td colspan="8" style="text-align: center;"> <table border="1" style="width: 100%; border-collapse: collapse; text-align: center;"> <tr> <td style="width: 10%;"></td> <td style="width: 10%;"></td> <td style="width: 10%;"></td> <td style="width: 10%;"></td> <td style="width: 10%;"></td> <td style="width: 10%;"></td> <td style="width: 10%;"></td> <td style="width: 10%;"></td> <td style="width: 10%;"></td> <td style="width: 10%;"></td> </tr> <tr> <td></td> <td></td> <td colspan="8" style="text-align: center;"> <table border="1" style="width: 100%; border-collapse: collapse; text-align: center;"> <tr> <td style="width: 10%;"></td> <td style="width: 10%;"></td> <td style="width: 10%;"></td> <td style="width: 10%;"></td> <td style="width: 10%;"></td> <td style="width: 10%;"></td> <td style="width: 10%;"></td> <td style="width: 10%;"></td> <td style="width: 10%;"></td> <td style="width: 10%;"></td> </tr> <tr> <td></td> <td></td> <td colspan="8" style="text-align: center;"> <table border="1" style="width: 100%; border-collapse: collapse; text-align: center;"> <tr> <td style="width: 10%;"></td> <td style="width: 10%;"></td> <td style="width: 10%;"></td> <td style="width: 10%;"></td> <td style="width: 10%;"></td> <td style="width: 10%;"></td> <td style="width: 10%;"></td> <td style="width: 10%;"></td> <td style="width: 10%;"></td> <td style="width: 10%;"></td> </tr> <tr> <td></td> <td></td> <td colspan="8" style="text-align: center;"> <table border="1" style="width: 100%; border-collapse: collapse; text-align: center;"> <tr> <td style="width: 10%;"></td> <td style="width: 10%;"></td> <td style="width: 10%;"></td> <td style="width: 10%;"></td> <td style="width: 10%;"></td> <td style="width: 10%;"></td> <td style="width: 10%;"></td> <td style="width: 10%;"></td> <td style="width: 10%;"></td> <td style="width: 10%;"></td> </tr> <tr> <td></td> <td></td> <td colspan="8" style="text-align: center;"> <table border="1" style="width: 100%; border-collapse: collapse; text-align: center;"> <tr> </tr></table></td></tr></table></td></tr></table></td></tr></table></td></tr></table></td></tr></table></td></tr></table></td></tr></table></td></tr></table></td></tr></table></td></tr></table></td></tr></table></td></tr></table></td></tr></table></td></tr></table></td></tr></table></td></tr></table></td></tr></table></td></tr></table></td></tr></table></td></tr></table>
 | | | | | | | | | | | | | | | | | | | | <table border="1" style="width: 100%; border-collapse: collapse; text-align: center;"> <tr> <td style="width: 10%;"></td> <td style="width: 10%;"></td> <td style="width: 10%;"></td> <td style="width: 10%;"></td> <td style="width: 10%;"></td> <td style="width: 10%;"></td> <td style="width: 10%;"></td> <td style="width: 10%;"></td> <td style="width: 10%;"></td> <td style="width: 10%;"></td> </tr> <tr> <td></td> <td></td> <td colspan="8" style="text-align: center;"> <table border="1" style="width: 100%; border-collapse: collapse; text-align: center;"> <tr> <td style="width: 10%;"></td> <td style="width: 10%;"></td> <td style="width: 10%;"></td> <td style="width: 10%;"></td> <td style="width: 10%;"></td> <td style="width: 10%;"></td> <td style="width: 10%;"></td> <td style="width: 10%;"></td> <td style="width: 10%;"></td> <td style="width: 10%;"></td> </tr> <tr> <td></td> <td></td> <td colspan="8" style="text-align: center;"> <table border="1" style="width: 100%; border-collapse: collapse; text-align: center;"> <tr> <td style="width: 10%;"></td> <td style="width: 10%;"></td> <td style="width: 10%;"></td> <td style="width: 10%;"></td> <td style="width: 10%;"></td> <td style="width: 10%;"></td> <td style="width: 10%;"></td> <td style="width: 10%;"></td> <td style="width:
10%;"></td> <td style="width: 10%;"></td> </tr> <tr> <td></td> <td></td> <td colspan="8" style="text-align: center;"> <table border="1" style="width: 100%; border-collapse: collapse; text-align: center;"> <tr> <td style="width: 10%;"></td> <td style="width: 10%;"></td> <td style="width: 10%;"></td> <td style="width: 10%;"></td> <td style="width: 10%;"></td> <td style="width: 10%;"></td> <td style="width: 10%;"></td> <td style="width: 10%;"></td> <td style="width: 10%;"></td> <td style="width: 10%;"></td> </tr> <tr> <td></td> <td></td> <td colspan="8" style="text-align: center;"> <table border="1" style="width: 100%; border-collapse: collapse; text-align: center;"> <tr> <td style="width: 10%;"></td> <td style="width: 10%;"></td> <td style="width: 10%;"></td> <td style="width: 10%;"></td> <td style="width: 10%;"></td> <td style="width: 10%;"></td> <td style="width: 10%;"></td> <td style="width: 10%;"></td> <td style="width: 10%;"></td> <td style="width: 10%;"></td> </tr> <tr> <td></td> <td></td> <td colspan="8" style="text-align: center;"> <table border="1" style="width: 100%; border-collapse: collapse; text-align: center;"> <tr> <td style="width: 10%;"></td> <td style="width: 10%;"></td> <td style="width: 10%;"></td> <td style="width: 10%;"></td> <td style="width: 10%;"></td> <td style="width: 10%;"></td> <td style="width: 10%;"></td> <td style="width: 10%;"></td> <td style="width: 10%;"></td> <td style="width: 10%;"></td> </tr> <tr> <td></td> <td></td> <td colspan="8" style="text-align: center;"> <table border="1" style="width: 100%; border-collapse: collapse; text-align: center;"> <tr> <td style="width: 10%;"></td> <td style="width: 10%;"></td> <td style="width: 10%;"></td> <td style="width: 10%;"></td> <td style="width: 10%;"></td> <td style="width: 10%;"></td> <td style="width: 10%;"></td> <td style="width: 10%;"></td> <td style="width: 10%;"></td> <td style="width: 10%;"></td> </tr> <tr> <td></td> <td></td> <td colspan="8" style="text-align: center;"> <table border="1" style="width: 100%; border-collapse: collapse; text-align: center;"> <tr> <td style="width: 10%;"></td> <td style="width: 10%;"></td> <td style="width: 10%;"></td> <td style="width: 10%;"></td> <td style="width: 10%;"></td> <td style="width: 10%;"></td> <td style="width: 10%;"></td> <td style="width: 10%;"></td> <td style="width: 10%;"></td> <td style="width: 10%;"></td> </tr> <tr> <td></td> <td></td> <td colspan="8" style="text-align: center;"> <table border="1" style="width: 100%; border-collapse: collapse; text-align: center;"> <tr> <td style="width: 10%;"></td> <td style="width: 10%;"></td> <td style="width: 10%;"></td> <td style="width: 10%;"></td> <td style="width: 10%;"></td> <td style="width: 10%;"></td> <td style="width: 10%;"></td> <td style="width: 10%;"></td> <td style="width: 10%;"></td> <td style="width: 10%;"></td> </tr> <tr> <td></td> <td></td> <td colspan="8" style="text-align: center;"> <table border="1" style="width: 100%; border-collapse: collapse; text-align: center;"> <tr> <td style="width: 10%;"></td> <td style="width: 10%;"></td> <td style="width: 10%;"></td> <td style="width: 10%;"></td> <td style="width: 10%;"></td> <td style="width: 10%;"></td> <td style="width: 10%;"></td> <td style="width: 10%;"></td> <td style="width: 10%;"></td> <td style="width: 10%;"></td> </tr> <tr> <td></td> <td></td> <td colspan="8" style="text-align: center;"> <table border="1" style="width: 100%; border-collapse: collapse; text-align: center;"> <tr> <td style="width: 10%;"></td> <td style="width: 10%;"></td> <td style="width: 10%;"></td> <td style="width: 10%;"></td> <td style="width: 10%;"></td> <td style="width: 10%;"></td> <td style="width: 10%;"></td> <td style="width: 10%;"></td> <td style="width: 10%;"></td> <td style="width: 10%;"></td> </tr> <tr> <td></td> <td></td> <td colspan="8" style="text-align: center;"> <table border="1" style="width: 100%; border-collapse: collapse; text-align: center;"> <tr> <td style="width: 10%;"></td> <td style="width: 10%;"></td> <td style="width: 10%;"></td> <td style="width: 10%;"></td> <td style="width: 10%;"></td> <td style="width: 10%;"></td> <td style="width: 10%;"></td> <td style="width: 10%;"></td> <td style="width: 10%;"></td> <td style="width: 10%;"></td> </tr> <tr> <td></td> <td></td> <td colspan="8" style="text-align: center;"> <table border="1" style="width: 100%; border-collapse: collapse; text-align: center;"> <tr> <td style="width: 10%;"></td> <td style="width: 10%;"></td> <td style="width: 10%;"></td> <td style="width: 10%;"></td> <td style="width: 10%;"></td> <td style="width: 10%;"></td> <td style="width: 10%;"></td> <td style="width: 10%;"></td> <td style="width: 10%;"></td> <td style="width: 10%;"></td> </tr> <tr> <td></td> <td></td> <td colspan="8" style="text-align: center;"> <table border="1" style="width: 100%; border-collapse: collapse; text-align: center;"> <tr> <td style="width: 10%;"></td> <td style="width: 10%;"></td> <td style="width: 10%;"></td> <td style="width: 10%;"></td> <td style="width: 10%;"></td> <td style="width: 10%;"></td> <td style="width: 10%;"></td> <td style="width: 10%;"></td> <td style="width: 10%;"></td> <td style="width: 10%;"></td> </tr> <tr> <td></td> <td></td> <td colspan="8" style="text-align: center;"> <table border="1" style="width: 100%; border-collapse: collapse; text-align: center;"> <tr> <td style="width: 10%;"></td> <td style="width: 10%;"></td> <td style="width: 10%;"></td> <td style="width: 10%;"></td> <td style="width: 10%;"></td> <td style="width: 10%;"></td> <td style="width: 10%;"></td> <td style="width: 10%;"></td> <td style="width: 10%;"></td> <td style="width: 10%;"></td> </tr> <tr> <td></td> <td></td> <td colspan="8" style="text-align: center;"> <table border="1" style="width: 100%; border-collapse: collapse; text-align: center;"> <tr> <td style="width: 10%;"></td> <td style="width: 10%;"></td> <td style="width: 10%;"></td> <td style="width: 10%;"></td> <td style="width: 10%;"></td> <td style="width: 10%;"></td> <td style="width: 10%;"></td> <td style="width: 10%;"></td> <td style="width: 10%;"></td> <td style="width: 10%;"></td> </tr> <tr> <td></td> <td></td> <td colspan="8" style="text-align: center;"> <table border="1" style="width: 100%; border-collapse: collapse; text-align: center;"> <tr> <td style="width: 10%;"></td> <td style="width: 10%;"></td> <td style="width: 10%;"></td> <td style="width: 10%;"></td> <td style="width: 10%;"></td> <td style="width: 10%;"></td> <td style="width: 10%;"></td> <td style="width: 10%;"></td> <td style="width: 10%;"></td> <td style="width: 10%;"></td> </tr> <tr> <td></td> <td></td> <td colspan="8" style="text-align: center;"> <table border="1" style="width: 100%; border-collapse: collapse; text-align: center;"> <tr> <td style="width: 10%;"></td> <td style="width: 10%;"></td> <td style="width: 10%;"></td> <td style="width: 10%;"></td> <td style="width: 10%;"></td> <td style="width: 10%;"></td> <td style="width: 10%;"></td> <td style="width: 10%;"></td> <td style="width: 10%;"></td> <td style="width: 10%;"></td> </tr> <tr> <td></td> <td></td> <td colspan="8" style="text-align: center;"> <table border="1" style="width: 100%; border-collapse: collapse; text-align: center;"> <tr> <td style="width: 10%;"></td> <td style="width: 10%;"></td> <td style="width: 10%;"></td> <td style="width: 10%;"></td> <td style="width: 10%;"></td> <td style="width: 10%;"></td> <td style="width: 10%;"></td> <td style="width: 10%;"></td> <td style="width: 10%;"></td> <td style="width: 10%;"></td> </tr> <tr> <td></td> <td></td> <td colspan="8" style="text-align: center;"> <table border="1" style="width: 100%; border-collapse: collapse; text-align: center;"> <tr> </tr></table></td></tr></table></td></tr></table></td></tr></table></td></tr></table></td></tr></table></td></tr></table></td></tr></table></td></tr></table></td></tr></table></td></tr></table></td></tr></table></td></tr></table></td></tr></table></td></tr></table></td></tr></table></td></tr></table></td></tr></table></td></tr></table></td></tr></table>

 | | | | | | | | | | | | | | | | | | | | <table border="1" style="width: 100%; border-collapse: collapse; text-align: center;"> <tr> <td style="width: 10%;"></td> <td style="width: 10%;"></td> <td style="width: 10%;"></td> <td style="width: 10%;"></td> <td style="width: 10%;"></td> <td style="width: 10%;"></td> <td style="width: 10%;"></td> <td style="width: 10%;"></td> <td style="width: 10%;"></td> <td style="width: 10%;"></td> </tr> <tr> <td></td> <td></td> <td colspan="8" style="text-align: center;"> <table border="1" style="width: 100%; border-collapse: collapse; text-align: center;"> <tr> <td style="width: 10%;"></td> <td style="width: 10%;"></td> <td style="width: 10%;"></td> <td style="width: 10%;"></td> <td style="width: 10%;"></td> <td style="width: 10%;"></td> <td style="width: 10%;"></td> <td style="width: 10%;"></td> <td style="width: 10%;"></td> <td style="width: 10%;"></td> </tr> <tr> <td></td> <td></td> <td colspan="8" style="text-align: center;"> <table border="1" style="width: 100%; border-collapse: collapse; text-align: center;"> <tr> <td style="width: 10%;"></td> <td style="width: 10%;"></td> <td style="width: 10%;"></td> <td style="width: 10%;"></td> <td style="width: 10%;"></td> <td style="width: 10%;"></td> <td style="width: 10%;"></td> <td style="width: 10%;"></td> <td style="width: 10%;"></td> <td style="width: 10%;"></td> </tr> <tr> <td></td> <td></td> <td colspan="8" style="text-align: center;"> <table border="1" style="width: 100%; border-collapse: collapse; text-align: center;"> <tr> <td style="width: 10%;"></td> <td style="width: 10%;"></td> <td style="width: 10%;"></td> <td style="width: 10%;"></td> <td style="width: 10%;"></td> <td style="width: 10%;"></td> <td style="width: 10%;"></td> <td style="width: 10%;"></td> <td style="width: 10%;"></td> <td style="width: 10%;"></td> </tr> <tr> <td></td> <td></td> <td colspan="8" style="text-align: center;"> <table border="1" style="width: 100%; border-collapse: collapse; text-align: center;"> <tr> <td style="width: 10%;"></td> <td style="width: 10%;"></td> <td style="width: 10%;"></td> <td style="width: 10%;"></td> <td style="width: 10%;"></td> <td style="width: 10%;"></td> <td style="width: 10%;"></td> <td style="width: 10%;"></td> <td style="width: 10%;"></td> <td style="width: 10%;"></td> </tr> <tr> <td></td> <td></td> <td colspan="8" style="text-align: center;"> <table border="1" style="width: 100%; border-collapse: collapse; text-align: center;"> <tr> <td style="width: 10%;"></td> <td style="width: 10%;"></td> <td style="width: 10%;"></td> <td style="width: 10%;"></td> <td style="width: 10%;"></td> <td style="width: 10%;"></td> <td style="width: 10%;"></td> <td style="width: 10%;"></td> <td style="width: 10%;"></td> <td style="width: 10%;"></td> </tr> <tr> <td></td> <td></td> <td colspan="8" style="text-align: center;"> <table border="1" style="width: 100%; border-collapse: collapse; text-align: center;"> <tr> <td style="width: 10%;"></td> <td style="width: 10%;"></td> <td style="width: 10%;"></td> <td style="width: 10%;"></td> <td style="width: 10%;"></td> <td style="width: 10%;"></td> <td style="width: 10%;"></td> <td style="width: 10%;"></td> <td style="width: 10%;"></td> <td style="width: 10%;"></td> </tr> <tr> <td></td> <td></td> <td colspan="8" style="text-align: center;"> <table border="1" style="width: 100%; border-collapse: collapse; text-align: center;"> <tr> <td style="width: 10%;"></td> <td style="width: 10%;"></td> <td style="width: 10%;"></td> <td style="width: 10%;"></td> <td style="width: 10%;"></td> <td style="width: 10%;"></td> <td style="width: 10%;"></td> <td style="width: 10%;"></td> <td style="width: 10%;"></td> <td style="width: 10%;"></td> </tr> <tr> <td></td> <td></td> <td colspan="8" style="text-align: center;"> <table border="1" style="width: 100%; border-collapse: collapse; text-align: center;"> <tr> <td style="width: 10%;"></td> <td style="width: 10%;"></td> <td style="width: 10%;"></td> <td style="width: 10%;"></td> <td style="width: 10%;"></td> <td style="width: 10%;"></td> <td style="width: 10%;"></td> <td style="width: 10%;"></td> <td style="width: 10%;"></td> <td style="width: 10%;"></td> </tr> <tr> <td></td> <td></td> <td colspan="8" style="text-align: center;"> <table border="1" style="width: 100%; border-collapse: collapse; text-align: center;"> <tr> <td style="width: 10%;"></td> <td style="width: 10%;"></td> <td style="width: 10%;"></td> <td style="width: 10%;"></td> <td style="width: 10%;"></td> <td style="width: 10%;"></td> <td style="width: 10%;"></td> <td style="width: 10%;"></td> <td style="width: 10%;"></td> <td style="width: 10%;"></td> </tr> <tr> <td></td> <td></td> <td colspan="8" style="text-align: center;"> <table border="1" style="width: 100%; border-collapse: collapse; text-align: center;"> <tr> <td style="width: 10%;"></td> <td style="width: 10%;"></td> <td style="width: 10%;"></td> <td style="width: 10%;"></td> <td style="width: 10%;"></td> <td style="width: 10%;"></td> <td style="width: 10%;"></td> <td style="width: 10%;"></td> <td style="width: 10%;"></td> <td style="width: 10%;"></td> </tr> <tr> <td></td> <td></td> <td colspan="8" style="text-align: center;"> <table border="1" style="width: 100%; border-collapse: collapse; text-align: center;"> <tr> <td style="width: 10%;"></td> <td style="width: 10%;"></td> <td style="width: 10%;"></td> <td style="width: 10%;"></td> <td style="width: 10%;"></td> <td style="width: 10%;"></td> <td style="width: 10%;"></td> <td style="width: 10%;"></td> <td style="width: 10%;"></td> <td style="width: 10%;"></td> </tr> <tr> <td></td> <td></td> <td colspan="8" style="text-align: center;"> <table border="1" style="width: 100%; border-collapse: collapse; text-align: center;"> <tr> <td style="width: 10%;"></td> <td style="width: 10%;"></td> <td style="width: 10%;"></td> <td style="width: 10%;"></td> <td style="width: 10%;"></td> <td style="width: 10%;"></td> <td style="width: 10%;"></td> <td style="width: 10%;"></td> <td style="width: 10%;"></td> <td style="width: 10%;"></td> </tr> <tr> <td></td> <td></td> <td colspan="8" style="text-align: center;"> <table border="1" style="width: 100%; border-collapse: collapse; text-align: center;"> <tr> <td style="width: 10%;"></td> <td style="width: 10%;"></td> <td style="width: 10%;"></td> <td style="width: 10%;"></td> <td style="width: 10%;"></td> <td
style="width: 10%;"></td> <td style="width: 10%;"></td> <td style="width: 10%;"></td> <td style="width: 10%;"></td> <td style="width: 10%;"></td> </tr> <tr> <td></td> <td></td> <td colspan="8" style="text-align: center;"> <table border="1" style="width: 100%; border-collapse: collapse; text-align: center;"> <tr> <td style="width: 10%;"></td> <td style="width: 10%;"></td> <td style="width: 10%;"></td> <td style="width: 10%;"></td> <td style="width: 10%;"></td> <td style="width: 10%;"></td> <td style="width: 10%;"></td> <td style="width: 10%;"></td> <td style="width: 10%;"></td> <td style="width: 10%;"></td> </tr> <tr> <td></td> <td></td> <td colspan="8" style="text-align: center;"> <table border="1" style="width: 100%; border-collapse: collapse; text-align: center;"> <tr> <td style="width: 10%;"></td> <td style="width: 10%;"></td> <td style="width: 10%;"></td> <td style="width: 10%;"></td> <td style="width: 10%;"></td> <td style="width: 10%;"></td> <td style="width: 10%;"></td> <td style="width: 10%;"></td> <td style="width: 10%;"></td> <td style="width: 10%;"></td> </tr> <tr> <td></td> <td></td> <td colspan="8" style="text-align: center;"> <table border="1" style="width: 100%; border-collapse: collapse; text-align: center;"> <tr> <td style="width: 10%;"></td> <td style="width: 10%;"></td> <td style="width: 10%;"></td> <td style="width: 10%;"></td> <td style="width: 10%;"></td> <td style="width: 10%;"></td> <td style="width: 10%;"></td> <td style="width: 10%;"></td> <td style="width: 10%;"></td> <td style="width: 10%;"></td> </tr> <tr> <td></td> <td></td> <td colspan="8" style="text-align: center;"> <table border="1" style="width: 100%; border-collapse: collapse; text-align: center;"> <tr> <td style="width: 10%;"></td> <td style="width: 10%;"></td> <td style="width: 10%;"></td> <td style="width: 10%;"></td> <td style="width: 10%;"></td> <td style="width: 10%;"></td> <td style="width: 10%;"></td> <td style="width: 10%;"></td> <td style="width: 10%;"></td> <td style="width: 10%;"></td> </tr> <tr> <td></td> <td></td> <td colspan="8" style="text-align: center;"> <table border="1" style="width: 100%; border-collapse: collapse; text-align: center;"> <tr> </tr></table></td></tr></table></td></tr></table></td></tr></table></td></tr></table></td></tr></table></td></tr></table></td></tr></table></td></tr></table></td></tr></table></td></tr></table></td></tr></table></td></tr></table></td></tr></table></td></tr></table></td></tr></table></td></tr></table></td></tr></table></td></tr></table>
 | | | | | | | | | | | | | | | | | | | | <table border="1" style="width: 100%; border-collapse: collapse; text-align: center;"> <tr> <td style="width: 10%;"></td> <td style="width: 10%;"></td> <td style="width: 10%;"></td> <td style="width: 10%;"></td> <td style="width: 10%;"></td> <td style="width: 10%;"></td> <td style="width: 10%;"></td> <td style="width: 10%;"></td> <td style="width: 10%;"></td> <td style="width: 10%;"></td> </tr> <tr> <td></td> <td></td> <td colspan="8" style="text-align: center;"> <table border="1" style="width: 100%; border-collapse: collapse; text-align: center;"> <tr> <td style="width: 10%;"></td> <td style="width: 10%;"></td> <td style="width: 10%;"></td> <td style="width: 10%;"></td> <td style="width: 10%;"></td> <td style="width: 10%;"></td> <td style="width: 10%;"></td> <td style="width: 10%;"></td> <td style="width: 10%;"></td> <td style="width: 10%;"></td> </tr> <tr> <td></td> <td></td> <td colspan="8" style="text-align: center;"> <table border="1" style="width: 100%; border-collapse: collapse; text-align: center;"> <tr> <td style="width: 10%;"></td> <td style="width: 10%;"></td> <td style="width: 10%;"></td> <td style="width: 10%;"></td> <td style="width: 10%;"></td> <td style="width: 10%;"></td> <td style="width: 10%;"></td> <td style="width: 10%;"></td> <td style="width: 10%;"></td> <td style="width: 10%;"></td> </tr> <tr> <td></td> <td></td> <td colspan="8" style="text-align: center;"> <table border="1" style="width: 100%; border-collapse: collapse; text-align: center;"> <tr> <td style="width: 10%;"></td> <td style="width: 10%;"></td> <td style="width: 10%;"></td> <td style="width: 10%;"></td> <td style="width: 10%;"></td> <td style="width: 10%;"></td> <td style="width: 10%;"></td> <td style="width: 10%;"></td> <td style="width: 10%;"></td> <td style="width: 10%;"></td> </tr> <tr> <td></td> <td></td> <td colspan="8" style="text-align:
center;"> <table border="1" style="width: 100%; border-collapse: collapse; text-align: center;"> <tr> <td style="width: 10%;"></td> <td style="width: 10%;"></td> <td style="width: 10%;"></td> <td style="width: 10%;"></td> <td style="width: 10%;"></td> <td style="width: 10%;"></td> <td style="width: 10%;"></td> <td style="width: 10%;"></td> <td style="width: 10%;"></td> <td style="width: 10%;"></td> </tr> <tr> <td></td> <td></td> <td colspan="8" style="text-align: center;"> <table border="1" style="width: 100%; border-collapse: collapse; text-align: center;"> <tr> <td style="width: 10%;"></td> <td style="width: 10%;"></td> <td style="width: 10%;"></td> <td style="width: 10%;"></td> <td style="width: 10%;"></td> <td style="width: 10%;"></td> <td style="width: 10%;"></td> <td style="width: 10%;"></td> <td style="width: 10%;"></td> <td style="width: 10%;"></td> </tr> <tr> <td></td> <td></td> <td colspan="8" style="text-align: center;"> <table border="1" style="width: 100%; border-collapse: collapse; text-align: center;"> <tr> <td style="width: 10%;"></td> <td style="width: 10%;"></td> <td style="width: 10%;"></td> <td style="width: 10%;"></td> <td style="width: 10%;"></td> <td style="width: 10%;"></td> <td style="width: 10%;"></td> <td style="width: 10%;"></td> <td style="width: 10%;"></td> <td style="width: 10%;"></td> </tr> <tr> <td></td> <td></td> <td colspan="8" style="text-align: center;"> <table border="1" style="width: 100%; border-collapse: collapse; text-align: center;"> <tr> <td style="width: 10%;"></td> <td style="width: 10%;"></td> <td style="width: 10%;"></td> <td style="width: 10%;"></td> <td style="width: 10%;"></td> <td style="width: 10%;"></td> <td style="width: 10%;"></td> <td style="width: 10%;"></td> <td style="width: 10%;"></td> <td style="width: 10%;"></td> </tr> <tr> <td></td> <td></td> <td colspan="8" style="text-align: center;"> <table border="1" style="width: 100%; border-collapse: collapse; text-align: center;"> <tr> <td style="width: 10%;"></td> <td style="width: 10%;"></td> <td style="width: 10%;"></td> <td style="width: 10%;"></td> <td style="width: 10%;"></td> <td style="width: 10%;"></td> <td style="width: 10%;"></td> <td style="width: 10%;"></td> <td style="width: 10%;"></td> <td style="width: 10%;"></td> </tr> <tr> <td></td> <td></td> <td colspan="8" style="text-align: center;"> <table border="1" style="width: 100%; border-collapse: collapse; text-align: center;"> <tr> <td style="width: 10%;"></td> <td style="width: 10%;"></td> <td style="width: 10%;"></td> <td style="width: 10%;"></td> <td style="width: 10%;"></td> <td style="width: 10%;"></td> <td style="width: 10%;"></td> <td style="width: 10%;"></td> <td style="width: 10%;"></td> <td style="width: 10%;"></td> </tr> <tr> <td></td> <td></td> <td colspan="8" style="text-align: center;"> <table border="1" style="width: 100%; border-collapse: collapse; text-align: center;"> <tr> <td style="width: 10%;"></td> <td style="width: 10%;"></td> <td style="width: 10%;"></td> <td style="width: 10%;"></td> <td style="width: 10%;"></td> <td style="width: 10%;"></td> <td style="width: 10%;"></td> <td style="width: 10%;"></td> <td style="width: 10%;"></td> <td style="width: 10%;"></td> </tr> <tr> <td></td> <td></td> <td colspan="8" style="text-align: center;"> <table border="1" style="width: 100%; border-collapse: collapse; text-align: center;"> <tr> <td style="width: 10%;"></td> <td style="width: 10%;"></td> <td style="width: 10%;"></td> <td style="width: 10%;"></td> <td style="width: 10%;"></td> <td style="width: 10%;"></td> <td style="width: 10%;"></td> <td style="width: 10%;"></td> <td style="width: 10%;"></td> <td style="width: 10%;"></td> </tr> <tr> <td></td> <td></td> <td colspan="8" style="text-align: center;"> <table border="1" style="width: 100%; border-collapse: collapse; text-align: center;"> <tr> <td style="width: 10%;"></td> <td style="width: 10%;"></td> <td style="width: 10%;"></td> <td style="width: 10%;"></td> <td style="width: 10%;"></td> <td style="width: 10%;"></td> <td style="width: 10%;"></td> <td style="width: 10%;"></td> <td style="width: 10%;"></td> <td style="width: 10%;"></td> </tr> <tr> <td></td> <td></td> <td colspan="8" style="text-align: center;"> <table border="1" style="width: 100%; border-collapse: collapse; text-align: center;"> <tr> <td style="width: 10%;"></td> <td style="width: 10%;"></td> <td style="width: 10%;"></td> <td style="width: 10%;"></td> <td style="width: 10%;"></td> <td style="width: 10%;"></td> <td style="width: 10%;"></td> <td style="width: 10%;"></td> <td style="width: 10%;"></td> <td style="width: 10%;"></td> </tr> <tr> <td></td> <td></td> <td colspan="8" style="text-align: center;"> <table border="1" style="width: 100%; border-collapse: collapse; text-align: center;"> <tr> <td style="width: 10%;"></td> <td style="width: 10%;"></td> <td style="width: 10%;"></td> <td style="width: 10%;"></td> <td style="width: 10%;"></td> <td style="width: 10%;"></td> <td style="width: 10%;"></td> <td style="width: 10%;"></td> <td style="width: 10%;"></td> <td style="width: 10%;"></td> </tr> <tr> <td></td> <td></td> <td colspan="8" style="text-align: center;"> <table border="1" style="width: 100%; border-collapse: collapse; text-align: center;"> <tr> <td style="width: 10%;"></td> <td style="width: 10%;"></td> <td style="width: 10%;"></td> <td style="width: 10%;"></td> <td style="width: 10%;"></td> <td style="width: 10%;"></td> <td style="width: 10%;"></td> <td style="width: 10%;"></td> <td style="width: 10%;"></td> <td style="width: 10%;"></td> </tr> <tr> <td></td> <td></td> <td colspan="8" style="text-align: center;"> <table border="1" style="width: 100%; border-collapse: collapse; text-align: center;"> <tr> <td style="width: 10%;"></td> <td style="width: 10%;"></td> <td style="width: 10%;"></td> <td style="width: 10%;"></td> <td style="width: 10%;"></td> <td style="width: 10%;"></td> <td style="width: 10%;"></td> <td style="width: 10%;"></td> <td style="width: 10%;"></td> <td style="width: 10%;"></td> </tr> <tr> <td></td> <td></td> <td colspan="8" style="text-align: center;"> <table border="1" style="width: 100%; border-collapse: collapse; text-align: center;"> <tr> </tr></table></td></tr></table></td></tr></table></td></tr></table></td></tr></table></td></tr></table></td></tr></table></td></tr></table></td></tr></table></td></tr></table></td></tr></table></td></tr></table></td></tr></table></td></tr></table></td></tr></table></td></tr></table></td></tr></table></td></tr></table>

 | | | | | | | | | | | | | | | | | | | | <table border="1" style="width: 100%; border-collapse: collapse; text-align: center;"> <tr> <td style="width: 10%;"></td> <td style="width: 10%;"></td> <td style="width: 10%;"></td> <td style="width: 10%;"></td> <td style="width: 10%;"></td> <td style="width: 10%;"></td> <td style="width: 10%;"></td> <td style="width: 10%;"></td> <td style="width: 10%;"></td> <td style="width: 10%;"></td> </tr> <tr> <td></td> <td></td> <td colspan="8" style="text-align: center;"> <table border="1" style="width: 100%; border-collapse: collapse; text-align: center;"> <tr> <td style="width: 10%;"></td> <td style="width: 10%;"></td> <td style="width: 10%;"></td> <td style="width: 10%;"></td> <td style="width: 10%;"></td> <td style="width: 10%;"></td> <td style="width: 10%;"></td> <td style="width: 10%;"></td> <td style="width: 10%;"></td> <td style="width: 10%;"></td> </tr> <tr> <td></td> <td></td> <td colspan="8" style="text-align: center;"> <table border="1" style="width: 100%; border-collapse: collapse; text-align: center;"> <tr> <td style="width: 10%;"></td> <td style="width: 10%;"></td> <td style="width: 10%;"></td> <td style="width: 10%;"></td> <td style="width: 10%;"></td> <td style="width: 10%;"></td> <td style="width: 10%;"></td> <td style="width: 10%;"></td> <td style="width: 10%;"></td> <td style="width: 10%;"></td> </tr> <tr> <td></td> <td></td> <td colspan="8" style="text-align: center;"> <table border="1" style="width: 100%; border-collapse: collapse; text-align: center;"> <tr> <td style="width: 10%;"></td> <td style="width: 10%;"></td> <td style="width: 10%;"></td> <td style="width: 10%;"></td> <td style="width: 10%;"></td> <td style="width: 10%;"></td> <td style="width: 10%;"></td> <td style="width: 10%;"></td> <td style="width: 10%;"></td> <td style="width: 10%;"></td> </tr> <tr> <td></td> <td></td> <td colspan="8" style="text-align: center;"> <table border="1" style="width: 100%; border-collapse: collapse; text-align: center;"> <tr> <td style="width: 10%;"></td> <td style="width: 10%;"></td> <td style="width: 10%;"></td> <td style="width: 10%;"></td> <td style="width: 10%;"></td> <td style="width: 10%;"></td> <td style="width: 10%;"></td> <td style="width: 10%;"></td> <td style="width: 10%;"></td> <td style="width: 10%;"></td> </tr> <tr> <td></td> <td></td> <td colspan="8" style="text-align: center;"> <table border="1" style="width: 100%; border-collapse: collapse; text-align: center;"> <tr> <td style="width: 10%;"></td> <td style="width: 10%;"></td> <td style="width: 10%;"></td> <td style="width: 10%;"></td> <td style="width: 10%;"></td> <td style="width: 10%;"></td> <td style="width: 10%;"></td> <td style="width: 10%;"></td> <td style="width: 10%;"></td> <td style="width: 10%;"></td> </tr> <tr> <td></td> <td></td> <td colspan="8" style="text-align: center;"> <table border="1" style="width: 100%; border-collapse: collapse; text-align: center;"> <tr> <td style="width: 10%;"></td> <td style="width: 10%;"></td> <td style="width: 10%;"></td> <td style="width: 10%;"></td> <td style="width: 10%;"></td> <td style="width: 10%;"></td> <td style="width: 10%;"></td> <td style="width: 10%;"></td> <td style="width: 10%;"></td> <td style="width: 10%;"></td> </tr> <tr> <td></td> <td></td> <td colspan="8" style="text-align: center;"> <table border="1" style="width: 100%; border-collapse: collapse; text-align: center;"> <tr> <td style="width: 10%;"></td> <td style="width: 10%;"></td> <td style="width: 10%;"></td> <td style="width: 10%;"></td> <td style="width: 10%;"></td> <td style="width: 10%;"></td> <td style="width: 10%;"></td> <td style="width: 10%;"></td> <td style="width: 10%;"></td> <td style="width: 10%;"></td> </tr> <tr> <td></td> <td></td> <td colspan="8" style="text-align: center;"> <table border="1" style="width: 100%; border-collapse: collapse; text-align: center;"> <tr> <td style="width: 10%;"></td> <td style="width: 10%;"></td> <td style="width: 10%;"></td> <td style="width: 10%;"></td> <td style="width: 10%;"></td> <td style="width: 10%;"></td> <td style="width: 10%;"></td> <td style="width: 10%;"></td> <td style="width: 10%;"></td> <td style="width: 10%;"></td> </tr> <tr> <td></td> <td></td> <td colspan="8" style="text-align: center;"> <table border="1" style="width: 100%; border-collapse: collapse; text-align: center;"> <tr> <td style="width: 10%;"></td> <td style="width: 10%;"></td> <td style="width: 10%;"></td> <td style="width: 10%;"></td> <td style="width: 10%;"></td> <td style="width: 10%;"></td> <td style="width: 10%;"></td> <td style="width: 10%;"></td> <td style="width: 10%;"></td> <td style="width: 10%;"></td> </tr> <tr> <td></td> <td></td> <td colspan="8" style="text-align: center;"> <table border="1" style="width: 100%; border-collapse: collapse; text-align: center;"> <tr> <td style="width: 10%;"></td> <td style="width: 10%;"></td> <td style="width: 10%;"></td> <td style="width: 10%;"></td> <td style="width: 10%;"></td> <td style="width: 10%;"></td> <td style="width: 10%;"></td> <td style="width: 10%;"></td> <td style="width: 10%;"></td> <td style="width: 10%;"></td> </tr> <tr> <td></td> <td></td> <td colspan="8" style="text-align: center;"> <table border="1" style="width: 100%; border-collapse: collapse; text-align: center;"> <tr> <td style="width: 10%;"></td> <td style="width: 10%;"></td> <td style="width: 10%;"></td> <td style="width: 10%;"></td> <td style="width: 10%;"></td> <td style="width: 10%;"></td> <td style="width: 10%;"></td> <td style="width: 10%;"></td> <td style="width: 10%;"></td> <td style="width: 10%;"></td> </tr> <tr> <td></td> <td></td> <td colspan="8" style="text-align: center;"> <table border="1" style="width: 100%; border-collapse: collapse; text-align: center;"> <tr> <td style="width: 10%;"></td> <td style="width: 10%;"></td> <td style="width: 10%;"></td> <td style="width: 10%;"></td> <td style="width: 10%;"></td> <td style="width: 10%;"></td> <td style="width: 10%;"></td> <td style="width: 10%;"></td> <td style="width: 10%;"></td> <td style="width: 10%;"></td> </tr> <tr> <td></td> <td></td> <td colspan="8" style="text-align: center;"> <table border="1" style="width: 100%; border-collapse: collapse; text-align: center;"> <tr> <td style="width: 10%;"></td> <td style="width: 10%;"></td> <td style="width: 10%;"></td> <td style="width: 10%;"></td> <td style="width: 10%;"></td> <td style="width: 10%;"></td> <td style="width: 10%;"></td> <td style="width: 10%;"></td> <td style="width: 10%;"></td> <td style="width: 10%;"></td> </tr> <tr> <td></td> <td></td> <td colspan="8" style="text-align: center;"> <table border="1" style="width: 100%; border-collapse: collapse; text-align: center;"> <tr> <td style="width: 10%;"></td> <td style="width: 10%;"></td> <td style="width: 10%;"></td> <td style="width: 10%;"></td> <td style="width: 10%;"></td> <td style="width: 10%;"></td> <td style="width: 10%;"></td> <td style="width: 10%;"></td> <td style="width: 10%;"></td> <td style="width: 10%;"></td> </tr> <tr> <td></td> <td></td> <td colspan="8" style="text-align: center;"> <table border="1" style="width: 100%; border-collapse: collapse; text-align: center;"> <tr> <td style="width: 10%;"></td> <td style="width: 10%;"></td> <td style="width: 10%;"></td> <td style="width: 10%;"></td> <td style="width: 10%;"></td> <td style="width: 10%;"></td> <td style="width: 10%;"></td> <td style="width: 10%;"></td> <td style="width: 10%;"></td> <td style="width: 10%;"></td> </tr> <tr> <td></td> <td></td> <td colspan="8" style="text-align: center;"> <table border="1" style="width: 100%; border-collapse: collapse; text-align: center;"> <tr> </tr></table></td></tr></table></td></tr></table></td></tr></table></td></tr></table></td></tr></table></td></tr></table></td></tr></table></td></tr></table></td></tr></table></td></tr></table></td></tr></table></td></tr></table></td></tr></table></td></tr></table></td></tr></table></td></tr></table>

 | | | | | | | | | | | | | | | | | | | | <table border="1" style="width: 100%; border-collapse: collapse; text-align: center;"> <tr> <td style="width: 10%;"></td> <td style="width: 10%;"></td> <td style="width: 10%;"></td> <td style="width: 10%;"></td> <td style="width: 10%;"></td> <td style="width: 10%;"></td> <td style="width: 10%;"></td> <td style="width: 10%;"></td> <td style="width: 10%;"></td> <td style="width: 10%;"></td> </tr> <tr> <td></td> <td></td> <td colspan="8" style="text-align: center;"> <table border="1" style="width: 100%; border-collapse: collapse; text-align: center;"> <tr> <td style="width: 10%;"></td> <td style="width: 10%;"></td> <td style="width: 10%;"></td> <td style="width: 10%;"></td> <td style="width: 10%;"></td> <td style="width: 10%;"></td> <td style="width: 10%;"></td> <td style="width: 10%;"></td> <td style="width: 10%;"></td> <td style="width: 10%;"></td> </tr> <tr> <td></td> <td></td> <td colspan="8" style="text-align: center;"> <table border="1" style="width: 100%; border-collapse: collapse; text-align: center;"> <tr> <td style="width: 10%;"></td> <td style="width: 10%;"></td> <td style="width: 10%;"></td> <td style="width: 10%;"></td> <td style="width: 10%;"></td> <td style="width: 10%;"></td> <td style="width: 10%;"></td> <td style="width: 10%;"></td> <td style="width: 10%;"></td> <td style="width: 10%;"></td> </tr> <tr> <td></td> <td></td> <td colspan="8" style="text-align: center;"> <table border="1" style="width: 100%; border-collapse: collapse; text-align: center;"> <tr> <td style="width: 10%;"></td> <td style="width: 10%;"></td> <td style="width: 10%;"></td> <td style="width: 10%;"></td> <td style="width: 10%;"></td> <td style="width: 10%;"></td> <td style="width: 10%;"></td> <td style="width: 10%;"></td> <td style="width: 10%;"></td> <td style="width: 10%;"></td> </tr> <tr> <td></td> <td></td> <td colspan="8" style="text-align: center;"> <table border="1" style="width: 100%; border-collapse: collapse; text-align: center;"> <tr> <td style="width: 10%;"></td> <td style="width: 10%;"></td> <td style="width: 10%;"></td> <td style="width: 10%;"></td> <td style="width: 10%;"></td> <td style="width: 10%;"></td> <td style="width: 10%;"></td> <td style="width: 10%;"></td> <td style="width: 10%;"></td> <td style="width: 10%;"></td> </tr> <tr> <td></td> <td></td> <td colspan="8" style="text-align: center;"> <table border="1" style="width: 100%; border-collapse: collapse; text-align: center;"> <tr> <td style="width: 10%;"></td> <td style="width: 10%;"></td> <td style="width: 10%;"></td> <td style="width: 10%;"></td> <td style="width: 10%;"></td> <td style="width: 10%;"></td> <td style="width: 10%;"></td> <td style="width: 10%;"></td> <td style="width: 10%;"></td> <td style="width: 10%;"></td> </tr> <tr> <td></td> <td></td> <td colspan="8" style="text-align: center;"> <table border="1" style="width: 100%; border-collapse: collapse; text-align: center;"> <tr> <td style="width: 10%;"></td> <td style="width: 10%;"></td> <td style="width: 10%;"></td> <td style="width: 10%;"></td> <td style="width: 10%;"></td> <td style="width: 10%;"></td> <td style="width: 10%;"></td> <td style="width: 10%;"></td> <td style="width: 10%;"></td> <td style="width: 10%;"></td> </tr> <tr> <td></td> <td></td> <td colspan="8" style="text-align: center;"> <table border="1" style="width: 100%; border-collapse: collapse; text-align: center;"> <tr> <td style="width: 10%;"></td> <td style="width: 10%;"></td> <td style="width: 10%;"></td> <td style="width: 10%;"></td> <td style="width: 10%;"></td> <td style="width: 10%;"></td> <td style="width: 10%;"></td> <td style="width: 10%;"></td> <td style="width: 10%;"></td> <td style="width: 10%;"></td> </tr> <tr> <td></td> <td></td> <td colspan="8" style="text-align: center;"> <table border="1" style="width: 100%; border-collapse: collapse; text-align: center;"> <tr> <td style="width: 10%;"></td> <td style="width: 10%;"></td> <td style="width: 10%;"></td> <td style="width: 10%;"></td> <td style="width: 10%;"></td> <td style="width: 10%;"></td> <td style="width: 10%;"></td> <td style="width: 10%;"></td> <td style="width: 10%;"></td> <td style="width: 10%;"></td> </tr> <tr> <td></td> <td></td> <td colspan="8" style="text-align: center;"> <table border="1" style="width: 100%; border-collapse: collapse; text-align: center;"> <tr> <td style="width: 10%;"></td> <td style="width: 10%;"></td> <td style="width:
10%;"></td> <td style="width: 10%;"></td> <td style="width: 10%;"></td> <td style="width: 10%;"></td> <td style="width: 10%;"></td> <td style="width: 10%;"></td> <td style="width: 10%;"></td> <td style="width: 10%;"></td> </tr> <tr> <td></td> <td></td> <td colspan="8" style="text-align: center;"> <table border="1" style="width: 100%; border-collapse: collapse; text-align: center;"> <tr> <td style="width: 10%;"></td> <td style="width: 10%;"></td> <td style="width: 10%;"></td> <td style="width: 10%;"></td> <td style="width: 10%;"></td> <td style="width: 10%;"></td> <td style="width: 10%;"></td> <td style="width: 10%;"></td> <td style="width: 10%;"></td> <td style="width: 10%;"></td> </tr> <tr> <td></td> <td></td> <td colspan="8" style="text-align: center;"> <table border="1" style="width: 100%; border-collapse: collapse; text-align: center;"> <tr> <td style="width: 10%;"></td> <td style="width: 10%;"></td> <td style="width: 10%;"></td> <td style="width: 10%;"></td> <td style="width: 10%;"></td> <td style="width: 10%;"></td> <td style="width: 10%;"></td> <td style="width: 10%;"></td> <td style="width: 10%;"></td> <td style="width: 10%;"></td> </tr> <tr> <td></td> <td></td> <td colspan="8" style="text-align: center;"> <table border="1" style="width: 100%; border-collapse: collapse; text-align: center;"> <tr> <td style="width: 10%;"></td> <td style="width: 10%;"></td> <td style="width: 10%;"></td> <td style="width: 10%;"></td> <td style="width: 10%;"></td> <td style="width: 10%;"></td> <td style="width: 10%;"></td> <td style="width: 10%;"></td> <td style="width: 10%;"></td> <td style="width: 10%;"></td> </tr> <tr> <td></td> <td></td> <td colspan="8" style="text-align: center;"> <table border="1" style="width: 100%; border-collapse: collapse; text-align: center;"> <tr> <td style="width: 10%;"></td> <td style="width: 10%;"></td> <td style="width: 10%;"></td> <td style="width: 10%;"></td> <td style="width: 10%;"></td> <td style="width: 10%;"></td> <td style="width: 10%;"></td> <td style="width: 10%;"></td> <td style="width: 10%;"></td> <td style="width: 10%;"></td> </tr> <tr> <td></td> <td></td> <td colspan="8" style="text-align: center;"> <table border="1" style="width: 100%; border-collapse: collapse; text-align: center;"> <tr> <td style="width: 10%;"></td> <td style="width: 10%;"></td> <td style="width: 10%;"></td> <td style="width: 10%;"></td> <td style="width: 10%;"></td> <td style="width: 10%;"></td> <td style="width: 10%;"></td> <td style="width: 10%;"></td> <td style="width: 10%;"></td> <td style="width: 10%;"></td> </tr> <tr> <td></td> <td></td> <td colspan="8" style="text-align: center;"> <table border="1" style="width: 100%; border-collapse: collapse; text-align: center;"> <tr> </tr></table></td></tr></table></td></tr></table></td></tr></table></td></tr></table></td></tr></table></td></tr></table></td></tr></table></td></tr></table></td></tr></table></td></tr></table></td></tr></table></td></tr></table></td></tr></table></td></tr></table></td></tr></table>
 | | | | | | | | | | | | | | | | | | | | <table border="1" style="width: 100%; border-collapse: collapse; text-align: center;"> <tr> <td style="width: 10%;"></td> <td style="width: 10%;"></td> <td style="width: 10%;"></td> <td style="width: 10%;"></td> <td style="width: 10%;"></td> <td style="width: 10%;"></td> <td style="width: 10%;"></td> <td style="width: 10%;"></td> <td style="width: 10%;"></td> <td style="width: 10%;"></td> </tr> <tr> <td></td> <td></td> <td colspan="8" style="text-align: center;"> <table border="1" style="width: 100%; border-collapse: collapse; text-align: center;"> <tr> <td style="width: 10%;"></td> <td style="width: 10%;"></td> <td style="width: 10%;"></td> <td style="width: 10%;"></td> <td style="width: 10%;"></td> <td style="width: 10%;"></td> <td style="width: 10%;"></td> <td style="width: 10%;"></td> <td style="width: 10%;"></td> <td style="width: 10%;"></td> </tr> <tr> <td></td> <td></td> <td colspan="8" style="text-align: center;"> <table border="1" style="width: 100%; border-collapse: collapse; text-align: center;"> <tr> <td style="width: 10%;"></td> <td style="width: 10%;"></td> <td style="width: 10%;"></td> <td style="width: 10%;"></td> <td style="width: 10%;"></td> <td style="width: 10%;"></td> <td style="width: 10%;"></td> <td style="width: 10%;"></td> <td style="width: 10%;"></td> <td style="width: 10%;"></td> </tr> <tr> <td></td> <td></td> <td colspan="8"
style="text-align: center;"> <table border="1" style="width: 100%; border-collapse: collapse; text-align: center;"> <tr> <td style="width: 10%;"></td> <td style="width: 10%;"></td> <td style="width: 10%;"></td> <td style="width: 10%;"></td> <td style="width: 10%;"></td> <td style="width: 10%;"></td> <td style="width: 10%;"></td> <td style="width: 10%;"></td> <td style="width: 10%;"></td> <td style="width: 10%;"></td> </tr> <tr> <td></td> <td></td> <td colspan="8" style="text-align: center;"> <table border="1" style="width: 100%; border-collapse: collapse; text-align: center;"> <tr> <td style="width: 10%;"></td> <td style="width: 10%;"></td> <td style="width: 10%;"></td> <td style="width: 10%;"></td> <td style="width: 10%;"></td> <td style="width: 10%;"></td> <td style="width: 10%;"></td> <td style="width: 10%;"></td> <td style="width: 10%;"></td> <td style="width: 10%;"></td> </tr> <tr> <td></td> <td></td> <td colspan="8" style="text-align: center;"> <table border="1" style="width: 100%; border-collapse: collapse; text-align: center;"> <tr> <td style="width: 10%;"></td> <td style="width: 10%;"></td> <td style="width: 10%;"></td> <td style="width: 10%;"></td> <td style="width: 10%;"></td> <td style="width: 10%;"></td> <td style="width: 10%;"></td> <td style="width: 10%;"></td> <td style="width: 10%;"></td> <td style="width: 10%;"></td> </tr> <tr> <td></td> <td></td> <td colspan="8" style="text-align: center;"> <table border="1" style="width: 100%; border-collapse: collapse; text-align: center;"> <tr> <td style="width: 10%;"></td> <td style="width: 10%;"></td> <td style="width: 10%;"></td> <td style="width: 10%;"></td> <td style="width: 10%;"></td> <td style="width: 10%;"></td> <td style="width: 10%;"></td> <td style="width: 10%;"></td> <td style="width: 10%;"></td> <td style="width: 10%;"></td> </tr> <tr> <td></td> <td></td> <td colspan="8" style="text-align: center;"> <table border="1" style="width: 100%; border-collapse: collapse; text-align: center;"> <tr> <td style="width: 10%;"></td> <td style="width: 10%;"></td> <td style="width: 10%;"></td> <td style="width: 10%;"></td> <td style="width: 10%;"></td> <td style="width: 10%;"></td> <td style="width: 10%;"></td> <td style="width: 10%;"></td> <td style="width: 10%;"></td> <td style="width: 10%;"></td> </tr> <tr> <td></td> <td></td> <td colspan="8" style="text-align: center;"> <table border="1" style="width: 100%; border-collapse: collapse; text-align: center;"> <tr> <td style="width: 10%;"></td> <td style="width: 10%;"></td> <td style="width: 10%;"></td> <td style="width: 10%;"></td> <td style="width: 10%;"></td> <td style="width: 10%;"></td> <td style="width: 10%;"></td> <td style="width: 10%;"></td> <td style="width: 10%;"></td> <td style="width: 10%;"></td> </tr> <tr> <td></td> <td></td> <td colspan="8" style="text-align: center;"> <table border="1" style="width: 100%; border-collapse: collapse; text-align: center;"> <tr> <td style="width: 10%;"></td> <td style="width: 10%;"></td> <td style="width: 10%;"></td> <td style="width: 10%;"></td> <td style="width: 10%;"></td> <td style="width: 10%;"></td> <td style="width: 10%;"></td> <td style="width: 10%;"></td> <td style="width: 10%;"></td> <td style="width: 10%;"></td> </tr> <tr> <td></td> <td></td> <td colspan="8" style="text-align: center;"> <table border="1" style="width: 100%; border-collapse: collapse; text-align: center;"> <tr> <td style="width: 10%;"></td> <td style="width: 10%;"></td> <td style="width: 10%;"></td> <td style="width: 10%;"></td> <td style="width: 10%;"></td> <td style="width: 10%;"></td> <td style="width: 10%;"></td> <td style="width: 10%;"></td> <td style="width: 10%;"></td> <td style="width: 10%;"></td> </tr> <tr> <td></td> <td></td> <td colspan="8" style="text-align: center;"> <table border="1" style="width: 100%; border-collapse: collapse; text-align: center;"> <tr> <td style="width: 10%;"></td> <td style="width: 10%;"></td> <td style="width: 10%;"></td> <td style="width: 10%;"></td> <td style="width: 10%;"></td> <td style="width: 10%;"></td> <td style="width: 10%;"></td> <td style="width: 10%;"></td> <td style="width: 10%;"></td> <td style="width: 10%;"></td> </tr> <tr> <td></td> <td></td> <td colspan="8" style="text-align: center;"> <table border="1" style="width: 100%; border-collapse: collapse; text-align: center;"> <tr> <td style="width: 10%;"></td> <td style="width: 10%;"></td> <td style="width: 10%;"></td> <td style="width: 10%;"></td> <td style="width: 10%;"></td> <td style="width: 10%;"></td> <td style="width: 10%;"></td> <td style="width: 10%;"></td> <td style="width: 10%;"></td> <td style="width: 10%;"></td> </tr> <tr> <td></td> <td></td> <td colspan="8" style="text-align: center;"> <table border="1" style="width: 100%; border-collapse: collapse; text-align: center;"> <tr> <td style="width: 10%;"></td> <td style="width: 10%;"></td> <td style="width: 10%;"></td> <td style="width: 10%;"></td> <td style="width: 10%;"></td> <td style="width: 10%;"></td> <td style="width: 10%;"></td> <td style="width: 10%;"></td> <td style="width: 10%;"></td> <td style="width: 10%;"></td> </tr> <tr> <td></td> <td></td> <td colspan="8" style="text-align: center;"> <table border="1" style="width: 100%; border-collapse: collapse; text-align: center;"> <tr> </tr></table></td></tr></table></td></tr></table></td></tr></table></td></tr></table></td></tr></table></td></tr></table></td></tr></table></td></tr></table></td></tr></table></td></tr></table></td></tr></table></td></tr></table></td></tr></table></td></tr></table>

 | | | | | | | | | | | | | | | | | | | | <table border="1" style="width: 100%; border-collapse: collapse; text-align: center;"> <tr> <td style="width: 10%;"></td> <td style="width: 10%;"></td> <td style="width: 10%;"></td> <td style="width: 10%;"></td> <td style="width: 10%;"></td> <td style="width: 10%;"></td> <td style="width: 10%;"></td> <td style="width: 10%;"></td> <td style="width: 10%;"></td> <td style="width: 10%;"></td> </tr> <tr> <td></td> <td></td> <td colspan="8" style="text-align: center;"> <table border="1" style="width: 100%; border-collapse: collapse; text-align: center;"> <tr> <td style="width: 10%;"></td> <td style="width: 10%;"></td> <td style="width: 10%;"></td> <td style="width: 10%;"></td> <td style="width: 10%;"></td> <td style="width: 10%;"></td> <td style="width: 10%;"></td> <td style="width: 10%;"></td> <td style="width: 10%;"></td> <td style="width: 10%;"></td> </tr> <tr> <td></td> <td></td> <td colspan="8" style="text-align: center;"> <table border="1" style="width: 100%; border-collapse: collapse; text-align: center;"> <tr> <td style="width: 10%;"></td> <td style="width: 10%;"></td> <td style="width: 10%;"></td> <td style="width: 10%;"></td> <td style="width: 10%;"></td> <td style="width: 10%;"></td> <td style="width: 10%;"></td> <td style="width: 10%;"></td> <td style="width: 10%;"></td> <td style="width: 10%;"></td> </tr> <tr> <td></td> <td></td> <td colspan="8" style="text-align: center;"> <table border="1" style="width: 100%; border-collapse: collapse; text-align: center;"> <tr> <td style="width: 10%;"></td> <td style="width: 10%;"></td> <td style="width: 10%;"></td> <td style="width: 10%;"></td> <td style="width: 10%;"></td> <td style="width: 10%;"></td> <td style="width: 10%;"></td> <td style="width: 10%;"></td> <td style="width: 10%;"></td> <td style="width: 10%;"></td> </tr> <tr> <td></td> <td></td> <td colspan="8" style="text-align: center;"> <table border="1" style="width: 100%; border-collapse: collapse; text-align: center;"> <tr> <td style="width: 10%;"></td> <td style="width: 10%;"></td> <td style="width: 10%;"></td> <td style="width: 10%;"></td> <td style="width: 10%;"></td> <td style="width: 10%;"></td> <td style="width: 10%;"></td> <td style="width: 10%;"></td> <td style="width: 10%;"></td> <td style="width: 10%;"></td> </tr> <tr> <td></td> <td></td> <td colspan="8" style="text-align: center;"> <table border="1" style="width: 100%; border-collapse: collapse; text-align: center;"> <tr> <td style="width: 10%;"></td> <td style="width: 10%;"></td> <td style="width: 10%;"></td> <td style="width: 10%;"></td> <td style="width: 10%;"></td> <td style="width: 10%;"></td> <td style="width: 10%;"></td> <td style="width: 10%;"></td> <td style="width: 10%;"></td> <td style="width: 10%;"></td> </tr> <tr> <td></td> <td></td> <td colspan="8" style="text-align: center;"> <table border="1" style="width: 100%; border-collapse: collapse; text-align: center;"> <tr> <td style="width: 10%;"></td> <td style="width: 10%;"></td> <td style="width: 10%;"></td> <td style="width: 10%;"></td> <td style="width: 10%;"></td> <td style="width: 10%;"></td> <td style="width: 10%;"></td> <td style="width: 10%;"></td> <td style="width: 10%;"></td> <td style="width: 10%;"></td> </tr> <tr> <td></td> <td></td> <td colspan="8" style="text-align: center;"> <table border="1" style="width: 100%; border-collapse: collapse; text-align: center;"> <tr> <td style="width: 10%;"></td> <td style="width: 10%;"></td> <td style="width: 10%;"></td> <td style="width: 10%;"></td> <td style="width: 10%;"></td> <td style="width: 10%;"></td> <td style="width: 10%;"></td> <td style="width: 10%;"></td> <td style="width: 10%;"></td> <td style="width: 10%;"></td> </tr> <tr> <td></td> <td></td> <td colspan="8" style="text-align: center;"> <table border="1" style="width: 100%; border-collapse: collapse; text-align: center;"> <tr> <td style="width: 10%;"></td> <td style="width: 10%;"></td> <td style="width: 10%;"></td> <td style="width: 10%;"></td> <td style="width: 10%;"></td> <td style="width: 10%;"></td> <td style="width: 10%;"></td> <td style="width: 10%;"></td> <td style="width: 10%;"></td> <td style="width: 10%;"></td> </tr> <tr> <td></td> <td></td> <td colspan="8" style="text-align: center;"> <table border="1" style="width: 100%; border-collapse: collapse; text-align: center;"> <tr> <td style="width: 10%;"></td> <td style="width: 10%;"></td> <td style="width: 10%;"></td> <td style="width: 10%;"></td> <td style="width: 10%;"></td> <td style="width: 10%;"></td> <td style="width: 10%;"></td> <td style="width: 10%;"></td> <td style="width: 10%;"></td> <td style="width: 10%;"></td> </tr> <tr> <td></td> <td></td> <td colspan="8" style="text-align: center;"> <table border="1" style="width: 100%; border-collapse: collapse; text-align: center;"> <tr> <td style="width: 10%;"></td> <td style="width: 10%;"></td> <td style="width: 10%;"></td> <td style="width: 10%;"></td> <td style="width: 10%;"></td> <td style="width: 10%;"></td> <td style="width: 10%;"></td> <td style="width: 10%;"></td> <td style="width: 10%;"></td> <td style="width: 10%;"></td> </tr> <tr> <td></td> <td></td> <td colspan="8" style="text-align: center;"> <table border="1" style="width: 100%; border-collapse: collapse; text-align: center;"> <tr> <td style="width: 10%;"></td> <td style="width: 10%;"></td> <td style="width: 10%;"></td> <td style="width: 10%;"></td> <td style="width: 10%;"></td> <td style="width: 10%;"></td> <td style="width: 10%;"></td> <td style="width: 10%;"></td> <td style="width: 10%;"></td> <td style="width: 10%;"></td> </tr> <tr> <td></td> <td></td> <td colspan="8" style="text-align: center;"> <table border="1" style="width: 100%; border-collapse: collapse; text-align: center;"> <tr> <td style="width: 10%;"></td> <td style="width: 10%;"></td> <td style="width: 10%;"></td> <td style="width: 10%;"></td> <td style="width: 10%;"></td> <td style="width: 10%;"></td> <td style="width: 10%;"></td> <td style="width: 10%;"></td> <td style="width: 10%;"></td> <td style="width: 10%;"></td> </tr> <tr> <td></td> <td></td> <td colspan="8" style="text-align: center;"> <table border="1" style="width: 100%; border-collapse: collapse; text-align: center;"> <tr> </tr></table></td></tr></table></td></tr></table></td></tr></table></td></tr></table></td></tr></table></td></tr></table></td></tr></table></td></tr></table></td></tr></table></td></tr></table></td></tr></table></td></tr></table></td></tr></table>

 | | | | | | | | | | | | | | | | | | | | <table border="1" style="width: 100%; border-collapse: collapse; text-align: center;"> <tr> <td style="width: 10%;"></td> <td style="width: 10%;"></td> <td style="width: 10%;"></td> <td style="width: 10%;"></td> <td style="width: 10%;"></td> <td style="width: 10%;"></td> <td style="width: 10%;"></td> <td style="width: 10%;"></td> <td style="width: 10%;"></td> <td style="width: 10%;"></td> </tr> <tr> <td></td> <td></td> <td colspan="8" style="text-align: center;"> <table border="1" style="width: 100%; border-collapse: collapse; text-align: center;"> <tr> <td style="width: 10%;"></td> <td style="width: 10%;"></td> <td style="width: 10%;"></td> <td style="width: 10%;"></td> <td style="width: 10%;"></td> <td style="width: 10%;"></td> <td style="width: 10%;"></td> <td style="width: 10%;"></td> <td style="width: 10%;"></td> <td style="width: 10%;"></td> </tr> <tr> <td></td> <td></td> <td colspan="8" style="text-align: center;"> <table border="1" style="width: 100%; border-collapse: collapse; text-align: center;"> <tr> <td style="width: 10%;"></td> <td style="width: 10%;"></td> <td style="width: 10%;"></td> <td style="width: 10%;"></td> <td style="width: 10%;"></td> <td style="width: 10%;"></td> <td style="width: 10%;"></td> <td style="width: 10%;"></td> <td style="width: 10%;"></td> <td style="width: 10%;"></td> </tr> <tr> <td></td> <td></td> <td colspan="8" style="text-align: center;"> <table border="1" style="width: 100%; border-collapse: collapse; text-align: center;"> <tr> <td style="width: 10%;"></td> <td style="width: 10%;"></td> <td style="width: 10%;"></td> <td style="width: 10%;"></td> <td style="width: 10%;"></td> <td style="width: 10%;"></td> <td style="width: 10%;"></td> <td style="width: 10%;"></td> <td style="width: 10%;"></td> <td style="width: 10%;"></td> </tr> <tr> <td></td> <td></td> <td colspan="8" style="text-align: center;"> <table border="1" style="width: 100%; border-collapse: collapse; text-align: center;"> <tr> <td style="width: 10%;"></td> <td style="width: 10%;"></td> <td style="width: 10%;"></td> <td style="width: 10%;"></td> <td style="width: 10%;"></td> <td style="width: 10%;"></td> <td style="width: 10%;"></td> <td style="width: 10%;"></td> <td style="width: 10%;"></td> <td style="width: 10%;"></td> </tr> <tr> <td></td> <td></td> <td colspan="8" style="text-align: center;"> <table border="1" style="width: 100%; border-collapse: collapse; text-align: center;"> <tr> <td style="width: 10%;"></td> <td style="width: 10%;"></td> <td style="width: 10%;"></td> <td style="width: 10%;"></td> <td style="width: 10%;"></td> <td style="width: 10%;"></td> <td style="width: 10%;"></td> <td style="width: 10%;"></td> <td style="width: 10%;"></td> <td style="width: 10%;"></td> </tr> <tr> <td></td> <td></td> <td colspan="8" style="text-align: center;"> <table border="1" style="width: 100%; border-collapse: collapse; text-align: center;"> <tr> <td style="width: 10%;"></td> <td style="width: 10%;"></td> <td style="width: 10%;"></td> <td style="width: 10%;"></td> <td style="width: 10%;"></td> <td style="width: 10%;"></td> <td style="width: 10%;"></td> <td style="width: 10%;"></td> <td style="width: 10%;"></td> <td style="width: 10%;"></td> </tr> <tr> <td></td> <td></td> <td colspan="8" style="text-align: center;"> <table border="1" style="width: 100%; border-collapse: collapse; text-align: center;"> <tr> <td style="width: 10%;"></td> <td style="width: 10%;"></td> <td style="width: 10%;"></td> <td style="width: 10%;"></td> <td style="width: 10%;"></td> <td style="width: 10%;"></td> <td style="width: 10%;"></td> <td style="width: 10%;"></td> <td style="width: 10%;"></td> <td style="width: 10%;"></td> </tr> <tr> <td></td> <td></td> <td colspan="8" style="text-align: center;"> <table border="1" style="width: 100%; border-collapse: collapse; text-align: center;"> <tr> <td style="width: 10%;"></td> <td style="width: 10%;"></td> <td style="width: 10%;"></td> <td style="width: 10%;"></td> <td style="width: 10%;"></td> <td style="width: 10%;"></td> <td style="width: 10%;"></td> <td style="width: 10%;"></td> <td style="width: 10%;"></td> <td style="width: 10%;"></td> </tr> <tr> <td></td> <td></td> <td colspan="8" style="text-align: center;"> <table border="1" style="width: 100%; border-collapse: collapse; text-align: center;"> <tr> <td style="width: 10%;"></td> <td style="width: 10%;"></td> <td style="width: 10%;"></td> <td style="width: 10%;"></td> <td style="width: 10%;"></td> <td style="width: 10%;"></td> <td style="width: 10%;"></td> <td style="width: 10%;"></td> <td style="width: 10%;"></td> <td style="width: 10%;"></td> </tr> <tr> <td></td> <td></td> <td colspan="8" style="text-align: center;"> <table border="1" style="width: 100%; border-collapse: collapse; text-align: center;"> <tr> <td style="width: 10%;"></td> <td style="width: 10%;"></td> <td style="width: 10%;"></td> <td style="width: 10%;"></td> <td style="width: 10%;"></td> <td style="width: 10%;"></td> <td style="width: 10%;"></td> <td style="width: 10%;"></td> <td style="width: 10%;"></td> <td style="width: 10%;"></td> </tr> <tr> <td></td> <td></td> <td colspan="8" style="text-align: center;"> <table border="1" style="width: 100%; border-collapse: collapse; text-align: center;"> <tr> <td style="width: 10%;"></td> <td style="width: 10%;"></td> <td style="width: 10%;"></td> <td style="width: 10%;"></td> <td style="width: 10%;"></td> <td style="width: 10%;"></td> <td style="width: 10%;"></td> <td style="width: 10%;"></td> <td style="width: 10%;"></td> <td style="width: 10%;"></td> </tr> <tr> <td></td> <td></td> <td colspan="8" style="text-align: center;"> <table border="1" style="width: 100%; border-collapse: collapse; text-align: center;"> <tr> </tr></table></td></tr></table></td></tr></table></td></tr></table></td></tr></table></td></tr></table></td></tr></table></td></tr></table></td></tr></table></td></tr></table></td></tr></table></td></tr></table></td></tr></table>

 | | | | | | | | | | | | | | | | | | | | <table border="1" style="width: 100%; border-collapse: collapse; text-align: center;"> <tr> <td style="width: 10%;"></td> <td style="width: 10%;"></td> <td style="width: 10%;"></td> <td style="width: 10%;"></td> <td style="width: 10%;"></td> <td style="width: 10%;"></td> <td style="width: 10%;"></td> <td style="width: 10%;"></td> <td style="width: 10%;"></td> <td style="width: 10%;"></td> </tr> <tr> <td></td> <td></td> <td colspan="8" style="text-align: center;"> <table border="1" style="width: 100%; border-collapse: collapse; text-align: center;"> <tr> <td style="width: 10%;"></td> <td style="width: 10%;"></td> <td style="width: 10%;"></td> <td style="width: 10%;"></td> <td style="width: 10%;"></td> <td style="width: 10%;"></td> <td style="width: 10%;"></td> <td style="width: 10%;"></td> <td style="width: 10%;"></td> <td style="width: 10%;"></td> </tr> <tr> <td></td> <td></td> <td colspan="8" style="text-align: center;"> <table border="1" style="width: 100%; border-collapse: collapse; text-align: center;"> <tr> <td style="width: 10%;"></td> <td style="width: 10%;"></td> <td style="width: 10%;"></td> <td style="width: 10%;"></td> <td style="width: 10%;"></td> <td style="width: 10%;"></td> <td style="width: 10%;"></td> <td style="width: 10%;"></td> <td style="width: 10%;"></td> <td style="width: 10%;"></td> </tr> <tr> <td></td> <td></td> <td colspan="8" style="text-align: center;"> <table border="1" style="width: 100%; border-collapse: collapse; text-align: center;"> <tr> <td style="width: 10%;"></td> <td style="width: 10%;"></td> <td style="width: 10%;"></td> <td style="width: 10%;"></td> <td style="width: 10%;"></td> <td style="width: 10%;"></td> <td style="width: 10%;"></td> <td style="width: 10%;"></td> <td style="width: 10%;"></td> <td style="width: 10%;"></td> </tr> <tr> <td></td> <td></td> <td colspan="8" style="text-align: center;"> <table border="1" style="width: 100%; border-collapse: collapse; text-align: center;"> <tr> <td style="width: 10%;"></td> <td style="width: 10%;"></td> <td style="width: 10%;"></td> <td style="width: 10%;"></td> <td style="width: 10%;"></td> <td style="width: 10%;"></td> <td style="width: 10%;"></td> <td style="width: 10%;"></td> <td style="width: 10%;"></td> <td style="width: 10%;"></td> </tr> <tr> <td></td> <td></td> <td colspan="8" style="text-align: center;"> <table border="1" style="width: 100%; border-collapse: collapse; text-align: center;"> <tr> <td style="width: 10%;"></td> <td style="width: 10%;"></td> <td style="width: 10%;"></td> <td style="width: 10%;"></td> <td style="width: 10%;"></td> <td style="width: 10%;"></td> <td style="width: 10%;"></td> <td style="width: 10%;"></td> <td style="width: 10%;"></td> <td style="width: 10%;"></td> </tr> <tr> <td></td> <td></td> <td colspan="8" style="text-align: center;"> <table border="1" style="width: 100%; border-collapse: collapse; text-align: center;"> <tr> <td style="width: 10%;"></td> <td style="width: 10%;"></td> <td style="width: 10%;"></td> <td style="width: 10%;"></td> <td style="width: 10%;"></td> <td style="width: 10%;"></td> <td style="width: 10%;"></td> <td style="width: 10%;"></td> <td style="width: 10%;"></td> <td style="width: 10%;"></td> </tr> <tr> <td></td> <td></td> <td colspan="8" style="text-align: center;"> <table border="1" style="width: 100%; border-collapse: collapse; text-align: center;"> <tr> <td style="width: 10%;"></td> <td style="width: 10%;"></td> <td style="width: 10%;"></td> <td style="width: 10%;"></td> <td style="width: 10%;"></td> <td style="width: 10%;"></td> <td style="width: 10%;"></td> <td style="width: 10%;"></td> <td style="width: 10%;"></td> <td style="width: 10%;"></td> </tr> <tr> <td></td> <td></td> <td colspan="8" style="text-align: center;"> <table border="1" style="width: 100%; border-collapse: collapse; text-align: center;"> <tr> <td style="width: 10%;"></td> <td style="width: 10%;"></td> <td style="width: 10%;"></td> <td style="width: 10%;"></td> <td style="width: 10%;"></td> <td style="width: 10%;"></td> <td style="width: 10%;"></td> <td style="width: 10%;"></td> <td style="width: 10%;"></td> <td style="width: 10%;"></td> </tr> <tr> <td></td> <td></td> <td colspan="8" style="text-align: center;"> <table border="1" style="width: 100%; border-collapse: collapse; text-align: center;"> <tr> <td style="width: 10%;"></td> <td style="width: 10%;"></td> <td style="width: 10%;"></td> <td style="width: 10%;"></td> <td style="width: 10%;"></td> <td style="width: 10%;"></td> <td style="width: 10%;"></td> <td style="width: 10%;"></td> <td style="width: 10%;"></td> <td style="width: 10%;"></td> </tr> <tr> <td></td> <td></td> <td colspan="8" style="text-align: center;"> <table border="1" style="width: 100%; border-collapse: collapse; text-align: center;"> <tr> <td style="width: 10%;"></td> <td style="width: 10%;"></td> <td style="width: 10%;"></td> <td style="width: 10%;"></td> <td style="width: 10%;"></td> <td style="width: 10%;"></td> <td style="width: 10%;"></td> <td style="width: 10%;"></td> <td style="width: 10%;"></td> <td style="width: 10%;"></td> </tr> <tr> <td></td> <td></td> <td colspan="8" style="text-align: center;"> <table border="1" style="width: 100%; border-collapse: collapse; text-align: center;"> <tr>
</tr></table></td></tr></table></td></tr></table></td></tr></table></td></tr></table></td></tr></table></td></tr></table></td></tr></table></td></tr></table></td></tr></table></td></tr></table></td></tr></table>
 | | | | | | | | | | | | | | | | | | | | <table border="1" style="width: 100%; border-collapse: collapse; text-align: center;"> <tr> <td style="width: 10%;"></td> <td style="width: 10%;"></td> <td style="width: 10%;"></td> <td style="width: 10%;"></td> <td style="width: 10%;"></td> <td style="width: 10%;"></td> <td style="width: 10%;"></td> <td style="width: 10%;"></td> <td style="width: 10%;"></td> <td style="width: 10%;"></td> </tr> <tr> <td></td> <td></td> <td colspan="8" style="text-align: center;"> <table border="1" style="width: 100%; border-collapse: collapse; text-align: center;"> <tr> <td style="width: 10%;"></td> <td style="width: 10%;"></td> <td style="width: 10%;"></td> <td style="width: 10%;"></td> <td style="width: 10%;"></td> <td style="width: 10%;"></td> <td style="width: 10%;"></td> <td style="width: 10%;"></td> <td style="width: 10%;"></td> <td style="width: 10%;"></td> </tr> <tr> <td></td> <td></td> <td colspan="8" style="text-align: center;"> <table border="1" style="width: 100%; border-collapse: collapse; text-align: center;"> <tr> <td style="width: 10%;"></td> <td style="width: 10%;"></td> <td style="width: 10%;"></td> <td style="width: 10%;"></td> <td style="width: 10%;"></td> <td style="width: 10%;"></td> <td style="width: 10%;"></td> <td style="width: 10%;"></td> <td style="width: 10%;"></td> <td style="width: 10%;"></td> </tr> <tr> <td></td> <td></td> <td colspan="8" style="text-align: center;"> <table border="1" style="width: 100%; border-collapse: collapse; text-align: center;"> <tr> <td style="width: 10%;"></td> <td style="width: 10%;"></td> <td style="width: 10%;"></td> <td style="width: 10%;"></td> <td style="width: 10%;"></td> <td style="width: 10%;"></td> <td style="width: 10%;"></td> <td style="width: 10%;"></td> <td style="width: 10%;"></td> <td style="width: 10%;"></td> </tr> <tr> <td></td> <td></td> <td colspan="8" style="text-align: center;"> <table border="1" style="width: 100%; border-collapse: collapse; text-align: center;"> <tr> <td style="width: 10%;"></td> <td style="width: 10%;"></td> <td style="width: 10%;"></td> <td style="width: 10%;"></td> <td style="width: 10%;"></td> <td style="width: 10%;"></td> <td style="width: 10%;"></td> <td style="width: 10%;"></td> <td style="width: 10%;"></td> <td style="width: 10%;"></td> </tr> <tr> <td></td> <td></td> <td colspan="8" style="text-align: center;"> <table border="1" style="width: 100%; border-collapse: collapse; text-align: center;"> <tr> <td style="width: 10%;"></td> <td style="width: 10%;"></td> <td style="width: 10%;"></td> <td style="width: 10%;"></td> <td style="width: 10%;"></td> <td style="width: 10%;"></td> <td style="width: 10%;"></td> <td style="width: 10%;"></td> <td style="width: 10%;"></td> <td style="width: 10%;"></td> </tr> <tr> <td></td> <td></td> <td colspan="8" style="text-align: center;"> <table border="1" style="width: 100%; border-collapse: collapse; text-align: center;"> <tr> <td style="width: 10%;"></td> <td style="width: 10%;"></td> <td style="width: 10%;"></td> <td style="width: 10%;"></td> <td style="width: 10%;"></td> <td style="width: 10%;"></td> <td style="width: 10%;"></td> <td style="width: 10%;"></td> <td style="width: 10%;"></td> <td style="width: 10%;"></td> </tr> <tr> <td></td> <td></td> <td colspan="8" style="text-align: center;"> <table border="1" style="width: 100%; border-collapse: collapse; text-align: center;"> <tr> <td style="width: 10%;"></td> <td style="width: 10%;"></td> <td style="width: 10%;"></td> <td style="width: 10%;"></td> <td style="width: 10%;"></td> <td style="width: 10%;"></td> <td style="width: 10%;"></td> <td style="width: 10%;"></td> <td style="width: 10%;"></td> <td style="width: 10%;"></td> </tr> <tr> <td></td> <td></td> <td colspan="8" style="text-align: center;"> <table border="1" style="width: 100%; border-collapse: collapse; text-align: center;"> <tr> <td style="width: 10%;"></td> <td style="width: 10%;"></td> <td style="width: 10%;"></td> <td style="width: 10%;"></td> <td style="width: 10%;"></td> <td style="width: 10%;"></td> <td style="width: 10%;"></td> <td style="width: 10%;"></td> <td style="width: 10%;"></td> <td style="width: 10%;"></td> </tr> <tr> <td></td> <td></td> <td
colspan="8" style="text-align: center;"> <table border="1" style="width: 100%; border-collapse: collapse; text-align: center;"> <tr> <td style="width: 10%;"></td> <td style="width: 10%;"></td> <td style="width: 10%;"></td> <td style="width: 10%;"></td> <td style="width: 10%;"></td> <td style="width: 10%;"></td> <td style="width: 10%;"></td> <td style="width: 10%;"></td> <td style="width: 10%;"></td> <td style="width: 10%;"></td> </tr> <tr> <td></td> <td></td> <td colspan="8" style="text-align: center;"> <table border="1" style="width: 100%; border-collapse: collapse; text-align: center;"> <tr> </tr></table></td></tr></table></td></tr></table></td></tr></table></td></tr></table></td></tr></table></td></tr></table></td></tr></table></td></tr></table></td></tr></table></td></tr></table>
 | | | | | | | | | | | | | | | | | | | | <table border="1" style="width: 100%; border-collapse: collapse; text-align: center;"> <tr> <td style="width: 10%;"></td> <td style="width: 10%;"></td> <td style="width: 10%;"></td> <td style="width: 10%;"></td> <td style="width: 10%;"></td> <td style="width: 10%;"></td> <td style="width: 10%;"></td> <td style="width: 10%;"></td> <td style="width: 10%;"></td> <td style="width: 10%;"></td> </tr> <tr> <td></td> <td></td> <td colspan="8" style="text-align: center;"> <table border="1" style="width: 100%; border-collapse: collapse; text-align: center;"> <tr> <td style="width: 10%;"></td> <td style="width: 10%;"></td> <td style="width: 10%;"></td> <td style="width: 10%;"></td> <td style="width: 10%;"></td> <td style="width: 10%;"></td> <td style="width: 10%;"></td> <td style="width: 10%;"></td> <td style="width: 10%;"></td> <td style="width: 10%;"></td> </tr> <tr> <td></td> <td></td> <td colspan="8" style="text-align: center;"> <table border="1" style="width: 100%; border-collapse: collapse; text-align: center;"> <tr> <td style="width: 10%;"></td> <td style="width: 10%;"></td> <td style="width: 10%;"></td> <td style="width: 10%;"></td> <td style="width: 10%;"></td> <td style="width: 10%;"></td> <td style="width: 10%;"></td> <td style="width: 10%;"></td> <td style="width: 10%;"></td> <td style="width: 10%;"></td> </tr> <tr> <td></td> <td></td> <td colspan="8" style="text-align: center;"> <table border="1" style="width: 100%; border-collapse: collapse; text-align: center;"> <tr> <td style="width: 10%;"></td> <td style="width: 10%;"></td> <td style="width: 10%;"></td> <td style="width: 10%;"></td> <td style="width: 10%;"></td> <td style="width: 10%;"></td> <td style="width: 10%;"></td> <td style="width: 10%;"></td> <td style="width: 10%;"></td> <td style="width: 10%;"></td> </tr> <tr> <td></td> <td></td> <td colspan="8" style="text-align: center;"> <table border="1" style="width: 100%; border-collapse: collapse; text-align: center;"> <tr> <td style="width: 10%;"></td> <td style="width: 10%;"></td> <td style="width: 10%;"></td> <td style="width: 10%;"></td> <td style="width: 10%;"></td> <td style="width: 10%;"></td> <td style="width: 10%;"></td> <td style="width: 10%;"></td> <td style="width: 10%;"></td> <td style="width: 10%;"></td> </tr> <tr> <td></td> <td></td> <td colspan="8" style="text-align: center;"> <table border="1" style="width: 100%; border-collapse: collapse; text-align: center;"> <tr> <td style="width: 10%;"></td> <td style="width: 10%;"></td> <td style="width: 10%;"></td> <td style="width: 10%;"></td> <td style="width: 10%;"></td> <td style="width: 10%;"></td> <td style="width: 10%;"></td> <td style="width: 10%;"></td> <td style="width: 10%;"></td> <td style="width: 10%;"></td> </tr> <tr> <td></td> <td></td> <td colspan="8" style="text-align: center;"> <table border="1" style="width: 100%; border-collapse: collapse; text-align: center;"> <tr> <td style="width: 10%;"></td> <td style="width: 10%;"></td> <td style="width: 10%;"></td> <td style="width: 10%;"></td> <td style="width: 10%;"></td> <td style="width: 10%;"></td> <td style="width: 10%;"></td> <td style="width: 10%;"></td> <td style="width: 10%;"></td> <td style="width: 10%;"></td> </tr> <tr> <td></td> <td></td> <td colspan="8" style="text-align: center;"> <table border="1" style="width: 100%; border-collapse: collapse; text-align: center;"> <tr> <td style="width: 10%;"></td> <td style="width: 10%;"></td> <td style="width: 10%;"></td> <td style="width: 10%;"></td> <td style="width: 10%;"></td> <td style="width: 10%;"></td> <td style="width: 10%;"></td> <td
style="width: 10%;"></td> <td style="width: 10%;"></td> <td style="width: 10%;"></td> </tr> <tr> <td></td> <td></td> <td colspan="8" style="text-align: center;"> <table border="1" style="width: 100%; border-collapse: collapse; text-align: center;"> <tr> <td style="width: 10%;"></td> <td style="width: 10%;"></td> <td style="width: 10%;"></td> <td style="width: 10%;"></td> <td style="width: 10%;"></td> <td style="width: 10%;"></td> <td style="width: 10%;"></td> <td style="width: 10%;"></td> <td style="width: 10%;"></td> <td style="width: 10%;"></td> </tr> <tr> <td></td> <td></td> <td colspan="8" style="text-align: center;"> <table border="1" style="width: 100%; border-collapse: collapse; text-align: center;"> <tr> </tr></table></td></tr></table></td></tr></table></td></tr></table></td></tr></table></td></tr></table></td></tr></table></td></tr></table></td></tr></table></td></tr></table>
 | | | | | | | | | | | | | | | | | | | | <table border="1" style="width: 100%; border-collapse: collapse; text-align: center;"> <tr> <td style="width: 10%;"></td> <td style="width: 10%;"></td> <td style="width: 10%;"></td> <td style="width: 10%;"></td> <td style="width: 10%;"></td> <td style="width: 10%;"></td> <td style="width: 10%;"></td> <td style="width: 10%;"></td> <td style="width: 10%;"></td> <td style="width: 10%;"></td> </tr> <tr> <td></td> <td></td> <td colspan="8" style="text-align: center;"> <table border="1" style="width: 100%; border-collapse: collapse; text-align: center;"> <tr> <td style="width: 10%;"></td> <td style="width: 10%;"></td> <td style="width: 10%;"></td> <td style="width: 10%;"></td> <td style="width: 10%;"></td> <td style="width: 10%;"></td> <td style="width: 10%;"></td> <td style="width: 10%;"></td> <td style="width: 10%;"></td> <td style="width: 10%;"></td> </tr> <tr> <td></td> <td></td> <td colspan="8" style="text-align: center;"> <table border="1" style="width: 100%; border-collapse: collapse; text-align: center;"> <tr> <td style="width: 10%;"></td> <td style="width: 10%;"></td> <td style="width: 10%;"></td> <td style="width: 10%;"></td> <td style="width: 10%;"></td> <td style="width: 10%;"></td> <td style="width: 10%;"></td> <td style="width: 10%;"></td> <td style="width: 10%;"></td> <td style="width: 10%;"></td> </tr> <tr> <td></td> <td></td> <td colspan="8" style="text-align: center;"> <table border="1" style="width: 100%; border-collapse: collapse; text-align: center;"> <tr> <td style="width: 10%;"></td> <td style="width: 10%;"></td> <td style="width: 10%;"></td> <td style="width: 10%;"></td> <td style="width: 10%;"></td> <td style="width: 10%;"></td> <td style="width: 10%;"></td> <td style="width: 10%;"></td> <td style="width: 10%;"></td> <td style="width: 10%;"></td> </tr> <tr> <td></td> <td></td> <td colspan="8" style="text-align: center;"> <table border="1" style="width: 100%; border-collapse: collapse; text-align: center;"> <tr> <td style="width: 10%;"></td> <td style="width: 10%;"></td> <td style="width: 10%;"></td> <td style="width: 10%;"></td> <td style="width: 10%;"></td> <td style="width: 10%;"></td> <td style="width: 10%;"></td> <td style="width: 10%;"></td> <td style="width: 10%;"></td> <td style="width: 10%;"></td> </tr> <tr> <td></td> <td></td> <td colspan="8" style="text-align: center;"> <table border="1" style="width: 100%; border-collapse: collapse; text-align: center;"> <tr> <td style="width: 10%;"></td> <td style="width: 10%;"></td> <td style="width: 10%;"></td> <td style="width: 10%;"></td> <td style="width: 10%;"></td> <td style="width: 10%;"></td> <td style="width: 10%;"></td> <td style="width: 10%;"></td> <td style="width: 10%;"></td> <td style="width: 10%;"></td> </tr> <tr> <td></td> <td></td> <td colspan="8" style="text-align: center;"> <table border="1" style="width: 100%; border-collapse: collapse; text-align: center;"> <tr> <td style="width: 10%;"></td> <td style="width: 10%;"></td> <td style="width: 10%;"></td> <td style="width: 10%;"></td> <td style="width: 10%;"></td> <td style="width: 10%;"></td> <td style="width: 10%;"></td> <td style="width: 10%;"></td> <td style="width: 10%;"></td> <td style="width: 10%;"></td> </tr> <tr> <td></td> <td></td> <td colspan="8" style="text-align: center;"> <table border="1" style="width: 100%; border-collapse: collapse; text-align: center;"> <tr> <td style="width: 10%;"></td> <td style="width: 10%;"></td> <td style="width: 10%;"></td> <td style="width: 10%;"></td>
<td style="width: 10%;"></td> <td style="width: 10%;"></td> <td style="width: 10%;"></td> <td style="width: 10%;"></td> <td style="width: 10%;"></td> <td style="width: 10%;"></td> </tr> <tr> <td></td> <td></td> <td colspan="8" style="text-align: center;"> <table border="1" style="width: 100%; border-collapse: collapse; text-align: center;"> <tr> </tr></table></td></tr></table></td></tr></table></td></tr></table></td></tr></table></td></tr></table></td></tr></table></td></tr></table></td></tr></table>
 | | | | | | | | | | | | | | | | | | | | <table border="1" style="width: 100%; border-collapse: collapse; text-align: center;"> <tr> <td style="width: 10%;"></td> <td style="width: 10%;"></td> <td style="width: 10%;"></td> <td style="width: 10%;"></td> <td style="width: 10%;"></td> <td style="width: 10%;"></td> <td style="width: 10%;"></td> <td style="width: 10%;"></td> <td style="width: 10%;"></td> <td style="width: 10%;"></td> </tr> <tr> <td></td> <td></td> <td colspan="8" style="text-align: center;"> <table border="1" style="width: 100%; border-collapse: collapse; text-align: center;"> <tr> <td style="width: 10%;"></td> <td style="width: 10%;"></td> <td style="width: 10%;"></td> <td style="width: 10%;"></td> <td style="width: 10%;"></td> <td style="width: 10%;"></td> <td style="width: 10%;"></td> <td style="width: 10%;"></td> <td style="width: 10%;"></td> <td style="width: 10%;"></td> </tr> <tr> <td></td> <td></td> <td colspan="8" style="text-align: center;"> <table border="1" style="width: 100%; border-collapse: collapse; text-align: center;"> <tr> <td style="width: 10%;"></td> <td style="width: 10%;"></td> <td style="width: 10%;"></td> <td style="width: 10%;"></td> <td style="width: 10%;"></td> <td style="width: 10%;"></td> <td style="width: 10%;"></td> <td style="width: 10%;"></td> <td style="width: 10%;"></td> <td style="width: 10%;"></td> </tr> <tr> <td></td> <td></td> <td colspan="8" style="text-align: center;"> <table border="1" style="width: 100%; border-collapse: collapse; text-align: center;"> <tr> <td style="width: 10%;"></td> <td style="width: 10%;"></td> <td style="width: 10%;"></td> <td style="width: 10%;"></td> <td style="width: 10%;"></td> <td style="width: 10%;"></td> <td style="width: 10%;"></td> <td style="width: 10%;"></td> <td style="width: 10%;"></td> <td style="width: 10%;"></td> </tr> <tr> <td></td> <td></td> <td colspan="8" style="text-align: center;"> <table border="1" style="width: 100%; border-collapse: collapse; text-align: center;"> <tr> <td style="width: 10%;"></td> <td style="width: 10%;"></td> <td style="width: 10%;"></td> <td style="width: 10%;"></td> <td style="width: 10%;"></td> <td style="width: 10%;"></td> <td style="width: 10%;"></td> <td style="width: 10%;"></td> <td style="width: 10%;"></td> <td style="width: 10%;"></td> </tr> <tr> <td></td> <td></td> <td colspan="8" style="text-align: center;"> <table border="1" style="width: 100%; border-collapse: collapse; text-align: center;"> <tr> <td style="width: 10%;"></td> <td style="width: 10%;"></td> <td style="width: 10%;"></td> <td style="width: 10%;"></td> <td style="width: 10%;"></td> <td style="width: 10%;"></td> <td style="width: 10%;"></td> <td style="width: 10%;"></td> <td style="width: 10%;"></td> <td style="width: 10%;"></td> </tr> <tr> <td></td> <td></td> <td colspan="8" style="text-align: center;"> <table border="1" style="width: 100%; border-collapse: collapse; text-align: center;"> <tr> <td style="width: 10%;"></td> <td style="width: 10%;"></td> <td style="width: 10%;"></td> <td style="width: 10%;"></td> <td style="width: 10%;"></td> <td style="width: 10%;"></td> <td style="width: 10%;"></td> <td style="width: 10%;"></td> <td style="width: 10%;"></td> <td style="width: 10%;"></td> </tr> <tr> <td></td> <td></td> <td colspan="8" style="text-align: center;"> <table border="1" style="width: 100%; border-collapse: collapse; text-align: center;"> <tr> </tr></table></td></tr></table></td></tr></table></td></tr></table></td></tr></table></td></tr></table></td></tr></table></td></tr></table>

 | | | | | | | | | | | | | | | | | | | | <table border="1" style="width: 100%; border-collapse: collapse; text-align: center;"> <tr> <td style="width: 10%;"></td> <td style="width: 10%;"></td> <td style="width: 10%;"></td> <td style="width: 10%;"></td> <td style="width: 10%;"></td> <td style="width: 10%;"></td> <td style="width: 10%;"></td> <td style="width: 10%;"></td> <td style="width: 10%;"></td> <td style="width: 10%;"></td> </tr> <tr> <td></td> <td></td> <td colspan="8" style="text-align: center;"> <table border="1" style="width: 100%; border-collapse: collapse; text-align: center;"> <tr> <td style="width: 10%;"></td> <td style="width: 10%;"></td> <td style="width: 10%;"></td> <td style="width: 10%;"></td> <td style="width: 10%;"></td> <td style="width: 10%;"></td> <td style="width: 10%;"></td> <td style="width: 10%;"></td> <td style="width: 10%;"></td> <td style="width: 10%;"></td> </tr> <tr> <td></td> <td></td> <td colspan="8" style="text-align: center;"> <table border="1" style="width: 100%; border-collapse: collapse; text-align: center;"> <tr> <td style="width: 10%;"></td> <td style="width: 10%;"></td> <td style="width: 10%;"></td> <td style="width: 10%;"></td> <td style="width: 10%;"></td> <td style="width: 10%;"></td> <td style="width: 10%;"></td> <td style="width: 10%;"></td> <td style="width: 10%;"></td> <td style="width: 10%;"></td> </tr> <tr> <td></td> <td></td> <td colspan="8" style="text-align: center;"> <table border="1" style="width: 100%; border-collapse: collapse; text-align: center;"> <tr> <td style="width: 10%;"></td> <td style="width: 10%;"></td> <td style="width: 10%;"></td> <td style="width: 10%;"></td> <td style="width: 10%;"></td> <td style="width: 10%;"></td> <td style="width: 10%;"></td> <td style="width: 10%;"></td> <td style="width: 10%;"></td> <td style="width: 10%;"></td> </tr> <tr> <td></td> <td></td> <td colspan="8" style="text-align: center;"> <table border="1" style="width: 100%; border-collapse: collapse; text-align: center;"> <tr> <td style="width: 10%;"></td> <td style="width: 10%;"></td> <td style="width: 10%;"></td> <td style="width: 10%;"></td> <td style="width: 10%;"></td> <td style="width: 10%;"></td> <td style="width: 10%;"></td> <td style="width: 10%;"></td> <td style="width: 10%;"></td> <td style="width: 10%;"></td> </tr> <tr> <td></td> <td></td> <td colspan="8" style="text-align: center;"> <table border="1" style="width: 100%; border-collapse: collapse; text-align: center;"> <tr> <td style="width: 10%;"></td> <td style="width: 10%;"></td> <td style="width: 10%;"></td> <td style="width: 10%;"></td> <td style="width: 10%;"></td> <td style="width: 10%;"></td> <td style="width: 10%;"></td> <td style="width: 10%;"></td> <td style="width: 10%;"></td> <td style="width: 10%;"></td> </tr> <tr> <td></td> <td></td> <td colspan="8" style="text-align: center;"> <table border="1" style="width: 100%; border-collapse: collapse; text-align: center;"> <tr> </tr></table></td></tr></table></td></tr></table></td></tr></table></td></tr></table></td></tr></table></td></tr></table>

 | | | | | | | | | | | | | | | | | | | | <table border="1" style="width: 100%; border-collapse: collapse; text-align: center;"> <tr> <td style="width: 10%;"></td> <td style="width: 10%;"></td> <td style="width: 10%;"></td> <td style="width: 10%;"></td> <td style="width: 10%;"></td> <td style="width: 10%;"></td> <td style="width: 10%;"></td> <td style="width: 10%;"></td> <td style="width: 10%;"></td> <td style="width: 10%;"></td> </tr> <tr> <td></td> <td></td> <td colspan="8" style="text-align: center;"> <table border="1" style="width: 100%; border-collapse: collapse; text-align: center;"> <tr> <td style="width: 10%;"></td> <td style="width: 10%;"></td> <td style="width: 10%;"></td> <td style="width: 10%;"></td> <td style="width: 10%;"></td> <td style="width: 10%;"></td> <td style="width: 10%;"></td> <td style="width: 10%;"></td> <td style="width: 10%;"></td> <td style="width: 10%;"></td> </tr> <tr> <td></td> <td></td> <td colspan="8" style="text-align: center;"> <table border="1" style="width: 100%; border-collapse: collapse; text-align: center;"> <tr> <td style="width: 10%;"></td> <td style="width: 10%;"></td> <td style="width: 10%;"></td> <td style="width: 10%;"></td> <td style="width: 10%;"></td> <td style="width: 10%;"></td> <td style="width: 10%;"></td> <td style="width: 10%;"></td> <td style="width: 10%;"></td> <td style="width: 10%;"></td> </tr> <tr> <td></td> <td></td> <td colspan="8" style="text-align: center;"> <table border="1" style="width: 100%; border-collapse: collapse; text-align: center;"> <tr> <td style="width: 10%;"></td> <td style="width: 10%;"></td> <td style="width: 10%;"></td> <td style="width: 10%;"></td> <td style="width: 10%;"></td> <td style="width: 10%;"></td> <td style="width: 10%;"></td> <td style="width: 10%;"></td> <td style="width: 10%;"></td> <td style="width: 10%;"></td> </tr> <tr> <td></td> <td></td> <td colspan="8" style="text-align: center;"> <table border="1" style="width: 100%; border-collapse: collapse; text-align: center;"> <tr> <td style="width: 10%;"></td> <td style="width: 10%;"></td> <td style="width: 10%;"></td> <td style="width: 10%;"></td> <td style="width: 10%;"></td> <td style="width: 10%;"></td> <td style="width: 10%;"></td> <td style="width: 10%;"></td> <td style="width: 10%;"></td> <td style="width: 10%;"></td> </tr> <tr> <td></td> <td></td> <td colspan="8" style="text-align: center;"> <table border="1" style="width: 100%; border-collapse: collapse; text-align: center;"> <tr> </tr></table></td></tr></table></td></tr></table></td></tr></table></td></tr></table></td></tr></table>

 | | | | | | | | | | | | | | | | | | | | <table border="1" style="width: 100%; border-collapse: collapse; text-align: center;"> <tr> <td style="width: 10%;"></td> <td style="width: 10%;"></td> <td style="width: 10%;"></td> <td style="width: 10%;"></td> <td style="width: 10%;"></td> <td style="width: 10%;"></td> <td style="width: 10%;"></td> <td style="width: 10%;"></td> <td style="width: 10%;"></td> <td style="width: 10%;"></td> </tr> <tr> <td></td> <td></td> <td colspan="8" style="text-align: center;"> <table border="1" style="width: 100%; border-collapse: collapse; text-align: center;"> <tr> <td style="width: 10%;"></td> <td style="width: 10%;"></td> <td style="width: 10%;"></td> <td style="width: 10%;"></td> <td style="width: 10%;"></td> <td style="width: 10%;"></td> <td style="width: 10%;"></td> <td style="width: 10%;"></td> <td style="width: 10%;"></td> <td style="width: 10%;"></td> </tr> <tr> <td></td> <td></td> <td colspan="8" style="text-align: center;"> <table border="1" style="width: 100%; border-collapse: collapse; text-align: center;"> <tr> <td style="width: 10%;"></td> <td style="width: 10%;"></td> <td style="width: 10%;"></td> <td style="width: 10%;"></td> <td style="width: 10%;"></td> <td style="width: 10%;"></td> <td style="width: 10%;"></td> <td style="width: 10%;"></td> <td style="width: 10%;"></td> <td style="width: 10%;"></td> </tr> <tr> <td></td> <td></td> <td colspan="8" style="text-align: center;"> <table border="1" style="width: 100%; border-collapse: collapse; text-align: center;"> <tr> <td style="width: 10%;"></td> <td style="width: 10%;"></td> <td style="width: 10%;"></td> <td style="width: 10%;"></td> <td style="width: 10%;"></td> <td style="width: 10%;"></td> <td style="width: 10%;"></td> <td style="width: 10%;"></td> <td style="width: 10%;"></td> <td style="width: 10%;"></td> </tr> <tr> <td></td> <td></td> <td colspan="8" style="text-align: center;"> <table border="1" style="width: 100%; border-collapse: collapse; text-align: center;"> <tr> </tr></table></td></tr></table></td></tr></table></td></tr></table></td></tr></table>
 | | | | | | | | | | | | | | | | | | | | <table border="1" style="width: 100%; border-collapse: collapse; text-align: center;"> <tr> <td style="width: 10%;"></td> <td style="width: 10%;"></td> <td style="width: 10%;"></td> <td style="width: 10%;"></td> <td style="width: 10%;"></td> <td style="width: 10%;"></td> <td style="width: 10%;"></td> <td style="width:
10%;"></td> <td style="width: 10%;"></td> <td style="width: 10%;"></td> </tr> <tr> <td></td> <td></td> <td colspan="8" style="text-align: center;"> <table border="1" style="width: 100%; border-collapse: collapse; text-align: center;"> <tr> <td style="width: 10%;"></td> <td style="width: 10%;"></td> <td style="width: 10%;"></td> <td style="width: 10%;"></td> <td style="width: 10%;"></td> <td style="width: 10%;"></td> <td style="width: 10%;"></td> <td style="width: 10%;"></td> <td style="width: 10%;"></td> <td style="width: 10%;"></td> </tr> <tr> <td></td> <td></td> <td colspan="8" style="text-align: center;"> <table border="1" style="width: 100%; border-collapse: collapse; text-align: center;"> <tr> <td style="width: 10%;"></td> <td style="width: 10%;"></td> <td style="width: 10%;"></td> <td style="width: 10%;"></td> <td style="width: 10%;"></td> <td style="width: 10%;"></td> <td style="width: 10%;"></td> <td style="width: 10%;"></td> <td style="width: 10%;"></td> <td style="width: 10%;"></td> </tr> <tr> <td></td> <td></td> <td colspan="8" style="text-align: center;"> <table border="1" style="width: 100%; border-collapse: collapse; text-align: center;"> <tr> </tr></table></td></tr></table></td></tr></table></td></tr></table>
 | | | | | | | | | | | | | | | | | | | | <table border="1" style="width: 100%; border-collapse: collapse; text-align: center;"> <tr> <td style="width: 10%;"></td> <td style="width: 10%;"></td> <td style="width: 10%;"></td> <td style="width: 10%;"></td> <td style="width: 10%;"></td> <td style="width: 10%;"></td> <td style="width: 10%;"></td> <td style="width: 10%;"></td> <td style="width: 10%;"></td> <td style="width: 10%;"></td> </tr> <tr> <td></td> <td></td> <td colspan="8" style="text-align: center;"> <table border="1" style="width: 100%; border-collapse: collapse; text-align: center;"> <tr> <td style="width: 10%;"></td> <td style="width: 10%;"></td> <td style="width: 10%;"></td> <td style="width: 10%;"></td> <td style="width: 10%;"></td> <td style="width: 10%;"></td> <td style="width: 10%;"></td> <td style="width: 10%;"></td> <td style="width: 10%;"></td> <td style="width: 10%;"></td> </tr> <tr> <td></td> <td></td> <td colspan="8" style="text-align: center;"> <table border="1" style="width: 100%; border-collapse: collapse; text-align: center;"> <tr> </tr></table></td></tr></table></td></tr></table>

 | | | | | | | | | | | | | | | | | | | | <table border="1" style="width: 100%; border-collapse: collapse; text-align: center;"> <tr> <td style="width: 10%;"></td> <td style="width: 10%;"></td> <td style="width: 10%;"></td> <td style="width: 10%;"></td> <td style="width: 10%;"></td> <td style="width: 10%;"></td> <td style="width: 10%;"></td> <td style="width: 10%;"></td> <td style="width: 10%;"></td> <td style="width: 10%;"></td> </tr> <tr> <td></td> <td></td> <td colspan="8" style="text-align: center;"> <table border="1" style="width: 100%; border-collapse: collapse; text-align: center;"> <tr> </tr></table></td></tr></table>
 | | | | | | | | | | | | | | | | | | | | <table border="1" style="width: 100%; border-collapse: collapse; text-align: center;"> <tr> </tr></table>

 | | | | | | | | | | | | | | | | | | | |

 | | | | | | | | | | | | | | | | | | | |
 | | | | | | | | | | | | | | | | | | | |
 | | | | | | | | | | | | | | | | | | | |

 | | | | | | | | | | | | | | | | | | | |
 | | | | | | | | | | | | | | | | | | | |
 | | | | | | | | | | | | | | | | | | | |

 | | | | | | | | | | | | | | | | | | | | | | | | | | | | | | | | | | | | | | | | | | | | | | | | | | | | | | | | | | | | | | | | | | | | | | | | | | | | | | | | | | | | | | | | | | | | | | | | | | | |
 | | | | | | | | | | | | | | | | | | | |
 | | | | | | | | | | | | | | | | | | | |
 | | | | | | | | | | | | | | | | | | | |
 | | | | | | | | | | | | | | | | | | | |
 | | | | | | | | | | | | | | | | | | | |
 | | | | | | | | | | | | | | | | | | | |
 | | | | | | | | | | | | | | | | | | | |
 | | | | | | | | | | | | | | | | | | | |
 | | | | | | | | | | | | | | | | | | | | | | | | | | | | | | | | | | | | | | | |
 | | | | | | | | | | | | | | | | | | | |
 | | | | | | | | | | | | | | | | | | | | | | | | | | | | | | | | | | | | | | | |
 | | | | | | | | | | | | | | | | | | | | | | | | | | | | | | | | | | | | | | | |
 | | | | | | | | | | | | | | | | | | | | | | | | | | | | | | | | | | | | | | | |
 | | | | | | | | | | | | | | | | | | | | | | | | | | | | | | | | | | | | | | | | | | | | | | | | | | | | | | | | | | | | | | | | | | | | | | | | | | | | | | | | | | | | | | | | | | | | | | | | | | | |
 | | | | | | | | | | | | | | | | | | | | | | | | | | | | | | | | | | | | | | | | | | | | | | | |
| | |

 | | | | | | | | | | | | | | | | | | | |

 | | | | | | | | | | | | | | | | | | | |

 | | | | | | | | | | | | | | | | | | | |

 | | | | | | | | | | | | | | | | | | | |

 | | | | | | | | | | | | | | | | | | | |

 | | | | | | | | | | | | | | | | | | | |

 | | | | | | | | | | | | | | | | | | | |

 | | | | | | | | | | | | | | | | | | | |

 | | | | | | | | | | | | | | | | | | | |

 | | | | | | | | | | | | | | | | | | | |

 | | | | | | | | | | | | | | | | | | | |

 | | | | | | | | | | | | | | | | | | | |

 | | | | | | | | | | | | | | | | | | | |

 | | | | | | | | | | | | | | | | | | | |

 | | | | | | | | | | | | | | | | | | | |

 | | | | | | | | | | | | | | | | | | | |

 | | | | | | | | | | | | | | | | | | | |

 | | | | | | | | | | | | | | | | | | | |

 | | | | | | | | | | | | | | | | | | | |

 | | | | | | | | | | | | | | | | | | | |

 | | | | | | | | | | | | | | | | | | | |

 | | | | | | | | | | | | | | | | | | | |

 | | | | | | | | | | | | | | | | | | | |

 | | | | | | | | | | | | | | | | | | | |

 | | | | | | | | | | | | | | | | | | | |

 | | | | | | | | | | | | | | | | | | | |

 | | | | | | | | | | | | | | | | | | | |

 | | | | | | | | | | | | | | | | | | | |
 | | | | | | | | | | | | | | | | | | | |

 | | | | | | | | | | | | | | | | | | | |

 | | | | | | | | | | | | | | | | | | | |
 | | | | | | | | | | | | | | | | | | | |

 | | | | | | | | | | | | | | | | | | | |

 | | | | | | | | | | | | | | | | | | | |
 | | | | | | | | | | | | | | | | | | | |
 | | | | | | | | | | | | | | | | | | | |

 | | | | | | | | | | | | | | | | | | | |
 | | | | | | | | | | | | | | | | | | | |
 | | | | | | | | | | | | | | | | | | | |

 | | | | | | | | | | | | | | | | | | | | | | | | | | | | | | | | | | | | | | | | | | | | | | | | | | | | | | | | | | | | | | | | | | | | | | | | | | | | | | | | | | | | | | | | | | | | | | | | | | | |
 | | | | | | | | | | | | | | | | | | | |
 | | | | | | | | | | | | | | | | | | | |
 | | | | | | | | | | | | | | | | | | | |
 | | | | | | | | | | | | | | | | | | | |
 | | | | | | | | | | | | | | | | | | | |
 | | | | | | | | | | | | | | | | | | | |
 | | | | | | | | | | | | | | | | | | | |
 | | | | | | | | | | | | | | | | | | | |
 | | | | | | | | | | | | | | | | | | | | | | | | | | | | | | | | | | | | | | | |
 | | | | | | | | | | | | | | | | | | | |
 | | | | | | | | | | | | | | | | | | | | | | | | | | | | | | | | | | | | | | | |
 | | | | | | | | | | | | | | | | | | | | | | | | | | | | | | | | | | | | | | | |
 | | | | | | | | | | | | | | | | | | | | | | | | | | | | | | | | | | | | | | | |
 | | | | | | | | | | | | | | | | | | | | | | | | | | | | | | | | | | | | | | | | | | | | | | | | | | | | | | | | | | | | | | | | | | | | | | | | | | | | | | | | | | | | | | | | | | | | | | | | | | | |
 | | | | | | | | | | | | | | | | | | | | | | | | | | | | | | | | | | | | | | | | | | | | | | | |
| | | <table border="1" style="width: 100%; border-collapse: collapse; text-align: center;"> <tr> <td style="width: 10%;"></td> <td style="width: 10%;"></td> <td style="width: 10%;"></td> <td style="width: 10%;"></td> <td style="width: 10%;"></td> <td style="width: 10%;"></td> <td style="width: 10%;"></td> <td style="width: 10%;"></td> <td style="width: 10%;"></td> <td style="width: 10%;"></td> </tr> <tr> <td></td> <td></td> <td colspan="8" style="text-align: center;"> <table border="1" style="width: 100%; border-collapse: collapse; text-align: center;"> <tr> <td style="width: 10%;"></td> <td style="width: 10%;"></td> <td style="width: 10%;"></td> <td style="width: 10%;"></td> <td style="width: 10%;"></td> <td style="width: 10%;"></td> <td style="width: 10%;"></td> <td style="width: 10%;"></td> <td style="width: 10%;"></td> <td style="width: 10%;"></td> </tr> <tr> <td></td> <td></td> <td colspan="8" style="text-align: center;"> <table border="1" style="width: 100%; border-collapse: collapse; text-align: center;"> <tr> <td style="width: 10%;"></td> <td style="width: 10%;"></td> <td style="width: 10%;"></td> <td style="width: 10%;"></td> <td style="width: 10%;"></td> <td style="width: 10%;"></td> <td style="width: 10%;"></td> <td style="width: 10%;"></td> <td style="width: 10%;"></td> <td style="width: 10%;"></td> </tr> <tr> <td></td> <td></td> <td colspan="8" style="text-align: center;"> <table border="1" style="width: 100%; border-collapse: collapse; text-align: center;"> <tr> <td style="width: 10%;"></td> <td style="width: 10%;"></td> <td style="width: 10%;"></td> <td style="width: 10%;"></td> <td style="width: 10%;"></td> <td style="width: 10%;"></td> <td style="width: 10%;"></td> <td style="width: 10%;"></td> <td style="width: 10%;"></td> <td style="width: 10%;"></td> </tr> <tr> <td></td> <td></td> <td colspan="8" style="text-align: center;"> <table border="1" style="width: 100%; border-collapse: collapse; text-align: center;"> <tr> <td style="width: 10%;"></td> <td style="width: 10%;"></td> <td style="width: 10%;"></td> <td style="width: 10%;"></td> <td style="width: 10%;"></td> <td style="width: 10%;"></td> <td style="width: 10%;"></td> <td style="width: 10%;"></td> <td style="width: 10%;"></td> <td style="width: 10%;"></td> </tr> <tr> <td></td> <td></td> <td colspan="8" style="text-align: center;"> <table border="1" style="width: 100%; border-collapse: collapse; text-align: center;"> <tr> <td style="width: 10%;"></td> <td style="width: 10%;"></td> <td style="width: 10%;"></td> <td style="width: 10%;"></td> <td style="width: 10%;"></td> <td style="width: 10%;"></td> <td style="width: 10%;"></td> <td style="width: 10%;"></td> <td style="width: 10%;"></td> <td style="width: 10%;"></td> </tr> <tr> <td></td> <td></td> <td colspan="8" style="text-align: center;"> <table border="1" style="width: 100%; border-collapse: collapse; text-align: center;"> <tr> <td style="width: 10%;"></td> <td style="width: 10%;"></td> <td style="width: 10%;"></td> <td style="width: 10%;"></td> <td style="width: 10%;"></td> <td style="width: 10%;"></td> <td style="width: 10%;"></td> <td style="width: 10%;"></td> <td style="width: 10%;"></td> <td style="width: 10%;"></td> </tr> <tr> <td></td> <td></td> <td colspan="8" style="text-align: center;"> <table border="1" style="width: 100%; border-collapse: collapse; text-align: center;"> <tr> <td style="width: 10%;"></td> <td style="width: 10%;"></td> <td style="width: 10%;"></td> <td style="width: 10%;"></td> <td style="width: 10%;"></td> <td style="width: 10%;"></td> <td style="width: 10%;"></td> <td style="width: 10%;"></td> <td style="width: 10%;"></td> <td style="width: 10%;"></td> </tr> <tr> <td></td> <td></td> <td colspan="8" style="text-align: center;"> <table border="1" style="width: 100%; border-collapse: collapse; text-align: center;"> <tr> <td style="width: 10%;"></td> <td style="width: 10%;"></td> <td style="width: 10%;"></td> <td style="width: 10%;"></td> <td style="width: 10%;"></td> <td style="width: 10%;"></td> <td style="width: 10%;"></td> <td style="width: 10%;"></td> <td style="width: 10%;"></td> <td style="width: 10%;"></td> </tr> <tr> <td></td> <td></td> <td colspan="8" style="text-align: center;"> <table border="1" style="width: 100%; border-collapse: collapse; text-align: center;"> <tr> <td style="width: 10%;"></td> <td style="width: 10%;"></td> <td style="width: 10%;"></td> <td style="width: 10%;"></td> <td style="width: 10%;"></td> <td style="width: 10%;"></td> <td style="width: 10%;"></td> <td style="width: 10%;"></td> <td style="width: 10%;"></td> <td style="width: 10%;"></td> </tr> <tr> <td></td> <td></td> <td colspan="8" style="text-align: center;"> <table border="1" style="width: 100%; border-collapse: collapse; text-align: center;"> <tr> <td style="width: 10%;"></td> <td style="width: 10%;"></td> <td style="width: 10%;"></td> <td style="width: 10%;"></td> <td style="width: 10%;"></td> <td style="width: 10%;"></td> <td style="width: 10%;"></td> <td style="width: 10%;"></td> <td style="width: 10%;"></td> <td style="width: 10%;"></td> </tr> <tr> <td></td> <td></td> <td colspan="8" style="text-align: center;"> <table border="1" style="width: 100%; border-collapse: collapse; text-align: center;"> <tr> <td style="width: 10%;"></td> <td style="width: 10%;"></td> <td style="width: 10%;"></td> <td style="width: 10%;"></td> <td style="width: 10%;"></td> <td style="width: 10%;"></td> <td style="width: 10%;"></td> <td style="width: 10%;"></td> <td style="width: 10%;"></td> <td style="width: 10%;"></td> </tr> <tr> <td></td> <td></td> <td colspan="8" style="text-align: center;"> <table border="1" style="width: 100%; border-collapse: collapse; text-align: center;"> <tr> <td style="width: 10%;"></td> <td style="width: 10%;"></td> <td style="width: 10%;"></td> <td style="width: 10%;"></td> <td style="width: 10%;"></td> <td style="width: 10%;"></td> <td style="width: 10%;"></td> <td style="width: 10%;"></td> <td style="width: 10%;"></td> <td style="width: 10%;"></td> </tr> <tr> <td></td> <td></td> <td colspan="8" style="text-align: center;"> <table border="1" style="width: 100%; border-collapse: collapse; text-align: center;"> <tr> <td style="width: 10%;"></td> <td style="width: 10%;"></td> <td style="width: 10%;"></td> <td style="width: 10%;"></td> <td style="width: 10%;"></td> <td style="width: 10%;"></td> <td style="width: 10%;"></td> <td style="width: 10%;"></td> <td style="width: 10%;"></td> <td style="width: 10%;"></td> </tr> <tr> <td></td> <td></td> <td colspan="8" style="text-align: center;"> <table border="1" style="width: 100%; border-collapse: collapse; text-align: center;"> <tr> <td style="width: 10%;"></td> <td style="width: 10%;"></td> <td style="width: 10%;"></td> <td style="width: 10%;"></td> <td style="width: 10%;"></td> <td style="width: 10%;"></td> <td style="width: 10%;"></td> <td style="width: 10%;"></td> <td style="width: 10%;"></td> <td style="width: 10%;"></td> </tr> <tr> <td></td> <td></td> <td colspan="8" style="text-align: center;"> <table border="1" style="width: 100%; border-collapse: collapse; text-align: center;"> <tr> <td style="width: 10%;"></td> <td style="width: 10%;"></td> <td style="width: 10%;"></td> <td style="width: 10%;"></td> <td style="width: 10%;"></td> <td style="width: 10%;"></td> <td style="width: 10%;"></td> <td style="width: 10%;"></td> <td style="width: 10%;"></td> <td style="width: 10%;"></td> </tr> <tr> <td></td> <td></td> <td colspan="8" style="text-align: center;"> <table border="1" style="width: 100%; border-collapse: collapse; text-align: center;"> <tr> <td style="width: 10%;"></td> <td style="width: 10%;"></td> <td style="width: 10%;"></td> <td style="width: 10%;"></td> <td style="width: 10%;"></td> <td style="width: 10%;"></td> <td style="width: 10%;"></td> <td style="width: 10%;"></td> <td style="width: 10%;"></td> <td style="width: 10%;"></td> </tr> <tr> <td></td> <td></td> <td colspan="8" style="text-align: center;"> <table border="1" style="width: 100%; border-collapse: collapse; text-align: center;"> <tr> <td style="width: 10%;"></td> <td style="width: 10%;"></td> <td style="width: 10%;"></td> <td style="width: 10%;"></td> <td style="width: 10%;"></td> <td style="width: 10%;"></td> <td style="width: 10%;"></td> <td style="width: 10%;"></td> <td style="width: 10%;"></td> <td style="width: 10%;"></td> </tr> <tr> <td></td> <td></td> <td colspan="8" style="text-align: center;"> <table border="1" style="width: 100%; border-collapse: collapse; text-align: center;"> <tr> <td style="width: 10%;"></td> <td style="width: 10%;"></td> <td style="width: 10%;"></td> <td style="width: 10%;"></td> <td style="width: 10%;"></td> <td style="width: 10%;"></td> <td style="width: 10%;"></td> <td style="width: 10%;"></td> <td style="width: 10%;"></td> <td style="width: 10%;"></td> </tr> <tr> <td></td> <td></td> <td colspan="8" style="text-align: center;"> <table border="1" style="width: 100%; border-collapse: collapse; text-align: center;"> <tr> <td style="width: 10%;"></td> <td style="width: 10%;"></td> <td style="width: 10%;"></td> <td style="width: 10%;"></td> <td style="width: 10%;"></td> <td style="width: 10%;"></td> <td style="width: 10%;"></td> <td style="width: 10%;"></td> <td style="width: 10%;"></td> <td style="width: 10%;"></td> </tr> <tr> <td></td> <td></td> <td colspan="8" style="text-align: center;"> <table border="1" style="width: 100%; border-collapse: collapse; text-align: center;"> <tr> <td style="width: 10%;"></td> <td style="width: 10%;"></td> <td style="width: 10%;"></td> <td style="width: 10%;"></td> <td style="width: 10%;"></td> <td style="width: 10%;"></td> <td style="width: 10%;"></td> <td style="width: 10%;"></td> <td style="width: 10%;"></td> <td style="width: 10%;"></td> </tr> <tr> <td></td> <td></td> <td colspan="8" style="text-align: center;"> <table border="1" style="width: 100%; border-collapse: collapse; text-align: center;"> <tr> <td style="width: 10%;"></td> <td style="width: 10%;"></td> <td
style="width: 10%;"></td> <td style="width: 10%;"></td> <td style="width: 10%;"></td> <td style="width: 10%;"></td> <td style="width: 10%;"></td> <td style="width: 10%;"></td> <td style="width: 10%;"></td> <td style="width: 10%;"></td> </tr> <tr> <td></td> <td></td> <td colspan="8" style="text-align: center;"> <table border="1" style="width: 100%; border-collapse: collapse; text-align: center;"> <tr> <td style="width: 10%;"></td> <td style="width: 10%;"></td> <td style="width: 10%;"></td> <td style="width: 10%;"></td> <td style="width: 10%;"></td> <td style="width: 10%;"></td> <td style="width: 10%;"></td> <td style="width: 10%;"></td> <td style="width: 10%;"></td> <td style="width: 10%;"></td> </tr> <tr> <td></td> <td></td> <td colspan="8" style="text-align: center;"> <table border="1" style="width: 100%; border-collapse: collapse; text-align: center;"> <tr> <td style="width: 10%;"></td> <td style="width: 10%;"></td> <td style="width: 10%;"></td> <td style="width: 10%;"></td> <td style="width: 10%;"></td> <td style="width: 10%;"></td> <td style="width: 10%;"></td> <td style="width: 10%;"></td> <td style="width: 10%;"></td> <td style="width: 10%;"></td> </tr> <tr> <td></td> <td></td> <td colspan="8" style="text-align: center;"> <table border="1" style="width: 100%; border-collapse: collapse; text-align: center;"> <tr> <td style="width: 10%;"></td> <td style="width: 10%;"></td> <td style="width: 10%;"></td> <td style="width: 10%;"></td> <td style="width: 10%;"></td> <td style="width: 10%;"></td> <td style="width: 10%;"></td> <td style="width: 10%;"></td> <td style="width: 10%;"></td> <td style="width: 10%;"></td> </tr> <tr> <td></td> <td></td> <td colspan="8" style="text-align: center;"> <table border="1" style="width: 100%; border-collapse: collapse; text-align: center;"> <tr> <td style="width: 10%;"></td> <td style="width: 10%;"></td> <td style="width: 10%;"></td> <td style="width: 10%;"></td> <td style="width: 10%;"></td> <td style="width: 10%;"></td> <td style="width: 10%;"></td> <td style="width: 10%;"></td> <td style="width: 10%;"></td> <td style="width: 10%;"></td> </tr> <tr> <td></td> <td></td> <td colspan="8" style="text-align: center;"> <table border="1" style="width: 100%; border-collapse: collapse; text-align: center;"> <tr> <td style="width: 10%;"></td> <td style="width: 10%;"></td> <td style="width: 10%;"></td> <td style="width: 10%;"></td> <td style="width: 10%;"></td> <td style="width: 10%;"></td> <td style="width: 10%;"></td> <td style="width: 10%;"></td> <td style="width: 10%;"></td> <td style="width: 10%;"></td> </tr> <tr> <td></td> <td></td> <td colspan="8" style="text-align: center;"> <table border="1" style="width: 100%; border-collapse: collapse; text-align: center;"> <tr> <td style="width: 10%;"></td> <td style="width: 10%;"></td> <td style="width: 10%;"></td> <td style="width: 10%;"></td> <td style="width: 10%;"></td> <td style="width: 10%;"></td> <td style="width: 10%;"></td> <td style="width: 10%;"></td> <td style="width: 10%;"></td> <td style="width: 10%;"></td> </tr> <tr> <td></td> <td></td> <td colspan="8" style="text-align: center;"> <table border="1" style="width: 100%; border-collapse: collapse; text-align: center;"> <tr> <td style="width: 10%;"></td> <td style="width: 10%;"></td> <td style="width: 10%;"></td> <td style="width: 10%;"></td> <td style="width: 10%;"></td> <td style="width: 10%;"></td> <td style="width: 10%;"></td> <td style="width: 10%;"></td> <td style="width: 10%;"></td> <td style="width: 10%;"></td> </tr> <tr> <td></td> <td></td> <td colspan="8" style="text-align: center;"> <table border="1" style="width: 100%; border-collapse: collapse; text-align: center;"> <tr> <td style="width: 10%;"></td> <td style="width: 10%;"></td> <td style="width: 10%;"></td> <td style="width: 10%;"></td> <td style="width: 10%;"></td> <td style="width: 10%;"></td> <td style="width: 10%;"></td> <td style="width: 10%;"></td> <td style="width: 10%;"></td> <td style="width: 10%;"></td> </tr> <tr> <td></td> <td></td> <td colspan="8" style="text-align: center;"> <table border="1" style="width: 100%; border-collapse: collapse; text-align: center;"> <tr> <td style="width: 10%;"></td> <td style="width: 10%;"></td> <td style="width: 10%;"></td> <td style="width: 10%;"></td> <td style="width: 10%;"></td> <td style="width: 10%;"></td> <td style="width: 10%;"></td> <td style="width: 10%;"></td> <td style="width: 10%;"></td> <td style="width: 10%;"></td> </tr> <tr> <td></td> <td></td> <td colspan="8" style="text-align: center;"> <table border="1" style="width: 100%; border-collapse: collapse; text-align: center;"> <tr> </tr></table></td></tr></table></td></tr></table></td></tr></table></td></tr></table></td></tr></table></td></tr></table></td></tr></table></td></tr></table></td></tr></table></td></tr></table></td></tr></table></td></tr></table></td></tr></table></td></tr></table></td></tr></table></td></tr></table></td></tr></table></td></tr></table></td></tr></table></td></tr></table></td></tr></table></td></tr></table></td></tr></table></td></tr></table></td></tr></table></td></tr></table></td></tr></table></td></tr></table></td></tr></table></td></tr></table></td></tr></table>

 | | | | | | | | | | | | | | | | | | | | <table border="1" style="width: 100%; border-collapse: collapse; text-align: center;"> <tr> <td style="width: 10%;"></td> <td style="width: 10%;"></td> <td style="width: 10%;"></td> <td style="width: 10%;"></td> <td style="width: 10%;"></td> <td style="width: 10%;"></td> <td style="width: 10%;"></td> <td style="width: 10%;"></td> <td style="width: 10%;"></td> <td style="width: 10%;"></td> </tr> <tr> <td></td> <td></td> <td colspan="8" style="text-align: center;"> <table border="1" style="width: 100%; border-collapse: collapse; text-align: center;"> <tr> <td style="width: 10%;"></td> <td style="width: 10%;"></td> <td style="width: 10%;"></td> <td style="width: 10%;"></td> <td style="width: 10%;"></td> <td style="width: 10%;"></td> <td style="width: 10%;"></td> <td style="width: 10%;"></td> <td style="width: 10%;"></td> <td style="width: 10%;"></td> </tr> <tr> <td></td> <td></td> <td colspan="8" style="text-align: center;"> <table border="1" style="width: 100%; border-collapse: collapse; text-align: center;"> <tr> <td style="width: 10%;"></td> <td style="width: 10%;"></td> <td style="width: 10%;"></td> <td style="width: 10%;"></td> <td style="width: 10%;"></td> <td style="width: 10%;"></td> <td style="width: 10%;"></td> <td style="width: 10%;"></td> <td style="width: 10%;"></td> <td style="width: 10%;"></td> </tr> <tr> <td></td> <td></td> <td colspan="8" style="text-align: center;"> <table border="1" style="width: 100%; border-collapse: collapse; text-align: center;"> <tr> <td style="width: 10%;"></td> <td style="width: 10%;"></td> <td style="width: 10%;"></td> <td style="width: 10%;"></td> <td style="width: 10%;"></td> <td style="width: 10%;"></td> <td style="width: 10%;"></td> <td style="width: 10%;"></td> <td style="width: 10%;"></td> <td style="width: 10%;"></td> </tr> <tr> <td></td> <td></td> <td colspan="8" style="text-align: center;"> <table border="1" style="width: 100%; border-collapse: collapse; text-align: center;"> <tr> <td style="width: 10%;"></td> <td style="width: 10%;"></td> <td style="width: 10%;"></td> <td style="width: 10%;"></td> <td style="width: 10%;"></td> <td style="width: 10%;"></td> <td style="width: 10%;"></td> <td style="width: 10%;"></td> <td style="width: 10%;"></td> <td style="width: 10%;"></td> </tr> <tr> <td></td> <td></td> <td colspan="8" style="text-align: center;"> <table border="1" style="width: 100%; border-collapse: collapse; text-align: center;"> <tr> <td style="width: 10%;"></td> <td style="width: 10%;"></td> <td style="width: 10%;"></td> <td style="width: 10%;"></td> <td style="width: 10%;"></td> <td style="width: 10%;"></td> <td style="width: 10%;"></td> <td style="width: 10%;"></td> <td style="width: 10%;"></td> <td style="width: 10%;"></td> </tr> <tr> <td></td> <td></td> <td colspan="8" style="text-align: center;"> <table border="1" style="width: 100%; border-collapse: collapse; text-align: center;"> <tr> <td style="width: 10%;"></td> <td style="width: 10%;"></td> <td style="width: 10%;"></td> <td style="width: 10%;"></td> <td style="width: 10%;"></td> <td style="width: 10%;"></td> <td style="width: 10%;"></td> <td style="width: 10%;"></td> <td style="width: 10%;"></td> <td style="width: 10%;"></td> </tr> <tr> <td></td> <td></td> <td colspan="8" style="text-align: center;"> <table border="1" style="width: 100%; border-collapse: collapse; text-align: center;"> <tr> <td style="width: 10%;"></td> <td style="width: 10%;"></td> <td style="width: 10%;"></td> <td style="width: 10%;"></td> <td style="width: 10%;"></td> <td style="width: 10%;"></td> <td style="width: 10%;"></td> <td style="width: 10%;"></td> <td style="width: 10%;"></td> <td style="width: 10%;"></td> </tr> <tr> <td></td> <td></td> <td colspan="8" style="text-align: center;"> <table border="1" style="width: 100%; border-collapse: collapse; text-align: center;"> <tr> <td style="width: 10%;"></td> <td style="width: 10%;"></td> <td style="width: 10%;"></td> <td style="width: 10%;"></td> <td style="width: 10%;"></td> <td style="width: 10%;"></td> <td style="width: 10%;"></td> <td style="width: 10%;"></td> <td style="width: 10%;"></td> <td style="width: 10%;"></td> </tr> <tr> <td></td> <td></td> <td colspan="8" style="text-align: center;"> <table border="1" style="width: 100%; border-collapse: collapse; text-align: center;"> <tr> <td style="width: 10%;"></td> <td style="width: 10%;"></td> <td style="width: 10%;"></td> <td style="width: 10%;"></td> <td style="width: 10%;"></td> <td style="width: 10%;"></td> <td style="width: 10%;"></td> <td style="width: 10%;"></td> <td style="width: 10%;"></td> <td style="width: 10%;"></td> </tr> <tr> <td></td> <td></td> <td colspan="8" style="text-align: center;"> <table border="1" style="width: 100%; border-collapse: collapse; text-align: center;"> <tr> <td style="width: 10%;"></td> <td style="width: 10%;"></td> <td style="width: 10%;"></td> <td style="width: 10%;"></td> <td style="width: 10%;"></td> <td style="width: 10%;"></td> <td style="width: 10%;"></td> <td style="width: 10%;"></td> <td style="width: 10%;"></td> <td style="width: 10%;"></td> </tr> <tr> <td></td> <td></td> <td colspan="8" style="text-align: center;"> <table border="1" style="width: 100%; border-collapse: collapse; text-align: center;"> <tr> <td style="width: 10%;"></td> <td style="width: 10%;"></td> <td style="width: 10%;"></td> <td style="width: 10%;"></td> <td style="width: 10%;"></td> <td style="width: 10%;"></td> <td style="width: 10%;"></td> <td style="width: 10%;"></td> <td style="width: 10%;"></td> <td style="width: 10%;"></td> </tr> <tr> <td></td> <td></td> <td colspan="8" style="text-align: center;"> <table border="1" style="width: 100%; border-collapse: collapse; text-align: center;"> <tr> <td style="width: 10%;"></td> <td style="width: 10%;"></td> <td style="width: 10%;"></td> <td style="width: 10%;"></td> <td style="width: 10%;"></td> <td style="width: 10%;"></td> <td style="width: 10%;"></td> <td style="width: 10%;"></td> <td style="width: 10%;"></td> <td style="width: 10%;"></td> </tr> <tr> <td></td> <td></td> <td colspan="8" style="text-align: center;"> <table border="1" style="width: 100%; border-collapse: collapse; text-align: center;"> <tr> <td style="width: 10%;"></td> <td style="width: 10%;"></td> <td style="width: 10%;"></td> <td style="width: 10%;"></td> <td style="width: 10%;"></td> <td style="width: 10%;"></td> <td style="width: 10%;"></td> <td style="width: 10%;"></td> <td style="width: 10%;"></td> <td style="width: 10%;"></td> </tr> <tr> <td></td> <td></td> <td colspan="8" style="text-align: center;"> <table border="1" style="width: 100%; border-collapse: collapse; text-align: center;"> <tr> <td style="width: 10%;"></td> <td style="width: 10%;"></td> <td style="width: 10%;"></td> <td style="width: 10%;"></td> <td style="width: 10%;"></td> <td style="width: 10%;"></td> <td style="width: 10%;"></td> <td style="width: 10%;"></td> <td style="width: 10%;"></td> <td style="width: 10%;"></td> </tr> <tr> <td></td> <td></td> <td colspan="8" style="text-align: center;"> <table border="1" style="width: 100%; border-collapse: collapse; text-align: center;"> <tr> <td style="width: 10%;"></td> <td style="width: 10%;"></td> <td style="width: 10%;"></td> <td style="width: 10%;"></td> <td style="width: 10%;"></td> <td style="width: 10%;"></td> <td style="width: 10%;"></td> <td style="width: 10%;"></td> <td style="width: 10%;"></td> <td style="width: 10%;"></td> </tr> <tr> <td></td> <td></td> <td colspan="8" style="text-align: center;"> <table border="1" style="width: 100%; border-collapse: collapse; text-align: center;"> <tr> <td style="width: 10%;"></td> <td style="width: 10%;"></td> <td style="width: 10%;"></td> <td style="width: 10%;"></td> <td style="width: 10%;"></td> <td style="width: 10%;"></td> <td style="width: 10%;"></td> <td style="width: 10%;"></td> <td style="width: 10%;"></td> <td style="width: 10%;"></td> </tr> <tr> <td></td> <td></td> <td colspan="8" style="text-align: center;"> <table border="1" style="width: 100%; border-collapse: collapse; text-align: center;"> <tr> <td style="width: 10%;"></td> <td style="width: 10%;"></td> <td style="width: 10%;"></td> <td style="width: 10%;"></td> <td style="width: 10%;"></td> <td style="width: 10%;"></td> <td style="width: 10%;"></td> <td style="width: 10%;"></td> <td style="width: 10%;"></td> <td style="width: 10%;"></td> </tr> <tr> <td></td> <td></td> <td colspan="8" style="text-align: center;"> <table border="1" style="width: 100%; border-collapse: collapse; text-align: center;"> <tr> <td style="width: 10%;"></td> <td style="width: 10%;"></td> <td style="width: 10%;"></td> <td style="width: 10%;"></td> <td style="width: 10%;"></td> <td style="width: 10%;"></td> <td
style="width: 10%;"></td> <td style="width: 10%;"></td> <td style="width: 10%;"></td> <td style="width: 10%;"></td> </tr> <tr> <td></td> <td></td> <td colspan="8" style="text-align: center;"> <table border="1" style="width: 100%; border-collapse: collapse; text-align: center;"> <tr> <td style="width: 10%;"></td> <td style="width: 10%;"></td> <td style="width: 10%;"></td> <td style="width: 10%;"></td> <td style="width: 10%;"></td> <td style="width: 10%;"></td> <td style="width: 10%;"></td> <td style="width: 10%;"></td> <td style="width: 10%;"></td> <td style="width: 10%;"></td> </tr> <tr> <td></td> <td></td> <td colspan="8" style="text-align: center;"> <table border="1" style="width: 100%; border-collapse: collapse; text-align: center;"> <tr> <td style="width: 10%;"></td> <td style="width: 10%;"></td> <td style="width: 10%;"></td> <td style="width: 10%;"></td> <td style="width: 10%;"></td> <td style="width: 10%;"></td> <td style="width: 10%;"></td> <td style="width: 10%;"></td> <td style="width: 10%;"></td> <td style="width: 10%;"></td> </tr> <tr> <td></td> <td></td> <td colspan="8" style="text-align: center;"> <table border="1" style="width: 100%; border-collapse: collapse; text-align: center;"> <tr> <td style="width: 10%;"></td> <td style="width: 10%;"></td> <td style="width: 10%;"></td> <td style="width: 10%;"></td> <td style="width: 10%;"></td> <td style="width: 10%;"></td> <td style="width: 10%;"></td> <td style="width: 10%;"></td> <td style="width: 10%;"></td> <td style="width: 10%;"></td> </tr> <tr> <td></td> <td></td> <td colspan="8" style="text-align: center;"> <table border="1" style="width: 100%; border-collapse: collapse; text-align: center;"> <tr> <td style="width: 10%;"></td> <td style="width: 10%;"></td> <td style="width: 10%;"></td> <td style="width: 10%;"></td> <td style="width: 10%;"></td> <td style="width: 10%;"></td> <td style="width: 10%;"></td> <td style="width: 10%;"></td> <td style="width: 10%;"></td> <td style="width: 10%;"></td> </tr> <tr> <td></td> <td></td> <td colspan="8" style="text-align: center;"> <table border="1" style="width: 100%; border-collapse: collapse; text-align: center;"> <tr> <td style="width: 10%;"></td> <td style="width: 10%;"></td> <td style="width: 10%;"></td> <td style="width: 10%;"></td> <td style="width: 10%;"></td> <td style="width: 10%;"></td> <td style="width: 10%;"></td> <td style="width: 10%;"></td> <td style="width: 10%;"></td> <td style="width: 10%;"></td> </tr> <tr> <td></td> <td></td> <td colspan="8" style="text-align: center;"> <table border="1" style="width: 100%; border-collapse: collapse; text-align: center;"> <tr> <td style="width: 10%;"></td> <td style="width: 10%;"></td> <td style="width: 10%;"></td> <td style="width: 10%;"></td> <td style="width: 10%;"></td> <td style="width: 10%;"></td> <td style="width: 10%;"></td> <td style="width: 10%;"></td> <td style="width: 10%;"></td> <td style="width: 10%;"></td> </tr> <tr> <td></td> <td></td> <td colspan="8" style="text-align: center;"> <table border="1" style="width: 100%; border-collapse: collapse; text-align: center;"> <tr> <td style="width: 10%;"></td> <td style="width: 10%;"></td> <td style="width: 10%;"></td> <td style="width: 10%;"></td> <td style="width: 10%;"></td> <td style="width: 10%;"></td> <td style="width: 10%;"></td> <td style="width: 10%;"></td> <td style="width: 10%;"></td> <td style="width: 10%;"></td> </tr> <tr> <td></td> <td></td> <td colspan="8" style="text-align: center;"> <table border="1" style="width: 100%; border-collapse: collapse; text-align: center;"> <tr> <td style="width: 10%;"></td> <td style="width: 10%;"></td> <td style="width: 10%;"></td> <td style="width: 10%;"></td> <td style="width: 10%;"></td> <td style="width: 10%;"></td> <td style="width: 10%;"></td> <td style="width: 10%;"></td> <td style="width: 10%;"></td> <td style="width: 10%;"></td> </tr> <tr> <td></td> <td></td> <td colspan="8" style="text-align: center;"> <table border="1" style="width: 100%; border-collapse: collapse; text-align: center;"> <tr> <td style="width: 10%;"></td> <td style="width: 10%;"></td> <td style="width: 10%;"></td> <td style="width: 10%;"></td> <td style="width: 10%;"></td> <td style="width: 10%;"></td> <td style="width: 10%;"></td> <td style="width: 10%;"></td> <td style="width: 10%;"></td> <td style="width: 10%;"></td> </tr> <tr> <td></td> <td></td> <td colspan="8" style="text-align: center;"> <table border="1" style="width: 100%; border-collapse: collapse; text-align: center;"> <tr> <td style="width: 10%;"></td> <td style="width: 10%;"></td> <td style="width: 10%;"></td> <td style="width: 10%;"></td> <td style="width: 10%;"></td> <td style="width: 10%;"></td> <td style="width: 10%;"></td> <td style="width: 10%;"></td> <td style="width: 10%;"></td> <td style="width: 10%;"></td> </tr> <tr> <td></td> <td></td> <td colspan="8" style="text-align: center;"> <table border="1" style="width: 100%; border-collapse: collapse; text-align: center;"> <tr> <td style="width: 10%;"></td> <td style="width: 10%;"></td> <td style="width: 10%;"></td> <td style="width: 10%;"></td> <td style="width: 10%;"></td> <td style="width: 10%;"></td> <td style="width: 10%;"></td> <td style="width: 10%;"></td> <td style="width: 10%;"></td> <td style="width: 10%;"></td> </tr> <tr> <td></td> <td></td> <td colspan="8" style="text-align: center;"> <table border="1" style="width: 100%; border-collapse: collapse; text-align: center;"> <tr> </tr></table></td></tr></table></td></tr></table></td></tr></table></td></tr></table></td></tr></table></td></tr></table></td></tr></table></td></tr></table></td></tr></table></td></tr></table></td></tr></table></td></tr></table></td></tr></table></td></tr></table></td></tr></table></td></tr></table></td></tr></table></td></tr></table></td></tr></table></td></tr></table></td></tr></table></td></tr></table></td></tr></table></td></tr></table></td></tr></table></td></tr></table></td></tr></table></td></tr></table></td></tr></table></td></tr></table>

 | | | | | | | | | | | | | | | | | | | | <table border="1" style="width: 100%; border-collapse: collapse; text-align: center;"> <tr> <td style="width: 10%;"></td> <td style="width: 10%;"></td> <td style="width: 10%;"></td> <td style="width: 10%;"></td> <td style="width: 10%;"></td> <td style="width: 10%;"></td> <td style="width: 10%;"></td> <td style="width: 10%;"></td> <td style="width: 10%;"></td> <td style="width: 10%;"></td> </tr> <tr> <td></td> <td></td> <td colspan="8" style="text-align: center;"> <table border="1" style="width: 100%; border-collapse: collapse; text-align: center;"> <tr> <td style="width: 10%;"></td> <td style="width: 10%;"></td> <td style="width: 10%;"></td> <td style="width: 10%;"></td> <td style="width: 10%;"></td> <td style="width: 10%;"></td> <td style="width: 10%;"></td> <td style="width: 10%;"></td> <td style="width: 10%;"></td> <td style="width: 10%;"></td> </tr> <tr> <td></td> <td></td> <td colspan="8" style="text-align: center;"> <table border="1" style="width: 100%; border-collapse: collapse; text-align: center;"> <tr> <td style="width: 10%;"></td> <td style="width: 10%;"></td> <td style="width: 10%;"></td> <td style="width: 10%;"></td> <td style="width: 10%;"></td> <td style="width: 10%;"></td> <td style="width: 10%;"></td> <td style="width: 10%;"></td> <td style="width: 10%;"></td> <td style="width: 10%;"></td> </tr> <tr> <td></td> <td></td> <td colspan="8" style="text-align: center;"> <table border="1" style="width: 100%; border-collapse: collapse; text-align: center;"> <tr> <td style="width: 10%;"></td> <td style="width: 10%;"></td> <td style="width: 10%;"></td> <td style="width: 10%;"></td> <td style="width: 10%;"></td> <td style="width: 10%;"></td> <td style="width: 10%;"></td> <td style="width: 10%;"></td> <td style="width: 10%;"></td> <td style="width: 10%;"></td> </tr> <tr> <td></td> <td></td> <td colspan="8" style="text-align: center;"> <table border="1" style="width: 100%; border-collapse: collapse; text-align: center;"> <tr> <td style="width: 10%;"></td> <td style="width: 10%;"></td> <td style="width: 10%;"></td> <td style="width: 10%;"></td> <td style="width: 10%;"></td> <td style="width: 10%;"></td> <td style="width: 10%;"></td> <td style="width: 10%;"></td> <td style="width: 10%;"></td> <td style="width: 10%;"></td> </tr> <tr> <td></td> <td></td> <td colspan="8" style="text-align: center;"> <table border="1" style="width: 100%; border-collapse: collapse; text-align: center;"> <tr> <td style="width: 10%;"></td> <td style="width: 10%;"></td> <td style="width: 10%;"></td> <td style="width: 10%;"></td> <td style="width: 10%;"></td> <td style="width: 10%;"></td> <td style="width: 10%;"></td> <td style="width: 10%;"></td> <td style="width: 10%;"></td> <td style="width: 10%;"></td> </tr> <tr> <td></td> <td></td> <td colspan="8" style="text-align: center;"> <table border="1" style="width: 100%; border-collapse: collapse; text-align: center;"> <tr> <td style="width: 10%;"></td> <td style="width: 10%;"></td> <td style="width: 10%;"></td> <td style="width: 10%;"></td> <td style="width: 10%;"></td> <td style="width: 10%;"></td> <td style="width: 10%;"></td> <td style="width: 10%;"></td> <td style="width: 10%;"></td> <td style="width: 10%;"></td> </tr> <tr> <td></td> <td></td> <td colspan="8" style="text-align: center;"> <table border="1" style="width: 100%; border-collapse: collapse; text-align: center;"> <tr> <td style="width: 10%;"></td> <td style="width: 10%;"></td> <td style="width: 10%;"></td> <td style="width: 10%;"></td> <td style="width: 10%;"></td> <td style="width: 10%;"></td> <td style="width: 10%;"></td> <td style="width: 10%;"></td> <td style="width: 10%;"></td> <td style="width: 10%;"></td> </tr> <tr> <td></td> <td></td> <td colspan="8" style="text-align: center;"> <table border="1" style="width: 100%; border-collapse: collapse; text-align: center;"> <tr> <td style="width: 10%;"></td> <td style="width: 10%;"></td> <td style="width: 10%;"></td> <td style="width: 10%;"></td> <td style="width: 10%;"></td> <td style="width: 10%;"></td> <td style="width: 10%;"></td> <td style="width: 10%;"></td> <td style="width: 10%;"></td> <td style="width: 10%;"></td> </tr> <tr> <td></td> <td></td> <td colspan="8" style="text-align: center;"> <table border="1" style="width: 100%; border-collapse: collapse; text-align: center;"> <tr> <td style="width: 10%;"></td> <td style="width: 10%;"></td> <td style="width: 10%;"></td> <td style="width: 10%;"></td> <td style="width: 10%;"></td> <td style="width: 10%;"></td> <td style="width: 10%;"></td> <td style="width: 10%;"></td> <td style="width: 10%;"></td> <td style="width: 10%;"></td> </tr> <tr> <td></td> <td></td> <td colspan="8" style="text-align: center;"> <table border="1" style="width: 100%; border-collapse: collapse; text-align: center;"> <tr> <td style="width: 10%;"></td> <td style="width: 10%;"></td> <td style="width: 10%;"></td> <td style="width: 10%;"></td> <td style="width: 10%;"></td> <td style="width: 10%;"></td> <td style="width: 10%;"></td> <td style="width: 10%;"></td> <td style="width: 10%;"></td> <td style="width: 10%;"></td> </tr> <tr> <td></td> <td></td> <td colspan="8" style="text-align: center;"> <table border="1" style="width: 100%; border-collapse: collapse; text-align: center;"> <tr> <td style="width: 10%;"></td> <td style="width: 10%;"></td> <td style="width: 10%;"></td> <td style="width: 10%;"></td> <td style="width: 10%;"></td> <td style="width: 10%;"></td> <td style="width: 10%;"></td> <td style="width: 10%;"></td> <td style="width: 10%;"></td> <td style="width: 10%;"></td> </tr> <tr> <td></td> <td></td> <td colspan="8" style="text-align: center;"> <table border="1" style="width: 100%; border-collapse: collapse; text-align: center;"> <tr> <td style="width: 10%;"></td> <td style="width: 10%;"></td> <td style="width: 10%;"></td> <td style="width: 10%;"></td> <td style="width: 10%;"></td> <td style="width: 10%;"></td> <td style="width: 10%;"></td> <td style="width: 10%;"></td> <td style="width: 10%;"></td> <td style="width: 10%;"></td> </tr> <tr> <td></td> <td></td> <td colspan="8" style="text-align: center;"> <table border="1" style="width: 100%; border-collapse: collapse; text-align: center;"> <tr> <td style="width: 10%;"></td> <td style="width: 10%;"></td> <td style="width: 10%;"></td> <td style="width: 10%;"></td> <td style="width: 10%;"></td> <td style="width: 10%;"></td> <td style="width: 10%;"></td> <td style="width: 10%;"></td> <td style="width: 10%;"></td> <td style="width: 10%;"></td> </tr> <tr> <td></td> <td></td> <td colspan="8" style="text-align: center;"> <table border="1" style="width: 100%; border-collapse: collapse; text-align: center;"> <tr> <td style="width: 10%;"></td> <td style="width: 10%;"></td> <td style="width: 10%;"></td> <td style="width: 10%;"></td> <td style="width: 10%;"></td> <td style="width: 10%;"></td> <td style="width: 10%;"></td> <td style="width: 10%;"></td> <td style="width: 10%;"></td> <td style="width: 10%;"></td> </tr> <tr> <td></td> <td></td> <td colspan="8" style="text-align: center;"> <table border="1" style="width: 100%; border-collapse: collapse; text-align: center;"> <tr> <td style="width: 10%;"></td> <td style="width: 10%;"></td> <td style="width: 10%;"></td> <td style="width: 10%;"></td> <td style="width: 10%;"></td> <td style="width: 10%;"></td> <td style="width: 10%;"></td> <td style="width: 10%;"></td> <td style="width: 10%;"></td> <td style="width: 10%;"></td> </tr> <tr> <td></td> <td></td> <td colspan="8" style="text-align: center;"> <table border="1" style="width: 100%; border-collapse: collapse; text-align: center;"> <tr> <td style="width: 10%;"></td> <td style="width: 10%;"></td> <td style="width: 10%;"></td> <td style="width: 10%;"></td> <td style="width: 10%;"></td> <td style="width: 10%;"></td> <td style="width: 10%;"></td> <td style="width: 10%;"></td> <td style="width: 10%;"></td> <td style="width: 10%;"></td> </tr> <tr> <td></td> <td></td> <td
colspan="8" style="text-align: center;"> <table border="1" style="width: 100%; border-collapse: collapse; text-align: center;"> <tr> <td style="width: 10%;"></td> <td style="width: 10%;"></td> <td style="width: 10%;"></td> <td style="width: 10%;"></td> <td style="width: 10%;"></td> <td style="width: 10%;"></td> <td style="width: 10%;"></td> <td style="width: 10%;"></td> <td style="width: 10%;"></td> <td style="width: 10%;"></td> </tr> <tr> <td></td> <td></td> <td colspan="8" style="text-align: center;"> <table border="1" style="width: 100%; border-collapse: collapse; text-align: center;"> <tr> <td style="width: 10%;"></td> <td style="width: 10%;"></td> <td style="width: 10%;"></td> <td style="width: 10%;"></td> <td style="width: 10%;"></td> <td style="width: 10%;"></td> <td style="width: 10%;"></td> <td style="width: 10%;"></td> <td style="width: 10%;"></td> <td style="width: 10%;"></td> </tr> <tr> <td></td> <td></td> <td colspan="8" style="text-align: center;"> <table border="1" style="width: 100%; border-collapse: collapse; text-align: center;"> <tr> <td style="width: 10%;"></td> <td style="width: 10%;"></td> <td style="width: 10%;"></td> <td style="width: 10%;"></td> <td style="width: 10%;"></td> <td style="width: 10%;"></td> <td style="width: 10%;"></td> <td style="width: 10%;"></td> <td style="width: 10%;"></td> <td style="width: 10%;"></td> </tr> <tr> <td></td> <td></td> <td colspan="8" style="text-align: center;"> <table border="1" style="width: 100%; border-collapse: collapse; text-align: center;"> <tr> <td style="width: 10%;"></td> <td style="width: 10%;"></td> <td style="width: 10%;"></td> <td style="width: 10%;"></td> <td style="width: 10%;"></td> <td style="width: 10%;"></td> <td style="width: 10%;"></td> <td style="width: 10%;"></td> <td style="width: 10%;"></td> <td style="width: 10%;"></td> </tr> <tr> <td></td> <td></td> <td colspan="8" style="text-align: center;"> <table border="1" style="width: 100%; border-collapse: collapse; text-align: center;"> <tr> <td style="width: 10%;"></td> <td style="width: 10%;"></td> <td style="width: 10%;"></td> <td style="width: 10%;"></td> <td style="width: 10%;"></td> <td style="width: 10%;"></td> <td style="width: 10%;"></td> <td style="width: 10%;"></td> <td style="width: 10%;"></td> <td style="width: 10%;"></td> </tr> <tr> <td></td> <td></td> <td colspan="8" style="text-align: center;"> <table border="1" style="width: 100%; border-collapse: collapse; text-align: center;"> <tr> <td style="width: 10%;"></td> <td style="width: 10%;"></td> <td style="width: 10%;"></td> <td style="width: 10%;"></td> <td style="width: 10%;"></td> <td style="width: 10%;"></td> <td style="width: 10%;"></td> <td style="width: 10%;"></td> <td style="width: 10%;"></td> <td style="width: 10%;"></td> </tr> <tr> <td></td> <td></td> <td colspan="8" style="text-align: center;"> <table border="1" style="width: 100%; border-collapse: collapse; text-align: center;"> <tr> <td style="width: 10%;"></td> <td style="width: 10%;"></td> <td style="width: 10%;"></td> <td style="width: 10%;"></td> <td style="width: 10%;"></td> <td style="width: 10%;"></td> <td style="width: 10%;"></td> <td style="width: 10%;"></td> <td style="width: 10%;"></td> <td style="width: 10%;"></td> </tr> <tr> <td></td> <td></td> <td colspan="8" style="text-align: center;"> <table border="1" style="width: 100%; border-collapse: collapse; text-align: center;"> <tr> <td style="width: 10%;"></td> <td style="width: 10%;"></td> <td style="width: 10%;"></td> <td style="width: 10%;"></td> <td style="width: 10%;"></td> <td style="width: 10%;"></td> <td style="width: 10%;"></td> <td style="width: 10%;"></td> <td style="width: 10%;"></td> <td style="width: 10%;"></td> </tr> <tr> <td></td> <td></td> <td colspan="8" style="text-align: center;"> <table border="1" style="width: 100%; border-collapse: collapse; text-align: center;"> <tr> <td style="width: 10%;"></td> <td style="width: 10%;"></td> <td style="width: 10%;"></td> <td style="width: 10%;"></td> <td style="width: 10%;"></td> <td style="width: 10%;"></td> <td style="width: 10%;"></td> <td style="width: 10%;"></td> <td style="width: 10%;"></td> <td style="width: 10%;"></td> </tr> <tr> <td></td> <td></td> <td colspan="8" style="text-align: center;"> <table border="1" style="width: 100%; border-collapse: collapse; text-align: center;"> <tr> <td style="width: 10%;"></td> <td style="width: 10%;"></td> <td style="width: 10%;"></td> <td style="width: 10%;"></td> <td style="width: 10%;"></td> <td style="width: 10%;"></td> <td style="width: 10%;"></td> <td style="width: 10%;"></td> <td style="width: 10%;"></td> <td style="width: 10%;"></td> </tr> <tr> <td></td> <td></td> <td colspan="8" style="text-align: center;"> <table border="1" style="width: 100%; border-collapse: collapse; text-align: center;"> <tr> <td style="width: 10%;"></td> <td style="width: 10%;"></td> <td style="width: 10%;"></td> <td style="width: 10%;"></td> <td style="width: 10%;"></td> <td style="width: 10%;"></td> <td style="width: 10%;"></td> <td style="width: 10%;"></td> <td style="width: 10%;"></td> <td style="width: 10%;"></td> </tr> <tr> <td></td> <td></td> <td colspan="8" style="text-align: center;"> <table border="1" style="width: 100%; border-collapse: collapse; text-align: center;"> <tr> <td style="width: 10%;"></td> <td style="width: 10%;"></td> <td style="width: 10%;"></td> <td style="width: 10%;"></td> <td style="width: 10%;"></td> <td style="width: 10%;"></td> <td style="width: 10%;"></td> <td style="width: 10%;"></td> <td style="width: 10%;"></td> <td style="width: 10%;"></td> </tr> <tr> <td></td> <td></td> <td colspan="8" style="text-align: center;"> <table border="1" style="width: 100%; border-collapse: collapse; text-align: center;"> <tr> </tr></table></td></tr></table></td></tr></table></td></tr></table></td></tr></table></td></tr></table></td></tr></table></td></tr></table></td></tr></table></td></tr></table></td></tr></table></td></tr></table></td></tr></table></td></tr></table></td></tr></table></td></tr></table></td></tr></table></td></tr></table></td></tr></table></td></tr></table></td></tr></table></td></tr></table></td></tr></table></td></tr></table></td></tr></table></td></tr></table></td></tr></table></td></tr></table></td></tr></table></td></tr></table>

 | | | | | | | | | | | | | | | | | | | | <table border="1" style="width: 100%; border-collapse: collapse; text-align: center;"> <tr> <td style="width: 10%;"></td> <td style="width: 10%;"></td> <td style="width: 10%;"></td> <td style="width: 10%;"></td> <td style="width: 10%;"></td> <td style="width: 10%;"></td> <td style="width: 10%;"></td> <td style="width: 10%;"></td> <td style="width: 10%;"></td> <td style="width: 10%;"></td> </tr> <tr> <td></td> <td></td> <td colspan="8" style="text-align: center;"> <table border="1" style="width: 100%; border-collapse: collapse; text-align: center;"> <tr> <td style="width: 10%;"></td> <td style="width: 10%;"></td> <td style="width: 10%;"></td> <td style="width: 10%;"></td> <td style="width: 10%;"></td> <td style="width: 10%;"></td> <td style="width: 10%;"></td> <td style="width: 10%;"></td> <td style="width: 10%;"></td> <td style="width: 10%;"></td> </tr> <tr> <td></td> <td></td> <td colspan="8" style="text-align: center;"> <table border="1" style="width: 100%; border-collapse: collapse; text-align: center;"> <tr> <td style="width: 10%;"></td> <td style="width: 10%;"></td> <td style="width: 10%;"></td> <td style="width: 10%;"></td> <td style="width: 10%;"></td> <td style="width: 10%;"></td> <td style="width: 10%;"></td> <td style="width: 10%;"></td> <td style="width: 10%;"></td> <td style="width: 10%;"></td> </tr> <tr> <td></td> <td></td> <td colspan="8" style="text-align: center;"> <table border="1" style="width: 100%; border-collapse: collapse; text-align: center;"> <tr> <td style="width: 10%;"></td> <td style="width: 10%;"></td> <td style="width: 10%;"></td> <td style="width: 10%;"></td> <td style="width: 10%;"></td> <td style="width: 10%;"></td> <td style="width: 10%;"></td> <td style="width: 10%;"></td> <td style="width: 10%;"></td> <td style="width: 10%;"></td> </tr> <tr> <td></td> <td></td> <td colspan="8" style="text-align: center;"> <table border="1" style="width: 100%; border-collapse: collapse; text-align: center;"> <tr> <td style="width: 10%;"></td> <td style="width: 10%;"></td> <td style="width: 10%;"></td> <td style="width: 10%;"></td> <td style="width: 10%;"></td> <td style="width: 10%;"></td> <td style="width: 10%;"></td> <td style="width: 10%;"></td> <td style="width: 10%;"></td> <td style="width: 10%;"></td> </tr> <tr> <td></td> <td></td> <td colspan="8" style="text-align: center;"> <table border="1" style="width: 100%; border-collapse: collapse; text-align: center;"> <tr> <td style="width: 10%;"></td> <td style="width: 10%;"></td> <td style="width: 10%;"></td> <td style="width: 10%;"></td> <td style="width: 10%;"></td> <td style="width: 10%;"></td> <td style="width: 10%;"></td> <td style="width: 10%;"></td> <td style="width: 10%;"></td> <td style="width: 10%;"></td> </tr> <tr> <td></td> <td></td> <td colspan="8" style="text-align: center;"> <table border="1" style="width: 100%; border-collapse: collapse; text-align: center;"> <tr> <td style="width: 10%;"></td> <td style="width: 10%;"></td> <td style="width: 10%;"></td> <td style="width: 10%;"></td> <td style="width: 10%;"></td> <td style="width: 10%;"></td> <td style="width: 10%;"></td> <td style="width: 10%;"></td> <td style="width: 10%;"></td> <td style="width: 10%;"></td> </tr> <tr> <td></td> <td></td> <td colspan="8" style="text-align: center;"> <table border="1" style="width: 100%; border-collapse: collapse; text-align: center;"> <tr> <td style="width: 10%;"></td> <td style="width: 10%;"></td> <td style="width: 10%;"></td> <td style="width: 10%;"></td> <td style="width: 10%;"></td> <td style="width: 10%;"></td> <td style="width: 10%;"></td> <td style="width: 10%;"></td> <td style="width: 10%;"></td> <td style="width: 10%;"></td> </tr> <tr> <td></td> <td></td> <td colspan="8" style="text-align: center;"> <table border="1" style="width: 100%; border-collapse: collapse; text-align: center;"> <tr> <td style="width: 10%;"></td> <td style="width: 10%;"></td> <td style="width: 10%;"></td> <td style="width: 10%;"></td> <td style="width: 10%;"></td> <td style="width: 10%;"></td> <td style="width: 10%;"></td> <td style="width: 10%;"></td> <td style="width: 10%;"></td> <td style="width: 10%;"></td> </tr> <tr> <td></td> <td></td> <td colspan="8" style="text-align: center;"> <table border="1" style="width: 100%; border-collapse: collapse; text-align: center;"> <tr> <td style="width: 10%;"></td> <td style="width: 10%;"></td> <td style="width: 10%;"></td> <td style="width: 10%;"></td> <td style="width: 10%;"></td> <td style="width: 10%;"></td> <td style="width: 10%;"></td> <td style="width: 10%;"></td> <td style="width: 10%;"></td> <td style="width: 10%;"></td> </tr> <tr> <td></td> <td></td> <td colspan="8" style="text-align: center;"> <table border="1" style="width: 100%; border-collapse: collapse; text-align: center;"> <tr> <td style="width: 10%;"></td> <td style="width: 10%;"></td> <td style="width: 10%;"></td> <td style="width: 10%;"></td> <td style="width: 10%;"></td> <td style="width: 10%;"></td> <td style="width: 10%;"></td> <td style="width: 10%;"></td> <td style="width: 10%;"></td> <td style="width: 10%;"></td> </tr> <tr> <td></td> <td></td> <td colspan="8" style="text-align: center;"> <table border="1" style="width: 100%; border-collapse: collapse; text-align: center;"> <tr> <td style="width: 10%;"></td> <td style="width: 10%;"></td> <td style="width: 10%;"></td> <td style="width: 10%;"></td> <td style="width: 10%;"></td> <td style="width: 10%;"></td> <td style="width: 10%;"></td> <td style="width: 10%;"></td> <td style="width: 10%;"></td> <td style="width: 10%;"></td> </tr> <tr> <td></td> <td></td> <td colspan="8" style="text-align: center;"> <table border="1" style="width: 100%; border-collapse: collapse; text-align: center;"> <tr> <td style="width: 10%;"></td> <td style="width: 10%;"></td> <td style="width: 10%;"></td> <td style="width: 10%;"></td> <td style="width: 10%;"></td> <td style="width: 10%;"></td> <td style="width: 10%;"></td> <td style="width: 10%;"></td> <td style="width: 10%;"></td> <td style="width: 10%;"></td> </tr> <tr> <td></td> <td></td> <td colspan="8" style="text-align: center;"> <table border="1" style="width: 100%; border-collapse: collapse; text-align: center;"> <tr> <td style="width: 10%;"></td> <td style="width: 10%;"></td> <td style="width: 10%;"></td> <td style="width: 10%;"></td> <td style="width: 10%;"></td> <td style="width: 10%;"></td> <td style="width: 10%;"></td> <td style="width: 10%;"></td> <td style="width: 10%;"></td> <td style="width: 10%;"></td> </tr> <tr> <td></td> <td></td> <td colspan="8" style="text-align: center;"> <table border="1" style="width: 100%; border-collapse: collapse; text-align: center;"> <tr> <td style="width: 10%;"></td> <td style="width: 10%;"></td> <td style="width: 10%;"></td> <td style="width: 10%;"></td> <td style="width: 10%;"></td> <td style="width: 10%;"></td> <td style="width: 10%;"></td> <td style="width: 10%;"></td> <td style="width: 10%;"></td> <td style="width: 10%;"></td> </tr> <tr> <td></td> <td></td> <td colspan="8" style="text-align: center;"> <table border="1" style="width: 100%; border-collapse: collapse; text-align: center;"> <tr> <td style="width: 10%;"></td> <td style="width: 10%;"></td> <td style="width: 10%;"></td> <td style="width: 10%;"></td> <td style="width: 10%;"></td> <td style="width: 10%;"></td> <td style="width: 10%;"></td> <td style="width: 10%;"></td> <td style="width: 10%;"></td> <td style="width: 10%;"></td> </tr> <tr> <td></td> <td></td> <td colspan="8" style="text-align: center;"> <table border="1" style="width: 100%; border-collapse: collapse; text-align: center;"> <tr> <td style="width: 10%;"></td> <td
style="width: 10%;"></td> <td style="width: 10%;"></td> <td style="width: 10%;"></td> <td style="width: 10%;"></td> <td style="width: 10%;"></td> <td style="width: 10%;"></td> <td style="width: 10%;"></td> <td style="width: 10%;"></td> <td style="width: 10%;"></td> </tr> <tr> <td></td> <td></td> <td colspan="8" style="text-align: center;"> <table border="1" style="width: 100%; border-collapse: collapse; text-align: center;"> <tr> <td style="width: 10%;"></td> <td style="width: 10%;"></td> <td style="width: 10%;"></td> <td style="width: 10%;"></td> <td style="width: 10%;"></td> <td style="width: 10%;"></td> <td style="width: 10%;"></td> <td style="width: 10%;"></td> <td style="width: 10%;"></td> <td style="width: 10%;"></td> </tr> <tr> <td></td> <td></td> <td colspan="8" style="text-align: center;"> <table border="1" style="width: 100%; border-collapse: collapse; text-align: center;"> <tr> <td style="width: 10%;"></td> <td style="width: 10%;"></td> <td style="width: 10%;"></td> <td style="width: 10%;"></td> <td style="width: 10%;"></td> <td style="width: 10%;"></td> <td style="width: 10%;"></td> <td style="width: 10%;"></td> <td style="width: 10%;"></td> <td style="width: 10%;"></td> </tr> <tr> <td></td> <td></td> <td colspan="8" style="text-align: center;"> <table border="1" style="width: 100%; border-collapse: collapse; text-align: center;"> <tr> <td style="width: 10%;"></td> <td style="width: 10%;"></td> <td style="width: 10%;"></td> <td style="width: 10%;"></td> <td style="width: 10%;"></td> <td style="width: 10%;"></td> <td style="width: 10%;"></td> <td style="width: 10%;"></td> <td style="width: 10%;"></td> <td style="width: 10%;"></td> </tr> <tr> <td></td> <td></td> <td colspan="8" style="text-align: center;"> <table border="1" style="width: 100%; border-collapse: collapse; text-align: center;"> <tr> <td style="width: 10%;"></td> <td style="width: 10%;"></td> <td style="width: 10%;"></td> <td style="width: 10%;"></td> <td style="width: 10%;"></td> <td style="width: 10%;"></td> <td style="width: 10%;"></td> <td style="width: 10%;"></td> <td style="width: 10%;"></td> <td style="width: 10%;"></td> </tr> <tr> <td></td> <td></td> <td colspan="8" style="text-align: center;"> <table border="1" style="width: 100%; border-collapse: collapse; text-align: center;"> <tr> <td style="width: 10%;"></td> <td style="width: 10%;"></td> <td style="width: 10%;"></td> <td style="width: 10%;"></td> <td style="width: 10%;"></td> <td style="width: 10%;"></td> <td style="width: 10%;"></td> <td style="width: 10%;"></td> <td style="width: 10%;"></td> <td style="width: 10%;"></td> </tr> <tr> <td></td> <td></td> <td colspan="8" style="text-align: center;"> <table border="1" style="width: 100%; border-collapse: collapse; text-align: center;"> <tr> <td style="width: 10%;"></td> <td style="width: 10%;"></td> <td style="width: 10%;"></td> <td style="width: 10%;"></td> <td style="width: 10%;"></td> <td style="width: 10%;"></td> <td style="width: 10%;"></td> <td style="width: 10%;"></td> <td style="width: 10%;"></td> <td style="width: 10%;"></td> </tr> <tr> <td></td> <td></td> <td colspan="8" style="text-align: center;"> <table border="1" style="width: 100%; border-collapse: collapse; text-align: center;"> <tr> <td style="width: 10%;"></td> <td style="width: 10%;"></td> <td style="width: 10%;"></td> <td style="width: 10%;"></td> <td style="width: 10%;"></td> <td style="width: 10%;"></td> <td style="width: 10%;"></td> <td style="width: 10%;"></td> <td style="width: 10%;"></td> <td style="width: 10%;"></td> </tr> <tr> <td></td> <td></td> <td colspan="8" style="text-align: center;"> <table border="1" style="width: 100%; border-collapse: collapse; text-align: center;"> <tr> <td style="width: 10%;"></td> <td style="width: 10%;"></td> <td style="width: 10%;"></td> <td style="width: 10%;"></td> <td style="width: 10%;"></td> <td style="width: 10%;"></td> <td style="width: 10%;"></td> <td style="width: 10%;"></td> <td style="width: 10%;"></td> <td style="width: 10%;"></td> </tr> <tr> <td></td> <td></td> <td colspan="8" style="text-align: center;"> <table border="1" style="width: 100%; border-collapse: collapse; text-align: center;"> <tr> <td style="width: 10%;"></td> <td style="width: 10%;"></td> <td style="width: 10%;"></td> <td style="width: 10%;"></td> <td style="width: 10%;"></td> <td style="width: 10%;"></td> <td style="width: 10%;"></td> <td style="width: 10%;"></td> <td style="width: 10%;"></td> <td style="width: 10%;"></td> </tr> <tr> <td></td> <td></td> <td colspan="8" style="text-align: center;"> <table border="1" style="width: 100%; border-collapse: collapse; text-align: center;"> <tr> <td style="width: 10%;"></td> <td style="width: 10%;"></td> <td style="width: 10%;"></td> <td style="width: 10%;"></td> <td style="width: 10%;"></td> <td style="width: 10%;"></td> <td style="width: 10%;"></td> <td style="width: 10%;"></td> <td style="width: 10%;"></td> <td style="width: 10%;"></td> </tr> <tr> <td></td> <td></td> <td colspan="8" style="text-align: center;"> <table border="1" style="width: 100%; border-collapse: collapse; text-align: center;"> <tr> <td style="width: 10%;"></td> <td style="width: 10%;"></td> <td style="width: 10%;"></td> <td style="width: 10%;"></td> <td style="width: 10%;"></td> <td style="width: 10%;"></td> <td style="width: 10%;"></td> <td style="width: 10%;"></td> <td style="width: 10%;"></td> <td style="width: 10%;"></td> </tr> <tr> <td></td> <td></td> <td colspan="8" style="text-align: center;"> <table border="1" style="width: 100%; border-collapse: collapse; text-align: center;"> <tr> </tr></table></td></tr></table></td></tr></table></td></tr></table></td></tr></table></td></tr></table></td></tr></table></td></tr></table></td></tr></table></td></tr></table></td></tr></table></td></tr></table></td></tr></table></td></tr></table></td></tr></table></td></tr></table></td></tr></table></td></tr></table></td></tr></table></td></tr></table></td></tr></table></td></tr></table></td></tr></table></td></tr></table></td></tr></table></td></tr></table></td></tr></table></td></tr></table></td></tr></table>

 | | | | | | | | | | | | | | | | | | | | <table border="1" style="width: 100%; border-collapse: collapse; text-align: center;"> <tr> <td style="width: 10%;"></td> <td style="width: 10%;"></td> <td style="width: 10%;"></td> <td style="width: 10%;"></td> <td style="width: 10%;"></td> <td style="width: 10%;"></td> <td style="width: 10%;"></td> <td style="width: 10%;"></td> <td style="width: 10%;"></td> <td style="width: 10%;"></td> </tr> <tr> <td></td> <td></td> <td colspan="8" style="text-align: center;"> <table border="1" style="width: 100%; border-collapse: collapse; text-align: center;"> <tr> <td style="width: 10%;"></td> <td style="width: 10%;"></td> <td style="width: 10%;"></td> <td style="width: 10%;"></td> <td style="width: 10%;"></td> <td style="width: 10%;"></td> <td style="width: 10%;"></td> <td style="width: 10%;"></td> <td style="width: 10%;"></td> <td style="width: 10%;"></td> </tr> <tr> <td></td> <td></td> <td colspan="8" style="text-align: center;"> <table border="1" style="width: 100%; border-collapse: collapse; text-align: center;"> <tr> <td style="width: 10%;"></td> <td style="width: 10%;"></td> <td style="width: 10%;"></td> <td style="width: 10%;"></td> <td style="width: 10%;"></td> <td style="width: 10%;"></td> <td style="width: 10%;"></td> <td style="width: 10%;"></td> <td style="width: 10%;"></td> <td style="width: 10%;"></td> </tr> <tr> <td></td> <td></td> <td colspan="8" style="text-align: center;"> <table border="1" style="width: 100%; border-collapse: collapse; text-align: center;"> <tr> <td style="width: 10%;"></td> <td style="width: 10%;"></td> <td style="width: 10%;"></td> <td style="width: 10%;"></td> <td style="width: 10%;"></td> <td style="width: 10%;"></td> <td style="width: 10%;"></td> <td style="width: 10%;"></td> <td style="width: 10%;"></td> <td style="width: 10%;"></td> </tr> <tr> <td></td> <td></td> <td colspan="8" style="text-align: center;"> <table border="1" style="width: 100%; border-collapse: collapse; text-align: center;"> <tr> <td style="width: 10%;"></td> <td style="width: 10%;"></td> <td style="width: 10%;"></td> <td style="width: 10%;"></td> <td style="width: 10%;"></td> <td style="width: 10%;"></td> <td style="width: 10%;"></td> <td style="width: 10%;"></td> <td style="width: 10%;"></td> <td style="width: 10%;"></td> </tr> <tr> <td></td> <td></td> <td colspan="8" style="text-align: center;"> <table border="1" style="width: 100%; border-collapse: collapse; text-align: center;"> <tr> <td style="width: 10%;"></td> <td style="width: 10%;"></td> <td style="width: 10%;"></td> <td style="width: 10%;"></td> <td style="width: 10%;"></td> <td style="width: 10%;"></td> <td style="width: 10%;"></td> <td style="width: 10%;"></td> <td style="width: 10%;"></td> <td style="width: 10%;"></td> </tr> <tr> <td></td> <td></td> <td colspan="8" style="text-align: center;"> <table border="1" style="width: 100%; border-collapse: collapse; text-align: center;"> <tr> <td style="width: 10%;"></td> <td style="width: 10%;"></td> <td style="width: 10%;"></td> <td style="width: 10%;"></td> <td style="width: 10%;"></td> <td style="width: 10%;"></td> <td style="width: 10%;"></td> <td style="width: 10%;"></td> <td style="width: 10%;"></td> <td style="width: 10%;"></td> </tr> <tr> <td></td> <td></td> <td colspan="8" style="text-align: center;"> <table border="1" style="width: 100%; border-collapse: collapse; text-align: center;"> <tr> <td style="width: 10%;"></td> <td style="width: 10%;"></td> <td style="width: 10%;"></td> <td style="width: 10%;"></td> <td style="width: 10%;"></td> <td style="width: 10%;"></td> <td style="width: 10%;"></td> <td style="width: 10%;"></td> <td style="width: 10%;"></td> <td style="width: 10%;"></td> </tr> <tr> <td></td> <td></td> <td colspan="8" style="text-align: center;"> <table border="1" style="width: 100%; border-collapse: collapse; text-align: center;"> <tr> <td style="width: 10%;"></td> <td style="width: 10%;"></td> <td style="width: 10%;"></td> <td style="width: 10%;"></td> <td style="width: 10%;"></td> <td style="width: 10%;"></td> <td style="width: 10%;"></td> <td style="width: 10%;"></td> <td style="width: 10%;"></td> <td style="width: 10%;"></td> </tr> <tr> <td></td> <td></td> <td colspan="8" style="text-align: center;"> <table border="1" style="width: 100%; border-collapse: collapse; text-align: center;"> <tr> <td style="width: 10%;"></td> <td style="width: 10%;"></td> <td style="width: 10%;"></td> <td style="width: 10%;"></td> <td style="width: 10%;"></td> <td style="width: 10%;"></td> <td style="width: 10%;"></td> <td style="width: 10%;"></td> <td style="width: 10%;"></td> <td style="width: 10%;"></td> </tr> <tr> <td></td> <td></td> <td colspan="8" style="text-align: center;"> <table border="1" style="width: 100%; border-collapse: collapse; text-align: center;"> <tr> <td style="width: 10%;"></td> <td style="width: 10%;"></td> <td style="width: 10%;"></td> <td style="width: 10%;"></td> <td style="width: 10%;"></td> <td style="width: 10%;"></td> <td style="width: 10%;"></td> <td style="width: 10%;"></td> <td style="width: 10%;"></td> <td style="width: 10%;"></td> </tr> <tr> <td></td> <td></td> <td colspan="8" style="text-align: center;"> <table border="1" style="width: 100%; border-collapse: collapse; text-align: center;"> <tr> <td style="width: 10%;"></td> <td style="width: 10%;"></td> <td style="width: 10%;"></td> <td style="width: 10%;"></td> <td style="width: 10%;"></td> <td style="width: 10%;"></td> <td style="width: 10%;"></td> <td style="width: 10%;"></td> <td style="width: 10%;"></td> <td style="width: 10%;"></td> </tr> <tr> <td></td> <td></td> <td colspan="8" style="text-align: center;"> <table border="1" style="width: 100%; border-collapse: collapse; text-align: center;"> <tr> <td style="width: 10%;"></td> <td style="width: 10%;"></td> <td style="width: 10%;"></td> <td style="width: 10%;"></td> <td style="width: 10%;"></td> <td style="width: 10%;"></td> <td style="width: 10%;"></td> <td style="width: 10%;"></td> <td style="width: 10%;"></td> <td style="width: 10%;"></td> </tr> <tr> <td></td> <td></td> <td colspan="8" style="text-align: center;"> <table border="1" style="width: 100%; border-collapse: collapse; text-align: center;"> <tr> <td style="width: 10%;"></td> <td style="width: 10%;"></td> <td style="width: 10%;"></td> <td style="width: 10%;"></td> <td style="width: 10%;"></td> <td style="width: 10%;"></td> <td style="width: 10%;"></td> <td style="width: 10%;"></td> <td style="width: 10%;"></td> <td style="width: 10%;"></td> </tr> <tr> <td></td> <td></td> <td colspan="8" style="text-align: center;"> <table border="1" style="width: 100%; border-collapse: collapse; text-align: center;"> <tr> <td style="width: 10%;"></td> <td style="width: 10%;"></td> <td style="width: 10%;"></td> <td style="width: 10%;"></td> <td style="width: 10%;"></td> <td style="width: 10%;"></td> <td style="width: 10%;"></td> <td style="width: 10%;"></td> <td style="width: 10%;"></td> <td style="width: 10%;"></td> </tr> <tr> <td></td> <td></td> <td colspan="8" style="text-align: center;"> <table border="1" style="width: 100%; border-collapse: collapse; text-align: center;"> <tr> <td style="width: 10%;"></td> <td style="width: 10%;"></td> <td style="width: 10%;"></td> <td style="width: 10%;"></td> <td style="width: 10%;"></td> <td style="width: 10%;"></td> <td style="width: 10%;"></td> <td style="width: 10%;"></td> <td style="width: 10%;"></td> <td style="width: 10%;"></td> </tr> <tr> <td></td> <td></td> <td colspan="8" style="text-align: center;"> <table border="1" style="width: 100%; border-collapse: collapse; text-align: center;"> <tr> <td style="width: 10%;"></td> <td style="width: 10%;"></td> <td style="width: 10%;"></td> <td style="width: 10%;"></td> <td style="width: 10%;"></td> <td style="width: 10%;"></td> <td style="width: 10%;"></td> <td
style="width: 10%;"></td> <td style="width: 10%;"></td> <td style="width: 10%;"></td> </tr> <tr> <td></td> <td></td> <td colspan="8" style="text-align: center;"> <table border="1" style="width: 100%; border-collapse: collapse; text-align: center;"> <tr> <td style="width: 10%;"></td> <td style="width: 10%;"></td> <td style="width: 10%;"></td> <td style="width: 10%;"></td> <td style="width: 10%;"></td> <td style="width: 10%;"></td> <td style="width: 10%;"></td> <td style="width: 10%;"></td> <td style="width: 10%;"></td> <td style="width: 10%;"></td> </tr> <tr> <td></td> <td></td> <td colspan="8" style="text-align: center;"> <table border="1" style="width: 100%; border-collapse: collapse; text-align: center;"> <tr> <td style="width: 10%;"></td> <td style="width: 10%;"></td> <td style="width: 10%;"></td> <td style="width: 10%;"></td> <td style="width: 10%;"></td> <td style="width: 10%;"></td> <td style="width: 10%;"></td> <td style="width: 10%;"></td> <td style="width: 10%;"></td> <td style="width: 10%;"></td> </tr> <tr> <td></td> <td></td> <td colspan="8" style="text-align: center;"> <table border="1" style="width: 100%; border-collapse: collapse; text-align: center;"> <tr> <td style="width: 10%;"></td> <td style="width: 10%;"></td> <td style="width: 10%;"></td> <td style="width: 10%;"></td> <td style="width: 10%;"></td> <td style="width: 10%;"></td> <td style="width: 10%;"></td> <td style="width: 10%;"></td> <td style="width: 10%;"></td> <td style="width: 10%;"></td> </tr> <tr> <td></td> <td></td> <td colspan="8" style="text-align: center;"> <table border="1" style="width: 100%; border-collapse: collapse; text-align: center;"> <tr> <td style="width: 10%;"></td> <td style="width: 10%;"></td> <td style="width: 10%;"></td> <td style="width: 10%;"></td> <td style="width: 10%;"></td> <td style="width: 10%;"></td> <td style="width: 10%;"></td> <td style="width: 10%;"></td> <td style="width: 10%;"></td> <td style="width: 10%;"></td> </tr> <tr> <td></td> <td></td> <td colspan="8" style="text-align: center;"> <table border="1" style="width: 100%; border-collapse: collapse; text-align: center;"> <tr> <td style="width: 10%;"></td> <td style="width: 10%;"></td> <td style="width: 10%;"></td> <td style="width: 10%;"></td> <td style="width: 10%;"></td> <td style="width: 10%;"></td> <td style="width: 10%;"></td> <td style="width: 10%;"></td> <td style="width: 10%;"></td> <td style="width: 10%;"></td> </tr> <tr> <td></td> <td></td> <td colspan="8" style="text-align: center;"> <table border="1" style="width: 100%; border-collapse: collapse; text-align: center;"> <tr> <td style="width: 10%;"></td> <td style="width: 10%;"></td> <td style="width: 10%;"></td> <td style="width: 10%;"></td> <td style="width: 10%;"></td> <td style="width: 10%;"></td> <td style="width: 10%;"></td> <td style="width: 10%;"></td> <td style="width: 10%;"></td> <td style="width: 10%;"></td> </tr> <tr> <td></td> <td></td> <td colspan="8" style="text-align: center;"> <table border="1" style="width: 100%; border-collapse: collapse; text-align: center;"> <tr> <td style="width: 10%;"></td> <td style="width: 10%;"></td> <td style="width: 10%;"></td> <td style="width: 10%;"></td> <td style="width: 10%;"></td> <td style="width: 10%;"></td> <td style="width: 10%;"></td> <td style="width: 10%;"></td> <td style="width: 10%;"></td> <td style="width: 10%;"></td> </tr> <tr> <td></td> <td></td> <td colspan="8" style="text-align: center;"> <table border="1" style="width: 100%; border-collapse: collapse; text-align: center;"> <tr> <td style="width: 10%;"></td> <td style="width: 10%;"></td> <td style="width: 10%;"></td> <td style="width: 10%;"></td> <td style="width: 10%;"></td> <td style="width: 10%;"></td> <td style="width: 10%;"></td> <td style="width: 10%;"></td> <td style="width: 10%;"></td> <td style="width: 10%;"></td> </tr> <tr> <td></td> <td></td> <td colspan="8" style="text-align: center;"> <table border="1" style="width: 100%; border-collapse: collapse; text-align: center;"> <tr> <td style="width: 10%;"></td> <td style="width: 10%;"></td> <td style="width: 10%;"></td> <td style="width: 10%;"></td> <td style="width: 10%;"></td> <td style="width: 10%;"></td> <td style="width: 10%;"></td> <td style="width: 10%;"></td> <td style="width: 10%;"></td> <td style="width: 10%;"></td> </tr> <tr> <td></td> <td></td> <td colspan="8" style="text-align: center;"> <table border="1" style="width: 100%; border-collapse: collapse; text-align: center;"> <tr> <td style="width: 10%;"></td> <td style="width: 10%;"></td> <td style="width: 10%;"></td> <td style="width: 10%;"></td> <td style="width: 10%;"></td> <td style="width: 10%;"></td> <td style="width: 10%;"></td> <td style="width: 10%;"></td> <td style="width: 10%;"></td> <td style="width: 10%;"></td> </tr> <tr> <td></td> <td></td> <td colspan="8" style="text-align: center;"> <table border="1" style="width: 100%; border-collapse: collapse; text-align: center;"> <tr> </tr></table></td></tr></table></td></tr></table></td></tr></table></td></tr></table></td></tr></table></td></tr></table></td></tr></table></td></tr></table></td></tr></table></td></tr></table></td></tr></table></td></tr></table></td></tr></table></td></tr></table></td></tr></table></td></tr></table></td></tr></table></td></tr></table></td></tr></table></td></tr></table></td></tr></table></td></tr></table></td></tr></table></td></tr></table></td></tr></table></td></tr></table></td></tr></table>

 | | | | | | | | | | | | | | | | | | | | <table border="1" style="width: 100%; border-collapse: collapse; text-align: center;"> <tr> <td style="width: 10%;"></td> <td style="width: 10%;"></td> <td style="width: 10%;"></td> <td style="width: 10%;"></td> <td style="width: 10%;"></td> <td style="width: 10%;"></td> <td style="width: 10%;"></td> <td style="width: 10%;"></td> <td style="width: 10%;"></td> <td style="width: 10%;"></td> </tr> <tr> <td></td> <td></td> <td colspan="8" style="text-align: center;"> <table border="1" style="width: 100%; border-collapse: collapse; text-align: center;"> <tr> <td style="width: 10%;"></td> <td style="width: 10%;"></td> <td style="width: 10%;"></td> <td style="width: 10%;"></td> <td style="width: 10%;"></td> <td style="width: 10%;"></td> <td style="width: 10%;"></td> <td style="width: 10%;"></td> <td style="width: 10%;"></td> <td style="width: 10%;"></td> </tr> <tr> <td></td> <td></td> <td colspan="8" style="text-align: center;"> <table border="1" style="width: 100%; border-collapse: collapse; text-align: center;"> <tr> <td style="width: 10%;"></td> <td style="width: 10%;"></td> <td style="width: 10%;"></td> <td style="width: 10%;"></td> <td style="width: 10%;"></td> <td style="width: 10%;"></td> <td style="width: 10%;"></td> <td style="width: 10%;"></td> <td style="width: 10%;"></td> <td style="width: 10%;"></td> </tr> <tr> <td></td> <td></td> <td colspan="8" style="text-align: center;"> <table border="1" style="width: 100%; border-collapse: collapse; text-align: center;"> <tr> <td style="width: 10%;"></td> <td style="width: 10%;"></td> <td style="width: 10%;"></td> <td style="width: 10%;"></td> <td style="width: 10%;"></td> <td style="width: 10%;"></td> <td style="width: 10%;"></td> <td style="width: 10%;"></td> <td style="width: 10%;"></td> <td style="width: 10%;"></td> </tr> <tr> <td></td> <td></td> <td colspan="8" style="text-align: center;"> <table border="1" style="width: 100%; border-collapse: collapse; text-align: center;"> <tr> <td style="width: 10%;"></td> <td style="width: 10%;"></td> <td style="width: 10%;"></td> <td style="width: 10%;"></td> <td style="width: 10%;"></td> <td style="width: 10%;"></td> <td style="width: 10%;"></td> <td style="width: 10%;"></td> <td style="width: 10%;"></td> <td style="width: 10%;"></td> </tr> <tr> <td></td> <td></td> <td colspan="8" style="text-align: center;"> <table border="1" style="width: 100%; border-collapse: collapse; text-align: center;"> <tr> <td style="width: 10%;"></td> <td style="width: 10%;"></td> <td style="width: 10%;"></td> <td style="width: 10%;"></td> <td style="width: 10%;"></td> <td style="width: 10%;"></td> <td style="width: 10%;"></td> <td style="width: 10%;"></td> <td style="width: 10%;"></td> <td style="width: 10%;"></td> </tr> <tr> <td></td> <td></td> <td colspan="8" style="text-align: center;"> <table border="1" style="width: 100%; border-collapse: collapse; text-align: center;"> <tr> <td style="width: 10%;"></td> <td style="width: 10%;"></td> <td style="width: 10%;"></td> <td style="width: 10%;"></td> <td style="width: 10%;"></td> <td style="width: 10%;"></td> <td style="width: 10%;"></td> <td style="width: 10%;"></td> <td style="width: 10%;"></td> <td style="width: 10%;"></td> </tr> <tr> <td></td> <td></td> <td colspan="8" style="text-align: center;"> <table border="1" style="width: 100%; border-collapse: collapse; text-align: center;"> <tr> <td style="width: 10%;"></td> <td style="width: 10%;"></td> <td style="width: 10%;"></td> <td style="width: 10%;"></td> <td style="width: 10%;"></td> <td style="width: 10%;"></td> <td style="width: 10%;"></td> <td style="width: 10%;"></td> <td style="width: 10%;"></td> <td style="width: 10%;"></td> </tr> <tr> <td></td> <td></td> <td colspan="8" style="text-align: center;"> <table border="1" style="width: 100%; border-collapse: collapse; text-align: center;"> <tr> <td style="width: 10%;"></td> <td style="width: 10%;"></td> <td style="width: 10%;"></td> <td style="width: 10%;"></td> <td style="width: 10%;"></td> <td style="width: 10%;"></td> <td style="width: 10%;"></td> <td style="width: 10%;"></td> <td style="width: 10%;"></td> <td style="width: 10%;"></td> </tr> <tr> <td></td> <td></td> <td colspan="8" style="text-align: center;"> <table border="1" style="width: 100%; border-collapse: collapse; text-align: center;"> <tr> <td style="width: 10%;"></td> <td style="width: 10%;"></td> <td style="width: 10%;"></td> <td style="width: 10%;"></td> <td style="width: 10%;"></td> <td style="width: 10%;"></td> <td style="width: 10%;"></td> <td style="width: 10%;"></td> <td style="width: 10%;"></td> <td style="width: 10%;"></td> </tr> <tr> <td></td> <td></td> <td colspan="8" style="text-align: center;"> <table border="1" style="width: 100%; border-collapse: collapse; text-align: center;"> <tr> <td style="width: 10%;"></td> <td style="width: 10%;"></td> <td style="width: 10%;"></td> <td style="width: 10%;"></td> <td style="width: 10%;"></td> <td style="width: 10%;"></td> <td style="width: 10%;"></td> <td style="width: 10%;"></td> <td style="width: 10%;"></td> <td style="width: 10%;"></td> </tr> <tr> <td></td> <td></td> <td colspan="8" style="text-align: center;"> <table border="1" style="width: 100%; border-collapse: collapse; text-align: center;"> <tr> <td style="width: 10%;"></td> <td style="width: 10%;"></td> <td style="width: 10%;"></td> <td style="width: 10%;"></td> <td style="width: 10%;"></td> <td style="width: 10%;"></td> <td style="width: 10%;"></td> <td style="width: 10%;"></td> <td style="width: 10%;"></td> <td style="width: 10%;"></td> </tr> <tr> <td></td> <td></td> <td colspan="8" style="text-align: center;"> <table border="1" style="width: 100%; border-collapse: collapse; text-align: center;"> <tr> <td style="width: 10%;"></td> <td style="width: 10%;"></td> <td style="width: 10%;"></td> <td style="width: 10%;"></td> <td style="width: 10%;"></td> <td style="width: 10%;"></td> <td style="width: 10%;"></td> <td style="width: 10%;"></td> <td style="width: 10%;"></td> <td style="width: 10%;"></td> </tr> <tr> <td></td> <td></td> <td colspan="8" style="text-align: center;"> <table border="1" style="width: 100%; border-collapse: collapse; text-align: center;"> <tr> <td style="width: 10%;"></td> <td style="width: 10%;"></td> <td style="width: 10%;"></td> <td style="width: 10%;"></td> <td style="width: 10%;"></td> <td style="width: 10%;"></td> <td style="width: 10%;"></td> <td style="width: 10%;"></td> <td style="width: 10%;"></td> <td style="width: 10%;"></td> </tr> <tr> <td></td> <td></td> <td colspan="8" style="text-align: center;"> <table border="1" style="width: 100%; border-collapse: collapse; text-align: center;"> <tr> <td style="width: 10%;"></td> <td style="width: 10%;"></td> <td style="width: 10%;"></td> <td style="width: 10%;"></td> <td style="width: 10%;"></td> <td style="width: 10%;"></td> <td style="width: 10%;"></td> <td style="width: 10%;"></td> <td style="width: 10%;"></td> <td style="width: 10%;"></td> </tr> <tr> <td></td> <td></td> <td colspan="8" style="text-align: center;"> <table border="1" style="width: 100%; border-collapse: collapse; text-align: center;"> <tr> <td style="width: 10%;"></td> <td style="width: 10%;"></td> <td style="width: 10%;"></td> <td style="width: 10%;"></td> <td style="width: 10%;"></td> <td style="width: 10%;"></td> <td style="width: 10%;"></td> <td style="width: 10%;"></td> <td style="width: 10%;"></td> <td style="width: 10%;"></td> </tr> <tr> <td></td> <td></td> <td colspan="8" style="text-align: center;"> <table border="1" style="width: 100%; border-collapse: collapse; text-align: center;"> <tr> <td style="width: 10%;"></td> <td style="width: 10%;"></td> <td style="width: 10%;"></td> <td style="width: 10%;"></td> <td style="width: 10%;"></td> <td style="width: 10%;"></td> <td style="width: 10%;"></td> <td style="width: 10%;"></td> <td style="width: 10%;"></td> <td style="width: 10%;"></td> </tr> <tr> <td></td> <td></td> <td colspan="8" style="text-align: center;"> <table border="1" style="width: 100%; border-collapse: collapse; text-align: center;"> <tr> <td style="width: 10%;"></td> <td style="width: 10%;"></td> <td style="width: 10%;"></td> <td style="width: 10%;"></td> <td style="width: 10%;"></td> <td style="width: 10%;"></td> <td style="width: 10%;"></td> <td style="width: 10%;"></td> <td style="width: 10%;"></td> <td style="width: 10%;"></td> </tr> <tr> <td></td> <td></td> <td colspan="8" style="text-align: center;"> <table border="1" style="width: 100%;
border-collapse: collapse; text-align: center;"> <tr> <td style="width: 10%;"></td> <td style="width: 10%;"></td> <td style="width: 10%;"></td> <td style="width: 10%;"></td> <td style="width: 10%;"></td> <td style="width: 10%;"></td> <td style="width: 10%;"></td> <td style="width: 10%;"></td> <td style="width: 10%;"></td> <td style="width: 10%;"></td> </tr> <tr> <td></td> <td></td> <td colspan="8" style="text-align: center;"> <table border="1" style="width: 100%; border-collapse: collapse; text-align: center;"> <tr> <td style="width: 10%;"></td> <td style="width: 10%;"></td> <td style="width: 10%;"></td> <td style="width: 10%;"></td> <td style="width: 10%;"></td> <td style="width: 10%;"></td> <td style="width: 10%;"></td> <td style="width: 10%;"></td> <td style="width: 10%;"></td> <td style="width: 10%;"></td> </tr> <tr> <td></td> <td></td> <td colspan="8" style="text-align: center;"> <table border="1" style="width: 100%; border-collapse: collapse; text-align: center;"> <tr> <td style="width: 10%;"></td> <td style="width: 10%;"></td> <td style="width: 10%;"></td> <td style="width: 10%;"></td> <td style="width: 10%;"></td> <td style="width: 10%;"></td> <td style="width: 10%;"></td> <td style="width: 10%;"></td> <td style="width: 10%;"></td> <td style="width: 10%;"></td> </tr> <tr> <td></td> <td></td> <td colspan="8" style="text-align: center;"> <table border="1" style="width: 100%; border-collapse: collapse; text-align: center;"> <tr> <td style="width: 10%;"></td> <td style="width: 10%;"></td> <td style="width: 10%;"></td> <td style="width: 10%;"></td> <td style="width: 10%;"></td> <td style="width: 10%;"></td> <td style="width: 10%;"></td> <td style="width: 10%;"></td> <td style="width: 10%;"></td> <td style="width: 10%;"></td> </tr> <tr> <td></td> <td></td> <td colspan="8" style="text-align: center;"> <table border="1" style="width: 100%; border-collapse: collapse; text-align: center;"> <tr> <td style="width: 10%;"></td> <td style="width: 10%;"></td> <td style="width: 10%;"></td> <td style="width: 10%;"></td> <td style="width: 10%;"></td> <td style="width: 10%;"></td> <td style="width: 10%;"></td> <td style="width: 10%;"></td> <td style="width: 10%;"></td> <td style="width: 10%;"></td> </tr> <tr> <td></td> <td></td> <td colspan="8" style="text-align: center;"> <table border="1" style="width: 100%; border-collapse: collapse; text-align: center;"> <tr> <td style="width: 10%;"></td> <td style="width: 10%;"></td> <td style="width: 10%;"></td> <td style="width: 10%;"></td> <td style="width: 10%;"></td> <td style="width: 10%;"></td> <td style="width: 10%;"></td> <td style="width: 10%;"></td> <td style="width: 10%;"></td> <td style="width: 10%;"></td> </tr> <tr> <td></td> <td></td> <td colspan="8" style="text-align: center;"> <table border="1" style="width: 100%; border-collapse: collapse; text-align: center;"> <tr> <td style="width: 10%;"></td> <td style="width: 10%;"></td> <td style="width: 10%;"></td> <td style="width: 10%;"></td> <td style="width: 10%;"></td> <td style="width: 10%;"></td> <td style="width: 10%;"></td> <td style="width: 10%;"></td> <td style="width: 10%;"></td> <td style="width: 10%;"></td> </tr> <tr> <td></td> <td></td> <td colspan="8" style="text-align: center;"> <table border="1" style="width: 100%; border-collapse: collapse; text-align: center;"> <tr> <td style="width: 10%;"></td> <td style="width: 10%;"></td> <td style="width: 10%;"></td> <td style="width: 10%;"></td> <td style="width: 10%;"></td> <td style="width: 10%;"></td> <td style="width: 10%;"></td> <td style="width: 10%;"></td> <td style="width: 10%;"></td> <td style="width: 10%;"></td> </tr> <tr> <td></td> <td></td> <td colspan="8" style="text-align: center;"> <table border="1" style="width: 100%; border-collapse: collapse; text-align: center;"> <tr> </tr></table></td></tr></table></td></tr></table></td></tr></table></td></tr></table></td></tr></table></td></tr></table></td></tr></table></td></tr></table></td></tr></table></td></tr></table></td></tr></table></td></tr></table></td></tr></table></td></tr></table></td></tr></table></td></tr></table></td></tr></table></td></tr></table></td></tr></table></td></tr></table></td></tr></table></td></tr></table></td></tr></table></td></tr></table></td></tr></table></td></tr></table>

 | | | | | | | | | | | | | | | | | | | | <table border="1" style="width: 100%; border-collapse: collapse; text-align: center;"> <tr> <td style="width: 10%;"></td> <td style="width: 10%;"></td> <td style="width: 10%;"></td> <td style="width: 10%;"></td> <td style="width: 10%;"></td> <td style="width: 10%;"></td> <td style="width: 10%;"></td> <td style="width: 10%;"></td> <td style="width: 10%;"></td> <td style="width: 10%;"></td> </tr> <tr> <td></td> <td></td> <td colspan="8" style="text-align: center;"> <table border="1" style="width: 100%; border-collapse: collapse; text-align: center;"> <tr> <td style="width: 10%;"></td> <td style="width: 10%;"></td> <td style="width: 10%;"></td> <td style="width: 10%;"></td> <td style="width: 10%;"></td> <td style="width: 10%;"></td> <td style="width: 10%;"></td> <td style="width: 10%;"></td> <td style="width: 10%;"></td> <td style="width: 10%;"></td> </tr> <tr> <td></td> <td></td> <td colspan="8" style="text-align: center;"> <table border="1" style="width: 100%; border-collapse: collapse; text-align: center;"> <tr> <td style="width: 10%;"></td> <td style="width: 10%;"></td> <td style="width: 10%;"></td> <td style="width: 10%;"></td> <td style="width: 10%;"></td> <td style="width: 10%;"></td> <td style="width: 10%;"></td> <td style="width: 10%;"></td> <td style="width: 10%;"></td> <td style="width: 10%;"></td> </tr> <tr> <td></td> <td></td> <td colspan="8" style="text-align: center;"> <table border="1" style="width: 100%; border-collapse: collapse; text-align: center;"> <tr> <td style="width: 10%;"></td> <td style="width: 10%;"></td> <td style="width: 10%;"></td> <td style="width: 10%;"></td> <td style="width: 10%;"></td> <td style="width: 10%;"></td> <td style="width: 10%;"></td> <td style="width: 10%;"></td> <td style="width: 10%;"></td> <td style="width: 10%;"></td> </tr> <tr> <td></td> <td></td> <td colspan="8" style="text-align: center;"> <table border="1" style="width: 100%; border-collapse: collapse; text-align: center;"> <tr> <td style="width: 10%;"></td> <td style="width: 10%;"></td> <td style="width: 10%;"></td> <td style="width: 10%;"></td> <td style="width: 10%;"></td> <td style="width: 10%;"></td> <td style="width: 10%;"></td> <td style="width: 10%;"></td> <td style="width: 10%;"></td> <td style="width: 10%;"></td> </tr> <tr> <td></td> <td></td> <td colspan="8" style="text-align: center;"> <table border="1" style="width: 100%; border-collapse: collapse; text-align: center;"> <tr> <td style="width: 10%;"></td> <td style="width: 10%;"></td> <td style="width: 10%;"></td> <td style="width: 10%;"></td> <td style="width: 10%;"></td> <td style="width: 10%;"></td> <td style="width: 10%;"></td> <td style="width: 10%;"></td> <td style="width: 10%;"></td> <td style="width: 10%;"></td> </tr> <tr> <td></td> <td></td> <td colspan="8" style="text-align: center;"> <table border="1" style="width: 100%; border-collapse: collapse; text-align: center;"> <tr> <td style="width: 10%;"></td> <td style="width: 10%;"></td> <td style="width: 10%;"></td> <td style="width: 10%;"></td> <td style="width: 10%;"></td> <td style="width: 10%;"></td> <td style="width: 10%;"></td> <td style="width: 10%;"></td> <td style="width: 10%;"></td> <td style="width: 10%;"></td> </tr> <tr> <td></td> <td></td> <td colspan="8" style="text-align: center;"> <table border="1" style="width: 100%; border-collapse: collapse; text-align: center;"> <tr> <td style="width: 10%;"></td> <td style="width: 10%;"></td> <td style="width: 10%;"></td> <td style="width: 10%;"></td> <td style="width: 10%;"></td> <td style="width: 10%;"></td> <td style="width: 10%;"></td> <td style="width: 10%;"></td> <td style="width: 10%;"></td> <td style="width: 10%;"></td> </tr> <tr> <td></td> <td></td> <td colspan="8" style="text-align: center;"> <table border="1" style="width: 100%; border-collapse: collapse; text-align: center;"> <tr> <td style="width: 10%;"></td> <td style="width: 10%;"></td> <td style="width: 10%;"></td> <td style="width: 10%;"></td> <td style="width: 10%;"></td> <td style="width: 10%;"></td> <td style="width: 10%;"></td> <td style="width: 10%;"></td> <td style="width: 10%;"></td> <td style="width: 10%;"></td> </tr> <tr> <td></td> <td></td> <td colspan="8" style="text-align: center;"> <table border="1" style="width: 100%; border-collapse: collapse; text-align: center;"> <tr> <td style="width: 10%;"></td> <td style="width: 10%;"></td> <td style="width: 10%;"></td> <td style="width: 10%;"></td> <td style="width: 10%;"></td> <td style="width: 10%;"></td> <td style="width: 10%;"></td> <td style="width: 10%;"></td> <td style="width: 10%;"></td> <td style="width: 10%;"></td> </tr> <tr> <td></td> <td></td> <td colspan="8" style="text-align: center;"> <table border="1" style="width: 100%; border-collapse: collapse; text-align: center;"> <tr> <td style="width: 10%;"></td> <td style="width: 10%;"></td> <td style="width: 10%;"></td> <td style="width: 10%;"></td> <td style="width: 10%;"></td> <td style="width: 10%;"></td> <td style="width: 10%;"></td> <td style="width: 10%;"></td> <td style="width: 10%;"></td> <td style="width: 10%;"></td> </tr> <tr> <td></td> <td></td> <td colspan="8" style="text-align: center;"> <table border="1" style="width: 100%; border-collapse: collapse; text-align: center;"> <tr> <td style="width: 10%;"></td> <td style="width: 10%;"></td> <td style="width: 10%;"></td> <td style="width: 10%;"></td> <td style="width: 10%;"></td> <td style="width: 10%;"></td> <td style="width: 10%;"></td> <td style="width: 10%;"></td> <td style="width: 10%;"></td> <td style="width: 10%;"></td> </tr> <tr> <td></td> <td></td> <td colspan="8" style="text-align: center;"> <table border="1" style="width: 100%; border-collapse: collapse; text-align: center;"> <tr> <td style="width: 10%;"></td> <td style="width: 10%;"></td> <td style="width: 10%;"></td> <td style="width: 10%;"></td> <td style="width: 10%;"></td> <td style="width: 10%;"></td> <td style="width: 10%;"></td> <td style="width: 10%;"></td> <td style="width: 10%;"></td> <td style="width: 10%;"></td> </tr> <tr> <td></td> <td></td> <td colspan="8" style="text-align: center;"> <table border="1" style="width: 100%; border-collapse: collapse; text-align: center;"> <tr> <td style="width: 10%;"></td> <td style="width: 10%;"></td> <td style="width: 10%;"></td> <td style="width: 10%;"></td> <td style="width: 10%;"></td> <td style="width: 10%;"></td> <td style="width: 10%;"></td> <td style="width: 10%;"></td> <td style="width: 10%;"></td> <td style="width: 10%;"></td> </tr> <tr> <td></td> <td></td> <td colspan="8" style="text-align: center;"> <table border="1" style="width: 100%; border-collapse: collapse; text-align: center;"> <tr> <td style="width: 10%;"></td> <td style="width: 10%;"></td> <td style="width: 10%;"></td> <td style="width: 10%;"></td> <td style="width: 10%;"></td> <td style="width: 10%;"></td> <td style="width: 10%;"></td> <td style="width: 10%;"></td> <td style="width: 10%;"></td> <td style="width: 10%;"></td> </tr> <tr> <td></td> <td></td> <td colspan="8" style="text-align: center;"> <table border="1" style="width: 100%; border-collapse: collapse; text-align: center;"> <tr> <td style="width: 10%;"></td> <td style="width: 10%;"></td> <td style="width: 10%;"></td> <td style="width: 10%;"></td> <td style="width: 10%;"></td> <td style="width: 10%;"></td> <td style="width: 10%;"></td> <td style="width: 10%;"></td> <td style="width: 10%;"></td> <td style="width: 10%;"></td> </tr> <tr> <td></td> <td></td> <td colspan="8" style="text-align: center;"> <table border="1" style="width: 100%; border-collapse: collapse; text-align: center;"> <tr> <td style="width: 10%;"></td> <td style="width: 10%;"></td> <td style="width: 10%;"></td> <td style="width: 10%;"></td> <td style="width: 10%;"></td> <td style="width: 10%;"></td> <td style="width: 10%;"></td> <td style="width: 10%;"></td> <td style="width: 10%;"></td> <td style="width: 10%;"></td> </tr> <tr> <td></td> <td></td> <td colspan="8" style="text-align: center;"> <table border="1" style="width: 100%; border-collapse: collapse; text-align: center;"> <tr> <td style="width: 10%;"></td> <td style="width: 10%;"></td> <td style="width: 10%;"></td> <td style="width: 10%;"></td> <td style="width: 10%;"></td> <td style="width: 10%;"></td> <td style="width: 10%;"></td> <td style="width: 10%;"></td> <td style="width: 10%;"></td> <td style="width: 10%;"></td> </tr> <tr> <td></td> <td></td> <td colspan="8" style="text-align: center;"> <table border="1" style="width: 100%; border-collapse: collapse; text-align: center;"> <tr> <td style="width: 10%;"></td> <td style="width: 10%;"></td> <td style="width: 10%;"></td> <td style="width: 10%;"></td> <td style="width: 10%;"></td> <td style="width: 10%;"></td> <td style="width: 10%;"></td> <td style="width: 10%;"></td> <td style="width: 10%;"></td> <td style="width: 10%;"></td> </tr> <tr> <td></td> <td></td> <td colspan="8" style="text-align: center;"> <table border="1" style="width: 100%; border-collapse: collapse; text-align: center;"> <tr> <td style="width: 10%;"></td> <td style="width: 10%;"></td> <td style="width: 10%;"></td> <td style="width: 10%;"></td> <td style="width: 10%;"></td> <td style="width: 10%;"></td> <td style="width: 10%;"></td> <td style="width: 10%;"></td> <td style="width: 10%;"></td> <td style="width: 10%;"></td> </tr> <tr> <td></td> <td></td> <td colspan="8" style="text-align: center;"> <table border="1" style="width: 100%; border-collapse: collapse; text-align: center;"> <tr> <td style="width: 10%;"></td> <td style="width: 10%;"></td> <td style="width: 10%;"></td> <td style="width: 10%;"></td> <td style="width: 10%;"></td> <td style="width:
10%;"></td> <td style="width: 10%;"></td> <td style="width: 10%;"></td> <td style="width: 10%;"></td> <td style="width: 10%;"></td> </tr> <tr> <td></td> <td></td> <td colspan="8" style="text-align: center;"> <table border="1" style="width: 100%; border-collapse: collapse; text-align: center;"> <tr> <td style="width: 10%;"></td> <td style="width: 10%;"></td> <td style="width: 10%;"></td> <td style="width: 10%;"></td> <td style="width: 10%;"></td> <td style="width: 10%;"></td> <td style="width: 10%;"></td> <td style="width: 10%;"></td> <td style="width: 10%;"></td> <td style="width: 10%;"></td> </tr> <tr> <td></td> <td></td> <td colspan="8" style="text-align: center;"> <table border="1" style="width: 100%; border-collapse: collapse; text-align: center;"> <tr> <td style="width: 10%;"></td> <td style="width: 10%;"></td> <td style="width: 10%;"></td> <td style="width: 10%;"></td> <td style="width: 10%;"></td> <td style="width: 10%;"></td> <td style="width: 10%;"></td> <td style="width: 10%;"></td> <td style="width: 10%;"></td> <td style="width: 10%;"></td> </tr> <tr> <td></td> <td></td> <td colspan="8" style="text-align: center;"> <table border="1" style="width: 100%; border-collapse: collapse; text-align: center;"> <tr> <td style="width: 10%;"></td> <td style="width: 10%;"></td> <td style="width: 10%;"></td> <td style="width: 10%;"></td> <td style="width: 10%;"></td> <td style="width: 10%;"></td> <td style="width: 10%;"></td> <td style="width: 10%;"></td> <td style="width: 10%;"></td> <td style="width: 10%;"></td> </tr> <tr> <td></td> <td></td> <td colspan="8" style="text-align: center;"> <table border="1" style="width: 100%; border-collapse: collapse; text-align: center;"> <tr> <td style="width: 10%;"></td> <td style="width: 10%;"></td> <td style="width: 10%;"></td> <td style="width: 10%;"></td> <td style="width: 10%;"></td> <td style="width: 10%;"></td> <td style="width: 10%;"></td> <td style="width: 10%;"></td> <td style="width: 10%;"></td> <td style="width: 10%;"></td> </tr> <tr> <td></td> <td></td> <td colspan="8" style="text-align: center;"> <table border="1" style="width: 100%; border-collapse: collapse; text-align: center;"> <tr> </tr></table></td></tr></table></td></tr></table></td></tr></table></td></tr></table></td></tr></table></td></tr></table></td></tr></table></td></tr></table></td></tr></table></td></tr></table></td></tr></table></td></tr></table></td></tr></table></td></tr></table></td></tr></table></td></tr></table></td></tr></table></td></tr></table></td></tr></table></td></tr></table></td></tr></table></td></tr></table></td></tr></table></td></tr></table></td></tr></table>
 | | | | | | | | | | | | | | | | | | | | <table border="1" style="width: 100%; border-collapse: collapse; text-align: center;"> <tr> <td style="width: 10%;"></td> <td style="width: 10%;"></td> <td style="width: 10%;"></td> <td style="width: 10%;"></td> <td style="width: 10%;"></td> <td style="width: 10%;"></td> <td style="width: 10%;"></td> <td style="width: 10%;"></td> <td style="width: 10%;"></td> <td style="width: 10%;"></td> </tr> <tr> <td></td> <td></td> <td colspan="8" style="text-align: center;"> <table border="1" style="width: 100%; border-collapse: collapse; text-align: center;"> <tr> <td style="width: 10%;"></td> <td style="width: 10%;"></td> <td style="width: 10%;"></td> <td style="width: 10%;"></td> <td style="width: 10%;"></td> <td style="width: 10%;"></td> <td style="width: 10%;"></td> <td style="width: 10%;"></td> <td style="width: 10%;"></td> <td style="width: 10%;"></td> </tr> <tr> <td></td> <td></td> <td colspan="8" style="text-align: center;"> <table border="1" style="width: 100%; border-collapse: collapse; text-align: center;"> <tr> <td style="width: 10%;"></td> <td style="width: 10%;"></td> <td style="width: 10%;"></td> <td style="width: 10%;"></td> <td style="width: 10%;"></td> <td style="width: 10%;"></td> <td style="width: 10%;"></td> <td style="width:
10%;"></td> <td style="width: 10%;"></td> <td style="width: 10%;"></td> </tr> <tr> <td></td> <td></td> <td colspan="8" style="text-align: center;"> <table border="1" style="width: 100%; border-collapse: collapse; text-align: center;"> <tr> <td style="width: 10%;"></td> <td style="width: 10%;"></td> <td style="width: 10%;"></td> <td style="width: 10%;"></td> <td style="width: 10%;"></td> <td style="width: 10%;"></td> <td style="width: 10%;"></td> <td style="width: 10%;"></td> <td style="width: 10%;"></td> <td style="width: 10%;"></td> </tr> <tr> <td></td> <td></td> <td colspan="8" style="text-align: center;"> <table border="1" style="width: 100%; border-collapse: collapse; text-align: center;"> <tr> <td style="width: 10%;"></td> <td style="width: 10%;"></td> <td style="width: 10%;"></td> <td style="width: 10%;"></td> <td style="width: 10%;"></td> <td style="width: 10%;"></td> <td style="width: 10%;"></td> <td style="width: 10%;"></td> <td style="width: 10%;"></td> <td style="width: 10%;"></td> </tr> <tr> <td></td> <td></td> <td colspan="8" style="text-align: center;"> <table border="1" style="width: 100%; border-collapse: collapse; text-align: center;"> <tr> <td style="width: 10%;"></td> <td style="width: 10%;"></td> <td style="width: 10%;"></td> <td style="width: 10%;"></td> <td style="width: 10%;"></td> <td style="width: 10%;"></td> <td style="width: 10%;"></td> <td style="width: 10%;"></td> <td style="width: 10%;"></td> <td style="width: 10%;"></td> </tr> <tr> <td></td> <td></td> <td colspan="8" style="text-align: center;"> <table border="1" style="width: 100%; border-collapse: collapse; text-align: center;"> <tr> <td style="width: 10%;"></td> <td style="width: 10%;"></td> <td style="width: 10%;"></td> <td style="width: 10%;"></td> <td style="width: 10%;"></td> <td style="width: 10%;"></td> <td style="width: 10%;"></td> <td style="width: 10%;"></td> <td style="width: 10%;"></td> <td style="width: 10%;"></td> </tr> <tr> <td></td> <td></td> <td colspan="8" style="text-align: center;"> <table border="1" style="width: 100%; border-collapse: collapse; text-align: center;"> <tr> <td style="width: 10%;"></td> <td style="width: 10%;"></td> <td style="width: 10%;"></td> <td style="width: 10%;"></td> <td style="width: 10%;"></td> <td style="width: 10%;"></td> <td style="width: 10%;"></td> <td style="width: 10%;"></td> <td style="width: 10%;"></td> <td style="width: 10%;"></td> </tr> <tr> <td></td> <td></td> <td colspan="8" style="text-align: center;"> <table border="1" style="width: 100%; border-collapse: collapse; text-align: center;"> <tr> <td style="width: 10%;"></td> <td style="width: 10%;"></td> <td style="width: 10%;"></td> <td style="width: 10%;"></td> <td style="width: 10%;"></td> <td style="width: 10%;"></td> <td style="width: 10%;"></td> <td style="width: 10%;"></td> <td style="width: 10%;"></td> <td style="width: 10%;"></td> </tr> <tr> <td></td> <td></td> <td colspan="8" style="text-align: center;"> <table border="1" style="width: 100%; border-collapse: collapse; text-align: center;"> <tr> <td style="width: 10%;"></td> <td style="width: 10%;"></td> <td style="width: 10%;"></td> <td style="width: 10%;"></td> <td style="width: 10%;"></td> <td style="width: 10%;"></td> <td style="width: 10%;"></td> <td style="width: 10%;"></td> <td style="width: 10%;"></td> <td style="width: 10%;"></td> </tr> <tr> <td></td> <td></td> <td colspan="8" style="text-align: center;"> <table border="1" style="width: 100%; border-collapse: collapse; text-align: center;"> <tr> <td style="width: 10%;"></td> <td style="width: 10%;"></td> <td style="width: 10%;"></td> <td style="width: 10%;"></td> <td style="width: 10%;"></td> <td style="width: 10%;"></td> <td style="width: 10%;"></td> <td style="width: 10%;"></td> <td style="width: 10%;"></td> <td style="width: 10%;"></td> </tr> <tr> <td></td> <td></td> <td colspan="8" style="text-align: center;"> <table border="1" style="width: 100%; border-collapse: collapse; text-align: center;"> <tr> <td style="width: 10%;"></td> <td style="width: 10%;"></td> <td style="width: 10%;"></td> <td style="width: 10%;"></td> <td style="width: 10%;"></td> <td style="width: 10%;"></td> <td style="width: 10%;"></td> <td style="width: 10%;"></td> <td style="width: 10%;"></td> <td style="width: 10%;"></td> </tr> <tr> <td></td> <td></td> <td colspan="8" style="text-align: center;"> <table border="1" style="width: 100%; border-collapse: collapse; text-align: center;"> <tr> <td style="width: 10%;"></td> <td style="width: 10%;"></td> <td style="width: 10%;"></td> <td style="width: 10%;"></td> <td style="width: 10%;"></td> <td style="width: 10%;"></td> <td style="width: 10%;"></td> <td style="width: 10%;"></td> <td style="width: 10%;"></td> <td style="width: 10%;"></td> </tr> <tr> <td></td> <td></td> <td colspan="8" style="text-align: center;"> <table border="1" style="width: 100%; border-collapse: collapse; text-align: center;"> <tr> <td style="width: 10%;"></td> <td style="width: 10%;"></td> <td style="width: 10%;"></td> <td style="width: 10%;"></td> <td style="width: 10%;"></td> <td style="width: 10%;"></td> <td style="width: 10%;"></td> <td style="width: 10%;"></td> <td style="width: 10%;"></td> <td style="width: 10%;"></td> </tr> <tr> <td></td> <td></td> <td colspan="8" style="text-align: center;"> <table border="1" style="width: 100%; border-collapse: collapse; text-align: center;"> <tr> <td style="width: 10%;"></td> <td style="width: 10%;"></td> <td style="width: 10%;"></td> <td style="width: 10%;"></td> <td style="width: 10%;"></td> <td style="width: 10%;"></td> <td style="width: 10%;"></td> <td style="width: 10%;"></td> <td style="width: 10%;"></td> <td style="width: 10%;"></td> </tr> <tr> <td></td> <td></td> <td colspan="8" style="text-align: center;"> <table border="1" style="width: 100%; border-collapse: collapse; text-align: center;"> <tr> <td style="width: 10%;"></td> <td style="width: 10%;"></td> <td style="width: 10%;"></td> <td style="width: 10%;"></td> <td style="width: 10%;"></td> <td style="width: 10%;"></td> <td style="width: 10%;"></td> <td style="width: 10%;"></td> <td style="width: 10%;"></td> <td style="width: 10%;"></td> </tr> <tr> <td></td> <td></td> <td colspan="8" style="text-align: center;"> <table border="1" style="width: 100%; border-collapse: collapse; text-align: center;"> <tr> <td style="width: 10%;"></td> <td style="width: 10%;"></td> <td style="width: 10%;"></td> <td style="width: 10%;"></td> <td style="width: 10%;"></td> <td style="width: 10%;"></td> <td style="width: 10%;"></td> <td style="width: 10%;"></td> <td style="width: 10%;"></td> <td style="width: 10%;"></td> </tr> <tr> <td></td> <td></td> <td colspan="8" style="text-align: center;"> <table border="1" style="width: 100%; border-collapse: collapse; text-align: center;"> <tr> <td style="width: 10%;"></td> <td style="width: 10%;"></td> <td style="width: 10%;"></td> <td style="width: 10%;"></td> <td style="width: 10%;"></td> <td style="width: 10%;"></td> <td style="width: 10%;"></td> <td style="width: 10%;"></td> <td style="width: 10%;"></td> <td style="width: 10%;"></td> </tr> <tr> <td></td> <td></td> <td colspan="8" style="text-align: center;"> <table border="1" style="width: 100%; border-collapse: collapse; text-align: center;"> <tr> <td style="width: 10%;"></td> <td style="width: 10%;"></td> <td style="width: 10%;"></td> <td style="width: 10%;"></td> <td style="width: 10%;"></td> <td style="width: 10%;"></td> <td style="width: 10%;"></td> <td style="width: 10%;"></td> <td style="width: 10%;"></td> <td style="width: 10%;"></td> </tr> <tr> <td></td> <td></td> <td colspan="8" style="text-align: center;"> <table border="1" style="width: 100%; border-collapse: collapse; text-align: center;"> <tr> <td style="width: 10%;"></td> <td style="width: 10%;"></td> <td style="width: 10%;"></td> <td style="width: 10%;"></td> <td style="width: 10%;"></td> <td style="width: 10%;"></td> <td style="width: 10%;"></td> <td style="width: 10%;"></td> <td style="width: 10%;"></td> <td style="width: 10%;"></td> </tr> <tr> <td></td> <td></td> <td colspan="8" style="text-align: center;"> <table border="1" style="width: 100%; border-collapse: collapse; text-align: center;"> <tr> <td style="width: 10%;"></td> <td style="width: 10%;"></td> <td style="width: 10%;"></td> <td style="width: 10%;"></td> <td style="width: 10%;"></td> <td style="width: 10%;"></td> <td style="width: 10%;"></td> <td style="width: 10%;"></td> <td style="width: 10%;"></td> <td style="width: 10%;"></td> </tr> <tr> <td></td> <td></td> <td colspan="8" style="text-align: center;"> <table border="1" style="width: 100%; border-collapse: collapse; text-align: center;"> <tr> <td style="width: 10%;"></td> <td style="width: 10%;"></td> <td style="width: 10%;"></td> <td style="width: 10%;"></td> <td style="width: 10%;"></td> <td style="width: 10%;"></td> <td style="width: 10%;"></td> <td style="width: 10%;"></td> <td style="width: 10%;"></td> <td style="width: 10%;"></td> </tr> <tr> <td></td> <td></td> <td colspan="8" style="text-align: center;"> <table border="1" style="width: 100%; border-collapse: collapse; text-align: center;"> <tr> <td style="width: 10%;"></td> <td style="width: 10%;"></td> <td style="width: 10%;"></td> <td style="width: 10%;"></td> <td style="width: 10%;"></td> <td style="width: 10%;"></td> <td style="width: 10%;"></td> <td style="width: 10%;"></td> <td style="width: 10%;"></td> <td style="width: 10%;"></td> </tr> <tr> <td></td> <td></td> <td colspan="8" style="text-align: center;"> <table border="1" style="width: 100%; border-collapse: collapse; text-align: center;"> <tr> <td style="width: 10%;"></td> <td style="width: 10%;"></td> <td style="width: 10%;"></td> <td style="width: 10%;"></td> <td style="width: 10%;"></td> <td style="width: 10%;"></td> <td style="width: 10%;"></td> <td style="width: 10%;"></td> <td style="width: 10%;"></td> <td style="width: 10%;"></td> </tr> <tr> <td></td> <td></td> <td colspan="8" style="text-align: center;"> <table border="1"
style="width: 100%; border-collapse: collapse; text-align: center;"> <tr> </tr></table></td></tr></table></td></tr></table></td></tr></table></td></tr></table></td></tr></table></td></tr></table></td></tr></table></td></tr></table></td></tr></table></td></tr></table></td></tr></table></td></tr></table></td></tr></table></td></tr></table></td></tr></table></td></tr></table></td></tr></table></td></tr></table></td></tr></table></td></tr></table></td></tr></table></td></tr></table></td></tr></table></td></tr></table>
 | | | | | | | | | | | | | | | | | | | | <table border="1" style="width: 100%; border-collapse: collapse; text-align: center;"> <tr> <td style="width: 10%;"></td> <td style="width: 10%;"></td> <td style="width: 10%;"></td> <td style="width: 10%;"></td> <td style="width: 10%;"></td> <td style="width: 10%;"></td> <td style="width: 10%;"></td> <td style="width: 10%;"></td> <td style="width: 10%;"></td> <td style="width: 10%;"></td> </tr> <tr> <td></td> <td></td> <td colspan="8" style="text-align: center;"> <table border="1" style="width: 100%; border-collapse: collapse; text-align: center;"> <tr> <td style="width: 10%;"></td> <td style="width: 10%;"></td> <td style="width: 10%;"></td> <td style="width: 10%;"></td> <td style="width: 10%;"></td> <td style="width: 10%;"></td> <td style="width: 10%;"></td> <td style="width: 10%;"></td> <td style="width: 10%;"></td> <td style="width: 10%;"></td> </tr> <tr> <td></td> <td></td> <td colspan="8" style="text-align: center;"> <table border="1" style="width: 100%; border-collapse: collapse; text-align: center;"> <tr> <td style="width: 10%;"></td> <td style="width: 10%;"></td> <td style="width: 10%;"></td> <td style="width: 10%;"></td> <td style="width: 10%;"></td> <td style="width: 10%;"></td> <td style="width: 10%;"></td> <td style="width: 10%;"></td> <td style="width: 10%;"></td> <td style="width: 10%;"></td> </tr> <tr> <td></td> <td></td> <td colspan="8" style="text-align: center;"> <table border="1" style="width: 100%; border-collapse: collapse; text-align: center;"> <tr> <td style="width: 10%;"></td> <td style="width: 10%;"></td> <td style="width: 10%;"></td> <td style="width: 10%;"></td> <td style="width: 10%;"></td> <td style="width: 10%;"></td> <td style="width: 10%;"></td> <td style="width: 10%;"></td> <td style="width: 10%;"></td> <td style="width: 10%;"></td> </tr> <tr> <td></td> <td></td> <td colspan="8" style="text-align: center;"> <table border="1" style="width: 100%; border-collapse: collapse; text-align: center;"> <tr> <td style="width: 10%;"></td> <td style="width: 10%;"></td> <td style="width: 10%;"></td> <td style="width: 10%;"></td> <td style="width: 10%;"></td> <td style="width: 10%;"></td> <td style="width: 10%;"></td> <td style="width: 10%;"></td> <td style="width: 10%;"></td> <td style="width: 10%;"></td> </tr> <tr> <td></td> <td></td> <td colspan="8" style="text-align: center;"> <table border="1" style="width: 100%; border-collapse: collapse; text-align: center;"> <tr> <td style="width: 10%;"></td> <td style="width: 10%;"></td> <td style="width: 10%;"></td> <td style="width: 10%;"></td> <td style="width: 10%;"></td> <td style="width: 10%;"></td> <td style="width: 10%;"></td> <td style="width: 10%;"></td> <td style="width: 10%;"></td> <td style="width: 10%;"></td> </tr> <tr> <td></td> <td></td> <td colspan="8" style="text-align: center;"> <table border="1" style="width: 100%; border-collapse: collapse; text-align: center;"> <tr> <td style="width: 10%;"></td> <td style="width: 10%;"></td> <td style="width: 10%;"></td> <td style="width: 10%;"></td> <td style="width: 10%;"></td> <td style="width: 10%;"></td> <td style="width: 10%;"></td> <td style="width: 10%;"></td> <td style="width: 10%;"></td> <td style="width: 10%;"></td> </tr> <tr> <td></td> <td></td> <td colspan="8" style="text-align: center;"> <table border="1" style="width: 100%; border-collapse: collapse; text-align: center;"> <tr> <td
style="width: 10%;"></td> <td style="width: 10%;"></td> <td style="width: 10%;"></td> <td style="width: 10%;"></td> <td style="width: 10%;"></td> <td style="width: 10%;"></td> <td style="width: 10%;"></td> <td style="width: 10%;"></td> <td style="width: 10%;"></td> <td style="width: 10%;"></td> </tr> <tr> <td></td> <td></td> <td colspan="8" style="text-align: center;"> <table border="1" style="width: 100%; border-collapse: collapse; text-align: center;"> <tr> <td style="width: 10%;"></td> <td style="width: 10%;"></td> <td style="width: 10%;"></td> <td style="width: 10%;"></td> <td style="width: 10%;"></td> <td style="width: 10%;"></td> <td style="width: 10%;"></td> <td style="width: 10%;"></td> <td style="width: 10%;"></td> <td style="width: 10%;"></td> </tr> <tr> <td></td> <td></td> <td colspan="8" style="text-align: center;"> <table border="1" style="width: 100%; border-collapse: collapse; text-align: center;"> <tr> <td style="width: 10%;"></td> <td style="width: 10%;"></td> <td style="width: 10%;"></td> <td style="width: 10%;"></td> <td style="width: 10%;"></td> <td style="width: 10%;"></td> <td style="width: 10%;"></td> <td style="width: 10%;"></td> <td style="width: 10%;"></td> <td style="width: 10%;"></td> </tr> <tr> <td></td> <td></td> <td colspan="8" style="text-align: center;"> <table border="1" style="width: 100%; border-collapse: collapse; text-align: center;"> <tr> <td style="width: 10%;"></td> <td style="width: 10%;"></td> <td style="width: 10%;"></td> <td style="width: 10%;"></td> <td style="width: 10%;"></td> <td style="width: 10%;"></td> <td style="width: 10%;"></td> <td style="width: 10%;"></td> <td style="width: 10%;"></td> <td style="width: 10%;"></td> </tr> <tr> <td></td> <td></td> <td colspan="8" style="text-align: center;"> <table border="1" style="width: 100%; border-collapse: collapse; text-align: center;"> <tr> <td style="width: 10%;"></td> <td style="width: 10%;"></td> <td style="width: 10%;"></td> <td style="width: 10%;"></td> <td style="width: 10%;"></td> <td style="width: 10%;"></td> <td style="width: 10%;"></td> <td style="width: 10%;"></td> <td style="width: 10%;"></td> <td style="width: 10%;"></td> </tr> <tr> <td></td> <td></td> <td colspan="8" style="text-align: center;"> <table border="1" style="width: 100%; border-collapse: collapse; text-align: center;"> <tr> <td style="width: 10%;"></td> <td style="width: 10%;"></td> <td style="width: 10%;"></td> <td style="width: 10%;"></td> <td style="width: 10%;"></td> <td style="width: 10%;"></td> <td style="width: 10%;"></td> <td style="width: 10%;"></td> <td style="width: 10%;"></td> <td style="width: 10%;"></td> </tr> <tr> <td></td> <td></td> <td colspan="8" style="text-align: center;"> <table border="1" style="width: 100%; border-collapse: collapse; text-align: center;"> <tr> <td style="width: 10%;"></td> <td style="width: 10%;"></td> <td style="width: 10%;"></td> <td style="width: 10%;"></td> <td style="width: 10%;"></td> <td style="width: 10%;"></td> <td style="width: 10%;"></td> <td style="width: 10%;"></td> <td style="width: 10%;"></td> <td style="width: 10%;"></td> </tr> <tr> <td></td> <td></td> <td colspan="8" style="text-align: center;"> <table border="1" style="width: 100%; border-collapse: collapse; text-align: center;"> <tr> <td style="width: 10%;"></td> <td style="width: 10%;"></td> <td style="width: 10%;"></td> <td style="width: 10%;"></td> <td style="width: 10%;"></td> <td style="width: 10%;"></td> <td style="width: 10%;"></td> <td style="width: 10%;"></td> <td style="width: 10%;"></td> <td style="width: 10%;"></td> </tr> <tr> <td></td> <td></td> <td colspan="8" style="text-align: center;"> <table border="1" style="width: 100%; border-collapse: collapse; text-align: center;"> <tr> <td style="width: 10%;"></td> <td style="width: 10%;"></td> <td style="width: 10%;"></td> <td style="width: 10%;"></td> <td style="width: 10%;"></td> <td style="width: 10%;"></td> <td style="width: 10%;"></td> <td style="width: 10%;"></td> <td style="width: 10%;"></td> <td style="width: 10%;"></td> </tr> <tr> <td></td> <td></td> <td colspan="8" style="text-align: center;"> <table border="1" style="width: 100%; border-collapse: collapse; text-align: center;"> <tr> <td style="width: 10%;"></td> <td style="width: 10%;"></td> <td style="width: 10%;"></td> <td style="width: 10%;"></td> <td style="width: 10%;"></td> <td style="width: 10%;"></td> <td style="width: 10%;"></td> <td style="width: 10%;"></td> <td style="width: 10%;"></td> <td style="width: 10%;"></td> </tr> <tr> <td></td> <td></td> <td colspan="8" style="text-align: center;"> <table border="1" style="width: 100%; border-collapse: collapse; text-align: center;"> <tr> <td style="width: 10%;"></td> <td style="width: 10%;"></td> <td style="width: 10%;"></td> <td style="width: 10%;"></td> <td style="width: 10%;"></td> <td style="width: 10%;"></td> <td style="width: 10%;"></td> <td style="width: 10%;"></td> <td style="width: 10%;"></td> <td style="width: 10%;"></td> </tr> <tr> <td></td> <td></td> <td colspan="8" style="text-align: center;"> <table border="1" style="width: 100%; border-collapse: collapse; text-align: center;"> <tr> <td style="width: 10%;"></td> <td style="width: 10%;"></td> <td style="width: 10%;"></td> <td style="width: 10%;"></td> <td style="width: 10%;"></td> <td style="width: 10%;"></td> <td style="width: 10%;"></td> <td style="width: 10%;"></td> <td style="width: 10%;"></td> <td style="width: 10%;"></td> </tr> <tr> <td></td> <td></td> <td colspan="8" style="text-align: center;"> <table border="1" style="width: 100%; border-collapse: collapse; text-align: center;"> <tr> <td style="width: 10%;"></td> <td style="width: 10%;"></td> <td style="width: 10%;"></td> <td style="width: 10%;"></td> <td style="width: 10%;"></td> <td style="width: 10%;"></td> <td style="width: 10%;"></td> <td style="width: 10%;"></td> <td style="width: 10%;"></td> <td style="width: 10%;"></td> </tr> <tr> <td></td> <td></td> <td colspan="8" style="text-align: center;"> <table border="1" style="width: 100%; border-collapse: collapse; text-align: center;"> <tr> <td style="width: 10%;"></td> <td style="width: 10%;"></td> <td style="width: 10%;"></td> <td style="width: 10%;"></td> <td style="width: 10%;"></td> <td style="width: 10%;"></td> <td style="width: 10%;"></td> <td style="width: 10%;"></td> <td style="width: 10%;"></td> <td style="width: 10%;"></td> </tr> <tr> <td></td> <td></td> <td colspan="8" style="text-align: center;"> <table border="1" style="width: 100%; border-collapse: collapse; text-align: center;"> <tr> <td style="width: 10%;"></td> <td style="width: 10%;"></td> <td style="width: 10%;"></td> <td style="width: 10%;"></td> <td style="width: 10%;"></td> <td style="width: 10%;"></td> <td style="width: 10%;"></td> <td style="width: 10%;"></td> <td style="width: 10%;"></td> <td style="width: 10%;"></td> </tr> <tr> <td></td> <td></td> <td colspan="8" style="text-align: center;"> <table border="1" style="width: 100%; border-collapse: collapse; text-align: center;"> <tr> <td style="width: 10%;"></td> <td style="width: 10%;"></td> <td style="width: 10%;"></td> <td style="width: 10%;"></td> <td style="width: 10%;"></td> <td style="width: 10%;"></td> <td style="width: 10%;"></td> <td style="width: 10%;"></td> <td style="width: 10%;"></td> <td style="width: 10%;"></td> </tr> <tr> <td></td> <td></td> <td colspan="8" style="text-align: center;"> <table border="1" style="width: 100%; border-collapse: collapse; text-align: center;"> <tr> </tr></table></td></tr></table></td></tr></table></td></tr></table></td></tr></table></td></tr></table></td></tr></table></td></tr></table></td></tr></table></td></tr></table></td></tr></table></td></tr></table></td></tr></table></td></tr></table></td></tr></table></td></tr></table></td></tr></table></td></tr></table></td></tr></table></td></tr></table></td></tr></table></td></tr></table></td></tr></table></td></tr></table>

 | | | | | | | | | | | | | | | | | | | | <table border="1" style="width: 100%; border-collapse: collapse; text-align: center;"> <tr> <td style="width: 10%;"></td> <td style="width: 10%;"></td> <td style="width: 10%;"></td> <td style="width: 10%;"></td> <td style="width: 10%;"></td> <td style="width: 10%;"></td> <td style="width: 10%;"></td> <td style="width: 10%;"></td> <td style="width: 10%;"></td> <td style="width: 10%;"></td> </tr> <tr> <td></td> <td></td> <td colspan="8" style="text-align: center;"> <table border="1" style="width: 100%; border-collapse: collapse; text-align: center;"> <tr> <td style="width: 10%;"></td> <td style="width: 10%;"></td> <td style="width: 10%;"></td> <td style="width: 10%;"></td> <td style="width: 10%;"></td> <td style="width: 10%;"></td> <td style="width: 10%;"></td> <td style="width: 10%;"></td> <td style="width: 10%;"></td> <td style="width: 10%;"></td> </tr> <tr> <td></td> <td></td> <td colspan="8" style="text-align: center;"> <table border="1" style="width: 100%; border-collapse: collapse; text-align: center;"> <tr> <td style="width: 10%;"></td> <td style="width: 10%;"></td> <td style="width: 10%;"></td> <td style="width: 10%;"></td> <td style="width: 10%;"></td> <td style="width: 10%;"></td> <td style="width: 10%;"></td> <td style="width: 10%;"></td> <td style="width: 10%;"></td> <td style="width: 10%;"></td> </tr> <tr> <td></td> <td></td> <td colspan="8" style="text-align: center;"> <table border="1" style="width: 100%; border-collapse: collapse; text-align: center;"> <tr> <td style="width: 10%;"></td> <td style="width: 10%;"></td> <td style="width: 10%;"></td> <td style="width: 10%;"></td> <td style="width: 10%;"></td> <td style="width: 10%;"></td> <td style="width: 10%;"></td> <td style="width: 10%;"></td> <td style="width: 10%;"></td> <td style="width: 10%;"></td> </tr> <tr> <td></td> <td></td> <td colspan="8" style="text-align: center;"> <table border="1" style="width: 100%; border-collapse: collapse; text-align: center;"> <tr> <td style="width: 10%;"></td> <td style="width: 10%;"></td> <td style="width: 10%;"></td> <td style="width: 10%;"></td> <td style="width: 10%;"></td> <td style="width: 10%;"></td> <td style="width: 10%;"></td> <td style="width: 10%;"></td> <td style="width: 10%;"></td> <td style="width: 10%;"></td> </tr> <tr> <td></td> <td></td> <td colspan="8" style="text-align: center;"> <table border="1" style="width: 100%; border-collapse: collapse; text-align: center;"> <tr> <td style="width: 10%;"></td> <td style="width: 10%;"></td> <td style="width: 10%;"></td> <td style="width: 10%;"></td> <td style="width: 10%;"></td> <td style="width: 10%;"></td> <td style="width: 10%;"></td> <td style="width: 10%;"></td> <td style="width: 10%;"></td> <td style="width: 10%;"></td> </tr> <tr> <td></td> <td></td> <td colspan="8" style="text-align: center;"> <table border="1" style="width: 100%; border-collapse: collapse; text-align: center;"> <tr> <td style="width: 10%;"></td> <td style="width: 10%;"></td> <td style="width: 10%;"></td> <td style="width: 10%;"></td> <td style="width: 10%;"></td> <td style="width: 10%;"></td> <td style="width: 10%;"></td> <td style="width: 10%;"></td> <td style="width: 10%;"></td> <td style="width: 10%;"></td> </tr> <tr> <td></td> <td></td> <td colspan="8" style="text-align: center;"> <table border="1" style="width: 100%; border-collapse: collapse; text-align: center;"> <tr> <td style="width: 10%;"></td> <td style="width: 10%;"></td> <td style="width: 10%;"></td> <td style="width: 10%;"></td> <td style="width: 10%;"></td> <td style="width: 10%;"></td> <td style="width: 10%;"></td> <td style="width: 10%;"></td> <td style="width: 10%;"></td> <td style="width: 10%;"></td> </tr> <tr> <td></td> <td></td> <td colspan="8" style="text-align: center;"> <table border="1" style="width: 100%; border-collapse: collapse; text-align: center;"> <tr> <td style="width: 10%;"></td> <td style="width: 10%;"></td> <td style="width: 10%;"></td> <td style="width: 10%;"></td> <td style="width: 10%;"></td> <td style="width: 10%;"></td> <td style="width: 10%;"></td> <td style="width: 10%;"></td> <td style="width: 10%;"></td> <td style="width: 10%;"></td> </tr> <tr> <td></td> <td></td> <td colspan="8" style="text-align: center;"> <table border="1" style="width: 100%; border-collapse: collapse; text-align: center;"> <tr> <td style="width: 10%;"></td> <td style="width: 10%;"></td> <td style="width: 10%;"></td> <td style="width: 10%;"></td> <td style="width: 10%;"></td> <td style="width: 10%;"></td> <td style="width: 10%;"></td> <td style="width: 10%;"></td> <td style="width: 10%;"></td> <td style="width: 10%;"></td> </tr> <tr> <td></td> <td></td> <td colspan="8" style="text-align: center;"> <table border="1" style="width: 100%; border-collapse: collapse; text-align: center;"> <tr> <td style="width: 10%;"></td> <td style="width: 10%;"></td> <td style="width: 10%;"></td> <td style="width: 10%;"></td> <td style="width: 10%;"></td> <td style="width: 10%;"></td> <td style="width: 10%;"></td> <td style="width: 10%;"></td> <td style="width: 10%;"></td> <td style="width: 10%;"></td> </tr> <tr> <td></td> <td></td> <td colspan="8" style="text-align: center;"> <table border="1" style="width: 100%; border-collapse: collapse; text-align: center;"> <tr> <td style="width: 10%;"></td> <td style="width: 10%;"></td> <td style="width: 10%;"></td> <td style="width: 10%;"></td> <td style="width: 10%;"></td> <td style="width: 10%;"></td> <td style="width: 10%;"></td> <td style="width: 10%;"></td> <td style="width: 10%;"></td> <td style="width: 10%;"></td> </tr> <tr> <td></td> <td></td> <td colspan="8" style="text-align: center;"> <table border="1" style="width: 100%; border-collapse: collapse; text-align: center;"> <tr> <td style="width: 10%;"></td> <td style="width: 10%;"></td> <td style="width: 10%;"></td> <td style="width: 10%;"></td> <td style="width: 10%;"></td> <td style="width: 10%;"></td> <td style="width: 10%;"></td> <td style="width: 10%;"></td> <td style="width: 10%;"></td> <td
style="width: 10%;"></td> </tr> <tr> <td></td> <td></td> <td colspan="8" style="text-align: center;"> <table border="1" style="width: 100%; border-collapse: collapse; text-align: center;"> <tr> <td style="width: 10%;"></td> <td style="width: 10%;"></td> <td style="width: 10%;"></td> <td style="width: 10%;"></td> <td style="width: 10%;"></td> <td style="width: 10%;"></td> <td style="width: 10%;"></td> <td style="width: 10%;"></td> <td style="width: 10%;"></td> <td style="width: 10%;"></td> </tr> <tr> <td></td> <td></td> <td colspan="8" style="text-align: center;"> <table border="1" style="width: 100%; border-collapse: collapse; text-align: center;"> <tr> <td style="width: 10%;"></td> <td style="width: 10%;"></td> <td style="width: 10%;"></td> <td style="width: 10%;"></td> <td style="width: 10%;"></td> <td style="width: 10%;"></td> <td style="width: 10%;"></td> <td style="width: 10%;"></td> <td style="width: 10%;"></td> <td style="width: 10%;"></td> </tr> <tr> <td></td> <td></td> <td colspan="8" style="text-align: center;"> <table border="1" style="width: 100%; border-collapse: collapse; text-align: center;"> <tr> <td style="width: 10%;"></td> <td style="width: 10%;"></td> <td style="width: 10%;"></td> <td style="width: 10%;"></td> <td style="width: 10%;"></td> <td style="width: 10%;"></td> <td style="width: 10%;"></td> <td style="width: 10%;"></td> <td style="width: 10%;"></td> <td style="width: 10%;"></td> </tr> <tr> <td></td> <td></td> <td colspan="8" style="text-align: center;"> <table border="1" style="width: 100%; border-collapse: collapse; text-align: center;"> <tr> <td style="width: 10%;"></td> <td style="width: 10%;"></td> <td style="width: 10%;"></td> <td style="width: 10%;"></td> <td style="width: 10%;"></td> <td style="width: 10%;"></td> <td style="width: 10%;"></td> <td style="width: 10%;"></td> <td style="width: 10%;"></td> <td style="width: 10%;"></td> </tr> <tr> <td></td> <td></td> <td colspan="8" style="text-align: center;"> <table border="1" style="width: 100%; border-collapse: collapse; text-align: center;"> <tr> <td style="width: 10%;"></td> <td style="width: 10%;"></td> <td style="width: 10%;"></td> <td style="width: 10%;"></td> <td style="width: 10%;"></td> <td style="width: 10%;"></td> <td style="width: 10%;"></td> <td style="width: 10%;"></td> <td style="width: 10%;"></td> <td style="width: 10%;"></td> </tr> <tr> <td></td> <td></td> <td colspan="8" style="text-align: center;"> <table border="1" style="width: 100%; border-collapse: collapse; text-align: center;"> <tr> <td style="width: 10%;"></td> <td style="width: 10%;"></td> <td style="width: 10%;"></td> <td style="width: 10%;"></td> <td style="width: 10%;"></td> <td style="width: 10%;"></td> <td style="width: 10%;"></td> <td style="width: 10%;"></td> <td style="width: 10%;"></td> <td style="width: 10%;"></td> </tr> <tr> <td></td> <td></td> <td colspan="8" style="text-align: center;"> <table border="1" style="width: 100%; border-collapse: collapse; text-align: center;"> <tr> <td style="width: 10%;"></td> <td style="width: 10%;"></td> <td style="width: 10%;"></td> <td style="width: 10%;"></td> <td style="width: 10%;"></td> <td style="width: 10%;"></td> <td style="width: 10%;"></td> <td style="width: 10%;"></td> <td style="width: 10%;"></td> <td style="width: 10%;"></td> </tr> <tr> <td></td> <td></td> <td colspan="8" style="text-align: center;"> <table border="1" style="width: 100%; border-collapse: collapse; text-align: center;"> <tr> <td style="width: 10%;"></td> <td style="width: 10%;"></td> <td style="width: 10%;"></td> <td style="width: 10%;"></td> <td style="width: 10%;"></td> <td style="width: 10%;"></td> <td style="width: 10%;"></td> <td style="width: 10%;"></td> <td style="width: 10%;"></td> <td style="width: 10%;"></td> </tr> <tr> <td></td> <td></td> <td colspan="8" style="text-align: center;"> <table border="1" style="width: 100%; border-collapse: collapse; text-align: center;"> <tr> <td style="width: 10%;"></td> <td style="width: 10%;"></td> <td style="width: 10%;"></td> <td style="width: 10%;"></td> <td style="width: 10%;"></td> <td style="width: 10%;"></td> <td style="width: 10%;"></td> <td style="width: 10%;"></td> <td style="width: 10%;"></td> <td style="width: 10%;"></td> </tr> <tr> <td></td> <td></td> <td colspan="8" style="text-align: center;"> <table border="1" style="width: 100%; border-collapse: collapse; text-align: center;"> <tr> </tr></table></td></tr></table></td></tr></table></td></tr></table></td></tr></table></td></tr></table></td></tr></table></td></tr></table></td></tr></table></td></tr></table></td></tr></table></td></tr></table></td></tr></table></td></tr></table></td></tr></table></td></tr></table></td></tr></table></td></tr></table></td></tr></table></td></tr></table></td></tr></table></td></tr></table></td></tr></table>

 | | | | | | | | | | | | | | | | | | | | <table border="1" style="width: 100%; border-collapse: collapse; text-align: center;"> <tr> <td style="width: 10%;"></td> <td style="width: 10%;"></td> <td style="width: 10%;"></td> <td style="width: 10%;"></td> <td style="width: 10%;"></td> <td style="width: 10%;"></td> <td style="width: 10%;"></td> <td style="width: 10%;"></td> <td style="width: 10%;"></td> <td style="width: 10%;"></td> </tr> <tr> <td></td> <td></td> <td colspan="8" style="text-align: center;"> <table border="1" style="width: 100%; border-collapse: collapse; text-align: center;"> <tr> <td style="width: 10%;"></td> <td style="width: 10%;"></td> <td style="width: 10%;"></td> <td style="width: 10%;"></td> <td style="width: 10%;"></td> <td style="width: 10%;"></td> <td style="width: 10%;"></td> <td style="width: 10%;"></td> <td style="width: 10%;"></td> <td style="width: 10%;"></td> </tr> <tr> <td></td> <td></td> <td colspan="8" style="text-align: center;"> <table border="1" style="width: 100%; border-collapse: collapse; text-align: center;"> <tr> <td style="width: 10%;"></td> <td style="width: 10%;"></td> <td style="width: 10%;"></td> <td style="width: 10%;"></td> <td style="width: 10%;"></td> <td style="width: 10%;"></td> <td style="width: 10%;"></td> <td style="width: 10%;"></td> <td style="width: 10%;"></td> <td style="width: 10%;"></td> </tr> <tr> <td></td> <td></td> <td colspan="8" style="text-align: center;"> <table border="1" style="width: 100%; border-collapse: collapse; text-align: center;"> <tr> <td style="width: 10%;"></td> <td style="width: 10%;"></td> <td style="width: 10%;"></td> <td style="width: 10%;"></td> <td style="width: 10%;"></td> <td style="width: 10%;"></td> <td style="width: 10%;"></td> <td style="width: 10%;"></td> <td style="width: 10%;"></td> <td style="width: 10%;"></td> </tr> <tr> <td></td> <td></td> <td colspan="8" style="text-align: center;"> <table border="1" style="width: 100%; border-collapse: collapse; text-align: center;"> <tr> <td style="width: 10%;"></td> <td style="width: 10%;"></td> <td style="width: 10%;"></td> <td style="width: 10%;"></td> <td style="width: 10%;"></td> <td style="width: 10%;"></td> <td style="width: 10%;"></td> <td style="width: 10%;"></td> <td style="width: 10%;"></td> <td style="width: 10%;"></td> </tr> <tr> <td></td> <td></td> <td colspan="8" style="text-align: center;"> <table border="1" style="width: 100%; border-collapse: collapse; text-align: center;"> <tr> <td style="width: 10%;"></td> <td style="width: 10%;"></td> <td style="width: 10%;"></td> <td style="width: 10%;"></td> <td style="width: 10%;"></td> <td style="width: 10%;"></td> <td style="width: 10%;"></td> <td style="width: 10%;"></td> <td style="width: 10%;"></td> <td style="width: 10%;"></td> </tr> <tr> <td></td> <td></td> <td colspan="8" style="text-align: center;"> <table border="1" style="width: 100%; border-collapse: collapse; text-align: center;"> <tr> <td style="width: 10%;"></td> <td style="width: 10%;"></td> <td style="width: 10%;"></td> <td style="width: 10%;"></td> <td style="width: 10%;"></td> <td style="width: 10%;"></td> <td style="width: 10%;"></td> <td style="width: 10%;"></td> <td style="width: 10%;"></td> <td style="width: 10%;"></td> </tr> <tr> <td></td> <td></td> <td colspan="8" style="text-align: center;"> <table border="1" style="width: 100%; border-collapse: collapse; text-align: center;"> <tr> <td style="width: 10%;"></td> <td style="width: 10%;"></td> <td style="width: 10%;"></td> <td style="width: 10%;"></td> <td style="width: 10%;"></td> <td style="width: 10%;"></td> <td style="width: 10%;"></td> <td style="width: 10%;"></td> <td style="width: 10%;"></td> <td style="width: 10%;"></td> </tr> <tr> <td></td> <td></td> <td colspan="8" style="text-align: center;"> <table border="1" style="width: 100%; border-collapse: collapse; text-align: center;"> <tr> <td style="width: 10%;"></td> <td style="width: 10%;"></td> <td style="width: 10%;"></td> <td style="width: 10%;"></td> <td style="width: 10%;"></td> <td style="width: 10%;"></td> <td style="width: 10%;"></td> <td style="width: 10%;"></td> <td style="width: 10%;"></td> <td style="width: 10%;"></td> </tr> <tr> <td></td> <td></td> <td colspan="8" style="text-align: center;"> <table border="1" style="width: 100%; border-collapse: collapse; text-align: center;"> <tr> <td style="width: 10%;"></td> <td style="width: 10%;"></td> <td style="width: 10%;"></td> <td style="width: 10%;"></td> <td style="width: 10%;"></td> <td style="width: 10%;"></td> <td style="width: 10%;"></td> <td style="width: 10%;"></td> <td style="width: 10%;"></td> <td style="width: 10%;"></td> </tr> <tr> <td></td> <td></td> <td colspan="8" style="text-align: center;"> <table border="1" style="width: 100%; border-collapse: collapse; text-align: center;"> <tr> <td style="width: 10%;"></td> <td style="width: 10%;"></td> <td style="width: 10%;"></td> <td style="width: 10%;"></td> <td style="width: 10%;"></td> <td style="width: 10%;"></td> <td style="width: 10%;"></td> <td style="width: 10%;"></td> <td style="width: 10%;"></td> <td style="width: 10%;"></td> </tr> <tr> <td></td> <td></td> <td colspan="8" style="text-align: center;"> <table border="1" style="width: 100%; border-collapse: collapse; text-align: center;"> <tr> <td style="width: 10%;"></td> <td style="width: 10%;"></td> <td style="width: 10%;"></td> <td style="width: 10%;"></td> <td style="width: 10%;"></td> <td style="width: 10%;"></td> <td style="width: 10%;"></td> <td style="width: 10%;"></td> <td style="width: 10%;"></td> <td style="width: 10%;"></td> </tr> <tr> <td></td> <td></td> <td colspan="8" style="text-align: center;"> <table border="1" style="width: 100%; border-collapse: collapse; text-align: center;"> <tr> <td style="width: 10%;"></td> <td style="width: 10%;"></td> <td style="width: 10%;"></td> <td style="width: 10%;"></td> <td style="width: 10%;"></td> <td style="width: 10%;"></td> <td style="width: 10%;"></td> <td style="width: 10%;"></td> <td style="width: 10%;"></td> <td style="width: 10%;"></td> </tr> <tr> <td></td> <td></td> <td colspan="8" style="text-align: center;"> <table border="1" style="width: 100%; border-collapse: collapse; text-align: center;"> <tr> <td style="width: 10%;"></td> <td style="width: 10%;"></td> <td style="width: 10%;"></td> <td style="width: 10%;"></td> <td style="width: 10%;"></td> <td style="width: 10%;"></td> <td style="width: 10%;"></td> <td style="width: 10%;"></td> <td style="width: 10%;"></td> <td style="width: 10%;"></td> </tr> <tr> <td></td> <td></td> <td colspan="8" style="text-align: center;"> <table border="1" style="width: 100%; border-collapse: collapse; text-align: center;"> <tr> <td style="width: 10%;"></td> <td style="width: 10%;"></td> <td style="width: 10%;"></td> <td style="width: 10%;"></td> <td style="width: 10%;"></td> <td style="width: 10%;"></td> <td style="width: 10%;"></td> <td style="width: 10%;"></td> <td style="width: 10%;"></td> <td style="width: 10%;"></td> </tr> <tr> <td></td> <td></td> <td colspan="8" style="text-align: center;"> <table border="1" style="width: 100%; border-collapse: collapse; text-align: center;"> <tr> <td style="width: 10%;"></td> <td style="width: 10%;"></td> <td style="width: 10%;"></td> <td style="width: 10%;"></td> <td style="width: 10%;"></td> <td style="width: 10%;"></td> <td style="width: 10%;"></td> <td style="width: 10%;"></td> <td style="width: 10%;"></td> <td style="width: 10%;"></td> </tr> <tr> <td></td> <td></td> <td colspan="8" style="text-align: center;"> <table border="1" style="width: 100%; border-collapse: collapse; text-align: center;"> <tr> <td style="width: 10%;"></td> <td style="width: 10%;"></td> <td style="width: 10%;"></td> <td style="width: 10%;"></td> <td style="width: 10%;"></td> <td style="width: 10%;"></td> <td style="width: 10%;"></td> <td style="width: 10%;"></td> <td style="width: 10%;"></td> <td style="width: 10%;"></td> </tr> <tr> <td></td> <td></td> <td colspan="8" style="text-align: center;"> <table border="1" style="width: 100%; border-collapse: collapse; text-align: center;"> <tr> <td style="width: 10%;"></td> <td style="width: 10%;"></td> <td style="width: 10%;"></td> <td style="width: 10%;"></td> <td style="width: 10%;"></td> <td style="width: 10%;"></td> <td style="width: 10%;"></td> <td style="width: 10%;"></td> <td style="width: 10%;"></td> <td style="width: 10%;"></td> </tr> <tr> <td></td> <td></td> <td colspan="8" style="text-align: center;"> <table border="1" style="width: 100%; border-collapse: collapse; text-align: center;"> <tr> <td style="width: 10%;"></td> <td style="width: 10%;"></td> <td style="width: 10%;"></td> <td style="width: 10%;"></td> <td style="width: 10%;"></td> <td style="width: 10%;"></td> <td style="width: 10%;"></td> <td style="width: 10%;"></td> <td style="width: 10%;"></td> <td style="width: 10%;"></td> </tr> <tr> <td></td> <td></td> <td colspan="8" style="text-align: center;"> <table border="1" style="width: 100%; border-collapse: collapse; text-align: center;"> <tr> <td style="width: 10%;"></td> <td style="width: 10%;"></td> <td style="width: 10%;"></td> <td
style="width: 10%;"></td> <td style="width: 10%;"></td> <td style="width: 10%;"></td> <td style="width: 10%;"></td> <td style="width: 10%;"></td> <td style="width: 10%;"></td> <td style="width: 10%;"></td> </tr> <tr> <td></td> <td></td> <td colspan="8" style="text-align: center;"> <table border="1" style="width: 100%; border-collapse: collapse; text-align: center;"> <tr> <td style="width: 10%;"></td> <td style="width: 10%;"></td> <td style="width: 10%;"></td> <td style="width: 10%;"></td> <td style="width: 10%;"></td> <td style="width: 10%;"></td> <td style="width: 10%;"></td> <td style="width: 10%;"></td> <td style="width: 10%;"></td> <td style="width: 10%;"></td> </tr> <tr> <td></td> <td></td> <td colspan="8" style="text-align: center;"> <table border="1" style="width: 100%; border-collapse: collapse; text-align: center;"> <tr> </tr></table></td></tr></table></td></tr></table></td></tr></table></td></tr></table></td></tr></table></td></tr></table></td></tr></table></td></tr></table></td></tr></table></td></tr></table></td></tr></table></td></tr></table></td></tr></table></td></tr></table></td></tr></table></td></tr></table></td></tr></table></td></tr></table></td></tr></table></td></tr></table></td></tr></table>
 | | | | | | | | | | | | | | | | | | | | <table border="1" style="width: 100%; border-collapse: collapse; text-align: center;"> <tr> <td style="width: 10%;"></td> <td style="width: 10%;"></td> <td style="width: 10%;"></td> <td style="width: 10%;"></td> <td style="width: 10%;"></td> <td style="width: 10%;"></td> <td style="width: 10%;"></td> <td style="width: 10%;"></td> <td style="width: 10%;"></td> <td style="width: 10%;"></td> </tr> <tr> <td></td> <td></td> <td colspan="8" style="text-align: center;"> <table border="1" style="width: 100%; border-collapse: collapse; text-align: center;"> <tr> <td style="width: 10%;"></td> <td style="width: 10%;"></td> <td style="width: 10%;"></td> <td style="width: 10%;"></td> <td style="width: 10%;"></td> <td style="width: 10%;"></td> <td style="width: 10%;"></td> <td style="width: 10%;"></td> <td style="width: 10%;"></td> <td style="width: 10%;"></td> </tr> <tr> <td></td> <td></td> <td colspan="8" style="text-align: center;"> <table border="1" style="width: 100%; border-collapse: collapse; text-align: center;"> <tr> <td style="width: 10%;"></td> <td style="width: 10%;"></td> <td style="width: 10%;"></td> <td style="width: 10%;"></td> <td style="width: 10%;"></td> <td style="width: 10%;"></td> <td style="width: 10%;"></td> <td style="width: 10%;"></td> <td style="width: 10%;"></td> <td style="width: 10%;"></td> </tr> <tr> <td></td> <td></td> <td colspan="8" style="text-align: center;"> <table border="1" style="width: 100%; border-collapse: collapse; text-align: center;"> <tr> <td style="width: 10%;"></td> <td style="width: 10%;"></td> <td style="width: 10%;"></td> <td style="width: 10%;"></td> <td style="width: 10%;"></td> <td style="width: 10%;"></td> <td style="width: 10%;"></td> <td style="width: 10%;"></td> <td style="width: 10%;"></td> <td style="width: 10%;"></td> </tr> <tr> <td></td> <td></td> <td colspan="8" style="text-align: center;"> <table border="1" style="width: 100%; border-collapse: collapse; text-align: center;"> <tr> <td style="width: 10%;"></td> <td style="width: 10%;"></td> <td style="width: 10%;"></td> <td style="width: 10%;"></td> <td style="width: 10%;"></td> <td style="width: 10%;"></td> <td style="width: 10%;"></td> <td style="width: 10%;"></td> <td style="width: 10%;"></td> <td style="width: 10%;"></td> </tr> <tr> <td></td> <td></td> <td colspan="8" style="text-align: center;"> <table border="1" style="width: 100%; border-collapse: collapse; text-align: center;"> <tr> <td style="width: 10%;"></td> <td style="width: 10%;"></td> <td style="width: 10%;"></td> <td style="width: 10%;"></td> <td style="width: 10%;"></td> <td style="width: 10%;"></td> <td style="width: 10%;"></td> <td style="width:
10%;"></td> <td style="width: 10%;"></td> <td style="width: 10%;"></td> </tr> <tr> <td></td> <td></td> <td colspan="8" style="text-align: center;"> <table border="1" style="width: 100%; border-collapse: collapse; text-align: center;"> <tr> <td style="width: 10%;"></td> <td style="width: 10%;"></td> <td style="width: 10%;"></td> <td style="width: 10%;"></td> <td style="width: 10%;"></td> <td style="width: 10%;"></td> <td style="width: 10%;"></td> <td style="width: 10%;"></td> <td style="width: 10%;"></td> <td style="width: 10%;"></td> </tr> <tr> <td></td> <td></td> <td colspan="8" style="text-align: center;"> <table border="1" style="width: 100%; border-collapse: collapse; text-align: center;"> <tr> <td style="width: 10%;"></td> <td style="width: 10%;"></td> <td style="width: 10%;"></td> <td style="width: 10%;"></td> <td style="width: 10%;"></td> <td style="width: 10%;"></td> <td style="width: 10%;"></td> <td style="width: 10%;"></td> <td style="width: 10%;"></td> <td style="width: 10%;"></td> </tr> <tr> <td></td> <td></td> <td colspan="8" style="text-align: center;"> <table border="1" style="width: 100%; border-collapse: collapse; text-align: center;"> <tr> <td style="width: 10%;"></td> <td style="width: 10%;"></td> <td style="width: 10%;"></td> <td style="width: 10%;"></td> <td style="width: 10%;"></td> <td style="width: 10%;"></td> <td style="width: 10%;"></td> <td style="width: 10%;"></td> <td style="width: 10%;"></td> <td style="width: 10%;"></td> </tr> <tr> <td></td> <td></td> <td colspan="8" style="text-align: center;"> <table border="1" style="width: 100%; border-collapse: collapse; text-align: center;"> <tr> <td style="width: 10%;"></td> <td style="width: 10%;"></td> <td style="width: 10%;"></td> <td style="width: 10%;"></td> <td style="width: 10%;"></td> <td style="width: 10%;"></td> <td style="width: 10%;"></td> <td style="width: 10%;"></td> <td style="width: 10%;"></td> <td style="width: 10%;"></td> </tr> <tr> <td></td> <td></td> <td colspan="8" style="text-align: center;"> <table border="1" style="width: 100%; border-collapse: collapse; text-align: center;"> <tr> <td style="width: 10%;"></td> <td style="width: 10%;"></td> <td style="width: 10%;"></td> <td style="width: 10%;"></td> <td style="width: 10%;"></td> <td style="width: 10%;"></td> <td style="width: 10%;"></td> <td style="width: 10%;"></td> <td style="width: 10%;"></td> <td style="width: 10%;"></td> </tr> <tr> <td></td> <td></td> <td colspan="8" style="text-align: center;"> <table border="1" style="width: 100%; border-collapse: collapse; text-align: center;"> <tr> <td style="width: 10%;"></td> <td style="width: 10%;"></td> <td style="width: 10%;"></td> <td style="width: 10%;"></td> <td style="width: 10%;"></td> <td style="width: 10%;"></td> <td style="width: 10%;"></td> <td style="width: 10%;"></td> <td style="width: 10%;"></td> <td style="width: 10%;"></td> </tr> <tr> <td></td> <td></td> <td colspan="8" style="text-align: center;"> <table border="1" style="width: 100%; border-collapse: collapse; text-align: center;"> <tr> <td style="width: 10%;"></td> <td style="width: 10%;"></td> <td style="width: 10%;"></td> <td style="width: 10%;"></td> <td style="width: 10%;"></td> <td style="width: 10%;"></td> <td style="width: 10%;"></td> <td style="width: 10%;"></td> <td style="width: 10%;"></td> <td style="width: 10%;"></td> </tr> <tr> <td></td> <td></td> <td colspan="8" style="text-align: center;"> <table border="1" style="width: 100%; border-collapse: collapse; text-align: center;"> <tr> <td style="width: 10%;"></td> <td style="width: 10%;"></td> <td style="width: 10%;"></td> <td style="width: 10%;"></td> <td style="width: 10%;"></td> <td style="width: 10%;"></td> <td style="width: 10%;"></td> <td style="width: 10%;"></td> <td style="width: 10%;"></td> <td style="width: 10%;"></td> </tr> <tr> <td></td> <td></td> <td colspan="8" style="text-align: center;"> <table border="1" style="width: 100%; border-collapse: collapse; text-align: center;"> <tr> <td style="width: 10%;"></td> <td style="width: 10%;"></td> <td style="width: 10%;"></td> <td style="width: 10%;"></td> <td style="width: 10%;"></td> <td style="width: 10%;"></td> <td style="width: 10%;"></td> <td style="width: 10%;"></td> <td style="width: 10%;"></td> <td style="width: 10%;"></td> </tr> <tr> <td></td> <td></td> <td colspan="8" style="text-align: center;"> <table border="1" style="width: 100%; border-collapse: collapse; text-align: center;"> <tr> <td style="width: 10%;"></td> <td style="width: 10%;"></td> <td style="width: 10%;"></td> <td style="width: 10%;"></td> <td style="width: 10%;"></td> <td style="width: 10%;"></td> <td style="width: 10%;"></td> <td style="width: 10%;"></td> <td style="width: 10%;"></td> <td style="width: 10%;"></td> </tr> <tr> <td></td> <td></td> <td colspan="8" style="text-align: center;"> <table border="1" style="width: 100%; border-collapse: collapse; text-align: center;"> <tr> <td style="width: 10%;"></td> <td style="width: 10%;"></td> <td style="width: 10%;"></td> <td style="width: 10%;"></td> <td style="width: 10%;"></td> <td style="width: 10%;"></td> <td style="width: 10%;"></td> <td style="width: 10%;"></td> <td style="width: 10%;"></td> <td style="width: 10%;"></td> </tr> <tr> <td></td> <td></td> <td colspan="8" style="text-align: center;"> <table border="1" style="width: 100%; border-collapse: collapse; text-align: center;"> <tr> <td style="width: 10%;"></td> <td style="width: 10%;"></td> <td style="width: 10%;"></td> <td style="width: 10%;"></td> <td style="width: 10%;"></td> <td style="width: 10%;"></td> <td style="width: 10%;"></td> <td style="width: 10%;"></td> <td style="width: 10%;"></td> <td style="width: 10%;"></td> </tr> <tr> <td></td> <td></td> <td colspan="8" style="text-align: center;"> <table border="1" style="width: 100%; border-collapse: collapse; text-align: center;"> <tr> <td style="width: 10%;"></td> <td style="width: 10%;"></td> <td style="width: 10%;"></td> <td style="width: 10%;"></td> <td style="width: 10%;"></td> <td style="width: 10%;"></td> <td style="width: 10%;"></td> <td style="width: 10%;"></td> <td style="width: 10%;"></td> <td style="width: 10%;"></td> </tr> <tr> <td></td> <td></td> <td colspan="8" style="text-align: center;"> <table border="1" style="width: 100%; border-collapse: collapse; text-align: center;"> <tr> <td style="width: 10%;"></td> <td style="width: 10%;"></td> <td style="width: 10%;"></td> <td style="width: 10%;"></td> <td style="width: 10%;"></td> <td style="width: 10%;"></td> <td style="width: 10%;"></td> <td style="width: 10%;"></td> <td style="width: 10%;"></td> <td style="width: 10%;"></td> </tr> <tr> <td></td> <td></td> <td colspan="8" style="text-align: center;"> <table border="1" style="width: 100%; border-collapse: collapse; text-align: center;"> <tr> </tr></table></td></tr></table></td></tr></table></td></tr></table></td></tr></table></td></tr></table></td></tr></table></td></tr></table></td></tr></table></td></tr></table></td></tr></table></td></tr></table></td></tr></table></td></tr></table></td></tr></table></td></tr></table></td></tr></table></td></tr></table></td></tr></table></td></tr></table></td></tr></table>

 | | | | | | | | | | | | | | | | | | | | <table border="1" style="width: 100%; border-collapse: collapse; text-align: center;"> <tr> <td style="width: 10%;"></td> <td style="width: 10%;"></td> <td style="width: 10%;"></td> <td style="width: 10%;"></td> <td style="width: 10%;"></td> <td style="width: 10%;"></td> <td style="width: 10%;"></td> <td style="width: 10%;"></td> <td style="width: 10%;"></td> <td style="width: 10%;"></td> </tr> <tr> <td></td> <td></td> <td colspan="8" style="text-align: center;"> <table border="1" style="width: 100%; border-collapse: collapse; text-align: center;"> <tr> <td style="width: 10%;"></td> <td style="width: 10%;"></td> <td style="width: 10%;"></td> <td style="width: 10%;"></td> <td style="width: 10%;"></td> <td style="width: 10%;"></td> <td style="width: 10%;"></td> <td style="width: 10%;"></td> <td style="width: 10%;"></td> <td style="width: 10%;"></td> </tr> <tr> <td></td> <td></td> <td colspan="8" style="text-align: center;"> <table border="1" style="width: 100%; border-collapse: collapse; text-align: center;"> <tr> <td style="width: 10%;"></td> <td style="width: 10%;"></td> <td style="width: 10%;"></td> <td style="width: 10%;"></td> <td style="width: 10%;"></td> <td style="width: 10%;"></td> <td style="width: 10%;"></td> <td style="width: 10%;"></td> <td style="width: 10%;"></td> <td style="width: 10%;"></td> </tr> <tr> <td></td> <td></td> <td colspan="8" style="text-align: center;"> <table border="1" style="width: 100%; border-collapse: collapse; text-align: center;"> <tr> <td style="width: 10%;"></td> <td style="width: 10%;"></td> <td style="width: 10%;"></td> <td style="width: 10%;"></td> <td style="width: 10%;"></td> <td style="width: 10%;"></td> <td style="width: 10%;"></td> <td style="width: 10%;"></td> <td style="width: 10%;"></td> <td style="width: 10%;"></td> </tr> <tr> <td></td> <td></td> <td colspan="8" style="text-align: center;"> <table border="1" style="width: 100%; border-collapse: collapse; text-align: center;"> <tr> <td style="width: 10%;"></td> <td style="width: 10%;"></td> <td style="width: 10%;"></td> <td style="width: 10%;"></td> <td style="width: 10%;"></td> <td style="width: 10%;"></td> <td style="width: 10%;"></td> <td style="width: 10%;"></td> <td style="width: 10%;"></td> <td style="width: 10%;"></td> </tr> <tr> <td></td> <td></td> <td colspan="8" style="text-align: center;"> <table border="1" style="width: 100%; border-collapse: collapse; text-align: center;"> <tr> <td style="width: 10%;"></td> <td style="width: 10%;"></td> <td style="width: 10%;"></td> <td style="width: 10%;"></td> <td style="width: 10%;"></td> <td style="width: 10%;"></td> <td style="width: 10%;"></td> <td style="width: 10%;"></td> <td style="width: 10%;"></td> <td style="width: 10%;"></td> </tr> <tr> <td></td> <td></td> <td colspan="8" style="text-align: center;"> <table border="1" style="width: 100%; border-collapse: collapse; text-align: center;"> <tr> <td style="width: 10%;"></td> <td style="width: 10%;"></td> <td style="width: 10%;"></td> <td style="width: 10%;"></td> <td style="width: 10%;"></td> <td style="width: 10%;"></td> <td style="width: 10%;"></td> <td style="width: 10%;"></td> <td style="width: 10%;"></td> <td style="width: 10%;"></td> </tr> <tr> <td></td> <td></td> <td colspan="8" style="text-align: center;"> <table border="1" style="width: 100%; border-collapse: collapse; text-align: center;"> <tr> <td style="width: 10%;"></td> <td style="width: 10%;"></td> <td style="width: 10%;"></td> <td style="width: 10%;"></td> <td style="width: 10%;"></td> <td style="width: 10%;"></td> <td style="width: 10%;"></td> <td style="width: 10%;"></td> <td style="width: 10%;"></td> <td style="width: 10%;"></td> </tr> <tr> <td></td> <td></td> <td colspan="8" style="text-align: center;"> <table border="1" style="width: 100%; border-collapse: collapse; text-align: center;"> <tr> <td style="width: 10%;"></td> <td style="width: 10%;"></td> <td style="width: 10%;"></td> <td style="width: 10%;"></td> <td style="width: 10%;"></td> <td style="width: 10%;"></td> <td style="width: 10%;"></td> <td style="width: 10%;"></td> <td style="width: 10%;"></td> <td style="width: 10%;"></td> </tr> <tr> <td></td> <td></td> <td colspan="8" style="text-align: center;"> <table border="1" style="width: 100%; border-collapse: collapse; text-align: center;"> <tr> <td style="width: 10%;"></td> <td style="width: 10%;"></td> <td style="width: 10%;"></td> <td style="width: 10%;"></td> <td style="width: 10%;"></td> <td style="width: 10%;"></td> <td style="width: 10%;"></td> <td style="width: 10%;"></td> <td style="width: 10%;"></td> <td style="width: 10%;"></td> </tr> <tr> <td></td> <td></td> <td colspan="8" style="text-align: center;"> <table border="1" style="width: 100%; border-collapse: collapse; text-align: center;"> <tr> <td style="width: 10%;"></td> <td style="width: 10%;"></td> <td style="width: 10%;"></td> <td style="width: 10%;"></td> <td style="width: 10%;"></td> <td style="width: 10%;"></td> <td style="width: 10%;"></td> <td style="width: 10%;"></td> <td style="width: 10%;"></td> <td style="width: 10%;"></td> </tr> <tr> <td></td> <td></td> <td colspan="8" style="text-align: center;"> <table border="1" style="width: 100%; border-collapse: collapse; text-align: center;"> <tr> <td style="width: 10%;"></td> <td style="width: 10%;"></td> <td style="width: 10%;"></td> <td style="width: 10%;"></td> <td style="width: 10%;"></td> <td style="width: 10%;"></td> <td style="width: 10%;"></td> <td style="width: 10%;"></td> <td style="width: 10%;"></td> <td style="width: 10%;"></td> </tr> <tr> <td></td> <td></td> <td colspan="8" style="text-align: center;"> <table border="1" style="width: 100%; border-collapse: collapse; text-align: center;"> <tr> <td style="width: 10%;"></td> <td style="width: 10%;"></td> <td style="width: 10%;"></td> <td style="width: 10%;"></td> <td style="width: 10%;"></td> <td style="width: 10%;"></td> <td style="width: 10%;"></td> <td style="width: 10%;"></td> <td style="width: 10%;"></td> <td style="width: 10%;"></td> </tr> <tr> <td></td> <td></td> <td colspan="8" style="text-align: center;"> <table border="1" style="width: 100%; border-collapse: collapse; text-align: center;"> <tr> <td style="width: 10%;"></td> <td style="width: 10%;"></td> <td style="width: 10%;"></td> <td style="width: 10%;"></td> <td style="width: 10%;"></td> <td style="width: 10%;"></td> <td style="width: 10%;"></td> <td style="width: 10%;"></td> <td style="width: 10%;"></td> <td style="width: 10%;"></td> </tr> <tr> <td></td> <td></td> <td colspan="8" style="text-align: center;"> <table border="1" style="width: 100%; border-collapse: collapse; text-align: center;"> <tr> <td style="width: 10%;"></td> <td style="width: 10%;"></td> <td style="width: 10%;"></td>
<td style="width: 10%;"></td> <td style="width: 10%;"></td> <td style="width: 10%;"></td> <td style="width: 10%;"></td> <td style="width: 10%;"></td> <td style="width: 10%;"></td> <td style="width: 10%;"></td> </tr> <tr> <td></td> <td></td> <td colspan="8" style="text-align: center;"> <table border="1" style="width: 100%; border-collapse: collapse; text-align: center;"> <tr> <td style="width: 10%;"></td> <td style="width: 10%;"></td> <td style="width: 10%;"></td> <td style="width: 10%;"></td> <td style="width: 10%;"></td> <td style="width: 10%;"></td> <td style="width: 10%;"></td> <td style="width: 10%;"></td> <td style="width: 10%;"></td> <td style="width: 10%;"></td> </tr> <tr> <td></td> <td></td> <td colspan="8" style="text-align: center;"> <table border="1" style="width: 100%; border-collapse: collapse; text-align: center;"> <tr> <td style="width: 10%;"></td> <td style="width: 10%;"></td> <td style="width: 10%;"></td> <td style="width: 10%;"></td> <td style="width: 10%;"></td> <td style="width: 10%;"></td> <td style="width: 10%;"></td> <td style="width: 10%;"></td> <td style="width: 10%;"></td> <td style="width: 10%;"></td> </tr> <tr> <td></td> <td></td> <td colspan="8" style="text-align: center;"> <table border="1" style="width: 100%; border-collapse: collapse; text-align: center;"> <tr> <td style="width: 10%;"></td> <td style="width: 10%;"></td> <td style="width: 10%;"></td> <td style="width: 10%;"></td> <td style="width: 10%;"></td> <td style="width: 10%;"></td> <td style="width: 10%;"></td> <td style="width: 10%;"></td> <td style="width: 10%;"></td> <td style="width: 10%;"></td> </tr> <tr> <td></td> <td></td> <td colspan="8" style="text-align: center;"> <table border="1" style="width: 100%; border-collapse: collapse; text-align: center;"> <tr> <td style="width: 10%;"></td> <td style="width: 10%;"></td> <td style="width: 10%;"></td> <td style="width: 10%;"></td> <td style="width: 10%;"></td> <td style="width: 10%;"></td> <td style="width: 10%;"></td> <td style="width: 10%;"></td> <td style="width: 10%;"></td> <td style="width: 10%;"></td> </tr> <tr> <td></td> <td></td> <td colspan="8" style="text-align: center;"> <table border="1" style="width: 100%; border-collapse: collapse; text-align: center;"> <tr> </tr></table></td></tr></table></td></tr></table></td></tr></table></td></tr></table></td></tr></table></td></tr></table></td></tr></table></td></tr></table></td></tr></table></td></tr></table></td></tr></table></td></tr></table></td></tr></table></td></tr></table></td></tr></table></td></tr></table></td></tr></table></td></tr></table></td></tr></table>
 | | | | | | | | | | | | | | | | | | | | <table border="1" style="width: 100%; border-collapse: collapse; text-align: center;"> <tr> <td style="width: 10%;"></td> <td style="width: 10%;"></td> <td style="width: 10%;"></td> <td style="width: 10%;"></td> <td style="width: 10%;"></td> <td style="width: 10%;"></td> <td style="width: 10%;"></td> <td style="width: 10%;"></td> <td style="width: 10%;"></td> <td style="width: 10%;"></td> </tr> <tr> <td></td> <td></td> <td colspan="8" style="text-align: center;"> <table border="1" style="width: 100%; border-collapse: collapse; text-align: center;"> <tr> <td style="width: 10%;"></td> <td style="width: 10%;"></td> <td style="width: 10%;"></td> <td style="width: 10%;"></td> <td style="width: 10%;"></td> <td style="width: 10%;"></td> <td style="width: 10%;"></td> <td style="width: 10%;"></td> <td style="width: 10%;"></td> <td style="width: 10%;"></td> </tr> <tr> <td></td> <td></td> <td colspan="8" style="text-align: center;"> <table border="1" style="width: 100%; border-collapse: collapse; text-align: center;"> <tr> <td style="width: 10%;"></td> <td style="width: 10%;"></td> <td style="width: 10%;"></td> <td style="width: 10%;"></td> <td style="width: 10%;"></td> <td style="width: 10%;"></td> <td style="width: 10%;"></td> <td style="width: 10%;"></td> <td style="width:
10%;"></td> <td style="width: 10%;"></td> </tr> <tr> <td></td> <td></td> <td colspan="8" style="text-align: center;"> <table border="1" style="width: 100%; border-collapse: collapse; text-align: center;"> <tr> <td style="width: 10%;"></td> <td style="width: 10%;"></td> <td style="width: 10%;"></td> <td style="width: 10%;"></td> <td style="width: 10%;"></td> <td style="width: 10%;"></td> <td style="width: 10%;"></td> <td style="width: 10%;"></td> <td style="width: 10%;"></td> <td style="width: 10%;"></td> </tr> <tr> <td></td> <td></td> <td colspan="8" style="text-align: center;"> <table border="1" style="width: 100%; border-collapse: collapse; text-align: center;"> <tr> <td style="width: 10%;"></td> <td style="width: 10%;"></td> <td style="width: 10%;"></td> <td style="width: 10%;"></td> <td style="width: 10%;"></td> <td style="width: 10%;"></td> <td style="width: 10%;"></td> <td style="width: 10%;"></td> <td style="width: 10%;"></td> <td style="width: 10%;"></td> </tr> <tr> <td></td> <td></td> <td colspan="8" style="text-align: center;"> <table border="1" style="width: 100%; border-collapse: collapse; text-align: center;"> <tr> <td style="width: 10%;"></td> <td style="width: 10%;"></td> <td style="width: 10%;"></td> <td style="width: 10%;"></td> <td style="width: 10%;"></td> <td style="width: 10%;"></td> <td style="width: 10%;"></td> <td style="width: 10%;"></td> <td style="width: 10%;"></td> <td style="width: 10%;"></td> </tr> <tr> <td></td> <td></td> <td colspan="8" style="text-align: center;"> <table border="1" style="width: 100%; border-collapse: collapse; text-align: center;"> <tr> <td style="width: 10%;"></td> <td style="width: 10%;"></td> <td style="width: 10%;"></td> <td style="width: 10%;"></td> <td style="width: 10%;"></td> <td style="width: 10%;"></td> <td style="width: 10%;"></td> <td style="width: 10%;"></td> <td style="width: 10%;"></td> <td style="width: 10%;"></td> </tr> <tr> <td></td> <td></td> <td colspan="8" style="text-align: center;"> <table border="1" style="width: 100%; border-collapse: collapse; text-align: center;"> <tr> <td style="width: 10%;"></td> <td style="width: 10%;"></td> <td style="width: 10%;"></td> <td style="width: 10%;"></td> <td style="width: 10%;"></td> <td style="width: 10%;"></td> <td style="width: 10%;"></td> <td style="width: 10%;"></td> <td style="width: 10%;"></td> <td style="width: 10%;"></td> </tr> <tr> <td></td> <td></td> <td colspan="8" style="text-align: center;"> <table border="1" style="width: 100%; border-collapse: collapse; text-align: center;"> <tr> <td style="width: 10%;"></td> <td style="width: 10%;"></td> <td style="width: 10%;"></td> <td style="width: 10%;"></td> <td style="width: 10%;"></td> <td style="width: 10%;"></td> <td style="width: 10%;"></td> <td style="width: 10%;"></td> <td style="width: 10%;"></td> <td style="width: 10%;"></td> </tr> <tr> <td></td> <td></td> <td colspan="8" style="text-align: center;"> <table border="1" style="width: 100%; border-collapse: collapse; text-align: center;"> <tr> <td style="width: 10%;"></td> <td style="width: 10%;"></td> <td style="width: 10%;"></td> <td style="width: 10%;"></td> <td style="width: 10%;"></td> <td style="width: 10%;"></td> <td style="width: 10%;"></td> <td style="width: 10%;"></td> <td style="width: 10%;"></td> <td style="width: 10%;"></td> </tr> <tr> <td></td> <td></td> <td colspan="8" style="text-align: center;"> <table border="1" style="width: 100%; border-collapse: collapse; text-align: center;"> <tr> <td style="width: 10%;"></td> <td style="width: 10%;"></td> <td style="width: 10%;"></td> <td style="width: 10%;"></td> <td style="width: 10%;"></td> <td style="width: 10%;"></td> <td style="width: 10%;"></td> <td style="width: 10%;"></td> <td style="width: 10%;"></td> <td style="width: 10%;"></td> </tr> <tr> <td></td> <td></td> <td colspan="8" style="text-align: center;"> <table border="1" style="width: 100%; border-collapse: collapse; text-align: center;"> <tr> <td style="width: 10%;"></td> <td style="width: 10%;"></td> <td style="width: 10%;"></td> <td style="width: 10%;"></td> <td style="width: 10%;"></td> <td style="width: 10%;"></td> <td style="width: 10%;"></td> <td style="width: 10%;"></td> <td style="width: 10%;"></td> <td style="width: 10%;"></td> </tr> <tr> <td></td> <td></td> <td colspan="8" style="text-align: center;"> <table border="1" style="width: 100%; border-collapse: collapse; text-align: center;"> <tr> <td style="width: 10%;"></td> <td style="width: 10%;"></td> <td style="width: 10%;"></td> <td style="width: 10%;"></td> <td style="width: 10%;"></td> <td style="width: 10%;"></td> <td style="width: 10%;"></td> <td style="width: 10%;"></td> <td style="width: 10%;"></td> <td style="width: 10%;"></td> </tr> <tr> <td></td> <td></td> <td colspan="8" style="text-align: center;"> <table border="1" style="width: 100%; border-collapse: collapse; text-align: center;"> <tr> <td style="width: 10%;"></td> <td style="width: 10%;"></td> <td style="width: 10%;"></td> <td style="width: 10%;"></td> <td style="width: 10%;"></td> <td style="width: 10%;"></td> <td style="width: 10%;"></td> <td style="width: 10%;"></td> <td style="width: 10%;"></td> <td style="width: 10%;"></td> </tr> <tr> <td></td> <td></td> <td colspan="8" style="text-align: center;"> <table border="1" style="width: 100%; border-collapse: collapse; text-align: center;"> <tr> <td style="width: 10%;"></td> <td style="width: 10%;"></td> <td style="width: 10%;"></td> <td style="width: 10%;"></td> <td style="width: 10%;"></td> <td style="width: 10%;"></td> <td style="width: 10%;"></td> <td style="width: 10%;"></td> <td style="width: 10%;"></td> <td style="width: 10%;"></td> </tr> <tr> <td></td> <td></td> <td colspan="8" style="text-align: center;"> <table border="1" style="width: 100%; border-collapse: collapse; text-align: center;"> <tr> <td style="width: 10%;"></td> <td style="width: 10%;"></td> <td style="width: 10%;"></td> <td style="width: 10%;"></td> <td style="width: 10%;"></td> <td style="width: 10%;"></td> <td style="width: 10%;"></td> <td style="width: 10%;"></td> <td style="width: 10%;"></td> <td style="width: 10%;"></td> </tr> <tr> <td></td> <td></td> <td colspan="8" style="text-align: center;"> <table border="1" style="width: 100%; border-collapse: collapse; text-align: center;"> <tr> <td style="width: 10%;"></td> <td style="width: 10%;"></td> <td style="width: 10%;"></td> <td style="width: 10%;"></td> <td style="width: 10%;"></td> <td style="width: 10%;"></td> <td style="width: 10%;"></td> <td style="width: 10%;"></td> <td style="width: 10%;"></td> <td style="width: 10%;"></td> </tr> <tr> <td></td> <td></td> <td colspan="8" style="text-align: center;"> <table border="1" style="width: 100%; border-collapse: collapse; text-align: center;"> <tr> <td style="width: 10%;"></td> <td style="width: 10%;"></td> <td style="width: 10%;"></td> <td style="width: 10%;"></td> <td style="width: 10%;"></td> <td style="width: 10%;"></td> <td style="width: 10%;"></td> <td style="width: 10%;"></td> <td style="width: 10%;"></td> <td style="width: 10%;"></td> </tr> <tr> <td></td> <td></td> <td colspan="8" style="text-align: center;"> <table border="1" style="width: 100%; border-collapse: collapse; text-align: center;"> <tr> </tr></table></td></tr></table></td></tr></table></td></tr></table></td></tr></table></td></tr></table></td></tr></table></td></tr></table></td></tr></table></td></tr></table></td></tr></table></td></tr></table></td></tr></table></td></tr></table></td></tr></table></td></tr></table></td></tr></table></td></tr></table></td></tr></table>

 | | | | | | | | | | | | | | | | | | | | <table border="1" style="width: 100%; border-collapse: collapse; text-align: center;"> <tr> <td style="width: 10%;"></td> <td style="width: 10%;"></td> <td style="width: 10%;"></td> <td style="width: 10%;"></td> <td style="width: 10%;"></td> <td style="width: 10%;"></td> <td style="width: 10%;"></td> <td style="width: 10%;"></td> <td style="width: 10%;"></td> <td style="width: 10%;"></td> </tr> <tr> <td></td> <td></td> <td colspan="8" style="text-align: center;"> <table border="1" style="width: 100%; border-collapse: collapse; text-align: center;"> <tr> <td style="width: 10%;"></td> <td style="width: 10%;"></td> <td style="width: 10%;"></td> <td style="width: 10%;"></td> <td style="width: 10%;"></td> <td style="width: 10%;"></td> <td style="width: 10%;"></td> <td style="width: 10%;"></td> <td style="width: 10%;"></td> <td style="width: 10%;"></td> </tr> <tr> <td></td> <td></td> <td colspan="8" style="text-align: center;"> <table border="1" style="width: 100%; border-collapse: collapse; text-align: center;"> <tr> <td style="width: 10%;"></td> <td style="width: 10%;"></td> <td style="width: 10%;"></td> <td style="width: 10%;"></td> <td style="width: 10%;"></td> <td style="width: 10%;"></td> <td style="width: 10%;"></td> <td style="width: 10%;"></td> <td style="width: 10%;"></td> <td style="width: 10%;"></td> </tr> <tr> <td></td> <td></td> <td colspan="8" style="text-align: center;"> <table border="1" style="width: 100%; border-collapse: collapse; text-align: center;"> <tr> <td style="width: 10%;"></td> <td style="width: 10%;"></td> <td style="width: 10%;"></td> <td style="width: 10%;"></td> <td style="width: 10%;"></td> <td style="width: 10%;"></td> <td style="width: 10%;"></td> <td style="width: 10%;"></td> <td style="width: 10%;"></td> <td style="width: 10%;"></td> </tr> <tr> <td></td> <td></td> <td colspan="8" style="text-align: center;"> <table border="1" style="width: 100%; border-collapse: collapse; text-align: center;"> <tr> <td style="width: 10%;"></td> <td style="width: 10%;"></td> <td style="width: 10%;"></td> <td style="width: 10%;"></td> <td style="width: 10%;"></td> <td style="width: 10%;"></td> <td style="width: 10%;"></td> <td style="width: 10%;"></td> <td style="width: 10%;"></td> <td style="width: 10%;"></td> </tr> <tr> <td></td> <td></td> <td colspan="8" style="text-align: center;"> <table border="1" style="width: 100%; border-collapse: collapse; text-align: center;"> <tr> <td style="width: 10%;"></td> <td style="width: 10%;"></td> <td style="width: 10%;"></td> <td style="width: 10%;"></td> <td style="width: 10%;"></td> <td style="width: 10%;"></td> <td style="width: 10%;"></td> <td style="width: 10%;"></td> <td style="width: 10%;"></td> <td style="width: 10%;"></td> </tr> <tr> <td></td> <td></td> <td colspan="8" style="text-align: center;"> <table border="1" style="width: 100%; border-collapse: collapse; text-align: center;"> <tr> <td style="width: 10%;"></td> <td style="width: 10%;"></td> <td style="width: 10%;"></td> <td style="width: 10%;"></td> <td style="width: 10%;"></td> <td style="width: 10%;"></td> <td style="width: 10%;"></td> <td style="width: 10%;"></td> <td style="width: 10%;"></td> <td style="width: 10%;"></td> </tr> <tr> <td></td> <td></td> <td colspan="8" style="text-align: center;"> <table border="1" style="width: 100%; border-collapse: collapse; text-align: center;"> <tr> <td style="width: 10%;"></td> <td style="width: 10%;"></td> <td style="width: 10%;"></td> <td style="width: 10%;"></td> <td style="width: 10%;"></td> <td style="width: 10%;"></td> <td style="width: 10%;"></td> <td style="width: 10%;"></td> <td style="width: 10%;"></td> <td style="width: 10%;"></td> </tr> <tr> <td></td> <td></td> <td colspan="8" style="text-align: center;"> <table border="1" style="width: 100%; border-collapse: collapse; text-align: center;"> <tr> <td style="width: 10%;"></td> <td style="width: 10%;"></td> <td style="width: 10%;"></td> <td style="width: 10%;"></td> <td style="width: 10%;"></td> <td style="width: 10%;"></td> <td style="width: 10%;"></td> <td style="width: 10%;"></td> <td style="width: 10%;"></td> <td style="width: 10%;"></td> </tr> <tr> <td></td> <td></td> <td colspan="8" style="text-align: center;"> <table border="1" style="width: 100%; border-collapse: collapse; text-align: center;"> <tr> <td style="width: 10%;"></td> <td style="width: 10%;"></td> <td style="width: 10%;"></td> <td style="width: 10%;"></td> <td style="width: 10%;"></td> <td style="width: 10%;"></td> <td style="width: 10%;"></td> <td style="width: 10%;"></td> <td style="width: 10%;"></td> <td style="width: 10%;"></td> </tr> <tr> <td></td> <td></td> <td colspan="8" style="text-align: center;"> <table border="1" style="width: 100%; border-collapse: collapse; text-align: center;"> <tr> <td style="width: 10%;"></td> <td style="width: 10%;"></td> <td style="width: 10%;"></td> <td style="width: 10%;"></td> <td style="width: 10%;"></td> <td style="width: 10%;"></td> <td style="width: 10%;"></td> <td style="width: 10%;"></td> <td style="width: 10%;"></td> <td style="width: 10%;"></td> </tr> <tr> <td></td> <td></td> <td colspan="8" style="text-align: center;"> <table border="1" style="width: 100%; border-collapse: collapse; text-align: center;"> <tr> <td style="width: 10%;"></td> <td style="width: 10%;"></td> <td style="width: 10%;"></td> <td style="width: 10%;"></td> <td style="width: 10%;"></td> <td style="width: 10%;"></td> <td style="width: 10%;"></td> <td style="width: 10%;"></td> <td style="width: 10%;"></td> <td style="width: 10%;"></td> </tr> <tr> <td></td> <td></td> <td colspan="8" style="text-align: center;"> <table border="1" style="width: 100%; border-collapse: collapse; text-align: center;"> <tr> <td style="width: 10%;"></td> <td style="width: 10%;"></td> <td style="width: 10%;"></td> <td style="width: 10%;"></td> <td style="width: 10%;"></td> <td style="width: 10%;"></td> <td style="width: 10%;"></td> <td style="width: 10%;"></td> <td style="width: 10%;"></td> <td style="width: 10%;"></td> </tr> <tr> <td></td> <td></td> <td colspan="8" style="text-align: center;"> <table border="1" style="width: 100%; border-collapse: collapse; text-align: center;"> <tr> <td style="width: 10%;"></td> <td style="width: 10%;"></td> <td style="width: 10%;"></td> <td style="width: 10%;"></td> <td style="width: 10%;"></td> <td
style="width: 10%;"></td> <td style="width: 10%;"></td> <td style="width: 10%;"></td> <td style="width: 10%;"></td> <td style="width: 10%;"></td> </tr> <tr> <td></td> <td></td> <td colspan="8" style="text-align: center;"> <table border="1" style="width: 100%; border-collapse: collapse; text-align: center;"> <tr> <td style="width: 10%;"></td> <td style="width: 10%;"></td> <td style="width: 10%;"></td> <td style="width: 10%;"></td> <td style="width: 10%;"></td> <td style="width: 10%;"></td> <td style="width: 10%;"></td> <td style="width: 10%;"></td> <td style="width: 10%;"></td> <td style="width: 10%;"></td> </tr> <tr> <td></td> <td></td> <td colspan="8" style="text-align: center;"> <table border="1" style="width: 100%; border-collapse: collapse; text-align: center;"> <tr> <td style="width: 10%;"></td> <td style="width: 10%;"></td> <td style="width: 10%;"></td> <td style="width: 10%;"></td> <td style="width: 10%;"></td> <td style="width: 10%;"></td> <td style="width: 10%;"></td> <td style="width: 10%;"></td> <td style="width: 10%;"></td> <td style="width: 10%;"></td> </tr> <tr> <td></td> <td></td> <td colspan="8" style="text-align: center;"> <table border="1" style="width: 100%; border-collapse: collapse; text-align: center;"> <tr> <td style="width: 10%;"></td> <td style="width: 10%;"></td> <td style="width: 10%;"></td> <td style="width: 10%;"></td> <td style="width: 10%;"></td> <td style="width: 10%;"></td> <td style="width: 10%;"></td> <td style="width: 10%;"></td> <td style="width: 10%;"></td> <td style="width: 10%;"></td> </tr> <tr> <td></td> <td></td> <td colspan="8" style="text-align: center;"> <table border="1" style="width: 100%; border-collapse: collapse; text-align: center;"> <tr> </tr></table></td></tr></table></td></tr></table></td></tr></table></td></tr></table></td></tr></table></td></tr></table></td></tr></table></td></tr></table></td></tr></table></td></tr></table></td></tr></table></td></tr></table></td></tr></table></td></tr></table></td></tr></table></td></tr></table></td></tr></table>
 | | | | | | | | | | | | | | | | | | | | <table border="1" style="width: 100%; border-collapse: collapse; text-align: center;"> <tr> <td style="width: 10%;"></td> <td style="width: 10%;"></td> <td style="width: 10%;"></td> <td style="width: 10%;"></td> <td style="width: 10%;"></td> <td style="width: 10%;"></td> <td style="width: 10%;"></td> <td style="width: 10%;"></td> <td style="width: 10%;"></td> <td style="width: 10%;"></td> </tr> <tr> <td></td> <td></td> <td colspan="8" style="text-align: center;"> <table border="1" style="width: 100%; border-collapse: collapse; text-align: center;"> <tr> <td style="width: 10%;"></td> <td style="width: 10%;"></td> <td style="width: 10%;"></td> <td style="width: 10%;"></td> <td style="width: 10%;"></td> <td style="width: 10%;"></td> <td style="width: 10%;"></td> <td style="width: 10%;"></td> <td style="width: 10%;"></td> <td style="width: 10%;"></td> </tr> <tr> <td></td> <td></td> <td colspan="8" style="text-align: center;"> <table border="1" style="width: 100%; border-collapse: collapse; text-align: center;"> <tr> <td style="width: 10%;"></td> <td style="width: 10%;"></td> <td style="width: 10%;"></td> <td style="width: 10%;"></td> <td style="width: 10%;"></td> <td style="width: 10%;"></td> <td style="width: 10%;"></td> <td style="width: 10%;"></td> <td style="width: 10%;"></td> <td style="width: 10%;"></td> </tr> <tr> <td></td> <td></td> <td colspan="8" style="text-align: center;"> <table border="1" style="width: 100%; border-collapse: collapse; text-align: center;"> <tr> <td style="width: 10%;"></td> <td style="width: 10%;"></td> <td style="width: 10%;"></td> <td style="width: 10%;"></td> <td style="width: 10%;"></td> <td style="width: 10%;"></td> <td style="width: 10%;"></td> <td style="width: 10%;"></td> <td style="width: 10%;"></td> <td style="width: 10%;"></td> </tr> <tr> <td></td> <td></td> <td colspan="8" style="text-align:
center;"> <table border="1" style="width: 100%; border-collapse: collapse; text-align: center;"> <tr> <td style="width: 10%;"></td> <td style="width: 10%;"></td> <td style="width: 10%;"></td> <td style="width: 10%;"></td> <td style="width: 10%;"></td> <td style="width: 10%;"></td> <td style="width: 10%;"></td> <td style="width: 10%;"></td> <td style="width: 10%;"></td> <td style="width: 10%;"></td> </tr> <tr> <td></td> <td></td> <td colspan="8" style="text-align: center;"> <table border="1" style="width: 100%; border-collapse: collapse; text-align: center;"> <tr> <td style="width: 10%;"></td> <td style="width: 10%;"></td> <td style="width: 10%;"></td> <td style="width: 10%;"></td> <td style="width: 10%;"></td> <td style="width: 10%;"></td> <td style="width: 10%;"></td> <td style="width: 10%;"></td> <td style="width: 10%;"></td> <td style="width: 10%;"></td> </tr> <tr> <td></td> <td></td> <td colspan="8" style="text-align: center;"> <table border="1" style="width: 100%; border-collapse: collapse; text-align: center;"> <tr> <td style="width: 10%;"></td> <td style="width: 10%;"></td> <td style="width: 10%;"></td> <td style="width: 10%;"></td> <td style="width: 10%;"></td> <td style="width: 10%;"></td> <td style="width: 10%;"></td> <td style="width: 10%;"></td> <td style="width: 10%;"></td> <td style="width: 10%;"></td> </tr> <tr> <td></td> <td></td> <td colspan="8" style="text-align: center;"> <table border="1" style="width: 100%; border-collapse: collapse; text-align: center;"> <tr> <td style="width: 10%;"></td> <td style="width: 10%;"></td> <td style="width: 10%;"></td> <td style="width: 10%;"></td> <td style="width: 10%;"></td> <td style="width: 10%;"></td> <td style="width: 10%;"></td> <td style="width: 10%;"></td> <td style="width: 10%;"></td> <td style="width: 10%;"></td> </tr> <tr> <td></td> <td></td> <td colspan="8" style="text-align: center;"> <table border="1" style="width: 100%; border-collapse: collapse; text-align: center;"> <tr> <td style="width: 10%;"></td> <td style="width: 10%;"></td> <td style="width: 10%;"></td> <td style="width: 10%;"></td> <td style="width: 10%;"></td> <td style="width: 10%;"></td> <td style="width: 10%;"></td> <td style="width: 10%;"></td> <td style="width: 10%;"></td> <td style="width: 10%;"></td> </tr> <tr> <td></td> <td></td> <td colspan="8" style="text-align: center;"> <table border="1" style="width: 100%; border-collapse: collapse; text-align: center;"> <tr> <td style="width: 10%;"></td> <td style="width: 10%;"></td> <td style="width: 10%;"></td> <td style="width: 10%;"></td> <td style="width: 10%;"></td> <td style="width: 10%;"></td> <td style="width: 10%;"></td> <td style="width: 10%;"></td> <td style="width: 10%;"></td> <td style="width: 10%;"></td> </tr> <tr> <td></td> <td></td> <td colspan="8" style="text-align: center;"> <table border="1" style="width: 100%; border-collapse: collapse; text-align: center;"> <tr> <td style="width: 10%;"></td> <td style="width: 10%;"></td> <td style="width: 10%;"></td> <td style="width: 10%;"></td> <td style="width: 10%;"></td> <td style="width: 10%;"></td> <td style="width: 10%;"></td> <td style="width: 10%;"></td> <td style="width: 10%;"></td> <td style="width: 10%;"></td> </tr> <tr> <td></td> <td></td> <td colspan="8" style="text-align: center;"> <table border="1" style="width: 100%; border-collapse: collapse; text-align: center;"> <tr> <td style="width: 10%;"></td> <td style="width: 10%;"></td> <td style="width: 10%;"></td> <td style="width: 10%;"></td> <td style="width: 10%;"></td> <td style="width: 10%;"></td> <td style="width: 10%;"></td> <td style="width: 10%;"></td> <td style="width: 10%;"></td> <td style="width: 10%;"></td> </tr> <tr> <td></td> <td></td> <td colspan="8" style="text-align: center;"> <table border="1" style="width: 100%; border-collapse: collapse; text-align: center;"> <tr> <td style="width: 10%;"></td> <td style="width: 10%;"></td> <td style="width: 10%;"></td> <td style="width: 10%;"></td> <td style="width: 10%;"></td> <td style="width: 10%;"></td> <td style="width: 10%;"></td> <td style="width: 10%;"></td> <td style="width: 10%;"></td> <td style="width: 10%;"></td> </tr> <tr> <td></td> <td></td> <td colspan="8" style="text-align: center;"> <table border="1" style="width: 100%; border-collapse: collapse; text-align: center;"> <tr> <td style="width: 10%;"></td> <td style="width: 10%;"></td> <td style="width: 10%;"></td> <td style="width: 10%;"></td> <td style="width: 10%;"></td> <td style="width: 10%;"></td> <td style="width: 10%;"></td> <td style="width: 10%;"></td> <td style="width: 10%;"></td> <td style="width: 10%;"></td> </tr> <tr> <td></td> <td></td> <td colspan="8" style="text-align: center;"> <table border="1" style="width: 100%; border-collapse: collapse; text-align: center;"> <tr> <td style="width: 10%;"></td> <td style="width: 10%;"></td> <td style="width: 10%;"></td> <td style="width: 10%;"></td> <td style="width: 10%;"></td> <td style="width: 10%;"></td> <td style="width: 10%;"></td> <td style="width: 10%;"></td> <td style="width: 10%;"></td> <td style="width: 10%;"></td> </tr> <tr> <td></td> <td></td> <td colspan="8" style="text-align: center;"> <table border="1" style="width: 100%; border-collapse: collapse; text-align: center;"> <tr> <td style="width: 10%;"></td> <td style="width: 10%;"></td> <td style="width: 10%;"></td> <td style="width: 10%;"></td> <td style="width: 10%;"></td> <td style="width: 10%;"></td> <td style="width: 10%;"></td> <td style="width: 10%;"></td> <td style="width: 10%;"></td> <td style="width: 10%;"></td> </tr> <tr> <td></td> <td></td> <td colspan="8" style="text-align: center;"> <table border="1" style="width: 100%; border-collapse: collapse; text-align: center;"> <tr> </tr></table></td></tr></table></td></tr></table></td></tr></table></td></tr></table></td></tr></table></td></tr></table></td></tr></table></td></tr></table></td></tr></table></td></tr></table></td></tr></table></td></tr></table></td></tr></table></td></tr></table></td></tr></table></td></tr></table>

 | | | | | | | | | | | | | | | | | | | | <table border="1" style="width: 100%; border-collapse: collapse; text-align: center;"> <tr> <td style="width: 10%;"></td> <td style="width: 10%;"></td> <td style="width: 10%;"></td> <td style="width: 10%;"></td> <td style="width: 10%;"></td> <td style="width: 10%;"></td> <td style="width: 10%;"></td> <td style="width: 10%;"></td> <td style="width: 10%;"></td> <td style="width: 10%;"></td> </tr> <tr> <td></td> <td></td> <td colspan="8" style="text-align: center;"> <table border="1" style="width: 100%; border-collapse: collapse; text-align: center;"> <tr> <td style="width: 10%;"></td> <td style="width: 10%;"></td> <td style="width: 10%;"></td> <td style="width: 10%;"></td> <td style="width: 10%;"></td> <td style="width: 10%;"></td> <td style="width: 10%;"></td> <td style="width: 10%;"></td> <td style="width: 10%;"></td> <td style="width: 10%;"></td> </tr> <tr> <td></td> <td></td> <td colspan="8" style="text-align: center;"> <table border="1" style="width: 100%; border-collapse: collapse; text-align: center;"> <tr> <td style="width: 10%;"></td> <td style="width: 10%;"></td> <td style="width: 10%;"></td> <td style="width: 10%;"></td> <td style="width: 10%;"></td> <td style="width: 10%;"></td> <td style="width: 10%;"></td> <td style="width: 10%;"></td> <td style="width: 10%;"></td> <td style="width: 10%;"></td> </tr> <tr> <td></td> <td></td> <td colspan="8" style="text-align: center;"> <table border="1" style="width: 100%; border-collapse: collapse; text-align: center;"> <tr> <td style="width: 10%;"></td> <td style="width: 10%;"></td> <td style="width: 10%;"></td> <td style="width: 10%;"></td> <td style="width: 10%;"></td> <td style="width: 10%;"></td> <td style="width: 10%;"></td> <td style="width: 10%;"></td> <td style="width: 10%;"></td> <td style="width: 10%;"></td> </tr> <tr> <td></td> <td></td> <td colspan="8" style="text-align: center;"> <table border="1" style="width: 100%; border-collapse: collapse; text-align: center;"> <tr> <td style="width: 10%;"></td> <td style="width: 10%;"></td> <td style="width: 10%;"></td> <td style="width: 10%;"></td> <td style="width: 10%;"></td> <td style="width: 10%;"></td> <td style="width: 10%;"></td> <td style="width: 10%;"></td> <td style="width: 10%;"></td> <td style="width: 10%;"></td> </tr> <tr> <td></td> <td></td> <td colspan="8" style="text-align: center;"> <table border="1" style="width: 100%; border-collapse: collapse; text-align: center;"> <tr> <td style="width: 10%;"></td> <td style="width: 10%;"></td> <td style="width: 10%;"></td> <td style="width: 10%;"></td> <td style="width: 10%;"></td> <td style="width: 10%;"></td> <td style="width: 10%;"></td> <td style="width: 10%;"></td> <td style="width: 10%;"></td> <td style="width: 10%;"></td> </tr> <tr> <td></td> <td></td> <td colspan="8" style="text-align: center;"> <table border="1" style="width: 100%; border-collapse: collapse; text-align: center;"> <tr> <td style="width: 10%;"></td> <td style="width: 10%;"></td> <td style="width: 10%;"></td> <td style="width: 10%;"></td> <td style="width: 10%;"></td> <td style="width: 10%;"></td> <td style="width: 10%;"></td> <td style="width: 10%;"></td> <td style="width: 10%;"></td> <td style="width: 10%;"></td> </tr> <tr> <td></td> <td></td> <td colspan="8" style="text-align: center;"> <table border="1" style="width: 100%; border-collapse: collapse; text-align: center;"> <tr> <td style="width: 10%;"></td> <td style="width: 10%;"></td> <td style="width: 10%;"></td> <td style="width: 10%;"></td> <td style="width: 10%;"></td> <td style="width: 10%;"></td> <td style="width: 10%;"></td> <td style="width: 10%;"></td> <td style="width: 10%;"></td> <td style="width: 10%;"></td> </tr> <tr> <td></td> <td></td> <td colspan="8" style="text-align: center;"> <table border="1" style="width: 100%; border-collapse: collapse; text-align: center;"> <tr> <td style="width: 10%;"></td> <td style="width: 10%;"></td> <td style="width: 10%;"></td> <td style="width: 10%;"></td> <td style="width: 10%;"></td> <td style="width: 10%;"></td> <td style="width: 10%;"></td> <td style="width: 10%;"></td> <td style="width: 10%;"></td> <td style="width: 10%;"></td> </tr> <tr> <td></td> <td></td> <td colspan="8" style="text-align: center;"> <table border="1" style="width: 100%; border-collapse: collapse; text-align: center;"> <tr> <td style="width: 10%;"></td> <td style="width: 10%;"></td> <td style="width: 10%;"></td> <td style="width: 10%;"></td> <td style="width: 10%;"></td> <td style="width: 10%;"></td> <td style="width: 10%;"></td> <td style="width: 10%;"></td> <td style="width: 10%;"></td> <td style="width: 10%;"></td> </tr> <tr> <td></td> <td></td> <td colspan="8" style="text-align: center;"> <table border="1" style="width: 100%; border-collapse: collapse; text-align: center;"> <tr> <td style="width: 10%;"></td> <td style="width: 10%;"></td> <td style="width: 10%;"></td> <td style="width: 10%;"></td> <td style="width: 10%;"></td> <td style="width: 10%;"></td> <td style="width: 10%;"></td> <td style="width: 10%;"></td> <td style="width: 10%;"></td> <td style="width: 10%;"></td> </tr> <tr> <td></td> <td></td> <td colspan="8" style="text-align: center;"> <table border="1" style="width: 100%; border-collapse: collapse; text-align: center;"> <tr> <td style="width: 10%;"></td> <td style="width: 10%;"></td> <td style="width: 10%;"></td> <td style="width: 10%;"></td> <td style="width: 10%;"></td> <td style="width: 10%;"></td> <td style="width: 10%;"></td> <td style="width: 10%;"></td> <td style="width: 10%;"></td> <td style="width: 10%;"></td> </tr> <tr> <td></td> <td></td> <td colspan="8" style="text-align: center;"> <table border="1" style="width: 100%; border-collapse: collapse; text-align: center;"> <tr> <td style="width: 10%;"></td> <td style="width: 10%;"></td> <td style="width: 10%;"></td> <td style="width: 10%;"></td> <td style="width: 10%;"></td> <td style="width: 10%;"></td> <td style="width: 10%;"></td> <td style="width: 10%;"></td> <td style="width: 10%;"></td> <td style="width: 10%;"></td> </tr> <tr> <td></td> <td></td> <td colspan="8" style="text-align: center;"> <table border="1" style="width: 100%; border-collapse: collapse; text-align: center;"> <tr> <td style="width: 10%;"></td> <td style="width: 10%;"></td> <td style="width: 10%;"></td> <td style="width: 10%;"></td> <td style="width: 10%;"></td> <td style="width: 10%;"></td> <td style="width: 10%;"></td> <td style="width: 10%;"></td> <td style="width: 10%;"></td> <td style="width: 10%;"></td> </tr> <tr> <td></td> <td></td> <td colspan="8" style="text-align: center;"> <table border="1" style="width: 100%; border-collapse: collapse; text-align: center;"> <tr> <td style="width: 10%;"></td> <td style="width: 10%;"></td> <td style="width: 10%;"></td> <td style="width: 10%;"></td> <td style="width: 10%;"></td> <td style="width: 10%;"></td> <td style="width: 10%;"></td> <td style="width: 10%;"></td> <td style="width: 10%;"></td> <td style="width: 10%;"></td> </tr> <tr> <td></td> <td></td> <td colspan="8" style="text-align: center;"> <table border="1" style="width: 100%; border-collapse: collapse; text-align: center;"> <tr> </tr></table></td></tr></table></td></tr></table></td></tr></table></td></tr></table></td></tr></table></td></tr></table></td></tr></table></td></tr></table></td></tr></table></td></tr></table></td></tr></table></td></tr></table></td></tr></table></td></tr></table></td></tr></table>

 | | | | | | | | | | | | | | | | | | | | <table border="1" style="width: 100%; border-collapse: collapse; text-align: center;"> <tr> <td style="width: 10%;"></td> <td style="width: 10%;"></td> <td style="width: 10%;"></td> <td style="width: 10%;"></td> <td style="width: 10%;"></td> <td style="width: 10%;"></td> <td style="width: 10%;"></td> <td style="width: 10%;"></td> <td style="width: 10%;"></td> <td style="width: 10%;"></td> </tr> <tr> <td></td> <td></td> <td colspan="8" style="text-align: center;"> <table border="1" style="width: 100%; border-collapse: collapse; text-align: center;"> <tr> <td style="width: 10%;"></td> <td style="width: 10%;"></td> <td style="width: 10%;"></td> <td style="width: 10%;"></td> <td style="width: 10%;"></td> <td style="width: 10%;"></td> <td style="width: 10%;"></td> <td style="width: 10%;"></td> <td style="width: 10%;"></td> <td style="width: 10%;"></td> </tr> <tr> <td></td> <td></td> <td colspan="8" style="text-align: center;"> <table border="1" style="width: 100%; border-collapse: collapse; text-align: center;"> <tr> <td style="width: 10%;"></td> <td style="width: 10%;"></td> <td style="width: 10%;"></td> <td style="width: 10%;"></td> <td style="width: 10%;"></td> <td style="width: 10%;"></td> <td style="width: 10%;"></td> <td style="width: 10%;"></td> <td style="width: 10%;"></td> <td style="width: 10%;"></td> </tr> <tr> <td></td> <td></td> <td colspan="8" style="text-align: center;"> <table border="1" style="width: 100%; border-collapse: collapse; text-align: center;"> <tr> <td style="width: 10%;"></td> <td style="width: 10%;"></td> <td style="width: 10%;"></td> <td style="width: 10%;"></td> <td style="width: 10%;"></td> <td style="width: 10%;"></td> <td style="width: 10%;"></td> <td style="width: 10%;"></td> <td style="width: 10%;"></td> <td style="width: 10%;"></td> </tr> <tr> <td></td> <td></td> <td colspan="8" style="text-align: center;"> <table border="1" style="width: 100%; border-collapse: collapse; text-align: center;"> <tr> <td style="width: 10%;"></td> <td style="width: 10%;"></td> <td style="width: 10%;"></td> <td style="width: 10%;"></td> <td style="width: 10%;"></td> <td style="width: 10%;"></td> <td style="width: 10%;"></td> <td style="width: 10%;"></td> <td style="width: 10%;"></td> <td style="width: 10%;"></td> </tr> <tr> <td></td> <td></td> <td colspan="8" style="text-align: center;"> <table border="1" style="width: 100%; border-collapse: collapse; text-align: center;"> <tr> <td style="width: 10%;"></td> <td style="width: 10%;"></td> <td style="width: 10%;"></td> <td style="width: 10%;"></td> <td style="width: 10%;"></td> <td style="width: 10%;"></td> <td style="width: 10%;"></td> <td style="width: 10%;"></td> <td style="width: 10%;"></td> <td style="width: 10%;"></td> </tr> <tr> <td></td> <td></td> <td colspan="8" style="text-align: center;"> <table border="1" style="width: 100%; border-collapse: collapse; text-align: center;"> <tr> <td style="width: 10%;"></td> <td style="width: 10%;"></td> <td style="width: 10%;"></td> <td style="width: 10%;"></td> <td style="width: 10%;"></td> <td style="width: 10%;"></td> <td style="width: 10%;"></td> <td style="width: 10%;"></td> <td style="width: 10%;"></td> <td style="width: 10%;"></td> </tr> <tr> <td></td> <td></td> <td colspan="8" style="text-align: center;"> <table border="1" style="width: 100%; border-collapse: collapse; text-align: center;"> <tr> <td style="width: 10%;"></td> <td style="width: 10%;"></td> <td style="width: 10%;"></td> <td style="width: 10%;"></td> <td style="width: 10%;"></td> <td style="width: 10%;"></td> <td style="width: 10%;"></td> <td style="width: 10%;"></td> <td style="width: 10%;"></td> <td style="width: 10%;"></td> </tr> <tr> <td></td> <td></td> <td colspan="8" style="text-align: center;"> <table border="1" style="width: 100%; border-collapse: collapse; text-align: center;"> <tr> <td style="width: 10%;"></td> <td style="width: 10%;"></td> <td style="width: 10%;"></td> <td style="width: 10%;"></td> <td style="width: 10%;"></td> <td style="width: 10%;"></td> <td style="width: 10%;"></td> <td style="width: 10%;"></td> <td style="width: 10%;"></td> <td style="width: 10%;"></td> </tr> <tr> <td></td> <td></td> <td colspan="8" style="text-align: center;"> <table border="1" style="width: 100%; border-collapse: collapse; text-align: center;"> <tr> <td style="width: 10%;"></td> <td style="width: 10%;"></td> <td style="width:
10%;"></td> <td style="width: 10%;"></td> <td style="width: 10%;"></td> <td style="width: 10%;"></td> <td style="width: 10%;"></td> <td style="width: 10%;"></td> <td style="width: 10%;"></td> <td style="width: 10%;"></td> </tr> <tr> <td></td> <td></td> <td colspan="8" style="text-align: center;"> <table border="1" style="width: 100%; border-collapse: collapse; text-align: center;"> <tr> <td style="width: 10%;"></td> <td style="width: 10%;"></td> <td style="width: 10%;"></td> <td style="width: 10%;"></td> <td style="width: 10%;"></td> <td style="width: 10%;"></td> <td style="width: 10%;"></td> <td style="width: 10%;"></td> <td style="width: 10%;"></td> <td style="width: 10%;"></td> </tr> <tr> <td></td> <td></td> <td colspan="8" style="text-align: center;"> <table border="1" style="width: 100%; border-collapse: collapse; text-align: center;"> <tr> <td style="width: 10%;"></td> <td style="width: 10%;"></td> <td style="width: 10%;"></td> <td style="width: 10%;"></td> <td style="width: 10%;"></td> <td style="width: 10%;"></td> <td style="width: 10%;"></td> <td style="width: 10%;"></td> <td style="width: 10%;"></td> <td style="width: 10%;"></td> </tr> <tr> <td></td> <td></td> <td colspan="8" style="text-align: center;"> <table border="1" style="width: 100%; border-collapse: collapse; text-align: center;"> <tr> <td style="width: 10%;"></td> <td style="width: 10%;"></td> <td style="width: 10%;"></td> <td style="width: 10%;"></td> <td style="width: 10%;"></td> <td style="width: 10%;"></td> <td style="width: 10%;"></td> <td style="width: 10%;"></td> <td style="width: 10%;"></td> <td style="width: 10%;"></td> </tr> <tr> <td></td> <td></td> <td colspan="8" style="text-align: center;"> <table border="1" style="width: 100%; border-collapse: collapse; text-align: center;"> <tr> <td style="width: 10%;"></td> <td style="width: 10%;"></td> <td style="width: 10%;"></td> <td style="width: 10%;"></td> <td style="width: 10%;"></td> <td style="width: 10%;"></td> <td style="width: 10%;"></td> <td style="width: 10%;"></td> <td style="width: 10%;"></td> <td style="width: 10%;"></td> </tr> <tr> <td></td> <td></td> <td colspan="8" style="text-align: center;"> <table border="1" style="width: 100%; border-collapse: collapse; text-align: center;"> <tr> </tr></table></td></tr></table></td></tr></table></td></tr></table></td></tr></table></td></tr></table></td></tr></table></td></tr></table></td></tr></table></td></tr></table></td></tr></table></td></tr></table></td></tr></table></td></tr></table></td></tr></table>
 | | | | | | | | | | | | | | | | | | | | <table border="1" style="width: 100%; border-collapse: collapse; text-align: center;"> <tr> <td style="width: 10%;"></td> <td style="width: 10%;"></td> <td style="width: 10%;"></td> <td style="width: 10%;"></td> <td style="width: 10%;"></td> <td style="width: 10%;"></td> <td style="width: 10%;"></td> <td style="width: 10%;"></td> <td style="width: 10%;"></td> <td style="width: 10%;"></td> </tr> <tr> <td></td> <td></td> <td colspan="8" style="text-align: center;"> <table border="1" style="width: 100%; border-collapse: collapse; text-align: center;"> <tr> <td style="width: 10%;"></td> <td style="width: 10%;"></td> <td style="width: 10%;"></td> <td style="width: 10%;"></td> <td style="width: 10%;"></td> <td style="width: 10%;"></td> <td style="width: 10%;"></td> <td style="width: 10%;"></td> <td style="width: 10%;"></td> <td style="width: 10%;"></td> </tr> <tr> <td></td> <td></td> <td colspan="8" style="text-align: center;"> <table border="1" style="width: 100%; border-collapse: collapse; text-align: center;"> <tr> <td style="width: 10%;"></td> <td style="width: 10%;"></td> <td style="width: 10%;"></td> <td style="width: 10%;"></td> <td style="width: 10%;"></td> <td style="width: 10%;"></td> <td style="width: 10%;"></td> <td style="width: 10%;"></td> <td style="width: 10%;"></td> <td style="width: 10%;"></td> </tr> <tr> <td></td> <td></td> <td colspan="8"
style="text-align: center;"> <table border="1" style="width: 100%; border-collapse: collapse; text-align: center;"> <tr> <td style="width: 10%;"></td> <td style="width: 10%;"></td> <td style="width: 10%;"></td> <td style="width: 10%;"></td> <td style="width: 10%;"></td> <td style="width: 10%;"></td> <td style="width: 10%;"></td> <td style="width: 10%;"></td> <td style="width: 10%;"></td> <td style="width: 10%;"></td> </tr> <tr> <td></td> <td></td> <td colspan="8" style="text-align: center;"> <table border="1" style="width: 100%; border-collapse: collapse; text-align: center;"> <tr> <td style="width: 10%;"></td> <td style="width: 10%;"></td> <td style="width: 10%;"></td> <td style="width: 10%;"></td> <td style="width: 10%;"></td> <td style="width: 10%;"></td> <td style="width: 10%;"></td> <td style="width: 10%;"></td> <td style="width: 10%;"></td> <td style="width: 10%;"></td> </tr> <tr> <td></td> <td></td> <td colspan="8" style="text-align: center;"> <table border="1" style="width: 100%; border-collapse: collapse; text-align: center;"> <tr> <td style="width: 10%;"></td> <td style="width: 10%;"></td> <td style="width: 10%;"></td> <td style="width: 10%;"></td> <td style="width: 10%;"></td> <td style="width: 10%;"></td> <td style="width: 10%;"></td> <td style="width: 10%;"></td> <td style="width: 10%;"></td> <td style="width: 10%;"></td> </tr> <tr> <td></td> <td></td> <td colspan="8" style="text-align: center;"> <table border="1" style="width: 100%; border-collapse: collapse; text-align: center;"> <tr> <td style="width: 10%;"></td> <td style="width: 10%;"></td> <td style="width: 10%;"></td> <td style="width: 10%;"></td> <td style="width: 10%;"></td> <td style="width: 10%;"></td> <td style="width: 10%;"></td> <td style="width: 10%;"></td> <td style="width: 10%;"></td> <td style="width: 10%;"></td> </tr> <tr> <td></td> <td></td> <td colspan="8" style="text-align: center;"> <table border="1" style="width: 100%; border-collapse: collapse; text-align: center;"> <tr> <td style="width: 10%;"></td> <td style="width: 10%;"></td> <td style="width: 10%;"></td> <td style="width: 10%;"></td> <td style="width: 10%;"></td> <td style="width: 10%;"></td> <td style="width: 10%;"></td> <td style="width: 10%;"></td> <td style="width: 10%;"></td> <td style="width: 10%;"></td> </tr> <tr> <td></td> <td></td> <td colspan="8" style="text-align: center;"> <table border="1" style="width: 100%; border-collapse: collapse; text-align: center;"> <tr> <td style="width: 10%;"></td> <td style="width: 10%;"></td> <td style="width: 10%;"></td> <td style="width: 10%;"></td> <td style="width: 10%;"></td> <td style="width: 10%;"></td> <td style="width: 10%;"></td> <td style="width: 10%;"></td> <td style="width: 10%;"></td> <td style="width: 10%;"></td> </tr> <tr> <td></td> <td></td> <td colspan="8" style="text-align: center;"> <table border="1" style="width: 100%; border-collapse: collapse; text-align: center;"> <tr> <td style="width: 10%;"></td> <td style="width: 10%;"></td> <td style="width: 10%;"></td> <td style="width: 10%;"></td> <td style="width: 10%;"></td> <td style="width: 10%;"></td> <td style="width: 10%;"></td> <td style="width: 10%;"></td> <td style="width: 10%;"></td> <td style="width: 10%;"></td> </tr> <tr> <td></td> <td></td> <td colspan="8" style="text-align: center;"> <table border="1" style="width: 100%; border-collapse: collapse; text-align: center;"> <tr> <td style="width: 10%;"></td> <td style="width: 10%;"></td> <td style="width: 10%;"></td> <td style="width: 10%;"></td> <td style="width: 10%;"></td> <td style="width: 10%;"></td> <td style="width: 10%;"></td> <td style="width: 10%;"></td> <td style="width: 10%;"></td> <td style="width: 10%;"></td> </tr> <tr> <td></td> <td></td> <td colspan="8" style="text-align: center;"> <table border="1" style="width: 100%; border-collapse: collapse; text-align: center;"> <tr> <td style="width: 10%;"></td> <td style="width: 10%;"></td> <td style="width: 10%;"></td> <td style="width: 10%;"></td> <td style="width: 10%;"></td> <td style="width: 10%;"></td> <td style="width: 10%;"></td> <td style="width: 10%;"></td> <td style="width: 10%;"></td> <td style="width: 10%;"></td> </tr> <tr> <td></td> <td></td> <td colspan="8" style="text-align: center;"> <table border="1" style="width: 100%; border-collapse: collapse; text-align: center;"> <tr> <td style="width: 10%;"></td> <td style="width: 10%;"></td> <td style="width: 10%;"></td> <td style="width: 10%;"></td> <td style="width: 10%;"></td> <td style="width: 10%;"></td> <td style="width: 10%;"></td> <td style="width: 10%;"></td> <td style="width: 10%;"></td> <td style="width: 10%;"></td> </tr> <tr> <td></td> <td></td> <td colspan="8" style="text-align: center;"> <table border="1" style="width: 100%; border-collapse: collapse; text-align: center;"> <tr> </tr></table></td></tr></table></td></tr></table></td></tr></table></td></tr></table></td></tr></table></td></tr></table></td></tr></table></td></tr></table></td></tr></table></td></tr></table></td></tr></table></td></tr></table></td></tr></table>

 | | | | | | | | | | | | | | | | | | | | <table border="1" style="width: 100%; border-collapse: collapse; text-align: center;"> <tr> <td style="width: 10%;"></td> <td style="width: 10%;"></td> <td style="width: 10%;"></td> <td style="width: 10%;"></td> <td style="width: 10%;"></td> <td style="width: 10%;"></td> <td style="width: 10%;"></td> <td style="width: 10%;"></td> <td style="width: 10%;"></td> <td style="width: 10%;"></td> </tr> <tr> <td></td> <td></td> <td colspan="8" style="text-align: center;"> <table border="1" style="width: 100%; border-collapse: collapse; text-align: center;"> <tr> <td style="width: 10%;"></td> <td style="width: 10%;"></td> <td style="width: 10%;"></td> <td style="width: 10%;"></td> <td style="width: 10%;"></td> <td style="width: 10%;"></td> <td style="width: 10%;"></td> <td style="width: 10%;"></td> <td style="width: 10%;"></td> <td style="width: 10%;"></td> </tr> <tr> <td></td> <td></td> <td colspan="8" style="text-align: center;"> <table border="1" style="width: 100%; border-collapse: collapse; text-align: center;"> <tr> <td style="width: 10%;"></td> <td style="width: 10%;"></td> <td style="width: 10%;"></td> <td style="width: 10%;"></td> <td style="width: 10%;"></td> <td style="width: 10%;"></td> <td style="width: 10%;"></td> <td style="width: 10%;"></td> <td style="width: 10%;"></td> <td style="width: 10%;"></td> </tr> <tr> <td></td> <td></td> <td colspan="8" style="text-align: center;"> <table border="1" style="width: 100%; border-collapse: collapse; text-align: center;"> <tr> <td style="width: 10%;"></td> <td style="width: 10%;"></td> <td style="width: 10%;"></td> <td style="width: 10%;"></td> <td style="width: 10%;"></td> <td style="width: 10%;"></td> <td style="width: 10%;"></td> <td style="width: 10%;"></td> <td style="width: 10%;"></td> <td style="width: 10%;"></td> </tr> <tr> <td></td> <td></td> <td colspan="8" style="text-align: center;"> <table border="1" style="width: 100%; border-collapse: collapse; text-align: center;"> <tr> <td style="width: 10%;"></td> <td style="width: 10%;"></td> <td style="width: 10%;"></td> <td style="width: 10%;"></td> <td style="width: 10%;"></td> <td style="width: 10%;"></td> <td style="width: 10%;"></td> <td style="width: 10%;"></td> <td style="width: 10%;"></td> <td style="width: 10%;"></td> </tr> <tr> <td></td> <td></td> <td colspan="8" style="text-align: center;"> <table border="1" style="width: 100%; border-collapse: collapse; text-align: center;"> <tr> <td style="width: 10%;"></td> <td style="width: 10%;"></td> <td style="width: 10%;"></td> <td style="width: 10%;"></td> <td style="width: 10%;"></td> <td style="width: 10%;"></td> <td style="width: 10%;"></td> <td style="width: 10%;"></td> <td style="width: 10%;"></td> <td style="width: 10%;"></td> </tr> <tr> <td></td> <td></td> <td colspan="8" style="text-align: center;"> <table border="1" style="width: 100%; border-collapse: collapse; text-align: center;"> <tr> <td style="width: 10%;"></td> <td style="width: 10%;"></td> <td style="width: 10%;"></td> <td style="width: 10%;"></td> <td style="width: 10%;"></td> <td style="width: 10%;"></td> <td style="width: 10%;"></td> <td style="width: 10%;"></td> <td style="width: 10%;"></td> <td style="width: 10%;"></td> </tr> <tr> <td></td> <td></td> <td colspan="8" style="text-align: center;"> <table border="1" style="width: 100%; border-collapse: collapse; text-align: center;"> <tr> <td style="width: 10%;"></td> <td style="width: 10%;"></td> <td style="width: 10%;"></td> <td style="width: 10%;"></td> <td style="width: 10%;"></td> <td style="width: 10%;"></td> <td style="width: 10%;"></td> <td style="width: 10%;"></td> <td style="width: 10%;"></td> <td style="width: 10%;"></td> </tr> <tr> <td></td> <td></td> <td colspan="8" style="text-align: center;"> <table border="1" style="width: 100%; border-collapse: collapse; text-align: center;"> <tr> <td style="width: 10%;"></td> <td style="width: 10%;"></td> <td style="width: 10%;"></td> <td style="width: 10%;"></td> <td style="width: 10%;"></td> <td style="width: 10%;"></td> <td style="width: 10%;"></td> <td style="width: 10%;"></td> <td style="width: 10%;"></td> <td style="width: 10%;"></td> </tr> <tr> <td></td> <td></td> <td colspan="8" style="text-align: center;"> <table border="1" style="width: 100%; border-collapse: collapse; text-align: center;"> <tr> <td style="width: 10%;"></td> <td style="width: 10%;"></td> <td style="width: 10%;"></td> <td style="width: 10%;"></td> <td style="width: 10%;"></td> <td style="width: 10%;"></td> <td style="width: 10%;"></td> <td style="width: 10%;"></td> <td style="width: 10%;"></td> <td style="width: 10%;"></td> </tr> <tr> <td></td> <td></td> <td colspan="8" style="text-align: center;"> <table border="1" style="width: 100%; border-collapse: collapse; text-align: center;"> <tr> <td style="width: 10%;"></td> <td style="width: 10%;"></td> <td style="width: 10%;"></td> <td style="width: 10%;"></td> <td style="width: 10%;"></td> <td style="width: 10%;"></td> <td style="width: 10%;"></td> <td style="width: 10%;"></td> <td style="width: 10%;"></td> <td style="width: 10%;"></td> </tr> <tr> <td></td> <td></td> <td colspan="8" style="text-align: center;"> <table border="1" style="width: 100%; border-collapse: collapse; text-align: center;"> <tr> <td style="width: 10%;"></td> <td style="width: 10%;"></td> <td style="width: 10%;"></td> <td style="width: 10%;"></td> <td style="width: 10%;"></td> <td style="width: 10%;"></td> <td style="width: 10%;"></td> <td style="width: 10%;"></td> <td style="width: 10%;"></td> <td style="width: 10%;"></td> </tr> <tr> <td></td> <td></td> <td colspan="8" style="text-align: center;"> <table border="1" style="width: 100%; border-collapse: collapse; text-align: center;"> <tr> </tr></table></td></tr></table></td></tr></table></td></tr></table></td></tr></table></td></tr></table></td></tr></table></td></tr></table></td></tr></table></td></tr></table></td></tr></table></td></tr></table></td></tr></table>

 | | | | | | | | | | | | | | | | | | | | <table border="1" style="width: 100%; border-collapse: collapse; text-align: center;"> <tr> <td style="width: 10%;"></td> <td style="width: 10%;"></td> <td style="width: 10%;"></td> <td style="width: 10%;"></td> <td style="width: 10%;"></td> <td style="width: 10%;"></td> <td style="width: 10%;"></td> <td style="width: 10%;"></td> <td style="width: 10%;"></td> <td style="width: 10%;"></td> </tr> <tr> <td></td> <td></td> <td colspan="8" style="text-align: center;"> <table border="1" style="width: 100%; border-collapse: collapse; text-align: center;"> <tr> <td style="width: 10%;"></td> <td style="width: 10%;"></td> <td style="width: 10%;"></td> <td style="width: 10%;"></td> <td style="width: 10%;"></td> <td style="width: 10%;"></td> <td style="width: 10%;"></td> <td style="width: 10%;"></td> <td style="width: 10%;"></td> <td style="width: 10%;"></td> </tr> <tr> <td></td> <td></td> <td colspan="8" style="text-align: center;"> <table border="1" style="width: 100%; border-collapse: collapse; text-align: center;"> <tr> <td style="width: 10%;"></td> <td style="width: 10%;"></td> <td style="width: 10%;"></td> <td style="width: 10%;"></td> <td style="width: 10%;"></td> <td style="width: 10%;"></td> <td style="width: 10%;"></td> <td style="width: 10%;"></td> <td style="width: 10%;"></td> <td style="width: 10%;"></td> </tr> <tr> <td></td> <td></td> <td colspan="8" style="text-align: center;"> <table border="1" style="width: 100%; border-collapse: collapse; text-align: center;"> <tr> <td style="width: 10%;"></td> <td style="width: 10%;"></td> <td style="width: 10%;"></td> <td style="width: 10%;"></td> <td style="width: 10%;"></td> <td style="width: 10%;"></td> <td style="width: 10%;"></td> <td style="width: 10%;"></td> <td style="width: 10%;"></td> <td style="width: 10%;"></td> </tr> <tr> <td></td> <td></td> <td colspan="8" style="text-align: center;"> <table border="1" style="width: 100%; border-collapse: collapse; text-align: center;"> <tr> <td style="width: 10%;"></td> <td style="width: 10%;"></td> <td style="width: 10%;"></td> <td style="width: 10%;"></td> <td style="width: 10%;"></td> <td style="width: 10%;"></td> <td style="width: 10%;"></td> <td style="width: 10%;"></td> <td style="width: 10%;"></td> <td style="width: 10%;"></td> </tr> <tr> <td></td> <td></td> <td colspan="8" style="text-align: center;"> <table border="1" style="width: 100%; border-collapse: collapse; text-align: center;"> <tr> <td style="width: 10%;"></td> <td style="width: 10%;"></td> <td style="width: 10%;"></td> <td style="width: 10%;"></td> <td style="width: 10%;"></td> <td style="width: 10%;"></td> <td style="width: 10%;"></td> <td style="width: 10%;"></td> <td style="width: 10%;"></td> <td style="width: 10%;"></td> </tr> <tr> <td></td> <td></td> <td colspan="8" style="text-align: center;"> <table border="1" style="width: 100%; border-collapse: collapse; text-align: center;"> <tr> <td style="width: 10%;"></td> <td style="width: 10%;"></td> <td style="width: 10%;"></td> <td style="width: 10%;"></td> <td style="width: 10%;"></td> <td style="width: 10%;"></td> <td style="width: 10%;"></td> <td style="width: 10%;"></td> <td style="width: 10%;"></td> <td style="width: 10%;"></td> </tr> <tr> <td></td> <td></td> <td colspan="8" style="text-align: center;"> <table border="1" style="width: 100%; border-collapse: collapse; text-align: center;"> <tr> <td style="width: 10%;"></td> <td style="width: 10%;"></td> <td style="width: 10%;"></td> <td style="width: 10%;"></td> <td style="width: 10%;"></td> <td style="width: 10%;"></td> <td style="width: 10%;"></td> <td style="width: 10%;"></td> <td style="width: 10%;"></td> <td style="width: 10%;"></td> </tr> <tr> <td></td> <td></td> <td colspan="8" style="text-align: center;"> <table border="1" style="width: 100%; border-collapse: collapse; text-align: center;"> <tr> <td style="width: 10%;"></td> <td style="width: 10%;"></td> <td style="width: 10%;"></td> <td style="width: 10%;"></td> <td style="width: 10%;"></td> <td style="width: 10%;"></td> <td style="width: 10%;"></td> <td style="width: 10%;"></td> <td style="width: 10%;"></td> <td style="width: 10%;"></td> </tr> <tr> <td></td> <td></td> <td colspan="8" style="text-align: center;"> <table border="1" style="width: 100%; border-collapse: collapse; text-align: center;"> <tr> <td style="width: 10%;"></td> <td style="width: 10%;"></td> <td style="width: 10%;"></td> <td style="width: 10%;"></td> <td style="width: 10%;"></td> <td style="width: 10%;"></td> <td style="width: 10%;"></td> <td style="width: 10%;"></td> <td style="width: 10%;"></td> <td style="width: 10%;"></td> </tr> <tr> <td></td> <td></td> <td colspan="8" style="text-align: center;"> <table border="1" style="width: 100%; border-collapse: collapse; text-align: center;"> <tr> <td style="width: 10%;"></td> <td style="width: 10%;"></td> <td style="width: 10%;"></td> <td style="width: 10%;"></td> <td style="width: 10%;"></td> <td style="width: 10%;"></td> <td style="width: 10%;"></td> <td style="width: 10%;"></td> <td style="width: 10%;"></td> <td style="width: 10%;"></td> </tr> <tr> <td></td> <td></td> <td colspan="8" style="text-align: center;"> <table border="1" style="width: 100%; border-collapse: collapse; text-align: center;"> <tr> </tr></table></td></tr></table></td></tr></table></td></tr></table></td></tr></table></td></tr></table></td></tr></table></td></tr></table></td></tr></table></td></tr></table></td></tr></table></td></tr></table>

 | | | | | | | | | | | | | | | | | | | | <table border="1" style="width: 100%; border-collapse: collapse; text-align: center;"> <tr> <td style="width: 10%;"></td> <td style="width: 10%;"></td> <td style="width: 10%;"></td> <td style="width: 10%;"></td> <td style="width: 10%;"></td> <td style="width: 10%;"></td> <td style="width: 10%;"></td> <td style="width: 10%;"></td> <td style="width: 10%;"></td> <td style="width: 10%;"></td> </tr> <tr> <td></td> <td></td> <td colspan="8" style="text-align: center;"> <table border="1" style="width: 100%; border-collapse: collapse; text-align: center;"> <tr> <td style="width: 10%;"></td> <td style="width: 10%;"></td> <td style="width: 10%;"></td> <td style="width: 10%;"></td> <td style="width: 10%;"></td> <td style="width: 10%;"></td> <td style="width: 10%;"></td> <td style="width: 10%;"></td> <td style="width: 10%;"></td> <td style="width: 10%;"></td> </tr> <tr> <td></td> <td></td> <td colspan="8" style="text-align: center;"> <table border="1" style="width: 100%; border-collapse: collapse; text-align: center;"> <tr> <td style="width: 10%;"></td> <td style="width: 10%;"></td> <td style="width: 10%;"></td> <td style="width: 10%;"></td> <td style="width: 10%;"></td> <td style="width: 10%;"></td> <td style="width: 10%;"></td> <td style="width: 10%;"></td> <td style="width: 10%;"></td> <td style="width: 10%;"></td> </tr> <tr> <td></td> <td></td> <td colspan="8" style="text-align: center;"> <table border="1" style="width: 100%; border-collapse: collapse; text-align: center;"> <tr> <td style="width: 10%;"></td> <td style="width: 10%;"></td> <td style="width: 10%;"></td> <td style="width: 10%;"></td> <td style="width: 10%;"></td> <td style="width: 10%;"></td> <td style="width: 10%;"></td> <td style="width: 10%;"></td> <td style="width: 10%;"></td> <td style="width: 10%;"></td> </tr> <tr> <td></td> <td></td> <td colspan="8" style="text-align: center;"> <table border="1" style="width: 100%; border-collapse: collapse; text-align: center;"> <tr> <td style="width: 10%;"></td> <td style="width: 10%;"></td> <td style="width: 10%;"></td> <td style="width: 10%;"></td> <td style="width: 10%;"></td> <td style="width: 10%;"></td> <td style="width: 10%;"></td> <td style="width: 10%;"></td> <td style="width: 10%;"></td> <td style="width: 10%;"></td> </tr> <tr> <td></td> <td></td> <td colspan="8" style="text-align: center;"> <table border="1" style="width: 100%; border-collapse: collapse; text-align: center;"> <tr> <td style="width: 10%;"></td> <td style="width: 10%;"></td> <td style="width: 10%;"></td> <td style="width: 10%;"></td> <td style="width: 10%;"></td> <td style="width: 10%;"></td> <td style="width: 10%;"></td> <td style="width: 10%;"></td> <td style="width: 10%;"></td> <td style="width: 10%;"></td> </tr> <tr> <td></td> <td></td> <td colspan="8" style="text-align: center;"> <table border="1" style="width: 100%; border-collapse: collapse; text-align: center;"> <tr> <td style="width: 10%;"></td> <td style="width: 10%;"></td> <td style="width: 10%;"></td> <td style="width: 10%;"></td> <td style="width: 10%;"></td> <td style="width: 10%;"></td> <td style="width: 10%;"></td> <td style="width: 10%;"></td> <td style="width: 10%;"></td> <td style="width: 10%;"></td> </tr> <tr> <td></td> <td></td> <td colspan="8" style="text-align: center;"> <table border="1" style="width: 100%; border-collapse: collapse; text-align: center;"> <tr> <td style="width: 10%;"></td> <td style="width: 10%;"></td> <td style="width: 10%;"></td> <td style="width: 10%;"></td> <td style="width: 10%;"></td> <td style="width: 10%;"></td> <td style="width: 10%;"></td> <td style="width: 10%;"></td> <td style="width: 10%;"></td> <td style="width: 10%;"></td> </tr> <tr> <td></td> <td></td> <td colspan="8" style="text-align: center;"> <table border="1" style="width: 100%; border-collapse: collapse; text-align: center;"> <tr> <td style="width: 10%;"></td> <td style="width: 10%;"></td> <td style="width: 10%;"></td> <td style="width: 10%;"></td> <td style="width: 10%;"></td> <td style="width: 10%;"></td> <td style="width: 10%;"></td> <td style="width: 10%;"></td> <td style="width: 10%;"></td> <td style="width: 10%;"></td> </tr> <tr> <td></td> <td></td> <td colspan="8" style="text-align: center;"> <table border="1" style="width: 100%; border-collapse: collapse; text-align: center;"> <tr> <td style="width: 10%;"></td> <td style="width: 10%;"></td> <td style="width: 10%;"></td> <td style="width: 10%;"></td> <td style="width: 10%;"></td> <td style="width: 10%;"></td> <td style="width: 10%;"></td> <td style="width: 10%;"></td> <td style="width: 10%;"></td> <td style="width: 10%;"></td> </tr> <tr> <td></td> <td></td> <td colspan="8" style="text-align: center;"> <table border="1" style="width: 100%; border-collapse: collapse; text-align: center;"> <tr> </tr></table></td></tr></table></td></tr></table></td></tr></table></td></tr></table></td></tr></table></td></tr></table></td></tr></table></td></tr></table></td></tr></table></td></tr></table>

 | | | | | | | | | | | | | | | | | | | | <table border="1" style="width: 100%; border-collapse: collapse; text-align: center;"> <tr> <td style="width: 10%;"></td> <td style="width: 10%;"></td> <td style="width: 10%;"></td> <td style="width: 10%;"></td> <td style="width: 10%;"></td> <td style="width: 10%;"></td> <td style="width: 10%;"></td> <td style="width: 10%;"></td> <td style="width: 10%;"></td> <td style="width: 10%;"></td> </tr> <tr> <td></td> <td></td> <td colspan="8" style="text-align: center;"> <table border="1" style="width: 100%; border-collapse: collapse; text-align: center;"> <tr> <td style="width: 10%;"></td> <td style="width: 10%;"></td> <td style="width: 10%;"></td> <td style="width: 10%;"></td> <td style="width: 10%;"></td> <td style="width: 10%;"></td> <td style="width: 10%;"></td> <td style="width: 10%;"></td> <td style="width: 10%;"></td> <td style="width: 10%;"></td> </tr> <tr> <td></td> <td></td> <td colspan="8" style="text-align: center;"> <table border="1" style="width: 100%; border-collapse: collapse; text-align: center;"> <tr> <td style="width: 10%;"></td> <td style="width: 10%;"></td> <td style="width: 10%;"></td> <td style="width: 10%;"></td> <td style="width: 10%;"></td> <td style="width: 10%;"></td> <td style="width: 10%;"></td> <td style="width: 10%;"></td> <td style="width: 10%;"></td> <td style="width: 10%;"></td> </tr> <tr> <td></td> <td></td> <td colspan="8" style="text-align: center;"> <table border="1" style="width: 100%; border-collapse: collapse; text-align: center;"> <tr> <td style="width: 10%;"></td> <td style="width: 10%;"></td> <td style="width: 10%;"></td> <td style="width: 10%;"></td> <td style="width: 10%;"></td> <td style="width: 10%;"></td> <td style="width: 10%;"></td> <td style="width: 10%;"></td> <td style="width: 10%;"></td> <td style="width: 10%;"></td> </tr> <tr> <td></td> <td></td> <td colspan="8" style="text-align: center;"> <table border="1" style="width: 100%; border-collapse: collapse; text-align: center;"> <tr> <td style="width: 10%;"></td> <td style="width: 10%;"></td> <td style="width: 10%;"></td> <td style="width: 10%;"></td> <td style="width: 10%;"></td> <td style="width: 10%;"></td> <td style="width: 10%;"></td> <td style="width: 10%;"></td> <td style="width: 10%;"></td> <td style="width: 10%;"></td> </tr> <tr> <td></td> <td></td> <td colspan="8" style="text-align: center;"> <table border="1" style="width: 100%; border-collapse: collapse; text-align: center;"> <tr> <td style="width: 10%;"></td> <td style="width: 10%;"></td> <td style="width: 10%;"></td> <td style="width: 10%;"></td> <td style="width: 10%;"></td> <td style="width: 10%;"></td> <td style="width: 10%;"></td> <td style="width: 10%;"></td> <td style="width: 10%;"></td> <td style="width: 10%;"></td> </tr> <tr> <td></td> <td></td> <td colspan="8" style="text-align: center;"> <table border="1" style="width: 100%; border-collapse: collapse; text-align: center;"> <tr> <td style="width: 10%;"></td> <td style="width: 10%;"></td> <td style="width: 10%;"></td> <td style="width: 10%;"></td> <td style="width: 10%;"></td> <td style="width: 10%;"></td> <td style="width: 10%;"></td> <td style="width: 10%;"></td> <td style="width: 10%;"></td> <td style="width: 10%;"></td> </tr> <tr> <td></td> <td></td> <td colspan="8" style="text-align: center;"> <table border="1" style="width: 100%; border-collapse: collapse; text-align: center;"> <tr> <td style="width: 10%;"></td> <td style="width: 10%;"></td> <td style="width: 10%;"></td> <td style="width: 10%;"></td> <td style="width: 10%;"></td> <td style="width: 10%;"></td> <td style="width: 10%;"></td> <td style="width: 10%;"></td> <td style="width: 10%;"></td> <td style="width: 10%;"></td> </tr> <tr> <td></td> <td></td> <td colspan="8" style="text-align: center;"> <table border="1" style="width: 100%; border-collapse: collapse; text-align: center;"> <tr> <td style="width: 10%;"></td> <td style="width: 10%;"></td> <td style="width: 10%;"></td> <td style="width: 10%;"></td> <td style="width: 10%;"></td> <td style="width: 10%;"></td> <td style="width: 10%;"></td> <td style="width: 10%;"></td> <td style="width: 10%;"></td> <td style="width: 10%;"></td> </tr> <tr> <td></td> <td></td> <td colspan="8" style="text-align:
center;"> <table border="1" style="width: 100%; border-collapse: collapse; text-align: center;"> <tr> </tr></table></td></tr></table></td></tr></table></td></tr></table></td></tr></table></td></tr></table></td></tr></table></td></tr></table></td></tr></table></td></tr></table>
 | | | | | | | | | | | | | | | | | | | | <table border="1" style="width: 100%; border-collapse: collapse; text-align: center;"> <tr> <td style="width: 10%;"></td> <td style="width: 10%;"></td> <td style="width: 10%;"></td> <td style="width: 10%;"></td> <td style="width: 10%;"></td> <td style="width: 10%;"></td> <td style="width: 10%;"></td> <td style="width: 10%;"></td> <td style="width: 10%;"></td> <td style="width: 10%;"></td> </tr> <tr> <td></td> <td></td> <td colspan="8" style="text-align: center;"> <table border="1" style="width: 100%; border-collapse: collapse; text-align: center;"> <tr> <td style="width: 10%;"></td> <td style="width: 10%;"></td> <td style="width: 10%;"></td> <td style="width: 10%;"></td> <td style="width: 10%;"></td> <td style="width: 10%;"></td> <td style="width: 10%;"></td> <td style="width: 10%;"></td> <td style="width: 10%;"></td> <td style="width: 10%;"></td> </tr> <tr> <td></td> <td></td> <td colspan="8" style="text-align: center;"> <table border="1" style="width: 100%; border-collapse: collapse; text-align: center;"> <tr> <td style="width: 10%;"></td> <td style="width: 10%;"></td> <td style="width: 10%;"></td> <td style="width: 10%;"></td> <td style="width: 10%;"></td> <td style="width: 10%;"></td> <td style="width: 10%;"></td> <td style="width: 10%;"></td> <td style="width: 10%;"></td> <td style="width: 10%;"></td> </tr> <tr> <td></td> <td></td> <td colspan="8" style="text-align: center;"> <table border="1" style="width: 100%; border-collapse: collapse; text-align: center;"> <tr> <td style="width: 10%;"></td> <td style="width: 10%;"></td> <td style="width: 10%;"></td> <td style="width: 10%;"></td> <td style="width: 10%;"></td> <td style="width: 10%;"></td> <td style="width: 10%;"></td> <td style="width: 10%;"></td> <td style="width: 10%;"></td> <td style="width: 10%;"></td> </tr> <tr> <td></td> <td></td> <td colspan="8" style="text-align: center;"> <table border="1" style="width: 100%; border-collapse: collapse; text-align: center;"> <tr> <td style="width: 10%;"></td> <td style="width: 10%;"></td> <td style="width: 10%;"></td> <td style="width: 10%;"></td> <td style="width: 10%;"></td> <td style="width: 10%;"></td> <td style="width: 10%;"></td> <td style="width: 10%;"></td> <td style="width: 10%;"></td> <td style="width: 10%;"></td> </tr> <tr> <td></td> <td></td> <td colspan="8" style="text-align: center;"> <table border="1" style="width: 100%; border-collapse: collapse; text-align: center;"> <tr> <td style="width: 10%;"></td> <td style="width: 10%;"></td> <td style="width: 10%;"></td> <td style="width: 10%;"></td> <td style="width: 10%;"></td> <td style="width: 10%;"></td> <td style="width: 10%;"></td> <td style="width: 10%;"></td> <td style="width: 10%;"></td> <td style="width: 10%;"></td> </tr> <tr> <td></td> <td></td> <td colspan="8" style="text-align: center;"> <table border="1" style="width: 100%; border-collapse: collapse; text-align: center;"> <tr> <td style="width: 10%;"></td> <td style="width: 10%;"></td> <td style="width: 10%;"></td> <td style="width: 10%;"></td> <td style="width: 10%;"></td> <td style="width: 10%;"></td> <td style="width: 10%;"></td> <td style="width: 10%;"></td> <td style="width: 10%;"></td> <td style="width: 10%;"></td> </tr> <tr> <td></td> <td></td> <td colspan="8" style="text-align: center;"> <table border="1" style="width: 100%; border-collapse: collapse; text-align: center;"> <tr> <td style="width: 10%;"></td> <td style="width: 10%;"></td> <td style="width: 10%;"></td> <td style="width: 10%;"></td> <td style="width: 10%;"></td> <td style="width: 10%;"></td> <td style="width: 10%;"></td> <td style="width: 10%;"></td> <td
style="width: 10%;"></td> <td style="width: 10%;"></td> </tr> <tr> <td></td> <td></td> <td colspan="8" style="text-align: center;"> <table border="1" style="width: 100%; border-collapse: collapse; text-align: center;"> <tr> </tr></table></td></tr></table></td></tr></table></td></tr></table></td></tr></table></td></tr></table></td></tr></table></td></tr></table></td></tr></table>
 | | | | | | | | | | | | | | | | | | | | <table border="1" style="width: 100%; border-collapse: collapse; text-align: center;"> <tr> <td style="width: 10%;"></td> <td style="width: 10%;"></td> <td style="width: 10%;"></td> <td style="width: 10%;"></td> <td style="width: 10%;"></td> <td style="width: 10%;"></td> <td style="width: 10%;"></td> <td style="width: 10%;"></td> <td style="width: 10%;"></td> <td style="width: 10%;"></td> </tr> <tr> <td></td> <td></td> <td colspan="8" style="text-align: center;"> <table border="1" style="width: 100%; border-collapse: collapse; text-align: center;"> <tr> <td style="width: 10%;"></td> <td style="width: 10%;"></td> <td style="width: 10%;"></td> <td style="width: 10%;"></td> <td style="width: 10%;"></td> <td style="width: 10%;"></td> <td style="width: 10%;"></td> <td style="width: 10%;"></td> <td style="width: 10%;"></td> <td style="width: 10%;"></td> </tr> <tr> <td></td> <td></td> <td colspan="8" style="text-align: center;"> <table border="1" style="width: 100%; border-collapse: collapse; text-align: center;"> <tr> <td style="width: 10%;"></td> <td style="width: 10%;"></td> <td style="width: 10%;"></td> <td style="width: 10%;"></td> <td style="width: 10%;"></td> <td style="width: 10%;"></td> <td style="width: 10%;"></td> <td style="width: 10%;"></td> <td style="width: 10%;"></td> <td style="width: 10%;"></td> </tr> <tr> <td></td> <td></td> <td colspan="8" style="text-align: center;"> <table border="1" style="width: 100%; border-collapse: collapse; text-align: center;"> <tr> <td style="width: 10%;"></td> <td style="width: 10%;"></td> <td style="width: 10%;"></td> <td style="width: 10%;"></td> <td style="width: 10%;"></td> <td style="width: 10%;"></td> <td style="width: 10%;"></td> <td style="width: 10%;"></td> <td style="width: 10%;"></td> <td style="width: 10%;"></td> </tr> <tr> <td></td> <td></td> <td colspan="8" style="text-align: center;"> <table border="1" style="width: 100%; border-collapse: collapse; text-align: center;"> <tr> <td style="width: 10%;"></td> <td style="width: 10%;"></td> <td style="width: 10%;"></td> <td style="width: 10%;"></td> <td style="width: 10%;"></td> <td style="width: 10%;"></td> <td style="width: 10%;"></td> <td style="width: 10%;"></td> <td style="width: 10%;"></td> <td style="width: 10%;"></td> </tr> <tr> <td></td> <td></td> <td colspan="8" style="text-align: center;"> <table border="1" style="width: 100%; border-collapse: collapse; text-align: center;"> <tr> <td style="width: 10%;"></td> <td style="width: 10%;"></td> <td style="width: 10%;"></td> <td style="width: 10%;"></td> <td style="width: 10%;"></td> <td style="width: 10%;"></td> <td style="width: 10%;"></td> <td style="width: 10%;"></td> <td style="width: 10%;"></td> <td style="width: 10%;"></td> </tr> <tr> <td></td> <td></td> <td colspan="8" style="text-align: center;"> <table border="1" style="width: 100%; border-collapse: collapse; text-align: center;"> <tr> <td style="width: 10%;"></td> <td style="width: 10%;"></td> <td style="width: 10%;"></td> <td style="width: 10%;"></td> <td style="width: 10%;"></td> <td style="width: 10%;"></td> <td style="width: 10%;"></td> <td style="width: 10%;"></td> <td style="width: 10%;"></td> <td style="width: 10%;"></td> </tr> <tr> <td></td> <td></td> <td colspan="8" style="text-align: center;"> <table border="1" style="width: 100%; border-collapse: collapse; text-align: center;"> <tr> </tr></table></td></tr></table></td></tr></table></td></tr></table></td></tr></table></td></tr></table></td></tr></table></td></tr></table>

 | | | | | | | | | | | | | | | | | | | | <table border="1" style="width: 100%; border-collapse: collapse; text-align: center;"> <tr> <td style="width: 10%;"></td> <td style="width: 10%;"></td> <td style="width: 10%;"></td> <td style="width: 10%;"></td> <td style="width: 10%;"></td> <td style="width: 10%;"></td> <td style="width: 10%;"></td> <td style="width: 10%;"></td> <td style="width: 10%;"></td> <td style="width: 10%;"></td> </tr> <tr> <td></td> <td></td> <td colspan="8" style="text-align: center;"> <table border="1" style="width: 100%; border-collapse: collapse; text-align: center;"> <tr> <td style="width: 10%;"></td> <td style="width: 10%;"></td> <td style="width: 10%;"></td> <td style="width: 10%;"></td> <td style="width: 10%;"></td> <td style="width: 10%;"></td> <td style="width: 10%;"></td> <td style="width: 10%;"></td> <td style="width: 10%;"></td> <td style="width: 10%;"></td> </tr> <tr> <td></td> <td></td> <td colspan="8" style="text-align: center;"> <table border="1" style="width: 100%; border-collapse: collapse; text-align: center;"> <tr> <td style="width: 10%;"></td> <td style="width: 10%;"></td> <td style="width: 10%;"></td> <td style="width: 10%;"></td> <td style="width: 10%;"></td> <td style="width: 10%;"></td> <td style="width: 10%;"></td> <td style="width: 10%;"></td> <td style="width: 10%;"></td> <td style="width: 10%;"></td> </tr> <tr> <td></td> <td></td> <td colspan="8" style="text-align: center;"> <table border="1" style="width: 100%; border-collapse: collapse; text-align: center;"> <tr> <td style="width: 10%;"></td> <td style="width: 10%;"></td> <td style="width: 10%;"></td> <td style="width: 10%;"></td> <td style="width: 10%;"></td> <td style="width: 10%;"></td> <td style="width: 10%;"></td> <td style="width: 10%;"></td> <td style="width: 10%;"></td> <td style="width: 10%;"></td> </tr> <tr> <td></td> <td></td> <td colspan="8" style="text-align: center;"> <table border="1" style="width: 100%; border-collapse: collapse; text-align: center;"> <tr> <td style="width: 10%;"></td> <td style="width: 10%;"></td> <td style="width: 10%;"></td> <td style="width: 10%;"></td> <td style="width: 10%;"></td> <td style="width: 10%;"></td> <td style="width: 10%;"></td> <td style="width: 10%;"></td> <td style="width: 10%;"></td> <td style="width: 10%;"></td> </tr> <tr> <td></td> <td></td> <td colspan="8" style="text-align: center;"> <table border="1" style="width: 100%; border-collapse: collapse; text-align: center;"> <tr> <td style="width: 10%;"></td> <td style="width: 10%;"></td> <td style="width: 10%;"></td> <td style="width: 10%;"></td> <td style="width: 10%;"></td> <td style="width: 10%;"></td> <td style="width: 10%;"></td> <td style="width: 10%;"></td> <td style="width: 10%;"></td> <td style="width: 10%;"></td> </tr> <tr> <td></td> <td></td> <td colspan="8" style="text-align: center;"> <table border="1" style="width: 100%; border-collapse: collapse; text-align: center;"> <tr> </tr></table></td></tr></table></td></tr></table></td></tr></table></td></tr></table></td></tr></table></td></tr></table>

 | | | | | | | | | | | | | | | | | | | | <table border="1" style="width: 100%; border-collapse: collapse; text-align: center;"> <tr> <td style="width: 10%;"></td> <td style="width: 10%;"></td> <td style="width: 10%;"></td> <td style="width: 10%;"></td> <td style="width: 10%;"></td> <td style="width: 10%;"></td> <td style="width: 10%;"></td> <td style="width: 10%;"></td> <td style="width: 10%;"></td> <td style="width: 10%;"></td> </tr> <tr> <td></td> <td></td> <td colspan="8" style="text-align: center;"> <table border="1" style="width: 100%; border-collapse: collapse; text-align: center;"> <tr> <td style="width: 10%;"></td> <td style="width: 10%;"></td> <td style="width: 10%;"></td> <td style="width: 10%;"></td> <td style="width: 10%;"></td> <td style="width: 10%;"></td> <td style="width: 10%;"></td> <td style="width: 10%;"></td> <td style="width: 10%;"></td> <td style="width: 10%;"></td> </tr> <tr> <td></td> <td></td> <td colspan="8" style="text-align: center;"> <table border="1" style="width: 100%; border-collapse: collapse; text-align: center;"> <tr> <td style="width: 10%;"></td> <td style="width: 10%;"></td> <td style="width: 10%;"></td> <td style="width: 10%;"></td> <td style="width: 10%;"></td> <td style="width: 10%;"></td> <td style="width: 10%;"></td> <td style="width: 10%;"></td> <td style="width: 10%;"></td> <td style="width: 10%;"></td> </tr> <tr> <td></td> <td></td> <td colspan="8" style="text-align: center;"> <table border="1" style="width: 100%; border-collapse: collapse; text-align: center;"> <tr> <td style="width: 10%;"></td> <td style="width: 10%;"></td> <td style="width: 10%;"></td> <td style="width: 10%;"></td> <td style="width: 10%;"></td> <td style="width: 10%;"></td> <td style="width: 10%;"></td> <td style="width: 10%;"></td> <td style="width: 10%;"></td> <td style="width: 10%;"></td> </tr> <tr> <td></td> <td></td> <td colspan="8" style="text-align: center;"> <table border="1" style="width: 100%; border-collapse: collapse; text-align: center;"> <tr> <td style="width: 10%;"></td> <td style="width: 10%;"></td> <td style="width: 10%;"></td> <td style="width: 10%;"></td> <td style="width: 10%;"></td> <td style="width: 10%;"></td> <td style="width: 10%;"></td> <td style="width: 10%;"></td> <td style="width: 10%;"></td> <td style="width: 10%;"></td> </tr> <tr> <td></td> <td></td> <td colspan="8" style="text-align: center;"> <table border="1" style="width: 100%; border-collapse: collapse; text-align: center;"> <tr> </tr></table></td></tr></table></td></tr></table></td></tr></table></td></tr></table></td></tr></table>

 | | | | | | | | | | | | | | | | | | | | <table border="1" style="width: 100%; border-collapse: collapse; text-align: center;"> <tr> <td style="width: 10%;"></td> <td style="width: 10%;"></td> <td style="width: 10%;"></td> <td style="width: 10%;"></td> <td style="width: 10%;"></td> <td style="width: 10%;"></td> <td style="width: 10%;"></td> <td style="width: 10%;"></td> <td style="width: 10%;"></td> <td style="width: 10%;"></td> </tr> <tr> <td></td> <td></td> <td colspan="8" style="text-align: center;"> <table border="1" style="width: 100%; border-collapse: collapse; text-align: center;"> <tr> <td style="width: 10%;"></td> <td style="width: 10%;"></td> <td style="width: 10%;"></td> <td style="width: 10%;"></td> <td style="width: 10%;"></td> <td style="width: 10%;"></td> <td style="width: 10%;"></td> <td style="width: 10%;"></td> <td style="width: 10%;"></td> <td style="width: 10%;"></td> </tr> <tr> <td></td> <td></td> <td colspan="8" style="text-align: center;"> <table border="1" style="width: 100%; border-collapse: collapse; text-align: center;"> <tr> <td style="width: 10%;"></td> <td style="width: 10%;"></td> <td style="width: 10%;"></td> <td style="width: 10%;"></td> <td style="width: 10%;"></td> <td style="width: 10%;"></td> <td style="width: 10%;"></td> <td style="width: 10%;"></td> <td style="width: 10%;"></td> <td style="width: 10%;"></td> </tr> <tr> <td></td> <td></td> <td colspan="8" style="text-align: center;"> <table border="1" style="width: 100%; border-collapse: collapse; text-align: center;"> <tr> <td style="width: 10%;"></td> <td style="width: 10%;"></td> <td style="width: 10%;"></td> <td style="width: 10%;"></td> <td style="width: 10%;"></td> <td style="width: 10%;"></td> <td style="width: 10%;"></td> <td style="width: 10%;"></td> <td style="width: 10%;"></td> <td style="width: 10%;"></td> </tr> <tr> <td></td> <td></td> <td colspan="8" style="text-align: center;"> <table border="1" style="width: 100%; border-collapse: collapse; text-align: center;"> <tr> </tr></table></td></tr></table></td></tr></table></td></tr></table></td></tr></table>

 | | | | | | | | | | | | | | | | | | | | <table border="1" style="width: 100%; border-collapse: collapse; text-align: center;"> <tr> <td style="width: 10%;"></td> <td style="width: 10%;"></td> <td style="width: 10%;"></td> <td style="width: 10%;"></td> <td style="width: 10%;"></td> <td style="width: 10%;"></td> <td style="width: 10%;"></td> <td style="width: 10%;"></td> <td style="width: 10%;"></td> <td style="width: 10%;"></td> </tr> <tr> <td></td> <td></td> <td colspan="8" style="text-align: center;"> <table border="1" style="width: 100%; border-collapse: collapse; text-align: center;"> <tr> <td style="width: 10%;"></td> <td style="width: 10%;"></td> <td style="width: 10%;"></td> <td style="width: 10%;"></td> <td style="width: 10%;"></td> <td style="width: 10%;"></td> <td style="width: 10%;"></td> <td style="width: 10%;"></td> <td style="width: 10%;"></td> <td style="width: 10%;"></td> </tr> <tr> <td></td> <td></td> <td colspan="8" style="text-align: center;"> <table border="1" style="width: 100%; border-collapse: collapse; text-align: center;"> <tr> <td style="width: 10%;"></td> <td style="width: 10%;"></td> <td style="width: 10%;"></td> <td style="width: 10%;"></td> <td style="width: 10%;"></td> <td style="width: 10%;"></td> <td style="width: 10%;"></td> <td style="width: 10%;"></td> <td style="width: 10%;"></td> <td style="width: 10%;"></td> </tr> <tr> <td></td> <td></td> <td colspan="8" style="text-align: center;"> <table border="1" style="width: 100%; border-collapse: collapse; text-align: center;"> <tr> </tr></table></td></tr></table></td></tr></table></td></tr></table>
 | | | | | | | | | | | | | | | | | | | | <table border="1" style="width: 100%; border-collapse: collapse; text-align: center;"> <tr> <td style="width: 10%;"></td> <td style="width: 10%;"></td> <td style="width: 10%;"></td> <td style="width: 10%;"></td> <td style="width: 10%;"></td> <td style="width: 10%;"></td> <td style="width: 10%;"></td> <td style="width: 10%;"></td> <td style="width:
10%;"></td> <td style="width: 10%;"></td> </tr> <tr> <td></td> <td></td> <td colspan="8" style="text-align: center;"> <table border="1" style="width: 100%; border-collapse: collapse; text-align: center;"> <tr> <td style="width: 10%;"></td> <td style="width: 10%;"></td> <td style="width: 10%;"></td> <td style="width: 10%;"></td> <td style="width: 10%;"></td> <td style="width: 10%;"></td> <td style="width: 10%;"></td> <td style="width: 10%;"></td> <td style="width: 10%;"></td> <td style="width: 10%;"></td> </tr> <tr> <td></td> <td></td> <td colspan="8" style="text-align: center;"> <table border="1" style="width: 100%; border-collapse: collapse; text-align: center;"> <tr> </tr></table></td></tr></table></td></tr></table>
 | | | | | | | | | | | | | | | | | | | | <table border="1" style="width: 100%; border-collapse: collapse; text-align: center;"> <tr> <td style="width: 10%;"></td> <td style="width: 10%;"></td> <td style="width: 10%;"></td> <td style="width: 10%;"></td> <td style="width: 10%;"></td> <td style="width: 10%;"></td> <td style="width: 10%;"></td> <td style="width: 10%;"></td> <td style="width: 10%;"></td> <td style="width: 10%;"></td> </tr> <tr> <td></td> <td></td> <td colspan="8" style="text-align: center;"> <table border="1" style="width: 100%; border-collapse: collapse; text-align: center;"> <tr> </tr></table></td></tr></table>

 | | | | | | | | | | | | | | | | | | | | <table border="1" style="width: 100%; border-collapse: collapse; text-align: center;"> <tr> </tr></table>
 | | | | | | | | | | | | | | | | | | | |

 | | | | | | | | | | | | | | | | | | | |

 | | | | | | | | | | | | | | | | | | | |
 | | | | | | | | | | | | | | | | | | | |
 | | | | | | | | | | | | | | | | | | | |

 | | | | | | | | | | | | | | | | | | | |
 | | | | | | | | | | | | | | | | | | | |
 | | | | | | | | | | | | | | | | | | | |

 | | | | | | | | | | | | | | | | | | | | | | | | | | | | | | | | | | | | | | | | | | | | | | | | | | | | | | | | | | | | | | | | | | | | | | | | | | | | | | | | | | | | | | | | | | | | | | | | | | | |
 | | | | | | | | | | | | | | | | | | | |
 | | | | | | | | | | | | | | | | | | | |
 | | | | | | | | | | | | | | | | | | | |
 | | | | | | | | | | | | | | | | | | | |
 | | | | | | | | | | | | | | | | | | | |
 | | | | | | | | | | | | | | | | | | | |
 | | | | | | | | | | | | | | | | | | | |
 | | | | | | | | | | | | | | | | | | | |
 | | | | | | | | | | | | | | | | | | | | | | | | | | | | | | | | | | | | | | | |
 | | | | | | | | | | | | | | | | | | | |
 | | | | | | | | | | | | | | | | | | | | | | | | | | | | | | | | | | | | | | | |
 | | | | | | | | | | | | | | | | | | | | | | | | | | | | | | | | | | | | | | | |
 | | | | | | | | | | | | | | | | | | | | | | | | | | | | | | | | | | | | | | | |
 | | | | | | | | | | | | | | | | | | | | | | | | | | | | | | | | | | | | | | | | | | | | | | | | | | | | | | | | | | | | | | | | | | | | | | | | | | | | | | | | | | | | | | | | | | | | | | | | | | | |
 | | | | | | | | | | | | | | | | | | | | | | | | | | | | | | | | | | | | | | | | | | | | | | | |
| | |

 | | | | | | | | | | | | | | | | | | | |

 | | | | | | | | | | | | | | | | | | | |

 | | | | | | | | | | | | | | | | | | | |

 | | | | | | | | | | | | | | | | | | | |

 | | | | | | | | | | | | | | | | | | | |

 | | | | | | | | | | | | | | | | | | | |

 | | | | | | | | | | | | | | | | | | | |

 | | | | | | | | | | | | | | | | | | | |

 | | | | | | | | | | | | | | | | | | | |

 | | | | | | | | | | | | | | | | | | | |

 | | | | | | | | | | | | | | | | | | | |

 | | | | | | | | | | | | | | | | | | | |

 | | | | | | | | | | | | | | | | | | | |

 | | | | | | | | | | | | | | | | | | | |

 | | | | | | | | | | | | | | | | | | | |

 | | | | | | | | | | | | | | | | | | | |

 | | | | | | | | | | | | | | | | | | | |

 | | | | | | | | | | | | | | | | | | | |

 | | | | | | | | | | | | | | | | | | | |

 | | | | | | | | | | | | | | | | | | | |

 | | | | | | | | | | | | | | | | | | | |

 | | | | | | | | | | | | | | | | | | | |

 | | | | | | | | | | | | | | | | | | | |

 | | | | | | | | | | | | | | | | | | | |

 | | | | | | | | | | | | | | | | | | | |

 | | | | | | | | | | | | | | | | | | | |

 | | | | | | | | | | | | | | | | | | | |

 | | | | | | | | | | | | | | | | | | | |
 | | | | | | | | | | | | | | | | | | | |

 | | | | | | | | | | | | | | | | | | | |

 | | | | | | | | | | | | | | | | | | | |
 | | | | | | | | | | | | | | | | | | | |

 | | | | | | | | | | | | | | | | | | | |

 | | | | | | | | | | | | | | | | | | | |
 | | | | | | | | | | | | | | | | | | | |
 | | | | | | | | | | | | | | | | | | | |

 | | | | | | | | | | | | | | | | | | | |
 | | | | | | | | | | | | | | | | | | | |
 | | | | | | | | | | | | | | | | | | | |

 | | | | | | | | | | | | | | | | | | | | | | | | | | | | | | | | | | | | | | | | | | | | | | | | | | | | | | | | | | | | | | | | | | | | | | | | | | | | | | | | | | | | | | | | | | | | | | | | | | | |
 | | | | | | | | | | | | | | | | | | | |
 | | | | | | | | | | | | | | | | | | | |
 | | | | | | | | | | | | | | | | | | | |
 | | | | | | | | | | | | | | | | | | | |
 | | | | | | | | | | | | | | | | | | | |
 | | | | | | | | | | | | | | | | | | | |
 | | | | | | | | | | | | | | | | | | | |
 | | | | | | | | | | | | | | | | | | | |
 | | | | | | | | | | | | | | | | | | | | | | | | | | | | | | | | | | | | | | | |
 | | | | | | | | | | | | | | | | | | | |
 | | | | | | | | | | | | | | | | | | | | | | | | | | | | | | | | | | | | | | | |
 | | | | | | | | | | | | | | | | | | | | | | | | | | | | | | | | | | | | | | | |
 | | | | | | | | | | | | | | | | | | | | | | | | | | | | | | | | | | | | | | | |
 | | | | | | | | | | | | | | | | | | | | | | | | | | | | | | | | | | | | | | | | | | | | | | | | | | | | | | | | | | | | | | | | | | | | | | | | | | | | | | | | | | | | | | | | | | | | | | | | | | | |
 | | | | | | | | | | | | | | | | | | | | | | | | | | | | | | | | | | | | | | | | | | | | | | | |
| | | <table border="1" style="width: 100%; border-collapse: collapse; text-align: center;"> <tr> <td style="width: 10%;"></td> <td style="width: 10%;"></td> <td style="width: 10%;"></td> <td style="width: 10%;"></td> <td style="width: 10%;"></td> <td style="width: 10%;"></td> <td style="width: 10%;"></td> <td style="width: 10%;"></td> <td style="width: 10%;"></td> <td style="width: 10%;"></td> </tr> <tr> <td></td> <td></td> <td colspan="8" style="text-align: center;"> <table border="1" style="width: 100%; border-collapse: collapse; text-align: center;"> <tr> <td style="width: 10%;"></td> <td style="width: 10%;"></td> <td style="width: 10%;"></td> <td style="width: 10%;"></td> <td style="width: 10%;"></td> <td style="width: 10%;"></td> <td style="width: 10%;"></td> <td style="width: 10%;"></td> <td style="width: 10%;"></td> <td style="width: 10%;"></td> </tr> <tr> <td></td> <td></td> <td colspan="8" style="text-align: center;"> <table border="1" style="width: 100%; border-collapse: collapse; text-align: center;"> <tr> <td style="width: 10%;"></td> <td style="width: 10%;"></td> <td style="width: 10%;"></td> <td style="width: 10%;"></td> <td style="width: 10%;"></td> <td style="width: 10%;"></td> <td style="width: 10%;"></td> <td style="width: 10%;"></td> <td style="width: 10%;"></td> <td style="width: 10%;"></td> </tr> <tr> <td></td> <td></td> <td colspan="8" style="text-align: center;"> <table border="1" style="width: 100%; border-collapse: collapse; text-align: center;"> <tr> <td style="width: 10%;"></td> <td style="width: 10%;"></td> <td style="width: 10%;"></td> <td style="width: 10%;"></td> <td style="width: 10%;"></td> <td style="width: 10%;"></td> <td style="width: 10%;"></td> <td style="width: 10%;"></td> <td style="width: 10%;"></td> <td style="width: 10%;"></td> </tr> <tr> <td></td> <td></td> <td colspan="8" style="text-align: center;"> <table border="1" style="width: 100%; border-collapse: collapse; text-align: center;"> <tr> <td style="width: 10%;"></td> <td style="width: 10%;"></td> <td style="width: 10%;"></td> <td style="width: 10%;"></td> <td style="width: 10%;"></td> <td style="width: 10%;"></td> <td style="width: 10%;"></td> <td style="width: 10%;"></td> <td style="width: 10%;"></td> <td style="width: 10%;"></td> </tr> <tr> <td></td> <td></td> <td colspan="8" style="text-align: center;"> <table border="1" style="width: 100%; border-collapse: collapse; text-align: center;"> <tr> <td style="width: 10%;"></td> <td style="width: 10%;"></td> <td style="width: 10%;"></td> <td style="width: 10%;"></td> <td style="width: 10%;"></td> <td style="width: 10%;"></td> <td style="width: 10%;"></td> <td style="width: 10%;"></td> <td style="width: 10%;"></td> <td style="width: 10%;"></td> </tr> <tr> <td></td> <td></td> <td colspan="8" style="text-align: center;"> <table border="1" style="width: 100%; border-collapse: collapse; text-align: center;"> <tr> <td style="width: 10%;"></td> <td style="width: 10%;"></td> <td style="width: 10%;"></td> <td style="width: 10%;"></td> <td style="width: 10%;"></td> <td style="width: 10%;"></td> <td style="width: 10%;"></td> <td style="width: 10%;"></td> <td style="width: 10%;"></td> <td style="width: 10%;"></td> </tr> <tr> <td></td> <td></td> <td colspan="8" style="text-align: center;"> <table border="1" style="width: 100%; border-collapse: collapse; text-align: center;"> <tr> <td style="width: 10%;"></td> <td style="width: 10%;"></td> <td style="width: 10%;"></td> <td style="width: 10%;"></td> <td style="width: 10%;"></td> <td style="width: 10%;"></td> <td style="width: 10%;"></td> <td style="width: 10%;"></td> <td style="width: 10%;"></td> <td style="width: 10%;"></td> </tr> <tr> <td></td> <td></td> <td colspan="8" style="text-align: center;"> <table border="1" style="width: 100%; border-collapse: collapse; text-align: center;"> <tr> <td style="width: 10%;"></td> <td style="width: 10%;"></td> <td style="width: 10%;"></td> <td style="width: 10%;"></td> <td style="width: 10%;"></td> <td style="width: 10%;"></td> <td style="width: 10%;"></td> <td style="width: 10%;"></td> <td style="width: 10%;"></td> <td style="width: 10%;"></td> </tr> <tr> <td></td> <td></td> <td colspan="8" style="text-align: center;"> <table border="1" style="width: 100%; border-collapse: collapse; text-align: center;"> <tr> <td style="width: 10%;"></td> <td style="width: 10%;"></td> <td style="width: 10%;"></td> <td style="width: 10%;"></td> <td style="width: 10%;"></td> <td style="width: 10%;"></td> <td style="width: 10%;"></td> <td style="width: 10%;"></td> <td style="width: 10%;"></td> <td style="width: 10%;"></td> </tr> <tr> <td></td> <td></td> <td colspan="8" style="text-align: center;"> <table border="1" style="width: 100%; border-collapse: collapse; text-align: center;"> <tr> <td style="width: 10%;"></td> <td style="width: 10%;"></td> <td style="width: 10%;"></td> <td style="width: 10%;"></td> <td style="width: 10%;"></td> <td style="width: 10%;"></td> <td style="width: 10%;"></td> <td style="width: 10%;"></td> <td style="width: 10%;"></td> <td style="width: 10%;"></td> </tr> <tr> <td></td> <td></td> <td colspan="8" style="text-align: center;"> <table border="1" style="width: 100%; border-collapse: collapse; text-align: center;"> <tr> <td style="width: 10%;"></td> <td style="width: 10%;"></td> <td style="width: 10%;"></td> <td style="width: 10%;"></td> <td style="width: 10%;"></td> <td style="width: 10%;"></td> <td style="width: 10%;"></td> <td style="width: 10%;"></td> <td style="width: 10%;"></td> <td style="width: 10%;"></td> </tr> <tr> <td></td> <td></td> <td colspan="8" style="text-align: center;"> <table border="1" style="width: 100%; border-collapse: collapse; text-align: center;"> <tr> <td style="width: 10%;"></td> <td style="width: 10%;"></td> <td style="width: 10%;"></td> <td style="width: 10%;"></td> <td style="width: 10%;"></td> <td style="width: 10%;"></td> <td style="width: 10%;"></td> <td style="width: 10%;"></td> <td style="width: 10%;"></td> <td style="width: 10%;"></td> </tr> <tr> <td></td> <td></td> <td colspan="8" style="text-align: center;"> <table border="1" style="width: 100%; border-collapse: collapse; text-align: center;"> <tr> <td style="width: 10%;"></td> <td style="width: 10%;"></td> <td style="width: 10%;"></td> <td style="width: 10%;"></td> <td style="width: 10%;"></td> <td style="width: 10%;"></td> <td style="width: 10%;"></td> <td style="width: 10%;"></td> <td style="width: 10%;"></td> <td style="width: 10%;"></td> </tr> <tr> <td></td> <td></td> <td colspan="8" style="text-align: center;"> <table border="1" style="width: 100%; border-collapse: collapse; text-align: center;"> <tr> <td style="width: 10%;"></td> <td style="width: 10%;"></td> <td style="width: 10%;"></td> <td style="width: 10%;"></td> <td style="width: 10%;"></td> <td style="width: 10%;"></td> <td style="width: 10%;"></td> <td style="width: 10%;"></td> <td style="width: 10%;"></td> <td style="width: 10%;"></td> </tr> <tr> <td></td> <td></td> <td colspan="8" style="text-align: center;"> <table border="1" style="width: 100%; border-collapse: collapse; text-align: center;"> <tr> <td style="width: 10%;"></td> <td style="width: 10%;"></td> <td style="width: 10%;"></td> <td style="width: 10%;"></td> <td style="width: 10%;"></td> <td style="width: 10%;"></td> <td style="width: 10%;"></td> <td style="width: 10%;"></td> <td style="width: 10%;"></td> <td style="width: 10%;"></td> </tr> <tr> <td></td> <td></td> <td colspan="8" style="text-align: center;"> <table border="1" style="width: 100%; border-collapse: collapse; text-align: center;"> <tr> <td style="width: 10%;"></td> <td style="width: 10%;"></td> <td style="width: 10%;"></td> <td style="width: 10%;"></td> <td style="width: 10%;"></td> <td style="width: 10%;"></td> <td style="width: 10%;"></td> <td style="width: 10%;"></td> <td style="width: 10%;"></td> <td style="width: 10%;"></td> </tr> <tr> <td></td> <td></td> <td colspan="8" style="text-align: center;"> <table border="1" style="width: 100%; border-collapse: collapse; text-align: center;"> <tr> <td style="width: 10%;"></td> <td style="width: 10%;"></td> <td style="width: 10%;"></td> <td style="width: 10%;"></td> <td style="width: 10%;"></td> <td style="width: 10%;"></td> <td style="width: 10%;"></td> <td style="width: 10%;"></td> <td style="width: 10%;"></td> <td style="width: 10%;"></td> </tr> <tr> <td></td> <td></td> <td colspan="8" style="text-align: center;"> <table border="1" style="width: 100%; border-collapse: collapse; text-align: center;"> <tr> <td style="width: 10%;"></td> <td style="width: 10%;"></td> <td style="width: 10%;"></td> <td style="width: 10%;"></td> <td style="width: 10%;"></td> <td style="width: 10%;"></td> <td style="width: 10%;"></td> <td style="width: 10%;"></td> <td style="width: 10%;"></td> <td style="width: 10%;"></td> </tr> <tr> <td></td> <td></td> <td colspan="8" style="text-align: center;"> <table border="1" style="width: 100%; border-collapse: collapse; text-align: center;"> <tr> <td style="width: 10%;"></td> <td style="width: 10%;"></td> <td style="width: 10%;"></td> <td style="width: 10%;"></td> <td style="width: 10%;"></td> <td style="width: 10%;"></td> <td style="width: 10%;"></td> <td style="width: 10%;"></td> <td style="width: 10%;"></td> <td style="width: 10%;"></td> </tr> <tr> <td></td> <td></td> <td colspan="8" style="text-align: center;"> <table border="1" style="width: 100%; border-collapse: collapse; text-align: center;"> <tr> <td style="width: 10%;"></td> <td style="width: 10%;"></td> <td style="width: 10%;"></td> <td style="width: 10%;"></td> <td style="width: 10%;"></td> <td style="width: 10%;"></td> <td style="width: 10%;"></td> <td style="width: 10%;"></td> <td style="width: 10%;"></td> <td style="width: 10%;"></td> </tr> <tr> <td></td> <td></td> <td colspan="8" style="text-align: center;"> <table border="1" style="width: 100%; border-collapse: collapse; text-align: center;"> <tr> <td style="width: 10%;"></td> <td style="width: 10%;"></td> <td
style="width: 10%;"></td> <td style="width: 10%;"></td> <td style="width: 10%;"></td> <td style="width: 10%;"></td> <td style="width: 10%;"></td> <td style="width: 10%;"></td> <td style="width: 10%;"></td> <td style="width: 10%;"></td> </tr> <tr> <td></td> <td></td> <td colspan="8" style="text-align: center;"> <table border="1" style="width: 100%; border-collapse: collapse; text-align: center;"> <tr> <td style="width: 10%;"></td> <td style="width: 10%;"></td> <td style="width: 10%;"></td> <td style="width: 10%;"></td> <td style="width: 10%;"></td> <td style="width: 10%;"></td> <td style="width: 10%;"></td> <td style="width: 10%;"></td> <td style="width: 10%;"></td> <td style="width: 10%;"></td> </tr> <tr> <td></td> <td></td> <td colspan="8" style="text-align: center;"> <table border="1" style="width: 100%; border-collapse: collapse; text-align: center;"> <tr> <td style="width: 10%;"></td> <td style="width: 10%;"></td> <td style="width: 10%;"></td> <td style="width: 10%;"></td> <td style="width: 10%;"></td> <td style="width: 10%;"></td> <td style="width: 10%;"></td> <td style="width: 10%;"></td> <td style="width: 10%;"></td> <td style="width: 10%;"></td> </tr> <tr> <td></td> <td></td> <td colspan="8" style="text-align: center;"> <table border="1" style="width: 100%; border-collapse: collapse; text-align: center;"> <tr> <td style="width: 10%;"></td> <td style="width: 10%;"></td> <td style="width: 10%;"></td> <td style="width: 10%;"></td> <td style="width: 10%;"></td> <td style="width: 10%;"></td> <td style="width: 10%;"></td> <td style="width: 10%;"></td> <td style="width: 10%;"></td> <td style="width: 10%;"></td> </tr> <tr> <td></td> <td></td> <td colspan="8" style="text-align: center;"> <table border="1" style="width: 100%; border-collapse: collapse; text-align: center;"> <tr> <td style="width: 10%;"></td> <td style="width: 10%;"></td> <td style="width: 10%;"></td> <td style="width: 10%;"></td> <td style="width: 10%;"></td> <td style="width: 10%;"></td> <td style="width: 10%;"></td> <td style="width: 10%;"></td> <td style="width: 10%;"></td> <td style="width: 10%;"></td> </tr> <tr> <td></td> <td></td> <td colspan="8" style="text-align: center;"> <table border="1" style="width: 100%; border-collapse: collapse; text-align: center;"> <tr> <td style="width: 10%;"></td> <td style="width: 10%;"></td> <td style="width: 10%;"></td> <td style="width: 10%;"></td> <td style="width: 10%;"></td> <td style="width: 10%;"></td> <td style="width: 10%;"></td> <td style="width: 10%;"></td> <td style="width: 10%;"></td> <td style="width: 10%;"></td> </tr> <tr> <td></td> <td></td> <td colspan="8" style="text-align: center;"> <table border="1" style="width: 100%; border-collapse: collapse; text-align: center;"> <tr> <td style="width: 10%;"></td> <td style="width: 10%;"></td> <td style="width: 10%;"></td> <td style="width: 10%;"></td> <td style="width: 10%;"></td> <td style="width: 10%;"></td> <td style="width: 10%;"></td> <td style="width: 10%;"></td> <td style="width: 10%;"></td> <td style="width: 10%;"></td> </tr> <tr> <td></td> <td></td> <td colspan="8" style="text-align: center;"> <table border="1" style="width: 100%; border-collapse: collapse; text-align: center;"> <tr> <td style="width: 10%;"></td> <td style="width: 10%;"></td> <td style="width: 10%;"></td> <td style="width: 10%;"></td> <td style="width: 10%;"></td> <td style="width: 10%;"></td> <td style="width: 10%;"></td> <td style="width: 10%;"></td> <td style="width: 10%;"></td> <td style="width: 10%;"></td> </tr> <tr> <td></td> <td></td> <td colspan="8" style="text-align: center;"> <table border="1" style="width: 100%; border-collapse: collapse; text-align: center;"> <tr> <td style="width: 10%;"></td> <td style="width: 10%;"></td> <td style="width: 10%;"></td> <td style="width: 10%;"></td> <td style="width: 10%;"></td> <td style="width: 10%;"></td> <td style="width: 10%;"></td> <td style="width: 10%;"></td> <td style="width: 10%;"></td> <td style="width: 10%;"></td> </tr> <tr> <td></td> <td></td> <td colspan="8" style="text-align: center;"> <table border="1" style="width: 100%; border-collapse: collapse; text-align: center;"> <tr> </tr></table></td></tr></table></td></tr></table></td></tr></table></td></tr></table></td></tr></table></td></tr></table></td></tr></table></td></tr></table></td></tr></table></td></tr></table></td></tr></table></td></tr></table></td></tr></table></td></tr></table></td></tr></table></td></tr></table></td></tr></table></td></tr></table></td></tr></table></td></tr></table></td></tr></table></td></tr></table></td></tr></table></td></tr></table></td></tr></table></td></tr></table></td></tr></table></td></tr></table></td></tr></table></td></tr></table>

 | | | | | | | | | | | | | | | | | | | | <table border="1" style="width: 100%; border-collapse: collapse; text-align: center;"> <tr> <td style="width: 10%;"></td> <td style="width: 10%;"></td> <td style="width: 10%;"></td> <td style="width: 10%;"></td> <td style="width: 10%;"></td> <td style="width: 10%;"></td> <td style="width: 10%;"></td> <td style="width: 10%;"></td> <td style="width: 10%;"></td> <td style="width: 10%;"></td> </tr> <tr> <td></td> <td></td> <td colspan="8" style="text-align: center;"> <table border="1" style="width: 100%; border-collapse: collapse; text-align: center;"> <tr> <td style="width: 10%;"></td> <td style="width: 10%;"></td> <td style="width: 10%;"></td> <td style="width: 10%;"></td> <td style="width: 10%;"></td> <td style="width: 10%;"></td> <td style="width: 10%;"></td> <td style="width: 10%;"></td> <td style="width: 10%;"></td> <td style="width: 10%;"></td> </tr> <tr> <td></td> <td></td> <td colspan="8" style="text-align: center;"> <table border="1" style="width: 100%; border-collapse: collapse; text-align: center;"> <tr> <td style="width: 10%;"></td> <td style="width: 10%;"></td> <td style="width: 10%;"></td> <td style="width: 10%;"></td> <td style="width: 10%;"></td> <td style="width: 10%;"></td> <td style="width: 10%;"></td> <td style="width: 10%;"></td> <td style="width: 10%;"></td> <td style="width: 10%;"></td> </tr> <tr> <td></td> <td></td> <td colspan="8" style="text-align: center;"> <table border="1" style="width: 100%; border-collapse: collapse; text-align: center;"> <tr> <td style="width: 10%;"></td> <td style="width: 10%;"></td> <td style="width: 10%;"></td> <td style="width: 10%;"></td> <td style="width: 10%;"></td> <td style="width: 10%;"></td> <td style="width: 10%;"></td> <td style="width: 10%;"></td> <td style="width: 10%;"></td> <td style="width: 10%;"></td> </tr> <tr> <td></td> <td></td> <td colspan="8" style="text-align: center;"> <table border="1" style="width: 100%; border-collapse: collapse; text-align: center;"> <tr> <td style="width: 10%;"></td> <td style="width: 10%;"></td> <td style="width: 10%;"></td> <td style="width: 10%;"></td> <td style="width: 10%;"></td> <td style="width: 10%;"></td> <td style="width: 10%;"></td> <td style="width: 10%;"></td> <td style="width: 10%;"></td> <td style="width: 10%;"></td> </tr> <tr> <td></td> <td></td> <td colspan="8" style="text-align: center;"> <table border="1" style="width: 100%; border-collapse: collapse; text-align: center;"> <tr> <td style="width: 10%;"></td> <td style="width: 10%;"></td> <td style="width: 10%;"></td> <td style="width: 10%;"></td> <td style="width: 10%;"></td> <td style="width: 10%;"></td> <td style="width: 10%;"></td> <td style="width: 10%;"></td> <td style="width: 10%;"></td> <td style="width: 10%;"></td> </tr> <tr> <td></td> <td></td> <td colspan="8" style="text-align: center;"> <table border="1" style="width: 100%; border-collapse: collapse; text-align: center;"> <tr> <td style="width: 10%;"></td> <td style="width: 10%;"></td> <td style="width: 10%;"></td> <td style="width: 10%;"></td> <td style="width: 10%;"></td> <td style="width: 10%;"></td> <td style="width: 10%;"></td> <td style="width: 10%;"></td> <td style="width: 10%;"></td> <td style="width: 10%;"></td> </tr> <tr> <td></td> <td></td> <td colspan="8" style="text-align: center;"> <table border="1" style="width: 100%; border-collapse: collapse; text-align: center;"> <tr> <td style="width: 10%;"></td> <td style="width: 10%;"></td> <td style="width: 10%;"></td> <td style="width: 10%;"></td> <td style="width: 10%;"></td> <td style="width: 10%;"></td> <td style="width: 10%;"></td> <td style="width: 10%;"></td> <td style="width: 10%;"></td> <td style="width: 10%;"></td> </tr> <tr> <td></td> <td></td> <td colspan="8" style="text-align: center;"> <table border="1" style="width: 100%; border-collapse: collapse; text-align: center;"> <tr> <td style="width: 10%;"></td> <td style="width: 10%;"></td> <td style="width: 10%;"></td> <td style="width: 10%;"></td> <td style="width: 10%;"></td> <td style="width: 10%;"></td> <td style="width: 10%;"></td> <td style="width: 10%;"></td> <td style="width: 10%;"></td> <td style="width: 10%;"></td> </tr> <tr> <td></td> <td></td> <td colspan="8" style="text-align: center;"> <table border="1" style="width: 100%; border-collapse: collapse; text-align: center;"> <tr> <td style="width: 10%;"></td> <td style="width: 10%;"></td> <td style="width: 10%;"></td> <td style="width: 10%;"></td> <td style="width: 10%;"></td> <td style="width: 10%;"></td> <td style="width: 10%;"></td> <td style="width: 10%;"></td> <td style="width: 10%;"></td> <td style="width: 10%;"></td> </tr> <tr> <td></td> <td></td> <td colspan="8" style="text-align: center;"> <table border="1" style="width: 100%; border-collapse: collapse; text-align: center;"> <tr> <td style="width: 10%;"></td> <td style="width: 10%;"></td> <td style="width: 10%;"></td> <td style="width: 10%;"></td> <td style="width: 10%;"></td> <td style="width: 10%;"></td> <td style="width: 10%;"></td> <td style="width: 10%;"></td> <td style="width: 10%;"></td> <td style="width: 10%;"></td> </tr> <tr> <td></td> <td></td> <td colspan="8" style="text-align: center;"> <table border="1" style="width: 100%; border-collapse: collapse; text-align: center;"> <tr> <td style="width: 10%;"></td> <td style="width: 10%;"></td> <td style="width: 10%;"></td> <td style="width: 10%;"></td> <td style="width: 10%;"></td> <td style="width: 10%;"></td> <td style="width: 10%;"></td> <td style="width: 10%;"></td> <td style="width: 10%;"></td> <td style="width: 10%;"></td> </tr> <tr> <td></td> <td></td> <td colspan="8" style="text-align: center;"> <table border="1" style="width: 100%; border-collapse: collapse; text-align: center;"> <tr> <td style="width: 10%;"></td> <td style="width: 10%;"></td> <td style="width: 10%;"></td> <td style="width: 10%;"></td> <td style="width: 10%;"></td> <td style="width: 10%;"></td> <td style="width: 10%;"></td> <td style="width: 10%;"></td> <td style="width: 10%;"></td> <td style="width: 10%;"></td> </tr> <tr> <td></td> <td></td> <td colspan="8" style="text-align: center;"> <table border="1" style="width: 100%; border-collapse: collapse; text-align: center;"> <tr> <td style="width: 10%;"></td> <td style="width: 10%;"></td> <td style="width: 10%;"></td> <td style="width: 10%;"></td> <td style="width: 10%;"></td> <td style="width: 10%;"></td> <td style="width: 10%;"></td> <td style="width: 10%;"></td> <td style="width: 10%;"></td> <td style="width: 10%;"></td> </tr> <tr> <td></td> <td></td> <td colspan="8" style="text-align: center;"> <table border="1" style="width: 100%; border-collapse: collapse; text-align: center;"> <tr> <td style="width: 10%;"></td> <td style="width: 10%;"></td> <td style="width: 10%;"></td> <td style="width: 10%;"></td> <td style="width: 10%;"></td> <td style="width: 10%;"></td> <td style="width: 10%;"></td> <td style="width: 10%;"></td> <td style="width: 10%;"></td> <td style="width: 10%;"></td> </tr> <tr> <td></td> <td></td> <td colspan="8" style="text-align: center;"> <table border="1" style="width: 100%; border-collapse: collapse; text-align: center;"> <tr> <td style="width: 10%;"></td> <td style="width: 10%;"></td> <td style="width: 10%;"></td> <td style="width: 10%;"></td> <td style="width: 10%;"></td> <td style="width: 10%;"></td> <td style="width: 10%;"></td> <td style="width: 10%;"></td> <td style="width: 10%;"></td> <td style="width: 10%;"></td> </tr> <tr> <td></td> <td></td> <td colspan="8" style="text-align: center;"> <table border="1" style="width: 100%; border-collapse: collapse; text-align: center;"> <tr> <td style="width: 10%;"></td> <td style="width: 10%;"></td> <td style="width: 10%;"></td> <td style="width: 10%;"></td> <td style="width: 10%;"></td> <td style="width: 10%;"></td> <td style="width: 10%;"></td> <td style="width: 10%;"></td> <td style="width: 10%;"></td> <td style="width: 10%;"></td> </tr> <tr> <td></td> <td></td> <td colspan="8" style="text-align: center;"> <table border="1" style="width: 100%; border-collapse: collapse; text-align: center;"> <tr> <td style="width: 10%;"></td> <td style="width: 10%;"></td> <td style="width: 10%;"></td> <td style="width: 10%;"></td> <td style="width: 10%;"></td> <td style="width: 10%;"></td> <td style="width: 10%;"></td> <td style="width: 10%;"></td> <td style="width: 10%;"></td> <td style="width: 10%;"></td> </tr> <tr> <td></td> <td></td> <td colspan="8" style="text-align: center;"> <table border="1" style="width: 100%; border-collapse: collapse; text-align: center;"> <tr> <td style="width: 10%;"></td> <td style="width: 10%;"></td> <td style="width: 10%;"></td> <td style="width: 10%;"></td> <td style="width: 10%;"></td> <td style="width: 10%;"></td> <td
style="width: 10%;"></td> <td style="width: 10%;"></td> <td style="width: 10%;"></td> <td style="width: 10%;"></td> </tr> <tr> <td></td> <td></td> <td colspan="8" style="text-align: center;"> <table border="1" style="width: 100%; border-collapse: collapse; text-align: center;"> <tr> <td style="width: 10%;"></td> <td style="width: 10%;"></td> <td style="width: 10%;"></td> <td style="width: 10%;"></td> <td style="width: 10%;"></td> <td style="width: 10%;"></td> <td style="width: 10%;"></td> <td style="width: 10%;"></td> <td style="width: 10%;"></td> <td style="width: 10%;"></td> </tr> <tr> <td></td> <td></td> <td colspan="8" style="text-align: center;"> <table border="1" style="width: 100%; border-collapse: collapse; text-align: center;"> <tr> <td style="width: 10%;"></td> <td style="width: 10%;"></td> <td style="width: 10%;"></td> <td style="width: 10%;"></td> <td style="width: 10%;"></td> <td style="width: 10%;"></td> <td style="width: 10%;"></td> <td style="width: 10%;"></td> <td style="width: 10%;"></td> <td style="width: 10%;"></td> </tr> <tr> <td></td> <td></td> <td colspan="8" style="text-align: center;"> <table border="1" style="width: 100%; border-collapse: collapse; text-align: center;"> <tr> <td style="width: 10%;"></td> <td style="width: 10%;"></td> <td style="width: 10%;"></td> <td style="width: 10%;"></td> <td style="width: 10%;"></td> <td style="width: 10%;"></td> <td style="width: 10%;"></td> <td style="width: 10%;"></td> <td style="width: 10%;"></td> <td style="width: 10%;"></td> </tr> <tr> <td></td> <td></td> <td colspan="8" style="text-align: center;"> <table border="1" style="width: 100%; border-collapse: collapse; text-align: center;"> <tr> <td style="width: 10%;"></td> <td style="width: 10%;"></td> <td style="width: 10%;"></td> <td style="width: 10%;"></td> <td style="width: 10%;"></td> <td style="width: 10%;"></td> <td style="width: 10%;"></td> <td style="width: 10%;"></td> <td style="width: 10%;"></td> <td style="width: 10%;"></td> </tr> <tr> <td></td> <td></td> <td colspan="8" style="text-align: center;"> <table border="1" style="width: 100%; border-collapse: collapse; text-align: center;"> <tr> <td style="width: 10%;"></td> <td style="width: 10%;"></td> <td style="width: 10%;"></td> <td style="width: 10%;"></td> <td style="width: 10%;"></td> <td style="width: 10%;"></td> <td style="width: 10%;"></td> <td style="width: 10%;"></td> <td style="width: 10%;"></td> <td style="width: 10%;"></td> </tr> <tr> <td></td> <td></td> <td colspan="8" style="text-align: center;"> <table border="1" style="width: 100%; border-collapse: collapse; text-align: center;"> <tr> <td style="width: 10%;"></td> <td style="width: 10%;"></td> <td style="width: 10%;"></td> <td style="width: 10%;"></td> <td style="width: 10%;"></td> <td style="width: 10%;"></td> <td style="width: 10%;"></td> <td style="width: 10%;"></td> <td style="width: 10%;"></td> <td style="width: 10%;"></td> </tr> <tr> <td></td> <td></td> <td colspan="8" style="text-align: center;"> <table border="1" style="width: 100%; border-collapse: collapse; text-align: center;"> <tr> <td style="width: 10%;"></td> <td style="width: 10%;"></td> <td style="width: 10%;"></td> <td style="width: 10%;"></td> <td style="width: 10%;"></td> <td style="width: 10%;"></td> <td style="width: 10%;"></td> <td style="width: 10%;"></td> <td style="width: 10%;"></td> <td style="width: 10%;"></td> </tr> <tr> <td></td> <td></td> <td colspan="8" style="text-align: center;"> <table border="1" style="width: 100%; border-collapse: collapse; text-align: center;"> <tr> <td style="width: 10%;"></td> <td style="width: 10%;"></td> <td style="width: 10%;"></td> <td style="width: 10%;"></td> <td style="width: 10%;"></td> <td style="width: 10%;"></td> <td style="width: 10%;"></td> <td style="width: 10%;"></td> <td style="width: 10%;"></td> <td style="width: 10%;"></td> </tr> <tr> <td></td> <td></td> <td colspan="8" style="text-align: center;"> <table border="1" style="width: 100%; border-collapse: collapse; text-align: center;"> <tr> <td style="width: 10%;"></td> <td style="width: 10%;"></td> <td style="width: 10%;"></td> <td style="width: 10%;"></td> <td style="width: 10%;"></td> <td style="width: 10%;"></td> <td style="width: 10%;"></td> <td style="width: 10%;"></td> <td style="width: 10%;"></td> <td style="width: 10%;"></td> </tr> <tr> <td></td> <td></td> <td colspan="8" style="text-align: center;"> <table border="1" style="width: 100%; border-collapse: collapse; text-align: center;"> <tr> <td style="width: 10%;"></td> <td style="width: 10%;"></td> <td style="width: 10%;"></td> <td style="width: 10%;"></td> <td style="width: 10%;"></td> <td style="width: 10%;"></td> <td style="width: 10%;"></td> <td style="width: 10%;"></td> <td style="width: 10%;"></td> <td style="width: 10%;"></td> </tr> <tr> <td></td> <td></td> <td colspan="8" style="text-align: center;"> <table border="1" style="width: 100%; border-collapse: collapse; text-align: center;"> <tr> </tr></table></td></tr></table></td></tr></table></td></tr></table></td></tr></table></td></tr></table></td></tr></table></td></tr></table></td></tr></table></td></tr></table></td></tr></table></td></tr></table></td></tr></table></td></tr></table></td></tr></table></td></tr></table></td></tr></table></td></tr></table></td></tr></table></td></tr></table></td></tr></table></td></tr></table></td></tr></table></td></tr></table></td></tr></table></td></tr></table></td></tr></table></td></tr></table></td></tr></table></td></tr></table>

 | | | | | | | | | | | | | | | | | | | | <table border="1" style="width: 100%; border-collapse: collapse; text-align: center;"> <tr> <td style="width: 10%;"></td> <td style="width: 10%;"></td> <td style="width: 10%;"></td> <td style="width: 10%;"></td> <td style="width: 10%;"></td> <td style="width: 10%;"></td> <td style="width: 10%;"></td> <td style="width: 10%;"></td> <td style="width: 10%;"></td> <td style="width: 10%;"></td> </tr> <tr> <td></td> <td></td> <td colspan="8" style="text-align: center;"> <table border="1" style="width: 100%; border-collapse: collapse; text-align: center;"> <tr> <td style="width: 10%;"></td> <td style="width: 10%;"></td> <td style="width: 10%;"></td> <td style="width: 10%;"></td> <td style="width: 10%;"></td> <td style="width: 10%;"></td> <td style="width: 10%;"></td> <td style="width: 10%;"></td> <td style="width: 10%;"></td> <td style="width: 10%;"></td> </tr> <tr> <td></td> <td></td> <td colspan="8" style="text-align: center;"> <table border="1" style="width: 100%; border-collapse: collapse; text-align: center;"> <tr> <td style="width: 10%;"></td> <td style="width: 10%;"></td> <td style="width: 10%;"></td> <td style="width: 10%;"></td> <td style="width: 10%;"></td> <td style="width: 10%;"></td> <td style="width: 10%;"></td> <td style="width: 10%;"></td> <td style="width: 10%;"></td> <td style="width: 10%;"></td> </tr> <tr> <td></td> <td></td> <td colspan="8" style="text-align: center;"> <table border="1" style="width: 100%; border-collapse: collapse; text-align: center;"> <tr> <td style="width: 10%;"></td> <td style="width: 10%;"></td> <td style="width: 10%;"></td> <td style="width: 10%;"></td> <td style="width: 10%;"></td> <td style="width: 10%;"></td> <td style="width: 10%;"></td> <td style="width: 10%;"></td> <td style="width: 10%;"></td> <td style="width: 10%;"></td> </tr> <tr> <td></td> <td></td> <td colspan="8" style="text-align: center;"> <table border="1" style="width: 100%; border-collapse: collapse; text-align: center;"> <tr> <td style="width: 10%;"></td> <td style="width: 10%;"></td> <td style="width: 10%;"></td> <td style="width: 10%;"></td> <td style="width: 10%;"></td> <td style="width: 10%;"></td> <td style="width: 10%;"></td> <td style="width: 10%;"></td> <td style="width: 10%;"></td> <td style="width: 10%;"></td> </tr> <tr> <td></td> <td></td> <td colspan="8" style="text-align: center;"> <table border="1" style="width: 100%; border-collapse: collapse; text-align: center;"> <tr> <td style="width: 10%;"></td> <td style="width: 10%;"></td> <td style="width: 10%;"></td> <td style="width: 10%;"></td> <td style="width: 10%;"></td> <td style="width: 10%;"></td> <td style="width: 10%;"></td> <td style="width: 10%;"></td> <td style="width: 10%;"></td> <td style="width: 10%;"></td> </tr> <tr> <td></td> <td></td> <td colspan="8" style="text-align: center;"> <table border="1" style="width: 100%; border-collapse: collapse; text-align: center;"> <tr> <td style="width: 10%;"></td> <td style="width: 10%;"></td> <td style="width: 10%;"></td> <td style="width: 10%;"></td> <td style="width: 10%;"></td> <td style="width: 10%;"></td> <td style="width: 10%;"></td> <td style="width: 10%;"></td> <td style="width: 10%;"></td> <td style="width: 10%;"></td> </tr> <tr> <td></td> <td></td> <td colspan="8" style="text-align: center;"> <table border="1" style="width: 100%; border-collapse: collapse; text-align: center;"> <tr> <td style="width: 10%;"></td> <td style="width: 10%;"></td> <td style="width: 10%;"></td> <td style="width: 10%;"></td> <td style="width: 10%;"></td> <td style="width: 10%;"></td> <td style="width: 10%;"></td> <td style="width: 10%;"></td> <td style="width: 10%;"></td> <td style="width: 10%;"></td> </tr> <tr> <td></td> <td></td> <td colspan="8" style="text-align: center;"> <table border="1" style="width: 100%; border-collapse: collapse; text-align: center;"> <tr> <td style="width: 10%;"></td> <td style="width: 10%;"></td> <td style="width: 10%;"></td> <td style="width: 10%;"></td> <td style="width: 10%;"></td> <td style="width: 10%;"></td> <td style="width: 10%;"></td> <td style="width: 10%;"></td> <td style="width: 10%;"></td> <td style="width: 10%;"></td> </tr> <tr> <td></td> <td></td> <td colspan="8" style="text-align: center;"> <table border="1" style="width: 100%; border-collapse: collapse; text-align: center;"> <tr> <td style="width: 10%;"></td> <td style="width: 10%;"></td> <td style="width: 10%;"></td> <td style="width: 10%;"></td> <td style="width: 10%;"></td> <td style="width: 10%;"></td> <td style="width: 10%;"></td> <td style="width: 10%;"></td> <td style="width: 10%;"></td> <td style="width: 10%;"></td> </tr> <tr> <td></td> <td></td> <td colspan="8" style="text-align: center;"> <table border="1" style="width: 100%; border-collapse: collapse; text-align: center;"> <tr> <td style="width: 10%;"></td> <td style="width: 10%;"></td> <td style="width: 10%;"></td> <td style="width: 10%;"></td> <td style="width: 10%;"></td> <td style="width: 10%;"></td> <td style="width: 10%;"></td> <td style="width: 10%;"></td> <td style="width: 10%;"></td> <td style="width: 10%;"></td> </tr> <tr> <td></td> <td></td> <td colspan="8" style="text-align: center;"> <table border="1" style="width: 100%; border-collapse: collapse; text-align: center;"> <tr> <td style="width: 10%;"></td> <td style="width: 10%;"></td> <td style="width: 10%;"></td> <td style="width: 10%;"></td> <td style="width: 10%;"></td> <td style="width: 10%;"></td> <td style="width: 10%;"></td> <td style="width: 10%;"></td> <td style="width: 10%;"></td> <td style="width: 10%;"></td> </tr> <tr> <td></td> <td></td> <td colspan="8" style="text-align: center;"> <table border="1" style="width: 100%; border-collapse: collapse; text-align: center;"> <tr> <td style="width: 10%;"></td> <td style="width: 10%;"></td> <td style="width: 10%;"></td> <td style="width: 10%;"></td> <td style="width: 10%;"></td> <td style="width: 10%;"></td> <td style="width: 10%;"></td> <td style="width: 10%;"></td> <td style="width: 10%;"></td> <td style="width: 10%;"></td> </tr> <tr> <td></td> <td></td> <td colspan="8" style="text-align: center;"> <table border="1" style="width: 100%; border-collapse: collapse; text-align: center;"> <tr> <td style="width: 10%;"></td> <td style="width: 10%;"></td> <td style="width: 10%;"></td> <td style="width: 10%;"></td> <td style="width: 10%;"></td> <td style="width: 10%;"></td> <td style="width: 10%;"></td> <td style="width: 10%;"></td> <td style="width: 10%;"></td> <td style="width: 10%;"></td> </tr> <tr> <td></td> <td></td> <td colspan="8" style="text-align: center;"> <table border="1" style="width: 100%; border-collapse: collapse; text-align: center;"> <tr> <td style="width: 10%;"></td> <td style="width: 10%;"></td> <td style="width: 10%;"></td> <td style="width: 10%;"></td> <td style="width: 10%;"></td> <td style="width: 10%;"></td> <td style="width: 10%;"></td> <td style="width: 10%;"></td> <td style="width: 10%;"></td> <td style="width: 10%;"></td> </tr> <tr> <td></td> <td></td> <td colspan="8" style="text-align: center;"> <table border="1" style="width: 100%; border-collapse: collapse; text-align: center;"> <tr> <td style="width: 10%;"></td> <td style="width: 10%;"></td> <td style="width: 10%;"></td> <td style="width: 10%;"></td> <td style="width: 10%;"></td> <td style="width: 10%;"></td> <td style="width: 10%;"></td> <td style="width: 10%;"></td> <td style="width: 10%;"></td> <td style="width: 10%;"></td> </tr> <tr> <td></td> <td></td> <td colspan="8" style="text-align: center;"> <table border="1" style="width: 100%; border-collapse: collapse; text-align: center;"> <tr> <td style="width: 10%;"></td> <td style="width: 10%;"></td> <td style="width: 10%;"></td> <td style="width: 10%;"></td> <td style="width: 10%;"></td> <td style="width: 10%;"></td> <td style="width: 10%;"></td> <td style="width: 10%;"></td> <td style="width: 10%;"></td> <td style="width: 10%;"></td> </tr> <tr> <td></td> <td></td> <td
colspan="8" style="text-align: center;"> <table border="1" style="width: 100%; border-collapse: collapse; text-align: center;"> <tr> <td style="width: 10%;"></td> <td style="width: 10%;"></td> <td style="width: 10%;"></td> <td style="width: 10%;"></td> <td style="width: 10%;"></td> <td style="width: 10%;"></td> <td style="width: 10%;"></td> <td style="width: 10%;"></td> <td style="width: 10%;"></td> <td style="width: 10%;"></td> </tr> <tr> <td></td> <td></td> <td colspan="8" style="text-align: center;"> <table border="1" style="width: 100%; border-collapse: collapse; text-align: center;"> <tr> <td style="width: 10%;"></td> <td style="width: 10%;"></td> <td style="width: 10%;"></td> <td style="width: 10%;"></td> <td style="width: 10%;"></td> <td style="width: 10%;"></td> <td style="width: 10%;"></td> <td style="width: 10%;"></td> <td style="width: 10%;"></td> <td style="width: 10%;"></td> </tr> <tr> <td></td> <td></td> <td colspan="8" style="text-align: center;"> <table border="1" style="width: 100%; border-collapse: collapse; text-align: center;"> <tr> <td style="width: 10%;"></td> <td style="width: 10%;"></td> <td style="width: 10%;"></td> <td style="width: 10%;"></td> <td style="width: 10%;"></td> <td style="width: 10%;"></td> <td style="width: 10%;"></td> <td style="width: 10%;"></td> <td style="width: 10%;"></td> <td style="width: 10%;"></td> </tr> <tr> <td></td> <td></td> <td colspan="8" style="text-align: center;"> <table border="1" style="width: 100%; border-collapse: collapse; text-align: center;"> <tr> <td style="width: 10%;"></td> <td style="width: 10%;"></td> <td style="width: 10%;"></td> <td style="width: 10%;"></td> <td style="width: 10%;"></td> <td style="width: 10%;"></td> <td style="width: 10%;"></td> <td style="width: 10%;"></td> <td style="width: 10%;"></td> <td style="width: 10%;"></td> </tr> <tr> <td></td> <td></td> <td colspan="8" style="text-align: center;"> <table border="1" style="width: 100%; border-collapse: collapse; text-align: center;"> <tr> <td style="width: 10%;"></td> <td style="width: 10%;"></td> <td style="width: 10%;"></td> <td style="width: 10%;"></td> <td style="width: 10%;"></td> <td style="width: 10%;"></td> <td style="width: 10%;"></td> <td style="width: 10%;"></td> <td style="width: 10%;"></td> <td style="width: 10%;"></td> </tr> <tr> <td></td> <td></td> <td colspan="8" style="text-align: center;"> <table border="1" style="width: 100%; border-collapse: collapse; text-align: center;"> <tr> <td style="width: 10%;"></td> <td style="width: 10%;"></td> <td style="width: 10%;"></td> <td style="width: 10%;"></td> <td style="width: 10%;"></td> <td style="width: 10%;"></td> <td style="width: 10%;"></td> <td style="width: 10%;"></td> <td style="width: 10%;"></td> <td style="width: 10%;"></td> </tr> <tr> <td></td> <td></td> <td colspan="8" style="text-align: center;"> <table border="1" style="width: 100%; border-collapse: collapse; text-align: center;"> <tr> <td style="width: 10%;"></td> <td style="width: 10%;"></td> <td style="width: 10%;"></td> <td style="width: 10%;"></td> <td style="width: 10%;"></td> <td style="width: 10%;"></td> <td style="width: 10%;"></td> <td style="width: 10%;"></td> <td style="width: 10%;"></td> <td style="width: 10%;"></td> </tr> <tr> <td></td> <td></td> <td colspan="8" style="text-align: center;"> <table border="1" style="width: 100%; border-collapse: collapse; text-align: center;"> <tr> <td style="width: 10%;"></td> <td style="width: 10%;"></td> <td style="width: 10%;"></td> <td style="width: 10%;"></td> <td style="width: 10%;"></td> <td style="width: 10%;"></td> <td style="width: 10%;"></td> <td style="width: 10%;"></td> <td style="width: 10%;"></td> <td style="width: 10%;"></td> </tr> <tr> <td></td> <td></td> <td colspan="8" style="text-align: center;"> <table border="1" style="width: 100%; border-collapse: collapse; text-align: center;"> <tr> <td style="width: 10%;"></td> <td style="width: 10%;"></td> <td style="width: 10%;"></td> <td style="width: 10%;"></td> <td style="width: 10%;"></td> <td style="width: 10%;"></td> <td style="width: 10%;"></td> <td style="width: 10%;"></td> <td style="width: 10%;"></td> <td style="width: 10%;"></td> </tr> <tr> <td></td> <td></td> <td colspan="8" style="text-align: center;"> <table border="1" style="width: 100%; border-collapse: collapse; text-align: center;"> <tr> <td style="width: 10%;"></td> <td style="width: 10%;"></td> <td style="width: 10%;"></td> <td style="width: 10%;"></td> <td style="width: 10%;"></td> <td style="width: 10%;"></td> <td style="width: 10%;"></td> <td style="width: 10%;"></td> <td style="width: 10%;"></td> <td style="width: 10%;"></td> </tr> <tr> <td></td> <td></td> <td colspan="8" style="text-align: center;"> <table border="1" style="width: 100%; border-collapse: collapse; text-align: center;"> <tr> <td style="width: 10%;"></td> <td style="width: 10%;"></td> <td style="width: 10%;"></td> <td style="width: 10%;"></td> <td style="width: 10%;"></td> <td style="width: 10%;"></td> <td style="width: 10%;"></td> <td style="width: 10%;"></td> <td style="width: 10%;"></td> <td style="width: 10%;"></td> </tr> <tr> <td></td> <td></td> <td colspan="8" style="text-align: center;"> <table border="1" style="width: 100%; border-collapse: collapse; text-align: center;"> <tr> </tr></table></td></tr></table></td></tr></table></td></tr></table></td></tr></table></td></tr></table></td></tr></table></td></tr></table></td></tr></table></td></tr></table></td></tr></table></td></tr></table></td></tr></table></td></tr></table></td></tr></table></td></tr></table></td></tr></table></td></tr></table></td></tr></table></td></tr></table></td></tr></table></td></tr></table></td></tr></table></td></tr></table></td></tr></table></td></tr></table></td></tr></table></td></tr></table></td></tr></table>

 | | | | | | | | | | | | | | | | | | | | <table border="1" style="width: 100%; border-collapse: collapse; text-align: center;"> <tr> <td style="width: 10%;"></td> <td style="width: 10%;"></td> <td style="width: 10%;"></td> <td style="width: 10%;"></td> <td style="width: 10%;"></td> <td style="width: 10%;"></td> <td style="width: 10%;"></td> <td style="width: 10%;"></td> <td style="width: 10%;"></td> <td style="width: 10%;"></td> </tr> <tr> <td></td> <td></td> <td colspan="8" style="text-align: center;"> <table border="1" style="width: 100%; border-collapse: collapse; text-align: center;"> <tr> <td style="width: 10%;"></td> <td style="width: 10%;"></td> <td style="width: 10%;"></td> <td style="width: 10%;"></td> <td style="width: 10%;"></td> <td style="width: 10%;"></td> <td style="width: 10%;"></td> <td style="width: 10%;"></td> <td style="width: 10%;"></td> <td style="width: 10%;"></td> </tr> <tr> <td></td> <td></td> <td colspan="8" style="text-align: center;"> <table border="1" style="width: 100%; border-collapse: collapse; text-align: center;"> <tr> <td style="width: 10%;"></td> <td style="width: 10%;"></td> <td style="width: 10%;"></td> <td style="width: 10%;"></td> <td style="width: 10%;"></td> <td style="width: 10%;"></td> <td style="width: 10%;"></td> <td style="width: 10%;"></td> <td style="width: 10%;"></td> <td style="width: 10%;"></td> </tr> <tr> <td></td> <td></td> <td colspan="8" style="text-align: center;"> <table border="1" style="width: 100%; border-collapse: collapse; text-align: center;"> <tr> <td style="width: 10%;"></td> <td style="width: 10%;"></td> <td style="width: 10%;"></td> <td style="width: 10%;"></td> <td style="width: 10%;"></td> <td style="width: 10%;"></td> <td style="width: 10%;"></td> <td style="width: 10%;"></td> <td style="width: 10%;"></td> <td style="width: 10%;"></td> </tr> <tr> <td></td> <td></td> <td colspan="8" style="text-align: center;"> <table border="1" style="width: 100%; border-collapse: collapse; text-align: center;"> <tr> <td style="width: 10%;"></td> <td style="width: 10%;"></td> <td style="width: 10%;"></td> <td style="width: 10%;"></td> <td style="width: 10%;"></td> <td style="width: 10%;"></td> <td style="width: 10%;"></td> <td style="width: 10%;"></td> <td style="width: 10%;"></td> <td style="width: 10%;"></td> </tr> <tr> <td></td> <td></td> <td colspan="8" style="text-align: center;"> <table border="1" style="width: 100%; border-collapse: collapse; text-align: center;"> <tr> <td style="width: 10%;"></td> <td style="width: 10%;"></td> <td style="width: 10%;"></td> <td style="width: 10%;"></td> <td style="width: 10%;"></td> <td style="width: 10%;"></td> <td style="width: 10%;"></td> <td style="width: 10%;"></td> <td style="width: 10%;"></td> <td style="width: 10%;"></td> </tr> <tr> <td></td> <td></td> <td colspan="8" style="text-align: center;"> <table border="1" style="width: 100%; border-collapse: collapse; text-align: center;"> <tr> <td style="width: 10%;"></td> <td style="width: 10%;"></td> <td style="width: 10%;"></td> <td style="width: 10%;"></td> <td style="width: 10%;"></td> <td style="width: 10%;"></td> <td style="width: 10%;"></td> <td style="width: 10%;"></td> <td style="width: 10%;"></td> <td style="width: 10%;"></td> </tr> <tr> <td></td> <td></td> <td colspan="8" style="text-align: center;"> <table border="1" style="width: 100%; border-collapse: collapse; text-align: center;"> <tr> <td style="width: 10%;"></td> <td style="width: 10%;"></td> <td style="width: 10%;"></td> <td style="width: 10%;"></td> <td style="width: 10%;"></td> <td style="width: 10%;"></td> <td style="width: 10%;"></td> <td style="width: 10%;"></td> <td style="width: 10%;"></td> <td style="width: 10%;"></td> </tr> <tr> <td></td> <td></td> <td colspan="8" style="text-align: center;"> <table border="1" style="width: 100%; border-collapse: collapse; text-align: center;"> <tr> <td style="width: 10%;"></td> <td style="width: 10%;"></td> <td style="width: 10%;"></td> <td style="width: 10%;"></td> <td style="width: 10%;"></td> <td style="width: 10%;"></td> <td style="width: 10%;"></td> <td style="width: 10%;"></td> <td style="width: 10%;"></td> <td style="width: 10%;"></td> </tr> <tr> <td></td> <td></td> <td colspan="8" style="text-align: center;"> <table border="1" style="width: 100%; border-collapse: collapse; text-align: center;"> <tr> <td style="width: 10%;"></td> <td style="width: 10%;"></td> <td style="width: 10%;"></td> <td style="width: 10%;"></td> <td style="width: 10%;"></td> <td style="width: 10%;"></td> <td style="width: 10%;"></td> <td style="width: 10%;"></td> <td style="width: 10%;"></td> <td style="width: 10%;"></td> </tr> <tr> <td></td> <td></td> <td colspan="8" style="text-align: center;"> <table border="1" style="width: 100%; border-collapse: collapse; text-align: center;"> <tr> <td style="width: 10%;"></td> <td style="width: 10%;"></td> <td style="width: 10%;"></td> <td style="width: 10%;"></td> <td style="width: 10%;"></td> <td style="width: 10%;"></td> <td style="width: 10%;"></td> <td style="width: 10%;"></td> <td style="width: 10%;"></td> <td style="width: 10%;"></td> </tr> <tr> <td></td> <td></td> <td colspan="8" style="text-align: center;"> <table border="1" style="width: 100%; border-collapse: collapse; text-align: center;"> <tr> <td style="width: 10%;"></td> <td style="width: 10%;"></td> <td style="width: 10%;"></td> <td style="width: 10%;"></td> <td style="width: 10%;"></td> <td style="width: 10%;"></td> <td style="width: 10%;"></td> <td style="width: 10%;"></td> <td style="width: 10%;"></td> <td style="width: 10%;"></td> </tr> <tr> <td></td> <td></td> <td colspan="8" style="text-align: center;"> <table border="1" style="width: 100%; border-collapse: collapse; text-align: center;"> <tr> <td style="width: 10%;"></td> <td style="width: 10%;"></td> <td style="width: 10%;"></td> <td style="width: 10%;"></td> <td style="width: 10%;"></td> <td style="width: 10%;"></td> <td style="width: 10%;"></td> <td style="width: 10%;"></td> <td style="width: 10%;"></td> <td style="width: 10%;"></td> </tr> <tr> <td></td> <td></td> <td colspan="8" style="text-align: center;"> <table border="1" style="width: 100%; border-collapse: collapse; text-align: center;"> <tr> <td style="width: 10%;"></td> <td style="width: 10%;"></td> <td style="width: 10%;"></td> <td style="width: 10%;"></td> <td style="width: 10%;"></td> <td style="width: 10%;"></td> <td style="width: 10%;"></td> <td style="width: 10%;"></td> <td style="width: 10%;"></td> <td style="width: 10%;"></td> </tr> <tr> <td></td> <td></td> <td colspan="8" style="text-align: center;"> <table border="1" style="width: 100%; border-collapse: collapse; text-align: center;"> <tr> <td style="width: 10%;"></td> <td style="width: 10%;"></td> <td style="width: 10%;"></td> <td style="width: 10%;"></td> <td style="width: 10%;"></td> <td style="width: 10%;"></td> <td style="width: 10%;"></td> <td style="width: 10%;"></td> <td style="width: 10%;"></td> <td style="width: 10%;"></td> </tr> <tr> <td></td> <td></td> <td colspan="8" style="text-align: center;"> <table border="1" style="width: 100%; border-collapse: collapse; text-align: center;"> <tr> <td style="width: 10%;"></td> <td style="width: 10%;"></td> <td style="width: 10%;"></td> <td style="width: 10%;"></td> <td style="width: 10%;"></td> <td style="width: 10%;"></td> <td style="width: 10%;"></td> <td style="width: 10%;"></td> <td style="width: 10%;"></td> <td style="width: 10%;"></td> </tr> <tr> <td></td> <td></td> <td colspan="8" style="text-align: center;"> <table border="1" style="width: 100%; border-collapse: collapse; text-align: center;"> <tr> <td style="width: 10%;"></td> <td
style="width: 10%;"></td> <td style="width: 10%;"></td> <td style="width: 10%;"></td> <td style="width: 10%;"></td> <td style="width: 10%;"></td> <td style="width: 10%;"></td> <td style="width: 10%;"></td> <td style="width: 10%;"></td> <td style="width: 10%;"></td> </tr> <tr> <td></td> <td></td> <td colspan="8" style="text-align: center;"> <table border="1" style="width: 100%; border-collapse: collapse; text-align: center;"> <tr> <td style="width: 10%;"></td> <td style="width: 10%;"></td> <td style="width: 10%;"></td> <td style="width: 10%;"></td> <td style="width: 10%;"></td> <td style="width: 10%;"></td> <td style="width: 10%;"></td> <td style="width: 10%;"></td> <td style="width: 10%;"></td> <td style="width: 10%;"></td> </tr> <tr> <td></td> <td></td> <td colspan="8" style="text-align: center;"> <table border="1" style="width: 100%; border-collapse: collapse; text-align: center;"> <tr> <td style="width: 10%;"></td> <td style="width: 10%;"></td> <td style="width: 10%;"></td> <td style="width: 10%;"></td> <td style="width: 10%;"></td> <td style="width: 10%;"></td> <td style="width: 10%;"></td> <td style="width: 10%;"></td> <td style="width: 10%;"></td> <td style="width: 10%;"></td> </tr> <tr> <td></td> <td></td> <td colspan="8" style="text-align: center;"> <table border="1" style="width: 100%; border-collapse: collapse; text-align: center;"> <tr> <td style="width: 10%;"></td> <td style="width: 10%;"></td> <td style="width: 10%;"></td> <td style="width: 10%;"></td> <td style="width: 10%;"></td> <td style="width: 10%;"></td> <td style="width: 10%;"></td> <td style="width: 10%;"></td> <td style="width: 10%;"></td> <td style="width: 10%;"></td> </tr> <tr> <td></td> <td></td> <td colspan="8" style="text-align: center;"> <table border="1" style="width: 100%; border-collapse: collapse; text-align: center;"> <tr> <td style="width: 10%;"></td> <td style="width: 10%;"></td> <td style="width: 10%;"></td> <td style="width: 10%;"></td> <td style="width: 10%;"></td> <td style="width: 10%;"></td> <td style="width: 10%;"></td> <td style="width: 10%;"></td> <td style="width: 10%;"></td> <td style="width: 10%;"></td> </tr> <tr> <td></td> <td></td> <td colspan="8" style="text-align: center;"> <table border="1" style="width: 100%; border-collapse: collapse; text-align: center;"> <tr> <td style="width: 10%;"></td> <td style="width: 10%;"></td> <td style="width: 10%;"></td> <td style="width: 10%;"></td> <td style="width: 10%;"></td> <td style="width: 10%;"></td> <td style="width: 10%;"></td> <td style="width: 10%;"></td> <td style="width: 10%;"></td> <td style="width: 10%;"></td> </tr> <tr> <td></td> <td></td> <td colspan="8" style="text-align: center;"> <table border="1" style="width: 100%; border-collapse: collapse; text-align: center;"> <tr> <td style="width: 10%;"></td> <td style="width: 10%;"></td> <td style="width: 10%;"></td> <td style="width: 10%;"></td> <td style="width: 10%;"></td> <td style="width: 10%;"></td> <td style="width: 10%;"></td> <td style="width: 10%;"></td> <td style="width: 10%;"></td> <td style="width: 10%;"></td> </tr> <tr> <td></td> <td></td> <td colspan="8" style="text-align: center;"> <table border="1" style="width: 100%; border-collapse: collapse; text-align: center;"> <tr> <td style="width: 10%;"></td> <td style="width: 10%;"></td> <td style="width: 10%;"></td> <td style="width: 10%;"></td> <td style="width: 10%;"></td> <td style="width: 10%;"></td> <td style="width: 10%;"></td> <td style="width: 10%;"></td> <td style="width: 10%;"></td> <td style="width: 10%;"></td> </tr> <tr> <td></td> <td></td> <td colspan="8" style="text-align: center;"> <table border="1" style="width: 100%; border-collapse: collapse; text-align: center;"> <tr> <td style="width: 10%;"></td> <td style="width: 10%;"></td> <td style="width: 10%;"></td> <td style="width: 10%;"></td> <td style="width: 10%;"></td> <td style="width: 10%;"></td> <td style="width: 10%;"></td> <td style="width: 10%;"></td> <td style="width: 10%;"></td> <td style="width: 10%;"></td> </tr> <tr> <td></td> <td></td> <td colspan="8" style="text-align: center;"> <table border="1" style="width: 100%; border-collapse: collapse; text-align: center;"> <tr> <td style="width: 10%;"></td> <td style="width: 10%;"></td> <td style="width: 10%;"></td> <td style="width: 10%;"></td> <td style="width: 10%;"></td> <td style="width: 10%;"></td> <td style="width: 10%;"></td> <td style="width: 10%;"></td> <td style="width: 10%;"></td> <td style="width: 10%;"></td> </tr> <tr> <td></td> <td></td> <td colspan="8" style="text-align: center;"> <table border="1" style="width: 100%; border-collapse: collapse; text-align: center;"> <tr> <td style="width: 10%;"></td> <td style="width: 10%;"></td> <td style="width: 10%;"></td> <td style="width: 10%;"></td> <td style="width: 10%;"></td> <td style="width: 10%;"></td> <td style="width: 10%;"></td> <td style="width: 10%;"></td> <td style="width: 10%;"></td> <td style="width: 10%;"></td> </tr> <tr> <td></td> <td></td> <td colspan="8" style="text-align: center;"> <table border="1" style="width: 100%; border-collapse: collapse; text-align: center;"> <tr> </tr></table></td></tr></table></td></tr></table></td></tr></table></td></tr></table></td></tr></table></td></tr></table></td></tr></table></td></tr></table></td></tr></table></td></tr></table></td></tr></table></td></tr></table></td></tr></table></td></tr></table></td></tr></table></td></tr></table></td></tr></table></td></tr></table></td></tr></table></td></tr></table></td></tr></table></td></tr></table></td></tr></table></td></tr></table></td></tr></table></td></tr></table></td></tr></table>

 | | | | | | | | | | | | | | | | | | | | <table border="1" style="width: 100%; border-collapse: collapse; text-align: center;"> <tr> <td style="width: 10%;"></td> <td style="width: 10%;"></td> <td style="width: 10%;"></td> <td style="width: 10%;"></td> <td style="width: 10%;"></td> <td style="width: 10%;"></td> <td style="width: 10%;"></td> <td style="width: 10%;"></td> <td style="width: 10%;"></td> <td style="width: 10%;"></td> </tr> <tr> <td></td> <td></td> <td colspan="8" style="text-align: center;"> <table border="1" style="width: 100%; border-collapse: collapse; text-align: center;"> <tr> <td style="width: 10%;"></td> <td style="width: 10%;"></td> <td style="width: 10%;"></td> <td style="width: 10%;"></td> <td style="width: 10%;"></td> <td style="width: 10%;"></td> <td style="width: 10%;"></td> <td style="width: 10%;"></td> <td style="width: 10%;"></td> <td style="width: 10%;"></td> </tr> <tr> <td></td> <td></td> <td colspan="8" style="text-align: center;"> <table border="1" style="width: 100%; border-collapse: collapse; text-align: center;"> <tr> <td style="width: 10%;"></td> <td style="width: 10%;"></td> <td style="width: 10%;"></td> <td style="width: 10%;"></td> <td style="width: 10%;"></td> <td style="width: 10%;"></td> <td style="width: 10%;"></td> <td style="width: 10%;"></td> <td style="width: 10%;"></td> <td style="width: 10%;"></td> </tr> <tr> <td></td> <td></td> <td colspan="8" style="text-align: center;"> <table border="1" style="width: 100%; border-collapse: collapse; text-align: center;"> <tr> <td style="width: 10%;"></td> <td style="width: 10%;"></td> <td style="width: 10%;"></td> <td style="width: 10%;"></td> <td style="width: 10%;"></td> <td style="width: 10%;"></td> <td style="width: 10%;"></td> <td style="width: 10%;"></td> <td style="width: 10%;"></td> <td style="width: 10%;"></td> </tr> <tr> <td></td> <td></td> <td colspan="8" style="text-align: center;"> <table border="1" style="width: 100%; border-collapse: collapse; text-align: center;"> <tr> <td style="width: 10%;"></td> <td style="width: 10%;"></td> <td style="width: 10%;"></td> <td style="width: 10%;"></td> <td style="width: 10%;"></td> <td style="width: 10%;"></td> <td style="width: 10%;"></td> <td style="width: 10%;"></td> <td style="width: 10%;"></td> <td style="width: 10%;"></td> </tr> <tr> <td></td> <td></td> <td colspan="8" style="text-align: center;"> <table border="1" style="width: 100%; border-collapse: collapse; text-align: center;"> <tr> <td style="width: 10%;"></td> <td style="width: 10%;"></td> <td style="width: 10%;"></td> <td style="width: 10%;"></td> <td style="width: 10%;"></td> <td style="width: 10%;"></td> <td style="width: 10%;"></td> <td style="width: 10%;"></td> <td style="width: 10%;"></td> <td style="width: 10%;"></td> </tr> <tr> <td></td> <td></td> <td colspan="8" style="text-align: center;"> <table border="1" style="width: 100%; border-collapse: collapse; text-align: center;"> <tr> <td style="width: 10%;"></td> <td style="width: 10%;"></td> <td style="width: 10%;"></td> <td style="width: 10%;"></td> <td style="width: 10%;"></td> <td style="width: 10%;"></td> <td style="width: 10%;"></td> <td style="width: 10%;"></td> <td style="width: 10%;"></td> <td style="width: 10%;"></td> </tr> <tr> <td></td> <td></td> <td colspan="8" style="text-align: center;"> <table border="1" style="width: 100%; border-collapse: collapse; text-align: center;"> <tr> <td style="width: 10%;"></td> <td style="width: 10%;"></td> <td style="width: 10%;"></td> <td style="width: 10%;"></td> <td style="width: 10%;"></td> <td style="width: 10%;"></td> <td style="width: 10%;"></td> <td style="width: 10%;"></td> <td style="width: 10%;"></td> <td style="width: 10%;"></td> </tr> <tr> <td></td> <td></td> <td colspan="8" style="text-align: center;"> <table border="1" style="width: 100%; border-collapse: collapse; text-align: center;"> <tr> <td style="width: 10%;"></td> <td style="width: 10%;"></td> <td style="width: 10%;"></td> <td style="width: 10%;"></td> <td style="width: 10%;"></td> <td style="width: 10%;"></td> <td style="width: 10%;"></td> <td style="width: 10%;"></td> <td style="width: 10%;"></td> <td style="width: 10%;"></td> </tr> <tr> <td></td> <td></td> <td colspan="8" style="text-align: center;"> <table border="1" style="width: 100%; border-collapse: collapse; text-align: center;"> <tr> <td style="width: 10%;"></td> <td style="width: 10%;"></td> <td style="width: 10%;"></td> <td style="width: 10%;"></td> <td style="width: 10%;"></td> <td style="width: 10%;"></td> <td style="width: 10%;"></td> <td style="width: 10%;"></td> <td style="width: 10%;"></td> <td style="width: 10%;"></td> </tr> <tr> <td></td> <td></td> <td colspan="8" style="text-align: center;"> <table border="1" style="width: 100%; border-collapse: collapse; text-align: center;"> <tr> <td style="width: 10%;"></td> <td style="width: 10%;"></td> <td style="width: 10%;"></td> <td style="width: 10%;"></td> <td style="width: 10%;"></td> <td style="width: 10%;"></td> <td style="width: 10%;"></td> <td style="width: 10%;"></td> <td style="width: 10%;"></td> <td style="width: 10%;"></td> </tr> <tr> <td></td> <td></td> <td colspan="8" style="text-align: center;"> <table border="1" style="width: 100%; border-collapse: collapse; text-align: center;"> <tr> <td style="width: 10%;"></td> <td style="width: 10%;"></td> <td style="width: 10%;"></td> <td style="width: 10%;"></td> <td style="width: 10%;"></td> <td style="width: 10%;"></td> <td style="width: 10%;"></td> <td style="width: 10%;"></td> <td style="width: 10%;"></td> <td style="width: 10%;"></td> </tr> <tr> <td></td> <td></td> <td colspan="8" style="text-align: center;"> <table border="1" style="width: 100%; border-collapse: collapse; text-align: center;"> <tr> <td style="width: 10%;"></td> <td style="width: 10%;"></td> <td style="width: 10%;"></td> <td style="width: 10%;"></td> <td style="width: 10%;"></td> <td style="width: 10%;"></td> <td style="width: 10%;"></td> <td style="width: 10%;"></td> <td style="width: 10%;"></td> <td style="width: 10%;"></td> </tr> <tr> <td></td> <td></td> <td colspan="8" style="text-align: center;"> <table border="1" style="width: 100%; border-collapse: collapse; text-align: center;"> <tr> <td style="width: 10%;"></td> <td style="width: 10%;"></td> <td style="width: 10%;"></td> <td style="width: 10%;"></td> <td style="width: 10%;"></td> <td style="width: 10%;"></td> <td style="width: 10%;"></td> <td style="width: 10%;"></td> <td style="width: 10%;"></td> <td style="width: 10%;"></td> </tr> <tr> <td></td> <td></td> <td colspan="8" style="text-align: center;"> <table border="1" style="width: 100%; border-collapse: collapse; text-align: center;"> <tr> <td style="width: 10%;"></td> <td style="width: 10%;"></td> <td style="width: 10%;"></td> <td style="width: 10%;"></td> <td style="width: 10%;"></td> <td style="width: 10%;"></td> <td style="width: 10%;"></td> <td style="width: 10%;"></td> <td style="width: 10%;"></td> <td style="width: 10%;"></td> </tr> <tr> <td></td> <td></td> <td colspan="8" style="text-align: center;"> <table border="1" style="width: 100%; border-collapse: collapse; text-align: center;"> <tr> <td style="width: 10%;"></td> <td style="width: 10%;"></td> <td style="width: 10%;"></td> <td style="width: 10%;"></td> <td style="width: 10%;"></td> <td style="width: 10%;"></td> <td style="width: 10%;"></td> <td style="width: 10%;"></td> <td style="width: 10%;"></td> <td style="width: 10%;"></td> </tr> <tr> <td></td> <td></td> <td colspan="8" style="text-align: center;"> <table border="1" style="width: 100%; border-collapse: collapse; text-align: center;"> <tr> <td style="width: 10%;"></td> <td style="width: 10%;"></td> <td style="width: 10%;"></td> <td style="width: 10%;"></td> <td style="width: 10%;"></td> <td style="width: 10%;"></td> <td style="width: 10%;"></td> <td
style="width: 10%;"></td> <td style="width: 10%;"></td> <td style="width: 10%;"></td> </tr> <tr> <td></td> <td></td> <td colspan="8" style="text-align: center;"> <table border="1" style="width: 100%; border-collapse: collapse; text-align: center;"> <tr> <td style="width: 10%;"></td> <td style="width: 10%;"></td> <td style="width: 10%;"></td> <td style="width: 10%;"></td> <td style="width: 10%;"></td> <td style="width: 10%;"></td> <td style="width: 10%;"></td> <td style="width: 10%;"></td> <td style="width: 10%;"></td> <td style="width: 10%;"></td> </tr> <tr> <td></td> <td></td> <td colspan="8" style="text-align: center;"> <table border="1" style="width: 100%; border-collapse: collapse; text-align: center;"> <tr> <td style="width: 10%;"></td> <td style="width: 10%;"></td> <td style="width: 10%;"></td> <td style="width: 10%;"></td> <td style="width: 10%;"></td> <td style="width: 10%;"></td> <td style="width: 10%;"></td> <td style="width: 10%;"></td> <td style="width: 10%;"></td> <td style="width: 10%;"></td> </tr> <tr> <td></td> <td></td> <td colspan="8" style="text-align: center;"> <table border="1" style="width: 100%; border-collapse: collapse; text-align: center;"> <tr> <td style="width: 10%;"></td> <td style="width: 10%;"></td> <td style="width: 10%;"></td> <td style="width: 10%;"></td> <td style="width: 10%;"></td> <td style="width: 10%;"></td> <td style="width: 10%;"></td> <td style="width: 10%;"></td> <td style="width: 10%;"></td> <td style="width: 10%;"></td> </tr> <tr> <td></td> <td></td> <td colspan="8" style="text-align: center;"> <table border="1" style="width: 100%; border-collapse: collapse; text-align: center;"> <tr> <td style="width: 10%;"></td> <td style="width: 10%;"></td> <td style="width: 10%;"></td> <td style="width: 10%;"></td> <td style="width: 10%;"></td> <td style="width: 10%;"></td> <td style="width: 10%;"></td> <td style="width: 10%;"></td> <td style="width: 10%;"></td> <td style="width: 10%;"></td> </tr> <tr> <td></td> <td></td> <td colspan="8" style="text-align: center;"> <table border="1" style="width: 100%; border-collapse: collapse; text-align: center;"> <tr> <td style="width: 10%;"></td> <td style="width: 10%;"></td> <td style="width: 10%;"></td> <td style="width: 10%;"></td> <td style="width: 10%;"></td> <td style="width: 10%;"></td> <td style="width: 10%;"></td> <td style="width: 10%;"></td> <td style="width: 10%;"></td> <td style="width: 10%;"></td> </tr> <tr> <td></td> <td></td> <td colspan="8" style="text-align: center;"> <table border="1" style="width: 100%; border-collapse: collapse; text-align: center;"> <tr> <td style="width: 10%;"></td> <td style="width: 10%;"></td> <td style="width: 10%;"></td> <td style="width: 10%;"></td> <td style="width: 10%;"></td> <td style="width: 10%;"></td> <td style="width: 10%;"></td> <td style="width: 10%;"></td> <td style="width: 10%;"></td> <td style="width: 10%;"></td> </tr> <tr> <td></td> <td></td> <td colspan="8" style="text-align: center;"> <table border="1" style="width: 100%; border-collapse: collapse; text-align: center;"> <tr> <td style="width: 10%;"></td> <td style="width: 10%;"></td> <td style="width: 10%;"></td> <td style="width: 10%;"></td> <td style="width: 10%;"></td> <td style="width: 10%;"></td> <td style="width: 10%;"></td> <td style="width: 10%;"></td> <td style="width: 10%;"></td> <td style="width: 10%;"></td> </tr> <tr> <td></td> <td></td> <td colspan="8" style="text-align: center;"> <table border="1" style="width: 100%; border-collapse: collapse; text-align: center;"> <tr> <td style="width: 10%;"></td> <td style="width: 10%;"></td> <td style="width: 10%;"></td> <td style="width: 10%;"></td> <td style="width: 10%;"></td> <td style="width: 10%;"></td> <td style="width: 10%;"></td> <td style="width: 10%;"></td> <td style="width: 10%;"></td> <td style="width: 10%;"></td> </tr> <tr> <td></td> <td></td> <td colspan="8" style="text-align: center;"> <table border="1" style="width: 100%; border-collapse: collapse; text-align: center;"> <tr> <td style="width: 10%;"></td> <td style="width: 10%;"></td> <td style="width: 10%;"></td> <td style="width: 10%;"></td> <td style="width: 10%;"></td> <td style="width: 10%;"></td> <td style="width: 10%;"></td> <td style="width: 10%;"></td> <td style="width: 10%;"></td> <td style="width: 10%;"></td> </tr> <tr> <td></td> <td></td> <td colspan="8" style="text-align: center;"> <table border="1" style="width: 100%; border-collapse: collapse; text-align: center;"> <tr> </tr></table></td></tr></table></td></tr></table></td></tr></table></td></tr></table></td></tr></table></td></tr></table></td></tr></table></td></tr></table></td></tr></table></td></tr></table></td></tr></table></td></tr></table></td></tr></table></td></tr></table></td></tr></table></td></tr></table></td></tr></table></td></tr></table></td></tr></table></td></tr></table></td></tr></table></td></tr></table></td></tr></table></td></tr></table></td></tr></table></td></tr></table>

 | | | | | | | | | | | | | | | | | | | | <table border="1" style="width: 100%; border-collapse: collapse; text-align: center;"> <tr> <td style="width: 10%;"></td> <td style="width: 10%;"></td> <td style="width: 10%;"></td> <td style="width: 10%;"></td> <td style="width: 10%;"></td> <td style="width: 10%;"></td> <td style="width: 10%;"></td> <td style="width: 10%;"></td> <td style="width: 10%;"></td> <td style="width: 10%;"></td> </tr> <tr> <td></td> <td></td> <td colspan="8" style="text-align: center;"> <table border="1" style="width: 100%; border-collapse: collapse; text-align: center;"> <tr> <td style="width: 10%;"></td> <td style="width: 10%;"></td> <td style="width: 10%;"></td> <td style="width: 10%;"></td> <td style="width: 10%;"></td> <td style="width: 10%;"></td> <td style="width: 10%;"></td> <td style="width: 10%;"></td> <td style="width: 10%;"></td> <td style="width: 10%;"></td> </tr> <tr> <td></td> <td></td> <td colspan="8" style="text-align: center;"> <table border="1" style="width: 100%; border-collapse: collapse; text-align: center;"> <tr> <td style="width: 10%;"></td> <td style="width: 10%;"></td> <td style="width: 10%;"></td> <td style="width: 10%;"></td> <td style="width: 10%;"></td> <td style="width: 10%;"></td> <td style="width: 10%;"></td> <td style="width: 10%;"></td> <td style="width: 10%;"></td> <td style="width: 10%;"></td> </tr> <tr> <td></td> <td></td> <td colspan="8" style="text-align: center;"> <table border="1" style="width: 100%; border-collapse: collapse; text-align: center;"> <tr> <td style="width: 10%;"></td> <td style="width: 10%;"></td> <td style="width: 10%;"></td> <td style="width: 10%;"></td> <td style="width: 10%;"></td> <td style="width: 10%;"></td> <td style="width: 10%;"></td> <td style="width: 10%;"></td> <td style="width: 10%;"></td> <td style="width: 10%;"></td> </tr> <tr> <td></td> <td></td> <td colspan="8" style="text-align: center;"> <table border="1" style="width: 100%; border-collapse: collapse; text-align: center;"> <tr> <td style="width: 10%;"></td> <td style="width: 10%;"></td> <td style="width: 10%;"></td> <td style="width: 10%;"></td> <td style="width: 10%;"></td> <td style="width: 10%;"></td> <td style="width: 10%;"></td> <td style="width: 10%;"></td> <td style="width: 10%;"></td> <td style="width: 10%;"></td> </tr> <tr> <td></td> <td></td> <td colspan="8" style="text-align: center;"> <table border="1" style="width: 100%; border-collapse: collapse; text-align: center;"> <tr> <td style="width: 10%;"></td> <td style="width: 10%;"></td> <td style="width: 10%;"></td> <td style="width: 10%;"></td> <td style="width: 10%;"></td> <td style="width: 10%;"></td> <td style="width: 10%;"></td> <td style="width: 10%;"></td> <td style="width: 10%;"></td> <td style="width: 10%;"></td> </tr> <tr> <td></td> <td></td> <td colspan="8" style="text-align: center;"> <table border="1" style="width: 100%; border-collapse: collapse; text-align: center;"> <tr> <td style="width: 10%;"></td> <td style="width: 10%;"></td> <td style="width: 10%;"></td> <td style="width: 10%;"></td> <td style="width: 10%;"></td> <td style="width: 10%;"></td> <td style="width: 10%;"></td> <td style="width: 10%;"></td> <td style="width: 10%;"></td> <td style="width: 10%;"></td> </tr> <tr> <td></td> <td></td> <td colspan="8" style="text-align: center;"> <table border="1" style="width: 100%; border-collapse: collapse; text-align: center;"> <tr> <td style="width: 10%;"></td> <td style="width: 10%;"></td> <td style="width: 10%;"></td> <td style="width: 10%;"></td> <td style="width: 10%;"></td> <td style="width: 10%;"></td> <td style="width: 10%;"></td> <td style="width: 10%;"></td> <td style="width: 10%;"></td> <td style="width: 10%;"></td> </tr> <tr> <td></td> <td></td> <td colspan="8" style="text-align: center;"> <table border="1" style="width: 100%; border-collapse: collapse; text-align: center;"> <tr> <td style="width: 10%;"></td> <td style="width: 10%;"></td> <td style="width: 10%;"></td> <td style="width: 10%;"></td> <td style="width: 10%;"></td> <td style="width: 10%;"></td> <td style="width: 10%;"></td> <td style="width: 10%;"></td> <td style="width: 10%;"></td> <td style="width: 10%;"></td> </tr> <tr> <td></td> <td></td> <td colspan="8" style="text-align: center;"> <table border="1" style="width: 100%; border-collapse: collapse; text-align: center;"> <tr> <td style="width: 10%;"></td> <td style="width: 10%;"></td> <td style="width: 10%;"></td> <td style="width: 10%;"></td> <td style="width: 10%;"></td> <td style="width: 10%;"></td> <td style="width: 10%;"></td> <td style="width: 10%;"></td> <td style="width: 10%;"></td> <td style="width: 10%;"></td> </tr> <tr> <td></td> <td></td> <td colspan="8" style="text-align: center;"> <table border="1" style="width: 100%; border-collapse: collapse; text-align: center;"> <tr> <td style="width: 10%;"></td> <td style="width: 10%;"></td> <td style="width: 10%;"></td> <td style="width: 10%;"></td> <td style="width: 10%;"></td> <td style="width: 10%;"></td> <td style="width: 10%;"></td> <td style="width: 10%;"></td> <td style="width: 10%;"></td> <td style="width: 10%;"></td> </tr> <tr> <td></td> <td></td> <td colspan="8" style="text-align: center;"> <table border="1" style="width: 100%; border-collapse: collapse; text-align: center;"> <tr> <td style="width: 10%;"></td> <td style="width: 10%;"></td> <td style="width: 10%;"></td> <td style="width: 10%;"></td> <td style="width: 10%;"></td> <td style="width: 10%;"></td> <td style="width: 10%;"></td> <td style="width: 10%;"></td> <td style="width: 10%;"></td> <td style="width: 10%;"></td> </tr> <tr> <td></td> <td></td> <td colspan="8" style="text-align: center;"> <table border="1" style="width: 100%; border-collapse: collapse; text-align: center;"> <tr> <td style="width: 10%;"></td> <td style="width: 10%;"></td> <td style="width: 10%;"></td> <td style="width: 10%;"></td> <td style="width: 10%;"></td> <td style="width: 10%;"></td> <td style="width: 10%;"></td> <td style="width: 10%;"></td> <td style="width: 10%;"></td> <td style="width: 10%;"></td> </tr> <tr> <td></td> <td></td> <td colspan="8" style="text-align: center;"> <table border="1" style="width: 100%; border-collapse: collapse; text-align: center;"> <tr> <td style="width: 10%;"></td> <td style="width: 10%;"></td> <td style="width: 10%;"></td> <td style="width: 10%;"></td> <td style="width: 10%;"></td> <td style="width: 10%;"></td> <td style="width: 10%;"></td> <td style="width: 10%;"></td> <td style="width: 10%;"></td> <td style="width: 10%;"></td> </tr> <tr> <td></td> <td></td> <td colspan="8" style="text-align: center;"> <table border="1" style="width: 100%; border-collapse: collapse; text-align: center;"> <tr> <td style="width: 10%;"></td> <td style="width: 10%;"></td> <td style="width: 10%;"></td> <td style="width: 10%;"></td> <td style="width: 10%;"></td> <td style="width: 10%;"></td> <td style="width: 10%;"></td> <td style="width: 10%;"></td> <td style="width: 10%;"></td> <td style="width: 10%;"></td> </tr> <tr> <td></td> <td></td> <td colspan="8" style="text-align: center;"> <table border="1" style="width: 100%; border-collapse: collapse; text-align: center;"> <tr> <td style="width: 10%;"></td> <td style="width: 10%;"></td> <td style="width: 10%;"></td> <td style="width: 10%;"></td> <td style="width: 10%;"></td> <td style="width: 10%;"></td> <td style="width: 10%;"></td> <td style="width: 10%;"></td> <td style="width: 10%;"></td> <td style="width: 10%;"></td> </tr> <tr> <td></td> <td></td> <td colspan="8" style="text-align: center;"> <table border="1" style="width: 100%; border-collapse: collapse; text-align: center;"> <tr> <td style="width: 10%;"></td> <td style="width: 10%;"></td> <td style="width: 10%;"></td> <td style="width: 10%;"></td> <td style="width: 10%;"></td> <td style="width: 10%;"></td> <td style="width: 10%;"></td> <td style="width: 10%;"></td> <td style="width: 10%;"></td> <td style="width: 10%;"></td> </tr> <tr> <td></td> <td></td> <td colspan="8" style="text-align: center;"> <table border="1" style="width: 100%; border-collapse: collapse; text-align: center;"> <tr> <td style="width: 10%;"></td> <td style="width: 10%;"></td> <td style="width: 10%;"></td> <td style="width: 10%;"></td> <td style="width: 10%;"></td> <td style="width: 10%;"></td> <td style="width: 10%;"></td> <td style="width: 10%;"></td> <td style="width: 10%;"></td> <td style="width: 10%;"></td> </tr> <tr> <td></td> <td></td> <td colspan="8" style="text-align: center;"> <table border="1" style="width: 100%;
border-collapse: collapse; text-align: center;"> <tr> <td style="width: 10%;"></td> <td style="width: 10%;"></td> <td style="width: 10%;"></td> <td style="width: 10%;"></td> <td style="width: 10%;"></td> <td style="width: 10%;"></td> <td style="width: 10%;"></td> <td style="width: 10%;"></td> <td style="width: 10%;"></td> <td style="width: 10%;"></td> </tr> <tr> <td></td> <td></td> <td colspan="8" style="text-align: center;"> <table border="1" style="width: 100%; border-collapse: collapse; text-align: center;"> <tr> <td style="width: 10%;"></td> <td style="width: 10%;"></td> <td style="width: 10%;"></td> <td style="width: 10%;"></td> <td style="width: 10%;"></td> <td style="width: 10%;"></td> <td style="width: 10%;"></td> <td style="width: 10%;"></td> <td style="width: 10%;"></td> <td style="width: 10%;"></td> </tr> <tr> <td></td> <td></td> <td colspan="8" style="text-align: center;"> <table border="1" style="width: 100%; border-collapse: collapse; text-align: center;"> <tr> <td style="width: 10%;"></td> <td style="width: 10%;"></td> <td style="width: 10%;"></td> <td style="width: 10%;"></td> <td style="width: 10%;"></td> <td style="width: 10%;"></td> <td style="width: 10%;"></td> <td style="width: 10%;"></td> <td style="width: 10%;"></td> <td style="width: 10%;"></td> </tr> <tr> <td></td> <td></td> <td colspan="8" style="text-align: center;"> <table border="1" style="width: 100%; border-collapse: collapse; text-align: center;"> <tr> <td style="width: 10%;"></td> <td style="width: 10%;"></td> <td style="width: 10%;"></td> <td style="width: 10%;"></td> <td style="width: 10%;"></td> <td style="width: 10%;"></td> <td style="width: 10%;"></td> <td style="width: 10%;"></td> <td style="width: 10%;"></td> <td style="width: 10%;"></td> </tr> <tr> <td></td> <td></td> <td colspan="8" style="text-align: center;"> <table border="1" style="width: 100%; border-collapse: collapse; text-align: center;"> <tr> <td style="width: 10%;"></td> <td style="width: 10%;"></td> <td style="width: 10%;"></td> <td style="width: 10%;"></td> <td style="width: 10%;"></td> <td style="width: 10%;"></td> <td style="width: 10%;"></td> <td style="width: 10%;"></td> <td style="width: 10%;"></td> <td style="width: 10%;"></td> </tr> <tr> <td></td> <td></td> <td colspan="8" style="text-align: center;"> <table border="1" style="width: 100%; border-collapse: collapse; text-align: center;"> <tr> <td style="width: 10%;"></td> <td style="width: 10%;"></td> <td style="width: 10%;"></td> <td style="width: 10%;"></td> <td style="width: 10%;"></td> <td style="width: 10%;"></td> <td style="width: 10%;"></td> <td style="width: 10%;"></td> <td style="width: 10%;"></td> <td style="width: 10%;"></td> </tr> <tr> <td></td> <td></td> <td colspan="8" style="text-align: center;"> <table border="1" style="width: 100%; border-collapse: collapse; text-align: center;"> <tr> <td style="width: 10%;"></td> <td style="width: 10%;"></td> <td style="width: 10%;"></td> <td style="width: 10%;"></td> <td style="width: 10%;"></td> <td style="width: 10%;"></td> <td style="width: 10%;"></td> <td style="width: 10%;"></td> <td style="width: 10%;"></td> <td style="width: 10%;"></td> </tr> <tr> <td></td> <td></td> <td colspan="8" style="text-align: center;"> <table border="1" style="width: 100%; border-collapse: collapse; text-align: center;"> <tr> </tr></table></td></tr></table></td></tr></table></td></tr></table></td></tr></table></td></tr></table></td></tr></table></td></tr></table></td></tr></table></td></tr></table></td></tr></table></td></tr></table></td></tr></table></td></tr></table></td></tr></table></td></tr></table></td></tr></table></td></tr></table></td></tr></table></td></tr></table></td></tr></table></td></tr></table></td></tr></table></td></tr></table></td></tr></table></td></tr></table>

 | | | | | | | | | | | | | | | | | | | | <table border="1" style="width: 100%; border-collapse: collapse; text-align: center;"> <tr> <td style="width: 10%;"></td> <td style="width: 10%;"></td> <td style="width: 10%;"></td> <td style="width: 10%;"></td> <td style="width: 10%;"></td> <td style="width: 10%;"></td> <td style="width: 10%;"></td> <td style="width: 10%;"></td> <td style="width: 10%;"></td> <td style="width: 10%;"></td> </tr> <tr> <td></td> <td></td> <td colspan="8" style="text-align: center;"> <table border="1" style="width: 100%; border-collapse: collapse; text-align: center;"> <tr> <td style="width: 10%;"></td> <td style="width: 10%;"></td> <td style="width: 10%;"></td> <td style="width: 10%;"></td> <td style="width: 10%;"></td> <td style="width: 10%;"></td> <td style="width: 10%;"></td> <td style="width: 10%;"></td> <td style="width: 10%;"></td> <td style="width: 10%;"></td> </tr> <tr> <td></td> <td></td> <td colspan="8" style="text-align: center;"> <table border="1" style="width: 100%; border-collapse: collapse; text-align: center;"> <tr> <td style="width: 10%;"></td> <td style="width: 10%;"></td> <td style="width: 10%;"></td> <td style="width: 10%;"></td> <td style="width: 10%;"></td> <td style="width: 10%;"></td> <td style="width: 10%;"></td> <td style="width: 10%;"></td> <td style="width: 10%;"></td> <td style="width: 10%;"></td> </tr> <tr> <td></td> <td></td> <td colspan="8" style="text-align: center;"> <table border="1" style="width: 100%; border-collapse: collapse; text-align: center;"> <tr> <td style="width: 10%;"></td> <td style="width: 10%;"></td> <td style="width: 10%;"></td> <td style="width: 10%;"></td> <td style="width: 10%;"></td> <td style="width: 10%;"></td> <td style="width: 10%;"></td> <td style="width: 10%;"></td> <td style="width: 10%;"></td> <td style="width: 10%;"></td> </tr> <tr> <td></td> <td></td> <td colspan="8" style="text-align: center;"> <table border="1" style="width: 100%; border-collapse: collapse; text-align: center;"> <tr> <td style="width: 10%;"></td> <td style="width: 10%;"></td> <td style="width: 10%;"></td> <td style="width: 10%;"></td> <td style="width: 10%;"></td> <td style="width: 10%;"></td> <td style="width: 10%;"></td> <td style="width: 10%;"></td> <td style="width: 10%;"></td> <td style="width: 10%;"></td> </tr> <tr> <td></td> <td></td> <td colspan="8" style="text-align: center;"> <table border="1" style="width: 100%; border-collapse: collapse; text-align: center;"> <tr> <td style="width: 10%;"></td> <td style="width: 10%;"></td> <td style="width: 10%;"></td> <td style="width: 10%;"></td> <td style="width: 10%;"></td> <td style="width: 10%;"></td> <td style="width: 10%;"></td> <td style="width: 10%;"></td> <td style="width: 10%;"></td> <td style="width: 10%;"></td> </tr> <tr> <td></td> <td></td> <td colspan="8" style="text-align: center;"> <table border="1" style="width: 100%; border-collapse: collapse; text-align: center;"> <tr> <td style="width: 10%;"></td> <td style="width: 10%;"></td> <td style="width: 10%;"></td> <td style="width: 10%;"></td> <td style="width: 10%;"></td> <td style="width: 10%;"></td> <td style="width: 10%;"></td> <td style="width: 10%;"></td> <td style="width: 10%;"></td> <td style="width: 10%;"></td> </tr> <tr> <td></td> <td></td> <td colspan="8" style="text-align: center;"> <table border="1" style="width: 100%; border-collapse: collapse; text-align: center;"> <tr> <td style="width: 10%;"></td> <td style="width: 10%;"></td> <td style="width: 10%;"></td> <td style="width: 10%;"></td> <td style="width: 10%;"></td> <td style="width: 10%;"></td> <td style="width: 10%;"></td> <td style="width: 10%;"></td> <td style="width: 10%;"></td> <td style="width: 10%;"></td> </tr> <tr> <td></td> <td></td> <td colspan="8" style="text-align: center;"> <table border="1" style="width: 100%; border-collapse: collapse; text-align: center;"> <tr> <td style="width: 10%;"></td> <td style="width: 10%;"></td> <td style="width: 10%;"></td> <td style="width: 10%;"></td> <td style="width: 10%;"></td> <td style="width: 10%;"></td> <td style="width: 10%;"></td> <td style="width: 10%;"></td> <td style="width: 10%;"></td> <td style="width: 10%;"></td> </tr> <tr> <td></td> <td></td> <td colspan="8" style="text-align: center;"> <table border="1" style="width: 100%; border-collapse: collapse; text-align: center;"> <tr> <td style="width: 10%;"></td> <td style="width: 10%;"></td> <td style="width: 10%;"></td> <td style="width: 10%;"></td> <td style="width: 10%;"></td> <td style="width: 10%;"></td> <td style="width: 10%;"></td> <td style="width: 10%;"></td> <td style="width: 10%;"></td> <td style="width: 10%;"></td> </tr> <tr> <td></td> <td></td> <td colspan="8" style="text-align: center;"> <table border="1" style="width: 100%; border-collapse: collapse; text-align: center;"> <tr> <td style="width: 10%;"></td> <td style="width: 10%;"></td> <td style="width: 10%;"></td> <td style="width: 10%;"></td> <td style="width: 10%;"></td> <td style="width: 10%;"></td> <td style="width: 10%;"></td> <td style="width: 10%;"></td> <td style="width: 10%;"></td> <td style="width: 10%;"></td> </tr> <tr> <td></td> <td></td> <td colspan="8" style="text-align: center;"> <table border="1" style="width: 100%; border-collapse: collapse; text-align: center;"> <tr> <td style="width: 10%;"></td> <td style="width: 10%;"></td> <td style="width: 10%;"></td> <td style="width: 10%;"></td> <td style="width: 10%;"></td> <td style="width: 10%;"></td> <td style="width: 10%;"></td> <td style="width: 10%;"></td> <td style="width: 10%;"></td> <td style="width: 10%;"></td> </tr> <tr> <td></td> <td></td> <td colspan="8" style="text-align: center;"> <table border="1" style="width: 100%; border-collapse: collapse; text-align: center;"> <tr> <td style="width: 10%;"></td> <td style="width: 10%;"></td> <td style="width: 10%;"></td> <td style="width: 10%;"></td> <td style="width: 10%;"></td> <td style="width: 10%;"></td> <td style="width: 10%;"></td> <td style="width: 10%;"></td> <td style="width: 10%;"></td> <td style="width: 10%;"></td> </tr> <tr> <td></td> <td></td> <td colspan="8" style="text-align: center;"> <table border="1" style="width: 100%; border-collapse: collapse; text-align: center;"> <tr> <td style="width: 10%;"></td> <td style="width: 10%;"></td> <td style="width: 10%;"></td> <td style="width: 10%;"></td> <td style="width: 10%;"></td> <td style="width: 10%;"></td> <td style="width: 10%;"></td> <td style="width: 10%;"></td> <td style="width: 10%;"></td> <td style="width: 10%;"></td> </tr> <tr> <td></td> <td></td> <td colspan="8" style="text-align: center;"> <table border="1" style="width: 100%; border-collapse: collapse; text-align: center;"> <tr> <td style="width: 10%;"></td> <td style="width: 10%;"></td> <td style="width: 10%;"></td> <td style="width: 10%;"></td> <td style="width: 10%;"></td> <td style="width: 10%;"></td> <td style="width: 10%;"></td> <td style="width: 10%;"></td> <td style="width: 10%;"></td> <td style="width: 10%;"></td> </tr> <tr> <td></td> <td></td> <td colspan="8" style="text-align: center;"> <table border="1" style="width: 100%; border-collapse: collapse; text-align: center;"> <tr> <td style="width: 10%;"></td> <td style="width: 10%;"></td> <td style="width: 10%;"></td> <td style="width: 10%;"></td> <td style="width: 10%;"></td> <td style="width: 10%;"></td> <td style="width: 10%;"></td> <td style="width: 10%;"></td> <td style="width: 10%;"></td> <td style="width: 10%;"></td> </tr> <tr> <td></td> <td></td> <td colspan="8" style="text-align: center;"> <table border="1" style="width: 100%; border-collapse: collapse; text-align: center;"> <tr> <td style="width: 10%;"></td> <td style="width: 10%;"></td> <td style="width: 10%;"></td> <td style="width: 10%;"></td> <td style="width: 10%;"></td> <td style="width: 10%;"></td> <td style="width: 10%;"></td> <td style="width: 10%;"></td> <td style="width: 10%;"></td> <td style="width: 10%;"></td> </tr> <tr> <td></td> <td></td> <td colspan="8" style="text-align: center;"> <table border="1" style="width: 100%; border-collapse: collapse; text-align: center;"> <tr> <td style="width: 10%;"></td> <td style="width: 10%;"></td> <td style="width: 10%;"></td> <td style="width: 10%;"></td> <td style="width: 10%;"></td> <td style="width: 10%;"></td> <td style="width: 10%;"></td> <td style="width: 10%;"></td> <td style="width: 10%;"></td> <td style="width: 10%;"></td> </tr> <tr> <td></td> <td></td> <td colspan="8" style="text-align: center;"> <table border="1" style="width: 100%; border-collapse: collapse; text-align: center;"> <tr> <td style="width: 10%;"></td> <td style="width: 10%;"></td> <td style="width: 10%;"></td> <td style="width: 10%;"></td> <td style="width: 10%;"></td> <td style="width: 10%;"></td> <td style="width: 10%;"></td> <td style="width: 10%;"></td> <td style="width: 10%;"></td> <td style="width: 10%;"></td> </tr> <tr> <td></td> <td></td> <td colspan="8" style="text-align: center;"> <table border="1" style="width: 100%; border-collapse: collapse; text-align: center;"> <tr> <td style="width: 10%;"></td> <td style="width: 10%;"></td> <td style="width: 10%;"></td> <td style="width: 10%;"></td> <td style="width: 10%;"></td> <td style="width: 10%;"></td> <td style="width: 10%;"></td> <td style="width: 10%;"></td> <td style="width: 10%;"></td> <td style="width: 10%;"></td> </tr> <tr> <td></td> <td></td> <td colspan="8" style="text-align: center;"> <table border="1" style="width: 100%; border-collapse: collapse; text-align: center;"> <tr> <td style="width: 10%;"></td> <td style="width: 10%;"></td> <td style="width: 10%;"></td> <td style="width: 10%;"></td> <td style="width: 10%;"></td> <td style="width:
10%;"></td> <td style="width: 10%;"></td> <td style="width: 10%;"></td> <td style="width: 10%;"></td> <td style="width: 10%;"></td> </tr> <tr> <td></td> <td></td> <td colspan="8" style="text-align: center;"> <table border="1" style="width: 100%; border-collapse: collapse; text-align: center;"> <tr> <td style="width: 10%;"></td> <td style="width: 10%;"></td> <td style="width: 10%;"></td> <td style="width: 10%;"></td> <td style="width: 10%;"></td> <td style="width: 10%;"></td> <td style="width: 10%;"></td> <td style="width: 10%;"></td> <td style="width: 10%;"></td> <td style="width: 10%;"></td> </tr> <tr> <td></td> <td></td> <td colspan="8" style="text-align: center;"> <table border="1" style="width: 100%; border-collapse: collapse; text-align: center;"> <tr> <td style="width: 10%;"></td> <td style="width: 10%;"></td> <td style="width: 10%;"></td> <td style="width: 10%;"></td> <td style="width: 10%;"></td> <td style="width: 10%;"></td> <td style="width: 10%;"></td> <td style="width: 10%;"></td> <td style="width: 10%;"></td> <td style="width: 10%;"></td> </tr> <tr> <td></td> <td></td> <td colspan="8" style="text-align: center;"> <table border="1" style="width: 100%; border-collapse: collapse; text-align: center;"> <tr> <td style="width: 10%;"></td> <td style="width: 10%;"></td> <td style="width: 10%;"></td> <td style="width: 10%;"></td> <td style="width: 10%;"></td> <td style="width: 10%;"></td> <td style="width: 10%;"></td> <td style="width: 10%;"></td> <td style="width: 10%;"></td> <td style="width: 10%;"></td> </tr> <tr> <td></td> <td></td> <td colspan="8" style="text-align: center;"> <table border="1" style="width: 100%; border-collapse: collapse; text-align: center;"> <tr> </tr></table></td></tr></table></td></tr></table></td></tr></table></td></tr></table></td></tr></table></td></tr></table></td></tr></table></td></tr></table></td></tr></table></td></tr></table></td></tr></table></td></tr></table></td></tr></table></td></tr></table></td></tr></table></td></tr></table></td></tr></table></td></tr></table></td></tr></table></td></tr></table></td></tr></table></td></tr></table></td></tr></table></td></tr></table>
 | | | | | | | | | | | | | | | | | | | | <table border="1" style="width: 100%; border-collapse: collapse; text-align: center;"> <tr> <td style="width: 10%;"></td> <td style="width: 10%;"></td> <td style="width: 10%;"></td> <td style="width: 10%;"></td> <td style="width: 10%;"></td> <td style="width: 10%;"></td> <td style="width: 10%;"></td> <td style="width: 10%;"></td> <td style="width: 10%;"></td> <td style="width: 10%;"></td> </tr> <tr> <td></td> <td></td> <td colspan="8" style="text-align: center;"> <table border="1" style="width: 100%; border-collapse: collapse; text-align: center;"> <tr> <td style="width: 10%;"></td> <td style="width: 10%;"></td> <td style="width: 10%;"></td> <td style="width: 10%;"></td> <td style="width: 10%;"></td> <td style="width: 10%;"></td> <td style="width: 10%;"></td> <td style="width: 10%;"></td> <td style="width: 10%;"></td> <td style="width: 10%;"></td> </tr> <tr> <td></td> <td></td> <td colspan="8" style="text-align: center;"> <table border="1" style="width: 100%; border-collapse: collapse; text-align: center;"> <tr> <td style="width: 10%;"></td> <td style="width: 10%;"></td> <td style="width: 10%;"></td> <td style="width: 10%;"></td> <td style="width: 10%;"></td> <td style="width: 10%;"></td> <td style="width: 10%;"></td> <td style="width:
10%;"></td> <td style="width: 10%;"></td> <td style="width: 10%;"></td> </tr> <tr> <td></td> <td></td> <td colspan="8" style="text-align: center;"> <table border="1" style="width: 100%; border-collapse: collapse; text-align: center;"> <tr> <td style="width: 10%;"></td> <td style="width: 10%;"></td> <td style="width: 10%;"></td> <td style="width: 10%;"></td> <td style="width: 10%;"></td> <td style="width: 10%;"></td> <td style="width: 10%;"></td> <td style="width: 10%;"></td> <td style="width: 10%;"></td> <td style="width: 10%;"></td> </tr> <tr> <td></td> <td></td> <td colspan="8" style="text-align: center;"> <table border="1" style="width: 100%; border-collapse: collapse; text-align: center;"> <tr> <td style="width: 10%;"></td> <td style="width: 10%;"></td> <td style="width: 10%;"></td> <td style="width: 10%;"></td> <td style="width: 10%;"></td> <td style="width: 10%;"></td> <td style="width: 10%;"></td> <td style="width: 10%;"></td> <td style="width: 10%;"></td> <td style="width: 10%;"></td> </tr> <tr> <td></td> <td></td> <td colspan="8" style="text-align: center;"> <table border="1" style="width: 100%; border-collapse: collapse; text-align: center;"> <tr> <td style="width: 10%;"></td> <td style="width: 10%;"></td> <td style="width: 10%;"></td> <td style="width: 10%;"></td> <td style="width: 10%;"></td> <td style="width: 10%;"></td> <td style="width: 10%;"></td> <td style="width: 10%;"></td> <td style="width: 10%;"></td> <td style="width: 10%;"></td> </tr> <tr> <td></td> <td></td> <td colspan="8" style="text-align: center;"> <table border="1" style="width: 100%; border-collapse: collapse; text-align: center;"> <tr> <td style="width: 10%;"></td> <td style="width: 10%;"></td> <td style="width: 10%;"></td> <td style="width: 10%;"></td> <td style="width: 10%;"></td> <td style="width: 10%;"></td> <td style="width: 10%;"></td> <td style="width: 10%;"></td> <td style="width: 10%;"></td> <td style="width: 10%;"></td> </tr> <tr> <td></td> <td></td> <td colspan="8" style="text-align: center;"> <table border="1" style="width: 100%; border-collapse: collapse; text-align: center;"> <tr> <td style="width: 10%;"></td> <td style="width: 10%;"></td> <td style="width: 10%;"></td> <td style="width: 10%;"></td> <td style="width: 10%;"></td> <td style="width: 10%;"></td> <td style="width: 10%;"></td> <td style="width: 10%;"></td> <td style="width: 10%;"></td> <td style="width: 10%;"></td> </tr> <tr> <td></td> <td></td> <td colspan="8" style="text-align: center;"> <table border="1" style="width: 100%; border-collapse: collapse; text-align: center;"> <tr> <td style="width: 10%;"></td> <td style="width: 10%;"></td> <td style="width: 10%;"></td> <td style="width: 10%;"></td> <td style="width: 10%;"></td> <td style="width: 10%;"></td> <td style="width: 10%;"></td> <td style="width: 10%;"></td> <td style="width: 10%;"></td> <td style="width: 10%;"></td> </tr> <tr> <td></td> <td></td> <td colspan="8" style="text-align: center;"> <table border="1" style="width: 100%; border-collapse: collapse; text-align: center;"> <tr> <td style="width: 10%;"></td> <td style="width: 10%;"></td> <td style="width: 10%;"></td> <td style="width: 10%;"></td> <td style="width: 10%;"></td> <td style="width: 10%;"></td> <td style="width: 10%;"></td> <td style="width: 10%;"></td> <td style="width: 10%;"></td> <td style="width: 10%;"></td> </tr> <tr> <td></td> <td></td> <td colspan="8" style="text-align: center;"> <table border="1" style="width: 100%; border-collapse: collapse; text-align: center;"> <tr> <td style="width: 10%;"></td> <td style="width: 10%;"></td> <td style="width: 10%;"></td> <td style="width: 10%;"></td> <td style="width: 10%;"></td> <td style="width: 10%;"></td> <td style="width: 10%;"></td> <td style="width: 10%;"></td> <td style="width: 10%;"></td> <td style="width: 10%;"></td> </tr> <tr> <td></td> <td></td> <td colspan="8" style="text-align: center;"> <table border="1" style="width: 100%; border-collapse: collapse; text-align: center;"> <tr> <td style="width: 10%;"></td> <td style="width: 10%;"></td> <td style="width: 10%;"></td> <td style="width: 10%;"></td> <td style="width: 10%;"></td> <td style="width: 10%;"></td> <td style="width: 10%;"></td> <td style="width: 10%;"></td> <td style="width: 10%;"></td> <td style="width: 10%;"></td> </tr> <tr> <td></td> <td></td> <td colspan="8" style="text-align: center;"> <table border="1" style="width: 100%; border-collapse: collapse; text-align: center;"> <tr> <td style="width: 10%;"></td> <td style="width: 10%;"></td> <td style="width: 10%;"></td> <td style="width: 10%;"></td> <td style="width: 10%;"></td> <td style="width: 10%;"></td> <td style="width: 10%;"></td> <td style="width: 10%;"></td> <td style="width: 10%;"></td> <td style="width: 10%;"></td> </tr> <tr> <td></td> <td></td> <td colspan="8" style="text-align: center;"> <table border="1" style="width: 100%; border-collapse: collapse; text-align: center;"> <tr> <td style="width: 10%;"></td> <td style="width: 10%;"></td> <td style="width: 10%;"></td> <td style="width: 10%;"></td> <td style="width: 10%;"></td> <td style="width: 10%;"></td> <td style="width: 10%;"></td> <td style="width: 10%;"></td> <td style="width: 10%;"></td> <td style="width: 10%;"></td> </tr> <tr> <td></td> <td></td> <td colspan="8" style="text-align: center;"> <table border="1" style="width: 100%; border-collapse: collapse; text-align: center;"> <tr> <td style="width: 10%;"></td> <td style="width: 10%;"></td> <td style="width: 10%;"></td> <td style="width: 10%;"></td> <td style="width: 10%;"></td> <td style="width: 10%;"></td> <td style="width: 10%;"></td> <td style="width: 10%;"></td> <td style="width: 10%;"></td> <td style="width: 10%;"></td> </tr> <tr> <td></td> <td></td> <td colspan="8" style="text-align: center;"> <table border="1" style="width: 100%; border-collapse: collapse; text-align: center;"> <tr> <td style="width: 10%;"></td> <td style="width: 10%;"></td> <td style="width: 10%;"></td> <td style="width: 10%;"></td> <td style="width: 10%;"></td> <td style="width: 10%;"></td> <td style="width: 10%;"></td> <td style="width: 10%;"></td> <td style="width: 10%;"></td> <td style="width: 10%;"></td> </tr> <tr> <td></td> <td></td> <td colspan="8" style="text-align: center;"> <table border="1" style="width: 100%; border-collapse: collapse; text-align: center;"> <tr> <td style="width: 10%;"></td> <td style="width: 10%;"></td> <td style="width: 10%;"></td> <td style="width: 10%;"></td> <td style="width: 10%;"></td> <td style="width: 10%;"></td> <td style="width: 10%;"></td> <td style="width: 10%;"></td> <td style="width: 10%;"></td> <td style="width: 10%;"></td> </tr> <tr> <td></td> <td></td> <td colspan="8" style="text-align: center;"> <table border="1" style="width: 100%; border-collapse: collapse; text-align: center;"> <tr> <td style="width: 10%;"></td> <td style="width: 10%;"></td> <td style="width: 10%;"></td> <td style="width: 10%;"></td> <td style="width: 10%;"></td> <td style="width: 10%;"></td> <td style="width: 10%;"></td> <td style="width: 10%;"></td> <td style="width: 10%;"></td> <td style="width: 10%;"></td> </tr> <tr> <td></td> <td></td> <td colspan="8" style="text-align: center;"> <table border="1" style="width: 100%; border-collapse: collapse; text-align: center;"> <tr> <td style="width: 10%;"></td> <td style="width: 10%;"></td> <td style="width: 10%;"></td> <td style="width: 10%;"></td> <td style="width: 10%;"></td> <td style="width: 10%;"></td> <td style="width: 10%;"></td> <td style="width: 10%;"></td> <td style="width: 10%;"></td> <td style="width: 10%;"></td> </tr> <tr> <td></td> <td></td> <td colspan="8" style="text-align: center;"> <table border="1" style="width: 100%; border-collapse: collapse; text-align: center;"> <tr> <td style="width: 10%;"></td> <td style="width: 10%;"></td> <td style="width: 10%;"></td> <td style="width: 10%;"></td> <td style="width: 10%;"></td> <td style="width: 10%;"></td> <td style="width: 10%;"></td> <td style="width: 10%;"></td> <td style="width: 10%;"></td> <td style="width: 10%;"></td> </tr> <tr> <td></td> <td></td> <td colspan="8" style="text-align: center;"> <table border="1" style="width: 100%; border-collapse: collapse; text-align: center;"> <tr> <td style="width: 10%;"></td> <td style="width: 10%;"></td> <td style="width: 10%;"></td> <td style="width: 10%;"></td> <td style="width: 10%;"></td> <td style="width: 10%;"></td> <td style="width: 10%;"></td> <td style="width: 10%;"></td> <td style="width: 10%;"></td> <td style="width: 10%;"></td> </tr> <tr> <td></td> <td></td> <td colspan="8" style="text-align: center;"> <table border="1" style="width: 100%; border-collapse: collapse; text-align: center;"> <tr> <td style="width: 10%;"></td> <td style="width: 10%;"></td> <td style="width: 10%;"></td> <td style="width: 10%;"></td> <td style="width: 10%;"></td> <td style="width: 10%;"></td> <td style="width: 10%;"></td> <td style="width: 10%;"></td> <td style="width: 10%;"></td> <td style="width: 10%;"></td> </tr> <tr> <td></td> <td></td> <td colspan="8" style="text-align: center;"> <table border="1" style="width: 100%; border-collapse: collapse; text-align: center;"> <tr> <td style="width: 10%;"></td> <td style="width: 10%;"></td> <td style="width: 10%;"></td> <td style="width: 10%;"></td> <td style="width: 10%;"></td> <td style="width: 10%;"></td> <td style="width: 10%;"></td> <td style="width: 10%;"></td> <td style="width: 10%;"></td> <td style="width: 10%;"></td> </tr> <tr> <td></td> <td></td> <td colspan="8" style="text-align: center;"> <table border="1" style="width: 100%; border-collapse: collapse; text-align: center;"> <tr>
</tr></table></td></tr></table></td></tr></table></td></tr></table></td></tr></table></td></tr></table></td></tr></table></td></tr></table></td></tr></table></td></tr></table></td></tr></table></td></tr></table></td></tr></table></td></tr></table></td></tr></table></td></tr></table></td></tr></table></td></tr></table></td></tr></table></td></tr></table></td></tr></table></td></tr></table></td></tr></table></td></tr></table>
 | | | | | | | | | | | | | | | | | | | | <table border="1" style="width: 100%; border-collapse: collapse; text-align: center;"> <tr> <td style="width: 10%;"></td> <td style="width: 10%;"></td> <td style="width: 10%;"></td> <td style="width: 10%;"></td> <td style="width: 10%;"></td> <td style="width: 10%;"></td> <td style="width: 10%;"></td> <td style="width: 10%;"></td> <td style="width: 10%;"></td> <td style="width: 10%;"></td> </tr> <tr> <td></td> <td></td> <td colspan="8" style="text-align: center;"> <table border="1" style="width: 100%; border-collapse: collapse; text-align: center;"> <tr> <td style="width: 10%;"></td> <td style="width: 10%;"></td> <td style="width: 10%;"></td> <td style="width: 10%;"></td> <td style="width: 10%;"></td> <td style="width: 10%;"></td> <td style="width: 10%;"></td> <td style="width: 10%;"></td> <td style="width: 10%;"></td> <td style="width: 10%;"></td> </tr> <tr> <td></td> <td></td> <td colspan="8" style="text-align: center;"> <table border="1" style="width: 100%; border-collapse: collapse; text-align: center;"> <tr> <td style="width: 10%;"></td> <td style="width: 10%;"></td> <td style="width: 10%;"></td> <td style="width: 10%;"></td> <td style="width: 10%;"></td> <td style="width: 10%;"></td> <td style="width: 10%;"></td> <td style="width: 10%;"></td> <td style="width: 10%;"></td> <td style="width: 10%;"></td> </tr> <tr> <td></td> <td></td> <td colspan="8" style="text-align: center;"> <table border="1" style="width: 100%; border-collapse: collapse; text-align: center;"> <tr> <td style="width: 10%;"></td> <td style="width: 10%;"></td> <td style="width: 10%;"></td> <td style="width: 10%;"></td> <td style="width: 10%;"></td> <td style="width: 10%;"></td> <td style="width: 10%;"></td> <td style="width: 10%;"></td> <td style="width: 10%;"></td> <td style="width: 10%;"></td> </tr> <tr> <td></td> <td></td> <td colspan="8" style="text-align: center;"> <table border="1" style="width: 100%; border-collapse: collapse; text-align: center;"> <tr> <td style="width: 10%;"></td> <td style="width: 10%;"></td> <td style="width: 10%;"></td> <td style="width: 10%;"></td> <td style="width: 10%;"></td> <td style="width: 10%;"></td> <td style="width: 10%;"></td> <td style="width: 10%;"></td> <td style="width: 10%;"></td> <td style="width: 10%;"></td> </tr> <tr> <td></td> <td></td> <td colspan="8" style="text-align: center;"> <table border="1" style="width: 100%; border-collapse: collapse; text-align: center;"> <tr> <td style="width: 10%;"></td> <td style="width: 10%;"></td> <td style="width: 10%;"></td> <td style="width: 10%;"></td> <td style="width: 10%;"></td> <td style="width: 10%;"></td> <td style="width: 10%;"></td> <td style="width: 10%;"></td> <td style="width: 10%;"></td> <td style="width: 10%;"></td> </tr> <tr> <td></td> <td></td> <td colspan="8" style="text-align: center;"> <table border="1" style="width: 100%; border-collapse: collapse; text-align: center;"> <tr> <td style="width: 10%;"></td> <td style="width: 10%;"></td> <td style="width:
10%;"></td> <td style="width: 10%;"></td> <td style="width: 10%;"></td> <td style="width: 10%;"></td> <td style="width: 10%;"></td> <td style="width: 10%;"></td> <td style="width: 10%;"></td> <td style="width: 10%;"></td> </tr> <tr> <td></td> <td></td> <td colspan="8" style="text-align: center;"> <table border="1" style="width: 100%; border-collapse: collapse; text-align: center;"> <tr> <td style="width: 10%;"></td> <td style="width: 10%;"></td> <td style="width: 10%;"></td> <td style="width: 10%;"></td> <td style="width: 10%;"></td> <td style="width: 10%;"></td> <td style="width: 10%;"></td> <td style="width: 10%;"></td> <td style="width: 10%;"></td> <td style="width: 10%;"></td> </tr> <tr> <td></td> <td></td> <td colspan="8" style="text-align: center;"> <table border="1" style="width: 100%; border-collapse: collapse; text-align: center;"> <tr> <td style="width: 10%;"></td> <td style="width: 10%;"></td> <td style="width: 10%;"></td> <td style="width: 10%;"></td> <td style="width: 10%;"></td> <td style="width: 10%;"></td> <td style="width: 10%;"></td> <td style="width: 10%;"></td> <td style="width: 10%;"></td> <td style="width: 10%;"></td> </tr> <tr> <td></td> <td></td> <td colspan="8" style="text-align: center;"> <table border="1" style="width: 100%; border-collapse: collapse; text-align: center;"> <tr> <td style="width: 10%;"></td> <td style="width: 10%;"></td> <td style="width: 10%;"></td> <td style="width: 10%;"></td> <td style="width: 10%;"></td> <td style="width: 10%;"></td> <td style="width: 10%;"></td> <td style="width: 10%;"></td> <td style="width: 10%;"></td> <td style="width: 10%;"></td> </tr> <tr> <td></td> <td></td> <td colspan="8" style="text-align: center;"> <table border="1" style="width: 100%; border-collapse: collapse; text-align: center;"> <tr> <td style="width: 10%;"></td> <td style="width: 10%;"></td> <td style="width: 10%;"></td> <td style="width: 10%;"></td> <td style="width: 10%;"></td> <td style="width: 10%;"></td> <td style="width: 10%;"></td> <td style="width: 10%;"></td> <td style="width: 10%;"></td> <td style="width: 10%;"></td> </tr> <tr> <td></td> <td></td> <td colspan="8" style="text-align: center;"> <table border="1" style="width: 100%; border-collapse: collapse; text-align: center;"> <tr> <td style="width: 10%;"></td> <td style="width: 10%;"></td> <td style="width: 10%;"></td> <td style="width: 10%;"></td> <td style="width: 10%;"></td> <td style="width: 10%;"></td> <td style="width: 10%;"></td> <td style="width: 10%;"></td> <td style="width: 10%;"></td> <td style="width: 10%;"></td> </tr> <tr> <td></td> <td></td> <td colspan="8" style="text-align: center;"> <table border="1" style="width: 100%; border-collapse: collapse; text-align: center;"> <tr> <td style="width: 10%;"></td> <td style="width: 10%;"></td> <td style="width: 10%;"></td> <td style="width: 10%;"></td> <td style="width: 10%;"></td> <td style="width: 10%;"></td> <td style="width: 10%;"></td> <td style="width: 10%;"></td> <td style="width: 10%;"></td> <td style="width: 10%;"></td> </tr> <tr> <td></td> <td></td> <td colspan="8" style="text-align: center;"> <table border="1" style="width: 100%; border-collapse: collapse; text-align: center;"> <tr> <td style="width: 10%;"></td> <td style="width: 10%;"></td> <td style="width: 10%;"></td> <td style="width: 10%;"></td> <td style="width: 10%;"></td> <td style="width: 10%;"></td> <td style="width: 10%;"></td> <td style="width: 10%;"></td> <td style="width: 10%;"></td> <td style="width: 10%;"></td> </tr> <tr> <td></td> <td></td> <td colspan="8" style="text-align: center;"> <table border="1" style="width: 100%; border-collapse: collapse; text-align: center;"> <tr> <td style="width: 10%;"></td> <td style="width: 10%;"></td> <td style="width: 10%;"></td> <td style="width: 10%;"></td> <td style="width: 10%;"></td> <td style="width: 10%;"></td> <td style="width: 10%;"></td> <td style="width: 10%;"></td> <td style="width: 10%;"></td> <td style="width: 10%;"></td> </tr> <tr> <td></td> <td></td> <td colspan="8" style="text-align: center;"> <table border="1" style="width: 100%; border-collapse: collapse; text-align: center;"> <tr> <td style="width: 10%;"></td> <td style="width: 10%;"></td> <td style="width: 10%;"></td> <td style="width: 10%;"></td> <td style="width: 10%;"></td> <td style="width: 10%;"></td> <td style="width: 10%;"></td> <td style="width: 10%;"></td> <td style="width: 10%;"></td> <td style="width: 10%;"></td> </tr> <tr> <td></td> <td></td> <td colspan="8" style="text-align: center;"> <table border="1" style="width: 100%; border-collapse: collapse; text-align: center;"> <tr> <td style="width: 10%;"></td> <td style="width: 10%;"></td> <td style="width: 10%;"></td> <td style="width: 10%;"></td> <td style="width: 10%;"></td> <td style="width: 10%;"></td> <td style="width: 10%;"></td> <td style="width: 10%;"></td> <td style="width: 10%;"></td> <td style="width: 10%;"></td> </tr> <tr> <td></td> <td></td> <td colspan="8" style="text-align: center;"> <table border="1" style="width: 100%; border-collapse: collapse; text-align: center;"> <tr> <td style="width: 10%;"></td> <td style="width: 10%;"></td> <td style="width: 10%;"></td> <td style="width: 10%;"></td> <td style="width: 10%;"></td> <td style="width: 10%;"></td> <td style="width: 10%;"></td> <td style="width: 10%;"></td> <td style="width: 10%;"></td> <td style="width: 10%;"></td> </tr> <tr> <td></td> <td></td> <td colspan="8" style="text-align: center;"> <table border="1" style="width: 100%; border-collapse: collapse; text-align: center;"> <tr> <td style="width: 10%;"></td> <td style="width: 10%;"></td> <td style="width: 10%;"></td> <td style="width: 10%;"></td> <td style="width: 10%;"></td> <td style="width: 10%;"></td> <td style="width: 10%;"></td> <td style="width: 10%;"></td> <td style="width: 10%;"></td> <td style="width: 10%;"></td> </tr> <tr> <td></td> <td></td> <td colspan="8" style="text-align: center;"> <table border="1" style="width: 100%; border-collapse: collapse; text-align: center;"> <tr> <td style="width: 10%;"></td> <td style="width: 10%;"></td> <td style="width: 10%;"></td> <td style="width: 10%;"></td> <td style="width: 10%;"></td> <td style="width: 10%;"></td> <td style="width: 10%;"></td> <td style="width: 10%;"></td> <td style="width: 10%;"></td> <td style="width: 10%;"></td> </tr> <tr> <td></td> <td></td> <td colspan="8" style="text-align: center;"> <table border="1" style="width: 100%; border-collapse: collapse; text-align: center;"> <tr> <td style="width: 10%;"></td> <td style="width: 10%;"></td> <td style="width: 10%;"></td> <td style="width: 10%;"></td> <td style="width: 10%;"></td> <td style="width: 10%;"></td> <td style="width: 10%;"></td> <td style="width: 10%;"></td> <td style="width: 10%;"></td> <td style="width: 10%;"></td> </tr> <tr> <td></td> <td></td> <td colspan="8" style="text-align: center;"> <table border="1" style="width: 100%; border-collapse: collapse; text-align: center;"> <tr> <td style="width: 10%;"></td> <td style="width: 10%;"></td> <td style="width: 10%;"></td> <td style="width: 10%;"></td> <td style="width: 10%;"></td> <td style="width: 10%;"></td> <td style="width: 10%;"></td> <td style="width: 10%;"></td> <td style="width: 10%;"></td> <td style="width: 10%;"></td> </tr> <tr> <td></td> <td></td> <td colspan="8" style="text-align: center;"> <table border="1" style="width: 100%; border-collapse: collapse; text-align: center;"> <tr> </tr></table></td></tr></table></td></tr></table></td></tr></table></td></tr></table></td></tr></table></td></tr></table></td></tr></table></td></tr></table></td></tr></table></td></tr></table></td></tr></table></td></tr></table></td></tr></table></td></tr></table></td></tr></table></td></tr></table></td></tr></table></td></tr></table></td></tr></table></td></tr></table></td></tr></table></td></tr></table>

 | | | | | | | | | | | | | | | | | | | | <table border="1" style="width: 100%; border-collapse: collapse; text-align: center;"> <tr> <td style="width: 10%;"></td> <td style="width: 10%;"></td> <td style="width: 10%;"></td> <td style="width: 10%;"></td> <td style="width: 10%;"></td> <td style="width: 10%;"></td> <td style="width: 10%;"></td> <td style="width: 10%;"></td> <td style="width: 10%;"></td> <td style="width: 10%;"></td> </tr> <tr> <td></td> <td></td> <td colspan="8" style="text-align: center;"> <table border="1" style="width: 100%; border-collapse: collapse; text-align: center;"> <tr> <td style="width: 10%;"></td> <td style="width: 10%;"></td> <td style="width: 10%;"></td> <td style="width: 10%;"></td> <td style="width: 10%;"></td> <td style="width: 10%;"></td> <td style="width: 10%;"></td> <td style="width: 10%;"></td> <td style="width: 10%;"></td> <td style="width: 10%;"></td> </tr> <tr> <td></td> <td></td> <td colspan="8" style="text-align: center;"> <table border="1" style="width: 100%; border-collapse: collapse; text-align: center;"> <tr> <td style="width: 10%;"></td> <td style="width: 10%;"></td> <td style="width: 10%;"></td> <td style="width: 10%;"></td> <td style="width: 10%;"></td> <td style="width: 10%;"></td> <td style="width: 10%;"></td> <td style="width: 10%;"></td> <td style="width: 10%;"></td> <td style="width: 10%;"></td> </tr> <tr> <td></td> <td></td> <td colspan="8" style="text-align: center;"> <table border="1" style="width: 100%; border-collapse: collapse; text-align: center;"> <tr> <td style="width: 10%;"></td> <td style="width: 10%;"></td> <td style="width: 10%;"></td> <td style="width: 10%;"></td> <td style="width: 10%;"></td> <td style="width: 10%;"></td> <td style="width: 10%;"></td> <td style="width: 10%;"></td> <td style="width: 10%;"></td> <td style="width: 10%;"></td> </tr> <tr> <td></td> <td></td> <td colspan="8" style="text-align: center;"> <table border="1" style="width: 100%; border-collapse: collapse; text-align: center;"> <tr> <td style="width: 10%;"></td> <td style="width: 10%;"></td> <td style="width: 10%;"></td> <td style="width: 10%;"></td> <td style="width: 10%;"></td> <td style="width: 10%;"></td> <td style="width: 10%;"></td> <td style="width: 10%;"></td> <td style="width: 10%;"></td> <td style="width: 10%;"></td> </tr> <tr> <td></td> <td></td> <td colspan="8" style="text-align: center;"> <table border="1" style="width: 100%; border-collapse: collapse; text-align: center;"> <tr> <td style="width: 10%;"></td> <td style="width: 10%;"></td> <td style="width: 10%;"></td> <td style="width: 10%;"></td> <td style="width: 10%;"></td> <td style="width: 10%;"></td> <td style="width: 10%;"></td> <td style="width: 10%;"></td> <td style="width: 10%;"></td> <td style="width: 10%;"></td> </tr> <tr> <td></td> <td></td> <td colspan="8" style="text-align: center;"> <table border="1" style="width: 100%; border-collapse: collapse; text-align: center;"> <tr> <td style="width: 10%;"></td> <td style="width: 10%;"></td> <td style="width: 10%;"></td> <td style="width: 10%;"></td> <td style="width: 10%;"></td> <td style="width: 10%;"></td> <td style="width: 10%;"></td> <td style="width: 10%;"></td> <td style="width: 10%;"></td> <td style="width: 10%;"></td> </tr> <tr> <td></td> <td></td> <td colspan="8" style="text-align: center;"> <table border="1" style="width: 100%; border-collapse: collapse; text-align: center;"> <tr> <td style="width: 10%;"></td> <td style="width: 10%;"></td> <td style="width: 10%;"></td> <td style="width: 10%;"></td> <td style="width: 10%;"></td> <td style="width: 10%;"></td> <td style="width: 10%;"></td> <td style="width: 10%;"></td> <td style="width: 10%;"></td> <td style="width: 10%;"></td> </tr> <tr> <td></td> <td></td> <td colspan="8" style="text-align: center;"> <table border="1" style="width: 100%; border-collapse: collapse; text-align: center;"> <tr> <td style="width: 10%;"></td> <td style="width: 10%;"></td> <td style="width: 10%;"></td> <td style="width: 10%;"></td> <td style="width: 10%;"></td> <td style="width: 10%;"></td> <td style="width: 10%;"></td> <td style="width: 10%;"></td> <td style="width: 10%;"></td> <td style="width: 10%;"></td> </tr> <tr> <td></td> <td></td> <td colspan="8" style="text-align: center;"> <table border="1" style="width: 100%; border-collapse: collapse; text-align: center;"> <tr> <td style="width: 10%;"></td> <td style="width: 10%;"></td> <td style="width: 10%;"></td> <td style="width: 10%;"></td> <td style="width: 10%;"></td> <td style="width: 10%;"></td> <td style="width: 10%;"></td> <td style="width: 10%;"></td> <td style="width: 10%;"></td> <td style="width: 10%;"></td> </tr> <tr> <td></td> <td></td> <td colspan="8" style="text-align: center;"> <table border="1" style="width: 100%; border-collapse: collapse; text-align: center;"> <tr> <td style="width: 10%;"></td> <td style="width: 10%;"></td> <td style="width: 10%;"></td> <td style="width: 10%;"></td> <td style="width: 10%;"></td> <td style="width: 10%;"></td> <td style="width: 10%;"></td> <td style="width: 10%;"></td> <td style="width: 10%;"></td> <td style="width: 10%;"></td> </tr> <tr> <td></td> <td></td> <td colspan="8" style="text-align: center;"> <table border="1" style="width: 100%; border-collapse: collapse; text-align: center;"> <tr> <td style="width: 10%;"></td> <td style="width: 10%;"></td> <td style="width: 10%;"></td> <td style="width: 10%;"></td> <td style="width: 10%;"></td> <td style="width: 10%;"></td> <td style="width: 10%;"></td> <td style="width: 10%;"></td> <td style="width: 10%;"></td> <td style="width: 10%;"></td> </tr> <tr> <td></td> <td></td> <td colspan="8"
style="text-align: center;"> <table border="1" style="width: 100%; border-collapse: collapse; text-align: center;"> <tr> <td style="width: 10%;"></td> <td style="width: 10%;"></td> <td style="width: 10%;"></td> <td style="width: 10%;"></td> <td style="width: 10%;"></td> <td style="width: 10%;"></td> <td style="width: 10%;"></td> <td style="width: 10%;"></td> <td style="width: 10%;"></td> <td style="width: 10%;"></td> </tr> <tr> <td></td> <td></td> <td colspan="8" style="text-align: center;"> <table border="1" style="width: 100%; border-collapse: collapse; text-align: center;"> <tr> <td style="width: 10%;"></td> <td style="width: 10%;"></td> <td style="width: 10%;"></td> <td style="width: 10%;"></td> <td style="width: 10%;"></td> <td style="width: 10%;"></td> <td style="width: 10%;"></td> <td style="width: 10%;"></td> <td style="width: 10%;"></td> <td style="width: 10%;"></td> </tr> <tr> <td></td> <td></td> <td colspan="8" style="text-align: center;"> <table border="1" style="width: 100%; border-collapse: collapse; text-align: center;"> <tr> <td style="width: 10%;"></td> <td style="width: 10%;"></td> <td style="width: 10%;"></td> <td style="width: 10%;"></td> <td style="width: 10%;"></td> <td style="width: 10%;"></td> <td style="width: 10%;"></td> <td style="width: 10%;"></td> <td style="width: 10%;"></td> <td style="width: 10%;"></td> </tr> <tr> <td></td> <td></td> <td colspan="8" style="text-align: center;"> <table border="1" style="width: 100%; border-collapse: collapse; text-align: center;"> <tr> <td style="width: 10%;"></td> <td style="width: 10%;"></td> <td style="width: 10%;"></td> <td style="width: 10%;"></td> <td style="width: 10%;"></td> <td style="width: 10%;"></td> <td style="width: 10%;"></td> <td style="width: 10%;"></td> <td style="width: 10%;"></td> <td style="width: 10%;"></td> </tr> <tr> <td></td> <td></td> <td colspan="8" style="text-align: center;"> <table border="1" style="width: 100%; border-collapse: collapse; text-align: center;"> <tr> <td style="width: 10%;"></td> <td style="width: 10%;"></td> <td style="width: 10%;"></td> <td style="width: 10%;"></td> <td style="width: 10%;"></td> <td style="width: 10%;"></td> <td style="width: 10%;"></td> <td style="width: 10%;"></td> <td style="width: 10%;"></td> <td style="width: 10%;"></td> </tr> <tr> <td></td> <td></td> <td colspan="8" style="text-align: center;"> <table border="1" style="width: 100%; border-collapse: collapse; text-align: center;"> <tr> <td style="width: 10%;"></td> <td style="width: 10%;"></td> <td style="width: 10%;"></td> <td style="width: 10%;"></td> <td style="width: 10%;"></td> <td style="width: 10%;"></td> <td style="width: 10%;"></td> <td style="width: 10%;"></td> <td style="width: 10%;"></td> <td style="width: 10%;"></td> </tr> <tr> <td></td> <td></td> <td colspan="8" style="text-align: center;"> <table border="1" style="width: 100%; border-collapse: collapse; text-align: center;"> <tr> <td style="width: 10%;"></td> <td style="width: 10%;"></td> <td style="width: 10%;"></td> <td style="width: 10%;"></td> <td style="width: 10%;"></td> <td style="width: 10%;"></td> <td style="width: 10%;"></td> <td style="width: 10%;"></td> <td style="width: 10%;"></td> <td style="width: 10%;"></td> </tr> <tr> <td></td> <td></td> <td colspan="8" style="text-align: center;"> <table border="1" style="width: 100%; border-collapse: collapse; text-align: center;"> <tr> <td style="width: 10%;"></td> <td style="width: 10%;"></td> <td style="width: 10%;"></td> <td style="width: 10%;"></td> <td style="width: 10%;"></td> <td style="width: 10%;"></td> <td style="width: 10%;"></td> <td style="width: 10%;"></td> <td style="width: 10%;"></td> <td style="width: 10%;"></td> </tr> <tr> <td></td> <td></td> <td colspan="8" style="text-align: center;"> <table border="1" style="width: 100%; border-collapse: collapse; text-align: center;"> <tr> <td style="width: 10%;"></td> <td style="width: 10%;"></td> <td style="width: 10%;"></td> <td style="width: 10%;"></td> <td style="width: 10%;"></td> <td style="width: 10%;"></td> <td style="width: 10%;"></td> <td style="width: 10%;"></td> <td style="width: 10%;"></td> <td style="width: 10%;"></td> </tr> <tr> <td></td> <td></td> <td colspan="8" style="text-align: center;"> <table border="1" style="width: 100%; border-collapse: collapse; text-align: center;"> <tr> </tr></table></td></tr></table></td></tr></table></td></tr></table></td></tr></table></td></tr></table></td></tr></table></td></tr></table></td></tr></table></td></tr></table></td></tr></table></td></tr></table></td></tr></table></td></tr></table></td></tr></table></td></tr></table></td></tr></table></td></tr></table></td></tr></table></td></tr></table></td></tr></table></td></tr></table>

 | | | | | | | | | | | | | | | | | | | | <table border="1" style="width: 100%; border-collapse: collapse; text-align: center;"> <tr> <td style="width: 10%;"></td> <td style="width: 10%;"></td> <td style="width: 10%;"></td> <td style="width: 10%;"></td> <td style="width: 10%;"></td> <td style="width: 10%;"></td> <td style="width: 10%;"></td> <td style="width: 10%;"></td> <td style="width: 10%;"></td> <td style="width: 10%;"></td> </tr> <tr> <td></td> <td></td> <td colspan="8" style="text-align: center;"> <table border="1" style="width: 100%; border-collapse: collapse; text-align: center;"> <tr> <td style="width: 10%;"></td> <td style="width: 10%;"></td> <td style="width: 10%;"></td> <td style="width: 10%;"></td> <td style="width: 10%;"></td> <td style="width: 10%;"></td> <td style="width: 10%;"></td> <td style="width: 10%;"></td> <td style="width: 10%;"></td> <td style="width: 10%;"></td> </tr> <tr> <td></td> <td></td> <td colspan="8" style="text-align: center;"> <table border="1" style="width: 100%; border-collapse: collapse; text-align: center;"> <tr> <td style="width: 10%;"></td> <td style="width: 10%;"></td> <td style="width: 10%;"></td> <td style="width: 10%;"></td> <td style="width: 10%;"></td> <td style="width: 10%;"></td> <td style="width: 10%;"></td> <td style="width: 10%;"></td> <td style="width: 10%;"></td> <td style="width: 10%;"></td> </tr> <tr> <td></td> <td></td> <td colspan="8" style="text-align: center;"> <table border="1" style="width: 100%; border-collapse: collapse; text-align: center;"> <tr> <td style="width: 10%;"></td> <td style="width: 10%;"></td> <td style="width: 10%;"></td> <td style="width: 10%;"></td> <td style="width: 10%;"></td> <td style="width: 10%;"></td> <td style="width: 10%;"></td> <td style="width: 10%;"></td> <td style="width: 10%;"></td> <td style="width: 10%;"></td> </tr> <tr> <td></td> <td></td> <td colspan="8" style="text-align: center;"> <table border="1" style="width: 100%; border-collapse: collapse; text-align: center;"> <tr> <td style="width: 10%;"></td> <td style="width: 10%;"></td> <td style="width: 10%;"></td> <td style="width: 10%;"></td> <td style="width: 10%;"></td> <td style="width: 10%;"></td> <td style="width: 10%;"></td> <td style="width: 10%;"></td> <td style="width: 10%;"></td> <td style="width: 10%;"></td> </tr> <tr> <td></td> <td></td> <td colspan="8" style="text-align: center;"> <table border="1" style="width: 100%; border-collapse: collapse; text-align: center;"> <tr> <td style="width: 10%;"></td> <td style="width: 10%;"></td> <td style="width: 10%;"></td> <td style="width: 10%;"></td> <td style="width: 10%;"></td> <td style="width: 10%;"></td> <td style="width: 10%;"></td> <td style="width: 10%;"></td> <td style="width: 10%;"></td> <td style="width: 10%;"></td> </tr> <tr> <td></td> <td></td> <td colspan="8" style="text-align: center;"> <table border="1" style="width: 100%; border-collapse: collapse; text-align: center;"> <tr> <td style="width: 10%;"></td> <td style="width: 10%;"></td> <td style="width: 10%;"></td> <td style="width: 10%;"></td> <td style="width: 10%;"></td> <td style="width: 10%;"></td> <td style="width: 10%;"></td> <td style="width: 10%;"></td> <td style="width: 10%;"></td> <td style="width: 10%;"></td> </tr> <tr> <td></td> <td></td> <td colspan="8" style="text-align: center;"> <table border="1" style="width: 100%; border-collapse: collapse; text-align: center;"> <tr> <td style="width: 10%;"></td> <td style="width: 10%;"></td> <td style="width: 10%;"></td> <td style="width: 10%;"></td> <td style="width: 10%;"></td> <td style="width: 10%;"></td> <td style="width: 10%;"></td> <td style="width: 10%;"></td> <td style="width: 10%;"></td> <td style="width: 10%;"></td> </tr> <tr> <td></td> <td></td> <td colspan="8" style="text-align: center;"> <table border="1" style="width: 100%; border-collapse: collapse; text-align: center;"> <tr> <td style="width: 10%;"></td> <td style="width: 10%;"></td> <td style="width: 10%;"></td> <td style="width: 10%;"></td> <td style="width: 10%;"></td> <td style="width: 10%;"></td> <td style="width: 10%;"></td> <td style="width: 10%;"></td> <td style="width: 10%;"></td> <td style="width: 10%;"></td> </tr> <tr> <td></td> <td></td> <td colspan="8" style="text-align: center;"> <table border="1" style="width: 100%; border-collapse: collapse; text-align: center;"> <tr> <td style="width: 10%;"></td> <td style="width: 10%;"></td> <td style="width: 10%;"></td> <td style="width: 10%;"></td> <td style="width: 10%;"></td> <td style="width: 10%;"></td> <td style="width: 10%;"></td> <td style="width: 10%;"></td> <td style="width: 10%;"></td> <td style="width: 10%;"></td> </tr> <tr> <td></td> <td></td> <td colspan="8" style="text-align: center;"> <table border="1" style="width: 100%; border-collapse: collapse; text-align: center;"> <tr> <td style="width: 10%;"></td> <td style="width: 10%;"></td> <td style="width: 10%;"></td> <td style="width: 10%;"></td> <td style="width: 10%;"></td> <td style="width: 10%;"></td> <td style="width: 10%;"></td> <td style="width: 10%;"></td> <td style="width: 10%;"></td> <td style="width: 10%;"></td> </tr> <tr> <td></td> <td></td> <td colspan="8" style="text-align: center;"> <table border="1" style="width: 100%; border-collapse: collapse; text-align: center;"> <tr> <td style="width: 10%;"></td> <td style="width: 10%;"></td> <td style="width: 10%;"></td> <td style="width: 10%;"></td> <td style="width: 10%;"></td> <td style="width: 10%;"></td> <td style="width: 10%;"></td> <td style="width: 10%;"></td> <td style="width: 10%;"></td> <td style="width: 10%;"></td> </tr> <tr> <td></td> <td></td> <td colspan="8" style="text-align: center;"> <table border="1" style="width: 100%; border-collapse: collapse; text-align: center;"> <tr> <td style="width: 10%;"></td> <td style="width: 10%;"></td> <td style="width: 10%;"></td> <td style="width: 10%;"></td> <td style="width: 10%;"></td> <td style="width: 10%;"></td> <td style="width: 10%;"></td> <td style="width: 10%;"></td> <td style="width: 10%;"></td> <td style="width: 10%;"></td> </tr> <tr> <td></td> <td></td> <td colspan="8" style="text-align: center;"> <table border="1" style="width: 100%; border-collapse: collapse; text-align: center;"> <tr> <td style="width: 10%;"></td> <td style="width: 10%;"></td> <td style="width: 10%;"></td> <td style="width: 10%;"></td> <td style="width: 10%;"></td> <td style="width: 10%;"></td> <td style="width: 10%;"></td> <td style="width: 10%;"></td> <td style="width: 10%;"></td> <td style="width: 10%;"></td> </tr> <tr> <td></td> <td></td> <td colspan="8" style="text-align: center;"> <table border="1" style="width: 100%; border-collapse: collapse; text-align: center;"> <tr> <td style="width: 10%;"></td> <td style="width: 10%;"></td> <td style="width: 10%;"></td> <td style="width: 10%;"></td> <td style="width: 10%;"></td> <td style="width: 10%;"></td> <td style="width: 10%;"></td> <td style="width: 10%;"></td> <td style="width: 10%;"></td> <td style="width: 10%;"></td> </tr> <tr> <td></td> <td></td> <td colspan="8" style="text-align: center;"> <table border="1" style="width: 100%; border-collapse: collapse; text-align: center;"> <tr> <td style="width: 10%;"></td> <td style="width: 10%;"></td> <td style="width: 10%;"></td> <td style="width: 10%;"></td> <td style="width: 10%;"></td> <td style="width: 10%;"></td> <td style="width: 10%;"></td> <td style="width: 10%;"></td> <td style="width: 10%;"></td> <td style="width: 10%;"></td> </tr> <tr> <td></td> <td></td> <td colspan="8" style="text-align: center;"> <table border="1" style="width: 100%; border-collapse: collapse; text-align: center;"> <tr> <td style="width: 10%;"></td> <td style="width: 10%;"></td> <td style="width: 10%;"></td> <td style="width: 10%;"></td> <td style="width: 10%;"></td> <td style="width: 10%;"></td> <td style="width: 10%;"></td> <td style="width: 10%;"></td> <td style="width: 10%;"></td> <td style="width: 10%;"></td> </tr> <tr> <td></td> <td></td> <td colspan="8" style="text-align: center;"> <table border="1" style="width: 100%; border-collapse: collapse; text-align: center;"> <tr> <td style="width: 10%;"></td> <td style="width: 10%;"></td> <td style="width: 10%;"></td> <td style="width: 10%;"></td> <td style="width: 10%;"></td> <td style="width: 10%;"></td> <td style="width: 10%;"></td> <td style="width: 10%;"></td> <td style="width: 10%;"></td> <td style="width: 10%;"></td> </tr> <tr> <td></td> <td></td> <td colspan="8" style="text-align: center;"> <table border="1" style="width: 100%; border-collapse: collapse; text-align: center;"> <tr> <td style="width: 10%;"></td> <td style="width: 10%;"></td> <td style="width: 10%;"></td> <td style="width: 10%;"></td> <td style="width: 10%;"></td> <td style="width:
10%;"></td> <td style="width: 10%;"></td> <td style="width: 10%;"></td> <td style="width: 10%;"></td> <td style="width: 10%;"></td> </tr> <tr> <td></td> <td></td> <td colspan="8" style="text-align: center;"> <table border="1" style="width: 100%; border-collapse: collapse; text-align: center;"> <tr> <td style="width: 10%;"></td> <td style="width: 10%;"></td> <td style="width: 10%;"></td> <td style="width: 10%;"></td> <td style="width: 10%;"></td> <td style="width: 10%;"></td> <td style="width: 10%;"></td> <td style="width: 10%;"></td> <td style="width: 10%;"></td> <td style="width: 10%;"></td> </tr> <tr> <td></td> <td></td> <td colspan="8" style="text-align: center;"> <table border="1" style="width: 100%; border-collapse: collapse; text-align: center;"> <tr> </tr></table></td></tr></table></td></tr></table></td></tr></table></td></tr></table></td></tr></table></td></tr></table></td></tr></table></td></tr></table></td></tr></table></td></tr></table></td></tr></table></td></tr></table></td></tr></table></td></tr></table></td></tr></table></td></tr></table></td></tr></table></td></tr></table></td></tr></table></td></tr></table>
 | | | | | | | | | | | | | | | | | | | | <table border="1" style="width: 100%; border-collapse: collapse; text-align: center;"> <tr> <td style="width: 10%;"></td> <td style="width: 10%;"></td> <td style="width: 10%;"></td> <td style="width: 10%;"></td> <td style="width: 10%;"></td> <td style="width: 10%;"></td> <td style="width: 10%;"></td> <td style="width: 10%;"></td> <td style="width: 10%;"></td> <td style="width: 10%;"></td> </tr> <tr> <td></td> <td></td> <td colspan="8" style="text-align: center;"> <table border="1" style="width: 100%; border-collapse: collapse; text-align: center;"> <tr> <td style="width: 10%;"></td> <td style="width: 10%;"></td> <td style="width: 10%;"></td> <td style="width: 10%;"></td> <td style="width: 10%;"></td> <td style="width: 10%;"></td> <td style="width: 10%;"></td> <td style="width: 10%;"></td> <td style="width: 10%;"></td> <td style="width: 10%;"></td> </tr> <tr> <td></td> <td></td> <td colspan="8" style="text-align: center;"> <table border="1" style="width: 100%; border-collapse: collapse; text-align: center;"> <tr> <td style="width: 10%;"></td> <td style="width: 10%;"></td> <td style="width: 10%;"></td> <td style="width: 10%;"></td> <td style="width: 10%;"></td> <td style="width: 10%;"></td> <td style="width: 10%;"></td> <td style="width: 10%;"></td> <td style="width: 10%;"></td> <td style="width: 10%;"></td> </tr> <tr> <td></td> <td></td> <td colspan="8" style="text-align: center;"> <table border="1" style="width: 100%; border-collapse: collapse; text-align: center;"> <tr> <td style="width: 10%;"></td> <td style="width: 10%;"></td> <td style="width: 10%;"></td> <td style="width: 10%;"></td> <td style="width: 10%;"></td> <td style="width: 10%;"></td> <td style="width: 10%;"></td> <td style="width: 10%;"></td> <td style="width: 10%;"></td> <td style="width: 10%;"></td> </tr> <tr> <td></td> <td></td> <td colspan="8" style="text-align: center;"> <table border="1" style="width: 100%; border-collapse: collapse; text-align: center;"> <tr> <td style="width: 10%;"></td> <td style="width: 10%;"></td> <td style="width: 10%;"></td> <td style="width: 10%;"></td> <td style="width: 10%;"></td> <td style="width: 10%;"></td> <td style="width: 10%;"></td> <td style="width: 10%;"></td> <td style="width: 10%;"></td> <td style="width: 10%;"></td> </tr> <tr>
<td></td> <td></td> <td colspan="8" style="text-align: center;"> <table border="1" style="width: 100%; border-collapse: collapse; text-align: center;"> <tr> <td style="width: 10%;"></td> <td style="width: 10%;"></td> <td style="width: 10%;"></td> <td style="width: 10%;"></td> <td style="width: 10%;"></td> <td style="width: 10%;"></td> <td style="width: 10%;"></td> <td style="width: 10%;"></td> <td style="width: 10%;"></td> <td style="width: 10%;"></td> </tr> <tr> <td></td> <td></td> <td colspan="8" style="text-align: center;"> <table border="1" style="width: 100%; border-collapse: collapse; text-align: center;"> <tr> <td style="width: 10%;"></td> <td style="width: 10%;"></td> <td style="width: 10%;"></td> <td style="width: 10%;"></td> <td style="width: 10%;"></td> <td style="width: 10%;"></td> <td style="width: 10%;"></td> <td style="width: 10%;"></td> <td style="width: 10%;"></td> <td style="width: 10%;"></td> </tr> <tr> <td></td> <td></td> <td colspan="8" style="text-align: center;"> <table border="1" style="width: 100%; border-collapse: collapse; text-align: center;"> <tr> <td style="width: 10%;"></td> <td style="width: 10%;"></td> <td style="width: 10%;"></td> <td style="width: 10%;"></td> <td style="width: 10%;"></td> <td style="width: 10%;"></td> <td style="width: 10%;"></td> <td style="width: 10%;"></td> <td style="width: 10%;"></td> <td style="width: 10%;"></td> </tr> <tr> <td></td> <td></td> <td colspan="8" style="text-align: center;"> <table border="1" style="width: 100%; border-collapse: collapse; text-align: center;"> <tr> <td style="width: 10%;"></td> <td style="width: 10%;"></td> <td style="width: 10%;"></td> <td style="width: 10%;"></td> <td style="width: 10%;"></td> <td style="width: 10%;"></td> <td style="width: 10%;"></td> <td style="width: 10%;"></td> <td style="width: 10%;"></td> <td style="width: 10%;"></td> </tr> <tr> <td></td> <td></td> <td colspan="8" style="text-align: center;"> <table border="1" style="width: 100%; border-collapse: collapse; text-align: center;"> <tr> <td style="width: 10%;"></td> <td style="width: 10%;"></td> <td style="width: 10%;"></td> <td style="width: 10%;"></td> <td style="width: 10%;"></td> <td style="width: 10%;"></td> <td style="width: 10%;"></td> <td style="width: 10%;"></td> <td style="width: 10%;"></td> <td style="width: 10%;"></td> </tr> <tr> <td></td> <td></td> <td colspan="8" style="text-align: center;"> <table border="1" style="width: 100%; border-collapse: collapse; text-align: center;"> <tr> <td style="width: 10%;"></td> <td style="width: 10%;"></td> <td style="width: 10%;"></td> <td style="width: 10%;"></td> <td style="width: 10%;"></td> <td style="width: 10%;"></td> <td style="width: 10%;"></td> <td style="width: 10%;"></td> <td style="width: 10%;"></td> <td style="width: 10%;"></td> </tr> <tr> <td></td> <td></td> <td colspan="8" style="text-align: center;"> <table border="1" style="width: 100%; border-collapse: collapse; text-align: center;"> <tr> <td style="width: 10%;"></td> <td style="width: 10%;"></td> <td style="width: 10%;"></td> <td style="width: 10%;"></td> <td style="width: 10%;"></td> <td style="width: 10%;"></td> <td style="width: 10%;"></td> <td style="width: 10%;"></td> <td style="width: 10%;"></td> <td style="width: 10%;"></td> </tr> <tr> <td></td> <td></td> <td colspan="8" style="text-align: center;"> <table border="1" style="width: 100%; border-collapse: collapse; text-align: center;"> <tr> <td style="width: 10%;"></td> <td style="width: 10%;"></td> <td style="width: 10%;"></td> <td style="width: 10%;"></td> <td style="width: 10%;"></td> <td style="width: 10%;"></td> <td style="width: 10%;"></td> <td style="width: 10%;"></td> <td style="width: 10%;"></td> <td style="width: 10%;"></td> </tr> <tr> <td></td> <td></td> <td colspan="8" style="text-align: center;"> <table border="1" style="width: 100%; border-collapse: collapse; text-align: center;"> <tr> <td style="width: 10%;"></td> <td style="width: 10%;"></td> <td style="width: 10%;"></td> <td style="width: 10%;"></td> <td style="width: 10%;"></td> <td style="width: 10%;"></td> <td style="width: 10%;"></td> <td style="width: 10%;"></td> <td style="width: 10%;"></td> <td style="width: 10%;"></td> </tr> <tr> <td></td> <td></td> <td colspan="8" style="text-align: center;"> <table border="1" style="width: 100%; border-collapse: collapse; text-align: center;"> <tr> <td style="width: 10%;"></td> <td style="width: 10%;"></td> <td style="width: 10%;"></td> <td style="width: 10%;"></td> <td style="width: 10%;"></td> <td style="width: 10%;"></td> <td style="width: 10%;"></td> <td style="width: 10%;"></td> <td style="width: 10%;"></td> <td style="width: 10%;"></td> </tr> <tr> <td></td> <td></td> <td colspan="8" style="text-align: center;"> <table border="1" style="width: 100%; border-collapse: collapse; text-align: center;"> <tr> <td style="width: 10%;"></td> <td style="width: 10%;"></td> <td style="width: 10%;"></td> <td style="width: 10%;"></td> <td style="width: 10%;"></td> <td style="width: 10%;"></td> <td style="width: 10%;"></td> <td style="width: 10%;"></td> <td style="width: 10%;"></td> <td style="width: 10%;"></td> </tr> <tr> <td></td> <td></td> <td colspan="8" style="text-align: center;"> <table border="1" style="width: 100%; border-collapse: collapse; text-align: center;"> <tr> <td style="width: 10%;"></td> <td style="width: 10%;"></td> <td style="width: 10%;"></td> <td style="width: 10%;"></td> <td style="width: 10%;"></td> <td style="width: 10%;"></td> <td style="width: 10%;"></td> <td style="width: 10%;"></td> <td style="width: 10%;"></td> <td style="width: 10%;"></td> </tr> <tr> <td></td> <td></td> <td colspan="8" style="text-align: center;"> <table border="1" style="width: 100%; border-collapse: collapse; text-align: center;"> <tr> <td style="width: 10%;"></td> <td style="width: 10%;"></td> <td style="width: 10%;"></td> <td style="width: 10%;"></td> <td style="width: 10%;"></td> <td style="width: 10%;"></td> <td style="width: 10%;"></td> <td style="width: 10%;"></td> <td style="width: 10%;"></td> <td style="width: 10%;"></td> </tr> <tr> <td></td> <td></td> <td colspan="8" style="text-align: center;"> <table border="1" style="width: 100%; border-collapse: collapse; text-align: center;"> <tr> <td style="width: 10%;"></td> <td style="width: 10%;"></td> <td style="width: 10%;"></td> <td style="width: 10%;"></td> <td style="width: 10%;"></td> <td style="width: 10%;"></td> <td style="width: 10%;"></td> <td style="width: 10%;"></td> <td style="width: 10%;"></td> <td style="width: 10%;"></td> </tr> <tr> <td></td> <td></td> <td colspan="8" style="text-align: center;"> <table border="1" style="width: 100%; border-collapse: collapse; text-align: center;"> <tr> </tr></table></td></tr></table></td></tr></table></td></tr></table></td></tr></table></td></tr></table></td></tr></table></td></tr></table></td></tr></table></td></tr></table></td></tr></table></td></tr></table></td></tr></table></td></tr></table></td></tr></table></td></tr></table></td></tr></table></td></tr></table></td></tr></table></td></tr></table>

 | | | | | | | | | | | | | | | | | | | | <table border="1" style="width: 100%; border-collapse: collapse; text-align: center;"> <tr> <td style="width: 10%;"></td> <td style="width: 10%;"></td> <td style="width: 10%;"></td> <td style="width: 10%;"></td> <td style="width: 10%;"></td> <td style="width: 10%;"></td> <td style="width: 10%;"></td> <td style="width: 10%;"></td> <td style="width: 10%;"></td> <td style="width: 10%;"></td> </tr> <tr> <td></td> <td></td> <td colspan="8" style="text-align: center;"> <table border="1" style="width: 100%; border-collapse: collapse; text-align: center;"> <tr> <td style="width: 10%;"></td> <td style="width: 10%;"></td> <td style="width: 10%;"></td> <td style="width: 10%;"></td> <td style="width: 10%;"></td> <td style="width: 10%;"></td> <td style="width: 10%;"></td> <td style="width: 10%;"></td> <td style="width: 10%;"></td> <td style="width: 10%;"></td> </tr> <tr> <td></td> <td></td> <td colspan="8" style="text-align: center;"> <table border="1" style="width: 100%; border-collapse: collapse; text-align: center;"> <tr> <td style="width: 10%;"></td> <td style="width: 10%;"></td> <td style="width: 10%;"></td> <td style="width: 10%;"></td> <td style="width: 10%;"></td> <td style="width: 10%;"></td> <td style="width: 10%;"></td> <td style="width: 10%;"></td> <td style="width: 10%;"></td> <td style="width: 10%;"></td> </tr> <tr> <td></td> <td></td> <td colspan="8" style="text-align: center;"> <table border="1" style="width: 100%; border-collapse: collapse; text-align: center;"> <tr> <td style="width: 10%;"></td> <td style="width: 10%;"></td> <td style="width: 10%;"></td> <td style="width: 10%;"></td> <td style="width: 10%;"></td> <td style="width: 10%;"></td> <td style="width: 10%;"></td> <td style="width: 10%;"></td> <td style="width: 10%;"></td> <td style="width: 10%;"></td> </tr> <tr> <td></td> <td></td> <td colspan="8" style="text-align: center;"> <table border="1" style="width: 100%; border-collapse: collapse; text-align: center;"> <tr> <td style="width: 10%;"></td> <td style="width: 10%;"></td> <td style="width: 10%;"></td> <td style="width: 10%;"></td> <td style="width: 10%;"></td> <td style="width: 10%;"></td> <td style="width: 10%;"></td> <td style="width: 10%;"></td> <td style="width: 10%;"></td> <td style="width: 10%;"></td> </tr> <tr> <td></td> <td></td> <td colspan="8" style="text-align: center;"> <table border="1" style="width: 100%; border-collapse: collapse; text-align: center;"> <tr> <td style="width: 10%;"></td> <td style="width: 10%;"></td> <td style="width: 10%;"></td> <td style="width: 10%;"></td> <td style="width: 10%;"></td> <td style="width: 10%;"></td> <td style="width: 10%;"></td> <td style="width: 10%;"></td> <td style="width: 10%;"></td> <td style="width: 10%;"></td> </tr> <tr> <td></td> <td></td> <td colspan="8" style="text-align: center;"> <table border="1" style="width: 100%; border-collapse: collapse; text-align: center;"> <tr> <td style="width: 10%;"></td> <td style="width: 10%;"></td> <td style="width: 10%;"></td> <td style="width: 10%;"></td> <td style="width: 10%;"></td> <td style="width: 10%;"></td> <td style="width: 10%;"></td> <td style="width: 10%;"></td> <td style="width: 10%;"></td> <td style="width: 10%;"></td> </tr> <tr> <td></td> <td></td> <td colspan="8" style="text-align: center;"> <table border="1" style="width: 100%; border-collapse: collapse; text-align: center;"> <tr> <td style="width: 10%;"></td> <td style="width: 10%;"></td> <td style="width: 10%;"></td> <td style="width: 10%;"></td> <td style="width: 10%;"></td> <td style="width: 10%;"></td> <td style="width: 10%;"></td> <td style="width: 10%;"></td> <td style="width: 10%;"></td> <td style="width: 10%;"></td> </tr> <tr> <td></td> <td></td> <td colspan="8" style="text-align: center;"> <table border="1" style="width: 100%; border-collapse: collapse; text-align: center;"> <tr> <td style="width: 10%;"></td> <td style="width: 10%;"></td> <td style="width: 10%;"></td> <td style="width: 10%;"></td> <td style="width: 10%;"></td> <td style="width: 10%;"></td> <td style="width: 10%;"></td> <td style="width: 10%;"></td> <td style="width: 10%;"></td> <td style="width: 10%;"></td> </tr> <tr> <td></td> <td></td> <td colspan="8" style="text-align: center;"> <table border="1" style="width: 100%; border-collapse: collapse; text-align: center;"> <tr> <td style="width: 10%;"></td> <td style="width: 10%;"></td> <td style="width: 10%;"></td> <td style="width: 10%;"></td> <td style="width: 10%;"></td> <td style="width: 10%;"></td> <td style="width: 10%;"></td> <td style="width: 10%;"></td> <td style="width: 10%;"></td> <td style="width: 10%;"></td> </tr> <tr> <td></td> <td></td> <td colspan="8" style="text-align: center;"> <table border="1" style="width: 100%; border-collapse: collapse; text-align: center;"> <tr> <td style="width: 10%;"></td> <td style="width: 10%;"></td> <td style="width: 10%;"></td> <td style="width: 10%;"></td> <td style="width: 10%;"></td> <td style="width: 10%;"></td> <td style="width: 10%;"></td> <td style="width: 10%;"></td> <td style="width: 10%;"></td> <td style="width: 10%;"></td> </tr> <tr> <td></td> <td></td> <td colspan="8" style="text-align: center;"> <table border="1" style="width: 100%; border-collapse: collapse; text-align: center;"> <tr> <td style="width: 10%;"></td> <td style="width: 10%;"></td> <td style="width: 10%;"></td> <td style="width: 10%;"></td> <td style="width: 10%;"></td> <td style="width: 10%;"></td> <td style="width: 10%;"></td> <td style="width: 10%;"></td> <td style="width: 10%;"></td> <td style="width: 10%;"></td> </tr> <tr> <td></td> <td></td> <td colspan="8" style="text-align: center;"> <table border="1" style="width: 100%; border-collapse: collapse; text-align: center;"> <tr> <td style="width: 10%;"></td> <td style="width: 10%;"></td> <td style="width: 10%;"></td> <td style="width: 10%;"></td> <td style="width: 10%;"></td> <td style="width: 10%;"></td> <td style="width: 10%;"></td> <td style="width: 10%;"></td> <td style="width: 10%;"></td> <td style="width: 10%;"></td> </tr> <tr> <td></td> <td></td> <td colspan="8" style="text-align: center;"> <table border="1" style="width: 100%; border-collapse: collapse; text-align: center;"> <tr> <td style="width: 10%;"></td> <td style="width: 10%;"></td> <td style="width: 10%;"></td> <td style="width: 10%;"></td> <td style="width: 10%;"></td> <td style="width:
10%;"></td> <td style="width: 10%;"></td> <td style="width: 10%;"></td> <td style="width: 10%;"></td> <td style="width: 10%;"></td> </tr> <tr> <td></td> <td></td> <td colspan="8" style="text-align: center;"> <table border="1" style="width: 100%; border-collapse: collapse; text-align: center;"> <tr> <td style="width: 10%;"></td> <td style="width: 10%;"></td> <td style="width: 10%;"></td> <td style="width: 10%;"></td> <td style="width: 10%;"></td> <td style="width: 10%;"></td> <td style="width: 10%;"></td> <td style="width: 10%;"></td> <td style="width: 10%;"></td> <td style="width: 10%;"></td> </tr> <tr> <td></td> <td></td> <td colspan="8" style="text-align: center;"> <table border="1" style="width: 100%; border-collapse: collapse; text-align: center;"> <tr> <td style="width: 10%;"></td> <td style="width: 10%;"></td> <td style="width: 10%;"></td> <td style="width: 10%;"></td> <td style="width: 10%;"></td> <td style="width: 10%;"></td> <td style="width: 10%;"></td> <td style="width: 10%;"></td> <td style="width: 10%;"></td> <td style="width: 10%;"></td> </tr> <tr> <td></td> <td></td> <td colspan="8" style="text-align: center;"> <table border="1" style="width: 100%; border-collapse: collapse; text-align: center;"> <tr> <td style="width: 10%;"></td> <td style="width: 10%;"></td> <td style="width: 10%;"></td> <td style="width: 10%;"></td> <td style="width: 10%;"></td> <td style="width: 10%;"></td> <td style="width: 10%;"></td> <td style="width: 10%;"></td> <td style="width: 10%;"></td> <td style="width: 10%;"></td> </tr> <tr> <td></td> <td></td> <td colspan="8" style="text-align: center;"> <table border="1" style="width: 100%; border-collapse: collapse; text-align: center;"> <tr> <td style="width: 10%;"></td> <td style="width: 10%;"></td> <td style="width: 10%;"></td> <td style="width: 10%;"></td> <td style="width: 10%;"></td> <td style="width: 10%;"></td> <td style="width: 10%;"></td> <td style="width: 10%;"></td> <td style="width: 10%;"></td> <td style="width: 10%;"></td> </tr> <tr> <td></td> <td></td> <td colspan="8" style="text-align: center;"> <table border="1" style="width: 100%; border-collapse: collapse; text-align: center;"> <tr> </tr></table></td></tr></table></td></tr></table></td></tr></table></td></tr></table></td></tr></table></td></tr></table></td></tr></table></td></tr></table></td></tr></table></td></tr></table></td></tr></table></td></tr></table></td></tr></table></td></tr></table></td></tr></table></td></tr></table></td></tr></table></td></tr></table>
 | | | | | | | | | | | | | | | | | | | | <table border="1" style="width: 100%; border-collapse: collapse; text-align: center;"> <tr> <td style="width: 10%;"></td> <td style="width: 10%;"></td> <td style="width: 10%;"></td> <td style="width: 10%;"></td> <td style="width: 10%;"></td> <td style="width: 10%;"></td> <td style="width: 10%;"></td> <td style="width: 10%;"></td> <td style="width: 10%;"></td> <td style="width: 10%;"></td> </tr> <tr> <td></td> <td></td> <td colspan="8" style="text-align: center;"> <table border="1" style="width: 100%; border-collapse: collapse; text-align: center;"> <tr> <td style="width: 10%;"></td> <td style="width: 10%;"></td> <td style="width: 10%;"></td> <td style="width: 10%;"></td> <td style="width: 10%;"></td> <td style="width: 10%;"></td> <td style="width: 10%;"></td> <td style="width: 10%;"></td> <td style="width: 10%;"></td> <td style="width: 10%;"></td> </tr> <tr> <td></td> <td></td> <td colspan="8"
style="text-align: center;"> <table border="1" style="width: 100%; border-collapse: collapse; text-align: center;"> <tr> <td style="width: 10%;"></td> <td style="width: 10%;"></td> <td style="width: 10%;"></td> <td style="width: 10%;"></td> <td style="width: 10%;"></td> <td style="width: 10%;"></td> <td style="width: 10%;"></td> <td style="width: 10%;"></td> <td style="width: 10%;"></td> <td style="width: 10%;"></td> </tr> <tr> <td></td> <td></td> <td colspan="8" style="text-align: center;"> <table border="1" style="width: 100%; border-collapse: collapse; text-align: center;"> <tr> <td style="width: 10%;"></td> <td style="width: 10%;"></td> <td style="width: 10%;"></td> <td style="width: 10%;"></td> <td style="width: 10%;"></td> <td style="width: 10%;"></td> <td style="width: 10%;"></td> <td style="width: 10%;"></td> <td style="width: 10%;"></td> <td style="width: 10%;"></td> </tr> <tr> <td></td> <td></td> <td colspan="8" style="text-align: center;"> <table border="1" style="width: 100%; border-collapse: collapse; text-align: center;"> <tr> <td style="width: 10%;"></td> <td style="width: 10%;"></td> <td style="width: 10%;"></td> <td style="width: 10%;"></td> <td style="width: 10%;"></td> <td style="width: 10%;"></td> <td style="width: 10%;"></td> <td style="width: 10%;"></td> <td style="width: 10%;"></td> <td style="width: 10%;"></td> </tr> <tr> <td></td> <td></td> <td colspan="8" style="text-align: center;"> <table border="1" style="width: 100%; border-collapse: collapse; text-align: center;"> <tr> <td style="width: 10%;"></td> <td style="width: 10%;"></td> <td style="width: 10%;"></td> <td style="width: 10%;"></td> <td style="width: 10%;"></td> <td style="width: 10%;"></td> <td style="width: 10%;"></td> <td style="width: 10%;"></td> <td style="width: 10%;"></td> <td style="width: 10%;"></td> </tr> <tr> <td></td> <td></td> <td colspan="8" style="text-align: center;"> <table border="1" style="width: 100%; border-collapse: collapse; text-align: center;"> <tr> <td style="width: 10%;"></td> <td style="width: 10%;"></td> <td style="width: 10%;"></td> <td style="width: 10%;"></td> <td style="width: 10%;"></td> <td style="width: 10%;"></td> <td style="width: 10%;"></td> <td style="width: 10%;"></td> <td style="width: 10%;"></td> <td style="width: 10%;"></td> </tr> <tr> <td></td> <td></td> <td colspan="8" style="text-align: center;"> <table border="1" style="width: 100%; border-collapse: collapse; text-align: center;"> <tr> <td style="width: 10%;"></td> <td style="width: 10%;"></td> <td style="width: 10%;"></td> <td style="width: 10%;"></td> <td style="width: 10%;"></td> <td style="width: 10%;"></td> <td style="width: 10%;"></td> <td style="width: 10%;"></td> <td style="width: 10%;"></td> <td style="width: 10%;"></td> </tr> <tr> <td></td> <td></td> <td colspan="8" style="text-align: center;"> <table border="1" style="width: 100%; border-collapse: collapse; text-align: center;"> <tr> <td style="width: 10%;"></td> <td style="width: 10%;"></td> <td style="width: 10%;"></td> <td style="width: 10%;"></td> <td style="width: 10%;"></td> <td style="width: 10%;"></td> <td style="width: 10%;"></td> <td style="width: 10%;"></td> <td style="width: 10%;"></td> <td style="width: 10%;"></td> </tr> <tr> <td></td> <td></td> <td colspan="8" style="text-align: center;"> <table border="1" style="width: 100%; border-collapse: collapse; text-align: center;"> <tr> <td style="width: 10%;"></td> <td style="width: 10%;"></td> <td style="width: 10%;"></td> <td style="width: 10%;"></td> <td style="width: 10%;"></td> <td style="width: 10%;"></td> <td style="width: 10%;"></td> <td style="width: 10%;"></td> <td style="width: 10%;"></td> <td style="width: 10%;"></td> </tr> <tr> <td></td> <td></td> <td colspan="8" style="text-align: center;"> <table border="1" style="width: 100%; border-collapse: collapse; text-align: center;"> <tr> <td style="width: 10%;"></td> <td style="width: 10%;"></td> <td style="width: 10%;"></td> <td style="width: 10%;"></td> <td style="width: 10%;"></td> <td style="width: 10%;"></td> <td style="width: 10%;"></td> <td style="width: 10%;"></td> <td style="width: 10%;"></td> <td style="width: 10%;"></td> </tr> <tr> <td></td> <td></td> <td colspan="8" style="text-align: center;"> <table border="1" style="width: 100%; border-collapse: collapse; text-align: center;"> <tr> <td style="width: 10%;"></td> <td style="width: 10%;"></td> <td style="width: 10%;"></td> <td style="width: 10%;"></td> <td style="width: 10%;"></td> <td style="width: 10%;"></td> <td style="width: 10%;"></td> <td style="width: 10%;"></td> <td style="width: 10%;"></td> <td style="width: 10%;"></td> </tr> <tr> <td></td> <td></td> <td colspan="8" style="text-align: center;"> <table border="1" style="width: 100%; border-collapse: collapse; text-align: center;"> <tr> <td style="width: 10%;"></td> <td style="width: 10%;"></td> <td style="width: 10%;"></td> <td style="width: 10%;"></td> <td style="width: 10%;"></td> <td style="width: 10%;"></td> <td style="width: 10%;"></td> <td style="width: 10%;"></td> <td style="width: 10%;"></td> <td style="width: 10%;"></td> </tr> <tr> <td></td> <td></td> <td colspan="8" style="text-align: center;"> <table border="1" style="width: 100%; border-collapse: collapse; text-align: center;"> <tr> <td style="width: 10%;"></td> <td style="width: 10%;"></td> <td style="width: 10%;"></td> <td style="width: 10%;"></td> <td style="width: 10%;"></td> <td style="width: 10%;"></td> <td style="width: 10%;"></td> <td style="width: 10%;"></td> <td style="width: 10%;"></td> <td style="width: 10%;"></td> </tr> <tr> <td></td> <td></td> <td colspan="8" style="text-align: center;"> <table border="1" style="width: 100%; border-collapse: collapse; text-align: center;"> <tr> <td style="width: 10%;"></td> <td style="width: 10%;"></td> <td style="width: 10%;"></td> <td style="width: 10%;"></td> <td style="width: 10%;"></td> <td style="width: 10%;"></td> <td style="width: 10%;"></td> <td style="width: 10%;"></td> <td style="width: 10%;"></td> <td style="width: 10%;"></td> </tr> <tr> <td></td> <td></td> <td colspan="8" style="text-align: center;"> <table border="1" style="width: 100%; border-collapse: collapse; text-align: center;"> <tr> <td style="width: 10%;"></td> <td style="width: 10%;"></td> <td style="width: 10%;"></td> <td style="width: 10%;"></td> <td style="width: 10%;"></td> <td style="width: 10%;"></td> <td style="width: 10%;"></td> <td style="width: 10%;"></td> <td style="width: 10%;"></td> <td style="width: 10%;"></td> </tr> <tr> <td></td> <td></td> <td colspan="8" style="text-align: center;"> <table border="1" style="width: 100%; border-collapse: collapse; text-align: center;"> <tr> <td style="width: 10%;"></td> <td style="width: 10%;"></td> <td style="width: 10%;"></td> <td style="width: 10%;"></td> <td style="width: 10%;"></td> <td style="width: 10%;"></td> <td style="width: 10%;"></td> <td style="width: 10%;"></td> <td style="width: 10%;"></td> <td style="width: 10%;"></td> </tr> <tr> <td></td> <td></td> <td colspan="8" style="text-align: center;"> <table border="1" style="width: 100%; border-collapse: collapse; text-align: center;"> <tr> </tr></table></td></tr></table></td></tr></table></td></tr></table></td></tr></table></td></tr></table></td></tr></table></td></tr></table></td></tr></table></td></tr></table></td></tr></table></td></tr></table></td></tr></table></td></tr></table></td></tr></table></td></tr></table></td></tr></table></td></tr></table>

 | | | | | | | | | | | | | | | | | | | | <table border="1" style="width: 100%; border-collapse: collapse; text-align: center;"> <tr> <td style="width: 10%;"></td> <td style="width: 10%;"></td> <td style="width: 10%;"></td> <td style="width: 10%;"></td> <td style="width: 10%;"></td> <td style="width: 10%;"></td> <td style="width: 10%;"></td> <td style="width: 10%;"></td> <td style="width: 10%;"></td> <td style="width: 10%;"></td> </tr> <tr> <td></td> <td></td> <td colspan="8" style="text-align: center;"> <table border="1" style="width: 100%; border-collapse: collapse; text-align: center;"> <tr> <td style="width: 10%;"></td> <td style="width: 10%;"></td> <td style="width: 10%;"></td> <td style="width: 10%;"></td> <td style="width: 10%;"></td> <td style="width: 10%;"></td> <td style="width: 10%;"></td> <td style="width: 10%;"></td> <td style="width: 10%;"></td> <td style="width: 10%;"></td> </tr> <tr> <td></td> <td></td> <td colspan="8" style="text-align: center;"> <table border="1" style="width: 100%; border-collapse: collapse; text-align: center;"> <tr> <td style="width: 10%;"></td> <td style="width: 10%;"></td> <td style="width: 10%;"></td> <td style="width: 10%;"></td> <td style="width: 10%;"></td> <td style="width: 10%;"></td> <td style="width: 10%;"></td> <td style="width: 10%;"></td> <td style="width: 10%;"></td> <td style="width: 10%;"></td> </tr> <tr> <td></td> <td></td> <td colspan="8" style="text-align: center;"> <table border="1" style="width: 100%; border-collapse: collapse; text-align: center;"> <tr> <td style="width: 10%;"></td> <td style="width: 10%;"></td> <td style="width: 10%;"></td> <td style="width: 10%;"></td> <td style="width: 10%;"></td> <td style="width: 10%;"></td> <td style="width: 10%;"></td> <td style="width: 10%;"></td> <td style="width: 10%;"></td> <td style="width: 10%;"></td> </tr> <tr> <td></td> <td></td> <td colspan="8" style="text-align: center;"> <table border="1" style="width: 100%; border-collapse: collapse; text-align: center;"> <tr> <td style="width: 10%;"></td> <td style="width: 10%;"></td> <td style="width: 10%;"></td> <td style="width: 10%;"></td> <td style="width: 10%;"></td> <td style="width: 10%;"></td> <td style="width: 10%;"></td> <td style="width: 10%;"></td> <td style="width: 10%;"></td> <td style="width: 10%;"></td> </tr> <tr> <td></td> <td></td> <td colspan="8" style="text-align: center;"> <table border="1" style="width: 100%; border-collapse: collapse; text-align: center;"> <tr> <td style="width: 10%;"></td> <td style="width: 10%;"></td> <td style="width: 10%;"></td> <td style="width: 10%;"></td> <td style="width: 10%;"></td> <td style="width: 10%;"></td> <td style="width: 10%;"></td> <td style="width: 10%;"></td> <td style="width: 10%;"></td> <td style="width: 10%;"></td> </tr> <tr> <td></td> <td></td> <td colspan="8" style="text-align: center;"> <table border="1" style="width: 100%; border-collapse: collapse; text-align: center;"> <tr> <td style="width: 10%;"></td> <td style="width: 10%;"></td> <td style="width: 10%;"></td> <td style="width: 10%;"></td> <td style="width: 10%;"></td> <td style="width: 10%;"></td> <td style="width: 10%;"></td> <td style="width: 10%;"></td> <td style="width: 10%;"></td> <td style="width: 10%;"></td> </tr> <tr> <td></td> <td></td> <td colspan="8" style="text-align: center;"> <table border="1" style="width: 100%; border-collapse: collapse; text-align: center;"> <tr> <td style="width: 10%;"></td> <td style="width: 10%;"></td> <td style="width: 10%;"></td> <td style="width: 10%;"></td> <td style="width: 10%;"></td> <td style="width: 10%;"></td> <td style="width: 10%;"></td> <td style="width: 10%;"></td> <td style="width: 10%;"></td> <td style="width: 10%;"></td> </tr> <tr> <td></td> <td></td> <td colspan="8" style="text-align: center;"> <table border="1" style="width: 100%; border-collapse: collapse; text-align: center;"> <tr> <td style="width: 10%;"></td> <td style="width: 10%;"></td> <td style="width: 10%;"></td> <td style="width: 10%;"></td> <td style="width: 10%;"></td> <td style="width: 10%;"></td> <td style="width: 10%;"></td> <td style="width: 10%;"></td> <td style="width: 10%;"></td> <td style="width: 10%;"></td> </tr> <tr> <td></td> <td></td> <td colspan="8" style="text-align: center;"> <table border="1" style="width: 100%; border-collapse: collapse; text-align: center;"> <tr> <td style="width: 10%;"></td> <td style="width: 10%;"></td> <td style="width: 10%;"></td> <td style="width: 10%;"></td> <td style="width: 10%;"></td> <td style="width: 10%;"></td> <td style="width: 10%;"></td> <td style="width: 10%;"></td> <td style="width: 10%;"></td> <td style="width: 10%;"></td> </tr> <tr> <td></td> <td></td> <td colspan="8" style="text-align: center;"> <table border="1" style="width: 100%; border-collapse: collapse; text-align: center;"> <tr> <td style="width: 10%;"></td> <td style="width: 10%;"></td> <td style="width: 10%;"></td> <td style="width: 10%;"></td> <td style="width: 10%;"></td> <td style="width: 10%;"></td> <td style="width: 10%;"></td> <td style="width: 10%;"></td> <td style="width: 10%;"></td> <td style="width: 10%;"></td> </tr> <tr> <td></td> <td></td> <td colspan="8" style="text-align: center;"> <table border="1" style="width: 100%; border-collapse: collapse; text-align: center;"> <tr> <td style="width: 10%;"></td> <td style="width: 10%;"></td> <td style="width: 10%;"></td> <td style="width: 10%;"></td> <td style="width: 10%;"></td> <td style="width: 10%;"></td> <td style="width: 10%;"></td> <td style="width: 10%;"></td> <td style="width: 10%;"></td> <td style="width: 10%;"></td> </tr> <tr> <td></td> <td></td> <td colspan="8" style="text-align: center;"> <table border="1" style="width: 100%; border-collapse: collapse; text-align: center;"> <tr> <td style="width: 10%;"></td> <td style="width: 10%;"></td> <td style="width: 10%;"></td> <td style="width: 10%;"></td> <td style="width: 10%;"></td> <td style="width: 10%;"></td> <td style="width: 10%;"></td> <td style="width: 10%;"></td> <td
style="width: 10%;"></td> <td style="width: 10%;"></td> </tr> <tr> <td></td> <td></td> <td colspan="8" style="text-align: center;"> <table border="1" style="width: 100%; border-collapse: collapse; text-align: center;"> <tr> <td style="width: 10%;"></td> <td style="width: 10%;"></td> <td style="width: 10%;"></td> <td style="width: 10%;"></td> <td style="width: 10%;"></td> <td style="width: 10%;"></td> <td style="width: 10%;"></td> <td style="width: 10%;"></td> <td style="width: 10%;"></td> <td style="width: 10%;"></td> </tr> <tr> <td></td> <td></td> <td colspan="8" style="text-align: center;"> <table border="1" style="width: 100%; border-collapse: collapse; text-align: center;"> <tr> <td style="width: 10%;"></td> <td style="width: 10%;"></td> <td style="width: 10%;"></td> <td style="width: 10%;"></td> <td style="width: 10%;"></td> <td style="width: 10%;"></td> <td style="width: 10%;"></td> <td style="width: 10%;"></td> <td style="width: 10%;"></td> <td style="width: 10%;"></td> </tr> <tr> <td></td> <td></td> <td colspan="8" style="text-align: center;"> <table border="1" style="width: 100%; border-collapse: collapse; text-align: center;"> <tr> <td style="width: 10%;"></td> <td style="width: 10%;"></td> <td style="width: 10%;"></td> <td style="width: 10%;"></td> <td style="width: 10%;"></td> <td style="width: 10%;"></td> <td style="width: 10%;"></td> <td style="width: 10%;"></td> <td style="width: 10%;"></td> <td style="width: 10%;"></td> </tr> <tr> <td></td> <td></td> <td colspan="8" style="text-align: center;"> <table border="1" style="width: 100%; border-collapse: collapse; text-align: center;"> <tr> </tr></table></td></tr></table></td></tr></table></td></tr></table></td></tr></table></td></tr></table></td></tr></table></td></tr></table></td></tr></table></td></tr></table></td></tr></table></td></tr></table></td></tr></table></td></tr></table></td></tr></table></td></tr></table></td></tr></table>
 | | | | | | | | | | | | | | | | | | | | <table border="1" style="width: 100%; border-collapse: collapse; text-align: center;"> <tr> <td style="width: 10%;"></td> <td style="width: 10%;"></td> <td style="width: 10%;"></td> <td style="width: 10%;"></td> <td style="width: 10%;"></td> <td style="width: 10%;"></td> <td style="width: 10%;"></td> <td style="width: 10%;"></td> <td style="width: 10%;"></td> <td style="width: 10%;"></td> </tr> <tr> <td></td> <td></td> <td colspan="8" style="text-align: center;"> <table border="1" style="width: 100%; border-collapse: collapse; text-align: center;"> <tr> <td style="width: 10%;"></td> <td style="width: 10%;"></td> <td style="width: 10%;"></td> <td style="width: 10%;"></td> <td style="width: 10%;"></td> <td style="width: 10%;"></td> <td style="width: 10%;"></td> <td style="width: 10%;"></td> <td style="width: 10%;"></td> <td style="width: 10%;"></td> </tr> <tr> <td></td> <td></td> <td colspan="8" style="text-align: center;"> <table border="1" style="width: 100%; border-collapse: collapse; text-align: center;"> <tr> <td style="width: 10%;"></td> <td style="width: 10%;"></td> <td style="width: 10%;"></td> <td style="width: 10%;"></td> <td style="width: 10%;"></td> <td style="width: 10%;"></td> <td style="width: 10%;"></td> <td style="width: 10%;"></td> <td style="width: 10%;"></td> <td style="width: 10%;"></td> </tr> <tr> <td></td> <td></td> <td colspan="8" style="text-align: center;"> <table border="1" style="width: 100%; border-collapse: collapse; text-align:
center;"> <tr> <td style="width: 10%;"></td> <td style="width: 10%;"></td> <td style="width: 10%;"></td> <td style="width: 10%;"></td> <td style="width: 10%;"></td> <td style="width: 10%;"></td> <td style="width: 10%;"></td> <td style="width: 10%;"></td> <td style="width: 10%;"></td> <td style="width: 10%;"></td> </tr> <tr> <td></td> <td></td> <td colspan="8" style="text-align: center;"> <table border="1" style="width: 100%; border-collapse: collapse; text-align: center;"> <tr> <td style="width: 10%;"></td> <td style="width: 10%;"></td> <td style="width: 10%;"></td> <td style="width: 10%;"></td> <td style="width: 10%;"></td> <td style="width: 10%;"></td> <td style="width: 10%;"></td> <td style="width: 10%;"></td> <td style="width: 10%;"></td> <td style="width: 10%;"></td> </tr> <tr> <td></td> <td></td> <td colspan="8" style="text-align: center;"> <table border="1" style="width: 100%; border-collapse: collapse; text-align: center;"> <tr> <td style="width: 10%;"></td> <td style="width: 10%;"></td> <td style="width: 10%;"></td> <td style="width: 10%;"></td> <td style="width: 10%;"></td> <td style="width: 10%;"></td> <td style="width: 10%;"></td> <td style="width: 10%;"></td> <td style="width: 10%;"></td> <td style="width: 10%;"></td> </tr> <tr> <td></td> <td></td> <td colspan="8" style="text-align: center;"> <table border="1" style="width: 100%; border-collapse: collapse; text-align: center;"> <tr> <td style="width: 10%;"></td> <td style="width: 10%;"></td> <td style="width: 10%;"></td> <td style="width: 10%;"></td> <td style="width: 10%;"></td> <td style="width: 10%;"></td> <td style="width: 10%;"></td> <td style="width: 10%;"></td> <td style="width: 10%;"></td> <td style="width: 10%;"></td> </tr> <tr> <td></td> <td></td> <td colspan="8" style="text-align: center;"> <table border="1" style="width: 100%; border-collapse: collapse; text-align: center;"> <tr> <td style="width: 10%;"></td> <td style="width: 10%;"></td> <td style="width: 10%;"></td> <td style="width: 10%;"></td> <td style="width: 10%;"></td> <td style="width: 10%;"></td> <td style="width: 10%;"></td> <td style="width: 10%;"></td> <td style="width: 10%;"></td> <td style="width: 10%;"></td> </tr> <tr> <td></td> <td></td> <td colspan="8" style="text-align: center;"> <table border="1" style="width: 100%; border-collapse: collapse; text-align: center;"> <tr> <td style="width: 10%;"></td> <td style="width: 10%;"></td> <td style="width: 10%;"></td> <td style="width: 10%;"></td> <td style="width: 10%;"></td> <td style="width: 10%;"></td> <td style="width: 10%;"></td> <td style="width: 10%;"></td> <td style="width: 10%;"></td> <td style="width: 10%;"></td> </tr> <tr> <td></td> <td></td> <td colspan="8" style="text-align: center;"> <table border="1" style="width: 100%; border-collapse: collapse; text-align: center;"> <tr> <td style="width: 10%;"></td> <td style="width: 10%;"></td> <td style="width: 10%;"></td> <td style="width: 10%;"></td> <td style="width: 10%;"></td> <td style="width: 10%;"></td> <td style="width: 10%;"></td> <td style="width: 10%;"></td> <td style="width: 10%;"></td> <td style="width: 10%;"></td> </tr> <tr> <td></td> <td></td> <td colspan="8" style="text-align: center;"> <table border="1" style="width: 100%; border-collapse: collapse; text-align: center;"> <tr> <td style="width: 10%;"></td> <td style="width: 10%;"></td> <td style="width: 10%;"></td> <td style="width: 10%;"></td> <td style="width: 10%;"></td> <td style="width: 10%;"></td> <td style="width: 10%;"></td> <td style="width: 10%;"></td> <td style="width: 10%;"></td> <td style="width: 10%;"></td> </tr> <tr> <td></td> <td></td> <td colspan="8" style="text-align: center;"> <table border="1" style="width: 100%; border-collapse: collapse; text-align: center;"> <tr> <td style="width: 10%;"></td> <td style="width: 10%;"></td> <td style="width: 10%;"></td> <td style="width: 10%;"></td> <td style="width: 10%;"></td> <td style="width: 10%;"></td> <td style="width: 10%;"></td> <td style="width: 10%;"></td> <td style="width: 10%;"></td> <td style="width: 10%;"></td> </tr> <tr> <td></td> <td></td> <td colspan="8" style="text-align: center;"> <table border="1" style="width: 100%; border-collapse: collapse; text-align: center;"> <tr> <td style="width: 10%;"></td> <td style="width: 10%;"></td> <td style="width: 10%;"></td> <td style="width: 10%;"></td> <td style="width: 10%;"></td> <td style="width: 10%;"></td> <td style="width: 10%;"></td> <td style="width: 10%;"></td> <td style="width: 10%;"></td> <td style="width: 10%;"></td> </tr> <tr> <td></td> <td></td> <td colspan="8" style="text-align: center;"> <table border="1" style="width: 100%; border-collapse: collapse; text-align: center;"> <tr> <td style="width: 10%;"></td> <td style="width: 10%;"></td> <td style="width: 10%;"></td> <td style="width: 10%;"></td> <td style="width: 10%;"></td> <td style="width: 10%;"></td> <td style="width: 10%;"></td> <td style="width: 10%;"></td> <td style="width: 10%;"></td> <td style="width: 10%;"></td> </tr> <tr> <td></td> <td></td> <td colspan="8" style="text-align: center;"> <table border="1" style="width: 100%; border-collapse: collapse; text-align: center;"> <tr> <td style="width: 10%;"></td> <td style="width: 10%;"></td> <td style="width: 10%;"></td> <td style="width: 10%;"></td> <td style="width: 10%;"></td> <td style="width: 10%;"></td> <td style="width: 10%;"></td> <td style="width: 10%;"></td> <td style="width: 10%;"></td> <td style="width: 10%;"></td> </tr> <tr> <td></td> <td></td> <td colspan="8" style="text-align: center;"> <table border="1" style="width: 100%; border-collapse: collapse; text-align: center;"> <tr> </tr></table></td></tr></table></td></tr></table></td></tr></table></td></tr></table></td></tr></table></td></tr></table></td></tr></table></td></tr></table></td></tr></table></td></tr></table></td></tr></table></td></tr></table></td></tr></table></td></tr></table></td></tr></table>

 | | | | | | | | | | | | | | | | | | | | <table border="1" style="width: 100%; border-collapse: collapse; text-align: center;"> <tr> <td style="width: 10%;"></td> <td style="width: 10%;"></td> <td style="width: 10%;"></td> <td style="width: 10%;"></td> <td style="width: 10%;"></td> <td style="width: 10%;"></td> <td style="width: 10%;"></td> <td style="width: 10%;"></td> <td style="width: 10%;"></td> <td style="width: 10%;"></td> </tr> <tr> <td></td> <td></td> <td colspan="8" style="text-align: center;"> <table border="1" style="width: 100%; border-collapse: collapse; text-align: center;"> <tr> <td style="width: 10%;"></td> <td style="width: 10%;"></td> <td style="width: 10%;"></td> <td style="width: 10%;"></td> <td style="width: 10%;"></td> <td style="width: 10%;"></td> <td style="width: 10%;"></td> <td style="width: 10%;"></td> <td style="width: 10%;"></td> <td style="width: 10%;"></td> </tr> <tr> <td></td> <td></td> <td colspan="8" style="text-align: center;"> <table border="1" style="width: 100%; border-collapse: collapse; text-align: center;"> <tr> <td style="width: 10%;"></td> <td style="width: 10%;"></td> <td style="width: 10%;"></td> <td style="width: 10%;"></td> <td style="width: 10%;"></td> <td style="width: 10%;"></td> <td style="width: 10%;"></td> <td style="width: 10%;"></td> <td style="width: 10%;"></td> <td style="width: 10%;"></td> </tr> <tr> <td></td> <td></td> <td colspan="8" style="text-align: center;"> <table border="1" style="width: 100%; border-collapse: collapse; text-align: center;"> <tr> <td style="width: 10%;"></td> <td style="width: 10%;"></td> <td style="width: 10%;"></td> <td style="width: 10%;"></td> <td style="width: 10%;"></td> <td style="width: 10%;"></td> <td style="width: 10%;"></td> <td style="width: 10%;"></td> <td style="width: 10%;"></td> <td style="width: 10%;"></td> </tr> <tr> <td></td> <td></td> <td colspan="8" style="text-align: center;"> <table border="1" style="width: 100%; border-collapse: collapse; text-align: center;"> <tr> <td style="width: 10%;"></td> <td style="width: 10%;"></td> <td style="width: 10%;"></td> <td style="width: 10%;"></td> <td style="width: 10%;"></td> <td style="width: 10%;"></td> <td style="width: 10%;"></td> <td style="width: 10%;"></td> <td style="width: 10%;"></td> <td style="width: 10%;"></td> </tr> <tr> <td></td> <td></td> <td colspan="8" style="text-align: center;"> <table border="1" style="width: 100%; border-collapse: collapse; text-align: center;"> <tr> <td style="width: 10%;"></td> <td style="width: 10%;"></td> <td style="width: 10%;"></td> <td style="width: 10%;"></td> <td style="width: 10%;"></td> <td style="width: 10%;"></td> <td style="width: 10%;"></td> <td style="width: 10%;"></td> <td style="width: 10%;"></td> <td style="width: 10%;"></td> </tr> <tr> <td></td> <td></td> <td colspan="8" style="text-align: center;"> <table border="1" style="width: 100%; border-collapse: collapse; text-align: center;"> <tr> <td style="width: 10%;"></td> <td style="width: 10%;"></td> <td style="width: 10%;"></td> <td style="width: 10%;"></td> <td style="width: 10%;"></td> <td style="width: 10%;"></td> <td style="width: 10%;"></td> <td style="width: 10%;"></td> <td style="width: 10%;"></td> <td style="width: 10%;"></td> </tr> <tr> <td></td> <td></td> <td colspan="8" style="text-align: center;"> <table border="1" style="width: 100%; border-collapse: collapse; text-align: center;"> <tr> <td style="width: 10%;"></td> <td style="width: 10%;"></td> <td style="width: 10%;"></td> <td style="width: 10%;"></td> <td style="width: 10%;"></td> <td style="width: 10%;"></td> <td style="width: 10%;"></td> <td style="width: 10%;"></td> <td style="width: 10%;"></td> <td style="width: 10%;"></td> </tr> <tr> <td></td> <td></td> <td colspan="8" style="text-align: center;"> <table border="1" style="width: 100%; border-collapse: collapse; text-align: center;"> <tr> <td style="width: 10%;"></td> <td style="width: 10%;"></td> <td style="width: 10%;"></td> <td style="width: 10%;"></td> <td style="width: 10%;"></td> <td style="width: 10%;"></td> <td style="width: 10%;"></td> <td style="width: 10%;"></td> <td style="width: 10%;"></td> <td style="width: 10%;"></td> </tr> <tr> <td></td> <td></td> <td colspan="8" style="text-align: center;"> <table border="1" style="width: 100%; border-collapse: collapse; text-align: center;"> <tr> <td style="width: 10%;"></td> <td style="width: 10%;"></td> <td style="width: 10%;"></td> <td style="width: 10%;"></td> <td style="width: 10%;"></td> <td style="width: 10%;"></td> <td style="width: 10%;"></td> <td style="width: 10%;"></td> <td style="width: 10%;"></td> <td style="width: 10%;"></td> </tr> <tr> <td></td> <td></td> <td colspan="8" style="text-align: center;"> <table border="1" style="width: 100%; border-collapse: collapse; text-align: center;"> <tr> <td style="width: 10%;"></td> <td style="width: 10%;"></td> <td style="width: 10%;"></td> <td style="width: 10%;"></td> <td style="width: 10%;"></td> <td style="width: 10%;"></td> <td style="width: 10%;"></td> <td style="width: 10%;"></td> <td style="width: 10%;"></td> <td style="width: 10%;"></td> </tr> <tr> <td></td> <td></td> <td colspan="8" style="text-align: center;"> <table border="1" style="width: 100%; border-collapse: collapse; text-align: center;"> <tr> <td style="width: 10%;"></td> <td style="width: 10%;"></td> <td style="width: 10%;"></td> <td style="width: 10%;"></td> <td style="width: 10%;"></td> <td style="width: 10%;"></td> <td style="width: 10%;"></td> <td style="width: 10%;"></td> <td style="width: 10%;"></td> <td style="width: 10%;"></td> </tr> <tr> <td></td> <td></td> <td colspan="8" style="text-align: center;"> <table border="1" style="width: 100%; border-collapse: collapse; text-align: center;"> <tr> <td style="width: 10%;"></td> <td style="width: 10%;"></td> <td style="width: 10%;"></td> <td style="width: 10%;"></td> <td style="width: 10%;"></td> <td style="width: 10%;"></td> <td style="width: 10%;"></td> <td style="width: 10%;"></td> <td style="width: 10%;"></td> <td style="width: 10%;"></td> </tr> <tr> <td></td> <td></td> <td colspan="8" style="text-align: center;"> <table border="1" style="width: 100%; border-collapse: collapse; text-align: center;"> <tr> <td style="width: 10%;"></td> <td style="width: 10%;"></td> <td style="width: 10%;"></td> <td style="width: 10%;"></td> <td style="width: 10%;"></td> <td style="width: 10%;"></td> <td style="width: 10%;"></td> <td style="width: 10%;"></td> <td style="width: 10%;"></td> <td style="width: 10%;"></td> </tr> <tr> <td></td> <td></td> <td colspan="8" style="text-align: center;"> <table border="1" style="width: 100%; border-collapse: collapse; text-align: center;"> <tr> </tr></table></td></tr></table></td></tr></table></td></tr></table></td></tr></table></td></tr></table></td></tr></table></td></tr></table></td></tr></table></td></tr></table></td></tr></table></td></tr></table></td></tr></table></td></tr></table></td></tr></table>

 | | | | | | | | | | | | | | | | | | | | <table border="1" style="width: 100%; border-collapse: collapse; text-align: center;"> <tr> <td style="width: 10%;"></td> <td style="width: 10%;"></td> <td style="width: 10%;"></td> <td style="width: 10%;"></td> <td style="width: 10%;"></td> <td style="width: 10%;"></td> <td style="width: 10%;"></td> <td style="width: 10%;"></td> <td style="width: 10%;"></td> <td style="width: 10%;"></td> </tr> <tr> <td></td> <td></td> <td colspan="8" style="text-align: center;"> <table border="1" style="width: 100%; border-collapse: collapse; text-align: center;"> <tr> <td style="width: 10%;"></td> <td style="width: 10%;"></td> <td style="width: 10%;"></td> <td style="width: 10%;"></td> <td style="width: 10%;"></td> <td style="width: 10%;"></td> <td style="width: 10%;"></td> <td style="width: 10%;"></td> <td style="width: 10%;"></td> <td style="width: 10%;"></td> </tr> <tr> <td></td> <td></td> <td colspan="8" style="text-align: center;"> <table border="1" style="width: 100%; border-collapse: collapse; text-align: center;"> <tr> <td style="width: 10%;"></td> <td style="width: 10%;"></td> <td style="width: 10%;"></td> <td style="width: 10%;"></td> <td style="width: 10%;"></td> <td style="width: 10%;"></td> <td style="width: 10%;"></td> <td style="width: 10%;"></td> <td style="width: 10%;"></td> <td style="width: 10%;"></td> </tr> <tr> <td></td> <td></td> <td colspan="8" style="text-align: center;"> <table border="1" style="width: 100%; border-collapse: collapse; text-align: center;"> <tr> <td style="width: 10%;"></td> <td style="width: 10%;"></td> <td style="width: 10%;"></td> <td style="width: 10%;"></td> <td style="width: 10%;"></td> <td style="width: 10%;"></td> <td style="width: 10%;"></td> <td style="width: 10%;"></td> <td style="width: 10%;"></td> <td style="width: 10%;"></td> </tr> <tr> <td></td> <td></td> <td colspan="8" style="text-align: center;"> <table border="1" style="width: 100%; border-collapse: collapse; text-align: center;"> <tr> <td style="width: 10%;"></td> <td style="width: 10%;"></td> <td style="width: 10%;"></td> <td style="width: 10%;"></td> <td style="width: 10%;"></td> <td style="width: 10%;"></td> <td style="width: 10%;"></td> <td style="width: 10%;"></td> <td style="width: 10%;"></td> <td style="width: 10%;"></td> </tr> <tr> <td></td> <td></td> <td colspan="8" style="text-align: center;"> <table border="1" style="width: 100%; border-collapse: collapse; text-align: center;"> <tr> <td style="width: 10%;"></td> <td style="width: 10%;"></td> <td style="width: 10%;"></td> <td style="width: 10%;"></td> <td style="width: 10%;"></td> <td style="width: 10%;"></td> <td style="width: 10%;"></td> <td style="width: 10%;"></td> <td style="width: 10%;"></td> <td style="width: 10%;"></td> </tr> <tr> <td></td> <td></td> <td colspan="8" style="text-align: center;"> <table border="1" style="width: 100%; border-collapse: collapse; text-align: center;"> <tr> <td style="width: 10%;"></td> <td style="width: 10%;"></td> <td style="width: 10%;"></td> <td style="width: 10%;"></td> <td style="width: 10%;"></td> <td style="width: 10%;"></td> <td style="width: 10%;"></td> <td style="width: 10%;"></td> <td style="width: 10%;"></td> <td style="width: 10%;"></td> </tr> <tr> <td></td> <td></td> <td colspan="8" style="text-align: center;"> <table border="1" style="width: 100%; border-collapse: collapse; text-align: center;"> <tr> <td style="width: 10%;"></td> <td style="width: 10%;"></td> <td style="width: 10%;"></td> <td style="width: 10%;"></td> <td style="width: 10%;"></td> <td style="width: 10%;"></td> <td style="width: 10%;"></td> <td style="width: 10%;"></td> <td style="width: 10%;"></td> <td style="width: 10%;"></td> </tr> <tr> <td></td> <td></td> <td colspan="8" style="text-align: center;"> <table border="1" style="width: 100%; border-collapse: collapse; text-align: center;"> <tr> <td style="width: 10%;"></td> <td style="width: 10%;"></td> <td style="width: 10%;"></td> <td style="width: 10%;"></td> <td style="width: 10%;"></td> <td style="width:
10%;"></td> <td style="width: 10%;"></td> <td style="width: 10%;"></td> <td style="width: 10%;"></td> <td style="width: 10%;"></td> </tr> <tr> <td></td> <td></td> <td colspan="8" style="text-align: center;"> <table border="1" style="width: 100%; border-collapse: collapse; text-align: center;"> <tr> <td style="width: 10%;"></td> <td style="width: 10%;"></td> <td style="width: 10%;"></td> <td style="width: 10%;"></td> <td style="width: 10%;"></td> <td style="width: 10%;"></td> <td style="width: 10%;"></td> <td style="width: 10%;"></td> <td style="width: 10%;"></td> <td style="width: 10%;"></td> </tr> <tr> <td></td> <td></td> <td colspan="8" style="text-align: center;"> <table border="1" style="width: 100%; border-collapse: collapse; text-align: center;"> <tr> <td style="width: 10%;"></td> <td style="width: 10%;"></td> <td style="width: 10%;"></td> <td style="width: 10%;"></td> <td style="width: 10%;"></td> <td style="width: 10%;"></td> <td style="width: 10%;"></td> <td style="width: 10%;"></td> <td style="width: 10%;"></td> <td style="width: 10%;"></td> </tr> <tr> <td></td> <td></td> <td colspan="8" style="text-align: center;"> <table border="1" style="width: 100%; border-collapse: collapse; text-align: center;"> <tr> <td style="width: 10%;"></td> <td style="width: 10%;"></td> <td style="width: 10%;"></td> <td style="width: 10%;"></td> <td style="width: 10%;"></td> <td style="width: 10%;"></td> <td style="width: 10%;"></td> <td style="width: 10%;"></td> <td style="width: 10%;"></td> <td style="width: 10%;"></td> </tr> <tr> <td></td> <td></td> <td colspan="8" style="text-align: center;"> <table border="1" style="width: 100%; border-collapse: collapse; text-align: center;"> <tr> <td style="width: 10%;"></td> <td style="width: 10%;"></td> <td style="width: 10%;"></td> <td style="width: 10%;"></td> <td style="width: 10%;"></td> <td style="width: 10%;"></td> <td style="width: 10%;"></td> <td style="width: 10%;"></td> <td style="width: 10%;"></td> <td style="width: 10%;"></td> </tr> <tr> <td></td> <td></td> <td colspan="8" style="text-align: center;"> <table border="1" style="width: 100%; border-collapse: collapse; text-align: center;"> <tr> </tr></table></td></tr></table></td></tr></table></td></tr></table></td></tr></table></td></tr></table></td></tr></table></td></tr></table></td></tr></table></td></tr></table></td></tr></table></td></tr></table></td></tr></table></td></tr></table>
 | | | | | | | | | | | | | | | | | | | | <table border="1" style="width: 100%; border-collapse: collapse; text-align: center;"> <tr> <td style="width: 10%;"></td> <td style="width: 10%;"></td> <td style="width: 10%;"></td> <td style="width: 10%;"></td> <td style="width: 10%;"></td> <td style="width: 10%;"></td> <td style="width: 10%;"></td> <td style="width: 10%;"></td> <td style="width: 10%;"></td> <td style="width: 10%;"></td> </tr> <tr> <td></td> <td></td> <td colspan="8" style="text-align: center;"> <table border="1" style="width: 100%; border-collapse: collapse; text-align: center;"> <tr> <td style="width: 10%;"></td> <td style="width: 10%;"></td> <td style="width: 10%;"></td> <td style="width: 10%;"></td> <td style="width: 10%;"></td> <td style="width: 10%;"></td> <td style="width: 10%;"></td> <td style="width: 10%;"></td> <td style="width: 10%;"></td> <td style="width: 10%;"></td> </tr> <tr> <td></td> <td></td> <td colspan="8" style="text-align: center;"> <table border="1" style="width: 100%; border-collapse:
collapse; text-align: center;"> <tr> <td style="width: 10%;"></td> <td style="width: 10%;"></td> <td style="width: 10%;"></td> <td style="width: 10%;"></td> <td style="width: 10%;"></td> <td style="width: 10%;"></td> <td style="width: 10%;"></td> <td style="width: 10%;"></td> <td style="width: 10%;"></td> <td style="width: 10%;"></td> </tr> <tr> <td></td> <td></td> <td colspan="8" style="text-align: center;"> <table border="1" style="width: 100%; border-collapse: collapse; text-align: center;"> <tr> <td style="width: 10%;"></td> <td style="width: 10%;"></td> <td style="width: 10%;"></td> <td style="width: 10%;"></td> <td style="width: 10%;"></td> <td style="width: 10%;"></td> <td style="width: 10%;"></td> <td style="width: 10%;"></td> <td style="width: 10%;"></td> <td style="width: 10%;"></td> </tr> <tr> <td></td> <td></td> <td colspan="8" style="text-align: center;"> <table border="1" style="width: 100%; border-collapse: collapse; text-align: center;"> <tr> <td style="width: 10%;"></td> <td style="width: 10%;"></td> <td style="width: 10%;"></td> <td style="width: 10%;"></td> <td style="width: 10%;"></td> <td style="width: 10%;"></td> <td style="width: 10%;"></td> <td style="width: 10%;"></td> <td style="width: 10%;"></td> <td style="width: 10%;"></td> </tr> <tr> <td></td> <td></td> <td colspan="8" style="text-align: center;"> <table border="1" style="width: 100%; border-collapse: collapse; text-align: center;"> <tr> <td style="width: 10%;"></td> <td style="width: 10%;"></td> <td style="width: 10%;"></td> <td style="width: 10%;"></td> <td style="width: 10%;"></td> <td style="width: 10%;"></td> <td style="width: 10%;"></td> <td style="width: 10%;"></td> <td style="width: 10%;"></td> <td style="width: 10%;"></td> </tr> <tr> <td></td> <td></td> <td colspan="8" style="text-align: center;"> <table border="1" style="width: 100%; border-collapse: collapse; text-align: center;"> <tr> <td style="width: 10%;"></td> <td style="width: 10%;"></td> <td style="width: 10%;"></td> <td style="width: 10%;"></td> <td style="width: 10%;"></td> <td style="width: 10%;"></td> <td style="width: 10%;"></td> <td style="width: 10%;"></td> <td style="width: 10%;"></td> <td style="width: 10%;"></td> </tr> <tr> <td></td> <td></td> <td colspan="8" style="text-align: center;"> <table border="1" style="width: 100%; border-collapse: collapse; text-align: center;"> <tr> <td style="width: 10%;"></td> <td style="width: 10%;"></td> <td style="width: 10%;"></td> <td style="width: 10%;"></td> <td style="width: 10%;"></td> <td style="width: 10%;"></td> <td style="width: 10%;"></td> <td style="width: 10%;"></td> <td style="width: 10%;"></td> <td style="width: 10%;"></td> </tr> <tr> <td></td> <td></td> <td colspan="8" style="text-align: center;"> <table border="1" style="width: 100%; border-collapse: collapse; text-align: center;"> <tr> <td style="width: 10%;"></td> <td style="width: 10%;"></td> <td style="width: 10%;"></td> <td style="width: 10%;"></td> <td style="width: 10%;"></td> <td style="width: 10%;"></td> <td style="width: 10%;"></td> <td style="width: 10%;"></td> <td style="width: 10%;"></td> <td style="width: 10%;"></td> </tr> <tr> <td></td> <td></td> <td colspan="8" style="text-align: center;"> <table border="1" style="width: 100%; border-collapse: collapse; text-align: center;"> <tr> <td style="width: 10%;"></td> <td style="width: 10%;"></td> <td style="width: 10%;"></td> <td style="width: 10%;"></td> <td style="width: 10%;"></td> <td style="width: 10%;"></td> <td style="width: 10%;"></td> <td style="width: 10%;"></td> <td style="width: 10%;"></td> <td style="width: 10%;"></td> </tr> <tr> <td></td> <td></td> <td colspan="8" style="text-align: center;"> <table border="1" style="width: 100%; border-collapse: collapse; text-align: center;"> <tr> <td style="width: 10%;"></td> <td style="width: 10%;"></td> <td style="width: 10%;"></td> <td style="width: 10%;"></td> <td style="width: 10%;"></td> <td style="width: 10%;"></td> <td style="width: 10%;"></td> <td style="width: 10%;"></td> <td style="width: 10%;"></td> <td style="width: 10%;"></td> </tr> <tr> <td></td> <td></td> <td colspan="8" style="text-align: center;"> <table border="1" style="width: 100%; border-collapse: collapse; text-align: center;"> <tr> <td style="width: 10%;"></td> <td style="width: 10%;"></td> <td style="width: 10%;"></td> <td style="width: 10%;"></td> <td style="width: 10%;"></td> <td style="width: 10%;"></td> <td style="width: 10%;"></td> <td style="width: 10%;"></td> <td style="width: 10%;"></td> <td style="width: 10%;"></td> </tr> <tr> <td></td> <td></td> <td colspan="8" style="text-align: center;"> <table border="1" style="width: 100%; border-collapse: collapse; text-align: center;"> <tr> </tr></table></td></tr></table></td></tr></table></td></tr></table></td></tr></table></td></tr></table></td></tr></table></td></tr></table></td></tr></table></td></tr></table></td></tr></table></td></tr></table></td></tr></table>

 | | | | | | | | | | | | | | | | | | | | <table border="1" style="width: 100%; border-collapse: collapse; text-align: center;"> <tr> <td style="width: 10%;"></td> <td style="width: 10%;"></td> <td style="width: 10%;"></td> <td style="width: 10%;"></td> <td style="width: 10%;"></td> <td style="width: 10%;"></td> <td style="width: 10%;"></td> <td style="width: 10%;"></td> <td style="width: 10%;"></td> <td style="width: 10%;"></td> </tr> <tr> <td></td> <td></td> <td colspan="8" style="text-align: center;"> <table border="1" style="width: 100%; border-collapse: collapse; text-align: center;"> <tr> <td style="width: 10%;"></td> <td style="width: 10%;"></td> <td style="width: 10%;"></td> <td style="width: 10%;"></td> <td style="width: 10%;"></td> <td style="width: 10%;"></td> <td style="width: 10%;"></td> <td style="width: 10%;"></td> <td style="width: 10%;"></td> <td style="width: 10%;"></td> </tr> <tr> <td></td> <td></td> <td colspan="8" style="text-align: center;"> <table border="1" style="width: 100%; border-collapse: collapse; text-align: center;"> <tr> <td style="width: 10%;"></td> <td style="width: 10%;"></td> <td style="width: 10%;"></td> <td style="width: 10%;"></td> <td style="width: 10%;"></td> <td style="width: 10%;"></td> <td style="width: 10%;"></td> <td style="width: 10%;"></td> <td style="width: 10%;"></td> <td style="width: 10%;"></td> </tr> <tr> <td></td> <td></td> <td colspan="8" style="text-align: center;"> <table border="1" style="width: 100%; border-collapse: collapse; text-align: center;"> <tr> <td style="width: 10%;"></td> <td style="width: 10%;"></td> <td style="width: 10%;"></td> <td style="width: 10%;"></td> <td style="width: 10%;"></td> <td style="width: 10%;"></td> <td style="width: 10%;"></td> <td style="width: 10%;"></td> <td style="width: 10%;"></td> <td style="width: 10%;"></td> </tr> <tr> <td></td> <td></td> <td colspan="8" style="text-align: center;"> <table border="1" style="width: 100%; border-collapse: collapse; text-align: center;"> <tr> <td style="width: 10%;"></td> <td style="width: 10%;"></td> <td style="width: 10%;"></td> <td style="width: 10%;"></td> <td style="width: 10%;"></td> <td style="width: 10%;"></td> <td style="width: 10%;"></td> <td style="width: 10%;"></td> <td style="width: 10%;"></td> <td style="width: 10%;"></td> </tr> <tr> <td></td> <td></td> <td colspan="8" style="text-align: center;"> <table border="1" style="width: 100%; border-collapse: collapse; text-align: center;"> <tr> <td style="width: 10%;"></td> <td style="width: 10%;"></td> <td style="width: 10%;"></td> <td style="width: 10%;"></td> <td style="width: 10%;"></td> <td style="width: 10%;"></td> <td style="width: 10%;"></td> <td style="width: 10%;"></td> <td style="width: 10%;"></td> <td style="width: 10%;"></td> </tr> <tr> <td></td> <td></td> <td colspan="8" style="text-align: center;"> <table border="1" style="width: 100%; border-collapse: collapse; text-align: center;"> <tr> <td style="width: 10%;"></td> <td style="width: 10%;"></td> <td style="width: 10%;"></td> <td style="width: 10%;"></td> <td style="width: 10%;"></td> <td style="width: 10%;"></td> <td style="width: 10%;"></td> <td style="width: 10%;"></td> <td style="width: 10%;"></td> <td style="width: 10%;"></td> </tr> <tr> <td></td> <td></td> <td colspan="8" style="text-align: center;"> <table border="1" style="width: 100%; border-collapse: collapse; text-align: center;"> <tr> <td style="width: 10%;"></td> <td style="width: 10%;"></td> <td style="width: 10%;"></td> <td style="width: 10%;"></td> <td style="width: 10%;"></td> <td style="width: 10%;"></td> <td style="width: 10%;"></td> <td style="width: 10%;"></td> <td style="width: 10%;"></td> <td style="width: 10%;"></td> </tr> <tr> <td></td> <td></td> <td colspan="8" style="text-align: center;"> <table border="1" style="width: 100%; border-collapse: collapse; text-align: center;"> <tr> <td style="width: 10%;"></td> <td style="width: 10%;"></td> <td style="width: 10%;"></td> <td style="width: 10%;"></td> <td style="width: 10%;"></td> <td style="width: 10%;"></td> <td style="width: 10%;"></td> <td style="width: 10%;"></td> <td style="width: 10%;"></td> <td style="width: 10%;"></td> </tr> <tr> <td></td> <td></td> <td colspan="8" style="text-align: center;"> <table border="1" style="width: 100%; border-collapse: collapse; text-align: center;"> <tr> <td style="width: 10%;"></td> <td style="width: 10%;"></td> <td style="width: 10%;"></td> <td style="width: 10%;"></td> <td style="width: 10%;"></td> <td style="width: 10%;"></td> <td style="width: 10%;"></td> <td style="width: 10%;"></td> <td style="width: 10%;"></td> <td style="width: 10%;"></td> </tr> <tr> <td></td> <td></td> <td colspan="8" style="text-align: center;"> <table border="1" style="width: 100%; border-collapse: collapse; text-align: center;"> <tr> <td style="width: 10%;"></td> <td style="width: 10%;"></td> <td style="width: 10%;"></td> <td style="width: 10%;"></td> <td style="width: 10%;"></td> <td style="width: 10%;"></td> <td style="width: 10%;"></td> <td style="width: 10%;"></td> <td style="width: 10%;"></td> <td style="width: 10%;"></td> </tr> <tr> <td></td> <td></td> <td colspan="8" style="text-align: center;"> <table border="1" style="width: 100%; border-collapse: collapse; text-align: center;"> <tr> </tr></table></td></tr></table></td></tr></table></td></tr></table></td></tr></table></td></tr></table></td></tr></table></td></tr></table></td></tr></table></td></tr></table></td></tr></table></td></tr></table>

 | | | | | | | | | | | | | | | | | | | | <table border="1" style="width: 100%; border-collapse: collapse; text-align: center;"> <tr> <td style="width: 10%;"></td> <td style="width: 10%;"></td> <td style="width: 10%;"></td> <td style="width: 10%;"></td> <td style="width: 10%;"></td> <td style="width: 10%;"></td> <td style="width: 10%;"></td> <td style="width: 10%;"></td> <td style="width: 10%;"></td> <td style="width: 10%;"></td> </tr> <tr> <td></td> <td></td> <td colspan="8" style="text-align: center;"> <table border="1" style="width: 100%; border-collapse: collapse; text-align: center;"> <tr> <td style="width: 10%;"></td> <td style="width: 10%;"></td> <td style="width: 10%;"></td> <td style="width: 10%;"></td> <td style="width: 10%;"></td> <td style="width: 10%;"></td> <td style="width: 10%;"></td> <td style="width: 10%;"></td> <td style="width: 10%;"></td> <td style="width: 10%;"></td> </tr> <tr> <td></td> <td></td> <td colspan="8" style="text-align: center;"> <table border="1" style="width: 100%; border-collapse: collapse; text-align: center;"> <tr> <td style="width: 10%;"></td> <td style="width: 10%;"></td> <td style="width: 10%;"></td> <td style="width: 10%;"></td> <td style="width: 10%;"></td> <td style="width: 10%;"></td> <td style="width: 10%;"></td> <td style="width: 10%;"></td> <td style="width: 10%;"></td> <td style="width: 10%;"></td> </tr> <tr> <td></td> <td></td> <td colspan="8" style="text-align: center;"> <table border="1" style="width: 100%; border-collapse: collapse; text-align: center;"> <tr> <td style="width: 10%;"></td> <td style="width: 10%;"></td> <td style="width: 10%;"></td> <td style="width: 10%;"></td> <td style="width: 10%;"></td> <td style="width: 10%;"></td> <td style="width: 10%;"></td> <td style="width: 10%;"></td> <td style="width: 10%;"></td> <td style="width: 10%;"></td> </tr> <tr> <td></td> <td></td> <td colspan="8" style="text-align: center;"> <table border="1" style="width: 100%; border-collapse: collapse; text-align: center;"> <tr> <td style="width: 10%;"></td> <td style="width: 10%;"></td> <td style="width: 10%;"></td> <td style="width: 10%;"></td> <td style="width: 10%;"></td> <td style="width: 10%;"></td> <td style="width: 10%;"></td> <td style="width: 10%;"></td> <td style="width: 10%;"></td> <td style="width: 10%;"></td> </tr> <tr> <td></td> <td></td> <td colspan="8" style="text-align: center;"> <table border="1" style="width: 100%; border-collapse: collapse; text-align: center;"> <tr> <td style="width: 10%;"></td> <td style="width: 10%;"></td> <td style="width: 10%;"></td> <td style="width: 10%;"></td> <td style="width: 10%;"></td> <td style="width: 10%;"></td> <td style="width: 10%;"></td> <td style="width: 10%;"></td> <td style="width: 10%;"></td> <td style="width: 10%;"></td> </tr> <tr> <td></td> <td></td> <td colspan="8" style="text-align: center;"> <table border="1" style="width: 100%; border-collapse: collapse; text-align: center;"> <tr> <td style="width: 10%;"></td> <td style="width: 10%;"></td> <td style="width: 10%;"></td> <td style="width: 10%;"></td> <td style="width: 10%;"></td> <td style="width: 10%;"></td> <td style="width: 10%;"></td> <td style="width: 10%;"></td> <td style="width: 10%;"></td> <td style="width: 10%;"></td> </tr> <tr> <td></td> <td></td> <td colspan="8" style="text-align: center;"> <table border="1" style="width: 100%; border-collapse: collapse; text-align: center;"> <tr> <td style="width: 10%;"></td> <td style="width: 10%;"></td> <td style="width: 10%;"></td> <td style="width: 10%;"></td> <td style="width: 10%;"></td> <td style="width: 10%;"></td> <td style="width: 10%;"></td> <td style="width: 10%;"></td> <td style="width: 10%;"></td> <td style="width: 10%;"></td> </tr> <tr> <td></td> <td></td> <td colspan="8" style="text-align: center;"> <table border="1" style="width: 100%; border-collapse: collapse; text-align: center;"> <tr> <td style="width: 10%;"></td> <td style="width: 10%;"></td> <td style="width: 10%;"></td> <td style="width: 10%;"></td> <td style="width: 10%;"></td> <td style="width: 10%;"></td> <td style="width: 10%;"></td> <td style="width: 10%;"></td> <td style="width: 10%;"></td> <td style="width: 10%;"></td> </tr> <tr> <td></td> <td></td> <td colspan="8" style="text-align: center;"> <table border="1" style="width: 100%; border-collapse: collapse; text-align: center;"> <tr> <td style="width: 10%;"></td> <td style="width: 10%;"></td> <td style="width: 10%;"></td> <td style="width: 10%;"></td> <td style="width: 10%;"></td> <td style="width: 10%;"></td> <td style="width: 10%;"></td> <td style="width: 10%;"></td> <td style="width: 10%;"></td> <td style="width: 10%;"></td> </tr> <tr> <td></td> <td></td> <td colspan="8" style="text-align: center;"> <table border="1" style="width: 100%; border-collapse: collapse; text-align: center;"> <tr> </tr></table></td></tr></table></td></tr></table></td></tr></table></td></tr></table></td></tr></table></td></tr></table></td></tr></table></td></tr></table></td></tr></table></td></tr></table>

 | | | | | | | | | | | | | | | | | | | | <table border="1" style="width: 100%; border-collapse: collapse; text-align: center;"> <tr> <td style="width: 10%;"></td> <td style="width: 10%;"></td> <td style="width: 10%;"></td> <td style="width: 10%;"></td> <td style="width: 10%;"></td> <td style="width: 10%;"></td> <td style="width: 10%;"></td> <td style="width: 10%;"></td> <td style="width: 10%;"></td> <td style="width: 10%;"></td> </tr> <tr> <td></td> <td></td> <td colspan="8" style="text-align: center;"> <table border="1" style="width: 100%; border-collapse: collapse; text-align: center;"> <tr> <td style="width: 10%;"></td> <td style="width: 10%;"></td> <td style="width: 10%;"></td> <td style="width: 10%;"></td> <td style="width: 10%;"></td> <td style="width: 10%;"></td> <td style="width: 10%;"></td> <td style="width: 10%;"></td> <td style="width: 10%;"></td> <td style="width: 10%;"></td> </tr> <tr> <td></td> <td></td> <td colspan="8" style="text-align: center;"> <table border="1" style="width: 100%; border-collapse: collapse; text-align: center;"> <tr> <td style="width: 10%;"></td> <td style="width: 10%;"></td> <td style="width: 10%;"></td> <td style="width: 10%;"></td> <td style="width: 10%;"></td> <td style="width: 10%;"></td> <td style="width: 10%;"></td> <td style="width: 10%;"></td> <td style="width: 10%;"></td> <td style="width: 10%;"></td> </tr> <tr> <td></td> <td></td> <td colspan="8" style="text-align: center;"> <table border="1" style="width: 100%; border-collapse: collapse; text-align: center;"> <tr> <td style="width: 10%;"></td> <td style="width: 10%;"></td> <td style="width: 10%;"></td> <td style="width: 10%;"></td> <td style="width: 10%;"></td> <td style="width: 10%;"></td> <td style="width: 10%;"></td> <td style="width: 10%;"></td> <td style="width: 10%;"></td> <td style="width: 10%;"></td> </tr> <tr> <td></td> <td></td> <td colspan="8" style="text-align: center;"> <table border="1" style="width: 100%; border-collapse: collapse; text-align: center;"> <tr> <td style="width: 10%;"></td> <td style="width: 10%;"></td> <td style="width: 10%;"></td> <td style="width: 10%;"></td> <td style="width: 10%;"></td> <td style="width: 10%;"></td> <td style="width: 10%;"></td> <td style="width: 10%;"></td> <td style="width: 10%;"></td> <td style="width: 10%;"></td> </tr> <tr> <td></td> <td></td> <td colspan="8" style="text-align: center;"> <table border="1" style="width: 100%; border-collapse: collapse; text-align: center;"> <tr> <td style="width: 10%;"></td> <td style="width: 10%;"></td> <td style="width: 10%;"></td> <td style="width: 10%;"></td> <td style="width: 10%;"></td> <td style="width: 10%;"></td> <td style="width: 10%;"></td> <td style="width: 10%;"></td> <td style="width: 10%;"></td> <td style="width: 10%;"></td> </tr> <tr> <td></td> <td></td> <td colspan="8" style="text-align: center;"> <table border="1" style="width: 100%; border-collapse: collapse; text-align: center;"> <tr> <td style="width: 10%;"></td> <td style="width: 10%;"></td> <td style="width: 10%;"></td> <td style="width: 10%;"></td> <td style="width: 10%;"></td> <td style="width: 10%;"></td> <td style="width: 10%;"></td> <td style="width: 10%;"></td> <td style="width: 10%;"></td> <td style="width: 10%;"></td> </tr> <tr> <td></td> <td></td> <td colspan="8" style="text-align: center;"> <table border="1" style="width: 100%; border-collapse: collapse; text-align: center;"> <tr> <td style="width: 10%;"></td> <td style="width: 10%;"></td> <td style="width: 10%;"></td> <td style="width: 10%;"></td> <td style="width: 10%;"></td> <td style="width: 10%;"></td> <td style="width: 10%;"></td> <td style="width: 10%;"></td> <td style="width: 10%;"></td> <td style="width: 10%;"></td> </tr> <tr> <td></td> <td></td> <td colspan="8" style="text-align: center;"> <table border="1" style="width: 100%; border-collapse: collapse; text-align: center;"> <tr> <td style="width: 10%;"></td> <td style="width: 10%;"></td> <td style="width: 10%;"></td> <td style="width: 10%;"></td> <td style="width: 10%;"></td> <td style="width: 10%;"></td> <td style="width: 10%;"></td> <td style="width: 10%;"></td> <td style="width: 10%;"></td> <td style="width: 10%;"></td> </tr> <tr> <td></td> <td></td> <td colspan="8" style="text-align: center;"> <table border="1" style="width: 100%; border-collapse: collapse; text-align: center;"> <tr> </tr></table></td></tr></table></td></tr></table></td></tr></table></td></tr></table></td></tr></table></td></tr></table></td></tr></table></td></tr></table></td></tr></table>

 | | | | | | | | | | | | | | | | | | | | <table border="1" style="width: 100%; border-collapse: collapse; text-align: center;"> <tr> <td style="width: 10%;"></td> <td style="width: 10%;"></td> <td style="width: 10%;"></td> <td style="width: 10%;"></td> <td style="width: 10%;"></td> <td style="width: 10%;"></td> <td style="width: 10%;"></td> <td style="width: 10%;"></td> <td style="width: 10%;"></td> <td style="width: 10%;"></td> </tr> <tr> <td></td> <td></td> <td colspan="8" style="text-align: center;"> <table border="1" style="width: 100%; border-collapse: collapse; text-align: center;"> <tr> <td style="width: 10%;"></td> <td style="width: 10%;"></td> <td style="width: 10%;"></td> <td style="width: 10%;"></td> <td style="width: 10%;"></td> <td style="width: 10%;"></td> <td style="width: 10%;"></td> <td style="width: 10%;"></td> <td style="width: 10%;"></td> <td style="width: 10%;"></td> </tr> <tr> <td></td> <td></td> <td colspan="8" style="text-align: center;"> <table border="1" style="width: 100%; border-collapse: collapse; text-align: center;"> <tr> <td style="width: 10%;"></td> <td style="width: 10%;"></td> <td style="width: 10%;"></td> <td style="width: 10%;"></td> <td style="width: 10%;"></td> <td style="width: 10%;"></td> <td style="width: 10%;"></td> <td style="width: 10%;"></td> <td style="width: 10%;"></td> <td style="width: 10%;"></td> </tr> <tr> <td></td> <td></td> <td colspan="8" style="text-align: center;"> <table border="1" style="width: 100%; border-collapse: collapse; text-align: center;"> <tr> <td style="width: 10%;"></td> <td style="width: 10%;"></td> <td style="width: 10%;"></td> <td style="width: 10%;"></td> <td style="width: 10%;"></td> <td style="width: 10%;"></td> <td style="width: 10%;"></td> <td style="width: 10%;"></td> <td style="width: 10%;"></td> <td style="width: 10%;"></td> </tr> <tr> <td></td> <td></td> <td colspan="8" style="text-align: center;"> <table border="1" style="width: 100%; border-collapse: collapse; text-align: center;"> <tr> <td style="width: 10%;"></td> <td style="width: 10%;"></td> <td style="width: 10%;"></td> <td style="width: 10%;"></td> <td style="width: 10%;"></td> <td style="width: 10%;"></td> <td style="width: 10%;"></td> <td style="width: 10%;"></td> <td style="width: 10%;"></td> <td style="width: 10%;"></td> </tr> <tr> <td></td> <td></td> <td colspan="8" style="text-align: center;"> <table border="1" style="width: 100%; border-collapse: collapse; text-align: center;"> <tr> <td style="width: 10%;"></td> <td style="width: 10%;"></td> <td style="width: 10%;"></td> <td style="width: 10%;"></td> <td style="width: 10%;"></td> <td style="width: 10%;"></td> <td style="width: 10%;"></td> <td style="width: 10%;"></td> <td style="width: 10%;"></td> <td style="width: 10%;"></td> </tr> <tr> <td></td> <td></td> <td colspan="8" style="text-align: center;"> <table border="1" style="width: 100%; border-collapse: collapse; text-align: center;"> <tr> <td style="width: 10%;"></td> <td style="width: 10%;"></td> <td style="width: 10%;"></td> <td style="width: 10%;"></td> <td style="width: 10%;"></td> <td style="width: 10%;"></td> <td style="width: 10%;"></td> <td style="width: 10%;"></td> <td style="width: 10%;"></td> <td style="width: 10%;"></td> </tr> <tr> <td></td> <td></td> <td colspan="8" style="text-align: center;"> <table border="1" style="width: 100%; border-collapse: collapse; text-align: center;"> <tr> <td style="width: 10%;"></td> <td style="width: 10%;"></td> <td style="width: 10%;"></td> <td style="width: 10%;"></td> <td style="width: 10%;"></td> <td style="width: 10%;"></td> <td style="width: 10%;"></td> <td style="width: 10%;"></td> <td style="width: 10%;"></td> <td style="width: 10%;"></td> </tr> <tr> <td></td> <td></td> <td colspan="8" style="text-align: center;"> <table border="1" style="width: 100%; border-collapse: collapse; text-align:
center;"> <tr> </tr></table></td></tr></table></td></tr></table></td></tr></table></td></tr></table></td></tr></table></td></tr></table></td></tr></table></td></tr></table>
 | | | | | | | | | | | | | | | | | | | | <table border="1" style="width: 100%; border-collapse: collapse; text-align: center;"> <tr> <td style="width: 10%;"></td> <td style="width: 10%;"></td> <td style="width: 10%;"></td> <td style="width: 10%;"></td> <td style="width: 10%;"></td> <td style="width: 10%;"></td> <td style="width: 10%;"></td> <td style="width: 10%;"></td> <td style="width: 10%;"></td> <td style="width: 10%;"></td> </tr> <tr> <td></td> <td></td> <td colspan="8" style="text-align: center;"> <table border="1" style="width: 100%; border-collapse: collapse; text-align: center;"> <tr> <td style="width: 10%;"></td> <td style="width: 10%;"></td> <td style="width: 10%;"></td> <td style="width: 10%;"></td> <td style="width: 10%;"></td> <td style="width: 10%;"></td> <td style="width: 10%;"></td> <td style="width: 10%;"></td> <td style="width: 10%;"></td> <td style="width: 10%;"></td> </tr> <tr> <td></td> <td></td> <td colspan="8" style="text-align: center;"> <table border="1" style="width: 100%; border-collapse: collapse; text-align: center;"> <tr> <td style="width: 10%;"></td> <td style="width: 10%;"></td> <td style="width: 10%;"></td> <td style="width: 10%;"></td> <td style="width: 10%;"></td> <td style="width: 10%;"></td> <td style="width: 10%;"></td> <td style="width: 10%;"></td> <td style="width: 10%;"></td> <td style="width: 10%;"></td> </tr> <tr> <td></td> <td></td> <td colspan="8" style="text-align: center;"> <table border="1" style="width: 100%; border-collapse: collapse; text-align: center;"> <tr> <td style="width: 10%;"></td> <td style="width: 10%;"></td> <td style="width: 10%;"></td> <td style="width: 10%;"></td> <td style="width: 10%;"></td> <td style="width: 10%;"></td> <td style="width: 10%;"></td> <td style="width: 10%;"></td> <td style="width: 10%;"></td> <td style="width: 10%;"></td> </tr> <tr> <td></td> <td></td> <td colspan="8" style="text-align: center;"> <table border="1" style="width: 100%; border-collapse: collapse; text-align: center;"> <tr> <td style="width: 10%;"></td> <td style="width: 10%;"></td> <td style="width: 10%;"></td> <td style="width: 10%;"></td> <td style="width: 10%;"></td> <td style="width: 10%;"></td> <td style="width: 10%;"></td> <td style="width: 10%;"></td> <td style="width: 10%;"></td> <td style="width: 10%;"></td> </tr> <tr> <td></td> <td></td> <td colspan="8" style="text-align: center;"> <table border="1" style="width: 100%; border-collapse: collapse; text-align: center;"> <tr> <td style="width: 10%;"></td> <td style="width: 10%;"></td> <td style="width: 10%;"></td> <td style="width: 10%;"></td> <td style="width: 10%;"></td> <td style="width: 10%;"></td> <td style="width: 10%;"></td> <td style="width: 10%;"></td> <td style="width: 10%;"></td> <td style="width: 10%;"></td> </tr> <tr> <td></td> <td></td> <td colspan="8" style="text-align: center;"> <table border="1" style="width: 100%; border-collapse: collapse; text-align: center;"> <tr> <td style="width: 10%;"></td> <td style="width: 10%;"></td> <td style="width: 10%;"></td> <td style="width: 10%;"></td> <td style="width: 10%;"></td> <td style="width: 10%;"></td> <td style="width: 10%;"></td> <td style="width: 10%;"></td> <td style="width: 10%;"></td> <td style="width: 10%;"></td> </tr> <tr> <td></td> <td></td> <td
colspan="8" style="text-align: center;"> <table border="1" style="width: 100%; border-collapse: collapse; text-align: center;"> <tr> </tr></table></td></tr></table></td></tr></table></td></tr></table></td></tr></table></td></tr></table></td></tr></table></td></tr></table>
 | | | | | | | | | | | | | | | | | | | | <table border="1" style="width: 100%; border-collapse: collapse; text-align: center;"> <tr> <td style="width: 10%;"></td> <td style="width: 10%;"></td> <td style="width: 10%;"></td> <td style="width: 10%;"></td> <td style="width: 10%;"></td> <td style="width: 10%;"></td> <td style="width: 10%;"></td> <td style="width: 10%;"></td> <td style="width: 10%;"></td> <td style="width: 10%;"></td> </tr> <tr> <td></td> <td></td> <td colspan="8" style="text-align: center;"> <table border="1" style="width: 100%; border-collapse: collapse; text-align: center;"> <tr> <td style="width: 10%;"></td> <td style="width: 10%;"></td> <td style="width: 10%;"></td> <td style="width: 10%;"></td> <td style="width: 10%;"></td> <td style="width: 10%;"></td> <td style="width: 10%;"></td> <td style="width: 10%;"></td> <td style="width: 10%;"></td> <td style="width: 10%;"></td> </tr> <tr> <td></td> <td></td> <td colspan="8" style="text-align: center;"> <table border="1" style="width: 100%; border-collapse: collapse; text-align: center;"> <tr> <td style="width: 10%;"></td> <td style="width: 10%;"></td> <td style="width: 10%;"></td> <td style="width: 10%;"></td> <td style="width: 10%;"></td> <td style="width: 10%;"></td> <td style="width: 10%;"></td> <td style="width: 10%;"></td> <td style="width: 10%;"></td> <td style="width: 10%;"></td> </tr> <tr> <td></td> <td></td> <td colspan="8" style="text-align: center;"> <table border="1" style="width: 100%; border-collapse: collapse; text-align: center;"> <tr> <td style="width: 10%;"></td> <td style="width: 10%;"></td> <td style="width: 10%;"></td> <td style="width: 10%;"></td> <td style="width: 10%;"></td> <td style="width: 10%;"></td> <td style="width: 10%;"></td> <td style="width: 10%;"></td> <td style="width: 10%;"></td> <td style="width: 10%;"></td> </tr> <tr> <td></td> <td></td> <td colspan="8" style="text-align: center;"> <table border="1" style="width: 100%; border-collapse: collapse; text-align: center;"> <tr> <td style="width: 10%;"></td> <td style="width: 10%;"></td> <td style="width: 10%;"></td> <td style="width: 10%;"></td> <td style="width: 10%;"></td> <td style="width: 10%;"></td> <td style="width: 10%;"></td> <td style="width: 10%;"></td> <td style="width: 10%;"></td> <td style="width: 10%;"></td> </tr> <tr> <td></td> <td></td> <td colspan="8" style="text-align: center;"> <table border="1" style="width: 100%; border-collapse: collapse; text-align: center;"> <tr> <td style="width: 10%;"></td> <td style="width: 10%;"></td> <td style="width: 10%;"></td> <td style="width: 10%;"></td> <td style="width: 10%;"></td> <td style="width: 10%;"></td> <td style="width: 10%;"></td> <td style="width: 10%;"></td> <td style="width: 10%;"></td> <td style="width: 10%;"></td> </tr> <tr> <td></td> <td></td> <td colspan="8" style="text-align: center;"> <table border="1" style="width: 100%; border-collapse: collapse; text-align: center;"> <tr> </tr></table></td></tr></table></td></tr></table></td></tr></table></td></tr></table></td></tr></table></td></tr></table>

 | | | | | | | | | | | | | | | | | | | | <table border="1" style="width: 100%; border-collapse: collapse; text-align: center;"> <tr> <td style="width: 10%;"></td> <td style="width: 10%;"></td> <td style="width: 10%;"></td> <td style="width: 10%;"></td> <td style="width: 10%;"></td> <td style="width: 10%;"></td> <td style="width: 10%;"></td> <td style="width: 10%;"></td> <td style="width: 10%;"></td> <td style="width: 10%;"></td> </tr> <tr> <td></td> <td></td> <td colspan="8" style="text-align: center;"> <table border="1" style="width: 100%; border-collapse: collapse; text-align: center;"> <tr> <td style="width: 10%;"></td> <td style="width: 10%;"></td> <td style="width: 10%;"></td> <td style="width: 10%;"></td> <td style="width: 10%;"></td> <td style="width: 10%;"></td> <td style="width: 10%;"></td> <td style="width: 10%;"></td> <td style="width: 10%;"></td> <td style="width: 10%;"></td> </tr> <tr> <td></td> <td></td> <td colspan="8" style="text-align: center;"> <table border="1" style="width: 100%; border-collapse: collapse; text-align: center;"> <tr> <td style="width: 10%;"></td> <td style="width: 10%;"></td> <td style="width: 10%;"></td> <td style="width: 10%;"></td> <td style="width: 10%;"></td> <td style="width: 10%;"></td> <td style="width: 10%;"></td> <td style="width: 10%;"></td> <td style="width: 10%;"></td> <td style="width: 10%;"></td> </tr> <tr> <td></td> <td></td> <td colspan="8" style="text-align: center;"> <table border="1" style="width: 100%; border-collapse: collapse; text-align: center;"> <tr> <td style="width: 10%;"></td> <td style="width: 10%;"></td> <td style="width: 10%;"></td> <td style="width: 10%;"></td> <td style="width: 10%;"></td> <td style="width: 10%;"></td> <td style="width: 10%;"></td> <td style="width: 10%;"></td> <td style="width: 10%;"></td> <td style="width: 10%;"></td> </tr> <tr> <td></td> <td></td> <td colspan="8" style="text-align: center;"> <table border="1" style="width: 100%; border-collapse: collapse; text-align: center;"> <tr> <td style="width: 10%;"></td> <td style="width: 10%;"></td> <td style="width: 10%;"></td> <td style="width: 10%;"></td> <td style="width: 10%;"></td> <td style="width: 10%;"></td> <td style="width: 10%;"></td> <td style="width: 10%;"></td> <td style="width: 10%;"></td> <td style="width: 10%;"></td> </tr> <tr> <td></td> <td></td> <td colspan="8" style="text-align: center;"> <table border="1" style="width: 100%; border-collapse: collapse; text-align: center;"> <tr> </tr></table></td></tr></table></td></tr></table></td></tr></table></td></tr></table></td></tr></table>

 | | | | | | | | | | | | | | | | | | | | <table border="1" style="width: 100%; border-collapse: collapse; text-align: center;"> <tr> <td style="width: 10%;"></td> <td style="width: 10%;"></td> <td style="width: 10%;"></td> <td style="width: 10%;"></td> <td style="width: 10%;"></td> <td style="width: 10%;"></td> <td style="width: 10%;"></td> <td style="width: 10%;"></td> <td style="width: 10%;"></td> <td style="width: 10%;"></td> </tr> <tr> <td></td> <td></td> <td colspan="8" style="text-align: center;"> <table border="1" style="width: 100%; border-collapse: collapse; text-align: center;"> <tr> <td style="width: 10%;"></td> <td style="width: 10%;"></td> <td style="width: 10%;"></td> <td style="width: 10%;"></td> <td style="width: 10%;"></td> <td style="width: 10%;"></td> <td style="width: 10%;"></td> <td style="width: 10%;"></td> <td style="width: 10%;"></td> <td style="width: 10%;"></td> </tr> <tr> <td></td> <td></td> <td colspan="8" style="text-align: center;"> <table border="1" style="width: 100%; border-collapse: collapse; text-align: center;"> <tr> <td style="width: 10%;"></td> <td style="width: 10%;"></td> <td style="width: 10%;"></td> <td style="width: 10%;"></td> <td style="width: 10%;"></td> <td style="width: 10%;"></td> <td style="width: 10%;"></td> <td style="width: 10%;"></td> <td style="width: 10%;"></td> <td style="width: 10%;"></td> </tr> <tr> <td></td> <td></td> <td colspan="8" style="text-align: center;"> <table border="1" style="width: 100%; border-collapse: collapse; text-align: center;"> <tr> <td style="width: 10%;"></td> <td style="width: 10%;"></td> <td style="width: 10%;"></td> <td style="width: 10%;"></td> <td style="width: 10%;"></td> <td style="width: 10%;"></td> <td style="width: 10%;"></td> <td style="width: 10%;"></td> <td style="width: 10%;"></td> <td style="width: 10%;"></td> </tr> <tr> <td></td> <td></td> <td colspan="8" style="text-align: center;"> <table border="1" style="width: 100%; border-collapse: collapse; text-align: center;"> <tr> </tr></table></td></tr></table></td></tr></table></td></tr></table></td></tr></table>

 | | | | | | | | | | | | | | | | | | | | <table border="1" style="width: 100%; border-collapse: collapse; text-align: center;"> <tr> <td style="width: 10%;"></td> <td style="width: 10%;"></td> <td style="width: 10%;"></td> <td style="width: 10%;"></td> <td style="width: 10%;"></td> <td style="width: 10%;"></td> <td style="width: 10%;"></td> <td style="width: 10%;"></td> <td style="width: 10%;"></td> <td style="width: 10%;"></td> </tr> <tr> <td></td> <td></td> <td colspan="8" style="text-align: center;"> <table border="1" style="width: 100%; border-collapse: collapse; text-align: center;"> <tr> <td style="width: 10%;"></td> <td style="width: 10%;"></td> <td style="width: 10%;"></td> <td style="width: 10%;"></td> <td style="width: 10%;"></td> <td style="width: 10%;"></td> <td style="width: 10%;"></td> <td style="width: 10%;"></td> <td style="width: 10%;"></td> <td style="width: 10%;"></td> </tr> <tr> <td></td> <td></td> <td colspan="8" style="text-align: center;"> <table border="1" style="width: 100%; border-collapse: collapse; text-align: center;"> <tr> <td style="width: 10%;"></td> <td style="width: 10%;"></td> <td style="width: 10%;"></td> <td style="width: 10%;"></td> <td style="width: 10%;"></td> <td style="width: 10%;"></td> <td style="width: 10%;"></td> <td style="width: 10%;"></td> <td style="width: 10%;"></td> <td style="width: 10%;"></td> </tr> <tr> <td></td> <td></td> <td colspan="8" style="text-align: center;"> <table border="1" style="width: 100%; border-collapse: collapse; text-align: center;"> <tr> </tr></table></td></tr></table></td></tr></table></td></tr></table>

 | | | | | | | | | | | | | | | | | | | | <table border="1" style="width: 100%; border-collapse: collapse; text-align: center;"> <tr> <td style="width: 10%;"></td> <td style="width: 10%;"></td> <td style="width: 10%;"></td> <td style="width: 10%;"></td> <td style="width: 10%;"></td> <td style="width: 10%;"></td> <td style="width: 10%;"></td> <td style="width: 10%;"></td> <td style="width: 10%;"></td> <td style="width: 10%;"></td> </tr> <tr> <td></td> <td></td> <td colspan="8" style="text-align: center;"> <table border="1" style="width: 100%; border-collapse: collapse; text-align: center;"> <tr> <td style="width: 10%;"></td> <td style="width: 10%;"></td> <td style="width: 10%;"></td> <td style="width: 10%;"></td> <td style="width: 10%;"></td> <td style="width: 10%;"></td> <td style="width: 10%;"></td> <td style="width: 10%;"></td> <td style="width: 10%;"></td> <td style="width: 10%;"></td> </tr> <tr> <td></td> <td></td> <td colspan="8" style="text-align: center;"> <table border="1" style="width: 100%; border-collapse: collapse; text-align: center;"> <tr> </tr></table></td></tr></table></td></tr></table>
 | | | | | | | | | | | | |
 | | | | | | | <table border="1" style="width: 100%; border-collapse: collapse; text-align: center;"> <tr> <td style="width: 10%;"></td> <td style="width: 10%;"></td> <td style="width: 10%;"></td> <td style="width: 10%;"></td> <td style="width: 10%;"></td> <td style="width: 10%;"></td> <td style="width: 10%;"></td> <td style="width: 10%;"></td> <td style="width: 10%;"></td> <td style="width: 10%;"></td> </tr> <tr> <td></td> <td></td> <td colspan="8" style="text-align: center;"> <table border="1" style="width: 100%; border-collapse: collapse; text-align: center;"> <tr> </tr></table></td></tr></table>
 | | | | | | | | | | | | | | | | | | | | <table border="1" style="width: 100%; border-collapse: collapse; text-align: center;"> <tr> </tr></table>

 | | | | | | | | | | | | | | | | | | | |

 | | | | | | | | | | | | | | | | | | | |
 | | | | | | | | | | | | | | | | | | | |

 | | | | | | | | | | | | | | | | | | | |
 | | | | | | | | | | | | | | | | | | | |
 | | | | | |
 | | | | | | | | | | | | |
 | | | | | | | | | | | | | | | | | | | |
 | | | | | | | | | | | | | | | | | | | |
 | | | | | | | | | | | | | | | | | | | |

 | | | | | | | | | | | | | | | | | | | | | | | | | | | | | | | | | | | | | | | | | | | | | | | | | | | | | | | | | | | | | | | | | | | | | | | | | | | | | | | |
 | | | | | | | | | | | | | | | | | | | |
 | | | | | | | | | | | | | | | | | | | |
 | | | | | | | | | | | | | | | | | | | |
 | | | | | | | | | | | | | | | | | | | |
 | | | | | | | | | | | | | | | | | | | |
 | | | | | | | | | | | | | | | | | | | |
 | | | | | | | | | | | | | | | | | | | |
 | | | | | | | | | | | | | | | | | | | |
 | | | | | | | | | | | | | | | | | | | | | | | | | | | | | | | | | | | | | | | |
 | | | | | | | | | | | | | | | | | | | |
 | | | | | | | | | | | | | | | | | | | | | | | | | | | | | | | | | | | | | | | |
 | | | | | | | | | | | | | | | | | | | | | | | | | | | | | | | | | | | | | | | |
 | | | | | | | | | | | | | | | | | | | | | | | | | | | | | | | | | | | | | | | |
 | | | | | | | | | | | | | | | | | | | | | | | | | | | | | | | | | | | | | | | | | | | | | | | | | | | | | | | | | | | | | | | | | | | | | | | | | | | | | | | |
 | | | | | | | | | | | | | | | | | | | | | | | | | | | | | | | | | | | | | | | | | | | | | | | | | | | | | | | | | | | | | | | | | | | |
| | |

 | | | | | | | | | | | | | | | | | | | |

 | | | | | | | | | | | | | | | | | | | |

 | | | | | | | | | | | | | | | | | | | |

 | | | | | | | | | | | | | | | | | | | |

 | | | | | | | | | | | | | | | | | | | |

 | | | | | | | | | | | | | | | | | | | |

 | | | | | | | | | | | | | | | | | | | |

 | | | | | | | | | | | | | | | | | | | |

 | | | | | | | | | | | | | | | | | | | |

 | | | | | | | | | | | | | | | | | | | |

 | | | | | | | | | | | | | | | | | | | |

 | | | | | | | | | | | | | | | | | | | |

 | | | | | | | | | | | | | | | | | | | |

 | | | | | | | | | | | | | | | | | | | |

 | | | | | | | | | | | | | | | | | | | |

 | | | | | | | | | | | | | | | | | | | |

 | | | | | | | | | | | | | | | | | | | |

 | | | | | | | | | | | | | | | | | | | |

 | | | | | | | | | | | | | | | | | | | |

 | | | | | | | | | | | | | | | | | | | |

 | | | | | | | | | | | | | | | | | | | |

 | | | | | | | | | | | | | | | | | | | |

 | | | | | | | | | | | | | | | | | | | |

 | | | | | | | | | | | | | | | | | | | |

 | | | | | | | | | | | | | | | | | | | |

 | | | | | | | | | | | | | | | | | | | |

 | | | | | | | | | | | | | | | | | | | |

 | | | | | | | | | | | | | | | | | | | |
 | | | | | | | | | | | | | | | | | | | |

 | | | | | | | | | | | | | | | | | | | |

 | | | | | | | | | | | | | | | | | | | |
 | | | | | | | | | | | | | | | | | | | |

 | | | | | | | | | | | | | | | | | | | |

 | | | | | | | | | | | | | | | | | | | |
 | | | | | | | | | | | | | | | | | | | |
 | | | | | | | | | | | | | | | | | | | |

 | | | | | | | | | | | | | | | | | | | |
 | | | | | | | | | | | | | | | | | | | |
 | | | | | | | | | | | | | | | | | | | |

 | | | | | | | | | | | | | | | | | | | | | | | | | | | | | | | | | | | | | | | | | | | | | | | | | | | | | | | | | | | | | | | | | | | | | | | | | | | | | | | | | | | | | | | | | | | | | | | | | | | |
 | | | | | | | | | | | | | | | | | | | |
 | | | | | | | | | | | | | | | | | | | |
 | | | | | | | | | | | | | | | | | | | |
 | | | | | | | | | | | | | | | | | | | |
 | | | | | | | | | | | | | | | | | | | |
 | | | | | | | | | | | | | | | | | | | |
 | | | | | | | | | | | | | | | | | | | |
 | | | | | | | | | | | | | | | | | | | |
 | | | | | | | | | | | | | | | | | | | | | | | | | | | | | | | | | | | | | | | |
 | | | | | | | | | | | | | | | | | | | |
 | | | | | | | | | | | | | | | | | | | | | | | | | | | | | | | | | | | | | | | |
 | | | | | | | | | | | | | | | | | | | | | | | | | | | | | | | | | | | | | | | |
 | | | | | | | | | | | | | | | | | | | | | | | | | | | | | | | | | | | | | | | |
 | | | | | | | | | | | | | | | | | | | | | | | | | | | | | | | | | | | | | | | | | | | | | | | | | | | | | | | | | | | | | | | | | | | | | | | | | | | | | | | | | | | | | | | | | | | | | | | | | | | |
 | | | | | | | | | | | | | | | | | | | | | | | | | | | | | | | | | | | | | | | | | | | | | | | |
| | | <table border="1" style="width: 100%; border-collapse: collapse; text-align: center;"> <tr> <td style="width: 10%;"></td> <td style="width: 10%;"></td> <td style="width: 10%;"></td> <td style="width: 10%;"></td> <td style="width: 10%;"></td> <td style="width: 10%;"></td> <td style="width: 10%;"></td> <td style="width: 10%;"></td> <td style="width: 10%;"></td> <td style="width: 10%;"></td> </tr> <tr> <td></td> <td></td> <td colspan="8" style="text-align: center;"> <table border="1" style="width: 100%; border-collapse: collapse; text-align: center;"> <tr> <td style="width: 10%;"></td> <td style="width: 10%;"></td> <td style="width: 10%;"></td> <td style="width: 10%;"></td> <td style="width: 10%;"></td> <td style="width: 10%;"></td> <td style="width: 10%;"></td> <td style="width: 10%;"></td> <td style="width: 10%;"></td> <td style="width: 10%;"></td> </tr> <tr> <td></td> <td></td> <td colspan="8" style="text-align: center;"> <table border="1" style="width: 100%; border-collapse: collapse; text-align: center;"> <tr> <td style="width: 10%;"></td> <td style="width: 10%;"></td> <td style="width: 10%;"></td> <td style="width: 10%;"></td> <td style="width: 10%;"></td> <td style="width: 10%;"></td> <td style="width: 10%;"></td> <td style="width: 10%;"></td> <td style="width: 10%;"></td> <td style="width: 10%;"></td> </tr> <tr> <td></td> <td></td> <td colspan="8" style="text-align: center;"> <table border="1" style="width: 100%; border-collapse: collapse; text-align: center;"> <tr> <td style="width: 10%;"></td> <td style="width: 10%;"></td> <td style="width: 10%;"></td> <td style="width: 10%;"></td> <td style="width: 10%;"></td> <td style="width: 10%;"></td> <td style="width: 10%;"></td> <td style="width: 10%;"></td> <td style="width: 10%;"></td> <td style="width: 10%;"></td> </tr> <tr> <td></td> <td></td> <td colspan="8" style="text-align: center;"> <table border="1" style="width: 100%; border-collapse: collapse; text-align: center;"> <tr> <td style="width: 10%;"></td> <td style="width: 10%;"></td> <td style="width: 10%;"></td> <td style="width: 10%;"></td> <td style="width: 10%;"></td> <td style="width: 10%;"></td> <td style="width: 10%;"></td> <td style="width: 10%;"></td> <td style="width: 10%;"></td> <td style="width: 10%;"></td> </tr> <tr> <td></td> <td></td> <td colspan="8" style="text-align: center;"> <table border="1" style="width: 100%; border-collapse: collapse; text-align: center;"> <tr> <td style="width: 10%;"></td> <td style="width: 10%;"></td> <td style="width: 10%;"></td> <td style="width: 10%;"></td> <td style="width: 10%;"></td> <td style="width: 10%;"></td> <td style="width: 10%;"></td> <td style="width: 10%;"></td> <td style="width: 10%;"></td> <td style="width: 10%;"></td> </tr> <tr> <td></td> <td></td> <td colspan="8" style="text-align: center;"> <table border="1" style="width: 100%; border-collapse: collapse; text-align: center;"> <tr> <td style="width: 10%;"></td> <td style="width: 10%;"></td> <td style="width: 10%;"></td> <td style="width: 10%;"></td> <td style="width: 10%;"></td> <td style="width: 10%;"></td> <td style="width: 10%;"></td> <td style="width: 10%;"></td> <td style="width: 10%;"></td> <td style="width: 10%;"></td> </tr> <tr> <td></td> <td></td> <td colspan="8" style="text-align: center;"> <table border="1" style="width: 100%; border-collapse: collapse; text-align: center;"> <tr> <td style="width: 10%;"></td> <td style="width: 10%;"></td> <td style="width: 10%;"></td> <td style="width: 10%;"></td> <td style="width: 10%;"></td> <td style="width: 10%;"></td> <td style="width: 10%;"></td> <td style="width: 10%;"></td> <td style="width: 10%;"></td> <td style="width: 10%;"></td> </tr> <tr> <td></td> <td></td> <td colspan="8" style="text-align: center;"> <table border="1" style="width: 100%; border-collapse: collapse; text-align: center;"> <tr> <td style="width: 10%;"></td> <td style="width: 10%;"></td> <td style="width: 10%;"></td> <td style="width: 10%;"></td> <td style="width: 10%;"></td> <td style="width: 10%;"></td> <td style="width: 10%;"></td> <td style="width: 10%;"></td> <td style="width: 10%;"></td> <td style="width: 10%;"></td> </tr> <tr> <td></td> <td></td> <td colspan="8" style="text-align: center;"> <table border="1" style="width: 100%; border-collapse: collapse; text-align: center;"> <tr> <td style="width: 10%;"></td> <td style="width: 10%;"></td> <td style="width: 10%;"></td> <td style="width: 10%;"></td> <td style="width: 10%;"></td> <td style="width: 10%;"></td> <td style="width: 10%;"></td> <td style="width: 10%;"></td> <td style="width: 10%;"></td> <td style="width: 10%;"></td> </tr> <tr> <td></td> <td></td> <td colspan="8" style="text-align: center;"> <table border="1" style="width: 100%; border-collapse: collapse; text-align: center;"> <tr> <td style="width: 10%;"></td> <td style="width: 10%;"></td> <td style="width: 10%;"></td> <td style="width: 10%;"></td> <td style="width: 10%;"></td> <td style="width: 10%;"></td> <td style="width: 10%;"></td> <td style="width: 10%;"></td> <td style="width: 10%;"></td> <td style="width: 10%;"></td> </tr> <tr> <td></td> <td></td> <td colspan="8" style="text-align: center;"> <table border="1" style="width: 100%; border-collapse: collapse; text-align: center;"> <tr> <td style="width: 10%;"></td> <td style="width: 10%;"></td> <td style="width: 10%;"></td> <td style="width: 10%;"></td> <td style="width: 10%;"></td> <td style="width: 10%;"></td> <td style="width: 10%;"></td> <td style="width: 10%;"></td> <td style="width: 10%;"></td> <td style="width: 10%;"></td> </tr> <tr> <td></td> <td></td> <td colspan="8" style="text-align: center;"> <table border="1" style="width: 100%; border-collapse: collapse; text-align: center;"> <tr> <td style="width: 10%;"></td> <td style="width: 10%;"></td> <td style="width: 10%;"></td> <td style="width: 10%;"></td> <td style="width: 10%;"></td> <td style="width: 10%;"></td> <td style="width: 10%;"></td> <td style="width: 10%;"></td> <td style="width: 10%;"></td> <td style="width: 10%;"></td> </tr> <tr> <td></td> <td></td> <td colspan="8" style="text-align: center;"> <table border="1" style="width: 100%; border-collapse: collapse; text-align: center;"> <tr> <td style="width: 10%;"></td> <td style="width: 10%;"></td> <td style="width: 10%;"></td> <td style="width: 10%;"></td> <td style="width: 10%;"></td> <td style="width: 10%;"></td> <td style="width: 10%;"></td> <td style="width: 10%;"></td> <td style="width: 10%;"></td> <td style="width: 10%;"></td> </tr> <tr> <td></td> <td></td> <td colspan="8" style="text-align: center;"> <table border="1" style="width: 100%; border-collapse: collapse; text-align: center;"> <tr> <td style="width: 10%;"></td> <td style="width: 10%;"></td> <td style="width: 10%;"></td> <td style="width: 10%;"></td> <td style="width: 10%;"></td> <td style="width: 10%;"></td> <td style="width: 10%;"></td> <td style="width: 10%;"></td> <td style="width: 10%;"></td> <td style="width: 10%;"></td> </tr> <tr> <td></td> <td></td> <td colspan="8" style="text-align: center;"> <table border="1" style="width: 100%; border-collapse: collapse; text-align: center;"> <tr> <td style="width: 10%;"></td> <td style="width: 10%;"></td> <td style="width: 10%;"></td> <td style="width: 10%;"></td> <td style="width: 10%;"></td> <td style="width: 10%;"></td> <td style="width: 10%;"></td> <td style="width: 10%;"></td> <td style="width: 10%;"></td> <td style="width: 10%;"></td> </tr> <tr> <td></td> <td></td> <td colspan="8" style="text-align: center;"> <table border="1" style="width: 100%; border-collapse: collapse; text-align: center;"> <tr> <td style="width: 10%;"></td> <td style="width: 10%;"></td> <td style="width: 10%;"></td> <td style="width: 10%;"></td> <td style="width: 10%;"></td> <td style="width: 10%;"></td> <td style="width: 10%;"></td> <td style="width: 10%;"></td> <td style="width: 10%;"></td> <td style="width: 10%;"></td> </tr> <tr> <td></td> <td></td> <td colspan="8" style="text-align: center;"> <table border="1" style="width: 100%; border-collapse: collapse; text-align: center;"> <tr> <td style="width: 10%;"></td> <td style="width: 10%;"></td> <td style="width: 10%;"></td> <td style="width: 10%;"></td> <td style="width: 10%;"></td> <td style="width: 10%;"></td> <td style="width: 10%;"></td> <td style="width: 10%;"></td> <td style="width: 10%;"></td> <td style="width: 10%;"></td> </tr> <tr> <td></td> <td></td> <td colspan="8" style="text-align: center;"> <table border="1" style="width: 100%; border-collapse: collapse; text-align: center;"> <tr> <td style="width: 10%;"></td> <td style="width: 10%;"></td> <td style="width: 10%;"></td> <td style="width: 10%;"></td> <td style="width: 10%;"></td> <td style="width: 10%;"></td> <td style="width: 10%;"></td> <td style="width: 10%;"></td> <td style="width: 10%;"></td> <td style="width: 10%;"></td> </tr> <tr> <td></td> <td></td> <td colspan="8" style="text-align: center;"> <table border="1" style="width: 100%; border-collapse: collapse; text-align: center;"> <tr> <td style="width: 10%;"></td> <td style="width: 10%;"></td> <td style="width: 10%;"></td> <td style="width: 10%;"></td> <td style="width: 10%;"></td> <td style="width: 10%;"></td> <td style="width: 10%;"></td> <td style="width: 10%;"></td> <td style="width: 10%;"></td> <td style="width: 10%;"></td> </tr> <tr> <td></td> <td></td> <td colspan="8" style="text-align: center;"> <table border="1" style="width: 100%; border-collapse: collapse; text-align: center;"> <tr> <td style="width: 10%;"></td> <td style="width: 10%;"></td> <td style="width: 10%;"></td> <td style="width: 10%;"></td> <td style="width: 10%;"></td> <td style="width: 10%;"></td> <td style="width: 10%;"></td> <td style="width: 10%;"></td> <td style="width: 10%;"></td> <td style="width: 10%;"></td> </tr> <tr> <td></td> <td></td> <td colspan="8" style="text-align: center;"> <table border="1" style="width: 100%; border-collapse: collapse; text-align: center;"> <tr> <td style="width: 10%;"></td> <td style="width: 10%;"></td> <td
style="width: 10%;"></td> <td style="width: 10%;"></td> <td style="width: 10%;"></td> <td style="width: 10%;"></td> <td style="width: 10%;"></td> <td style="width: 10%;"></td> <td style="width: 10%;"></td> <td style="width: 10%;"></td> </tr> <tr> <td></td> <td></td> <td colspan="8" style="text-align: center;"> <table border="1" style="width: 100%; border-collapse: collapse; text-align: center;"> <tr> <td style="width: 10%;"></td> <td style="width: 10%;"></td> <td style="width: 10%;"></td> <td style="width: 10%;"></td> <td style="width: 10%;"></td> <td style="width: 10%;"></td> <td style="width: 10%;"></td> <td style="width: 10%;"></td> <td style="width: 10%;"></td> <td style="width: 10%;"></td> </tr> <tr> <td></td> <td></td> <td colspan="8" style="text-align: center;"> <table border="1" style="width: 100%; border-collapse: collapse; text-align: center;"> <tr> <td style="width: 10%;"></td> <td style="width: 10%;"></td> <td style="width: 10%;"></td> <td style="width: 10%;"></td> <td style="width: 10%;"></td> <td style="width: 10%;"></td> <td style="width: 10%;"></td> <td style="width: 10%;"></td> <td style="width: 10%;"></td> <td style="width: 10%;"></td> </tr> <tr> <td></td> <td></td> <td colspan="8" style="text-align: center;"> <table border="1" style="width: 100%; border-collapse: collapse; text-align: center;"> <tr> <td style="width: 10%;"></td> <td style="width: 10%;"></td> <td style="width: 10%;"></td> <td style="width: 10%;"></td> <td style="width: 10%;"></td> <td style="width: 10%;"></td> <td style="width: 10%;"></td> <td style="width: 10%;"></td> <td style="width: 10%;"></td> <td style="width: 10%;"></td> </tr> <tr> <td></td> <td></td> <td colspan="8" style="text-align: center;"> <table border="1" style="width: 100%; border-collapse: collapse; text-align: center;"> <tr> <td style="width: 10%;"></td> <td style="width: 10%;"></td> <td style="width: 10%;"></td> <td style="width: 10%;"></td> <td style="width: 10%;"></td> <td style="width: 10%;"></td> <td style="width: 10%;"></td> <td style="width: 10%;"></td> <td style="width: 10%;"></td> <td style="width: 10%;"></td> </tr> <tr> <td></td> <td></td> <td colspan="8" style="text-align: center;"> <table border="1" style="width: 100%; border-collapse: collapse; text-align: center;"> <tr> <td style="width: 10%;"></td> <td style="width: 10%;"></td> <td style="width: 10%;"></td> <td style="width: 10%;"></td> <td style="width: 10%;"></td> <td style="width: 10%;"></td> <td style="width: 10%;"></td> <td style="width: 10%;"></td> <td style="width: 10%;"></td> <td style="width: 10%;"></td> </tr> <tr> <td></td> <td></td> <td colspan="8" style="text-align: center;"> <table border="1" style="width: 100%; border-collapse: collapse; text-align: center;"> <tr> <td style="width: 10%;"></td> <td style="width: 10%;"></td> <td style="width: 10%;"></td> <td style="width: 10%;"></td> <td style="width: 10%;"></td> <td style="width: 10%;"></td> <td style="width: 10%;"></td> <td style="width: 10%;"></td> <td style="width: 10%;"></td> <td style="width: 10%;"></td> </tr> <tr> <td></td> <td></td> <td colspan="8" style="text-align: center;"> <table border="1" style="width: 100%; border-collapse: collapse; text-align: center;"> <tr> <td style="width: 10%;"></td> <td style="width: 10%;"></td> <td style="width: 10%;"></td> <td style="width: 10%;"></td> <td style="width: 10%;"></td> <td style="width: 10%;"></td> <td style="width: 10%;"></td> <td style="width: 10%;"></td> <td style="width: 10%;"></td> <td style="width: 10%;"></td> </tr> <tr> <td></td> <td></td> <td colspan="8" style="text-align: center;"> <table border="1" style="width: 100%; border-collapse: collapse; text-align: center;"> <tr> </tr></table></td></tr></table></td></tr></table></td></tr></table></td></tr></table></td></tr></table></td></tr></table></td></tr></table></td></tr></table></td></tr></table></td></tr></table></td></tr></table></td></tr></table></td></tr></table></td></tr></table></td></tr></table></td></tr></table></td></tr></table></td></tr></table></td></tr></table></td></tr></table></td></tr></table></td></tr></table></td></tr></table></td></tr></table></td></tr></table></td></tr></table></td></tr></table></td></tr></table></td></tr></table>

 | | | | | | | | | | | | | | | | | | | | <table border="1" style="width: 100%; border-collapse: collapse; text-align: center;"> <tr> <td style="width: 10%;"></td> <td style="width: 10%;"></td> <td style="width: 10%;"></td> <td style="width: 10%;"></td> <td style="width: 10%;"></td> <td style="width: 10%;"></td> <td style="width: 10%;"></td> <td style="width: 10%;"></td> <td style="width: 10%;"></td> <td style="width: 10%;"></td> </tr> <tr> <td></td> <td></td> <td colspan="8" style="text-align: center;"> <table border="1" style="width: 100%; border-collapse: collapse; text-align: center;"> <tr> <td style="width: 10%;"></td> <td style="width: 10%;"></td> <td style="width: 10%;"></td> <td style="width: 10%;"></td> <td style="width: 10%;"></td> <td style="width: 10%;"></td> <td style="width: 10%;"></td> <td style="width: 10%;"></td> <td style="width: 10%;"></td> <td style="width: 10%;"></td> </tr> <tr> <td></td> <td></td> <td colspan="8" style="text-align: center;"> <table border="1" style="width: 100%; border-collapse: collapse; text-align: center;"> <tr> <td style="width: 10%;"></td> <td style="width: 10%;"></td> <td style="width: 10%;"></td> <td style="width: 10%;"></td> <td style="width: 10%;"></td> <td style="width: 10%;"></td> <td style="width: 10%;"></td> <td style="width: 10%;"></td> <td style="width: 10%;"></td> <td style="width: 10%;"></td> </tr> <tr> <td></td> <td></td> <td colspan="8" style="text-align: center;"> <table border="1" style="width: 100%; border-collapse: collapse; text-align: center;"> <tr> <td style="width: 10%;"></td> <td style="width: 10%;"></td> <td style="width: 10%;"></td> <td style="width: 10%;"></td> <td style="width: 10%;"></td> <td style="width: 10%;"></td> <td style="width: 10%;"></td> <td style="width: 10%;"></td> <td style="width: 10%;"></td> <td style="width: 10%;"></td> </tr> <tr> <td></td> <td></td> <td colspan="8" style="text-align: center;"> <table border="1" style="width: 100%; border-collapse: collapse; text-align: center;"> <tr> <td style="width: 10%;"></td> <td style="width: 10%;"></td> <td style="width: 10%;"></td> <td style="width: 10%;"></td> <td style="width: 10%;"></td> <td style="width: 10%;"></td> <td style="width: 10%;"></td> <td style="width: 10%;"></td> <td style="width: 10%;"></td> <td style="width: 10%;"></td> </tr> <tr> <td></td> <td></td> <td colspan="8" style="text-align: center;"> <table border="1" style="width: 100%; border-collapse: collapse; text-align: center;"> <tr> <td style="width: 10%;"></td> <td style="width: 10%;"></td> <td style="width: 10%;"></td> <td style="width: 10%;"></td> <td style="width: 10%;"></td> <td style="width: 10%;"></td> <td style="width: 10%;"></td> <td style="width: 10%;"></td> <td style="width: 10%;"></td> <td style="width: 10%;"></td> </tr> <tr> <td></td> <td></td> <td colspan="8" style="text-align: center;"> <table border="1" style="width: 100%; border-collapse: collapse; text-align: center;"> <tr> <td style="width: 10%;"></td> <td style="width: 10%;"></td> <td style="width: 10%;"></td> <td style="width: 10%;"></td> <td style="width: 10%;"></td> <td style="width: 10%;"></td> <td style="width: 10%;"></td> <td style="width: 10%;"></td> <td style="width: 10%;"></td> <td style="width: 10%;"></td> </tr> <tr> <td></td> <td></td> <td colspan="8" style="text-align: center;"> <table border="1" style="width: 100%; border-collapse: collapse; text-align: center;"> <tr> <td style="width: 10%;"></td> <td style="width: 10%;"></td> <td style="width: 10%;"></td> <td style="width: 10%;"></td> <td style="width: 10%;"></td> <td style="width: 10%;"></td> <td style="width: 10%;"></td> <td style="width: 10%;"></td> <td style="width: 10%;"></td> <td style="width: 10%;"></td> </tr> <tr> <td></td> <td></td> <td colspan="8" style="text-align: center;"> <table border="1" style="width: 100%; border-collapse: collapse; text-align: center;"> <tr> <td style="width: 10%;"></td> <td style="width: 10%;"></td> <td style="width: 10%;"></td> <td style="width: 10%;"></td> <td style="width: 10%;"></td> <td style="width: 10%;"></td> <td style="width: 10%;"></td> <td style="width: 10%;"></td> <td style="width: 10%;"></td> <td style="width: 10%;"></td> </tr> <tr> <td></td> <td></td> <td colspan="8" style="text-align: center;"> <table border="1" style="width: 100%; border-collapse: collapse; text-align: center;"> <tr> <td style="width: 10%;"></td> <td style="width: 10%;"></td> <td style="width: 10%;"></td> <td style="width: 10%;"></td> <td style="width: 10%;"></td> <td style="width: 10%;"></td> <td style="width: 10%;"></td> <td style="width: 10%;"></td> <td style="width: 10%;"></td> <td style="width: 10%;"></td> </tr> <tr> <td></td> <td></td> <td colspan="8" style="text-align: center;"> <table border="1" style="width: 100%; border-collapse: collapse; text-align: center;"> <tr> <td style="width: 10%;"></td> <td style="width: 10%;"></td> <td style="width: 10%;"></td> <td style="width: 10%;"></td> <td style="width: 10%;"></td> <td style="width: 10%;"></td> <td style="width: 10%;"></td> <td style="width: 10%;"></td> <td style="width: 10%;"></td> <td style="width: 10%;"></td> </tr> <tr> <td></td> <td></td> <td colspan="8" style="text-align: center;"> <table border="1" style="width: 100%; border-collapse: collapse; text-align: center;"> <tr> <td style="width: 10%;"></td> <td style="width: 10%;"></td> <td style="width: 10%;"></td> <td style="width: 10%;"></td> <td style="width: 10%;"></td> <td style="width: 10%;"></td> <td style="width: 10%;"></td> <td style="width: 10%;"></td> <td style="width: 10%;"></td> <td style="width: 10%;"></td> </tr> <tr> <td></td> <td></td> <td colspan="8" style="text-align: center;"> <table border="1" style="width: 100%; border-collapse: collapse; text-align: center;"> <tr> <td style="width: 10%;"></td> <td style="width: 10%;"></td> <td style="width: 10%;"></td> <td style="width: 10%;"></td> <td style="width: 10%;"></td> <td style="width: 10%;"></td> <td style="width: 10%;"></td> <td style="width: 10%;"></td> <td style="width: 10%;"></td> <td style="width: 10%;"></td> </tr> <tr> <td></td> <td></td> <td colspan="8" style="text-align: center;"> <table border="1" style="width: 100%; border-collapse: collapse; text-align: center;"> <tr> <td style="width: 10%;"></td> <td style="width: 10%;"></td> <td style="width: 10%;"></td> <td style="width: 10%;"></td> <td style="width: 10%;"></td> <td style="width: 10%;"></td> <td style="width: 10%;"></td> <td style="width: 10%;"></td> <td style="width: 10%;"></td> <td style="width: 10%;"></td> </tr> <tr> <td></td> <td></td> <td colspan="8" style="text-align: center;"> <table border="1" style="width: 100%; border-collapse: collapse; text-align: center;"> <tr> <td style="width: 10%;"></td> <td style="width: 10%;"></td> <td style="width: 10%;"></td> <td style="width: 10%;"></td> <td style="width: 10%;"></td> <td style="width: 10%;"></td> <td style="width: 10%;"></td> <td style="width: 10%;"></td> <td style="width: 10%;"></td> <td style="width: 10%;"></td> </tr> <tr> <td></td> <td></td> <td colspan="8" style="text-align: center;"> <table border="1" style="width: 100%; border-collapse: collapse; text-align: center;"> <tr> <td style="width: 10%;"></td> <td style="width: 10%;"></td> <td style="width: 10%;"></td> <td style="width: 10%;"></td> <td style="width: 10%;"></td> <td style="width: 10%;"></td> <td style="width: 10%;"></td> <td style="width: 10%;"></td> <td style="width: 10%;"></td> <td style="width: 10%;"></td> </tr> <tr> <td></td> <td></td> <td colspan="8" style="text-align: center;"> <table border="1" style="width: 100%; border-collapse: collapse; text-align: center;"> <tr> <td style="width: 10%;"></td> <td style="width: 10%;"></td> <td style="width: 10%;"></td> <td style="width: 10%;"></td> <td style="width: 10%;"></td> <td style="width: 10%;"></td> <td style="width: 10%;"></td> <td style="width: 10%;"></td> <td style="width: 10%;"></td> <td style="width: 10%;"></td> </tr> <tr> <td></td> <td></td> <td colspan="8" style="text-align: center;"> <table border="1" style="width: 100%; border-collapse: collapse; text-align: center;"> <tr> <td style="width: 10%;"></td> <td style="width: 10%;"></td> <td style="width: 10%;"></td> <td style="width: 10%;"></td> <td style="width: 10%;"></td> <td style="width: 10%;"></td> <td style="width: 10%;"></td> <td style="width: 10%;"></td> <td style="width: 10%;"></td> <td style="width: 10%;"></td> </tr> <tr> <td></td> <td></td> <td colspan="8" style="text-align: center;"> <table border="1" style="width: 100%; border-collapse: collapse; text-align: center;"> <tr> <td style="width: 10%;"></td> <td style="width: 10%;"></td> <td style="width: 10%;"></td> <td style="width: 10%;"></td> <td style="width: 10%;"></td> <td style="width: 10%;"></td> <td
style="width: 10%;"></td> <td style="width: 10%;"></td> <td style="width: 10%;"></td> <td style="width: 10%;"></td> </tr> <tr> <td></td> <td></td> <td colspan="8" style="text-align: center;"> <table border="1" style="width: 100%; border-collapse: collapse; text-align: center;"> <tr> <td style="width: 10%;"></td> <td style="width: 10%;"></td> <td style="width: 10%;"></td> <td style="width: 10%;"></td> <td style="width: 10%;"></td> <td style="width: 10%;"></td> <td style="width: 10%;"></td> <td style="width: 10%;"></td> <td style="width: 10%;"></td> <td style="width: 10%;"></td> </tr> <tr> <td></td> <td></td> <td colspan="8" style="text-align: center;"> <table border="1" style="width: 100%; border-collapse: collapse; text-align: center;"> <tr> <td style="width: 10%;"></td> <td style="width: 10%;"></td> <td style="width: 10%;"></td> <td style="width: 10%;"></td> <td style="width: 10%;"></td> <td style="width: 10%;"></td> <td style="width: 10%;"></td> <td style="width: 10%;"></td> <td style="width: 10%;"></td> <td style="width: 10%;"></td> </tr> <tr> <td></td> <td></td> <td colspan="8" style="text-align: center;"> <table border="1" style="width: 100%; border-collapse: collapse; text-align: center;"> <tr> <td style="width: 10%;"></td> <td style="width: 10%;"></td> <td style="width: 10%;"></td> <td style="width: 10%;"></td> <td style="width: 10%;"></td> <td style="width: 10%;"></td> <td style="width: 10%;"></td> <td style="width: 10%;"></td> <td style="width: 10%;"></td> <td style="width: 10%;"></td> </tr> <tr> <td></td> <td></td> <td colspan="8" style="text-align: center;"> <table border="1" style="width: 100%; border-collapse: collapse; text-align: center;"> <tr> <td style="width: 10%;"></td> <td style="width: 10%;"></td> <td style="width: 10%;"></td> <td style="width: 10%;"></td> <td style="width: 10%;"></td> <td style="width: 10%;"></td> <td style="width: 10%;"></td> <td style="width: 10%;"></td> <td style="width: 10%;"></td> <td style="width: 10%;"></td> </tr> <tr> <td></td> <td></td> <td colspan="8" style="text-align: center;"> <table border="1" style="width: 100%; border-collapse: collapse; text-align: center;"> <tr> <td style="width: 10%;"></td> <td style="width: 10%;"></td> <td style="width: 10%;"></td> <td style="width: 10%;"></td> <td style="width: 10%;"></td> <td style="width: 10%;"></td> <td style="width: 10%;"></td> <td style="width: 10%;"></td> <td style="width: 10%;"></td> <td style="width: 10%;"></td> </tr> <tr> <td></td> <td></td> <td colspan="8" style="text-align: center;"> <table border="1" style="width: 100%; border-collapse: collapse; text-align: center;"> <tr> <td style="width: 10%;"></td> <td style="width: 10%;"></td> <td style="width: 10%;"></td> <td style="width: 10%;"></td> <td style="width: 10%;"></td> <td style="width: 10%;"></td> <td style="width: 10%;"></td> <td style="width: 10%;"></td> <td style="width: 10%;"></td> <td style="width: 10%;"></td> </tr> <tr> <td></td> <td></td> <td colspan="8" style="text-align: center;"> <table border="1" style="width: 100%; border-collapse: collapse; text-align: center;"> <tr> <td style="width: 10%;"></td> <td style="width: 10%;"></td> <td style="width: 10%;"></td> <td style="width: 10%;"></td> <td style="width: 10%;"></td> <td style="width: 10%;"></td> <td style="width: 10%;"></td> <td style="width: 10%;"></td> <td style="width: 10%;"></td> <td style="width: 10%;"></td> </tr> <tr> <td></td> <td></td> <td colspan="8" style="text-align: center;"> <table border="1" style="width: 100%; border-collapse: collapse; text-align: center;"> <tr> <td style="width: 10%;"></td> <td style="width: 10%;"></td> <td style="width: 10%;"></td> <td style="width: 10%;"></td> <td style="width: 10%;"></td> <td style="width: 10%;"></td> <td style="width: 10%;"></td> <td style="width: 10%;"></td> <td style="width: 10%;"></td> <td style="width: 10%;"></td> </tr> <tr> <td></td> <td></td> <td colspan="8" style="text-align: center;"> <table border="1" style="width: 100%; border-collapse: collapse; text-align: center;"> <tr> <td style="width: 10%;"></td> <td style="width: 10%;"></td> <td style="width: 10%;"></td> <td style="width: 10%;"></td> <td style="width: 10%;"></td> <td style="width: 10%;"></td> <td style="width: 10%;"></td> <td style="width: 10%;"></td> <td style="width: 10%;"></td> <td style="width: 10%;"></td> </tr> <tr> <td></td> <td></td> <td colspan="8" style="text-align: center;"> <table border="1" style="width: 100%; border-collapse: collapse; text-align: center;"> <tr> </tr></table></td></tr></table></td></tr></table></td></tr></table></td></tr></table></td></tr></table></td></tr></table></td></tr></table></td></tr></table></td></tr></table></td></tr></table></td></tr></table></td></tr></table></td></tr></table></td></tr></table></td></tr></table></td></tr></table></td></tr></table></td></tr></table></td></tr></table></td></tr></table></td></tr></table></td></tr></table></td></tr></table></td></tr></table></td></tr></table></td></tr></table></td></tr></table></td></tr></table>

 | | | | | | | | | | | | | | | | | | | | <table border="1" style="width: 100%; border-collapse: collapse; text-align: center;"> <tr> <td style="width: 10%;"></td> <td style="width: 10%;"></td> <td style="width: 10%;"></td> <td style="width: 10%;"></td> <td style="width: 10%;"></td> <td style="width: 10%;"></td> <td style="width: 10%;"></td> <td style="width: 10%;"></td> <td style="width: 10%;"></td> <td style="width: 10%;"></td> </tr> <tr> <td></td> <td></td> <td colspan="8" style="text-align: center;"> <table border="1" style="width: 100%; border-collapse: collapse; text-align: center;"> <tr> <td style="width: 10%;"></td> <td style="width: 10%;"></td> <td style="width: 10%;"></td> <td style="width: 10%;"></td> <td style="width: 10%;"></td> <td style="width: 10%;"></td> <td style="width: 10%;"></td> <td style="width: 10%;"></td> <td style="width: 10%;"></td> <td style="width: 10%;"></td> </tr> <tr> <td></td> <td></td> <td colspan="8" style="text-align: center;"> <table border="1" style="width: 100%; border-collapse: collapse; text-align: center;"> <tr> <td style="width: 10%;"></td> <td style="width: 10%;"></td> <td style="width: 10%;"></td> <td style="width: 10%;"></td> <td style="width: 10%;"></td> <td style="width: 10%;"></td> <td style="width: 10%;"></td> <td style="width: 10%;"></td> <td style="width: 10%;"></td> <td style="width: 10%;"></td> </tr> <tr> <td></td> <td></td> <td colspan="8" style="text-align: center;"> <table border="1" style="width: 100%; border-collapse: collapse; text-align: center;"> <tr> <td style="width: 10%;"></td> <td style="width: 10%;"></td> <td style="width: 10%;"></td> <td style="width: 10%;"></td> <td style="width: 10%;"></td> <td style="width: 10%;"></td> <td style="width: 10%;"></td> <td style="width: 10%;"></td> <td style="width: 10%;"></td> <td style="width: 10%;"></td> </tr> <tr> <td></td> <td></td> <td colspan="8" style="text-align: center;"> <table border="1" style="width: 100%; border-collapse: collapse; text-align: center;"> <tr> <td style="width: 10%;"></td> <td style="width: 10%;"></td> <td style="width: 10%;"></td> <td style="width: 10%;"></td> <td style="width: 10%;"></td> <td style="width: 10%;"></td> <td style="width: 10%;"></td> <td style="width: 10%;"></td> <td style="width: 10%;"></td> <td style="width: 10%;"></td> </tr> <tr> <td></td> <td></td> <td colspan="8" style="text-align: center;"> <table border="1" style="width: 100%; border-collapse: collapse; text-align: center;"> <tr> <td style="width: 10%;"></td> <td style="width: 10%;"></td> <td style="width: 10%;"></td> <td style="width: 10%;"></td> <td style="width: 10%;"></td> <td style="width: 10%;"></td> <td style="width: 10%;"></td> <td style="width: 10%;"></td> <td style="width: 10%;"></td> <td style="width: 10%;"></td> </tr> <tr> <td></td> <td></td> <td colspan="8" style="text-align: center;"> <table border="1" style="width: 100%; border-collapse: collapse; text-align: center;"> <tr> <td style="width: 10%;"></td> <td style="width: 10%;"></td> <td style="width: 10%;"></td> <td style="width: 10%;"></td> <td style="width: 10%;"></td> <td style="width: 10%;"></td> <td style="width: 10%;"></td> <td style="width: 10%;"></td> <td style="width: 10%;"></td> <td style="width: 10%;"></td> </tr> <tr> <td></td> <td></td> <td colspan="8" style="text-align: center;"> <table border="1" style="width: 100%; border-collapse: collapse; text-align: center;"> <tr> <td style="width: 10%;"></td> <td style="width: 10%;"></td> <td style="width: 10%;"></td> <td style="width: 10%;"></td> <td style="width: 10%;"></td> <td style="width: 10%;"></td> <td style="width: 10%;"></td> <td style="width: 10%;"></td> <td style="width: 10%;"></td> <td style="width: 10%;"></td> </tr> <tr> <td></td> <td></td> <td colspan="8" style="text-align: center;"> <table border="1" style="width: 100%; border-collapse: collapse; text-align: center;"> <tr> <td style="width: 10%;"></td> <td style="width: 10%;"></td> <td style="width: 10%;"></td> <td style="width: 10%;"></td> <td style="width: 10%;"></td> <td style="width: 10%;"></td> <td style="width: 10%;"></td> <td style="width: 10%;"></td> <td style="width: 10%;"></td> <td style="width: 10%;"></td> </tr> <tr> <td></td> <td></td> <td colspan="8" style="text-align: center;"> <table border="1" style="width: 100%; border-collapse: collapse; text-align: center;"> <tr> <td style="width: 10%;"></td> <td style="width: 10%;"></td> <td style="width: 10%;"></td> <td style="width: 10%;"></td> <td style="width: 10%;"></td> <td style="width: 10%;"></td> <td style="width: 10%;"></td> <td style="width: 10%;"></td> <td style="width: 10%;"></td> <td style="width: 10%;"></td> </tr> <tr> <td></td> <td></td> <td colspan="8" style="text-align: center;"> <table border="1" style="width: 100%; border-collapse: collapse; text-align: center;"> <tr> <td style="width: 10%;"></td> <td style="width: 10%;"></td> <td style="width: 10%;"></td> <td style="width: 10%;"></td> <td style="width: 10%;"></td> <td style="width: 10%;"></td> <td style="width: 10%;"></td> <td style="width: 10%;"></td> <td style="width: 10%;"></td> <td style="width: 10%;"></td> </tr> <tr> <td></td> <td></td> <td colspan="8" style="text-align: center;"> <table border="1" style="width: 100%; border-collapse: collapse; text-align: center;"> <tr> <td style="width: 10%;"></td> <td style="width: 10%;"></td> <td style="width: 10%;"></td> <td style="width: 10%;"></td> <td style="width: 10%;"></td> <td style="width: 10%;"></td> <td style="width: 10%;"></td> <td style="width: 10%;"></td> <td style="width: 10%;"></td> <td style="width: 10%;"></td> </tr> <tr> <td></td> <td></td> <td colspan="8" style="text-align: center;"> <table border="1" style="width: 100%; border-collapse: collapse; text-align: center;"> <tr> <td style="width: 10%;"></td> <td style="width: 10%;"></td> <td style="width: 10%;"></td> <td style="width: 10%;"></td> <td style="width: 10%;"></td> <td style="width: 10%;"></td> <td style="width: 10%;"></td> <td style="width: 10%;"></td> <td style="width: 10%;"></td> <td style="width: 10%;"></td> </tr> <tr> <td></td> <td></td> <td colspan="8" style="text-align: center;"> <table border="1" style="width: 100%; border-collapse: collapse; text-align: center;"> <tr> <td style="width: 10%;"></td> <td style="width: 10%;"></td> <td style="width: 10%;"></td> <td style="width: 10%;"></td> <td style="width: 10%;"></td> <td style="width: 10%;"></td> <td style="width: 10%;"></td> <td style="width: 10%;"></td> <td style="width: 10%;"></td> <td style="width: 10%;"></td> </tr> <tr> <td></td> <td></td> <td colspan="8" style="text-align: center;"> <table border="1" style="width: 100%; border-collapse: collapse; text-align: center;"> <tr> <td style="width: 10%;"></td> <td style="width: 10%;"></td> <td style="width: 10%;"></td> <td style="width: 10%;"></td> <td style="width: 10%;"></td> <td style="width: 10%;"></td> <td style="width: 10%;"></td> <td style="width: 10%;"></td> <td style="width: 10%;"></td> <td style="width: 10%;"></td> </tr> <tr> <td></td> <td></td> <td colspan="8" style="text-align: center;"> <table border="1" style="width: 100%; border-collapse: collapse; text-align: center;"> <tr> <td style="width: 10%;"></td> <td style="width: 10%;"></td> <td style="width: 10%;"></td> <td style="width: 10%;"></td> <td style="width: 10%;"></td> <td style="width: 10%;"></td> <td style="width: 10%;"></td> <td style="width: 10%;"></td> <td style="width: 10%;"></td> <td style="width: 10%;"></td> </tr> <tr> <td></td> <td></td> <td colspan="8" style="text-align: center;"> <table border="1" style="width: 100%; border-collapse: collapse; text-align: center;"> <tr> <td style="width: 10%;"></td> <td style="width: 10%;"></td> <td style="width: 10%;"></td> <td style="width: 10%;"></td> <td style="width: 10%;"></td> <td style="width: 10%;"></td> <td style="width: 10%;"></td> <td style="width: 10%;"></td> <td style="width: 10%;"></td> <td style="width: 10%;"></td> </tr> <tr> <td></td> <td></td> <td
colspan="8" style="text-align: center;"> <table border="1" style="width: 100%; border-collapse: collapse; text-align: center;"> <tr> <td style="width: 10%;"></td> <td style="width: 10%;"></td> <td style="width: 10%;"></td> <td style="width: 10%;"></td> <td style="width: 10%;"></td> <td style="width: 10%;"></td> <td style="width: 10%;"></td> <td style="width: 10%;"></td> <td style="width: 10%;"></td> <td style="width: 10%;"></td> </tr> <tr> <td></td> <td></td> <td colspan="8" style="text-align: center;"> <table border="1" style="width: 100%; border-collapse: collapse; text-align: center;"> <tr> <td style="width: 10%;"></td> <td style="width: 10%;"></td> <td style="width: 10%;"></td> <td style="width: 10%;"></td> <td style="width: 10%;"></td> <td style="width: 10%;"></td> <td style="width: 10%;"></td> <td style="width: 10%;"></td> <td style="width: 10%;"></td> <td style="width: 10%;"></td> </tr> <tr> <td></td> <td></td> <td colspan="8" style="text-align: center;"> <table border="1" style="width: 100%; border-collapse: collapse; text-align: center;"> <tr> <td style="width: 10%;"></td> <td style="width: 10%;"></td> <td style="width: 10%;"></td> <td style="width: 10%;"></td> <td style="width: 10%;"></td> <td style="width: 10%;"></td> <td style="width: 10%;"></td> <td style="width: 10%;"></td> <td style="width: 10%;"></td> <td style="width: 10%;"></td> </tr> <tr> <td></td> <td></td> <td colspan="8" style="text-align: center;"> <table border="1" style="width: 100%; border-collapse: collapse; text-align: center;"> <tr> <td style="width: 10%;"></td> <td style="width: 10%;"></td> <td style="width: 10%;"></td> <td style="width: 10%;"></td> <td style="width: 10%;"></td> <td style="width: 10%;"></td> <td style="width: 10%;"></td> <td style="width: 10%;"></td> <td style="width: 10%;"></td> <td style="width: 10%;"></td> </tr> <tr> <td></td> <td></td> <td colspan="8" style="text-align: center;"> <table border="1" style="width: 100%; border-collapse: collapse; text-align: center;"> <tr> <td style="width: 10%;"></td> <td style="width: 10%;"></td> <td style="width: 10%;"></td> <td style="width: 10%;"></td> <td style="width: 10%;"></td> <td style="width: 10%;"></td> <td style="width: 10%;"></td> <td style="width: 10%;"></td> <td style="width: 10%;"></td> <td style="width: 10%;"></td> </tr> <tr> <td></td> <td></td> <td colspan="8" style="text-align: center;"> <table border="1" style="width: 100%; border-collapse: collapse; text-align: center;"> <tr> <td style="width: 10%;"></td> <td style="width: 10%;"></td> <td style="width: 10%;"></td> <td style="width: 10%;"></td> <td style="width: 10%;"></td> <td style="width: 10%;"></td> <td style="width: 10%;"></td> <td style="width: 10%;"></td> <td style="width: 10%;"></td> <td style="width: 10%;"></td> </tr> <tr> <td></td> <td></td> <td colspan="8" style="text-align: center;"> <table border="1" style="width: 100%; border-collapse: collapse; text-align: center;"> <tr> <td style="width: 10%;"></td> <td style="width: 10%;"></td> <td style="width: 10%;"></td> <td style="width: 10%;"></td> <td style="width: 10%;"></td> <td style="width: 10%;"></td> <td style="width: 10%;"></td> <td style="width: 10%;"></td> <td style="width: 10%;"></td> <td style="width: 10%;"></td> </tr> <tr> <td></td> <td></td> <td colspan="8" style="text-align: center;"> <table border="1" style="width: 100%; border-collapse: collapse; text-align: center;"> <tr> <td style="width: 10%;"></td> <td style="width: 10%;"></td> <td style="width: 10%;"></td> <td style="width: 10%;"></td> <td style="width: 10%;"></td> <td style="width: 10%;"></td> <td style="width: 10%;"></td> <td style="width: 10%;"></td> <td style="width: 10%;"></td> <td style="width: 10%;"></td> </tr> <tr> <td></td> <td></td> <td colspan="8" style="text-align: center;"> <table border="1" style="width: 100%; border-collapse: collapse; text-align: center;"> <tr> <td style="width: 10%;"></td> <td style="width: 10%;"></td> <td style="width: 10%;"></td> <td style="width: 10%;"></td> <td style="width: 10%;"></td> <td style="width: 10%;"></td> <td style="width: 10%;"></td> <td style="width: 10%;"></td> <td style="width: 10%;"></td> <td style="width: 10%;"></td> </tr> <tr> <td></td> <td></td> <td colspan="8" style="text-align: center;"> <table border="1" style="width: 100%; border-collapse: collapse; text-align: center;"> <tr> <td style="width: 10%;"></td> <td style="width: 10%;"></td> <td style="width: 10%;"></td> <td style="width: 10%;"></td> <td style="width: 10%;"></td> <td style="width: 10%;"></td> <td style="width: 10%;"></td> <td style="width: 10%;"></td> <td style="width: 10%;"></td> <td style="width: 10%;"></td> </tr> <tr> <td></td> <td></td> <td colspan="8" style="text-align: center;"> <table border="1" style="width: 100%; border-collapse: collapse; text-align: center;"> <tr> </tr></table></td></tr></table></td></tr></table></td></tr></table></td></tr></table></td></tr></table></td></tr></table></td></tr></table></td></tr></table></td></tr></table></td></tr></table></td></tr></table></td></tr></table></td></tr></table></td></tr></table></td></tr></table></td></tr></table></td></tr></table></td></tr></table></td></tr></table></td></tr></table></td></tr></table></td></tr></table></td></tr></table></td></tr></table></td></tr></table></td></tr></table></td></tr></table>

 | | | | | | | | | | | | | | | | | | | | <table border="1" style="width: 100%; border-collapse: collapse; text-align: center;"> <tr> <td style="width: 10%;"></td> <td style="width: 10%;"></td> <td style="width: 10%;"></td> <td style="width: 10%;"></td> <td style="width: 10%;"></td> <td style="width: 10%;"></td> <td style="width: 10%;"></td> <td style="width: 10%;"></td> <td style="width: 10%;"></td> <td style="width: 10%;"></td> </tr> <tr> <td></td> <td></td> <td colspan="8" style="text-align: center;"> <table border="1" style="width: 100%; border-collapse: collapse; text-align: center;"> <tr> <td style="width: 10%;"></td> <td style="width: 10%;"></td> <td style="width: 10%;"></td> <td style="width: 10%;"></td> <td style="width: 10%;"></td> <td style="width: 10%;"></td> <td style="width: 10%;"></td> <td style="width: 10%;"></td> <td style="width: 10%;"></td> <td style="width: 10%;"></td> </tr> <tr> <td></td> <td></td> <td colspan="8" style="text-align: center;"> <table border="1" style="width: 100%; border-collapse: collapse; text-align: center;"> <tr> <td style="width: 10%;"></td> <td style="width: 10%;"></td> <td style="width: 10%;"></td> <td style="width: 10%;"></td> <td style="width: 10%;"></td> <td style="width: 10%;"></td> <td style="width: 10%;"></td> <td style="width: 10%;"></td> <td style="width: 10%;"></td> <td style="width: 10%;"></td> </tr> <tr> <td></td> <td></td> <td colspan="8" style="text-align: center;"> <table border="1" style="width: 100%; border-collapse: collapse; text-align: center;"> <tr> <td style="width: 10%;"></td> <td style="width: 10%;"></td> <td style="width: 10%;"></td> <td style="width: 10%;"></td> <td style="width: 10%;"></td> <td style="width: 10%;"></td> <td style="width: 10%;"></td> <td style="width: 10%;"></td> <td style="width: 10%;"></td> <td style="width: 10%;"></td> </tr> <tr> <td></td> <td></td> <td colspan="8" style="text-align: center;"> <table border="1" style="width: 100%; border-collapse: collapse; text-align: center;"> <tr> <td style="width: 10%;"></td> <td style="width: 10%;"></td> <td style="width: 10%;"></td> <td style="width: 10%;"></td> <td style="width: 10%;"></td> <td style="width: 10%;"></td> <td style="width: 10%;"></td> <td style="width: 10%;"></td> <td style="width: 10%;"></td> <td style="width: 10%;"></td> </tr> <tr> <td></td> <td></td> <td colspan="8" style="text-align: center;"> <table border="1" style="width: 100%; border-collapse: collapse; text-align: center;"> <tr> <td style="width: 10%;"></td> <td style="width: 10%;"></td> <td style="width: 10%;"></td> <td style="width: 10%;"></td> <td style="width: 10%;"></td> <td style="width: 10%;"></td> <td style="width: 10%;"></td> <td style="width: 10%;"></td> <td style="width: 10%;"></td> <td style="width: 10%;"></td> </tr> <tr> <td></td> <td></td> <td colspan="8" style="text-align: center;"> <table border="1" style="width: 100%; border-collapse: collapse; text-align: center;"> <tr> <td style="width: 10%;"></td> <td style="width: 10%;"></td> <td style="width: 10%;"></td> <td style="width: 10%;"></td> <td style="width: 10%;"></td> <td style="width: 10%;"></td> <td style="width: 10%;"></td> <td style="width: 10%;"></td> <td style="width: 10%;"></td> <td style="width: 10%;"></td> </tr> <tr> <td></td> <td></td> <td colspan="8" style="text-align: center;"> <table border="1" style="width: 100%; border-collapse: collapse; text-align: center;"> <tr> <td style="width: 10%;"></td> <td style="width: 10%;"></td> <td style="width: 10%;"></td> <td style="width: 10%;"></td> <td style="width: 10%;"></td> <td style="width: 10%;"></td> <td style="width: 10%;"></td> <td style="width: 10%;"></td> <td style="width: 10%;"></td> <td style="width: 10%;"></td> </tr> <tr> <td></td> <td></td> <td colspan="8" style="text-align: center;"> <table border="1" style="width: 100%; border-collapse: collapse; text-align: center;"> <tr> <td style="width: 10%;"></td> <td style="width: 10%;"></td> <td style="width: 10%;"></td> <td style="width: 10%;"></td> <td style="width: 10%;"></td> <td style="width: 10%;"></td> <td style="width: 10%;"></td> <td style="width: 10%;"></td> <td style="width: 10%;"></td> <td style="width: 10%;"></td> </tr> <tr> <td></td> <td></td> <td colspan="8" style="text-align: center;"> <table border="1" style="width: 100%; border-collapse: collapse; text-align: center;"> <tr> <td style="width: 10%;"></td> <td style="width: 10%;"></td> <td style="width: 10%;"></td> <td style="width: 10%;"></td> <td style="width: 10%;"></td> <td style="width: 10%;"></td> <td style="width: 10%;"></td> <td style="width: 10%;"></td> <td style="width: 10%;"></td> <td style="width: 10%;"></td> </tr> <tr> <td></td> <td></td> <td colspan="8" style="text-align: center;"> <table border="1" style="width: 100%; border-collapse: collapse; text-align: center;"> <tr> <td style="width: 10%;"></td> <td style="width: 10%;"></td> <td style="width: 10%;"></td> <td style="width: 10%;"></td> <td style="width: 10%;"></td> <td style="width: 10%;"></td> <td style="width: 10%;"></td> <td style="width: 10%;"></td> <td style="width: 10%;"></td> <td style="width: 10%;"></td> </tr> <tr> <td></td> <td></td> <td colspan="8" style="text-align: center;"> <table border="1" style="width: 100%; border-collapse: collapse; text-align: center;"> <tr> <td style="width: 10%;"></td> <td style="width: 10%;"></td> <td style="width: 10%;"></td> <td style="width: 10%;"></td> <td style="width: 10%;"></td> <td style="width: 10%;"></td> <td style="width: 10%;"></td> <td style="width: 10%;"></td> <td style="width: 10%;"></td> <td style="width: 10%;"></td> </tr> <tr> <td></td> <td></td> <td colspan="8" style="text-align: center;"> <table border="1" style="width: 100%; border-collapse: collapse; text-align: center;"> <tr> <td style="width: 10%;"></td> <td style="width: 10%;"></td> <td style="width: 10%;"></td> <td style="width: 10%;"></td> <td style="width: 10%;"></td> <td style="width: 10%;"></td> <td style="width: 10%;"></td> <td style="width: 10%;"></td> <td style="width: 10%;"></td> <td style="width: 10%;"></td> </tr> <tr> <td></td> <td></td> <td colspan="8" style="text-align: center;"> <table border="1" style="width: 100%; border-collapse: collapse; text-align: center;"> <tr> <td style="width: 10%;"></td> <td style="width: 10%;"></td> <td style="width: 10%;"></td> <td style="width: 10%;"></td> <td style="width: 10%;"></td> <td style="width: 10%;"></td> <td style="width: 10%;"></td> <td style="width: 10%;"></td> <td style="width: 10%;"></td> <td style="width: 10%;"></td> </tr> <tr> <td></td> <td></td> <td colspan="8" style="text-align: center;"> <table border="1" style="width: 100%; border-collapse: collapse; text-align: center;"> <tr> <td style="width: 10%;"></td> <td style="width: 10%;"></td> <td style="width: 10%;"></td> <td style="width: 10%;"></td> <td style="width: 10%;"></td> <td style="width: 10%;"></td> <td style="width: 10%;"></td> <td style="width: 10%;"></td> <td style="width: 10%;"></td> <td style="width: 10%;"></td> </tr> <tr> <td></td> <td></td> <td colspan="8" style="text-align: center;"> <table border="1" style="width: 100%; border-collapse: collapse; text-align: center;"> <tr> <td style="width: 10%;"></td> <td style="width: 10%;"></td> <td style="width: 10%;"></td> <td style="width: 10%;"></td> <td style="width: 10%;"></td> <td style="width: 10%;"></td> <td style="width: 10%;"></td> <td style="width: 10%;"></td> <td style="width: 10%;"></td> <td style="width: 10%;"></td> </tr> <tr> <td></td> <td></td> <td colspan="8" style="text-align: center;"> <table border="1" style="width: 100%; border-collapse: collapse; text-align: center;"> <tr> <td style="width: 10%;"></td> <td
style="width: 10%;"></td> <td style="width: 10%;"></td> <td style="width: 10%;"></td> <td style="width: 10%;"></td> <td style="width: 10%;"></td> <td style="width: 10%;"></td> <td style="width: 10%;"></td> <td style="width: 10%;"></td> <td style="width: 10%;"></td> </tr> <tr> <td></td> <td></td> <td colspan="8" style="text-align: center;"> <table border="1" style="width: 100%; border-collapse: collapse; text-align: center;"> <tr> <td style="width: 10%;"></td> <td style="width: 10%;"></td> <td style="width: 10%;"></td> <td style="width: 10%;"></td> <td style="width: 10%;"></td> <td style="width: 10%;"></td> <td style="width: 10%;"></td> <td style="width: 10%;"></td> <td style="width: 10%;"></td> <td style="width: 10%;"></td> </tr> <tr> <td></td> <td></td> <td colspan="8" style="text-align: center;"> <table border="1" style="width: 100%; border-collapse: collapse; text-align: center;"> <tr> <td style="width: 10%;"></td> <td style="width: 10%;"></td> <td style="width: 10%;"></td> <td style="width: 10%;"></td> <td style="width: 10%;"></td> <td style="width: 10%;"></td> <td style="width: 10%;"></td> <td style="width: 10%;"></td> <td style="width: 10%;"></td> <td style="width: 10%;"></td> </tr> <tr> <td></td> <td></td> <td colspan="8" style="text-align: center;"> <table border="1" style="width: 100%; border-collapse: collapse; text-align: center;"> <tr> <td style="width: 10%;"></td> <td style="width: 10%;"></td> <td style="width: 10%;"></td> <td style="width: 10%;"></td> <td style="width: 10%;"></td> <td style="width: 10%;"></td> <td style="width: 10%;"></td> <td style="width: 10%;"></td> <td style="width: 10%;"></td> <td style="width: 10%;"></td> </tr> <tr> <td></td> <td></td> <td colspan="8" style="text-align: center;"> <table border="1" style="width: 100%; border-collapse: collapse; text-align: center;"> <tr> <td style="width: 10%;"></td> <td style="width: 10%;"></td> <td style="width: 10%;"></td> <td style="width: 10%;"></td> <td style="width: 10%;"></td> <td style="width: 10%;"></td> <td style="width: 10%;"></td> <td style="width: 10%;"></td> <td style="width: 10%;"></td> <td style="width: 10%;"></td> </tr> <tr> <td></td> <td></td> <td colspan="8" style="text-align: center;"> <table border="1" style="width: 100%; border-collapse: collapse; text-align: center;"> <tr> <td style="width: 10%;"></td> <td style="width: 10%;"></td> <td style="width: 10%;"></td> <td style="width: 10%;"></td> <td style="width: 10%;"></td> <td style="width: 10%;"></td> <td style="width: 10%;"></td> <td style="width: 10%;"></td> <td style="width: 10%;"></td> <td style="width: 10%;"></td> </tr> <tr> <td></td> <td></td> <td colspan="8" style="text-align: center;"> <table border="1" style="width: 100%; border-collapse: collapse; text-align: center;"> <tr> <td style="width: 10%;"></td> <td style="width: 10%;"></td> <td style="width: 10%;"></td> <td style="width: 10%;"></td> <td style="width: 10%;"></td> <td style="width: 10%;"></td> <td style="width: 10%;"></td> <td style="width: 10%;"></td> <td style="width: 10%;"></td> <td style="width: 10%;"></td> </tr> <tr> <td></td> <td></td> <td colspan="8" style="text-align: center;"> <table border="1" style="width: 100%; border-collapse: collapse; text-align: center;"> <tr> <td style="width: 10%;"></td> <td style="width: 10%;"></td> <td style="width: 10%;"></td> <td style="width: 10%;"></td> <td style="width: 10%;"></td> <td style="width: 10%;"></td> <td style="width: 10%;"></td> <td style="width: 10%;"></td> <td style="width: 10%;"></td> <td style="width: 10%;"></td> </tr> <tr> <td></td> <td></td> <td colspan="8" style="text-align: center;"> <table border="1" style="width: 100%; border-collapse: collapse; text-align: center;"> <tr> <td style="width: 10%;"></td> <td style="width: 10%;"></td> <td style="width: 10%;"></td> <td style="width: 10%;"></td> <td style="width: 10%;"></td> <td style="width: 10%;"></td> <td style="width: 10%;"></td> <td style="width: 10%;"></td> <td style="width: 10%;"></td> <td style="width: 10%;"></td> </tr> <tr> <td></td> <td></td> <td colspan="8" style="text-align: center;"> <table border="1" style="width: 100%; border-collapse: collapse; text-align: center;"> <tr> <td style="width: 10%;"></td> <td style="width: 10%;"></td> <td style="width: 10%;"></td> <td style="width: 10%;"></td> <td style="width: 10%;"></td> <td style="width: 10%;"></td> <td style="width: 10%;"></td> <td style="width: 10%;"></td> <td style="width: 10%;"></td> <td style="width: 10%;"></td> </tr> <tr> <td></td> <td></td> <td colspan="8" style="text-align: center;"> <table border="1" style="width: 100%; border-collapse: collapse; text-align: center;"> <tr> </tr></table></td></tr></table></td></tr></table></td></tr></table></td></tr></table></td></tr></table></td></tr></table></td></tr></table></td></tr></table></td></tr></table></td></tr></table></td></tr></table></td></tr></table></td></tr></table></td></tr></table></td></tr></table></td></tr></table></td></tr></table></td></tr></table></td></tr></table></td></tr></table></td></tr></table></td></tr></table></td></tr></table></td></tr></table></td></tr></table></td></tr></table>

 | | | | | | | | | | | | | | | | | | | | <table border="1" style="width: 100%; border-collapse: collapse; text-align: center;"> <tr> <td style="width: 10%;"></td> <td style="width: 10%;"></td> <td style="width: 10%;"></td> <td style="width: 10%;"></td> <td style="width: 10%;"></td> <td style="width: 10%;"></td> <td style="width: 10%;"></td> <td style="width: 10%;"></td> <td style="width: 10%;"></td> <td style="width: 10%;"></td> </tr> <tr> <td></td> <td></td> <td colspan="8" style="text-align: center;"> <table border="1" style="width: 100%; border-collapse: collapse; text-align: center;"> <tr> <td style="width: 10%;"></td> <td style="width: 10%;"></td> <td style="width: 10%;"></td> <td style="width: 10%;"></td> <td style="width: 10%;"></td> <td style="width: 10%;"></td> <td style="width: 10%;"></td> <td style="width: 10%;"></td> <td style="width: 10%;"></td> <td style="width: 10%;"></td> </tr> <tr> <td></td> <td></td> <td colspan="8" style="text-align: center;"> <table border="1" style="width: 100%; border-collapse: collapse; text-align: center;"> <tr> <td style="width: 10%;"></td> <td style="width: 10%;"></td> <td style="width: 10%;"></td> <td style="width: 10%;"></td> <td style="width: 10%;"></td> <td style="width: 10%;"></td> <td style="width: 10%;"></td> <td style="width: 10%;"></td> <td style="width: 10%;"></td> <td style="width: 10%;"></td> </tr> <tr> <td></td> <td></td> <td colspan="8" style="text-align: center;"> <table border="1" style="width: 100%; border-collapse: collapse; text-align: center;"> <tr> <td style="width: 10%;"></td> <td style="width: 10%;"></td> <td style="width: 10%;"></td> <td style="width: 10%;"></td> <td style="width: 10%;"></td> <td style="width: 10%;"></td> <td style="width: 10%;"></td> <td style="width: 10%;"></td> <td style="width: 10%;"></td> <td style="width: 10%;"></td> </tr> <tr> <td></td> <td></td> <td colspan="8" style="text-align: center;"> <table border="1" style="width: 100%; border-collapse: collapse; text-align: center;"> <tr> <td style="width: 10%;"></td> <td style="width: 10%;"></td> <td style="width: 10%;"></td> <td style="width: 10%;"></td> <td style="width: 10%;"></td> <td style="width: 10%;"></td> <td style="width: 10%;"></td> <td style="width: 10%;"></td> <td style="width: 10%;"></td> <td style="width: 10%;"></td> </tr> <tr> <td></td> <td></td> <td colspan="8" style="text-align: center;"> <table border="1" style="width: 100%; border-collapse: collapse; text-align: center;"> <tr> <td style="width: 10%;"></td> <td style="width: 10%;"></td> <td style="width: 10%;"></td> <td style="width: 10%;"></td> <td style="width: 10%;"></td> <td style="width: 10%;"></td> <td style="width: 10%;"></td> <td style="width: 10%;"></td> <td style="width: 10%;"></td> <td style="width: 10%;"></td> </tr> <tr> <td></td> <td></td> <td colspan="8" style="text-align: center;"> <table border="1" style="width: 100%; border-collapse: collapse; text-align: center;"> <tr> <td style="width: 10%;"></td> <td style="width: 10%;"></td> <td style="width: 10%;"></td> <td style="width: 10%;"></td> <td style="width: 10%;"></td> <td style="width: 10%;"></td> <td style="width: 10%;"></td> <td style="width: 10%;"></td> <td style="width: 10%;"></td> <td style="width: 10%;"></td> </tr> <tr> <td></td> <td></td> <td colspan="8" style="text-align: center;"> <table border="1" style="width: 100%; border-collapse: collapse; text-align: center;"> <tr> <td style="width: 10%;"></td> <td style="width: 10%;"></td> <td style="width: 10%;"></td> <td style="width: 10%;"></td> <td style="width: 10%;"></td> <td style="width: 10%;"></td> <td style="width: 10%;"></td> <td style="width: 10%;"></td> <td style="width: 10%;"></td> <td style="width: 10%;"></td> </tr> <tr> <td></td> <td></td> <td colspan="8" style="text-align: center;"> <table border="1" style="width: 100%; border-collapse: collapse; text-align: center;"> <tr> <td style="width: 10%;"></td> <td style="width: 10%;"></td> <td style="width: 10%;"></td> <td style="width: 10%;"></td> <td style="width: 10%;"></td> <td style="width: 10%;"></td> <td style="width: 10%;"></td> <td style="width: 10%;"></td> <td style="width: 10%;"></td> <td style="width: 10%;"></td> </tr> <tr> <td></td> <td></td> <td colspan="8" style="text-align: center;"> <table border="1" style="width: 100%; border-collapse: collapse; text-align: center;"> <tr> <td style="width: 10%;"></td> <td style="width: 10%;"></td> <td style="width: 10%;"></td> <td style="width: 10%;"></td> <td style="width: 10%;"></td> <td style="width: 10%;"></td> <td style="width: 10%;"></td> <td style="width: 10%;"></td> <td style="width: 10%;"></td> <td style="width: 10%;"></td> </tr> <tr> <td></td> <td></td> <td colspan="8" style="text-align: center;"> <table border="1" style="width: 100%; border-collapse: collapse; text-align: center;"> <tr> <td style="width: 10%;"></td> <td style="width: 10%;"></td> <td style="width: 10%;"></td> <td style="width: 10%;"></td> <td style="width: 10%;"></td> <td style="width: 10%;"></td> <td style="width: 10%;"></td> <td style="width: 10%;"></td> <td style="width: 10%;"></td> <td style="width: 10%;"></td> </tr> <tr> <td></td> <td></td> <td colspan="8" style="text-align: center;"> <table border="1" style="width: 100%; border-collapse: collapse; text-align: center;"> <tr> <td style="width: 10%;"></td> <td style="width: 10%;"></td> <td style="width: 10%;"></td> <td style="width: 10%;"></td> <td style="width: 10%;"></td> <td style="width: 10%;"></td> <td style="width: 10%;"></td> <td style="width: 10%;"></td> <td style="width: 10%;"></td> <td style="width: 10%;"></td> </tr> <tr> <td></td> <td></td> <td colspan="8" style="text-align: center;"> <table border="1" style="width: 100%; border-collapse: collapse; text-align: center;"> <tr> <td style="width: 10%;"></td> <td style="width: 10%;"></td> <td style="width: 10%;"></td> <td style="width: 10%;"></td> <td style="width: 10%;"></td> <td style="width: 10%;"></td> <td style="width: 10%;"></td> <td style="width: 10%;"></td> <td style="width: 10%;"></td> <td style="width: 10%;"></td> </tr> <tr> <td></td> <td></td> <td colspan="8" style="text-align: center;"> <table border="1" style="width: 100%; border-collapse: collapse; text-align: center;"> <tr> <td style="width: 10%;"></td> <td style="width: 10%;"></td> <td style="width: 10%;"></td> <td style="width: 10%;"></td> <td style="width: 10%;"></td> <td style="width: 10%;"></td> <td style="width: 10%;"></td> <td style="width: 10%;"></td> <td style="width: 10%;"></td> <td style="width: 10%;"></td> </tr> <tr> <td></td> <td></td> <td colspan="8" style="text-align: center;"> <table border="1" style="width: 100%; border-collapse: collapse; text-align: center;"> <tr> <td style="width: 10%;"></td> <td style="width: 10%;"></td> <td style="width: 10%;"></td> <td style="width: 10%;"></td> <td style="width: 10%;"></td> <td style="width: 10%;"></td> <td style="width: 10%;"></td> <td style="width: 10%;"></td> <td style="width: 10%;"></td> <td style="width: 10%;"></td> </tr> <tr> <td></td> <td></td> <td colspan="8" style="text-align: center;"> <table border="1" style="width: 100%; border-collapse: collapse; text-align: center;"> <tr> <td style="width: 10%;"></td> <td style="width: 10%;"></td> <td style="width: 10%;"></td> <td style="width: 10%;"></td> <td style="width: 10%;"></td> <td style="width: 10%;"></td> <td style="width: 10%;"></td> <td style="width: 10%;"></td> <td style="width: 10%;"></td> <td style="width: 10%;"></td> </tr> <tr> <td></td> <td></td> <td colspan="8" style="text-align: center;"> <table border="1" style="width: 100%; border-collapse: collapse; text-align: center;"> <tr> <td style="width: 10%;"></td> <td style="width: 10%;"></td> <td style="width: 10%;"></td> <td style="width: 10%;"></td> <td style="width: 10%;"></td> <td style="width: 10%;"></td> <td style="width: 10%;"></td> <td
style="width: 10%;"></td> <td style="width: 10%;"></td> <td style="width: 10%;"></td> </tr> <tr> <td></td> <td></td> <td colspan="8" style="text-align: center;"> <table border="1" style="width: 100%; border-collapse: collapse; text-align: center;"> <tr> <td style="width: 10%;"></td> <td style="width: 10%;"></td> <td style="width: 10%;"></td> <td style="width: 10%;"></td> <td style="width: 10%;"></td> <td style="width: 10%;"></td> <td style="width: 10%;"></td> <td style="width: 10%;"></td> <td style="width: 10%;"></td> <td style="width: 10%;"></td> </tr> <tr> <td></td> <td></td> <td colspan="8" style="text-align: center;"> <table border="1" style="width: 100%; border-collapse: collapse; text-align: center;"> <tr> <td style="width: 10%;"></td> <td style="width: 10%;"></td> <td style="width: 10%;"></td> <td style="width: 10%;"></td> <td style="width: 10%;"></td> <td style="width: 10%;"></td> <td style="width: 10%;"></td> <td style="width: 10%;"></td> <td style="width: 10%;"></td> <td style="width: 10%;"></td> </tr> <tr> <td></td> <td></td> <td colspan="8" style="text-align: center;"> <table border="1" style="width: 100%; border-collapse: collapse; text-align: center;"> <tr> <td style="width: 10%;"></td> <td style="width: 10%;"></td> <td style="width: 10%;"></td> <td style="width: 10%;"></td> <td style="width: 10%;"></td> <td style="width: 10%;"></td> <td style="width: 10%;"></td> <td style="width: 10%;"></td> <td style="width: 10%;"></td> <td style="width: 10%;"></td> </tr> <tr> <td></td> <td></td> <td colspan="8" style="text-align: center;"> <table border="1" style="width: 100%; border-collapse: collapse; text-align: center;"> <tr> <td style="width: 10%;"></td> <td style="width: 10%;"></td> <td style="width: 10%;"></td> <td style="width: 10%;"></td> <td style="width: 10%;"></td> <td style="width: 10%;"></td> <td style="width: 10%;"></td> <td style="width: 10%;"></td> <td style="width: 10%;"></td> <td style="width: 10%;"></td> </tr> <tr> <td></td> <td></td> <td colspan="8" style="text-align: center;"> <table border="1" style="width: 100%; border-collapse: collapse; text-align: center;"> <tr> <td style="width: 10%;"></td> <td style="width: 10%;"></td> <td style="width: 10%;"></td> <td style="width: 10%;"></td> <td style="width: 10%;"></td> <td style="width: 10%;"></td> <td style="width: 10%;"></td> <td style="width: 10%;"></td> <td style="width: 10%;"></td> <td style="width: 10%;"></td> </tr> <tr> <td></td> <td></td> <td colspan="8" style="text-align: center;"> <table border="1" style="width: 100%; border-collapse: collapse; text-align: center;"> <tr> <td style="width: 10%;"></td> <td style="width: 10%;"></td> <td style="width: 10%;"></td> <td style="width: 10%;"></td> <td style="width: 10%;"></td> <td style="width: 10%;"></td> <td style="width: 10%;"></td> <td style="width: 10%;"></td> <td style="width: 10%;"></td> <td style="width: 10%;"></td> </tr> <tr> <td></td> <td></td> <td colspan="8" style="text-align: center;"> <table border="1" style="width: 100%; border-collapse: collapse; text-align: center;"> <tr> <td style="width: 10%;"></td> <td style="width: 10%;"></td> <td style="width: 10%;"></td> <td style="width: 10%;"></td> <td style="width: 10%;"></td> <td style="width: 10%;"></td> <td style="width: 10%;"></td> <td style="width: 10%;"></td> <td style="width: 10%;"></td> <td style="width: 10%;"></td> </tr> <tr> <td></td> <td></td> <td colspan="8" style="text-align: center;"> <table border="1" style="width: 100%; border-collapse: collapse; text-align: center;"> <tr> <td style="width: 10%;"></td> <td style="width: 10%;"></td> <td style="width: 10%;"></td> <td style="width: 10%;"></td> <td style="width: 10%;"></td> <td style="width: 10%;"></td> <td style="width: 10%;"></td> <td style="width: 10%;"></td> <td style="width: 10%;"></td> <td style="width: 10%;"></td> </tr> <tr> <td></td> <td></td> <td colspan="8" style="text-align: center;"> <table border="1" style="width: 100%; border-collapse: collapse; text-align: center;"> <tr> </tr></table></td></tr></table></td></tr></table></td></tr></table></td></tr></table></td></tr></table></td></tr></table></td></tr></table></td></tr></table></td></tr></table></td></tr></table></td></tr></table></td></tr></table></td></tr></table></td></tr></table></td></tr></table></td></tr></table></td></tr></table></td></tr></table></td></tr></table></td></tr></table></td></tr></table></td></tr></table></td></tr></table></td></tr></table></td></tr></table>

 | | | | | | | | | | | | | | | | | | | | <table border="1" style="width: 100%; border-collapse: collapse; text-align: center;"> <tr> <td style="width: 10%;"></td> <td style="width: 10%;"></td> <td style="width: 10%;"></td> <td style="width: 10%;"></td> <td style="width: 10%;"></td> <td style="width: 10%;"></td> <td style="width: 10%;"></td> <td style="width: 10%;"></td> <td style="width: 10%;"></td> <td style="width: 10%;"></td> </tr> <tr> <td></td> <td></td> <td colspan="8" style="text-align: center;"> <table border="1" style="width: 100%; border-collapse: collapse; text-align: center;"> <tr> <td style="width: 10%;"></td> <td style="width: 10%;"></td> <td style="width: 10%;"></td> <td style="width: 10%;"></td> <td style="width: 10%;"></td> <td style="width: 10%;"></td> <td style="width: 10%;"></td> <td style="width: 10%;"></td> <td style="width: 10%;"></td> <td style="width: 10%;"></td> </tr> <tr> <td></td> <td></td> <td colspan="8" style="text-align: center;"> <table border="1" style="width: 100%; border-collapse: collapse; text-align: center;"> <tr> <td style="width: 10%;"></td> <td style="width: 10%;"></td> <td style="width: 10%;"></td> <td style="width: 10%;"></td> <td style="width: 10%;"></td> <td style="width: 10%;"></td> <td style="width: 10%;"></td> <td style="width: 10%;"></td> <td style="width: 10%;"></td> <td style="width: 10%;"></td> </tr> <tr> <td></td> <td></td> <td colspan="8" style="text-align: center;"> <table border="1" style="width: 100%; border-collapse: collapse; text-align: center;"> <tr> <td style="width: 10%;"></td> <td style="width: 10%;"></td> <td style="width: 10%;"></td> <td style="width: 10%;"></td> <td style="width: 10%;"></td> <td style="width: 10%;"></td> <td style="width: 10%;"></td> <td style="width: 10%;"></td> <td style="width: 10%;"></td> <td style="width: 10%;"></td> </tr> <tr> <td></td> <td></td> <td colspan="8" style="text-align: center;"> <table border="1" style="width: 100%; border-collapse: collapse; text-align: center;"> <tr> <td style="width: 10%;"></td> <td style="width: 10%;"></td> <td style="width: 10%;"></td> <td style="width: 10%;"></td> <td style="width: 10%;"></td> <td style="width: 10%;"></td> <td style="width: 10%;"></td> <td style="width: 10%;"></td> <td style="width: 10%;"></td> <td style="width: 10%;"></td> </tr> <tr> <td></td> <td></td> <td colspan="8" style="text-align: center;"> <table border="1" style="width: 100%; border-collapse: collapse; text-align: center;"> <tr> <td style="width: 10%;"></td> <td style="width: 10%;"></td> <td style="width: 10%;"></td> <td style="width: 10%;"></td> <td style="width: 10%;"></td> <td style="width: 10%;"></td> <td style="width: 10%;"></td> <td style="width: 10%;"></td> <td style="width: 10%;"></td> <td style="width: 10%;"></td> </tr> <tr> <td></td> <td></td> <td colspan="8" style="text-align: center;"> <table border="1" style="width: 100%; border-collapse: collapse; text-align: center;"> <tr> <td style="width: 10%;"></td> <td style="width: 10%;"></td> <td style="width: 10%;"></td> <td style="width: 10%;"></td> <td style="width: 10%;"></td> <td style="width: 10%;"></td> <td style="width: 10%;"></td> <td style="width: 10%;"></td> <td style="width: 10%;"></td> <td style="width: 10%;"></td> </tr> <tr> <td></td> <td></td> <td colspan="8" style="text-align: center;"> <table border="1" style="width: 100%; border-collapse: collapse; text-align: center;"> <tr> <td style="width: 10%;"></td> <td style="width: 10%;"></td> <td style="width: 10%;"></td> <td style="width: 10%;"></td> <td style="width: 10%;"></td> <td style="width: 10%;"></td> <td style="width: 10%;"></td> <td style="width: 10%;"></td> <td style="width: 10%;"></td> <td style="width: 10%;"></td> </tr> <tr> <td></td> <td></td> <td colspan="8" style="text-align: center;"> <table border="1" style="width: 100%; border-collapse: collapse; text-align: center;"> <tr> <td style="width: 10%;"></td> <td style="width: 10%;"></td> <td style="width: 10%;"></td> <td style="width: 10%;"></td> <td style="width: 10%;"></td> <td style="width: 10%;"></td> <td style="width: 10%;"></td> <td style="width: 10%;"></td> <td style="width: 10%;"></td> <td style="width: 10%;"></td> </tr> <tr> <td></td> <td></td> <td colspan="8" style="text-align: center;"> <table border="1" style="width: 100%; border-collapse: collapse; text-align: center;"> <tr> <td style="width: 10%;"></td> <td style="width: 10%;"></td> <td style="width: 10%;"></td> <td style="width: 10%;"></td> <td style="width: 10%;"></td> <td style="width: 10%;"></td> <td style="width: 10%;"></td> <td style="width: 10%;"></td> <td style="width: 10%;"></td> <td style="width: 10%;"></td> </tr> <tr> <td></td> <td></td> <td colspan="8" style="text-align: center;"> <table border="1" style="width: 100%; border-collapse: collapse; text-align: center;"> <tr> <td style="width: 10%;"></td> <td style="width: 10%;"></td> <td style="width: 10%;"></td> <td style="width: 10%;"></td> <td style="width: 10%;"></td> <td style="width: 10%;"></td> <td style="width: 10%;"></td> <td style="width: 10%;"></td> <td style="width: 10%;"></td> <td style="width: 10%;"></td> </tr> <tr> <td></td> <td></td> <td colspan="8" style="text-align: center;"> <table border="1" style="width: 100%; border-collapse: collapse; text-align: center;"> <tr> <td style="width: 10%;"></td> <td style="width: 10%;"></td> <td style="width: 10%;"></td> <td style="width: 10%;"></td> <td style="width: 10%;"></td> <td style="width: 10%;"></td> <td style="width: 10%;"></td> <td style="width: 10%;"></td> <td style="width: 10%;"></td> <td style="width: 10%;"></td> </tr> <tr> <td></td> <td></td> <td colspan="8" style="text-align: center;"> <table border="1" style="width: 100%; border-collapse: collapse; text-align: center;"> <tr> <td style="width: 10%;"></td> <td style="width: 10%;"></td> <td style="width: 10%;"></td> <td style="width: 10%;"></td> <td style="width: 10%;"></td> <td style="width: 10%;"></td> <td style="width: 10%;"></td> <td style="width: 10%;"></td> <td style="width: 10%;"></td> <td style="width: 10%;"></td> </tr> <tr> <td></td> <td></td> <td colspan="8" style="text-align: center;"> <table border="1" style="width: 100%; border-collapse: collapse; text-align: center;"> <tr> <td style="width: 10%;"></td> <td style="width: 10%;"></td> <td style="width: 10%;"></td> <td style="width: 10%;"></td> <td style="width: 10%;"></td> <td style="width: 10%;"></td> <td style="width: 10%;"></td> <td style="width: 10%;"></td> <td style="width: 10%;"></td> <td style="width: 10%;"></td> </tr> <tr> <td></td> <td></td> <td colspan="8" style="text-align: center;"> <table border="1" style="width: 100%; border-collapse: collapse; text-align: center;"> <tr> <td style="width: 10%;"></td> <td style="width: 10%;"></td> <td style="width: 10%;"></td> <td style="width: 10%;"></td> <td style="width: 10%;"></td> <td style="width: 10%;"></td> <td style="width: 10%;"></td> <td style="width: 10%;"></td> <td style="width: 10%;"></td> <td style="width: 10%;"></td> </tr> <tr> <td></td> <td></td> <td colspan="8" style="text-align: center;"> <table border="1" style="width: 100%; border-collapse: collapse; text-align: center;"> <tr> <td style="width: 10%;"></td> <td style="width: 10%;"></td> <td style="width: 10%;"></td> <td style="width: 10%;"></td> <td style="width: 10%;"></td> <td style="width: 10%;"></td> <td style="width: 10%;"></td> <td style="width: 10%;"></td> <td style="width: 10%;"></td> <td style="width: 10%;"></td> </tr> <tr> <td></td> <td></td> <td colspan="8" style="text-align: center;"> <table border="1" style="width: 100%; border-collapse: collapse; text-align: center;"> <tr> <td style="width: 10%;"></td> <td style="width: 10%;"></td> <td style="width: 10%;"></td> <td style="width: 10%;"></td> <td style="width: 10%;"></td> <td style="width: 10%;"></td> <td style="width: 10%;"></td> <td style="width: 10%;"></td> <td style="width: 10%;"></td> <td style="width: 10%;"></td> </tr> <tr> <td></td> <td></td> <td colspan="8" style="text-align: center;"> <table border="1" style="width: 100%; border-collapse: collapse; text-align: center;"> <tr> <td style="width: 10%;"></td> <td style="width: 10%;"></td> <td style="width: 10%;"></td> <td style="width: 10%;"></td> <td style="width: 10%;"></td> <td style="width: 10%;"></td> <td style="width: 10%;"></td> <td style="width: 10%;"></td> <td style="width: 10%;"></td> <td style="width: 10%;"></td> </tr> <tr> <td></td> <td></td> <td colspan="8" style="text-align: center;"> <table border="1" style="width: 100%;
border-collapse: collapse; text-align: center;"> <tr> <td style="width: 10%;"></td> <td style="width: 10%;"></td> <td style="width: 10%;"></td> <td style="width: 10%;"></td> <td style="width: 10%;"></td> <td style="width: 10%;"></td> <td style="width: 10%;"></td> <td style="width: 10%;"></td> <td style="width: 10%;"></td> <td style="width: 10%;"></td> </tr> <tr> <td></td> <td></td> <td colspan="8" style="text-align: center;"> <table border="1" style="width: 100%; border-collapse: collapse; text-align: center;"> <tr> <td style="width: 10%;"></td> <td style="width: 10%;"></td> <td style="width: 10%;"></td> <td style="width: 10%;"></td> <td style="width: 10%;"></td> <td style="width: 10%;"></td> <td style="width: 10%;"></td> <td style="width: 10%;"></td> <td style="width: 10%;"></td> <td style="width: 10%;"></td> </tr> <tr> <td></td> <td></td> <td colspan="8" style="text-align: center;"> <table border="1" style="width: 100%; border-collapse: collapse; text-align: center;"> <tr> <td style="width: 10%;"></td> <td style="width: 10%;"></td> <td style="width: 10%;"></td> <td style="width: 10%;"></td> <td style="width: 10%;"></td> <td style="width: 10%;"></td> <td style="width: 10%;"></td> <td style="width: 10%;"></td> <td style="width: 10%;"></td> <td style="width: 10%;"></td> </tr> <tr> <td></td> <td></td> <td colspan="8" style="text-align: center;"> <table border="1" style="width: 100%; border-collapse: collapse; text-align: center;"> <tr> <td style="width: 10%;"></td> <td style="width: 10%;"></td> <td style="width: 10%;"></td> <td style="width: 10%;"></td> <td style="width: 10%;"></td> <td style="width: 10%;"></td> <td style="width: 10%;"></td> <td style="width: 10%;"></td> <td style="width: 10%;"></td> <td style="width: 10%;"></td> </tr> <tr> <td></td> <td></td> <td colspan="8" style="text-align: center;"> <table border="1" style="width: 100%; border-collapse: collapse; text-align: center;"> <tr> <td style="width: 10%;"></td> <td style="width: 10%;"></td> <td style="width: 10%;"></td> <td style="width: 10%;"></td> <td style="width: 10%;"></td> <td style="width: 10%;"></td> <td style="width: 10%;"></td> <td style="width: 10%;"></td> <td style="width: 10%;"></td> <td style="width: 10%;"></td> </tr> <tr> <td></td> <td></td> <td colspan="8" style="text-align: center;"> <table border="1" style="width: 100%; border-collapse: collapse; text-align: center;"> <tr> <td style="width: 10%;"></td> <td style="width: 10%;"></td> <td style="width: 10%;"></td> <td style="width: 10%;"></td> <td style="width: 10%;"></td> <td style="width: 10%;"></td> <td style="width: 10%;"></td> <td style="width: 10%;"></td> <td style="width: 10%;"></td> <td style="width: 10%;"></td> </tr> <tr> <td></td> <td></td> <td colspan="8" style="text-align: center;"> <table border="1" style="width: 100%; border-collapse: collapse; text-align: center;"> <tr> </tr></table></td></tr></table></td></tr></table></td></tr></table></td></tr></table></td></tr></table></td></tr></table></td></tr></table></td></tr></table></td></tr></table></td></tr></table></td></tr></table></td></tr></table></td></tr></table></td></tr></table></td></tr></table></td></tr></table></td></tr></table></td></tr></table></td></tr></table></td></tr></table></td></tr></table></td></tr></table></td></tr></table></td></tr></table>

 | | | | | | | | | | | | | | | | | | | | <table border="1" style="width: 100%; border-collapse: collapse; text-align: center;"> <tr> <td style="width: 10%;"></td> <td style="width: 10%;"></td> <td style="width: 10%;"></td> <td style="width: 10%;"></td> <td style="width: 10%;"></td> <td style="width: 10%;"></td> <td style="width: 10%;"></td> <td style="width: 10%;"></td> <td style="width: 10%;"></td> <td style="width: 10%;"></td> </tr> <tr> <td></td> <td></td> <td colspan="8" style="text-align: center;"> <table border="1" style="width: 100%; border-collapse: collapse; text-align: center;"> <tr> <td style="width: 10%;"></td> <td style="width: 10%;"></td> <td style="width: 10%;"></td> <td style="width: 10%;"></td> <td style="width: 10%;"></td> <td style="width: 10%;"></td> <td style="width: 10%;"></td> <td style="width: 10%;"></td> <td style="width: 10%;"></td> <td style="width: 10%;"></td> </tr> <tr> <td></td> <td></td> <td colspan="8" style="text-align: center;"> <table border="1" style="width: 100%; border-collapse: collapse; text-align: center;"> <tr> <td style="width: 10%;"></td> <td style="width: 10%;"></td> <td style="width: 10%;"></td> <td style="width: 10%;"></td> <td style="width: 10%;"></td> <td style="width: 10%;"></td> <td style="width: 10%;"></td> <td style="width: 10%;"></td> <td style="width: 10%;"></td> <td style="width: 10%;"></td> </tr> <tr> <td></td> <td></td> <td colspan="8" style="text-align: center;"> <table border="1" style="width: 100%; border-collapse: collapse; text-align: center;"> <tr> <td style="width: 10%;"></td> <td style="width: 10%;"></td> <td style="width: 10%;"></td> <td style="width: 10%;"></td> <td style="width: 10%;"></td> <td style="width: 10%;"></td> <td style="width: 10%;"></td> <td style="width: 10%;"></td> <td style="width: 10%;"></td> <td style="width: 10%;"></td> </tr> <tr> <td></td> <td></td> <td colspan="8" style="text-align: center;"> <table border="1" style="width: 100%; border-collapse: collapse; text-align: center;"> <tr> <td style="width: 10%;"></td> <td style="width: 10%;"></td> <td style="width: 10%;"></td> <td style="width: 10%;"></td> <td style="width: 10%;"></td> <td style="width: 10%;"></td> <td style="width: 10%;"></td> <td style="width: 10%;"></td> <td style="width: 10%;"></td> <td style="width: 10%;"></td> </tr> <tr> <td></td> <td></td> <td colspan="8" style="text-align: center;"> <table border="1" style="width: 100%; border-collapse: collapse; text-align: center;"> <tr> <td style="width: 10%;"></td> <td style="width: 10%;"></td> <td style="width: 10%;"></td> <td style="width: 10%;"></td> <td style="width: 10%;"></td> <td style="width: 10%;"></td> <td style="width: 10%;"></td> <td style="width: 10%;"></td> <td style="width: 10%;"></td> <td style="width: 10%;"></td> </tr> <tr> <td></td> <td></td> <td colspan="8" style="text-align: center;"> <table border="1" style="width: 100%; border-collapse: collapse; text-align: center;"> <tr> <td style="width: 10%;"></td> <td style="width: 10%;"></td> <td style="width: 10%;"></td> <td style="width: 10%;"></td> <td style="width: 10%;"></td> <td style="width: 10%;"></td> <td style="width: 10%;"></td> <td style="width: 10%;"></td> <td style="width: 10%;"></td> <td style="width: 10%;"></td> </tr> <tr> <td></td> <td></td> <td colspan="8" style="text-align: center;"> <table border="1" style="width: 100%; border-collapse: collapse; text-align: center;"> <tr> <td style="width: 10%;"></td> <td style="width: 10%;"></td> <td style="width: 10%;"></td> <td style="width: 10%;"></td> <td style="width: 10%;"></td> <td style="width: 10%;"></td> <td style="width: 10%;"></td> <td style="width: 10%;"></td> <td style="width: 10%;"></td> <td style="width: 10%;"></td> </tr> <tr> <td></td> <td></td> <td colspan="8" style="text-align: center;"> <table border="1" style="width: 100%; border-collapse: collapse; text-align: center;"> <tr> <td style="width: 10%;"></td> <td style="width: 10%;"></td> <td style="width: 10%;"></td> <td style="width: 10%;"></td> <td style="width: 10%;"></td> <td style="width: 10%;"></td> <td style="width: 10%;"></td> <td style="width: 10%;"></td> <td style="width: 10%;"></td> <td style="width: 10%;"></td> </tr> <tr> <td></td> <td></td> <td colspan="8" style="text-align: center;"> <table border="1" style="width: 100%; border-collapse: collapse; text-align: center;"> <tr> <td style="width: 10%;"></td> <td style="width: 10%;"></td> <td style="width: 10%;"></td> <td style="width: 10%;"></td> <td style="width: 10%;"></td> <td style="width: 10%;"></td> <td style="width: 10%;"></td> <td style="width: 10%;"></td> <td style="width: 10%;"></td> <td style="width: 10%;"></td> </tr> <tr> <td></td> <td></td> <td colspan="8" style="text-align: center;"> <table border="1" style="width: 100%; border-collapse: collapse; text-align: center;"> <tr> <td style="width: 10%;"></td> <td style="width: 10%;"></td> <td style="width: 10%;"></td> <td style="width: 10%;"></td> <td style="width: 10%;"></td> <td style="width: 10%;"></td> <td style="width: 10%;"></td> <td style="width: 10%;"></td> <td style="width: 10%;"></td> <td style="width: 10%;"></td> </tr> <tr> <td></td> <td></td> <td colspan="8" style="text-align: center;"> <table border="1" style="width: 100%; border-collapse: collapse; text-align: center;"> <tr> <td style="width: 10%;"></td> <td style="width: 10%;"></td> <td style="width: 10%;"></td> <td style="width: 10%;"></td> <td style="width: 10%;"></td> <td style="width: 10%;"></td> <td style="width: 10%;"></td> <td style="width: 10%;"></td> <td style="width: 10%;"></td> <td style="width: 10%;"></td> </tr> <tr> <td></td> <td></td> <td colspan="8" style="text-align: center;"> <table border="1" style="width: 100%; border-collapse: collapse; text-align: center;"> <tr> <td style="width: 10%;"></td> <td style="width: 10%;"></td> <td style="width: 10%;"></td> <td style="width: 10%;"></td> <td style="width: 10%;"></td> <td style="width: 10%;"></td> <td style="width: 10%;"></td> <td style="width: 10%;"></td> <td style="width: 10%;"></td> <td style="width: 10%;"></td> </tr> <tr> <td></td> <td></td> <td colspan="8" style="text-align: center;"> <table border="1" style="width: 100%; border-collapse: collapse; text-align: center;"> <tr> <td style="width: 10%;"></td> <td style="width: 10%;"></td> <td style="width: 10%;"></td> <td style="width: 10%;"></td> <td style="width: 10%;"></td> <td style="width: 10%;"></td> <td style="width: 10%;"></td> <td style="width: 10%;"></td> <td style="width: 10%;"></td> <td style="width: 10%;"></td> </tr> <tr> <td></td> <td></td> <td colspan="8" style="text-align: center;"> <table border="1" style="width: 100%; border-collapse: collapse; text-align: center;"> <tr> <td style="width: 10%;"></td> <td style="width: 10%;"></td> <td style="width: 10%;"></td> <td style="width: 10%;"></td> <td style="width: 10%;"></td> <td style="width: 10%;"></td> <td style="width: 10%;"></td> <td style="width: 10%;"></td> <td style="width: 10%;"></td> <td style="width: 10%;"></td> </tr> <tr> <td></td> <td></td> <td colspan="8" style="text-align: center;"> <table border="1" style="width: 100%; border-collapse: collapse; text-align: center;"> <tr> <td style="width: 10%;"></td> <td style="width: 10%;"></td> <td style="width: 10%;"></td> <td style="width: 10%;"></td> <td style="width: 10%;"></td> <td style="width: 10%;"></td> <td style="width: 10%;"></td> <td style="width: 10%;"></td> <td style="width: 10%;"></td> <td style="width: 10%;"></td> </tr> <tr> <td></td> <td></td> <td colspan="8" style="text-align: center;"> <table border="1" style="width: 100%; border-collapse: collapse; text-align: center;"> <tr> <td style="width: 10%;"></td> <td style="width: 10%;"></td> <td style="width: 10%;"></td> <td style="width: 10%;"></td> <td style="width: 10%;"></td> <td style="width: 10%;"></td> <td style="width: 10%;"></td> <td style="width: 10%;"></td> <td style="width: 10%;"></td> <td style="width: 10%;"></td> </tr> <tr> <td></td> <td></td> <td colspan="8" style="text-align: center;"> <table border="1" style="width: 100%; border-collapse: collapse; text-align: center;"> <tr> <td style="width: 10%;"></td> <td style="width: 10%;"></td> <td style="width: 10%;"></td> <td style="width: 10%;"></td> <td style="width: 10%;"></td> <td style="width: 10%;"></td> <td style="width: 10%;"></td> <td style="width: 10%;"></td> <td style="width: 10%;"></td> <td style="width: 10%;"></td> </tr> <tr> <td></td> <td></td> <td colspan="8" style="text-align: center;"> <table border="1" style="width: 100%; border-collapse: collapse; text-align: center;"> <tr> <td style="width: 10%;"></td> <td style="width: 10%;"></td> <td style="width: 10%;"></td> <td style="width: 10%;"></td> <td style="width: 10%;"></td> <td style="width: 10%;"></td> <td style="width: 10%;"></td> <td style="width: 10%;"></td> <td style="width: 10%;"></td> <td style="width: 10%;"></td> </tr> <tr> <td></td> <td></td> <td colspan="8" style="text-align: center;"> <table border="1" style="width: 100%; border-collapse: collapse; text-align: center;"> <tr> <td style="width: 10%;"></td> <td style="width: 10%;"></td> <td style="width: 10%;"></td> <td style="width: 10%;"></td> <td style="width: 10%;"></td> <td style="width: 10%;"></td> <td style="width: 10%;"></td> <td style="width: 10%;"></td> <td style="width: 10%;"></td> <td style="width: 10%;"></td> </tr> <tr> <td></td> <td></td> <td colspan="8" style="text-align: center;"> <table border="1" style="width: 100%; border-collapse: collapse; text-align: center;"> <tr> <td style="width: 10%;"></td> <td style="width: 10%;"></td> <td style="width: 10%;"></td> <td style="width: 10%;"></td> <td style="width: 10%;"></td> <td style="width:
10%;"></td> <td style="width: 10%;"></td> <td style="width: 10%;"></td> <td style="width: 10%;"></td> <td style="width: 10%;"></td> </tr> <tr> <td></td> <td></td> <td colspan="8" style="text-align: center;"> <table border="1" style="width: 100%; border-collapse: collapse; text-align: center;"> <tr> <td style="width: 10%;"></td> <td style="width: 10%;"></td> <td style="width: 10%;"></td> <td style="width: 10%;"></td> <td style="width: 10%;"></td> <td style="width: 10%;"></td> <td style="width: 10%;"></td> <td style="width: 10%;"></td> <td style="width: 10%;"></td> <td style="width: 10%;"></td> </tr> <tr> <td></td> <td></td> <td colspan="8" style="text-align: center;"> <table border="1" style="width: 100%; border-collapse: collapse; text-align: center;"> <tr> <td style="width: 10%;"></td> <td style="width: 10%;"></td> <td style="width: 10%;"></td> <td style="width: 10%;"></td> <td style="width: 10%;"></td> <td style="width: 10%;"></td> <td style="width: 10%;"></td> <td style="width: 10%;"></td> <td style="width: 10%;"></td> <td style="width: 10%;"></td> </tr> <tr> <td></td> <td></td> <td colspan="8" style="text-align: center;"> <table border="1" style="width: 100%; border-collapse: collapse; text-align: center;"> <tr> </tr></table></td></tr></table></td></tr></table></td></tr></table></td></tr></table></td></tr></table></td></tr></table></td></tr></table></td></tr></table></td></tr></table></td></tr></table></td></tr></table></td></tr></table></td></tr></table></td></tr></table></td></tr></table></td></tr></table></td></tr></table></td></tr></table></td></tr></table></td></tr></table></td></tr></table></td></tr></table></td></tr></table>
 | | | | | | | | | | | | | | | | | | | | <table border="1" style="width: 100%; border-collapse: collapse; text-align: center;"> <tr> <td style="width: 10%;"></td> <td style="width: 10%;"></td> <td style="width: 10%;"></td> <td style="width: 10%;"></td> <td style="width: 10%;"></td> <td style="width: 10%;"></td> <td style="width: 10%;"></td> <td style="width: 10%;"></td> <td style="width: 10%;"></td> <td style="width: 10%;"></td> </tr> <tr> <td></td> <td></td> <td colspan="8" style="text-align: center;"> <table border="1" style="width: 100%; border-collapse: collapse; text-align: center;"> <tr> <td style="width: 10%;"></td> <td style="width: 10%;"></td> <td style="width: 10%;"></td> <td style="width: 10%;"></td> <td style="width: 10%;"></td> <td style="width: 10%;"></td> <td style="width: 10%;"></td> <td style="width: 10%;"></td> <td style="width: 10%;"></td> <td style="width: 10%;"></td> </tr> <tr> <td></td> <td></td> <td colspan="8" style="text-align: center;"> <table border="1" style="width: 100%; border-collapse: collapse; text-align: center;"> <tr> <td style="width: 10%;"></td> <td style="width: 10%;"></td> <td style="width: 10%;"></td> <td style="width: 10%;"></td> <td style="width: 10%;"></td> <td style="width: 10%;"></td> <td style="width: 10%;"></td> <td style="width:
10%;"></td> <td style="width: 10%;"></td> <td style="width: 10%;"></td> </tr> <tr> <td></td> <td></td> <td colspan="8" style="text-align: center;"> <table border="1" style="width: 100%; border-collapse: collapse; text-align: center;"> <tr> <td style="width: 10%;"></td> <td style="width: 10%;"></td> <td style="width: 10%;"></td> <td style="width: 10%;"></td> <td style="width: 10%;"></td> <td style="width: 10%;"></td> <td style="width: 10%;"></td> <td style="width: 10%;"></td> <td style="width: 10%;"></td> <td style="width: 10%;"></td> </tr> <tr> <td></td> <td></td> <td colspan="8" style="text-align: center;"> <table border="1" style="width: 100%; border-collapse: collapse; text-align: center;"> <tr> <td style="width: 10%;"></td> <td style="width: 10%;"></td> <td style="width: 10%;"></td> <td style="width: 10%;"></td> <td style="width: 10%;"></td> <td style="width: 10%;"></td> <td style="width: 10%;"></td> <td style="width: 10%;"></td> <td style="width: 10%;"></td> <td style="width: 10%;"></td> </tr> <tr> <td></td> <td></td> <td colspan="8" style="text-align: center;"> <table border="1" style="width: 100%; border-collapse: collapse; text-align: center;"> <tr> <td style="width: 10%;"></td> <td style="width: 10%;"></td> <td style="width: 10%;"></td> <td style="width: 10%;"></td> <td style="width: 10%;"></td> <td style="width: 10%;"></td> <td style="width: 10%;"></td> <td style="width: 10%;"></td> <td style="width: 10%;"></td> <td style="width: 10%;"></td> </tr> <tr> <td></td> <td></td> <td colspan="8" style="text-align: center;"> <table border="1" style="width: 100%; border-collapse: collapse; text-align: center;"> <tr> <td style="width: 10%;"></td> <td style="width: 10%;"></td> <td style="width: 10%;"></td> <td style="width: 10%;"></td> <td style="width: 10%;"></td> <td style="width: 10%;"></td> <td style="width: 10%;"></td> <td style="width: 10%;"></td> <td style="width: 10%;"></td> <td style="width: 10%;"></td> </tr> <tr> <td></td> <td></td> <td colspan="8" style="text-align: center;"> <table border="1" style="width: 100%; border-collapse: collapse; text-align: center;"> <tr> <td style="width: 10%;"></td> <td style="width: 10%;"></td> <td style="width: 10%;"></td> <td style="width: 10%;"></td> <td style="width: 10%;"></td> <td style="width: 10%;"></td> <td style="width: 10%;"></td> <td style="width: 10%;"></td> <td style="width: 10%;"></td> <td style="width: 10%;"></td> </tr> <tr> <td></td> <td></td> <td colspan="8" style="text-align: center;"> <table border="1" style="width: 100%; border-collapse: collapse; text-align: center;"> <tr> <td style="width: 10%;"></td> <td style="width: 10%;"></td> <td style="width: 10%;"></td> <td style="width: 10%;"></td> <td style="width: 10%;"></td> <td style="width: 10%;"></td> <td style="width: 10%;"></td> <td style="width: 10%;"></td> <td style="width: 10%;"></td> <td style="width: 10%;"></td> </tr> <tr> <td></td> <td></td> <td colspan="8" style="text-align: center;"> <table border="1" style="width: 100%; border-collapse: collapse; text-align: center;"> <tr> <td style="width: 10%;"></td> <td style="width: 10%;"></td> <td style="width: 10%;"></td> <td style="width: 10%;"></td> <td style="width: 10%;"></td> <td style="width: 10%;"></td> <td style="width: 10%;"></td> <td style="width: 10%;"></td> <td style="width: 10%;"></td> <td style="width: 10%;"></td> </tr> <tr> <td></td> <td></td> <td colspan="8" style="text-align: center;"> <table border="1" style="width: 100%; border-collapse: collapse; text-align: center;"> <tr> <td style="width: 10%;"></td> <td style="width: 10%;"></td> <td style="width: 10%;"></td> <td style="width: 10%;"></td> <td style="width: 10%;"></td> <td style="width: 10%;"></td> <td style="width: 10%;"></td> <td style="width: 10%;"></td> <td style="width: 10%;"></td> <td style="width: 10%;"></td> </tr> <tr> <td></td> <td></td> <td colspan="8" style="text-align: center;"> <table border="1" style="width: 100%; border-collapse: collapse; text-align: center;"> <tr> <td style="width: 10%;"></td> <td style="width: 10%;"></td> <td style="width: 10%;"></td> <td style="width: 10%;"></td> <td style="width: 10%;"></td> <td style="width: 10%;"></td> <td style="width: 10%;"></td> <td style="width: 10%;"></td> <td style="width: 10%;"></td> <td style="width: 10%;"></td> </tr> <tr> <td></td> <td></td> <td colspan="8" style="text-align: center;"> <table border="1" style="width: 100%; border-collapse: collapse; text-align: center;"> <tr> <td style="width: 10%;"></td> <td style="width: 10%;"></td> <td style="width: 10%;"></td> <td style="width: 10%;"></td> <td style="width: 10%;"></td> <td style="width: 10%;"></td> <td style="width: 10%;"></td> <td style="width: 10%;"></td> <td style="width: 10%;"></td> <td style="width: 10%;"></td> </tr> <tr> <td></td> <td></td> <td colspan="8" style="text-align: center;"> <table border="1" style="width: 100%; border-collapse: collapse; text-align: center;"> <tr> <td style="width: 10%;"></td> <td style="width: 10%;"></td> <td style="width: 10%;"></td> <td style="width: 10%;"></td> <td style="width: 10%;"></td> <td style="width: 10%;"></td> <td style="width: 10%;"></td> <td style="width: 10%;"></td> <td style="width: 10%;"></td> <td style="width: 10%;"></td> </tr> <tr> <td></td> <td></td> <td colspan="8" style="text-align: center;"> <table border="1" style="width: 100%; border-collapse: collapse; text-align: center;"> <tr> <td style="width: 10%;"></td> <td style="width: 10%;"></td> <td style="width: 10%;"></td> <td style="width: 10%;"></td> <td style="width: 10%;"></td> <td style="width: 10%;"></td> <td style="width: 10%;"></td> <td style="width: 10%;"></td> <td style="width: 10%;"></td> <td style="width: 10%;"></td> </tr> <tr> <td></td> <td></td> <td colspan="8" style="text-align: center;"> <table border="1" style="width: 100%; border-collapse: collapse; text-align: center;"> <tr> <td style="width: 10%;"></td> <td style="width: 10%;"></td> <td style="width: 10%;"></td> <td style="width: 10%;"></td> <td style="width: 10%;"></td> <td style="width: 10%;"></td> <td style="width: 10%;"></td> <td style="width: 10%;"></td> <td style="width: 10%;"></td> <td style="width: 10%;"></td> </tr> <tr> <td></td> <td></td> <td colspan="8" style="text-align: center;"> <table border="1" style="width: 100%; border-collapse: collapse; text-align: center;"> <tr> <td style="width: 10%;"></td> <td style="width: 10%;"></td> <td style="width: 10%;"></td> <td style="width: 10%;"></td> <td style="width: 10%;"></td> <td style="width: 10%;"></td> <td style="width: 10%;"></td> <td style="width: 10%;"></td> <td style="width: 10%;"></td> <td style="width: 10%;"></td> </tr> <tr> <td></td> <td></td> <td colspan="8" style="text-align: center;"> <table border="1" style="width: 100%; border-collapse: collapse; text-align: center;"> <tr> <td style="width: 10%;"></td> <td style="width: 10%;"></td> <td style="width: 10%;"></td> <td style="width: 10%;"></td> <td style="width: 10%;"></td> <td style="width: 10%;"></td> <td style="width: 10%;"></td> <td style="width: 10%;"></td> <td style="width: 10%;"></td> <td style="width: 10%;"></td> </tr> <tr> <td></td> <td></td> <td colspan="8" style="text-align: center;"> <table border="1" style="width: 100%; border-collapse: collapse; text-align: center;"> <tr> <td style="width: 10%;"></td> <td style="width: 10%;"></td> <td style="width: 10%;"></td> <td style="width: 10%;"></td> <td style="width: 10%;"></td> <td style="width: 10%;"></td> <td style="width: 10%;"></td> <td style="width: 10%;"></td> <td style="width: 10%;"></td> <td style="width: 10%;"></td> </tr> <tr> <td></td> <td></td> <td colspan="8" style="text-align: center;"> <table border="1" style="width: 100%; border-collapse: collapse; text-align: center;"> <tr> <td style="width: 10%;"></td> <td style="width: 10%;"></td> <td style="width: 10%;"></td> <td style="width: 10%;"></td> <td style="width: 10%;"></td> <td style="width: 10%;"></td> <td style="width: 10%;"></td> <td style="width: 10%;"></td> <td style="width: 10%;"></td> <td style="width: 10%;"></td> </tr> <tr> <td></td> <td></td> <td colspan="8" style="text-align: center;"> <table border="1" style="width: 100%; border-collapse: collapse; text-align: center;"> <tr> <td style="width: 10%;"></td> <td style="width: 10%;"></td> <td style="width: 10%;"></td> <td style="width: 10%;"></td> <td style="width: 10%;"></td> <td style="width: 10%;"></td> <td style="width: 10%;"></td> <td style="width: 10%;"></td> <td style="width: 10%;"></td> <td style="width: 10%;"></td> </tr> <tr> <td></td> <td></td> <td colspan="8" style="text-align: center;"> <table border="1" style="width: 100%; border-collapse: collapse; text-align: center;"> <tr> <td style="width: 10%;"></td> <td style="width: 10%;"></td> <td style="width: 10%;"></td> <td style="width: 10%;"></td> <td style="width: 10%;"></td> <td style="width: 10%;"></td> <td style="width: 10%;"></td> <td style="width: 10%;"></td> <td style="width: 10%;"></td> <td style="width: 10%;"></td> </tr> <tr> <td></td> <td></td> <td colspan="8" style="text-align: center;"> <table border="1" style="width: 100%; border-collapse: collapse; text-align: center;"> <tr> </tr></table></td></tr></table></td></tr></table></td></tr></table></td></tr></table></td></tr></table></td></tr></table></td></tr></table></td></tr></table></td></tr></table></td></tr></table></td></tr></table></td></tr></table></td></tr></table></td></tr></table></td></tr></table></td></tr></table></td></tr></table></td></tr></table></td></tr></table></td></tr></table></td></tr></table></td></tr></table>

 | | | | | | | | | | | | | | | | | | | | <table border="1" style="width: 100%; border-collapse: collapse; text-align: center;"> <tr> <td style="width: 10%;"></td> <td style="width: 10%;"></td> <td style="width: 10%;"></td> <td style="width: 10%;"></td> <td style="width: 10%;"></td> <td style="width: 10%;"></td> <td style="width: 10%;"></td> <td style="width: 10%;"></td> <td style="width: 10%;"></td> <td style="width: 10%;"></td> </tr> <tr> <td></td> <td></td> <td colspan="8" style="text-align: center;"> <table border="1" style="width: 100%; border-collapse: collapse; text-align: center;"> <tr> <td style="width: 10%;"></td> <td style="width: 10%;"></td> <td style="width: 10%;"></td> <td style="width: 10%;"></td> <td style="width: 10%;"></td> <td style="width: 10%;"></td> <td style="width: 10%;"></td> <td style="width: 10%;"></td> <td style="width: 10%;"></td> <td style="width: 10%;"></td> </tr> <tr> <td></td> <td></td> <td colspan="8" style="text-align: center;"> <table border="1" style="width: 100%; border-collapse: collapse; text-align: center;"> <tr> <td style="width: 10%;"></td> <td style="width: 10%;"></td> <td style="width: 10%;"></td> <td style="width: 10%;"></td> <td style="width: 10%;"></td> <td style="width: 10%;"></td> <td style="width: 10%;"></td> <td style="width: 10%;"></td> <td style="width: 10%;"></td> <td style="width: 10%;"></td> </tr> <tr> <td></td> <td></td> <td colspan="8" style="text-align: center;"> <table border="1" style="width: 100%; border-collapse: collapse; text-align: center;"> <tr> <td style="width: 10%;"></td> <td style="width: 10%;"></td> <td style="width: 10%;"></td> <td style="width: 10%;"></td> <td style="width: 10%;"></td> <td style="width: 10%;"></td> <td style="width: 10%;"></td> <td style="width: 10%;"></td> <td style="width: 10%;"></td> <td style="width: 10%;"></td> </tr> <tr> <td></td> <td></td> <td colspan="8" style="text-align: center;"> <table border="1" style="width: 100%; border-collapse: collapse; text-align: center;"> <tr> <td style="width: 10%;"></td> <td style="width: 10%;"></td> <td style="width: 10%;"></td> <td style="width: 10%;"></td> <td style="width: 10%;"></td> <td style="width: 10%;"></td> <td style="width: 10%;"></td> <td style="width: 10%;"></td> <td style="width: 10%;"></td> <td style="width: 10%;"></td> </tr> <tr> <td></td> <td></td> <td colspan="8" style="text-align: center;"> <table border="1" style="width: 100%; border-collapse: collapse; text-align: center;"> <tr> <td style="width: 10%;"></td> <td style="width: 10%;"></td> <td style="width: 10%;"></td> <td style="width: 10%;"></td> <td style="width: 10%;"></td> <td style="width: 10%;"></td> <td style="width: 10%;"></td> <td style="width: 10%;"></td> <td style="width: 10%;"></td> <td style="width: 10%;"></td> </tr> <tr> <td></td> <td></td> <td colspan="8" style="text-align: center;"> <table border="1" style="width: 100%; border-collapse: collapse; text-align: center;"> <tr> <td style="width: 10%;"></td> <td style="width: 10%;"></td> <td style="width: 10%;"></td> <td style="width: 10%;"></td> <td style="width: 10%;"></td> <td style="width: 10%;"></td> <td style="width: 10%;"></td> <td style="width: 10%;"></td> <td style="width: 10%;"></td> <td style="width: 10%;"></td> </tr> <tr> <td></td> <td></td> <td colspan="8" style="text-align: center;"> <table border="1" style="width: 100%; border-collapse: collapse; text-align: center;"> <tr> <td style="width:
10%;"></td> <td style="width: 10%;"></td> <td style="width: 10%;"></td> <td style="width: 10%;"></td> <td style="width: 10%;"></td> <td style="width: 10%;"></td> <td style="width: 10%;"></td> <td style="width: 10%;"></td> <td style="width: 10%;"></td> <td style="width: 10%;"></td> </tr> <tr> <td></td> <td></td> <td colspan="8" style="text-align: center;"> <table border="1" style="width: 100%; border-collapse: collapse; text-align: center;"> <tr> <td style="width: 10%;"></td> <td style="width: 10%;"></td> <td style="width: 10%;"></td> <td style="width: 10%;"></td> <td style="width: 10%;"></td> <td style="width: 10%;"></td> <td style="width: 10%;"></td> <td style="width: 10%;"></td> <td style="width: 10%;"></td> <td style="width: 10%;"></td> </tr> <tr> <td></td> <td></td> <td colspan="8" style="text-align: center;"> <table border="1" style="width: 100%; border-collapse: collapse; text-align: center;"> <tr> <td style="width: 10%;"></td> <td style="width: 10%;"></td> <td style="width: 10%;"></td> <td style="width: 10%;"></td> <td style="width: 10%;"></td> <td style="width: 10%;"></td> <td style="width: 10%;"></td> <td style="width: 10%;"></td> <td style="width: 10%;"></td> <td style="width: 10%;"></td> </tr> <tr> <td></td> <td></td> <td colspan="8" style="text-align: center;"> <table border="1" style="width: 100%; border-collapse: collapse; text-align: center;"> <tr> <td style="width: 10%;"></td> <td style="width: 10%;"></td> <td style="width: 10%;"></td> <td style="width: 10%;"></td> <td style="width: 10%;"></td> <td style="width: 10%;"></td> <td style="width: 10%;"></td> <td style="width: 10%;"></td> <td style="width: 10%;"></td> <td style="width: 10%;"></td> </tr> <tr> <td></td> <td></td> <td colspan="8" style="text-align: center;"> <table border="1" style="width: 100%; border-collapse: collapse; text-align: center;"> <tr> <td style="width: 10%;"></td> <td style="width: 10%;"></td> <td style="width: 10%;"></td> <td style="width: 10%;"></td> <td style="width: 10%;"></td> <td style="width: 10%;"></td> <td style="width: 10%;"></td> <td style="width: 10%;"></td> <td style="width: 10%;"></td> <td style="width: 10%;"></td> </tr> <tr> <td></td> <td></td> <td colspan="8" style="text-align: center;"> <table border="1" style="width: 100%; border-collapse: collapse; text-align: center;"> <tr> <td style="width: 10%;"></td> <td style="width: 10%;"></td> <td style="width: 10%;"></td> <td style="width: 10%;"></td> <td style="width: 10%;"></td> <td style="width: 10%;"></td> <td style="width: 10%;"></td> <td style="width: 10%;"></td> <td style="width: 10%;"></td> <td style="width: 10%;"></td> </tr> <tr> <td></td> <td></td> <td colspan="8" style="text-align: center;"> <table border="1" style="width: 100%; border-collapse: collapse; text-align: center;"> <tr> <td style="width: 10%;"></td> <td style="width: 10%;"></td> <td style="width: 10%;"></td> <td style="width: 10%;"></td> <td style="width: 10%;"></td> <td style="width: 10%;"></td> <td style="width: 10%;"></td> <td style="width: 10%;"></td> <td style="width: 10%;"></td> <td style="width: 10%;"></td> </tr> <tr> <td></td> <td></td> <td colspan="8" style="text-align: center;"> <table border="1" style="width: 100%; border-collapse: collapse; text-align: center;"> <tr> <td style="width: 10%;"></td> <td style="width: 10%;"></td> <td style="width: 10%;"></td> <td style="width: 10%;"></td> <td style="width: 10%;"></td> <td style="width: 10%;"></td> <td style="width: 10%;"></td> <td style="width: 10%;"></td> <td style="width: 10%;"></td> <td style="width: 10%;"></td> </tr> <tr> <td></td> <td></td> <td colspan="8" style="text-align: center;"> <table border="1" style="width: 100%; border-collapse: collapse; text-align: center;"> <tr> <td style="width: 10%;"></td> <td style="width: 10%;"></td> <td style="width: 10%;"></td> <td style="width: 10%;"></td> <td style="width: 10%;"></td> <td style="width: 10%;"></td> <td style="width: 10%;"></td> <td style="width: 10%;"></td> <td style="width: 10%;"></td> <td style="width: 10%;"></td> </tr> <tr> <td></td> <td></td> <td colspan="8" style="text-align: center;"> <table border="1" style="width: 100%; border-collapse: collapse; text-align: center;"> <tr> <td style="width: 10%;"></td> <td style="width: 10%;"></td> <td style="width: 10%;"></td> <td style="width: 10%;"></td> <td style="width: 10%;"></td> <td style="width: 10%;"></td> <td style="width: 10%;"></td> <td style="width: 10%;"></td> <td style="width: 10%;"></td> <td style="width: 10%;"></td> </tr> <tr> <td></td> <td></td> <td colspan="8" style="text-align: center;"> <table border="1" style="width: 100%; border-collapse: collapse; text-align: center;"> <tr> <td style="width: 10%;"></td> <td style="width: 10%;"></td> <td style="width: 10%;"></td> <td style="width: 10%;"></td> <td style="width: 10%;"></td> <td style="width: 10%;"></td> <td style="width: 10%;"></td> <td style="width: 10%;"></td> <td style="width: 10%;"></td> <td style="width: 10%;"></td> </tr> <tr> <td></td> <td></td> <td colspan="8" style="text-align: center;"> <table border="1" style="width: 100%; border-collapse: collapse; text-align: center;"> <tr> <td style="width: 10%;"></td> <td style="width: 10%;"></td> <td style="width: 10%;"></td> <td style="width: 10%;"></td> <td style="width: 10%;"></td> <td style="width: 10%;"></td> <td style="width: 10%;"></td> <td style="width: 10%;"></td> <td style="width: 10%;"></td> <td style="width: 10%;"></td> </tr> <tr> <td></td> <td></td> <td colspan="8" style="text-align: center;"> <table border="1" style="width: 100%; border-collapse: collapse; text-align: center;"> <tr> <td style="width: 10%;"></td> <td style="width: 10%;"></td> <td style="width: 10%;"></td> <td style="width: 10%;"></td> <td style="width: 10%;"></td> <td style="width: 10%;"></td> <td style="width: 10%;"></td> <td style="width: 10%;"></td> <td style="width: 10%;"></td> <td style="width: 10%;"></td> </tr> <tr> <td></td> <td></td> <td colspan="8" style="text-align: center;"> <table border="1" style="width: 100%; border-collapse: collapse; text-align: center;"> <tr> <td style="width: 10%;"></td> <td style="width: 10%;"></td> <td style="width: 10%;"></td> <td style="width: 10%;"></td> <td style="width: 10%;"></td> <td style="width: 10%;"></td> <td style="width: 10%;"></td> <td style="width: 10%;"></td> <td style="width: 10%;"></td> <td style="width: 10%;"></td> </tr> <tr> <td></td> <td></td> <td colspan="8" style="text-align: center;"> <table border="1" style="width: 100%; border-collapse: collapse; text-align: center;"> <tr> </tr></table></td></tr></table></td></tr></table></td></tr></table></td></tr></table></td></tr></table></td></tr></table></td></tr></table></td></tr></table></td></tr></table></td></tr></table></td></tr></table></td></tr></table></td></tr></table></td></tr></table></td></tr></table></td></tr></table></td></tr></table></td></tr></table></td></tr></table></td></tr></table></td></tr></table>

 | | | | | | | | | | | | | | | | | | | | <table border="1" style="width: 100%; border-collapse: collapse; text-align: center;"> <tr> <td style="width: 10%;"></td> <td style="width: 10%;"></td> <td style="width: 10%;"></td> <td style="width: 10%;"></td> <td style="width: 10%;"></td> <td style="width: 10%;"></td> <td style="width: 10%;"></td> <td style="width: 10%;"></td> <td style="width: 10%;"></td> <td style="width: 10%;"></td> </tr> <tr> <td></td> <td></td> <td colspan="8" style="text-align: center;"> <table border="1" style="width: 100%; border-collapse: collapse; text-align: center;"> <tr> <td style="width: 10%;"></td> <td style="width: 10%;"></td> <td style="width: 10%;"></td> <td style="width: 10%;"></td> <td style="width: 10%;"></td> <td style="width: 10%;"></td> <td style="width: 10%;"></td> <td style="width: 10%;"></td> <td style="width: 10%;"></td> <td style="width: 10%;"></td> </tr> <tr> <td></td> <td></td> <td colspan="8" style="text-align: center;"> <table border="1" style="width: 100%; border-collapse: collapse; text-align: center;"> <tr> <td style="width: 10%;"></td> <td style="width: 10%;"></td> <td style="width: 10%;"></td> <td style="width: 10%;"></td> <td style="width: 10%;"></td> <td style="width: 10%;"></td> <td style="width: 10%;"></td> <td style="width: 10%;"></td> <td style="width: 10%;"></td> <td style="width: 10%;"></td> </tr> <tr> <td></td> <td></td> <td colspan="8" style="text-align: center;"> <table border="1" style="width: 100%; border-collapse: collapse; text-align: center;"> <tr> <td style="width: 10%;"></td> <td style="width: 10%;"></td> <td style="width: 10%;"></td> <td style="width: 10%;"></td> <td style="width: 10%;"></td> <td style="width: 10%;"></td> <td style="width: 10%;"></td> <td style="width: 10%;"></td> <td style="width: 10%;"></td> <td style="width: 10%;"></td> </tr> <tr> <td></td> <td></td> <td colspan="8" style="text-align: center;"> <table border="1" style="width: 100%; border-collapse: collapse; text-align: center;"> <tr> <td style="width: 10%;"></td> <td style="width: 10%;"></td> <td style="width: 10%;"></td> <td style="width: 10%;"></td> <td style="width: 10%;"></td> <td style="width: 10%;"></td> <td style="width: 10%;"></td> <td style="width: 10%;"></td> <td style="width: 10%;"></td> <td style="width: 10%;"></td> </tr> <tr> <td></td> <td></td> <td colspan="8" style="text-align: center;"> <table border="1" style="width: 100%; border-collapse: collapse; text-align: center;"> <tr> <td style="width: 10%;"></td> <td style="width: 10%;"></td> <td style="width: 10%;"></td> <td style="width: 10%;"></td> <td style="width: 10%;"></td> <td style="width: 10%;"></td> <td style="width: 10%;"></td> <td style="width: 10%;"></td> <td style="width: 10%;"></td> <td style="width: 10%;"></td> </tr> <tr> <td></td> <td></td> <td colspan="8" style="text-align: center;"> <table border="1" style="width: 100%; border-collapse: collapse; text-align: center;"> <tr> <td style="width: 10%;"></td> <td style="width: 10%;"></td> <td style="width: 10%;"></td> <td style="width: 10%;"></td> <td style="width: 10%;"></td> <td style="width: 10%;"></td> <td style="width: 10%;"></td> <td style="width: 10%;"></td> <td style="width: 10%;"></td> <td style="width: 10%;"></td> </tr> <tr> <td></td> <td></td> <td colspan="8" style="text-align: center;"> <table border="1" style="width: 100%; border-collapse: collapse; text-align: center;"> <tr> <td style="width: 10%;"></td> <td style="width: 10%;"></td> <td style="width: 10%;"></td> <td style="width: 10%;"></td> <td style="width: 10%;"></td> <td style="width: 10%;"></td> <td style="width: 10%;"></td> <td style="width: 10%;"></td> <td style="width: 10%;"></td> <td style="width: 10%;"></td> </tr> <tr> <td></td> <td></td> <td colspan="8" style="text-align: center;"> <table border="1" style="width: 100%; border-collapse: collapse; text-align: center;"> <tr> <td style="width: 10%;"></td> <td style="width: 10%;"></td> <td style="width: 10%;"></td> <td style="width: 10%;"></td> <td style="width: 10%;"></td> <td style="width: 10%;"></td> <td style="width: 10%;"></td> <td style="width: 10%;"></td> <td style="width: 10%;"></td> <td style="width: 10%;"></td> </tr> <tr> <td></td> <td></td> <td colspan="8" style="text-align: center;"> <table border="1" style="width: 100%; border-collapse: collapse; text-align: center;"> <tr> <td style="width: 10%;"></td> <td style="width: 10%;"></td> <td style="width: 10%;"></td> <td style="width: 10%;"></td> <td style="width: 10%;"></td> <td style="width: 10%;"></td> <td style="width: 10%;"></td> <td style="width: 10%;"></td> <td style="width: 10%;"></td> <td style="width: 10%;"></td> </tr> <tr> <td></td> <td></td> <td colspan="8" style="text-align: center;"> <table border="1" style="width: 100%; border-collapse: collapse; text-align: center;"> <tr> <td style="width: 10%;"></td> <td style="width: 10%;"></td> <td style="width: 10%;"></td> <td style="width: 10%;"></td> <td style="width: 10%;"></td> <td style="width: 10%;"></td> <td style="width: 10%;"></td> <td style="width: 10%;"></td> <td style="width: 10%;"></td> <td style="width: 10%;"></td> </tr> <tr> <td></td> <td></td> <td colspan="8" style="text-align: center;"> <table border="1" style="width: 100%; border-collapse: collapse; text-align: center;"> <tr> <td style="width: 10%;"></td> <td style="width: 10%;"></td> <td style="width: 10%;"></td> <td style="width: 10%;"></td> <td style="width: 10%;"></td> <td style="width: 10%;"></td> <td style="width: 10%;"></td> <td style="width: 10%;"></td> <td style="width: 10%;"></td> <td style="width: 10%;"></td> </tr> <tr> <td></td> <td></td> <td colspan="8" style="text-align: center;"> <table border="1" style="width: 100%; border-collapse: collapse; text-align: center;"> <tr> <td style="width: 10%;"></td> <td style="width: 10%;"></td> <td style="width: 10%;"></td> <td style="width: 10%;"></td> <td style="width: 10%;"></td> <td style="width: 10%;"></td> <td style="width: 10%;"></td> <td style="width: 10%;"></td> <td style="width: 10%;"></td> <td style="width:
10%;"></td> </tr> <tr> <td></td> <td></td> <td colspan="8" style="text-align: center;"> <table border="1" style="width: 100%; border-collapse: collapse; text-align: center;"> <tr> <td style="width: 10%;"></td> <td style="width: 10%;"></td> <td style="width: 10%;"></td> <td style="width: 10%;"></td> <td style="width: 10%;"></td> <td style="width: 10%;"></td> <td style="width: 10%;"></td> <td style="width: 10%;"></td> <td style="width: 10%;"></td> <td style="width: 10%;"></td> </tr> <tr> <td></td> <td></td> <td colspan="8" style="text-align: center;"> <table border="1" style="width: 100%; border-collapse: collapse; text-align: center;"> <tr> <td style="width: 10%;"></td> <td style="width: 10%;"></td> <td style="width: 10%;"></td> <td style="width: 10%;"></td> <td style="width: 10%;"></td> <td style="width: 10%;"></td> <td style="width: 10%;"></td> <td style="width: 10%;"></td> <td style="width: 10%;"></td> <td style="width: 10%;"></td> </tr> <tr> <td></td> <td></td> <td colspan="8" style="text-align: center;"> <table border="1" style="width: 100%; border-collapse: collapse; text-align: center;"> <tr> <td style="width: 10%;"></td> <td style="width: 10%;"></td> <td style="width: 10%;"></td> <td style="width: 10%;"></td> <td style="width: 10%;"></td> <td style="width: 10%;"></td> <td style="width: 10%;"></td> <td style="width: 10%;"></td> <td style="width: 10%;"></td> <td style="width: 10%;"></td> </tr> <tr> <td></td> <td></td> <td colspan="8" style="text-align: center;"> <table border="1" style="width: 100%; border-collapse: collapse; text-align: center;"> <tr> <td style="width: 10%;"></td> <td style="width: 10%;"></td> <td style="width: 10%;"></td> <td style="width: 10%;"></td> <td style="width: 10%;"></td> <td style="width: 10%;"></td> <td style="width: 10%;"></td> <td style="width: 10%;"></td> <td style="width: 10%;"></td> <td style="width: 10%;"></td> </tr> <tr> <td></td> <td></td> <td colspan="8" style="text-align: center;"> <table border="1" style="width: 100%; border-collapse: collapse; text-align: center;"> <tr> <td style="width: 10%;"></td> <td style="width: 10%;"></td> <td style="width: 10%;"></td> <td style="width: 10%;"></td> <td style="width: 10%;"></td> <td style="width: 10%;"></td> <td style="width: 10%;"></td> <td style="width: 10%;"></td> <td style="width: 10%;"></td> <td style="width: 10%;"></td> </tr> <tr> <td></td> <td></td> <td colspan="8" style="text-align: center;"> <table border="1" style="width: 100%; border-collapse: collapse; text-align: center;"> <tr> <td style="width: 10%;"></td> <td style="width: 10%;"></td> <td style="width: 10%;"></td> <td style="width: 10%;"></td> <td style="width: 10%;"></td> <td style="width: 10%;"></td> <td style="width: 10%;"></td> <td style="width: 10%;"></td> <td style="width: 10%;"></td> <td style="width: 10%;"></td> </tr> <tr> <td></td> <td></td> <td colspan="8" style="text-align: center;"> <table border="1" style="width: 100%; border-collapse: collapse; text-align: center;"> <tr> <td style="width: 10%;"></td> <td style="width: 10%;"></td> <td style="width: 10%;"></td> <td style="width: 10%;"></td> <td style="width: 10%;"></td> <td style="width: 10%;"></td> <td style="width: 10%;"></td> <td style="width: 10%;"></td> <td style="width: 10%;"></td> <td style="width: 10%;"></td> </tr> <tr> <td></td> <td></td> <td colspan="8" style="text-align: center;"> <table border="1" style="width: 100%; border-collapse: collapse; text-align: center;"> <tr> </tr></table></td></tr></table></td></tr></table></td></tr></table></td></tr></table></td></tr></table></td></tr></table></td></tr></table></td></tr></table></td></tr></table></td></tr></table></td></tr></table></td></tr></table></td></tr></table></td></tr></table></td></tr></table></td></tr></table></td></tr></table></td></tr></table></td></tr></table></td></tr></table>

 | | | | | | | | | | | | | | | | | | | | <table border="1" style="width: 100%; border-collapse: collapse; text-align: center;"> <tr> <td style="width: 10%;"></td> <td style="width: 10%;"></td> <td style="width: 10%;"></td> <td style="width: 10%;"></td> <td style="width: 10%;"></td> <td style="width: 10%;"></td> <td style="width: 10%;"></td> <td style="width: 10%;"></td> <td style="width: 10%;"></td> <td style="width: 10%;"></td> </tr> <tr> <td></td> <td></td> <td colspan="8" style="text-align: center;"> <table border="1" style="width: 100%; border-collapse: collapse; text-align: center;"> <tr> <td style="width: 10%;"></td> <td style="width: 10%;"></td> <td style="width: 10%;"></td> <td style="width: 10%;"></td> <td style="width: 10%;"></td> <td style="width: 10%;"></td> <td style="width: 10%;"></td> <td style="width: 10%;"></td> <td style="width: 10%;"></td> <td style="width: 10%;"></td> </tr> <tr> <td></td> <td></td> <td colspan="8" style="text-align: center;"> <table border="1" style="width: 100%; border-collapse: collapse; text-align: center;"> <tr> <td style="width: 10%;"></td> <td style="width: 10%;"></td> <td style="width: 10%;"></td> <td style="width: 10%;"></td> <td style="width: 10%;"></td> <td style="width: 10%;"></td> <td style="width: 10%;"></td> <td style="width: 10%;"></td> <td style="width: 10%;"></td> <td style="width: 10%;"></td> </tr> <tr> <td></td> <td></td> <td colspan="8" style="text-align: center;"> <table border="1" style="width: 100%; border-collapse: collapse; text-align: center;"> <tr> <td style="width: 10%;"></td> <td style="width: 10%;"></td> <td style="width: 10%;"></td> <td style="width: 10%;"></td> <td style="width: 10%;"></td> <td style="width: 10%;"></td> <td style="width: 10%;"></td> <td style="width: 10%;"></td> <td style="width: 10%;"></td> <td style="width: 10%;"></td> </tr> <tr> <td></td> <td></td> <td colspan="8" style="text-align: center;"> <table border="1" style="width: 100%; border-collapse: collapse; text-align: center;"> <tr> <td style="width: 10%;"></td> <td style="width: 10%;"></td> <td style="width: 10%;"></td> <td style="width: 10%;"></td> <td style="width: 10%;"></td> <td style="width: 10%;"></td> <td style="width: 10%;"></td> <td style="width: 10%;"></td> <td style="width: 10%;"></td> <td style="width: 10%;"></td> </tr> <tr> <td></td> <td></td> <td colspan="8" style="text-align: center;"> <table border="1" style="width: 100%; border-collapse: collapse; text-align: center;"> <tr> <td style="width: 10%;"></td> <td style="width: 10%;"></td> <td style="width: 10%;"></td> <td style="width: 10%;"></td> <td style="width: 10%;"></td> <td style="width: 10%;"></td> <td style="width: 10%;"></td> <td style="width: 10%;"></td> <td style="width: 10%;"></td> <td style="width: 10%;"></td> </tr> <tr> <td></td> <td></td> <td colspan="8" style="text-align: center;"> <table border="1" style="width: 100%; border-collapse: collapse; text-align: center;"> <tr> <td style="width: 10%;"></td> <td style="width: 10%;"></td> <td style="width: 10%;"></td> <td style="width: 10%;"></td> <td style="width: 10%;"></td> <td style="width: 10%;"></td> <td style="width: 10%;"></td> <td style="width: 10%;"></td> <td style="width: 10%;"></td> <td style="width: 10%;"></td> </tr> <tr> <td></td> <td></td> <td colspan="8" style="text-align: center;"> <table border="1" style="width: 100%; border-collapse: collapse; text-align: center;"> <tr> <td style="width: 10%;"></td> <td style="width: 10%;"></td> <td style="width: 10%;"></td> <td style="width: 10%;"></td> <td style="width: 10%;"></td> <td style="width: 10%;"></td> <td style="width: 10%;"></td> <td style="width: 10%;"></td> <td style="width: 10%;"></td> <td style="width: 10%;"></td> </tr> <tr> <td></td> <td></td> <td colspan="8" style="text-align: center;"> <table border="1" style="width: 100%; border-collapse: collapse; text-align: center;"> <tr> <td style="width: 10%;"></td> <td style="width: 10%;"></td> <td style="width: 10%;"></td> <td style="width: 10%;"></td> <td style="width: 10%;"></td> <td style="width: 10%;"></td> <td style="width: 10%;"></td> <td style="width: 10%;"></td> <td style="width: 10%;"></td> <td style="width: 10%;"></td> </tr> <tr> <td></td> <td></td> <td colspan="8" style="text-align: center;"> <table border="1" style="width: 100%; border-collapse: collapse; text-align: center;"> <tr> <td style="width: 10%;"></td> <td style="width: 10%;"></td> <td style="width: 10%;"></td> <td style="width: 10%;"></td> <td style="width: 10%;"></td> <td style="width: 10%;"></td> <td style="width: 10%;"></td> <td style="width: 10%;"></td> <td style="width: 10%;"></td> <td style="width: 10%;"></td> </tr> <tr> <td></td> <td></td> <td colspan="8" style="text-align: center;"> <table border="1" style="width: 100%; border-collapse: collapse; text-align: center;"> <tr> <td style="width: 10%;"></td> <td style="width: 10%;"></td> <td style="width: 10%;"></td> <td style="width: 10%;"></td> <td style="width: 10%;"></td> <td style="width: 10%;"></td> <td style="width: 10%;"></td> <td style="width: 10%;"></td> <td style="width: 10%;"></td> <td style="width: 10%;"></td> </tr> <tr> <td></td> <td></td> <td colspan="8" style="text-align: center;"> <table border="1" style="width: 100%; border-collapse: collapse; text-align: center;"> <tr> <td style="width: 10%;"></td> <td style="width: 10%;"></td> <td style="width: 10%;"></td> <td style="width: 10%;"></td> <td style="width: 10%;"></td> <td style="width: 10%;"></td> <td style="width: 10%;"></td> <td style="width: 10%;"></td> <td style="width: 10%;"></td> <td style="width: 10%;"></td> </tr> <tr> <td></td> <td></td> <td colspan="8" style="text-align: center;"> <table border="1" style="width: 100%; border-collapse: collapse; text-align: center;"> <tr> <td style="width: 10%;"></td> <td style="width: 10%;"></td> <td style="width: 10%;"></td> <td style="width: 10%;"></td> <td style="width: 10%;"></td> <td style="width: 10%;"></td> <td style="width: 10%;"></td> <td style="width: 10%;"></td> <td style="width: 10%;"></td> <td style="width: 10%;"></td> </tr> <tr> <td></td> <td></td> <td colspan="8" style="text-align: center;"> <table border="1" style="width: 100%; border-collapse: collapse; text-align: center;"> <tr> <td style="width: 10%;"></td> <td style="width: 10%;"></td> <td style="width: 10%;"></td> <td style="width: 10%;"></td> <td style="width: 10%;"></td> <td style="width: 10%;"></td> <td style="width: 10%;"></td> <td style="width: 10%;"></td> <td style="width: 10%;"></td> <td style="width: 10%;"></td> </tr> <tr> <td></td> <td></td> <td colspan="8" style="text-align: center;"> <table border="1" style="width: 100%; border-collapse: collapse; text-align: center;"> <tr> <td style="width: 10%;"></td> <td style="width: 10%;"></td> <td style="width: 10%;"></td> <td style="width: 10%;"></td> <td style="width: 10%;"></td> <td style="width: 10%;"></td> <td style="width: 10%;"></td> <td style="width: 10%;"></td> <td style="width: 10%;"></td> <td style="width: 10%;"></td> </tr> <tr> <td></td> <td></td> <td colspan="8" style="text-align: center;"> <table border="1" style="width: 100%; border-collapse: collapse; text-align: center;"> <tr> <td style="width: 10%;"></td> <td style="width: 10%;"></td> <td style="width: 10%;"></td> <td style="width: 10%;"></td> <td style="width: 10%;"></td> <td style="width: 10%;"></td> <td style="width: 10%;"></td> <td style="width: 10%;"></td> <td style="width: 10%;"></td> <td style="width: 10%;"></td> </tr> <tr> <td></td> <td></td> <td colspan="8" style="text-align: center;"> <table border="1" style="width: 100%; border-collapse: collapse; text-align: center;"> <tr> <td style="width: 10%;"></td> <td style="width: 10%;"></td> <td style="width: 10%;"></td> <td style="width: 10%;"></td> <td style="width: 10%;"></td> <td style="width: 10%;"></td> <td style="width: 10%;"></td> <td style="width: 10%;"></td> <td style="width: 10%;"></td> <td style="width: 10%;"></td> </tr> <tr> <td></td> <td></td> <td colspan="8" style="text-align: center;"> <table border="1" style="width: 100%; border-collapse: collapse; text-align: center;"> <tr> <td style="width: 10%;"></td> <td style="width: 10%;"></td> <td style="width: 10%;"></td> <td style="width: 10%;"></td> <td style="width: 10%;"></td> <td style="width: 10%;"></td> <td style="width: 10%;"></td> <td style="width: 10%;"></td> <td style="width: 10%;"></td> <td style="width: 10%;"></td> </tr> <tr> <td></td> <td></td> <td colspan="8" style="text-align: center;"> <table border="1" style="width: 100%; border-collapse: collapse; text-align: center;"> <tr> <td style="width: 10%;"></td> <td style="width: 10%;"></td> <td style="width: 10%;"></td> <td style="width: 10%;"></td> <td style="width: 10%;"></td> <td style="width: 10%;"></td> <td style="width: 10%;"></td> <td style="width: 10%;"></td> <td style="width: 10%;"></td> <td style="width: 10%;"></td> </tr> <tr> <td></td> <td></td> <td colspan="8" style="text-align: center;"> <table border="1" style="width: 100%; border-collapse: collapse; text-align: center;"> <tr>
</tr></table></td></tr></table></td></tr></table></td></tr></table></td></tr></table></td></tr></table></td></tr></table></td></tr></table></td></tr></table></td></tr></table></td></tr></table></td></tr></table></td></tr></table></td></tr></table></td></tr></table></td></tr></table></td></tr></table></td></tr></table></td></tr></table></td></tr></table>
 | | | | | | | | | | | | | | | | | | | | <table border="1" style="width: 100%; border-collapse: collapse; text-align: center;"> <tr> <td style="width: 10%;"></td> <td style="width: 10%;"></td> <td style="width: 10%;"></td> <td style="width: 10%;"></td> <td style="width: 10%;"></td> <td style="width: 10%;"></td> <td style="width: 10%;"></td> <td style="width: 10%;"></td> <td style="width: 10%;"></td> <td style="width: 10%;"></td> </tr> <tr> <td></td> <td></td> <td colspan="8" style="text-align: center;"> <table border="1" style="width: 100%; border-collapse: collapse; text-align: center;"> <tr> <td style="width: 10%;"></td> <td style="width: 10%;"></td> <td style="width: 10%;"></td> <td style="width: 10%;"></td> <td style="width: 10%;"></td> <td style="width: 10%;"></td> <td style="width: 10%;"></td> <td style="width: 10%;"></td> <td style="width: 10%;"></td> <td style="width: 10%;"></td> </tr> <tr> <td></td> <td></td> <td colspan="8" style="text-align: center;"> <table border="1" style="width: 100%; border-collapse: collapse; text-align: center;"> <tr> <td style="width: 10%;"></td> <td style="width: 10%;"></td> <td style="width: 10%;"></td> <td style="width: 10%;"></td> <td style="width: 10%;"></td> <td style="width: 10%;"></td> <td style="width: 10%;"></td> <td style="width: 10%;"></td> <td style="width: 10%;"></td> <td style="width: 10%;"></td> </tr> <tr> <td></td> <td></td> <td colspan="8" style="text-align: center;"> <table border="1" style="width: 100%; border-collapse: collapse; text-align: center;"> <tr> <td style="width: 10%;"></td> <td style="width: 10%;"></td> <td style="width: 10%;"></td> <td style="width: 10%;"></td> <td style="width: 10%;"></td> <td style="width: 10%;"></td> <td style="width: 10%;"></td> <td style="width: 10%;"></td> <td style="width: 10%;"></td> <td style="width: 10%;"></td> </tr> <tr> <td></td> <td></td> <td colspan="8" style="text-align: center;"> <table border="1" style="width: 100%; border-collapse: collapse; text-align: center;"> <tr> <td style="width: 10%;"></td> <td style="width: 10%;"></td> <td style="width: 10%;"></td> <td style="width: 10%;"></td> <td style="width: 10%;"></td> <td style="width: 10%;"></td> <td style="width: 10%;"></td> <td style="width: 10%;"></td> <td style="width: 10%;"></td> <td style="width: 10%;"></td> </tr> <tr> <td></td> <td></td> <td colspan="8" style="text-align: center;"> <table border="1" style="width: 100%; border-collapse: collapse; text-align: center;"> <tr> <td style="width: 10%;"></td> <td style="width: 10%;"></td> <td style="width: 10%;"></td> <td style="width: 10%;"></td> <td style="width:
10%;"></td> <td style="width: 10%;"></td> <td style="width: 10%;"></td> <td style="width: 10%;"></td> <td style="width: 10%;"></td> <td style="width: 10%;"></td> </tr> <tr> <td></td> <td></td> <td colspan="8" style="text-align: center;"> <table border="1" style="width: 100%; border-collapse: collapse; text-align: center;"> <tr> <td style="width: 10%;"></td> <td style="width: 10%;"></td> <td style="width: 10%;"></td> <td style="width: 10%;"></td> <td style="width: 10%;"></td> <td style="width: 10%;"></td> <td style="width: 10%;"></td> <td style="width: 10%;"></td> <td style="width: 10%;"></td> <td style="width: 10%;"></td> </tr> <tr> <td></td> <td></td> <td colspan="8" style="text-align: center;"> <table border="1" style="width: 100%; border-collapse: collapse; text-align: center;"> <tr> <td style="width: 10%;"></td> <td style="width: 10%;"></td> <td style="width: 10%;"></td> <td style="width: 10%;"></td> <td style="width: 10%;"></td> <td style="width: 10%;"></td> <td style="width: 10%;"></td> <td style="width: 10%;"></td> <td style="width: 10%;"></td> <td style="width: 10%;"></td> </tr> <tr> <td></td> <td></td> <td colspan="8" style="text-align: center;"> <table border="1" style="width: 100%; border-collapse: collapse; text-align: center;"> <tr> <td style="width: 10%;"></td> <td style="width: 10%;"></td> <td style="width: 10%;"></td> <td style="width: 10%;"></td> <td style="width: 10%;"></td> <td style="width: 10%;"></td> <td style="width: 10%;"></td> <td style="width: 10%;"></td> <td style="width: 10%;"></td> <td style="width: 10%;"></td> </tr> <tr> <td></td> <td></td> <td colspan="8" style="text-align: center;"> <table border="1" style="width: 100%; border-collapse: collapse; text-align: center;"> <tr> <td style="width: 10%;"></td> <td style="width: 10%;"></td> <td style="width: 10%;"></td> <td style="width: 10%;"></td> <td style="width: 10%;"></td> <td style="width: 10%;"></td> <td style="width: 10%;"></td> <td style="width: 10%;"></td> <td style="width: 10%;"></td> <td style="width: 10%;"></td> </tr> <tr> <td></td> <td></td> <td colspan="8" style="text-align: center;"> <table border="1" style="width: 100%; border-collapse: collapse; text-align: center;"> <tr> <td style="width: 10%;"></td> <td style="width: 10%;"></td> <td style="width: 10%;"></td> <td style="width: 10%;"></td> <td style="width: 10%;"></td> <td style="width: 10%;"></td> <td style="width: 10%;"></td> <td style="width: 10%;"></td> <td style="width: 10%;"></td> <td style="width: 10%;"></td> </tr> <tr> <td></td> <td></td> <td colspan="8" style="text-align: center;"> <table border="1" style="width: 100%; border-collapse: collapse; text-align: center;"> <tr> <td style="width: 10%;"></td> <td style="width: 10%;"></td> <td style="width: 10%;"></td> <td style="width: 10%;"></td> <td style="width: 10%;"></td> <td style="width: 10%;"></td> <td style="width: 10%;"></td> <td style="width: 10%;"></td> <td style="width: 10%;"></td> <td style="width: 10%;"></td> </tr> <tr> <td></td> <td></td> <td colspan="8" style="text-align: center;"> <table border="1" style="width: 100%; border-collapse: collapse; text-align: center;"> <tr> <td style="width: 10%;"></td> <td style="width: 10%;"></td> <td style="width: 10%;"></td> <td style="width: 10%;"></td> <td style="width: 10%;"></td> <td style="width: 10%;"></td> <td style="width: 10%;"></td> <td style="width: 10%;"></td> <td style="width: 10%;"></td> <td style="width: 10%;"></td> </tr> <tr> <td></td> <td></td> <td colspan="8" style="text-align: center;"> <table border="1" style="width: 100%; border-collapse: collapse; text-align: center;"> <tr> <td style="width: 10%;"></td> <td style="width: 10%;"></td> <td style="width: 10%;"></td> <td style="width: 10%;"></td> <td style="width: 10%;"></td> <td style="width: 10%;"></td> <td style="width: 10%;"></td> <td style="width: 10%;"></td> <td style="width: 10%;"></td> <td style="width: 10%;"></td> </tr> <tr> <td></td> <td></td> <td colspan="8" style="text-align: center;"> <table border="1" style="width: 100%; border-collapse: collapse; text-align: center;"> <tr> <td style="width: 10%;"></td> <td style="width: 10%;"></td> <td style="width: 10%;"></td> <td style="width: 10%;"></td> <td style="width: 10%;"></td> <td style="width: 10%;"></td> <td style="width: 10%;"></td> <td style="width: 10%;"></td> <td style="width: 10%;"></td> <td style="width: 10%;"></td> </tr> <tr> <td></td> <td></td> <td colspan="8" style="text-align: center;"> <table border="1" style="width: 100%; border-collapse: collapse; text-align: center;"> <tr> <td style="width: 10%;"></td> <td style="width: 10%;"></td> <td style="width: 10%;"></td> <td style="width: 10%;"></td> <td style="width: 10%;"></td> <td style="width: 10%;"></td> <td style="width: 10%;"></td> <td style="width: 10%;"></td> <td style="width: 10%;"></td> <td style="width: 10%;"></td> </tr> <tr> <td></td> <td></td> <td colspan="8" style="text-align: center;"> <table border="1" style="width: 100%; border-collapse: collapse; text-align: center;"> <tr> <td style="width: 10%;"></td> <td style="width: 10%;"></td> <td style="width: 10%;"></td> <td style="width: 10%;"></td> <td style="width: 10%;"></td> <td style="width: 10%;"></td> <td style="width: 10%;"></td> <td style="width: 10%;"></td> <td style="width: 10%;"></td> <td style="width: 10%;"></td> </tr> <tr> <td></td> <td></td> <td colspan="8" style="text-align: center;"> <table border="1" style="width: 100%; border-collapse: collapse; text-align: center;"> <tr> <td style="width: 10%;"></td> <td style="width: 10%;"></td> <td style="width: 10%;"></td> <td style="width: 10%;"></td> <td style="width: 10%;"></td> <td style="width: 10%;"></td> <td style="width: 10%;"></td> <td style="width: 10%;"></td> <td style="width: 10%;"></td> <td style="width: 10%;"></td> </tr> <tr> <td></td> <td></td> <td colspan="8" style="text-align: center;"> <table border="1" style="width: 100%; border-collapse: collapse; text-align: center;"> <tr> </tr></table></td></tr></table></td></tr></table></td></tr></table></td></tr></table></td></tr></table></td></tr></table></td></tr></table></td></tr></table></td></tr></table></td></tr></table></td></tr></table></td></tr></table></td></tr></table></td></tr></table></td></tr></table></td></tr></table></td></tr></table></td></tr></table>

 | | | | | | | | | | | | | | | | | | | | <table border="1" style="width: 100%; border-collapse: collapse; text-align: center;"> <tr> <td style="width: 10%;"></td> <td style="width: 10%;"></td> <td style="width: 10%;"></td> <td style="width: 10%;"></td> <td style="width: 10%;"></td> <td style="width: 10%;"></td> <td style="width: 10%;"></td> <td style="width: 10%;"></td> <td style="width: 10%;"></td> <td style="width: 10%;"></td> </tr> <tr> <td></td> <td></td> <td colspan="8" style="text-align: center;"> <table border="1" style="width: 100%; border-collapse: collapse; text-align: center;"> <tr> <td style="width: 10%;"></td> <td style="width: 10%;"></td> <td style="width: 10%;"></td> <td style="width: 10%;"></td> <td style="width: 10%;"></td> <td style="width: 10%;"></td> <td style="width: 10%;"></td> <td style="width: 10%;"></td> <td style="width: 10%;"></td> <td style="width: 10%;"></td> </tr> <tr> <td></td> <td></td> <td colspan="8" style="text-align: center;"> <table border="1" style="width: 100%; border-collapse: collapse; text-align: center;"> <tr> <td style="width: 10%;"></td> <td style="width: 10%;"></td> <td style="width: 10%;"></td> <td style="width: 10%;"></td> <td style="width: 10%;"></td> <td style="width: 10%;"></td> <td style="width: 10%;"></td> <td style="width: 10%;"></td> <td style="width: 10%;"></td> <td style="width: 10%;"></td> </tr> <tr> <td></td> <td></td> <td colspan="8" style="text-align: center;"> <table border="1" style="width: 100%; border-collapse: collapse; text-align: center;"> <tr> <td style="width: 10%;"></td> <td style="width: 10%;"></td> <td style="width: 10%;"></td> <td style="width: 10%;"></td> <td style="width: 10%;"></td> <td style="width: 10%;"></td> <td style="width: 10%;"></td> <td style="width: 10%;"></td> <td style="width: 10%;"></td> <td style="width: 10%;"></td> </tr> <tr> <td></td> <td></td> <td colspan="8" style="text-align: center;"> <table border="1" style="width: 100%; border-collapse: collapse; text-align: center;"> <tr> <td style="width: 10%;"></td> <td style="width: 10%;"></td> <td style="width: 10%;"></td> <td style="width: 10%;"></td> <td style="width: 10%;"></td> <td style="width: 10%;"></td> <td style="width: 10%;"></td> <td style="width: 10%;"></td> <td style="width: 10%;"></td> <td style="width: 10%;"></td> </tr> <tr> <td></td> <td></td> <td colspan="8" style="text-align: center;"> <table border="1" style="width: 100%; border-collapse: collapse; text-align: center;"> <tr> <td style="width: 10%;"></td> <td style="width: 10%;"></td> <td style="width: 10%;"></td> <td style="width: 10%;"></td> <td style="width: 10%;"></td> <td style="width: 10%;"></td> <td style="width: 10%;"></td> <td style="width: 10%;"></td> <td style="width: 10%;"></td> <td style="width: 10%;"></td> </tr> <tr> <td></td> <td></td> <td colspan="8" style="text-align: center;"> <table border="1" style="width: 100%; border-collapse: collapse; text-align: center;"> <tr> <td style="width: 10%;"></td> <td style="width: 10%;"></td> <td style="width: 10%;"></td> <td style="width: 10%;"></td> <td style="width: 10%;"></td> <td style="width: 10%;"></td> <td style="width: 10%;"></td> <td style="width: 10%;"></td> <td style="width: 10%;"></td> <td style="width: 10%;"></td> </tr> <tr> <td></td> <td></td> <td colspan="8" style="text-align: center;"> <table border="1" style="width: 100%; border-collapse: collapse; text-align: center;"> <tr> <td style="width: 10%;"></td> <td style="width: 10%;"></td> <td style="width: 10%;"></td> <td style="width: 10%;"></td> <td style="width: 10%;"></td> <td style="width: 10%;"></td> <td style="width: 10%;"></td> <td style="width: 10%;"></td> <td style="width: 10%;"></td> <td style="width: 10%;"></td> </tr> <tr> <td></td> <td></td> <td colspan="8" style="text-align: center;"> <table border="1" style="width: 100%; border-collapse: collapse; text-align: center;"> <tr> <td style="width: 10%;"></td> <td style="width: 10%;"></td> <td style="width: 10%;"></td> <td style="width: 10%;"></td> <td style="width: 10%;"></td> <td style="width: 10%;"></td> <td style="width: 10%;"></td> <td style="width: 10%;"></td> <td style="width: 10%;"></td> <td style="width: 10%;"></td> </tr> <tr> <td></td> <td></td> <td colspan="8" style="text-align: center;"> <table border="1" style="width: 100%; border-collapse: collapse; text-align: center;"> <tr> <td style="width: 10%;"></td> <td style="width: 10%;"></td> <td style="width: 10%;"></td> <td style="width: 10%;"></td> <td style="width: 10%;"></td> <td style="width: 10%;"></td> <td style="width: 10%;"></td> <td style="width: 10%;"></td> <td style="width: 10%;"></td> <td style="width: 10%;"></td> </tr> <tr> <td></td> <td></td> <td colspan="8" style="text-align: center;"> <table border="1" style="width: 100%; border-collapse: collapse; text-align: center;"> <tr> <td style="width: 10%;"></td> <td style="width: 10%;"></td> <td style="width: 10%;"></td> <td style="width: 10%;"></td> <td style="width: 10%;"></td> <td style="width: 10%;"></td> <td style="width: 10%;"></td> <td style="width: 10%;"></td> <td style="width: 10%;"></td> <td style="width: 10%;"></td> </tr> <tr> <td></td> <td></td> <td colspan="8" style="text-align: center;"> <table border="1" style="width: 100%; border-collapse: collapse; text-align: center;"> <tr> <td style="width: 10%;"></td> <td style="width: 10%;"></td> <td style="width: 10%;"></td> <td style="width: 10%;"></td> <td style="width: 10%;"></td> <td style="width: 10%;"></td> <td style="width: 10%;"></td> <td style="width: 10%;"></td> <td style="width: 10%;"></td> <td style="width: 10%;"></td> </tr> <tr> <td></td> <td></td> <td colspan="8" style="text-align: center;"> <table border="1" style="width: 100%; border-collapse: collapse; text-align: center;"> <tr> <td style="width: 10%;"></td> <td style="width: 10%;"></td> <td style="width: 10%;"></td> <td style="width: 10%;"></td> <td style="width: 10%;"></td> <td style="width: 10%;"></td> <td style="width: 10%;"></td> <td style="width: 10%;"></td> <td style="width: 10%;"></td> <td style="width: 10%;"></td> </tr> <tr> <td></td> <td></td> <td colspan="8" style="text-align: center;"> <table border="1" style="width: 100%; border-collapse: collapse; text-align: center;"> <tr> <td style="width: 10%;"></td> <td style="width: 10%;"></td> <td style="width: 10%;"></td> <td style="width: 10%;"></td> <td style="width: 10%;"></td> <td style="width: 10%;"></td> <td style="width: 10%;"></td> <td style="width: 10%;"></td> <td style="width: 10%;"></td> <td style="width: 10%;"></td> </tr> <tr> <td></td> <td></td> <td colspan="8" style="text-align: center;"> <table border="1" style="width: 100%; border-collapse: collapse; text-align: center;"> <tr>
<td style="width: 10%;"></td> <td style="width: 10%;"></td> <td style="width: 10%;"></td> <td style="width: 10%;"></td> <td style="width: 10%;"></td> <td style="width: 10%;"></td> <td style="width: 10%;"></td> <td style="width: 10%;"></td> <td style="width: 10%;"></td> <td style="width: 10%;"></td> </tr> <tr> <td></td> <td></td> <td colspan="8" style="text-align: center;"> <table border="1" style="width: 100%; border-collapse: collapse; text-align: center;"> <tr> <td style="width: 10%;"></td> <td style="width: 10%;"></td> <td style="width: 10%;"></td> <td style="width: 10%;"></td> <td style="width: 10%;"></td> <td style="width: 10%;"></td> <td style="width: 10%;"></td> <td style="width: 10%;"></td> <td style="width: 10%;"></td> <td style="width: 10%;"></td> </tr> <tr> <td></td> <td></td> <td colspan="8" style="text-align: center;"> <table border="1" style="width: 100%; border-collapse: collapse; text-align: center;"> <tr> <td style="width: 10%;"></td> <td style="width: 10%;"></td> <td style="width: 10%;"></td> <td style="width: 10%;"></td> <td style="width: 10%;"></td> <td style="width: 10%;"></td> <td style="width: 10%;"></td> <td style="width: 10%;"></td> <td style="width: 10%;"></td> <td style="width: 10%;"></td> </tr> <tr> <td></td> <td></td> <td colspan="8" style="text-align: center;"> <table border="1" style="width: 100%; border-collapse: collapse; text-align: center;"> <tr> </tr></table></td></tr></table></td></tr></table></td></tr></table></td></tr></table></td></tr></table></td></tr></table></td></tr></table></td></tr></table></td></tr></table></td></tr></table></td></tr></table></td></tr></table></td></tr></table></td></tr></table></td></tr></table></td></tr></table></td></tr></table>
 | | | | | | | | | | | | | | | | | | | | <table border="1" style="width: 100%; border-collapse: collapse; text-align: center;"> <tr> <td style="width: 10%;"></td> <td style="width: 10%;"></td> <td style="width: 10%;"></td> <td style="width: 10%;"></td> <td style="width: 10%;"></td> <td style="width: 10%;"></td> <td style="width: 10%;"></td> <td style="width: 10%;"></td> <td style="width: 10%;"></td> <td style="width: 10%;"></td> </tr> <tr> <td></td> <td></td> <td colspan="8" style="text-align: center;"> <table border="1" style="width: 100%; border-collapse: collapse; text-align: center;"> <tr> <td style="width: 10%;"></td> <td style="width: 10%;"></td> <td style="width: 10%;"></td> <td style="width: 10%;"></td> <td style="width: 10%;"></td> <td style="width: 10%;"></td> <td style="width: 10%;"></td> <td style="width: 10%;"></td> <td style="width: 10%;"></td> <td style="width: 10%;"></td> </tr> <tr> <td></td> <td></td> <td colspan="8" style="text-align: center;"> <table border="1" style="width: 100%; border-collapse: collapse; text-align: center;"> <tr> <td style="width: 10%;"></td> <td style="width: 10%;"></td> <td style="width: 10%;"></td> <td style="width: 10%;"></td> <td style="width: 10%;"></td> <td style="width:
10%;"></td> <td style="width: 10%;"></td> <td style="width: 10%;"></td> <td style="width: 10%;"></td> <td style="width: 10%;"></td> </tr> <tr> <td></td> <td></td> <td colspan="8" style="text-align: center;"> <table border="1" style="width: 100%; border-collapse: collapse; text-align: center;"> <tr> <td style="width: 10%;"></td> <td style="width: 10%;"></td> <td style="width: 10%;"></td> <td style="width: 10%;"></td> <td style="width: 10%;"></td> <td style="width: 10%;"></td> <td style="width: 10%;"></td> <td style="width: 10%;"></td> <td style="width: 10%;"></td> <td style="width: 10%;"></td> </tr> <tr> <td></td> <td></td> <td colspan="8" style="text-align: center;"> <table border="1" style="width: 100%; border-collapse: collapse; text-align: center;"> <tr> <td style="width: 10%;"></td> <td style="width: 10%;"></td> <td style="width: 10%;"></td> <td style="width: 10%;"></td> <td style="width: 10%;"></td> <td style="width: 10%;"></td> <td style="width: 10%;"></td> <td style="width: 10%;"></td> <td style="width: 10%;"></td> <td style="width: 10%;"></td> </tr> <tr> <td></td> <td></td> <td colspan="8" style="text-align: center;"> <table border="1" style="width: 100%; border-collapse: collapse; text-align: center;"> <tr> <td style="width: 10%;"></td> <td style="width: 10%;"></td> <td style="width: 10%;"></td> <td style="width: 10%;"></td> <td style="width: 10%;"></td> <td style="width: 10%;"></td> <td style="width: 10%;"></td> <td style="width: 10%;"></td> <td style="width: 10%;"></td> <td style="width: 10%;"></td> </tr> <tr> <td></td> <td></td> <td colspan="8" style="text-align: center;"> <table border="1" style="width: 100%; border-collapse: collapse; text-align: center;"> <tr> <td style="width: 10%;"></td> <td style="width: 10%;"></td> <td style="width: 10%;"></td> <td style="width: 10%;"></td> <td style="width: 10%;"></td> <td style="width: 10%;"></td> <td style="width: 10%;"></td> <td style="width: 10%;"></td> <td style="width: 10%;"></td> <td style="width: 10%;"></td> </tr> <tr> <td></td> <td></td> <td colspan="8" style="text-align: center;"> <table border="1" style="width: 100%; border-collapse: collapse; text-align: center;"> <tr> <td style="width: 10%;"></td> <td style="width: 10%;"></td> <td style="width: 10%;"></td> <td style="width: 10%;"></td> <td style="width: 10%;"></td> <td style="width: 10%;"></td> <td style="width: 10%;"></td> <td style="width: 10%;"></td> <td style="width: 10%;"></td> <td style="width: 10%;"></td> </tr> <tr> <td></td> <td></td> <td colspan="8" style="text-align: center;"> <table border="1" style="width: 100%; border-collapse: collapse; text-align: center;"> <tr> <td style="width: 10%;"></td> <td style="width: 10%;"></td> <td style="width: 10%;"></td> <td style="width: 10%;"></td> <td style="width: 10%;"></td> <td style="width: 10%;"></td> <td style="width: 10%;"></td> <td style="width: 10%;"></td> <td style="width: 10%;"></td> <td style="width: 10%;"></td> </tr> <tr> <td></td> <td></td> <td colspan="8" style="text-align: center;"> <table border="1" style="width: 100%; border-collapse: collapse; text-align: center;"> <tr> <td style="width: 10%;"></td> <td style="width: 10%;"></td> <td style="width: 10%;"></td> <td style="width: 10%;"></td> <td style="width: 10%;"></td> <td style="width: 10%;"></td> <td style="width: 10%;"></td> <td style="width: 10%;"></td> <td style="width: 10%;"></td> <td style="width: 10%;"></td> </tr> <tr> <td></td> <td></td> <td colspan="8" style="text-align: center;"> <table border="1" style="width: 100%; border-collapse: collapse; text-align: center;"> <tr> <td style="width: 10%;"></td> <td style="width: 10%;"></td> <td style="width: 10%;"></td> <td style="width: 10%;"></td> <td style="width: 10%;"></td> <td style="width: 10%;"></td> <td style="width: 10%;"></td> <td style="width: 10%;"></td> <td style="width: 10%;"></td> <td style="width: 10%;"></td> </tr> <tr> <td></td> <td></td> <td colspan="8" style="text-align: center;"> <table border="1" style="width: 100%; border-collapse: collapse; text-align: center;"> <tr> <td style="width: 10%;"></td> <td style="width: 10%;"></td> <td style="width: 10%;"></td> <td style="width: 10%;"></td> <td style="width: 10%;"></td> <td style="width: 10%;"></td> <td style="width: 10%;"></td> <td style="width: 10%;"></td> <td style="width: 10%;"></td> <td style="width: 10%;"></td> </tr> <tr> <td></td> <td></td> <td colspan="8" style="text-align: center;"> <table border="1" style="width: 100%; border-collapse: collapse; text-align: center;"> <tr> <td style="width: 10%;"></td> <td style="width: 10%;"></td> <td style="width: 10%;"></td> <td style="width: 10%;"></td> <td style="width: 10%;"></td> <td style="width: 10%;"></td> <td style="width: 10%;"></td> <td style="width: 10%;"></td> <td style="width: 10%;"></td> <td style="width: 10%;"></td> </tr> <tr> <td></td> <td></td> <td colspan="8" style="text-align: center;"> <table border="1" style="width: 100%; border-collapse: collapse; text-align: center;"> <tr> <td style="width: 10%;"></td> <td style="width: 10%;"></td> <td style="width: 10%;"></td> <td style="width: 10%;"></td> <td style="width: 10%;"></td> <td style="width: 10%;"></td> <td style="width: 10%;"></td> <td style="width: 10%;"></td> <td style="width: 10%;"></td> <td style="width: 10%;"></td> </tr> <tr> <td></td> <td></td> <td colspan="8" style="text-align: center;"> <table border="1" style="width: 100%; border-collapse: collapse; text-align: center;"> <tr> <td style="width: 10%;"></td> <td style="width: 10%;"></td> <td style="width: 10%;"></td> <td style="width: 10%;"></td> <td style="width: 10%;"></td> <td style="width: 10%;"></td> <td style="width: 10%;"></td> <td style="width: 10%;"></td> <td style="width: 10%;"></td> <td style="width: 10%;"></td> </tr> <tr> <td></td> <td></td> <td colspan="8" style="text-align: center;"> <table border="1" style="width: 100%; border-collapse: collapse; text-align: center;"> <tr> <td style="width: 10%;"></td> <td style="width: 10%;"></td> <td style="width: 10%;"></td> <td style="width: 10%;"></td> <td style="width: 10%;"></td> <td style="width: 10%;"></td> <td style="width: 10%;"></td> <td style="width: 10%;"></td> <td style="width: 10%;"></td> <td style="width: 10%;"></td> </tr> <tr> <td></td> <td></td> <td colspan="8" style="text-align: center;"> <table border="1" style="width: 100%; border-collapse: collapse; text-align: center;"> <tr> </tr></table></td></tr></table></td></tr></table></td></tr></table></td></tr></table></td></tr></table></td></tr></table></td></tr></table></td></tr></table></td></tr></table></td></tr></table></td></tr></table></td></tr></table></td></tr></table></td></tr></table></td></tr></table></td></tr></table>

 | | | | | | | | | | | | | | | | | | | | <table border="1" style="width: 100%; border-collapse: collapse; text-align: center;"> <tr> <td style="width: 10%;"></td> <td style="width: 10%;"></td> <td style="width: 10%;"></td> <td style="width: 10%;"></td> <td style="width: 10%;"></td> <td style="width: 10%;"></td> <td style="width: 10%;"></td> <td style="width: 10%;"></td> <td style="width: 10%;"></td> <td style="width: 10%;"></td> </tr> <tr> <td></td> <td></td> <td colspan="8" style="text-align: center;"> <table border="1" style="width: 100%; border-collapse: collapse; text-align: center;"> <tr> <td style="width: 10%;"></td> <td style="width: 10%;"></td> <td style="width: 10%;"></td> <td style="width: 10%;"></td> <td style="width: 10%;"></td> <td style="width: 10%;"></td> <td style="width: 10%;"></td> <td style="width: 10%;"></td> <td style="width: 10%;"></td> <td style="width: 10%;"></td> </tr> <tr> <td></td> <td></td> <td colspan="8" style="text-align: center;"> <table border="1" style="width: 100%; border-collapse: collapse; text-align: center;"> <tr> <td style="width: 10%;"></td> <td style="width: 10%;"></td> <td style="width: 10%;"></td> <td style="width: 10%;"></td> <td style="width: 10%;"></td> <td style="width: 10%;"></td> <td style="width: 10%;"></td> <td style="width: 10%;"></td> <td style="width: 10%;"></td> <td style="width: 10%;"></td> </tr> <tr> <td></td> <td></td> <td colspan="8" style="text-align: center;"> <table border="1" style="width: 100%; border-collapse: collapse; text-align: center;"> <tr> <td style="width: 10%;"></td> <td style="width: 10%;"></td> <td style="width: 10%;"></td> <td style="width: 10%;"></td> <td style="width: 10%;"></td> <td style="width: 10%;"></td> <td style="width: 10%;"></td> <td style="width: 10%;"></td> <td style="width: 10%;"></td> <td style="width: 10%;"></td> </tr> <tr> <td></td> <td></td> <td colspan="8" style="text-align: center;"> <table border="1" style="width: 100%; border-collapse: collapse; text-align: center;"> <tr> <td style="width: 10%;"></td> <td style="width: 10%;"></td> <td style="width: 10%;"></td> <td style="width: 10%;"></td> <td style="width: 10%;"></td> <td style="width: 10%;"></td> <td style="width: 10%;"></td> <td style="width: 10%;"></td> <td style="width: 10%;"></td> <td style="width: 10%;"></td> </tr> <tr> <td></td> <td></td> <td colspan="8" style="text-align: center;"> <table border="1" style="width: 100%; border-collapse: collapse; text-align: center;"> <tr> <td style="width: 10%;"></td> <td style="width: 10%;"></td> <td style="width: 10%;"></td> <td style="width: 10%;"></td> <td style="width: 10%;"></td> <td style="width: 10%;"></td> <td style="width: 10%;"></td> <td style="width: 10%;"></td> <td style="width: 10%;"></td> <td style="width: 10%;"></td> </tr> <tr> <td></td> <td></td> <td colspan="8" style="text-align: center;"> <table border="1" style="width: 100%; border-collapse: collapse; text-align: center;"> <tr> <td style="width: 10%;"></td> <td style="width: 10%;"></td> <td style="width: 10%;"></td> <td style="width: 10%;"></td> <td style="width: 10%;"></td> <td style="width: 10%;"></td> <td style="width: 10%;"></td> <td style="width: 10%;"></td> <td style="width: 10%;"></td> <td style="width: 10%;"></td> </tr> <tr> <td></td> <td></td> <td colspan="8" style="text-align: center;"> <table border="1" style="width: 100%; border-collapse: collapse; text-align: center;"> <tr> <td style="width: 10%;"></td> <td style="width: 10%;"></td> <td style="width: 10%;"></td> <td style="width: 10%;"></td> <td style="width: 10%;"></td> <td style="width: 10%;"></td> <td style="width: 10%;"></td> <td style="width: 10%;"></td> <td style="width: 10%;"></td> <td style="width: 10%;"></td> </tr> <tr> <td></td> <td></td> <td colspan="8" style="text-align: center;"> <table border="1" style="width: 100%; border-collapse: collapse; text-align: center;"> <tr> <td style="width: 10%;"></td> <td style="width: 10%;"></td> <td style="width: 10%;"></td> <td style="width: 10%;"></td> <td style="width: 10%;"></td> <td style="width: 10%;"></td> <td style="width: 10%;"></td> <td style="width: 10%;"></td> <td style="width: 10%;"></td> <td style="width: 10%;"></td> </tr> <tr> <td></td> <td></td> <td colspan="8" style="text-align: center;"> <table border="1" style="width: 100%; border-collapse: collapse; text-align: center;"> <tr> <td style="width: 10%;"></td> <td style="width: 10%;"></td> <td style="width: 10%;"></td> <td style="width: 10%;"></td> <td style="width: 10%;"></td> <td style="width: 10%;"></td> <td style="width: 10%;"></td> <td style="width: 10%;"></td> <td style="width: 10%;"></td> <td style="width: 10%;"></td> </tr> <tr> <td></td> <td></td> <td colspan="8" style="text-align: center;"> <table border="1" style="width: 100%; border-collapse: collapse; text-align: center;"> <tr> <td style="width: 10%;"></td> <td style="width: 10%;"></td> <td style="width: 10%;"></td> <td style="width: 10%;"></td> <td style="width: 10%;"></td> <td style="width: 10%;"></td> <td style="width: 10%;"></td> <td style="width: 10%;"></td> <td style="width: 10%;"></td> <td style="width: 10%;"></td> </tr> <tr> <td></td> <td></td> <td colspan="8" style="text-align: center;"> <table border="1" style="width: 100%; border-collapse: collapse; text-align: center;"> <tr> <td style="width: 10%;"></td> <td style="width: 10%;"></td> <td style="width: 10%;"></td> <td style="width: 10%;"></td> <td style="width: 10%;"></td> <td style="width: 10%;"></td> <td style="width: 10%;"></td> <td style="width: 10%;"></td> <td style="width: 10%;"></td> <td style="width: 10%;"></td> </tr> <tr> <td></td> <td></td> <td colspan="8" style="text-align: center;"> <table border="1" style="width: 100%; border-collapse: collapse; text-align: center;"> <tr> <td style="width: 10%;"></td> <td style="width: 10%;"></td> <td style="width: 10%;"></td> <td style="width: 10%;"></td> <td style="width: 10%;"></td> <td style="width: 10%;"></td> <td style="width: 10%;"></td> <td style="width: 10%;"></td> <td style="width: 10%;"></td> <td style="width: 10%;"></td> </tr> <tr> <td></td> <td></td> <td colspan="8" style="text-align: center;"> <table border="1" style="width: 100%; border-collapse: collapse; text-align: center;"> <tr> <td style="width: 10%;"></td> <td style="width: 10%;"></td> <td
style="width: 10%;"></td> <td style="width: 10%;"></td> <td style="width: 10%;"></td> <td style="width: 10%;"></td> <td style="width: 10%;"></td> <td style="width: 10%;"></td> <td style="width: 10%;"></td> <td style="width: 10%;"></td> </tr> <tr> <td></td> <td></td> <td colspan="8" style="text-align: center;"> <table border="1" style="width: 100%; border-collapse: collapse; text-align: center;"> <tr> <td style="width: 10%;"></td> <td style="width: 10%;"></td> <td style="width: 10%;"></td> <td style="width: 10%;"></td> <td style="width: 10%;"></td> <td style="width: 10%;"></td> <td style="width: 10%;"></td> <td style="width: 10%;"></td> <td style="width: 10%;"></td> <td style="width: 10%;"></td> </tr> <tr> <td></td> <td></td> <td colspan="8" style="text-align: center;"> <table border="1" style="width: 100%; border-collapse: collapse; text-align: center;"> <tr> </tr></table></td></tr></table></td></tr></table></td></tr></table></td></tr></table></td></tr></table></td></tr></table></td></tr></table></td></tr></table></td></tr></table></td></tr></table></td></tr></table></td></tr></table></td></tr></table></td></tr></table></td></tr></table>
 | | | | | | | | | | | | | | | | | | | | <table border="1" style="width: 100%; border-collapse: collapse; text-align: center;"> <tr> <td style="width: 10%;"></td> <td style="width: 10%;"></td> <td style="width: 10%;"></td> <td style="width: 10%;"></td> <td style="width: 10%;"></td> <td style="width: 10%;"></td> <td style="width: 10%;"></td> <td style="width: 10%;"></td> <td style="width: 10%;"></td> <td style="width: 10%;"></td> </tr> <tr> <td></td> <td></td> <td colspan="8" style="text-align: center;"> <table border="1" style="width: 100%; border-collapse: collapse; text-align: center;"> <tr> <td style="width: 10%;"></td> <td style="width: 10%;"></td> <td style="width: 10%;"></td> <td style="width: 10%;"></td> <td style="width: 10%;"></td> <td style="width: 10%;"></td> <td style="width: 10%;"></td> <td style="width: 10%;"></td> <td style="width: 10%;"></td> <td style="width: 10%;"></td> </tr> <tr> <td></td> <td></td> <td colspan="8" style="text-align: center;"> <table border="1" style="width: 100%; border-collapse: collapse; text-align: center;"> <tr> <td style="width: 10%;"></td> <td style="width: 10%;"></td> <td style="width: 10%;"></td> <td style="width: 10%;"></td> <td style="width: 10%;"></td> <td style="width: 10%;"></td> <td style="width: 10%;"></td> <td style="width: 10%;"></td> <td style="width: 10%;"></td> <td style="width: 10%;"></td> </tr> <tr> <td></td> <td></td> <td colspan="8" style="text-align: center;"> <table border="1" style="width: 100%; border-collapse: collapse; text-align: center;"> <tr> <td style="width: 10%;"></td> <td style="width: 10%;"></td> <td style="width: 10%;"></td> <td style="width: 10%;"></td> <td style="width: 10%;"></td> <td style="width: 10%;"></td> <td style="width: 10%;"></td> <td style="width: 10%;"></td> <td style="width: 10%;"></td> <td
style="width: 10%;"></td> </tr> <tr> <td></td> <td></td> <td colspan="8" style="text-align: center;"> <table border="1" style="width: 100%; border-collapse: collapse; text-align: center;"> <tr> <td style="width: 10%;"></td> <td style="width: 10%;"></td> <td style="width: 10%;"></td> <td style="width: 10%;"></td> <td style="width: 10%;"></td> <td style="width: 10%;"></td> <td style="width: 10%;"></td> <td style="width: 10%;"></td> <td style="width: 10%;"></td> <td style="width: 10%;"></td> </tr> <tr> <td></td> <td></td> <td colspan="8" style="text-align: center;"> <table border="1" style="width: 100%; border-collapse: collapse; text-align: center;"> <tr> <td style="width: 10%;"></td> <td style="width: 10%;"></td> <td style="width: 10%;"></td> <td style="width: 10%;"></td> <td style="width: 10%;"></td> <td style="width: 10%;"></td> <td style="width: 10%;"></td> <td style="width: 10%;"></td> <td style="width: 10%;"></td> <td style="width: 10%;"></td> </tr> <tr> <td></td> <td></td> <td colspan="8" style="text-align: center;"> <table border="1" style="width: 100%; border-collapse: collapse; text-align: center;"> <tr> <td style="width: 10%;"></td> <td style="width: 10%;"></td> <td style="width: 10%;"></td> <td style="width: 10%;"></td> <td style="width: 10%;"></td> <td style="width: 10%;"></td> <td style="width: 10%;"></td> <td style="width: 10%;"></td> <td style="width: 10%;"></td> <td style="width: 10%;"></td> </tr> <tr> <td></td> <td></td> <td colspan="8" style="text-align: center;"> <table border="1" style="width: 100%; border-collapse: collapse; text-align: center;"> <tr> <td style="width: 10%;"></td> <td style="width: 10%;"></td> <td style="width: 10%;"></td> <td style="width: 10%;"></td> <td style="width: 10%;"></td> <td style="width: 10%;"></td> <td style="width: 10%;"></td> <td style="width: 10%;"></td> <td style="width: 10%;"></td> <td style="width: 10%;"></td> </tr> <tr> <td></td> <td></td> <td colspan="8" style="text-align: center;"> <table border="1" style="width: 100%; border-collapse: collapse; text-align: center;"> <tr> <td style="width: 10%;"></td> <td style="width: 10%;"></td> <td style="width: 10%;"></td> <td style="width: 10%;"></td> <td style="width: 10%;"></td> <td style="width: 10%;"></td> <td style="width: 10%;"></td> <td style="width: 10%;"></td> <td style="width: 10%;"></td> <td style="width: 10%;"></td> </tr> <tr> <td></td> <td></td> <td colspan="8" style="text-align: center;"> <table border="1" style="width: 100%; border-collapse: collapse; text-align: center;"> <tr> <td style="width: 10%;"></td> <td style="width: 10%;"></td> <td style="width: 10%;"></td> <td style="width: 10%;"></td> <td style="width: 10%;"></td> <td style="width: 10%;"></td> <td style="width: 10%;"></td> <td style="width: 10%;"></td> <td style="width: 10%;"></td> <td style="width: 10%;"></td> </tr> <tr> <td></td> <td></td> <td colspan="8" style="text-align: center;"> <table border="1" style="width: 100%; border-collapse: collapse; text-align: center;"> <tr> <td style="width: 10%;"></td> <td style="width: 10%;"></td> <td style="width: 10%;"></td> <td style="width: 10%;"></td> <td style="width: 10%;"></td> <td style="width: 10%;"></td> <td style="width: 10%;"></td> <td style="width: 10%;"></td> <td style="width: 10%;"></td> <td style="width: 10%;"></td> </tr> <tr> <td></td> <td></td> <td colspan="8" style="text-align: center;"> <table border="1" style="width: 100%; border-collapse: collapse; text-align: center;"> <tr> <td style="width: 10%;"></td> <td style="width: 10%;"></td> <td style="width: 10%;"></td> <td style="width: 10%;"></td> <td style="width: 10%;"></td> <td style="width: 10%;"></td> <td style="width: 10%;"></td> <td style="width: 10%;"></td> <td style="width: 10%;"></td> <td style="width: 10%;"></td> </tr> <tr> <td></td> <td></td> <td colspan="8" style="text-align: center;"> <table border="1" style="width: 100%; border-collapse: collapse; text-align: center;"> <tr> <td style="width: 10%;"></td> <td style="width: 10%;"></td> <td style="width: 10%;"></td> <td style="width: 10%;"></td> <td style="width: 10%;"></td> <td style="width: 10%;"></td> <td style="width: 10%;"></td> <td style="width: 10%;"></td> <td style="width: 10%;"></td> <td style="width: 10%;"></td> </tr> <tr> <td></td> <td></td> <td colspan="8" style="text-align: center;"> <table border="1" style="width: 100%; border-collapse: collapse; text-align: center;"> <tr> <td style="width: 10%;"></td> <td style="width: 10%;"></td> <td style="width: 10%;"></td> <td style="width: 10%;"></td> <td style="width: 10%;"></td> <td style="width: 10%;"></td> <td style="width: 10%;"></td> <td style="width: 10%;"></td> <td style="width: 10%;"></td> <td style="width: 10%;"></td> </tr> <tr> <td></td> <td></td> <td colspan="8" style="text-align: center;"> <table border="1" style="width: 100%; border-collapse: collapse; text-align: center;"> <tr> </tr></table></td></tr></table></td></tr></table></td></tr></table></td></tr></table></td></tr></table></td></tr></table></td></tr></table></td></tr></table></td></tr></table></td></tr></table></td></tr></table></td></tr></table></td></tr></table></td></tr></table>

 | | | | | | | | | | | | | | | | | | | | <table border="1" style="width: 100%; border-collapse: collapse; text-align: center;"> <tr> <td style="width: 10%;"></td> <td style="width: 10%;"></td> <td style="width: 10%;"></td> <td style="width: 10%;"></td> <td style="width: 10%;"></td> <td style="width: 10%;"></td> <td style="width: 10%;"></td> <td style="width: 10%;"></td> <td style="width: 10%;"></td> <td style="width: 10%;"></td> </tr> <tr> <td></td> <td></td> <td colspan="8" style="text-align: center;"> <table border="1" style="width: 100%; border-collapse: collapse; text-align: center;"> <tr> <td style="width: 10%;"></td> <td style="width: 10%;"></td> <td style="width: 10%;"></td> <td style="width: 10%;"></td> <td style="width: 10%;"></td> <td style="width: 10%;"></td> <td style="width: 10%;"></td> <td style="width: 10%;"></td> <td style="width: 10%;"></td> <td style="width: 10%;"></td> </tr> <tr> <td></td> <td></td> <td colspan="8" style="text-align: center;"> <table border="1" style="width: 100%; border-collapse: collapse; text-align: center;"> <tr> <td style="width: 10%;"></td> <td style="width: 10%;"></td> <td style="width: 10%;"></td> <td style="width: 10%;"></td> <td style="width: 10%;"></td> <td style="width: 10%;"></td> <td style="width: 10%;"></td> <td style="width: 10%;"></td> <td style="width: 10%;"></td> <td style="width: 10%;"></td> </tr> <tr> <td></td> <td></td> <td colspan="8" style="text-align: center;"> <table border="1" style="width: 100%; border-collapse: collapse; text-align: center;"> <tr> <td style="width: 10%;"></td> <td style="width: 10%;"></td> <td style="width: 10%;"></td> <td style="width: 10%;"></td> <td style="width: 10%;"></td> <td style="width: 10%;"></td> <td style="width: 10%;"></td> <td style="width: 10%;"></td> <td style="width: 10%;"></td> <td style="width: 10%;"></td> </tr> <tr> <td></td> <td></td> <td colspan="8" style="text-align: center;"> <table border="1" style="width: 100%; border-collapse: collapse; text-align: center;"> <tr> <td style="width: 10%;"></td> <td style="width: 10%;"></td> <td style="width: 10%;"></td> <td style="width: 10%;"></td> <td style="width: 10%;"></td> <td style="width: 10%;"></td> <td style="width: 10%;"></td> <td style="width: 10%;"></td> <td style="width: 10%;"></td> <td style="width: 10%;"></td> </tr> <tr> <td></td> <td></td> <td colspan="8" style="text-align: center;"> <table border="1" style="width: 100%; border-collapse: collapse; text-align: center;"> <tr> <td style="width: 10%;"></td> <td style="width: 10%;"></td> <td style="width: 10%;"></td> <td style="width: 10%;"></td> <td style="width: 10%;"></td> <td style="width: 10%;"></td> <td style="width: 10%;"></td> <td style="width: 10%;"></td> <td style="width: 10%;"></td> <td style="width: 10%;"></td> </tr> <tr> <td></td> <td></td> <td colspan="8" style="text-align: center;"> <table border="1" style="width: 100%; border-collapse: collapse; text-align: center;"> <tr> <td style="width: 10%;"></td> <td style="width: 10%;"></td> <td style="width: 10%;"></td> <td style="width: 10%;"></td> <td style="width: 10%;"></td> <td style="width: 10%;"></td> <td style="width: 10%;"></td> <td style="width: 10%;"></td> <td style="width: 10%;"></td> <td style="width: 10%;"></td> </tr> <tr> <td></td> <td></td> <td colspan="8" style="text-align: center;"> <table border="1" style="width: 100%; border-collapse: collapse; text-align: center;"> <tr> <td style="width: 10%;"></td> <td style="width: 10%;"></td> <td style="width: 10%;"></td> <td style="width: 10%;"></td> <td style="width: 10%;"></td> <td style="width: 10%;"></td> <td style="width: 10%;"></td> <td style="width: 10%;"></td> <td style="width: 10%;"></td> <td style="width: 10%;"></td> </tr> <tr> <td></td> <td></td> <td colspan="8" style="text-align: center;"> <table border="1" style="width: 100%; border-collapse: collapse; text-align: center;"> <tr> <td style="width: 10%;"></td> <td style="width: 10%;"></td> <td style="width: 10%;"></td> <td style="width: 10%;"></td> <td style="width: 10%;"></td> <td style="width: 10%;"></td> <td style="width: 10%;"></td> <td style="width: 10%;"></td> <td style="width: 10%;"></td> <td style="width: 10%;"></td> </tr> <tr> <td></td> <td></td> <td colspan="8" style="text-align: center;"> <table border="1" style="width: 100%; border-collapse: collapse; text-align: center;"> <tr> <td style="width: 10%;"></td> <td style="width: 10%;"></td> <td style="width: 10%;"></td> <td style="width: 10%;"></td> <td style="width: 10%;"></td> <td style="width: 10%;"></td> <td style="width: 10%;"></td> <td style="width: 10%;"></td> <td style="width: 10%;"></td> <td style="width: 10%;"></td> </tr> <tr> <td></td> <td></td> <td colspan="8" style="text-align: center;"> <table border="1" style="width: 100%; border-collapse: collapse; text-align: center;"> <tr> <td style="width: 10%;"></td> <td style="width: 10%;"></td> <td style="width: 10%;"></td> <td style="width: 10%;"></td> <td style="width: 10%;"></td> <td style="width: 10%;"></td> <td style="width: 10%;"></td> <td style="width: 10%;"></td> <td style="width: 10%;"></td> <td style="width: 10%;"></td> </tr> <tr> <td></td> <td></td> <td colspan="8" style="text-align: center;"> <table border="1" style="width: 100%; border-collapse: collapse; text-align: center;"> <tr> <td style="width: 10%;"></td> <td style="width: 10%;"></td> <td style="width: 10%;"></td> <td style="width: 10%;"></td> <td style="width: 10%;"></td> <td style="width: 10%;"></td> <td style="width: 10%;"></td> <td style="width: 10%;"></td> <td style="width: 10%;"></td> <td style="width: 10%;"></td> </tr> <tr> <td></td> <td></td> <td colspan="8" style="text-align: center;"> <table border="1" style="width: 100%; border-collapse: collapse; text-align: center;"> <tr> <td style="width: 10%;"></td> <td style="width: 10%;"></td> <td style="width: 10%;"></td> <td style="width: 10%;"></td> <td style="width: 10%;"></td> <td style="width: 10%;"></td> <td style="width: 10%;"></td> <td style="width: 10%;"></td> <td style="width: 10%;"></td> <td style="width: 10%;"></td> </tr> <tr> <td></td> <td></td> <td colspan="8" style="text-align: center;"> <table border="1" style="width: 100%; border-collapse: collapse; text-align: center;"> <tr> </tr></table></td></tr></table></td></tr></table></td></tr></table></td></tr></table></td></tr></table></td></tr></table></td></tr></table></td></tr></table></td></tr></table></td></tr></table></td></tr></table></td></tr></table></td></tr></table>

 | | | | | | | | | | | | | | | | | | | | <table border="1" style="width: 100%; border-collapse: collapse; text-align: center;"> <tr> <td style="width: 10%;"></td> <td style="width: 10%;"></td> <td style="width: 10%;"></td> <td style="width: 10%;"></td> <td style="width: 10%;"></td> <td style="width: 10%;"></td> <td style="width: 10%;"></td> <td style="width: 10%;"></td> <td style="width: 10%;"></td> <td style="width: 10%;"></td> </tr> <tr> <td></td> <td></td> <td colspan="8" style="text-align: center;"> <table border="1" style="width: 100%; border-collapse: collapse; text-align: center;"> <tr> <td style="width: 10%;"></td> <td style="width: 10%;"></td> <td style="width: 10%;"></td> <td style="width: 10%;"></td> <td style="width: 10%;"></td> <td style="width: 10%;"></td> <td style="width: 10%;"></td> <td style="width: 10%;"></td> <td style="width: 10%;"></td> <td style="width: 10%;"></td> </tr> <tr> <td></td> <td></td> <td colspan="8" style="text-align: center;"> <table border="1" style="width: 100%; border-collapse: collapse; text-align: center;"> <tr> <td style="width: 10%;"></td> <td style="width: 10%;"></td> <td style="width: 10%;"></td> <td style="width: 10%;"></td> <td style="width: 10%;"></td> <td style="width: 10%;"></td> <td style="width: 10%;"></td> <td style="width: 10%;"></td> <td style="width: 10%;"></td> <td style="width: 10%;"></td> </tr> <tr> <td></td> <td></td> <td colspan="8" style="text-align: center;"> <table border="1" style="width: 100%; border-collapse: collapse; text-align: center;"> <tr> <td style="width: 10%;"></td> <td style="width: 10%;"></td> <td style="width: 10%;"></td> <td style="width: 10%;"></td> <td style="width: 10%;"></td> <td style="width: 10%;"></td> <td style="width: 10%;"></td> <td style="width: 10%;"></td> <td style="width: 10%;"></td> <td style="width: 10%;"></td> </tr> <tr> <td></td> <td></td> <td colspan="8" style="text-align: center;"> <table border="1" style="width: 100%; border-collapse: collapse; text-align: center;"> <tr> <td style="width: 10%;"></td> <td style="width: 10%;"></td> <td style="width: 10%;"></td> <td style="width: 10%;"></td> <td style="width: 10%;"></td> <td style="width: 10%;"></td> <td style="width: 10%;"></td> <td style="width: 10%;"></td> <td style="width: 10%;"></td> <td style="width: 10%;"></td> </tr> <tr> <td></td> <td></td> <td colspan="8" style="text-align: center;"> <table border="1" style="width: 100%; border-collapse: collapse; text-align: center;"> <tr> <td style="width: 10%;"></td> <td style="width: 10%;"></td> <td style="width: 10%;"></td> <td style="width: 10%;"></td> <td style="width: 10%;"></td> <td style="width: 10%;"></td> <td style="width: 10%;"></td> <td style="width: 10%;"></td> <td style="width: 10%;"></td> <td style="width: 10%;"></td> </tr> <tr> <td></td> <td></td> <td colspan="8" style="text-align: center;"> <table border="1" style="width: 100%; border-collapse: collapse; text-align: center;"> <tr> <td style="width: 10%;"></td> <td style="width: 10%;"></td> <td style="width: 10%;"></td> <td style="width: 10%;"></td> <td style="width: 10%;"></td> <td style="width: 10%;"></td> <td style="width: 10%;"></td> <td style="width: 10%;"></td> <td style="width: 10%;"></td> <td style="width: 10%;"></td> </tr> <tr> <td></td> <td></td> <td colspan="8" style="text-align: center;"> <table border="1" style="width: 100%; border-collapse: collapse; text-align: center;"> <tr> <td style="width: 10%;"></td> <td style="width: 10%;"></td> <td style="width: 10%;"></td> <td style="width: 10%;"></td> <td style="width: 10%;"></td> <td style="width: 10%;"></td> <td style="width: 10%;"></td> <td style="width: 10%;"></td> <td style="width: 10%;"></td> <td style="width: 10%;"></td> </tr> <tr> <td></td> <td></td> <td colspan="8" style="text-align: center;"> <table border="1" style="width: 100%; border-collapse: collapse; text-align: center;"> <tr> <td style="width: 10%;"></td> <td style="width: 10%;"></td> <td style="width: 10%;"></td> <td style="width: 10%;"></td> <td style="width: 10%;"></td> <td style="width: 10%;"></td> <td style="width: 10%;"></td> <td style="width: 10%;"></td> <td style="width: 10%;"></td> <td style="width: 10%;"></td> </tr> <tr> <td></td> <td></td> <td colspan="8" style="text-align: center;"> <table border="1" style="width: 100%; border-collapse: collapse; text-align:
center;"> <tr> <td style="width: 10%;"></td> <td style="width: 10%;"></td> <td style="width: 10%;"></td> <td style="width: 10%;"></td> <td style="width: 10%;"></td> <td style="width: 10%;"></td> <td style="width: 10%;"></td> <td style="width: 10%;"></td> <td style="width: 10%;"></td> <td style="width: 10%;"></td> </tr> <tr> <td></td> <td></td> <td colspan="8" style="text-align: center;"> <table border="1" style="width: 100%; border-collapse: collapse; text-align: center;"> <tr> <td style="width: 10%;"></td> <td style="width: 10%;"></td> <td style="width: 10%;"></td> <td style="width: 10%;"></td> <td style="width: 10%;"></td> <td style="width: 10%;"></td> <td style="width: 10%;"></td> <td style="width: 10%;"></td> <td style="width: 10%;"></td> <td style="width: 10%;"></td> </tr> <tr> <td></td> <td></td> <td colspan="8" style="text-align: center;"> <table border="1" style="width: 100%; border-collapse: collapse; text-align: center;"> <tr> <td style="width: 10%;"></td> <td style="width: 10%;"></td> <td style="width: 10%;"></td> <td style="width: 10%;"></td> <td style="width: 10%;"></td> <td style="width: 10%;"></td> <td style="width: 10%;"></td> <td style="width: 10%;"></td> <td style="width: 10%;"></td> <td style="width: 10%;"></td> </tr> <tr> <td></td> <td></td> <td colspan="8" style="text-align: center;"> <table border="1" style="width: 100%; border-collapse: collapse; text-align: center;"> <tr> </tr></table></td></tr></table></td></tr></table></td></tr></table></td></tr></table></td></tr></table></td></tr></table></td></tr></table></td></tr></table></td></tr></table></td></tr></table></td></tr></table></td></tr></table>
 | | | | | | | | | | | | | | | | | | | | <table border="1" style="width: 100%; border-collapse: collapse; text-align: center;"> <tr> <td style="width: 10%;"></td> <td style="width: 10%;"></td> <td style="width: 10%;"></td> <td style="width: 10%;"></td> <td style="width: 10%;"></td> <td style="width: 10%;"></td> <td style="width: 10%;"></td> <td style="width: 10%;"></td> <td style="width: 10%;"></td> <td style="width: 10%;"></td> </tr> <tr> <td></td> <td></td> <td colspan="8" style="text-align: center;"> <table border="1" style="width: 100%; border-collapse: collapse; text-align: center;"> <tr> <td style="width: 10%;"></td> <td style="width: 10%;"></td> <td style="width: 10%;"></td> <td style="width: 10%;"></td> <td style="width: 10%;"></td> <td style="width: 10%;"></td> <td style="width: 10%;"></td> <td style="width: 10%;"></td> <td style="width: 10%;"></td> <td style="width: 10%;"></td> </tr> <tr> <td></td> <td></td> <td colspan="8" style="text-align: center;"> <table border="1" style="width: 100%; border-collapse: collapse; text-align: center;"> <tr> <td style="width: 10%;"></td> <td style="width: 10%;"></td> <td style="width: 10%;"></td> <td style="width: 10%;"></td> <td style="width: 10%;"></td> <td style="width: 10%;"></td> <td style="width: 10%;"></td> <td style="width: 10%;"></td> <td
style="width: 10%;"></td> <td style="width: 10%;"></td> </tr> <tr> <td></td> <td></td> <td colspan="8" style="text-align: center;"> <table border="1" style="width: 100%; border-collapse: collapse; text-align: center;"> <tr> <td style="width: 10%;"></td> <td style="width: 10%;"></td> <td style="width: 10%;"></td> <td style="width: 10%;"></td> <td style="width: 10%;"></td> <td style="width: 10%;"></td> <td style="width: 10%;"></td> <td style="width: 10%;"></td> <td style="width: 10%;"></td> <td style="width: 10%;"></td> </tr> <tr> <td></td> <td></td> <td colspan="8" style="text-align: center;"> <table border="1" style="width: 100%; border-collapse: collapse; text-align: center;"> <tr> <td style="width: 10%;"></td> <td style="width: 10%;"></td> <td style="width: 10%;"></td> <td style="width: 10%;"></td> <td style="width: 10%;"></td> <td style="width: 10%;"></td> <td style="width: 10%;"></td> <td style="width: 10%;"></td> <td style="width: 10%;"></td> <td style="width: 10%;"></td> </tr> <tr> <td></td> <td></td> <td colspan="8" style="text-align: center;"> <table border="1" style="width: 100%; border-collapse: collapse; text-align: center;"> <tr> <td style="width: 10%;"></td> <td style="width: 10%;"></td> <td style="width: 10%;"></td> <td style="width: 10%;"></td> <td style="width: 10%;"></td> <td style="width: 10%;"></td> <td style="width: 10%;"></td> <td style="width: 10%;"></td> <td style="width: 10%;"></td> <td style="width: 10%;"></td> </tr> <tr> <td></td> <td></td> <td colspan="8" style="text-align: center;"> <table border="1" style="width: 100%; border-collapse: collapse; text-align: center;"> <tr> <td style="width: 10%;"></td> <td style="width: 10%;"></td> <td style="width: 10%;"></td> <td style="width: 10%;"></td> <td style="width: 10%;"></td> <td style="width: 10%;"></td> <td style="width: 10%;"></td> <td style="width: 10%;"></td> <td style="width: 10%;"></td> <td style="width: 10%;"></td> </tr> <tr> <td></td> <td></td> <td colspan="8" style="text-align: center;"> <table border="1" style="width: 100%; border-collapse: collapse; text-align: center;"> <tr> <td style="width: 10%;"></td> <td style="width: 10%;"></td> <td style="width: 10%;"></td> <td style="width: 10%;"></td> <td style="width: 10%;"></td> <td style="width: 10%;"></td> <td style="width: 10%;"></td> <td style="width: 10%;"></td> <td style="width: 10%;"></td> <td style="width: 10%;"></td> </tr> <tr> <td></td> <td></td> <td colspan="8" style="text-align: center;"> <table border="1" style="width: 100%; border-collapse: collapse; text-align: center;"> <tr> <td style="width: 10%;"></td> <td style="width: 10%;"></td> <td style="width: 10%;"></td> <td style="width: 10%;"></td> <td style="width: 10%;"></td> <td style="width: 10%;"></td> <td style="width: 10%;"></td> <td style="width: 10%;"></td> <td style="width: 10%;"></td> <td style="width: 10%;"></td> </tr> <tr> <td></td> <td></td> <td colspan="8" style="text-align: center;"> <table border="1" style="width: 100%; border-collapse: collapse; text-align: center;"> <tr> <td style="width: 10%;"></td> <td style="width: 10%;"></td> <td style="width: 10%;"></td> <td style="width: 10%;"></td> <td style="width: 10%;"></td> <td style="width: 10%;"></td> <td style="width: 10%;"></td> <td style="width: 10%;"></td> <td style="width: 10%;"></td> <td style="width: 10%;"></td> </tr> <tr> <td></td> <td></td> <td colspan="8" style="text-align: center;"> <table border="1" style="width: 100%; border-collapse: collapse; text-align: center;"> <tr> <td style="width: 10%;"></td> <td style="width: 10%;"></td> <td style="width: 10%;"></td> <td style="width: 10%;"></td> <td style="width: 10%;"></td> <td style="width: 10%;"></td> <td style="width: 10%;"></td> <td style="width: 10%;"></td> <td style="width: 10%;"></td> <td style="width: 10%;"></td> </tr> <tr> <td></td> <td></td> <td colspan="8" style="text-align: center;"> <table border="1" style="width: 100%; border-collapse: collapse; text-align: center;"> <tr> </tr></table></td></tr></table></td></tr></table></td></tr></table></td></tr></table></td></tr></table></td></tr></table></td></tr></table></td></tr></table></td></tr></table></td></tr></table></td></tr></table>

 | | | | | | | | | | | | | | | | | | | | <table border="1" style="width: 100%; border-collapse: collapse; text-align: center;"> <tr> <td style="width: 10%;"></td> <td style="width: 10%;"></td> <td style="width: 10%;"></td> <td style="width: 10%;"></td> <td style="width: 10%;"></td> <td style="width: 10%;"></td> <td style="width: 10%;"></td> <td style="width: 10%;"></td> <td style="width: 10%;"></td> <td style="width: 10%;"></td> </tr> <tr> <td></td> <td></td> <td colspan="8" style="text-align: center;"> <table border="1" style="width: 100%; border-collapse: collapse; text-align: center;"> <tr> <td style="width: 10%;"></td> <td style="width: 10%;"></td> <td style="width: 10%;"></td> <td style="width: 10%;"></td> <td style="width: 10%;"></td> <td style="width: 10%;"></td> <td style="width: 10%;"></td> <td style="width: 10%;"></td> <td style="width: 10%;"></td> <td style="width: 10%;"></td> </tr> <tr> <td></td> <td></td> <td colspan="8" style="text-align: center;"> <table border="1" style="width: 100%; border-collapse: collapse; text-align: center;"> <tr> <td style="width: 10%;"></td> <td style="width: 10%;"></td> <td style="width: 10%;"></td> <td style="width: 10%;"></td> <td style="width: 10%;"></td> <td style="width: 10%;"></td> <td style="width: 10%;"></td> <td style="width: 10%;"></td> <td style="width: 10%;"></td> <td style="width: 10%;"></td> </tr> <tr> <td></td> <td></td> <td colspan="8" style="text-align: center;"> <table border="1" style="width: 100%; border-collapse: collapse; text-align: center;"> <tr> <td style="width: 10%;"></td> <td style="width: 10%;"></td> <td style="width: 10%;"></td> <td style="width: 10%;"></td> <td style="width: 10%;"></td> <td style="width: 10%;"></td> <td style="width: 10%;"></td> <td style="width: 10%;"></td> <td style="width: 10%;"></td> <td style="width: 10%;"></td> </tr> <tr> <td></td> <td></td> <td colspan="8" style="text-align: center;"> <table border="1" style="width: 100%; border-collapse: collapse; text-align: center;"> <tr> <td style="width: 10%;"></td> <td style="width: 10%;"></td> <td style="width: 10%;"></td> <td style="width: 10%;"></td> <td style="width: 10%;"></td> <td style="width: 10%;"></td> <td style="width: 10%;"></td> <td style="width: 10%;"></td> <td style="width: 10%;"></td> <td style="width: 10%;"></td> </tr> <tr> <td></td> <td></td> <td colspan="8" style="text-align: center;"> <table border="1" style="width: 100%; border-collapse: collapse; text-align: center;"> <tr> <td style="width: 10%;"></td> <td style="width: 10%;"></td> <td style="width: 10%;"></td> <td style="width: 10%;"></td> <td style="width: 10%;"></td> <td style="width: 10%;"></td> <td style="width: 10%;"></td> <td style="width: 10%;"></td> <td style="width: 10%;"></td> <td style="width: 10%;"></td> </tr> <tr> <td></td> <td></td> <td colspan="8" style="text-align: center;"> <table border="1" style="width: 100%; border-collapse: collapse; text-align: center;"> <tr> <td style="width: 10%;"></td> <td style="width: 10%;"></td> <td style="width: 10%;"></td> <td style="width: 10%;"></td> <td style="width: 10%;"></td> <td style="width: 10%;"></td> <td style="width: 10%;"></td> <td style="width: 10%;"></td> <td style="width: 10%;"></td> <td style="width: 10%;"></td> </tr> <tr> <td></td> <td></td> <td colspan="8" style="text-align: center;"> <table border="1" style="width: 100%; border-collapse: collapse; text-align: center;"> <tr> <td style="width: 10%;"></td> <td style="width: 10%;"></td> <td style="width: 10%;"></td> <td style="width: 10%;"></td> <td style="width: 10%;"></td> <td style="width: 10%;"></td> <td style="width: 10%;"></td> <td style="width: 10%;"></td> <td style="width: 10%;"></td> <td style="width: 10%;"></td> </tr> <tr> <td></td> <td></td> <td colspan="8" style="text-align: center;"> <table border="1" style="width: 100%; border-collapse: collapse; text-align: center;"> <tr> <td style="width: 10%;"></td> <td style="width: 10%;"></td> <td style="width: 10%;"></td> <td style="width: 10%;"></td> <td style="width: 10%;"></td> <td style="width: 10%;"></td> <td style="width: 10%;"></td> <td style="width: 10%;"></td> <td style="width: 10%;"></td> <td style="width: 10%;"></td> </tr> <tr> <td></td> <td></td> <td colspan="8" style="text-align: center;"> <table border="1" style="width: 100%; border-collapse: collapse; text-align: center;"> <tr> <td style="width: 10%;"></td> <td style="width: 10%;"></td> <td style="width: 10%;"></td> <td style="width: 10%;"></td> <td style="width: 10%;"></td> <td style="width: 10%;"></td> <td style="width: 10%;"></td> <td style="width: 10%;"></td> <td style="width: 10%;"></td> <td style="width: 10%;"></td> </tr> <tr> <td></td> <td></td> <td colspan="8" style="text-align: center;"> <table border="1" style="width: 100%; border-collapse: collapse; text-align: center;"> <tr> </tr></table></td></tr></table></td></tr></table></td></tr></table></td></tr></table></td></tr></table></td></tr></table></td></tr></table></td></tr></table></td></tr></table></td></tr></table>

 | | | | | | | | | | | | | | | | | | | | <table border="1" style="width: 100%; border-collapse: collapse; text-align: center;"> <tr> <td style="width: 10%;"></td> <td style="width: 10%;"></td> <td style="width: 10%;"></td> <td style="width: 10%;"></td> <td style="width: 10%;"></td> <td style="width: 10%;"></td> <td style="width: 10%;"></td> <td style="width: 10%;"></td> <td style="width: 10%;"></td> <td style="width: 10%;"></td> </tr> <tr> <td></td> <td></td> <td colspan="8" style="text-align: center;"> <table border="1" style="width: 100%; border-collapse: collapse; text-align: center;"> <tr> <td style="width: 10%;"></td> <td style="width: 10%;"></td> <td style="width: 10%;"></td> <td style="width: 10%;"></td> <td style="width: 10%;"></td> <td style="width: 10%;"></td> <td style="width: 10%;"></td> <td style="width: 10%;"></td> <td style="width: 10%;"></td> <td style="width: 10%;"></td> </tr> <tr> <td></td> <td></td> <td colspan="8" style="text-align: center;"> <table border="1" style="width: 100%; border-collapse: collapse; text-align: center;"> <tr> <td style="width: 10%;"></td> <td style="width: 10%;"></td> <td style="width: 10%;"></td> <td style="width: 10%;"></td> <td style="width: 10%;"></td> <td style="width: 10%;"></td> <td style="width: 10%;"></td> <td style="width: 10%;"></td> <td style="width: 10%;"></td> <td style="width: 10%;"></td> </tr> <tr> <td></td> <td></td> <td colspan="8" style="text-align: center;"> <table border="1" style="width: 100%; border-collapse: collapse; text-align: center;"> <tr> <td style="width: 10%;"></td> <td style="width: 10%;"></td> <td style="width: 10%;"></td> <td style="width: 10%;"></td> <td style="width: 10%;"></td> <td style="width: 10%;"></td> <td style="width: 10%;"></td> <td style="width: 10%;"></td> <td style="width: 10%;"></td> <td style="width: 10%;"></td> </tr> <tr> <td></td> <td></td> <td colspan="8" style="text-align: center;"> <table border="1" style="width: 100%; border-collapse: collapse; text-align: center;"> <tr> <td style="width: 10%;"></td> <td style="width: 10%;"></td> <td style="width: 10%;"></td> <td style="width: 10%;"></td> <td style="width: 10%;"></td> <td style="width: 10%;"></td> <td style="width: 10%;"></td> <td style="width: 10%;"></td> <td style="width: 10%;"></td> <td style="width: 10%;"></td> </tr> <tr> <td></td> <td></td> <td colspan="8" style="text-align: center;"> <table border="1" style="width: 100%; border-collapse: collapse; text-align: center;"> <tr> <td style="width: 10%;"></td> <td style="width: 10%;"></td> <td style="width: 10%;"></td> <td style="width: 10%;"></td> <td style="width: 10%;"></td> <td style="width: 10%;"></td> <td style="width: 10%;"></td> <td style="width: 10%;"></td> <td style="width: 10%;"></td> <td style="width: 10%;"></td> </tr> <tr> <td></td> <td></td> <td colspan="8" style="text-align: center;"> <table border="1" style="width: 100%; border-collapse: collapse; text-align: center;"> <tr> <td style="width: 10%;"></td> <td style="width: 10%;"></td> <td style="width: 10%;"></td> <td style="width: 10%;"></td> <td style="width: 10%;"></td> <td style="width: 10%;"></td> <td style="width: 10%;"></td> <td style="width: 10%;"></td> <td style="width: 10%;"></td> <td style="width: 10%;"></td> </tr> <tr> <td></td> <td></td> <td colspan="8" style="text-align: center;"> <table border="1" style="width: 100%; border-collapse: collapse; text-align: center;"> <tr> <td style="width: 10%;"></td> <td style="width: 10%;"></td> <td style="width: 10%;"></td> <td style="width: 10%;"></td> <td style="width: 10%;"></td> <td style="width: 10%;"></td> <td style="width: 10%;"></td> <td style="width: 10%;"></td> <td style="width: 10%;"></td> <td style="width: 10%;"></td> </tr> <tr> <td></td> <td></td> <td colspan="8" style="text-align: center;"> <table border="1" style="width: 100%; border-collapse: collapse; text-align: center;"> <tr> <td style="width: 10%;"></td> <td style="width: 10%;"></td> <td style="width: 10%;"></td> <td style="width: 10%;"></td> <td style="width: 10%;"></td> <td style="width: 10%;"></td> <td style="width: 10%;"></td> <td style="width: 10%;"></td> <td style="width: 10%;"></td> <td style="width: 10%;"></td> </tr> <tr> <td></td> <td></td> <td colspan="8" style="text-align: center;"> <table border="1" style="width: 100%; border-collapse: collapse; text-align: center;"> <tr> </tr></table></td></tr></table></td></tr></table></td></tr></table></td></tr></table></td></tr></table></td></tr></table></td></tr></table></td></tr></table></td></tr></table>

 | | | | | | | | | | | | | | | | | | | | <table border="1" style="width: 100%; border-collapse: collapse; text-align: center;"> <tr> <td style="width: 10%;"></td> <td style="width: 10%;"></td> <td style="width: 10%;"></td> <td style="width: 10%;"></td> <td style="width: 10%;"></td> <td style="width: 10%;"></td> <td style="width: 10%;"></td> <td style="width: 10%;"></td> <td style="width: 10%;"></td> <td style="width: 10%;"></td> </tr> <tr> <td></td> <td></td> <td colspan="8" style="text-align: center;"> <table border="1" style="width: 100%; border-collapse: collapse; text-align: center;"> <tr> <td style="width: 10%;"></td> <td style="width: 10%;"></td> <td style="width: 10%;"></td> <td style="width: 10%;"></td> <td style="width: 10%;"></td> <td style="width: 10%;"></td> <td style="width: 10%;"></td> <td style="width: 10%;"></td> <td style="width: 10%;"></td> <td style="width: 10%;"></td> </tr> <tr> <td></td> <td></td> <td colspan="8" style="text-align: center;"> <table border="1" style="width: 100%; border-collapse: collapse; text-align: center;"> <tr> <td style="width: 10%;"></td> <td style="width: 10%;"></td> <td style="width: 10%;"></td> <td style="width: 10%;"></td> <td style="width: 10%;"></td> <td style="width: 10%;"></td> <td style="width: 10%;"></td> <td style="width: 10%;"></td> <td style="width: 10%;"></td> <td style="width: 10%;"></td> </tr> <tr> <td></td> <td></td> <td colspan="8" style="text-align: center;"> <table border="1" style="width: 100%; border-collapse: collapse; text-align: center;"> <tr> <td style="width: 10%;"></td> <td style="width: 10%;"></td> <td style="width: 10%;"></td> <td style="width: 10%;"></td> <td style="width: 10%;"></td> <td style="width: 10%;"></td> <td style="width: 10%;"></td> <td style="width: 10%;"></td> <td style="width: 10%;"></td> <td style="width: 10%;"></td> </tr> <tr> <td></td> <td></td> <td colspan="8" style="text-align: center;"> <table border="1" style="width: 100%; border-collapse: collapse; text-align: center;"> <tr> <td style="width: 10%;"></td> <td style="width: 10%;"></td> <td style="width: 10%;"></td> <td style="width: 10%;"></td> <td style="width: 10%;"></td> <td style="width: 10%;"></td> <td style="width: 10%;"></td> <td style="width: 10%;"></td> <td style="width: 10%;"></td> <td style="width: 10%;"></td> </tr> <tr> <td></td> <td></td> <td colspan="8" style="text-align: center;"> <table border="1" style="width: 100%; border-collapse: collapse; text-align: center;"> <tr> <td style="width: 10%;"></td> <td style="width: 10%;"></td> <td style="width: 10%;"></td> <td style="width: 10%;"></td> <td style="width: 10%;"></td> <td style="width: 10%;"></td> <td style="width: 10%;"></td> <td style="width: 10%;"></td> <td style="width: 10%;"></td> <td style="width: 10%;"></td> </tr> <tr> <td></td> <td></td> <td colspan="8" style="text-align: center;"> <table border="1" style="width: 100%; border-collapse: collapse; text-align: center;"> <tr> <td style="width: 10%;"></td> <td style="width: 10%;"></td> <td style="width: 10%;"></td> <td style="width: 10%;"></td> <td style="width: 10%;"></td> <td style="width: 10%;"></td> <td style="width: 10%;"></td> <td style="width: 10%;"></td> <td style="width: 10%;"></td> <td style="width: 10%;"></td> </tr> <tr> <td></td> <td></td> <td colspan="8" style="text-align: center;"> <table border="1" style="width: 100%; border-collapse: collapse; text-align: center;"> <tr> <td style="width: 10%;"></td> <td style="width: 10%;"></td> <td style="width: 10%;"></td> <td style="width: 10%;"></td> <td style="width: 10%;"></td> <td style="width: 10%;"></td> <td style="width: 10%;"></td> <td style="width: 10%;"></td> <td style="width: 10%;"></td> <td style="width: 10%;"></td> </tr> <tr> <td></td> <td></td> <td colspan="8" style="text-align: center;"> <table border="1" style="width: 100%; border-collapse: collapse; text-align: center;"> <tr> </tr></table></td></tr></table></td></tr></table></td></tr></table></td></tr></table></td></tr></table></td></tr></table></td></tr></table></td></tr></table>

 | | | | | | | | | | | | | | | | | | | | <table border="1" style="width: 100%; border-collapse: collapse; text-align: center;"> <tr> <td style="width: 10%;"></td> <td style="width: 10%;"></td> <td style="width: 10%;"></td> <td style="width: 10%;"></td> <td style="width: 10%;"></td> <td style="width: 10%;"></td> <td style="width: 10%;"></td> <td style="width: 10%;"></td> <td style="width: 10%;"></td> <td style="width: 10%;"></td> </tr> <tr> <td></td> <td></td> <td colspan="8" style="text-align: center;"> <table border="1" style="width: 100%; border-collapse: collapse; text-align: center;"> <tr> <td style="width: 10%;"></td> <td style="width: 10%;"></td> <td style="width: 10%;"></td> <td style="width: 10%;"></td> <td style="width: 10%;"></td> <td style="width: 10%;"></td> <td style="width: 10%;"></td> <td style="width: 10%;"></td> <td style="width: 10%;"></td> <td style="width: 10%;"></td> </tr> <tr> <td></td> <td></td> <td colspan="8" style="text-align: center;"> <table border="1" style="width: 100%; border-collapse: collapse; text-align: center;"> <tr> <td style="width: 10%;"></td> <td style="width: 10%;"></td> <td style="width: 10%;"></td> <td style="width: 10%;"></td> <td style="width: 10%;"></td> <td style="width: 10%;"></td> <td style="width: 10%;"></td> <td style="width: 10%;"></td> <td style="width: 10%;"></td> <td style="width: 10%;"></td> </tr> <tr> <td></td> <td></td> <td colspan="8" style="text-align: center;"> <table border="1" style="width: 100%; border-collapse: collapse; text-align: center;"> <tr> <td style="width: 10%;"></td> <td style="width: 10%;"></td> <td style="width: 10%;"></td> <td style="width: 10%;"></td> <td style="width: 10%;"></td> <td style="width: 10%;"></td> <td style="width: 10%;"></td> <td style="width: 10%;"></td> <td style="width: 10%;"></td> <td style="width: 10%;"></td> </tr> <tr> <td></td> <td></td> <td colspan="8" style="text-align: center;"> <table border="1" style="width: 100%; border-collapse: collapse; text-align: center;"> <tr> <td style="width: 10%;"></td> <td style="width: 10%;"></td> <td style="width: 10%;"></td> <td style="width: 10%;"></td> <td style="width: 10%;"></td> <td style="width: 10%;"></td> <td style="width: 10%;"></td> <td style="width: 10%;"></td> <td style="width: 10%;"></td> <td style="width: 10%;"></td> </tr> <tr> <td></td> <td></td> <td colspan="8" style="text-align: center;"> <table border="1" style="width: 100%; border-collapse: collapse; text-align: center;"> <tr> <td style="width: 10%;"></td> <td style="width: 10%;"></td> <td style="width: 10%;"></td> <td style="width: 10%;"></td> <td style="width: 10%;"></td> <td style="width: 10%;"></td> <td style="width: 10%;"></td> <td style="width: 10%;"></td> <td style="width: 10%;"></td> <td style="width: 10%;"></td> </tr> <tr> <td></td> <td></td> <td colspan="8" style="text-align: center;"> <table border="1" style="width: 100%; border-collapse: collapse; text-align: center;"> <tr> <td style="width: 10%;"></td> <td style="width: 10%;"></td> <td style="width: 10%;"></td> <td style="width: 10%;"></td> <td style="width: 10%;"></td> <td style="width: 10%;"></td> <td style="width: 10%;"></td> <td style="width: 10%;"></td> <td style="width: 10%;"></td> <td style="width: 10%;"></td> </tr> <tr> <td></td> <td></td> <td colspan="8" style="text-align: center;"> <table border="1" style="width: 100%; border-collapse: collapse; text-align: center;"> <tr> </tr></table></td></tr></table></td></tr></table></td></tr></table></td></tr></table></td></tr></table></td></tr></table></td></tr></table>

 | | | | | | | | | | | | | | | | | | | | <table border="1" style="width: 100%; border-collapse: collapse; text-align: center;"> <tr> <td style="width: 10%;"></td> <td style="width: 10%;"></td> <td style="width: 10%;"></td> <td style="width: 10%;"></td> <td style="width: 10%;"></td> <td style="width: 10%;"></td> <td style="width: 10%;"></td> <td style="width: 10%;"></td> <td style="width: 10%;"></td> <td style="width: 10%;"></td> </tr> <tr> <td></td> <td></td> <td colspan="8" style="text-align: center;"> <table border="1" style="width: 100%; border-collapse: collapse; text-align: center;"> <tr> <td style="width: 10%;"></td> <td style="width: 10%;"></td> <td style="width: 10%;"></td> <td style="width: 10%;"></td> <td style="width: 10%;"></td> <td style="width: 10%;"></td> <td style="width: 10%;"></td> <td style="width: 10%;"></td> <td style="width: 10%;"></td> <td style="width: 10%;"></td> </tr> <tr> <td></td> <td></td> <td colspan="8" style="text-align: center;"> <table border="1" style="width: 100%; border-collapse: collapse; text-align: center;"> <tr> <td style="width: 10%;"></td> <td style="width: 10%;"></td> <td style="width: 10%;"></td> <td style="width: 10%;"></td> <td style="width: 10%;"></td> <td style="width: 10%;"></td> <td style="width: 10%;"></td> <td style="width: 10%;"></td> <td style="width: 10%;"></td> <td style="width: 10%;"></td> </tr> <tr> <td></td> <td></td> <td colspan="8" style="text-align: center;"> <table border="1" style="width: 100%; border-collapse: collapse; text-align: center;"> <tr> <td style="width: 10%;"></td> <td style="width: 10%;"></td> <td style="width: 10%;"></td> <td style="width: 10%;"></td> <td style="width: 10%;"></td> <td style="width: 10%;"></td> <td style="width: 10%;"></td> <td style="width: 10%;"></td> <td style="width: 10%;"></td> <td style="width: 10%;"></td> </tr> <tr> <td></td> <td></td> <td colspan="8" style="text-align: center;"> <table border="1" style="width: 100%; border-collapse: collapse; text-align: center;"> <tr> <td style="width: 10%;"></td> <td style="width: 10%;"></td> <td style="width: 10%;"></td> <td style="width: 10%;"></td> <td style="width: 10%;"></td> <td style="width: 10%;"></td> <td style="width: 10%;"></td> <td style="width: 10%;"></td> <td style="width: 10%;"></td> <td style="width: 10%;"></td> </tr> <tr> <td></td> <td></td> <td colspan="8" style="text-align: center;"> <table border="1" style="width: 100%; border-collapse: collapse; text-align: center;"> <tr> <td style="width: 10%;"></td> <td style="width: 10%;"></td> <td style="width: 10%;"></td> <td style="width: 10%;"></td> <td style="width: 10%;"></td> <td style="width: 10%;"></td> <td style="width: 10%;"></td> <td style="width: 10%;"></td> <td style="width: 10%;"></td> <td style="width: 10%;"></td> </tr> <tr> <td></td> <td></td> <td colspan="8" style="text-align: center;"> <table border="1" style="width: 100%; border-collapse: collapse; text-align: center;"> <tr> </tr></table></td></tr></table></td></tr></table></td></tr></table></td></tr></table></td></tr></table></td></tr></table>

 | | | | | | | | | | | | | | | | | | | | <table border="1" style="width: 100%; border-collapse: collapse; text-align: center;"> <tr> <td style="width: 10%;"></td> <td style="width: 10%;"></td> <td style="width: 10%;"></td> <td style="width: 10%;"></td> <td style="width: 10%;"></td> <td style="width: 10%;"></td> <td style="width: 10%;"></td> <td style="width: 10%;"></td> <td style="width: 10%;"></td> <td style="width: 10%;"></td> </tr> <tr> <td></td> <td></td> <td colspan="8" style="text-align: center;"> <table border="1" style="width: 100%; border-collapse: collapse; text-align: center;"> <tr> <td style="width: 10%;"></td> <td style="width: 10%;"></td> <td style="width: 10%;"></td> <td style="width: 10%;"></td> <td style="width: 10%;"></td> <td style="width: 10%;"></td> <td style="width: 10%;"></td> <td style="width: 10%;"></td> <td style="width: 10%;"></td> <td style="width: 10%;"></td> </tr> <tr> <td></td> <td></td> <td colspan="8" style="text-align: center;"> <table border="1" style="width: 100%; border-collapse: collapse; text-align: center;"> <tr> <td style="width: 10%;"></td> <td style="width: 10%;"></td> <td style="width: 10%;"></td> <td style="width: 10%;"></td> <td style="width: 10%;"></td> <td style="width: 10%;"></td> <td style="width: 10%;"></td> <td style="width: 10%;"></td> <td style="width: 10%;"></td> <td style="width: 10%;"></td> </tr> <tr> <td></td> <td></td> <td colspan="8" style="text-align: center;"> <table border="1" style="width: 100%; border-collapse: collapse; text-align: center;"> <tr> <td style="width: 10%;"></td> <td style="width: 10%;"></td> <td style="width: 10%;"></td> <td style="width: 10%;"></td> <td style="width: 10%;"></td> <td style="width: 10%;"></td> <td style="width: 10%;"></td> <td style="width: 10%;"></td> <td style="width: 10%;"></td> <td style="width: 10%;"></td> </tr> <tr> <td></td> <td></td> <td colspan="8" style="text-align: center;"> <table border="1" style="width: 100%; border-collapse: collapse; text-align: center;"> <tr> <td style="width: 10%;"></td> <td style="width: 10%;"></td> <td style="width: 10%;"></td> <td style="width: 10%;"></td> <td style="width: 10%;"></td> <td style="width: 10%;"></td> <td style="width: 10%;"></td> <td style="width: 10%;"></td> <td style="width: 10%;"></td> <td style="width: 10%;"></td> </tr> <tr> <td></td> <td></td> <td colspan="8" style="text-align: center;"> <table border="1" style="width: 100%; border-collapse: collapse; text-align: center;"> <tr> </tr></table></td></tr></table></td></tr></table></td></tr></table></td></tr></table></td></tr></table>

 | | | | | | | | | | | | | | | | | | | | <table border="1" style="width: 100%; border-collapse: collapse; text-align: center;"> <tr> <td style="width: 10%;"></td> <td style="width: 10%;"></td> <td style="width: 10%;"></td> <td style="width: 10%;"></td> <td style="width: 10%;"></td> <td style="width: 10%;"></td> <td style="width: 10%;"></td> <td style="width: 10%;"></td> <td style="width: 10%;"></td> <td style="width: 10%;"></td> </tr> <tr> <td></td> <td></td> <td colspan="8" style="text-align: center;"> <table border="1" style="width: 100%; border-collapse: collapse; text-align: center;"> <tr> <td style="width: 10%;"></td> <td style="width: 10%;"></td> <td style="width: 10%;"></td> <td style="width: 10%;"></td> <td style="width: 10%;"></td> <td style="width: 10%;"></td> <td style="width: 10%;"></td> <td style="width: 10%;"></td> <td style="width: 10%;"></td> <td style="width: 10%;"></td> </tr> <tr> <td></td> <td></td> <td colspan="8" style="text-align: center;"> <table border="1" style="width: 100%; border-collapse: collapse; text-align: center;"> <tr> <td style="width: 10%;"></td> <td style="width: 10%;"></td> <td style="width: 10%;"></td> <td style="width: 10%;"></td> <td style="width: 10%;"></td> <td style="width: 10%;"></td> <td style="width: 10%;"></td> <td style="width: 10%;"></td> <td style="width: 10%;"></td> <td style="width: 10%;"></td> </tr> <tr> <td></td> <td></td> <td colspan="8" style="text-align: center;"> <table border="1" style="width: 100%; border-collapse: collapse; text-align: center;"> <tr> <td style="width: 10%;"></td> <td style="width: 10%;"></td> <td style="width: 10%;"></td> <td style="width: 10%;"></td> <td style="width: 10%;"></td> <td style="width: 10%;"></td> <td style="width: 10%;"></td> <td style="width: 10%;"></td> <td style="width: 10%;"></td> <td style="width: 10%;"></td> </tr> <tr> <td></td> <td></td> <td colspan="8" style="text-align: center;"> <table border="1" style="width: 100%; border-collapse: collapse; text-align: center;"> <tr> </tr></table></td></tr></table></td></tr></table></td></tr></table></td></tr></table>

 | | | | | | | | | | | | | | | | | | | | <table border="1" style="width: 100%; border-collapse: collapse; text-align: center;"> <tr> <td style="width: 10%;"></td> <td style="width: 10%;"></td> <td style="width: 10%;"></td> <td style="width: 10%;"></td> <td style="width: 10%;"></td> <td style="width: 10%;"></td> <td style="width: 10%;"></td> <td style="width: 10%;"></td> <td style="width: 10%;"></td> <td style="width: 10%;"></td> </tr> <tr> <td></td> <td></td> <td colspan="8" style="text-align: center;"> <table border="1" style="width: 100%; border-collapse: collapse; text-align: center;"> <tr> <td style="width: 10%;"></td> <td style="width: 10%;"></td> <td style="width: 10%;"></td> <td style="width: 10%;"></td> <td style="width: 10%;"></td> <td style="width: 10%;"></td> <td style="width: 10%;"></td> <td style="width: 10%;"></td> <td style="width: 10%;"></td> <td style="width: 10%;"></td> </tr> <tr> <td></td> <td></td> <td colspan="8" style="text-align: center;"> <table border="1" style="width: 100%; border-collapse: collapse; text-align: center;"> <tr> <td style="width: 10%;"></td> <td style="width: 10%;"></td> <td style="width: 10%;"></td> <td style="width: 10%;"></td> <td style="width: 10%;"></td> <td style="width: 10%;"></td> <td style="width: 10%;"></td> <td style="width: 10%;"></td> <td style="width: 10%;"></td> <td style="width: 10%;"></td> </tr> <tr> <td></td> <td></td> <td colspan="8" style="text-align: center;"> <table border="1" style="width: 100%; border-collapse: collapse; text-align: center;"> <tr> </tr></table></td></tr></table></td></tr></table></td></tr></table>

 | | | | | | | | | | | | | | | | | | | | <table border="1" style="width: 100%; border-collapse: collapse; text-align: center;"> <tr> <td style="width: 10%;"></td> <td style="width: 10%;"></td> <td style="width: 10%;"></td> <td style="width: 10%;"></td> <td style="width: 10%;"></td> <td style="width: 10%;"></td> <td style="width: 10%;"></td> <td style="width: 10%;"></td> <td style="width: 10%;"></td> <td style="width: 10%;"></td> </tr> <tr> <td></td> <td></td> <td colspan="8" style="text-align: center;"> <table border="1" style="width: 100%; border-collapse: collapse; text-align: center;"> <tr> <td style="width: 10%;"></td> <td style="width: 10%;"></td> <td style="width: 10%;"></td> <td style="width: 10%;"></td> <td style="width: 10%;"></td> <td style="width: 10%;"></td> <td style="width: 10%;"></td> <td style="width: 10%;"></td> <td style="width: 10%;"></td> <td style="width: 10%;"></td> </tr> <tr> <td></td> <td></td> <td colspan="8" style="text-align: center;"> <table border="1" style="width: 100%; border-collapse: collapse; text-align: center;"> <tr> </tr></table></td></tr></table></td></tr></table>

 | | | | | | | | | | | | | | | | | | | | <table border="1" style="width: 100%; border-collapse: collapse; text-align: center;"> <tr> <td style="width: 10%;"></td> <td style="width: 10%;"></td> <td style="width: 10%;"></td> <td style="width: 10%;"></td> <td style="width: 10%;"></td> <td style="width: 10%;"></td> <td style="width: 10%;"></td> <td style="width: 10%;"></td> <td style="width: 10%;"></td> <td style="width: 10%;"></td> </tr> <tr> <td></td> <td></td> <td colspan="8" style="text-align: center;"> <table border="1" style="width: 100%; border-collapse: collapse; text-align: center;"> <tr> </tr></table></td></tr></table>
 | | | | | | | | | | | | | | | | | | | | <table border="1" style="width: 100%; border-collapse: collapse; text-align: center;"> <tr> </tr></table>

 | | | | | | | | | | | | | | | | | | | |

 | | | | | | | | | | | | | | | | | | | |
 | | | | | | | | | | | | | | | | | | | |

 | | | | | | | | | | | | | | | | | | | |

 | | | | | | | | | | | | | | | | | | | |
 | | | | | | | | | | | | | | | | | | | |
 | | | | | | | | | | | | | | | | | | | |

 | | | | | | | | | | | | | | | | | | | |
 | | | | | | | | | | | | | | | | | | | |
 | | | | | | | | | | | | | | | | | | | |

 | | | | | | | | | | | | | | | | | | | | | | | | | | | | | | | | | | | | | | | | | | | | | | | | | | | | | | | | | | | | | | | | | | | | | | | | | | | | | | | | | | | | | | | | | | | | | | | | | | | |
 | | | | | | | | | | | | | | | | | | | |
 | | | | | | | | | | | | | | | | | | | |
 | | | | | | | | | | | | | | | | | | | |
 | | | | | | | | | | | | | | | | | | | |
 | | | | | | | | | | | | | | | | | | | |
 | | | | | | | | | | | | | | | | | | | |
 | | | | | | | | | | | | | | | | | | | |
 | | | | | | | | | | | | | | | | | | | |
 | | | | | | | | | | | | | | | | | | | | | | | | | | | | | | | | | | | | | | | |
 | | | | | | | | | | | | | | | | | | | |
 | | | | | | | | | | | | | | | | | | | | | | | | | | | | | | | | | | | | | | | |
 | | | | | | | | | | | | | | | | | | | | | | | | | | | | | | | | | | | | | | | |
 | | | | | | | | | | | | | | | | | | | | | | | | | | | | | | | | | | | | | | | |
 | | | | | | | | | | | | | | | | | | | | | | | | | | | | | | | | | | | | | | | | | | | | | | | | | | | | | | | | | | | | | | | | | | | | | | | | | | | | | | | | | | | | | | | | | | | | | | | | | | | |
 | | | | | | | | | | | | | | | | | | | | | | | | | | | | | | | | | | | | | | | | | | | | | | | |
| | |

 | | | | | | | | | | | | | | | | | | | |

 | | | | | | | | | | | | | | | | | | | |

 | | | | | | | | | | | | | | | | | | | |

 | | | | | | | | | | | | | | | | | | | |

 | | | | | | | | | | | | | | | | | | | |

 | | | | | | | | | | | | | | | | | | | |

 | | | | | | | | | | | | | | | | | | | |

 | | | | | | | | | | | | | | | | | | | |

 | | | | | | | | | | | | | | | | | | | |

 | | | | | | | | | | | | | | | | | | | |

 | | | | | | | | | | | | | | | | | | | |

 | | | | | | | | | | | | | | | | | | | |

 | | | | | | | | | | | | | | | | | | | |

 | | | | | | | | | | | | | | | | | | | |

 | | | | | | | | | | | | | | | | | | | |

 | | | | | | | | | | | | | | | | | | | |

 | | | | | | | | | | | | | | | | | | | |

 | | | | | | | | | | | | | | | | | | | |

 | | | | | | | | | | | | | | | | | | | |

 | | | | | | | | | | | | | | | | | | | |

 | | | | | | | | | | | | | | | | | | | |

 | | | | | | | | | | | | | | | | | | | |

 | | | | | | | | | | | | | | | | | | | |

 | | | | | | | | | | | | | | | | | | | |

 | | | | | | | | | | | | | | | | | | | |

 | | | | | | | | | | | | | | | | | | | |

 | | | | | | | | | | | | | | | | | | | |

 | | | | | | | | | | | | | | | | | | | |
 | | | | | | | | | | | | | | | | | | | |

 | | | | | | | | | | | | | | | | | | | |

 | | | | | | | | | | | | | | | | | | | |
 | | | | | | | | | | | | | | | | | | | |

 | | | | | | | | | | | | | | | | | | | |

 | | | | | | | | | | | | | | | | | | | |
 | | | | | | | | | | | | | | | | | | | |
 | | | | | | | | | | | | | | | | | | | |

 | | | | | | | | | | | | | | | | | | | |
 | | | | | | | | | | | | | | | | | | | |
 | | | | | | | | | | | | | | | | | | | |

 | | | | | | | | | | | | | | | | | | | | | | | | | | | | | | | | | | | | | | | | | | | | | | | | | | | | | | | | | | | | | | | | | | | | | | | | | | | | | | | | | | | | | | | | | | | | | | | | | | | |
 | | | | | | | | | | | | | | | | | | | |
 | | | | | | | | | | | | | | | | | | | |
 | | | | | | | | | | | | | | | | | | | |
 | | | | | | | | | | | | | | | | | | | |
 | | | | | | | | | | | | | | | | | | | |
 | | | | | | | | | | | | | | | | | | | |
 | | | | | | | | | | | | | | | | | | | |
 | | | | | | | | | | | | | | | | | | | |
 | | | | | | | | | | | | | | | | | | | | | | | | | | | | | | | | | | | | | | | |
 | | | | | | | | | | | | | | | | | | | |
 | | | | | | | | | | | | | | | | | | | | | | | | | | | | | | | | | | | | | | | |
 | | | | | | | | | | | | | | | | | | | | | | | | | | | | | | | | | | | | | | | |
 | | | | | | | | | | | | | | | | | | | | | | | | | | | | | | | | | | | | | | | |
 | | | | | | | | | | | | | | | | | | | | | | | | | | | | | | | | | | | | | | | | | | | | | | | | | | | | | | | | | | | | | | | | | | | | | | | | | | | | | | | | | | | | | | | | | | | | | | | | | | | |
 | | | | | | | | | | | | | | | | | | | | | | | | | | | | | | | | | | | | | | | | | | | | | | | |
| | | <table border="1" style="width: 100%; border-collapse: collapse; text-align: center;"> <tr> <td style="width: 10%;"></td> <td style="width: 10%;"></td> <td style="width: 10%;"></td> <td style="width: 10%;"></td> <td style="width: 10%;"></td> <td style="width: 10%;"></td> <td style="width: 10%;"></td> <td style="width: 10%;"></td> <td style="width: 10%;"></td> <td style="width: 10%;"></td> </tr> <tr> <td></td> <td></td> <td colspan="8" style="text-align: center;"> <table border="1" style="width: 100%; border-collapse: collapse; text-align: center;"> <tr> <td style="width: 10%;"></td> <td style="width: 10%;"></td> <td style="width: 10%;"></td> <td style="width: 10%;"></td> <td style="width: 10%;"></td> <td style="width: 10%;"></td> <td style="width: 10%;"></td> <td style="width: 10%;"></td> <td style="width: 10%;"></td> <td style="width: 10%;"></td> </tr> <tr> <td></td> <td></td> <td colspan="8" style="text-align: center;"> <table border="1" style="width: 100%; border-collapse: collapse; text-align: center;"> <tr> <td style="width: 10%;"></td> <td style="width: 10%;"></td> <td style="width: 10%;"></td> <td style="width: 10%;"></td> <td style="width: 10%;"></td> <td style="width: 10%;"></td> <td style="width: 10%;"></td> <td style="width: 10%;"></td> <td style="width: 10%;"></td> <td style="width: 10%;"></td> </tr> <tr> <td></td> <td></td> <td colspan="8" style="text-align: center;"> <table border="1" style="width: 100%; border-collapse: collapse; text-align: center;"> <tr> <td style="width: 10%;"></td> <td style="width: 10%;"></td> <td style="width: 10%;"></td> <td style="width: 10%;"></td> <td style="width: 10%;"></td> <td style="width: 10%;"></td> <td style="width: 10%;"></td> <td style="width: 10%;"></td> <td style="width: 10%;"></td> <td style="width: 10%;"></td> </tr> <tr> <td></td> <td></td> <td colspan="8" style="text-align: center;"> <table border="1" style="width: 100%; border-collapse: collapse; text-align: center;"> <tr> <td style="width: 10%;"></td> <td style="width: 10%;"></td> <td style="width: 10%;"></td> <td style="width: 10%;"></td> <td style="width: 10%;"></td> <td style="width: 10%;"></td> <td style="width: 10%;"></td> <td style="width: 10%;"></td> <td style="width: 10%;"></td> <td style="width: 10%;"></td> </tr> <tr> <td></td> <td></td> <td colspan="8" style="text-align: center;"> <table border="1" style="width: 100%; border-collapse: collapse; text-align: center;"> <tr> <td style="width: 10%;"></td> <td style="width: 10%;"></td> <td style="width: 10%;"></td> <td style="width: 10%;"></td> <td style="width: 10%;"></td> <td style="width: 10%;"></td> <td style="width: 10%;"></td> <td style="width: 10%;"></td> <td style="width: 10%;"></td> <td style="width: 10%;"></td> </tr> <tr> <td></td> <td></td> <td colspan="8" style="text-align: center;"> <table border="1" style="width: 100%; border-collapse: collapse; text-align: center;"> <tr> <td style="width: 10%;"></td> <td style="width: 10%;"></td> <td style="width: 10%;"></td> <td style="width: 10%;"></td> <td style="width: 10%;"></td> <td style="width: 10%;"></td> <td style="width: 10%;"></td> <td style="width: 10%;"></td> <td style="width: 10%;"></td> <td style="width: 10%;"></td> </tr> <tr> <td></td> <td></td> <td colspan="8" style="text-align: center;"> <table border="1" style="width: 100%; border-collapse: collapse; text-align: center;"> <tr> <td style="width: 10%;"></td> <td style="width: 10%;"></td> <td style="width: 10%;"></td> <td style="width: 10%;"></td> <td style="width: 10%;"></td> <td style="width: 10%;"></td> <td style="width: 10%;"></td> <td style="width: 10%;"></td> <td style="width: 10%;"></td> <td style="width: 10%;"></td> </tr> <tr> <td></td> <td></td> <td colspan="8" style="text-align: center;"> <table border="1" style="width: 100%; border-collapse: collapse; text-align: center;"> <tr> <td style="width: 10%;"></td> <td style="width: 10%;"></td> <td style="width: 10%;"></td> <td style="width: 10%;"></td> <td style="width: 10%;"></td> <td style="width: 10%;"></td> <td style="width: 10%;"></td> <td style="width: 10%;"></td> <td style="width: 10%;"></td> <td style="width: 10%;"></td> </tr> <tr> <td></td> <td></td> <td colspan="8" style="text-align: center;"> <table border="1" style="width: 100%; border-collapse: collapse; text-align: center;"> <tr> <td style="width: 10%;"></td> <td style="width: 10%;"></td> <td style="width: 10%;"></td> <td style="width: 10%;"></td> <td style="width: 10%;"></td> <td style="width: 10%;"></td> <td style="width: 10%;"></td> <td style="width: 10%;"></td> <td style="width: 10%;"></td> <td style="width: 10%;"></td> </tr> <tr> <td></td> <td></td> <td colspan="8" style="text-align: center;"> <table border="1" style="width: 100%; border-collapse: collapse; text-align: center;"> <tr> <td style="width: 10%;"></td> <td style="width: 10%;"></td> <td style="width: 10%;"></td> <td style="width: 10%;"></td> <td style="width: 10%;"></td> <td style="width: 10%;"></td> <td style="width: 10%;"></td> <td style="width: 10%;"></td> <td style="width: 10%;"></td> <td style="width: 10%;"></td> </tr> <tr> <td></td> <td></td> <td colspan="8" style="text-align: center;"> <table border="1" style="width: 100%; border-collapse: collapse; text-align: center;"> <tr> <td style="width: 10%;"></td> <td style="width: 10%;"></td> <td style="width: 10%;"></td> <td style="width: 10%;"></td> <td style="width: 10%;"></td> <td style="width: 10%;"></td> <td style="width: 10%;"></td> <td style="width: 10%;"></td> <td style="width: 10%;"></td> <td style="width: 10%;"></td> </tr> <tr> <td></td> <td></td> <td colspan="8" style="text-align: center;"> <table border="1" style="width: 100%; border-collapse: collapse; text-align: center;"> <tr> <td style="width: 10%;"></td> <td style="width: 10%;"></td> <td style="width: 10%;"></td> <td style="width: 10%;"></td> <td style="width: 10%;"></td> <td style="width: 10%;"></td> <td style="width: 10%;"></td> <td style="width: 10%;"></td> <td style="width: 10%;"></td> <td style="width: 10%;"></td> </tr> <tr> <td></td> <td></td> <td colspan="8" style="text-align: center;"> <table border="1" style="width: 100%; border-collapse: collapse; text-align: center;"> <tr> <td style="width: 10%;"></td> <td style="width: 10%;"></td> <td style="width: 10%;"></td> <td style="width: 10%;"></td> <td style="width: 10%;"></td> <td style="width: 10%;"></td> <td style="width: 10%;"></td> <td style="width: 10%;"></td> <td style="width: 10%;"></td> <td style="width: 10%;"></td> </tr> <tr> <td></td> <td></td> <td colspan="8" style="text-align: center;"> <table border="1" style="width: 100%; border-collapse: collapse; text-align: center;"> <tr> <td style="width: 10%;"></td> <td style="width: 10%;"></td> <td style="width: 10%;"></td> <td style="width: 10%;"></td> <td style="width: 10%;"></td> <td style="width: 10%;"></td> <td style="width: 10%;"></td> <td style="width: 10%;"></td> <td style="width: 10%;"></td> <td style="width: 10%;"></td> </tr> <tr> <td></td> <td></td> <td colspan="8" style="text-align: center;"> <table border="1" style="width: 100%; border-collapse: collapse; text-align: center;"> <tr> <td style="width: 10%;"></td> <td style="width: 10%;"></td> <td style="width: 10%;"></td> <td style="width: 10%;"></td> <td style="width: 10%;"></td> <td style="width: 10%;"></td> <td style="width: 10%;"></td> <td style="width: 10%;"></td> <td style="width: 10%;"></td> <td style="width: 10%;"></td> </tr> <tr> <td></td> <td></td> <td colspan="8" style="text-align: center;"> <table border="1" style="width: 100%; border-collapse: collapse; text-align: center;"> <tr> <td style="width: 10%;"></td> <td style="width: 10%;"></td> <td style="width: 10%;"></td> <td style="width: 10%;"></td> <td style="width: 10%;"></td> <td style="width: 10%;"></td> <td style="width: 10%;"></td> <td style="width: 10%;"></td> <td style="width: 10%;"></td> <td style="width: 10%;"></td> </tr> <tr> <td></td> <td></td> <td colspan="8" style="text-align: center;"> <table border="1" style="width: 100%; border-collapse: collapse; text-align: center;"> <tr> <td style="width: 10%;"></td> <td style="width: 10%;"></td> <td style="width: 10%;"></td> <td style="width: 10%;"></td> <td style="width: 10%;"></td> <td style="width: 10%;"></td> <td style="width: 10%;"></td> <td style="width: 10%;"></td> <td style="width: 10%;"></td> <td style="width: 10%;"></td> </tr> <tr> <td></td> <td></td> <td colspan="8" style="text-align: center;"> <table border="1" style="width: 100%; border-collapse: collapse; text-align: center;"> <tr> <td style="width: 10%;"></td> <td style="width: 10%;"></td> <td style="width: 10%;"></td> <td style="width: 10%;"></td> <td style="width: 10%;"></td> <td style="width: 10%;"></td> <td style="width: 10%;"></td> <td style="width: 10%;"></td> <td style="width: 10%;"></td> <td style="width: 10%;"></td> </tr> <tr> <td></td> <td></td> <td colspan="8" style="text-align: center;"> <table border="1" style="width: 100%; border-collapse: collapse; text-align: center;"> <tr> <td style="width: 10%;"></td> <td style="width: 10%;"></td> <td style="width: 10%;"></td> <td style="width: 10%;"></td> <td style="width: 10%;"></td> <td style="width: 10%;"></td> <td style="width: 10%;"></td> <td style="width: 10%;"></td> <td style="width: 10%;"></td> <td style="width: 10%;"></td> </tr> <tr> <td></td> <td></td> <td colspan="8" style="text-align: center;"> <table border="1" style="width: 100%; border-collapse: collapse; text-align: center;"> <tr> <td style="width: 10%;"></td> <td style="width: 10%;"></td> <td style="width: 10%;"></td> <td style="width: 10%;"></td> <td style="width: 10%;"></td> <td style="width: 10%;"></td> <td style="width: 10%;"></td> <td style="width: 10%;"></td> <td style="width: 10%;"></td> <td style="width: 10%;"></td> </tr> <tr> <td></td> <td></td> <td colspan="8" style="text-align: center;"> <table border="1" style="width: 100%; border-collapse: collapse; text-align: center;"> <tr> <td style="width: 10%;"></td> <td style="width: 10%;"></td> <td
style="width: 10%;"></td> <td style="width: 10%;"></td> <td style="width: 10%;"></td> <td style="width: 10%;"></td> <td style="width: 10%;"></td> <td style="width: 10%;"></td> <td style="width: 10%;"></td> <td style="width: 10%;"></td> </tr> <tr> <td></td> <td></td> <td colspan="8" style="text-align: center;"> <table border="1" style="width: 100%; border-collapse: collapse; text-align: center;"> <tr> <td style="width: 10%;"></td> <td style="width: 10%;"></td> <td style="width: 10%;"></td> <td style="width: 10%;"></td> <td style="width: 10%;"></td> <td style="width: 10%;"></td> <td style="width: 10%;"></td> <td style="width: 10%;"></td> <td style="width: 10%;"></td> <td style="width: 10%;"></td> </tr> <tr> <td></td> <td></td> <td colspan="8" style="text-align: center;"> <table border="1" style="width: 100%; border-collapse: collapse; text-align: center;"> <tr> <td style="width: 10%;"></td> <td style="width: 10%;"></td> <td style="width: 10%;"></td> <td style="width: 10%;"></td> <td style="width: 10%;"></td> <td style="width: 10%;"></td> <td style="width: 10%;"></td> <td style="width: 10%;"></td> <td style="width: 10%;"></td> <td style="width: 10%;"></td> </tr> <tr> <td></td> <td></td> <td colspan="8" style="text-align: center;"> <table border="1" style="width: 100%; border-collapse: collapse; text-align: center;"> <tr> <td style="width: 10%;"></td> <td style="width: 10%;"></td> <td style="width: 10%;"></td> <td style="width: 10%;"></td> <td style="width: 10%;"></td> <td style="width: 10%;"></td> <td style="width: 10%;"></td> <td style="width: 10%;"></td> <td style="width: 10%;"></td> <td style="width: 10%;"></td> </tr> <tr> <td></td> <td></td> <td colspan="8" style="text-align: center;"> <table border="1" style="width: 100%; border-collapse: collapse; text-align: center;"> <tr> <td style="width: 10%;"></td> <td style="width: 10%;"></td> <td style="width: 10%;"></td> <td style="width: 10%;"></td> <td style="width: 10%;"></td> <td style="width: 10%;"></td> <td style="width: 10%;"></td> <td style="width: 10%;"></td> <td style="width: 10%;"></td> <td style="width: 10%;"></td> </tr> <tr> <td></td> <td></td> <td colspan="8" style="text-align: center;"> <table border="1" style="width: 100%; border-collapse: collapse; text-align: center;"> <tr> <td style="width: 10%;"></td> <td style="width: 10%;"></td> <td style="width: 10%;"></td> <td style="width: 10%;"></td> <td style="width: 10%;"></td> <td style="width: 10%;"></td> <td style="width: 10%;"></td> <td style="width: 10%;"></td> <td style="width: 10%;"></td> <td style="width: 10%;"></td> </tr> <tr> <td></td> <td></td> <td colspan="8" style="text-align: center;"> <table border="1" style="width: 100%; border-collapse: collapse; text-align: center;"> <tr> <td style="width: 10%;"></td> <td style="width: 10%;"></td> <td style="width: 10%;"></td> <td style="width: 10%;"></td> <td style="width: 10%;"></td> <td style="width: 10%;"></td> <td style="width: 10%;"></td> <td style="width: 10%;"></td> <td style="width: 10%;"></td> <td style="width: 10%;"></td> </tr> <tr> <td></td> <td></td> <td colspan="8" style="text-align: center;"> <table border="1" style="width: 100%; border-collapse: collapse; text-align: center;"> <tr> </tr></table></td></tr></table></td></tr></table></td></tr></table></td></tr></table></td></tr></table></td></tr></table></td></tr></table></td></tr></table></td></tr></table></td></tr></table></td></tr></table></td></tr></table></td></tr></table></td></tr></table></td></tr></table></td></tr></table></td></tr></table></td></tr></table></td></tr></table></td></tr></table></td></tr></table></td></tr></table></td></tr></table></td></tr></table></td></tr></table></td></tr></table></td></tr></table></td></tr></table>

 | | | | | | | | | | | | | | | | | | | | <table border="1" style="width: 100%; border-collapse: collapse; text-align: center;"> <tr> <td style="width: 10%;"></td> <td style="width: 10%;"></td> <td style="width: 10%;"></td> <td style="width: 10%;"></td> <td style="width: 10%;"></td> <td style="width: 10%;"></td> <td style="width: 10%;"></td> <td style="width: 10%;"></td> <td style="width: 10%;"></td> <td style="width: 10%;"></td> </tr> <tr> <td></td> <td></td> <td colspan="8" style="text-align: center;"> <table border="1" style="width: 100%; border-collapse: collapse; text-align: center;"> <tr> <td style="width: 10%;"></td> <td style="width: 10%;"></td> <td style="width: 10%;"></td> <td style="width: 10%;"></td> <td style="width: 10%;"></td> <td style="width: 10%;"></td> <td style="width: 10%;"></td> <td style="width: 10%;"></td> <td style="width: 10%;"></td> <td style="width: 10%;"></td> </tr> <tr> <td></td> <td></td> <td colspan="8" style="text-align: center;"> <table border="1" style="width: 100%; border-collapse: collapse; text-align: center;"> <tr> <td style="width: 10%;"></td> <td style="width: 10%;"></td> <td style="width: 10%;"></td> <td style="width: 10%;"></td> <td style="width: 10%;"></td> <td style="width: 10%;"></td> <td style="width: 10%;"></td> <td style="width: 10%;"></td> <td style="width: 10%;"></td> <td style="width: 10%;"></td> </tr> <tr> <td></td> <td></td> <td colspan="8" style="text-align: center;"> <table border="1" style="width: 100%; border-collapse: collapse; text-align: center;"> <tr> <td style="width: 10%;"></td> <td style="width: 10%;"></td> <td style="width: 10%;"></td> <td style="width: 10%;"></td> <td style="width: 10%;"></td> <td style="width: 10%;"></td> <td style="width: 10%;"></td> <td style="width: 10%;"></td> <td style="width: 10%;"></td> <td style="width: 10%;"></td> </tr> <tr> <td></td> <td></td> <td colspan="8" style="text-align: center;"> <table border="1" style="width: 100%; border-collapse: collapse; text-align: center;"> <tr> <td style="width: 10%;"></td> <td style="width: 10%;"></td> <td style="width: 10%;"></td> <td style="width: 10%;"></td> <td style="width: 10%;"></td> <td style="width: 10%;"></td> <td style="width: 10%;"></td> <td style="width: 10%;"></td> <td style="width: 10%;"></td> <td style="width: 10%;"></td> </tr> <tr> <td></td> <td></td> <td colspan="8" style="text-align: center;"> <table border="1" style="width: 100%; border-collapse: collapse; text-align: center;"> <tr> <td style="width: 10%;"></td> <td style="width: 10%;"></td> <td style="width: 10%;"></td> <td style="width: 10%;"></td> <td style="width: 10%;"></td> <td style="width: 10%;"></td> <td style="width: 10%;"></td> <td style="width: 10%;"></td> <td style="width: 10%;"></td> <td style="width: 10%;"></td> </tr> <tr> <td></td> <td></td> <td colspan="8" style="text-align: center;"> <table border="1" style="width: 100%; border-collapse: collapse; text-align: center;"> <tr> <td style="width: 10%;"></td> <td style="width: 10%;"></td> <td style="width: 10%;"></td> <td style="width: 10%;"></td> <td style="width: 10%;"></td> <td style="width: 10%;"></td> <td style="width: 10%;"></td> <td style="width: 10%;"></td> <td style="width: 10%;"></td> <td style="width: 10%;"></td> </tr> <tr> <td></td> <td></td> <td colspan="8" style="text-align: center;"> <table border="1" style="width: 100%; border-collapse: collapse; text-align: center;"> <tr> <td style="width: 10%;"></td> <td style="width: 10%;"></td> <td style="width: 10%;"></td> <td style="width: 10%;"></td> <td style="width: 10%;"></td> <td style="width: 10%;"></td> <td style="width: 10%;"></td> <td style="width: 10%;"></td> <td style="width: 10%;"></td> <td style="width: 10%;"></td> </tr> <tr> <td></td> <td></td> <td colspan="8" style="text-align: center;"> <table border="1" style="width: 100%; border-collapse: collapse; text-align: center;"> <tr> <td style="width: 10%;"></td> <td style="width: 10%;"></td> <td style="width: 10%;"></td> <td style="width: 10%;"></td> <td style="width: 10%;"></td> <td style="width: 10%;"></td> <td style="width: 10%;"></td> <td style="width: 10%;"></td> <td style="width: 10%;"></td> <td style="width: 10%;"></td> </tr> <tr> <td></td> <td></td> <td colspan="8" style="text-align: center;"> <table border="1" style="width: 100%; border-collapse: collapse; text-align: center;"> <tr> <td style="width: 10%;"></td> <td style="width: 10%;"></td> <td style="width: 10%;"></td> <td style="width: 10%;"></td> <td style="width: 10%;"></td> <td style="width: 10%;"></td> <td style="width: 10%;"></td> <td style="width: 10%;"></td> <td style="width: 10%;"></td> <td style="width: 10%;"></td> </tr> <tr> <td></td> <td></td> <td colspan="8" style="text-align: center;"> <table border="1" style="width: 100%; border-collapse: collapse; text-align: center;"> <tr> <td style="width: 10%;"></td> <td style="width: 10%;"></td> <td style="width: 10%;"></td> <td style="width: 10%;"></td> <td style="width: 10%;"></td> <td style="width: 10%;"></td> <td style="width: 10%;"></td> <td style="width: 10%;"></td> <td style="width: 10%;"></td> <td style="width: 10%;"></td> </tr> <tr> <td></td> <td></td> <td colspan="8" style="text-align: center;"> <table border="1" style="width: 100%; border-collapse: collapse; text-align: center;"> <tr> <td style="width: 10%;"></td> <td style="width: 10%;"></td> <td style="width: 10%;"></td> <td style="width: 10%;"></td> <td style="width: 10%;"></td> <td style="width: 10%;"></td> <td style="width: 10%;"></td> <td style="width: 10%;"></td> <td style="width: 10%;"></td> <td style="width: 10%;"></td> </tr> <tr> <td></td> <td></td> <td colspan="8" style="text-align: center;"> <table border="1" style="width: 100%; border-collapse: collapse; text-align: center;"> <tr> <td style="width: 10%;"></td> <td style="width: 10%;"></td> <td style="width: 10%;"></td> <td style="width: 10%;"></td> <td style="width: 10%;"></td> <td style="width: 10%;"></td> <td style="width: 10%;"></td> <td style="width: 10%;"></td> <td style="width: 10%;"></td> <td style="width: 10%;"></td> </tr> <tr> <td></td> <td></td> <td colspan="8" style="text-align: center;"> <table border="1" style="width: 100%; border-collapse: collapse; text-align: center;"> <tr> <td style="width: 10%;"></td> <td style="width: 10%;"></td> <td style="width: 10%;"></td> <td style="width: 10%;"></td> <td style="width: 10%;"></td> <td style="width: 10%;"></td> <td style="width: 10%;"></td> <td style="width: 10%;"></td> <td style="width: 10%;"></td> <td style="width: 10%;"></td> </tr> <tr> <td></td> <td></td> <td colspan="8" style="text-align: center;"> <table border="1" style="width: 100%; border-collapse: collapse; text-align: center;"> <tr> <td style="width: 10%;"></td> <td style="width: 10%;"></td> <td style="width: 10%;"></td> <td style="width: 10%;"></td> <td style="width: 10%;"></td> <td style="width: 10%;"></td> <td style="width: 10%;"></td> <td style="width: 10%;"></td> <td style="width: 10%;"></td> <td style="width: 10%;"></td> </tr> <tr> <td></td> <td></td> <td colspan="8" style="text-align: center;"> <table border="1" style="width: 100%; border-collapse: collapse; text-align: center;"> <tr> <td style="width: 10%;"></td> <td style="width: 10%;"></td> <td style="width: 10%;"></td> <td style="width: 10%;"></td> <td style="width: 10%;"></td> <td style="width: 10%;"></td> <td style="width: 10%;"></td> <td style="width: 10%;"></td> <td style="width: 10%;"></td> <td style="width: 10%;"></td> </tr> <tr> <td></td> <td></td> <td colspan="8" style="text-align: center;"> <table border="1" style="width: 100%; border-collapse: collapse; text-align: center;"> <tr> <td style="width: 10%;"></td> <td style="width: 10%;"></td> <td style="width: 10%;"></td> <td style="width: 10%;"></td> <td style="width: 10%;"></td> <td style="width: 10%;"></td> <td style="width: 10%;"></td> <td style="width: 10%;"></td> <td style="width: 10%;"></td> <td style="width: 10%;"></td> </tr> <tr> <td></td> <td></td> <td colspan="8" style="text-align: center;"> <table border="1" style="width: 100%; border-collapse: collapse; text-align: center;"> <tr> <td style="width: 10%;"></td> <td style="width: 10%;"></td> <td style="width: 10%;"></td> <td style="width: 10%;"></td> <td style="width: 10%;"></td> <td style="width: 10%;"></td> <td style="width: 10%;"></td> <td style="width: 10%;"></td> <td style="width: 10%;"></td> <td style="width: 10%;"></td> </tr> <tr> <td></td> <td></td> <td colspan="8" style="text-align: center;"> <table border="1" style="width: 100%; border-collapse: collapse; text-align: center;"> <tr> <td style="width: 10%;"></td> <td style="width: 10%;"></td> <td style="width: 10%;"></td> <td style="width: 10%;"></td> <td style="width: 10%;"></td> <td style="width: 10%;"></td> <td
style="width: 10%;"></td> <td style="width: 10%;"></td> <td style="width: 10%;"></td> <td style="width: 10%;"></td> </tr> <tr> <td></td> <td></td> <td colspan="8" style="text-align: center;"> <table border="1" style="width: 100%; border-collapse: collapse; text-align: center;"> <tr> <td style="width: 10%;"></td> <td style="width: 10%;"></td> <td style="width: 10%;"></td> <td style="width: 10%;"></td> <td style="width: 10%;"></td> <td style="width: 10%;"></td> <td style="width: 10%;"></td> <td style="width: 10%;"></td> <td style="width: 10%;"></td> <td style="width: 10%;"></td> </tr> <tr> <td></td> <td></td> <td colspan="8" style="text-align: center;"> <table border="1" style="width: 100%; border-collapse: collapse; text-align: center;"> <tr> <td style="width: 10%;"></td> <td style="width: 10%;"></td> <td style="width: 10%;"></td> <td style="width: 10%;"></td> <td style="width: 10%;"></td> <td style="width: 10%;"></td> <td style="width: 10%;"></td> <td style="width: 10%;"></td> <td style="width: 10%;"></td> <td style="width: 10%;"></td> </tr> <tr> <td></td> <td></td> <td colspan="8" style="text-align: center;"> <table border="1" style="width: 100%; border-collapse: collapse; text-align: center;"> <tr> <td style="width: 10%;"></td> <td style="width: 10%;"></td> <td style="width: 10%;"></td> <td style="width: 10%;"></td> <td style="width: 10%;"></td> <td style="width: 10%;"></td> <td style="width: 10%;"></td> <td style="width: 10%;"></td> <td style="width: 10%;"></td> <td style="width: 10%;"></td> </tr> <tr> <td></td> <td></td> <td colspan="8" style="text-align: center;"> <table border="1" style="width: 100%; border-collapse: collapse; text-align: center;"> <tr> <td style="width: 10%;"></td> <td style="width: 10%;"></td> <td style="width: 10%;"></td> <td style="width: 10%;"></td> <td style="width: 10%;"></td> <td style="width: 10%;"></td> <td style="width: 10%;"></td> <td style="width: 10%;"></td> <td style="width: 10%;"></td> <td style="width: 10%;"></td> </tr> <tr> <td></td> <td></td> <td colspan="8" style="text-align: center;"> <table border="1" style="width: 100%; border-collapse: collapse; text-align: center;"> <tr> <td style="width: 10%;"></td> <td style="width: 10%;"></td> <td style="width: 10%;"></td> <td style="width: 10%;"></td> <td style="width: 10%;"></td> <td style="width: 10%;"></td> <td style="width: 10%;"></td> <td style="width: 10%;"></td> <td style="width: 10%;"></td> <td style="width: 10%;"></td> </tr> <tr> <td></td> <td></td> <td colspan="8" style="text-align: center;"> <table border="1" style="width: 100%; border-collapse: collapse; text-align: center;"> <tr> <td style="width: 10%;"></td> <td style="width: 10%;"></td> <td style="width: 10%;"></td> <td style="width: 10%;"></td> <td style="width: 10%;"></td> <td style="width: 10%;"></td> <td style="width: 10%;"></td> <td style="width: 10%;"></td> <td style="width: 10%;"></td> <td style="width: 10%;"></td> </tr> <tr> <td></td> <td></td> <td colspan="8" style="text-align: center;"> <table border="1" style="width: 100%; border-collapse: collapse; text-align: center;"> <tr> <td style="width: 10%;"></td> <td style="width: 10%;"></td> <td style="width: 10%;"></td> <td style="width: 10%;"></td> <td style="width: 10%;"></td> <td style="width: 10%;"></td> <td style="width: 10%;"></td> <td style="width: 10%;"></td> <td style="width: 10%;"></td> <td style="width: 10%;"></td> </tr> <tr> <td></td> <td></td> <td colspan="8" style="text-align: center;"> <table border="1" style="width: 100%; border-collapse: collapse; text-align: center;"> <tr> <td style="width: 10%;"></td> <td style="width: 10%;"></td> <td style="width: 10%;"></td> <td style="width: 10%;"></td> <td style="width: 10%;"></td> <td style="width: 10%;"></td> <td style="width: 10%;"></td> <td style="width: 10%;"></td> <td style="width: 10%;"></td> <td style="width: 10%;"></td> </tr> <tr> <td></td> <td></td> <td colspan="8" style="text-align: center;"> <table border="1" style="width: 100%; border-collapse: collapse; text-align: center;"> <tr> </tr></table></td></tr></table></td></tr></table></td></tr></table></td></tr></table></td></tr></table></td></tr></table></td></tr></table></td></tr></table></td></tr></table></td></tr></table></td></tr></table></td></tr></table></td></tr></table></td></tr></table></td></tr></table></td></tr></table></td></tr></table></td></tr></table></td></tr></table></td></tr></table></td></tr></table></td></tr></table></td></tr></table></td></tr></table></td></tr></table></td></tr></table></td></tr></table>

 | | | | | | | | | | | | | | | | | | | | <table border="1" style="width: 100%; border-collapse: collapse; text-align: center;"> <tr> <td style="width: 10%;"></td> <td style="width: 10%;"></td> <td style="width: 10%;"></td> <td style="width: 10%;"></td> <td style="width: 10%;"></td> <td style="width: 10%;"></td> <td style="width: 10%;"></td> <td style="width: 10%;"></td> <td style="width: 10%;"></td> <td style="width: 10%;"></td> </tr> <tr> <td></td> <td></td> <td colspan="8" style="text-align: center;"> <table border="1" style="width: 100%; border-collapse: collapse; text-align: center;"> <tr> <td style="width: 10%;"></td> <td style="width: 10%;"></td> <td style="width: 10%;"></td> <td style="width: 10%;"></td> <td style="width: 10%;"></td> <td style="width: 10%;"></td> <td style="width: 10%;"></td> <td style="width: 10%;"></td> <td style="width: 10%;"></td> <td style="width: 10%;"></td> </tr> <tr> <td></td> <td></td> <td colspan="8" style="text-align: center;"> <table border="1" style="width: 100%; border-collapse: collapse; text-align: center;"> <tr> <td style="width: 10%;"></td> <td style="width: 10%;"></td> <td style="width: 10%;"></td> <td style="width: 10%;"></td> <td style="width: 10%;"></td> <td style="width: 10%;"></td> <td style="width: 10%;"></td> <td style="width: 10%;"></td> <td style="width: 10%;"></td> <td style="width: 10%;"></td> </tr> <tr> <td></td> <td></td> <td colspan="8" style="text-align: center;"> <table border="1" style="width: 100%; border-collapse: collapse; text-align: center;"> <tr> <td style="width: 10%;"></td> <td style="width: 10%;"></td> <td style="width: 10%;"></td> <td style="width: 10%;"></td> <td style="width: 10%;"></td> <td style="width: 10%;"></td> <td style="width: 10%;"></td> <td style="width: 10%;"></td> <td style="width: 10%;"></td> <td style="width: 10%;"></td> </tr> <tr> <td></td> <td></td> <td colspan="8" style="text-align: center;"> <table border="1" style="width: 100%; border-collapse: collapse; text-align: center;"> <tr> <td style="width: 10%;"></td> <td style="width: 10%;"></td> <td style="width: 10%;"></td> <td style="width: 10%;"></td> <td style="width: 10%;"></td> <td style="width: 10%;"></td> <td style="width: 10%;"></td> <td style="width: 10%;"></td> <td style="width: 10%;"></td> <td style="width: 10%;"></td> </tr> <tr> <td></td> <td></td> <td colspan="8" style="text-align: center;"> <table border="1" style="width: 100%; border-collapse: collapse; text-align: center;"> <tr> <td style="width: 10%;"></td> <td style="width: 10%;"></td> <td style="width: 10%;"></td> <td style="width: 10%;"></td> <td style="width: 10%;"></td> <td style="width: 10%;"></td> <td style="width: 10%;"></td> <td style="width: 10%;"></td> <td style="width: 10%;"></td> <td style="width: 10%;"></td> </tr> <tr> <td></td> <td></td> <td colspan="8" style="text-align: center;"> <table border="1" style="width: 100%; border-collapse: collapse; text-align: center;"> <tr> <td style="width: 10%;"></td> <td style="width: 10%;"></td> <td style="width: 10%;"></td> <td style="width: 10%;"></td> <td style="width: 10%;"></td> <td style="width: 10%;"></td> <td style="width: 10%;"></td> <td style="width: 10%;"></td> <td style="width: 10%;"></td> <td style="width: 10%;"></td> </tr> <tr> <td></td> <td></td> <td colspan="8" style="text-align: center;"> <table border="1" style="width: 100%; border-collapse: collapse; text-align: center;"> <tr> <td style="width: 10%;"></td> <td style="width: 10%;"></td> <td style="width: 10%;"></td> <td style="width: 10%;"></td> <td style="width: 10%;"></td> <td style="width: 10%;"></td> <td style="width: 10%;"></td> <td style="width: 10%;"></td> <td style="width: 10%;"></td> <td style="width: 10%;"></td> </tr> <tr> <td></td> <td></td> <td colspan="8" style="text-align: center;"> <table border="1" style="width: 100%; border-collapse: collapse; text-align: center;"> <tr> <td style="width: 10%;"></td> <td style="width: 10%;"></td> <td style="width: 10%;"></td> <td style="width: 10%;"></td> <td style="width: 10%;"></td> <td style="width: 10%;"></td> <td style="width: 10%;"></td> <td style="width: 10%;"></td> <td style="width: 10%;"></td> <td style="width: 10%;"></td> </tr> <tr> <td></td> <td></td> <td colspan="8" style="text-align: center;"> <table border="1" style="width: 100%; border-collapse: collapse; text-align: center;"> <tr> <td style="width: 10%;"></td> <td style="width: 10%;"></td> <td style="width: 10%;"></td> <td style="width: 10%;"></td> <td style="width: 10%;"></td> <td style="width: 10%;"></td> <td style="width: 10%;"></td> <td style="width: 10%;"></td> <td style="width: 10%;"></td> <td style="width: 10%;"></td> </tr> <tr> <td></td> <td></td> <td colspan="8" style="text-align: center;"> <table border="1" style="width: 100%; border-collapse: collapse; text-align: center;"> <tr> <td style="width: 10%;"></td> <td style="width: 10%;"></td> <td style="width: 10%;"></td> <td style="width: 10%;"></td> <td style="width: 10%;"></td> <td style="width: 10%;"></td> <td style="width: 10%;"></td> <td style="width: 10%;"></td> <td style="width: 10%;"></td> <td style="width: 10%;"></td> </tr> <tr> <td></td> <td></td> <td colspan="8" style="text-align: center;"> <table border="1" style="width: 100%; border-collapse: collapse; text-align: center;"> <tr> <td style="width: 10%;"></td> <td style="width: 10%;"></td> <td style="width: 10%;"></td> <td style="width: 10%;"></td> <td style="width: 10%;"></td> <td style="width: 10%;"></td> <td style="width: 10%;"></td> <td style="width: 10%;"></td> <td style="width: 10%;"></td> <td style="width: 10%;"></td> </tr> <tr> <td></td> <td></td> <td colspan="8" style="text-align: center;"> <table border="1" style="width: 100%; border-collapse: collapse; text-align: center;"> <tr> <td style="width: 10%;"></td> <td style="width: 10%;"></td> <td style="width: 10%;"></td> <td style="width: 10%;"></td> <td style="width: 10%;"></td> <td style="width: 10%;"></td> <td style="width: 10%;"></td> <td style="width: 10%;"></td> <td style="width: 10%;"></td> <td style="width: 10%;"></td> </tr> <tr> <td></td> <td></td> <td colspan="8" style="text-align: center;"> <table border="1" style="width: 100%; border-collapse: collapse; text-align: center;"> <tr> <td style="width: 10%;"></td> <td style="width: 10%;"></td> <td style="width: 10%;"></td> <td style="width: 10%;"></td> <td style="width: 10%;"></td> <td style="width: 10%;"></td> <td style="width: 10%;"></td> <td style="width: 10%;"></td> <td style="width: 10%;"></td> <td style="width: 10%;"></td> </tr> <tr> <td></td> <td></td> <td colspan="8" style="text-align: center;"> <table border="1" style="width: 100%; border-collapse: collapse; text-align: center;"> <tr> <td style="width: 10%;"></td> <td style="width: 10%;"></td> <td style="width: 10%;"></td> <td style="width: 10%;"></td> <td style="width: 10%;"></td> <td style="width: 10%;"></td> <td style="width: 10%;"></td> <td style="width: 10%;"></td> <td style="width: 10%;"></td> <td style="width: 10%;"></td> </tr> <tr> <td></td> <td></td> <td colspan="8" style="text-align: center;"> <table border="1" style="width: 100%; border-collapse: collapse; text-align: center;"> <tr> <td style="width: 10%;"></td> <td style="width: 10%;"></td> <td style="width: 10%;"></td> <td style="width: 10%;"></td> <td style="width: 10%;"></td> <td style="width: 10%;"></td> <td style="width: 10%;"></td> <td style="width: 10%;"></td> <td style="width: 10%;"></td> <td style="width: 10%;"></td> </tr> <tr> <td></td> <td></td> <td colspan="8" style="text-align: center;"> <table border="1" style="width: 100%; border-collapse: collapse; text-align: center;"> <tr> <td style="width: 10%;"></td> <td style="width: 10%;"></td> <td style="width: 10%;"></td> <td style="width: 10%;"></td> <td style="width: 10%;"></td> <td style="width: 10%;"></td> <td style="width: 10%;"></td> <td style="width: 10%;"></td> <td style="width: 10%;"></td> <td style="width: 10%;"></td> </tr> <tr> <td></td> <td></td> <td
colspan="8" style="text-align: center;"> <table border="1" style="width: 100%; border-collapse: collapse; text-align: center;"> <tr> <td style="width: 10%;"></td> <td style="width: 10%;"></td> <td style="width: 10%;"></td> <td style="width: 10%;"></td> <td style="width: 10%;"></td> <td style="width: 10%;"></td> <td style="width: 10%;"></td> <td style="width: 10%;"></td> <td style="width: 10%;"></td> <td style="width: 10%;"></td> </tr> <tr> <td></td> <td></td> <td colspan="8" style="text-align: center;"> <table border="1" style="width: 100%; border-collapse: collapse; text-align: center;"> <tr> <td style="width: 10%;"></td> <td style="width: 10%;"></td> <td style="width: 10%;"></td> <td style="width: 10%;"></td> <td style="width: 10%;"></td> <td style="width: 10%;"></td> <td style="width: 10%;"></td> <td style="width: 10%;"></td> <td style="width: 10%;"></td> <td style="width: 10%;"></td> </tr> <tr> <td></td> <td></td> <td colspan="8" style="text-align: center;"> <table border="1" style="width: 100%; border-collapse: collapse; text-align: center;"> <tr> <td style="width: 10%;"></td> <td style="width: 10%;"></td> <td style="width: 10%;"></td> <td style="width: 10%;"></td> <td style="width: 10%;"></td> <td style="width: 10%;"></td> <td style="width: 10%;"></td> <td style="width: 10%;"></td> <td style="width: 10%;"></td> <td style="width: 10%;"></td> </tr> <tr> <td></td> <td></td> <td colspan="8" style="text-align: center;"> <table border="1" style="width: 100%; border-collapse: collapse; text-align: center;"> <tr> <td style="width: 10%;"></td> <td style="width: 10%;"></td> <td style="width: 10%;"></td> <td style="width: 10%;"></td> <td style="width: 10%;"></td> <td style="width: 10%;"></td> <td style="width: 10%;"></td> <td style="width: 10%;"></td> <td style="width: 10%;"></td> <td style="width: 10%;"></td> </tr> <tr> <td></td> <td></td> <td colspan="8" style="text-align: center;"> <table border="1" style="width: 100%; border-collapse: collapse; text-align: center;"> <tr> <td style="width: 10%;"></td> <td style="width: 10%;"></td> <td style="width: 10%;"></td> <td style="width: 10%;"></td> <td style="width: 10%;"></td> <td style="width: 10%;"></td> <td style="width: 10%;"></td> <td style="width: 10%;"></td> <td style="width: 10%;"></td> <td style="width: 10%;"></td> </tr> <tr> <td></td> <td></td> <td colspan="8" style="text-align: center;"> <table border="1" style="width: 100%; border-collapse: collapse; text-align: center;"> <tr> <td style="width: 10%;"></td> <td style="width: 10%;"></td> <td style="width: 10%;"></td> <td style="width: 10%;"></td> <td style="width: 10%;"></td> <td style="width: 10%;"></td> <td style="width: 10%;"></td> <td style="width: 10%;"></td> <td style="width: 10%;"></td> <td style="width: 10%;"></td> </tr> <tr> <td></td> <td></td> <td colspan="8" style="text-align: center;"> <table border="1" style="width: 100%; border-collapse: collapse; text-align: center;"> <tr> <td style="width: 10%;"></td> <td style="width: 10%;"></td> <td style="width: 10%;"></td> <td style="width: 10%;"></td> <td style="width: 10%;"></td> <td style="width: 10%;"></td> <td style="width: 10%;"></td> <td style="width: 10%;"></td> <td style="width: 10%;"></td> <td style="width: 10%;"></td> </tr> <tr> <td></td> <td></td> <td colspan="8" style="text-align: center;"> <table border="1" style="width: 100%; border-collapse: collapse; text-align: center;"> <tr> <td style="width: 10%;"></td> <td style="width: 10%;"></td> <td style="width: 10%;"></td> <td style="width: 10%;"></td> <td style="width: 10%;"></td> <td style="width: 10%;"></td> <td style="width: 10%;"></td> <td style="width: 10%;"></td> <td style="width: 10%;"></td> <td style="width: 10%;"></td> </tr> <tr> <td></td> <td></td> <td colspan="8" style="text-align: center;"> <table border="1" style="width: 100%; border-collapse: collapse; text-align: center;"> <tr> <td style="width: 10%;"></td> <td style="width: 10%;"></td> <td style="width: 10%;"></td> <td style="width: 10%;"></td> <td style="width: 10%;"></td> <td style="width: 10%;"></td> <td style="width: 10%;"></td> <td style="width: 10%;"></td> <td style="width: 10%;"></td> <td style="width: 10%;"></td> </tr> <tr> <td></td> <td></td> <td colspan="8" style="text-align: center;"> <table border="1" style="width: 100%; border-collapse: collapse; text-align: center;"> <tr> </tr></table></td></tr></table></td></tr></table></td></tr></table></td></tr></table></td></tr></table></td></tr></table></td></tr></table></td></tr></table></td></tr></table></td></tr></table></td></tr></table></td></tr></table></td></tr></table></td></tr></table></td></tr></table></td></tr></table></td></tr></table></td></tr></table></td></tr></table></td></tr></table></td></tr></table></td></tr></table></td></tr></table></td></tr></table></td></tr></table></td></tr></table>

 | | | | | | | | | | | | | | | | | | | | <table border="1" style="width: 100%; border-collapse: collapse; text-align: center;"> <tr> <td style="width: 10%;"></td> <td style="width: 10%;"></td> <td style="width: 10%;"></td> <td style="width: 10%;"></td> <td style="width: 10%;"></td> <td style="width: 10%;"></td> <td style="width: 10%;"></td> <td style="width: 10%;"></td> <td style="width: 10%;"></td> <td style="width: 10%;"></td> </tr> <tr> <td></td> <td></td> <td colspan="8" style="text-align: center;"> <table border="1" style="width: 100%; border-collapse: collapse; text-align: center;"> <tr> <td style="width: 10%;"></td> <td style="width: 10%;"></td> <td style="width: 10%;"></td> <td style="width: 10%;"></td> <td style="width: 10%;"></td> <td style="width: 10%;"></td> <td style="width: 10%;"></td> <td style="width: 10%;"></td> <td style="width: 10%;"></td> <td style="width: 10%;"></td> </tr> <tr> <td></td> <td></td> <td colspan="8" style="text-align: center;"> <table border="1" style="width: 100%; border-collapse: collapse; text-align: center;"> <tr> <td style="width: 10%;"></td> <td style="width: 10%;"></td> <td style="width: 10%;"></td> <td style="width: 10%;"></td> <td style="width: 10%;"></td> <td style="width: 10%;"></td> <td style="width: 10%;"></td> <td style="width: 10%;"></td> <td style="width: 10%;"></td> <td style="width: 10%;"></td> </tr> <tr> <td></td> <td></td> <td colspan="8" style="text-align: center;"> <table border="1" style="width: 100%; border-collapse: collapse; text-align: center;"> <tr> <td style="width: 10%;"></td> <td style="width: 10%;"></td> <td style="width: 10%;"></td> <td style="width: 10%;"></td> <td style="width: 10%;"></td> <td style="width: 10%;"></td> <td style="width: 10%;"></td> <td style="width: 10%;"></td> <td style="width: 10%;"></td> <td style="width: 10%;"></td> </tr> <tr> <td></td> <td></td> <td colspan="8" style="text-align: center;"> <table border="1" style="width: 100%; border-collapse: collapse; text-align: center;"> <tr> <td style="width: 10%;"></td> <td style="width: 10%;"></td> <td style="width: 10%;"></td> <td style="width: 10%;"></td> <td style="width: 10%;"></td> <td style="width: 10%;"></td> <td style="width: 10%;"></td> <td style="width: 10%;"></td> <td style="width: 10%;"></td> <td style="width: 10%;"></td> </tr> <tr> <td></td> <td></td> <td colspan="8" style="text-align: center;"> <table border="1" style="width: 100%; border-collapse: collapse; text-align: center;"> <tr> <td style="width: 10%;"></td> <td style="width: 10%;"></td> <td style="width: 10%;"></td> <td style="width: 10%;"></td> <td style="width: 10%;"></td> <td style="width: 10%;"></td> <td style="width: 10%;"></td> <td style="width: 10%;"></td> <td style="width: 10%;"></td> <td style="width: 10%;"></td> </tr> <tr> <td></td> <td></td> <td colspan="8" style="text-align: center;"> <table border="1" style="width: 100%; border-collapse: collapse; text-align: center;"> <tr> <td style="width: 10%;"></td> <td style="width: 10%;"></td> <td style="width: 10%;"></td> <td style="width: 10%;"></td> <td style="width: 10%;"></td> <td style="width: 10%;"></td> <td style="width: 10%;"></td> <td style="width: 10%;"></td> <td style="width: 10%;"></td> <td style="width: 10%;"></td> </tr> <tr> <td></td> <td></td> <td colspan="8" style="text-align: center;"> <table border="1" style="width: 100%; border-collapse: collapse; text-align: center;"> <tr> <td style="width: 10%;"></td> <td style="width: 10%;"></td> <td style="width: 10%;"></td> <td style="width: 10%;"></td> <td style="width: 10%;"></td> <td style="width: 10%;"></td> <td style="width: 10%;"></td> <td style="width: 10%;"></td> <td style="width: 10%;"></td> <td style="width: 10%;"></td> </tr> <tr> <td></td> <td></td> <td colspan="8" style="text-align: center;"> <table border="1" style="width: 100%; border-collapse: collapse; text-align: center;"> <tr> <td style="width: 10%;"></td> <td style="width: 10%;"></td> <td style="width: 10%;"></td> <td style="width: 10%;"></td> <td style="width: 10%;"></td> <td style="width: 10%;"></td> <td style="width: 10%;"></td> <td style="width: 10%;"></td> <td style="width: 10%;"></td> <td style="width: 10%;"></td> </tr> <tr> <td></td> <td></td> <td colspan="8" style="text-align: center;"> <table border="1" style="width: 100%; border-collapse: collapse; text-align: center;"> <tr> <td style="width: 10%;"></td> <td style="width: 10%;"></td> <td style="width: 10%;"></td> <td style="width: 10%;"></td> <td style="width: 10%;"></td> <td style="width: 10%;"></td> <td style="width: 10%;"></td> <td style="width: 10%;"></td> <td style="width: 10%;"></td> <td style="width: 10%;"></td> </tr> <tr> <td></td> <td></td> <td colspan="8" style="text-align: center;"> <table border="1" style="width: 100%; border-collapse: collapse; text-align: center;"> <tr> <td style="width: 10%;"></td> <td style="width: 10%;"></td> <td style="width: 10%;"></td> <td style="width: 10%;"></td> <td style="width: 10%;"></td> <td style="width: 10%;"></td> <td style="width: 10%;"></td> <td style="width: 10%;"></td> <td style="width: 10%;"></td> <td style="width: 10%;"></td> </tr> <tr> <td></td> <td></td> <td colspan="8" style="text-align: center;"> <table border="1" style="width: 100%; border-collapse: collapse; text-align: center;"> <tr> <td style="width: 10%;"></td> <td style="width: 10%;"></td> <td style="width: 10%;"></td> <td style="width: 10%;"></td> <td style="width: 10%;"></td> <td style="width: 10%;"></td> <td style="width: 10%;"></td> <td style="width: 10%;"></td> <td style="width: 10%;"></td> <td style="width: 10%;"></td> </tr> <tr> <td></td> <td></td> <td colspan="8" style="text-align: center;"> <table border="1" style="width: 100%; border-collapse: collapse; text-align: center;"> <tr> <td style="width: 10%;"></td> <td style="width: 10%;"></td> <td style="width: 10%;"></td> <td style="width: 10%;"></td> <td style="width: 10%;"></td> <td style="width: 10%;"></td> <td style="width: 10%;"></td> <td style="width: 10%;"></td> <td style="width: 10%;"></td> <td style="width: 10%;"></td> </tr> <tr> <td></td> <td></td> <td colspan="8" style="text-align: center;"> <table border="1" style="width: 100%; border-collapse: collapse; text-align: center;"> <tr> <td style="width: 10%;"></td> <td style="width: 10%;"></td> <td style="width: 10%;"></td> <td style="width: 10%;"></td> <td style="width: 10%;"></td> <td style="width: 10%;"></td> <td style="width: 10%;"></td> <td style="width: 10%;"></td> <td style="width: 10%;"></td> <td style="width: 10%;"></td> </tr> <tr> <td></td> <td></td> <td colspan="8" style="text-align: center;"> <table border="1" style="width: 100%; border-collapse: collapse; text-align: center;"> <tr> <td style="width: 10%;"></td> <td style="width: 10%;"></td> <td style="width: 10%;"></td> <td style="width: 10%;"></td> <td style="width: 10%;"></td> <td style="width: 10%;"></td> <td style="width: 10%;"></td> <td style="width: 10%;"></td> <td style="width: 10%;"></td> <td style="width: 10%;"></td> </tr> <tr> <td></td> <td></td> <td colspan="8" style="text-align: center;"> <table border="1" style="width: 100%; border-collapse: collapse; text-align: center;"> <tr> <td style="width: 10%;"></td> <td style="width: 10%;"></td> <td style="width: 10%;"></td> <td style="width: 10%;"></td> <td style="width: 10%;"></td> <td style="width: 10%;"></td> <td style="width: 10%;"></td> <td style="width: 10%;"></td> <td style="width: 10%;"></td> <td style="width: 10%;"></td> </tr> <tr> <td></td> <td></td> <td colspan="8" style="text-align: center;"> <table border="1" style="width: 100%; border-collapse: collapse; text-align: center;"> <tr> <td style="width: 10%;"></td> <td
style="width: 10%;"></td> <td style="width: 10%;"></td> <td style="width: 10%;"></td> <td style="width: 10%;"></td> <td style="width: 10%;"></td> <td style="width: 10%;"></td> <td style="width: 10%;"></td> <td style="width: 10%;"></td> <td style="width: 10%;"></td> </tr> <tr> <td></td> <td></td> <td colspan="8" style="text-align: center;"> <table border="1" style="width: 100%; border-collapse: collapse; text-align: center;"> <tr> <td style="width: 10%;"></td> <td style="width: 10%;"></td> <td style="width: 10%;"></td> <td style="width: 10%;"></td> <td style="width: 10%;"></td> <td style="width: 10%;"></td> <td style="width: 10%;"></td> <td style="width: 10%;"></td> <td style="width: 10%;"></td> <td style="width: 10%;"></td> </tr> <tr> <td></td> <td></td> <td colspan="8" style="text-align: center;"> <table border="1" style="width: 100%; border-collapse: collapse; text-align: center;"> <tr> <td style="width: 10%;"></td> <td style="width: 10%;"></td> <td style="width: 10%;"></td> <td style="width: 10%;"></td> <td style="width: 10%;"></td> <td style="width: 10%;"></td> <td style="width: 10%;"></td> <td style="width: 10%;"></td> <td style="width: 10%;"></td> <td style="width: 10%;"></td> </tr> <tr> <td></td> <td></td> <td colspan="8" style="text-align: center;"> <table border="1" style="width: 100%; border-collapse: collapse; text-align: center;"> <tr> <td style="width: 10%;"></td> <td style="width: 10%;"></td> <td style="width: 10%;"></td> <td style="width: 10%;"></td> <td style="width: 10%;"></td> <td style="width: 10%;"></td> <td style="width: 10%;"></td> <td style="width: 10%;"></td> <td style="width: 10%;"></td> <td style="width: 10%;"></td> </tr> <tr> <td></td> <td></td> <td colspan="8" style="text-align: center;"> <table border="1" style="width: 100%; border-collapse: collapse; text-align: center;"> <tr> <td style="width: 10%;"></td> <td style="width: 10%;"></td> <td style="width: 10%;"></td> <td style="width: 10%;"></td> <td style="width: 10%;"></td> <td style="width: 10%;"></td> <td style="width: 10%;"></td> <td style="width: 10%;"></td> <td style="width: 10%;"></td> <td style="width: 10%;"></td> </tr> <tr> <td></td> <td></td> <td colspan="8" style="text-align: center;"> <table border="1" style="width: 100%; border-collapse: collapse; text-align: center;"> <tr> <td style="width: 10%;"></td> <td style="width: 10%;"></td> <td style="width: 10%;"></td> <td style="width: 10%;"></td> <td style="width: 10%;"></td> <td style="width: 10%;"></td> <td style="width: 10%;"></td> <td style="width: 10%;"></td> <td style="width: 10%;"></td> <td style="width: 10%;"></td> </tr> <tr> <td></td> <td></td> <td colspan="8" style="text-align: center;"> <table border="1" style="width: 100%; border-collapse: collapse; text-align: center;"> <tr> <td style="width: 10%;"></td> <td style="width: 10%;"></td> <td style="width: 10%;"></td> <td style="width: 10%;"></td> <td style="width: 10%;"></td> <td style="width: 10%;"></td> <td style="width: 10%;"></td> <td style="width: 10%;"></td> <td style="width: 10%;"></td> <td style="width: 10%;"></td> </tr> <tr> <td></td> <td></td> <td colspan="8" style="text-align: center;"> <table border="1" style="width: 100%; border-collapse: collapse; text-align: center;"> <tr> <td style="width: 10%;"></td> <td style="width: 10%;"></td> <td style="width: 10%;"></td> <td style="width: 10%;"></td> <td style="width: 10%;"></td> <td style="width: 10%;"></td> <td style="width: 10%;"></td> <td style="width: 10%;"></td> <td style="width: 10%;"></td> <td style="width: 10%;"></td> </tr> <tr> <td></td> <td></td> <td colspan="8" style="text-align: center;"> <table border="1" style="width: 100%; border-collapse: collapse; text-align: center;"> <tr> <td style="width: 10%;"></td> <td style="width: 10%;"></td> <td style="width: 10%;"></td> <td style="width: 10%;"></td> <td style="width: 10%;"></td> <td style="width: 10%;"></td> <td style="width: 10%;"></td> <td style="width: 10%;"></td> <td style="width: 10%;"></td> <td style="width: 10%;"></td> </tr> <tr> <td></td> <td></td> <td colspan="8" style="text-align: center;"> <table border="1" style="width: 100%; border-collapse: collapse; text-align: center;"> <tr> </tr></table></td></tr></table></td></tr></table></td></tr></table></td></tr></table></td></tr></table></td></tr></table></td></tr></table></td></tr></table></td></tr></table></td></tr></table></td></tr></table></td></tr></table></td></tr></table></td></tr></table></td></tr></table></td></tr></table></td></tr></table></td></tr></table></td></tr></table></td></tr></table></td></tr></table></td></tr></table></td></tr></table></td></tr></table></td></tr></table>

 | | | | | | | | | | | | | | | | | | | | <table border="1" style="width: 100%; border-collapse: collapse; text-align: center;"> <tr> <td style="width: 10%;"></td> <td style="width: 10%;"></td> <td style="width: 10%;"></td> <td style="width: 10%;"></td> <td style="width: 10%;"></td> <td style="width: 10%;"></td> <td style="width: 10%;"></td> <td style="width: 10%;"></td> <td style="width: 10%;"></td> <td style="width: 10%;"></td> </tr> <tr> <td></td> <td></td> <td colspan="8" style="text-align: center;"> <table border="1" style="width: 100%; border-collapse: collapse; text-align: center;"> <tr> <td style="width: 10%;"></td> <td style="width: 10%;"></td> <td style="width: 10%;"></td> <td style="width: 10%;"></td> <td style="width: 10%;"></td> <td style="width: 10%;"></td> <td style="width: 10%;"></td> <td style="width: 10%;"></td> <td style="width: 10%;"></td> <td style="width: 10%;"></td> </tr> <tr> <td></td> <td></td> <td colspan="8" style="text-align: center;"> <table border="1" style="width: 100%; border-collapse: collapse; text-align: center;"> <tr> <td style="width: 10%;"></td> <td style="width: 10%;"></td> <td style="width: 10%;"></td> <td style="width: 10%;"></td> <td style="width: 10%;"></td> <td style="width: 10%;"></td> <td style="width: 10%;"></td> <td style="width: 10%;"></td> <td style="width: 10%;"></td> <td style="width: 10%;"></td> </tr> <tr> <td></td> <td></td> <td colspan="8" style="text-align: center;"> <table border="1" style="width: 100%; border-collapse: collapse; text-align: center;"> <tr> <td style="width: 10%;"></td> <td style="width: 10%;"></td> <td style="width: 10%;"></td> <td style="width: 10%;"></td> <td style="width: 10%;"></td> <td style="width: 10%;"></td> <td style="width: 10%;"></td> <td style="width: 10%;"></td> <td style="width: 10%;"></td> <td style="width: 10%;"></td> </tr> <tr> <td></td> <td></td> <td colspan="8" style="text-align: center;"> <table border="1" style="width: 100%; border-collapse: collapse; text-align: center;"> <tr> <td style="width: 10%;"></td> <td style="width: 10%;"></td> <td style="width: 10%;"></td> <td style="width: 10%;"></td> <td style="width: 10%;"></td> <td style="width: 10%;"></td> <td style="width: 10%;"></td> <td style="width: 10%;"></td> <td style="width: 10%;"></td> <td style="width: 10%;"></td> </tr> <tr> <td></td> <td></td> <td colspan="8" style="text-align: center;"> <table border="1" style="width: 100%; border-collapse: collapse; text-align: center;"> <tr> <td style="width: 10%;"></td> <td style="width: 10%;"></td> <td style="width: 10%;"></td> <td style="width: 10%;"></td> <td style="width: 10%;"></td> <td style="width: 10%;"></td> <td style="width: 10%;"></td> <td style="width: 10%;"></td> <td style="width: 10%;"></td> <td style="width: 10%;"></td> </tr> <tr> <td></td> <td></td> <td colspan="8" style="text-align: center;"> <table border="1" style="width: 100%; border-collapse: collapse; text-align: center;"> <tr> <td style="width: 10%;"></td> <td style="width: 10%;"></td> <td style="width: 10%;"></td> <td style="width: 10%;"></td> <td style="width: 10%;"></td> <td style="width: 10%;"></td> <td style="width: 10%;"></td> <td style="width: 10%;"></td> <td style="width: 10%;"></td> <td style="width: 10%;"></td> </tr> <tr> <td></td> <td></td> <td colspan="8" style="text-align: center;"> <table border="1" style="width: 100%; border-collapse: collapse; text-align: center;"> <tr> <td style="width: 10%;"></td> <td style="width: 10%;"></td> <td style="width: 10%;"></td> <td style="width: 10%;"></td> <td style="width: 10%;"></td> <td style="width: 10%;"></td> <td style="width: 10%;"></td> <td style="width: 10%;"></td> <td style="width: 10%;"></td> <td style="width: 10%;"></td> </tr> <tr> <td></td> <td></td> <td colspan="8" style="text-align: center;"> <table border="1" style="width: 100%; border-collapse: collapse; text-align: center;"> <tr> <td style="width: 10%;"></td> <td style="width: 10%;"></td> <td style="width: 10%;"></td> <td style="width: 10%;"></td> <td style="width: 10%;"></td> <td style="width: 10%;"></td> <td style="width: 10%;"></td> <td style="width: 10%;"></td> <td style="width: 10%;"></td> <td style="width: 10%;"></td> </tr> <tr> <td></td> <td></td> <td colspan="8" style="text-align: center;"> <table border="1" style="width: 100%; border-collapse: collapse; text-align: center;"> <tr> <td style="width: 10%;"></td> <td style="width: 10%;"></td> <td style="width: 10%;"></td> <td style="width: 10%;"></td> <td style="width: 10%;"></td> <td style="width: 10%;"></td> <td style="width: 10%;"></td> <td style="width: 10%;"></td> <td style="width: 10%;"></td> <td style="width: 10%;"></td> </tr> <tr> <td></td> <td></td> <td colspan="8" style="text-align: center;"> <table border="1" style="width: 100%; border-collapse: collapse; text-align: center;"> <tr> <td style="width: 10%;"></td> <td style="width: 10%;"></td> <td style="width: 10%;"></td> <td style="width: 10%;"></td> <td style="width: 10%;"></td> <td style="width: 10%;"></td> <td style="width: 10%;"></td> <td style="width: 10%;"></td> <td style="width: 10%;"></td> <td style="width: 10%;"></td> </tr> <tr> <td></td> <td></td> <td colspan="8" style="text-align: center;"> <table border="1" style="width: 100%; border-collapse: collapse; text-align: center;"> <tr> <td style="width: 10%;"></td> <td style="width: 10%;"></td> <td style="width: 10%;"></td> <td style="width: 10%;"></td> <td style="width: 10%;"></td> <td style="width: 10%;"></td> <td style="width: 10%;"></td> <td style="width: 10%;"></td> <td style="width: 10%;"></td> <td style="width: 10%;"></td> </tr> <tr> <td></td> <td></td> <td colspan="8" style="text-align: center;"> <table border="1" style="width: 100%; border-collapse: collapse; text-align: center;"> <tr> <td style="width: 10%;"></td> <td style="width: 10%;"></td> <td style="width: 10%;"></td> <td style="width: 10%;"></td> <td style="width: 10%;"></td> <td style="width: 10%;"></td> <td style="width: 10%;"></td> <td style="width: 10%;"></td> <td style="width: 10%;"></td> <td style="width: 10%;"></td> </tr> <tr> <td></td> <td></td> <td colspan="8" style="text-align: center;"> <table border="1" style="width: 100%; border-collapse: collapse; text-align: center;"> <tr> <td style="width: 10%;"></td> <td style="width: 10%;"></td> <td style="width: 10%;"></td> <td style="width: 10%;"></td> <td style="width: 10%;"></td> <td style="width: 10%;"></td> <td style="width: 10%;"></td> <td style="width: 10%;"></td> <td style="width: 10%;"></td> <td style="width: 10%;"></td> </tr> <tr> <td></td> <td></td> <td colspan="8" style="text-align: center;"> <table border="1" style="width: 100%; border-collapse: collapse; text-align: center;"> <tr> <td style="width: 10%;"></td> <td style="width: 10%;"></td> <td style="width: 10%;"></td> <td style="width: 10%;"></td> <td style="width: 10%;"></td> <td style="width: 10%;"></td> <td style="width: 10%;"></td> <td style="width: 10%;"></td> <td style="width: 10%;"></td> <td style="width: 10%;"></td> </tr> <tr> <td></td> <td></td> <td colspan="8" style="text-align: center;"> <table border="1" style="width: 100%; border-collapse: collapse; text-align: center;"> <tr> <td style="width: 10%;"></td> <td style="width: 10%;"></td> <td style="width: 10%;"></td> <td style="width: 10%;"></td> <td style="width: 10%;"></td> <td style="width: 10%;"></td> <td style="width: 10%;"></td> <td style="width: 10%;"></td> <td style="width: 10%;"></td> <td style="width: 10%;"></td> </tr> <tr> <td></td> <td></td> <td colspan="8" style="text-align: center;"> <table border="1" style="width: 100%; border-collapse: collapse; text-align: center;"> <tr> <td style="width: 10%;"></td> <td style="width: 10%;"></td> <td style="width: 10%;"></td> <td style="width: 10%;"></td> <td style="width: 10%;"></td> <td style="width: 10%;"></td> <td style="width: 10%;"></td> <td
style="width: 10%;"></td> <td style="width: 10%;"></td> <td style="width: 10%;"></td> </tr> <tr> <td></td> <td></td> <td colspan="8" style="text-align: center;"> <table border="1" style="width: 100%; border-collapse: collapse; text-align: center;"> <tr> <td style="width: 10%;"></td> <td style="width: 10%;"></td> <td style="width: 10%;"></td> <td style="width: 10%;"></td> <td style="width: 10%;"></td> <td style="width: 10%;"></td> <td style="width: 10%;"></td> <td style="width: 10%;"></td> <td style="width: 10%;"></td> <td style="width: 10%;"></td> </tr> <tr> <td></td> <td></td> <td colspan="8" style="text-align: center;"> <table border="1" style="width: 100%; border-collapse: collapse; text-align: center;"> <tr> <td style="width: 10%;"></td> <td style="width: 10%;"></td> <td style="width: 10%;"></td> <td style="width: 10%;"></td> <td style="width: 10%;"></td> <td style="width: 10%;"></td> <td style="width: 10%;"></td> <td style="width: 10%;"></td> <td style="width: 10%;"></td> <td style="width: 10%;"></td> </tr> <tr> <td></td> <td></td> <td colspan="8" style="text-align: center;"> <table border="1" style="width: 100%; border-collapse: collapse; text-align: center;"> <tr> <td style="width: 10%;"></td> <td style="width: 10%;"></td> <td style="width: 10%;"></td> <td style="width: 10%;"></td> <td style="width: 10%;"></td> <td style="width: 10%;"></td> <td style="width: 10%;"></td> <td style="width: 10%;"></td> <td style="width: 10%;"></td> <td style="width: 10%;"></td> </tr> <tr> <td></td> <td></td> <td colspan="8" style="text-align: center;"> <table border="1" style="width: 100%; border-collapse: collapse; text-align: center;"> <tr> <td style="width: 10%;"></td> <td style="width: 10%;"></td> <td style="width: 10%;"></td> <td style="width: 10%;"></td> <td style="width: 10%;"></td> <td style="width: 10%;"></td> <td style="width: 10%;"></td> <td style="width: 10%;"></td> <td style="width: 10%;"></td> <td style="width: 10%;"></td> </tr> <tr> <td></td> <td></td> <td colspan="8" style="text-align: center;"> <table border="1" style="width: 100%; border-collapse: collapse; text-align: center;"> <tr> <td style="width: 10%;"></td> <td style="width: 10%;"></td> <td style="width: 10%;"></td> <td style="width: 10%;"></td> <td style="width: 10%;"></td> <td style="width: 10%;"></td> <td style="width: 10%;"></td> <td style="width: 10%;"></td> <td style="width: 10%;"></td> <td style="width: 10%;"></td> </tr> <tr> <td></td> <td></td> <td colspan="8" style="text-align: center;"> <table border="1" style="width: 100%; border-collapse: collapse; text-align: center;"> <tr> <td style="width: 10%;"></td> <td style="width: 10%;"></td> <td style="width: 10%;"></td> <td style="width: 10%;"></td> <td style="width: 10%;"></td> <td style="width: 10%;"></td> <td style="width: 10%;"></td> <td style="width: 10%;"></td> <td style="width: 10%;"></td> <td style="width: 10%;"></td> </tr> <tr> <td></td> <td></td> <td colspan="8" style="text-align: center;"> <table border="1" style="width: 100%; border-collapse: collapse; text-align: center;"> <tr> <td style="width: 10%;"></td> <td style="width: 10%;"></td> <td style="width: 10%;"></td> <td style="width: 10%;"></td> <td style="width: 10%;"></td> <td style="width: 10%;"></td> <td style="width: 10%;"></td> <td style="width: 10%;"></td> <td style="width: 10%;"></td> <td style="width: 10%;"></td> </tr> <tr> <td></td> <td></td> <td colspan="8" style="text-align: center;"> <table border="1" style="width: 100%; border-collapse: collapse; text-align: center;"> <tr> </tr></table></td></tr></table></td></tr></table></td></tr></table></td></tr></table></td></tr></table></td></tr></table></td></tr></table></td></tr></table></td></tr></table></td></tr></table></td></tr></table></td></tr></table></td></tr></table></td></tr></table></td></tr></table></td></tr></table></td></tr></table></td></tr></table></td></tr></table></td></tr></table></td></tr></table></td></tr></table></td></tr></table></td></tr></table>

 | | | | | | | | | | | | | | | | | | | | <table border="1" style="width: 100%; border-collapse: collapse; text-align: center;"> <tr> <td style="width: 10%;"></td> <td style="width: 10%;"></td> <td style="width: 10%;"></td> <td style="width: 10%;"></td> <td style="width: 10%;"></td> <td style="width: 10%;"></td> <td style="width: 10%;"></td> <td style="width: 10%;"></td> <td style="width: 10%;"></td> <td style="width: 10%;"></td> </tr> <tr> <td></td> <td></td> <td colspan="8" style="text-align: center;"> <table border="1" style="width: 100%; border-collapse: collapse; text-align: center;"> <tr> <td style="width: 10%;"></td> <td style="width: 10%;"></td> <td style="width: 10%;"></td> <td style="width: 10%;"></td> <td style="width: 10%;"></td> <td style="width: 10%;"></td> <td style="width: 10%;"></td> <td style="width: 10%;"></td> <td style="width: 10%;"></td> <td style="width: 10%;"></td> </tr> <tr> <td></td> <td></td> <td colspan="8" style="text-align: center;"> <table border="1" style="width: 100%; border-collapse: collapse; text-align: center;"> <tr> <td style="width: 10%;"></td> <td style="width: 10%;"></td> <td style="width: 10%;"></td> <td style="width: 10%;"></td> <td style="width: 10%;"></td> <td style="width: 10%;"></td> <td style="width: 10%;"></td> <td style="width: 10%;"></td> <td style="width: 10%;"></td> <td style="width: 10%;"></td> </tr> <tr> <td></td> <td></td> <td colspan="8" style="text-align: center;"> <table border="1" style="width: 100%; border-collapse: collapse; text-align: center;"> <tr> <td style="width: 10%;"></td> <td style="width: 10%;"></td> <td style="width: 10%;"></td> <td style="width: 10%;"></td> <td style="width: 10%;"></td> <td style="width: 10%;"></td> <td style="width: 10%;"></td> <td style="width: 10%;"></td> <td style="width: 10%;"></td> <td style="width: 10%;"></td> </tr> <tr> <td></td> <td></td> <td colspan="8" style="text-align: center;"> <table border="1" style="width: 100%; border-collapse: collapse; text-align: center;"> <tr> <td style="width: 10%;"></td> <td style="width: 10%;"></td> <td style="width: 10%;"></td> <td style="width: 10%;"></td> <td style="width: 10%;"></td> <td style="width: 10%;"></td> <td style="width: 10%;"></td> <td style="width: 10%;"></td> <td style="width: 10%;"></td> <td style="width: 10%;"></td> </tr> <tr> <td></td> <td></td> <td colspan="8" style="text-align: center;"> <table border="1" style="width: 100%; border-collapse: collapse; text-align: center;"> <tr> <td style="width: 10%;"></td> <td style="width: 10%;"></td> <td style="width: 10%;"></td> <td style="width: 10%;"></td> <td style="width: 10%;"></td> <td style="width: 10%;"></td> <td style="width: 10%;"></td> <td style="width: 10%;"></td> <td style="width: 10%;"></td> <td style="width: 10%;"></td> </tr> <tr> <td></td> <td></td> <td colspan="8" style="text-align: center;"> <table border="1" style="width: 100%; border-collapse: collapse; text-align: center;"> <tr> <td style="width: 10%;"></td> <td style="width: 10%;"></td> <td style="width: 10%;"></td> <td style="width: 10%;"></td> <td style="width: 10%;"></td> <td style="width: 10%;"></td> <td style="width: 10%;"></td> <td style="width: 10%;"></td> <td style="width: 10%;"></td> <td style="width: 10%;"></td> </tr> <tr> <td></td> <td></td> <td colspan="8" style="text-align: center;"> <table border="1" style="width: 100%; border-collapse: collapse; text-align: center;"> <tr> <td style="width: 10%;"></td> <td style="width: 10%;"></td> <td style="width: 10%;"></td> <td style="width: 10%;"></td> <td style="width: 10%;"></td> <td style="width: 10%;"></td> <td style="width: 10%;"></td> <td style="width: 10%;"></td> <td style="width: 10%;"></td> <td style="width: 10%;"></td> </tr> <tr> <td></td> <td></td> <td colspan="8" style="text-align: center;"> <table border="1" style="width: 100%; border-collapse: collapse; text-align: center;"> <tr> <td style="width: 10%;"></td> <td style="width: 10%;"></td> <td style="width: 10%;"></td> <td style="width: 10%;"></td> <td style="width: 10%;"></td> <td style="width: 10%;"></td> <td style="width: 10%;"></td> <td style="width: 10%;"></td> <td style="width: 10%;"></td> <td style="width: 10%;"></td> </tr> <tr> <td></td> <td></td> <td colspan="8" style="text-align: center;"> <table border="1" style="width: 100%; border-collapse: collapse; text-align: center;"> <tr> <td style="width: 10%;"></td> <td style="width: 10%;"></td> <td style="width: 10%;"></td> <td style="width: 10%;"></td> <td style="width: 10%;"></td> <td style="width: 10%;"></td> <td style="width: 10%;"></td> <td style="width: 10%;"></td> <td style="width: 10%;"></td> <td style="width: 10%;"></td> </tr> <tr> <td></td> <td></td> <td colspan="8" style="text-align: center;"> <table border="1" style="width: 100%; border-collapse: collapse; text-align: center;"> <tr> <td style="width: 10%;"></td> <td style="width: 10%;"></td> <td style="width: 10%;"></td> <td style="width: 10%;"></td> <td style="width: 10%;"></td> <td style="width: 10%;"></td> <td style="width: 10%;"></td> <td style="width: 10%;"></td> <td style="width: 10%;"></td> <td style="width: 10%;"></td> </tr> <tr> <td></td> <td></td> <td colspan="8" style="text-align: center;"> <table border="1" style="width: 100%; border-collapse: collapse; text-align: center;"> <tr> <td style="width: 10%;"></td> <td style="width: 10%;"></td> <td style="width: 10%;"></td> <td style="width: 10%;"></td> <td style="width: 10%;"></td> <td style="width: 10%;"></td> <td style="width: 10%;"></td> <td style="width: 10%;"></td> <td style="width: 10%;"></td> <td style="width: 10%;"></td> </tr> <tr> <td></td> <td></td> <td colspan="8" style="text-align: center;"> <table border="1" style="width: 100%; border-collapse: collapse; text-align: center;"> <tr> <td style="width: 10%;"></td> <td style="width: 10%;"></td> <td style="width: 10%;"></td> <td style="width: 10%;"></td> <td style="width: 10%;"></td> <td style="width: 10%;"></td> <td style="width: 10%;"></td> <td style="width: 10%;"></td> <td style="width: 10%;"></td> <td style="width: 10%;"></td> </tr> <tr> <td></td> <td></td> <td colspan="8" style="text-align: center;"> <table border="1" style="width: 100%; border-collapse: collapse; text-align: center;"> <tr> <td style="width: 10%;"></td> <td style="width: 10%;"></td> <td style="width: 10%;"></td> <td style="width: 10%;"></td> <td style="width: 10%;"></td> <td style="width: 10%;"></td> <td style="width: 10%;"></td> <td style="width: 10%;"></td> <td style="width: 10%;"></td> <td style="width: 10%;"></td> </tr> <tr> <td></td> <td></td> <td colspan="8" style="text-align: center;"> <table border="1" style="width: 100%; border-collapse: collapse; text-align: center;"> <tr> <td style="width: 10%;"></td> <td style="width: 10%;"></td> <td style="width: 10%;"></td> <td style="width: 10%;"></td> <td style="width: 10%;"></td> <td style="width: 10%;"></td> <td style="width: 10%;"></td> <td style="width: 10%;"></td> <td style="width: 10%;"></td> <td style="width: 10%;"></td> </tr> <tr> <td></td> <td></td> <td colspan="8" style="text-align: center;"> <table border="1" style="width: 100%; border-collapse: collapse; text-align: center;"> <tr> <td style="width: 10%;"></td> <td style="width: 10%;"></td> <td style="width: 10%;"></td> <td style="width: 10%;"></td> <td style="width: 10%;"></td> <td style="width: 10%;"></td> <td style="width: 10%;"></td> <td style="width: 10%;"></td> <td style="width: 10%;"></td> <td style="width: 10%;"></td> </tr> <tr> <td></td> <td></td> <td colspan="8" style="text-align: center;"> <table border="1" style="width: 100%; border-collapse: collapse; text-align: center;"> <tr> <td style="width: 10%;"></td> <td style="width: 10%;"></td> <td style="width: 10%;"></td> <td style="width: 10%;"></td> <td style="width: 10%;"></td> <td style="width: 10%;"></td> <td style="width: 10%;"></td> <td style="width: 10%;"></td> <td style="width: 10%;"></td> <td style="width: 10%;"></td> </tr> <tr> <td></td> <td></td> <td colspan="8" style="text-align: center;"> <table border="1" style="width: 100%; border-collapse: collapse; text-align: center;"> <tr> <td style="width: 10%;"></td> <td style="width: 10%;"></td> <td style="width: 10%;"></td> <td style="width: 10%;"></td> <td style="width: 10%;"></td> <td style="width: 10%;"></td> <td style="width: 10%;"></td> <td style="width: 10%;"></td> <td style="width: 10%;"></td> <td style="width: 10%;"></td> </tr> <tr> <td></td> <td></td> <td colspan="8" style="text-align: center;"> <table border="1" style="width: 100%;
border-collapse: collapse; text-align: center;"> <tr> <td style="width: 10%;"></td> <td style="width: 10%;"></td> <td style="width: 10%;"></td> <td style="width: 10%;"></td> <td style="width: 10%;"></td> <td style="width: 10%;"></td> <td style="width: 10%;"></td> <td style="width: 10%;"></td> <td style="width: 10%;"></td> <td style="width: 10%;"></td> </tr> <tr> <td></td> <td></td> <td colspan="8" style="text-align: center;"> <table border="1" style="width: 100%; border-collapse: collapse; text-align: center;"> <tr> <td style="width: 10%;"></td> <td style="width: 10%;"></td> <td style="width: 10%;"></td> <td style="width: 10%;"></td> <td style="width: 10%;"></td> <td style="width: 10%;"></td> <td style="width: 10%;"></td> <td style="width: 10%;"></td> <td style="width: 10%;"></td> <td style="width: 10%;"></td> </tr> <tr> <td></td> <td></td> <td colspan="8" style="text-align: center;"> <table border="1" style="width: 100%; border-collapse: collapse; text-align: center;"> <tr> <td style="width: 10%;"></td> <td style="width: 10%;"></td> <td style="width: 10%;"></td> <td style="width: 10%;"></td> <td style="width: 10%;"></td> <td style="width: 10%;"></td> <td style="width: 10%;"></td> <td style="width: 10%;"></td> <td style="width: 10%;"></td> <td style="width: 10%;"></td> </tr> <tr> <td></td> <td></td> <td colspan="8" style="text-align: center;"> <table border="1" style="width: 100%; border-collapse: collapse; text-align: center;"> <tr> <td style="width: 10%;"></td> <td style="width: 10%;"></td> <td style="width: 10%;"></td> <td style="width: 10%;"></td> <td style="width: 10%;"></td> <td style="width: 10%;"></td> <td style="width: 10%;"></td> <td style="width: 10%;"></td> <td style="width: 10%;"></td> <td style="width: 10%;"></td> </tr> <tr> <td></td> <td></td> <td colspan="8" style="text-align: center;"> <table border="1" style="width: 100%; border-collapse: collapse; text-align: center;"> <tr> <td style="width: 10%;"></td> <td style="width: 10%;"></td> <td style="width: 10%;"></td> <td style="width: 10%;"></td> <td style="width: 10%;"></td> <td style="width: 10%;"></td> <td style="width: 10%;"></td> <td style="width: 10%;"></td> <td style="width: 10%;"></td> <td style="width: 10%;"></td> </tr> <tr> <td></td> <td></td> <td colspan="8" style="text-align: center;"> <table border="1" style="width: 100%; border-collapse: collapse; text-align: center;"> <tr> </tr></table></td></tr></table></td></tr></table></td></tr></table></td></tr></table></td></tr></table></td></tr></table></td></tr></table></td></tr></table></td></tr></table></td></tr></table></td></tr></table></td></tr></table></td></tr></table></td></tr></table></td></tr></table></td></tr></table></td></tr></table></td></tr></table></td></tr></table></td></tr></table></td></tr></table></td></tr></table></td></tr></table>

 | | | | | | | | | | | | | | | | | | | | <table border="1" style="width: 100%; border-collapse: collapse; text-align: center;"> <tr> <td style="width: 10%;"></td> <td style="width: 10%;"></td> <td style="width: 10%;"></td> <td style="width: 10%;"></td> <td style="width: 10%;"></td> <td style="width: 10%;"></td> <td style="width: 10%;"></td> <td style="width: 10%;"></td> <td style="width: 10%;"></td> <td style="width: 10%;"></td> </tr> <tr> <td></td> <td></td> <td colspan="8" style="text-align: center;"> <table border="1" style="width: 100%; border-collapse: collapse; text-align: center;"> <tr> <td style="width: 10%;"></td> <td style="width: 10%;"></td> <td style="width: 10%;"></td> <td style="width: 10%;"></td> <td style="width: 10%;"></td> <td style="width: 10%;"></td> <td style="width: 10%;"></td> <td style="width: 10%;"></td> <td style="width: 10%;"></td> <td style="width: 10%;"></td> </tr> <tr> <td></td> <td></td> <td colspan="8" style="text-align: center;"> <table border="1" style="width: 100%; border-collapse: collapse; text-align: center;"> <tr> <td style="width: 10%;"></td> <td style="width: 10%;"></td> <td style="width: 10%;"></td> <td style="width: 10%;"></td> <td style="width: 10%;"></td> <td style="width: 10%;"></td> <td style="width: 10%;"></td> <td style="width: 10%;"></td> <td style="width: 10%;"></td> <td style="width: 10%;"></td> </tr> <tr> <td></td> <td></td> <td colspan="8" style="text-align: center;"> <table border="1" style="width: 100%; border-collapse: collapse; text-align: center;"> <tr> <td style="width: 10%;"></td> <td style="width: 10%;"></td> <td style="width: 10%;"></td> <td style="width: 10%;"></td> <td style="width: 10%;"></td> <td style="width: 10%;"></td> <td style="width: 10%;"></td> <td style="width: 10%;"></td> <td style="width: 10%;"></td> <td style="width: 10%;"></td> </tr> <tr> <td></td> <td></td> <td colspan="8" style="text-align: center;"> <table border="1" style="width: 100%; border-collapse: collapse; text-align: center;"> <tr> <td style="width: 10%;"></td> <td style="width: 10%;"></td> <td style="width: 10%;"></td> <td style="width: 10%;"></td> <td style="width: 10%;"></td> <td style="width: 10%;"></td> <td style="width: 10%;"></td> <td style="width: 10%;"></td> <td style="width: 10%;"></td> <td style="width: 10%;"></td> </tr> <tr> <td></td> <td></td> <td colspan="8" style="text-align: center;"> <table border="1" style="width: 100%; border-collapse: collapse; text-align: center;"> <tr> <td style="width: 10%;"></td> <td style="width: 10%;"></td> <td style="width: 10%;"></td> <td style="width: 10%;"></td> <td style="width: 10%;"></td> <td style="width: 10%;"></td> <td style="width: 10%;"></td> <td style="width: 10%;"></td> <td style="width: 10%;"></td> <td style="width: 10%;"></td> </tr> <tr> <td></td> <td></td> <td colspan="8" style="text-align: center;"> <table border="1" style="width: 100%; border-collapse: collapse; text-align: center;"> <tr> <td style="width: 10%;"></td> <td style="width: 10%;"></td> <td style="width: 10%;"></td> <td style="width: 10%;"></td> <td style="width: 10%;"></td> <td style="width: 10%;"></td> <td style="width: 10%;"></td> <td style="width: 10%;"></td> <td style="width: 10%;"></td> <td style="width: 10%;"></td> </tr> <tr> <td></td> <td></td> <td colspan="8" style="text-align: center;"> <table border="1" style="width: 100%; border-collapse: collapse; text-align: center;"> <tr> <td style="width: 10%;"></td> <td style="width: 10%;"></td> <td style="width: 10%;"></td> <td style="width: 10%;"></td> <td style="width: 10%;"></td> <td style="width: 10%;"></td> <td style="width: 10%;"></td> <td style="width: 10%;"></td> <td style="width: 10%;"></td> <td style="width: 10%;"></td> </tr> <tr> <td></td> <td></td> <td colspan="8" style="text-align: center;"> <table border="1" style="width: 100%; border-collapse: collapse; text-align: center;"> <tr> <td style="width: 10%;"></td> <td style="width: 10%;"></td> <td style="width: 10%;"></td> <td style="width: 10%;"></td> <td style="width: 10%;"></td> <td style="width: 10%;"></td> <td style="width: 10%;"></td> <td style="width: 10%;"></td> <td style="width: 10%;"></td> <td style="width: 10%;"></td> </tr> <tr> <td></td> <td></td> <td colspan="8" style="text-align: center;"> <table border="1" style="width: 100%; border-collapse: collapse; text-align: center;"> <tr> <td style="width: 10%;"></td> <td style="width: 10%;"></td> <td style="width: 10%;"></td> <td style="width: 10%;"></td> <td style="width: 10%;"></td> <td style="width: 10%;"></td> <td style="width: 10%;"></td> <td style="width: 10%;"></td> <td style="width: 10%;"></td> <td style="width: 10%;"></td> </tr> <tr> <td></td> <td></td> <td colspan="8" style="text-align: center;"> <table border="1" style="width: 100%; border-collapse: collapse; text-align: center;"> <tr> <td style="width: 10%;"></td> <td style="width: 10%;"></td> <td style="width: 10%;"></td> <td style="width: 10%;"></td> <td style="width: 10%;"></td> <td style="width: 10%;"></td> <td style="width: 10%;"></td> <td style="width: 10%;"></td> <td style="width: 10%;"></td> <td style="width: 10%;"></td> </tr> <tr> <td></td> <td></td> <td colspan="8" style="text-align: center;"> <table border="1" style="width: 100%; border-collapse: collapse; text-align: center;"> <tr> <td style="width: 10%;"></td> <td style="width: 10%;"></td> <td style="width: 10%;"></td> <td style="width: 10%;"></td> <td style="width: 10%;"></td> <td style="width: 10%;"></td> <td style="width: 10%;"></td> <td style="width: 10%;"></td> <td style="width: 10%;"></td> <td style="width: 10%;"></td> </tr> <tr> <td></td> <td></td> <td colspan="8" style="text-align: center;"> <table border="1" style="width: 100%; border-collapse: collapse; text-align: center;"> <tr> <td style="width: 10%;"></td> <td style="width: 10%;"></td> <td style="width: 10%;"></td> <td style="width: 10%;"></td> <td style="width: 10%;"></td> <td style="width: 10%;"></td> <td style="width: 10%;"></td> <td style="width: 10%;"></td> <td style="width: 10%;"></td> <td style="width: 10%;"></td> </tr> <tr> <td></td> <td></td> <td colspan="8" style="text-align: center;"> <table border="1" style="width: 100%; border-collapse: collapse; text-align: center;"> <tr> <td style="width: 10%;"></td> <td style="width: 10%;"></td> <td style="width: 10%;"></td> <td style="width: 10%;"></td> <td style="width: 10%;"></td> <td style="width: 10%;"></td> <td style="width: 10%;"></td> <td style="width: 10%;"></td> <td style="width: 10%;"></td> <td style="width: 10%;"></td> </tr> <tr> <td></td> <td></td> <td colspan="8" style="text-align: center;"> <table border="1" style="width: 100%; border-collapse: collapse; text-align: center;"> <tr> <td style="width: 10%;"></td> <td style="width: 10%;"></td> <td style="width: 10%;"></td> <td style="width: 10%;"></td> <td style="width: 10%;"></td> <td style="width: 10%;"></td> <td style="width: 10%;"></td> <td style="width: 10%;"></td> <td style="width: 10%;"></td> <td style="width: 10%;"></td> </tr> <tr> <td></td> <td></td> <td colspan="8" style="text-align: center;"> <table border="1" style="width: 100%; border-collapse: collapse; text-align: center;"> <tr> <td style="width: 10%;"></td> <td style="width: 10%;"></td> <td style="width: 10%;"></td> <td style="width: 10%;"></td> <td style="width: 10%;"></td> <td style="width: 10%;"></td> <td style="width: 10%;"></td> <td style="width: 10%;"></td> <td style="width: 10%;"></td> <td style="width: 10%;"></td> </tr> <tr> <td></td> <td></td> <td colspan="8" style="text-align: center;"> <table border="1" style="width: 100%; border-collapse: collapse; text-align: center;"> <tr> <td style="width: 10%;"></td> <td style="width: 10%;"></td> <td style="width: 10%;"></td> <td style="width: 10%;"></td> <td style="width: 10%;"></td> <td style="width: 10%;"></td> <td style="width: 10%;"></td> <td style="width: 10%;"></td> <td style="width: 10%;"></td> <td style="width: 10%;"></td> </tr> <tr> <td></td> <td></td> <td colspan="8" style="text-align: center;"> <table border="1" style="width: 100%; border-collapse: collapse; text-align: center;"> <tr> <td style="width: 10%;"></td> <td style="width: 10%;"></td> <td style="width: 10%;"></td> <td style="width: 10%;"></td> <td style="width: 10%;"></td> <td style="width: 10%;"></td> <td style="width: 10%;"></td> <td style="width: 10%;"></td> <td style="width: 10%;"></td> <td style="width: 10%;"></td> </tr> <tr> <td></td> <td></td> <td colspan="8" style="text-align: center;"> <table border="1" style="width: 100%; border-collapse: collapse; text-align: center;"> <tr> <td style="width: 10%;"></td> <td style="width: 10%;"></td> <td style="width: 10%;"></td> <td style="width: 10%;"></td> <td style="width: 10%;"></td> <td style="width: 10%;"></td> <td style="width: 10%;"></td> <td style="width: 10%;"></td> <td style="width: 10%;"></td> <td style="width: 10%;"></td> </tr> <tr> <td></td> <td></td> <td colspan="8" style="text-align: center;"> <table border="1" style="width: 100%; border-collapse: collapse; text-align: center;"> <tr> <td style="width: 10%;"></td> <td style="width: 10%;"></td> <td style="width: 10%;"></td> <td style="width: 10%;"></td> <td style="width: 10%;"></td> <td style="width: 10%;"></td> <td style="width: 10%;"></td> <td style="width: 10%;"></td> <td style="width: 10%;"></td> <td style="width: 10%;"></td> </tr> <tr> <td></td> <td></td> <td colspan="8" style="text-align: center;"> <table border="1" style="width: 100%; border-collapse: collapse; text-align: center;"> <tr> <td style="width: 10%;"></td> <td style="width: 10%;"></td> <td style="width: 10%;"></td> <td style="width: 10%;"></td> <td style="width: 10%;"></td> <td style="width:
10%;"></td> <td style="width: 10%;"></td> <td style="width: 10%;"></td> <td style="width: 10%;"></td> <td style="width: 10%;"></td> </tr> <tr> <td></td> <td></td> <td colspan="8" style="text-align: center;"> <table border="1" style="width: 100%; border-collapse: collapse; text-align: center;"> <tr> <td style="width: 10%;"></td> <td style="width: 10%;"></td> <td style="width: 10%;"></td> <td style="width: 10%;"></td> <td style="width: 10%;"></td> <td style="width: 10%;"></td> <td style="width: 10%;"></td> <td style="width: 10%;"></td> <td style="width: 10%;"></td> <td style="width: 10%;"></td> </tr> <tr> <td></td> <td></td> <td colspan="8" style="text-align: center;"> <table border="1" style="width: 100%; border-collapse: collapse; text-align: center;"> <tr> </tr></table></td></tr></table></td></tr></table></td></tr></table></td></tr></table></td></tr></table></td></tr></table></td></tr></table></td></tr></table></td></tr></table></td></tr></table></td></tr></table></td></tr></table></td></tr></table></td></tr></table></td></tr></table></td></tr></table></td></tr></table></td></tr></table></td></tr></table></td></tr></table></td></tr></table></td></tr></table>
 | | | | | | | | | | | | | | | | | | | | <table border="1" style="width: 100%; border-collapse: collapse; text-align: center;"> <tr> <td style="width: 10%;"></td> <td style="width: 10%;"></td> <td style="width: 10%;"></td> <td style="width: 10%;"></td> <td style="width: 10%;"></td> <td style="width: 10%;"></td> <td style="width: 10%;"></td> <td style="width: 10%;"></td> <td style="width: 10%;"></td> <td style="width: 10%;"></td> </tr> <tr> <td></td> <td></td> <td colspan="8" style="text-align: center;"> <table border="1" style="width: 100%; border-collapse: collapse; text-align: center;"> <tr> <td style="width: 10%;"></td> <td style="width: 10%;"></td> <td style="width: 10%;"></td> <td style="width: 10%;"></td> <td style="width: 10%;"></td> <td style="width: 10%;"></td> <td style="width: 10%;"></td> <td style="width: 10%;"></td> <td style="width: 10%;"></td> <td style="width: 10%;"></td> </tr> <tr> <td></td> <td></td> <td colspan="8" style="text-align: center;"> <table border="1" style="width: 100%; border-collapse: collapse; text-align: center;"> <tr> <td style="width: 10%;"></td> <td style="width: 10%;"></td> <td style="width: 10%;"></td> <td style="width: 10%;"></td> <td style="width: 10%;"></td> <td style="width: 10%;"></td> <td style="width: 10%;"></td> <td style="width:
10%;"></td> <td style="width: 10%;"></td> <td style="width: 10%;"></td> </tr> <tr> <td></td> <td></td> <td colspan="8" style="text-align: center;"> <table border="1" style="width: 100%; border-collapse: collapse; text-align: center;"> <tr> <td style="width: 10%;"></td> <td style="width: 10%;"></td> <td style="width: 10%;"></td> <td style="width: 10%;"></td> <td style="width: 10%;"></td> <td style="width: 10%;"></td> <td style="width: 10%;"></td> <td style="width: 10%;"></td> <td style="width: 10%;"></td> <td style="width: 10%;"></td> </tr> <tr> <td></td> <td></td> <td colspan="8" style="text-align: center;"> <table border="1" style="width: 100%; border-collapse: collapse; text-align: center;"> <tr> <td style="width: 10%;"></td> <td style="width: 10%;"></td> <td style="width: 10%;"></td> <td style="width: 10%;"></td> <td style="width: 10%;"></td> <td style="width: 10%;"></td> <td style="width: 10%;"></td> <td style="width: 10%;"></td> <td style="width: 10%;"></td> <td style="width: 10%;"></td> </tr> <tr> <td></td> <td></td> <td colspan="8" style="text-align: center;"> <table border="1" style="width: 100%; border-collapse: collapse; text-align: center;"> <tr> <td style="width: 10%;"></td> <td style="width: 10%;"></td> <td style="width: 10%;"></td> <td style="width: 10%;"></td> <td style="width: 10%;"></td> <td style="width: 10%;"></td> <td style="width: 10%;"></td> <td style="width: 10%;"></td> <td style="width: 10%;"></td> <td style="width: 10%;"></td> </tr> <tr> <td></td> <td></td> <td colspan="8" style="text-align: center;"> <table border="1" style="width: 100%; border-collapse: collapse; text-align: center;"> <tr> <td style="width: 10%;"></td> <td style="width: 10%;"></td> <td style="width: 10%;"></td> <td style="width: 10%;"></td> <td style="width: 10%;"></td> <td style="width: 10%;"></td> <td style="width: 10%;"></td> <td style="width: 10%;"></td> <td style="width: 10%;"></td> <td style="width: 10%;"></td> </tr> <tr> <td></td> <td></td> <td colspan="8" style="text-align: center;"> <table border="1" style="width: 100%; border-collapse: collapse; text-align: center;"> <tr> <td style="width: 10%;"></td> <td style="width: 10%;"></td> <td style="width: 10%;"></td> <td style="width: 10%;"></td> <td style="width: 10%;"></td> <td style="width: 10%;"></td> <td style="width: 10%;"></td> <td style="width: 10%;"></td> <td style="width: 10%;"></td> <td style="width: 10%;"></td> </tr> <tr> <td></td> <td></td> <td colspan="8" style="text-align: center;"> <table border="1" style="width: 100%; border-collapse: collapse; text-align: center;"> <tr> <td style="width: 10%;"></td> <td style="width: 10%;"></td> <td style="width: 10%;"></td> <td style="width: 10%;"></td> <td style="width: 10%;"></td> <td style="width: 10%;"></td> <td style="width: 10%;"></td> <td style="width: 10%;"></td> <td style="width: 10%;"></td> <td style="width: 10%;"></td> </tr> <tr> <td></td> <td></td> <td colspan="8" style="text-align: center;"> <table border="1" style="width: 100%; border-collapse: collapse; text-align: center;"> <tr> <td style="width: 10%;"></td> <td style="width: 10%;"></td> <td style="width: 10%;"></td> <td style="width: 10%;"></td> <td style="width: 10%;"></td> <td style="width: 10%;"></td> <td style="width: 10%;"></td> <td style="width: 10%;"></td> <td style="width: 10%;"></td> <td style="width: 10%;"></td> </tr> <tr> <td></td> <td></td> <td colspan="8" style="text-align: center;"> <table border="1" style="width: 100%; border-collapse: collapse; text-align: center;"> <tr> <td style="width: 10%;"></td> <td style="width: 10%;"></td> <td style="width: 10%;"></td> <td style="width: 10%;"></td> <td style="width: 10%;"></td> <td style="width: 10%;"></td> <td style="width: 10%;"></td> <td style="width: 10%;"></td> <td style="width: 10%;"></td> <td style="width: 10%;"></td> </tr> <tr> <td></td> <td></td> <td colspan="8" style="text-align: center;"> <table border="1" style="width: 100%; border-collapse: collapse; text-align: center;"> <tr> <td style="width: 10%;"></td> <td style="width: 10%;"></td> <td style="width: 10%;"></td> <td style="width: 10%;"></td> <td style="width: 10%;"></td> <td style="width: 10%;"></td> <td style="width: 10%;"></td> <td style="width: 10%;"></td> <td style="width: 10%;"></td> <td style="width: 10%;"></td> </tr> <tr> <td></td> <td></td> <td colspan="8" style="text-align: center;"> <table border="1" style="width: 100%; border-collapse: collapse; text-align: center;"> <tr> <td style="width: 10%;"></td> <td style="width: 10%;"></td> <td style="width: 10%;"></td> <td style="width: 10%;"></td> <td style="width: 10%;"></td> <td style="width: 10%;"></td> <td style="width: 10%;"></td> <td style="width: 10%;"></td> <td style="width: 10%;"></td> <td style="width: 10%;"></td> </tr> <tr> <td></td> <td></td> <td colspan="8" style="text-align: center;"> <table border="1" style="width: 100%; border-collapse: collapse; text-align: center;"> <tr> <td style="width: 10%;"></td> <td style="width: 10%;"></td> <td style="width: 10%;"></td> <td style="width: 10%;"></td> <td style="width: 10%;"></td> <td style="width: 10%;"></td> <td style="width: 10%;"></td> <td style="width: 10%;"></td> <td style="width: 10%;"></td> <td style="width: 10%;"></td> </tr> <tr> <td></td> <td></td> <td colspan="8" style="text-align: center;"> <table border="1" style="width: 100%; border-collapse: collapse; text-align: center;"> <tr> <td style="width: 10%;"></td> <td style="width: 10%;"></td> <td style="width: 10%;"></td> <td style="width: 10%;"></td> <td style="width: 10%;"></td> <td style="width: 10%;"></td> <td style="width: 10%;"></td> <td style="width: 10%;"></td> <td style="width: 10%;"></td> <td style="width: 10%;"></td> </tr> <tr> <td></td> <td></td> <td colspan="8" style="text-align: center;"> <table border="1" style="width: 100%; border-collapse: collapse; text-align: center;"> <tr> <td style="width: 10%;"></td> <td style="width: 10%;"></td> <td style="width: 10%;"></td> <td style="width: 10%;"></td> <td style="width: 10%;"></td> <td style="width: 10%;"></td> <td style="width: 10%;"></td> <td style="width: 10%;"></td> <td style="width: 10%;"></td> <td style="width: 10%;"></td> </tr> <tr> <td></td> <td></td> <td colspan="8" style="text-align: center;"> <table border="1" style="width: 100%; border-collapse: collapse; text-align: center;"> <tr> <td style="width: 10%;"></td> <td style="width: 10%;"></td> <td style="width: 10%;"></td> <td style="width: 10%;"></td> <td style="width: 10%;"></td> <td style="width: 10%;"></td> <td style="width: 10%;"></td> <td style="width: 10%;"></td> <td style="width: 10%;"></td> <td style="width: 10%;"></td> </tr> <tr> <td></td> <td></td> <td colspan="8" style="text-align: center;"> <table border="1" style="width: 100%; border-collapse: collapse; text-align: center;"> <tr> <td style="width: 10%;"></td> <td style="width: 10%;"></td> <td style="width: 10%;"></td> <td style="width: 10%;"></td> <td style="width: 10%;"></td> <td style="width: 10%;"></td> <td style="width: 10%;"></td> <td style="width: 10%;"></td> <td style="width: 10%;"></td> <td style="width: 10%;"></td> </tr> <tr> <td></td> <td></td> <td colspan="8" style="text-align: center;"> <table border="1" style="width: 100%; border-collapse: collapse; text-align: center;"> <tr> <td style="width: 10%;"></td> <td style="width: 10%;"></td> <td style="width: 10%;"></td> <td style="width: 10%;"></td> <td style="width: 10%;"></td> <td style="width: 10%;"></td> <td style="width: 10%;"></td> <td style="width: 10%;"></td> <td style="width: 10%;"></td> <td style="width: 10%;"></td> </tr> <tr> <td></td> <td></td> <td colspan="8" style="text-align: center;"> <table border="1" style="width: 100%; border-collapse: collapse; text-align: center;"> <tr> <td style="width: 10%;"></td> <td style="width: 10%;"></td> <td style="width: 10%;"></td> <td style="width: 10%;"></td> <td style="width: 10%;"></td> <td style="width: 10%;"></td> <td style="width: 10%;"></td> <td style="width: 10%;"></td> <td style="width: 10%;"></td> <td style="width: 10%;"></td> </tr> <tr> <td></td> <td></td> <td colspan="8" style="text-align: center;"> <table border="1" style="width: 100%; border-collapse: collapse; text-align: center;"> <tr> <td style="width: 10%;"></td> <td style="width: 10%;"></td> <td style="width: 10%;"></td> <td style="width: 10%;"></td> <td style="width: 10%;"></td> <td style="width: 10%;"></td> <td style="width: 10%;"></td> <td style="width: 10%;"></td> <td style="width: 10%;"></td> <td style="width: 10%;"></td> </tr> <tr> <td></td> <td></td> <td colspan="8" style="text-align: center;"> <table border="1" style="width: 100%; border-collapse: collapse; text-align: center;"> <tr> </tr></table></td></tr></table></td></tr></table></td></tr></table></td></tr></table></td></tr></table></td></tr></table></td></tr></table></td></tr></table></td></tr></table></td></tr></table></td></tr></table></td></tr></table></td></tr></table></td></tr></table></td></tr></table></td></tr></table></td></tr></table></td></tr></table></td></tr></table></td></tr></table></td></tr></table>

 | | | | | | | | | | | | | | | | | | | | <table border="1" style="width: 100%; border-collapse: collapse; text-align: center;"> <tr> <td style="width: 10%;"></td> <td style="width: 10%;"></td> <td style="width: 10%;"></td> <td style="width: 10%;"></td> <td style="width: 10%;"></td> <td style="width: 10%;"></td> <td style="width: 10%;"></td> <td style="width: 10%;"></td> <td style="width: 10%;"></td> <td style="width: 10%;"></td> </tr> <tr> <td></td> <td></td> <td colspan="8" style="text-align: center;"> <table border="1" style="width: 100%; border-collapse: collapse; text-align: center;"> <tr> <td style="width: 10%;"></td> <td style="width: 10%;"></td> <td style="width: 10%;"></td> <td style="width: 10%;"></td> <td style="width: 10%;"></td> <td style="width: 10%;"></td> <td style="width: 10%;"></td> <td style="width: 10%;"></td> <td style="width: 10%;"></td> <td style="width: 10%;"></td> </tr> <tr> <td></td> <td></td> <td colspan="8" style="text-align: center;"> <table border="1" style="width: 100%; border-collapse: collapse; text-align: center;"> <tr> <td style="width: 10%;"></td> <td style="width: 10%;"></td> <td style="width: 10%;"></td> <td style="width: 10%;"></td> <td style="width: 10%;"></td> <td style="width: 10%;"></td> <td style="width: 10%;"></td> <td style="width: 10%;"></td> <td style="width: 10%;"></td> <td style="width: 10%;"></td> </tr> <tr> <td></td> <td></td> <td colspan="8" style="text-align: center;"> <table border="1" style="width: 100%; border-collapse: collapse; text-align: center;"> <tr> <td style="width: 10%;"></td> <td style="width: 10%;"></td> <td style="width: 10%;"></td> <td style="width: 10%;"></td> <td style="width: 10%;"></td> <td style="width: 10%;"></td> <td style="width: 10%;"></td> <td style="width: 10%;"></td> <td style="width: 10%;"></td> <td style="width: 10%;"></td> </tr> <tr> <td></td> <td></td> <td colspan="8" style="text-align: center;"> <table border="1" style="width: 100%; border-collapse: collapse; text-align: center;"> <tr> <td style="width: 10%;"></td> <td style="width: 10%;"></td> <td style="width: 10%;"></td> <td style="width: 10%;"></td> <td style="width: 10%;"></td> <td style="width: 10%;"></td> <td style="width: 10%;"></td> <td style="width: 10%;"></td> <td style="width: 10%;"></td> <td style="width: 10%;"></td> </tr> <tr> <td></td> <td></td> <td colspan="8" style="text-align: center;"> <table border="1" style="width: 100%; border-collapse: collapse; text-align: center;"> <tr> <td style="width: 10%;"></td> <td style="width: 10%;"></td> <td style="width: 10%;"></td> <td style="width: 10%;"></td> <td style="width: 10%;"></td> <td style="width: 10%;"></td> <td style="width: 10%;"></td> <td style="width: 10%;"></td> <td style="width: 10%;"></td> <td style="width: 10%;"></td> </tr> <tr> <td></td> <td></td> <td colspan="8" style="text-align: center;"> <table border="1" style="width: 100%; border-collapse: collapse; text-align: center;"> <tr> <td style="width: 10%;"></td> <td style="width: 10%;"></td> <td style="width: 10%;"></td> <td style="width: 10%;"></td> <td style="width: 10%;"></td> <td style="width: 10%;"></td> <td style="width: 10%;"></td> <td style="width: 10%;"></td> <td style="width: 10%;"></td> <td style="width: 10%;"></td> </tr> <tr> <td></td> <td></td> <td colspan="8" style="text-align: center;"> <table border="1" style="width: 100%; border-collapse: collapse; text-align: center;"> <tr> <td style="width:
10%;"></td> <td style="width: 10%;"></td> <td style="width: 10%;"></td> <td style="width: 10%;"></td> <td style="width: 10%;"></td> <td style="width: 10%;"></td> <td style="width: 10%;"></td> <td style="width: 10%;"></td> <td style="width: 10%;"></td> <td style="width: 10%;"></td> </tr> <tr> <td></td> <td></td> <td colspan="8" style="text-align: center;"> <table border="1" style="width: 100%; border-collapse: collapse; text-align: center;"> <tr> <td style="width: 10%;"></td> <td style="width: 10%;"></td> <td style="width: 10%;"></td> <td style="width: 10%;"></td> <td style="width: 10%;"></td> <td style="width: 10%;"></td> <td style="width: 10%;"></td> <td style="width: 10%;"></td> <td style="width: 10%;"></td> <td style="width: 10%;"></td> </tr> <tr> <td></td> <td></td> <td colspan="8" style="text-align: center;"> <table border="1" style="width: 100%; border-collapse: collapse; text-align: center;"> <tr> <td style="width: 10%;"></td> <td style="width: 10%;"></td> <td style="width: 10%;"></td> <td style="width: 10%;"></td> <td style="width: 10%;"></td> <td style="width: 10%;"></td> <td style="width: 10%;"></td> <td style="width: 10%;"></td> <td style="width: 10%;"></td> <td style="width: 10%;"></td> </tr> <tr> <td></td> <td></td> <td colspan="8" style="text-align: center;"> <table border="1" style="width: 100%; border-collapse: collapse; text-align: center;"> <tr> <td style="width: 10%;"></td> <td style="width: 10%;"></td> <td style="width: 10%;"></td> <td style="width: 10%;"></td> <td style="width: 10%;"></td> <td style="width: 10%;"></td> <td style="width: 10%;"></td> <td style="width: 10%;"></td> <td style="width: 10%;"></td> <td style="width: 10%;"></td> </tr> <tr> <td></td> <td></td> <td colspan="8" style="text-align: center;"> <table border="1" style="width: 100%; border-collapse: collapse; text-align: center;"> <tr> <td style="width: 10%;"></td> <td style="width: 10%;"></td> <td style="width: 10%;"></td> <td style="width: 10%;"></td> <td style="width: 10%;"></td> <td style="width: 10%;"></td> <td style="width: 10%;"></td> <td style="width: 10%;"></td> <td style="width: 10%;"></td> <td style="width: 10%;"></td> </tr> <tr> <td></td> <td></td> <td colspan="8" style="text-align: center;"> <table border="1" style="width: 100%; border-collapse: collapse; text-align: center;"> <tr> <td style="width: 10%;"></td> <td style="width: 10%;"></td> <td style="width: 10%;"></td> <td style="width: 10%;"></td> <td style="width: 10%;"></td> <td style="width: 10%;"></td> <td style="width: 10%;"></td> <td style="width: 10%;"></td> <td style="width: 10%;"></td> <td style="width: 10%;"></td> </tr> <tr> <td></td> <td></td> <td colspan="8" style="text-align: center;"> <table border="1" style="width: 100%; border-collapse: collapse; text-align: center;"> <tr> <td style="width: 10%;"></td> <td style="width: 10%;"></td> <td style="width: 10%;"></td> <td style="width: 10%;"></td> <td style="width: 10%;"></td> <td style="width: 10%;"></td> <td style="width: 10%;"></td> <td style="width: 10%;"></td> <td style="width: 10%;"></td> <td style="width: 10%;"></td> </tr> <tr> <td></td> <td></td> <td colspan="8" style="text-align: center;"> <table border="1" style="width: 100%; border-collapse: collapse; text-align: center;"> <tr> <td style="width: 10%;"></td> <td style="width: 10%;"></td> <td style="width: 10%;"></td> <td style="width: 10%;"></td> <td style="width: 10%;"></td> <td style="width: 10%;"></td> <td style="width: 10%;"></td> <td style="width: 10%;"></td> <td style="width: 10%;"></td> <td style="width: 10%;"></td> </tr> <tr> <td></td> <td></td> <td colspan="8" style="text-align: center;"> <table border="1" style="width: 100%; border-collapse: collapse; text-align: center;"> <tr> <td style="width: 10%;"></td> <td style="width: 10%;"></td> <td style="width: 10%;"></td> <td style="width: 10%;"></td> <td style="width: 10%;"></td> <td style="width: 10%;"></td> <td style="width: 10%;"></td> <td style="width: 10%;"></td> <td style="width: 10%;"></td> <td style="width: 10%;"></td> </tr> <tr> <td></td> <td></td> <td colspan="8" style="text-align: center;"> <table border="1" style="width: 100%; border-collapse: collapse; text-align: center;"> <tr> <td style="width: 10%;"></td> <td style="width: 10%;"></td> <td style="width: 10%;"></td> <td style="width: 10%;"></td> <td style="width: 10%;"></td> <td style="width: 10%;"></td> <td style="width: 10%;"></td> <td style="width: 10%;"></td> <td style="width: 10%;"></td> <td style="width: 10%;"></td> </tr> <tr> <td></td> <td></td> <td colspan="8" style="text-align: center;"> <table border="1" style="width: 100%; border-collapse: collapse; text-align: center;"> <tr> <td style="width: 10%;"></td> <td style="width: 10%;"></td> <td style="width: 10%;"></td> <td style="width: 10%;"></td> <td style="width: 10%;"></td> <td style="width: 10%;"></td> <td style="width: 10%;"></td> <td style="width: 10%;"></td> <td style="width: 10%;"></td> <td style="width: 10%;"></td> </tr> <tr> <td></td> <td></td> <td colspan="8" style="text-align: center;"> <table border="1" style="width: 100%; border-collapse: collapse; text-align: center;"> <tr> <td style="width: 10%;"></td> <td style="width: 10%;"></td> <td style="width: 10%;"></td> <td style="width: 10%;"></td> <td style="width: 10%;"></td> <td style="width: 10%;"></td> <td style="width: 10%;"></td> <td style="width: 10%;"></td> <td style="width: 10%;"></td> <td style="width: 10%;"></td> </tr> <tr> <td></td> <td></td> <td colspan="8" style="text-align: center;"> <table border="1" style="width: 100%; border-collapse: collapse; text-align: center;"> <tr> <td style="width: 10%;"></td> <td style="width: 10%;"></td> <td style="width: 10%;"></td> <td style="width: 10%;"></td> <td style="width: 10%;"></td> <td style="width: 10%;"></td> <td style="width: 10%;"></td> <td style="width: 10%;"></td> <td style="width: 10%;"></td> <td style="width: 10%;"></td> </tr> <tr> <td></td> <td></td> <td colspan="8" style="text-align: center;"> <table border="1" style="width: 100%; border-collapse: collapse; text-align: center;"> <tr> </tr></table></td></tr></table></td></tr></table></td></tr></table></td></tr></table></td></tr></table></td></tr></table></td></tr></table></td></tr></table></td></tr></table></td></tr></table></td></tr></table></td></tr></table></td></tr></table></td></tr></table></td></tr></table></td></tr></table></td></tr></table></td></tr></table></td></tr></table></td></tr></table>

 | | | | | | | | | | | | | | | | | | | | <table border="1" style="width: 100%; border-collapse: collapse; text-align: center;"> <tr> <td style="width: 10%;"></td> <td style="width: 10%;"></td> <td style="width: 10%;"></td> <td style="width: 10%;"></td> <td style="width: 10%;"></td> <td style="width: 10%;"></td> <td style="width: 10%;"></td> <td style="width: 10%;"></td> <td style="width: 10%;"></td> <td style="width: 10%;"></td> </tr> <tr> <td></td> <td></td> <td colspan="8" style="text-align: center;"> <table border="1" style="width: 100%; border-collapse: collapse; text-align: center;"> <tr> <td style="width: 10%;"></td> <td style="width: 10%;"></td> <td style="width: 10%;"></td> <td style="width: 10%;"></td> <td style="width: 10%;"></td> <td style="width: 10%;"></td> <td style="width: 10%;"></td> <td style="width: 10%;"></td> <td style="width: 10%;"></td> <td style="width: 10%;"></td> </tr> <tr> <td></td> <td></td> <td colspan="8" style="text-align: center;"> <table border="1" style="width: 100%; border-collapse: collapse; text-align: center;"> <tr> <td style="width: 10%;"></td> <td style="width: 10%;"></td> <td style="width: 10%;"></td> <td style="width: 10%;"></td> <td style="width: 10%;"></td> <td style="width: 10%;"></td> <td style="width: 10%;"></td> <td style="width: 10%;"></td> <td style="width: 10%;"></td> <td style="width: 10%;"></td> </tr> <tr> <td></td> <td></td> <td colspan="8" style="text-align: center;"> <table border="1" style="width: 100%; border-collapse: collapse; text-align: center;"> <tr> <td style="width: 10%;"></td> <td style="width: 10%;"></td> <td style="width: 10%;"></td> <td style="width: 10%;"></td> <td style="width: 10%;"></td> <td style="width: 10%;"></td> <td style="width: 10%;"></td> <td style="width: 10%;"></td> <td style="width: 10%;"></td> <td style="width: 10%;"></td> </tr> <tr> <td></td> <td></td> <td colspan="8" style="text-align: center;"> <table border="1" style="width: 100%; border-collapse: collapse; text-align: center;"> <tr> <td style="width: 10%;"></td> <td style="width: 10%;"></td> <td style="width: 10%;"></td> <td style="width: 10%;"></td> <td style="width: 10%;"></td> <td style="width: 10%;"></td> <td style="width: 10%;"></td> <td style="width: 10%;"></td> <td style="width: 10%;"></td> <td style="width: 10%;"></td> </tr> <tr> <td></td> <td></td> <td colspan="8" style="text-align: center;"> <table border="1" style="width: 100%; border-collapse: collapse; text-align: center;"> <tr> <td style="width: 10%;"></td> <td style="width: 10%;"></td> <td style="width: 10%;"></td> <td style="width: 10%;"></td> <td style="width: 10%;"></td> <td style="width: 10%;"></td> <td style="width: 10%;"></td> <td style="width: 10%;"></td> <td style="width: 10%;"></td> <td style="width: 10%;"></td> </tr> <tr> <td></td> <td></td> <td colspan="8" style="text-align: center;"> <table border="1" style="width: 100%; border-collapse: collapse; text-align: center;"> <tr> <td style="width: 10%;"></td> <td style="width: 10%;"></td> <td style="width: 10%;"></td> <td style="width: 10%;"></td> <td style="width: 10%;"></td> <td style="width: 10%;"></td> <td style="width: 10%;"></td> <td style="width: 10%;"></td> <td style="width: 10%;"></td> <td style="width: 10%;"></td> </tr> <tr> <td></td> <td></td> <td colspan="8" style="text-align: center;"> <table border="1" style="width: 100%; border-collapse: collapse; text-align: center;"> <tr> <td style="width: 10%;"></td> <td style="width: 10%;"></td> <td style="width: 10%;"></td> <td style="width: 10%;"></td> <td style="width: 10%;"></td> <td style="width: 10%;"></td> <td style="width: 10%;"></td> <td style="width: 10%;"></td> <td style="width: 10%;"></td> <td style="width: 10%;"></td> </tr> <tr> <td></td> <td></td> <td colspan="8" style="text-align: center;"> <table border="1" style="width: 100%; border-collapse: collapse; text-align: center;"> <tr> <td style="width: 10%;"></td> <td style="width: 10%;"></td> <td style="width: 10%;"></td> <td style="width: 10%;"></td> <td style="width: 10%;"></td> <td style="width: 10%;"></td> <td style="width: 10%;"></td> <td style="width: 10%;"></td> <td style="width: 10%;"></td> <td style="width: 10%;"></td> </tr> <tr> <td></td> <td></td> <td colspan="8" style="text-align: center;"> <table border="1" style="width: 100%; border-collapse: collapse; text-align: center;"> <tr> <td style="width: 10%;"></td> <td style="width: 10%;"></td> <td style="width: 10%;"></td> <td style="width: 10%;"></td> <td style="width: 10%;"></td> <td style="width: 10%;"></td> <td style="width: 10%;"></td> <td style="width: 10%;"></td> <td style="width: 10%;"></td> <td style="width: 10%;"></td> </tr> <tr> <td></td> <td></td> <td colspan="8" style="text-align: center;"> <table border="1" style="width: 100%; border-collapse: collapse; text-align: center;"> <tr> <td style="width: 10%;"></td> <td style="width: 10%;"></td> <td style="width: 10%;"></td> <td style="width: 10%;"></td> <td style="width: 10%;"></td> <td style="width: 10%;"></td> <td style="width: 10%;"></td> <td style="width: 10%;"></td> <td style="width: 10%;"></td> <td style="width: 10%;"></td> </tr> <tr> <td></td> <td></td> <td colspan="8" style="text-align: center;"> <table border="1" style="width: 100%; border-collapse: collapse; text-align: center;"> <tr> <td style="width: 10%;"></td> <td style="width: 10%;"></td> <td style="width: 10%;"></td> <td style="width: 10%;"></td> <td style="width: 10%;"></td> <td style="width: 10%;"></td> <td style="width: 10%;"></td> <td style="width: 10%;"></td> <td style="width: 10%;"></td> <td style="width: 10%;"></td> </tr> <tr> <td></td> <td></td> <td colspan="8" style="text-align: center;"> <table border="1" style="width: 100%; border-collapse: collapse; text-align: center;"> <tr> <td style="width: 10%;"></td> <td style="width: 10%;"></td> <td style="width: 10%;"></td> <td style="width: 10%;"></td> <td style="width: 10%;"></td> <td style="width: 10%;"></td> <td style="width: 10%;"></td> <td style="width: 10%;"></td> <td style="width: 10%;"></td> <td style="width:
10%;"></td> </tr> <tr> <td></td> <td></td> <td colspan="8" style="text-align: center;"> <table border="1" style="width: 100%; border-collapse: collapse; text-align: center;"> <tr> <td style="width: 10%;"></td> <td style="width: 10%;"></td> <td style="width: 10%;"></td> <td style="width: 10%;"></td> <td style="width: 10%;"></td> <td style="width: 10%;"></td> <td style="width: 10%;"></td> <td style="width: 10%;"></td> <td style="width: 10%;"></td> <td style="width: 10%;"></td> </tr> <tr> <td></td> <td></td> <td colspan="8" style="text-align: center;"> <table border="1" style="width: 100%; border-collapse: collapse; text-align: center;"> <tr> <td style="width: 10%;"></td> <td style="width: 10%;"></td> <td style="width: 10%;"></td> <td style="width: 10%;"></td> <td style="width: 10%;"></td> <td style="width: 10%;"></td> <td style="width: 10%;"></td> <td style="width: 10%;"></td> <td style="width: 10%;"></td> <td style="width: 10%;"></td> </tr> <tr> <td></td> <td></td> <td colspan="8" style="text-align: center;"> <table border="1" style="width: 100%; border-collapse: collapse; text-align: center;"> <tr> <td style="width: 10%;"></td> <td style="width: 10%;"></td> <td style="width: 10%;"></td> <td style="width: 10%;"></td> <td style="width: 10%;"></td> <td style="width: 10%;"></td> <td style="width: 10%;"></td> <td style="width: 10%;"></td> <td style="width: 10%;"></td> <td style="width: 10%;"></td> </tr> <tr> <td></td> <td></td> <td colspan="8" style="text-align: center;"> <table border="1" style="width: 100%; border-collapse: collapse; text-align: center;"> <tr> <td style="width: 10%;"></td> <td style="width: 10%;"></td> <td style="width: 10%;"></td> <td style="width: 10%;"></td> <td style="width: 10%;"></td> <td style="width: 10%;"></td> <td style="width: 10%;"></td> <td style="width: 10%;"></td> <td style="width: 10%;"></td> <td style="width: 10%;"></td> </tr> <tr> <td></td> <td></td> <td colspan="8" style="text-align: center;"> <table border="1" style="width: 100%; border-collapse: collapse; text-align: center;"> <tr> <td style="width: 10%;"></td> <td style="width: 10%;"></td> <td style="width: 10%;"></td> <td style="width: 10%;"></td> <td style="width: 10%;"></td> <td style="width: 10%;"></td> <td style="width: 10%;"></td> <td style="width: 10%;"></td> <td style="width: 10%;"></td> <td style="width: 10%;"></td> </tr> <tr> <td></td> <td></td> <td colspan="8" style="text-align: center;"> <table border="1" style="width: 100%; border-collapse: collapse; text-align: center;"> <tr> <td style="width: 10%;"></td> <td style="width: 10%;"></td> <td style="width: 10%;"></td> <td style="width: 10%;"></td> <td style="width: 10%;"></td> <td style="width: 10%;"></td> <td style="width: 10%;"></td> <td style="width: 10%;"></td> <td style="width: 10%;"></td> <td style="width: 10%;"></td> </tr> <tr> <td></td> <td></td> <td colspan="8" style="text-align: center;"> <table border="1" style="width: 100%; border-collapse: collapse; text-align: center;"> <tr> </tr></table></td></tr></table></td></tr></table></td></tr></table></td></tr></table></td></tr></table></td></tr></table></td></tr></table></td></tr></table></td></tr></table></td></tr></table></td></tr></table></td></tr></table></td></tr></table></td></tr></table></td></tr></table></td></tr></table></td></tr></table></td></tr></table></td></tr></table>

 | | | | | | | | | | | | | | | | | | | | <table border="1" style="width: 100%; border-collapse: collapse; text-align: center;"> <tr> <td style="width: 10%;"></td> <td style="width: 10%;"></td> <td style="width: 10%;"></td> <td style="width: 10%;"></td> <td style="width: 10%;"></td> <td style="width: 10%;"></td> <td style="width: 10%;"></td> <td style="width: 10%;"></td> <td style="width: 10%;"></td> <td style="width: 10%;"></td> </tr> <tr> <td></td> <td></td> <td colspan="8" style="text-align: center;"> <table border="1" style="width: 100%; border-collapse: collapse; text-align: center;"> <tr> <td style="width: 10%;"></td> <td style="width: 10%;"></td> <td style="width: 10%;"></td> <td style="width: 10%;"></td> <td style="width: 10%;"></td> <td style="width: 10%;"></td> <td style="width: 10%;"></td> <td style="width: 10%;"></td> <td style="width: 10%;"></td> <td style="width: 10%;"></td> </tr> <tr> <td></td> <td></td> <td colspan="8" style="text-align: center;"> <table border="1" style="width: 100%; border-collapse: collapse; text-align: center;"> <tr> <td style="width: 10%;"></td> <td style="width: 10%;"></td> <td style="width: 10%;"></td> <td style="width: 10%;"></td> <td style="width: 10%;"></td> <td style="width: 10%;"></td> <td style="width: 10%;"></td> <td style="width: 10%;"></td> <td style="width: 10%;"></td> <td style="width: 10%;"></td> </tr> <tr> <td></td> <td></td> <td colspan="8" style="text-align: center;"> <table border="1" style="width: 100%; border-collapse: collapse; text-align: center;"> <tr> <td style="width: 10%;"></td> <td style="width: 10%;"></td> <td style="width: 10%;"></td> <td style="width: 10%;"></td> <td style="width: 10%;"></td> <td style="width: 10%;"></td> <td style="width: 10%;"></td> <td style="width: 10%;"></td> <td style="width: 10%;"></td> <td style="width: 10%;"></td> </tr> <tr> <td></td> <td></td> <td colspan="8" style="text-align: center;"> <table border="1" style="width: 100%; border-collapse: collapse; text-align: center;"> <tr> <td style="width: 10%;"></td> <td style="width: 10%;"></td> <td style="width: 10%;"></td> <td style="width: 10%;"></td> <td style="width: 10%;"></td> <td style="width: 10%;"></td> <td style="width: 10%;"></td> <td style="width: 10%;"></td> <td style="width: 10%;"></td> <td style="width: 10%;"></td> </tr> <tr> <td></td> <td></td> <td colspan="8" style="text-align: center;"> <table border="1" style="width: 100%; border-collapse: collapse; text-align: center;"> <tr> <td style="width: 10%;"></td> <td style="width: 10%;"></td> <td style="width: 10%;"></td> <td style="width: 10%;"></td> <td style="width: 10%;"></td> <td style="width: 10%;"></td> <td style="width: 10%;"></td> <td style="width: 10%;"></td> <td style="width: 10%;"></td> <td style="width: 10%;"></td> </tr> <tr> <td></td> <td></td> <td colspan="8" style="text-align: center;"> <table border="1" style="width: 100%; border-collapse: collapse; text-align: center;"> <tr> <td style="width: 10%;"></td> <td style="width: 10%;"></td> <td style="width: 10%;"></td> <td style="width: 10%;"></td> <td style="width: 10%;"></td> <td style="width: 10%;"></td> <td style="width: 10%;"></td> <td style="width: 10%;"></td> <td style="width: 10%;"></td> <td style="width: 10%;"></td> </tr> <tr> <td></td> <td></td> <td colspan="8" style="text-align: center;"> <table border="1" style="width: 100%; border-collapse: collapse; text-align: center;"> <tr> <td style="width: 10%;"></td> <td style="width: 10%;"></td> <td style="width: 10%;"></td> <td style="width: 10%;"></td> <td style="width: 10%;"></td> <td style="width: 10%;"></td> <td style="width: 10%;"></td> <td style="width: 10%;"></td> <td style="width: 10%;"></td> <td style="width: 10%;"></td> </tr> <tr> <td></td> <td></td> <td colspan="8" style="text-align: center;"> <table border="1" style="width: 100%; border-collapse: collapse; text-align: center;"> <tr> <td style="width: 10%;"></td> <td style="width: 10%;"></td> <td style="width: 10%;"></td> <td style="width: 10%;"></td> <td style="width: 10%;"></td> <td style="width: 10%;"></td> <td style="width: 10%;"></td> <td style="width: 10%;"></td> <td style="width: 10%;"></td> <td style="width: 10%;"></td> </tr> <tr> <td></td> <td></td> <td colspan="8" style="text-align: center;"> <table border="1" style="width: 100%; border-collapse: collapse; text-align: center;"> <tr> <td style="width: 10%;"></td> <td style="width: 10%;"></td> <td style="width: 10%;"></td> <td style="width: 10%;"></td> <td style="width: 10%;"></td> <td style="width: 10%;"></td> <td style="width: 10%;"></td> <td style="width: 10%;"></td> <td style="width: 10%;"></td> <td style="width: 10%;"></td> </tr> <tr> <td></td> <td></td> <td colspan="8" style="text-align: center;"> <table border="1" style="width: 100%; border-collapse: collapse; text-align: center;"> <tr> <td style="width: 10%;"></td> <td style="width: 10%;"></td> <td style="width: 10%;"></td> <td style="width: 10%;"></td> <td style="width: 10%;"></td> <td style="width: 10%;"></td> <td style="width: 10%;"></td> <td style="width: 10%;"></td> <td style="width: 10%;"></td> <td style="width: 10%;"></td> </tr> <tr> <td></td> <td></td> <td colspan="8" style="text-align: center;"> <table border="1" style="width: 100%; border-collapse: collapse; text-align: center;"> <tr> <td style="width: 10%;"></td> <td style="width: 10%;"></td> <td style="width: 10%;"></td> <td style="width: 10%;"></td> <td style="width: 10%;"></td> <td style="width: 10%;"></td> <td style="width: 10%;"></td> <td style="width: 10%;"></td> <td style="width: 10%;"></td> <td style="width: 10%;"></td> </tr> <tr> <td></td> <td></td> <td colspan="8" style="text-align: center;"> <table border="1" style="width: 100%; border-collapse: collapse; text-align: center;"> <tr> <td style="width: 10%;"></td> <td style="width: 10%;"></td> <td style="width: 10%;"></td> <td style="width: 10%;"></td> <td style="width: 10%;"></td> <td style="width: 10%;"></td> <td style="width: 10%;"></td> <td style="width: 10%;"></td> <td style="width: 10%;"></td> <td style="width: 10%;"></td> </tr> <tr> <td></td> <td></td> <td colspan="8" style="text-align: center;"> <table border="1" style="width: 100%; border-collapse: collapse; text-align: center;"> <tr> <td style="width: 10%;"></td> <td style="width: 10%;"></td> <td style="width: 10%;"></td> <td style="width: 10%;"></td> <td style="width: 10%;"></td> <td style="width: 10%;"></td> <td style="width: 10%;"></td> <td style="width: 10%;"></td> <td style="width: 10%;"></td> <td style="width: 10%;"></td> </tr> <tr> <td></td> <td></td> <td colspan="8" style="text-align: center;"> <table border="1" style="width: 100%; border-collapse: collapse; text-align: center;"> <tr> <td style="width: 10%;"></td> <td style="width: 10%;"></td> <td style="width: 10%;"></td> <td style="width: 10%;"></td> <td style="width: 10%;"></td> <td style="width: 10%;"></td> <td style="width: 10%;"></td> <td style="width: 10%;"></td> <td style="width: 10%;"></td> <td style="width: 10%;"></td> </tr> <tr> <td></td> <td></td> <td colspan="8" style="text-align: center;"> <table border="1" style="width: 100%; border-collapse: collapse; text-align: center;"> <tr> <td style="width: 10%;"></td> <td style="width: 10%;"></td> <td style="width: 10%;"></td> <td style="width: 10%;"></td> <td style="width: 10%;"></td> <td style="width: 10%;"></td> <td style="width: 10%;"></td> <td style="width: 10%;"></td> <td style="width: 10%;"></td> <td style="width: 10%;"></td> </tr> <tr> <td></td> <td></td> <td colspan="8" style="text-align: center;"> <table border="1" style="width: 100%; border-collapse: collapse; text-align: center;"> <tr> <td style="width: 10%;"></td> <td style="width: 10%;"></td> <td style="width: 10%;"></td> <td style="width: 10%;"></td> <td style="width: 10%;"></td> <td style="width: 10%;"></td> <td style="width: 10%;"></td> <td style="width: 10%;"></td> <td style="width: 10%;"></td> <td style="width: 10%;"></td> </tr> <tr> <td></td> <td></td> <td colspan="8" style="text-align: center;"> <table border="1" style="width: 100%; border-collapse: collapse; text-align: center;"> <tr> <td style="width: 10%;"></td> <td style="width: 10%;"></td> <td style="width: 10%;"></td> <td style="width: 10%;"></td> <td style="width: 10%;"></td> <td style="width: 10%;"></td> <td style="width: 10%;"></td> <td style="width: 10%;"></td> <td style="width: 10%;"></td> <td style="width: 10%;"></td> </tr> <tr> <td></td> <td></td> <td colspan="8" style="text-align: center;"> <table border="1" style="width: 100%; border-collapse: collapse; text-align: center;"> <tr> </tr></table></td></tr></table></td></tr></table></td></tr></table></td></tr></table></td></tr></table></td></tr></table></td></tr></table></td></tr></table></td></tr></table></td></tr></table></td></tr></table></td></tr></table></td></tr></table></td></tr></table></td></tr></table></td></tr></table></td></tr></table></td></tr></table>

 | | | | | | | | | | | | | | | | | | | | <table border="1" style="width: 100%; border-collapse: collapse; text-align: center;"> <tr> <td style="width: 10%;"></td> <td style="width: 10%;"></td> <td style="width: 10%;"></td> <td style="width: 10%;"></td> <td style="width: 10%;"></td> <td style="width: 10%;"></td> <td style="width: 10%;"></td> <td style="width: 10%;"></td> <td style="width: 10%;"></td> <td style="width: 10%;"></td> </tr> <tr> <td></td> <td></td> <td colspan="8" style="text-align: center;"> <table border="1" style="width: 100%; border-collapse: collapse; text-align: center;"> <tr> <td style="width: 10%;"></td> <td style="width: 10%;"></td> <td style="width: 10%;"></td> <td style="width: 10%;"></td> <td style="width: 10%;"></td> <td style="width: 10%;"></td> <td style="width: 10%;"></td> <td style="width: 10%;"></td> <td style="width: 10%;"></td> <td style="width: 10%;"></td> </tr> <tr> <td></td> <td></td> <td colspan="8" style="text-align: center;"> <table border="1" style="width: 100%; border-collapse: collapse; text-align: center;"> <tr> <td style="width: 10%;"></td> <td style="width: 10%;"></td> <td style="width: 10%;"></td> <td style="width: 10%;"></td> <td style="width: 10%;"></td> <td style="width: 10%;"></td> <td style="width: 10%;"></td> <td style="width: 10%;"></td> <td style="width: 10%;"></td> <td style="width: 10%;"></td> </tr> <tr> <td></td> <td></td> <td colspan="8" style="text-align: center;"> <table border="1" style="width: 100%; border-collapse: collapse; text-align: center;"> <tr> <td style="width: 10%;"></td> <td style="width: 10%;"></td> <td style="width: 10%;"></td> <td style="width: 10%;"></td> <td style="width: 10%;"></td> <td style="width: 10%;"></td> <td style="width: 10%;"></td> <td style="width: 10%;"></td> <td style="width: 10%;"></td> <td style="width: 10%;"></td> </tr> <tr> <td></td> <td></td> <td colspan="8" style="text-align: center;"> <table border="1" style="width: 100%; border-collapse: collapse; text-align: center;"> <tr> <td style="width: 10%;"></td> <td style="width: 10%;"></td> <td style="width: 10%;"></td> <td style="width: 10%;"></td> <td style="width: 10%;"></td> <td style="width: 10%;"></td> <td style="width: 10%;"></td> <td style="width: 10%;"></td> <td style="width: 10%;"></td> <td style="width: 10%;"></td> </tr> <tr> <td></td> <td></td> <td colspan="8" style="text-align: center;"> <table border="1" style="width: 100%; border-collapse: collapse; text-align: center;"> <tr> <td style="width: 10%;"></td> <td style="width: 10%;"></td> <td style="width: 10%;"></td> <td style="width: 10%;"></td> <td style="width: 10%;"></td> <td style="width: 10%;"></td> <td style="width: 10%;"></td> <td style="width: 10%;"></td> <td style="width:
10%;"></td> <td style="width: 10%;"></td> </tr> <tr> <td></td> <td></td> <td colspan="8" style="text-align: center;"> <table border="1" style="width: 100%; border-collapse: collapse; text-align: center;"> <tr> <td style="width: 10%;"></td> <td style="width: 10%;"></td> <td style="width: 10%;"></td> <td style="width: 10%;"></td> <td style="width: 10%;"></td> <td style="width: 10%;"></td> <td style="width: 10%;"></td> <td style="width: 10%;"></td> <td style="width: 10%;"></td> <td style="width: 10%;"></td> </tr> <tr> <td></td> <td></td> <td colspan="8" style="text-align: center;"> <table border="1" style="width: 100%; border-collapse: collapse; text-align: center;"> <tr> <td style="width: 10%;"></td> <td style="width: 10%;"></td> <td style="width: 10%;"></td> <td style="width: 10%;"></td> <td style="width: 10%;"></td> <td style="width: 10%;"></td> <td style="width: 10%;"></td> <td style="width: 10%;"></td> <td style="width: 10%;"></td> <td style="width: 10%;"></td> </tr> <tr> <td></td> <td></td> <td colspan="8" style="text-align: center;"> <table border="1" style="width: 100%; border-collapse: collapse; text-align: center;"> <tr> <td style="width: 10%;"></td> <td style="width: 10%;"></td> <td style="width: 10%;"></td> <td style="width: 10%;"></td> <td style="width: 10%;"></td> <td style="width: 10%;"></td> <td style="width: 10%;"></td> <td style="width: 10%;"></td> <td style="width: 10%;"></td> <td style="width: 10%;"></td> </tr> <tr> <td></td> <td></td> <td colspan="8" style="text-align: center;"> <table border="1" style="width: 100%; border-collapse: collapse; text-align: center;"> <tr> <td style="width: 10%;"></td> <td style="width: 10%;"></td> <td style="width: 10%;"></td> <td style="width: 10%;"></td> <td style="width: 10%;"></td> <td style="width: 10%;"></td> <td style="width: 10%;"></td> <td style="width: 10%;"></td> <td style="width: 10%;"></td> <td style="width: 10%;"></td> </tr> <tr> <td></td> <td></td> <td colspan="8" style="text-align: center;"> <table border="1" style="width: 100%; border-collapse: collapse; text-align: center;"> <tr> <td style="width: 10%;"></td> <td style="width: 10%;"></td> <td style="width: 10%;"></td> <td style="width: 10%;"></td> <td style="width: 10%;"></td> <td style="width: 10%;"></td> <td style="width: 10%;"></td> <td style="width: 10%;"></td> <td style="width: 10%;"></td> <td style="width: 10%;"></td> </tr> <tr> <td></td> <td></td> <td colspan="8" style="text-align: center;"> <table border="1" style="width: 100%; border-collapse: collapse; text-align: center;"> <tr> <td style="width: 10%;"></td> <td style="width: 10%;"></td> <td style="width: 10%;"></td> <td style="width: 10%;"></td> <td style="width: 10%;"></td> <td style="width: 10%;"></td> <td style="width: 10%;"></td> <td style="width: 10%;"></td> <td style="width: 10%;"></td> <td style="width: 10%;"></td> </tr> <tr> <td></td> <td></td> <td colspan="8" style="text-align: center;"> <table border="1" style="width: 100%; border-collapse: collapse; text-align: center;"> <tr> <td style="width: 10%;"></td> <td style="width: 10%;"></td> <td style="width: 10%;"></td> <td style="width: 10%;"></td> <td style="width: 10%;"></td> <td style="width: 10%;"></td> <td style="width: 10%;"></td> <td style="width: 10%;"></td> <td style="width: 10%;"></td> <td style="width: 10%;"></td> </tr> <tr> <td></td> <td></td> <td colspan="8" style="text-align: center;"> <table border="1" style="width: 100%; border-collapse: collapse; text-align: center;"> <tr> <td style="width: 10%;"></td> <td style="width: 10%;"></td> <td style="width: 10%;"></td> <td style="width: 10%;"></td> <td style="width: 10%;"></td> <td style="width: 10%;"></td> <td style="width: 10%;"></td> <td style="width: 10%;"></td> <td style="width: 10%;"></td> <td style="width: 10%;"></td> </tr> <tr> <td></td> <td></td> <td colspan="8" style="text-align: center;"> <table border="1" style="width: 100%; border-collapse: collapse; text-align: center;"> <tr> <td style="width: 10%;"></td> <td style="width: 10%;"></td> <td style="width: 10%;"></td> <td style="width: 10%;"></td> <td style="width: 10%;"></td> <td style="width: 10%;"></td> <td style="width: 10%;"></td> <td style="width: 10%;"></td> <td style="width: 10%;"></td> <td style="width: 10%;"></td> </tr> <tr> <td></td> <td></td> <td colspan="8" style="text-align: center;"> <table border="1" style="width: 100%; border-collapse: collapse; text-align: center;"> <tr> <td style="width: 10%;"></td> <td style="width: 10%;"></td> <td style="width: 10%;"></td> <td style="width: 10%;"></td> <td style="width: 10%;"></td> <td style="width: 10%;"></td> <td style="width: 10%;"></td> <td style="width: 10%;"></td> <td style="width: 10%;"></td> <td style="width: 10%;"></td> </tr> <tr> <td></td> <td></td> <td colspan="8" style="text-align: center;"> <table border="1" style="width: 100%; border-collapse: collapse; text-align: center;"> <tr> <td style="width: 10%;"></td> <td style="width: 10%;"></td> <td style="width: 10%;"></td> <td style="width: 10%;"></td> <td style="width: 10%;"></td> <td style="width: 10%;"></td> <td style="width: 10%;"></td> <td style="width: 10%;"></td> <td style="width: 10%;"></td> <td style="width: 10%;"></td> </tr> <tr> <td></td> <td></td> <td colspan="8" style="text-align: center;"> <table border="1" style="width: 100%; border-collapse: collapse; text-align: center;"> <tr> </tr></table></td></tr></table></td></tr></table></td></tr></table></td></tr></table></td></tr></table></td></tr></table></td></tr></table></td></tr></table></td></tr></table></td></tr></table></td></tr></table></td></tr></table></td></tr></table></td></tr></table></td></tr></table></td></tr></table></td></tr></table>

 | | | | | | | | | | | | | | | | | | | | <table border="1" style="width: 100%; border-collapse: collapse; text-align: center;"> <tr> <td style="width: 10%;"></td> <td style="width: 10%;"></td> <td style="width: 10%;"></td> <td style="width: 10%;"></td> <td style="width: 10%;"></td> <td style="width: 10%;"></td> <td style="width: 10%;"></td> <td style="width: 10%;"></td> <td style="width: 10%;"></td> <td style="width: 10%;"></td> </tr> <tr> <td></td> <td></td> <td colspan="8" style="text-align: center;"> <table border="1" style="width: 100%; border-collapse: collapse; text-align: center;"> <tr> <td style="width: 10%;"></td> <td style="width: 10%;"></td> <td style="width: 10%;"></td> <td style="width: 10%;"></td> <td style="width: 10%;"></td> <td style="width: 10%;"></td> <td style="width: 10%;"></td> <td style="width: 10%;"></td> <td style="width: 10%;"></td> <td style="width: 10%;"></td> </tr> <tr> <td></td> <td></td> <td colspan="8" style="text-align: center;"> <table border="1" style="width: 100%; border-collapse: collapse; text-align: center;"> <tr> <td style="width: 10%;"></td> <td style="width: 10%;"></td> <td style="width: 10%;"></td> <td style="width: 10%;"></td> <td style="width: 10%;"></td> <td style="width: 10%;"></td> <td style="width: 10%;"></td> <td style="width: 10%;"></td> <td style="width: 10%;"></td> <td style="width: 10%;"></td> </tr> <tr> <td></td> <td></td> <td colspan="8" style="text-align: center;"> <table border="1" style="width: 100%; border-collapse: collapse; text-align: center;"> <tr> <td style="width: 10%;"></td> <td style="width: 10%;"></td> <td style="width: 10%;"></td> <td style="width: 10%;"></td> <td style="width: 10%;"></td> <td style="width: 10%;"></td> <td style="width: 10%;"></td> <td style="width: 10%;"></td> <td style="width: 10%;"></td> <td style="width: 10%;"></td> </tr> <tr> <td></td> <td></td> <td colspan="8" style="text-align: center;"> <table border="1" style="width: 100%; border-collapse: collapse; text-align: center;"> <tr> <td style="width: 10%;"></td> <td style="width: 10%;"></td> <td style="width: 10%;"></td> <td style="width: 10%;"></td> <td style="width: 10%;"></td> <td style="width: 10%;"></td> <td style="width: 10%;"></td> <td style="width: 10%;"></td> <td style="width: 10%;"></td> <td style="width: 10%;"></td> </tr> <tr> <td></td> <td></td> <td colspan="8" style="text-align: center;"> <table border="1" style="width: 100%; border-collapse: collapse; text-align: center;"> <tr> <td style="width: 10%;"></td> <td style="width: 10%;"></td> <td style="width: 10%;"></td> <td style="width: 10%;"></td> <td style="width: 10%;"></td> <td style="width: 10%;"></td> <td style="width: 10%;"></td> <td style="width: 10%;"></td> <td style="width: 10%;"></td> <td style="width: 10%;"></td> </tr> <tr> <td></td> <td></td> <td colspan="8" style="text-align: center;"> <table border="1" style="width: 100%; border-collapse: collapse; text-align: center;"> <tr> <td style="width: 10%;"></td> <td style="width: 10%;"></td> <td style="width: 10%;"></td> <td style="width: 10%;"></td> <td style="width: 10%;"></td> <td style="width: 10%;"></td> <td style="width: 10%;"></td> <td style="width: 10%;"></td> <td style="width: 10%;"></td> <td style="width: 10%;"></td> </tr> <tr> <td></td> <td></td> <td colspan="8" style="text-align: center;"> <table border="1" style="width: 100%; border-collapse: collapse; text-align: center;"> <tr> <td style="width: 10%;"></td> <td style="width: 10%;"></td> <td style="width: 10%;"></td> <td style="width: 10%;"></td> <td style="width: 10%;"></td> <td style="width: 10%;"></td> <td style="width: 10%;"></td> <td style="width: 10%;"></td> <td style="width: 10%;"></td> <td style="width: 10%;"></td> </tr> <tr> <td></td> <td></td> <td colspan="8" style="text-align: center;"> <table border="1" style="width: 100%; border-collapse: collapse; text-align: center;"> <tr> <td style="width: 10%;"></td> <td style="width: 10%;"></td> <td style="width: 10%;"></td> <td style="width: 10%;"></td> <td style="width: 10%;"></td> <td style="width: 10%;"></td> <td style="width: 10%;"></td> <td style="width: 10%;"></td> <td style="width: 10%;"></td> <td style="width: 10%;"></td> </tr> <tr> <td></td> <td></td> <td colspan="8" style="text-align: center;"> <table border="1" style="width: 100%; border-collapse: collapse; text-align: center;"> <tr> <td style="width: 10%;"></td> <td style="width: 10%;"></td> <td style="width: 10%;"></td> <td style="width: 10%;"></td> <td style="width: 10%;"></td> <td style="width: 10%;"></td> <td style="width: 10%;"></td> <td style="width: 10%;"></td> <td style="width: 10%;"></td> <td style="width: 10%;"></td> </tr> <tr> <td></td> <td></td> <td colspan="8" style="text-align: center;"> <table border="1" style="width: 100%; border-collapse: collapse; text-align: center;"> <tr> <td style="width: 10%;"></td> <td style="width: 10%;"></td> <td style="width: 10%;"></td> <td style="width: 10%;"></td> <td style="width: 10%;"></td> <td style="width: 10%;"></td> <td style="width: 10%;"></td> <td style="width: 10%;"></td> <td style="width: 10%;"></td> <td style="width: 10%;"></td> </tr> <tr> <td></td> <td></td> <td colspan="8" style="text-align: center;"> <table border="1" style="width: 100%; border-collapse: collapse; text-align: center;"> <tr> <td style="width: 10%;"></td> <td style="width: 10%;"></td> <td style="width: 10%;"></td> <td style="width: 10%;"></td> <td style="width: 10%;"></td> <td style="width: 10%;"></td> <td style="width: 10%;"></td> <td style="width: 10%;"></td> <td style="width: 10%;"></td> <td style="width: 10%;"></td> </tr> <tr> <td></td> <td></td> <td colspan="8" style="text-align: center;"> <table border="1" style="width: 100%; border-collapse: collapse; text-align: center;"> <tr> <td style="width: 10%;"></td> <td style="width: 10%;"></td> <td style="width: 10%;"></td> <td style="width: 10%;"></td> <td style="width: 10%;"></td> <td style="width: 10%;"></td> <td style="width: 10%;"></td> <td style="width: 10%;"></td> <td style="width: 10%;"></td> <td style="width: 10%;"></td> </tr> <tr> <td></td> <td></td> <td colspan="8" style="text-align: center;"> <table border="1" style="width: 100%; border-collapse: collapse; text-align: center;"> <tr> <td style="width: 10%;"></td> <td style="width: 10%;"></td> <td style="width: 10%;"></td> <td style="width: 10%;"></td> <td style="width: 10%;"></td> <td style="width: 10%;"></td> <td style="width: 10%;"></td> <td style="width: 10%;"></td> <td style="width: 10%;"></td> <td style="width: 10%;"></td> </tr> <tr> <td></td> <td></td> <td colspan="8" style="text-align: center;"> <table border="1" style="width: 100%; border-collapse: collapse; text-align: center;"> <tr> <td style="width: 10%;"></td> <td style="width: 10%;"></td> <td style="width: 10%;"></td> <td style="width: 10%;"></td>
<td style="width: 10%;"></td> <td style="width: 10%;"></td> <td style="width: 10%;"></td> <td style="width: 10%;"></td> <td style="width: 10%;"></td> <td style="width: 10%;"></td> </tr> <tr> <td></td> <td></td> <td colspan="8" style="text-align: center;"> <table border="1" style="width: 100%; border-collapse: collapse; text-align: center;"> <tr> <td style="width: 10%;"></td> <td style="width: 10%;"></td> <td style="width: 10%;"></td> <td style="width: 10%;"></td> <td style="width: 10%;"></td> <td style="width: 10%;"></td> <td style="width: 10%;"></td> <td style="width: 10%;"></td> <td style="width: 10%;"></td> <td style="width: 10%;"></td> </tr> <tr> <td></td> <td></td> <td colspan="8" style="text-align: center;"> <table border="1" style="width: 100%; border-collapse: collapse; text-align: center;"> <tr> </tr></table></td></tr></table></td></tr></table></td></tr></table></td></tr></table></td></tr></table></td></tr></table></td></tr></table></td></tr></table></td></tr></table></td></tr></table></td></tr></table></td></tr></table></td></tr></table></td></tr></table></td></tr></table></td></tr></table>
 | | | | | | | | | | | | | | | | | | | | <table border="1" style="width: 100%; border-collapse: collapse; text-align: center;"> <tr> <td style="width: 10%;"></td> <td style="width: 10%;"></td> <td style="width: 10%;"></td> <td style="width: 10%;"></td> <td style="width: 10%;"></td> <td style="width: 10%;"></td> <td style="width: 10%;"></td> <td style="width: 10%;"></td> <td style="width: 10%;"></td> <td style="width: 10%;"></td> </tr> <tr> <td></td> <td></td> <td colspan="8" style="text-align: center;"> <table border="1" style="width: 100%; border-collapse: collapse; text-align: center;"> <tr> <td style="width: 10%;"></td> <td style="width: 10%;"></td> <td style="width: 10%;"></td> <td style="width: 10%;"></td> <td style="width: 10%;"></td> <td style="width: 10%;"></td> <td style="width: 10%;"></td> <td style="width: 10%;"></td> <td style="width: 10%;"></td> <td style="width: 10%;"></td> </tr> <tr> <td></td> <td></td> <td colspan="8" style="text-align: center;"> <table border="1" style="width: 100%; border-collapse: collapse; text-align: center;"> <tr> <td style="width: 10%;"></td> <td style="width: 10%;"></td> <td style="width: 10%;"></td> <td style="width: 10%;"></td> <td style="width: 10%;"></td> <td style="width: 10%;"></td> <td style="width: 10%;"></td> <td style="width: 10%;"></td> <td style="width: 10%;"></td> <td style="width:
10%;"></td> </tr> <tr> <td></td> <td></td> <td colspan="8" style="text-align: center;"> <table border="1" style="width: 100%; border-collapse: collapse; text-align: center;"> <tr> <td style="width: 10%;"></td> <td style="width: 10%;"></td> <td style="width: 10%;"></td> <td style="width: 10%;"></td> <td style="width: 10%;"></td> <td style="width: 10%;"></td> <td style="width: 10%;"></td> <td style="width: 10%;"></td> <td style="width: 10%;"></td> <td style="width: 10%;"></td> </tr> <tr> <td></td> <td></td> <td colspan="8" style="text-align: center;"> <table border="1" style="width: 100%; border-collapse: collapse; text-align: center;"> <tr> <td style="width: 10%;"></td> <td style="width: 10%;"></td> <td style="width: 10%;"></td> <td style="width: 10%;"></td> <td style="width: 10%;"></td> <td style="width: 10%;"></td> <td style="width: 10%;"></td> <td style="width: 10%;"></td> <td style="width: 10%;"></td> <td style="width: 10%;"></td> </tr> <tr> <td></td> <td></td> <td colspan="8" style="text-align: center;"> <table border="1" style="width: 100%; border-collapse: collapse; text-align: center;"> <tr> <td style="width: 10%;"></td> <td style="width: 10%;"></td> <td style="width: 10%;"></td> <td style="width: 10%;"></td> <td style="width: 10%;"></td> <td style="width: 10%;"></td> <td style="width: 10%;"></td> <td style="width: 10%;"></td> <td style="width: 10%;"></td> <td style="width: 10%;"></td> </tr> <tr> <td></td> <td></td> <td colspan="8" style="text-align: center;"> <table border="1" style="width: 100%; border-collapse: collapse; text-align: center;"> <tr> <td style="width: 10%;"></td> <td style="width: 10%;"></td> <td style="width: 10%;"></td> <td style="width: 10%;"></td> <td style="width: 10%;"></td> <td style="width: 10%;"></td> <td style="width: 10%;"></td> <td style="width: 10%;"></td> <td style="width: 10%;"></td> <td style="width: 10%;"></td> </tr> <tr> <td></td> <td></td> <td colspan="8" style="text-align: center;"> <table border="1" style="width: 100%; border-collapse: collapse; text-align: center;"> <tr> <td style="width: 10%;"></td> <td style="width: 10%;"></td> <td style="width: 10%;"></td> <td style="width: 10%;"></td> <td style="width: 10%;"></td> <td style="width: 10%;"></td> <td style="width: 10%;"></td> <td style="width: 10%;"></td> <td style="width: 10%;"></td> <td style="width: 10%;"></td> </tr> <tr> <td></td> <td></td> <td colspan="8" style="text-align: center;"> <table border="1" style="width: 100%; border-collapse: collapse; text-align: center;"> <tr> <td style="width: 10%;"></td> <td style="width: 10%;"></td> <td style="width: 10%;"></td> <td style="width: 10%;"></td> <td style="width: 10%;"></td> <td style="width: 10%;"></td> <td style="width: 10%;"></td> <td style="width: 10%;"></td> <td style="width: 10%;"></td> <td style="width: 10%;"></td> </tr> <tr> <td></td> <td></td> <td colspan="8" style="text-align: center;"> <table border="1" style="width: 100%; border-collapse: collapse; text-align: center;"> <tr> <td style="width: 10%;"></td> <td style="width: 10%;"></td> <td style="width: 10%;"></td> <td style="width: 10%;"></td> <td style="width: 10%;"></td> <td style="width: 10%;"></td> <td style="width: 10%;"></td> <td style="width: 10%;"></td> <td style="width: 10%;"></td> <td style="width: 10%;"></td> </tr> <tr> <td></td> <td></td> <td colspan="8" style="text-align: center;"> <table border="1" style="width: 100%; border-collapse: collapse; text-align: center;"> <tr> <td style="width: 10%;"></td> <td style="width: 10%;"></td> <td style="width: 10%;"></td> <td style="width: 10%;"></td> <td style="width: 10%;"></td> <td style="width: 10%;"></td> <td style="width: 10%;"></td> <td style="width: 10%;"></td> <td style="width: 10%;"></td> <td style="width: 10%;"></td> </tr> <tr> <td></td> <td></td> <td colspan="8" style="text-align: center;"> <table border="1" style="width: 100%; border-collapse: collapse; text-align: center;"> <tr> <td style="width: 10%;"></td> <td style="width: 10%;"></td> <td style="width: 10%;"></td> <td style="width: 10%;"></td> <td style="width: 10%;"></td> <td style="width: 10%;"></td> <td style="width: 10%;"></td> <td style="width: 10%;"></td> <td style="width: 10%;"></td> <td style="width: 10%;"></td> </tr> <tr> <td></td> <td></td> <td colspan="8" style="text-align: center;"> <table border="1" style="width: 100%; border-collapse: collapse; text-align: center;"> <tr> <td style="width: 10%;"></td> <td style="width: 10%;"></td> <td style="width: 10%;"></td> <td style="width: 10%;"></td> <td style="width: 10%;"></td> <td style="width: 10%;"></td> <td style="width: 10%;"></td> <td style="width: 10%;"></td> <td style="width: 10%;"></td> <td style="width: 10%;"></td> </tr> <tr> <td></td> <td></td> <td colspan="8" style="text-align: center;"> <table border="1" style="width: 100%; border-collapse: collapse; text-align: center;"> <tr> <td style="width: 10%;"></td> <td style="width: 10%;"></td> <td style="width: 10%;"></td> <td style="width: 10%;"></td> <td style="width: 10%;"></td> <td style="width: 10%;"></td> <td style="width: 10%;"></td> <td style="width: 10%;"></td> <td style="width: 10%;"></td> <td style="width: 10%;"></td> </tr> <tr> <td></td> <td></td> <td colspan="8" style="text-align: center;"> <table border="1" style="width: 100%; border-collapse: collapse; text-align: center;"> <tr> <td style="width: 10%;"></td> <td style="width: 10%;"></td> <td style="width: 10%;"></td> <td style="width: 10%;"></td> <td style="width: 10%;"></td> <td style="width: 10%;"></td> <td style="width: 10%;"></td> <td style="width: 10%;"></td> <td style="width: 10%;"></td> <td style="width: 10%;"></td> </tr> <tr> <td></td> <td></td> <td colspan="8" style="text-align: center;"> <table border="1" style="width: 100%; border-collapse: collapse; text-align: center;"> <tr> </tr></table></td></tr></table></td></tr></table></td></tr></table></td></tr></table></td></tr></table></td></tr></table></td></tr></table></td></tr></table></td></tr></table></td></tr></table></td></tr></table></td></tr></table></td></tr></table></td></tr></table></td></tr></table>

 | | | | | | | | | | | | | | | | | | | | <table border="1" style="width: 100%; border-collapse: collapse; text-align: center;"> <tr> <td style="width: 10%;"></td> <td style="width: 10%;"></td> <td style="width: 10%;"></td> <td style="width: 10%;"></td> <td style="width: 10%;"></td> <td style="width: 10%;"></td> <td style="width: 10%;"></td> <td style="width: 10%;"></td> <td style="width: 10%;"></td> <td style="width: 10%;"></td> </tr> <tr> <td></td> <td></td> <td colspan="8" style="text-align: center;"> <table border="1" style="width: 100%; border-collapse: collapse; text-align: center;"> <tr> <td style="width: 10%;"></td> <td style="width: 10%;"></td> <td style="width: 10%;"></td> <td style="width: 10%;"></td> <td style="width: 10%;"></td> <td style="width: 10%;"></td> <td style="width: 10%;"></td> <td style="width: 10%;"></td> <td style="width: 10%;"></td> <td style="width: 10%;"></td> </tr> <tr> <td></td> <td></td> <td colspan="8" style="text-align: center;"> <table border="1" style="width: 100%; border-collapse: collapse; text-align: center;"> <tr> <td style="width: 10%;"></td> <td style="width: 10%;"></td> <td style="width: 10%;"></td> <td style="width: 10%;"></td> <td style="width: 10%;"></td> <td style="width: 10%;"></td> <td style="width: 10%;"></td> <td style="width: 10%;"></td> <td style="width: 10%;"></td> <td style="width: 10%;"></td> </tr> <tr> <td></td> <td></td> <td colspan="8" style="text-align: center;"> <table border="1" style="width: 100%; border-collapse: collapse; text-align: center;"> <tr> <td style="width: 10%;"></td> <td style="width: 10%;"></td> <td style="width: 10%;"></td> <td style="width: 10%;"></td> <td style="width: 10%;"></td> <td style="width: 10%;"></td> <td style="width: 10%;"></td> <td style="width: 10%;"></td> <td style="width: 10%;"></td> <td style="width: 10%;"></td> </tr> <tr> <td></td> <td></td> <td colspan="8" style="text-align: center;"> <table border="1" style="width: 100%; border-collapse: collapse; text-align: center;"> <tr> <td style="width: 10%;"></td> <td style="width: 10%;"></td> <td style="width: 10%;"></td> <td style="width: 10%;"></td> <td style="width: 10%;"></td> <td style="width: 10%;"></td> <td style="width: 10%;"></td> <td style="width: 10%;"></td> <td style="width: 10%;"></td> <td style="width: 10%;"></td> </tr> <tr> <td></td> <td></td> <td colspan="8" style="text-align: center;"> <table border="1" style="width: 100%; border-collapse: collapse; text-align: center;"> <tr> <td style="width: 10%;"></td> <td style="width: 10%;"></td> <td style="width: 10%;"></td> <td style="width: 10%;"></td> <td style="width: 10%;"></td> <td style="width: 10%;"></td> <td style="width: 10%;"></td> <td style="width: 10%;"></td> <td style="width: 10%;"></td> <td style="width: 10%;"></td> </tr> <tr> <td></td> <td></td> <td colspan="8" style="text-align: center;"> <table border="1" style="width: 100%; border-collapse: collapse; text-align: center;"> <tr> <td style="width: 10%;"></td> <td style="width: 10%;"></td> <td style="width: 10%;"></td> <td style="width: 10%;"></td> <td style="width: 10%;"></td> <td style="width: 10%;"></td> <td style="width: 10%;"></td> <td style="width: 10%;"></td> <td style="width: 10%;"></td> <td style="width: 10%;"></td> </tr> <tr> <td></td> <td></td> <td colspan="8" style="text-align: center;"> <table border="1" style="width: 100%; border-collapse: collapse; text-align: center;"> <tr> <td style="width: 10%;"></td> <td style="width: 10%;"></td> <td style="width: 10%;"></td> <td style="width: 10%;"></td> <td style="width: 10%;"></td> <td style="width: 10%;"></td> <td style="width: 10%;"></td> <td style="width: 10%;"></td> <td style="width: 10%;"></td> <td style="width: 10%;"></td> </tr> <tr> <td></td> <td></td> <td colspan="8" style="text-align: center;"> <table border="1" style="width: 100%; border-collapse: collapse; text-align: center;"> <tr> <td style="width: 10%;"></td> <td style="width: 10%;"></td> <td style="width: 10%;"></td> <td style="width: 10%;"></td> <td style="width: 10%;"></td> <td style="width: 10%;"></td> <td style="width: 10%;"></td> <td style="width: 10%;"></td> <td style="width: 10%;"></td> <td style="width: 10%;"></td> </tr> <tr> <td></td> <td></td> <td colspan="8" style="text-align: center;"> <table border="1" style="width: 100%; border-collapse: collapse; text-align: center;"> <tr> <td style="width: 10%;"></td> <td style="width: 10%;"></td> <td style="width: 10%;"></td> <td style="width: 10%;"></td> <td style="width: 10%;"></td> <td style="width: 10%;"></td> <td style="width: 10%;"></td> <td style="width: 10%;"></td> <td style="width: 10%;"></td> <td style="width: 10%;"></td> </tr> <tr> <td></td> <td></td> <td colspan="8" style="text-align: center;"> <table border="1" style="width: 100%; border-collapse: collapse; text-align: center;"> <tr> <td style="width: 10%;"></td> <td style="width: 10%;"></td> <td style="width: 10%;"></td> <td style="width: 10%;"></td> <td style="width: 10%;"></td> <td style="width: 10%;"></td> <td style="width: 10%;"></td> <td style="width: 10%;"></td> <td style="width: 10%;"></td> <td style="width: 10%;"></td> </tr> <tr> <td></td> <td></td> <td colspan="8" style="text-align: center;"> <table border="1" style="width: 100%; border-collapse: collapse; text-align: center;"> <tr> <td style="width: 10%;"></td> <td style="width: 10%;"></td> <td style="width: 10%;"></td> <td style="width: 10%;"></td> <td style="width: 10%;"></td> <td style="width: 10%;"></td> <td style="width: 10%;"></td> <td style="width: 10%;"></td> <td style="width: 10%;"></td> <td style="width: 10%;"></td> </tr> <tr> <td></td> <td></td> <td colspan="8" style="text-align: center;"> <table border="1" style="width: 100%; border-collapse: collapse; text-align: center;"> <tr> <td style="width: 10%;"></td> <td style="width: 10%;"></td> <td style="width: 10%;"></td> <td style="width: 10%;"></td> <td style="width: 10%;"></td> <td style="width: 10%;"></td> <td style="width: 10%;"></td> <td style="width: 10%;"></td> <td style="width: 10%;"></td> <td style="width: 10%;"></td> </tr> <tr> <td></td> <td></td> <td colspan="8" style="text-align: center;"> <table border="1" style="width: 100%; border-collapse: collapse; text-align: center;"> <tr> <td style="width: 10%;"></td> <td style="width: 10%;"></td> <td style="width: 10%;"></td> <td style="width: 10%;"></td> <td style="width: 10%;"></td> <td style="width: 10%;"></td> <td
style="width: 10%;"></td> <td style="width: 10%;"></td> <td style="width: 10%;"></td> <td style="width: 10%;"></td> </tr> <tr> <td></td> <td></td> <td colspan="8" style="text-align: center;"> <table border="1" style="width: 100%; border-collapse: collapse; text-align: center;"> <tr> </tr></table></td></tr></table></td></tr></table></td></tr></table></td></tr></table></td></tr></table></td></tr></table></td></tr></table></td></tr></table></td></tr></table></td></tr></table></td></tr></table></td></tr></table></td></tr></table></td></tr></table>
 | | | | | | | | | | | | | | | | | | | | <table border="1" style="width: 100%; border-collapse: collapse; text-align: center;"> <tr> <td style="width: 10%;"></td> <td style="width: 10%;"></td> <td style="width: 10%;"></td> <td style="width: 10%;"></td> <td style="width: 10%;"></td> <td style="width: 10%;"></td> <td style="width: 10%;"></td> <td style="width: 10%;"></td> <td style="width: 10%;"></td> <td style="width: 10%;"></td> </tr> <tr> <td></td> <td></td> <td colspan="8" style="text-align: center;"> <table border="1" style="width: 100%; border-collapse: collapse; text-align: center;"> <tr> <td style="width: 10%;"></td> <td style="width: 10%;"></td> <td style="width: 10%;"></td> <td style="width: 10%;"></td> <td style="width: 10%;"></td> <td style="width: 10%;"></td> <td style="width: 10%;"></td> <td style="width: 10%;"></td> <td style="width: 10%;"></td> <td style="width: 10%;"></td> </tr> <tr> <td></td> <td></td> <td colspan="8" style="text-align: center;"> <table border="1" style="width: 100%; border-collapse: collapse; text-align: center;"> <tr> <td style="width: 10%;"></td> <td style="width: 10%;"></td> <td style="width: 10%;"></td> <td style="width: 10%;"></td> <td style="width: 10%;"></td> <td style="width: 10%;"></td> <td style="width: 10%;"></td> <td style="width: 10%;"></td> <td style="width: 10%;"></td> <td style="width: 10%;"></td> </tr> <tr> <td></td> <td></td> <td colspan="8" style="text-align: center;"> <table border="1" style="width: 100%; border-collapse: collapse; text-align: center;"> <tr> <td style="width: 10%;"></td> <td style="width: 10%;"></td> <td style="width: 10%;"></td> <td style="width: 10%;"></td> <td style="width: 10%;"></td> <td style="width: 10%;"></td> <td style="width: 10%;"></td> <td style="width: 10%;"></td> <td style="width: 10%;"></td> <td style="width: 10%;"></td> </tr> <tr> <td></td> <td></td> <td colspan="8" style="text-align: center;"> <table border="1"
style="width: 100%; border-collapse: collapse; text-align: center;"> <tr> <td style="width: 10%;"></td> <td style="width: 10%;"></td> <td style="width: 10%;"></td> <td style="width: 10%;"></td> <td style="width: 10%;"></td> <td style="width: 10%;"></td> <td style="width: 10%;"></td> <td style="width: 10%;"></td> <td style="width: 10%;"></td> <td style="width: 10%;"></td> </tr> <tr> <td></td> <td></td> <td colspan="8" style="text-align: center;"> <table border="1" style="width: 100%; border-collapse: collapse; text-align: center;"> <tr> <td style="width: 10%;"></td> <td style="width: 10%;"></td> <td style="width: 10%;"></td> <td style="width: 10%;"></td> <td style="width: 10%;"></td> <td style="width: 10%;"></td> <td style="width: 10%;"></td> <td style="width: 10%;"></td> <td style="width: 10%;"></td> <td style="width: 10%;"></td> </tr> <tr> <td></td> <td></td> <td colspan="8" style="text-align: center;"> <table border="1" style="width: 100%; border-collapse: collapse; text-align: center;"> <tr> <td style="width: 10%;"></td> <td style="width: 10%;"></td> <td style="width: 10%;"></td> <td style="width: 10%;"></td> <td style="width: 10%;"></td> <td style="width: 10%;"></td> <td style="width: 10%;"></td> <td style="width: 10%;"></td> <td style="width: 10%;"></td> <td style="width: 10%;"></td> </tr> <tr> <td></td> <td></td> <td colspan="8" style="text-align: center;"> <table border="1" style="width: 100%; border-collapse: collapse; text-align: center;"> <tr> <td style="width: 10%;"></td> <td style="width: 10%;"></td> <td style="width: 10%;"></td> <td style="width: 10%;"></td> <td style="width: 10%;"></td> <td style="width: 10%;"></td> <td style="width: 10%;"></td> <td style="width: 10%;"></td> <td style="width: 10%;"></td> <td style="width: 10%;"></td> </tr> <tr> <td></td> <td></td> <td colspan="8" style="text-align: center;"> <table border="1" style="width: 100%; border-collapse: collapse; text-align: center;"> <tr> <td style="width: 10%;"></td> <td style="width: 10%;"></td> <td style="width: 10%;"></td> <td style="width: 10%;"></td> <td style="width: 10%;"></td> <td style="width: 10%;"></td> <td style="width: 10%;"></td> <td style="width: 10%;"></td> <td style="width: 10%;"></td> <td style="width: 10%;"></td> </tr> <tr> <td></td> <td></td> <td colspan="8" style="text-align: center;"> <table border="1" style="width: 100%; border-collapse: collapse; text-align: center;"> <tr> <td style="width: 10%;"></td> <td style="width: 10%;"></td> <td style="width: 10%;"></td> <td style="width: 10%;"></td> <td style="width: 10%;"></td> <td style="width: 10%;"></td> <td style="width: 10%;"></td> <td style="width: 10%;"></td> <td style="width: 10%;"></td> <td style="width: 10%;"></td> </tr> <tr> <td></td> <td></td> <td colspan="8" style="text-align: center;"> <table border="1" style="width: 100%; border-collapse: collapse; text-align: center;"> <tr> <td style="width: 10%;"></td> <td style="width: 10%;"></td> <td style="width: 10%;"></td> <td style="width: 10%;"></td> <td style="width: 10%;"></td> <td style="width: 10%;"></td> <td style="width: 10%;"></td> <td style="width: 10%;"></td> <td style="width: 10%;"></td> <td style="width: 10%;"></td> </tr> <tr> <td></td> <td></td> <td colspan="8" style="text-align: center;"> <table border="1" style="width: 100%; border-collapse: collapse; text-align: center;"> <tr> <td style="width: 10%;"></td> <td style="width: 10%;"></td> <td style="width: 10%;"></td> <td style="width: 10%;"></td> <td style="width: 10%;"></td> <td style="width: 10%;"></td> <td style="width: 10%;"></td> <td style="width: 10%;"></td> <td style="width: 10%;"></td> <td style="width: 10%;"></td> </tr> <tr> <td></td> <td></td> <td colspan="8" style="text-align: center;"> <table border="1" style="width: 100%; border-collapse: collapse; text-align: center;"> <tr> <td style="width: 10%;"></td> <td style="width: 10%;"></td> <td style="width: 10%;"></td> <td style="width: 10%;"></td> <td style="width: 10%;"></td> <td style="width: 10%;"></td> <td style="width: 10%;"></td> <td style="width: 10%;"></td> <td style="width: 10%;"></td> <td style="width: 10%;"></td> </tr> <tr> <td></td> <td></td> <td colspan="8" style="text-align: center;"> <table border="1" style="width: 100%; border-collapse: collapse; text-align: center;"> <tr> </tr></table></td></tr></table></td></tr></table></td></tr></table></td></tr></table></td></tr></table></td></tr></table></td></tr></table></td></tr></table></td></tr></table></td></tr></table></td></tr></table></td></tr></table></td></tr></table>

 | | | | | | | | | | | | | | | | | | | | <table border="1" style="width: 100%; border-collapse: collapse; text-align: center;"> <tr> <td style="width: 10%;"></td> <td style="width: 10%;"></td> <td style="width: 10%;"></td> <td style="width: 10%;"></td> <td style="width: 10%;"></td> <td style="width: 10%;"></td> <td style="width: 10%;"></td> <td style="width: 10%;"></td> <td style="width: 10%;"></td> <td style="width: 10%;"></td> </tr> <tr> <td></td> <td></td> <td colspan="8" style="text-align: center;"> <table border="1" style="width: 100%; border-collapse: collapse; text-align: center;"> <tr> <td style="width: 10%;"></td> <td style="width: 10%;"></td> <td style="width: 10%;"></td> <td style="width: 10%;"></td> <td style="width: 10%;"></td> <td style="width: 10%;"></td> <td style="width: 10%;"></td> <td style="width: 10%;"></td> <td style="width: 10%;"></td> <td style="width: 10%;"></td> </tr> <tr> <td></td> <td></td> <td colspan="8" style="text-align: center;"> <table border="1" style="width: 100%; border-collapse: collapse; text-align: center;"> <tr> <td style="width: 10%;"></td> <td style="width: 10%;"></td> <td style="width: 10%;"></td> <td style="width: 10%;"></td> <td style="width: 10%;"></td> <td style="width: 10%;"></td> <td style="width: 10%;"></td> <td style="width: 10%;"></td> <td style="width: 10%;"></td> <td style="width: 10%;"></td> </tr> <tr> <td></td> <td></td> <td colspan="8" style="text-align: center;"> <table border="1" style="width: 100%; border-collapse: collapse; text-align: center;"> <tr> <td style="width: 10%;"></td> <td style="width: 10%;"></td> <td style="width: 10%;"></td> <td style="width: 10%;"></td> <td style="width: 10%;"></td> <td style="width: 10%;"></td> <td style="width: 10%;"></td> <td style="width: 10%;"></td> <td style="width: 10%;"></td> <td style="width: 10%;"></td> </tr> <tr> <td></td> <td></td> <td colspan="8" style="text-align: center;"> <table border="1" style="width: 100%; border-collapse: collapse; text-align: center;"> <tr> <td style="width: 10%;"></td> <td style="width: 10%;"></td> <td style="width: 10%;"></td> <td style="width: 10%;"></td> <td style="width: 10%;"></td> <td style="width: 10%;"></td> <td style="width: 10%;"></td> <td style="width: 10%;"></td> <td style="width: 10%;"></td> <td style="width: 10%;"></td> </tr> <tr> <td></td> <td></td> <td colspan="8" style="text-align: center;"> <table border="1" style="width: 100%; border-collapse: collapse; text-align: center;"> <tr> <td style="width: 10%;"></td> <td style="width: 10%;"></td> <td style="width: 10%;"></td> <td style="width: 10%;"></td> <td style="width: 10%;"></td> <td style="width: 10%;"></td> <td style="width: 10%;"></td> <td style="width: 10%;"></td> <td style="width: 10%;"></td> <td style="width: 10%;"></td> </tr> <tr> <td></td> <td></td> <td colspan="8" style="text-align: center;"> <table border="1" style="width: 100%; border-collapse: collapse; text-align: center;"> <tr> <td style="width: 10%;"></td> <td style="width: 10%;"></td> <td style="width: 10%;"></td> <td style="width: 10%;"></td> <td style="width: 10%;"></td> <td style="width: 10%;"></td> <td style="width: 10%;"></td> <td style="width: 10%;"></td> <td style="width: 10%;"></td> <td style="width: 10%;"></td> </tr> <tr> <td></td> <td></td> <td colspan="8" style="text-align: center;"> <table border="1" style="width: 100%; border-collapse: collapse; text-align: center;"> <tr> <td style="width: 10%;"></td> <td style="width: 10%;"></td> <td style="width: 10%;"></td> <td style="width: 10%;"></td> <td style="width: 10%;"></td> <td style="width: 10%;"></td> <td style="width: 10%;"></td> <td style="width: 10%;"></td> <td style="width: 10%;"></td> <td style="width: 10%;"></td> </tr> <tr> <td></td> <td></td> <td colspan="8" style="text-align: center;"> <table border="1" style="width: 100%; border-collapse: collapse; text-align: center;"> <tr> <td style="width: 10%;"></td> <td style="width: 10%;"></td> <td style="width: 10%;"></td> <td style="width: 10%;"></td> <td style="width: 10%;"></td> <td style="width: 10%;"></td> <td style="width: 10%;"></td> <td style="width: 10%;"></td> <td style="width: 10%;"></td> <td style="width: 10%;"></td> </tr> <tr> <td></td> <td></td> <td colspan="8" style="text-align: center;"> <table border="1" style="width: 100%; border-collapse: collapse; text-align: center;"> <tr> <td style="width: 10%;"></td> <td style="width: 10%;"></td> <td style="width: 10%;"></td> <td style="width: 10%;"></td> <td style="width: 10%;"></td> <td style="width: 10%;"></td> <td style="width: 10%;"></td> <td style="width: 10%;"></td> <td style="width: 10%;"></td> <td style="width: 10%;"></td> </tr> <tr> <td></td> <td></td> <td colspan="8" style="text-align: center;"> <table border="1" style="width: 100%; border-collapse: collapse; text-align: center;"> <tr> <td style="width: 10%;"></td> <td style="width: 10%;"></td> <td style="width: 10%;"></td> <td style="width: 10%;"></td> <td style="width: 10%;"></td> <td style="width: 10%;"></td> <td style="width: 10%;"></td> <td style="width: 10%;"></td> <td style="width: 10%;"></td> <td style="width: 10%;"></td> </tr> <tr> <td></td> <td></td> <td colspan="8" style="text-align: center;"> <table border="1" style="width: 100%; border-collapse: collapse; text-align: center;"> <tr> <td style="width: 10%;"></td> <td style="width: 10%;"></td> <td style="width: 10%;"></td> <td style="width: 10%;"></td> <td style="width: 10%;"></td> <td style="width: 10%;"></td> <td style="width: 10%;"></td> <td style="width: 10%;"></td> <td style="width: 10%;"></td> <td style="width: 10%;"></td> </tr> <tr> <td></td> <td></td> <td colspan="8" style="text-align: center;"> <table border="1" style="width: 100%; border-collapse: collapse; text-align: center;"> <tr> </tr></table></td></tr></table></td></tr></table></td></tr></table></td></tr></table></td></tr></table></td></tr></table></td></tr></table></td></tr></table></td></tr></table></td></tr></table></td></tr></table></td></tr></table>

 | | | | | | | | | | | | | | | | | | | | <table border="1" style="width: 100%; border-collapse: collapse; text-align: center;"> <tr> <td style="width: 10%;"></td> <td style="width: 10%;"></td> <td style="width: 10%;"></td> <td style="width: 10%;"></td> <td style="width: 10%;"></td> <td style="width: 10%;"></td> <td style="width: 10%;"></td> <td style="width: 10%;"></td> <td style="width: 10%;"></td> <td style="width: 10%;"></td> </tr> <tr> <td></td> <td></td> <td colspan="8" style="text-align: center;"> <table border="1" style="width: 100%; border-collapse: collapse; text-align: center;"> <tr> <td style="width: 10%;"></td> <td style="width: 10%;"></td> <td style="width: 10%;"></td> <td style="width: 10%;"></td> <td style="width: 10%;"></td> <td style="width: 10%;"></td> <td style="width: 10%;"></td> <td style="width: 10%;"></td> <td style="width: 10%;"></td> <td style="width: 10%;"></td> </tr> <tr> <td></td> <td></td> <td colspan="8" style="text-align: center;"> <table border="1" style="width: 100%; border-collapse: collapse; text-align: center;"> <tr> <td style="width: 10%;"></td> <td style="width: 10%;"></td> <td style="width: 10%;"></td> <td style="width: 10%;"></td> <td style="width: 10%;"></td> <td style="width: 10%;"></td> <td style="width: 10%;"></td> <td style="width: 10%;"></td> <td style="width: 10%;"></td> <td style="width: 10%;"></td> </tr> <tr> <td></td> <td></td> <td colspan="8" style="text-align: center;"> <table border="1" style="width: 100%; border-collapse: collapse; text-align: center;"> <tr> <td style="width: 10%;"></td> <td style="width: 10%;"></td> <td style="width: 10%;"></td> <td style="width: 10%;"></td> <td style="width: 10%;"></td> <td style="width: 10%;"></td> <td style="width: 10%;"></td> <td style="width: 10%;"></td> <td style="width: 10%;"></td> <td style="width: 10%;"></td> </tr> <tr> <td></td> <td></td> <td colspan="8" style="text-align: center;"> <table border="1" style="width: 100%; border-collapse: collapse; text-align: center;"> <tr> <td style="width: 10%;"></td> <td style="width: 10%;"></td> <td style="width: 10%;"></td> <td style="width: 10%;"></td> <td style="width: 10%;"></td> <td style="width: 10%;"></td> <td style="width: 10%;"></td> <td style="width: 10%;"></td> <td style="width: 10%;"></td> <td style="width: 10%;"></td> </tr> <tr> <td></td> <td></td> <td colspan="8" style="text-align: center;"> <table border="1" style="width: 100%; border-collapse: collapse; text-align: center;"> <tr> <td style="width: 10%;"></td> <td style="width: 10%;"></td> <td style="width: 10%;"></td> <td style="width: 10%;"></td> <td style="width: 10%;"></td> <td style="width: 10%;"></td> <td style="width: 10%;"></td> <td style="width: 10%;"></td> <td style="width: 10%;"></td> <td style="width: 10%;"></td> </tr> <tr> <td></td> <td></td> <td colspan="8" style="text-align: center;"> <table border="1" style="width: 100%; border-collapse: collapse; text-align: center;"> <tr> <td style="width: 10%;"></td> <td style="width: 10%;"></td> <td style="width: 10%;"></td> <td style="width: 10%;"></td> <td style="width: 10%;"></td> <td style="width: 10%;"></td> <td style="width: 10%;"></td> <td style="width: 10%;"></td> <td style="width: 10%;"></td> <td style="width: 10%;"></td> </tr> <tr> <td></td> <td></td> <td colspan="8" style="text-align: center;"> <table border="1" style="width: 100%; border-collapse: collapse; text-align: center;"> <tr> <td style="width: 10%;"></td> <td style="width: 10%;"></td> <td style="width: 10%;"></td> <td style="width: 10%;"></td> <td style="width: 10%;"></td> <td style="width: 10%;"></td> <td style="width: 10%;"></td> <td style="width: 10%;"></td> <td style="width: 10%;"></td> <td style="width: 10%;"></td> </tr> <tr> <td></td> <td></td> <td colspan="8" style="text-align: center;"> <table border="1" style="width: 100%; border-collapse: collapse; text-align: center;"> <tr> <td style="width: 10%;"></td> <td style="width: 10%;"></td> <td style="width: 10%;"></td> <td style="width: 10%;"></td> <td style="width: 10%;"></td> <td style="width: 10%;"></td> <td style="width: 10%;"></td> <td style="width: 10%;"></td> <td style="width: 10%;"></td> <td style="width: 10%;"></td> </tr> <tr> <td></td> <td></td> <td colspan="8" style="text-align: center;"> <table border="1" style="width: 100%; border-collapse: collapse; text-align: center;"> <tr> <td style="width: 10%;"></td> <td style="width: 10%;"></td> <td style="width: 10%;"></td> <td style="width:
10%;"></td> <td style="width: 10%;"></td> <td style="width: 10%;"></td> <td style="width: 10%;"></td> <td style="width: 10%;"></td> <td style="width: 10%;"></td> <td style="width: 10%;"></td> </tr> <tr> <td></td> <td></td> <td colspan="8" style="text-align: center;"> <table border="1" style="width: 100%; border-collapse: collapse; text-align: center;"> <tr> <td style="width: 10%;"></td> <td style="width: 10%;"></td> <td style="width: 10%;"></td> <td style="width: 10%;"></td> <td style="width: 10%;"></td> <td style="width: 10%;"></td> <td style="width: 10%;"></td> <td style="width: 10%;"></td> <td style="width: 10%;"></td> <td style="width: 10%;"></td> </tr> <tr> <td></td> <td></td> <td colspan="8" style="text-align: center;"> <table border="1" style="width: 100%; border-collapse: collapse; text-align: center;"> <tr> </tr></table></td></tr></table></td></tr></table></td></tr></table></td></tr></table></td></tr></table></td></tr></table></td></tr></table></td></tr></table></td></tr></table></td></tr></table></td></tr></table>
 | | | | | | | | | | | | | | | | | | | | <table border="1" style="width: 100%; border-collapse: collapse; text-align: center;"> <tr> <td style="width: 10%;"></td> <td style="width: 10%;"></td> <td style="width: 10%;"></td> <td style="width: 10%;"></td> <td style="width: 10%;"></td> <td style="width: 10%;"></td> <td style="width: 10%;"></td> <td style="width: 10%;"></td> <td style="width: 10%;"></td> <td style="width: 10%;"></td> </tr> <tr> <td></td> <td></td> <td colspan="8" style="text-align: center;"> <table border="1" style="width: 100%; border-collapse: collapse; text-align: center;"> <tr> <td style="width: 10%;"></td> <td style="width: 10%;"></td> <td style="width: 10%;"></td> <td style="width: 10%;"></td> <td style="width: 10%;"></td> <td style="width: 10%;"></td> <td style="width: 10%;"></td> <td style="width: 10%;"></td> <td style="width: 10%;"></td> <td style="width: 10%;"></td> </tr> <tr> <td></td> <td></td> <td colspan="8" style="text-align: center;"> <table border="1" style="width: 100%; border-collapse: collapse; text-align: center;"> <tr> <td style="width: 10%;"></td> <td style="width: 10%;"></td> <td style="width: 10%;"></td> <td style="width: 10%;"></td> <td style="width: 10%;"></td> <td style="width: 10%;"></td> <td style="width: 10%;"></td> <td style="width: 10%;"></td> <td style="width: 10%;"></td> <td style="width: 10%;"></td> </tr> <tr> <td></td> <td></td> <td colspan="8" style="text-align: center;">
<table border="1" style="width: 100%; border-collapse: collapse; text-align: center;"> <tr> <td style="width: 10%;"></td> <td style="width: 10%;"></td> <td style="width: 10%;"></td> <td style="width: 10%;"></td> <td style="width: 10%;"></td> <td style="width: 10%;"></td> <td style="width: 10%;"></td> <td style="width: 10%;"></td> <td style="width: 10%;"></td> <td style="width: 10%;"></td> </tr> <tr> <td></td> <td></td> <td colspan="8" style="text-align: center;"> <table border="1" style="width: 100%; border-collapse: collapse; text-align: center;"> <tr> <td style="width: 10%;"></td> <td style="width: 10%;"></td> <td style="width: 10%;"></td> <td style="width: 10%;"></td> <td style="width: 10%;"></td> <td style="width: 10%;"></td> <td style="width: 10%;"></td> <td style="width: 10%;"></td> <td style="width: 10%;"></td> <td style="width: 10%;"></td> </tr> <tr> <td></td> <td></td> <td colspan="8" style="text-align: center;"> <table border="1" style="width: 100%; border-collapse: collapse; text-align: center;"> <tr> <td style="width: 10%;"></td> <td style="width: 10%;"></td> <td style="width: 10%;"></td> <td style="width: 10%;"></td> <td style="width: 10%;"></td> <td style="width: 10%;"></td> <td style="width: 10%;"></td> <td style="width: 10%;"></td> <td style="width: 10%;"></td> <td style="width: 10%;"></td> </tr> <tr> <td></td> <td></td> <td colspan="8" style="text-align: center;"> <table border="1" style="width: 100%; border-collapse: collapse; text-align: center;"> <tr> <td style="width: 10%;"></td> <td style="width: 10%;"></td> <td style="width: 10%;"></td> <td style="width: 10%;"></td> <td style="width: 10%;"></td> <td style="width: 10%;"></td> <td style="width: 10%;"></td> <td style="width: 10%;"></td> <td style="width: 10%;"></td> <td style="width: 10%;"></td> </tr> <tr> <td></td> <td></td> <td colspan="8" style="text-align: center;"> <table border="1" style="width: 100%; border-collapse: collapse; text-align: center;"> <tr> <td style="width: 10%;"></td> <td style="width: 10%;"></td> <td style="width: 10%;"></td> <td style="width: 10%;"></td> <td style="width: 10%;"></td> <td style="width: 10%;"></td> <td style="width: 10%;"></td> <td style="width: 10%;"></td> <td style="width: 10%;"></td> <td style="width: 10%;"></td> </tr> <tr> <td></td> <td></td> <td colspan="8" style="text-align: center;"> <table border="1" style="width: 100%; border-collapse: collapse; text-align: center;"> <tr> <td style="width: 10%;"></td> <td style="width: 10%;"></td> <td style="width: 10%;"></td> <td style="width: 10%;"></td> <td style="width: 10%;"></td> <td style="width: 10%;"></td> <td style="width: 10%;"></td> <td style="width: 10%;"></td> <td style="width: 10%;"></td> <td style="width: 10%;"></td> </tr> <tr> <td></td> <td></td> <td colspan="8" style="text-align: center;"> <table border="1" style="width: 100%; border-collapse: collapse; text-align: center;"> <tr> <td style="width: 10%;"></td> <td style="width: 10%;"></td> <td style="width: 10%;"></td> <td style="width: 10%;"></td> <td style="width: 10%;"></td> <td style="width: 10%;"></td> <td style="width: 10%;"></td> <td style="width: 10%;"></td> <td style="width: 10%;"></td> <td style="width: 10%;"></td> </tr> <tr> <td></td> <td></td> <td colspan="8" style="text-align: center;"> <table border="1" style="width: 100%; border-collapse: collapse; text-align: center;"> <tr> </tr></table></td></tr></table></td></tr></table></td></tr></table></td></tr></table></td></tr></table></td></tr></table></td></tr></table></td></tr></table></td></tr></table></td></tr></table>

 | | | | | | | | | | | | | | | | | | | | <table border="1" style="width: 100%; border-collapse: collapse; text-align: center;"> <tr> <td style="width: 10%;"></td> <td style="width: 10%;"></td> <td style="width: 10%;"></td> <td style="width: 10%;"></td> <td style="width: 10%;"></td> <td style="width: 10%;"></td> <td style="width: 10%;"></td> <td style="width: 10%;"></td> <td style="width: 10%;"></td> <td style="width: 10%;"></td> </tr> <tr> <td></td> <td></td> <td colspan="8" style="text-align: center;"> <table border="1" style="width: 100%; border-collapse: collapse; text-align: center;"> <tr> <td style="width: 10%;"></td> <td style="width: 10%;"></td> <td style="width: 10%;"></td> <td style="width: 10%;"></td> <td style="width: 10%;"></td> <td style="width: 10%;"></td> <td style="width: 10%;"></td> <td style="width: 10%;"></td> <td style="width: 10%;"></td> <td style="width: 10%;"></td> </tr> <tr> <td></td> <td></td> <td colspan="8" style="text-align: center;"> <table border="1" style="width: 100%; border-collapse: collapse; text-align: center;"> <tr> <td style="width: 10%;"></td> <td style="width: 10%;"></td> <td style="width: 10%;"></td> <td style="width: 10%;"></td> <td style="width: 10%;"></td> <td style="width: 10%;"></td> <td style="width: 10%;"></td> <td style="width: 10%;"></td> <td style="width: 10%;"></td> <td style="width: 10%;"></td> </tr> <tr> <td></td> <td></td> <td colspan="8" style="text-align: center;"> <table border="1" style="width: 100%; border-collapse: collapse; text-align: center;"> <tr> <td style="width: 10%;"></td> <td style="width: 10%;"></td> <td style="width: 10%;"></td> <td style="width: 10%;"></td> <td style="width: 10%;"></td> <td style="width: 10%;"></td> <td style="width: 10%;"></td> <td style="width: 10%;"></td> <td style="width: 10%;"></td> <td style="width: 10%;"></td> </tr> <tr> <td></td> <td></td> <td colspan="8" style="text-align: center;"> <table border="1" style="width: 100%; border-collapse: collapse; text-align: center;"> <tr> <td style="width: 10%;"></td> <td style="width: 10%;"></td> <td style="width: 10%;"></td> <td style="width: 10%;"></td> <td style="width: 10%;"></td> <td style="width: 10%;"></td> <td style="width: 10%;"></td> <td style="width: 10%;"></td> <td style="width: 10%;"></td> <td style="width: 10%;"></td> </tr> <tr> <td></td> <td></td> <td colspan="8" style="text-align: center;"> <table border="1" style="width: 100%; border-collapse: collapse; text-align: center;"> <tr> <td style="width: 10%;"></td> <td style="width: 10%;"></td> <td style="width: 10%;"></td> <td style="width: 10%;"></td> <td style="width: 10%;"></td> <td style="width: 10%;"></td> <td style="width: 10%;"></td> <td style="width: 10%;"></td> <td style="width: 10%;"></td> <td style="width: 10%;"></td> </tr> <tr> <td></td> <td></td> <td colspan="8" style="text-align: center;"> <table border="1" style="width: 100%; border-collapse: collapse; text-align: center;"> <tr> <td style="width: 10%;"></td> <td style="width: 10%;"></td> <td style="width: 10%;"></td> <td style="width: 10%;"></td> <td style="width: 10%;"></td> <td style="width: 10%;"></td> <td style="width: 10%;"></td> <td style="width: 10%;"></td> <td style="width: 10%;"></td> <td style="width: 10%;"></td> </tr> <tr> <td></td> <td></td> <td colspan="8" style="text-align: center;"> <table border="1" style="width: 100%; border-collapse: collapse; text-align: center;"> <tr> <td style="width: 10%;"></td> <td style="width: 10%;"></td> <td style="width: 10%;"></td> <td style="width: 10%;"></td> <td style="width: 10%;"></td> <td style="width: 10%;"></td> <td style="width: 10%;"></td> <td style="width: 10%;"></td> <td style="width: 10%;"></td> <td style="width: 10%;"></td> </tr> <tr> <td></td> <td></td> <td colspan="8" style="text-align: center;"> <table border="1" style="width: 100%; border-collapse: collapse; text-align: center;"> <tr> <td style="width: 10%;"></td> <td style="width: 10%;"></td> <td style="width: 10%;"></td> <td style="width: 10%;"></td> <td style="width: 10%;"></td> <td style="width: 10%;"></td> <td style="width: 10%;"></td> <td style="width: 10%;"></td> <td style="width: 10%;"></td> <td style="width: 10%;"></td> </tr> <tr> <td></td> <td></td> <td colspan="8" style="text-align: center;"> <table border="1" style="width: 100%; border-collapse: collapse; text-align: center;"> <tr> </tr></table></td></tr></table></td></tr></table></td></tr></table></td></tr></table></td></tr></table></td></tr></table></td></tr></table></td></tr></table></td></tr></table>

 | | | | | | | | | | | | | | | | | | | | <table border="1" style="width: 100%; border-collapse: collapse; text-align: center;"> <tr> <td style="width: 10%;"></td> <td style="width: 10%;"></td> <td style="width: 10%;"></td> <td style="width: 10%;"></td> <td style="width: 10%;"></td> <td style="width: 10%;"></td> <td style="width: 10%;"></td> <td style="width: 10%;"></td> <td style="width: 10%;"></td> <td style="width: 10%;"></td> </tr> <tr> <td></td> <td></td> <td colspan="8" style="text-align: center;"> <table border="1" style="width: 100%; border-collapse: collapse; text-align: center;"> <tr> <td style="width: 10%;"></td> <td style="width: 10%;"></td> <td style="width: 10%;"></td> <td style="width: 10%;"></td> <td style="width: 10%;"></td> <td style="width: 10%;"></td> <td style="width: 10%;"></td> <td style="width: 10%;"></td> <td style="width: 10%;"></td> <td style="width: 10%;"></td> </tr> <tr> <td></td> <td></td> <td colspan="8" style="text-align: center;"> <table border="1" style="width: 100%; border-collapse: collapse; text-align: center;"> <tr> <td style="width: 10%;"></td> <td style="width: 10%;"></td> <td style="width: 10%;"></td> <td style="width: 10%;"></td> <td style="width: 10%;"></td> <td style="width: 10%;"></td> <td style="width: 10%;"></td> <td style="width: 10%;"></td> <td style="width: 10%;"></td> <td style="width: 10%;"></td> </tr> <tr> <td></td> <td></td> <td colspan="8" style="text-align: center;"> <table border="1" style="width: 100%; border-collapse: collapse; text-align: center;"> <tr> <td style="width: 10%;"></td> <td style="width: 10%;"></td> <td style="width: 10%;"></td> <td style="width: 10%;"></td> <td style="width: 10%;"></td> <td style="width: 10%;"></td> <td style="width: 10%;"></td> <td style="width: 10%;"></td> <td style="width: 10%;"></td> <td style="width: 10%;"></td> </tr> <tr> <td></td> <td></td> <td colspan="8" style="text-align: center;"> <table border="1" style="width: 100%; border-collapse: collapse; text-align: center;"> <tr> <td style="width: 10%;"></td> <td style="width: 10%;"></td> <td style="width: 10%;"></td> <td style="width: 10%;"></td> <td style="width: 10%;"></td> <td style="width: 10%;"></td> <td style="width: 10%;"></td> <td style="width: 10%;"></td> <td style="width: 10%;"></td> <td style="width: 10%;"></td> </tr> <tr> <td></td> <td></td> <td colspan="8" style="text-align: center;"> <table border="1" style="width: 100%; border-collapse: collapse; text-align: center;"> <tr> <td style="width: 10%;"></td> <td style="width: 10%;"></td> <td style="width: 10%;"></td> <td style="width: 10%;"></td> <td style="width: 10%;"></td> <td style="width: 10%;"></td> <td style="width: 10%;"></td> <td style="width: 10%;"></td> <td style="width: 10%;"></td> <td style="width: 10%;"></td> </tr> <tr> <td></td> <td></td> <td colspan="8" style="text-align: center;"> <table border="1" style="width: 100%; border-collapse: collapse; text-align: center;"> <tr> <td style="width: 10%;"></td> <td style="width: 10%;"></td> <td style="width: 10%;"></td> <td style="width: 10%;"></td> <td style="width: 10%;"></td> <td style="width: 10%;"></td> <td style="width: 10%;"></td> <td style="width: 10%;"></td> <td style="width: 10%;"></td> <td style="width: 10%;"></td> </tr> <tr> <td></td> <td></td> <td colspan="8" style="text-align: center;"> <table border="1" style="width: 100%; border-collapse: collapse; text-align: center;"> <tr> <td style="width: 10%;"></td> <td style="width: 10%;"></td> <td style="width: 10%;"></td> <td style="width: 10%;"></td> <td style="width: 10%;"></td> <td style="width: 10%;"></td> <td style="width: 10%;"></td> <td style="width: 10%;"></td> <td style="width: 10%;"></td> <td style="width: 10%;"></td> </tr> <tr> <td></td> <td></td> <td colspan="8" style="text-align: center;"> <table border="1" style="width: 100%; border-collapse: collapse; text-align: center;"> <tr> </tr></table></td></tr></table></td></tr></table></td></tr></table></td></tr></table></td></tr></table></td></tr></table></td></tr></table></td></tr></table>

 | | | | | | | | | | | | | | | | | | | | <table border="1" style="width: 100%; border-collapse: collapse; text-align: center;"> <tr> <td style="width: 10%;"></td> <td style="width: 10%;"></td> <td style="width: 10%;"></td> <td style="width: 10%;"></td> <td style="width: 10%;"></td> <td style="width: 10%;"></td> <td style="width: 10%;"></td> <td style="width: 10%;"></td> <td style="width: 10%;"></td> <td style="width: 10%;"></td> </tr> <tr> <td></td> <td></td> <td colspan="8" style="text-align: center;"> <table border="1" style="width: 100%; border-collapse: collapse; text-align: center;"> <tr> <td style="width: 10%;"></td> <td style="width: 10%;"></td> <td style="width: 10%;"></td> <td style="width: 10%;"></td> <td style="width: 10%;"></td> <td style="width: 10%;"></td> <td style="width: 10%;"></td> <td style="width: 10%;"></td> <td style="width: 10%;"></td> <td style="width: 10%;"></td> </tr> <tr> <td></td> <td></td> <td colspan="8" style="text-align: center;"> <table border="1" style="width: 100%; border-collapse: collapse; text-align: center;"> <tr> <td style="width: 10%;"></td> <td style="width: 10%;"></td> <td style="width: 10%;"></td> <td style="width: 10%;"></td> <td style="width: 10%;"></td> <td style="width: 10%;"></td> <td style="width: 10%;"></td> <td style="width: 10%;"></td> <td style="width: 10%;"></td> <td style="width: 10%;"></td> </tr> <tr> <td></td> <td></td> <td colspan="8" style="text-align: center;"> <table border="1" style="width: 100%; border-collapse: collapse; text-align: center;"> <tr> <td style="width: 10%;"></td> <td style="width: 10%;"></td> <td style="width: 10%;"></td> <td style="width: 10%;"></td> <td style="width: 10%;"></td> <td style="width: 10%;"></td> <td style="width: 10%;"></td> <td style="width: 10%;"></td> <td style="width: 10%;"></td> <td style="width: 10%;"></td> </tr> <tr> <td></td> <td></td> <td colspan="8" style="text-align: center;"> <table border="1" style="width: 100%; border-collapse: collapse; text-align: center;"> <tr> <td style="width: 10%;"></td> <td style="width: 10%;"></td> <td style="width: 10%;"></td> <td style="width: 10%;"></td> <td style="width: 10%;"></td> <td style="width: 10%;"></td> <td style="width: 10%;"></td> <td style="width: 10%;"></td> <td style="width: 10%;"></td> <td style="width: 10%;"></td> </tr> <tr> <td></td> <td></td> <td colspan="8" style="text-align: center;"> <table border="1" style="width: 100%; border-collapse: collapse; text-align: center;"> <tr> <td style="width: 10%;"></td> <td style="width: 10%;"></td> <td style="width: 10%;"></td> <td style="width: 10%;"></td> <td style="width: 10%;"></td> <td style="width: 10%;"></td> <td style="width: 10%;"></td> <td style="width: 10%;"></td> <td style="width: 10%;"></td> <td style="width: 10%;"></td> </tr> <tr> <td></td> <td></td> <td colspan="8" style="text-align: center;"> <table border="1" style="width: 100%; border-collapse: collapse; text-align: center;"> <tr> <td style="width: 10%;"></td> <td style="width: 10%;"></td> <td style="width: 10%;"></td> <td style="width: 10%;"></td> <td style="width: 10%;"></td> <td style="width: 10%;"></td> <td style="width: 10%;"></td> <td style="width: 10%;"></td> <td style="width: 10%;"></td> <td style="width: 10%;"></td> </tr> <tr> <td></td> <td></td> <td colspan="8" style="text-align: center;"> <table border="1" style="width: 100%; border-collapse: collapse; text-align: center;"> <tr> </tr></table></td></tr></table></td></tr></table></td></tr></table></td></tr></table></td></tr></table></td></tr></table></td></tr></table>

 | | | | | | | | | | | | | | | | | | | | <table border="1" style="width: 100%; border-collapse: collapse; text-align: center;"> <tr> <td style="width: 10%;"></td> <td style="width: 10%;"></td> <td style="width: 10%;"></td> <td style="width: 10%;"></td> <td style="width: 10%;"></td> <td style="width: 10%;"></td> <td style="width: 10%;"></td> <td style="width: 10%;"></td> <td style="width: 10%;"></td> <td style="width: 10%;"></td> </tr> <tr> <td></td> <td></td> <td colspan="8" style="text-align: center;"> <table border="1" style="width: 100%; border-collapse: collapse; text-align: center;"> <tr> <td style="width: 10%;"></td> <td style="width: 10%;"></td> <td style="width: 10%;"></td> <td style="width: 10%;"></td> <td style="width: 10%;"></td> <td style="width: 10%;"></td> <td style="width: 10%;"></td> <td style="width: 10%;"></td> <td style="width: 10%;"></td> <td style="width: 10%;"></td> </tr> <tr> <td></td> <td></td> <td colspan="8" style="text-align: center;"> <table border="1" style="width: 100%; border-collapse: collapse; text-align: center;"> <tr> <td style="width: 10%;"></td> <td style="width: 10%;"></td> <td style="width: 10%;"></td> <td style="width: 10%;"></td> <td style="width: 10%;"></td> <td style="width: 10%;"></td> <td style="width: 10%;"></td> <td style="width: 10%;"></td> <td style="width: 10%;"></td> <td style="width: 10%;"></td> </tr> <tr> <td></td> <td></td> <td colspan="8" style="text-align: center;"> <table border="1" style="width: 100%; border-collapse: collapse; text-align: center;"> <tr> <td style="width: 10%;"></td> <td style="width: 10%;"></td> <td style="width: 10%;"></td> <td style="width: 10%;"></td> <td style="width: 10%;"></td> <td style="width: 10%;"></td> <td style="width: 10%;"></td> <td style="width: 10%;"></td> <td style="width: 10%;"></td> <td style="width: 10%;"></td> </tr> <tr> <td></td> <td></td> <td colspan="8" style="text-align: center;"> <table border="1" style="width: 100%; border-collapse: collapse; text-align: center;"> <tr> <td style="width: 10%;"></td> <td style="width: 10%;"></td> <td style="width: 10%;"></td> <td style="width: 10%;"></td> <td style="width: 10%;"></td> <td style="width: 10%;"></td> <td style="width: 10%;"></td> <td style="width: 10%;"></td> <td style="width: 10%;"></td> <td style="width: 10%;"></td> </tr> <tr> <td></td> <td></td> <td colspan="8" style="text-align: center;"> <table border="1" style="width: 100%; border-collapse: collapse; text-align: center;"> <tr> <td style="width: 10%;"></td> <td style="width: 10%;"></td> <td style="width: 10%;"></td> <td style="width: 10%;"></td> <td style="width: 10%;"></td> <td style="width: 10%;"></td> <td style="width: 10%;"></td> <td style="width: 10%;"></td> <td style="width: 10%;"></td> <td style="width: 10%;"></td> </tr> <tr> <td></td> <td></td> <td colspan="8" style="text-align: center;"> <table border="1" style="width: 100%; border-collapse: collapse; text-align: center;"> <tr> </tr></table></td></tr></table></td></tr></table></td></tr></table></td></tr></table></td></tr></table></td></tr></table>

 | | | | | | | | | | | | | | | | | | | | <table border="1" style="width: 100%; border-collapse: collapse; text-align: center;"> <tr> <td style="width: 10%;"></td> <td style="width: 10%;"></td> <td style="width: 10%;"></td> <td style="width: 10%;"></td> <td style="width: 10%;"></td> <td style="width: 10%;"></td> <td style="width: 10%;"></td> <td style="width: 10%;"></td> <td style="width: 10%;"></td> <td style="width: 10%;"></td> </tr> <tr> <td></td> <td></td> <td colspan="8" style="text-align: center;"> <table border="1" style="width: 100%; border-collapse: collapse; text-align: center;"> <tr> <td style="width: 10%;"></td> <td style="width: 10%;"></td> <td style="width: 10%;"></td> <td style="width: 10%;"></td> <td style="width: 10%;"></td> <td style="width: 10%;"></td> <td style="width: 10%;"></td> <td style="width: 10%;"></td> <td style="width: 10%;"></td> <td style="width: 10%;"></td> </tr> <tr> <td></td> <td></td> <td colspan="8" style="text-align: center;"> <table border="1" style="width: 100%; border-collapse: collapse; text-align: center;"> <tr> <td style="width: 10%;"></td> <td style="width: 10%;"></td> <td style="width: 10%;"></td> <td style="width: 10%;"></td> <td style="width: 10%;"></td> <td style="width: 10%;"></td> <td style="width: 10%;"></td> <td style="width: 10%;"></td> <td style="width: 10%;"></td> <td style="width: 10%;"></td> </tr> <tr> <td></td> <td></td> <td colspan="8" style="text-align: center;"> <table border="1" style="width: 100%; border-collapse: collapse; text-align: center;"> <tr> <td style="width: 10%;"></td> <td style="width: 10%;"></td> <td style="width: 10%;"></td> <td style="width: 10%;"></td> <td style="width: 10%;"></td> <td style="width: 10%;"></td> <td style="width: 10%;"></td> <td style="width: 10%;"></td> <td style="width: 10%;"></td> <td style="width: 10%;"></td> </tr> <tr> <td></td> <td></td> <td colspan="8" style="text-align: center;"> <table border="1" style="width: 100%; border-collapse: collapse; text-align: center;"> <tr> <td style="width: 10%;"></td> <td style="width: 10%;"></td> <td style="width: 10%;"></td> <td style="width: 10%;"></td> <td style="width: 10%;"></td> <td style="width: 10%;"></td> <td style="width: 10%;"></td> <td style="width: 10%;"></td> <td style="width: 10%;"></td> <td style="width: 10%;"></td> </tr> <tr> <td></td> <td></td> <td colspan="8" style="text-align: center;"> <table border="1" style="width: 100%; border-collapse: collapse; text-align: center;"> <tr> </tr></table></td></tr></table></td></tr></table></td></tr></table></td></tr></table></td></tr></table>

 | | | | | | | | | | | | | | | | | | | | <table border="1" style="width: 100%; border-collapse: collapse; text-align: center;"> <tr> <td style="width: 10%;"></td> <td style="width: 10%;"></td> <td style="width: 10%;"></td> <td style="width: 10%;"></td> <td style="width: 10%;"></td> <td style="width: 10%;"></td> <td style="width: 10%;"></td> <td style="width: 10%;"></td> <td style="width: 10%;"></td> <td style="width: 10%;"></td> </tr> <tr> <td></td> <td></td> <td colspan="8" style="text-align: center;"> <table border="1" style="width: 100%; border-collapse: collapse; text-align: center;"> <tr> <td style="width: 10%;"></td> <td style="width: 10%;"></td> <td style="width: 10%;"></td> <td style="width: 10%;"></td> <td style="width: 10%;"></td> <td style="width: 10%;"></td> <td style="width: 10%;"></td> <td style="width: 10%;"></td> <td style="width: 10%;"></td> <td style="width: 10%;"></td> </tr> <tr> <td></td> <td></td> <td colspan="8" style="text-align: center;"> <table border="1" style="width: 100%; border-collapse: collapse; text-align: center;"> <tr> <td style="width: 10%;"></td> <td style="width: 10%;"></td> <td style="width: 10%;"></td> <td style="width: 10%;"></td> <td style="width: 10%;"></td> <td style="width: 10%;"></td> <td style="width: 10%;"></td> <td style="width: 10%;"></td> <td style="width: 10%;"></td> <td style="width: 10%;"></td> </tr> <tr> <td></td> <td></td> <td colspan="8" style="text-align: center;"> <table border="1" style="width: 100%; border-collapse: collapse; text-align: center;"> <tr> <td style="width: 10%;"></td> <td style="width: 10%;"></td> <td style="width: 10%;"></td> <td style="width: 10%;"></td> <td style="width: 10%;"></td> <td style="width: 10%;"></td> <td style="width: 10%;"></td> <td style="width: 10%;"></td> <td style="width: 10%;"></td> <td style="width: 10%;"></td> </tr> <tr> <td></td> <td></td> <td colspan="8" style="text-align: center;"> <table border="1" style="width: 100%; border-collapse: collapse; text-align: center;"> <tr> </tr></table></td></tr></table></td></tr></table></td></tr></table></td></tr></table>

 | | | | | | | | | | | | | | | | | | | | <table border="1" style="width: 100%; border-collapse: collapse; text-align: center;"> <tr> <td style="width: 10%;"></td> <td style="width: 10%;"></td> <td style="width: 10%;"></td> <td style="width: 10%;"></td> <td style="width: 10%;"></td> <td style="width: 10%;"></td> <td style="width: 10%;"></td> <td style="width: 10%;"></td> <td style="width: 10%;"></td> <td style="width: 10%;"></td> </tr> <tr> <td></td> <td></td> <td colspan="8" style="text-align: center;"> <table border="1" style="width: 100%; border-collapse: collapse; text-align: center;"> <tr> <td style="width: 10%;"></td> <td style="width: 10%;"></td> <td style="width: 10%;"></td> <td style="width: 10%;"></td> <td style="width: 10%;"></td> <td style="width: 10%;"></td> <td style="width: 10%;"></td> <td style="width: 10%;"></td> <td style="width: 10%;"></td> <td style="width: 10%;"></td> </tr> <tr> <td></td> <td></td> <td colspan="8" style="text-align: center;"> <table border="1" style="width: 100%; border-collapse: collapse; text-align: center;"> <tr> <td style="width: 10%;"></td> <td style="width: 10%;"></td> <td style="width: 10%;"></td> <td style="width: 10%;"></td> <td style="width: 10%;"></td> <td style="width: 10%;"></td> <td style="width: 10%;"></td> <td style="width: 10%;"></td> <td style="width: 10%;"></td> <td style="width: 10%;"></td> </tr> <tr> <td></td> <td></td> <td colspan="8" style="text-align: center;"> <table border="1" style="width: 100%; border-collapse: collapse; text-align: center;"> <tr> </tr></table></td></tr></table></td></tr></table></td></tr></table>

 | | | | | | | | | | | | | | | | | | | | <table border="1" style="width: 100%; border-collapse: collapse; text-align: center;"> <tr> <td style="width: 10%;"></td> <td style="width: 10%;"></td> <td style="width: 10%;"></td> <td style="width: 10%;"></td> <td style="width: 10%;"></td> <td style="width: 10%;"></td> <td style="width: 10%;"></td> <td style="width: 10%;"></td> <td style="width: 10%;"></td> <td style="width: 10%;"></td> </tr> <tr> <td></td> <td></td> <td colspan="8" style="text-align: center;"> <table border="1" style="width: 100%; border-collapse: collapse; text-align: center;"> <tr> <td style="width: 10%;"></td> <td style="width: 10%;"></td> <td style="width: 10%;"></td> <td style="width: 10%;"></td> <td style="width: 10%;"></td> <td style="width: 10%;"></td> <td style="width: 10%;"></td> <td style="width: 10%;"></td> <td style="width: 10%;"></td> <td style="width: 10%;"></td> </tr> <tr> <td></td> <td></td> <td colspan="8" style="text-align: center;"> <table border="1" style="width: 100%; border-collapse: collapse; text-align: center;"> <tr> </tr></table></td></tr></table></td></tr></table>

 | | | | | | | | | | | | | | | | | | | | <table border="1" style="width: 100%; border-collapse: collapse; text-align: center;"> <tr> <td style="width: 10%;"></td> <td style="width: 10%;"></td> <td style="width: 10%;"></td> <td style="width: 10%;"></td> <td style="width: 10%;"></td> <td style="width: 10%;"></td> <td style="width: 10%;"></td> <td style="width: 10%;"></td> <td style="width: 10%;"></td> <td style="width: 10%;"></td> </tr> <tr> <td></td> <td></td> <td colspan="8" style="text-align: center;"> <table border="1" style="width: 100%; border-collapse: collapse; text-align: center;"> <tr> </tr></table></td></tr></table>

 | | | | | | | | | | | | | | | | | | | | <table border="1" style="width: 100%; border-collapse: collapse; text-align: center;"> <tr> </tr></table>
 | | | | | | | | | | | | | | | | | | | |

 | | | | | | | | | | | | | | | | | | | |

 | | | | | | | | | | | | | | | | | | | |
 | | | | | | | | | | | | | | | | | | | |

 | | | | | | | | | | | | | | | | | | | |

 | | | | | | | | | | | | | | | | | | | |
 | | | | | | | | | | | | | | | | | | | |
 | | | | | | | | | | | | | | | | | | | |

 | | | | | | | | | | | | | | | | | | | |
 | | | | | | | | | | | | | | | | | | | |
 | | | | | | | | | | | | | | | | | | | |

 | | | | | | | | | | | | | | | | | | | | | | | | | | | | | | | | | | | | | | | | | | | | | | | | | | | | | | | | | | | | | | | | | | | | | | | | | | | | | | | | | | | | | | | | | | | | | | | | | | | |
 | | | | | | | | | | | | | | | | | | | |
 | | | | | | | | | | | | | | | | | | | |
 | | | | | | | | | | | | | | | | | | | |
 | | | | | | | | | | | | | | | | | | | |
 | | | | | | | | | | | | | | | | | | | |
 | | | | | | | | | | | | | | | | | | | |
 | | | | | | | | | | | | | | | | | | | |
 | | | | | | | | | | | | | | | | | | | |
 | | | | | | | | | | | | | | | | | | | | | | | | | | | | | | | | | | | | | | | |
 | | | | | | | | | | | | | | | | | | | |
 | | | | | | | | | | | | | | | | | | | | | | | | | | | | | | | | | | | | | | | |
 | | | | | | | | | | | | | | | | | | | | | | | | | | | | | | | | | | | | | | | |
 | | | | | | | | | | | | | | | | | | | | | | | | | | | | | | | | | | | | | | | |
 | | | | | | | | | | | | | | | | | | | | | | | | | | | | | | | | | | | | | | | | | | | | | | | | | | | | | | | | | | | | | | | | | | | | | | | | | | | | | | | | | | | | | | | | | | | | | | | | | | | |
 | | | | | | | | | | | | | | | | | | | | | | | | | | | | | | | | | | | | | | | | | | | | | | | |
| | |

 | | | | | | | | | | | | | | | | | | | |

 | | | | | | | | | | | | | | | | | | | |

 | | | | | | | | | | | | | | | | | | | |

 | | | | | | | | | | | | | | | | | | | |

 | | | | | | | | | | | | | | | | | | | |

 | | | | | | | | | | | | | | | | | | | |

 | | | | | | | | | | | | | | | | | | | |

 | | | | | | | | | | | | | | | | | | | |

 | | | | | | | | | | | | | | | | | | | |

 | | | | | | | | | | | | | | | | | | | |

 | | | | | | | | | | | | | | | | | | | |

 | | | | | | | | | | | | | | | | | | | |

 | | | | | | | | | | | | | | | | | | | |

 | | | | | | | | | | | | | | | | | | | |

 | | | | | | | | | | | | | | | | | | | |

 | | | | | | | | | | | | | | | | | | | |

 | | | | | | | | | | | | | | | | | | | |

 | | | | | | | | | | | | | | | | | | | |

 | | | | | | | | | | | | | | | | | | | |

 | | | | | | | | | | | | | | | | | | | |

 | | | | | | | | | | | | | | | | | | | |

 | | | | | | | | | | | | | | | | | | | |

 | | | | | | | | | | | | | | | | | | | |

 | | | | | | | | | | | | | | | | | | | |

 | | | | | | | | | | | | | | | | | | | |

 | | | | | | | | | | | | | | | | | | | |

 | | | | | | | | | | | | | | | | | | | |

 | | | | | | | | | | | | | | | | | | | |
 | | | | | | | | | | | | | | | | | | | |

 | | | | | | | | | | | | | | | | | | | |

 | | | | | | | | | | | | | | | | | | | |
 | | | | | | | | | | | | | | | | | | | |

 | | | | | | | | | | | | | | | | | | | |

 | | | | | | | | | | | | | | | | | | | |
 | | | | | | | | | | | | | | | | | | | |
 | | | | | | | | | | | | | | | | | | | |

 | | | | | | | | | | | | | | | | | | | |
 | | | | | | | | | | | | | | | | | | | |
 | | | | | | | | | | | | | | | | | | | |

 | | | | | | | | | | | | | | | | | | | | | | | | | | | | | | | | | | | | | | | | | | | | | | | | | | | | | | | | | | | | | | | | | | | | | | | | | | | | | | | | | | | | | | | | | | | | | | | | | | | |
 | | | | | | | | | | | | | | | | | | | |
 | | | | | | | | | | | | | | | | | | | |
 | | | | | | | | | | | | | | | | | | | |
 | | | | | | | | | | | | | | | | | | | |
 | | | | | | | | | | | | | | | | | | | |
 | | | | | | | | | | | | | | | | | | | |
 | | | | | | | | | | | | | | | | | | | |
 | | | | | | | | | | | | | | | | | | | |
 | | | | | | | | | | | | | | | | | | | | | | | | | | | | | | | | | | | | | | | |
 | | | | | | | | | | | | | | | | | | | |
 | | | | | | | | | | | | | | | | | | | | | | | | | | | | | | | | | | | | | | | |
 | | | | | | | | | | | | | | | | | | | | | | | | | | | | | | | | | | | | | | | |
 | | | | | | | | | | | | | | | | | | | | | | | | | | | | | | | | | | | | | | | |
 | | | | | | | | | | | | | | | | | | | | | | | | | | | | | | | | | | | | | | | | | | | | | | | | | | | | | | | | | | | | | | | | | | | | | | | | | | | | | | | | | | | | | | | | | | | | | | | | | | | |
 | | | | | | | | | | | | | | | | | | | | | | | | | | | | | | | | | | | | | | | | | | | | | | | |
| | | <table border="1" style="width: 100%; border-collapse: collapse; text-align: center;"> <tr> <td style="width: 10%;"></td> <td style="width: 10%;"></td> <td style="width: 10%;"></td> <td style="width: 10%;"></td> <td style="width: 10%;"></td> <td style="width: 10%;"></td> <td style="width: 10%;"></td> <td style="width: 10%;"></td> <td style="width: 10%;"></td> <td style="width: 10%;"></td> </tr> <tr> <td></td> <td></td> <td colspan="8" style="text-align: center;"> <table border="1" style="width: 100%; border-collapse: collapse; text-align: center;"> <tr> <td style="width: 10%;"></td> <td style="width: 10%;"></td> <td style="width: 10%;"></td> <td style="width: 10%;"></td> <td style="width: 10%;"></td> <td style="width: 10%;"></td> <td style="width: 10%;"></td> <td style="width: 10%;"></td> <td style="width: 10%;"></td> <td style="width: 10%;"></td> </tr> <tr> <td></td> <td></td> <td colspan="8" style="text-align: center;"> <table border="1" style="width: 100%; border-collapse: collapse; text-align: center;"> <tr> <td style="width: 10%;"></td> <td style="width: 10%;"></td> <td style="width: 10%;"></td> <td style="width: 10%;"></td> <td style="width: 10%;"></td> <td style="width: 10%;"></td> <td style="width: 10%;"></td> <td style="width: 10%;"></td> <td style="width: 10%;"></td> <td style="width: 10%;"></td> </tr> <tr> <td></td> <td></td> <td colspan="8" style="text-align: center;"> <table border="1" style="width: 100%; border-collapse: collapse; text-align: center;"> <tr> <td style="width: 10%;"></td> <td style="width: 10%;"></td> <td style="width: 10%;"></td> <td style="width: 10%;"></td> <td style="width: 10%;"></td> <td style="width: 10%;"></td> <td style="width: 10%;"></td> <td style="width: 10%;"></td> <td style="width: 10%;"></td> <td style="width: 10%;"></td> </tr> <tr> <td></td> <td></td> <td colspan="8" style="text-align: center;"> <table border="1" style="width: 100%; border-collapse: collapse; text-align: center;"> <tr> <td style="width: 10%;"></td> <td style="width: 10%;"></td> <td style="width: 10%;"></td> <td style="width: 10%;"></td> <td style="width: 10%;"></td> <td style="width: 10%;"></td> <td style="width: 10%;"></td> <td style="width: 10%;"></td> <td style="width: 10%;"></td> <td style="width: 10%;"></td> </tr> <tr> <td></td> <td></td> <td colspan="8" style="text-align: center;"> <table border="1" style="width: 100%; border-collapse: collapse; text-align: center;"> <tr> <td style="width: 10%;"></td> <td style="width: 10%;"></td> <td style="width: 10%;"></td> <td style="width: 10%;"></td> <td style="width: 10%;"></td> <td style="width: 10%;"></td> <td style="width: 10%;"></td> <td style="width: 10%;"></td> <td style="width: 10%;"></td> <td style="width: 10%;"></td> </tr> <tr> <td></td> <td></td> <td colspan="8" style="text-align: center;"> <table border="1" style="width: 100%; border-collapse: collapse; text-align: center;"> <tr> <td style="width: 10%;"></td> <td style="width: 10%;"></td> <td style="width: 10%;"></td> <td style="width: 10%;"></td> <td style="width: 10%;"></td> <td style="width: 10%;"></td> <td style="width: 10%;"></td> <td style="width: 10%;"></td> <td style="width: 10%;"></td> <td style="width: 10%;"></td> </tr> <tr> <td></td> <td></td> <td colspan="8" style="text-align: center;"> <table border="1" style="width: 100%; border-collapse: collapse; text-align: center;"> <tr> <td style="width: 10%;"></td> <td style="width: 10%;"></td> <td style="width: 10%;"></td> <td style="width: 10%;"></td> <td style="width: 10%;"></td> <td style="width: 10%;"></td> <td style="width: 10%;"></td> <td style="width: 10%;"></td> <td style="width: 10%;"></td> <td style="width: 10%;"></td> </tr> <tr> <td></td> <td></td> <td colspan="8" style="text-align: center;"> <table border="1" style="width: 100%; border-collapse: collapse; text-align: center;"> <tr> <td style="width: 10%;"></td> <td style="width: 10%;"></td> <td style="width: 10%;"></td> <td style="width: 10%;"></td> <td style="width: 10%;"></td> <td style="width: 10%;"></td> <td style="width: 10%;"></td> <td style="width: 10%;"></td> <td style="width: 10%;"></td> <td style="width: 10%;"></td> </tr> <tr> <td></td> <td></td> <td colspan="8" style="text-align: center;"> <table border="1" style="width: 100%; border-collapse: collapse; text-align: center;"> <tr> <td style="width: 10%;"></td> <td style="width: 10%;"></td> <td style="width: 10%;"></td> <td style="width: 10%;"></td> <td style="width: 10%;"></td> <td style="width: 10%;"></td> <td style="width: 10%;"></td> <td style="width: 10%;"></td> <td style="width: 10%;"></td> <td style="width: 10%;"></td> </tr> <tr> <td></td> <td></td> <td colspan="8" style="text-align: center;"> <table border="1" style="width: 100%; border-collapse: collapse; text-align: center;"> <tr> <td style="width: 10%;"></td> <td style="width: 10%;"></td> <td style="width: 10%;"></td> <td style="width: 10%;"></td> <td style="width: 10%;"></td> <td style="width: 10%;"></td> <td style="width: 10%;"></td> <td style="width: 10%;"></td> <td style="width: 10%;"></td> <td style="width: 10%;"></td> </tr> <tr> <td></td> <td></td> <td colspan="8" style="text-align: center;"> <table border="1" style="width: 100%; border-collapse: collapse; text-align: center;"> <tr> <td style="width: 10%;"></td> <td style="width: 10%;"></td> <td style="width: 10%;"></td> <td style="width: 10%;"></td> <td style="width: 10%;"></td> <td style="width: 10%;"></td> <td style="width: 10%;"></td> <td style="width: 10%;"></td> <td style="width: 10%;"></td> <td style="width: 10%;"></td> </tr> <tr> <td></td> <td></td> <td colspan="8" style="text-align: center;"> <table border="1" style="width: 100%; border-collapse: collapse; text-align: center;"> <tr> <td style="width: 10%;"></td> <td style="width: 10%;"></td> <td style="width: 10%;"></td> <td style="width: 10%;"></td> <td style="width: 10%;"></td> <td style="width: 10%;"></td> <td style="width: 10%;"></td> <td style="width: 10%;"></td> <td style="width: 10%;"></td> <td style="width: 10%;"></td> </tr> <tr> <td></td> <td></td> <td colspan="8" style="text-align: center;"> <table border="1" style="width: 100%; border-collapse: collapse; text-align: center;"> <tr> <td style="width: 10%;"></td> <td style="width: 10%;"></td> <td style="width: 10%;"></td> <td style="width: 10%;"></td> <td style="width: 10%;"></td> <td style="width: 10%;"></td> <td style="width: 10%;"></td> <td style="width: 10%;"></td> <td style="width: 10%;"></td> <td style="width: 10%;"></td> </tr> <tr> <td></td> <td></td> <td colspan="8" style="text-align: center;"> <table border="1" style="width: 100%; border-collapse: collapse; text-align: center;"> <tr> <td style="width: 10%;"></td> <td style="width: 10%;"></td> <td style="width: 10%;"></td> <td style="width: 10%;"></td> <td style="width: 10%;"></td> <td style="width: 10%;"></td> <td style="width: 10%;"></td> <td style="width: 10%;"></td> <td style="width: 10%;"></td> <td style="width: 10%;"></td> </tr> <tr> <td></td> <td></td> <td colspan="8" style="text-align: center;"> <table border="1" style="width: 100%; border-collapse: collapse; text-align: center;"> <tr> <td style="width: 10%;"></td> <td style="width: 10%;"></td> <td style="width: 10%;"></td> <td style="width: 10%;"></td> <td style="width: 10%;"></td> <td style="width: 10%;"></td> <td style="width: 10%;"></td> <td style="width: 10%;"></td> <td style="width: 10%;"></td> <td style="width: 10%;"></td> </tr> <tr> <td></td> <td></td> <td colspan="8" style="text-align: center;"> <table border="1" style="width: 100%; border-collapse: collapse; text-align: center;"> <tr> <td style="width: 10%;"></td> <td style="width: 10%;"></td> <td style="width: 10%;"></td> <td style="width: 10%;"></td> <td style="width: 10%;"></td> <td style="width: 10%;"></td> <td style="width: 10%;"></td> <td style="width: 10%;"></td> <td style="width: 10%;"></td> <td style="width: 10%;"></td> </tr> <tr> <td></td> <td></td> <td colspan="8" style="text-align: center;"> <table border="1" style="width: 100%; border-collapse: collapse; text-align: center;"> <tr> <td style="width: 10%;"></td> <td style="width: 10%;"></td> <td style="width: 10%;"></td> <td style="width: 10%;"></td> <td style="width: 10%;"></td> <td style="width: 10%;"></td> <td style="width: 10%;"></td> <td style="width: 10%;"></td> <td style="width: 10%;"></td> <td style="width: 10%;"></td> </tr> <tr> <td></td> <td></td> <td colspan="8" style="text-align: center;"> <table border="1" style="width: 100%; border-collapse: collapse; text-align: center;"> <tr> <td style="width: 10%;"></td> <td style="width: 10%;"></td> <td style="width: 10%;"></td> <td style="width: 10%;"></td> <td style="width: 10%;"></td> <td style="width: 10%;"></td> <td style="width: 10%;"></td> <td style="width: 10%;"></td> <td style="width: 10%;"></td> <td style="width: 10%;"></td> </tr> <tr> <td></td> <td></td> <td colspan="8" style="text-align: center;"> <table border="1" style="width: 100%; border-collapse: collapse; text-align: center;"> <tr> <td style="width: 10%;"></td> <td style="width: 10%;"></td> <td style="width: 10%;"></td> <td style="width: 10%;"></td> <td style="width: 10%;"></td> <td style="width: 10%;"></td> <td style="width: 10%;"></td> <td style="width: 10%;"></td> <td style="width: 10%;"></td> <td style="width: 10%;"></td> </tr> <tr> <td></td> <td></td> <td colspan="8" style="text-align: center;"> <table border="1" style="width: 100%; border-collapse: collapse; text-align: center;"> <tr> <td style="width: 10%;"></td> <td style="width: 10%;"></td> <td style="width: 10%;"></td> <td style="width: 10%;"></td> <td style="width: 10%;"></td> <td style="width: 10%;"></td> <td style="width: 10%;"></td> <td style="width: 10%;"></td> <td style="width: 10%;"></td> <td style="width: 10%;"></td> </tr> <tr> <td></td> <td></td> <td colspan="8" style="text-align: center;"> <table border="1" style="width: 100%; border-collapse: collapse; text-align: center;"> <tr> <td style="width: 10%;"></td> <td style="width: 10%;"></td> <td
style="width: 10%;"></td> <td style="width: 10%;"></td> <td style="width: 10%;"></td> <td style="width: 10%;"></td> <td style="width: 10%;"></td> <td style="width: 10%;"></td> <td style="width: 10%;"></td> <td style="width: 10%;"></td> </tr> <tr> <td></td> <td></td> <td colspan="8" style="text-align: center;"> <table border="1" style="width: 100%; border-collapse: collapse; text-align: center;"> <tr> <td style="width: 10%;"></td> <td style="width: 10%;"></td> <td style="width: 10%;"></td> <td style="width: 10%;"></td> <td style="width: 10%;"></td> <td style="width: 10%;"></td> <td style="width: 10%;"></td> <td style="width: 10%;"></td> <td style="width: 10%;"></td> <td style="width: 10%;"></td> </tr> <tr> <td></td> <td></td> <td colspan="8" style="text-align: center;"> <table border="1" style="width: 100%; border-collapse: collapse; text-align: center;"> <tr> <td style="width: 10%;"></td> <td style="width: 10%;"></td> <td style="width: 10%;"></td> <td style="width: 10%;"></td> <td style="width: 10%;"></td> <td style="width: 10%;"></td> <td style="width: 10%;"></td> <td style="width: 10%;"></td> <td style="width: 10%;"></td> <td style="width: 10%;"></td> </tr> <tr> <td></td> <td></td> <td colspan="8" style="text-align: center;"> <table border="1" style="width: 100%; border-collapse: collapse; text-align: center;"> <tr> <td style="width: 10%;"></td> <td style="width: 10%;"></td> <td style="width: 10%;"></td> <td style="width: 10%;"></td> <td style="width: 10%;"></td> <td style="width: 10%;"></td> <td style="width: 10%;"></td> <td style="width: 10%;"></td> <td style="width: 10%;"></td> <td style="width: 10%;"></td> </tr> <tr> <td></td> <td></td> <td colspan="8" style="text-align: center;"> <table border="1" style="width: 100%; border-collapse: collapse; text-align: center;"> <tr> <td style="width: 10%;"></td> <td style="width: 10%;"></td> <td style="width: 10%;"></td> <td style="width: 10%;"></td> <td style="width: 10%;"></td> <td style="width: 10%;"></td> <td style="width: 10%;"></td> <td style="width: 10%;"></td> <td style="width: 10%;"></td> <td style="width: 10%;"></td> </tr> <tr> <td></td> <td></td> <td colspan="8" style="text-align: center;"> <table border="1" style="width: 100%; border-collapse: collapse; text-align: center;"> <tr> <td style="width: 10%;"></td> <td style="width: 10%;"></td> <td style="width: 10%;"></td> <td style="width: 10%;"></td> <td style="width: 10%;"></td> <td style="width: 10%;"></td> <td style="width: 10%;"></td> <td style="width: 10%;"></td> <td style="width: 10%;"></td> <td style="width: 10%;"></td> </tr> <tr> <td></td> <td></td> <td colspan="8" style="text-align: center;"> <table border="1" style="width: 100%; border-collapse: collapse; text-align: center;"> <tr> </tr></table></td></tr></table></td></tr></table></td></tr></table></td></tr></table></td></tr></table></td></tr></table></td></tr></table></td></tr></table></td></tr></table></td></tr></table></td></tr></table></td></tr></table></td></tr></table></td></tr></table></td></tr></table></td></tr></table></td></tr></table></td></tr></table></td></tr></table></td></tr></table></td></tr></table></td></tr></table></td></tr></table></td></tr></table></td></tr></table></td></tr></table></td></tr></table>

 | | | | | | | | | | | | | | | | | | | | <table border="1" style="width: 100%; border-collapse: collapse; text-align: center;"> <tr> <td style="width: 10%;"></td> <td style="width: 10%;"></td> <td style="width: 10%;"></td> <td style="width: 10%;"></td> <td style="width: 10%;"></td> <td style="width: 10%;"></td> <td style="width: 10%;"></td> <td style="width: 10%;"></td> <td style="width: 10%;"></td> <td style="width: 10%;"></td> </tr> <tr> <td></td> <td></td> <td colspan="8" style="text-align: center;"> <table border="1" style="width: 100%; border-collapse: collapse; text-align: center;"> <tr> <td style="width: 10%;"></td> <td style="width: 10%;"></td> <td style="width: 10%;"></td> <td style="width: 10%;"></td> <td style="width: 10%;"></td> <td style="width: 10%;"></td> <td style="width: 10%;"></td> <td style="width: 10%;"></td> <td style="width: 10%;"></td> <td style="width: 10%;"></td> </tr> <tr> <td></td> <td></td> <td colspan="8" style="text-align: center;"> <table border="1" style="width: 100%; border-collapse: collapse; text-align: center;"> <tr> <td style="width: 10%;"></td> <td style="width: 10%;"></td> <td style="width: 10%;"></td> <td style="width: 10%;"></td> <td style="width: 10%;"></td> <td style="width: 10%;"></td> <td style="width: 10%;"></td> <td style="width: 10%;"></td> <td style="width: 10%;"></td> <td style="width: 10%;"></td> </tr> <tr> <td></td> <td></td> <td colspan="8" style="text-align: center;"> <table border="1" style="width: 100%; border-collapse: collapse; text-align: center;"> <tr> <td style="width: 10%;"></td> <td style="width: 10%;"></td> <td style="width: 10%;"></td> <td style="width: 10%;"></td> <td style="width: 10%;"></td> <td style="width: 10%;"></td> <td style="width: 10%;"></td> <td style="width: 10%;"></td> <td style="width: 10%;"></td> <td style="width: 10%;"></td> </tr> <tr> <td></td> <td></td> <td colspan="8" style="text-align: center;"> <table border="1" style="width: 100%; border-collapse: collapse; text-align: center;"> <tr> <td style="width: 10%;"></td> <td style="width: 10%;"></td> <td style="width: 10%;"></td> <td style="width: 10%;"></td> <td style="width: 10%;"></td> <td style="width: 10%;"></td> <td style="width: 10%;"></td> <td style="width: 10%;"></td> <td style="width: 10%;"></td> <td style="width: 10%;"></td> </tr> <tr> <td></td> <td></td> <td colspan="8" style="text-align: center;"> <table border="1" style="width: 100%; border-collapse: collapse; text-align: center;"> <tr> <td style="width: 10%;"></td> <td style="width: 10%;"></td> <td style="width: 10%;"></td> <td style="width: 10%;"></td> <td style="width: 10%;"></td> <td style="width: 10%;"></td> <td style="width: 10%;"></td> <td style="width: 10%;"></td> <td style="width: 10%;"></td> <td style="width: 10%;"></td> </tr> <tr> <td></td> <td></td> <td colspan="8" style="text-align: center;"> <table border="1" style="width: 100%; border-collapse: collapse; text-align: center;"> <tr> <td style="width: 10%;"></td> <td style="width: 10%;"></td> <td style="width: 10%;"></td> <td style="width: 10%;"></td> <td style="width: 10%;"></td> <td style="width: 10%;"></td> <td style="width: 10%;"></td> <td style="width: 10%;"></td> <td style="width: 10%;"></td> <td style="width: 10%;"></td> </tr> <tr> <td></td> <td></td> <td colspan="8" style="text-align: center;"> <table border="1" style="width: 100%; border-collapse: collapse; text-align: center;"> <tr> <td style="width: 10%;"></td> <td style="width: 10%;"></td> <td style="width: 10%;"></td> <td style="width: 10%;"></td> <td style="width: 10%;"></td> <td style="width: 10%;"></td> <td style="width: 10%;"></td> <td style="width: 10%;"></td> <td style="width: 10%;"></td> <td style="width: 10%;"></td> </tr> <tr> <td></td> <td></td> <td colspan="8" style="text-align: center;"> <table border="1" style="width: 100%; border-collapse: collapse; text-align: center;"> <tr> <td style="width: 10%;"></td> <td style="width: 10%;"></td> <td style="width: 10%;"></td> <td style="width: 10%;"></td> <td style="width: 10%;"></td> <td style="width: 10%;"></td> <td style="width: 10%;"></td> <td style="width: 10%;"></td> <td style="width: 10%;"></td> <td style="width: 10%;"></td> </tr> <tr> <td></td> <td></td> <td colspan="8" style="text-align: center;"> <table border="1" style="width: 100%; border-collapse: collapse; text-align: center;"> <tr> <td style="width: 10%;"></td> <td style="width: 10%;"></td> <td style="width: 10%;"></td> <td style="width: 10%;"></td> <td style="width: 10%;"></td> <td style="width: 10%;"></td> <td style="width: 10%;"></td> <td style="width: 10%;"></td> <td style="width: 10%;"></td> <td style="width: 10%;"></td> </tr> <tr> <td></td> <td></td> <td colspan="8" style="text-align: center;"> <table border="1" style="width: 100%; border-collapse: collapse; text-align: center;"> <tr> <td style="width: 10%;"></td> <td style="width: 10%;"></td> <td style="width: 10%;"></td> <td style="width: 10%;"></td> <td style="width: 10%;"></td> <td style="width: 10%;"></td> <td style="width: 10%;"></td> <td style="width: 10%;"></td> <td style="width: 10%;"></td> <td style="width: 10%;"></td> </tr> <tr> <td></td> <td></td> <td colspan="8" style="text-align: center;"> <table border="1" style="width: 100%; border-collapse: collapse; text-align: center;"> <tr> <td style="width: 10%;"></td> <td style="width: 10%;"></td> <td style="width: 10%;"></td> <td style="width: 10%;"></td> <td style="width: 10%;"></td> <td style="width: 10%;"></td> <td style="width: 10%;"></td> <td style="width: 10%;"></td> <td style="width: 10%;"></td> <td style="width: 10%;"></td> </tr> <tr> <td></td> <td></td> <td colspan="8" style="text-align: center;"> <table border="1" style="width: 100%; border-collapse: collapse; text-align: center;"> <tr> <td style="width: 10%;"></td> <td style="width: 10%;"></td> <td style="width: 10%;"></td> <td style="width: 10%;"></td> <td style="width: 10%;"></td> <td style="width: 10%;"></td> <td style="width: 10%;"></td> <td style="width: 10%;"></td> <td style="width: 10%;"></td> <td style="width: 10%;"></td> </tr> <tr> <td></td> <td></td> <td colspan="8" style="text-align: center;"> <table border="1" style="width: 100%; border-collapse: collapse; text-align: center;"> <tr> <td style="width: 10%;"></td> <td style="width: 10%;"></td> <td style="width: 10%;"></td> <td style="width: 10%;"></td> <td style="width: 10%;"></td> <td style="width: 10%;"></td> <td style="width: 10%;"></td> <td style="width: 10%;"></td> <td style="width: 10%;"></td> <td style="width: 10%;"></td> </tr> <tr> <td></td> <td></td> <td colspan="8" style="text-align: center;"> <table border="1" style="width: 100%; border-collapse: collapse; text-align: center;"> <tr> <td style="width: 10%;"></td> <td style="width: 10%;"></td> <td style="width: 10%;"></td> <td style="width: 10%;"></td> <td style="width: 10%;"></td> <td style="width: 10%;"></td> <td style="width: 10%;"></td> <td style="width: 10%;"></td> <td style="width: 10%;"></td> <td style="width: 10%;"></td> </tr> <tr> <td></td> <td></td> <td colspan="8" style="text-align: center;"> <table border="1" style="width: 100%; border-collapse: collapse; text-align: center;"> <tr> <td style="width: 10%;"></td> <td style="width: 10%;"></td> <td style="width: 10%;"></td> <td style="width: 10%;"></td> <td style="width: 10%;"></td> <td style="width: 10%;"></td> <td style="width: 10%;"></td> <td style="width: 10%;"></td> <td style="width: 10%;"></td> <td style="width: 10%;"></td> </tr> <tr> <td></td> <td></td> <td colspan="8" style="text-align: center;"> <table border="1" style="width: 100%; border-collapse: collapse; text-align: center;"> <tr> <td style="width: 10%;"></td> <td style="width: 10%;"></td> <td style="width: 10%;"></td> <td style="width: 10%;"></td> <td style="width: 10%;"></td> <td style="width: 10%;"></td> <td style="width: 10%;"></td> <td style="width: 10%;"></td> <td style="width: 10%;"></td> <td style="width: 10%;"></td> </tr> <tr> <td></td> <td></td> <td colspan="8" style="text-align: center;"> <table border="1" style="width: 100%; border-collapse: collapse; text-align: center;"> <tr> <td style="width: 10%;"></td> <td style="width: 10%;"></td> <td style="width: 10%;"></td> <td style="width: 10%;"></td> <td style="width: 10%;"></td> <td style="width: 10%;"></td> <td style="width: 10%;"></td> <td style="width: 10%;"></td> <td style="width: 10%;"></td> <td style="width: 10%;"></td> </tr> <tr> <td></td> <td></td> <td colspan="8" style="text-align: center;"> <table border="1" style="width: 100%; border-collapse: collapse; text-align: center;"> <tr> <td style="width: 10%;"></td> <td style="width: 10%;"></td> <td style="width: 10%;"></td> <td style="width: 10%;"></td> <td style="width: 10%;"></td> <td style="width: 10%;"></td> <td
style="width: 10%;"></td> <td style="width: 10%;"></td> <td style="width: 10%;"></td> <td style="width: 10%;"></td> </tr> <tr> <td></td> <td></td> <td colspan="8" style="text-align: center;"> <table border="1" style="width: 100%; border-collapse: collapse; text-align: center;"> <tr> <td style="width: 10%;"></td> <td style="width: 10%;"></td> <td style="width: 10%;"></td> <td style="width: 10%;"></td> <td style="width: 10%;"></td> <td style="width: 10%;"></td> <td style="width: 10%;"></td> <td style="width: 10%;"></td> <td style="width: 10%;"></td> <td style="width: 10%;"></td> </tr> <tr> <td></td> <td></td> <td colspan="8" style="text-align: center;"> <table border="1" style="width: 100%; border-collapse: collapse; text-align: center;"> <tr> <td style="width: 10%;"></td> <td style="width: 10%;"></td> <td style="width: 10%;"></td> <td style="width: 10%;"></td> <td style="width: 10%;"></td> <td style="width: 10%;"></td> <td style="width: 10%;"></td> <td style="width: 10%;"></td> <td style="width: 10%;"></td> <td style="width: 10%;"></td> </tr> <tr> <td></td> <td></td> <td colspan="8" style="text-align: center;"> <table border="1" style="width: 100%; border-collapse: collapse; text-align: center;"> <tr> <td style="width: 10%;"></td> <td style="width: 10%;"></td> <td style="width: 10%;"></td> <td style="width: 10%;"></td> <td style="width: 10%;"></td> <td style="width: 10%;"></td> <td style="width: 10%;"></td> <td style="width: 10%;"></td> <td style="width: 10%;"></td> <td style="width: 10%;"></td> </tr> <tr> <td></td> <td></td> <td colspan="8" style="text-align: center;"> <table border="1" style="width: 100%; border-collapse: collapse; text-align: center;"> <tr> <td style="width: 10%;"></td> <td style="width: 10%;"></td> <td style="width: 10%;"></td> <td style="width: 10%;"></td> <td style="width: 10%;"></td> <td style="width: 10%;"></td> <td style="width: 10%;"></td> <td style="width: 10%;"></td> <td style="width: 10%;"></td> <td style="width: 10%;"></td> </tr> <tr> <td></td> <td></td> <td colspan="8" style="text-align: center;"> <table border="1" style="width: 100%; border-collapse: collapse; text-align: center;"> <tr> <td style="width: 10%;"></td> <td style="width: 10%;"></td> <td style="width: 10%;"></td> <td style="width: 10%;"></td> <td style="width: 10%;"></td> <td style="width: 10%;"></td> <td style="width: 10%;"></td> <td style="width: 10%;"></td> <td style="width: 10%;"></td> <td style="width: 10%;"></td> </tr> <tr> <td></td> <td></td> <td colspan="8" style="text-align: center;"> <table border="1" style="width: 100%; border-collapse: collapse; text-align: center;"> <tr> <td style="width: 10%;"></td> <td style="width: 10%;"></td> <td style="width: 10%;"></td> <td style="width: 10%;"></td> <td style="width: 10%;"></td> <td style="width: 10%;"></td> <td style="width: 10%;"></td> <td style="width: 10%;"></td> <td style="width: 10%;"></td> <td style="width: 10%;"></td> </tr> <tr> <td></td> <td></td> <td colspan="8" style="text-align: center;"> <table border="1" style="width: 100%; border-collapse: collapse; text-align: center;"> <tr> <td style="width: 10%;"></td> <td style="width: 10%;"></td> <td style="width: 10%;"></td> <td style="width: 10%;"></td> <td style="width: 10%;"></td> <td style="width: 10%;"></td> <td style="width: 10%;"></td> <td style="width: 10%;"></td> <td style="width: 10%;"></td> <td style="width: 10%;"></td> </tr> <tr> <td></td> <td></td> <td colspan="8" style="text-align: center;"> <table border="1" style="width: 100%; border-collapse: collapse; text-align: center;"> <tr> </tr></table></td></tr></table></td></tr></table></td></tr></table></td></tr></table></td></tr></table></td></tr></table></td></tr></table></td></tr></table></td></tr></table></td></tr></table></td></tr></table></td></tr></table></td></tr></table></td></tr></table></td></tr></table></td></tr></table></td></tr></table></td></tr></table></td></tr></table></td></tr></table></td></tr></table></td></tr></table></td></tr></table></td></tr></table></td></tr></table></td></tr></table>

 | | | | | | | | | | | | | | | | | | | | <table border="1" style="width: 100%; border-collapse: collapse; text-align: center;"> <tr> <td style="width: 10%;"></td> <td style="width: 10%;"></td> <td style="width: 10%;"></td> <td style="width: 10%;"></td> <td style="width: 10%;"></td> <td style="width: 10%;"></td> <td style="width: 10%;"></td> <td style="width: 10%;"></td> <td style="width: 10%;"></td> <td style="width: 10%;"></td> </tr> <tr> <td></td> <td></td> <td colspan="8" style="text-align: center;"> <table border="1" style="width: 100%; border-collapse: collapse; text-align: center;"> <tr> <td style="width: 10%;"></td> <td style="width: 10%;"></td> <td style="width: 10%;"></td> <td style="width: 10%;"></td> <td style="width: 10%;"></td> <td style="width: 10%;"></td> <td style="width: 10%;"></td> <td style="width: 10%;"></td> <td style="width: 10%;"></td> <td style="width: 10%;"></td> </tr> <tr> <td></td> <td></td> <td colspan="8" style="text-align: center;"> <table border="1" style="width: 100%; border-collapse: collapse; text-align: center;"> <tr> <td style="width: 10%;"></td> <td style="width: 10%;"></td> <td style="width: 10%;"></td> <td style="width: 10%;"></td> <td style="width: 10%;"></td> <td style="width: 10%;"></td> <td style="width: 10%;"></td> <td style="width: 10%;"></td> <td style="width: 10%;"></td> <td style="width: 10%;"></td> </tr> <tr> <td></td> <td></td> <td colspan="8" style="text-align: center;"> <table border="1" style="width: 100%; border-collapse: collapse; text-align: center;"> <tr> <td style="width: 10%;"></td> <td style="width: 10%;"></td> <td style="width: 10%;"></td> <td style="width: 10%;"></td> <td style="width: 10%;"></td> <td style="width: 10%;"></td> <td style="width: 10%;"></td> <td style="width: 10%;"></td> <td style="width: 10%;"></td> <td style="width: 10%;"></td> </tr> <tr> <td></td> <td></td> <td colspan="8" style="text-align: center;"> <table border="1" style="width: 100%; border-collapse: collapse; text-align: center;"> <tr> <td style="width: 10%;"></td> <td style="width: 10%;"></td> <td style="width: 10%;"></td> <td style="width: 10%;"></td> <td style="width: 10%;"></td> <td style="width: 10%;"></td> <td style="width: 10%;"></td> <td style="width: 10%;"></td> <td style="width: 10%;"></td> <td style="width: 10%;"></td> </tr> <tr> <td></td> <td></td> <td colspan="8" style="text-align: center;"> <table border="1" style="width: 100%; border-collapse: collapse; text-align: center;"> <tr> <td style="width: 10%;"></td> <td style="width: 10%;"></td> <td style="width: 10%;"></td> <td style="width: 10%;"></td> <td style="width: 10%;"></td> <td style="width: 10%;"></td> <td style="width: 10%;"></td> <td style="width: 10%;"></td> <td style="width: 10%;"></td> <td style="width: 10%;"></td> </tr> <tr> <td></td> <td></td> <td colspan="8" style="text-align: center;"> <table border="1" style="width: 100%; border-collapse: collapse; text-align: center;"> <tr> <td style="width: 10%;"></td> <td style="width: 10%;"></td> <td style="width: 10%;"></td> <td style="width: 10%;"></td> <td style="width: 10%;"></td> <td style="width: 10%;"></td> <td style="width: 10%;"></td> <td style="width: 10%;"></td> <td style="width: 10%;"></td> <td style="width: 10%;"></td> </tr> <tr> <td></td> <td></td> <td colspan="8" style="text-align: center;"> <table border="1" style="width: 100%; border-collapse: collapse; text-align: center;"> <tr> <td style="width: 10%;"></td> <td style="width: 10%;"></td> <td style="width: 10%;"></td> <td style="width: 10%;"></td> <td style="width: 10%;"></td> <td style="width: 10%;"></td> <td style="width: 10%;"></td> <td style="width: 10%;"></td> <td style="width: 10%;"></td> <td style="width: 10%;"></td> </tr> <tr> <td></td> <td></td> <td colspan="8" style="text-align: center;"> <table border="1" style="width: 100%; border-collapse: collapse; text-align: center;"> <tr> <td style="width: 10%;"></td> <td style="width: 10%;"></td> <td style="width: 10%;"></td> <td style="width: 10%;"></td> <td style="width: 10%;"></td> <td style="width: 10%;"></td> <td style="width: 10%;"></td> <td style="width: 10%;"></td> <td style="width: 10%;"></td> <td style="width: 10%;"></td> </tr> <tr> <td></td> <td></td> <td colspan="8" style="text-align: center;"> <table border="1" style="width: 100%; border-collapse: collapse; text-align: center;"> <tr> <td style="width: 10%;"></td> <td style="width: 10%;"></td> <td style="width: 10%;"></td> <td style="width: 10%;"></td> <td style="width: 10%;"></td> <td style="width: 10%;"></td> <td style="width: 10%;"></td> <td style="width: 10%;"></td> <td style="width: 10%;"></td> <td style="width: 10%;"></td> </tr> <tr> <td></td> <td></td> <td colspan="8" style="text-align: center;"> <table border="1" style="width: 100%; border-collapse: collapse; text-align: center;"> <tr> <td style="width: 10%;"></td> <td style="width: 10%;"></td> <td style="width: 10%;"></td> <td style="width: 10%;"></td> <td style="width: 10%;"></td> <td style="width: 10%;"></td> <td style="width: 10%;"></td> <td style="width: 10%;"></td> <td style="width: 10%;"></td> <td style="width: 10%;"></td> </tr> <tr> <td></td> <td></td> <td colspan="8" style="text-align: center;"> <table border="1" style="width: 100%; border-collapse: collapse; text-align: center;"> <tr> <td style="width: 10%;"></td> <td style="width: 10%;"></td> <td style="width: 10%;"></td> <td style="width: 10%;"></td> <td style="width: 10%;"></td> <td style="width: 10%;"></td> <td style="width: 10%;"></td> <td style="width: 10%;"></td> <td style="width: 10%;"></td> <td style="width: 10%;"></td> </tr> <tr> <td></td> <td></td> <td colspan="8" style="text-align: center;"> <table border="1" style="width: 100%; border-collapse: collapse; text-align: center;"> <tr> <td style="width: 10%;"></td> <td style="width: 10%;"></td> <td style="width: 10%;"></td> <td style="width: 10%;"></td> <td style="width: 10%;"></td> <td style="width: 10%;"></td> <td style="width: 10%;"></td> <td style="width: 10%;"></td> <td style="width: 10%;"></td> <td style="width: 10%;"></td> </tr> <tr> <td></td> <td></td> <td colspan="8" style="text-align: center;"> <table border="1" style="width: 100%; border-collapse: collapse; text-align: center;"> <tr> <td style="width: 10%;"></td> <td style="width: 10%;"></td> <td style="width: 10%;"></td> <td style="width: 10%;"></td> <td style="width: 10%;"></td> <td style="width: 10%;"></td> <td style="width: 10%;"></td> <td style="width: 10%;"></td> <td style="width: 10%;"></td> <td style="width: 10%;"></td> </tr> <tr> <td></td> <td></td> <td colspan="8" style="text-align: center;"> <table border="1" style="width: 100%; border-collapse: collapse; text-align: center;"> <tr> <td style="width: 10%;"></td> <td style="width: 10%;"></td> <td style="width: 10%;"></td> <td style="width: 10%;"></td> <td style="width: 10%;"></td> <td style="width: 10%;"></td> <td style="width: 10%;"></td> <td style="width: 10%;"></td> <td style="width: 10%;"></td> <td style="width: 10%;"></td> </tr> <tr> <td></td> <td></td> <td colspan="8" style="text-align: center;"> <table border="1" style="width: 100%; border-collapse: collapse; text-align: center;"> <tr> <td style="width: 10%;"></td> <td style="width: 10%;"></td> <td style="width: 10%;"></td> <td style="width: 10%;"></td> <td style="width: 10%;"></td> <td style="width: 10%;"></td> <td style="width: 10%;"></td> <td style="width: 10%;"></td> <td style="width: 10%;"></td> <td style="width: 10%;"></td> </tr> <tr> <td></td> <td></td> <td colspan="8" style="text-align: center;"> <table border="1" style="width: 100%; border-collapse: collapse; text-align: center;"> <tr> <td style="width: 10%;"></td> <td style="width: 10%;"></td> <td style="width: 10%;"></td> <td style="width: 10%;"></td> <td style="width: 10%;"></td> <td style="width: 10%;"></td> <td style="width: 10%;"></td> <td style="width: 10%;"></td> <td style="width: 10%;"></td> <td style="width: 10%;"></td> </tr> <tr> <td></td> <td></td> <td
colspan="8" style="text-align: center;"> <table border="1" style="width: 100%; border-collapse: collapse; text-align: center;"> <tr> <td style="width: 10%;"></td> <td style="width: 10%;"></td> <td style="width: 10%;"></td> <td style="width: 10%;"></td> <td style="width: 10%;"></td> <td style="width: 10%;"></td> <td style="width: 10%;"></td> <td style="width: 10%;"></td> <td style="width: 10%;"></td> <td style="width: 10%;"></td> </tr> <tr> <td></td> <td></td> <td colspan="8" style="text-align: center;"> <table border="1" style="width: 100%; border-collapse: collapse; text-align: center;"> <tr> <td style="width: 10%;"></td> <td style="width: 10%;"></td> <td style="width: 10%;"></td> <td style="width: 10%;"></td> <td style="width: 10%;"></td> <td style="width: 10%;"></td> <td style="width: 10%;"></td> <td style="width: 10%;"></td> <td style="width: 10%;"></td> <td style="width: 10%;"></td> </tr> <tr> <td></td> <td></td> <td colspan="8" style="text-align: center;"> <table border="1" style="width: 100%; border-collapse: collapse; text-align: center;"> <tr> <td style="width: 10%;"></td> <td style="width: 10%;"></td> <td style="width: 10%;"></td> <td style="width: 10%;"></td> <td style="width: 10%;"></td> <td style="width: 10%;"></td> <td style="width: 10%;"></td> <td style="width: 10%;"></td> <td style="width: 10%;"></td> <td style="width: 10%;"></td> </tr> <tr> <td></td> <td></td> <td colspan="8" style="text-align: center;"> <table border="1" style="width: 100%; border-collapse: collapse; text-align: center;"> <tr> <td style="width: 10%;"></td> <td style="width: 10%;"></td> <td style="width: 10%;"></td> <td style="width: 10%;"></td> <td style="width: 10%;"></td> <td style="width: 10%;"></td> <td style="width: 10%;"></td> <td style="width: 10%;"></td> <td style="width: 10%;"></td> <td style="width: 10%;"></td> </tr> <tr> <td></td> <td></td> <td colspan="8" style="text-align: center;"> <table border="1" style="width: 100%; border-collapse: collapse; text-align: center;"> <tr> <td style="width: 10%;"></td> <td style="width: 10%;"></td> <td style="width: 10%;"></td> <td style="width: 10%;"></td> <td style="width: 10%;"></td> <td style="width: 10%;"></td> <td style="width: 10%;"></td> <td style="width: 10%;"></td> <td style="width: 10%;"></td> <td style="width: 10%;"></td> </tr> <tr> <td></td> <td></td> <td colspan="8" style="text-align: center;"> <table border="1" style="width: 100%; border-collapse: collapse; text-align: center;"> <tr> <td style="width: 10%;"></td> <td style="width: 10%;"></td> <td style="width: 10%;"></td> <td style="width: 10%;"></td> <td style="width: 10%;"></td> <td style="width: 10%;"></td> <td style="width: 10%;"></td> <td style="width: 10%;"></td> <td style="width: 10%;"></td> <td style="width: 10%;"></td> </tr> <tr> <td></td> <td></td> <td colspan="8" style="text-align: center;"> <table border="1" style="width: 100%; border-collapse: collapse; text-align: center;"> <tr> <td style="width: 10%;"></td> <td style="width: 10%;"></td> <td style="width: 10%;"></td> <td style="width: 10%;"></td> <td style="width: 10%;"></td> <td style="width: 10%;"></td> <td style="width: 10%;"></td> <td style="width: 10%;"></td> <td style="width: 10%;"></td> <td style="width: 10%;"></td> </tr> <tr> <td></td> <td></td> <td colspan="8" style="text-align: center;"> <table border="1" style="width: 100%; border-collapse: collapse; text-align: center;"> <tr> <td style="width: 10%;"></td> <td style="width: 10%;"></td> <td style="width: 10%;"></td> <td style="width: 10%;"></td> <td style="width: 10%;"></td> <td style="width: 10%;"></td> <td style="width: 10%;"></td> <td style="width: 10%;"></td> <td style="width: 10%;"></td> <td style="width: 10%;"></td> </tr> <tr> <td></td> <td></td> <td colspan="8" style="text-align: center;"> <table border="1" style="width: 100%; border-collapse: collapse; text-align: center;"> <tr> </tr></table></td></tr></table></td></tr></table></td></tr></table></td></tr></table></td></tr></table></td></tr></table></td></tr></table></td></tr></table></td></tr></table></td></tr></table></td></tr></table></td></tr></table></td></tr></table></td></tr></table></td></tr></table></td></tr></table></td></tr></table></td></tr></table></td></tr></table></td></tr></table></td></tr></table></td></tr></table></td></tr></table></td></tr></table></td></tr></table>

 | | | | | | | | | | | | | | | | | | | | <table border="1" style="width: 100%; border-collapse: collapse; text-align: center;"> <tr> <td style="width: 10%;"></td> <td style="width: 10%;"></td> <td style="width: 10%;"></td> <td style="width: 10%;"></td> <td style="width: 10%;"></td> <td style="width: 10%;"></td> <td style="width: 10%;"></td> <td style="width: 10%;"></td> <td style="width: 10%;"></td> <td style="width: 10%;"></td> </tr> <tr> <td></td> <td></td> <td colspan="8" style="text-align: center;"> <table border="1" style="width: 100%; border-collapse: collapse; text-align: center;"> <tr> <td style="width: 10%;"></td> <td style="width: 10%;"></td> <td style="width: 10%;"></td> <td style="width: 10%;"></td> <td style="width: 10%;"></td> <td style="width: 10%;"></td> <td style="width: 10%;"></td> <td style="width: 10%;"></td> <td style="width: 10%;"></td> <td style="width: 10%;"></td> </tr> <tr> <td></td> <td></td> <td colspan="8" style="text-align: center;"> <table border="1" style="width: 100%; border-collapse: collapse; text-align: center;"> <tr> <td style="width: 10%;"></td> <td style="width: 10%;"></td> <td style="width: 10%;"></td> <td style="width: 10%;"></td> <td style="width: 10%;"></td> <td style="width: 10%;"></td> <td style="width: 10%;"></td> <td style="width: 10%;"></td> <td style="width: 10%;"></td> <td style="width: 10%;"></td> </tr> <tr> <td></td> <td></td> <td colspan="8" style="text-align: center;"> <table border="1" style="width: 100%; border-collapse: collapse; text-align: center;"> <tr> <td style="width: 10%;"></td> <td style="width: 10%;"></td> <td style="width: 10%;"></td> <td style="width: 10%;"></td> <td style="width: 10%;"></td> <td style="width: 10%;"></td> <td style="width: 10%;"></td> <td style="width: 10%;"></td> <td style="width: 10%;"></td> <td style="width: 10%;"></td> </tr> <tr> <td></td> <td></td> <td colspan="8" style="text-align: center;"> <table border="1" style="width: 100%; border-collapse: collapse; text-align: center;"> <tr> <td style="width: 10%;"></td> <td style="width: 10%;"></td> <td style="width: 10%;"></td> <td style="width: 10%;"></td> <td style="width: 10%;"></td> <td style="width: 10%;"></td> <td style="width: 10%;"></td> <td style="width: 10%;"></td> <td style="width: 10%;"></td> <td style="width: 10%;"></td> </tr> <tr> <td></td> <td></td> <td colspan="8" style="text-align: center;"> <table border="1" style="width: 100%; border-collapse: collapse; text-align: center;"> <tr> <td style="width: 10%;"></td> <td style="width: 10%;"></td> <td style="width: 10%;"></td> <td style="width: 10%;"></td> <td style="width: 10%;"></td> <td style="width: 10%;"></td> <td style="width: 10%;"></td> <td style="width: 10%;"></td> <td style="width: 10%;"></td> <td style="width: 10%;"></td> </tr> <tr> <td></td> <td></td> <td colspan="8" style="text-align: center;"> <table border="1" style="width: 100%; border-collapse: collapse; text-align: center;"> <tr> <td style="width: 10%;"></td> <td style="width: 10%;"></td> <td style="width: 10%;"></td> <td style="width: 10%;"></td> <td style="width: 10%;"></td> <td style="width: 10%;"></td> <td style="width: 10%;"></td> <td style="width: 10%;"></td> <td style="width: 10%;"></td> <td style="width: 10%;"></td> </tr> <tr> <td></td> <td></td> <td colspan="8" style="text-align: center;"> <table border="1" style="width: 100%; border-collapse: collapse; text-align: center;"> <tr> <td style="width: 10%;"></td> <td style="width: 10%;"></td> <td style="width: 10%;"></td> <td style="width: 10%;"></td> <td style="width: 10%;"></td> <td style="width: 10%;"></td> <td style="width: 10%;"></td> <td style="width: 10%;"></td> <td style="width: 10%;"></td> <td style="width: 10%;"></td> </tr> <tr> <td></td> <td></td> <td colspan="8" style="text-align: center;"> <table border="1" style="width: 100%; border-collapse: collapse; text-align: center;"> <tr> <td style="width: 10%;"></td> <td style="width: 10%;"></td> <td style="width: 10%;"></td> <td style="width: 10%;"></td> <td style="width: 10%;"></td> <td style="width: 10%;"></td> <td style="width: 10%;"></td> <td style="width: 10%;"></td> <td style="width: 10%;"></td> <td style="width: 10%;"></td> </tr> <tr> <td></td> <td></td> <td colspan="8" style="text-align: center;"> <table border="1" style="width: 100%; border-collapse: collapse; text-align: center;"> <tr> <td style="width: 10%;"></td> <td style="width: 10%;"></td> <td style="width: 10%;"></td> <td style="width: 10%;"></td> <td style="width: 10%;"></td> <td style="width: 10%;"></td> <td style="width: 10%;"></td> <td style="width: 10%;"></td> <td style="width: 10%;"></td> <td style="width: 10%;"></td> </tr> <tr> <td></td> <td></td> <td colspan="8" style="text-align: center;"> <table border="1" style="width: 100%; border-collapse: collapse; text-align: center;"> <tr> <td style="width: 10%;"></td> <td style="width: 10%;"></td> <td style="width: 10%;"></td> <td style="width: 10%;"></td> <td style="width: 10%;"></td> <td style="width: 10%;"></td> <td style="width: 10%;"></td> <td style="width: 10%;"></td> <td style="width: 10%;"></td> <td style="width: 10%;"></td> </tr> <tr> <td></td> <td></td> <td colspan="8" style="text-align: center;"> <table border="1" style="width: 100%; border-collapse: collapse; text-align: center;"> <tr> <td style="width: 10%;"></td> <td style="width: 10%;"></td> <td style="width: 10%;"></td> <td style="width: 10%;"></td> <td style="width: 10%;"></td> <td style="width: 10%;"></td> <td style="width: 10%;"></td> <td style="width: 10%;"></td> <td style="width: 10%;"></td> <td style="width: 10%;"></td> </tr> <tr> <td></td> <td></td> <td colspan="8" style="text-align: center;"> <table border="1" style="width: 100%; border-collapse: collapse; text-align: center;"> <tr> <td style="width: 10%;"></td> <td style="width: 10%;"></td> <td style="width: 10%;"></td> <td style="width: 10%;"></td> <td style="width: 10%;"></td> <td style="width: 10%;"></td> <td style="width: 10%;"></td> <td style="width: 10%;"></td> <td style="width: 10%;"></td> <td style="width: 10%;"></td> </tr> <tr> <td></td> <td></td> <td colspan="8" style="text-align: center;"> <table border="1" style="width: 100%; border-collapse: collapse; text-align: center;"> <tr> <td style="width: 10%;"></td> <td style="width: 10%;"></td> <td style="width: 10%;"></td> <td style="width: 10%;"></td> <td style="width: 10%;"></td> <td style="width: 10%;"></td> <td style="width: 10%;"></td> <td style="width: 10%;"></td> <td style="width: 10%;"></td> <td style="width: 10%;"></td> </tr> <tr> <td></td> <td></td> <td colspan="8" style="text-align: center;"> <table border="1" style="width: 100%; border-collapse: collapse; text-align: center;"> <tr> <td style="width: 10%;"></td> <td style="width: 10%;"></td> <td style="width: 10%;"></td> <td style="width: 10%;"></td> <td style="width: 10%;"></td> <td style="width: 10%;"></td> <td style="width: 10%;"></td> <td style="width: 10%;"></td> <td style="width: 10%;"></td> <td style="width: 10%;"></td> </tr> <tr> <td></td> <td></td> <td colspan="8" style="text-align: center;"> <table border="1" style="width: 100%; border-collapse: collapse; text-align: center;"> <tr> <td style="width: 10%;"></td> <td style="width: 10%;"></td> <td style="width: 10%;"></td> <td style="width: 10%;"></td> <td style="width: 10%;"></td> <td style="width: 10%;"></td> <td style="width: 10%;"></td> <td style="width: 10%;"></td> <td style="width: 10%;"></td> <td style="width: 10%;"></td> </tr> <tr> <td></td> <td></td> <td colspan="8" style="text-align: center;"> <table border="1" style="width: 100%; border-collapse: collapse; text-align: center;"> <tr> <td style="width: 10%;"></td> <td
style="width: 10%;"></td> <td style="width: 10%;"></td> <td style="width: 10%;"></td> <td style="width: 10%;"></td> <td style="width: 10%;"></td> <td style="width: 10%;"></td> <td style="width: 10%;"></td> <td style="width: 10%;"></td> <td style="width: 10%;"></td> </tr> <tr> <td></td> <td></td> <td colspan="8" style="text-align: center;"> <table border="1" style="width: 100%; border-collapse: collapse; text-align: center;"> <tr> <td style="width: 10%;"></td> <td style="width: 10%;"></td> <td style="width: 10%;"></td> <td style="width: 10%;"></td> <td style="width: 10%;"></td> <td style="width: 10%;"></td> <td style="width: 10%;"></td> <td style="width: 10%;"></td> <td style="width: 10%;"></td> <td style="width: 10%;"></td> </tr> <tr> <td></td> <td></td> <td colspan="8" style="text-align: center;"> <table border="1" style="width: 100%; border-collapse: collapse; text-align: center;"> <tr> <td style="width: 10%;"></td> <td style="width: 10%;"></td> <td style="width: 10%;"></td> <td style="width: 10%;"></td> <td style="width: 10%;"></td> <td style="width: 10%;"></td> <td style="width: 10%;"></td> <td style="width: 10%;"></td> <td style="width: 10%;"></td> <td style="width: 10%;"></td> </tr> <tr> <td></td> <td></td> <td colspan="8" style="text-align: center;"> <table border="1" style="width: 100%; border-collapse: collapse; text-align: center;"> <tr> <td style="width: 10%;"></td> <td style="width: 10%;"></td> <td style="width: 10%;"></td> <td style="width: 10%;"></td> <td style="width: 10%;"></td> <td style="width: 10%;"></td> <td style="width: 10%;"></td> <td style="width: 10%;"></td> <td style="width: 10%;"></td> <td style="width: 10%;"></td> </tr> <tr> <td></td> <td></td> <td colspan="8" style="text-align: center;"> <table border="1" style="width: 100%; border-collapse: collapse; text-align: center;"> <tr> <td style="width: 10%;"></td> <td style="width: 10%;"></td> <td style="width: 10%;"></td> <td style="width: 10%;"></td> <td style="width: 10%;"></td> <td style="width: 10%;"></td> <td style="width: 10%;"></td> <td style="width: 10%;"></td> <td style="width: 10%;"></td> <td style="width: 10%;"></td> </tr> <tr> <td></td> <td></td> <td colspan="8" style="text-align: center;"> <table border="1" style="width: 100%; border-collapse: collapse; text-align: center;"> <tr> <td style="width: 10%;"></td> <td style="width: 10%;"></td> <td style="width: 10%;"></td> <td style="width: 10%;"></td> <td style="width: 10%;"></td> <td style="width: 10%;"></td> <td style="width: 10%;"></td> <td style="width: 10%;"></td> <td style="width: 10%;"></td> <td style="width: 10%;"></td> </tr> <tr> <td></td> <td></td> <td colspan="8" style="text-align: center;"> <table border="1" style="width: 100%; border-collapse: collapse; text-align: center;"> <tr> <td style="width: 10%;"></td> <td style="width: 10%;"></td> <td style="width: 10%;"></td> <td style="width: 10%;"></td> <td style="width: 10%;"></td> <td style="width: 10%;"></td> <td style="width: 10%;"></td> <td style="width: 10%;"></td> <td style="width: 10%;"></td> <td style="width: 10%;"></td> </tr> <tr> <td></td> <td></td> <td colspan="8" style="text-align: center;"> <table border="1" style="width: 100%; border-collapse: collapse; text-align: center;"> <tr> <td style="width: 10%;"></td> <td style="width: 10%;"></td> <td style="width: 10%;"></td> <td style="width: 10%;"></td> <td style="width: 10%;"></td> <td style="width: 10%;"></td> <td style="width: 10%;"></td> <td style="width: 10%;"></td> <td style="width: 10%;"></td> <td style="width: 10%;"></td> </tr> <tr> <td></td> <td></td> <td colspan="8" style="text-align: center;"> <table border="1" style="width: 100%; border-collapse: collapse; text-align: center;"> <tr> </tr></table></td></tr></table></td></tr></table></td></tr></table></td></tr></table></td></tr></table></td></tr></table></td></tr></table></td></tr></table></td></tr></table></td></tr></table></td></tr></table></td></tr></table></td></tr></table></td></tr></table></td></tr></table></td></tr></table></td></tr></table></td></tr></table></td></tr></table></td></tr></table></td></tr></table></td></tr></table></td></tr></table></td></tr></table>

 | | | | | | | | | | | | | | | | | | | | <table border="1" style="width: 100%; border-collapse: collapse; text-align: center;"> <tr> <td style="width: 10%;"></td> <td style="width: 10%;"></td> <td style="width: 10%;"></td> <td style="width: 10%;"></td> <td style="width: 10%;"></td> <td style="width: 10%;"></td> <td style="width: 10%;"></td> <td style="width: 10%;"></td> <td style="width: 10%;"></td> <td style="width: 10%;"></td> </tr> <tr> <td></td> <td></td> <td colspan="8" style="text-align: center;"> <table border="1" style="width: 100%; border-collapse: collapse; text-align: center;"> <tr> <td style="width: 10%;"></td> <td style="width: 10%;"></td> <td style="width: 10%;"></td> <td style="width: 10%;"></td> <td style="width: 10%;"></td> <td style="width: 10%;"></td> <td style="width: 10%;"></td> <td style="width: 10%;"></td> <td style="width: 10%;"></td> <td style="width: 10%;"></td> </tr> <tr> <td></td> <td></td> <td colspan="8" style="text-align: center;"> <table border="1" style="width: 100%; border-collapse: collapse; text-align: center;"> <tr> <td style="width: 10%;"></td> <td style="width: 10%;"></td> <td style="width: 10%;"></td> <td style="width: 10%;"></td> <td style="width: 10%;"></td> <td style="width: 10%;"></td> <td style="width: 10%;"></td> <td style="width: 10%;"></td> <td style="width: 10%;"></td> <td style="width: 10%;"></td> </tr> <tr> <td></td> <td></td> <td colspan="8" style="text-align: center;"> <table border="1" style="width: 100%; border-collapse: collapse; text-align: center;"> <tr> <td style="width: 10%;"></td> <td style="width: 10%;"></td> <td style="width: 10%;"></td> <td style="width: 10%;"></td> <td style="width: 10%;"></td> <td style="width: 10%;"></td> <td style="width: 10%;"></td> <td style="width: 10%;"></td> <td style="width: 10%;"></td> <td style="width: 10%;"></td> </tr> <tr> <td></td> <td></td> <td colspan="8" style="text-align: center;"> <table border="1" style="width: 100%; border-collapse: collapse; text-align: center;"> <tr> <td style="width: 10%;"></td> <td style="width: 10%;"></td> <td style="width: 10%;"></td> <td style="width: 10%;"></td> <td style="width: 10%;"></td> <td style="width: 10%;"></td> <td style="width: 10%;"></td> <td style="width: 10%;"></td> <td style="width: 10%;"></td> <td style="width: 10%;"></td> </tr> <tr> <td></td> <td></td> <td colspan="8" style="text-align: center;"> <table border="1" style="width: 100%; border-collapse: collapse; text-align: center;"> <tr> <td style="width: 10%;"></td> <td style="width: 10%;"></td> <td style="width: 10%;"></td> <td style="width: 10%;"></td> <td style="width: 10%;"></td> <td style="width: 10%;"></td> <td style="width: 10%;"></td> <td style="width: 10%;"></td> <td style="width: 10%;"></td> <td style="width: 10%;"></td> </tr> <tr> <td></td> <td></td> <td colspan="8" style="text-align: center;"> <table border="1" style="width: 100%; border-collapse: collapse; text-align: center;"> <tr> <td style="width: 10%;"></td> <td style="width: 10%;"></td> <td style="width: 10%;"></td> <td style="width: 10%;"></td> <td style="width: 10%;"></td> <td style="width: 10%;"></td> <td style="width: 10%;"></td> <td style="width: 10%;"></td> <td style="width: 10%;"></td> <td style="width: 10%;"></td> </tr> <tr> <td></td> <td></td> <td colspan="8" style="text-align: center;"> <table border="1" style="width: 100%; border-collapse: collapse; text-align: center;"> <tr> <td style="width: 10%;"></td> <td style="width: 10%;"></td> <td style="width: 10%;"></td> <td style="width: 10%;"></td> <td style="width: 10%;"></td> <td style="width: 10%;"></td> <td style="width: 10%;"></td> <td style="width: 10%;"></td> <td style="width: 10%;"></td> <td style="width: 10%;"></td> </tr> <tr> <td></td> <td></td> <td colspan="8" style="text-align: center;"> <table border="1" style="width: 100%; border-collapse: collapse; text-align: center;"> <tr> <td style="width: 10%;"></td> <td style="width: 10%;"></td> <td style="width: 10%;"></td> <td style="width: 10%;"></td> <td style="width: 10%;"></td> <td style="width: 10%;"></td> <td style="width: 10%;"></td> <td style="width: 10%;"></td> <td style="width: 10%;"></td> <td style="width: 10%;"></td> </tr> <tr> <td></td> <td></td> <td colspan="8" style="text-align: center;"> <table border="1" style="width: 100%; border-collapse: collapse; text-align: center;"> <tr> <td style="width: 10%;"></td> <td style="width: 10%;"></td> <td style="width: 10%;"></td> <td style="width: 10%;"></td> <td style="width: 10%;"></td> <td style="width: 10%;"></td> <td style="width: 10%;"></td> <td style="width: 10%;"></td> <td style="width: 10%;"></td> <td style="width: 10%;"></td> </tr> <tr> <td></td> <td></td> <td colspan="8" style="text-align: center;"> <table border="1" style="width: 100%; border-collapse: collapse; text-align: center;"> <tr> <td style="width: 10%;"></td> <td style="width: 10%;"></td> <td style="width: 10%;"></td> <td style="width: 10%;"></td> <td style="width: 10%;"></td> <td style="width: 10%;"></td> <td style="width: 10%;"></td> <td style="width: 10%;"></td> <td style="width: 10%;"></td> <td style="width: 10%;"></td> </tr> <tr> <td></td> <td></td> <td colspan="8" style="text-align: center;"> <table border="1" style="width: 100%; border-collapse: collapse; text-align: center;"> <tr> <td style="width: 10%;"></td> <td style="width: 10%;"></td> <td style="width: 10%;"></td> <td style="width: 10%;"></td> <td style="width: 10%;"></td> <td style="width: 10%;"></td> <td style="width: 10%;"></td> <td style="width: 10%;"></td> <td style="width: 10%;"></td> <td style="width: 10%;"></td> </tr> <tr> <td></td> <td></td> <td colspan="8" style="text-align: center;"> <table border="1" style="width: 100%; border-collapse: collapse; text-align: center;"> <tr> <td style="width: 10%;"></td> <td style="width: 10%;"></td> <td style="width: 10%;"></td> <td style="width: 10%;"></td> <td style="width: 10%;"></td> <td style="width: 10%;"></td> <td style="width: 10%;"></td> <td style="width: 10%;"></td> <td style="width: 10%;"></td> <td style="width: 10%;"></td> </tr> <tr> <td></td> <td></td> <td colspan="8" style="text-align: center;"> <table border="1" style="width: 100%; border-collapse: collapse; text-align: center;"> <tr> <td style="width: 10%;"></td> <td style="width: 10%;"></td> <td style="width: 10%;"></td> <td style="width: 10%;"></td> <td style="width: 10%;"></td> <td style="width: 10%;"></td> <td style="width: 10%;"></td> <td style="width: 10%;"></td> <td style="width: 10%;"></td> <td style="width: 10%;"></td> </tr> <tr> <td></td> <td></td> <td colspan="8" style="text-align: center;"> <table border="1" style="width: 100%; border-collapse: collapse; text-align: center;"> <tr> <td style="width: 10%;"></td> <td style="width: 10%;"></td> <td style="width: 10%;"></td> <td style="width: 10%;"></td> <td style="width: 10%;"></td> <td style="width: 10%;"></td> <td style="width: 10%;"></td> <td style="width: 10%;"></td> <td style="width: 10%;"></td> <td style="width: 10%;"></td> </tr> <tr> <td></td> <td></td> <td colspan="8" style="text-align: center;"> <table border="1" style="width: 100%; border-collapse: collapse; text-align: center;"> <tr> <td style="width: 10%;"></td> <td style="width: 10%;"></td> <td style="width: 10%;"></td> <td style="width: 10%;"></td> <td style="width: 10%;"></td> <td style="width: 10%;"></td> <td style="width: 10%;"></td> <td style="width: 10%;"></td> <td style="width: 10%;"></td> <td style="width: 10%;"></td> </tr> <tr> <td></td> <td></td> <td colspan="8" style="text-align: center;"> <table border="1" style="width: 100%; border-collapse: collapse; text-align: center;"> <tr> <td style="width: 10%;"></td> <td style="width: 10%;"></td> <td style="width: 10%;"></td> <td style="width: 10%;"></td> <td style="width: 10%;"></td> <td style="width: 10%;"></td> <td style="width: 10%;"></td> <td
style="width: 10%;"></td> <td style="width: 10%;"></td> <td style="width: 10%;"></td> </tr> <tr> <td></td> <td></td> <td colspan="8" style="text-align: center;"> <table border="1" style="width: 100%; border-collapse: collapse; text-align: center;"> <tr> <td style="width: 10%;"></td> <td style="width: 10%;"></td> <td style="width: 10%;"></td> <td style="width: 10%;"></td> <td style="width: 10%;"></td> <td style="width: 10%;"></td> <td style="width: 10%;"></td> <td style="width: 10%;"></td> <td style="width: 10%;"></td> <td style="width: 10%;"></td> </tr> <tr> <td></td> <td></td> <td colspan="8" style="text-align: center;"> <table border="1" style="width: 100%; border-collapse: collapse; text-align: center;"> <tr> <td style="width: 10%;"></td> <td style="width: 10%;"></td> <td style="width: 10%;"></td> <td style="width: 10%;"></td> <td style="width: 10%;"></td> <td style="width: 10%;"></td> <td style="width: 10%;"></td> <td style="width: 10%;"></td> <td style="width: 10%;"></td> <td style="width: 10%;"></td> </tr> <tr> <td></td> <td></td> <td colspan="8" style="text-align: center;"> <table border="1" style="width: 100%; border-collapse: collapse; text-align: center;"> <tr> <td style="width: 10%;"></td> <td style="width: 10%;"></td> <td style="width: 10%;"></td> <td style="width: 10%;"></td> <td style="width: 10%;"></td> <td style="width: 10%;"></td> <td style="width: 10%;"></td> <td style="width: 10%;"></td> <td style="width: 10%;"></td> <td style="width: 10%;"></td> </tr> <tr> <td></td> <td></td> <td colspan="8" style="text-align: center;"> <table border="1" style="width: 100%; border-collapse: collapse; text-align: center;"> <tr> <td style="width: 10%;"></td> <td style="width: 10%;"></td> <td style="width: 10%;"></td> <td style="width: 10%;"></td> <td style="width: 10%;"></td> <td style="width: 10%;"></td> <td style="width: 10%;"></td> <td style="width: 10%;"></td> <td style="width: 10%;"></td> <td style="width: 10%;"></td> </tr> <tr> <td></td> <td></td> <td colspan="8" style="text-align: center;"> <table border="1" style="width: 100%; border-collapse: collapse; text-align: center;"> <tr> <td style="width: 10%;"></td> <td style="width: 10%;"></td> <td style="width: 10%;"></td> <td style="width: 10%;"></td> <td style="width: 10%;"></td> <td style="width: 10%;"></td> <td style="width: 10%;"></td> <td style="width: 10%;"></td> <td style="width: 10%;"></td> <td style="width: 10%;"></td> </tr> <tr> <td></td> <td></td> <td colspan="8" style="text-align: center;"> <table border="1" style="width: 100%; border-collapse: collapse; text-align: center;"> <tr> <td style="width: 10%;"></td> <td style="width: 10%;"></td> <td style="width: 10%;"></td> <td style="width: 10%;"></td> <td style="width: 10%;"></td> <td style="width: 10%;"></td> <td style="width: 10%;"></td> <td style="width: 10%;"></td> <td style="width: 10%;"></td> <td style="width: 10%;"></td> </tr> <tr> <td></td> <td></td> <td colspan="8" style="text-align: center;"> <table border="1" style="width: 100%; border-collapse: collapse; text-align: center;"> <tr> </tr></table></td></tr></table></td></tr></table></td></tr></table></td></tr></table></td></tr></table></td></tr></table></td></tr></table></td></tr></table></td></tr></table></td></tr></table></td></tr></table></td></tr></table></td></tr></table></td></tr></table></td></tr></table></td></tr></table></td></tr></table></td></tr></table></td></tr></table></td></tr></table></td></tr></table></td></tr></table></td></tr></table>

 | | | | | | | | | | | | | | | | | | | | <table border="1" style="width: 100%; border-collapse: collapse; text-align: center;"> <tr> <td style="width: 10%;"></td> <td style="width: 10%;"></td> <td style="width: 10%;"></td> <td style="width: 10%;"></td> <td style="width: 10%;"></td> <td style="width: 10%;"></td> <td style="width: 10%;"></td> <td style="width: 10%;"></td> <td style="width: 10%;"></td> <td style="width: 10%;"></td> </tr> <tr> <td></td> <td></td> <td colspan="8" style="text-align: center;"> <table border="1" style="width: 100%; border-collapse: collapse; text-align: center;"> <tr> <td style="width: 10%;"></td> <td style="width: 10%;"></td> <td style="width: 10%;"></td> <td style="width: 10%;"></td> <td style="width: 10%;"></td> <td style="width: 10%;"></td> <td style="width: 10%;"></td> <td style="width: 10%;"></td> <td style="width: 10%;"></td> <td style="width: 10%;"></td> </tr> <tr> <td></td> <td></td> <td colspan="8" style="text-align: center;"> <table border="1" style="width: 100%; border-collapse: collapse; text-align: center;"> <tr> <td style="width: 10%;"></td> <td style="width: 10%;"></td> <td style="width: 10%;"></td> <td style="width: 10%;"></td> <td style="width: 10%;"></td> <td style="width: 10%;"></td> <td style="width: 10%;"></td> <td style="width: 10%;"></td> <td style="width: 10%;"></td> <td style="width: 10%;"></td> </tr> <tr> <td></td> <td></td> <td colspan="8" style="text-align: center;"> <table border="1" style="width: 100%; border-collapse: collapse; text-align: center;"> <tr> <td style="width: 10%;"></td> <td style="width: 10%;"></td> <td style="width: 10%;"></td> <td style="width: 10%;"></td> <td style="width: 10%;"></td> <td style="width: 10%;"></td> <td style="width: 10%;"></td> <td style="width: 10%;"></td> <td style="width: 10%;"></td> <td style="width: 10%;"></td> </tr> <tr> <td></td> <td></td> <td colspan="8" style="text-align: center;"> <table border="1" style="width: 100%; border-collapse: collapse; text-align: center;"> <tr> <td style="width: 10%;"></td> <td style="width: 10%;"></td> <td style="width: 10%;"></td> <td style="width: 10%;"></td> <td style="width: 10%;"></td> <td style="width: 10%;"></td> <td style="width: 10%;"></td> <td style="width: 10%;"></td> <td style="width: 10%;"></td> <td style="width: 10%;"></td> </tr> <tr> <td></td> <td></td> <td colspan="8" style="text-align: center;"> <table border="1" style="width: 100%; border-collapse: collapse; text-align: center;"> <tr> <td style="width: 10%;"></td> <td style="width: 10%;"></td> <td style="width: 10%;"></td> <td style="width: 10%;"></td> <td style="width: 10%;"></td> <td style="width: 10%;"></td> <td style="width: 10%;"></td> <td style="width: 10%;"></td> <td style="width: 10%;"></td> <td style="width: 10%;"></td> </tr> <tr> <td></td> <td></td> <td colspan="8" style="text-align: center;"> <table border="1" style="width: 100%; border-collapse: collapse; text-align: center;"> <tr> <td style="width: 10%;"></td> <td style="width: 10%;"></td> <td style="width: 10%;"></td> <td style="width: 10%;"></td> <td style="width: 10%;"></td> <td style="width: 10%;"></td> <td style="width: 10%;"></td> <td style="width: 10%;"></td> <td style="width: 10%;"></td> <td style="width: 10%;"></td> </tr> <tr> <td></td> <td></td> <td colspan="8" style="text-align: center;"> <table border="1" style="width: 100%; border-collapse: collapse; text-align: center;"> <tr> <td style="width: 10%;"></td> <td style="width: 10%;"></td> <td style="width: 10%;"></td> <td style="width: 10%;"></td> <td style="width: 10%;"></td> <td style="width: 10%;"></td> <td style="width: 10%;"></td> <td style="width: 10%;"></td> <td style="width: 10%;"></td> <td style="width: 10%;"></td> </tr> <tr> <td></td> <td></td> <td colspan="8" style="text-align: center;"> <table border="1" style="width: 100%; border-collapse: collapse; text-align: center;"> <tr> <td style="width: 10%;"></td> <td style="width: 10%;"></td> <td style="width: 10%;"></td> <td style="width: 10%;"></td> <td style="width: 10%;"></td> <td style="width: 10%;"></td> <td style="width: 10%;"></td> <td style="width: 10%;"></td> <td style="width: 10%;"></td> <td style="width: 10%;"></td> </tr> <tr> <td></td> <td></td> <td colspan="8" style="text-align: center;"> <table border="1" style="width: 100%; border-collapse: collapse; text-align: center;"> <tr> <td style="width: 10%;"></td> <td style="width: 10%;"></td> <td style="width: 10%;"></td> <td style="width: 10%;"></td> <td style="width: 10%;"></td> <td style="width: 10%;"></td> <td style="width: 10%;"></td> <td style="width: 10%;"></td> <td style="width: 10%;"></td> <td style="width: 10%;"></td> </tr> <tr> <td></td> <td></td> <td colspan="8" style="text-align: center;"> <table border="1" style="width: 100%; border-collapse: collapse; text-align: center;"> <tr> <td style="width: 10%;"></td> <td style="width: 10%;"></td> <td style="width: 10%;"></td> <td style="width: 10%;"></td> <td style="width: 10%;"></td> <td style="width: 10%;"></td> <td style="width: 10%;"></td> <td style="width: 10%;"></td> <td style="width: 10%;"></td> <td style="width: 10%;"></td> </tr> <tr> <td></td> <td></td> <td colspan="8" style="text-align: center;"> <table border="1" style="width: 100%; border-collapse: collapse; text-align: center;"> <tr> <td style="width: 10%;"></td> <td style="width: 10%;"></td> <td style="width: 10%;"></td> <td style="width: 10%;"></td> <td style="width: 10%;"></td> <td style="width: 10%;"></td> <td style="width: 10%;"></td> <td style="width: 10%;"></td> <td style="width: 10%;"></td> <td style="width: 10%;"></td> </tr> <tr> <td></td> <td></td> <td colspan="8" style="text-align: center;"> <table border="1" style="width: 100%; border-collapse: collapse; text-align: center;"> <tr> <td style="width: 10%;"></td> <td style="width: 10%;"></td> <td style="width: 10%;"></td> <td style="width: 10%;"></td> <td style="width: 10%;"></td> <td style="width: 10%;"></td> <td style="width: 10%;"></td> <td style="width: 10%;"></td> <td style="width: 10%;"></td> <td style="width: 10%;"></td> </tr> <tr> <td></td> <td></td> <td colspan="8" style="text-align: center;"> <table border="1" style="width: 100%; border-collapse: collapse; text-align: center;"> <tr> <td style="width: 10%;"></td> <td style="width: 10%;"></td> <td style="width: 10%;"></td> <td style="width: 10%;"></td> <td style="width: 10%;"></td> <td style="width: 10%;"></td> <td style="width: 10%;"></td> <td style="width: 10%;"></td> <td style="width: 10%;"></td> <td style="width: 10%;"></td> </tr> <tr> <td></td> <td></td> <td colspan="8" style="text-align: center;"> <table border="1" style="width: 100%; border-collapse: collapse; text-align: center;"> <tr> <td style="width: 10%;"></td> <td style="width: 10%;"></td> <td style="width: 10%;"></td> <td style="width: 10%;"></td> <td style="width: 10%;"></td> <td style="width: 10%;"></td> <td style="width: 10%;"></td> <td style="width: 10%;"></td> <td style="width: 10%;"></td> <td style="width: 10%;"></td> </tr> <tr> <td></td> <td></td> <td colspan="8" style="text-align: center;"> <table border="1" style="width: 100%; border-collapse: collapse; text-align: center;"> <tr> <td style="width: 10%;"></td> <td style="width: 10%;"></td> <td style="width: 10%;"></td> <td style="width: 10%;"></td> <td style="width: 10%;"></td> <td style="width: 10%;"></td> <td style="width: 10%;"></td> <td style="width: 10%;"></td> <td style="width: 10%;"></td> <td style="width: 10%;"></td> </tr> <tr> <td></td> <td></td> <td colspan="8" style="text-align: center;"> <table border="1" style="width: 100%; border-collapse: collapse; text-align: center;"> <tr> <td style="width: 10%;"></td> <td style="width: 10%;"></td> <td style="width: 10%;"></td> <td style="width: 10%;"></td> <td style="width: 10%;"></td> <td style="width: 10%;"></td> <td style="width: 10%;"></td> <td style="width: 10%;"></td> <td style="width: 10%;"></td> <td style="width: 10%;"></td> </tr> <tr> <td></td> <td></td> <td colspan="8" style="text-align: center;"> <table border="1" style="width: 100%; border-collapse: collapse; text-align: center;"> <tr> <td style="width: 10%;"></td> <td style="width: 10%;"></td> <td style="width: 10%;"></td> <td style="width: 10%;"></td> <td style="width: 10%;"></td> <td style="width: 10%;"></td> <td style="width: 10%;"></td> <td style="width: 10%;"></td> <td style="width: 10%;"></td> <td style="width: 10%;"></td> </tr> <tr> <td></td> <td></td> <td colspan="8" style="text-align: center;"> <table border="1" style="width: 100%;
border-collapse: collapse; text-align: center;"> <tr> <td style="width: 10%;"></td> <td style="width: 10%;"></td> <td style="width: 10%;"></td> <td style="width: 10%;"></td> <td style="width: 10%;"></td> <td style="width: 10%;"></td> <td style="width: 10%;"></td> <td style="width: 10%;"></td> <td style="width: 10%;"></td> <td style="width: 10%;"></td> </tr> <tr> <td></td> <td></td> <td colspan="8" style="text-align: center;"> <table border="1" style="width: 100%; border-collapse: collapse; text-align: center;"> <tr> <td style="width: 10%;"></td> <td style="width: 10%;"></td> <td style="width: 10%;"></td> <td style="width: 10%;"></td> <td style="width: 10%;"></td> <td style="width: 10%;"></td> <td style="width: 10%;"></td> <td style="width: 10%;"></td> <td style="width: 10%;"></td> <td style="width: 10%;"></td> </tr> <tr> <td></td> <td></td> <td colspan="8" style="text-align: center;"> <table border="1" style="width: 100%; border-collapse: collapse; text-align: center;"> <tr> <td style="width: 10%;"></td> <td style="width: 10%;"></td> <td style="width: 10%;"></td> <td style="width: 10%;"></td> <td style="width: 10%;"></td> <td style="width: 10%;"></td> <td style="width: 10%;"></td> <td style="width: 10%;"></td> <td style="width: 10%;"></td> <td style="width: 10%;"></td> </tr> <tr> <td></td> <td></td> <td colspan="8" style="text-align: center;"> <table border="1" style="width: 100%; border-collapse: collapse; text-align: center;"> <tr> <td style="width: 10%;"></td> <td style="width: 10%;"></td> <td style="width: 10%;"></td> <td style="width: 10%;"></td> <td style="width: 10%;"></td> <td style="width: 10%;"></td> <td style="width: 10%;"></td> <td style="width: 10%;"></td> <td style="width: 10%;"></td> <td style="width: 10%;"></td> </tr> <tr> <td></td> <td></td> <td colspan="8" style="text-align: center;"> <table border="1" style="width: 100%; border-collapse: collapse; text-align: center;"> <tr> </tr></table></td></tr></table></td></tr></table></td></tr></table></td></tr></table></td></tr></table></td></tr></table></td></tr></table></td></tr></table></td></tr></table></td></tr></table></td></tr></table></td></tr></table></td></tr></table></td></tr></table></td></tr></table></td></tr></table></td></tr></table></td></tr></table></td></tr></table></td></tr></table></td></tr></table></td></tr></table>

 | | | | | | | | | | | | | | | | | | | | <table border="1" style="width: 100%; border-collapse: collapse; text-align: center;"> <tr> <td style="width: 10%;"></td> <td style="width: 10%;"></td> <td style="width: 10%;"></td> <td style="width: 10%;"></td> <td style="width: 10%;"></td> <td style="width: 10%;"></td> <td style="width: 10%;"></td> <td style="width: 10%;"></td> <td style="width: 10%;"></td> <td style="width: 10%;"></td> </tr> <tr> <td></td> <td></td> <td colspan="8" style="text-align: center;"> <table border="1" style="width: 100%; border-collapse: collapse; text-align: center;"> <tr> <td style="width: 10%;"></td> <td style="width: 10%;"></td> <td style="width: 10%;"></td> <td style="width: 10%;"></td> <td style="width: 10%;"></td> <td style="width: 10%;"></td> <td style="width: 10%;"></td> <td style="width: 10%;"></td> <td style="width: 10%;"></td> <td style="width: 10%;"></td> </tr> <tr> <td></td> <td></td> <td colspan="8" style="text-align: center;"> <table border="1" style="width: 100%; border-collapse: collapse; text-align: center;"> <tr> <td style="width: 10%;"></td> <td style="width: 10%;"></td> <td style="width: 10%;"></td> <td style="width: 10%;"></td> <td style="width: 10%;"></td> <td style="width: 10%;"></td> <td style="width: 10%;"></td> <td style="width: 10%;"></td> <td style="width: 10%;"></td> <td style="width: 10%;"></td> </tr> <tr> <td></td> <td></td> <td colspan="8" style="text-align: center;"> <table border="1" style="width: 100%; border-collapse: collapse; text-align: center;"> <tr> <td style="width: 10%;"></td> <td style="width: 10%;"></td> <td style="width: 10%;"></td> <td style="width: 10%;"></td> <td style="width: 10%;"></td> <td style="width: 10%;"></td> <td style="width: 10%;"></td> <td style="width: 10%;"></td> <td style="width: 10%;"></td> <td style="width: 10%;"></td> </tr> <tr> <td></td> <td></td> <td colspan="8" style="text-align: center;"> <table border="1" style="width: 100%; border-collapse: collapse; text-align: center;"> <tr> <td style="width: 10%;"></td> <td style="width: 10%;"></td> <td style="width: 10%;"></td> <td style="width: 10%;"></td> <td style="width: 10%;"></td> <td style="width: 10%;"></td> <td style="width: 10%;"></td> <td style="width: 10%;"></td> <td style="width: 10%;"></td> <td style="width: 10%;"></td> </tr> <tr> <td></td> <td></td> <td colspan="8" style="text-align: center;"> <table border="1" style="width: 100%; border-collapse: collapse; text-align: center;"> <tr> <td style="width: 10%;"></td> <td style="width: 10%;"></td> <td style="width: 10%;"></td> <td style="width: 10%;"></td> <td style="width: 10%;"></td> <td style="width: 10%;"></td> <td style="width: 10%;"></td> <td style="width: 10%;"></td> <td style="width: 10%;"></td> <td style="width: 10%;"></td> </tr> <tr> <td></td> <td></td> <td colspan="8" style="text-align: center;"> <table border="1" style="width: 100%; border-collapse: collapse; text-align: center;"> <tr> <td style="width: 10%;"></td> <td style="width: 10%;"></td> <td style="width: 10%;"></td> <td style="width: 10%;"></td> <td style="width: 10%;"></td> <td style="width: 10%;"></td> <td style="width: 10%;"></td> <td style="width: 10%;"></td> <td style="width: 10%;"></td> <td style="width: 10%;"></td> </tr> <tr> <td></td> <td></td> <td colspan="8" style="text-align: center;"> <table border="1" style="width: 100%; border-collapse: collapse; text-align: center;"> <tr> <td style="width: 10%;"></td> <td style="width: 10%;"></td> <td style="width: 10%;"></td> <td style="width: 10%;"></td> <td style="width: 10%;"></td> <td style="width: 10%;"></td> <td style="width: 10%;"></td> <td style="width: 10%;"></td> <td style="width: 10%;"></td> <td style="width: 10%;"></td> </tr> <tr> <td></td> <td></td> <td colspan="8" style="text-align: center;"> <table border="1" style="width: 100%; border-collapse: collapse; text-align: center;"> <tr> <td style="width: 10%;"></td> <td style="width: 10%;"></td> <td style="width: 10%;"></td> <td style="width: 10%;"></td> <td style="width: 10%;"></td> <td style="width: 10%;"></td> <td style="width: 10%;"></td> <td style="width: 10%;"></td> <td style="width: 10%;"></td> <td style="width: 10%;"></td> </tr> <tr> <td></td> <td></td> <td colspan="8" style="text-align: center;"> <table border="1" style="width: 100%; border-collapse: collapse; text-align: center;"> <tr> <td style="width: 10%;"></td> <td style="width: 10%;"></td> <td style="width: 10%;"></td> <td style="width: 10%;"></td> <td style="width: 10%;"></td> <td style="width: 10%;"></td> <td style="width: 10%;"></td> <td style="width: 10%;"></td> <td style="width: 10%;"></td> <td style="width: 10%;"></td> </tr> <tr> <td></td> <td></td> <td colspan="8" style="text-align: center;"> <table border="1" style="width: 100%; border-collapse: collapse; text-align: center;"> <tr> <td style="width: 10%;"></td> <td style="width: 10%;"></td> <td style="width: 10%;"></td> <td style="width: 10%;"></td> <td style="width: 10%;"></td> <td style="width: 10%;"></td> <td style="width: 10%;"></td> <td style="width: 10%;"></td> <td style="width: 10%;"></td> <td style="width: 10%;"></td> </tr> <tr> <td></td> <td></td> <td colspan="8" style="text-align: center;"> <table border="1" style="width: 100%; border-collapse: collapse; text-align: center;"> <tr> <td style="width: 10%;"></td> <td style="width: 10%;"></td> <td style="width: 10%;"></td> <td style="width: 10%;"></td> <td style="width: 10%;"></td> <td style="width: 10%;"></td> <td style="width: 10%;"></td> <td style="width: 10%;"></td> <td style="width: 10%;"></td> <td style="width: 10%;"></td> </tr> <tr> <td></td> <td></td> <td colspan="8" style="text-align: center;"> <table border="1" style="width: 100%; border-collapse: collapse; text-align: center;"> <tr> <td style="width: 10%;"></td> <td style="width: 10%;"></td> <td style="width: 10%;"></td> <td style="width: 10%;"></td> <td style="width: 10%;"></td> <td style="width: 10%;"></td> <td style="width: 10%;"></td> <td style="width: 10%;"></td> <td style="width: 10%;"></td> <td style="width: 10%;"></td> </tr> <tr> <td></td> <td></td> <td colspan="8" style="text-align: center;"> <table border="1" style="width: 100%; border-collapse: collapse; text-align: center;"> <tr> <td style="width: 10%;"></td> <td style="width: 10%;"></td> <td style="width: 10%;"></td> <td style="width: 10%;"></td> <td style="width: 10%;"></td> <td style="width: 10%;"></td> <td style="width: 10%;"></td> <td style="width: 10%;"></td> <td style="width: 10%;"></td> <td style="width: 10%;"></td> </tr> <tr> <td></td> <td></td> <td colspan="8" style="text-align: center;"> <table border="1" style="width: 100%; border-collapse: collapse; text-align: center;"> <tr> <td style="width: 10%;"></td> <td style="width: 10%;"></td> <td style="width: 10%;"></td> <td style="width: 10%;"></td> <td style="width: 10%;"></td> <td style="width: 10%;"></td> <td style="width: 10%;"></td> <td style="width: 10%;"></td> <td style="width: 10%;"></td> <td style="width: 10%;"></td> </tr> <tr> <td></td> <td></td> <td colspan="8" style="text-align: center;"> <table border="1" style="width: 100%; border-collapse: collapse; text-align: center;"> <tr> <td style="width: 10%;"></td> <td style="width: 10%;"></td> <td style="width: 10%;"></td> <td style="width: 10%;"></td> <td style="width: 10%;"></td> <td style="width: 10%;"></td> <td style="width: 10%;"></td> <td style="width: 10%;"></td> <td style="width: 10%;"></td> <td style="width: 10%;"></td> </tr> <tr> <td></td> <td></td> <td colspan="8" style="text-align: center;"> <table border="1" style="width: 100%; border-collapse: collapse; text-align: center;"> <tr> <td style="width: 10%;"></td> <td style="width: 10%;"></td> <td style="width: 10%;"></td> <td style="width: 10%;"></td> <td style="width: 10%;"></td> <td style="width: 10%;"></td> <td style="width: 10%;"></td> <td style="width: 10%;"></td> <td style="width: 10%;"></td> <td style="width: 10%;"></td> </tr> <tr> <td></td> <td></td> <td colspan="8" style="text-align: center;"> <table border="1" style="width: 100%; border-collapse: collapse; text-align: center;"> <tr> <td style="width: 10%;"></td> <td style="width: 10%;"></td> <td style="width: 10%;"></td> <td style="width: 10%;"></td> <td style="width: 10%;"></td> <td style="width: 10%;"></td> <td style="width: 10%;"></td> <td style="width: 10%;"></td> <td style="width: 10%;"></td> <td style="width: 10%;"></td> </tr> <tr> <td></td> <td></td> <td colspan="8" style="text-align: center;"> <table border="1" style="width: 100%; border-collapse: collapse; text-align: center;"> <tr> <td style="width: 10%;"></td> <td style="width: 10%;"></td> <td style="width: 10%;"></td> <td style="width: 10%;"></td> <td style="width: 10%;"></td> <td style="width: 10%;"></td> <td style="width: 10%;"></td> <td style="width: 10%;"></td> <td style="width: 10%;"></td> <td style="width: 10%;"></td> </tr> <tr> <td></td> <td></td> <td colspan="8" style="text-align: center;"> <table border="1" style="width: 100%; border-collapse: collapse; text-align: center;"> <tr> <td style="width: 10%;"></td> <td style="width: 10%;"></td> <td style="width: 10%;"></td> <td style="width: 10%;"></td> <td style="width: 10%;"></td> <td style="width: 10%;"></td> <td style="width: 10%;"></td> <td style="width: 10%;"></td> <td style="width: 10%;"></td> <td style="width: 10%;"></td> </tr> <tr> <td></td> <td></td> <td colspan="8" style="text-align: center;"> <table border="1" style="width: 100%; border-collapse: collapse; text-align: center;"> <tr> <td style="width: 10%;"></td> <td style="width: 10%;"></td> <td style="width: 10%;"></td> <td style="width: 10%;"></td> <td style="width: 10%;"></td> <td style="width:
10%;"></td> <td style="width: 10%;"></td> <td style="width: 10%;"></td> <td style="width: 10%;"></td> <td style="width: 10%;"></td> </tr> <tr> <td></td> <td></td> <td colspan="8" style="text-align: center;"> <table border="1" style="width: 100%; border-collapse: collapse; text-align: center;"> <tr> </tr></table></td></tr></table></td></tr></table></td></tr></table></td></tr></table></td></tr></table></td></tr></table></td></tr></table></td></tr></table></td></tr></table></td></tr></table></td></tr></table></td></tr></table></td></tr></table></td></tr></table></td></tr></table></td></tr></table></td></tr></table></td></tr></table></td></tr></table></td></tr></table></td></tr></table>
 | | | | | | | | | | | | | | | | | | | | <table border="1" style="width: 100%; border-collapse: collapse; text-align: center;"> <tr> <td style="width: 10%;"></td> <td style="width: 10%;"></td> <td style="width: 10%;"></td> <td style="width: 10%;"></td> <td style="width: 10%;"></td> <td style="width: 10%;"></td> <td style="width: 10%;"></td> <td style="width: 10%;"></td> <td style="width: 10%;"></td> <td style="width: 10%;"></td> </tr> <tr> <td></td> <td></td> <td colspan="8" style="text-align: center;"> <table border="1" style="width: 100%; border-collapse: collapse; text-align: center;"> <tr> <td style="width: 10%;"></td> <td style="width: 10%;"></td> <td style="width: 10%;"></td> <td style="width: 10%;"></td> <td style="width: 10%;"></td> <td style="width: 10%;"></td> <td style="width: 10%;"></td> <td style="width: 10%;"></td> <td style="width: 10%;"></td> <td style="width: 10%;"></td> </tr> <tr> <td></td> <td></td> <td colspan="8" style="text-align: center;"> <table border="1" style="width: 100%; border-collapse: collapse; text-align: center;"> <tr> <td style="width: 10%;"></td> <td style="width: 10%;"></td> <td style="width: 10%;"></td> <td style="width: 10%;"></td> <td style="width: 10%;"></td> <td style="width: 10%;"></td> <td style="width: 10%;"></td> <td style="width:
10%;"></td> <td style="width: 10%;"></td> <td style="width: 10%;"></td> </tr> <tr> <td></td> <td></td> <td colspan="8" style="text-align: center;"> <table border="1" style="width: 100%; border-collapse: collapse; text-align: center;"> <tr> <td style="width: 10%;"></td> <td style="width: 10%;"></td> <td style="width: 10%;"></td> <td style="width: 10%;"></td> <td style="width: 10%;"></td> <td style="width: 10%;"></td> <td style="width: 10%;"></td> <td style="width: 10%;"></td> <td style="width: 10%;"></td> <td style="width: 10%;"></td> </tr> <tr> <td></td> <td></td> <td colspan="8" style="text-align: center;"> <table border="1" style="width: 100%; border-collapse: collapse; text-align: center;"> <tr> <td style="width: 10%;"></td> <td style="width: 10%;"></td> <td style="width: 10%;"></td> <td style="width: 10%;"></td> <td style="width: 10%;"></td> <td style="width: 10%;"></td> <td style="width: 10%;"></td> <td style="width: 10%;"></td> <td style="width: 10%;"></td> <td style="width: 10%;"></td> </tr> <tr> <td></td> <td></td> <td colspan="8" style="text-align: center;"> <table border="1" style="width: 100%; border-collapse: collapse; text-align: center;"> <tr> <td style="width: 10%;"></td> <td style="width: 10%;"></td> <td style="width: 10%;"></td> <td style="width: 10%;"></td> <td style="width: 10%;"></td> <td style="width: 10%;"></td> <td style="width: 10%;"></td> <td style="width: 10%;"></td> <td style="width: 10%;"></td> <td style="width: 10%;"></td> </tr> <tr> <td></td> <td></td> <td colspan="8" style="text-align: center;"> <table border="1" style="width: 100%; border-collapse: collapse; text-align: center;"> <tr> <td style="width: 10%;"></td> <td style="width: 10%;"></td> <td style="width: 10%;"></td> <td style="width: 10%;"></td> <td style="width: 10%;"></td> <td style="width: 10%;"></td> <td style="width: 10%;"></td> <td style="width: 10%;"></td> <td style="width: 10%;"></td> <td style="width: 10%;"></td> </tr> <tr> <td></td> <td></td> <td colspan="8" style="text-align: center;"> <table border="1" style="width: 100%; border-collapse: collapse; text-align: center;"> <tr> <td style="width: 10%;"></td> <td style="width: 10%;"></td> <td style="width: 10%;"></td> <td style="width: 10%;"></td> <td style="width: 10%;"></td> <td style="width: 10%;"></td> <td style="width: 10%;"></td> <td style="width: 10%;"></td> <td style="width: 10%;"></td> <td style="width: 10%;"></td> </tr> <tr> <td></td> <td></td> <td colspan="8" style="text-align: center;"> <table border="1" style="width: 100%; border-collapse: collapse; text-align: center;"> <tr> <td style="width: 10%;"></td> <td style="width: 10%;"></td> <td style="width: 10%;"></td> <td style="width: 10%;"></td> <td style="width: 10%;"></td> <td style="width: 10%;"></td> <td style="width: 10%;"></td> <td style="width: 10%;"></td> <td style="width: 10%;"></td> <td style="width: 10%;"></td> </tr> <tr> <td></td> <td></td> <td colspan="8" style="text-align: center;"> <table border="1" style="width: 100%; border-collapse: collapse; text-align: center;"> <tr> <td style="width: 10%;"></td> <td style="width: 10%;"></td> <td style="width: 10%;"></td> <td style="width: 10%;"></td> <td style="width: 10%;"></td> <td style="width: 10%;"></td> <td style="width: 10%;"></td> <td style="width: 10%;"></td> <td style="width: 10%;"></td> <td style="width: 10%;"></td> </tr> <tr> <td></td> <td></td> <td colspan="8" style="text-align: center;"> <table border="1" style="width: 100%; border-collapse: collapse; text-align: center;"> <tr> <td style="width: 10%;"></td> <td style="width: 10%;"></td> <td style="width: 10%;"></td> <td style="width: 10%;"></td> <td style="width: 10%;"></td> <td style="width: 10%;"></td> <td style="width: 10%;"></td> <td style="width: 10%;"></td> <td style="width: 10%;"></td> <td style="width: 10%;"></td> </tr> <tr> <td></td> <td></td> <td colspan="8" style="text-align: center;"> <table border="1" style="width: 100%; border-collapse: collapse; text-align: center;"> <tr> <td style="width: 10%;"></td> <td style="width: 10%;"></td> <td style="width: 10%;"></td> <td style="width: 10%;"></td> <td style="width: 10%;"></td> <td style="width: 10%;"></td> <td style="width: 10%;"></td> <td style="width: 10%;"></td> <td style="width: 10%;"></td> <td style="width: 10%;"></td> </tr> <tr> <td></td> <td></td> <td colspan="8" style="text-align: center;"> <table border="1" style="width: 100%; border-collapse: collapse; text-align: center;"> <tr> <td style="width: 10%;"></td> <td style="width: 10%;"></td> <td style="width: 10%;"></td> <td style="width: 10%;"></td> <td style="width: 10%;"></td> <td style="width: 10%;"></td> <td style="width: 10%;"></td> <td style="width: 10%;"></td> <td style="width: 10%;"></td> <td style="width: 10%;"></td> </tr> <tr> <td></td> <td></td> <td colspan="8" style="text-align: center;"> <table border="1" style="width: 100%; border-collapse: collapse; text-align: center;"> <tr> <td style="width: 10%;"></td> <td style="width: 10%;"></td> <td style="width: 10%;"></td> <td style="width: 10%;"></td> <td style="width: 10%;"></td> <td style="width: 10%;"></td> <td style="width: 10%;"></td> <td style="width: 10%;"></td> <td style="width: 10%;"></td> <td style="width: 10%;"></td> </tr> <tr> <td></td> <td></td> <td colspan="8" style="text-align: center;"> <table border="1" style="width: 100%; border-collapse: collapse; text-align: center;"> <tr> <td style="width: 10%;"></td> <td style="width: 10%;"></td> <td style="width: 10%;"></td> <td style="width: 10%;"></td> <td style="width: 10%;"></td> <td style="width: 10%;"></td> <td style="width: 10%;"></td> <td style="width: 10%;"></td> <td style="width: 10%;"></td> <td style="width: 10%;"></td> </tr> <tr> <td></td> <td></td> <td colspan="8" style="text-align: center;"> <table border="1" style="width: 100%; border-collapse: collapse; text-align: center;"> <tr> <td style="width: 10%;"></td> <td style="width: 10%;"></td> <td style="width: 10%;"></td> <td style="width: 10%;"></td> <td style="width: 10%;"></td> <td style="width: 10%;"></td> <td style="width: 10%;"></td> <td style="width: 10%;"></td> <td style="width: 10%;"></td> <td style="width: 10%;"></td> </tr> <tr> <td></td> <td></td> <td colspan="8" style="text-align: center;"> <table border="1" style="width: 100%; border-collapse: collapse; text-align: center;"> <tr> <td style="width: 10%;"></td> <td style="width: 10%;"></td> <td style="width: 10%;"></td> <td style="width: 10%;"></td> <td style="width: 10%;"></td> <td style="width: 10%;"></td> <td style="width: 10%;"></td> <td style="width: 10%;"></td> <td style="width: 10%;"></td> <td style="width: 10%;"></td> </tr> <tr> <td></td> <td></td> <td colspan="8" style="text-align: center;"> <table border="1" style="width: 100%; border-collapse: collapse; text-align: center;"> <tr> <td style="width: 10%;"></td> <td style="width: 10%;"></td> <td style="width: 10%;"></td> <td style="width: 10%;"></td> <td style="width: 10%;"></td> <td style="width: 10%;"></td> <td style="width: 10%;"></td> <td style="width: 10%;"></td> <td style="width: 10%;"></td> <td style="width: 10%;"></td> </tr> <tr> <td></td> <td></td> <td colspan="8" style="text-align: center;"> <table border="1" style="width: 100%; border-collapse: collapse; text-align: center;"> <tr> <td style="width: 10%;"></td> <td style="width: 10%;"></td> <td style="width: 10%;"></td> <td style="width: 10%;"></td> <td style="width: 10%;"></td> <td style="width: 10%;"></td> <td style="width: 10%;"></td> <td style="width: 10%;"></td> <td style="width: 10%;"></td> <td style="width: 10%;"></td> </tr> <tr> <td></td> <td></td> <td colspan="8" style="text-align: center;"> <table border="1" style="width: 100%; border-collapse: collapse; text-align: center;"> <tr> <td style="width: 10%;"></td> <td style="width: 10%;"></td> <td style="width: 10%;"></td> <td style="width: 10%;"></td> <td style="width: 10%;"></td> <td style="width: 10%;"></td> <td style="width: 10%;"></td> <td style="width: 10%;"></td> <td style="width: 10%;"></td> <td style="width: 10%;"></td> </tr> <tr> <td></td> <td></td> <td colspan="8" style="text-align: center;"> <table border="1" style="width: 100%; border-collapse: collapse; text-align: center;"> <tr> </tr></table></td></tr></table></td></tr></table></td></tr></table></td></tr></table></td></tr></table></td></tr></table></td></tr></table></td></tr></table></td></tr></table></td></tr></table></td></tr></table></td></tr></table></td></tr></table></td></tr></table></td></tr></table></td></tr></table></td></tr></table></td></tr></table></td></tr></table></td></tr></table>

 | | | | | | | | | | | | | | | | | | | | <table border="1" style="width: 100%; border-collapse: collapse; text-align: center;"> <tr> <td style="width: 10%;"></td> <td style="width: 10%;"></td> <td style="width: 10%;"></td> <td style="width: 10%;"></td> <td style="width: 10%;"></td> <td style="width: 10%;"></td> <td style="width: 10%;"></td> <td style="width: 10%;"></td> <td style="width: 10%;"></td> <td style="width: 10%;"></td> </tr> <tr> <td></td> <td></td> <td colspan="8" style="text-align: center;"> <table border="1" style="width: 100%; border-collapse: collapse; text-align: center;"> <tr> <td style="width: 10%;"></td> <td style="width: 10%;"></td> <td style="width: 10%;"></td> <td style="width: 10%;"></td> <td style="width: 10%;"></td> <td style="width: 10%;"></td> <td style="width: 10%;"></td> <td style="width: 10%;"></td> <td style="width: 10%;"></td> <td style="width: 10%;"></td> </tr> <tr> <td></td> <td></td> <td colspan="8" style="text-align: center;"> <table border="1" style="width: 100%; border-collapse: collapse; text-align: center;"> <tr> <td style="width: 10%;"></td> <td style="width: 10%;"></td> <td style="width: 10%;"></td> <td style="width: 10%;"></td> <td style="width: 10%;"></td> <td style="width: 10%;"></td> <td style="width: 10%;"></td> <td style="width: 10%;"></td> <td style="width: 10%;"></td> <td style="width: 10%;"></td> </tr> <tr> <td></td> <td></td> <td colspan="8" style="text-align: center;"> <table border="1" style="width: 100%; border-collapse: collapse; text-align: center;"> <tr> <td style="width: 10%;"></td> <td style="width: 10%;"></td> <td style="width: 10%;"></td> <td style="width: 10%;"></td> <td style="width: 10%;"></td> <td style="width: 10%;"></td> <td style="width: 10%;"></td> <td style="width: 10%;"></td> <td style="width: 10%;"></td> <td style="width: 10%;"></td> </tr> <tr> <td></td> <td></td> <td colspan="8" style="text-align: center;"> <table border="1" style="width: 100%; border-collapse: collapse; text-align: center;"> <tr> <td style="width: 10%;"></td> <td style="width: 10%;"></td> <td style="width: 10%;"></td> <td style="width: 10%;"></td> <td style="width: 10%;"></td> <td style="width: 10%;"></td> <td style="width: 10%;"></td> <td style="width: 10%;"></td> <td style="width: 10%;"></td> <td style="width: 10%;"></td> </tr> <tr> <td></td> <td></td> <td colspan="8" style="text-align: center;"> <table border="1" style="width: 100%; border-collapse: collapse; text-align: center;"> <tr> <td style="width: 10%;"></td> <td style="width: 10%;"></td> <td style="width: 10%;"></td> <td style="width: 10%;"></td> <td style="width: 10%;"></td> <td style="width: 10%;"></td> <td style="width: 10%;"></td> <td style="width: 10%;"></td> <td style="width: 10%;"></td> <td style="width: 10%;"></td> </tr> <tr> <td></td> <td></td> <td colspan="8" style="text-align: center;"> <table border="1" style="width: 100%; border-collapse: collapse; text-align: center;"> <tr> <td style="width: 10%;"></td> <td style="width: 10%;"></td> <td style="width: 10%;"></td> <td style="width: 10%;"></td> <td style="width: 10%;"></td> <td style="width: 10%;"></td> <td style="width: 10%;"></td> <td style="width: 10%;"></td> <td style="width: 10%;"></td> <td style="width: 10%;"></td> </tr> <tr> <td></td> <td></td> <td colspan="8" style="text-align: center;"> <table border="1" style="width: 100%; border-collapse: collapse; text-align: center;"> <tr> <td style="width:
10%;"></td> <td style="width: 10%;"></td> <td style="width: 10%;"></td> <td style="width: 10%;"></td> <td style="width: 10%;"></td> <td style="width: 10%;"></td> <td style="width: 10%;"></td> <td style="width: 10%;"></td> <td style="width: 10%;"></td> <td style="width: 10%;"></td> </tr> <tr> <td></td> <td></td> <td colspan="8" style="text-align: center;"> <table border="1" style="width: 100%; border-collapse: collapse; text-align: center;"> <tr> <td style="width: 10%;"></td> <td style="width: 10%;"></td> <td style="width: 10%;"></td> <td style="width: 10%;"></td> <td style="width: 10%;"></td> <td style="width: 10%;"></td> <td style="width: 10%;"></td> <td style="width: 10%;"></td> <td style="width: 10%;"></td> <td style="width: 10%;"></td> </tr> <tr> <td></td> <td></td> <td colspan="8" style="text-align: center;"> <table border="1" style="width: 100%; border-collapse: collapse; text-align: center;"> <tr> <td style="width: 10%;"></td> <td style="width: 10%;"></td> <td style="width: 10%;"></td> <td style="width: 10%;"></td> <td style="width: 10%;"></td> <td style="width: 10%;"></td> <td style="width: 10%;"></td> <td style="width: 10%;"></td> <td style="width: 10%;"></td> <td style="width: 10%;"></td> </tr> <tr> <td></td> <td></td> <td colspan="8" style="text-align: center;"> <table border="1" style="width: 100%; border-collapse: collapse; text-align: center;"> <tr> <td style="width: 10%;"></td> <td style="width: 10%;"></td> <td style="width: 10%;"></td> <td style="width: 10%;"></td> <td style="width: 10%;"></td> <td style="width: 10%;"></td> <td style="width: 10%;"></td> <td style="width: 10%;"></td> <td style="width: 10%;"></td> <td style="width: 10%;"></td> </tr> <tr> <td></td> <td></td> <td colspan="8" style="text-align: center;"> <table border="1" style="width: 100%; border-collapse: collapse; text-align: center;"> <tr> <td style="width: 10%;"></td> <td style="width: 10%;"></td> <td style="width: 10%;"></td> <td style="width: 10%;"></td> <td style="width: 10%;"></td> <td style="width: 10%;"></td> <td style="width: 10%;"></td> <td style="width: 10%;"></td> <td style="width: 10%;"></td> <td style="width: 10%;"></td> </tr> <tr> <td></td> <td></td> <td colspan="8" style="text-align: center;"> <table border="1" style="width: 100%; border-collapse: collapse; text-align: center;"> <tr> <td style="width: 10%;"></td> <td style="width: 10%;"></td> <td style="width: 10%;"></td> <td style="width: 10%;"></td> <td style="width: 10%;"></td> <td style="width: 10%;"></td> <td style="width: 10%;"></td> <td style="width: 10%;"></td> <td style="width: 10%;"></td> <td style="width: 10%;"></td> </tr> <tr> <td></td> <td></td> <td colspan="8" style="text-align: center;"> <table border="1" style="width: 100%; border-collapse: collapse; text-align: center;"> <tr> <td style="width: 10%;"></td> <td style="width: 10%;"></td> <td style="width: 10%;"></td> <td style="width: 10%;"></td> <td style="width: 10%;"></td> <td style="width: 10%;"></td> <td style="width: 10%;"></td> <td style="width: 10%;"></td> <td style="width: 10%;"></td> <td style="width: 10%;"></td> </tr> <tr> <td></td> <td></td> <td colspan="8" style="text-align: center;"> <table border="1" style="width: 100%; border-collapse: collapse; text-align: center;"> <tr> <td style="width: 10%;"></td> <td style="width: 10%;"></td> <td style="width: 10%;"></td> <td style="width: 10%;"></td> <td style="width: 10%;"></td> <td style="width: 10%;"></td> <td style="width: 10%;"></td> <td style="width: 10%;"></td> <td style="width: 10%;"></td> <td style="width: 10%;"></td> </tr> <tr> <td></td> <td></td> <td colspan="8" style="text-align: center;"> <table border="1" style="width: 100%; border-collapse: collapse; text-align: center;"> <tr> <td style="width: 10%;"></td> <td style="width: 10%;"></td> <td style="width: 10%;"></td> <td style="width: 10%;"></td> <td style="width: 10%;"></td> <td style="width: 10%;"></td> <td style="width: 10%;"></td> <td style="width: 10%;"></td> <td style="width: 10%;"></td> <td style="width: 10%;"></td> </tr> <tr> <td></td> <td></td> <td colspan="8" style="text-align: center;"> <table border="1" style="width: 100%; border-collapse: collapse; text-align: center;"> <tr> <td style="width: 10%;"></td> <td style="width: 10%;"></td> <td style="width: 10%;"></td> <td style="width: 10%;"></td> <td style="width: 10%;"></td> <td style="width: 10%;"></td> <td style="width: 10%;"></td> <td style="width: 10%;"></td> <td style="width: 10%;"></td> <td style="width: 10%;"></td> </tr> <tr> <td></td> <td></td> <td colspan="8" style="text-align: center;"> <table border="1" style="width: 100%; border-collapse: collapse; text-align: center;"> <tr> <td style="width: 10%;"></td> <td style="width: 10%;"></td> <td style="width: 10%;"></td> <td style="width: 10%;"></td> <td style="width: 10%;"></td> <td style="width: 10%;"></td> <td style="width: 10%;"></td> <td style="width: 10%;"></td> <td style="width: 10%;"></td> <td style="width: 10%;"></td> </tr> <tr> <td></td> <td></td> <td colspan="8" style="text-align: center;"> <table border="1" style="width: 100%; border-collapse: collapse; text-align: center;"> <tr> <td style="width: 10%;"></td> <td style="width: 10%;"></td> <td style="width: 10%;"></td> <td style="width: 10%;"></td> <td style="width: 10%;"></td> <td style="width: 10%;"></td> <td style="width: 10%;"></td> <td style="width: 10%;"></td> <td style="width: 10%;"></td> <td style="width: 10%;"></td> </tr> <tr> <td></td> <td></td> <td colspan="8" style="text-align: center;"> <table border="1" style="width: 100%; border-collapse: collapse; text-align: center;"> <tr> </tr></table></td></tr></table></td></tr></table></td></tr></table></td></tr></table></td></tr></table></td></tr></table></td></tr></table></td></tr></table></td></tr></table></td></tr></table></td></tr></table></td></tr></table></td></tr></table></td></tr></table></td></tr></table></td></tr></table></td></tr></table></td></tr></table></td></tr></table>

 | | | | | | | | | | | | | | | | | | | | <table border="1" style="width: 100%; border-collapse: collapse; text-align: center;"> <tr> <td style="width: 10%;"></td> <td style="width: 10%;"></td> <td style="width: 10%;"></td> <td style="width: 10%;"></td> <td style="width: 10%;"></td> <td style="width: 10%;"></td> <td style="width: 10%;"></td> <td style="width: 10%;"></td> <td style="width: 10%;"></td> <td style="width: 10%;"></td> </tr> <tr> <td></td> <td></td> <td colspan="8" style="text-align: center;"> <table border="1" style="width: 100%; border-collapse: collapse; text-align: center;"> <tr> <td style="width: 10%;"></td> <td style="width: 10%;"></td> <td style="width: 10%;"></td> <td style="width: 10%;"></td> <td style="width: 10%;"></td> <td style="width: 10%;"></td> <td style="width: 10%;"></td> <td style="width: 10%;"></td> <td style="width: 10%;"></td> <td style="width: 10%;"></td> </tr> <tr> <td></td> <td></td> <td colspan="8" style="text-align: center;"> <table border="1" style="width: 100%; border-collapse: collapse; text-align: center;"> <tr> <td style="width: 10%;"></td> <td style="width: 10%;"></td> <td style="width: 10%;"></td> <td style="width: 10%;"></td> <td style="width: 10%;"></td> <td style="width: 10%;"></td> <td style="width: 10%;"></td> <td style="width: 10%;"></td> <td style="width: 10%;"></td> <td style="width: 10%;"></td> </tr> <tr> <td></td> <td></td> <td colspan="8" style="text-align: center;"> <table border="1" style="width: 100%; border-collapse: collapse; text-align: center;"> <tr> <td style="width: 10%;"></td> <td style="width: 10%;"></td> <td style="width: 10%;"></td> <td style="width: 10%;"></td> <td style="width: 10%;"></td> <td style="width: 10%;"></td> <td style="width: 10%;"></td> <td style="width: 10%;"></td> <td style="width: 10%;"></td> <td style="width: 10%;"></td> </tr> <tr> <td></td> <td></td> <td colspan="8" style="text-align: center;"> <table border="1" style="width: 100%; border-collapse: collapse; text-align: center;"> <tr> <td style="width: 10%;"></td> <td style="width: 10%;"></td> <td style="width: 10%;"></td> <td style="width: 10%;"></td> <td style="width: 10%;"></td> <td style="width: 10%;"></td> <td style="width: 10%;"></td> <td style="width: 10%;"></td> <td style="width: 10%;"></td> <td style="width: 10%;"></td> </tr> <tr> <td></td> <td></td> <td colspan="8" style="text-align: center;"> <table border="1" style="width: 100%; border-collapse: collapse; text-align: center;"> <tr> <td style="width: 10%;"></td> <td style="width: 10%;"></td> <td style="width: 10%;"></td> <td style="width: 10%;"></td> <td style="width: 10%;"></td> <td style="width: 10%;"></td> <td style="width: 10%;"></td> <td style="width: 10%;"></td> <td style="width: 10%;"></td> <td style="width: 10%;"></td> </tr> <tr> <td></td> <td></td> <td colspan="8" style="text-align: center;"> <table border="1" style="width: 100%; border-collapse: collapse; text-align: center;"> <tr> <td style="width: 10%;"></td> <td style="width: 10%;"></td> <td style="width: 10%;"></td> <td style="width: 10%;"></td> <td style="width: 10%;"></td> <td style="width: 10%;"></td> <td style="width: 10%;"></td> <td style="width: 10%;"></td> <td style="width: 10%;"></td> <td style="width: 10%;"></td> </tr> <tr> <td></td> <td></td> <td colspan="8" style="text-align: center;"> <table border="1" style="width: 100%; border-collapse: collapse; text-align: center;"> <tr> <td style="width: 10%;"></td> <td style="width: 10%;"></td> <td style="width: 10%;"></td> <td style="width: 10%;"></td> <td style="width: 10%;"></td> <td style="width: 10%;"></td> <td style="width: 10%;"></td> <td style="width: 10%;"></td> <td style="width: 10%;"></td> <td style="width: 10%;"></td> </tr> <tr> <td></td> <td></td> <td colspan="8" style="text-align: center;"> <table border="1" style="width: 100%; border-collapse: collapse; text-align: center;"> <tr> <td style="width: 10%;"></td> <td style="width: 10%;"></td> <td style="width: 10%;"></td> <td style="width: 10%;"></td> <td style="width: 10%;"></td> <td style="width: 10%;"></td> <td style="width: 10%;"></td> <td style="width: 10%;"></td> <td style="width: 10%;"></td> <td style="width: 10%;"></td> </tr> <tr> <td></td> <td></td> <td colspan="8" style="text-align: center;"> <table border="1" style="width: 100%; border-collapse: collapse; text-align: center;"> <tr> <td style="width: 10%;"></td> <td style="width: 10%;"></td> <td style="width: 10%;"></td> <td style="width: 10%;"></td> <td style="width: 10%;"></td> <td style="width: 10%;"></td> <td style="width: 10%;"></td> <td style="width: 10%;"></td> <td style="width: 10%;"></td> <td style="width: 10%;"></td> </tr> <tr> <td></td> <td></td> <td colspan="8" style="text-align: center;"> <table border="1" style="width: 100%; border-collapse: collapse; text-align: center;"> <tr> <td style="width: 10%;"></td> <td style="width: 10%;"></td> <td style="width: 10%;"></td> <td style="width: 10%;"></td> <td style="width: 10%;"></td> <td style="width: 10%;"></td> <td style="width: 10%;"></td> <td style="width: 10%;"></td> <td style="width: 10%;"></td> <td style="width: 10%;"></td> </tr> <tr> <td></td> <td></td> <td colspan="8" style="text-align: center;"> <table border="1" style="width: 100%; border-collapse: collapse; text-align: center;"> <tr> <td style="width: 10%;"></td> <td style="width: 10%;"></td> <td style="width: 10%;"></td> <td style="width: 10%;"></td> <td style="width: 10%;"></td> <td style="width: 10%;"></td> <td style="width: 10%;"></td> <td style="width: 10%;"></td> <td style="width: 10%;"></td> <td style="width: 10%;"></td> </tr> <tr> <td></td> <td></td> <td colspan="8" style="text-align: center;"> <table border="1" style="width: 100%; border-collapse: collapse; text-align: center;"> <tr> <td style="width: 10%;"></td> <td style="width: 10%;"></td> <td style="width: 10%;"></td> <td style="width: 10%;"></td> <td style="width: 10%;"></td> <td style="width: 10%;"></td> <td style="width: 10%;"></td> <td style="width: 10%;"></td> <td style="width: 10%;"></td> <td style="width:
10%;"></td> </tr> <tr> <td></td> <td></td> <td colspan="8" style="text-align: center;"> <table border="1" style="width: 100%; border-collapse: collapse; text-align: center;"> <tr> <td style="width: 10%;"></td> <td style="width: 10%;"></td> <td style="width: 10%;"></td> <td style="width: 10%;"></td> <td style="width: 10%;"></td> <td style="width: 10%;"></td> <td style="width: 10%;"></td> <td style="width: 10%;"></td> <td style="width: 10%;"></td> <td style="width: 10%;"></td> </tr> <tr> <td></td> <td></td> <td colspan="8" style="text-align: center;"> <table border="1" style="width: 100%; border-collapse: collapse; text-align: center;"> <tr> <td style="width: 10%;"></td> <td style="width: 10%;"></td> <td style="width: 10%;"></td> <td style="width: 10%;"></td> <td style="width: 10%;"></td> <td style="width: 10%;"></td> <td style="width: 10%;"></td> <td style="width: 10%;"></td> <td style="width: 10%;"></td> <td style="width: 10%;"></td> </tr> <tr> <td></td> <td></td> <td colspan="8" style="text-align: center;"> <table border="1" style="width: 100%; border-collapse: collapse; text-align: center;"> <tr> <td style="width: 10%;"></td> <td style="width: 10%;"></td> <td style="width: 10%;"></td> <td style="width: 10%;"></td> <td style="width: 10%;"></td> <td style="width: 10%;"></td> <td style="width: 10%;"></td> <td style="width: 10%;"></td> <td style="width: 10%;"></td> <td style="width: 10%;"></td> </tr> <tr> <td></td> <td></td> <td colspan="8" style="text-align: center;"> <table border="1" style="width: 100%; border-collapse: collapse; text-align: center;"> <tr> <td style="width: 10%;"></td> <td style="width: 10%;"></td> <td style="width: 10%;"></td> <td style="width: 10%;"></td> <td style="width: 10%;"></td> <td style="width: 10%;"></td> <td style="width: 10%;"></td> <td style="width: 10%;"></td> <td style="width: 10%;"></td> <td style="width: 10%;"></td> </tr> <tr> <td></td> <td></td> <td colspan="8" style="text-align: center;"> <table border="1" style="width: 100%; border-collapse: collapse; text-align: center;"> <tr> <td style="width: 10%;"></td> <td style="width: 10%;"></td> <td style="width: 10%;"></td> <td style="width: 10%;"></td> <td style="width: 10%;"></td> <td style="width: 10%;"></td> <td style="width: 10%;"></td> <td style="width: 10%;"></td> <td style="width: 10%;"></td> <td style="width: 10%;"></td> </tr> <tr> <td></td> <td></td> <td colspan="8" style="text-align: center;"> <table border="1" style="width: 100%; border-collapse: collapse; text-align: center;"> <tr> </tr></table></td></tr></table></td></tr></table></td></tr></table></td></tr></table></td></tr></table></td></tr></table></td></tr></table></td></tr></table></td></tr></table></td></tr></table></td></tr></table></td></tr></table></td></tr></table></td></tr></table></td></tr></table></td></tr></table></td></tr></table></td></tr></table>

 | | | | | | | | | | | | | | | | | | | | <table border="1" style="width: 100%; border-collapse: collapse; text-align: center;"> <tr> <td style="width: 10%;"></td> <td style="width: 10%;"></td> <td style="width: 10%;"></td> <td style="width: 10%;"></td> <td style="width: 10%;"></td> <td style="width: 10%;"></td> <td style="width: 10%;"></td> <td style="width: 10%;"></td> <td style="width: 10%;"></td> <td style="width: 10%;"></td> </tr> <tr> <td></td> <td></td> <td colspan="8" style="text-align: center;"> <table border="1" style="width: 100%; border-collapse: collapse; text-align: center;"> <tr> <td style="width: 10%;"></td> <td style="width: 10%;"></td> <td style="width: 10%;"></td> <td style="width: 10%;"></td> <td style="width: 10%;"></td> <td style="width: 10%;"></td> <td style="width: 10%;"></td> <td style="width: 10%;"></td> <td style="width: 10%;"></td> <td style="width: 10%;"></td> </tr> <tr> <td></td> <td></td> <td colspan="8" style="text-align: center;"> <table border="1" style="width: 100%; border-collapse: collapse; text-align: center;"> <tr> <td style="width: 10%;"></td> <td style="width: 10%;"></td> <td style="width: 10%;"></td> <td style="width: 10%;"></td> <td style="width: 10%;"></td> <td style="width: 10%;"></td> <td style="width: 10%;"></td> <td style="width: 10%;"></td> <td style="width: 10%;"></td> <td style="width: 10%;"></td> </tr> <tr> <td></td> <td></td> <td colspan="8" style="text-align: center;"> <table border="1" style="width: 100%; border-collapse: collapse; text-align: center;"> <tr> <td style="width: 10%;"></td> <td style="width: 10%;"></td> <td style="width: 10%;"></td> <td style="width: 10%;"></td> <td style="width: 10%;"></td> <td style="width: 10%;"></td> <td style="width: 10%;"></td> <td style="width: 10%;"></td> <td style="width: 10%;"></td> <td style="width: 10%;"></td> </tr> <tr> <td></td> <td></td> <td colspan="8" style="text-align: center;"> <table border="1" style="width: 100%; border-collapse: collapse; text-align: center;"> <tr> <td style="width: 10%;"></td> <td style="width: 10%;"></td> <td style="width: 10%;"></td> <td style="width: 10%;"></td> <td style="width: 10%;"></td> <td style="width: 10%;"></td> <td style="width: 10%;"></td> <td style="width: 10%;"></td> <td style="width: 10%;"></td> <td style="width: 10%;"></td> </tr> <tr> <td></td> <td></td> <td colspan="8" style="text-align: center;"> <table border="1" style="width: 100%; border-collapse: collapse; text-align: center;"> <tr> <td style="width: 10%;"></td> <td style="width: 10%;"></td> <td style="width: 10%;"></td> <td style="width: 10%;"></td> <td style="width: 10%;"></td> <td style="width: 10%;"></td> <td style="width: 10%;"></td> <td style="width: 10%;"></td> <td style="width: 10%;"></td> <td style="width: 10%;"></td> </tr> <tr> <td></td> <td></td> <td colspan="8" style="text-align: center;"> <table border="1" style="width: 100%; border-collapse: collapse; text-align: center;"> <tr> <td style="width: 10%;"></td> <td style="width: 10%;"></td> <td style="width: 10%;"></td> <td style="width: 10%;"></td> <td style="width: 10%;"></td> <td style="width: 10%;"></td> <td style="width: 10%;"></td> <td style="width: 10%;"></td> <td style="width: 10%;"></td> <td style="width: 10%;"></td> </tr> <tr> <td></td> <td></td> <td colspan="8" style="text-align: center;"> <table border="1" style="width: 100%; border-collapse: collapse; text-align: center;"> <tr> <td style="width: 10%;"></td> <td style="width: 10%;"></td> <td style="width: 10%;"></td> <td style="width: 10%;"></td> <td style="width: 10%;"></td> <td style="width: 10%;"></td> <td style="width: 10%;"></td> <td style="width: 10%;"></td> <td style="width: 10%;"></td> <td style="width: 10%;"></td> </tr> <tr> <td></td> <td></td> <td colspan="8" style="text-align: center;"> <table border="1" style="width: 100%; border-collapse: collapse; text-align: center;"> <tr> <td style="width: 10%;"></td> <td style="width: 10%;"></td> <td style="width: 10%;"></td> <td style="width: 10%;"></td> <td style="width: 10%;"></td> <td style="width: 10%;"></td> <td style="width: 10%;"></td> <td style="width: 10%;"></td> <td style="width: 10%;"></td> <td style="width: 10%;"></td> </tr> <tr> <td></td> <td></td> <td colspan="8" style="text-align: center;"> <table border="1" style="width: 100%; border-collapse: collapse; text-align: center;"> <tr> <td style="width: 10%;"></td> <td style="width: 10%;"></td> <td style="width: 10%;"></td> <td style="width: 10%;"></td> <td style="width: 10%;"></td> <td style="width: 10%;"></td> <td style="width: 10%;"></td> <td style="width: 10%;"></td> <td style="width: 10%;"></td> <td style="width: 10%;"></td> </tr> <tr> <td></td> <td></td> <td colspan="8" style="text-align: center;"> <table border="1" style="width: 100%; border-collapse: collapse; text-align: center;"> <tr> <td style="width: 10%;"></td> <td style="width: 10%;"></td> <td style="width: 10%;"></td> <td style="width: 10%;"></td> <td style="width: 10%;"></td> <td style="width: 10%;"></td> <td style="width: 10%;"></td> <td style="width: 10%;"></td> <td style="width: 10%;"></td> <td style="width: 10%;"></td> </tr> <tr> <td></td> <td></td> <td colspan="8" style="text-align: center;"> <table border="1" style="width: 100%; border-collapse: collapse; text-align: center;"> <tr> <td style="width: 10%;"></td> <td style="width: 10%;"></td> <td style="width: 10%;"></td> <td style="width: 10%;"></td> <td style="width: 10%;"></td> <td style="width: 10%;"></td> <td style="width: 10%;"></td> <td style="width: 10%;"></td> <td style="width: 10%;"></td> <td style="width: 10%;"></td> </tr> <tr> <td></td> <td></td> <td colspan="8" style="text-align: center;"> <table border="1" style="width: 100%; border-collapse: collapse; text-align: center;"> <tr> <td style="width: 10%;"></td> <td style="width: 10%;"></td> <td style="width: 10%;"></td> <td style="width: 10%;"></td> <td style="width: 10%;"></td> <td style="width: 10%;"></td> <td style="width: 10%;"></td> <td style="width: 10%;"></td> <td style="width: 10%;"></td> <td style="width: 10%;"></td> </tr> <tr> <td></td> <td></td> <td colspan="8" style="text-align: center;"> <table border="1" style="width: 100%; border-collapse: collapse; text-align: center;"> <tr> <td style="width: 10%;"></td> <td style="width: 10%;"></td> <td style="width: 10%;"></td> <td style="width: 10%;"></td> <td style="width: 10%;"></td> <td style="width: 10%;"></td> <td style="width: 10%;"></td> <td style="width: 10%;"></td> <td style="width: 10%;"></td> <td style="width: 10%;"></td> </tr> <tr> <td></td> <td></td> <td colspan="8" style="text-align: center;"> <table border="1" style="width: 100%; border-collapse: collapse; text-align: center;"> <tr> <td style="width: 10%;"></td> <td style="width: 10%;"></td> <td style="width: 10%;"></td> <td style="width: 10%;"></td> <td style="width: 10%;"></td> <td style="width: 10%;"></td> <td style="width: 10%;"></td> <td style="width: 10%;"></td> <td style="width: 10%;"></td> <td style="width: 10%;"></td> </tr> <tr> <td></td> <td></td> <td colspan="8" style="text-align: center;"> <table border="1" style="width: 100%; border-collapse: collapse; text-align: center;"> <tr> <td style="width: 10%;"></td> <td style="width: 10%;"></td> <td style="width: 10%;"></td> <td style="width: 10%;"></td> <td style="width: 10%;"></td> <td style="width: 10%;"></td> <td style="width: 10%;"></td> <td style="width: 10%;"></td> <td style="width: 10%;"></td> <td style="width: 10%;"></td> </tr> <tr> <td></td> <td></td> <td colspan="8" style="text-align: center;"> <table border="1" style="width: 100%; border-collapse: collapse; text-align: center;"> <tr> <td style="width: 10%;"></td> <td style="width: 10%;"></td> <td style="width: 10%;"></td> <td style="width: 10%;"></td> <td style="width: 10%;"></td> <td style="width: 10%;"></td> <td style="width: 10%;"></td> <td style="width: 10%;"></td> <td style="width: 10%;"></td> <td style="width: 10%;"></td> </tr> <tr> <td></td> <td></td> <td colspan="8" style="text-align: center;"> <table border="1" style="width: 100%; border-collapse: collapse; text-align: center;"> <tr> </tr></table></td></tr></table></td></tr></table></td></tr></table></td></tr></table></td></tr></table></td></tr></table></td></tr></table></td></tr></table></td></tr></table></td></tr></table></td></tr></table></td></tr></table></td></tr></table></td></tr></table></td></tr></table></td></tr></table></td></tr></table>

 | | | | | | | | | | | | | | | | | | | | <table border="1" style="width: 100%; border-collapse: collapse; text-align: center;"> <tr> <td style="width: 10%;"></td> <td style="width: 10%;"></td> <td style="width: 10%;"></td> <td style="width: 10%;"></td> <td style="width: 10%;"></td> <td style="width: 10%;"></td> <td style="width: 10%;"></td> <td style="width: 10%;"></td> <td style="width: 10%;"></td> <td style="width: 10%;"></td> </tr> <tr> <td></td> <td></td> <td colspan="8" style="text-align: center;"> <table border="1" style="width: 100%; border-collapse: collapse; text-align: center;"> <tr> <td style="width: 10%;"></td> <td style="width: 10%;"></td> <td style="width: 10%;"></td> <td style="width: 10%;"></td> <td style="width: 10%;"></td> <td style="width: 10%;"></td> <td style="width: 10%;"></td> <td style="width: 10%;"></td> <td style="width: 10%;"></td> <td style="width: 10%;"></td> </tr> <tr> <td></td> <td></td> <td colspan="8" style="text-align: center;"> <table border="1" style="width: 100%; border-collapse: collapse; text-align: center;"> <tr> <td style="width: 10%;"></td> <td style="width: 10%;"></td> <td style="width: 10%;"></td> <td style="width: 10%;"></td> <td style="width: 10%;"></td> <td style="width: 10%;"></td> <td style="width: 10%;"></td> <td style="width: 10%;"></td> <td style="width: 10%;"></td> <td style="width: 10%;"></td> </tr> <tr> <td></td> <td></td> <td colspan="8" style="text-align: center;"> <table border="1" style="width: 100%; border-collapse: collapse; text-align: center;"> <tr> <td style="width: 10%;"></td> <td style="width: 10%;"></td> <td style="width: 10%;"></td> <td style="width: 10%;"></td> <td style="width: 10%;"></td> <td style="width: 10%;"></td> <td style="width: 10%;"></td> <td style="width: 10%;"></td> <td style="width: 10%;"></td> <td style="width: 10%;"></td> </tr> <tr> <td></td> <td></td> <td colspan="8" style="text-align: center;"> <table border="1" style="width: 100%; border-collapse: collapse; text-align: center;"> <tr> <td style="width: 10%;"></td> <td style="width: 10%;"></td> <td style="width: 10%;"></td> <td style="width: 10%;"></td> <td style="width: 10%;"></td> <td style="width: 10%;"></td> <td style="width: 10%;"></td> <td style="width: 10%;"></td> <td style="width: 10%;"></td> <td style="width: 10%;"></td> </tr> <tr> <td></td> <td></td> <td colspan="8" style="text-align: center;"> <table border="1" style="width: 100%; border-collapse: collapse; text-align: center;"> <tr> <td style="width: 10%;"></td> <td style="width: 10%;"></td> <td style="width: 10%;"></td> <td style="width: 10%;"></td> <td style="width: 10%;"></td> <td style="width: 10%;"></td> <td style="width: 10%;"></td> <td style="width: 10%;"></td> <td style="width:
10%;"></td> <td style="width: 10%;"></td> </tr> <tr> <td></td> <td></td> <td colspan="8" style="text-align: center;"> <table border="1" style="width: 100%; border-collapse: collapse; text-align: center;"> <tr> <td style="width: 10%;"></td> <td style="width: 10%;"></td> <td style="width: 10%;"></td> <td style="width: 10%;"></td> <td style="width: 10%;"></td> <td style="width: 10%;"></td> <td style="width: 10%;"></td> <td style="width: 10%;"></td> <td style="width: 10%;"></td> <td style="width: 10%;"></td> </tr> <tr> <td></td> <td></td> <td colspan="8" style="text-align: center;"> <table border="1" style="width: 100%; border-collapse: collapse; text-align: center;"> <tr> <td style="width: 10%;"></td> <td style="width: 10%;"></td> <td style="width: 10%;"></td> <td style="width: 10%;"></td> <td style="width: 10%;"></td> <td style="width: 10%;"></td> <td style="width: 10%;"></td> <td style="width: 10%;"></td> <td style="width: 10%;"></td> <td style="width: 10%;"></td> </tr> <tr> <td></td> <td></td> <td colspan="8" style="text-align: center;"> <table border="1" style="width: 100%; border-collapse: collapse; text-align: center;"> <tr> <td style="width: 10%;"></td> <td style="width: 10%;"></td> <td style="width: 10%;"></td> <td style="width: 10%;"></td> <td style="width: 10%;"></td> <td style="width: 10%;"></td> <td style="width: 10%;"></td> <td style="width: 10%;"></td> <td style="width: 10%;"></td> <td style="width: 10%;"></td> </tr> <tr> <td></td> <td></td> <td colspan="8" style="text-align: center;"> <table border="1" style="width: 100%; border-collapse: collapse; text-align: center;"> <tr> <td style="width: 10%;"></td> <td style="width: 10%;"></td> <td style="width: 10%;"></td> <td style="width: 10%;"></td> <td style="width: 10%;"></td> <td style="width: 10%;"></td> <td style="width: 10%;"></td> <td style="width: 10%;"></td> <td style="width: 10%;"></td> <td style="width: 10%;"></td> </tr> <tr> <td></td> <td></td> <td colspan="8" style="text-align: center;"> <table border="1" style="width: 100%; border-collapse: collapse; text-align: center;"> <tr> <td style="width: 10%;"></td> <td style="width: 10%;"></td> <td style="width: 10%;"></td> <td style="width: 10%;"></td> <td style="width: 10%;"></td> <td style="width: 10%;"></td> <td style="width: 10%;"></td> <td style="width: 10%;"></td> <td style="width: 10%;"></td> <td style="width: 10%;"></td> </tr> <tr> <td></td> <td></td> <td colspan="8" style="text-align: center;"> <table border="1" style="width: 100%; border-collapse: collapse; text-align: center;"> <tr> <td style="width: 10%;"></td> <td style="width: 10%;"></td> <td style="width: 10%;"></td> <td style="width: 10%;"></td> <td style="width: 10%;"></td> <td style="width: 10%;"></td> <td style="width: 10%;"></td> <td style="width: 10%;"></td> <td style="width: 10%;"></td> <td style="width: 10%;"></td> </tr> <tr> <td></td> <td></td> <td colspan="8" style="text-align: center;"> <table border="1" style="width: 100%; border-collapse: collapse; text-align: center;"> <tr> <td style="width: 10%;"></td> <td style="width: 10%;"></td> <td style="width: 10%;"></td> <td style="width: 10%;"></td> <td style="width: 10%;"></td> <td style="width: 10%;"></td> <td style="width: 10%;"></td> <td style="width: 10%;"></td> <td style="width: 10%;"></td> <td style="width: 10%;"></td> </tr> <tr> <td></td> <td></td> <td colspan="8" style="text-align: center;"> <table border="1" style="width: 100%; border-collapse: collapse; text-align: center;"> <tr> <td style="width: 10%;"></td> <td style="width: 10%;"></td> <td style="width: 10%;"></td> <td style="width: 10%;"></td> <td style="width: 10%;"></td> <td style="width: 10%;"></td> <td style="width: 10%;"></td> <td style="width: 10%;"></td> <td style="width: 10%;"></td> <td style="width: 10%;"></td> </tr> <tr> <td></td> <td></td> <td colspan="8" style="text-align: center;"> <table border="1" style="width: 100%; border-collapse: collapse; text-align: center;"> <tr> <td style="width: 10%;"></td> <td style="width: 10%;"></td> <td style="width: 10%;"></td> <td style="width: 10%;"></td> <td style="width: 10%;"></td> <td style="width: 10%;"></td> <td style="width: 10%;"></td> <td style="width: 10%;"></td> <td style="width: 10%;"></td> <td style="width: 10%;"></td> </tr> <tr> <td></td> <td></td> <td colspan="8" style="text-align: center;"> <table border="1" style="width: 100%; border-collapse: collapse; text-align: center;"> <tr> <td style="width: 10%;"></td> <td style="width: 10%;"></td> <td style="width: 10%;"></td> <td style="width: 10%;"></td> <td style="width: 10%;"></td> <td style="width: 10%;"></td> <td style="width: 10%;"></td> <td style="width: 10%;"></td> <td style="width: 10%;"></td> <td style="width: 10%;"></td> </tr> <tr> <td></td> <td></td> <td colspan="8" style="text-align: center;"> <table border="1" style="width: 100%; border-collapse: collapse; text-align: center;"> <tr> </tr></table></td></tr></table></td></tr></table></td></tr></table></td></tr></table></td></tr></table></td></tr></table></td></tr></table></td></tr></table></td></tr></table></td></tr></table></td></tr></table></td></tr></table></td></tr></table></td></tr></table></td></tr></table></td></tr></table>

 | | | | | | | | | | | | | | | | | | | | <table border="1" style="width: 100%; border-collapse: collapse; text-align: center;"> <tr> <td style="width: 10%;"></td> <td style="width: 10%;"></td> <td style="width: 10%;"></td> <td style="width: 10%;"></td> <td style="width: 10%;"></td> <td style="width: 10%;"></td> <td style="width: 10%;"></td> <td style="width: 10%;"></td> <td style="width: 10%;"></td> <td style="width: 10%;"></td> </tr> <tr> <td></td> <td></td> <td colspan="8" style="text-align: center;"> <table border="1" style="width: 100%; border-collapse: collapse; text-align: center;"> <tr> <td style="width: 10%;"></td> <td style="width: 10%;"></td> <td style="width: 10%;"></td> <td style="width: 10%;"></td> <td style="width: 10%;"></td> <td style="width: 10%;"></td> <td style="width: 10%;"></td> <td style="width: 10%;"></td> <td style="width: 10%;"></td> <td style="width: 10%;"></td> </tr> <tr> <td></td> <td></td> <td colspan="8" style="text-align: center;"> <table border="1" style="width: 100%; border-collapse: collapse; text-align: center;"> <tr> <td style="width: 10%;"></td> <td style="width: 10%;"></td> <td style="width: 10%;"></td> <td style="width: 10%;"></td> <td style="width: 10%;"></td> <td style="width: 10%;"></td> <td style="width: 10%;"></td> <td style="width: 10%;"></td> <td style="width: 10%;"></td> <td style="width: 10%;"></td> </tr> <tr> <td></td> <td></td> <td colspan="8" style="text-align: center;"> <table border="1" style="width: 100%; border-collapse: collapse; text-align: center;"> <tr> <td style="width: 10%;"></td> <td style="width: 10%;"></td> <td style="width: 10%;"></td> <td style="width: 10%;"></td> <td style="width: 10%;"></td> <td style="width: 10%;"></td> <td style="width: 10%;"></td> <td style="width: 10%;"></td> <td style="width: 10%;"></td> <td style="width: 10%;"></td> </tr> <tr> <td></td> <td></td> <td colspan="8" style="text-align: center;"> <table border="1" style="width: 100%; border-collapse: collapse; text-align: center;"> <tr> <td style="width: 10%;"></td> <td style="width: 10%;"></td> <td style="width: 10%;"></td> <td style="width: 10%;"></td> <td style="width: 10%;"></td> <td style="width: 10%;"></td> <td style="width: 10%;"></td> <td style="width: 10%;"></td> <td style="width: 10%;"></td> <td style="width: 10%;"></td> </tr> <tr> <td></td> <td></td> <td colspan="8" style="text-align: center;"> <table border="1" style="width: 100%; border-collapse: collapse; text-align: center;"> <tr> <td style="width: 10%;"></td> <td style="width: 10%;"></td> <td style="width: 10%;"></td> <td style="width: 10%;"></td> <td style="width: 10%;"></td> <td style="width: 10%;"></td> <td style="width: 10%;"></td> <td style="width: 10%;"></td> <td style="width: 10%;"></td> <td style="width: 10%;"></td> </tr> <tr> <td></td> <td></td> <td colspan="8" style="text-align: center;"> <table border="1" style="width: 100%; border-collapse: collapse; text-align: center;"> <tr> <td style="width: 10%;"></td> <td style="width: 10%;"></td> <td style="width: 10%;"></td> <td style="width: 10%;"></td> <td style="width: 10%;"></td> <td style="width: 10%;"></td> <td style="width: 10%;"></td> <td style="width: 10%;"></td> <td style="width: 10%;"></td> <td style="width: 10%;"></td> </tr> <tr> <td></td> <td></td> <td colspan="8" style="text-align: center;"> <table border="1" style="width: 100%; border-collapse: collapse; text-align: center;"> <tr> <td style="width: 10%;"></td> <td style="width: 10%;"></td> <td style="width: 10%;"></td> <td style="width: 10%;"></td> <td style="width: 10%;"></td> <td style="width: 10%;"></td> <td style="width: 10%;"></td> <td style="width: 10%;"></td> <td style="width: 10%;"></td> <td style="width: 10%;"></td> </tr> <tr> <td></td> <td></td> <td colspan="8" style="text-align: center;"> <table border="1" style="width: 100%; border-collapse: collapse; text-align: center;"> <tr> <td style="width: 10%;"></td> <td style="width: 10%;"></td> <td style="width: 10%;"></td> <td style="width: 10%;"></td> <td style="width: 10%;"></td> <td style="width: 10%;"></td> <td style="width: 10%;"></td> <td style="width: 10%;"></td> <td style="width: 10%;"></td> <td style="width: 10%;"></td> </tr> <tr> <td></td> <td></td> <td colspan="8" style="text-align: center;"> <table border="1" style="width: 100%; border-collapse: collapse; text-align: center;"> <tr> <td style="width: 10%;"></td> <td style="width: 10%;"></td> <td style="width: 10%;"></td> <td style="width: 10%;"></td> <td style="width: 10%;"></td> <td style="width: 10%;"></td> <td style="width: 10%;"></td> <td style="width: 10%;"></td> <td style="width: 10%;"></td> <td style="width: 10%;"></td> </tr> <tr> <td></td> <td></td> <td colspan="8" style="text-align: center;"> <table border="1" style="width: 100%; border-collapse: collapse; text-align: center;"> <tr> <td style="width: 10%;"></td> <td style="width: 10%;"></td> <td style="width: 10%;"></td> <td style="width: 10%;"></td> <td style="width: 10%;"></td> <td style="width: 10%;"></td> <td style="width: 10%;"></td> <td style="width: 10%;"></td> <td style="width: 10%;"></td> <td style="width: 10%;"></td> </tr> <tr> <td></td> <td></td> <td colspan="8" style="text-align: center;"> <table border="1" style="width: 100%; border-collapse: collapse; text-align: center;"> <tr> <td style="width: 10%;"></td> <td style="width: 10%;"></td> <td style="width: 10%;"></td> <td style="width: 10%;"></td> <td style="width: 10%;"></td> <td style="width: 10%;"></td> <td style="width: 10%;"></td> <td style="width: 10%;"></td> <td style="width: 10%;"></td> <td style="width: 10%;"></td> </tr> <tr> <td></td> <td></td> <td colspan="8" style="text-align: center;"> <table border="1" style="width: 100%; border-collapse: collapse; text-align: center;"> <tr> <td style="width: 10%;"></td> <td style="width: 10%;"></td> <td style="width: 10%;"></td> <td style="width: 10%;"></td> <td style="width: 10%;"></td> <td style="width: 10%;"></td> <td style="width: 10%;"></td> <td style="width: 10%;"></td> <td style="width: 10%;"></td> <td style="width: 10%;"></td> </tr> <tr> <td></td> <td></td> <td colspan="8" style="text-align: center;"> <table border="1" style="width: 100%; border-collapse: collapse; text-align: center;"> <tr> <td style="width: 10%;"></td> <td style="width: 10%;"></td> <td style="width: 10%;"></td> <td style="width: 10%;"></td> <td style="width: 10%;"></td> <td style="width: 10%;"></td> <td style="width: 10%;"></td> <td style="width: 10%;"></td> <td style="width: 10%;"></td> <td style="width: 10%;"></td> </tr> <tr> <td></td> <td></td> <td colspan="8" style="text-align: center;"> <table border="1" style="width: 100%; border-collapse: collapse; text-align: center;"> <tr> <td style="width: 10%;"></td> <td style="width: 10%;"></td> <td style="width: 10%;"></td> <td style="width: 10%;"></td>
<td style="width: 10%;"></td> <td style="width: 10%;"></td> <td style="width: 10%;"></td> <td style="width: 10%;"></td> <td style="width: 10%;"></td> <td style="width: 10%;"></td> </tr> <tr> <td></td> <td></td> <td colspan="8" style="text-align: center;"> <table border="1" style="width: 100%; border-collapse: collapse; text-align: center;"> <tr> </tr></table></td></tr></table></td></tr></table></td></tr></table></td></tr></table></td></tr></table></td></tr></table></td></tr></table></td></tr></table></td></tr></table></td></tr></table></td></tr></table></td></tr></table></td></tr></table></td></tr></table></td></tr></table>
 | | | | | | | | | | | | | | | | | | | | <table border="1" style="width: 100%; border-collapse: collapse; text-align: center;"> <tr> <td style="width: 10%;"></td> <td style="width: 10%;"></td> <td style="width: 10%;"></td> <td style="width: 10%;"></td> <td style="width: 10%;"></td> <td style="width: 10%;"></td> <td style="width: 10%;"></td> <td style="width: 10%;"></td> <td style="width: 10%;"></td> <td style="width: 10%;"></td> </tr> <tr> <td></td> <td></td> <td colspan="8" style="text-align: center;"> <table border="1" style="width: 100%; border-collapse: collapse; text-align: center;"> <tr> <td style="width: 10%;"></td> <td style="width: 10%;"></td> <td style="width: 10%;"></td> <td style="width: 10%;"></td> <td style="width: 10%;"></td> <td style="width: 10%;"></td> <td style="width: 10%;"></td> <td style="width: 10%;"></td> <td style="width: 10%;"></td> <td style="width: 10%;"></td> </tr> <tr> <td></td> <td></td> <td colspan="8" style="text-align: center;"> <table border="1" style="width: 100%; border-collapse: collapse; text-align: center;"> <tr> <td style="width: 10%;"></td> <td style="width: 10%;"></td> <td style="width: 10%;"></td> <td style="width: 10%;"></td> <td style="width: 10%;"></td> <td style="width: 10%;"></td> <td style="width: 10%;"></td> <td style="width: 10%;"></td> <td style="width: 10%;"></td> <td style="width:
10%;"></td> </tr> <tr> <td></td> <td></td> <td colspan="8" style="text-align: center;"> <table border="1" style="width: 100%; border-collapse: collapse; text-align: center;"> <tr> <td style="width: 10%;"></td> <td style="width: 10%;"></td> <td style="width: 10%;"></td> <td style="width: 10%;"></td> <td style="width: 10%;"></td> <td style="width: 10%;"></td> <td style="width: 10%;"></td> <td style="width: 10%;"></td> <td style="width: 10%;"></td> <td style="width: 10%;"></td> </tr> <tr> <td></td> <td></td> <td colspan="8" style="text-align: center;"> <table border="1" style="width: 100%; border-collapse: collapse; text-align: center;"> <tr> <td style="width: 10%;"></td> <td style="width: 10%;"></td> <td style="width: 10%;"></td> <td style="width: 10%;"></td> <td style="width: 10%;"></td> <td style="width: 10%;"></td> <td style="width: 10%;"></td> <td style="width: 10%;"></td> <td style="width: 10%;"></td> <td style="width: 10%;"></td> </tr> <tr> <td></td> <td></td> <td colspan="8" style="text-align: center;"> <table border="1" style="width: 100%; border-collapse: collapse; text-align: center;"> <tr> <td style="width: 10%;"></td> <td style="width: 10%;"></td> <td style="width: 10%;"></td> <td style="width: 10%;"></td> <td style="width: 10%;"></td> <td style="width: 10%;"></td> <td style="width: 10%;"></td> <td style="width: 10%;"></td> <td style="width: 10%;"></td> <td style="width: 10%;"></td> </tr> <tr> <td></td> <td></td> <td colspan="8" style="text-align: center;"> <table border="1" style="width: 100%; border-collapse: collapse; text-align: center;"> <tr> <td style="width: 10%;"></td> <td style="width: 10%;"></td> <td style="width: 10%;"></td> <td style="width: 10%;"></td> <td style="width: 10%;"></td> <td style="width: 10%;"></td> <td style="width: 10%;"></td> <td style="width: 10%;"></td> <td style="width: 10%;"></td> <td style="width: 10%;"></td> </tr> <tr> <td></td> <td></td> <td colspan="8" style="text-align: center;"> <table border="1" style="width: 100%; border-collapse: collapse; text-align: center;"> <tr> <td style="width: 10%;"></td> <td style="width: 10%;"></td> <td style="width: 10%;"></td> <td style="width: 10%;"></td> <td style="width: 10%;"></td> <td style="width: 10%;"></td> <td style="width: 10%;"></td> <td style="width: 10%;"></td> <td style="width: 10%;"></td> <td style="width: 10%;"></td> </tr> <tr> <td></td> <td></td> <td colspan="8" style="text-align: center;"> <table border="1" style="width: 100%; border-collapse: collapse; text-align: center;"> <tr> <td style="width: 10%;"></td> <td style="width: 10%;"></td> <td style="width: 10%;"></td> <td style="width: 10%;"></td> <td style="width: 10%;"></td> <td style="width: 10%;"></td> <td style="width: 10%;"></td> <td style="width: 10%;"></td> <td style="width: 10%;"></td> <td style="width: 10%;"></td> </tr> <tr> <td></td> <td></td> <td colspan="8" style="text-align: center;"> <table border="1" style="width: 100%; border-collapse: collapse; text-align: center;"> <tr> <td style="width: 10%;"></td> <td style="width: 10%;"></td> <td style="width: 10%;"></td> <td style="width: 10%;"></td> <td style="width: 10%;"></td> <td style="width: 10%;"></td> <td style="width: 10%;"></td> <td style="width: 10%;"></td> <td style="width: 10%;"></td> <td style="width: 10%;"></td> </tr> <tr> <td></td> <td></td> <td colspan="8" style="text-align: center;"> <table border="1" style="width: 100%; border-collapse: collapse; text-align: center;"> <tr> <td style="width: 10%;"></td> <td style="width: 10%;"></td> <td style="width: 10%;"></td> <td style="width: 10%;"></td> <td style="width: 10%;"></td> <td style="width: 10%;"></td> <td style="width: 10%;"></td> <td style="width: 10%;"></td> <td style="width: 10%;"></td> <td style="width: 10%;"></td> </tr> <tr> <td></td> <td></td> <td colspan="8" style="text-align: center;"> <table border="1" style="width: 100%; border-collapse: collapse; text-align: center;"> <tr> <td style="width: 10%;"></td> <td style="width: 10%;"></td> <td style="width: 10%;"></td> <td style="width: 10%;"></td> <td style="width: 10%;"></td> <td style="width: 10%;"></td> <td style="width: 10%;"></td> <td style="width: 10%;"></td> <td style="width: 10%;"></td> <td style="width: 10%;"></td> </tr> <tr> <td></td> <td></td> <td colspan="8" style="text-align: center;"> <table border="1" style="width: 100%; border-collapse: collapse; text-align: center;"> <tr> <td style="width: 10%;"></td> <td style="width: 10%;"></td> <td style="width: 10%;"></td> <td style="width: 10%;"></td> <td style="width: 10%;"></td> <td style="width: 10%;"></td> <td style="width: 10%;"></td> <td style="width: 10%;"></td> <td style="width: 10%;"></td> <td style="width: 10%;"></td> </tr> <tr> <td></td> <td></td> <td colspan="8" style="text-align: center;"> <table border="1" style="width: 100%; border-collapse: collapse; text-align: center;"> <tr> <td style="width: 10%;"></td> <td style="width: 10%;"></td> <td style="width: 10%;"></td> <td style="width: 10%;"></td> <td style="width: 10%;"></td> <td style="width: 10%;"></td> <td style="width: 10%;"></td> <td style="width: 10%;"></td> <td style="width: 10%;"></td> <td style="width: 10%;"></td> </tr> <tr> <td></td> <td></td> <td colspan="8" style="text-align: center;"> <table border="1" style="width: 100%; border-collapse: collapse; text-align: center;"> <tr> </tr></table></td></tr></table></td></tr></table></td></tr></table></td></tr></table></td></tr></table></td></tr></table></td></tr></table></td></tr></table></td></tr></table></td></tr></table></td></tr></table></td></tr></table></td></tr></table></td></tr></table>

 | | | | | | | | | | | | | | | | | | | | <table border="1" style="width: 100%; border-collapse: collapse; text-align: center;"> <tr> <td style="width: 10%;"></td> <td style="width: 10%;"></td> <td style="width: 10%;"></td> <td style="width: 10%;"></td> <td style="width: 10%;"></td> <td style="width: 10%;"></td> <td style="width: 10%;"></td> <td style="width: 10%;"></td> <td style="width: 10%;"></td> <td style="width: 10%;"></td> </tr> <tr> <td></td> <td></td> <td colspan="8" style="text-align: center;"> <table border="1" style="width: 100%; border-collapse: collapse; text-align: center;"> <tr> <td style="width: 10%;"></td> <td style="width: 10%;"></td> <td style="width: 10%;"></td> <td style="width: 10%;"></td> <td style="width: 10%;"></td> <td style="width: 10%;"></td> <td style="width: 10%;"></td> <td style="width: 10%;"></td> <td style="width: 10%;"></td> <td style="width: 10%;"></td> </tr> <tr> <td></td> <td></td> <td colspan="8" style="text-align: center;"> <table border="1" style="width: 100%; border-collapse: collapse; text-align: center;"> <tr> <td style="width: 10%;"></td> <td style="width: 10%;"></td> <td style="width: 10%;"></td> <td style="width: 10%;"></td> <td style="width: 10%;"></td> <td style="width: 10%;"></td> <td style="width: 10%;"></td> <td style="width: 10%;"></td> <td style="width: 10%;"></td> <td style="width: 10%;"></td> </tr> <tr> <td></td> <td></td> <td colspan="8" style="text-align: center;"> <table border="1" style="width: 100%; border-collapse: collapse; text-align: center;"> <tr> <td style="width: 10%;"></td> <td style="width: 10%;"></td> <td style="width: 10%;"></td> <td style="width: 10%;"></td> <td style="width: 10%;"></td> <td style="width: 10%;"></td> <td style="width: 10%;"></td> <td style="width: 10%;"></td> <td style="width: 10%;"></td> <td style="width: 10%;"></td> </tr> <tr> <td></td> <td></td> <td colspan="8" style="text-align: center;"> <table border="1" style="width: 100%; border-collapse: collapse; text-align: center;"> <tr> <td style="width: 10%;"></td> <td style="width: 10%;"></td> <td style="width: 10%;"></td> <td style="width: 10%;"></td> <td style="width: 10%;"></td> <td style="width: 10%;"></td> <td style="width: 10%;"></td> <td style="width: 10%;"></td> <td style="width: 10%;"></td> <td style="width: 10%;"></td> </tr> <tr> <td></td> <td></td> <td colspan="8" style="text-align: center;"> <table border="1" style="width: 100%; border-collapse: collapse; text-align: center;"> <tr> <td style="width: 10%;"></td> <td style="width: 10%;"></td> <td style="width: 10%;"></td> <td style="width: 10%;"></td> <td style="width: 10%;"></td> <td style="width: 10%;"></td> <td style="width: 10%;"></td> <td style="width: 10%;"></td> <td style="width: 10%;"></td> <td style="width: 10%;"></td> </tr> <tr> <td></td> <td></td> <td colspan="8" style="text-align: center;"> <table border="1" style="width: 100%; border-collapse: collapse; text-align: center;"> <tr> <td style="width: 10%;"></td> <td style="width: 10%;"></td> <td style="width: 10%;"></td> <td style="width: 10%;"></td> <td style="width: 10%;"></td> <td style="width: 10%;"></td> <td style="width: 10%;"></td> <td style="width: 10%;"></td> <td style="width: 10%;"></td> <td style="width: 10%;"></td> </tr> <tr> <td></td> <td></td> <td colspan="8" style="text-align: center;"> <table border="1" style="width: 100%; border-collapse: collapse; text-align: center;"> <tr> <td style="width: 10%;"></td> <td style="width: 10%;"></td> <td style="width: 10%;"></td> <td style="width: 10%;"></td> <td style="width: 10%;"></td> <td style="width: 10%;"></td> <td style="width: 10%;"></td> <td style="width: 10%;"></td> <td style="width: 10%;"></td> <td style="width: 10%;"></td> </tr> <tr> <td></td> <td></td> <td colspan="8" style="text-align: center;"> <table border="1" style="width: 100%; border-collapse: collapse; text-align: center;"> <tr> <td style="width: 10%;"></td> <td style="width: 10%;"></td> <td style="width: 10%;"></td> <td style="width: 10%;"></td> <td style="width: 10%;"></td> <td style="width: 10%;"></td> <td style="width: 10%;"></td> <td style="width: 10%;"></td> <td style="width: 10%;"></td> <td style="width: 10%;"></td> </tr> <tr> <td></td> <td></td> <td colspan="8" style="text-align: center;"> <table border="1" style="width: 100%; border-collapse: collapse; text-align: center;"> <tr> <td style="width: 10%;"></td> <td style="width: 10%;"></td> <td style="width: 10%;"></td> <td style="width: 10%;"></td> <td style="width: 10%;"></td> <td style="width: 10%;"></td> <td style="width: 10%;"></td> <td style="width: 10%;"></td> <td style="width: 10%;"></td> <td style="width: 10%;"></td> </tr> <tr> <td></td> <td></td> <td colspan="8" style="text-align: center;"> <table border="1" style="width: 100%; border-collapse: collapse; text-align: center;"> <tr> <td style="width: 10%;"></td> <td style="width: 10%;"></td> <td style="width: 10%;"></td> <td style="width: 10%;"></td> <td style="width: 10%;"></td> <td style="width: 10%;"></td> <td style="width: 10%;"></td> <td style="width: 10%;"></td> <td style="width: 10%;"></td> <td style="width: 10%;"></td> </tr> <tr> <td></td> <td></td> <td colspan="8" style="text-align: center;"> <table border="1" style="width: 100%; border-collapse: collapse; text-align: center;"> <tr> <td style="width: 10%;"></td> <td style="width: 10%;"></td> <td style="width: 10%;"></td> <td style="width: 10%;"></td> <td style="width: 10%;"></td> <td style="width: 10%;"></td> <td style="width: 10%;"></td> <td style="width: 10%;"></td> <td style="width: 10%;"></td> <td style="width: 10%;"></td> </tr> <tr> <td></td> <td></td> <td colspan="8" style="text-align: center;"> <table border="1" style="width: 100%; border-collapse: collapse; text-align: center;"> <tr> <td style="width: 10%;"></td> <td style="width: 10%;"></td> <td style="width: 10%;"></td> <td style="width: 10%;"></td> <td style="width: 10%;"></td> <td style="width: 10%;"></td> <td style="width: 10%;"></td> <td style="width: 10%;"></td> <td style="width: 10%;"></td> <td style="width: 10%;"></td> </tr> <tr> <td></td> <td></td> <td colspan="8" style="text-align: center;"> <table border="1" style="width: 100%; border-collapse: collapse; text-align: center;"> <tr>
</tr></table></td></tr></table></td></tr></table></td></tr></table></td></tr></table></td></tr></table></td></tr></table></td></tr></table></td></tr></table></td></tr></table></td></tr></table></td></tr></table></td></tr></table></td></tr></table>
 | | | | | | | | | | | | | | | | | | | | <table border="1" style="width: 100%; border-collapse: collapse; text-align: center;"> <tr> <td style="width: 10%;"></td> <td style="width: 10%;"></td> <td style="width: 10%;"></td> <td style="width: 10%;"></td> <td style="width: 10%;"></td> <td style="width: 10%;"></td> <td style="width: 10%;"></td> <td style="width: 10%;"></td> <td style="width: 10%;"></td> <td style="width: 10%;"></td> </tr> <tr> <td></td> <td></td> <td colspan="8" style="text-align: center;"> <table border="1" style="width: 100%; border-collapse: collapse; text-align: center;"> <tr> <td style="width: 10%;"></td> <td style="width: 10%;"></td> <td style="width: 10%;"></td> <td style="width: 10%;"></td> <td style="width: 10%;"></td> <td style="width: 10%;"></td> <td style="width: 10%;"></td> <td style="width: 10%;"></td> <td style="width: 10%;"></td> <td style="width: 10%;"></td> </tr> <tr> <td></td> <td></td> <td colspan="8" style="text-align: center;"> <table border="1" style="width: 100%; border-collapse: collapse; text-align: center;"> <tr> <td style="width: 10%;"></td> <td style="width: 10%;"></td> <td style="width: 10%;"></td> <td style="width: 10%;"></td> <td style="width: 10%;"></td> <td style="width: 10%;"></td> <td style="width: 10%;"></td> <td style="width: 10%;"></td> <td style="width: 10%;"></td> <td style="width: 10%;"></td> </tr> <tr> <td></td> <td></td> <td colspan="8" style="text-align: center;"> <table border="1" style="width: 100%; border-collapse: collapse; text-align: center;"> <tr> <td style="width: 10%;"></td> <td style="width: 10%;"></td> <td style="width: 10%;"></td> <td style="width: 10%;"></td> <td style="width: 10%;"></td> <td style="width: 10%;"></td> <td style="width: 10%;"></td> <td
style="width: 10%;"></td> <td style="width: 10%;"></td> <td style="width: 10%;"></td> </tr> <tr> <td></td> <td></td> <td colspan="8" style="text-align: center;"> <table border="1" style="width: 100%; border-collapse: collapse; text-align: center;"> <tr> <td style="width: 10%;"></td> <td style="width: 10%;"></td> <td style="width: 10%;"></td> <td style="width: 10%;"></td> <td style="width: 10%;"></td> <td style="width: 10%;"></td> <td style="width: 10%;"></td> <td style="width: 10%;"></td> <td style="width: 10%;"></td> <td style="width: 10%;"></td> </tr> <tr> <td></td> <td></td> <td colspan="8" style="text-align: center;"> <table border="1" style="width: 100%; border-collapse: collapse; text-align: center;"> <tr> <td style="width: 10%;"></td> <td style="width: 10%;"></td> <td style="width: 10%;"></td> <td style="width: 10%;"></td> <td style="width: 10%;"></td> <td style="width: 10%;"></td> <td style="width: 10%;"></td> <td style="width: 10%;"></td> <td style="width: 10%;"></td> <td style="width: 10%;"></td> </tr> <tr> <td></td> <td></td> <td colspan="8" style="text-align: center;"> <table border="1" style="width: 100%; border-collapse: collapse; text-align: center;"> <tr> <td style="width: 10%;"></td> <td style="width: 10%;"></td> <td style="width: 10%;"></td> <td style="width: 10%;"></td> <td style="width: 10%;"></td> <td style="width: 10%;"></td> <td style="width: 10%;"></td> <td style="width: 10%;"></td> <td style="width: 10%;"></td> <td style="width: 10%;"></td> </tr> <tr> <td></td> <td></td> <td colspan="8" style="text-align: center;"> <table border="1" style="width: 100%; border-collapse: collapse; text-align: center;"> <tr> <td style="width: 10%;"></td> <td style="width: 10%;"></td> <td style="width: 10%;"></td> <td style="width: 10%;"></td> <td style="width: 10%;"></td> <td style="width: 10%;"></td> <td style="width: 10%;"></td> <td style="width: 10%;"></td> <td style="width: 10%;"></td> <td style="width: 10%;"></td> </tr> <tr> <td></td> <td></td> <td colspan="8" style="text-align: center;"> <table border="1" style="width: 100%; border-collapse: collapse; text-align: center;"> <tr> <td style="width: 10%;"></td> <td style="width: 10%;"></td> <td style="width: 10%;"></td> <td style="width: 10%;"></td> <td style="width: 10%;"></td> <td style="width: 10%;"></td> <td style="width: 10%;"></td> <td style="width: 10%;"></td> <td style="width: 10%;"></td> <td style="width: 10%;"></td> </tr> <tr> <td></td> <td></td> <td colspan="8" style="text-align: center;"> <table border="1" style="width: 100%; border-collapse: collapse; text-align: center;"> <tr> <td style="width: 10%;"></td> <td style="width: 10%;"></td> <td style="width: 10%;"></td> <td style="width: 10%;"></td> <td style="width: 10%;"></td> <td style="width: 10%;"></td> <td style="width: 10%;"></td> <td style="width: 10%;"></td> <td style="width: 10%;"></td> <td style="width: 10%;"></td> </tr> <tr> <td></td> <td></td> <td colspan="8" style="text-align: center;"> <table border="1" style="width: 100%; border-collapse: collapse; text-align: center;"> <tr> <td style="width: 10%;"></td> <td style="width: 10%;"></td> <td style="width: 10%;"></td> <td style="width: 10%;"></td> <td style="width: 10%;"></td> <td style="width: 10%;"></td> <td style="width: 10%;"></td> <td style="width: 10%;"></td> <td style="width: 10%;"></td> <td style="width: 10%;"></td> </tr> <tr> <td></td> <td></td> <td colspan="8" style="text-align: center;"> <table border="1" style="width: 100%; border-collapse: collapse; text-align: center;"> <tr> <td style="width: 10%;"></td> <td style="width: 10%;"></td> <td style="width: 10%;"></td> <td style="width: 10%;"></td> <td style="width: 10%;"></td> <td style="width: 10%;"></td> <td style="width: 10%;"></td> <td style="width: 10%;"></td> <td style="width: 10%;"></td> <td style="width: 10%;"></td> </tr> <tr> <td></td> <td></td> <td colspan="8" style="text-align: center;"> <table border="1" style="width: 100%; border-collapse: collapse; text-align: center;"> <tr> </tr></table></td></tr></table></td></tr></table></td></tr></table></td></tr></table></td></tr></table></td></tr></table></td></tr></table></td></tr></table></td></tr></table></td></tr></table></td></tr></table></td></tr></table>

 | | | | | | | | | | | | | | | | | | | | <table border="1" style="width: 100%; border-collapse: collapse; text-align: center;"> <tr> <td style="width: 10%;"></td> <td style="width: 10%;"></td> <td style="width: 10%;"></td> <td style="width: 10%;"></td> <td style="width: 10%;"></td> <td style="width: 10%;"></td> <td style="width: 10%;"></td> <td style="width: 10%;"></td> <td style="width: 10%;"></td> <td style="width: 10%;"></td> </tr> <tr> <td></td> <td></td> <td colspan="8" style="text-align: center;"> <table border="1" style="width: 100%; border-collapse: collapse; text-align: center;"> <tr> <td style="width: 10%;"></td> <td style="width: 10%;"></td> <td style="width: 10%;"></td> <td style="width: 10%;"></td> <td style="width: 10%;"></td> <td style="width: 10%;"></td> <td style="width: 10%;"></td> <td style="width: 10%;"></td> <td style="width: 10%;"></td> <td style="width: 10%;"></td> </tr> <tr> <td></td> <td></td> <td colspan="8" style="text-align: center;"> <table border="1" style="width: 100%; border-collapse: collapse; text-align: center;"> <tr> <td style="width: 10%;"></td> <td style="width: 10%;"></td> <td style="width: 10%;"></td> <td style="width: 10%;"></td> <td style="width: 10%;"></td> <td style="width: 10%;"></td> <td style="width: 10%;"></td> <td style="width: 10%;"></td> <td style="width: 10%;"></td> <td style="width: 10%;"></td> </tr> <tr> <td></td> <td></td> <td colspan="8" style="text-align: center;"> <table border="1" style="width: 100%; border-collapse: collapse; text-align: center;"> <tr> <td style="width: 10%;"></td> <td style="width: 10%;"></td> <td style="width: 10%;"></td> <td style="width: 10%;"></td> <td style="width: 10%;"></td> <td style="width: 10%;"></td> <td style="width: 10%;"></td> <td style="width: 10%;"></td> <td style="width: 10%;"></td> <td style="width: 10%;"></td> </tr> <tr> <td></td> <td></td> <td colspan="8" style="text-align: center;"> <table border="1" style="width: 100%; border-collapse: collapse; text-align: center;"> <tr> <td style="width: 10%;"></td> <td style="width: 10%;"></td> <td style="width: 10%;"></td> <td style="width: 10%;"></td> <td style="width: 10%;"></td> <td style="width: 10%;"></td> <td style="width: 10%;"></td> <td style="width: 10%;"></td> <td style="width: 10%;"></td> <td style="width: 10%;"></td> </tr> <tr> <td></td> <td></td> <td colspan="8" style="text-align: center;"> <table border="1" style="width: 100%; border-collapse: collapse; text-align: center;"> <tr> <td style="width: 10%;"></td> <td style="width: 10%;"></td> <td style="width: 10%;"></td> <td style="width: 10%;"></td> <td style="width: 10%;"></td> <td style="width: 10%;"></td> <td style="width: 10%;"></td> <td style="width: 10%;"></td> <td style="width: 10%;"></td> <td style="width: 10%;"></td> </tr> <tr> <td></td> <td></td> <td colspan="8" style="text-align: center;"> <table border="1" style="width: 100%; border-collapse: collapse; text-align: center;"> <tr> <td style="width: 10%;"></td> <td style="width: 10%;"></td> <td style="width: 10%;"></td> <td style="width: 10%;"></td> <td style="width: 10%;"></td> <td style="width: 10%;"></td> <td style="width: 10%;"></td> <td style="width: 10%;"></td> <td style="width: 10%;"></td> <td style="width: 10%;"></td> </tr> <tr> <td></td> <td></td> <td colspan="8" style="text-align: center;"> <table border="1" style="width: 100%; border-collapse: collapse; text-align: center;"> <tr> <td style="width: 10%;"></td> <td style="width: 10%;"></td> <td style="width: 10%;"></td> <td style="width: 10%;"></td> <td style="width: 10%;"></td> <td style="width: 10%;"></td> <td style="width: 10%;"></td> <td style="width: 10%;"></td> <td style="width: 10%;"></td> <td style="width: 10%;"></td> </tr> <tr> <td></td> <td></td> <td colspan="8" style="text-align: center;"> <table border="1" style="width: 100%; border-collapse: collapse; text-align: center;"> <tr> <td style="width: 10%;"></td> <td style="width: 10%;"></td> <td style="width: 10%;"></td> <td style="width: 10%;"></td> <td style="width: 10%;"></td> <td style="width: 10%;"></td> <td style="width: 10%;"></td> <td style="width: 10%;"></td> <td style="width: 10%;"></td> <td style="width: 10%;"></td> </tr> <tr> <td></td> <td></td> <td colspan="8" style="text-align: center;"> <table border="1" style="width: 100%; border-collapse: collapse; text-align: center;"> <tr> <td style="width: 10%;"></td> <td style="width: 10%;"></td> <td style="width: 10%;"></td> <td style="width: 10%;"></td> <td style="width: 10%;"></td> <td style="width: 10%;"></td> <td style="width: 10%;"></td> <td style="width: 10%;"></td> <td style="width: 10%;"></td> <td style="width: 10%;"></td> </tr> <tr> <td></td> <td></td> <td colspan="8" style="text-align: center;"> <table border="1" style="width: 100%; border-collapse: collapse; text-align: center;"> <tr> <td style="width: 10%;"></td> <td style="width: 10%;"></td> <td style="width: 10%;"></td> <td style="width: 10%;"></td> <td style="width: 10%;"></td> <td style="width: 10%;"></td> <td style="width: 10%;"></td> <td style="width: 10%;"></td> <td style="width: 10%;"></td> <td style="width: 10%;"></td> </tr> <tr> <td></td> <td></td> <td colspan="8" style="text-align: center;"> <table border="1" style="width: 100%; border-collapse: collapse; text-align: center;"> <tr> </tr></table></td></tr></table></td></tr></table></td></tr></table></td></tr></table></td></tr></table></td></tr></table></td></tr></table></td></tr></table></td></tr></table></td></tr></table></td></tr></table>

 | | | | | | | | | | | | | | | | | | | | <table border="1" style="width: 100%; border-collapse: collapse; text-align: center;"> <tr> <td style="width: 10%;"></td> <td style="width: 10%;"></td> <td style="width: 10%;"></td> <td style="width: 10%;"></td> <td style="width: 10%;"></td> <td style="width: 10%;"></td> <td style="width: 10%;"></td> <td style="width: 10%;"></td> <td style="width: 10%;"></td> <td style="width: 10%;"></td> </tr> <tr> <td></td> <td></td> <td colspan="8" style="text-align: center;"> <table border="1" style="width: 100%; border-collapse: collapse; text-align: center;"> <tr> <td style="width: 10%;"></td> <td style="width: 10%;"></td> <td style="width: 10%;"></td> <td style="width: 10%;"></td> <td style="width: 10%;"></td> <td style="width: 10%;"></td> <td style="width: 10%;"></td> <td style="width: 10%;"></td> <td style="width: 10%;"></td> <td style="width: 10%;"></td> </tr> <tr> <td></td> <td></td> <td colspan="8" style="text-align: center;"> <table border="1" style="width: 100%; border-collapse: collapse; text-align: center;"> <tr> <td style="width: 10%;"></td> <td style="width: 10%;"></td> <td style="width: 10%;"></td> <td style="width: 10%;"></td> <td style="width: 10%;"></td> <td style="width: 10%;"></td> <td style="width: 10%;"></td> <td style="width: 10%;"></td> <td style="width: 10%;"></td> <td style="width: 10%;"></td> </tr> <tr> <td></td> <td></td> <td colspan="8" style="text-align: center;"> <table border="1" style="width: 100%; border-collapse: collapse; text-align: center;"> <tr> <td style="width: 10%;"></td> <td style="width: 10%;"></td> <td style="width: 10%;"></td> <td style="width: 10%;"></td> <td style="width: 10%;"></td> <td style="width: 10%;"></td> <td style="width: 10%;"></td> <td style="width: 10%;"></td> <td style="width: 10%;"></td> <td style="width: 10%;"></td> </tr> <tr> <td></td> <td></td> <td colspan="8" style="text-align: center;"> <table border="1" style="width: 100%; border-collapse: collapse; text-align: center;"> <tr> <td style="width: 10%;"></td> <td style="width: 10%;"></td> <td style="width: 10%;"></td> <td style="width: 10%;"></td> <td style="width: 10%;"></td> <td style="width: 10%;"></td> <td style="width: 10%;"></td> <td style="width: 10%;"></td> <td style="width: 10%;"></td> <td style="width: 10%;"></td> </tr> <tr> <td></td> <td></td> <td colspan="8" style="text-align: center;"> <table border="1" style="width: 100%; border-collapse: collapse; text-align: center;"> <tr> <td style="width: 10%;"></td> <td style="width: 10%;"></td> <td style="width: 10%;"></td> <td style="width: 10%;"></td> <td style="width: 10%;"></td> <td style="width: 10%;"></td> <td style="width: 10%;"></td> <td style="width: 10%;"></td> <td style="width: 10%;"></td> <td style="width: 10%;"></td> </tr> <tr> <td></td> <td></td> <td colspan="8" style="text-align: center;"> <table border="1" style="width: 100%; border-collapse: collapse; text-align: center;"> <tr> <td style="width: 10%;"></td> <td style="width: 10%;"></td> <td style="width: 10%;"></td> <td style="width: 10%;"></td> <td style="width: 10%;"></td> <td style="width: 10%;"></td> <td style="width: 10%;"></td> <td style="width: 10%;"></td> <td style="width: 10%;"></td> <td style="width: 10%;"></td> </tr> <tr> <td></td> <td></td> <td colspan="8" style="text-align: center;"> <table border="1" style="width: 100%; border-collapse: collapse; text-align: center;"> <tr> <td style="width: 10%;"></td> <td style="width: 10%;"></td> <td style="width: 10%;"></td> <td style="width: 10%;"></td> <td style="width: 10%;"></td> <td style="width: 10%;"></td> <td style="width: 10%;"></td> <td style="width: 10%;"></td> <td style="width: 10%;"></td> <td style="width: 10%;"></td> </tr> <tr> <td></td> <td></td> <td colspan="8" style="text-align: center;"> <table border="1" style="width: 100%; border-collapse: collapse; text-align: center;"> <tr> <td style="width: 10%;"></td> <td style="width: 10%;"></td> <td style="width: 10%;"></td> <td style="width: 10%;"></td> <td style="width: 10%;"></td> <td style="width: 10%;"></td> <td style="width: 10%;"></td> <td style="width: 10%;"></td> <td style="width: 10%;"></td> <td style="width: 10%;"></td> </tr> <tr> <td></td> <td></td> <td colspan="8" style="text-align: center;"> <table border="1"
style="width: 100%; border-collapse: collapse; text-align: center;"> <tr> <td style="width: 10%;"></td> <td style="width: 10%;"></td> <td style="width: 10%;"></td> <td style="width: 10%;"></td> <td style="width: 10%;"></td> <td style="width: 10%;"></td> <td style="width: 10%;"></td> <td style="width: 10%;"></td> <td style="width: 10%;"></td> <td style="width: 10%;"></td> </tr> <tr> <td></td> <td></td> <td colspan="8" style="text-align: center;"> <table border="1" style="width: 100%; border-collapse: collapse; text-align: center;"> <tr> </tr></table></td></tr></table></td></tr></table></td></tr></table></td></tr></table></td></tr></table></td></tr></table></td></tr></table></td></tr></table></td></tr></table></td></tr></table>
 | | | | | | | | | | | | | | | | | | | | <table border="1" style="width: 100%; border-collapse: collapse; text-align: center;"> <tr> <td style="width: 10%;"></td> <td style="width: 10%;"></td> <td style="width: 10%;"></td> <td style="width: 10%;"></td> <td style="width: 10%;"></td> <td style="width: 10%;"></td> <td style="width: 10%;"></td> <td style="width: 10%;"></td> <td style="width: 10%;"></td> <td style="width: 10%;"></td> </tr> <tr> <td></td> <td></td> <td colspan="8" style="text-align: center;"> <table border="1" style="width: 100%; border-collapse: collapse; text-align: center;"> <tr> <td style="width: 10%;"></td> <td style="width: 10%;"></td> <td style="width: 10%;"></td> <td style="width: 10%;"></td> <td style="width: 10%;"></td> <td style="width: 10%;"></td> <td style="width: 10%;"></td> <td style="width: 10%;"></td> <td style="width: 10%;"></td> <td style="width: 10%;"></td> </tr> <tr> <td></td> <td></td> <td colspan="8" style="text-align: center;"> <table border="1" style="width: 100%; border-collapse: collapse; text-align: center;"> <tr> <td style="width: 10%;"></td> <td style="width: 10%;"></td> <td style="width: 10%;"></td> <td style="width: 10%;"></td> <td style="width: 10%;"></td> <td style="width: 10%;"></td> <td
style="width: 10%;"></td> <td style="width: 10%;"></td> <td style="width: 10%;"></td> <td style="width: 10%;"></td> </tr> <tr> <td></td> <td></td> <td colspan="8" style="text-align: center;"> <table border="1" style="width: 100%; border-collapse: collapse; text-align: center;"> <tr> <td style="width: 10%;"></td> <td style="width: 10%;"></td> <td style="width: 10%;"></td> <td style="width: 10%;"></td> <td style="width: 10%;"></td> <td style="width: 10%;"></td> <td style="width: 10%;"></td> <td style="width: 10%;"></td> <td style="width: 10%;"></td> <td style="width: 10%;"></td> </tr> <tr> <td></td> <td></td> <td colspan="8" style="text-align: center;"> <table border="1" style="width: 100%; border-collapse: collapse; text-align: center;"> <tr> <td style="width: 10%;"></td> <td style="width: 10%;"></td> <td style="width: 10%;"></td> <td style="width: 10%;"></td> <td style="width: 10%;"></td> <td style="width: 10%;"></td> <td style="width: 10%;"></td> <td style="width: 10%;"></td> <td style="width: 10%;"></td> <td style="width: 10%;"></td> </tr> <tr> <td></td> <td></td> <td colspan="8" style="text-align: center;"> <table border="1" style="width: 100%; border-collapse: collapse; text-align: center;"> <tr> <td style="width: 10%;"></td> <td style="width: 10%;"></td> <td style="width: 10%;"></td> <td style="width: 10%;"></td> <td style="width: 10%;"></td> <td style="width: 10%;"></td> <td style="width: 10%;"></td> <td style="width: 10%;"></td> <td style="width: 10%;"></td> <td style="width: 10%;"></td> </tr> <tr> <td></td> <td></td> <td colspan="8" style="text-align: center;"> <table border="1" style="width: 100%; border-collapse: collapse; text-align: center;"> <tr> <td style="width: 10%;"></td> <td style="width: 10%;"></td> <td style="width: 10%;"></td> <td style="width: 10%;"></td> <td style="width: 10%;"></td> <td style="width: 10%;"></td> <td style="width: 10%;"></td> <td style="width: 10%;"></td> <td style="width: 10%;"></td> <td style="width: 10%;"></td> </tr> <tr> <td></td> <td></td> <td colspan="8" style="text-align: center;"> <table border="1" style="width: 100%; border-collapse: collapse; text-align: center;"> <tr> <td style="width: 10%;"></td> <td style="width: 10%;"></td> <td style="width: 10%;"></td> <td style="width: 10%;"></td> <td style="width: 10%;"></td> <td style="width: 10%;"></td> <td style="width: 10%;"></td> <td style="width: 10%;"></td> <td style="width: 10%;"></td> <td style="width: 10%;"></td> </tr> <tr> <td></td> <td></td> <td colspan="8" style="text-align: center;"> <table border="1" style="width: 100%; border-collapse: collapse; text-align: center;"> <tr> <td style="width: 10%;"></td> <td style="width: 10%;"></td> <td style="width: 10%;"></td> <td style="width: 10%;"></td> <td style="width: 10%;"></td> <td style="width: 10%;"></td> <td style="width: 10%;"></td> <td style="width: 10%;"></td> <td style="width: 10%;"></td> <td style="width: 10%;"></td> </tr> <tr> <td></td> <td></td> <td colspan="8" style="text-align: center;"> <table border="1" style="width: 100%; border-collapse: collapse; text-align: center;"> <tr> </tr></table></td></tr></table></td></tr></table></td></tr></table></td></tr></table></td></tr></table></td></tr></table></td></tr></table></td></tr></table></td></tr></table>

 | | | | | | | | | | | | | | | | | | | | <table border="1" style="width: 100%; border-collapse: collapse; text-align: center;"> <tr> <td style="width: 10%;"></td> <td style="width: 10%;"></td> <td style="width: 10%;"></td> <td style="width: 10%;"></td> <td style="width: 10%;"></td> <td style="width: 10%;"></td> <td style="width: 10%;"></td> <td style="width: 10%;"></td> <td style="width: 10%;"></td> <td style="width: 10%;"></td> </tr> <tr> <td></td> <td></td> <td colspan="8" style="text-align: center;"> <table border="1" style="width: 100%; border-collapse: collapse; text-align: center;"> <tr> <td style="width: 10%;"></td> <td style="width: 10%;"></td> <td style="width: 10%;"></td> <td style="width: 10%;"></td> <td style="width: 10%;"></td> <td style="width: 10%;"></td> <td style="width: 10%;"></td> <td style="width: 10%;"></td> <td style="width: 10%;"></td> <td style="width: 10%;"></td> </tr> <tr> <td></td> <td></td> <td colspan="8" style="text-align: center;"> <table border="1" style="width: 100%; border-collapse: collapse; text-align: center;"> <tr> <td style="width: 10%;"></td> <td style="width: 10%;"></td> <td style="width: 10%;"></td> <td style="width: 10%;"></td> <td style="width: 10%;"></td> <td style="width: 10%;"></td> <td style="width: 10%;"></td> <td style="width: 10%;"></td> <td style="width: 10%;"></td> <td style="width: 10%;"></td> </tr> <tr> <td></td> <td></td> <td colspan="8" style="text-align: center;"> <table border="1" style="width: 100%; border-collapse: collapse; text-align: center;"> <tr> <td style="width: 10%;"></td> <td style="width: 10%;"></td> <td style="width: 10%;"></td> <td style="width: 10%;"></td> <td style="width: 10%;"></td> <td style="width: 10%;"></td> <td style="width: 10%;"></td> <td style="width: 10%;"></td> <td style="width: 10%;"></td> <td style="width: 10%;"></td> </tr> <tr> <td></td> <td></td> <td colspan="8" style="text-align: center;"> <table border="1" style="width: 100%; border-collapse: collapse; text-align: center;"> <tr> <td style="width: 10%;"></td> <td style="width: 10%;"></td> <td style="width: 10%;"></td> <td style="width: 10%;"></td> <td style="width: 10%;"></td> <td style="width: 10%;"></td> <td style="width: 10%;"></td> <td style="width: 10%;"></td> <td style="width: 10%;"></td> <td style="width: 10%;"></td> </tr> <tr> <td></td> <td></td> <td colspan="8" style="text-align: center;"> <table border="1" style="width: 100%; border-collapse: collapse; text-align: center;"> <tr> <td style="width: 10%;"></td> <td style="width: 10%;"></td> <td style="width: 10%;"></td> <td style="width: 10%;"></td> <td style="width: 10%;"></td> <td style="width: 10%;"></td> <td style="width: 10%;"></td> <td style="width: 10%;"></td> <td style="width: 10%;"></td> <td style="width: 10%;"></td> </tr> <tr> <td></td> <td></td> <td colspan="8" style="text-align: center;"> <table border="1" style="width: 100%; border-collapse: collapse; text-align: center;"> <tr> <td style="width: 10%;"></td> <td style="width: 10%;"></td> <td style="width: 10%;"></td> <td style="width: 10%;"></td> <td style="width: 10%;"></td> <td style="width: 10%;"></td> <td style="width: 10%;"></td> <td style="width: 10%;"></td> <td style="width: 10%;"></td> <td style="width: 10%;"></td> </tr> <tr> <td></td> <td></td> <td colspan="8" style="text-align: center;"> <table border="1" style="width: 100%; border-collapse: collapse; text-align: center;"> <tr> <td style="width: 10%;"></td> <td style="width: 10%;"></td> <td style="width: 10%;"></td> <td style="width: 10%;"></td> <td style="width: 10%;"></td> <td style="width: 10%;"></td> <td style="width: 10%;"></td> <td style="width: 10%;"></td> <td style="width: 10%;"></td> <td style="width: 10%;"></td> </tr> <tr> <td></td> <td></td> <td colspan="8" style="text-align: center;"> <table border="1" style="width: 100%; border-collapse: collapse; text-align: center;"> <tr> </tr></table></td></tr></table></td></tr></table></td></tr></table></td></tr></table></td></tr></table></td></tr></table></td></tr></table></td></tr></table>

 | | | | | | | | | | | | | | | | | | | | <table border="1" style="width: 100%; border-collapse: collapse; text-align: center;"> <tr> <td style="width: 10%;"></td> <td style="width: 10%;"></td> <td style="width: 10%;"></td> <td style="width: 10%;"></td> <td style="width: 10%;"></td> <td style="width: 10%;"></td> <td style="width: 10%;"></td> <td style="width: 10%;"></td> <td style="width: 10%;"></td> <td style="width: 10%;"></td> </tr> <tr> <td></td> <td></td> <td colspan="8" style="text-align: center;"> <table border="1" style="width: 100%; border-collapse: collapse; text-align: center;"> <tr> <td style="width: 10%;"></td> <td style="width: 10%;"></td> <td style="width: 10%;"></td> <td style="width: 10%;"></td> <td style="width: 10%;"></td> <td style="width: 10%;"></td> <td style="width: 10%;"></td> <td style="width: 10%;"></td> <td style="width: 10%;"></td> <td style="width: 10%;"></td> </tr> <tr> <td></td> <td></td> <td colspan="8" style="text-align: center;"> <table border="1" style="width: 100%; border-collapse: collapse; text-align: center;"> <tr> <td style="width: 10%;"></td> <td style="width: 10%;"></td> <td style="width: 10%;"></td> <td style="width: 10%;"></td> <td style="width: 10%;"></td> <td style="width: 10%;"></td> <td style="width: 10%;"></td> <td style="width: 10%;"></td> <td style="width: 10%;"></td> <td style="width: 10%;"></td> </tr> <tr> <td></td> <td></td> <td colspan="8" style="text-align: center;"> <table border="1" style="width: 100%; border-collapse: collapse; text-align: center;"> <tr> <td style="width: 10%;"></td> <td style="width: 10%;"></td> <td style="width: 10%;"></td> <td style="width: 10%;"></td> <td style="width: 10%;"></td> <td style="width: 10%;"></td> <td style="width: 10%;"></td> <td style="width: 10%;"></td> <td style="width: 10%;"></td> <td style="width: 10%;"></td> </tr> <tr> <td></td> <td></td> <td colspan="8" style="text-align: center;"> <table border="1" style="width: 100%; border-collapse: collapse; text-align: center;"> <tr> <td style="width: 10%;"></td> <td style="width: 10%;"></td> <td style="width: 10%;"></td> <td style="width: 10%;"></td> <td style="width: 10%;"></td> <td style="width: 10%;"></td> <td style="width: 10%;"></td> <td style="width: 10%;"></td> <td style="width: 10%;"></td> <td style="width: 10%;"></td> </tr> <tr> <td></td> <td></td> <td colspan="8" style="text-align: center;"> <table border="1" style="width: 100%; border-collapse: collapse; text-align: center;"> <tr> <td style="width: 10%;"></td> <td style="width: 10%;"></td> <td style="width: 10%;"></td> <td style="width: 10%;"></td> <td style="width: 10%;"></td> <td style="width: 10%;"></td> <td style="width: 10%;"></td> <td style="width: 10%;"></td> <td style="width: 10%;"></td> <td style="width: 10%;"></td> </tr> <tr> <td></td> <td></td> <td colspan="8" style="text-align: center;"> <table border="1" style="width: 100%; border-collapse: collapse; text-align: center;"> <tr> <td style="width: 10%;"></td> <td style="width: 10%;"></td> <td style="width: 10%;"></td> <td style="width: 10%;"></td> <td style="width: 10%;"></td> <td style="width: 10%;"></td> <td style="width: 10%;"></td> <td style="width: 10%;"></td> <td style="width: 10%;"></td> <td style="width: 10%;"></td> </tr> <tr> <td></td> <td></td> <td colspan="8" style="text-align: center;"> <table border="1" style="width: 100%; border-collapse: collapse; text-align: center;"> <tr> </tr></table></td></tr></table></td></tr></table></td></tr></table></td></tr></table></td></tr></table></td></tr></table></td></tr></table>

 | | | | | | | | | | | | | | | | | | | | <table border="1" style="width: 100%; border-collapse: collapse; text-align: center;"> <tr> <td style="width: 10%;"></td> <td style="width: 10%;"></td> <td style="width: 10%;"></td> <td style="width: 10%;"></td> <td style="width: 10%;"></td> <td style="width: 10%;"></td> <td style="width: 10%;"></td> <td style="width: 10%;"></td> <td style="width: 10%;"></td> <td style="width: 10%;"></td> </tr> <tr> <td></td> <td></td> <td colspan="8" style="text-align: center;"> <table border="1" style="width: 100%; border-collapse: collapse; text-align: center;"> <tr> <td style="width: 10%;"></td> <td style="width: 10%;"></td> <td style="width: 10%;"></td> <td style="width: 10%;"></td> <td style="width: 10%;"></td> <td style="width: 10%;"></td> <td style="width: 10%;"></td> <td style="width: 10%;"></td> <td style="width: 10%;"></td> <td style="width: 10%;"></td> </tr> <tr> <td></td> <td></td> <td colspan="8" style="text-align: center;"> <table border="1" style="width: 100%; border-collapse: collapse; text-align: center;"> <tr> <td style="width: 10%;"></td> <td style="width: 10%;"></td> <td style="width: 10%;"></td> <td style="width: 10%;"></td> <td style="width: 10%;"></td> <td style="width: 10%;"></td> <td style="width: 10%;"></td> <td style="width: 10%;"></td> <td style="width: 10%;"></td> <td style="width: 10%;"></td> </tr> <tr> <td></td> <td></td> <td colspan="8" style="text-align: center;"> <table border="1" style="width: 100%; border-collapse: collapse; text-align: center;"> <tr> <td style="width: 10%;"></td> <td style="width: 10%;"></td> <td style="width: 10%;"></td> <td style="width: 10%;"></td> <td style="width: 10%;"></td> <td style="width: 10%;"></td> <td style="width: 10%;"></td> <td style="width: 10%;"></td> <td style="width: 10%;"></td> <td style="width: 10%;"></td> </tr> <tr> <td></td> <td></td> <td colspan="8" style="text-align: center;"> <table border="1" style="width: 100%; border-collapse: collapse; text-align: center;"> <tr> <td style="width: 10%;"></td> <td style="width: 10%;"></td> <td style="width: 10%;"></td> <td style="width: 10%;"></td> <td style="width: 10%;"></td> <td style="width: 10%;"></td> <td style="width: 10%;"></td> <td style="width: 10%;"></td> <td style="width: 10%;"></td> <td style="width: 10%;"></td> </tr> <tr> <td></td> <td></td> <td colspan="8" style="text-align: center;"> <table border="1" style="width: 100%; border-collapse: collapse; text-align: center;"> <tr> <td style="width: 10%;"></td> <td style="width: 10%;"></td> <td style="width: 10%;"></td> <td style="width: 10%;"></td> <td style="width: 10%;"></td> <td style="width: 10%;"></td> <td style="width: 10%;"></td> <td style="width: 10%;"></td> <td style="width: 10%;"></td> <td style="width: 10%;"></td> </tr> <tr> <td></td> <td></td> <td colspan="8" style="text-align: center;"> <table border="1" style="width: 100%; border-collapse: collapse; text-align: center;"> <tr> </tr></table></td></tr></table></td></tr></table></td></tr></table></td></tr></table></td></tr></table></td></tr></table>

 | | | | | | | | | | | | | | | | | | | | <table border="1" style="width: 100%; border-collapse: collapse; text-align: center;"> <tr> <td style="width: 10%;"></td> <td style="width: 10%;"></td> <td style="width: 10%;"></td> <td style="width: 10%;"></td> <td style="width: 10%;"></td> <td style="width: 10%;"></td> <td style="width: 10%;"></td> <td style="width: 10%;"></td> <td style="width: 10%;"></td> <td style="width: 10%;"></td> </tr> <tr> <td></td> <td></td> <td colspan="8" style="text-align: center;"> <table border="1" style="width: 100%; border-collapse: collapse; text-align: center;"> <tr> <td style="width: 10%;"></td> <td style="width: 10%;"></td> <td style="width: 10%;"></td> <td style="width: 10%;"></td> <td style="width: 10%;"></td> <td style="width: 10%;"></td> <td style="width: 10%;"></td> <td style="width: 10%;"></td> <td style="width: 10%;"></td> <td style="width: 10%;"></td> </tr> <tr> <td></td> <td></td> <td colspan="8" style="text-align: center;"> <table border="1" style="width: 100%; border-collapse: collapse; text-align: center;"> <tr> <td style="width: 10%;"></td> <td style="width: 10%;"></td> <td style="width: 10%;"></td> <td style="width: 10%;"></td> <td style="width: 10%;"></td> <td style="width: 10%;"></td> <td style="width: 10%;"></td> <td style="width: 10%;"></td> <td style="width: 10%;"></td> <td style="width: 10%;"></td> </tr> <tr> <td></td> <td></td> <td colspan="8" style="text-align: center;"> <table border="1" style="width: 100%; border-collapse: collapse; text-align: center;"> <tr> <td style="width: 10%;"></td> <td style="width: 10%;"></td> <td style="width: 10%;"></td> <td style="width: 10%;"></td> <td style="width: 10%;"></td> <td style="width: 10%;"></td> <td style="width: 10%;"></td> <td style="width: 10%;"></td> <td style="width: 10%;"></td> <td style="width: 10%;"></td> </tr> <tr> <td></td> <td></td> <td colspan="8" style="text-align: center;"> <table border="1" style="width: 100%; border-collapse: collapse; text-align: center;"> <tr> <td style="width: 10%;"></td> <td style="width: 10%;"></td> <td style="width: 10%;"></td> <td style="width: 10%;"></td> <td style="width: 10%;"></td> <td style="width: 10%;"></td> <td style="width: 10%;"></td> <td style="width: 10%;"></td> <td style="width: 10%;"></td> <td style="width: 10%;"></td> </tr> <tr> <td></td> <td></td> <td colspan="8" style="text-align: center;"> <table border="1" style="width: 100%; border-collapse: collapse; text-align: center;"> <tr> </tr></table></td></tr></table></td></tr></table></td></tr></table></td></tr></table></td></tr></table>

 | | | | | | | | | | | | | | | | | | | | <table border="1" style="width: 100%; border-collapse: collapse; text-align: center;"> <tr> <td style="width: 10%;"></td> <td style="width: 10%;"></td> <td style="width: 10%;"></td> <td style="width: 10%;"></td> <td style="width: 10%;"></td> <td style="width: 10%;"></td> <td style="width: 10%;"></td> <td style="width: 10%;"></td> <td style="width: 10%;"></td> <td style="width: 10%;"></td> </tr> <tr> <td></td> <td></td> <td colspan="8" style="text-align: center;"> <table border="1" style="width: 100%; border-collapse: collapse; text-align: center;"> <tr> <td style="width: 10%;"></td> <td style="width: 10%;"></td> <td style="width: 10%;"></td> <td style="width: 10%;"></td> <td style="width: 10%;"></td> <td style="width: 10%;"></td> <td style="width: 10%;"></td> <td style="width: 10%;"></td> <td style="width: 10%;"></td> <td style="width: 10%;"></td> </tr> <tr> <td></td> <td></td> <td colspan="8" style="text-align: center;"> <table border="1" style="width: 100%; border-collapse: collapse; text-align: center;"> <tr> <td style="width: 10%;"></td> <td style="width: 10%;"></td> <td style="width: 10%;"></td> <td style="width: 10%;"></td> <td style="width: 10%;"></td> <td style="width: 10%;"></td> <td style="width: 10%;"></td> <td style="width: 10%;"></td> <td style="width: 10%;"></td> <td style="width: 10%;"></td> </tr> <tr> <td></td> <td></td> <td colspan="8" style="text-align: center;"> <table border="1" style="width: 100%; border-collapse: collapse; text-align: center;"> <tr> <td style="width: 10%;"></td> <td style="width: 10%;"></td> <td style="width: 10%;"></td> <td style="width: 10%;"></td> <td style="width: 10%;"></td> <td style="width: 10%;"></td> <td style="width: 10%;"></td> <td style="width: 10%;"></td> <td style="width: 10%;"></td> <td style="width: 10%;"></td> </tr> <tr> <td></td> <td></td> <td colspan="8" style="text-align: center;"> <table border="1" style="width: 100%; border-collapse: collapse; text-align: center;"> <tr> </tr></table></td></tr></table></td></tr></table></td></tr></table></td></tr></table>

 | | | | | | | | | | | | | | | | | | | | <table border="1" style="width: 100%; border-collapse: collapse; text-align: center;"> <tr> <td style="width: 10%;"></td> <td style="width: 10%;"></td> <td style="width: 10%;"></td> <td style="width: 10%;"></td> <td style="width: 10%;"></td> <td style="width: 10%;"></td> <td style="width: 10%;"></td> <td style="width: 10%;"></td> <td style="width: 10%;"></td> <td style="width: 10%;"></td> </tr> <tr> <td></td> <td></td> <td colspan="8" style="text-align: center;"> <table border="1" style="width: 100%; border-collapse: collapse; text-align: center;"> <tr> <td style="width: 10%;"></td> <td style="width: 10%;"></td> <td style="width: 10%;"></td> <td style="width: 10%;"></td> <td style="width: 10%;"></td> <td style="width: 10%;"></td> <td style="width: 10%;"></td> <td style="width: 10%;"></td> <td style="width: 10%;"></td> <td style="width: 10%;"></td> </tr> <tr> <td></td> <td></td> <td colspan="8" style="text-align: center;"> <table border="1" style="width: 100%; border-collapse: collapse; text-align: center;"> <tr> <td style="width: 10%;"></td> <td style="width: 10%;"></td> <td style="width: 10%;"></td> <td style="width: 10%;"></td> <td style="width: 10%;"></td> <td style="width: 10%;"></td> <td style="width: 10%;"></td> <td style="width: 10%;"></td> <td style="width: 10%;"></td> <td style="width: 10%;"></td> </tr> <tr> <td></td> <td></td> <td colspan="8" style="text-align: center;"> <table border="1" style="width: 100%; border-collapse: collapse; text-align: center;"> <tr> </tr></table></td></tr></table></td></tr></table></td></tr></table>

 | | | | | | | | | | | | | | | | | | | | <table border="1" style="width: 100%; border-collapse: collapse; text-align: center;"> <tr> <td style="width: 10%;"></td> <td style="width: 10%;"></td> <td style="width: 10%;"></td> <td style="width: 10%;"></td> <td style="width: 10%;"></td> <td style="width: 10%;"></td> <td style="width: 10%;"></td> <td style="width: 10%;"></td> <td style="width: 10%;"></td> <td style="width: 10%;"></td> </tr> <tr> <td></td> <td></td> <td colspan="8" style="text-align: center;"> <table border="1" style="width: 100%; border-collapse: collapse; text-align: center;"> <tr> <td style="width: 10%;"></td> <td style="width: 10%;"></td> <td style="width: 10%;"></td> <td style="width: 10%;"></td> <td style="width: 10%;"></td> <td style="width: 10%;"></td> <td style="width: 10%;"></td> <td style="width: 10%;"></td> <td style="width: 10%;"></td> <td style="width: 10%;"></td> </tr> <tr> <td></td> <td></td> <td colspan="8" style="text-align: center;"> <table border="1" style="width: 100%; border-collapse: collapse; text-align: center;"> <tr> </tr></table></td></tr></table></td></tr></table>

 | | | | | | | | | | | | | | | | | | | | <table border="1" style="width: 100%; border-collapse: collapse; text-align: center;"> <tr> <td style="width: 10%;"></td> <td style="width: 10%;"></td> <td style="width: 10%;"></td> <td style="width: 10%;"></td> <td style="width: 10%;"></td> <td style="width: 10%;"></td> <td style="width: 10%;"></td> <td style="width: 10%;"></td> <td style="width: 10%;"></td> <td style="width: 10%;"></td> </tr> <tr> <td></td> <td></td> <td colspan="8" style="text-align: center;"> <table border="1" style="width: 100%; border-collapse: collapse; text-align: center;"> <tr> </tr></table></td></tr></table>

 | | | | | | | | | | | | | | | | | | | | <table border="1" style="width: 100%; border-collapse: collapse; text-align: center;"> <tr> </tr></table>

 | | | | | | | | | | | | | | | | | | | |
 | | | | | | | | | | | | | | | | | | | |

 | | | | | | | | | | | | | | | | | | | |

 | | | | | | | | | | | | | | | | | | | |
 | | | | | | | | | | | | | | | | | | | |

 | | | | | | | | | | | | | | | | | | | |

 | | | | | | | | | | | | | | | | | | | |
 | | | | | | | | | | | | | | | | | | | |
 | | | | | | | | | | | | | | | | | | | |

 | | | | | | | | | | | | | | | | | | | |
 | | | | | | | | | | | | | | | | | | | |
 | | | | | | | | | | | | | | | | | | | |

 | | | | | | | | | | | | | | | | | | | | | | | | | | | | | | | | | | | | | | | | | | | | | | | | | | | | | | | | | | | | | | | | | | | | | | | | | | | | | | | | | | | | | | | | | | | | | | | | | | | |
 | | | | | | | | | | | | | | | | | | | |
 | | | | | | | | | | | | | | | | | | | |
 | | | | | | | | | | | | | | | | | | | |
 | | | | | | | | | | | | | | | | | | | |
 | | | | | | | | | | | | | | | | | | | |
 | | | | | | | | | | | | | | | | | | | |
 | | | | | | | | | | | | | | | | | | | |
 | | | | | | | | | | | | | | | | | | | |
 | | | | | | | | | | | | | | | | | | | | | | | | | | | | | | | | | | | | | | | |
 | | | | | | | | | | | | | | | | | | | |
 | | | | | | | | | | | | | | | | | | | | | | | | | | | | | | | | | | | | | | | |
 | | | | | | | | | | | | | | | | | | | | | | | | | | | | | | | | | | | | | | | |
 | | | | | | | | | | | | | | | | | | | | | | | | | | | | | | | | | | | | | | | |
 | | | | | | | | | | | | | | | | | | | | | | | | | | | | | | | | | | | | | | | | | | | | | | | | | | | | | | | | | | | | | | | | | | | | | | | | | | | | | | | | | | | | | | | | | | | | | | | | | | | |
 | | | | | | | | | | | | | | | | | | | | | | | | | | | | | | | | | | | | | | | | | | | | | | | |
| | |

 | | | | | | | | | | | | | | | | | | | |

 | | | | | | | | | | | | | | | | | | | |

 | | | | | | | | | | | | | | | | | | | |

 | | | | | | | | | | | | | | | | | | | |

 | | | | | | | | | | | | | | | | | | | |

 | | | | | | | | | | | | | | | | | | | |

 | | | | | | | | | | | | | | | | | | | |

 | | | | | | | | | | | | | | | | | | | |

 | | | | | | | | | | | | | | | | | | | |

 | | | | | | | | | | | | | | | | | | | |

 | | | | | | | | | | | | | | | | | | | |

 | | | | | | | | | | | | | | | | | | | |

 | | | | | | | | | | | | | | | | | | | |

 | | | | | | | | | | | | | | | | | | | |

 | | | | | | | | | | | | | | | | | | | |

 | | | | | | | | | | | | | | | | | | | |

 | | | | | | | | | | | | | | | | | | | |

 | | | | | | | | | | | | | | | | | | | |

 | | | | | | | | | | | | | | | | | | | |

 | | | | | | | | | | | | | | | | | | | |

 | | | | | | | | | | | | | | | | | | | |

 | | | | | | | | | | | | | | | | | | | |

 | | | | | | | | | | | | | | | | | | | |

 | | | | | | | | | | | | | | | | | | | |

 | | | | | | | | | | | | | | | | | | | |

 | | | | | | | | | | | | | | | | | | | |

 | | | | | | | | | | | | | | | | | | | |

 | | | | | | | | | | | | | | | | | | | |
 | | | | | | | | | | | | | | | | | | | |

 | | | | | | | | | | | | | | | | | | | |

 | | | | | | | | | | | | | | | | | | | |
 | | | | | | | | | | | | | | | | | | | |

 | | | | | | | | | | | | | | | | | | | |

 | | | | | | | | | | | | | | | | | | | |
 | | | | | | | | | | | | | | | | | | | |
 | | | | | | | | | | | | | | | | | | | |

 | | | | | | | | | | | | | | | | | | | |
 | | | | | | | | | | | | | | | | | | | |
 | | | | | | | | | | | | | | | | | | | |

 | | | | | | | | | | | | | | | | | | | | | | | | | | | | | | | | | | | | | | | | | | | | | | | | | | | | | | | | | | | | | | | | | | | | | | | | | | | | | | | | | | | | | | | | | | | | | | | | | | | |
 | | | | | | | | | | | | | | | | | | | |
 | | | | | | | | | | | | | | | | | | | |
 | | | | | | | | | | | | | | | | | | | |
 | | | | | | | | | | | | | | | | | | | |
 | | | | | | | | | | | | | | | | | | | |
 | | | | | | | | | | | | | | | | | | | |
 | | | | | | | | | | | | | | | | | | | |
 | | | | | | | | | | | | | | | | | | | |
 | | | | | | | | | | | | | | | | | | | | | | | | | | | | | | | | | | | | | | | |
 | | | | | | | | | | | | | | | | | | | |
 | | | | | | | | | | | | | | | | | | | | | | | | | | | | | | | | | | | | | | | |
 | | | | | | | | | | | | | | | | | | | | | | | | | | | | | | | | | | | | | | | |
 | | | | | | | | | | | | | | | | | | | | | | | | | | | | | | | | | | | | | | | |
 | | | | | | | | | | | | | | | | | | | | | | | | | | | | | | | | | | | | | | | | | | | | | | | | | | | | | | | | | | | | | | | | | | | | | | | | | | | | | | | | | | | | | | | | | | | | | | | | | | | |
 | | | | | | | | | | | | | | | | | | | | | | | | | | | | | | | | | | | | | | | | | | | | | | | |
| | | <table border="1" style="width: 100%; border-collapse: collapse; text-align: center;"> <tr> <td style="width: 10%;"></td> <td style="width: 10%;"></td> <td style="width: 10%;"></td> <td style="width: 10%;"></td> <td style="width: 10%;"></td> <td style="width: 10%;"></td> <td style="width: 10%;"></td> <td style="width: 10%;"></td> <td style="width: 10%;"></td> <td style="width: 10%;"></td> </tr> <tr> <td></td> <td></td> <td colspan="8" style="text-align: center;"> <table border="1" style="width: 100%; border-collapse: collapse; text-align: center;"> <tr> <td style="width: 10%;"></td> <td style="width: 10%;"></td> <td style="width: 10%;"></td> <td style="width: 10%;"></td> <td style="width: 10%;"></td> <td style="width: 10%;"></td> <td style="width: 10%;"></td> <td style="width: 10%;"></td> <td style="width: 10%;"></td> <td style="width: 10%;"></td> </tr> <tr> <td></td> <td></td> <td colspan="8" style="text-align: center;"> <table border="1" style="width: 100%; border-collapse: collapse; text-align: center;"> <tr> <td style="width: 10%;"></td> <td style="width: 10%;"></td> <td style="width: 10%;"></td> <td style="width: 10%;"></td> <td style="width: 10%;"></td> <td style="width: 10%;"></td> <td style="width: 10%;"></td> <td style="width: 10%;"></td> <td style="width: 10%;"></td> <td style="width: 10%;"></td> </tr> <tr> <td></td> <td></td> <td colspan="8" style="text-align: center;"> <table border="1" style="width: 100%; border-collapse: collapse; text-align: center;"> <tr> <td style="width: 10%;"></td> <td style="width: 10%;"></td> <td style="width: 10%;"></td> <td style="width: 10%;"></td> <td style="width: 10%;"></td> <td style="width: 10%;"></td> <td style="width: 10%;"></td> <td style="width: 10%;"></td> <td style="width: 10%;"></td> <td style="width: 10%;"></td> </tr> <tr> <td></td> <td></td> <td colspan="8" style="text-align: center;"> <table border="1" style="width: 100%; border-collapse: collapse; text-align: center;"> <tr> <td style="width: 10%;"></td> <td style="width: 10%;"></td> <td style="width: 10%;"></td> <td style="width: 10%;"></td> <td style="width: 10%;"></td> <td style="width: 10%;"></td> <td style="width: 10%;"></td> <td style="width: 10%;"></td> <td style="width: 10%;"></td> <td style="width: 10%;"></td> </tr> <tr> <td></td> <td></td> <td colspan="8" style="text-align: center;"> <table border="1" style="width: 100%; border-collapse: collapse; text-align: center;"> <tr> <td style="width: 10%;"></td> <td style="width: 10%;"></td> <td style="width: 10%;"></td> <td style="width: 10%;"></td> <td style="width: 10%;"></td> <td style="width: 10%;"></td> <td style="width: 10%;"></td> <td style="width: 10%;"></td> <td style="width: 10%;"></td> <td style="width: 10%;"></td> </tr> <tr> <td></td> <td></td> <td colspan="8" style="text-align: center;"> <table border="1" style="width: 100%; border-collapse: collapse; text-align: center;"> <tr> <td style="width: 10%;"></td> <td style="width: 10%;"></td> <td style="width: 10%;"></td> <td style="width: 10%;"></td> <td style="width: 10%;"></td> <td style="width: 10%;"></td> <td style="width: 10%;"></td> <td style="width: 10%;"></td> <td style="width: 10%;"></td> <td style="width: 10%;"></td> </tr> <tr> <td></td> <td></td> <td colspan="8" style="text-align: center;"> <table border="1" style="width: 100%; border-collapse: collapse; text-align: center;"> <tr> <td style="width: 10%;"></td> <td style="width: 10%;"></td> <td style="width: 10%;"></td> <td style="width: 10%;"></td> <td style="width: 10%;"></td> <td style="width: 10%;"></td> <td style="width: 10%;"></td> <td style="width: 10%;"></td> <td style="width: 10%;"></td> <td style="width: 10%;"></td> </tr> <tr> <td></td> <td></td> <td colspan="8" style="text-align: center;"> <table border="1" style="width: 100%; border-collapse: collapse; text-align: center;"> <tr> <td style="width: 10%;"></td> <td style="width: 10%;"></td> <td style="width: 10%;"></td> <td style="width: 10%;"></td> <td style="width: 10%;"></td> <td style="width: 10%;"></td> <td style="width: 10%;"></td> <td style="width: 10%;"></td> <td style="width: 10%;"></td> <td style="width: 10%;"></td> </tr> <tr> <td></td> <td></td> <td colspan="8" style="text-align: center;"> <table border="1" style="width: 100%; border-collapse: collapse; text-align: center;"> <tr> <td style="width: 10%;"></td> <td style="width: 10%;"></td> <td style="width: 10%;"></td> <td style="width: 10%;"></td> <td style="width: 10%;"></td> <td style="width: 10%;"></td> <td style="width: 10%;"></td> <td style="width: 10%;"></td> <td style="width: 10%;"></td> <td style="width: 10%;"></td> </tr> <tr> <td></td> <td></td> <td colspan="8" style="text-align: center;"> <table border="1" style="width: 100%; border-collapse: collapse; text-align: center;"> <tr> <td style="width: 10%;"></td> <td style="width: 10%;"></td> <td style="width: 10%;"></td> <td style="width: 10%;"></td> <td style="width: 10%;"></td> <td style="width: 10%;"></td> <td style="width: 10%;"></td> <td style="width: 10%;"></td> <td style="width: 10%;"></td> <td style="width: 10%;"></td> </tr> <tr> <td></td> <td></td> <td colspan="8" style="text-align: center;"> <table border="1" style="width: 100%; border-collapse: collapse; text-align: center;"> <tr> <td style="width: 10%;"></td> <td style="width: 10%;"></td> <td style="width: 10%;"></td> <td style="width: 10%;"></td> <td style="width: 10%;"></td> <td style="width: 10%;"></td> <td style="width: 10%;"></td> <td style="width: 10%;"></td> <td style="width: 10%;"></td> <td style="width: 10%;"></td> </tr> <tr> <td></td> <td></td> <td colspan="8" style="text-align: center;"> <table border="1" style="width: 100%; border-collapse: collapse; text-align: center;"> <tr> <td style="width: 10%;"></td> <td style="width: 10%;"></td> <td style="width: 10%;"></td> <td style="width: 10%;"></td> <td style="width: 10%;"></td> <td style="width: 10%;"></td> <td style="width: 10%;"></td> <td style="width: 10%;"></td> <td style="width: 10%;"></td> <td style="width: 10%;"></td> </tr> <tr> <td></td> <td></td> <td colspan="8" style="text-align: center;"> <table border="1" style="width: 100%; border-collapse: collapse; text-align: center;"> <tr> <td style="width: 10%;"></td> <td style="width: 10%;"></td> <td style="width: 10%;"></td> <td style="width: 10%;"></td> <td style="width: 10%;"></td> <td style="width: 10%;"></td> <td style="width: 10%;"></td> <td style="width: 10%;"></td> <td style="width: 10%;"></td> <td style="width: 10%;"></td> </tr> <tr> <td></td> <td></td> <td colspan="8" style="text-align: center;"> <table border="1" style="width: 100%; border-collapse: collapse; text-align: center;"> <tr> <td style="width: 10%;"></td> <td style="width: 10%;"></td> <td style="width: 10%;"></td> <td style="width: 10%;"></td> <td style="width: 10%;"></td> <td style="width: 10%;"></td> <td style="width: 10%;"></td> <td style="width: 10%;"></td> <td style="width: 10%;"></td> <td style="width: 10%;"></td> </tr> <tr> <td></td> <td></td> <td colspan="8" style="text-align: center;"> <table border="1" style="width: 100%; border-collapse: collapse; text-align: center;"> <tr> <td style="width: 10%;"></td> <td style="width: 10%;"></td> <td style="width: 10%;"></td> <td style="width: 10%;"></td> <td style="width: 10%;"></td> <td style="width: 10%;"></td> <td style="width: 10%;"></td> <td style="width: 10%;"></td> <td style="width: 10%;"></td> <td style="width: 10%;"></td> </tr> <tr> <td></td> <td></td> <td colspan="8" style="text-align: center;"> <table border="1" style="width: 100%; border-collapse: collapse; text-align: center;"> <tr> <td style="width: 10%;"></td> <td style="width: 10%;"></td> <td style="width: 10%;"></td> <td style="width: 10%;"></td> <td style="width: 10%;"></td> <td style="width: 10%;"></td> <td style="width: 10%;"></td> <td style="width: 10%;"></td> <td style="width: 10%;"></td> <td style="width: 10%;"></td> </tr> <tr> <td></td> <td></td> <td colspan="8" style="text-align: center;"> <table border="1" style="width: 100%; border-collapse: collapse; text-align: center;"> <tr> <td style="width: 10%;"></td> <td style="width: 10%;"></td> <td style="width: 10%;"></td> <td style="width: 10%;"></td> <td style="width: 10%;"></td> <td style="width: 10%;"></td> <td style="width: 10%;"></td> <td style="width: 10%;"></td> <td style="width: 10%;"></td> <td style="width: 10%;"></td> </tr> <tr> <td></td> <td></td> <td colspan="8" style="text-align: center;"> <table border="1" style="width: 100%; border-collapse: collapse; text-align: center;"> <tr> <td style="width: 10%;"></td> <td style="width: 10%;"></td> <td style="width: 10%;"></td> <td style="width: 10%;"></td> <td style="width: 10%;"></td> <td style="width: 10%;"></td> <td style="width: 10%;"></td> <td style="width: 10%;"></td> <td style="width: 10%;"></td> <td style="width: 10%;"></td> </tr> <tr> <td></td> <td></td> <td colspan="8" style="text-align: center;"> <table border="1" style="width: 100%; border-collapse: collapse; text-align: center;"> <tr> <td style="width: 10%;"></td> <td style="width: 10%;"></td> <td style="width: 10%;"></td> <td style="width: 10%;"></td> <td style="width: 10%;"></td> <td style="width: 10%;"></td> <td style="width: 10%;"></td> <td style="width: 10%;"></td> <td style="width: 10%;"></td> <td style="width: 10%;"></td> </tr> <tr> <td></td> <td></td> <td colspan="8" style="text-align: center;"> <table border="1" style="width: 100%; border-collapse: collapse; text-align: center;"> <tr> <td style="width: 10%;"></td> <td style="width: 10%;"></td> <td style="width: 10%;"></td> <td style="width: 10%;"></td> <td style="width: 10%;"></td> <td style="width: 10%;"></td> <td style="width: 10%;"></td> <td style="width: 10%;"></td> <td style="width: 10%;"></td> <td style="width: 10%;"></td> </tr> <tr> <td></td> <td></td> <td colspan="8" style="text-align: center;"> <table border="1" style="width: 100%; border-collapse: collapse; text-align: center;"> <tr> <td style="width: 10%;"></td> <td style="width: 10%;"></td> <td
style="width: 10%;"></td> <td style="width: 10%;"></td> <td style="width: 10%;"></td> <td style="width: 10%;"></td> <td style="width: 10%;"></td> <td style="width: 10%;"></td> <td style="width: 10%;"></td> <td style="width: 10%;"></td> </tr> <tr> <td></td> <td></td> <td colspan="8" style="text-align: center;"> <table border="1" style="width: 100%; border-collapse: collapse; text-align: center;"> <tr> <td style="width: 10%;"></td> <td style="width: 10%;"></td> <td style="width: 10%;"></td> <td style="width: 10%;"></td> <td style="width: 10%;"></td> <td style="width: 10%;"></td> <td style="width: 10%;"></td> <td style="width: 10%;"></td> <td style="width: 10%;"></td> <td style="width: 10%;"></td> </tr> <tr> <td></td> <td></td> <td colspan="8" style="text-align: center;"> <table border="1" style="width: 100%; border-collapse: collapse; text-align: center;"> <tr> <td style="width: 10%;"></td> <td style="width: 10%;"></td> <td style="width: 10%;"></td> <td style="width: 10%;"></td> <td style="width: 10%;"></td> <td style="width: 10%;"></td> <td style="width: 10%;"></td> <td style="width: 10%;"></td> <td style="width: 10%;"></td> <td style="width: 10%;"></td> </tr> <tr> <td></td> <td></td> <td colspan="8" style="text-align: center;"> <table border="1" style="width: 100%; border-collapse: collapse; text-align: center;"> <tr> <td style="width: 10%;"></td> <td style="width: 10%;"></td> <td style="width: 10%;"></td> <td style="width: 10%;"></td> <td style="width: 10%;"></td> <td style="width: 10%;"></td> <td style="width: 10%;"></td> <td style="width: 10%;"></td> <td style="width: 10%;"></td> <td style="width: 10%;"></td> </tr> <tr> <td></td> <td></td> <td colspan="8" style="text-align: center;"> <table border="1" style="width: 100%; border-collapse: collapse; text-align: center;"> <tr> <td style="width: 10%;"></td> <td style="width: 10%;"></td> <td style="width: 10%;"></td> <td style="width: 10%;"></td> <td style="width: 10%;"></td> <td style="width: 10%;"></td> <td style="width: 10%;"></td> <td style="width: 10%;"></td> <td style="width: 10%;"></td> <td style="width: 10%;"></td> </tr> <tr> <td></td> <td></td> <td colspan="8" style="text-align: center;"> <table border="1" style="width: 100%; border-collapse: collapse; text-align: center;"> <tr> </tr></table></td></tr></table></td></tr></table></td></tr></table></td></tr></table></td></tr></table></td></tr></table></td></tr></table></td></tr></table></td></tr></table></td></tr></table></td></tr></table></td></tr></table></td></tr></table></td></tr></table></td></tr></table></td></tr></table></td></tr></table></td></tr></table></td></tr></table></td></tr></table></td></tr></table></td></tr></table></td></tr></table></td></tr></table></td></tr></table></td></tr></table>

 | | | | | | | | | | | | | | | | | | | | <table border="1" style="width: 100%; border-collapse: collapse; text-align: center;"> <tr> <td style="width: 10%;"></td> <td style="width: 10%;"></td> <td style="width: 10%;"></td> <td style="width: 10%;"></td> <td style="width: 10%;"></td> <td style="width: 10%;"></td> <td style="width: 10%;"></td> <td style="width: 10%;"></td> <td style="width: 10%;"></td> <td style="width: 10%;"></td> </tr> <tr> <td></td> <td></td> <td colspan="8" style="text-align: center;"> <table border="1" style="width: 100%; border-collapse: collapse; text-align: center;"> <tr> <td style="width: 10%;"></td> <td style="width: 10%;"></td> <td style="width: 10%;"></td> <td style="width: 10%;"></td> <td style="width: 10%;"></td> <td style="width: 10%;"></td> <td style="width: 10%;"></td> <td style="width: 10%;"></td> <td style="width: 10%;"></td> <td style="width: 10%;"></td> </tr> <tr> <td></td> <td></td> <td colspan="8" style="text-align: center;"> <table border="1" style="width: 100%; border-collapse: collapse; text-align: center;"> <tr> <td style="width: 10%;"></td> <td style="width: 10%;"></td> <td style="width: 10%;"></td> <td style="width: 10%;"></td> <td style="width: 10%;"></td> <td style="width: 10%;"></td> <td style="width: 10%;"></td> <td style="width: 10%;"></td> <td style="width: 10%;"></td> <td style="width: 10%;"></td> </tr> <tr> <td></td> <td></td> <td colspan="8" style="text-align: center;"> <table border="1" style="width: 100%; border-collapse: collapse; text-align: center;"> <tr> <td style="width: 10%;"></td> <td style="width: 10%;"></td> <td style="width: 10%;"></td> <td style="width: 10%;"></td> <td style="width: 10%;"></td> <td style="width: 10%;"></td> <td style="width: 10%;"></td> <td style="width: 10%;"></td> <td style="width: 10%;"></td> <td style="width: 10%;"></td> </tr> <tr> <td></td> <td></td> <td colspan="8" style="text-align: center;"> <table border="1" style="width: 100%; border-collapse: collapse; text-align: center;"> <tr> <td style="width: 10%;"></td> <td style="width: 10%;"></td> <td style="width: 10%;"></td> <td style="width: 10%;"></td> <td style="width: 10%;"></td> <td style="width: 10%;"></td> <td style="width: 10%;"></td> <td style="width: 10%;"></td> <td style="width: 10%;"></td> <td style="width: 10%;"></td> </tr> <tr> <td></td> <td></td> <td colspan="8" style="text-align: center;"> <table border="1" style="width: 100%; border-collapse: collapse; text-align: center;"> <tr> <td style="width: 10%;"></td> <td style="width: 10%;"></td> <td style="width: 10%;"></td> <td style="width: 10%;"></td> <td style="width: 10%;"></td> <td style="width: 10%;"></td> <td style="width: 10%;"></td> <td style="width: 10%;"></td> <td style="width: 10%;"></td> <td style="width: 10%;"></td> </tr> <tr> <td></td> <td></td> <td colspan="8" style="text-align: center;"> <table border="1" style="width: 100%; border-collapse: collapse; text-align: center;"> <tr> <td style="width: 10%;"></td> <td style="width: 10%;"></td> <td style="width: 10%;"></td> <td style="width: 10%;"></td> <td style="width: 10%;"></td> <td style="width: 10%;"></td> <td style="width: 10%;"></td> <td style="width: 10%;"></td> <td style="width: 10%;"></td> <td style="width: 10%;"></td> </tr> <tr> <td></td> <td></td> <td colspan="8" style="text-align: center;"> <table border="1" style="width: 100%; border-collapse: collapse; text-align: center;"> <tr> <td style="width: 10%;"></td> <td style="width: 10%;"></td> <td style="width: 10%;"></td> <td style="width: 10%;"></td> <td style="width: 10%;"></td> <td style="width: 10%;"></td> <td style="width: 10%;"></td> <td style="width: 10%;"></td> <td style="width: 10%;"></td> <td style="width: 10%;"></td> </tr> <tr> <td></td> <td></td> <td colspan="8" style="text-align: center;"> <table border="1" style="width: 100%; border-collapse: collapse; text-align: center;"> <tr> <td style="width: 10%;"></td> <td style="width: 10%;"></td> <td style="width: 10%;"></td> <td style="width: 10%;"></td> <td style="width: 10%;"></td> <td style="width: 10%;"></td> <td style="width: 10%;"></td> <td style="width: 10%;"></td> <td style="width: 10%;"></td> <td style="width: 10%;"></td> </tr> <tr> <td></td> <td></td> <td colspan="8" style="text-align: center;"> <table border="1" style="width: 100%; border-collapse: collapse; text-align: center;"> <tr> <td style="width: 10%;"></td> <td style="width: 10%;"></td> <td style="width: 10%;"></td> <td style="width: 10%;"></td> <td style="width: 10%;"></td> <td style="width: 10%;"></td> <td style="width: 10%;"></td> <td style="width: 10%;"></td> <td style="width: 10%;"></td> <td style="width: 10%;"></td> </tr> <tr> <td></td> <td></td> <td colspan="8" style="text-align: center;"> <table border="1" style="width: 100%; border-collapse: collapse; text-align: center;"> <tr> <td style="width: 10%;"></td> <td style="width: 10%;"></td> <td style="width: 10%;"></td> <td style="width: 10%;"></td> <td style="width: 10%;"></td> <td style="width: 10%;"></td> <td style="width: 10%;"></td> <td style="width: 10%;"></td> <td style="width: 10%;"></td> <td style="width: 10%;"></td> </tr> <tr> <td></td> <td></td> <td colspan="8" style="text-align: center;"> <table border="1" style="width: 100%; border-collapse: collapse; text-align: center;"> <tr> <td style="width: 10%;"></td> <td style="width: 10%;"></td> <td style="width: 10%;"></td> <td style="width: 10%;"></td> <td style="width: 10%;"></td> <td style="width: 10%;"></td> <td style="width: 10%;"></td> <td style="width: 10%;"></td> <td style="width: 10%;"></td> <td style="width: 10%;"></td> </tr> <tr> <td></td> <td></td> <td colspan="8" style="text-align: center;"> <table border="1" style="width: 100%; border-collapse: collapse; text-align: center;"> <tr> <td style="width: 10%;"></td> <td style="width: 10%;"></td> <td style="width: 10%;"></td> <td style="width: 10%;"></td> <td style="width: 10%;"></td> <td style="width: 10%;"></td> <td style="width: 10%;"></td> <td style="width: 10%;"></td> <td style="width: 10%;"></td> <td style="width: 10%;"></td> </tr> <tr> <td></td> <td></td> <td colspan="8" style="text-align: center;"> <table border="1" style="width: 100%; border-collapse: collapse; text-align: center;"> <tr> <td style="width: 10%;"></td> <td style="width: 10%;"></td> <td style="width: 10%;"></td> <td style="width: 10%;"></td> <td style="width: 10%;"></td> <td style="width: 10%;"></td> <td style="width: 10%;"></td> <td style="width: 10%;"></td> <td style="width: 10%;"></td> <td style="width: 10%;"></td> </tr> <tr> <td></td> <td></td> <td colspan="8" style="text-align: center;"> <table border="1" style="width: 100%; border-collapse: collapse; text-align: center;"> <tr> <td style="width: 10%;"></td> <td style="width: 10%;"></td> <td style="width: 10%;"></td> <td style="width: 10%;"></td> <td style="width: 10%;"></td> <td style="width: 10%;"></td> <td style="width: 10%;"></td> <td style="width: 10%;"></td> <td style="width: 10%;"></td> <td style="width: 10%;"></td> </tr> <tr> <td></td> <td></td> <td colspan="8" style="text-align: center;"> <table border="1" style="width: 100%; border-collapse: collapse; text-align: center;"> <tr> <td style="width: 10%;"></td> <td style="width: 10%;"></td> <td style="width: 10%;"></td> <td style="width: 10%;"></td> <td style="width: 10%;"></td> <td style="width: 10%;"></td> <td style="width: 10%;"></td> <td style="width: 10%;"></td> <td style="width: 10%;"></td> <td style="width: 10%;"></td> </tr> <tr> <td></td> <td></td> <td colspan="8" style="text-align: center;"> <table border="1" style="width: 100%; border-collapse: collapse; text-align: center;"> <tr> <td style="width: 10%;"></td> <td style="width: 10%;"></td> <td style="width: 10%;"></td> <td style="width: 10%;"></td> <td style="width: 10%;"></td> <td style="width: 10%;"></td> <td style="width: 10%;"></td> <td style="width: 10%;"></td> <td style="width: 10%;"></td> <td style="width: 10%;"></td> </tr> <tr> <td></td> <td></td> <td colspan="8" style="text-align: center;"> <table border="1" style="width: 100%; border-collapse: collapse; text-align: center;"> <tr> <td style="width: 10%;"></td> <td style="width: 10%;"></td> <td style="width: 10%;"></td> <td style="width: 10%;"></td> <td style="width: 10%;"></td> <td style="width: 10%;"></td> <td style="width: 10%;"></td> <td style="width: 10%;"></td> <td style="width: 10%;"></td> <td style="width: 10%;"></td> </tr> <tr> <td></td> <td></td> <td colspan="8" style="text-align: center;"> <table border="1" style="width: 100%; border-collapse: collapse; text-align: center;"> <tr> <td style="width: 10%;"></td> <td style="width: 10%;"></td> <td style="width: 10%;"></td> <td style="width: 10%;"></td> <td style="width: 10%;"></td> <td style="width: 10%;"></td> <td
style="width: 10%;"></td> <td style="width: 10%;"></td> <td style="width: 10%;"></td> <td style="width: 10%;"></td> </tr> <tr> <td></td> <td></td> <td colspan="8" style="text-align: center;"> <table border="1" style="width: 100%; border-collapse: collapse; text-align: center;"> <tr> <td style="width: 10%;"></td> <td style="width: 10%;"></td> <td style="width: 10%;"></td> <td style="width: 10%;"></td> <td style="width: 10%;"></td> <td style="width: 10%;"></td> <td style="width: 10%;"></td> <td style="width: 10%;"></td> <td style="width: 10%;"></td> <td style="width: 10%;"></td> </tr> <tr> <td></td> <td></td> <td colspan="8" style="text-align: center;"> <table border="1" style="width: 100%; border-collapse: collapse; text-align: center;"> <tr> <td style="width: 10%;"></td> <td style="width: 10%;"></td> <td style="width: 10%;"></td> <td style="width: 10%;"></td> <td style="width: 10%;"></td> <td style="width: 10%;"></td> <td style="width: 10%;"></td> <td style="width: 10%;"></td> <td style="width: 10%;"></td> <td style="width: 10%;"></td> </tr> <tr> <td></td> <td></td> <td colspan="8" style="text-align: center;"> <table border="1" style="width: 100%; border-collapse: collapse; text-align: center;"> <tr> <td style="width: 10%;"></td> <td style="width: 10%;"></td> <td style="width: 10%;"></td> <td style="width: 10%;"></td> <td style="width: 10%;"></td> <td style="width: 10%;"></td> <td style="width: 10%;"></td> <td style="width: 10%;"></td> <td style="width: 10%;"></td> <td style="width: 10%;"></td> </tr> <tr> <td></td> <td></td> <td colspan="8" style="text-align: center;"> <table border="1" style="width: 100%; border-collapse: collapse; text-align: center;"> <tr> <td style="width: 10%;"></td> <td style="width: 10%;"></td> <td style="width: 10%;"></td> <td style="width: 10%;"></td> <td style="width: 10%;"></td> <td style="width: 10%;"></td> <td style="width: 10%;"></td> <td style="width: 10%;"></td> <td style="width: 10%;"></td> <td style="width: 10%;"></td> </tr> <tr> <td></td> <td></td> <td colspan="8" style="text-align: center;"> <table border="1" style="width: 100%; border-collapse: collapse; text-align: center;"> <tr> <td style="width: 10%;"></td> <td style="width: 10%;"></td> <td style="width: 10%;"></td> <td style="width: 10%;"></td> <td style="width: 10%;"></td> <td style="width: 10%;"></td> <td style="width: 10%;"></td> <td style="width: 10%;"></td> <td style="width: 10%;"></td> <td style="width: 10%;"></td> </tr> <tr> <td></td> <td></td> <td colspan="8" style="text-align: center;"> <table border="1" style="width: 100%; border-collapse: collapse; text-align: center;"> <tr> <td style="width: 10%;"></td> <td style="width: 10%;"></td> <td style="width: 10%;"></td> <td style="width: 10%;"></td> <td style="width: 10%;"></td> <td style="width: 10%;"></td> <td style="width: 10%;"></td> <td style="width: 10%;"></td> <td style="width: 10%;"></td> <td style="width: 10%;"></td> </tr> <tr> <td></td> <td></td> <td colspan="8" style="text-align: center;"> <table border="1" style="width: 100%; border-collapse: collapse; text-align: center;"> <tr> </tr></table></td></tr></table></td></tr></table></td></tr></table></td></tr></table></td></tr></table></td></tr></table></td></tr></table></td></tr></table></td></tr></table></td></tr></table></td></tr></table></td></tr></table></td></tr></table></td></tr></table></td></tr></table></td></tr></table></td></tr></table></td></tr></table></td></tr></table></td></tr></table></td></tr></table></td></tr></table></td></tr></table></td></tr></table></td></tr></table>

 | | | | | | | | | | | | | | | | | | | | <table border="1" style="width: 100%; border-collapse: collapse; text-align: center;"> <tr> <td style="width: 10%;"></td> <td style="width: 10%;"></td> <td style="width: 10%;"></td> <td style="width: 10%;"></td> <td style="width: 10%;"></td> <td style="width: 10%;"></td> <td style="width: 10%;"></td> <td style="width: 10%;"></td> <td style="width: 10%;"></td> <td style="width: 10%;"></td> </tr> <tr> <td></td> <td></td> <td colspan="8" style="text-align: center;"> <table border="1" style="width: 100%; border-collapse: collapse; text-align: center;"> <tr> <td style="width: 10%;"></td> <td style="width: 10%;"></td> <td style="width: 10%;"></td> <td style="width: 10%;"></td> <td style="width: 10%;"></td> <td style="width: 10%;"></td> <td style="width: 10%;"></td> <td style="width: 10%;"></td> <td style="width: 10%;"></td> <td style="width: 10%;"></td> </tr> <tr> <td></td> <td></td> <td colspan="8" style="text-align: center;"> <table border="1" style="width: 100%; border-collapse: collapse; text-align: center;"> <tr> <td style="width: 10%;"></td> <td style="width: 10%;"></td> <td style="width: 10%;"></td> <td style="width: 10%;"></td> <td style="width: 10%;"></td> <td style="width: 10%;"></td> <td style="width: 10%;"></td> <td style="width: 10%;"></td> <td style="width: 10%;"></td> <td style="width: 10%;"></td> </tr> <tr> <td></td> <td></td> <td colspan="8" style="text-align: center;"> <table border="1" style="width: 100%; border-collapse: collapse; text-align: center;"> <tr> <td style="width: 10%;"></td> <td style="width: 10%;"></td> <td style="width: 10%;"></td> <td style="width: 10%;"></td> <td style="width: 10%;"></td> <td style="width: 10%;"></td> <td style="width: 10%;"></td> <td style="width: 10%;"></td> <td style="width: 10%;"></td> <td style="width: 10%;"></td> </tr> <tr> <td></td> <td></td> <td colspan="8" style="text-align: center;"> <table border="1" style="width: 100%; border-collapse: collapse; text-align: center;"> <tr> <td style="width: 10%;"></td> <td style="width: 10%;"></td> <td style="width: 10%;"></td> <td style="width: 10%;"></td> <td style="width: 10%;"></td> <td style="width: 10%;"></td> <td style="width: 10%;"></td> <td style="width: 10%;"></td> <td style="width: 10%;"></td> <td style="width: 10%;"></td> </tr> <tr> <td></td> <td></td> <td colspan="8" style="text-align: center;"> <table border="1" style="width: 100%; border-collapse: collapse; text-align: center;"> <tr> <td style="width: 10%;"></td> <td style="width: 10%;"></td> <td style="width: 10%;"></td> <td style="width: 10%;"></td> <td style="width: 10%;"></td> <td style="width: 10%;"></td> <td style="width: 10%;"></td> <td style="width: 10%;"></td> <td style="width: 10%;"></td> <td style="width: 10%;"></td> </tr> <tr> <td></td> <td></td> <td colspan="8" style="text-align: center;"> <table border="1" style="width: 100%; border-collapse: collapse; text-align: center;"> <tr> <td style="width: 10%;"></td> <td style="width: 10%;"></td> <td style="width: 10%;"></td> <td style="width: 10%;"></td> <td style="width: 10%;"></td> <td style="width: 10%;"></td> <td style="width: 10%;"></td> <td style="width: 10%;"></td> <td style="width: 10%;"></td> <td style="width: 10%;"></td> </tr> <tr> <td></td> <td></td> <td colspan="8" style="text-align: center;"> <table border="1" style="width: 100%; border-collapse: collapse; text-align: center;"> <tr> <td style="width: 10%;"></td> <td style="width: 10%;"></td> <td style="width: 10%;"></td> <td style="width: 10%;"></td> <td style="width: 10%;"></td> <td style="width: 10%;"></td> <td style="width: 10%;"></td> <td style="width: 10%;"></td> <td style="width: 10%;"></td> <td style="width: 10%;"></td> </tr> <tr> <td></td> <td></td> <td colspan="8" style="text-align: center;"> <table border="1" style="width: 100%; border-collapse: collapse; text-align: center;"> <tr> <td style="width: 10%;"></td> <td style="width: 10%;"></td> <td style="width: 10%;"></td> <td style="width: 10%;"></td> <td style="width: 10%;"></td> <td style="width: 10%;"></td> <td style="width: 10%;"></td> <td style="width: 10%;"></td> <td style="width: 10%;"></td> <td style="width: 10%;"></td> </tr> <tr> <td></td> <td></td> <td colspan="8" style="text-align: center;"> <table border="1" style="width: 100%; border-collapse: collapse; text-align: center;"> <tr> <td style="width: 10%;"></td> <td style="width: 10%;"></td> <td style="width: 10%;"></td> <td style="width: 10%;"></td> <td style="width: 10%;"></td> <td style="width: 10%;"></td> <td style="width: 10%;"></td> <td style="width: 10%;"></td> <td style="width: 10%;"></td> <td style="width: 10%;"></td> </tr> <tr> <td></td> <td></td> <td colspan="8" style="text-align: center;"> <table border="1" style="width: 100%; border-collapse: collapse; text-align: center;"> <tr> <td style="width: 10%;"></td> <td style="width: 10%;"></td> <td style="width: 10%;"></td> <td style="width: 10%;"></td> <td style="width: 10%;"></td> <td style="width: 10%;"></td> <td style="width: 10%;"></td> <td style="width: 10%;"></td> <td style="width: 10%;"></td> <td style="width: 10%;"></td> </tr> <tr> <td></td> <td></td> <td colspan="8" style="text-align: center;"> <table border="1" style="width: 100%; border-collapse: collapse; text-align: center;"> <tr> <td style="width: 10%;"></td> <td style="width: 10%;"></td> <td style="width: 10%;"></td> <td style="width: 10%;"></td> <td style="width: 10%;"></td> <td style="width: 10%;"></td> <td style="width: 10%;"></td> <td style="width: 10%;"></td> <td style="width: 10%;"></td> <td style="width: 10%;"></td> </tr> <tr> <td></td> <td></td> <td colspan="8" style="text-align: center;"> <table border="1" style="width: 100%; border-collapse: collapse; text-align: center;"> <tr> <td style="width: 10%;"></td> <td style="width: 10%;"></td> <td style="width: 10%;"></td> <td style="width: 10%;"></td> <td style="width: 10%;"></td> <td style="width: 10%;"></td> <td style="width: 10%;"></td> <td style="width: 10%;"></td> <td style="width: 10%;"></td> <td style="width: 10%;"></td> </tr> <tr> <td></td> <td></td> <td colspan="8" style="text-align: center;"> <table border="1" style="width: 100%; border-collapse: collapse; text-align: center;"> <tr> <td style="width: 10%;"></td> <td style="width: 10%;"></td> <td style="width: 10%;"></td> <td style="width: 10%;"></td> <td style="width: 10%;"></td> <td style="width: 10%;"></td> <td style="width: 10%;"></td> <td style="width: 10%;"></td> <td style="width: 10%;"></td> <td style="width: 10%;"></td> </tr> <tr> <td></td> <td></td> <td colspan="8" style="text-align: center;"> <table border="1" style="width: 100%; border-collapse: collapse; text-align: center;"> <tr> <td style="width: 10%;"></td> <td style="width: 10%;"></td> <td style="width: 10%;"></td> <td style="width: 10%;"></td> <td style="width: 10%;"></td> <td style="width: 10%;"></td> <td style="width: 10%;"></td> <td style="width: 10%;"></td> <td style="width: 10%;"></td> <td style="width: 10%;"></td> </tr> <tr> <td></td> <td></td> <td colspan="8" style="text-align: center;"> <table border="1" style="width: 100%; border-collapse: collapse; text-align: center;"> <tr> <td style="width: 10%;"></td> <td style="width: 10%;"></td> <td style="width: 10%;"></td> <td style="width: 10%;"></td> <td style="width: 10%;"></td> <td style="width: 10%;"></td> <td style="width: 10%;"></td> <td style="width: 10%;"></td> <td style="width: 10%;"></td> <td style="width: 10%;"></td> </tr> <tr> <td></td> <td></td> <td colspan="8" style="text-align: center;"> <table border="1" style="width: 100%; border-collapse: collapse; text-align: center;"> <tr> <td style="width: 10%;"></td> <td style="width: 10%;"></td> <td style="width: 10%;"></td> <td style="width: 10%;"></td> <td style="width: 10%;"></td> <td style="width: 10%;"></td> <td style="width: 10%;"></td> <td style="width: 10%;"></td> <td style="width: 10%;"></td> <td style="width: 10%;"></td> </tr> <tr> <td></td> <td></td> <td
colspan="8" style="text-align: center;"> <table border="1" style="width: 100%; border-collapse: collapse; text-align: center;"> <tr> <td style="width: 10%;"></td> <td style="width: 10%;"></td> <td style="width: 10%;"></td> <td style="width: 10%;"></td> <td style="width: 10%;"></td> <td style="width: 10%;"></td> <td style="width: 10%;"></td> <td style="width: 10%;"></td> <td style="width: 10%;"></td> <td style="width: 10%;"></td> </tr> <tr> <td></td> <td></td> <td colspan="8" style="text-align: center;"> <table border="1" style="width: 100%; border-collapse: collapse; text-align: center;"> <tr> <td style="width: 10%;"></td> <td style="width: 10%;"></td> <td style="width: 10%;"></td> <td style="width: 10%;"></td> <td style="width: 10%;"></td> <td style="width: 10%;"></td> <td style="width: 10%;"></td> <td style="width: 10%;"></td> <td style="width: 10%;"></td> <td style="width: 10%;"></td> </tr> <tr> <td></td> <td></td> <td colspan="8" style="text-align: center;"> <table border="1" style="width: 100%; border-collapse: collapse; text-align: center;"> <tr> <td style="width: 10%;"></td> <td style="width: 10%;"></td> <td style="width: 10%;"></td> <td style="width: 10%;"></td> <td style="width: 10%;"></td> <td style="width: 10%;"></td> <td style="width: 10%;"></td> <td style="width: 10%;"></td> <td style="width: 10%;"></td> <td style="width: 10%;"></td> </tr> <tr> <td></td> <td></td> <td colspan="8" style="text-align: center;"> <table border="1" style="width: 100%; border-collapse: collapse; text-align: center;"> <tr> <td style="width: 10%;"></td> <td style="width: 10%;"></td> <td style="width: 10%;"></td> <td style="width: 10%;"></td> <td style="width: 10%;"></td> <td style="width: 10%;"></td> <td style="width: 10%;"></td> <td style="width: 10%;"></td> <td style="width: 10%;"></td> <td style="width: 10%;"></td> </tr> <tr> <td></td> <td></td> <td colspan="8" style="text-align: center;"> <table border="1" style="width: 100%; border-collapse: collapse; text-align: center;"> <tr> <td style="width: 10%;"></td> <td style="width: 10%;"></td> <td style="width: 10%;"></td> <td style="width: 10%;"></td> <td style="width: 10%;"></td> <td style="width: 10%;"></td> <td style="width: 10%;"></td> <td style="width: 10%;"></td> <td style="width: 10%;"></td> <td style="width: 10%;"></td> </tr> <tr> <td></td> <td></td> <td colspan="8" style="text-align: center;"> <table border="1" style="width: 100%; border-collapse: collapse; text-align: center;"> <tr> <td style="width: 10%;"></td> <td style="width: 10%;"></td> <td style="width: 10%;"></td> <td style="width: 10%;"></td> <td style="width: 10%;"></td> <td style="width: 10%;"></td> <td style="width: 10%;"></td> <td style="width: 10%;"></td> <td style="width: 10%;"></td> <td style="width: 10%;"></td> </tr> <tr> <td></td> <td></td> <td colspan="8" style="text-align: center;"> <table border="1" style="width: 100%; border-collapse: collapse; text-align: center;"> <tr> <td style="width: 10%;"></td> <td style="width: 10%;"></td> <td style="width: 10%;"></td> <td style="width: 10%;"></td> <td style="width: 10%;"></td> <td style="width: 10%;"></td> <td style="width: 10%;"></td> <td style="width: 10%;"></td> <td style="width: 10%;"></td> <td style="width: 10%;"></td> </tr> <tr> <td></td> <td></td> <td colspan="8" style="text-align: center;"> <table border="1" style="width: 100%; border-collapse: collapse; text-align: center;"> <tr> </tr></table></td></tr></table></td></tr></table></td></tr></table></td></tr></table></td></tr></table></td></tr></table></td></tr></table></td></tr></table></td></tr></table></td></tr></table></td></tr></table></td></tr></table></td></tr></table></td></tr></table></td></tr></table></td></tr></table></td></tr></table></td></tr></table></td></tr></table></td></tr></table></td></tr></table></td></tr></table></td></tr></table></td></tr></table>

 | | | | | | | | | | | | | | | | | | | | <table border="1" style="width: 100%; border-collapse: collapse; text-align: center;"> <tr> <td style="width: 10%;"></td> <td style="width: 10%;"></td> <td style="width: 10%;"></td> <td style="width: 10%;"></td> <td style="width: 10%;"></td> <td style="width: 10%;"></td> <td style="width: 10%;"></td> <td style="width: 10%;"></td> <td style="width: 10%;"></td> <td style="width: 10%;"></td> </tr> <tr> <td></td> <td></td> <td colspan="8" style="text-align: center;"> <table border="1" style="width: 100%; border-collapse: collapse; text-align: center;"> <tr> <td style="width: 10%;"></td> <td style="width: 10%;"></td> <td style="width: 10%;"></td> <td style="width: 10%;"></td> <td style="width: 10%;"></td> <td style="width: 10%;"></td> <td style="width: 10%;"></td> <td style="width: 10%;"></td> <td style="width: 10%;"></td> <td style="width: 10%;"></td> </tr> <tr> <td></td> <td></td> <td colspan="8" style="text-align: center;"> <table border="1" style="width: 100%; border-collapse: collapse; text-align: center;"> <tr> <td style="width: 10%;"></td> <td style="width: 10%;"></td> <td style="width: 10%;"></td> <td style="width: 10%;"></td> <td style="width: 10%;"></td> <td style="width: 10%;"></td> <td style="width: 10%;"></td> <td style="width: 10%;"></td> <td style="width: 10%;"></td> <td style="width: 10%;"></td> </tr> <tr> <td></td> <td></td> <td colspan="8" style="text-align: center;"> <table border="1" style="width: 100%; border-collapse: collapse; text-align: center;"> <tr> <td style="width: 10%;"></td> <td style="width: 10%;"></td> <td style="width: 10%;"></td> <td style="width: 10%;"></td> <td style="width: 10%;"></td> <td style="width: 10%;"></td> <td style="width: 10%;"></td> <td style="width: 10%;"></td> <td style="width: 10%;"></td> <td style="width: 10%;"></td> </tr> <tr> <td></td> <td></td> <td colspan="8" style="text-align: center;"> <table border="1" style="width: 100%; border-collapse: collapse; text-align: center;"> <tr> <td style="width: 10%;"></td> <td style="width: 10%;"></td> <td style="width: 10%;"></td> <td style="width: 10%;"></td> <td style="width: 10%;"></td> <td style="width: 10%;"></td> <td style="width: 10%;"></td> <td style="width: 10%;"></td> <td style="width: 10%;"></td> <td style="width: 10%;"></td> </tr> <tr> <td></td> <td></td> <td colspan="8" style="text-align: center;"> <table border="1" style="width: 100%; border-collapse: collapse; text-align: center;"> <tr> <td style="width: 10%;"></td> <td style="width: 10%;"></td> <td style="width: 10%;"></td> <td style="width: 10%;"></td> <td style="width: 10%;"></td> <td style="width: 10%;"></td> <td style="width: 10%;"></td> <td style="width: 10%;"></td> <td style="width: 10%;"></td> <td style="width: 10%;"></td> </tr> <tr> <td></td> <td></td> <td colspan="8" style="text-align: center;"> <table border="1" style="width: 100%; border-collapse: collapse; text-align: center;"> <tr> <td style="width: 10%;"></td> <td style="width: 10%;"></td> <td style="width: 10%;"></td> <td style="width: 10%;"></td> <td style="width: 10%;"></td> <td style="width: 10%;"></td> <td style="width: 10%;"></td> <td style="width: 10%;"></td> <td style="width: 10%;"></td> <td style="width: 10%;"></td> </tr> <tr> <td></td> <td></td> <td colspan="8" style="text-align: center;"> <table border="1" style="width: 100%; border-collapse: collapse; text-align: center;"> <tr> <td style="width: 10%;"></td> <td style="width: 10%;"></td> <td style="width: 10%;"></td> <td style="width: 10%;"></td> <td style="width: 10%;"></td> <td style="width: 10%;"></td> <td style="width: 10%;"></td> <td style="width: 10%;"></td> <td style="width: 10%;"></td> <td style="width: 10%;"></td> </tr> <tr> <td></td> <td></td> <td colspan="8" style="text-align: center;"> <table border="1" style="width: 100%; border-collapse: collapse; text-align: center;"> <tr> <td style="width: 10%;"></td> <td style="width: 10%;"></td> <td style="width: 10%;"></td> <td style="width: 10%;"></td> <td style="width: 10%;"></td> <td style="width: 10%;"></td> <td style="width: 10%;"></td> <td style="width: 10%;"></td> <td style="width: 10%;"></td> <td style="width: 10%;"></td> </tr> <tr> <td></td> <td></td> <td colspan="8" style="text-align: center;"> <table border="1" style="width: 100%; border-collapse: collapse; text-align: center;"> <tr> <td style="width: 10%;"></td> <td style="width: 10%;"></td> <td style="width: 10%;"></td> <td style="width: 10%;"></td> <td style="width: 10%;"></td> <td style="width: 10%;"></td> <td style="width: 10%;"></td> <td style="width: 10%;"></td> <td style="width: 10%;"></td> <td style="width: 10%;"></td> </tr> <tr> <td></td> <td></td> <td colspan="8" style="text-align: center;"> <table border="1" style="width: 100%; border-collapse: collapse; text-align: center;"> <tr> <td style="width: 10%;"></td> <td style="width: 10%;"></td> <td style="width: 10%;"></td> <td style="width: 10%;"></td> <td style="width: 10%;"></td> <td style="width: 10%;"></td> <td style="width: 10%;"></td> <td style="width: 10%;"></td> <td style="width: 10%;"></td> <td style="width: 10%;"></td> </tr> <tr> <td></td> <td></td> <td colspan="8" style="text-align: center;"> <table border="1" style="width: 100%; border-collapse: collapse; text-align: center;"> <tr> <td style="width: 10%;"></td> <td style="width: 10%;"></td> <td style="width: 10%;"></td> <td style="width: 10%;"></td> <td style="width: 10%;"></td> <td style="width: 10%;"></td> <td style="width: 10%;"></td> <td style="width: 10%;"></td> <td style="width: 10%;"></td> <td style="width: 10%;"></td> </tr> <tr> <td></td> <td></td> <td colspan="8" style="text-align: center;"> <table border="1" style="width: 100%; border-collapse: collapse; text-align: center;"> <tr> <td style="width: 10%;"></td> <td style="width: 10%;"></td> <td style="width: 10%;"></td> <td style="width: 10%;"></td> <td style="width: 10%;"></td> <td style="width: 10%;"></td> <td style="width: 10%;"></td> <td style="width: 10%;"></td> <td style="width: 10%;"></td> <td style="width: 10%;"></td> </tr> <tr> <td></td> <td></td> <td colspan="8" style="text-align: center;"> <table border="1" style="width: 100%; border-collapse: collapse; text-align: center;"> <tr> <td style="width: 10%;"></td> <td style="width: 10%;"></td> <td style="width: 10%;"></td> <td style="width: 10%;"></td> <td style="width: 10%;"></td> <td style="width: 10%;"></td> <td style="width: 10%;"></td> <td style="width: 10%;"></td> <td style="width: 10%;"></td> <td style="width: 10%;"></td> </tr> <tr> <td></td> <td></td> <td colspan="8" style="text-align: center;"> <table border="1" style="width: 100%; border-collapse: collapse; text-align: center;"> <tr> <td style="width: 10%;"></td> <td style="width: 10%;"></td> <td style="width: 10%;"></td> <td style="width: 10%;"></td> <td style="width: 10%;"></td> <td style="width: 10%;"></td> <td style="width: 10%;"></td> <td style="width: 10%;"></td> <td style="width: 10%;"></td> <td style="width: 10%;"></td> </tr> <tr> <td></td> <td></td> <td colspan="8" style="text-align: center;"> <table border="1" style="width: 100%; border-collapse: collapse; text-align: center;"> <tr> <td style="width: 10%;"></td> <td style="width: 10%;"></td> <td style="width: 10%;"></td> <td style="width: 10%;"></td> <td style="width: 10%;"></td> <td style="width: 10%;"></td> <td style="width: 10%;"></td> <td style="width: 10%;"></td> <td style="width: 10%;"></td> <td style="width: 10%;"></td> </tr> <tr> <td></td> <td></td> <td colspan="8" style="text-align: center;"> <table border="1" style="width: 100%; border-collapse: collapse; text-align: center;"> <tr> <td style="width: 10%;"></td> <td
style="width: 10%;"></td> <td style="width: 10%;"></td> <td style="width: 10%;"></td> <td style="width: 10%;"></td> <td style="width: 10%;"></td> <td style="width: 10%;"></td> <td style="width: 10%;"></td> <td style="width: 10%;"></td> <td style="width: 10%;"></td> </tr> <tr> <td></td> <td></td> <td colspan="8" style="text-align: center;"> <table border="1" style="width: 100%; border-collapse: collapse; text-align: center;"> <tr> <td style="width: 10%;"></td> <td style="width: 10%;"></td> <td style="width: 10%;"></td> <td style="width: 10%;"></td> <td style="width: 10%;"></td> <td style="width: 10%;"></td> <td style="width: 10%;"></td> <td style="width: 10%;"></td> <td style="width: 10%;"></td> <td style="width: 10%;"></td> </tr> <tr> <td></td> <td></td> <td colspan="8" style="text-align: center;"> <table border="1" style="width: 100%; border-collapse: collapse; text-align: center;"> <tr> <td style="width: 10%;"></td> <td style="width: 10%;"></td> <td style="width: 10%;"></td> <td style="width: 10%;"></td> <td style="width: 10%;"></td> <td style="width: 10%;"></td> <td style="width: 10%;"></td> <td style="width: 10%;"></td> <td style="width: 10%;"></td> <td style="width: 10%;"></td> </tr> <tr> <td></td> <td></td> <td colspan="8" style="text-align: center;"> <table border="1" style="width: 100%; border-collapse: collapse; text-align: center;"> <tr> <td style="width: 10%;"></td> <td style="width: 10%;"></td> <td style="width: 10%;"></td> <td style="width: 10%;"></td> <td style="width: 10%;"></td> <td style="width: 10%;"></td> <td style="width: 10%;"></td> <td style="width: 10%;"></td> <td style="width: 10%;"></td> <td style="width: 10%;"></td> </tr> <tr> <td></td> <td></td> <td colspan="8" style="text-align: center;"> <table border="1" style="width: 100%; border-collapse: collapse; text-align: center;"> <tr> <td style="width: 10%;"></td> <td style="width: 10%;"></td> <td style="width: 10%;"></td> <td style="width: 10%;"></td> <td style="width: 10%;"></td> <td style="width: 10%;"></td> <td style="width: 10%;"></td> <td style="width: 10%;"></td> <td style="width: 10%;"></td> <td style="width: 10%;"></td> </tr> <tr> <td></td> <td></td> <td colspan="8" style="text-align: center;"> <table border="1" style="width: 100%; border-collapse: collapse; text-align: center;"> <tr> <td style="width: 10%;"></td> <td style="width: 10%;"></td> <td style="width: 10%;"></td> <td style="width: 10%;"></td> <td style="width: 10%;"></td> <td style="width: 10%;"></td> <td style="width: 10%;"></td> <td style="width: 10%;"></td> <td style="width: 10%;"></td> <td style="width: 10%;"></td> </tr> <tr> <td></td> <td></td> <td colspan="8" style="text-align: center;"> <table border="1" style="width: 100%; border-collapse: collapse; text-align: center;"> <tr> <td style="width: 10%;"></td> <td style="width: 10%;"></td> <td style="width: 10%;"></td> <td style="width: 10%;"></td> <td style="width: 10%;"></td> <td style="width: 10%;"></td> <td style="width: 10%;"></td> <td style="width: 10%;"></td> <td style="width: 10%;"></td> <td style="width: 10%;"></td> </tr> <tr> <td></td> <td></td> <td colspan="8" style="text-align: center;"> <table border="1" style="width: 100%; border-collapse: collapse; text-align: center;"> <tr> </tr></table></td></tr></table></td></tr></table></td></tr></table></td></tr></table></td></tr></table></td></tr></table></td></tr></table></td></tr></table></td></tr></table></td></tr></table></td></tr></table></td></tr></table></td></tr></table></td></tr></table></td></tr></table></td></tr></table></td></tr></table></td></tr></table></td></tr></table></td></tr></table></td></tr></table></td></tr></table></td></tr></table>

 | | | | | | | | | | | | | | | | | | | | <table border="1" style="width: 100%; border-collapse: collapse; text-align: center;"> <tr> <td style="width: 10%;"></td> <td style="width: 10%;"></td> <td style="width: 10%;"></td> <td style="width: 10%;"></td> <td style="width: 10%;"></td> <td style="width: 10%;"></td> <td style="width: 10%;"></td> <td style="width: 10%;"></td> <td style="width: 10%;"></td> <td style="width: 10%;"></td> </tr> <tr> <td></td> <td></td> <td colspan="8" style="text-align: center;"> <table border="1" style="width: 100%; border-collapse: collapse; text-align: center;"> <tr> <td style="width: 10%;"></td> <td style="width: 10%;"></td> <td style="width: 10%;"></td> <td style="width: 10%;"></td> <td style="width: 10%;"></td> <td style="width: 10%;"></td> <td style="width: 10%;"></td> <td style="width: 10%;"></td> <td style="width: 10%;"></td> <td style="width: 10%;"></td> </tr> <tr> <td></td> <td></td> <td colspan="8" style="text-align: center;"> <table border="1" style="width: 100%; border-collapse: collapse; text-align: center;"> <tr> <td style="width: 10%;"></td> <td style="width: 10%;"></td> <td style="width: 10%;"></td> <td style="width: 10%;"></td> <td style="width: 10%;"></td> <td style="width: 10%;"></td> <td style="width: 10%;"></td> <td style="width: 10%;"></td> <td style="width: 10%;"></td> <td style="width: 10%;"></td> </tr> <tr> <td></td> <td></td> <td colspan="8" style="text-align: center;"> <table border="1" style="width: 100%; border-collapse: collapse; text-align: center;"> <tr> <td style="width: 10%;"></td> <td style="width: 10%;"></td> <td style="width: 10%;"></td> <td style="width: 10%;"></td> <td style="width: 10%;"></td> <td style="width: 10%;"></td> <td style="width: 10%;"></td> <td style="width: 10%;"></td> <td style="width: 10%;"></td> <td style="width: 10%;"></td> </tr> <tr> <td></td> <td></td> <td colspan="8" style="text-align: center;"> <table border="1" style="width: 100%; border-collapse: collapse; text-align: center;"> <tr> <td style="width: 10%;"></td> <td style="width: 10%;"></td> <td style="width: 10%;"></td> <td style="width: 10%;"></td> <td style="width: 10%;"></td> <td style="width: 10%;"></td> <td style="width: 10%;"></td> <td style="width: 10%;"></td> <td style="width: 10%;"></td> <td style="width: 10%;"></td> </tr> <tr> <td></td> <td></td> <td colspan="8" style="text-align: center;"> <table border="1" style="width: 100%; border-collapse: collapse; text-align: center;"> <tr> <td style="width: 10%;"></td> <td style="width: 10%;"></td> <td style="width: 10%;"></td> <td style="width: 10%;"></td> <td style="width: 10%;"></td> <td style="width: 10%;"></td> <td style="width: 10%;"></td> <td style="width: 10%;"></td> <td style="width: 10%;"></td> <td style="width: 10%;"></td> </tr> <tr> <td></td> <td></td> <td colspan="8" style="text-align: center;"> <table border="1" style="width: 100%; border-collapse: collapse; text-align: center;"> <tr> <td style="width: 10%;"></td> <td style="width: 10%;"></td> <td style="width: 10%;"></td> <td style="width: 10%;"></td> <td style="width: 10%;"></td> <td style="width: 10%;"></td> <td style="width: 10%;"></td> <td style="width: 10%;"></td> <td style="width: 10%;"></td> <td style="width: 10%;"></td> </tr> <tr> <td></td> <td></td> <td colspan="8" style="text-align: center;"> <table border="1" style="width: 100%; border-collapse: collapse; text-align: center;"> <tr> <td style="width: 10%;"></td> <td style="width: 10%;"></td> <td style="width: 10%;"></td> <td style="width: 10%;"></td> <td style="width: 10%;"></td> <td style="width: 10%;"></td> <td style="width: 10%;"></td> <td style="width: 10%;"></td> <td style="width: 10%;"></td> <td style="width: 10%;"></td> </tr> <tr> <td></td> <td></td> <td colspan="8" style="text-align: center;"> <table border="1" style="width: 100%; border-collapse: collapse; text-align: center;"> <tr> <td style="width: 10%;"></td> <td style="width: 10%;"></td> <td style="width: 10%;"></td> <td style="width: 10%;"></td> <td style="width: 10%;"></td> <td style="width: 10%;"></td> <td style="width: 10%;"></td> <td style="width: 10%;"></td> <td style="width: 10%;"></td> <td style="width: 10%;"></td> </tr> <tr> <td></td> <td></td> <td colspan="8" style="text-align: center;"> <table border="1" style="width: 100%; border-collapse: collapse; text-align: center;"> <tr> <td style="width: 10%;"></td> <td style="width: 10%;"></td> <td style="width: 10%;"></td> <td style="width: 10%;"></td> <td style="width: 10%;"></td> <td style="width: 10%;"></td> <td style="width: 10%;"></td> <td style="width: 10%;"></td> <td style="width: 10%;"></td> <td style="width: 10%;"></td> </tr> <tr> <td></td> <td></td> <td colspan="8" style="text-align: center;"> <table border="1" style="width: 100%; border-collapse: collapse; text-align: center;"> <tr> <td style="width: 10%;"></td> <td style="width: 10%;"></td> <td style="width: 10%;"></td> <td style="width: 10%;"></td> <td style="width: 10%;"></td> <td style="width: 10%;"></td> <td style="width: 10%;"></td> <td style="width: 10%;"></td> <td style="width: 10%;"></td> <td style="width: 10%;"></td> </tr> <tr> <td></td> <td></td> <td colspan="8" style="text-align: center;"> <table border="1" style="width: 100%; border-collapse: collapse; text-align: center;"> <tr> <td style="width: 10%;"></td> <td style="width: 10%;"></td> <td style="width: 10%;"></td> <td style="width: 10%;"></td> <td style="width: 10%;"></td> <td style="width: 10%;"></td> <td style="width: 10%;"></td> <td style="width: 10%;"></td> <td style="width: 10%;"></td> <td style="width: 10%;"></td> </tr> <tr> <td></td> <td></td> <td colspan="8" style="text-align: center;"> <table border="1" style="width: 100%; border-collapse: collapse; text-align: center;"> <tr> <td style="width: 10%;"></td> <td style="width: 10%;"></td> <td style="width: 10%;"></td> <td style="width: 10%;"></td> <td style="width: 10%;"></td> <td style="width: 10%;"></td> <td style="width: 10%;"></td> <td style="width: 10%;"></td> <td style="width: 10%;"></td> <td style="width: 10%;"></td> </tr> <tr> <td></td> <td></td> <td colspan="8" style="text-align: center;"> <table border="1" style="width: 100%; border-collapse: collapse; text-align: center;"> <tr> <td style="width: 10%;"></td> <td style="width: 10%;"></td> <td style="width: 10%;"></td> <td style="width: 10%;"></td> <td style="width: 10%;"></td> <td style="width: 10%;"></td> <td style="width: 10%;"></td> <td style="width: 10%;"></td> <td style="width: 10%;"></td> <td style="width: 10%;"></td> </tr> <tr> <td></td> <td></td> <td colspan="8" style="text-align: center;"> <table border="1" style="width: 100%; border-collapse: collapse; text-align: center;"> <tr> <td style="width: 10%;"></td> <td style="width: 10%;"></td> <td style="width: 10%;"></td> <td style="width: 10%;"></td> <td style="width: 10%;"></td> <td style="width: 10%;"></td> <td style="width: 10%;"></td> <td style="width: 10%;"></td> <td style="width: 10%;"></td> <td style="width: 10%;"></td> </tr> <tr> <td></td> <td></td> <td colspan="8" style="text-align: center;"> <table border="1" style="width: 100%; border-collapse: collapse; text-align: center;"> <tr> <td style="width: 10%;"></td> <td style="width: 10%;"></td> <td style="width: 10%;"></td> <td style="width: 10%;"></td> <td style="width: 10%;"></td> <td style="width: 10%;"></td> <td style="width: 10%;"></td> <td style="width: 10%;"></td> <td style="width: 10%;"></td> <td style="width: 10%;"></td> </tr> <tr> <td></td> <td></td> <td colspan="8" style="text-align: center;"> <table border="1" style="width: 100%; border-collapse: collapse; text-align: center;"> <tr> <td style="width: 10%;"></td> <td style="width: 10%;"></td> <td style="width: 10%;"></td> <td style="width: 10%;"></td> <td style="width: 10%;"></td> <td style="width: 10%;"></td> <td style="width: 10%;"></td> <td
style="width: 10%;"></td> <td style="width: 10%;"></td> <td style="width: 10%;"></td> </tr> <tr> <td></td> <td></td> <td colspan="8" style="text-align: center;"> <table border="1" style="width: 100%; border-collapse: collapse; text-align: center;"> <tr> <td style="width: 10%;"></td> <td style="width: 10%;"></td> <td style="width: 10%;"></td> <td style="width: 10%;"></td> <td style="width: 10%;"></td> <td style="width: 10%;"></td> <td style="width: 10%;"></td> <td style="width: 10%;"></td> <td style="width: 10%;"></td> <td style="width: 10%;"></td> </tr> <tr> <td></td> <td></td> <td colspan="8" style="text-align: center;"> <table border="1" style="width: 100%; border-collapse: collapse; text-align: center;"> <tr> <td style="width: 10%;"></td> <td style="width: 10%;"></td> <td style="width: 10%;"></td> <td style="width: 10%;"></td> <td style="width: 10%;"></td> <td style="width: 10%;"></td> <td style="width: 10%;"></td> <td style="width: 10%;"></td> <td style="width: 10%;"></td> <td style="width: 10%;"></td> </tr> <tr> <td></td> <td></td> <td colspan="8" style="text-align: center;"> <table border="1" style="width: 100%; border-collapse: collapse; text-align: center;"> <tr> <td style="width: 10%;"></td> <td style="width: 10%;"></td> <td style="width: 10%;"></td> <td style="width: 10%;"></td> <td style="width: 10%;"></td> <td style="width: 10%;"></td> <td style="width: 10%;"></td> <td style="width: 10%;"></td> <td style="width: 10%;"></td> <td style="width: 10%;"></td> </tr> <tr> <td></td> <td></td> <td colspan="8" style="text-align: center;"> <table border="1" style="width: 100%; border-collapse: collapse; text-align: center;"> <tr> <td style="width: 10%;"></td> <td style="width: 10%;"></td> <td style="width: 10%;"></td> <td style="width: 10%;"></td> <td style="width: 10%;"></td> <td style="width: 10%;"></td> <td style="width: 10%;"></td> <td style="width: 10%;"></td> <td style="width: 10%;"></td> <td style="width: 10%;"></td> </tr> <tr> <td></td> <td></td> <td colspan="8" style="text-align: center;"> <table border="1" style="width: 100%; border-collapse: collapse; text-align: center;"> <tr> <td style="width: 10%;"></td> <td style="width: 10%;"></td> <td style="width: 10%;"></td> <td style="width: 10%;"></td> <td style="width: 10%;"></td> <td style="width: 10%;"></td> <td style="width: 10%;"></td> <td style="width: 10%;"></td> <td style="width: 10%;"></td> <td style="width: 10%;"></td> </tr> <tr> <td></td> <td></td> <td colspan="8" style="text-align: center;"> <table border="1" style="width: 100%; border-collapse: collapse; text-align: center;"> <tr> </tr></table></td></tr></table></td></tr></table></td></tr></table></td></tr></table></td></tr></table></td></tr></table></td></tr></table></td></tr></table></td></tr></table></td></tr></table></td></tr></table></td></tr></table></td></tr></table></td></tr></table></td></tr></table></td></tr></table></td></tr></table></td></tr></table></td></tr></table></td></tr></table></td></tr></table></td></tr></table>

 | | | | | | | | | | | | | | | | | | | | <table border="1" style="width: 100%; border-collapse: collapse; text-align: center;"> <tr> <td style="width: 10%;"></td> <td style="width: 10%;"></td> <td style="width: 10%;"></td> <td style="width: 10%;"></td> <td style="width: 10%;"></td> <td style="width: 10%;"></td> <td style="width: 10%;"></td> <td style="width: 10%;"></td> <td style="width: 10%;"></td> <td style="width: 10%;"></td> </tr> <tr> <td></td> <td></td> <td colspan="8" style="text-align: center;"> <table border="1" style="width: 100%; border-collapse: collapse; text-align: center;"> <tr> <td style="width: 10%;"></td> <td style="width: 10%;"></td> <td style="width: 10%;"></td> <td style="width: 10%;"></td> <td style="width: 10%;"></td> <td style="width: 10%;"></td> <td style="width: 10%;"></td> <td style="width: 10%;"></td> <td style="width: 10%;"></td> <td style="width: 10%;"></td> </tr> <tr> <td></td> <td></td> <td colspan="8" style="text-align: center;"> <table border="1" style="width: 100%; border-collapse: collapse; text-align: center;"> <tr> <td style="width: 10%;"></td> <td style="width: 10%;"></td> <td style="width: 10%;"></td> <td style="width: 10%;"></td> <td style="width: 10%;"></td> <td style="width: 10%;"></td> <td style="width: 10%;"></td> <td style="width: 10%;"></td> <td style="width: 10%;"></td> <td style="width: 10%;"></td> </tr> <tr> <td></td> <td></td> <td colspan="8" style="text-align: center;"> <table border="1" style="width: 100%; border-collapse: collapse; text-align: center;"> <tr> <td style="width: 10%;"></td> <td style="width: 10%;"></td> <td style="width: 10%;"></td> <td style="width: 10%;"></td> <td style="width: 10%;"></td> <td style="width: 10%;"></td> <td style="width: 10%;"></td> <td style="width: 10%;"></td> <td style="width: 10%;"></td> <td style="width: 10%;"></td> </tr> <tr> <td></td> <td></td> <td colspan="8" style="text-align: center;"> <table border="1" style="width: 100%; border-collapse: collapse; text-align: center;"> <tr> <td style="width: 10%;"></td> <td style="width: 10%;"></td> <td style="width: 10%;"></td> <td style="width: 10%;"></td> <td style="width: 10%;"></td> <td style="width: 10%;"></td> <td style="width: 10%;"></td> <td style="width: 10%;"></td> <td style="width: 10%;"></td> <td style="width: 10%;"></td> </tr> <tr> <td></td> <td></td> <td colspan="8" style="text-align: center;"> <table border="1" style="width: 100%; border-collapse: collapse; text-align: center;"> <tr> <td style="width: 10%;"></td> <td style="width: 10%;"></td> <td style="width: 10%;"></td> <td style="width: 10%;"></td> <td style="width: 10%;"></td> <td style="width: 10%;"></td> <td style="width: 10%;"></td> <td style="width: 10%;"></td> <td style="width: 10%;"></td> <td style="width: 10%;"></td> </tr> <tr> <td></td> <td></td> <td colspan="8" style="text-align: center;"> <table border="1" style="width: 100%; border-collapse: collapse; text-align: center;"> <tr> <td style="width: 10%;"></td> <td style="width: 10%;"></td> <td style="width: 10%;"></td> <td style="width: 10%;"></td> <td style="width: 10%;"></td> <td style="width: 10%;"></td> <td style="width: 10%;"></td> <td style="width: 10%;"></td> <td style="width: 10%;"></td> <td style="width: 10%;"></td> </tr> <tr> <td></td> <td></td> <td colspan="8" style="text-align: center;"> <table border="1" style="width: 100%; border-collapse: collapse; text-align: center;"> <tr> <td style="width: 10%;"></td> <td style="width: 10%;"></td> <td style="width: 10%;"></td> <td style="width: 10%;"></td> <td style="width: 10%;"></td> <td style="width: 10%;"></td> <td style="width: 10%;"></td> <td style="width: 10%;"></td> <td style="width: 10%;"></td> <td style="width: 10%;"></td> </tr> <tr> <td></td> <td></td> <td colspan="8" style="text-align: center;"> <table border="1" style="width: 100%; border-collapse: collapse; text-align: center;"> <tr> <td style="width: 10%;"></td> <td style="width: 10%;"></td> <td style="width: 10%;"></td> <td style="width: 10%;"></td> <td style="width: 10%;"></td> <td style="width: 10%;"></td> <td style="width: 10%;"></td> <td style="width: 10%;"></td> <td style="width: 10%;"></td> <td style="width: 10%;"></td> </tr> <tr> <td></td> <td></td> <td colspan="8" style="text-align: center;"> <table border="1" style="width: 100%; border-collapse: collapse; text-align: center;"> <tr> <td style="width: 10%;"></td> <td style="width: 10%;"></td> <td style="width: 10%;"></td> <td style="width: 10%;"></td> <td style="width: 10%;"></td> <td style="width: 10%;"></td> <td style="width: 10%;"></td> <td style="width: 10%;"></td> <td style="width: 10%;"></td> <td style="width: 10%;"></td> </tr> <tr> <td></td> <td></td> <td colspan="8" style="text-align: center;"> <table border="1" style="width: 100%; border-collapse: collapse; text-align: center;"> <tr> <td style="width: 10%;"></td> <td style="width: 10%;"></td> <td style="width: 10%;"></td> <td style="width: 10%;"></td> <td style="width: 10%;"></td> <td style="width: 10%;"></td> <td style="width: 10%;"></td> <td style="width: 10%;"></td> <td style="width: 10%;"></td> <td style="width: 10%;"></td> </tr> <tr> <td></td> <td></td> <td colspan="8" style="text-align: center;"> <table border="1" style="width: 100%; border-collapse: collapse; text-align: center;"> <tr> <td style="width: 10%;"></td> <td style="width: 10%;"></td> <td style="width: 10%;"></td> <td style="width: 10%;"></td> <td style="width: 10%;"></td> <td style="width: 10%;"></td> <td style="width: 10%;"></td> <td style="width: 10%;"></td> <td style="width: 10%;"></td> <td style="width: 10%;"></td> </tr> <tr> <td></td> <td></td> <td colspan="8" style="text-align: center;"> <table border="1" style="width: 100%; border-collapse: collapse; text-align: center;"> <tr> <td style="width: 10%;"></td> <td style="width: 10%;"></td> <td style="width: 10%;"></td> <td style="width: 10%;"></td> <td style="width: 10%;"></td> <td style="width: 10%;"></td> <td style="width: 10%;"></td> <td style="width: 10%;"></td> <td style="width: 10%;"></td> <td style="width: 10%;"></td> </tr> <tr> <td></td> <td></td> <td colspan="8" style="text-align: center;"> <table border="1" style="width: 100%; border-collapse: collapse; text-align: center;"> <tr> <td style="width: 10%;"></td> <td style="width: 10%;"></td> <td style="width: 10%;"></td> <td style="width: 10%;"></td> <td style="width: 10%;"></td> <td style="width: 10%;"></td> <td style="width: 10%;"></td> <td style="width: 10%;"></td> <td style="width: 10%;"></td> <td style="width: 10%;"></td> </tr> <tr> <td></td> <td></td> <td colspan="8" style="text-align: center;"> <table border="1" style="width: 100%; border-collapse: collapse; text-align: center;"> <tr> <td style="width: 10%;"></td> <td style="width: 10%;"></td> <td style="width: 10%;"></td> <td style="width: 10%;"></td> <td style="width: 10%;"></td> <td style="width: 10%;"></td> <td style="width: 10%;"></td> <td style="width: 10%;"></td> <td style="width: 10%;"></td> <td style="width: 10%;"></td> </tr> <tr> <td></td> <td></td> <td colspan="8" style="text-align: center;"> <table border="1" style="width: 100%; border-collapse: collapse; text-align: center;"> <tr> <td style="width: 10%;"></td> <td style="width: 10%;"></td> <td style="width: 10%;"></td> <td style="width: 10%;"></td> <td style="width: 10%;"></td> <td style="width: 10%;"></td> <td style="width: 10%;"></td> <td style="width: 10%;"></td> <td style="width: 10%;"></td> <td style="width: 10%;"></td> </tr> <tr> <td></td> <td></td> <td colspan="8" style="text-align: center;"> <table border="1" style="width: 100%; border-collapse: collapse; text-align: center;"> <tr> <td style="width: 10%;"></td> <td style="width: 10%;"></td> <td style="width: 10%;"></td> <td style="width: 10%;"></td> <td style="width: 10%;"></td> <td style="width: 10%;"></td> <td style="width: 10%;"></td> <td style="width: 10%;"></td> <td style="width: 10%;"></td> <td style="width: 10%;"></td> </tr> <tr> <td></td> <td></td> <td colspan="8" style="text-align: center;"> <table border="1" style="width: 100%; border-collapse: collapse; text-align: center;"> <tr> <td style="width: 10%;"></td> <td style="width: 10%;"></td> <td style="width: 10%;"></td> <td style="width: 10%;"></td> <td style="width: 10%;"></td> <td style="width: 10%;"></td> <td style="width: 10%;"></td> <td style="width: 10%;"></td> <td style="width: 10%;"></td> <td style="width: 10%;"></td> </tr> <tr> <td></td> <td></td> <td colspan="8" style="text-align: center;"> <table border="1" style="width: 100%;
border-collapse: collapse; text-align: center;"> <tr> <td style="width: 10%;"></td> <td style="width: 10%;"></td> <td style="width: 10%;"></td> <td style="width: 10%;"></td> <td style="width: 10%;"></td> <td style="width: 10%;"></td> <td style="width: 10%;"></td> <td style="width: 10%;"></td> <td style="width: 10%;"></td> <td style="width: 10%;"></td> </tr> <tr> <td></td> <td></td> <td colspan="8" style="text-align: center;"> <table border="1" style="width: 100%; border-collapse: collapse; text-align: center;"> <tr> <td style="width: 10%;"></td> <td style="width: 10%;"></td> <td style="width: 10%;"></td> <td style="width: 10%;"></td> <td style="width: 10%;"></td> <td style="width: 10%;"></td> <td style="width: 10%;"></td> <td style="width: 10%;"></td> <td style="width: 10%;"></td> <td style="width: 10%;"></td> </tr> <tr> <td></td> <td></td> <td colspan="8" style="text-align: center;"> <table border="1" style="width: 100%; border-collapse: collapse; text-align: center;"> <tr> <td style="width: 10%;"></td> <td style="width: 10%;"></td> <td style="width: 10%;"></td> <td style="width: 10%;"></td> <td style="width: 10%;"></td> <td style="width: 10%;"></td> <td style="width: 10%;"></td> <td style="width: 10%;"></td> <td style="width: 10%;"></td> <td style="width: 10%;"></td> </tr> <tr> <td></td> <td></td> <td colspan="8" style="text-align: center;"> <table border="1" style="width: 100%; border-collapse: collapse; text-align: center;"> <tr> </tr></table></td></tr></table></td></tr></table></td></tr></table></td></tr></table></td></tr></table></td></tr></table></td></tr></table></td></tr></table></td></tr></table></td></tr></table></td></tr></table></td></tr></table></td></tr></table></td></tr></table></td></tr></table></td></tr></table></td></tr></table></td></tr></table></td></tr></table></td></tr></table></td></tr></table>

 | | | | | | | | | | | | | | | | | | | | <table border="1" style="width: 100%; border-collapse: collapse; text-align: center;"> <tr> <td style="width: 10%;"></td> <td style="width: 10%;"></td> <td style="width: 10%;"></td> <td style="width: 10%;"></td> <td style="width: 10%;"></td> <td style="width: 10%;"></td> <td style="width: 10%;"></td> <td style="width: 10%;"></td> <td style="width: 10%;"></td> <td style="width: 10%;"></td> </tr> <tr> <td></td> <td></td> <td colspan="8" style="text-align: center;"> <table border="1" style="width: 100%; border-collapse: collapse; text-align: center;"> <tr> <td style="width: 10%;"></td> <td style="width: 10%;"></td> <td style="width: 10%;"></td> <td style="width: 10%;"></td> <td style="width: 10%;"></td> <td style="width: 10%;"></td> <td style="width: 10%;"></td> <td style="width: 10%;"></td> <td style="width: 10%;"></td> <td style="width: 10%;"></td> </tr> <tr> <td></td> <td></td> <td colspan="8" style="text-align: center;"> <table border="1" style="width: 100%; border-collapse: collapse; text-align: center;"> <tr> <td style="width: 10%;"></td> <td style="width: 10%;"></td> <td style="width: 10%;"></td> <td style="width: 10%;"></td> <td style="width: 10%;"></td> <td style="width: 10%;"></td> <td style="width: 10%;"></td> <td style="width: 10%;"></td> <td style="width: 10%;"></td> <td style="width: 10%;"></td> </tr> <tr> <td></td> <td></td> <td colspan="8" style="text-align: center;"> <table border="1" style="width: 100%; border-collapse: collapse; text-align: center;"> <tr> <td style="width: 10%;"></td> <td style="width: 10%;"></td> <td style="width: 10%;"></td> <td style="width: 10%;"></td> <td style="width: 10%;"></td> <td style="width: 10%;"></td> <td style="width: 10%;"></td> <td style="width: 10%;"></td> <td style="width: 10%;"></td> <td style="width: 10%;"></td> </tr> <tr> <td></td> <td></td> <td colspan="8" style="text-align: center;"> <table border="1" style="width: 100%; border-collapse: collapse; text-align: center;"> <tr> <td style="width: 10%;"></td> <td style="width: 10%;"></td> <td style="width: 10%;"></td> <td style="width: 10%;"></td> <td style="width: 10%;"></td> <td style="width: 10%;"></td> <td style="width: 10%;"></td> <td style="width: 10%;"></td> <td style="width: 10%;"></td> <td style="width: 10%;"></td> </tr> <tr> <td></td> <td></td> <td colspan="8" style="text-align: center;"> <table border="1" style="width: 100%; border-collapse: collapse; text-align: center;"> <tr> <td style="width: 10%;"></td> <td style="width: 10%;"></td> <td style="width: 10%;"></td> <td style="width: 10%;"></td> <td style="width: 10%;"></td> <td style="width: 10%;"></td> <td style="width: 10%;"></td> <td style="width: 10%;"></td> <td style="width: 10%;"></td> <td style="width: 10%;"></td> </tr> <tr> <td></td> <td></td> <td colspan="8" style="text-align: center;"> <table border="1" style="width: 100%; border-collapse: collapse; text-align: center;"> <tr> <td style="width: 10%;"></td> <td style="width: 10%;"></td> <td style="width: 10%;"></td> <td style="width: 10%;"></td> <td style="width: 10%;"></td> <td style="width: 10%;"></td> <td style="width: 10%;"></td> <td style="width: 10%;"></td> <td style="width: 10%;"></td> <td style="width: 10%;"></td> </tr> <tr> <td></td> <td></td> <td colspan="8" style="text-align: center;"> <table border="1" style="width: 100%; border-collapse: collapse; text-align: center;"> <tr> <td style="width: 10%;"></td> <td style="width: 10%;"></td> <td style="width: 10%;"></td> <td style="width: 10%;"></td> <td style="width: 10%;"></td> <td style="width: 10%;"></td> <td style="width: 10%;"></td> <td style="width: 10%;"></td> <td style="width: 10%;"></td> <td style="width: 10%;"></td> </tr> <tr> <td></td> <td></td> <td colspan="8" style="text-align: center;"> <table border="1" style="width: 100%; border-collapse: collapse; text-align: center;"> <tr> <td style="width: 10%;"></td> <td style="width: 10%;"></td> <td style="width: 10%;"></td> <td style="width: 10%;"></td> <td style="width: 10%;"></td> <td style="width: 10%;"></td> <td style="width: 10%;"></td> <td style="width: 10%;"></td> <td style="width: 10%;"></td> <td style="width: 10%;"></td> </tr> <tr> <td></td> <td></td> <td colspan="8" style="text-align: center;"> <table border="1" style="width: 100%; border-collapse: collapse; text-align: center;"> <tr> <td style="width: 10%;"></td> <td style="width: 10%;"></td> <td style="width: 10%;"></td> <td style="width: 10%;"></td> <td style="width: 10%;"></td> <td style="width: 10%;"></td> <td style="width: 10%;"></td> <td style="width: 10%;"></td> <td style="width: 10%;"></td> <td style="width: 10%;"></td> </tr> <tr> <td></td> <td></td> <td colspan="8" style="text-align: center;"> <table border="1" style="width: 100%; border-collapse: collapse; text-align: center;"> <tr> <td style="width: 10%;"></td> <td style="width: 10%;"></td> <td style="width: 10%;"></td> <td style="width: 10%;"></td> <td style="width: 10%;"></td> <td style="width: 10%;"></td> <td style="width: 10%;"></td> <td style="width: 10%;"></td> <td style="width: 10%;"></td> <td style="width: 10%;"></td> </tr> <tr> <td></td> <td></td> <td colspan="8" style="text-align: center;"> <table border="1" style="width: 100%; border-collapse: collapse; text-align: center;"> <tr> <td style="width: 10%;"></td> <td style="width: 10%;"></td> <td style="width: 10%;"></td> <td style="width: 10%;"></td> <td style="width: 10%;"></td> <td style="width: 10%;"></td> <td style="width: 10%;"></td> <td style="width: 10%;"></td> <td style="width: 10%;"></td> <td style="width: 10%;"></td> </tr> <tr> <td></td> <td></td> <td colspan="8" style="text-align: center;"> <table border="1" style="width: 100%; border-collapse: collapse; text-align: center;"> <tr> <td style="width: 10%;"></td> <td style="width: 10%;"></td> <td style="width: 10%;"></td> <td style="width: 10%;"></td> <td style="width: 10%;"></td> <td style="width: 10%;"></td> <td style="width: 10%;"></td> <td style="width: 10%;"></td> <td style="width: 10%;"></td> <td style="width: 10%;"></td> </tr> <tr> <td></td> <td></td> <td colspan="8" style="text-align: center;"> <table border="1" style="width: 100%; border-collapse: collapse; text-align: center;"> <tr> <td style="width: 10%;"></td> <td style="width: 10%;"></td> <td style="width: 10%;"></td> <td style="width: 10%;"></td> <td style="width: 10%;"></td> <td style="width: 10%;"></td> <td style="width: 10%;"></td> <td style="width: 10%;"></td> <td style="width: 10%;"></td> <td style="width: 10%;"></td> </tr> <tr> <td></td> <td></td> <td colspan="8" style="text-align: center;"> <table border="1" style="width: 100%; border-collapse: collapse; text-align: center;"> <tr> <td style="width: 10%;"></td> <td style="width: 10%;"></td> <td style="width: 10%;"></td> <td style="width: 10%;"></td> <td style="width: 10%;"></td> <td style="width: 10%;"></td> <td style="width: 10%;"></td> <td style="width: 10%;"></td> <td style="width: 10%;"></td> <td style="width: 10%;"></td> </tr> <tr> <td></td> <td></td> <td colspan="8" style="text-align: center;"> <table border="1" style="width: 100%; border-collapse: collapse; text-align: center;"> <tr> <td style="width: 10%;"></td> <td style="width: 10%;"></td> <td style="width: 10%;"></td> <td style="width: 10%;"></td> <td style="width: 10%;"></td> <td style="width: 10%;"></td> <td style="width: 10%;"></td> <td style="width: 10%;"></td> <td style="width: 10%;"></td> <td style="width: 10%;"></td> </tr> <tr> <td></td> <td></td> <td colspan="8" style="text-align: center;"> <table border="1" style="width: 100%; border-collapse: collapse; text-align: center;"> <tr> <td style="width: 10%;"></td> <td style="width: 10%;"></td> <td style="width: 10%;"></td> <td style="width: 10%;"></td> <td style="width: 10%;"></td> <td style="width: 10%;"></td> <td style="width: 10%;"></td> <td style="width: 10%;"></td> <td style="width: 10%;"></td> <td style="width: 10%;"></td> </tr> <tr> <td></td> <td></td> <td colspan="8" style="text-align: center;"> <table border="1" style="width: 100%; border-collapse: collapse; text-align: center;"> <tr> <td style="width: 10%;"></td> <td style="width: 10%;"></td> <td style="width: 10%;"></td> <td style="width: 10%;"></td> <td style="width: 10%;"></td> <td style="width: 10%;"></td> <td style="width: 10%;"></td> <td style="width: 10%;"></td> <td style="width: 10%;"></td> <td style="width: 10%;"></td> </tr> <tr> <td></td> <td></td> <td colspan="8" style="text-align: center;"> <table border="1" style="width: 100%; border-collapse: collapse; text-align: center;"> <tr> <td style="width: 10%;"></td> <td style="width: 10%;"></td> <td style="width: 10%;"></td> <td style="width: 10%;"></td> <td style="width: 10%;"></td> <td style="width: 10%;"></td> <td style="width: 10%;"></td> <td style="width: 10%;"></td> <td style="width: 10%;"></td> <td style="width: 10%;"></td> </tr> <tr> <td></td> <td></td> <td colspan="8" style="text-align: center;"> <table border="1" style="width: 100%; border-collapse: collapse; text-align: center;"> <tr> <td style="width: 10%;"></td> <td style="width: 10%;"></td> <td style="width: 10%;"></td> <td style="width: 10%;"></td> <td style="width: 10%;"></td> <td style="width: 10%;"></td> <td style="width: 10%;"></td> <td style="width: 10%;"></td> <td style="width: 10%;"></td> <td style="width: 10%;"></td> </tr> <tr> <td></td> <td></td> <td colspan="8" style="text-align: center;"> <table border="1" style="width: 100%; border-collapse: collapse; text-align: center;"> <tr>
</tr></table></td></tr></table></td></tr></table></td></tr></table></td></tr></table></td></tr></table></td></tr></table></td></tr></table></td></tr></table></td></tr></table></td></tr></table></td></tr></table></td></tr></table></td></tr></table></td></tr></table></td></tr></table></td></tr></table></td></tr></table></td></tr></table></td></tr></table></td></tr></table>
 | | | | | | | | | | | | | | | | | | | | <table border="1" style="width: 100%; border-collapse: collapse; text-align: center;"> <tr> <td style="width: 10%;"></td> <td style="width: 10%;"></td> <td style="width: 10%;"></td> <td style="width: 10%;"></td> <td style="width: 10%;"></td> <td style="width: 10%;"></td> <td style="width: 10%;"></td> <td style="width: 10%;"></td> <td style="width: 10%;"></td> <td style="width: 10%;"></td> </tr> <tr> <td></td> <td></td> <td colspan="8" style="text-align: center;"> <table border="1" style="width: 100%; border-collapse: collapse; text-align: center;"> <tr> <td style="width: 10%;"></td> <td style="width: 10%;"></td> <td style="width: 10%;"></td> <td style="width: 10%;"></td> <td style="width: 10%;"></td> <td style="width: 10%;"></td> <td style="width: 10%;"></td> <td style="width: 10%;"></td> <td style="width: 10%;"></td> <td style="width: 10%;"></td> </tr> <tr> <td></td> <td></td> <td colspan="8" style="text-align: center;"> <table border="1" style="width: 100%; border-collapse: collapse; text-align: center;"> <tr> <td style="width: 10%;"></td> <td style="width: 10%;"></td> <td
style="width: 10%;"></td> <td style="width: 10%;"></td> <td style="width: 10%;"></td> <td style="width: 10%;"></td> <td style="width: 10%;"></td> <td style="width: 10%;"></td> <td style="width: 10%;"></td> <td style="width: 10%;"></td> </tr> <tr> <td></td> <td></td> <td colspan="8" style="text-align: center;"> <table border="1" style="width: 100%; border-collapse: collapse; text-align: center;"> <tr> <td style="width: 10%;"></td> <td style="width: 10%;"></td> <td style="width: 10%;"></td> <td style="width: 10%;"></td> <td style="width: 10%;"></td> <td style="width: 10%;"></td> <td style="width: 10%;"></td> <td style="width: 10%;"></td> <td style="width: 10%;"></td> <td style="width: 10%;"></td> </tr> <tr> <td></td> <td></td> <td colspan="8" style="text-align: center;"> <table border="1" style="width: 100%; border-collapse: collapse; text-align: center;"> <tr> <td style="width: 10%;"></td> <td style="width: 10%;"></td> <td style="width: 10%;"></td> <td style="width: 10%;"></td> <td style="width: 10%;"></td> <td style="width: 10%;"></td> <td style="width: 10%;"></td> <td style="width: 10%;"></td> <td style="width: 10%;"></td> <td style="width: 10%;"></td> </tr> <tr> <td></td> <td></td> <td colspan="8" style="text-align: center;"> <table border="1" style="width: 100%; border-collapse: collapse; text-align: center;"> <tr> <td style="width: 10%;"></td> <td style="width: 10%;"></td> <td style="width: 10%;"></td> <td style="width: 10%;"></td> <td style="width: 10%;"></td> <td style="width: 10%;"></td> <td style="width: 10%;"></td> <td style="width: 10%;"></td> <td style="width: 10%;"></td> <td style="width: 10%;"></td> </tr> <tr> <td></td> <td></td> <td colspan="8" style="text-align: center;"> <table border="1" style="width: 100%; border-collapse: collapse; text-align: center;"> <tr> <td style="width: 10%;"></td> <td style="width: 10%;"></td> <td style="width: 10%;"></td> <td style="width: 10%;"></td> <td style="width: 10%;"></td> <td style="width: 10%;"></td> <td style="width: 10%;"></td> <td style="width: 10%;"></td> <td style="width: 10%;"></td> <td style="width: 10%;"></td> </tr> <tr> <td></td> <td></td> <td colspan="8" style="text-align: center;"> <table border="1" style="width: 100%; border-collapse: collapse; text-align: center;"> <tr> <td style="width: 10%;"></td> <td style="width: 10%;"></td> <td style="width: 10%;"></td> <td style="width: 10%;"></td> <td style="width: 10%;"></td> <td style="width: 10%;"></td> <td style="width: 10%;"></td> <td style="width: 10%;"></td> <td style="width: 10%;"></td> <td style="width: 10%;"></td> </tr> <tr> <td></td> <td></td> <td colspan="8" style="text-align: center;"> <table border="1" style="width: 100%; border-collapse: collapse; text-align: center;"> <tr> <td style="width: 10%;"></td> <td style="width: 10%;"></td> <td style="width: 10%;"></td> <td style="width: 10%;"></td> <td style="width: 10%;"></td> <td style="width: 10%;"></td> <td style="width: 10%;"></td> <td style="width: 10%;"></td> <td style="width: 10%;"></td> <td style="width: 10%;"></td> </tr> <tr> <td></td> <td></td> <td colspan="8" style="text-align: center;"> <table border="1" style="width: 100%; border-collapse: collapse; text-align: center;"> <tr> <td style="width: 10%;"></td> <td style="width: 10%;"></td> <td style="width: 10%;"></td> <td style="width: 10%;"></td> <td style="width: 10%;"></td> <td style="width: 10%;"></td> <td style="width: 10%;"></td> <td style="width: 10%;"></td> <td style="width: 10%;"></td> <td style="width: 10%;"></td> </tr> <tr> <td></td> <td></td> <td colspan="8" style="text-align: center;"> <table border="1" style="width: 100%; border-collapse: collapse; text-align: center;"> <tr> <td style="width: 10%;"></td> <td style="width: 10%;"></td> <td style="width: 10%;"></td> <td style="width: 10%;"></td> <td style="width: 10%;"></td> <td style="width: 10%;"></td> <td style="width: 10%;"></td> <td style="width: 10%;"></td> <td style="width: 10%;"></td> <td style="width: 10%;"></td> </tr> <tr> <td></td> <td></td> <td colspan="8" style="text-align: center;"> <table border="1" style="width: 100%; border-collapse: collapse; text-align: center;"> <tr> <td style="width: 10%;"></td> <td style="width: 10%;"></td> <td style="width: 10%;"></td> <td style="width: 10%;"></td> <td style="width: 10%;"></td> <td style="width: 10%;"></td> <td style="width: 10%;"></td> <td style="width: 10%;"></td> <td style="width: 10%;"></td> <td style="width: 10%;"></td> </tr> <tr> <td></td> <td></td> <td colspan="8" style="text-align: center;"> <table border="1" style="width: 100%; border-collapse: collapse; text-align: center;"> <tr> <td style="width: 10%;"></td> <td style="width: 10%;"></td> <td style="width: 10%;"></td> <td style="width: 10%;"></td> <td style="width: 10%;"></td> <td style="width: 10%;"></td> <td style="width: 10%;"></td> <td style="width: 10%;"></td> <td style="width: 10%;"></td> <td style="width: 10%;"></td> </tr> <tr> <td></td> <td></td> <td colspan="8" style="text-align: center;"> <table border="1" style="width: 100%; border-collapse: collapse; text-align: center;"> <tr> <td style="width: 10%;"></td> <td style="width: 10%;"></td> <td style="width: 10%;"></td> <td style="width: 10%;"></td> <td style="width: 10%;"></td> <td style="width: 10%;"></td> <td style="width: 10%;"></td> <td style="width: 10%;"></td> <td style="width: 10%;"></td> <td style="width: 10%;"></td> </tr> <tr> <td></td> <td></td> <td colspan="8" style="text-align: center;"> <table border="1" style="width: 100%; border-collapse: collapse; text-align: center;"> <tr> <td style="width: 10%;"></td> <td style="width: 10%;"></td> <td style="width: 10%;"></td> <td style="width: 10%;"></td> <td style="width: 10%;"></td> <td style="width: 10%;"></td> <td style="width: 10%;"></td> <td style="width: 10%;"></td> <td style="width: 10%;"></td> <td style="width: 10%;"></td> </tr> <tr> <td></td> <td></td> <td colspan="8" style="text-align: center;"> <table border="1" style="width: 100%; border-collapse: collapse; text-align: center;"> <tr> <td style="width: 10%;"></td> <td style="width: 10%;"></td> <td style="width: 10%;"></td> <td style="width: 10%;"></td> <td style="width: 10%;"></td> <td style="width: 10%;"></td> <td style="width: 10%;"></td> <td style="width: 10%;"></td> <td style="width: 10%;"></td> <td style="width: 10%;"></td> </tr> <tr> <td></td> <td></td> <td colspan="8" style="text-align: center;"> <table border="1" style="width: 100%; border-collapse: collapse; text-align: center;"> <tr> <td style="width: 10%;"></td> <td style="width: 10%;"></td> <td style="width: 10%;"></td> <td style="width: 10%;"></td> <td style="width: 10%;"></td> <td style="width: 10%;"></td> <td style="width: 10%;"></td> <td style="width: 10%;"></td> <td style="width: 10%;"></td> <td style="width: 10%;"></td> </tr> <tr> <td></td> <td></td> <td colspan="8" style="text-align: center;"> <table border="1" style="width: 100%; border-collapse: collapse; text-align: center;"> <tr> <td style="width: 10%;"></td> <td style="width: 10%;"></td> <td style="width: 10%;"></td> <td style="width: 10%;"></td> <td style="width: 10%;"></td> <td style="width: 10%;"></td> <td style="width: 10%;"></td> <td style="width: 10%;"></td> <td style="width: 10%;"></td> <td style="width: 10%;"></td> </tr> <tr> <td></td> <td></td> <td colspan="8" style="text-align: center;"> <table border="1" style="width: 100%; border-collapse: collapse; text-align: center;"> <tr> <td style="width: 10%;"></td> <td style="width: 10%;"></td> <td style="width: 10%;"></td> <td style="width: 10%;"></td> <td style="width: 10%;"></td> <td style="width: 10%;"></td> <td style="width: 10%;"></td> <td style="width: 10%;"></td> <td style="width: 10%;"></td> <td style="width: 10%;"></td> </tr> <tr> <td></td> <td></td> <td colspan="8" style="text-align: center;"> <table border="1" style="width: 100%; border-collapse: collapse; text-align: center;"> <tr> </tr></table></td></tr></table></td></tr></table></td></tr></table></td></tr></table></td></tr></table></td></tr></table></td></tr></table></td></tr></table></td></tr></table></td></tr></table></td></tr></table></td></tr></table></td></tr></table></td></tr></table></td></tr></table></td></tr></table></td></tr></table></td></tr></table></td></tr></table>

 | | | | | | | | | | | | | | | | | | | | <table border="1" style="width: 100%; border-collapse: collapse; text-align: center;"> <tr> <td style="width: 10%;"></td> <td style="width: 10%;"></td> <td style="width: 10%;"></td> <td style="width: 10%;"></td> <td style="width: 10%;"></td> <td style="width: 10%;"></td> <td style="width: 10%;"></td> <td style="width: 10%;"></td> <td style="width: 10%;"></td> <td style="width: 10%;"></td> </tr> <tr> <td></td> <td></td> <td colspan="8" style="text-align: center;"> <table border="1" style="width: 100%; border-collapse: collapse; text-align: center;"> <tr> <td style="width: 10%;"></td> <td style="width: 10%;"></td> <td style="width: 10%;"></td> <td style="width: 10%;"></td> <td style="width: 10%;"></td> <td style="width: 10%;"></td> <td style="width: 10%;"></td> <td style="width: 10%;"></td> <td style="width: 10%;"></td> <td style="width: 10%;"></td> </tr> <tr> <td></td> <td></td> <td colspan="8" style="text-align: center;"> <table border="1" style="width: 100%; border-collapse: collapse; text-align: center;"> <tr> <td style="width: 10%;"></td> <td style="width: 10%;"></td> <td style="width: 10%;"></td> <td style="width: 10%;"></td> <td style="width: 10%;"></td> <td style="width: 10%;"></td> <td style="width: 10%;"></td> <td style="width: 10%;"></td> <td style="width: 10%;"></td> <td style="width: 10%;"></td> </tr> <tr> <td></td> <td></td> <td colspan="8" style="text-align: center;"> <table border="1" style="width: 100%; border-collapse: collapse; text-align: center;"> <tr> <td style="width: 10%;"></td> <td style="width: 10%;"></td> <td style="width: 10%;"></td> <td style="width: 10%;"></td> <td style="width: 10%;"></td> <td style="width: 10%;"></td> <td style="width: 10%;"></td> <td style="width: 10%;"></td> <td style="width: 10%;"></td> <td style="width: 10%;"></td> </tr> <tr> <td></td> <td></td> <td colspan="8" style="text-align: center;"> <table border="1" style="width: 100%; border-collapse: collapse; text-align: center;"> <tr> <td style="width: 10%;"></td> <td style="width: 10%;"></td> <td style="width: 10%;"></td> <td style="width: 10%;"></td> <td style="width: 10%;"></td> <td style="width: 10%;"></td> <td style="width: 10%;"></td> <td style="width: 10%;"></td> <td style="width: 10%;"></td> <td style="width: 10%;"></td> </tr> <tr> <td></td> <td></td> <td colspan="8" style="text-align: center;"> <table border="1" style="width: 100%; border-collapse: collapse; text-align: center;"> <tr> <td style="width: 10%;"></td> <td style="width: 10%;"></td> <td style="width: 10%;"></td> <td style="width: 10%;"></td> <td style="width: 10%;"></td> <td style="width: 10%;"></td> <td style="width: 10%;"></td> <td style="width: 10%;"></td> <td style="width: 10%;"></td> <td style="width: 10%;"></td> </tr> <tr> <td></td> <td></td> <td colspan="8" style="text-align: center;"> <table border="1" style="width: 100%; border-collapse: collapse; text-align: center;"> <tr> <td style="width: 10%;"></td> <td style="width: 10%;"></td> <td style="width: 10%;"></td> <td style="width: 10%;"></td> <td style="width: 10%;"></td> <td style="width: 10%;"></td> <td style="width: 10%;"></td> <td style="width: 10%;"></td> <td style="width: 10%;"></td> <td style="width: 10%;"></td> </tr> <tr> <td></td>
<td></td> <td colspan="8" style="text-align: center;"> <table border="1" style="width: 100%; border-collapse: collapse; text-align: center;"> <tr> <td style="width: 10%;"></td> <td style="width: 10%;"></td> <td style="width: 10%;"></td> <td style="width: 10%;"></td> <td style="width: 10%;"></td> <td style="width: 10%;"></td> <td style="width: 10%;"></td> <td style="width: 10%;"></td> <td style="width: 10%;"></td> <td style="width: 10%;"></td> </tr> <tr> <td></td> <td></td> <td colspan="8" style="text-align: center;"> <table border="1" style="width: 100%; border-collapse: collapse; text-align: center;"> <tr> <td style="width: 10%;"></td> <td style="width: 10%;"></td> <td style="width: 10%;"></td> <td style="width: 10%;"></td> <td style="width: 10%;"></td> <td style="width: 10%;"></td> <td style="width: 10%;"></td> <td style="width: 10%;"></td> <td style="width: 10%;"></td> <td style="width: 10%;"></td> </tr> <tr> <td></td> <td></td> <td colspan="8" style="text-align: center;"> <table border="1" style="width: 100%; border-collapse: collapse; text-align: center;"> <tr> <td style="width: 10%;"></td> <td style="width: 10%;"></td> <td style="width: 10%;"></td> <td style="width: 10%;"></td> <td style="width: 10%;"></td> <td style="width: 10%;"></td> <td style="width: 10%;"></td> <td style="width: 10%;"></td> <td style="width: 10%;"></td> <td style="width: 10%;"></td> </tr> <tr> <td></td> <td></td> <td colspan="8" style="text-align: center;"> <table border="1" style="width: 100%; border-collapse: collapse; text-align: center;"> <tr> <td style="width: 10%;"></td> <td style="width: 10%;"></td> <td style="width: 10%;"></td> <td style="width: 10%;"></td> <td style="width: 10%;"></td> <td style="width: 10%;"></td> <td style="width: 10%;"></td> <td style="width: 10%;"></td> <td style="width: 10%;"></td> <td style="width: 10%;"></td> </tr> <tr> <td></td> <td></td> <td colspan="8" style="text-align: center;"> <table border="1" style="width: 100%; border-collapse: collapse; text-align: center;"> <tr> <td style="width: 10%;"></td> <td style="width: 10%;"></td> <td style="width: 10%;"></td> <td style="width: 10%;"></td> <td style="width: 10%;"></td> <td style="width: 10%;"></td> <td style="width: 10%;"></td> <td style="width: 10%;"></td> <td style="width: 10%;"></td> <td style="width: 10%;"></td> </tr> <tr> <td></td> <td></td> <td colspan="8" style="text-align: center;"> <table border="1" style="width: 100%; border-collapse: collapse; text-align: center;"> <tr> <td style="width: 10%;"></td> <td style="width: 10%;"></td> <td style="width: 10%;"></td> <td style="width: 10%;"></td> <td style="width: 10%;"></td> <td style="width: 10%;"></td> <td style="width: 10%;"></td> <td style="width: 10%;"></td> <td style="width: 10%;"></td> <td style="width: 10%;"></td> </tr> <tr> <td></td> <td></td> <td colspan="8" style="text-align: center;"> <table border="1" style="width: 100%; border-collapse: collapse; text-align: center;"> <tr> <td style="width: 10%;"></td> <td style="width: 10%;"></td> <td style="width: 10%;"></td> <td style="width: 10%;"></td> <td style="width: 10%;"></td> <td style="width: 10%;"></td> <td style="width: 10%;"></td> <td style="width: 10%;"></td> <td style="width: 10%;"></td> <td style="width: 10%;"></td> </tr> <tr> <td></td> <td></td> <td colspan="8" style="text-align: center;"> <table border="1" style="width: 100%; border-collapse: collapse; text-align: center;"> <tr> <td style="width: 10%;"></td> <td style="width: 10%;"></td> <td style="width: 10%;"></td> <td style="width: 10%;"></td> <td style="width: 10%;"></td> <td style="width: 10%;"></td> <td style="width: 10%;"></td> <td style="width: 10%;"></td> <td style="width: 10%;"></td> <td style="width: 10%;"></td> </tr> <tr> <td></td> <td></td> <td colspan="8" style="text-align: center;"> <table border="1" style="width: 100%; border-collapse: collapse; text-align: center;"> <tr> <td style="width: 10%;"></td> <td style="width: 10%;"></td> <td style="width: 10%;"></td> <td style="width: 10%;"></td> <td style="width: 10%;"></td> <td style="width: 10%;"></td> <td style="width: 10%;"></td> <td style="width: 10%;"></td> <td style="width: 10%;"></td> <td style="width: 10%;"></td> </tr> <tr> <td></td> <td></td> <td colspan="8" style="text-align: center;"> <table border="1" style="width: 100%; border-collapse: collapse; text-align: center;"> <tr> <td style="width: 10%;"></td> <td style="width: 10%;"></td> <td style="width: 10%;"></td> <td style="width: 10%;"></td> <td style="width: 10%;"></td> <td style="width: 10%;"></td> <td style="width: 10%;"></td> <td style="width: 10%;"></td> <td style="width: 10%;"></td> <td style="width: 10%;"></td> </tr> <tr> <td></td> <td></td> <td colspan="8" style="text-align: center;"> <table border="1" style="width: 100%; border-collapse: collapse; text-align: center;"> <tr> <td style="width: 10%;"></td> <td style="width: 10%;"></td> <td style="width: 10%;"></td> <td style="width: 10%;"></td> <td style="width: 10%;"></td> <td style="width: 10%;"></td> <td style="width: 10%;"></td> <td style="width: 10%;"></td> <td style="width: 10%;"></td> <td style="width: 10%;"></td> </tr> <tr> <td></td> <td></td> <td colspan="8" style="text-align: center;"> <table border="1" style="width: 100%; border-collapse: collapse; text-align: center;"> <tr> </tr></table></td></tr></table></td></tr></table></td></tr></table></td></tr></table></td></tr></table></td></tr></table></td></tr></table></td></tr></table></td></tr></table></td></tr></table></td></tr></table></td></tr></table></td></tr></table></td></tr></table></td></tr></table></td></tr></table></td></tr></table></td></tr></table>

 | | | | | | | | | | | | | | | | | | | | <table border="1" style="width: 100%; border-collapse: collapse; text-align: center;"> <tr> <td style="width: 10%;"></td> <td style="width: 10%;"></td> <td style="width: 10%;"></td> <td style="width: 10%;"></td> <td style="width: 10%;"></td> <td style="width: 10%;"></td> <td style="width: 10%;"></td> <td style="width: 10%;"></td> <td style="width: 10%;"></td> <td style="width: 10%;"></td> </tr> <tr> <td></td> <td></td> <td colspan="8" style="text-align: center;"> <table border="1" style="width: 100%; border-collapse: collapse; text-align: center;"> <tr> <td style="width: 10%;"></td> <td style="width: 10%;"></td> <td style="width: 10%;"></td> <td style="width: 10%;"></td> <td style="width: 10%;"></td> <td style="width: 10%;"></td> <td style="width: 10%;"></td> <td style="width: 10%;"></td> <td style="width: 10%;"></td> <td style="width: 10%;"></td> </tr> <tr> <td></td> <td></td> <td colspan="8" style="text-align: center;"> <table border="1" style="width: 100%; border-collapse: collapse; text-align: center;"> <tr> <td style="width: 10%;"></td> <td style="width: 10%;"></td> <td style="width: 10%;"></td> <td style="width: 10%;"></td> <td style="width: 10%;"></td> <td style="width: 10%;"></td> <td style="width: 10%;"></td> <td style="width: 10%;"></td> <td style="width: 10%;"></td> <td style="width: 10%;"></td> </tr> <tr> <td></td> <td></td> <td colspan="8" style="text-align: center;"> <table border="1" style="width: 100%; border-collapse: collapse; text-align: center;"> <tr> <td style="width: 10%;"></td> <td style="width: 10%;"></td> <td style="width: 10%;"></td> <td style="width: 10%;"></td> <td style="width: 10%;"></td> <td style="width: 10%;"></td> <td style="width: 10%;"></td> <td style="width: 10%;"></td> <td style="width: 10%;"></td> <td style="width: 10%;"></td> </tr> <tr> <td></td> <td></td> <td colspan="8" style="text-align: center;"> <table border="1" style="width: 100%; border-collapse: collapse; text-align: center;"> <tr> <td style="width: 10%;"></td> <td style="width: 10%;"></td> <td style="width: 10%;"></td> <td style="width: 10%;"></td> <td style="width: 10%;"></td> <td style="width: 10%;"></td> <td style="width: 10%;"></td> <td style="width: 10%;"></td> <td style="width: 10%;"></td> <td style="width: 10%;"></td> </tr> <tr> <td></td> <td></td> <td colspan="8" style="text-align: center;"> <table border="1" style="width: 100%; border-collapse: collapse; text-align: center;"> <tr> <td style="width: 10%;"></td> <td style="width: 10%;"></td> <td style="width: 10%;"></td> <td style="width: 10%;"></td> <td style="width: 10%;"></td> <td style="width: 10%;"></td> <td style="width: 10%;"></td> <td style="width: 10%;"></td> <td style="width: 10%;"></td> <td style="width: 10%;"></td> </tr> <tr> <td></td> <td></td> <td colspan="8" style="text-align: center;"> <table border="1" style="width: 100%; border-collapse: collapse; text-align: center;"> <tr> <td style="width: 10%;"></td> <td style="width: 10%;"></td> <td style="width: 10%;"></td> <td style="width: 10%;"></td> <td style="width: 10%;"></td> <td style="width: 10%;"></td> <td style="width: 10%;"></td> <td style="width: 10%;"></td> <td style="width: 10%;"></td> <td style="width: 10%;"></td> </tr> <tr> <td></td> <td></td> <td colspan="8" style="text-align: center;"> <table border="1" style="width: 100%; border-collapse: collapse; text-align: center;"> <tr> <td style="width: 10%;"></td> <td style="width: 10%;"></td> <td style="width: 10%;"></td> <td style="width: 10%;"></td> <td style="width: 10%;"></td> <td style="width: 10%;"></td> <td style="width: 10%;"></td> <td style="width: 10%;"></td> <td style="width: 10%;"></td> <td style="width: 10%;"></td> </tr> <tr> <td></td> <td></td> <td colspan="8" style="text-align: center;"> <table border="1" style="width: 100%; border-collapse: collapse; text-align: center;"> <tr> <td style="width: 10%;"></td> <td style="width: 10%;"></td> <td style="width: 10%;"></td> <td style="width: 10%;"></td> <td style="width: 10%;"></td> <td style="width: 10%;"></td> <td style="width: 10%;"></td> <td style="width: 10%;"></td> <td style="width: 10%;"></td> <td style="width: 10%;"></td> </tr> <tr> <td></td> <td></td> <td colspan="8" style="text-align: center;"> <table border="1" style="width: 100%; border-collapse: collapse; text-align: center;"> <tr> <td style="width: 10%;"></td> <td style="width: 10%;"></td> <td style="width: 10%;"></td> <td style="width: 10%;"></td> <td style="width: 10%;"></td> <td style="width: 10%;"></td> <td style="width: 10%;"></td> <td style="width: 10%;"></td> <td style="width: 10%;"></td> <td style="width: 10%;"></td> </tr> <tr> <td></td> <td></td> <td colspan="8" style="text-align: center;"> <table border="1" style="width: 100%; border-collapse: collapse; text-align: center;"> <tr> <td style="width: 10%;"></td> <td style="width: 10%;"></td> <td style="width: 10%;"></td> <td style="width: 10%;"></td> <td style="width: 10%;"></td> <td style="width: 10%;"></td> <td style="width: 10%;"></td> <td style="width: 10%;"></td> <td style="width: 10%;"></td> <td style="width: 10%;"></td> </tr> <tr> <td></td> <td></td> <td colspan="8" style="text-align: center;"> <table border="1" style="width: 100%; border-collapse: collapse; text-align: center;"> <tr> <td style="width: 10%;"></td> <td style="width: 10%;"></td> <td style="width: 10%;"></td> <td style="width: 10%;"></td> <td style="width: 10%;"></td> <td style="width: 10%;"></td> <td style="width: 10%;"></td> <td style="width: 10%;"></td> <td style="width: 10%;"></td> <td style="width: 10%;"></td> </tr> <tr> <td></td> <td></td> <td colspan="8" style="text-align: center;"> <table border="1" style="width: 100%; border-collapse: collapse; text-align: center;"> <tr> <td style="width: 10%;"></td> <td style="width: 10%;"></td> <td style="width: 10%;"></td> <td style="width: 10%;"></td> <td
style="width: 10%;"></td> <td style="width: 10%;"></td> <td style="width: 10%;"></td> <td style="width: 10%;"></td> <td style="width: 10%;"></td> <td style="width: 10%;"></td> </tr> <tr> <td></td> <td></td> <td colspan="8" style="text-align: center;"> <table border="1" style="width: 100%; border-collapse: collapse; text-align: center;"> <tr> <td style="width: 10%;"></td> <td style="width: 10%;"></td> <td style="width: 10%;"></td> <td style="width: 10%;"></td> <td style="width: 10%;"></td> <td style="width: 10%;"></td> <td style="width: 10%;"></td> <td style="width: 10%;"></td> <td style="width: 10%;"></td> <td style="width: 10%;"></td> </tr> <tr> <td></td> <td></td> <td colspan="8" style="text-align: center;"> <table border="1" style="width: 100%; border-collapse: collapse; text-align: center;"> <tr> <td style="width: 10%;"></td> <td style="width: 10%;"></td> <td style="width: 10%;"></td> <td style="width: 10%;"></td> <td style="width: 10%;"></td> <td style="width: 10%;"></td> <td style="width: 10%;"></td> <td style="width: 10%;"></td> <td style="width: 10%;"></td> <td style="width: 10%;"></td> </tr> <tr> <td></td> <td></td> <td colspan="8" style="text-align: center;"> <table border="1" style="width: 100%; border-collapse: collapse; text-align: center;"> <tr> <td style="width: 10%;"></td> <td style="width: 10%;"></td> <td style="width: 10%;"></td> <td style="width: 10%;"></td> <td style="width: 10%;"></td> <td style="width: 10%;"></td> <td style="width: 10%;"></td> <td style="width: 10%;"></td> <td style="width: 10%;"></td> <td style="width: 10%;"></td> </tr> <tr> <td></td> <td></td> <td colspan="8" style="text-align: center;"> <table border="1" style="width: 100%; border-collapse: collapse; text-align: center;"> <tr> <td style="width: 10%;"></td> <td style="width: 10%;"></td> <td style="width: 10%;"></td> <td style="width: 10%;"></td> <td style="width: 10%;"></td> <td style="width: 10%;"></td> <td style="width: 10%;"></td> <td style="width: 10%;"></td> <td style="width: 10%;"></td> <td style="width: 10%;"></td> </tr> <tr> <td></td> <td></td> <td colspan="8" style="text-align: center;"> <table border="1" style="width: 100%; border-collapse: collapse; text-align: center;"> <tr> </tr></table></td></tr></table></td></tr></table></td></tr></table></td></tr></table></td></tr></table></td></tr></table></td></tr></table></td></tr></table></td></tr></table></td></tr></table></td></tr></table></td></tr></table></td></tr></table></td></tr></table></td></tr></table></td></tr></table></td></tr></table>

 | | | | | | | | | | | | | | | | | | | | <table border="1" style="width: 100%; border-collapse: collapse; text-align: center;"> <tr> <td style="width: 10%;"></td> <td style="width: 10%;"></td> <td style="width: 10%;"></td> <td style="width: 10%;"></td> <td style="width: 10%;"></td> <td style="width: 10%;"></td> <td style="width: 10%;"></td> <td style="width: 10%;"></td> <td style="width: 10%;"></td> <td style="width: 10%;"></td> </tr> <tr> <td></td> <td></td> <td colspan="8" style="text-align: center;"> <table border="1" style="width: 100%; border-collapse: collapse; text-align: center;"> <tr> <td style="width: 10%;"></td> <td style="width: 10%;"></td> <td style="width: 10%;"></td> <td style="width: 10%;"></td> <td style="width: 10%;"></td> <td style="width: 10%;"></td> <td style="width: 10%;"></td> <td style="width: 10%;"></td> <td style="width: 10%;"></td> <td style="width: 10%;"></td> </tr> <tr> <td></td> <td></td> <td colspan="8" style="text-align: center;"> <table border="1" style="width: 100%; border-collapse: collapse; text-align: center;"> <tr> <td style="width: 10%;"></td> <td style="width: 10%;"></td> <td style="width: 10%;"></td> <td style="width: 10%;"></td> <td style="width: 10%;"></td> <td style="width: 10%;"></td> <td style="width: 10%;"></td> <td style="width: 10%;"></td> <td style="width: 10%;"></td> <td style="width: 10%;"></td> </tr> <tr> <td></td> <td></td> <td colspan="8" style="text-align: center;"> <table border="1" style="width: 100%; border-collapse: collapse; text-align: center;"> <tr> <td style="width: 10%;"></td> <td style="width: 10%;"></td> <td style="width: 10%;"></td> <td style="width: 10%;"></td> <td style="width: 10%;"></td> <td style="width: 10%;"></td> <td style="width: 10%;"></td> <td style="width: 10%;"></td> <td style="width: 10%;"></td> <td style="width: 10%;"></td> </tr> <tr> <td></td> <td></td> <td colspan="8" style="text-align: center;"> <table border="1" style="width: 100%; border-collapse: collapse; text-align: center;"> <tr> <td style="width: 10%;"></td> <td style="width: 10%;"></td> <td style="width: 10%;"></td> <td style="width: 10%;"></td> <td style="width: 10%;"></td> <td style="width: 10%;"></td> <td style="width: 10%;"></td> <td style="width: 10%;"></td> <td style="width: 10%;"></td> <td style="width: 10%;"></td> </tr> <tr> <td></td> <td></td> <td colspan="8" style="text-align: center;"> <table border="1" style="width: 100%; border-collapse: collapse; text-align: center;"> <tr> <td style="width: 10%;"></td> <td style="width: 10%;"></td> <td style="width: 10%;"></td> <td style="width: 10%;"></td> <td style="width: 10%;"></td> <td style="width: 10%;"></td> <td style="width: 10%;"></td> <td style="width: 10%;"></td> <td style="width: 10%;"></td> <td style="width: 10%;"></td> </tr> <tr> <td></td> <td></td> <td colspan="8" style="text-align: center;"> <table border="1" style="width: 100%; border-collapse: collapse; text-align: center;"> <tr> <td style="width: 10%;"></td> <td style="width: 10%;"></td> <td style="width: 10%;"></td> <td style="width: 10%;"></td> <td style="width: 10%;"></td> <td style="width: 10%;"></td> <td style="width: 10%;"></td> <td style="width: 10%;"></td> <td style="width: 10%;"></td> <td style="width: 10%;"></td> </tr> <tr> <td></td> <td></td> <td colspan="8" style="text-align: center;"> <table border="1" style="width: 100%; border-collapse: collapse; text-align: center;"> <tr> <td style="width: 10%;"></td> <td style="width: 10%;"></td> <td style="width: 10%;"></td> <td style="width: 10%;"></td> <td style="width: 10%;"></td> <td style="width: 10%;"></td> <td style="width: 10%;"></td> <td style="width: 10%;"></td> <td style="width: 10%;"></td> <td style="width: 10%;"></td> </tr> <tr> <td></td> <td></td> <td colspan="8" style="text-align: center;"> <table border="1" style="width: 100%; border-collapse: collapse; text-align: center;"> <tr> <td style="width: 10%;"></td> <td style="width: 10%;"></td> <td style="width: 10%;"></td> <td style="width: 10%;"></td> <td style="width: 10%;"></td> <td style="width: 10%;"></td> <td style="width: 10%;"></td> <td style="width: 10%;"></td> <td style="width: 10%;"></td> <td style="width: 10%;"></td> </tr> <tr> <td></td> <td></td> <td colspan="8" style="text-align: center;"> <table border="1" style="width: 100%; border-collapse: collapse; text-align: center;"> <tr> <td style="width: 10%;"></td> <td style="width: 10%;"></td> <td style="width: 10%;"></td> <td style="width: 10%;"></td> <td style="width: 10%;"></td> <td style="width: 10%;"></td> <td style="width: 10%;"></td> <td style="width: 10%;"></td> <td style="width: 10%;"></td> <td style="width: 10%;"></td> </tr> <tr> <td></td> <td></td> <td colspan="8" style="text-align: center;"> <table border="1" style="width: 100%; border-collapse: collapse; text-align: center;"> <tr> <td style="width: 10%;"></td> <td style="width: 10%;"></td> <td style="width: 10%;"></td> <td style="width: 10%;"></td> <td style="width: 10%;"></td> <td style="width: 10%;"></td> <td style="width: 10%;"></td> <td style="width: 10%;"></td> <td style="width: 10%;"></td> <td style="width: 10%;"></td> </tr> <tr> <td></td> <td></td> <td colspan="8" style="text-align: center;"> <table border="1" style="width: 100%; border-collapse: collapse; text-align: center;"> <tr> <td style="width: 10%;"></td> <td style="width: 10%;"></td> <td style="width: 10%;"></td> <td style="width: 10%;"></td> <td style="width: 10%;"></td> <td style="width: 10%;"></td> <td style="width: 10%;"></td> <td style="width: 10%;"></td> <td style="width: 10%;"></td> <td style="width: 10%;"></td> </tr> <tr> <td></td> <td></td> <td colspan="8" style="text-align: center;"> <table border="1" style="width: 100%; border-collapse: collapse; text-align: center;"> <tr> <td style="width: 10%;"></td> <td style="width: 10%;"></td> <td style="width: 10%;"></td> <td style="width: 10%;"></td> <td style="width: 10%;"></td> <td style="width: 10%;"></td> <td style="width: 10%;"></td> <td style="width: 10%;"></td> <td style="width: 10%;"></td> <td style="width: 10%;"></td> </tr> <tr> <td></td> <td></td> <td colspan="8" style="text-align: center;"> <table border="1" style="width: 100%; border-collapse: collapse; text-align: center;"> <tr> <td style="width: 10%;"></td> <td style="width: 10%;"></td> <td style="width: 10%;"></td> <td style="width: 10%;"></td> <td style="width: 10%;"></td> <td style="width: 10%;"></td> <td style="width: 10%;"></td> <td style="width: 10%;"></td> <td style="width: 10%;"></td> <td style="width: 10%;"></td> </tr> <tr> <td></td> <td></td> <td colspan="8" style="text-align: center;"> <table border="1" style="width: 100%; border-collapse: collapse; text-align: center;"> <tr> <td style="width: 10%;"></td> <td style="width: 10%;"></td> <td style="width: 10%;"></td> <td style="width: 10%;"></td> <td style="width: 10%;"></td> <td style="width: 10%;"></td> <td style="width: 10%;"></td> <td style="width: 10%;"></td> <td style="width: 10%;"></td> <td style="width: 10%;"></td> </tr> <tr> <td></td> <td></td> <td colspan="8" style="text-align: center;"> <table border="1" style="width: 100%; border-collapse: collapse; text-align: center;"> <tr> <td style="width: 10%;"></td> <td style="width: 10%;"></td> <td style="width: 10%;"></td> <td style="width: 10%;"></td> <td style="width: 10%;"></td> <td style="width: 10%;"></td> <td style="width: 10%;"></td> <td style="width: 10%;"></td> <td style="width: 10%;"></td> <td style="width: 10%;"></td> </tr> <tr> <td></td> <td></td> <td colspan="8" style="text-align: center;"> <table border="1" style="width: 100%; border-collapse: collapse; text-align: center;"> <tr> </tr></table></td></tr></table></td></tr></table></td></tr></table></td></tr></table></td></tr></table></td></tr></table></td></tr></table></td></tr></table></td></tr></table></td></tr></table></td></tr></table></td></tr></table></td></tr></table></td></tr></table></td></tr></table></td></tr></table>

 | | | | | | | | | | | | | | | | | | | | <table border="1" style="width: 100%; border-collapse: collapse; text-align: center;"> <tr> <td style="width: 10%;"></td> <td style="width: 10%;"></td> <td style="width: 10%;"></td> <td style="width: 10%;"></td> <td style="width: 10%;"></td> <td style="width: 10%;"></td> <td style="width: 10%;"></td> <td style="width: 10%;"></td> <td style="width: 10%;"></td> <td style="width: 10%;"></td> </tr> <tr> <td></td> <td></td> <td colspan="8" style="text-align: center;"> <table border="1" style="width: 100%; border-collapse: collapse; text-align: center;"> <tr> <td style="width: 10%;"></td> <td style="width: 10%;"></td> <td style="width: 10%;"></td> <td style="width: 10%;"></td> <td style="width: 10%;"></td> <td style="width: 10%;"></td> <td style="width: 10%;"></td> <td style="width: 10%;"></td> <td style="width: 10%;"></td> <td style="width: 10%;"></td> </tr> <tr> <td></td> <td></td> <td colspan="8" style="text-align: center;"> <table border="1" style="width: 100%; border-collapse: collapse; text-align: center;"> <tr> <td style="width: 10%;"></td> <td style="width: 10%;"></td> <td style="width: 10%;"></td> <td style="width: 10%;"></td> <td style="width: 10%;"></td> <td style="width: 10%;"></td> <td style="width: 10%;"></td> <td style="width: 10%;"></td> <td style="width: 10%;"></td> <td style="width: 10%;"></td> </tr> <tr> <td></td> <td></td> <td colspan="8" style="text-align: center;"> <table border="1" style="width: 100%; border-collapse: collapse; text-align: center;"> <tr> <td style="width: 10%;"></td> <td style="width: 10%;"></td> <td style="width: 10%;"></td> <td style="width: 10%;"></td> <td style="width: 10%;"></td> <td style="width: 10%;"></td> <td style="width: 10%;"></td> <td style="width: 10%;"></td> <td style="width: 10%;"></td> <td style="width: 10%;"></td> </tr> <tr> <td></td> <td></td> <td colspan="8" style="text-align: center;"> <table border="1" style="width: 100%; border-collapse: collapse; text-align: center;"> <tr> <td style="width: 10%;"></td> <td style="width: 10%;"></td> <td style="width: 10%;"></td> <td style="width: 10%;"></td> <td style="width: 10%;"></td> <td style="width: 10%;"></td> <td style="width: 10%;"></td> <td style="width: 10%;"></td> <td style="width: 10%;"></td> <td style="width: 10%;"></td> </tr> <tr> <td></td> <td></td> <td colspan="8" style="text-align: center;"> <table border="1" style="width: 100%; border-collapse: collapse; text-align: center;"> <tr> <td style="width: 10%;"></td> <td style="width: 10%;"></td> <td style="width: 10%;"></td> <td
style="width: 10%;"></td> <td style="width: 10%;"></td> <td style="width: 10%;"></td> <td style="width: 10%;"></td> <td style="width: 10%;"></td> <td style="width: 10%;"></td> <td style="width: 10%;"></td> </tr> <tr> <td></td> <td></td> <td colspan="8" style="text-align: center;"> <table border="1" style="width: 100%; border-collapse: collapse; text-align: center;"> <tr> <td style="width: 10%;"></td> <td style="width: 10%;"></td> <td style="width: 10%;"></td> <td style="width: 10%;"></td> <td style="width: 10%;"></td> <td style="width: 10%;"></td> <td style="width: 10%;"></td> <td style="width: 10%;"></td> <td style="width: 10%;"></td> <td style="width: 10%;"></td> </tr> <tr> <td></td> <td></td> <td colspan="8" style="text-align: center;"> <table border="1" style="width: 100%; border-collapse: collapse; text-align: center;"> <tr> <td style="width: 10%;"></td> <td style="width: 10%;"></td> <td style="width: 10%;"></td> <td style="width: 10%;"></td> <td style="width: 10%;"></td> <td style="width: 10%;"></td> <td style="width: 10%;"></td> <td style="width: 10%;"></td> <td style="width: 10%;"></td> <td style="width: 10%;"></td> </tr> <tr> <td></td> <td></td> <td colspan="8" style="text-align: center;"> <table border="1" style="width: 100%; border-collapse: collapse; text-align: center;"> <tr> <td style="width: 10%;"></td> <td style="width: 10%;"></td> <td style="width: 10%;"></td> <td style="width: 10%;"></td> <td style="width: 10%;"></td> <td style="width: 10%;"></td> <td style="width: 10%;"></td> <td style="width: 10%;"></td> <td style="width: 10%;"></td> <td style="width: 10%;"></td> </tr> <tr> <td></td> <td></td> <td colspan="8" style="text-align: center;"> <table border="1" style="width: 100%; border-collapse: collapse; text-align: center;"> <tr> <td style="width: 10%;"></td> <td style="width: 10%;"></td> <td style="width: 10%;"></td> <td style="width: 10%;"></td> <td style="width: 10%;"></td> <td style="width: 10%;"></td> <td style="width: 10%;"></td> <td style="width: 10%;"></td> <td style="width: 10%;"></td> <td style="width: 10%;"></td> </tr> <tr> <td></td> <td></td> <td colspan="8" style="text-align: center;"> <table border="1" style="width: 100%; border-collapse: collapse; text-align: center;"> <tr> <td style="width: 10%;"></td> <td style="width: 10%;"></td> <td style="width: 10%;"></td> <td style="width: 10%;"></td> <td style="width: 10%;"></td> <td style="width: 10%;"></td> <td style="width: 10%;"></td> <td style="width: 10%;"></td> <td style="width: 10%;"></td> <td style="width: 10%;"></td> </tr> <tr> <td></td> <td></td> <td colspan="8" style="text-align: center;"> <table border="1" style="width: 100%; border-collapse: collapse; text-align: center;"> <tr> <td style="width: 10%;"></td> <td style="width: 10%;"></td> <td style="width: 10%;"></td> <td style="width: 10%;"></td> <td style="width: 10%;"></td> <td style="width: 10%;"></td> <td style="width: 10%;"></td> <td style="width: 10%;"></td> <td style="width: 10%;"></td> <td style="width: 10%;"></td> </tr> <tr> <td></td> <td></td> <td colspan="8" style="text-align: center;"> <table border="1" style="width: 100%; border-collapse: collapse; text-align: center;"> <tr> <td style="width: 10%;"></td> <td style="width: 10%;"></td> <td style="width: 10%;"></td> <td style="width: 10%;"></td> <td style="width: 10%;"></td> <td style="width: 10%;"></td> <td style="width: 10%;"></td> <td style="width: 10%;"></td> <td style="width: 10%;"></td> <td style="width: 10%;"></td> </tr> <tr> <td></td> <td></td> <td colspan="8" style="text-align: center;"> <table border="1" style="width: 100%; border-collapse: collapse; text-align: center;"> <tr> <td style="width: 10%;"></td> <td style="width: 10%;"></td> <td style="width: 10%;"></td> <td style="width: 10%;"></td> <td style="width: 10%;"></td> <td style="width: 10%;"></td> <td style="width: 10%;"></td> <td style="width: 10%;"></td> <td style="width: 10%;"></td> <td style="width: 10%;"></td> </tr> <tr> <td></td> <td></td> <td colspan="8" style="text-align: center;"> <table border="1" style="width: 100%; border-collapse: collapse; text-align: center;"> <tr> <td style="width: 10%;"></td> <td style="width: 10%;"></td> <td style="width: 10%;"></td> <td style="width: 10%;"></td> <td style="width: 10%;"></td> <td style="width: 10%;"></td> <td style="width: 10%;"></td> <td style="width: 10%;"></td> <td style="width: 10%;"></td> <td style="width: 10%;"></td> </tr> <tr> <td></td> <td></td> <td colspan="8" style="text-align: center;"> <table border="1" style="width: 100%; border-collapse: collapse; text-align: center;"> <tr> </tr></table></td></tr></table></td></tr></table></td></tr></table></td></tr></table></td></tr></table></td></tr></table></td></tr></table></td></tr></table></td></tr></table></td></tr></table></td></tr></table></td></tr></table></td></tr></table></td></tr></table></td></tr></table>

 | | | | | | | | | | | | | | | | | | | | <table border="1" style="width: 100%; border-collapse: collapse; text-align: center;"> <tr> <td style="width: 10%;"></td> <td style="width: 10%;"></td> <td style="width: 10%;"></td> <td style="width: 10%;"></td> <td style="width: 10%;"></td> <td style="width: 10%;"></td> <td style="width: 10%;"></td> <td style="width: 10%;"></td> <td style="width: 10%;"></td> <td style="width: 10%;"></td> </tr> <tr> <td></td> <td></td> <td colspan="8" style="text-align: center;"> <table border="1" style="width: 100%; border-collapse: collapse; text-align: center;"> <tr> <td style="width: 10%;"></td> <td style="width: 10%;"></td> <td style="width: 10%;"></td> <td style="width: 10%;"></td> <td style="width: 10%;"></td> <td style="width: 10%;"></td> <td style="width: 10%;"></td> <td style="width: 10%;"></td> <td style="width: 10%;"></td> <td style="width: 10%;"></td> </tr> <tr> <td></td> <td></td> <td colspan="8" style="text-align: center;"> <table border="1" style="width: 100%; border-collapse: collapse; text-align: center;"> <tr> <td style="width: 10%;"></td> <td style="width: 10%;"></td> <td style="width: 10%;"></td> <td style="width: 10%;"></td> <td style="width: 10%;"></td> <td style="width: 10%;"></td> <td style="width: 10%;"></td> <td style="width: 10%;"></td> <td style="width: 10%;"></td> <td style="width: 10%;"></td> </tr> <tr> <td></td> <td></td> <td colspan="8" style="text-align: center;"> <table border="1" style="width: 100%; border-collapse: collapse; text-align: center;"> <tr> <td style="width: 10%;"></td> <td style="width: 10%;"></td> <td style="width: 10%;"></td> <td style="width: 10%;"></td> <td style="width: 10%;"></td> <td style="width: 10%;"></td> <td style="width: 10%;"></td> <td style="width: 10%;"></td> <td style="width: 10%;"></td> <td style="width: 10%;"></td> </tr> <tr> <td></td> <td></td> <td colspan="8" style="text-align: center;"> <table border="1" style="width: 100%; border-collapse: collapse; text-align: center;"> <tr> <td style="width: 10%;"></td> <td style="width: 10%;"></td> <td style="width: 10%;"></td> <td style="width: 10%;"></td> <td style="width: 10%;"></td> <td style="width: 10%;"></td> <td style="width: 10%;"></td> <td style="width: 10%;"></td> <td style="width: 10%;"></td> <td style="width: 10%;"></td> </tr> <tr> <td></td> <td></td> <td colspan="8" style="text-align: center;"> <table border="1" style="width: 100%; border-collapse: collapse; text-align: center;"> <tr> <td style="width: 10%;"></td> <td style="width: 10%;"></td> <td style="width: 10%;"></td> <td style="width: 10%;"></td> <td style="width: 10%;"></td> <td style="width: 10%;"></td> <td style="width: 10%;"></td> <td style="width: 10%;"></td> <td style="width: 10%;"></td> <td style="width: 10%;"></td> </tr> <tr> <td></td> <td></td> <td colspan="8" style="text-align: center;"> <table border="1" style="width: 100%; border-collapse: collapse; text-align: center;"> <tr> <td style="width: 10%;"></td> <td style="width: 10%;"></td> <td style="width: 10%;"></td> <td style="width: 10%;"></td> <td style="width: 10%;"></td> <td style="width: 10%;"></td> <td style="width: 10%;"></td> <td style="width: 10%;"></td> <td style="width: 10%;"></td> <td style="width: 10%;"></td> </tr> <tr> <td></td> <td></td> <td colspan="8" style="text-align: center;"> <table border="1" style="width: 100%; border-collapse: collapse; text-align: center;"> <tr> <td style="width: 10%;"></td> <td style="width: 10%;"></td> <td style="width: 10%;"></td> <td style="width: 10%;"></td> <td style="width: 10%;"></td> <td style="width: 10%;"></td> <td style="width: 10%;"></td> <td style="width: 10%;"></td> <td style="width: 10%;"></td> <td style="width: 10%;"></td> </tr> <tr> <td></td> <td></td> <td colspan="8" style="text-align: center;"> <table border="1" style="width: 100%; border-collapse: collapse; text-align: center;"> <tr> <td style="width: 10%;"></td> <td style="width: 10%;"></td> <td style="width: 10%;"></td> <td style="width: 10%;"></td> <td style="width: 10%;"></td> <td style="width: 10%;"></td> <td style="width: 10%;"></td> <td style="width: 10%;"></td> <td style="width: 10%;"></td> <td style="width: 10%;"></td> </tr> <tr> <td></td> <td></td> <td colspan="8" style="text-align: center;"> <table border="1" style="width: 100%; border-collapse: collapse; text-align: center;"> <tr> <td style="width: 10%;"></td> <td style="width: 10%;"></td> <td style="width: 10%;"></td> <td style="width: 10%;"></td> <td style="width: 10%;"></td> <td style="width: 10%;"></td> <td style="width: 10%;"></td> <td style="width: 10%;"></td> <td style="width: 10%;"></td> <td style="width: 10%;"></td> </tr> <tr> <td></td> <td></td> <td colspan="8" style="text-align: center;"> <table border="1" style="width: 100%; border-collapse: collapse; text-align: center;"> <tr> <td style="width: 10%;"></td> <td style="width: 10%;"></td> <td style="width: 10%;"></td> <td style="width: 10%;"></td> <td style="width: 10%;"></td> <td style="width: 10%;"></td> <td style="width: 10%;"></td> <td style="width: 10%;"></td> <td style="width: 10%;"></td> <td style="width: 10%;"></td> </tr> <tr> <td></td> <td></td> <td colspan="8" style="text-align: center;"> <table border="1" style="width: 100%; border-collapse: collapse; text-align: center;"> <tr> <td style="width: 10%;"></td> <td style="width: 10%;"></td> <td style="width: 10%;"></td> <td style="width: 10%;"></td> <td style="width: 10%;"></td> <td style="width: 10%;"></td> <td style="width: 10%;"></td> <td style="width: 10%;"></td> <td style="width: 10%;"></td> <td style="width: 10%;"></td> </tr> <tr> <td></td> <td></td> <td colspan="8" style="text-align: center;"> <table border="1" style="width: 100%; border-collapse: collapse; text-align: center;"> <tr> <td style="width: 10%;"></td> <td style="width: 10%;"></td> <td style="width: 10%;"></td> <td style="width: 10%;"></td> <td style="width: 10%;"></td> <td style="width: 10%;"></td> <td style="width: 10%;"></td> <td style="width: 10%;"></td> <td style="width: 10%;"></td> <td style="width: 10%;"></td> </tr> <tr> <td></td> <td></td> <td colspan="8" style="text-align: center;"> <table border="1" style="width: 100%; border-collapse: collapse; text-align: center;"> <tr> <td style="width: 10%;"></td> <td style="width: 10%;"></td> <td style="width: 10%;"></td> <td style="width: 10%;"></td> <td style="width: 10%;"></td> <td style="width: 10%;"></td> <td style="width: 10%;"></td> <td style="width: 10%;"></td> <td style="width: 10%;"></td> <td style="width: 10%;"></td> </tr> <tr> <td></td> <td></td> <td colspan="8" style="text-align: center;"> <table border="1" style="width: 100%;
border-collapse: collapse; text-align: center;"> <tr> </tr></table></td></tr></table></td></tr></table></td></tr></table></td></tr></table></td></tr></table></td></tr></table></td></tr></table></td></tr></table></td></tr></table></td></tr></table></td></tr></table></td></tr></table></td></tr></table></td></tr></table>
 | | | | | | | | | | | | | | | | | | | | <table border="1" style="width: 100%; border-collapse: collapse; text-align: center;"> <tr> <td style="width: 10%;"></td> <td style="width: 10%;"></td> <td style="width: 10%;"></td> <td style="width: 10%;"></td> <td style="width: 10%;"></td> <td style="width: 10%;"></td> <td style="width: 10%;"></td> <td style="width: 10%;"></td> <td style="width: 10%;"></td> <td style="width: 10%;"></td> </tr> <tr> <td></td> <td></td> <td colspan="8" style="text-align: center;"> <table border="1" style="width: 100%; border-collapse: collapse; text-align: center;"> <tr> <td style="width: 10%;"></td> <td style="width: 10%;"></td> <td style="width: 10%;"></td> <td style="width: 10%;"></td> <td style="width: 10%;"></td> <td style="width: 10%;"></td> <td style="width: 10%;"></td> <td style="width: 10%;"></td> <td style="width: 10%;"></td> <td style="width: 10%;"></td> </tr> <tr> <td></td> <td></td> <td colspan="8" style="text-align: center;"> <table border="1" style="width: 100%; border-collapse: collapse; text-align: center;"> <tr> <td style="width: 10%;"></td> <td style="width: 10%;"></td> <td style="width: 10%;"></td> <td style="width: 10%;"></td> <td
style="width: 10%;"></td> <td style="width: 10%;"></td> <td style="width: 10%;"></td> <td style="width: 10%;"></td> <td style="width: 10%;"></td> <td style="width: 10%;"></td> </tr> <tr> <td></td> <td></td> <td colspan="8" style="text-align: center;"> <table border="1" style="width: 100%; border-collapse: collapse; text-align: center;"> <tr> <td style="width: 10%;"></td> <td style="width: 10%;"></td> <td style="width: 10%;"></td> <td style="width: 10%;"></td> <td style="width: 10%;"></td> <td style="width: 10%;"></td> <td style="width: 10%;"></td> <td style="width: 10%;"></td> <td style="width: 10%;"></td> <td style="width: 10%;"></td> </tr> <tr> <td></td> <td></td> <td colspan="8" style="text-align: center;"> <table border="1" style="width: 100%; border-collapse: collapse; text-align: center;"> <tr> <td style="width: 10%;"></td> <td style="width: 10%;"></td> <td style="width: 10%;"></td> <td style="width: 10%;"></td> <td style="width: 10%;"></td> <td style="width: 10%;"></td> <td style="width: 10%;"></td> <td style="width: 10%;"></td> <td style="width: 10%;"></td> <td style="width: 10%;"></td> </tr> <tr> <td></td> <td></td> <td colspan="8" style="text-align: center;"> <table border="1" style="width: 100%; border-collapse: collapse; text-align: center;"> <tr> <td style="width: 10%;"></td> <td style="width: 10%;"></td> <td style="width: 10%;"></td> <td style="width: 10%;"></td> <td style="width: 10%;"></td> <td style="width: 10%;"></td> <td style="width: 10%;"></td> <td style="width: 10%;"></td> <td style="width: 10%;"></td> <td style="width: 10%;"></td> </tr> <tr> <td></td> <td></td> <td colspan="8" style="text-align: center;"> <table border="1" style="width: 100%; border-collapse: collapse; text-align: center;"> <tr> <td style="width: 10%;"></td> <td style="width: 10%;"></td> <td style="width: 10%;"></td> <td style="width: 10%;"></td> <td style="width: 10%;"></td> <td style="width: 10%;"></td> <td style="width: 10%;"></td> <td style="width: 10%;"></td> <td style="width: 10%;"></td> <td style="width: 10%;"></td> </tr> <tr> <td></td> <td></td> <td colspan="8" style="text-align: center;"> <table border="1" style="width: 100%; border-collapse: collapse; text-align: center;"> <tr> <td style="width: 10%;"></td> <td style="width: 10%;"></td> <td style="width: 10%;"></td> <td style="width: 10%;"></td> <td style="width: 10%;"></td> <td style="width: 10%;"></td> <td style="width: 10%;"></td> <td style="width: 10%;"></td> <td style="width: 10%;"></td> <td style="width: 10%;"></td> </tr> <tr> <td></td> <td></td> <td colspan="8" style="text-align: center;"> <table border="1" style="width: 100%; border-collapse: collapse; text-align: center;"> <tr> <td style="width: 10%;"></td> <td style="width: 10%;"></td> <td style="width: 10%;"></td> <td style="width: 10%;"></td> <td style="width: 10%;"></td> <td style="width: 10%;"></td> <td style="width: 10%;"></td> <td style="width: 10%;"></td> <td style="width: 10%;"></td> <td style="width: 10%;"></td> </tr> <tr> <td></td> <td></td> <td colspan="8" style="text-align: center;"> <table border="1" style="width: 100%; border-collapse: collapse; text-align: center;"> <tr> <td style="width: 10%;"></td> <td style="width: 10%;"></td> <td style="width: 10%;"></td> <td style="width: 10%;"></td> <td style="width: 10%;"></td> <td style="width: 10%;"></td> <td style="width: 10%;"></td> <td style="width: 10%;"></td> <td style="width: 10%;"></td> <td style="width: 10%;"></td> </tr> <tr> <td></td> <td></td> <td colspan="8" style="text-align: center;"> <table border="1" style="width: 100%; border-collapse: collapse; text-align: center;"> <tr> <td style="width: 10%;"></td> <td style="width: 10%;"></td> <td style="width: 10%;"></td> <td style="width: 10%;"></td> <td style="width: 10%;"></td> <td style="width: 10%;"></td> <td style="width: 10%;"></td> <td style="width: 10%;"></td> <td style="width: 10%;"></td> <td style="width: 10%;"></td> </tr> <tr> <td></td> <td></td> <td colspan="8" style="text-align: center;"> <table border="1" style="width: 100%; border-collapse: collapse; text-align: center;"> <tr> <td style="width: 10%;"></td> <td style="width: 10%;"></td> <td style="width: 10%;"></td> <td style="width: 10%;"></td> <td style="width: 10%;"></td> <td style="width: 10%;"></td> <td style="width: 10%;"></td> <td style="width: 10%;"></td> <td style="width: 10%;"></td> <td style="width: 10%;"></td> </tr> <tr> <td></td> <td></td> <td colspan="8" style="text-align: center;"> <table border="1" style="width: 100%; border-collapse: collapse; text-align: center;"> <tr> <td style="width: 10%;"></td> <td style="width: 10%;"></td> <td style="width: 10%;"></td> <td style="width: 10%;"></td> <td style="width: 10%;"></td> <td style="width: 10%;"></td> <td style="width: 10%;"></td> <td style="width: 10%;"></td> <td style="width: 10%;"></td> <td style="width: 10%;"></td> </tr> <tr> <td></td> <td></td> <td colspan="8" style="text-align: center;"> <table border="1" style="width: 100%; border-collapse: collapse; text-align: center;"> <tr> </tr></table></td></tr></table></td></tr></table></td></tr></table></td></tr></table></td></tr></table></td></tr></table></td></tr></table></td></tr></table></td></tr></table></td></tr></table></td></tr></table></td></tr></table></td></tr></table>

 | | | | | | | | | | | | | | | | | | | | <table border="1" style="width: 100%; border-collapse: collapse; text-align: center;"> <tr> <td style="width: 10%;"></td> <td style="width: 10%;"></td> <td style="width: 10%;"></td> <td style="width: 10%;"></td> <td style="width: 10%;"></td> <td style="width: 10%;"></td> <td style="width: 10%;"></td> <td style="width: 10%;"></td> <td style="width: 10%;"></td> <td style="width: 10%;"></td> </tr> <tr> <td></td> <td></td> <td colspan="8" style="text-align: center;"> <table border="1" style="width: 100%; border-collapse: collapse; text-align: center;"> <tr> <td style="width: 10%;"></td> <td style="width: 10%;"></td> <td style="width: 10%;"></td> <td style="width: 10%;"></td> <td style="width: 10%;"></td> <td style="width: 10%;"></td> <td style="width: 10%;"></td> <td style="width: 10%;"></td> <td style="width: 10%;"></td> <td style="width: 10%;"></td> </tr> <tr> <td></td> <td></td> <td colspan="8" style="text-align: center;"> <table border="1" style="width: 100%; border-collapse: collapse; text-align: center;"> <tr> <td style="width: 10%;"></td> <td style="width: 10%;"></td> <td style="width: 10%;"></td> <td style="width: 10%;"></td> <td style="width: 10%;"></td> <td style="width: 10%;"></td> <td style="width: 10%;"></td> <td style="width: 10%;"></td> <td style="width: 10%;"></td> <td style="width: 10%;"></td> </tr> <tr> <td></td> <td></td> <td colspan="8" style="text-align: center;"> <table border="1" style="width: 100%; border-collapse: collapse; text-align: center;"> <tr> <td style="width: 10%;"></td> <td style="width: 10%;"></td> <td style="width: 10%;"></td> <td style="width: 10%;"></td> <td style="width: 10%;"></td> <td style="width: 10%;"></td> <td style="width: 10%;"></td> <td style="width: 10%;"></td> <td style="width: 10%;"></td> <td style="width: 10%;"></td> </tr> <tr> <td></td> <td></td> <td colspan="8" style="text-align: center;"> <table border="1" style="width: 100%; border-collapse: collapse; text-align: center;"> <tr> <td style="width: 10%;"></td> <td style="width: 10%;"></td> <td style="width: 10%;"></td> <td style="width: 10%;"></td> <td style="width: 10%;"></td> <td style="width: 10%;"></td> <td style="width: 10%;"></td> <td style="width: 10%;"></td> <td style="width: 10%;"></td> <td style="width: 10%;"></td> </tr> <tr> <td></td> <td></td> <td colspan="8" style="text-align: center;"> <table border="1" style="width: 100%; border-collapse: collapse; text-align: center;"> <tr> <td style="width: 10%;"></td> <td style="width: 10%;"></td> <td style="width: 10%;"></td> <td style="width: 10%;"></td> <td style="width: 10%;"></td> <td style="width: 10%;"></td> <td style="width: 10%;"></td> <td style="width: 10%;"></td> <td style="width: 10%;"></td> <td style="width: 10%;"></td> </tr> <tr> <td></td> <td></td> <td colspan="8" style="text-align: center;"> <table border="1" style="width: 100%; border-collapse: collapse; text-align: center;"> <tr> <td style="width: 10%;"></td> <td style="width: 10%;"></td> <td style="width: 10%;"></td> <td style="width: 10%;"></td> <td style="width: 10%;"></td> <td style="width: 10%;"></td> <td style="width: 10%;"></td> <td style="width: 10%;"></td> <td style="width: 10%;"></td> <td style="width: 10%;"></td> </tr> <tr> <td></td> <td></td> <td colspan="8" style="text-align: center;"> <table border="1" style="width: 100%; border-collapse: collapse; text-align: center;"> <tr> <td style="width: 10%;"></td> <td style="width: 10%;"></td> <td style="width: 10%;"></td> <td style="width: 10%;"></td> <td style="width: 10%;"></td> <td style="width: 10%;"></td> <td style="width: 10%;"></td> <td style="width: 10%;"></td> <td style="width: 10%;"></td> <td style="width: 10%;"></td> </tr> <tr> <td></td> <td></td> <td colspan="8" style="text-align: center;"> <table border="1" style="width: 100%; border-collapse: collapse; text-align: center;"> <tr> <td style="width: 10%;"></td> <td style="width: 10%;"></td> <td style="width: 10%;"></td> <td style="width: 10%;"></td> <td style="width: 10%;"></td> <td style="width: 10%;"></td> <td style="width: 10%;"></td> <td style="width: 10%;"></td> <td style="width: 10%;"></td> <td style="width: 10%;"></td> </tr> <tr> <td></td> <td></td> <td colspan="8" style="text-align: center;"> <table border="1" style="width: 100%; border-collapse: collapse; text-align: center;"> <tr> <td style="width: 10%;"></td> <td style="width: 10%;"></td> <td style="width: 10%;"></td> <td style="width: 10%;"></td> <td style="width: 10%;"></td> <td style="width: 10%;"></td> <td style="width: 10%;"></td> <td style="width: 10%;"></td> <td style="width: 10%;"></td> <td style="width: 10%;"></td> </tr> <tr> <td></td> <td></td> <td colspan="8" style="text-align: center;"> <table border="1" style="width: 100%; border-collapse: collapse; text-align: center;"> <tr> <td style="width: 10%;"></td> <td style="width: 10%;"></td> <td style="width: 10%;"></td> <td style="width: 10%;"></td> <td style="width: 10%;"></td> <td style="width: 10%;"></td> <td style="width: 10%;"></td> <td style="width: 10%;"></td> <td style="width: 10%;"></td> <td style="width: 10%;"></td> </tr> <tr> <td></td> <td></td> <td colspan="8" style="text-align: center;"> <table border="1" style="width: 100%; border-collapse: collapse; text-align: center;"> <tr> <td style="width: 10%;"></td> <td style="width: 10%;"></td> <td style="width: 10%;"></td> <td style="width: 10%;"></td> <td style="width: 10%;"></td> <td style="width: 10%;"></td> <td style="width: 10%;"></td> <td style="width: 10%;"></td> <td style="width: 10%;"></td> <td style="width: 10%;"></td> </tr> <tr> <td></td> <td></td> <td colspan="8" style="text-align: center;"> <table border="1" style="width: 100%; border-collapse: collapse; text-align: center;"> <tr> </tr></table></td></tr></table></td></tr></table></td></tr></table></td></tr></table></td></tr></table></td></tr></table></td></tr></table></td></tr></table></td></tr></table></td></tr></table></td></tr></table></td></tr></table>

 | | | | | | | | | | | | | | | | | | | | <table border="1" style="width: 100%; border-collapse: collapse; text-align: center;"> <tr> <td style="width: 10%;"></td> <td style="width: 10%;"></td> <td style="width: 10%;"></td> <td style="width: 10%;"></td> <td style="width: 10%;"></td> <td style="width: 10%;"></td> <td style="width: 10%;"></td> <td style="width: 10%;"></td> <td style="width: 10%;"></td> <td style="width: 10%;"></td> </tr> <tr> <td></td> <td></td> <td colspan="8" style="text-align: center;"> <table border="1" style="width: 100%; border-collapse: collapse; text-align: center;"> <tr> <td style="width: 10%;"></td> <td style="width: 10%;"></td> <td style="width: 10%;"></td> <td style="width: 10%;"></td> <td style="width: 10%;"></td> <td style="width: 10%;"></td> <td style="width: 10%;"></td> <td style="width: 10%;"></td> <td style="width: 10%;"></td> <td style="width: 10%;"></td> </tr> <tr> <td></td> <td></td> <td colspan="8" style="text-align: center;"> <table border="1" style="width: 100%; border-collapse: collapse; text-align: center;"> <tr> <td style="width: 10%;"></td> <td style="width: 10%;"></td> <td style="width: 10%;"></td> <td style="width: 10%;"></td> <td style="width: 10%;"></td> <td style="width: 10%;"></td> <td style="width: 10%;"></td> <td style="width: 10%;"></td> <td style="width: 10%;"></td> <td style="width: 10%;"></td> </tr> <tr> <td></td> <td></td> <td colspan="8" style="text-align: center;"> <table border="1" style="width: 100%; border-collapse: collapse; text-align: center;"> <tr> <td style="width: 10%;"></td> <td style="width: 10%;"></td> <td style="width: 10%;"></td> <td style="width: 10%;"></td> <td style="width: 10%;"></td> <td style="width: 10%;"></td> <td style="width: 10%;"></td> <td style="width: 10%;"></td>
<td style="width: 10%;"></td> <td style="width: 10%;"></td> </tr> <tr> <td></td> <td></td> <td colspan="8" style="text-align: center;"> <table border="1" style="width: 100%; border-collapse: collapse; text-align: center;"> <tr> <td style="width: 10%;"></td> <td style="width: 10%;"></td> <td style="width: 10%;"></td> <td style="width: 10%;"></td> <td style="width: 10%;"></td> <td style="width: 10%;"></td> <td style="width: 10%;"></td> <td style="width: 10%;"></td> <td style="width: 10%;"></td> <td style="width: 10%;"></td> </tr> <tr> <td></td> <td></td> <td colspan="8" style="text-align: center;"> <table border="1" style="width: 100%; border-collapse: collapse; text-align: center;"> <tr> <td style="width: 10%;"></td> <td style="width: 10%;"></td> <td style="width: 10%;"></td> <td style="width: 10%;"></td> <td style="width: 10%;"></td> <td style="width: 10%;"></td> <td style="width: 10%;"></td> <td style="width: 10%;"></td> <td style="width: 10%;"></td> <td style="width: 10%;"></td> </tr> <tr> <td></td> <td></td> <td colspan="8" style="text-align: center;"> <table border="1" style="width: 100%; border-collapse: collapse; text-align: center;"> <tr> <td style="width: 10%;"></td> <td style="width: 10%;"></td> <td style="width: 10%;"></td> <td style="width: 10%;"></td> <td style="width: 10%;"></td> <td style="width: 10%;"></td> <td style="width: 10%;"></td> <td style="width: 10%;"></td> <td style="width: 10%;"></td> <td style="width: 10%;"></td> </tr> <tr> <td></td> <td></td> <td colspan="8" style="text-align: center;"> <table border="1" style="width: 100%; border-collapse: collapse; text-align: center;"> <tr> <td style="width: 10%;"></td> <td style="width: 10%;"></td> <td style="width: 10%;"></td> <td style="width: 10%;"></td> <td style="width: 10%;"></td> <td style="width: 10%;"></td> <td style="width: 10%;"></td> <td style="width: 10%;"></td> <td style="width: 10%;"></td> <td style="width: 10%;"></td> </tr> <tr> <td></td> <td></td> <td colspan="8" style="text-align: center;"> <table border="1" style="width: 100%; border-collapse: collapse; text-align: center;"> <tr> <td style="width: 10%;"></td> <td style="width: 10%;"></td> <td style="width: 10%;"></td> <td style="width: 10%;"></td> <td style="width: 10%;"></td> <td style="width: 10%;"></td> <td style="width: 10%;"></td> <td style="width: 10%;"></td> <td style="width: 10%;"></td> <td style="width: 10%;"></td> </tr> <tr> <td></td> <td></td> <td colspan="8" style="text-align: center;"> <table border="1" style="width: 100%; border-collapse: collapse; text-align: center;"> <tr> <td style="width: 10%;"></td> <td style="width: 10%;"></td> <td style="width: 10%;"></td> <td style="width: 10%;"></td> <td style="width: 10%;"></td> <td style="width: 10%;"></td> <td style="width: 10%;"></td> <td style="width: 10%;"></td> <td style="width: 10%;"></td> <td style="width: 10%;"></td> </tr> <tr> <td></td> <td></td> <td colspan="8" style="text-align: center;"> <table border="1" style="width: 100%; border-collapse: collapse; text-align: center;"> <tr> <td style="width: 10%;"></td> <td style="width: 10%;"></td> <td style="width: 10%;"></td> <td style="width: 10%;"></td> <td style="width: 10%;"></td> <td style="width: 10%;"></td> <td style="width: 10%;"></td> <td style="width: 10%;"></td> <td style="width: 10%;"></td> <td style="width: 10%;"></td> </tr> <tr> <td></td> <td></td> <td colspan="8" style="text-align: center;"> <table border="1" style="width: 100%; border-collapse: collapse; text-align: center;"> <tr> </tr></table></td></tr></table></td></tr></table></td></tr></table></td></tr></table></td></tr></table></td></tr></table></td></tr></table></td></tr></table></td></tr></table></td></tr></table></td></tr></table>

 | | | | | | | | | | | | | | | | | | | | <table border="1" style="width: 100%; border-collapse: collapse; text-align: center;"> <tr> <td style="width: 10%;"></td> <td style="width: 10%;"></td> <td style="width: 10%;"></td> <td style="width: 10%;"></td> <td style="width: 10%;"></td> <td style="width: 10%;"></td> <td style="width: 10%;"></td> <td style="width: 10%;"></td> <td style="width: 10%;"></td> <td style="width: 10%;"></td> </tr> <tr> <td></td> <td></td> <td colspan="8" style="text-align: center;"> <table border="1" style="width: 100%; border-collapse: collapse; text-align: center;"> <tr> <td style="width: 10%;"></td> <td style="width: 10%;"></td> <td style="width: 10%;"></td> <td style="width: 10%;"></td> <td style="width: 10%;"></td> <td style="width: 10%;"></td> <td style="width: 10%;"></td> <td style="width: 10%;"></td> <td style="width: 10%;"></td> <td style="width: 10%;"></td> </tr> <tr> <td></td> <td></td> <td colspan="8" style="text-align: center;"> <table border="1" style="width: 100%; border-collapse: collapse; text-align: center;"> <tr> <td style="width: 10%;"></td> <td style="width: 10%;"></td> <td style="width: 10%;"></td> <td style="width: 10%;"></td> <td style="width: 10%;"></td> <td style="width: 10%;"></td> <td style="width: 10%;"></td> <td style="width: 10%;"></td> <td style="width: 10%;"></td> <td style="width: 10%;"></td> </tr> <tr> <td></td> <td></td> <td colspan="8" style="text-align: center;"> <table border="1" style="width: 100%; border-collapse: collapse; text-align: center;"> <tr> <td style="width: 10%;"></td> <td style="width: 10%;"></td> <td style="width: 10%;"></td> <td style="width: 10%;"></td> <td style="width: 10%;"></td> <td style="width: 10%;"></td> <td style="width: 10%;"></td> <td style="width: 10%;"></td> <td style="width: 10%;"></td> <td style="width: 10%;"></td> </tr> <tr> <td></td> <td></td> <td colspan="8" style="text-align: center;"> <table border="1" style="width: 100%; border-collapse: collapse; text-align: center;"> <tr> <td style="width: 10%;"></td> <td style="width: 10%;"></td> <td style="width: 10%;"></td> <td style="width: 10%;"></td> <td style="width: 10%;"></td> <td style="width: 10%;"></td> <td style="width: 10%;"></td> <td style="width: 10%;"></td> <td style="width: 10%;"></td> <td style="width: 10%;"></td> </tr> <tr> <td></td> <td></td> <td colspan="8" style="text-align: center;"> <table border="1" style="width: 100%; border-collapse: collapse; text-align: center;"> <tr> <td style="width: 10%;"></td> <td style="width: 10%;"></td> <td style="width: 10%;"></td> <td style="width: 10%;"></td> <td style="width: 10%;"></td> <td style="width: 10%;"></td> <td style="width: 10%;"></td> <td style="width: 10%;"></td> <td style="width: 10%;"></td> <td style="width: 10%;"></td> </tr> <tr> <td></td> <td></td> <td colspan="8" style="text-align: center;"> <table border="1" style="width: 100%; border-collapse: collapse; text-align: center;"> <tr> <td style="width: 10%;"></td> <td style="width: 10%;"></td> <td style="width: 10%;"></td> <td style="width: 10%;"></td> <td style="width: 10%;"></td> <td style="width: 10%;"></td> <td style="width: 10%;"></td> <td style="width: 10%;"></td> <td style="width: 10%;"></td> <td style="width: 10%;"></td> </tr> <tr> <td></td> <td></td> <td colspan="8" style="text-align: center;"> <table border="1" style="width: 100%; border-collapse: collapse; text-align: center;"> <tr> <td style="width: 10%;"></td> <td style="width: 10%;"></td> <td style="width: 10%;"></td> <td style="width: 10%;"></td> <td style="width: 10%;"></td> <td style="width: 10%;"></td> <td style="width: 10%;"></td> <td style="width: 10%;"></td> <td style="width: 10%;"></td> <td style="width: 10%;"></td> </tr> <tr> <td></td> <td></td> <td colspan="8" style="text-align: center;"> <table border="1" style="width: 100%; border-collapse: collapse; text-align: center;"> <tr> <td style="width: 10%;"></td> <td style="width: 10%;"></td> <td style="width: 10%;"></td> <td style="width: 10%;"></td> <td style="width: 10%;"></td> <td style="width: 10%;"></td> <td style="width: 10%;"></td> <td style="width: 10%;"></td> <td style="width: 10%;"></td> <td style="width: 10%;"></td> </tr> <tr> <td></td> <td></td> <td colspan="8" style="text-align: center;"> <table border="1" style="width: 100%; border-collapse: collapse; text-align: center;"> <tr> <td style="width: 10%;"></td> <td style="width: 10%;"></td> <td style="width: 10%;"></td> <td style="width: 10%;"></td> <td style="width: 10%;"></td> <td style="width: 10%;"></td> <td style="width: 10%;"></td> <td style="width: 10%;"></td> <td style="width: 10%;"></td> <td style="width: 10%;"></td> </tr> <tr> <td></td> <td></td> <td colspan="8" style="text-align: center;"> <table border="1" style="width: 100%; border-collapse: collapse; text-align: center;"> <tr> </tr></table></td></tr></table></td></tr></table></td></tr></table></td></tr></table></td></tr></table></td></tr></table></td></tr></table></td></tr></table></td></tr></table></td></tr></table>

 | | | | | | | | | | | | | | | | | | | | <table border="1" style="width: 100%; border-collapse: collapse; text-align: center;"> <tr> <td style="width: 10%;"></td> <td style="width: 10%;"></td> <td style="width: 10%;"></td> <td style="width: 10%;"></td> <td style="width: 10%;"></td> <td style="width: 10%;"></td> <td style="width: 10%;"></td> <td style="width: 10%;"></td> <td style="width: 10%;"></td> <td style="width: 10%;"></td> </tr> <tr> <td></td> <td></td> <td colspan="8" style="text-align: center;"> <table border="1" style="width: 100%; border-collapse: collapse; text-align: center;"> <tr> <td style="width: 10%;"></td> <td style="width: 10%;"></td> <td style="width: 10%;"></td> <td style="width: 10%;"></td> <td style="width: 10%;"></td> <td style="width: 10%;"></td> <td style="width: 10%;"></td> <td style="width: 10%;"></td> <td style="width: 10%;"></td> <td style="width: 10%;"></td> </tr> <tr> <td></td> <td></td> <td colspan="8" style="text-align: center;"> <table border="1" style="width: 100%; border-collapse: collapse; text-align: center;"> <tr> <td style="width: 10%;"></td> <td style="width: 10%;"></td> <td style="width: 10%;"></td> <td style="width: 10%;"></td> <td style="width: 10%;"></td> <td style="width: 10%;"></td> <td style="width: 10%;"></td> <td style="width: 10%;"></td> <td style="width: 10%;"></td> <td style="width: 10%;"></td> </tr> <tr> <td></td> <td></td> <td colspan="8" style="text-align: center;"> <table border="1" style="width: 100%; border-collapse: collapse; text-align: center;"> <tr> <td style="width: 10%;"></td> <td style="width: 10%;"></td> <td style="width: 10%;"></td> <td style="width: 10%;"></td> <td style="width: 10%;"></td> <td style="width: 10%;"></td> <td style="width: 10%;"></td> <td style="width: 10%;"></td> <td style="width: 10%;"></td> <td style="width: 10%;"></td> </tr> <tr> <td></td> <td></td> <td colspan="8" style="text-align: center;"> <table border="1" style="width: 100%; border-collapse: collapse; text-align: center;"> <tr> <td style="width: 10%;"></td> <td style="width: 10%;"></td> <td style="width: 10%;"></td> <td style="width: 10%;"></td> <td style="width: 10%;"></td> <td style="width: 10%;"></td> <td style="width: 10%;"></td> <td style="width: 10%;"></td> <td style="width: 10%;"></td> <td style="width: 10%;"></td> </tr> <tr> <td></td> <td></td> <td colspan="8" style="text-align: center;"> <table border="1" style="width: 100%; border-collapse: collapse; text-align: center;"> <tr> <td style="width: 10%;"></td> <td style="width: 10%;"></td> <td style="width: 10%;"></td> <td style="width: 10%;"></td> <td style="width: 10%;"></td> <td style="width: 10%;"></td> <td style="width: 10%;"></td> <td style="width: 10%;"></td> <td style="width: 10%;"></td> <td style="width: 10%;"></td> </tr> <tr> <td></td> <td></td> <td colspan="8" style="text-align: center;"> <table border="1" style="width: 100%; border-collapse: collapse; text-align: center;"> <tr> <td style="width: 10%;"></td> <td style="width: 10%;"></td> <td style="width: 10%;"></td> <td style="width: 10%;"></td> <td style="width: 10%;"></td> <td style="width: 10%;"></td> <td style="width: 10%;"></td> <td style="width: 10%;"></td> <td style="width: 10%;"></td> <td style="width: 10%;"></td> </tr> <tr> <td></td> <td></td> <td colspan="8" style="text-align: center;"> <table border="1" style="width: 100%; border-collapse: collapse; text-align: center;"> <tr> <td style="width: 10%;"></td> <td style="width: 10%;"></td> <td style="width: 10%;"></td> <td style="width: 10%;"></td> <td style="width: 10%;"></td> <td style="width: 10%;"></td> <td style="width: 10%;"></td> <td style="width: 10%;"></td> <td style="width: 10%;"></td> <td style="width: 10%;"></td> </tr> <tr> <td></td> <td></td> <td colspan="8" style="text-align: center;"> <table border="1" style="width: 100%; border-collapse: collapse; text-align: center;"> <tr> <td style="width: 10%;"></td> <td style="width: 10%;"></td> <td style="width: 10%;"></td> <td style="width: 10%;"></td> <td style="width: 10%;"></td> <td style="width: 10%;"></td> <td style="width: 10%;"></td> <td style="width: 10%;"></td> <td style="width: 10%;"></td> <td style="width: 10%;"></td> </tr> <tr> <td></td> <td></td> <td colspan="8" style="text-align: center;"> <table border="1" style="width: 100%;
border-collapse: collapse; text-align: center;"> <tr> </tr></table></td></tr></table></td></tr></table></td></tr></table></td></tr></table></td></tr></table></td></tr></table></td></tr></table></td></tr></table></td></tr></table>
 | | | | | | | | | | | | | | | | | | | | <table border="1" style="width: 100%; border-collapse: collapse; text-align: center;"> <tr> <td style="width: 10%;"></td> <td style="width: 10%;"></td> <td style="width: 10%;"></td> <td style="width: 10%;"></td> <td style="width: 10%;"></td> <td style="width: 10%;"></td> <td style="width: 10%;"></td> <td style="width: 10%;"></td> <td style="width: 10%;"></td> <td style="width: 10%;"></td> </tr> <tr> <td></td> <td></td> <td colspan="8" style="text-align: center;"> <table border="1" style="width: 100%; border-collapse: collapse; text-align: center;"> <tr> <td style="width: 10%;"></td> <td style="width: 10%;"></td> <td style="width: 10%;"></td> <td style="width: 10%;"></td> <td style="width: 10%;"></td> <td style="width: 10%;"></td> <td style="width: 10%;"></td> <td style="width: 10%;"></td> <td style="width: 10%;"></td> <td style="width: 10%;"></td> </tr> <tr> <td></td> <td></td> <td colspan="8" style="text-align: center;"> <table border="1" style="width: 100%; border-collapse: collapse; text-align: center;"> <tr> <td style="width: 10%;"></td> <td style="width: 10%;"></td> <td style="width: 10%;"></td> <td style="width: 10%;"></td> <td style="width: 10%;"></td> <td style="width: 10%;"></td> <td style="width: 10%;"></td> <td
style="width: 10%;"></td> <td style="width: 10%;"></td> <td style="width: 10%;"></td> </tr> <tr> <td></td> <td></td> <td colspan="8" style="text-align: center;"> <table border="1" style="width: 100%; border-collapse: collapse; text-align: center;"> <tr> <td style="width: 10%;"></td> <td style="width: 10%;"></td> <td style="width: 10%;"></td> <td style="width: 10%;"></td> <td style="width: 10%;"></td> <td style="width: 10%;"></td> <td style="width: 10%;"></td> <td style="width: 10%;"></td> <td style="width: 10%;"></td> <td style="width: 10%;"></td> </tr> <tr> <td></td> <td></td> <td colspan="8" style="text-align: center;"> <table border="1" style="width: 100%; border-collapse: collapse; text-align: center;"> <tr> <td style="width: 10%;"></td> <td style="width: 10%;"></td> <td style="width: 10%;"></td> <td style="width: 10%;"></td> <td style="width: 10%;"></td> <td style="width: 10%;"></td> <td style="width: 10%;"></td> <td style="width: 10%;"></td> <td style="width: 10%;"></td> <td style="width: 10%;"></td> </tr> <tr> <td></td> <td></td> <td colspan="8" style="text-align: center;"> <table border="1" style="width: 100%; border-collapse: collapse; text-align: center;"> <tr> <td style="width: 10%;"></td> <td style="width: 10%;"></td> <td style="width: 10%;"></td> <td style="width: 10%;"></td> <td style="width: 10%;"></td> <td style="width: 10%;"></td> <td style="width: 10%;"></td> <td style="width: 10%;"></td> <td style="width: 10%;"></td> <td style="width: 10%;"></td> </tr> <tr> <td></td> <td></td> <td colspan="8" style="text-align: center;"> <table border="1" style="width: 100%; border-collapse: collapse; text-align: center;"> <tr> <td style="width: 10%;"></td> <td style="width: 10%;"></td> <td style="width: 10%;"></td> <td style="width: 10%;"></td> <td style="width: 10%;"></td> <td style="width: 10%;"></td> <td style="width: 10%;"></td> <td style="width: 10%;"></td> <td style="width: 10%;"></td> <td style="width: 10%;"></td> </tr> <tr> <td></td> <td></td> <td colspan="8" style="text-align: center;"> <table border="1" style="width: 100%; border-collapse: collapse; text-align: center;"> <tr> <td style="width: 10%;"></td> <td style="width: 10%;"></td> <td style="width: 10%;"></td> <td style="width: 10%;"></td> <td style="width: 10%;"></td> <td style="width: 10%;"></td> <td style="width: 10%;"></td> <td style="width: 10%;"></td> <td style="width: 10%;"></td> <td style="width: 10%;"></td> </tr> <tr> <td></td> <td></td> <td colspan="8" style="text-align: center;"> <table border="1" style="width: 100%; border-collapse: collapse; text-align: center;"> <tr> </tr></table></td></tr></table></td></tr></table></td></tr></table></td></tr></table></td></tr></table></td></tr></table></td></tr></table></td></tr></table>

 | | | | | | | | | | | | | | | | | | | | <table border="1" style="width: 100%; border-collapse: collapse; text-align: center;"> <tr> <td style="width: 10%;"></td> <td style="width: 10%;"></td> <td style="width: 10%;"></td> <td style="width: 10%;"></td> <td style="width: 10%;"></td> <td style="width: 10%;"></td> <td style="width: 10%;"></td> <td style="width: 10%;"></td> <td style="width: 10%;"></td> <td style="width: 10%;"></td> </tr> <tr> <td></td> <td></td> <td colspan="8" style="text-align: center;"> <table border="1" style="width: 100%; border-collapse: collapse; text-align: center;"> <tr> <td style="width: 10%;"></td> <td style="width: 10%;"></td> <td style="width: 10%;"></td> <td style="width: 10%;"></td> <td style="width: 10%;"></td> <td style="width: 10%;"></td> <td style="width: 10%;"></td> <td style="width: 10%;"></td> <td style="width: 10%;"></td> <td style="width: 10%;"></td> </tr> <tr> <td></td> <td></td> <td colspan="8" style="text-align: center;"> <table border="1" style="width: 100%; border-collapse: collapse; text-align: center;"> <tr> <td style="width: 10%;"></td> <td style="width: 10%;"></td> <td style="width: 10%;"></td> <td style="width: 10%;"></td> <td style="width: 10%;"></td> <td style="width: 10%;"></td> <td style="width: 10%;"></td> <td style="width: 10%;"></td> <td style="width: 10%;"></td> <td style="width: 10%;"></td> </tr> <tr> <td></td> <td></td> <td colspan="8" style="text-align: center;"> <table border="1" style="width: 100%; border-collapse: collapse; text-align: center;"> <tr> <td style="width: 10%;"></td> <td style="width: 10%;"></td> <td style="width: 10%;"></td> <td style="width: 10%;"></td> <td style="width: 10%;"></td> <td style="width: 10%;"></td> <td style="width: 10%;"></td> <td style="width: 10%;"></td> <td style="width: 10%;"></td> <td style="width: 10%;"></td> </tr> <tr> <td></td> <td></td> <td colspan="8" style="text-align: center;"> <table border="1" style="width: 100%; border-collapse: collapse; text-align: center;"> <tr> <td style="width: 10%;"></td> <td style="width: 10%;"></td> <td style="width: 10%;"></td> <td style="width: 10%;"></td> <td style="width: 10%;"></td> <td style="width: 10%;"></td> <td style="width: 10%;"></td> <td style="width: 10%;"></td> <td style="width: 10%;"></td> <td style="width: 10%;"></td> </tr> <tr> <td></td> <td></td> <td colspan="8" style="text-align: center;"> <table border="1" style="width: 100%; border-collapse: collapse; text-align: center;"> <tr> <td style="width: 10%;"></td> <td style="width: 10%;"></td> <td style="width: 10%;"></td> <td style="width: 10%;"></td> <td style="width: 10%;"></td> <td style="width: 10%;"></td> <td style="width: 10%;"></td> <td style="width: 10%;"></td> <td style="width: 10%;"></td> <td style="width: 10%;"></td> </tr> <tr> <td></td> <td></td> <td colspan="8" style="text-align: center;"> <table border="1" style="width: 100%; border-collapse: collapse; text-align: center;"> <tr> <td style="width: 10%;"></td> <td style="width: 10%;"></td> <td style="width: 10%;"></td> <td style="width: 10%;"></td> <td style="width: 10%;"></td> <td style="width: 10%;"></td> <td style="width: 10%;"></td> <td style="width: 10%;"></td> <td style="width: 10%;"></td> <td style="width: 10%;"></td> </tr> <tr> <td></td> <td></td> <td colspan="8" style="text-align: center;"> <table border="1" style="width: 100%; border-collapse: collapse; text-align: center;"> <tr> </tr></table></td></tr></table></td></tr></table></td></tr></table></td></tr></table></td></tr></table></td></tr></table></td></tr></table>

 | | | | | | | | | | | | | | | | | | | | <table border="1" style="width: 100%; border-collapse: collapse; text-align: center;"> <tr> <td style="width: 10%;"></td> <td style="width: 10%;"></td> <td style="width: 10%;"></td> <td style="width: 10%;"></td> <td style="width: 10%;"></td> <td style="width: 10%;"></td> <td style="width: 10%;"></td> <td style="width: 10%;"></td> <td style="width: 10%;"></td> <td style="width: 10%;"></td> </tr> <tr> <td></td> <td></td> <td colspan="8" style="text-align: center;"> <table border="1" style="width: 100%; border-collapse: collapse; text-align: center;"> <tr> <td style="width: 10%;"></td> <td style="width: 10%;"></td> <td style="width: 10%;"></td> <td style="width: 10%;"></td> <td style="width: 10%;"></td> <td style="width: 10%;"></td> <td style="width: 10%;"></td> <td style="width: 10%;"></td> <td style="width: 10%;"></td> <td style="width: 10%;"></td> </tr> <tr> <td></td> <td></td> <td colspan="8" style="text-align: center;"> <table border="1" style="width: 100%; border-collapse: collapse; text-align: center;"> <tr> <td style="width: 10%;"></td> <td style="width: 10%;"></td> <td style="width: 10%;"></td> <td style="width: 10%;"></td> <td style="width: 10%;"></td> <td style="width: 10%;"></td> <td style="width: 10%;"></td> <td style="width: 10%;"></td> <td style="width: 10%;"></td> <td style="width: 10%;"></td> </tr> <tr> <td></td> <td></td> <td colspan="8" style="text-align: center;"> <table border="1" style="width: 100%; border-collapse: collapse; text-align: center;"> <tr> <td style="width: 10%;"></td> <td style="width: 10%;"></td> <td style="width: 10%;"></td> <td style="width: 10%;"></td> <td style="width: 10%;"></td> <td style="width: 10%;"></td> <td style="width: 10%;"></td> <td style="width: 10%;"></td> <td style="width: 10%;"></td> <td style="width: 10%;"></td> </tr> <tr> <td></td> <td></td> <td colspan="8" style="text-align: center;"> <table border="1" style="width: 100%; border-collapse: collapse; text-align: center;"> <tr> <td style="width: 10%;"></td> <td style="width: 10%;"></td> <td style="width: 10%;"></td> <td style="width: 10%;"></td> <td style="width: 10%;"></td> <td style="width: 10%;"></td> <td style="width: 10%;"></td> <td style="width: 10%;"></td> <td style="width: 10%;"></td> <td style="width: 10%;"></td> </tr> <tr> <td></td> <td></td> <td colspan="8" style="text-align: center;"> <table border="1" style="width: 100%; border-collapse: collapse; text-align: center;"> <tr> <td style="width: 10%;"></td> <td style="width: 10%;"></td> <td style="width: 10%;"></td> <td style="width: 10%;"></td> <td style="width: 10%;"></td> <td style="width: 10%;"></td> <td style="width: 10%;"></td> <td style="width: 10%;"></td> <td style="width: 10%;"></td> <td style="width: 10%;"></td> </tr> <tr> <td></td> <td></td> <td colspan="8" style="text-align: center;"> <table border="1" style="width: 100%; border-collapse: collapse; text-align: center;"> <tr> </tr></table></td></tr></table></td></tr></table></td></tr></table></td></tr></table></td></tr></table></td></tr></table>

 | | | | | | | | | | | | | | | | | | | | <table border="1" style="width: 100%; border-collapse: collapse; text-align: center;"> <tr> <td style="width: 10%;"></td> <td style="width: 10%;"></td> <td style="width: 10%;"></td> <td style="width: 10%;"></td> <td style="width: 10%;"></td> <td style="width: 10%;"></td> <td style="width: 10%;"></td> <td style="width: 10%;"></td> <td style="width: 10%;"></td> <td style="width: 10%;"></td> </tr> <tr> <td></td> <td></td> <td colspan="8" style="text-align: center;"> <table border="1" style="width: 100%; border-collapse: collapse; text-align: center;"> <tr> <td style="width: 10%;"></td> <td style="width: 10%;"></td> <td style="width: 10%;"></td> <td style="width: 10%;"></td> <td style="width: 10%;"></td> <td style="width: 10%;"></td> <td style="width: 10%;"></td> <td style="width: 10%;"></td> <td style="width: 10%;"></td> <td style="width: 10%;"></td> </tr> <tr> <td></td> <td></td> <td colspan="8" style="text-align: center;"> <table border="1" style="width: 100%; border-collapse: collapse; text-align: center;"> <tr> <td style="width: 10%;"></td> <td style="width: 10%;"></td> <td style="width: 10%;"></td> <td style="width: 10%;"></td> <td style="width: 10%;"></td> <td style="width: 10%;"></td> <td style="width: 10%;"></td> <td style="width: 10%;"></td> <td style="width: 10%;"></td> <td style="width: 10%;"></td> </tr> <tr> <td></td> <td></td> <td colspan="8" style="text-align: center;"> <table border="1" style="width: 100%; border-collapse: collapse; text-align: center;"> <tr> <td style="width: 10%;"></td> <td style="width: 10%;"></td> <td style="width: 10%;"></td> <td style="width: 10%;"></td> <td style="width: 10%;"></td> <td style="width: 10%;"></td> <td style="width: 10%;"></td> <td style="width: 10%;"></td> <td style="width: 10%;"></td> <td style="width: 10%;"></td> </tr> <tr> <td></td> <td></td> <td colspan="8" style="text-align: center;"> <table border="1" style="width: 100%; border-collapse: collapse; text-align: center;"> <tr> <td style="width: 10%;"></td> <td style="width: 10%;"></td> <td style="width: 10%;"></td> <td style="width: 10%;"></td> <td style="width: 10%;"></td> <td style="width: 10%;"></td> <td style="width: 10%;"></td> <td style="width: 10%;"></td> <td style="width: 10%;"></td> <td style="width: 10%;"></td> </tr> <tr> <td></td> <td></td> <td colspan="8" style="text-align: center;"> <table border="1" style="width: 100%; border-collapse: collapse; text-align: center;"> <tr> </tr></table></td></tr></table></td></tr></table></td></tr></table></td></tr></table></td></tr></table>

 | | | | | | | | | | | | | | | | | | | | <table border="1" style="width: 100%; border-collapse: collapse; text-align: center;"> <tr> <td style="width: 10%;"></td> <td style="width: 10%;"></td> <td style="width: 10%;"></td> <td style="width: 10%;"></td> <td style="width: 10%;"></td> <td style="width: 10%;"></td> <td style="width: 10%;"></td> <td style="width: 10%;"></td> <td style="width: 10%;"></td> <td style="width: 10%;"></td> </tr> <tr> <td></td> <td></td> <td colspan="8" style="text-align: center;"> <table border="1" style="width: 100%; border-collapse: collapse; text-align: center;"> <tr> <td style="width: 10%;"></td> <td style="width: 10%;"></td> <td style="width: 10%;"></td> <td style="width: 10%;"></td> <td style="width: 10%;"></td> <td style="width: 10%;"></td> <td style="width: 10%;"></td> <td style="width: 10%;"></td> <td style="width: 10%;"></td> <td style="width: 10%;"></td> </tr> <tr> <td></td> <td></td> <td colspan="8" style="text-align: center;"> <table border="1" style="width: 100%; border-collapse: collapse; text-align: center;"> <tr> <td style="width: 10%;"></td> <td style="width: 10%;"></td> <td style="width: 10%;"></td> <td style="width: 10%;"></td> <td style="width: 10%;"></td> <td style="width: 10%;"></td> <td style="width: 10%;"></td> <td style="width: 10%;"></td> <td style="width: 10%;"></td> <td style="width: 10%;"></td> </tr> <tr> <td></td> <td></td> <td colspan="8" style="text-align: center;"> <table border="1" style="width: 100%; border-collapse: collapse; text-align: center;"> <tr> <td style="width: 10%;"></td> <td style="width: 10%;"></td> <td style="width: 10%;"></td> <td style="width: 10%;"></td> <td style="width: 10%;"></td> <td style="width: 10%;"></td> <td style="width: 10%;"></td> <td style="width: 10%;"></td> <td style="width: 10%;"></td> <td style="width: 10%;"></td> </tr> <tr> <td></td> <td></td> <td colspan="8" style="text-align: center;"> <table border="1" style="width: 100%; border-collapse: collapse; text-align: center;"> <tr> </tr></table></td></tr></table></td></tr></table></td></tr></table></td></tr></table>

 | | | | | | | | | | | | | | | | | | | | <table border="1" style="width: 100%; border-collapse: collapse; text-align: center;"> <tr> <td style="width: 10%;"></td> <td style="width: 10%;"></td> <td style="width: 10%;"></td> <td style="width: 10%;"></td> <td style="width: 10%;"></td> <td style="width: 10%;"></td> <td style="width: 10%;"></td> <td style="width: 10%;"></td> <td style="width: 10%;"></td> <td style="width: 10%;"></td> </tr> <tr> <td></td> <td></td> <td colspan="8" style="text-align: center;"> <table border="1" style="width: 100%; border-collapse: collapse; text-align: center;"> <tr> <td style="width: 10%;"></td> <td style="width: 10%;"></td> <td style="width: 10%;"></td> <td style="width: 10%;"></td> <td style="width: 10%;"></td> <td style="width: 10%;"></td> <td style="width: 10%;"></td> <td style="width: 10%;"></td> <td style="width: 10%;"></td> <td style="width: 10%;"></td> </tr> <tr> <td></td> <td></td> <td colspan="8" style="text-align: center;"> <table border="1" style="width: 100%; border-collapse: collapse; text-align: center;"> <tr> <td style="width: 10%;"></td> <td style="width: 10%;"></td> <td style="width: 10%;"></td> <td style="width: 10%;"></td> <td style="width: 10%;"></td> <td style="width: 10%;"></td> <td style="width: 10%;"></td> <td style="width: 10%;"></td> <td style="width: 10%;"></td> <td style="width: 10%;"></td> </tr> <tr> <td></td> <td></td> <td colspan="8" style="text-align: center;"> <table border="1" style="width: 100%; border-collapse: collapse; text-align: center;"> <tr> </tr></table></td></tr></table></td></tr></table></td></tr></table>

 | | | | | | | | | | | | | | | | | | | | <table border="1" style="width: 100%; border-collapse: collapse; text-align: center;"> <tr> <td style="width: 10%;"></td> <td style="width: 10%;"></td> <td style="width: 10%;"></td> <td style="width: 10%;"></td> <td style="width: 10%;"></td> <td style="width: 10%;"></td> <td style="width: 10%;"></td> <td style="width: 10%;"></td> <td style="width: 10%;"></td> <td style="width: 10%;"></td> </tr> <tr> <td></td> <td></td> <td colspan="8" style="text-align: center;"> <table border="1" style="width: 100%; border-collapse: collapse; text-align: center;"> <tr> <td style="width: 10%;"></td> <td style="width: 10%;"></td> <td style="width: 10%;"></td> <td style="width: 10%;"></td> <td style="width: 10%;"></td> <td style="width: 10%;"></td> <td style="width: 10%;"></td> <td style="width: 10%;"></td> <td style="width: 10%;"></td> <td style="width: 10%;"></td> </tr> <tr> <td></td> <td></td> <td colspan="8" style="text-align: center;"> <table border="1" style="width: 100%; border-collapse: collapse; text-align: center;"> <tr> </tr></table></td></tr></table></td></tr></table>

 | | | | | | | | | | | | | | | | | | | | <table border="1" style="width: 100%; border-collapse: collapse; text-align: center;"> <tr> <td style="width: 10%;"></td> <td style="width: 10%;"></td> <td style="width: 10%;"></td> <td style="width: 10%;"></td> <td style="width: 10%;"></td> <td style="width: 10%;"></td> <td style="width: 10%;"></td> <td style="width: 10%;"></td> <td style="width: 10%;"></td> <td style="width: 10%;"></td> </tr> <tr> <td></td> <td></td> <td colspan="8" style="text-align: center;"> <table border="1" style="width: 100%; border-collapse: collapse; text-align: center;"> <tr> </tr></table></td></tr></table>

 | | | | | | | | | | | | | | | | | | | | <table border="1" style="width: 100%; border-collapse: collapse; text-align: center;"> <tr> </tr></table>

 | | | | | | | | | | | | | | | | | | | |

 | | | | | | | | | | | | | | | | | | | |
 | | | | | | | | | | | | | | | | | | | |

 | | | | | | | | | | | | | | | | | | | |

 | | | | | | | | | | | | | | | | | | | |
 | | | | | | | | | | | | | | | | | | | |

 | | | | | | | | | | | | | | | | | | | |

 | | | | | | | | | | | | | | | | | | | |
 | | | | | | | | | | | | | | | | | | | |
 | | | | | | | | | | | | | | | | | | | |

 | | | | | | | | | | | | | | | | | | | |
 | | | | | | | | | | | | | | | | | | | |
 | | | | | | | | | | | | | | | | | | | |

 | | | | | | | | | | | | | | | | | | | | | | | | | | | | | | | | | | | | | | | | | | | | | | | | | | | | | | | | | | | | | | | | | | | | | | | | | | | | | | | | | | | | | | | | | | | | | | | | | | | |
 | | | | | | | | | | | | | | | | | | | |
 | | | | | | | | | | | | | | | | | | | |
 | | | | | | | | | | | | | | | | | | | |
 | | | | | | | | | | | | | | | | | | | |
 | | | | | | | | | | | | | | | | | | | |
 | | | | | | | | | | | | | | | | | | | |
 | | | | | | | | | | | | | | | | | | | |
 | | | | | | | | | | | | | | | | | | | |
 | | | | | | | | | | | | | | | | | | | | | | | | | | | | | | | | | | | | | | | |
 | | | | | | | | | | | | | | | | | | | |
 | | | | | | | | | | | | | | | | | | | | | | | | | | | | | | | | | | | | | | | |
 | | | | | | | | | | | | | | | | | | | | | | | | | | | | | | | | | | | | | | | |
 | | | | | | | | | | | | | | | | | | | | | | | | | | | | | | | | | | | | | | | |
 | | | | | | | | | | | | | | | | | | | | | | | | | | | | | | | | | | | | | | | | | | | | | | | | | | | | | | | | | | | | | | | | | | | | | | | | | | | | | | | | | | | | | | | | | | | | | | | | | | | |
 | | | | | | | | | | | | | | | | | | | | | | | | | | | | | | | | | | | | | | | | | | | | | | | |
| | |

 | | | | | | | | | | | | | | | | | | | |

 | | | | | | | | | | | | | | | | | | | |

 | | | | | | | | | | | | | | | | | | | |

 | | | | | | | | | | | | | | | | | | | |

 | | | | | | | | | | | | | | | | | | | |

 | | | | | | | | | | | | | | | | | | | |

 | | | | | | | | | | | | | | | | | | | |

 | | | | | | | | | | | | | | | | | | | |

 | | | | | | | | | | | | | | | | | | | |

 | | | | | | | | | | | | | | | | | | | |

 | | | | | | | | | | | | | | | | | | | |

 | | | | | | | | | | | | | | | | | | | |

 | | | | | | | | | | | | | | | | | | | |

 | | | | | | | | | | | | | | | | | | | |

 | | | | | | | | | | | | | | | | | | | |

 | | | | | | | | | | | | | | | | | | | |

 | | | | | | | | | | | | | | | | | | | |

 | | | | | | | | | | | | | | | | | | | |

 | | | | | | | | | | | | | | | | | | | |

 | | | | | | | | | | | | | | | | | | | |

 | | | | | | | | | | | | | | | | | | | |

 | | | | | | | | | | | | | | | | | | | |

 | | | | | | | | | | | | | | | | | | | |

 | | | | | | | | | | | | | | | | | | | |

 | | | | | | | | | | | | | | | | | | | |

 | | | | | | | | | | | | | | | | | | | |

 | | | | | | | | | | | | | | | | | | | |

 | | | | | | | | | | | | | | | | | | | |
 | | | | | | | | | | | | | | | | | | | |

 | | | | | | | | | | | | | | | | | | | |

 | | | | | | | | | | | | | | | | | | | |
 | | | | | | | | | | | | | | | | | | | |

 | | | | | | | | | | | | | | | | | | | |

 | | | | | | | | | | | | | | | | | | | |
 | | | | | | | | | | | | | | | | | | | |
 | | | | | | | | | | | | | | | | | | | |

 | | | | | | | | | | | | | | | | | | | |
 | | | | | | | | | | | | | | | | | | | |
 | | | | | | | | | | | | | | | | | | | |

 | | | | | | | | | | | | | | | | | | | | | | | | | | | | | | | | | | | | | | | | | | | | | | | | | | | | | | | | | | | | | | | | | | | | | | | | | | | | | | | | | | | | | | | | | | | | | | | | | | | |
 | | | | | | | | | | | | | | | | | | | |
 | | | | | | | | | | | | | | | | | | | |
 | | | | | | | | | | | | | | | | | | | |
 | | | | | | | | | | | | | | | | | | | |
 | | | | | | | | | | | | | | | | | | | |
 | | | | | | | | | | | | | | | | | | | |
 | | | | | | | | | | | | | | | | | | | |
 | | | | | | | | | | | | | | | | | | | |
 | | | | | | | | | | | | | | | | | | | | | | | | | | | | | | | | | | | | | | | |
 | | | | | | | | | | | | | | | | | | | |
 | | | | | | | | | | | | | | | | | | | | | | | | | | | | | | | | | | | | | | | |
 | | | | | | | | | | | | | | | | | | | | | | | | | | | | | | | | | | | | | | | |
 | | | | | | | | | | | | | | | | | | | | | | | | | | | | | | | | | | | | | | | |
 | | | | | | | | | | | | | | | | | | | | | | | | | | | | | | | | | | | | | | | | | | | | | | | | | | | | | | | | | | | | | | | | | | | | | | | | | | | | | | | | | | | | | | | | | | | | | | | | | | | |
 | | | | | | | | | | | | | | | | | | | | | | | | | | | | | | | | | | | | | | | | | | | | | | | |
| | | <table border="1" style="width: 100%; border-collapse: collapse; text-align: center;"> <tr> <td style="width: 10%;"></td> <td style="width: 10%;"></td> <td style="width: 10%;"></td> <td style="width: 10%;"></td> <td style="width: 10%;"></td> <td style="width: 10%;"></td> <td style="width: 10%;"></td> <td style="width: 10%;"></td> <td style="width: 10%;"></td> <td style="width: 10%;"></td> </tr> <tr> <td></td> <td></td> <td colspan="8" style="text-align: center;"> <table border="1" style="width: 100%; border-collapse: collapse; text-align: center;"> <tr> <td style="width: 10%;"></td> <td style="width: 10%;"></td> <td style="width: 10%;"></td> <td style="width: 10%;"></td> <td style="width: 10%;"></td> <td style="width: 10%;"></td> <td style="width: 10%;"></td> <td style="width: 10%;"></td> <td style="width: 10%;"></td> <td style="width: 10%;"></td> </tr> <tr> <td></td> <td></td> <td colspan="8" style="text-align: center;"> <table border="1" style="width: 100%; border-collapse: collapse; text-align: center;"> <tr> <td style="width: 10%;"></td> <td style="width: 10%;"></td> <td style="width: 10%;"></td> <td style="width: 10%;"></td> <td style="width: 10%;"></td> <td style="width: 10%;"></td> <td style="width: 10%;"></td> <td style="width: 10%;"></td> <td style="width: 10%;"></td> <td style="width: 10%;"></td> </tr> <tr> <td></td> <td></td> <td colspan="8" style="text-align: center;"> <table border="1" style="width: 100%; border-collapse: collapse; text-align: center;"> <tr> <td style="width: 10%;"></td> <td style="width: 10%;"></td> <td style="width: 10%;"></td> <td style="width: 10%;"></td> <td style="width: 10%;"></td> <td style="width: 10%;"></td> <td style="width: 10%;"></td> <td style="width: 10%;"></td> <td style="width: 10%;"></td> <td style="width: 10%;"></td> </tr> <tr> <td></td> <td></td> <td colspan="8" style="text-align: center;"> <table border="1" style="width: 100%; border-collapse: collapse; text-align: center;"> <tr> <td style="width: 10%;"></td> <td style="width: 10%;"></td> <td style="width: 10%;"></td> <td style="width: 10%;"></td> <td style="width: 10%;"></td> <td style="width: 10%;"></td> <td style="width: 10%;"></td> <td style="width: 10%;"></td> <td style="width: 10%;"></td> <td style="width: 10%;"></td> </tr> <tr> <td></td> <td></td> <td colspan="8" style="text-align: center;"> <table border="1" style="width: 100%; border-collapse: collapse; text-align: center;"> <tr> <td style="width: 10%;"></td> <td style="width: 10%;"></td> <td style="width: 10%;"></td> <td style="width: 10%;"></td> <td style="width: 10%;"></td> <td style="width: 10%;"></td> <td style="width: 10%;"></td> <td style="width: 10%;"></td> <td style="width: 10%;"></td> <td style="width: 10%;"></td> </tr> <tr> <td></td> <td></td> <td colspan="8" style="text-align: center;"> <table border="1" style="width: 100%; border-collapse: collapse; text-align: center;"> <tr> <td style="width: 10%;"></td> <td style="width: 10%;"></td> <td style="width: 10%;"></td> <td style="width: 10%;"></td> <td style="width: 10%;"></td> <td style="width: 10%;"></td> <td style="width: 10%;"></td> <td style="width: 10%;"></td> <td style="width: 10%;"></td> <td style="width: 10%;"></td> </tr> <tr> <td></td> <td></td> <td colspan="8" style="text-align: center;"> <table border="1" style="width: 100%; border-collapse: collapse; text-align: center;"> <tr> <td style="width: 10%;"></td> <td style="width: 10%;"></td> <td style="width: 10%;"></td> <td style="width: 10%;"></td> <td style="width: 10%;"></td> <td style="width: 10%;"></td> <td style="width: 10%;"></td> <td style="width: 10%;"></td> <td style="width: 10%;"></td> <td style="width: 10%;"></td> </tr> <tr> <td></td> <td></td> <td colspan="8" style="text-align: center;"> <table border="1" style="width: 100%; border-collapse: collapse; text-align: center;"> <tr> <td style="width: 10%;"></td> <td style="width: 10%;"></td> <td style="width: 10%;"></td> <td style="width: 10%;"></td> <td style="width: 10%;"></td> <td style="width: 10%;"></td> <td style="width: 10%;"></td> <td style="width: 10%;"></td> <td style="width: 10%;"></td> <td style="width: 10%;"></td> </tr> <tr> <td></td> <td></td> <td colspan="8" style="text-align: center;"> <table border="1" style="width: 100%; border-collapse: collapse; text-align: center;"> <tr> <td style="width: 10%;"></td> <td style="width: 10%;"></td> <td style="width: 10%;"></td> <td style="width: 10%;"></td> <td style="width: 10%;"></td> <td style="width: 10%;"></td> <td style="width: 10%;"></td> <td style="width: 10%;"></td> <td style="width: 10%;"></td> <td style="width: 10%;"></td> </tr> <tr> <td></td> <td></td> <td colspan="8" style="text-align: center;"> <table border="1" style="width: 100%; border-collapse: collapse; text-align: center;"> <tr> <td style="width: 10%;"></td> <td style="width: 10%;"></td> <td style="width: 10%;"></td> <td style="width: 10%;"></td> <td style="width: 10%;"></td> <td style="width: 10%;"></td> <td style="width: 10%;"></td> <td style="width: 10%;"></td> <td style="width: 10%;"></td> <td style="width: 10%;"></td> </tr> <tr> <td></td> <td></td> <td colspan="8" style="text-align: center;"> <table border="1" style="width: 100%; border-collapse: collapse; text-align: center;"> <tr> <td style="width: 10%;"></td> <td style="width: 10%;"></td> <td style="width: 10%;"></td> <td style="width: 10%;"></td> <td style="width: 10%;"></td> <td style="width: 10%;"></td> <td style="width: 10%;"></td> <td style="width: 10%;"></td> <td style="width: 10%;"></td> <td style="width: 10%;"></td> </tr> <tr> <td></td> <td></td> <td colspan="8" style="text-align: center;"> <table border="1" style="width: 100%; border-collapse: collapse; text-align: center;"> <tr> <td style="width: 10%;"></td> <td style="width: 10%;"></td> <td style="width: 10%;"></td> <td style="width: 10%;"></td> <td style="width: 10%;"></td> <td style="width: 10%;"></td> <td style="width: 10%;"></td> <td style="width: 10%;"></td> <td style="width: 10%;"></td> <td style="width: 10%;"></td> </tr> <tr> <td></td> <td></td> <td colspan="8" style="text-align: center;"> <table border="1" style="width: 100%; border-collapse: collapse; text-align: center;"> <tr> <td style="width: 10%;"></td> <td style="width: 10%;"></td> <td style="width: 10%;"></td> <td style="width: 10%;"></td> <td style="width: 10%;"></td> <td style="width: 10%;"></td> <td style="width: 10%;"></td> <td style="width: 10%;"></td> <td style="width: 10%;"></td> <td style="width: 10%;"></td> </tr> <tr> <td></td> <td></td> <td colspan="8" style="text-align: center;"> <table border="1" style="width: 100%; border-collapse: collapse; text-align: center;"> <tr> <td style="width: 10%;"></td> <td style="width: 10%;"></td> <td style="width: 10%;"></td> <td style="width: 10%;"></td> <td style="width: 10%;"></td> <td style="width: 10%;"></td> <td style="width: 10%;"></td> <td style="width: 10%;"></td> <td style="width: 10%;"></td> <td style="width: 10%;"></td> </tr> <tr> <td></td> <td></td> <td colspan="8" style="text-align: center;"> <table border="1" style="width: 100%; border-collapse: collapse; text-align: center;"> <tr> <td style="width: 10%;"></td> <td style="width: 10%;"></td> <td style="width: 10%;"></td> <td style="width: 10%;"></td> <td style="width: 10%;"></td> <td style="width: 10%;"></td> <td style="width: 10%;"></td> <td style="width: 10%;"></td> <td style="width: 10%;"></td> <td style="width: 10%;"></td> </tr> <tr> <td></td> <td></td> <td colspan="8" style="text-align: center;"> <table border="1" style="width: 100%; border-collapse: collapse; text-align: center;"> <tr> <td style="width: 10%;"></td> <td style="width: 10%;"></td> <td style="width: 10%;"></td> <td style="width: 10%;"></td> <td style="width: 10%;"></td> <td style="width: 10%;"></td> <td style="width: 10%;"></td> <td style="width: 10%;"></td> <td style="width: 10%;"></td> <td style="width: 10%;"></td> </tr> <tr> <td></td> <td></td> <td colspan="8" style="text-align: center;"> <table border="1" style="width: 100%; border-collapse: collapse; text-align: center;"> <tr> <td style="width: 10%;"></td> <td style="width: 10%;"></td> <td style="width: 10%;"></td> <td style="width: 10%;"></td> <td style="width: 10%;"></td> <td style="width: 10%;"></td> <td style="width: 10%;"></td> <td style="width: 10%;"></td> <td style="width: 10%;"></td> <td style="width: 10%;"></td> </tr> <tr> <td></td> <td></td> <td colspan="8" style="text-align: center;"> <table border="1" style="width: 100%; border-collapse: collapse; text-align: center;"> <tr> <td style="width: 10%;"></td> <td style="width: 10%;"></td> <td style="width: 10%;"></td> <td style="width: 10%;"></td> <td style="width: 10%;"></td> <td style="width: 10%;"></td> <td style="width: 10%;"></td> <td style="width: 10%;"></td> <td style="width: 10%;"></td> <td style="width: 10%;"></td> </tr> <tr> <td></td> <td></td> <td colspan="8" style="text-align: center;"> <table border="1" style="width: 100%; border-collapse: collapse; text-align: center;"> <tr> <td style="width: 10%;"></td> <td style="width: 10%;"></td> <td style="width: 10%;"></td> <td style="width: 10%;"></td> <td style="width: 10%;"></td> <td style="width: 10%;"></td> <td style="width: 10%;"></td> <td style="width: 10%;"></td> <td style="width: 10%;"></td> <td style="width: 10%;"></td> </tr> <tr> <td></td> <td></td> <td colspan="8" style="text-align: center;"> <table border="1" style="width: 100%; border-collapse: collapse; text-align: center;"> <tr> <td style="width: 10%;"></td> <td style="width: 10%;"></td> <td style="width: 10%;"></td> <td style="width: 10%;"></td> <td style="width: 10%;"></td> <td style="width: 10%;"></td> <td style="width: 10%;"></td> <td style="width: 10%;"></td> <td style="width: 10%;"></td> <td style="width: 10%;"></td> </tr> <tr> <td></td> <td></td> <td colspan="8" style="text-align: center;"> <table border="1" style="width: 100%; border-collapse: collapse; text-align: center;"> <tr> <td style="width: 10%;"></td> <td style="width: 10%;"></td> <td
style="width: 10%;"></td> <td style="width: 10%;"></td> <td style="width: 10%;"></td> <td style="width: 10%;"></td> <td style="width: 10%;"></td> <td style="width: 10%;"></td> <td style="width: 10%;"></td> <td style="width: 10%;"></td> </tr> <tr> <td></td> <td></td> <td colspan="8" style="text-align: center;"> <table border="1" style="width: 100%; border-collapse: collapse; text-align: center;"> <tr> <td style="width: 10%;"></td> <td style="width: 10%;"></td> <td style="width: 10%;"></td> <td style="width: 10%;"></td> <td style="width: 10%;"></td> <td style="width: 10%;"></td> <td style="width: 10%;"></td> <td style="width: 10%;"></td> <td style="width: 10%;"></td> <td style="width: 10%;"></td> </tr> <tr> <td></td> <td></td> <td colspan="8" style="text-align: center;"> <table border="1" style="width: 100%; border-collapse: collapse; text-align: center;"> <tr> <td style="width: 10%;"></td> <td style="width: 10%;"></td> <td style="width: 10%;"></td> <td style="width: 10%;"></td> <td style="width: 10%;"></td> <td style="width: 10%;"></td> <td style="width: 10%;"></td> <td style="width: 10%;"></td> <td style="width: 10%;"></td> <td style="width: 10%;"></td> </tr> <tr> <td></td> <td></td> <td colspan="8" style="text-align: center;"> <table border="1" style="width: 100%; border-collapse: collapse; text-align: center;"> <tr> <td style="width: 10%;"></td> <td style="width: 10%;"></td> <td style="width: 10%;"></td> <td style="width: 10%;"></td> <td style="width: 10%;"></td> <td style="width: 10%;"></td> <td style="width: 10%;"></td> <td style="width: 10%;"></td> <td style="width: 10%;"></td> <td style="width: 10%;"></td> </tr> <tr> <td></td> <td></td> <td colspan="8" style="text-align: center;"> <table border="1" style="width: 100%; border-collapse: collapse; text-align: center;"> <tr> </tr></table></td></tr></table></td></tr></table></td></tr></table></td></tr></table></td></tr></table></td></tr></table></td></tr></table></td></tr></table></td></tr></table></td></tr></table></td></tr></table></td></tr></table></td></tr></table></td></tr></table></td></tr></table></td></tr></table></td></tr></table></td></tr></table></td></tr></table></td></tr></table></td></tr></table></td></tr></table></td></tr></table></td></tr></table></td></tr></table>

 | | | | | | | | | | | | | | | | | | | | <table border="1" style="width: 100%; border-collapse: collapse; text-align: center;"> <tr> <td style="width: 10%;"></td> <td style="width: 10%;"></td> <td style="width: 10%;"></td> <td style="width: 10%;"></td> <td style="width: 10%;"></td> <td style="width: 10%;"></td> <td style="width: 10%;"></td> <td style="width: 10%;"></td> <td style="width: 10%;"></td> <td style="width: 10%;"></td> </tr> <tr> <td></td> <td></td> <td colspan="8" style="text-align: center;"> <table border="1" style="width: 100%; border-collapse: collapse; text-align: center;"> <tr> <td style="width: 10%;"></td> <td style="width: 10%;"></td> <td style="width: 10%;"></td> <td style="width: 10%;"></td> <td style="width: 10%;"></td> <td style="width: 10%;"></td> <td style="width: 10%;"></td> <td style="width: 10%;"></td> <td style="width: 10%;"></td> <td style="width: 10%;"></td> </tr> <tr> <td></td> <td></td> <td colspan="8" style="text-align: center;"> <table border="1" style="width: 100%; border-collapse: collapse; text-align: center;"> <tr> <td style="width: 10%;"></td> <td style="width: 10%;"></td> <td style="width: 10%;"></td> <td style="width: 10%;"></td> <td style="width: 10%;"></td> <td style="width: 10%;"></td> <td style="width: 10%;"></td> <td style="width: 10%;"></td> <td style="width: 10%;"></td> <td style="width: 10%;"></td> </tr> <tr> <td></td> <td></td> <td colspan="8" style="text-align: center;"> <table border="1" style="width: 100%; border-collapse: collapse; text-align: center;"> <tr> <td style="width: 10%;"></td> <td style="width: 10%;"></td> <td style="width: 10%;"></td> <td style="width: 10%;"></td> <td style="width: 10%;"></td> <td style="width: 10%;"></td> <td style="width: 10%;"></td> <td style="width: 10%;"></td> <td style="width: 10%;"></td> <td style="width: 10%;"></td> </tr> <tr> <td></td> <td></td> <td colspan="8" style="text-align: center;"> <table border="1" style="width: 100%; border-collapse: collapse; text-align: center;"> <tr> <td style="width: 10%;"></td> <td style="width: 10%;"></td> <td style="width: 10%;"></td> <td style="width: 10%;"></td> <td style="width: 10%;"></td> <td style="width: 10%;"></td> <td style="width: 10%;"></td> <td style="width: 10%;"></td> <td style="width: 10%;"></td> <td style="width: 10%;"></td> </tr> <tr> <td></td> <td></td> <td colspan="8" style="text-align: center;"> <table border="1" style="width: 100%; border-collapse: collapse; text-align: center;"> <tr> <td style="width: 10%;"></td> <td style="width: 10%;"></td> <td style="width: 10%;"></td> <td style="width: 10%;"></td> <td style="width: 10%;"></td> <td style="width: 10%;"></td> <td style="width: 10%;"></td> <td style="width: 10%;"></td> <td style="width: 10%;"></td> <td style="width: 10%;"></td> </tr> <tr> <td></td> <td></td> <td colspan="8" style="text-align: center;"> <table border="1" style="width: 100%; border-collapse: collapse; text-align: center;"> <tr> <td style="width: 10%;"></td> <td style="width: 10%;"></td> <td style="width: 10%;"></td> <td style="width: 10%;"></td> <td style="width: 10%;"></td> <td style="width: 10%;"></td> <td style="width: 10%;"></td> <td style="width: 10%;"></td> <td style="width: 10%;"></td> <td style="width: 10%;"></td> </tr> <tr> <td></td> <td></td> <td colspan="8" style="text-align: center;"> <table border="1" style="width: 100%; border-collapse: collapse; text-align: center;"> <tr> <td style="width: 10%;"></td> <td style="width: 10%;"></td> <td style="width: 10%;"></td> <td style="width: 10%;"></td> <td style="width: 10%;"></td> <td style="width: 10%;"></td> <td style="width: 10%;"></td> <td style="width: 10%;"></td> <td style="width: 10%;"></td> <td style="width: 10%;"></td> </tr> <tr> <td></td> <td></td> <td colspan="8" style="text-align: center;"> <table border="1" style="width: 100%; border-collapse: collapse; text-align: center;"> <tr> <td style="width: 10%;"></td> <td style="width: 10%;"></td> <td style="width: 10%;"></td> <td style="width: 10%;"></td> <td style="width: 10%;"></td> <td style="width: 10%;"></td> <td style="width: 10%;"></td> <td style="width: 10%;"></td> <td style="width: 10%;"></td> <td style="width: 10%;"></td> </tr> <tr> <td></td> <td></td> <td colspan="8" style="text-align: center;"> <table border="1" style="width: 100%; border-collapse: collapse; text-align: center;"> <tr> <td style="width: 10%;"></td> <td style="width: 10%;"></td> <td style="width: 10%;"></td> <td style="width: 10%;"></td> <td style="width: 10%;"></td> <td style="width: 10%;"></td> <td style="width: 10%;"></td> <td style="width: 10%;"></td> <td style="width: 10%;"></td> <td style="width: 10%;"></td> </tr> <tr> <td></td> <td></td> <td colspan="8" style="text-align: center;"> <table border="1" style="width: 100%; border-collapse: collapse; text-align: center;"> <tr> <td style="width: 10%;"></td> <td style="width: 10%;"></td> <td style="width: 10%;"></td> <td style="width: 10%;"></td> <td style="width: 10%;"></td> <td style="width: 10%;"></td> <td style="width: 10%;"></td> <td style="width: 10%;"></td> <td style="width: 10%;"></td> <td style="width: 10%;"></td> </tr> <tr> <td></td> <td></td> <td colspan="8" style="text-align: center;"> <table border="1" style="width: 100%; border-collapse: collapse; text-align: center;"> <tr> <td style="width: 10%;"></td> <td style="width: 10%;"></td> <td style="width: 10%;"></td> <td style="width: 10%;"></td> <td style="width: 10%;"></td> <td style="width: 10%;"></td> <td style="width: 10%;"></td> <td style="width: 10%;"></td> <td style="width: 10%;"></td> <td style="width: 10%;"></td> </tr> <tr> <td></td> <td></td> <td colspan="8" style="text-align: center;"> <table border="1" style="width: 100%; border-collapse: collapse; text-align: center;"> <tr> <td style="width: 10%;"></td> <td style="width: 10%;"></td> <td style="width: 10%;"></td> <td style="width: 10%;"></td> <td style="width: 10%;"></td> <td style="width: 10%;"></td> <td style="width: 10%;"></td> <td style="width: 10%;"></td> <td style="width: 10%;"></td> <td style="width: 10%;"></td> </tr> <tr> <td></td> <td></td> <td colspan="8" style="text-align: center;"> <table border="1" style="width: 100%; border-collapse: collapse; text-align: center;"> <tr> <td style="width: 10%;"></td> <td style="width: 10%;"></td> <td style="width: 10%;"></td> <td style="width: 10%;"></td> <td style="width: 10%;"></td> <td style="width: 10%;"></td> <td style="width: 10%;"></td> <td style="width: 10%;"></td> <td style="width: 10%;"></td> <td style="width: 10%;"></td> </tr> <tr> <td></td> <td></td> <td colspan="8" style="text-align: center;"> <table border="1" style="width: 100%; border-collapse: collapse; text-align: center;"> <tr> <td style="width: 10%;"></td> <td style="width: 10%;"></td> <td style="width: 10%;"></td> <td style="width: 10%;"></td> <td style="width: 10%;"></td> <td style="width: 10%;"></td> <td style="width: 10%;"></td> <td style="width: 10%;"></td> <td style="width: 10%;"></td> <td style="width: 10%;"></td> </tr> <tr> <td></td> <td></td> <td colspan="8" style="text-align: center;"> <table border="1" style="width: 100%; border-collapse: collapse; text-align: center;"> <tr> <td style="width: 10%;"></td> <td style="width: 10%;"></td> <td style="width: 10%;"></td> <td style="width: 10%;"></td> <td style="width: 10%;"></td> <td style="width: 10%;"></td> <td style="width: 10%;"></td> <td style="width: 10%;"></td> <td style="width: 10%;"></td> <td style="width: 10%;"></td> </tr> <tr> <td></td> <td></td> <td colspan="8" style="text-align: center;"> <table border="1" style="width: 100%; border-collapse: collapse; text-align: center;"> <tr> <td style="width: 10%;"></td> <td style="width: 10%;"></td> <td style="width: 10%;"></td> <td style="width: 10%;"></td> <td style="width: 10%;"></td> <td style="width: 10%;"></td> <td style="width: 10%;"></td> <td style="width: 10%;"></td> <td style="width: 10%;"></td> <td style="width: 10%;"></td> </tr> <tr> <td></td> <td></td> <td colspan="8" style="text-align: center;"> <table border="1" style="width: 100%; border-collapse: collapse; text-align: center;"> <tr> <td style="width: 10%;"></td> <td style="width: 10%;"></td> <td style="width: 10%;"></td> <td style="width: 10%;"></td> <td style="width: 10%;"></td> <td style="width: 10%;"></td> <td style="width: 10%;"></td> <td style="width: 10%;"></td> <td style="width: 10%;"></td> <td style="width: 10%;"></td> </tr> <tr> <td></td> <td></td> <td colspan="8" style="text-align: center;"> <table border="1" style="width: 100%; border-collapse: collapse; text-align: center;"> <tr> <td style="width: 10%;"></td> <td style="width: 10%;"></td> <td style="width: 10%;"></td> <td style="width: 10%;"></td> <td style="width: 10%;"></td> <td style="width: 10%;"></td> <td
style="width: 10%;"></td> <td style="width: 10%;"></td> <td style="width: 10%;"></td> <td style="width: 10%;"></td> </tr> <tr> <td></td> <td></td> <td colspan="8" style="text-align: center;"> <table border="1" style="width: 100%; border-collapse: collapse; text-align: center;"> <tr> <td style="width: 10%;"></td> <td style="width: 10%;"></td> <td style="width: 10%;"></td> <td style="width: 10%;"></td> <td style="width: 10%;"></td> <td style="width: 10%;"></td> <td style="width: 10%;"></td> <td style="width: 10%;"></td> <td style="width: 10%;"></td> <td style="width: 10%;"></td> </tr> <tr> <td></td> <td></td> <td colspan="8" style="text-align: center;"> <table border="1" style="width: 100%; border-collapse: collapse; text-align: center;"> <tr> <td style="width: 10%;"></td> <td style="width: 10%;"></td> <td style="width: 10%;"></td> <td style="width: 10%;"></td> <td style="width: 10%;"></td> <td style="width: 10%;"></td> <td style="width: 10%;"></td> <td style="width: 10%;"></td> <td style="width: 10%;"></td> <td style="width: 10%;"></td> </tr> <tr> <td></td> <td></td> <td colspan="8" style="text-align: center;"> <table border="1" style="width: 100%; border-collapse: collapse; text-align: center;"> <tr> <td style="width: 10%;"></td> <td style="width: 10%;"></td> <td style="width: 10%;"></td> <td style="width: 10%;"></td> <td style="width: 10%;"></td> <td style="width: 10%;"></td> <td style="width: 10%;"></td> <td style="width: 10%;"></td> <td style="width: 10%;"></td> <td style="width: 10%;"></td> </tr> <tr> <td></td> <td></td> <td colspan="8" style="text-align: center;"> <table border="1" style="width: 100%; border-collapse: collapse; text-align: center;"> <tr> <td style="width: 10%;"></td> <td style="width: 10%;"></td> <td style="width: 10%;"></td> <td style="width: 10%;"></td> <td style="width: 10%;"></td> <td style="width: 10%;"></td> <td style="width: 10%;"></td> <td style="width: 10%;"></td> <td style="width: 10%;"></td> <td style="width: 10%;"></td> </tr> <tr> <td></td> <td></td> <td colspan="8" style="text-align: center;"> <table border="1" style="width: 100%; border-collapse: collapse; text-align: center;"> <tr> <td style="width: 10%;"></td> <td style="width: 10%;"></td> <td style="width: 10%;"></td> <td style="width: 10%;"></td> <td style="width: 10%;"></td> <td style="width: 10%;"></td> <td style="width: 10%;"></td> <td style="width: 10%;"></td> <td style="width: 10%;"></td> <td style="width: 10%;"></td> </tr> <tr> <td></td> <td></td> <td colspan="8" style="text-align: center;"> <table border="1" style="width: 100%; border-collapse: collapse; text-align: center;"> <tr> </tr></table></td></tr></table></td></tr></table></td></tr></table></td></tr></table></td></tr></table></td></tr></table></td></tr></table></td></tr></table></td></tr></table></td></tr></table></td></tr></table></td></tr></table></td></tr></table></td></tr></table></td></tr></table></td></tr></table></td></tr></table></td></tr></table></td></tr></table></td></tr></table></td></tr></table></td></tr></table></td></tr></table></td></tr></table>

 | | | | | | | | | | | | | | | | | | | | <table border="1" style="width: 100%; border-collapse: collapse; text-align: center;"> <tr> <td style="width: 10%;"></td> <td style="width: 10%;"></td> <td style="width: 10%;"></td> <td style="width: 10%;"></td> <td style="width: 10%;"></td> <td style="width: 10%;"></td> <td style="width: 10%;"></td> <td style="width: 10%;"></td> <td style="width: 10%;"></td> <td style="width: 10%;"></td> </tr> <tr> <td></td> <td></td> <td colspan="8" style="text-align: center;"> <table border="1" style="width: 100%; border-collapse: collapse; text-align: center;"> <tr> <td style="width: 10%;"></td> <td style="width: 10%;"></td> <td style="width: 10%;"></td> <td style="width: 10%;"></td> <td style="width: 10%;"></td> <td style="width: 10%;"></td> <td style="width: 10%;"></td> <td style="width: 10%;"></td> <td style="width: 10%;"></td> <td style="width: 10%;"></td> </tr> <tr> <td></td> <td></td> <td colspan="8" style="text-align: center;"> <table border="1" style="width: 100%; border-collapse: collapse; text-align: center;"> <tr> <td style="width: 10%;"></td> <td style="width: 10%;"></td> <td style="width: 10%;"></td> <td style="width: 10%;"></td> <td style="width: 10%;"></td> <td style="width: 10%;"></td> <td style="width: 10%;"></td> <td style="width: 10%;"></td> <td style="width: 10%;"></td> <td style="width: 10%;"></td> </tr> <tr> <td></td> <td></td> <td colspan="8" style="text-align: center;"> <table border="1" style="width: 100%; border-collapse: collapse; text-align: center;"> <tr> <td style="width: 10%;"></td> <td style="width: 10%;"></td> <td style="width: 10%;"></td> <td style="width: 10%;"></td> <td style="width: 10%;"></td> <td style="width: 10%;"></td> <td style="width: 10%;"></td> <td style="width: 10%;"></td> <td style="width: 10%;"></td> <td style="width: 10%;"></td> </tr> <tr> <td></td> <td></td> <td colspan="8" style="text-align: center;"> <table border="1" style="width: 100%; border-collapse: collapse; text-align: center;"> <tr> <td style="width: 10%;"></td> <td style="width: 10%;"></td> <td style="width: 10%;"></td> <td style="width: 10%;"></td> <td style="width: 10%;"></td> <td style="width: 10%;"></td> <td style="width: 10%;"></td> <td style="width: 10%;"></td> <td style="width: 10%;"></td> <td style="width: 10%;"></td> </tr> <tr> <td></td> <td></td> <td colspan="8" style="text-align: center;"> <table border="1" style="width: 100%; border-collapse: collapse; text-align: center;"> <tr> <td style="width: 10%;"></td> <td style="width: 10%;"></td> <td style="width: 10%;"></td> <td style="width: 10%;"></td> <td style="width: 10%;"></td> <td style="width: 10%;"></td> <td style="width: 10%;"></td> <td style="width: 10%;"></td> <td style="width: 10%;"></td> <td style="width: 10%;"></td> </tr> <tr> <td></td> <td></td> <td colspan="8" style="text-align: center;"> <table border="1" style="width: 100%; border-collapse: collapse; text-align: center;"> <tr> <td style="width: 10%;"></td> <td style="width: 10%;"></td> <td style="width: 10%;"></td> <td style="width: 10%;"></td> <td style="width: 10%;"></td> <td style="width: 10%;"></td> <td style="width: 10%;"></td> <td style="width: 10%;"></td> <td style="width: 10%;"></td> <td style="width: 10%;"></td> </tr> <tr> <td></td> <td></td> <td colspan="8" style="text-align: center;"> <table border="1" style="width: 100%; border-collapse: collapse; text-align: center;"> <tr> <td style="width: 10%;"></td> <td style="width: 10%;"></td> <td style="width: 10%;"></td> <td style="width: 10%;"></td> <td style="width: 10%;"></td> <td style="width: 10%;"></td> <td style="width: 10%;"></td> <td style="width: 10%;"></td> <td style="width: 10%;"></td> <td style="width: 10%;"></td> </tr> <tr> <td></td> <td></td> <td colspan="8" style="text-align: center;"> <table border="1" style="width: 100%; border-collapse: collapse; text-align: center;"> <tr> <td style="width: 10%;"></td> <td style="width: 10%;"></td> <td style="width: 10%;"></td> <td style="width: 10%;"></td> <td style="width: 10%;"></td> <td style="width: 10%;"></td> <td style="width: 10%;"></td> <td style="width: 10%;"></td> <td style="width: 10%;"></td> <td style="width: 10%;"></td> </tr> <tr> <td></td> <td></td> <td colspan="8" style="text-align: center;"> <table border="1" style="width: 100%; border-collapse: collapse; text-align: center;"> <tr> <td style="width: 10%;"></td> <td style="width: 10%;"></td> <td style="width: 10%;"></td> <td style="width: 10%;"></td> <td style="width: 10%;"></td> <td style="width: 10%;"></td> <td style="width: 10%;"></td> <td style="width: 10%;"></td> <td style="width: 10%;"></td> <td style="width: 10%;"></td> </tr> <tr> <td></td> <td></td> <td colspan="8" style="text-align: center;"> <table border="1" style="width: 100%; border-collapse: collapse; text-align: center;"> <tr> <td style="width: 10%;"></td> <td style="width: 10%;"></td> <td style="width: 10%;"></td> <td style="width: 10%;"></td> <td style="width: 10%;"></td> <td style="width: 10%;"></td> <td style="width: 10%;"></td> <td style="width: 10%;"></td> <td style="width: 10%;"></td> <td style="width: 10%;"></td> </tr> <tr> <td></td> <td></td> <td colspan="8" style="text-align: center;"> <table border="1" style="width: 100%; border-collapse: collapse; text-align: center;"> <tr> <td style="width: 10%;"></td> <td style="width: 10%;"></td> <td style="width: 10%;"></td> <td style="width: 10%;"></td> <td style="width: 10%;"></td> <td style="width: 10%;"></td> <td style="width: 10%;"></td> <td style="width: 10%;"></td> <td style="width: 10%;"></td> <td style="width: 10%;"></td> </tr> <tr> <td></td> <td></td> <td colspan="8" style="text-align: center;"> <table border="1" style="width: 100%; border-collapse: collapse; text-align: center;"> <tr> <td style="width: 10%;"></td> <td style="width: 10%;"></td> <td style="width: 10%;"></td> <td style="width: 10%;"></td> <td style="width: 10%;"></td> <td style="width: 10%;"></td> <td style="width: 10%;"></td> <td style="width: 10%;"></td> <td style="width: 10%;"></td> <td style="width: 10%;"></td> </tr> <tr> <td></td> <td></td> <td colspan="8" style="text-align: center;"> <table border="1" style="width: 100%; border-collapse: collapse; text-align: center;"> <tr> <td style="width: 10%;"></td> <td style="width: 10%;"></td> <td style="width: 10%;"></td> <td style="width: 10%;"></td> <td style="width: 10%;"></td> <td style="width: 10%;"></td> <td style="width: 10%;"></td> <td style="width: 10%;"></td> <td style="width: 10%;"></td> <td style="width: 10%;"></td> </tr> <tr> <td></td> <td></td> <td colspan="8" style="text-align: center;"> <table border="1" style="width: 100%; border-collapse: collapse; text-align: center;"> <tr> <td style="width: 10%;"></td> <td style="width: 10%;"></td> <td style="width: 10%;"></td> <td style="width: 10%;"></td> <td style="width: 10%;"></td> <td style="width: 10%;"></td> <td style="width: 10%;"></td> <td style="width: 10%;"></td> <td style="width: 10%;"></td> <td style="width: 10%;"></td> </tr> <tr> <td></td> <td></td> <td colspan="8" style="text-align: center;"> <table border="1" style="width: 100%; border-collapse: collapse; text-align: center;"> <tr> <td style="width: 10%;"></td> <td style="width: 10%;"></td> <td style="width: 10%;"></td> <td style="width: 10%;"></td> <td style="width: 10%;"></td> <td style="width: 10%;"></td> <td style="width: 10%;"></td> <td style="width: 10%;"></td> <td style="width: 10%;"></td> <td style="width: 10%;"></td> </tr> <tr> <td></td> <td></td> <td colspan="8" style="text-align: center;"> <table border="1" style="width: 100%; border-collapse: collapse; text-align: center;"> <tr> <td style="width: 10%;"></td> <td style="width: 10%;"></td> <td style="width: 10%;"></td> <td style="width: 10%;"></td> <td style="width: 10%;"></td> <td style="width: 10%;"></td> <td style="width: 10%;"></td> <td style="width: 10%;"></td> <td style="width: 10%;"></td> <td style="width: 10%;"></td> </tr> <tr> <td></td> <td></td> <td
colspan="8" style="text-align: center;"> <table border="1" style="width: 100%; border-collapse: collapse; text-align: center;"> <tr> <td style="width: 10%;"></td> <td style="width: 10%;"></td> <td style="width: 10%;"></td> <td style="width: 10%;"></td> <td style="width: 10%;"></td> <td style="width: 10%;"></td> <td style="width: 10%;"></td> <td style="width: 10%;"></td> <td style="width: 10%;"></td> <td style="width: 10%;"></td> </tr> <tr> <td></td> <td></td> <td colspan="8" style="text-align: center;"> <table border="1" style="width: 100%; border-collapse: collapse; text-align: center;"> <tr> <td style="width: 10%;"></td> <td style="width: 10%;"></td> <td style="width: 10%;"></td> <td style="width: 10%;"></td> <td style="width: 10%;"></td> <td style="width: 10%;"></td> <td style="width: 10%;"></td> <td style="width: 10%;"></td> <td style="width: 10%;"></td> <td style="width: 10%;"></td> </tr> <tr> <td></td> <td></td> <td colspan="8" style="text-align: center;"> <table border="1" style="width: 100%; border-collapse: collapse; text-align: center;"> <tr> <td style="width: 10%;"></td> <td style="width: 10%;"></td> <td style="width: 10%;"></td> <td style="width: 10%;"></td> <td style="width: 10%;"></td> <td style="width: 10%;"></td> <td style="width: 10%;"></td> <td style="width: 10%;"></td> <td style="width: 10%;"></td> <td style="width: 10%;"></td> </tr> <tr> <td></td> <td></td> <td colspan="8" style="text-align: center;"> <table border="1" style="width: 100%; border-collapse: collapse; text-align: center;"> <tr> <td style="width: 10%;"></td> <td style="width: 10%;"></td> <td style="width: 10%;"></td> <td style="width: 10%;"></td> <td style="width: 10%;"></td> <td style="width: 10%;"></td> <td style="width: 10%;"></td> <td style="width: 10%;"></td> <td style="width: 10%;"></td> <td style="width: 10%;"></td> </tr> <tr> <td></td> <td></td> <td colspan="8" style="text-align: center;"> <table border="1" style="width: 100%; border-collapse: collapse; text-align: center;"> <tr> <td style="width: 10%;"></td> <td style="width: 10%;"></td> <td style="width: 10%;"></td> <td style="width: 10%;"></td> <td style="width: 10%;"></td> <td style="width: 10%;"></td> <td style="width: 10%;"></td> <td style="width: 10%;"></td> <td style="width: 10%;"></td> <td style="width: 10%;"></td> </tr> <tr> <td></td> <td></td> <td colspan="8" style="text-align: center;"> <table border="1" style="width: 100%; border-collapse: collapse; text-align: center;"> <tr> <td style="width: 10%;"></td> <td style="width: 10%;"></td> <td style="width: 10%;"></td> <td style="width: 10%;"></td> <td style="width: 10%;"></td> <td style="width: 10%;"></td> <td style="width: 10%;"></td> <td style="width: 10%;"></td> <td style="width: 10%;"></td> <td style="width: 10%;"></td> </tr> <tr> <td></td> <td></td> <td colspan="8" style="text-align: center;"> <table border="1" style="width: 100%; border-collapse: collapse; text-align: center;"> <tr> </tr></table></td></tr></table></td></tr></table></td></tr></table></td></tr></table></td></tr></table></td></tr></table></td></tr></table></td></tr></table></td></tr></table></td></tr></table></td></tr></table></td></tr></table></td></tr></table></td></tr></table></td></tr></table></td></tr></table></td></tr></table></td></tr></table></td></tr></table></td></tr></table></td></tr></table></td></tr></table></td></tr></table>

 | | | | | | | | | | | | | | | | | | | | <table border="1" style="width: 100%; border-collapse: collapse; text-align: center;"> <tr> <td style="width: 10%;"></td> <td style="width: 10%;"></td> <td style="width: 10%;"></td> <td style="width: 10%;"></td> <td style="width: 10%;"></td> <td style="width: 10%;"></td> <td style="width: 10%;"></td> <td style="width: 10%;"></td> <td style="width: 10%;"></td> <td style="width: 10%;"></td> </tr> <tr> <td></td> <td></td> <td colspan="8" style="text-align: center;"> <table border="1" style="width: 100%; border-collapse: collapse; text-align: center;"> <tr> <td style="width: 10%;"></td> <td style="width: 10%;"></td> <td style="width: 10%;"></td> <td style="width: 10%;"></td> <td style="width: 10%;"></td> <td style="width: 10%;"></td> <td style="width: 10%;"></td> <td style="width: 10%;"></td> <td style="width: 10%;"></td> <td style="width: 10%;"></td> </tr> <tr> <td></td> <td></td> <td colspan="8" style="text-align: center;"> <table border="1" style="width: 100%; border-collapse: collapse; text-align: center;"> <tr> <td style="width: 10%;"></td> <td style="width: 10%;"></td> <td style="width: 10%;"></td> <td style="width: 10%;"></td> <td style="width: 10%;"></td> <td style="width: 10%;"></td> <td style="width: 10%;"></td> <td style="width: 10%;"></td> <td style="width: 10%;"></td> <td style="width: 10%;"></td> </tr> <tr> <td></td> <td></td> <td colspan="8" style="text-align: center;"> <table border="1" style="width: 100%; border-collapse: collapse; text-align: center;"> <tr> <td style="width: 10%;"></td> <td style="width: 10%;"></td> <td style="width: 10%;"></td> <td style="width: 10%;"></td> <td style="width: 10%;"></td> <td style="width: 10%;"></td> <td style="width: 10%;"></td> <td style="width: 10%;"></td> <td style="width: 10%;"></td> <td style="width: 10%;"></td> </tr> <tr> <td></td> <td></td> <td colspan="8" style="text-align: center;"> <table border="1" style="width: 100%; border-collapse: collapse; text-align: center;"> <tr> <td style="width: 10%;"></td> <td style="width: 10%;"></td> <td style="width: 10%;"></td> <td style="width: 10%;"></td> <td style="width: 10%;"></td> <td style="width: 10%;"></td> <td style="width: 10%;"></td> <td style="width: 10%;"></td> <td style="width: 10%;"></td> <td style="width: 10%;"></td> </tr> <tr> <td></td> <td></td> <td colspan="8" style="text-align: center;"> <table border="1" style="width: 100%; border-collapse: collapse; text-align: center;"> <tr> <td style="width: 10%;"></td> <td style="width: 10%;"></td> <td style="width: 10%;"></td> <td style="width: 10%;"></td> <td style="width: 10%;"></td> <td style="width: 10%;"></td> <td style="width: 10%;"></td> <td style="width: 10%;"></td> <td style="width: 10%;"></td> <td style="width: 10%;"></td> </tr> <tr> <td></td> <td></td> <td colspan="8" style="text-align: center;"> <table border="1" style="width: 100%; border-collapse: collapse; text-align: center;"> <tr> <td style="width: 10%;"></td> <td style="width: 10%;"></td> <td style="width: 10%;"></td> <td style="width: 10%;"></td> <td style="width: 10%;"></td> <td style="width: 10%;"></td> <td style="width: 10%;"></td> <td style="width: 10%;"></td> <td style="width: 10%;"></td> <td style="width: 10%;"></td> </tr> <tr> <td></td> <td></td> <td colspan="8" style="text-align: center;"> <table border="1" style="width: 100%; border-collapse: collapse; text-align: center;"> <tr> <td style="width: 10%;"></td> <td style="width: 10%;"></td> <td style="width: 10%;"></td> <td style="width: 10%;"></td> <td style="width: 10%;"></td> <td style="width: 10%;"></td> <td style="width: 10%;"></td> <td style="width: 10%;"></td> <td style="width: 10%;"></td> <td style="width: 10%;"></td> </tr> <tr> <td></td> <td></td> <td colspan="8" style="text-align: center;"> <table border="1" style="width: 100%; border-collapse: collapse; text-align: center;"> <tr> <td style="width: 10%;"></td> <td style="width: 10%;"></td> <td style="width: 10%;"></td> <td style="width: 10%;"></td> <td style="width: 10%;"></td> <td style="width: 10%;"></td> <td style="width: 10%;"></td> <td style="width: 10%;"></td> <td style="width: 10%;"></td> <td style="width: 10%;"></td> </tr> <tr> <td></td> <td></td> <td colspan="8" style="text-align: center;"> <table border="1" style="width: 100%; border-collapse: collapse; text-align: center;"> <tr> <td style="width: 10%;"></td> <td style="width: 10%;"></td> <td style="width: 10%;"></td> <td style="width: 10%;"></td> <td style="width: 10%;"></td> <td style="width: 10%;"></td> <td style="width: 10%;"></td> <td style="width: 10%;"></td> <td style="width: 10%;"></td> <td style="width: 10%;"></td> </tr> <tr> <td></td> <td></td> <td colspan="8" style="text-align: center;"> <table border="1" style="width: 100%; border-collapse: collapse; text-align: center;"> <tr> <td style="width: 10%;"></td> <td style="width: 10%;"></td> <td style="width: 10%;"></td> <td style="width: 10%;"></td> <td style="width: 10%;"></td> <td style="width: 10%;"></td> <td style="width: 10%;"></td> <td style="width: 10%;"></td> <td style="width: 10%;"></td> <td style="width: 10%;"></td> </tr> <tr> <td></td> <td></td> <td colspan="8" style="text-align: center;"> <table border="1" style="width: 100%; border-collapse: collapse; text-align: center;"> <tr> <td style="width: 10%;"></td> <td style="width: 10%;"></td> <td style="width: 10%;"></td> <td style="width: 10%;"></td> <td style="width: 10%;"></td> <td style="width: 10%;"></td> <td style="width: 10%;"></td> <td style="width: 10%;"></td> <td style="width: 10%;"></td> <td style="width: 10%;"></td> </tr> <tr> <td></td> <td></td> <td colspan="8" style="text-align: center;"> <table border="1" style="width: 100%; border-collapse: collapse; text-align: center;"> <tr> <td style="width: 10%;"></td> <td style="width: 10%;"></td> <td style="width: 10%;"></td> <td style="width: 10%;"></td> <td style="width: 10%;"></td> <td style="width: 10%;"></td> <td style="width: 10%;"></td> <td style="width: 10%;"></td> <td style="width: 10%;"></td> <td style="width: 10%;"></td> </tr> <tr> <td></td> <td></td> <td colspan="8" style="text-align: center;"> <table border="1" style="width: 100%; border-collapse: collapse; text-align: center;"> <tr> <td style="width: 10%;"></td> <td style="width: 10%;"></td> <td style="width: 10%;"></td> <td style="width: 10%;"></td> <td style="width: 10%;"></td> <td style="width: 10%;"></td> <td style="width: 10%;"></td> <td style="width: 10%;"></td> <td style="width: 10%;"></td> <td style="width: 10%;"></td> </tr> <tr> <td></td> <td></td> <td colspan="8" style="text-align: center;"> <table border="1" style="width: 100%; border-collapse: collapse; text-align: center;"> <tr> <td style="width: 10%;"></td> <td style="width: 10%;"></td> <td style="width: 10%;"></td> <td style="width: 10%;"></td> <td style="width: 10%;"></td> <td style="width: 10%;"></td> <td style="width: 10%;"></td> <td style="width: 10%;"></td> <td style="width: 10%;"></td> <td style="width: 10%;"></td> </tr> <tr> <td></td> <td></td> <td colspan="8" style="text-align: center;"> <table border="1" style="width: 100%; border-collapse: collapse; text-align: center;"> <tr> <td style="width: 10%;"></td> <td style="width: 10%;"></td> <td style="width: 10%;"></td> <td style="width: 10%;"></td> <td style="width: 10%;"></td> <td style="width: 10%;"></td> <td style="width: 10%;"></td> <td style="width: 10%;"></td> <td style="width: 10%;"></td> <td style="width: 10%;"></td> </tr> <tr> <td></td> <td></td> <td colspan="8" style="text-align: center;"> <table border="1" style="width: 100%; border-collapse: collapse; text-align: center;"> <tr> <td style="width: 10%;"></td> <td
style="width: 10%;"></td> <td style="width: 10%;"></td> <td style="width: 10%;"></td> <td style="width: 10%;"></td> <td style="width: 10%;"></td> <td style="width: 10%;"></td> <td style="width: 10%;"></td> <td style="width: 10%;"></td> <td style="width: 10%;"></td> </tr> <tr> <td></td> <td></td> <td colspan="8" style="text-align: center;"> <table border="1" style="width: 100%; border-collapse: collapse; text-align: center;"> <tr> <td style="width: 10%;"></td> <td style="width: 10%;"></td> <td style="width: 10%;"></td> <td style="width: 10%;"></td> <td style="width: 10%;"></td> <td style="width: 10%;"></td> <td style="width: 10%;"></td> <td style="width: 10%;"></td> <td style="width: 10%;"></td> <td style="width: 10%;"></td> </tr> <tr> <td></td> <td></td> <td colspan="8" style="text-align: center;"> <table border="1" style="width: 100%; border-collapse: collapse; text-align: center;"> <tr> <td style="width: 10%;"></td> <td style="width: 10%;"></td> <td style="width: 10%;"></td> <td style="width: 10%;"></td> <td style="width: 10%;"></td> <td style="width: 10%;"></td> <td style="width: 10%;"></td> <td style="width: 10%;"></td> <td style="width: 10%;"></td> <td style="width: 10%;"></td> </tr> <tr> <td></td> <td></td> <td colspan="8" style="text-align: center;"> <table border="1" style="width: 100%; border-collapse: collapse; text-align: center;"> <tr> <td style="width: 10%;"></td> <td style="width: 10%;"></td> <td style="width: 10%;"></td> <td style="width: 10%;"></td> <td style="width: 10%;"></td> <td style="width: 10%;"></td> <td style="width: 10%;"></td> <td style="width: 10%;"></td> <td style="width: 10%;"></td> <td style="width: 10%;"></td> </tr> <tr> <td></td> <td></td> <td colspan="8" style="text-align: center;"> <table border="1" style="width: 100%; border-collapse: collapse; text-align: center;"> <tr> <td style="width: 10%;"></td> <td style="width: 10%;"></td> <td style="width: 10%;"></td> <td style="width: 10%;"></td> <td style="width: 10%;"></td> <td style="width: 10%;"></td> <td style="width: 10%;"></td> <td style="width: 10%;"></td> <td style="width: 10%;"></td> <td style="width: 10%;"></td> </tr> <tr> <td></td> <td></td> <td colspan="8" style="text-align: center;"> <table border="1" style="width: 100%; border-collapse: collapse; text-align: center;"> <tr> <td style="width: 10%;"></td> <td style="width: 10%;"></td> <td style="width: 10%;"></td> <td style="width: 10%;"></td> <td style="width: 10%;"></td> <td style="width: 10%;"></td> <td style="width: 10%;"></td> <td style="width: 10%;"></td> <td style="width: 10%;"></td> <td style="width: 10%;"></td> </tr> <tr> <td></td> <td></td> <td colspan="8" style="text-align: center;"> <table border="1" style="width: 100%; border-collapse: collapse; text-align: center;"> <tr> </tr></table></td></tr></table></td></tr></table></td></tr></table></td></tr></table></td></tr></table></td></tr></table></td></tr></table></td></tr></table></td></tr></table></td></tr></table></td></tr></table></td></tr></table></td></tr></table></td></tr></table></td></tr></table></td></tr></table></td></tr></table></td></tr></table></td></tr></table></td></tr></table></td></tr></table></td></tr></table>

 | | | | | | | | | | | | | | | | | | | | <table border="1" style="width: 100%; border-collapse: collapse; text-align: center;"> <tr> <td style="width: 10%;"></td> <td style="width: 10%;"></td> <td style="width: 10%;"></td> <td style="width: 10%;"></td> <td style="width: 10%;"></td> <td style="width: 10%;"></td> <td style="width: 10%;"></td> <td style="width: 10%;"></td> <td style="width: 10%;"></td> <td style="width: 10%;"></td> </tr> <tr> <td></td> <td></td> <td colspan="8" style="text-align: center;"> <table border="1" style="width: 100%; border-collapse: collapse; text-align: center;"> <tr> <td style="width: 10%;"></td> <td style="width: 10%;"></td> <td style="width: 10%;"></td> <td style="width: 10%;"></td> <td style="width: 10%;"></td> <td style="width: 10%;"></td> <td style="width: 10%;"></td> <td style="width: 10%;"></td> <td style="width: 10%;"></td> <td style="width: 10%;"></td> </tr> <tr> <td></td> <td></td> <td colspan="8" style="text-align: center;"> <table border="1" style="width: 100%; border-collapse: collapse; text-align: center;"> <tr> <td style="width: 10%;"></td> <td style="width: 10%;"></td> <td style="width: 10%;"></td> <td style="width: 10%;"></td> <td style="width: 10%;"></td> <td style="width: 10%;"></td> <td style="width: 10%;"></td> <td style="width: 10%;"></td> <td style="width: 10%;"></td> <td style="width: 10%;"></td> </tr> <tr> <td></td> <td></td> <td colspan="8" style="text-align: center;"> <table border="1" style="width: 100%; border-collapse: collapse; text-align: center;"> <tr> <td style="width: 10%;"></td> <td style="width: 10%;"></td> <td style="width: 10%;"></td> <td style="width: 10%;"></td> <td style="width: 10%;"></td> <td style="width: 10%;"></td> <td style="width: 10%;"></td> <td style="width: 10%;"></td> <td style="width: 10%;"></td> <td style="width: 10%;"></td> </tr> <tr> <td></td> <td></td> <td colspan="8" style="text-align: center;"> <table border="1" style="width: 100%; border-collapse: collapse; text-align: center;"> <tr> <td style="width: 10%;"></td> <td style="width: 10%;"></td> <td style="width: 10%;"></td> <td style="width: 10%;"></td> <td style="width: 10%;"></td> <td style="width: 10%;"></td> <td style="width: 10%;"></td> <td style="width: 10%;"></td> <td style="width: 10%;"></td> <td style="width: 10%;"></td> </tr> <tr> <td></td> <td></td> <td colspan="8" style="text-align: center;"> <table border="1" style="width: 100%; border-collapse: collapse; text-align: center;"> <tr> <td style="width: 10%;"></td> <td style="width: 10%;"></td> <td style="width: 10%;"></td> <td style="width: 10%;"></td> <td style="width: 10%;"></td> <td style="width: 10%;"></td> <td style="width: 10%;"></td> <td style="width: 10%;"></td> <td style="width: 10%;"></td> <td style="width: 10%;"></td> </tr> <tr> <td></td> <td></td> <td colspan="8" style="text-align: center;"> <table border="1" style="width: 100%; border-collapse: collapse; text-align: center;"> <tr> <td style="width: 10%;"></td> <td style="width: 10%;"></td> <td style="width: 10%;"></td> <td style="width: 10%;"></td> <td style="width: 10%;"></td> <td style="width: 10%;"></td> <td style="width: 10%;"></td> <td style="width: 10%;"></td> <td style="width: 10%;"></td> <td style="width: 10%;"></td> </tr> <tr> <td></td> <td></td> <td colspan="8" style="text-align: center;"> <table border="1" style="width: 100%; border-collapse: collapse; text-align: center;"> <tr> <td style="width: 10%;"></td> <td style="width: 10%;"></td> <td style="width: 10%;"></td> <td style="width: 10%;"></td> <td style="width: 10%;"></td> <td style="width: 10%;"></td> <td style="width: 10%;"></td> <td style="width: 10%;"></td> <td style="width: 10%;"></td> <td style="width: 10%;"></td> </tr> <tr> <td></td> <td></td> <td colspan="8" style="text-align: center;"> <table border="1" style="width: 100%; border-collapse: collapse; text-align: center;"> <tr> <td style="width: 10%;"></td> <td style="width: 10%;"></td> <td style="width: 10%;"></td> <td style="width: 10%;"></td> <td style="width: 10%;"></td> <td style="width: 10%;"></td> <td style="width: 10%;"></td> <td style="width: 10%;"></td> <td style="width: 10%;"></td> <td style="width: 10%;"></td> </tr> <tr> <td></td> <td></td> <td colspan="8" style="text-align: center;"> <table border="1" style="width: 100%; border-collapse: collapse; text-align: center;"> <tr> <td style="width: 10%;"></td> <td style="width: 10%;"></td> <td style="width: 10%;"></td> <td style="width: 10%;"></td> <td style="width: 10%;"></td> <td style="width: 10%;"></td> <td style="width: 10%;"></td> <td style="width: 10%;"></td> <td style="width: 10%;"></td> <td style="width: 10%;"></td> </tr> <tr> <td></td> <td></td> <td colspan="8" style="text-align: center;"> <table border="1" style="width: 100%; border-collapse: collapse; text-align: center;"> <tr> <td style="width: 10%;"></td> <td style="width: 10%;"></td> <td style="width: 10%;"></td> <td style="width: 10%;"></td> <td style="width: 10%;"></td> <td style="width: 10%;"></td> <td style="width: 10%;"></td> <td style="width: 10%;"></td> <td style="width: 10%;"></td> <td style="width: 10%;"></td> </tr> <tr> <td></td> <td></td> <td colspan="8" style="text-align: center;"> <table border="1" style="width: 100%; border-collapse: collapse; text-align: center;"> <tr> <td style="width: 10%;"></td> <td style="width: 10%;"></td> <td style="width: 10%;"></td> <td style="width: 10%;"></td> <td style="width: 10%;"></td> <td style="width: 10%;"></td> <td style="width: 10%;"></td> <td style="width: 10%;"></td> <td style="width: 10%;"></td> <td style="width: 10%;"></td> </tr> <tr> <td></td> <td></td> <td colspan="8" style="text-align: center;"> <table border="1" style="width: 100%; border-collapse: collapse; text-align: center;"> <tr> <td style="width: 10%;"></td> <td style="width: 10%;"></td> <td style="width: 10%;"></td> <td style="width: 10%;"></td> <td style="width: 10%;"></td> <td style="width: 10%;"></td> <td style="width: 10%;"></td> <td style="width: 10%;"></td> <td style="width: 10%;"></td> <td style="width: 10%;"></td> </tr> <tr> <td></td> <td></td> <td colspan="8" style="text-align: center;"> <table border="1" style="width: 100%; border-collapse: collapse; text-align: center;"> <tr> <td style="width: 10%;"></td> <td style="width: 10%;"></td> <td style="width: 10%;"></td> <td style="width: 10%;"></td> <td style="width: 10%;"></td> <td style="width: 10%;"></td> <td style="width: 10%;"></td> <td style="width: 10%;"></td> <td style="width: 10%;"></td> <td style="width: 10%;"></td> </tr> <tr> <td></td> <td></td> <td colspan="8" style="text-align: center;"> <table border="1" style="width: 100%; border-collapse: collapse; text-align: center;"> <tr> <td style="width: 10%;"></td> <td style="width: 10%;"></td> <td style="width: 10%;"></td> <td style="width: 10%;"></td> <td style="width: 10%;"></td> <td style="width: 10%;"></td> <td style="width: 10%;"></td> <td style="width: 10%;"></td> <td style="width: 10%;"></td> <td style="width: 10%;"></td> </tr> <tr> <td></td> <td></td> <td colspan="8" style="text-align: center;"> <table border="1" style="width: 100%; border-collapse: collapse; text-align: center;"> <tr> <td style="width: 10%;"></td> <td style="width: 10%;"></td> <td style="width: 10%;"></td> <td style="width: 10%;"></td> <td style="width: 10%;"></td> <td style="width: 10%;"></td> <td style="width: 10%;"></td> <td style="width: 10%;"></td> <td style="width: 10%;"></td> <td style="width: 10%;"></td> </tr> <tr> <td></td> <td></td> <td colspan="8" style="text-align: center;"> <table border="1" style="width: 100%; border-collapse: collapse; text-align: center;"> <tr> <td style="width: 10%;"></td> <td style="width: 10%;"></td> <td style="width: 10%;"></td> <td style="width: 10%;"></td> <td style="width: 10%;"></td> <td style="width: 10%;"></td> <td style="width: 10%;"></td> <td
style="width: 10%;"></td> <td style="width: 10%;"></td> <td style="width: 10%;"></td> </tr> <tr> <td></td> <td></td> <td colspan="8" style="text-align: center;"> <table border="1" style="width: 100%; border-collapse: collapse; text-align: center;"> <tr> <td style="width: 10%;"></td> <td style="width: 10%;"></td> <td style="width: 10%;"></td> <td style="width: 10%;"></td> <td style="width: 10%;"></td> <td style="width: 10%;"></td> <td style="width: 10%;"></td> <td style="width: 10%;"></td> <td style="width: 10%;"></td> <td style="width: 10%;"></td> </tr> <tr> <td></td> <td></td> <td colspan="8" style="text-align: center;"> <table border="1" style="width: 100%; border-collapse: collapse; text-align: center;"> <tr> <td style="width: 10%;"></td> <td style="width: 10%;"></td> <td style="width: 10%;"></td> <td style="width: 10%;"></td> <td style="width: 10%;"></td> <td style="width: 10%;"></td> <td style="width: 10%;"></td> <td style="width: 10%;"></td> <td style="width: 10%;"></td> <td style="width: 10%;"></td> </tr> <tr> <td></td> <td></td> <td colspan="8" style="text-align: center;"> <table border="1" style="width: 100%; border-collapse: collapse; text-align: center;"> <tr> <td style="width: 10%;"></td> <td style="width: 10%;"></td> <td style="width: 10%;"></td> <td style="width: 10%;"></td> <td style="width: 10%;"></td> <td style="width: 10%;"></td> <td style="width: 10%;"></td> <td style="width: 10%;"></td> <td style="width: 10%;"></td> <td style="width: 10%;"></td> </tr> <tr> <td></td> <td></td> <td colspan="8" style="text-align: center;"> <table border="1" style="width: 100%; border-collapse: collapse; text-align: center;"> <tr> <td style="width: 10%;"></td> <td style="width: 10%;"></td> <td style="width: 10%;"></td> <td style="width: 10%;"></td> <td style="width: 10%;"></td> <td style="width: 10%;"></td> <td style="width: 10%;"></td> <td style="width: 10%;"></td> <td style="width: 10%;"></td> <td style="width: 10%;"></td> </tr> <tr> <td></td> <td></td> <td colspan="8" style="text-align: center;"> <table border="1" style="width: 100%; border-collapse: collapse; text-align: center;"> <tr> </tr></table></td></tr></table></td></tr></table></td></tr></table></td></tr></table></td></tr></table></td></tr></table></td></tr></table></td></tr></table></td></tr></table></td></tr></table></td></tr></table></td></tr></table></td></tr></table></td></tr></table></td></tr></table></td></tr></table></td></tr></table></td></tr></table></td></tr></table></td></tr></table></td></tr></table>

 | | | | | | | | | | | | | | | | | | | | <table border="1" style="width: 100%; border-collapse: collapse; text-align: center;"> <tr> <td style="width: 10%;"></td> <td style="width: 10%;"></td> <td style="width: 10%;"></td> <td style="width: 10%;"></td> <td style="width: 10%;"></td> <td style="width: 10%;"></td> <td style="width: 10%;"></td> <td style="width: 10%;"></td> <td style="width: 10%;"></td> <td style="width: 10%;"></td> </tr> <tr> <td></td> <td></td> <td colspan="8" style="text-align: center;"> <table border="1" style="width: 100%; border-collapse: collapse; text-align: center;"> <tr> <td style="width: 10%;"></td> <td style="width: 10%;"></td> <td style="width: 10%;"></td> <td style="width: 10%;"></td> <td style="width: 10%;"></td> <td style="width: 10%;"></td> <td style="width: 10%;"></td> <td style="width: 10%;"></td> <td style="width: 10%;"></td> <td style="width: 10%;"></td> </tr> <tr> <td></td> <td></td> <td colspan="8" style="text-align: center;"> <table border="1" style="width: 100%; border-collapse: collapse; text-align: center;"> <tr> <td style="width: 10%;"></td> <td style="width: 10%;"></td> <td style="width: 10%;"></td> <td style="width: 10%;"></td> <td style="width: 10%;"></td> <td style="width: 10%;"></td> <td style="width: 10%;"></td> <td style="width: 10%;"></td> <td style="width: 10%;"></td> <td style="width: 10%;"></td> </tr> <tr> <td></td> <td></td> <td colspan="8" style="text-align: center;"> <table border="1" style="width: 100%; border-collapse: collapse; text-align: center;"> <tr> <td style="width: 10%;"></td> <td style="width: 10%;"></td> <td style="width: 10%;"></td> <td style="width: 10%;"></td> <td style="width: 10%;"></td> <td style="width: 10%;"></td> <td style="width: 10%;"></td> <td style="width: 10%;"></td> <td style="width: 10%;"></td> <td style="width: 10%;"></td> </tr> <tr> <td></td> <td></td> <td colspan="8" style="text-align: center;"> <table border="1" style="width: 100%; border-collapse: collapse; text-align: center;"> <tr> <td style="width: 10%;"></td> <td style="width: 10%;"></td> <td style="width: 10%;"></td> <td style="width: 10%;"></td> <td style="width: 10%;"></td> <td style="width: 10%;"></td> <td style="width: 10%;"></td> <td style="width: 10%;"></td> <td style="width: 10%;"></td> <td style="width: 10%;"></td> </tr> <tr> <td></td> <td></td> <td colspan="8" style="text-align: center;"> <table border="1" style="width: 100%; border-collapse: collapse; text-align: center;"> <tr> <td style="width: 10%;"></td> <td style="width: 10%;"></td> <td style="width: 10%;"></td> <td style="width: 10%;"></td> <td style="width: 10%;"></td> <td style="width: 10%;"></td> <td style="width: 10%;"></td> <td style="width: 10%;"></td> <td style="width: 10%;"></td> <td style="width: 10%;"></td> </tr> <tr> <td></td> <td></td> <td colspan="8" style="text-align: center;"> <table border="1" style="width: 100%; border-collapse: collapse; text-align: center;"> <tr> <td style="width: 10%;"></td> <td style="width: 10%;"></td> <td style="width: 10%;"></td> <td style="width: 10%;"></td> <td style="width: 10%;"></td> <td style="width: 10%;"></td> <td style="width: 10%;"></td> <td style="width: 10%;"></td> <td style="width: 10%;"></td> <td style="width: 10%;"></td> </tr> <tr> <td></td> <td></td> <td colspan="8" style="text-align: center;"> <table border="1" style="width: 100%; border-collapse: collapse; text-align: center;"> <tr> <td style="width: 10%;"></td> <td style="width: 10%;"></td> <td style="width: 10%;"></td> <td style="width: 10%;"></td> <td style="width: 10%;"></td> <td style="width: 10%;"></td> <td style="width: 10%;"></td> <td style="width: 10%;"></td> <td style="width: 10%;"></td> <td style="width: 10%;"></td> </tr> <tr> <td></td> <td></td> <td colspan="8" style="text-align: center;"> <table border="1" style="width: 100%; border-collapse: collapse; text-align: center;"> <tr> <td style="width: 10%;"></td> <td style="width: 10%;"></td> <td style="width: 10%;"></td> <td style="width: 10%;"></td> <td style="width: 10%;"></td> <td style="width: 10%;"></td> <td style="width: 10%;"></td> <td style="width: 10%;"></td> <td style="width: 10%;"></td> <td style="width: 10%;"></td> </tr> <tr> <td></td> <td></td> <td colspan="8" style="text-align: center;"> <table border="1" style="width: 100%; border-collapse: collapse; text-align: center;"> <tr> <td style="width: 10%;"></td> <td style="width: 10%;"></td> <td style="width: 10%;"></td> <td style="width: 10%;"></td> <td style="width: 10%;"></td> <td style="width: 10%;"></td> <td style="width: 10%;"></td> <td style="width: 10%;"></td> <td style="width: 10%;"></td> <td style="width: 10%;"></td> </tr> <tr> <td></td> <td></td> <td colspan="8" style="text-align: center;"> <table border="1" style="width: 100%; border-collapse: collapse; text-align: center;"> <tr> <td style="width: 10%;"></td> <td style="width: 10%;"></td> <td style="width: 10%;"></td> <td style="width: 10%;"></td> <td style="width: 10%;"></td> <td style="width: 10%;"></td> <td style="width: 10%;"></td> <td style="width: 10%;"></td> <td style="width: 10%;"></td> <td style="width: 10%;"></td> </tr> <tr> <td></td> <td></td> <td colspan="8" style="text-align: center;"> <table border="1" style="width: 100%; border-collapse: collapse; text-align: center;"> <tr> <td style="width: 10%;"></td> <td style="width: 10%;"></td> <td style="width: 10%;"></td> <td style="width: 10%;"></td> <td style="width: 10%;"></td> <td style="width: 10%;"></td> <td style="width: 10%;"></td> <td style="width: 10%;"></td> <td style="width: 10%;"></td> <td style="width: 10%;"></td> </tr> <tr> <td></td> <td></td> <td colspan="8" style="text-align: center;"> <table border="1" style="width: 100%; border-collapse: collapse; text-align: center;"> <tr> <td style="width: 10%;"></td> <td style="width: 10%;"></td> <td style="width: 10%;"></td> <td style="width: 10%;"></td> <td style="width: 10%;"></td> <td style="width: 10%;"></td> <td style="width: 10%;"></td> <td style="width: 10%;"></td> <td style="width: 10%;"></td> <td style="width: 10%;"></td> </tr> <tr> <td></td> <td></td> <td colspan="8" style="text-align: center;"> <table border="1" style="width: 100%; border-collapse: collapse; text-align: center;"> <tr> <td style="width: 10%;"></td> <td style="width: 10%;"></td> <td style="width: 10%;"></td> <td style="width: 10%;"></td> <td style="width: 10%;"></td> <td style="width: 10%;"></td> <td style="width: 10%;"></td> <td style="width: 10%;"></td> <td style="width: 10%;"></td> <td style="width: 10%;"></td> </tr> <tr> <td></td> <td></td> <td colspan="8" style="text-align: center;"> <table border="1" style="width: 100%; border-collapse: collapse; text-align: center;"> <tr> <td style="width: 10%;"></td> <td style="width: 10%;"></td> <td style="width: 10%;"></td> <td style="width: 10%;"></td> <td style="width: 10%;"></td> <td style="width: 10%;"></td> <td style="width: 10%;"></td> <td style="width: 10%;"></td> <td style="width: 10%;"></td> <td style="width: 10%;"></td> </tr> <tr> <td></td> <td></td> <td colspan="8" style="text-align: center;"> <table border="1" style="width: 100%; border-collapse: collapse; text-align: center;"> <tr> <td style="width: 10%;"></td> <td style="width: 10%;"></td> <td style="width: 10%;"></td> <td style="width: 10%;"></td> <td style="width: 10%;"></td> <td style="width: 10%;"></td> <td style="width: 10%;"></td> <td style="width: 10%;"></td> <td style="width: 10%;"></td> <td style="width: 10%;"></td> </tr> <tr> <td></td> <td></td> <td colspan="8" style="text-align: center;"> <table border="1" style="width: 100%; border-collapse: collapse; text-align: center;"> <tr> <td style="width: 10%;"></td> <td style="width: 10%;"></td> <td style="width: 10%;"></td> <td style="width: 10%;"></td> <td style="width: 10%;"></td> <td style="width: 10%;"></td> <td style="width: 10%;"></td> <td style="width: 10%;"></td> <td style="width: 10%;"></td> <td style="width: 10%;"></td> </tr> <tr> <td></td> <td></td> <td colspan="8" style="text-align: center;"> <table border="1" style="width: 100%; border-collapse: collapse; text-align: center;"> <tr> <td style="width: 10%;"></td> <td style="width: 10%;"></td> <td style="width: 10%;"></td> <td style="width: 10%;"></td> <td style="width: 10%;"></td> <td style="width: 10%;"></td> <td style="width: 10%;"></td> <td style="width: 10%;"></td> <td style="width: 10%;"></td> <td style="width: 10%;"></td> </tr> <tr> <td></td> <td></td> <td colspan="8" style="text-align: center;"> <table border="1" style="width: 100%;
border-collapse: collapse; text-align: center;"> <tr> <td style="width: 10%;"></td> <td style="width: 10%;"></td> <td style="width: 10%;"></td> <td style="width: 10%;"></td> <td style="width: 10%;"></td> <td style="width: 10%;"></td> <td style="width: 10%;"></td> <td style="width: 10%;"></td> <td style="width: 10%;"></td> <td style="width: 10%;"></td> </tr> <tr> <td></td> <td></td> <td colspan="8" style="text-align: center;"> <table border="1" style="width: 100%; border-collapse: collapse; text-align: center;"> <tr> <td style="width: 10%;"></td> <td style="width: 10%;"></td> <td style="width: 10%;"></td> <td style="width: 10%;"></td> <td style="width: 10%;"></td> <td style="width: 10%;"></td> <td style="width: 10%;"></td> <td style="width: 10%;"></td> <td style="width: 10%;"></td> <td style="width: 10%;"></td> </tr> <tr> <td></td> <td></td> <td colspan="8" style="text-align: center;"> <table border="1" style="width: 100%; border-collapse: collapse; text-align: center;"> <tr> </tr></table></td></tr></table></td></tr></table></td></tr></table></td></tr></table></td></tr></table></td></tr></table></td></tr></table></td></tr></table></td></tr></table></td></tr></table></td></tr></table></td></tr></table></td></tr></table></td></tr></table></td></tr></table></td></tr></table></td></tr></table></td></tr></table></td></tr></table></td></tr></table>

 | | | | | | | | | | | | | | | | | | | | <table border="1" style="width: 100%; border-collapse: collapse; text-align: center;"> <tr> <td style="width: 10%;"></td> <td style="width: 10%;"></td> <td style="width: 10%;"></td> <td style="width: 10%;"></td> <td style="width: 10%;"></td> <td style="width: 10%;"></td> <td style="width: 10%;"></td> <td style="width: 10%;"></td> <td style="width: 10%;"></td> <td style="width: 10%;"></td> </tr> <tr> <td></td> <td></td> <td colspan="8" style="text-align: center;"> <table border="1" style="width: 100%; border-collapse: collapse; text-align: center;"> <tr> <td style="width: 10%;"></td> <td style="width: 10%;"></td> <td style="width: 10%;"></td> <td style="width: 10%;"></td> <td style="width: 10%;"></td> <td style="width: 10%;"></td> <td style="width: 10%;"></td> <td style="width: 10%;"></td> <td style="width: 10%;"></td> <td style="width: 10%;"></td> </tr> <tr> <td></td> <td></td> <td colspan="8" style="text-align: center;"> <table border="1" style="width: 100%; border-collapse: collapse; text-align: center;"> <tr> <td style="width: 10%;"></td> <td style="width: 10%;"></td> <td style="width: 10%;"></td> <td style="width: 10%;"></td> <td style="width: 10%;"></td> <td style="width: 10%;"></td> <td style="width: 10%;"></td> <td style="width: 10%;"></td> <td style="width: 10%;"></td> <td style="width: 10%;"></td> </tr> <tr> <td></td> <td></td> <td colspan="8" style="text-align: center;"> <table border="1" style="width: 100%; border-collapse: collapse; text-align: center;"> <tr> <td style="width: 10%;"></td> <td style="width: 10%;"></td> <td style="width: 10%;"></td> <td style="width: 10%;"></td> <td style="width: 10%;"></td> <td style="width: 10%;"></td> <td style="width: 10%;"></td> <td style="width: 10%;"></td> <td style="width: 10%;"></td> <td style="width: 10%;"></td> </tr> <tr> <td></td> <td></td> <td colspan="8" style="text-align: center;"> <table border="1" style="width: 100%; border-collapse: collapse; text-align: center;"> <tr> <td style="width: 10%;"></td> <td style="width: 10%;"></td> <td style="width: 10%;"></td> <td style="width: 10%;"></td> <td style="width: 10%;"></td> <td style="width: 10%;"></td> <td style="width: 10%;"></td> <td style="width: 10%;"></td> <td style="width: 10%;"></td> <td style="width: 10%;"></td> </tr> <tr> <td></td> <td></td> <td colspan="8" style="text-align: center;"> <table border="1" style="width: 100%; border-collapse: collapse; text-align: center;"> <tr> <td style="width: 10%;"></td> <td style="width: 10%;"></td> <td style="width: 10%;"></td> <td style="width: 10%;"></td> <td style="width: 10%;"></td> <td style="width: 10%;"></td> <td style="width: 10%;"></td> <td style="width: 10%;"></td> <td style="width: 10%;"></td> <td style="width: 10%;"></td> </tr> <tr> <td></td> <td></td> <td colspan="8" style="text-align: center;"> <table border="1" style="width: 100%; border-collapse: collapse; text-align: center;"> <tr> <td style="width: 10%;"></td> <td style="width: 10%;"></td> <td style="width: 10%;"></td> <td style="width: 10%;"></td> <td style="width: 10%;"></td> <td style="width: 10%;"></td> <td style="width: 10%;"></td> <td style="width: 10%;"></td> <td style="width: 10%;"></td> <td style="width: 10%;"></td> </tr> <tr> <td></td> <td></td> <td colspan="8" style="text-align: center;"> <table border="1" style="width: 100%; border-collapse: collapse; text-align: center;"> <tr> <td style="width: 10%;"></td> <td style="width: 10%;"></td> <td style="width: 10%;"></td> <td style="width: 10%;"></td> <td style="width: 10%;"></td> <td style="width: 10%;"></td> <td style="width: 10%;"></td> <td style="width: 10%;"></td> <td style="width: 10%;"></td> <td style="width: 10%;"></td> </tr> <tr> <td></td> <td></td> <td colspan="8" style="text-align: center;"> <table border="1" style="width: 100%; border-collapse: collapse; text-align: center;"> <tr> <td style="width: 10%;"></td> <td style="width: 10%;"></td> <td style="width: 10%;"></td> <td style="width: 10%;"></td> <td style="width: 10%;"></td> <td style="width: 10%;"></td> <td style="width: 10%;"></td> <td style="width: 10%;"></td> <td style="width: 10%;"></td> <td style="width: 10%;"></td> </tr> <tr> <td></td> <td></td> <td colspan="8" style="text-align: center;"> <table border="1" style="width: 100%; border-collapse: collapse; text-align: center;"> <tr> <td style="width: 10%;"></td> <td style="width: 10%;"></td> <td style="width: 10%;"></td> <td style="width: 10%;"></td> <td style="width: 10%;"></td> <td style="width: 10%;"></td> <td style="width: 10%;"></td> <td style="width: 10%;"></td> <td style="width: 10%;"></td> <td style="width: 10%;"></td> </tr> <tr> <td></td> <td></td> <td colspan="8" style="text-align: center;"> <table border="1" style="width: 100%; border-collapse: collapse; text-align: center;"> <tr> <td style="width: 10%;"></td> <td style="width: 10%;"></td> <td style="width: 10%;"></td> <td style="width: 10%;"></td> <td style="width: 10%;"></td> <td style="width: 10%;"></td> <td style="width: 10%;"></td> <td style="width: 10%;"></td> <td style="width: 10%;"></td> <td style="width: 10%;"></td> </tr> <tr> <td></td> <td></td> <td colspan="8" style="text-align: center;"> <table border="1" style="width: 100%; border-collapse: collapse; text-align: center;"> <tr> <td style="width: 10%;"></td> <td style="width: 10%;"></td> <td style="width: 10%;"></td> <td style="width: 10%;"></td> <td style="width: 10%;"></td> <td style="width: 10%;"></td> <td style="width: 10%;"></td> <td style="width: 10%;"></td> <td style="width: 10%;"></td> <td style="width: 10%;"></td> </tr> <tr> <td></td> <td></td> <td colspan="8" style="text-align: center;"> <table border="1" style="width: 100%; border-collapse: collapse; text-align: center;"> <tr> <td style="width: 10%;"></td> <td style="width: 10%;"></td> <td style="width: 10%;"></td> <td style="width: 10%;"></td> <td style="width: 10%;"></td> <td style="width: 10%;"></td> <td style="width: 10%;"></td> <td style="width: 10%;"></td> <td style="width: 10%;"></td> <td style="width: 10%;"></td> </tr> <tr> <td></td> <td></td> <td colspan="8" style="text-align: center;"> <table border="1" style="width: 100%; border-collapse: collapse; text-align: center;"> <tr> <td style="width: 10%;"></td> <td style="width: 10%;"></td> <td style="width: 10%;"></td> <td style="width: 10%;"></td> <td style="width: 10%;"></td> <td style="width: 10%;"></td> <td style="width: 10%;"></td> <td style="width: 10%;"></td> <td style="width: 10%;"></td> <td style="width: 10%;"></td> </tr> <tr> <td></td> <td></td> <td colspan="8" style="text-align: center;"> <table border="1" style="width: 100%; border-collapse: collapse; text-align: center;"> <tr> <td style="width: 10%;"></td> <td style="width: 10%;"></td> <td style="width: 10%;"></td> <td style="width: 10%;"></td> <td style="width: 10%;"></td> <td style="width: 10%;"></td> <td style="width: 10%;"></td> <td style="width: 10%;"></td> <td style="width: 10%;"></td> <td style="width: 10%;"></td> </tr> <tr> <td></td> <td></td> <td colspan="8" style="text-align: center;"> <table border="1" style="width: 100%; border-collapse: collapse; text-align: center;"> <tr> <td style="width: 10%;"></td> <td style="width: 10%;"></td> <td style="width: 10%;"></td> <td style="width: 10%;"></td> <td style="width: 10%;"></td> <td style="width: 10%;"></td> <td style="width: 10%;"></td> <td style="width: 10%;"></td> <td style="width: 10%;"></td> <td style="width: 10%;"></td> </tr> <tr> <td></td> <td></td> <td colspan="8" style="text-align: center;"> <table border="1" style="width: 100%; border-collapse: collapse; text-align: center;"> <tr> <td style="width: 10%;"></td> <td style="width: 10%;"></td> <td style="width: 10%;"></td> <td style="width: 10%;"></td> <td style="width: 10%;"></td> <td style="width: 10%;"></td> <td style="width: 10%;"></td> <td style="width: 10%;"></td> <td style="width: 10%;"></td> <td style="width: 10%;"></td> </tr> <tr> <td></td> <td></td> <td colspan="8" style="text-align: center;"> <table border="1" style="width: 100%; border-collapse: collapse; text-align: center;"> <tr> <td style="width: 10%;"></td> <td style="width: 10%;"></td> <td style="width: 10%;"></td> <td style="width: 10%;"></td> <td style="width: 10%;"></td> <td style="width: 10%;"></td> <td style="width: 10%;"></td> <td style="width: 10%;"></td> <td style="width: 10%;"></td> <td style="width: 10%;"></td> </tr> <tr> <td></td> <td></td> <td colspan="8" style="text-align: center;"> <table border="1" style="width: 100%; border-collapse: collapse; text-align: center;"> <tr> <td style="width: 10%;"></td> <td style="width: 10%;"></td> <td style="width: 10%;"></td> <td style="width: 10%;"></td> <td style="width: 10%;"></td> <td style="width: 10%;"></td> <td style="width: 10%;"></td> <td style="width: 10%;"></td> <td style="width: 10%;"></td> <td style="width: 10%;"></td> </tr> <tr> <td></td> <td></td> <td colspan="8" style="text-align: center;"> <table border="1" style="width: 100%; border-collapse: collapse; text-align: center;"> <tr> </tr></table></td></tr></table></td></tr></table></td></tr></table></td></tr></table></td></tr></table></td></tr></table></td></tr></table></td></tr></table></td></tr></table></td></tr></table></td></tr></table></td></tr></table></td></tr></table></td></tr></table></td></tr></table></td></tr></table></td></tr></table></td></tr></table></td></tr></table>

 | | | | | | | | | | | | | | | | | | | | <table border="1" style="width: 100%; border-collapse: collapse; text-align: center;"> <tr> <td style="width: 10%;"></td> <td style="width: 10%;"></td> <td style="width: 10%;"></td> <td style="width: 10%;"></td> <td style="width: 10%;"></td> <td style="width: 10%;"></td> <td style="width: 10%;"></td> <td style="width: 10%;"></td> <td style="width: 10%;"></td> <td style="width: 10%;"></td> </tr> <tr> <td></td> <td></td> <td colspan="8" style="text-align: center;"> <table border="1" style="width: 100%; border-collapse: collapse; text-align: center;"> <tr> <td style="width: 10%;"></td> <td style="width: 10%;"></td> <td style="width: 10%;"></td> <td style="width: 10%;"></td> <td style="width: 10%;"></td> <td style="width: 10%;"></td> <td style="width: 10%;"></td> <td style="width: 10%;"></td> <td style="width: 10%;"></td> <td style="width: 10%;"></td> </tr> <tr> <td></td> <td></td> <td colspan="8" style="text-align: center;"> <table border="1" style="width: 100%; border-collapse: collapse; text-align: center;"> <tr> <td style="width: 10%;"></td> <td style="width: 10%;"></td> <td style="width: 10%;"></td> <td style="width: 10%;"></td> <td style="width: 10%;"></td> <td style="width: 10%;"></td> <td style="width: 10%;"></td> <td style="width: 10%;"></td>
<td style="width: 10%;"></td> <td style="width: 10%;"></td> </tr> <tr> <td></td> <td></td> <td colspan="8" style="text-align: center;"> <table border="1" style="width: 100%; border-collapse: collapse; text-align: center;"> <tr> <td style="width: 10%;"></td> <td style="width: 10%;"></td> <td style="width: 10%;"></td> <td style="width: 10%;"></td> <td style="width: 10%;"></td> <td style="width: 10%;"></td> <td style="width: 10%;"></td> <td style="width: 10%;"></td> <td style="width: 10%;"></td> <td style="width: 10%;"></td> </tr> <tr> <td></td> <td></td> <td colspan="8" style="text-align: center;"> <table border="1" style="width: 100%; border-collapse: collapse; text-align: center;"> <tr> <td style="width: 10%;"></td> <td style="width: 10%;"></td> <td style="width: 10%;"></td> <td style="width: 10%;"></td> <td style="width: 10%;"></td> <td style="width: 10%;"></td> <td style="width: 10%;"></td> <td style="width: 10%;"></td> <td style="width: 10%;"></td> <td style="width: 10%;"></td> </tr> <tr> <td></td> <td></td> <td colspan="8" style="text-align: center;"> <table border="1" style="width: 100%; border-collapse: collapse; text-align: center;"> <tr> <td style="width: 10%;"></td> <td style="width: 10%;"></td> <td style="width: 10%;"></td> <td style="width: 10%;"></td> <td style="width: 10%;"></td> <td style="width: 10%;"></td> <td style="width: 10%;"></td> <td style="width: 10%;"></td> <td style="width: 10%;"></td> <td style="width: 10%;"></td> </tr> <tr> <td></td> <td></td> <td colspan="8" style="text-align: center;"> <table border="1" style="width: 100%; border-collapse: collapse; text-align: center;"> <tr> <td style="width: 10%;"></td> <td style="width: 10%;"></td> <td style="width: 10%;"></td> <td style="width: 10%;"></td> <td style="width: 10%;"></td> <td style="width: 10%;"></td> <td style="width: 10%;"></td> <td style="width: 10%;"></td> <td style="width: 10%;"></td> <td style="width: 10%;"></td> </tr> <tr> <td></td> <td></td> <td colspan="8" style="text-align: center;"> <table border="1" style="width: 100%; border-collapse: collapse; text-align: center;"> <tr> <td style="width: 10%;"></td> <td style="width: 10%;"></td> <td style="width: 10%;"></td> <td style="width: 10%;"></td> <td style="width: 10%;"></td> <td style="width: 10%;"></td> <td style="width: 10%;"></td> <td style="width: 10%;"></td> <td style="width: 10%;"></td> <td style="width: 10%;"></td> </tr> <tr> <td></td> <td></td> <td colspan="8" style="text-align: center;"> <table border="1" style="width: 100%; border-collapse: collapse; text-align: center;"> <tr> <td style="width: 10%;"></td> <td style="width: 10%;"></td> <td style="width: 10%;"></td> <td style="width: 10%;"></td> <td style="width: 10%;"></td> <td style="width: 10%;"></td> <td style="width: 10%;"></td> <td style="width: 10%;"></td> <td style="width: 10%;"></td> <td style="width: 10%;"></td> </tr> <tr> <td></td> <td></td> <td colspan="8" style="text-align: center;"> <table border="1" style="width: 100%; border-collapse: collapse; text-align: center;"> <tr> <td style="width: 10%;"></td> <td style="width: 10%;"></td> <td style="width: 10%;"></td> <td style="width: 10%;"></td> <td style="width: 10%;"></td> <td style="width: 10%;"></td> <td style="width: 10%;"></td> <td style="width: 10%;"></td> <td style="width: 10%;"></td> <td style="width: 10%;"></td> </tr> <tr> <td></td> <td></td> <td colspan="8" style="text-align: center;"> <table border="1" style="width: 100%; border-collapse: collapse; text-align: center;"> <tr> <td style="width: 10%;"></td> <td style="width: 10%;"></td> <td style="width: 10%;"></td> <td style="width: 10%;"></td> <td style="width: 10%;"></td> <td style="width: 10%;"></td> <td style="width: 10%;"></td> <td style="width: 10%;"></td> <td style="width: 10%;"></td> <td style="width: 10%;"></td> </tr> <tr> <td></td> <td></td> <td colspan="8" style="text-align: center;"> <table border="1" style="width: 100%; border-collapse: collapse; text-align: center;"> <tr> <td style="width: 10%;"></td> <td style="width: 10%;"></td> <td style="width: 10%;"></td> <td style="width: 10%;"></td> <td style="width: 10%;"></td> <td style="width: 10%;"></td> <td style="width: 10%;"></td> <td style="width: 10%;"></td> <td style="width: 10%;"></td> <td style="width: 10%;"></td> </tr> <tr> <td></td> <td></td> <td colspan="8" style="text-align: center;"> <table border="1" style="width: 100%; border-collapse: collapse; text-align: center;"> <tr> <td style="width: 10%;"></td> <td style="width: 10%;"></td> <td style="width: 10%;"></td> <td style="width: 10%;"></td> <td style="width: 10%;"></td> <td style="width: 10%;"></td> <td style="width: 10%;"></td> <td style="width: 10%;"></td> <td style="width: 10%;"></td> <td style="width: 10%;"></td> </tr> <tr> <td></td> <td></td> <td colspan="8" style="text-align: center;"> <table border="1" style="width: 100%; border-collapse: collapse; text-align: center;"> <tr> <td style="width: 10%;"></td> <td style="width: 10%;"></td> <td style="width: 10%;"></td> <td style="width: 10%;"></td> <td style="width: 10%;"></td> <td style="width: 10%;"></td> <td style="width: 10%;"></td> <td style="width: 10%;"></td> <td style="width: 10%;"></td> <td style="width: 10%;"></td> </tr> <tr> <td></td> <td></td> <td colspan="8" style="text-align: center;"> <table border="1" style="width: 100%; border-collapse: collapse; text-align: center;"> <tr> <td style="width: 10%;"></td> <td style="width: 10%;"></td> <td style="width: 10%;"></td> <td style="width: 10%;"></td> <td style="width: 10%;"></td> <td style="width: 10%;"></td> <td style="width: 10%;"></td> <td style="width: 10%;"></td> <td style="width: 10%;"></td> <td style="width: 10%;"></td> </tr> <tr> <td></td> <td></td> <td colspan="8" style="text-align: center;"> <table border="1" style="width: 100%; border-collapse: collapse; text-align: center;"> <tr> <td style="width: 10%;"></td> <td style="width: 10%;"></td> <td style="width: 10%;"></td> <td style="width: 10%;"></td> <td style="width: 10%;"></td> <td style="width: 10%;"></td> <td style="width: 10%;"></td> <td style="width: 10%;"></td> <td style="width: 10%;"></td> <td style="width: 10%;"></td> </tr> <tr> <td></td> <td></td> <td colspan="8" style="text-align: center;"> <table border="1" style="width: 100%; border-collapse: collapse; text-align: center;"> <tr> <td style="width: 10%;"></td> <td style="width: 10%;"></td> <td style="width: 10%;"></td> <td style="width: 10%;"></td> <td style="width: 10%;"></td> <td style="width: 10%;"></td> <td style="width: 10%;"></td> <td style="width: 10%;"></td> <td style="width: 10%;"></td> <td style="width: 10%;"></td> </tr> <tr> <td></td> <td></td> <td colspan="8" style="text-align: center;"> <table border="1" style="width: 100%; border-collapse: collapse; text-align: center;"> <tr> <td style="width: 10%;"></td> <td style="width: 10%;"></td> <td style="width: 10%;"></td> <td style="width: 10%;"></td> <td style="width: 10%;"></td> <td style="width: 10%;"></td> <td style="width: 10%;"></td> <td style="width: 10%;"></td> <td style="width: 10%;"></td> <td style="width: 10%;"></td> </tr> <tr> <td></td> <td></td> <td colspan="8" style="text-align: center;"> <table border="1" style="width: 100%; border-collapse: collapse; text-align: center;"> <tr> </tr></table></td></tr></table></td></tr></table></td></tr></table></td></tr></table></td></tr></table></td></tr></table></td></tr></table></td></tr></table></td></tr></table></td></tr></table></td></tr></table></td></tr></table></td></tr></table></td></tr></table></td></tr></table></td></tr></table></td></tr></table></td></tr></table>

 | | | | | | | | | | | | | | | | | | | | <table border="1" style="width: 100%; border-collapse: collapse; text-align: center;"> <tr> <td style="width: 10%;"></td> <td style="width: 10%;"></td> <td style="width: 10%;"></td> <td style="width: 10%;"></td> <td style="width: 10%;"></td> <td style="width: 10%;"></td> <td style="width: 10%;"></td> <td style="width: 10%;"></td> <td style="width: 10%;"></td> <td style="width: 10%;"></td> </tr> <tr> <td></td> <td></td> <td colspan="8" style="text-align: center;"> <table border="1" style="width: 100%; border-collapse: collapse; text-align: center;"> <tr> <td style="width: 10%;"></td> <td style="width: 10%;"></td> <td style="width: 10%;"></td> <td style="width: 10%;"></td> <td style="width: 10%;"></td> <td style="width: 10%;"></td> <td style="width: 10%;"></td> <td style="width: 10%;"></td> <td style="width: 10%;"></td> <td style="width: 10%;"></td> </tr> <tr> <td></td> <td></td> <td colspan="8" style="text-align: center;"> <table border="1" style="width: 100%; border-collapse: collapse; text-align: center;"> <tr> <td style="width: 10%;"></td> <td style="width: 10%;"></td> <td style="width: 10%;"></td> <td style="width: 10%;"></td> <td style="width: 10%;"></td> <td style="width: 10%;"></td> <td style="width: 10%;"></td> <td style="width: 10%;"></td> <td style="width: 10%;"></td> <td style="width: 10%;"></td> </tr> <tr> <td></td> <td></td> <td colspan="8" style="text-align: center;"> <table border="1" style="width: 100%; border-collapse: collapse; text-align: center;"> <tr> <td style="width: 10%;"></td> <td style="width: 10%;"></td> <td style="width: 10%;"></td> <td style="width: 10%;"></td> <td style="width: 10%;"></td> <td style="width: 10%;"></td> <td style="width: 10%;"></td> <td style="width: 10%;"></td> <td style="width: 10%;"></td> <td style="width: 10%;"></td> </tr> <tr> <td></td> <td></td> <td colspan="8" style="text-align: center;"> <table border="1" style="width: 100%; border-collapse: collapse; text-align: center;"> <tr> <td style="width: 10%;"></td> <td style="width: 10%;"></td> <td style="width: 10%;"></td> <td style="width: 10%;"></td> <td style="width: 10%;"></td> <td style="width: 10%;"></td> <td style="width: 10%;"></td> <td style="width: 10%;"></td> <td style="width: 10%;"></td> <td style="width: 10%;"></td> </tr> <tr> <td></td> <td></td> <td colspan="8" style="text-align: center;"> <table border="1" style="width: 100%; border-collapse: collapse; text-align: center;"> <tr> <td style="width: 10%;"></td> <td style="width: 10%;"></td> <td style="width: 10%;"></td> <td style="width: 10%;"></td> <td style="width: 10%;"></td> <td style="width: 10%;"></td> <td style="width: 10%;"></td> <td style="width: 10%;"></td> <td style="width: 10%;"></td> <td style="width: 10%;"></td> </tr> <tr> <td></td> <td></td> <td colspan="8" style="text-align: center;"> <table border="1" style="width: 100%; border-collapse: collapse; text-align: center;"> <tr> <td style="width: 10%;"></td> <td style="width: 10%;"></td> <td style="width: 10%;"></td> <td style="width: 10%;"></td> <td style="width: 10%;"></td> <td style="width: 10%;"></td> <td style="width: 10%;"></td> <td style="width: 10%;"></td> <td style="width: 10%;"></td> <td style="width: 10%;"></td> </tr> <tr> <td></td> <td></td> <td colspan="8" style="text-align: center;"> <table border="1" style="width: 100%; border-collapse: collapse; text-align: center;"> <tr> <td style="width: 10%;"></td>
<td style="width: 10%;"></td> <td style="width: 10%;"></td> <td style="width: 10%;"></td> <td style="width: 10%;"></td> <td style="width: 10%;"></td> <td style="width: 10%;"></td> <td style="width: 10%;"></td> <td style="width: 10%;"></td> <td style="width: 10%;"></td> </tr> <tr> <td></td> <td></td> <td colspan="8" style="text-align: center;"> <table border="1" style="width: 100%; border-collapse: collapse; text-align: center;"> <tr> <td style="width: 10%;"></td> <td style="width: 10%;"></td> <td style="width: 10%;"></td> <td style="width: 10%;"></td> <td style="width: 10%;"></td> <td style="width: 10%;"></td> <td style="width: 10%;"></td> <td style="width: 10%;"></td> <td style="width: 10%;"></td> <td style="width: 10%;"></td> </tr> <tr> <td></td> <td></td> <td colspan="8" style="text-align: center;"> <table border="1" style="width: 100%; border-collapse: collapse; text-align: center;"> <tr> <td style="width: 10%;"></td> <td style="width: 10%;"></td> <td style="width: 10%;"></td> <td style="width: 10%;"></td> <td style="width: 10%;"></td> <td style="width: 10%;"></td> <td style="width: 10%;"></td> <td style="width: 10%;"></td> <td style="width: 10%;"></td> <td style="width: 10%;"></td> </tr> <tr> <td></td> <td></td> <td colspan="8" style="text-align: center;"> <table border="1" style="width: 100%; border-collapse: collapse; text-align: center;"> <tr> <td style="width: 10%;"></td> <td style="width: 10%;"></td> <td style="width: 10%;"></td> <td style="width: 10%;"></td> <td style="width: 10%;"></td> <td style="width: 10%;"></td> <td style="width: 10%;"></td> <td style="width: 10%;"></td> <td style="width: 10%;"></td> <td style="width: 10%;"></td> </tr> <tr> <td></td> <td></td> <td colspan="8" style="text-align: center;"> <table border="1" style="width: 100%; border-collapse: collapse; text-align: center;"> <tr> <td style="width: 10%;"></td> <td style="width: 10%;"></td> <td style="width: 10%;"></td> <td style="width: 10%;"></td> <td style="width: 10%;"></td> <td style="width: 10%;"></td> <td style="width: 10%;"></td> <td style="width: 10%;"></td> <td style="width: 10%;"></td> <td style="width: 10%;"></td> </tr> <tr> <td></td> <td></td> <td colspan="8" style="text-align: center;"> <table border="1" style="width: 100%; border-collapse: collapse; text-align: center;"> <tr> <td style="width: 10%;"></td> <td style="width: 10%;"></td> <td style="width: 10%;"></td> <td style="width: 10%;"></td> <td style="width: 10%;"></td> <td style="width: 10%;"></td> <td style="width: 10%;"></td> <td style="width: 10%;"></td> <td style="width: 10%;"></td> <td style="width: 10%;"></td> </tr> <tr> <td></td> <td></td> <td colspan="8" style="text-align: center;"> <table border="1" style="width: 100%; border-collapse: collapse; text-align: center;"> <tr> <td style="width: 10%;"></td> <td style="width: 10%;"></td> <td style="width: 10%;"></td> <td style="width: 10%;"></td> <td style="width: 10%;"></td> <td style="width: 10%;"></td> <td style="width: 10%;"></td> <td style="width: 10%;"></td> <td style="width: 10%;"></td> <td style="width: 10%;"></td> </tr> <tr> <td></td> <td></td> <td colspan="8" style="text-align: center;"> <table border="1" style="width: 100%; border-collapse: collapse; text-align: center;"> <tr> <td style="width: 10%;"></td> <td style="width: 10%;"></td> <td style="width: 10%;"></td> <td style="width: 10%;"></td> <td style="width: 10%;"></td> <td style="width: 10%;"></td> <td style="width: 10%;"></td> <td style="width: 10%;"></td> <td style="width: 10%;"></td> <td style="width: 10%;"></td> </tr> <tr> <td></td> <td></td> <td colspan="8" style="text-align: center;"> <table border="1" style="width: 100%; border-collapse: collapse; text-align: center;"> <tr> <td style="width: 10%;"></td> <td style="width: 10%;"></td> <td style="width: 10%;"></td> <td style="width: 10%;"></td> <td style="width: 10%;"></td> <td style="width: 10%;"></td> <td style="width: 10%;"></td> <td style="width: 10%;"></td> <td style="width: 10%;"></td> <td style="width: 10%;"></td> </tr> <tr> <td></td> <td></td> <td colspan="8" style="text-align: center;"> <table border="1" style="width: 100%; border-collapse: collapse; text-align: center;"> <tr> <td style="width: 10%;"></td> <td style="width: 10%;"></td> <td style="width: 10%;"></td> <td style="width: 10%;"></td> <td style="width: 10%;"></td> <td style="width: 10%;"></td> <td style="width: 10%;"></td> <td style="width: 10%;"></td> <td style="width: 10%;"></td> <td style="width: 10%;"></td> </tr> <tr> <td></td> <td></td> <td colspan="8" style="text-align: center;"> <table border="1" style="width: 100%; border-collapse: collapse; text-align: center;"> <tr> </tr></table></td></tr></table></td></tr></table></td></tr></table></td></tr></table></td></tr></table></td></tr></table></td></tr></table></td></tr></table></td></tr></table></td></tr></table></td></tr></table></td></tr></table></td></tr></table></td></tr></table></td></tr></table></td></tr></table></td></tr></table>

 | | | | | | | | | | | | | | | | | | | | <table border="1" style="width: 100%; border-collapse: collapse; text-align: center;"> <tr> <td style="width: 10%;"></td> <td style="width: 10%;"></td> <td style="width: 10%;"></td> <td style="width: 10%;"></td> <td style="width: 10%;"></td> <td style="width: 10%;"></td> <td style="width: 10%;"></td> <td style="width: 10%;"></td> <td style="width: 10%;"></td> <td style="width: 10%;"></td> </tr> <tr> <td></td> <td></td> <td colspan="8" style="text-align: center;"> <table border="1" style="width: 100%; border-collapse: collapse; text-align: center;"> <tr> <td style="width: 10%;"></td> <td style="width: 10%;"></td> <td style="width: 10%;"></td> <td style="width: 10%;"></td> <td style="width: 10%;"></td> <td style="width: 10%;"></td> <td style="width: 10%;"></td> <td style="width: 10%;"></td> <td style="width: 10%;"></td> <td style="width: 10%;"></td> </tr> <tr> <td></td> <td></td> <td colspan="8" style="text-align: center;"> <table border="1" style="width: 100%; border-collapse: collapse; text-align: center;"> <tr> <td style="width: 10%;"></td> <td style="width: 10%;"></td> <td style="width: 10%;"></td> <td style="width: 10%;"></td> <td style="width: 10%;"></td> <td style="width: 10%;"></td> <td style="width: 10%;"></td> <td style="width: 10%;"></td> <td style="width: 10%;"></td> <td style="width: 10%;"></td> </tr> <tr> <td></td> <td></td> <td colspan="8" style="text-align: center;"> <table border="1" style="width: 100%; border-collapse: collapse; text-align: center;"> <tr> <td style="width: 10%;"></td> <td style="width: 10%;"></td> <td style="width: 10%;"></td> <td style="width: 10%;"></td> <td style="width: 10%;"></td> <td style="width: 10%;"></td> <td style="width: 10%;"></td> <td style="width: 10%;"></td> <td style="width: 10%;"></td> <td style="width: 10%;"></td> </tr> <tr> <td></td> <td></td> <td colspan="8" style="text-align: center;"> <table border="1" style="width: 100%; border-collapse: collapse; text-align: center;"> <tr> <td style="width: 10%;"></td> <td style="width: 10%;"></td> <td style="width: 10%;"></td> <td style="width: 10%;"></td> <td style="width: 10%;"></td> <td style="width: 10%;"></td> <td style="width: 10%;"></td> <td style="width: 10%;"></td> <td style="width: 10%;"></td> <td style="width: 10%;"></td> </tr> <tr> <td></td> <td></td> <td colspan="8" style="text-align: center;"> <table border="1" style="width: 100%; border-collapse: collapse; text-align: center;"> <tr> <td style="width: 10%;"></td> <td style="width: 10%;"></td> <td style="width: 10%;"></td> <td style="width: 10%;"></td> <td style="width: 10%;"></td> <td style="width: 10%;"></td> <td style="width: 10%;"></td> <td style="width: 10%;"></td> <td style="width: 10%;"></td> <td style="width: 10%;"></td> </tr> <tr> <td></td> <td></td> <td colspan="8" style="text-align: center;"> <table border="1" style="width: 100%; border-collapse: collapse; text-align: center;"> <tr> <td style="width: 10%;"></td> <td style="width: 10%;"></td> <td style="width: 10%;"></td> <td style="width: 10%;"></td> <td style="width: 10%;"></td> <td style="width: 10%;"></td> <td style="width: 10%;"></td> <td style="width: 10%;"></td> <td style="width: 10%;"></td> <td style="width: 10%;"></td> </tr> <tr> <td></td> <td></td> <td colspan="8" style="text-align: center;"> <table border="1" style="width: 100%; border-collapse: collapse; text-align: center;"> <tr> <td style="width: 10%;"></td> <td style="width: 10%;"></td> <td style="width: 10%;"></td> <td style="width: 10%;"></td> <td style="width: 10%;"></td> <td style="width: 10%;"></td> <td style="width: 10%;"></td> <td style="width: 10%;"></td> <td style="width: 10%;"></td> <td style="width: 10%;"></td> </tr> <tr> <td></td> <td></td> <td colspan="8" style="text-align: center;"> <table border="1" style="width: 100%; border-collapse: collapse; text-align: center;"> <tr> <td style="width: 10%;"></td> <td style="width: 10%;"></td> <td style="width: 10%;"></td> <td style="width: 10%;"></td> <td style="width: 10%;"></td> <td style="width: 10%;"></td> <td style="width: 10%;"></td> <td style="width: 10%;"></td> <td style="width: 10%;"></td> <td style="width: 10%;"></td> </tr> <tr> <td></td> <td></td> <td colspan="8" style="text-align: center;"> <table border="1" style="width: 100%; border-collapse: collapse; text-align: center;"> <tr> <td style="width: 10%;"></td> <td style="width: 10%;"></td> <td style="width: 10%;"></td> <td style="width: 10%;"></td> <td style="width: 10%;"></td> <td style="width: 10%;"></td> <td style="width: 10%;"></td> <td style="width: 10%;"></td> <td style="width: 10%;"></td> <td style="width: 10%;"></td> </tr> <tr> <td></td> <td></td> <td colspan="8" style="text-align: center;"> <table border="1" style="width: 100%; border-collapse: collapse; text-align: center;"> <tr> <td style="width: 10%;"></td> <td style="width: 10%;"></td> <td style="width: 10%;"></td> <td style="width: 10%;"></td> <td style="width: 10%;"></td> <td style="width: 10%;"></td> <td style="width: 10%;"></td> <td style="width: 10%;"></td> <td style="width: 10%;"></td> <td style="width: 10%;"></td> </tr> <tr> <td></td> <td></td> <td colspan="8" style="text-align: center;"> <table border="1" style="width: 100%; border-collapse: collapse; text-align: center;"> <tr> <td style="width: 10%;"></td> <td style="width: 10%;"></td> <td style="width: 10%;"></td> <td style="width: 10%;"></td> <td style="width: 10%;"></td> <td style="width: 10%;"></td> <td style="width: 10%;"></td> <td style="width: 10%;"></td> <td style="width: 10%;"></td> <td style="width: 10%;"></td> </tr> <tr> <td></td> <td></td> <td colspan="8" style="text-align: center;"> <table border="1" style="width: 100%; border-collapse: collapse; text-align: center;"> <tr> <td style="width: 10%;"></td> <td style="width: 10%;"></td> <td style="width: 10%;"></td> <td style="width: 10%;"></td> <td style="width: 10%;"></td> <td style="width: 10%;"></td> <td style="width: 10%;"></td> <td style="width: 10%;"></td> <td style="width: 10%;"></td> <td style="width: 10%;"></td> </tr>
<tr> <td></td> <td></td> <td colspan="8" style="text-align: center;"> <table border="1" style="width: 100%; border-collapse: collapse; text-align: center;"> <tr> <td style="width: 10%;"></td> <td style="width: 10%;"></td> <td style="width: 10%;"></td> <td style="width: 10%;"></td> <td style="width: 10%;"></td> <td style="width: 10%;"></td> <td style="width: 10%;"></td> <td style="width: 10%;"></td> <td style="width: 10%;"></td> <td style="width: 10%;"></td> </tr> <tr> <td></td> <td></td> <td colspan="8" style="text-align: center;"> <table border="1" style="width: 100%; border-collapse: collapse; text-align: center;"> <tr> <td style="width: 10%;"></td> <td style="width: 10%;"></td> <td style="width: 10%;"></td> <td style="width: 10%;"></td> <td style="width: 10%;"></td> <td style="width: 10%;"></td> <td style="width: 10%;"></td> <td style="width: 10%;"></td> <td style="width: 10%;"></td> <td style="width: 10%;"></td> </tr> <tr> <td></td> <td></td> <td colspan="8" style="text-align: center;"> <table border="1" style="width: 100%; border-collapse: collapse; text-align: center;"> <tr> <td style="width: 10%;"></td> <td style="width: 10%;"></td> <td style="width: 10%;"></td> <td style="width: 10%;"></td> <td style="width: 10%;"></td> <td style="width: 10%;"></td> <td style="width: 10%;"></td> <td style="width: 10%;"></td> <td style="width: 10%;"></td> <td style="width: 10%;"></td> </tr> <tr> <td></td> <td></td> <td colspan="8" style="text-align: center;"> <table border="1" style="width: 100%; border-collapse: collapse; text-align: center;"> <tr> </tr></table></td></tr></table></td></tr></table></td></tr></table></td></tr></table></td></tr></table></td></tr></table></td></tr></table></td></tr></table></td></tr></table></td></tr></table></td></tr></table></td></tr></table></td></tr></table></td></tr></table></td></tr></table></td></tr></table>

 | | | | | | | | | | | | | | | | | | | | <table border="1" style="width: 100%; border-collapse: collapse; text-align: center;"> <tr> <td style="width: 10%;"></td> <td style="width: 10%;"></td> <td style="width: 10%;"></td> <td style="width: 10%;"></td> <td style="width: 10%;"></td> <td style="width: 10%;"></td> <td style="width: 10%;"></td> <td style="width: 10%;"></td> <td style="width: 10%;"></td> <td style="width: 10%;"></td> </tr> <tr> <td></td> <td></td> <td colspan="8" style="text-align: center;"> <table border="1" style="width: 100%; border-collapse: collapse; text-align: center;"> <tr> <td style="width: 10%;"></td> <td style="width: 10%;"></td> <td style="width: 10%;"></td> <td style="width: 10%;"></td> <td style="width: 10%;"></td> <td style="width: 10%;"></td> <td style="width: 10%;"></td> <td style="width: 10%;"></td> <td style="width: 10%;"></td> <td style="width: 10%;"></td> </tr> <tr> <td></td> <td></td> <td colspan="8" style="text-align: center;"> <table border="1" style="width: 100%; border-collapse: collapse; text-align: center;"> <tr> <td style="width: 10%;"></td> <td style="width: 10%;"></td> <td style="width: 10%;"></td> <td style="width: 10%;"></td> <td style="width: 10%;"></td> <td style="width: 10%;"></td> <td style="width: 10%;"></td> <td style="width: 10%;"></td> <td style="width: 10%;"></td> <td style="width: 10%;"></td> </tr> <tr> <td></td> <td></td> <td colspan="8" style="text-align: center;"> <table border="1" style="width: 100%; border-collapse: collapse; text-align: center;"> <tr> <td style="width: 10%;"></td> <td style="width: 10%;"></td> <td style="width: 10%;"></td> <td style="width: 10%;"></td> <td style="width: 10%;"></td> <td style="width: 10%;"></td> <td style="width: 10%;"></td> <td style="width: 10%;"></td> <td style="width: 10%;"></td> <td style="width: 10%;"></td> </tr> <tr> <td></td> <td></td> <td colspan="8" style="text-align: center;"> <table border="1" style="width: 100%; border-collapse: collapse; text-align: center;"> <tr> <td style="width: 10%;"></td> <td style="width: 10%;"></td> <td style="width: 10%;"></td> <td style="width: 10%;"></td> <td style="width: 10%;"></td> <td style="width: 10%;"></td> <td style="width: 10%;"></td> <td style="width: 10%;"></td> <td style="width: 10%;"></td> <td style="width: 10%;"></td> </tr> <tr> <td></td> <td></td> <td colspan="8" style="text-align: center;"> <table border="1" style="width: 100%; border-collapse: collapse; text-align: center;"> <tr> <td style="width: 10%;"></td> <td style="width: 10%;"></td> <td style="width: 10%;"></td> <td style="width: 10%;"></td> <td style="width: 10%;"></td> <td style="width: 10%;"></td> <td style="width: 10%;"></td> <td style="width: 10%;"></td> <td style="width: 10%;"></td> <td style="width: 10%;"></td> </tr> <tr> <td></td> <td></td> <td colspan="8" style="text-align: center;"> <table border="1" style="width: 100%; border-collapse: collapse; text-align: center;"> <tr> <td style="width: 10%;"></td> <td style="width: 10%;"></td> <td style="width: 10%;"></td> <td style="width: 10%;"></td> <td style="width: 10%;"></td> <td style="width: 10%;"></td> <td style="width: 10%;"></td> <td style="width: 10%;"></td> <td style="width: 10%;"></td> <td style="width: 10%;"></td> </tr> <tr> <td></td> <td></td> <td colspan="8" style="text-align: center;"> <table border="1" style="width: 100%; border-collapse: collapse; text-align: center;"> <tr> <td style="width: 10%;"></td> <td style="width: 10%;"></td> <td style="width: 10%;"></td> <td style="width: 10%;"></td> <td style="width: 10%;"></td> <td style="width: 10%;"></td> <td style="width: 10%;"></td> <td style="width: 10%;"></td> <td style="width: 10%;"></td> <td style="width: 10%;"></td> </tr> <tr> <td></td> <td></td> <td colspan="8" style="text-align: center;"> <table border="1" style="width: 100%; border-collapse: collapse; text-align: center;"> <tr> <td style="width: 10%;"></td> <td style="width: 10%;"></td> <td style="width: 10%;"></td> <td style="width: 10%;"></td> <td style="width: 10%;"></td> <td style="width: 10%;"></td> <td style="width: 10%;"></td> <td style="width: 10%;"></td> <td style="width: 10%;"></td> <td style="width: 10%;"></td> </tr> <tr> <td></td> <td></td> <td colspan="8" style="text-align: center;"> <table border="1" style="width: 100%; border-collapse: collapse; text-align: center;"> <tr> <td style="width: 10%;"></td> <td style="width: 10%;"></td> <td style="width: 10%;"></td> <td style="width: 10%;"></td> <td style="width: 10%;"></td> <td style="width: 10%;"></td> <td style="width: 10%;"></td> <td style="width: 10%;"></td> <td style="width: 10%;"></td> <td style="width: 10%;"></td> </tr> <tr> <td></td> <td></td> <td colspan="8" style="text-align: center;"> <table border="1" style="width: 100%; border-collapse: collapse; text-align: center;"> <tr> <td style="width: 10%;"></td> <td style="width: 10%;"></td> <td style="width: 10%;"></td> <td style="width: 10%;"></td> <td style="width: 10%;"></td> <td style="width: 10%;"></td> <td style="width: 10%;"></td> <td style="width: 10%;"></td> <td style="width: 10%;"></td> <td style="width: 10%;"></td> </tr> <tr> <td></td> <td></td> <td colspan="8" style="text-align: center;"> <table border="1" style="width: 100%; border-collapse: collapse; text-align: center;"> <tr> <td style="width: 10%;"></td> <td style="width: 10%;"></td> <td style="width: 10%;"></td> <td style="width: 10%;"></td> <td style="width: 10%;"></td> <td style="width: 10%;"></td> <td style="width: 10%;"></td> <td style="width: 10%;"></td> <td style="width: 10%;"></td> <td style="width: 10%;"></td> </tr> <tr> <td></td> <td></td> <td colspan="8" style="text-align: center;"> <table border="1" style="width: 100%; border-collapse: collapse; text-align: center;"> <tr> <td style="width: 10%;"></td> <td style="width: 10%;"></td> <td style="width: 10%;"></td> <td style="width: 10%;"></td> <td style="width: 10%;"></td> <td style="width: 10%;"></td> <td style="width: 10%;"></td> <td style="width: 10%;"></td> <td style="width: 10%;"></td> <td style="width: 10%;"></td> </tr> <tr> <td></td> <td></td> <td colspan="8" style="text-align: center;"> <table border="1" style="width: 100%; border-collapse: collapse; text-align: center;"> <tr> <td style="width: 10%;"></td> <td style="width: 10%;"></td> <td style="width: 10%;"></td> <td style="width: 10%;"></td> <td style="width: 10%;"></td> <td style="width: 10%;"></td> <td style="width: 10%;"></td> <td style="width: 10%;"></td> <td style="width: 10%;"></td> <td style="width: 10%;"></td> </tr> <tr> <td></td> <td></td> <td colspan="8" style="text-align: center;"> <table border="1" style="width: 100%; border-collapse: collapse; text-align: center;"> <tr> <td style="width: 10%;"></td> <td style="width: 10%;"></td> <td style="width: 10%;"></td> <td style="width: 10%;"></td> <td style="width: 10%;"></td> <td style="width: 10%;"></td> <td style="width: 10%;"></td> <td style="width: 10%;"></td> <td style="width: 10%;"></td> <td style="width: 10%;"></td> </tr> <tr> <td></td> <td></td> <td colspan="8" style="text-align: center;"> <table border="1" style="width: 100%; border-collapse: collapse; text-align: center;"> <tr> </tr></table></td></tr></table></td></tr></table></td></tr></table></td></tr></table></td></tr></table></td></tr></table></td></tr></table></td></tr></table></td></tr></table></td></tr></table></td></tr></table></td></tr></table></td></tr></table></td></tr></table></td></tr></table>

 | | | | | | | | | | | | | | | | | | | | <table border="1" style="width: 100%; border-collapse: collapse; text-align: center;"> <tr> <td style="width: 10%;"></td> <td style="width: 10%;"></td> <td style="width: 10%;"></td> <td style="width: 10%;"></td> <td style="width: 10%;"></td> <td style="width: 10%;"></td> <td style="width: 10%;"></td> <td style="width: 10%;"></td> <td style="width: 10%;"></td> <td style="width: 10%;"></td> </tr> <tr> <td></td> <td></td> <td colspan="8" style="text-align: center;"> <table border="1" style="width: 100%; border-collapse: collapse; text-align: center;"> <tr> <td style="width: 10%;"></td> <td style="width: 10%;"></td> <td style="width: 10%;"></td> <td style="width: 10%;"></td> <td style="width: 10%;"></td> <td style="width: 10%;"></td> <td style="width: 10%;"></td> <td style="width: 10%;"></td> <td style="width: 10%;"></td> <td style="width: 10%;"></td> </tr> <tr> <td></td> <td></td> <td colspan="8" style="text-align: center;"> <table border="1" style="width: 100%; border-collapse: collapse; text-align: center;"> <tr> <td style="width: 10%;"></td> <td style="width: 10%;"></td> <td style="width: 10%;"></td> <td style="width: 10%;"></td> <td style="width: 10%;"></td> <td style="width: 10%;"></td> <td style="width: 10%;"></td> <td style="width: 10%;"></td> <td style="width: 10%;"></td> <td style="width: 10%;"></td> </tr> <tr> <td></td> <td></td> <td colspan="8" style="text-align: center;"> <table border="1" style="width: 100%; border-collapse: collapse; text-align: center;"> <tr> <td style="width: 10%;"></td> <td style="width: 10%;"></td> <td style="width: 10%;"></td> <td style="width: 10%;"></td> <td style="width: 10%;"></td> <td style="width: 10%;"></td> <td style="width: 10%;"></td> <td style="width: 10%;"></td> <td style="width: 10%;"></td> <td style="width: 10%;"></td> </tr> <tr> <td></td> <td></td> <td colspan="8" style="text-align: center;"> <table border="1" style="width: 100%; border-collapse: collapse; text-align: center;"> <tr> <td style="width: 10%;"></td> <td style="width: 10%;"></td> <td style="width: 10%;"></td> <td style="width: 10%;"></td> <td style="width: 10%;"></td> <td style="width: 10%;"></td> <td style="width: 10%;"></td> <td style="width: 10%;"></td> <td style="width: 10%;"></td> <td style="width: 10%;"></td> </tr> <tr> <td></td> <td></td> <td colspan="8" style="text-align: center;"> <table border="1" style="width: 100%; border-collapse: collapse; text-align: center;"> <tr> <td style="width: 10%;"></td> <td style="width: 10%;"></td> <td style="width: 10%;"></td> <td style="width: 10%;"></td> <td style="width: 10%;"></td> <td style="width: 10%;"></td> <td style="width: 10%;"></td> <td style="width: 10%;"></td> <td style="width: 10%;"></td> <td
style="width: 10%;"></td> </tr> <tr> <td></td> <td></td> <td colspan="8" style="text-align: center;"> <table border="1" style="width: 100%; border-collapse: collapse; text-align: center;"> <tr> <td style="width: 10%;"></td> <td style="width: 10%;"></td> <td style="width: 10%;"></td> <td style="width: 10%;"></td> <td style="width: 10%;"></td> <td style="width: 10%;"></td> <td style="width: 10%;"></td> <td style="width: 10%;"></td> <td style="width: 10%;"></td> <td style="width: 10%;"></td> </tr> <tr> <td></td> <td></td> <td colspan="8" style="text-align: center;"> <table border="1" style="width: 100%; border-collapse: collapse; text-align: center;"> <tr> <td style="width: 10%;"></td> <td style="width: 10%;"></td> <td style="width: 10%;"></td> <td style="width: 10%;"></td> <td style="width: 10%;"></td> <td style="width: 10%;"></td> <td style="width: 10%;"></td> <td style="width: 10%;"></td> <td style="width: 10%;"></td> <td style="width: 10%;"></td> </tr> <tr> <td></td> <td></td> <td colspan="8" style="text-align: center;"> <table border="1" style="width: 100%; border-collapse: collapse; text-align: center;"> <tr> <td style="width: 10%;"></td> <td style="width: 10%;"></td> <td style="width: 10%;"></td> <td style="width: 10%;"></td> <td style="width: 10%;"></td> <td style="width: 10%;"></td> <td style="width: 10%;"></td> <td style="width: 10%;"></td> <td style="width: 10%;"></td> <td style="width: 10%;"></td> </tr> <tr> <td></td> <td></td> <td colspan="8" style="text-align: center;"> <table border="1" style="width: 100%; border-collapse: collapse; text-align: center;"> <tr> <td style="width: 10%;"></td> <td style="width: 10%;"></td> <td style="width: 10%;"></td> <td style="width: 10%;"></td> <td style="width: 10%;"></td> <td style="width: 10%;"></td> <td style="width: 10%;"></td> <td style="width: 10%;"></td> <td style="width: 10%;"></td> <td style="width: 10%;"></td> </tr> <tr> <td></td> <td></td> <td colspan="8" style="text-align: center;"> <table border="1" style="width: 100%; border-collapse: collapse; text-align: center;"> <tr> <td style="width: 10%;"></td> <td style="width: 10%;"></td> <td style="width: 10%;"></td> <td style="width: 10%;"></td> <td style="width: 10%;"></td> <td style="width: 10%;"></td> <td style="width: 10%;"></td> <td style="width: 10%;"></td> <td style="width: 10%;"></td> <td style="width: 10%;"></td> </tr> <tr> <td></td> <td></td> <td colspan="8" style="text-align: center;"> <table border="1" style="width: 100%; border-collapse: collapse; text-align: center;"> <tr> <td style="width: 10%;"></td> <td style="width: 10%;"></td> <td style="width: 10%;"></td> <td style="width: 10%;"></td> <td style="width: 10%;"></td> <td style="width: 10%;"></td> <td style="width: 10%;"></td> <td style="width: 10%;"></td> <td style="width: 10%;"></td> <td style="width: 10%;"></td> </tr> <tr> <td></td> <td></td> <td colspan="8" style="text-align: center;"> <table border="1" style="width: 100%; border-collapse: collapse; text-align: center;"> <tr> <td style="width: 10%;"></td> <td style="width: 10%;"></td> <td style="width: 10%;"></td> <td style="width: 10%;"></td> <td style="width: 10%;"></td> <td style="width: 10%;"></td> <td style="width: 10%;"></td> <td style="width: 10%;"></td> <td style="width: 10%;"></td> <td style="width: 10%;"></td> </tr> <tr> <td></td> <td></td> <td colspan="8" style="text-align: center;"> <table border="1" style="width: 100%; border-collapse: collapse; text-align: center;"> <tr> <td style="width: 10%;"></td> <td style="width: 10%;"></td> <td style="width: 10%;"></td> <td style="width: 10%;"></td> <td style="width: 10%;"></td> <td style="width: 10%;"></td> <td style="width: 10%;"></td> <td style="width: 10%;"></td> <td style="width: 10%;"></td> <td style="width: 10%;"></td> </tr> <tr> <td></td> <td></td> <td colspan="8" style="text-align: center;"> <table border="1" style="width: 100%; border-collapse: collapse; text-align: center;"> <tr> </tr></table></td></tr></table></td></tr></table></td></tr></table></td></tr></table></td></tr></table></td></tr></table></td></tr></table></td></tr></table></td></tr></table></td></tr></table></td></tr></table></td></tr></table></td></tr></table></td></tr></table>

 | | | | | | | | | | | | | | | | | | | | <table border="1" style="width: 100%; border-collapse: collapse; text-align: center;"> <tr> <td style="width: 10%;"></td> <td style="width: 10%;"></td> <td style="width: 10%;"></td> <td style="width: 10%;"></td> <td style="width: 10%;"></td> <td style="width: 10%;"></td> <td style="width: 10%;"></td> <td style="width: 10%;"></td> <td style="width: 10%;"></td> <td style="width: 10%;"></td> </tr> <tr> <td></td> <td></td> <td colspan="8" style="text-align: center;"> <table border="1" style="width: 100%; border-collapse: collapse; text-align: center;"> <tr> <td style="width: 10%;"></td> <td style="width: 10%;"></td> <td style="width: 10%;"></td> <td style="width: 10%;"></td> <td style="width: 10%;"></td> <td style="width: 10%;"></td> <td style="width: 10%;"></td> <td style="width: 10%;"></td> <td style="width: 10%;"></td> <td style="width: 10%;"></td> </tr> <tr> <td></td> <td></td> <td colspan="8" style="text-align: center;"> <table border="1" style="width: 100%; border-collapse: collapse; text-align: center;"> <tr> <td style="width: 10%;"></td> <td style="width: 10%;"></td> <td style="width: 10%;"></td> <td style="width: 10%;"></td> <td style="width: 10%;"></td> <td style="width: 10%;"></td> <td style="width: 10%;"></td> <td style="width: 10%;"></td> <td style="width: 10%;"></td> <td style="width: 10%;"></td> </tr> <tr> <td></td> <td></td> <td colspan="8" style="text-align: center;"> <table border="1" style="width: 100%; border-collapse: collapse; text-align: center;"> <tr> <td style="width: 10%;"></td> <td style="width: 10%;"></td> <td style="width: 10%;"></td> <td style="width: 10%;"></td> <td style="width: 10%;"></td> <td style="width: 10%;"></td> <td style="width: 10%;"></td> <td style="width: 10%;"></td> <td style="width: 10%;"></td> <td style="width: 10%;"></td> </tr> <tr> <td></td> <td></td> <td colspan="8" style="text-align: center;"> <table border="1" style="width: 100%; border-collapse: collapse; text-align: center;"> <tr> <td style="width: 10%;"></td> <td style="width: 10%;"></td> <td style="width: 10%;"></td> <td style="width: 10%;"></td> <td style="width: 10%;"></td> <td style="width: 10%;"></td> <td style="width: 10%;"></td> <td style="width: 10%;"></td> <td style="width: 10%;"></td> <td style="width: 10%;"></td> </tr> <tr> <td></td> <td></td> <td colspan="8" style="text-align: center;"> <table border="1" style="width: 100%; border-collapse: collapse; text-align: center;"> <tr> <td style="width: 10%;"></td> <td style="width: 10%;"></td> <td style="width: 10%;"></td> <td style="width: 10%;"></td> <td style="width: 10%;"></td> <td style="width: 10%;"></td> <td style="width: 10%;"></td> <td style="width: 10%;"></td> <td style="width: 10%;"></td> <td style="width: 10%;"></td> </tr> <tr> <td></td> <td></td> <td colspan="8" style="text-align: center;"> <table border="1" style="width: 100%; border-collapse: collapse; text-align: center;"> <tr> <td style="width: 10%;"></td> <td style="width: 10%;"></td> <td style="width: 10%;"></td> <td style="width: 10%;"></td> <td style="width: 10%;"></td> <td style="width: 10%;"></td> <td style="width: 10%;"></td> <td style="width: 10%;"></td> <td style="width: 10%;"></td> <td style="width: 10%;"></td> </tr> <tr> <td></td> <td></td> <td colspan="8" style="text-align: center;"> <table border="1" style="width: 100%; border-collapse: collapse; text-align: center;"> <tr> <td style="width: 10%;"></td> <td style="width: 10%;"></td> <td style="width: 10%;"></td> <td style="width: 10%;"></td> <td style="width: 10%;"></td> <td style="width: 10%;"></td> <td style="width: 10%;"></td> <td style="width: 10%;"></td> <td style="width: 10%;"></td> <td style="width: 10%;"></td> </tr> <tr> <td></td> <td></td> <td colspan="8" style="text-align: center;"> <table border="1" style="width: 100%; border-collapse: collapse; text-align: center;"> <tr> <td style="width: 10%;"></td> <td style="width: 10%;"></td> <td style="width: 10%;"></td> <td style="width: 10%;"></td> <td style="width: 10%;"></td> <td style="width: 10%;"></td> <td style="width: 10%;"></td> <td style="width: 10%;"></td> <td style="width: 10%;"></td> <td style="width: 10%;"></td> </tr> <tr> <td></td> <td></td> <td colspan="8" style="text-align: center;"> <table border="1" style="width: 100%; border-collapse: collapse; text-align: center;"> <tr> <td style="width: 10%;"></td> <td style="width: 10%;"></td> <td style="width: 10%;"></td> <td style="width: 10%;"></td> <td style="width: 10%;"></td> <td style="width: 10%;"></td> <td style="width: 10%;"></td> <td style="width: 10%;"></td> <td style="width: 10%;"></td> <td style="width: 10%;"></td> </tr> <tr> <td></td> <td></td> <td colspan="8" style="text-align: center;"> <table border="1" style="width: 100%; border-collapse: collapse; text-align: center;"> <tr> <td style="width: 10%;"></td> <td style="width: 10%;"></td> <td style="width: 10%;"></td> <td style="width: 10%;"></td> <td style="width: 10%;"></td> <td style="width: 10%;"></td> <td style="width: 10%;"></td> <td style="width: 10%;"></td> <td style="width: 10%;"></td> <td style="width: 10%;"></td> </tr> <tr> <td></td> <td></td> <td colspan="8" style="text-align: center;"> <table border="1" style="width: 100%; border-collapse: collapse; text-align: center;"> <tr> <td style="width: 10%;"></td> <td style="width: 10%;"></td> <td style="width: 10%;"></td> <td style="width: 10%;"></td> <td style="width: 10%;"></td> <td style="width: 10%;"></td> <td style="width: 10%;"></td> <td style="width: 10%;"></td> <td style="width: 10%;"></td> <td style="width: 10%;"></td> </tr> <tr> <td></td> <td></td> <td colspan="8" style="text-align: center;"> <table border="1" style="width: 100%; border-collapse: collapse; text-align: center;"> <tr> <td style="width: 10%;"></td> <td style="width: 10%;"></td> <td style="width: 10%;"></td> <td style="width: 10%;"></td> <td style="width: 10%;"></td> <td style="width: 10%;"></td> <td style="width: 10%;"></td> <td style="width: 10%;"></td> <td style="width: 10%;"></td> <td style="width: 10%;"></td> </tr> <tr> <td></td> <td></td> <td colspan="8" style="text-align: center;"> <table border="1" style="width: 100%; border-collapse: collapse; text-align: center;"> <tr> </tr></table></td></tr></table></td></tr></table></td></tr></table></td></tr></table></td></tr></table></td></tr></table></td></tr></table></td></tr></table></td></tr></table></td></tr></table></td></tr></table></td></tr></table></td></tr></table>

 | | | | | | | | | | | | | | | | | | | | <table border="1" style="width: 100%; border-collapse: collapse; text-align: center;"> <tr> <td style="width: 10%;"></td> <td style="width: 10%;"></td> <td style="width: 10%;"></td> <td style="width: 10%;"></td> <td style="width: 10%;"></td> <td style="width: 10%;"></td> <td style="width: 10%;"></td> <td style="width: 10%;"></td> <td style="width: 10%;"></td> <td style="width: 10%;"></td> </tr> <tr> <td></td> <td></td> <td colspan="8" style="text-align: center;"> <table border="1" style="width: 100%; border-collapse: collapse; text-align: center;"> <tr> <td style="width: 10%;"></td> <td style="width: 10%;"></td> <td style="width: 10%;"></td> <td style="width: 10%;"></td> <td style="width: 10%;"></td> <td style="width: 10%;"></td> <td style="width: 10%;"></td> <td style="width: 10%;"></td> <td style="width: 10%;"></td> <td style="width: 10%;"></td> </tr> <tr> <td></td> <td></td> <td colspan="8" style="text-align: center;"> <table border="1" style="width: 100%; border-collapse: collapse; text-align: center;"> <tr> <td style="width: 10%;"></td> <td style="width: 10%;"></td> <td style="width: 10%;"></td> <td style="width: 10%;"></td> <td style="width: 10%;"></td> <td style="width: 10%;"></td> <td style="width: 10%;"></td> <td style="width: 10%;"></td> <td style="width: 10%;"></td> <td style="width: 10%;"></td> </tr> <tr>
<td></td> <td></td> <td colspan="8" style="text-align: center;"> <table border="1" style="width: 100%; border-collapse: collapse; text-align: center;"> <tr> <td style="width: 10%;"></td> <td style="width: 10%;"></td> <td style="width: 10%;"></td> <td style="width: 10%;"></td> <td style="width: 10%;"></td> <td style="width: 10%;"></td> <td style="width: 10%;"></td> <td style="width: 10%;"></td> <td style="width: 10%;"></td> <td style="width: 10%;"></td> </tr> <tr> <td></td> <td></td> <td colspan="8" style="text-align: center;"> <table border="1" style="width: 100%; border-collapse: collapse; text-align: center;"> <tr> <td style="width: 10%;"></td> <td style="width: 10%;"></td> <td style="width: 10%;"></td> <td style="width: 10%;"></td> <td style="width: 10%;"></td> <td style="width: 10%;"></td> <td style="width: 10%;"></td> <td style="width: 10%;"></td> <td style="width: 10%;"></td> <td style="width: 10%;"></td> </tr> <tr> <td></td> <td></td> <td colspan="8" style="text-align: center;"> <table border="1" style="width: 100%; border-collapse: collapse; text-align: center;"> <tr> <td style="width: 10%;"></td> <td style="width: 10%;"></td> <td style="width: 10%;"></td> <td style="width: 10%;"></td> <td style="width: 10%;"></td> <td style="width: 10%;"></td> <td style="width: 10%;"></td> <td style="width: 10%;"></td> <td style="width: 10%;"></td> <td style="width: 10%;"></td> </tr> <tr> <td></td> <td></td> <td colspan="8" style="text-align: center;"> <table border="1" style="width: 100%; border-collapse: collapse; text-align: center;"> <tr> <td style="width: 10%;"></td> <td style="width: 10%;"></td> <td style="width: 10%;"></td> <td style="width: 10%;"></td> <td style="width: 10%;"></td> <td style="width: 10%;"></td> <td style="width: 10%;"></td> <td style="width: 10%;"></td> <td style="width: 10%;"></td> <td style="width: 10%;"></td> </tr> <tr> <td></td> <td></td> <td colspan="8" style="text-align: center;"> <table border="1" style="width: 100%; border-collapse: collapse; text-align: center;"> <tr> <td style="width: 10%;"></td> <td style="width: 10%;"></td> <td style="width: 10%;"></td> <td style="width: 10%;"></td> <td style="width: 10%;"></td> <td style="width: 10%;"></td> <td style="width: 10%;"></td> <td style="width: 10%;"></td> <td style="width: 10%;"></td> <td style="width: 10%;"></td> </tr> <tr> <td></td> <td></td> <td colspan="8" style="text-align: center;"> <table border="1" style="width: 100%; border-collapse: collapse; text-align: center;"> <tr> <td style="width: 10%;"></td> <td style="width: 10%;"></td> <td style="width: 10%;"></td> <td style="width: 10%;"></td> <td style="width: 10%;"></td> <td style="width: 10%;"></td> <td style="width: 10%;"></td> <td style="width: 10%;"></td> <td style="width: 10%;"></td> <td style="width: 10%;"></td> </tr> <tr> <td></td> <td></td> <td colspan="8" style="text-align: center;"> <table border="1" style="width: 100%; border-collapse: collapse; text-align: center;"> <tr> <td style="width: 10%;"></td> <td style="width: 10%;"></td> <td style="width: 10%;"></td> <td style="width: 10%;"></td> <td style="width: 10%;"></td> <td style="width: 10%;"></td> <td style="width: 10%;"></td> <td style="width: 10%;"></td> <td style="width: 10%;"></td> <td style="width: 10%;"></td> </tr> <tr> <td></td> <td></td> <td colspan="8" style="text-align: center;"> <table border="1" style="width: 100%; border-collapse: collapse; text-align: center;"> <tr> <td style="width: 10%;"></td> <td style="width: 10%;"></td> <td style="width: 10%;"></td> <td style="width: 10%;"></td> <td style="width: 10%;"></td> <td style="width: 10%;"></td> <td style="width: 10%;"></td> <td style="width: 10%;"></td> <td style="width: 10%;"></td> <td style="width: 10%;"></td> </tr> <tr> <td></td> <td></td> <td colspan="8" style="text-align: center;"> <table border="1" style="width: 100%; border-collapse: collapse; text-align: center;"> <tr> <td style="width: 10%;"></td> <td style="width: 10%;"></td> <td style="width: 10%;"></td> <td style="width: 10%;"></td> <td style="width: 10%;"></td> <td style="width: 10%;"></td> <td style="width: 10%;"></td> <td style="width: 10%;"></td> <td style="width: 10%;"></td> <td style="width: 10%;"></td> </tr> <tr> <td></td> <td></td> <td colspan="8" style="text-align: center;"> <table border="1" style="width: 100%; border-collapse: collapse; text-align: center;"> <tr> </tr></table></td></tr></table></td></tr></table></td></tr></table></td></tr></table></td></tr></table></td></tr></table></td></tr></table></td></tr></table></td></tr></table></td></tr></table></td></tr></table></td></tr></table>

 | | | | | | | | | | | | | | | | | | | | <table border="1" style="width: 100%; border-collapse: collapse; text-align: center;"> <tr> <td style="width: 10%;"></td> <td style="width: 10%;"></td> <td style="width: 10%;"></td> <td style="width: 10%;"></td> <td style="width: 10%;"></td> <td style="width: 10%;"></td> <td style="width: 10%;"></td> <td style="width: 10%;"></td> <td style="width: 10%;"></td> <td style="width: 10%;"></td> </tr> <tr> <td></td> <td></td> <td colspan="8" style="text-align: center;"> <table border="1" style="width: 100%; border-collapse: collapse; text-align: center;"> <tr> <td style="width: 10%;"></td> <td style="width: 10%;"></td> <td style="width: 10%;"></td> <td style="width: 10%;"></td> <td style="width: 10%;"></td> <td style="width: 10%;"></td> <td style="width: 10%;"></td> <td style="width: 10%;"></td> <td style="width: 10%;"></td> <td style="width: 10%;"></td> </tr> <tr> <td></td> <td></td> <td colspan="8" style="text-align: center;"> <table border="1" style="width: 100%; border-collapse: collapse; text-align: center;"> <tr> <td style="width: 10%;"></td> <td style="width: 10%;"></td> <td style="width: 10%;"></td> <td style="width: 10%;"></td> <td style="width: 10%;"></td> <td style="width: 10%;"></td> <td style="width: 10%;"></td> <td style="width: 10%;"></td> <td style="width: 10%;"></td> <td style="width: 10%;"></td> </tr> <tr> <td></td> <td></td> <td colspan="8" style="text-align: center;"> <table border="1" style="width: 100%; border-collapse: collapse; text-align: center;"> <tr> <td style="width: 10%;"></td> <td style="width: 10%;"></td> <td style="width: 10%;"></td> <td style="width: 10%;"></td> <td style="width: 10%;"></td> <td style="width: 10%;"></td> <td style="width: 10%;"></td> <td style="width: 10%;"></td> <td style="width: 10%;"></td> <td style="width: 10%;"></td> </tr> <tr> <td></td> <td></td> <td colspan="8" style="text-align: center;"> <table border="1" style="width: 100%; border-collapse: collapse; text-align: center;"> <tr> <td style="width: 10%;"></td> <td style="width: 10%;"></td> <td style="width: 10%;"></td> <td style="width: 10%;"></td> <td style="width: 10%;"></td> <td style="width: 10%;"></td> <td style="width: 10%;"></td> <td style="width: 10%;"></td> <td style="width: 10%;"></td> <td style="width: 10%;"></td> </tr> <tr> <td></td> <td></td> <td colspan="8" style="text-align: center;"> <table border="1" style="width: 100%; border-collapse: collapse; text-align: center;"> <tr> <td style="width: 10%;"></td> <td style="width: 10%;"></td> <td style="width: 10%;"></td> <td style="width: 10%;"></td> <td style="width: 10%;"></td> <td style="width: 10%;"></td> <td style="width: 10%;"></td> <td style="width: 10%;"></td> <td style="width: 10%;"></td> <td style="width: 10%;"></td> </tr> <tr> <td></td> <td></td> <td colspan="8" style="text-align: center;"> <table border="1" style="width: 100%; border-collapse: collapse; text-align: center;"> <tr> <td style="width: 10%;"></td> <td style="width: 10%;"></td> <td style="width: 10%;"></td> <td style="width: 10%;"></td> <td style="width: 10%;"></td> <td style="width: 10%;"></td> <td style="width: 10%;"></td> <td style="width: 10%;"></td> <td style="width: 10%;"></td> <td style="width: 10%;"></td> </tr> <tr> <td></td> <td></td> <td colspan="8" style="text-align: center;"> <table border="1" style="width: 100%; border-collapse: collapse; text-align: center;"> <tr> <td style="width: 10%;"></td> <td style="width: 10%;"></td> <td style="width: 10%;"></td> <td style="width: 10%;"></td> <td style="width: 10%;"></td> <td style="width: 10%;"></td> <td style="width: 10%;"></td> <td style="width: 10%;"></td> <td style="width: 10%;"></td> <td style="width: 10%;"></td> </tr> <tr> <td></td> <td></td> <td colspan="8" style="text-align: center;"> <table border="1" style="width: 100%; border-collapse: collapse; text-align: center;"> <tr> <td style="width: 10%;"></td> <td style="width: 10%;"></td> <td style="width: 10%;"></td> <td style="width: 10%;"></td> <td style="width: 10%;"></td> <td style="width: 10%;"></td> <td style="width: 10%;"></td> <td style="width: 10%;"></td> <td style="width: 10%;"></td> <td style="width: 10%;"></td> </tr> <tr> <td></td> <td></td> <td colspan="8" style="text-align: center;"> <table border="1" style="width: 100%; border-collapse: collapse; text-align: center;"> <tr> <td style="width: 10%;"></td> <td style="width: 10%;"></td> <td style="width: 10%;"></td> <td style="width: 10%;"></td> <td style="width: 10%;"></td> <td style="width: 10%;"></td> <td style="width: 10%;"></td> <td style="width: 10%;"></td> <td style="width: 10%;"></td> <td style="width: 10%;"></td> </tr> <tr> <td></td> <td></td> <td colspan="8" style="text-align: center;"> <table border="1" style="width: 100%; border-collapse: collapse; text-align: center;"> <tr> <td style="width: 10%;"></td> <td style="width: 10%;"></td> <td style="width: 10%;"></td> <td style="width: 10%;"></td> <td style="width: 10%;"></td> <td style="width: 10%;"></td> <td style="width: 10%;"></td> <td style="width: 10%;"></td> <td style="width: 10%;"></td> <td style="width: 10%;"></td> </tr> <tr> <td></td> <td></td> <td colspan="8" style="text-align: center;"> <table border="1" style="width: 100%; border-collapse: collapse; text-align: center;"> <tr> </tr></table></td></tr></table></td></tr></table></td></tr></table></td></tr></table></td></tr></table></td></tr></table></td></tr></table></td></tr></table></td></tr></table></td></tr></table></td></tr></table>

 | | | | | | | | | | | | | | | | | | | | <table border="1" style="width: 100%; border-collapse: collapse; text-align: center;"> <tr> <td style="width: 10%;"></td> <td style="width: 10%;"></td> <td style="width: 10%;"></td> <td style="width: 10%;"></td> <td style="width: 10%;"></td> <td style="width: 10%;"></td> <td style="width: 10%;"></td> <td style="width: 10%;"></td> <td style="width: 10%;"></td> <td style="width: 10%;"></td> </tr> <tr> <td></td> <td></td> <td colspan="8" style="text-align: center;"> <table border="1" style="width: 100%; border-collapse: collapse; text-align: center;"> <tr> <td style="width: 10%;"></td> <td style="width: 10%;"></td> <td style="width: 10%;"></td> <td style="width: 10%;"></td> <td style="width: 10%;"></td> <td style="width: 10%;"></td> <td style="width: 10%;"></td> <td style="width: 10%;"></td> <td style="width: 10%;"></td> <td style="width: 10%;"></td> </tr> <tr> <td></td> <td></td> <td colspan="8" style="text-align: center;"> <table border="1" style="width: 100%; border-collapse: collapse; text-align: center;"> <tr> <td style="width: 10%;"></td> <td style="width: 10%;"></td> <td style="width: 10%;"></td> <td style="width: 10%;"></td> <td style="width: 10%;"></td> <td style="width: 10%;"></td> <td style="width: 10%;"></td> <td style="width: 10%;"></td> <td style="width: 10%;"></td> <td style="width: 10%;"></td> </tr> <tr> <td></td> <td></td> <td colspan="8" style="text-align: center;"> <table border="1" style="width: 100%; border-collapse: collapse; text-align: center;"> <tr> <td style="width: 10%;"></td> <td style="width: 10%;"></td> <td style="width: 10%;"></td> <td style="width: 10%;"></td> <td style="width: 10%;"></td> <td style="width: 10%;"></td> <td style="width: 10%;"></td> <td style="width: 10%;"></td> <td style="width: 10%;"></td> <td style="width: 10%;"></td> </tr> <tr> <td></td> <td></td> <td colspan="8" style="text-align: center;"> <table border="1" style="width: 100%;
border-collapse: collapse; text-align: center;"> <tr> <td style="width: 10%;"></td> <td style="width: 10%;"></td> <td style="width: 10%;"></td> <td style="width: 10%;"></td> <td style="width: 10%;"></td> <td style="width: 10%;"></td> <td style="width: 10%;"></td> <td style="width: 10%;"></td> <td style="width: 10%;"></td> <td style="width: 10%;"></td> </tr> <tr> <td></td> <td></td> <td colspan="8" style="text-align: center;"> <table border="1" style="width: 100%; border-collapse: collapse; text-align: center;"> <tr> <td style="width: 10%;"></td> <td style="width: 10%;"></td> <td style="width: 10%;"></td> <td style="width: 10%;"></td> <td style="width: 10%;"></td> <td style="width: 10%;"></td> <td style="width: 10%;"></td> <td style="width: 10%;"></td> <td style="width: 10%;"></td> <td style="width: 10%;"></td> </tr> <tr> <td></td> <td></td> <td colspan="8" style="text-align: center;"> <table border="1" style="width: 100%; border-collapse: collapse; text-align: center;"> <tr> <td style="width: 10%;"></td> <td style="width: 10%;"></td> <td style="width: 10%;"></td> <td style="width: 10%;"></td> <td style="width: 10%;"></td> <td style="width: 10%;"></td> <td style="width: 10%;"></td> <td style="width: 10%;"></td> <td style="width: 10%;"></td> <td style="width: 10%;"></td> </tr> <tr> <td></td> <td></td> <td colspan="8" style="text-align: center;"> <table border="1" style="width: 100%; border-collapse: collapse; text-align: center;"> <tr> <td style="width: 10%;"></td> <td style="width: 10%;"></td> <td style="width: 10%;"></td> <td style="width: 10%;"></td> <td style="width: 10%;"></td> <td style="width: 10%;"></td> <td style="width: 10%;"></td> <td style="width: 10%;"></td> <td style="width: 10%;"></td> <td style="width: 10%;"></td> </tr> <tr> <td></td> <td></td> <td colspan="8" style="text-align: center;"> <table border="1" style="width: 100%; border-collapse: collapse; text-align: center;"> <tr> <td style="width: 10%;"></td> <td style="width: 10%;"></td> <td style="width: 10%;"></td> <td style="width: 10%;"></td> <td style="width: 10%;"></td> <td style="width: 10%;"></td> <td style="width: 10%;"></td> <td style="width: 10%;"></td> <td style="width: 10%;"></td> <td style="width: 10%;"></td> </tr> <tr> <td></td> <td></td> <td colspan="8" style="text-align: center;"> <table border="1" style="width: 100%; border-collapse: collapse; text-align: center;"> <tr> <td style="width: 10%;"></td> <td style="width: 10%;"></td> <td style="width: 10%;"></td> <td style="width: 10%;"></td> <td style="width: 10%;"></td> <td style="width: 10%;"></td> <td style="width: 10%;"></td> <td style="width: 10%;"></td> <td style="width: 10%;"></td> <td style="width: 10%;"></td> </tr> <tr> <td></td> <td></td> <td colspan="8" style="text-align: center;"> <table border="1" style="width: 100%; border-collapse: collapse; text-align: center;"> <tr> </tr></table></td></tr></table></td></tr></table></td></tr></table></td></tr></table></td></tr></table></td></tr></table></td></tr></table></td></tr></table></td></tr></table></td></tr></table>

 | | | | | | | | | | | | | | | | | | | | <table border="1" style="width: 100%; border-collapse: collapse; text-align: center;"> <tr> <td style="width: 10%;"></td> <td style="width: 10%;"></td> <td style="width: 10%;"></td> <td style="width: 10%;"></td> <td style="width: 10%;"></td> <td style="width: 10%;"></td> <td style="width: 10%;"></td> <td style="width: 10%;"></td> <td style="width: 10%;"></td> <td style="width: 10%;"></td> </tr> <tr> <td></td> <td></td> <td colspan="8" style="text-align: center;"> <table border="1" style="width: 100%; border-collapse: collapse; text-align: center;"> <tr> <td style="width: 10%;"></td> <td style="width: 10%;"></td> <td style="width: 10%;"></td> <td style="width: 10%;"></td> <td style="width: 10%;"></td> <td style="width: 10%;"></td> <td style="width: 10%;"></td> <td style="width: 10%;"></td> <td style="width: 10%;"></td> <td style="width: 10%;"></td> </tr> <tr> <td></td> <td></td> <td colspan="8" style="text-align: center;"> <table border="1" style="width: 100%; border-collapse: collapse; text-align: center;"> <tr> <td style="width: 10%;"></td> <td style="width: 10%;"></td> <td style="width: 10%;"></td> <td style="width: 10%;"></td> <td style="width: 10%;"></td> <td style="width: 10%;"></td> <td style="width: 10%;"></td> <td style="width: 10%;"></td> <td style="width: 10%;"></td> <td style="width: 10%;"></td> </tr> <tr> <td></td> <td></td> <td colspan="8" style="text-align: center;"> <table border="1" style="width: 100%; border-collapse: collapse; text-align: center;"> <tr> <td style="width: 10%;"></td> <td style="width: 10%;"></td> <td style="width: 10%;"></td> <td style="width: 10%;"></td> <td style="width: 10%;"></td> <td style="width: 10%;"></td> <td style="width: 10%;"></td> <td style="width: 10%;"></td> <td style="width: 10%;"></td> <td style="width: 10%;"></td> </tr> <tr> <td></td> <td></td> <td colspan="8" style="text-align: center;"> <table border="1" style="width: 100%; border-collapse: collapse; text-align: center;"> <tr> <td style="width: 10%;"></td> <td style="width: 10%;"></td> <td style="width: 10%;"></td> <td style="width: 10%;"></td> <td style="width: 10%;"></td> <td style="width: 10%;"></td> <td style="width: 10%;"></td> <td style="width: 10%;"></td> <td style="width: 10%;"></td> <td style="width: 10%;"></td> </tr> <tr> <td></td> <td></td> <td colspan="8" style="text-align: center;"> <table border="1" style="width: 100%; border-collapse: collapse; text-align: center;"> <tr> <td style="width: 10%;"></td> <td style="width: 10%;"></td> <td style="width: 10%;"></td> <td style="width: 10%;"></td> <td style="width: 10%;"></td> <td style="width: 10%;"></td> <td style="width: 10%;"></td> <td style="width: 10%;"></td> <td style="width: 10%;"></td> <td style="width: 10%;"></td> </tr> <tr> <td></td> <td></td> <td colspan="8" style="text-align: center;"> <table border="1" style="width: 100%; border-collapse: collapse; text-align: center;"> <tr> <td style="width: 10%;"></td> <td style="width: 10%;"></td> <td style="width: 10%;"></td> <td style="width: 10%;"></td> <td style="width: 10%;"></td> <td style="width: 10%;"></td> <td style="width: 10%;"></td> <td style="width: 10%;"></td> <td style="width: 10%;"></td> <td style="width: 10%;"></td> </tr> <tr> <td></td> <td></td> <td colspan="8" style="text-align: center;"> <table border="1" style="width: 100%; border-collapse: collapse; text-align: center;"> <tr> <td style="width: 10%;"></td> <td style="width: 10%;"></td> <td style="width: 10%;"></td> <td style="width: 10%;"></td> <td style="width: 10%;"></td> <td style="width: 10%;"></td> <td style="width: 10%;"></td> <td style="width: 10%;"></td> <td style="width: 10%;"></td> <td style="width: 10%;"></td> </tr> <tr> <td></td> <td></td> <td colspan="8" style="text-align: center;"> <table border="1" style="width: 100%; border-collapse: collapse; text-align: center;"> <tr> <td style="width: 10%;"></td> <td style="width: 10%;"></td> <td style="width: 10%;"></td> <td style="width: 10%;"></td> <td style="width: 10%;"></td> <td style="width: 10%;"></td> <td style="width: 10%;"></td> <td style="width: 10%;"></td> <td style="width: 10%;"></td> <td style="width: 10%;"></td> </tr> <tr> <td></td> <td></td> <td colspan="8" style="text-align: center;"> <table border="1" style="width: 100%; border-collapse: collapse; text-align: center;"> <tr> </tr></table></td></tr></table></td></tr></table></td></tr></table></td></tr></table></td></tr></table></td></tr></table></td></tr></table></td></tr></table></td></tr></table>

 | | | | | | | | | | | | | | | | | | | | <table border="1" style="width: 100%; border-collapse: collapse; text-align: center;"> <tr> <td style="width: 10%;"></td> <td style="width: 10%;"></td> <td style="width: 10%;"></td> <td style="width: 10%;"></td> <td style="width: 10%;"></td> <td style="width: 10%;"></td> <td style="width: 10%;"></td> <td style="width: 10%;"></td> <td style="width: 10%;"></td> <td style="width: 10%;"></td> </tr> <tr> <td></td> <td></td> <td colspan="8" style="text-align: center;"> <table border="1" style="width: 100%; border-collapse: collapse; text-align: center;"> <tr> <td style="width: 10%;"></td> <td style="width: 10%;"></td> <td style="width: 10%;"></td> <td style="width: 10%;"></td> <td style="width: 10%;"></td> <td style="width: 10%;"></td> <td style="width: 10%;"></td> <td style="width: 10%;"></td> <td style="width: 10%;"></td> <td style="width: 10%;"></td> </tr> <tr> <td></td> <td></td> <td colspan="8" style="text-align: center;"> <table border="1" style="width: 100%; border-collapse: collapse; text-align: center;"> <tr> <td style="width: 10%;"></td> <td style="width: 10%;"></td> <td style="width: 10%;"></td> <td style="width: 10%;"></td> <td style="width: 10%;"></td> <td style="width: 10%;"></td> <td style="width: 10%;"></td> <td style="width: 10%;"></td> <td style="width: 10%;"></td> <td style="width: 10%;"></td> </tr> <tr> <td></td> <td></td> <td colspan="8" style="text-align: center;"> <table border="1" style="width: 100%; border-collapse: collapse; text-align: center;"> <tr> <td style="width: 10%;"></td> <td style="width: 10%;"></td> <td style="width: 10%;"></td> <td style="width: 10%;"></td> <td style="width: 10%;"></td> <td style="width: 10%;"></td> <td style="width: 10%;"></td> <td style="width: 10%;"></td> <td style="width: 10%;"></td> <td style="width: 10%;"></td> </tr> <tr> <td></td> <td></td> <td colspan="8" style="text-align: center;"> <table border="1" style="width: 100%; border-collapse: collapse; text-align: center;"> <tr> <td style="width: 10%;"></td> <td style="width: 10%;"></td> <td style="width: 10%;"></td> <td style="width: 10%;"></td> <td style="width: 10%;"></td> <td style="width: 10%;"></td> <td style="width: 10%;"></td> <td style="width: 10%;"></td> <td style="width: 10%;"></td> <td style="width: 10%;"></td> </tr> <tr> <td></td> <td></td> <td colspan="8" style="text-align: center;"> <table border="1" style="width: 100%; border-collapse: collapse; text-align: center;"> <tr> <td style="width: 10%;"></td> <td style="width: 10%;"></td> <td style="width: 10%;"></td> <td style="width: 10%;"></td> <td style="width: 10%;"></td> <td style="width: 10%;"></td> <td style="width: 10%;"></td> <td style="width: 10%;"></td> <td style="width: 10%;"></td> <td style="width: 10%;"></td> </tr> <tr> <td></td> <td></td> <td colspan="8" style="text-align: center;"> <table border="1" style="width: 100%; border-collapse: collapse; text-align: center;"> <tr> <td style="width: 10%;"></td> <td style="width: 10%;"></td> <td style="width: 10%;"></td> <td style="width: 10%;"></td> <td style="width: 10%;"></td> <td style="width: 10%;"></td> <td style="width: 10%;"></td> <td style="width: 10%;"></td> <td style="width: 10%;"></td> <td style="width: 10%;"></td> </tr> <tr> <td></td> <td></td> <td colspan="8" style="text-align: center;"> <table border="1" style="width: 100%; border-collapse: collapse; text-align: center;"> <tr> <td style="width: 10%;"></td> <td style="width: 10%;"></td> <td style="width: 10%;"></td> <td style="width: 10%;"></td> <td style="width: 10%;"></td> <td style="width: 10%;"></td> <td style="width: 10%;"></td> <td style="width: 10%;"></td> <td style="width: 10%;"></td> <td style="width: 10%;"></td> </tr> <tr> <td></td> <td></td> <td colspan="8" style="text-align: center;"> <table border="1" style="width: 100%; border-collapse: collapse; text-align: center;"> <tr> </tr></table></td></tr></table></td></tr></table></td></tr></table></td></tr></table></td></tr></table></td></tr></table></td></tr></table></td></tr></table>

 | | | | | | | | | | | | | | | | | | | | <table border="1" style="width: 100%; border-collapse: collapse; text-align: center;"> <tr> <td style="width: 10%;"></td> <td style="width: 10%;"></td> <td style="width: 10%;"></td> <td style="width: 10%;"></td> <td style="width: 10%;"></td> <td style="width: 10%;"></td> <td style="width: 10%;"></td> <td style="width: 10%;"></td> <td style="width: 10%;"></td> <td style="width: 10%;"></td> </tr> <tr> <td></td> <td></td> <td colspan="8" style="text-align: center;"> <table border="1" style="width: 100%; border-collapse: collapse; text-align: center;"> <tr> <td style="width: 10%;"></td> <td style="width: 10%;"></td> <td style="width: 10%;"></td> <td style="width: 10%;"></td> <td style="width: 10%;"></td> <td style="width: 10%;"></td> <td style="width: 10%;"></td> <td style="width: 10%;"></td> <td style="width: 10%;"></td> <td style="width: 10%;"></td> </tr> <tr> <td></td> <td></td> <td colspan="8" style="text-align: center;"> <table border="1" style="width: 100%; border-collapse: collapse; text-align: center;"> <tr> <td style="width: 10%;"></td> <td style="width: 10%;"></td> <td style="width: 10%;"></td> <td style="width: 10%;"></td> <td style="width: 10%;"></td> <td style="width: 10%;"></td> <td style="width: 10%;"></td> <td style="width: 10%;"></td> <td style="width: 10%;"></td> <td style="width: 10%;"></td> </tr> <tr> <td></td> <td></td> <td colspan="8" style="text-align: center;"> <table border="1"
style="width: 100%; border-collapse: collapse; text-align: center;"> <tr> <td style="width: 10%;"></td> <td style="width: 10%;"></td> <td style="width: 10%;"></td> <td style="width: 10%;"></td> <td style="width: 10%;"></td> <td style="width: 10%;"></td> <td style="width: 10%;"></td> <td style="width: 10%;"></td> <td style="width: 10%;"></td> <td style="width: 10%;"></td> </tr> <tr> <td></td> <td></td> <td colspan="8" style="text-align: center;"> <table border="1" style="width: 100%; border-collapse: collapse; text-align: center;"> <tr> <td style="width: 10%;"></td> <td style="width: 10%;"></td> <td style="width: 10%;"></td> <td style="width: 10%;"></td> <td style="width: 10%;"></td> <td style="width: 10%;"></td> <td style="width: 10%;"></td> <td style="width: 10%;"></td> <td style="width: 10%;"></td> <td style="width: 10%;"></td> </tr> <tr> <td></td> <td></td> <td colspan="8" style="text-align: center;"> <table border="1" style="width: 100%; border-collapse: collapse; text-align: center;"> <tr> <td style="width: 10%;"></td> <td style="width: 10%;"></td> <td style="width: 10%;"></td> <td style="width: 10%;"></td> <td style="width: 10%;"></td> <td style="width: 10%;"></td> <td style="width: 10%;"></td> <td style="width: 10%;"></td> <td style="width: 10%;"></td> <td style="width: 10%;"></td> </tr> <tr> <td></td> <td></td> <td colspan="8" style="text-align: center;"> <table border="1" style="width: 100%; border-collapse: collapse; text-align: center;"> <tr> <td style="width: 10%;"></td> <td style="width: 10%;"></td> <td style="width: 10%;"></td> <td style="width: 10%;"></td> <td style="width: 10%;"></td> <td style="width: 10%;"></td> <td style="width: 10%;"></td> <td style="width: 10%;"></td> <td style="width: 10%;"></td> <td style="width: 10%;"></td> </tr> <tr> <td></td> <td></td> <td colspan="8" style="text-align: center;"> <table border="1" style="width: 100%; border-collapse: collapse; text-align: center;"> <tr> </tr></table></td></tr></table></td></tr></table></td></tr></table></td></tr></table></td></tr></table></td></tr></table></td></tr></table>

 | | | | | | | | | | | | | | | | | | | | <table border="1" style="width: 100%; border-collapse: collapse; text-align: center;"> <tr> <td style="width: 10%;"></td> <td style="width: 10%;"></td> <td style="width: 10%;"></td> <td style="width: 10%;"></td> <td style="width: 10%;"></td> <td style="width: 10%;"></td> <td style="width: 10%;"></td> <td style="width: 10%;"></td> <td style="width: 10%;"></td> <td style="width: 10%;"></td> </tr> <tr> <td></td> <td></td> <td colspan="8" style="text-align: center;"> <table border="1" style="width: 100%; border-collapse: collapse; text-align: center;"> <tr> <td style="width: 10%;"></td> <td style="width: 10%;"></td> <td style="width: 10%;"></td> <td style="width: 10%;"></td> <td style="width: 10%;"></td> <td style="width: 10%;"></td> <td style="width: 10%;"></td> <td style="width: 10%;"></td> <td style="width: 10%;"></td> <td style="width: 10%;"></td> </tr> <tr> <td></td> <td></td> <td colspan="8" style="text-align: center;"> <table border="1" style="width: 100%; border-collapse: collapse; text-align: center;"> <tr> <td style="width: 10%;"></td> <td style="width: 10%;"></td> <td style="width: 10%;"></td> <td style="width: 10%;"></td> <td style="width: 10%;"></td> <td style="width: 10%;"></td> <td style="width: 10%;"></td> <td style="width: 10%;"></td> <td style="width: 10%;"></td> <td style="width: 10%;"></td> </tr> <tr> <td></td> <td></td> <td colspan="8" style="text-align: center;"> <table border="1" style="width: 100%; border-collapse: collapse; text-align: center;"> <tr> <td style="width: 10%;"></td> <td style="width: 10%;"></td> <td style="width: 10%;"></td> <td style="width: 10%;"></td> <td style="width: 10%;"></td> <td style="width: 10%;"></td> <td style="width: 10%;"></td> <td style="width: 10%;"></td> <td style="width: 10%;"></td> <td style="width: 10%;"></td> </tr> <tr> <td></td> <td></td> <td colspan="8" style="text-align: center;"> <table border="1" style="width: 100%; border-collapse: collapse; text-align: center;"> <tr> <td style="width: 10%;"></td> <td style="width: 10%;"></td> <td style="width: 10%;"></td> <td style="width: 10%;"></td> <td style="width: 10%;"></td> <td style="width: 10%;"></td> <td style="width: 10%;"></td> <td style="width: 10%;"></td> <td style="width: 10%;"></td> <td style="width: 10%;"></td> </tr> <tr> <td></td> <td></td> <td colspan="8" style="text-align: center;"> <table border="1" style="width: 100%; border-collapse: collapse; text-align: center;"> <tr> <td style="width: 10%;"></td> <td style="width: 10%;"></td> <td style="width: 10%;"></td> <td style="width: 10%;"></td> <td style="width: 10%;"></td> <td style="width: 10%;"></td> <td style="width: 10%;"></td> <td style="width: 10%;"></td> <td style="width: 10%;"></td> <td style="width: 10%;"></td> </tr> <tr> <td></td> <td></td> <td colspan="8" style="text-align: center;"> <table border="1" style="width: 100%; border-collapse: collapse; text-align: center;"> <tr> </tr></table></td></tr></table></td></tr></table></td></tr></table></td></tr></table></td></tr></table></td></tr></table>

 | | | | | | | | | | | | | | | | | | | | <table border="1" style="width: 100%; border-collapse: collapse; text-align: center;"> <tr> <td style="width: 10%;"></td> <td style="width: 10%;"></td> <td style="width: 10%;"></td> <td style="width: 10%;"></td> <td style="width: 10%;"></td> <td style="width: 10%;"></td> <td style="width: 10%;"></td> <td style="width: 10%;"></td> <td style="width: 10%;"></td> <td style="width: 10%;"></td> </tr> <tr> <td></td> <td></td> <td colspan="8" style="text-align: center;"> <table border="1" style="width: 100%; border-collapse: collapse; text-align: center;"> <tr> <td style="width: 10%;"></td> <td style="width: 10%;"></td> <td style="width: 10%;"></td> <td style="width: 10%;"></td> <td style="width: 10%;"></td> <td style="width: 10%;"></td> <td style="width: 10%;"></td> <td style="width: 10%;"></td> <td style="width: 10%;"></td> <td style="width: 10%;"></td> </tr> <tr> <td></td> <td></td> <td colspan="8" style="text-align: center;"> <table border="1" style="width: 100%; border-collapse: collapse; text-align: center;"> <tr> <td style="width: 10%;"></td> <td style="width: 10%;"></td> <td style="width: 10%;"></td> <td style="width: 10%;"></td> <td style="width: 10%;"></td> <td style="width: 10%;"></td> <td style="width: 10%;"></td> <td style="width: 10%;"></td> <td style="width: 10%;"></td> <td style="width: 10%;"></td> </tr> <tr> <td></td> <td></td> <td colspan="8" style="text-align: center;"> <table border="1" style="width: 100%; border-collapse: collapse; text-align: center;"> <tr> <td style="width: 10%;"></td> <td style="width: 10%;"></td> <td style="width: 10%;"></td> <td style="width: 10%;"></td> <td style="width: 10%;"></td> <td style="width: 10%;"></td> <td style="width: 10%;"></td> <td style="width: 10%;"></td> <td style="width: 10%;"></td> <td style="width: 10%;"></td> </tr> <tr> <td></td> <td></td> <td colspan="8" style="text-align: center;"> <table border="1" style="width: 100%; border-collapse: collapse; text-align: center;"> <tr> <td style="width: 10%;"></td> <td style="width: 10%;"></td> <td style="width: 10%;"></td> <td style="width: 10%;"></td> <td style="width: 10%;"></td> <td style="width: 10%;"></td> <td style="width: 10%;"></td> <td style="width: 10%;"></td> <td style="width: 10%;"></td> <td style="width: 10%;"></td> </tr> <tr> <td></td> <td></td> <td colspan="8" style="text-align: center;"> <table border="1" style="width: 100%; border-collapse: collapse; text-align: center;"> <tr> </tr></table></td></tr></table></td></tr></table></td></tr></table></td></tr></table></td></tr></table>

 | | | | | | | | | | | | | | | | | | | | <table border="1" style="width: 100%; border-collapse: collapse; text-align: center;"> <tr> <td style="width: 10%;"></td> <td style="width: 10%;"></td> <td style="width: 10%;"></td> <td style="width: 10%;"></td> <td style="width: 10%;"></td> <td style="width: 10%;"></td> <td style="width: 10%;"></td> <td style="width: 10%;"></td> <td style="width: 10%;"></td> <td style="width: 10%;"></td> </tr> <tr> <td></td> <td></td> <td colspan="8" style="text-align: center;"> <table border="1" style="width: 100%; border-collapse: collapse; text-align: center;"> <tr> <td style="width: 10%;"></td> <td style="width: 10%;"></td> <td style="width: 10%;"></td> <td style="width: 10%;"></td> <td style="width: 10%;"></td> <td style="width: 10%;"></td> <td style="width: 10%;"></td> <td style="width: 10%;"></td> <td style="width: 10%;"></td> <td style="width: 10%;"></td> </tr> <tr> <td></td> <td></td> <td colspan="8" style="text-align: center;"> <table border="1" style="width: 100%; border-collapse: collapse; text-align: center;"> <tr> <td style="width: 10%;"></td> <td style="width: 10%;"></td> <td style="width: 10%;"></td> <td style="width: 10%;"></td> <td style="width: 10%;"></td> <td style="width: 10%;"></td> <td style="width: 10%;"></td> <td style="width: 10%;"></td> <td style="width: 10%;"></td> <td style="width: 10%;"></td> </tr> <tr> <td></td> <td></td> <td colspan="8" style="text-align: center;"> <table border="1" style="width: 100%; border-collapse: collapse; text-align: center;"> <tr> <td style="width: 10%;"></td> <td style="width: 10%;"></td> <td style="width: 10%;"></td> <td style="width: 10%;"></td> <td style="width: 10%;"></td> <td style="width: 10%;"></td> <td style="width: 10%;"></td> <td style="width: 10%;"></td> <td style="width: 10%;"></td> <td style="width: 10%;"></td> </tr> <tr> <td></td> <td></td> <td colspan="8" style="text-align: center;"> <table border="1" style="width: 100%; border-collapse: collapse; text-align: center;"> <tr> </tr></table></td></tr></table></td></tr></table></td></tr></table></td></tr></table>

 | | | | | | | | | | | | | | | | | | | | <table border="1" style="width: 100%; border-collapse: collapse; text-align: center;"> <tr> <td style="width: 10%;"></td> <td style="width: 10%;"></td> <td style="width: 10%;"></td> <td style="width: 10%;"></td> <td style="width: 10%;"></td> <td style="width: 10%;"></td> <td style="width: 10%;"></td> <td style="width: 10%;"></td> <td style="width: 10%;"></td> <td style="width: 10%;"></td> </tr> <tr> <td></td> <td></td> <td colspan="8" style="text-align: center;"> <table border="1" style="width: 100%; border-collapse: collapse; text-align: center;"> <tr> <td style="width: 10%;"></td> <td style="width: 10%;"></td> <td style="width: 10%;"></td> <td style="width: 10%;"></td> <td style="width: 10%;"></td> <td style="width: 10%;"></td> <td style="width: 10%;"></td> <td style="width: 10%;"></td> <td style="width: 10%;"></td> <td style="width: 10%;"></td> </tr> <tr> <td></td> <td></td> <td colspan="8" style="text-align: center;"> <table border="1" style="width: 100%; border-collapse: collapse; text-align: center;"> <tr> <td style="width: 10%;"></td> <td style="width: 10%;"></td> <td style="width: 10%;"></td> <td style="width: 10%;"></td> <td style="width: 10%;"></td> <td style="width: 10%;"></td> <td style="width: 10%;"></td> <td style="width: 10%;"></td> <td style="width: 10%;"></td> <td style="width: 10%;"></td> </tr> <tr> <td></td> <td></td> <td colspan="8" style="text-align: center;"> <table border="1" style="width: 100%; border-collapse: collapse; text-align: center;"> <tr> </tr></table></td></tr></table></td></tr></table></td></tr></table>

 | | | | | | | | | | | | | | | | | | | | <table border="1" style="width: 100%; border-collapse: collapse; text-align: center;"> <tr> <td style="width: 10%;"></td> <td style="width: 10%;"></td> <td style="width: 10%;"></td> <td style="width: 10%;"></td> <td style="width: 10%;"></td> <td style="width: 10%;"></td> <td style="width: 10%;"></td> <td style="width: 10%;"></td> <td style="width: 10%;"></td> <td style="width: 10%;"></td> </tr> <tr> <td></td> <td></td> <td colspan="8" style="text-align: center;"> <table border="1" style="width: 100%; border-collapse: collapse; text-align: center;"> <tr> <td style="width: 10%;"></td> <td style="width: 10%;"></td> <td style="width: 10%;"></td> <td style="width: 10%;"></td> <td style="width: 10%;"></td> <td style="width: 10%;"></td> <td style="width: 10%;"></td> <td style="width: 10%;"></td> <td style="width: 10%;"></td> <td style="width: 10%;"></td> </tr> <tr> <td></td> <td></td> <td colspan="8" style="text-align: center;"> <table border="1" style="width: 100%; border-collapse: collapse; text-align: center;"> <tr> </tr></table></td></tr></table></td></tr></table>

 | | | | | | | | | | | | | | | | | | | | <table border="1" style="width: 100%; border-collapse: collapse; text-align: center;"> <tr> <td style="width: 10%;"></td> <td style="width: 10%;"></td> <td style="width: 10%;"></td> <td style="width: 10%;"></td> <td style="width: 10%;"></td> <td style="width: 10%;"></td> <td style="width: 10%;"></td> <td style="width: 10%;"></td> <td style="width: 10%;"></td> <td style="width: 10%;"></td> </tr> <tr> <td></td> <td></td> <td colspan="8" style="text-align: center;"> <table border="1" style="width: 100%; border-collapse: collapse; text-align: center;"> <tr> </tr></table></td></tr></table>

 | | | | | | | | | | | | | | | | | | | | <table border="1" style="width: 100%; border-collapse: collapse; text-align: center;"> <tr> </tr></table>

 | | | | | | | | | | | | | | | | | | | |

 | | | | | | | | | | | | | | | | | | | |

 | | | | | | | | | | | | | | | | | | | |
 | | | | | | | | | | | | | | | | | | | |

 | | | | | | | | | | | | | | | | | | | |

 | | | | | | | | | | | | | | | | | | | |
 | | | | | | | | | | | | | | | | | | | |

 | | | | | | | | | | | | | | | | | | | |

 | | | | | | | | | | | | | | | | | | | |
 | | | | | | | | | | | | | | | | | | | |
 | | | | | | | | | | | | | | | | | | | |

 | | | | | | | | | | | | | | | | | | | |
 | | | | | | | | | | | | | | | | | | | |
 | | | | | | | | | | | | | | | | | | | |

 | | | | | | | | | | | | | | | | | | | | | | | | | | | | | | | | | | | | | | | | | | | | | | | | | | | | | | | | | | | | | | | | | | | | | | | | | | | | | | | | | | | | | | | | | | | | | | | | | | | |
 | | | | | | | | | | | | | | | | | | | |
 | | | | | | | | | | | | | | | | | | | |
 | | | | | | | | | | | | | | | | | | | |
 | | | | | | | | | | | | | | | | | | | |
 | | | | | | | | | | | | | | | | | | | |
 | | | | | | | | | | | | | | | | | | | |
 | | | | | | | | | | | | | | | | | | | |
 | | | | | | | | | | | | | | | | | | | |
 | | | | | | | | | | | | | | | | | | | | | | | | | | | | | | | | | | | | | | | |
 | | | | | | | | | | | | | | | | | | | |
 | | | | | | | | | | | | | | | | | | | | | | | | | | | | | | | | | | | | | | | |
 | | | | | | | | | | | | | | | | | | | | | | | | | | | | | | | | | | | | | | | |
 | | | | | | | | | | | | | | | | | | | | | | | | | | | | | | | | | | | | | | | |
 | | | | | | | | | | | | | | | | | | | | | | | | | | | | | | | | | | | | | | | | | | | | | | | | | | | | | | | | | | | | | | | | | | | | | | | | | | | | | | | | | | | | | | | | | | | | | | | | | | | |
 | | | | | | | | | | | | | | | | | | | | | | | | | | | | | | | | | | | | | | | | | | | | | | | |
| | |

 | | | | | | | | | | | | | | | | | | | |

 | | | | | | | | | | | | | | | | | | | |

 | | | | | | | | | | | | | | | | | | | |

 | | | | | | | | | | | | | | | | | | | |

 | | | | | | | | | | | | | | | | | | | |

 | | | | | | | | | | | | | | | | | | | |

 | | | | | | | | | | | | | | | | | | | |

 | | | | | | | | | | | | | | | | | | | |

 | | | | | | | | | | | | | | | | | | | |

 | | | | | | | | | | | | | | | | | | | |

 | | | | | | | | | | | | | | | | | | | |

 | | | | | | | | | | | | | | | | | | | |

 | | | | | | | | | | | | | | | | | | | |

 | | | | | | | | | | | | | | | | | | | |

 | | | | | | | | | | | | | | | | | | | |

 | | | | | | | | | | | | | | | | | | | |

 | | | | | | | | | | | | | | | | | | | |

 | | | | | | | | | | | | | | | | | | | |

 | | | | | | | | | | | | | | | | | | | |

 | | | | | | | | | | | | | | | | | | | |

 | | | | | | | | | | | | | | | | | | | |

 | | | | | | | | | | | | | | | | | | | |

 | | | | | | | | | | | | | | | | | | | |

 | | | | | | | | | | | | | | | | | | | |

 | | | | | | | | | | | | | | | | | | | |

 | | | | | | | | | | | | | | | | | | | |

 | | | | | | | | | | | | | | | | | | | |

 | | | | | | | | | | | | | | | | | | | |
 | | | | | | | | | | | | | | | | | | | |

 | | | | | | | | | | | | | | | | | | | |

 | | | | | | | | | | | | | | | | | | | |
 | | | | | | | | | | | | | | | | | | | |

 | | | | | | | | | | | | | | | | | | | |

 | | | | | | | | | | | | | | | | | | | |
 | | | | | | | | | | | | | | | | | | | |
 | | | | | | | | | | | | | | | | | | | |

 | | | | | | | | | | | | | | | | | | | |
 | | | | | | | | | | | | | | | | | | | |
 | | | | | | | | | | | | | | | | | | | |

 | | | | | | | | | | | | | | | | | | | | | | | | | | | | | | | | | | | | | | | | | | | | | | | | | | | | | | | | | | | | | | | | | | | | | | | | | | | | | | | | | | | | | | | | | | | | | | | | | | | |
 | | | | | | | | | | | | | | | | | | | |
 | | | | | | | | | | | | | | | | | | | |
 | | | | | | | | | | | | | | | | | | | |
 | | | | | | | | | | | | | | | | | | | |
 | | | | | | | | | | | | | | | | | | | |
 | | | | | | | | | | | | | | | | | | | |
 | | | | | | | | | | | | | | | | | | | |
 | | | | | | | | | | | | | | | | | | | |
 | | | | | | | | | | | | | | | | | | | | | | | | | | | | | | | | | | | | | | | |
 | | | | | | | | | | | | | | | | | | | |
 | | | | | | | | | | | | | | | | | | | | | | | | | | | | | | | | | | | | | | | |
 | | | | | | | | | | | | | | | | | | | | | | | | | | | | | | | | | | | | | | | |
 | | | | | | | | | | | | | | | | | | | | | | | | | | | | | | | | | | | | | | | |
 | | | | | | | | | | | | | | | | | | | | | | | | | | | | | | | | | | | | | | | | | | | | | | | | | | | | | | | | | | | | | | | | | | | | | | | | | | | | | | | | | | | | | | | | | | | | | | | | | | | |
 | | | | | | | | | | | | | | | | | | | | | | | | | | | | | | | | | | | | | | | | | | | | | | | |
| | | <table border="1" style="width: 100%; border-collapse: collapse; text-align: center;"> <tr> <td style="width: 10%;"></td> <td style="width: 10%;"></td> <td style="width: 10%;"></td> <td style="width: 10%;"></td> <td style="width: 10%;"></td> <td style="width: 10%;"></td> <td style="width: 10%;"></td> <td style="width: 10%;"></td> <td style="width: 10%;"></td> <td style="width: 10%;"></td> </tr> <tr> <td></td> <td></td> <td colspan="8" style="text-align: center;"> <table border="1" style="width: 100%; border-collapse: collapse; text-align: center;"> <tr> <td style="width: 10%;"></td> <td style="width: 10%;"></td> <td style="width: 10%;"></td> <td style="width: 10%;"></td> <td style="width: 10%;"></td> <td style="width: 10%;"></td> <td style="width: 10%;"></td> <td style="width: 10%;"></td> <td style="width: 10%;"></td> <td style="width: 10%;"></td> </tr> <tr> <td></td> <td></td> <td colspan="8" style="text-align: center;"> <table border="1" style="width: 100%; border-collapse: collapse; text-align: center;"> <tr> <td style="width: 10%;"></td> <td style="width: 10%;"></td> <td style="width: 10%;"></td> <td style="width: 10%;"></td> <td style="width: 10%;"></td> <td style="width: 10%;"></td> <td style="width: 10%;"></td> <td style="width: 10%;"></td> <td style="width: 10%;"></td> <td style="width: 10%;"></td> </tr> <tr> <td></td> <td></td> <td colspan="8" style="text-align: center;"> <table border="1" style="width: 100%; border-collapse: collapse; text-align: center;"> <tr> <td style="width: 10%;"></td> <td style="width: 10%;"></td> <td style="width: 10%;"></td> <td style="width: 10%;"></td> <td style="width: 10%;"></td> <td style="width: 10%;"></td> <td style="width: 10%;"></td> <td style="width: 10%;"></td> <td style="width: 10%;"></td> <td style="width: 10%;"></td> </tr> <tr> <td></td> <td></td> <td colspan="8" style="text-align: center;"> <table border="1" style="width: 100%; border-collapse: collapse; text-align: center;"> <tr> <td style="width: 10%;"></td> <td style="width: 10%;"></td> <td style="width: 10%;"></td> <td style="width: 10%;"></td> <td style="width: 10%;"></td> <td style="width: 10%;"></td> <td style="width: 10%;"></td> <td style="width: 10%;"></td> <td style="width: 10%;"></td> <td style="width: 10%;"></td> </tr> <tr> <td></td> <td></td> <td colspan="8" style="text-align: center;"> <table border="1" style="width: 100%; border-collapse: collapse; text-align: center;"> <tr> <td style="width: 10%;"></td> <td style="width: 10%;"></td> <td style="width: 10%;"></td> <td style="width: 10%;"></td> <td style="width: 10%;"></td> <td style="width: 10%;"></td> <td style="width: 10%;"></td> <td style="width: 10%;"></td> <td style="width: 10%;"></td> <td style="width: 10%;"></td> </tr> <tr> <td></td> <td></td> <td colspan="8" style="text-align: center;"> <table border="1" style="width: 100%; border-collapse: collapse; text-align: center;"> <tr> <td style="width: 10%;"></td> <td style="width: 10%;"></td> <td style="width: 10%;"></td> <td style="width: 10%;"></td> <td style="width: 10%;"></td> <td style="width: 10%;"></td> <td style="width: 10%;"></td> <td style="width: 10%;"></td> <td style="width: 10%;"></td> <td style="width: 10%;"></td> </tr> <tr> <td></td> <td></td> <td colspan="8" style="text-align: center;"> <table border="1" style="width: 100%; border-collapse: collapse; text-align: center;"> <tr> <td style="width: 10%;"></td> <td style="width: 10%;"></td> <td style="width: 10%;"></td> <td style="width: 10%;"></td> <td style="width: 10%;"></td> <td style="width: 10%;"></td> <td style="width: 10%;"></td> <td style="width: 10%;"></td> <td style="width: 10%;"></td> <td style="width: 10%;"></td> </tr> <tr> <td></td> <td></td> <td colspan="8" style="text-align: center;"> <table border="1" style="width: 100%; border-collapse: collapse; text-align: center;"> <tr> <td style="width: 10%;"></td> <td style="width: 10%;"></td> <td style="width: 10%;"></td> <td style="width: 10%;"></td> <td style="width: 10%;"></td> <td style="width: 10%;"></td> <td style="width: 10%;"></td> <td style="width: 10%;"></td> <td style="width: 10%;"></td> <td style="width: 10%;"></td> </tr> <tr> <td></td> <td></td> <td colspan="8" style="text-align: center;"> <table border="1" style="width: 100%; border-collapse: collapse; text-align: center;"> <tr> <td style="width: 10%;"></td> <td style="width: 10%;"></td> <td style="width: 10%;"></td> <td style="width: 10%;"></td> <td style="width: 10%;"></td> <td style="width: 10%;"></td> <td style="width: 10%;"></td> <td style="width: 10%;"></td> <td style="width: 10%;"></td> <td style="width: 10%;"></td> </tr> <tr> <td></td> <td></td> <td colspan="8" style="text-align: center;"> <table border="1" style="width: 100%; border-collapse: collapse; text-align: center;"> <tr> <td style="width: 10%;"></td> <td style="width: 10%;"></td> <td style="width: 10%;"></td> <td style="width: 10%;"></td> <td style="width: 10%;"></td> <td style="width: 10%;"></td> <td style="width: 10%;"></td> <td style="width: 10%;"></td> <td style="width: 10%;"></td> <td style="width: 10%;"></td> </tr> <tr> <td></td> <td></td> <td colspan="8" style="text-align: center;"> <table border="1" style="width: 100%; border-collapse: collapse; text-align: center;"> <tr> <td style="width: 10%;"></td> <td style="width: 10%;"></td> <td style="width: 10%;"></td> <td style="width: 10%;"></td> <td style="width: 10%;"></td> <td style="width: 10%;"></td> <td style="width: 10%;"></td> <td style="width: 10%;"></td> <td style="width: 10%;"></td> <td style="width: 10%;"></td> </tr> <tr> <td></td> <td></td> <td colspan="8" style="text-align: center;"> <table border="1" style="width: 100%; border-collapse: collapse; text-align: center;"> <tr> <td style="width: 10%;"></td> <td style="width: 10%;"></td> <td style="width: 10%;"></td> <td style="width: 10%;"></td> <td style="width: 10%;"></td> <td style="width: 10%;"></td> <td style="width: 10%;"></td> <td style="width: 10%;"></td> <td style="width: 10%;"></td> <td style="width: 10%;"></td> </tr> <tr> <td></td> <td></td> <td colspan="8" style="text-align: center;"> <table border="1" style="width: 100%; border-collapse: collapse; text-align: center;"> <tr> <td style="width: 10%;"></td> <td style="width: 10%;"></td> <td style="width: 10%;"></td> <td style="width: 10%;"></td> <td style="width: 10%;"></td> <td style="width: 10%;"></td> <td style="width: 10%;"></td> <td style="width: 10%;"></td> <td style="width: 10%;"></td> <td style="width: 10%;"></td> </tr> <tr> <td></td> <td></td> <td colspan="8" style="text-align: center;"> <table border="1" style="width: 100%; border-collapse: collapse; text-align: center;"> <tr> <td style="width: 10%;"></td> <td style="width: 10%;"></td> <td style="width: 10%;"></td> <td style="width: 10%;"></td> <td style="width: 10%;"></td> <td style="width: 10%;"></td> <td style="width: 10%;"></td> <td style="width: 10%;"></td> <td style="width: 10%;"></td> <td style="width: 10%;"></td> </tr> <tr> <td></td> <td></td> <td colspan="8" style="text-align: center;"> <table border="1" style="width: 100%; border-collapse: collapse; text-align: center;"> <tr> <td style="width: 10%;"></td> <td style="width: 10%;"></td> <td style="width: 10%;"></td> <td style="width: 10%;"></td> <td style="width: 10%;"></td> <td style="width: 10%;"></td> <td style="width: 10%;"></td> <td style="width: 10%;"></td> <td style="width: 10%;"></td> <td style="width: 10%;"></td> </tr> <tr> <td></td> <td></td> <td colspan="8" style="text-align: center;"> <table border="1" style="width: 100%; border-collapse: collapse; text-align: center;"> <tr> <td style="width: 10%;"></td> <td style="width: 10%;"></td> <td style="width: 10%;"></td> <td style="width: 10%;"></td> <td style="width: 10%;"></td> <td style="width: 10%;"></td> <td style="width: 10%;"></td> <td style="width: 10%;"></td> <td style="width: 10%;"></td> <td style="width: 10%;"></td> </tr> <tr> <td></td> <td></td> <td colspan="8" style="text-align: center;"> <table border="1" style="width: 100%; border-collapse: collapse; text-align: center;"> <tr> <td style="width: 10%;"></td> <td style="width: 10%;"></td> <td style="width: 10%;"></td> <td style="width: 10%;"></td> <td style="width: 10%;"></td> <td style="width: 10%;"></td> <td style="width: 10%;"></td> <td style="width: 10%;"></td> <td style="width: 10%;"></td> <td style="width: 10%;"></td> </tr> <tr> <td></td> <td></td> <td colspan="8" style="text-align: center;"> <table border="1" style="width: 100%; border-collapse: collapse; text-align: center;"> <tr> <td style="width: 10%;"></td> <td style="width: 10%;"></td> <td style="width: 10%;"></td> <td style="width: 10%;"></td> <td style="width: 10%;"></td> <td style="width: 10%;"></td> <td style="width: 10%;"></td> <td style="width: 10%;"></td> <td style="width: 10%;"></td> <td style="width: 10%;"></td> </tr> <tr> <td></td> <td></td> <td colspan="8" style="text-align: center;"> <table border="1" style="width: 100%; border-collapse: collapse; text-align: center;"> <tr> <td style="width: 10%;"></td> <td style="width: 10%;"></td> <td style="width: 10%;"></td> <td style="width: 10%;"></td> <td style="width: 10%;"></td> <td style="width: 10%;"></td> <td style="width: 10%;"></td> <td style="width: 10%;"></td> <td style="width: 10%;"></td> <td style="width: 10%;"></td> </tr> <tr> <td></td> <td></td> <td colspan="8" style="text-align: center;"> <table border="1" style="width: 100%; border-collapse: collapse; text-align: center;"> <tr> <td style="width: 10%;"></td> <td style="width: 10%;"></td> <td style="width: 10%;"></td> <td style="width: 10%;"></td> <td style="width: 10%;"></td> <td style="width: 10%;"></td> <td style="width: 10%;"></td> <td style="width: 10%;"></td> <td style="width: 10%;"></td> <td style="width: 10%;"></td> </tr> <tr> <td></td> <td></td> <td colspan="8" style="text-align: center;"> <table border="1" style="width: 100%; border-collapse: collapse; text-align: center;"> <tr> <td style="width: 10%;"></td> <td style="width: 10%;"></td> <td
style="width: 10%;"></td> <td style="width: 10%;"></td> <td style="width: 10%;"></td> <td style="width: 10%;"></td> <td style="width: 10%;"></td> <td style="width: 10%;"></td> <td style="width: 10%;"></td> <td style="width: 10%;"></td> </tr> <tr> <td></td> <td></td> <td colspan="8" style="text-align: center;"> <table border="1" style="width: 100%; border-collapse: collapse; text-align: center;"> <tr> <td style="width: 10%;"></td> <td style="width: 10%;"></td> <td style="width: 10%;"></td> <td style="width: 10%;"></td> <td style="width: 10%;"></td> <td style="width: 10%;"></td> <td style="width: 10%;"></td> <td style="width: 10%;"></td> <td style="width: 10%;"></td> <td style="width: 10%;"></td> </tr> <tr> <td></td> <td></td> <td colspan="8" style="text-align: center;"> <table border="1" style="width: 100%; border-collapse: collapse; text-align: center;"> <tr> <td style="width: 10%;"></td> <td style="width: 10%;"></td> <td style="width: 10%;"></td> <td style="width: 10%;"></td> <td style="width: 10%;"></td> <td style="width: 10%;"></td> <td style="width: 10%;"></td> <td style="width: 10%;"></td> <td style="width: 10%;"></td> <td style="width: 10%;"></td> </tr> <tr> <td></td> <td></td> <td colspan="8" style="text-align: center;"> <table border="1" style="width: 100%; border-collapse: collapse; text-align: center;"> <tr> </tr></table></td></tr></table></td></tr></table></td></tr></table></td></tr></table></td></tr></table></td></tr></table></td></tr></table></td></tr></table></td></tr></table></td></tr></table></td></tr></table></td></tr></table></td></tr></table></td></tr></table></td></tr></table></td></tr></table></td></tr></table></td></tr></table></td></tr></table></td></tr></table></td></tr></table></td></tr></table></td></tr></table></td></tr></table>

 | | | | | | | | | | | | | | | | | | | | <table border="1" style="width: 100%; border-collapse: collapse; text-align: center;"> <tr> <td style="width: 10%;"></td> <td style="width: 10%;"></td> <td style="width: 10%;"></td> <td style="width: 10%;"></td> <td style="width: 10%;"></td> <td style="width: 10%;"></td> <td style="width: 10%;"></td> <td style="width: 10%;"></td> <td style="width: 10%;"></td> <td style="width: 10%;"></td> </tr> <tr> <td></td> <td></td> <td colspan="8" style="text-align: center;"> <table border="1" style="width: 100%; border-collapse: collapse; text-align: center;"> <tr> <td style="width: 10%;"></td> <td style="width: 10%;"></td> <td style="width: 10%;"></td> <td style="width: 10%;"></td> <td style="width: 10%;"></td> <td style="width: 10%;"></td> <td style="width: 10%;"></td> <td style="width: 10%;"></td> <td style="width: 10%;"></td> <td style="width: 10%;"></td> </tr> <tr> <td></td> <td></td> <td colspan="8" style="text-align: center;"> <table border="1" style="width: 100%; border-collapse: collapse; text-align: center;"> <tr> <td style="width: 10%;"></td> <td style="width: 10%;"></td> <td style="width: 10%;"></td> <td style="width: 10%;"></td> <td style="width: 10%;"></td> <td style="width: 10%;"></td> <td style="width: 10%;"></td> <td style="width: 10%;"></td> <td style="width: 10%;"></td> <td style="width: 10%;"></td> </tr> <tr> <td></td> <td></td> <td colspan="8" style="text-align: center;"> <table border="1" style="width: 100%; border-collapse: collapse; text-align: center;"> <tr> <td style="width: 10%;"></td> <td style="width: 10%;"></td> <td style="width: 10%;"></td> <td style="width: 10%;"></td> <td style="width: 10%;"></td> <td style="width: 10%;"></td> <td style="width: 10%;"></td> <td style="width: 10%;"></td> <td style="width: 10%;"></td> <td style="width: 10%;"></td> </tr> <tr> <td></td> <td></td> <td colspan="8" style="text-align: center;"> <table border="1" style="width: 100%; border-collapse: collapse; text-align: center;"> <tr> <td style="width: 10%;"></td> <td style="width: 10%;"></td> <td style="width: 10%;"></td> <td style="width: 10%;"></td> <td style="width: 10%;"></td> <td style="width: 10%;"></td> <td style="width: 10%;"></td> <td style="width: 10%;"></td> <td style="width: 10%;"></td> <td style="width: 10%;"></td> </tr> <tr> <td></td> <td></td> <td colspan="8" style="text-align: center;"> <table border="1" style="width: 100%; border-collapse: collapse; text-align: center;"> <tr> <td style="width: 10%;"></td> <td style="width: 10%;"></td> <td style="width: 10%;"></td> <td style="width: 10%;"></td> <td style="width: 10%;"></td> <td style="width: 10%;"></td> <td style="width: 10%;"></td> <td style="width: 10%;"></td> <td style="width: 10%;"></td> <td style="width: 10%;"></td> </tr> <tr> <td></td> <td></td> <td colspan="8" style="text-align: center;"> <table border="1" style="width: 100%; border-collapse: collapse; text-align: center;"> <tr> <td style="width: 10%;"></td> <td style="width: 10%;"></td> <td style="width: 10%;"></td> <td style="width: 10%;"></td> <td style="width: 10%;"></td> <td style="width: 10%;"></td> <td style="width: 10%;"></td> <td style="width: 10%;"></td> <td style="width: 10%;"></td> <td style="width: 10%;"></td> </tr> <tr> <td></td> <td></td> <td colspan="8" style="text-align: center;"> <table border="1" style="width: 100%; border-collapse: collapse; text-align: center;"> <tr> <td style="width: 10%;"></td> <td style="width: 10%;"></td> <td style="width: 10%;"></td> <td style="width: 10%;"></td> <td style="width: 10%;"></td> <td style="width: 10%;"></td> <td style="width: 10%;"></td> <td style="width: 10%;"></td> <td style="width: 10%;"></td> <td style="width: 10%;"></td> </tr> <tr> <td></td> <td></td> <td colspan="8" style="text-align: center;"> <table border="1" style="width: 100%; border-collapse: collapse; text-align: center;"> <tr> <td style="width: 10%;"></td> <td style="width: 10%;"></td> <td style="width: 10%;"></td> <td style="width: 10%;"></td> <td style="width: 10%;"></td> <td style="width: 10%;"></td> <td style="width: 10%;"></td> <td style="width: 10%;"></td> <td style="width: 10%;"></td> <td style="width: 10%;"></td> </tr> <tr> <td></td> <td></td> <td colspan="8" style="text-align: center;"> <table border="1" style="width: 100%; border-collapse: collapse; text-align: center;"> <tr> <td style="width: 10%;"></td> <td style="width: 10%;"></td> <td style="width: 10%;"></td> <td style="width: 10%;"></td> <td style="width: 10%;"></td> <td style="width: 10%;"></td> <td style="width: 10%;"></td> <td style="width: 10%;"></td> <td style="width: 10%;"></td> <td style="width: 10%;"></td> </tr> <tr> <td></td> <td></td> <td colspan="8" style="text-align: center;"> <table border="1" style="width: 100%; border-collapse: collapse; text-align: center;"> <tr> <td style="width: 10%;"></td> <td style="width: 10%;"></td> <td style="width: 10%;"></td> <td style="width: 10%;"></td> <td style="width: 10%;"></td> <td style="width: 10%;"></td> <td style="width: 10%;"></td> <td style="width: 10%;"></td> <td style="width: 10%;"></td> <td style="width: 10%;"></td> </tr> <tr> <td></td> <td></td> <td colspan="8" style="text-align: center;"> <table border="1" style="width: 100%; border-collapse: collapse; text-align: center;"> <tr> <td style="width: 10%;"></td> <td style="width: 10%;"></td> <td style="width: 10%;"></td> <td style="width: 10%;"></td> <td style="width: 10%;"></td> <td style="width: 10%;"></td> <td style="width: 10%;"></td> <td style="width: 10%;"></td> <td style="width: 10%;"></td> <td style="width: 10%;"></td> </tr> <tr> <td></td> <td></td> <td colspan="8" style="text-align: center;"> <table border="1" style="width: 100%; border-collapse: collapse; text-align: center;"> <tr> <td style="width: 10%;"></td> <td style="width: 10%;"></td> <td style="width: 10%;"></td> <td style="width: 10%;"></td> <td style="width: 10%;"></td> <td style="width: 10%;"></td> <td style="width: 10%;"></td> <td style="width: 10%;"></td> <td style="width: 10%;"></td> <td style="width: 10%;"></td> </tr> <tr> <td></td> <td></td> <td colspan="8" style="text-align: center;"> <table border="1" style="width: 100%; border-collapse: collapse; text-align: center;"> <tr> <td style="width: 10%;"></td> <td style="width: 10%;"></td> <td style="width: 10%;"></td> <td style="width: 10%;"></td> <td style="width: 10%;"></td> <td style="width: 10%;"></td> <td style="width: 10%;"></td> <td style="width: 10%;"></td> <td style="width: 10%;"></td> <td style="width: 10%;"></td> </tr> <tr> <td></td> <td></td> <td colspan="8" style="text-align: center;"> <table border="1" style="width: 100%; border-collapse: collapse; text-align: center;"> <tr> <td style="width: 10%;"></td> <td style="width: 10%;"></td> <td style="width: 10%;"></td> <td style="width: 10%;"></td> <td style="width: 10%;"></td> <td style="width: 10%;"></td> <td style="width: 10%;"></td> <td style="width: 10%;"></td> <td style="width: 10%;"></td> <td style="width: 10%;"></td> </tr> <tr> <td></td> <td></td> <td colspan="8" style="text-align: center;"> <table border="1" style="width: 100%; border-collapse: collapse; text-align: center;"> <tr> <td style="width: 10%;"></td> <td style="width: 10%;"></td> <td style="width: 10%;"></td> <td style="width: 10%;"></td> <td style="width: 10%;"></td> <td style="width: 10%;"></td> <td style="width: 10%;"></td> <td style="width: 10%;"></td> <td style="width: 10%;"></td> <td style="width: 10%;"></td> </tr> <tr> <td></td> <td></td> <td colspan="8" style="text-align: center;"> <table border="1" style="width: 100%; border-collapse: collapse; text-align: center;"> <tr> <td style="width: 10%;"></td> <td style="width: 10%;"></td> <td style="width: 10%;"></td> <td style="width: 10%;"></td> <td style="width: 10%;"></td> <td style="width: 10%;"></td> <td style="width: 10%;"></td> <td style="width: 10%;"></td> <td style="width: 10%;"></td> <td style="width: 10%;"></td> </tr> <tr> <td></td> <td></td> <td colspan="8" style="text-align: center;"> <table border="1" style="width: 100%; border-collapse: collapse; text-align: center;"> <tr> <td style="width: 10%;"></td> <td style="width: 10%;"></td> <td style="width: 10%;"></td> <td style="width: 10%;"></td> <td style="width: 10%;"></td> <td style="width: 10%;"></td> <td style="width: 10%;"></td> <td style="width: 10%;"></td> <td style="width: 10%;"></td> <td style="width: 10%;"></td> </tr> <tr> <td></td> <td></td> <td colspan="8" style="text-align: center;"> <table border="1" style="width: 100%; border-collapse: collapse; text-align: center;"> <tr> <td style="width: 10%;"></td> <td style="width: 10%;"></td> <td style="width: 10%;"></td> <td style="width: 10%;"></td> <td style="width: 10%;"></td> <td style="width: 10%;"></td> <td
style="width: 10%;"></td> <td style="width: 10%;"></td> <td style="width: 10%;"></td> <td style="width: 10%;"></td> </tr> <tr> <td></td> <td></td> <td colspan="8" style="text-align: center;"> <table border="1" style="width: 100%; border-collapse: collapse; text-align: center;"> <tr> <td style="width: 10%;"></td> <td style="width: 10%;"></td> <td style="width: 10%;"></td> <td style="width: 10%;"></td> <td style="width: 10%;"></td> <td style="width: 10%;"></td> <td style="width: 10%;"></td> <td style="width: 10%;"></td> <td style="width: 10%;"></td> <td style="width: 10%;"></td> </tr> <tr> <td></td> <td></td> <td colspan="8" style="text-align: center;"> <table border="1" style="width: 100%; border-collapse: collapse; text-align: center;"> <tr> <td style="width: 10%;"></td> <td style="width: 10%;"></td> <td style="width: 10%;"></td> <td style="width: 10%;"></td> <td style="width: 10%;"></td> <td style="width: 10%;"></td> <td style="width: 10%;"></td> <td style="width: 10%;"></td> <td style="width: 10%;"></td> <td style="width: 10%;"></td> </tr> <tr> <td></td> <td></td> <td colspan="8" style="text-align: center;"> <table border="1" style="width: 100%; border-collapse: collapse; text-align: center;"> <tr> <td style="width: 10%;"></td> <td style="width: 10%;"></td> <td style="width: 10%;"></td> <td style="width: 10%;"></td> <td style="width: 10%;"></td> <td style="width: 10%;"></td> <td style="width: 10%;"></td> <td style="width: 10%;"></td> <td style="width: 10%;"></td> <td style="width: 10%;"></td> </tr> <tr> <td></td> <td></td> <td colspan="8" style="text-align: center;"> <table border="1" style="width: 100%; border-collapse: collapse; text-align: center;"> <tr> <td style="width: 10%;"></td> <td style="width: 10%;"></td> <td style="width: 10%;"></td> <td style="width: 10%;"></td> <td style="width: 10%;"></td> <td style="width: 10%;"></td> <td style="width: 10%;"></td> <td style="width: 10%;"></td> <td style="width: 10%;"></td> <td style="width: 10%;"></td> </tr> <tr> <td></td> <td></td> <td colspan="8" style="text-align: center;"> <table border="1" style="width: 100%; border-collapse: collapse; text-align: center;"> <tr> </tr></table></td></tr></table></td></tr></table></td></tr></table></td></tr></table></td></tr></table></td></tr></table></td></tr></table></td></tr></table></td></tr></table></td></tr></table></td></tr></table></td></tr></table></td></tr></table></td></tr></table></td></tr></table></td></tr></table></td></tr></table></td></tr></table></td></tr></table></td></tr></table></td></tr></table></td></tr></table></td></tr></table>

 | | | | | | | | | | | | | | | | | | | | <table border="1" style="width: 100%; border-collapse: collapse; text-align: center;"> <tr> <td style="width: 10%;"></td> <td style="width: 10%;"></td> <td style="width: 10%;"></td> <td style="width: 10%;"></td> <td style="width: 10%;"></td> <td style="width: 10%;"></td> <td style="width: 10%;"></td> <td style="width: 10%;"></td> <td style="width: 10%;"></td> <td style="width: 10%;"></td> </tr> <tr> <td></td> <td></td> <td colspan="8" style="text-align: center;"> <table border="1" style="width: 100%; border-collapse: collapse; text-align: center;"> <tr> <td style="width: 10%;"></td> <td style="width: 10%;"></td> <td style="width: 10%;"></td> <td style="width: 10%;"></td> <td style="width: 10%;"></td> <td style="width: 10%;"></td> <td style="width: 10%;"></td> <td style="width: 10%;"></td> <td style="width: 10%;"></td> <td style="width: 10%;"></td> </tr> <tr> <td></td> <td></td> <td colspan="8" style="text-align: center;"> <table border="1" style="width: 100%; border-collapse: collapse; text-align: center;"> <tr> <td style="width: 10%;"></td> <td style="width: 10%;"></td> <td style="width: 10%;"></td> <td style="width: 10%;"></td> <td style="width: 10%;"></td> <td style="width: 10%;"></td> <td style="width: 10%;"></td> <td style="width: 10%;"></td> <td style="width: 10%;"></td> <td style="width: 10%;"></td> </tr> <tr> <td></td> <td></td> <td colspan="8" style="text-align: center;"> <table border="1" style="width: 100%; border-collapse: collapse; text-align: center;"> <tr> <td style="width: 10%;"></td> <td style="width: 10%;"></td> <td style="width: 10%;"></td> <td style="width: 10%;"></td> <td style="width: 10%;"></td> <td style="width: 10%;"></td> <td style="width: 10%;"></td> <td style="width: 10%;"></td> <td style="width: 10%;"></td> <td style="width: 10%;"></td> </tr> <tr> <td></td> <td></td> <td colspan="8" style="text-align: center;"> <table border="1" style="width: 100%; border-collapse: collapse; text-align: center;"> <tr> <td style="width: 10%;"></td> <td style="width: 10%;"></td> <td style="width: 10%;"></td> <td style="width: 10%;"></td> <td style="width: 10%;"></td> <td style="width: 10%;"></td> <td style="width: 10%;"></td> <td style="width: 10%;"></td> <td style="width: 10%;"></td> <td style="width: 10%;"></td> </tr> <tr> <td></td> <td></td> <td colspan="8" style="text-align: center;"> <table border="1" style="width: 100%; border-collapse: collapse; text-align: center;"> <tr> <td style="width: 10%;"></td> <td style="width: 10%;"></td> <td style="width: 10%;"></td> <td style="width: 10%;"></td> <td style="width: 10%;"></td> <td style="width: 10%;"></td> <td style="width: 10%;"></td> <td style="width: 10%;"></td> <td style="width: 10%;"></td> <td style="width: 10%;"></td> </tr> <tr> <td></td> <td></td> <td colspan="8" style="text-align: center;"> <table border="1" style="width: 100%; border-collapse: collapse; text-align: center;"> <tr> <td style="width: 10%;"></td> <td style="width: 10%;"></td> <td style="width: 10%;"></td> <td style="width: 10%;"></td> <td style="width: 10%;"></td> <td style="width: 10%;"></td> <td style="width: 10%;"></td> <td style="width: 10%;"></td> <td style="width: 10%;"></td> <td style="width: 10%;"></td> </tr> <tr> <td></td> <td></td> <td colspan="8" style="text-align: center;"> <table border="1" style="width: 100%; border-collapse: collapse; text-align: center;"> <tr> <td style="width: 10%;"></td> <td style="width: 10%;"></td> <td style="width: 10%;"></td> <td style="width: 10%;"></td> <td style="width: 10%;"></td> <td style="width: 10%;"></td> <td style="width: 10%;"></td> <td style="width: 10%;"></td> <td style="width: 10%;"></td> <td style="width: 10%;"></td> </tr> <tr> <td></td> <td></td> <td colspan="8" style="text-align: center;"> <table border="1" style="width: 100%; border-collapse: collapse; text-align: center;"> <tr> <td style="width: 10%;"></td> <td style="width: 10%;"></td> <td style="width: 10%;"></td> <td style="width: 10%;"></td> <td style="width: 10%;"></td> <td style="width: 10%;"></td> <td style="width: 10%;"></td> <td style="width: 10%;"></td> <td style="width: 10%;"></td> <td style="width: 10%;"></td> </tr> <tr> <td></td> <td></td> <td colspan="8" style="text-align: center;"> <table border="1" style="width: 100%; border-collapse: collapse; text-align: center;"> <tr> <td style="width: 10%;"></td> <td style="width: 10%;"></td> <td style="width: 10%;"></td> <td style="width: 10%;"></td> <td style="width: 10%;"></td> <td style="width: 10%;"></td> <td style="width: 10%;"></td> <td style="width: 10%;"></td> <td style="width: 10%;"></td> <td style="width: 10%;"></td> </tr> <tr> <td></td> <td></td> <td colspan="8" style="text-align: center;"> <table border="1" style="width: 100%; border-collapse: collapse; text-align: center;"> <tr> <td style="width: 10%;"></td> <td style="width: 10%;"></td> <td style="width: 10%;"></td> <td style="width: 10%;"></td> <td style="width: 10%;"></td> <td style="width: 10%;"></td> <td style="width: 10%;"></td> <td style="width: 10%;"></td> <td style="width: 10%;"></td> <td style="width: 10%;"></td> </tr> <tr> <td></td> <td></td> <td colspan="8" style="text-align: center;"> <table border="1" style="width: 100%; border-collapse: collapse; text-align: center;"> <tr> <td style="width: 10%;"></td> <td style="width: 10%;"></td> <td style="width: 10%;"></td> <td style="width: 10%;"></td> <td style="width: 10%;"></td> <td style="width: 10%;"></td> <td style="width: 10%;"></td> <td style="width: 10%;"></td> <td style="width: 10%;"></td> <td style="width: 10%;"></td> </tr> <tr> <td></td> <td></td> <td colspan="8" style="text-align: center;"> <table border="1" style="width: 100%; border-collapse: collapse; text-align: center;"> <tr> <td style="width: 10%;"></td> <td style="width: 10%;"></td> <td style="width: 10%;"></td> <td style="width: 10%;"></td> <td style="width: 10%;"></td> <td style="width: 10%;"></td> <td style="width: 10%;"></td> <td style="width: 10%;"></td> <td style="width: 10%;"></td> <td style="width: 10%;"></td> </tr> <tr> <td></td> <td></td> <td colspan="8" style="text-align: center;"> <table border="1" style="width: 100%; border-collapse: collapse; text-align: center;"> <tr> <td style="width: 10%;"></td> <td style="width: 10%;"></td> <td style="width: 10%;"></td> <td style="width: 10%;"></td> <td style="width: 10%;"></td> <td style="width: 10%;"></td> <td style="width: 10%;"></td> <td style="width: 10%;"></td> <td style="width: 10%;"></td> <td style="width: 10%;"></td> </tr> <tr> <td></td> <td></td> <td colspan="8" style="text-align: center;"> <table border="1" style="width: 100%; border-collapse: collapse; text-align: center;"> <tr> <td style="width: 10%;"></td> <td style="width: 10%;"></td> <td style="width: 10%;"></td> <td style="width: 10%;"></td> <td style="width: 10%;"></td> <td style="width: 10%;"></td> <td style="width: 10%;"></td> <td style="width: 10%;"></td> <td style="width: 10%;"></td> <td style="width: 10%;"></td> </tr> <tr> <td></td> <td></td> <td colspan="8" style="text-align: center;"> <table border="1" style="width: 100%; border-collapse: collapse; text-align: center;"> <tr> <td style="width: 10%;"></td> <td style="width: 10%;"></td> <td style="width: 10%;"></td> <td style="width: 10%;"></td> <td style="width: 10%;"></td> <td style="width: 10%;"></td> <td style="width: 10%;"></td> <td style="width: 10%;"></td> <td style="width: 10%;"></td> <td style="width: 10%;"></td> </tr> <tr> <td></td> <td></td> <td colspan="8" style="text-align: center;"> <table border="1" style="width: 100%; border-collapse: collapse; text-align: center;"> <tr> <td style="width: 10%;"></td> <td style="width: 10%;"></td> <td style="width: 10%;"></td> <td style="width: 10%;"></td> <td style="width: 10%;"></td> <td style="width: 10%;"></td> <td style="width: 10%;"></td> <td style="width: 10%;"></td> <td style="width: 10%;"></td> <td style="width: 10%;"></td> </tr> <tr> <td></td> <td></td> <td
colspan="8" style="text-align: center;"> <table border="1" style="width: 100%; border-collapse: collapse; text-align: center;"> <tr> <td style="width: 10%;"></td> <td style="width: 10%;"></td> <td style="width: 10%;"></td> <td style="width: 10%;"></td> <td style="width: 10%;"></td> <td style="width: 10%;"></td> <td style="width: 10%;"></td> <td style="width: 10%;"></td> <td style="width: 10%;"></td> <td style="width: 10%;"></td> </tr> <tr> <td></td> <td></td> <td colspan="8" style="text-align: center;"> <table border="1" style="width: 100%; border-collapse: collapse; text-align: center;"> <tr> <td style="width: 10%;"></td> <td style="width: 10%;"></td> <td style="width: 10%;"></td> <td style="width: 10%;"></td> <td style="width: 10%;"></td> <td style="width: 10%;"></td> <td style="width: 10%;"></td> <td style="width: 10%;"></td> <td style="width: 10%;"></td> <td style="width: 10%;"></td> </tr> <tr> <td></td> <td></td> <td colspan="8" style="text-align: center;"> <table border="1" style="width: 100%; border-collapse: collapse; text-align: center;"> <tr> <td style="width: 10%;"></td> <td style="width: 10%;"></td> <td style="width: 10%;"></td> <td style="width: 10%;"></td> <td style="width: 10%;"></td> <td style="width: 10%;"></td> <td style="width: 10%;"></td> <td style="width: 10%;"></td> <td style="width: 10%;"></td> <td style="width: 10%;"></td> </tr> <tr> <td></td> <td></td> <td colspan="8" style="text-align: center;"> <table border="1" style="width: 100%; border-collapse: collapse; text-align: center;"> <tr> <td style="width: 10%;"></td> <td style="width: 10%;"></td> <td style="width: 10%;"></td> <td style="width: 10%;"></td> <td style="width: 10%;"></td> <td style="width: 10%;"></td> <td style="width: 10%;"></td> <td style="width: 10%;"></td> <td style="width: 10%;"></td> <td style="width: 10%;"></td> </tr> <tr> <td></td> <td></td> <td colspan="8" style="text-align: center;"> <table border="1" style="width: 100%; border-collapse: collapse; text-align: center;"> <tr> <td style="width: 10%;"></td> <td style="width: 10%;"></td> <td style="width: 10%;"></td> <td style="width: 10%;"></td> <td style="width: 10%;"></td> <td style="width: 10%;"></td> <td style="width: 10%;"></td> <td style="width: 10%;"></td> <td style="width: 10%;"></td> <td style="width: 10%;"></td> </tr> <tr> <td></td> <td></td> <td colspan="8" style="text-align: center;"> <table border="1" style="width: 100%; border-collapse: collapse; text-align: center;"> <tr> </tr></table></td></tr></table></td></tr></table></td></tr></table></td></tr></table></td></tr></table></td></tr></table></td></tr></table></td></tr></table></td></tr></table></td></tr></table></td></tr></table></td></tr></table></td></tr></table></td></tr></table></td></tr></table></td></tr></table></td></tr></table></td></tr></table></td></tr></table></td></tr></table></td></tr></table></td></tr></table>

 | | | | | | | | | | | | | | | | | | | | <table border="1" style="width: 100%; border-collapse: collapse; text-align: center;"> <tr> <td style="width: 10%;"></td> <td style="width: 10%;"></td> <td style="width: 10%;"></td> <td style="width: 10%;"></td> <td style="width: 10%;"></td> <td style="width: 10%;"></td> <td style="width: 10%;"></td> <td style="width: 10%;"></td> <td style="width: 10%;"></td> <td style="width: 10%;"></td> </tr> <tr> <td></td> <td></td> <td colspan="8" style="text-align: center;"> <table border="1" style="width: 100%; border-collapse: collapse; text-align: center;"> <tr> <td style="width: 10%;"></td> <td style="width: 10%;"></td> <td style="width: 10%;"></td> <td style="width: 10%;"></td> <td style="width: 10%;"></td> <td style="width: 10%;"></td> <td style="width: 10%;"></td> <td style="width: 10%;"></td> <td style="width: 10%;"></td> <td style="width: 10%;"></td> </tr> <tr> <td></td> <td></td> <td colspan="8" style="text-align: center;"> <table border="1" style="width: 100%; border-collapse: collapse; text-align: center;"> <tr> <td style="width: 10%;"></td> <td style="width: 10%;"></td> <td style="width: 10%;"></td> <td style="width: 10%;"></td> <td style="width: 10%;"></td> <td style="width: 10%;"></td> <td style="width: 10%;"></td> <td style="width: 10%;"></td> <td style="width: 10%;"></td> <td style="width: 10%;"></td> </tr> <tr> <td></td> <td></td> <td colspan="8" style="text-align: center;"> <table border="1" style="width: 100%; border-collapse: collapse; text-align: center;"> <tr> <td style="width: 10%;"></td> <td style="width: 10%;"></td> <td style="width: 10%;"></td> <td style="width: 10%;"></td> <td style="width: 10%;"></td> <td style="width: 10%;"></td> <td style="width: 10%;"></td> <td style="width: 10%;"></td> <td style="width: 10%;"></td> <td style="width: 10%;"></td> </tr> <tr> <td></td> <td></td> <td colspan="8" style="text-align: center;"> <table border="1" style="width: 100%; border-collapse: collapse; text-align: center;"> <tr> <td style="width: 10%;"></td> <td style="width: 10%;"></td> <td style="width: 10%;"></td> <td style="width: 10%;"></td> <td style="width: 10%;"></td> <td style="width: 10%;"></td> <td style="width: 10%;"></td> <td style="width: 10%;"></td> <td style="width: 10%;"></td> <td style="width: 10%;"></td> </tr> <tr> <td></td> <td></td> <td colspan="8" style="text-align: center;"> <table border="1" style="width: 100%; border-collapse: collapse; text-align: center;"> <tr> <td style="width: 10%;"></td> <td style="width: 10%;"></td> <td style="width: 10%;"></td> <td style="width: 10%;"></td> <td style="width: 10%;"></td> <td style="width: 10%;"></td> <td style="width: 10%;"></td> <td style="width: 10%;"></td> <td style="width: 10%;"></td> <td style="width: 10%;"></td> </tr> <tr> <td></td> <td></td> <td colspan="8" style="text-align: center;"> <table border="1" style="width: 100%; border-collapse: collapse; text-align: center;"> <tr> <td style="width: 10%;"></td> <td style="width: 10%;"></td> <td style="width: 10%;"></td> <td style="width: 10%;"></td> <td style="width: 10%;"></td> <td style="width: 10%;"></td> <td style="width: 10%;"></td> <td style="width: 10%;"></td> <td style="width: 10%;"></td> <td style="width: 10%;"></td> </tr> <tr> <td></td> <td></td> <td colspan="8" style="text-align: center;"> <table border="1" style="width: 100%; border-collapse: collapse; text-align: center;"> <tr> <td style="width: 10%;"></td> <td style="width: 10%;"></td> <td style="width: 10%;"></td> <td style="width: 10%;"></td> <td style="width: 10%;"></td> <td style="width: 10%;"></td> <td style="width: 10%;"></td> <td style="width: 10%;"></td> <td style="width: 10%;"></td> <td style="width: 10%;"></td> </tr> <tr> <td></td> <td></td> <td colspan="8" style="text-align: center;"> <table border="1" style="width: 100%; border-collapse: collapse; text-align: center;"> <tr> <td style="width: 10%;"></td> <td style="width: 10%;"></td> <td style="width: 10%;"></td> <td style="width: 10%;"></td> <td style="width: 10%;"></td> <td style="width: 10%;"></td> <td style="width: 10%;"></td> <td style="width: 10%;"></td> <td style="width: 10%;"></td> <td style="width: 10%;"></td> </tr> <tr> <td></td> <td></td> <td colspan="8" style="text-align: center;"> <table border="1" style="width: 100%; border-collapse: collapse; text-align: center;"> <tr> <td style="width: 10%;"></td> <td style="width: 10%;"></td> <td style="width: 10%;"></td> <td style="width: 10%;"></td> <td style="width: 10%;"></td> <td style="width: 10%;"></td> <td style="width: 10%;"></td> <td style="width: 10%;"></td> <td style="width: 10%;"></td> <td style="width: 10%;"></td> </tr> <tr> <td></td> <td></td> <td colspan="8" style="text-align: center;"> <table border="1" style="width: 100%; border-collapse: collapse; text-align: center;"> <tr> <td style="width: 10%;"></td> <td style="width: 10%;"></td> <td style="width: 10%;"></td> <td style="width: 10%;"></td> <td style="width: 10%;"></td> <td style="width: 10%;"></td> <td style="width: 10%;"></td> <td style="width: 10%;"></td> <td style="width: 10%;"></td> <td style="width: 10%;"></td> </tr> <tr> <td></td> <td></td> <td colspan="8" style="text-align: center;"> <table border="1" style="width: 100%; border-collapse: collapse; text-align: center;"> <tr> <td style="width: 10%;"></td> <td style="width: 10%;"></td> <td style="width: 10%;"></td> <td style="width: 10%;"></td> <td style="width: 10%;"></td> <td style="width: 10%;"></td> <td style="width: 10%;"></td> <td style="width: 10%;"></td> <td style="width: 10%;"></td> <td style="width: 10%;"></td> </tr> <tr> <td></td> <td></td> <td colspan="8" style="text-align: center;"> <table border="1" style="width: 100%; border-collapse: collapse; text-align: center;"> <tr> <td style="width: 10%;"></td> <td style="width: 10%;"></td> <td style="width: 10%;"></td> <td style="width: 10%;"></td> <td style="width: 10%;"></td> <td style="width: 10%;"></td> <td style="width: 10%;"></td> <td style="width: 10%;"></td> <td style="width: 10%;"></td> <td style="width: 10%;"></td> </tr> <tr> <td></td> <td></td> <td colspan="8" style="text-align: center;"> <table border="1" style="width: 100%; border-collapse: collapse; text-align: center;"> <tr> <td style="width: 10%;"></td> <td style="width: 10%;"></td> <td style="width: 10%;"></td> <td style="width: 10%;"></td> <td style="width: 10%;"></td> <td style="width: 10%;"></td> <td style="width: 10%;"></td> <td style="width: 10%;"></td> <td style="width: 10%;"></td> <td style="width: 10%;"></td> </tr> <tr> <td></td> <td></td> <td colspan="8" style="text-align: center;"> <table border="1" style="width: 100%; border-collapse: collapse; text-align: center;"> <tr> <td style="width: 10%;"></td> <td style="width: 10%;"></td> <td style="width: 10%;"></td> <td style="width: 10%;"></td> <td style="width: 10%;"></td> <td style="width: 10%;"></td> <td style="width: 10%;"></td> <td style="width: 10%;"></td> <td style="width: 10%;"></td> <td style="width: 10%;"></td> </tr> <tr> <td></td> <td></td> <td colspan="8" style="text-align: center;"> <table border="1" style="width: 100%; border-collapse: collapse; text-align: center;"> <tr> <td style="width: 10%;"></td> <td style="width: 10%;"></td> <td style="width: 10%;"></td> <td style="width: 10%;"></td> <td style="width: 10%;"></td> <td style="width: 10%;"></td> <td style="width: 10%;"></td> <td style="width: 10%;"></td> <td style="width: 10%;"></td> <td style="width: 10%;"></td> </tr> <tr> <td></td> <td></td> <td colspan="8" style="text-align: center;"> <table border="1" style="width: 100%; border-collapse: collapse; text-align: center;"> <tr> <td style="width: 10%;"></td> <td
style="width: 10%;"></td> <td style="width: 10%;"></td> <td style="width: 10%;"></td> <td style="width: 10%;"></td> <td style="width: 10%;"></td> <td style="width: 10%;"></td> <td style="width: 10%;"></td> <td style="width: 10%;"></td> <td style="width: 10%;"></td> </tr> <tr> <td></td> <td></td> <td colspan="8" style="text-align: center;"> <table border="1" style="width: 100%; border-collapse: collapse; text-align: center;"> <tr> <td style="width: 10%;"></td> <td style="width: 10%;"></td> <td style="width: 10%;"></td> <td style="width: 10%;"></td> <td style="width: 10%;"></td> <td style="width: 10%;"></td> <td style="width: 10%;"></td> <td style="width: 10%;"></td> <td style="width: 10%;"></td> <td style="width: 10%;"></td> </tr> <tr> <td></td> <td></td> <td colspan="8" style="text-align: center;"> <table border="1" style="width: 100%; border-collapse: collapse; text-align: center;"> <tr> <td style="width: 10%;"></td> <td style="width: 10%;"></td> <td style="width: 10%;"></td> <td style="width: 10%;"></td> <td style="width: 10%;"></td> <td style="width: 10%;"></td> <td style="width: 10%;"></td> <td style="width: 10%;"></td> <td style="width: 10%;"></td> <td style="width: 10%;"></td> </tr> <tr> <td></td> <td></td> <td colspan="8" style="text-align: center;"> <table border="1" style="width: 100%; border-collapse: collapse; text-align: center;"> <tr> <td style="width: 10%;"></td> <td style="width: 10%;"></td> <td style="width: 10%;"></td> <td style="width: 10%;"></td> <td style="width: 10%;"></td> <td style="width: 10%;"></td> <td style="width: 10%;"></td> <td style="width: 10%;"></td> <td style="width: 10%;"></td> <td style="width: 10%;"></td> </tr> <tr> <td></td> <td></td> <td colspan="8" style="text-align: center;"> <table border="1" style="width: 100%; border-collapse: collapse; text-align: center;"> <tr> <td style="width: 10%;"></td> <td style="width: 10%;"></td> <td style="width: 10%;"></td> <td style="width: 10%;"></td> <td style="width: 10%;"></td> <td style="width: 10%;"></td> <td style="width: 10%;"></td> <td style="width: 10%;"></td> <td style="width: 10%;"></td> <td style="width: 10%;"></td> </tr> <tr> <td></td> <td></td> <td colspan="8" style="text-align: center;"> <table border="1" style="width: 100%; border-collapse: collapse; text-align: center;"> <tr> </tr></table></td></tr></table></td></tr></table></td></tr></table></td></tr></table></td></tr></table></td></tr></table></td></tr></table></td></tr></table></td></tr></table></td></tr></table></td></tr></table></td></tr></table></td></tr></table></td></tr></table></td></tr></table></td></tr></table></td></tr></table></td></tr></table></td></tr></table></td></tr></table></td></tr></table>

 | | | | | | | | | | | | | | | | | | | | <table border="1" style="width: 100%; border-collapse: collapse; text-align: center;"> <tr> <td style="width: 10%;"></td> <td style="width: 10%;"></td> <td style="width: 10%;"></td> <td style="width: 10%;"></td> <td style="width: 10%;"></td> <td style="width: 10%;"></td> <td style="width: 10%;"></td> <td style="width: 10%;"></td> <td style="width: 10%;"></td> <td style="width: 10%;"></td> </tr> <tr> <td></td> <td></td> <td colspan="8" style="text-align: center;"> <table border="1" style="width: 100%; border-collapse: collapse; text-align: center;"> <tr> <td style="width: 10%;"></td> <td style="width: 10%;"></td> <td style="width: 10%;"></td> <td style="width: 10%;"></td> <td style="width: 10%;"></td> <td style="width: 10%;"></td> <td style="width: 10%;"></td> <td style="width: 10%;"></td> <td style="width: 10%;"></td> <td style="width: 10%;"></td> </tr> <tr> <td></td> <td></td> <td colspan="8" style="text-align: center;"> <table border="1" style="width: 100%; border-collapse: collapse; text-align: center;"> <tr> <td style="width: 10%;"></td> <td style="width: 10%;"></td> <td style="width: 10%;"></td> <td style="width: 10%;"></td> <td style="width: 10%;"></td> <td style="width: 10%;"></td> <td style="width: 10%;"></td> <td style="width: 10%;"></td> <td style="width: 10%;"></td> <td style="width: 10%;"></td> </tr> <tr> <td></td> <td></td> <td colspan="8" style="text-align: center;"> <table border="1" style="width: 100%; border-collapse: collapse; text-align: center;"> <tr> <td style="width: 10%;"></td> <td style="width: 10%;"></td> <td style="width: 10%;"></td> <td style="width: 10%;"></td> <td style="width: 10%;"></td> <td style="width: 10%;"></td> <td style="width: 10%;"></td> <td style="width: 10%;"></td> <td style="width: 10%;"></td> <td style="width: 10%;"></td> </tr> <tr> <td></td> <td></td> <td colspan="8" style="text-align: center;"> <table border="1" style="width: 100%; border-collapse: collapse; text-align: center;"> <tr> <td style="width: 10%;"></td> <td style="width: 10%;"></td> <td style="width: 10%;"></td> <td style="width: 10%;"></td> <td style="width: 10%;"></td> <td style="width: 10%;"></td> <td style="width: 10%;"></td> <td style="width: 10%;"></td> <td style="width: 10%;"></td> <td style="width: 10%;"></td> </tr> <tr> <td></td> <td></td> <td colspan="8" style="text-align: center;"> <table border="1" style="width: 100%; border-collapse: collapse; text-align: center;"> <tr> <td style="width: 10%;"></td> <td style="width: 10%;"></td> <td style="width: 10%;"></td> <td style="width: 10%;"></td> <td style="width: 10%;"></td> <td style="width: 10%;"></td> <td style="width: 10%;"></td> <td style="width: 10%;"></td> <td style="width: 10%;"></td> <td style="width: 10%;"></td> </tr> <tr> <td></td> <td></td> <td colspan="8" style="text-align: center;"> <table border="1" style="width: 100%; border-collapse: collapse; text-align: center;"> <tr> <td style="width: 10%;"></td> <td style="width: 10%;"></td> <td style="width: 10%;"></td> <td style="width: 10%;"></td> <td style="width: 10%;"></td> <td style="width: 10%;"></td> <td style="width: 10%;"></td> <td style="width: 10%;"></td> <td style="width: 10%;"></td> <td style="width: 10%;"></td> </tr> <tr> <td></td> <td></td> <td colspan="8" style="text-align: center;"> <table border="1" style="width: 100%; border-collapse: collapse; text-align: center;"> <tr> <td style="width: 10%;"></td> <td style="width: 10%;"></td> <td style="width: 10%;"></td> <td style="width: 10%;"></td> <td style="width: 10%;"></td> <td style="width: 10%;"></td> <td style="width: 10%;"></td> <td style="width: 10%;"></td> <td style="width: 10%;"></td> <td style="width: 10%;"></td> </tr> <tr> <td></td> <td></td> <td colspan="8" style="text-align: center;"> <table border="1" style="width: 100%; border-collapse: collapse; text-align: center;"> <tr> <td style="width: 10%;"></td> <td style="width: 10%;"></td> <td style="width: 10%;"></td> <td style="width: 10%;"></td> <td style="width: 10%;"></td> <td style="width: 10%;"></td> <td style="width: 10%;"></td> <td style="width: 10%;"></td> <td style="width: 10%;"></td> <td style="width: 10%;"></td> </tr> <tr> <td></td> <td></td> <td colspan="8" style="text-align: center;"> <table border="1" style="width: 100%; border-collapse: collapse; text-align: center;"> <tr> <td style="width: 10%;"></td> <td style="width: 10%;"></td> <td style="width: 10%;"></td> <td style="width: 10%;"></td> <td style="width: 10%;"></td> <td style="width: 10%;"></td> <td style="width: 10%;"></td> <td style="width: 10%;"></td> <td style="width: 10%;"></td> <td style="width: 10%;"></td> </tr> <tr> <td></td> <td></td> <td colspan="8" style="text-align: center;"> <table border="1" style="width: 100%; border-collapse: collapse; text-align: center;"> <tr> <td style="width: 10%;"></td> <td style="width: 10%;"></td> <td style="width: 10%;"></td> <td style="width: 10%;"></td> <td style="width: 10%;"></td> <td style="width: 10%;"></td> <td style="width: 10%;"></td> <td style="width: 10%;"></td> <td style="width: 10%;"></td> <td style="width: 10%;"></td> </tr> <tr> <td></td> <td></td> <td colspan="8" style="text-align: center;"> <table border="1" style="width: 100%; border-collapse: collapse; text-align: center;"> <tr> <td style="width: 10%;"></td> <td style="width: 10%;"></td> <td style="width: 10%;"></td> <td style="width: 10%;"></td> <td style="width: 10%;"></td> <td style="width: 10%;"></td> <td style="width: 10%;"></td> <td style="width: 10%;"></td> <td style="width: 10%;"></td> <td style="width: 10%;"></td> </tr> <tr> <td></td> <td></td> <td colspan="8" style="text-align: center;"> <table border="1" style="width: 100%; border-collapse: collapse; text-align: center;"> <tr> <td style="width: 10%;"></td> <td style="width: 10%;"></td> <td style="width: 10%;"></td> <td style="width: 10%;"></td> <td style="width: 10%;"></td> <td style="width: 10%;"></td> <td style="width: 10%;"></td> <td style="width: 10%;"></td> <td style="width: 10%;"></td> <td style="width: 10%;"></td> </tr> <tr> <td></td> <td></td> <td colspan="8" style="text-align: center;"> <table border="1" style="width: 100%; border-collapse: collapse; text-align: center;"> <tr> <td style="width: 10%;"></td> <td style="width: 10%;"></td> <td style="width: 10%;"></td> <td style="width: 10%;"></td> <td style="width: 10%;"></td> <td style="width: 10%;"></td> <td style="width: 10%;"></td> <td style="width: 10%;"></td> <td style="width: 10%;"></td> <td style="width: 10%;"></td> </tr> <tr> <td></td> <td></td> <td colspan="8" style="text-align: center;"> <table border="1" style="width: 100%; border-collapse: collapse; text-align: center;"> <tr> <td style="width: 10%;"></td> <td style="width: 10%;"></td> <td style="width: 10%;"></td> <td style="width: 10%;"></td> <td style="width: 10%;"></td> <td style="width: 10%;"></td> <td style="width: 10%;"></td> <td style="width: 10%;"></td> <td style="width: 10%;"></td> <td style="width: 10%;"></td> </tr> <tr> <td></td> <td></td> <td colspan="8" style="text-align: center;"> <table border="1" style="width: 100%; border-collapse: collapse; text-align: center;"> <tr> <td style="width: 10%;"></td> <td style="width: 10%;"></td> <td style="width: 10%;"></td> <td style="width: 10%;"></td> <td style="width: 10%;"></td> <td style="width: 10%;"></td> <td style="width: 10%;"></td> <td style="width: 10%;"></td> <td style="width: 10%;"></td> <td style="width: 10%;"></td> </tr> <tr> <td></td> <td></td> <td colspan="8" style="text-align: center;"> <table border="1" style="width: 100%; border-collapse: collapse; text-align: center;"> <tr> <td style="width: 10%;"></td> <td style="width: 10%;"></td> <td style="width: 10%;"></td> <td style="width: 10%;"></td> <td style="width: 10%;"></td> <td style="width: 10%;"></td> <td style="width: 10%;"></td> <td
style="width: 10%;"></td> <td style="width: 10%;"></td> <td style="width: 10%;"></td> </tr> <tr> <td></td> <td></td> <td colspan="8" style="text-align: center;"> <table border="1" style="width: 100%; border-collapse: collapse; text-align: center;"> <tr> <td style="width: 10%;"></td> <td style="width: 10%;"></td> <td style="width: 10%;"></td> <td style="width: 10%;"></td> <td style="width: 10%;"></td> <td style="width: 10%;"></td> <td style="width: 10%;"></td> <td style="width: 10%;"></td> <td style="width: 10%;"></td> <td style="width: 10%;"></td> </tr> <tr> <td></td> <td></td> <td colspan="8" style="text-align: center;"> <table border="1" style="width: 100%; border-collapse: collapse; text-align: center;"> <tr> <td style="width: 10%;"></td> <td style="width: 10%;"></td> <td style="width: 10%;"></td> <td style="width: 10%;"></td> <td style="width: 10%;"></td> <td style="width: 10%;"></td> <td style="width: 10%;"></td> <td style="width: 10%;"></td> <td style="width: 10%;"></td> <td style="width: 10%;"></td> </tr> <tr> <td></td> <td></td> <td colspan="8" style="text-align: center;"> <table border="1" style="width: 100%; border-collapse: collapse; text-align: center;"> <tr> <td style="width: 10%;"></td> <td style="width: 10%;"></td> <td style="width: 10%;"></td> <td style="width: 10%;"></td> <td style="width: 10%;"></td> <td style="width: 10%;"></td> <td style="width: 10%;"></td> <td style="width: 10%;"></td> <td style="width: 10%;"></td> <td style="width: 10%;"></td> </tr> <tr> <td></td> <td></td> <td colspan="8" style="text-align: center;"> <table border="1" style="width: 100%; border-collapse: collapse; text-align: center;"> <tr> </tr></table></td></tr></table></td></tr></table></td></tr></table></td></tr></table></td></tr></table></td></tr></table></td></tr></table></td></tr></table></td></tr></table></td></tr></table></td></tr></table></td></tr></table></td></tr></table></td></tr></table></td></tr></table></td></tr></table></td></tr></table></td></tr></table></td></tr></table></td></tr></table>

 | | | | | | | | | | | | | | | | | | | | <table border="1" style="width: 100%; border-collapse: collapse; text-align: center;"> <tr> <td style="width: 10%;"></td> <td style="width: 10%;"></td> <td style="width: 10%;"></td> <td style="width: 10%;"></td> <td style="width: 10%;"></td> <td style="width: 10%;"></td> <td style="width: 10%;"></td> <td style="width: 10%;"></td> <td style="width: 10%;"></td> <td style="width: 10%;"></td> </tr> <tr> <td></td> <td></td> <td colspan="8" style="text-align: center;"> <table border="1" style="width: 100%; border-collapse: collapse; text-align: center;"> <tr> <td style="width: 10%;"></td> <td style="width: 10%;"></td> <td style="width: 10%;"></td> <td style="width: 10%;"></td> <td style="width: 10%;"></td> <td style="width: 10%;"></td> <td style="width: 10%;"></td> <td style="width: 10%;"></td> <td style="width: 10%;"></td> <td style="width: 10%;"></td> </tr> <tr> <td></td> <td></td> <td colspan="8" style="text-align: center;"> <table border="1" style="width: 100%; border-collapse: collapse; text-align: center;"> <tr> <td style="width: 10%;"></td> <td style="width: 10%;"></td> <td style="width: 10%;"></td> <td style="width: 10%;"></td> <td style="width: 10%;"></td> <td style="width: 10%;"></td> <td style="width: 10%;"></td> <td style="width: 10%;"></td> <td style="width: 10%;"></td> <td style="width: 10%;"></td> </tr> <tr> <td></td> <td></td> <td colspan="8" style="text-align: center;"> <table border="1" style="width: 100%; border-collapse: collapse; text-align: center;"> <tr> <td style="width: 10%;"></td> <td style="width: 10%;"></td> <td style="width: 10%;"></td> <td style="width: 10%;"></td> <td style="width: 10%;"></td> <td style="width: 10%;"></td> <td style="width: 10%;"></td> <td style="width: 10%;"></td> <td style="width: 10%;"></td> <td style="width: 10%;"></td> </tr> <tr> <td></td> <td></td> <td colspan="8" style="text-align: center;"> <table border="1" style="width: 100%; border-collapse: collapse; text-align: center;"> <tr> <td style="width: 10%;"></td> <td style="width: 10%;"></td> <td style="width: 10%;"></td> <td style="width: 10%;"></td> <td style="width: 10%;"></td> <td style="width: 10%;"></td> <td style="width: 10%;"></td> <td style="width: 10%;"></td> <td style="width: 10%;"></td> <td style="width: 10%;"></td> </tr> <tr> <td></td> <td></td> <td colspan="8" style="text-align: center;"> <table border="1" style="width: 100%; border-collapse: collapse; text-align: center;"> <tr> <td style="width: 10%;"></td> <td style="width: 10%;"></td> <td style="width: 10%;"></td> <td style="width: 10%;"></td> <td style="width: 10%;"></td> <td style="width: 10%;"></td> <td style="width: 10%;"></td> <td style="width: 10%;"></td> <td style="width: 10%;"></td> <td style="width: 10%;"></td> </tr> <tr> <td></td> <td></td> <td colspan="8" style="text-align: center;"> <table border="1" style="width: 100%; border-collapse: collapse; text-align: center;"> <tr> <td style="width: 10%;"></td> <td style="width: 10%;"></td> <td style="width: 10%;"></td> <td style="width: 10%;"></td> <td style="width: 10%;"></td> <td style="width: 10%;"></td> <td style="width: 10%;"></td> <td style="width: 10%;"></td> <td style="width: 10%;"></td> <td style="width: 10%;"></td> </tr> <tr> <td></td> <td></td> <td colspan="8" style="text-align: center;"> <table border="1" style="width: 100%; border-collapse: collapse; text-align: center;"> <tr> <td style="width: 10%;"></td> <td style="width: 10%;"></td> <td style="width: 10%;"></td> <td style="width: 10%;"></td> <td style="width: 10%;"></td> <td style="width: 10%;"></td> <td style="width: 10%;"></td> <td style="width: 10%;"></td> <td style="width: 10%;"></td> <td style="width: 10%;"></td> </tr> <tr> <td></td> <td></td> <td colspan="8" style="text-align: center;"> <table border="1" style="width: 100%; border-collapse: collapse; text-align: center;"> <tr> <td style="width: 10%;"></td> <td style="width: 10%;"></td> <td style="width: 10%;"></td> <td style="width: 10%;"></td> <td style="width: 10%;"></td> <td style="width: 10%;"></td> <td style="width: 10%;"></td> <td style="width: 10%;"></td> <td style="width: 10%;"></td> <td style="width: 10%;"></td> </tr> <tr> <td></td> <td></td> <td colspan="8" style="text-align: center;"> <table border="1" style="width: 100%; border-collapse: collapse; text-align: center;"> <tr> <td style="width: 10%;"></td> <td style="width: 10%;"></td> <td style="width: 10%;"></td> <td style="width: 10%;"></td> <td style="width: 10%;"></td> <td style="width: 10%;"></td> <td style="width: 10%;"></td> <td style="width: 10%;"></td> <td style="width: 10%;"></td> <td style="width: 10%;"></td> </tr> <tr> <td></td> <td></td> <td colspan="8" style="text-align: center;"> <table border="1" style="width: 100%; border-collapse: collapse; text-align: center;"> <tr> <td style="width: 10%;"></td> <td style="width: 10%;"></td> <td style="width: 10%;"></td> <td style="width: 10%;"></td> <td style="width: 10%;"></td> <td style="width: 10%;"></td> <td style="width: 10%;"></td> <td style="width: 10%;"></td> <td style="width: 10%;"></td> <td style="width: 10%;"></td> </tr> <tr> <td></td> <td></td> <td colspan="8" style="text-align: center;"> <table border="1" style="width: 100%; border-collapse: collapse; text-align: center;"> <tr> <td style="width: 10%;"></td> <td style="width: 10%;"></td> <td style="width: 10%;"></td> <td style="width: 10%;"></td> <td style="width: 10%;"></td> <td style="width: 10%;"></td> <td style="width: 10%;"></td> <td style="width: 10%;"></td> <td style="width: 10%;"></td> <td style="width: 10%;"></td> </tr> <tr> <td></td> <td></td> <td colspan="8" style="text-align: center;"> <table border="1" style="width: 100%; border-collapse: collapse; text-align: center;"> <tr> <td style="width: 10%;"></td> <td style="width: 10%;"></td> <td style="width: 10%;"></td> <td style="width: 10%;"></td> <td style="width: 10%;"></td> <td style="width: 10%;"></td> <td style="width: 10%;"></td> <td style="width: 10%;"></td> <td style="width: 10%;"></td> <td style="width: 10%;"></td> </tr> <tr> <td></td> <td></td> <td colspan="8" style="text-align: center;"> <table border="1" style="width: 100%; border-collapse: collapse; text-align: center;"> <tr> <td style="width: 10%;"></td> <td style="width: 10%;"></td> <td style="width: 10%;"></td> <td style="width: 10%;"></td> <td style="width: 10%;"></td> <td style="width: 10%;"></td> <td style="width: 10%;"></td> <td style="width: 10%;"></td> <td style="width: 10%;"></td> <td style="width: 10%;"></td> </tr> <tr> <td></td> <td></td> <td colspan="8" style="text-align: center;"> <table border="1" style="width: 100%; border-collapse: collapse; text-align: center;"> <tr> <td style="width: 10%;"></td> <td style="width: 10%;"></td> <td style="width: 10%;"></td> <td style="width: 10%;"></td> <td style="width: 10%;"></td> <td style="width: 10%;"></td> <td style="width: 10%;"></td> <td style="width: 10%;"></td> <td style="width: 10%;"></td> <td style="width: 10%;"></td> </tr> <tr> <td></td> <td></td> <td colspan="8" style="text-align: center;"> <table border="1" style="width: 100%; border-collapse: collapse; text-align: center;"> <tr> <td style="width: 10%;"></td> <td style="width: 10%;"></td> <td style="width: 10%;"></td> <td style="width: 10%;"></td> <td style="width: 10%;"></td> <td style="width: 10%;"></td> <td style="width: 10%;"></td> <td style="width: 10%;"></td> <td style="width: 10%;"></td> <td style="width: 10%;"></td> </tr> <tr> <td></td> <td></td> <td colspan="8" style="text-align: center;"> <table border="1" style="width: 100%; border-collapse: collapse; text-align: center;"> <tr> <td style="width: 10%;"></td> <td style="width: 10%;"></td> <td style="width: 10%;"></td> <td style="width: 10%;"></td> <td style="width: 10%;"></td> <td style="width: 10%;"></td> <td style="width: 10%;"></td> <td style="width: 10%;"></td> <td style="width: 10%;"></td> <td style="width: 10%;"></td> </tr> <tr> <td></td> <td></td> <td colspan="8" style="text-align: center;"> <table border="1" style="width: 100%; border-collapse: collapse; text-align: center;"> <tr> <td style="width: 10%;"></td> <td style="width: 10%;"></td> <td style="width: 10%;"></td> <td style="width: 10%;"></td> <td style="width: 10%;"></td> <td style="width: 10%;"></td> <td style="width: 10%;"></td> <td style="width: 10%;"></td> <td style="width: 10%;"></td> <td style="width: 10%;"></td> </tr> <tr> <td></td> <td></td> <td colspan="8" style="text-align: center;"> <table border="1" style="width: 100%;
border-collapse: collapse; text-align: center;"> <tr> <td style="width: 10%;"></td> <td style="width: 10%;"></td> <td style="width: 10%;"></td> <td style="width: 10%;"></td> <td style="width: 10%;"></td> <td style="width: 10%;"></td> <td style="width: 10%;"></td> <td style="width: 10%;"></td> <td style="width: 10%;"></td> <td style="width: 10%;"></td> </tr> <tr> <td></td> <td></td> <td colspan="8" style="text-align: center;"> <table border="1" style="width: 100%; border-collapse: collapse; text-align: center;"> <tr> </tr></table></td></tr></table></td></tr></table></td></tr></table></td></tr></table></td></tr></table></td></tr></table></td></tr></table></td></tr></table></td></tr></table></td></tr></table></td></tr></table></td></tr></table></td></tr></table></td></tr></table></td></tr></table></td></tr></table></td></tr></table></td></tr></table></td></tr></table>

 | | | | | | | | | | | | | | | | | | | | <table border="1" style="width: 100%; border-collapse: collapse; text-align: center;"> <tr> <td style="width: 10%;"></td> <td style="width: 10%;"></td> <td style="width: 10%;"></td> <td style="width: 10%;"></td> <td style="width: 10%;"></td> <td style="width: 10%;"></td> <td style="width: 10%;"></td> <td style="width: 10%;"></td> <td style="width: 10%;"></td> <td style="width: 10%;"></td> </tr> <tr> <td></td> <td></td> <td colspan="8" style="text-align: center;"> <table border="1" style="width: 100%; border-collapse: collapse; text-align: center;"> <tr> <td style="width: 10%;"></td> <td style="width: 10%;"></td> <td style="width: 10%;"></td> <td style="width: 10%;"></td> <td style="width: 10%;"></td> <td style="width: 10%;"></td> <td style="width: 10%;"></td> <td style="width: 10%;"></td> <td style="width: 10%;"></td> <td style="width: 10%;"></td> </tr> <tr> <td></td> <td></td> <td colspan="8" style="text-align: center;"> <table border="1" style="width: 100%; border-collapse: collapse; text-align: center;"> <tr> <td style="width: 10%;"></td> <td style="width: 10%;"></td> <td style="width: 10%;"></td> <td style="width: 10%;"></td> <td style="width: 10%;"></td> <td style="width: 10%;"></td> <td style="width: 10%;"></td> <td style="width: 10%;"></td> <td style="width: 10%;"></td> <td style="width: 10%;"></td> </tr> <tr> <td></td> <td></td> <td colspan="8" style="text-align: center;"> <table border="1" style="width: 100%; border-collapse: collapse; text-align: center;"> <tr> <td style="width: 10%;"></td> <td style="width: 10%;"></td> <td style="width: 10%;"></td> <td style="width: 10%;"></td> <td style="width: 10%;"></td> <td style="width: 10%;"></td> <td style="width: 10%;"></td> <td style="width: 10%;"></td> <td style="width: 10%;"></td> <td style="width: 10%;"></td> </tr> <tr> <td></td> <td></td> <td colspan="8" style="text-align: center;"> <table border="1" style="width: 100%; border-collapse: collapse; text-align: center;"> <tr> <td style="width: 10%;"></td> <td style="width: 10%;"></td> <td style="width: 10%;"></td> <td style="width: 10%;"></td> <td style="width: 10%;"></td> <td style="width: 10%;"></td> <td style="width: 10%;"></td> <td style="width: 10%;"></td> <td style="width: 10%;"></td> <td style="width: 10%;"></td> </tr> <tr> <td></td> <td></td> <td colspan="8" style="text-align: center;"> <table border="1" style="width: 100%; border-collapse: collapse; text-align: center;"> <tr> <td style="width: 10%;"></td> <td style="width: 10%;"></td> <td style="width: 10%;"></td> <td style="width: 10%;"></td> <td style="width: 10%;"></td> <td style="width: 10%;"></td> <td style="width: 10%;"></td> <td style="width: 10%;"></td> <td style="width: 10%;"></td> <td style="width: 10%;"></td> </tr> <tr> <td></td> <td></td> <td colspan="8" style="text-align: center;"> <table border="1" style="width: 100%; border-collapse: collapse; text-align: center;"> <tr> <td style="width: 10%;"></td> <td style="width: 10%;"></td> <td style="width: 10%;"></td> <td style="width: 10%;"></td> <td style="width: 10%;"></td> <td style="width: 10%;"></td> <td style="width: 10%;"></td> <td style="width: 10%;"></td> <td style="width: 10%;"></td> <td style="width: 10%;"></td> </tr> <tr> <td></td> <td></td> <td colspan="8" style="text-align: center;"> <table border="1" style="width: 100%; border-collapse: collapse; text-align: center;"> <tr> <td style="width: 10%;"></td> <td style="width: 10%;"></td> <td style="width: 10%;"></td> <td style="width: 10%;"></td> <td style="width: 10%;"></td> <td style="width: 10%;"></td> <td style="width: 10%;"></td> <td style="width: 10%;"></td> <td style="width: 10%;"></td> <td style="width: 10%;"></td> </tr> <tr> <td></td> <td></td> <td colspan="8" style="text-align: center;"> <table border="1" style="width: 100%; border-collapse: collapse; text-align: center;"> <tr> <td style="width: 10%;"></td> <td style="width: 10%;"></td> <td style="width: 10%;"></td> <td style="width: 10%;"></td> <td style="width: 10%;"></td> <td style="width: 10%;"></td> <td style="width: 10%;"></td> <td style="width: 10%;"></td> <td style="width: 10%;"></td> <td style="width: 10%;"></td> </tr> <tr> <td></td> <td></td> <td colspan="8" style="text-align: center;"> <table border="1" style="width: 100%; border-collapse: collapse; text-align: center;"> <tr> <td style="width: 10%;"></td> <td style="width: 10%;"></td> <td style="width: 10%;"></td> <td style="width: 10%;"></td> <td style="width: 10%;"></td> <td style="width: 10%;"></td> <td style="width: 10%;"></td> <td style="width: 10%;"></td> <td style="width: 10%;"></td> <td style="width: 10%;"></td> </tr> <tr> <td></td> <td></td> <td colspan="8" style="text-align: center;"> <table border="1" style="width: 100%; border-collapse: collapse; text-align: center;"> <tr> <td style="width: 10%;"></td> <td style="width: 10%;"></td> <td style="width: 10%;"></td> <td style="width: 10%;"></td> <td style="width: 10%;"></td> <td style="width: 10%;"></td> <td style="width: 10%;"></td> <td style="width: 10%;"></td> <td style="width: 10%;"></td> <td style="width: 10%;"></td> </tr> <tr> <td></td> <td></td> <td colspan="8" style="text-align: center;"> <table border="1" style="width: 100%; border-collapse: collapse; text-align: center;"> <tr> <td style="width: 10%;"></td> <td style="width: 10%;"></td> <td style="width: 10%;"></td> <td style="width: 10%;"></td> <td style="width: 10%;"></td> <td style="width: 10%;"></td> <td style="width: 10%;"></td> <td style="width: 10%;"></td> <td style="width: 10%;"></td> <td style="width: 10%;"></td> </tr> <tr> <td></td> <td></td> <td colspan="8" style="text-align: center;"> <table border="1" style="width: 100%; border-collapse: collapse; text-align: center;"> <tr> <td style="width: 10%;"></td> <td style="width: 10%;"></td> <td style="width: 10%;"></td> <td style="width: 10%;"></td> <td style="width: 10%;"></td> <td style="width: 10%;"></td> <td style="width: 10%;"></td> <td style="width: 10%;"></td> <td style="width: 10%;"></td> <td style="width: 10%;"></td> </tr> <tr> <td></td> <td></td> <td colspan="8" style="text-align: center;"> <table border="1" style="width: 100%; border-collapse: collapse; text-align: center;"> <tr> <td style="width: 10%;"></td> <td style="width: 10%;"></td> <td style="width: 10%;"></td> <td style="width: 10%;"></td> <td style="width: 10%;"></td> <td style="width: 10%;"></td> <td style="width: 10%;"></td> <td style="width: 10%;"></td> <td style="width: 10%;"></td> <td style="width: 10%;"></td> </tr> <tr> <td></td> <td></td> <td colspan="8" style="text-align: center;"> <table border="1" style="width: 100%; border-collapse: collapse; text-align: center;"> <tr> <td style="width: 10%;"></td> <td style="width: 10%;"></td> <td style="width: 10%;"></td> <td style="width: 10%;"></td> <td style="width: 10%;"></td> <td style="width: 10%;"></td> <td style="width: 10%;"></td> <td style="width: 10%;"></td> <td style="width: 10%;"></td> <td style="width: 10%;"></td> </tr> <tr> <td></td> <td></td> <td colspan="8" style="text-align: center;"> <table border="1" style="width: 100%; border-collapse: collapse; text-align: center;"> <tr> <td style="width: 10%;"></td> <td style="width: 10%;"></td> <td style="width: 10%;"></td> <td style="width: 10%;"></td> <td style="width: 10%;"></td> <td style="width: 10%;"></td> <td style="width: 10%;"></td> <td style="width: 10%;"></td> <td style="width: 10%;"></td> <td style="width: 10%;"></td> </tr> <tr> <td></td> <td></td> <td colspan="8" style="text-align: center;"> <table border="1" style="width: 100%; border-collapse: collapse; text-align: center;"> <tr> <td style="width: 10%;"></td> <td style="width: 10%;"></td> <td style="width: 10%;"></td> <td style="width: 10%;"></td> <td style="width: 10%;"></td> <td style="width: 10%;"></td> <td style="width: 10%;"></td> <td style="width: 10%;"></td> <td style="width: 10%;"></td> <td style="width: 10%;"></td> </tr> <tr> <td></td> <td></td> <td colspan="8" style="text-align: center;"> <table border="1" style="width: 100%; border-collapse: collapse; text-align: center;"> <tr> <td style="width: 10%;"></td> <td style="width: 10%;"></td> <td style="width: 10%;"></td> <td style="width: 10%;"></td> <td style="width: 10%;"></td> <td style="width: 10%;"></td> <td style="width: 10%;"></td> <td style="width: 10%;"></td> <td style="width: 10%;"></td> <td style="width: 10%;"></td> </tr> <tr> <td></td> <td></td> <td colspan="8" style="text-align: center;"> <table border="1" style="width: 100%; border-collapse: collapse; text-align: center;"> <tr> </tr></table></td></tr></table></td></tr></table></td></tr></table></td></tr></table></td></tr></table></td></tr></table></td></tr></table></td></tr></table></td></tr></table></td></tr></table></td></tr></table></td></tr></table></td></tr></table></td></tr></table></td></tr></table></td></tr></table></td></tr></table></td></tr></table>

 | | | | | | | | | | | | | | | | | | | | <table border="1" style="width: 100%; border-collapse: collapse; text-align: center;"> <tr> <td style="width: 10%;"></td> <td style="width: 10%;"></td> <td style="width: 10%;"></td> <td style="width: 10%;"></td> <td style="width: 10%;"></td> <td style="width: 10%;"></td> <td style="width: 10%;"></td> <td style="width: 10%;"></td> <td style="width: 10%;"></td> <td style="width: 10%;"></td> </tr> <tr> <td></td> <td></td> <td colspan="8" style="text-align: center;"> <table border="1" style="width: 100%; border-collapse: collapse; text-align: center;"> <tr> <td style="width: 10%;"></td> <td style="width: 10%;"></td> <td style="width: 10%;"></td> <td style="width: 10%;"></td> <td style="width: 10%;"></td> <td style="width: 10%;"></td> <td style="width: 10%;"></td> <td style="width: 10%;"></td> <td style="width: 10%;"></td> <td style="width: 10%;"></td> </tr> <tr> <td></td> <td></td> <td colspan="8" style="text-align: center;"> <table border="1" style="width: 100%; border-collapse: collapse; text-align: center;"> <tr> <td style="width: 10%;"></td> <td style="width: 10%;"></td> <td style="width: 10%;"></td> <td style="width: 10%;"></td> <td style="width: 10%;"></td> <td style="width: 10%;"></td> <td style="width: 10%;"></td> <td style="width: 10%;"></td>
<td style="width: 10%;"></td> <td style="width: 10%;"></td> </tr> <tr> <td></td> <td></td> <td colspan="8" style="text-align: center;"> <table border="1" style="width: 100%; border-collapse: collapse; text-align: center;"> <tr> <td style="width: 10%;"></td> <td style="width: 10%;"></td> <td style="width: 10%;"></td> <td style="width: 10%;"></td> <td style="width: 10%;"></td> <td style="width: 10%;"></td> <td style="width: 10%;"></td> <td style="width: 10%;"></td> <td style="width: 10%;"></td> <td style="width: 10%;"></td> </tr> <tr> <td></td> <td></td> <td colspan="8" style="text-align: center;"> <table border="1" style="width: 100%; border-collapse: collapse; text-align: center;"> <tr> <td style="width: 10%;"></td> <td style="width: 10%;"></td> <td style="width: 10%;"></td> <td style="width: 10%;"></td> <td style="width: 10%;"></td> <td style="width: 10%;"></td> <td style="width: 10%;"></td> <td style="width: 10%;"></td> <td style="width: 10%;"></td> <td style="width: 10%;"></td> </tr> <tr> <td></td> <td></td> <td colspan="8" style="text-align: center;"> <table border="1" style="width: 100%; border-collapse: collapse; text-align: center;"> <tr> <td style="width: 10%;"></td> <td style="width: 10%;"></td> <td style="width: 10%;"></td> <td style="width: 10%;"></td> <td style="width: 10%;"></td> <td style="width: 10%;"></td> <td style="width: 10%;"></td> <td style="width: 10%;"></td> <td style="width: 10%;"></td> <td style="width: 10%;"></td> </tr> <tr> <td></td> <td></td> <td colspan="8" style="text-align: center;"> <table border="1" style="width: 100%; border-collapse: collapse; text-align: center;"> <tr> <td style="width: 10%;"></td> <td style="width: 10%;"></td> <td style="width: 10%;"></td> <td style="width: 10%;"></td> <td style="width: 10%;"></td> <td style="width: 10%;"></td> <td style="width: 10%;"></td> <td style="width: 10%;"></td> <td style="width: 10%;"></td> <td style="width: 10%;"></td> </tr> <tr> <td></td> <td></td> <td colspan="8" style="text-align: center;"> <table border="1" style="width: 100%; border-collapse: collapse; text-align: center;"> <tr> <td style="width: 10%;"></td> <td style="width: 10%;"></td> <td style="width: 10%;"></td> <td style="width: 10%;"></td> <td style="width: 10%;"></td> <td style="width: 10%;"></td> <td style="width: 10%;"></td> <td style="width: 10%;"></td> <td style="width: 10%;"></td> <td style="width: 10%;"></td> </tr> <tr> <td></td> <td></td> <td colspan="8" style="text-align: center;"> <table border="1" style="width: 100%; border-collapse: collapse; text-align: center;"> <tr> <td style="width: 10%;"></td> <td style="width: 10%;"></td> <td style="width: 10%;"></td> <td style="width: 10%;"></td> <td style="width: 10%;"></td> <td style="width: 10%;"></td> <td style="width: 10%;"></td> <td style="width: 10%;"></td> <td style="width: 10%;"></td> <td style="width: 10%;"></td> </tr> <tr> <td></td> <td></td> <td colspan="8" style="text-align: center;"> <table border="1" style="width: 100%; border-collapse: collapse; text-align: center;"> <tr> <td style="width: 10%;"></td> <td style="width: 10%;"></td> <td style="width: 10%;"></td> <td style="width: 10%;"></td> <td style="width: 10%;"></td> <td style="width: 10%;"></td> <td style="width: 10%;"></td> <td style="width: 10%;"></td> <td style="width: 10%;"></td> <td style="width: 10%;"></td> </tr> <tr> <td></td> <td></td> <td colspan="8" style="text-align: center;"> <table border="1" style="width: 100%; border-collapse: collapse; text-align: center;"> <tr> <td style="width: 10%;"></td> <td style="width: 10%;"></td> <td style="width: 10%;"></td> <td style="width: 10%;"></td> <td style="width: 10%;"></td> <td style="width: 10%;"></td> <td style="width: 10%;"></td> <td style="width: 10%;"></td> <td style="width: 10%;"></td> <td style="width: 10%;"></td> </tr> <tr> <td></td> <td></td> <td colspan="8" style="text-align: center;"> <table border="1" style="width: 100%; border-collapse: collapse; text-align: center;"> <tr> <td style="width: 10%;"></td> <td style="width: 10%;"></td> <td style="width: 10%;"></td> <td style="width: 10%;"></td> <td style="width: 10%;"></td> <td style="width: 10%;"></td> <td style="width: 10%;"></td> <td style="width: 10%;"></td> <td style="width: 10%;"></td> <td style="width: 10%;"></td> </tr> <tr> <td></td> <td></td> <td colspan="8" style="text-align: center;"> <table border="1" style="width: 100%; border-collapse: collapse; text-align: center;"> <tr> <td style="width: 10%;"></td> <td style="width: 10%;"></td> <td style="width: 10%;"></td> <td style="width: 10%;"></td> <td style="width: 10%;"></td> <td style="width: 10%;"></td> <td style="width: 10%;"></td> <td style="width: 10%;"></td> <td style="width: 10%;"></td> <td style="width: 10%;"></td> </tr> <tr> <td></td> <td></td> <td colspan="8" style="text-align: center;"> <table border="1" style="width: 100%; border-collapse: collapse; text-align: center;"> <tr> <td style="width: 10%;"></td> <td style="width: 10%;"></td> <td style="width: 10%;"></td> <td style="width: 10%;"></td> <td style="width: 10%;"></td> <td style="width: 10%;"></td> <td style="width: 10%;"></td> <td style="width: 10%;"></td> <td style="width: 10%;"></td> <td style="width: 10%;"></td> </tr> <tr> <td></td> <td></td> <td colspan="8" style="text-align: center;"> <table border="1" style="width: 100%; border-collapse: collapse; text-align: center;"> <tr> <td style="width: 10%;"></td> <td style="width: 10%;"></td> <td style="width: 10%;"></td> <td style="width: 10%;"></td> <td style="width: 10%;"></td> <td style="width: 10%;"></td> <td style="width: 10%;"></td> <td style="width: 10%;"></td> <td style="width: 10%;"></td> <td style="width: 10%;"></td> </tr> <tr> <td></td> <td></td> <td colspan="8" style="text-align: center;"> <table border="1" style="width: 100%; border-collapse: collapse; text-align: center;"> <tr> <td style="width: 10%;"></td> <td style="width: 10%;"></td> <td style="width: 10%;"></td> <td style="width: 10%;"></td> <td style="width: 10%;"></td> <td style="width: 10%;"></td> <td style="width: 10%;"></td> <td style="width: 10%;"></td> <td style="width: 10%;"></td> <td style="width: 10%;"></td> </tr> <tr> <td></td> <td></td> <td colspan="8" style="text-align: center;"> <table border="1" style="width: 100%; border-collapse: collapse; text-align: center;"> <tr> <td style="width: 10%;"></td> <td style="width: 10%;"></td> <td style="width: 10%;"></td> <td style="width: 10%;"></td> <td style="width: 10%;"></td> <td style="width: 10%;"></td> <td style="width: 10%;"></td> <td style="width: 10%;"></td> <td style="width: 10%;"></td> <td style="width: 10%;"></td> </tr> <tr> <td></td> <td></td> <td colspan="8" style="text-align: center;"> <table border="1" style="width: 100%; border-collapse: collapse; text-align: center;"> <tr> </tr></table></td></tr></table></td></tr></table></td></tr></table></td></tr></table></td></tr></table></td></tr></table></td></tr></table></td></tr></table></td></tr></table></td></tr></table></td></tr></table></td></tr></table></td></tr></table></td></tr></table></td></tr></table></td></tr></table></td></tr></table>

 | | | | | | | | | | | | | | | | | | | | <table border="1" style="width: 100%; border-collapse: collapse; text-align: center;"> <tr> <td style="width: 10%;"></td> <td style="width: 10%;"></td> <td style="width: 10%;"></td> <td style="width: 10%;"></td> <td style="width: 10%;"></td> <td style="width: 10%;"></td> <td style="width: 10%;"></td> <td style="width: 10%;"></td> <td style="width: 10%;"></td> <td style="width: 10%;"></td> </tr> <tr> <td></td> <td></td> <td colspan="8" style="text-align: center;"> <table border="1" style="width: 100%; border-collapse: collapse; text-align: center;"> <tr> <td style="width: 10%;"></td> <td style="width: 10%;"></td> <td style="width: 10%;"></td> <td style="width: 10%;"></td> <td style="width: 10%;"></td> <td style="width: 10%;"></td> <td style="width: 10%;"></td> <td style="width: 10%;"></td> <td style="width: 10%;"></td> <td style="width: 10%;"></td> </tr> <tr> <td></td> <td></td> <td colspan="8" style="text-align: center;"> <table border="1" style="width: 100%; border-collapse: collapse; text-align: center;"> <tr> <td style="width: 10%;"></td> <td style="width: 10%;"></td> <td style="width: 10%;"></td> <td style="width: 10%;"></td> <td style="width: 10%;"></td> <td style="width: 10%;"></td> <td style="width: 10%;"></td> <td style="width: 10%;"></td> <td style="width: 10%;"></td> <td style="width: 10%;"></td> </tr> <tr> <td></td> <td></td> <td colspan="8" style="text-align: center;"> <table border="1" style="width: 100%; border-collapse: collapse; text-align: center;"> <tr> <td style="width: 10%;"></td> <td style="width: 10%;"></td> <td style="width: 10%;"></td> <td style="width: 10%;"></td> <td style="width: 10%;"></td> <td style="width: 10%;"></td> <td style="width: 10%;"></td> <td style="width: 10%;"></td> <td style="width: 10%;"></td> <td style="width: 10%;"></td> </tr> <tr> <td></td> <td></td> <td colspan="8" style="text-align: center;"> <table border="1" style="width: 100%; border-collapse: collapse; text-align: center;"> <tr> <td style="width: 10%;"></td> <td style="width: 10%;"></td> <td style="width: 10%;"></td> <td style="width: 10%;"></td> <td style="width: 10%;"></td> <td style="width: 10%;"></td> <td style="width: 10%;"></td> <td style="width: 10%;"></td> <td style="width: 10%;"></td> <td style="width: 10%;"></td> </tr> <tr> <td></td> <td></td> <td colspan="8" style="text-align: center;"> <table border="1" style="width: 100%; border-collapse: collapse; text-align: center;"> <tr> <td style="width: 10%;"></td> <td style="width: 10%;"></td> <td style="width: 10%;"></td> <td style="width: 10%;"></td> <td style="width: 10%;"></td> <td style="width: 10%;"></td> <td style="width: 10%;"></td> <td style="width: 10%;"></td> <td style="width: 10%;"></td> <td style="width: 10%;"></td> </tr> <tr> <td></td> <td></td> <td colspan="8" style="text-align: center;"> <table border="1" style="width: 100%; border-collapse: collapse; text-align: center;"> <tr> <td style="width: 10%;"></td> <td style="width: 10%;"></td> <td style="width: 10%;"></td> <td style="width: 10%;"></td> <td style="width: 10%;"></td> <td style="width: 10%;"></td> <td style="width: 10%;"></td> <td style="width: 10%;"></td> <td style="width: 10%;"></td> <td style="width: 10%;"></td> </tr> <tr> <td></td> <td></td> <td colspan="8" style="text-align: center;"> <table border="1" style="width: 100%; border-collapse: collapse; text-align: center;"> <tr> <td style="width: 10%;"></td>
<td style="width: 10%;"></td> <td style="width: 10%;"></td> <td style="width: 10%;"></td> <td style="width: 10%;"></td> <td style="width: 10%;"></td> <td style="width: 10%;"></td> <td style="width: 10%;"></td> <td style="width: 10%;"></td> <td style="width: 10%;"></td> </tr> <tr> <td></td> <td></td> <td colspan="8" style="text-align: center;"> <table border="1" style="width: 100%; border-collapse: collapse; text-align: center;"> <tr> <td style="width: 10%;"></td> <td style="width: 10%;"></td> <td style="width: 10%;"></td> <td style="width: 10%;"></td> <td style="width: 10%;"></td> <td style="width: 10%;"></td> <td style="width: 10%;"></td> <td style="width: 10%;"></td> <td style="width: 10%;"></td> <td style="width: 10%;"></td> </tr> <tr> <td></td> <td></td> <td colspan="8" style="text-align: center;"> <table border="1" style="width: 100%; border-collapse: collapse; text-align: center;"> <tr> <td style="width: 10%;"></td> <td style="width: 10%;"></td> <td style="width: 10%;"></td> <td style="width: 10%;"></td> <td style="width: 10%;"></td> <td style="width: 10%;"></td> <td style="width: 10%;"></td> <td style="width: 10%;"></td> <td style="width: 10%;"></td> <td style="width: 10%;"></td> </tr> <tr> <td></td> <td></td> <td colspan="8" style="text-align: center;"> <table border="1" style="width: 100%; border-collapse: collapse; text-align: center;"> <tr> <td style="width: 10%;"></td> <td style="width: 10%;"></td> <td style="width: 10%;"></td> <td style="width: 10%;"></td> <td style="width: 10%;"></td> <td style="width: 10%;"></td> <td style="width: 10%;"></td> <td style="width: 10%;"></td> <td style="width: 10%;"></td> <td style="width: 10%;"></td> </tr> <tr> <td></td> <td></td> <td colspan="8" style="text-align: center;"> <table border="1" style="width: 100%; border-collapse: collapse; text-align: center;"> <tr> <td style="width: 10%;"></td> <td style="width: 10%;"></td> <td style="width: 10%;"></td> <td style="width: 10%;"></td> <td style="width: 10%;"></td> <td style="width: 10%;"></td> <td style="width: 10%;"></td> <td style="width: 10%;"></td> <td style="width: 10%;"></td> <td style="width: 10%;"></td> </tr> <tr> <td></td> <td></td> <td colspan="8" style="text-align: center;"> <table border="1" style="width: 100%; border-collapse: collapse; text-align: center;"> <tr> <td style="width: 10%;"></td> <td style="width: 10%;"></td> <td style="width: 10%;"></td> <td style="width: 10%;"></td> <td style="width: 10%;"></td> <td style="width: 10%;"></td> <td style="width: 10%;"></td> <td style="width: 10%;"></td> <td style="width: 10%;"></td> <td style="width: 10%;"></td> </tr> <tr> <td></td> <td></td> <td colspan="8" style="text-align: center;"> <table border="1" style="width: 100%; border-collapse: collapse; text-align: center;"> <tr> <td style="width: 10%;"></td> <td style="width: 10%;"></td> <td style="width: 10%;"></td> <td style="width: 10%;"></td> <td style="width: 10%;"></td> <td style="width: 10%;"></td> <td style="width: 10%;"></td> <td style="width: 10%;"></td> <td style="width: 10%;"></td> <td style="width: 10%;"></td> </tr> <tr> <td></td> <td></td> <td colspan="8" style="text-align: center;"> <table border="1" style="width: 100%; border-collapse: collapse; text-align: center;"> <tr> <td style="width: 10%;"></td> <td style="width: 10%;"></td> <td style="width: 10%;"></td> <td style="width: 10%;"></td> <td style="width: 10%;"></td> <td style="width: 10%;"></td> <td style="width: 10%;"></td> <td style="width: 10%;"></td> <td style="width: 10%;"></td> <td style="width: 10%;"></td> </tr> <tr> <td></td> <td></td> <td colspan="8" style="text-align: center;"> <table border="1" style="width: 100%; border-collapse: collapse; text-align: center;"> <tr> <td style="width: 10%;"></td> <td style="width: 10%;"></td> <td style="width: 10%;"></td> <td style="width: 10%;"></td> <td style="width: 10%;"></td> <td style="width: 10%;"></td> <td style="width: 10%;"></td> <td style="width: 10%;"></td> <td style="width: 10%;"></td> <td style="width: 10%;"></td> </tr> <tr> <td></td> <td></td> <td colspan="8" style="text-align: center;"> <table border="1" style="width: 100%; border-collapse: collapse; text-align: center;"> <tr> </tr></table></td></tr></table></td></tr></table></td></tr></table></td></tr></table></td></tr></table></td></tr></table></td></tr></table></td></tr></table></td></tr></table></td></tr></table></td></tr></table></td></tr></table></td></tr></table></td></tr></table></td></tr></table></td></tr></table>

 | | | | | | | | | | | | | | | | | | | | <table border="1" style="width: 100%; border-collapse: collapse; text-align: center;"> <tr> <td style="width: 10%;"></td> <td style="width: 10%;"></td> <td style="width: 10%;"></td> <td style="width: 10%;"></td> <td style="width: 10%;"></td> <td style="width: 10%;"></td> <td style="width: 10%;"></td> <td style="width: 10%;"></td> <td style="width: 10%;"></td> <td style="width: 10%;"></td> </tr> <tr> <td></td> <td></td> <td colspan="8" style="text-align: center;"> <table border="1" style="width: 100%; border-collapse: collapse; text-align: center;"> <tr> <td style="width: 10%;"></td> <td style="width: 10%;"></td> <td style="width: 10%;"></td> <td style="width: 10%;"></td> <td style="width: 10%;"></td> <td style="width: 10%;"></td> <td style="width: 10%;"></td> <td style="width: 10%;"></td> <td style="width: 10%;"></td> <td style="width: 10%;"></td> </tr> <tr> <td></td> <td></td> <td colspan="8" style="text-align: center;"> <table border="1" style="width: 100%; border-collapse: collapse; text-align: center;"> <tr> <td style="width: 10%;"></td> <td style="width: 10%;"></td> <td style="width: 10%;"></td> <td style="width: 10%;"></td> <td style="width: 10%;"></td> <td style="width: 10%;"></td> <td style="width: 10%;"></td> <td style="width: 10%;"></td> <td style="width: 10%;"></td> <td style="width: 10%;"></td> </tr> <tr> <td></td> <td></td> <td colspan="8" style="text-align: center;"> <table border="1" style="width: 100%; border-collapse: collapse; text-align: center;"> <tr> <td style="width: 10%;"></td> <td style="width: 10%;"></td> <td style="width: 10%;"></td> <td style="width: 10%;"></td> <td style="width: 10%;"></td> <td style="width: 10%;"></td> <td style="width: 10%;"></td> <td style="width: 10%;"></td> <td style="width: 10%;"></td> <td style="width: 10%;"></td> </tr> <tr> <td></td> <td></td> <td colspan="8" style="text-align: center;"> <table border="1" style="width: 100%; border-collapse: collapse; text-align: center;"> <tr> <td style="width: 10%;"></td> <td style="width: 10%;"></td> <td style="width: 10%;"></td> <td style="width: 10%;"></td> <td style="width: 10%;"></td> <td style="width: 10%;"></td> <td style="width: 10%;"></td> <td style="width: 10%;"></td> <td style="width: 10%;"></td> <td style="width: 10%;"></td> </tr> <tr> <td></td> <td></td> <td colspan="8" style="text-align: center;"> <table border="1" style="width: 100%; border-collapse: collapse; text-align: center;"> <tr> <td style="width: 10%;"></td> <td style="width: 10%;"></td> <td style="width: 10%;"></td> <td style="width: 10%;"></td> <td style="width: 10%;"></td> <td style="width: 10%;"></td> <td style="width: 10%;"></td> <td style="width: 10%;"></td> <td style="width: 10%;"></td> <td style="width: 10%;"></td> </tr> <tr> <td></td> <td></td> <td colspan="8" style="text-align: center;"> <table border="1" style="width: 100%; border-collapse: collapse; text-align: center;"> <tr> <td style="width: 10%;"></td> <td style="width: 10%;"></td> <td style="width: 10%;"></td> <td style="width: 10%;"></td> <td style="width: 10%;"></td> <td style="width: 10%;"></td> <td style="width: 10%;"></td> <td style="width: 10%;"></td> <td style="width: 10%;"></td> <td style="width: 10%;"></td> </tr> <tr> <td></td> <td></td> <td colspan="8" style="text-align: center;"> <table border="1" style="width: 100%; border-collapse: collapse; text-align: center;"> <tr> <td style="width: 10%;"></td> <td style="width: 10%;"></td> <td style="width: 10%;"></td> <td style="width: 10%;"></td> <td style="width: 10%;"></td> <td style="width: 10%;"></td> <td style="width: 10%;"></td> <td style="width: 10%;"></td> <td style="width: 10%;"></td> <td style="width: 10%;"></td> </tr> <tr> <td></td> <td></td> <td colspan="8" style="text-align: center;"> <table border="1" style="width: 100%; border-collapse: collapse; text-align: center;"> <tr> <td style="width: 10%;"></td> <td style="width: 10%;"></td> <td style="width: 10%;"></td> <td style="width: 10%;"></td> <td style="width: 10%;"></td> <td style="width: 10%;"></td> <td style="width: 10%;"></td> <td style="width: 10%;"></td> <td style="width: 10%;"></td> <td style="width: 10%;"></td> </tr> <tr> <td></td> <td></td> <td colspan="8" style="text-align: center;"> <table border="1" style="width: 100%; border-collapse: collapse; text-align: center;"> <tr> <td style="width: 10%;"></td> <td style="width: 10%;"></td> <td style="width: 10%;"></td> <td style="width: 10%;"></td> <td style="width: 10%;"></td> <td style="width: 10%;"></td> <td style="width: 10%;"></td> <td style="width: 10%;"></td> <td style="width: 10%;"></td> <td style="width: 10%;"></td> </tr> <tr> <td></td> <td></td> <td colspan="8" style="text-align: center;"> <table border="1" style="width: 100%; border-collapse: collapse; text-align: center;"> <tr> <td style="width: 10%;"></td> <td style="width: 10%;"></td> <td style="width: 10%;"></td> <td style="width: 10%;"></td> <td style="width: 10%;"></td> <td style="width: 10%;"></td> <td style="width: 10%;"></td> <td style="width: 10%;"></td> <td style="width: 10%;"></td> <td style="width: 10%;"></td> </tr> <tr> <td></td> <td></td> <td colspan="8" style="text-align: center;"> <table border="1" style="width: 100%; border-collapse: collapse; text-align: center;"> <tr> <td style="width: 10%;"></td> <td style="width: 10%;"></td> <td style="width: 10%;"></td> <td style="width: 10%;"></td> <td style="width: 10%;"></td> <td style="width: 10%;"></td> <td style="width: 10%;"></td> <td style="width: 10%;"></td> <td style="width: 10%;"></td> <td style="width: 10%;"></td> </tr> <tr> <td></td> <td></td> <td colspan="8" style="text-align: center;"> <table border="1" style="width: 100%; border-collapse: collapse; text-align: center;"> <tr> <td style="width: 10%;"></td> <td style="width: 10%;"></td> <td style="width: 10%;"></td> <td style="width: 10%;"></td> <td style="width: 10%;"></td> <td style="width: 10%;"></td> <td style="width: 10%;"></td> <td style="width: 10%;"></td> <td style="width: 10%;"></td> <td style="width: 10%;"></td> </tr>
<tr> <td></td> <td></td> <td colspan="8" style="text-align: center;"> <table border="1" style="width: 100%; border-collapse: collapse; text-align: center;"> <tr> <td style="width: 10%;"></td> <td style="width: 10%;"></td> <td style="width: 10%;"></td> <td style="width: 10%;"></td> <td style="width: 10%;"></td> <td style="width: 10%;"></td> <td style="width: 10%;"></td> <td style="width: 10%;"></td> <td style="width: 10%;"></td> <td style="width: 10%;"></td> </tr> <tr> <td></td> <td></td> <td colspan="8" style="text-align: center;"> <table border="1" style="width: 100%; border-collapse: collapse; text-align: center;"> <tr> <td style="width: 10%;"></td> <td style="width: 10%;"></td> <td style="width: 10%;"></td> <td style="width: 10%;"></td> <td style="width: 10%;"></td> <td style="width: 10%;"></td> <td style="width: 10%;"></td> <td style="width: 10%;"></td> <td style="width: 10%;"></td> <td style="width: 10%;"></td> </tr> <tr> <td></td> <td></td> <td colspan="8" style="text-align: center;"> <table border="1" style="width: 100%; border-collapse: collapse; text-align: center;"> <tr> </tr></table></td></tr></table></td></tr></table></td></tr></table></td></tr></table></td></tr></table></td></tr></table></td></tr></table></td></tr></table></td></tr></table></td></tr></table></td></tr></table></td></tr></table></td></tr></table></td></tr></table></td></tr></table>

 | | | | | | | | | | | | | | | | | | | | <table border="1" style="width: 100%; border-collapse: collapse; text-align: center;"> <tr> <td style="width: 10%;"></td> <td style="width: 10%;"></td> <td style="width: 10%;"></td> <td style="width: 10%;"></td> <td style="width: 10%;"></td> <td style="width: 10%;"></td> <td style="width: 10%;"></td> <td style="width: 10%;"></td> <td style="width: 10%;"></td> <td style="width: 10%;"></td> </tr> <tr> <td></td> <td></td> <td colspan="8" style="text-align: center;"> <table border="1" style="width: 100%; border-collapse: collapse; text-align: center;"> <tr> <td style="width: 10%;"></td> <td style="width: 10%;"></td> <td style="width: 10%;"></td> <td style="width: 10%;"></td> <td style="width: 10%;"></td> <td style="width: 10%;"></td> <td style="width: 10%;"></td> <td style="width: 10%;"></td> <td style="width: 10%;"></td> <td style="width: 10%;"></td> </tr> <tr> <td></td> <td></td> <td colspan="8" style="text-align: center;"> <table border="1" style="width: 100%; border-collapse: collapse; text-align: center;"> <tr> <td style="width: 10%;"></td> <td style="width: 10%;"></td> <td style="width: 10%;"></td> <td style="width: 10%;"></td> <td style="width: 10%;"></td> <td style="width: 10%;"></td> <td style="width: 10%;"></td> <td style="width: 10%;"></td> <td style="width: 10%;"></td> <td style="width: 10%;"></td> </tr> <tr> <td></td> <td></td> <td colspan="8" style="text-align: center;"> <table border="1" style="width: 100%; border-collapse: collapse; text-align: center;"> <tr> <td style="width: 10%;"></td> <td style="width: 10%;"></td> <td style="width: 10%;"></td> <td style="width: 10%;"></td> <td style="width: 10%;"></td> <td style="width: 10%;"></td> <td style="width: 10%;"></td> <td style="width: 10%;"></td> <td style="width: 10%;"></td> <td style="width: 10%;"></td> </tr> <tr> <td></td> <td></td> <td colspan="8" style="text-align: center;"> <table border="1" style="width: 100%; border-collapse: collapse; text-align: center;"> <tr> <td style="width: 10%;"></td> <td style="width: 10%;"></td> <td style="width: 10%;"></td> <td style="width: 10%;"></td> <td style="width: 10%;"></td> <td style="width: 10%;"></td> <td style="width: 10%;"></td> <td style="width: 10%;"></td> <td style="width: 10%;"></td> <td style="width: 10%;"></td> </tr> <tr> <td></td> <td></td> <td colspan="8" style="text-align: center;"> <table border="1" style="width: 100%; border-collapse: collapse; text-align: center;"> <tr> <td style="width: 10%;"></td> <td style="width: 10%;"></td> <td style="width: 10%;"></td> <td style="width: 10%;"></td> <td style="width: 10%;"></td> <td style="width: 10%;"></td> <td style="width: 10%;"></td> <td style="width: 10%;"></td> <td style="width: 10%;"></td> <td style="width: 10%;"></td> </tr> <tr> <td></td> <td></td> <td colspan="8" style="text-align: center;"> <table border="1" style="width: 100%; border-collapse: collapse; text-align: center;"> <tr> <td style="width: 10%;"></td> <td style="width: 10%;"></td> <td style="width: 10%;"></td> <td style="width: 10%;"></td> <td style="width: 10%;"></td> <td style="width: 10%;"></td> <td style="width: 10%;"></td> <td style="width: 10%;"></td> <td style="width: 10%;"></td> <td style="width: 10%;"></td> </tr> <tr> <td></td> <td></td> <td colspan="8" style="text-align: center;"> <table border="1" style="width: 100%; border-collapse: collapse; text-align: center;"> <tr> <td style="width: 10%;"></td> <td style="width: 10%;"></td> <td style="width: 10%;"></td> <td style="width: 10%;"></td> <td style="width: 10%;"></td> <td style="width: 10%;"></td> <td style="width: 10%;"></td> <td style="width: 10%;"></td> <td style="width: 10%;"></td> <td style="width: 10%;"></td> </tr> <tr> <td></td> <td></td> <td colspan="8" style="text-align: center;"> <table border="1" style="width: 100%; border-collapse: collapse; text-align: center;"> <tr> <td style="width: 10%;"></td> <td style="width: 10%;"></td> <td style="width: 10%;"></td> <td style="width: 10%;"></td> <td style="width: 10%;"></td> <td style="width: 10%;"></td> <td style="width: 10%;"></td> <td style="width: 10%;"></td> <td style="width: 10%;"></td> <td style="width: 10%;"></td> </tr> <tr> <td></td> <td></td> <td colspan="8" style="text-align: center;"> <table border="1" style="width: 100%; border-collapse: collapse; text-align: center;"> <tr> <td style="width: 10%;"></td> <td style="width: 10%;"></td> <td style="width: 10%;"></td> <td style="width: 10%;"></td> <td style="width: 10%;"></td> <td style="width: 10%;"></td> <td style="width: 10%;"></td> <td style="width: 10%;"></td> <td style="width: 10%;"></td> <td style="width: 10%;"></td> </tr> <tr> <td></td> <td></td> <td colspan="8" style="text-align: center;"> <table border="1" style="width: 100%; border-collapse: collapse; text-align: center;"> <tr> <td style="width: 10%;"></td> <td style="width: 10%;"></td> <td style="width: 10%;"></td> <td style="width: 10%;"></td> <td style="width: 10%;"></td> <td style="width: 10%;"></td> <td style="width: 10%;"></td> <td style="width: 10%;"></td> <td style="width: 10%;"></td> <td style="width: 10%;"></td> </tr> <tr> <td></td> <td></td> <td colspan="8" style="text-align: center;"> <table border="1" style="width: 100%; border-collapse: collapse; text-align: center;"> <tr> <td style="width: 10%;"></td> <td style="width: 10%;"></td> <td style="width: 10%;"></td> <td style="width: 10%;"></td> <td style="width: 10%;"></td> <td style="width: 10%;"></td> <td style="width: 10%;"></td> <td style="width: 10%;"></td> <td style="width: 10%;"></td> <td style="width: 10%;"></td> </tr> <tr> <td></td> <td></td> <td colspan="8" style="text-align: center;"> <table border="1" style="width: 100%; border-collapse: collapse; text-align: center;"> <tr> <td style="width: 10%;"></td> <td style="width: 10%;"></td> <td style="width: 10%;"></td> <td style="width: 10%;"></td> <td style="width: 10%;"></td> <td style="width: 10%;"></td> <td style="width: 10%;"></td> <td style="width: 10%;"></td> <td style="width: 10%;"></td> <td style="width: 10%;"></td> </tr> <tr> <td></td> <td></td> <td colspan="8" style="text-align: center;"> <table border="1" style="width: 100%; border-collapse: collapse; text-align: center;"> <tr> <td style="width: 10%;"></td> <td style="width: 10%;"></td> <td style="width: 10%;"></td> <td style="width: 10%;"></td> <td style="width: 10%;"></td> <td style="width: 10%;"></td> <td style="width: 10%;"></td> <td style="width: 10%;"></td> <td style="width: 10%;"></td> <td style="width: 10%;"></td> </tr> <tr> <td></td> <td></td> <td colspan="8" style="text-align: center;"> <table border="1" style="width: 100%; border-collapse: collapse; text-align: center;"> <tr> </tr></table></td></tr></table></td></tr></table></td></tr></table></td></tr></table></td></tr></table></td></tr></table></td></tr></table></td></tr></table></td></tr></table></td></tr></table></td></tr></table></td></tr></table></td></tr></table></td></tr></table>

 | | | | | | | | | | | | | | | | | | | | <table border="1" style="width: 100%; border-collapse: collapse; text-align: center;"> <tr> <td style="width: 10%;"></td> <td style="width: 10%;"></td> <td style="width: 10%;"></td> <td style="width: 10%;"></td> <td style="width: 10%;"></td> <td style="width: 10%;"></td> <td style="width: 10%;"></td> <td style="width: 10%;"></td> <td style="width: 10%;"></td> <td style="width: 10%;"></td> </tr> <tr> <td></td> <td></td> <td colspan="8" style="text-align: center;"> <table border="1" style="width: 100%; border-collapse: collapse; text-align: center;"> <tr> <td style="width: 10%;"></td> <td style="width: 10%;"></td> <td style="width: 10%;"></td> <td style="width: 10%;"></td> <td style="width: 10%;"></td> <td style="width: 10%;"></td> <td style="width: 10%;"></td> <td style="width: 10%;"></td> <td style="width: 10%;"></td> <td style="width: 10%;"></td> </tr> <tr> <td></td> <td></td> <td colspan="8" style="text-align: center;"> <table border="1" style="width: 100%; border-collapse: collapse; text-align: center;"> <tr> <td style="width: 10%;"></td> <td style="width: 10%;"></td> <td style="width: 10%;"></td> <td style="width: 10%;"></td> <td style="width: 10%;"></td> <td style="width: 10%;"></td> <td style="width: 10%;"></td> <td style="width: 10%;"></td> <td style="width: 10%;"></td> <td style="width: 10%;"></td> </tr> <tr> <td></td> <td></td> <td colspan="8" style="text-align: center;"> <table border="1" style="width: 100%; border-collapse: collapse; text-align: center;"> <tr> <td style="width: 10%;"></td> <td style="width: 10%;"></td> <td style="width: 10%;"></td> <td style="width: 10%;"></td> <td style="width: 10%;"></td> <td style="width: 10%;"></td> <td style="width: 10%;"></td> <td style="width: 10%;"></td> <td style="width: 10%;"></td> <td style="width: 10%;"></td> </tr> <tr> <td></td> <td></td> <td colspan="8" style="text-align: center;"> <table border="1" style="width: 100%; border-collapse: collapse; text-align: center;"> <tr> <td style="width: 10%;"></td> <td style="width: 10%;"></td> <td style="width: 10%;"></td> <td style="width: 10%;"></td> <td style="width: 10%;"></td> <td style="width: 10%;"></td> <td style="width: 10%;"></td> <td style="width: 10%;"></td> <td style="width: 10%;"></td> <td style="width: 10%;"></td> </tr> <tr> <td></td> <td></td> <td colspan="8" style="text-align: center;"> <table border="1" style="width: 100%; border-collapse: collapse; text-align: center;"> <tr> <td style="width: 10%;"></td> <td style="width: 10%;"></td> <td style="width: 10%;"></td> <td style="width: 10%;"></td> <td style="width: 10%;"></td> <td style="width: 10%;"></td> <td style="width: 10%;"></td> <td style="width: 10%;"></td> <td style="width: 10%;"></td> <td
style="width: 10%;"></td> </tr> <tr> <td></td> <td></td> <td colspan="8" style="text-align: center;"> <table border="1" style="width: 100%; border-collapse: collapse; text-align: center;"> <tr> <td style="width: 10%;"></td> <td style="width: 10%;"></td> <td style="width: 10%;"></td> <td style="width: 10%;"></td> <td style="width: 10%;"></td> <td style="width: 10%;"></td> <td style="width: 10%;"></td> <td style="width: 10%;"></td> <td style="width: 10%;"></td> <td style="width: 10%;"></td> </tr> <tr> <td></td> <td></td> <td colspan="8" style="text-align: center;"> <table border="1" style="width: 100%; border-collapse: collapse; text-align: center;"> <tr> <td style="width: 10%;"></td> <td style="width: 10%;"></td> <td style="width: 10%;"></td> <td style="width: 10%;"></td> <td style="width: 10%;"></td> <td style="width: 10%;"></td> <td style="width: 10%;"></td> <td style="width: 10%;"></td> <td style="width: 10%;"></td> <td style="width: 10%;"></td> </tr> <tr> <td></td> <td></td> <td colspan="8" style="text-align: center;"> <table border="1" style="width: 100%; border-collapse: collapse; text-align: center;"> <tr> <td style="width: 10%;"></td> <td style="width: 10%;"></td> <td style="width: 10%;"></td> <td style="width: 10%;"></td> <td style="width: 10%;"></td> <td style="width: 10%;"></td> <td style="width: 10%;"></td> <td style="width: 10%;"></td> <td style="width: 10%;"></td> <td style="width: 10%;"></td> </tr> <tr> <td></td> <td></td> <td colspan="8" style="text-align: center;"> <table border="1" style="width: 100%; border-collapse: collapse; text-align: center;"> <tr> <td style="width: 10%;"></td> <td style="width: 10%;"></td> <td style="width: 10%;"></td> <td style="width: 10%;"></td> <td style="width: 10%;"></td> <td style="width: 10%;"></td> <td style="width: 10%;"></td> <td style="width: 10%;"></td> <td style="width: 10%;"></td> <td style="width: 10%;"></td> </tr> <tr> <td></td> <td></td> <td colspan="8" style="text-align: center;"> <table border="1" style="width: 100%; border-collapse: collapse; text-align: center;"> <tr> <td style="width: 10%;"></td> <td style="width: 10%;"></td> <td style="width: 10%;"></td> <td style="width: 10%;"></td> <td style="width: 10%;"></td> <td style="width: 10%;"></td> <td style="width: 10%;"></td> <td style="width: 10%;"></td> <td style="width: 10%;"></td> <td style="width: 10%;"></td> </tr> <tr> <td></td> <td></td> <td colspan="8" style="text-align: center;"> <table border="1" style="width: 100%; border-collapse: collapse; text-align: center;"> <tr> <td style="width: 10%;"></td> <td style="width: 10%;"></td> <td style="width: 10%;"></td> <td style="width: 10%;"></td> <td style="width: 10%;"></td> <td style="width: 10%;"></td> <td style="width: 10%;"></td> <td style="width: 10%;"></td> <td style="width: 10%;"></td> <td style="width: 10%;"></td> </tr> <tr> <td></td> <td></td> <td colspan="8" style="text-align: center;"> <table border="1" style="width: 100%; border-collapse: collapse; text-align: center;"> <tr> <td style="width: 10%;"></td> <td style="width: 10%;"></td> <td style="width: 10%;"></td> <td style="width: 10%;"></td> <td style="width: 10%;"></td> <td style="width: 10%;"></td> <td style="width: 10%;"></td> <td style="width: 10%;"></td> <td style="width: 10%;"></td> <td style="width: 10%;"></td> </tr> <tr> <td></td> <td></td> <td colspan="8" style="text-align: center;"> <table border="1" style="width: 100%; border-collapse: collapse; text-align: center;"> <tr> </tr></table></td></tr></table></td></tr></table></td></tr></table></td></tr></table></td></tr></table></td></tr></table></td></tr></table></td></tr></table></td></tr></table></td></tr></table></td></tr></table></td></tr></table></td></tr></table>

 | | | | | | | | | | | | | | | | | | | | <table border="1" style="width: 100%; border-collapse: collapse; text-align: center;"> <tr> <td style="width: 10%;"></td> <td style="width: 10%;"></td> <td style="width: 10%;"></td> <td style="width: 10%;"></td> <td style="width: 10%;"></td> <td style="width: 10%;"></td> <td style="width: 10%;"></td> <td style="width: 10%;"></td> <td style="width: 10%;"></td> <td style="width: 10%;"></td> </tr> <tr> <td></td> <td></td> <td colspan="8" style="text-align: center;"> <table border="1" style="width: 100%; border-collapse: collapse; text-align: center;"> <tr> <td style="width: 10%;"></td> <td style="width: 10%;"></td> <td style="width: 10%;"></td> <td style="width: 10%;"></td> <td style="width: 10%;"></td> <td style="width: 10%;"></td> <td style="width: 10%;"></td> <td style="width: 10%;"></td> <td style="width: 10%;"></td> <td style="width: 10%;"></td> </tr> <tr> <td></td> <td></td> <td colspan="8" style="text-align: center;"> <table border="1" style="width: 100%; border-collapse: collapse; text-align: center;"> <tr> <td style="width: 10%;"></td> <td style="width: 10%;"></td> <td style="width: 10%;"></td> <td style="width: 10%;"></td> <td style="width: 10%;"></td> <td style="width: 10%;"></td> <td style="width: 10%;"></td> <td style="width: 10%;"></td> <td style="width: 10%;"></td> <td style="width: 10%;"></td> </tr> <tr> <td></td> <td></td> <td colspan="8" style="text-align: center;"> <table border="1" style="width: 100%; border-collapse: collapse; text-align: center;"> <tr> <td style="width: 10%;"></td> <td style="width: 10%;"></td> <td style="width: 10%;"></td> <td style="width: 10%;"></td> <td style="width: 10%;"></td> <td style="width: 10%;"></td> <td style="width: 10%;"></td> <td style="width: 10%;"></td> <td style="width: 10%;"></td> <td style="width: 10%;"></td> </tr> <tr> <td></td> <td></td> <td colspan="8" style="text-align: center;"> <table border="1" style="width: 100%; border-collapse: collapse; text-align: center;"> <tr> <td style="width: 10%;"></td> <td style="width: 10%;"></td> <td style="width: 10%;"></td> <td style="width: 10%;"></td> <td style="width: 10%;"></td> <td style="width: 10%;"></td> <td style="width: 10%;"></td> <td style="width: 10%;"></td> <td style="width: 10%;"></td> <td style="width: 10%;"></td> </tr> <tr> <td></td> <td></td> <td colspan="8" style="text-align: center;"> <table border="1" style="width: 100%; border-collapse: collapse; text-align: center;"> <tr> <td style="width: 10%;"></td> <td style="width: 10%;"></td> <td style="width: 10%;"></td> <td style="width: 10%;"></td> <td style="width: 10%;"></td> <td style="width: 10%;"></td> <td style="width: 10%;"></td> <td style="width: 10%;"></td> <td style="width: 10%;"></td> <td style="width: 10%;"></td> </tr> <tr> <td></td> <td></td> <td colspan="8" style="text-align: center;"> <table border="1" style="width: 100%; border-collapse: collapse; text-align: center;"> <tr> <td style="width: 10%;"></td> <td style="width: 10%;"></td> <td style="width: 10%;"></td> <td style="width: 10%;"></td> <td style="width: 10%;"></td> <td style="width: 10%;"></td> <td style="width: 10%;"></td> <td style="width: 10%;"></td> <td style="width: 10%;"></td> <td style="width: 10%;"></td> </tr> <tr> <td></td> <td></td> <td colspan="8" style="text-align: center;"> <table border="1" style="width: 100%; border-collapse: collapse; text-align: center;"> <tr> <td style="width: 10%;"></td> <td style="width: 10%;"></td> <td style="width: 10%;"></td> <td style="width: 10%;"></td> <td style="width: 10%;"></td> <td style="width: 10%;"></td> <td style="width: 10%;"></td> <td style="width: 10%;"></td> <td style="width: 10%;"></td> <td style="width: 10%;"></td> </tr> <tr> <td></td> <td></td> <td colspan="8" style="text-align: center;"> <table border="1" style="width: 100%; border-collapse: collapse; text-align: center;"> <tr> <td style="width: 10%;"></td> <td style="width: 10%;"></td> <td style="width: 10%;"></td> <td style="width: 10%;"></td> <td style="width: 10%;"></td> <td style="width: 10%;"></td> <td style="width: 10%;"></td> <td style="width: 10%;"></td> <td style="width: 10%;"></td> <td style="width: 10%;"></td> </tr> <tr> <td></td> <td></td> <td colspan="8" style="text-align: center;"> <table border="1" style="width: 100%; border-collapse: collapse; text-align: center;"> <tr> <td style="width: 10%;"></td> <td style="width: 10%;"></td> <td style="width: 10%;"></td> <td style="width: 10%;"></td> <td style="width: 10%;"></td> <td style="width: 10%;"></td> <td style="width: 10%;"></td> <td style="width: 10%;"></td> <td style="width: 10%;"></td> <td style="width: 10%;"></td> </tr> <tr> <td></td> <td></td> <td colspan="8" style="text-align: center;"> <table border="1" style="width: 100%; border-collapse: collapse; text-align: center;"> <tr> <td style="width: 10%;"></td> <td style="width: 10%;"></td> <td style="width: 10%;"></td> <td style="width: 10%;"></td> <td style="width: 10%;"></td> <td style="width: 10%;"></td> <td style="width: 10%;"></td> <td style="width: 10%;"></td> <td style="width: 10%;"></td> <td style="width: 10%;"></td> </tr> <tr> <td></td> <td></td> <td colspan="8" style="text-align: center;"> <table border="1" style="width: 100%; border-collapse: collapse; text-align: center;"> <tr> <td style="width: 10%;"></td> <td style="width: 10%;"></td> <td style="width: 10%;"></td> <td style="width: 10%;"></td> <td style="width: 10%;"></td> <td style="width: 10%;"></td> <td style="width: 10%;"></td> <td style="width: 10%;"></td> <td style="width: 10%;"></td> <td style="width: 10%;"></td> </tr> <tr> <td></td> <td></td> <td colspan="8" style="text-align: center;"> <table border="1" style="width: 100%; border-collapse: collapse; text-align: center;"> <tr> </tr></table></td></tr></table></td></tr></table></td></tr></table></td></tr></table></td></tr></table></td></tr></table></td></tr></table></td></tr></table></td></tr></table></td></tr></table></td></tr></table></td></tr></table>

 | | | | | | | | | | | | | | | | | | | | <table border="1" style="width: 100%; border-collapse: collapse; text-align: center;"> <tr> <td style="width: 10%;"></td> <td style="width: 10%;"></td> <td style="width: 10%;"></td> <td style="width: 10%;"></td> <td style="width: 10%;"></td> <td style="width: 10%;"></td> <td style="width: 10%;"></td> <td style="width: 10%;"></td> <td style="width: 10%;"></td> <td style="width: 10%;"></td> </tr> <tr> <td></td> <td></td> <td colspan="8" style="text-align: center;"> <table border="1" style="width: 100%; border-collapse: collapse; text-align: center;"> <tr> <td style="width: 10%;"></td> <td style="width: 10%;"></td> <td style="width: 10%;"></td> <td style="width: 10%;"></td> <td style="width: 10%;"></td> <td style="width: 10%;"></td> <td style="width: 10%;"></td> <td style="width: 10%;"></td> <td style="width: 10%;"></td> <td style="width: 10%;"></td> </tr> <tr> <td></td> <td></td> <td colspan="8" style="text-align: center;"> <table border="1" style="width: 100%; border-collapse: collapse; text-align: center;"> <tr> <td style="width: 10%;"></td> <td style="width: 10%;"></td> <td style="width: 10%;"></td> <td style="width: 10%;"></td> <td style="width: 10%;"></td> <td style="width: 10%;"></td> <td style="width: 10%;"></td> <td style="width: 10%;"></td> <td style="width: 10%;"></td> <td style="width: 10%;"></td> </tr> <tr>
<td></td> <td></td> <td colspan="8" style="text-align: center;"> <table border="1" style="width: 100%; border-collapse: collapse; text-align: center;"> <tr> <td style="width: 10%;"></td> <td style="width: 10%;"></td> <td style="width: 10%;"></td> <td style="width: 10%;"></td> <td style="width: 10%;"></td> <td style="width: 10%;"></td> <td style="width: 10%;"></td> <td style="width: 10%;"></td> <td style="width: 10%;"></td> <td style="width: 10%;"></td> </tr> <tr> <td></td> <td></td> <td colspan="8" style="text-align: center;"> <table border="1" style="width: 100%; border-collapse: collapse; text-align: center;"> <tr> <td style="width: 10%;"></td> <td style="width: 10%;"></td> <td style="width: 10%;"></td> <td style="width: 10%;"></td> <td style="width: 10%;"></td> <td style="width: 10%;"></td> <td style="width: 10%;"></td> <td style="width: 10%;"></td> <td style="width: 10%;"></td> <td style="width: 10%;"></td> </tr> <tr> <td></td> <td></td> <td colspan="8" style="text-align: center;"> <table border="1" style="width: 100%; border-collapse: collapse; text-align: center;"> <tr> <td style="width: 10%;"></td> <td style="width: 10%;"></td> <td style="width: 10%;"></td> <td style="width: 10%;"></td> <td style="width: 10%;"></td> <td style="width: 10%;"></td> <td style="width: 10%;"></td> <td style="width: 10%;"></td> <td style="width: 10%;"></td> <td style="width: 10%;"></td> </tr> <tr> <td></td> <td></td> <td colspan="8" style="text-align: center;"> <table border="1" style="width: 100%; border-collapse: collapse; text-align: center;"> <tr> <td style="width: 10%;"></td> <td style="width: 10%;"></td> <td style="width: 10%;"></td> <td style="width: 10%;"></td> <td style="width: 10%;"></td> <td style="width: 10%;"></td> <td style="width: 10%;"></td> <td style="width: 10%;"></td> <td style="width: 10%;"></td> <td style="width: 10%;"></td> </tr> <tr> <td></td> <td></td> <td colspan="8" style="text-align: center;"> <table border="1" style="width: 100%; border-collapse: collapse; text-align: center;"> <tr> <td style="width: 10%;"></td> <td style="width: 10%;"></td> <td style="width: 10%;"></td> <td style="width: 10%;"></td> <td style="width: 10%;"></td> <td style="width: 10%;"></td> <td style="width: 10%;"></td> <td style="width: 10%;"></td> <td style="width: 10%;"></td> <td style="width: 10%;"></td> </tr> <tr> <td></td> <td></td> <td colspan="8" style="text-align: center;"> <table border="1" style="width: 100%; border-collapse: collapse; text-align: center;"> <tr> <td style="width: 10%;"></td> <td style="width: 10%;"></td> <td style="width: 10%;"></td> <td style="width: 10%;"></td> <td style="width: 10%;"></td> <td style="width: 10%;"></td> <td style="width: 10%;"></td> <td style="width: 10%;"></td> <td style="width: 10%;"></td> <td style="width: 10%;"></td> </tr> <tr> <td></td> <td></td> <td colspan="8" style="text-align: center;"> <table border="1" style="width: 100%; border-collapse: collapse; text-align: center;"> <tr> <td style="width: 10%;"></td> <td style="width: 10%;"></td> <td style="width: 10%;"></td> <td style="width: 10%;"></td> <td style="width: 10%;"></td> <td style="width: 10%;"></td> <td style="width: 10%;"></td> <td style="width: 10%;"></td> <td style="width: 10%;"></td> <td style="width: 10%;"></td> </tr> <tr> <td></td> <td></td> <td colspan="8" style="text-align: center;"> <table border="1" style="width: 100%; border-collapse: collapse; text-align: center;"> <tr> <td style="width: 10%;"></td> <td style="width: 10%;"></td> <td style="width: 10%;"></td> <td style="width: 10%;"></td> <td style="width: 10%;"></td> <td style="width: 10%;"></td> <td style="width: 10%;"></td> <td style="width: 10%;"></td> <td style="width: 10%;"></td> <td style="width: 10%;"></td> </tr> <tr> <td></td> <td></td> <td colspan="8" style="text-align: center;"> <table border="1" style="width: 100%; border-collapse: collapse; text-align: center;"> <tr> </tr></table></td></tr></table></td></tr></table></td></tr></table></td></tr></table></td></tr></table></td></tr></table></td></tr></table></td></tr></table></td></tr></table></td></tr></table></td></tr></table>

 | | | | | | | | | | | | | | | | | | | | <table border="1" style="width: 100%; border-collapse: collapse; text-align: center;"> <tr> <td style="width: 10%;"></td> <td style="width: 10%;"></td> <td style="width: 10%;"></td> <td style="width: 10%;"></td> <td style="width: 10%;"></td> <td style="width: 10%;"></td> <td style="width: 10%;"></td> <td style="width: 10%;"></td> <td style="width: 10%;"></td> <td style="width: 10%;"></td> </tr> <tr> <td></td> <td></td> <td colspan="8" style="text-align: center;"> <table border="1" style="width: 100%; border-collapse: collapse; text-align: center;"> <tr> <td style="width: 10%;"></td> <td style="width: 10%;"></td> <td style="width: 10%;"></td> <td style="width: 10%;"></td> <td style="width: 10%;"></td> <td style="width: 10%;"></td> <td style="width: 10%;"></td> <td style="width: 10%;"></td> <td style="width: 10%;"></td> <td style="width: 10%;"></td> </tr> <tr> <td></td> <td></td> <td colspan="8" style="text-align: center;"> <table border="1" style="width: 100%; border-collapse: collapse; text-align: center;"> <tr> <td style="width: 10%;"></td> <td style="width: 10%;"></td> <td style="width: 10%;"></td> <td style="width: 10%;"></td> <td style="width: 10%;"></td> <td style="width: 10%;"></td> <td style="width: 10%;"></td> <td style="width: 10%;"></td> <td style="width: 10%;"></td> <td style="width: 10%;"></td> </tr> <tr> <td></td> <td></td> <td colspan="8" style="text-align: center;"> <table border="1" style="width: 100%; border-collapse: collapse; text-align: center;"> <tr> <td style="width: 10%;"></td> <td style="width: 10%;"></td> <td style="width: 10%;"></td> <td style="width: 10%;"></td> <td style="width: 10%;"></td> <td style="width: 10%;"></td> <td style="width: 10%;"></td> <td style="width: 10%;"></td> <td style="width: 10%;"></td> <td style="width: 10%;"></td> </tr> <tr> <td></td> <td></td> <td colspan="8" style="text-align: center;"> <table border="1" style="width: 100%; border-collapse: collapse; text-align: center;"> <tr> <td style="width: 10%;"></td> <td style="width: 10%;"></td> <td style="width: 10%;"></td> <td style="width: 10%;"></td> <td style="width: 10%;"></td> <td style="width: 10%;"></td> <td style="width: 10%;"></td> <td style="width: 10%;"></td> <td style="width: 10%;"></td> <td style="width: 10%;"></td> </tr> <tr> <td></td> <td></td> <td colspan="8" style="text-align: center;"> <table border="1" style="width: 100%; border-collapse: collapse; text-align: center;"> <tr> <td style="width: 10%;"></td> <td style="width: 10%;"></td> <td style="width: 10%;"></td> <td style="width: 10%;"></td> <td style="width: 10%;"></td> <td style="width: 10%;"></td> <td style="width: 10%;"></td> <td style="width: 10%;"></td> <td style="width: 10%;"></td> <td style="width: 10%;"></td> </tr> <tr> <td></td> <td></td> <td colspan="8" style="text-align: center;"> <table border="1" style="width: 100%; border-collapse: collapse; text-align: center;"> <tr> <td style="width: 10%;"></td> <td style="width: 10%;"></td> <td style="width: 10%;"></td> <td style="width: 10%;"></td> <td style="width: 10%;"></td> <td style="width: 10%;"></td> <td style="width: 10%;"></td> <td style="width: 10%;"></td> <td style="width: 10%;"></td> <td style="width: 10%;"></td> </tr> <tr> <td></td> <td></td> <td colspan="8" style="text-align: center;"> <table border="1" style="width: 100%; border-collapse: collapse; text-align: center;"> <tr> <td style="width: 10%;"></td> <td style="width: 10%;"></td> <td style="width: 10%;"></td> <td style="width: 10%;"></td> <td style="width: 10%;"></td> <td style="width: 10%;"></td> <td style="width: 10%;"></td> <td style="width: 10%;"></td> <td style="width: 10%;"></td> <td style="width: 10%;"></td> </tr> <tr> <td></td> <td></td> <td colspan="8" style="text-align: center;"> <table border="1" style="width: 100%; border-collapse: collapse; text-align: center;"> <tr> <td style="width: 10%;"></td> <td style="width: 10%;"></td> <td style="width: 10%;"></td> <td style="width: 10%;"></td> <td style="width: 10%;"></td> <td style="width: 10%;"></td> <td style="width: 10%;"></td> <td style="width: 10%;"></td> <td style="width: 10%;"></td> <td style="width: 10%;"></td> </tr> <tr> <td></td> <td></td> <td colspan="8" style="text-align: center;"> <table border="1" style="width: 100%; border-collapse: collapse; text-align: center;"> <tr> <td style="width: 10%;"></td> <td style="width: 10%;"></td> <td style="width: 10%;"></td> <td style="width: 10%;"></td> <td style="width: 10%;"></td> <td style="width: 10%;"></td> <td style="width: 10%;"></td> <td style="width: 10%;"></td> <td style="width: 10%;"></td> <td style="width: 10%;"></td> </tr> <tr> <td></td> <td></td> <td colspan="8" style="text-align: center;"> <table border="1" style="width: 100%; border-collapse: collapse; text-align: center;"> <tr> </tr></table></td></tr></table></td></tr></table></td></tr></table></td></tr></table></td></tr></table></td></tr></table></td></tr></table></td></tr></table></td></tr></table></td></tr></table>

 | | | | | | | | | | | | | | | | | | | | <table border="1" style="width: 100%; border-collapse: collapse; text-align: center;"> <tr> <td style="width: 10%;"></td> <td style="width: 10%;"></td> <td style="width: 10%;"></td> <td style="width: 10%;"></td> <td style="width: 10%;"></td> <td style="width: 10%;"></td> <td style="width: 10%;"></td> <td style="width: 10%;"></td> <td style="width: 10%;"></td> <td style="width: 10%;"></td> </tr> <tr> <td></td> <td></td> <td colspan="8" style="text-align: center;"> <table border="1" style="width: 100%; border-collapse: collapse; text-align: center;"> <tr> <td style="width: 10%;"></td> <td style="width: 10%;"></td> <td style="width: 10%;"></td> <td style="width: 10%;"></td> <td style="width: 10%;"></td> <td style="width: 10%;"></td> <td style="width: 10%;"></td> <td style="width: 10%;"></td> <td style="width: 10%;"></td> <td style="width: 10%;"></td> </tr> <tr> <td></td> <td></td> <td colspan="8" style="text-align: center;"> <table border="1" style="width: 100%; border-collapse: collapse; text-align: center;"> <tr> <td style="width: 10%;"></td> <td style="width: 10%;"></td> <td style="width: 10%;"></td> <td style="width: 10%;"></td> <td style="width: 10%;"></td> <td style="width: 10%;"></td> <td style="width: 10%;"></td> <td style="width: 10%;"></td> <td style="width: 10%;"></td> <td style="width: 10%;"></td> </tr> <tr> <td></td> <td></td> <td colspan="8" style="text-align: center;"> <table border="1" style="width: 100%; border-collapse: collapse; text-align: center;"> <tr> <td style="width: 10%;"></td> <td style="width: 10%;"></td> <td style="width: 10%;"></td> <td style="width: 10%;"></td> <td style="width: 10%;"></td> <td style="width: 10%;"></td> <td style="width: 10%;"></td> <td style="width: 10%;"></td> <td style="width: 10%;"></td> <td style="width: 10%;"></td> </tr> <tr> <td></td> <td></td> <td colspan="8" style="text-align: center;"> <table border="1" style="width: 100%;
border-collapse: collapse; text-align: center;"> <tr> <td style="width: 10%;"></td> <td style="width: 10%;"></td> <td style="width: 10%;"></td> <td style="width: 10%;"></td> <td style="width: 10%;"></td> <td style="width: 10%;"></td> <td style="width: 10%;"></td> <td style="width: 10%;"></td> <td style="width: 10%;"></td> <td style="width: 10%;"></td> </tr> <tr> <td></td> <td></td> <td colspan="8" style="text-align: center;"> <table border="1" style="width: 100%; border-collapse: collapse; text-align: center;"> <tr> <td style="width: 10%;"></td> <td style="width: 10%;"></td> <td style="width: 10%;"></td> <td style="width: 10%;"></td> <td style="width: 10%;"></td> <td style="width: 10%;"></td> <td style="width: 10%;"></td> <td style="width: 10%;"></td> <td style="width: 10%;"></td> <td style="width: 10%;"></td> </tr> <tr> <td></td> <td></td> <td colspan="8" style="text-align: center;"> <table border="1" style="width: 100%; border-collapse: collapse; text-align: center;"> <tr> <td style="width: 10%;"></td> <td style="width: 10%;"></td> <td style="width: 10%;"></td> <td style="width: 10%;"></td> <td style="width: 10%;"></td> <td style="width: 10%;"></td> <td style="width: 10%;"></td> <td style="width: 10%;"></td> <td style="width: 10%;"></td> <td style="width: 10%;"></td> </tr> <tr> <td></td> <td></td> <td colspan="8" style="text-align: center;"> <table border="1" style="width: 100%; border-collapse: collapse; text-align: center;"> <tr> <td style="width: 10%;"></td> <td style="width: 10%;"></td> <td style="width: 10%;"></td> <td style="width: 10%;"></td> <td style="width: 10%;"></td> <td style="width: 10%;"></td> <td style="width: 10%;"></td> <td style="width: 10%;"></td> <td style="width: 10%;"></td> <td style="width: 10%;"></td> </tr> <tr> <td></td> <td></td> <td colspan="8" style="text-align: center;"> <table border="1" style="width: 100%; border-collapse: collapse; text-align: center;"> <tr> <td style="width: 10%;"></td> <td style="width: 10%;"></td> <td style="width: 10%;"></td> <td style="width: 10%;"></td> <td style="width: 10%;"></td> <td style="width: 10%;"></td> <td style="width: 10%;"></td> <td style="width: 10%;"></td> <td style="width: 10%;"></td> <td style="width: 10%;"></td> </tr> <tr> <td></td> <td></td> <td colspan="8" style="text-align: center;"> <table border="1" style="width: 100%; border-collapse: collapse; text-align: center;"> <tr> </tr></table></td></tr></table></td></tr></table></td></tr></table></td></tr></table></td></tr></table></td></tr></table></td></tr></table></td></tr></table></td></tr></table>

 | | | | | | | | | | | | | | | | | | | | <table border="1" style="width: 100%; border-collapse: collapse; text-align: center;"> <tr> <td style="width: 10%;"></td> <td style="width: 10%;"></td> <td style="width: 10%;"></td> <td style="width: 10%;"></td> <td style="width: 10%;"></td> <td style="width: 10%;"></td> <td style="width: 10%;"></td> <td style="width: 10%;"></td> <td style="width: 10%;"></td> <td style="width: 10%;"></td> </tr> <tr> <td></td> <td></td> <td colspan="8" style="text-align: center;"> <table border="1" style="width: 100%; border-collapse: collapse; text-align: center;"> <tr> <td style="width: 10%;"></td> <td style="width: 10%;"></td> <td style="width: 10%;"></td> <td style="width: 10%;"></td> <td style="width: 10%;"></td> <td style="width: 10%;"></td> <td style="width: 10%;"></td> <td style="width: 10%;"></td> <td style="width: 10%;"></td> <td style="width: 10%;"></td> </tr> <tr> <td></td> <td></td> <td colspan="8" style="text-align: center;"> <table border="1" style="width: 100%; border-collapse: collapse; text-align: center;"> <tr> <td style="width: 10%;"></td> <td style="width: 10%;"></td> <td style="width: 10%;"></td> <td style="width: 10%;"></td> <td style="width: 10%;"></td> <td style="width: 10%;"></td> <td style="width: 10%;"></td> <td style="width: 10%;"></td> <td style="width: 10%;"></td> <td style="width: 10%;"></td> </tr> <tr> <td></td> <td></td> <td colspan="8" style="text-align: center;"> <table border="1" style="width: 100%; border-collapse: collapse; text-align: center;"> <tr> <td style="width: 10%;"></td> <td style="width: 10%;"></td> <td style="width: 10%;"></td> <td style="width: 10%;"></td> <td style="width: 10%;"></td> <td style="width: 10%;"></td> <td style="width: 10%;"></td> <td style="width: 10%;"></td> <td style="width: 10%;"></td> <td style="width: 10%;"></td> </tr> <tr> <td></td> <td></td> <td colspan="8" style="text-align: center;"> <table border="1" style="width: 100%; border-collapse: collapse; text-align: center;"> <tr> <td style="width: 10%;"></td> <td style="width: 10%;"></td> <td style="width: 10%;"></td> <td style="width: 10%;"></td> <td style="width: 10%;"></td> <td style="width: 10%;"></td> <td style="width: 10%;"></td> <td style="width: 10%;"></td> <td style="width: 10%;"></td> <td style="width: 10%;"></td> </tr> <tr> <td></td> <td></td> <td colspan="8" style="text-align: center;"> <table border="1" style="width: 100%; border-collapse: collapse; text-align: center;"> <tr> <td style="width: 10%;"></td> <td style="width: 10%;"></td> <td style="width: 10%;"></td> <td style="width: 10%;"></td> <td style="width: 10%;"></td> <td style="width: 10%;"></td> <td style="width: 10%;"></td> <td style="width: 10%;"></td> <td style="width: 10%;"></td> <td style="width: 10%;"></td> </tr> <tr> <td></td> <td></td> <td colspan="8" style="text-align: center;"> <table border="1" style="width: 100%; border-collapse: collapse; text-align: center;"> <tr> <td style="width: 10%;"></td> <td style="width: 10%;"></td> <td style="width: 10%;"></td> <td style="width: 10%;"></td> <td style="width: 10%;"></td> <td style="width: 10%;"></td> <td style="width: 10%;"></td> <td style="width: 10%;"></td> <td style="width: 10%;"></td> <td style="width: 10%;"></td> </tr> <tr> <td></td> <td></td> <td colspan="8" style="text-align: center;"> <table border="1" style="width: 100%; border-collapse: collapse; text-align: center;"> <tr> <td style="width: 10%;"></td> <td style="width: 10%;"></td> <td style="width: 10%;"></td> <td style="width: 10%;"></td> <td style="width: 10%;"></td> <td style="width: 10%;"></td> <td style="width: 10%;"></td> <td style="width: 10%;"></td> <td style="width: 10%;"></td> <td style="width: 10%;"></td> </tr> <tr> <td></td> <td></td> <td colspan="8" style="text-align: center;"> <table border="1" style="width: 100%; border-collapse: collapse; text-align: center;"> <tr> </tr></table></td></tr></table></td></tr></table></td></tr></table></td></tr></table></td></tr></table></td></tr></table></td></tr></table></td></tr></table>

 | | | | | | | | | | | | | | | | | | | | <table border="1" style="width: 100%; border-collapse: collapse; text-align: center;"> <tr> <td style="width: 10%;"></td> <td style="width: 10%;"></td> <td style="width: 10%;"></td> <td style="width: 10%;"></td> <td style="width: 10%;"></td> <td style="width: 10%;"></td> <td style="width: 10%;"></td> <td style="width: 10%;"></td> <td style="width: 10%;"></td> <td style="width: 10%;"></td> </tr> <tr> <td></td> <td></td> <td colspan="8" style="text-align: center;"> <table border="1" style="width: 100%; border-collapse: collapse; text-align: center;"> <tr> <td style="width: 10%;"></td> <td style="width: 10%;"></td> <td style="width: 10%;"></td> <td style="width: 10%;"></td> <td style="width: 10%;"></td> <td style="width: 10%;"></td> <td style="width: 10%;"></td> <td style="width: 10%;"></td> <td style="width: 10%;"></td> <td style="width: 10%;"></td> </tr> <tr> <td></td> <td></td> <td colspan="8" style="text-align: center;"> <table border="1" style="width: 100%; border-collapse: collapse; text-align: center;"> <tr> <td style="width: 10%;"></td> <td style="width: 10%;"></td> <td style="width: 10%;"></td> <td style="width: 10%;"></td> <td style="width: 10%;"></td> <td style="width: 10%;"></td> <td style="width: 10%;"></td> <td style="width: 10%;"></td> <td style="width: 10%;"></td> <td style="width: 10%;"></td> </tr> <tr> <td></td> <td></td> <td colspan="8" style="text-align: center;"> <table border="1" style="width: 100%; border-collapse: collapse; text-align: center;"> <tr> <td style="width: 10%;"></td> <td style="width: 10%;"></td> <td style="width: 10%;"></td> <td style="width: 10%;"></td> <td style="width: 10%;"></td> <td style="width: 10%;"></td> <td style="width: 10%;"></td> <td style="width: 10%;"></td> <td style="width: 10%;"></td> <td style="width: 10%;"></td> </tr> <tr> <td></td> <td></td> <td colspan="8" style="text-align: center;"> <table border="1" style="width: 100%; border-collapse: collapse; text-align: center;"> <tr> <td style="width: 10%;"></td> <td style="width: 10%;"></td> <td style="width: 10%;"></td> <td style="width: 10%;"></td> <td style="width: 10%;"></td> <td style="width: 10%;"></td> <td style="width: 10%;"></td> <td style="width: 10%;"></td> <td style="width: 10%;"></td> <td style="width: 10%;"></td> </tr> <tr> <td></td> <td></td> <td colspan="8" style="text-align: center;"> <table border="1" style="width: 100%; border-collapse: collapse; text-align: center;"> <tr> <td style="width: 10%;"></td> <td style="width: 10%;"></td> <td style="width: 10%;"></td> <td style="width: 10%;"></td> <td style="width: 10%;"></td> <td style="width: 10%;"></td> <td style="width: 10%;"></td> <td style="width: 10%;"></td> <td style="width: 10%;"></td> <td style="width: 10%;"></td> </tr> <tr> <td></td> <td></td> <td colspan="8" style="text-align: center;"> <table border="1" style="width: 100%; border-collapse: collapse; text-align: center;"> <tr> <td style="width: 10%;"></td> <td style="width: 10%;"></td> <td style="width: 10%;"></td> <td style="width: 10%;"></td> <td style="width: 10%;"></td> <td style="width: 10%;"></td> <td style="width: 10%;"></td> <td style="width: 10%;"></td> <td style="width: 10%;"></td> <td style="width: 10%;"></td> </tr> <tr> <td></td> <td></td> <td colspan="8" style="text-align: center;"> <table border="1" style="width: 100%; border-collapse: collapse; text-align: center;"> <tr> </tr></table></td></tr></table></td></tr></table></td></tr></table></td></tr></table></td></tr></table></td></tr></table></td></tr></table>

 | | | | | | | | | | | | | | | | | | | | <table border="1" style="width: 100%; border-collapse: collapse; text-align: center;"> <tr> <td style="width: 10%;"></td> <td style="width: 10%;"></td> <td style="width: 10%;"></td> <td style="width: 10%;"></td> <td style="width: 10%;"></td> <td style="width: 10%;"></td> <td style="width: 10%;"></td> <td style="width: 10%;"></td> <td style="width: 10%;"></td> <td style="width: 10%;"></td> </tr> <tr> <td></td> <td></td> <td colspan="8" style="text-align: center;"> <table border="1" style="width: 100%; border-collapse: collapse; text-align: center;"> <tr> <td style="width: 10%;"></td> <td style="width: 10%;"></td> <td style="width: 10%;"></td> <td style="width: 10%;"></td> <td style="width: 10%;"></td> <td style="width: 10%;"></td> <td style="width: 10%;"></td> <td style="width: 10%;"></td> <td style="width: 10%;"></td> <td style="width: 10%;"></td> </tr> <tr> <td></td> <td></td> <td colspan="8" style="text-align: center;"> <table border="1" style="width: 100%; border-collapse: collapse; text-align: center;"> <tr> <td style="width: 10%;"></td> <td style="width: 10%;"></td> <td style="width: 10%;"></td> <td style="width: 10%;"></td> <td style="width: 10%;"></td> <td style="width: 10%;"></td> <td style="width: 10%;"></td> <td style="width: 10%;"></td> <td style="width: 10%;"></td> <td style="width: 10%;"></td> </tr> <tr> <td></td> <td></td> <td colspan="8" style="text-align: center;"> <table border="1"
style="width: 100%; border-collapse: collapse; text-align: center;"> <tr> <td style="width: 10%;"></td> <td style="width: 10%;"></td> <td style="width: 10%;"></td> <td style="width: 10%;"></td> <td style="width: 10%;"></td> <td style="width: 10%;"></td> <td style="width: 10%;"></td> <td style="width: 10%;"></td> <td style="width: 10%;"></td> <td style="width: 10%;"></td> </tr> <tr> <td></td> <td></td> <td colspan="8" style="text-align: center;"> <table border="1" style="width: 100%; border-collapse: collapse; text-align: center;"> <tr> <td style="width: 10%;"></td> <td style="width: 10%;"></td> <td style="width: 10%;"></td> <td style="width: 10%;"></td> <td style="width: 10%;"></td> <td style="width: 10%;"></td> <td style="width: 10%;"></td> <td style="width: 10%;"></td> <td style="width: 10%;"></td> <td style="width: 10%;"></td> </tr> <tr> <td></td> <td></td> <td colspan="8" style="text-align: center;"> <table border="1" style="width: 100%; border-collapse: collapse; text-align: center;"> <tr> <td style="width: 10%;"></td> <td style="width: 10%;"></td> <td style="width: 10%;"></td> <td style="width: 10%;"></td> <td style="width: 10%;"></td> <td style="width: 10%;"></td> <td style="width: 10%;"></td> <td style="width: 10%;"></td> <td style="width: 10%;"></td> <td style="width: 10%;"></td> </tr> <tr> <td></td> <td></td> <td colspan="8" style="text-align: center;"> <table border="1" style="width: 100%; border-collapse: collapse; text-align: center;"> <tr> </tr></table></td></tr></table></td></tr></table></td></tr></table></td></tr></table></td></tr></table></td></tr></table>

 | | | | | | | | | | | | | | | | | | | | <table border="1" style="width: 100%; border-collapse: collapse; text-align: center;"> <tr> <td style="width: 10%;"></td> <td style="width: 10%;"></td> <td style="width: 10%;"></td> <td style="width: 10%;"></td> <td style="width: 10%;"></td> <td style="width: 10%;"></td> <td style="width: 10%;"></td> <td style="width: 10%;"></td> <td style="width: 10%;"></td> <td style="width: 10%;"></td> </tr> <tr> <td></td> <td></td> <td colspan="8" style="text-align: center;"> <table border="1" style="width: 100%; border-collapse: collapse; text-align: center;"> <tr> <td style="width: 10%;"></td> <td style="width: 10%;"></td> <td style="width: 10%;"></td> <td style="width: 10%;"></td> <td style="width: 10%;"></td> <td style="width: 10%;"></td> <td style="width: 10%;"></td> <td style="width: 10%;"></td> <td style="width: 10%;"></td> <td style="width: 10%;"></td> </tr> <tr> <td></td> <td></td> <td colspan="8" style="text-align: center;"> <table border="1" style="width: 100%; border-collapse: collapse; text-align: center;"> <tr> <td style="width: 10%;"></td> <td style="width: 10%;"></td> <td style="width: 10%;"></td> <td style="width: 10%;"></td> <td style="width: 10%;"></td> <td style="width: 10%;"></td> <td style="width: 10%;"></td> <td style="width: 10%;"></td> <td style="width: 10%;"></td> <td style="width: 10%;"></td> </tr> <tr> <td></td> <td></td> <td colspan="8" style="text-align: center;"> <table border="1" style="width: 100%; border-collapse: collapse; text-align: center;"> <tr> <td style="width: 10%;"></td> <td style="width: 10%;"></td> <td style="width: 10%;"></td> <td style="width: 10%;"></td> <td style="width: 10%;"></td> <td style="width: 10%;"></td> <td style="width: 10%;"></td> <td style="width: 10%;"></td> <td style="width: 10%;"></td> <td style="width: 10%;"></td> </tr> <tr> <td></td> <td></td> <td colspan="8" style="text-align: center;"> <table border="1" style="width: 100%; border-collapse: collapse; text-align: center;"> <tr> <td style="width: 10%;"></td> <td style="width: 10%;"></td> <td style="width: 10%;"></td> <td style="width: 10%;"></td> <td style="width: 10%;"></td> <td style="width: 10%;"></td> <td style="width: 10%;"></td> <td style="width: 10%;"></td> <td style="width: 10%;"></td> <td style="width: 10%;"></td> </tr> <tr> <td></td> <td></td> <td colspan="8" style="text-align: center;"> <table border="1" style="width: 100%; border-collapse: collapse; text-align: center;"> <tr> </tr></table></td></tr></table></td></tr></table></td></tr></table></td></tr></table></td></tr></table>

 | | | | | | | | | | | | | | | | | | | | <table border="1" style="width: 100%; border-collapse: collapse; text-align: center;"> <tr> <td style="width: 10%;"></td> <td style="width: 10%;"></td> <td style="width: 10%;"></td> <td style="width: 10%;"></td> <td style="width: 10%;"></td> <td style="width: 10%;"></td> <td style="width: 10%;"></td> <td style="width: 10%;"></td> <td style="width: 10%;"></td> <td style="width: 10%;"></td> </tr> <tr> <td></td> <td></td> <td colspan="8" style="text-align: center;"> <table border="1" style="width: 100%; border-collapse: collapse; text-align: center;"> <tr> <td style="width: 10%;"></td> <td style="width: 10%;"></td> <td style="width: 10%;"></td> <td style="width: 10%;"></td> <td style="width: 10%;"></td> <td style="width: 10%;"></td> <td style="width: 10%;"></td> <td style="width: 10%;"></td> <td style="width: 10%;"></td> <td style="width: 10%;"></td> </tr> <tr> <td></td> <td></td> <td colspan="8" style="text-align: center;"> <table border="1" style="width: 100%; border-collapse: collapse; text-align: center;"> <tr> <td style="width: 10%;"></td> <td style="width: 10%;"></td> <td style="width: 10%;"></td> <td style="width: 10%;"></td> <td style="width: 10%;"></td> <td style="width: 10%;"></td> <td style="width: 10%;"></td> <td style="width: 10%;"></td> <td style="width: 10%;"></td> <td style="width: 10%;"></td> </tr> <tr> <td></td> <td></td> <td colspan="8" style="text-align: center;"> <table border="1" style="width: 100%; border-collapse: collapse; text-align: center;"> <tr> <td style="width: 10%;"></td> <td style="width: 10%;"></td> <td style="width: 10%;"></td> <td style="width: 10%;"></td> <td style="width: 10%;"></td> <td style="width: 10%;"></td> <td style="width: 10%;"></td> <td style="width: 10%;"></td> <td style="width: 10%;"></td> <td style="width: 10%;"></td> </tr> <tr> <td></td> <td></td> <td colspan="8" style="text-align: center;"> <table border="1" style="width: 100%; border-collapse: collapse; text-align: center;"> <tr> </tr></table></td></tr></table></td></tr></table></td></tr></table></td></tr></table>

 | | | | | | | | | | | | | | | | | | | | <table border="1" style="width: 100%; border-collapse: collapse; text-align: center;"> <tr> <td style="width: 10%;"></td> <td style="width: 10%;"></td> <td style="width: 10%;"></td> <td style="width: 10%;"></td> <td style="width: 10%;"></td> <td style="width: 10%;"></td> <td style="width: 10%;"></td> <td style="width: 10%;"></td> <td style="width: 10%;"></td> <td style="width: 10%;"></td> </tr> <tr> <td></td> <td></td> <td colspan="8" style="text-align: center;"> <table border="1" style="width: 100%; border-collapse: collapse; text-align: center;"> <tr> <td style="width: 10%;"></td> <td style="width: 10%;"></td> <td style="width: 10%;"></td> <td style="width: 10%;"></td> <td style="width: 10%;"></td> <td style="width: 10%;"></td> <td style="width: 10%;"></td> <td style="width: 10%;"></td> <td style="width: 10%;"></td> <td style="width: 10%;"></td> </tr> <tr> <td></td> <td></td> <td colspan="8" style="text-align: center;"> <table border="1" style="width: 100%; border-collapse: collapse; text-align: center;"> <tr> <td style="width: 10%;"></td> <td style="width: 10%;"></td> <td style="width: 10%;"></td> <td style="width: 10%;"></td> <td style="width: 10%;"></td> <td style="width: 10%;"></td> <td style="width: 10%;"></td> <td style="width: 10%;"></td> <td style="width: 10%;"></td> <td style="width: 10%;"></td> </tr> <tr> <td></td> <td></td> <td colspan="8" style="text-align: center;"> <table border="1" style="width: 100%; border-collapse: collapse; text-align: center;"> <tr> </tr></table></td></tr></table></td></tr></table></td></tr></table>

 | | | | | | | | | | | | | | | | | | | | <table border="1" style="width: 100%; border-collapse: collapse; text-align: center;"> <tr> <td style="width: 10%;"></td> <td style="width: 10%;"></td> <td style="width: 10%;"></td> <td style="width: 10%;"></td> <td style="width: 10%;"></td> <td style="width: 10%;"></td> <td style="width: 10%;"></td> <td style="width: 10%;"></td> <td style="width: 10%;"></td> <td style="width: 10%;"></td> </tr> <tr> <td></td> <td></td> <td colspan="8" style="text-align: center;"> <table border="1" style="width: 100%; border-collapse: collapse; text-align: center;"> <tr> <td style="width: 10%;"></td> <td style="width: 10%;"></td> <td style="width: 10%;"></td> <td style="width: 10%;"></td> <td style="width: 10%;"></td> <td style="width: 10%;"></td> <td style="width: 10%;"></td> <td style="width: 10%;"></td> <td style="width: 10%;"></td> <td style="width: 10%;"></td> </tr> <tr> <td></td> <td></td> <td colspan="8" style="text-align: center;"> <table border="1" style="width: 100%; border-collapse: collapse; text-align: center;"> <tr> </tr></table></td></tr></table></td></tr></table>

 | | | | | | | | | | | | | | | | | | | | <table border="1" style="width: 100%; border-collapse: collapse; text-align: center;"> <tr> <td style="width: 10%;"></td> <td style="width: 10%;"></td> <td style="width: 10%;"></td> <td style="width: 10%;"></td> <td style="width: 10%;"></td> <td style="width: 10%;"></td> <td style="width: 10%;"></td> <td style="width: 10%;"></td> <td style="width: 10%;"></td> <td style="width: 10%;"></td> </tr> <tr> <td></td> <td></td> <td colspan="8" style="text-align: center;"> <table border="1" style="width: 100%; border-collapse: collapse; text-align: center;"> <tr> </tr></table></td></tr></table>

 | | | | | | | | | | | | | | | | | | | | <table border="1" style="width: 100%; border-collapse: collapse; text-align: center;"> <tr> </tr></table>

 | | | | | | | | | | | | | | | | | | | |

 | | | | | | | | | | | | | | | | | | | |

 | | | | | | | | | | | | | | | | | | | |

 | | | | | | | | | | | | | | | | | | | |
 | | | | | | | | | | | | | | | | | | | |

 | | | | | | | | | | | | | | | | | | | |

 | | | | | | | | | | | | | | | | | | | |
 | | | | | | | | | | | | | | | | | | | |

 | | | | | | | | | | | | | | | | | | | |

 | | | | | | | | | | | | | | | | | | | |
 | | | | | | | | | | | | | | | | | | | |
 | | | | | | | | | | | | | | | | | | | |

 | | | | | | | | | | | | | | | | | | | |
 | | | | | | | | | | | | | | | | | | | |
 | | | | | | | | | | | | | | | | | | | |

 | | | | | | | | | | | | | | | | | | | | | | | | | | | | | | | | | | | | | | | | | | | | | | | | | | | | | | | | | | | | | | | | | | | | | | | | | | | | | | | | | | | | | | | | | | | | | | | | | | | |
 | | | | | | | | | | | | | | | | | | | |
 | | | | | | | | | | | | | | | | | | | |
 | | | | | | | | | | | | | | | | | | | |
 | | | | | | | | | | | | | | | | | | | |
 | | | | | | | | | | | | | | | | | | | |
 | | | | | | | | | | | | | | | | | | | |
 | | | | | | | | | | | | | | | | | | | |
 | | | | | | | | | | | | | | | | | | | |
 | | | | | | | | | | | | | | | | | | | | | | | | | | | | | | | | | | | | | | | |
 | | | | | | | | | | | | | | | | | | | |
 | | | | | | | | | | | | | | | | | | | | | | | | | | | | | | | | | | | | | | | |
 | | | | | | | | | | | | | | | | | | | | | | | | | | | | | | | | | | | | | | | |
 | | | | | | | | | | | | | | | | | | | | | | | | | | | | | | | | | | | | | | | |
 | | | | | | | | | | | | | | | | | | | | | | | | | | | | | | | | | | | | | | | | | | | | | | | | | | | | | | | | | | | | | | | | | | | | | | | | | | | | | | | | | | | | | | | | | | | | | | | | | | | |
 | | | | | | | | | | | | | | | | | | | | | | | | | | | | | | | | | | | | | | | | | | | | | | | |
| | |

 | | | | | | | | | | | | | | | | | | | |

 | | | | | | | | | | | | | | | | | | | |

 | | | | | | | | | | | | | | | | | | | |

 | | | | | | | | | | | | | | | | | | | |

 | | | | | | | | | | | | | | | | | | | |

 | | | | | | | | | | | | | | | | | | | |

 | | | | | | | | | | | | | | | | | | | |

 | | | | | | | | | | | | | | | | | | | |

 | | | | | | | | | | | | | | | | | | | |

 | | | | | | | | | | | | | | | | | | | |

 | | | | | | | | | | | | | | | | | | | |

 | | | | | | | | | | | | | | | | | | | |

 | | | | | | | | | | | | | | | | | | | |

 | | | | | | | | | | | | | | | | | | | |

 | | | | | | | | | | | | | | | | | | | |

 | | | | | | | | | | | | | | | | | | | |

 | | | | | | | | | | | | | | | | | | | |

 | | | | | | | | | | | | | | | | | | | |

 | | | | | | | | | | | | | | | | | | | |

 | | | | | | | | | | | | | | | | | | | |

 | | | | | | | | | | | | | | | | | | | |

 | | | | | | | | | | | | | | | | | | | |

 | | | | | | | | | | | | | | | | | | | |

 | | | | | | | | | | | | | | | | | | | |

 | | | | | | | | | | | | | | | | | | | |

 | | | | | | | | | | | | | | | | | | | |

 | | | | | | | | | | | | | | | | | | | |

 | | | | | | | | | | | | | | | | | | | |
 | | | | | | | | | | | | | | | | | | | |

 | | | | | | | | | | | | | | | | | | | |

 | | | | | | | | | | | | | | | | | | | |
 | | | | | | | | | | | | | | | | | | | |

 | | | | | | | | | | | | | | | | | | | |

 | | | | | | | | | | | | | | | | | | | |
 | | | | | | | | | | | | | | | | | | | |
 | | | | | | | | | | | | | | | | | | | |

 | | | | | | | | | | | | | | | | | | | |
 | | | | | | | | | | | | | | | | | | | |
 | | | | | | | | | | | | | | | | | | | |

 | | | | | | | | | | | | | | | | | | | | | | | | | | | | | | | | | | | | | | | | | | | | | | | | | | | | | | | | | | | | | | | | | | | | | | | | | | | | | | | | | | | | | | | | | | | | | | | | | | | |
 | | | | | | | | | | | | | | | | | | | |
 | | | | | | | | | | | | | | | | | | | |
 | | | | | | | | | | | | | | | | | | | |
 | | | | | | | | | | | | | | | | | | | |
 | | | | | | | | | | | | | | | | | | | |
 | | | | | | | | | | | | | | | | | | | |
 | | | | | | | | | | | | | | | | | | | |
 | | | | | | | | | | | | | | | | | | | |
 | | | | | | | | | | | | | | | | | | | | | | | | | | | | | | | | | | | | | | | |
 | | | | | | | | | | | | | | | | | | | |
 | | | | | | | | | | | | | | | | | | | | | | | | | | | | | | | | | | | | | | | |
 | | | | | | | | | | | | | | | | | | | | | | | | | | | | | | | | | | | | | | | |
 | | | | | | | | | | | | | | | | | | | | | | | | | | | | | | | | | | | | | | | |
 | | | | | | | | | | | | | | | | | | | | | | | | | | | | | | | | | | | | | | | | | | | | | | | | | | | | | | | | | | | | | | | | | | | | | | | | | | | | | | | | | | | | | | | | | | | | | | | | | | | |
 | | | | | | | | | | | | | | | | | | | | | | | | | | | | | | | | | | | | | | | | | | | | | | | |
| | | <table border="1" style="width: 100%; border-collapse: collapse; text-align: center;"> <tr> <td style="width: 10%;"></td> <td style="width: 10%;"></td> <td style="width: 10%;"></td> <td style="width: 10%;"></td> <td style="width: 10%;"></td> <td style="width: 10%;"></td> <td style="width: 10%;"></td> <td style="width: 10%;"></td> <td style="width: 10%;"></td> <td style="width: 10%;"></td> </tr> <tr> <td></td> <td></td> <td colspan="8" style="text-align: center;"> <table border="1" style="width: 100%; border-collapse: collapse; text-align: center;"> <tr> <td style="width: 10%;"></td> <td style="width: 10%;"></td> <td style="width: 10%;"></td> <td style="width: 10%;"></td> <td style="width: 10%;"></td> <td style="width: 10%;"></td> <td style="width: 10%;"></td> <td style="width: 10%;"></td> <td style="width: 10%;"></td> <td style="width: 10%;"></td> </tr> <tr> <td></td> <td></td> <td colspan="8" style="text-align: center;"> <table border="1" style="width: 100%; border-collapse: collapse; text-align: center;"> <tr> <td style="width: 10%;"></td> <td style="width: 10%;"></td> <td style="width: 10%;"></td> <td style="width: 10%;"></td> <td style="width: 10%;"></td> <td style="width: 10%;"></td> <td style="width: 10%;"></td> <td style="width: 10%;"></td> <td style="width: 10%;"></td> <td style="width: 10%;"></td> </tr> <tr> <td></td> <td></td> <td colspan="8" style="text-align: center;"> <table border="1" style="width: 100%; border-collapse: collapse; text-align: center;"> <tr> <td style="width: 10%;"></td> <td style="width: 10%;"></td> <td style="width: 10%;"></td> <td style="width: 10%;"></td> <td style="width: 10%;"></td> <td style="width: 10%;"></td> <td style="width: 10%;"></td> <td style="width: 10%;"></td> <td style="width: 10%;"></td> <td style="width: 10%;"></td> </tr> <tr> <td></td> <td></td> <td colspan="8" style="text-align: center;"> <table border="1" style="width: 100%; border-collapse: collapse; text-align: center;"> <tr> <td style="width: 10%;"></td> <td style="width: 10%;"></td> <td style="width: 10%;"></td> <td style="width: 10%;"></td> <td style="width: 10%;"></td> <td style="width: 10%;"></td> <td style="width: 10%;"></td> <td style="width: 10%;"></td> <td style="width: 10%;"></td> <td style="width: 10%;"></td> </tr> <tr> <td></td> <td></td> <td colspan="8" style="text-align: center;"> <table border="1" style="width: 100%; border-collapse: collapse; text-align: center;"> <tr> <td style="width: 10%;"></td> <td style="width: 10%;"></td> <td style="width: 10%;"></td> <td style="width: 10%;"></td> <td style="width: 10%;"></td> <td style="width: 10%;"></td> <td style="width: 10%;"></td> <td style="width: 10%;"></td> <td style="width: 10%;"></td> <td style="width: 10%;"></td> </tr> <tr> <td></td> <td></td> <td colspan="8" style="text-align: center;"> <table border="1" style="width: 100%; border-collapse: collapse; text-align: center;"> <tr> <td style="width: 10%;"></td> <td style="width: 10%;"></td> <td style="width: 10%;"></td> <td style="width: 10%;"></td> <td style="width: 10%;"></td> <td style="width: 10%;"></td> <td style="width: 10%;"></td> <td style="width: 10%;"></td> <td style="width: 10%;"></td> <td style="width: 10%;"></td> </tr> <tr> <td></td> <td></td> <td colspan="8" style="text-align: center;"> <table border="1" style="width: 100%; border-collapse: collapse; text-align: center;"> <tr> <td style="width: 10%;"></td> <td style="width: 10%;"></td> <td style="width: 10%;"></td> <td style="width: 10%;"></td> <td style="width: 10%;"></td> <td style="width: 10%;"></td> <td style="width: 10%;"></td> <td style="width: 10%;"></td> <td style="width: 10%;"></td> <td style="width: 10%;"></td> </tr> <tr> <td></td> <td></td> <td colspan="8" style="text-align: center;"> <table border="1" style="width: 100%; border-collapse: collapse; text-align: center;"> <tr> <td style="width: 10%;"></td> <td style="width: 10%;"></td> <td style="width: 10%;"></td> <td style="width: 10%;"></td> <td style="width: 10%;"></td> <td style="width: 10%;"></td> <td style="width: 10%;"></td> <td style="width: 10%;"></td> <td style="width: 10%;"></td> <td style="width: 10%;"></td> </tr> <tr> <td></td> <td></td> <td colspan="8" style="text-align: center;"> <table border="1" style="width: 100%; border-collapse: collapse; text-align: center;"> <tr> <td style="width: 10%;"></td> <td style="width: 10%;"></td> <td style="width: 10%;"></td> <td style="width: 10%;"></td> <td style="width: 10%;"></td> <td style="width: 10%;"></td> <td style="width: 10%;"></td> <td style="width: 10%;"></td> <td style="width: 10%;"></td> <td style="width: 10%;"></td> </tr> <tr> <td></td> <td></td> <td colspan="8" style="text-align: center;"> <table border="1" style="width: 100%; border-collapse: collapse; text-align: center;"> <tr> <td style="width: 10%;"></td> <td style="width: 10%;"></td> <td style="width: 10%;"></td> <td style="width: 10%;"></td> <td style="width: 10%;"></td> <td style="width: 10%;"></td> <td style="width: 10%;"></td> <td style="width: 10%;"></td> <td style="width: 10%;"></td> <td style="width: 10%;"></td> </tr> <tr> <td></td> <td></td> <td colspan="8" style="text-align: center;"> <table border="1" style="width: 100%; border-collapse: collapse; text-align: center;"> <tr> <td style="width: 10%;"></td> <td style="width: 10%;"></td> <td style="width: 10%;"></td> <td style="width: 10%;"></td> <td style="width: 10%;"></td> <td style="width: 10%;"></td> <td style="width: 10%;"></td> <td style="width: 10%;"></td> <td style="width: 10%;"></td> <td style="width: 10%;"></td> </tr> <tr> <td></td> <td></td> <td colspan="8" style="text-align: center;"> <table border="1" style="width: 100%; border-collapse: collapse; text-align: center;"> <tr> <td style="width: 10%;"></td> <td style="width: 10%;"></td> <td style="width: 10%;"></td> <td style="width: 10%;"></td> <td style="width: 10%;"></td> <td style="width: 10%;"></td> <td style="width: 10%;"></td> <td style="width: 10%;"></td> <td style="width: 10%;"></td> <td style="width: 10%;"></td> </tr> <tr> <td></td> <td></td> <td colspan="8" style="text-align: center;"> <table border="1" style="width: 100%; border-collapse: collapse; text-align: center;"> <tr> <td style="width: 10%;"></td> <td style="width: 10%;"></td> <td style="width: 10%;"></td> <td style="width: 10%;"></td> <td style="width: 10%;"></td> <td style="width: 10%;"></td> <td style="width: 10%;"></td> <td style="width: 10%;"></td> <td style="width: 10%;"></td> <td style="width: 10%;"></td> </tr> <tr> <td></td> <td></td> <td colspan="8" style="text-align: center;"> <table border="1" style="width: 100%; border-collapse: collapse; text-align: center;"> <tr> <td style="width: 10%;"></td> <td style="width: 10%;"></td> <td style="width: 10%;"></td> <td style="width: 10%;"></td> <td style="width: 10%;"></td> <td style="width: 10%;"></td> <td style="width: 10%;"></td> <td style="width: 10%;"></td> <td style="width: 10%;"></td> <td style="width: 10%;"></td> </tr> <tr> <td></td> <td></td> <td colspan="8" style="text-align: center;"> <table border="1" style="width: 100%; border-collapse: collapse; text-align: center;"> <tr> <td style="width: 10%;"></td> <td style="width: 10%;"></td> <td style="width: 10%;"></td> <td style="width: 10%;"></td> <td style="width: 10%;"></td> <td style="width: 10%;"></td> <td style="width: 10%;"></td> <td style="width: 10%;"></td> <td style="width: 10%;"></td> <td style="width: 10%;"></td> </tr> <tr> <td></td> <td></td> <td colspan="8" style="text-align: center;"> <table border="1" style="width: 100%; border-collapse: collapse; text-align: center;"> <tr> <td style="width: 10%;"></td> <td style="width: 10%;"></td> <td style="width: 10%;"></td> <td style="width: 10%;"></td> <td style="width: 10%;"></td> <td style="width: 10%;"></td> <td style="width: 10%;"></td> <td style="width: 10%;"></td> <td style="width: 10%;"></td> <td style="width: 10%;"></td> </tr> <tr> <td></td> <td></td> <td colspan="8" style="text-align: center;"> <table border="1" style="width: 100%; border-collapse: collapse; text-align: center;"> <tr> <td style="width: 10%;"></td> <td style="width: 10%;"></td> <td style="width: 10%;"></td> <td style="width: 10%;"></td> <td style="width: 10%;"></td> <td style="width: 10%;"></td> <td style="width: 10%;"></td> <td style="width: 10%;"></td> <td style="width: 10%;"></td> <td style="width: 10%;"></td> </tr> <tr> <td></td> <td></td> <td colspan="8" style="text-align: center;"> <table border="1" style="width: 100%; border-collapse: collapse; text-align: center;"> <tr> <td style="width: 10%;"></td> <td style="width: 10%;"></td> <td style="width: 10%;"></td> <td style="width: 10%;"></td> <td style="width: 10%;"></td> <td style="width: 10%;"></td> <td style="width: 10%;"></td> <td style="width: 10%;"></td> <td style="width: 10%;"></td> <td style="width: 10%;"></td> </tr> <tr> <td></td> <td></td> <td colspan="8" style="text-align: center;"> <table border="1" style="width: 100%; border-collapse: collapse; text-align: center;"> <tr> <td style="width: 10%;"></td> <td style="width: 10%;"></td> <td style="width: 10%;"></td> <td style="width: 10%;"></td> <td style="width: 10%;"></td> <td style="width: 10%;"></td> <td style="width: 10%;"></td> <td style="width: 10%;"></td> <td style="width: 10%;"></td> <td style="width: 10%;"></td> </tr> <tr> <td></td> <td></td> <td colspan="8" style="text-align: center;"> <table border="1" style="width: 100%; border-collapse: collapse; text-align: center;"> <tr> <td style="width: 10%;"></td> <td style="width: 10%;"></td> <td style="width: 10%;"></td> <td style="width: 10%;"></td> <td style="width: 10%;"></td> <td style="width: 10%;"></td> <td style="width: 10%;"></td> <td style="width: 10%;"></td> <td style="width: 10%;"></td> <td style="width: 10%;"></td> </tr> <tr> <td></td> <td></td> <td colspan="8" style="text-align: center;"> <table border="1" style="width: 100%; border-collapse: collapse; text-align: center;"> <tr> <td style="width: 10%;"></td> <td style="width: 10%;"></td> <td
style="width: 10%;"></td> <td style="width: 10%;"></td> <td style="width: 10%;"></td> <td style="width: 10%;"></td> <td style="width: 10%;"></td> <td style="width: 10%;"></td> <td style="width: 10%;"></td> <td style="width: 10%;"></td> </tr> <tr> <td></td> <td></td> <td colspan="8" style="text-align: center;"> <table border="1" style="width: 100%; border-collapse: collapse; text-align: center;"> <tr> <td style="width: 10%;"></td> <td style="width: 10%;"></td> <td style="width: 10%;"></td> <td style="width: 10%;"></td> <td style="width: 10%;"></td> <td style="width: 10%;"></td> <td style="width: 10%;"></td> <td style="width: 10%;"></td> <td style="width: 10%;"></td> <td style="width: 10%;"></td> </tr> <tr> <td></td> <td></td> <td colspan="8" style="text-align: center;"> <table border="1" style="width: 100%; border-collapse: collapse; text-align: center;"> <tr> </tr></table></td></tr></table></td></tr></table></td></tr></table></td></tr></table></td></tr></table></td></tr></table></td></tr></table></td></tr></table></td></tr></table></td></tr></table></td></tr></table></td></tr></table></td></tr></table></td></tr></table></td></tr></table></td></tr></table></td></tr></table></td></tr></table></td></tr></table></td></tr></table></td></tr></table></td></tr></table></td></tr></table>

 | | | | | | | | | | | | | | | | | | | | <table border="1" style="width: 100%; border-collapse: collapse; text-align: center;"> <tr> <td style="width: 10%;"></td> <td style="width: 10%;"></td> <td style="width: 10%;"></td> <td style="width: 10%;"></td> <td style="width: 10%;"></td> <td style="width: 10%;"></td> <td style="width: 10%;"></td> <td style="width: 10%;"></td> <td style="width: 10%;"></td> <td style="width: 10%;"></td> </tr> <tr> <td></td> <td></td> <td colspan="8" style="text-align: center;"> <table border="1" style="width: 100%; border-collapse: collapse; text-align: center;"> <tr> <td style="width: 10%;"></td> <td style="width: 10%;"></td> <td style="width: 10%;"></td> <td style="width: 10%;"></td> <td style="width: 10%;"></td> <td style="width: 10%;"></td> <td style="width: 10%;"></td> <td style="width: 10%;"></td> <td style="width: 10%;"></td> <td style="width: 10%;"></td> </tr> <tr> <td></td> <td></td> <td colspan="8" style="text-align: center;"> <table border="1" style="width: 100%; border-collapse: collapse; text-align: center;"> <tr> <td style="width: 10%;"></td> <td style="width: 10%;"></td> <td style="width: 10%;"></td> <td style="width: 10%;"></td> <td style="width: 10%;"></td> <td style="width: 10%;"></td> <td style="width: 10%;"></td> <td style="width: 10%;"></td> <td style="width: 10%;"></td> <td style="width: 10%;"></td> </tr> <tr> <td></td> <td></td> <td colspan="8" style="text-align: center;"> <table border="1" style="width: 100%; border-collapse: collapse; text-align: center;"> <tr> <td style="width: 10%;"></td> <td style="width: 10%;"></td> <td style="width: 10%;"></td> <td style="width: 10%;"></td> <td style="width: 10%;"></td> <td style="width: 10%;"></td> <td style="width: 10%;"></td> <td style="width: 10%;"></td> <td style="width: 10%;"></td> <td style="width: 10%;"></td> </tr> <tr> <td></td> <td></td> <td colspan="8" style="text-align: center;"> <table border="1" style="width: 100%; border-collapse: collapse; text-align: center;"> <tr> <td style="width: 10%;"></td> <td style="width: 10%;"></td> <td style="width: 10%;"></td> <td style="width: 10%;"></td> <td style="width: 10%;"></td> <td style="width: 10%;"></td> <td style="width: 10%;"></td> <td style="width: 10%;"></td> <td style="width: 10%;"></td> <td style="width: 10%;"></td> </tr> <tr> <td></td> <td></td> <td colspan="8" style="text-align: center;"> <table border="1" style="width: 100%; border-collapse: collapse; text-align: center;"> <tr> <td style="width: 10%;"></td> <td style="width: 10%;"></td> <td style="width: 10%;"></td> <td style="width: 10%;"></td> <td style="width: 10%;"></td> <td style="width: 10%;"></td> <td style="width: 10%;"></td> <td style="width: 10%;"></td> <td style="width: 10%;"></td> <td style="width: 10%;"></td> </tr> <tr> <td></td> <td></td> <td colspan="8" style="text-align: center;"> <table border="1" style="width: 100%; border-collapse: collapse; text-align: center;"> <tr> <td style="width: 10%;"></td> <td style="width: 10%;"></td> <td style="width: 10%;"></td> <td style="width: 10%;"></td> <td style="width: 10%;"></td> <td style="width: 10%;"></td> <td style="width: 10%;"></td> <td style="width: 10%;"></td> <td style="width: 10%;"></td> <td style="width: 10%;"></td> </tr> <tr> <td></td> <td></td> <td colspan="8" style="text-align: center;"> <table border="1" style="width: 100%; border-collapse: collapse; text-align: center;"> <tr> <td style="width: 10%;"></td> <td style="width: 10%;"></td> <td style="width: 10%;"></td> <td style="width: 10%;"></td> <td style="width: 10%;"></td> <td style="width: 10%;"></td> <td style="width: 10%;"></td> <td style="width: 10%;"></td> <td style="width: 10%;"></td> <td style="width: 10%;"></td> </tr> <tr> <td></td> <td></td> <td colspan="8" style="text-align: center;"> <table border="1" style="width: 100%; border-collapse: collapse; text-align: center;"> <tr> <td style="width: 10%;"></td> <td style="width: 10%;"></td> <td style="width: 10%;"></td> <td style="width: 10%;"></td> <td style="width: 10%;"></td> <td style="width: 10%;"></td> <td style="width: 10%;"></td> <td style="width: 10%;"></td> <td style="width: 10%;"></td> <td style="width: 10%;"></td> </tr> <tr> <td></td> <td></td> <td colspan="8" style="text-align: center;"> <table border="1" style="width: 100%; border-collapse: collapse; text-align: center;"> <tr> <td style="width: 10%;"></td> <td style="width: 10%;"></td> <td style="width: 10%;"></td> <td style="width: 10%;"></td> <td style="width: 10%;"></td> <td style="width: 10%;"></td> <td style="width: 10%;"></td> <td style="width: 10%;"></td> <td style="width: 10%;"></td> <td style="width: 10%;"></td> </tr> <tr> <td></td> <td></td> <td colspan="8" style="text-align: center;"> <table border="1" style="width: 100%; border-collapse: collapse; text-align: center;"> <tr> <td style="width: 10%;"></td> <td style="width: 10%;"></td> <td style="width: 10%;"></td> <td style="width: 10%;"></td> <td style="width: 10%;"></td> <td style="width: 10%;"></td> <td style="width: 10%;"></td> <td style="width: 10%;"></td> <td style="width: 10%;"></td> <td style="width: 10%;"></td> </tr> <tr> <td></td> <td></td> <td colspan="8" style="text-align: center;"> <table border="1" style="width: 100%; border-collapse: collapse; text-align: center;"> <tr> <td style="width: 10%;"></td> <td style="width: 10%;"></td> <td style="width: 10%;"></td> <td style="width: 10%;"></td> <td style="width: 10%;"></td> <td style="width: 10%;"></td> <td style="width: 10%;"></td> <td style="width: 10%;"></td> <td style="width: 10%;"></td> <td style="width: 10%;"></td> </tr> <tr> <td></td> <td></td> <td colspan="8" style="text-align: center;"> <table border="1" style="width: 100%; border-collapse: collapse; text-align: center;"> <tr> <td style="width: 10%;"></td> <td style="width: 10%;"></td> <td style="width: 10%;"></td> <td style="width: 10%;"></td> <td style="width: 10%;"></td> <td style="width: 10%;"></td> <td style="width: 10%;"></td> <td style="width: 10%;"></td> <td style="width: 10%;"></td> <td style="width: 10%;"></td> </tr> <tr> <td></td> <td></td> <td colspan="8" style="text-align: center;"> <table border="1" style="width: 100%; border-collapse: collapse; text-align: center;"> <tr> <td style="width: 10%;"></td> <td style="width: 10%;"></td> <td style="width: 10%;"></td> <td style="width: 10%;"></td> <td style="width: 10%;"></td> <td style="width: 10%;"></td> <td style="width: 10%;"></td> <td style="width: 10%;"></td> <td style="width: 10%;"></td> <td style="width: 10%;"></td> </tr> <tr> <td></td> <td></td> <td colspan="8" style="text-align: center;"> <table border="1" style="width: 100%; border-collapse: collapse; text-align: center;"> <tr> <td style="width: 10%;"></td> <td style="width: 10%;"></td> <td style="width: 10%;"></td> <td style="width: 10%;"></td> <td style="width: 10%;"></td> <td style="width: 10%;"></td> <td style="width: 10%;"></td> <td style="width: 10%;"></td> <td style="width: 10%;"></td> <td style="width: 10%;"></td> </tr> <tr> <td></td> <td></td> <td colspan="8" style="text-align: center;"> <table border="1" style="width: 100%; border-collapse: collapse; text-align: center;"> <tr> <td style="width: 10%;"></td> <td style="width: 10%;"></td> <td style="width: 10%;"></td> <td style="width: 10%;"></td> <td style="width: 10%;"></td> <td style="width: 10%;"></td> <td style="width: 10%;"></td> <td style="width: 10%;"></td> <td style="width: 10%;"></td> <td style="width: 10%;"></td> </tr> <tr> <td></td> <td></td> <td colspan="8" style="text-align: center;"> <table border="1" style="width: 100%; border-collapse: collapse; text-align: center;"> <tr> <td style="width: 10%;"></td> <td style="width: 10%;"></td> <td style="width: 10%;"></td> <td style="width: 10%;"></td> <td style="width: 10%;"></td> <td style="width: 10%;"></td> <td style="width: 10%;"></td> <td style="width: 10%;"></td> <td style="width: 10%;"></td> <td style="width: 10%;"></td> </tr> <tr> <td></td> <td></td> <td colspan="8" style="text-align: center;"> <table border="1" style="width: 100%; border-collapse: collapse; text-align: center;"> <tr> <td style="width: 10%;"></td> <td style="width: 10%;"></td> <td style="width: 10%;"></td> <td style="width: 10%;"></td> <td style="width: 10%;"></td> <td style="width: 10%;"></td> <td style="width: 10%;"></td> <td style="width: 10%;"></td> <td style="width: 10%;"></td> <td style="width: 10%;"></td> </tr> <tr> <td></td> <td></td> <td colspan="8" style="text-align: center;"> <table border="1" style="width: 100%; border-collapse: collapse; text-align: center;"> <tr> <td style="width: 10%;"></td> <td style="width: 10%;"></td> <td style="width: 10%;"></td> <td style="width: 10%;"></td> <td style="width: 10%;"></td> <td style="width: 10%;"></td> <td
style="width: 10%;"></td> <td style="width: 10%;"></td> <td style="width: 10%;"></td> <td style="width: 10%;"></td> </tr> <tr> <td></td> <td></td> <td colspan="8" style="text-align: center;"> <table border="1" style="width: 100%; border-collapse: collapse; text-align: center;"> <tr> <td style="width: 10%;"></td> <td style="width: 10%;"></td> <td style="width: 10%;"></td> <td style="width: 10%;"></td> <td style="width: 10%;"></td> <td style="width: 10%;"></td> <td style="width: 10%;"></td> <td style="width: 10%;"></td> <td style="width: 10%;"></td> <td style="width: 10%;"></td> </tr> <tr> <td></td> <td></td> <td colspan="8" style="text-align: center;"> <table border="1" style="width: 100%; border-collapse: collapse; text-align: center;"> <tr> <td style="width: 10%;"></td> <td style="width: 10%;"></td> <td style="width: 10%;"></td> <td style="width: 10%;"></td> <td style="width: 10%;"></td> <td style="width: 10%;"></td> <td style="width: 10%;"></td> <td style="width: 10%;"></td> <td style="width: 10%;"></td> <td style="width: 10%;"></td> </tr> <tr> <td></td> <td></td> <td colspan="8" style="text-align: center;"> <table border="1" style="width: 100%; border-collapse: collapse; text-align: center;"> <tr> <td style="width: 10%;"></td> <td style="width: 10%;"></td> <td style="width: 10%;"></td> <td style="width: 10%;"></td> <td style="width: 10%;"></td> <td style="width: 10%;"></td> <td style="width: 10%;"></td> <td style="width: 10%;"></td> <td style="width: 10%;"></td> <td style="width: 10%;"></td> </tr> <tr> <td></td> <td></td> <td colspan="8" style="text-align: center;"> <table border="1" style="width: 100%; border-collapse: collapse; text-align: center;"> <tr> </tr></table></td></tr></table></td></tr></table></td></tr></table></td></tr></table></td></tr></table></td></tr></table></td></tr></table></td></tr></table></td></tr></table></td></tr></table></td></tr></table></td></tr></table></td></tr></table></td></tr></table></td></tr></table></td></tr></table></td></tr></table></td></tr></table></td></tr></table></td></tr></table></td></tr></table></td></tr></table>

 | | | | | | | | | | | | | | | | | | | | <table border="1" style="width: 100%; border-collapse: collapse; text-align: center;"> <tr> <td style="width: 10%;"></td> <td style="width: 10%;"></td> <td style="width: 10%;"></td> <td style="width: 10%;"></td> <td style="width: 10%;"></td> <td style="width: 10%;"></td> <td style="width: 10%;"></td> <td style="width: 10%;"></td> <td style="width: 10%;"></td> <td style="width: 10%;"></td> </tr> <tr> <td></td> <td></td> <td colspan="8" style="text-align: center;"> <table border="1" style="width: 100%; border-collapse: collapse; text-align: center;"> <tr> <td style="width: 10%;"></td> <td style="width: 10%;"></td> <td style="width: 10%;"></td> <td style="width: 10%;"></td> <td style="width: 10%;"></td> <td style="width: 10%;"></td> <td style="width: 10%;"></td> <td style="width: 10%;"></td> <td style="width: 10%;"></td> <td style="width: 10%;"></td> </tr> <tr> <td></td> <td></td> <td colspan="8" style="text-align: center;"> <table border="1" style="width: 100%; border-collapse: collapse; text-align: center;"> <tr> <td style="width: 10%;"></td> <td style="width: 10%;"></td> <td style="width: 10%;"></td> <td style="width: 10%;"></td> <td style="width: 10%;"></td> <td style="width: 10%;"></td> <td style="width: 10%;"></td> <td style="width: 10%;"></td> <td style="width: 10%;"></td> <td style="width: 10%;"></td> </tr> <tr> <td></td> <td></td> <td colspan="8" style="text-align: center;"> <table border="1" style="width: 100%; border-collapse: collapse; text-align: center;"> <tr> <td style="width: 10%;"></td> <td style="width: 10%;"></td> <td style="width: 10%;"></td> <td style="width: 10%;"></td> <td style="width: 10%;"></td> <td style="width: 10%;"></td> <td style="width: 10%;"></td> <td style="width: 10%;"></td> <td style="width: 10%;"></td> <td style="width: 10%;"></td> </tr> <tr> <td></td> <td></td> <td colspan="8" style="text-align: center;"> <table border="1" style="width: 100%; border-collapse: collapse; text-align: center;"> <tr> <td style="width: 10%;"></td> <td style="width: 10%;"></td> <td style="width: 10%;"></td> <td style="width: 10%;"></td> <td style="width: 10%;"></td> <td style="width: 10%;"></td> <td style="width: 10%;"></td> <td style="width: 10%;"></td> <td style="width: 10%;"></td> <td style="width: 10%;"></td> </tr> <tr> <td></td> <td></td> <td colspan="8" style="text-align: center;"> <table border="1" style="width: 100%; border-collapse: collapse; text-align: center;"> <tr> <td style="width: 10%;"></td> <td style="width: 10%;"></td> <td style="width: 10%;"></td> <td style="width: 10%;"></td> <td style="width: 10%;"></td> <td style="width: 10%;"></td> <td style="width: 10%;"></td> <td style="width: 10%;"></td> <td style="width: 10%;"></td> <td style="width: 10%;"></td> </tr> <tr> <td></td> <td></td> <td colspan="8" style="text-align: center;"> <table border="1" style="width: 100%; border-collapse: collapse; text-align: center;"> <tr> <td style="width: 10%;"></td> <td style="width: 10%;"></td> <td style="width: 10%;"></td> <td style="width: 10%;"></td> <td style="width: 10%;"></td> <td style="width: 10%;"></td> <td style="width: 10%;"></td> <td style="width: 10%;"></td> <td style="width: 10%;"></td> <td style="width: 10%;"></td> </tr> <tr> <td></td> <td></td> <td colspan="8" style="text-align: center;"> <table border="1" style="width: 100%; border-collapse: collapse; text-align: center;"> <tr> <td style="width: 10%;"></td> <td style="width: 10%;"></td> <td style="width: 10%;"></td> <td style="width: 10%;"></td> <td style="width: 10%;"></td> <td style="width: 10%;"></td> <td style="width: 10%;"></td> <td style="width: 10%;"></td> <td style="width: 10%;"></td> <td style="width: 10%;"></td> </tr> <tr> <td></td> <td></td> <td colspan="8" style="text-align: center;"> <table border="1" style="width: 100%; border-collapse: collapse; text-align: center;"> <tr> <td style="width: 10%;"></td> <td style="width: 10%;"></td> <td style="width: 10%;"></td> <td style="width: 10%;"></td> <td style="width: 10%;"></td> <td style="width: 10%;"></td> <td style="width: 10%;"></td> <td style="width: 10%;"></td> <td style="width: 10%;"></td> <td style="width: 10%;"></td> </tr> <tr> <td></td> <td></td> <td colspan="8" style="text-align: center;"> <table border="1" style="width: 100%; border-collapse: collapse; text-align: center;"> <tr> <td style="width: 10%;"></td> <td style="width: 10%;"></td> <td style="width: 10%;"></td> <td style="width: 10%;"></td> <td style="width: 10%;"></td> <td style="width: 10%;"></td> <td style="width: 10%;"></td> <td style="width: 10%;"></td> <td style="width: 10%;"></td> <td style="width: 10%;"></td> </tr> <tr> <td></td> <td></td> <td colspan="8" style="text-align: center;"> <table border="1" style="width: 100%; border-collapse: collapse; text-align: center;"> <tr> <td style="width: 10%;"></td> <td style="width: 10%;"></td> <td style="width: 10%;"></td> <td style="width: 10%;"></td> <td style="width: 10%;"></td> <td style="width: 10%;"></td> <td style="width: 10%;"></td> <td style="width: 10%;"></td> <td style="width: 10%;"></td> <td style="width: 10%;"></td> </tr> <tr> <td></td> <td></td> <td colspan="8" style="text-align: center;"> <table border="1" style="width: 100%; border-collapse: collapse; text-align: center;"> <tr> <td style="width: 10%;"></td> <td style="width: 10%;"></td> <td style="width: 10%;"></td> <td style="width: 10%;"></td> <td style="width: 10%;"></td> <td style="width: 10%;"></td> <td style="width: 10%;"></td> <td style="width: 10%;"></td> <td style="width: 10%;"></td> <td style="width: 10%;"></td> </tr> <tr> <td></td> <td></td> <td colspan="8" style="text-align: center;"> <table border="1" style="width: 100%; border-collapse: collapse; text-align: center;"> <tr> <td style="width: 10%;"></td> <td style="width: 10%;"></td> <td style="width: 10%;"></td> <td style="width: 10%;"></td> <td style="width: 10%;"></td> <td style="width: 10%;"></td> <td style="width: 10%;"></td> <td style="width: 10%;"></td> <td style="width: 10%;"></td> <td style="width: 10%;"></td> </tr> <tr> <td></td> <td></td> <td colspan="8" style="text-align: center;"> <table border="1" style="width: 100%; border-collapse: collapse; text-align: center;"> <tr> <td style="width: 10%;"></td> <td style="width: 10%;"></td> <td style="width: 10%;"></td> <td style="width: 10%;"></td> <td style="width: 10%;"></td> <td style="width: 10%;"></td> <td style="width: 10%;"></td> <td style="width: 10%;"></td> <td style="width: 10%;"></td> <td style="width: 10%;"></td> </tr> <tr> <td></td> <td></td> <td colspan="8" style="text-align: center;"> <table border="1" style="width: 100%; border-collapse: collapse; text-align: center;"> <tr> <td style="width: 10%;"></td> <td style="width: 10%;"></td> <td style="width: 10%;"></td> <td style="width: 10%;"></td> <td style="width: 10%;"></td> <td style="width: 10%;"></td> <td style="width: 10%;"></td> <td style="width: 10%;"></td> <td style="width: 10%;"></td> <td style="width: 10%;"></td> </tr> <tr> <td></td> <td></td> <td colspan="8" style="text-align: center;"> <table border="1" style="width: 100%; border-collapse: collapse; text-align: center;"> <tr> <td style="width: 10%;"></td> <td style="width: 10%;"></td> <td style="width: 10%;"></td> <td style="width: 10%;"></td> <td style="width: 10%;"></td> <td style="width: 10%;"></td> <td style="width: 10%;"></td> <td style="width: 10%;"></td> <td style="width: 10%;"></td> <td style="width: 10%;"></td> </tr> <tr> <td></td> <td></td> <td colspan="8" style="text-align: center;"> <table border="1" style="width: 100%; border-collapse: collapse; text-align: center;"> <tr> <td style="width: 10%;"></td> <td style="width: 10%;"></td> <td style="width: 10%;"></td> <td style="width: 10%;"></td> <td style="width: 10%;"></td> <td style="width: 10%;"></td> <td style="width: 10%;"></td> <td style="width: 10%;"></td> <td style="width: 10%;"></td> <td style="width: 10%;"></td> </tr> <tr> <td></td> <td></td> <td
colspan="8" style="text-align: center;"> <table border="1" style="width: 100%; border-collapse: collapse; text-align: center;"> <tr> <td style="width: 10%;"></td> <td style="width: 10%;"></td> <td style="width: 10%;"></td> <td style="width: 10%;"></td> <td style="width: 10%;"></td> <td style="width: 10%;"></td> <td style="width: 10%;"></td> <td style="width: 10%;"></td> <td style="width: 10%;"></td> <td style="width: 10%;"></td> </tr> <tr> <td></td> <td></td> <td colspan="8" style="text-align: center;"> <table border="1" style="width: 100%; border-collapse: collapse; text-align: center;"> <tr> <td style="width: 10%;"></td> <td style="width: 10%;"></td> <td style="width: 10%;"></td> <td style="width: 10%;"></td> <td style="width: 10%;"></td> <td style="width: 10%;"></td> <td style="width: 10%;"></td> <td style="width: 10%;"></td> <td style="width: 10%;"></td> <td style="width: 10%;"></td> </tr> <tr> <td></td> <td></td> <td colspan="8" style="text-align: center;"> <table border="1" style="width: 100%; border-collapse: collapse; text-align: center;"> <tr> <td style="width: 10%;"></td> <td style="width: 10%;"></td> <td style="width: 10%;"></td> <td style="width: 10%;"></td> <td style="width: 10%;"></td> <td style="width: 10%;"></td> <td style="width: 10%;"></td> <td style="width: 10%;"></td> <td style="width: 10%;"></td> <td style="width: 10%;"></td> </tr> <tr> <td></td> <td></td> <td colspan="8" style="text-align: center;"> <table border="1" style="width: 100%; border-collapse: collapse; text-align: center;"> <tr> <td style="width: 10%;"></td> <td style="width: 10%;"></td> <td style="width: 10%;"></td> <td style="width: 10%;"></td> <td style="width: 10%;"></td> <td style="width: 10%;"></td> <td style="width: 10%;"></td> <td style="width: 10%;"></td> <td style="width: 10%;"></td> <td style="width: 10%;"></td> </tr> <tr> <td></td> <td></td> <td colspan="8" style="text-align: center;"> <table border="1" style="width: 100%; border-collapse: collapse; text-align: center;"> <tr> </tr></table></td></tr></table></td></tr></table></td></tr></table></td></tr></table></td></tr></table></td></tr></table></td></tr></table></td></tr></table></td></tr></table></td></tr></table></td></tr></table></td></tr></table></td></tr></table></td></tr></table></td></tr></table></td></tr></table></td></tr></table></td></tr></table></td></tr></table></td></tr></table></td></tr></table>

 | | | | | | | | | | | | | | | | | | | | <table border="1" style="width: 100%; border-collapse: collapse; text-align: center;"> <tr> <td style="width: 10%;"></td> <td style="width: 10%;"></td> <td style="width: 10%;"></td> <td style="width: 10%;"></td> <td style="width: 10%;"></td> <td style="width: 10%;"></td> <td style="width: 10%;"></td> <td style="width: 10%;"></td> <td style="width: 10%;"></td> <td style="width: 10%;"></td> </tr> <tr> <td></td> <td></td> <td colspan="8" style="text-align: center;"> <table border="1" style="width: 100%; border-collapse: collapse; text-align: center;"> <tr> <td style="width: 10%;"></td> <td style="width: 10%;"></td> <td style="width: 10%;"></td> <td style="width: 10%;"></td> <td style="width: 10%;"></td> <td style="width: 10%;"></td> <td style="width: 10%;"></td> <td style="width: 10%;"></td> <td style="width: 10%;"></td> <td style="width: 10%;"></td> </tr> <tr> <td></td> <td></td> <td colspan="8" style="text-align: center;"> <table border="1" style="width: 100%; border-collapse: collapse; text-align: center;"> <tr> <td style="width: 10%;"></td> <td style="width: 10%;"></td> <td style="width: 10%;"></td> <td style="width: 10%;"></td> <td style="width: 10%;"></td> <td style="width: 10%;"></td> <td style="width: 10%;"></td> <td style="width: 10%;"></td> <td style="width: 10%;"></td> <td style="width: 10%;"></td> </tr> <tr> <td></td> <td></td> <td colspan="8" style="text-align: center;"> <table border="1" style="width: 100%; border-collapse: collapse; text-align: center;"> <tr> <td style="width: 10%;"></td> <td style="width: 10%;"></td> <td style="width: 10%;"></td> <td style="width: 10%;"></td> <td style="width: 10%;"></td> <td style="width: 10%;"></td> <td style="width: 10%;"></td> <td style="width: 10%;"></td> <td style="width: 10%;"></td> <td style="width: 10%;"></td> </tr> <tr> <td></td> <td></td> <td colspan="8" style="text-align: center;"> <table border="1" style="width: 100%; border-collapse: collapse; text-align: center;"> <tr> <td style="width: 10%;"></td> <td style="width: 10%;"></td> <td style="width: 10%;"></td> <td style="width: 10%;"></td> <td style="width: 10%;"></td> <td style="width: 10%;"></td> <td style="width: 10%;"></td> <td style="width: 10%;"></td> <td style="width: 10%;"></td> <td style="width: 10%;"></td> </tr> <tr> <td></td> <td></td> <td colspan="8" style="text-align: center;"> <table border="1" style="width: 100%; border-collapse: collapse; text-align: center;"> <tr> <td style="width: 10%;"></td> <td style="width: 10%;"></td> <td style="width: 10%;"></td> <td style="width: 10%;"></td> <td style="width: 10%;"></td> <td style="width: 10%;"></td> <td style="width: 10%;"></td> <td style="width: 10%;"></td> <td style="width: 10%;"></td> <td style="width: 10%;"></td> </tr> <tr> <td></td> <td></td> <td colspan="8" style="text-align: center;"> <table border="1" style="width: 100%; border-collapse: collapse; text-align: center;"> <tr> <td style="width: 10%;"></td> <td style="width: 10%;"></td> <td style="width: 10%;"></td> <td style="width: 10%;"></td> <td style="width: 10%;"></td> <td style="width: 10%;"></td> <td style="width: 10%;"></td> <td style="width: 10%;"></td> <td style="width: 10%;"></td> <td style="width: 10%;"></td> </tr> <tr> <td></td> <td></td> <td colspan="8" style="text-align: center;"> <table border="1" style="width: 100%; border-collapse: collapse; text-align: center;"> <tr> <td style="width: 10%;"></td> <td style="width: 10%;"></td> <td style="width: 10%;"></td> <td style="width: 10%;"></td> <td style="width: 10%;"></td> <td style="width: 10%;"></td> <td style="width: 10%;"></td> <td style="width: 10%;"></td> <td style="width: 10%;"></td> <td style="width: 10%;"></td> </tr> <tr> <td></td> <td></td> <td colspan="8" style="text-align: center;"> <table border="1" style="width: 100%; border-collapse: collapse; text-align: center;"> <tr> <td style="width: 10%;"></td> <td style="width: 10%;"></td> <td style="width: 10%;"></td> <td style="width: 10%;"></td> <td style="width: 10%;"></td> <td style="width: 10%;"></td> <td style="width: 10%;"></td> <td style="width: 10%;"></td> <td style="width: 10%;"></td> <td style="width: 10%;"></td> </tr> <tr> <td></td> <td></td> <td colspan="8" style="text-align: center;"> <table border="1" style="width: 100%; border-collapse: collapse; text-align: center;"> <tr> <td style="width: 10%;"></td> <td style="width: 10%;"></td> <td style="width: 10%;"></td> <td style="width: 10%;"></td> <td style="width: 10%;"></td> <td style="width: 10%;"></td> <td style="width: 10%;"></td> <td style="width: 10%;"></td> <td style="width: 10%;"></td> <td style="width: 10%;"></td> </tr> <tr> <td></td> <td></td> <td colspan="8" style="text-align: center;"> <table border="1" style="width: 100%; border-collapse: collapse; text-align: center;"> <tr> <td style="width: 10%;"></td> <td style="width: 10%;"></td> <td style="width: 10%;"></td> <td style="width: 10%;"></td> <td style="width: 10%;"></td> <td style="width: 10%;"></td> <td style="width: 10%;"></td> <td style="width: 10%;"></td> <td style="width: 10%;"></td> <td style="width: 10%;"></td> </tr> <tr> <td></td> <td></td> <td colspan="8" style="text-align: center;"> <table border="1" style="width: 100%; border-collapse: collapse; text-align: center;"> <tr> <td style="width: 10%;"></td> <td style="width: 10%;"></td> <td style="width: 10%;"></td> <td style="width: 10%;"></td> <td style="width: 10%;"></td> <td style="width: 10%;"></td> <td style="width: 10%;"></td> <td style="width: 10%;"></td> <td style="width: 10%;"></td> <td style="width: 10%;"></td> </tr> <tr> <td></td> <td></td> <td colspan="8" style="text-align: center;"> <table border="1" style="width: 100%; border-collapse: collapse; text-align: center;"> <tr> <td style="width: 10%;"></td> <td style="width: 10%;"></td> <td style="width: 10%;"></td> <td style="width: 10%;"></td> <td style="width: 10%;"></td> <td style="width: 10%;"></td> <td style="width: 10%;"></td> <td style="width: 10%;"></td> <td style="width: 10%;"></td> <td style="width: 10%;"></td> </tr> <tr> <td></td> <td></td> <td colspan="8" style="text-align: center;"> <table border="1" style="width: 100%; border-collapse: collapse; text-align: center;"> <tr> <td style="width: 10%;"></td> <td style="width: 10%;"></td> <td style="width: 10%;"></td> <td style="width: 10%;"></td> <td style="width: 10%;"></td> <td style="width: 10%;"></td> <td style="width: 10%;"></td> <td style="width: 10%;"></td> <td style="width: 10%;"></td> <td style="width: 10%;"></td> </tr> <tr> <td></td> <td></td> <td colspan="8" style="text-align: center;"> <table border="1" style="width: 100%; border-collapse: collapse; text-align: center;"> <tr> <td style="width: 10%;"></td> <td style="width: 10%;"></td> <td style="width: 10%;"></td> <td style="width: 10%;"></td> <td style="width: 10%;"></td> <td style="width: 10%;"></td> <td style="width: 10%;"></td> <td style="width: 10%;"></td> <td style="width: 10%;"></td> <td style="width: 10%;"></td> </tr> <tr> <td></td> <td></td> <td colspan="8" style="text-align: center;"> <table border="1" style="width: 100%; border-collapse: collapse; text-align: center;"> <tr> <td style="width: 10%;"></td> <td style="width: 10%;"></td> <td style="width: 10%;"></td> <td style="width: 10%;"></td> <td style="width: 10%;"></td> <td style="width: 10%;"></td> <td style="width: 10%;"></td> <td style="width: 10%;"></td> <td style="width: 10%;"></td> <td style="width: 10%;"></td> </tr> <tr> <td></td> <td></td> <td colspan="8" style="text-align: center;"> <table border="1" style="width: 100%; border-collapse: collapse; text-align: center;"> <tr> <td style="width: 10%;"></td> <td
style="width: 10%;"></td> <td style="width: 10%;"></td> <td style="width: 10%;"></td> <td style="width: 10%;"></td> <td style="width: 10%;"></td> <td style="width: 10%;"></td> <td style="width: 10%;"></td> <td style="width: 10%;"></td> <td style="width: 10%;"></td> </tr> <tr> <td></td> <td></td> <td colspan="8" style="text-align: center;"> <table border="1" style="width: 100%; border-collapse: collapse; text-align: center;"> <tr> <td style="width: 10%;"></td> <td style="width: 10%;"></td> <td style="width: 10%;"></td> <td style="width: 10%;"></td> <td style="width: 10%;"></td> <td style="width: 10%;"></td> <td style="width: 10%;"></td> <td style="width: 10%;"></td> <td style="width: 10%;"></td> <td style="width: 10%;"></td> </tr> <tr> <td></td> <td></td> <td colspan="8" style="text-align: center;"> <table border="1" style="width: 100%; border-collapse: collapse; text-align: center;"> <tr> <td style="width: 10%;"></td> <td style="width: 10%;"></td> <td style="width: 10%;"></td> <td style="width: 10%;"></td> <td style="width: 10%;"></td> <td style="width: 10%;"></td> <td style="width: 10%;"></td> <td style="width: 10%;"></td> <td style="width: 10%;"></td> <td style="width: 10%;"></td> </tr> <tr> <td></td> <td></td> <td colspan="8" style="text-align: center;"> <table border="1" style="width: 100%; border-collapse: collapse; text-align: center;"> <tr> <td style="width: 10%;"></td> <td style="width: 10%;"></td> <td style="width: 10%;"></td> <td style="width: 10%;"></td> <td style="width: 10%;"></td> <td style="width: 10%;"></td> <td style="width: 10%;"></td> <td style="width: 10%;"></td> <td style="width: 10%;"></td> <td style="width: 10%;"></td> </tr> <tr> <td></td> <td></td> <td colspan="8" style="text-align: center;"> <table border="1" style="width: 100%; border-collapse: collapse; text-align: center;"> <tr> </tr></table></td></tr></table></td></tr></table></td></tr></table></td></tr></table></td></tr></table></td></tr></table></td></tr></table></td></tr></table></td></tr></table></td></tr></table></td></tr></table></td></tr></table></td></tr></table></td></tr></table></td></tr></table></td></tr></table></td></tr></table></td></tr></table></td></tr></table></td></tr></table>

 | | | | | | | | | | | | | | | | | | | | <table border="1" style="width: 100%; border-collapse: collapse; text-align: center;"> <tr> <td style="width: 10%;"></td> <td style="width: 10%;"></td> <td style="width: 10%;"></td> <td style="width: 10%;"></td> <td style="width: 10%;"></td> <td style="width: 10%;"></td> <td style="width: 10%;"></td> <td style="width: 10%;"></td> <td style="width: 10%;"></td> <td style="width: 10%;"></td> </tr> <tr> <td></td> <td></td> <td colspan="8" style="text-align: center;"> <table border="1" style="width: 100%; border-collapse: collapse; text-align: center;"> <tr> <td style="width: 10%;"></td> <td style="width: 10%;"></td> <td style="width: 10%;"></td> <td style="width: 10%;"></td> <td style="width: 10%;"></td> <td style="width: 10%;"></td> <td style="width: 10%;"></td> <td style="width: 10%;"></td> <td style="width: 10%;"></td> <td style="width: 10%;"></td> </tr> <tr> <td></td> <td></td> <td colspan="8" style="text-align: center;"> <table border="1" style="width: 100%; border-collapse: collapse; text-align: center;"> <tr> <td style="width: 10%;"></td> <td style="width: 10%;"></td> <td style="width: 10%;"></td> <td style="width: 10%;"></td> <td style="width: 10%;"></td> <td style="width: 10%;"></td> <td style="width: 10%;"></td> <td style="width: 10%;"></td> <td style="width: 10%;"></td> <td style="width: 10%;"></td> </tr> <tr> <td></td> <td></td> <td colspan="8" style="text-align: center;"> <table border="1" style="width: 100%; border-collapse: collapse; text-align: center;"> <tr> <td style="width: 10%;"></td> <td style="width: 10%;"></td> <td style="width: 10%;"></td> <td style="width: 10%;"></td> <td style="width: 10%;"></td> <td style="width: 10%;"></td> <td style="width: 10%;"></td> <td style="width: 10%;"></td> <td style="width: 10%;"></td> <td style="width: 10%;"></td> </tr> <tr> <td></td> <td></td> <td colspan="8" style="text-align: center;"> <table border="1" style="width: 100%; border-collapse: collapse; text-align: center;"> <tr> <td style="width: 10%;"></td> <td style="width: 10%;"></td> <td style="width: 10%;"></td> <td style="width: 10%;"></td> <td style="width: 10%;"></td> <td style="width: 10%;"></td> <td style="width: 10%;"></td> <td style="width: 10%;"></td> <td style="width: 10%;"></td> <td style="width: 10%;"></td> </tr> <tr> <td></td> <td></td> <td colspan="8" style="text-align: center;"> <table border="1" style="width: 100%; border-collapse: collapse; text-align: center;"> <tr> <td style="width: 10%;"></td> <td style="width: 10%;"></td> <td style="width: 10%;"></td> <td style="width: 10%;"></td> <td style="width: 10%;"></td> <td style="width: 10%;"></td> <td style="width: 10%;"></td> <td style="width: 10%;"></td> <td style="width: 10%;"></td> <td style="width: 10%;"></td> </tr> <tr> <td></td> <td></td> <td colspan="8" style="text-align: center;"> <table border="1" style="width: 100%; border-collapse: collapse; text-align: center;"> <tr> <td style="width: 10%;"></td> <td style="width: 10%;"></td> <td style="width: 10%;"></td> <td style="width: 10%;"></td> <td style="width: 10%;"></td> <td style="width: 10%;"></td> <td style="width: 10%;"></td> <td style="width: 10%;"></td> <td style="width: 10%;"></td> <td style="width: 10%;"></td> </tr> <tr> <td></td> <td></td> <td colspan="8" style="text-align: center;"> <table border="1" style="width: 100%; border-collapse: collapse; text-align: center;"> <tr> <td style="width: 10%;"></td> <td style="width: 10%;"></td> <td style="width: 10%;"></td> <td style="width: 10%;"></td> <td style="width: 10%;"></td> <td style="width: 10%;"></td> <td style="width: 10%;"></td> <td style="width: 10%;"></td> <td style="width: 10%;"></td> <td style="width: 10%;"></td> </tr> <tr> <td></td> <td></td> <td colspan="8" style="text-align: center;"> <table border="1" style="width: 100%; border-collapse: collapse; text-align: center;"> <tr> <td style="width: 10%;"></td> <td style="width: 10%;"></td> <td style="width: 10%;"></td> <td style="width: 10%;"></td> <td style="width: 10%;"></td> <td style="width: 10%;"></td> <td style="width: 10%;"></td> <td style="width: 10%;"></td> <td style="width: 10%;"></td> <td style="width: 10%;"></td> </tr> <tr> <td></td> <td></td> <td colspan="8" style="text-align: center;"> <table border="1" style="width: 100%; border-collapse: collapse; text-align: center;"> <tr> <td style="width: 10%;"></td> <td style="width: 10%;"></td> <td style="width: 10%;"></td> <td style="width: 10%;"></td> <td style="width: 10%;"></td> <td style="width: 10%;"></td> <td style="width: 10%;"></td> <td style="width: 10%;"></td> <td style="width: 10%;"></td> <td style="width: 10%;"></td> </tr> <tr> <td></td> <td></td> <td colspan="8" style="text-align: center;"> <table border="1" style="width: 100%; border-collapse: collapse; text-align: center;"> <tr> <td style="width: 10%;"></td> <td style="width: 10%;"></td> <td style="width: 10%;"></td> <td style="width: 10%;"></td> <td style="width: 10%;"></td> <td style="width: 10%;"></td> <td style="width: 10%;"></td> <td style="width: 10%;"></td> <td style="width: 10%;"></td> <td style="width: 10%;"></td> </tr> <tr> <td></td> <td></td> <td colspan="8" style="text-align: center;"> <table border="1" style="width: 100%; border-collapse: collapse; text-align: center;"> <tr> <td style="width: 10%;"></td> <td style="width: 10%;"></td> <td style="width: 10%;"></td> <td style="width: 10%;"></td> <td style="width: 10%;"></td> <td style="width: 10%;"></td> <td style="width: 10%;"></td> <td style="width: 10%;"></td> <td style="width: 10%;"></td> <td style="width: 10%;"></td> </tr> <tr> <td></td> <td></td> <td colspan="8" style="text-align: center;"> <table border="1" style="width: 100%; border-collapse: collapse; text-align: center;"> <tr> <td style="width: 10%;"></td> <td style="width: 10%;"></td> <td style="width: 10%;"></td> <td style="width: 10%;"></td> <td style="width: 10%;"></td> <td style="width: 10%;"></td> <td style="width: 10%;"></td> <td style="width: 10%;"></td> <td style="width: 10%;"></td> <td style="width: 10%;"></td> </tr> <tr> <td></td> <td></td> <td colspan="8" style="text-align: center;"> <table border="1" style="width: 100%; border-collapse: collapse; text-align: center;"> <tr> <td style="width: 10%;"></td> <td style="width: 10%;"></td> <td style="width: 10%;"></td> <td style="width: 10%;"></td> <td style="width: 10%;"></td> <td style="width: 10%;"></td> <td style="width: 10%;"></td> <td style="width: 10%;"></td> <td style="width: 10%;"></td> <td style="width: 10%;"></td> </tr> <tr> <td></td> <td></td> <td colspan="8" style="text-align: center;"> <table border="1" style="width: 100%; border-collapse: collapse; text-align: center;"> <tr> <td style="width: 10%;"></td> <td style="width: 10%;"></td> <td style="width: 10%;"></td> <td style="width: 10%;"></td> <td style="width: 10%;"></td> <td style="width: 10%;"></td> <td style="width: 10%;"></td> <td style="width: 10%;"></td> <td style="width: 10%;"></td> <td style="width: 10%;"></td> </tr> <tr> <td></td> <td></td> <td colspan="8" style="text-align: center;"> <table border="1" style="width: 100%; border-collapse: collapse; text-align: center;"> <tr> <td style="width: 10%;"></td> <td style="width: 10%;"></td> <td style="width: 10%;"></td> <td style="width: 10%;"></td> <td style="width: 10%;"></td> <td style="width: 10%;"></td> <td style="width: 10%;"></td> <td style="width: 10%;"></td> <td style="width: 10%;"></td> <td style="width: 10%;"></td> </tr> <tr> <td></td> <td></td> <td colspan="8" style="text-align: center;"> <table border="1" style="width: 100%; border-collapse: collapse; text-align: center;"> <tr> <td style="width: 10%;"></td> <td style="width: 10%;"></td> <td style="width: 10%;"></td> <td style="width: 10%;"></td> <td style="width: 10%;"></td> <td style="width: 10%;"></td> <td style="width: 10%;"></td> <td
style="width: 10%;"></td> <td style="width: 10%;"></td> <td style="width: 10%;"></td> </tr> <tr> <td></td> <td></td> <td colspan="8" style="text-align: center;"> <table border="1" style="width: 100%; border-collapse: collapse; text-align: center;"> <tr> <td style="width: 10%;"></td> <td style="width: 10%;"></td> <td style="width: 10%;"></td> <td style="width: 10%;"></td> <td style="width: 10%;"></td> <td style="width: 10%;"></td> <td style="width: 10%;"></td> <td style="width: 10%;"></td> <td style="width: 10%;"></td> <td style="width: 10%;"></td> </tr> <tr> <td></td> <td></td> <td colspan="8" style="text-align: center;"> <table border="1" style="width: 100%; border-collapse: collapse; text-align: center;"> <tr> <td style="width: 10%;"></td> <td style="width: 10%;"></td> <td style="width: 10%;"></td> <td style="width: 10%;"></td> <td style="width: 10%;"></td> <td style="width: 10%;"></td> <td style="width: 10%;"></td> <td style="width: 10%;"></td> <td style="width: 10%;"></td> <td style="width: 10%;"></td> </tr> <tr> <td></td> <td></td> <td colspan="8" style="text-align: center;"> <table border="1" style="width: 100%; border-collapse: collapse; text-align: center;"> <tr> </tr></table></td></tr></table></td></tr></table></td></tr></table></td></tr></table></td></tr></table></td></tr></table></td></tr></table></td></tr></table></td></tr></table></td></tr></table></td></tr></table></td></tr></table></td></tr></table></td></tr></table></td></tr></table></td></tr></table></td></tr></table></td></tr></table></td></tr></table>

 | | | | | | | | | | | | | | | | | | | | <table border="1" style="width: 100%; border-collapse: collapse; text-align: center;"> <tr> <td style="width: 10%;"></td> <td style="width: 10%;"></td> <td style="width: 10%;"></td> <td style="width: 10%;"></td> <td style="width: 10%;"></td> <td style="width: 10%;"></td> <td style="width: 10%;"></td> <td style="width: 10%;"></td> <td style="width: 10%;"></td> <td style="width: 10%;"></td> </tr> <tr> <td></td> <td></td> <td colspan="8" style="text-align: center;"> <table border="1" style="width: 100%; border-collapse: collapse; text-align: center;"> <tr> <td style="width: 10%;"></td> <td style="width: 10%;"></td> <td style="width: 10%;"></td> <td style="width: 10%;"></td> <td style="width: 10%;"></td> <td style="width: 10%;"></td> <td style="width: 10%;"></td> <td style="width: 10%;"></td> <td style="width: 10%;"></td> <td style="width: 10%;"></td> </tr> <tr> <td></td> <td></td> <td colspan="8" style="text-align: center;"> <table border="1" style="width: 100%; border-collapse: collapse; text-align: center;"> <tr> <td style="width: 10%;"></td> <td style="width: 10%;"></td> <td style="width: 10%;"></td> <td style="width: 10%;"></td> <td style="width: 10%;"></td> <td style="width: 10%;"></td> <td style="width: 10%;"></td> <td style="width: 10%;"></td> <td style="width: 10%;"></td> <td style="width: 10%;"></td> </tr> <tr> <td></td> <td></td> <td colspan="8" style="text-align: center;"> <table border="1" style="width: 100%; border-collapse: collapse; text-align: center;"> <tr> <td style="width: 10%;"></td> <td style="width: 10%;"></td> <td style="width: 10%;"></td> <td style="width: 10%;"></td> <td style="width: 10%;"></td> <td style="width: 10%;"></td> <td style="width: 10%;"></td> <td style="width: 10%;"></td> <td style="width: 10%;"></td> <td style="width: 10%;"></td> </tr> <tr> <td></td> <td></td> <td colspan="8" style="text-align: center;"> <table border="1" style="width: 100%; border-collapse: collapse; text-align: center;"> <tr> <td style="width: 10%;"></td> <td style="width: 10%;"></td> <td style="width: 10%;"></td> <td style="width: 10%;"></td> <td style="width: 10%;"></td> <td style="width: 10%;"></td> <td style="width: 10%;"></td> <td style="width: 10%;"></td> <td style="width: 10%;"></td> <td style="width: 10%;"></td> </tr> <tr> <td></td> <td></td> <td colspan="8" style="text-align: center;"> <table border="1" style="width: 100%; border-collapse: collapse; text-align: center;"> <tr> <td style="width: 10%;"></td> <td style="width: 10%;"></td> <td style="width: 10%;"></td> <td style="width: 10%;"></td> <td style="width: 10%;"></td> <td style="width: 10%;"></td> <td style="width: 10%;"></td> <td style="width: 10%;"></td> <td style="width: 10%;"></td> <td style="width: 10%;"></td> </tr> <tr> <td></td> <td></td> <td colspan="8" style="text-align: center;"> <table border="1" style="width: 100%; border-collapse: collapse; text-align: center;"> <tr> <td style="width: 10%;"></td> <td style="width: 10%;"></td> <td style="width: 10%;"></td> <td style="width: 10%;"></td> <td style="width: 10%;"></td> <td style="width: 10%;"></td> <td style="width: 10%;"></td> <td style="width: 10%;"></td> <td style="width: 10%;"></td> <td style="width: 10%;"></td> </tr> <tr> <td></td> <td></td> <td colspan="8" style="text-align: center;"> <table border="1" style="width: 100%; border-collapse: collapse; text-align: center;"> <tr> <td style="width: 10%;"></td> <td style="width: 10%;"></td> <td style="width: 10%;"></td> <td style="width: 10%;"></td> <td style="width: 10%;"></td> <td style="width: 10%;"></td> <td style="width: 10%;"></td> <td style="width: 10%;"></td> <td style="width: 10%;"></td> <td style="width: 10%;"></td> </tr> <tr> <td></td> <td></td> <td colspan="8" style="text-align: center;"> <table border="1" style="width: 100%; border-collapse: collapse; text-align: center;"> <tr> <td style="width: 10%;"></td> <td style="width: 10%;"></td> <td style="width: 10%;"></td> <td style="width: 10%;"></td> <td style="width: 10%;"></td> <td style="width: 10%;"></td> <td style="width: 10%;"></td> <td style="width: 10%;"></td> <td style="width: 10%;"></td> <td style="width: 10%;"></td> </tr> <tr> <td></td> <td></td> <td colspan="8" style="text-align: center;"> <table border="1" style="width: 100%; border-collapse: collapse; text-align: center;"> <tr> <td style="width: 10%;"></td> <td style="width: 10%;"></td> <td style="width: 10%;"></td> <td style="width: 10%;"></td> <td style="width: 10%;"></td> <td style="width: 10%;"></td> <td style="width: 10%;"></td> <td style="width: 10%;"></td> <td style="width: 10%;"></td> <td style="width: 10%;"></td> </tr> <tr> <td></td> <td></td> <td colspan="8" style="text-align: center;"> <table border="1" style="width: 100%; border-collapse: collapse; text-align: center;"> <tr> <td style="width: 10%;"></td> <td style="width: 10%;"></td> <td style="width: 10%;"></td> <td style="width: 10%;"></td> <td style="width: 10%;"></td> <td style="width: 10%;"></td> <td style="width: 10%;"></td> <td style="width: 10%;"></td> <td style="width: 10%;"></td> <td style="width: 10%;"></td> </tr> <tr> <td></td> <td></td> <td colspan="8" style="text-align: center;"> <table border="1" style="width: 100%; border-collapse: collapse; text-align: center;"> <tr> <td style="width: 10%;"></td> <td style="width: 10%;"></td> <td style="width: 10%;"></td> <td style="width: 10%;"></td> <td style="width: 10%;"></td> <td style="width: 10%;"></td> <td style="width: 10%;"></td> <td style="width: 10%;"></td> <td style="width: 10%;"></td> <td style="width: 10%;"></td> </tr> <tr> <td></td> <td></td> <td colspan="8" style="text-align: center;"> <table border="1" style="width: 100%; border-collapse: collapse; text-align: center;"> <tr> <td style="width: 10%;"></td> <td style="width: 10%;"></td> <td style="width: 10%;"></td> <td style="width: 10%;"></td> <td style="width: 10%;"></td> <td style="width: 10%;"></td> <td style="width: 10%;"></td> <td style="width: 10%;"></td> <td style="width: 10%;"></td> <td style="width: 10%;"></td> </tr> <tr> <td></td> <td></td> <td colspan="8" style="text-align: center;"> <table border="1" style="width: 100%; border-collapse: collapse; text-align: center;"> <tr> <td style="width: 10%;"></td> <td style="width: 10%;"></td> <td style="width: 10%;"></td> <td style="width: 10%;"></td> <td style="width: 10%;"></td> <td style="width: 10%;"></td> <td style="width: 10%;"></td> <td style="width: 10%;"></td> <td style="width: 10%;"></td> <td style="width: 10%;"></td> </tr> <tr> <td></td> <td></td> <td colspan="8" style="text-align: center;"> <table border="1" style="width: 100%; border-collapse: collapse; text-align: center;"> <tr> <td style="width: 10%;"></td> <td style="width: 10%;"></td> <td style="width: 10%;"></td> <td style="width: 10%;"></td> <td style="width: 10%;"></td> <td style="width: 10%;"></td> <td style="width: 10%;"></td> <td style="width: 10%;"></td> <td style="width: 10%;"></td> <td style="width: 10%;"></td> </tr> <tr> <td></td> <td></td> <td colspan="8" style="text-align: center;"> <table border="1" style="width: 100%; border-collapse: collapse; text-align: center;"> <tr> <td style="width: 10%;"></td> <td style="width: 10%;"></td> <td style="width: 10%;"></td> <td style="width: 10%;"></td> <td style="width: 10%;"></td> <td style="width: 10%;"></td> <td style="width: 10%;"></td> <td style="width: 10%;"></td> <td style="width: 10%;"></td> <td style="width: 10%;"></td> </tr> <tr> <td></td> <td></td> <td colspan="8" style="text-align: center;"> <table border="1" style="width: 100%; border-collapse: collapse; text-align: center;"> <tr> <td style="width: 10%;"></td> <td style="width: 10%;"></td> <td style="width: 10%;"></td> <td style="width: 10%;"></td> <td style="width: 10%;"></td> <td style="width: 10%;"></td> <td style="width: 10%;"></td> <td style="width: 10%;"></td> <td style="width: 10%;"></td> <td style="width: 10%;"></td> </tr> <tr> <td></td> <td></td> <td colspan="8" style="text-align: center;"> <table border="1" style="width: 100%; border-collapse: collapse; text-align: center;"> <tr> <td style="width: 10%;"></td> <td style="width: 10%;"></td> <td style="width: 10%;"></td> <td style="width: 10%;"></td> <td style="width: 10%;"></td> <td style="width: 10%;"></td> <td style="width: 10%;"></td> <td style="width: 10%;"></td> <td style="width: 10%;"></td> <td style="width: 10%;"></td> </tr> <tr> <td></td> <td></td> <td colspan="8" style="text-align: center;"> <table border="1" style="width: 100%;
border-collapse: collapse; text-align: center;"> <tr> </tr></table></td></tr></table></td></tr></table></td></tr></table></td></tr></table></td></tr></table></td></tr></table></td></tr></table></td></tr></table></td></tr></table></td></tr></table></td></tr></table></td></tr></table></td></tr></table></td></tr></table></td></tr></table></td></tr></table></td></tr></table></td></tr></table>

 | | | | | | | | | | | | | | | | | | | | <table border="1" style="width: 100%; border-collapse: collapse; text-align: center;"> <tr> <td style="width: 10%;"></td> <td style="width: 10%;"></td> <td style="width: 10%;"></td> <td style="width: 10%;"></td> <td style="width: 10%;"></td> <td style="width: 10%;"></td> <td style="width: 10%;"></td> <td style="width: 10%;"></td> <td style="width: 10%;"></td> <td style="width: 10%;"></td> </tr> <tr> <td></td> <td></td> <td colspan="8" style="text-align: center;"> <table border="1" style="width: 100%; border-collapse: collapse; text-align: center;"> <tr> <td style="width: 10%;"></td> <td style="width: 10%;"></td> <td style="width: 10%;"></td> <td style="width: 10%;"></td> <td style="width: 10%;"></td> <td style="width: 10%;"></td> <td style="width: 10%;"></td> <td style="width: 10%;"></td> <td style="width: 10%;"></td> <td style="width: 10%;"></td> </tr> <tr> <td></td> <td></td> <td colspan="8" style="text-align: center;"> <table border="1" style="width: 100%; border-collapse: collapse; text-align: center;"> <tr> <td style="width: 10%;"></td> <td style="width: 10%;"></td> <td style="width: 10%;"></td> <td style="width: 10%;"></td> <td style="width: 10%;"></td> <td style="width: 10%;"></td> <td style="width: 10%;"></td> <td style="width: 10%;"></td> <td style="width: 10%;"></td> <td style="width: 10%;"></td> </tr> <tr> <td></td> <td></td> <td colspan="8" style="text-align: center;"> <table border="1" style="width: 100%; border-collapse: collapse; text-align: center;"> <tr> <td style="width: 10%;"></td> <td style="width: 10%;"></td> <td style="width: 10%;"></td> <td style="width: 10%;"></td> <td style="width: 10%;"></td> <td style="width: 10%;"></td> <td style="width: 10%;"></td> <td style="width: 10%;"></td> <td style="width: 10%;"></td> <td style="width: 10%;"></td> </tr> <tr> <td></td> <td></td> <td colspan="8" style="text-align: center;"> <table border="1" style="width: 100%; border-collapse: collapse; text-align: center;"> <tr> <td style="width: 10%;"></td> <td style="width: 10%;"></td> <td style="width: 10%;"></td> <td style="width: 10%;"></td> <td style="width: 10%;"></td> <td style="width: 10%;"></td> <td style="width: 10%;"></td> <td style="width: 10%;"></td> <td style="width: 10%;"></td> <td style="width: 10%;"></td> </tr> <tr> <td></td> <td></td> <td colspan="8" style="text-align: center;"> <table border="1" style="width: 100%; border-collapse: collapse; text-align: center;"> <tr> <td style="width: 10%;"></td> <td style="width: 10%;"></td> <td style="width: 10%;"></td> <td style="width: 10%;"></td> <td style="width: 10%;"></td> <td style="width: 10%;"></td> <td style="width: 10%;"></td> <td style="width: 10%;"></td> <td style="width: 10%;"></td> <td style="width: 10%;"></td> </tr> <tr> <td></td> <td></td> <td colspan="8" style="text-align: center;"> <table border="1" style="width: 100%; border-collapse: collapse; text-align: center;"> <tr> <td style="width: 10%;"></td> <td style="width: 10%;"></td> <td style="width: 10%;"></td> <td style="width: 10%;"></td> <td style="width: 10%;"></td> <td style="width: 10%;"></td> <td style="width: 10%;"></td> <td style="width: 10%;"></td> <td style="width: 10%;"></td> <td style="width: 10%;"></td> </tr> <tr> <td></td> <td></td> <td colspan="8" style="text-align: center;"> <table border="1" style="width: 100%; border-collapse: collapse; text-align: center;"> <tr> <td style="width: 10%;"></td> <td style="width: 10%;"></td> <td style="width: 10%;"></td> <td style="width: 10%;"></td> <td style="width: 10%;"></td> <td style="width: 10%;"></td> <td style="width: 10%;"></td> <td style="width: 10%;"></td> <td style="width: 10%;"></td> <td style="width: 10%;"></td> </tr> <tr> <td></td> <td></td> <td colspan="8" style="text-align: center;"> <table border="1" style="width: 100%; border-collapse: collapse; text-align: center;"> <tr> <td style="width: 10%;"></td> <td style="width: 10%;"></td> <td style="width: 10%;"></td> <td style="width: 10%;"></td> <td style="width: 10%;"></td> <td style="width: 10%;"></td> <td style="width: 10%;"></td> <td style="width: 10%;"></td> <td style="width: 10%;"></td> <td style="width: 10%;"></td> </tr> <tr> <td></td> <td></td> <td colspan="8" style="text-align: center;"> <table border="1" style="width: 100%; border-collapse: collapse; text-align: center;"> <tr> <td style="width: 10%;"></td> <td style="width: 10%;"></td> <td style="width: 10%;"></td> <td style="width: 10%;"></td> <td style="width: 10%;"></td> <td style="width: 10%;"></td> <td style="width: 10%;"></td> <td style="width: 10%;"></td> <td style="width: 10%;"></td> <td style="width: 10%;"></td> </tr> <tr> <td></td> <td></td> <td colspan="8" style="text-align: center;"> <table border="1" style="width: 100%; border-collapse: collapse; text-align: center;"> <tr> <td style="width: 10%;"></td> <td style="width: 10%;"></td> <td style="width: 10%;"></td> <td style="width: 10%;"></td> <td style="width: 10%;"></td> <td style="width: 10%;"></td> <td style="width: 10%;"></td> <td style="width: 10%;"></td> <td style="width: 10%;"></td> <td style="width: 10%;"></td> </tr> <tr> <td></td> <td></td> <td colspan="8" style="text-align: center;"> <table border="1" style="width: 100%; border-collapse: collapse; text-align: center;"> <tr> <td style="width: 10%;"></td> <td style="width: 10%;"></td> <td style="width: 10%;"></td> <td style="width: 10%;"></td> <td style="width: 10%;"></td> <td style="width: 10%;"></td> <td style="width: 10%;"></td> <td style="width: 10%;"></td> <td style="width: 10%;"></td> <td style="width: 10%;"></td> </tr> <tr> <td></td> <td></td> <td colspan="8" style="text-align: center;"> <table border="1" style="width: 100%; border-collapse: collapse; text-align: center;"> <tr> <td style="width: 10%;"></td> <td style="width: 10%;"></td> <td style="width: 10%;"></td> <td style="width: 10%;"></td> <td style="width: 10%;"></td> <td style="width: 10%;"></td> <td style="width: 10%;"></td> <td style="width: 10%;"></td> <td style="width: 10%;"></td> <td style="width: 10%;"></td> </tr> <tr> <td></td> <td></td> <td colspan="8" style="text-align: center;"> <table border="1" style="width: 100%; border-collapse: collapse; text-align: center;"> <tr> <td style="width: 10%;"></td> <td style="width: 10%;"></td> <td style="width: 10%;"></td> <td style="width: 10%;"></td> <td style="width: 10%;"></td> <td style="width: 10%;"></td> <td style="width: 10%;"></td> <td style="width: 10%;"></td> <td style="width: 10%;"></td> <td style="width: 10%;"></td> </tr> <tr> <td></td> <td></td> <td colspan="8" style="text-align: center;"> <table border="1" style="width: 100%; border-collapse: collapse; text-align: center;"> <tr> <td style="width: 10%;"></td> <td style="width: 10%;"></td> <td style="width: 10%;"></td> <td style="width: 10%;"></td> <td style="width: 10%;"></td> <td style="width: 10%;"></td> <td style="width: 10%;"></td> <td style="width: 10%;"></td> <td style="width: 10%;"></td> <td style="width: 10%;"></td> </tr> <tr> <td></td> <td></td> <td colspan="8" style="text-align: center;"> <table border="1" style="width: 100%; border-collapse: collapse; text-align: center;"> <tr> <td style="width: 10%;"></td> <td style="width: 10%;"></td> <td style="width: 10%;"></td> <td style="width: 10%;"></td> <td style="width: 10%;"></td> <td style="width: 10%;"></td> <td style="width: 10%;"></td> <td style="width: 10%;"></td> <td style="width: 10%;"></td> <td style="width: 10%;"></td> </tr> <tr> <td></td> <td></td> <td colspan="8" style="text-align: center;"> <table border="1" style="width: 100%; border-collapse: collapse; text-align: center;"> <tr> <td style="width: 10%;"></td> <td style="width: 10%;"></td> <td style="width: 10%;"></td> <td style="width: 10%;"></td> <td style="width: 10%;"></td> <td style="width: 10%;"></td> <td style="width: 10%;"></td> <td style="width: 10%;"></td> <td style="width: 10%;"></td> <td style="width: 10%;"></td> </tr> <tr> <td></td> <td></td> <td colspan="8" style="text-align: center;"> <table border="1" style="width: 100%; border-collapse: collapse; text-align: center;"> <tr> </tr></table></td></tr></table></td></tr></table></td></tr></table></td></tr></table></td></tr></table></td></tr></table></td></tr></table></td></tr></table></td></tr></table></td></tr></table></td></tr></table></td></tr></table></td></tr></table></td></tr></table></td></tr></table></td></tr></table></td></tr></table>

 | | | | | | | | | | | | | | | | | | | | <table border="1" style="width: 100%; border-collapse: collapse; text-align: center;"> <tr> <td style="width: 10%;"></td> <td style="width: 10%;"></td> <td style="width: 10%;"></td> <td style="width: 10%;"></td> <td style="width: 10%;"></td> <td style="width: 10%;"></td> <td style="width: 10%;"></td> <td style="width: 10%;"></td> <td style="width: 10%;"></td> <td style="width: 10%;"></td> </tr> <tr> <td></td> <td></td> <td colspan="8" style="text-align: center;"> <table border="1" style="width: 100%; border-collapse: collapse; text-align: center;"> <tr> <td style="width: 10%;"></td> <td style="width: 10%;"></td> <td style="width: 10%;"></td> <td style="width: 10%;"></td> <td style="width: 10%;"></td> <td style="width: 10%;"></td> <td style="width: 10%;"></td> <td style="width: 10%;"></td> <td style="width: 10%;"></td> <td style="width: 10%;"></td> </tr> <tr> <td></td> <td></td> <td colspan="8" style="text-align: center;"> <table border="1" style="width: 100%; border-collapse: collapse; text-align: center;"> <tr> <td style="width: 10%;"></td> <td style="width: 10%;"></td> <td style="width: 10%;"></td> <td style="width: 10%;"></td> <td style="width: 10%;"></td> <td style="width: 10%;"></td> <td style="width: 10%;"></td> <td style="width: 10%;"></td>
<td style="width: 10%;"></td> <td style="width: 10%;"></td> </tr> <tr> <td></td> <td></td> <td colspan="8" style="text-align: center;"> <table border="1" style="width: 100%; border-collapse: collapse; text-align: center;"> <tr> <td style="width: 10%;"></td> <td style="width: 10%;"></td> <td style="width: 10%;"></td> <td style="width: 10%;"></td> <td style="width: 10%;"></td> <td style="width: 10%;"></td> <td style="width: 10%;"></td> <td style="width: 10%;"></td> <td style="width: 10%;"></td> <td style="width: 10%;"></td> </tr> <tr> <td></td> <td></td> <td colspan="8" style="text-align: center;"> <table border="1" style="width: 100%; border-collapse: collapse; text-align: center;"> <tr> <td style="width: 10%;"></td> <td style="width: 10%;"></td> <td style="width: 10%;"></td> <td style="width: 10%;"></td> <td style="width: 10%;"></td> <td style="width: 10%;"></td> <td style="width: 10%;"></td> <td style="width: 10%;"></td> <td style="width: 10%;"></td> <td style="width: 10%;"></td> </tr> <tr> <td></td> <td></td> <td colspan="8" style="text-align: center;"> <table border="1" style="width: 100%; border-collapse: collapse; text-align: center;"> <tr> <td style="width: 10%;"></td> <td style="width: 10%;"></td> <td style="width: 10%;"></td> <td style="width: 10%;"></td> <td style="width: 10%;"></td> <td style="width: 10%;"></td> <td style="width: 10%;"></td> <td style="width: 10%;"></td> <td style="width: 10%;"></td> <td style="width: 10%;"></td> </tr> <tr> <td></td> <td></td> <td colspan="8" style="text-align: center;"> <table border="1" style="width: 100%; border-collapse: collapse; text-align: center;"> <tr> <td style="width: 10%;"></td> <td style="width: 10%;"></td> <td style="width: 10%;"></td> <td style="width: 10%;"></td> <td style="width: 10%;"></td> <td style="width: 10%;"></td> <td style="width: 10%;"></td> <td style="width: 10%;"></td> <td style="width: 10%;"></td> <td style="width: 10%;"></td> </tr> <tr> <td></td> <td></td> <td colspan="8" style="text-align: center;"> <table border="1" style="width: 100%; border-collapse: collapse; text-align: center;"> <tr> <td style="width: 10%;"></td> <td style="width: 10%;"></td> <td style="width: 10%;"></td> <td style="width: 10%;"></td> <td style="width: 10%;"></td> <td style="width: 10%;"></td> <td style="width: 10%;"></td> <td style="width: 10%;"></td> <td style="width: 10%;"></td> <td style="width: 10%;"></td> </tr> <tr> <td></td> <td></td> <td colspan="8" style="text-align: center;"> <table border="1" style="width: 100%; border-collapse: collapse; text-align: center;"> <tr> <td style="width: 10%;"></td> <td style="width: 10%;"></td> <td style="width: 10%;"></td> <td style="width: 10%;"></td> <td style="width: 10%;"></td> <td style="width: 10%;"></td> <td style="width: 10%;"></td> <td style="width: 10%;"></td> <td style="width: 10%;"></td> <td style="width: 10%;"></td> </tr> <tr> <td></td> <td></td> <td colspan="8" style="text-align: center;"> <table border="1" style="width: 100%; border-collapse: collapse; text-align: center;"> <tr> <td style="width: 10%;"></td> <td style="width: 10%;"></td> <td style="width: 10%;"></td> <td style="width: 10%;"></td> <td style="width: 10%;"></td> <td style="width: 10%;"></td> <td style="width: 10%;"></td> <td style="width: 10%;"></td> <td style="width: 10%;"></td> <td style="width: 10%;"></td> </tr> <tr> <td></td> <td></td> <td colspan="8" style="text-align: center;"> <table border="1" style="width: 100%; border-collapse: collapse; text-align: center;"> <tr> <td style="width: 10%;"></td> <td style="width: 10%;"></td> <td style="width: 10%;"></td> <td style="width: 10%;"></td> <td style="width: 10%;"></td> <td style="width: 10%;"></td> <td style="width: 10%;"></td> <td style="width: 10%;"></td> <td style="width: 10%;"></td> <td style="width: 10%;"></td> </tr> <tr> <td></td> <td></td> <td colspan="8" style="text-align: center;"> <table border="1" style="width: 100%; border-collapse: collapse; text-align: center;"> <tr> <td style="width: 10%;"></td> <td style="width: 10%;"></td> <td style="width: 10%;"></td> <td style="width: 10%;"></td> <td style="width: 10%;"></td> <td style="width: 10%;"></td> <td style="width: 10%;"></td> <td style="width: 10%;"></td> <td style="width: 10%;"></td> <td style="width: 10%;"></td> </tr> <tr> <td></td> <td></td> <td colspan="8" style="text-align: center;"> <table border="1" style="width: 100%; border-collapse: collapse; text-align: center;"> <tr> <td style="width: 10%;"></td> <td style="width: 10%;"></td> <td style="width: 10%;"></td> <td style="width: 10%;"></td> <td style="width: 10%;"></td> <td style="width: 10%;"></td> <td style="width: 10%;"></td> <td style="width: 10%;"></td> <td style="width: 10%;"></td> <td style="width: 10%;"></td> </tr> <tr> <td></td> <td></td> <td colspan="8" style="text-align: center;"> <table border="1" style="width: 100%; border-collapse: collapse; text-align: center;"> <tr> <td style="width: 10%;"></td> <td style="width: 10%;"></td> <td style="width: 10%;"></td> <td style="width: 10%;"></td> <td style="width: 10%;"></td> <td style="width: 10%;"></td> <td style="width: 10%;"></td> <td style="width: 10%;"></td> <td style="width: 10%;"></td> <td style="width: 10%;"></td> </tr> <tr> <td></td> <td></td> <td colspan="8" style="text-align: center;"> <table border="1" style="width: 100%; border-collapse: collapse; text-align: center;"> <tr> <td style="width: 10%;"></td> <td style="width: 10%;"></td> <td style="width: 10%;"></td> <td style="width: 10%;"></td> <td style="width: 10%;"></td> <td style="width: 10%;"></td> <td style="width: 10%;"></td> <td style="width: 10%;"></td> <td style="width: 10%;"></td> <td style="width: 10%;"></td> </tr> <tr> <td></td> <td></td> <td colspan="8" style="text-align: center;"> <table border="1" style="width: 100%; border-collapse: collapse; text-align: center;"> <tr> <td style="width: 10%;"></td> <td style="width: 10%;"></td> <td style="width: 10%;"></td> <td style="width: 10%;"></td> <td style="width: 10%;"></td> <td style="width: 10%;"></td> <td style="width: 10%;"></td> <td style="width: 10%;"></td> <td style="width: 10%;"></td> <td style="width: 10%;"></td> </tr> <tr> <td></td> <td></td> <td colspan="8" style="text-align: center;"> <table border="1" style="width: 100%; border-collapse: collapse; text-align: center;"> <tr> </tr></table></td></tr></table></td></tr></table></td></tr></table></td></tr></table></td></tr></table></td></tr></table></td></tr></table></td></tr></table></td></tr></table></td></tr></table></td></tr></table></td></tr></table></td></tr></table></td></tr></table></td></tr></table></td></tr></table>

 | | | | | | | | | | | | | | | | | | | | <table border="1" style="width: 100%; border-collapse: collapse; text-align: center;"> <tr> <td style="width: 10%;"></td> <td style="width: 10%;"></td> <td style="width: 10%;"></td> <td style="width: 10%;"></td> <td style="width: 10%;"></td> <td style="width: 10%;"></td> <td style="width: 10%;"></td> <td style="width: 10%;"></td> <td style="width: 10%;"></td> <td style="width: 10%;"></td> </tr> <tr> <td></td> <td></td> <td colspan="8" style="text-align: center;"> <table border="1" style="width: 100%; border-collapse: collapse; text-align: center;"> <tr> <td style="width: 10%;"></td> <td style="width: 10%;"></td> <td style="width: 10%;"></td> <td style="width: 10%;"></td> <td style="width: 10%;"></td> <td style="width: 10%;"></td> <td style="width: 10%;"></td> <td style="width: 10%;"></td> <td style="width: 10%;"></td> <td style="width: 10%;"></td> </tr> <tr> <td></td> <td></td> <td colspan="8" style="text-align: center;"> <table border="1" style="width: 100%; border-collapse: collapse; text-align: center;"> <tr> <td style="width: 10%;"></td> <td style="width: 10%;"></td> <td style="width: 10%;"></td> <td style="width: 10%;"></td> <td style="width: 10%;"></td> <td style="width: 10%;"></td> <td style="width: 10%;"></td> <td style="width: 10%;"></td> <td style="width: 10%;"></td> <td style="width: 10%;"></td> </tr> <tr> <td></td> <td></td> <td colspan="8" style="text-align: center;"> <table border="1" style="width: 100%; border-collapse: collapse; text-align: center;"> <tr> <td style="width: 10%;"></td> <td style="width: 10%;"></td> <td style="width: 10%;"></td> <td style="width: 10%;"></td> <td style="width: 10%;"></td> <td style="width: 10%;"></td> <td style="width: 10%;"></td> <td style="width: 10%;"></td> <td style="width: 10%;"></td> <td style="width: 10%;"></td> </tr> <tr> <td></td> <td></td> <td colspan="8" style="text-align: center;"> <table border="1" style="width: 100%; border-collapse: collapse; text-align: center;"> <tr> <td style="width: 10%;"></td> <td style="width: 10%;"></td> <td style="width: 10%;"></td> <td style="width: 10%;"></td> <td style="width: 10%;"></td> <td style="width: 10%;"></td> <td style="width: 10%;"></td> <td style="width: 10%;"></td> <td style="width: 10%;"></td> <td style="width: 10%;"></td> </tr> <tr> <td></td> <td></td> <td colspan="8" style="text-align: center;"> <table border="1" style="width: 100%; border-collapse: collapse; text-align: center;"> <tr> <td style="width: 10%;"></td> <td style="width: 10%;"></td> <td style="width: 10%;"></td> <td style="width: 10%;"></td> <td style="width: 10%;"></td> <td style="width: 10%;"></td> <td style="width: 10%;"></td> <td style="width: 10%;"></td> <td style="width: 10%;"></td> <td style="width: 10%;"></td> </tr> <tr> <td></td> <td></td> <td colspan="8" style="text-align: center;"> <table border="1" style="width: 100%; border-collapse: collapse; text-align: center;"> <tr> <td style="width: 10%;"></td> <td style="width: 10%;"></td> <td style="width: 10%;"></td> <td style="width: 10%;"></td> <td style="width: 10%;"></td> <td style="width: 10%;"></td> <td style="width: 10%;"></td> <td style="width: 10%;"></td> <td style="width: 10%;"></td> <td style="width: 10%;"></td> </tr> <tr> <td></td> <td></td> <td colspan="8" style="text-align: center;"> <table border="1" style="width: 100%; border-collapse: collapse; text-align: center;"> <tr> <td style="width: 10%;"></td>
<td style="width: 10%;"></td> <td style="width: 10%;"></td> <td style="width: 10%;"></td> <td style="width: 10%;"></td> <td style="width: 10%;"></td> <td style="width: 10%;"></td> <td style="width: 10%;"></td> <td style="width: 10%;"></td> <td style="width: 10%;"></td> </tr> <tr> <td></td> <td></td> <td colspan="8" style="text-align: center;"> <table border="1" style="width: 100%; border-collapse: collapse; text-align: center;"> <tr> <td style="width: 10%;"></td> <td style="width: 10%;"></td> <td style="width: 10%;"></td> <td style="width: 10%;"></td> <td style="width: 10%;"></td> <td style="width: 10%;"></td> <td style="width: 10%;"></td> <td style="width: 10%;"></td> <td style="width: 10%;"></td> <td style="width: 10%;"></td> </tr> <tr> <td></td> <td></td> <td colspan="8" style="text-align: center;"> <table border="1" style="width: 100%; border-collapse: collapse; text-align: center;"> <tr> <td style="width: 10%;"></td> <td style="width: 10%;"></td> <td style="width: 10%;"></td> <td style="width: 10%;"></td> <td style="width: 10%;"></td> <td style="width: 10%;"></td> <td style="width: 10%;"></td> <td style="width: 10%;"></td> <td style="width: 10%;"></td> <td style="width: 10%;"></td> </tr> <tr> <td></td> <td></td> <td colspan="8" style="text-align: center;"> <table border="1" style="width: 100%; border-collapse: collapse; text-align: center;"> <tr> <td style="width: 10%;"></td> <td style="width: 10%;"></td> <td style="width: 10%;"></td> <td style="width: 10%;"></td> <td style="width: 10%;"></td> <td style="width: 10%;"></td> <td style="width: 10%;"></td> <td style="width: 10%;"></td> <td style="width: 10%;"></td> <td style="width: 10%;"></td> </tr> <tr> <td></td> <td></td> <td colspan="8" style="text-align: center;"> <table border="1" style="width: 100%; border-collapse: collapse; text-align: center;"> <tr> <td style="width: 10%;"></td> <td style="width: 10%;"></td> <td style="width: 10%;"></td> <td style="width: 10%;"></td> <td style="width: 10%;"></td> <td style="width: 10%;"></td> <td style="width: 10%;"></td> <td style="width: 10%;"></td> <td style="width: 10%;"></td> <td style="width: 10%;"></td> </tr> <tr> <td></td> <td></td> <td colspan="8" style="text-align: center;"> <table border="1" style="width: 100%; border-collapse: collapse; text-align: center;"> <tr> <td style="width: 10%;"></td> <td style="width: 10%;"></td> <td style="width: 10%;"></td> <td style="width: 10%;"></td> <td style="width: 10%;"></td> <td style="width: 10%;"></td> <td style="width: 10%;"></td> <td style="width: 10%;"></td> <td style="width: 10%;"></td> <td style="width: 10%;"></td> </tr> <tr> <td></td> <td></td> <td colspan="8" style="text-align: center;"> <table border="1" style="width: 100%; border-collapse: collapse; text-align: center;"> <tr> <td style="width: 10%;"></td> <td style="width: 10%;"></td> <td style="width: 10%;"></td> <td style="width: 10%;"></td> <td style="width: 10%;"></td> <td style="width: 10%;"></td> <td style="width: 10%;"></td> <td style="width: 10%;"></td> <td style="width: 10%;"></td> <td style="width: 10%;"></td> </tr> <tr> <td></td> <td></td> <td colspan="8" style="text-align: center;"> <table border="1" style="width: 100%; border-collapse: collapse; text-align: center;"> <tr> <td style="width: 10%;"></td> <td style="width: 10%;"></td> <td style="width: 10%;"></td> <td style="width: 10%;"></td> <td style="width: 10%;"></td> <td style="width: 10%;"></td> <td style="width: 10%;"></td> <td style="width: 10%;"></td> <td style="width: 10%;"></td> <td style="width: 10%;"></td> </tr> <tr> <td></td> <td></td> <td colspan="8" style="text-align: center;"> <table border="1" style="width: 100%; border-collapse: collapse; text-align: center;"> <tr> </tr></table></td></tr></table></td></tr></table></td></tr></table></td></tr></table></td></tr></table></td></tr></table></td></tr></table></td></tr></table></td></tr></table></td></tr></table></td></tr></table></td></tr></table></td></tr></table></td></tr></table></td></tr></table>

 | | | | | | | | | | | | | | | | | | | | <table border="1" style="width: 100%; border-collapse: collapse; text-align: center;"> <tr> <td style="width: 10%;"></td> <td style="width: 10%;"></td> <td style="width: 10%;"></td> <td style="width: 10%;"></td> <td style="width: 10%;"></td> <td style="width: 10%;"></td> <td style="width: 10%;"></td> <td style="width: 10%;"></td> <td style="width: 10%;"></td> <td style="width: 10%;"></td> </tr> <tr> <td></td> <td></td> <td colspan="8" style="text-align: center;"> <table border="1" style="width: 100%; border-collapse: collapse; text-align: center;"> <tr> <td style="width: 10%;"></td> <td style="width: 10%;"></td> <td style="width: 10%;"></td> <td style="width: 10%;"></td> <td style="width: 10%;"></td> <td style="width: 10%;"></td> <td style="width: 10%;"></td> <td style="width: 10%;"></td> <td style="width: 10%;"></td> <td style="width: 10%;"></td> </tr> <tr> <td></td> <td></td> <td colspan="8" style="text-align: center;"> <table border="1" style="width: 100%; border-collapse: collapse; text-align: center;"> <tr> <td style="width: 10%;"></td> <td style="width: 10%;"></td> <td style="width: 10%;"></td> <td style="width: 10%;"></td> <td style="width: 10%;"></td> <td style="width: 10%;"></td> <td style="width: 10%;"></td> <td style="width: 10%;"></td> <td style="width: 10%;"></td> <td style="width: 10%;"></td> </tr> <tr> <td></td> <td></td> <td colspan="8" style="text-align: center;"> <table border="1" style="width: 100%; border-collapse: collapse; text-align: center;"> <tr> <td style="width: 10%;"></td> <td style="width: 10%;"></td> <td style="width: 10%;"></td> <td style="width: 10%;"></td> <td style="width: 10%;"></td> <td style="width: 10%;"></td> <td style="width: 10%;"></td> <td style="width: 10%;"></td> <td style="width: 10%;"></td> <td style="width: 10%;"></td> </tr> <tr> <td></td> <td></td> <td colspan="8" style="text-align: center;"> <table border="1" style="width: 100%; border-collapse: collapse; text-align: center;"> <tr> <td style="width: 10%;"></td> <td style="width: 10%;"></td> <td style="width: 10%;"></td> <td style="width: 10%;"></td> <td style="width: 10%;"></td> <td style="width: 10%;"></td> <td style="width: 10%;"></td> <td style="width: 10%;"></td> <td style="width: 10%;"></td> <td style="width: 10%;"></td> </tr> <tr> <td></td> <td></td> <td colspan="8" style="text-align: center;"> <table border="1" style="width: 100%; border-collapse: collapse; text-align: center;"> <tr> <td style="width: 10%;"></td> <td style="width: 10%;"></td> <td style="width: 10%;"></td> <td style="width: 10%;"></td> <td style="width: 10%;"></td> <td style="width: 10%;"></td> <td style="width: 10%;"></td> <td style="width: 10%;"></td> <td style="width: 10%;"></td> <td style="width: 10%;"></td> </tr> <tr> <td></td> <td></td> <td colspan="8" style="text-align: center;"> <table border="1" style="width: 100%; border-collapse: collapse; text-align: center;"> <tr> <td style="width: 10%;"></td> <td style="width: 10%;"></td> <td style="width: 10%;"></td> <td style="width: 10%;"></td> <td style="width: 10%;"></td> <td style="width: 10%;"></td> <td style="width: 10%;"></td> <td style="width: 10%;"></td> <td style="width: 10%;"></td> <td style="width: 10%;"></td> </tr> <tr> <td></td> <td></td> <td colspan="8" style="text-align: center;"> <table border="1" style="width: 100%; border-collapse: collapse; text-align: center;"> <tr> <td style="width: 10%;"></td> <td style="width: 10%;"></td> <td style="width: 10%;"></td> <td style="width: 10%;"></td> <td style="width: 10%;"></td> <td style="width: 10%;"></td> <td style="width: 10%;"></td> <td style="width: 10%;"></td> <td style="width: 10%;"></td> <td style="width: 10%;"></td> </tr> <tr> <td></td> <td></td> <td colspan="8" style="text-align: center;"> <table border="1" style="width: 100%; border-collapse: collapse; text-align: center;"> <tr> <td style="width: 10%;"></td> <td style="width: 10%;"></td> <td style="width: 10%;"></td> <td style="width: 10%;"></td> <td style="width: 10%;"></td> <td style="width: 10%;"></td> <td style="width: 10%;"></td> <td style="width: 10%;"></td> <td style="width: 10%;"></td> <td style="width: 10%;"></td> </tr> <tr> <td></td> <td></td> <td colspan="8" style="text-align: center;"> <table border="1" style="width: 100%; border-collapse: collapse; text-align: center;"> <tr> <td style="width: 10%;"></td> <td style="width: 10%;"></td> <td style="width: 10%;"></td> <td style="width: 10%;"></td> <td style="width: 10%;"></td> <td style="width: 10%;"></td> <td style="width: 10%;"></td> <td style="width: 10%;"></td> <td style="width: 10%;"></td> <td style="width: 10%;"></td> </tr> <tr> <td></td> <td></td> <td colspan="8" style="text-align: center;"> <table border="1" style="width: 100%; border-collapse: collapse; text-align: center;"> <tr> <td style="width: 10%;"></td> <td style="width: 10%;"></td> <td style="width: 10%;"></td> <td style="width: 10%;"></td> <td style="width: 10%;"></td> <td style="width: 10%;"></td> <td style="width: 10%;"></td> <td style="width: 10%;"></td> <td style="width: 10%;"></td> <td style="width: 10%;"></td> </tr> <tr> <td></td> <td></td> <td colspan="8" style="text-align: center;"> <table border="1" style="width: 100%; border-collapse: collapse; text-align: center;"> <tr> <td style="width: 10%;"></td> <td style="width: 10%;"></td> <td style="width: 10%;"></td> <td style="width: 10%;"></td> <td style="width: 10%;"></td> <td style="width: 10%;"></td> <td style="width: 10%;"></td> <td style="width: 10%;"></td> <td style="width: 10%;"></td> <td style="width: 10%;"></td> </tr> <tr> <td></td> <td></td> <td colspan="8" style="text-align: center;"> <table border="1" style="width: 100%; border-collapse: collapse; text-align: center;"> <tr> <td style="width: 10%;"></td> <td style="width: 10%;"></td> <td style="width: 10%;"></td> <td style="width: 10%;"></td> <td style="width: 10%;"></td> <td style="width: 10%;"></td> <td style="width: 10%;"></td> <td style="width: 10%;"></td> <td style="width: 10%;"></td> <td style="width: 10%;"></td> </tr>
<tr> <td></td> <td></td> <td colspan="8" style="text-align: center;"> <table border="1" style="width: 100%; border-collapse: collapse; text-align: center;"> <tr> <td style="width: 10%;"></td> <td style="width: 10%;"></td> <td style="width: 10%;"></td> <td style="width: 10%;"></td> <td style="width: 10%;"></td> <td style="width: 10%;"></td> <td style="width: 10%;"></td> <td style="width: 10%;"></td> <td style="width: 10%;"></td> <td style="width: 10%;"></td> </tr> <tr> <td></td> <td></td> <td colspan="8" style="text-align: center;"> <table border="1" style="width: 100%; border-collapse: collapse; text-align: center;"> <tr> </tr></table></td></tr></table></td></tr></table></td></tr></table></td></tr></table></td></tr></table></td></tr></table></td></tr></table></td></tr></table></td></tr></table></td></tr></table></td></tr></table></td></tr></table></td></tr></table></td></tr></table>

 | | | | | | | | | | | | | | | | | | | | <table border="1" style="width: 100%; border-collapse: collapse; text-align: center;"> <tr> <td style="width: 10%;"></td> <td style="width: 10%;"></td> <td style="width: 10%;"></td> <td style="width: 10%;"></td> <td style="width: 10%;"></td> <td style="width: 10%;"></td> <td style="width: 10%;"></td> <td style="width: 10%;"></td> <td style="width: 10%;"></td> <td style="width: 10%;"></td> </tr> <tr> <td></td> <td></td> <td colspan="8" style="text-align: center;"> <table border="1" style="width: 100%; border-collapse: collapse; text-align: center;"> <tr> <td style="width: 10%;"></td> <td style="width: 10%;"></td> <td style="width: 10%;"></td> <td style="width: 10%;"></td> <td style="width: 10%;"></td> <td style="width: 10%;"></td> <td style="width: 10%;"></td> <td style="width: 10%;"></td> <td style="width: 10%;"></td> <td style="width: 10%;"></td> </tr> <tr> <td></td> <td></td> <td colspan="8" style="text-align: center;"> <table border="1" style="width: 100%; border-collapse: collapse; text-align: center;"> <tr> <td style="width: 10%;"></td> <td style="width: 10%;"></td> <td style="width: 10%;"></td> <td style="width: 10%;"></td> <td style="width: 10%;"></td> <td style="width: 10%;"></td> <td style="width: 10%;"></td> <td style="width: 10%;"></td> <td style="width: 10%;"></td> <td style="width: 10%;"></td> </tr> <tr> <td></td> <td></td> <td colspan="8" style="text-align: center;"> <table border="1" style="width: 100%; border-collapse: collapse; text-align: center;"> <tr> <td style="width: 10%;"></td> <td style="width: 10%;"></td> <td style="width: 10%;"></td> <td style="width: 10%;"></td> <td style="width: 10%;"></td> <td style="width: 10%;"></td> <td style="width: 10%;"></td> <td style="width: 10%;"></td> <td style="width: 10%;"></td> <td style="width: 10%;"></td> </tr> <tr> <td></td> <td></td> <td colspan="8" style="text-align: center;"> <table border="1" style="width: 100%; border-collapse: collapse; text-align: center;"> <tr> <td style="width: 10%;"></td> <td style="width: 10%;"></td> <td style="width: 10%;"></td> <td style="width: 10%;"></td> <td style="width: 10%;"></td> <td style="width: 10%;"></td> <td style="width: 10%;"></td> <td style="width: 10%;"></td> <td style="width: 10%;"></td> <td style="width: 10%;"></td> </tr> <tr> <td></td> <td></td> <td colspan="8" style="text-align: center;"> <table border="1" style="width: 100%; border-collapse: collapse; text-align: center;"> <tr> <td style="width: 10%;"></td> <td style="width: 10%;"></td> <td style="width: 10%;"></td> <td style="width: 10%;"></td> <td style="width: 10%;"></td> <td style="width: 10%;"></td> <td style="width: 10%;"></td> <td style="width: 10%;"></td> <td style="width: 10%;"></td> <td style="width: 10%;"></td> </tr> <tr> <td></td> <td></td> <td colspan="8" style="text-align: center;"> <table border="1" style="width: 100%; border-collapse: collapse; text-align: center;"> <tr> <td style="width: 10%;"></td> <td style="width: 10%;"></td> <td style="width: 10%;"></td> <td style="width: 10%;"></td> <td style="width: 10%;"></td> <td style="width: 10%;"></td> <td style="width: 10%;"></td> <td style="width: 10%;"></td> <td style="width: 10%;"></td> <td style="width: 10%;"></td> </tr> <tr> <td></td> <td></td> <td colspan="8" style="text-align: center;"> <table border="1" style="width: 100%; border-collapse: collapse; text-align: center;"> <tr> <td style="width: 10%;"></td> <td style="width: 10%;"></td> <td style="width: 10%;"></td> <td style="width: 10%;"></td> <td style="width: 10%;"></td> <td style="width: 10%;"></td> <td style="width: 10%;"></td> <td style="width: 10%;"></td> <td style="width: 10%;"></td> <td style="width: 10%;"></td> </tr> <tr> <td></td> <td></td> <td colspan="8" style="text-align: center;"> <table border="1" style="width: 100%; border-collapse: collapse; text-align: center;"> <tr> <td style="width: 10%;"></td> <td style="width: 10%;"></td> <td style="width: 10%;"></td> <td style="width: 10%;"></td> <td style="width: 10%;"></td> <td style="width: 10%;"></td> <td style="width: 10%;"></td> <td style="width: 10%;"></td> <td style="width: 10%;"></td> <td style="width: 10%;"></td> </tr> <tr> <td></td> <td></td> <td colspan="8" style="text-align: center;"> <table border="1" style="width: 100%; border-collapse: collapse; text-align: center;"> <tr> <td style="width: 10%;"></td> <td style="width: 10%;"></td> <td style="width: 10%;"></td> <td style="width: 10%;"></td> <td style="width: 10%;"></td> <td style="width: 10%;"></td> <td style="width: 10%;"></td> <td style="width: 10%;"></td> <td style="width: 10%;"></td> <td style="width: 10%;"></td> </tr> <tr> <td></td> <td></td> <td colspan="8" style="text-align: center;"> <table border="1" style="width: 100%; border-collapse: collapse; text-align: center;"> <tr> <td style="width: 10%;"></td> <td style="width: 10%;"></td> <td style="width: 10%;"></td> <td style="width: 10%;"></td> <td style="width: 10%;"></td> <td style="width: 10%;"></td> <td style="width: 10%;"></td> <td style="width: 10%;"></td> <td style="width: 10%;"></td> <td style="width: 10%;"></td> </tr> <tr> <td></td> <td></td> <td colspan="8" style="text-align: center;"> <table border="1" style="width: 100%; border-collapse: collapse; text-align: center;"> <tr> <td style="width: 10%;"></td> <td style="width: 10%;"></td> <td style="width: 10%;"></td> <td style="width: 10%;"></td> <td style="width: 10%;"></td> <td style="width: 10%;"></td> <td style="width: 10%;"></td> <td style="width: 10%;"></td> <td style="width: 10%;"></td> <td style="width: 10%;"></td> </tr> <tr> <td></td> <td></td> <td colspan="8" style="text-align: center;"> <table border="1" style="width: 100%; border-collapse: collapse; text-align: center;"> <tr> <td style="width: 10%;"></td> <td style="width: 10%;"></td> <td style="width: 10%;"></td> <td style="width: 10%;"></td> <td style="width: 10%;"></td> <td style="width: 10%;"></td> <td style="width: 10%;"></td> <td style="width: 10%;"></td> <td style="width: 10%;"></td> <td style="width: 10%;"></td> </tr> <tr> <td></td> <td></td> <td colspan="8" style="text-align: center;"> <table border="1" style="width: 100%; border-collapse: collapse; text-align: center;"> <tr> </tr></table></td></tr></table></td></tr></table></td></tr></table></td></tr></table></td></tr></table></td></tr></table></td></tr></table></td></tr></table></td></tr></table></td></tr></table></td></tr></table></td></tr></table></td></tr></table>

 | | | | | | | | | | | | | | | | | | | | <table border="1" style="width: 100%; border-collapse: collapse; text-align: center;"> <tr> <td style="width: 10%;"></td> <td style="width: 10%;"></td> <td style="width: 10%;"></td> <td style="width: 10%;"></td> <td style="width: 10%;"></td> <td style="width: 10%;"></td> <td style="width: 10%;"></td> <td style="width: 10%;"></td> <td style="width: 10%;"></td> <td style="width: 10%;"></td> </tr> <tr> <td></td> <td></td> <td colspan="8" style="text-align: center;"> <table border="1" style="width: 100%; border-collapse: collapse; text-align: center;"> <tr> <td style="width: 10%;"></td> <td style="width: 10%;"></td> <td style="width: 10%;"></td> <td style="width: 10%;"></td> <td style="width: 10%;"></td> <td style="width: 10%;"></td> <td style="width: 10%;"></td> <td style="width: 10%;"></td> <td style="width: 10%;"></td> <td style="width: 10%;"></td> </tr> <tr> <td></td> <td></td> <td colspan="8" style="text-align: center;"> <table border="1" style="width: 100%; border-collapse: collapse; text-align: center;"> <tr> <td style="width: 10%;"></td> <td style="width: 10%;"></td> <td style="width: 10%;"></td> <td style="width: 10%;"></td> <td style="width: 10%;"></td> <td style="width: 10%;"></td> <td style="width: 10%;"></td> <td style="width: 10%;"></td> <td style="width: 10%;"></td> <td style="width: 10%;"></td> </tr> <tr> <td></td> <td></td> <td colspan="8" style="text-align: center;"> <table border="1" style="width: 100%; border-collapse: collapse; text-align: center;"> <tr> <td style="width: 10%;"></td> <td style="width: 10%;"></td> <td style="width: 10%;"></td> <td style="width: 10%;"></td> <td style="width: 10%;"></td> <td style="width: 10%;"></td> <td style="width: 10%;"></td> <td style="width: 10%;"></td> <td style="width: 10%;"></td> <td style="width: 10%;"></td> </tr> <tr> <td></td> <td></td> <td colspan="8" style="text-align: center;"> <table border="1" style="width: 100%; border-collapse: collapse; text-align: center;"> <tr> <td style="width: 10%;"></td> <td style="width: 10%;"></td> <td style="width: 10%;"></td> <td style="width: 10%;"></td> <td style="width: 10%;"></td> <td style="width: 10%;"></td> <td style="width: 10%;"></td> <td style="width: 10%;"></td> <td style="width: 10%;"></td> <td style="width: 10%;"></td> </tr> <tr> <td></td> <td></td> <td colspan="8" style="text-align: center;"> <table border="1" style="width: 100%; border-collapse: collapse; text-align: center;"> <tr> <td style="width: 10%;"></td> <td style="width: 10%;"></td> <td style="width: 10%;"></td> <td style="width: 10%;"></td> <td style="width: 10%;"></td> <td style="width: 10%;"></td> <td style="width: 10%;"></td> <td style="width: 10%;"></td> <td style="width: 10%;"></td> <td
style="width: 10%;"></td> </tr> <tr> <td></td> <td></td> <td colspan="8" style="text-align: center;"> <table border="1" style="width: 100%; border-collapse: collapse; text-align: center;"> <tr> <td style="width: 10%;"></td> <td style="width: 10%;"></td> <td style="width: 10%;"></td> <td style="width: 10%;"></td> <td style="width: 10%;"></td> <td style="width: 10%;"></td> <td style="width: 10%;"></td> <td style="width: 10%;"></td> <td style="width: 10%;"></td> <td style="width: 10%;"></td> </tr> <tr> <td></td> <td></td> <td colspan="8" style="text-align: center;"> <table border="1" style="width: 100%; border-collapse: collapse; text-align: center;"> <tr> <td style="width: 10%;"></td> <td style="width: 10%;"></td> <td style="width: 10%;"></td> <td style="width: 10%;"></td> <td style="width: 10%;"></td> <td style="width: 10%;"></td> <td style="width: 10%;"></td> <td style="width: 10%;"></td> <td style="width: 10%;"></td> <td style="width: 10%;"></td> </tr> <tr> <td></td> <td></td> <td colspan="8" style="text-align: center;"> <table border="1" style="width: 100%; border-collapse: collapse; text-align: center;"> <tr> <td style="width: 10%;"></td> <td style="width: 10%;"></td> <td style="width: 10%;"></td> <td style="width: 10%;"></td> <td style="width: 10%;"></td> <td style="width: 10%;"></td> <td style="width: 10%;"></td> <td style="width: 10%;"></td> <td style="width: 10%;"></td> <td style="width: 10%;"></td> </tr> <tr> <td></td> <td></td> <td colspan="8" style="text-align: center;"> <table border="1" style="width: 100%; border-collapse: collapse; text-align: center;"> <tr> <td style="width: 10%;"></td> <td style="width: 10%;"></td> <td style="width: 10%;"></td> <td style="width: 10%;"></td> <td style="width: 10%;"></td> <td style="width: 10%;"></td> <td style="width: 10%;"></td> <td style="width: 10%;"></td> <td style="width: 10%;"></td> <td style="width: 10%;"></td> </tr> <tr> <td></td> <td></td> <td colspan="8" style="text-align: center;"> <table border="1" style="width: 100%; border-collapse: collapse; text-align: center;"> <tr> <td style="width: 10%;"></td> <td style="width: 10%;"></td> <td style="width: 10%;"></td> <td style="width: 10%;"></td> <td style="width: 10%;"></td> <td style="width: 10%;"></td> <td style="width: 10%;"></td> <td style="width: 10%;"></td> <td style="width: 10%;"></td> <td style="width: 10%;"></td> </tr> <tr> <td></td> <td></td> <td colspan="8" style="text-align: center;"> <table border="1" style="width: 100%; border-collapse: collapse; text-align: center;"> <tr> <td style="width: 10%;"></td> <td style="width: 10%;"></td> <td style="width: 10%;"></td> <td style="width: 10%;"></td> <td style="width: 10%;"></td> <td style="width: 10%;"></td> <td style="width: 10%;"></td> <td style="width: 10%;"></td> <td style="width: 10%;"></td> <td style="width: 10%;"></td> </tr> <tr> <td></td> <td></td> <td colspan="8" style="text-align: center;"> <table border="1" style="width: 100%; border-collapse: collapse; text-align: center;"> <tr> </tr></table></td></tr></table></td></tr></table></td></tr></table></td></tr></table></td></tr></table></td></tr></table></td></tr></table></td></tr></table></td></tr></table></td></tr></table></td></tr></table></td></tr></table>

 | | | | | | | | | | | | | | | | | | | | <table border="1" style="width: 100%; border-collapse: collapse; text-align: center;"> <tr> <td style="width: 10%;"></td> <td style="width: 10%;"></td> <td style="width: 10%;"></td> <td style="width: 10%;"></td> <td style="width: 10%;"></td> <td style="width: 10%;"></td> <td style="width: 10%;"></td> <td style="width: 10%;"></td> <td style="width: 10%;"></td> <td style="width: 10%;"></td> </tr> <tr> <td></td> <td></td> <td colspan="8" style="text-align: center;"> <table border="1" style="width: 100%; border-collapse: collapse; text-align: center;"> <tr> <td style="width: 10%;"></td> <td style="width: 10%;"></td> <td style="width: 10%;"></td> <td style="width: 10%;"></td> <td style="width: 10%;"></td> <td style="width: 10%;"></td> <td style="width: 10%;"></td> <td style="width: 10%;"></td> <td style="width: 10%;"></td> <td style="width: 10%;"></td> </tr> <tr> <td></td> <td></td> <td colspan="8" style="text-align: center;"> <table border="1" style="width: 100%; border-collapse: collapse; text-align: center;"> <tr> <td style="width: 10%;"></td> <td style="width: 10%;"></td> <td style="width: 10%;"></td> <td style="width: 10%;"></td> <td style="width: 10%;"></td> <td style="width: 10%;"></td> <td style="width: 10%;"></td> <td style="width: 10%;"></td> <td style="width: 10%;"></td> <td style="width: 10%;"></td> </tr> <tr> <td></td> <td></td> <td colspan="8" style="text-align: center;"> <table border="1" style="width: 100%; border-collapse: collapse; text-align: center;"> <tr> <td style="width: 10%;"></td> <td style="width: 10%;"></td> <td style="width: 10%;"></td> <td style="width: 10%;"></td> <td style="width: 10%;"></td> <td style="width: 10%;"></td> <td style="width: 10%;"></td> <td style="width: 10%;"></td> <td style="width: 10%;"></td> <td style="width: 10%;"></td> </tr> <tr> <td></td> <td></td> <td colspan="8" style="text-align: center;"> <table border="1" style="width: 100%; border-collapse: collapse; text-align: center;"> <tr> <td style="width: 10%;"></td> <td style="width: 10%;"></td> <td style="width: 10%;"></td> <td style="width: 10%;"></td> <td style="width: 10%;"></td> <td style="width: 10%;"></td> <td style="width: 10%;"></td> <td style="width: 10%;"></td> <td style="width: 10%;"></td> <td style="width: 10%;"></td> </tr> <tr> <td></td> <td></td> <td colspan="8" style="text-align: center;"> <table border="1" style="width: 100%; border-collapse: collapse; text-align: center;"> <tr> <td style="width: 10%;"></td> <td style="width: 10%;"></td> <td style="width: 10%;"></td> <td style="width: 10%;"></td> <td style="width: 10%;"></td> <td style="width: 10%;"></td> <td style="width: 10%;"></td> <td style="width: 10%;"></td> <td style="width: 10%;"></td> <td style="width: 10%;"></td> </tr> <tr> <td></td> <td></td> <td colspan="8" style="text-align: center;"> <table border="1" style="width: 100%; border-collapse: collapse; text-align: center;"> <tr> <td style="width: 10%;"></td> <td style="width: 10%;"></td> <td style="width: 10%;"></td> <td style="width: 10%;"></td> <td style="width: 10%;"></td> <td style="width: 10%;"></td> <td style="width: 10%;"></td> <td style="width: 10%;"></td> <td style="width: 10%;"></td> <td style="width: 10%;"></td> </tr> <tr> <td></td> <td></td> <td colspan="8" style="text-align: center;"> <table border="1" style="width: 100%; border-collapse: collapse; text-align: center;"> <tr> <td style="width: 10%;"></td> <td style="width: 10%;"></td> <td style="width: 10%;"></td> <td style="width: 10%;"></td> <td style="width: 10%;"></td> <td style="width: 10%;"></td> <td style="width: 10%;"></td> <td style="width: 10%;"></td> <td style="width: 10%;"></td> <td style="width: 10%;"></td> </tr> <tr> <td></td> <td></td> <td colspan="8" style="text-align: center;"> <table border="1" style="width: 100%; border-collapse: collapse; text-align: center;"> <tr> <td style="width: 10%;"></td> <td style="width: 10%;"></td> <td style="width: 10%;"></td> <td style="width: 10%;"></td> <td style="width: 10%;"></td> <td style="width: 10%;"></td> <td style="width: 10%;"></td> <td style="width: 10%;"></td> <td style="width: 10%;"></td> <td style="width: 10%;"></td> </tr> <tr> <td></td> <td></td> <td colspan="8" style="text-align: center;"> <table border="1" style="width: 100%; border-collapse: collapse; text-align: center;"> <tr> <td style="width: 10%;"></td> <td style="width: 10%;"></td> <td style="width: 10%;"></td> <td style="width: 10%;"></td> <td style="width: 10%;"></td> <td style="width: 10%;"></td> <td style="width: 10%;"></td> <td style="width: 10%;"></td> <td style="width: 10%;"></td> <td style="width: 10%;"></td> </tr> <tr> <td></td> <td></td> <td colspan="8" style="text-align: center;"> <table border="1" style="width: 100%; border-collapse: collapse; text-align: center;"> <tr> <td style="width: 10%;"></td> <td style="width: 10%;"></td> <td style="width: 10%;"></td> <td style="width: 10%;"></td> <td style="width: 10%;"></td> <td style="width: 10%;"></td> <td style="width: 10%;"></td> <td style="width: 10%;"></td> <td style="width: 10%;"></td> <td style="width: 10%;"></td> </tr> <tr> <td></td> <td></td> <td colspan="8" style="text-align: center;"> <table border="1" style="width: 100%; border-collapse: collapse; text-align: center;"> <tr> </tr></table></td></tr></table></td></tr></table></td></tr></table></td></tr></table></td></tr></table></td></tr></table></td></tr></table></td></tr></table></td></tr></table></td></tr></table></td></tr></table>

 | | | | | | | | | | | | | | | | | | | | <table border="1" style="width: 100%; border-collapse: collapse; text-align: center;"> <tr> <td style="width: 10%;"></td> <td style="width: 10%;"></td> <td style="width: 10%;"></td> <td style="width: 10%;"></td> <td style="width: 10%;"></td> <td style="width: 10%;"></td> <td style="width: 10%;"></td> <td style="width: 10%;"></td> <td style="width: 10%;"></td> <td style="width: 10%;"></td> </tr> <tr> <td></td> <td></td> <td colspan="8" style="text-align: center;"> <table border="1" style="width: 100%; border-collapse: collapse; text-align: center;"> <tr> <td style="width: 10%;"></td> <td style="width: 10%;"></td> <td style="width: 10%;"></td> <td style="width: 10%;"></td> <td style="width: 10%;"></td> <td style="width: 10%;"></td> <td style="width: 10%;"></td> <td style="width: 10%;"></td> <td style="width: 10%;"></td> <td style="width: 10%;"></td> </tr> <tr> <td></td> <td></td> <td colspan="8" style="text-align: center;"> <table border="1" style="width: 100%; border-collapse: collapse; text-align: center;"> <tr> <td style="width: 10%;"></td> <td style="width: 10%;"></td> <td style="width: 10%;"></td> <td style="width: 10%;"></td> <td style="width: 10%;"></td> <td style="width: 10%;"></td> <td style="width: 10%;"></td> <td style="width: 10%;"></td> <td style="width: 10%;"></td> <td style="width: 10%;"></td> </tr> <tr>
<td></td> <td></td> <td colspan="8" style="text-align: center;"> <table border="1" style="width: 100%; border-collapse: collapse; text-align: center;"> <tr> <td style="width: 10%;"></td> <td style="width: 10%;"></td> <td style="width: 10%;"></td> <td style="width: 10%;"></td> <td style="width: 10%;"></td> <td style="width: 10%;"></td> <td style="width: 10%;"></td> <td style="width: 10%;"></td> <td style="width: 10%;"></td> <td style="width: 10%;"></td> </tr> <tr> <td></td> <td></td> <td colspan="8" style="text-align: center;"> <table border="1" style="width: 100%; border-collapse: collapse; text-align: center;"> <tr> <td style="width: 10%;"></td> <td style="width: 10%;"></td> <td style="width: 10%;"></td> <td style="width: 10%;"></td> <td style="width: 10%;"></td> <td style="width: 10%;"></td> <td style="width: 10%;"></td> <td style="width: 10%;"></td> <td style="width: 10%;"></td> <td style="width: 10%;"></td> </tr> <tr> <td></td> <td></td> <td colspan="8" style="text-align: center;"> <table border="1" style="width: 100%; border-collapse: collapse; text-align: center;"> <tr> <td style="width: 10%;"></td> <td style="width: 10%;"></td> <td style="width: 10%;"></td> <td style="width: 10%;"></td> <td style="width: 10%;"></td> <td style="width: 10%;"></td> <td style="width: 10%;"></td> <td style="width: 10%;"></td> <td style="width: 10%;"></td> <td style="width: 10%;"></td> </tr> <tr> <td></td> <td></td> <td colspan="8" style="text-align: center;"> <table border="1" style="width: 100%; border-collapse: collapse; text-align: center;"> <tr> <td style="width: 10%;"></td> <td style="width: 10%;"></td> <td style="width: 10%;"></td> <td style="width: 10%;"></td> <td style="width: 10%;"></td> <td style="width: 10%;"></td> <td style="width: 10%;"></td> <td style="width: 10%;"></td> <td style="width: 10%;"></td> <td style="width: 10%;"></td> </tr> <tr> <td></td> <td></td> <td colspan="8" style="text-align: center;"> <table border="1" style="width: 100%; border-collapse: collapse; text-align: center;"> <tr> <td style="width: 10%;"></td> <td style="width: 10%;"></td> <td style="width: 10%;"></td> <td style="width: 10%;"></td> <td style="width: 10%;"></td> <td style="width: 10%;"></td> <td style="width: 10%;"></td> <td style="width: 10%;"></td> <td style="width: 10%;"></td> <td style="width: 10%;"></td> </tr> <tr> <td></td> <td></td> <td colspan="8" style="text-align: center;"> <table border="1" style="width: 100%; border-collapse: collapse; text-align: center;"> <tr> <td style="width: 10%;"></td> <td style="width: 10%;"></td> <td style="width: 10%;"></td> <td style="width: 10%;"></td> <td style="width: 10%;"></td> <td style="width: 10%;"></td> <td style="width: 10%;"></td> <td style="width: 10%;"></td> <td style="width: 10%;"></td> <td style="width: 10%;"></td> </tr> <tr> <td></td> <td></td> <td colspan="8" style="text-align: center;"> <table border="1" style="width: 100%; border-collapse: collapse; text-align: center;"> <tr> <td style="width: 10%;"></td> <td style="width: 10%;"></td> <td style="width: 10%;"></td> <td style="width: 10%;"></td> <td style="width: 10%;"></td> <td style="width: 10%;"></td> <td style="width: 10%;"></td> <td style="width: 10%;"></td> <td style="width: 10%;"></td> <td style="width: 10%;"></td> </tr> <tr> <td></td> <td></td> <td colspan="8" style="text-align: center;"> <table border="1" style="width: 100%; border-collapse: collapse; text-align: center;"> <tr> </tr></table></td></tr></table></td></tr></table></td></tr></table></td></tr></table></td></tr></table></td></tr></table></td></tr></table></td></tr></table></td></tr></table></td></tr></table>

 | | | | | | | | | | | | | | | | | | | | <table border="1" style="width: 100%; border-collapse: collapse; text-align: center;"> <tr> <td style="width: 10%;"></td> <td style="width: 10%;"></td> <td style="width: 10%;"></td> <td style="width: 10%;"></td> <td style="width: 10%;"></td> <td style="width: 10%;"></td> <td style="width: 10%;"></td> <td style="width: 10%;"></td> <td style="width: 10%;"></td> <td style="width: 10%;"></td> </tr> <tr> <td></td> <td></td> <td colspan="8" style="text-align: center;"> <table border="1" style="width: 100%; border-collapse: collapse; text-align: center;"> <tr> <td style="width: 10%;"></td> <td style="width: 10%;"></td> <td style="width: 10%;"></td> <td style="width: 10%;"></td> <td style="width: 10%;"></td> <td style="width: 10%;"></td> <td style="width: 10%;"></td> <td style="width: 10%;"></td> <td style="width: 10%;"></td> <td style="width: 10%;"></td> </tr> <tr> <td></td> <td></td> <td colspan="8" style="text-align: center;"> <table border="1" style="width: 100%; border-collapse: collapse; text-align: center;"> <tr> <td style="width: 10%;"></td> <td style="width: 10%;"></td> <td style="width: 10%;"></td> <td style="width: 10%;"></td> <td style="width: 10%;"></td> <td style="width: 10%;"></td> <td style="width: 10%;"></td> <td style="width: 10%;"></td> <td style="width: 10%;"></td> <td style="width: 10%;"></td> </tr> <tr> <td></td> <td></td> <td colspan="8" style="text-align: center;"> <table border="1" style="width: 100%; border-collapse: collapse; text-align: center;"> <tr> <td style="width: 10%;"></td> <td style="width: 10%;"></td> <td style="width: 10%;"></td> <td style="width: 10%;"></td> <td style="width: 10%;"></td> <td style="width: 10%;"></td> <td style="width: 10%;"></td> <td style="width: 10%;"></td> <td style="width: 10%;"></td> <td style="width: 10%;"></td> </tr> <tr> <td></td> <td></td> <td colspan="8" style="text-align: center;"> <table border="1" style="width: 100%; border-collapse: collapse; text-align: center;"> <tr> <td style="width: 10%;"></td> <td style="width: 10%;"></td> <td style="width: 10%;"></td> <td style="width: 10%;"></td> <td style="width: 10%;"></td> <td style="width: 10%;"></td> <td style="width: 10%;"></td> <td style="width: 10%;"></td> <td style="width: 10%;"></td> <td style="width: 10%;"></td> </tr> <tr> <td></td> <td></td> <td colspan="8" style="text-align: center;"> <table border="1" style="width: 100%; border-collapse: collapse; text-align: center;"> <tr> <td style="width: 10%;"></td> <td style="width: 10%;"></td> <td style="width: 10%;"></td> <td style="width: 10%;"></td> <td style="width: 10%;"></td> <td style="width: 10%;"></td> <td style="width: 10%;"></td> <td style="width: 10%;"></td> <td style="width: 10%;"></td> <td style="width: 10%;"></td> </tr> <tr> <td></td> <td></td> <td colspan="8" style="text-align: center;"> <table border="1" style="width: 100%; border-collapse: collapse; text-align: center;"> <tr> <td style="width: 10%;"></td> <td style="width: 10%;"></td> <td style="width: 10%;"></td> <td style="width: 10%;"></td> <td style="width: 10%;"></td> <td style="width: 10%;"></td> <td style="width: 10%;"></td> <td style="width: 10%;"></td> <td style="width: 10%;"></td> <td style="width: 10%;"></td> </tr> <tr> <td></td> <td></td> <td colspan="8" style="text-align: center;"> <table border="1" style="width: 100%; border-collapse: collapse; text-align: center;"> <tr> <td style="width: 10%;"></td> <td style="width: 10%;"></td> <td style="width: 10%;"></td> <td style="width: 10%;"></td> <td style="width: 10%;"></td> <td style="width: 10%;"></td> <td style="width: 10%;"></td> <td style="width: 10%;"></td> <td style="width: 10%;"></td> <td style="width: 10%;"></td> </tr> <tr> <td></td> <td></td> <td colspan="8" style="text-align: center;"> <table border="1" style="width: 100%; border-collapse: collapse; text-align: center;"> <tr> <td style="width: 10%;"></td> <td style="width: 10%;"></td> <td style="width: 10%;"></td> <td style="width: 10%;"></td> <td style="width: 10%;"></td> <td style="width: 10%;"></td> <td style="width: 10%;"></td> <td style="width: 10%;"></td> <td style="width: 10%;"></td> <td style="width: 10%;"></td> </tr> <tr> <td></td> <td></td> <td colspan="8" style="text-align: center;"> <table border="1" style="width: 100%; border-collapse: collapse; text-align: center;"> <tr> </tr></table></td></tr></table></td></tr></table></td></tr></table></td></tr></table></td></tr></table></td></tr></table></td></tr></table></td></tr></table></td></tr></table>

 | | | | | | | | | | | | | | | | | | | | <table border="1" style="width: 100%; border-collapse: collapse; text-align: center;"> <tr> <td style="width: 10%;"></td> <td style="width: 10%;"></td> <td style="width: 10%;"></td> <td style="width: 10%;"></td> <td style="width: 10%;"></td> <td style="width: 10%;"></td> <td style="width: 10%;"></td> <td style="width: 10%;"></td> <td style="width: 10%;"></td> <td style="width: 10%;"></td> </tr> <tr> <td></td> <td></td> <td colspan="8" style="text-align: center;"> <table border="1" style="width: 100%; border-collapse: collapse; text-align: center;"> <tr> <td style="width: 10%;"></td> <td style="width: 10%;"></td> <td style="width: 10%;"></td> <td style="width: 10%;"></td> <td style="width: 10%;"></td> <td style="width: 10%;"></td> <td style="width: 10%;"></td> <td style="width: 10%;"></td> <td style="width: 10%;"></td> <td style="width: 10%;"></td> </tr> <tr> <td></td> <td></td> <td colspan="8" style="text-align: center;"> <table border="1" style="width: 100%; border-collapse: collapse; text-align: center;"> <tr> <td style="width: 10%;"></td> <td style="width: 10%;"></td> <td style="width: 10%;"></td> <td style="width: 10%;"></td> <td style="width: 10%;"></td> <td style="width: 10%;"></td> <td style="width: 10%;"></td> <td style="width: 10%;"></td> <td style="width: 10%;"></td> <td style="width: 10%;"></td> </tr> <tr> <td></td> <td></td> <td colspan="8" style="text-align: center;"> <table border="1" style="width: 100%; border-collapse: collapse; text-align: center;"> <tr> <td style="width: 10%;"></td> <td style="width: 10%;"></td> <td style="width: 10%;"></td> <td style="width: 10%;"></td> <td style="width: 10%;"></td> <td style="width: 10%;"></td> <td style="width: 10%;"></td> <td style="width: 10%;"></td> <td style="width: 10%;"></td> <td style="width: 10%;"></td> </tr> <tr> <td></td> <td></td> <td colspan="8" style="text-align: center;"> <table border="1" style="width: 100%;
border-collapse: collapse; text-align: center;"> <tr> <td style="width: 10%;"></td> <td style="width: 10%;"></td> <td style="width: 10%;"></td> <td style="width: 10%;"></td> <td style="width: 10%;"></td> <td style="width: 10%;"></td> <td style="width: 10%;"></td> <td style="width: 10%;"></td> <td style="width: 10%;"></td> <td style="width: 10%;"></td> </tr> <tr> <td></td> <td></td> <td colspan="8" style="text-align: center;"> <table border="1" style="width: 100%; border-collapse: collapse; text-align: center;"> <tr> <td style="width: 10%;"></td> <td style="width: 10%;"></td> <td style="width: 10%;"></td> <td style="width: 10%;"></td> <td style="width: 10%;"></td> <td style="width: 10%;"></td> <td style="width: 10%;"></td> <td style="width: 10%;"></td> <td style="width: 10%;"></td> <td style="width: 10%;"></td> </tr> <tr> <td></td> <td></td> <td colspan="8" style="text-align: center;"> <table border="1" style="width: 100%; border-collapse: collapse; text-align: center;"> <tr> <td style="width: 10%;"></td> <td style="width: 10%;"></td> <td style="width: 10%;"></td> <td style="width: 10%;"></td> <td style="width: 10%;"></td> <td style="width: 10%;"></td> <td style="width: 10%;"></td> <td style="width: 10%;"></td> <td style="width: 10%;"></td> <td style="width: 10%;"></td> </tr> <tr> <td></td> <td></td> <td colspan="8" style="text-align: center;"> <table border="1" style="width: 100%; border-collapse: collapse; text-align: center;"> <tr> <td style="width: 10%;"></td> <td style="width: 10%;"></td> <td style="width: 10%;"></td> <td style="width: 10%;"></td> <td style="width: 10%;"></td> <td style="width: 10%;"></td> <td style="width: 10%;"></td> <td style="width: 10%;"></td> <td style="width: 10%;"></td> <td style="width: 10%;"></td> </tr> <tr> <td></td> <td></td> <td colspan="8" style="text-align: center;"> <table border="1" style="width: 100%; border-collapse: collapse; text-align: center;"> <tr> </tr></table></td></tr></table></td></tr></table></td></tr></table></td></tr></table></td></tr></table></td></tr></table></td></tr></table></td></tr></table>

 | | | | | | | | | | | | | | | | | | | | <table border="1" style="width: 100%; border-collapse: collapse; text-align: center;"> <tr> <td style="width: 10%;"></td> <td style="width: 10%;"></td> <td style="width: 10%;"></td> <td style="width: 10%;"></td> <td style="width: 10%;"></td> <td style="width: 10%;"></td> <td style="width: 10%;"></td> <td style="width: 10%;"></td> <td style="width: 10%;"></td> <td style="width: 10%;"></td> </tr> <tr> <td></td> <td></td> <td colspan="8" style="text-align: center;"> <table border="1" style="width: 100%; border-collapse: collapse; text-align: center;"> <tr> <td style="width: 10%;"></td> <td style="width: 10%;"></td> <td style="width: 10%;"></td> <td style="width: 10%;"></td> <td style="width: 10%;"></td> <td style="width: 10%;"></td> <td style="width: 10%;"></td> <td style="width: 10%;"></td> <td style="width: 10%;"></td> <td style="width: 10%;"></td> </tr> <tr> <td></td> <td></td> <td colspan="8" style="text-align: center;"> <table border="1" style="width: 100%; border-collapse: collapse; text-align: center;"> <tr> <td style="width: 10%;"></td> <td style="width: 10%;"></td> <td style="width: 10%;"></td> <td style="width: 10%;"></td> <td style="width: 10%;"></td> <td style="width: 10%;"></td> <td style="width: 10%;"></td> <td style="width: 10%;"></td> <td style="width: 10%;"></td> <td style="width: 10%;"></td> </tr> <tr> <td></td> <td></td> <td colspan="8" style="text-align: center;"> <table border="1" style="width: 100%; border-collapse: collapse; text-align: center;"> <tr> <td style="width: 10%;"></td> <td style="width: 10%;"></td> <td style="width: 10%;"></td> <td style="width: 10%;"></td> <td style="width: 10%;"></td> <td style="width: 10%;"></td> <td style="width: 10%;"></td> <td style="width: 10%;"></td> <td style="width: 10%;"></td> <td style="width: 10%;"></td> </tr> <tr> <td></td> <td></td> <td colspan="8" style="text-align: center;"> <table border="1" style="width: 100%; border-collapse: collapse; text-align: center;"> <tr> <td style="width: 10%;"></td> <td style="width: 10%;"></td> <td style="width: 10%;"></td> <td style="width: 10%;"></td> <td style="width: 10%;"></td> <td style="width: 10%;"></td> <td style="width: 10%;"></td> <td style="width: 10%;"></td> <td style="width: 10%;"></td> <td style="width: 10%;"></td> </tr> <tr> <td></td> <td></td> <td colspan="8" style="text-align: center;"> <table border="1" style="width: 100%; border-collapse: collapse; text-align: center;"> <tr> <td style="width: 10%;"></td> <td style="width: 10%;"></td> <td style="width: 10%;"></td> <td style="width: 10%;"></td> <td style="width: 10%;"></td> <td style="width: 10%;"></td> <td style="width: 10%;"></td> <td style="width: 10%;"></td> <td style="width: 10%;"></td> <td style="width: 10%;"></td> </tr> <tr> <td></td> <td></td> <td colspan="8" style="text-align: center;"> <table border="1" style="width: 100%; border-collapse: collapse; text-align: center;"> <tr> <td style="width: 10%;"></td> <td style="width: 10%;"></td> <td style="width: 10%;"></td> <td style="width: 10%;"></td> <td style="width: 10%;"></td> <td style="width: 10%;"></td> <td style="width: 10%;"></td> <td style="width: 10%;"></td> <td style="width: 10%;"></td> <td style="width: 10%;"></td> </tr> <tr> <td></td> <td></td> <td colspan="8" style="text-align: center;"> <table border="1" style="width: 100%; border-collapse: collapse; text-align: center;"> <tr> </tr></table></td></tr></table></td></tr></table></td></tr></table></td></tr></table></td></tr></table></td></tr></table></td></tr></table>

 | | | | | | | | | | | | | | | | | | | | <table border="1" style="width: 100%; border-collapse: collapse; text-align: center;"> <tr> <td style="width: 10%;"></td> <td style="width: 10%;"></td> <td style="width: 10%;"></td> <td style="width: 10%;"></td> <td style="width: 10%;"></td> <td style="width: 10%;"></td> <td style="width: 10%;"></td> <td style="width: 10%;"></td> <td style="width: 10%;"></td> <td style="width: 10%;"></td> </tr> <tr> <td></td> <td></td> <td colspan="8" style="text-align: center;"> <table border="1" style="width: 100%; border-collapse: collapse; text-align: center;"> <tr> <td style="width: 10%;"></td> <td style="width: 10%;"></td> <td style="width: 10%;"></td> <td style="width: 10%;"></td> <td style="width: 10%;"></td> <td style="width: 10%;"></td> <td style="width: 10%;"></td> <td style="width: 10%;"></td> <td style="width: 10%;"></td> <td style="width: 10%;"></td> </tr> <tr> <td></td> <td></td> <td colspan="8" style="text-align: center;"> <table border="1" style="width: 100%; border-collapse: collapse; text-align: center;"> <tr> <td style="width: 10%;"></td> <td style="width: 10%;"></td> <td style="width: 10%;"></td> <td style="width: 10%;"></td> <td style="width: 10%;"></td> <td style="width: 10%;"></td> <td style="width: 10%;"></td> <td style="width: 10%;"></td> <td style="width: 10%;"></td> <td style="width: 10%;"></td> </tr> <tr> <td></td> <td></td> <td colspan="8" style="text-align: center;"> <table border="1" style="width: 100%; border-collapse: collapse; text-align: center;"> <tr> <td style="width: 10%;"></td> <td style="width: 10%;"></td> <td style="width: 10%;"></td> <td style="width: 10%;"></td> <td style="width: 10%;"></td> <td style="width: 10%;"></td> <td style="width: 10%;"></td> <td style="width: 10%;"></td> <td style="width: 10%;"></td> <td style="width: 10%;"></td> </tr> <tr> <td></td> <td></td> <td colspan="8" style="text-align: center;"> <table border="1" style="width: 100%; border-collapse: collapse; text-align: center;"> <tr> <td style="width: 10%;"></td> <td style="width: 10%;"></td> <td style="width: 10%;"></td> <td style="width: 10%;"></td> <td style="width: 10%;"></td> <td style="width: 10%;"></td> <td style="width: 10%;"></td> <td style="width: 10%;"></td> <td style="width: 10%;"></td> <td style="width: 10%;"></td> </tr> <tr> <td></td> <td></td> <td colspan="8" style="text-align: center;"> <table border="1" style="width: 100%; border-collapse: collapse; text-align: center;"> <tr> <td style="width: 10%;"></td> <td style="width: 10%;"></td> <td style="width: 10%;"></td> <td style="width: 10%;"></td> <td style="width: 10%;"></td> <td style="width: 10%;"></td> <td style="width: 10%;"></td> <td style="width: 10%;"></td> <td style="width: 10%;"></td> <td style="width: 10%;"></td> </tr> <tr> <td></td> <td></td> <td colspan="8" style="text-align: center;"> <table border="1" style="width: 100%; border-collapse: collapse; text-align: center;"> <tr> </tr></table></td></tr></table></td></tr></table></td></tr></table></td></tr></table></td></tr></table></td></tr></table>

 | | | | | | | | | | | | | | | | | | | | <table border="1" style="width: 100%; border-collapse: collapse; text-align: center;"> <tr> <td style="width: 10%;"></td> <td style="width: 10%;"></td> <td style="width: 10%;"></td> <td style="width: 10%;"></td> <td style="width: 10%;"></td> <td style="width: 10%;"></td> <td style="width: 10%;"></td> <td style="width: 10%;"></td> <td style="width: 10%;"></td> <td style="width: 10%;"></td> </tr> <tr> <td></td> <td></td> <td colspan="8" style="text-align: center;"> <table border="1" style="width: 100%; border-collapse: collapse; text-align: center;"> <tr> <td style="width: 10%;"></td> <td style="width: 10%;"></td> <td style="width: 10%;"></td> <td style="width: 10%;"></td> <td style="width: 10%;"></td> <td style="width: 10%;"></td> <td style="width: 10%;"></td> <td style="width: 10%;"></td> <td style="width: 10%;"></td> <td style="width: 10%;"></td> </tr> <tr> <td></td> <td></td> <td colspan="8" style="text-align: center;"> <table border="1" style="width: 100%; border-collapse: collapse; text-align: center;"> <tr> <td style="width: 10%;"></td> <td style="width: 10%;"></td> <td style="width: 10%;"></td> <td style="width: 10%;"></td> <td style="width: 10%;"></td> <td style="width: 10%;"></td> <td style="width: 10%;"></td> <td style="width: 10%;"></td> <td style="width: 10%;"></td> <td style="width: 10%;"></td> </tr> <tr> <td></td> <td></td> <td colspan="8" style="text-align: center;"> <table border="1"
style="width: 100%; border-collapse: collapse; text-align: center;"> <tr> <td style="width: 10%;"></td> <td style="width: 10%;"></td> <td style="width: 10%;"></td> <td style="width: 10%;"></td> <td style="width: 10%;"></td> <td style="width: 10%;"></td> <td style="width: 10%;"></td> <td style="width: 10%;"></td> <td style="width: 10%;"></td> <td style="width: 10%;"></td> </tr> <tr> <td></td> <td></td> <td colspan="8" style="text-align: center;"> <table border="1" style="width: 100%; border-collapse: collapse; text-align: center;"> <tr> <td style="width: 10%;"></td> <td style="width: 10%;"></td> <td style="width: 10%;"></td> <td style="width: 10%;"></td> <td style="width: 10%;"></td> <td style="width: 10%;"></td> <td style="width: 10%;"></td> <td style="width: 10%;"></td> <td style="width: 10%;"></td> <td style="width: 10%;"></td> </tr> <tr> <td></td> <td></td> <td colspan="8" style="text-align: center;"> <table border="1" style="width: 100%; border-collapse: collapse; text-align: center;"> <tr> </tr></table></td></tr></table></td></tr></table></td></tr></table></td></tr></table></td></tr></table>

 | | | | | | | | | | | | | | | | | | | | <table border="1" style="width: 100%; border-collapse: collapse; text-align: center;"> <tr> <td style="width: 10%;"></td> <td style="width: 10%;"></td> <td style="width: 10%;"></td> <td style="width: 10%;"></td> <td style="width: 10%;"></td> <td style="width: 10%;"></td> <td style="width: 10%;"></td> <td style="width: 10%;"></td> <td style="width: 10%;"></td> <td style="width: 10%;"></td> </tr> <tr> <td></td> <td></td> <td colspan="8" style="text-align: center;"> <table border="1" style="width: 100%; border-collapse: collapse; text-align: center;"> <tr> <td style="width: 10%;"></td> <td style="width: 10%;"></td> <td style="width: 10%;"></td> <td style="width: 10%;"></td> <td style="width: 10%;"></td> <td style="width: 10%;"></td> <td style="width: 10%;"></td> <td style="width: 10%;"></td> <td style="width: 10%;"></td> <td style="width: 10%;"></td> </tr> <tr> <td></td> <td></td> <td colspan="8" style="text-align: center;"> <table border="1" style="width: 100%; border-collapse: collapse; text-align: center;"> <tr> <td style="width: 10%;"></td> <td style="width: 10%;"></td> <td style="width: 10%;"></td> <td style="width: 10%;"></td> <td style="width: 10%;"></td> <td style="width: 10%;"></td> <td style="width: 10%;"></td> <td style="width: 10%;"></td> <td style="width: 10%;"></td> <td style="width: 10%;"></td> </tr> <tr> <td></td> <td></td> <td colspan="8" style="text-align: center;"> <table border="1" style="width: 100%; border-collapse: collapse; text-align: center;"> <tr> <td style="width: 10%;"></td> <td style="width: 10%;"></td> <td style="width: 10%;"></td> <td style="width: 10%;"></td> <td style="width: 10%;"></td> <td style="width: 10%;"></td> <td style="width: 10%;"></td> <td style="width: 10%;"></td> <td style="width: 10%;"></td> <td style="width: 10%;"></td> </tr> <tr> <td></td> <td></td> <td colspan="8" style="text-align: center;"> <table border="1" style="width: 100%; border-collapse: collapse; text-align: center;"> <tr> </tr></table></td></tr></table></td></tr></table></td></tr></table></td></tr></table>

 | | | | | | | | | | | | | | | | | | | | <table border="1" style="width: 100%; border-collapse: collapse; text-align: center;"> <tr> <td style="width: 10%;"></td> <td style="width: 10%;"></td> <td style="width: 10%;"></td> <td style="width: 10%;"></td> <td style="width: 10%;"></td> <td style="width: 10%;"></td> <td style="width: 10%;"></td> <td style="width: 10%;"></td> <td style="width: 10%;"></td> <td style="width: 10%;"></td> </tr> <tr> <td></td> <td></td> <td colspan="8" style="text-align: center;"> <table border="1" style="width: 100%; border-collapse: collapse; text-align: center;"> <tr> <td style="width: 10%;"></td> <td style="width: 10%;"></td> <td style="width: 10%;"></td> <td style="width: 10%;"></td> <td style="width: 10%;"></td> <td style="width: 10%;"></td> <td style="width: 10%;"></td> <td style="width: 10%;"></td> <td style="width: 10%;"></td> <td style="width: 10%;"></td> </tr> <tr> <td></td> <td></td> <td colspan="8" style="text-align: center;"> <table border="1" style="width: 100%; border-collapse: collapse; text-align: center;"> <tr> <td style="width: 10%;"></td> <td style="width: 10%;"></td> <td style="width: 10%;"></td> <td style="width: 10%;"></td> <td style="width: 10%;"></td> <td style="width: 10%;"></td> <td style="width: 10%;"></td> <td style="width: 10%;"></td> <td style="width: 10%;"></td> <td style="width: 10%;"></td> </tr> <tr> <td></td> <td></td> <td colspan="8" style="text-align: center;"> <table border="1" style="width: 100%; border-collapse: collapse; text-align: center;"> <tr> </tr></table></td></tr></table></td></tr></table></td></tr></table>

 | | | | | | | | | | | | | | | | | | | | <table border="1" style="width: 100%; border-collapse: collapse; text-align: center;"> <tr> <td style="width: 10%;"></td> <td style="width: 10%;"></td> <td style="width: 10%;"></td> <td style="width: 10%;"></td> <td style="width: 10%;"></td> <td style="width: 10%;"></td> <td style="width: 10%;"></td> <td style="width: 10%;"></td> <td style="width: 10%;"></td> <td style="width: 10%;"></td> </tr> <tr> <td></td> <td></td> <td colspan="8" style="text-align: center;"> <table border="1" style="width: 100%; border-collapse: collapse; text-align: center;"> <tr> <td style="width: 10%;"></td> <td style="width: 10%;"></td> <td style="width: 10%;"></td> <td style="width: 10%;"></td> <td style="width: 10%;"></td> <td style="width: 10%;"></td> <td style="width: 10%;"></td> <td style="width: 10%;"></td> <td style="width: 10%;"></td> <td style="width: 10%;"></td> </tr> <tr> <td></td> <td></td> <td colspan="8" style="text-align: center;"> <table border="1" style="width: 100%; border-collapse: collapse; text-align: center;"> <tr> </tr></table></td></tr></table></td></tr></table>

 | | | | | | | | | | | | | | | | | | | | <table border="1" style="width: 100%; border-collapse: collapse; text-align: center;"> <tr> <td style="width: 10%;"></td> <td style="width: 10%;"></td> <td style="width: 10%;"></td> <td style="width: 10%;"></td> <td style="width: 10%;"></td> <td style="width: 10%;"></td> <td style="width: 10%;"></td> <td style="width: 10%;"></td> <td style="width: 10%;"></td> <td style="width: 10%;"></td> </tr> <tr> <td></td> <td></td> <td colspan="8" style="text-align: center;"> <table border="1" style="width: 100%; border-collapse: collapse; text-align: center;"> <tr> </tr></table></td></tr></table>

 | | | | | | | | | | | | | | | | | | | | <table border="1" style="width: 100%; border-collapse: collapse; text-align: center;"> <tr> </tr></table>

 | | | | | | | | | | | | | | | | | | | |

 | | | | | | | | | | | | | | | | | | | |

 | | | | | | | | | | | | | | | | | | | |

 | | | | | | | | | | | | | | | | | | | |

 | | | | | | | | | | | | | | | | | | | |
 | | | | | | | | | | | | | | | | | | | |

 | | | | | | | | | | | | | | | | | | | |

 | | | | | | | | | | | | | | | | | | | |
 | | | | | | | | | | | | | | | | | | | |

 | | | | | | | | | | | | | | | | | | | |

 | | | | | | | | | | | | | | | | | | | |
 | | | | | | | | | | | | | | | | | | | |
 | | | | | | | | | | | | | | | | | | | |

 | | | | | | | | | | | | | | | | | | | |
 | | | | | | | | | | | | | | | | | | | |
 | | | | | | | | | | | | | | | | | | | |

 | | | | | | | | | | | | | | | | | | | | | | | | | | | | | | | | | | | | | | | | | | | | | | | | | | | | | | | | | | | | | | | | | | | | | | | | | | | | | | | | | | | | | | | | | | | | | | | | | | | |
 | | | | | | | | | | | | | | | | | | | |
 | | | | | | | | | | | | | | | | | | | |
 | | | | | | | | | | | | | | | | | | | |
 | | | | | | | | | | | | | | | | | | | |
 | | | | | | | | | | | | | | | | | | | |
 | | | | | | | | | | | | | | | | | | | |
 | | | | | | | | | | | | | | | | | | | |
 | | | | | | | | | | | | | | | | | | | |
 | | | | | | | | | | | | | | | | | | | | | | | | | | | | | | | | | | | | | | | |
 | | | | | | | | | | | | | | | | | | | |
 | | | | | | | | | | | | | | | | | | | | | | | | | | | | | | | | | | | | | | | |
 | | | | | | | | | | | | | | | | | | | | | | | | | | | | | | | | | | | | | | | |
 | | | | | | | | | | | | | | | | | | | | | | | | | | | | | | | | | | | | | | | |
 | | | | | | | | | | | | | | | | | | | | | | | | | | | | | | | | | | | | | | | | | | | | | | | | | | | | | | | | | | | | | | | | | | | | | | | | | | | | | | | | | | | | | | | | | | | | | | | | | | | |
 | | | | | | | | | | | | | | | | | | | | | | | | | | | | | | | | | | | | | | | | | | | | | | | |
| | |

 | | | | | | | | | | | | | | | | | | | |

 | | | | | | | | | | | | | | | | | | | |

 | | | | | | | | | | | | | | | | | | | |

 | | | | | | | | | | | | | | | | | | | |

 | | | | | | | | | | | | | | | | | | | |

 | | | | | | | | | | | | | | | | | | | |

 | | | | | | | | | | | | | | | | | | | |

 | | | | | | | | | | | | | | | | | | | |

 | | | | | | | | | | | | | | | | | | | |

 | | | | | | | | | | | | | | | | | | | |

 | | | | | | | | | | | | | | | | | | | |

 | | | | | | | | | | | | | | | | | | | |

 | | | | | | | | | | | | | | | | | | | |

 | | | | | | | | | | | | | | | | | | | |

 | | | | | | | | | | | | | | | | | | | |

 | | | | | | | | | | | | | | | | | | | |

 | | | | | | | | | | | | | | | | | | | |

 | | | | | | | | | | | | | | | | | | | |

 | | | | | | | | | | | | | | | | | | | |

 | | | | | | | | | | | | | | | | | | | |

 | | | | | | | | | | | | | | | | | | | |

 | | | | | | | | | | | | | | | | | | | |

 | | | | | | | | | | | | | | | | | | | |

 | | | | | | | | | | | | | | | | | | | |

 | | | | | | | | | | | | | | | | | | | |

 | | | | | | | | | | | | | | | | | | | |

 | | | | | | | | | | | | | | | | | | | |

 | | | | | | | | | | | | | | | | | | | |
 | | | | | | | | | | | | | | | | | | | |

 | | | | | | | | | | | | | | | | | | | |

 | | | | | | | | | | | | | | | | | | | |
 | | | | | | | | | | | | | | | | | | | |

 | | | | | | | | | | | | | | | | | | | |

 | | | | | | | | | | | | | | | | | | | |
 | | | | | | | | | | | | | | | | | | | |
 | | | | | | | | | | | | | | | | | | | |

 | | | | | | | | | | | | | | | | | | | |
 | | | | | | | | | | | | | | | | | | | |
 | | | | | | | | | | | | | | | | | | | |

 | | | | | | | | | | | | | | | | | | | | | | | | | | | | | | | | | | | | | | | | | | | | | | | | | | | | | | | | | | | | | | | | | | | | | | | | | | | | | | | | | | | | | | | | | | | | | | | | | | | |
 | | | | | | | | | | | | | | | | | | | |
 | | | | | | | | | | | | | | | | | | | |
 | | | | | | | | | | | | | | | | | | | |
 | | | | | | | | | | | | | | | | | | | |
 | | | | | | | | | | | | | | | | | | | |
 | | | | | | | | | | | | | | | | | | | |
 | | | | | | | | | | | | | | | | | | | |
 | | | | | | | | | | | | | | | | | | | |
 | | | | | | | | | | | | | | | | | | | | | | | | | | | | | | | | | | | | | | | |
 | | | | | | | | | | | | | | | | | | | |
 | | | | | | | | | | | | | | | | | | | | | | | | | | | | | | | | | | | | | | | |
 | | | | | | | | | | | | | | | | | | | | | | | | | | | | | | | | | | | | | | | |
 | | | | | | | | | | | | | | | | | | | | | | | | | | | | | | | | | | | | | | | |
 | | | | | | | | | | | | | | | | | | | | | | | | | | | | | | | | | | | | | | | | | | | | | | | | | | | | | | | | | | | | | | | | | | | | | | | | | | | | | | | | | | | | | | | | | | | | | | | | | | | |
 | | | | | | | | | | | | | | | | | | | | | | | | | | | | | | | | | | | | | | | | | | | | | | | |
| | | <table border="1" style="width: 100%; border-collapse: collapse; text-align: center;"> <tr> <td style="width: 10%;"></td> <td style="width: 10%;"></td> <td style="width: 10%;"></td> <td style="width: 10%;"></td> <td style="width: 10%;"></td> <td style="width: 10%;"></td> <td style="width: 10%;"></td> <td style="width: 10%;"></td> <td style="width: 10%;"></td> <td style="width: 10%;"></td> </tr> <tr> <td></td> <td></td> <td colspan="8" style="text-align: center;"> <table border="1" style="width: 100%; border-collapse: collapse; text-align: center;"> <tr> <td style="width: 10%;"></td> <td style="width: 10%;"></td> <td style="width: 10%;"></td> <td style="width: 10%;"></td> <td style="width: 10%;"></td> <td style="width: 10%;"></td> <td style="width: 10%;"></td> <td style="width: 10%;"></td> <td style="width: 10%;"></td> <td style="width: 10%;"></td> </tr> <tr> <td></td> <td></td> <td colspan="8" style="text-align: center;"> <table border="1" style="width: 100%; border-collapse: collapse; text-align: center;"> <tr> <td style="width: 10%;"></td> <td style="width: 10%;"></td> <td style="width: 10%;"></td> <td style="width: 10%;"></td> <td style="width: 10%;"></td> <td style="width: 10%;"></td> <td style="width: 10%;"></td> <td style="width: 10%;"></td> <td style="width: 10%;"></td> <td style="width: 10%;"></td> </tr> <tr> <td></td> <td></td> <td colspan="8" style="text-align: center;"> <table border="1" style="width: 100%; border-collapse: collapse; text-align: center;"> <tr> <td style="width: 10%;"></td> <td style="width: 10%;"></td> <td style="width: 10%;"></td> <td style="width: 10%;"></td> <td style="width: 10%;"></td> <td style="width: 10%;"></td> <td style="width: 10%;"></td> <td style="width: 10%;"></td> <td style="width: 10%;"></td> <td style="width: 10%;"></td> </tr> <tr> <td></td> <td></td> <td colspan="8" style="text-align: center;"> <table border="1" style="width: 100%; border-collapse: collapse; text-align: center;"> <tr> <td style="width: 10%;"></td> <td style="width: 10%;"></td> <td style="width: 10%;"></td> <td style="width: 10%;"></td> <td style="width: 10%;"></td> <td style="width: 10%;"></td> <td style="width: 10%;"></td> <td style="width: 10%;"></td> <td style="width: 10%;"></td> <td style="width: 10%;"></td> </tr> <tr> <td></td> <td></td> <td colspan="8" style="text-align: center;"> <table border="1" style="width: 100%; border-collapse: collapse; text-align: center;"> <tr> <td style="width: 10%;"></td> <td style="width: 10%;"></td> <td style="width: 10%;"></td> <td style="width: 10%;"></td> <td style="width: 10%;"></td> <td style="width: 10%;"></td> <td style="width: 10%;"></td> <td style="width: 10%;"></td> <td style="width: 10%;"></td> <td style="width: 10%;"></td> </tr> <tr> <td></td> <td></td> <td colspan="8" style="text-align: center;"> <table border="1" style="width: 100%; border-collapse: collapse; text-align: center;"> <tr> <td style="width: 10%;"></td> <td style="width: 10%;"></td> <td style="width: 10%;"></td> <td style="width: 10%;"></td> <td style="width: 10%;"></td> <td style="width: 10%;"></td> <td style="width: 10%;"></td> <td style="width: 10%;"></td> <td style="width: 10%;"></td> <td style="width: 10%;"></td> </tr> <tr> <td></td> <td></td> <td colspan="8" style="text-align: center;"> <table border="1" style="width: 100%; border-collapse: collapse; text-align: center;"> <tr> <td style="width: 10%;"></td> <td style="width: 10%;"></td> <td style="width: 10%;"></td> <td style="width: 10%;"></td> <td style="width: 10%;"></td> <td style="width: 10%;"></td> <td style="width: 10%;"></td> <td style="width: 10%;"></td> <td style="width: 10%;"></td> <td style="width: 10%;"></td> </tr> <tr> <td></td> <td></td> <td colspan="8" style="text-align: center;"> <table border="1" style="width: 100%; border-collapse: collapse; text-align: center;"> <tr> <td style="width: 10%;"></td> <td style="width: 10%;"></td> <td style="width: 10%;"></td> <td style="width: 10%;"></td> <td style="width: 10%;"></td> <td style="width: 10%;"></td> <td style="width: 10%;"></td> <td style="width: 10%;"></td> <td style="width: 10%;"></td> <td style="width: 10%;"></td> </tr> <tr> <td></td> <td></td> <td colspan="8" style="text-align: center;"> <table border="1" style="width: 100%; border-collapse: collapse; text-align: center;"> <tr> <td style="width: 10%;"></td> <td style="width: 10%;"></td> <td style="width: 10%;"></td> <td style="width: 10%;"></td> <td style="width: 10%;"></td> <td style="width: 10%;"></td> <td style="width: 10%;"></td> <td style="width: 10%;"></td> <td style="width: 10%;"></td> <td style="width: 10%;"></td> </tr> <tr> <td></td> <td></td> <td colspan="8" style="text-align: center;"> <table border="1" style="width: 100%; border-collapse: collapse; text-align: center;"> <tr> <td style="width: 10%;"></td> <td style="width: 10%;"></td> <td style="width: 10%;"></td> <td style="width: 10%;"></td> <td style="width: 10%;"></td> <td style="width: 10%;"></td> <td style="width: 10%;"></td> <td style="width: 10%;"></td> <td style="width: 10%;"></td> <td style="width: 10%;"></td> </tr> <tr> <td></td> <td></td> <td colspan="8" style="text-align: center;"> <table border="1" style="width: 100%; border-collapse: collapse; text-align: center;"> <tr> <td style="width: 10%;"></td> <td style="width: 10%;"></td> <td style="width: 10%;"></td> <td style="width: 10%;"></td> <td style="width: 10%;"></td> <td style="width: 10%;"></td> <td style="width: 10%;"></td> <td style="width: 10%;"></td> <td style="width: 10%;"></td> <td style="width: 10%;"></td> </tr> <tr> <td></td> <td></td> <td colspan="8" style="text-align: center;"> <table border="1" style="width: 100%; border-collapse: collapse; text-align: center;"> <tr> <td style="width: 10%;"></td> <td style="width: 10%;"></td> <td style="width: 10%;"></td> <td style="width: 10%;"></td> <td style="width: 10%;"></td> <td style="width: 10%;"></td> <td style="width: 10%;"></td> <td style="width: 10%;"></td> <td style="width: 10%;"></td> <td style="width: 10%;"></td> </tr> <tr> <td></td> <td></td> <td colspan="8" style="text-align: center;"> <table border="1" style="width: 100%; border-collapse: collapse; text-align: center;"> <tr> <td style="width: 10%;"></td> <td style="width: 10%;"></td> <td style="width: 10%;"></td> <td style="width: 10%;"></td> <td style="width: 10%;"></td> <td style="width: 10%;"></td> <td style="width: 10%;"></td> <td style="width: 10%;"></td> <td style="width: 10%;"></td> <td style="width: 10%;"></td> </tr> <tr> <td></td> <td></td> <td colspan="8" style="text-align: center;"> <table border="1" style="width: 100%; border-collapse: collapse; text-align: center;"> <tr> <td style="width: 10%;"></td> <td style="width: 10%;"></td> <td style="width: 10%;"></td> <td style="width: 10%;"></td> <td style="width: 10%;"></td> <td style="width: 10%;"></td> <td style="width: 10%;"></td> <td style="width: 10%;"></td> <td style="width: 10%;"></td> <td style="width: 10%;"></td> </tr> <tr> <td></td> <td></td> <td colspan="8" style="text-align: center;"> <table border="1" style="width: 100%; border-collapse: collapse; text-align: center;"> <tr> <td style="width: 10%;"></td> <td style="width: 10%;"></td> <td style="width: 10%;"></td> <td style="width: 10%;"></td> <td style="width: 10%;"></td> <td style="width: 10%;"></td> <td style="width: 10%;"></td> <td style="width: 10%;"></td> <td style="width: 10%;"></td> <td style="width: 10%;"></td> </tr> <tr> <td></td> <td></td> <td colspan="8" style="text-align: center;"> <table border="1" style="width: 100%; border-collapse: collapse; text-align: center;"> <tr> <td style="width: 10%;"></td> <td style="width: 10%;"></td> <td style="width: 10%;"></td> <td style="width: 10%;"></td> <td style="width: 10%;"></td> <td style="width: 10%;"></td> <td style="width: 10%;"></td> <td style="width: 10%;"></td> <td style="width: 10%;"></td> <td style="width: 10%;"></td> </tr> <tr> <td></td> <td></td> <td colspan="8" style="text-align: center;"> <table border="1" style="width: 100%; border-collapse: collapse; text-align: center;"> <tr> <td style="width: 10%;"></td> <td style="width: 10%;"></td> <td style="width: 10%;"></td> <td style="width: 10%;"></td> <td style="width: 10%;"></td> <td style="width: 10%;"></td> <td style="width: 10%;"></td> <td style="width: 10%;"></td> <td style="width: 10%;"></td> <td style="width: 10%;"></td> </tr> <tr> <td></td> <td></td> <td colspan="8" style="text-align: center;"> <table border="1" style="width: 100%; border-collapse: collapse; text-align: center;"> <tr> <td style="width: 10%;"></td> <td style="width: 10%;"></td> <td style="width: 10%;"></td> <td style="width: 10%;"></td> <td style="width: 10%;"></td> <td style="width: 10%;"></td> <td style="width: 10%;"></td> <td style="width: 10%;"></td> <td style="width: 10%;"></td> <td style="width: 10%;"></td> </tr> <tr> <td></td> <td></td> <td colspan="8" style="text-align: center;"> <table border="1" style="width: 100%; border-collapse: collapse; text-align: center;"> <tr> <td style="width: 10%;"></td> <td style="width: 10%;"></td> <td style="width: 10%;"></td> <td style="width: 10%;"></td> <td style="width: 10%;"></td> <td style="width: 10%;"></td> <td style="width: 10%;"></td> <td style="width: 10%;"></td> <td style="width: 10%;"></td> <td style="width: 10%;"></td> </tr> <tr> <td></td> <td></td> <td colspan="8" style="text-align: center;"> <table border="1" style="width: 100%; border-collapse: collapse; text-align: center;"> <tr> <td style="width: 10%;"></td> <td style="width: 10%;"></td> <td style="width: 10%;"></td> <td style="width: 10%;"></td> <td style="width: 10%;"></td> <td style="width: 10%;"></td> <td style="width: 10%;"></td> <td style="width: 10%;"></td> <td style="width: 10%;"></td> <td style="width: 10%;"></td> </tr> <tr> <td></td> <td></td> <td colspan="8" style="text-align: center;"> <table border="1" style="width: 100%; border-collapse: collapse; text-align: center;"> <tr> <td style="width: 10%;"></td> <td style="width: 10%;"></td> <td
style="width: 10%;"></td> <td style="width: 10%;"></td> <td style="width: 10%;"></td> <td style="width: 10%;"></td> <td style="width: 10%;"></td> <td style="width: 10%;"></td> <td style="width: 10%;"></td> <td style="width: 10%;"></td> </tr> <tr> <td></td> <td></td> <td colspan="8" style="text-align: center;"> <table border="1" style="width: 100%; border-collapse: collapse; text-align: center;"> <tr> </tr></table></td></tr></table></td></tr></table></td></tr></table></td></tr></table></td></tr></table></td></tr></table></td></tr></table></td></tr></table></td></tr></table></td></tr></table></td></tr></table></td></tr></table></td></tr></table></td></tr></table></td></tr></table></td></tr></table></td></tr></table></td></tr></table></td></tr></table></td></tr></table></td></tr></table></td></tr></table>

 | | | | | | | | | | | | | | | | | | | | <table border="1" style="width: 100%; border-collapse: collapse; text-align: center;"> <tr> <td style="width: 10%;"></td> <td style="width: 10%;"></td> <td style="width: 10%;"></td> <td style="width: 10%;"></td> <td style="width: 10%;"></td> <td style="width: 10%;"></td> <td style="width: 10%;"></td> <td style="width: 10%;"></td> <td style="width: 10%;"></td> <td style="width: 10%;"></td> </tr> <tr> <td></td> <td></td> <td colspan="8" style="text-align: center;"> <table border="1" style="width: 100%; border-collapse: collapse; text-align: center;"> <tr> <td style="width: 10%;"></td> <td style="width: 10%;"></td> <td style="width: 10%;"></td> <td style="width: 10%;"></td> <td style="width: 10%;"></td> <td style="width: 10%;"></td> <td style="width: 10%;"></td> <td style="width: 10%;"></td> <td style="width: 10%;"></td> <td style="width: 10%;"></td> </tr> <tr> <td></td> <td></td> <td colspan="8" style="text-align: center;"> <table border="1" style="width: 100%; border-collapse: collapse; text-align: center;"> <tr> <td style="width: 10%;"></td> <td style="width: 10%;"></td> <td style="width: 10%;"></td> <td style="width: 10%;"></td> <td style="width: 10%;"></td> <td style="width: 10%;"></td> <td style="width: 10%;"></td> <td style="width: 10%;"></td> <td style="width: 10%;"></td> <td style="width: 10%;"></td> </tr> <tr> <td></td> <td></td> <td colspan="8" style="text-align: center;"> <table border="1" style="width: 100%; border-collapse: collapse; text-align: center;"> <tr> <td style="width: 10%;"></td> <td style="width: 10%;"></td> <td style="width: 10%;"></td> <td style="width: 10%;"></td> <td style="width: 10%;"></td> <td style="width: 10%;"></td> <td style="width: 10%;"></td> <td style="width: 10%;"></td> <td style="width: 10%;"></td> <td style="width: 10%;"></td> </tr> <tr> <td></td> <td></td> <td colspan="8" style="text-align: center;"> <table border="1" style="width: 100%; border-collapse: collapse; text-align: center;"> <tr> <td style="width: 10%;"></td> <td style="width: 10%;"></td> <td style="width: 10%;"></td> <td style="width: 10%;"></td> <td style="width: 10%;"></td> <td style="width: 10%;"></td> <td style="width: 10%;"></td> <td style="width: 10%;"></td> <td style="width: 10%;"></td> <td style="width: 10%;"></td> </tr> <tr> <td></td> <td></td> <td colspan="8" style="text-align: center;"> <table border="1" style="width: 100%; border-collapse: collapse; text-align: center;"> <tr> <td style="width: 10%;"></td> <td style="width: 10%;"></td> <td style="width: 10%;"></td> <td style="width: 10%;"></td> <td style="width: 10%;"></td> <td style="width: 10%;"></td> <td style="width: 10%;"></td> <td style="width: 10%;"></td> <td style="width: 10%;"></td> <td style="width: 10%;"></td> </tr> <tr> <td></td> <td></td> <td colspan="8" style="text-align: center;"> <table border="1" style="width: 100%; border-collapse: collapse; text-align: center;"> <tr> <td style="width: 10%;"></td> <td style="width: 10%;"></td> <td style="width: 10%;"></td> <td style="width: 10%;"></td> <td style="width: 10%;"></td> <td style="width: 10%;"></td> <td style="width: 10%;"></td> <td style="width: 10%;"></td> <td style="width: 10%;"></td> <td style="width: 10%;"></td> </tr> <tr> <td></td> <td></td> <td colspan="8" style="text-align: center;"> <table border="1" style="width: 100%; border-collapse: collapse; text-align: center;"> <tr> <td style="width: 10%;"></td> <td style="width: 10%;"></td> <td style="width: 10%;"></td> <td style="width: 10%;"></td> <td style="width: 10%;"></td> <td style="width: 10%;"></td> <td style="width: 10%;"></td> <td style="width: 10%;"></td> <td style="width: 10%;"></td> <td style="width: 10%;"></td> </tr> <tr> <td></td> <td></td> <td colspan="8" style="text-align: center;"> <table border="1" style="width: 100%; border-collapse: collapse; text-align: center;"> <tr> <td style="width: 10%;"></td> <td style="width: 10%;"></td> <td style="width: 10%;"></td> <td style="width: 10%;"></td> <td style="width: 10%;"></td> <td style="width: 10%;"></td> <td style="width: 10%;"></td> <td style="width: 10%;"></td> <td style="width: 10%;"></td> <td style="width: 10%;"></td> </tr> <tr> <td></td> <td></td> <td colspan="8" style="text-align: center;"> <table border="1" style="width: 100%; border-collapse: collapse; text-align: center;"> <tr> <td style="width: 10%;"></td> <td style="width: 10%;"></td> <td style="width: 10%;"></td> <td style="width: 10%;"></td> <td style="width: 10%;"></td> <td style="width: 10%;"></td> <td style="width: 10%;"></td> <td style="width: 10%;"></td> <td style="width: 10%;"></td> <td style="width: 10%;"></td> </tr> <tr> <td></td> <td></td> <td colspan="8" style="text-align: center;"> <table border="1" style="width: 100%; border-collapse: collapse; text-align: center;"> <tr> <td style="width: 10%;"></td> <td style="width: 10%;"></td> <td style="width: 10%;"></td> <td style="width: 10%;"></td> <td style="width: 10%;"></td> <td style="width: 10%;"></td> <td style="width: 10%;"></td> <td style="width: 10%;"></td> <td style="width: 10%;"></td> <td style="width: 10%;"></td> </tr> <tr> <td></td> <td></td> <td colspan="8" style="text-align: center;"> <table border="1" style="width: 100%; border-collapse: collapse; text-align: center;"> <tr> <td style="width: 10%;"></td> <td style="width: 10%;"></td> <td style="width: 10%;"></td> <td style="width: 10%;"></td> <td style="width: 10%;"></td> <td style="width: 10%;"></td> <td style="width: 10%;"></td> <td style="width: 10%;"></td> <td style="width: 10%;"></td> <td style="width: 10%;"></td> </tr> <tr> <td></td> <td></td> <td colspan="8" style="text-align: center;"> <table border="1" style="width: 100%; border-collapse: collapse; text-align: center;"> <tr> <td style="width: 10%;"></td> <td style="width: 10%;"></td> <td style="width: 10%;"></td> <td style="width: 10%;"></td> <td style="width: 10%;"></td> <td style="width: 10%;"></td> <td style="width: 10%;"></td> <td style="width: 10%;"></td> <td style="width: 10%;"></td> <td style="width: 10%;"></td> </tr> <tr> <td></td> <td></td> <td colspan="8" style="text-align: center;"> <table border="1" style="width: 100%; border-collapse: collapse; text-align: center;"> <tr> <td style="width: 10%;"></td> <td style="width: 10%;"></td> <td style="width: 10%;"></td> <td style="width: 10%;"></td> <td style="width: 10%;"></td> <td style="width: 10%;"></td> <td style="width: 10%;"></td> <td style="width: 10%;"></td> <td style="width: 10%;"></td> <td style="width: 10%;"></td> </tr> <tr> <td></td> <td></td> <td colspan="8" style="text-align: center;"> <table border="1" style="width: 100%; border-collapse: collapse; text-align: center;"> <tr> <td style="width: 10%;"></td> <td style="width: 10%;"></td> <td style="width: 10%;"></td> <td style="width: 10%;"></td> <td style="width: 10%;"></td> <td style="width: 10%;"></td> <td style="width: 10%;"></td> <td style="width: 10%;"></td> <td style="width: 10%;"></td> <td style="width: 10%;"></td> </tr> <tr> <td></td> <td></td> <td colspan="8" style="text-align: center;"> <table border="1" style="width: 100%; border-collapse: collapse; text-align: center;"> <tr> <td style="width: 10%;"></td> <td style="width: 10%;"></td> <td style="width: 10%;"></td> <td style="width: 10%;"></td> <td style="width: 10%;"></td> <td style="width: 10%;"></td> <td style="width: 10%;"></td> <td style="width: 10%;"></td> <td style="width: 10%;"></td> <td style="width: 10%;"></td> </tr> <tr> <td></td> <td></td> <td colspan="8" style="text-align: center;"> <table border="1" style="width: 100%; border-collapse: collapse; text-align: center;"> <tr> <td style="width: 10%;"></td> <td style="width: 10%;"></td> <td style="width: 10%;"></td> <td style="width: 10%;"></td> <td style="width: 10%;"></td> <td style="width: 10%;"></td> <td style="width: 10%;"></td> <td style="width: 10%;"></td> <td style="width: 10%;"></td> <td style="width: 10%;"></td> </tr> <tr> <td></td> <td></td> <td colspan="8" style="text-align: center;"> <table border="1" style="width: 100%; border-collapse: collapse; text-align: center;"> <tr> <td style="width: 10%;"></td> <td style="width: 10%;"></td> <td style="width: 10%;"></td> <td style="width: 10%;"></td> <td style="width: 10%;"></td> <td style="width: 10%;"></td> <td style="width: 10%;"></td> <td style="width: 10%;"></td> <td style="width: 10%;"></td> <td style="width: 10%;"></td> </tr> <tr> <td></td> <td></td> <td colspan="8" style="text-align: center;"> <table border="1" style="width: 100%; border-collapse: collapse; text-align: center;"> <tr> <td style="width: 10%;"></td> <td style="width: 10%;"></td> <td style="width: 10%;"></td> <td style="width: 10%;"></td> <td style="width: 10%;"></td> <td style="width: 10%;"></td> <td
style="width: 10%;"></td> <td style="width: 10%;"></td> <td style="width: 10%;"></td> <td style="width: 10%;"></td> </tr> <tr> <td></td> <td></td> <td colspan="8" style="text-align: center;"> <table border="1" style="width: 100%; border-collapse: collapse; text-align: center;"> <tr> <td style="width: 10%;"></td> <td style="width: 10%;"></td> <td style="width: 10%;"></td> <td style="width: 10%;"></td> <td style="width: 10%;"></td> <td style="width: 10%;"></td> <td style="width: 10%;"></td> <td style="width: 10%;"></td> <td style="width: 10%;"></td> <td style="width: 10%;"></td> </tr> <tr> <td></td> <td></td> <td colspan="8" style="text-align: center;"> <table border="1" style="width: 100%; border-collapse: collapse; text-align: center;"> <tr> <td style="width: 10%;"></td> <td style="width: 10%;"></td> <td style="width: 10%;"></td> <td style="width: 10%;"></td> <td style="width: 10%;"></td> <td style="width: 10%;"></td> <td style="width: 10%;"></td> <td style="width: 10%;"></td> <td style="width: 10%;"></td> <td style="width: 10%;"></td> </tr> <tr> <td></td> <td></td> <td colspan="8" style="text-align: center;"> <table border="1" style="width: 100%; border-collapse: collapse; text-align: center;"> <tr> </tr></table></td></tr></table></td></tr></table></td></tr></table></td></tr></table></td></tr></table></td></tr></table></td></tr></table></td></tr></table></td></tr></table></td></tr></table></td></tr></table></td></tr></table></td></tr></table></td></tr></table></td></tr></table></td></tr></table></td></tr></table></td></tr></table></td></tr></table></td></tr></table></td></tr></table>

 | | | | | | | | | | | | | | | | | | | | <table border="1" style="width: 100%; border-collapse: collapse; text-align: center;"> <tr> <td style="width: 10%;"></td> <td style="width: 10%;"></td> <td style="width: 10%;"></td> <td style="width: 10%;"></td> <td style="width: 10%;"></td> <td style="width: 10%;"></td> <td style="width: 10%;"></td> <td style="width: 10%;"></td> <td style="width: 10%;"></td> <td style="width: 10%;"></td> </tr> <tr> <td></td> <td></td> <td colspan="8" style="text-align: center;"> <table border="1" style="width: 100%; border-collapse: collapse; text-align: center;"> <tr> <td style="width: 10%;"></td> <td style="width: 10%;"></td> <td style="width: 10%;"></td> <td style="width: 10%;"></td> <td style="width: 10%;"></td> <td style="width: 10%;"></td> <td style="width: 10%;"></td> <td style="width: 10%;"></td> <td style="width: 10%;"></td> <td style="width: 10%;"></td> </tr> <tr> <td></td> <td></td> <td colspan="8" style="text-align: center;"> <table border="1" style="width: 100%; border-collapse: collapse; text-align: center;"> <tr> <td style="width: 10%;"></td> <td style="width: 10%;"></td> <td style="width: 10%;"></td> <td style="width: 10%;"></td> <td style="width: 10%;"></td> <td style="width: 10%;"></td> <td style="width: 10%;"></td> <td style="width: 10%;"></td> <td style="width: 10%;"></td> <td style="width: 10%;"></td> </tr> <tr> <td></td> <td></td> <td colspan="8" style="text-align: center;"> <table border="1" style="width: 100%; border-collapse: collapse; text-align: center;"> <tr> <td style="width: 10%;"></td> <td style="width: 10%;"></td> <td style="width: 10%;"></td> <td style="width: 10%;"></td> <td style="width: 10%;"></td> <td style="width: 10%;"></td> <td style="width: 10%;"></td> <td style="width: 10%;"></td> <td style="width: 10%;"></td> <td style="width: 10%;"></td> </tr> <tr> <td></td> <td></td> <td colspan="8" style="text-align: center;"> <table border="1" style="width: 100%; border-collapse: collapse; text-align: center;"> <tr> <td style="width: 10%;"></td> <td style="width: 10%;"></td> <td style="width: 10%;"></td> <td style="width: 10%;"></td> <td style="width: 10%;"></td> <td style="width: 10%;"></td> <td style="width: 10%;"></td> <td style="width: 10%;"></td> <td style="width: 10%;"></td> <td style="width: 10%;"></td> </tr> <tr> <td></td> <td></td> <td colspan="8" style="text-align: center;"> <table border="1" style="width: 100%; border-collapse: collapse; text-align: center;"> <tr> <td style="width: 10%;"></td> <td style="width: 10%;"></td> <td style="width: 10%;"></td> <td style="width: 10%;"></td> <td style="width: 10%;"></td> <td style="width: 10%;"></td> <td style="width: 10%;"></td> <td style="width: 10%;"></td> <td style="width: 10%;"></td> <td style="width: 10%;"></td> </tr> <tr> <td></td> <td></td> <td colspan="8" style="text-align: center;"> <table border="1" style="width: 100%; border-collapse: collapse; text-align: center;"> <tr> <td style="width: 10%;"></td> <td style="width: 10%;"></td> <td style="width: 10%;"></td> <td style="width: 10%;"></td> <td style="width: 10%;"></td> <td style="width: 10%;"></td> <td style="width: 10%;"></td> <td style="width: 10%;"></td> <td style="width: 10%;"></td> <td style="width: 10%;"></td> </tr> <tr> <td></td> <td></td> <td colspan="8" style="text-align: center;"> <table border="1" style="width: 100%; border-collapse: collapse; text-align: center;"> <tr> <td style="width: 10%;"></td> <td style="width: 10%;"></td> <td style="width: 10%;"></td> <td style="width: 10%;"></td> <td style="width: 10%;"></td> <td style="width: 10%;"></td> <td style="width: 10%;"></td> <td style="width: 10%;"></td> <td style="width: 10%;"></td> <td style="width: 10%;"></td> </tr> <tr> <td></td> <td></td> <td colspan="8" style="text-align: center;"> <table border="1" style="width: 100%; border-collapse: collapse; text-align: center;"> <tr> <td style="width: 10%;"></td> <td style="width: 10%;"></td> <td style="width: 10%;"></td> <td style="width: 10%;"></td> <td style="width: 10%;"></td> <td style="width: 10%;"></td> <td style="width: 10%;"></td> <td style="width: 10%;"></td> <td style="width: 10%;"></td> <td style="width: 10%;"></td> </tr> <tr> <td></td> <td></td> <td colspan="8" style="text-align: center;"> <table border="1" style="width: 100%; border-collapse: collapse; text-align: center;"> <tr> <td style="width: 10%;"></td> <td style="width: 10%;"></td> <td style="width: 10%;"></td> <td style="width: 10%;"></td> <td style="width: 10%;"></td> <td style="width: 10%;"></td> <td style="width: 10%;"></td> <td style="width: 10%;"></td> <td style="width: 10%;"></td> <td style="width: 10%;"></td> </tr> <tr> <td></td> <td></td> <td colspan="8" style="text-align: center;"> <table border="1" style="width: 100%; border-collapse: collapse; text-align: center;"> <tr> <td style="width: 10%;"></td> <td style="width: 10%;"></td> <td style="width: 10%;"></td> <td style="width: 10%;"></td> <td style="width: 10%;"></td> <td style="width: 10%;"></td> <td style="width: 10%;"></td> <td style="width: 10%;"></td> <td style="width: 10%;"></td> <td style="width: 10%;"></td> </tr> <tr> <td></td> <td></td> <td colspan="8" style="text-align: center;"> <table border="1" style="width: 100%; border-collapse: collapse; text-align: center;"> <tr> <td style="width: 10%;"></td> <td style="width: 10%;"></td> <td style="width: 10%;"></td> <td style="width: 10%;"></td> <td style="width: 10%;"></td> <td style="width: 10%;"></td> <td style="width: 10%;"></td> <td style="width: 10%;"></td> <td style="width: 10%;"></td> <td style="width: 10%;"></td> </tr> <tr> <td></td> <td></td> <td colspan="8" style="text-align: center;"> <table border="1" style="width: 100%; border-collapse: collapse; text-align: center;"> <tr> <td style="width: 10%;"></td> <td style="width: 10%;"></td> <td style="width: 10%;"></td> <td style="width: 10%;"></td> <td style="width: 10%;"></td> <td style="width: 10%;"></td> <td style="width: 10%;"></td> <td style="width: 10%;"></td> <td style="width: 10%;"></td> <td style="width: 10%;"></td> </tr> <tr> <td></td> <td></td> <td colspan="8" style="text-align: center;"> <table border="1" style="width: 100%; border-collapse: collapse; text-align: center;"> <tr> <td style="width: 10%;"></td> <td style="width: 10%;"></td> <td style="width: 10%;"></td> <td style="width: 10%;"></td> <td style="width: 10%;"></td> <td style="width: 10%;"></td> <td style="width: 10%;"></td> <td style="width: 10%;"></td> <td style="width: 10%;"></td> <td style="width: 10%;"></td> </tr> <tr> <td></td> <td></td> <td colspan="8" style="text-align: center;"> <table border="1" style="width: 100%; border-collapse: collapse; text-align: center;"> <tr> <td style="width: 10%;"></td> <td style="width: 10%;"></td> <td style="width: 10%;"></td> <td style="width: 10%;"></td> <td style="width: 10%;"></td> <td style="width: 10%;"></td> <td style="width: 10%;"></td> <td style="width: 10%;"></td> <td style="width: 10%;"></td> <td style="width: 10%;"></td> </tr> <tr> <td></td> <td></td> <td colspan="8" style="text-align: center;"> <table border="1" style="width: 100%; border-collapse: collapse; text-align: center;"> <tr> <td style="width: 10%;"></td> <td style="width: 10%;"></td> <td style="width: 10%;"></td> <td style="width: 10%;"></td> <td style="width: 10%;"></td> <td style="width: 10%;"></td> <td style="width: 10%;"></td> <td style="width: 10%;"></td> <td style="width: 10%;"></td> <td style="width: 10%;"></td> </tr> <tr> <td></td> <td></td> <td colspan="8" style="text-align: center;"> <table border="1" style="width: 100%; border-collapse: collapse; text-align: center;"> <tr> <td style="width: 10%;"></td> <td style="width: 10%;"></td> <td style="width: 10%;"></td> <td style="width: 10%;"></td> <td style="width: 10%;"></td> <td style="width: 10%;"></td> <td style="width: 10%;"></td> <td style="width: 10%;"></td> <td style="width: 10%;"></td> <td style="width: 10%;"></td> </tr> <tr> <td></td> <td></td> <td
colspan="8" style="text-align: center;"> <table border="1" style="width: 100%; border-collapse: collapse; text-align: center;"> <tr> <td style="width: 10%;"></td> <td style="width: 10%;"></td> <td style="width: 10%;"></td> <td style="width: 10%;"></td> <td style="width: 10%;"></td> <td style="width: 10%;"></td> <td style="width: 10%;"></td> <td style="width: 10%;"></td> <td style="width: 10%;"></td> <td style="width: 10%;"></td> </tr> <tr> <td></td> <td></td> <td colspan="8" style="text-align: center;"> <table border="1" style="width: 100%; border-collapse: collapse; text-align: center;"> <tr> <td style="width: 10%;"></td> <td style="width: 10%;"></td> <td style="width: 10%;"></td> <td style="width: 10%;"></td> <td style="width: 10%;"></td> <td style="width: 10%;"></td> <td style="width: 10%;"></td> <td style="width: 10%;"></td> <td style="width: 10%;"></td> <td style="width: 10%;"></td> </tr> <tr> <td></td> <td></td> <td colspan="8" style="text-align: center;"> <table border="1" style="width: 100%; border-collapse: collapse; text-align: center;"> <tr> <td style="width: 10%;"></td> <td style="width: 10%;"></td> <td style="width: 10%;"></td> <td style="width: 10%;"></td> <td style="width: 10%;"></td> <td style="width: 10%;"></td> <td style="width: 10%;"></td> <td style="width: 10%;"></td> <td style="width: 10%;"></td> <td style="width: 10%;"></td> </tr> <tr> <td></td> <td></td> <td colspan="8" style="text-align: center;"> <table border="1" style="width: 100%; border-collapse: collapse; text-align: center;"> <tr> </tr></table></td></tr></table></td></tr></table></td></tr></table></td></tr></table></td></tr></table></td></tr></table></td></tr></table></td></tr></table></td></tr></table></td></tr></table></td></tr></table></td></tr></table></td></tr></table></td></tr></table></td></tr></table></td></tr></table></td></tr></table></td></tr></table></td></tr></table></td></tr></table>

 | | | | | | | | | | | | | | | | | | | | <table border="1" style="width: 100%; border-collapse: collapse; text-align: center;"> <tr> <td style="width: 10%;"></td> <td style="width: 10%;"></td> <td style="width: 10%;"></td> <td style="width: 10%;"></td> <td style="width: 10%;"></td> <td style="width: 10%;"></td> <td style="width: 10%;"></td> <td style="width: 10%;"></td> <td style="width: 10%;"></td> <td style="width: 10%;"></td> </tr> <tr> <td></td> <td></td> <td colspan="8" style="text-align: center;"> <table border="1" style="width: 100%; border-collapse: collapse; text-align: center;"> <tr> <td style="width: 10%;"></td> <td style="width: 10%;"></td> <td style="width: 10%;"></td> <td style="width: 10%;"></td> <td style="width: 10%;"></td> <td style="width: 10%;"></td> <td style="width: 10%;"></td> <td style="width: 10%;"></td> <td style="width: 10%;"></td> <td style="width: 10%;"></td> </tr> <tr> <td></td> <td></td> <td colspan="8" style="text-align: center;"> <table border="1" style="width: 100%; border-collapse: collapse; text-align: center;"> <tr> <td style="width: 10%;"></td> <td style="width: 10%;"></td> <td style="width: 10%;"></td> <td style="width: 10%;"></td> <td style="width: 10%;"></td> <td style="width: 10%;"></td> <td style="width: 10%;"></td> <td style="width: 10%;"></td> <td style="width: 10%;"></td> <td style="width: 10%;"></td> </tr> <tr> <td></td> <td></td> <td colspan="8" style="text-align: center;"> <table border="1" style="width: 100%; border-collapse: collapse; text-align: center;"> <tr> <td style="width: 10%;"></td> <td style="width: 10%;"></td> <td style="width: 10%;"></td> <td style="width: 10%;"></td> <td style="width: 10%;"></td> <td style="width: 10%;"></td> <td style="width: 10%;"></td> <td style="width: 10%;"></td> <td style="width: 10%;"></td> <td style="width: 10%;"></td> </tr> <tr> <td></td> <td></td> <td colspan="8" style="text-align: center;"> <table border="1" style="width: 100%; border-collapse: collapse; text-align: center;"> <tr> <td style="width: 10%;"></td> <td style="width: 10%;"></td> <td style="width: 10%;"></td> <td style="width: 10%;"></td> <td style="width: 10%;"></td> <td style="width: 10%;"></td> <td style="width: 10%;"></td> <td style="width: 10%;"></td> <td style="width: 10%;"></td> <td style="width: 10%;"></td> </tr> <tr> <td></td> <td></td> <td colspan="8" style="text-align: center;"> <table border="1" style="width: 100%; border-collapse: collapse; text-align: center;"> <tr> <td style="width: 10%;"></td> <td style="width: 10%;"></td> <td style="width: 10%;"></td> <td style="width: 10%;"></td> <td style="width: 10%;"></td> <td style="width: 10%;"></td> <td style="width: 10%;"></td> <td style="width: 10%;"></td> <td style="width: 10%;"></td> <td style="width: 10%;"></td> </tr> <tr> <td></td> <td></td> <td colspan="8" style="text-align: center;"> <table border="1" style="width: 100%; border-collapse: collapse; text-align: center;"> <tr> <td style="width: 10%;"></td> <td style="width: 10%;"></td> <td style="width: 10%;"></td> <td style="width: 10%;"></td> <td style="width: 10%;"></td> <td style="width: 10%;"></td> <td style="width: 10%;"></td> <td style="width: 10%;"></td> <td style="width: 10%;"></td> <td style="width: 10%;"></td> </tr> <tr> <td></td> <td></td> <td colspan="8" style="text-align: center;"> <table border="1" style="width: 100%; border-collapse: collapse; text-align: center;"> <tr> <td style="width: 10%;"></td> <td style="width: 10%;"></td> <td style="width: 10%;"></td> <td style="width: 10%;"></td> <td style="width: 10%;"></td> <td style="width: 10%;"></td> <td style="width: 10%;"></td> <td style="width: 10%;"></td> <td style="width: 10%;"></td> <td style="width: 10%;"></td> </tr> <tr> <td></td> <td></td> <td colspan="8" style="text-align: center;"> <table border="1" style="width: 100%; border-collapse: collapse; text-align: center;"> <tr> <td style="width: 10%;"></td> <td style="width: 10%;"></td> <td style="width: 10%;"></td> <td style="width: 10%;"></td> <td style="width: 10%;"></td> <td style="width: 10%;"></td> <td style="width: 10%;"></td> <td style="width: 10%;"></td> <td style="width: 10%;"></td> <td style="width: 10%;"></td> </tr> <tr> <td></td> <td></td> <td colspan="8" style="text-align: center;"> <table border="1" style="width: 100%; border-collapse: collapse; text-align: center;"> <tr> <td style="width: 10%;"></td> <td style="width: 10%;"></td> <td style="width: 10%;"></td> <td style="width: 10%;"></td> <td style="width: 10%;"></td> <td style="width: 10%;"></td> <td style="width: 10%;"></td> <td style="width: 10%;"></td> <td style="width: 10%;"></td> <td style="width: 10%;"></td> </tr> <tr> <td></td> <td></td> <td colspan="8" style="text-align: center;"> <table border="1" style="width: 100%; border-collapse: collapse; text-align: center;"> <tr> <td style="width: 10%;"></td> <td style="width: 10%;"></td> <td style="width: 10%;"></td> <td style="width: 10%;"></td> <td style="width: 10%;"></td> <td style="width: 10%;"></td> <td style="width: 10%;"></td> <td style="width: 10%;"></td> <td style="width: 10%;"></td> <td style="width: 10%;"></td> </tr> <tr> <td></td> <td></td> <td colspan="8" style="text-align: center;"> <table border="1" style="width: 100%; border-collapse: collapse; text-align: center;"> <tr> <td style="width: 10%;"></td> <td style="width: 10%;"></td> <td style="width: 10%;"></td> <td style="width: 10%;"></td> <td style="width: 10%;"></td> <td style="width: 10%;"></td> <td style="width: 10%;"></td> <td style="width: 10%;"></td> <td style="width: 10%;"></td> <td style="width: 10%;"></td> </tr> <tr> <td></td> <td></td> <td colspan="8" style="text-align: center;"> <table border="1" style="width: 100%; border-collapse: collapse; text-align: center;"> <tr> <td style="width: 10%;"></td> <td style="width: 10%;"></td> <td style="width: 10%;"></td> <td style="width: 10%;"></td> <td style="width: 10%;"></td> <td style="width: 10%;"></td> <td style="width: 10%;"></td> <td style="width: 10%;"></td> <td style="width: 10%;"></td> <td style="width: 10%;"></td> </tr> <tr> <td></td> <td></td> <td colspan="8" style="text-align: center;"> <table border="1" style="width: 100%; border-collapse: collapse; text-align: center;"> <tr> <td style="width: 10%;"></td> <td style="width: 10%;"></td> <td style="width: 10%;"></td> <td style="width: 10%;"></td> <td style="width: 10%;"></td> <td style="width: 10%;"></td> <td style="width: 10%;"></td> <td style="width: 10%;"></td> <td style="width: 10%;"></td> <td style="width: 10%;"></td> </tr> <tr> <td></td> <td></td> <td colspan="8" style="text-align: center;"> <table border="1" style="width: 100%; border-collapse: collapse; text-align: center;"> <tr> <td style="width: 10%;"></td> <td style="width: 10%;"></td> <td style="width: 10%;"></td> <td style="width: 10%;"></td> <td style="width: 10%;"></td> <td style="width: 10%;"></td> <td style="width: 10%;"></td> <td style="width: 10%;"></td> <td style="width: 10%;"></td> <td style="width: 10%;"></td> </tr> <tr> <td></td> <td></td> <td colspan="8" style="text-align: center;"> <table border="1" style="width: 100%; border-collapse: collapse; text-align: center;"> <tr> <td style="width: 10%;"></td> <td style="width: 10%;"></td> <td style="width: 10%;"></td> <td style="width: 10%;"></td> <td style="width: 10%;"></td> <td style="width: 10%;"></td> <td style="width: 10%;"></td> <td style="width: 10%;"></td> <td style="width: 10%;"></td> <td style="width: 10%;"></td> </tr> <tr> <td></td> <td></td> <td colspan="8" style="text-align: center;"> <table border="1" style="width: 100%; border-collapse: collapse; text-align: center;"> <tr> <td style="width: 10%;"></td> <td
style="width: 10%;"></td> <td style="width: 10%;"></td> <td style="width: 10%;"></td> <td style="width: 10%;"></td> <td style="width: 10%;"></td> <td style="width: 10%;"></td> <td style="width: 10%;"></td> <td style="width: 10%;"></td> <td style="width: 10%;"></td> </tr> <tr> <td></td> <td></td> <td colspan="8" style="text-align: center;"> <table border="1" style="width: 100%; border-collapse: collapse; text-align: center;"> <tr> <td style="width: 10%;"></td> <td style="width: 10%;"></td> <td style="width: 10%;"></td> <td style="width: 10%;"></td> <td style="width: 10%;"></td> <td style="width: 10%;"></td> <td style="width: 10%;"></td> <td style="width: 10%;"></td> <td style="width: 10%;"></td> <td style="width: 10%;"></td> </tr> <tr> <td></td> <td></td> <td colspan="8" style="text-align: center;"> <table border="1" style="width: 100%; border-collapse: collapse; text-align: center;"> <tr> <td style="width: 10%;"></td> <td style="width: 10%;"></td> <td style="width: 10%;"></td> <td style="width: 10%;"></td> <td style="width: 10%;"></td> <td style="width: 10%;"></td> <td style="width: 10%;"></td> <td style="width: 10%;"></td> <td style="width: 10%;"></td> <td style="width: 10%;"></td> </tr> <tr> <td></td> <td></td> <td colspan="8" style="text-align: center;"> <table border="1" style="width: 100%; border-collapse: collapse; text-align: center;"> <tr> </tr></table></td></tr></table></td></tr></table></td></tr></table></td></tr></table></td></tr></table></td></tr></table></td></tr></table></td></tr></table></td></tr></table></td></tr></table></td></tr></table></td></tr></table></td></tr></table></td></tr></table></td></tr></table></td></tr></table></td></tr></table></td></tr></table></td></tr></table>

 | | | | | | | | | | | | | | | | | | | | <table border="1" style="width: 100%; border-collapse: collapse; text-align: center;"> <tr> <td style="width: 10%;"></td> <td style="width: 10%;"></td> <td style="width: 10%;"></td> <td style="width: 10%;"></td> <td style="width: 10%;"></td> <td style="width: 10%;"></td> <td style="width: 10%;"></td> <td style="width: 10%;"></td> <td style="width: 10%;"></td> <td style="width: 10%;"></td> </tr> <tr> <td></td> <td></td> <td colspan="8" style="text-align: center;"> <table border="1" style="width: 100%; border-collapse: collapse; text-align: center;"> <tr> <td style="width: 10%;"></td> <td style="width: 10%;"></td> <td style="width: 10%;"></td> <td style="width: 10%;"></td> <td style="width: 10%;"></td> <td style="width: 10%;"></td> <td style="width: 10%;"></td> <td style="width: 10%;"></td> <td style="width: 10%;"></td> <td style="width: 10%;"></td> </tr> <tr> <td></td> <td></td> <td colspan="8" style="text-align: center;"> <table border="1" style="width: 100%; border-collapse: collapse; text-align: center;"> <tr> <td style="width: 10%;"></td> <td style="width: 10%;"></td> <td style="width: 10%;"></td> <td style="width: 10%;"></td> <td style="width: 10%;"></td> <td style="width: 10%;"></td> <td style="width: 10%;"></td> <td style="width: 10%;"></td> <td style="width: 10%;"></td> <td style="width: 10%;"></td> </tr> <tr> <td></td> <td></td> <td colspan="8" style="text-align: center;"> <table border="1" style="width: 100%; border-collapse: collapse; text-align: center;"> <tr> <td style="width: 10%;"></td> <td style="width: 10%;"></td> <td style="width: 10%;"></td> <td style="width: 10%;"></td> <td style="width: 10%;"></td> <td style="width: 10%;"></td> <td style="width: 10%;"></td> <td style="width: 10%;"></td> <td style="width: 10%;"></td> <td style="width: 10%;"></td> </tr> <tr> <td></td> <td></td> <td colspan="8" style="text-align: center;"> <table border="1" style="width: 100%; border-collapse: collapse; text-align: center;"> <tr> <td style="width: 10%;"></td> <td style="width: 10%;"></td> <td style="width: 10%;"></td> <td style="width: 10%;"></td> <td style="width: 10%;"></td> <td style="width: 10%;"></td> <td style="width: 10%;"></td> <td style="width: 10%;"></td> <td style="width: 10%;"></td> <td style="width: 10%;"></td> </tr> <tr> <td></td> <td></td> <td colspan="8" style="text-align: center;"> <table border="1" style="width: 100%; border-collapse: collapse; text-align: center;"> <tr> <td style="width: 10%;"></td> <td style="width: 10%;"></td> <td style="width: 10%;"></td> <td style="width: 10%;"></td> <td style="width: 10%;"></td> <td style="width: 10%;"></td> <td style="width: 10%;"></td> <td style="width: 10%;"></td> <td style="width: 10%;"></td> <td style="width: 10%;"></td> </tr> <tr> <td></td> <td></td> <td colspan="8" style="text-align: center;"> <table border="1" style="width: 100%; border-collapse: collapse; text-align: center;"> <tr> <td style="width: 10%;"></td> <td style="width: 10%;"></td> <td style="width: 10%;"></td> <td style="width: 10%;"></td> <td style="width: 10%;"></td> <td style="width: 10%;"></td> <td style="width: 10%;"></td> <td style="width: 10%;"></td> <td style="width: 10%;"></td> <td style="width: 10%;"></td> </tr> <tr> <td></td> <td></td> <td colspan="8" style="text-align: center;"> <table border="1" style="width: 100%; border-collapse: collapse; text-align: center;"> <tr> <td style="width: 10%;"></td> <td style="width: 10%;"></td> <td style="width: 10%;"></td> <td style="width: 10%;"></td> <td style="width: 10%;"></td> <td style="width: 10%;"></td> <td style="width: 10%;"></td> <td style="width: 10%;"></td> <td style="width: 10%;"></td> <td style="width: 10%;"></td> </tr> <tr> <td></td> <td></td> <td colspan="8" style="text-align: center;"> <table border="1" style="width: 100%; border-collapse: collapse; text-align: center;"> <tr> <td style="width: 10%;"></td> <td style="width: 10%;"></td> <td style="width: 10%;"></td> <td style="width: 10%;"></td> <td style="width: 10%;"></td> <td style="width: 10%;"></td> <td style="width: 10%;"></td> <td style="width: 10%;"></td> <td style="width: 10%;"></td> <td style="width: 10%;"></td> </tr> <tr> <td></td> <td></td> <td colspan="8" style="text-align: center;"> <table border="1" style="width: 100%; border-collapse: collapse; text-align: center;"> <tr> <td style="width: 10%;"></td> <td style="width: 10%;"></td> <td style="width: 10%;"></td> <td style="width: 10%;"></td> <td style="width: 10%;"></td> <td style="width: 10%;"></td> <td style="width: 10%;"></td> <td style="width: 10%;"></td> <td style="width: 10%;"></td> <td style="width: 10%;"></td> </tr> <tr> <td></td> <td></td> <td colspan="8" style="text-align: center;"> <table border="1" style="width: 100%; border-collapse: collapse; text-align: center;"> <tr> <td style="width: 10%;"></td> <td style="width: 10%;"></td> <td style="width: 10%;"></td> <td style="width: 10%;"></td> <td style="width: 10%;"></td> <td style="width: 10%;"></td> <td style="width: 10%;"></td> <td style="width: 10%;"></td> <td style="width: 10%;"></td> <td style="width: 10%;"></td> </tr> <tr> <td></td> <td></td> <td colspan="8" style="text-align: center;"> <table border="1" style="width: 100%; border-collapse: collapse; text-align: center;"> <tr> <td style="width: 10%;"></td> <td style="width: 10%;"></td> <td style="width: 10%;"></td> <td style="width: 10%;"></td> <td style="width: 10%;"></td> <td style="width: 10%;"></td> <td style="width: 10%;"></td> <td style="width: 10%;"></td> <td style="width: 10%;"></td> <td style="width: 10%;"></td> </tr> <tr> <td></td> <td></td> <td colspan="8" style="text-align: center;"> <table border="1" style="width: 100%; border-collapse: collapse; text-align: center;"> <tr> <td style="width: 10%;"></td> <td style="width: 10%;"></td> <td style="width: 10%;"></td> <td style="width: 10%;"></td> <td style="width: 10%;"></td> <td style="width: 10%;"></td> <td style="width: 10%;"></td> <td style="width: 10%;"></td> <td style="width: 10%;"></td> <td style="width: 10%;"></td> </tr> <tr> <td></td> <td></td> <td colspan="8" style="text-align: center;"> <table border="1" style="width: 100%; border-collapse: collapse; text-align: center;"> <tr> <td style="width: 10%;"></td> <td style="width: 10%;"></td> <td style="width: 10%;"></td> <td style="width: 10%;"></td> <td style="width: 10%;"></td> <td style="width: 10%;"></td> <td style="width: 10%;"></td> <td style="width: 10%;"></td> <td style="width: 10%;"></td> <td style="width: 10%;"></td> </tr> <tr> <td></td> <td></td> <td colspan="8" style="text-align: center;"> <table border="1" style="width: 100%; border-collapse: collapse; text-align: center;"> <tr> <td style="width: 10%;"></td> <td style="width: 10%;"></td> <td style="width: 10%;"></td> <td style="width: 10%;"></td> <td style="width: 10%;"></td> <td style="width: 10%;"></td> <td style="width: 10%;"></td> <td style="width: 10%;"></td> <td style="width: 10%;"></td> <td style="width: 10%;"></td> </tr> <tr> <td></td> <td></td> <td colspan="8" style="text-align: center;"> <table border="1" style="width: 100%; border-collapse: collapse; text-align: center;"> <tr> <td style="width: 10%;"></td> <td style="width: 10%;"></td> <td style="width: 10%;"></td> <td style="width: 10%;"></td> <td style="width: 10%;"></td> <td style="width: 10%;"></td> <td style="width: 10%;"></td> <td style="width: 10%;"></td> <td style="width: 10%;"></td> <td style="width: 10%;"></td> </tr> <tr> <td></td> <td></td> <td colspan="8" style="text-align: center;"> <table border="1" style="width: 100%; border-collapse: collapse; text-align: center;"> <tr> <td style="width: 10%;"></td> <td style="width: 10%;"></td> <td style="width: 10%;"></td> <td style="width: 10%;"></td> <td style="width: 10%;"></td> <td style="width: 10%;"></td> <td style="width: 10%;"></td> <td
style="width: 10%;"></td> <td style="width: 10%;"></td> <td style="width: 10%;"></td> </tr> <tr> <td></td> <td></td> <td colspan="8" style="text-align: center;"> <table border="1" style="width: 100%; border-collapse: collapse; text-align: center;"> <tr> <td style="width: 10%;"></td> <td style="width: 10%;"></td> <td style="width: 10%;"></td> <td style="width: 10%;"></td> <td style="width: 10%;"></td> <td style="width: 10%;"></td> <td style="width: 10%;"></td> <td style="width: 10%;"></td> <td style="width: 10%;"></td> <td style="width: 10%;"></td> </tr> <tr> <td></td> <td></td> <td colspan="8" style="text-align: center;"> <table border="1" style="width: 100%; border-collapse: collapse; text-align: center;"> <tr> </tr></table></td></tr></table></td></tr></table></td></tr></table></td></tr></table></td></tr></table></td></tr></table></td></tr></table></td></tr></table></td></tr></table></td></tr></table></td></tr></table></td></tr></table></td></tr></table></td></tr></table></td></tr></table></td></tr></table></td></tr></table></td></tr></table>

 | | | | | | | | | | | | | | | | | | | | <table border="1" style="width: 100%; border-collapse: collapse; text-align: center;"> <tr> <td style="width: 10%;"></td> <td style="width: 10%;"></td> <td style="width: 10%;"></td> <td style="width: 10%;"></td> <td style="width: 10%;"></td> <td style="width: 10%;"></td> <td style="width: 10%;"></td> <td style="width: 10%;"></td> <td style="width: 10%;"></td> <td style="width: 10%;"></td> </tr> <tr> <td></td> <td></td> <td colspan="8" style="text-align: center;"> <table border="1" style="width: 100%; border-collapse: collapse; text-align: center;"> <tr> <td style="width: 10%;"></td> <td style="width: 10%;"></td> <td style="width: 10%;"></td> <td style="width: 10%;"></td> <td style="width: 10%;"></td> <td style="width: 10%;"></td> <td style="width: 10%;"></td> <td style="width: 10%;"></td> <td style="width: 10%;"></td> <td style="width: 10%;"></td> </tr> <tr> <td></td> <td></td> <td colspan="8" style="text-align: center;"> <table border="1" style="width: 100%; border-collapse: collapse; text-align: center;"> <tr> <td style="width: 10%;"></td> <td style="width: 10%;"></td> <td style="width: 10%;"></td> <td style="width: 10%;"></td> <td style="width: 10%;"></td> <td style="width: 10%;"></td> <td style="width: 10%;"></td> <td style="width: 10%;"></td> <td style="width: 10%;"></td> <td style="width: 10%;"></td> </tr> <tr> <td></td> <td></td> <td colspan="8" style="text-align: center;"> <table border="1" style="width: 100%; border-collapse: collapse; text-align: center;"> <tr> <td style="width: 10%;"></td> <td style="width: 10%;"></td> <td style="width: 10%;"></td> <td style="width: 10%;"></td> <td style="width: 10%;"></td> <td style="width: 10%;"></td> <td style="width: 10%;"></td> <td style="width: 10%;"></td> <td style="width: 10%;"></td> <td style="width: 10%;"></td> </tr> <tr> <td></td> <td></td> <td colspan="8" style="text-align: center;"> <table border="1" style="width: 100%; border-collapse: collapse; text-align: center;"> <tr> <td style="width: 10%;"></td> <td style="width: 10%;"></td> <td style="width: 10%;"></td> <td style="width: 10%;"></td> <td style="width: 10%;"></td> <td style="width: 10%;"></td> <td style="width: 10%;"></td> <td style="width: 10%;"></td> <td style="width: 10%;"></td> <td style="width: 10%;"></td> </tr> <tr> <td></td> <td></td> <td colspan="8" style="text-align: center;"> <table border="1" style="width: 100%; border-collapse: collapse; text-align: center;"> <tr> <td style="width: 10%;"></td> <td style="width: 10%;"></td> <td style="width: 10%;"></td> <td style="width: 10%;"></td> <td style="width: 10%;"></td> <td style="width: 10%;"></td> <td style="width: 10%;"></td> <td style="width: 10%;"></td> <td style="width: 10%;"></td> <td style="width: 10%;"></td> </tr> <tr> <td></td> <td></td> <td colspan="8" style="text-align: center;"> <table border="1" style="width: 100%; border-collapse: collapse; text-align: center;"> <tr> <td style="width: 10%;"></td> <td style="width: 10%;"></td> <td style="width: 10%;"></td> <td style="width: 10%;"></td> <td style="width: 10%;"></td> <td style="width: 10%;"></td> <td style="width: 10%;"></td> <td style="width: 10%;"></td> <td style="width: 10%;"></td> <td style="width: 10%;"></td> </tr> <tr> <td></td> <td></td> <td colspan="8" style="text-align: center;"> <table border="1" style="width: 100%; border-collapse: collapse; text-align: center;"> <tr> <td style="width: 10%;"></td> <td style="width: 10%;"></td> <td style="width: 10%;"></td> <td style="width: 10%;"></td> <td style="width: 10%;"></td> <td style="width: 10%;"></td> <td style="width: 10%;"></td> <td style="width: 10%;"></td> <td style="width: 10%;"></td> <td style="width: 10%;"></td> </tr> <tr> <td></td> <td></td> <td colspan="8" style="text-align: center;"> <table border="1" style="width: 100%; border-collapse: collapse; text-align: center;"> <tr> <td style="width: 10%;"></td> <td style="width: 10%;"></td> <td style="width: 10%;"></td> <td style="width: 10%;"></td> <td style="width: 10%;"></td> <td style="width: 10%;"></td> <td style="width: 10%;"></td> <td style="width: 10%;"></td> <td style="width: 10%;"></td> <td style="width: 10%;"></td> </tr> <tr> <td></td> <td></td> <td colspan="8" style="text-align: center;"> <table border="1" style="width: 100%; border-collapse: collapse; text-align: center;"> <tr> <td style="width: 10%;"></td> <td style="width: 10%;"></td> <td style="width: 10%;"></td> <td style="width: 10%;"></td> <td style="width: 10%;"></td> <td style="width: 10%;"></td> <td style="width: 10%;"></td> <td style="width: 10%;"></td> <td style="width: 10%;"></td> <td style="width: 10%;"></td> </tr> <tr> <td></td> <td></td> <td colspan="8" style="text-align: center;"> <table border="1" style="width: 100%; border-collapse: collapse; text-align: center;"> <tr> <td style="width: 10%;"></td> <td style="width: 10%;"></td> <td style="width: 10%;"></td> <td style="width: 10%;"></td> <td style="width: 10%;"></td> <td style="width: 10%;"></td> <td style="width: 10%;"></td> <td style="width: 10%;"></td> <td style="width: 10%;"></td> <td style="width: 10%;"></td> </tr> <tr> <td></td> <td></td> <td colspan="8" style="text-align: center;"> <table border="1" style="width: 100%; border-collapse: collapse; text-align: center;"> <tr> <td style="width: 10%;"></td> <td style="width: 10%;"></td> <td style="width: 10%;"></td> <td style="width: 10%;"></td> <td style="width: 10%;"></td> <td style="width: 10%;"></td> <td style="width: 10%;"></td> <td style="width: 10%;"></td> <td style="width: 10%;"></td> <td style="width: 10%;"></td> </tr> <tr> <td></td> <td></td> <td colspan="8" style="text-align: center;"> <table border="1" style="width: 100%; border-collapse: collapse; text-align: center;"> <tr> <td style="width: 10%;"></td> <td style="width: 10%;"></td> <td style="width: 10%;"></td> <td style="width: 10%;"></td> <td style="width: 10%;"></td> <td style="width: 10%;"></td> <td style="width: 10%;"></td> <td style="width: 10%;"></td> <td style="width: 10%;"></td> <td style="width: 10%;"></td> </tr> <tr> <td></td> <td></td> <td colspan="8" style="text-align: center;"> <table border="1" style="width: 100%; border-collapse: collapse; text-align: center;"> <tr> <td style="width: 10%;"></td> <td style="width: 10%;"></td> <td style="width: 10%;"></td> <td style="width: 10%;"></td> <td style="width: 10%;"></td> <td style="width: 10%;"></td> <td style="width: 10%;"></td> <td style="width: 10%;"></td> <td style="width: 10%;"></td> <td style="width: 10%;"></td> </tr> <tr> <td></td> <td></td> <td colspan="8" style="text-align: center;"> <table border="1" style="width: 100%; border-collapse: collapse; text-align: center;"> <tr> <td style="width: 10%;"></td> <td style="width: 10%;"></td> <td style="width: 10%;"></td> <td style="width: 10%;"></td> <td style="width: 10%;"></td> <td style="width: 10%;"></td> <td style="width: 10%;"></td> <td style="width: 10%;"></td> <td style="width: 10%;"></td> <td style="width: 10%;"></td> </tr> <tr> <td></td> <td></td> <td colspan="8" style="text-align: center;"> <table border="1" style="width: 100%; border-collapse: collapse; text-align: center;"> <tr> <td style="width: 10%;"></td> <td style="width: 10%;"></td> <td style="width: 10%;"></td> <td style="width: 10%;"></td> <td style="width: 10%;"></td> <td style="width: 10%;"></td> <td style="width: 10%;"></td> <td style="width: 10%;"></td> <td style="width: 10%;"></td> <td style="width: 10%;"></td> </tr> <tr> <td></td> <td></td> <td colspan="8" style="text-align: center;"> <table border="1" style="width: 100%; border-collapse: collapse; text-align: center;"> <tr> <td style="width: 10%;"></td> <td style="width: 10%;"></td> <td style="width: 10%;"></td> <td style="width: 10%;"></td> <td style="width: 10%;"></td> <td style="width: 10%;"></td> <td style="width: 10%;"></td> <td style="width: 10%;"></td> <td style="width: 10%;"></td> <td style="width: 10%;"></td> </tr> <tr> <td></td> <td></td> <td colspan="8" style="text-align: center;"> <table border="1" style="width: 100%; border-collapse: collapse; text-align: center;"> <tr> </tr></table></td></tr></table></td></tr></table></td></tr></table></td></tr></table></td></tr></table></td></tr></table></td></tr></table></td></tr></table></td></tr></table></td></tr></table></td></tr></table></td></tr></table></td></tr></table></td></tr></table></td></tr></table></td></tr></table></td></tr></table>

 | | | | | | | | | | | | | | | | | | | | <table border="1" style="width: 100%; border-collapse: collapse; text-align: center;"> <tr> <td style="width: 10%;"></td> <td style="width: 10%;"></td> <td style="width: 10%;"></td> <td style="width: 10%;"></td> <td style="width: 10%;"></td> <td style="width: 10%;"></td> <td style="width: 10%;"></td> <td style="width: 10%;"></td> <td style="width: 10%;"></td> <td style="width: 10%;"></td> </tr> <tr> <td></td> <td></td> <td colspan="8" style="text-align: center;"> <table border="1" style="width: 100%; border-collapse: collapse; text-align: center;"> <tr> <td style="width: 10%;"></td> <td style="width: 10%;"></td> <td style="width: 10%;"></td> <td style="width: 10%;"></td> <td style="width: 10%;"></td> <td style="width: 10%;"></td> <td style="width: 10%;"></td> <td style="width: 10%;"></td> <td style="width: 10%;"></td> <td style="width: 10%;"></td> </tr> <tr> <td></td> <td></td> <td colspan="8" style="text-align: center;"> <table border="1" style="width: 100%; border-collapse: collapse; text-align: center;"> <tr> <td style="width: 10%;"></td> <td style="width: 10%;"></td> <td style="width: 10%;"></td> <td style="width: 10%;"></td> <td style="width: 10%;"></td> <td style="width: 10%;"></td> <td style="width: 10%;"></td> <td style="width: 10%;"></td> <td style="width: 10%;"></td> <td style="width: 10%;"></td> </tr> <tr> <td></td> <td></td> <td colspan="8" style="text-align: center;"> <table border="1" style="width: 100%; border-collapse: collapse; text-align: center;"> <tr> <td style="width: 10%;"></td> <td style="width: 10%;"></td> <td style="width: 10%;"></td> <td style="width: 10%;"></td> <td style="width: 10%;"></td> <td style="width: 10%;"></td> <td style="width: 10%;"></td> <td style="width: 10%;"></td> <td style="width: 10%;"></td> <td style="width: 10%;"></td> </tr> <tr> <td></td> <td></td> <td colspan="8" style="text-align: center;"> <table border="1" style="width: 100%; border-collapse: collapse; text-align: center;"> <tr> <td style="width: 10%;"></td> <td style="width: 10%;"></td> <td style="width: 10%;"></td> <td style="width: 10%;"></td> <td style="width: 10%;"></td> <td style="width: 10%;"></td> <td style="width: 10%;"></td> <td style="width: 10%;"></td> <td style="width: 10%;"></td> <td style="width: 10%;"></td> </tr> <tr> <td></td> <td></td> <td colspan="8" style="text-align: center;"> <table border="1" style="width: 100%; border-collapse: collapse; text-align: center;"> <tr> <td style="width: 10%;"></td> <td style="width: 10%;"></td> <td style="width: 10%;"></td> <td style="width: 10%;"></td> <td style="width: 10%;"></td> <td style="width: 10%;"></td> <td style="width: 10%;"></td> <td style="width: 10%;"></td> <td style="width: 10%;"></td> <td style="width: 10%;"></td> </tr> <tr> <td></td> <td></td> <td colspan="8" style="text-align: center;"> <table border="1" style="width: 100%; border-collapse: collapse; text-align: center;"> <tr> <td style="width: 10%;"></td> <td style="width: 10%;"></td> <td style="width: 10%;"></td> <td style="width: 10%;"></td> <td style="width: 10%;"></td> <td style="width: 10%;"></td> <td style="width: 10%;"></td> <td style="width: 10%;"></td> <td style="width: 10%;"></td> <td style="width: 10%;"></td> </tr> <tr> <td></td> <td></td> <td colspan="8" style="text-align: center;"> <table border="1" style="width: 100%; border-collapse: collapse; text-align: center;"> <tr> <td style="width: 10%;"></td> <td style="width: 10%;"></td> <td style="width: 10%;"></td> <td style="width: 10%;"></td> <td style="width: 10%;"></td> <td style="width: 10%;"></td> <td style="width: 10%;"></td> <td style="width: 10%;"></td> <td style="width: 10%;"></td> <td style="width: 10%;"></td> </tr> <tr> <td></td> <td></td> <td colspan="8" style="text-align: center;"> <table border="1" style="width: 100%; border-collapse: collapse; text-align: center;"> <tr> <td style="width: 10%;"></td> <td style="width: 10%;"></td> <td style="width: 10%;"></td> <td style="width: 10%;"></td> <td style="width: 10%;"></td> <td style="width: 10%;"></td> <td style="width: 10%;"></td> <td style="width: 10%;"></td> <td style="width: 10%;"></td> <td style="width: 10%;"></td> </tr> <tr> <td></td> <td></td> <td colspan="8" style="text-align: center;"> <table border="1" style="width: 100%; border-collapse: collapse; text-align: center;"> <tr> <td style="width: 10%;"></td> <td style="width: 10%;"></td> <td style="width: 10%;"></td> <td style="width: 10%;"></td> <td style="width: 10%;"></td> <td style="width: 10%;"></td> <td style="width: 10%;"></td> <td style="width: 10%;"></td> <td style="width: 10%;"></td> <td style="width: 10%;"></td> </tr> <tr> <td></td> <td></td> <td colspan="8" style="text-align: center;"> <table border="1" style="width: 100%; border-collapse: collapse; text-align: center;"> <tr> <td style="width: 10%;"></td> <td style="width: 10%;"></td> <td style="width: 10%;"></td> <td style="width: 10%;"></td> <td style="width: 10%;"></td> <td style="width: 10%;"></td> <td style="width: 10%;"></td> <td style="width: 10%;"></td> <td style="width: 10%;"></td> <td style="width: 10%;"></td> </tr> <tr> <td></td> <td></td> <td colspan="8" style="text-align: center;"> <table border="1" style="width: 100%; border-collapse: collapse; text-align: center;"> <tr> <td style="width: 10%;"></td> <td style="width: 10%;"></td> <td style="width: 10%;"></td> <td style="width: 10%;"></td> <td style="width: 10%;"></td> <td style="width: 10%;"></td> <td style="width: 10%;"></td> <td style="width: 10%;"></td> <td style="width: 10%;"></td> <td style="width: 10%;"></td> </tr> <tr> <td></td> <td></td> <td colspan="8" style="text-align: center;"> <table border="1" style="width: 100%; border-collapse: collapse; text-align: center;"> <tr> <td style="width: 10%;"></td> <td style="width: 10%;"></td> <td style="width: 10%;"></td> <td style="width: 10%;"></td> <td style="width: 10%;"></td> <td style="width: 10%;"></td> <td style="width: 10%;"></td> <td style="width: 10%;"></td> <td style="width: 10%;"></td> <td style="width: 10%;"></td> </tr> <tr> <td></td> <td></td> <td colspan="8" style="text-align: center;"> <table border="1" style="width: 100%; border-collapse: collapse; text-align: center;"> <tr> <td style="width: 10%;"></td> <td style="width: 10%;"></td> <td style="width: 10%;"></td> <td style="width: 10%;"></td> <td style="width: 10%;"></td> <td style="width: 10%;"></td> <td style="width: 10%;"></td> <td style="width: 10%;"></td> <td style="width: 10%;"></td> <td style="width: 10%;"></td> </tr> <tr> <td></td> <td></td> <td colspan="8" style="text-align: center;"> <table border="1" style="width: 100%; border-collapse: collapse; text-align: center;"> <tr> <td style="width: 10%;"></td> <td style="width: 10%;"></td> <td style="width: 10%;"></td> <td style="width: 10%;"></td> <td style="width: 10%;"></td> <td style="width: 10%;"></td> <td style="width: 10%;"></td> <td style="width: 10%;"></td> <td style="width: 10%;"></td> <td style="width: 10%;"></td> </tr> <tr> <td></td> <td></td> <td colspan="8" style="text-align: center;"> <table border="1" style="width: 100%; border-collapse: collapse; text-align: center;"> <tr> <td style="width: 10%;"></td> <td style="width: 10%;"></td> <td style="width: 10%;"></td> <td style="width: 10%;"></td> <td style="width: 10%;"></td> <td style="width: 10%;"></td> <td style="width: 10%;"></td> <td style="width: 10%;"></td> <td style="width: 10%;"></td> <td style="width: 10%;"></td> </tr> <tr> <td></td> <td></td> <td colspan="8" style="text-align: center;"> <table border="1" style="width: 100%; border-collapse: collapse; text-align: center;"> <tr> </tr></table></td></tr></table></td></tr></table></td></tr></table></td></tr></table></td></tr></table></td></tr></table></td></tr></table></td></tr></table></td></tr></table></td></tr></table></td></tr></table></td></tr></table></td></tr></table></td></tr></table></td></tr></table></td></tr></table>

 | | | | | | | | | | | | | | | | | | | | <table border="1" style="width: 100%; border-collapse: collapse; text-align: center;"> <tr> <td style="width: 10%;"></td> <td style="width: 10%;"></td> <td style="width: 10%;"></td> <td style="width: 10%;"></td> <td style="width: 10%;"></td> <td style="width: 10%;"></td> <td style="width: 10%;"></td> <td style="width: 10%;"></td> <td style="width: 10%;"></td> <td style="width: 10%;"></td> </tr> <tr> <td></td> <td></td> <td colspan="8" style="text-align: center;"> <table border="1" style="width: 100%; border-collapse: collapse; text-align: center;"> <tr> <td style="width: 10%;"></td> <td style="width: 10%;"></td> <td style="width: 10%;"></td> <td style="width: 10%;"></td> <td style="width: 10%;"></td> <td style="width: 10%;"></td> <td style="width: 10%;"></td> <td style="width: 10%;"></td> <td style="width: 10%;"></td> <td style="width: 10%;"></td> </tr> <tr> <td></td> <td></td> <td colspan="8" style="text-align: center;"> <table border="1" style="width: 100%; border-collapse: collapse; text-align: center;"> <tr> <td style="width: 10%;"></td> <td style="width: 10%;"></td> <td style="width: 10%;"></td> <td style="width: 10%;"></td> <td style="width: 10%;"></td> <td style="width: 10%;"></td> <td style="width: 10%;"></td> <td style="width: 10%;"></td> <td
style="width: 10%;"></td> <td style="width: 10%;"></td> </tr> <tr> <td></td> <td></td> <td colspan="8" style="text-align: center;"> <table border="1" style="width: 100%; border-collapse: collapse; text-align: center;"> <tr> <td style="width: 10%;"></td> <td style="width: 10%;"></td> <td style="width: 10%;"></td> <td style="width: 10%;"></td> <td style="width: 10%;"></td> <td style="width: 10%;"></td> <td style="width: 10%;"></td> <td style="width: 10%;"></td> <td style="width: 10%;"></td> <td style="width: 10%;"></td> </tr> <tr> <td></td> <td></td> <td colspan="8" style="text-align: center;"> <table border="1" style="width: 100%; border-collapse: collapse; text-align: center;"> <tr> <td style="width: 10%;"></td> <td style="width: 10%;"></td> <td style="width: 10%;"></td> <td style="width: 10%;"></td> <td style="width: 10%;"></td> <td style="width: 10%;"></td> <td style="width: 10%;"></td> <td style="width: 10%;"></td> <td style="width: 10%;"></td> <td style="width: 10%;"></td> </tr> <tr> <td></td> <td></td> <td colspan="8" style="text-align: center;"> <table border="1" style="width: 100%; border-collapse: collapse; text-align: center;"> <tr> <td style="width: 10%;"></td> <td style="width: 10%;"></td> <td style="width: 10%;"></td> <td style="width: 10%;"></td> <td style="width: 10%;"></td> <td style="width: 10%;"></td> <td style="width: 10%;"></td> <td style="width: 10%;"></td> <td style="width: 10%;"></td> <td style="width: 10%;"></td> </tr> <tr> <td></td> <td></td> <td colspan="8" style="text-align: center;"> <table border="1" style="width: 100%; border-collapse: collapse; text-align: center;"> <tr> <td style="width: 10%;"></td> <td style="width: 10%;"></td> <td style="width: 10%;"></td> <td style="width: 10%;"></td> <td style="width: 10%;"></td> <td style="width: 10%;"></td> <td style="width: 10%;"></td> <td style="width: 10%;"></td> <td style="width: 10%;"></td> <td style="width: 10%;"></td> </tr> <tr> <td></td> <td></td> <td colspan="8" style="text-align: center;"> <table border="1" style="width: 100%; border-collapse: collapse; text-align: center;"> <tr> <td style="width: 10%;"></td> <td style="width: 10%;"></td> <td style="width: 10%;"></td> <td style="width: 10%;"></td> <td style="width: 10%;"></td> <td style="width: 10%;"></td> <td style="width: 10%;"></td> <td style="width: 10%;"></td> <td style="width: 10%;"></td> <td style="width: 10%;"></td> </tr> <tr> <td></td> <td></td> <td colspan="8" style="text-align: center;"> <table border="1" style="width: 100%; border-collapse: collapse; text-align: center;"> <tr> <td style="width: 10%;"></td> <td style="width: 10%;"></td> <td style="width: 10%;"></td> <td style="width: 10%;"></td> <td style="width: 10%;"></td> <td style="width: 10%;"></td> <td style="width: 10%;"></td> <td style="width: 10%;"></td> <td style="width: 10%;"></td> <td style="width: 10%;"></td> </tr> <tr> <td></td> <td></td> <td colspan="8" style="text-align: center;"> <table border="1" style="width: 100%; border-collapse: collapse; text-align: center;"> <tr> <td style="width: 10%;"></td> <td style="width: 10%;"></td> <td style="width: 10%;"></td> <td style="width: 10%;"></td> <td style="width: 10%;"></td> <td style="width: 10%;"></td> <td style="width: 10%;"></td> <td style="width: 10%;"></td> <td style="width: 10%;"></td> <td style="width: 10%;"></td> </tr> <tr> <td></td> <td></td> <td colspan="8" style="text-align: center;"> <table border="1" style="width: 100%; border-collapse: collapse; text-align: center;"> <tr> <td style="width: 10%;"></td> <td style="width: 10%;"></td> <td style="width: 10%;"></td> <td style="width: 10%;"></td> <td style="width: 10%;"></td> <td style="width: 10%;"></td> <td style="width: 10%;"></td> <td style="width: 10%;"></td> <td style="width: 10%;"></td> <td style="width: 10%;"></td> </tr> <tr> <td></td> <td></td> <td colspan="8" style="text-align: center;"> <table border="1" style="width: 100%; border-collapse: collapse; text-align: center;"> <tr> <td style="width: 10%;"></td> <td style="width: 10%;"></td> <td style="width: 10%;"></td> <td style="width: 10%;"></td> <td style="width: 10%;"></td> <td style="width: 10%;"></td> <td style="width: 10%;"></td> <td style="width: 10%;"></td> <td style="width: 10%;"></td> <td style="width: 10%;"></td> </tr> <tr> <td></td> <td></td> <td colspan="8" style="text-align: center;"> <table border="1" style="width: 100%; border-collapse: collapse; text-align: center;"> <tr> <td style="width: 10%;"></td> <td style="width: 10%;"></td> <td style="width: 10%;"></td> <td style="width: 10%;"></td> <td style="width: 10%;"></td> <td style="width: 10%;"></td> <td style="width: 10%;"></td> <td style="width: 10%;"></td> <td style="width: 10%;"></td> <td style="width: 10%;"></td> </tr> <tr> <td></td> <td></td> <td colspan="8" style="text-align: center;"> <table border="1" style="width: 100%; border-collapse: collapse; text-align: center;"> <tr> <td style="width: 10%;"></td> <td style="width: 10%;"></td> <td style="width: 10%;"></td> <td style="width: 10%;"></td> <td style="width: 10%;"></td> <td style="width: 10%;"></td> <td style="width: 10%;"></td> <td style="width: 10%;"></td> <td style="width: 10%;"></td> <td style="width: 10%;"></td> </tr> <tr> <td></td> <td></td> <td colspan="8" style="text-align: center;"> <table border="1" style="width: 100%; border-collapse: collapse; text-align: center;"> <tr> <td style="width: 10%;"></td> <td style="width: 10%;"></td> <td style="width: 10%;"></td> <td style="width: 10%;"></td> <td style="width: 10%;"></td> <td style="width: 10%;"></td> <td style="width: 10%;"></td> <td style="width: 10%;"></td> <td style="width: 10%;"></td> <td style="width: 10%;"></td> </tr> <tr> <td></td> <td></td> <td colspan="8" style="text-align: center;"> <table border="1" style="width: 100%; border-collapse: collapse; text-align: center;"> <tr> </tr></table></td></tr></table></td></tr></table></td></tr></table></td></tr></table></td></tr></table></td></tr></table></td></tr></table></td></tr></table></td></tr></table></td></tr></table></td></tr></table></td></tr></table></td></tr></table></td></tr></table></td></tr></table>

 | | | | | | | | | | | | | | | | | | | | <table border="1" style="width: 100%; border-collapse: collapse; text-align: center;"> <tr> <td style="width: 10%;"></td> <td style="width: 10%;"></td> <td style="width: 10%;"></td> <td style="width: 10%;"></td> <td style="width: 10%;"></td> <td style="width: 10%;"></td> <td style="width: 10%;"></td> <td style="width: 10%;"></td> <td style="width: 10%;"></td> <td style="width: 10%;"></td> </tr> <tr> <td></td> <td></td> <td colspan="8" style="text-align: center;"> <table border="1" style="width: 100%; border-collapse: collapse; text-align: center;"> <tr> <td style="width: 10%;"></td> <td style="width: 10%;"></td> <td style="width: 10%;"></td> <td style="width: 10%;"></td> <td style="width: 10%;"></td> <td style="width: 10%;"></td> <td style="width: 10%;"></td> <td style="width: 10%;"></td> <td style="width: 10%;"></td> <td style="width: 10%;"></td> </tr> <tr> <td></td> <td></td> <td colspan="8" style="text-align: center;"> <table border="1" style="width: 100%; border-collapse: collapse; text-align: center;"> <tr> <td style="width: 10%;"></td> <td style="width: 10%;"></td> <td style="width: 10%;"></td> <td style="width: 10%;"></td> <td style="width: 10%;"></td> <td style="width: 10%;"></td> <td style="width: 10%;"></td> <td style="width: 10%;"></td> <td style="width: 10%;"></td> <td style="width: 10%;"></td> </tr> <tr> <td></td> <td></td> <td colspan="8" style="text-align: center;"> <table border="1" style="width: 100%; border-collapse: collapse; text-align: center;"> <tr> <td style="width: 10%;"></td> <td style="width: 10%;"></td> <td style="width: 10%;"></td> <td style="width: 10%;"></td> <td style="width: 10%;"></td> <td style="width: 10%;"></td> <td style="width: 10%;"></td> <td style="width: 10%;"></td> <td style="width: 10%;"></td> <td style="width: 10%;"></td> </tr> <tr> <td></td> <td></td> <td colspan="8" style="text-align: center;"> <table border="1" style="width: 100%; border-collapse: collapse; text-align: center;"> <tr> <td style="width: 10%;"></td> <td style="width: 10%;"></td> <td style="width: 10%;"></td> <td style="width: 10%;"></td> <td style="width: 10%;"></td> <td style="width: 10%;"></td> <td style="width: 10%;"></td> <td style="width: 10%;"></td> <td style="width: 10%;"></td> <td style="width: 10%;"></td> </tr> <tr> <td></td> <td></td> <td colspan="8" style="text-align: center;"> <table border="1" style="width: 100%; border-collapse: collapse; text-align: center;"> <tr> <td style="width: 10%;"></td> <td style="width: 10%;"></td> <td style="width: 10%;"></td> <td style="width: 10%;"></td> <td style="width: 10%;"></td> <td style="width: 10%;"></td> <td style="width: 10%;"></td> <td style="width: 10%;"></td> <td style="width: 10%;"></td> <td style="width: 10%;"></td> </tr> <tr> <td></td> <td></td> <td colspan="8" style="text-align: center;"> <table border="1" style="width: 100%; border-collapse: collapse; text-align: center;"> <tr> <td style="width: 10%;"></td> <td style="width: 10%;"></td> <td style="width: 10%;"></td> <td style="width: 10%;"></td> <td style="width: 10%;"></td> <td style="width: 10%;"></td> <td style="width: 10%;"></td> <td style="width: 10%;"></td> <td style="width: 10%;"></td> <td style="width: 10%;"></td> </tr> <tr> <td></td> <td></td> <td colspan="8" style="text-align: center;"> <table border="1" style="width: 100%; border-collapse: collapse; text-align: center;"> <tr> <td style="width: 10%;"></td> <td
style="width: 10%;"></td> <td style="width: 10%;"></td> <td style="width: 10%;"></td> <td style="width: 10%;"></td> <td style="width: 10%;"></td> <td style="width: 10%;"></td> <td style="width: 10%;"></td> <td style="width: 10%;"></td> <td style="width: 10%;"></td> </tr> <tr> <td></td> <td></td> <td colspan="8" style="text-align: center;"> <table border="1" style="width: 100%; border-collapse: collapse; text-align: center;"> <tr> <td style="width: 10%;"></td> <td style="width: 10%;"></td> <td style="width: 10%;"></td> <td style="width: 10%;"></td> <td style="width: 10%;"></td> <td style="width: 10%;"></td> <td style="width: 10%;"></td> <td style="width: 10%;"></td> <td style="width: 10%;"></td> <td style="width: 10%;"></td> </tr> <tr> <td></td> <td></td> <td colspan="8" style="text-align: center;"> <table border="1" style="width: 100%; border-collapse: collapse; text-align: center;"> <tr> <td style="width: 10%;"></td> <td style="width: 10%;"></td> <td style="width: 10%;"></td> <td style="width: 10%;"></td> <td style="width: 10%;"></td> <td style="width: 10%;"></td> <td style="width: 10%;"></td> <td style="width: 10%;"></td> <td style="width: 10%;"></td> <td style="width: 10%;"></td> </tr> <tr> <td></td> <td></td> <td colspan="8" style="text-align: center;"> <table border="1" style="width: 100%; border-collapse: collapse; text-align: center;"> <tr> <td style="width: 10%;"></td> <td style="width: 10%;"></td> <td style="width: 10%;"></td> <td style="width: 10%;"></td> <td style="width: 10%;"></td> <td style="width: 10%;"></td> <td style="width: 10%;"></td> <td style="width: 10%;"></td> <td style="width: 10%;"></td> <td style="width: 10%;"></td> </tr> <tr> <td></td> <td></td> <td colspan="8" style="text-align: center;"> <table border="1" style="width: 100%; border-collapse: collapse; text-align: center;"> <tr> <td style="width: 10%;"></td> <td style="width: 10%;"></td> <td style="width: 10%;"></td> <td style="width: 10%;"></td> <td style="width: 10%;"></td> <td style="width: 10%;"></td> <td style="width: 10%;"></td> <td style="width: 10%;"></td> <td style="width: 10%;"></td> <td style="width: 10%;"></td> </tr> <tr> <td></td> <td></td> <td colspan="8" style="text-align: center;"> <table border="1" style="width: 100%; border-collapse: collapse; text-align: center;"> <tr> <td style="width: 10%;"></td> <td style="width: 10%;"></td> <td style="width: 10%;"></td> <td style="width: 10%;"></td> <td style="width: 10%;"></td> <td style="width: 10%;"></td> <td style="width: 10%;"></td> <td style="width: 10%;"></td> <td style="width: 10%;"></td> <td style="width: 10%;"></td> </tr> <tr> <td></td> <td></td> <td colspan="8" style="text-align: center;"> <table border="1" style="width: 100%; border-collapse: collapse; text-align: center;"> <tr> <td style="width: 10%;"></td> <td style="width: 10%;"></td> <td style="width: 10%;"></td> <td style="width: 10%;"></td> <td style="width: 10%;"></td> <td style="width: 10%;"></td> <td style="width: 10%;"></td> <td style="width: 10%;"></td> <td style="width: 10%;"></td> <td style="width: 10%;"></td> </tr> <tr> <td></td> <td></td> <td colspan="8" style="text-align: center;"> <table border="1" style="width: 100%; border-collapse: collapse; text-align: center;"> <tr> </tr></table></td></tr></table></td></tr></table></td></tr></table></td></tr></table></td></tr></table></td></tr></table></td></tr></table></td></tr></table></td></tr></table></td></tr></table></td></tr></table></td></tr></table></td></tr></table></td></tr></table>

 | | | | | | | | | | | | | | | | | | | | <table border="1" style="width: 100%; border-collapse: collapse; text-align: center;"> <tr> <td style="width: 10%;"></td> <td style="width: 10%;"></td> <td style="width: 10%;"></td> <td style="width: 10%;"></td> <td style="width: 10%;"></td> <td style="width: 10%;"></td> <td style="width: 10%;"></td> <td style="width: 10%;"></td> <td style="width: 10%;"></td> <td style="width: 10%;"></td> </tr> <tr> <td></td> <td></td> <td colspan="8" style="text-align: center;"> <table border="1" style="width: 100%; border-collapse: collapse; text-align: center;"> <tr> <td style="width: 10%;"></td> <td style="width: 10%;"></td> <td style="width: 10%;"></td> <td style="width: 10%;"></td> <td style="width: 10%;"></td> <td style="width: 10%;"></td> <td style="width: 10%;"></td> <td style="width: 10%;"></td> <td style="width: 10%;"></td> <td style="width: 10%;"></td> </tr> <tr> <td></td> <td></td> <td colspan="8" style="text-align: center;"> <table border="1" style="width: 100%; border-collapse: collapse; text-align: center;"> <tr> <td style="width: 10%;"></td> <td style="width: 10%;"></td> <td style="width: 10%;"></td> <td style="width: 10%;"></td> <td style="width: 10%;"></td> <td style="width: 10%;"></td> <td style="width: 10%;"></td> <td style="width: 10%;"></td> <td style="width: 10%;"></td> <td style="width: 10%;"></td> </tr> <tr> <td></td> <td></td> <td colspan="8" style="text-align: center;"> <table border="1" style="width: 100%; border-collapse: collapse; text-align: center;"> <tr> <td style="width: 10%;"></td> <td style="width: 10%;"></td> <td style="width: 10%;"></td> <td style="width: 10%;"></td> <td style="width: 10%;"></td> <td style="width: 10%;"></td> <td style="width: 10%;"></td> <td style="width: 10%;"></td> <td style="width: 10%;"></td> <td style="width: 10%;"></td> </tr> <tr> <td></td> <td></td> <td colspan="8" style="text-align: center;"> <table border="1" style="width: 100%; border-collapse: collapse; text-align: center;"> <tr> <td style="width: 10%;"></td> <td style="width: 10%;"></td> <td style="width: 10%;"></td> <td style="width: 10%;"></td> <td style="width: 10%;"></td> <td style="width: 10%;"></td> <td style="width: 10%;"></td> <td style="width: 10%;"></td> <td style="width: 10%;"></td> <td style="width: 10%;"></td> </tr> <tr> <td></td> <td></td> <td colspan="8" style="text-align: center;"> <table border="1" style="width: 100%; border-collapse: collapse; text-align: center;"> <tr> <td style="width: 10%;"></td> <td style="width: 10%;"></td> <td style="width: 10%;"></td> <td style="width: 10%;"></td> <td style="width: 10%;"></td> <td style="width: 10%;"></td> <td style="width: 10%;"></td> <td style="width: 10%;"></td> <td style="width: 10%;"></td> <td style="width: 10%;"></td> </tr> <tr> <td></td> <td></td> <td colspan="8" style="text-align: center;"> <table border="1" style="width: 100%; border-collapse: collapse; text-align: center;"> <tr> <td style="width: 10%;"></td> <td style="width: 10%;"></td> <td style="width: 10%;"></td> <td style="width: 10%;"></td> <td style="width: 10%;"></td> <td style="width: 10%;"></td> <td style="width: 10%;"></td> <td style="width: 10%;"></td> <td style="width: 10%;"></td> <td style="width: 10%;"></td> </tr> <tr> <td></td> <td></td> <td colspan="8" style="text-align: center;"> <table border="1" style="width: 100%; border-collapse: collapse; text-align: center;"> <tr> <td style="width: 10%;"></td> <td style="width: 10%;"></td> <td style="width: 10%;"></td> <td style="width: 10%;"></td> <td style="width: 10%;"></td> <td style="width: 10%;"></td> <td style="width: 10%;"></td> <td style="width: 10%;"></td> <td style="width: 10%;"></td> <td style="width: 10%;"></td> </tr> <tr> <td></td> <td></td> <td colspan="8" style="text-align: center;"> <table border="1" style="width: 100%; border-collapse: collapse; text-align: center;"> <tr> <td style="width: 10%;"></td> <td style="width: 10%;"></td> <td style="width: 10%;"></td> <td style="width: 10%;"></td> <td style="width: 10%;"></td> <td style="width: 10%;"></td> <td style="width: 10%;"></td> <td style="width: 10%;"></td> <td style="width: 10%;"></td> <td style="width: 10%;"></td> </tr> <tr> <td></td> <td></td> <td colspan="8" style="text-align: center;"> <table border="1" style="width: 100%; border-collapse: collapse; text-align: center;"> <tr> <td style="width: 10%;"></td> <td style="width: 10%;"></td> <td style="width: 10%;"></td> <td style="width: 10%;"></td> <td style="width: 10%;"></td> <td style="width: 10%;"></td> <td style="width: 10%;"></td> <td style="width: 10%;"></td> <td style="width: 10%;"></td> <td style="width: 10%;"></td> </tr> <tr> <td></td> <td></td> <td colspan="8" style="text-align: center;"> <table border="1" style="width: 100%; border-collapse: collapse; text-align: center;"> <tr> <td style="width: 10%;"></td> <td style="width: 10%;"></td> <td style="width: 10%;"></td> <td style="width: 10%;"></td> <td style="width: 10%;"></td> <td style="width: 10%;"></td> <td style="width: 10%;"></td> <td style="width: 10%;"></td> <td style="width: 10%;"></td> <td style="width: 10%;"></td> </tr> <tr> <td></td> <td></td> <td colspan="8" style="text-align: center;"> <table border="1" style="width: 100%; border-collapse: collapse; text-align: center;"> <tr> <td style="width: 10%;"></td> <td style="width: 10%;"></td> <td style="width: 10%;"></td> <td style="width: 10%;"></td> <td style="width: 10%;"></td> <td style="width: 10%;"></td> <td style="width: 10%;"></td> <td style="width: 10%;"></td> <td style="width: 10%;"></td> <td style="width: 10%;"></td> </tr> <tr> <td></td> <td></td> <td colspan="8" style="text-align: center;"> <table border="1" style="width: 100%; border-collapse: collapse; text-align: center;"> <tr> <td style="width: 10%;"></td> <td style="width: 10%;"></td> <td style="width: 10%;"></td> <td style="width: 10%;"></td> <td style="width: 10%;"></td> <td style="width: 10%;"></td> <td style="width: 10%;"></td> <td style="width: 10%;"></td> <td style="width: 10%;"></td> <td style="width: 10%;"></td> </tr> <tr>
<td></td> <td></td> <td colspan="8" style="text-align: center;"> <table border="1" style="width: 100%; border-collapse: collapse; text-align: center;"> <tr> </tr></table></td></tr></table></td></tr></table></td></tr></table></td></tr></table></td></tr></table></td></tr></table></td></tr></table></td></tr></table></td></tr></table></td></tr></table></td></tr></table></td></tr></table></td></tr></table>

 | | | | | | | | | | | | | | | | | | | | <table border="1" style="width: 100%; border-collapse: collapse; text-align: center;"> <tr> <td style="width: 10%;"></td> <td style="width: 10%;"></td> <td style="width: 10%;"></td> <td style="width: 10%;"></td> <td style="width: 10%;"></td> <td style="width: 10%;"></td> <td style="width: 10%;"></td> <td style="width: 10%;"></td> <td style="width: 10%;"></td> <td style="width: 10%;"></td> </tr> <tr> <td></td> <td></td> <td colspan="8" style="text-align: center;"> <table border="1" style="width: 100%; border-collapse: collapse; text-align: center;"> <tr> <td style="width: 10%;"></td> <td style="width: 10%;"></td> <td style="width: 10%;"></td> <td style="width: 10%;"></td> <td style="width: 10%;"></td> <td style="width: 10%;"></td> <td style="width: 10%;"></td> <td style="width: 10%;"></td> <td style="width: 10%;"></td> <td style="width: 10%;"></td> </tr> <tr> <td></td> <td></td> <td colspan="8" style="text-align: center;"> <table border="1" style="width: 100%; border-collapse: collapse; text-align: center;"> <tr> <td style="width: 10%;"></td> <td style="width: 10%;"></td> <td style="width: 10%;"></td> <td style="width: 10%;"></td> <td style="width: 10%;"></td> <td style="width: 10%;"></td> <td style="width: 10%;"></td> <td style="width: 10%;"></td> <td style="width: 10%;"></td> <td style="width: 10%;"></td> </tr> <tr> <td></td> <td></td> <td colspan="8" style="text-align: center;"> <table border="1" style="width: 100%; border-collapse: collapse; text-align: center;"> <tr> <td style="width: 10%;"></td> <td style="width: 10%;"></td> <td style="width: 10%;"></td> <td style="width: 10%;"></td> <td style="width: 10%;"></td> <td style="width: 10%;"></td> <td style="width: 10%;"></td> <td style="width: 10%;"></td> <td style="width: 10%;"></td> <td style="width: 10%;"></td> </tr> <tr> <td></td> <td></td> <td colspan="8" style="text-align: center;"> <table border="1" style="width: 100%; border-collapse: collapse; text-align: center;"> <tr> <td style="width: 10%;"></td> <td style="width: 10%;"></td> <td style="width: 10%;"></td> <td style="width: 10%;"></td> <td style="width: 10%;"></td> <td style="width: 10%;"></td> <td style="width: 10%;"></td> <td style="width: 10%;"></td> <td style="width: 10%;"></td> <td style="width: 10%;"></td> </tr> <tr> <td></td> <td></td> <td colspan="8" style="text-align: center;"> <table border="1" style="width: 100%; border-collapse: collapse; text-align: center;"> <tr> <td style="width: 10%;"></td> <td style="width: 10%;"></td> <td style="width: 10%;"></td> <td style="width: 10%;"></td> <td style="width: 10%;"></td> <td style="width: 10%;"></td> <td style="width: 10%;"></td> <td style="width: 10%;"></td> <td style="width: 10%;"></td> <td style="width: 10%;"></td> </tr> <tr> <td></td> <td></td> <td colspan="8" style="text-align: center;"> <table border="1" style="width: 100%; border-collapse: collapse; text-align: center;"> <tr> <td style="width: 10%;"></td> <td style="width: 10%;"></td> <td style="width: 10%;"></td> <td style="width: 10%;"></td> <td style="width: 10%;"></td> <td style="width: 10%;"></td> <td style="width: 10%;"></td> <td style="width: 10%;"></td> <td style="width: 10%;"></td> <td style="width: 10%;"></td> </tr> <tr> <td></td> <td></td> <td colspan="8" style="text-align: center;"> <table border="1" style="width: 100%; border-collapse: collapse; text-align: center;"> <tr> <td style="width: 10%;"></td> <td style="width: 10%;"></td> <td style="width: 10%;"></td> <td style="width: 10%;"></td> <td style="width: 10%;"></td> <td style="width: 10%;"></td> <td style="width: 10%;"></td> <td style="width: 10%;"></td> <td style="width: 10%;"></td> <td style="width: 10%;"></td> </tr> <tr> <td></td> <td></td> <td colspan="8" style="text-align: center;"> <table border="1" style="width: 100%; border-collapse: collapse; text-align: center;"> <tr> <td style="width: 10%;"></td> <td style="width: 10%;"></td> <td style="width: 10%;"></td> <td style="width: 10%;"></td> <td style="width: 10%;"></td> <td style="width: 10%;"></td> <td style="width: 10%;"></td> <td style="width: 10%;"></td> <td style="width: 10%;"></td> <td style="width: 10%;"></td> </tr> <tr> <td></td> <td></td> <td colspan="8" style="text-align: center;"> <table border="1" style="width: 100%; border-collapse: collapse; text-align: center;"> <tr> <td style="width: 10%;"></td> <td style="width: 10%;"></td> <td style="width: 10%;"></td> <td style="width: 10%;"></td> <td style="width: 10%;"></td> <td style="width: 10%;"></td> <td style="width: 10%;"></td> <td style="width: 10%;"></td> <td style="width: 10%;"></td> <td style="width: 10%;"></td> </tr> <tr> <td></td> <td></td> <td colspan="8" style="text-align: center;"> <table border="1" style="width: 100%; border-collapse: collapse; text-align: center;"> <tr> <td style="width: 10%;"></td> <td style="width: 10%;"></td> <td style="width: 10%;"></td> <td style="width: 10%;"></td> <td style="width: 10%;"></td> <td style="width: 10%;"></td> <td style="width: 10%;"></td> <td style="width: 10%;"></td> <td style="width: 10%;"></td> <td style="width: 10%;"></td> </tr> <tr> <td></td> <td></td> <td colspan="8" style="text-align: center;"> <table border="1" style="width: 100%; border-collapse: collapse; text-align: center;"> <tr> <td style="width: 10%;"></td> <td style="width: 10%;"></td> <td style="width: 10%;"></td> <td style="width: 10%;"></td> <td style="width: 10%;"></td> <td style="width: 10%;"></td> <td style="width: 10%;"></td> <td style="width: 10%;"></td> <td style="width: 10%;"></td> <td style="width: 10%;"></td> </tr> <tr> <td></td> <td></td> <td colspan="8" style="text-align: center;"> <table border="1" style="width: 100%; border-collapse: collapse; text-align: center;"> <tr> </tr></table></td></tr></table></td></tr></table></td></tr></table></td></tr></table></td></tr></table></td></tr></table></td></tr></table></td></tr></table></td></tr></table></td></tr></table></td></tr></table></td></tr></table>

 | | | | | | | | | | | | | | | | | | | | <table border="1" style="width: 100%; border-collapse: collapse; text-align: center;"> <tr> <td style="width: 10%;"></td> <td style="width: 10%;"></td> <td style="width: 10%;"></td> <td style="width: 10%;"></td> <td style="width: 10%;"></td> <td style="width: 10%;"></td> <td style="width: 10%;"></td> <td style="width: 10%;"></td> <td style="width: 10%;"></td> <td style="width: 10%;"></td> </tr> <tr> <td></td> <td></td> <td colspan="8" style="text-align: center;"> <table border="1" style="width: 100%; border-collapse: collapse; text-align: center;"> <tr> <td style="width: 10%;"></td> <td style="width: 10%;"></td> <td style="width: 10%;"></td> <td style="width: 10%;"></td> <td style="width: 10%;"></td> <td style="width: 10%;"></td> <td style="width: 10%;"></td> <td style="width: 10%;"></td> <td style="width: 10%;"></td> <td style="width: 10%;"></td> </tr> <tr> <td></td> <td></td> <td colspan="8" style="text-align: center;"> <table border="1" style="width: 100%; border-collapse: collapse; text-align: center;"> <tr> <td style="width: 10%;"></td> <td style="width: 10%;"></td> <td style="width: 10%;"></td> <td style="width: 10%;"></td> <td style="width: 10%;"></td> <td style="width: 10%;"></td> <td style="width: 10%;"></td> <td style="width: 10%;"></td> <td style="width: 10%;"></td> <td style="width: 10%;"></td> </tr> <tr> <td></td> <td></td> <td colspan="8" style="text-align: center;"> <table border="1" style="width: 100%; border-collapse: collapse; text-align: center;"> <tr> <td style="width: 10%;"></td> <td style="width: 10%;"></td> <td style="width: 10%;"></td> <td style="width: 10%;"></td> <td style="width: 10%;"></td> <td style="width: 10%;"></td> <td style="width: 10%;"></td> <td style="width: 10%;"></td> <td style="width: 10%;"></td> <td style="width: 10%;"></td> </tr> <tr> <td></td> <td></td> <td colspan="8" style="text-align: center;"> <table border="1" style="width: 100%; border-collapse: collapse; text-align: center;"> <tr> <td style="width: 10%;"></td> <td style="width: 10%;"></td> <td style="width: 10%;"></td> <td style="width: 10%;"></td> <td style="width: 10%;"></td> <td style="width: 10%;"></td> <td style="width: 10%;"></td> <td style="width: 10%;"></td> <td style="width: 10%;"></td> <td style="width: 10%;"></td> </tr> <tr> <td></td> <td></td> <td colspan="8" style="text-align: center;"> <table border="1" style="width: 100%; border-collapse: collapse; text-align: center;"> <tr> <td style="width: 10%;"></td> <td style="width: 10%;"></td> <td style="width: 10%;"></td> <td style="width: 10%;"></td> <td style="width: 10%;"></td> <td style="width: 10%;"></td> <td style="width: 10%;"></td> <td style="width: 10%;"></td> <td style="width: 10%;"></td> <td
style="width: 10%;"></td> </tr> <tr> <td></td> <td></td> <td colspan="8" style="text-align: center;"> <table border="1" style="width: 100%; border-collapse: collapse; text-align: center;"> <tr> <td style="width: 10%;"></td> <td style="width: 10%;"></td> <td style="width: 10%;"></td> <td style="width: 10%;"></td> <td style="width: 10%;"></td> <td style="width: 10%;"></td> <td style="width: 10%;"></td> <td style="width: 10%;"></td> <td style="width: 10%;"></td> <td style="width: 10%;"></td> </tr> <tr> <td></td> <td></td> <td colspan="8" style="text-align: center;"> <table border="1" style="width: 100%; border-collapse: collapse; text-align: center;"> <tr> <td style="width: 10%;"></td> <td style="width: 10%;"></td> <td style="width: 10%;"></td> <td style="width: 10%;"></td> <td style="width: 10%;"></td> <td style="width: 10%;"></td> <td style="width: 10%;"></td> <td style="width: 10%;"></td> <td style="width: 10%;"></td> <td style="width: 10%;"></td> </tr> <tr> <td></td> <td></td> <td colspan="8" style="text-align: center;"> <table border="1" style="width: 100%; border-collapse: collapse; text-align: center;"> <tr> <td style="width: 10%;"></td> <td style="width: 10%;"></td> <td style="width: 10%;"></td> <td style="width: 10%;"></td> <td style="width: 10%;"></td> <td style="width: 10%;"></td> <td style="width: 10%;"></td> <td style="width: 10%;"></td> <td style="width: 10%;"></td> <td style="width: 10%;"></td> </tr> <tr> <td></td> <td></td> <td colspan="8" style="text-align: center;"> <table border="1" style="width: 100%; border-collapse: collapse; text-align: center;"> <tr> <td style="width: 10%;"></td> <td style="width: 10%;"></td> <td style="width: 10%;"></td> <td style="width: 10%;"></td> <td style="width: 10%;"></td> <td style="width: 10%;"></td> <td style="width: 10%;"></td> <td style="width: 10%;"></td> <td style="width: 10%;"></td> <td style="width: 10%;"></td> </tr> <tr> <td></td> <td></td> <td colspan="8" style="text-align: center;"> <table border="1" style="width: 100%; border-collapse: collapse; text-align: center;"> <tr> <td style="width: 10%;"></td> <td style="width: 10%;"></td> <td style="width: 10%;"></td> <td style="width: 10%;"></td> <td style="width: 10%;"></td> <td style="width: 10%;"></td> <td style="width: 10%;"></td> <td style="width: 10%;"></td> <td style="width: 10%;"></td> <td style="width: 10%;"></td> </tr> <tr> <td></td> <td></td> <td colspan="8" style="text-align: center;"> <table border="1" style="width: 100%; border-collapse: collapse; text-align: center;"> <tr> </tr></table></td></tr></table></td></tr></table></td></tr></table></td></tr></table></td></tr></table></td></tr></table></td></tr></table></td></tr></table></td></tr></table></td></tr></table></td></tr></table>

 | | | | | | | | | | | | | | | | | | | | <table border="1" style="width: 100%; border-collapse: collapse; text-align: center;"> <tr> <td style="width: 10%;"></td> <td style="width: 10%;"></td> <td style="width: 10%;"></td> <td style="width: 10%;"></td> <td style="width: 10%;"></td> <td style="width: 10%;"></td> <td style="width: 10%;"></td> <td style="width: 10%;"></td> <td style="width: 10%;"></td> <td style="width: 10%;"></td> </tr> <tr> <td></td> <td></td> <td colspan="8" style="text-align: center;"> <table border="1" style="width: 100%; border-collapse: collapse; text-align: center;"> <tr> <td style="width: 10%;"></td> <td style="width: 10%;"></td> <td style="width: 10%;"></td> <td style="width: 10%;"></td> <td style="width: 10%;"></td> <td style="width: 10%;"></td> <td style="width: 10%;"></td> <td style="width: 10%;"></td> <td style="width: 10%;"></td> <td style="width: 10%;"></td> </tr> <tr> <td></td> <td></td> <td colspan="8" style="text-align: center;"> <table border="1" style="width: 100%; border-collapse: collapse; text-align: center;"> <tr> <td style="width: 10%;"></td> <td style="width: 10%;"></td> <td style="width: 10%;"></td> <td style="width: 10%;"></td> <td style="width: 10%;"></td> <td style="width: 10%;"></td> <td style="width: 10%;"></td> <td style="width: 10%;"></td> <td style="width: 10%;"></td> <td style="width: 10%;"></td> </tr> <tr> <td></td> <td></td> <td colspan="8" style="text-align: center;"> <table border="1" style="width: 100%; border-collapse: collapse; text-align: center;"> <tr> <td style="width: 10%;"></td> <td style="width: 10%;"></td> <td style="width: 10%;"></td> <td style="width: 10%;"></td> <td style="width: 10%;"></td> <td style="width: 10%;"></td> <td style="width: 10%;"></td> <td style="width: 10%;"></td> <td style="width: 10%;"></td> <td style="width: 10%;"></td> </tr> <tr> <td></td> <td></td> <td colspan="8" style="text-align: center;"> <table border="1" style="width: 100%; border-collapse: collapse; text-align: center;"> <tr> <td style="width: 10%;"></td> <td style="width: 10%;"></td> <td style="width: 10%;"></td> <td style="width: 10%;"></td> <td style="width: 10%;"></td> <td style="width: 10%;"></td> <td style="width: 10%;"></td> <td style="width: 10%;"></td> <td style="width: 10%;"></td> <td style="width: 10%;"></td> </tr> <tr> <td></td> <td></td> <td colspan="8" style="text-align: center;"> <table border="1" style="width: 100%; border-collapse: collapse; text-align: center;"> <tr> <td style="width: 10%;"></td> <td style="width: 10%;"></td> <td style="width: 10%;"></td> <td style="width: 10%;"></td> <td style="width: 10%;"></td> <td style="width: 10%;"></td> <td style="width: 10%;"></td> <td style="width: 10%;"></td> <td style="width: 10%;"></td> <td style="width: 10%;"></td> </tr> <tr> <td></td> <td></td> <td colspan="8" style="text-align: center;"> <table border="1" style="width: 100%; border-collapse: collapse; text-align: center;"> <tr> <td style="width: 10%;"></td> <td style="width: 10%;"></td> <td style="width: 10%;"></td> <td style="width: 10%;"></td> <td style="width: 10%;"></td> <td style="width: 10%;"></td> <td style="width: 10%;"></td> <td style="width: 10%;"></td> <td style="width: 10%;"></td> <td style="width: 10%;"></td> </tr> <tr> <td></td> <td></td> <td colspan="8" style="text-align: center;"> <table border="1" style="width: 100%; border-collapse: collapse; text-align: center;"> <tr> <td style="width: 10%;"></td> <td style="width: 10%;"></td> <td style="width: 10%;"></td> <td style="width: 10%;"></td> <td style="width: 10%;"></td> <td style="width: 10%;"></td> <td style="width: 10%;"></td> <td style="width: 10%;"></td> <td style="width: 10%;"></td> <td style="width: 10%;"></td> </tr> <tr> <td></td> <td></td> <td colspan="8" style="text-align: center;"> <table border="1" style="width: 100%; border-collapse: collapse; text-align: center;"> <tr> <td style="width: 10%;"></td> <td style="width: 10%;"></td> <td style="width: 10%;"></td> <td style="width: 10%;"></td> <td style="width: 10%;"></td> <td style="width: 10%;"></td> <td style="width: 10%;"></td> <td style="width: 10%;"></td> <td style="width: 10%;"></td> <td style="width: 10%;"></td> </tr> <tr> <td></td> <td></td> <td colspan="8" style="text-align: center;"> <table border="1" style="width: 100%; border-collapse: collapse; text-align: center;"> <tr> <td style="width: 10%;"></td> <td style="width: 10%;"></td> <td style="width: 10%;"></td> <td style="width: 10%;"></td> <td style="width: 10%;"></td> <td style="width: 10%;"></td> <td style="width: 10%;"></td> <td style="width: 10%;"></td> <td style="width: 10%;"></td> <td style="width: 10%;"></td> </tr> <tr> <td></td> <td></td> <td colspan="8" style="text-align: center;"> <table border="1" style="width: 100%; border-collapse: collapse; text-align: center;"> <tr> </tr></table></td></tr></table></td></tr></table></td></tr></table></td></tr></table></td></tr></table></td></tr></table></td></tr></table></td></tr></table></td></tr></table></td></tr></table>

 | | | | | | | | | | | | | | | | | | | | <table border="1" style="width: 100%; border-collapse: collapse; text-align: center;"> <tr> <td style="width: 10%;"></td> <td style="width: 10%;"></td> <td style="width: 10%;"></td> <td style="width: 10%;"></td> <td style="width: 10%;"></td> <td style="width: 10%;"></td> <td style="width: 10%;"></td> <td style="width: 10%;"></td> <td style="width: 10%;"></td> <td style="width: 10%;"></td> </tr> <tr> <td></td> <td></td> <td colspan="8" style="text-align: center;"> <table border="1" style="width: 100%; border-collapse: collapse; text-align: center;"> <tr> <td style="width: 10%;"></td> <td style="width: 10%;"></td> <td style="width: 10%;"></td> <td style="width: 10%;"></td> <td style="width: 10%;"></td> <td style="width: 10%;"></td> <td style="width: 10%;"></td> <td style="width: 10%;"></td> <td style="width: 10%;"></td> <td style="width: 10%;"></td> </tr> <tr> <td></td> <td></td> <td colspan="8" style="text-align: center;"> <table border="1" style="width: 100%; border-collapse: collapse; text-align: center;"> <tr> <td style="width: 10%;"></td> <td style="width: 10%;"></td> <td style="width: 10%;"></td> <td style="width: 10%;"></td> <td style="width: 10%;"></td> <td style="width: 10%;"></td> <td style="width: 10%;"></td> <td style="width: 10%;"></td> <td style="width: 10%;"></td> <td style="width: 10%;"></td> </tr> <tr>
<td></td> <td></td> <td colspan="8" style="text-align: center;"> <table border="1" style="width: 100%; border-collapse: collapse; text-align: center;"> <tr> <td style="width: 10%;"></td> <td style="width: 10%;"></td> <td style="width: 10%;"></td> <td style="width: 10%;"></td> <td style="width: 10%;"></td> <td style="width: 10%;"></td> <td style="width: 10%;"></td> <td style="width: 10%;"></td> <td style="width: 10%;"></td> <td style="width: 10%;"></td> </tr> <tr> <td></td> <td></td> <td colspan="8" style="text-align: center;"> <table border="1" style="width: 100%; border-collapse: collapse; text-align: center;"> <tr> <td style="width: 10%;"></td> <td style="width: 10%;"></td> <td style="width: 10%;"></td> <td style="width: 10%;"></td> <td style="width: 10%;"></td> <td style="width: 10%;"></td> <td style="width: 10%;"></td> <td style="width: 10%;"></td> <td style="width: 10%;"></td> <td style="width: 10%;"></td> </tr> <tr> <td></td> <td></td> <td colspan="8" style="text-align: center;"> <table border="1" style="width: 100%; border-collapse: collapse; text-align: center;"> <tr> <td style="width: 10%;"></td> <td style="width: 10%;"></td> <td style="width: 10%;"></td> <td style="width: 10%;"></td> <td style="width: 10%;"></td> <td style="width: 10%;"></td> <td style="width: 10%;"></td> <td style="width: 10%;"></td> <td style="width: 10%;"></td> <td style="width: 10%;"></td> </tr> <tr> <td></td> <td></td> <td colspan="8" style="text-align: center;"> <table border="1" style="width: 100%; border-collapse: collapse; text-align: center;"> <tr> <td style="width: 10%;"></td> <td style="width: 10%;"></td> <td style="width: 10%;"></td> <td style="width: 10%;"></td> <td style="width: 10%;"></td> <td style="width: 10%;"></td> <td style="width: 10%;"></td> <td style="width: 10%;"></td> <td style="width: 10%;"></td> <td style="width: 10%;"></td> </tr> <tr> <td></td> <td></td> <td colspan="8" style="text-align: center;"> <table border="1" style="width: 100%; border-collapse: collapse; text-align: center;"> <tr> <td style="width: 10%;"></td> <td style="width: 10%;"></td> <td style="width: 10%;"></td> <td style="width: 10%;"></td> <td style="width: 10%;"></td> <td style="width: 10%;"></td> <td style="width: 10%;"></td> <td style="width: 10%;"></td> <td style="width: 10%;"></td> <td style="width: 10%;"></td> </tr> <tr> <td></td> <td></td> <td colspan="8" style="text-align: center;"> <table border="1" style="width: 100%; border-collapse: collapse; text-align: center;"> <tr> <td style="width: 10%;"></td> <td style="width: 10%;"></td> <td style="width: 10%;"></td> <td style="width: 10%;"></td> <td style="width: 10%;"></td> <td style="width: 10%;"></td> <td style="width: 10%;"></td> <td style="width: 10%;"></td> <td style="width: 10%;"></td> <td style="width: 10%;"></td> </tr> <tr> <td></td> <td></td> <td colspan="8" style="text-align: center;"> <table border="1" style="width: 100%; border-collapse: collapse; text-align: center;"> <tr> </tr></table></td></tr></table></td></tr></table></td></tr></table></td></tr></table></td></tr></table></td></tr></table></td></tr></table></td></tr></table></td></tr></table>

 | | | | | | | | | | | | | | | | | | | | <table border="1" style="width: 100%; border-collapse: collapse; text-align: center;"> <tr> <td style="width: 10%;"></td> <td style="width: 10%;"></td> <td style="width: 10%;"></td> <td style="width: 10%;"></td> <td style="width: 10%;"></td> <td style="width: 10%;"></td> <td style="width: 10%;"></td> <td style="width: 10%;"></td> <td style="width: 10%;"></td> <td style="width: 10%;"></td> </tr> <tr> <td></td> <td></td> <td colspan="8" style="text-align: center;"> <table border="1" style="width: 100%; border-collapse: collapse; text-align: center;"> <tr> <td style="width: 10%;"></td> <td style="width: 10%;"></td> <td style="width: 10%;"></td> <td style="width: 10%;"></td> <td style="width: 10%;"></td> <td style="width: 10%;"></td> <td style="width: 10%;"></td> <td style="width: 10%;"></td> <td style="width: 10%;"></td> <td style="width: 10%;"></td> </tr> <tr> <td></td> <td></td> <td colspan="8" style="text-align: center;"> <table border="1" style="width: 100%; border-collapse: collapse; text-align: center;"> <tr> <td style="width: 10%;"></td> <td style="width: 10%;"></td> <td style="width: 10%;"></td> <td style="width: 10%;"></td> <td style="width: 10%;"></td> <td style="width: 10%;"></td> <td style="width: 10%;"></td> <td style="width: 10%;"></td> <td style="width: 10%;"></td> <td style="width: 10%;"></td> </tr> <tr> <td></td> <td></td> <td colspan="8" style="text-align: center;"> <table border="1" style="width: 100%; border-collapse: collapse; text-align: center;"> <tr> <td style="width: 10%;"></td> <td style="width: 10%;"></td> <td style="width: 10%;"></td> <td style="width: 10%;"></td> <td style="width: 10%;"></td> <td style="width: 10%;"></td> <td style="width: 10%;"></td> <td style="width: 10%;"></td> <td style="width: 10%;"></td> <td style="width: 10%;"></td> </tr> <tr> <td></td> <td></td> <td colspan="8" style="text-align: center;"> <table border="1" style="width: 100%; border-collapse: collapse; text-align: center;"> <tr> <td style="width: 10%;"></td> <td style="width: 10%;"></td> <td style="width: 10%;"></td> <td style="width: 10%;"></td> <td style="width: 10%;"></td> <td style="width: 10%;"></td> <td style="width: 10%;"></td> <td style="width: 10%;"></td> <td style="width: 10%;"></td> <td style="width: 10%;"></td> </tr> <tr> <td></td> <td></td> <td colspan="8" style="text-align: center;"> <table border="1" style="width: 100%; border-collapse: collapse; text-align: center;"> <tr> <td style="width: 10%;"></td> <td style="width: 10%;"></td> <td style="width: 10%;"></td> <td style="width: 10%;"></td> <td style="width: 10%;"></td> <td style="width: 10%;"></td> <td style="width: 10%;"></td> <td style="width: 10%;"></td> <td style="width: 10%;"></td> <td style="width: 10%;"></td> </tr> <tr> <td></td> <td></td> <td colspan="8" style="text-align: center;"> <table border="1" style="width: 100%; border-collapse: collapse; text-align: center;"> <tr> <td style="width: 10%;"></td> <td style="width: 10%;"></td> <td style="width: 10%;"></td> <td style="width: 10%;"></td> <td style="width: 10%;"></td> <td style="width: 10%;"></td> <td style="width: 10%;"></td> <td style="width: 10%;"></td> <td style="width: 10%;"></td> <td style="width: 10%;"></td> </tr> <tr> <td></td> <td></td> <td colspan="8" style="text-align: center;"> <table border="1" style="width: 100%; border-collapse: collapse; text-align: center;"> <tr> <td style="width: 10%;"></td> <td style="width: 10%;"></td> <td style="width: 10%;"></td> <td style="width: 10%;"></td> <td style="width: 10%;"></td> <td style="width: 10%;"></td> <td style="width: 10%;"></td> <td style="width: 10%;"></td> <td style="width: 10%;"></td> <td style="width: 10%;"></td> </tr> <tr> <td></td> <td></td> <td colspan="8" style="text-align: center;"> <table border="1" style="width: 100%; border-collapse: collapse; text-align: center;"> <tr> </tr></table></td></tr></table></td></tr></table></td></tr></table></td></tr></table></td></tr></table></td></tr></table></td></tr></table></td></tr></table>

 | | | | | | | | | | | | | | | | | | | | <table border="1" style="width: 100%; border-collapse: collapse; text-align: center;"> <tr> <td style="width: 10%;"></td> <td style="width: 10%;"></td> <td style="width: 10%;"></td> <td style="width: 10%;"></td> <td style="width: 10%;"></td> <td style="width: 10%;"></td> <td style="width: 10%;"></td> <td style="width: 10%;"></td> <td style="width: 10%;"></td> <td style="width: 10%;"></td> </tr> <tr> <td></td> <td></td> <td colspan="8" style="text-align: center;"> <table border="1" style="width: 100%; border-collapse: collapse; text-align: center;"> <tr> <td style="width: 10%;"></td> <td style="width: 10%;"></td> <td style="width: 10%;"></td> <td style="width: 10%;"></td> <td style="width: 10%;"></td> <td style="width: 10%;"></td> <td style="width: 10%;"></td> <td style="width: 10%;"></td> <td style="width: 10%;"></td> <td style="width: 10%;"></td> </tr> <tr> <td></td> <td></td> <td colspan="8" style="text-align: center;"> <table border="1" style="width: 100%; border-collapse: collapse; text-align: center;"> <tr> <td style="width: 10%;"></td> <td style="width: 10%;"></td> <td style="width: 10%;"></td> <td style="width: 10%;"></td> <td style="width: 10%;"></td> <td style="width: 10%;"></td> <td style="width: 10%;"></td> <td style="width: 10%;"></td> <td style="width: 10%;"></td> <td style="width: 10%;"></td> </tr> <tr> <td></td> <td></td> <td colspan="8" style="text-align: center;"> <table border="1" style="width: 100%; border-collapse: collapse; text-align: center;"> <tr> <td style="width: 10%;"></td> <td style="width: 10%;"></td> <td style="width: 10%;"></td> <td style="width: 10%;"></td> <td style="width: 10%;"></td> <td style="width: 10%;"></td> <td style="width: 10%;"></td> <td style="width: 10%;"></td> <td style="width: 10%;"></td> <td style="width: 10%;"></td> </tr> <tr> <td></td> <td></td> <td colspan="8" style="text-align: center;"> <table border="1" style="width: 100%;
border-collapse: collapse; text-align: center;"> <tr> <td style="width: 10%;"></td> <td style="width: 10%;"></td> <td style="width: 10%;"></td> <td style="width: 10%;"></td> <td style="width: 10%;"></td> <td style="width: 10%;"></td> <td style="width: 10%;"></td> <td style="width: 10%;"></td> <td style="width: 10%;"></td> <td style="width: 10%;"></td> </tr> <tr> <td></td> <td></td> <td colspan="8" style="text-align: center;"> <table border="1" style="width: 100%; border-collapse: collapse; text-align: center;"> <tr> <td style="width: 10%;"></td> <td style="width: 10%;"></td> <td style="width: 10%;"></td> <td style="width: 10%;"></td> <td style="width: 10%;"></td> <td style="width: 10%;"></td> <td style="width: 10%;"></td> <td style="width: 10%;"></td> <td style="width: 10%;"></td> <td style="width: 10%;"></td> </tr> <tr> <td></td> <td></td> <td colspan="8" style="text-align: center;"> <table border="1" style="width: 100%; border-collapse: collapse; text-align: center;"> <tr> <td style="width: 10%;"></td> <td style="width: 10%;"></td> <td style="width: 10%;"></td> <td style="width: 10%;"></td> <td style="width: 10%;"></td> <td style="width: 10%;"></td> <td style="width: 10%;"></td> <td style="width: 10%;"></td> <td style="width: 10%;"></td> <td style="width: 10%;"></td> </tr> <tr> <td></td> <td></td> <td colspan="8" style="text-align: center;"> <table border="1" style="width: 100%; border-collapse: collapse; text-align: center;"> <tr> </tr></table></td></tr></table></td></tr></table></td></tr></table></td></tr></table></td></tr></table></td></tr></table></td></tr></table>

 | | | | | | | | | | | | | | | | | | | | <table border="1" style="width: 100%; border-collapse: collapse; text-align: center;"> <tr> <td style="width: 10%;"></td> <td style="width: 10%;"></td> <td style="width: 10%;"></td> <td style="width: 10%;"></td> <td style="width: 10%;"></td> <td style="width: 10%;"></td> <td style="width: 10%;"></td> <td style="width: 10%;"></td> <td style="width: 10%;"></td> <td style="width: 10%;"></td> </tr> <tr> <td></td> <td></td> <td colspan="8" style="text-align: center;"> <table border="1" style="width: 100%; border-collapse: collapse; text-align: center;"> <tr> <td style="width: 10%;"></td> <td style="width: 10%;"></td> <td style="width: 10%;"></td> <td style="width: 10%;"></td> <td style="width: 10%;"></td> <td style="width: 10%;"></td> <td style="width: 10%;"></td> <td style="width: 10%;"></td> <td style="width: 10%;"></td> <td style="width: 10%;"></td> </tr> <tr> <td></td> <td></td> <td colspan="8" style="text-align: center;"> <table border="1" style="width: 100%; border-collapse: collapse; text-align: center;"> <tr> <td style="width: 10%;"></td> <td style="width: 10%;"></td> <td style="width: 10%;"></td> <td style="width: 10%;"></td> <td style="width: 10%;"></td> <td style="width: 10%;"></td> <td style="width: 10%;"></td> <td style="width: 10%;"></td> <td style="width: 10%;"></td> <td style="width: 10%;"></td> </tr> <tr> <td></td> <td></td> <td colspan="8" style="text-align: center;"> <table border="1" style="width: 100%; border-collapse: collapse; text-align: center;"> <tr> <td style="width: 10%;"></td> <td style="width: 10%;"></td> <td style="width: 10%;"></td> <td style="width: 10%;"></td> <td style="width: 10%;"></td> <td style="width: 10%;"></td> <td style="width: 10%;"></td> <td style="width: 10%;"></td> <td style="width: 10%;"></td> <td style="width: 10%;"></td> </tr> <tr> <td></td> <td></td> <td colspan="8" style="text-align: center;"> <table border="1" style="width: 100%; border-collapse: collapse; text-align: center;"> <tr> <td style="width: 10%;"></td> <td style="width: 10%;"></td> <td style="width: 10%;"></td> <td style="width: 10%;"></td> <td style="width: 10%;"></td> <td style="width: 10%;"></td> <td style="width: 10%;"></td> <td style="width: 10%;"></td> <td style="width: 10%;"></td> <td style="width: 10%;"></td> </tr> <tr> <td></td> <td></td> <td colspan="8" style="text-align: center;"> <table border="1" style="width: 100%; border-collapse: collapse; text-align: center;"> <tr> <td style="width: 10%;"></td> <td style="width: 10%;"></td> <td style="width: 10%;"></td> <td style="width: 10%;"></td> <td style="width: 10%;"></td> <td style="width: 10%;"></td> <td style="width: 10%;"></td> <td style="width: 10%;"></td> <td style="width: 10%;"></td> <td style="width: 10%;"></td> </tr> <tr> <td></td> <td></td> <td colspan="8" style="text-align: center;"> <table border="1" style="width: 100%; border-collapse: collapse; text-align: center;"> <tr> </tr></table></td></tr></table></td></tr></table></td></tr></table></td></tr></table></td></tr></table></td></tr></table>

 | | | | | | | | | | | | | | | | | | | | <table border="1" style="width: 100%; border-collapse: collapse; text-align: center;"> <tr> <td style="width: 10%;"></td> <td style="width: 10%;"></td> <td style="width: 10%;"></td> <td style="width: 10%;"></td> <td style="width: 10%;"></td> <td style="width: 10%;"></td> <td style="width: 10%;"></td> <td style="width: 10%;"></td> <td style="width: 10%;"></td> <td style="width: 10%;"></td> </tr> <tr> <td></td> <td></td> <td colspan="8" style="text-align: center;"> <table border="1" style="width: 100%; border-collapse: collapse; text-align: center;"> <tr> <td style="width: 10%;"></td> <td style="width: 10%;"></td> <td style="width: 10%;"></td> <td style="width: 10%;"></td> <td style="width: 10%;"></td> <td style="width: 10%;"></td> <td style="width: 10%;"></td> <td style="width: 10%;"></td> <td style="width: 10%;"></td> <td style="width: 10%;"></td> </tr> <tr> <td></td> <td></td> <td colspan="8" style="text-align: center;"> <table border="1" style="width: 100%; border-collapse: collapse; text-align: center;"> <tr> <td style="width: 10%;"></td> <td style="width: 10%;"></td> <td style="width: 10%;"></td> <td style="width: 10%;"></td> <td style="width: 10%;"></td> <td style="width: 10%;"></td> <td style="width: 10%;"></td> <td style="width: 10%;"></td> <td style="width: 10%;"></td> <td style="width: 10%;"></td> </tr> <tr> <td></td> <td></td> <td colspan="8" style="text-align: center;"> <table border="1" style="width: 100%; border-collapse: collapse; text-align: center;"> <tr> <td style="width: 10%;"></td> <td style="width: 10%;"></td> <td style="width: 10%;"></td> <td style="width: 10%;"></td> <td style="width: 10%;"></td> <td style="width: 10%;"></td> <td style="width: 10%;"></td> <td style="width: 10%;"></td> <td style="width: 10%;"></td> <td style="width: 10%;"></td> </tr> <tr> <td></td> <td></td> <td colspan="8" style="text-align: center;"> <table border="1" style="width: 100%; border-collapse: collapse; text-align: center;"> <tr> <td style="width: 10%;"></td> <td style="width: 10%;"></td> <td style="width: 10%;"></td> <td style="width: 10%;"></td> <td style="width: 10%;"></td> <td style="width: 10%;"></td> <td style="width: 10%;"></td> <td style="width: 10%;"></td> <td style="width: 10%;"></td> <td style="width: 10%;"></td> </tr> <tr> <td></td> <td></td> <td colspan="8" style="text-align: center;"> <table border="1" style="width: 100%; border-collapse: collapse; text-align: center;"> <tr> </tr></table></td></tr></table></td></tr></table></td></tr></table></td></tr></table></td></tr></table>

 | | | | | | | | | | | | | | | | | | | | <table border="1" style="width: 100%; border-collapse: collapse; text-align: center;"> <tr> <td style="width: 10%;"></td> <td style="width: 10%;"></td> <td style="width: 10%;"></td> <td style="width: 10%;"></td> <td style="width: 10%;"></td> <td style="width: 10%;"></td> <td style="width: 10%;"></td> <td style="width: 10%;"></td> <td style="width: 10%;"></td> <td style="width: 10%;"></td> </tr> <tr> <td></td> <td></td> <td colspan="8" style="text-align: center;"> <table border="1" style="width: 100%; border-collapse: collapse; text-align: center;"> <tr> <td style="width: 10%;"></td> <td style="width: 10%;"></td> <td style="width: 10%;"></td> <td style="width: 10%;"></td> <td style="width: 10%;"></td> <td style="width: 10%;"></td> <td style="width: 10%;"></td> <td style="width: 10%;"></td> <td style="width: 10%;"></td> <td style="width: 10%;"></td> </tr> <tr> <td></td> <td></td> <td colspan="8" style="text-align: center;"> <table border="1" style="width: 100%; border-collapse: collapse; text-align: center;"> <tr> <td style="width: 10%;"></td> <td style="width: 10%;"></td> <td style="width: 10%;"></td> <td style="width: 10%;"></td> <td style="width: 10%;"></td> <td style="width: 10%;"></td> <td style="width: 10%;"></td> <td style="width: 10%;"></td> <td style="width: 10%;"></td> <td style="width: 10%;"></td> </tr> <tr> <td></td> <td></td> <td colspan="8" style="text-align: center;"> <table border="1"
style="width: 100%; border-collapse: collapse; text-align: center;"> <tr> <td style="width: 10%;"></td> <td style="width: 10%;"></td> <td style="width: 10%;"></td> <td style="width: 10%;"></td> <td style="width: 10%;"></td> <td style="width: 10%;"></td> <td style="width: 10%;"></td> <td style="width: 10%;"></td> <td style="width: 10%;"></td> <td style="width: 10%;"></td> </tr> <tr> <td></td> <td></td> <td colspan="8" style="text-align: center;"> <table border="1" style="width: 100%; border-collapse: collapse; text-align: center;"> <tr> </tr></table></td></tr></table></td></tr></table></td></tr></table></td></tr></table>

 | | | | | | | | | | | | | | | | | | | | <table border="1" style="width: 100%; border-collapse: collapse; text-align: center;"> <tr> <td style="width: 10%;"></td> <td style="width: 10%;"></td> <td style="width: 10%;"></td> <td style="width: 10%;"></td> <td style="width: 10%;"></td> <td style="width: 10%;"></td> <td style="width: 10%;"></td> <td style="width: 10%;"></td> <td style="width: 10%;"></td> <td style="width: 10%;"></td> </tr> <tr> <td></td> <td></td> <td colspan="8" style="text-align: center;"> <table border="1" style="width: 100%; border-collapse: collapse; text-align: center;"> <tr> <td style="width: 10%;"></td> <td style="width: 10%;"></td> <td style="width: 10%;"></td> <td style="width: 10%;"></td> <td style="width: 10%;"></td> <td style="width: 10%;"></td> <td style="width: 10%;"></td> <td style="width: 10%;"></td> <td style="width: 10%;"></td> <td style="width: 10%;"></td> </tr> <tr> <td></td> <td></td> <td colspan="8" style="text-align: center;"> <table border="1" style="width: 100%; border-collapse: collapse; text-align: center;"> <tr> <td style="width: 10%;"></td> <td style="width: 10%;"></td> <td style="width: 10%;"></td> <td style="width: 10%;"></td> <td style="width: 10%;"></td> <td style="width: 10%;"></td> <td style="width: 10%;"></td> <td style="width: 10%;"></td> <td style="width: 10%;"></td> <td style="width: 10%;"></td> </tr> <tr> <td></td> <td></td> <td colspan="8" style="text-align: center;"> <table border="1" style="width: 100%; border-collapse: collapse; text-align: center;"> <tr> </tr></table></td></tr></table></td></tr></table></td></tr></table>

 | | | | | | | | | | | | | | | | | | | | <table border="1" style="width: 100%; border-collapse: collapse; text-align: center;"> <tr> <td style="width: 10%;"></td> <td style="width: 10%;"></td> <td style="width: 10%;"></td> <td style="width: 10%;"></td> <td style="width: 10%;"></td> <td style="width: 10%;"></td> <td style="width: 10%;"></td> <td style="width: 10%;"></td> <td style="width: 10%;"></td> <td style="width: 10%;"></td> </tr> <tr> <td></td> <td></td> <td colspan="8" style="text-align: center;"> <table border="1" style="width: 100%; border-collapse: collapse; text-align: center;"> <tr> <td style="width: 10%;"></td> <td style="width: 10%;"></td> <td style="width: 10%;"></td> <td style="width: 10%;"></td> <td style="width: 10%;"></td> <td style="width: 10%;"></td> <td style="width: 10%;"></td> <td style="width: 10%;"></td> <td style="width: 10%;"></td> <td style="width: 10%;"></td> </tr> <tr> <td></td> <td></td> <td colspan="8" style="text-align: center;"> <table border="1" style="width: 100%; border-collapse: collapse; text-align: center;"> <tr> </tr></table></td></tr></table></td></tr></table>

 | | | | | | | | | | | | | | | | | | | | <table border="1" style="width: 100%; border-collapse: collapse; text-align: center;"> <tr> <td style="width: 10%;"></td> <td style="width: 10%;"></td> <td style="width: 10%;"></td> <td style="width: 10%;"></td> <td style="width: 10%;"></td> <td style="width: 10%;"></td> <td style="width: 10%;"></td> <td style="width: 10%;"></td> <td style="width: 10%;"></td> <td style="width: 10%;"></td> </tr> <tr> <td></td> <td></td> <td colspan="8" style="text-align: center;"> <table border="1" style="width: 100%; border-collapse: collapse; text-align: center;"> <tr> </tr></table></td></tr></table>

 | | | | | | | | | | | | | | | | | | | | <table border="1" style="width: 100%; border-collapse: collapse; text-align: center;"> <tr> </tr></table>

 | | | | | | | | | | | | | | | | | | | |

 | | | | | | | | | | | | | | | | | | | |

 | | | | | | | | | | | | | | | | | | | |

 | | | | | | | | | | | | | | | | | | | |

 | | | | | | | | | | | | | | | | | | | |

 | | | | | | | | | | | | | | | | | | | |
 | | | | | | | | | | | | | | | | | | | |

 | | | | | | | | | | | | | | | | | | | |

 | | | | | | | | | | | | | | | | | | | |
 | | | | | | | | | | | | | | | | | | | |

 | | | | | | | | | | | | | | | | | | | |

 | | | | | | | | | | | | | | | | | | | |
 | | | | | | | | | | | | | | | | | | | |
 | | | | | | | | | | | | | | | | | | | |

 | | | | | | | | | | | | | | | | | | | |
 | | | | | | | | | | | | | | | | | | | |
 | | | | | | | | | | | | | | | | | | | |

 | | | | | | | | | | | | | | | | | | | | | | | | | | | | | | | | | | | | | | | | | | | | | | | | | | | | | | | | | | | | | | | | | | | | | | | | | | | | | | | | | | | | | | | | | | | | | | | | | | | |
 | | | | | | | | | | | | | | | | | | | |
 | | | | | | | | | | | | | | | | | | | |
 | | | | | | | | | | | | | | | | | | | |
 | | | | | | | | | | | | | | | | | | | |
 | | | | | | | | | | | | | | | | | | | |
 | | | | | | | | | | | | | | | | | | | |
 | | | | | | | | | | | | | | | | | | | |
 | | | | | | | | | | | | | | | | | | | |
 | | | | | | | | | | | | | | | | | | | | | | | | | | | | | | | | | | | | | | | |
 | | | | | | | | | | | | | | | | | | | |
 | | | | | | | | | | | | | | | | | | | | | | | | | | | | | | | | | | | | | | | |
 | | | | | | | | | | | | | | | | | | | | | | | | | | | | | | | | | | | | | | | |
 | | | | | | | | | | | | | | | | | | | | | | | | | | | | | | | | | | | | | | | |
 | | | | | | | | | | | | | | | | | | | | | | | | | | | | | | | | | | | | | | | | | | | | | | | | | | | | | | | | | | | | | | | | | | | | | | | | | | | | | | | | | | | | | | | | | | | | | | | | | | | |
 | | | | | | | | | | | | | | | | | | | | | | | | | | | | | | | | | | | | | | | | | | | | | | | |
| | |

 | | | | | | | | | | | | | | | | | | | |

 | | | | | | | | | | | | | | | | | | | |

 | | | | | | | | | | | | | | | | | | | |

 | | | | | | | | | | | | | | | | | | | |

 | | | | | | | | | | | | | | | | | | | |

 | | | | | | | | | | | | | | | | | | | |

 | | | | | | | | | | | | | | | | | | | |

 | | | | | | | | | | | | | | | | | | | |

 | | | | | | | | | | | | | | | | | | | |

 | | | | | | | | | | | | | | | | | | | |

 | | | | | | | | | | | | | | | | | | | |

 | | | | | | | | | | | | | | | | | | | |

 | | | | | | | | | | | | | | | | | | | |

 | | | | | | | | | | | | | | | | | | | |

 | | | | | | | | | | | | | | | | | | | |

 | | | | | | | | | | | | | | | | | | | |

 | | | | | | | | | | | | | | | | | | | |

 | | | | | | | | | | | | | | | | | | | |

 | | | | | | | | | | | | | | | | | | | |

 | | | | | | | | | | | | | | | | | | | |

 | | | | | | | | | | | | | | | | | | | |

 | | | | | | | | | | | | | | | | | | | |

 | | | | | | | | | | | | | | | | | | | |

 | | | | | | | | | | | | | | | | | | | |

 | | | | | | | | | | | | | | | | | | | |

 | | | | | | | | | | | | | | | | | | | |

 | | | | | | | | | | | | | | | | | | | |

 | | | | | | | | | | | | | | | | | | | |
 | | | | | | | | | | | | | | | | | | | |

 | | | | | | | | | | | | | | | | | | | |

 | | | | | | | | | | | | | | | | | | | |
 | | | | | | | | | | | | | | | | | | | |

 | | | | | | | | | | | | | | | | | | | |

 | | | | | | | | | | | | | | | | | | | |
 | | | | | | | | | | | | | | | | | | | |
 | | | | | | | | | | | | | | | | | | | |

 | | | | | | | | | | | | | | | | | | | |
 | | | | | | | | | | | | | | | | | | | |
 | | | | | | | | | | | | | | | | | | | |

 | | | | | | | | | | | | | | | | | | | | | | | | | | | | | | | | | | | | | | | | | | | | | | | | | | | | | | | | | | | | | | | | | | | | | | | | | | | | | | | | | | | | | | | | | | | | | | | | | | | |
 | | | | | | | | | | | | | | | | | | | |
 | | | | | | | | | | | | | | | | | | | |
 | | | | | | | | | | | | | | | | | | | |
 | | | | | | | | | | | | | | | | | | | |
 | | | | | | | | | | | | | | | | | | | |
 | | | | | | | | | | | | | | | | | | | |
 | | | | | | | | | | | | | | | | | | | |
 | | | | | | | | | | | | | | | | | | | |
 | | | | | | | | | | | | | | | | | | | | | | | | | | | | | | | | | | | | | | | |
 | | | | | | | | | | | | | | | | | | | |
 | | | | | | | | | | | | | | | | | | | | | | | | | | | | | | | | | | | | | | | |
 | | | | | | | | | | | | | | | | | | | | | | | | | | | | | | | | | | | | | | | |
 | | | | | | | | | | | | | | | | | | | | | | | | | | | | | | | | | | | | | | | |
 | | | | | | | | | | | | | | | | | | | | | | | | | | | | | | | | | | | | | | | | | | | | | | | | | | | | | | | | | | | | | | | | | | | | | | | | | | | | | | | | | | | | | | | | | | | | | | | | | | | |
 | | | | | | | | | | | | | | | | | | | | | | | | | | | | | | | | | | | | | | | | | | | | | | | |
| | | <table border="1" style="width: 100%; border-collapse: collapse; text-align: center;"> <tr> <td style="width: 10%;"></td> <td style="width: 10%;"></td> <td style="width: 10%;"></td> <td style="width: 10%;"></td> <td style="width: 10%;"></td> <td style="width: 10%;"></td> <td style="width: 10%;"></td> <td style="width: 10%;"></td> <td style="width: 10%;"></td> <td style="width: 10%;"></td> </tr> <tr> <td></td> <td></td> <td colspan="8" style="text-align: center;"> <table border="1" style="width: 100%; border-collapse: collapse; text-align: center;"> <tr> <td style="width: 10%;"></td> <td style="width: 10%;"></td> <td style="width: 10%;"></td> <td style="width: 10%;"></td> <td style="width: 10%;"></td> <td style="width: 10%;"></td> <td style="width: 10%;"></td> <td style="width: 10%;"></td> <td style="width: 10%;"></td> <td style="width: 10%;"></td> </tr> <tr> <td></td> <td></td> <td colspan="8" style="text-align: center;"> <table border="1" style="width: 100%; border-collapse: collapse; text-align: center;"> <tr> <td style="width: 10%;"></td> <td style="width: 10%;"></td> <td style="width: 10%;"></td> <td style="width: 10%;"></td> <td style="width: 10%;"></td> <td style="width: 10%;"></td> <td style="width: 10%;"></td> <td style="width: 10%;"></td> <td style="width: 10%;"></td> <td style="width: 10%;"></td> </tr> <tr> <td></td> <td></td> <td colspan="8" style="text-align: center;"> <table border="1" style="width: 100%; border-collapse: collapse; text-align: center;"> <tr> <td style="width: 10%;"></td> <td style="width: 10%;"></td> <td style="width: 10%;"></td> <td style="width: 10%;"></td> <td style="width: 10%;"></td> <td style="width: 10%;"></td> <td style="width: 10%;"></td> <td style="width: 10%;"></td> <td style="width: 10%;"></td> <td style="width: 10%;"></td> </tr> <tr> <td></td> <td></td> <td colspan="8" style="text-align: center;"> <table border="1" style="width: 100%; border-collapse: collapse; text-align: center;"> <tr> <td style="width: 10%;"></td> <td style="width: 10%;"></td> <td style="width: 10%;"></td> <td style="width: 10%;"></td> <td style="width: 10%;"></td> <td style="width: 10%;"></td> <td style="width: 10%;"></td> <td style="width: 10%;"></td> <td style="width: 10%;"></td> <td style="width: 10%;"></td> </tr> <tr> <td></td> <td></td> <td colspan="8" style="text-align: center;"> <table border="1" style="width: 100%; border-collapse: collapse; text-align: center;"> <tr> <td style="width: 10%;"></td> <td style="width: 10%;"></td> <td style="width: 10%;"></td> <td style="width: 10%;"></td> <td style="width: 10%;"></td> <td style="width: 10%;"></td> <td style="width: 10%;"></td> <td style="width: 10%;"></td> <td style="width: 10%;"></td> <td style="width: 10%;"></td> </tr> <tr> <td></td> <td></td> <td colspan="8" style="text-align: center;"> <table border="1" style="width: 100%; border-collapse: collapse; text-align: center;"> <tr> <td style="width: 10%;"></td> <td style="width: 10%;"></td> <td style="width: 10%;"></td> <td style="width: 10%;"></td> <td style="width: 10%;"></td> <td style="width: 10%;"></td> <td style="width: 10%;"></td> <td style="width: 10%;"></td> <td style="width: 10%;"></td> <td style="width: 10%;"></td> </tr> <tr> <td></td> <td></td> <td colspan="8" style="text-align: center;"> <table border="1" style="width: 100%; border-collapse: collapse; text-align: center;"> <tr> <td style="width: 10%;"></td> <td style="width: 10%;"></td> <td style="width: 10%;"></td> <td style="width: 10%;"></td> <td style="width: 10%;"></td> <td style="width: 10%;"></td> <td style="width: 10%;"></td> <td style="width: 10%;"></td> <td style="width: 10%;"></td> <td style="width: 10%;"></td> </tr> <tr> <td></td> <td></td> <td colspan="8" style="text-align: center;"> <table border="1" style="width: 100%; border-collapse: collapse; text-align: center;"> <tr> <td style="width: 10%;"></td> <td style="width: 10%;"></td> <td style="width: 10%;"></td> <td style="width: 10%;"></td> <td style="width: 10%;"></td> <td style="width: 10%;"></td> <td style="width: 10%;"></td> <td style="width: 10%;"></td> <td style="width: 10%;"></td> <td style="width: 10%;"></td> </tr> <tr> <td></td> <td></td> <td colspan="8" style="text-align: center;"> <table border="1" style="width: 100%; border-collapse: collapse; text-align: center;"> <tr> <td style="width: 10%;"></td> <td style="width: 10%;"></td> <td style="width: 10%;"></td> <td style="width: 10%;"></td> <td style="width: 10%;"></td> <td style="width: 10%;"></td> <td style="width: 10%;"></td> <td style="width: 10%;"></td> <td style="width: 10%;"></td> <td style="width: 10%;"></td> </tr> <tr> <td></td> <td></td> <td colspan="8" style="text-align: center;"> <table border="1" style="width: 100%; border-collapse: collapse; text-align: center;"> <tr> <td style="width: 10%;"></td> <td style="width: 10%;"></td> <td style="width: 10%;"></td> <td style="width: 10%;"></td> <td style="width: 10%;"></td> <td style="width: 10%;"></td> <td style="width: 10%;"></td> <td style="width: 10%;"></td> <td style="width: 10%;"></td> <td style="width: 10%;"></td> </tr> <tr> <td></td> <td></td> <td colspan="8" style="text-align: center;"> <table border="1" style="width: 100%; border-collapse: collapse; text-align: center;"> <tr> <td style="width: 10%;"></td> <td style="width: 10%;"></td> <td style="width: 10%;"></td> <td style="width: 10%;"></td> <td style="width: 10%;"></td> <td style="width: 10%;"></td> <td style="width: 10%;"></td> <td style="width: 10%;"></td> <td style="width: 10%;"></td> <td style="width: 10%;"></td> </tr> <tr> <td></td> <td></td> <td colspan="8" style="text-align: center;"> <table border="1" style="width: 100%; border-collapse: collapse; text-align: center;"> <tr> <td style="width: 10%;"></td> <td style="width: 10%;"></td> <td style="width: 10%;"></td> <td style="width: 10%;"></td> <td style="width: 10%;"></td> <td style="width: 10%;"></td> <td style="width: 10%;"></td> <td style="width: 10%;"></td> <td style="width: 10%;"></td> <td style="width: 10%;"></td> </tr> <tr> <td></td> <td></td> <td colspan="8" style="text-align: center;"> <table border="1" style="width: 100%; border-collapse: collapse; text-align: center;"> <tr> <td style="width: 10%;"></td> <td style="width: 10%;"></td> <td style="width: 10%;"></td> <td style="width: 10%;"></td> <td style="width: 10%;"></td> <td style="width: 10%;"></td> <td style="width: 10%;"></td> <td style="width: 10%;"></td> <td style="width: 10%;"></td> <td style="width: 10%;"></td> </tr> <tr> <td></td> <td></td> <td colspan="8" style="text-align: center;"> <table border="1" style="width: 100%; border-collapse: collapse; text-align: center;"> <tr> <td style="width: 10%;"></td> <td style="width: 10%;"></td> <td style="width: 10%;"></td> <td style="width: 10%;"></td> <td style="width: 10%;"></td> <td style="width: 10%;"></td> <td style="width: 10%;"></td> <td style="width: 10%;"></td> <td style="width: 10%;"></td> <td style="width: 10%;"></td> </tr> <tr> <td></td> <td></td> <td colspan="8" style="text-align: center;"> <table border="1" style="width: 100%; border-collapse: collapse; text-align: center;"> <tr> <td style="width: 10%;"></td> <td style="width: 10%;"></td> <td style="width: 10%;"></td> <td style="width: 10%;"></td> <td style="width: 10%;"></td> <td style="width: 10%;"></td> <td style="width: 10%;"></td> <td style="width: 10%;"></td> <td style="width: 10%;"></td> <td style="width: 10%;"></td> </tr> <tr> <td></td> <td></td> <td colspan="8" style="text-align: center;"> <table border="1" style="width: 100%; border-collapse: collapse; text-align: center;"> <tr> <td style="width: 10%;"></td> <td style="width: 10%;"></td> <td style="width: 10%;"></td> <td style="width: 10%;"></td> <td style="width: 10%;"></td> <td style="width: 10%;"></td> <td style="width: 10%;"></td> <td style="width: 10%;"></td> <td style="width: 10%;"></td> <td style="width: 10%;"></td> </tr> <tr> <td></td> <td></td> <td colspan="8" style="text-align: center;"> <table border="1" style="width: 100%; border-collapse: collapse; text-align: center;"> <tr> <td style="width: 10%;"></td> <td style="width: 10%;"></td> <td style="width: 10%;"></td> <td style="width: 10%;"></td> <td style="width: 10%;"></td> <td style="width: 10%;"></td> <td style="width: 10%;"></td> <td style="width: 10%;"></td> <td style="width: 10%;"></td> <td style="width: 10%;"></td> </tr> <tr> <td></td> <td></td> <td colspan="8" style="text-align: center;"> <table border="1" style="width: 100%; border-collapse: collapse; text-align: center;"> <tr> <td style="width: 10%;"></td> <td style="width: 10%;"></td> <td style="width: 10%;"></td> <td style="width: 10%;"></td> <td style="width: 10%;"></td> <td style="width: 10%;"></td> <td style="width: 10%;"></td> <td style="width: 10%;"></td> <td style="width: 10%;"></td> <td style="width: 10%;"></td> </tr> <tr> <td></td> <td></td> <td colspan="8" style="text-align: center;"> <table border="1" style="width: 100%; border-collapse: collapse; text-align: center;"> <tr> <td style="width: 10%;"></td> <td style="width: 10%;"></td> <td style="width: 10%;"></td> <td style="width: 10%;"></td> <td style="width: 10%;"></td> <td style="width: 10%;"></td> <td style="width: 10%;"></td> <td style="width: 10%;"></td> <td style="width: 10%;"></td> <td style="width: 10%;"></td> </tr> <tr> <td></td> <td></td> <td colspan="8" style="text-align: center;"> <table border="1" style="width: 100%; border-collapse: collapse; text-align: center;"> <tr> <td style="width: 10%;"></td> <td style="width: 10%;"></td> <td style="width: 10%;"></td> <td style="width: 10%;"></td> <td style="width: 10%;"></td> <td style="width: 10%;"></td> <td style="width: 10%;"></td> <td style="width: 10%;"></td> <td style="width: 10%;"></td> <td style="width: 10%;"></td> </tr> <tr> <td></td> <td></td> <td colspan="8" style="text-align: center;"> <table border="1" style="width: 100%; border-collapse: collapse; text-align: center;"> <tr>
</tr></table></td></tr></table></td></tr></table></td></tr></table></td></tr></table></td></tr></table></td></tr></table></td></tr></table></td></tr></table></td></tr></table></td></tr></table></td></tr></table></td></tr></table></td></tr></table></td></tr></table></td></tr></table></td></tr></table></td></tr></table></td></tr></table></td></tr></table></td></tr></table></td></tr></table>

 | | | | | | | | | | | | | | | | | | | | <table border="1" style="width: 100%; border-collapse: collapse; text-align: center;"> <tr> <td style="width: 10%;"></td> <td style="width: 10%;"></td> <td style="width: 10%;"></td> <td style="width: 10%;"></td> <td style="width: 10%;"></td> <td style="width: 10%;"></td> <td style="width: 10%;"></td> <td style="width: 10%;"></td> <td style="width: 10%;"></td> <td style="width: 10%;"></td> </tr> <tr> <td></td> <td></td> <td colspan="8" style="text-align: center;"> <table border="1" style="width: 100%; border-collapse: collapse; text-align: center;"> <tr> <td style="width: 10%;"></td> <td style="width: 10%;"></td> <td style="width: 10%;"></td> <td style="width: 10%;"></td> <td style="width: 10%;"></td> <td style="width: 10%;"></td> <td style="width: 10%;"></td> <td style="width: 10%;"></td> <td style="width: 10%;"></td> <td style="width: 10%;"></td> </tr> <tr> <td></td> <td></td> <td colspan="8" style="text-align: center;"> <table border="1" style="width: 100%; border-collapse: collapse; text-align: center;"> <tr> <td style="width: 10%;"></td> <td style="width: 10%;"></td> <td style="width: 10%;"></td> <td style="width: 10%;"></td> <td style="width: 10%;"></td> <td style="width: 10%;"></td> <td style="width: 10%;"></td> <td style="width: 10%;"></td> <td style="width: 10%;"></td> <td style="width: 10%;"></td> </tr> <tr> <td></td> <td></td> <td colspan="8" style="text-align: center;"> <table border="1" style="width: 100%; border-collapse: collapse; text-align: center;"> <tr> <td style="width: 10%;"></td> <td style="width: 10%;"></td> <td style="width: 10%;"></td> <td style="width: 10%;"></td> <td style="width: 10%;"></td> <td style="width: 10%;"></td> <td style="width: 10%;"></td> <td style="width: 10%;"></td> <td style="width: 10%;"></td> <td style="width: 10%;"></td> </tr> <tr> <td></td> <td></td> <td colspan="8" style="text-align: center;"> <table border="1" style="width: 100%; border-collapse: collapse; text-align: center;"> <tr> <td style="width: 10%;"></td> <td style="width: 10%;"></td> <td style="width: 10%;"></td> <td style="width: 10%;"></td> <td style="width: 10%;"></td> <td style="width: 10%;"></td> <td style="width: 10%;"></td> <td style="width: 10%;"></td> <td style="width: 10%;"></td> <td style="width: 10%;"></td> </tr> <tr> <td></td> <td></td> <td colspan="8" style="text-align: center;"> <table border="1" style="width: 100%; border-collapse: collapse; text-align: center;"> <tr> <td style="width: 10%;"></td> <td style="width: 10%;"></td> <td style="width: 10%;"></td> <td style="width: 10%;"></td> <td style="width: 10%;"></td> <td style="width: 10%;"></td> <td style="width: 10%;"></td> <td style="width: 10%;"></td> <td style="width: 10%;"></td> <td style="width: 10%;"></td> </tr> <tr> <td></td> <td></td> <td colspan="8" style="text-align: center;"> <table border="1" style="width: 100%; border-collapse: collapse; text-align: center;"> <tr> <td style="width: 10%;"></td> <td style="width: 10%;"></td> <td style="width: 10%;"></td> <td style="width: 10%;"></td> <td style="width: 10%;"></td> <td style="width: 10%;"></td> <td style="width: 10%;"></td> <td style="width: 10%;"></td> <td style="width: 10%;"></td> <td style="width: 10%;"></td> </tr> <tr> <td></td> <td></td> <td colspan="8" style="text-align: center;"> <table border="1" style="width: 100%; border-collapse: collapse; text-align: center;"> <tr> <td style="width: 10%;"></td> <td style="width: 10%;"></td> <td style="width: 10%;"></td> <td style="width: 10%;"></td> <td style="width: 10%;"></td> <td style="width: 10%;"></td> <td style="width: 10%;"></td> <td style="width: 10%;"></td> <td style="width: 10%;"></td> <td style="width: 10%;"></td> </tr> <tr> <td></td> <td></td> <td colspan="8" style="text-align: center;"> <table border="1" style="width: 100%; border-collapse: collapse; text-align: center;"> <tr> <td style="width: 10%;"></td> <td style="width: 10%;"></td> <td style="width: 10%;"></td> <td style="width: 10%;"></td> <td style="width: 10%;"></td> <td style="width: 10%;"></td> <td style="width: 10%;"></td> <td style="width: 10%;"></td> <td style="width: 10%;"></td> <td style="width: 10%;"></td> </tr> <tr> <td></td> <td></td> <td colspan="8" style="text-align: center;"> <table border="1" style="width: 100%; border-collapse: collapse; text-align: center;"> <tr> <td style="width: 10%;"></td> <td style="width: 10%;"></td> <td style="width: 10%;"></td> <td style="width: 10%;"></td> <td style="width: 10%;"></td> <td style="width: 10%;"></td> <td style="width: 10%;"></td> <td style="width: 10%;"></td> <td style="width: 10%;"></td> <td style="width: 10%;"></td> </tr> <tr> <td></td> <td></td> <td colspan="8" style="text-align: center;"> <table border="1" style="width: 100%; border-collapse: collapse; text-align: center;"> <tr> <td style="width: 10%;"></td> <td style="width: 10%;"></td> <td style="width: 10%;"></td> <td style="width: 10%;"></td> <td style="width: 10%;"></td> <td style="width: 10%;"></td> <td style="width: 10%;"></td> <td style="width: 10%;"></td> <td style="width: 10%;"></td> <td style="width: 10%;"></td> </tr> <tr> <td></td> <td></td> <td colspan="8" style="text-align: center;"> <table border="1" style="width: 100%; border-collapse: collapse; text-align: center;"> <tr> <td style="width: 10%;"></td> <td style="width: 10%;"></td> <td style="width: 10%;"></td> <td style="width: 10%;"></td> <td style="width: 10%;"></td> <td style="width: 10%;"></td> <td style="width: 10%;"></td> <td style="width: 10%;"></td> <td style="width: 10%;"></td> <td style="width: 10%;"></td> </tr> <tr> <td></td> <td></td> <td colspan="8" style="text-align: center;"> <table border="1" style="width: 100%; border-collapse: collapse; text-align: center;"> <tr> <td style="width: 10%;"></td> <td style="width: 10%;"></td> <td style="width: 10%;"></td> <td style="width: 10%;"></td> <td style="width: 10%;"></td> <td style="width: 10%;"></td> <td style="width: 10%;"></td> <td style="width: 10%;"></td> <td style="width: 10%;"></td> <td style="width: 10%;"></td> </tr> <tr> <td></td> <td></td> <td colspan="8" style="text-align: center;"> <table border="1" style="width: 100%; border-collapse: collapse; text-align: center;"> <tr> <td style="width: 10%;"></td> <td style="width: 10%;"></td> <td style="width: 10%;"></td> <td style="width: 10%;"></td> <td style="width: 10%;"></td> <td style="width: 10%;"></td> <td style="width: 10%;"></td> <td style="width: 10%;"></td> <td style="width: 10%;"></td> <td style="width: 10%;"></td> </tr> <tr> <td></td> <td></td> <td colspan="8" style="text-align: center;"> <table border="1" style="width: 100%; border-collapse: collapse; text-align: center;"> <tr> <td style="width: 10%;"></td> <td style="width: 10%;"></td> <td style="width: 10%;"></td> <td style="width: 10%;"></td> <td style="width: 10%;"></td> <td style="width: 10%;"></td> <td style="width: 10%;"></td> <td style="width: 10%;"></td> <td style="width: 10%;"></td> <td style="width: 10%;"></td> </tr> <tr> <td></td> <td></td> <td colspan="8" style="text-align: center;"> <table border="1" style="width: 100%; border-collapse: collapse; text-align: center;"> <tr> <td style="width: 10%;"></td> <td style="width: 10%;"></td> <td style="width: 10%;"></td> <td style="width: 10%;"></td> <td style="width: 10%;"></td> <td style="width: 10%;"></td> <td style="width: 10%;"></td> <td style="width: 10%;"></td> <td style="width: 10%;"></td> <td style="width: 10%;"></td> </tr> <tr> <td></td> <td></td> <td colspan="8" style="text-align: center;"> <table border="1" style="width: 100%; border-collapse: collapse; text-align: center;"> <tr> <td style="width: 10%;"></td> <td style="width: 10%;"></td> <td style="width: 10%;"></td> <td style="width: 10%;"></td> <td style="width: 10%;"></td> <td style="width: 10%;"></td> <td style="width: 10%;"></td> <td style="width: 10%;"></td> <td style="width: 10%;"></td> <td style="width: 10%;"></td> </tr> <tr> <td></td> <td></td> <td colspan="8" style="text-align: center;"> <table border="1" style="width: 100%; border-collapse: collapse; text-align: center;"> <tr> <td style="width: 10%;"></td> <td style="width: 10%;"></td> <td style="width: 10%;"></td> <td style="width: 10%;"></td> <td style="width: 10%;"></td> <td style="width: 10%;"></td> <td style="width: 10%;"></td> <td style="width: 10%;"></td> <td style="width: 10%;"></td> <td style="width: 10%;"></td> </tr> <tr> <td></td> <td></td> <td colspan="8" style="text-align: center;"> <table border="1" style="width: 100%; border-collapse: collapse; text-align: center;"> <tr> <td style="width: 10%;"></td> <td style="width: 10%;"></td> <td style="width: 10%;"></td> <td style="width: 10%;"></td>
<td style="width: 10%;"></td> <td style="width: 10%;"></td> <td style="width: 10%;"></td> <td style="width: 10%;"></td> <td style="width: 10%;"></td> <td style="width: 10%;"></td> </tr> <tr> <td></td> <td></td> <td colspan="8" style="text-align: center;"> <table border="1" style="width: 100%; border-collapse: collapse; text-align: center;"> <tr> <td style="width: 10%;"></td> <td style="width: 10%;"></td> <td style="width: 10%;"></td> <td style="width: 10%;"></td> <td style="width: 10%;"></td> <td style="width: 10%;"></td> <td style="width: 10%;"></td> <td style="width: 10%;"></td> <td style="width: 10%;"></td> <td style="width: 10%;"></td> </tr> <tr> <td></td> <td></td> <td colspan="8" style="text-align: center;"> <table border="1" style="width: 100%; border-collapse: collapse; text-align: center;"> <tr> </tr></table></td></tr></table></td></tr></table></td></tr></table></td></tr></table></td></tr></table></td></tr></table></td></tr></table></td></tr></table></td></tr></table></td></tr></table></td></tr></table></td></tr></table></td></tr></table></td></tr></table></td></tr></table></td></tr></table></td></tr></table></td></tr></table></td></tr></table></td></tr></table>

 | | | | | | | | | | | | | | | | | | | | <table border="1" style="width: 100%; border-collapse: collapse; text-align: center;"> <tr> <td style="width: 10%;"></td> <td style="width: 10%;"></td> <td style="width: 10%;"></td> <td style="width: 10%;"></td> <td style="width: 10%;"></td> <td style="width: 10%;"></td> <td style="width: 10%;"></td> <td style="width: 10%;"></td> <td style="width: 10%;"></td> <td style="width: 10%;"></td> </tr> <tr> <td></td> <td></td> <td colspan="8" style="text-align: center;"> <table border="1" style="width: 100%; border-collapse: collapse; text-align: center;"> <tr> <td style="width: 10%;"></td> <td style="width: 10%;"></td> <td style="width: 10%;"></td> <td style="width: 10%;"></td> <td style="width: 10%;"></td> <td style="width: 10%;"></td> <td style="width: 10%;"></td> <td style="width: 10%;"></td> <td style="width: 10%;"></td> <td style="width: 10%;"></td> </tr> <tr> <td></td> <td></td> <td colspan="8" style="text-align: center;"> <table border="1" style="width: 100%; border-collapse: collapse; text-align: center;"> <tr> <td style="width: 10%;"></td> <td style="width: 10%;"></td> <td style="width: 10%;"></td> <td style="width: 10%;"></td> <td style="width: 10%;"></td> <td style="width: 10%;"></td> <td style="width: 10%;"></td> <td style="width: 10%;"></td> <td style="width: 10%;"></td> <td style="width: 10%;"></td> </tr> <tr> <td></td> <td></td> <td colspan="8" style="text-align: center;"> <table border="1" style="width: 100%; border-collapse: collapse; text-align: center;"> <tr> <td style="width: 10%;"></td> <td style="width: 10%;"></td> <td style="width: 10%;"></td> <td style="width: 10%;"></td> <td style="width: 10%;"></td> <td style="width: 10%;"></td> <td style="width: 10%;"></td> <td style="width: 10%;"></td> <td style="width: 10%;"></td> <td style="width: 10%;"></td> </tr> <tr> <td></td> <td></td> <td colspan="8" style="text-align: center;"> <table border="1" style="width: 100%; border-collapse: collapse; text-align: center;"> <tr> <td style="width: 10%;"></td> <td style="width: 10%;"></td> <td style="width: 10%;"></td> <td style="width: 10%;"></td> <td style="width: 10%;"></td> <td style="width: 10%;"></td> <td style="width: 10%;"></td> <td style="width: 10%;"></td> <td style="width: 10%;"></td> <td style="width: 10%;"></td> </tr> <tr> <td></td> <td></td> <td colspan="8" style="text-align: center;"> <table border="1" style="width: 100%; border-collapse: collapse; text-align: center;"> <tr> <td style="width: 10%;"></td> <td style="width: 10%;"></td> <td style="width: 10%;"></td> <td style="width: 10%;"></td> <td style="width: 10%;"></td> <td style="width: 10%;"></td> <td style="width: 10%;"></td> <td style="width: 10%;"></td> <td style="width: 10%;"></td> <td style="width: 10%;"></td> </tr> <tr> <td></td> <td></td> <td colspan="8" style="text-align: center;"> <table border="1" style="width: 100%; border-collapse: collapse; text-align: center;"> <tr> <td style="width: 10%;"></td> <td style="width: 10%;"></td> <td style="width: 10%;"></td> <td style="width: 10%;"></td> <td style="width: 10%;"></td> <td style="width: 10%;"></td> <td style="width: 10%;"></td> <td style="width: 10%;"></td> <td style="width: 10%;"></td> <td style="width: 10%;"></td> </tr> <tr> <td></td> <td></td> <td colspan="8" style="text-align: center;"> <table border="1" style="width: 100%; border-collapse: collapse; text-align: center;"> <tr> <td style="width: 10%;"></td> <td style="width: 10%;"></td> <td style="width: 10%;"></td> <td style="width: 10%;"></td> <td style="width: 10%;"></td> <td style="width: 10%;"></td> <td style="width: 10%;"></td> <td style="width: 10%;"></td> <td style="width: 10%;"></td> <td style="width: 10%;"></td> </tr> <tr> <td></td> <td></td> <td colspan="8" style="text-align: center;"> <table border="1" style="width: 100%; border-collapse: collapse; text-align: center;"> <tr> <td style="width: 10%;"></td> <td style="width: 10%;"></td> <td style="width: 10%;"></td> <td style="width: 10%;"></td> <td style="width: 10%;"></td> <td style="width: 10%;"></td> <td style="width: 10%;"></td> <td style="width: 10%;"></td> <td style="width: 10%;"></td> <td style="width: 10%;"></td> </tr> <tr> <td></td> <td></td> <td colspan="8" style="text-align: center;"> <table border="1" style="width: 100%; border-collapse: collapse; text-align: center;"> <tr> <td style="width: 10%;"></td> <td style="width: 10%;"></td> <td style="width: 10%;"></td> <td style="width: 10%;"></td> <td style="width: 10%;"></td> <td style="width: 10%;"></td> <td style="width: 10%;"></td> <td style="width: 10%;"></td> <td style="width: 10%;"></td> <td style="width: 10%;"></td> </tr> <tr> <td></td> <td></td> <td colspan="8" style="text-align: center;"> <table border="1" style="width: 100%; border-collapse: collapse; text-align: center;"> <tr> <td style="width: 10%;"></td> <td style="width: 10%;"></td> <td style="width: 10%;"></td> <td style="width: 10%;"></td> <td style="width: 10%;"></td> <td style="width: 10%;"></td> <td style="width: 10%;"></td> <td style="width: 10%;"></td> <td style="width: 10%;"></td> <td style="width: 10%;"></td> </tr> <tr> <td></td> <td></td> <td colspan="8" style="text-align: center;"> <table border="1" style="width: 100%; border-collapse: collapse; text-align: center;"> <tr> <td style="width: 10%;"></td> <td style="width: 10%;"></td> <td style="width: 10%;"></td> <td style="width: 10%;"></td> <td style="width: 10%;"></td> <td style="width: 10%;"></td> <td style="width: 10%;"></td> <td style="width: 10%;"></td> <td style="width: 10%;"></td> <td style="width: 10%;"></td> </tr> <tr> <td></td> <td></td> <td colspan="8" style="text-align: center;"> <table border="1" style="width: 100%; border-collapse: collapse; text-align: center;"> <tr> <td style="width: 10%;"></td> <td style="width: 10%;"></td> <td style="width: 10%;"></td> <td style="width: 10%;"></td> <td style="width: 10%;"></td> <td style="width: 10%;"></td> <td style="width: 10%;"></td> <td style="width: 10%;"></td> <td style="width: 10%;"></td> <td style="width: 10%;"></td> </tr> <tr> <td></td> <td></td> <td colspan="8" style="text-align: center;"> <table border="1" style="width: 100%; border-collapse: collapse; text-align: center;"> <tr> <td style="width: 10%;"></td> <td style="width: 10%;"></td> <td style="width: 10%;"></td> <td style="width: 10%;"></td> <td style="width: 10%;"></td> <td style="width: 10%;"></td> <td style="width: 10%;"></td> <td style="width: 10%;"></td> <td style="width: 10%;"></td> <td style="width: 10%;"></td> </tr> <tr> <td></td> <td></td> <td colspan="8" style="text-align: center;"> <table border="1" style="width: 100%; border-collapse: collapse; text-align: center;"> <tr> <td style="width: 10%;"></td> <td style="width: 10%;"></td> <td style="width: 10%;"></td> <td style="width: 10%;"></td> <td style="width: 10%;"></td> <td style="width: 10%;"></td> <td style="width: 10%;"></td> <td style="width: 10%;"></td> <td style="width: 10%;"></td> <td style="width: 10%;"></td> </tr> <tr> <td></td> <td></td> <td colspan="8" style="text-align: center;"> <table border="1" style="width: 100%; border-collapse: collapse; text-align: center;"> <tr> <td style="width: 10%;"></td> <td style="width: 10%;"></td> <td style="width: 10%;"></td> <td style="width: 10%;"></td> <td style="width: 10%;"></td> <td style="width: 10%;"></td> <td style="width: 10%;"></td> <td style="width: 10%;"></td> <td style="width: 10%;"></td> <td style="width: 10%;"></td> </tr> <tr> <td></td> <td></td> <td colspan="8" style="text-align: center;"> <table border="1" style="width: 100%; border-collapse: collapse; text-align: center;"> <tr> <td style="width: 10%;"></td> <td style="width: 10%;"></td> <td style="width: 10%;"></td> <td style="width: 10%;"></td> <td style="width: 10%;"></td> <td style="width: 10%;"></td> <td style="width: 10%;"></td> <td style="width: 10%;"></td> <td style="width: 10%;"></td>
<td style="width: 10%;"></td> </tr> <tr> <td></td> <td></td> <td colspan="8" style="text-align: center;"> <table border="1" style="width: 100%; border-collapse: collapse; text-align: center;"> <tr> <td style="width: 10%;"></td> <td style="width: 10%;"></td> <td style="width: 10%;"></td> <td style="width: 10%;"></td> <td style="width: 10%;"></td> <td style="width: 10%;"></td> <td style="width: 10%;"></td> <td style="width: 10%;"></td> <td style="width: 10%;"></td> <td style="width: 10%;"></td> </tr> <tr> <td></td> <td></td> <td colspan="8" style="text-align: center;"> <table border="1" style="width: 100%; border-collapse: collapse; text-align: center;"> <tr> <td style="width: 10%;"></td> <td style="width: 10%;"></td> <td style="width: 10%;"></td> <td style="width: 10%;"></td> <td style="width: 10%;"></td> <td style="width: 10%;"></td> <td style="width: 10%;"></td> <td style="width: 10%;"></td> <td style="width: 10%;"></td> <td style="width: 10%;"></td> </tr> <tr> <td></td> <td></td> <td colspan="8" style="text-align: center;"> <table border="1" style="width: 100%; border-collapse: collapse; text-align: center;"> <tr> </tr></table></td></tr></table></td></tr></table></td></tr></table></td></tr></table></td></tr></table></td></tr></table></td></tr></table></td></tr></table></td></tr></table></td></tr></table></td></tr></table></td></tr></table></td></tr></table></td></tr></table></td></tr></table></td></tr></table></td></tr></table></td></tr></table></td></tr></table>

 | | | | | | | | | | | | | | | | | | | | <table border="1" style="width: 100%; border-collapse: collapse; text-align: center;"> <tr> <td style="width: 10%;"></td> <td style="width: 10%;"></td> <td style="width: 10%;"></td> <td style="width: 10%;"></td> <td style="width: 10%;"></td> <td style="width: 10%;"></td> <td style="width: 10%;"></td> <td style="width: 10%;"></td> <td style="width: 10%;"></td> <td style="width: 10%;"></td> </tr> <tr> <td></td> <td></td> <td colspan="8" style="text-align: center;"> <table border="1" style="width: 100%; border-collapse: collapse; text-align: center;"> <tr> <td style="width: 10%;"></td> <td style="width: 10%;"></td> <td style="width: 10%;"></td> <td style="width: 10%;"></td> <td style="width: 10%;"></td> <td style="width: 10%;"></td> <td style="width: 10%;"></td> <td style="width: 10%;"></td> <td style="width: 10%;"></td> <td style="width: 10%;"></td> </tr> <tr> <td></td> <td></td> <td colspan="8" style="text-align: center;"> <table border="1" style="width: 100%; border-collapse: collapse; text-align: center;"> <tr> <td style="width: 10%;"></td> <td style="width: 10%;"></td> <td style="width: 10%;"></td> <td style="width: 10%;"></td> <td style="width: 10%;"></td> <td style="width: 10%;"></td> <td style="width: 10%;"></td> <td style="width: 10%;"></td> <td style="width: 10%;"></td> <td style="width: 10%;"></td> </tr> <tr> <td></td> <td></td> <td colspan="8" style="text-align: center;"> <table border="1" style="width: 100%; border-collapse: collapse; text-align: center;"> <tr> <td style="width: 10%;"></td> <td style="width: 10%;"></td> <td style="width: 10%;"></td> <td style="width: 10%;"></td> <td style="width: 10%;"></td> <td style="width: 10%;"></td> <td style="width: 10%;"></td> <td style="width: 10%;"></td> <td style="width: 10%;"></td> <td style="width: 10%;"></td> </tr> <tr> <td></td> <td></td> <td colspan="8" style="text-align: center;"> <table border="1" style="width: 100%; border-collapse: collapse; text-align: center;"> <tr> <td style="width: 10%;"></td> <td style="width: 10%;"></td> <td style="width: 10%;"></td> <td style="width: 10%;"></td> <td style="width: 10%;"></td> <td style="width: 10%;"></td> <td style="width: 10%;"></td> <td style="width: 10%;"></td> <td style="width: 10%;"></td> <td style="width: 10%;"></td> </tr> <tr> <td></td> <td></td> <td colspan="8" style="text-align: center;"> <table border="1" style="width: 100%; border-collapse: collapse; text-align: center;"> <tr> <td style="width: 10%;"></td> <td style="width: 10%;"></td> <td style="width: 10%;"></td> <td style="width: 10%;"></td> <td style="width: 10%;"></td> <td style="width: 10%;"></td> <td style="width: 10%;"></td> <td style="width: 10%;"></td> <td style="width: 10%;"></td> <td style="width: 10%;"></td> </tr> <tr> <td></td> <td></td> <td colspan="8" style="text-align: center;"> <table border="1" style="width: 100%; border-collapse: collapse; text-align: center;"> <tr> <td style="width: 10%;"></td> <td style="width: 10%;"></td> <td style="width: 10%;"></td> <td style="width: 10%;"></td> <td style="width: 10%;"></td> <td style="width: 10%;"></td> <td style="width: 10%;"></td> <td style="width: 10%;"></td> <td style="width: 10%;"></td> <td style="width: 10%;"></td> </tr> <tr> <td></td> <td></td> <td colspan="8" style="text-align: center;"> <table border="1" style="width: 100%; border-collapse: collapse; text-align: center;"> <tr> <td style="width: 10%;"></td> <td style="width: 10%;"></td> <td style="width: 10%;"></td> <td style="width: 10%;"></td> <td style="width: 10%;"></td> <td style="width: 10%;"></td> <td style="width: 10%;"></td> <td style="width: 10%;"></td> <td style="width: 10%;"></td> <td style="width: 10%;"></td> </tr> <tr> <td></td> <td></td> <td colspan="8" style="text-align: center;"> <table border="1" style="width: 100%; border-collapse: collapse; text-align: center;"> <tr> <td style="width: 10%;"></td> <td style="width: 10%;"></td> <td style="width: 10%;"></td> <td style="width: 10%;"></td> <td style="width: 10%;"></td> <td style="width: 10%;"></td> <td style="width: 10%;"></td> <td style="width: 10%;"></td> <td style="width: 10%;"></td> <td style="width: 10%;"></td> </tr> <tr> <td></td> <td></td> <td colspan="8" style="text-align: center;"> <table border="1" style="width: 100%; border-collapse: collapse; text-align: center;"> <tr> <td style="width: 10%;"></td> <td style="width: 10%;"></td> <td style="width: 10%;"></td> <td style="width: 10%;"></td> <td style="width: 10%;"></td> <td style="width: 10%;"></td> <td style="width: 10%;"></td> <td style="width: 10%;"></td> <td style="width: 10%;"></td> <td style="width: 10%;"></td> </tr> <tr> <td></td> <td></td> <td colspan="8" style="text-align: center;"> <table border="1" style="width: 100%; border-collapse: collapse; text-align: center;"> <tr> <td style="width: 10%;"></td> <td style="width: 10%;"></td> <td style="width: 10%;"></td> <td style="width: 10%;"></td> <td style="width: 10%;"></td> <td style="width: 10%;"></td> <td style="width: 10%;"></td> <td style="width: 10%;"></td> <td style="width: 10%;"></td> <td style="width: 10%;"></td> </tr> <tr> <td></td> <td></td> <td colspan="8" style="text-align: center;"> <table border="1" style="width: 100%; border-collapse: collapse; text-align: center;"> <tr> <td style="width: 10%;"></td> <td style="width: 10%;"></td> <td style="width: 10%;"></td> <td style="width: 10%;"></td> <td style="width: 10%;"></td> <td style="width: 10%;"></td> <td style="width: 10%;"></td> <td style="width: 10%;"></td> <td style="width: 10%;"></td> <td style="width: 10%;"></td> </tr> <tr> <td></td> <td></td> <td colspan="8" style="text-align: center;"> <table border="1" style="width: 100%; border-collapse: collapse; text-align: center;"> <tr> <td style="width: 10%;"></td> <td style="width: 10%;"></td> <td style="width: 10%;"></td> <td style="width: 10%;"></td> <td style="width: 10%;"></td> <td style="width: 10%;"></td> <td style="width: 10%;"></td> <td style="width: 10%;"></td> <td style="width: 10%;"></td> <td style="width: 10%;"></td> </tr> <tr> <td></td> <td></td> <td colspan="8" style="text-align: center;"> <table border="1" style="width: 100%; border-collapse: collapse; text-align: center;"> <tr> <td style="width: 10%;"></td> <td style="width: 10%;"></td> <td style="width: 10%;"></td> <td style="width: 10%;"></td> <td style="width: 10%;"></td> <td style="width: 10%;"></td> <td style="width: 10%;"></td> <td style="width: 10%;"></td> <td style="width: 10%;"></td> <td style="width: 10%;"></td> </tr> <tr> <td></td> <td></td> <td colspan="8" style="text-align: center;"> <table border="1" style="width: 100%; border-collapse: collapse; text-align: center;"> <tr> <td style="width: 10%;"></td> <td style="width: 10%;"></td> <td style="width: 10%;"></td> <td style="width: 10%;"></td> <td style="width: 10%;"></td> <td style="width: 10%;"></td> <td style="width: 10%;"></td> <td style="width: 10%;"></td> <td style="width: 10%;"></td> <td style="width: 10%;"></td> </tr> <tr> <td></td> <td></td> <td colspan="8" style="text-align: center;"> <table border="1" style="width: 100%; border-collapse: collapse; text-align: center;"> <tr> <td style="width: 10%;"></td> <td style="width: 10%;"></td> <td style="width: 10%;"></td> <td style="width: 10%;"></td> <td style="width: 10%;"></td> <td style="width: 10%;"></td> <td style="width: 10%;"></td> <td style="width: 10%;"></td> <td style="width: 10%;"></td> <td style="width: 10%;"></td> </tr> <tr> <td></td> <td></td> <td colspan="8" style="text-align: center;"> <table border="1" style="width: 100%; border-collapse: collapse;
text-align: center;"> <tr> <td style="width: 10%;"></td> <td style="width: 10%;"></td> <td style="width: 10%;"></td> <td style="width: 10%;"></td> <td style="width: 10%;"></td> <td style="width: 10%;"></td> <td style="width: 10%;"></td> <td style="width: 10%;"></td> <td style="width: 10%;"></td> <td style="width: 10%;"></td> </tr> <tr> <td></td> <td></td> <td colspan="8" style="text-align: center;"> <table border="1" style="width: 100%; border-collapse: collapse; text-align: center;"> <tr> <td style="width: 10%;"></td> <td style="width: 10%;"></td> <td style="width: 10%;"></td> <td style="width: 10%;"></td> <td style="width: 10%;"></td> <td style="width: 10%;"></td> <td style="width: 10%;"></td> <td style="width: 10%;"></td> <td style="width: 10%;"></td> <td style="width: 10%;"></td> </tr> <tr> <td></td> <td></td> <td colspan="8" style="text-align: center;"> <table border="1" style="width: 100%; border-collapse: collapse; text-align: center;"> <tr> </tr></table></td></tr></table></td></tr></table></td></tr></table></td></tr></table></td></tr></table></td></tr></table></td></tr></table></td></tr></table></td></tr></table></td></tr></table></td></tr></table></td></tr></table></td></tr></table></td></tr></table></td></tr></table></td></tr></table></td></tr></table></td></tr></table>

 | | | | | | | | | | | | | | | | | | | | <table border="1" style="width: 100%; border-collapse: collapse; text-align: center;"> <tr> <td style="width: 10%;"></td> <td style="width: 10%;"></td> <td style="width: 10%;"></td> <td style="width: 10%;"></td> <td style="width: 10%;"></td> <td style="width: 10%;"></td> <td style="width: 10%;"></td> <td style="width: 10%;"></td> <td style="width: 10%;"></td> <td style="width: 10%;"></td> </tr> <tr> <td></td> <td></td> <td colspan="8" style="text-align: center;"> <table border="1" style="width: 100%; border-collapse: collapse; text-align: center;"> <tr> <td style="width: 10%;"></td> <td style="width: 10%;"></td> <td style="width: 10%;"></td> <td style="width: 10%;"></td> <td style="width: 10%;"></td> <td style="width: 10%;"></td> <td style="width: 10%;"></td> <td style="width: 10%;"></td> <td style="width: 10%;"></td> <td style="width: 10%;"></td> </tr> <tr> <td></td> <td></td> <td colspan="8" style="text-align: center;"> <table border="1" style="width: 100%; border-collapse: collapse; text-align: center;"> <tr> <td style="width: 10%;"></td> <td style="width: 10%;"></td> <td style="width: 10%;"></td> <td style="width: 10%;"></td> <td style="width: 10%;"></td> <td style="width: 10%;"></td> <td style="width: 10%;"></td> <td style="width: 10%;"></td> <td style="width: 10%;"></td> <td style="width: 10%;"></td> </tr> <tr> <td></td> <td></td> <td colspan="8" style="text-align: center;"> <table border="1" style="width: 100%; border-collapse: collapse; text-align: center;"> <tr> <td style="width: 10%;"></td> <td style="width: 10%;"></td> <td style="width: 10%;"></td> <td style="width: 10%;"></td> <td style="width: 10%;"></td> <td style="width: 10%;"></td> <td style="width: 10%;"></td> <td style="width: 10%;"></td> <td style="width: 10%;"></td> <td style="width: 10%;"></td> </tr> <tr> <td></td> <td></td> <td colspan="8" style="text-align: center;"> <table border="1" style="width: 100%; border-collapse: collapse; text-align: center;"> <tr> <td style="width: 10%;"></td> <td style="width: 10%;"></td> <td style="width: 10%;"></td> <td style="width: 10%;"></td> <td style="width: 10%;"></td> <td style="width: 10%;"></td> <td style="width: 10%;"></td> <td style="width: 10%;"></td> <td style="width: 10%;"></td> <td style="width: 10%;"></td> </tr> <tr> <td></td> <td></td> <td colspan="8" style="text-align: center;"> <table border="1" style="width: 100%; border-collapse: collapse; text-align: center;"> <tr> <td style="width: 10%;"></td> <td style="width: 10%;"></td> <td style="width: 10%;"></td> <td style="width: 10%;"></td> <td style="width: 10%;"></td> <td style="width: 10%;"></td> <td style="width: 10%;"></td> <td style="width: 10%;"></td> <td style="width: 10%;"></td> <td style="width: 10%;"></td> </tr> <tr> <td></td> <td></td> <td colspan="8" style="text-align: center;"> <table border="1" style="width: 100%; border-collapse: collapse; text-align: center;"> <tr> <td style="width: 10%;"></td> <td style="width: 10%;"></td> <td style="width: 10%;"></td> <td style="width: 10%;"></td> <td style="width: 10%;"></td> <td style="width: 10%;"></td> <td style="width: 10%;"></td> <td style="width: 10%;"></td> <td style="width: 10%;"></td> <td style="width: 10%;"></td> </tr> <tr> <td></td> <td></td> <td colspan="8" style="text-align: center;"> <table border="1" style="width: 100%; border-collapse: collapse; text-align: center;"> <tr> <td style="width: 10%;"></td> <td style="width: 10%;"></td> <td style="width: 10%;"></td> <td style="width: 10%;"></td> <td style="width: 10%;"></td> <td style="width: 10%;"></td> <td style="width: 10%;"></td> <td style="width: 10%;"></td> <td style="width: 10%;"></td> <td style="width: 10%;"></td> </tr> <tr> <td></td> <td></td> <td colspan="8" style="text-align: center;"> <table border="1" style="width: 100%; border-collapse: collapse; text-align: center;"> <tr> <td style="width: 10%;"></td> <td style="width: 10%;"></td> <td style="width: 10%;"></td> <td style="width: 10%;"></td> <td style="width: 10%;"></td> <td style="width: 10%;"></td> <td style="width: 10%;"></td> <td style="width: 10%;"></td> <td style="width: 10%;"></td> <td style="width: 10%;"></td> </tr> <tr> <td></td> <td></td> <td colspan="8" style="text-align: center;"> <table border="1" style="width: 100%; border-collapse: collapse; text-align: center;"> <tr> <td style="width: 10%;"></td> <td style="width: 10%;"></td> <td style="width: 10%;"></td> <td style="width: 10%;"></td> <td style="width: 10%;"></td> <td style="width: 10%;"></td> <td style="width: 10%;"></td> <td style="width: 10%;"></td> <td style="width: 10%;"></td> <td style="width: 10%;"></td> </tr> <tr> <td></td> <td></td> <td colspan="8" style="text-align: center;"> <table border="1" style="width: 100%; border-collapse: collapse; text-align: center;"> <tr> <td style="width: 10%;"></td> <td style="width: 10%;"></td> <td style="width: 10%;"></td> <td style="width: 10%;"></td> <td style="width: 10%;"></td> <td style="width: 10%;"></td> <td style="width: 10%;"></td> <td style="width: 10%;"></td> <td style="width: 10%;"></td> <td style="width: 10%;"></td> </tr> <tr> <td></td> <td></td> <td colspan="8" style="text-align: center;"> <table border="1" style="width: 100%; border-collapse: collapse; text-align: center;"> <tr> <td style="width: 10%;"></td> <td style="width: 10%;"></td> <td style="width: 10%;"></td> <td style="width: 10%;"></td> <td style="width: 10%;"></td> <td style="width: 10%;"></td> <td style="width: 10%;"></td> <td style="width: 10%;"></td> <td style="width: 10%;"></td> <td style="width: 10%;"></td> </tr> <tr> <td></td> <td></td> <td colspan="8" style="text-align: center;"> <table border="1" style="width: 100%; border-collapse: collapse; text-align: center;"> <tr> <td style="width: 10%;"></td> <td style="width: 10%;"></td> <td style="width: 10%;"></td> <td style="width: 10%;"></td> <td style="width: 10%;"></td> <td style="width: 10%;"></td> <td style="width: 10%;"></td> <td style="width: 10%;"></td> <td style="width: 10%;"></td> <td style="width: 10%;"></td> </tr> <tr> <td></td> <td></td> <td colspan="8" style="text-align: center;"> <table border="1" style="width: 100%; border-collapse: collapse; text-align: center;"> <tr> <td style="width: 10%;"></td> <td style="width: 10%;"></td> <td style="width: 10%;"></td> <td style="width: 10%;"></td> <td style="width: 10%;"></td> <td style="width: 10%;"></td> <td style="width: 10%;"></td> <td style="width: 10%;"></td> <td style="width: 10%;"></td> <td style="width: 10%;"></td> </tr> <tr> <td></td> <td></td> <td colspan="8" style="text-align: center;"> <table border="1" style="width: 100%; border-collapse: collapse; text-align: center;"> <tr> <td style="width: 10%;"></td> <td style="width: 10%;"></td> <td style="width: 10%;"></td> <td style="width: 10%;"></td> <td style="width: 10%;"></td> <td style="width: 10%;"></td> <td style="width: 10%;"></td> <td style="width: 10%;"></td> <td style="width: 10%;"></td> <td style="width: 10%;"></td> </tr> <tr> <td></td> <td></td> <td colspan="8" style="text-align: center;"> <table border="1" style="width: 100%; border-collapse: collapse; text-align: center;"> <tr> <td style="width: 10%;"></td> <td style="width: 10%;"></td> <td style="width: 10%;"></td> <td style="width: 10%;"></td> <td style="width: 10%;"></td> <td style="width: 10%;"></td> <td style="width: 10%;"></td> <td style="width: 10%;"></td> <td style="width: 10%;"></td> <td style="width: 10%;"></td> </tr> <tr> <td></td> <td></td> <td colspan="8" style="text-align: center;"> <table border="1" style="width: 100%; border-collapse: collapse; text-align: center;"> <tr> <td style="width: 10%;"></td> <td style="width: 10%;"></td> <td style="width: 10%;"></td> <td style="width: 10%;"></td> <td style="width: 10%;"></td> <td
style="width: 10%;"></td> <td style="width: 10%;"></td> <td style="width: 10%;"></td> <td style="width: 10%;"></td> <td style="width: 10%;"></td> </tr> <tr> <td></td> <td></td> <td colspan="8" style="text-align: center;"> <table border="1" style="width: 100%; border-collapse: collapse; text-align: center;"> <tr> </tr></table></td></tr></table></td></tr></table></td></tr></table></td></tr></table></td></tr></table></td></tr></table></td></tr></table></td></tr></table></td></tr></table></td></tr></table></td></tr></table></td></tr></table></td></tr></table></td></tr></table></td></tr></table></td></tr></table></td></tr></table>

 | | | | | | | | | | | | | | | | | | | | <table border="1" style="width: 100%; border-collapse: collapse; text-align: center;"> <tr> <td style="width: 10%;"></td> <td style="width: 10%;"></td> <td style="width: 10%;"></td> <td style="width: 10%;"></td> <td style="width: 10%;"></td> <td style="width: 10%;"></td> <td style="width: 10%;"></td> <td style="width: 10%;"></td> <td style="width: 10%;"></td> <td style="width: 10%;"></td> </tr> <tr> <td></td> <td></td> <td colspan="8" style="text-align: center;"> <table border="1" style="width: 100%; border-collapse: collapse; text-align: center;"> <tr> <td style="width: 10%;"></td> <td style="width: 10%;"></td> <td style="width: 10%;"></td> <td style="width: 10%;"></td> <td style="width: 10%;"></td> <td style="width: 10%;"></td> <td style="width: 10%;"></td> <td style="width: 10%;"></td> <td style="width: 10%;"></td> <td style="width: 10%;"></td> </tr> <tr> <td></td> <td></td> <td colspan="8" style="text-align: center;"> <table border="1" style="width: 100%; border-collapse: collapse; text-align: center;"> <tr> <td style="width: 10%;"></td> <td style="width: 10%;"></td> <td style="width: 10%;"></td> <td style="width: 10%;"></td> <td style="width: 10%;"></td> <td style="width: 10%;"></td> <td style="width: 10%;"></td> <td style="width: 10%;"></td> <td style="width: 10%;"></td> <td style="width: 10%;"></td> </tr> <tr> <td></td> <td></td> <td colspan="8" style="text-align: center;"> <table border="1" style="width: 100%; border-collapse: collapse; text-align: center;"> <tr> <td style="width: 10%;"></td> <td style="width: 10%;"></td> <td style="width: 10%;"></td> <td style="width: 10%;"></td> <td style="width: 10%;"></td> <td style="width: 10%;"></td> <td style="width: 10%;"></td> <td style="width: 10%;"></td> <td style="width: 10%;"></td> <td style="width: 10%;"></td> </tr> <tr> <td></td> <td></td> <td colspan="8" style="text-align: center;"> <table border="1" style="width: 100%; border-collapse: collapse; text-align: center;"> <tr> <td style="width: 10%;"></td> <td style="width: 10%;"></td> <td style="width: 10%;"></td> <td style="width: 10%;"></td> <td style="width: 10%;"></td> <td style="width: 10%;"></td> <td style="width: 10%;"></td> <td style="width: 10%;"></td> <td style="width: 10%;"></td> <td style="width: 10%;"></td> </tr> <tr> <td></td> <td></td> <td colspan="8" style="text-align: center;"> <table border="1" style="width: 100%; border-collapse: collapse; text-align: center;"> <tr> <td style="width: 10%;"></td> <td style="width: 10%;"></td> <td style="width: 10%;"></td> <td style="width: 10%;"></td> <td style="width: 10%;"></td> <td style="width: 10%;"></td> <td style="width: 10%;"></td> <td style="width: 10%;"></td> <td style="width: 10%;"></td> <td style="width: 10%;"></td> </tr> <tr> <td></td> <td></td> <td colspan="8" style="text-align: center;"> <table border="1" style="width: 100%; border-collapse: collapse; text-align: center;"> <tr> <td style="width: 10%;"></td> <td style="width: 10%;"></td> <td style="width: 10%;"></td> <td style="width: 10%;"></td> <td style="width: 10%;"></td> <td style="width: 10%;"></td> <td style="width: 10%;"></td> <td style="width: 10%;"></td> <td style="width: 10%;"></td> <td style="width: 10%;"></td> </tr> <tr> <td></td> <td></td> <td colspan="8" style="text-align: center;"> <table border="1" style="width: 100%; border-collapse: collapse; text-align: center;"> <tr> <td style="width: 10%;"></td> <td style="width: 10%;"></td> <td style="width: 10%;"></td> <td style="width: 10%;"></td> <td style="width: 10%;"></td> <td style="width: 10%;"></td> <td style="width: 10%;"></td> <td style="width: 10%;"></td> <td style="width: 10%;"></td> <td style="width: 10%;"></td> </tr> <tr> <td></td> <td></td> <td colspan="8" style="text-align: center;"> <table border="1" style="width: 100%; border-collapse: collapse; text-align: center;"> <tr> <td style="width: 10%;"></td> <td style="width: 10%;"></td> <td style="width: 10%;"></td> <td style="width: 10%;"></td> <td style="width: 10%;"></td> <td style="width: 10%;"></td> <td style="width: 10%;"></td> <td style="width: 10%;"></td> <td style="width: 10%;"></td> <td style="width: 10%;"></td> </tr> <tr> <td></td> <td></td> <td colspan="8" style="text-align: center;"> <table border="1" style="width: 100%; border-collapse: collapse; text-align: center;"> <tr> <td style="width: 10%;"></td> <td style="width: 10%;"></td> <td style="width: 10%;"></td> <td style="width: 10%;"></td> <td style="width: 10%;"></td> <td style="width: 10%;"></td> <td style="width: 10%;"></td> <td style="width: 10%;"></td> <td style="width: 10%;"></td> <td style="width: 10%;"></td> </tr> <tr> <td></td> <td></td> <td colspan="8" style="text-align: center;"> <table border="1" style="width: 100%; border-collapse: collapse; text-align: center;"> <tr> <td style="width: 10%;"></td> <td style="width: 10%;"></td> <td style="width: 10%;"></td> <td style="width: 10%;"></td> <td style="width: 10%;"></td> <td style="width: 10%;"></td> <td style="width: 10%;"></td> <td style="width: 10%;"></td> <td style="width: 10%;"></td> <td style="width: 10%;"></td> </tr> <tr> <td></td> <td></td> <td colspan="8" style="text-align: center;"> <table border="1" style="width: 100%; border-collapse: collapse; text-align: center;"> <tr> <td style="width: 10%;"></td> <td style="width: 10%;"></td> <td style="width: 10%;"></td> <td style="width: 10%;"></td> <td style="width: 10%;"></td> <td style="width: 10%;"></td> <td style="width: 10%;"></td> <td style="width: 10%;"></td> <td style="width: 10%;"></td> <td style="width: 10%;"></td> </tr> <tr> <td></td> <td></td> <td colspan="8" style="text-align: center;"> <table border="1" style="width: 100%; border-collapse: collapse; text-align: center;"> <tr> <td style="width: 10%;"></td> <td style="width: 10%;"></td> <td style="width: 10%;"></td> <td style="width: 10%;"></td> <td style="width: 10%;"></td> <td style="width: 10%;"></td> <td style="width: 10%;"></td> <td style="width: 10%;"></td> <td style="width: 10%;"></td> <td style="width: 10%;"></td> </tr> <tr> <td></td> <td></td> <td colspan="8" style="text-align: center;"> <table border="1" style="width: 100%; border-collapse: collapse; text-align: center;"> <tr> <td style="width: 10%;"></td> <td style="width: 10%;"></td> <td style="width: 10%;"></td> <td style="width: 10%;"></td> <td style="width: 10%;"></td> <td style="width: 10%;"></td> <td style="width: 10%;"></td> <td style="width: 10%;"></td> <td style="width: 10%;"></td> <td style="width: 10%;"></td> </tr> <tr> <td></td> <td></td> <td colspan="8" style="text-align: center;"> <table border="1" style="width: 100%; border-collapse: collapse; text-align: center;"> <tr> <td style="width: 10%;"></td> <td style="width: 10%;"></td> <td style="width: 10%;"></td> <td style="width: 10%;"></td> <td style="width: 10%;"></td> <td style="width: 10%;"></td> <td style="width: 10%;"></td> <td style="width: 10%;"></td> <td style="width: 10%;"></td> <td style="width: 10%;"></td> </tr> <tr> <td></td> <td></td> <td colspan="8" style="text-align: center;"> <table border="1" style="width: 100%; border-collapse: collapse; text-align: center;"> <tr> <td style="width: 10%;"></td> <td style="width: 10%;"></td> <td style="width: 10%;"></td> <td style="width: 10%;"></td> <td style="width: 10%;"></td> <td style="width: 10%;"></td> <td style="width: 10%;"></td> <td style="width: 10%;"></td> <td style="width: 10%;"></td> <td style="width: 10%;"></td> </tr> <tr> <td></td> <td></td> <td colspan="8" style="text-align: center;"> <table border="1" style="width: 100%; border-collapse: collapse; text-align: center;"> <tr> </tr></table></td></tr></table></td></tr></table></td></tr></table></td></tr></table></td></tr></table></td></tr></table></td></tr></table></td></tr></table></td></tr></table></td></tr></table></td></tr></table></td></tr></table></td></tr></table></td></tr></table></td></tr></table></td></tr></table>

 | | | | | | | | | | | | | | | | | | | | <table border="1" style="width: 100%; border-collapse: collapse; text-align: center;"> <tr> <td style="width: 10%;"></td> <td style="width: 10%;"></td> <td style="width: 10%;"></td> <td style="width: 10%;"></td> <td style="width: 10%;"></td> <td style="width: 10%;"></td> <td style="width: 10%;"></td> <td style="width: 10%;"></td> <td style="width: 10%;"></td> <td style="width: 10%;"></td> </tr> <tr> <td></td> <td></td> <td colspan="8" style="text-align: center;"> <table border="1" style="width: 100%; border-collapse: collapse; text-align: center;"> <tr> <td style="width: 10%;"></td> <td style="width: 10%;"></td> <td style="width: 10%;"></td> <td style="width: 10%;"></td> <td style="width: 10%;"></td> <td style="width: 10%;"></td> <td style="width: 10%;"></td> <td style="width: 10%;"></td> <td style="width: 10%;"></td> <td style="width: 10%;"></td> </tr> <tr> <td></td> <td></td> <td colspan="8" style="text-align: center;"> <table border="1" style="width: 100%; border-collapse: collapse; text-align: center;"> <tr> <td style="width: 10%;"></td> <td style="width: 10%;"></td> <td style="width: 10%;"></td> <td style="width: 10%;"></td> <td style="width: 10%;"></td> <td style="width: 10%;"></td> <td style="width: 10%;"></td> <td style="width: 10%;"></td> <td style="width: 10%;"></td> <td style="width: 10%;"></td> </tr> <tr> <td></td> <td></td> <td colspan="8" style="text-align: center;"> <table border="1" style="width: 100%; border-collapse: collapse; text-align: center;"> <tr> <td style="width: 10%;"></td> <td style="width: 10%;"></td> <td style="width: 10%;"></td> <td style="width: 10%;"></td> <td style="width: 10%;"></td> <td style="width: 10%;"></td> <td style="width: 10%;"></td> <td style="width: 10%;"></td> <td style="width: 10%;"></td> <td style="width: 10%;"></td> </tr> <tr> <td></td> <td></td> <td colspan="8" style="text-align: center;"> <table border="1" style="width: 100%; border-collapse: collapse; text-align: center;"> <tr> <td style="width: 10%;"></td> <td style="width: 10%;"></td> <td style="width: 10%;"></td> <td style="width: 10%;"></td> <td style="width: 10%;"></td> <td style="width: 10%;"></td> <td style="width: 10%;"></td> <td style="width: 10%;"></td> <td style="width: 10%;"></td> <td style="width: 10%;"></td> </tr> <tr> <td></td> <td></td> <td colspan="8" style="text-align: center;"> <table border="1" style="width: 100%; border-collapse: collapse; text-align: center;"> <tr> <td style="width: 10%;"></td> <td style="width: 10%;"></td> <td style="width: 10%;"></td> <td style="width: 10%;"></td> <td style="width: 10%;"></td> <td style="width: 10%;"></td> <td style="width: 10%;"></td> <td style="width: 10%;"></td> <td style="width: 10%;"></td> <td style="width: 10%;"></td> </tr> <tr> <td></td> <td></td> <td colspan="8" style="text-align: center;"> <table border="1" style="width: 100%; border-collapse: collapse; text-align: center;"> <tr> <td style="width: 10%;"></td> <td style="width: 10%;"></td> <td style="width: 10%;"></td> <td style="width: 10%;"></td> <td style="width: 10%;"></td> <td style="width: 10%;"></td> <td style="width: 10%;"></td> <td style="width: 10%;"></td> <td style="width: 10%;"></td> <td style="width: 10%;"></td> </tr> <tr> <td></td> <td></td> <td colspan="8" style="text-align: center;"> <table border="1" style="width: 100%; border-collapse: collapse; text-align: center;"> <tr> <td style="width: 10%;"></td> <td style="width: 10%;"></td> <td style="width: 10%;"></td> <td style="width: 10%;"></td> <td style="width: 10%;"></td> <td style="width: 10%;"></td> <td style="width: 10%;"></td> <td style="width: 10%;"></td> <td style="width: 10%;"></td> <td style="width: 10%;"></td> </tr> <tr> <td></td> <td></td> <td colspan="8" style="text-align: center;"> <table border="1" style="width: 100%; border-collapse: collapse; text-align: center;"> <tr> <td style="width: 10%;"></td> <td style="width: 10%;"></td> <td style="width: 10%;"></td> <td style="width: 10%;"></td> <td style="width: 10%;"></td> <td style="width: 10%;"></td> <td style="width: 10%;"></td> <td style="width: 10%;"></td> <td style="width: 10%;"></td> <td style="width: 10%;"></td> </tr> <tr> <td></td> <td></td> <td colspan="8" style="text-align: center;"> <table border="1" style="width: 100%; border-collapse: collapse; text-align: center;"> <tr> <td style="width: 10%;"></td> <td style="width: 10%;"></td> <td style="width: 10%;"></td> <td style="width: 10%;"></td> <td style="width: 10%;"></td> <td style="width: 10%;"></td> <td style="width: 10%;"></td> <td style="width: 10%;"></td> <td style="width: 10%;"></td> <td style="width: 10%;"></td> </tr> <tr> <td></td> <td></td> <td colspan="8" style="text-align: center;"> <table border="1" style="width: 100%; border-collapse: collapse; text-align: center;"> <tr> <td style="width: 10%;"></td> <td style="width: 10%;"></td> <td style="width: 10%;"></td> <td style="width: 10%;"></td> <td style="width: 10%;"></td> <td style="width: 10%;"></td> <td style="width: 10%;"></td> <td style="width: 10%;"></td> <td style="width: 10%;"></td> <td style="width: 10%;"></td> </tr> <tr> <td></td> <td></td> <td colspan="8" style="text-align: center;"> <table border="1" style="width: 100%; border-collapse: collapse; text-align: center;"> <tr> <td style="width: 10%;"></td> <td style="width: 10%;"></td> <td style="width: 10%;"></td> <td style="width: 10%;"></td> <td style="width: 10%;"></td> <td style="width: 10%;"></td> <td style="width: 10%;"></td> <td style="width: 10%;"></td> <td style="width: 10%;"></td> <td style="width: 10%;"></td> </tr> <tr> <td></td> <td></td> <td colspan="8" style="text-align: center;"> <table border="1" style="width: 100%; border-collapse: collapse; text-align: center;"> <tr> <td style="width: 10%;"></td> <td style="width: 10%;"></td> <td style="width: 10%;"></td> <td style="width: 10%;"></td> <td style="width: 10%;"></td> <td style="width: 10%;"></td> <td style="width: 10%;"></td> <td style="width: 10%;"></td> <td style="width: 10%;"></td> <td style="width: 10%;"></td> </tr> <tr> <td></td> <td></td> <td colspan="8" style="text-align: center;"> <table border="1" style="width: 100%; border-collapse: collapse; text-align: center;"> <tr> <td style="width: 10%;"></td> <td style="width: 10%;"></td> <td style="width: 10%;"></td> <td style="width: 10%;"></td> <td style="width: 10%;"></td> <td style="width: 10%;"></td> <td style="width: 10%;"></td> <td style="width: 10%;"></td> <td style="width: 10%;"></td> <td style="width: 10%;"></td> </tr> <tr> <td></td> <td></td> <td colspan="8" style="text-align: center;"> <table border="1" style="width: 100%; border-collapse: collapse; text-align: center;"> <tr> <td style="width: 10%;"></td> <td style="width: 10%;"></td> <td style="width: 10%;"></td> <td style="width: 10%;"></td> <td style="width: 10%;"></td> <td style="width: 10%;"></td> <td style="width: 10%;"></td> <td style="width: 10%;"></td> <td style="width: 10%;"></td> <td style="width: 10%;"></td> </tr> <tr> <td></td> <td></td> <td colspan="8" style="text-align: center;"> <table border="1" style="width: 100%; border-collapse: collapse; text-align: center;"> <tr> </tr></table></td></tr></table></td></tr></table></td></tr></table></td></tr></table></td></tr></table></td></tr></table></td></tr></table></td></tr></table></td></tr></table></td></tr></table></td></tr></table></td></tr></table></td></tr></table></td></tr></table></td></tr></table>

 | | | | | | | | | | | | | | | | | | | | <table border="1" style="width: 100%; border-collapse: collapse; text-align: center;"> <tr> <td style="width: 10%;"></td> <td style="width: 10%;"></td> <td style="width: 10%;"></td> <td style="width: 10%;"></td> <td style="width: 10%;"></td> <td style="width: 10%;"></td> <td style="width: 10%;"></td> <td style="width: 10%;"></td> <td style="width: 10%;"></td> <td style="width: 10%;"></td> </tr> <tr> <td></td> <td></td> <td colspan="8" style="text-align: center;"> <table border="1" style="width: 100%; border-collapse: collapse; text-align: center;"> <tr> <td style="width: 10%;"></td> <td style="width: 10%;"></td> <td style="width: 10%;"></td> <td style="width: 10%;"></td> <td style="width: 10%;"></td> <td style="width: 10%;"></td> <td style="width: 10%;"></td> <td style="width: 10%;"></td> <td style="width: 10%;"></td> <td style="width: 10%;"></td> </tr> <tr> <td></td> <td></td> <td colspan="8" style="text-align: center;"> <table border="1" style="width: 100%; border-collapse: collapse; text-align: center;"> <tr> <td style="width: 10%;"></td> <td style="width: 10%;"></td> <td style="width: 10%;"></td> <td style="width: 10%;"></td> <td style="width: 10%;"></td> <td style="width: 10%;"></td> <td
style="width: 10%;"></td> <td style="width: 10%;"></td> <td style="width: 10%;"></td> <td style="width: 10%;"></td> </tr> <tr> <td></td> <td></td> <td colspan="8" style="text-align: center;"> <table border="1" style="width: 100%; border-collapse: collapse; text-align: center;"> <tr> <td style="width: 10%;"></td> <td style="width: 10%;"></td> <td style="width: 10%;"></td> <td style="width: 10%;"></td> <td style="width: 10%;"></td> <td style="width: 10%;"></td> <td style="width: 10%;"></td> <td style="width: 10%;"></td> <td style="width: 10%;"></td> <td style="width: 10%;"></td> </tr> <tr> <td></td> <td></td> <td colspan="8" style="text-align: center;"> <table border="1" style="width: 100%; border-collapse: collapse; text-align: center;"> <tr> <td style="width: 10%;"></td> <td style="width: 10%;"></td> <td style="width: 10%;"></td> <td style="width: 10%;"></td> <td style="width: 10%;"></td> <td style="width: 10%;"></td> <td style="width: 10%;"></td> <td style="width: 10%;"></td> <td style="width: 10%;"></td> <td style="width: 10%;"></td> </tr> <tr> <td></td> <td></td> <td colspan="8" style="text-align: center;"> <table border="1" style="width: 100%; border-collapse: collapse; text-align: center;"> <tr> <td style="width: 10%;"></td> <td style="width: 10%;"></td> <td style="width: 10%;"></td> <td style="width: 10%;"></td> <td style="width: 10%;"></td> <td style="width: 10%;"></td> <td style="width: 10%;"></td> <td style="width: 10%;"></td> <td style="width: 10%;"></td> <td style="width: 10%;"></td> </tr> <tr> <td></td> <td></td> <td colspan="8" style="text-align: center;"> <table border="1" style="width: 100%; border-collapse: collapse; text-align: center;"> <tr> <td style="width: 10%;"></td> <td style="width: 10%;"></td> <td style="width: 10%;"></td> <td style="width: 10%;"></td> <td style="width: 10%;"></td> <td style="width: 10%;"></td> <td style="width: 10%;"></td> <td style="width: 10%;"></td> <td style="width: 10%;"></td> <td style="width: 10%;"></td> </tr> <tr> <td></td> <td></td> <td colspan="8" style="text-align: center;"> <table border="1" style="width: 100%; border-collapse: collapse; text-align: center;"> <tr> <td style="width: 10%;"></td> <td style="width: 10%;"></td> <td style="width: 10%;"></td> <td style="width: 10%;"></td> <td style="width: 10%;"></td> <td style="width: 10%;"></td> <td style="width: 10%;"></td> <td style="width: 10%;"></td> <td style="width: 10%;"></td> <td style="width: 10%;"></td> </tr> <tr> <td></td> <td></td> <td colspan="8" style="text-align: center;"> <table border="1" style="width: 100%; border-collapse: collapse; text-align: center;"> <tr> <td style="width: 10%;"></td> <td style="width: 10%;"></td> <td style="width: 10%;"></td> <td style="width: 10%;"></td> <td style="width: 10%;"></td> <td style="width: 10%;"></td> <td style="width: 10%;"></td> <td style="width: 10%;"></td> <td style="width: 10%;"></td> <td style="width: 10%;"></td> </tr> <tr> <td></td> <td></td> <td colspan="8" style="text-align: center;"> <table border="1" style="width: 100%; border-collapse: collapse; text-align: center;"> <tr> <td style="width: 10%;"></td> <td style="width: 10%;"></td> <td style="width: 10%;"></td> <td style="width: 10%;"></td> <td style="width: 10%;"></td> <td style="width: 10%;"></td> <td style="width: 10%;"></td> <td style="width: 10%;"></td> <td style="width: 10%;"></td> <td style="width: 10%;"></td> </tr> <tr> <td></td> <td></td> <td colspan="8" style="text-align: center;"> <table border="1" style="width: 100%; border-collapse: collapse; text-align: center;"> <tr> <td style="width: 10%;"></td> <td style="width: 10%;"></td> <td style="width: 10%;"></td> <td style="width: 10%;"></td> <td style="width: 10%;"></td> <td style="width: 10%;"></td> <td style="width: 10%;"></td> <td style="width: 10%;"></td> <td style="width: 10%;"></td> <td style="width: 10%;"></td> </tr> <tr> <td></td> <td></td> <td colspan="8" style="text-align: center;"> <table border="1" style="width: 100%; border-collapse: collapse; text-align: center;"> <tr> <td style="width: 10%;"></td> <td style="width: 10%;"></td> <td style="width: 10%;"></td> <td style="width: 10%;"></td> <td style="width: 10%;"></td> <td style="width: 10%;"></td> <td style="width: 10%;"></td> <td style="width: 10%;"></td> <td style="width: 10%;"></td> <td style="width: 10%;"></td> </tr> <tr> <td></td> <td></td> <td colspan="8" style="text-align: center;"> <table border="1" style="width: 100%; border-collapse: collapse; text-align: center;"> <tr> <td style="width: 10%;"></td> <td style="width: 10%;"></td> <td style="width: 10%;"></td> <td style="width: 10%;"></td> <td style="width: 10%;"></td> <td style="width: 10%;"></td> <td style="width: 10%;"></td> <td style="width: 10%;"></td> <td style="width: 10%;"></td> <td style="width: 10%;"></td> </tr> <tr> <td></td> <td></td> <td colspan="8" style="text-align: center;"> <table border="1" style="width: 100%; border-collapse: collapse; text-align: center;"> <tr> <td style="width: 10%;"></td> <td style="width: 10%;"></td> <td style="width: 10%;"></td> <td style="width: 10%;"></td> <td style="width: 10%;"></td> <td style="width: 10%;"></td> <td style="width: 10%;"></td> <td style="width: 10%;"></td> <td style="width: 10%;"></td> <td style="width: 10%;"></td> </tr> <tr> <td></td> <td></td> <td colspan="8" style="text-align: center;"> <table border="1" style="width: 100%; border-collapse: collapse; text-align: center;"> <tr> </tr></table></td></tr></table></td></tr></table></td></tr></table></td></tr></table></td></tr></table></td></tr></table></td></tr></table></td></tr></table></td></tr></table></td></tr></table></td></tr></table></td></tr></table></td></tr></table></td></tr></table>

 | | | | | | | | | | | | | | | | | | | | <table border="1" style="width: 100%; border-collapse: collapse; text-align: center;"> <tr> <td style="width: 10%;"></td> <td style="width: 10%;"></td> <td style="width: 10%;"></td> <td style="width: 10%;"></td> <td style="width: 10%;"></td> <td style="width: 10%;"></td> <td style="width: 10%;"></td> <td style="width: 10%;"></td> <td style="width: 10%;"></td> <td style="width: 10%;"></td> </tr> <tr> <td></td> <td></td> <td colspan="8" style="text-align: center;"> <table border="1" style="width: 100%; border-collapse: collapse; text-align: center;"> <tr> <td style="width: 10%;"></td> <td style="width: 10%;"></td> <td style="width: 10%;"></td> <td style="width: 10%;"></td> <td style="width: 10%;"></td> <td style="width: 10%;"></td> <td style="width: 10%;"></td> <td style="width: 10%;"></td> <td style="width: 10%;"></td> <td style="width: 10%;"></td> </tr> <tr> <td></td> <td></td> <td colspan="8" style="text-align: center;"> <table border="1" style="width: 100%; border-collapse: collapse; text-align: center;"> <tr> <td style="width: 10%;"></td> <td style="width: 10%;"></td> <td style="width: 10%;"></td> <td style="width: 10%;"></td> <td style="width: 10%;"></td> <td style="width: 10%;"></td> <td style="width: 10%;"></td> <td style="width: 10%;"></td> <td style="width: 10%;"></td> <td style="width: 10%;"></td> </tr> <tr> <td></td> <td></td> <td colspan="8" style="text-align: center;"> <table border="1" style="width: 100%; border-collapse: collapse; text-align: center;"> <tr> <td style="width: 10%;"></td> <td style="width: 10%;"></td> <td style="width: 10%;"></td> <td style="width: 10%;"></td> <td style="width: 10%;"></td> <td style="width: 10%;"></td> <td style="width: 10%;"></td> <td style="width: 10%;"></td> <td style="width: 10%;"></td> <td style="width: 10%;"></td> </tr> <tr> <td></td> <td></td> <td colspan="8" style="text-align: center;"> <table border="1" style="width: 100%; border-collapse: collapse; text-align: center;"> <tr> <td style="width: 10%;"></td> <td style="width: 10%;"></td> <td style="width: 10%;"></td> <td style="width: 10%;"></td> <td style="width: 10%;"></td> <td style="width: 10%;"></td> <td style="width: 10%;"></td> <td style="width: 10%;"></td> <td style="width: 10%;"></td> <td style="width: 10%;"></td> </tr> <tr> <td></td> <td></td> <td colspan="8" style="text-align: center;"> <table border="1" style="width: 100%; border-collapse: collapse; text-align: center;"> <tr> <td style="width: 10%;"></td> <td style="width: 10%;"></td> <td style="width: 10%;"></td> <td style="width: 10%;"></td> <td style="width: 10%;"></td> <td style="width: 10%;"></td> <td style="width: 10%;"></td> <td style="width: 10%;"></td> <td style="width: 10%;"></td> <td style="width: 10%;"></td> </tr> <tr> <td></td> <td></td> <td colspan="8" style="text-align: center;"> <table border="1" style="width: 100%; border-collapse: collapse; text-align: center;"> <tr> <td style="width: 10%;"></td> <td style="width: 10%;"></td> <td style="width: 10%;"></td> <td style="width: 10%;"></td> <td style="width: 10%;"></td> <td style="width: 10%;"></td> <td style="width: 10%;"></td> <td style="width: 10%;"></td> <td style="width: 10%;"></td> <td style="width: 10%;"></td> </tr> <tr> <td></td> <td></td> <td colspan="8" style="text-align: center;"> <table border="1" style="width: 100%; border-collapse: collapse;
text-align: center;"> <tr> <td style="width: 10%;"></td> <td style="width: 10%;"></td> <td style="width: 10%;"></td> <td style="width: 10%;"></td> <td style="width: 10%;"></td> <td style="width: 10%;"></td> <td style="width: 10%;"></td> <td style="width: 10%;"></td> <td style="width: 10%;"></td> <td style="width: 10%;"></td> </tr> <tr> <td></td> <td></td> <td colspan="8" style="text-align: center;"> <table border="1" style="width: 100%; border-collapse: collapse; text-align: center;"> <tr> <td style="width: 10%;"></td> <td style="width: 10%;"></td> <td style="width: 10%;"></td> <td style="width: 10%;"></td> <td style="width: 10%;"></td> <td style="width: 10%;"></td> <td style="width: 10%;"></td> <td style="width: 10%;"></td> <td style="width: 10%;"></td> <td style="width: 10%;"></td> </tr> <tr> <td></td> <td></td> <td colspan="8" style="text-align: center;"> <table border="1" style="width: 100%; border-collapse: collapse; text-align: center;"> <tr> <td style="width: 10%;"></td> <td style="width: 10%;"></td> <td style="width: 10%;"></td> <td style="width: 10%;"></td> <td style="width: 10%;"></td> <td style="width: 10%;"></td> <td style="width: 10%;"></td> <td style="width: 10%;"></td> <td style="width: 10%;"></td> <td style="width: 10%;"></td> </tr> <tr> <td></td> <td></td> <td colspan="8" style="text-align: center;"> <table border="1" style="width: 100%; border-collapse: collapse; text-align: center;"> <tr> <td style="width: 10%;"></td> <td style="width: 10%;"></td> <td style="width: 10%;"></td> <td style="width: 10%;"></td> <td style="width: 10%;"></td> <td style="width: 10%;"></td> <td style="width: 10%;"></td> <td style="width: 10%;"></td> <td style="width: 10%;"></td> <td style="width: 10%;"></td> </tr> <tr> <td></td> <td></td> <td colspan="8" style="text-align: center;"> <table border="1" style="width: 100%; border-collapse: collapse; text-align: center;"> <tr> <td style="width: 10%;"></td> <td style="width: 10%;"></td> <td style="width: 10%;"></td> <td style="width: 10%;"></td> <td style="width: 10%;"></td> <td style="width: 10%;"></td> <td style="width: 10%;"></td> <td style="width: 10%;"></td> <td style="width: 10%;"></td> <td style="width: 10%;"></td> </tr> <tr> <td></td> <td></td> <td colspan="8" style="text-align: center;"> <table border="1" style="width: 100%; border-collapse: collapse; text-align: center;"> <tr> <td style="width: 10%;"></td> <td style="width: 10%;"></td> <td style="width: 10%;"></td> <td style="width: 10%;"></td> <td style="width: 10%;"></td> <td style="width: 10%;"></td> <td style="width: 10%;"></td> <td style="width: 10%;"></td> <td style="width: 10%;"></td> <td style="width: 10%;"></td> </tr> <tr> <td></td> <td></td> <td colspan="8" style="text-align: center;"> <table border="1" style="width: 100%; border-collapse: collapse; text-align: center;"> <tr> </tr></table></td></tr></table></td></tr></table></td></tr></table></td></tr></table></td></tr></table></td></tr></table></td></tr></table></td></tr></table></td></tr></table></td></tr></table></td></tr></table></td></tr></table></td></tr></table>

 | | | | | | | | | | | | | | | | | | | | <table border="1" style="width: 100%; border-collapse: collapse; text-align: center;"> <tr> <td style="width: 10%;"></td> <td style="width: 10%;"></td> <td style="width: 10%;"></td> <td style="width: 10%;"></td> <td style="width: 10%;"></td> <td style="width: 10%;"></td> <td style="width: 10%;"></td> <td style="width: 10%;"></td> <td style="width: 10%;"></td> <td style="width: 10%;"></td> </tr> <tr> <td></td> <td></td> <td colspan="8" style="text-align: center;"> <table border="1" style="width: 100%; border-collapse: collapse; text-align: center;"> <tr> <td style="width: 10%;"></td> <td style="width: 10%;"></td> <td style="width: 10%;"></td> <td style="width: 10%;"></td> <td style="width: 10%;"></td> <td style="width: 10%;"></td> <td style="width: 10%;"></td> <td style="width: 10%;"></td> <td style="width: 10%;"></td> <td style="width: 10%;"></td> </tr> <tr> <td></td> <td></td> <td colspan="8" style="text-align: center;"> <table border="1" style="width: 100%; border-collapse: collapse; text-align: center;"> <tr> <td style="width: 10%;"></td> <td style="width: 10%;"></td> <td style="width: 10%;"></td> <td style="width: 10%;"></td> <td style="width: 10%;"></td> <td style="width: 10%;"></td> <td style="width: 10%;"></td> <td style="width: 10%;"></td> <td style="width: 10%;"></td> <td style="width: 10%;"></td> </tr> <tr> <td></td> <td></td> <td colspan="8" style="text-align: center;"> <table border="1" style="width: 100%; border-collapse: collapse; text-align: center;"> <tr> <td style="width: 10%;"></td> <td style="width: 10%;"></td> <td style="width: 10%;"></td> <td style="width: 10%;"></td> <td style="width: 10%;"></td> <td style="width: 10%;"></td> <td style="width: 10%;"></td> <td style="width: 10%;"></td> <td style="width: 10%;"></td> <td style="width: 10%;"></td> </tr> <tr> <td></td> <td></td> <td colspan="8" style="text-align: center;"> <table border="1" style="width: 100%; border-collapse: collapse; text-align: center;"> <tr> <td style="width: 10%;"></td> <td style="width: 10%;"></td> <td style="width: 10%;"></td> <td style="width: 10%;"></td> <td style="width: 10%;"></td> <td style="width: 10%;"></td> <td style="width: 10%;"></td> <td style="width: 10%;"></td> <td style="width: 10%;"></td> <td style="width: 10%;"></td> </tr> <tr> <td></td> <td></td> <td colspan="8" style="text-align: center;"> <table border="1" style="width: 100%; border-collapse: collapse; text-align: center;"> <tr> <td style="width: 10%;"></td> <td style="width: 10%;"></td> <td style="width: 10%;"></td> <td style="width: 10%;"></td> <td style="width: 10%;"></td> <td style="width: 10%;"></td> <td style="width: 10%;"></td> <td style="width: 10%;"></td> <td style="width: 10%;"></td> <td style="width: 10%;"></td> </tr> <tr> <td></td> <td></td> <td colspan="8" style="text-align: center;"> <table border="1" style="width: 100%; border-collapse: collapse; text-align: center;"> <tr> <td style="width: 10%;"></td> <td style="width: 10%;"></td> <td style="width: 10%;"></td> <td style="width: 10%;"></td> <td style="width: 10%;"></td> <td style="width: 10%;"></td> <td style="width: 10%;"></td> <td style="width: 10%;"></td> <td style="width: 10%;"></td> <td style="width: 10%;"></td> </tr> <tr> <td></td> <td></td> <td colspan="8" style="text-align: center;"> <table border="1" style="width: 100%; border-collapse: collapse; text-align: center;"> <tr> <td style="width: 10%;"></td> <td style="width: 10%;"></td> <td style="width: 10%;"></td> <td style="width: 10%;"></td> <td style="width: 10%;"></td> <td style="width: 10%;"></td> <td style="width: 10%;"></td> <td style="width: 10%;"></td> <td style="width: 10%;"></td> <td style="width: 10%;"></td> </tr> <tr> <td></td> <td></td> <td colspan="8" style="text-align: center;"> <table border="1" style="width: 100%; border-collapse: collapse; text-align: center;"> <tr> <td style="width: 10%;"></td> <td style="width: 10%;"></td> <td style="width: 10%;"></td> <td style="width: 10%;"></td> <td style="width: 10%;"></td> <td style="width: 10%;"></td> <td style="width: 10%;"></td> <td style="width: 10%;"></td> <td style="width: 10%;"></td> <td style="width: 10%;"></td> </tr> <tr> <td></td> <td></td> <td colspan="8" style="text-align: center;"> <table border="1" style="width: 100%; border-collapse: collapse; text-align: center;"> <tr> <td style="width: 10%;"></td> <td style="width: 10%;"></td> <td style="width: 10%;"></td> <td style="width: 10%;"></td> <td style="width: 10%;"></td> <td style="width: 10%;"></td> <td style="width: 10%;"></td> <td style="width: 10%;"></td> <td style="width: 10%;"></td> <td style="width: 10%;"></td> </tr> <tr> <td></td> <td></td> <td colspan="8" style="text-align: center;"> <table border="1" style="width: 100%; border-collapse: collapse; text-align: center;"> <tr> <td style="width: 10%;"></td> <td style="width: 10%;"></td> <td style="width: 10%;"></td> <td style="width: 10%;"></td> <td style="width: 10%;"></td> <td style="width: 10%;"></td> <td style="width: 10%;"></td> <td style="width: 10%;"></td> <td style="width: 10%;"></td> <td style="width: 10%;"></td> </tr> <tr> <td></td> <td></td> <td colspan="8" style="text-align: center;"> <table border="1" style="width: 100%; border-collapse: collapse; text-align: center;"> <tr> <td style="width: 10%;"></td> <td style="width: 10%;"></td> <td style="width: 10%;"></td> <td style="width: 10%;"></td> <td style="width: 10%;"></td> <td style="width: 10%;"></td> <td style="width: 10%;"></td> <td style="width: 10%;"></td> <td style="width: 10%;"></td> <td style="width: 10%;"></td> </tr> <tr> <td></td> <td></td> <td colspan="8" style="text-align: center;"> <table border="1" style="width: 100%; border-collapse: collapse; text-align: center;"> <tr> </tr></table></td></tr></table></td></tr></table></td></tr></table></td></tr></table></td></tr></table></td></tr></table></td></tr></table></td></tr></table></td></tr></table></td></tr></table></td></tr></table></td></tr></table>

 | | | | | | | | | | | | | | | | | | | | <table border="1" style="width: 100%; border-collapse: collapse; text-align: center;"> <tr> <td style="width: 10%;"></td> <td style="width: 10%;"></td> <td style="width: 10%;"></td> <td style="width: 10%;"></td> <td style="width: 10%;"></td> <td style="width: 10%;"></td> <td style="width: 10%;"></td> <td style="width: 10%;"></td> <td style="width: 10%;"></td> <td style="width: 10%;"></td> </tr> <tr> <td></td> <td></td> <td colspan="8" style="text-align: center;"> <table border="1" style="width: 100%; border-collapse: collapse; text-align: center;"> <tr> <td style="width: 10%;"></td> <td style="width: 10%;"></td> <td style="width: 10%;"></td> <td style="width: 10%;"></td> <td style="width: 10%;"></td> <td style="width: 10%;"></td> <td style="width: 10%;"></td> <td style="width: 10%;"></td> <td style="width: 10%;"></td> <td style="width: 10%;"></td> </tr> <tr> <td></td> <td></td> <td colspan="8" style="text-align: center;"> <table border="1" style="width: 100%; border-collapse: collapse; text-align: center;"> <tr> <td style="width: 10%;"></td> <td style="width: 10%;"></td> <td style="width: 10%;"></td> <td style="width: 10%;"></td> <td style="width: 10%;"></td> <td style="width: 10%;"></td> <td style="width: 10%;"></td> <td style="width: 10%;"></td> <td style="width: 10%;"></td> <td style="width: 10%;"></td> </tr> <tr> <td></td> <td></td> <td colspan="8" style="text-align: center;"> <table border="1" style="width: 100%; border-collapse: collapse; text-align: center;"> <tr> <td style="width: 10%;"></td> <td style="width: 10%;"></td> <td style="width: 10%;"></td> <td style="width: 10%;"></td> <td style="width: 10%;"></td> <td style="width: 10%;"></td> <td style="width: 10%;"></td> <td style="width: 10%;"></td> <td style="width: 10%;"></td> <td style="width: 10%;"></td> </tr> <tr> <td></td> <td></td> <td colspan="8" style="text-align: center;"> <table border="1" style="width: 100%; border-collapse: collapse; text-align: center;"> <tr> <td style="width: 10%;"></td> <td style="width: 10%;"></td> <td style="width: 10%;"></td> <td style="width: 10%;"></td> <td style="width: 10%;"></td> <td style="width: 10%;"></td> <td style="width: 10%;"></td> <td style="width: 10%;"></td> <td style="width: 10%;"></td> <td style="width: 10%;"></td> </tr> <tr> <td></td> <td></td> <td colspan="8" style="text-align: center;"> <table border="1" style="width: 100%; border-collapse: collapse; text-align: center;"> <tr> <td style="width: 10%;"></td> <td style="width: 10%;"></td> <td style="width: 10%;"></td> <td style="width: 10%;"></td> <td style="width: 10%;"></td> <td style="width: 10%;"></td> <td style="width: 10%;"></td> <td style="width: 10%;"></td> <td style="width: 10%;"></td> <td style="width: 10%;"></td> </tr> <tr> <td></td> <td></td> <td colspan="8" style="text-align: center;"> <table border="1" style="width: 100%; border-collapse: collapse; text-align: center;"> <tr> <td style="width: 10%;"></td> <td style="width: 10%;"></td> <td style="width: 10%;"></td> <td style="width: 10%;"></td> <td style="width: 10%;"></td> <td style="width: 10%;"></td> <td style="width: 10%;"></td> <td style="width: 10%;"></td> <td style="width: 10%;"></td> <td style="width: 10%;"></td> </tr> <tr> <td></td> <td></td> <td colspan="8" style="text-align: center;"> <table border="1" style="width: 100%; border-collapse: collapse; text-align: center;"> <tr> <td style="width: 10%;"></td> <td style="width: 10%;"></td> <td style="width: 10%;"></td> <td style="width: 10%;"></td> <td style="width: 10%;"></td> <td style="width: 10%;"></td> <td style="width: 10%;"></td> <td style="width: 10%;"></td> <td style="width: 10%;"></td> <td style="width: 10%;"></td> </tr> <tr> <td></td> <td></td> <td colspan="8" style="text-align: center;"> <table border="1" style="width: 100%; border-collapse: collapse; text-align: center;"> <tr> <td style="width: 10%;"></td> <td style="width: 10%;"></td> <td style="width: 10%;"></td> <td style="width: 10%;"></td> <td style="width: 10%;"></td> <td style="width: 10%;"></td> <td style="width: 10%;"></td> <td style="width: 10%;"></td> <td style="width: 10%;"></td> <td style="width: 10%;"></td> </tr> <tr> <td></td> <td></td> <td colspan="8" style="text-align: center;"> <table border="1" style="width: 100%; border-collapse: collapse; text-align: center;"> <tr> <td style="width: 10%;"></td> <td style="width: 10%;"></td> <td style="width: 10%;"></td> <td style="width: 10%;"></td> <td style="width: 10%;"></td> <td style="width: 10%;"></td> <td style="width: 10%;"></td> <td style="width: 10%;"></td> <td style="width: 10%;"></td> <td style="width: 10%;"></td> </tr> <tr> <td></td> <td></td> <td colspan="8" style="text-align: center;"> <table border="1" style="width: 100%; border-collapse: collapse; text-align: center;"> <tr> <td style="width: 10%;"></td> <td style="width: 10%;"></td> <td style="width: 10%;"></td> <td style="width: 10%;"></td> <td style="width: 10%;"></td> <td style="width: 10%;"></td> <td style="width: 10%;"></td> <td style="width: 10%;"></td> <td style="width: 10%;"></td> <td style="width: 10%;"></td> </tr> <tr> <td></td> <td></td> <td colspan="8" style="text-align: center;"> <table border="1" style="width: 100%; border-collapse: collapse; text-align: center;"> <tr> </tr></table></td></tr></table></td></tr></table></td></tr></table></td></tr></table></td></tr></table></td></tr></table></td></tr></table></td></tr></table></td></tr></table></td></tr></table></td></tr></table>

 | | | | | | | | | | | | | | | | | | | | <table border="1" style="width: 100%; border-collapse: collapse; text-align: center;"> <tr> <td style="width: 10%;"></td> <td style="width: 10%;"></td> <td style="width: 10%;"></td> <td style="width: 10%;"></td> <td style="width: 10%;"></td> <td style="width: 10%;"></td> <td style="width: 10%;"></td> <td style="width: 10%;"></td> <td style="width: 10%;"></td> <td style="width: 10%;"></td> </tr> <tr> <td></td> <td></td> <td colspan="8" style="text-align: center;"> <table border="1" style="width: 100%; border-collapse: collapse; text-align: center;"> <tr> <td style="width: 10%;"></td> <td style="width: 10%;"></td> <td style="width: 10%;"></td> <td style="width: 10%;"></td> <td style="width: 10%;"></td> <td style="width: 10%;"></td> <td style="width: 10%;"></td> <td style="width: 10%;"></td> <td style="width: 10%;"></td> <td style="width: 10%;"></td> </tr> <tr> <td></td> <td></td> <td colspan="8" style="text-align: center;"> <table border="1" style="width: 100%; border-collapse: collapse; text-align: center;"> <tr> <td style="width: 10%;"></td> <td style="width: 10%;"></td> <td style="width: 10%;"></td> <td style="width: 10%;"></td> <td style="width: 10%;"></td> <td style="width: 10%;"></td> <td style="width: 10%;"></td> <td style="width: 10%;"></td> <td style="width: 10%;"></td> <td style="width: 10%;"></td> </tr> <tr> <td></td> <td></td> <td colspan="8" style="text-align: center;"> <table border="1" style="width: 100%; border-collapse: collapse; text-align: center;"> <tr> <td style="width: 10%;"></td> <td style="width: 10%;"></td> <td style="width: 10%;"></td> <td style="width: 10%;"></td> <td style="width: 10%;"></td> <td style="width: 10%;"></td> <td style="width: 10%;"></td> <td style="width: 10%;"></td> <td style="width: 10%;"></td> <td style="width: 10%;"></td> </tr> <tr> <td></td> <td></td> <td colspan="8" style="text-align: center;"> <table border="1" style="width: 100%; border-collapse: collapse; text-align: center;"> <tr> <td style="width: 10%;"></td> <td style="width: 10%;"></td> <td style="width: 10%;"></td> <td style="width: 10%;"></td> <td style="width: 10%;"></td> <td style="width: 10%;"></td> <td style="width: 10%;"></td> <td style="width: 10%;"></td> <td style="width: 10%;"></td> <td style="width: 10%;"></td> </tr> <tr> <td></td> <td></td> <td colspan="8" style="text-align: center;"> <table border="1" style="width: 100%; border-collapse: collapse; text-align: center;"> <tr> <td style="width: 10%;"></td> <td style="width: 10%;"></td> <td style="width: 10%;"></td> <td style="width: 10%;"></td> <td style="width: 10%;"></td> <td style="width: 10%;"></td> <td style="width: 10%;"></td> <td
style="width: 10%;"></td> <td style="width: 10%;"></td> <td style="width: 10%;"></td> </tr> <tr> <td></td> <td></td> <td colspan="8" style="text-align: center;"> <table border="1" style="width: 100%; border-collapse: collapse; text-align: center;"> <tr> <td style="width: 10%;"></td> <td style="width: 10%;"></td> <td style="width: 10%;"></td> <td style="width: 10%;"></td> <td style="width: 10%;"></td> <td style="width: 10%;"></td> <td style="width: 10%;"></td> <td style="width: 10%;"></td> <td style="width: 10%;"></td> <td style="width: 10%;"></td> </tr> <tr> <td></td> <td></td> <td colspan="8" style="text-align: center;"> <table border="1" style="width: 100%; border-collapse: collapse; text-align: center;"> <tr> <td style="width: 10%;"></td> <td style="width: 10%;"></td> <td style="width: 10%;"></td> <td style="width: 10%;"></td> <td style="width: 10%;"></td> <td style="width: 10%;"></td> <td style="width: 10%;"></td> <td style="width: 10%;"></td> <td style="width: 10%;"></td> <td style="width: 10%;"></td> </tr> <tr> <td></td> <td></td> <td colspan="8" style="text-align: center;"> <table border="1" style="width: 100%; border-collapse: collapse; text-align: center;"> <tr> <td style="width: 10%;"></td> <td style="width: 10%;"></td> <td style="width: 10%;"></td> <td style="width: 10%;"></td> <td style="width: 10%;"></td> <td style="width: 10%;"></td> <td style="width: 10%;"></td> <td style="width: 10%;"></td> <td style="width: 10%;"></td> <td style="width: 10%;"></td> </tr> <tr> <td></td> <td></td> <td colspan="8" style="text-align: center;"> <table border="1" style="width: 100%; border-collapse: collapse; text-align: center;"> <tr> <td style="width: 10%;"></td> <td style="width: 10%;"></td> <td style="width: 10%;"></td> <td style="width: 10%;"></td> <td style="width: 10%;"></td> <td style="width: 10%;"></td> <td style="width: 10%;"></td> <td style="width: 10%;"></td> <td style="width: 10%;"></td> <td style="width: 10%;"></td> </tr> <tr> <td></td> <td></td> <td colspan="8" style="text-align: center;"> <table border="1" style="width: 100%; border-collapse: collapse; text-align: center;"> <tr> </tr></table></td></tr></table></td></tr></table></td></tr></table></td></tr></table></td></tr></table></td></tr></table></td></tr></table></td></tr></table></td></tr></table></td></tr></table>

 | | | | | | | | | | | | | | | | | | | | <table border="1" style="width: 100%; border-collapse: collapse; text-align: center;"> <tr> <td style="width: 10%;"></td> <td style="width: 10%;"></td> <td style="width: 10%;"></td> <td style="width: 10%;"></td> <td style="width: 10%;"></td> <td style="width: 10%;"></td> <td style="width: 10%;"></td> <td style="width: 10%;"></td> <td style="width: 10%;"></td> <td style="width: 10%;"></td> </tr> <tr> <td></td> <td></td> <td colspan="8" style="text-align: center;"> <table border="1" style="width: 100%; border-collapse: collapse; text-align: center;"> <tr> <td style="width: 10%;"></td> <td style="width: 10%;"></td> <td style="width: 10%;"></td> <td style="width: 10%;"></td> <td style="width: 10%;"></td> <td style="width: 10%;"></td> <td style="width: 10%;"></td> <td style="width: 10%;"></td> <td style="width: 10%;"></td> <td style="width: 10%;"></td> </tr> <tr> <td></td> <td></td> <td colspan="8" style="text-align: center;"> <table border="1" style="width: 100%; border-collapse: collapse; text-align: center;"> <tr> <td style="width: 10%;"></td> <td style="width: 10%;"></td> <td style="width: 10%;"></td> <td style="width: 10%;"></td> <td style="width: 10%;"></td> <td style="width: 10%;"></td> <td style="width: 10%;"></td> <td style="width: 10%;"></td> <td style="width: 10%;"></td> <td style="width: 10%;"></td> </tr> <tr> <td></td> <td></td> <td colspan="8" style="text-align: center;"> <table border="1" style="width: 100%; border-collapse: collapse; text-align: center;"> <tr> <td style="width: 10%;"></td> <td style="width: 10%;"></td> <td style="width: 10%;"></td> <td style="width: 10%;"></td> <td style="width: 10%;"></td> <td style="width: 10%;"></td> <td style="width: 10%;"></td> <td style="width: 10%;"></td> <td style="width: 10%;"></td> <td style="width: 10%;"></td> </tr> <tr> <td></td> <td></td> <td colspan="8" style="text-align: center;"> <table border="1" style="width: 100%; border-collapse: collapse; text-align: center;"> <tr> <td style="width: 10%;"></td> <td style="width: 10%;"></td> <td style="width: 10%;"></td> <td style="width: 10%;"></td> <td style="width: 10%;"></td> <td style="width: 10%;"></td> <td style="width: 10%;"></td> <td style="width: 10%;"></td> <td style="width: 10%;"></td> <td style="width: 10%;"></td> </tr> <tr> <td></td> <td></td> <td colspan="8" style="text-align: center;"> <table border="1" style="width: 100%; border-collapse: collapse; text-align: center;"> <tr> <td style="width: 10%;"></td> <td style="width: 10%;"></td> <td style="width: 10%;"></td> <td style="width: 10%;"></td> <td style="width: 10%;"></td> <td style="width: 10%;"></td> <td style="width: 10%;"></td> <td style="width: 10%;"></td> <td style="width: 10%;"></td> <td style="width: 10%;"></td> </tr> <tr> <td></td> <td></td> <td colspan="8" style="text-align: center;"> <table border="1" style="width: 100%; border-collapse: collapse; text-align: center;"> <tr> <td style="width: 10%;"></td> <td style="width: 10%;"></td> <td style="width: 10%;"></td> <td style="width: 10%;"></td> <td style="width: 10%;"></td> <td style="width: 10%;"></td> <td style="width: 10%;"></td> <td style="width: 10%;"></td> <td style="width: 10%;"></td> <td style="width: 10%;"></td> </tr> <tr> <td></td> <td></td> <td colspan="8" style="text-align: center;"> <table border="1" style="width: 100%; border-collapse: collapse; text-align: center;"> <tr> <td style="width: 10%;"></td> <td style="width: 10%;"></td> <td style="width: 10%;"></td> <td style="width: 10%;"></td> <td style="width: 10%;"></td> <td style="width: 10%;"></td> <td style="width: 10%;"></td> <td style="width: 10%;"></td> <td style="width: 10%;"></td> <td style="width: 10%;"></td> </tr> <tr> <td></td> <td></td> <td colspan="8" style="text-align: center;"> <table border="1" style="width: 100%; border-collapse: collapse; text-align: center;"> <tr> <td style="width: 10%;"></td> <td style="width: 10%;"></td> <td style="width: 10%;"></td> <td style="width: 10%;"></td> <td style="width: 10%;"></td> <td style="width: 10%;"></td> <td style="width: 10%;"></td> <td style="width: 10%;"></td> <td style="width: 10%;"></td> <td style="width: 10%;"></td> </tr> <tr> <td></td> <td></td> <td colspan="8" style="text-align: center;"> <table border="1" style="width: 100%; border-collapse: collapse; text-align: center;"> <tr> </tr></table></td></tr></table></td></tr></table></td></tr></table></td></tr></table></td></tr></table></td></tr></table></td></tr></table></td></tr></table></td></tr></table>

 | | | | | | | | | | | | | | | | | | | | <table border="1" style="width: 100%; border-collapse: collapse; text-align: center;"> <tr> <td style="width: 10%;"></td> <td style="width: 10%;"></td> <td style="width: 10%;"></td> <td style="width: 10%;"></td> <td style="width: 10%;"></td> <td style="width: 10%;"></td> <td style="width: 10%;"></td> <td style="width: 10%;"></td> <td style="width: 10%;"></td> <td style="width: 10%;"></td> </tr> <tr> <td></td> <td></td> <td colspan="8" style="text-align: center;"> <table border="1" style="width: 100%; border-collapse: collapse; text-align: center;"> <tr> <td style="width: 10%;"></td> <td style="width: 10%;"></td> <td style="width: 10%;"></td> <td style="width: 10%;"></td> <td style="width: 10%;"></td> <td style="width: 10%;"></td> <td style="width: 10%;"></td> <td style="width: 10%;"></td> <td style="width: 10%;"></td> <td style="width: 10%;"></td> </tr> <tr> <td></td> <td></td> <td colspan="8" style="text-align: center;"> <table border="1" style="width: 100%; border-collapse: collapse; text-align: center;"> <tr> <td style="width: 10%;"></td> <td style="width: 10%;"></td> <td style="width: 10%;"></td> <td style="width: 10%;"></td> <td style="width: 10%;"></td> <td style="width: 10%;"></td> <td style="width: 10%;"></td> <td style="width: 10%;"></td> <td style="width:
10%;"></td> <td style="width: 10%;"></td> </tr> <tr> <td></td> <td></td> <td colspan="8" style="text-align: center;"> <table border="1" style="width: 100%; border-collapse: collapse; text-align: center;"> <tr> <td style="width: 10%;"></td> <td style="width: 10%;"></td> <td style="width: 10%;"></td> <td style="width: 10%;"></td> <td style="width: 10%;"></td> <td style="width: 10%;"></td> <td style="width: 10%;"></td> <td style="width: 10%;"></td> <td style="width: 10%;"></td> <td style="width: 10%;"></td> </tr> <tr> <td></td> <td></td> <td colspan="8" style="text-align: center;"> <table border="1" style="width: 100%; border-collapse: collapse; text-align: center;"> <tr> <td style="width: 10%;"></td> <td style="width: 10%;"></td> <td style="width: 10%;"></td> <td style="width: 10%;"></td> <td style="width: 10%;"></td> <td style="width: 10%;"></td> <td style="width: 10%;"></td> <td style="width: 10%;"></td> <td style="width: 10%;"></td> <td style="width: 10%;"></td> </tr> <tr> <td></td> <td></td> <td colspan="8" style="text-align: center;"> <table border="1" style="width: 100%; border-collapse: collapse; text-align: center;"> <tr> <td style="width: 10%;"></td> <td style="width: 10%;"></td> <td style="width: 10%;"></td> <td style="width: 10%;"></td> <td style="width: 10%;"></td> <td style="width: 10%;"></td> <td style="width: 10%;"></td> <td style="width: 10%;"></td> <td style="width: 10%;"></td> <td style="width: 10%;"></td> </tr> <tr> <td></td> <td></td> <td colspan="8" style="text-align: center;"> <table border="1" style="width: 100%; border-collapse: collapse; text-align: center;"> <tr> <td style="width: 10%;"></td> <td style="width: 10%;"></td> <td style="width: 10%;"></td> <td style="width: 10%;"></td> <td style="width: 10%;"></td> <td style="width: 10%;"></td> <td style="width: 10%;"></td> <td style="width: 10%;"></td> <td style="width: 10%;"></td> <td style="width: 10%;"></td> </tr> <tr> <td></td> <td></td> <td colspan="8" style="text-align: center;"> <table border="1" style="width: 100%; border-collapse: collapse; text-align: center;"> <tr> <td style="width: 10%;"></td> <td style="width: 10%;"></td> <td style="width: 10%;"></td> <td style="width: 10%;"></td> <td style="width: 10%;"></td> <td style="width: 10%;"></td> <td style="width: 10%;"></td> <td style="width: 10%;"></td> <td style="width: 10%;"></td> <td style="width: 10%;"></td> </tr> <tr> <td></td> <td></td> <td colspan="8" style="text-align: center;"> <table border="1" style="width: 100%; border-collapse: collapse; text-align: center;"> <tr> </tr></table></td></tr></table></td></tr></table></td></tr></table></td></tr></table></td></tr></table></td></tr></table></td></tr></table></td></tr></table>

 | | | | | | | | | | | | | | | | | | | | <table border="1" style="width: 100%; border-collapse: collapse; text-align: center;"> <tr> <td style="width: 10%;"></td> <td style="width: 10%;"></td> <td style="width: 10%;"></td> <td style="width: 10%;"></td> <td style="width: 10%;"></td> <td style="width: 10%;"></td> <td style="width: 10%;"></td> <td style="width: 10%;"></td> <td style="width: 10%;"></td> <td style="width: 10%;"></td> </tr> <tr> <td></td> <td></td> <td colspan="8" style="text-align: center;"> <table border="1" style="width: 100%; border-collapse: collapse; text-align: center;"> <tr> <td style="width: 10%;"></td> <td style="width: 10%;"></td> <td style="width: 10%;"></td> <td style="width: 10%;"></td> <td style="width: 10%;"></td> <td style="width: 10%;"></td> <td style="width: 10%;"></td> <td style="width: 10%;"></td> <td style="width: 10%;"></td> <td style="width: 10%;"></td> </tr> <tr> <td></td> <td></td> <td colspan="8" style="text-align: center;"> <table border="1" style="width: 100%; border-collapse: collapse; text-align: center;"> <tr> <td style="width: 10%;"></td> <td style="width: 10%;"></td> <td style="width: 10%;"></td> <td style="width: 10%;"></td> <td style="width: 10%;"></td> <td style="width: 10%;"></td> <td style="width: 10%;"></td> <td style="width: 10%;"></td> <td style="width: 10%;"></td> <td style="width: 10%;"></td> </tr> <tr> <td></td> <td></td> <td colspan="8" style="text-align: center;"> <table border="1" style="width: 100%; border-collapse: collapse; text-align: center;"> <tr> <td style="width: 10%;"></td> <td style="width: 10%;"></td> <td style="width: 10%;"></td> <td style="width: 10%;"></td> <td style="width: 10%;"></td> <td style="width: 10%;"></td> <td style="width: 10%;"></td> <td style="width: 10%;"></td> <td style="width: 10%;"></td> <td style="width: 10%;"></td> </tr> <tr> <td></td> <td></td> <td colspan="8" style="text-align: center;"> <table border="1" style="width: 100%; border-collapse: collapse; text-align: center;"> <tr> <td style="width: 10%;"></td> <td style="width: 10%;"></td> <td style="width: 10%;"></td> <td style="width: 10%;"></td> <td style="width: 10%;"></td> <td style="width: 10%;"></td> <td style="width: 10%;"></td> <td style="width: 10%;"></td> <td style="width: 10%;"></td> <td style="width: 10%;"></td> </tr> <tr> <td></td> <td></td> <td colspan="8" style="text-align: center;"> <table border="1" style="width: 100%; border-collapse: collapse; text-align: center;"> <tr> <td style="width: 10%;"></td> <td style="width: 10%;"></td> <td style="width: 10%;"></td> <td style="width: 10%;"></td> <td style="width: 10%;"></td> <td style="width: 10%;"></td> <td style="width: 10%;"></td> <td style="width: 10%;"></td> <td style="width: 10%;"></td> <td style="width: 10%;"></td> </tr> <tr> <td></td> <td></td> <td colspan="8" style="text-align: center;"> <table border="1" style="width: 100%; border-collapse: collapse; text-align: center;"> <tr> <td style="width: 10%;"></td> <td style="width: 10%;"></td> <td style="width: 10%;"></td> <td style="width: 10%;"></td> <td style="width: 10%;"></td> <td style="width: 10%;"></td> <td style="width: 10%;"></td> <td style="width: 10%;"></td> <td style="width: 10%;"></td> <td style="width: 10%;"></td> </tr> <tr> <td></td> <td></td> <td colspan="8" style="text-align: center;"> <table border="1" style="width: 100%; border-collapse: collapse; text-align: center;"> <tr> </tr></table></td></tr></table></td></tr></table></td></tr></table></td></tr></table></td></tr></table></td></tr></table></td></tr></table>

 | | | | | | | | | | | | | | | | | | | | <table border="1" style="width: 100%; border-collapse: collapse; text-align: center;"> <tr> <td style="width: 10%;"></td> <td style="width: 10%;"></td> <td style="width: 10%;"></td> <td style="width: 10%;"></td> <td style="width: 10%;"></td> <td style="width: 10%;"></td> <td style="width: 10%;"></td> <td style="width: 10%;"></td> <td style="width: 10%;"></td> <td style="width: 10%;"></td> </tr> <tr> <td></td> <td></td> <td colspan="8" style="text-align: center;"> <table border="1" style="width: 100%; border-collapse: collapse; text-align: center;"> <tr> <td style="width: 10%;"></td> <td style="width: 10%;"></td> <td style="width: 10%;"></td> <td style="width: 10%;"></td> <td style="width: 10%;"></td> <td style="width: 10%;"></td> <td style="width: 10%;"></td> <td style="width: 10%;"></td> <td style="width: 10%;"></td> <td style="width: 10%;"></td> </tr> <tr> <td></td> <td></td> <td colspan="8" style="text-align: center;"> <table border="1" style="width: 100%; border-collapse: collapse; text-align: center;"> <tr> <td style="width: 10%;"></td> <td style="width: 10%;"></td> <td style="width: 10%;"></td> <td style="width: 10%;"></td> <td style="width: 10%;"></td> <td style="width: 10%;"></td> <td style="width: 10%;"></td> <td style="width: 10%;"></td> <td style="width: 10%;"></td> <td style="width: 10%;"></td> </tr> <tr> <td></td> <td></td> <td colspan="8" style="text-align: center;"> <table border="1" style="width: 100%; border-collapse: collapse; text-align: center;"> <tr> <td style="width: 10%;"></td> <td style="width: 10%;"></td> <td style="width: 10%;"></td> <td style="width: 10%;"></td> <td style="width: 10%;"></td> <td style="width: 10%;"></td> <td style="width: 10%;"></td> <td style="width: 10%;"></td> <td style="width: 10%;"></td> <td style="width: 10%;"></td> </tr> <tr> <td></td> <td></td> <td colspan="8" style="text-align:
center;"> <table border="1" style="width: 100%; border-collapse: collapse; text-align: center;"> <tr> <td style="width: 10%;"></td> <td style="width: 10%;"></td> <td style="width: 10%;"></td> <td style="width: 10%;"></td> <td style="width: 10%;"></td> <td style="width: 10%;"></td> <td style="width: 10%;"></td> <td style="width: 10%;"></td> <td style="width: 10%;"></td> <td style="width: 10%;"></td> </tr> <tr> <td></td> <td></td> <td colspan="8" style="text-align: center;"> <table border="1" style="width: 100%; border-collapse: collapse; text-align: center;"> <tr> <td style="width: 10%;"></td> <td style="width: 10%;"></td> <td style="width: 10%;"></td> <td style="width: 10%;"></td> <td style="width: 10%;"></td> <td style="width: 10%;"></td> <td style="width: 10%;"></td> <td style="width: 10%;"></td> <td style="width: 10%;"></td> <td style="width: 10%;"></td> </tr> <tr> <td></td> <td></td> <td colspan="8" style="text-align: center;"> <table border="1" style="width: 100%; border-collapse: collapse; text-align: center;"> <tr> </tr></table></td></tr></table></td></tr></table></td></tr></table></td></tr></table></td></tr></table></td></tr></table>

 | | | | | | | | | | | | | | | | | | | | <table border="1" style="width: 100%; border-collapse: collapse; text-align: center;"> <tr> <td style="width: 10%;"></td> <td style="width: 10%;"></td> <td style="width: 10%;"></td> <td style="width: 10%;"></td> <td style="width: 10%;"></td> <td style="width: 10%;"></td> <td style="width: 10%;"></td> <td style="width: 10%;"></td> <td style="width: 10%;"></td> <td style="width: 10%;"></td> </tr> <tr> <td></td> <td></td> <td colspan="8" style="text-align: center;"> <table border="1" style="width: 100%; border-collapse: collapse; text-align: center;"> <tr> <td style="width: 10%;"></td> <td style="width: 10%;"></td> <td style="width: 10%;"></td> <td style="width: 10%;"></td> <td style="width: 10%;"></td> <td style="width: 10%;"></td> <td style="width: 10%;"></td> <td style="width: 10%;"></td> <td style="width: 10%;"></td> <td style="width: 10%;"></td> </tr> <tr> <td></td> <td></td> <td colspan="8" style="text-align: center;"> <table border="1" style="width: 100%; border-collapse: collapse; text-align: center;"> <tr> <td style="width: 10%;"></td> <td style="width: 10%;"></td> <td style="width: 10%;"></td> <td style="width: 10%;"></td> <td style="width: 10%;"></td> <td style="width: 10%;"></td> <td style="width: 10%;"></td> <td style="width: 10%;"></td> <td style="width: 10%;"></td> <td style="width: 10%;"></td> </tr> <tr> <td></td> <td></td> <td colspan="8" style="text-align: center;"> <table border="1" style="width: 100%; border-collapse: collapse; text-align: center;"> <tr> <td style="width: 10%;"></td> <td style="width: 10%;"></td> <td style="width: 10%;"></td> <td style="width: 10%;"></td> <td style="width: 10%;"></td> <td style="width: 10%;"></td> <td style="width: 10%;"></td> <td style="width: 10%;"></td> <td style="width: 10%;"></td> <td style="width: 10%;"></td> </tr> <tr> <td></td> <td></td> <td colspan="8" style="text-align: center;"> <table border="1" style="width: 100%; border-collapse: collapse; text-align: center;"> <tr> <td style="width: 10%;"></td> <td style="width: 10%;"></td> <td style="width: 10%;"></td> <td style="width: 10%;"></td> <td style="width: 10%;"></td> <td style="width: 10%;"></td> <td style="width: 10%;"></td> <td style="width: 10%;"></td> <td style="width: 10%;"></td> <td style="width: 10%;"></td> </tr> <tr> <td></td> <td></td> <td colspan="8" style="text-align: center;"> <table border="1" style="width: 100%; border-collapse: collapse; text-align: center;"> <tr> </tr></table></td></tr></table></td></tr></table></td></tr></table></td></tr></table></td></tr></table>

 | | | | | | | | | | | | | | | | | | | | <table border="1" style="width: 100%; border-collapse: collapse; text-align: center;"> <tr> <td style="width: 10%;"></td> <td style="width: 10%;"></td> <td style="width: 10%;"></td> <td style="width: 10%;"></td> <td style="width: 10%;"></td> <td style="width: 10%;"></td> <td style="width: 10%;"></td> <td style="width: 10%;"></td> <td style="width: 10%;"></td> <td style="width: 10%;"></td> </tr> <tr> <td></td> <td></td> <td colspan="8" style="text-align: center;"> <table border="1" style="width: 100%; border-collapse: collapse; text-align: center;"> <tr> <td style="width: 10%;"></td> <td style="width: 10%;"></td> <td style="width: 10%;"></td> <td style="width: 10%;"></td> <td style="width: 10%;"></td> <td style="width: 10%;"></td> <td style="width: 10%;"></td> <td style="width: 10%;"></td> <td style="width: 10%;"></td> <td style="width: 10%;"></td> </tr> <tr> <td></td> <td></td> <td colspan="8" style="text-align: center;"> <table border="1" style="width: 100%; border-collapse: collapse; text-align: center;"> <tr> <td style="width: 10%;"></td> <td style="width: 10%;"></td> <td style="width: 10%;"></td> <td style="width: 10%;"></td> <td style="width: 10%;"></td> <td style="width: 10%;"></td> <td style="width: 10%;"></td> <td style="width: 10%;"></td> <td style="width: 10%;"></td> <td style="width: 10%;"></td> </tr> <tr> <td></td> <td></td> <td colspan="8" style="text-align: center;"> <table border="1" style="width: 100%; border-collapse: collapse; text-align: center;"> <tr> <td style="width: 10%;"></td> <td style="width: 10%;"></td> <td style="width: 10%;"></td> <td style="width: 10%;"></td> <td style="width: 10%;"></td> <td style="width: 10%;"></td> <td style="width: 10%;"></td> <td style="width: 10%;"></td> <td style="width: 10%;"></td> <td style="width: 10%;"></td> </tr> <tr> <td></td> <td></td> <td colspan="8" style="text-align: center;"> <table border="1" style="width: 100%; border-collapse: collapse; text-align: center;"> <tr> </tr></table></td></tr></table></td></tr></table></td></tr></table></td></tr></table>

 | | | | | | | | | | | | | | | | | | | | <table border="1" style="width: 100%; border-collapse: collapse; text-align: center;"> <tr> <td style="width: 10%;"></td> <td style="width: 10%;"></td> <td style="width: 10%;"></td> <td style="width: 10%;"></td> <td style="width: 10%;"></td> <td style="width: 10%;"></td> <td style="width: 10%;"></td> <td style="width: 10%;"></td> <td style="width: 10%;"></td> <td style="width: 10%;"></td> </tr> <tr> <td></td> <td></td> <td colspan="8" style="text-align: center;"> <table border="1" style="width: 100%; border-collapse: collapse; text-align: center;"> <tr> <td style="width: 10%;"></td> <td style="width: 10%;"></td> <td style="width: 10%;"></td> <td style="width: 10%;"></td> <td style="width: 10%;"></td> <td style="width: 10%;"></td> <td style="width: 10%;"></td> <td style="width: 10%;"></td> <td style="width: 10%;"></td> <td style="width: 10%;"></td> </tr> <tr> <td></td> <td></td> <td colspan="8" style="text-align: center;"> <table border="1" style="width: 100%; border-collapse: collapse; text-align: center;"> <tr> <td style="width: 10%;"></td> <td style="width: 10%;"></td> <td style="width: 10%;"></td> <td style="width: 10%;"></td> <td style="width: 10%;"></td> <td style="width: 10%;"></td> <td style="width: 10%;"></td> <td style="width: 10%;"></td> <td style="width: 10%;"></td> <td style="width: 10%;"></td> </tr> <tr> <td></td> <td></td> <td colspan="8"
style="text-align: center;"> <table border="1" style="width: 100%; border-collapse: collapse; text-align: center;"> <tr> </tr></table></td></tr></table></td></tr></table></td></tr></table>

 | | | | | | | | | | | | | | | | | | | | <table border="1" style="width: 100%; border-collapse: collapse; text-align: center;"> <tr> <td style="width: 10%;"></td> <td style="width: 10%;"></td> <td style="width: 10%;"></td> <td style="width: 10%;"></td> <td style="width: 10%;"></td> <td style="width: 10%;"></td> <td style="width: 10%;"></td> <td style="width: 10%;"></td> <td style="width: 10%;"></td> <td style="width: 10%;"></td> </tr> <tr> <td></td> <td></td> <td colspan="8" style="text-align: center;"> <table border="1" style="width: 100%; border-collapse: collapse; text-align: center;"> <tr> <td style="width: 10%;"></td> <td style="width: 10%;"></td> <td style="width: 10%;"></td> <td style="width: 10%;"></td> <td style="width: 10%;"></td> <td style="width: 10%;"></td> <td style="width: 10%;"></td> <td style="width: 10%;"></td> <td style="width: 10%;"></td> <td style="width: 10%;"></td> </tr> <tr> <td></td> <td></td> <td colspan="8" style="text-align: center;"> <table border="1" style="width: 100%; border-collapse: collapse; text-align: center;"> <tr> </tr></table></td></tr></table></td></tr></table>

 | | | | | | | | | | | | | | | | | | | | <table border="1" style="width: 100%; border-collapse: collapse; text-align: center;"> <tr> <td style="width: 10%;"></td> <td style="width: 10%;"></td> <td style="width: 10%;"></td> <td style="width: 10%;"></td> <td style="width: 10%;"></td> <td style="width: 10%;"></td> <td style="width: 10%;"></td> <td style="width: 10%;"></td> <td style="width: 10%;"></td> <td style="width: 10%;"></td> </tr> <tr> <td></td> <td></td> <td colspan="8" style="text-align: center;"> <table border="1" style="width: 100%; border-collapse: collapse; text-align: center;"> <tr> </tr></table></td></tr></table>

 | | | | | | | | | | | | | | | | | | | | <table border="1" style="width: 100%; border-collapse: collapse; text-align: center;"> <tr> </tr></table>

 | | | | | | | | | | | | | | | | | | | |

 | | | | | | | | | | | | | | | | | | | |

 | | | | | | | | | | | | | | | | | | | |

 | | | | | | | | | | | | | | | | | | | |

 | | | | | | | | | | | | | | | | | | | |

 | | | | | | | | | | | | | | | | | | | |

 | | | | | | | | | | | | | | | | | | | |
 | | | | | | | | | | | | | | | | | | | |

 | | | | | | | | | | | | | | | | | | | |

 | | | | | | | | | | | | | | | | | | | |
 | | | | | | | | | | | | | | | | | | | |

 | | | | | | | | | | | | | | | | | | | |

 | | | | | | | | | | | | | | | | | | | |
 | | | | | | | | | | | | | | | | | | | |
 | | | | | | | | | | | | | | | | | | | |

 | | | | | | | | | | | | | | | | | | | |
 | | | | | | | | | | | | | | | | | | | |
 | | | | | | | | | | | | | | | | | | | |

 | | | | | | | | | | | | | | | | | | | | | | | | | | | | | | | | | | | | | | | | | | | | | | | | | | | | | | | | | | | | | | | | | | | | | | | | | | | | | | | | | | | | | | | | | | | | | | | | | | | |
 | | | | | | | | | | | | | | | | | | | |
 | | | | | | | | | | | | | | | | | | | |
 | | | | | | | | | | | | | | | | | | | |
 | | | | | | | | | | | | | | | | | | | |
 | | | | | | | | | | | | | | | | | | | |
 | | | | | | | | | | | | | | | | | | | |
 | | | | | | | | | | | | | | | | | | | |
 | | | | | | | | | | | | | | | | | | | |
 | | | | | | | | | | | | | | | | | | | | | | | | | | | | | | | | | | | | | | | |
 | | | | | | | | | | | | | | | | | | | |
 | | | | | | | | | | | | | | | | | | | | | | | | | | | | | | | | | | | | | | | |
 | | | | | | | | | | | | | | | | | | | | | | | | | | | | | | | | | | | | | | | |
 | | | | | | | | | | | | | | | | | | | | | | | | | | | | | | | | | | | | | | | |
 | | | | | | | | | | | | | | | | | | | | | | | | | | | | | | | | | | | | | | | | | | | | | | | | | | | | | | | | | | | | | | | | | | | | | | | | | | | | | | | | | | | | | | | | | | | | | | | | | | | |
 | | | | | | | | | | | | | | | | | | | | | | | | | | | | | | | | | | | | | | | | | | | | | | | |
| | |

 | | | | | | | | | | | | | | | | | | | |

 | | | | | | | | | | | | | | | | | | | |

 | | | | | | | | | | | | | | | | | | | |

 | | | | | | | | | | | | | | | | | | | |

 | | | | | | | | | | | | | | | | | | | |

 | | | | | | | | | | | | | | | | | | | |

 | | | | | | | | | | | | | | | | | | | |

 | | | | | | | | | | | | | | | | | | | |

 | | | | | | | | | | | | | | | | | | | |

 | | | | | | | | | | | | | | | | | | | |

 | | | | | | | | | | | | | | | | | | | |

 | | | | | | | | | | | | | | | | | | | |

 | | | | | | | | | | | | | | | | | | | |

 | | | | | | | | | | | | | | | | | | | |

 | | | | | | | | | | | | | | | | | | | |

 | | | | | | | | | | | | | | | | | | | |

 | | | | | | | | | | | | | | | | | | | |

 | | | | | | | | | | | | | | | | | | | |

 | | | | | | | | | | | | | | | | | | | |

 | | | | | | | | | | | | | | | | | | | |

 | | | | | | | | | | | | | | | | | | | |

 | | | | | | | | | | | | | | | | | | | |

 | | | | | | | | | | | | | | | | | | | |

 | | | | | | | | | | | | | | | | | | | |

 | | | | | | | | | | | | | | | | | | | |

 | | | | | | | | | | | | | | | | | | | |

 | | | | | | | | | | | | | | | | | | | |

 | | | | | | | | | | | | | | | | | | | |
 | | | | | | | | | | | | | | | | | | | |

 | | | | | | | | | | | | | | | | | | | |

 | | | | | | | | | | | | | | | | | | | |
 | | | | | | | | | | | | | | | | | | | |

 | | | | | | | | | | | | | | | | | | | |

 | | | | | | | | | | | | | | | | | | | |
 | | | | | | | | | | | | | | | | | | | |
 | | | | | | | | | | | | | | | | | | | |

 | | | | | | | | | | | | | | | | | | | |
 | | | | | | | | | | | | | | | | | | | |
 | | | | | | | | | | | | | | | | | | | |

 | | | | | | | | | | | | | | | | | | | | | | | | | | | | | | | | | | | | | | | | | | | | | | | | | | | | | | | | | | | | | | | | | | | | | | | | | | | | | | | | | | | | | | | | | | | | | | | | | | | |
 | | | | | | | | | | | | | | | | | | | |
 | | | | | | | | | | | | | | | | | | | |
 | | | | | | | | | | | | | | | | | | | |
 | | | | | | | | | | | | | | | | | | | |
 | | | | | | | | | | | | | | | | | | | |
 | | | | | | | | | | | | | | | | | | | |
 | | | | | | | | | | | | | | | | | | | |
 | | | | | | | | | | | | | | | | | | | |
 | | | | | | | | | | | | | | | | | | | | | | | | | | | | | | | | | | | | | | | |
 | | | | | | | | | | | | | | | | | | | |
 | | | | | | | | | | | | | | | | | | | | | | | | | | | | | | | | | | | | | | | |
 | | | | | | | | | | | | | | | | | | | | | | | | | | | | | | | | | | | | | | | |
 | | | | | | | | | | | | | | | | | | | | | | | | | | | | | | | | | | | | | | | |
 | | | | | | | | | | | | | | | | | | | | | | | | | | | | | | | | | | | | | | | | | | | | | | | | | | | | | | | | | | | | | | | | | | | | | | | | | | | | | | | | | | | | | | | | | | | | | | | | | | | |
 | | | | | | | | | | | | | | | | | | | | | | | | | | | | | | | | | | | | | | | | | | | | | | | |
| | | <table border="1" style="width: 100%; border-collapse: collapse; text-align: center;"> <tr> <td style="width: 10%;"></td> <td style="width: 10%;"></td> <td style="width: 10%;"></td> <td style="width: 10%;"></td> <td style="width: 10%;"></td> <td style="width: 10%;"></td> <td style="width: 10%;"></td> <td style="width: 10%;"></td> <td style="width: 10%;"></td> <td style="width: 10%;"></td> </tr> <tr> <td></td> <td></td> <td colspan="8" style="text-align: center;"> <table border="1" style="width: 100%; border-collapse: collapse; text-align: center;"> <tr> <td style="width: 10%;"></td> <td style="width: 10%;"></td> <td style="width: 10%;"></td> <td style="width: 10%;"></td> <td style="width: 10%;"></td> <td style="width: 10%;"></td> <td style="width: 10%;"></td> <td style="width: 10%;"></td> <td style="width: 10%;"></td> <td style="width: 10%;"></td> </tr> <tr> <td></td> <td></td> <td colspan="8" style="text-align: center;"> <table border="1" style="width: 100%; border-collapse: collapse; text-align: center;"> <tr> <td style="width: 10%;"></td> <td style="width: 10%;"></td> <td style="width: 10%;"></td> <td style="width: 10%;"></td> <td style="width: 10%;"></td> <td style="width: 10%;"></td> <td style="width: 10%;"></td> <td style="width: 10%;"></td> <td style="width: 10%;"></td> <td style="width: 10%;"></td> </tr> <tr> <td></td> <td></td> <td colspan="8" style="text-align: center;"> <table border="1" style="width: 100%; border-collapse: collapse; text-align: center;"> <tr> <td style="width: 10%;"></td> <td style="width: 10%;"></td> <td style="width: 10%;"></td> <td style="width: 10%;"></td> <td style="width: 10%;"></td> <td style="width: 10%;"></td> <td style="width: 10%;"></td> <td style="width: 10%;"></td> <td style="width: 10%;"></td> <td style="width: 10%;"></td> </tr> <tr> <td></td> <td></td> <td colspan="8" style="text-align: center;"> <table border="1" style="width: 100%; border-collapse: collapse; text-align: center;"> <tr> <td style="width: 10%;"></td> <td style="width: 10%;"></td> <td style="width: 10%;"></td> <td style="width: 10%;"></td> <td style="width: 10%;"></td> <td style="width: 10%;"></td> <td style="width: 10%;"></td> <td style="width: 10%;"></td> <td style="width: 10%;"></td> <td style="width: 10%;"></td> </tr> <tr> <td></td> <td></td> <td colspan="8" style="text-align: center;"> <table border="1" style="width: 100%; border-collapse: collapse; text-align: center;"> <tr> <td style="width: 10%;"></td> <td style="width: 10%;"></td> <td style="width: 10%;"></td> <td style="width: 10%;"></td> <td style="width: 10%;"></td> <td style="width: 10%;"></td> <td style="width: 10%;"></td> <td style="width: 10%;"></td> <td style="width: 10%;"></td> <td style="width: 10%;"></td> </tr> <tr> <td></td> <td></td> <td colspan="8" style="text-align: center;"> <table border="1" style="width: 100%; border-collapse: collapse; text-align: center;"> <tr> <td style="width: 10%;"></td> <td style="width: 10%;"></td> <td style="width: 10%;"></td> <td style="width: 10%;"></td> <td style="width: 10%;"></td> <td style="width: 10%;"></td> <td style="width: 10%;"></td> <td style="width: 10%;"></td> <td style="width: 10%;"></td> <td style="width: 10%;"></td> </tr> <tr> <td></td> <td></td> <td colspan="8" style="text-align: center;"> <table border="1" style="width: 100%; border-collapse: collapse; text-align: center;"> <tr> <td style="width: 10%;"></td> <td style="width: 10%;"></td> <td style="width: 10%;"></td> <td style="width: 10%;"></td> <td style="width: 10%;"></td> <td style="width: 10%;"></td> <td style="width: 10%;"></td> <td style="width: 10%;"></td> <td style="width: 10%;"></td> <td style="width: 10%;"></td> </tr> <tr> <td></td> <td></td> <td colspan="8" style="text-align: center;"> <table border="1" style="width: 100%; border-collapse: collapse; text-align: center;"> <tr> <td style="width: 10%;"></td> <td style="width: 10%;"></td> <td style="width: 10%;"></td> <td style="width: 10%;"></td> <td style="width: 10%;"></td> <td style="width: 10%;"></td> <td style="width: 10%;"></td> <td style="width: 10%;"></td> <td style="width: 10%;"></td> <td style="width: 10%;"></td> </tr> <tr> <td></td> <td></td> <td colspan="8" style="text-align: center;"> <table border="1" style="width: 100%; border-collapse: collapse; text-align: center;"> <tr> <td style="width: 10%;"></td> <td style="width: 10%;"></td> <td style="width: 10%;"></td> <td style="width: 10%;"></td> <td style="width: 10%;"></td> <td style="width: 10%;"></td> <td style="width: 10%;"></td> <td style="width: 10%;"></td> <td style="width: 10%;"></td> <td style="width: 10%;"></td> </tr> <tr> <td></td> <td></td> <td colspan="8" style="text-align: center;"> <table border="1" style="width: 100%; border-collapse: collapse; text-align: center;"> <tr> <td style="width: 10%;"></td> <td style="width: 10%;"></td> <td style="width: 10%;"></td> <td style="width: 10%;"></td> <td style="width: 10%;"></td> <td style="width: 10%;"></td> <td style="width: 10%;"></td> <td style="width: 10%;"></td> <td style="width: 10%;"></td> <td style="width: 10%;"></td> </tr> <tr> <td></td> <td></td> <td colspan="8" style="text-align: center;"> <table border="1" style="width: 100%; border-collapse: collapse; text-align: center;"> <tr> <td style="width: 10%;"></td> <td style="width: 10%;"></td> <td style="width: 10%;"></td> <td style="width: 10%;"></td> <td style="width: 10%;"></td> <td style="width: 10%;"></td> <td style="width: 10%;"></td> <td style="width: 10%;"></td> <td style="width: 10%;"></td> <td style="width: 10%;"></td> </tr> <tr> <td></td> <td></td> <td colspan="8" style="text-align: center;"> <table border="1" style="width: 100%; border-collapse: collapse; text-align: center;"> <tr> <td style="width: 10%;"></td> <td style="width: 10%;"></td> <td style="width: 10%;"></td> <td style="width: 10%;"></td> <td style="width: 10%;"></td> <td style="width: 10%;"></td> <td style="width: 10%;"></td> <td style="width: 10%;"></td> <td style="width: 10%;"></td> <td style="width: 10%;"></td> </tr> <tr> <td></td> <td></td> <td colspan="8" style="text-align: center;"> <table border="1" style="width: 100%; border-collapse: collapse; text-align: center;"> <tr> <td style="width: 10%;"></td> <td style="width: 10%;"></td> <td style="width: 10%;"></td> <td style="width: 10%;"></td> <td style="width: 10%;"></td> <td style="width: 10%;"></td> <td style="width: 10%;"></td> <td style="width: 10%;"></td> <td style="width: 10%;"></td> <td style="width: 10%;"></td> </tr> <tr> <td></td> <td></td> <td colspan="8" style="text-align: center;"> <table border="1" style="width: 100%; border-collapse: collapse; text-align: center;"> <tr> <td style="width: 10%;"></td> <td style="width: 10%;"></td> <td style="width: 10%;"></td> <td style="width: 10%;"></td> <td style="width: 10%;"></td> <td style="width: 10%;"></td> <td style="width: 10%;"></td> <td style="width: 10%;"></td> <td style="width: 10%;"></td> <td style="width: 10%;"></td> </tr> <tr> <td></td> <td></td> <td colspan="8" style="text-align: center;"> <table border="1" style="width: 100%; border-collapse: collapse; text-align: center;"> <tr> <td style="width: 10%;"></td> <td style="width: 10%;"></td> <td style="width: 10%;"></td> <td style="width: 10%;"></td> <td style="width: 10%;"></td> <td style="width: 10%;"></td> <td style="width: 10%;"></td> <td style="width: 10%;"></td> <td style="width: 10%;"></td> <td style="width: 10%;"></td> </tr> <tr> <td></td> <td></td> <td colspan="8" style="text-align: center;"> <table border="1" style="width: 100%; border-collapse: collapse; text-align: center;"> <tr> <td style="width: 10%;"></td> <td style="width: 10%;"></td> <td style="width: 10%;"></td> <td style="width: 10%;"></td> <td style="width: 10%;"></td> <td style="width: 10%;"></td> <td style="width: 10%;"></td> <td style="width: 10%;"></td> <td style="width: 10%;"></td> <td style="width: 10%;"></td> </tr> <tr> <td></td> <td></td> <td colspan="8" style="text-align: center;"> <table border="1" style="width: 100%; border-collapse: collapse; text-align: center;"> <tr> <td style="width: 10%;"></td> <td style="width: 10%;"></td> <td style="width: 10%;"></td> <td style="width: 10%;"></td> <td style="width: 10%;"></td> <td style="width: 10%;"></td> <td style="width: 10%;"></td> <td style="width: 10%;"></td> <td style="width: 10%;"></td> <td style="width: 10%;"></td> </tr> <tr> <td></td> <td></td> <td colspan="8" style="text-align: center;"> <table border="1" style="width: 100%; border-collapse: collapse; text-align: center;"> <tr> <td style="width: 10%;"></td> <td style="width: 10%;"></td> <td style="width: 10%;"></td> <td style="width: 10%;"></td> <td style="width: 10%;"></td> <td style="width: 10%;"></td> <td style="width: 10%;"></td> <td style="width: 10%;"></td> <td style="width: 10%;"></td> <td style="width: 10%;"></td> </tr> <tr> <td></td> <td></td> <td colspan="8" style="text-align: center;"> <table border="1" style="width: 100%; border-collapse: collapse; text-align: center;"> <tr> <td style="width: 10%;"></td> <td style="width: 10%;"></td> <td style="width: 10%;"></td> <td style="width: 10%;"></td> <td style="width: 10%;"></td> <td style="width: 10%;"></td> <td style="width: 10%;"></td> <td style="width: 10%;"></td> <td style="width: 10%;"></td> <td style="width: 10%;"></td> </tr> <tr> <td></td> <td></td> <td colspan="8" style="text-align: center;"> <table border="1" style="width: 100%; border-collapse: collapse; text-align: center;"> <tr> </tr></table></td></tr></table></td></tr></table></td></tr></table></td></tr></table></td></tr></table></td></tr></table></td></tr></table></td></tr></table></td></tr></table></td></tr></table></td></tr></table></td></tr></table></td></tr></table></td></tr></table></td></tr></table></td></tr></table></td></tr></table></td></tr></table></td></tr></table></td></tr></table>

 | | | | | | | | | | | | | | | | | | | | <table border="1" style="width: 100%; border-collapse: collapse; text-align: center;"> <tr> <td style="width: 10%;"></td> <td style="width: 10%;"></td> <td style="width: 10%;"></td> <td style="width: 10%;"></td> <td style="width: 10%;"></td> <td style="width: 10%;"></td> <td style="width: 10%;"></td> <td style="width: 10%;"></td> <td style="width: 10%;"></td> <td style="width: 10%;"></td> </tr> <tr> <td></td> <td></td> <td colspan="8" style="text-align: center;"> <table border="1" style="width: 100%; border-collapse: collapse; text-align: center;"> <tr> <td style="width: 10%;"></td> <td style="width: 10%;"></td> <td style="width: 10%;"></td> <td style="width: 10%;"></td> <td style="width: 10%;"></td> <td style="width: 10%;"></td> <td style="width: 10%;"></td> <td style="width: 10%;"></td> <td style="width: 10%;"></td> <td style="width: 10%;"></td> </tr> <tr> <td></td> <td></td> <td colspan="8" style="text-align: center;"> <table border="1" style="width: 100%; border-collapse: collapse; text-align: center;"> <tr> <td style="width: 10%;"></td> <td style="width: 10%;"></td> <td style="width: 10%;"></td> <td style="width: 10%;"></td> <td style="width: 10%;"></td> <td style="width: 10%;"></td> <td style="width: 10%;"></td> <td style="width: 10%;"></td> <td style="width: 10%;"></td> <td style="width: 10%;"></td> </tr> <tr> <td></td> <td></td> <td colspan="8" style="text-align: center;"> <table border="1" style="width: 100%; border-collapse: collapse; text-align: center;"> <tr> <td style="width: 10%;"></td> <td style="width: 10%;"></td> <td style="width: 10%;"></td> <td style="width: 10%;"></td> <td style="width: 10%;"></td> <td style="width: 10%;"></td> <td style="width: 10%;"></td> <td style="width: 10%;"></td> <td style="width: 10%;"></td> <td style="width: 10%;"></td> </tr> <tr> <td></td> <td></td> <td colspan="8" style="text-align: center;"> <table border="1" style="width: 100%; border-collapse: collapse; text-align: center;"> <tr> <td style="width: 10%;"></td> <td style="width: 10%;"></td> <td style="width: 10%;"></td> <td style="width: 10%;"></td> <td style="width: 10%;"></td> <td style="width: 10%;"></td> <td style="width: 10%;"></td> <td style="width: 10%;"></td> <td style="width: 10%;"></td> <td style="width: 10%;"></td> </tr> <tr> <td></td> <td></td> <td colspan="8" style="text-align: center;"> <table border="1" style="width: 100%; border-collapse: collapse; text-align: center;"> <tr> <td style="width: 10%;"></td> <td style="width: 10%;"></td> <td style="width: 10%;"></td> <td style="width: 10%;"></td> <td style="width: 10%;"></td> <td style="width: 10%;"></td> <td style="width: 10%;"></td> <td style="width: 10%;"></td> <td style="width: 10%;"></td> <td style="width: 10%;"></td> </tr> <tr> <td></td> <td></td> <td colspan="8" style="text-align: center;"> <table border="1" style="width: 100%; border-collapse: collapse; text-align: center;"> <tr> <td style="width: 10%;"></td> <td style="width: 10%;"></td> <td style="width: 10%;"></td> <td style="width: 10%;"></td> <td style="width: 10%;"></td> <td style="width: 10%;"></td> <td style="width: 10%;"></td> <td style="width: 10%;"></td> <td style="width: 10%;"></td> <td style="width: 10%;"></td> </tr> <tr> <td></td> <td></td> <td colspan="8" style="text-align: center;"> <table border="1" style="width: 100%; border-collapse: collapse; text-align: center;"> <tr> <td style="width: 10%;"></td> <td style="width: 10%;"></td> <td style="width: 10%;"></td> <td style="width: 10%;"></td> <td style="width: 10%;"></td> <td style="width: 10%;"></td> <td style="width: 10%;"></td> <td style="width: 10%;"></td> <td style="width: 10%;"></td> <td style="width: 10%;"></td> </tr> <tr> <td></td> <td></td> <td colspan="8" style="text-align: center;"> <table border="1" style="width: 100%; border-collapse: collapse; text-align: center;"> <tr> <td style="width: 10%;"></td> <td style="width: 10%;"></td> <td style="width: 10%;"></td> <td style="width: 10%;"></td> <td style="width: 10%;"></td> <td style="width: 10%;"></td> <td style="width: 10%;"></td> <td style="width: 10%;"></td> <td style="width: 10%;"></td> <td style="width: 10%;"></td> </tr> <tr> <td></td> <td></td> <td colspan="8" style="text-align: center;"> <table border="1" style="width: 100%; border-collapse: collapse; text-align: center;"> <tr> <td style="width: 10%;"></td> <td style="width: 10%;"></td> <td style="width: 10%;"></td> <td style="width: 10%;"></td> <td style="width: 10%;"></td> <td style="width: 10%;"></td> <td style="width: 10%;"></td> <td style="width: 10%;"></td> <td style="width: 10%;"></td> <td style="width: 10%;"></td> </tr> <tr> <td></td> <td></td> <td colspan="8" style="text-align: center;"> <table border="1" style="width: 100%; border-collapse: collapse; text-align: center;"> <tr> <td style="width: 10%;"></td> <td style="width: 10%;"></td> <td style="width: 10%;"></td> <td style="width: 10%;"></td> <td style="width: 10%;"></td> <td style="width: 10%;"></td> <td style="width: 10%;"></td> <td style="width: 10%;"></td> <td style="width: 10%;"></td> <td style="width: 10%;"></td> </tr> <tr> <td></td> <td></td> <td colspan="8" style="text-align: center;"> <table border="1" style="width: 100%; border-collapse: collapse; text-align: center;"> <tr> <td style="width: 10%;"></td> <td style="width: 10%;"></td> <td style="width: 10%;"></td> <td style="width: 10%;"></td> <td style="width: 10%;"></td> <td style="width: 10%;"></td> <td style="width: 10%;"></td> <td style="width: 10%;"></td> <td style="width: 10%;"></td> <td style="width: 10%;"></td> </tr> <tr> <td></td> <td></td> <td colspan="8" style="text-align: center;"> <table border="1" style="width: 100%; border-collapse: collapse; text-align: center;"> <tr> <td style="width: 10%;"></td> <td style="width: 10%;"></td> <td style="width: 10%;"></td> <td style="width: 10%;"></td> <td style="width: 10%;"></td> <td style="width: 10%;"></td> <td style="width: 10%;"></td> <td style="width: 10%;"></td> <td style="width: 10%;"></td> <td style="width: 10%;"></td> </tr> <tr> <td></td> <td></td> <td colspan="8" style="text-align: center;"> <table border="1" style="width: 100%; border-collapse: collapse; text-align: center;"> <tr> <td style="width: 10%;"></td> <td style="width: 10%;"></td> <td style="width: 10%;"></td> <td style="width: 10%;"></td> <td style="width: 10%;"></td> <td style="width: 10%;"></td> <td style="width: 10%;"></td> <td style="width: 10%;"></td> <td style="width: 10%;"></td> <td style="width: 10%;"></td> </tr> <tr> <td></td> <td></td> <td colspan="8" style="text-align: center;"> <table border="1" style="width: 100%; border-collapse: collapse; text-align: center;"> <tr> <td style="width: 10%;"></td> <td style="width: 10%;"></td> <td style="width: 10%;"></td> <td style="width: 10%;"></td> <td style="width: 10%;"></td> <td style="width: 10%;"></td> <td style="width: 10%;"></td> <td style="width: 10%;"></td> <td style="width: 10%;"></td> <td style="width: 10%;"></td> </tr> <tr> <td></td> <td></td> <td colspan="8" style="text-align: center;"> <table border="1" style="width: 100%; border-collapse: collapse; text-align: center;"> <tr> <td style="width: 10%;"></td> <td style="width: 10%;"></td> <td style="width: 10%;"></td> <td style="width: 10%;"></td> <td style="width: 10%;"></td> <td style="width: 10%;"></td> <td style="width: 10%;"></td> <td style="width: 10%;"></td> <td style="width: 10%;"></td> <td style="width: 10%;"></td> </tr> <tr> <td></td> <td></td> <td colspan="8" style="text-align: center;"> <table border="1" style="width: 100%; border-collapse: collapse; text-align: center;"> <tr> <td style="width: 10%;"></td> <td style="width: 10%;"></td> <td style="width: 10%;"></td> <td style="width: 10%;"></td> <td style="width: 10%;"></td> <td style="width: 10%;"></td> <td style="width: 10%;"></td> <td style="width: 10%;"></td> <td style="width: 10%;"></td> <td style="width: 10%;"></td> </tr> <tr> <td></td> <td></td> <td colspan="8" style="text-align: center;"> <table border="1" style="width: 100%; border-collapse: collapse; text-align: center;"> <tr> <td style="width: 10%;"></td> <td style="width: 10%;"></td> <td style="width: 10%;"></td> <td style="width: 10%;"></td> <td style="width: 10%;"></td> <td style="width: 10%;"></td> <td style="width: 10%;"></td> <td style="width: 10%;"></td> <td style="width: 10%;"></td> <td style="width: 10%;"></td> </tr> <tr> <td></td> <td></td> <td colspan="8" style="text-align: center;"> <table border="1" style="width: 100%; border-collapse: collapse; text-align: center;"> <tr> <td style="width: 10%;"></td> <td style="width: 10%;"></td> <td style="width: 10%;"></td> <td style="width: 10%;"></td> <td style="width: 10%;"></td> <td style="width: 10%;"></td> <td
style="width: 10%;"></td> <td style="width: 10%;"></td> <td style="width: 10%;"></td> <td style="width: 10%;"></td> </tr> <tr> <td></td> <td></td> <td colspan="8" style="text-align: center;"> <table border="1" style="width: 100%; border-collapse: collapse; text-align: center;"> <tr> </tr></table></td></tr></table></td></tr></table></td></tr></table></td></tr></table></td></tr></table></td></tr></table></td></tr></table></td></tr></table></td></tr></table></td></tr></table></td></tr></table></td></tr></table></td></tr></table></td></tr></table></td></tr></table></td></tr></table></td></tr></table></td></tr></table></td></tr></table>

 | | | | | | | | | | | | | | | | | | | | <table border="1" style="width: 100%; border-collapse: collapse; text-align: center;"> <tr> <td style="width: 10%;"></td> <td style="width: 10%;"></td> <td style="width: 10%;"></td> <td style="width: 10%;"></td> <td style="width: 10%;"></td> <td style="width: 10%;"></td> <td style="width: 10%;"></td> <td style="width: 10%;"></td> <td style="width: 10%;"></td> <td style="width: 10%;"></td> </tr> <tr> <td></td> <td></td> <td colspan="8" style="text-align: center;"> <table border="1" style="width: 100%; border-collapse: collapse; text-align: center;"> <tr> <td style="width: 10%;"></td> <td style="width: 10%;"></td> <td style="width: 10%;"></td> <td style="width: 10%;"></td> <td style="width: 10%;"></td> <td style="width: 10%;"></td> <td style="width: 10%;"></td> <td style="width: 10%;"></td> <td style="width: 10%;"></td> <td style="width: 10%;"></td> </tr> <tr> <td></td> <td></td> <td colspan="8" style="text-align: center;"> <table border="1" style="width: 100%; border-collapse: collapse; text-align: center;"> <tr> <td style="width: 10%;"></td> <td style="width: 10%;"></td> <td style="width: 10%;"></td> <td style="width: 10%;"></td> <td style="width: 10%;"></td> <td style="width: 10%;"></td> <td style="width: 10%;"></td> <td style="width: 10%;"></td> <td style="width: 10%;"></td> <td style="width: 10%;"></td> </tr> <tr> <td></td> <td></td> <td colspan="8" style="text-align: center;"> <table border="1" style="width: 100%; border-collapse: collapse; text-align: center;"> <tr> <td style="width: 10%;"></td> <td style="width: 10%;"></td> <td style="width: 10%;"></td> <td style="width: 10%;"></td> <td style="width: 10%;"></td> <td style="width: 10%;"></td> <td style="width: 10%;"></td> <td style="width: 10%;"></td> <td style="width: 10%;"></td> <td style="width: 10%;"></td> </tr> <tr> <td></td> <td></td> <td colspan="8" style="text-align: center;"> <table border="1" style="width: 100%; border-collapse: collapse; text-align: center;"> <tr> <td style="width: 10%;"></td> <td style="width: 10%;"></td> <td style="width: 10%;"></td> <td style="width: 10%;"></td> <td style="width: 10%;"></td> <td style="width: 10%;"></td> <td style="width: 10%;"></td> <td style="width: 10%;"></td> <td style="width: 10%;"></td> <td style="width: 10%;"></td> </tr> <tr> <td></td> <td></td> <td colspan="8" style="text-align: center;"> <table border="1" style="width: 100%; border-collapse: collapse; text-align: center;"> <tr> <td style="width: 10%;"></td> <td style="width: 10%;"></td> <td style="width: 10%;"></td> <td style="width: 10%;"></td> <td style="width: 10%;"></td> <td style="width: 10%;"></td> <td style="width: 10%;"></td> <td style="width: 10%;"></td> <td style="width: 10%;"></td> <td style="width: 10%;"></td> </tr> <tr> <td></td> <td></td> <td colspan="8" style="text-align: center;"> <table border="1" style="width: 100%; border-collapse: collapse; text-align: center;"> <tr> <td style="width: 10%;"></td> <td style="width: 10%;"></td> <td style="width: 10%;"></td> <td style="width: 10%;"></td> <td style="width: 10%;"></td> <td style="width: 10%;"></td> <td style="width: 10%;"></td> <td style="width: 10%;"></td> <td style="width: 10%;"></td> <td style="width: 10%;"></td> </tr> <tr> <td></td> <td></td> <td colspan="8" style="text-align: center;"> <table border="1" style="width: 100%; border-collapse: collapse; text-align: center;"> <tr> <td style="width: 10%;"></td> <td style="width: 10%;"></td> <td style="width: 10%;"></td> <td style="width: 10%;"></td> <td style="width: 10%;"></td> <td style="width: 10%;"></td> <td style="width: 10%;"></td> <td style="width: 10%;"></td> <td style="width: 10%;"></td> <td style="width: 10%;"></td> </tr> <tr> <td></td> <td></td> <td colspan="8" style="text-align: center;"> <table border="1" style="width: 100%; border-collapse: collapse; text-align: center;"> <tr> <td style="width: 10%;"></td> <td style="width: 10%;"></td> <td style="width: 10%;"></td> <td style="width: 10%;"></td> <td style="width: 10%;"></td> <td style="width: 10%;"></td> <td style="width: 10%;"></td> <td style="width: 10%;"></td> <td style="width: 10%;"></td> <td style="width: 10%;"></td> </tr> <tr> <td></td> <td></td> <td colspan="8" style="text-align: center;"> <table border="1" style="width: 100%; border-collapse: collapse; text-align: center;"> <tr> <td style="width: 10%;"></td> <td style="width: 10%;"></td> <td style="width: 10%;"></td> <td style="width: 10%;"></td> <td style="width: 10%;"></td> <td style="width: 10%;"></td> <td style="width: 10%;"></td> <td style="width: 10%;"></td> <td style="width: 10%;"></td> <td style="width: 10%;"></td> </tr> <tr> <td></td> <td></td> <td colspan="8" style="text-align: center;"> <table border="1" style="width: 100%; border-collapse: collapse; text-align: center;"> <tr> <td style="width: 10%;"></td> <td style="width: 10%;"></td> <td style="width: 10%;"></td> <td style="width: 10%;"></td> <td style="width: 10%;"></td> <td style="width: 10%;"></td> <td style="width: 10%;"></td> <td style="width: 10%;"></td> <td style="width: 10%;"></td> <td style="width: 10%;"></td> </tr> <tr> <td></td> <td></td> <td colspan="8" style="text-align: center;"> <table border="1" style="width: 100%; border-collapse: collapse; text-align: center;"> <tr> <td style="width: 10%;"></td> <td style="width: 10%;"></td> <td style="width: 10%;"></td> <td style="width: 10%;"></td> <td style="width: 10%;"></td> <td style="width: 10%;"></td> <td style="width: 10%;"></td> <td style="width: 10%;"></td> <td style="width: 10%;"></td> <td style="width: 10%;"></td> </tr> <tr> <td></td> <td></td> <td colspan="8" style="text-align: center;"> <table border="1" style="width: 100%; border-collapse: collapse; text-align: center;"> <tr> <td style="width: 10%;"></td> <td style="width: 10%;"></td> <td style="width: 10%;"></td> <td style="width: 10%;"></td> <td style="width: 10%;"></td> <td style="width: 10%;"></td> <td style="width: 10%;"></td> <td style="width: 10%;"></td> <td style="width: 10%;"></td> <td style="width: 10%;"></td> </tr> <tr> <td></td> <td></td> <td colspan="8" style="text-align: center;"> <table border="1" style="width: 100%; border-collapse: collapse; text-align: center;"> <tr> <td style="width: 10%;"></td> <td style="width: 10%;"></td> <td style="width: 10%;"></td> <td style="width: 10%;"></td> <td style="width: 10%;"></td> <td style="width: 10%;"></td> <td style="width: 10%;"></td> <td style="width: 10%;"></td> <td style="width: 10%;"></td> <td style="width: 10%;"></td> </tr> <tr> <td></td> <td></td> <td colspan="8" style="text-align: center;"> <table border="1" style="width: 100%; border-collapse: collapse; text-align: center;"> <tr> <td style="width: 10%;"></td> <td style="width: 10%;"></td> <td style="width: 10%;"></td> <td style="width: 10%;"></td> <td style="width: 10%;"></td> <td style="width: 10%;"></td> <td style="width: 10%;"></td> <td style="width: 10%;"></td> <td style="width: 10%;"></td> <td style="width: 10%;"></td> </tr> <tr> <td></td> <td></td> <td colspan="8" style="text-align: center;"> <table border="1" style="width: 100%; border-collapse: collapse; text-align: center;"> <tr> <td style="width: 10%;"></td> <td style="width: 10%;"></td> <td style="width: 10%;"></td> <td style="width: 10%;"></td> <td style="width: 10%;"></td> <td style="width: 10%;"></td> <td style="width: 10%;"></td> <td style="width: 10%;"></td> <td style="width: 10%;"></td> <td style="width: 10%;"></td> </tr> <tr> <td></td> <td></td> <td colspan="8" style="text-align: center;"> <table border="1" style="width: 100%; border-collapse: collapse; text-align: center;"> <tr> <td style="width: 10%;"></td> <td style="width: 10%;"></td> <td style="width: 10%;"></td> <td style="width: 10%;"></td> <td style="width: 10%;"></td> <td style="width: 10%;"></td> <td style="width: 10%;"></td> <td style="width: 10%;"></td> <td style="width: 10%;"></td> <td style="width: 10%;"></td> </tr> <tr> <td></td> <td></td> <td
colspan="8" style="text-align: center;"> <table border="1" style="width: 100%; border-collapse: collapse; text-align: center;"> <tr> <td style="width: 10%;"></td> <td style="width: 10%;"></td> <td style="width: 10%;"></td> <td style="width: 10%;"></td> <td style="width: 10%;"></td> <td style="width: 10%;"></td> <td style="width: 10%;"></td> <td style="width: 10%;"></td> <td style="width: 10%;"></td> <td style="width: 10%;"></td> </tr> <tr> <td></td> <td></td> <td colspan="8" style="text-align: center;"> <table border="1" style="width: 100%; border-collapse: collapse; text-align: center;"> <tr> </tr></table></td></tr></table></td></tr></table></td></tr></table></td></tr></table></td></tr></table></td></tr></table></td></tr></table></td></tr></table></td></tr></table></td></tr></table></td></tr></table></td></tr></table></td></tr></table></td></tr></table></td></tr></table></td></tr></table></td></tr></table></td></tr></table>

 | | | | | | | | | | | | | | | | | | | | <table border="1" style="width: 100%; border-collapse: collapse; text-align: center;"> <tr> <td style="width: 10%;"></td> <td style="width: 10%;"></td> <td style="width: 10%;"></td> <td style="width: 10%;"></td> <td style="width: 10%;"></td> <td style="width: 10%;"></td> <td style="width: 10%;"></td> <td style="width: 10%;"></td> <td style="width: 10%;"></td> <td style="width: 10%;"></td> </tr> <tr> <td></td> <td></td> <td colspan="8" style="text-align: center;"> <table border="1" style="width: 100%; border-collapse: collapse; text-align: center;"> <tr> <td style="width: 10%;"></td> <td style="width: 10%;"></td> <td style="width: 10%;"></td> <td style="width: 10%;"></td> <td style="width: 10%;"></td> <td style="width: 10%;"></td> <td style="width: 10%;"></td> <td style="width: 10%;"></td> <td style="width: 10%;"></td> <td style="width: 10%;"></td> </tr> <tr> <td></td> <td></td> <td colspan="8" style="text-align: center;"> <table border="1" style="width: 100%; border-collapse: collapse; text-align: center;"> <tr> <td style="width: 10%;"></td> <td style="width: 10%;"></td> <td style="width: 10%;"></td> <td style="width: 10%;"></td> <td style="width: 10%;"></td> <td style="width: 10%;"></td> <td style="width: 10%;"></td> <td style="width: 10%;"></td> <td style="width: 10%;"></td> <td style="width: 10%;"></td> </tr> <tr> <td></td> <td></td> <td colspan="8" style="text-align: center;"> <table border="1" style="width: 100%; border-collapse: collapse; text-align: center;"> <tr> <td style="width: 10%;"></td> <td style="width: 10%;"></td> <td style="width: 10%;"></td> <td style="width: 10%;"></td> <td style="width: 10%;"></td> <td style="width: 10%;"></td> <td style="width: 10%;"></td> <td style="width: 10%;"></td> <td style="width: 10%;"></td> <td style="width: 10%;"></td> </tr> <tr> <td></td> <td></td> <td colspan="8" style="text-align: center;"> <table border="1" style="width: 100%; border-collapse: collapse; text-align: center;"> <tr> <td style="width: 10%;"></td> <td style="width: 10%;"></td> <td style="width: 10%;"></td> <td style="width: 10%;"></td> <td style="width: 10%;"></td> <td style="width: 10%;"></td> <td style="width: 10%;"></td> <td style="width: 10%;"></td> <td style="width: 10%;"></td> <td style="width: 10%;"></td> </tr> <tr> <td></td> <td></td> <td colspan="8" style="text-align: center;"> <table border="1" style="width: 100%; border-collapse: collapse; text-align: center;"> <tr> <td style="width: 10%;"></td> <td style="width: 10%;"></td> <td style="width: 10%;"></td> <td style="width: 10%;"></td> <td style="width: 10%;"></td> <td style="width: 10%;"></td> <td style="width: 10%;"></td> <td style="width: 10%;"></td> <td style="width: 10%;"></td> <td style="width: 10%;"></td> </tr> <tr> <td></td> <td></td> <td colspan="8" style="text-align: center;"> <table border="1" style="width: 100%; border-collapse: collapse; text-align: center;"> <tr> <td style="width: 10%;"></td> <td style="width: 10%;"></td> <td style="width: 10%;"></td> <td style="width: 10%;"></td> <td style="width: 10%;"></td> <td style="width: 10%;"></td> <td style="width: 10%;"></td> <td style="width: 10%;"></td> <td style="width: 10%;"></td> <td style="width: 10%;"></td> </tr> <tr> <td></td> <td></td> <td colspan="8" style="text-align: center;"> <table border="1" style="width: 100%; border-collapse: collapse; text-align: center;"> <tr> <td style="width: 10%;"></td> <td style="width: 10%;"></td> <td style="width: 10%;"></td> <td style="width: 10%;"></td> <td style="width: 10%;"></td> <td style="width: 10%;"></td> <td style="width: 10%;"></td> <td style="width: 10%;"></td> <td style="width: 10%;"></td> <td style="width: 10%;"></td> </tr> <tr> <td></td> <td></td> <td colspan="8" style="text-align: center;"> <table border="1" style="width: 100%; border-collapse: collapse; text-align: center;"> <tr> <td style="width: 10%;"></td> <td style="width: 10%;"></td> <td style="width: 10%;"></td> <td style="width: 10%;"></td> <td style="width: 10%;"></td> <td style="width: 10%;"></td> <td style="width: 10%;"></td> <td style="width: 10%;"></td> <td style="width: 10%;"></td> <td style="width: 10%;"></td> </tr> <tr> <td></td> <td></td> <td colspan="8" style="text-align: center;"> <table border="1" style="width: 100%; border-collapse: collapse; text-align: center;"> <tr> <td style="width: 10%;"></td> <td style="width: 10%;"></td> <td style="width: 10%;"></td> <td style="width: 10%;"></td> <td style="width: 10%;"></td> <td style="width: 10%;"></td> <td style="width: 10%;"></td> <td style="width: 10%;"></td> <td style="width: 10%;"></td> <td style="width: 10%;"></td> </tr> <tr> <td></td> <td></td> <td colspan="8" style="text-align: center;"> <table border="1" style="width: 100%; border-collapse: collapse; text-align: center;"> <tr> <td style="width: 10%;"></td> <td style="width: 10%;"></td> <td style="width: 10%;"></td> <td style="width: 10%;"></td> <td style="width: 10%;"></td> <td style="width: 10%;"></td> <td style="width: 10%;"></td> <td style="width: 10%;"></td> <td style="width: 10%;"></td> <td style="width: 10%;"></td> </tr> <tr> <td></td> <td></td> <td colspan="8" style="text-align: center;"> <table border="1" style="width: 100%; border-collapse: collapse; text-align: center;"> <tr> <td style="width: 10%;"></td> <td style="width: 10%;"></td> <td style="width: 10%;"></td> <td style="width: 10%;"></td> <td style="width: 10%;"></td> <td style="width: 10%;"></td> <td style="width: 10%;"></td> <td style="width: 10%;"></td> <td style="width: 10%;"></td> <td style="width: 10%;"></td> </tr> <tr> <td></td> <td></td> <td colspan="8" style="text-align: center;"> <table border="1" style="width: 100%; border-collapse: collapse; text-align: center;"> <tr> <td style="width: 10%;"></td> <td style="width: 10%;"></td> <td style="width: 10%;"></td> <td style="width: 10%;"></td> <td style="width: 10%;"></td> <td style="width: 10%;"></td> <td style="width: 10%;"></td> <td style="width: 10%;"></td> <td style="width: 10%;"></td> <td style="width: 10%;"></td> </tr> <tr> <td></td> <td></td> <td colspan="8" style="text-align: center;"> <table border="1" style="width: 100%; border-collapse: collapse; text-align: center;"> <tr> <td style="width: 10%;"></td> <td style="width: 10%;"></td> <td style="width: 10%;"></td> <td style="width: 10%;"></td> <td style="width: 10%;"></td> <td style="width: 10%;"></td> <td style="width: 10%;"></td> <td style="width: 10%;"></td> <td style="width: 10%;"></td> <td style="width: 10%;"></td> </tr> <tr> <td></td> <td></td> <td colspan="8" style="text-align: center;"> <table border="1" style="width: 100%; border-collapse: collapse; text-align: center;"> <tr> <td style="width: 10%;"></td> <td style="width: 10%;"></td> <td style="width: 10%;"></td> <td style="width: 10%;"></td> <td style="width: 10%;"></td> <td style="width: 10%;"></td> <td style="width: 10%;"></td> <td style="width: 10%;"></td> <td style="width: 10%;"></td> <td style="width: 10%;"></td> </tr> <tr> <td></td> <td></td> <td colspan="8" style="text-align: center;"> <table border="1" style="width: 100%; border-collapse: collapse; text-align: center;"> <tr> <td style="width: 10%;"></td> <td style="width: 10%;"></td> <td style="width: 10%;"></td> <td style="width: 10%;"></td> <td style="width: 10%;"></td> <td style="width: 10%;"></td> <td style="width: 10%;"></td> <td style="width: 10%;"></td> <td style="width: 10%;"></td> <td style="width: 10%;"></td> </tr> <tr> <td></td> <td></td> <td colspan="8" style="text-align: center;"> <table border="1" style="width: 100%; border-collapse: collapse; text-align: center;"> <tr> <td style="width: 10%;"></td> <td
style="width: 10%;"></td> <td style="width: 10%;"></td> <td style="width: 10%;"></td> <td style="width: 10%;"></td> <td style="width: 10%;"></td> <td style="width: 10%;"></td> <td style="width: 10%;"></td> <td style="width: 10%;"></td> <td style="width: 10%;"></td> </tr> <tr> <td></td> <td></td> <td colspan="8" style="text-align: center;"> <table border="1" style="width: 100%; border-collapse: collapse; text-align: center;"> <tr> </tr></table></td></tr></table></td></tr></table></td></tr></table></td></tr></table></td></tr></table></td></tr></table></td></tr></table></td></tr></table></td></tr></table></td></tr></table></td></tr></table></td></tr></table></td></tr></table></td></tr></table></td></tr></table></td></tr></table></td></tr></table>

 | | | | | | | | | | | | | | | | | | | | <table border="1" style="width: 100%; border-collapse: collapse; text-align: center;"> <tr> <td style="width: 10%;"></td> <td style="width: 10%;"></td> <td style="width: 10%;"></td> <td style="width: 10%;"></td> <td style="width: 10%;"></td> <td style="width: 10%;"></td> <td style="width: 10%;"></td> <td style="width: 10%;"></td> <td style="width: 10%;"></td> <td style="width: 10%;"></td> </tr> <tr> <td></td> <td></td> <td colspan="8" style="text-align: center;"> <table border="1" style="width: 100%; border-collapse: collapse; text-align: center;"> <tr> <td style="width: 10%;"></td> <td style="width: 10%;"></td> <td style="width: 10%;"></td> <td style="width: 10%;"></td> <td style="width: 10%;"></td> <td style="width: 10%;"></td> <td style="width: 10%;"></td> <td style="width: 10%;"></td> <td style="width: 10%;"></td> <td style="width: 10%;"></td> </tr> <tr> <td></td> <td></td> <td colspan="8" style="text-align: center;"> <table border="1" style="width: 100%; border-collapse: collapse; text-align: center;"> <tr> <td style="width: 10%;"></td> <td style="width: 10%;"></td> <td style="width: 10%;"></td> <td style="width: 10%;"></td> <td style="width: 10%;"></td> <td style="width: 10%;"></td> <td style="width: 10%;"></td> <td style="width: 10%;"></td> <td style="width: 10%;"></td> <td style="width: 10%;"></td> </tr> <tr> <td></td> <td></td> <td colspan="8" style="text-align: center;"> <table border="1" style="width: 100%; border-collapse: collapse; text-align: center;"> <tr> <td style="width: 10%;"></td> <td style="width: 10%;"></td> <td style="width: 10%;"></td> <td style="width: 10%;"></td> <td style="width: 10%;"></td> <td style="width: 10%;"></td> <td style="width: 10%;"></td> <td style="width: 10%;"></td> <td style="width: 10%;"></td> <td style="width: 10%;"></td> </tr> <tr> <td></td> <td></td> <td colspan="8" style="text-align: center;"> <table border="1" style="width: 100%; border-collapse: collapse; text-align: center;"> <tr> <td style="width: 10%;"></td> <td style="width: 10%;"></td> <td style="width: 10%;"></td> <td style="width: 10%;"></td> <td style="width: 10%;"></td> <td style="width: 10%;"></td> <td style="width: 10%;"></td> <td style="width: 10%;"></td> <td style="width: 10%;"></td> <td style="width: 10%;"></td> </tr> <tr> <td></td> <td></td> <td colspan="8" style="text-align: center;"> <table border="1" style="width: 100%; border-collapse: collapse; text-align: center;"> <tr> <td style="width: 10%;"></td> <td style="width: 10%;"></td> <td style="width: 10%;"></td> <td style="width: 10%;"></td> <td style="width: 10%;"></td> <td style="width: 10%;"></td> <td style="width: 10%;"></td> <td style="width: 10%;"></td> <td style="width: 10%;"></td> <td style="width: 10%;"></td> </tr> <tr> <td></td> <td></td> <td colspan="8" style="text-align: center;"> <table border="1" style="width: 100%; border-collapse: collapse; text-align: center;"> <tr> <td style="width: 10%;"></td> <td style="width: 10%;"></td> <td style="width: 10%;"></td> <td style="width: 10%;"></td> <td style="width: 10%;"></td> <td style="width: 10%;"></td> <td style="width: 10%;"></td> <td style="width: 10%;"></td> <td style="width: 10%;"></td> <td style="width: 10%;"></td> </tr> <tr> <td></td> <td></td> <td colspan="8" style="text-align: center;"> <table border="1" style="width: 100%; border-collapse: collapse; text-align: center;"> <tr> <td style="width: 10%;"></td> <td style="width: 10%;"></td> <td style="width: 10%;"></td> <td style="width: 10%;"></td> <td style="width: 10%;"></td> <td style="width: 10%;"></td> <td style="width: 10%;"></td> <td style="width: 10%;"></td> <td style="width: 10%;"></td> <td style="width: 10%;"></td> </tr> <tr> <td></td> <td></td> <td colspan="8" style="text-align: center;"> <table border="1" style="width: 100%; border-collapse: collapse; text-align: center;"> <tr> <td style="width: 10%;"></td> <td style="width: 10%;"></td> <td style="width: 10%;"></td> <td style="width: 10%;"></td> <td style="width: 10%;"></td> <td style="width: 10%;"></td> <td style="width: 10%;"></td> <td style="width: 10%;"></td> <td style="width: 10%;"></td> <td style="width: 10%;"></td> </tr> <tr> <td></td> <td></td> <td colspan="8" style="text-align: center;"> <table border="1" style="width: 100%; border-collapse: collapse; text-align: center;"> <tr> <td style="width: 10%;"></td> <td style="width: 10%;"></td> <td style="width: 10%;"></td> <td style="width: 10%;"></td> <td style="width: 10%;"></td> <td style="width: 10%;"></td> <td style="width: 10%;"></td> <td style="width: 10%;"></td> <td style="width: 10%;"></td> <td style="width: 10%;"></td> </tr> <tr> <td></td> <td></td> <td colspan="8" style="text-align: center;"> <table border="1" style="width: 100%; border-collapse: collapse; text-align: center;"> <tr> <td style="width: 10%;"></td> <td style="width: 10%;"></td> <td style="width: 10%;"></td> <td style="width: 10%;"></td> <td style="width: 10%;"></td> <td style="width: 10%;"></td> <td style="width: 10%;"></td> <td style="width: 10%;"></td> <td style="width: 10%;"></td> <td style="width: 10%;"></td> </tr> <tr> <td></td> <td></td> <td colspan="8" style="text-align: center;"> <table border="1" style="width: 100%; border-collapse: collapse; text-align: center;"> <tr> <td style="width: 10%;"></td> <td style="width: 10%;"></td> <td style="width: 10%;"></td> <td style="width: 10%;"></td> <td style="width: 10%;"></td> <td style="width: 10%;"></td> <td style="width: 10%;"></td> <td style="width: 10%;"></td> <td style="width: 10%;"></td> <td style="width: 10%;"></td> </tr> <tr> <td></td> <td></td> <td colspan="8" style="text-align: center;"> <table border="1" style="width: 100%; border-collapse: collapse; text-align: center;"> <tr> <td style="width: 10%;"></td> <td style="width: 10%;"></td> <td style="width: 10%;"></td> <td style="width: 10%;"></td> <td style="width: 10%;"></td> <td style="width: 10%;"></td> <td style="width: 10%;"></td> <td style="width: 10%;"></td> <td style="width: 10%;"></td> <td style="width: 10%;"></td> </tr> <tr> <td></td> <td></td> <td colspan="8" style="text-align: center;"> <table border="1" style="width: 100%; border-collapse: collapse; text-align: center;"> <tr> <td style="width: 10%;"></td> <td style="width: 10%;"></td> <td style="width: 10%;"></td> <td style="width: 10%;"></td> <td style="width: 10%;"></td> <td style="width: 10%;"></td> <td style="width: 10%;"></td> <td style="width: 10%;"></td> <td style="width: 10%;"></td> <td style="width: 10%;"></td> </tr> <tr> <td></td> <td></td> <td colspan="8" style="text-align: center;"> <table border="1" style="width: 100%; border-collapse: collapse; text-align: center;"> <tr> <td style="width: 10%;"></td> <td style="width: 10%;"></td> <td style="width: 10%;"></td> <td style="width: 10%;"></td> <td style="width: 10%;"></td> <td style="width: 10%;"></td> <td style="width: 10%;"></td> <td style="width: 10%;"></td> <td style="width: 10%;"></td> <td style="width: 10%;"></td> </tr> <tr> <td></td> <td></td> <td colspan="8" style="text-align: center;"> <table border="1" style="width: 100%; border-collapse: collapse; text-align: center;"> <tr> <td style="width: 10%;"></td> <td style="width: 10%;"></td> <td style="width: 10%;"></td> <td style="width: 10%;"></td> <td style="width: 10%;"></td> <td style="width: 10%;"></td> <td style="width: 10%;"></td> <td style="width: 10%;"></td> <td style="width: 10%;"></td> <td style="width: 10%;"></td> </tr> <tr> <td></td> <td></td> <td colspan="8" style="text-align: center;"> <table border="1" style="width: 100%; border-collapse: collapse; text-align: center;"> <tr>
</tr></table></td></tr></table></td></tr></table></td></tr></table></td></tr></table></td></tr></table></td></tr></table></td></tr></table></td></tr></table></td></tr></table></td></tr></table></td></tr></table></td></tr></table></td></tr></table></td></tr></table></td></tr></table></td></tr></table>

 | | | | | | | | | | | | | | | | | | | | <table border="1" style="width: 100%; border-collapse: collapse; text-align: center;"> <tr> <td style="width: 10%;"></td> <td style="width: 10%;"></td> <td style="width: 10%;"></td> <td style="width: 10%;"></td> <td style="width: 10%;"></td> <td style="width: 10%;"></td> <td style="width: 10%;"></td> <td style="width: 10%;"></td> <td style="width: 10%;"></td> <td style="width: 10%;"></td> </tr> <tr> <td></td> <td></td> <td colspan="8" style="text-align: center;"> <table border="1" style="width: 100%; border-collapse: collapse; text-align: center;"> <tr> <td style="width: 10%;"></td> <td style="width: 10%;"></td> <td style="width: 10%;"></td> <td style="width: 10%;"></td> <td style="width: 10%;"></td> <td style="width: 10%;"></td> <td style="width: 10%;"></td> <td style="width: 10%;"></td> <td style="width: 10%;"></td> <td style="width: 10%;"></td> </tr> <tr> <td></td> <td></td> <td colspan="8" style="text-align: center;"> <table border="1" style="width: 100%; border-collapse: collapse; text-align: center;"> <tr> <td style="width: 10%;"></td> <td style="width: 10%;"></td> <td style="width: 10%;"></td> <td style="width: 10%;"></td> <td style="width: 10%;"></td> <td style="width: 10%;"></td> <td style="width: 10%;"></td> <td style="width: 10%;"></td> <td style="width: 10%;"></td> <td style="width: 10%;"></td> </tr> <tr> <td></td> <td></td> <td colspan="8" style="text-align: center;"> <table border="1" style="width: 100%; border-collapse: collapse; text-align: center;"> <tr> <td style="width: 10%;"></td> <td style="width: 10%;"></td> <td style="width: 10%;"></td> <td style="width: 10%;"></td> <td style="width: 10%;"></td> <td style="width: 10%;"></td> <td style="width: 10%;"></td> <td style="width: 10%;"></td> <td style="width: 10%;"></td> <td style="width: 10%;"></td> </tr> <tr> <td></td> <td></td> <td colspan="8" style="text-align: center;"> <table border="1" style="width: 100%; border-collapse: collapse; text-align: center;"> <tr> <td style="width: 10%;"></td> <td style="width: 10%;"></td> <td style="width: 10%;"></td> <td style="width: 10%;"></td> <td style="width: 10%;"></td> <td style="width: 10%;"></td> <td style="width: 10%;"></td> <td style="width: 10%;"></td> <td style="width: 10%;"></td> <td style="width: 10%;"></td> </tr> <tr> <td></td> <td></td> <td colspan="8" style="text-align: center;"> <table border="1" style="width: 100%; border-collapse: collapse; text-align: center;"> <tr> <td style="width: 10%;"></td> <td style="width: 10%;"></td> <td style="width: 10%;"></td> <td style="width: 10%;"></td> <td style="width: 10%;"></td> <td style="width: 10%;"></td> <td style="width: 10%;"></td> <td style="width: 10%;"></td> <td style="width: 10%;"></td> <td style="width: 10%;"></td> </tr> <tr> <td></td> <td></td> <td colspan="8" style="text-align: center;"> <table border="1" style="width: 100%; border-collapse: collapse; text-align: center;"> <tr> <td style="width: 10%;"></td> <td style="width: 10%;"></td> <td style="width: 10%;"></td> <td style="width: 10%;"></td> <td style="width: 10%;"></td> <td style="width: 10%;"></td> <td style="width: 10%;"></td> <td style="width: 10%;"></td> <td style="width: 10%;"></td> <td style="width: 10%;"></td> </tr> <tr> <td></td> <td></td> <td colspan="8" style="text-align: center;"> <table border="1" style="width: 100%; border-collapse: collapse; text-align: center;"> <tr> <td style="width: 10%;"></td> <td style="width: 10%;"></td> <td style="width: 10%;"></td> <td style="width: 10%;"></td> <td style="width: 10%;"></td> <td style="width: 10%;"></td> <td style="width: 10%;"></td> <td style="width: 10%;"></td> <td style="width: 10%;"></td> <td style="width: 10%;"></td> </tr> <tr> <td></td> <td></td> <td colspan="8" style="text-align: center;"> <table border="1" style="width: 100%; border-collapse: collapse; text-align: center;"> <tr> <td style="width: 10%;"></td> <td style="width: 10%;"></td> <td style="width: 10%;"></td> <td style="width: 10%;"></td> <td style="width: 10%;"></td> <td style="width: 10%;"></td> <td style="width: 10%;"></td> <td style="width: 10%;"></td> <td style="width: 10%;"></td> <td style="width: 10%;"></td> </tr> <tr> <td></td> <td></td> <td colspan="8" style="text-align: center;"> <table border="1" style="width: 100%; border-collapse: collapse; text-align: center;"> <tr> <td style="width: 10%;"></td> <td style="width: 10%;"></td> <td style="width: 10%;"></td> <td style="width: 10%;"></td> <td style="width: 10%;"></td> <td style="width: 10%;"></td> <td style="width: 10%;"></td> <td style="width: 10%;"></td> <td style="width: 10%;"></td> <td style="width: 10%;"></td> </tr> <tr> <td></td> <td></td> <td colspan="8" style="text-align: center;"> <table border="1" style="width: 100%; border-collapse: collapse; text-align: center;"> <tr> <td style="width: 10%;"></td> <td style="width: 10%;"></td> <td style="width: 10%;"></td> <td style="width: 10%;"></td> <td style="width: 10%;"></td> <td style="width: 10%;"></td> <td style="width: 10%;"></td> <td style="width: 10%;"></td> <td style="width: 10%;"></td> <td style="width: 10%;"></td> </tr> <tr> <td></td> <td></td> <td colspan="8" style="text-align: center;"> <table border="1" style="width: 100%; border-collapse: collapse; text-align: center;"> <tr> <td style="width: 10%;"></td> <td style="width: 10%;"></td> <td style="width: 10%;"></td> <td style="width: 10%;"></td> <td style="width: 10%;"></td> <td style="width: 10%;"></td> <td style="width: 10%;"></td> <td style="width: 10%;"></td> <td style="width: 10%;"></td> <td style="width: 10%;"></td> </tr> <tr> <td></td> <td></td> <td colspan="8" style="text-align: center;"> <table border="1" style="width: 100%; border-collapse: collapse; text-align: center;"> <tr> <td style="width: 10%;"></td> <td style="width: 10%;"></td> <td style="width: 10%;"></td> <td style="width: 10%;"></td> <td style="width: 10%;"></td> <td style="width: 10%;"></td> <td style="width: 10%;"></td> <td style="width: 10%;"></td> <td style="width: 10%;"></td> <td style="width: 10%;"></td> </tr> <tr> <td></td> <td></td> <td colspan="8" style="text-align: center;"> <table border="1" style="width: 100%; border-collapse: collapse; text-align: center;"> <tr> <td style="width: 10%;"></td> <td style="width: 10%;"></td> <td style="width: 10%;"></td> <td style="width: 10%;"></td> <td style="width: 10%;"></td> <td style="width: 10%;"></td> <td style="width: 10%;"></td> <td style="width: 10%;"></td> <td style="width: 10%;"></td> <td style="width: 10%;"></td> </tr> <tr> <td></td> <td></td> <td colspan="8" style="text-align: center;"> <table border="1" style="width: 100%; border-collapse: collapse; text-align: center;"> <tr> <td style="width: 10%;"></td> <td style="width: 10%;"></td> <td style="width: 10%;"></td> <td style="width: 10%;"></td> <td style="width: 10%;"></td> <td style="width: 10%;"></td> <td style="width: 10%;"></td> <td style="width: 10%;"></td> <td style="width: 10%;"></td> <td style="width: 10%;"></td> </tr> <tr> <td></td> <td></td> <td colspan="8" style="text-align: center;"> <table border="1" style="width: 100%; border-collapse: collapse; text-align: center;"> <tr> </tr></table></td></tr></table></td></tr></table></td></tr></table></td></tr></table></td></tr></table></td></tr></table></td></tr></table></td></tr></table></td></tr></table></td></tr></table></td></tr></table></td></tr></table></td></tr></table></td></tr></table></td></tr></table>

 | | | | | | | | | | | | | | | | | | | | <table border="1" style="width: 100%; border-collapse: collapse; text-align: center;"> <tr> <td style="width: 10%;"></td> <td style="width: 10%;"></td> <td style="width: 10%;"></td> <td style="width: 10%;"></td> <td style="width: 10%;"></td> <td style="width: 10%;"></td> <td style="width: 10%;"></td> <td style="width: 10%;"></td> <td style="width: 10%;"></td> <td style="width: 10%;"></td> </tr> <tr> <td></td> <td></td> <td colspan="8" style="text-align: center;"> <table border="1" style="width: 100%; border-collapse: collapse; text-align: center;"> <tr> <td style="width: 10%;"></td> <td style="width: 10%;"></td> <td style="width: 10%;"></td> <td style="width: 10%;"></td> <td style="width: 10%;"></td> <td style="width: 10%;"></td> <td style="width: 10%;"></td> <td style="width: 10%;"></td> <td style="width: 10%;"></td> <td style="width: 10%;"></td> </tr> <tr> <td></td> <td></td> <td colspan="8" style="text-align: center;"> <table border="1" style="width: 100%; border-collapse: collapse; text-align: center;"> <tr> <td style="width: 10%;"></td> <td style="width: 10%;"></td> <td style="width: 10%;"></td> <td style="width: 10%;"></td> <td style="width: 10%;"></td> <td style="width: 10%;"></td> <td style="width: 10%;"></td> <td style="width: 10%;"></td> <td style="width: 10%;"></td> <td style="width: 10%;"></td> </tr> <tr> <td></td> <td></td> <td colspan="8" style="text-align: center;"> <table border="1" style="width: 100%; border-collapse: collapse; text-align: center;"> <tr> <td style="width: 10%;"></td> <td style="width: 10%;"></td> <td style="width: 10%;"></td> <td style="width: 10%;"></td> <td style="width: 10%;"></td> <td style="width: 10%;"></td> <td style="width: 10%;"></td> <td style="width: 10%;"></td> <td style="width: 10%;"></td> <td style="width: 10%;"></td> </tr> <tr> <td></td> <td></td> <td colspan="8" style="text-align: center;"> <table border="1" style="width: 100%; border-collapse: collapse; text-align: center;"> <tr> <td style="width: 10%;"></td> <td style="width: 10%;"></td> <td style="width: 10%;"></td> <td style="width: 10%;"></td> <td style="width: 10%;"></td> <td style="width: 10%;"></td> <td style="width: 10%;"></td> <td style="width: 10%;"></td> <td style="width: 10%;"></td> <td style="width: 10%;"></td> </tr> <tr> <td></td> <td></td> <td colspan="8" style="text-align: center;"> <table border="1" style="width: 100%; border-collapse: collapse; text-align: center;"> <tr> <td style="width: 10%;"></td> <td style="width: 10%;"></td> <td style="width: 10%;"></td> <td style="width: 10%;"></td> <td style="width: 10%;"></td> <td style="width: 10%;"></td> <td style="width: 10%;"></td> <td style="width: 10%;"></td> <td style="width: 10%;"></td> <td style="width: 10%;"></td> </tr> <tr> <td></td> <td></td> <td colspan="8" style="text-align: center;"> <table border="1" style="width: 100%; border-collapse: collapse; text-align: center;"> <tr> <td style="width: 10%;"></td> <td style="width: 10%;"></td> <td style="width: 10%;"></td> <td style="width: 10%;"></td> <td style="width: 10%;"></td> <td style="width: 10%;"></td> <td style="width: 10%;"></td> <td style="width: 10%;"></td> <td style="width: 10%;"></td> <td style="width: 10%;"></td> </tr> <tr> <td></td> <td></td> <td colspan="8" style="text-align: center;"> <table border="1" style="width: 100%; border-collapse: collapse; text-align: center;"> <tr> <td style="width: 10%;"></td> <td style="width: 10%;"></td> <td style="width: 10%;"></td> <td style="width: 10%;"></td> <td style="width: 10%;"></td> <td style="width: 10%;"></td> <td style="width: 10%;"></td> <td style="width: 10%;"></td> <td style="width: 10%;"></td> <td style="width: 10%;"></td> </tr> <tr> <td></td> <td></td> <td colspan="8" style="text-align: center;"> <table border="1" style="width: 100%; border-collapse: collapse; text-align: center;"> <tr> <td style="width: 10%;"></td> <td style="width: 10%;"></td> <td style="width: 10%;"></td> <td style="width: 10%;"></td> <td style="width: 10%;"></td> <td style="width: 10%;"></td> <td style="width: 10%;"></td> <td style="width: 10%;"></td> <td style="width: 10%;"></td> <td style="width: 10%;"></td> </tr> <tr> <td></td> <td></td> <td colspan="8" style="text-align: center;"> <table border="1" style="width: 100%; border-collapse: collapse; text-align: center;"> <tr> <td style="width: 10%;"></td> <td style="width: 10%;"></td> <td style="width: 10%;"></td> <td style="width: 10%;"></td> <td style="width: 10%;"></td> <td style="width: 10%;"></td> <td style="width: 10%;"></td> <td style="width: 10%;"></td> <td style="width: 10%;"></td> <td style="width: 10%;"></td> </tr> <tr> <td></td> <td></td> <td colspan="8" style="text-align: center;"> <table border="1" style="width: 100%; border-collapse: collapse; text-align: center;"> <tr> <td style="width: 10%;"></td> <td style="width: 10%;"></td> <td style="width: 10%;"></td> <td style="width: 10%;"></td> <td style="width: 10%;"></td> <td style="width: 10%;"></td> <td style="width: 10%;"></td> <td style="width: 10%;"></td> <td style="width: 10%;"></td> <td style="width: 10%;"></td> </tr> <tr> <td></td> <td></td> <td colspan="8" style="text-align: center;"> <table border="1" style="width: 100%; border-collapse: collapse; text-align: center;"> <tr> <td style="width: 10%;"></td> <td style="width: 10%;"></td> <td style="width: 10%;"></td> <td style="width: 10%;"></td> <td style="width: 10%;"></td> <td style="width: 10%;"></td> <td style="width: 10%;"></td> <td style="width: 10%;"></td> <td style="width: 10%;"></td> <td style="width: 10%;"></td> </tr> <tr> <td></td> <td></td> <td colspan="8" style="text-align: center;"> <table border="1" style="width: 100%; border-collapse: collapse; text-align: center;"> <tr> <td style="width: 10%;"></td> <td style="width: 10%;"></td> <td style="width: 10%;"></td> <td style="width: 10%;"></td> <td style="width: 10%;"></td> <td style="width: 10%;"></td> <td style="width: 10%;"></td> <td style="width: 10%;"></td> <td style="width: 10%;"></td> <td style="width: 10%;"></td> </tr> <tr> <td></td> <td></td> <td colspan="8" style="text-align: center;"> <table border="1" style="width: 100%; border-collapse: collapse; text-align: center;"> <tr> <td style="width: 10%;"></td> <td style="width: 10%;"></td> <td style="width: 10%;"></td> <td style="width: 10%;"></td> <td style="width: 10%;"></td> <td style="width: 10%;"></td> <td style="width: 10%;"></td> <td style="width: 10%;"></td> <td style="width: 10%;"></td> <td style="width: 10%;"></td> </tr> <tr> <td></td> <td></td> <td colspan="8" style="text-align: center;"> <table border="1" style="width: 100%; border-collapse: collapse; text-align: center;"> <tr> </tr></table></td></tr></table></td></tr></table></td></tr></table></td></tr></table></td></tr></table></td></tr></table></td></tr></table></td></tr></table></td></tr></table></td></tr></table></td></tr></table></td></tr></table></td></tr></table></td></tr></table>

 | | | | | | | | | | | | | | | | | | | | <table border="1" style="width: 100%; border-collapse: collapse; text-align: center;"> <tr> <td style="width: 10%;"></td> <td style="width: 10%;"></td> <td style="width: 10%;"></td> <td style="width: 10%;"></td> <td style="width: 10%;"></td> <td style="width: 10%;"></td> <td style="width: 10%;"></td> <td style="width: 10%;"></td> <td style="width: 10%;"></td> <td style="width: 10%;"></td> </tr> <tr> <td></td> <td></td> <td colspan="8" style="text-align: center;"> <table border="1" style="width: 100%; border-collapse: collapse; text-align: center;"> <tr> <td style="width: 10%;"></td> <td style="width: 10%;"></td> <td style="width: 10%;"></td> <td style="width: 10%;"></td> <td style="width: 10%;"></td> <td style="width: 10%;"></td> <td style="width: 10%;"></td> <td style="width: 10%;"></td> <td style="width: 10%;"></td> <td style="width: 10%;"></td> </tr> <tr> <td></td> <td></td> <td colspan="8" style="text-align: center;"> <table border="1" style="width: 100%; border-collapse: collapse; text-align: center;"> <tr> <td style="width: 10%;"></td> <td
style="width: 10%;"></td> <td style="width: 10%;"></td> <td style="width: 10%;"></td> <td style="width: 10%;"></td> <td style="width: 10%;"></td> <td style="width: 10%;"></td> <td style="width: 10%;"></td> <td style="width: 10%;"></td> <td style="width: 10%;"></td> </tr> <tr> <td></td> <td></td> <td colspan="8" style="text-align: center;"> <table border="1" style="width: 100%; border-collapse: collapse; text-align: center;"> <tr> <td style="width: 10%;"></td> <td style="width: 10%;"></td> <td style="width: 10%;"></td> <td style="width: 10%;"></td> <td style="width: 10%;"></td> <td style="width: 10%;"></td> <td style="width: 10%;"></td> <td style="width: 10%;"></td> <td style="width: 10%;"></td> <td style="width: 10%;"></td> </tr> <tr> <td></td> <td></td> <td colspan="8" style="text-align: center;"> <table border="1" style="width: 100%; border-collapse: collapse; text-align: center;"> <tr> <td style="width: 10%;"></td> <td style="width: 10%;"></td> <td style="width: 10%;"></td> <td style="width: 10%;"></td> <td style="width: 10%;"></td> <td style="width: 10%;"></td> <td style="width: 10%;"></td> <td style="width: 10%;"></td> <td style="width: 10%;"></td> <td style="width: 10%;"></td> </tr> <tr> <td></td> <td></td> <td colspan="8" style="text-align: center;"> <table border="1" style="width: 100%; border-collapse: collapse; text-align: center;"> <tr> <td style="width: 10%;"></td> <td style="width: 10%;"></td> <td style="width: 10%;"></td> <td style="width: 10%;"></td> <td style="width: 10%;"></td> <td style="width: 10%;"></td> <td style="width: 10%;"></td> <td style="width: 10%;"></td> <td style="width: 10%;"></td> <td style="width: 10%;"></td> </tr> <tr> <td></td> <td></td> <td colspan="8" style="text-align: center;"> <table border="1" style="width: 100%; border-collapse: collapse; text-align: center;"> <tr> <td style="width: 10%;"></td> <td style="width: 10%;"></td> <td style="width: 10%;"></td> <td style="width: 10%;"></td> <td style="width: 10%;"></td> <td style="width: 10%;"></td> <td style="width: 10%;"></td> <td style="width: 10%;"></td> <td style="width: 10%;"></td> <td style="width: 10%;"></td> </tr> <tr> <td></td> <td></td> <td colspan="8" style="text-align: center;"> <table border="1" style="width: 100%; border-collapse: collapse; text-align: center;"> <tr> <td style="width: 10%;"></td> <td style="width: 10%;"></td> <td style="width: 10%;"></td> <td style="width: 10%;"></td> <td style="width: 10%;"></td> <td style="width: 10%;"></td> <td style="width: 10%;"></td> <td style="width: 10%;"></td> <td style="width: 10%;"></td> <td style="width: 10%;"></td> </tr> <tr> <td></td> <td></td> <td colspan="8" style="text-align: center;"> <table border="1" style="width: 100%; border-collapse: collapse; text-align: center;"> <tr> <td style="width: 10%;"></td> <td style="width: 10%;"></td> <td style="width: 10%;"></td> <td style="width: 10%;"></td> <td style="width: 10%;"></td> <td style="width: 10%;"></td> <td style="width: 10%;"></td> <td style="width: 10%;"></td> <td style="width: 10%;"></td> <td style="width: 10%;"></td> </tr> <tr> <td></td> <td></td> <td colspan="8" style="text-align: center;"> <table border="1" style="width: 100%; border-collapse: collapse; text-align: center;"> <tr> <td style="width: 10%;"></td> <td style="width: 10%;"></td> <td style="width: 10%;"></td> <td style="width: 10%;"></td> <td style="width: 10%;"></td> <td style="width: 10%;"></td> <td style="width: 10%;"></td> <td style="width: 10%;"></td> <td style="width: 10%;"></td> <td style="width: 10%;"></td> </tr> <tr> <td></td> <td></td> <td colspan="8" style="text-align: center;"> <table border="1" style="width: 100%; border-collapse: collapse; text-align: center;"> <tr> <td style="width: 10%;"></td> <td style="width: 10%;"></td> <td style="width: 10%;"></td> <td style="width: 10%;"></td> <td style="width: 10%;"></td> <td style="width: 10%;"></td> <td style="width: 10%;"></td> <td style="width: 10%;"></td> <td style="width: 10%;"></td> <td style="width: 10%;"></td> </tr> <tr> <td></td> <td></td> <td colspan="8" style="text-align: center;"> <table border="1" style="width: 100%; border-collapse: collapse; text-align: center;"> <tr> <td style="width: 10%;"></td> <td style="width: 10%;"></td> <td style="width: 10%;"></td> <td style="width: 10%;"></td> <td style="width: 10%;"></td> <td style="width: 10%;"></td> <td style="width: 10%;"></td> <td style="width: 10%;"></td> <td style="width: 10%;"></td> <td style="width: 10%;"></td> </tr> <tr> <td></td> <td></td> <td colspan="8" style="text-align: center;"> <table border="1" style="width: 100%; border-collapse: collapse; text-align: center;"> <tr> <td style="width: 10%;"></td> <td style="width: 10%;"></td> <td style="width: 10%;"></td> <td style="width: 10%;"></td> <td style="width: 10%;"></td> <td style="width: 10%;"></td> <td style="width: 10%;"></td> <td style="width: 10%;"></td> <td style="width: 10%;"></td> <td style="width: 10%;"></td> </tr> <tr> <td></td> <td></td> <td colspan="8" style="text-align: center;"> <table border="1" style="width: 100%; border-collapse: collapse; text-align: center;"> <tr> </tr></table></td></tr></table></td></tr></table></td></tr></table></td></tr></table></td></tr></table></td></tr></table></td></tr></table></td></tr></table></td></tr></table></td></tr></table></td></tr></table></td></tr></table></td></tr></table>

 | | | | | | | | | | | | | | | | | | | | <table border="1" style="width: 100%; border-collapse: collapse; text-align: center;"> <tr> <td style="width: 10%;"></td> <td style="width: 10%;"></td> <td style="width: 10%;"></td> <td style="width: 10%;"></td> <td style="width: 10%;"></td> <td style="width: 10%;"></td> <td style="width: 10%;"></td> <td style="width: 10%;"></td> <td style="width: 10%;"></td> <td style="width: 10%;"></td> </tr> <tr> <td></td> <td></td> <td colspan="8" style="text-align: center;"> <table border="1" style="width: 100%; border-collapse: collapse; text-align: center;"> <tr> <td style="width: 10%;"></td> <td style="width: 10%;"></td> <td style="width: 10%;"></td> <td style="width: 10%;"></td> <td style="width: 10%;"></td> <td style="width: 10%;"></td> <td style="width: 10%;"></td> <td style="width: 10%;"></td> <td style="width: 10%;"></td> <td style="width: 10%;"></td> </tr> <tr> <td></td> <td></td> <td colspan="8" style="text-align: center;"> <table border="1" style="width: 100%; border-collapse: collapse; text-align: center;"> <tr> <td style="width: 10%;"></td> <td style="width: 10%;"></td> <td style="width: 10%;"></td> <td style="width: 10%;"></td> <td style="width: 10%;"></td> <td style="width: 10%;"></td> <td style="width: 10%;"></td> <td style="width: 10%;"></td> <td style="width: 10%;"></td> <td style="width: 10%;"></td> </tr> <tr> <td></td> <td></td> <td colspan="8" style="text-align: center;"> <table border="1" style="width: 100%; border-collapse: collapse; text-align: center;"> <tr> <td style="width: 10%;"></td> <td style="width: 10%;"></td> <td style="width: 10%;"></td> <td style="width: 10%;"></td> <td style="width: 10%;"></td> <td style="width: 10%;"></td> <td style="width: 10%;"></td> <td style="width: 10%;"></td> <td style="width: 10%;"></td> <td style="width: 10%;"></td> </tr> <tr> <td></td> <td></td> <td colspan="8" style="text-align: center;"> <table border="1" style="width: 100%; border-collapse: collapse; text-align: center;"> <tr> <td style="width: 10%;"></td> <td style="width: 10%;"></td> <td style="width: 10%;"></td> <td style="width: 10%;"></td> <td style="width: 10%;"></td> <td style="width: 10%;"></td> <td style="width: 10%;"></td> <td style="width: 10%;"></td> <td style="width: 10%;"></td> <td style="width: 10%;"></td> </tr> <tr> <td></td> <td></td> <td colspan="8" style="text-align: center;"> <table border="1" style="width: 100%; border-collapse: collapse; text-align: center;"> <tr> <td style="width: 10%;"></td> <td style="width: 10%;"></td> <td style="width: 10%;"></td> <td style="width: 10%;"></td> <td style="width: 10%;"></td> <td style="width: 10%;"></td> <td style="width: 10%;"></td> <td style="width: 10%;"></td> <td style="width: 10%;"></td> <td style="width: 10%;"></td> </tr> <tr> <td></td> <td></td> <td colspan="8" style="text-align: center;"> <table border="1" style="width: 100%; border-collapse: collapse; text-align: center;"> <tr> <td style="width: 10%;"></td> <td style="width: 10%;"></td> <td style="width: 10%;"></td> <td style="width: 10%;"></td> <td style="width: 10%;"></td> <td style="width: 10%;"></td> <td style="width: 10%;"></td> <td style="width: 10%;"></td> <td style="width: 10%;"></td> <td style="width:
10%;"></td> </tr> <tr> <td></td> <td></td> <td colspan="8" style="text-align: center;"> <table border="1" style="width: 100%; border-collapse: collapse; text-align: center;"> <tr> <td style="width: 10%;"></td> <td style="width: 10%;"></td> <td style="width: 10%;"></td> <td style="width: 10%;"></td> <td style="width: 10%;"></td> <td style="width: 10%;"></td> <td style="width: 10%;"></td> <td style="width: 10%;"></td> <td style="width: 10%;"></td> <td style="width: 10%;"></td> </tr> <tr> <td></td> <td></td> <td colspan="8" style="text-align: center;"> <table border="1" style="width: 100%; border-collapse: collapse; text-align: center;"> <tr> <td style="width: 10%;"></td> <td style="width: 10%;"></td> <td style="width: 10%;"></td> <td style="width: 10%;"></td> <td style="width: 10%;"></td> <td style="width: 10%;"></td> <td style="width: 10%;"></td> <td style="width: 10%;"></td> <td style="width: 10%;"></td> <td style="width: 10%;"></td> </tr> <tr> <td></td> <td></td> <td colspan="8" style="text-align: center;"> <table border="1" style="width: 100%; border-collapse: collapse; text-align: center;"> <tr> <td style="width: 10%;"></td> <td style="width: 10%;"></td> <td style="width: 10%;"></td> <td style="width: 10%;"></td> <td style="width: 10%;"></td> <td style="width: 10%;"></td> <td style="width: 10%;"></td> <td style="width: 10%;"></td> <td style="width: 10%;"></td> <td style="width: 10%;"></td> </tr> <tr> <td></td> <td></td> <td colspan="8" style="text-align: center;"> <table border="1" style="width: 100%; border-collapse: collapse; text-align: center;"> <tr> <td style="width: 10%;"></td> <td style="width: 10%;"></td> <td style="width: 10%;"></td> <td style="width: 10%;"></td> <td style="width: 10%;"></td> <td style="width: 10%;"></td> <td style="width: 10%;"></td> <td style="width: 10%;"></td> <td style="width: 10%;"></td> <td style="width: 10%;"></td> </tr> <tr> <td></td> <td></td> <td colspan="8" style="text-align: center;"> <table border="1" style="width: 100%; border-collapse: collapse; text-align: center;"> <tr> <td style="width: 10%;"></td> <td style="width: 10%;"></td> <td style="width: 10%;"></td> <td style="width: 10%;"></td> <td style="width: 10%;"></td> <td style="width: 10%;"></td> <td style="width: 10%;"></td> <td style="width: 10%;"></td> <td style="width: 10%;"></td> <td style="width: 10%;"></td> </tr> <tr> <td></td> <td></td> <td colspan="8" style="text-align: center;"> <table border="1" style="width: 100%; border-collapse: collapse; text-align: center;"> <tr> </tr></table></td></tr></table></td></tr></table></td></tr></table></td></tr></table></td></tr></table></td></tr></table></td></tr></table></td></tr></table></td></tr></table></td></tr></table></td></tr></table></td></tr></table>

 | | | | | | | | | | | | | | | | | | | | <table border="1" style="width: 100%; border-collapse: collapse; text-align: center;"> <tr> <td style="width: 10%;"></td> <td style="width: 10%;"></td> <td style="width: 10%;"></td> <td style="width: 10%;"></td> <td style="width: 10%;"></td> <td style="width: 10%;"></td> <td style="width: 10%;"></td> <td style="width: 10%;"></td> <td style="width: 10%;"></td> <td style="width: 10%;"></td> </tr> <tr> <td></td> <td></td> <td colspan="8" style="text-align: center;"> <table border="1" style="width: 100%; border-collapse: collapse; text-align: center;"> <tr> <td style="width: 10%;"></td> <td style="width: 10%;"></td> <td style="width: 10%;"></td> <td style="width: 10%;"></td> <td style="width: 10%;"></td> <td style="width: 10%;"></td> <td style="width: 10%;"></td> <td style="width: 10%;"></td> <td style="width: 10%;"></td> <td style="width: 10%;"></td> </tr> <tr> <td></td> <td></td> <td colspan="8" style="text-align: center;"> <table border="1" style="width: 100%; border-collapse: collapse; text-align: center;"> <tr> <td style="width: 10%;"></td> <td style="width: 10%;"></td> <td style="width: 10%;"></td> <td style="width: 10%;"></td> <td style="width: 10%;"></td> <td style="width: 10%;"></td> <td style="width: 10%;"></td> <td style="width: 10%;"></td> <td style="width: 10%;"></td> <td style="width: 10%;"></td> </tr> <tr> <td></td> <td></td> <td colspan="8" style="text-align: center;"> <table border="1" style="width: 100%; border-collapse: collapse; text-align: center;"> <tr> <td style="width: 10%;"></td> <td style="width: 10%;"></td> <td style="width: 10%;"></td> <td style="width: 10%;"></td> <td style="width: 10%;"></td> <td style="width: 10%;"></td> <td style="width: 10%;"></td> <td style="width: 10%;"></td> <td style="width: 10%;"></td> <td style="width: 10%;"></td> </tr> <tr> <td></td> <td></td> <td colspan="8" style="text-align: center;"> <table border="1" style="width: 100%; border-collapse: collapse; text-align: center;"> <tr> <td style="width: 10%;"></td> <td style="width: 10%;"></td> <td style="width: 10%;"></td> <td style="width: 10%;"></td> <td style="width: 10%;"></td> <td style="width: 10%;"></td> <td style="width: 10%;"></td> <td style="width: 10%;"></td> <td style="width: 10%;"></td> <td style="width: 10%;"></td> </tr> <tr> <td></td> <td></td> <td colspan="8" style="text-align: center;"> <table border="1" style="width: 100%; border-collapse: collapse; text-align: center;"> <tr> <td style="width: 10%;"></td> <td style="width: 10%;"></td> <td style="width: 10%;"></td> <td style="width: 10%;"></td> <td style="width: 10%;"></td> <td style="width: 10%;"></td> <td style="width: 10%;"></td> <td style="width: 10%;"></td> <td style="width: 10%;"></td> <td style="width: 10%;"></td> </tr> <tr> <td></td> <td></td> <td colspan="8" style="text-align: center;"> <table border="1" style="width: 100%; border-collapse: collapse; text-align: center;"> <tr> <td style="width: 10%;"></td> <td style="width: 10%;"></td> <td style="width: 10%;"></td> <td style="width: 10%;"></td> <td style="width: 10%;"></td> <td style="width: 10%;"></td> <td style="width: 10%;"></td> <td style="width: 10%;"></td> <td style="width: 10%;"></td> <td style="width: 10%;"></td> </tr> <tr> <td></td> <td></td> <td colspan="8" style="text-align: center;"> <table border="1" style="width: 100%; border-collapse: collapse; text-align: center;"> <tr> <td style="width: 10%;"></td> <td style="width: 10%;"></td> <td style="width: 10%;"></td> <td style="width: 10%;"></td> <td style="width: 10%;"></td> <td style="width: 10%;"></td> <td style="width: 10%;"></td> <td style="width: 10%;"></td> <td style="width: 10%;"></td> <td style="width: 10%;"></td> </tr> <tr> <td></td> <td></td> <td colspan="8" style="text-align: center;"> <table border="1" style="width: 100%; border-collapse: collapse; text-align: center;"> <tr> <td style="width: 10%;"></td> <td style="width: 10%;"></td> <td style="width: 10%;"></td> <td style="width: 10%;"></td> <td style="width: 10%;"></td> <td style="width: 10%;"></td> <td style="width: 10%;"></td> <td style="width: 10%;"></td> <td style="width: 10%;"></td> <td style="width: 10%;"></td> </tr> <tr> <td></td> <td></td> <td colspan="8" style="text-align: center;"> <table border="1" style="width: 100%; border-collapse: collapse; text-align: center;"> <tr> <td style="width: 10%;"></td> <td style="width: 10%;"></td> <td style="width: 10%;"></td> <td style="width: 10%;"></td> <td style="width: 10%;"></td> <td style="width: 10%;"></td> <td style="width: 10%;"></td> <td style="width: 10%;"></td> <td style="width: 10%;"></td> <td style="width: 10%;"></td> </tr> <tr> <td></td> <td></td> <td colspan="8" style="text-align: center;"> <table border="1" style="width: 100%; border-collapse: collapse; text-align: center;"> <tr> <td style="width: 10%;"></td> <td style="width: 10%;"></td> <td style="width: 10%;"></td> <td style="width: 10%;"></td> <td style="width: 10%;"></td> <td style="width: 10%;"></td> <td style="width: 10%;"></td> <td style="width: 10%;"></td> <td style="width: 10%;"></td> <td style="width: 10%;"></td> </tr> <tr> <td></td> <td></td> <td colspan="8" style="text-align: center;"> <table border="1" style="width: 100%; border-collapse: collapse; text-align: center;"> <tr> </tr></table></td></tr></table></td></tr></table></td></tr></table></td></tr></table></td></tr></table></td></tr></table></td></tr></table></td></tr></table></td></tr></table></td></tr></table></td></tr></table>

 | | | | | | | | | | | | | | | | | | | | <table border="1" style="width: 100%; border-collapse: collapse; text-align: center;"> <tr> <td style="width: 10%;"></td> <td style="width: 10%;"></td> <td style="width: 10%;"></td> <td style="width: 10%;"></td> <td style="width: 10%;"></td> <td style="width: 10%;"></td> <td style="width: 10%;"></td> <td style="width: 10%;"></td> <td style="width: 10%;"></td> <td style="width: 10%;"></td> </tr> <tr> <td></td> <td></td> <td colspan="8" style="text-align: center;"> <table border="1" style="width: 100%; border-collapse: collapse; text-align: center;"> <tr> <td style="width: 10%;"></td> <td style="width: 10%;"></td> <td style="width: 10%;"></td> <td style="width: 10%;"></td> <td style="width: 10%;"></td> <td style="width: 10%;"></td> <td style="width: 10%;"></td> <td style="width: 10%;"></td> <td style="width: 10%;"></td> <td style="width: 10%;"></td> </tr> <tr> <td></td> <td></td> <td colspan="8" style="text-align: center;"> <table border="1" style="width: 100%; border-collapse: collapse; text-align: center;"> <tr> <td style="width: 10%;"></td> <td style="width: 10%;"></td> <td style="width: 10%;"></td> <td style="width: 10%;"></td> <td style="width: 10%;"></td> <td style="width: 10%;"></td> <td style="width: 10%;"></td> <td style="width: 10%;"></td> <td style="width: 10%;"></td> <td style="width: 10%;"></td> </tr> <tr> <td></td> <td></td> <td colspan="8" style="text-align: center;"> <table border="1" style="width: 100%; border-collapse: collapse; text-align: center;"> <tr> <td style="width: 10%;"></td> <td style="width: 10%;"></td> <td style="width: 10%;"></td> <td style="width: 10%;"></td> <td style="width: 10%;"></td> <td style="width: 10%;"></td> <td style="width: 10%;"></td> <td style="width: 10%;"></td> <td style="width: 10%;"></td> <td style="width: 10%;"></td> </tr> <tr> <td></td> <td></td> <td colspan="8" style="text-align: center;"> <table border="1" style="width: 100%; border-collapse: collapse; text-align: center;"> <tr> <td style="width: 10%;"></td> <td style="width: 10%;"></td> <td style="width: 10%;"></td> <td style="width: 10%;"></td> <td style="width: 10%;"></td> <td style="width: 10%;"></td> <td style="width: 10%;"></td> <td style="width: 10%;"></td> <td style="width: 10%;"></td> <td style="width: 10%;"></td> </tr> <tr> <td></td> <td></td> <td colspan="8" style="text-align: center;"> <table border="1" style="width: 100%; border-collapse: collapse; text-align: center;"> <tr> <td style="width: 10%;"></td> <td style="width: 10%;"></td> <td style="width: 10%;"></td> <td style="width: 10%;"></td> <td style="width: 10%;"></td> <td style="width: 10%;"></td> <td style="width: 10%;"></td> <td style="width: 10%;"></td> <td style="width: 10%;"></td> <td style="width: 10%;"></td> </tr> <tr> <td></td> <td></td> <td colspan="8" style="text-align: center;"> <table border="1" style="width: 100%; border-collapse: collapse; text-align: center;"> <tr> <td style="width: 10%;"></td> <td style="width: 10%;"></td> <td style="width: 10%;"></td> <td style="width: 10%;"></td> <td style="width: 10%;"></td> <td style="width: 10%;"></td> <td style="width: 10%;"></td> <td style="width: 10%;"></td> <td style="width: 10%;"></td> <td style="width: 10%;"></td> </tr> <tr> <td></td> <td></td> <td colspan="8" style="text-align: center;"> <table border="1" style="width: 100%; border-collapse: collapse; text-align: center;"> <tr> <td style="width: 10%;"></td> <td style="width: 10%;"></td> <td style="width: 10%;"></td> <td style="width: 10%;"></td> <td style="width: 10%;"></td> <td style="width: 10%;"></td> <td style="width: 10%;"></td> <td style="width: 10%;"></td> <td style="width: 10%;"></td> <td style="width: 10%;"></td> </tr> <tr> <td></td> <td></td> <td colspan="8" style="text-align: center;"> <table border="1" style="width: 100%; border-collapse: collapse; text-align: center;"> <tr> <td style="width: 10%;"></td> <td style="width: 10%;"></td> <td style="width: 10%;"></td> <td style="width: 10%;"></td> <td style="width: 10%;"></td> <td style="width: 10%;"></td> <td style="width: 10%;"></td> <td style="width: 10%;"></td> <td style="width: 10%;"></td> <td style="width: 10%;"></td> </tr> <tr> <td></td> <td></td> <td colspan="8" style="text-align: center;"> <table border="1" style="width: 100%; border-collapse: collapse; text-align: center;"> <tr> <td style="width: 10%;"></td> <td style="width: 10%;"></td> <td style="width: 10%;"></td> <td style="width: 10%;"></td> <td style="width: 10%;"></td> <td style="width: 10%;"></td> <td style="width: 10%;"></td> <td style="width: 10%;"></td> <td style="width: 10%;"></td> <td style="width: 10%;"></td> </tr> <tr> <td></td> <td></td> <td colspan="8" style="text-align: center;"> <table border="1" style="width: 100%; border-collapse: collapse; text-align: center;"> <tr> </tr></table></td></tr></table></td></tr></table></td></tr></table></td></tr></table></td></tr></table></td></tr></table></td></tr></table></td></tr></table></td></tr></table></td></tr></table>

 | | | | | | | | | | | | | | | | | | | | <table border="1" style="width: 100%; border-collapse: collapse; text-align: center;"> <tr> <td style="width: 10%;"></td> <td style="width: 10%;"></td> <td style="width: 10%;"></td> <td style="width: 10%;"></td> <td style="width: 10%;"></td> <td style="width: 10%;"></td> <td style="width: 10%;"></td> <td style="width: 10%;"></td> <td style="width: 10%;"></td> <td style="width: 10%;"></td> </tr> <tr> <td></td> <td></td> <td colspan="8" style="text-align: center;"> <table border="1" style="width: 100%; border-collapse: collapse; text-align: center;"> <tr> <td style="width: 10%;"></td> <td style="width: 10%;"></td> <td style="width: 10%;"></td> <td style="width: 10%;"></td> <td style="width: 10%;"></td> <td style="width: 10%;"></td> <td style="width: 10%;"></td> <td style="width: 10%;"></td> <td style="width: 10%;"></td> <td style="width: 10%;"></td> </tr> <tr> <td></td> <td></td> <td colspan="8" style="text-align: center;"> <table border="1" style="width: 100%; border-collapse: collapse; text-align: center;"> <tr> <td style="width: 10%;"></td> <td style="width: 10%;"></td> <td style="width: 10%;"></td> <td style="width: 10%;"></td> <td style="width: 10%;"></td> <td style="width: 10%;"></td> <td style="width: 10%;"></td> <td style="width: 10%;"></td> <td style="width: 10%;"></td> <td style="width: 10%;"></td> </tr> <tr> <td></td> <td></td> <td colspan="8" style="text-align: center;"> <table border="1" style="width: 100%; border-collapse: collapse; text-align: center;"> <tr> <td style="width: 10%;"></td> <td style="width: 10%;"></td> <td style="width: 10%;"></td> <td style="width: 10%;"></td> <td style="width: 10%;"></td> <td style="width: 10%;"></td> <td style="width: 10%;"></td> <td style="width: 10%;"></td> <td style="width: 10%;"></td> <td style="width: 10%;"></td> </tr> <tr> <td></td> <td></td> <td colspan="8" style="text-align: center;"> <table border="1" style="width: 100%; border-collapse: collapse; text-align: center;"> <tr> <td style="width: 10%;"></td> <td style="width: 10%;"></td> <td style="width: 10%;"></td> <td style="width: 10%;"></td> <td style="width: 10%;"></td> <td style="width: 10%;"></td> <td style="width: 10%;"></td> <td style="width: 10%;"></td> <td style="width: 10%;"></td> <td style="width: 10%;"></td> </tr> <tr> <td></td> <td></td> <td colspan="8" style="text-align: center;"> <table border="1" style="width: 100%; border-collapse: collapse; text-align: center;"> <tr> <td style="width: 10%;"></td> <td style="width: 10%;"></td> <td
style="width: 10%;"></td> <td style="width: 10%;"></td> <td style="width: 10%;"></td> <td style="width: 10%;"></td> <td style="width: 10%;"></td> <td style="width: 10%;"></td> <td style="width: 10%;"></td> <td style="width: 10%;"></td> </tr> <tr> <td></td> <td></td> <td colspan="8" style="text-align: center;"> <table border="1" style="width: 100%; border-collapse: collapse; text-align: center;"> <tr> <td style="width: 10%;"></td> <td style="width: 10%;"></td> <td style="width: 10%;"></td> <td style="width: 10%;"></td> <td style="width: 10%;"></td> <td style="width: 10%;"></td> <td style="width: 10%;"></td> <td style="width: 10%;"></td> <td style="width: 10%;"></td> <td style="width: 10%;"></td> </tr> <tr> <td></td> <td></td> <td colspan="8" style="text-align: center;"> <table border="1" style="width: 100%; border-collapse: collapse; text-align: center;"> <tr> <td style="width: 10%;"></td> <td style="width: 10%;"></td> <td style="width: 10%;"></td> <td style="width: 10%;"></td> <td style="width: 10%;"></td> <td style="width: 10%;"></td> <td style="width: 10%;"></td> <td style="width: 10%;"></td> <td style="width: 10%;"></td> <td style="width: 10%;"></td> </tr> <tr> <td></td> <td></td> <td colspan="8" style="text-align: center;"> <table border="1" style="width: 100%; border-collapse: collapse; text-align: center;"> <tr> <td style="width: 10%;"></td> <td style="width: 10%;"></td> <td style="width: 10%;"></td> <td style="width: 10%;"></td> <td style="width: 10%;"></td> <td style="width: 10%;"></td> <td style="width: 10%;"></td> <td style="width: 10%;"></td> <td style="width: 10%;"></td> <td style="width: 10%;"></td> </tr> <tr> <td></td> <td></td> <td colspan="8" style="text-align: center;"> <table border="1" style="width: 100%; border-collapse: collapse; text-align: center;"> <tr> </tr></table></td></tr></table></td></tr></table></td></tr></table></td></tr></table></td></tr></table></td></tr></table></td></tr></table></td></tr></table></td></tr></table>

 | | | | | | | | | | | | | | | | | | | | <table border="1" style="width: 100%; border-collapse: collapse; text-align: center;"> <tr> <td style="width: 10%;"></td> <td style="width: 10%;"></td> <td style="width: 10%;"></td> <td style="width: 10%;"></td> <td style="width: 10%;"></td> <td style="width: 10%;"></td> <td style="width: 10%;"></td> <td style="width: 10%;"></td> <td style="width: 10%;"></td> <td style="width: 10%;"></td> </tr> <tr> <td></td> <td></td> <td colspan="8" style="text-align: center;"> <table border="1" style="width: 100%; border-collapse: collapse; text-align: center;"> <tr> <td style="width: 10%;"></td> <td style="width: 10%;"></td> <td style="width: 10%;"></td> <td style="width: 10%;"></td> <td style="width: 10%;"></td> <td style="width: 10%;"></td> <td style="width: 10%;"></td> <td style="width: 10%;"></td> <td style="width: 10%;"></td> <td style="width: 10%;"></td> </tr> <tr> <td></td> <td></td> <td colspan="8" style="text-align: center;"> <table border="1" style="width: 100%; border-collapse: collapse; text-align: center;"> <tr> <td style="width: 10%;"></td> <td style="width: 10%;"></td> <td style="width: 10%;"></td> <td style="width: 10%;"></td> <td style="width: 10%;"></td> <td style="width: 10%;"></td> <td style="width: 10%;"></td> <td style="width: 10%;"></td> <td style="width: 10%;"></td> <td style="width: 10%;"></td> </tr> <tr> <td></td> <td></td> <td colspan="8" style="text-align: center;"> <table border="1" style="width: 100%; border-collapse: collapse; text-align: center;"> <tr> <td style="width: 10%;"></td> <td style="width: 10%;"></td> <td style="width: 10%;"></td> <td style="width: 10%;"></td> <td style="width: 10%;"></td> <td style="width: 10%;"></td> <td style="width: 10%;"></td> <td style="width: 10%;"></td> <td style="width: 10%;"></td> <td style="width: 10%;"></td> </tr> <tr> <td></td> <td></td> <td colspan="8" style="text-align: center;"> <table border="1" style="width: 100%; border-collapse: collapse; text-align: center;"> <tr> <td style="width: 10%;"></td> <td style="width: 10%;"></td> <td style="width: 10%;"></td> <td style="width: 10%;"></td> <td style="width: 10%;"></td> <td style="width: 10%;"></td> <td style="width: 10%;"></td> <td style="width: 10%;"></td> <td style="width: 10%;"></td> <td style="width: 10%;"></td> </tr> <tr> <td></td> <td></td> <td colspan="8" style="text-align: center;"> <table border="1" style="width: 100%; border-collapse: collapse; text-align: center;"> <tr> <td style="width: 10%;"></td> <td style="width: 10%;"></td> <td style="width: 10%;"></td> <td style="width: 10%;"></td> <td style="width: 10%;"></td> <td style="width: 10%;"></td> <td style="width: 10%;"></td> <td style="width: 10%;"></td> <td style="width: 10%;"></td> <td style="width: 10%;"></td> </tr> <tr> <td></td> <td></td> <td colspan="8" style="text-align: center;"> <table border="1" style="width: 100%; border-collapse: collapse; text-align: center;"> <tr> <td style="width: 10%;"></td> <td style="width: 10%;"></td> <td style="width: 10%;"></td> <td style="width: 10%;"></td> <td style="width: 10%;"></td> <td style="width: 10%;"></td> <td style="width: 10%;"></td> <td style="width: 10%;"></td> <td style="width: 10%;"></td> <td style="width: 10%;"></td> </tr> <tr> <td></td> <td></td> <td colspan="8" style="text-align: center;"> <table border="1" style="width: 100%; border-collapse: collapse; text-align: center;"> <tr> <td style="width: 10%;"></td> <td style="width: 10%;"></td> <td style="width: 10%;"></td> <td style="width: 10%;"></td> <td style="width: 10%;"></td> <td style="width: 10%;"></td> <td style="width: 10%;"></td> <td style="width: 10%;"></td> <td style="width: 10%;"></td> <td style="width: 10%;"></td> </tr> <tr> <td></td> <td></td> <td colspan="8" style="text-align: center;"> <table border="1" style="width: 100%; border-collapse: collapse; text-align: center;"> <tr> </tr></table></td></tr></table></td></tr></table></td></tr></table></td></tr></table></td></tr></table></td></tr></table></td></tr></table></td></tr></table>

 | | | | | | | | | | | | | | | | | | | | <table border="1" style="width: 100%; border-collapse: collapse; text-align: center;"> <tr> <td style="width: 10%;"></td> <td style="width: 10%;"></td> <td style="width: 10%;"></td> <td style="width: 10%;"></td> <td style="width: 10%;"></td> <td style="width: 10%;"></td> <td style="width: 10%;"></td> <td style="width: 10%;"></td> <td style="width: 10%;"></td> <td style="width: 10%;"></td> </tr> <tr> <td></td> <td></td> <td colspan="8" style="text-align: center;"> <table border="1" style="width: 100%; border-collapse: collapse; text-align: center;"> <tr> <td style="width: 10%;"></td> <td style="width: 10%;"></td> <td style="width: 10%;"></td> <td style="width: 10%;"></td> <td style="width: 10%;"></td> <td style="width: 10%;"></td> <td style="width: 10%;"></td> <td style="width: 10%;"></td> <td style="width: 10%;"></td> <td style="width: 10%;"></td> </tr> <tr> <td></td> <td></td> <td colspan="8" style="text-align: center;"> <table border="1" style="width: 100%; border-collapse: collapse; text-align: center;"> <tr> <td style="width: 10%;"></td> <td style="width: 10%;"></td> <td style="width: 10%;"></td> <td style="width:
10%;"></td> <td style="width: 10%;"></td> <td style="width: 10%;"></td> <td style="width: 10%;"></td> <td style="width: 10%;"></td> <td style="width: 10%;"></td> <td style="width: 10%;"></td> </tr> <tr> <td></td> <td></td> <td colspan="8" style="text-align: center;"> <table border="1" style="width: 100%; border-collapse: collapse; text-align: center;"> <tr> <td style="width: 10%;"></td> <td style="width: 10%;"></td> <td style="width: 10%;"></td> <td style="width: 10%;"></td> <td style="width: 10%;"></td> <td style="width: 10%;"></td> <td style="width: 10%;"></td> <td style="width: 10%;"></td> <td style="width: 10%;"></td> <td style="width: 10%;"></td> </tr> <tr> <td></td> <td></td> <td colspan="8" style="text-align: center;"> <table border="1" style="width: 100%; border-collapse: collapse; text-align: center;"> <tr> <td style="width: 10%;"></td> <td style="width: 10%;"></td> <td style="width: 10%;"></td> <td style="width: 10%;"></td> <td style="width: 10%;"></td> <td style="width: 10%;"></td> <td style="width: 10%;"></td> <td style="width: 10%;"></td> <td style="width: 10%;"></td> <td style="width: 10%;"></td> </tr> <tr> <td></td> <td></td> <td colspan="8" style="text-align: center;"> <table border="1" style="width: 100%; border-collapse: collapse; text-align: center;"> <tr> <td style="width: 10%;"></td> <td style="width: 10%;"></td> <td style="width: 10%;"></td> <td style="width: 10%;"></td> <td style="width: 10%;"></td> <td style="width: 10%;"></td> <td style="width: 10%;"></td> <td style="width: 10%;"></td> <td style="width: 10%;"></td> <td style="width: 10%;"></td> </tr> <tr> <td></td> <td></td> <td colspan="8" style="text-align: center;"> <table border="1" style="width: 100%; border-collapse: collapse; text-align: center;"> <tr> <td style="width: 10%;"></td> <td style="width: 10%;"></td> <td style="width: 10%;"></td> <td style="width: 10%;"></td> <td style="width: 10%;"></td> <td style="width: 10%;"></td> <td style="width: 10%;"></td> <td style="width: 10%;"></td> <td style="width: 10%;"></td> <td style="width: 10%;"></td> </tr> <tr> <td></td> <td></td> <td colspan="8" style="text-align: center;"> <table border="1" style="width: 100%; border-collapse: collapse; text-align: center;"> <tr> </tr></table></td></tr></table></td></tr></table></td></tr></table></td></tr></table></td></tr></table></td></tr></table></td></tr></table>

 | | | | | | | | | | | | | | | | | | | | <table border="1" style="width: 100%; border-collapse: collapse; text-align: center;"> <tr> <td style="width: 10%;"></td> <td style="width: 10%;"></td> <td style="width: 10%;"></td> <td style="width: 10%;"></td> <td style="width: 10%;"></td> <td style="width: 10%;"></td> <td style="width: 10%;"></td> <td style="width: 10%;"></td> <td style="width: 10%;"></td> <td style="width: 10%;"></td> </tr> <tr> <td></td> <td></td> <td colspan="8" style="text-align: center;"> <table border="1" style="width: 100%; border-collapse: collapse; text-align: center;"> <tr> <td style="width: 10%;"></td> <td style="width: 10%;"></td> <td style="width: 10%;"></td> <td style="width: 10%;"></td> <td style="width: 10%;"></td> <td style="width: 10%;"></td> <td style="width: 10%;"></td> <td style="width: 10%;"></td> <td style="width: 10%;"></td> <td style="width: 10%;"></td> </tr> <tr> <td></td> <td></td> <td colspan="8" style="text-align: center;"> <table border="1" style="width: 100%; border-collapse: collapse; text-align: center;"> <tr> <td style="width: 10%;"></td> <td style="width: 10%;"></td> <td style="width: 10%;"></td> <td style="width: 10%;"></td> <td style="width: 10%;"></td> <td style="width: 10%;"></td> <td style="width: 10%;"></td> <td style="width: 10%;"></td> <td style="width: 10%;"></td> <td style="width: 10%;"></td> </tr> <tr> <td></td> <td></td> <td colspan="8" style="text-align: center;"> <table border="1" style="width: 100%; border-collapse: collapse; text-align: center;"> <tr> <td style="width: 10%;"></td> <td style="width: 10%;"></td> <td style="width: 10%;"></td> <td style="width: 10%;"></td> <td style="width: 10%;"></td> <td style="width: 10%;"></td> <td style="width: 10%;"></td> <td style="width: 10%;"></td> <td style="width: 10%;"></td> <td style="width: 10%;"></td> </tr> <tr> <td></td> <td></td> <td colspan="8" style="text-align: center;"> <table border="1" style="width: 100%; border-collapse: collapse; text-align: center;"> <tr> <td style="width: 10%;"></td> <td style="width: 10%;"></td> <td style="width: 10%;"></td> <td style="width: 10%;"></td> <td style="width: 10%;"></td> <td style="width: 10%;"></td> <td style="width: 10%;"></td> <td style="width: 10%;"></td> <td style="width: 10%;"></td> <td style="width: 10%;"></td> </tr> <tr> <td></td> <td></td> <td colspan="8" style="text-align: center;"> <table border="1" style="width: 100%; border-collapse: collapse; text-align: center;"> <tr> <td style="width: 10%;"></td> <td style="width: 10%;"></td> <td style="width: 10%;"></td> <td style="width: 10%;"></td> <td style="width: 10%;"></td> <td style="width: 10%;"></td> <td style="width: 10%;"></td> <td style="width: 10%;"></td> <td style="width: 10%;"></td> <td style="width: 10%;"></td> </tr> <tr> <td></td> <td></td> <td colspan="8" style="text-align: center;"> <table border="1" style="width: 100%; border-collapse: collapse; text-align: center;"> <tr> </tr></table></td></tr></table></td></tr></table></td></tr></table></td></tr></table></td></tr></table></td></tr></table>

 | | | | | | | | | | | | | | | | | | | | <table border="1" style="width: 100%; border-collapse: collapse; text-align: center;"> <tr> <td style="width: 10%;"></td> <td style="width: 10%;"></td> <td style="width: 10%;"></td> <td style="width: 10%;"></td> <td style="width: 10%;"></td> <td style="width: 10%;"></td> <td style="width: 10%;"></td> <td style="width: 10%;"></td> <td style="width: 10%;"></td> <td style="width: 10%;"></td> </tr> <tr> <td></td> <td></td> <td colspan="8" style="text-align: center;"> <table border="1" style="width: 100%; border-collapse: collapse; text-align: center;"> <tr> <td style="width: 10%;"></td> <td style="width: 10%;"></td> <td style="width: 10%;"></td> <td style="width: 10%;"></td> <td style="width: 10%;"></td> <td style="width: 10%;"></td> <td style="width: 10%;"></td> <td style="width: 10%;"></td> <td style="width: 10%;"></td> <td style="width: 10%;"></td> </tr> <tr> <td></td> <td></td> <td colspan="8" style="text-align: center;"> <table border="1" style="width: 100%; border-collapse: collapse; text-align: center;"> <tr> <td style="width: 10%;"></td> <td style="width: 10%;"></td> <td style="width: 10%;"></td> <td style="width: 10%;"></td> <td style="width: 10%;"></td> <td style="width: 10%;"></td> <td style="width: 10%;"></td> <td style="width: 10%;"></td> <td style="width: 10%;"></td> <td style="width: 10%;"></td> </tr> <tr> <td></td> <td></td> <td colspan="8" style="text-align: center;"> <table border="1" style="width: 100%; border-collapse: collapse; text-align: center;"> <tr> <td style="width: 10%;"></td> <td style="width: 10%;"></td> <td style="width: 10%;"></td> <td style="width: 10%;"></td> <td style="width: 10%;"></td> <td style="width: 10%;"></td> <td style="width: 10%;"></td> <td
style="width: 10%;"></td> <td style="width: 10%;"></td> <td style="width: 10%;"></td> </tr> <tr> <td></td> <td></td> <td colspan="8" style="text-align: center;"> <table border="1" style="width: 100%; border-collapse: collapse; text-align: center;"> <tr> <td style="width: 10%;"></td> <td style="width: 10%;"></td> <td style="width: 10%;"></td> <td style="width: 10%;"></td> <td style="width: 10%;"></td> <td style="width: 10%;"></td> <td style="width: 10%;"></td> <td style="width: 10%;"></td> <td style="width: 10%;"></td> <td style="width: 10%;"></td> </tr> <tr> <td></td> <td></td> <td colspan="8" style="text-align: center;"> <table border="1" style="width: 100%; border-collapse: collapse; text-align: center;"> <tr> </tr></table></td></tr></table></td></tr></table></td></tr></table></td></tr></table></td></tr></table>

 | | | | | | | | | | | | | | | | | | | | <table border="1" style="width: 100%; border-collapse: collapse; text-align: center;"> <tr> <td style="width: 10%;"></td> <td style="width: 10%;"></td> <td style="width: 10%;"></td> <td style="width: 10%;"></td> <td style="width: 10%;"></td> <td style="width: 10%;"></td> <td style="width: 10%;"></td> <td style="width: 10%;"></td> <td style="width: 10%;"></td> <td style="width: 10%;"></td> </tr> <tr> <td></td> <td></td> <td colspan="8" style="text-align: center;"> <table border="1" style="width: 100%; border-collapse: collapse; text-align: center;"> <tr> <td style="width: 10%;"></td> <td style="width: 10%;"></td> <td style="width: 10%;"></td> <td style="width: 10%;"></td> <td style="width: 10%;"></td> <td style="width: 10%;"></td> <td style="width: 10%;"></td> <td style="width: 10%;"></td> <td style="width: 10%;"></td> <td style="width: 10%;"></td> </tr> <tr> <td></td> <td></td> <td colspan="8" style="text-align: center;"> <table border="1" style="width: 100%; border-collapse: collapse; text-align: center;"> <tr> <td style="width: 10%;"></td> <td style="width: 10%;"></td> <td style="width: 10%;"></td> <td style="width: 10%;"></td> <td style="width: 10%;"></td> <td style="width: 10%;"></td> <td style="width: 10%;"></td> <td style="width: 10%;"></td> <td style="width: 10%;"></td> <td style="width: 10%;"></td> </tr> <tr> <td></td> <td></td> <td colspan="8" style="text-align: center;"> <table border="1" style="width: 100%; border-collapse: collapse; text-align: center;"> <tr> <td style="width: 10%;"></td> <td style="width: 10%;"></td> <td style="width: 10%;"></td> <td style="width: 10%;"></td> <td style="width: 10%;"></td> <td style="width: 10%;"></td> <td style="width: 10%;"></td> <td style="width: 10%;"></td> <td style="width: 10%;"></td> <td style="width: 10%;"></td> </tr> <tr> <td></td> <td></td> <td colspan="8" style="text-align: center;"> <table border="1" style="width: 100%; border-collapse: collapse; text-align: center;"> <tr> </tr></table></td></tr></table></td></tr></table></td></tr></table></td></tr></table>

 | | | | | | | | | | | | | | | | | | | | <table border="1" style="width: 100%; border-collapse: collapse; text-align: center;"> <tr> <td style="width: 10%;"></td> <td style="width: 10%;"></td> <td style="width: 10%;"></td> <td style="width: 10%;"></td> <td style="width: 10%;"></td> <td style="width: 10%;"></td> <td style="width: 10%;"></td> <td style="width: 10%;"></td> <td style="width: 10%;"></td> <td style="width: 10%;"></td> </tr> <tr> <td></td> <td></td> <td colspan="8" style="text-align: center;"> <table border="1" style="width: 100%; border-collapse: collapse; text-align: center;"> <tr> <td style="width: 10%;"></td> <td style="width: 10%;"></td> <td style="width: 10%;"></td> <td style="width: 10%;"></td> <td style="width: 10%;"></td> <td style="width: 10%;"></td> <td style="width: 10%;"></td> <td style="width: 10%;"></td> <td style="width: 10%;"></td> <td style="width: 10%;"></td> </tr> <tr> <td></td> <td></td> <td colspan="8" style="text-align: center;"> <table border="1" style="width: 100%; border-collapse: collapse; text-align: center;"> <tr> <td style="width: 10%;"></td> <td style="width: 10%;"></td> <td style="width: 10%;"></td> <td style="width: 10%;"></td> <td style="width: 10%;"></td> <td style="width: 10%;"></td> <td style="width: 10%;"></td> <td style="width: 10%;"></td> <td style="width: 10%;"></td> <td style="width: 10%;"></td> </tr> <tr> <td></td> <td></td> <td colspan="8" style="text-align: center;"> <table border="1" style="width: 100%; border-collapse: collapse; text-align: center;"> <tr> </tr></table></td></tr></table></td></tr></table></td></tr></table>

 | | | | | | | | | | | | | | | | | | | | <table border="1" style="width: 100%; border-collapse: collapse; text-align: center;"> <tr> <td style="width: 10%;"></td> <td style="width: 10%;"></td> <td style="width: 10%;"></td> <td style="width: 10%;"></td> <td style="width: 10%;"></td> <td style="width: 10%;"></td> <td style="width: 10%;"></td> <td style="width: 10%;"></td> <td style="width: 10%;"></td> <td style="width: 10%;"></td> </tr> <tr> <td></td> <td></td> <td colspan="8" style="text-align: center;"> <table border="1" style="width: 100%; border-collapse: collapse; text-align: center;"> <tr> <td style="width: 10%;"></td> <td style="width: 10%;"></td> <td style="width: 10%;"></td> <td style="width: 10%;"></td> <td style="width: 10%;"></td> <td style="width: 10%;"></td> <td style="width: 10%;"></td> <td style="width: 10%;"></td> <td style="width: 10%;"></td> <td style="width: 10%;"></td> </tr> <tr> <td></td> <td></td> <td colspan="8" style="text-align: center;"> <table border="1" style="width: 100%; border-collapse: collapse; text-align: center;"> <tr> </tr></table></td></tr></table></td></tr></table>

 | | | | | | | | | | | | | | | | | | | | <table border="1" style="width: 100%; border-collapse: collapse; text-align: center;"> <tr> <td style="width: 10%;"></td> <td style="width: 10%;"></td> <td style="width: 10%;"></td> <td style="width: 10%;"></td> <td style="width: 10%;"></td> <td style="width: 10%;"></td> <td style="width: 10%;"></td> <td style="width: 10%;"></td> <td style="width: 10%;"></td> <td style="width: 10%;"></td> </tr> <tr> <td></td> <td></td> <td colspan="8" style="text-align: center;"> <table border="1" style="width: 100%; border-collapse: collapse; text-align: center;"> <tr> </tr></table></td></tr></table>

 | | | | | | | | | | | | | | | | | | | | <table border="1" style="width: 100%; border-collapse: collapse; text-align: center;"> <tr> </tr></table>

 | | | | | | | | | | | | | | | | | | | |

 | | | | | | | | | | | | | | | | | | | |

 | | | | | | | | | | | | | | | | | | | |

 | | | | | | | | | | | | | | | | | | | |

 | | | | | | | | | | | | | | | | | | | |

 | | | | | | | | | | | | | | | | | | | |

 | | | | | | | | | | | | | | | | | | | |

 | | | | | | | | | | | | | | | | | | | |
 | | | | | | | | | | | | | | | | | | | |

 | | | | | | | | | | | | | | | | | | | |

 | | | | | | | | | | | | | | | | | | | |
 | | | | | | | | | | | | | | | | | | | |

 | | | | | | | | | | | | | | | | | | | |

 | | | | | | | | | | | | | | | | | | | |
 | | | | | | | | | | | | | | | | | | | |
 | | | | | | | | | | | | | | | | | | | |

 | | | | | | | | | | | | | | | | | | | |
 | | | | | | | | | | | | | | | | | | | |
 | | | | | | | | | | | | | | | | | | | |

 | | | | | | | | | | | | | | | | | | | | | | | | | | | | | | | | | | | | | | | | | | | | | | | | | | | | | | | | | | | | | | | | | | | | | | | | | | | | | | | | | | | | | | | | | | | | | | | | | | | |
 | | | | | | | | | | | | | | | | | | | |
 | | | | | | | | | | | | | | | | | | | |
 | | | | | | | | | | | | | | | | | | | |
 | | | | | | | | | | | | | | | | | | | |
 | | | | | | | | | | | | | | | | | | | |
 | | | | | | | | | | | | | | | | | | | |
 | | | | | | | | | | | | | | | | | | | |
 | | | | | | | | | | | | | | | | | | | |
 | | | | | | | | | | | | | | | | | | | | | | | | | | | | | | | | | | | | | | | |
 | | | | | | | | | | | | | | | | | | | |
 | | | | | | | | | | | | | | | | | | | | | | | | | | | | | | | | | | | | | | | |
 | | | | | | | | | | | | | | | | | | | | | | | | | | | | | | | | | | | | | | | |
 | | | | | | | | | | | | | | | | | | | | | | | | | | | | | | | | | | | | | | | |
 | | | | | | | | | | | | | | | | | | | | | | | | | | | | | | | | | | | | | | | | | | | | | | | | | | | | | | | | | | | | | | | | | | | | | | | | | | | | | | | | | | | | | | | | | | | | | | | | | | | |
 | | | | | | | | | | | | | | | | | | | | | | | | | | | | | | | | | | | | | | | | | | | | | | | |
| | |

 | | | | | | | | | | | | | | | | | | | |

 | | | | | | | | | | | | | | | | | | | |

 | | | | | | | | | | | | | | | | | | | |

 | | | | | | | | | | | | | | | | | | | |

 | | | | | | | | | | | | | | | | | | | |

 | | | | | | | | | | | | | | | | | | | |

 | | | | | | | | | | | | | | | | | | | |

 | | | | | | | | | | | | | | | | | | | |

 | | | | | | | | | | | | | | | | | | | |

 | | | | | | | | | | | | | | | | | | | |

 | | | | | | | | | | | | | | | | | | | |

 | | | | | | | | | | | | | | | | | | | |

 | | | | | | | | | | | | | | | | | | | |

 | | | | | | | | | | | | | | | | | | | |

 | | | | | | | | | | | | | | | | | | | |

 | | | | | | | | | | | | | | | | | | | |

 | | | | | | | | | | | | | | | | | | | |

 | | | | | | | | | | | | | | | | | | | |

 | | | | | | | | | | | | | | | | | | | |

 | | | | | | | | | | | | | | | | | | | |

 | | | | | | | | | | | | | | | | | | | |

 | | | | | | | | | | | | | | | | | | | |

 | | | | | | | | | | | | | | | | | | | |

 | | | | | | | | | | | | | | | | | | | |

 | | | | | | | | | | | | | | | | | | | |

 | | | | | | | | | | | | | | | | | | | |

 | | | | | | | | | | | | | | | | | | | |

 | | | | | | | | | | | | | | | | | | | |
 | | | | | | | | | | | | | | | | | | | |

 | | | | | | | | | | | | | | | | | | | |

 | | | | | | | | | | | | | | | | | | | |
 | | | | | | | | | | | | | | | | | | | |

 | | | | | | | | | | | | | | | | | | | |

 | | | | | | | | | | | | | | | | | | | |
 | | | | | | | | | | | | | | | | | | | |
 | | | | | | | | | | | | | | | | | | | |

 | | | | | | | | | | | | | | | | | | | |
 | | | | | | | | | | | | | | | | | | | |
 | | | | | | | | | | | | | | | | | | | |

 | | | | | | | | | | | | | | | | | | | | | | | | | | | | | | | | | | | | | | | | | | | | | | | | | | | | | | | | | | | | | | | | | | | | | | | | | | | | | | | | | | | | | | | | | | | | | | | | | | | |
 | | | | | | | | | | | | | | | | | | | |
 | | | | | | | | | | | | | | | | | | | |
 | | | | | | | | | | | | | | | | | | | |
 | | | | | | | | | | | | | | | | | | | |
 | | | | | | | | | | | | | | | | | | | |
 | | | | | | | | | | | | | | | | | | | |
 | | | | | | | | | | | | | | | | | | | |
 | | | | | | | | | | | | | | | | | | | |
 | | | | | | | | | | | | | | | | | | | | | | | | | | | | | | | | | | | | | | | |
 | | | | | | | | | | | | | | | | | | | |
 | | | | | | | | | | | | | | | | | | | | | | | | | | | | | | | | | | | | | | | |
 | | | | | | | | | | | | | | | | | | | | | | | | | | | | | | | | | | | | | | | |
 | | | | | | | | | | | | | | | | | | | | | | | | | | | | | | | | | | | | | | | |
 | | | | | | | | | | | | | | | | | | | | | | | | | | | | | | | | | | | | | | | | | | | | | | | | | | | | | | | | | | | | | | | | | | | | | | | | | | | | | | | | | | | | | | | | | | | | | | | | | | | |
 | | | | | | | | | | | | | | | | | | | | | | | | | | | | | | | | | | | | | | | | | | | | | | | |
| | | <table border="1" style="width: 100%; border-collapse: collapse; text-align: center;"> <tr> <td style="width: 10%;"></td> <td style="width: 10%;"></td> <td style="width: 10%;"></td> <td style="width: 10%;"></td> <td style="width: 10%;"></td> <td style="width: 10%;"></td> <td style="width: 10%;"></td> <td style="width: 10%;"></td> <td style="width: 10%;"></td> <td style="width: 10%;"></td> </tr> <tr> <td></td> <td></td> <td colspan="8" style="text-align: center;"> <table border="1" style="width: 100%; border-collapse: collapse; text-align: center;"> <tr> <td style="width: 10%;"></td> <td style="width: 10%;"></td> <td style="width: 10%;"></td> <td style="width: 10%;"></td> <td style="width: 10%;"></td> <td style="width: 10%;"></td> <td style="width: 10%;"></td> <td style="width: 10%;"></td> <td style="width: 10%;"></td> <td style="width: 10%;"></td> </tr> <tr> <td></td> <td></td> <td colspan="8" style="text-align: center;"> <table border="1" style="width: 100%; border-collapse: collapse; text-align: center;"> <tr> <td style="width: 10%;"></td> <td style="width: 10%;"></td> <td style="width: 10%;"></td> <td style="width: 10%;"></td> <td style="width: 10%;"></td> <td style="width: 10%;"></td> <td style="width: 10%;"></td> <td style="width: 10%;"></td> <td style="width: 10%;"></td> <td style="width: 10%;"></td> </tr> <tr> <td></td> <td></td> <td colspan="8" style="text-align: center;"> <table border="1" style="width: 100%; border-collapse: collapse; text-align: center;"> <tr> <td style="width: 10%;"></td> <td style="width: 10%;"></td> <td style="width: 10%;"></td> <td style="width: 10%;"></td> <td style="width: 10%;"></td> <td style="width: 10%;"></td> <td style="width: 10%;"></td> <td style="width: 10%;"></td> <td style="width: 10%;"></td> <td style="width: 10%;"></td> </tr> <tr> <td></td> <td></td> <td colspan="8" style="text-align: center;"> <table border="1" style="width: 100%; border-collapse: collapse; text-align: center;"> <tr> <td style="width: 10%;"></td> <td style="width: 10%;"></td> <td style="width: 10%;"></td> <td style="width: 10%;"></td> <td style="width: 10%;"></td> <td style="width: 10%;"></td> <td style="width: 10%;"></td> <td style="width: 10%;"></td> <td style="width: 10%;"></td> <td style="width: 10%;"></td> </tr> <tr> <td></td> <td></td> <td colspan="8" style="text-align: center;"> <table border="1" style="width: 100%; border-collapse: collapse; text-align: center;"> <tr> <td style="width: 10%;"></td> <td style="width: 10%;"></td> <td style="width: 10%;"></td> <td style="width: 10%;"></td> <td style="width: 10%;"></td> <td style="width: 10%;"></td> <td style="width: 10%;"></td> <td style="width: 10%;"></td> <td style="width: 10%;"></td> <td style="width: 10%;"></td> </tr> <tr> <td></td> <td></td> <td colspan="8" style="text-align: center;"> <table border="1" style="width: 100%; border-collapse: collapse; text-align: center;"> <tr> <td style="width: 10%;"></td> <td style="width: 10%;"></td> <td style="width: 10%;"></td> <td style="width: 10%;"></td> <td style="width: 10%;"></td> <td style="width: 10%;"></td> <td style="width: 10%;"></td> <td style="width: 10%;"></td> <td style="width: 10%;"></td> <td style="width: 10%;"></td> </tr> <tr> <td></td> <td></td> <td colspan="8" style="text-align: center;"> <table border="1" style="width: 100%; border-collapse: collapse; text-align: center;"> <tr> <td style="width: 10%;"></td> <td style="width: 10%;"></td> <td style="width: 10%;"></td> <td style="width: 10%;"></td> <td style="width: 10%;"></td> <td style="width: 10%;"></td> <td style="width: 10%;"></td> <td style="width: 10%;"></td> <td style="width: 10%;"></td> <td style="width: 10%;"></td> </tr> <tr> <td></td> <td></td> <td colspan="8" style="text-align: center;"> <table border="1" style="width: 100%; border-collapse: collapse; text-align: center;"> <tr> <td style="width: 10%;"></td> <td style="width: 10%;"></td> <td style="width: 10%;"></td> <td style="width: 10%;"></td> <td style="width: 10%;"></td> <td style="width: 10%;"></td> <td style="width: 10%;"></td> <td style="width: 10%;"></td> <td style="width: 10%;"></td> <td style="width: 10%;"></td> </tr> <tr> <td></td> <td></td> <td colspan="8" style="text-align: center;"> <table border="1" style="width: 100%; border-collapse: collapse; text-align: center;"> <tr> <td style="width: 10%;"></td> <td style="width: 10%;"></td> <td style="width: 10%;"></td> <td style="width: 10%;"></td> <td style="width: 10%;"></td> <td style="width: 10%;"></td> <td style="width: 10%;"></td> <td style="width: 10%;"></td> <td style="width: 10%;"></td> <td style="width: 10%;"></td> </tr> <tr> <td></td> <td></td> <td colspan="8" style="text-align: center;"> <table border="1" style="width: 100%; border-collapse: collapse; text-align: center;"> <tr> <td style="width: 10%;"></td> <td style="width: 10%;"></td> <td style="width: 10%;"></td> <td style="width: 10%;"></td> <td style="width: 10%;"></td> <td style="width: 10%;"></td> <td style="width: 10%;"></td> <td style="width: 10%;"></td> <td style="width: 10%;"></td> <td style="width: 10%;"></td> </tr> <tr> <td></td> <td></td> <td colspan="8" style="text-align: center;"> <table border="1" style="width: 100%; border-collapse: collapse; text-align: center;"> <tr> <td style="width: 10%;"></td> <td style="width: 10%;"></td> <td style="width: 10%;"></td> <td style="width: 10%;"></td> <td style="width: 10%;"></td> <td style="width: 10%;"></td> <td style="width: 10%;"></td> <td style="width: 10%;"></td> <td style="width: 10%;"></td> <td style="width: 10%;"></td> </tr> <tr> <td></td> <td></td> <td colspan="8" style="text-align: center;"> <table border="1" style="width: 100%; border-collapse: collapse; text-align: center;"> <tr> <td style="width: 10%;"></td> <td style="width: 10%;"></td> <td style="width: 10%;"></td> <td style="width: 10%;"></td> <td style="width: 10%;"></td> <td style="width: 10%;"></td> <td style="width: 10%;"></td> <td style="width: 10%;"></td> <td style="width: 10%;"></td> <td style="width: 10%;"></td> </tr> <tr> <td></td> <td></td> <td colspan="8" style="text-align: center;"> <table border="1" style="width: 100%; border-collapse: collapse; text-align: center;"> <tr> <td style="width: 10%;"></td> <td style="width: 10%;"></td> <td style="width: 10%;"></td> <td style="width: 10%;"></td> <td style="width: 10%;"></td> <td style="width: 10%;"></td> <td style="width: 10%;"></td> <td style="width: 10%;"></td> <td style="width: 10%;"></td> <td style="width: 10%;"></td> </tr> <tr> <td></td> <td></td> <td colspan="8" style="text-align: center;"> <table border="1" style="width: 100%; border-collapse: collapse; text-align: center;"> <tr> <td style="width: 10%;"></td> <td style="width: 10%;"></td> <td style="width: 10%;"></td> <td style="width: 10%;"></td> <td style="width: 10%;"></td> <td style="width: 10%;"></td> <td style="width: 10%;"></td> <td style="width: 10%;"></td> <td style="width: 10%;"></td> <td style="width: 10%;"></td> </tr> <tr> <td></td> <td></td> <td colspan="8" style="text-align: center;"> <table border="1" style="width: 100%; border-collapse: collapse; text-align: center;"> <tr> <td style="width: 10%;"></td> <td style="width: 10%;"></td> <td style="width: 10%;"></td> <td style="width: 10%;"></td> <td style="width: 10%;"></td> <td style="width: 10%;"></td> <td style="width: 10%;"></td> <td style="width: 10%;"></td> <td style="width: 10%;"></td> <td style="width: 10%;"></td> </tr> <tr> <td></td> <td></td> <td colspan="8" style="text-align: center;"> <table border="1" style="width: 100%; border-collapse: collapse; text-align: center;"> <tr> <td style="width: 10%;"></td> <td style="width: 10%;"></td> <td style="width: 10%;"></td> <td style="width: 10%;"></td> <td style="width: 10%;"></td> <td style="width: 10%;"></td> <td style="width: 10%;"></td> <td style="width: 10%;"></td> <td style="width: 10%;"></td> <td style="width: 10%;"></td> </tr> <tr> <td></td> <td></td> <td colspan="8" style="text-align: center;"> <table border="1" style="width: 100%; border-collapse: collapse; text-align: center;"> <tr> <td style="width: 10%;"></td> <td style="width: 10%;"></td> <td style="width: 10%;"></td> <td style="width: 10%;"></td> <td style="width: 10%;"></td> <td style="width: 10%;"></td> <td style="width: 10%;"></td> <td style="width: 10%;"></td> <td style="width: 10%;"></td> <td style="width: 10%;"></td> </tr> <tr> <td></td> <td></td> <td colspan="8" style="text-align: center;"> <table border="1" style="width: 100%; border-collapse: collapse; text-align: center;"> <tr> <td style="width: 10%;"></td> <td style="width: 10%;"></td> <td style="width: 10%;"></td> <td style="width: 10%;"></td> <td style="width: 10%;"></td> <td style="width: 10%;"></td> <td style="width: 10%;"></td> <td style="width: 10%;"></td> <td style="width: 10%;"></td> <td style="width: 10%;"></td> </tr> <tr> <td></td> <td></td> <td colspan="8" style="text-align: center;"> <table border="1" style="width: 100%; border-collapse: collapse; text-align: center;"> <tr> </tr></table></td></tr></table></td></tr></table></td></tr></table></td></tr></table></td></tr></table></td></tr></table></td></tr></table></td></tr></table></td></tr></table></td></tr></table></td></tr></table></td></tr></table></td></tr></table></td></tr></table></td></tr></table></td></tr></table></td></tr></table></td></tr></table></td></tr></table>

 | | | | | | | | | | | | | | | | | | | | <table border="1" style="width: 100%; border-collapse: collapse; text-align: center;"> <tr> <td style="width: 10%;"></td> <td style="width: 10%;"></td> <td style="width: 10%;"></td> <td style="width: 10%;"></td> <td style="width: 10%;"></td> <td style="width: 10%;"></td> <td style="width: 10%;"></td> <td style="width: 10%;"></td> <td style="width: 10%;"></td> <td style="width: 10%;"></td> </tr> <tr> <td></td> <td></td> <td colspan="8" style="text-align: center;"> <table border="1" style="width: 100%; border-collapse: collapse; text-align: center;"> <tr> <td style="width: 10%;"></td> <td style="width: 10%;"></td> <td style="width: 10%;"></td> <td style="width: 10%;"></td> <td style="width: 10%;"></td> <td style="width: 10%;"></td> <td style="width: 10%;"></td> <td style="width: 10%;"></td> <td style="width: 10%;"></td> <td style="width: 10%;"></td> </tr> <tr> <td></td> <td></td> <td colspan="8" style="text-align: center;"> <table border="1" style="width: 100%; border-collapse: collapse; text-align: center;"> <tr> <td style="width: 10%;"></td> <td style="width: 10%;"></td> <td style="width: 10%;"></td> <td style="width: 10%;"></td> <td style="width: 10%;"></td> <td style="width: 10%;"></td> <td style="width: 10%;"></td> <td style="width: 10%;"></td> <td style="width: 10%;"></td> <td style="width: 10%;"></td> </tr> <tr> <td></td> <td></td> <td colspan="8" style="text-align: center;"> <table border="1" style="width: 100%; border-collapse: collapse; text-align: center;"> <tr> <td style="width: 10%;"></td> <td style="width: 10%;"></td> <td style="width: 10%;"></td> <td style="width: 10%;"></td> <td style="width: 10%;"></td> <td style="width: 10%;"></td> <td style="width: 10%;"></td> <td style="width: 10%;"></td> <td style="width: 10%;"></td> <td style="width: 10%;"></td> </tr> <tr> <td></td> <td></td> <td colspan="8" style="text-align: center;"> <table border="1" style="width: 100%; border-collapse: collapse; text-align: center;"> <tr> <td style="width: 10%;"></td> <td style="width: 10%;"></td> <td style="width: 10%;"></td> <td style="width: 10%;"></td> <td style="width: 10%;"></td> <td style="width: 10%;"></td> <td style="width: 10%;"></td> <td style="width: 10%;"></td> <td style="width: 10%;"></td> <td style="width: 10%;"></td> </tr> <tr> <td></td> <td></td> <td colspan="8" style="text-align: center;"> <table border="1" style="width: 100%; border-collapse: collapse; text-align: center;"> <tr> <td style="width: 10%;"></td> <td style="width: 10%;"></td> <td style="width: 10%;"></td> <td style="width: 10%;"></td> <td style="width: 10%;"></td> <td style="width: 10%;"></td> <td style="width: 10%;"></td> <td style="width: 10%;"></td> <td style="width: 10%;"></td> <td style="width: 10%;"></td> </tr> <tr> <td></td> <td></td> <td colspan="8" style="text-align: center;"> <table border="1" style="width: 100%; border-collapse: collapse; text-align: center;"> <tr> <td style="width: 10%;"></td> <td style="width: 10%;"></td> <td style="width: 10%;"></td> <td style="width: 10%;"></td> <td style="width: 10%;"></td> <td style="width: 10%;"></td> <td style="width: 10%;"></td> <td style="width: 10%;"></td> <td style="width: 10%;"></td> <td style="width: 10%;"></td> </tr> <tr> <td></td> <td></td> <td colspan="8" style="text-align: center;"> <table border="1" style="width: 100%; border-collapse: collapse; text-align: center;"> <tr> <td style="width: 10%;"></td> <td style="width: 10%;"></td> <td style="width: 10%;"></td> <td style="width: 10%;"></td> <td style="width: 10%;"></td> <td style="width: 10%;"></td> <td style="width: 10%;"></td> <td style="width: 10%;"></td> <td style="width: 10%;"></td> <td style="width: 10%;"></td> </tr> <tr> <td></td> <td></td> <td colspan="8" style="text-align: center;"> <table border="1" style="width: 100%; border-collapse: collapse; text-align: center;"> <tr> <td style="width: 10%;"></td> <td style="width: 10%;"></td> <td style="width: 10%;"></td> <td style="width: 10%;"></td> <td style="width: 10%;"></td> <td style="width: 10%;"></td> <td style="width: 10%;"></td> <td style="width: 10%;"></td> <td style="width: 10%;"></td> <td style="width: 10%;"></td> </tr> <tr> <td></td> <td></td> <td colspan="8" style="text-align: center;"> <table border="1" style="width: 100%; border-collapse: collapse; text-align: center;"> <tr> <td style="width: 10%;"></td> <td style="width: 10%;"></td> <td style="width: 10%;"></td> <td style="width: 10%;"></td> <td style="width: 10%;"></td> <td style="width: 10%;"></td> <td style="width: 10%;"></td> <td style="width: 10%;"></td> <td style="width: 10%;"></td> <td style="width: 10%;"></td> </tr> <tr> <td></td> <td></td> <td colspan="8" style="text-align: center;"> <table border="1" style="width: 100%; border-collapse: collapse; text-align: center;"> <tr> <td style="width: 10%;"></td> <td style="width: 10%;"></td> <td style="width: 10%;"></td> <td style="width: 10%;"></td> <td style="width: 10%;"></td> <td style="width: 10%;"></td> <td style="width: 10%;"></td> <td style="width: 10%;"></td> <td style="width: 10%;"></td> <td style="width: 10%;"></td> </tr> <tr> <td></td> <td></td> <td colspan="8" style="text-align: center;"> <table border="1" style="width: 100%; border-collapse: collapse; text-align: center;"> <tr> <td style="width: 10%;"></td> <td style="width: 10%;"></td> <td style="width: 10%;"></td> <td style="width: 10%;"></td> <td style="width: 10%;"></td> <td style="width: 10%;"></td> <td style="width: 10%;"></td> <td style="width: 10%;"></td> <td style="width: 10%;"></td> <td style="width: 10%;"></td> </tr> <tr> <td></td> <td></td> <td colspan="8" style="text-align: center;"> <table border="1" style="width: 100%; border-collapse: collapse; text-align: center;"> <tr> <td style="width: 10%;"></td> <td style="width: 10%;"></td> <td style="width: 10%;"></td> <td style="width: 10%;"></td> <td style="width: 10%;"></td> <td style="width: 10%;"></td> <td style="width: 10%;"></td> <td style="width: 10%;"></td> <td style="width: 10%;"></td> <td style="width: 10%;"></td> </tr> <tr> <td></td> <td></td> <td colspan="8" style="text-align: center;"> <table border="1" style="width: 100%; border-collapse: collapse; text-align: center;"> <tr> <td style="width: 10%;"></td> <td style="width: 10%;"></td> <td style="width: 10%;"></td> <td style="width: 10%;"></td> <td style="width: 10%;"></td> <td style="width: 10%;"></td> <td style="width: 10%;"></td> <td style="width: 10%;"></td> <td style="width: 10%;"></td> <td style="width: 10%;"></td> </tr> <tr> <td></td> <td></td> <td colspan="8" style="text-align: center;"> <table border="1" style="width: 100%; border-collapse: collapse; text-align: center;"> <tr> <td style="width: 10%;"></td> <td style="width: 10%;"></td> <td style="width: 10%;"></td> <td style="width: 10%;"></td> <td style="width: 10%;"></td> <td style="width: 10%;"></td> <td style="width: 10%;"></td> <td style="width: 10%;"></td> <td style="width: 10%;"></td> <td style="width: 10%;"></td> </tr> <tr> <td></td> <td></td> <td colspan="8" style="text-align: center;"> <table border="1" style="width: 100%; border-collapse: collapse; text-align: center;"> <tr> <td style="width: 10%;"></td> <td style="width: 10%;"></td> <td style="width: 10%;"></td> <td style="width: 10%;"></td> <td style="width: 10%;"></td> <td style="width: 10%;"></td> <td style="width: 10%;"></td> <td style="width: 10%;"></td> <td style="width: 10%;"></td> <td style="width: 10%;"></td> </tr> <tr> <td></td> <td></td> <td colspan="8" style="text-align: center;"> <table border="1" style="width: 100%; border-collapse: collapse; text-align: center;"> <tr> <td style="width: 10%;"></td> <td style="width: 10%;"></td> <td style="width: 10%;"></td> <td style="width: 10%;"></td> <td style="width: 10%;"></td> <td style="width: 10%;"></td> <td style="width: 10%;"></td> <td style="width: 10%;"></td> <td style="width: 10%;"></td> <td style="width: 10%;"></td> </tr> <tr> <td></td> <td></td> <td colspan="8" style="text-align: center;"> <table border="1" style="width: 100%; border-collapse: collapse; text-align: center;"> <tr> <td style="width: 10%;"></td> <td style="width: 10%;"></td> <td style="width: 10%;"></td> <td style="width: 10%;"></td> <td style="width: 10%;"></td> <td style="width: 10%;"></td> <td style="width: 10%;"></td> <td style="width: 10%;"></td> <td style="width: 10%;"></td> <td style="width: 10%;"></td> </tr> <tr> <td></td> <td></td> <td colspan="8" style="text-align: center;"> <table border="1" style="width: 100%; border-collapse: collapse; text-align: center;"> <tr>
</tr></table></td></tr></table></td></tr></table></td></tr></table></td></tr></table></td></tr></table></td></tr></table></td></tr></table></td></tr></table></td></tr></table></td></tr></table></td></tr></table></td></tr></table></td></tr></table></td></tr></table></td></tr></table></td></tr></table></td></tr></table></td></tr></table>

 | | | | | | | | | | | | | | | | | | | | <table border="1" style="width: 100%; border-collapse: collapse; text-align: center;"> <tr> <td style="width: 10%;"></td> <td style="width: 10%;"></td> <td style="width: 10%;"></td> <td style="width: 10%;"></td> <td style="width: 10%;"></td> <td style="width: 10%;"></td> <td style="width: 10%;"></td> <td style="width: 10%;"></td> <td style="width: 10%;"></td> <td style="width: 10%;"></td> </tr> <tr> <td></td> <td></td> <td colspan="8" style="text-align: center;"> <table border="1" style="width: 100%; border-collapse: collapse; text-align: center;"> <tr> <td style="width: 10%;"></td> <td style="width: 10%;"></td> <td style="width: 10%;"></td> <td style="width: 10%;"></td> <td style="width: 10%;"></td> <td style="width: 10%;"></td> <td style="width: 10%;"></td> <td style="width: 10%;"></td> <td style="width: 10%;"></td> <td style="width: 10%;"></td> </tr> <tr> <td></td> <td></td> <td colspan="8" style="text-align: center;"> <table border="1" style="width: 100%; border-collapse: collapse; text-align: center;"> <tr> <td style="width: 10%;"></td> <td style="width: 10%;"></td> <td style="width: 10%;"></td> <td style="width: 10%;"></td> <td style="width: 10%;"></td> <td style="width: 10%;"></td> <td style="width: 10%;"></td> <td style="width: 10%;"></td> <td style="width: 10%;"></td> <td style="width: 10%;"></td> </tr> <tr> <td></td> <td></td> <td colspan="8" style="text-align: center;"> <table border="1" style="width: 100%; border-collapse: collapse; text-align: center;"> <tr> <td style="width: 10%;"></td> <td style="width: 10%;"></td> <td style="width: 10%;"></td> <td style="width: 10%;"></td> <td style="width: 10%;"></td> <td style="width: 10%;"></td> <td style="width: 10%;"></td> <td style="width: 10%;"></td> <td style="width: 10%;"></td> <td style="width: 10%;"></td> </tr> <tr> <td></td> <td></td> <td colspan="8" style="text-align: center;"> <table border="1" style="width: 100%; border-collapse: collapse; text-align: center;"> <tr> <td style="width: 10%;"></td> <td style="width: 10%;"></td> <td style="width: 10%;"></td> <td style="width: 10%;"></td> <td style="width: 10%;"></td> <td style="width: 10%;"></td> <td style="width: 10%;"></td> <td style="width: 10%;"></td> <td style="width: 10%;"></td> <td style="width: 10%;"></td> </tr> <tr> <td></td> <td></td> <td colspan="8" style="text-align: center;"> <table border="1" style="width: 100%; border-collapse: collapse; text-align: center;"> <tr> <td style="width: 10%;"></td> <td style="width: 10%;"></td> <td style="width: 10%;"></td> <td style="width: 10%;"></td> <td style="width: 10%;"></td> <td style="width: 10%;"></td> <td style="width: 10%;"></td> <td style="width: 10%;"></td> <td style="width: 10%;"></td> <td style="width: 10%;"></td> </tr> <tr> <td></td> <td></td> <td colspan="8" style="text-align: center;"> <table border="1" style="width: 100%; border-collapse: collapse; text-align: center;"> <tr> <td style="width: 10%;"></td> <td style="width: 10%;"></td> <td style="width: 10%;"></td> <td style="width: 10%;"></td> <td style="width: 10%;"></td> <td style="width: 10%;"></td> <td style="width: 10%;"></td> <td style="width: 10%;"></td> <td style="width: 10%;"></td> <td style="width: 10%;"></td> </tr> <tr> <td></td> <td></td> <td colspan="8" style="text-align: center;"> <table border="1" style="width: 100%; border-collapse: collapse; text-align: center;"> <tr> <td style="width: 10%;"></td> <td style="width: 10%;"></td> <td style="width: 10%;"></td> <td style="width: 10%;"></td> <td style="width: 10%;"></td> <td style="width: 10%;"></td> <td style="width: 10%;"></td> <td style="width: 10%;"></td> <td style="width: 10%;"></td> <td style="width: 10%;"></td> </tr> <tr> <td></td> <td></td> <td colspan="8" style="text-align: center;"> <table border="1" style="width: 100%; border-collapse: collapse; text-align: center;"> <tr> <td style="width: 10%;"></td> <td style="width: 10%;"></td> <td style="width: 10%;"></td> <td style="width: 10%;"></td> <td style="width: 10%;"></td> <td style="width: 10%;"></td> <td style="width: 10%;"></td> <td style="width: 10%;"></td> <td style="width: 10%;"></td> <td style="width: 10%;"></td> </tr> <tr> <td></td> <td></td> <td colspan="8" style="text-align: center;"> <table border="1" style="width: 100%; border-collapse: collapse; text-align: center;"> <tr> <td style="width: 10%;"></td> <td style="width: 10%;"></td> <td style="width: 10%;"></td> <td style="width: 10%;"></td> <td style="width: 10%;"></td> <td style="width: 10%;"></td> <td style="width: 10%;"></td> <td style="width: 10%;"></td> <td style="width: 10%;"></td> <td style="width: 10%;"></td> </tr> <tr> <td></td> <td></td> <td colspan="8" style="text-align: center;"> <table border="1" style="width: 100%; border-collapse: collapse; text-align: center;"> <tr> <td style="width: 10%;"></td> <td style="width: 10%;"></td> <td style="width: 10%;"></td> <td style="width: 10%;"></td> <td style="width: 10%;"></td> <td style="width: 10%;"></td> <td style="width: 10%;"></td> <td style="width: 10%;"></td> <td style="width: 10%;"></td> <td style="width: 10%;"></td> </tr> <tr> <td></td> <td></td> <td colspan="8" style="text-align: center;"> <table border="1" style="width: 100%; border-collapse: collapse; text-align: center;"> <tr> <td style="width: 10%;"></td> <td style="width: 10%;"></td> <td style="width: 10%;"></td> <td style="width: 10%;"></td> <td style="width: 10%;"></td> <td style="width: 10%;"></td> <td style="width: 10%;"></td> <td style="width: 10%;"></td> <td style="width: 10%;"></td> <td style="width: 10%;"></td> </tr> <tr> <td></td> <td></td> <td colspan="8" style="text-align: center;"> <table border="1" style="width: 100%; border-collapse: collapse; text-align: center;"> <tr> <td style="width: 10%;"></td> <td style="width: 10%;"></td> <td style="width: 10%;"></td> <td style="width: 10%;"></td> <td style="width: 10%;"></td> <td style="width: 10%;"></td> <td style="width: 10%;"></td> <td style="width: 10%;"></td> <td style="width: 10%;"></td> <td style="width: 10%;"></td> </tr> <tr> <td></td> <td></td> <td colspan="8" style="text-align: center;"> <table border="1" style="width: 100%; border-collapse: collapse; text-align: center;"> <tr> <td style="width: 10%;"></td> <td style="width: 10%;"></td> <td style="width: 10%;"></td> <td style="width: 10%;"></td> <td style="width: 10%;"></td> <td style="width: 10%;"></td> <td style="width: 10%;"></td> <td style="width: 10%;"></td> <td style="width: 10%;"></td> <td style="width: 10%;"></td> </tr> <tr> <td></td> <td></td> <td colspan="8" style="text-align: center;"> <table border="1" style="width: 100%; border-collapse: collapse; text-align: center;"> <tr> <td style="width: 10%;"></td> <td style="width: 10%;"></td> <td style="width: 10%;"></td> <td style="width: 10%;"></td> <td style="width: 10%;"></td> <td style="width: 10%;"></td> <td style="width: 10%;"></td> <td style="width: 10%;"></td> <td style="width: 10%;"></td> <td style="width: 10%;"></td> </tr> <tr> <td></td> <td></td> <td colspan="8" style="text-align: center;"> <table border="1" style="width: 100%; border-collapse: collapse; text-align: center;"> <tr> <td style="width: 10%;"></td> <td style="width: 10%;"></td> <td style="width: 10%;"></td> <td style="width: 10%;"></td> <td style="width: 10%;"></td> <td style="width: 10%;"></td> <td style="width: 10%;"></td> <td style="width: 10%;"></td> <td style="width: 10%;"></td> <td style="width: 10%;"></td> </tr> <tr> <td></td> <td></td> <td colspan="8" style="text-align: center;"> <table border="1" style="width: 100%; border-collapse: collapse; text-align: center;"> <tr> <td style="width: 10%;"></td> <td style="width: 10%;"></td> <td style="width: 10%;"></td> <td style="width: 10%;"></td> <td style="width: 10%;"></td>
<td style="width: 10%;"></td> <td style="width: 10%;"></td> <td style="width: 10%;"></td> <td style="width: 10%;"></td> <td style="width: 10%;"></td> </tr> <tr> <td></td> <td></td> <td colspan="8" style="text-align: center;"> <table border="1" style="width: 100%; border-collapse: collapse; text-align: center;"> <tr> </tr></table></td></tr></table></td></tr></table></td></tr></table></td></tr></table></td></tr></table></td></tr></table></td></tr></table></td></tr></table></td></tr></table></td></tr></table></td></tr></table></td></tr></table></td></tr></table></td></tr></table></td></tr></table></td></tr></table></td></tr></table>

 | | | | | | | | | | | | | | | | | | | | <table border="1" style="width: 100%; border-collapse: collapse; text-align: center;"> <tr> <td style="width: 10%;"></td> <td style="width: 10%;"></td> <td style="width: 10%;"></td> <td style="width: 10%;"></td> <td style="width: 10%;"></td> <td style="width: 10%;"></td> <td style="width: 10%;"></td> <td style="width: 10%;"></td> <td style="width: 10%;"></td> <td style="width: 10%;"></td> </tr> <tr> <td></td> <td></td> <td colspan="8" style="text-align: center;"> <table border="1" style="width: 100%; border-collapse: collapse; text-align: center;"> <tr> <td style="width: 10%;"></td> <td style="width: 10%;"></td> <td style="width: 10%;"></td> <td style="width: 10%;"></td> <td style="width: 10%;"></td> <td style="width: 10%;"></td> <td style="width: 10%;"></td> <td style="width: 10%;"></td> <td style="width: 10%;"></td> <td style="width: 10%;"></td> </tr> <tr> <td></td> <td></td> <td colspan="8" style="text-align: center;"> <table border="1" style="width: 100%; border-collapse: collapse; text-align: center;"> <tr> <td style="width: 10%;"></td> <td style="width: 10%;"></td> <td style="width: 10%;"></td> <td style="width: 10%;"></td> <td style="width: 10%;"></td> <td style="width: 10%;"></td> <td style="width: 10%;"></td> <td style="width: 10%;"></td> <td style="width: 10%;"></td> <td style="width: 10%;"></td> </tr> <tr> <td></td> <td></td> <td colspan="8" style="text-align: center;"> <table border="1" style="width: 100%; border-collapse: collapse; text-align: center;"> <tr> <td style="width: 10%;"></td> <td style="width: 10%;"></td> <td style="width: 10%;"></td> <td style="width: 10%;"></td> <td style="width: 10%;"></td> <td style="width: 10%;"></td> <td style="width: 10%;"></td> <td style="width: 10%;"></td> <td style="width: 10%;"></td> <td style="width: 10%;"></td> </tr> <tr> <td></td> <td></td> <td colspan="8" style="text-align: center;"> <table border="1" style="width: 100%; border-collapse: collapse; text-align: center;"> <tr> <td style="width: 10%;"></td> <td style="width: 10%;"></td> <td style="width: 10%;"></td> <td style="width: 10%;"></td> <td style="width: 10%;"></td> <td style="width: 10%;"></td> <td style="width: 10%;"></td> <td style="width: 10%;"></td> <td style="width: 10%;"></td> <td style="width: 10%;"></td> </tr> <tr> <td></td> <td></td> <td colspan="8" style="text-align: center;"> <table border="1" style="width: 100%; border-collapse: collapse; text-align: center;"> <tr> <td style="width: 10%;"></td> <td style="width: 10%;"></td> <td style="width: 10%;"></td> <td style="width: 10%;"></td> <td style="width: 10%;"></td> <td style="width: 10%;"></td> <td style="width: 10%;"></td> <td style="width: 10%;"></td> <td style="width: 10%;"></td> <td style="width: 10%;"></td> </tr> <tr> <td></td> <td></td> <td colspan="8" style="text-align: center;"> <table border="1" style="width: 100%; border-collapse: collapse; text-align: center;"> <tr> <td style="width: 10%;"></td> <td style="width: 10%;"></td> <td style="width: 10%;"></td> <td style="width: 10%;"></td> <td style="width: 10%;"></td> <td style="width: 10%;"></td> <td style="width: 10%;"></td> <td style="width: 10%;"></td> <td style="width: 10%;"></td> <td style="width: 10%;"></td> </tr> <tr> <td></td> <td></td> <td colspan="8" style="text-align: center;"> <table border="1" style="width: 100%; border-collapse: collapse; text-align: center;"> <tr> <td style="width: 10%;"></td> <td style="width: 10%;"></td> <td style="width: 10%;"></td> <td style="width: 10%;"></td> <td style="width: 10%;"></td> <td style="width: 10%;"></td> <td style="width: 10%;"></td> <td style="width: 10%;"></td> <td style="width: 10%;"></td> <td style="width: 10%;"></td> </tr> <tr> <td></td> <td></td> <td colspan="8" style="text-align: center;"> <table border="1" style="width: 100%; border-collapse: collapse; text-align: center;"> <tr> <td style="width: 10%;"></td> <td style="width: 10%;"></td> <td style="width: 10%;"></td> <td style="width: 10%;"></td> <td style="width: 10%;"></td> <td style="width: 10%;"></td> <td style="width: 10%;"></td> <td style="width: 10%;"></td> <td style="width: 10%;"></td> <td style="width: 10%;"></td> </tr> <tr> <td></td> <td></td> <td colspan="8" style="text-align: center;"> <table border="1" style="width: 100%; border-collapse: collapse; text-align: center;"> <tr> <td style="width: 10%;"></td> <td style="width: 10%;"></td> <td style="width: 10%;"></td> <td style="width: 10%;"></td> <td style="width: 10%;"></td> <td style="width: 10%;"></td> <td style="width: 10%;"></td> <td style="width: 10%;"></td> <td style="width: 10%;"></td> <td style="width: 10%;"></td> </tr> <tr> <td></td> <td></td> <td colspan="8" style="text-align: center;"> <table border="1" style="width: 100%; border-collapse: collapse; text-align: center;"> <tr> <td style="width: 10%;"></td> <td style="width: 10%;"></td> <td style="width: 10%;"></td> <td style="width: 10%;"></td> <td style="width: 10%;"></td> <td style="width: 10%;"></td> <td style="width: 10%;"></td> <td style="width: 10%;"></td> <td style="width: 10%;"></td> <td style="width: 10%;"></td> </tr> <tr> <td></td> <td></td> <td colspan="8" style="text-align: center;"> <table border="1" style="width: 100%; border-collapse: collapse; text-align: center;"> <tr> <td style="width: 10%;"></td> <td style="width: 10%;"></td> <td style="width: 10%;"></td> <td style="width: 10%;"></td> <td style="width: 10%;"></td> <td style="width: 10%;"></td> <td style="width: 10%;"></td> <td style="width: 10%;"></td> <td style="width: 10%;"></td> <td style="width: 10%;"></td> </tr> <tr> <td></td> <td></td> <td colspan="8" style="text-align: center;"> <table border="1" style="width: 100%; border-collapse: collapse; text-align: center;"> <tr> <td style="width: 10%;"></td> <td style="width: 10%;"></td> <td style="width: 10%;"></td> <td style="width: 10%;"></td> <td style="width: 10%;"></td> <td style="width: 10%;"></td> <td style="width: 10%;"></td> <td style="width: 10%;"></td> <td style="width: 10%;"></td> <td style="width: 10%;"></td> </tr> <tr> <td></td> <td></td> <td colspan="8" style="text-align: center;"> <table border="1" style="width: 100%; border-collapse: collapse; text-align: center;"> <tr> <td style="width: 10%;"></td> <td style="width: 10%;"></td> <td style="width: 10%;"></td> <td style="width: 10%;"></td> <td style="width: 10%;"></td> <td style="width: 10%;"></td> <td style="width: 10%;"></td> <td style="width: 10%;"></td> <td style="width: 10%;"></td> <td style="width: 10%;"></td> </tr> <tr> <td></td> <td></td> <td colspan="8" style="text-align: center;"> <table border="1" style="width: 100%; border-collapse: collapse; text-align: center;"> <tr> <td style="width: 10%;"></td> <td style="width: 10%;"></td> <td style="width: 10%;"></td> <td style="width: 10%;"></td> <td style="width: 10%;"></td> <td style="width: 10%;"></td> <td style="width: 10%;"></td> <td style="width: 10%;"></td> <td style="width: 10%;"></td> <td style="width: 10%;"></td> </tr> <tr> <td></td> <td></td> <td colspan="8" style="text-align: center;"> <table border="1" style="width: 100%; border-collapse: collapse; text-align: center;"> <tr> <td style="width: 10%;"></td> <td style="width: 10%;"></td> <td style="width: 10%;"></td> <td style="width: 10%;"></td> <td style="width: 10%;"></td> <td style="width: 10%;"></td> <td style="width: 10%;"></td> <td style="width: 10%;"></td> <td style="width: 10%;"></td> <td style="width: 10%;"></td> </tr> <tr> <td></td>
<td></td> <td colspan="8" style="text-align: center;"> <table border="1" style="width: 100%; border-collapse: collapse; text-align: center;"> <tr> </tr></table></td></tr></table></td></tr></table></td></tr></table></td></tr></table></td></tr></table></td></tr></table></td></tr></table></td></tr></table></td></tr></table></td></tr></table></td></tr></table></td></tr></table></td></tr></table></td></tr></table></td></tr></table></td></tr></table>

 | | | | | | | | | | | | | | | | | | | | <table border="1" style="width: 100%; border-collapse: collapse; text-align: center;"> <tr> <td style="width: 10%;"></td> <td style="width: 10%;"></td> <td style="width: 10%;"></td> <td style="width: 10%;"></td> <td style="width: 10%;"></td> <td style="width: 10%;"></td> <td style="width: 10%;"></td> <td style="width: 10%;"></td> <td style="width: 10%;"></td> <td style="width: 10%;"></td> </tr> <tr> <td></td> <td></td> <td colspan="8" style="text-align: center;"> <table border="1" style="width: 100%; border-collapse: collapse; text-align: center;"> <tr> <td style="width: 10%;"></td> <td style="width: 10%;"></td> <td style="width: 10%;"></td> <td style="width: 10%;"></td> <td style="width: 10%;"></td> <td style="width: 10%;"></td> <td style="width: 10%;"></td> <td style="width: 10%;"></td> <td style="width: 10%;"></td> <td style="width: 10%;"></td> </tr> <tr> <td></td> <td></td> <td colspan="8" style="text-align: center;"> <table border="1" style="width: 100%; border-collapse: collapse; text-align: center;"> <tr> <td style="width: 10%;"></td> <td style="width: 10%;"></td> <td style="width: 10%;"></td> <td style="width: 10%;"></td> <td style="width: 10%;"></td> <td style="width: 10%;"></td> <td style="width: 10%;"></td> <td style="width: 10%;"></td> <td style="width: 10%;"></td> <td style="width: 10%;"></td> </tr> <tr> <td></td> <td></td> <td colspan="8" style="text-align: center;"> <table border="1" style="width: 100%; border-collapse: collapse; text-align: center;"> <tr> <td style="width: 10%;"></td> <td style="width: 10%;"></td> <td style="width: 10%;"></td> <td style="width: 10%;"></td> <td style="width: 10%;"></td> <td style="width: 10%;"></td> <td style="width: 10%;"></td> <td style="width: 10%;"></td> <td style="width: 10%;"></td> <td style="width: 10%;"></td> </tr> <tr> <td></td> <td></td> <td colspan="8" style="text-align: center;"> <table border="1" style="width: 100%; border-collapse: collapse; text-align: center;"> <tr> <td style="width: 10%;"></td> <td style="width: 10%;"></td> <td style="width: 10%;"></td> <td style="width: 10%;"></td> <td style="width: 10%;"></td> <td style="width: 10%;"></td> <td style="width: 10%;"></td> <td style="width: 10%;"></td> <td style="width: 10%;"></td> <td style="width: 10%;"></td> </tr> <tr> <td></td> <td></td> <td colspan="8" style="text-align: center;"> <table border="1" style="width: 100%; border-collapse: collapse; text-align: center;"> <tr> <td style="width: 10%;"></td> <td style="width: 10%;"></td> <td style="width: 10%;"></td> <td style="width: 10%;"></td> <td style="width: 10%;"></td> <td style="width: 10%;"></td> <td style="width: 10%;"></td> <td style="width: 10%;"></td> <td style="width: 10%;"></td> <td style="width: 10%;"></td> </tr> <tr> <td></td> <td></td> <td colspan="8" style="text-align: center;"> <table border="1" style="width: 100%; border-collapse: collapse; text-align: center;"> <tr> <td style="width: 10%;"></td> <td style="width: 10%;"></td> <td style="width: 10%;"></td> <td style="width: 10%;"></td> <td style="width: 10%;"></td> <td style="width: 10%;"></td> <td style="width: 10%;"></td> <td style="width: 10%;"></td> <td style="width: 10%;"></td> <td style="width: 10%;"></td> </tr> <tr> <td></td> <td></td> <td colspan="8" style="text-align: center;"> <table border="1" style="width: 100%; border-collapse: collapse; text-align: center;"> <tr> <td style="width: 10%;"></td> <td style="width: 10%;"></td> <td style="width: 10%;"></td> <td style="width: 10%;"></td> <td style="width: 10%;"></td> <td style="width: 10%;"></td> <td style="width: 10%;"></td> <td style="width: 10%;"></td> <td style="width: 10%;"></td> <td style="width: 10%;"></td> </tr> <tr> <td></td> <td></td> <td colspan="8" style="text-align: center;"> <table border="1" style="width: 100%; border-collapse: collapse; text-align: center;"> <tr> <td style="width: 10%;"></td> <td style="width: 10%;"></td> <td style="width: 10%;"></td> <td style="width: 10%;"></td> <td style="width: 10%;"></td> <td style="width: 10%;"></td> <td style="width: 10%;"></td> <td style="width: 10%;"></td> <td style="width: 10%;"></td> <td style="width: 10%;"></td> </tr> <tr> <td></td> <td></td> <td colspan="8" style="text-align: center;"> <table border="1" style="width: 100%; border-collapse: collapse; text-align: center;"> <tr> <td style="width: 10%;"></td> <td style="width: 10%;"></td> <td style="width: 10%;"></td> <td style="width: 10%;"></td> <td style="width: 10%;"></td> <td style="width: 10%;"></td> <td style="width: 10%;"></td> <td style="width: 10%;"></td> <td style="width: 10%;"></td> <td style="width: 10%;"></td> </tr> <tr> <td></td> <td></td> <td colspan="8" style="text-align: center;"> <table border="1" style="width: 100%; border-collapse: collapse; text-align: center;"> <tr> <td style="width: 10%;"></td> <td style="width: 10%;"></td> <td style="width: 10%;"></td> <td style="width: 10%;"></td> <td style="width: 10%;"></td> <td style="width: 10%;"></td> <td style="width: 10%;"></td> <td style="width: 10%;"></td> <td style="width: 10%;"></td> <td style="width: 10%;"></td> </tr> <tr> <td></td> <td></td> <td colspan="8" style="text-align: center;"> <table border="1" style="width: 100%; border-collapse: collapse; text-align: center;"> <tr> <td style="width: 10%;"></td> <td style="width: 10%;"></td> <td style="width: 10%;"></td> <td style="width: 10%;"></td> <td style="width: 10%;"></td> <td style="width: 10%;"></td> <td style="width: 10%;"></td> <td style="width: 10%;"></td> <td style="width: 10%;"></td> <td style="width: 10%;"></td> </tr> <tr> <td></td> <td></td> <td colspan="8" style="text-align: center;"> <table border="1" style="width: 100%; border-collapse: collapse; text-align: center;"> <tr> <td style="width: 10%;"></td> <td style="width: 10%;"></td> <td style="width: 10%;"></td> <td style="width: 10%;"></td> <td style="width: 10%;"></td> <td style="width: 10%;"></td> <td style="width: 10%;"></td> <td style="width: 10%;"></td> <td style="width: 10%;"></td> <td style="width: 10%;"></td> </tr> <tr> <td></td> <td></td> <td colspan="8" style="text-align: center;"> <table border="1" style="width: 100%; border-collapse: collapse; text-align: center;"> <tr> <td style="width: 10%;"></td> <td style="width: 10%;"></td> <td style="width: 10%;"></td> <td style="width: 10%;"></td> <td style="width: 10%;"></td> <td style="width: 10%;"></td> <td style="width: 10%;"></td> <td style="width: 10%;"></td> <td style="width: 10%;"></td> <td style="width: 10%;"></td> </tr> <tr> <td></td> <td></td> <td colspan="8" style="text-align: center;"> <table border="1" style="width: 100%; border-collapse: collapse; text-align: center;"> <tr> <td style="width: 10%;"></td> <td style="width: 10%;"></td> <td style="width: 10%;"></td> <td style="width: 10%;"></td> <td style="width: 10%;"></td> <td style="width: 10%;"></td> <td style="width: 10%;"></td> <td style="width: 10%;"></td> <td style="width: 10%;"></td> <td style="width: 10%;"></td> </tr> <tr> <td></td> <td></td> <td colspan="8" style="text-align: center;"> <table border="1" style="width: 100%; border-collapse: collapse; text-align: center;"> <tr> </tr></table></td></tr></table></td></tr></table></td></tr></table></td></tr></table></td></tr></table></td></tr></table></td></tr></table></td></tr></table></td></tr></table></td></tr></table></td></tr></table></td></tr></table></td></tr></table></td></tr></table></td></tr></table>

 | | | | | | | | | | | | | | | | | | | | <table border="1" style="width: 100%; border-collapse: collapse; text-align: center;"> <tr> <td style="width: 10%;"></td> <td style="width: 10%;"></td> <td style="width: 10%;"></td> <td style="width: 10%;"></td> <td style="width: 10%;"></td> <td style="width: 10%;"></td> <td style="width: 10%;"></td> <td style="width: 10%;"></td> <td style="width: 10%;"></td> <td style="width: 10%;"></td> </tr> <tr> <td></td> <td></td> <td colspan="8" style="text-align: center;"> <table border="1" style="width: 100%; border-collapse: collapse; text-align: center;"> <tr> <td style="width: 10%;"></td> <td style="width: 10%;"></td> <td style="width: 10%;"></td> <td style="width: 10%;"></td> <td style="width: 10%;"></td> <td style="width: 10%;"></td> <td style="width: 10%;"></td> <td style="width: 10%;"></td> <td style="width: 10%;"></td> <td style="width: 10%;"></td> </tr> <tr> <td></td> <td></td> <td colspan="8" style="text-align: center;"> <table border="1" style="width: 100%; border-collapse: collapse; text-align: center;"> <tr> <td style="width: 10%;"></td> <td style="width: 10%;"></td> <td style="width: 10%;"></td> <td style="width: 10%;"></td> <td style="width: 10%;"></td> <td style="width: 10%;"></td> <td style="width: 10%;"></td> <td style="width: 10%;"></td> <td style="width: 10%;"></td> <td style="width: 10%;"></td> </tr> <tr> <td></td> <td></td> <td colspan="8" style="text-align: center;"> <table border="1" style="width: 100%; border-collapse: collapse; text-align: center;"> <tr> <td style="width: 10%;"></td> <td style="width: 10%;"></td> <td style="width: 10%;"></td> <td style="width: 10%;"></td> <td style="width: 10%;"></td> <td style="width: 10%;"></td> <td style="width: 10%;"></td> <td style="width: 10%;"></td> <td style="width: 10%;"></td> <td style="width: 10%;"></td> </tr> <tr> <td></td> <td></td> <td colspan="8" style="text-align: center;"> <table border="1" style="width: 100%; border-collapse: collapse; text-align: center;"> <tr> <td style="width: 10%;"></td> <td style="width: 10%;"></td> <td style="width: 10%;"></td> <td style="width: 10%;"></td> <td style="width: 10%;"></td> <td style="width: 10%;"></td> <td style="width: 10%;"></td> <td style="width: 10%;"></td> <td style="width: 10%;"></td> <td style="width: 10%;"></td> </tr> <tr> <td></td> <td></td> <td colspan="8" style="text-align: center;"> <table border="1" style="width: 100%; border-collapse: collapse; text-align: center;"> <tr> <td style="width: 10%;"></td> <td style="width: 10%;"></td> <td style="width: 10%;"></td> <td style="width: 10%;"></td> <td style="width: 10%;"></td> <td style="width: 10%;"></td> <td style="width: 10%;"></td> <td style="width: 10%;"></td> <td style="width: 10%;"></td> <td style="width: 10%;"></td> </tr> <tr> <td></td> <td></td> <td colspan="8" style="text-align: center;"> <table border="1" style="width: 100%; border-collapse: collapse; text-align: center;"> <tr> <td style="width: 10%;"></td> <td style="width: 10%;"></td> <td style="width: 10%;"></td> <td style="width: 10%;"></td> <td style="width: 10%;"></td> <td style="width: 10%;"></td> <td style="width: 10%;"></td> <td style="width: 10%;"></td> <td style="width: 10%;"></td> <td style="width: 10%;"></td> </tr> <tr> <td></td> <td></td> <td colspan="8" style="text-align: center;"> <table border="1" style="width: 100%; border-collapse: collapse; text-align: center;"> <tr> <td style="width: 10%;"></td> <td style="width: 10%;"></td> <td style="width: 10%;"></td> <td style="width: 10%;"></td> <td style="width: 10%;"></td> <td style="width: 10%;"></td> <td style="width: 10%;"></td> <td style="width: 10%;"></td> <td style="width: 10%;"></td> <td style="width: 10%;"></td> </tr> <tr> <td></td> <td></td> <td colspan="8" style="text-align: center;"> <table border="1" style="width: 100%; border-collapse: collapse; text-align: center;"> <tr> <td style="width: 10%;"></td> <td style="width: 10%;"></td> <td style="width: 10%;"></td> <td style="width: 10%;"></td> <td style="width: 10%;"></td> <td style="width: 10%;"></td> <td style="width: 10%;"></td> <td style="width: 10%;"></td> <td style="width: 10%;"></td> <td style="width: 10%;"></td> </tr> <tr> <td></td> <td></td> <td colspan="8" style="text-align: center;"> <table border="1" style="width: 100%; border-collapse: collapse; text-align: center;"> <tr> <td style="width: 10%;"></td> <td style="width: 10%;"></td> <td style="width: 10%;"></td> <td style="width: 10%;"></td> <td style="width: 10%;"></td> <td style="width: 10%;"></td> <td style="width: 10%;"></td> <td style="width: 10%;"></td> <td style="width: 10%;"></td> <td style="width: 10%;"></td> </tr> <tr> <td></td> <td></td> <td colspan="8" style="text-align: center;"> <table border="1" style="width: 100%; border-collapse: collapse; text-align: center;"> <tr> <td style="width: 10%;"></td> <td style="width: 10%;"></td> <td style="width: 10%;"></td> <td style="width: 10%;"></td> <td style="width: 10%;"></td> <td style="width: 10%;"></td> <td style="width: 10%;"></td> <td style="width: 10%;"></td> <td style="width: 10%;"></td> <td style="width: 10%;"></td> </tr> <tr> <td></td> <td></td> <td colspan="8" style="text-align: center;"> <table border="1" style="width: 100%; border-collapse: collapse; text-align: center;"> <tr> <td style="width: 10%;"></td> <td style="width: 10%;"></td> <td style="width: 10%;"></td> <td style="width: 10%;"></td> <td style="width: 10%;"></td> <td style="width: 10%;"></td> <td style="width: 10%;"></td> <td style="width: 10%;"></td> <td style="width: 10%;"></td> <td style="width: 10%;"></td> </tr> <tr> <td></td> <td></td> <td colspan="8" style="text-align: center;"> <table border="1" style="width: 100%; border-collapse: collapse; text-align: center;"> <tr> <td style="width: 10%;"></td> <td style="width: 10%;"></td> <td style="width: 10%;"></td> <td style="width: 10%;"></td> <td style="width: 10%;"></td> <td style="width: 10%;"></td> <td style="width: 10%;"></td> <td style="width: 10%;"></td> <td style="width: 10%;"></td> <td style="width: 10%;"></td> </tr> <tr> <td></td> <td></td> <td colspan="8" style="text-align: center;"> <table border="1" style="width: 100%; border-collapse: collapse; text-align: center;"> <tr> <td style="width: 10%;"></td> <td style="width: 10%;"></td> <td style="width: 10%;"></td> <td style="width: 10%;"></td> <td style="width: 10%;"></td> <td style="width: 10%;"></td> <td style="width: 10%;"></td> <td style="width: 10%;"></td> <td style="width: 10%;"></td> <td style="width: 10%;"></td> </tr> <tr> <td></td> <td></td> <td colspan="8" style="text-align: center;"> <table border="1" style="width: 100%; border-collapse: collapse; text-align: center;"> <tr> </tr></table></td></tr></table></td></tr></table></td></tr></table></td></tr></table></td></tr></table></td></tr></table></td></tr></table></td></tr></table></td></tr></table></td></tr></table></td></tr></table></td></tr></table></td></tr></table></td></tr></table>

 | | | | | | | | | | | | | | | | | | | | <table border="1" style="width: 100%; border-collapse: collapse; text-align: center;"> <tr> <td style="width: 10%;"></td> <td style="width: 10%;"></td> <td style="width: 10%;"></td> <td style="width: 10%;"></td> <td style="width: 10%;"></td> <td style="width: 10%;"></td> <td style="width: 10%;"></td> <td style="width: 10%;"></td> <td style="width: 10%;"></td> <td style="width: 10%;"></td> </tr> <tr> <td></td> <td></td> <td colspan="8" style="text-align: center;"> <table border="1" style="width: 100%; border-collapse: collapse; text-align: center;"> <tr> <td style="width: 10%;"></td> <td style="width: 10%;"></td> <td style="width: 10%;"></td> <td style="width: 10%;"></td> <td style="width: 10%;"></td> <td style="width: 10%;"></td> <td style="width: 10%;"></td> <td style="width: 10%;"></td> <td style="width: 10%;"></td> <td style="width: 10%;"></td> </tr> <tr> <td></td> <td></td> <td colspan="8" style="text-align: center;"> <table border="1" style="width: 100%; border-collapse: collapse; text-align: center;"> <tr> <td style="width: 10%;"></td> <td style="width: 10%;"></td> <td style="width: 10%;"></td> <td style="width: 10%;"></td> <td style="width: 10%;"></td> <td style="width: 10%;"></td> <td style="width: 10%;"></td> <td style="width: 10%;"></td> <td style="width: 10%;"></td> <td style="width: 10%;"></td> </tr> <tr> <td></td> <td></td> <td colspan="8" style="text-align: center;"> <table border="1" style="width: 100%; border-collapse: collapse; text-align: center;"> <tr> <td style="width: 10%;"></td> <td style="width: 10%;"></td> <td style="width: 10%;"></td> <td style="width: 10%;"></td> <td style="width: 10%;"></td> <td style="width: 10%;"></td> <td style="width: 10%;"></td> <td style="width: 10%;"></td> <td style="width: 10%;"></td> <td style="width: 10%;"></td> </tr> <tr> <td></td> <td></td> <td colspan="8" style="text-align: center;"> <table border="1" style="width: 100%; border-collapse: collapse; text-align: center;"> <tr> <td style="width: 10%;"></td> <td style="width: 10%;"></td> <td style="width: 10%;"></td> <td style="width: 10%;"></td> <td style="width: 10%;"></td> <td style="width: 10%;"></td> <td style="width: 10%;"></td> <td style="width: 10%;"></td> <td style="width: 10%;"></td> <td style="width: 10%;"></td> </tr> <tr> <td></td> <td></td> <td colspan="8" style="text-align: center;"> <table border="1" style="width: 100%; border-collapse: collapse; text-align: center;"> <tr> <td style="width: 10%;"></td> <td style="width: 10%;"></td> <td style="width: 10%;"></td> <td style="width: 10%;"></td> <td style="width: 10%;"></td> <td style="width: 10%;"></td> <td style="width: 10%;"></td> <td style="width: 10%;"></td> <td style="width: 10%;"></td> <td style="width: 10%;"></td> </tr> <tr> <td></td> <td></td> <td colspan="8" style="text-align: center;"> <table border="1" style="width: 100%; border-collapse: collapse; text-align: center;"> <tr> <td style="width: 10%;"></td> <td style="width: 10%;"></td> <td style="width: 10%;"></td> <td style="width: 10%;"></td> <td style="width: 10%;"></td> <td style="width: 10%;"></td> <td style="width: 10%;"></td> <td style="width: 10%;"></td> <td style="width: 10%;"></td> <td style="width: 10%;"></td> </tr> <tr> <td></td> <td></td> <td colspan="8" style="text-align: center;"> <table border="1" style="width: 100%; border-collapse: collapse; text-align: center;"> <tr> <td style="width: 10%;"></td> <td style="width: 10%;"></td> <td style="width: 10%;"></td> <td style="width: 10%;"></td> <td style="width: 10%;"></td> <td style="width: 10%;"></td> <td style="width: 10%;"></td> <td style="width: 10%;"></td> <td style="width: 10%;"></td> <td style="width: 10%;"></td> </tr> <tr> <td></td> <td></td> <td colspan="8" style="text-align: center;"> <table border="1" style="width: 100%; border-collapse: collapse; text-align: center;"> <tr> <td style="width: 10%;"></td> <td style="width: 10%;"></td> <td style="width: 10%;"></td> <td style="width: 10%;"></td> <td style="width: 10%;"></td> <td style="width: 10%;"></td> <td style="width: 10%;"></td> <td style="width: 10%;"></td> <td style="width: 10%;"></td> <td style="width: 10%;"></td> </tr> <tr> <td></td> <td></td> <td colspan="8" style="text-align: center;"> <table border="1" style="width: 100%; border-collapse: collapse; text-align: center;"> <tr> <td style="width: 10%;"></td> <td style="width: 10%;"></td> <td style="width: 10%;"></td> <td style="width: 10%;"></td> <td style="width: 10%;"></td> <td style="width: 10%;"></td> <td style="width: 10%;"></td> <td style="width: 10%;"></td> <td style="width: 10%;"></td> <td style="width: 10%;"></td> </tr> <tr> <td></td> <td></td> <td colspan="8" style="text-align: center;"> <table border="1" style="width: 100%; border-collapse: collapse; text-align: center;"> <tr> <td style="width: 10%;"></td> <td style="width: 10%;"></td> <td style="width: 10%;"></td> <td style="width: 10%;"></td> <td style="width: 10%;"></td> <td style="width: 10%;"></td> <td style="width: 10%;"></td> <td style="width: 10%;"></td> <td style="width: 10%;"></td> <td style="width: 10%;"></td> </tr> <tr> <td></td> <td></td> <td colspan="8" style="text-align: center;"> <table border="1" style="width: 100%; border-collapse: collapse; text-align: center;"> <tr> <td style="width: 10%;"></td> <td style="width: 10%;"></td> <td style="width: 10%;"></td> <td style="width: 10%;"></td> <td style="width: 10%;"></td> <td style="width: 10%;"></td> <td style="width: 10%;"></td> <td style="width: 10%;"></td> <td style="width: 10%;"></td> <td style="width: 10%;"></td> </tr> <tr> <td></td> <td></td> <td colspan="8" style="text-align: center;"> <table border="1" style="width: 100%; border-collapse: collapse; text-align: center;"> <tr> <td style="width: 10%;"></td> <td style="width: 10%;"></td> <td style="width: 10%;"></td> <td style="width: 10%;"></td> <td style="width: 10%;"></td> <td style="width: 10%;"></td> <td style="width: 10%;"></td> <td style="width: 10%;"></td> <td style="width: 10%;"></td> <td style="width: 10%;"></td> </tr> <tr> <td></td> <td></td> <td colspan="8" style="text-align: center;"> <table border="1" style="width: 100%; border-collapse: collapse; text-align: center;"> <tr> </tr></table></td></tr></table></td></tr></table></td></tr></table></td></tr></table></td></tr></table></td></tr></table></td></tr></table></td></tr></table></td></tr></table></td></tr></table></td></tr></table></td></tr></table></td></tr></table>

 | | | | | | | | | | | | | | | | | | | | <table border="1" style="width: 100%; border-collapse: collapse; text-align: center;"> <tr> <td style="width: 10%;"></td> <td style="width: 10%;"></td> <td style="width: 10%;"></td> <td style="width: 10%;"></td> <td style="width: 10%;"></td> <td style="width: 10%;"></td> <td style="width: 10%;"></td> <td style="width: 10%;"></td> <td style="width: 10%;"></td> <td style="width: 10%;"></td> </tr> <tr> <td></td> <td></td> <td colspan="8" style="text-align: center;"> <table border="1" style="width: 100%; border-collapse: collapse; text-align: center;"> <tr> <td style="width: 10%;"></td> <td style="width: 10%;"></td> <td style="width: 10%;"></td> <td style="width: 10%;"></td> <td style="width: 10%;"></td> <td style="width: 10%;"></td> <td style="width: 10%;"></td> <td style="width: 10%;"></td> <td style="width: 10%;"></td> <td style="width: 10%;"></td> </tr> <tr> <td></td> <td></td> <td colspan="8" style="text-align: center;"> <table border="1" style="width: 100%; border-collapse: collapse; text-align: center;"> <tr> <td style="width: 10%;"></td> <td style="width: 10%;"></td> <td
style="width: 10%;"></td> <td style="width: 10%;"></td> <td style="width: 10%;"></td> <td style="width: 10%;"></td> <td style="width: 10%;"></td> <td style="width: 10%;"></td> <td style="width: 10%;"></td> <td style="width: 10%;"></td> </tr> <tr> <td></td> <td></td> <td colspan="8" style="text-align: center;"> <table border="1" style="width: 100%; border-collapse: collapse; text-align: center;"> <tr> <td style="width: 10%;"></td> <td style="width: 10%;"></td> <td style="width: 10%;"></td> <td style="width: 10%;"></td> <td style="width: 10%;"></td> <td style="width: 10%;"></td> <td style="width: 10%;"></td> <td style="width: 10%;"></td> <td style="width: 10%;"></td> <td style="width: 10%;"></td> </tr> <tr> <td></td> <td></td> <td colspan="8" style="text-align: center;"> <table border="1" style="width: 100%; border-collapse: collapse; text-align: center;"> <tr> <td style="width: 10%;"></td> <td style="width: 10%;"></td> <td style="width: 10%;"></td> <td style="width: 10%;"></td> <td style="width: 10%;"></td> <td style="width: 10%;"></td> <td style="width: 10%;"></td> <td style="width: 10%;"></td> <td style="width: 10%;"></td> <td style="width: 10%;"></td> </tr> <tr> <td></td> <td></td> <td colspan="8" style="text-align: center;"> <table border="1" style="width: 100%; border-collapse: collapse; text-align: center;"> <tr> <td style="width: 10%;"></td> <td style="width: 10%;"></td> <td style="width: 10%;"></td> <td style="width: 10%;"></td> <td style="width: 10%;"></td> <td style="width: 10%;"></td> <td style="width: 10%;"></td> <td style="width: 10%;"></td> <td style="width: 10%;"></td> <td style="width: 10%;"></td> </tr> <tr> <td></td> <td></td> <td colspan="8" style="text-align: center;"> <table border="1" style="width: 100%; border-collapse: collapse; text-align: center;"> <tr> <td style="width: 10%;"></td> <td style="width: 10%;"></td> <td style="width: 10%;"></td> <td style="width: 10%;"></td> <td style="width: 10%;"></td> <td style="width: 10%;"></td> <td style="width: 10%;"></td> <td style="width: 10%;"></td> <td style="width: 10%;"></td> <td style="width: 10%;"></td> </tr> <tr> <td></td> <td></td> <td colspan="8" style="text-align: center;"> <table border="1" style="width: 100%; border-collapse: collapse; text-align: center;"> <tr> <td style="width: 10%;"></td> <td style="width: 10%;"></td> <td style="width: 10%;"></td> <td style="width: 10%;"></td> <td style="width: 10%;"></td> <td style="width: 10%;"></td> <td style="width: 10%;"></td> <td style="width: 10%;"></td> <td style="width: 10%;"></td> <td style="width: 10%;"></td> </tr> <tr> <td></td> <td></td> <td colspan="8" style="text-align: center;"> <table border="1" style="width: 100%; border-collapse: collapse; text-align: center;"> <tr> <td style="width: 10%;"></td> <td style="width: 10%;"></td> <td style="width: 10%;"></td> <td style="width: 10%;"></td> <td style="width: 10%;"></td> <td style="width: 10%;"></td> <td style="width: 10%;"></td> <td style="width: 10%;"></td> <td style="width: 10%;"></td> <td style="width: 10%;"></td> </tr> <tr> <td></td> <td></td> <td colspan="8" style="text-align: center;"> <table border="1" style="width: 100%; border-collapse: collapse; text-align: center;"> <tr> <td style="width: 10%;"></td> <td style="width: 10%;"></td> <td style="width: 10%;"></td> <td style="width: 10%;"></td> <td style="width: 10%;"></td> <td style="width: 10%;"></td> <td style="width: 10%;"></td> <td style="width: 10%;"></td> <td style="width: 10%;"></td> <td style="width: 10%;"></td> </tr> <tr> <td></td> <td></td> <td colspan="8" style="text-align: center;"> <table border="1" style="width: 100%; border-collapse: collapse; text-align: center;"> <tr> <td style="width: 10%;"></td> <td style="width: 10%;"></td> <td style="width: 10%;"></td> <td style="width: 10%;"></td> <td style="width: 10%;"></td> <td style="width: 10%;"></td> <td style="width: 10%;"></td> <td style="width: 10%;"></td> <td style="width: 10%;"></td> <td style="width: 10%;"></td> </tr> <tr> <td></td> <td></td> <td colspan="8" style="text-align: center;"> <table border="1" style="width: 100%; border-collapse: collapse; text-align: center;"> <tr> <td style="width: 10%;"></td> <td style="width: 10%;"></td> <td style="width: 10%;"></td> <td style="width: 10%;"></td> <td style="width: 10%;"></td> <td style="width: 10%;"></td> <td style="width: 10%;"></td> <td style="width: 10%;"></td> <td style="width: 10%;"></td> <td style="width: 10%;"></td> </tr> <tr> <td></td> <td></td> <td colspan="8" style="text-align: center;"> <table border="1" style="width: 100%; border-collapse: collapse; text-align: center;"> <tr> </tr></table></td></tr></table></td></tr></table></td></tr></table></td></tr></table></td></tr></table></td></tr></table></td></tr></table></td></tr></table></td></tr></table></td></tr></table></td></tr></table></td></tr></table>

 | | | | | | | | | | | | | | | | | | | | <table border="1" style="width: 100%; border-collapse: collapse; text-align: center;"> <tr> <td style="width: 10%;"></td> <td style="width: 10%;"></td> <td style="width: 10%;"></td> <td style="width: 10%;"></td> <td style="width: 10%;"></td> <td style="width: 10%;"></td> <td style="width: 10%;"></td> <td style="width: 10%;"></td> <td style="width: 10%;"></td> <td style="width: 10%;"></td> </tr> <tr> <td></td> <td></td> <td colspan="8" style="text-align: center;"> <table border="1" style="width: 100%; border-collapse: collapse; text-align: center;"> <tr> <td style="width: 10%;"></td> <td style="width: 10%;"></td> <td style="width: 10%;"></td> <td style="width: 10%;"></td> <td style="width: 10%;"></td> <td style="width: 10%;"></td> <td style="width: 10%;"></td> <td style="width: 10%;"></td> <td style="width: 10%;"></td> <td style="width: 10%;"></td> </tr> <tr> <td></td> <td></td> <td colspan="8" style="text-align: center;"> <table border="1" style="width: 100%; border-collapse: collapse; text-align: center;"> <tr> <td style="width: 10%;"></td> <td style="width: 10%;"></td> <td style="width: 10%;"></td> <td style="width: 10%;"></td> <td style="width: 10%;"></td> <td style="width: 10%;"></td> <td style="width: 10%;"></td> <td style="width: 10%;"></td> <td style="width: 10%;"></td> <td style="width: 10%;"></td> </tr> <tr> <td></td> <td></td> <td colspan="8" style="text-align: center;"> <table border="1" style="width: 100%; border-collapse: collapse; text-align: center;"> <tr> <td style="width: 10%;"></td> <td style="width: 10%;"></td> <td style="width: 10%;"></td> <td style="width: 10%;"></td> <td style="width: 10%;"></td> <td style="width: 10%;"></td> <td style="width: 10%;"></td> <td style="width: 10%;"></td> <td style="width: 10%;"></td> <td style="width: 10%;"></td> </tr> <tr> <td></td> <td></td> <td colspan="8" style="text-align: center;"> <table border="1" style="width: 100%; border-collapse: collapse; text-align: center;"> <tr> <td style="width: 10%;"></td> <td style="width: 10%;"></td> <td style="width: 10%;"></td> <td style="width: 10%;"></td> <td style="width: 10%;"></td> <td style="width: 10%;"></td> <td style="width: 10%;"></td> <td style="width: 10%;"></td> <td style="width: 10%;"></td> <td style="width: 10%;"></td> </tr> <tr> <td></td> <td></td> <td colspan="8" style="text-align: center;"> <table border="1" style="width: 100%; border-collapse: collapse; text-align: center;"> <tr> <td style="width: 10%;"></td> <td style="width: 10%;"></td> <td style="width: 10%;"></td> <td style="width: 10%;"></td> <td style="width: 10%;"></td> <td style="width: 10%;"></td> <td style="width: 10%;"></td> <td style="width: 10%;"></td> <td style="width: 10%;"></td> <td style="width: 10%;"></td> </tr> <tr> <td></td> <td></td> <td colspan="8" style="text-align: center;"> <table border="1" style="width: 100%; border-collapse: collapse; text-align: center;"> <tr> <td style="width: 10%;"></td> <td style="width: 10%;"></td> <td style="width: 10%;"></td> <td style="width: 10%;"></td> <td style="width: 10%;"></td> <td style="width: 10%;"></td> <td style="width: 10%;"></td> <td style="width: 10%;"></td> <td style="width: 10%;"></td> <td style="width: 10%;"></td> </tr> <tr> <td></td>
<td></td> <td colspan="8" style="text-align: center;"> <table border="1" style="width: 100%; border-collapse: collapse; text-align: center;"> <tr> <td style="width: 10%;"></td> <td style="width: 10%;"></td> <td style="width: 10%;"></td> <td style="width: 10%;"></td> <td style="width: 10%;"></td> <td style="width: 10%;"></td> <td style="width: 10%;"></td> <td style="width: 10%;"></td> <td style="width: 10%;"></td> <td style="width: 10%;"></td> </tr> <tr> <td></td> <td></td> <td colspan="8" style="text-align: center;"> <table border="1" style="width: 100%; border-collapse: collapse; text-align: center;"> <tr> <td style="width: 10%;"></td> <td style="width: 10%;"></td> <td style="width: 10%;"></td> <td style="width: 10%;"></td> <td style="width: 10%;"></td> <td style="width: 10%;"></td> <td style="width: 10%;"></td> <td style="width: 10%;"></td> <td style="width: 10%;"></td> <td style="width: 10%;"></td> </tr> <tr> <td></td> <td></td> <td colspan="8" style="text-align: center;"> <table border="1" style="width: 100%; border-collapse: collapse; text-align: center;"> <tr> <td style="width: 10%;"></td> <td style="width: 10%;"></td> <td style="width: 10%;"></td> <td style="width: 10%;"></td> <td style="width: 10%;"></td> <td style="width: 10%;"></td> <td style="width: 10%;"></td> <td style="width: 10%;"></td> <td style="width: 10%;"></td> <td style="width: 10%;"></td> </tr> <tr> <td></td> <td></td> <td colspan="8" style="text-align: center;"> <table border="1" style="width: 100%; border-collapse: collapse; text-align: center;"> <tr> <td style="width: 10%;"></td> <td style="width: 10%;"></td> <td style="width: 10%;"></td> <td style="width: 10%;"></td> <td style="width: 10%;"></td> <td style="width: 10%;"></td> <td style="width: 10%;"></td> <td style="width: 10%;"></td> <td style="width: 10%;"></td> <td style="width: 10%;"></td> </tr> <tr> <td></td> <td></td> <td colspan="8" style="text-align: center;"> <table border="1" style="width: 100%; border-collapse: collapse; text-align: center;"> <tr> </tr></table></td></tr></table></td></tr></table></td></tr></table></td></tr></table></td></tr></table></td></tr></table></td></tr></table></td></tr></table></td></tr></table></td></tr></table></td></tr></table>

 | | | | | | | | | | | | | | | | | | | | <table border="1" style="width: 100%; border-collapse: collapse; text-align: center;"> <tr> <td style="width: 10%;"></td> <td style="width: 10%;"></td> <td style="width: 10%;"></td> <td style="width: 10%;"></td> <td style="width: 10%;"></td> <td style="width: 10%;"></td> <td style="width: 10%;"></td> <td style="width: 10%;"></td> <td style="width: 10%;"></td> <td style="width: 10%;"></td> </tr> <tr> <td></td> <td></td> <td colspan="8" style="text-align: center;"> <table border="1" style="width: 100%; border-collapse: collapse; text-align: center;"> <tr> <td style="width: 10%;"></td> <td style="width: 10%;"></td> <td style="width: 10%;"></td> <td style="width: 10%;"></td> <td style="width: 10%;"></td> <td style="width: 10%;"></td> <td style="width: 10%;"></td> <td style="width: 10%;"></td> <td style="width: 10%;"></td> <td style="width: 10%;"></td> </tr> <tr> <td></td> <td></td> <td colspan="8" style="text-align: center;"> <table border="1" style="width: 100%; border-collapse: collapse; text-align: center;"> <tr> <td style="width: 10%;"></td> <td style="width: 10%;"></td> <td style="width: 10%;"></td> <td style="width: 10%;"></td> <td style="width: 10%;"></td> <td style="width: 10%;"></td> <td style="width: 10%;"></td> <td style="width: 10%;"></td> <td style="width: 10%;"></td> <td style="width: 10%;"></td> </tr> <tr> <td></td> <td></td> <td colspan="8" style="text-align: center;"> <table border="1" style="width: 100%; border-collapse: collapse; text-align: center;"> <tr> <td style="width: 10%;"></td> <td style="width: 10%;"></td> <td style="width: 10%;"></td> <td style="width: 10%;"></td> <td style="width: 10%;"></td> <td style="width: 10%;"></td> <td style="width: 10%;"></td> <td style="width: 10%;"></td> <td style="width: 10%;"></td> <td style="width: 10%;"></td> </tr> <tr> <td></td> <td></td> <td colspan="8" style="text-align: center;"> <table border="1" style="width: 100%; border-collapse: collapse; text-align: center;"> <tr> <td style="width: 10%;"></td> <td style="width: 10%;"></td> <td style="width: 10%;"></td> <td style="width: 10%;"></td> <td style="width: 10%;"></td> <td style="width: 10%;"></td> <td style="width: 10%;"></td> <td style="width: 10%;"></td> <td style="width: 10%;"></td> <td style="width: 10%;"></td> </tr> <tr> <td></td> <td></td> <td colspan="8" style="text-align: center;"> <table border="1" style="width: 100%; border-collapse: collapse; text-align: center;"> <tr> <td style="width: 10%;"></td> <td style="width: 10%;"></td> <td style="width: 10%;"></td> <td style="width: 10%;"></td> <td style="width: 10%;"></td> <td style="width: 10%;"></td> <td style="width: 10%;"></td> <td style="width: 10%;"></td> <td style="width: 10%;"></td> <td style="width: 10%;"></td> </tr> <tr> <td></td> <td></td> <td colspan="8" style="text-align: center;"> <table border="1" style="width: 100%; border-collapse: collapse; text-align: center;"> <tr> <td style="width: 10%;"></td> <td style="width: 10%;"></td> <td style="width: 10%;"></td> <td style="width: 10%;"></td> <td style="width: 10%;"></td> <td style="width: 10%;"></td> <td style="width: 10%;"></td> <td style="width: 10%;"></td> <td style="width: 10%;"></td> <td style="width: 10%;"></td> </tr> <tr> <td></td> <td></td> <td colspan="8" style="text-align: center;"> <table border="1" style="width: 100%; border-collapse: collapse; text-align: center;"> <tr> <td style="width: 10%;"></td> <td style="width: 10%;"></td> <td style="width: 10%;"></td> <td style="width: 10%;"></td> <td style="width: 10%;"></td> <td style="width: 10%;"></td> <td style="width: 10%;"></td> <td style="width: 10%;"></td> <td style="width: 10%;"></td> <td style="width: 10%;"></td> </tr> <tr> <td></td> <td></td> <td colspan="8" style="text-align: center;"> <table border="1" style="width: 100%; border-collapse: collapse; text-align: center;"> <tr> <td style="width: 10%;"></td> <td style="width: 10%;"></td> <td style="width: 10%;"></td> <td style="width: 10%;"></td> <td style="width: 10%;"></td> <td style="width: 10%;"></td> <td style="width: 10%;"></td> <td style="width: 10%;"></td> <td style="width: 10%;"></td> <td style="width: 10%;"></td> </tr> <tr> <td></td> <td></td> <td colspan="8" style="text-align: center;"> <table border="1" style="width: 100%; border-collapse: collapse; text-align: center;"> <tr> <td style="width: 10%;"></td> <td style="width: 10%;"></td> <td style="width: 10%;"></td> <td style="width: 10%;"></td> <td style="width: 10%;"></td> <td style="width: 10%;"></td> <td style="width: 10%;"></td> <td style="width: 10%;"></td> <td style="width: 10%;"></td> <td style="width: 10%;"></td> </tr> <tr> <td></td> <td></td> <td colspan="8" style="text-align: center;"> <table border="1" style="width: 100%; border-collapse: collapse; text-align: center;"> <tr> </tr></table></td></tr></table></td></tr></table></td></tr></table></td></tr></table></td></tr></table></td></tr></table></td></tr></table></td></tr></table></td></tr></table></td></tr></table>

 | | | | | | | | | | | | | | | | | | | | <table border="1" style="width: 100%; border-collapse: collapse; text-align: center;"> <tr> <td style="width: 10%;"></td> <td style="width: 10%;"></td> <td style="width: 10%;"></td> <td style="width: 10%;"></td> <td style="width: 10%;"></td> <td style="width: 10%;"></td> <td style="width: 10%;"></td> <td style="width: 10%;"></td> <td style="width: 10%;"></td> <td style="width: 10%;"></td> </tr> <tr> <td></td> <td></td> <td colspan="8" style="text-align: center;"> <table border="1" style="width: 100%; border-collapse: collapse; text-align: center;"> <tr> <td style="width: 10%;"></td> <td style="width: 10%;"></td> <td style="width: 10%;"></td> <td style="width: 10%;"></td> <td style="width: 10%;"></td> <td style="width: 10%;"></td> <td style="width: 10%;"></td> <td style="width: 10%;"></td> <td style="width: 10%;"></td> <td style="width: 10%;"></td> </tr> <tr> <td></td> <td></td> <td colspan="8" style="text-align: center;"> <table border="1" style="width: 100%; border-collapse: collapse; text-align: center;"> <tr> <td style="width: 10%;"></td> <td style="width: 10%;"></td> <td style="width: 10%;"></td> <td style="width: 10%;"></td> <td style="width: 10%;"></td> <td style="width: 10%;"></td> <td style="width: 10%;"></td> <td style="width: 10%;"></td> <td style="width: 10%;"></td> <td style="width: 10%;"></td> </tr> <tr> <td></td> <td></td> <td colspan="8" style="text-align: center;"> <table border="1" style="width: 100%; border-collapse: collapse; text-align: center;"> <tr> <td style="width: 10%;"></td> <td style="width: 10%;"></td> <td style="width: 10%;"></td> <td style="width: 10%;"></td> <td style="width: 10%;"></td> <td style="width: 10%;"></td> <td style="width: 10%;"></td> <td style="width: 10%;"></td> <td style="width: 10%;"></td> <td style="width: 10%;"></td> </tr> <tr> <td></td> <td></td> <td colspan="8" style="text-align: center;"> <table border="1" style="width: 100%; border-collapse: collapse; text-align: center;"> <tr> <td style="width: 10%;"></td> <td style="width: 10%;"></td> <td style="width: 10%;"></td> <td style="width: 10%;"></td> <td style="width: 10%;"></td> <td style="width: 10%;"></td> <td style="width: 10%;"></td> <td style="width: 10%;"></td> <td style="width: 10%;"></td> <td style="width: 10%;"></td> </tr> <tr> <td></td> <td></td> <td colspan="8" style="text-align: center;"> <table border="1" style="width: 100%; border-collapse: collapse; text-align: center;"> <tr> <td style="width: 10%;"></td> <td style="width: 10%;"></td> <td style="width: 10%;"></td> <td style="width: 10%;"></td> <td style="width: 10%;"></td> <td style="width: 10%;"></td> <td style="width: 10%;"></td> <td style="width: 10%;"></td> <td style="width: 10%;"></td> <td style="width: 10%;"></td> </tr> <tr> <td></td> <td></td> <td colspan="8" style="text-align: center;"> <table border="1" style="width: 100%; border-collapse: collapse; text-align: center;"> <tr> <td style="width: 10%;"></td> <td style="width: 10%;"></td> <td style="width: 10%;"></td> <td style="width: 10%;"></td> <td style="width: 10%;"></td> <td style="width: 10%;"></td> <td style="width: 10%;"></td> <td style="width: 10%;"></td> <td style="width: 10%;"></td> <td style="width: 10%;"></td> </tr> <tr> <td></td> <td></td> <td colspan="8" style="text-align: center;"> <table border="1" style="width: 100%; border-collapse: collapse; text-align: center;"> <tr> <td style="width: 10%;"></td> <td style="width: 10%;"></td> <td style="width: 10%;"></td> <td style="width: 10%;"></td> <td style="width: 10%;"></td> <td style="width: 10%;"></td> <td style="width: 10%;"></td> <td style="width: 10%;"></td> <td style="width: 10%;"></td> <td style="width: 10%;"></td> </tr> <tr> <td></td> <td></td> <td colspan="8" style="text-align: center;"> <table border="1" style="width: 100%; border-collapse: collapse; text-align: center;"> <tr> <td style="width: 10%;"></td> <td style="width: 10%;"></td> <td style="width: 10%;"></td> <td style="width: 10%;"></td> <td style="width: 10%;"></td> <td style="width: 10%;"></td> <td style="width: 10%;"></td> <td style="width: 10%;"></td> <td style="width: 10%;"></td> <td style="width: 10%;"></td> </tr> <tr> <td></td> <td></td> <td colspan="8" style="text-align: center;"> <table border="1" style="width: 100%; border-collapse: collapse; text-align: center;"> <tr> </tr></table></td></tr></table></td></tr></table></td></tr></table></td></tr></table></td></tr></table></td></tr></table></td></tr></table></td></tr></table></td></tr></table>

 | | | | | | | | | | | | | | | | | | | | <table border="1" style="width: 100%; border-collapse: collapse; text-align: center;"> <tr> <td style="width: 10%;"></td> <td style="width: 10%;"></td> <td style="width: 10%;"></td> <td style="width: 10%;"></td> <td style="width: 10%;"></td> <td style="width: 10%;"></td> <td style="width: 10%;"></td> <td style="width: 10%;"></td> <td style="width: 10%;"></td> <td style="width: 10%;"></td> </tr> <tr> <td></td> <td></td> <td colspan="8" style="text-align: center;"> <table border="1" style="width: 100%; border-collapse: collapse; text-align: center;"> <tr> <td style="width: 10%;"></td> <td style="width: 10%;"></td> <td style="width: 10%;"></td> <td style="width: 10%;"></td> <td style="width: 10%;"></td> <td style="width: 10%;"></td> <td style="width: 10%;"></td> <td style="width: 10%;"></td> <td style="width: 10%;"></td> <td style="width: 10%;"></td> </tr> <tr> <td></td> <td></td> <td colspan="8" style="text-align: center;"> <table border="1" style="width: 100%; border-collapse: collapse; text-align: center;"> <tr> <td style="width: 10%;"></td> <td style="width: 10%;"></td> <td style="width: 10%;"></td> <td style="width: 10%;"></td> <td style="width: 10%;"></td> <td style="width: 10%;"></td> <td style="width: 10%;"></td> <td style="width: 10%;"></td> <td style="width: 10%;"></td> <td style="width: 10%;"></td> </tr> <tr> <td></td> <td></td> <td colspan="8" style="text-align: center;"> <table border="1" style="width: 100%; border-collapse: collapse; text-align: center;"> <tr> <td style="width: 10%;"></td> <td style="width: 10%;"></td> <td style="width: 10%;"></td> <td style="width: 10%;"></td> <td style="width: 10%;"></td> <td style="width: 10%;"></td> <td style="width: 10%;"></td> <td style="width: 10%;"></td> <td style="width: 10%;"></td> <td style="width: 10%;"></td> </tr> <tr> <td></td> <td></td> <td colspan="8" style="text-align: center;"> <table border="1" style="width: 100%; border-collapse: collapse; text-align: center;"> <tr> <td style="width: 10%;"></td> <td style="width: 10%;"></td> <td style="width: 10%;"></td> <td style="width: 10%;"></td> <td style="width: 10%;"></td> <td style="width: 10%;"></td> <td style="width: 10%;"></td> <td style="width: 10%;"></td> <td style="width: 10%;"></td> <td style="width: 10%;"></td> </tr> <tr> <td></td> <td></td> <td colspan="8" style="text-align: center;"> <table border="1" style="width: 100%; border-collapse: collapse; text-align: center;"> <tr> <td style="width: 10%;"></td> <td style="width: 10%;"></td> <td style="width: 10%;"></td> <td
style="width: 10%;"></td> <td style="width: 10%;"></td> <td style="width: 10%;"></td> <td style="width: 10%;"></td> <td style="width: 10%;"></td> <td style="width: 10%;"></td> <td style="width: 10%;"></td> </tr> <tr> <td></td> <td></td> <td colspan="8" style="text-align: center;"> <table border="1" style="width: 100%; border-collapse: collapse; text-align: center;"> <tr> <td style="width: 10%;"></td> <td style="width: 10%;"></td> <td style="width: 10%;"></td> <td style="width: 10%;"></td> <td style="width: 10%;"></td> <td style="width: 10%;"></td> <td style="width: 10%;"></td> <td style="width: 10%;"></td> <td style="width: 10%;"></td> <td style="width: 10%;"></td> </tr> <tr> <td></td> <td></td> <td colspan="8" style="text-align: center;"> <table border="1" style="width: 100%; border-collapse: collapse; text-align: center;"> <tr> <td style="width: 10%;"></td> <td style="width: 10%;"></td> <td style="width: 10%;"></td> <td style="width: 10%;"></td> <td style="width: 10%;"></td> <td style="width: 10%;"></td> <td style="width: 10%;"></td> <td style="width: 10%;"></td> <td style="width: 10%;"></td> <td style="width: 10%;"></td> </tr> <tr> <td></td> <td></td> <td colspan="8" style="text-align: center;"> <table border="1" style="width: 100%; border-collapse: collapse; text-align: center;"> <tr> </tr></table></td></tr></table></td></tr></table></td></tr></table></td></tr></table></td></tr></table></td></tr></table></td></tr></table></td></tr></table>

 | | | | | | | | | | | | | | | | | | | | <table border="1" style="width: 100%; border-collapse: collapse; text-align: center;"> <tr> <td style="width: 10%;"></td> <td style="width: 10%;"></td> <td style="width: 10%;"></td> <td style="width: 10%;"></td> <td style="width: 10%;"></td> <td style="width: 10%;"></td> <td style="width: 10%;"></td> <td style="width: 10%;"></td> <td style="width: 10%;"></td> <td style="width: 10%;"></td> </tr> <tr> <td></td> <td></td> <td colspan="8" style="text-align: center;"> <table border="1" style="width: 100%; border-collapse: collapse; text-align: center;"> <tr> <td style="width: 10%;"></td> <td style="width: 10%;"></td> <td style="width: 10%;"></td> <td style="width: 10%;"></td> <td style="width: 10%;"></td> <td style="width: 10%;"></td> <td style="width: 10%;"></td> <td style="width: 10%;"></td> <td style="width: 10%;"></td> <td style="width: 10%;"></td> </tr> <tr> <td></td> <td></td> <td colspan="8" style="text-align: center;"> <table border="1" style="width: 100%; border-collapse: collapse; text-align: center;"> <tr> <td style="width: 10%;"></td> <td style="width: 10%;"></td> <td style="width: 10%;"></td> <td style="width: 10%;"></td> <td style="width: 10%;"></td> <td style="width: 10%;"></td> <td style="width: 10%;"></td> <td style="width: 10%;"></td> <td style="width: 10%;"></td> <td style="width: 10%;"></td> </tr> <tr> <td></td> <td></td> <td colspan="8" style="text-align: center;"> <table border="1" style="width: 100%; border-collapse: collapse; text-align: center;"> <tr> <td style="width: 10%;"></td> <td style="width: 10%;"></td> <td style="width: 10%;"></td> <td style="width: 10%;"></td> <td style="width: 10%;"></td> <td style="width: 10%;"></td> <td style="width: 10%;"></td> <td style="width: 10%;"></td> <td style="width: 10%;"></td> <td style="width: 10%;"></td> </tr> <tr> <td></td> <td></td> <td colspan="8" style="text-align: center;"> <table border="1" style="width: 100%; border-collapse: collapse; text-align: center;"> <tr> <td style="width: 10%;"></td> <td style="width: 10%;"></td> <td style="width: 10%;"></td> <td style="width: 10%;"></td> <td style="width: 10%;"></td> <td style="width: 10%;"></td> <td style="width: 10%;"></td> <td style="width: 10%;"></td> <td style="width: 10%;"></td> <td style="width: 10%;"></td> </tr> <tr> <td></td> <td></td> <td colspan="8" style="text-align: center;"> <table border="1" style="width: 100%; border-collapse: collapse; text-align: center;"> <tr> <td style="width: 10%;"></td> <td style="width: 10%;"></td> <td style="width: 10%;"></td> <td style="width: 10%;"></td> <td style="width: 10%;"></td> <td style="width: 10%;"></td> <td style="width: 10%;"></td> <td style="width: 10%;"></td> <td style="width: 10%;"></td> <td style="width: 10%;"></td> </tr> <tr> <td></td> <td></td> <td colspan="8" style="text-align: center;"> <table border="1" style="width: 100%; border-collapse: collapse; text-align: center;"> <tr> <td style="width: 10%;"></td> <td style="width: 10%;"></td> <td style="width: 10%;"></td> <td style="width: 10%;"></td> <td style="width: 10%;"></td> <td style="width: 10%;"></td> <td style="width: 10%;"></td> <td style="width: 10%;"></td> <td style="width: 10%;"></td> <td style="width: 10%;"></td> </tr> <tr> <td></td> <td></td> <td colspan="8" style="text-align: center;"> <table border="1" style="width: 100%; border-collapse: collapse; text-align: center;"> <tr> </tr></table></td></tr></table></td></tr></table></td></tr></table></td></tr></table></td></tr></table></td></tr></table></td></tr></table>

 | | | | | | | | | | | | | | | | | | | | <table border="1" style="width: 100%; border-collapse: collapse; text-align: center;"> <tr> <td style="width: 10%;"></td> <td style="width: 10%;"></td> <td style="width: 10%;"></td> <td style="width: 10%;"></td> <td style="width: 10%;"></td> <td style="width: 10%;"></td> <td style="width: 10%;"></td> <td style="width: 10%;"></td> <td style="width: 10%;"></td> <td style="width: 10%;"></td> </tr> <tr> <td></td> <td></td> <td colspan="8" style="text-align: center;"> <table border="1" style="width: 100%; border-collapse: collapse; text-align: center;"> <tr> <td style="width: 10%;"></td> <td style="width: 10%;"></td> <td style="width: 10%;"></td> <td style="width: 10%;"></td> <td style="width: 10%;"></td> <td style="width: 10%;"></td> <td style="width: 10%;"></td> <td style="width: 10%;"></td> <td style="width: 10%;"></td> <td style="width: 10%;"></td> </tr> <tr> <td></td> <td></td> <td colspan="8" style="text-align: center;"> <table border="1" style="width: 100%; border-collapse: collapse; text-align: center;"> <tr> <td style="width: 10%;"></td> <td style="width: 10%;"></td> <td style="width: 10%;"></td> <td style="width: 10%;"></td> <td style="width:
10%;"></td> <td style="width: 10%;"></td> <td style="width: 10%;"></td> <td style="width: 10%;"></td> <td style="width: 10%;"></td> <td style="width: 10%;"></td> </tr> <tr> <td></td> <td></td> <td colspan="8" style="text-align: center;"> <table border="1" style="width: 100%; border-collapse: collapse; text-align: center;"> <tr> <td style="width: 10%;"></td> <td style="width: 10%;"></td> <td style="width: 10%;"></td> <td style="width: 10%;"></td> <td style="width: 10%;"></td> <td style="width: 10%;"></td> <td style="width: 10%;"></td> <td style="width: 10%;"></td> <td style="width: 10%;"></td> <td style="width: 10%;"></td> </tr> <tr> <td></td> <td></td> <td colspan="8" style="text-align: center;"> <table border="1" style="width: 100%; border-collapse: collapse; text-align: center;"> <tr> <td style="width: 10%;"></td> <td style="width: 10%;"></td> <td style="width: 10%;"></td> <td style="width: 10%;"></td> <td style="width: 10%;"></td> <td style="width: 10%;"></td> <td style="width: 10%;"></td> <td style="width: 10%;"></td> <td style="width: 10%;"></td> <td style="width: 10%;"></td> </tr> <tr> <td></td> <td></td> <td colspan="8" style="text-align: center;"> <table border="1" style="width: 100%; border-collapse: collapse; text-align: center;"> <tr> <td style="width: 10%;"></td> <td style="width: 10%;"></td> <td style="width: 10%;"></td> <td style="width: 10%;"></td> <td style="width: 10%;"></td> <td style="width: 10%;"></td> <td style="width: 10%;"></td> <td style="width: 10%;"></td> <td style="width: 10%;"></td> <td style="width: 10%;"></td> </tr> <tr> <td></td> <td></td> <td colspan="8" style="text-align: center;"> <table border="1" style="width: 100%; border-collapse: collapse; text-align: center;"> <tr> </tr></table></td></tr></table></td></tr></table></td></tr></table></td></tr></table></td></tr></table></td></tr></table>

 | | | | | | | | | | | | | | | | | | | | <table border="1" style="width: 100%; border-collapse: collapse; text-align: center;"> <tr> <td style="width: 10%;"></td> <td style="width: 10%;"></td> <td style="width: 10%;"></td> <td style="width: 10%;"></td> <td style="width: 10%;"></td> <td style="width: 10%;"></td> <td style="width: 10%;"></td> <td style="width: 10%;"></td> <td style="width: 10%;"></td> <td style="width: 10%;"></td> </tr> <tr> <td></td> <td></td> <td colspan="8" style="text-align: center;"> <table border="1" style="width: 100%; border-collapse: collapse; text-align: center;"> <tr> <td style="width: 10%;"></td> <td style="width: 10%;"></td> <td style="width: 10%;"></td> <td style="width: 10%;"></td> <td style="width: 10%;"></td> <td style="width: 10%;"></td> <td style="width: 10%;"></td> <td style="width: 10%;"></td> <td style="width: 10%;"></td> <td style="width: 10%;"></td> </tr> <tr> <td></td> <td></td> <td colspan="8" style="text-align: center;"> <table border="1" style="width: 100%; border-collapse: collapse; text-align: center;"> <tr> <td style="width: 10%;"></td> <td style="width: 10%;"></td> <td style="width: 10%;"></td> <td style="width: 10%;"></td> <td style="width: 10%;"></td> <td style="width: 10%;"></td> <td style="width: 10%;"></td> <td style="width: 10%;"></td> <td style="width: 10%;"></td> <td style="width: 10%;"></td> </tr> <tr> <td></td> <td></td> <td colspan="8" style="text-align: center;"> <table border="1" style="width: 100%; border-collapse: collapse; text-align: center;"> <tr> <td style="width: 10%;"></td> <td style="width: 10%;"></td> <td style="width: 10%;"></td> <td style="width: 10%;"></td> <td style="width: 10%;"></td> <td style="width: 10%;"></td> <td style="width: 10%;"></td> <td style="width: 10%;"></td> <td style="width: 10%;"></td> <td style="width: 10%;"></td> </tr> <tr> <td></td> <td></td> <td colspan="8" style="text-align: center;"> <table border="1" style="width: 100%; border-collapse: collapse; text-align: center;"> <tr> <td style="width: 10%;"></td> <td style="width: 10%;"></td> <td style="width: 10%;"></td> <td style="width: 10%;"></td> <td style="width: 10%;"></td> <td style="width: 10%;"></td> <td style="width: 10%;"></td> <td style="width: 10%;"></td> <td style="width: 10%;"></td> <td style="width: 10%;"></td> </tr> <tr> <td></td> <td></td> <td colspan="8" style="text-align: center;"> <table border="1" style="width: 100%; border-collapse: collapse; text-align: center;"> <tr> </tr></table></td></tr></table></td></tr></table></td></tr></table></td></tr></table></td></tr></table>

 | | | | | | | | | | | | | | | | | | | | <table border="1" style="width: 100%; border-collapse: collapse; text-align: center;"> <tr> <td style="width: 10%;"></td> <td style="width: 10%;"></td> <td style="width: 10%;"></td> <td style="width: 10%;"></td> <td style="width: 10%;"></td> <td style="width: 10%;"></td> <td style="width: 10%;"></td> <td style="width: 10%;"></td> <td style="width: 10%;"></td> <td style="width: 10%;"></td> </tr> <tr> <td></td> <td></td> <td colspan="8" style="text-align: center;"> <table border="1" style="width: 100%; border-collapse: collapse; text-align: center;"> <tr> <td style="width: 10%;"></td> <td style="width: 10%;"></td> <td style="width: 10%;"></td> <td style="width: 10%;"></td> <td style="width: 10%;"></td> <td style="width: 10%;"></td> <td style="width: 10%;"></td> <td style="width: 10%;"></td> <td style="width: 10%;"></td> <td style="width: 10%;"></td> </tr> <tr> <td></td> <td></td> <td colspan="8" style="text-align: center;"> <table border="1" style="width: 100%; border-collapse: collapse; text-align: center;"> <tr> <td style="width: 10%;"></td> <td style="width: 10%;"></td> <td style="width: 10%;"></td> <td style="width: 10%;"></td> <td style="width: 10%;"></td> <td style="width: 10%;"></td> <td style="width: 10%;"></td> <td style="width: 10%;"></td> <td style="width: 10%;"></td> <td style="width: 10%;"></td> </tr> <tr> <td></td> <td></td> <td colspan="8" style="text-align: center;"> <table border="1" style="width: 100%; border-collapse: collapse; text-align: center;"> <tr> <td style="width: 10%;"></td> <td style="width: 10%;"></td> <td style="width: 10%;"></td> <td style="width: 10%;"></td> <td style="width: 10%;"></td> <td style="width: 10%;"></td> <td style="width: 10%;"></td> <td style="width: 10%;"></td> <td
style="width: 10%;"></td> <td style="width: 10%;"></td> </tr> <tr> <td></td> <td></td> <td colspan="8" style="text-align: center;"> <table border="1" style="width: 100%; border-collapse: collapse; text-align: center;"> <tr> </tr></table></td></tr></table></td></tr></table></td></tr></table></td></tr></table>

 | | | | | | | | | | | | | | | | | | | | <table border="1" style="width: 100%; border-collapse: collapse; text-align: center;"> <tr> <td style="width: 10%;"></td> <td style="width: 10%;"></td> <td style="width: 10%;"></td> <td style="width: 10%;"></td> <td style="width: 10%;"></td> <td style="width: 10%;"></td> <td style="width: 10%;"></td> <td style="width: 10%;"></td> <td style="width: 10%;"></td> <td style="width: 10%;"></td> </tr> <tr> <td></td> <td></td> <td colspan="8" style="text-align: center;"> <table border="1" style="width: 100%; border-collapse: collapse; text-align: center;"> <tr> <td style="width: 10%;"></td> <td style="width: 10%;"></td> <td style="width: 10%;"></td> <td style="width: 10%;"></td> <td style="width: 10%;"></td> <td style="width: 10%;"></td> <td style="width: 10%;"></td> <td style="width: 10%;"></td> <td style="width: 10%;"></td> <td style="width: 10%;"></td> </tr> <tr> <td></td> <td></td> <td colspan="8" style="text-align: center;"> <table border="1" style="width: 100%; border-collapse: collapse; text-align: center;"> <tr> <td style="width: 10%;"></td> <td style="width: 10%;"></td> <td style="width: 10%;"></td> <td style="width: 10%;"></td> <td style="width: 10%;"></td> <td style="width: 10%;"></td> <td style="width: 10%;"></td> <td style="width: 10%;"></td> <td style="width: 10%;"></td> <td style="width: 10%;"></td> </tr> <tr> <td></td> <td></td> <td colspan="8" style="text-align: center;"> <table border="1" style="width: 100%; border-collapse: collapse; text-align: center;"> <tr> </tr></table></td></tr></table></td></tr></table></td></tr></table>

 | | | | | | | | | | | | | | | | | | | | <table border="1" style="width: 100%; border-collapse: collapse; text-align: center;"> <tr> <td style="width: 10%;"></td> <td style="width: 10%;"></td> <td style="width: 10%;"></td> <td style="width: 10%;"></td> <td style="width: 10%;"></td> <td style="width: 10%;"></td> <td style="width: 10%;"></td> <td style="width: 10%;"></td> <td style="width: 10%;"></td> <td style="width: 10%;"></td> </tr> <tr> <td></td> <td></td> <td colspan="8" style="text-align: center;"> <table border="1" style="width: 100%; border-collapse: collapse; text-align: center;"> <tr> <td style="width: 10%;"></td> <td style="width: 10%;"></td> <td style="width: 10%;"></td> <td style="width: 10%;"></td> <td style="width: 10%;"></td> <td style="width: 10%;"></td> <td style="width: 10%;"></td> <td style="width: 10%;"></td> <td style="width: 10%;"></td> <td style="width: 10%;"></td> </tr> <tr> <td></td> <td></td> <td colspan="8" style="text-align: center;"> <table border="1" style="width: 100%; border-collapse: collapse; text-align: center;"> <tr> </tr></table></td></tr></table></td></tr></table>

 | | | | | | | | | | | | | | | | | | | | <table border="1" style="width: 100%; border-collapse: collapse; text-align: center;"> <tr> <td style="width: 10%;"></td> <td style="width: 10%;"></td> <td style="width: 10%;"></td> <td style="width: 10%;"></td> <td style="width: 10%;"></td> <td style="width: 10%;"></td> <td style="width: 10%;"></td> <td style="width: 10%;"></td> <td style="width: 10%;"></td> <td style="width: 10%;"></td> </tr> <tr> <td></td> <td></td> <td colspan="8" style="text-align: center;"> <table border="1" style="width: 100%; border-collapse: collapse; text-align: center;"> <tr> </tr></table></td></tr></table>

 | | | | | | | | | | | | | | | | | | | | <table border="1" style="width: 100%; border-collapse: collapse; text-align: center;"> <tr> </tr></table>

 | | | | | | | | | | | | | | | | | | | |

 | | | | | | | | | | | | | | | | | | | |

 | | | | | | | | | | | | | | | | | | | |

 | | | | | | | | | | | | | | | | | | | |

 | | | | | | | | | | | | | | | | | | | |

 | | | | | | | | | | | | | | | | | | | |

 | | | | | | | | | | | | | | | | | | | |

 | | | | | | | | | | | | | | | | | | | |

 | | | | | | | | | | | | | | | | | | | |
 | | | | | | | | | | | | | | | | | | | |

 | | | | | | | | | | | | | | | | | | | |

 | | | | | | | | | | | | | | | | | | | |
 | | | | | | | | | | | | | | | | | | | |

 | | | | | | | | | | | | | | | | | | | |

 | | | | | | | | | | | | | | | | | | | |
 | | | | | | | | | | | | | | | | | | | |
 | | | | | | | | | | | | | | | | | | | |

 | | | | | | | | | | | | | | | | | | | |
 | | | | | | | | | | | | | | | | | | | |
 | | | | | | | | | | | | | | | | | | | |

 | | | | | | | | | | | | | | | | | | | | | | | | | | | | | | | | | | | | | | | | | | | | | | | | | | | | | | | | | | | | | | | | | | | | | | | | | | | | | | | | | | | | | | | | | | | | | | | | | | | |
 | | | | | | | | | | | | | | | | | | | |
 | | | | | | | | | | | | | | | | | | | |
 | | | | | | | | | | | | | | | | | | | |
 | | | | | | | | | | | | | | | | | | | |
 | | | | | | | | | | | | | | | | | | | |
 | | | | | | | | | | | | | | | | | | | |
 | | | | | | | | | | | | | | | | | | | |
 | | | | | | | | | | | | | | | | | | | |
 | | | | | | | | | | | | | | | | | | | | | | | | | | | | | | | | | | | | | | | |
 | | | | | | | | | | | | | | | | | | | |
 | | | | | | | | | | | | | | | | | | | | | | | | | | | | | | | | | | | | | | | |
 | | | | | | | | | | | | | | | | | | | | | | | | | | | | | | | | | | | | | | | |
 | | | | | | | | | | | | | | | | | | | | | | | | | | | | | | | | | | | | | | | |
 | | | | | | | | | | | | | | | | | | | | | | | | | | | | | | | | | | | | | | | | | | | | | | | | | | | | | | | | | | | | | | | | | | | | | | | | | | | | | | | | | | | | | | | | | | | | | | | | | | | |
 | | | | | | | | | | | | | | | | | | | | | | | | | | | | | | | | | | | | | | | | | | | | | | | |
| | |

 | | | | | | | | | | | | | | | | | | | |

 | | | | | | | | | | | | | | | | | | | |

 | | | | | | | | | | | | | | | | | | | |

 | | | | | | | | | | | | | | | | | | | |

 | | | | | | | | | | | | | | | | | | | |

 | | | | | | | | | | | | | | | | | | | |

 | | | | | | | | | | | | | | | | | | | |

 | | | | | | | | | | | | | | | | | | | |

 | | | | | | | | | | | | | | | | | | | |

 | | | | | | | | | | | | | | | | | | | |

 | | | | | | | | | | | | | | | | | | | |

 | | | | | | | | | | | | | | | | | | | |

 | | | | | | | | | | | | | | | | | | | |

 | | | | | | | | | | | | | | | | | | | |

 | | | | | | | | | | | | | | | | | | | |

 | | | | | | | | | | | | | | | | | | | |

 | | | | | | | | | | | | | | | | | | | |

 | | | | | | | | | | | | | | | | | | | |

 | | | | | | | | | | | | | | | | | | | |

 | | | | | | | | | | | | | | | | | | | |

 | | | | | | | | | | | | | | | | | | | |

 | | | | | | | | | | | | | | | | | | | |

 | | | | | | | | | | | | | | | | | | | |

 | | | | | | | | | | | | | | | | | | | |

 | | | | | | | | | | | | | | | | | | | |

 | | | | | | | | | | | | | | | | | | | |

 | | | | | | | | | | | | | | | | | | | |

 | | | | | | | | | | | | | | | | | | | |
 | | | | | | | | | | | | | | | | | | | |

 | | | | | | | | | | | | | | | | | | | |

 | | | | | | | | | | | | | | | | | | | |
 | | | | | | | | | | | | | | | | | | | |

 | | | | | | | | | | | | | | | | | | | |

 | | | | | | | | | | | | | | | | | | | |
 | | | | | | | | | | | | | | | | | | | |
 | | | | | | | | | | | | | | | | | | | |

 | | | | | | | | | | | | | | | | | | | |
 | | | | | | | | | | | | | | | | | | | |
 | | | | | | | | | | | | | | | | | | | |

 | | | | | | | | | | | | | | | | | | | | | | | | | | | | | | | | | | | | | | | | | | | | | | | | | | | | | | | | | | | | | | | | | | | | | | | | | | | | | | | | | | | | | | | | | | | | | | | | | | | |
 | | | | | | | | | | | | | | | | | | | |
 | | | | | | | | | | | | | | | | | | | |
 | | | | | | | | | | | | | | | | | | | |
 | | | | | | | | | | | | | | | | | | | |
 | | | | | | | | | | | | | | | | | | | |
 | | | | | | | | | | | | | | | | | | | |
 | | | | | | | | | | | | | | | | | | | |
 | | | | | | | | | | | | | | | | | | | |
 | | | | | | | | | | | | | | | | | | | | | | | | | | | | | | | | | | | | | | | |
 | | | | | | | | | | | | | | | | | | | |
 | | | | | | | | | | | | | | | | | | | | | | | | | | | | | | | | | | | | | | | |
 | | | | | | | | | | | | | | | | | | | | | | | | | | | | | | | | | | | | | | | |
 | | | | | | | | | | | | | | | | | | | | | | | | | | | | | | | | | | | | | | | |
 | | | | | | | | | | | | | | | | | | | | | | | | | | | | | | | | | | | | | | | | | | | | | | | | | | | | | | | | | | | | | | | | | | | | | | | | | | | | | | | | | | | | | | | | | | | | | | | | | | | |
 | | | | | | | | | | | | | | | | | | | | | | | | | | | | | | | | | | | | | | | | | | | | | | | |
| | | <table border="1" style="width: 100%; border-collapse: collapse; text-align: center;"> <tr> <td style="width: 10%;"></td> <td style="width: 10%;"></td> <td style="width: 10%;"></td> <td style="width: 10%;"></td> <td style="width: 10%;"></td> <td style="width: 10%;"></td> <td style="width: 10%;"></td> <td style="width: 10%;"></td> <td style="width: 10%;"></td> <td style="width: 10%;"></td> </tr> <tr> <td></td> <td></td> <td colspan="8" style="text-align: center;"> <table border="1" style="width: 100%; border-collapse: collapse; text-align: center;"> <tr> <td style="width: 10%;"></td> <td style="width: 10%;"></td> <td style="width: 10%;"></td> <td style="width: 10%;"></td> <td style="width: 10%;"></td> <td style="width: 10%;"></td> <td style="width: 10%;"></td> <td style="width: 10%;"></td> <td style="width: 10%;"></td> <td style="width: 10%;"></td> </tr> <tr> <td></td> <td></td> <td colspan="8" style="text-align: center;"> <table border="1" style="width: 100%; border-collapse: collapse; text-align: center;"> <tr> <td style="width: 10%;"></td> <td style="width: 10%;"></td> <td style="width: 10%;"></td> <td style="width: 10%;"></td> <td style="width: 10%;"></td> <td style="width: 10%;"></td> <td style="width: 10%;"></td> <td style="width: 10%;"></td> <td style="width: 10%;"></td> <td style="width: 10%;"></td> </tr> <tr> <td></td> <td></td> <td colspan="8" style="text-align: center;"> <table border="1" style="width: 100%; border-collapse: collapse; text-align: center;"> <tr> <td style="width: 10%;"></td> <td style="width: 10%;"></td> <td style="width: 10%;"></td> <td style="width: 10%;"></td> <td style="width: 10%;"></td> <td style="width: 10%;"></td> <td style="width: 10%;"></td> <td style="width: 10%;"></td> <td style="width: 10%;"></td> <td style="width: 10%;"></td> </tr> <tr> <td></td> <td></td> <td colspan="8" style="text-align: center;"> <table border="1" style="width: 100%; border-collapse: collapse; text-align: center;"> <tr> <td style="width: 10%;"></td> <td style="width: 10%;"></td> <td style="width: 10%;"></td> <td style="width: 10%;"></td> <td style="width: 10%;"></td> <td style="width: 10%;"></td> <td style="width: 10%;"></td> <td style="width: 10%;"></td> <td style="width: 10%;"></td> <td style="width: 10%;"></td> </tr> <tr> <td></td> <td></td> <td colspan="8" style="text-align: center;"> <table border="1" style="width: 100%; border-collapse: collapse; text-align: center;"> <tr> <td style="width: 10%;"></td> <td style="width: 10%;"></td> <td style="width: 10%;"></td> <td style="width: 10%;"></td> <td style="width: 10%;"></td> <td style="width: 10%;"></td> <td style="width: 10%;"></td> <td style="width: 10%;"></td> <td style="width: 10%;"></td> <td style="width: 10%;"></td> </tr> <tr> <td></td> <td></td> <td colspan="8" style="text-align: center;"> <table border="1" style="width: 100%; border-collapse: collapse; text-align: center;"> <tr> <td style="width: 10%;"></td> <td style="width: 10%;"></td> <td style="width: 10%;"></td> <td style="width: 10%;"></td> <td style="width: 10%;"></td> <td style="width: 10%;"></td> <td style="width: 10%;"></td> <td style="width: 10%;"></td> <td style="width: 10%;"></td> <td style="width: 10%;"></td> </tr> <tr> <td></td> <td></td> <td colspan="8" style="text-align: center;"> <table border="1" style="width: 100%; border-collapse: collapse; text-align: center;"> <tr> <td style="width: 10%;"></td> <td style="width: 10%;"></td> <td style="width: 10%;"></td> <td style="width: 10%;"></td> <td style="width: 10%;"></td> <td style="width: 10%;"></td> <td style="width: 10%;"></td> <td style="width: 10%;"></td> <td style="width: 10%;"></td> <td style="width: 10%;"></td> </tr> <tr> <td></td> <td></td> <td colspan="8" style="text-align: center;"> <table border="1" style="width: 100%; border-collapse: collapse; text-align: center;"> <tr> <td style="width: 10%;"></td> <td style="width: 10%;"></td> <td style="width: 10%;"></td> <td style="width: 10%;"></td> <td style="width: 10%;"></td> <td style="width: 10%;"></td> <td style="width: 10%;"></td> <td style="width: 10%;"></td> <td style="width: 10%;"></td> <td style="width: 10%;"></td> </tr> <tr> <td></td> <td></td> <td colspan="8" style="text-align: center;"> <table border="1" style="width: 100%; border-collapse: collapse; text-align: center;"> <tr> <td style="width: 10%;"></td> <td style="width: 10%;"></td> <td style="width: 10%;"></td> <td style="width: 10%;"></td> <td style="width: 10%;"></td> <td style="width: 10%;"></td> <td style="width: 10%;"></td> <td style="width: 10%;"></td> <td style="width: 10%;"></td> <td style="width: 10%;"></td> </tr> <tr> <td></td> <td></td> <td colspan="8" style="text-align: center;"> <table border="1" style="width: 100%; border-collapse: collapse; text-align: center;"> <tr> <td style="width: 10%;"></td> <td style="width: 10%;"></td> <td style="width: 10%;"></td> <td style="width: 10%;"></td> <td style="width: 10%;"></td> <td style="width: 10%;"></td> <td style="width: 10%;"></td> <td style="width: 10%;"></td> <td style="width: 10%;"></td> <td style="width: 10%;"></td> </tr> <tr> <td></td> <td></td> <td colspan="8" style="text-align: center;"> <table border="1" style="width: 100%; border-collapse: collapse; text-align: center;"> <tr> <td style="width: 10%;"></td> <td style="width: 10%;"></td> <td style="width: 10%;"></td> <td style="width: 10%;"></td> <td style="width: 10%;"></td> <td style="width: 10%;"></td> <td style="width: 10%;"></td> <td style="width: 10%;"></td> <td style="width: 10%;"></td> <td style="width: 10%;"></td> </tr> <tr> <td></td> <td></td> <td colspan="8" style="text-align: center;"> <table border="1" style="width: 100%; border-collapse: collapse; text-align: center;"> <tr> <td style="width: 10%;"></td> <td style="width: 10%;"></td> <td style="width: 10%;"></td> <td style="width: 10%;"></td> <td style="width: 10%;"></td> <td style="width: 10%;"></td> <td style="width: 10%;"></td> <td style="width: 10%;"></td> <td style="width: 10%;"></td> <td style="width: 10%;"></td> </tr> <tr> <td></td> <td></td> <td colspan="8" style="text-align: center;"> <table border="1" style="width: 100%; border-collapse: collapse; text-align: center;"> <tr> <td style="width: 10%;"></td> <td style="width: 10%;"></td> <td style="width: 10%;"></td> <td style="width: 10%;"></td> <td style="width: 10%;"></td> <td style="width: 10%;"></td> <td style="width: 10%;"></td> <td style="width: 10%;"></td> <td style="width: 10%;"></td> <td style="width: 10%;"></td> </tr> <tr> <td></td> <td></td> <td colspan="8" style="text-align: center;"> <table border="1" style="width: 100%; border-collapse: collapse; text-align: center;"> <tr> <td style="width: 10%;"></td> <td style="width: 10%;"></td> <td style="width: 10%;"></td> <td style="width: 10%;"></td> <td style="width: 10%;"></td> <td style="width: 10%;"></td> <td style="width: 10%;"></td> <td style="width: 10%;"></td> <td style="width: 10%;"></td> <td style="width: 10%;"></td> </tr> <tr> <td></td> <td></td> <td colspan="8" style="text-align: center;"> <table border="1" style="width: 100%; border-collapse: collapse; text-align: center;"> <tr> <td style="width: 10%;"></td> <td style="width: 10%;"></td> <td style="width: 10%;"></td> <td style="width: 10%;"></td> <td style="width: 10%;"></td> <td style="width: 10%;"></td> <td style="width: 10%;"></td> <td style="width: 10%;"></td> <td style="width: 10%;"></td> <td style="width: 10%;"></td> </tr> <tr> <td></td> <td></td> <td colspan="8" style="text-align: center;"> <table border="1" style="width: 100%; border-collapse: collapse; text-align: center;"> <tr> <td style="width: 10%;"></td> <td style="width: 10%;"></td> <td style="width: 10%;"></td> <td style="width: 10%;"></td> <td style="width: 10%;"></td> <td style="width: 10%;"></td> <td style="width: 10%;"></td> <td style="width: 10%;"></td> <td style="width: 10%;"></td> <td style="width: 10%;"></td> </tr> <tr> <td></td> <td></td> <td colspan="8" style="text-align: center;"> <table border="1" style="width: 100%; border-collapse: collapse; text-align: center;"> <tr> <td style="width: 10%;"></td> <td style="width: 10%;"></td> <td style="width: 10%;"></td> <td style="width: 10%;"></td> <td style="width: 10%;"></td> <td style="width: 10%;"></td> <td style="width: 10%;"></td> <td style="width: 10%;"></td> <td style="width: 10%;"></td> <td style="width: 10%;"></td> </tr> <tr> <td></td> <td></td> <td colspan="8" style="text-align: center;"> <table border="1" style="width: 100%; border-collapse: collapse; text-align: center;"> <tr> </tr></table></td></tr></table></td></tr></table></td></tr></table></td></tr></table></td></tr></table></td></tr></table></td></tr></table></td></tr></table></td></tr></table></td></tr></table></td></tr></table></td></tr></table></td></tr></table></td></tr></table></td></tr></table></td></tr></table></td></tr></table></td></tr></table>

 | | | | | | | | | | | | | | | | | | | | <table border="1" style="width: 100%; border-collapse: collapse; text-align: center;"> <tr> <td style="width: 10%;"></td> <td style="width: 10%;"></td> <td style="width: 10%;"></td> <td style="width: 10%;"></td> <td style="width: 10%;"></td> <td style="width: 10%;"></td> <td style="width: 10%;"></td> <td style="width: 10%;"></td> <td style="width: 10%;"></td> <td style="width: 10%;"></td> </tr> <tr> <td></td> <td></td> <td colspan="8" style="text-align: center;"> <table border="1" style="width: 100%; border-collapse: collapse; text-align: center;"> <tr> <td style="width: 10%;"></td> <td style="width: 10%;"></td> <td style="width: 10%;"></td> <td style="width: 10%;"></td> <td style="width: 10%;"></td> <td style="width: 10%;"></td> <td style="width: 10%;"></td> <td style="width: 10%;"></td> <td style="width: 10%;"></td> <td style="width: 10%;"></td> </tr> <tr> <td></td> <td></td> <td colspan="8" style="text-align: center;"> <table border="1" style="width: 100%; border-collapse: collapse; text-align: center;"> <tr> <td style="width: 10%;"></td> <td style="width: 10%;"></td> <td style="width: 10%;"></td> <td style="width: 10%;"></td> <td style="width: 10%;"></td> <td style="width: 10%;"></td> <td style="width: 10%;"></td> <td style="width: 10%;"></td> <td style="width: 10%;"></td> <td style="width: 10%;"></td> </tr> <tr> <td></td> <td></td> <td colspan="8" style="text-align: center;"> <table border="1" style="width: 100%; border-collapse: collapse; text-align: center;"> <tr> <td style="width: 10%;"></td> <td style="width: 10%;"></td> <td style="width: 10%;"></td> <td style="width: 10%;"></td> <td style="width: 10%;"></td> <td style="width: 10%;"></td> <td style="width: 10%;"></td> <td style="width: 10%;"></td> <td style="width: 10%;"></td> <td style="width: 10%;"></td> </tr> <tr> <td></td> <td></td> <td colspan="8" style="text-align: center;"> <table border="1" style="width: 100%; border-collapse: collapse; text-align: center;"> <tr> <td style="width: 10%;"></td> <td style="width: 10%;"></td> <td style="width: 10%;"></td> <td style="width: 10%;"></td> <td style="width: 10%;"></td> <td style="width: 10%;"></td> <td style="width: 10%;"></td> <td style="width: 10%;"></td> <td style="width: 10%;"></td> <td style="width: 10%;"></td> </tr> <tr> <td></td> <td></td> <td colspan="8" style="text-align: center;"> <table border="1" style="width: 100%; border-collapse: collapse; text-align: center;"> <tr> <td style="width: 10%;"></td> <td style="width: 10%;"></td> <td style="width: 10%;"></td> <td style="width: 10%;"></td> <td style="width: 10%;"></td> <td style="width: 10%;"></td> <td style="width: 10%;"></td> <td style="width: 10%;"></td> <td style="width: 10%;"></td> <td style="width: 10%;"></td> </tr> <tr> <td></td> <td></td> <td colspan="8" style="text-align: center;"> <table border="1" style="width: 100%; border-collapse: collapse; text-align: center;"> <tr> <td style="width: 10%;"></td> <td style="width: 10%;"></td> <td style="width: 10%;"></td> <td style="width: 10%;"></td> <td style="width: 10%;"></td> <td style="width: 10%;"></td> <td style="width: 10%;"></td> <td style="width: 10%;"></td> <td style="width: 10%;"></td> <td style="width: 10%;"></td> </tr> <tr> <td></td> <td></td> <td colspan="8" style="text-align: center;"> <table border="1" style="width: 100%; border-collapse: collapse; text-align: center;"> <tr> <td style="width: 10%;"></td> <td style="width: 10%;"></td> <td style="width: 10%;"></td> <td style="width: 10%;"></td> <td style="width: 10%;"></td> <td style="width: 10%;"></td> <td style="width: 10%;"></td> <td style="width: 10%;"></td> <td style="width: 10%;"></td> <td style="width: 10%;"></td> </tr> <tr> <td></td> <td></td> <td colspan="8" style="text-align: center;"> <table border="1" style="width: 100%; border-collapse: collapse; text-align: center;"> <tr> <td style="width: 10%;"></td> <td style="width: 10%;"></td> <td style="width: 10%;"></td> <td style="width: 10%;"></td> <td style="width: 10%;"></td> <td style="width: 10%;"></td> <td style="width: 10%;"></td> <td style="width: 10%;"></td> <td style="width: 10%;"></td> <td style="width: 10%;"></td> </tr> <tr> <td></td> <td></td> <td colspan="8" style="text-align: center;"> <table border="1" style="width: 100%; border-collapse: collapse; text-align: center;"> <tr> <td style="width: 10%;"></td> <td style="width: 10%;"></td> <td style="width: 10%;"></td> <td style="width: 10%;"></td> <td style="width: 10%;"></td> <td style="width: 10%;"></td> <td style="width: 10%;"></td> <td style="width: 10%;"></td> <td style="width: 10%;"></td> <td style="width: 10%;"></td> </tr> <tr> <td></td> <td></td> <td colspan="8" style="text-align: center;"> <table border="1" style="width: 100%; border-collapse: collapse; text-align: center;"> <tr> <td style="width: 10%;"></td> <td style="width: 10%;"></td> <td style="width: 10%;"></td> <td style="width: 10%;"></td> <td style="width: 10%;"></td> <td style="width: 10%;"></td> <td style="width: 10%;"></td> <td style="width: 10%;"></td> <td style="width: 10%;"></td> <td style="width: 10%;"></td> </tr> <tr> <td></td> <td></td> <td colspan="8" style="text-align: center;"> <table border="1" style="width: 100%; border-collapse: collapse; text-align: center;"> <tr> <td style="width: 10%;"></td> <td style="width: 10%;"></td> <td style="width: 10%;"></td> <td style="width: 10%;"></td> <td style="width: 10%;"></td> <td style="width: 10%;"></td> <td style="width: 10%;"></td> <td style="width: 10%;"></td> <td style="width: 10%;"></td> <td style="width: 10%;"></td> </tr> <tr> <td></td> <td></td> <td colspan="8" style="text-align: center;"> <table border="1" style="width: 100%; border-collapse: collapse; text-align: center;"> <tr> <td style="width: 10%;"></td> <td style="width: 10%;"></td> <td style="width: 10%;"></td> <td style="width: 10%;"></td> <td style="width: 10%;"></td> <td style="width: 10%;"></td> <td style="width: 10%;"></td> <td style="width: 10%;"></td> <td style="width: 10%;"></td> <td style="width: 10%;"></td> </tr> <tr> <td></td> <td></td> <td colspan="8" style="text-align: center;"> <table border="1" style="width: 100%; border-collapse: collapse; text-align: center;"> <tr> <td style="width: 10%;"></td> <td style="width: 10%;"></td> <td style="width: 10%;"></td> <td style="width: 10%;"></td> <td style="width: 10%;"></td> <td style="width: 10%;"></td> <td style="width: 10%;"></td> <td style="width: 10%;"></td> <td style="width: 10%;"></td> <td style="width: 10%;"></td> </tr> <tr> <td></td> <td></td> <td colspan="8" style="text-align: center;"> <table border="1" style="width: 100%; border-collapse: collapse; text-align: center;"> <tr> <td style="width: 10%;"></td> <td style="width: 10%;"></td> <td style="width: 10%;"></td> <td style="width: 10%;"></td> <td style="width: 10%;"></td> <td style="width: 10%;"></td> <td style="width: 10%;"></td> <td style="width: 10%;"></td> <td style="width: 10%;"></td> <td style="width: 10%;"></td> </tr> <tr> <td></td> <td></td> <td colspan="8" style="text-align: center;"> <table border="1" style="width: 100%; border-collapse: collapse; text-align: center;"> <tr> <td style="width: 10%;"></td> <td style="width: 10%;"></td> <td style="width: 10%;"></td> <td style="width: 10%;"></td> <td style="width: 10%;"></td> <td style="width: 10%;"></td> <td style="width: 10%;"></td> <td style="width: 10%;"></td> <td style="width: 10%;"></td> <td style="width: 10%;"></td> </tr> <tr> <td></td> <td></td> <td colspan="8" style="text-align: center;"> <table border="1" style="width: 100%; border-collapse: collapse; text-align: center;"> <tr> <td style="width: 10%;"></td> <td style="width: 10%;"></td> <td style="width: 10%;"></td> <td style="width: 10%;"></td> <td style="width: 10%;"></td> <td style="width: 10%;"></td> <td style="width: 10%;"></td> <td style="width: 10%;"></td> <td style="width: 10%;"></td> <td style="width: 10%;"></td> </tr> <tr> <td></td> <td></td> <td colspan="8" style="text-align: center;"> <table border="1" style="width: 100%; border-collapse: collapse; text-align: center;"> <tr> </tr></table></td></tr></table></td></tr></table></td></tr></table></td></tr></table></td></tr></table></td></tr></table></td></tr></table></td></tr></table></td></tr></table></td></tr></table></td></tr></table></td></tr></table></td></tr></table></td></tr></table></td></tr></table></td></tr></table></td></tr></table>

 | | | | | | | | | | | | | | | | | | | | <table border="1" style="width: 100%; border-collapse: collapse; text-align: center;"> <tr> <td style="width: 10%;"></td> <td style="width: 10%;"></td> <td style="width: 10%;"></td> <td style="width: 10%;"></td> <td style="width: 10%;"></td> <td style="width: 10%;"></td> <td style="width: 10%;"></td> <td style="width: 10%;"></td> <td style="width: 10%;"></td> <td style="width: 10%;"></td> </tr> <tr> <td></td> <td></td> <td colspan="8" style="text-align: center;"> <table border="1" style="width: 100%; border-collapse: collapse; text-align: center;"> <tr> <td style="width: 10%;"></td> <td style="width: 10%;"></td> <td style="width: 10%;"></td> <td style="width: 10%;"></td> <td style="width: 10%;"></td> <td style="width: 10%;"></td> <td style="width: 10%;"></td> <td style="width: 10%;"></td> <td style="width: 10%;"></td> <td style="width: 10%;"></td> </tr> <tr> <td></td> <td></td> <td colspan="8" style="text-align: center;"> <table border="1" style="width: 100%; border-collapse: collapse; text-align: center;"> <tr> <td style="width: 10%;"></td> <td style="width: 10%;"></td> <td style="width: 10%;"></td> <td style="width: 10%;"></td> <td style="width: 10%;"></td> <td style="width: 10%;"></td> <td style="width: 10%;"></td> <td style="width: 10%;"></td> <td style="width: 10%;"></td> <td style="width: 10%;"></td> </tr> <tr> <td></td> <td></td> <td colspan="8" style="text-align: center;"> <table border="1" style="width: 100%; border-collapse: collapse; text-align: center;"> <tr> <td style="width: 10%;"></td> <td style="width: 10%;"></td> <td style="width: 10%;"></td> <td style="width: 10%;"></td> <td style="width: 10%;"></td> <td style="width: 10%;"></td> <td style="width: 10%;"></td> <td style="width: 10%;"></td> <td style="width: 10%;"></td> <td style="width: 10%;"></td> </tr> <tr> <td></td> <td></td> <td colspan="8" style="text-align: center;"> <table border="1" style="width: 100%; border-collapse: collapse; text-align: center;"> <tr> <td style="width: 10%;"></td> <td style="width: 10%;"></td> <td style="width: 10%;"></td> <td style="width: 10%;"></td> <td style="width: 10%;"></td> <td style="width: 10%;"></td> <td style="width: 10%;"></td> <td style="width: 10%;"></td> <td style="width: 10%;"></td> <td style="width: 10%;"></td> </tr> <tr> <td></td> <td></td> <td colspan="8" style="text-align: center;"> <table border="1" style="width: 100%; border-collapse: collapse; text-align: center;"> <tr> <td style="width: 10%;"></td> <td style="width: 10%;"></td> <td style="width: 10%;"></td> <td style="width: 10%;"></td> <td style="width: 10%;"></td> <td style="width: 10%;"></td> <td style="width: 10%;"></td> <td style="width: 10%;"></td> <td style="width: 10%;"></td> <td style="width: 10%;"></td> </tr> <tr> <td></td> <td></td> <td colspan="8" style="text-align: center;"> <table border="1" style="width: 100%; border-collapse: collapse; text-align: center;"> <tr> <td style="width: 10%;"></td> <td style="width: 10%;"></td> <td style="width: 10%;"></td> <td style="width: 10%;"></td> <td style="width: 10%;"></td> <td style="width: 10%;"></td> <td style="width: 10%;"></td> <td style="width: 10%;"></td> <td style="width: 10%;"></td> <td style="width: 10%;"></td> </tr> <tr> <td></td> <td></td> <td colspan="8" style="text-align: center;"> <table border="1" style="width: 100%; border-collapse: collapse; text-align: center;"> <tr> <td style="width: 10%;"></td> <td style="width: 10%;"></td> <td style="width: 10%;"></td> <td style="width: 10%;"></td> <td style="width: 10%;"></td> <td style="width: 10%;"></td> <td style="width: 10%;"></td> <td style="width: 10%;"></td> <td style="width: 10%;"></td> <td style="width: 10%;"></td> </tr> <tr> <td></td> <td></td> <td colspan="8" style="text-align: center;"> <table border="1" style="width: 100%; border-collapse: collapse; text-align: center;"> <tr> <td style="width: 10%;"></td> <td style="width: 10%;"></td> <td style="width: 10%;"></td> <td style="width: 10%;"></td> <td style="width: 10%;"></td> <td style="width: 10%;"></td> <td style="width: 10%;"></td> <td style="width: 10%;"></td> <td style="width: 10%;"></td> <td style="width: 10%;"></td> </tr> <tr> <td></td> <td></td> <td colspan="8" style="text-align: center;"> <table border="1" style="width: 100%; border-collapse: collapse; text-align: center;"> <tr> <td style="width: 10%;"></td> <td style="width: 10%;"></td> <td style="width: 10%;"></td> <td style="width: 10%;"></td> <td style="width: 10%;"></td> <td style="width: 10%;"></td> <td style="width: 10%;"></td> <td style="width: 10%;"></td> <td style="width: 10%;"></td> <td style="width: 10%;"></td> </tr> <tr> <td></td> <td></td> <td colspan="8" style="text-align: center;"> <table border="1" style="width: 100%; border-collapse: collapse; text-align: center;"> <tr> <td style="width: 10%;"></td> <td style="width: 10%;"></td> <td style="width: 10%;"></td> <td style="width: 10%;"></td> <td style="width: 10%;"></td> <td style="width: 10%;"></td> <td style="width: 10%;"></td> <td style="width: 10%;"></td> <td style="width: 10%;"></td> <td style="width: 10%;"></td> </tr> <tr> <td></td> <td></td> <td colspan="8" style="text-align: center;"> <table border="1" style="width: 100%; border-collapse: collapse; text-align: center;"> <tr> <td style="width: 10%;"></td> <td style="width: 10%;"></td> <td style="width: 10%;"></td> <td style="width: 10%;"></td> <td style="width: 10%;"></td> <td style="width: 10%;"></td> <td style="width: 10%;"></td> <td style="width: 10%;"></td> <td style="width: 10%;"></td> <td style="width: 10%;"></td> </tr> <tr> <td></td> <td></td> <td colspan="8" style="text-align: center;"> <table border="1" style="width: 100%; border-collapse: collapse; text-align: center;"> <tr> <td style="width: 10%;"></td> <td style="width: 10%;"></td> <td style="width: 10%;"></td> <td style="width: 10%;"></td> <td style="width: 10%;"></td> <td style="width: 10%;"></td> <td style="width: 10%;"></td> <td style="width: 10%;"></td> <td style="width: 10%;"></td> <td style="width: 10%;"></td> </tr> <tr> <td></td> <td></td> <td colspan="8" style="text-align: center;"> <table border="1" style="width: 100%; border-collapse: collapse; text-align: center;"> <tr> <td style="width: 10%;"></td> <td style="width: 10%;"></td> <td style="width: 10%;"></td> <td style="width: 10%;"></td> <td style="width: 10%;"></td> <td style="width: 10%;"></td> <td style="width: 10%;"></td> <td style="width: 10%;"></td> <td style="width: 10%;"></td> <td style="width: 10%;"></td> </tr> <tr> <td></td> <td></td> <td colspan="8" style="text-align: center;"> <table border="1" style="width: 100%; border-collapse: collapse; text-align: center;"> <tr> <td style="width: 10%;"></td> <td style="width: 10%;"></td> <td style="width: 10%;"></td> <td style="width: 10%;"></td> <td style="width: 10%;"></td> <td style="width: 10%;"></td> <td style="width: 10%;"></td> <td style="width: 10%;"></td> <td style="width: 10%;"></td> <td style="width: 10%;"></td> </tr> <tr> <td></td> <td></td> <td colspan="8" style="text-align: center;"> <table border="1" style="width: 100%; border-collapse: collapse; text-align: center;"> <tr> <td style="width: 10%;"></td> <td style="width: 10%;"></td> <td style="width: 10%;"></td> <td style="width: 10%;"></td> <td style="width: 10%;"></td> <td style="width: 10%;"></td> <td style="width: 10%;"></td> <td style="width: 10%;"></td> <td style="width: 10%;"></td> <td style="width: 10%;"></td> </tr> <tr> <td></td> <td></td> <td colspan="8" style="text-align: center;"> <table border="1" style="width: 100%; border-collapse: collapse; text-align: center;"> <tr> </tr></table></td></tr></table></td></tr></table></td></tr></table></td></tr></table></td></tr></table></td></tr></table></td></tr></table></td></tr></table></td></tr></table></td></tr></table></td></tr></table></td></tr></table></td></tr></table></td></tr></table></td></tr></table></td></tr></table>

 | | | | | | | | | | | | | | | | | | | | <table border="1" style="width: 100%; border-collapse: collapse; text-align: center;"> <tr> <td style="width: 10%;"></td> <td style="width: 10%;"></td> <td style="width: 10%;"></td> <td style="width: 10%;"></td> <td style="width: 10%;"></td> <td style="width: 10%;"></td> <td style="width: 10%;"></td> <td style="width: 10%;"></td> <td style="width: 10%;"></td> <td style="width: 10%;"></td> </tr> <tr> <td></td> <td></td> <td colspan="8" style="text-align: center;"> <table border="1" style="width: 100%; border-collapse: collapse; text-align: center;"> <tr> <td style="width: 10%;"></td> <td style="width: 10%;"></td> <td style="width: 10%;"></td> <td style="width: 10%;"></td> <td style="width: 10%;"></td> <td style="width: 10%;"></td> <td style="width: 10%;"></td> <td style="width: 10%;"></td> <td style="width: 10%;"></td> <td style="width: 10%;"></td> </tr> <tr> <td></td> <td></td> <td colspan="8" style="text-align: center;"> <table border="1" style="width: 100%; border-collapse: collapse; text-align: center;"> <tr> <td style="width: 10%;"></td> <td style="width: 10%;"></td> <td style="width: 10%;"></td> <td style="width: 10%;"></td> <td style="width: 10%;"></td> <td style="width: 10%;"></td> <td style="width: 10%;"></td> <td style="width: 10%;"></td> <td style="width: 10%;"></td> <td style="width: 10%;"></td> </tr> <tr> <td></td> <td></td> <td colspan="8" style="text-align: center;"> <table border="1" style="width: 100%; border-collapse: collapse; text-align: center;"> <tr> <td style="width: 10%;"></td> <td style="width: 10%;"></td> <td style="width: 10%;"></td> <td style="width: 10%;"></td> <td style="width: 10%;"></td> <td style="width: 10%;"></td> <td style="width: 10%;"></td> <td style="width: 10%;"></td> <td style="width: 10%;"></td> <td style="width: 10%;"></td> </tr> <tr> <td></td> <td></td> <td colspan="8" style="text-align: center;"> <table border="1" style="width: 100%; border-collapse: collapse; text-align: center;"> <tr> <td style="width: 10%;"></td> <td style="width: 10%;"></td> <td style="width: 10%;"></td> <td style="width: 10%;"></td> <td style="width: 10%;"></td> <td style="width: 10%;"></td> <td style="width: 10%;"></td> <td style="width: 10%;"></td> <td style="width: 10%;"></td> <td style="width: 10%;"></td> </tr> <tr> <td></td> <td></td> <td colspan="8" style="text-align: center;"> <table border="1" style="width: 100%; border-collapse: collapse; text-align: center;"> <tr> <td style="width: 10%;"></td> <td style="width: 10%;"></td> <td style="width: 10%;"></td> <td style="width: 10%;"></td> <td style="width: 10%;"></td> <td style="width: 10%;"></td> <td style="width: 10%;"></td> <td style="width: 10%;"></td> <td style="width: 10%;"></td> <td style="width: 10%;"></td> </tr> <tr> <td></td> <td></td> <td colspan="8" style="text-align: center;"> <table border="1" style="width: 100%; border-collapse: collapse; text-align: center;"> <tr> <td style="width: 10%;"></td> <td style="width: 10%;"></td> <td style="width: 10%;"></td> <td style="width: 10%;"></td> <td style="width: 10%;"></td> <td style="width: 10%;"></td> <td style="width: 10%;"></td> <td style="width: 10%;"></td> <td style="width: 10%;"></td> <td style="width: 10%;"></td> </tr> <tr> <td></td> <td></td> <td colspan="8" style="text-align: center;"> <table border="1" style="width: 100%; border-collapse: collapse; text-align: center;"> <tr> <td style="width: 10%;"></td> <td style="width: 10%;"></td> <td style="width: 10%;"></td> <td style="width: 10%;"></td> <td style="width: 10%;"></td> <td style="width: 10%;"></td> <td style="width: 10%;"></td> <td style="width: 10%;"></td> <td style="width: 10%;"></td> <td style="width: 10%;"></td> </tr> <tr> <td></td> <td></td> <td colspan="8" style="text-align: center;"> <table border="1" style="width: 100%; border-collapse: collapse; text-align: center;"> <tr> <td style="width: 10%;"></td> <td style="width: 10%;"></td> <td style="width: 10%;"></td> <td style="width: 10%;"></td> <td style="width: 10%;"></td> <td style="width: 10%;"></td> <td style="width: 10%;"></td> <td style="width: 10%;"></td> <td style="width: 10%;"></td> <td style="width: 10%;"></td> </tr> <tr> <td></td> <td></td> <td colspan="8" style="text-align: center;"> <table border="1" style="width: 100%; border-collapse: collapse; text-align: center;"> <tr> <td style="width: 10%;"></td> <td style="width: 10%;"></td> <td style="width: 10%;"></td> <td style="width: 10%;"></td> <td style="width: 10%;"></td> <td style="width: 10%;"></td> <td style="width: 10%;"></td> <td style="width: 10%;"></td> <td style="width: 10%;"></td> <td style="width: 10%;"></td> </tr> <tr> <td></td> <td></td> <td colspan="8" style="text-align: center;"> <table border="1" style="width: 100%; border-collapse: collapse; text-align: center;"> <tr> <td style="width: 10%;"></td> <td style="width: 10%;"></td> <td style="width: 10%;"></td> <td style="width: 10%;"></td> <td style="width: 10%;"></td> <td style="width: 10%;"></td> <td style="width: 10%;"></td> <td style="width: 10%;"></td> <td style="width: 10%;"></td> <td style="width: 10%;"></td> </tr> <tr> <td></td> <td></td> <td colspan="8" style="text-align: center;"> <table border="1" style="width: 100%; border-collapse: collapse; text-align: center;"> <tr> <td style="width: 10%;"></td> <td style="width: 10%;"></td> <td style="width: 10%;"></td> <td style="width: 10%;"></td> <td style="width: 10%;"></td> <td style="width: 10%;"></td> <td style="width: 10%;"></td> <td style="width: 10%;"></td> <td style="width: 10%;"></td> <td style="width: 10%;"></td> </tr> <tr> <td></td> <td></td> <td colspan="8" style="text-align: center;"> <table border="1" style="width: 100%; border-collapse: collapse; text-align: center;"> <tr> <td style="width: 10%;"></td> <td style="width: 10%;"></td> <td style="width: 10%;"></td> <td style="width: 10%;"></td> <td style="width: 10%;"></td> <td style="width: 10%;"></td> <td style="width: 10%;"></td> <td style="width: 10%;"></td> <td style="width: 10%;"></td> <td style="width: 10%;"></td> </tr> <tr> <td></td> <td></td> <td colspan="8" style="text-align: center;"> <table border="1" style="width: 100%; border-collapse: collapse; text-align: center;"> <tr> <td style="width: 10%;"></td> <td style="width: 10%;"></td> <td style="width: 10%;"></td> <td style="width: 10%;"></td> <td style="width: 10%;"></td> <td style="width: 10%;"></td> <td style="width: 10%;"></td> <td style="width: 10%;"></td> <td style="width: 10%;"></td> <td style="width: 10%;"></td> </tr> <tr> <td></td> <td></td> <td colspan="8" style="text-align: center;"> <table border="1" style="width: 100%; border-collapse: collapse; text-align: center;"> <tr> <td style="width: 10%;"></td> <td style="width: 10%;"></td> <td style="width: 10%;"></td> <td style="width: 10%;"></td> <td style="width: 10%;"></td> <td style="width: 10%;"></td> <td style="width: 10%;"></td> <td style="width: 10%;"></td> <td style="width: 10%;"></td> <td style="width: 10%;"></td> </tr> <tr> <td></td> <td></td> <td colspan="8" style="text-align: center;"> <table border="1" style="width: 100%; border-collapse: collapse; text-align: center;"> <tr> </tr></table></td></tr></table></td></tr></table></td></tr></table></td></tr></table></td></tr></table></td></tr></table></td></tr></table></td></tr></table></td></tr></table></td></tr></table></td></tr></table></td></tr></table></td></tr></table></td></tr></table></td></tr></table>

 | | | | | | | | | | | | | | | | | | | | <table border="1" style="width: 100%; border-collapse: collapse; text-align: center;"> <tr> <td style="width: 10%;"></td> <td style="width: 10%;"></td> <td style="width: 10%;"></td> <td style="width: 10%;"></td> <td style="width: 10%;"></td> <td style="width: 10%;"></td> <td style="width: 10%;"></td> <td style="width: 10%;"></td> <td style="width: 10%;"></td> <td style="width: 10%;"></td> </tr> <tr> <td></td> <td></td> <td colspan="8" style="text-align: center;"> <table border="1" style="width: 100%; border-collapse: collapse; text-align: center;"> <tr> <td style="width: 10%;"></td> <td style="width: 10%;"></td> <td style="width: 10%;"></td> <td style="width: 10%;"></td> <td style="width: 10%;"></td> <td style="width: 10%;"></td> <td style="width: 10%;"></td> <td style="width: 10%;"></td> <td style="width: 10%;"></td> <td style="width: 10%;"></td> </tr> <tr> <td></td> <td></td> <td colspan="8" style="text-align: center;"> <table border="1" style="width: 100%; border-collapse: collapse; text-align: center;"> <tr> <td style="width: 10%;"></td> <td style="width: 10%;"></td> <td style="width: 10%;"></td> <td style="width: 10%;"></td> <td style="width: 10%;"></td> <td style="width: 10%;"></td> <td style="width: 10%;"></td> <td style="width: 10%;"></td> <td style="width: 10%;"></td> <td style="width: 10%;"></td> </tr> <tr> <td></td> <td></td> <td colspan="8" style="text-align: center;"> <table border="1" style="width: 100%; border-collapse: collapse; text-align: center;"> <tr> <td style="width: 10%;"></td> <td style="width: 10%;"></td> <td style="width: 10%;"></td> <td style="width: 10%;"></td> <td style="width: 10%;"></td> <td style="width: 10%;"></td> <td style="width: 10%;"></td> <td style="width: 10%;"></td> <td style="width: 10%;"></td> <td style="width: 10%;"></td> </tr> <tr> <td></td> <td></td> <td colspan="8" style="text-align: center;"> <table border="1" style="width: 100%; border-collapse: collapse; text-align: center;"> <tr> <td style="width: 10%;"></td> <td style="width: 10%;"></td> <td style="width: 10%;"></td> <td style="width: 10%;"></td> <td style="width: 10%;"></td> <td style="width: 10%;"></td> <td style="width: 10%;"></td> <td style="width: 10%;"></td> <td style="width: 10%;"></td> <td style="width: 10%;"></td> </tr> <tr> <td></td> <td></td> <td colspan="8" style="text-align: center;"> <table border="1" style="width: 100%; border-collapse: collapse; text-align: center;"> <tr> <td style="width: 10%;"></td> <td style="width: 10%;"></td> <td style="width: 10%;"></td> <td style="width: 10%;"></td> <td style="width: 10%;"></td> <td style="width: 10%;"></td> <td style="width: 10%;"></td> <td style="width: 10%;"></td> <td style="width: 10%;"></td> <td style="width: 10%;"></td> </tr> <tr> <td></td> <td></td> <td colspan="8" style="text-align: center;"> <table border="1" style="width: 100%; border-collapse: collapse; text-align: center;"> <tr> <td style="width: 10%;"></td> <td style="width: 10%;"></td> <td style="width: 10%;"></td> <td style="width: 10%;"></td> <td style="width: 10%;"></td> <td style="width: 10%;"></td> <td style="width: 10%;"></td> <td style="width: 10%;"></td> <td style="width: 10%;"></td> <td style="width: 10%;"></td> </tr> <tr> <td></td> <td></td> <td colspan="8" style="text-align: center;"> <table border="1" style="width: 100%; border-collapse: collapse; text-align: center;"> <tr> <td style="width: 10%;"></td> <td style="width: 10%;"></td> <td style="width: 10%;"></td> <td style="width: 10%;"></td> <td style="width: 10%;"></td> <td style="width: 10%;"></td> <td style="width: 10%;"></td> <td style="width: 10%;"></td> <td style="width: 10%;"></td> <td style="width: 10%;"></td> </tr> <tr> <td></td> <td></td> <td colspan="8" style="text-align: center;"> <table border="1" style="width: 100%; border-collapse: collapse; text-align: center;"> <tr> <td style="width: 10%;"></td> <td style="width: 10%;"></td> <td style="width: 10%;"></td> <td style="width: 10%;"></td> <td style="width: 10%;"></td> <td style="width: 10%;"></td> <td style="width: 10%;"></td> <td style="width: 10%;"></td> <td style="width: 10%;"></td> <td style="width: 10%;"></td> </tr> <tr> <td></td> <td></td> <td colspan="8" style="text-align: center;"> <table border="1" style="width: 100%; border-collapse: collapse; text-align: center;"> <tr> <td style="width: 10%;"></td> <td style="width: 10%;"></td> <td style="width: 10%;"></td> <td style="width: 10%;"></td> <td style="width: 10%;"></td> <td style="width: 10%;"></td> <td style="width: 10%;"></td> <td style="width: 10%;"></td> <td style="width: 10%;"></td> <td style="width: 10%;"></td> </tr> <tr> <td></td> <td></td> <td colspan="8" style="text-align: center;"> <table border="1" style="width: 100%; border-collapse: collapse; text-align: center;"> <tr> <td style="width: 10%;"></td> <td style="width: 10%;"></td> <td style="width: 10%;"></td> <td style="width: 10%;"></td> <td style="width: 10%;"></td> <td style="width: 10%;"></td> <td style="width: 10%;"></td> <td style="width: 10%;"></td> <td style="width: 10%;"></td> <td style="width: 10%;"></td> </tr> <tr> <td></td> <td></td> <td colspan="8" style="text-align: center;"> <table border="1" style="width: 100%; border-collapse: collapse; text-align: center;"> <tr> <td style="width: 10%;"></td> <td style="width: 10%;"></td> <td style="width: 10%;"></td> <td style="width: 10%;"></td> <td style="width: 10%;"></td> <td style="width: 10%;"></td> <td style="width: 10%;"></td> <td style="width: 10%;"></td> <td style="width: 10%;"></td> <td style="width: 10%;"></td> </tr> <tr> <td></td> <td></td> <td colspan="8" style="text-align: center;"> <table border="1" style="width: 100%; border-collapse: collapse; text-align: center;"> <tr> <td style="width: 10%;"></td> <td style="width: 10%;"></td> <td style="width: 10%;"></td> <td style="width: 10%;"></td> <td style="width: 10%;"></td> <td style="width: 10%;"></td> <td style="width: 10%;"></td> <td style="width: 10%;"></td> <td style="width: 10%;"></td> <td style="width: 10%;"></td> </tr> <tr> <td></td> <td></td> <td colspan="8" style="text-align: center;"> <table border="1" style="width: 100%; border-collapse: collapse; text-align: center;"> <tr> <td style="width: 10%;"></td> <td style="width: 10%;"></td> <td style="width: 10%;"></td> <td style="width: 10%;"></td> <td style="width: 10%;"></td> <td style="width: 10%;"></td> <td style="width: 10%;"></td> <td style="width: 10%;"></td> <td style="width: 10%;"></td> <td style="width: 10%;"></td> </tr> <tr> <td></td> <td></td> <td colspan="8" style="text-align: center;"> <table border="1" style="width: 100%; border-collapse: collapse; text-align: center;"> <tr> </tr></table></td></tr></table></td></tr></table></td></tr></table></td></tr></table></td></tr></table></td></tr></table></td></tr></table></td></tr></table></td></tr></table></td></tr></table></td></tr></table></td></tr></table></td></tr></table></td></tr></table>

 | | | | | | | | | | | | | | | | | | | | <table border="1" style="width: 100%; border-collapse: collapse; text-align: center;"> <tr> <td style="width: 10%;"></td> <td style="width: 10%;"></td> <td style="width: 10%;"></td> <td style="width: 10%;"></td> <td style="width: 10%;"></td> <td style="width: 10%;"></td> <td style="width: 10%;"></td> <td style="width: 10%;"></td> <td style="width: 10%;"></td> <td style="width: 10%;"></td> </tr> <tr> <td></td> <td></td> <td colspan="8" style="text-align: center;"> <table border="1" style="width: 100%; border-collapse: collapse; text-align: center;"> <tr> <td style="width: 10%;"></td> <td style="width: 10%;"></td> <td style="width: 10%;"></td> <td style="width: 10%;"></td> <td style="width: 10%;"></td> <td style="width: 10%;"></td> <td style="width: 10%;"></td> <td style="width: 10%;"></td> <td style="width: 10%;"></td> <td style="width: 10%;"></td> </tr> <tr> <td></td> <td></td> <td colspan="8" style="text-align: center;"> <table border="1" style="width: 100%; border-collapse: collapse; text-align: center;"> <tr> <td style="width: 10%;"></td> <td style="width: 10%;"></td> <td style="width: 10%;"></td> <td style="width: 10%;"></td> <td style="width: 10%;"></td> <td style="width: 10%;"></td> <td style="width: 10%;"></td> <td style="width: 10%;"></td> <td style="width: 10%;"></td> <td style="width: 10%;"></td> </tr> <tr> <td></td> <td></td> <td colspan="8" style="text-align: center;"> <table border="1" style="width: 100%; border-collapse: collapse; text-align: center;"> <tr> <td style="width: 10%;"></td> <td style="width: 10%;"></td> <td style="width: 10%;"></td> <td style="width: 10%;"></td> <td style="width: 10%;"></td> <td style="width: 10%;"></td> <td style="width: 10%;"></td> <td style="width: 10%;"></td> <td style="width: 10%;"></td> <td style="width: 10%;"></td> </tr> <tr> <td></td> <td></td> <td colspan="8" style="text-align: center;"> <table border="1" style="width: 100%; border-collapse: collapse; text-align: center;"> <tr> <td style="width: 10%;"></td> <td style="width: 10%;"></td> <td style="width: 10%;"></td> <td style="width: 10%;"></td> <td style="width: 10%;"></td> <td style="width: 10%;"></td> <td style="width: 10%;"></td> <td style="width: 10%;"></td> <td style="width: 10%;"></td> <td style="width: 10%;"></td> </tr> <tr> <td></td> <td></td> <td colspan="8" style="text-align: center;"> <table border="1" style="width: 100%; border-collapse: collapse; text-align: center;"> <tr> <td style="width: 10%;"></td> <td style="width: 10%;"></td> <td style="width: 10%;"></td> <td style="width: 10%;"></td> <td style="width: 10%;"></td> <td style="width: 10%;"></td> <td style="width: 10%;"></td> <td style="width: 10%;"></td> <td style="width: 10%;"></td> <td style="width: 10%;"></td> </tr> <tr> <td></td> <td></td> <td colspan="8" style="text-align: center;"> <table border="1" style="width: 100%; border-collapse: collapse; text-align: center;"> <tr> <td style="width: 10%;"></td> <td style="width: 10%;"></td> <td style="width: 10%;"></td> <td style="width: 10%;"></td> <td style="width: 10%;"></td> <td style="width: 10%;"></td> <td style="width: 10%;"></td> <td style="width: 10%;"></td> <td style="width: 10%;"></td> <td style="width: 10%;"></td> </tr> <tr> <td></td> <td></td> <td colspan="8" style="text-align: center;"> <table border="1" style="width: 100%; border-collapse: collapse; text-align: center;"> <tr> <td style="width: 10%;"></td> <td style="width: 10%;"></td> <td style="width: 10%;"></td> <td style="width: 10%;"></td> <td style="width: 10%;"></td> <td style="width: 10%;"></td> <td style="width: 10%;"></td> <td style="width: 10%;"></td> <td style="width: 10%;"></td> <td style="width: 10%;"></td> </tr> <tr> <td></td> <td></td> <td colspan="8" style="text-align: center;"> <table border="1" style="width: 100%; border-collapse: collapse; text-align: center;"> <tr> <td style="width: 10%;"></td> <td style="width: 10%;"></td> <td style="width: 10%;"></td> <td style="width: 10%;"></td> <td style="width: 10%;"></td> <td style="width: 10%;"></td> <td style="width: 10%;"></td> <td style="width: 10%;"></td> <td style="width: 10%;"></td> <td style="width: 10%;"></td> </tr> <tr> <td></td> <td></td> <td colspan="8" style="text-align: center;"> <table border="1" style="width: 100%; border-collapse: collapse; text-align: center;"> <tr> <td style="width: 10%;"></td> <td style="width: 10%;"></td> <td style="width: 10%;"></td> <td style="width: 10%;"></td> <td style="width: 10%;"></td> <td style="width: 10%;"></td> <td style="width: 10%;"></td> <td style="width: 10%;"></td> <td style="width: 10%;"></td> <td style="width: 10%;"></td> </tr> <tr> <td></td> <td></td> <td colspan="8" style="text-align: center;"> <table border="1" style="width: 100%; border-collapse: collapse; text-align: center;"> <tr> <td style="width: 10%;"></td> <td style="width: 10%;"></td> <td style="width: 10%;"></td> <td style="width: 10%;"></td> <td style="width: 10%;"></td> <td style="width: 10%;"></td> <td style="width: 10%;"></td> <td style="width: 10%;"></td> <td style="width: 10%;"></td> <td style="width: 10%;"></td> </tr> <tr> <td></td> <td></td> <td colspan="8" style="text-align: center;"> <table border="1" style="width: 100%; border-collapse: collapse; text-align: center;"> <tr> <td style="width: 10%;"></td> <td style="width: 10%;"></td> <td style="width: 10%;"></td> <td style="width: 10%;"></td> <td style="width: 10%;"></td> <td style="width: 10%;"></td> <td style="width: 10%;"></td> <td style="width: 10%;"></td> <td style="width: 10%;"></td> <td style="width: 10%;"></td> </tr> <tr> <td></td> <td></td> <td colspan="8" style="text-align: center;"> <table border="1" style="width: 100%; border-collapse: collapse; text-align: center;"> <tr> <td style="width: 10%;"></td> <td style="width: 10%;"></td> <td style="width: 10%;"></td> <td style="width: 10%;"></td> <td style="width: 10%;"></td> <td style="width: 10%;"></td> <td style="width: 10%;"></td> <td style="width: 10%;"></td> <td style="width: 10%;"></td> <td style="width: 10%;"></td> </tr> <tr> <td></td> <td></td> <td colspan="8" style="text-align: center;"> <table border="1" style="width: 100%; border-collapse: collapse; text-align: center;"> <tr> </tr></table></td></tr></table></td></tr></table></td></tr></table></td></tr></table></td></tr></table></td></tr></table></td></tr></table></td></tr></table></td></tr></table></td></tr></table></td></tr></table></td></tr></table></td></tr></table>

 | | | | | | | | | | | | | | | | | | | | <table border="1" style="width: 100%; border-collapse: collapse; text-align: center;"> <tr> <td style="width: 10%;"></td> <td style="width: 10%;"></td> <td style="width: 10%;"></td> <td style="width: 10%;"></td> <td style="width: 10%;"></td> <td style="width: 10%;"></td> <td style="width: 10%;"></td> <td style="width: 10%;"></td> <td style="width: 10%;"></td> <td style="width: 10%;"></td> </tr> <tr> <td></td> <td></td> <td colspan="8" style="text-align: center;"> <table border="1" style="width: 100%; border-collapse: collapse; text-align: center;"> <tr> <td style="width: 10%;"></td> <td style="width: 10%;"></td> <td style="width: 10%;"></td> <td style="width: 10%;"></td> <td style="width: 10%;"></td> <td style="width: 10%;"></td> <td style="width: 10%;"></td> <td style="width: 10%;"></td> <td style="width: 10%;"></td> <td style="width: 10%;"></td> </tr> <tr> <td></td> <td></td> <td colspan="8" style="text-align: center;"> <table border="1" style="width: 100%; border-collapse: collapse; text-align: center;"> <tr> <td style="width: 10%;"></td> <td style="width: 10%;"></td> <td style="width: 10%;"></td> <td style="width: 10%;"></td> <td style="width: 10%;"></td> <td style="width: 10%;"></td> <td style="width: 10%;"></td> <td style="width: 10%;"></td> <td style="width: 10%;"></td> <td style="width: 10%;"></td> </tr> <tr> <td></td> <td></td> <td colspan="8" style="text-align: center;"> <table border="1" style="width: 100%; border-collapse: collapse; text-align: center;"> <tr> <td style="width: 10%;"></td> <td style="width: 10%;"></td> <td style="width: 10%;"></td> <td style="width: 10%;"></td> <td style="width: 10%;"></td> <td style="width: 10%;"></td> <td style="width: 10%;"></td> <td style="width: 10%;"></td> <td style="width: 10%;"></td> <td style="width: 10%;"></td> </tr> <tr> <td></td> <td></td> <td colspan="8" style="text-align: center;"> <table border="1" style="width: 100%; border-collapse: collapse; text-align: center;"> <tr> <td style="width: 10%;"></td> <td style="width: 10%;"></td> <td style="width: 10%;"></td> <td style="width: 10%;"></td> <td style="width: 10%;"></td> <td style="width: 10%;"></td> <td style="width: 10%;"></td> <td style="width: 10%;"></td> <td style="width: 10%;"></td> <td style="width: 10%;"></td> </tr> <tr> <td></td> <td></td> <td colspan="8" style="text-align: center;"> <table border="1" style="width: 100%; border-collapse: collapse; text-align: center;"> <tr> <td style="width: 10%;"></td> <td style="width: 10%;"></td> <td style="width: 10%;"></td> <td style="width: 10%;"></td> <td style="width: 10%;"></td> <td style="width: 10%;"></td> <td style="width: 10%;"></td> <td style="width: 10%;"></td> <td style="width: 10%;"></td> <td style="width: 10%;"></td> </tr> <tr> <td></td> <td></td> <td colspan="8" style="text-align: center;"> <table border="1" style="width: 100%; border-collapse: collapse; text-align: center;"> <tr> <td style="width: 10%;"></td> <td style="width: 10%;"></td> <td style="width: 10%;"></td> <td style="width: 10%;"></td> <td style="width: 10%;"></td> <td style="width: 10%;"></td> <td style="width: 10%;"></td> <td style="width: 10%;"></td> <td style="width: 10%;"></td> <td style="width: 10%;"></td> </tr> <tr> <td></td> <td></td> <td colspan="8" style="text-align: center;"> <table border="1" style="width: 100%; border-collapse: collapse; text-align: center;"> <tr> <td style="width: 10%;"></td> <td style="width: 10%;"></td> <td style="width: 10%;"></td> <td style="width: 10%;"></td> <td style="width: 10%;"></td> <td style="width: 10%;"></td> <td style="width: 10%;"></td> <td style="width: 10%;"></td> <td style="width: 10%;"></td> <td style="width: 10%;"></td> </tr> <tr> <td></td> <td></td> <td colspan="8" style="text-align: center;"> <table border="1" style="width: 100%; border-collapse: collapse; text-align: center;"> <tr> <td style="width: 10%;"></td> <td style="width: 10%;"></td> <td style="width: 10%;"></td> <td style="width: 10%;"></td> <td style="width: 10%;"></td> <td style="width: 10%;"></td> <td style="width: 10%;"></td> <td style="width: 10%;"></td> <td style="width: 10%;"></td> <td style="width: 10%;"></td> </tr> <tr> <td></td> <td></td> <td colspan="8" style="text-align: center;"> <table border="1" style="width: 100%; border-collapse: collapse; text-align: center;"> <tr> <td style="width: 10%;"></td> <td style="width: 10%;"></td> <td style="width: 10%;"></td> <td style="width: 10%;"></td> <td style="width: 10%;"></td> <td style="width: 10%;"></td> <td style="width: 10%;"></td> <td style="width: 10%;"></td> <td style="width: 10%;"></td> <td style="width: 10%;"></td> </tr> <tr> <td></td> <td></td> <td colspan="8" style="text-align: center;"> <table border="1" style="width: 100%; border-collapse: collapse; text-align: center;"> <tr> <td style="width: 10%;"></td> <td style="width: 10%;"></td> <td style="width: 10%;"></td> <td style="width: 10%;"></td> <td style="width: 10%;"></td> <td style="width: 10%;"></td> <td style="width: 10%;"></td> <td style="width: 10%;"></td> <td style="width: 10%;"></td> <td style="width: 10%;"></td> </tr> <tr> <td></td> <td></td> <td colspan="8" style="text-align: center;"> <table border="1" style="width: 100%; border-collapse: collapse; text-align: center;"> <tr> <td style="width: 10%;"></td> <td style="width: 10%;"></td> <td style="width: 10%;"></td> <td style="width: 10%;"></td> <td style="width: 10%;"></td> <td style="width: 10%;"></td> <td style="width: 10%;"></td> <td style="width: 10%;"></td> <td style="width: 10%;"></td> <td style="width: 10%;"></td> </tr> <tr> <td></td> <td></td> <td colspan="8" style="text-align: center;"> <table border="1" style="width: 100%; border-collapse: collapse; text-align: center;"> <tr> </tr></table></td></tr></table></td></tr></table></td></tr></table></td></tr></table></td></tr></table></td></tr></table></td></tr></table></td></tr></table></td></tr></table></td></tr></table></td></tr></table></td></tr></table>

 | | | | | | | | | | | | | | | | | | | | <table border="1" style="width: 100%; border-collapse: collapse; text-align: center;"> <tr> <td style="width: 10%;"></td> <td style="width: 10%;"></td> <td style="width: 10%;"></td> <td style="width: 10%;"></td> <td style="width: 10%;"></td> <td style="width: 10%;"></td> <td style="width: 10%;"></td> <td style="width: 10%;"></td> <td style="width: 10%;"></td> <td style="width: 10%;"></td> </tr> <tr> <td></td> <td></td> <td colspan="8" style="text-align: center;"> <table border="1" style="width: 100%; border-collapse: collapse; text-align: center;"> <tr> <td style="width: 10%;"></td> <td style="width: 10%;"></td> <td style="width: 10%;"></td> <td style="width: 10%;"></td> <td style="width: 10%;"></td> <td style="width: 10%;"></td> <td style="width: 10%;"></td> <td style="width: 10%;"></td> <td style="width: 10%;"></td> <td style="width: 10%;"></td> </tr> <tr> <td></td> <td></td> <td colspan="8" style="text-align: center;"> <table border="1" style="width: 100%; border-collapse: collapse; text-align: center;"> <tr> <td style="width: 10%;"></td> <td style="width: 10%;"></td> <td style="width: 10%;"></td> <td style="width: 10%;"></td> <td style="width: 10%;"></td> <td style="width: 10%;"></td> <td style="width: 10%;"></td> <td style="width: 10%;"></td> <td style="width:
10%;"></td> <td style="width: 10%;"></td> </tr> <tr> <td></td> <td></td> <td colspan="8" style="text-align: center;"> <table border="1" style="width: 100%; border-collapse: collapse; text-align: center;"> <tr> <td style="width: 10%;"></td> <td style="width: 10%;"></td> <td style="width: 10%;"></td> <td style="width: 10%;"></td> <td style="width: 10%;"></td> <td style="width: 10%;"></td> <td style="width: 10%;"></td> <td style="width: 10%;"></td> <td style="width: 10%;"></td> <td style="width: 10%;"></td> </tr> <tr> <td></td> <td></td> <td colspan="8" style="text-align: center;"> <table border="1" style="width: 100%; border-collapse: collapse; text-align: center;"> <tr> <td style="width: 10%;"></td> <td style="width: 10%;"></td> <td style="width: 10%;"></td> <td style="width: 10%;"></td> <td style="width: 10%;"></td> <td style="width: 10%;"></td> <td style="width: 10%;"></td> <td style="width: 10%;"></td> <td style="width: 10%;"></td> <td style="width: 10%;"></td> </tr> <tr> <td></td> <td></td> <td colspan="8" style="text-align: center;"> <table border="1" style="width: 100%; border-collapse: collapse; text-align: center;"> <tr> <td style="width: 10%;"></td> <td style="width: 10%;"></td> <td style="width: 10%;"></td> <td style="width: 10%;"></td> <td style="width: 10%;"></td> <td style="width: 10%;"></td> <td style="width: 10%;"></td> <td style="width: 10%;"></td> <td style="width: 10%;"></td> <td style="width: 10%;"></td> </tr> <tr> <td></td> <td></td> <td colspan="8" style="text-align: center;"> <table border="1" style="width: 100%; border-collapse: collapse; text-align: center;"> <tr> <td style="width: 10%;"></td> <td style="width: 10%;"></td> <td style="width: 10%;"></td> <td style="width: 10%;"></td> <td style="width: 10%;"></td> <td style="width: 10%;"></td> <td style="width: 10%;"></td> <td style="width: 10%;"></td> <td style="width: 10%;"></td> <td style="width: 10%;"></td> </tr> <tr> <td></td> <td></td> <td colspan="8" style="text-align: center;"> <table border="1" style="width: 100%; border-collapse: collapse; text-align: center;"> <tr> <td style="width: 10%;"></td> <td style="width: 10%;"></td> <td style="width: 10%;"></td> <td style="width: 10%;"></td> <td style="width: 10%;"></td> <td style="width: 10%;"></td> <td style="width: 10%;"></td> <td style="width: 10%;"></td> <td style="width: 10%;"></td> <td style="width: 10%;"></td> </tr> <tr> <td></td> <td></td> <td colspan="8" style="text-align: center;"> <table border="1" style="width: 100%; border-collapse: collapse; text-align: center;"> <tr> <td style="width: 10%;"></td> <td style="width: 10%;"></td> <td style="width: 10%;"></td> <td style="width: 10%;"></td> <td style="width: 10%;"></td> <td style="width: 10%;"></td> <td style="width: 10%;"></td> <td style="width: 10%;"></td> <td style="width: 10%;"></td> <td style="width: 10%;"></td> </tr> <tr> <td></td> <td></td> <td colspan="8" style="text-align: center;"> <table border="1" style="width: 100%; border-collapse: collapse; text-align: center;"> <tr> <td style="width: 10%;"></td> <td style="width: 10%;"></td> <td style="width: 10%;"></td> <td style="width: 10%;"></td> <td style="width: 10%;"></td> <td style="width: 10%;"></td> <td style="width: 10%;"></td> <td style="width: 10%;"></td> <td style="width: 10%;"></td> <td style="width: 10%;"></td> </tr> <tr> <td></td> <td></td> <td colspan="8" style="text-align: center;"> <table border="1" style="width: 100%; border-collapse: collapse; text-align: center;"> <tr> <td style="width: 10%;"></td> <td style="width: 10%;"></td> <td style="width: 10%;"></td> <td style="width: 10%;"></td> <td style="width: 10%;"></td> <td style="width: 10%;"></td> <td style="width: 10%;"></td> <td style="width: 10%;"></td> <td style="width: 10%;"></td> <td style="width: 10%;"></td> </tr> <tr> <td></td> <td></td> <td colspan="8" style="text-align: center;"> <table border="1" style="width: 100%; border-collapse: collapse; text-align: center;"> <tr> </tr></table></td></tr></table></td></tr></table></td></tr></table></td></tr></table></td></tr></table></td></tr></table></td></tr></table></td></tr></table></td></tr></table></td></tr></table></td></tr></table>

 | | | | | | | | | | | | | | | | | | | | <table border="1" style="width: 100%; border-collapse: collapse; text-align: center;"> <tr> <td style="width: 10%;"></td> <td style="width: 10%;"></td> <td style="width: 10%;"></td> <td style="width: 10%;"></td> <td style="width: 10%;"></td> <td style="width: 10%;"></td> <td style="width: 10%;"></td> <td style="width: 10%;"></td> <td style="width: 10%;"></td> <td style="width: 10%;"></td> </tr> <tr> <td></td> <td></td> <td colspan="8" style="text-align: center;"> <table border="1" style="width: 100%; border-collapse: collapse; text-align: center;"> <tr> <td style="width: 10%;"></td> <td style="width: 10%;"></td> <td style="width: 10%;"></td> <td style="width: 10%;"></td> <td style="width: 10%;"></td> <td style="width: 10%;"></td> <td style="width: 10%;"></td> <td style="width: 10%;"></td> <td style="width: 10%;"></td> <td style="width: 10%;"></td> </tr> <tr> <td></td> <td></td> <td colspan="8" style="text-align: center;"> <table border="1" style="width: 100%; border-collapse: collapse; text-align: center;"> <tr> <td style="width: 10%;"></td> <td style="width: 10%;"></td> <td style="width: 10%;"></td> <td style="width: 10%;"></td> <td style="width: 10%;"></td> <td style="width: 10%;"></td> <td style="width: 10%;"></td> <td style="width: 10%;"></td> <td style="width: 10%;"></td> <td style="width: 10%;"></td> </tr> <tr> <td></td> <td></td> <td colspan="8" style="text-align: center;"> <table border="1" style="width: 100%; border-collapse: collapse; text-align: center;"> <tr> <td style="width: 10%;"></td> <td style="width: 10%;"></td> <td style="width: 10%;"></td> <td style="width: 10%;"></td> <td style="width: 10%;"></td> <td style="width: 10%;"></td> <td style="width: 10%;"></td> <td style="width: 10%;"></td> <td style="width: 10%;"></td> <td style="width: 10%;"></td> </tr> <tr> <td></td> <td></td> <td colspan="8" style="text-align: center;"> <table border="1" style="width: 100%; border-collapse: collapse; text-align: center;"> <tr> <td style="width: 10%;"></td> <td style="width: 10%;"></td> <td style="width: 10%;"></td> <td style="width: 10%;"></td> <td style="width: 10%;"></td> <td style="width: 10%;"></td> <td style="width: 10%;"></td> <td style="width: 10%;"></td> <td style="width: 10%;"></td> <td style="width: 10%;"></td> </tr> <tr> <td></td> <td></td> <td colspan="8" style="text-align: center;"> <table border="1" style="width: 100%; border-collapse: collapse; text-align: center;"> <tr> <td style="width: 10%;"></td> <td style="width: 10%;"></td> <td style="width: 10%;"></td> <td style="width: 10%;"></td> <td style="width: 10%;"></td> <td style="width: 10%;"></td> <td style="width: 10%;"></td> <td style="width: 10%;"></td> <td style="width: 10%;"></td> <td style="width: 10%;"></td> </tr> <tr> <td></td> <td></td> <td colspan="8" style="text-align: center;"> <table border="1" style="width: 100%; border-collapse: collapse; text-align: center;"> <tr> <td style="width: 10%;"></td> <td style="width: 10%;"></td> <td style="width: 10%;"></td> <td style="width: 10%;"></td> <td style="width: 10%;"></td> <td style="width: 10%;"></td> <td style="width: 10%;"></td> <td style="width: 10%;"></td> <td style="width: 10%;"></td> <td style="width: 10%;"></td> </tr> <tr> <td></td> <td></td> <td colspan="8" style="text-align: center;"> <table border="1" style="width: 100%; border-collapse: collapse; text-align: center;"> <tr> <td style="width: 10%;"></td> <td style="width:
10%;"></td> <td style="width: 10%;"></td> <td style="width: 10%;"></td> <td style="width: 10%;"></td> <td style="width: 10%;"></td> <td style="width: 10%;"></td> <td style="width: 10%;"></td> <td style="width: 10%;"></td> <td style="width: 10%;"></td> </tr> <tr> <td></td> <td></td> <td colspan="8" style="text-align: center;"> <table border="1" style="width: 100%; border-collapse: collapse; text-align: center;"> <tr> <td style="width: 10%;"></td> <td style="width: 10%;"></td> <td style="width: 10%;"></td> <td style="width: 10%;"></td> <td style="width: 10%;"></td> <td style="width: 10%;"></td> <td style="width: 10%;"></td> <td style="width: 10%;"></td> <td style="width: 10%;"></td> <td style="width: 10%;"></td> </tr> <tr> <td></td> <td></td> <td colspan="8" style="text-align: center;"> <table border="1" style="width: 100%; border-collapse: collapse; text-align: center;"> <tr> <td style="width: 10%;"></td> <td style="width: 10%;"></td> <td style="width: 10%;"></td> <td style="width: 10%;"></td> <td style="width: 10%;"></td> <td style="width: 10%;"></td> <td style="width: 10%;"></td> <td style="width: 10%;"></td> <td style="width: 10%;"></td> <td style="width: 10%;"></td> </tr> <tr> <td></td> <td></td> <td colspan="8" style="text-align: center;"> <table border="1" style="width: 100%; border-collapse: collapse; text-align: center;"> <tr> </tr></table></td></tr></table></td></tr></table></td></tr></table></td></tr></table></td></tr></table></td></tr></table></td></tr></table></td></tr></table></td></tr></table></td></tr></table>

 | | | | | | | | | | | | | | | | | | | | <table border="1" style="width: 100%; border-collapse: collapse; text-align: center;"> <tr> <td style="width: 10%;"></td> <td style="width: 10%;"></td> <td style="width: 10%;"></td> <td style="width: 10%;"></td> <td style="width: 10%;"></td> <td style="width: 10%;"></td> <td style="width: 10%;"></td> <td style="width: 10%;"></td> <td style="width: 10%;"></td> <td style="width: 10%;"></td> </tr> <tr> <td></td> <td></td> <td colspan="8" style="text-align: center;"> <table border="1" style="width: 100%; border-collapse: collapse; text-align: center;"> <tr> <td style="width: 10%;"></td> <td style="width: 10%;"></td> <td style="width: 10%;"></td> <td style="width: 10%;"></td> <td style="width: 10%;"></td> <td style="width: 10%;"></td> <td style="width: 10%;"></td> <td style="width: 10%;"></td> <td style="width: 10%;"></td> <td style="width: 10%;"></td> </tr> <tr> <td></td> <td></td> <td colspan="8" style="text-align: center;"> <table border="1" style="width: 100%; border-collapse: collapse; text-align: center;"> <tr> <td style="width: 10%;"></td> <td style="width: 10%;"></td> <td style="width: 10%;"></td> <td style="width: 10%;"></td> <td style="width: 10%;"></td> <td style="width: 10%;"></td> <td style="width: 10%;"></td> <td style="width: 10%;"></td> <td style="width: 10%;"></td> <td style="width: 10%;"></td> </tr> <tr> <td></td> <td></td> <td colspan="8" style="text-align: center;"> <table border="1" style="width: 100%; border-collapse: collapse; text-align: center;"> <tr> <td style="width: 10%;"></td> <td style="width: 10%;"></td> <td style="width: 10%;"></td> <td style="width: 10%;"></td> <td style="width: 10%;"></td> <td style="width: 10%;"></td> <td style="width: 10%;"></td> <td style="width: 10%;"></td> <td style="width: 10%;"></td> <td style="width: 10%;"></td> </tr> <tr> <td></td> <td></td> <td colspan="8" style="text-align: center;"> <table border="1" style="width: 100%; border-collapse: collapse; text-align: center;"> <tr> <td style="width: 10%;"></td> <td style="width: 10%;"></td> <td style="width: 10%;"></td> <td style="width: 10%;"></td> <td style="width: 10%;"></td> <td style="width: 10%;"></td> <td style="width: 10%;"></td> <td style="width: 10%;"></td> <td style="width: 10%;"></td> <td style="width: 10%;"></td> </tr> <tr> <td></td> <td></td> <td colspan="8" style="text-align: center;"> <table border="1" style="width: 100%; border-collapse: collapse; text-align: center;"> <tr> <td style="width: 10%;"></td> <td style="width: 10%;"></td> <td style="width: 10%;"></td> <td style="width: 10%;"></td> <td style="width: 10%;"></td> <td style="width: 10%;"></td> <td style="width: 10%;"></td> <td style="width: 10%;"></td> <td style="width: 10%;"></td> <td style="width: 10%;"></td> </tr> <tr> <td></td> <td></td> <td colspan="8" style="text-align: center;"> <table border="1" style="width: 100%; border-collapse: collapse; text-align: center;"> <tr> <td style="width: 10%;"></td> <td style="width: 10%;"></td> <td style="width: 10%;"></td> <td style="width: 10%;"></td> <td style="width: 10%;"></td> <td style="width: 10%;"></td> <td style="width: 10%;"></td> <td style="width: 10%;"></td> <td style="width: 10%;"></td> <td style="width: 10%;"></td> </tr> <tr> <td></td> <td></td> <td colspan="8" style="text-align: center;"> <table border="1" style="width: 100%; border-collapse: collapse; text-align: center;"> <tr> <td style="width: 10%;"></td> <td style="width: 10%;"></td> <td style="width: 10%;"></td> <td style="width: 10%;"></td> <td style="width: 10%;"></td> <td style="width: 10%;"></td> <td style="width: 10%;"></td> <td style="width: 10%;"></td> <td style="width: 10%;"></td> <td style="width: 10%;"></td> </tr> <tr> <td></td> <td></td> <td colspan="8" style="text-align: center;"> <table border="1" style="width: 100%; border-collapse: collapse; text-align: center;"> <tr> <td style="width: 10%;"></td> <td style="width: 10%;"></td> <td style="width: 10%;"></td> <td style="width: 10%;"></td> <td style="width: 10%;"></td> <td style="width: 10%;"></td> <td style="width: 10%;"></td> <td style="width: 10%;"></td> <td style="width: 10%;"></td> <td style="width: 10%;"></td> </tr> <tr> <td></td> <td></td> <td colspan="8" style="text-align: center;"> <table border="1" style="width: 100%; border-collapse: collapse; text-align: center;"> <tr> </tr></table></td></tr></table></td></tr></table></td></tr></table></td></tr></table></td></tr></table></td></tr></table></td></tr></table></td></tr></table></td></tr></table>

 | | | | | | | | | | | | | | | | | | | | <table border="1" style="width: 100%; border-collapse: collapse; text-align: center;"> <tr> <td style="width: 10%;"></td> <td style="width: 10%;"></td> <td style="width: 10%;"></td> <td style="width: 10%;"></td> <td style="width: 10%;"></td> <td style="width: 10%;"></td> <td style="width: 10%;"></td> <td style="width: 10%;"></td> <td style="width: 10%;"></td> <td style="width: 10%;"></td> </tr> <tr> <td></td> <td></td> <td colspan="8" style="text-align: center;"> <table border="1" style="width: 100%; border-collapse: collapse; text-align: center;"> <tr> <td style="width: 10%;"></td> <td style="width: 10%;"></td> <td style="width: 10%;"></td> <td style="width: 10%;"></td> <td style="width: 10%;"></td> <td style="width: 10%;"></td> <td style="width: 10%;"></td> <td style="width: 10%;"></td> <td style="width: 10%;"></td> <td style="width: 10%;"></td> </tr> <tr> <td></td> <td></td> <td colspan="8" style="text-align: center;"> <table border="1" style="width: 100%; border-collapse: collapse; text-align: center;"> <tr> <td style="width: 10%;"></td> <td style="width: 10%;"></td> <td style="width: 10%;"></td> <td style="width: 10%;"></td> <td style="width: 10%;"></td> <td style="width: 10%;"></td> <td style="width: 10%;"></td> <td style="width: 10%;"></td> <td style="width: 10%;"></td> <td style="width: 10%;"></td> </tr> <tr> <td></td> <td></td> <td colspan="8" style="text-align: center;"> <table border="1" style="width: 100%; border-collapse: collapse; text-align: center;"> <tr> <td style="width: 10%;"></td> <td style="width: 10%;"></td> <td style="width: 10%;"></td> <td style="width: 10%;"></td> <td style="width: 10%;"></td> <td style="width: 10%;"></td> <td style="width: 10%;"></td> <td style="width: 10%;"></td> <td style="width: 10%;"></td> <td style="width: 10%;"></td> </tr> <tr> <td></td> <td></td> <td colspan="8" style="text-align: center;"> <table border="1" style="width: 100%; border-collapse: collapse; text-align: center;"> <tr> <td style="width: 10%;"></td> <td style="width: 10%;"></td> <td style="width: 10%;"></td> <td style="width: 10%;"></td> <td style="width: 10%;"></td> <td style="width: 10%;"></td> <td style="width: 10%;"></td> <td style="width: 10%;"></td> <td style="width: 10%;"></td> <td style="width: 10%;"></td> </tr> <tr> <td></td> <td></td> <td colspan="8" style="text-align: center;"> <table border="1" style="width: 100%; border-collapse: collapse; text-align: center;"> <tr> <td style="width: 10%;"></td> <td style="width: 10%;"></td> <td style="width: 10%;"></td> <td style="width: 10%;"></td> <td style="width: 10%;"></td> <td style="width: 10%;"></td> <td style="width: 10%;"></td> <td style="width: 10%;"></td> <td style="width: 10%;"></td> <td style="width: 10%;"></td> </tr> <tr> <td></td> <td></td> <td colspan="8" style="text-align: center;"> <table border="1" style="width: 100%; border-collapse: collapse; text-align: center;"> <tr> <td style="width: 10%;"></td> <td style="width: 10%;"></td> <td style="width: 10%;"></td> <td style="width: 10%;"></td> <td style="width: 10%;"></td> <td style="width: 10%;"></td> <td style="width: 10%;"></td> <td style="width: 10%;"></td> <td style="width: 10%;"></td> <td style="width: 10%;"></td> </tr> <tr> <td></td> <td></td> <td colspan="8" style="text-align: center;"> <table border="1" style="width: 100%; border-collapse: collapse; text-align: center;"> <tr> <td style="width: 10%;"></td> <td style="width: 10%;"></td> <td style="width: 10%;"></td> <td style="width: 10%;"></td> <td style="width: 10%;"></td> <td style="width: 10%;"></td> <td style="width: 10%;"></td> <td style="width: 10%;"></td> <td style="width: 10%;"></td> <td style="width: 10%;"></td> </tr> <tr> <td></td> <td></td> <td colspan="8" style="text-align: center;"> <table border="1" style="width: 100%; border-collapse: collapse; text-align: center;"> <tr> </tr></table></td></tr></table></td></tr></table></td></tr></table></td></tr></table></td></tr></table></td></tr></table></td></tr></table></td></tr></table>

 | | | | | | | | | | | | | | | | | | | | <table border="1" style="width: 100%; border-collapse: collapse; text-align: center;"> <tr> <td style="width: 10%;"></td> <td style="width: 10%;"></td> <td style="width: 10%;"></td> <td style="width: 10%;"></td> <td style="width: 10%;"></td> <td style="width: 10%;"></td> <td style="width: 10%;"></td> <td style="width: 10%;"></td> <td style="width: 10%;"></td> <td style="width: 10%;"></td> </tr> <tr> <td></td> <td></td> <td colspan="8" style="text-align: center;"> <table border="1" style="width: 100%; border-collapse: collapse; text-align: center;"> <tr> <td style="width: 10%;"></td> <td style="width: 10%;"></td> <td style="width: 10%;"></td> <td style="width: 10%;"></td> <td style="width: 10%;"></td> <td style="width: 10%;"></td> <td style="width: 10%;"></td> <td style="width: 10%;"></td> <td style="width: 10%;"></td> <td style="width: 10%;"></td> </tr> <tr> <td></td> <td></td> <td colspan="8" style="text-align: center;"> <table border="1" style="width: 100%; border-collapse: collapse; text-align: center;"> <tr> <td style="width: 10%;"></td> <td style="width: 10%;"></td> <td style="width: 10%;"></td> <td style="width: 10%;"></td> <td style="width: 10%;"></td> <td style="width: 10%;"></td> <td style="width: 10%;"></td> <td style="width: 10%;"></td> <td style="width: 10%;"></td> <td style="width: 10%;"></td> </tr> <tr> <td></td> <td></td> <td colspan="8" style="text-align: center;"> <table border="1" style="width: 100%; border-collapse: collapse; text-align: center;"> <tr> <td style="width: 10%;"></td> <td style="width: 10%;"></td> <td style="width: 10%;"></td> <td style="width: 10%;"></td> <td style="width: 10%;"></td> <td style="width: 10%;"></td> <td style="width: 10%;"></td> <td style="width: 10%;"></td> <td style="width: 10%;"></td> <td style="width: 10%;"></td> </tr> <tr> <td></td> <td></td> <td colspan="8" style="text-align: center;"> <table border="1" style="width: 100%; border-collapse: collapse; text-align: center;"> <tr> <td style="width: 10%;"></td> <td style="width: 10%;"></td> <td style="width: 10%;"></td> <td style="width: 10%;"></td> <td style="width: 10%;"></td> <td style="width: 10%;"></td> <td style="width: 10%;"></td> <td style="width: 10%;"></td> <td style="width: 10%;"></td> <td style="width: 10%;"></td> </tr> <tr> <td></td> <td></td> <td colspan="8" style="text-align: center;"> <table border="1" style="width: 100%; border-collapse: collapse; text-align: center;"> <tr> <td style="width: 10%;"></td> <td style="width: 10%;"></td> <td style="width: 10%;"></td> <td style="width: 10%;"></td> <td style="width: 10%;"></td> <td style="width: 10%;"></td> <td style="width: 10%;"></td> <td style="width: 10%;"></td> <td style="width: 10%;"></td> <td style="width:
10%;"></td> </tr> <tr> <td></td> <td></td> <td colspan="8" style="text-align: center;"> <table border="1" style="width: 100%; border-collapse: collapse; text-align: center;"> <tr> <td style="width: 10%;"></td> <td style="width: 10%;"></td> <td style="width: 10%;"></td> <td style="width: 10%;"></td> <td style="width: 10%;"></td> <td style="width: 10%;"></td> <td style="width: 10%;"></td> <td style="width: 10%;"></td> <td style="width: 10%;"></td> <td style="width: 10%;"></td> </tr> <tr> <td></td> <td></td> <td colspan="8" style="text-align: center;"> <table border="1" style="width: 100%; border-collapse: collapse; text-align: center;"> <tr> </tr></table></td></tr></table></td></tr></table></td></tr></table></td></tr></table></td></tr></table></td></tr></table></td></tr></table>

 | | | | | | | | | | | | | | | | | | | | <table border="1" style="width: 100%; border-collapse: collapse; text-align: center;"> <tr> <td style="width: 10%;"></td> <td style="width: 10%;"></td> <td style="width: 10%;"></td> <td style="width: 10%;"></td> <td style="width: 10%;"></td> <td style="width: 10%;"></td> <td style="width: 10%;"></td> <td style="width: 10%;"></td> <td style="width: 10%;"></td> <td style="width: 10%;"></td> </tr> <tr> <td></td> <td></td> <td colspan="8" style="text-align: center;"> <table border="1" style="width: 100%; border-collapse: collapse; text-align: center;"> <tr> <td style="width: 10%;"></td> <td style="width: 10%;"></td> <td style="width: 10%;"></td> <td style="width: 10%;"></td> <td style="width: 10%;"></td> <td style="width: 10%;"></td> <td style="width: 10%;"></td> <td style="width: 10%;"></td> <td style="width: 10%;"></td> <td style="width: 10%;"></td> </tr> <tr> <td></td> <td></td> <td colspan="8" style="text-align: center;"> <table border="1" style="width: 100%; border-collapse: collapse; text-align: center;"> <tr> <td style="width: 10%;"></td> <td style="width: 10%;"></td> <td style="width: 10%;"></td> <td style="width: 10%;"></td> <td style="width: 10%;"></td> <td style="width: 10%;"></td> <td style="width: 10%;"></td> <td style="width: 10%;"></td> <td style="width: 10%;"></td> <td style="width: 10%;"></td> </tr> <tr> <td></td> <td></td> <td colspan="8" style="text-align: center;"> <table border="1" style="width: 100%; border-collapse: collapse; text-align: center;"> <tr> <td style="width: 10%;"></td> <td style="width: 10%;"></td> <td style="width: 10%;"></td> <td style="width: 10%;"></td> <td style="width: 10%;"></td> <td style="width: 10%;"></td> <td style="width: 10%;"></td> <td style="width: 10%;"></td> <td style="width: 10%;"></td> <td style="width: 10%;"></td> </tr> <tr> <td></td> <td></td> <td colspan="8" style="text-align: center;"> <table border="1" style="width: 100%; border-collapse: collapse; text-align: center;"> <tr> <td style="width: 10%;"></td> <td style="width: 10%;"></td> <td style="width: 10%;"></td> <td style="width: 10%;"></td> <td style="width: 10%;"></td> <td style="width: 10%;"></td> <td style="width: 10%;"></td> <td style="width: 10%;"></td> <td style="width: 10%;"></td> <td style="width: 10%;"></td> </tr> <tr> <td></td> <td></td> <td colspan="8" style="text-align: center;"> <table border="1" style="width: 100%; border-collapse: collapse; text-align: center;"> <tr> <td style="width: 10%;"></td> <td style="width: 10%;"></td> <td style="width: 10%;"></td> <td style="width: 10%;"></td> <td style="width: 10%;"></td> <td style="width: 10%;"></td> <td style="width: 10%;"></td> <td style="width: 10%;"></td> <td style="width: 10%;"></td> <td style="width: 10%;"></td> </tr> <tr> <td></td> <td></td> <td colspan="8" style="text-align: center;"> <table border="1" style="width: 100%; border-collapse: collapse; text-align: center;"> <tr> </tr></table></td></tr></table></td></tr></table></td></tr></table></td></tr></table></td></tr></table></td></tr></table>

 | | | | | | | | | | | | | | | | | | | | <table border="1" style="width: 100%; border-collapse: collapse; text-align: center;"> <tr> <td style="width: 10%;"></td> <td style="width: 10%;"></td> <td style="width: 10%;"></td> <td style="width: 10%;"></td> <td style="width: 10%;"></td> <td style="width: 10%;"></td> <td style="width: 10%;"></td> <td style="width: 10%;"></td> <td style="width: 10%;"></td> <td style="width: 10%;"></td> </tr> <tr> <td></td> <td></td> <td colspan="8" style="text-align: center;"> <table border="1" style="width: 100%; border-collapse: collapse; text-align: center;"> <tr> <td style="width: 10%;"></td> <td style="width: 10%;"></td> <td style="width: 10%;"></td> <td style="width: 10%;"></td> <td style="width: 10%;"></td> <td style="width: 10%;"></td> <td style="width: 10%;"></td> <td style="width: 10%;"></td> <td style="width: 10%;"></td> <td style="width: 10%;"></td> </tr> <tr> <td></td> <td></td> <td colspan="8" style="text-align: center;"> <table border="1" style="width: 100%; border-collapse: collapse; text-align: center;"> <tr> <td style="width: 10%;"></td> <td style="width: 10%;"></td> <td style="width: 10%;"></td> <td style="width: 10%;"></td> <td style="width: 10%;"></td> <td style="width: 10%;"></td> <td style="width: 10%;"></td> <td style="width: 10%;"></td> <td style="width: 10%;"></td> <td style="width: 10%;"></td> </tr> <tr> <td></td> <td></td>
<td colspan="8" style="text-align: center;"> <table border="1" style="width: 100%; border-collapse: collapse; text-align: center;"> <tr> <td style="width: 10%;"></td> <td style="width: 10%;"></td> <td style="width: 10%;"></td> <td style="width: 10%;"></td> <td style="width: 10%;"></td> <td style="width: 10%;"></td> <td style="width: 10%;"></td> <td style="width: 10%;"></td> <td style="width: 10%;"></td> <td style="width: 10%;"></td> </tr> <tr> <td></td> <td></td> <td colspan="8" style="text-align: center;"> <table border="1" style="width: 100%; border-collapse: collapse; text-align: center;"> <tr> <td style="width: 10%;"></td> <td style="width: 10%;"></td> <td style="width: 10%;"></td> <td style="width: 10%;"></td> <td style="width: 10%;"></td> <td style="width: 10%;"></td> <td style="width: 10%;"></td> <td style="width: 10%;"></td> <td style="width: 10%;"></td> <td style="width: 10%;"></td> </tr> <tr> <td></td> <td></td> <td colspan="8" style="text-align: center;"> <table border="1" style="width: 100%; border-collapse: collapse; text-align: center;"> <tr> </tr></table></td></tr></table></td></tr></table></td></tr></table></td></tr></table></td></tr></table>

 | | | | | | | | | | | | | | | | | | | | <table border="1" style="width: 100%; border-collapse: collapse; text-align: center;"> <tr> <td style="width: 10%;"></td> <td style="width: 10%;"></td> <td style="width: 10%;"></td> <td style="width: 10%;"></td> <td style="width: 10%;"></td> <td style="width: 10%;"></td> <td style="width: 10%;"></td> <td style="width: 10%;"></td> <td style="width: 10%;"></td> <td style="width: 10%;"></td> </tr> <tr> <td></td> <td></td> <td colspan="8" style="text-align: center;"> <table border="1" style="width: 100%; border-collapse: collapse; text-align: center;"> <tr> <td style="width: 10%;"></td> <td style="width: 10%;"></td> <td style="width: 10%;"></td> <td style="width: 10%;"></td> <td style="width: 10%;"></td> <td style="width: 10%;"></td> <td style="width: 10%;"></td> <td style="width: 10%;"></td> <td style="width: 10%;"></td> <td style="width: 10%;"></td> </tr> <tr> <td></td> <td></td> <td colspan="8" style="text-align: center;"> <table border="1" style="width: 100%; border-collapse: collapse; text-align: center;"> <tr> <td style="width: 10%;"></td> <td style="width: 10%;"></td> <td style="width: 10%;"></td> <td style="width: 10%;"></td> <td style="width: 10%;"></td> <td style="width: 10%;"></td> <td style="width: 10%;"></td> <td style="width: 10%;"></td> <td style="width: 10%;"></td> <td style="width: 10%;"></td> </tr> <tr> <td></td> <td></td> <td colspan="8" style="text-align: center;"> <table border="1" style="width: 100%; border-collapse: collapse; text-align: center;"> <tr> <td style="width: 10%;"></td> <td style="width: 10%;"></td> <td style="width: 10%;"></td> <td style="width: 10%;"></td> <td style="width: 10%;"></td> <td style="width: 10%;"></td> <td style="width: 10%;"></td> <td style="width: 10%;"></td> <td style="width: 10%;"></td> <td style="width: 10%;"></td> </tr> <tr> <td></td> <td></td> <td colspan="8" style="text-align: center;"> <table border="1" style="width: 100%; border-collapse: collapse; text-align: center;"> <tr> </tr></table></td></tr></table></td></tr></table></td></tr></table></td></tr></table>

 | | | | | | | | | | | | | | | | | | | | <table border="1" style="width: 100%; border-collapse: collapse; text-align: center;"> <tr> <td style="width: 10%;"></td> <td style="width: 10%;"></td> <td style="width: 10%;"></td> <td style="width: 10%;"></td> <td style="width: 10%;"></td> <td style="width: 10%;"></td> <td style="width: 10%;"></td> <td style="width: 10%;"></td> <td style="width: 10%;"></td> <td style="width: 10%;"></td> </tr> <tr> <td></td> <td></td> <td colspan="8" style="text-align: center;"> <table border="1" style="width: 100%; border-collapse: collapse; text-align: center;"> <tr> <td style="width: 10%;"></td> <td style="width: 10%;"></td> <td style="width: 10%;"></td> <td style="width: 10%;"></td> <td style="width: 10%;"></td> <td style="width: 10%;"></td> <td style="width: 10%;"></td> <td style="width: 10%;"></td> <td style="width: 10%;"></td> <td style="width: 10%;"></td> </tr> <tr> <td></td> <td></td> <td colspan="8" style="text-align: center;"> <table border="1" style="width: 100%; border-collapse: collapse; text-align: center;"> <tr> <td style="width: 10%;"></td> <td style="width: 10%;"></td> <td style="width: 10%;"></td> <td style="width: 10%;"></td> <td style="width: 10%;"></td> <td style="width: 10%;"></td> <td style="width: 10%;"></td> <td style="width: 10%;"></td> <td style="width: 10%;"></td> <td style="width: 10%;"></td> </tr> <tr> <td></td> <td></td> <td colspan="8" style="text-align: center;"> <table border="1" style="width: 100%; border-collapse: collapse; text-align: center;"> <tr> </tr></table></td></tr></table></td></tr></table></td></tr></table>

 | | | | | | | | | | | | | | | | | | | | <table border="1" style="width: 100%; border-collapse: collapse; text-align: center;"> <tr> <td style="width: 10%;"></td> <td style="width: 10%;"></td> <td style="width: 10%;"></td> <td style="width: 10%;"></td> <td style="width: 10%;"></td> <td style="width: 10%;"></td> <td style="width: 10%;"></td> <td style="width: 10%;"></td> <td style="width: 10%;"></td> <td style="width: 10%;"></td> </tr> <tr> <td></td> <td></td> <td colspan="8" style="text-align: center;"> <table border="1" style="width: 100%; border-collapse: collapse; text-align: center;"> <tr> <td style="width: 10%;"></td> <td style="width: 10%;"></td> <td style="width: 10%;"></td> <td style="width: 10%;"></td> <td style="width: 10%;"></td> <td style="width: 10%;"></td> <td style="width: 10%;"></td> <td style="width: 10%;"></td> <td style="width: 10%;"></td> <td style="width: 10%;"></td> </tr> <tr> <td></td> <td></td> <td colspan="8" style="text-align: center;"> <table border="1" style="width: 100%; border-collapse: collapse; text-align: center;"> <tr> </tr></table></td></tr></table></td></tr></table>

 | | | | | | | | | | | | | | | | | | | | <table border="1" style="width: 100%; border-collapse: collapse; text-align: center;"> <tr> <td style="width: 10%;"></td> <td style="width: 10%;"></td> <td style="width: 10%;"></td> <td style="width: 10%;"></td> <td style="width: 10%;"></td> <td style="width: 10%;"></td> <td style="width: 10%;"></td> <td style="width: 10%;"></td> <td style="width: 10%;"></td> <td style="width: 10%;"></td> </tr> <tr> <td></td> <td></td> <td colspan="8" style="text-align: center;"> <table border="1" style="width: 100%; border-collapse: collapse; text-align: center;"> <tr> </tr></table></td></tr></table>

 | | | | | | | | | | | | | | | | | | | | <table border="1" style="width: 100%; border-collapse: collapse; text-align: center;"> <tr> </tr></table>

 | | | | | | | | | | | | | | | | | | | |

 | | | | | | | | | | | | | | | | | | | |

 | | | | | | | | | | | | | | | | | | | |

 | | | | | | | | | | | | | | | | | | | |

 | | | | | | | | | | | | | | | | | | | |

 | | | | | | | | | | | | | | | | | | | |

 | | | | | | | | | | | | | | | | | | | |

 | | | | | | | | | | | | | | | | | | | |

 | | | | | | | | | | | | | | | | | | | |

 | | | | | | | | | | | | | | | | | | | |
 | | | | | | | | | | | | | | | | | | | |

 | | | | | | | | | | | | | | | | | | | |

 | | | | | | | | | | | | | | | | | | | |
 | | | | | | | | | | | | | | | | | | | |

 | | | | | | | | | | | | | | | | | | | |

 | | | | | | | | | | | | | | | | | | | |
 | | | | | | | | | | | | | | | | | | | |
 | | | | | | | | | | | | | | | | | | | |

 | | | | | | | | | | | | | | | | | | | |
 | | | | | | | | | | | | | | | | | | | |
 | | | | | | | | | | | | | | | | | | | |

 | | | | | | | | | | | | | | | | | | | | | | | | | | | | | | | | | | | | | | | | | | | | | | | | | | | | | | | | | | | | | | | | | | | | | | | | | | | | | | | | | | | | | | | | | | | | | | | | | | | |
 | | | | | | | | | | | | | | | | | | | |
 | | | | | | | | | | | | | | | | | | | |
 | | | | | | | | | | | | | | | | | | | |
 | | | | | | | | | | | | | | | | | | | |
 | | | | | | | | | | | | | | | | | | | |
 | | | | | | | | | | | | | | | | | | | |
 | | | | | | | | | | | | | | | | | | | |
 | | | | | | | | | | | | | | | | | | | |
 | | | | | | | | | | | | | | | | | | | | | | | | | | | | | | | | | | | | | | | |
 | | | | | | | | | | | | | | | | | | | |
 | | | | | | | | | | | | | | | | | | | | | | | | | | | | | | | | | | | | | | | |
 | | | | | | | | | | | | | | | | | | | | | | | | | | | | | | | | | | | | | | | |
 | | | | | | | | | | | | | | | | | | | | | | | | | | | | | | | | | | | | | | | |
 | | | | | | | | | | | | | | | | | | | | | | | | | | | | | | | | | | | | | | | | | | | | | | | | | | | | | | | | | | | | | | | | | | | | | | | | | | | | | | | | | | | | | | | | | | | | | | | | | | | |
 | | | | | | | | | | | | | | | | | | | | | | | | | | | | | | | | | | | | | | | | | | | | | | | |
| | |

 | | | | | | | | | | | | | | | | | | | |

 | | | | | | | | | | | | | | | | | | | |

 | | | | | | | | | | | | | | | | | | | |

 | | | | | | | | | | | | | | | | | | | |

 | | | | | | | | | | | | | | | | | | | |

 | | | | | | | | | | | | | | | | | | | |

 | | | | | | | | | | | | | | | | | | | |

 | | | | | | | | | | | | | | | | | | | |

 | | | | | | | | | | | | | | | | | | | |

 | | | | | | | | | | | | | | | | | | | |

 | | | | | | | | | | | | | | | | | | | |

 | | | | | | | | | | | | | | | | | | | |

 | | | | | | | | | | | | | | | | | | | |

 | | | | | | | | | | | | | | | | | | | |

 | | | | | | | | | | | | | | | | | | | |

 | | | | | | | | | | | | | | | | | | | |

 | | | | | | | | | | | | | | | | | | | |

 | | | | | | | | | | | | | | | | | | | |

 | | | | | | | | | | | | | | | | | | | |

 | | | | | | | | | | | | | | | | | | | |

 | | | | | | | | | | | | | | | | | | | |

 | | | | | | | | | | | | | | | | | | | |

 | | | | | | | | | | | | | | | | | | | |

 | | | | | | | | | | | | | | | | | | | |

 | | | | | | | | | | | | | | | | | | | |

 | | | | | | | | | | | | | | | | | | | |

 | | | | | | | | | | | | | | | | | | | |

 | | | | | | | | | | | | | | | | | | | |
 | | | | | | | | | | | | | | | | | | | |

 | | | | | | | | | | | | | | | | | | | |

 | | | | | | | | | | | | | | | | | | | |
 | | | | | | | | | | | | | | | | | | | |

 | | | | | | | | | | | | | | | | | | | |

 | | | | | | | | | | | | | | | | | | | |
 | | | | | | | | | | | | | | | | | | | |
 | | | | | | | | | | | | | | | | | | | |

 | | | | | | | | | | | | | | | | | | | |
 | | | | | | | | | | | | | | | | | | | |
 | | | | | | | | | | | | | | | | | | | |

 | | | | | | | | | | | | | | | | | | | | | | | | | | | | | | | | | | | | | | | | | | | | | | | | | | | | | | | | | | | | | | | | | | | | | | | | | | | | | | | | | | | | | | | | | | | | | | | | | | | |
 | | | | | | | | | | | | | | | | | | | |
 | | | | | | | | | | | | | | | | | | | |
 | | | | | | | | | | | | | | | | | | | |
 | | | | | | | | | | | | | | | | | | | |
 | | | | | | | | | | | | | | | | | | | |
 | | | | | | | | | | | | | | | | | | | |
 | | | | | | | | | | | | | | | | | | | |
 | | | | | | | | | | | | | | | | | | | |
 | | | | | | | | | | | | | | | | | | | | | | | | | | | | | | | | | | | | | | | |
 | | | | | | | | | | | | | | | | | | | |
 | | | | | | | | | | | | | | | | | | | | | | | | | | | | | | | | | | | | | | | |
 | | | | | | | | | | | | | | | | | | | | | | | | | | | | | | | | | | | | | | | |
 | | | | | | | | | | | | | | | | | | | | | | | | | | | | | | | | | | | | | | | |
 | | | | | | | | | | | | | | | | | | | | | | | | | | | | | | | | | | | | | | | | | | | | | | | | | | | | | | | | | | | | | | | | | | | | | | | | | | | | | | | | | | | | | | | | | | | | | | | | | | | |
 | | | | | | | | | | | | | | | | | | | | | | | | | | | | | | | | | | | | | | | | | | | | | | | |
| | | <table border="1" style="width: 100%; border-collapse: collapse; text-align: center;"> <tr> <td style="width: 10%;"></td> <td style="width: 10%;"></td> <td style="width: 10%;"></td> <td style="width: 10%;"></td> <td style="width: 10%;"></td> <td style="width: 10%;"></td> <td style="width: 10%;"></td> <td style="width: 10%;"></td> <td style="width: 10%;"></td> <td style="width: 10%;"></td> </tr> <tr> <td></td> <td></td> <td colspan="8" style="text-align: center;"> <table border="1" style="width: 100%; border-collapse: collapse; text-align: center;"> <tr> <td style="width: 10%;"></td> <td style="width: 10%;"></td> <td style="width: 10%;"></td> <td style="width: 10%;"></td> <td style="width: 10%;"></td> <td style="width: 10%;"></td> <td style="width: 10%;"></td> <td style="width: 10%;"></td> <td style="width: 10%;"></td> <td style="width: 10%;"></td> </tr> <tr> <td></td> <td></td> <td colspan="8" style="text-align: center;"> <table border="1" style="width: 100%; border-collapse: collapse; text-align: center;"> <tr> <td style="width: 10%;"></td> <td style="width: 10%;"></td> <td style="width: 10%;"></td> <td style="width: 10%;"></td> <td style="width: 10%;"></td> <td style="width: 10%;"></td> <td style="width: 10%;"></td> <td style="width: 10%;"></td> <td style="width: 10%;"></td> <td style="width: 10%;"></td> </tr> <tr> <td></td> <td></td> <td colspan="8" style="text-align: center;"> <table border="1" style="width: 100%; border-collapse: collapse; text-align: center;"> <tr> <td style="width: 10%;"></td> <td style="width: 10%;"></td> <td style="width: 10%;"></td> <td style="width: 10%;"></td> <td style="width: 10%;"></td> <td style="width: 10%;"></td> <td style="width: 10%;"></td> <td style="width: 10%;"></td> <td style="width: 10%;"></td> <td style="width: 10%;"></td> </tr> <tr> <td></td> <td></td> <td colspan="8" style="text-align: center;"> <table border="1" style="width: 100%; border-collapse: collapse; text-align: center;"> <tr> <td style="width: 10%;"></td> <td style="width: 10%;"></td> <td style="width: 10%;"></td> <td style="width: 10%;"></td> <td style="width: 10%;"></td> <td style="width: 10%;"></td> <td style="width: 10%;"></td> <td style="width: 10%;"></td> <td style="width: 10%;"></td> <td style="width: 10%;"></td> </tr> <tr> <td></td> <td></td> <td colspan="8" style="text-align: center;"> <table border="1" style="width: 100%; border-collapse: collapse; text-align: center;"> <tr> <td style="width: 10%;"></td> <td style="width: 10%;"></td> <td style="width: 10%;"></td> <td style="width: 10%;"></td> <td style="width: 10%;"></td> <td style="width: 10%;"></td> <td style="width: 10%;"></td> <td style="width: 10%;"></td> <td style="width: 10%;"></td> <td style="width: 10%;"></td> </tr> <tr> <td></td> <td></td> <td colspan="8" style="text-align: center;"> <table border="1" style="width: 100%; border-collapse: collapse; text-align: center;"> <tr> <td style="width: 10%;"></td> <td style="width: 10%;"></td> <td style="width: 10%;"></td> <td style="width: 10%;"></td> <td style="width: 10%;"></td> <td style="width: 10%;"></td> <td style="width: 10%;"></td> <td style="width: 10%;"></td> <td style="width: 10%;"></td> <td style="width: 10%;"></td> </tr> <tr> <td></td> <td></td> <td colspan="8" style="text-align: center;"> <table border="1" style="width: 100%; border-collapse: collapse; text-align: center;"> <tr> <td style="width: 10%;"></td> <td style="width: 10%;"></td> <td style="width: 10%;"></td> <td style="width: 10%;"></td> <td style="width: 10%;"></td> <td style="width: 10%;"></td> <td style="width: 10%;"></td> <td style="width: 10%;"></td> <td style="width: 10%;"></td> <td style="width: 10%;"></td> </tr> <tr> <td></td> <td></td> <td colspan="8" style="text-align: center;"> <table border="1" style="width: 100%; border-collapse: collapse; text-align: center;"> <tr> <td style="width: 10%;"></td> <td style="width: 10%;"></td> <td style="width: 10%;"></td> <td style="width: 10%;"></td> <td style="width: 10%;"></td> <td style="width: 10%;"></td> <td style="width: 10%;"></td> <td style="width: 10%;"></td> <td style="width: 10%;"></td> <td style="width: 10%;"></td> </tr> <tr> <td></td> <td></td> <td colspan="8" style="text-align: center;"> <table border="1" style="width: 100%; border-collapse: collapse; text-align: center;"> <tr> <td style="width: 10%;"></td> <td style="width: 10%;"></td> <td style="width: 10%;"></td> <td style="width: 10%;"></td> <td style="width: 10%;"></td> <td style="width: 10%;"></td> <td style="width: 10%;"></td> <td style="width: 10%;"></td> <td style="width: 10%;"></td> <td style="width: 10%;"></td> </tr> <tr> <td></td> <td></td> <td colspan="8" style="text-align: center;"> <table border="1" style="width: 100%; border-collapse: collapse; text-align: center;"> <tr> <td style="width: 10%;"></td> <td style="width: 10%;"></td> <td style="width: 10%;"></td> <td style="width: 10%;"></td> <td style="width: 10%;"></td> <td style="width: 10%;"></td> <td style="width: 10%;"></td> <td style="width: 10%;"></td> <td style="width: 10%;"></td> <td style="width: 10%;"></td> </tr> <tr> <td></td> <td></td> <td colspan="8" style="text-align: center;"> <table border="1" style="width: 100%; border-collapse: collapse; text-align: center;"> <tr> <td style="width: 10%;"></td> <td style="width: 10%;"></td> <td style="width: 10%;"></td> <td style="width: 10%;"></td> <td style="width: 10%;"></td> <td style="width: 10%;"></td> <td style="width: 10%;"></td> <td style="width: 10%;"></td> <td style="width: 10%;"></td> <td style="width: 10%;"></td> </tr> <tr> <td></td> <td></td> <td colspan="8" style="text-align: center;"> <table border="1" style="width: 100%; border-collapse: collapse; text-align: center;"> <tr> <td style="width: 10%;"></td> <td style="width: 10%;"></td> <td style="width: 10%;"></td> <td style="width: 10%;"></td> <td style="width: 10%;"></td> <td style="width: 10%;"></td> <td style="width: 10%;"></td> <td style="width: 10%;"></td> <td style="width: 10%;"></td> <td style="width: 10%;"></td> </tr> <tr> <td></td> <td></td> <td colspan="8" style="text-align: center;"> <table border="1" style="width: 100%; border-collapse: collapse; text-align: center;"> <tr> <td style="width: 10%;"></td> <td style="width: 10%;"></td> <td style="width: 10%;"></td> <td style="width: 10%;"></td> <td style="width: 10%;"></td> <td style="width: 10%;"></td> <td style="width: 10%;"></td> <td style="width: 10%;"></td> <td style="width: 10%;"></td> <td style="width: 10%;"></td> </tr> <tr> <td></td> <td></td> <td colspan="8" style="text-align: center;"> <table border="1" style="width: 100%; border-collapse: collapse; text-align: center;"> <tr> <td style="width: 10%;"></td> <td style="width: 10%;"></td> <td style="width: 10%;"></td> <td style="width: 10%;"></td> <td style="width: 10%;"></td> <td style="width: 10%;"></td> <td style="width: 10%;"></td> <td style="width: 10%;"></td> <td style="width: 10%;"></td> <td style="width: 10%;"></td> </tr> <tr> <td></td> <td></td> <td colspan="8" style="text-align: center;"> <table border="1" style="width: 100%; border-collapse: collapse; text-align: center;"> <tr> <td style="width: 10%;"></td> <td style="width: 10%;"></td> <td style="width: 10%;"></td> <td style="width: 10%;"></td> <td style="width: 10%;"></td> <td style="width: 10%;"></td> <td style="width: 10%;"></td> <td style="width: 10%;"></td> <td style="width: 10%;"></td> <td style="width: 10%;"></td> </tr> <tr> <td></td> <td></td> <td colspan="8" style="text-align: center;"> <table border="1" style="width: 100%; border-collapse: collapse; text-align: center;"> <tr> <td style="width: 10%;"></td> <td style="width: 10%;"></td> <td style="width: 10%;"></td> <td style="width: 10%;"></td> <td style="width: 10%;"></td> <td style="width: 10%;"></td> <td style="width: 10%;"></td> <td style="width: 10%;"></td> <td style="width: 10%;"></td> <td style="width: 10%;"></td> </tr> <tr> <td></td> <td></td> <td colspan="8" style="text-align: center;"> <table border="1" style="width: 100%; border-collapse: collapse; text-align: center;"> <tr> </tr></table></td></tr></table></td></tr></table></td></tr></table></td></tr></table></td></tr></table></td></tr></table></td></tr></table></td></tr></table></td></tr></table></td></tr></table></td></tr></table></td></tr></table></td></tr></table></td></tr></table></td></tr></table></td></tr></table></td></tr></table>

 | | | | | | | | | | | | | | | | | | | | <table border="1" style="width: 100%; border-collapse: collapse; text-align: center;"> <tr> <td style="width: 10%;"></td> <td style="width: 10%;"></td> <td style="width: 10%;"></td> <td style="width: 10%;"></td> <td style="width: 10%;"></td> <td style="width: 10%;"></td> <td style="width: 10%;"></td> <td style="width: 10%;"></td> <td style="width: 10%;"></td> <td style="width: 10%;"></td> </tr> <tr> <td></td> <td></td> <td colspan="8" style="text-align: center;"> <table border="1" style="width: 100%; border-collapse: collapse; text-align: center;"> <tr> <td style="width: 10%;"></td> <td style="width: 10%;"></td> <td style="width: 10%;"></td> <td style="width: 10%;"></td> <td style="width: 10%;"></td> <td style="width: 10%;"></td> <td style="width: 10%;"></td> <td style="width: 10%;"></td> <td style="width: 10%;"></td> <td style="width: 10%;"></td> </tr> <tr> <td></td> <td></td> <td colspan="8" style="text-align: center;"> <table border="1" style="width: 100%; border-collapse: collapse; text-align: center;"> <tr> <td style="width: 10%;"></td> <td style="width: 10%;"></td> <td style="width: 10%;"></td> <td style="width: 10%;"></td> <td style="width: 10%;"></td> <td style="width: 10%;"></td> <td style="width: 10%;"></td> <td style="width: 10%;"></td> <td style="width: 10%;"></td> <td style="width: 10%;"></td> </tr> <tr> <td></td> <td></td> <td colspan="8" style="text-align: center;"> <table border="1" style="width: 100%; border-collapse: collapse; text-align: center;"> <tr> <td style="width: 10%;"></td> <td style="width: 10%;"></td> <td style="width: 10%;"></td> <td style="width: 10%;"></td> <td style="width: 10%;"></td> <td style="width: 10%;"></td> <td style="width: 10%;"></td> <td style="width: 10%;"></td> <td style="width: 10%;"></td> <td style="width: 10%;"></td> </tr> <tr> <td></td> <td></td> <td colspan="8" style="text-align: center;"> <table border="1" style="width: 100%; border-collapse: collapse; text-align: center;"> <tr> <td style="width: 10%;"></td> <td style="width: 10%;"></td> <td style="width: 10%;"></td> <td style="width: 10%;"></td> <td style="width: 10%;"></td> <td style="width: 10%;"></td> <td style="width: 10%;"></td> <td style="width: 10%;"></td> <td style="width: 10%;"></td> <td style="width: 10%;"></td> </tr> <tr> <td></td> <td></td> <td colspan="8" style="text-align: center;"> <table border="1" style="width: 100%; border-collapse: collapse; text-align: center;"> <tr> <td style="width: 10%;"></td> <td style="width: 10%;"></td> <td style="width: 10%;"></td> <td style="width: 10%;"></td> <td style="width: 10%;"></td> <td style="width: 10%;"></td> <td style="width: 10%;"></td> <td style="width: 10%;"></td> <td style="width: 10%;"></td> <td style="width: 10%;"></td> </tr> <tr> <td></td> <td></td> <td colspan="8" style="text-align: center;"> <table border="1" style="width: 100%; border-collapse: collapse; text-align: center;"> <tr> <td style="width: 10%;"></td> <td style="width: 10%;"></td> <td style="width: 10%;"></td> <td style="width: 10%;"></td> <td style="width: 10%;"></td> <td style="width: 10%;"></td> <td style="width: 10%;"></td> <td style="width: 10%;"></td> <td style="width: 10%;"></td> <td style="width: 10%;"></td> </tr> <tr> <td></td> <td></td> <td colspan="8" style="text-align: center;"> <table border="1" style="width: 100%; border-collapse: collapse; text-align: center;"> <tr> <td style="width: 10%;"></td> <td style="width: 10%;"></td> <td style="width: 10%;"></td> <td style="width: 10%;"></td> <td style="width: 10%;"></td> <td style="width: 10%;"></td> <td style="width: 10%;"></td> <td style="width: 10%;"></td> <td style="width: 10%;"></td> <td style="width: 10%;"></td> </tr> <tr> <td></td> <td></td> <td colspan="8" style="text-align: center;"> <table border="1" style="width: 100%; border-collapse: collapse; text-align: center;"> <tr> <td style="width: 10%;"></td> <td style="width: 10%;"></td> <td style="width: 10%;"></td> <td style="width: 10%;"></td> <td style="width: 10%;"></td> <td style="width: 10%;"></td> <td style="width: 10%;"></td> <td style="width: 10%;"></td> <td style="width: 10%;"></td> <td style="width: 10%;"></td> </tr> <tr> <td></td> <td></td> <td colspan="8" style="text-align: center;"> <table border="1" style="width: 100%; border-collapse: collapse; text-align: center;"> <tr> <td style="width: 10%;"></td> <td style="width: 10%;"></td> <td style="width: 10%;"></td> <td style="width: 10%;"></td> <td style="width: 10%;"></td> <td style="width: 10%;"></td> <td style="width: 10%;"></td> <td style="width: 10%;"></td> <td style="width: 10%;"></td> <td style="width: 10%;"></td> </tr> <tr> <td></td> <td></td> <td colspan="8" style="text-align: center;"> <table border="1" style="width: 100%; border-collapse: collapse; text-align: center;"> <tr> <td style="width: 10%;"></td> <td style="width: 10%;"></td> <td style="width: 10%;"></td> <td style="width: 10%;"></td> <td style="width: 10%;"></td> <td style="width: 10%;"></td> <td style="width: 10%;"></td> <td style="width: 10%;"></td> <td style="width: 10%;"></td> <td style="width: 10%;"></td> </tr> <tr> <td></td> <td></td> <td colspan="8" style="text-align: center;"> <table border="1" style="width: 100%; border-collapse: collapse; text-align: center;"> <tr> <td style="width: 10%;"></td> <td style="width: 10%;"></td> <td style="width: 10%;"></td> <td style="width: 10%;"></td> <td style="width: 10%;"></td> <td style="width: 10%;"></td> <td style="width: 10%;"></td> <td style="width: 10%;"></td> <td style="width: 10%;"></td> <td style="width: 10%;"></td> </tr> <tr> <td></td> <td></td> <td colspan="8" style="text-align: center;"> <table border="1" style="width: 100%; border-collapse: collapse; text-align: center;"> <tr> <td style="width: 10%;"></td> <td style="width: 10%;"></td> <td style="width: 10%;"></td> <td style="width: 10%;"></td> <td style="width: 10%;"></td> <td style="width: 10%;"></td> <td style="width: 10%;"></td> <td style="width: 10%;"></td> <td style="width: 10%;"></td> <td style="width: 10%;"></td> </tr> <tr> <td></td> <td></td> <td colspan="8" style="text-align: center;"> <table border="1" style="width: 100%; border-collapse: collapse; text-align: center;"> <tr> <td style="width: 10%;"></td> <td style="width: 10%;"></td> <td style="width: 10%;"></td> <td style="width: 10%;"></td> <td style="width: 10%;"></td> <td style="width: 10%;"></td> <td style="width: 10%;"></td> <td style="width: 10%;"></td> <td style="width: 10%;"></td> <td style="width: 10%;"></td> </tr> <tr> <td></td> <td></td> <td colspan="8" style="text-align: center;"> <table border="1" style="width: 100%; border-collapse: collapse; text-align: center;"> <tr> <td style="width: 10%;"></td> <td style="width: 10%;"></td> <td style="width: 10%;"></td> <td style="width: 10%;"></td> <td style="width: 10%;"></td> <td style="width: 10%;"></td> <td style="width: 10%;"></td> <td style="width: 10%;"></td> <td style="width: 10%;"></td> <td style="width: 10%;"></td> </tr> <tr> <td></td> <td></td> <td colspan="8" style="text-align: center;"> <table border="1" style="width: 100%; border-collapse: collapse; text-align: center;"> <tr> <td style="width: 10%;"></td> <td style="width: 10%;"></td> <td style="width: 10%;"></td> <td style="width: 10%;"></td> <td style="width: 10%;"></td> <td style="width: 10%;"></td> <td style="width: 10%;"></td> <td style="width: 10%;"></td> <td style="width: 10%;"></td> <td style="width: 10%;"></td> </tr> <tr> <td></td> <td></td> <td colspan="8" style="text-align: center;"> <table border="1" style="width: 100%; border-collapse: collapse; text-align: center;"> <tr> </tr></table></td></tr></table></td></tr></table></td></tr></table></td></tr></table></td></tr></table></td></tr></table></td></tr></table></td></tr></table></td></tr></table></td></tr></table></td></tr></table></td></tr></table></td></tr></table></td></tr></table></td></tr></table></td></tr></table>

 | | | | | | | | | | | | | | | | | | | | <table border="1" style="width: 100%; border-collapse: collapse; text-align: center;"> <tr> <td style="width: 10%;"></td> <td style="width: 10%;"></td> <td style="width: 10%;"></td> <td style="width: 10%;"></td> <td style="width: 10%;"></td> <td style="width: 10%;"></td> <td style="width: 10%;"></td> <td style="width: 10%;"></td> <td style="width: 10%;"></td> <td style="width: 10%;"></td> </tr> <tr> <td></td> <td></td> <td colspan="8" style="text-align: center;"> <table border="1" style="width: 100%; border-collapse: collapse; text-align: center;"> <tr> <td style="width: 10%;"></td> <td style="width: 10%;"></td> <td style="width: 10%;"></td> <td style="width: 10%;"></td> <td style="width: 10%;"></td> <td style="width: 10%;"></td> <td style="width: 10%;"></td> <td style="width: 10%;"></td> <td style="width: 10%;"></td> <td style="width: 10%;"></td> </tr> <tr> <td></td> <td></td> <td colspan="8" style="text-align: center;"> <table border="1" style="width: 100%; border-collapse: collapse; text-align: center;"> <tr> <td style="width: 10%;"></td> <td style="width: 10%;"></td> <td style="width: 10%;"></td> <td style="width: 10%;"></td> <td style="width: 10%;"></td> <td style="width: 10%;"></td> <td style="width: 10%;"></td> <td style="width: 10%;"></td> <td style="width: 10%;"></td> <td style="width: 10%;"></td> </tr> <tr> <td></td> <td></td> <td colspan="8" style="text-align: center;"> <table border="1" style="width: 100%; border-collapse: collapse; text-align: center;"> <tr> <td style="width: 10%;"></td> <td style="width: 10%;"></td> <td style="width: 10%;"></td> <td style="width: 10%;"></td> <td style="width: 10%;"></td> <td style="width: 10%;"></td> <td style="width: 10%;"></td> <td style="width: 10%;"></td> <td style="width: 10%;"></td> <td style="width: 10%;"></td> </tr> <tr> <td></td> <td></td> <td colspan="8" style="text-align: center;"> <table border="1" style="width: 100%; border-collapse: collapse; text-align: center;"> <tr> <td style="width: 10%;"></td> <td style="width: 10%;"></td> <td style="width: 10%;"></td> <td style="width: 10%;"></td> <td style="width: 10%;"></td> <td style="width: 10%;"></td> <td style="width: 10%;"></td> <td style="width: 10%;"></td> <td style="width: 10%;"></td> <td style="width: 10%;"></td> </tr> <tr> <td></td> <td></td> <td colspan="8" style="text-align: center;"> <table border="1" style="width: 100%; border-collapse: collapse; text-align: center;"> <tr> <td style="width: 10%;"></td> <td style="width: 10%;"></td> <td style="width: 10%;"></td> <td style="width: 10%;"></td> <td style="width: 10%;"></td> <td style="width: 10%;"></td> <td style="width: 10%;"></td> <td style="width: 10%;"></td> <td style="width: 10%;"></td> <td style="width: 10%;"></td> </tr> <tr> <td></td> <td></td> <td colspan="8" style="text-align: center;"> <table border="1" style="width: 100%; border-collapse: collapse; text-align: center;"> <tr> <td style="width: 10%;"></td> <td style="width: 10%;"></td> <td style="width: 10%;"></td> <td style="width: 10%;"></td> <td style="width: 10%;"></td> <td style="width: 10%;"></td> <td style="width: 10%;"></td> <td style="width: 10%;"></td> <td style="width: 10%;"></td> <td style="width: 10%;"></td> </tr> <tr> <td></td> <td></td> <td colspan="8" style="text-align: center;"> <table border="1" style="width: 100%; border-collapse: collapse; text-align: center;"> <tr> <td style="width: 10%;"></td> <td style="width: 10%;"></td> <td style="width: 10%;"></td> <td style="width: 10%;"></td> <td style="width: 10%;"></td> <td style="width: 10%;"></td> <td style="width: 10%;"></td> <td style="width: 10%;"></td> <td style="width: 10%;"></td> <td style="width: 10%;"></td> </tr> <tr> <td></td> <td></td> <td colspan="8" style="text-align: center;"> <table border="1" style="width: 100%; border-collapse: collapse; text-align: center;"> <tr> <td style="width: 10%;"></td> <td style="width: 10%;"></td> <td style="width: 10%;"></td> <td style="width: 10%;"></td> <td style="width: 10%;"></td> <td style="width: 10%;"></td> <td style="width: 10%;"></td> <td style="width: 10%;"></td> <td style="width: 10%;"></td> <td style="width: 10%;"></td> </tr> <tr> <td></td> <td></td> <td colspan="8" style="text-align: center;"> <table border="1" style="width: 100%; border-collapse: collapse; text-align: center;"> <tr> <td style="width: 10%;"></td> <td style="width: 10%;"></td> <td style="width: 10%;"></td> <td style="width: 10%;"></td> <td style="width: 10%;"></td> <td style="width: 10%;"></td> <td style="width: 10%;"></td> <td style="width: 10%;"></td> <td style="width: 10%;"></td> <td style="width: 10%;"></td> </tr> <tr> <td></td> <td></td> <td colspan="8" style="text-align: center;"> <table border="1" style="width: 100%; border-collapse: collapse; text-align: center;"> <tr> <td style="width: 10%;"></td> <td style="width: 10%;"></td> <td style="width: 10%;"></td> <td style="width: 10%;"></td> <td style="width: 10%;"></td> <td style="width: 10%;"></td> <td style="width: 10%;"></td> <td style="width: 10%;"></td> <td style="width: 10%;"></td> <td style="width: 10%;"></td> </tr> <tr> <td></td> <td></td> <td colspan="8" style="text-align: center;"> <table border="1" style="width: 100%; border-collapse: collapse; text-align: center;"> <tr> <td style="width: 10%;"></td> <td style="width: 10%;"></td> <td style="width: 10%;"></td> <td style="width: 10%;"></td> <td style="width: 10%;"></td> <td style="width: 10%;"></td> <td style="width: 10%;"></td> <td style="width: 10%;"></td> <td style="width: 10%;"></td> <td style="width: 10%;"></td> </tr> <tr> <td></td> <td></td> <td colspan="8" style="text-align: center;"> <table border="1" style="width: 100%; border-collapse: collapse; text-align: center;"> <tr> <td style="width: 10%;"></td> <td style="width: 10%;"></td> <td style="width: 10%;"></td> <td style="width: 10%;"></td> <td style="width: 10%;"></td> <td style="width: 10%;"></td> <td style="width: 10%;"></td> <td style="width: 10%;"></td> <td style="width: 10%;"></td> <td style="width: 10%;"></td> </tr> <tr> <td></td> <td></td> <td colspan="8" style="text-align: center;"> <table border="1" style="width: 100%; border-collapse: collapse; text-align: center;"> <tr> <td style="width: 10%;"></td> <td style="width: 10%;"></td> <td style="width: 10%;"></td> <td style="width: 10%;"></td> <td style="width: 10%;"></td> <td style="width: 10%;"></td> <td style="width: 10%;"></td> <td style="width: 10%;"></td> <td style="width: 10%;"></td> <td style="width: 10%;"></td> </tr> <tr> <td></td> <td></td> <td colspan="8" style="text-align: center;"> <table border="1" style="width: 100%; border-collapse: collapse; text-align: center;"> <tr> <td style="width: 10%;"></td> <td style="width: 10%;"></td> <td style="width: 10%;"></td> <td style="width: 10%;"></td> <td style="width: 10%;"></td> <td style="width: 10%;"></td> <td style="width: 10%;"></td> <td style="width: 10%;"></td> <td style="width: 10%;"></td> <td style="width: 10%;"></td> </tr> <tr> <td></td> <td></td> <td colspan="8" style="text-align: center;"> <table border="1" style="width: 100%; border-collapse: collapse; text-align: center;"> <tr> </tr></table></td></tr></table></td></tr></table></td></tr></table></td></tr></table></td></tr></table></td></tr></table></td></tr></table></td></tr></table></td></tr></table></td></tr></table></td></tr></table></td></tr></table></td></tr></table></td></tr></table></td></tr></table>

 | | | | | | | | | | | | | | | | | | | | <table border="1" style="width: 100%; border-collapse: collapse; text-align: center;"> <tr> <td style="width: 10%;"></td> <td style="width: 10%;"></td> <td style="width: 10%;"></td> <td style="width: 10%;"></td> <td style="width: 10%;"></td> <td style="width: 10%;"></td> <td style="width: 10%;"></td> <td style="width: 10%;"></td> <td style="width: 10%;"></td> <td style="width: 10%;"></td> </tr> <tr> <td></td> <td></td> <td colspan="8" style="text-align: center;"> <table border="1" style="width: 100%; border-collapse: collapse; text-align: center;"> <tr> <td style="width: 10%;"></td> <td style="width: 10%;"></td> <td style="width: 10%;"></td> <td style="width: 10%;"></td> <td style="width: 10%;"></td> <td style="width: 10%;"></td> <td style="width: 10%;"></td> <td style="width: 10%;"></td> <td style="width: 10%;"></td> <td style="width: 10%;"></td> </tr> <tr> <td></td> <td></td> <td colspan="8" style="text-align: center;"> <table border="1" style="width: 100%; border-collapse: collapse; text-align: center;"> <tr> <td style="width: 10%;"></td> <td style="width: 10%;"></td> <td style="width: 10%;"></td> <td style="width: 10%;"></td> <td style="width: 10%;"></td> <td style="width: 10%;"></td> <td style="width: 10%;"></td> <td style="width: 10%;"></td> <td style="width: 10%;"></td> <td style="width: 10%;"></td> </tr> <tr> <td></td> <td></td> <td colspan="8" style="text-align: center;"> <table border="1" style="width: 100%; border-collapse: collapse; text-align: center;"> <tr> <td style="width: 10%;"></td> <td style="width: 10%;"></td> <td style="width: 10%;"></td> <td style="width: 10%;"></td> <td style="width: 10%;"></td> <td style="width: 10%;"></td> <td style="width: 10%;"></td> <td style="width: 10%;"></td> <td style="width: 10%;"></td> <td style="width: 10%;"></td> </tr> <tr> <td></td> <td></td> <td colspan="8" style="text-align: center;"> <table border="1" style="width: 100%; border-collapse: collapse; text-align: center;"> <tr> <td style="width: 10%;"></td> <td style="width: 10%;"></td> <td style="width: 10%;"></td> <td style="width: 10%;"></td> <td style="width: 10%;"></td> <td style="width: 10%;"></td> <td style="width: 10%;"></td> <td style="width: 10%;"></td> <td style="width: 10%;"></td> <td style="width: 10%;"></td> </tr> <tr> <td></td> <td></td> <td colspan="8" style="text-align: center;"> <table border="1" style="width: 100%; border-collapse: collapse; text-align: center;"> <tr> <td style="width: 10%;"></td> <td style="width: 10%;"></td> <td style="width: 10%;"></td> <td style="width: 10%;"></td> <td style="width: 10%;"></td> <td style="width: 10%;"></td> <td style="width: 10%;"></td> <td style="width: 10%;"></td> <td style="width: 10%;"></td> <td style="width: 10%;"></td> </tr> <tr> <td></td> <td></td> <td colspan="8" style="text-align: center;"> <table border="1" style="width: 100%; border-collapse: collapse; text-align: center;"> <tr> <td style="width: 10%;"></td> <td style="width: 10%;"></td> <td style="width: 10%;"></td> <td style="width: 10%;"></td> <td style="width: 10%;"></td> <td style="width: 10%;"></td> <td style="width: 10%;"></td> <td style="width: 10%;"></td> <td style="width: 10%;"></td> <td style="width: 10%;"></td> </tr> <tr> <td></td> <td></td> <td colspan="8" style="text-align: center;"> <table border="1" style="width: 100%; border-collapse: collapse; text-align: center;"> <tr> <td style="width: 10%;"></td> <td style="width: 10%;"></td> <td style="width: 10%;"></td> <td style="width: 10%;"></td> <td style="width: 10%;"></td> <td style="width: 10%;"></td> <td style="width: 10%;"></td> <td style="width: 10%;"></td> <td style="width: 10%;"></td> <td style="width: 10%;"></td> </tr> <tr> <td></td> <td></td> <td colspan="8" style="text-align: center;"> <table border="1" style="width: 100%; border-collapse: collapse; text-align: center;"> <tr> <td style="width: 10%;"></td> <td style="width: 10%;"></td> <td style="width: 10%;"></td> <td style="width: 10%;"></td> <td style="width: 10%;"></td> <td style="width: 10%;"></td> <td style="width: 10%;"></td> <td style="width: 10%;"></td> <td style="width: 10%;"></td> <td style="width: 10%;"></td> </tr> <tr> <td></td> <td></td> <td colspan="8" style="text-align: center;"> <table border="1" style="width: 100%; border-collapse: collapse; text-align: center;"> <tr> <td style="width: 10%;"></td> <td style="width: 10%;"></td> <td style="width: 10%;"></td> <td style="width: 10%;"></td> <td style="width: 10%;"></td> <td style="width: 10%;"></td> <td style="width: 10%;"></td> <td style="width: 10%;"></td> <td style="width: 10%;"></td> <td style="width: 10%;"></td> </tr> <tr> <td></td> <td></td> <td colspan="8" style="text-align: center;"> <table border="1" style="width: 100%; border-collapse: collapse; text-align: center;"> <tr> <td style="width: 10%;"></td> <td style="width: 10%;"></td> <td style="width: 10%;"></td> <td style="width: 10%;"></td> <td style="width: 10%;"></td> <td style="width: 10%;"></td> <td style="width: 10%;"></td> <td style="width: 10%;"></td> <td style="width: 10%;"></td> <td style="width: 10%;"></td> </tr> <tr> <td></td> <td></td> <td colspan="8" style="text-align: center;"> <table border="1" style="width: 100%; border-collapse: collapse; text-align: center;"> <tr> <td style="width: 10%;"></td> <td style="width: 10%;"></td> <td style="width: 10%;"></td> <td style="width: 10%;"></td> <td style="width: 10%;"></td> <td style="width: 10%;"></td> <td style="width: 10%;"></td> <td style="width: 10%;"></td> <td style="width: 10%;"></td> <td style="width: 10%;"></td> </tr> <tr> <td></td> <td></td> <td colspan="8" style="text-align: center;"> <table border="1" style="width: 100%; border-collapse: collapse; text-align: center;"> <tr> <td style="width: 10%;"></td> <td style="width: 10%;"></td> <td style="width: 10%;"></td> <td style="width: 10%;"></td> <td style="width: 10%;"></td> <td style="width: 10%;"></td> <td style="width: 10%;"></td> <td style="width: 10%;"></td> <td style="width: 10%;"></td> <td style="width: 10%;"></td> </tr> <tr> <td></td> <td></td> <td colspan="8" style="text-align: center;"> <table border="1" style="width: 100%; border-collapse: collapse; text-align: center;"> <tr> <td style="width: 10%;"></td> <td style="width: 10%;"></td> <td style="width: 10%;"></td> <td style="width: 10%;"></td> <td style="width: 10%;"></td> <td style="width: 10%;"></td> <td style="width: 10%;"></td> <td style="width: 10%;"></td> <td style="width: 10%;"></td> <td style="width: 10%;"></td> </tr> <tr> <td></td> <td></td> <td colspan="8" style="text-align: center;"> <table border="1" style="width: 100%; border-collapse: collapse; text-align: center;"> <tr> </tr></table></td></tr></table></td></tr></table></td></tr></table></td></tr></table></td></tr></table></td></tr></table></td></tr></table></td></tr></table></td></tr></table></td></tr></table></td></tr></table></td></tr></table></td></tr></table></td></tr></table>

 | | | | | | | | | | | | | | | | | | | | <table border="1" style="width: 100%; border-collapse: collapse; text-align: center;"> <tr> <td style="width: 10%;"></td> <td style="width: 10%;"></td> <td style="width: 10%;"></td> <td style="width: 10%;"></td> <td style="width: 10%;"></td> <td style="width: 10%;"></td> <td style="width: 10%;"></td> <td style="width: 10%;"></td> <td style="width: 10%;"></td> <td style="width: 10%;"></td> </tr> <tr> <td></td> <td></td> <td colspan="8" style="text-align: center;"> <table border="1" style="width: 100%; border-collapse: collapse; text-align: center;"> <tr> <td style="width: 10%;"></td> <td style="width: 10%;"></td> <td style="width: 10%;"></td> <td style="width: 10%;"></td> <td style="width: 10%;"></td> <td style="width: 10%;"></td> <td style="width: 10%;"></td> <td style="width: 10%;"></td> <td style="width: 10%;"></td> <td style="width: 10%;"></td> </tr> <tr> <td></td> <td></td> <td colspan="8" style="text-align: center;"> <table border="1" style="width: 100%; border-collapse: collapse; text-align: center;"> <tr> <td style="width: 10%;"></td> <td style="width: 10%;"></td> <td style="width: 10%;"></td> <td style="width: 10%;"></td> <td style="width: 10%;"></td> <td style="width: 10%;"></td> <td style="width: 10%;"></td> <td style="width: 10%;"></td> <td style="width: 10%;"></td> <td style="width: 10%;"></td> </tr> <tr> <td></td> <td></td> <td colspan="8" style="text-align: center;"> <table border="1" style="width: 100%; border-collapse: collapse; text-align: center;"> <tr> <td style="width: 10%;"></td> <td style="width: 10%;"></td> <td style="width: 10%;"></td> <td style="width: 10%;"></td> <td style="width: 10%;"></td> <td style="width: 10%;"></td> <td style="width: 10%;"></td> <td style="width: 10%;"></td> <td style="width: 10%;"></td> <td style="width: 10%;"></td> </tr> <tr> <td></td> <td></td> <td colspan="8" style="text-align: center;"> <table border="1" style="width: 100%; border-collapse: collapse; text-align: center;"> <tr> <td style="width: 10%;"></td> <td style="width: 10%;"></td> <td style="width: 10%;"></td> <td style="width: 10%;"></td> <td style="width: 10%;"></td> <td style="width: 10%;"></td> <td style="width: 10%;"></td> <td style="width: 10%;"></td> <td style="width: 10%;"></td> <td style="width: 10%;"></td> </tr> <tr> <td></td> <td></td> <td colspan="8" style="text-align: center;"> <table border="1" style="width: 100%; border-collapse: collapse; text-align: center;"> <tr> <td style="width: 10%;"></td> <td style="width: 10%;"></td> <td style="width: 10%;"></td> <td style="width: 10%;"></td> <td style="width: 10%;"></td> <td style="width: 10%;"></td> <td style="width: 10%;"></td> <td style="width: 10%;"></td> <td style="width: 10%;"></td> <td style="width: 10%;"></td> </tr> <tr> <td></td> <td></td> <td colspan="8" style="text-align: center;"> <table border="1" style="width: 100%; border-collapse: collapse; text-align: center;"> <tr> <td style="width: 10%;"></td> <td style="width: 10%;"></td> <td style="width: 10%;"></td> <td style="width: 10%;"></td> <td style="width: 10%;"></td> <td style="width: 10%;"></td> <td style="width: 10%;"></td> <td style="width: 10%;"></td> <td style="width: 10%;"></td> <td style="width: 10%;"></td> </tr> <tr> <td></td> <td></td> <td colspan="8" style="text-align: center;"> <table border="1" style="width: 100%; border-collapse: collapse; text-align: center;"> <tr> <td style="width: 10%;"></td> <td style="width: 10%;"></td> <td style="width: 10%;"></td> <td style="width: 10%;"></td> <td style="width: 10%;"></td> <td style="width: 10%;"></td> <td style="width: 10%;"></td> <td style="width: 10%;"></td> <td style="width: 10%;"></td> <td style="width: 10%;"></td> </tr> <tr> <td></td> <td></td> <td colspan="8" style="text-align: center;"> <table border="1" style="width: 100%; border-collapse: collapse; text-align: center;"> <tr> <td style="width: 10%;"></td> <td style="width: 10%;"></td> <td style="width: 10%;"></td> <td style="width: 10%;"></td> <td style="width: 10%;"></td> <td style="width: 10%;"></td> <td style="width: 10%;"></td> <td style="width: 10%;"></td> <td style="width: 10%;"></td> <td style="width: 10%;"></td> </tr> <tr> <td></td> <td></td> <td colspan="8" style="text-align: center;"> <table border="1" style="width: 100%; border-collapse: collapse; text-align: center;"> <tr> <td style="width: 10%;"></td> <td style="width: 10%;"></td> <td style="width: 10%;"></td> <td style="width: 10%;"></td> <td style="width: 10%;"></td> <td style="width: 10%;"></td> <td style="width: 10%;"></td> <td style="width: 10%;"></td> <td style="width: 10%;"></td> <td style="width: 10%;"></td> </tr> <tr> <td></td> <td></td> <td colspan="8" style="text-align: center;"> <table border="1" style="width: 100%; border-collapse: collapse; text-align: center;"> <tr> <td style="width: 10%;"></td> <td style="width: 10%;"></td> <td style="width: 10%;"></td> <td style="width: 10%;"></td> <td style="width: 10%;"></td> <td style="width: 10%;"></td> <td style="width: 10%;"></td> <td style="width: 10%;"></td> <td style="width: 10%;"></td> <td style="width: 10%;"></td> </tr> <tr> <td></td> <td></td> <td colspan="8" style="text-align: center;"> <table border="1" style="width: 100%; border-collapse: collapse; text-align: center;"> <tr> <td style="width: 10%;"></td> <td style="width: 10%;"></td> <td style="width: 10%;"></td> <td style="width: 10%;"></td> <td style="width: 10%;"></td> <td style="width: 10%;"></td> <td style="width: 10%;"></td> <td style="width: 10%;"></td> <td style="width: 10%;"></td> <td style="width: 10%;"></td> </tr> <tr> <td></td> <td></td> <td colspan="8" style="text-align: center;"> <table border="1" style="width: 100%; border-collapse: collapse; text-align: center;"> <tr> <td style="width: 10%;"></td> <td style="width: 10%;"></td> <td style="width: 10%;"></td> <td style="width: 10%;"></td> <td style="width: 10%;"></td> <td style="width: 10%;"></td> <td style="width: 10%;"></td> <td style="width: 10%;"></td> <td style="width: 10%;"></td> <td style="width: 10%;"></td> </tr> <tr> <td></td> <td></td> <td colspan="8" style="text-align: center;"> <table border="1" style="width: 100%; border-collapse: collapse; text-align: center;"> <tr> </tr></table></td></tr></table></td></tr></table></td></tr></table></td></tr></table></td></tr></table></td></tr></table></td></tr></table></td></tr></table></td></tr></table></td></tr></table></td></tr></table></td></tr></table></td></tr></table>

 | | | | | | | | | | | | | | | | | | | | <table border="1" style="width: 100%; border-collapse: collapse; text-align: center;"> <tr> <td style="width: 10%;"></td> <td style="width: 10%;"></td> <td style="width: 10%;"></td> <td style="width: 10%;"></td> <td style="width: 10%;"></td> <td style="width: 10%;"></td> <td style="width: 10%;"></td> <td style="width: 10%;"></td> <td style="width: 10%;"></td> <td style="width: 10%;"></td> </tr> <tr> <td></td> <td></td> <td colspan="8" style="text-align: center;"> <table border="1" style="width: 100%; border-collapse: collapse; text-align: center;"> <tr> <td style="width: 10%;"></td> <td style="width: 10%;"></td> <td style="width: 10%;"></td> <td style="width: 10%;"></td> <td style="width: 10%;"></td> <td style="width: 10%;"></td> <td style="width: 10%;"></td> <td style="width: 10%;"></td> <td style="width: 10%;"></td> <td style="width: 10%;"></td> </tr> <tr> <td></td> <td></td> <td colspan="8" style="text-align: center;"> <table border="1" style="width: 100%; border-collapse: collapse; text-align: center;"> <tr> <td style="width: 10%;"></td> <td style="width: 10%;"></td> <td style="width: 10%;"></td> <td style="width: 10%;"></td> <td style="width: 10%;"></td> <td style="width: 10%;"></td> <td style="width: 10%;"></td> <td style="width: 10%;"></td> <td style="width: 10%;"></td> <td style="width: 10%;"></td> </tr> <tr> <td></td> <td></td> <td colspan="8" style="text-align: center;"> <table border="1" style="width: 100%; border-collapse: collapse; text-align: center;"> <tr> <td style="width: 10%;"></td> <td style="width: 10%;"></td> <td style="width: 10%;"></td> <td style="width: 10%;"></td> <td style="width: 10%;"></td> <td style="width: 10%;"></td> <td style="width: 10%;"></td> <td style="width: 10%;"></td> <td style="width: 10%;"></td> <td style="width: 10%;"></td> </tr> <tr> <td></td> <td></td> <td colspan="8" style="text-align: center;"> <table border="1" style="width: 100%; border-collapse: collapse; text-align: center;"> <tr> <td style="width: 10%;"></td> <td style="width: 10%;"></td> <td style="width: 10%;"></td> <td style="width: 10%;"></td> <td style="width: 10%;"></td> <td style="width: 10%;"></td> <td style="width: 10%;"></td> <td style="width: 10%;"></td> <td style="width: 10%;"></td> <td style="width: 10%;"></td> </tr> <tr> <td></td> <td></td> <td colspan="8" style="text-align: center;"> <table border="1" style="width: 100%; border-collapse: collapse; text-align: center;"> <tr> <td style="width: 10%;"></td> <td style="width: 10%;"></td> <td style="width: 10%;"></td> <td style="width: 10%;"></td> <td style="width: 10%;"></td> <td style="width: 10%;"></td> <td style="width: 10%;"></td> <td style="width: 10%;"></td> <td style="width: 10%;"></td> <td style="width: 10%;"></td> </tr> <tr> <td></td> <td></td> <td colspan="8" style="text-align: center;"> <table border="1" style="width: 100%; border-collapse: collapse; text-align: center;"> <tr> <td style="width: 10%;"></td> <td style="width: 10%;"></td> <td style="width: 10%;"></td> <td style="width: 10%;"></td> <td style="width: 10%;"></td> <td style="width: 10%;"></td> <td style="width: 10%;"></td> <td style="width: 10%;"></td> <td style="width: 10%;"></td> <td style="width: 10%;"></td> </tr> <tr> <td></td> <td></td> <td colspan="8" style="text-align: center;"> <table border="1" style="width: 100%; border-collapse: collapse; text-align: center;"> <tr> <td style="width: 10%;"></td> <td style="width: 10%;"></td> <td style="width: 10%;"></td> <td style="width: 10%;"></td> <td style="width: 10%;"></td> <td style="width: 10%;"></td> <td style="width: 10%;"></td> <td style="width: 10%;"></td> <td style="width: 10%;"></td> <td style="width: 10%;"></td> </tr> <tr> <td></td> <td></td> <td colspan="8" style="text-align: center;"> <table border="1" style="width: 100%; border-collapse: collapse; text-align: center;"> <tr> <td style="width: 10%;"></td> <td style="width: 10%;"></td> <td style="width: 10%;"></td> <td style="width: 10%;"></td> <td style="width: 10%;"></td> <td style="width: 10%;"></td> <td style="width: 10%;"></td> <td style="width: 10%;"></td> <td style="width: 10%;"></td> <td style="width: 10%;"></td> </tr> <tr> <td></td> <td></td> <td colspan="8" style="text-align: center;"> <table border="1" style="width: 100%; border-collapse: collapse; text-align: center;"> <tr> <td style="width: 10%;"></td> <td style="width: 10%;"></td> <td style="width: 10%;"></td> <td style="width: 10%;"></td> <td style="width: 10%;"></td> <td style="width: 10%;"></td> <td style="width: 10%;"></td> <td style="width: 10%;"></td> <td style="width: 10%;"></td> <td style="width: 10%;"></td> </tr> <tr> <td></td> <td></td> <td colspan="8" style="text-align: center;"> <table border="1" style="width: 100%; border-collapse: collapse; text-align: center;"> <tr> <td style="width: 10%;"></td> <td style="width: 10%;"></td> <td style="width: 10%;"></td> <td style="width: 10%;"></td> <td style="width: 10%;"></td> <td style="width: 10%;"></td> <td style="width: 10%;"></td> <td style="width: 10%;"></td> <td style="width: 10%;"></td> <td style="width: 10%;"></td> </tr> <tr> <td></td> <td></td> <td colspan="8" style="text-align: center;"> <table border="1" style="width: 100%; border-collapse: collapse; text-align: center;"> <tr> <td style="width: 10%;"></td> <td style="width: 10%;"></td> <td style="width: 10%;"></td> <td style="width: 10%;"></td> <td style="width: 10%;"></td> <td style="width: 10%;"></td> <td style="width: 10%;"></td> <td style="width: 10%;"></td> <td style="width: 10%;"></td> <td style="width: 10%;"></td> </tr> <tr> <td></td> <td></td> <td colspan="8" style="text-align: center;"> <table border="1" style="width: 100%; border-collapse: collapse; text-align: center;"> <tr> </tr></table></td></tr></table></td></tr></table></td></tr></table></td></tr></table></td></tr></table></td></tr></table></td></tr></table></td></tr></table></td></tr></table></td></tr></table></td></tr></table></td></tr></table>

 | | | | | | | | | | | | | | | | | | | | <table border="1" style="width: 100%; border-collapse: collapse; text-align: center;"> <tr> <td style="width: 10%;"></td> <td style="width: 10%;"></td> <td style="width: 10%;"></td> <td style="width: 10%;"></td> <td style="width: 10%;"></td> <td style="width: 10%;"></td> <td style="width: 10%;"></td> <td style="width: 10%;"></td> <td style="width: 10%;"></td> <td style="width: 10%;"></td> </tr> <tr> <td></td> <td></td> <td colspan="8" style="text-align: center;"> <table border="1" style="width: 100%; border-collapse: collapse; text-align: center;"> <tr> <td style="width: 10%;"></td> <td style="width: 10%;"></td> <td style="width: 10%;"></td> <td style="width: 10%;"></td> <td style="width: 10%;"></td> <td style="width: 10%;"></td> <td style="width: 10%;"></td> <td style="width: 10%;"></td> <td style="width: 10%;"></td> <td style="width: 10%;"></td> </tr> <tr> <td></td> <td></td> <td colspan="8" style="text-align: center;"> <table border="1" style="width: 100%; border-collapse: collapse; text-align: center;"> <tr> <td style="width: 10%;"></td> <td style="width: 10%;"></td> <td style="width: 10%;"></td> <td style="width: 10%;"></td> <td style="width: 10%;"></td> <td style="width: 10%;"></td> <td style="width: 10%;"></td> <td style="width: 10%;"></td> <td style="width: 10%;"></td> <td style="width: 10%;"></td> </tr> <tr> <td></td> <td></td> <td colspan="8" style="text-align: center;"> <table border="1" style="width: 100%; border-collapse: collapse; text-align: center;"> <tr> <td style="width: 10%;"></td> <td style="width: 10%;"></td> <td style="width: 10%;"></td> <td style="width: 10%;"></td> <td style="width: 10%;"></td> <td style="width: 10%;"></td> <td style="width: 10%;"></td> <td style="width: 10%;"></td> <td style="width: 10%;"></td> <td style="width: 10%;"></td> </tr> <tr> <td></td> <td></td> <td colspan="8" style="text-align: center;"> <table border="1" style="width: 100%; border-collapse: collapse; text-align: center;"> <tr> <td style="width: 10%;"></td> <td style="width: 10%;"></td> <td style="width: 10%;"></td> <td style="width: 10%;"></td> <td style="width: 10%;"></td> <td style="width: 10%;"></td> <td style="width: 10%;"></td> <td style="width: 10%;"></td> <td style="width: 10%;"></td> <td style="width: 10%;"></td> </tr> <tr> <td></td> <td></td> <td colspan="8" style="text-align: center;"> <table border="1" style="width: 100%; border-collapse: collapse; text-align: center;"> <tr> <td style="width: 10%;"></td> <td style="width: 10%;"></td> <td style="width: 10%;"></td> <td style="width: 10%;"></td> <td style="width: 10%;"></td> <td style="width: 10%;"></td> <td style="width: 10%;"></td> <td style="width: 10%;"></td> <td style="width: 10%;"></td> <td style="width: 10%;"></td> </tr> <tr> <td></td> <td></td> <td colspan="8" style="text-align: center;"> <table border="1" style="width: 100%; border-collapse: collapse; text-align: center;"> <tr> <td style="width: 10%;"></td> <td style="width: 10%;"></td> <td style="width: 10%;"></td> <td style="width: 10%;"></td> <td style="width: 10%;"></td> <td style="width: 10%;"></td> <td style="width: 10%;"></td> <td style="width: 10%;"></td> <td style="width: 10%;"></td> <td style="width: 10%;"></td> </tr> <tr> <td></td> <td></td> <td colspan="8" style="text-align: center;"> <table border="1" style="width: 100%; border-collapse: collapse; text-align: center;"> <tr> <td style="width: 10%;"></td> <td style="width: 10%;"></td> <td style="width: 10%;"></td> <td style="width: 10%;"></td> <td style="width: 10%;"></td> <td style="width: 10%;"></td> <td style="width: 10%;"></td> <td style="width: 10%;"></td> <td style="width: 10%;"></td> <td style="width: 10%;"></td> </tr> <tr> <td></td> <td></td> <td colspan="8" style="text-align: center;"> <table border="1" style="width: 100%; border-collapse: collapse; text-align: center;"> <tr> <td style="width: 10%;"></td> <td style="width: 10%;"></td> <td style="width: 10%;"></td> <td style="width: 10%;"></td> <td style="width: 10%;"></td> <td style="width: 10%;"></td> <td style="width: 10%;"></td> <td style="width: 10%;"></td> <td style="width: 10%;"></td> <td style="width: 10%;"></td> </tr> <tr> <td></td> <td></td> <td colspan="8" style="text-align: center;"> <table border="1" style="width: 100%; border-collapse: collapse; text-align: center;"> <tr> <td style="width: 10%;"></td> <td style="width: 10%;"></td> <td style="width: 10%;"></td> <td style="width: 10%;"></td> <td style="width: 10%;"></td> <td style="width: 10%;"></td> <td style="width: 10%;"></td> <td style="width: 10%;"></td> <td style="width: 10%;"></td> <td style="width: 10%;"></td> </tr> <tr> <td></td> <td></td> <td colspan="8" style="text-align: center;"> <table border="1" style="width: 100%; border-collapse: collapse; text-align: center;"> <tr> <td style="width: 10%;"></td> <td style="width: 10%;"></td> <td style="width: 10%;"></td> <td style="width: 10%;"></td> <td style="width: 10%;"></td> <td style="width: 10%;"></td> <td style="width: 10%;"></td> <td style="width: 10%;"></td> <td style="width: 10%;"></td> <td style="width: 10%;"></td> </tr> <tr> <td></td> <td></td> <td colspan="8" style="text-align: center;"> <table border="1" style="width: 100%; border-collapse: collapse; text-align: center;"> <tr> </tr></table></td></tr></table></td></tr></table></td></tr></table></td></tr></table></td></tr></table></td></tr></table></td></tr></table></td></tr></table></td></tr></table></td></tr></table></td></tr></table>

 | | | | | | | | | | | | | | | | | | | | <table border="1" style="width: 100%; border-collapse: collapse; text-align: center;"> <tr> <td style="width: 10%;"></td> <td style="width: 10%;"></td> <td style="width: 10%;"></td> <td style="width: 10%;"></td> <td style="width: 10%;"></td> <td style="width: 10%;"></td> <td style="width: 10%;"></td> <td style="width: 10%;"></td> <td style="width: 10%;"></td> <td style="width: 10%;"></td> </tr> <tr> <td></td> <td></td> <td colspan="8" style="text-align: center;"> <table border="1" style="width: 100%; border-collapse: collapse; text-align: center;"> <tr> <td style="width: 10%;"></td> <td style="width: 10%;"></td> <td style="width: 10%;"></td> <td style="width: 10%;"></td> <td style="width: 10%;"></td> <td style="width: 10%;"></td> <td style="width: 10%;"></td> <td style="width: 10%;"></td> <td style="width: 10%;"></td> <td style="width: 10%;"></td> </tr> <tr> <td></td> <td></td> <td colspan="8" style="text-align: center;"> <table border="1" style="width: 100%; border-collapse: collapse; text-align: center;"> <tr> <td style="width: 10%;"></td> <td style="width: 10%;"></td> <td style="width: 10%;"></td> <td style="width: 10%;"></td> <td style="width: 10%;"></td> <td style="width: 10%;"></td> <td style="width: 10%;"></td> <td style="width: 10%;"></td> <td style="width:
10%;"></td> <td style="width: 10%;"></td> </tr> <tr> <td></td> <td></td> <td colspan="8" style="text-align: center;"> <table border="1" style="width: 100%; border-collapse: collapse; text-align: center;"> <tr> <td style="width: 10%;"></td> <td style="width: 10%;"></td> <td style="width: 10%;"></td> <td style="width: 10%;"></td> <td style="width: 10%;"></td> <td style="width: 10%;"></td> <td style="width: 10%;"></td> <td style="width: 10%;"></td> <td style="width: 10%;"></td> <td style="width: 10%;"></td> </tr> <tr> <td></td> <td></td> <td colspan="8" style="text-align: center;"> <table border="1" style="width: 100%; border-collapse: collapse; text-align: center;"> <tr> <td style="width: 10%;"></td> <td style="width: 10%;"></td> <td style="width: 10%;"></td> <td style="width: 10%;"></td> <td style="width: 10%;"></td> <td style="width: 10%;"></td> <td style="width: 10%;"></td> <td style="width: 10%;"></td> <td style="width: 10%;"></td> <td style="width: 10%;"></td> </tr> <tr> <td></td> <td></td> <td colspan="8" style="text-align: center;"> <table border="1" style="width: 100%; border-collapse: collapse; text-align: center;"> <tr> <td style="width: 10%;"></td> <td style="width: 10%;"></td> <td style="width: 10%;"></td> <td style="width: 10%;"></td> <td style="width: 10%;"></td> <td style="width: 10%;"></td> <td style="width: 10%;"></td> <td style="width: 10%;"></td> <td style="width: 10%;"></td> <td style="width: 10%;"></td> </tr> <tr> <td></td> <td></td> <td colspan="8" style="text-align: center;"> <table border="1" style="width: 100%; border-collapse: collapse; text-align: center;"> <tr> <td style="width: 10%;"></td> <td style="width: 10%;"></td> <td style="width: 10%;"></td> <td style="width: 10%;"></td> <td style="width: 10%;"></td> <td style="width: 10%;"></td> <td style="width: 10%;"></td> <td style="width: 10%;"></td> <td style="width: 10%;"></td> <td style="width: 10%;"></td> </tr> <tr> <td></td> <td></td> <td colspan="8" style="text-align: center;"> <table border="1" style="width: 100%; border-collapse: collapse; text-align: center;"> <tr> <td style="width: 10%;"></td> <td style="width: 10%;"></td> <td style="width: 10%;"></td> <td style="width: 10%;"></td> <td style="width: 10%;"></td> <td style="width: 10%;"></td> <td style="width: 10%;"></td> <td style="width: 10%;"></td> <td style="width: 10%;"></td> <td style="width: 10%;"></td> </tr> <tr> <td></td> <td></td> <td colspan="8" style="text-align: center;"> <table border="1" style="width: 100%; border-collapse: collapse; text-align: center;"> <tr> <td style="width: 10%;"></td> <td style="width: 10%;"></td> <td style="width: 10%;"></td> <td style="width: 10%;"></td> <td style="width: 10%;"></td> <td style="width: 10%;"></td> <td style="width: 10%;"></td> <td style="width: 10%;"></td> <td style="width: 10%;"></td> <td style="width: 10%;"></td> </tr> <tr> <td></td> <td></td> <td colspan="8" style="text-align: center;"> <table border="1" style="width: 100%; border-collapse: collapse; text-align: center;"> <tr> <td style="width: 10%;"></td> <td style="width: 10%;"></td> <td style="width: 10%;"></td> <td style="width: 10%;"></td> <td style="width: 10%;"></td> <td style="width: 10%;"></td> <td style="width: 10%;"></td> <td style="width: 10%;"></td> <td style="width: 10%;"></td> <td style="width: 10%;"></td> </tr> <tr> <td></td> <td></td> <td colspan="8" style="text-align: center;"> <table border="1" style="width: 100%; border-collapse: collapse; text-align: center;"> <tr> </tr></table></td></tr></table></td></tr></table></td></tr></table></td></tr></table></td></tr></table></td></tr></table></td></tr></table></td></tr></table></td></tr></table></td></tr></table>

 | | | | | | | | | | | | | | | | | | | | <table border="1" style="width: 100%; border-collapse: collapse; text-align: center;"> <tr> <td style="width: 10%;"></td> <td style="width: 10%;"></td> <td style="width: 10%;"></td> <td style="width: 10%;"></td> <td style="width: 10%;"></td> <td style="width: 10%;"></td> <td style="width: 10%;"></td> <td style="width: 10%;"></td> <td style="width: 10%;"></td> <td style="width: 10%;"></td> </tr> <tr> <td></td> <td></td> <td colspan="8" style="text-align: center;"> <table border="1" style="width: 100%; border-collapse: collapse; text-align: center;"> <tr> <td style="width: 10%;"></td> <td style="width: 10%;"></td> <td style="width: 10%;"></td> <td style="width: 10%;"></td> <td style="width: 10%;"></td> <td style="width: 10%;"></td> <td style="width: 10%;"></td> <td style="width: 10%;"></td> <td style="width: 10%;"></td> <td style="width: 10%;"></td> </tr> <tr> <td></td> <td></td> <td colspan="8" style="text-align: center;"> <table border="1" style="width: 100%; border-collapse: collapse; text-align: center;"> <tr> <td style="width: 10%;"></td> <td style="width: 10%;"></td> <td style="width: 10%;"></td> <td style="width: 10%;"></td> <td style="width: 10%;"></td> <td style="width: 10%;"></td> <td style="width: 10%;"></td> <td style="width: 10%;"></td> <td style="width: 10%;"></td> <td style="width: 10%;"></td> </tr> <tr> <td></td> <td></td> <td colspan="8" style="text-align: center;"> <table border="1" style="width: 100%; border-collapse: collapse; text-align: center;"> <tr> <td style="width: 10%;"></td> <td style="width: 10%;"></td> <td style="width: 10%;"></td> <td style="width: 10%;"></td> <td style="width: 10%;"></td> <td style="width: 10%;"></td> <td style="width: 10%;"></td> <td style="width: 10%;"></td> <td style="width: 10%;"></td> <td style="width: 10%;"></td> </tr> <tr> <td></td> <td></td> <td colspan="8" style="text-align: center;"> <table border="1" style="width: 100%; border-collapse: collapse; text-align: center;"> <tr> <td style="width: 10%;"></td> <td style="width: 10%;"></td> <td style="width: 10%;"></td> <td style="width: 10%;"></td> <td style="width: 10%;"></td> <td style="width: 10%;"></td> <td style="width: 10%;"></td> <td style="width: 10%;"></td> <td style="width: 10%;"></td> <td style="width: 10%;"></td> </tr> <tr> <td></td> <td></td> <td colspan="8" style="text-align: center;"> <table border="1" style="width: 100%; border-collapse: collapse; text-align: center;"> <tr> <td style="width: 10%;"></td> <td style="width: 10%;"></td> <td style="width: 10%;"></td> <td style="width: 10%;"></td> <td style="width: 10%;"></td> <td style="width: 10%;"></td> <td style="width: 10%;"></td> <td style="width: 10%;"></td> <td style="width: 10%;"></td> <td style="width: 10%;"></td> </tr> <tr> <td></td> <td></td> <td colspan="8" style="text-align: center;"> <table border="1" style="width: 100%; border-collapse: collapse; text-align: center;"> <tr> <td style="width: 10%;"></td> <td style="width: 10%;"></td> <td style="width: 10%;"></td> <td style="width: 10%;"></td> <td style="width: 10%;"></td> <td style="width: 10%;"></td> <td style="width: 10%;"></td> <td style="width: 10%;"></td> <td style="width: 10%;"></td> <td style="width: 10%;"></td> </tr> <tr> <td></td> <td></td> <td colspan="8" style="text-align: center;"> <table border="1" style="width: 100%; border-collapse: collapse; text-align: center;"> <tr> <td style="width: 10%;"></td> <td style="width:
10%;"></td> <td style="width: 10%;"></td> <td style="width: 10%;"></td> <td style="width: 10%;"></td> <td style="width: 10%;"></td> <td style="width: 10%;"></td> <td style="width: 10%;"></td> <td style="width: 10%;"></td> <td style="width: 10%;"></td> </tr> <tr> <td></td> <td></td> <td colspan="8" style="text-align: center;"> <table border="1" style="width: 100%; border-collapse: collapse; text-align: center;"> <tr> <td style="width: 10%;"></td> <td style="width: 10%;"></td> <td style="width: 10%;"></td> <td style="width: 10%;"></td> <td style="width: 10%;"></td> <td style="width: 10%;"></td> <td style="width: 10%;"></td> <td style="width: 10%;"></td> <td style="width: 10%;"></td> <td style="width: 10%;"></td> </tr> <tr> <td></td> <td></td> <td colspan="8" style="text-align: center;"> <table border="1" style="width: 100%; border-collapse: collapse; text-align: center;"> <tr> </tr></table></td></tr></table></td></tr></table></td></tr></table></td></tr></table></td></tr></table></td></tr></table></td></tr></table></td></tr></table></td></tr></table>

 | | | | | | | | | | | | | | | | | | | | <table border="1" style="width: 100%; border-collapse: collapse; text-align: center;"> <tr> <td style="width: 10%;"></td> <td style="width: 10%;"></td> <td style="width: 10%;"></td> <td style="width: 10%;"></td> <td style="width: 10%;"></td> <td style="width: 10%;"></td> <td style="width: 10%;"></td> <td style="width: 10%;"></td> <td style="width: 10%;"></td> <td style="width: 10%;"></td> </tr> <tr> <td></td> <td></td> <td colspan="8" style="text-align: center;"> <table border="1" style="width: 100%; border-collapse: collapse; text-align: center;"> <tr> <td style="width: 10%;"></td> <td style="width: 10%;"></td> <td style="width: 10%;"></td> <td style="width: 10%;"></td> <td style="width: 10%;"></td> <td style="width: 10%;"></td> <td style="width: 10%;"></td> <td style="width: 10%;"></td> <td style="width: 10%;"></td> <td style="width: 10%;"></td> </tr> <tr> <td></td> <td></td> <td colspan="8" style="text-align: center;"> <table border="1" style="width: 100%; border-collapse: collapse; text-align: center;"> <tr> <td style="width: 10%;"></td> <td style="width: 10%;"></td> <td style="width: 10%;"></td> <td style="width: 10%;"></td> <td style="width: 10%;"></td> <td style="width: 10%;"></td> <td style="width: 10%;"></td> <td style="width: 10%;"></td> <td style="width: 10%;"></td> <td style="width: 10%;"></td> </tr> <tr> <td></td> <td></td> <td colspan="8" style="text-align: center;"> <table border="1" style="width: 100%; border-collapse: collapse; text-align: center;"> <tr> <td style="width: 10%;"></td> <td style="width: 10%;"></td> <td style="width: 10%;"></td> <td style="width: 10%;"></td> <td style="width: 10%;"></td> <td style="width: 10%;"></td> <td style="width: 10%;"></td> <td style="width: 10%;"></td> <td style="width: 10%;"></td> <td style="width: 10%;"></td> </tr> <tr> <td></td> <td></td> <td colspan="8" style="text-align: center;"> <table border="1" style="width: 100%; border-collapse: collapse; text-align: center;"> <tr> <td style="width: 10%;"></td> <td style="width: 10%;"></td> <td style="width: 10%;"></td> <td style="width: 10%;"></td> <td style="width: 10%;"></td> <td style="width: 10%;"></td> <td style="width: 10%;"></td> <td style="width: 10%;"></td> <td style="width: 10%;"></td> <td style="width: 10%;"></td> </tr> <tr> <td></td> <td></td> <td colspan="8" style="text-align: center;"> <table border="1" style="width: 100%; border-collapse: collapse; text-align: center;"> <tr> <td style="width: 10%;"></td> <td style="width: 10%;"></td> <td style="width: 10%;"></td> <td style="width: 10%;"></td> <td style="width: 10%;"></td> <td style="width: 10%;"></td> <td style="width: 10%;"></td> <td style="width: 10%;"></td> <td style="width: 10%;"></td> <td style="width: 10%;"></td> </tr> <tr> <td></td> <td></td> <td colspan="8" style="text-align: center;"> <table border="1" style="width: 100%; border-collapse: collapse; text-align: center;"> <tr> <td style="width: 10%;"></td> <td style="width: 10%;"></td> <td style="width: 10%;"></td> <td style="width: 10%;"></td> <td style="width: 10%;"></td> <td style="width: 10%;"></td> <td style="width: 10%;"></td> <td style="width: 10%;"></td> <td style="width: 10%;"></td> <td style="width: 10%;"></td> </tr> <tr> <td></td> <td></td> <td colspan="8" style="text-align: center;"> <table border="1" style="width: 100%; border-collapse: collapse; text-align: center;"> <tr> <td style="width: 10%;"></td> <td style="width: 10%;"></td> <td style="width: 10%;"></td> <td style="width: 10%;"></td> <td style="width: 10%;"></td> <td style="width: 10%;"></td> <td style="width: 10%;"></td> <td style="width: 10%;"></td> <td style="width: 10%;"></td> <td style="width: 10%;"></td> </tr> <tr> <td></td> <td></td> <td colspan="8" style="text-align: center;"> <table border="1" style="width: 100%; border-collapse: collapse; text-align: center;"> <tr> </tr></table></td></tr></table></td></tr></table></td></tr></table></td></tr></table></td></tr></table></td></tr></table></td></tr></table></td></tr></table>

 | | | | | | | | | | | | | | | | | | | | <table border="1" style="width: 100%; border-collapse: collapse; text-align: center;"> <tr> <td style="width: 10%;"></td> <td style="width: 10%;"></td> <td style="width: 10%;"></td> <td style="width: 10%;"></td> <td style="width: 10%;"></td> <td style="width: 10%;"></td> <td style="width: 10%;"></td> <td style="width: 10%;"></td> <td style="width: 10%;"></td> <td style="width: 10%;"></td> </tr> <tr> <td></td> <td></td> <td colspan="8" style="text-align: center;"> <table border="1" style="width: 100%; border-collapse: collapse; text-align: center;"> <tr> <td style="width: 10%;"></td> <td style="width: 10%;"></td> <td style="width: 10%;"></td> <td style="width: 10%;"></td> <td style="width: 10%;"></td> <td style="width: 10%;"></td> <td style="width: 10%;"></td> <td style="width: 10%;"></td> <td style="width: 10%;"></td> <td style="width: 10%;"></td> </tr> <tr> <td></td> <td></td> <td colspan="8" style="text-align: center;"> <table border="1" style="width: 100%; border-collapse: collapse; text-align: center;"> <tr> <td style="width: 10%;"></td> <td style="width: 10%;"></td> <td style="width: 10%;"></td> <td style="width: 10%;"></td> <td style="width: 10%;"></td> <td style="width: 10%;"></td> <td style="width: 10%;"></td> <td style="width: 10%;"></td> <td style="width: 10%;"></td> <td style="width: 10%;"></td> </tr> <tr> <td></td> <td></td> <td colspan="8" style="text-align: center;"> <table border="1" style="width: 100%; border-collapse: collapse; text-align: center;"> <tr> <td style="width: 10%;"></td> <td style="width: 10%;"></td> <td style="width: 10%;"></td> <td style="width: 10%;"></td> <td style="width: 10%;"></td> <td style="width: 10%;"></td> <td style="width: 10%;"></td> <td style="width: 10%;"></td> <td style="width: 10%;"></td> <td style="width: 10%;"></td> </tr> <tr> <td></td> <td></td> <td colspan="8" style="text-align: center;"> <table border="1" style="width: 100%; border-collapse: collapse; text-align: center;"> <tr> <td style="width: 10%;"></td> <td style="width: 10%;"></td> <td style="width: 10%;"></td> <td style="width: 10%;"></td> <td style="width: 10%;"></td> <td style="width: 10%;"></td> <td style="width: 10%;"></td> <td style="width: 10%;"></td> <td style="width: 10%;"></td> <td style="width: 10%;"></td> </tr> <tr> <td></td> <td></td> <td colspan="8" style="text-align: center;"> <table border="1" style="width: 100%; border-collapse: collapse; text-align: center;"> <tr> <td style="width: 10%;"></td> <td style="width: 10%;"></td> <td style="width: 10%;"></td> <td style="width: 10%;"></td> <td style="width: 10%;"></td> <td style="width: 10%;"></td> <td style="width: 10%;"></td> <td style="width: 10%;"></td> <td style="width: 10%;"></td> <td style="width: 10%;"></td> </tr> <tr> <td></td> <td></td> <td colspan="8" style="text-align: center;"> <table border="1" style="width: 100%; border-collapse: collapse; text-align: center;"> <tr> <td style="width: 10%;"></td> <td style="width: 10%;"></td> <td style="width: 10%;"></td> <td style="width: 10%;"></td> <td style="width: 10%;"></td> <td style="width: 10%;"></td> <td style="width: 10%;"></td> <td style="width: 10%;"></td> <td style="width: 10%;"></td> <td style="width: 10%;"></td> </tr> <tr> <td></td> <td></td> <td colspan="8" style="text-align: center;"> <table border="1" style="width: 100%; border-collapse: collapse; text-align: center;"> <tr> </tr></table></td></tr></table></td></tr></table></td></tr></table></td></tr></table></td></tr></table></td></tr></table></td></tr></table>

 | | | | | | | | | | | | | | | | | | | | <table border="1" style="width: 100%; border-collapse: collapse; text-align: center;"> <tr> <td style="width: 10%;"></td> <td style="width: 10%;"></td> <td style="width: 10%;"></td> <td style="width: 10%;"></td> <td style="width: 10%;"></td> <td style="width: 10%;"></td> <td style="width: 10%;"></td> <td style="width: 10%;"></td> <td style="width: 10%;"></td> <td style="width: 10%;"></td> </tr> <tr> <td></td> <td></td> <td colspan="8" style="text-align: center;"> <table border="1" style="width: 100%; border-collapse: collapse; text-align: center;"> <tr> <td style="width: 10%;"></td> <td style="width: 10%;"></td> <td style="width: 10%;"></td> <td style="width: 10%;"></td> <td style="width: 10%;"></td> <td style="width: 10%;"></td> <td style="width: 10%;"></td> <td style="width: 10%;"></td> <td style="width: 10%;"></td> <td style="width: 10%;"></td> </tr> <tr> <td></td> <td></td> <td colspan="8" style="text-align: center;"> <table border="1" style="width: 100%; border-collapse: collapse; text-align: center;"> <tr> <td style="width: 10%;"></td> <td style="width: 10%;"></td> <td style="width: 10%;"></td> <td style="width: 10%;"></td> <td style="width: 10%;"></td> <td style="width: 10%;"></td> <td style="width: 10%;"></td> <td style="width: 10%;"></td> <td style="width: 10%;"></td> <td style="width: 10%;"></td> </tr> <tr> <td></td> <td></td> <td colspan="8" style="text-align: center;"> <table border="1" style="width: 100%; border-collapse: collapse; text-align: center;"> <tr> <td style="width: 10%;"></td> <td style="width: 10%;"></td> <td style="width: 10%;"></td> <td style="width: 10%;"></td> <td style="width: 10%;"></td> <td style="width: 10%;"></td> <td style="width: 10%;"></td> <td style="width: 10%;"></td> <td style="width: 10%;"></td> <td style="width: 10%;"></td> </tr> <tr> <td></td> <td></td> <td colspan="8" style="text-align: center;"> <table border="1" style="width: 100%; border-collapse: collapse; text-align: center;"> <tr> <td style="width: 10%;"></td> <td style="width: 10%;"></td> <td style="width: 10%;"></td> <td style="width: 10%;"></td> <td style="width: 10%;"></td> <td style="width: 10%;"></td> <td style="width: 10%;"></td> <td style="width: 10%;"></td> <td style="width: 10%;"></td> <td style="width: 10%;"></td> </tr> <tr> <td></td> <td></td> <td colspan="8" style="text-align: center;"> <table border="1" style="width: 100%; border-collapse: collapse; text-align: center;"> <tr> <td style="width: 10%;"></td> <td style="width: 10%;"></td> <td style="width: 10%;"></td> <td style="width: 10%;"></td> <td style="width: 10%;"></td> <td style="width: 10%;"></td> <td style="width: 10%;"></td> <td style="width: 10%;"></td> <td style="width: 10%;"></td> <td style="width:
10%;"></td> </tr> <tr> <td></td> <td></td> <td colspan="8" style="text-align: center;"> <table border="1" style="width: 100%; border-collapse: collapse; text-align: center;"> <tr> </tr></table></td></tr></table></td></tr></table></td></tr></table></td></tr></table></td></tr></table></td></tr></table>

 | | | | | | | | | | | | | | | | | | | | <table border="1" style="width: 100%; border-collapse: collapse; text-align: center;"> <tr> <td style="width: 10%;"></td> <td style="width: 10%;"></td> <td style="width: 10%;"></td> <td style="width: 10%;"></td> <td style="width: 10%;"></td> <td style="width: 10%;"></td> <td style="width: 10%;"></td> <td style="width: 10%;"></td> <td style="width: 10%;"></td> <td style="width: 10%;"></td> </tr> <tr> <td></td> <td></td> <td colspan="8" style="text-align: center;"> <table border="1" style="width: 100%; border-collapse: collapse; text-align: center;"> <tr> <td style="width: 10%;"></td> <td style="width: 10%;"></td> <td style="width: 10%;"></td> <td style="width: 10%;"></td> <td style="width: 10%;"></td> <td style="width: 10%;"></td> <td style="width: 10%;"></td> <td style="width: 10%;"></td> <td style="width: 10%;"></td> <td style="width: 10%;"></td> </tr> <tr> <td></td> <td></td> <td colspan="8" style="text-align: center;"> <table border="1" style="width: 100%; border-collapse: collapse; text-align: center;"> <tr> <td style="width: 10%;"></td> <td style="width: 10%;"></td> <td style="width: 10%;"></td> <td style="width: 10%;"></td> <td style="width: 10%;"></td> <td style="width: 10%;"></td> <td style="width: 10%;"></td> <td style="width: 10%;"></td> <td style="width: 10%;"></td> <td style="width: 10%;"></td> </tr> <tr> <td></td> <td></td> <td colspan="8" style="text-align: center;"> <table border="1" style="width: 100%; border-collapse: collapse; text-align: center;"> <tr> <td style="width: 10%;"></td> <td style="width: 10%;"></td> <td style="width: 10%;"></td> <td style="width: 10%;"></td> <td style="width: 10%;"></td> <td style="width: 10%;"></td> <td style="width: 10%;"></td> <td style="width: 10%;"></td> <td style="width: 10%;"></td> <td style="width: 10%;"></td> </tr> <tr> <td></td> <td></td> <td colspan="8" style="text-align: center;"> <table border="1" style="width: 100%; border-collapse: collapse; text-align: center;"> <tr> <td style="width: 10%;"></td> <td style="width: 10%;"></td> <td style="width: 10%;"></td> <td style="width: 10%;"></td> <td style="width: 10%;"></td> <td style="width: 10%;"></td> <td style="width: 10%;"></td> <td style="width: 10%;"></td> <td style="width: 10%;"></td> <td style="width: 10%;"></td> </tr> <tr> <td></td> <td></td> <td colspan="8" style="text-align: center;"> <table border="1" style="width: 100%; border-collapse: collapse; text-align: center;"> <tr> </tr></table></td></tr></table></td></tr></table></td></tr></table></td></tr></table></td></tr></table>

 | | | | | | | | | | | | | | | | | | | | <table border="1" style="width: 100%; border-collapse: collapse; text-align: center;"> <tr> <td style="width: 10%;"></td> <td style="width: 10%;"></td> <td style="width: 10%;"></td> <td style="width: 10%;"></td> <td style="width: 10%;"></td> <td style="width: 10%;"></td> <td style="width: 10%;"></td> <td style="width: 10%;"></td> <td style="width: 10%;"></td> <td style="width: 10%;"></td> </tr> <tr> <td></td> <td></td> <td colspan="8" style="text-align: center;"> <table border="1" style="width: 100%; border-collapse: collapse; text-align: center;"> <tr> <td style="width: 10%;"></td> <td style="width: 10%;"></td> <td style="width: 10%;"></td> <td style="width: 10%;"></td> <td style="width: 10%;"></td> <td style="width: 10%;"></td> <td style="width: 10%;"></td> <td style="width: 10%;"></td> <td style="width: 10%;"></td> <td style="width: 10%;"></td> </tr> <tr> <td></td> <td></td> <td colspan="8" style="text-align: center;"> <table border="1" style="width: 100%; border-collapse: collapse; text-align: center;"> <tr> <td style="width: 10%;"></td> <td style="width: 10%;"></td> <td style="width: 10%;"></td> <td style="width: 10%;"></td> <td style="width: 10%;"></td> <td style="width: 10%;"></td> <td style="width: 10%;"></td> <td style="width: 10%;"></td> <td style="width: 10%;"></td> <td style="width: 10%;"></td> </tr> <tr> <td></td> <td></td>
<td colspan="8" style="text-align: center;"> <table border="1" style="width: 100%; border-collapse: collapse; text-align: center;"> <tr> <td style="width: 10%;"></td> <td style="width: 10%;"></td> <td style="width: 10%;"></td> <td style="width: 10%;"></td> <td style="width: 10%;"></td> <td style="width: 10%;"></td> <td style="width: 10%;"></td> <td style="width: 10%;"></td> <td style="width: 10%;"></td> <td style="width: 10%;"></td> </tr> <tr> <td></td> <td></td> <td colspan="8" style="text-align: center;"> <table border="1" style="width: 100%; border-collapse: collapse; text-align: center;"> <tr> </tr></table></td></tr></table></td></tr></table></td></tr></table></td></tr></table>

 | | | | | | | | | | | | | | | | | | | | <table border="1" style="width: 100%; border-collapse: collapse; text-align: center;"> <tr> <td style="width: 10%;"></td> <td style="width: 10%;"></td> <td style="width: 10%;"></td> <td style="width: 10%;"></td> <td style="width: 10%;"></td> <td style="width: 10%;"></td> <td style="width: 10%;"></td> <td style="width: 10%;"></td> <td style="width: 10%;"></td> <td style="width: 10%;"></td> </tr> <tr> <td></td> <td></td> <td colspan="8" style="text-align: center;"> <table border="1" style="width: 100%; border-collapse: collapse; text-align: center;"> <tr> <td style="width: 10%;"></td> <td style="width: 10%;"></td> <td style="width: 10%;"></td> <td style="width: 10%;"></td> <td style="width: 10%;"></td> <td style="width: 10%;"></td> <td style="width: 10%;"></td> <td style="width: 10%;"></td> <td style="width: 10%;"></td> <td style="width: 10%;"></td> </tr> <tr> <td></td> <td></td> <td colspan="8" style="text-align: center;"> <table border="1" style="width: 100%; border-collapse: collapse; text-align: center;"> <tr> <td style="width: 10%;"></td> <td style="width: 10%;"></td> <td style="width: 10%;"></td> <td style="width: 10%;"></td> <td style="width: 10%;"></td> <td style="width: 10%;"></td> <td style="width: 10%;"></td> <td style="width: 10%;"></td> <td style="width: 10%;"></td> <td style="width: 10%;"></td> </tr> <tr> <td></td> <td></td> <td colspan="8" style="text-align: center;"> <table border="1" style="width: 100%; border-collapse: collapse; text-align: center;"> <tr> </tr></table></td></tr></table></td></tr></table></td></tr></table>

 | | | | | | | | | | | | | | | | | | | | <table border="1" style="width: 100%; border-collapse: collapse; text-align: center;"> <tr> <td style="width: 10%;"></td> <td style="width: 10%;"></td> <td style="width: 10%;"></td> <td style="width: 10%;"></td> <td style="width: 10%;"></td> <td style="width: 10%;"></td> <td style="width: 10%;"></td> <td style="width: 10%;"></td> <td style="width: 10%;"></td> <td style="width: 10%;"></td> </tr> <tr> <td></td> <td></td> <td colspan="8" style="text-align: center;"> <table border="1" style="width: 100%; border-collapse: collapse; text-align: center;"> <tr> <td style="width: 10%;"></td> <td style="width: 10%;"></td> <td style="width: 10%;"></td> <td style="width: 10%;"></td> <td style="width: 10%;"></td> <td style="width: 10%;"></td> <td style="width: 10%;"></td> <td style="width: 10%;"></td> <td style="width: 10%;"></td> <td style="width: 10%;"></td> </tr> <tr> <td></td> <td></td> <td colspan="8" style="text-align: center;"> <table border="1" style="width: 100%; border-collapse: collapse; text-align: center;"> <tr> </tr></table></td></tr></table></td></tr></table>

 | | | | | | | | | | | | | | | | | | | | <table border="1" style="width: 100%; border-collapse: collapse; text-align: center;"> <tr> <td style="width: 10%;"></td> <td style="width: 10%;"></td> <td style="width: 10%;"></td> <td style="width: 10%;"></td> <td style="width: 10%;"></td> <td style="width: 10%;"></td> <td style="width: 10%;"></td> <td style="width: 10%;"></td> <td style="width: 10%;"></td> <td style="width: 10%;"></td> </tr> <tr> <td></td> <td></td> <td colspan="8" style="text-align: center;"> <table border="1" style="width: 100%; border-collapse: collapse; text-align: center;"> <tr> </tr></table></td></tr></table>

 | | | | | | | | | | | | | | | | | | | | <table border="1" style="width: 100%; border-collapse: collapse; text-align: center;"> <tr> </tr></table>

 | | | | | | | | | | | | | | | | | | | |

 | | | | | | | | | | | | | | | | | | | |

 | | | | | | | | | | | | | | | | | | | |

 | | | | | | | | | | | | | | | | | | | |

 | | | | | | | | | | | | | | | | | | | |

 | | | | | | | | | | | | | | | | | | | |

 | | | | | | | | | | | | | | | | | | | |

 | | | | | | | | | | | | | | | | | | | |

 | | | | | | | | | | | | | | | | | | | |

 | | | | | | | | | | | | | | | | | | | |

 | | | | | | | | | | | | | | | | | | | |
 | | | | | | | | | | | | | | | | | | | |

 | | | | | | | | | | | | | | | | | | | |

 | | | | | | | | | | | | | | | | | | | |
 | | | | | | | | | | | | | | | | | | | |

 | | | | | | | | | | | | | | | | | | | |

 | | | | | | | | | | | | | | | | | | | |
 | | | | | | | | | | | | | | | | | | | |
 | | | | | | | | | | | | | | | | | | | |

 | | | | | | | | | | | | | | | | | | | |
 | | | | | | | | | | | | | | | | | | | |
 | | | | | | | | | | | | | | | | | | | |

 | | | | | | | | | | | | | | | | | | | | | | | | | | | | | | | | | | | | | | | | | | | | | | | | | | | | | | | | | | | | | | | | | | | | | | | | | | | | | | | | | | | | | | | | | | | | | | | | | | | |
 | | | | | | | | | | | | | | | | | | | |
 | | | | | | | | | | | | | | | | | | | |
 | | | | | | | | | | | | | | | | | | | |
 | | | | | | | | | | | | | | | | | | | |
 | | | | | | | | | | | | | | | | | | | |
 | | | | | | | | | | | | | | | | | | | |
 | | | | | | | | | | | | | | | | | | | |
 | | | | | | | | | | | | | | | | | | | |
 | | | | | | | | | | | | | | | | | | | | | | | | | | | | | | | | | | | | | | | |
 | | | | | | | | | | | | | | | | | | | |
 | | | | | | | | | | | | | | | | | | | | | | | | | | | | | | | | | | | | | | | |
 | | | | | | | | | | | | | | | | | | | | | | | | | | | | | | | | | | | | | | | |
 | | | | | | | | | | | | | | | | | | | | | | | | | | | | | | | | | | | | | | | |
 | | | | | | | | | | | | | | | | | | | | | | | | | | | | | | | | | | | | | | | | | | | | | | | | | | | | | | | | | | | | | | | | | | | | | | | | | | | | | | | | | | | | | | | | | | | | | | | | | | | |
 | | | | | | | | | | | | | | | | | | | | | | | | | | | | | | | | | | | | | | | | | | | | | | | |
| | |

 | | | | | | | | | | | | | | | | | | | |

 | | | | | | | | | | | | | | | | | | | |

 | | | | | | | | | | | | | | | | | | | |

 | | | | | | | | | | | | | | | | | | | |

 | | | | | | | | | | | | | | | | | | | |

 | | | | | | | | | | | | | | | | | | | |

 | | | | | | | | | | | | | | | | | | | |

 | | | | | | | | | | | | | | | | | | | |

 | | | | | | | | | | | | | | | | | | | |

 | | | | | | | | | | | | | | | | | | | |

 | | | | | | | | | | | | | | | | | | | |

 | | | | | | | | | | | | | | | | | | | |

 | | | | | | | | | | | | | | | | | | | |

 | | | | | | | | | | | | | | | | | | | |

 | | | | | | | | | | | | | | | | | | | |

 | | | | | | | | | | | | | | | | | | | |

 | | | | | | | | | | | | | | | | | | | |

 | | | | | | | | | | | | | | | | | | | |

 | | | | | | | | | | | | | | | | | | | |

 | | | | | | | | | | | | | | | | | | | |

 | | | | | | | | | | | | | | | | | | | |

 | | | | | | | | | | | | | | | | | | | |

 | | | | | | | | | | | | | | | | | | | |

 | | | | | | | | | | | | | | | | | | | |

 | | | | | | | | | | | | | | | | | | | |

 | | | | | | | | | | | | | | | | | | | |

 | | | | | | | | | | | | | | | | | | | |

 | | | | | | | | | | | | | | | | | | | |
 | | | | | | | | | | | | | | | | | | | |

 | | | | | | | | | | | | | | | | | | | |

 | | | | | | | | | | | | | | | | | | | |
 | | | | | | | | | | | | | | | | | | | |

 | | | | | | | | | | | | | | | | | | | |

 | | | | | | | | | | | | | | | | | | | |
 | | | | | | | | | | | | | | | | | | | |
 | | | | | | | | | | | | | | | | | | | |

 | | | | | | | | | | | | | | | | | | | |
 | | | | | | | | | | | | | | | | | | | |
 | | | | | | | | | | | | | | | | | | | |

 | | | | | | | | | | | | | | | | | | | | | | | | | | | | | | | | | | | | | | | | | | | | | | | | | | | | | | | | | | | | | | | | | | | | | | | | | | | | | | | | | | | | | | | | | | | | | | | | | | | |
 | | | | | | | | | | | | | | | | | | | |
 | | | | | | | | | | | | | | | | | | | |
 | | | | | | | | | | | | | | | | | | | |
 | | | | | | | | | | | | | | | | | | | |
 | | | | | | | | | | | | | | | | | | | |
 | | | | | | | | | | | | | | | | | | | |
 | | | | | | | | | | | | | | | | | | | |
 | | | | | | | | | | | | | | | | | | | |
 | | | | | | | | | | | | | | | | | | | | | | | | | | | | | | | | | | | | | | | |
 | | | | | | | | | | | | | | | | | | | |
 | | | | | | | | | | | | | | | | | | | | | | | | | | | | | | | | | | | | | | | |
 | | | | | | | | | | | | | | | | | | | | | | | | | | | | | | | | | | | | | | | |
 | | | | | | | | | | | | | | | | | | | | | | | | | | | | | | | | | | | | | | | |
 | | | | | | | | | | | | | | | | | | | | | | | | | | | | | | | | | | | | | | | | | | | | | | | | | | | | | | | | | | | | | | | | | | | | | | | | | | | | | | | | | | | | | | | | | | | | | | | | | | | |
 | | | | | | | | | | | | | | | | | | | | | | | | | | | | | | | | | | | | | | | | | | | | | | | |
| | | <table border="1" style="width: 100%; border-collapse: collapse; text-align: center;"> <tr> <td style="width: 10%;"></td> <td style="width: 10%;"></td> <td style="width: 10%;"></td> <td style="width: 10%;"></td> <td style="width: 10%;"></td> <td style="width: 10%;"></td> <td style="width: 10%;"></td> <td style="width: 10%;"></td> <td style="width: 10%;"></td> <td style="width: 10%;"></td> </tr> <tr> <td></td> <td></td> <td colspan="8" style="text-align: center;"> <table border="1" style="width: 100%; border-collapse: collapse; text-align: center;"> <tr> <td style="width: 10%;"></td> <td style="width: 10%;"></td> <td style="width: 10%;"></td> <td style="width: 10%;"></td> <td style="width: 10%;"></td> <td style="width: 10%;"></td> <td style="width: 10%;"></td> <td style="width: 10%;"></td> <td style="width: 10%;"></td> <td style="width: 10%;"></td> </tr> <tr> <td></td> <td></td> <td colspan="8" style="text-align: center;"> <table border="1" style="width: 100%; border-collapse: collapse; text-align: center;"> <tr> <td style="width: 10%;"></td> <td style="width: 10%;"></td> <td style="width: 10%;"></td> <td style="width: 10%;"></td> <td style="width: 10%;"></td> <td style="width: 10%;"></td> <td style="width: 10%;"></td> <td style="width: 10%;"></td> <td style="width: 10%;"></td> <td style="width: 10%;"></td> </tr> <tr> <td></td> <td></td> <td colspan="8" style="text-align: center;"> <table border="1" style="width: 100%; border-collapse: collapse; text-align: center;"> <tr> <td style="width: 10%;"></td> <td style="width: 10%;"></td> <td style="width: 10%;"></td> <td style="width: 10%;"></td> <td style="width: 10%;"></td> <td style="width: 10%;"></td> <td style="width: 10%;"></td> <td style="width: 10%;"></td> <td style="width: 10%;"></td> <td style="width: 10%;"></td> </tr> <tr> <td></td> <td></td> <td colspan="8" style="text-align: center;"> <table border="1" style="width: 100%; border-collapse: collapse; text-align: center;"> <tr> <td style="width: 10%;"></td> <td style="width: 10%;"></td> <td style="width: 10%;"></td> <td style="width: 10%;"></td> <td style="width: 10%;"></td> <td style="width: 10%;"></td> <td style="width: 10%;"></td> <td style="width: 10%;"></td> <td style="width: 10%;"></td> <td style="width: 10%;"></td> </tr> <tr> <td></td> <td></td> <td colspan="8" style="text-align: center;"> <table border="1" style="width: 100%; border-collapse: collapse; text-align: center;"> <tr> <td style="width: 10%;"></td> <td style="width: 10%;"></td> <td style="width: 10%;"></td> <td style="width: 10%;"></td> <td style="width: 10%;"></td> <td style="width: 10%;"></td> <td style="width: 10%;"></td> <td style="width: 10%;"></td> <td style="width: 10%;"></td> <td style="width: 10%;"></td> </tr> <tr> <td></td> <td></td> <td colspan="8" style="text-align: center;"> <table border="1" style="width: 100%; border-collapse: collapse; text-align: center;"> <tr> <td style="width: 10%;"></td> <td style="width: 10%;"></td> <td style="width: 10%;"></td> <td style="width: 10%;"></td> <td style="width: 10%;"></td> <td style="width: 10%;"></td> <td style="width: 10%;"></td> <td style="width: 10%;"></td> <td style="width: 10%;"></td> <td style="width: 10%;"></td> </tr> <tr> <td></td> <td></td> <td colspan="8" style="text-align: center;"> <table border="1" style="width: 100%; border-collapse: collapse; text-align: center;"> <tr> <td style="width: 10%;"></td> <td style="width: 10%;"></td> <td style="width: 10%;"></td> <td style="width: 10%;"></td> <td style="width: 10%;"></td> <td style="width: 10%;"></td> <td style="width: 10%;"></td> <td style="width: 10%;"></td> <td style="width: 10%;"></td> <td style="width: 10%;"></td> </tr> <tr> <td></td> <td></td> <td colspan="8" style="text-align: center;"> <table border="1" style="width: 100%; border-collapse: collapse; text-align: center;"> <tr> <td style="width: 10%;"></td> <td style="width: 10%;"></td> <td style="width: 10%;"></td> <td style="width: 10%;"></td> <td style="width: 10%;"></td> <td style="width: 10%;"></td> <td style="width: 10%;"></td> <td style="width: 10%;"></td> <td style="width: 10%;"></td> <td style="width: 10%;"></td> </tr> <tr> <td></td> <td></td> <td colspan="8" style="text-align: center;"> <table border="1" style="width: 100%; border-collapse: collapse; text-align: center;"> <tr> <td style="width: 10%;"></td> <td style="width: 10%;"></td> <td style="width: 10%;"></td> <td style="width: 10%;"></td> <td style="width: 10%;"></td> <td style="width: 10%;"></td> <td style="width: 10%;"></td> <td style="width: 10%;"></td> <td style="width: 10%;"></td> <td style="width: 10%;"></td> </tr> <tr> <td></td> <td></td> <td colspan="8" style="text-align: center;"> <table border="1" style="width: 100%; border-collapse: collapse; text-align: center;"> <tr> <td style="width: 10%;"></td> <td style="width: 10%;"></td> <td style="width: 10%;"></td> <td style="width: 10%;"></td> <td style="width: 10%;"></td> <td style="width: 10%;"></td> <td style="width: 10%;"></td> <td style="width: 10%;"></td> <td style="width: 10%;"></td> <td style="width: 10%;"></td> </tr> <tr> <td></td> <td></td> <td colspan="8" style="text-align: center;"> <table border="1" style="width: 100%; border-collapse: collapse; text-align: center;"> <tr> <td style="width: 10%;"></td> <td style="width: 10%;"></td> <td style="width: 10%;"></td> <td style="width: 10%;"></td> <td style="width: 10%;"></td> <td style="width: 10%;"></td> <td style="width: 10%;"></td> <td style="width: 10%;"></td> <td style="width: 10%;"></td> <td style="width: 10%;"></td> </tr> <tr> <td></td> <td></td> <td colspan="8" style="text-align: center;"> <table border="1" style="width: 100%; border-collapse: collapse; text-align: center;"> <tr> <td style="width: 10%;"></td> <td style="width: 10%;"></td> <td style="width: 10%;"></td> <td style="width: 10%;"></td> <td style="width: 10%;"></td> <td style="width: 10%;"></td> <td style="width: 10%;"></td> <td style="width: 10%;"></td> <td style="width: 10%;"></td> <td style="width: 10%;"></td> </tr> <tr> <td></td> <td></td> <td colspan="8" style="text-align: center;"> <table border="1" style="width: 100%; border-collapse: collapse; text-align: center;"> <tr> <td style="width: 10%;"></td> <td style="width: 10%;"></td> <td style="width: 10%;"></td> <td style="width: 10%;"></td> <td style="width: 10%;"></td> <td style="width: 10%;"></td> <td style="width: 10%;"></td> <td style="width: 10%;"></td> <td style="width: 10%;"></td> <td style="width: 10%;"></td> </tr> <tr> <td></td> <td></td> <td colspan="8" style="text-align: center;"> <table border="1" style="width: 100%; border-collapse: collapse; text-align: center;"> <tr> <td style="width: 10%;"></td> <td style="width: 10%;"></td> <td style="width: 10%;"></td> <td style="width: 10%;"></td> <td style="width: 10%;"></td> <td style="width: 10%;"></td> <td style="width: 10%;"></td> <td style="width: 10%;"></td> <td style="width: 10%;"></td> <td style="width: 10%;"></td> </tr> <tr> <td></td> <td></td> <td colspan="8" style="text-align: center;"> <table border="1" style="width: 100%; border-collapse: collapse; text-align: center;"> <tr> <td style="width: 10%;"></td> <td style="width: 10%;"></td> <td style="width: 10%;"></td> <td style="width: 10%;"></td> <td style="width: 10%;"></td> <td style="width: 10%;"></td> <td style="width: 10%;"></td> <td style="width: 10%;"></td> <td style="width: 10%;"></td> <td style="width: 10%;"></td> </tr> <tr> <td></td> <td></td> <td colspan="8" style="text-align: center;"> <table border="1" style="width: 100%; border-collapse: collapse; text-align: center;"> <tr> </tr></table></td></tr></table></td></tr></table></td></tr></table></td></tr></table></td></tr></table></td></tr></table></td></tr></table></td></tr></table></td></tr></table></td></tr></table></td></tr></table></td></tr></table></td></tr></table></td></tr></table></td></tr></table></td></tr></table>

 | | | | | | | | | | | | | | | | | | | | <table border="1" style="width: 100%; border-collapse: collapse; text-align: center;"> <tr> <td style="width: 10%;"></td> <td style="width: 10%;"></td> <td style="width: 10%;"></td> <td style="width: 10%;"></td> <td style="width: 10%;"></td> <td style="width: 10%;"></td> <td style="width: 10%;"></td> <td style="width: 10%;"></td> <td style="width: 10%;"></td> <td style="width: 10%;"></td> </tr> <tr> <td></td> <td></td> <td colspan="8" style="text-align: center;"> <table border="1" style="width: 100%; border-collapse: collapse; text-align: center;"> <tr> <td style="width: 10%;"></td> <td style="width: 10%;"></td> <td style="width: 10%;"></td> <td style="width: 10%;"></td> <td style="width: 10%;"></td> <td style="width: 10%;"></td> <td style="width: 10%;"></td> <td style="width: 10%;"></td> <td style="width: 10%;"></td> <td style="width: 10%;"></td> </tr> <tr> <td></td> <td></td> <td colspan="8" style="text-align: center;"> <table border="1" style="width: 100%; border-collapse: collapse; text-align: center;"> <tr> <td style="width: 10%;"></td> <td style="width: 10%;"></td> <td style="width: 10%;"></td> <td style="width: 10%;"></td> <td style="width: 10%;"></td> <td style="width: 10%;"></td> <td style="width: 10%;"></td> <td style="width: 10%;"></td> <td style="width: 10%;"></td> <td style="width: 10%;"></td> </tr> <tr> <td></td> <td></td> <td colspan="8" style="text-align: center;"> <table border="1" style="width: 100%; border-collapse: collapse; text-align: center;"> <tr> <td style="width: 10%;"></td> <td style="width: 10%;"></td> <td style="width: 10%;"></td> <td style="width: 10%;"></td> <td style="width: 10%;"></td> <td style="width: 10%;"></td> <td style="width: 10%;"></td> <td style="width: 10%;"></td> <td style="width: 10%;"></td> <td style="width: 10%;"></td> </tr> <tr> <td></td> <td></td> <td colspan="8" style="text-align: center;"> <table border="1" style="width: 100%; border-collapse: collapse; text-align: center;"> <tr> <td style="width: 10%;"></td> <td style="width: 10%;"></td> <td style="width: 10%;"></td> <td style="width: 10%;"></td> <td style="width: 10%;"></td> <td style="width: 10%;"></td> <td style="width: 10%;"></td> <td style="width: 10%;"></td> <td style="width: 10%;"></td> <td style="width: 10%;"></td> </tr> <tr> <td></td> <td></td> <td colspan="8" style="text-align: center;"> <table border="1" style="width: 100%; border-collapse: collapse; text-align: center;"> <tr> <td style="width: 10%;"></td> <td style="width: 10%;"></td> <td style="width: 10%;"></td> <td style="width: 10%;"></td> <td style="width: 10%;"></td> <td style="width: 10%;"></td> <td style="width: 10%;"></td> <td style="width: 10%;"></td> <td style="width: 10%;"></td> <td style="width: 10%;"></td> </tr> <tr> <td></td> <td></td> <td colspan="8" style="text-align: center;"> <table border="1" style="width: 100%; border-collapse: collapse; text-align: center;"> <tr> <td style="width: 10%;"></td> <td style="width: 10%;"></td> <td style="width: 10%;"></td> <td style="width: 10%;"></td> <td style="width: 10%;"></td> <td style="width: 10%;"></td> <td style="width: 10%;"></td> <td style="width: 10%;"></td> <td style="width: 10%;"></td> <td style="width: 10%;"></td> </tr> <tr> <td></td> <td></td> <td colspan="8" style="text-align: center;"> <table border="1" style="width: 100%; border-collapse: collapse; text-align: center;"> <tr> <td style="width: 10%;"></td> <td style="width: 10%;"></td> <td style="width: 10%;"></td> <td style="width: 10%;"></td> <td style="width: 10%;"></td> <td style="width: 10%;"></td> <td style="width: 10%;"></td> <td style="width: 10%;"></td> <td style="width: 10%;"></td> <td style="width: 10%;"></td> </tr> <tr> <td></td> <td></td> <td colspan="8" style="text-align: center;"> <table border="1" style="width: 100%; border-collapse: collapse; text-align: center;"> <tr> <td style="width: 10%;"></td> <td style="width: 10%;"></td> <td style="width: 10%;"></td> <td style="width: 10%;"></td> <td style="width: 10%;"></td> <td style="width: 10%;"></td> <td style="width: 10%;"></td> <td style="width: 10%;"></td> <td style="width: 10%;"></td> <td style="width: 10%;"></td> </tr> <tr> <td></td> <td></td> <td colspan="8" style="text-align: center;"> <table border="1" style="width: 100%; border-collapse: collapse; text-align: center;"> <tr> <td style="width: 10%;"></td> <td style="width: 10%;"></td> <td style="width: 10%;"></td> <td style="width: 10%;"></td> <td style="width: 10%;"></td> <td style="width: 10%;"></td> <td style="width: 10%;"></td> <td style="width: 10%;"></td> <td style="width: 10%;"></td> <td style="width: 10%;"></td> </tr> <tr> <td></td> <td></td> <td colspan="8" style="text-align: center;"> <table border="1" style="width: 100%; border-collapse: collapse; text-align: center;"> <tr> <td style="width: 10%;"></td> <td style="width: 10%;"></td> <td style="width: 10%;"></td> <td style="width: 10%;"></td> <td style="width: 10%;"></td> <td style="width: 10%;"></td> <td style="width: 10%;"></td> <td style="width: 10%;"></td> <td style="width: 10%;"></td> <td style="width: 10%;"></td> </tr> <tr> <td></td> <td></td> <td colspan="8" style="text-align: center;"> <table border="1" style="width: 100%; border-collapse: collapse; text-align: center;"> <tr> <td style="width: 10%;"></td> <td style="width: 10%;"></td> <td style="width: 10%;"></td> <td style="width: 10%;"></td> <td style="width: 10%;"></td> <td style="width: 10%;"></td> <td style="width: 10%;"></td> <td style="width: 10%;"></td> <td style="width: 10%;"></td> <td style="width: 10%;"></td> </tr> <tr> <td></td> <td></td> <td colspan="8" style="text-align: center;"> <table border="1" style="width: 100%; border-collapse: collapse; text-align: center;"> <tr> <td style="width: 10%;"></td> <td style="width: 10%;"></td> <td style="width: 10%;"></td> <td style="width: 10%;"></td> <td style="width: 10%;"></td> <td style="width: 10%;"></td> <td style="width: 10%;"></td> <td style="width: 10%;"></td> <td style="width: 10%;"></td> <td style="width: 10%;"></td> </tr> <tr> <td></td> <td></td> <td colspan="8" style="text-align: center;"> <table border="1" style="width: 100%; border-collapse: collapse; text-align: center;"> <tr> <td style="width: 10%;"></td> <td style="width: 10%;"></td> <td style="width: 10%;"></td> <td style="width: 10%;"></td> <td style="width: 10%;"></td> <td style="width: 10%;"></td> <td style="width: 10%;"></td> <td style="width: 10%;"></td> <td style="width: 10%;"></td> <td style="width: 10%;"></td> </tr> <tr> <td></td> <td></td> <td colspan="8" style="text-align: center;"> <table border="1" style="width: 100%; border-collapse: collapse; text-align: center;"> <tr> <td style="width: 10%;"></td> <td style="width: 10%;"></td> <td style="width: 10%;"></td> <td style="width: 10%;"></td> <td style="width: 10%;"></td> <td style="width: 10%;"></td> <td style="width: 10%;"></td> <td style="width: 10%;"></td> <td style="width: 10%;"></td> <td style="width: 10%;"></td> </tr> <tr> <td></td> <td></td> <td colspan="8" style="text-align: center;"> <table border="1" style="width: 100%; border-collapse: collapse; text-align: center;"> <tr> </tr></table></td></tr></table></td></tr></table></td></tr></table></td></tr></table></td></tr></table></td></tr></table></td></tr></table></td></tr></table></td></tr></table></td></tr></table></td></tr></table></td></tr></table></td></tr></table></td></tr></table></td></tr></table>

 | | | | | | | | | | | | | | | | | | | | <table border="1" style="width: 100%; border-collapse: collapse; text-align: center;"> <tr> <td style="width: 10%;"></td> <td style="width: 10%;"></td> <td style="width: 10%;"></td> <td style="width: 10%;"></td> <td style="width: 10%;"></td> <td style="width: 10%;"></td> <td style="width: 10%;"></td> <td style="width: 10%;"></td> <td style="width: 10%;"></td> <td style="width: 10%;"></td> </tr> <tr> <td></td> <td></td> <td colspan="8" style="text-align: center;"> <table border="1" style="width: 100%; border-collapse: collapse; text-align: center;"> <tr> <td style="width: 10%;"></td> <td style="width: 10%;"></td> <td style="width: 10%;"></td> <td style="width: 10%;"></td> <td style="width: 10%;"></td> <td style="width: 10%;"></td> <td style="width: 10%;"></td> <td style="width: 10%;"></td> <td style="width: 10%;"></td> <td style="width: 10%;"></td> </tr> <tr> <td></td> <td></td> <td colspan="8" style="text-align: center;"> <table border="1" style="width: 100%; border-collapse: collapse; text-align: center;"> <tr> <td style="width: 10%;"></td> <td style="width: 10%;"></td> <td style="width: 10%;"></td> <td style="width: 10%;"></td> <td style="width: 10%;"></td> <td style="width: 10%;"></td> <td style="width: 10%;"></td> <td style="width: 10%;"></td> <td style="width: 10%;"></td> <td style="width: 10%;"></td> </tr> <tr> <td></td> <td></td> <td colspan="8" style="text-align: center;"> <table border="1" style="width: 100%; border-collapse: collapse; text-align: center;"> <tr> <td style="width: 10%;"></td> <td style="width: 10%;"></td> <td style="width: 10%;"></td> <td style="width: 10%;"></td> <td style="width: 10%;"></td> <td style="width: 10%;"></td> <td style="width: 10%;"></td> <td style="width: 10%;"></td> <td style="width: 10%;"></td> <td style="width: 10%;"></td> </tr> <tr> <td></td> <td></td> <td colspan="8" style="text-align: center;"> <table border="1" style="width: 100%; border-collapse: collapse; text-align: center;"> <tr> <td style="width: 10%;"></td> <td style="width: 10%;"></td> <td style="width: 10%;"></td> <td style="width: 10%;"></td> <td style="width: 10%;"></td> <td style="width: 10%;"></td> <td style="width: 10%;"></td> <td style="width: 10%;"></td> <td style="width: 10%;"></td> <td style="width: 10%;"></td> </tr> <tr> <td></td> <td></td> <td colspan="8" style="text-align: center;"> <table border="1" style="width: 100%; border-collapse: collapse; text-align: center;"> <tr> <td style="width: 10%;"></td> <td style="width: 10%;"></td> <td style="width: 10%;"></td> <td style="width: 10%;"></td> <td style="width: 10%;"></td> <td style="width: 10%;"></td> <td style="width: 10%;"></td> <td style="width: 10%;"></td> <td style="width: 10%;"></td> <td style="width: 10%;"></td> </tr> <tr> <td></td> <td></td> <td colspan="8" style="text-align: center;"> <table border="1" style="width: 100%; border-collapse: collapse; text-align: center;"> <tr> <td style="width: 10%;"></td> <td style="width: 10%;"></td> <td style="width: 10%;"></td> <td style="width: 10%;"></td> <td style="width: 10%;"></td> <td style="width: 10%;"></td> <td style="width: 10%;"></td> <td style="width: 10%;"></td> <td style="width: 10%;"></td> <td style="width: 10%;"></td> </tr> <tr> <td></td> <td></td> <td colspan="8" style="text-align: center;"> <table border="1" style="width: 100%; border-collapse: collapse; text-align: center;"> <tr> <td style="width: 10%;"></td> <td style="width: 10%;"></td> <td style="width: 10%;"></td> <td style="width: 10%;"></td> <td style="width: 10%;"></td> <td style="width: 10%;"></td> <td style="width: 10%;"></td> <td style="width: 10%;"></td> <td style="width: 10%;"></td> <td style="width: 10%;"></td> </tr> <tr> <td></td> <td></td> <td colspan="8" style="text-align: center;"> <table border="1" style="width: 100%; border-collapse: collapse; text-align: center;"> <tr> <td style="width: 10%;"></td> <td style="width: 10%;"></td> <td style="width: 10%;"></td> <td style="width: 10%;"></td> <td style="width: 10%;"></td> <td style="width: 10%;"></td> <td style="width: 10%;"></td> <td style="width: 10%;"></td> <td style="width: 10%;"></td> <td style="width: 10%;"></td> </tr> <tr> <td></td> <td></td> <td colspan="8" style="text-align: center;"> <table border="1" style="width: 100%; border-collapse: collapse; text-align: center;"> <tr> <td style="width: 10%;"></td> <td style="width: 10%;"></td> <td style="width: 10%;"></td> <td style="width: 10%;"></td> <td style="width: 10%;"></td> <td style="width: 10%;"></td> <td style="width: 10%;"></td> <td style="width: 10%;"></td> <td style="width: 10%;"></td> <td style="width: 10%;"></td> </tr> <tr> <td></td> <td></td> <td colspan="8" style="text-align: center;"> <table border="1" style="width: 100%; border-collapse: collapse; text-align: center;"> <tr> <td style="width: 10%;"></td> <td style="width: 10%;"></td> <td style="width: 10%;"></td> <td style="width: 10%;"></td> <td style="width: 10%;"></td> <td style="width: 10%;"></td> <td style="width: 10%;"></td> <td style="width: 10%;"></td> <td style="width: 10%;"></td> <td style="width: 10%;"></td> </tr> <tr> <td></td> <td></td> <td colspan="8" style="text-align: center;"> <table border="1" style="width: 100%; border-collapse: collapse; text-align: center;"> <tr> <td style="width: 10%;"></td> <td style="width: 10%;"></td> <td style="width: 10%;"></td> <td style="width: 10%;"></td> <td style="width: 10%;"></td> <td style="width: 10%;"></td> <td style="width: 10%;"></td> <td style="width: 10%;"></td> <td style="width: 10%;"></td> <td style="width: 10%;"></td> </tr> <tr> <td></td> <td></td> <td colspan="8" style="text-align: center;"> <table border="1" style="width: 100%; border-collapse: collapse; text-align: center;"> <tr> <td style="width: 10%;"></td> <td style="width: 10%;"></td> <td style="width: 10%;"></td> <td style="width: 10%;"></td> <td style="width: 10%;"></td> <td style="width: 10%;"></td> <td style="width: 10%;"></td> <td style="width: 10%;"></td> <td style="width: 10%;"></td> <td style="width: 10%;"></td> </tr> <tr> <td></td> <td></td> <td colspan="8" style="text-align: center;"> <table border="1" style="width: 100%; border-collapse: collapse; text-align: center;"> <tr> <td style="width: 10%;"></td> <td style="width: 10%;"></td> <td style="width: 10%;"></td> <td style="width: 10%;"></td> <td style="width: 10%;"></td> <td style="width: 10%;"></td> <td style="width: 10%;"></td> <td style="width: 10%;"></td> <td style="width: 10%;"></td> <td style="width: 10%;"></td> </tr> <tr> <td></td> <td></td> <td colspan="8" style="text-align: center;"> <table border="1" style="width: 100%; border-collapse: collapse; text-align: center;"> <tr> </tr></table></td></tr></table></td></tr></table></td></tr></table></td></tr></table></td></tr></table></td></tr></table></td></tr></table></td></tr></table></td></tr></table></td></tr></table></td></tr></table></td></tr></table></td></tr></table></td></tr></table>

 | | | | | | | | | | | | | | | | | | | | <table border="1" style="width: 100%; border-collapse: collapse; text-align: center;"> <tr> <td style="width: 10%;"></td> <td style="width: 10%;"></td> <td style="width: 10%;"></td> <td style="width: 10%;"></td> <td style="width: 10%;"></td> <td style="width: 10%;"></td> <td style="width: 10%;"></td> <td style="width: 10%;"></td> <td style="width: 10%;"></td> <td style="width: 10%;"></td> </tr> <tr> <td></td> <td></td> <td colspan="8" style="text-align: center;"> <table border="1" style="width: 100%; border-collapse: collapse; text-align: center;"> <tr> <td style="width: 10%;"></td> <td style="width: 10%;"></td> <td style="width: 10%;"></td> <td style="width: 10%;"></td> <td style="width: 10%;"></td> <td style="width: 10%;"></td> <td style="width: 10%;"></td> <td style="width: 10%;"></td> <td style="width: 10%;"></td> <td style="width: 10%;"></td> </tr> <tr> <td></td> <td></td> <td colspan="8" style="text-align: center;"> <table border="1" style="width: 100%; border-collapse: collapse; text-align: center;"> <tr> <td style="width: 10%;"></td> <td style="width: 10%;"></td> <td style="width: 10%;"></td> <td style="width: 10%;"></td> <td style="width: 10%;"></td> <td style="width: 10%;"></td> <td style="width: 10%;"></td> <td style="width: 10%;"></td> <td style="width: 10%;"></td> <td style="width: 10%;"></td> </tr> <tr> <td></td> <td></td> <td colspan="8" style="text-align: center;"> <table border="1" style="width: 100%; border-collapse: collapse; text-align: center;"> <tr> <td style="width: 10%;"></td> <td style="width: 10%;"></td> <td style="width: 10%;"></td> <td style="width: 10%;"></td> <td style="width: 10%;"></td> <td style="width: 10%;"></td> <td style="width: 10%;"></td> <td style="width: 10%;"></td> <td style="width: 10%;"></td> <td style="width: 10%;"></td> </tr> <tr> <td></td> <td></td> <td colspan="8" style="text-align: center;"> <table border="1" style="width: 100%; border-collapse: collapse; text-align: center;"> <tr> <td style="width: 10%;"></td> <td style="width: 10%;"></td> <td style="width: 10%;"></td> <td style="width: 10%;"></td> <td style="width: 10%;"></td> <td style="width: 10%;"></td> <td style="width: 10%;"></td> <td style="width: 10%;"></td> <td style="width: 10%;"></td> <td style="width: 10%;"></td> </tr> <tr> <td></td> <td></td> <td colspan="8" style="text-align: center;"> <table border="1" style="width: 100%; border-collapse: collapse; text-align: center;"> <tr> <td style="width: 10%;"></td> <td style="width: 10%;"></td> <td style="width: 10%;"></td> <td style="width: 10%;"></td> <td style="width: 10%;"></td> <td style="width: 10%;"></td> <td style="width: 10%;"></td> <td style="width: 10%;"></td> <td style="width: 10%;"></td> <td style="width: 10%;"></td> </tr> <tr> <td></td> <td></td> <td colspan="8" style="text-align: center;"> <table border="1" style="width: 100%; border-collapse: collapse; text-align: center;"> <tr> <td style="width: 10%;"></td> <td style="width: 10%;"></td> <td style="width: 10%;"></td> <td style="width: 10%;"></td> <td style="width: 10%;"></td> <td style="width: 10%;"></td> <td style="width: 10%;"></td> <td style="width: 10%;"></td> <td style="width: 10%;"></td> <td style="width: 10%;"></td> </tr> <tr> <td></td> <td></td> <td colspan="8" style="text-align: center;"> <table border="1" style="width: 100%; border-collapse: collapse; text-align: center;"> <tr> <td style="width: 10%;"></td> <td style="width: 10%;"></td> <td style="width: 10%;"></td> <td style="width: 10%;"></td> <td style="width: 10%;"></td> <td style="width: 10%;"></td> <td style="width: 10%;"></td> <td style="width: 10%;"></td> <td style="width: 10%;"></td> <td style="width: 10%;"></td> </tr> <tr> <td></td> <td></td> <td colspan="8" style="text-align: center;"> <table border="1" style="width: 100%; border-collapse: collapse; text-align: center;"> <tr> <td style="width: 10%;"></td> <td style="width: 10%;"></td> <td style="width: 10%;"></td> <td style="width: 10%;"></td> <td style="width: 10%;"></td> <td style="width: 10%;"></td> <td style="width: 10%;"></td> <td style="width: 10%;"></td> <td style="width: 10%;"></td> <td style="width: 10%;"></td> </tr> <tr> <td></td> <td></td> <td colspan="8" style="text-align: center;"> <table border="1" style="width: 100%; border-collapse: collapse; text-align: center;"> <tr> <td style="width: 10%;"></td> <td style="width: 10%;"></td> <td style="width: 10%;"></td> <td style="width: 10%;"></td> <td style="width: 10%;"></td> <td style="width: 10%;"></td> <td style="width: 10%;"></td> <td style="width: 10%;"></td> <td style="width: 10%;"></td> <td style="width: 10%;"></td> </tr> <tr> <td></td> <td></td> <td colspan="8" style="text-align: center;"> <table border="1" style="width: 100%; border-collapse: collapse; text-align: center;"> <tr> <td style="width: 10%;"></td> <td style="width: 10%;"></td> <td style="width: 10%;"></td> <td style="width: 10%;"></td> <td style="width: 10%;"></td> <td style="width: 10%;"></td> <td style="width: 10%;"></td> <td style="width: 10%;"></td> <td style="width: 10%;"></td> <td style="width: 10%;"></td> </tr> <tr> <td></td> <td></td> <td colspan="8" style="text-align: center;"> <table border="1" style="width: 100%; border-collapse: collapse; text-align: center;"> <tr> <td style="width: 10%;"></td> <td style="width: 10%;"></td> <td style="width: 10%;"></td> <td style="width: 10%;"></td> <td style="width: 10%;"></td> <td style="width: 10%;"></td> <td style="width: 10%;"></td> <td style="width: 10%;"></td> <td style="width: 10%;"></td> <td style="width: 10%;"></td> </tr> <tr> <td></td> <td></td> <td colspan="8" style="text-align: center;"> <table border="1" style="width: 100%; border-collapse: collapse; text-align: center;"> <tr> <td style="width: 10%;"></td> <td style="width: 10%;"></td> <td style="width: 10%;"></td> <td style="width: 10%;"></td> <td style="width: 10%;"></td> <td style="width: 10%;"></td> <td style="width: 10%;"></td> <td style="width: 10%;"></td> <td style="width: 10%;"></td> <td style="width: 10%;"></td> </tr> <tr> <td></td> <td></td> <td colspan="8" style="text-align: center;"> <table border="1" style="width: 100%; border-collapse: collapse; text-align: center;"> <tr> </tr></table></td></tr></table></td></tr></table></td></tr></table></td></tr></table></td></tr></table></td></tr></table></td></tr></table></td></tr></table></td></tr></table></td></tr></table></td></tr></table></td></tr></table></td></tr></table>

 | | | | | | | | | | | | | | | | | | | | <table border="1" style="width: 100%; border-collapse: collapse; text-align: center;"> <tr> <td style="width: 10%;"></td> <td style="width: 10%;"></td> <td style="width: 10%;"></td> <td style="width: 10%;"></td> <td style="width: 10%;"></td> <td style="width: 10%;"></td> <td style="width: 10%;"></td> <td style="width: 10%;"></td> <td style="width: 10%;"></td> <td style="width: 10%;"></td> </tr> <tr> <td></td> <td></td> <td colspan="8" style="text-align: center;"> <table border="1" style="width: 100%; border-collapse: collapse; text-align: center;"> <tr> <td style="width: 10%;"></td> <td style="width: 10%;"></td> <td style="width: 10%;"></td> <td style="width: 10%;"></td> <td style="width: 10%;"></td> <td style="width: 10%;"></td> <td style="width: 10%;"></td> <td style="width: 10%;"></td> <td style="width: 10%;"></td> <td style="width: 10%;"></td> </tr> <tr> <td></td> <td></td> <td colspan="8" style="text-align: center;"> <table border="1" style="width: 100%; border-collapse: collapse; text-align: center;"> <tr> <td style="width: 10%;"></td> <td style="width: 10%;"></td> <td style="width: 10%;"></td> <td style="width: 10%;"></td> <td style="width: 10%;"></td> <td style="width: 10%;"></td> <td style="width: 10%;"></td> <td style="width: 10%;"></td> <td style="width: 10%;"></td> <td style="width: 10%;"></td> </tr> <tr> <td></td> <td></td> <td colspan="8" style="text-align: center;"> <table border="1" style="width: 100%; border-collapse: collapse; text-align: center;"> <tr> <td style="width: 10%;"></td> <td style="width: 10%;"></td> <td style="width: 10%;"></td> <td style="width: 10%;"></td> <td style="width: 10%;"></td> <td style="width: 10%;"></td> <td style="width: 10%;"></td> <td style="width: 10%;"></td> <td style="width: 10%;"></td> <td style="width: 10%;"></td> </tr> <tr> <td></td> <td></td> <td colspan="8" style="text-align: center;"> <table border="1" style="width: 100%; border-collapse: collapse; text-align: center;"> <tr> <td style="width: 10%;"></td> <td style="width: 10%;"></td> <td style="width: 10%;"></td> <td style="width: 10%;"></td> <td style="width: 10%;"></td> <td style="width: 10%;"></td> <td style="width: 10%;"></td> <td style="width: 10%;"></td> <td style="width: 10%;"></td> <td style="width: 10%;"></td> </tr> <tr> <td></td> <td></td> <td colspan="8" style="text-align: center;"> <table border="1" style="width: 100%; border-collapse: collapse; text-align: center;"> <tr> <td style="width: 10%;"></td> <td style="width: 10%;"></td> <td style="width: 10%;"></td> <td style="width: 10%;"></td> <td style="width: 10%;"></td> <td style="width: 10%;"></td> <td style="width: 10%;"></td> <td style="width: 10%;"></td> <td style="width: 10%;"></td> <td style="width: 10%;"></td> </tr> <tr> <td></td> <td></td> <td colspan="8" style="text-align: center;"> <table border="1" style="width: 100%; border-collapse: collapse; text-align: center;"> <tr> <td style="width: 10%;"></td> <td style="width: 10%;"></td> <td style="width: 10%;"></td> <td style="width: 10%;"></td> <td style="width: 10%;"></td> <td style="width: 10%;"></td> <td style="width: 10%;"></td> <td style="width: 10%;"></td> <td style="width: 10%;"></td> <td style="width: 10%;"></td> </tr> <tr> <td></td> <td></td> <td colspan="8" style="text-align: center;"> <table border="1" style="width: 100%; border-collapse: collapse; text-align: center;"> <tr> <td style="width: 10%;"></td> <td style="width: 10%;"></td> <td style="width: 10%;"></td> <td style="width: 10%;"></td> <td style="width: 10%;"></td> <td style="width: 10%;"></td> <td style="width: 10%;"></td> <td style="width: 10%;"></td> <td style="width: 10%;"></td> <td style="width: 10%;"></td> </tr> <tr> <td></td> <td></td> <td colspan="8" style="text-align: center;"> <table border="1" style="width: 100%; border-collapse: collapse; text-align: center;"> <tr> <td style="width: 10%;"></td> <td style="width: 10%;"></td> <td style="width: 10%;"></td> <td style="width: 10%;"></td> <td style="width: 10%;"></td> <td style="width: 10%;"></td> <td style="width: 10%;"></td> <td style="width: 10%;"></td> <td style="width: 10%;"></td> <td style="width: 10%;"></td> </tr> <tr> <td></td> <td></td> <td colspan="8" style="text-align: center;"> <table border="1" style="width: 100%; border-collapse: collapse; text-align: center;"> <tr> <td style="width: 10%;"></td> <td style="width: 10%;"></td> <td style="width: 10%;"></td> <td style="width: 10%;"></td> <td style="width: 10%;"></td> <td style="width: 10%;"></td> <td style="width: 10%;"></td> <td style="width: 10%;"></td> <td style="width: 10%;"></td> <td style="width: 10%;"></td> </tr> <tr> <td></td> <td></td> <td colspan="8" style="text-align: center;"> <table border="1" style="width: 100%; border-collapse: collapse; text-align: center;"> <tr> <td style="width: 10%;"></td> <td style="width: 10%;"></td> <td style="width: 10%;"></td> <td style="width: 10%;"></td> <td style="width: 10%;"></td> <td style="width: 10%;"></td> <td style="width: 10%;"></td> <td style="width: 10%;"></td> <td style="width: 10%;"></td> <td style="width: 10%;"></td> </tr> <tr> <td></td> <td></td> <td colspan="8" style="text-align: center;"> <table border="1" style="width: 100%; border-collapse: collapse; text-align: center;"> <tr> <td style="width: 10%;"></td> <td style="width: 10%;"></td> <td style="width: 10%;"></td> <td style="width: 10%;"></td> <td style="width: 10%;"></td> <td style="width: 10%;"></td> <td style="width: 10%;"></td> <td style="width: 10%;"></td> <td style="width: 10%;"></td> <td style="width: 10%;"></td> </tr> <tr> <td></td> <td></td> <td colspan="8" style="text-align: center;"> <table border="1" style="width: 100%; border-collapse: collapse; text-align: center;"> <tr> </tr></table></td></tr></table></td></tr></table></td></tr></table></td></tr></table></td></tr></table></td></tr></table></td></tr></table></td></tr></table></td></tr></table></td></tr></table></td></tr></table></td></tr></table>

 | | | | | | | | | | | | | | | | | | | | <table border="1" style="width: 100%; border-collapse: collapse; text-align: center;"> <tr> <td style="width: 10%;"></td> <td style="width: 10%;"></td> <td style="width: 10%;"></td> <td style="width: 10%;"></td> <td style="width: 10%;"></td> <td style="width: 10%;"></td> <td style="width: 10%;"></td> <td style="width: 10%;"></td> <td style="width: 10%;"></td> <td style="width: 10%;"></td> </tr> <tr> <td></td> <td></td> <td colspan="8" style="text-align: center;"> <table border="1" style="width: 100%; border-collapse: collapse; text-align: center;"> <tr> <td style="width: 10%;"></td> <td style="width: 10%;"></td> <td style="width: 10%;"></td> <td style="width: 10%;"></td> <td style="width: 10%;"></td> <td style="width: 10%;"></td> <td style="width: 10%;"></td> <td style="width: 10%;"></td> <td style="width: 10%;"></td> <td style="width: 10%;"></td> </tr> <tr> <td></td> <td></td> <td colspan="8" style="text-align: center;"> <table border="1" style="width: 100%; border-collapse: collapse; text-align: center;"> <tr> <td style="width: 10%;"></td> <td style="width: 10%;"></td> <td style="width: 10%;"></td> <td style="width: 10%;"></td> <td style="width: 10%;"></td> <td style="width: 10%;"></td> <td style="width: 10%;"></td> <td style="width: 10%;"></td> <td style="width: 10%;"></td> <td style="width: 10%;"></td> </tr> <tr> <td></td> <td></td> <td colspan="8" style="text-align: center;"> <table border="1" style="width: 100%; border-collapse: collapse; text-align: center;"> <tr> <td style="width: 10%;"></td> <td style="width: 10%;"></td> <td style="width: 10%;"></td> <td style="width: 10%;"></td> <td style="width: 10%;"></td> <td style="width: 10%;"></td> <td style="width: 10%;"></td> <td style="width: 10%;"></td> <td style="width: 10%;"></td> <td style="width: 10%;"></td> </tr> <tr> <td></td> <td></td> <td colspan="8" style="text-align: center;"> <table border="1" style="width: 100%; border-collapse: collapse; text-align: center;"> <tr> <td style="width: 10%;"></td> <td style="width: 10%;"></td> <td style="width: 10%;"></td> <td style="width: 10%;"></td> <td style="width: 10%;"></td> <td style="width: 10%;"></td> <td style="width: 10%;"></td> <td style="width: 10%;"></td> <td style="width: 10%;"></td> <td style="width: 10%;"></td> </tr> <tr> <td></td> <td></td> <td colspan="8" style="text-align: center;"> <table border="1" style="width: 100%; border-collapse: collapse; text-align: center;"> <tr> <td style="width: 10%;"></td> <td style="width: 10%;"></td> <td style="width: 10%;"></td> <td style="width: 10%;"></td> <td style="width: 10%;"></td> <td style="width: 10%;"></td> <td style="width: 10%;"></td> <td style="width: 10%;"></td> <td style="width: 10%;"></td> <td style="width: 10%;"></td> </tr> <tr> <td></td> <td></td> <td colspan="8" style="text-align: center;"> <table border="1" style="width: 100%; border-collapse: collapse; text-align: center;"> <tr> <td style="width: 10%;"></td> <td style="width: 10%;"></td> <td style="width: 10%;"></td> <td style="width: 10%;"></td> <td style="width: 10%;"></td> <td style="width: 10%;"></td> <td style="width: 10%;"></td> <td style="width: 10%;"></td> <td style="width: 10%;"></td> <td style="width: 10%;"></td> </tr> <tr> <td></td> <td></td> <td colspan="8" style="text-align: center;"> <table border="1" style="width: 100%; border-collapse: collapse; text-align: center;"> <tr> <td style="width: 10%;"></td> <td style="width: 10%;"></td> <td style="width: 10%;"></td> <td style="width: 10%;"></td> <td style="width: 10%;"></td> <td style="width: 10%;"></td> <td style="width: 10%;"></td> <td style="width: 10%;"></td> <td style="width: 10%;"></td> <td style="width: 10%;"></td> </tr> <tr> <td></td> <td></td> <td colspan="8" style="text-align: center;"> <table border="1" style="width: 100%; border-collapse: collapse; text-align: center;"> <tr> <td style="width: 10%;"></td> <td style="width: 10%;"></td> <td style="width: 10%;"></td> <td style="width: 10%;"></td> <td style="width: 10%;"></td> <td style="width: 10%;"></td> <td style="width: 10%;"></td> <td style="width: 10%;"></td> <td style="width: 10%;"></td> <td style="width: 10%;"></td> </tr> <tr> <td></td> <td></td> <td colspan="8" style="text-align: center;"> <table border="1" style="width: 100%; border-collapse: collapse; text-align: center;"> <tr> <td style="width: 10%;"></td> <td style="width: 10%;"></td> <td style="width: 10%;"></td> <td style="width: 10%;"></td> <td style="width: 10%;"></td> <td style="width: 10%;"></td> <td style="width: 10%;"></td> <td style="width: 10%;"></td> <td style="width: 10%;"></td> <td style="width: 10%;"></td> </tr> <tr> <td></td> <td></td> <td colspan="8" style="text-align: center;"> <table border="1" style="width: 100%; border-collapse: collapse; text-align: center;"> <tr> <td style="width: 10%;"></td> <td style="width: 10%;"></td> <td style="width: 10%;"></td> <td style="width: 10%;"></td> <td style="width: 10%;"></td> <td style="width: 10%;"></td> <td style="width: 10%;"></td> <td style="width: 10%;"></td> <td style="width: 10%;"></td> <td style="width: 10%;"></td> </tr> <tr> <td></td> <td></td> <td colspan="8" style="text-align: center;"> <table border="1" style="width: 100%; border-collapse: collapse; text-align: center;"> <tr> </tr></table></td></tr></table></td></tr></table></td></tr></table></td></tr></table></td></tr></table></td></tr></table></td></tr></table></td></tr></table></td></tr></table></td></tr></table></td></tr></table>

 | | | | | | | | | | | | | | | | | | | | <table border="1" style="width: 100%; border-collapse: collapse; text-align: center;"> <tr> <td style="width: 10%;"></td> <td style="width: 10%;"></td> <td style="width: 10%;"></td> <td style="width: 10%;"></td> <td style="width: 10%;"></td> <td style="width: 10%;"></td> <td style="width: 10%;"></td> <td style="width: 10%;"></td> <td style="width: 10%;"></td> <td style="width: 10%;"></td> </tr> <tr> <td></td> <td></td> <td colspan="8" style="text-align: center;"> <table border="1" style="width: 100%; border-collapse: collapse; text-align: center;"> <tr> <td style="width: 10%;"></td> <td style="width: 10%;"></td> <td style="width: 10%;"></td> <td style="width: 10%;"></td> <td style="width: 10%;"></td> <td style="width: 10%;"></td> <td style="width: 10%;"></td> <td style="width: 10%;"></td> <td style="width: 10%;"></td> <td style="width: 10%;"></td> </tr> <tr> <td></td> <td></td> <td colspan="8" style="text-align: center;"> <table border="1" style="width: 100%; border-collapse: collapse; text-align: center;"> <tr> <td style="width: 10%;"></td> <td style="width: 10%;"></td> <td style="width: 10%;"></td> <td style="width: 10%;"></td> <td style="width: 10%;"></td> <td style="width: 10%;"></td> <td style="width: 10%;"></td> <td style="width: 10%;"></td> <td style="width: 10%;"></td> <td style="width: 10%;"></td> </tr> <tr> <td></td> <td></td> <td colspan="8" style="text-align: center;"> <table border="1" style="width: 100%; border-collapse: collapse; text-align: center;"> <tr> <td style="width: 10%;"></td> <td style="width: 10%;"></td> <td style="width: 10%;"></td> <td style="width: 10%;"></td> <td style="width: 10%;"></td> <td style="width: 10%;"></td> <td style="width: 10%;"></td> <td style="width: 10%;"></td> <td style="width: 10%;"></td> <td style="width: 10%;"></td> </tr> <tr> <td></td> <td></td> <td colspan="8" style="text-align: center;"> <table border="1" style="width: 100%; border-collapse: collapse; text-align: center;"> <tr> <td style="width: 10%;"></td> <td style="width: 10%;"></td> <td style="width: 10%;"></td> <td style="width: 10%;"></td> <td style="width: 10%;"></td> <td style="width: 10%;"></td> <td style="width: 10%;"></td> <td style="width: 10%;"></td> <td style="width: 10%;"></td> <td style="width: 10%;"></td> </tr> <tr> <td></td> <td></td> <td colspan="8" style="text-align: center;"> <table border="1" style="width: 100%; border-collapse: collapse; text-align: center;"> <tr> <td style="width: 10%;"></td> <td style="width: 10%;"></td> <td style="width: 10%;"></td> <td style="width: 10%;"></td> <td style="width: 10%;"></td> <td style="width: 10%;"></td> <td style="width: 10%;"></td> <td style="width: 10%;"></td> <td style="width: 10%;"></td> <td style="width: 10%;"></td> </tr> <tr> <td></td> <td></td> <td colspan="8" style="text-align: center;"> <table border="1" style="width: 100%; border-collapse: collapse; text-align: center;"> <tr> <td style="width: 10%;"></td> <td style="width: 10%;"></td> <td style="width: 10%;"></td> <td style="width: 10%;"></td> <td style="width: 10%;"></td> <td style="width: 10%;"></td> <td style="width: 10%;"></td> <td style="width: 10%;"></td> <td style="width: 10%;"></td> <td style="width: 10%;"></td> </tr> <tr> <td></td> <td></td> <td colspan="8" style="text-align: center;"> <table border="1" style="width: 100%; border-collapse: collapse; text-align: center;"> <tr> <td style="width: 10%;"></td> <td style="width: 10%;"></td> <td style="width: 10%;"></td> <td style="width: 10%;"></td> <td style="width: 10%;"></td> <td style="width: 10%;"></td> <td style="width: 10%;"></td> <td style="width: 10%;"></td> <td style="width: 10%;"></td> <td style="width: 10%;"></td> </tr> <tr> <td></td> <td></td> <td colspan="8" style="text-align: center;"> <table border="1" style="width: 100%; border-collapse: collapse; text-align: center;"> <tr> <td style="width: 10%;"></td> <td style="width: 10%;"></td> <td style="width: 10%;"></td> <td style="width: 10%;"></td> <td style="width: 10%;"></td> <td style="width: 10%;"></td> <td style="width: 10%;"></td> <td style="width: 10%;"></td> <td style="width: 10%;"></td> <td style="width: 10%;"></td> </tr> <tr> <td></td> <td></td> <td colspan="8" style="text-align: center;"> <table border="1" style="width: 100%; border-collapse: collapse; text-align: center;"> <tr> <td style="width: 10%;"></td> <td style="width: 10%;"></td> <td style="width: 10%;"></td> <td style="width: 10%;"></td> <td style="width: 10%;"></td> <td style="width: 10%;"></td> <td style="width: 10%;"></td> <td style="width: 10%;"></td> <td style="width: 10%;"></td> <td style="width: 10%;"></td> </tr> <tr> <td></td> <td></td> <td colspan="8" style="text-align: center;"> <table border="1" style="width: 100%; border-collapse: collapse; text-align: center;"> <tr> </tr></table></td></tr></table></td></tr></table></td></tr></table></td></tr></table></td></tr></table></td></tr></table></td></tr></table></td></tr></table></td></tr></table></td></tr></table>

 | | | | | | | | | | | | | | | | | | | | <table border="1" style="width: 100%; border-collapse: collapse; text-align: center;"> <tr> <td style="width: 10%;"></td> <td style="width: 10%;"></td> <td style="width: 10%;"></td> <td style="width: 10%;"></td> <td style="width: 10%;"></td> <td style="width: 10%;"></td> <td style="width: 10%;"></td> <td style="width: 10%;"></td> <td style="width: 10%;"></td> <td style="width: 10%;"></td> </tr> <tr> <td></td> <td></td> <td colspan="8" style="text-align: center;"> <table border="1" style="width: 100%; border-collapse: collapse; text-align: center;"> <tr> <td style="width: 10%;"></td> <td style="width: 10%;"></td> <td style="width: 10%;"></td> <td style="width: 10%;"></td> <td style="width: 10%;"></td> <td style="width: 10%;"></td> <td style="width: 10%;"></td> <td style="width: 10%;"></td> <td style="width: 10%;"></td> <td style="width: 10%;"></td> </tr> <tr> <td></td> <td></td> <td colspan="8" style="text-align: center;"> <table border="1" style="width: 100%; border-collapse: collapse; text-align: center;"> <tr> <td style="width: 10%;"></td> <td style="width: 10%;"></td> <td style="width: 10%;"></td> <td style="width: 10%;"></td> <td style="width: 10%;"></td> <td style="width: 10%;"></td> <td style="width: 10%;"></td> <td style="width: 10%;"></td> <td style="width:
10%;"></td> <td style="width: 10%;"></td> </tr> <tr> <td></td> <td></td> <td colspan="8" style="text-align: center;"> <table border="1" style="width: 100%; border-collapse: collapse; text-align: center;"> <tr> <td style="width: 10%;"></td> <td style="width: 10%;"></td> <td style="width: 10%;"></td> <td style="width: 10%;"></td> <td style="width: 10%;"></td> <td style="width: 10%;"></td> <td style="width: 10%;"></td> <td style="width: 10%;"></td> <td style="width: 10%;"></td> <td style="width: 10%;"></td> </tr> <tr> <td></td> <td></td> <td colspan="8" style="text-align: center;"> <table border="1" style="width: 100%; border-collapse: collapse; text-align: center;"> <tr> <td style="width: 10%;"></td> <td style="width: 10%;"></td> <td style="width: 10%;"></td> <td style="width: 10%;"></td> <td style="width: 10%;"></td> <td style="width: 10%;"></td> <td style="width: 10%;"></td> <td style="width: 10%;"></td> <td style="width: 10%;"></td> <td style="width: 10%;"></td> </tr> <tr> <td></td> <td></td> <td colspan="8" style="text-align: center;"> <table border="1" style="width: 100%; border-collapse: collapse; text-align: center;"> <tr> <td style="width: 10%;"></td> <td style="width: 10%;"></td> <td style="width: 10%;"></td> <td style="width: 10%;"></td> <td style="width: 10%;"></td> <td style="width: 10%;"></td> <td style="width: 10%;"></td> <td style="width: 10%;"></td> <td style="width: 10%;"></td> <td style="width: 10%;"></td> </tr> <tr> <td></td> <td></td> <td colspan="8" style="text-align: center;"> <table border="1" style="width: 100%; border-collapse: collapse; text-align: center;"> <tr> <td style="width: 10%;"></td> <td style="width: 10%;"></td> <td style="width: 10%;"></td> <td style="width: 10%;"></td> <td style="width: 10%;"></td> <td style="width: 10%;"></td> <td style="width: 10%;"></td> <td style="width: 10%;"></td> <td style="width: 10%;"></td> <td style="width: 10%;"></td> </tr> <tr> <td></td> <td></td> <td colspan="8" style="text-align: center;"> <table border="1" style="width: 100%; border-collapse: collapse; text-align: center;"> <tr> <td style="width: 10%;"></td> <td style="width: 10%;"></td> <td style="width: 10%;"></td> <td style="width: 10%;"></td> <td style="width: 10%;"></td> <td style="width: 10%;"></td> <td style="width: 10%;"></td> <td style="width: 10%;"></td> <td style="width: 10%;"></td> <td style="width: 10%;"></td> </tr> <tr> <td></td> <td></td> <td colspan="8" style="text-align: center;"> <table border="1" style="width: 100%; border-collapse: collapse; text-align: center;"> <tr> <td style="width: 10%;"></td> <td style="width: 10%;"></td> <td style="width: 10%;"></td> <td style="width: 10%;"></td> <td style="width: 10%;"></td> <td style="width: 10%;"></td> <td style="width: 10%;"></td> <td style="width: 10%;"></td> <td style="width: 10%;"></td> <td style="width: 10%;"></td> </tr> <tr> <td></td> <td></td> <td colspan="8" style="text-align: center;"> <table border="1" style="width: 100%; border-collapse: collapse; text-align: center;"> <tr> </tr></table></td></tr></table></td></tr></table></td></tr></table></td></tr></table></td></tr></table></td></tr></table></td></tr></table></td></tr></table></td></tr></table>

 | | | | | | | | | | | | | | | | | | | | <table border="1" style="width: 100%; border-collapse: collapse; text-align: center;"> <tr> <td style="width: 10%;"></td> <td style="width: 10%;"></td> <td style="width: 10%;"></td> <td style="width: 10%;"></td> <td style="width: 10%;"></td> <td style="width: 10%;"></td> <td style="width: 10%;"></td> <td style="width: 10%;"></td> <td style="width: 10%;"></td> <td style="width: 10%;"></td> </tr> <tr> <td></td> <td></td> <td colspan="8" style="text-align: center;"> <table border="1" style="width: 100%; border-collapse: collapse; text-align: center;"> <tr> <td style="width: 10%;"></td> <td style="width: 10%;"></td> <td style="width: 10%;"></td> <td style="width: 10%;"></td> <td style="width: 10%;"></td> <td style="width: 10%;"></td> <td style="width: 10%;"></td> <td style="width: 10%;"></td> <td style="width: 10%;"></td> <td style="width: 10%;"></td> </tr> <tr> <td></td> <td></td> <td colspan="8" style="text-align: center;"> <table border="1" style="width: 100%; border-collapse: collapse; text-align: center;"> <tr> <td style="width: 10%;"></td> <td style="width: 10%;"></td> <td style="width: 10%;"></td> <td style="width: 10%;"></td> <td style="width: 10%;"></td> <td style="width: 10%;"></td> <td style="width: 10%;"></td> <td style="width: 10%;"></td> <td style="width: 10%;"></td> <td style="width: 10%;"></td> </tr> <tr> <td></td> <td></td> <td colspan="8" style="text-align: center;"> <table border="1" style="width: 100%; border-collapse: collapse; text-align: center;"> <tr> <td style="width: 10%;"></td> <td style="width: 10%;"></td> <td style="width: 10%;"></td> <td style="width: 10%;"></td> <td style="width: 10%;"></td> <td style="width: 10%;"></td> <td style="width: 10%;"></td> <td style="width: 10%;"></td> <td style="width: 10%;"></td> <td style="width: 10%;"></td> </tr> <tr> <td></td> <td></td> <td colspan="8" style="text-align: center;"> <table border="1" style="width: 100%; border-collapse: collapse; text-align: center;"> <tr> <td style="width: 10%;"></td> <td style="width: 10%;"></td> <td style="width: 10%;"></td> <td style="width: 10%;"></td> <td style="width: 10%;"></td> <td style="width: 10%;"></td> <td style="width: 10%;"></td> <td style="width: 10%;"></td> <td style="width: 10%;"></td> <td style="width: 10%;"></td> </tr> <tr> <td></td> <td></td> <td colspan="8" style="text-align: center;"> <table border="1" style="width: 100%; border-collapse: collapse; text-align: center;"> <tr> <td style="width: 10%;"></td> <td style="width: 10%;"></td> <td style="width: 10%;"></td> <td style="width: 10%;"></td> <td style="width: 10%;"></td> <td style="width: 10%;"></td> <td style="width: 10%;"></td> <td style="width: 10%;"></td> <td style="width: 10%;"></td> <td style="width: 10%;"></td> </tr> <tr> <td></td> <td></td> <td colspan="8" style="text-align: center;"> <table border="1" style="width: 100%; border-collapse: collapse; text-align: center;"> <tr> <td style="width: 10%;"></td> <td style="width: 10%;"></td> <td style="width: 10%;"></td> <td style="width: 10%;"></td> <td style="width: 10%;"></td> <td style="width: 10%;"></td> <td style="width: 10%;"></td> <td style="width: 10%;"></td> <td style="width: 10%;"></td> <td style="width: 10%;"></td> </tr> <tr> <td></td> <td></td> <td colspan="8" style="text-align: center;"> <table border="1" style="width: 100%; border-collapse: collapse; text-align: center;"> <tr> <td style="width: 10%;"></td> <td style="width:
10%;"></td> <td style="width: 10%;"></td> <td style="width: 10%;"></td> <td style="width: 10%;"></td> <td style="width: 10%;"></td> <td style="width: 10%;"></td> <td style="width: 10%;"></td> <td style="width: 10%;"></td> <td style="width: 10%;"></td> </tr> <tr> <td></td> <td></td> <td colspan="8" style="text-align: center;"> <table border="1" style="width: 100%; border-collapse: collapse; text-align: center;"> <tr> </tr></table></td></tr></table></td></tr></table></td></tr></table></td></tr></table></td></tr></table></td></tr></table></td></tr></table></td></tr></table>

 | | | | | | | | | | | | | | | | | | | | <table border="1" style="width: 100%; border-collapse: collapse; text-align: center;"> <tr> <td style="width: 10%;"></td> <td style="width: 10%;"></td> <td style="width: 10%;"></td> <td style="width: 10%;"></td> <td style="width: 10%;"></td> <td style="width: 10%;"></td> <td style="width: 10%;"></td> <td style="width: 10%;"></td> <td style="width: 10%;"></td> <td style="width: 10%;"></td> </tr> <tr> <td></td> <td></td> <td colspan="8" style="text-align: center;"> <table border="1" style="width: 100%; border-collapse: collapse; text-align: center;"> <tr> <td style="width: 10%;"></td> <td style="width: 10%;"></td> <td style="width: 10%;"></td> <td style="width: 10%;"></td> <td style="width: 10%;"></td> <td style="width: 10%;"></td> <td style="width: 10%;"></td> <td style="width: 10%;"></td> <td style="width: 10%;"></td> <td style="width: 10%;"></td> </tr> <tr> <td></td> <td></td> <td colspan="8" style="text-align: center;"> <table border="1" style="width: 100%; border-collapse: collapse; text-align: center;"> <tr> <td style="width: 10%;"></td> <td style="width: 10%;"></td> <td style="width: 10%;"></td> <td style="width: 10%;"></td> <td style="width: 10%;"></td> <td style="width: 10%;"></td> <td style="width: 10%;"></td> <td style="width: 10%;"></td> <td style="width: 10%;"></td> <td style="width: 10%;"></td> </tr> <tr> <td></td> <td></td> <td colspan="8" style="text-align: center;"> <table border="1" style="width: 100%; border-collapse: collapse; text-align: center;"> <tr> <td style="width: 10%;"></td> <td style="width: 10%;"></td> <td style="width: 10%;"></td> <td style="width: 10%;"></td> <td style="width: 10%;"></td> <td style="width: 10%;"></td> <td style="width: 10%;"></td> <td style="width: 10%;"></td> <td style="width: 10%;"></td> <td style="width: 10%;"></td> </tr> <tr> <td></td> <td></td> <td colspan="8" style="text-align: center;"> <table border="1" style="width: 100%; border-collapse: collapse; text-align: center;"> <tr> <td style="width: 10%;"></td> <td style="width: 10%;"></td> <td style="width: 10%;"></td> <td style="width: 10%;"></td> <td style="width: 10%;"></td> <td style="width: 10%;"></td> <td style="width: 10%;"></td> <td style="width: 10%;"></td> <td style="width: 10%;"></td> <td style="width: 10%;"></td> </tr> <tr> <td></td> <td></td> <td colspan="8" style="text-align: center;"> <table border="1" style="width: 100%; border-collapse: collapse; text-align: center;"> <tr> <td style="width: 10%;"></td> <td style="width: 10%;"></td> <td style="width: 10%;"></td> <td style="width: 10%;"></td> <td style="width: 10%;"></td> <td style="width: 10%;"></td> <td style="width: 10%;"></td> <td style="width: 10%;"></td> <td style="width: 10%;"></td> <td style="width: 10%;"></td> </tr> <tr> <td></td> <td></td> <td colspan="8" style="text-align: center;"> <table border="1" style="width: 100%; border-collapse: collapse; text-align: center;"> <tr> <td style="width: 10%;"></td> <td style="width: 10%;"></td> <td style="width: 10%;"></td> <td style="width: 10%;"></td> <td style="width: 10%;"></td> <td style="width: 10%;"></td> <td style="width: 10%;"></td> <td style="width: 10%;"></td> <td style="width: 10%;"></td> <td style="width: 10%;"></td> </tr> <tr> <td></td> <td></td> <td colspan="8" style="text-align: center;"> <table border="1" style="width: 100%; border-collapse: collapse; text-align: center;"> <tr> </tr></table></td></tr></table></td></tr></table></td></tr></table></td></tr></table></td></tr></table></td></tr></table></td></tr></table>

 | | | | | | | | | | | | | | | | | | | | <table border="1" style="width: 100%; border-collapse: collapse; text-align: center;"> <tr> <td style="width: 10%;"></td> <td style="width: 10%;"></td> <td style="width: 10%;"></td> <td style="width: 10%;"></td> <td style="width: 10%;"></td> <td style="width: 10%;"></td> <td style="width: 10%;"></td> <td style="width: 10%;"></td> <td style="width: 10%;"></td> <td style="width: 10%;"></td> </tr> <tr> <td></td> <td></td> <td colspan="8" style="text-align: center;"> <table border="1" style="width: 100%; border-collapse: collapse; text-align: center;"> <tr> <td style="width: 10%;"></td> <td style="width: 10%;"></td> <td style="width: 10%;"></td> <td style="width: 10%;"></td> <td style="width: 10%;"></td> <td style="width: 10%;"></td> <td style="width: 10%;"></td> <td style="width: 10%;"></td> <td style="width: 10%;"></td> <td style="width: 10%;"></td> </tr> <tr> <td></td> <td></td> <td colspan="8" style="text-align: center;"> <table border="1" style="width: 100%; border-collapse: collapse; text-align: center;"> <tr> <td style="width: 10%;"></td> <td style="width: 10%;"></td> <td style="width: 10%;"></td> <td style="width: 10%;"></td> <td style="width: 10%;"></td> <td style="width: 10%;"></td> <td style="width: 10%;"></td> <td style="width: 10%;"></td> <td style="width: 10%;"></td> <td style="width: 10%;"></td> </tr> <tr> <td></td> <td></td> <td colspan="8" style="text-align: center;"> <table border="1" style="width: 100%; border-collapse: collapse; text-align: center;"> <tr> <td style="width: 10%;"></td> <td style="width: 10%;"></td> <td style="width: 10%;"></td> <td style="width: 10%;"></td> <td style="width: 10%;"></td> <td style="width: 10%;"></td> <td style="width: 10%;"></td> <td style="width: 10%;"></td> <td style="width: 10%;"></td> <td style="width: 10%;"></td> </tr> <tr> <td></td> <td></td> <td colspan="8" style="text-align: center;"> <table border="1" style="width: 100%; border-collapse: collapse; text-align: center;"> <tr> <td style="width: 10%;"></td> <td style="width: 10%;"></td> <td style="width: 10%;"></td> <td style="width: 10%;"></td> <td style="width: 10%;"></td> <td style="width: 10%;"></td> <td style="width: 10%;"></td> <td style="width: 10%;"></td> <td style="width: 10%;"></td> <td style="width: 10%;"></td> </tr> <tr> <td></td> <td></td> <td colspan="8" style="text-align: center;"> <table border="1" style="width: 100%; border-collapse: collapse; text-align: center;"> <tr> <td style="width: 10%;"></td> <td style="width: 10%;"></td> <td style="width: 10%;"></td> <td style="width: 10%;"></td> <td style="width: 10%;"></td> <td style="width: 10%;"></td> <td style="width: 10%;"></td> <td style="width: 10%;"></td> <td style="width: 10%;"></td> <td style="width: 10%;"></td> </tr> <tr> <td></td> <td></td> <td colspan="8" style="text-align: center;"> <table border="1" style="width: 100%; border-collapse: collapse; text-align: center;"> <tr> </tr></table></td></tr></table></td></tr></table></td></tr></table></td></tr></table></td></tr></table></td></tr></table>

 | | | | | | | | | | | | | | | | | | | | <table border="1" style="width: 100%; border-collapse: collapse; text-align: center;"> <tr> <td style="width: 10%;"></td> <td style="width: 10%;"></td> <td style="width: 10%;"></td> <td style="width: 10%;"></td> <td style="width: 10%;"></td> <td style="width: 10%;"></td> <td style="width: 10%;"></td> <td style="width: 10%;"></td> <td style="width: 10%;"></td> <td style="width: 10%;"></td> </tr> <tr> <td></td> <td></td> <td colspan="8" style="text-align: center;"> <table border="1" style="width: 100%; border-collapse: collapse; text-align: center;"> <tr> <td style="width: 10%;"></td> <td style="width: 10%;"></td> <td style="width: 10%;"></td> <td style="width: 10%;"></td> <td style="width: 10%;"></td> <td style="width: 10%;"></td> <td style="width: 10%;"></td> <td style="width: 10%;"></td> <td style="width: 10%;"></td> <td style="width: 10%;"></td> </tr> <tr> <td></td> <td></td> <td colspan="8" style="text-align: center;"> <table border="1" style="width: 100%; border-collapse: collapse; text-align: center;"> <tr> <td style="width: 10%;"></td> <td style="width: 10%;"></td> <td style="width: 10%;"></td> <td style="width: 10%;"></td> <td style="width: 10%;"></td> <td style="width: 10%;"></td> <td style="width: 10%;"></td> <td style="width: 10%;"></td> <td style="width: 10%;"></td> <td style="width: 10%;"></td> </tr> <tr> <td></td> <td></td> <td colspan="8" style="text-align: center;"> <table border="1" style="width: 100%; border-collapse: collapse; text-align: center;"> <tr> <td style="width: 10%;"></td> <td style="width: 10%;"></td> <td style="width: 10%;"></td> <td style="width: 10%;"></td> <td style="width: 10%;"></td> <td style="width: 10%;"></td> <td style="width: 10%;"></td> <td style="width: 10%;"></td> <td style="width: 10%;"></td> <td style="width: 10%;"></td> </tr> <tr> <td></td> <td></td> <td colspan="8" style="text-align: center;"> <table border="1" style="width: 100%; border-collapse: collapse; text-align: center;"> <tr> <td style="width: 10%;"></td> <td style="width: 10%;"></td> <td style="width: 10%;"></td> <td style="width: 10%;"></td> <td style="width: 10%;"></td> <td style="width: 10%;"></td> <td style="width: 10%;"></td> <td style="width: 10%;"></td> <td style="width: 10%;"></td> <td style="width: 10%;"></td> </tr> <tr> <td></td> <td></td> <td colspan="8" style="text-align: center;"> <table border="1" style="width: 100%; border-collapse: collapse; text-align: center;"> <tr> </tr></table></td></tr></table></td></tr></table></td></tr></table></td></tr></table></td></tr></table>

 | | | | | | | | | | | | | | | | | | | | <table border="1" style="width: 100%; border-collapse: collapse; text-align: center;"> <tr> <td style="width: 10%;"></td> <td style="width: 10%;"></td> <td style="width: 10%;"></td> <td style="width: 10%;"></td> <td style="width: 10%;"></td> <td style="width: 10%;"></td> <td style="width: 10%;"></td> <td style="width: 10%;"></td> <td style="width: 10%;"></td> <td style="width: 10%;"></td> </tr> <tr> <td></td> <td></td> <td colspan="8" style="text-align: center;"> <table border="1" style="width: 100%; border-collapse: collapse; text-align: center;"> <tr> <td style="width: 10%;"></td> <td style="width: 10%;"></td> <td style="width: 10%;"></td> <td style="width: 10%;"></td> <td style="width: 10%;"></td> <td style="width: 10%;"></td> <td style="width: 10%;"></td> <td style="width: 10%;"></td> <td style="width: 10%;"></td> <td style="width: 10%;"></td> </tr> <tr> <td></td> <td></td> <td colspan="8" style="text-align: center;"> <table border="1" style="width: 100%; border-collapse: collapse; text-align: center;"> <tr> <td style="width: 10%;"></td> <td style="width: 10%;"></td> <td style="width: 10%;"></td> <td style="width: 10%;"></td> <td style="width: 10%;"></td> <td style="width: 10%;"></td> <td style="width: 10%;"></td> <td style="width: 10%;"></td> <td style="width: 10%;"></td> <td style="width: 10%;"></td> </tr> <tr> <td></td> <td></td> <td colspan="8" style="text-align: center;"> <table border="1" style="width: 100%; border-collapse: collapse; text-align: center;"> <tr> <td style="width: 10%;"></td> <td style="width: 10%;"></td> <td style="width: 10%;"></td> <td style="width: 10%;"></td> <td style="width: 10%;"></td> <td style="width: 10%;"></td> <td style="width: 10%;"></td> <td style="width: 10%;"></td> <td style="width: 10%;"></td> <td style="width: 10%;"></td> </tr> <tr> <td></td> <td></td> <td colspan="8" style="text-align: center;"> <table border="1" style="width: 100%; border-collapse: collapse; text-align: center;"> <tr> </tr></table></td></tr></table></td></tr></table></td></tr></table></td></tr></table>

 | | | | | | | | | | | | | | | | | | | | <table border="1" style="width: 100%; border-collapse: collapse; text-align: center;"> <tr> <td style="width: 10%;"></td> <td style="width: 10%;"></td> <td style="width: 10%;"></td> <td style="width: 10%;"></td> <td style="width: 10%;"></td> <td style="width: 10%;"></td> <td style="width: 10%;"></td> <td style="width: 10%;"></td> <td style="width: 10%;"></td> <td style="width: 10%;"></td> </tr> <tr> <td></td> <td></td> <td colspan="8" style="text-align: center;"> <table border="1" style="width: 100%; border-collapse: collapse; text-align: center;"> <tr> <td style="width: 10%;"></td> <td style="width: 10%;"></td> <td style="width: 10%;"></td> <td style="width: 10%;"></td> <td style="width: 10%;"></td> <td style="width: 10%;"></td> <td style="width: 10%;"></td> <td style="width: 10%;"></td> <td style="width: 10%;"></td> <td style="width: 10%;"></td> </tr> <tr> <td></td> <td></td> <td colspan="8" style="text-align: center;"> <table border="1" style="width: 100%; border-collapse: collapse; text-align: center;"> <tr> <td style="width: 10%;"></td> <td style="width: 10%;"></td> <td style="width: 10%;"></td> <td style="width: 10%;"></td> <td style="width: 10%;"></td> <td style="width: 10%;"></td> <td style="width: 10%;"></td> <td style="width: 10%;"></td> <td style="width: 10%;"></td> <td style="width: 10%;"></td> </tr> <tr> <td></td> <td></td> <td
colspan="8" style="text-align: center;"> <table border="1" style="width: 100%; border-collapse: collapse; text-align: center;"> <tr> </tr></table></td></tr></table></td></tr></table></td></tr></table>

 | | | | | | | | | | | | | | | | | | | | <table border="1" style="width: 100%; border-collapse: collapse; text-align: center;"> <tr> <td style="width: 10%;"></td> <td style="width: 10%;"></td> <td style="width: 10%;"></td> <td style="width: 10%;"></td> <td style="width: 10%;"></td> <td style="width: 10%;"></td> <td style="width: 10%;"></td> <td style="width: 10%;"></td> <td style="width: 10%;"></td> <td style="width: 10%;"></td> </tr> <tr> <td></td> <td></td> <td colspan="8" style="text-align: center;"> <table border="1" style="width: 100%; border-collapse: collapse; text-align: center;"> <tr> <td style="width: 10%;"></td> <td style="width: 10%;"></td> <td style="width: 10%;"></td> <td style="width: 10%;"></td> <td style="width: 10%;"></td> <td style="width: 10%;"></td> <td style="width: 10%;"></td> <td style="width: 10%;"></td> <td style="width: 10%;"></td> <td style="width: 10%;"></td> </tr> <tr> <td></td> <td></td> <td colspan="8" style="text-align: center;"> <table border="1" style="width: 100%; border-collapse: collapse; text-align: center;"> <tr> </tr></table></td></tr></table></td></tr></table>

 | | | | | | | | | | | | | | | | | | | | <table border="1" style="width: 100%; border-collapse: collapse; text-align: center;"> <tr> <td style="width: 10%;"></td> <td style="width: 10%;"></td> <td style="width: 10%;"></td> <td style="width: 10%;"></td> <td style="width: 10%;"></td> <td style="width: 10%;"></td> <td style="width: 10%;"></td> <td style="width: 10%;"></td> <td style="width: 10%;"></td> <td style="width: 10%;"></td> </tr> <tr> <td></td> <td></td> <td colspan="8" style="text-align: center;"> <table border="1" style="width: 100%; border-collapse: collapse; text-align: center;"> <tr> </tr></table></td></tr></table>

 | | | | | | | | | | | | | | | | | | | | <table border="1" style="width: 100%; border-collapse: collapse; text-align: center;"> <tr> </tr></table>

 | | | | | | | | | | | | | | | | | | | |

 | | | | | | | | | | | | | | | | | | | |

 | | | | | | | | | | | | | | | | | | | |

 | | | | | | | | | | | | | | | | | | | |

 | | | | | | | | | | | | | | | | | | | |

 | | | | | | | | | | | | | | | | | | | |

 | | | | | | | | | | | | | | | | | | | |

 | | | | | | | | | | | | | | | | | | | |

 | | | | | | | | | | | | | | | | | | | |

 | | | | | | | | | | | | | | | | | | | |

 | | | | | | | | | | | | | | | | | | | |

 | | | | | | | | | | | | | | | | | | | |
 | | | | | | | | | | | | | | | | | | | |

 | | | | | | | | | | | | | | | | | | | |

 | | | | | | | | | | | | | | | | | | | |
 | | | | | | | | | | | | | | | | | | | |

 | | | | | | | | | | | | | | | | | | | |

 | | | | | | | | | | | | | | | | | | | |
 | | | | | | | | | | | | | | | | | | | |
 | | | | | | | | | | | | | | | | | | | |

 | | | | | | | | | | | | | | | | | | | |
 | | | | | | | | | | | | | | | | | | | |
 | | | | | | | | | | | | | | | | | | | |

 | | | | | | | | | | | | | | | | | | | | | | | | | | | | | | | | | | | | | | | | | | | | | | | | | | | | | | | | | | | | | | | | | | | | | | | | | | | | | | | | | | | | | | | | | | | | | | | | | | | |
 | | | | | | | | | | | | | | | | | | | |
 | | | | | | | | | | | | | | | | | | | |
 | | | | | | | | | | | | | | | | | | | |
 | | | | | | | | | | | | | | | | | | | |
 | | | | | | | | | | | | | | | | | | | |
 | | | | | | | | | | | | | | | | | | | |
 | | | | | | | | | | | | | | | | | | | |
 | | | | | | | | | | | | | | | | | | | |
 | | | | | | | | | | | | | | | | | | | | | | | | | | | | | | | | | | | | | | | |
 | | | | | | | | | | | | | | | | | | | |
 | | | | | | | | | | | | | | | | | | | | | | | | | | | | | | | | | | | | | | | |
 | | | | | | | | | | | | | | | | | | | | | | | | | | | | | | | | | | | | | | | |
 | | | | | | | | | | | | | | | | | | | | | | | | | | | | | | | | | | | | | | | |
 | | | | | | | | | | | | | | | | | | | | | | | | | | | | | | | | | | | | | | | | | | | | | | | | | | | | | | | | | | | | | | | | | | | | | | | | | | | | | | | | | | | | | | | | | | | | | | | | | | | |
 | | | | | | | | | | | | | | | | | | | | | | | | | | | | | | | | | | | | | | | | | | | | | | | |
| | |

 | | | | | | | | | | | | | | | | | | | |

 | | | | | | | | | | | | | | | | | | | |

 | | | | | | | | | | | | | | | | | | | |

 | | | | | | | | | | | | | | | | | | | |

 | | | | | | | | | | | | | | | | | | | |

 | | | | | | | | | | | | | | | | | | | |

 | | | | | | | | | | | | | | | | | | | |

 | | | | | | | | | | | | | | | | | | | |

 | | | | | | | | | | | | | | | | | | | |

 | | | | | | | | | | | | | | | | | | | |

 | | | | | | | | | | | | | | | | | | | |

 | | | | | | | | | | | | | | | | | | | |

 | | | | | | | | | | | | | | | | | | | |

 | | | | | | | | | | | | | | | | | | | |

 | | | | | | | | | | | | | | | | | | | |

 | | | | | | | | | | | | | | | | | | | |

 | | | | | | | | | | | | | | | | | | | |

 | | | | | | | | | | | | | | | | | | | |

 | | | | | | | | | | | | | | | | | | | |

 | | | | | | | | | | | | | | | | | | | |

 | | | | | | | | | | | | | | | | | | | |

 | | | | | | | | | | | | | | | | | | | |

 | | | | | | | | | | | | | | | | | | | |

 | | | | | | | | | | | | | | | | | | | |

 | | | | | | | | | | | | | | | | | | | |

 | | | | | | | | | | | | | | | | | | | |

 | | | | | | | | | | | | | | | | | | | |

 | | | | | | | | | | | | | | | | | | | |
 | | | | | | | | | | | | | | | | | | | |

 | | | | | | | | | | | | | | | | | | | |

 | | | | | | | | | | | | | | | | | | | |
 | | | | | | | | | | | | | | | | | | | |

 | | | | | | | | | | | | | | | | | | | |

 | | | | | | | | | | | | | | | | | | | |
 | | | | | | | | | | | | | | | | | | | |
 | | | | | | | | | | | | | | | | | | | |

 | | | | | | | | | | | | | | | | | | | |
 | | | | | | | | | | | | | | | | | | | |
 | | | | | | | | | | | | | | | | | | | |

 | | | | | | | | | | | | | | | | | | | | | | | | | | | | | | | | | | | | | | | | | | | | | | | | | | | | | | | | | | | | | | | | | | | | | | | | | | | | | | | | | | | | | | | | | | | | | | | | | | | |
 | | | | | | | | | | | | | | | | | | | |
 | | | | | | | | | | | | | | | | | | | |
 | | | | | | | | | | | | | | | | | | | |
 | | | | | | | | | | | | | | | | | | | |
 | | | | | | | | | | | | | | | | | | | |
 | | | | | | | | | | | | | | | | | | | |
 | | | | | | | | | | | | | | | | | | | |
 | | | | | | | | | | | | | | | | | | | |
 | | | | | | | | | | | | | | | | | | | | | | | | | | | | | | | | | | | | | | | |
 | | | | | | | | | | | | | | | | | | | |
 | | | | | | | | | | | | | | | | | | | | | | | | | | | | | | | | | | | | | | | |
 | | | | | | | | | | | | | | | | | | | | | | | | | | | | | | | | | | | | | | | |
 | | | | | | | | | | | | | | | | | | | | | | | | | | | | | | | | | | | | | | | |
 | | | | | | | | | | | | | | | | | | | | | | | | | | | | | | | | | | | | | | | | | | | | | | | | | | | | | | | | | | | | | | | | | | | | | | | | | | | | | | | | | | | | | | | | | | | | | | | | | | | |
 | | | | | | | | | | | | | | | | | | | | | | | | | | | | | | | | | | | | | | | | | | | | | | | |
| | | <table border="1" style="width: 100%; border-collapse: collapse; text-align: center;"> <tr> <td style="width: 10%;"></td> <td style="width: 10%;"></td> <td style="width: 10%;"></td> <td style="width: 10%;"></td> <td style="width: 10%;"></td> <td style="width: 10%;"></td> <td style="width: 10%;"></td> <td style="width: 10%;"></td> <td style="width: 10%;"></td> <td style="width: 10%;"></td> </tr> <tr> <td></td> <td></td> <td colspan="8" style="text-align: center;"> <table border="1" style="width: 100%; border-collapse: collapse; text-align: center;"> <tr> <td style="width: 10%;"></td> <td style="width: 10%;"></td> <td style="width: 10%;"></td> <td style="width: 10%;"></td> <td style="width: 10%;"></td> <td style="width: 10%;"></td> <td style="width: 10%;"></td> <td style="width: 10%;"></td> <td style="width: 10%;"></td> <td style="width: 10%;"></td> </tr> <tr> <td></td> <td></td> <td colspan="8" style="text-align: center;"> <table border="1" style="width: 100%; border-collapse: collapse; text-align: center;"> <tr> <td style="width: 10%;"></td> <td style="width: 10%;"></td> <td style="width: 10%;"></td> <td style="width: 10%;"></td> <td style="width: 10%;"></td> <td style="width: 10%;"></td> <td style="width: 10%;"></td> <td style="width: 10%;"></td> <td style="width: 10%;"></td> <td style="width: 10%;"></td> </tr> <tr> <td></td> <td></td> <td colspan="8" style="text-align: center;"> <table border="1" style="width: 100%; border-collapse: collapse; text-align: center;"> <tr> <td style="width: 10%;"></td> <td style="width: 10%;"></td> <td style="width: 10%;"></td> <td style="width: 10%;"></td> <td style="width: 10%;"></td> <td style="width: 10%;"></td> <td style="width: 10%;"></td> <td style="width: 10%;"></td> <td style="width: 10%;"></td> <td style="width: 10%;"></td> </tr> <tr> <td></td> <td></td> <td colspan="8" style="text-align: center;"> <table border="1" style="width: 100%; border-collapse: collapse; text-align: center;"> <tr> <td style="width: 10%;"></td> <td style="width: 10%;"></td> <td style="width: 10%;"></td> <td style="width: 10%;"></td> <td style="width: 10%;"></td> <td style="width: 10%;"></td> <td style="width: 10%;"></td> <td style="width: 10%;"></td> <td style="width: 10%;"></td> <td style="width: 10%;"></td> </tr> <tr> <td></td> <td></td> <td colspan="8" style="text-align: center;"> <table border="1" style="width: 100%; border-collapse: collapse; text-align: center;"> <tr> <td style="width: 10%;"></td> <td style="width: 10%;"></td> <td style="width: 10%;"></td> <td style="width: 10%;"></td> <td style="width: 10%;"></td> <td style="width: 10%;"></td> <td style="width: 10%;"></td> <td style="width: 10%;"></td> <td style="width: 10%;"></td> <td style="width: 10%;"></td> </tr> <tr> <td></td> <td></td> <td colspan="8" style="text-align: center;"> <table border="1" style="width: 100%; border-collapse: collapse; text-align: center;"> <tr> <td style="width: 10%;"></td> <td style="width: 10%;"></td> <td style="width: 10%;"></td> <td style="width: 10%;"></td> <td style="width: 10%;"></td> <td style="width: 10%;"></td> <td style="width: 10%;"></td> <td style="width: 10%;"></td> <td style="width: 10%;"></td> <td style="width: 10%;"></td> </tr> <tr> <td></td> <td></td> <td colspan="8" style="text-align: center;"> <table border="1" style="width: 100%; border-collapse: collapse; text-align: center;"> <tr> <td style="width: 10%;"></td> <td style="width: 10%;"></td> <td style="width: 10%;"></td> <td style="width: 10%;"></td> <td style="width: 10%;"></td> <td style="width: 10%;"></td> <td style="width: 10%;"></td> <td style="width: 10%;"></td> <td style="width: 10%;"></td> <td style="width: 10%;"></td> </tr> <tr> <td></td> <td></td> <td colspan="8" style="text-align: center;"> <table border="1" style="width: 100%; border-collapse: collapse; text-align: center;"> <tr> <td style="width: 10%;"></td> <td style="width: 10%;"></td> <td style="width: 10%;"></td> <td style="width: 10%;"></td> <td style="width: 10%;"></td> <td style="width: 10%;"></td> <td style="width: 10%;"></td> <td style="width: 10%;"></td> <td style="width: 10%;"></td> <td style="width: 10%;"></td> </tr> <tr> <td></td> <td></td> <td colspan="8" style="text-align: center;"> <table border="1" style="width: 100%; border-collapse: collapse; text-align: center;"> <tr> <td style="width: 10%;"></td> <td style="width: 10%;"></td> <td style="width: 10%;"></td> <td style="width: 10%;"></td> <td style="width: 10%;"></td> <td style="width: 10%;"></td> <td style="width: 10%;"></td> <td style="width: 10%;"></td> <td style="width: 10%;"></td> <td style="width: 10%;"></td> </tr> <tr> <td></td> <td></td> <td colspan="8" style="text-align: center;"> <table border="1" style="width: 100%; border-collapse: collapse; text-align: center;"> <tr> <td style="width: 10%;"></td> <td style="width: 10%;"></td> <td style="width: 10%;"></td> <td style="width: 10%;"></td> <td style="width: 10%;"></td> <td style="width: 10%;"></td> <td style="width: 10%;"></td> <td style="width: 10%;"></td> <td style="width: 10%;"></td> <td style="width: 10%;"></td> </tr> <tr> <td></td> <td></td> <td colspan="8" style="text-align: center;"> <table border="1" style="width: 100%; border-collapse: collapse; text-align: center;"> <tr> <td style="width: 10%;"></td> <td style="width: 10%;"></td> <td style="width: 10%;"></td> <td style="width: 10%;"></td> <td style="width: 10%;"></td> <td style="width: 10%;"></td> <td style="width: 10%;"></td> <td style="width: 10%;"></td> <td style="width: 10%;"></td> <td style="width: 10%;"></td> </tr> <tr> <td></td> <td></td> <td colspan="8" style="text-align: center;"> <table border="1" style="width: 100%; border-collapse: collapse; text-align: center;"> <tr> <td style="width: 10%;"></td> <td style="width: 10%;"></td> <td style="width: 10%;"></td> <td style="width: 10%;"></td> <td style="width: 10%;"></td> <td style="width: 10%;"></td> <td style="width: 10%;"></td> <td style="width: 10%;"></td> <td style="width: 10%;"></td> <td style="width: 10%;"></td> </tr> <tr> <td></td> <td></td> <td colspan="8" style="text-align: center;"> <table border="1" style="width: 100%; border-collapse: collapse; text-align: center;"> <tr> <td style="width: 10%;"></td> <td style="width: 10%;"></td> <td style="width: 10%;"></td> <td style="width: 10%;"></td> <td style="width: 10%;"></td> <td style="width: 10%;"></td> <td style="width: 10%;"></td> <td style="width: 10%;"></td> <td style="width: 10%;"></td> <td style="width: 10%;"></td> </tr> <tr> <td></td> <td></td> <td colspan="8" style="text-align: center;"> <table border="1" style="width: 100%; border-collapse: collapse; text-align: center;"> <tr> <td style="width: 10%;"></td> <td style="width: 10%;"></td> <td style="width: 10%;"></td> <td style="width: 10%;"></td> <td style="width: 10%;"></td> <td style="width: 10%;"></td> <td style="width: 10%;"></td> <td style="width: 10%;"></td> <td style="width: 10%;"></td> <td style="width: 10%;"></td> </tr> <tr> <td></td> <td></td> <td colspan="8" style="text-align: center;"> <table border="1" style="width: 100%; border-collapse: collapse; text-align: center;"> <tr> </tr></table></td></tr></table></td></tr></table></td></tr></table></td></tr></table></td></tr></table></td></tr></table></td></tr></table></td></tr></table></td></tr></table></td></tr></table></td></tr></table></td></tr></table></td></tr></table></td></tr></table></td></tr></table>

 | | | | | | | | | | | | | | | | | | | | <table border="1" style="width: 100%; border-collapse: collapse; text-align: center;"> <tr> <td style="width: 10%;"></td> <td style="width: 10%;"></td> <td style="width: 10%;"></td> <td style="width: 10%;"></td> <td style="width: 10%;"></td> <td style="width: 10%;"></td> <td style="width: 10%;"></td> <td style="width: 10%;"></td> <td style="width: 10%;"></td> <td style="width: 10%;"></td> </tr> <tr> <td></td> <td></td> <td colspan="8" style="text-align: center;"> <table border="1" style="width: 100%; border-collapse: collapse; text-align: center;"> <tr> <td style="width: 10%;"></td> <td style="width: 10%;"></td> <td style="width: 10%;"></td> <td style="width: 10%;"></td> <td style="width: 10%;"></td> <td style="width: 10%;"></td> <td style="width: 10%;"></td> <td style="width: 10%;"></td> <td style="width: 10%;"></td> <td style="width: 10%;"></td> </tr> <tr> <td></td> <td></td> <td colspan="8" style="text-align: center;"> <table border="1" style="width: 100%; border-collapse: collapse; text-align: center;"> <tr> <td style="width: 10%;"></td> <td style="width: 10%;"></td> <td style="width: 10%;"></td> <td style="width: 10%;"></td> <td style="width: 10%;"></td> <td style="width: 10%;"></td> <td style="width: 10%;"></td> <td style="width: 10%;"></td> <td style="width: 10%;"></td> <td style="width: 10%;"></td> </tr> <tr> <td></td> <td></td> <td colspan="8" style="text-align: center;"> <table border="1" style="width: 100%; border-collapse: collapse; text-align: center;"> <tr> <td style="width: 10%;"></td> <td style="width: 10%;"></td> <td style="width: 10%;"></td> <td style="width: 10%;"></td> <td style="width: 10%;"></td> <td style="width: 10%;"></td> <td style="width: 10%;"></td> <td style="width: 10%;"></td> <td style="width: 10%;"></td> <td style="width: 10%;"></td> </tr> <tr> <td></td> <td></td> <td colspan="8" style="text-align: center;"> <table border="1" style="width: 100%; border-collapse: collapse; text-align: center;"> <tr> <td style="width: 10%;"></td> <td style="width: 10%;"></td> <td style="width: 10%;"></td> <td style="width: 10%;"></td> <td style="width: 10%;"></td> <td style="width: 10%;"></td> <td style="width: 10%;"></td> <td style="width: 10%;"></td> <td style="width: 10%;"></td> <td style="width: 10%;"></td> </tr> <tr> <td></td> <td></td> <td colspan="8" style="text-align: center;"> <table border="1" style="width: 100%; border-collapse: collapse; text-align: center;"> <tr> <td style="width: 10%;"></td> <td style="width: 10%;"></td> <td style="width: 10%;"></td> <td style="width: 10%;"></td> <td style="width: 10%;"></td> <td style="width: 10%;"></td> <td style="width: 10%;"></td> <td style="width: 10%;"></td> <td style="width: 10%;"></td> <td style="width: 10%;"></td> </tr> <tr> <td></td> <td></td> <td colspan="8" style="text-align: center;"> <table border="1" style="width: 100%; border-collapse: collapse; text-align: center;"> <tr> <td style="width: 10%;"></td> <td style="width: 10%;"></td> <td style="width: 10%;"></td> <td style="width: 10%;"></td> <td style="width: 10%;"></td> <td style="width: 10%;"></td> <td style="width: 10%;"></td> <td style="width: 10%;"></td> <td style="width: 10%;"></td> <td style="width: 10%;"></td> </tr> <tr> <td></td> <td></td> <td colspan="8" style="text-align: center;"> <table border="1" style="width: 100%; border-collapse: collapse; text-align: center;"> <tr> <td style="width: 10%;"></td> <td style="width: 10%;"></td> <td style="width: 10%;"></td> <td style="width: 10%;"></td> <td style="width: 10%;"></td> <td style="width: 10%;"></td> <td style="width: 10%;"></td> <td style="width: 10%;"></td> <td style="width: 10%;"></td> <td style="width: 10%;"></td> </tr> <tr> <td></td> <td></td> <td colspan="8" style="text-align: center;"> <table border="1" style="width: 100%; border-collapse: collapse; text-align: center;"> <tr> <td style="width: 10%;"></td> <td style="width: 10%;"></td> <td style="width: 10%;"></td> <td style="width: 10%;"></td> <td style="width: 10%;"></td> <td style="width: 10%;"></td> <td style="width: 10%;"></td> <td style="width: 10%;"></td> <td style="width: 10%;"></td> <td style="width: 10%;"></td> </tr> <tr> <td></td> <td></td> <td colspan="8" style="text-align: center;"> <table border="1" style="width: 100%; border-collapse: collapse; text-align: center;"> <tr> <td style="width: 10%;"></td> <td style="width: 10%;"></td> <td style="width: 10%;"></td> <td style="width: 10%;"></td> <td style="width: 10%;"></td> <td style="width: 10%;"></td> <td style="width: 10%;"></td> <td style="width: 10%;"></td> <td style="width: 10%;"></td> <td style="width: 10%;"></td> </tr> <tr> <td></td> <td></td> <td colspan="8" style="text-align: center;"> <table border="1" style="width: 100%; border-collapse: collapse; text-align: center;"> <tr> <td style="width: 10%;"></td> <td style="width: 10%;"></td> <td style="width: 10%;"></td> <td style="width: 10%;"></td> <td style="width: 10%;"></td> <td style="width: 10%;"></td> <td style="width: 10%;"></td> <td style="width: 10%;"></td> <td style="width: 10%;"></td> <td style="width: 10%;"></td> </tr> <tr> <td></td> <td></td> <td colspan="8" style="text-align: center;"> <table border="1" style="width: 100%; border-collapse: collapse; text-align: center;"> <tr> <td style="width: 10%;"></td> <td style="width: 10%;"></td> <td style="width: 10%;"></td> <td style="width: 10%;"></td> <td style="width: 10%;"></td> <td style="width: 10%;"></td> <td style="width: 10%;"></td> <td style="width: 10%;"></td> <td style="width: 10%;"></td> <td style="width: 10%;"></td> </tr> <tr> <td></td> <td></td> <td colspan="8" style="text-align: center;"> <table border="1" style="width: 100%; border-collapse: collapse; text-align: center;"> <tr> <td style="width: 10%;"></td> <td style="width: 10%;"></td> <td style="width: 10%;"></td> <td style="width: 10%;"></td> <td style="width: 10%;"></td> <td style="width: 10%;"></td> <td style="width: 10%;"></td> <td style="width: 10%;"></td> <td style="width: 10%;"></td> <td style="width: 10%;"></td> </tr> <tr> <td></td> <td></td> <td colspan="8" style="text-align: center;"> <table border="1" style="width: 100%; border-collapse: collapse; text-align: center;"> <tr> <td style="width: 10%;"></td> <td style="width: 10%;"></td> <td style="width: 10%;"></td> <td style="width: 10%;"></td> <td style="width: 10%;"></td> <td style="width: 10%;"></td> <td style="width: 10%;"></td> <td style="width: 10%;"></td> <td style="width: 10%;"></td> <td style="width: 10%;"></td> </tr> <tr> <td></td> <td></td> <td colspan="8" style="text-align: center;"> <table border="1" style="width: 100%; border-collapse: collapse; text-align: center;"> <tr> </tr></table></td></tr></table></td></tr></table></td></tr></table></td></tr></table></td></tr></table></td></tr></table></td></tr></table></td></tr></table></td></tr></table></td></tr></table></td></tr></table></td></tr></table></td></tr></table></td></tr></table>

 | | | | | | | | | | | | | | | | | | | | <table border="1" style="width: 100%; border-collapse: collapse; text-align: center;"> <tr> <td style="width: 10%;"></td> <td style="width: 10%;"></td> <td style="width: 10%;"></td> <td style="width: 10%;"></td> <td style="width: 10%;"></td> <td style="width: 10%;"></td> <td style="width: 10%;"></td> <td style="width: 10%;"></td> <td style="width: 10%;"></td> <td style="width: 10%;"></td> </tr> <tr> <td></td> <td></td> <td colspan="8" style="text-align: center;"> <table border="1" style="width: 100%; border-collapse: collapse; text-align: center;"> <tr> <td style="width: 10%;"></td> <td style="width: 10%;"></td> <td style="width: 10%;"></td> <td style="width: 10%;"></td> <td style="width: 10%;"></td> <td style="width: 10%;"></td> <td style="width: 10%;"></td> <td style="width: 10%;"></td> <td style="width: 10%;"></td> <td style="width: 10%;"></td> </tr> <tr> <td></td> <td></td> <td colspan="8" style="text-align: center;"> <table border="1" style="width: 100%; border-collapse: collapse; text-align: center;"> <tr> <td style="width: 10%;"></td> <td style="width: 10%;"></td> <td style="width: 10%;"></td> <td style="width: 10%;"></td> <td style="width: 10%;"></td> <td style="width: 10%;"></td> <td style="width: 10%;"></td> <td style="width: 10%;"></td> <td style="width: 10%;"></td> <td style="width: 10%;"></td> </tr> <tr> <td></td> <td></td> <td colspan="8" style="text-align: center;"> <table border="1" style="width: 100%; border-collapse: collapse; text-align: center;"> <tr> <td style="width: 10%;"></td> <td style="width: 10%;"></td> <td style="width: 10%;"></td> <td style="width: 10%;"></td> <td style="width: 10%;"></td> <td style="width: 10%;"></td> <td style="width: 10%;"></td> <td style="width: 10%;"></td> <td style="width: 10%;"></td> <td style="width: 10%;"></td> </tr> <tr> <td></td> <td></td> <td colspan="8" style="text-align: center;"> <table border="1" style="width: 100%; border-collapse: collapse; text-align: center;"> <tr> <td style="width: 10%;"></td> <td style="width: 10%;"></td> <td style="width: 10%;"></td> <td style="width: 10%;"></td> <td style="width: 10%;"></td> <td style="width: 10%;"></td> <td style="width: 10%;"></td> <td style="width: 10%;"></td> <td style="width: 10%;"></td> <td style="width: 10%;"></td> </tr> <tr> <td></td> <td></td> <td colspan="8" style="text-align: center;"> <table border="1" style="width: 100%; border-collapse: collapse; text-align: center;"> <tr> <td style="width: 10%;"></td> <td style="width: 10%;"></td> <td style="width: 10%;"></td> <td style="width: 10%;"></td> <td style="width: 10%;"></td> <td style="width: 10%;"></td> <td style="width: 10%;"></td> <td style="width: 10%;"></td> <td style="width: 10%;"></td> <td style="width: 10%;"></td> </tr> <tr> <td></td> <td></td> <td colspan="8" style="text-align: center;"> <table border="1" style="width: 100%; border-collapse: collapse; text-align: center;"> <tr> <td style="width: 10%;"></td> <td style="width: 10%;"></td> <td style="width: 10%;"></td> <td style="width: 10%;"></td> <td style="width: 10%;"></td> <td style="width: 10%;"></td> <td style="width: 10%;"></td> <td style="width: 10%;"></td> <td style="width: 10%;"></td> <td style="width: 10%;"></td> </tr> <tr> <td></td> <td></td> <td colspan="8" style="text-align: center;"> <table border="1" style="width: 100%; border-collapse: collapse; text-align: center;"> <tr> <td style="width: 10%;"></td> <td style="width: 10%;"></td> <td style="width: 10%;"></td> <td style="width: 10%;"></td> <td style="width: 10%;"></td> <td style="width: 10%;"></td> <td style="width: 10%;"></td> <td style="width: 10%;"></td> <td style="width: 10%;"></td> <td style="width: 10%;"></td> </tr> <tr> <td></td> <td></td> <td colspan="8" style="text-align: center;"> <table border="1" style="width: 100%; border-collapse: collapse; text-align: center;"> <tr> <td style="width: 10%;"></td> <td style="width: 10%;"></td> <td style="width: 10%;"></td> <td style="width: 10%;"></td> <td style="width: 10%;"></td> <td style="width: 10%;"></td> <td style="width: 10%;"></td> <td style="width: 10%;"></td> <td style="width: 10%;"></td> <td style="width: 10%;"></td> </tr> <tr> <td></td> <td></td> <td colspan="8" style="text-align: center;"> <table border="1" style="width: 100%; border-collapse: collapse; text-align: center;"> <tr> <td style="width: 10%;"></td> <td style="width: 10%;"></td> <td style="width: 10%;"></td> <td style="width: 10%;"></td> <td style="width: 10%;"></td> <td style="width: 10%;"></td> <td style="width: 10%;"></td> <td style="width: 10%;"></td> <td style="width: 10%;"></td> <td style="width: 10%;"></td> </tr> <tr> <td></td> <td></td> <td colspan="8" style="text-align: center;"> <table border="1" style="width: 100%; border-collapse: collapse; text-align: center;"> <tr> <td style="width: 10%;"></td> <td style="width: 10%;"></td> <td style="width: 10%;"></td> <td style="width: 10%;"></td> <td style="width: 10%;"></td> <td style="width: 10%;"></td> <td style="width: 10%;"></td> <td style="width: 10%;"></td> <td style="width: 10%;"></td> <td style="width: 10%;"></td> </tr> <tr> <td></td> <td></td> <td colspan="8" style="text-align: center;"> <table border="1" style="width: 100%; border-collapse: collapse; text-align: center;"> <tr> <td style="width: 10%;"></td> <td style="width: 10%;"></td> <td style="width: 10%;"></td> <td style="width: 10%;"></td> <td style="width: 10%;"></td> <td style="width: 10%;"></td> <td style="width: 10%;"></td> <td style="width: 10%;"></td> <td style="width: 10%;"></td> <td style="width: 10%;"></td> </tr> <tr> <td></td> <td></td> <td colspan="8" style="text-align: center;"> <table border="1" style="width: 100%; border-collapse: collapse; text-align: center;"> <tr> <td style="width: 10%;"></td> <td style="width: 10%;"></td> <td style="width: 10%;"></td> <td style="width: 10%;"></td> <td style="width: 10%;"></td> <td style="width: 10%;"></td> <td style="width: 10%;"></td> <td style="width: 10%;"></td> <td style="width: 10%;"></td> <td style="width: 10%;"></td> </tr> <tr> <td></td> <td></td> <td colspan="8" style="text-align: center;"> <table border="1" style="width: 100%; border-collapse: collapse; text-align: center;"> <tr> </tr></table></td></tr></table></td></tr></table></td></tr></table></td></tr></table></td></tr></table></td></tr></table></td></tr></table></td></tr></table></td></tr></table></td></tr></table></td></tr></table></td></tr></table></td></tr></table>

 | | | | | | | | | | | | | | | | | | | | <table border="1" style="width: 100%; border-collapse: collapse; text-align: center;"> <tr> <td style="width: 10%;"></td> <td style="width: 10%;"></td> <td style="width: 10%;"></td> <td style="width: 10%;"></td> <td style="width: 10%;"></td> <td style="width: 10%;"></td> <td style="width: 10%;"></td> <td style="width: 10%;"></td> <td style="width: 10%;"></td> <td style="width: 10%;"></td> </tr> <tr> <td></td> <td></td> <td colspan="8" style="text-align: center;"> <table border="1" style="width: 100%; border-collapse: collapse; text-align: center;"> <tr> <td style="width: 10%;"></td> <td style="width: 10%;"></td> <td style="width: 10%;"></td> <td style="width: 10%;"></td> <td style="width: 10%;"></td> <td style="width: 10%;"></td> <td style="width: 10%;"></td> <td style="width: 10%;"></td> <td style="width: 10%;"></td> <td style="width: 10%;"></td> </tr> <tr> <td></td> <td></td> <td colspan="8" style="text-align: center;"> <table border="1" style="width: 100%; border-collapse: collapse; text-align: center;"> <tr> <td style="width: 10%;"></td> <td style="width: 10%;"></td> <td style="width: 10%;"></td> <td style="width: 10%;"></td> <td style="width: 10%;"></td> <td style="width: 10%;"></td> <td style="width: 10%;"></td> <td style="width: 10%;"></td> <td style="width: 10%;"></td> <td style="width: 10%;"></td> </tr> <tr> <td></td> <td></td> <td colspan="8" style="text-align: center;"> <table border="1" style="width: 100%; border-collapse: collapse; text-align: center;"> <tr> <td style="width: 10%;"></td> <td style="width: 10%;"></td> <td style="width: 10%;"></td> <td style="width: 10%;"></td> <td style="width: 10%;"></td> <td style="width: 10%;"></td> <td style="width: 10%;"></td> <td style="width: 10%;"></td> <td style="width: 10%;"></td> <td style="width: 10%;"></td> </tr> <tr> <td></td> <td></td> <td colspan="8" style="text-align: center;"> <table border="1" style="width: 100%; border-collapse: collapse; text-align: center;"> <tr> <td style="width: 10%;"></td> <td style="width: 10%;"></td> <td style="width: 10%;"></td> <td style="width: 10%;"></td> <td style="width: 10%;"></td> <td style="width: 10%;"></td> <td style="width: 10%;"></td> <td style="width: 10%;"></td> <td style="width: 10%;"></td> <td style="width: 10%;"></td> </tr> <tr> <td></td> <td></td> <td colspan="8" style="text-align: center;"> <table border="1" style="width: 100%; border-collapse: collapse; text-align: center;"> <tr> <td style="width: 10%;"></td> <td style="width: 10%;"></td> <td style="width: 10%;"></td> <td style="width: 10%;"></td> <td style="width: 10%;"></td> <td style="width: 10%;"></td> <td style="width: 10%;"></td> <td style="width: 10%;"></td> <td style="width: 10%;"></td> <td style="width: 10%;"></td> </tr> <tr> <td></td> <td></td> <td colspan="8" style="text-align: center;"> <table border="1" style="width: 100%; border-collapse: collapse; text-align: center;"> <tr> <td style="width: 10%;"></td> <td style="width: 10%;"></td> <td style="width: 10%;"></td> <td style="width: 10%;"></td> <td style="width: 10%;"></td> <td style="width: 10%;"></td> <td style="width: 10%;"></td> <td style="width: 10%;"></td> <td style="width: 10%;"></td> <td style="width: 10%;"></td> </tr> <tr> <td></td> <td></td> <td colspan="8" style="text-align: center;"> <table border="1" style="width: 100%; border-collapse: collapse; text-align: center;"> <tr> <td style="width: 10%;"></td> <td style="width: 10%;"></td> <td style="width: 10%;"></td> <td style="width: 10%;"></td> <td style="width: 10%;"></td> <td style="width: 10%;"></td> <td style="width: 10%;"></td> <td style="width: 10%;"></td> <td style="width: 10%;"></td> <td style="width: 10%;"></td> </tr> <tr> <td></td> <td></td> <td colspan="8" style="text-align: center;"> <table border="1" style="width: 100%; border-collapse: collapse; text-align: center;"> <tr> <td style="width: 10%;"></td> <td style="width: 10%;"></td> <td style="width: 10%;"></td> <td style="width: 10%;"></td> <td style="width: 10%;"></td> <td style="width: 10%;"></td> <td style="width: 10%;"></td> <td style="width: 10%;"></td> <td style="width: 10%;"></td> <td style="width: 10%;"></td> </tr> <tr> <td></td> <td></td> <td colspan="8" style="text-align: center;"> <table border="1" style="width: 100%; border-collapse: collapse; text-align: center;"> <tr> <td style="width: 10%;"></td> <td style="width: 10%;"></td> <td style="width: 10%;"></td> <td style="width: 10%;"></td> <td style="width: 10%;"></td> <td style="width: 10%;"></td> <td style="width: 10%;"></td> <td style="width: 10%;"></td> <td style="width: 10%;"></td> <td style="width: 10%;"></td> </tr> <tr> <td></td> <td></td> <td colspan="8" style="text-align: center;"> <table border="1" style="width: 100%; border-collapse: collapse; text-align: center;"> <tr> <td style="width: 10%;"></td> <td style="width: 10%;"></td> <td style="width: 10%;"></td> <td style="width: 10%;"></td> <td style="width: 10%;"></td> <td style="width: 10%;"></td> <td style="width: 10%;"></td> <td style="width: 10%;"></td> <td style="width: 10%;"></td> <td style="width: 10%;"></td> </tr> <tr> <td></td> <td></td> <td colspan="8" style="text-align: center;"> <table border="1" style="width: 100%; border-collapse: collapse; text-align: center;"> <tr> <td style="width: 10%;"></td> <td style="width: 10%;"></td> <td style="width: 10%;"></td> <td style="width: 10%;"></td> <td style="width: 10%;"></td> <td style="width: 10%;"></td> <td style="width: 10%;"></td> <td style="width: 10%;"></td> <td style="width: 10%;"></td> <td style="width: 10%;"></td> </tr> <tr> <td></td> <td></td> <td colspan="8" style="text-align: center;"> <table border="1" style="width: 100%; border-collapse: collapse; text-align: center;"> <tr> </tr></table></td></tr></table></td></tr></table></td></tr></table></td></tr></table></td></tr></table></td></tr></table></td></tr></table></td></tr></table></td></tr></table></td></tr></table></td></tr></table></td></tr></table>

 | | | | | | | | | | | | | | | | | | | | <table border="1" style="width: 100%; border-collapse: collapse; text-align: center;"> <tr> <td style="width: 10%;"></td> <td style="width: 10%;"></td> <td style="width: 10%;"></td> <td style="width: 10%;"></td> <td style="width: 10%;"></td> <td style="width: 10%;"></td> <td style="width: 10%;"></td> <td style="width: 10%;"></td> <td style="width: 10%;"></td> <td style="width: 10%;"></td> </tr> <tr> <td></td> <td></td> <td colspan="8" style="text-align: center;"> <table border="1" style="width: 100%; border-collapse: collapse; text-align: center;"> <tr> <td style="width: 10%;"></td> <td style="width: 10%;"></td> <td style="width: 10%;"></td> <td style="width: 10%;"></td> <td style="width: 10%;"></td> <td style="width: 10%;"></td> <td style="width: 10%;"></td> <td style="width: 10%;"></td> <td style="width: 10%;"></td> <td style="width: 10%;"></td> </tr> <tr> <td></td> <td></td> <td colspan="8" style="text-align: center;"> <table border="1" style="width: 100%; border-collapse: collapse; text-align: center;"> <tr> <td style="width: 10%;"></td> <td style="width: 10%;"></td> <td style="width: 10%;"></td> <td style="width: 10%;"></td> <td style="width: 10%;"></td> <td style="width: 10%;"></td> <td style="width: 10%;"></td> <td style="width: 10%;"></td> <td style="width: 10%;"></td> <td style="width: 10%;"></td> </tr> <tr> <td></td> <td></td> <td colspan="8" style="text-align: center;"> <table border="1" style="width: 100%; border-collapse: collapse; text-align: center;"> <tr> <td style="width: 10%;"></td> <td style="width: 10%;"></td> <td style="width: 10%;"></td> <td style="width: 10%;"></td> <td style="width: 10%;"></td> <td style="width: 10%;"></td> <td style="width: 10%;"></td> <td style="width: 10%;"></td> <td style="width: 10%;"></td> <td style="width: 10%;"></td> </tr> <tr> <td></td> <td></td> <td colspan="8" style="text-align: center;"> <table border="1" style="width: 100%; border-collapse: collapse; text-align: center;"> <tr> <td style="width: 10%;"></td> <td style="width: 10%;"></td> <td style="width: 10%;"></td> <td style="width: 10%;"></td> <td style="width: 10%;"></td> <td style="width: 10%;"></td> <td style="width: 10%;"></td> <td style="width: 10%;"></td> <td style="width: 10%;"></td> <td style="width: 10%;"></td> </tr> <tr> <td></td> <td></td> <td colspan="8" style="text-align: center;"> <table border="1" style="width: 100%; border-collapse: collapse; text-align: center;"> <tr> <td style="width: 10%;"></td> <td style="width: 10%;"></td> <td style="width: 10%;"></td> <td style="width: 10%;"></td> <td style="width: 10%;"></td> <td style="width: 10%;"></td> <td style="width: 10%;"></td> <td style="width: 10%;"></td> <td style="width: 10%;"></td> <td style="width: 10%;"></td> </tr> <tr> <td></td> <td></td> <td colspan="8" style="text-align: center;"> <table border="1" style="width: 100%; border-collapse: collapse; text-align: center;"> <tr> <td style="width: 10%;"></td> <td style="width: 10%;"></td> <td style="width: 10%;"></td> <td style="width: 10%;"></td> <td style="width: 10%;"></td> <td style="width: 10%;"></td> <td style="width: 10%;"></td> <td style="width: 10%;"></td> <td style="width: 10%;"></td> <td style="width: 10%;"></td> </tr> <tr> <td></td> <td></td> <td colspan="8" style="text-align: center;"> <table border="1" style="width: 100%; border-collapse: collapse; text-align: center;"> <tr> <td style="width: 10%;"></td> <td style="width: 10%;"></td> <td style="width: 10%;"></td> <td style="width: 10%;"></td> <td style="width: 10%;"></td> <td style="width: 10%;"></td> <td style="width: 10%;"></td> <td style="width: 10%;"></td> <td style="width: 10%;"></td> <td style="width: 10%;"></td> </tr> <tr> <td></td> <td></td> <td colspan="8" style="text-align: center;"> <table border="1" style="width: 100%; border-collapse: collapse; text-align: center;"> <tr> <td style="width: 10%;"></td> <td style="width: 10%;"></td> <td style="width: 10%;"></td> <td style="width: 10%;"></td> <td style="width: 10%;"></td> <td style="width: 10%;"></td> <td style="width: 10%;"></td> <td style="width: 10%;"></td> <td style="width: 10%;"></td> <td style="width: 10%;"></td> </tr> <tr> <td></td> <td></td> <td colspan="8" style="text-align: center;"> <table border="1" style="width: 100%; border-collapse: collapse; text-align: center;"> <tr> <td style="width: 10%;"></td> <td style="width: 10%;"></td> <td style="width: 10%;"></td> <td style="width: 10%;"></td> <td style="width: 10%;"></td> <td style="width: 10%;"></td> <td style="width: 10%;"></td> <td style="width: 10%;"></td> <td style="width: 10%;"></td> <td style="width: 10%;"></td> </tr> <tr> <td></td> <td></td> <td colspan="8" style="text-align: center;"> <table border="1" style="width: 100%; border-collapse: collapse; text-align: center;"> <tr> <td style="width: 10%;"></td> <td style="width: 10%;"></td> <td style="width: 10%;"></td> <td style="width: 10%;"></td> <td style="width: 10%;"></td> <td style="width: 10%;"></td> <td style="width: 10%;"></td> <td style="width: 10%;"></td> <td style="width: 10%;"></td> <td style="width: 10%;"></td> </tr> <tr> <td></td> <td></td> <td colspan="8" style="text-align: center;"> <table border="1" style="width: 100%; border-collapse: collapse; text-align: center;"> <tr> </tr></table></td></tr></table></td></tr></table></td></tr></table></td></tr></table></td></tr></table></td></tr></table></td></tr></table></td></tr></table></td></tr></table></td></tr></table></td></tr></table>

 | | | | | | | | | | | | | | | | | | | | <table border="1" style="width: 100%; border-collapse: collapse; text-align: center;"> <tr> <td style="width: 10%;"></td> <td style="width: 10%;"></td> <td style="width: 10%;"></td> <td style="width: 10%;"></td> <td style="width: 10%;"></td> <td style="width: 10%;"></td> <td style="width: 10%;"></td> <td style="width: 10%;"></td> <td style="width: 10%;"></td> <td style="width: 10%;"></td> </tr> <tr> <td></td> <td></td> <td colspan="8" style="text-align: center;"> <table border="1" style="width: 100%; border-collapse: collapse; text-align: center;"> <tr> <td style="width: 10%;"></td> <td style="width: 10%;"></td> <td style="width: 10%;"></td> <td style="width: 10%;"></td> <td style="width: 10%;"></td> <td style="width: 10%;"></td> <td style="width: 10%;"></td> <td style="width: 10%;"></td> <td style="width: 10%;"></td> <td style="width: 10%;"></td> </tr> <tr> <td></td> <td></td> <td colspan="8" style="text-align: center;"> <table border="1" style="width: 100%; border-collapse: collapse; text-align: center;"> <tr> <td style="width: 10%;"></td> <td style="width: 10%;"></td> <td style="width: 10%;"></td> <td style="width: 10%;"></td> <td style="width: 10%;"></td> <td style="width: 10%;"></td> <td style="width: 10%;"></td> <td style="width: 10%;"></td> <td style="width: 10%;"></td> <td style="width: 10%;"></td> </tr> <tr> <td></td> <td></td> <td colspan="8" style="text-align: center;"> <table border="1" style="width: 100%; border-collapse: collapse; text-align: center;"> <tr> <td style="width: 10%;"></td> <td style="width: 10%;"></td> <td style="width: 10%;"></td> <td style="width: 10%;"></td> <td style="width: 10%;"></td> <td style="width: 10%;"></td> <td style="width: 10%;"></td> <td style="width: 10%;"></td> <td style="width: 10%;"></td> <td style="width: 10%;"></td> </tr> <tr> <td></td> <td></td> <td colspan="8" style="text-align: center;"> <table border="1" style="width: 100%; border-collapse: collapse; text-align: center;"> <tr> <td style="width: 10%;"></td> <td style="width: 10%;"></td> <td style="width: 10%;"></td> <td style="width: 10%;"></td> <td style="width: 10%;"></td> <td style="width: 10%;"></td> <td style="width: 10%;"></td> <td style="width: 10%;"></td> <td style="width: 10%;"></td> <td style="width: 10%;"></td> </tr> <tr> <td></td> <td></td> <td colspan="8" style="text-align: center;"> <table border="1" style="width: 100%; border-collapse: collapse; text-align: center;"> <tr> <td style="width: 10%;"></td> <td style="width: 10%;"></td> <td style="width: 10%;"></td> <td style="width: 10%;"></td> <td style="width: 10%;"></td> <td style="width: 10%;"></td> <td style="width: 10%;"></td> <td style="width: 10%;"></td> <td style="width: 10%;"></td> <td style="width: 10%;"></td> </tr> <tr> <td></td> <td></td> <td colspan="8" style="text-align: center;"> <table border="1" style="width: 100%; border-collapse: collapse; text-align: center;"> <tr> <td style="width: 10%;"></td> <td style="width: 10%;"></td> <td style="width: 10%;"></td> <td style="width: 10%;"></td> <td style="width: 10%;"></td> <td style="width: 10%;"></td> <td style="width: 10%;"></td> <td style="width: 10%;"></td> <td style="width: 10%;"></td> <td style="width: 10%;"></td> </tr> <tr> <td></td> <td></td> <td colspan="8" style="text-align: center;"> <table border="1" style="width: 100%; border-collapse: collapse; text-align: center;"> <tr> <td style="width: 10%;"></td> <td style="width: 10%;"></td> <td style="width: 10%;"></td> <td style="width: 10%;"></td> <td style="width: 10%;"></td> <td style="width: 10%;"></td> <td style="width: 10%;"></td> <td style="width: 10%;"></td> <td style="width: 10%;"></td> <td style="width: 10%;"></td> </tr> <tr> <td></td> <td></td> <td colspan="8" style="text-align: center;"> <table border="1" style="width: 100%; border-collapse: collapse; text-align: center;"> <tr> <td style="width: 10%;"></td> <td style="width: 10%;"></td> <td style="width: 10%;"></td> <td style="width: 10%;"></td> <td style="width: 10%;"></td> <td style="width: 10%;"></td> <td style="width: 10%;"></td> <td style="width: 10%;"></td> <td style="width: 10%;"></td> <td style="width: 10%;"></td> </tr> <tr> <td></td> <td></td> <td colspan="8" style="text-align: center;"> <table border="1" style="width: 100%; border-collapse: collapse; text-align: center;"> <tr> <td style="width: 10%;"></td> <td style="width: 10%;"></td> <td style="width: 10%;"></td> <td style="width: 10%;"></td> <td style="width: 10%;"></td> <td style="width: 10%;"></td> <td style="width: 10%;"></td> <td style="width: 10%;"></td> <td style="width: 10%;"></td> <td style="width: 10%;"></td> </tr> <tr> <td></td> <td></td> <td colspan="8" style="text-align: center;"> <table border="1" style="width: 100%; border-collapse: collapse; text-align: center;"> <tr> </tr></table></td></tr></table></td></tr></table></td></tr></table></td></tr></table></td></tr></table></td></tr></table></td></tr></table></td></tr></table></td></tr></table></td></tr></table>

 | | | | | | | | | | | | | | | | | | | | <table border="1" style="width: 100%; border-collapse: collapse; text-align: center;"> <tr> <td style="width: 10%;"></td> <td style="width: 10%;"></td> <td style="width: 10%;"></td> <td style="width: 10%;"></td> <td style="width: 10%;"></td> <td style="width: 10%;"></td> <td style="width: 10%;"></td> <td style="width: 10%;"></td> <td style="width: 10%;"></td> <td style="width: 10%;"></td> </tr> <tr> <td></td> <td></td> <td colspan="8" style="text-align: center;"> <table border="1" style="width: 100%; border-collapse: collapse; text-align: center;"> <tr> <td style="width: 10%;"></td> <td style="width: 10%;"></td> <td style="width: 10%;"></td> <td style="width: 10%;"></td> <td style="width: 10%;"></td> <td style="width: 10%;"></td> <td style="width: 10%;"></td> <td style="width: 10%;"></td> <td style="width: 10%;"></td> <td style="width: 10%;"></td> </tr> <tr> <td></td> <td></td> <td colspan="8" style="text-align: center;"> <table border="1" style="width: 100%; border-collapse: collapse; text-align: center;"> <tr> <td style="width: 10%;"></td> <td style="width: 10%;"></td> <td style="width: 10%;"></td> <td style="width: 10%;"></td> <td style="width: 10%;"></td> <td style="width: 10%;"></td> <td style="width: 10%;"></td> <td style="width: 10%;"></td> <td style="width: 10%;"></td> <td style="width: 10%;"></td> </tr> <tr> <td></td> <td></td> <td colspan="8" style="text-align: center;"> <table border="1" style="width: 100%; border-collapse: collapse; text-align: center;"> <tr> <td style="width: 10%;"></td> <td style="width: 10%;"></td> <td style="width: 10%;"></td> <td style="width: 10%;"></td> <td style="width: 10%;"></td> <td style="width: 10%;"></td> <td style="width: 10%;"></td> <td style="width: 10%;"></td> <td style="width: 10%;"></td> <td style="width: 10%;"></td> </tr> <tr> <td></td> <td></td> <td colspan="8" style="text-align: center;"> <table border="1" style="width: 100%; border-collapse: collapse; text-align: center;"> <tr> <td style="width: 10%;"></td> <td style="width: 10%;"></td> <td style="width: 10%;"></td> <td style="width: 10%;"></td> <td style="width: 10%;"></td> <td style="width: 10%;"></td> <td style="width: 10%;"></td> <td style="width: 10%;"></td> <td style="width: 10%;"></td> <td style="width: 10%;"></td> </tr> <tr> <td></td> <td></td> <td colspan="8" style="text-align: center;"> <table border="1" style="width: 100%; border-collapse: collapse; text-align: center;"> <tr> <td style="width: 10%;"></td> <td style="width: 10%;"></td> <td style="width: 10%;"></td> <td style="width: 10%;"></td> <td style="width: 10%;"></td> <td style="width: 10%;"></td> <td style="width: 10%;"></td> <td style="width: 10%;"></td> <td style="width: 10%;"></td> <td style="width: 10%;"></td> </tr> <tr> <td></td> <td></td> <td colspan="8" style="text-align: center;"> <table border="1" style="width: 100%; border-collapse: collapse; text-align: center;"> <tr> <td style="width: 10%;"></td> <td style="width: 10%;"></td> <td style="width: 10%;"></td> <td style="width: 10%;"></td> <td style="width: 10%;"></td> <td style="width: 10%;"></td> <td style="width: 10%;"></td> <td style="width: 10%;"></td> <td style="width: 10%;"></td> <td style="width: 10%;"></td> </tr> <tr> <td></td> <td></td> <td colspan="8" style="text-align: center;"> <table border="1" style="width: 100%; border-collapse: collapse; text-align: center;"> <tr> <td style="width: 10%;"></td> <td style="width: 10%;"></td> <td style="width: 10%;"></td> <td style="width: 10%;"></td> <td style="width: 10%;"></td> <td style="width: 10%;"></td> <td style="width: 10%;"></td> <td style="width: 10%;"></td> <td style="width: 10%;"></td> <td style="width: 10%;"></td> </tr> <tr> <td></td> <td></td> <td colspan="8" style="text-align: center;"> <table border="1" style="width: 100%; border-collapse: collapse; text-align: center;"> <tr> <td style="width: 10%;"></td> <td style="width: 10%;"></td> <td style="width: 10%;"></td> <td style="width: 10%;"></td> <td style="width: 10%;"></td> <td style="width: 10%;"></td> <td style="width: 10%;"></td> <td style="width: 10%;"></td> <td style="width: 10%;"></td> <td style="width: 10%;"></td> </tr> <tr> <td></td> <td></td> <td colspan="8" style="text-align: center;"> <table border="1" style="width: 100%; border-collapse: collapse; text-align: center;"> <tr> </tr></table></td></tr></table></td></tr></table></td></tr></table></td></tr></table></td></tr></table></td></tr></table></td></tr></table></td></tr></table></td></tr></table>

 | | | | | | | | | | | | | | | | | | | | <table border="1" style="width: 100%; border-collapse: collapse; text-align: center;"> <tr> <td style="width: 10%;"></td> <td style="width: 10%;"></td> <td style="width: 10%;"></td> <td style="width: 10%;"></td> <td style="width: 10%;"></td> <td style="width: 10%;"></td> <td style="width: 10%;"></td> <td style="width: 10%;"></td> <td style="width: 10%;"></td> <td style="width: 10%;"></td> </tr> <tr> <td></td> <td></td> <td colspan="8" style="text-align: center;"> <table border="1" style="width: 100%; border-collapse: collapse; text-align: center;"> <tr> <td style="width: 10%;"></td> <td style="width: 10%;"></td> <td style="width: 10%;"></td> <td style="width: 10%;"></td> <td style="width: 10%;"></td> <td style="width: 10%;"></td> <td style="width: 10%;"></td> <td style="width: 10%;"></td> <td style="width: 10%;"></td> <td style="width: 10%;"></td> </tr> <tr> <td></td> <td></td> <td colspan="8" style="text-align: center;"> <table border="1" style="width: 100%; border-collapse: collapse; text-align: center;"> <tr> <td style="width: 10%;"></td> <td style="width: 10%;"></td> <td style="width: 10%;"></td> <td style="width: 10%;"></td> <td style="width: 10%;"></td> <td style="width: 10%;"></td> <td style="width: 10%;"></td> <td style="width: 10%;"></td> <td style="width:
10%;"></td> <td style="width: 10%;"></td> </tr> <tr> <td></td> <td></td> <td colspan="8" style="text-align: center;"> <table border="1" style="width: 100%; border-collapse: collapse; text-align: center;"> <tr> <td style="width: 10%;"></td> <td style="width: 10%;"></td> <td style="width: 10%;"></td> <td style="width: 10%;"></td> <td style="width: 10%;"></td> <td style="width: 10%;"></td> <td style="width: 10%;"></td> <td style="width: 10%;"></td> <td style="width: 10%;"></td> <td style="width: 10%;"></td> </tr> <tr> <td></td> <td></td> <td colspan="8" style="text-align: center;"> <table border="1" style="width: 100%; border-collapse: collapse; text-align: center;"> <tr> <td style="width: 10%;"></td> <td style="width: 10%;"></td> <td style="width: 10%;"></td> <td style="width: 10%;"></td> <td style="width: 10%;"></td> <td style="width: 10%;"></td> <td style="width: 10%;"></td> <td style="width: 10%;"></td> <td style="width: 10%;"></td> <td style="width: 10%;"></td> </tr> <tr> <td></td> <td></td> <td colspan="8" style="text-align: center;"> <table border="1" style="width: 100%; border-collapse: collapse; text-align: center;"> <tr> <td style="width: 10%;"></td> <td style="width: 10%;"></td> <td style="width: 10%;"></td> <td style="width: 10%;"></td> <td style="width: 10%;"></td> <td style="width: 10%;"></td> <td style="width: 10%;"></td> <td style="width: 10%;"></td> <td style="width: 10%;"></td> <td style="width: 10%;"></td> </tr> <tr> <td></td> <td></td> <td colspan="8" style="text-align: center;"> <table border="1" style="width: 100%; border-collapse: collapse; text-align: center;"> <tr> <td style="width: 10%;"></td> <td style="width: 10%;"></td> <td style="width: 10%;"></td> <td style="width: 10%;"></td> <td style="width: 10%;"></td> <td style="width: 10%;"></td> <td style="width: 10%;"></td> <td style="width: 10%;"></td> <td style="width: 10%;"></td> <td style="width: 10%;"></td> </tr> <tr> <td></td> <td></td> <td colspan="8" style="text-align: center;"> <table border="1" style="width: 100%; border-collapse: collapse; text-align: center;"> <tr> <td style="width: 10%;"></td> <td style="width: 10%;"></td> <td style="width: 10%;"></td> <td style="width: 10%;"></td> <td style="width: 10%;"></td> <td style="width: 10%;"></td> <td style="width: 10%;"></td> <td style="width: 10%;"></td> <td style="width: 10%;"></td> <td style="width: 10%;"></td> </tr> <tr> <td></td> <td></td> <td colspan="8" style="text-align: center;"> <table border="1" style="width: 100%; border-collapse: collapse; text-align: center;"> <tr> </tr></table></td></tr></table></td></tr></table></td></tr></table></td></tr></table></td></tr></table></td></tr></table></td></tr></table></td></tr></table>

 | | | | | | | | | | | | | | | | | | | | <table border="1" style="width: 100%; border-collapse: collapse; text-align: center;"> <tr> <td style="width: 10%;"></td> <td style="width: 10%;"></td> <td style="width: 10%;"></td> <td style="width: 10%;"></td> <td style="width: 10%;"></td> <td style="width: 10%;"></td> <td style="width: 10%;"></td> <td style="width: 10%;"></td> <td style="width: 10%;"></td> <td style="width: 10%;"></td> </tr> <tr> <td></td> <td></td> <td colspan="8" style="text-align: center;"> <table border="1" style="width: 100%; border-collapse: collapse; text-align: center;"> <tr> <td style="width: 10%;"></td> <td style="width: 10%;"></td> <td style="width: 10%;"></td> <td style="width: 10%;"></td> <td style="width: 10%;"></td> <td style="width: 10%;"></td> <td style="width: 10%;"></td> <td style="width: 10%;"></td> <td style="width: 10%;"></td> <td style="width: 10%;"></td> </tr> <tr> <td></td> <td></td> <td colspan="8" style="text-align: center;"> <table border="1" style="width: 100%; border-collapse: collapse; text-align: center;"> <tr> <td style="width: 10%;"></td> <td style="width: 10%;"></td> <td style="width: 10%;"></td> <td style="width: 10%;"></td> <td style="width: 10%;"></td> <td style="width: 10%;"></td> <td style="width: 10%;"></td> <td style="width: 10%;"></td> <td style="width: 10%;"></td> <td style="width: 10%;"></td> </tr> <tr> <td></td> <td></td> <td colspan="8" style="text-align: center;"> <table border="1" style="width: 100%; border-collapse: collapse; text-align: center;"> <tr> <td style="width: 10%;"></td> <td style="width: 10%;"></td> <td style="width: 10%;"></td> <td style="width: 10%;"></td> <td style="width: 10%;"></td> <td style="width: 10%;"></td> <td style="width: 10%;"></td> <td style="width: 10%;"></td> <td style="width: 10%;"></td> <td style="width: 10%;"></td> </tr> <tr> <td></td> <td></td> <td colspan="8" style="text-align: center;"> <table border="1" style="width: 100%; border-collapse: collapse; text-align: center;"> <tr> <td style="width: 10%;"></td> <td style="width: 10%;"></td> <td style="width: 10%;"></td> <td style="width: 10%;"></td> <td style="width: 10%;"></td> <td style="width: 10%;"></td> <td style="width: 10%;"></td> <td style="width: 10%;"></td> <td style="width: 10%;"></td> <td style="width: 10%;"></td> </tr> <tr> <td></td> <td></td> <td colspan="8" style="text-align: center;"> <table border="1" style="width: 100%; border-collapse: collapse; text-align: center;"> <tr> <td style="width: 10%;"></td> <td style="width: 10%;"></td> <td style="width: 10%;"></td> <td style="width: 10%;"></td> <td style="width: 10%;"></td> <td style="width: 10%;"></td> <td style="width: 10%;"></td> <td style="width: 10%;"></td> <td style="width: 10%;"></td> <td style="width: 10%;"></td> </tr> <tr> <td></td> <td></td> <td colspan="8" style="text-align: center;"> <table border="1" style="width: 100%; border-collapse: collapse; text-align: center;"> <tr> <td style="width: 10%;"></td> <td style="width: 10%;"></td> <td style="width: 10%;"></td> <td style="width: 10%;"></td> <td style="width: 10%;"></td> <td style="width: 10%;"></td> <td style="width: 10%;"></td> <td style="width: 10%;"></td> <td style="width: 10%;"></td> <td style="width: 10%;"></td> </tr> <tr> <td></td> <td></td> <td colspan="8" style="text-align: center;"> <table border="1" style="width: 100%; border-collapse: collapse; text-align: center;"> <tr>
</tr></table></td></tr></table></td></tr></table></td></tr></table></td></tr></table></td></tr></table></td></tr></table></td></tr></table>

 | | | | | | | | | | | | | | | | | | | | <table border="1" style="width: 100%; border-collapse: collapse; text-align: center;"> <tr> <td style="width: 10%;"></td> <td style="width: 10%;"></td> <td style="width: 10%;"></td> <td style="width: 10%;"></td> <td style="width: 10%;"></td> <td style="width: 10%;"></td> <td style="width: 10%;"></td> <td style="width: 10%;"></td> <td style="width: 10%;"></td> <td style="width: 10%;"></td> </tr> <tr> <td></td> <td></td> <td colspan="8" style="text-align: center;"> <table border="1" style="width: 100%; border-collapse: collapse; text-align: center;"> <tr> <td style="width: 10%;"></td> <td style="width: 10%;"></td> <td style="width: 10%;"></td> <td style="width: 10%;"></td> <td style="width: 10%;"></td> <td style="width: 10%;"></td> <td style="width: 10%;"></td> <td style="width: 10%;"></td> <td style="width: 10%;"></td> <td style="width: 10%;"></td> </tr> <tr> <td></td> <td></td> <td colspan="8" style="text-align: center;"> <table border="1" style="width: 100%; border-collapse: collapse; text-align: center;"> <tr> <td style="width: 10%;"></td> <td style="width: 10%;"></td> <td style="width: 10%;"></td> <td style="width: 10%;"></td> <td style="width: 10%;"></td> <td style="width: 10%;"></td> <td style="width: 10%;"></td> <td style="width: 10%;"></td> <td style="width: 10%;"></td> <td style="width: 10%;"></td> </tr> <tr> <td></td> <td></td> <td colspan="8" style="text-align: center;"> <table border="1" style="width: 100%; border-collapse: collapse; text-align: center;"> <tr> <td style="width: 10%;"></td> <td style="width: 10%;"></td> <td style="width: 10%;"></td> <td style="width: 10%;"></td> <td style="width: 10%;"></td> <td style="width: 10%;"></td> <td style="width: 10%;"></td> <td style="width: 10%;"></td> <td style="width: 10%;"></td> <td style="width: 10%;"></td> </tr> <tr> <td></td> <td></td> <td colspan="8" style="text-align: center;"> <table border="1" style="width: 100%; border-collapse: collapse; text-align: center;"> <tr> <td style="width: 10%;"></td> <td style="width: 10%;"></td> <td style="width: 10%;"></td> <td style="width: 10%;"></td> <td style="width: 10%;"></td> <td style="width: 10%;"></td> <td style="width: 10%;"></td> <td style="width: 10%;"></td> <td style="width: 10%;"></td> <td style="width: 10%;"></td> </tr> <tr> <td></td> <td></td> <td colspan="8" style="text-align: center;"> <table border="1" style="width: 100%; border-collapse: collapse; text-align: center;"> <tr> <td style="width: 10%;"></td> <td style="width: 10%;"></td> <td style="width: 10%;"></td> <td style="width: 10%;"></td> <td style="width: 10%;"></td> <td style="width: 10%;"></td> <td style="width: 10%;"></td> <td style="width: 10%;"></td> <td style="width: 10%;"></td> <td style="width: 10%;"></td> </tr> <tr> <td></td> <td></td> <td colspan="8" style="text-align: center;"> <table border="1" style="width: 100%; border-collapse: collapse; text-align: center;"> <tr> </tr></table></td></tr></table></td></tr></table></td></tr></table></td></tr></table></td></tr></table></td></tr></table>

 | | | | | | | | | | | | | | | | | | | | <table border="1" style="width: 100%; border-collapse: collapse; text-align: center;"> <tr> <td style="width: 10%;"></td> <td style="width: 10%;"></td> <td style="width: 10%;"></td> <td style="width: 10%;"></td> <td style="width: 10%;"></td> <td style="width: 10%;"></td> <td style="width: 10%;"></td> <td style="width: 10%;"></td> <td style="width: 10%;"></td> <td style="width: 10%;"></td> </tr> <tr> <td></td> <td></td> <td colspan="8" style="text-align: center;"> <table border="1" style="width: 100%; border-collapse: collapse; text-align: center;"> <tr> <td style="width: 10%;"></td> <td style="width: 10%;"></td> <td style="width: 10%;"></td> <td style="width: 10%;"></td> <td style="width: 10%;"></td> <td style="width: 10%;"></td> <td style="width: 10%;"></td> <td style="width: 10%;"></td> <td style="width: 10%;"></td> <td style="width: 10%;"></td> </tr> <tr> <td></td> <td></td> <td colspan="8" style="text-align: center;"> <table border="1" style="width: 100%; border-collapse: collapse; text-align: center;"> <tr> <td style="width: 10%;"></td> <td style="width: 10%;"></td> <td style="width: 10%;"></td> <td style="width: 10%;"></td> <td style="width: 10%;"></td> <td style="width: 10%;"></td> <td style="width: 10%;"></td> <td style="width: 10%;"></td> <td style="width: 10%;"></td> <td style="width: 10%;"></td> </tr> <tr> <td></td> <td></td> <td colspan="8" style="text-align: center;"> <table border="1" style="width: 100%; border-collapse: collapse; text-align: center;"> <tr> <td style="width: 10%;"></td> <td style="width: 10%;"></td> <td style="width: 10%;"></td> <td style="width: 10%;"></td> <td style="width: 10%;"></td> <td style="width: 10%;"></td> <td style="width: 10%;"></td> <td style="width: 10%;"></td> <td style="width: 10%;"></td> <td style="width: 10%;"></td> </tr> <tr> <td></td> <td></td> <td colspan="8" style="text-align: center;"> <table border="1" style="width: 100%; border-collapse: collapse; text-align: center;"> <tr> <td style="width: 10%;"></td> <td style="width: 10%;"></td> <td style="width: 10%;"></td> <td style="width: 10%;"></td> <td style="width: 10%;"></td> <td style="width: 10%;"></td> <td style="width: 10%;"></td> <td style="width: 10%;"></td> <td style="width: 10%;"></td> <td style="width: 10%;"></td> </tr> <tr> <td></td> <td></td> <td colspan="8" style="text-align: center;"> <table border="1" style="width: 100%; border-collapse: collapse; text-align: center;"> <tr> </tr></table></td></tr></table></td></tr></table></td></tr></table></td></tr></table></td></tr></table>

 | | | | | | | | | | | | | | | | | | | | <table border="1" style="width: 100%; border-collapse: collapse; text-align: center;"> <tr> <td style="width: 10%;"></td> <td style="width: 10%;"></td> <td style="width: 10%;"></td> <td style="width: 10%;"></td> <td style="width: 10%;"></td> <td style="width: 10%;"></td> <td style="width: 10%;"></td> <td style="width: 10%;"></td> <td style="width: 10%;"></td> <td style="width: 10%;"></td> </tr> <tr> <td></td> <td></td> <td colspan="8" style="text-align: center;"> <table border="1" style="width: 100%; border-collapse: collapse; text-align: center;"> <tr> <td style="width: 10%;"></td> <td style="width: 10%;"></td> <td style="width: 10%;"></td> <td style="width: 10%;"></td> <td style="width: 10%;"></td> <td style="width: 10%;"></td> <td style="width: 10%;"></td> <td style="width: 10%;"></td> <td style="width: 10%;"></td> <td style="width: 10%;"></td> </tr> <tr> <td></td> <td></td> <td colspan="8" style="text-align: center;"> <table border="1" style="width: 100%; border-collapse: collapse; text-align: center;"> <tr> <td style="width: 10%;"></td> <td style="width: 10%;"></td> <td style="width: 10%;"></td> <td style="width: 10%;"></td> <td style="width: 10%;"></td> <td style="width: 10%;"></td> <td style="width: 10%;"></td> <td style="width: 10%;"></td> <td style="width: 10%;"></td> <td style="width: 10%;"></td> </tr> <tr> <td></td> <td></td> <td colspan="8" style="text-align: center;"> <table border="1" style="width: 100%; border-collapse: collapse; text-align: center;"> <tr> <td style="width: 10%;"></td> <td style="width: 10%;"></td> <td style="width: 10%;"></td> <td style="width: 10%;"></td> <td style="width: 10%;"></td> <td style="width: 10%;"></td> <td style="width: 10%;"></td> <td style="width: 10%;"></td> <td style="width: 10%;"></td> <td style="width: 10%;"></td> </tr> <tr> <td></td> <td></td> <td colspan="8" style="text-align: center;"> <table border="1" style="width: 100%; border-collapse: collapse; text-align: center;"> <tr> </tr></table></td></tr></table></td></tr></table></td></tr></table></td></tr></table>

 | | | | | | | | | | | | | | | | | | | | <table border="1" style="width: 100%; border-collapse: collapse; text-align: center;"> <tr> <td style="width: 10%;"></td> <td style="width: 10%;"></td> <td style="width: 10%;"></td> <td style="width: 10%;"></td> <td style="width: 10%;"></td> <td style="width: 10%;"></td> <td style="width: 10%;"></td> <td style="width: 10%;"></td> <td style="width: 10%;"></td> <td style="width: 10%;"></td> </tr> <tr> <td></td> <td></td> <td colspan="8" style="text-align: center;"> <table border="1" style="width: 100%; border-collapse: collapse; text-align: center;"> <tr> <td style="width: 10%;"></td> <td style="width: 10%;"></td> <td style="width: 10%;"></td> <td style="width: 10%;"></td> <td style="width: 10%;"></td> <td style="width: 10%;"></td> <td style="width: 10%;"></td> <td style="width: 10%;"></td> <td style="width: 10%;"></td> <td style="width: 10%;"></td> </tr> <tr> <td></td> <td></td> <td colspan="8" style="text-align: center;"> <table border="1" style="width: 100%; border-collapse: collapse; text-align: center;"> <tr> <td style="width: 10%;"></td> <td style="width: 10%;"></td> <td style="width: 10%;"></td> <td style="width: 10%;"></td> <td style="width: 10%;"></td> <td style="width: 10%;"></td> <td style="width: 10%;"></td> <td style="width: 10%;"></td> <td style="width: 10%;"></td> <td style="width: 10%;"></td> </tr> <tr> <td></td> <td></td> <td colspan="8" style="text-align: center;"> <table border="1" style="width: 100%; border-collapse: collapse; text-align: center;"> <tr> </tr></table></td></tr></table></td></tr></table></td></tr></table>

 | | | | | | | | | | | | | | | | | | | | <table border="1" style="width: 100%; border-collapse: collapse; text-align: center;"> <tr> <td style="width: 10%;"></td> <td style="width: 10%;"></td> <td style="width: 10%;"></td> <td style="width: 10%;"></td> <td style="width: 10%;"></td> <td style="width: 10%;"></td> <td style="width: 10%;"></td> <td style="width: 10%;"></td> <td style="width: 10%;"></td> <td style="width: 10%;"></td> </tr> <tr> <td></td> <td></td> <td colspan="8" style="text-align: center;"> <table border="1" style="width: 100%; border-collapse: collapse; text-align: center;"> <tr> <td style="width: 10%;"></td> <td style="width: 10%;"></td> <td style="width: 10%;"></td> <td style="width: 10%;"></td> <td style="width: 10%;"></td> <td style="width: 10%;"></td> <td style="width: 10%;"></td> <td style="width: 10%;"></td> <td style="width: 10%;"></td> <td style="width: 10%;"></td> </tr> <tr> <td></td> <td></td> <td colspan="8" style="text-align: center;"> <table border="1" style="width: 100%; border-collapse: collapse; text-align: center;"> <tr> </tr></table></td></tr></table></td></tr></table>

 | | | | | | | | | | | | | | | | | | | | <table border="1" style="width: 100%; border-collapse: collapse; text-align: center;"> <tr> <td style="width: 10%;"></td> <td style="width: 10%;"></td> <td style="width: 10%;"></td> <td style="width: 10%;"></td> <td style="width: 10%;"></td> <td style="width: 10%;"></td> <td style="width: 10%;"></td> <td style="width: 10%;"></td> <td style="width: 10%;"></td> <td style="width: 10%;"></td> </tr> <tr> <td></td> <td></td> <td colspan="8" style="text-align: center;"> <table border="1" style="width: 100%; border-collapse: collapse; text-align: center;"> <tr> </tr></table></td></tr></table>

 | | | | | | | | | | | | | | | | | | | | <table border="1" style="width: 100%; border-collapse: collapse; text-align: center;"> <tr> </tr></table>

 | | | | | | | | | | | | | | | | | | | |

 | | | | | | | | | | | | | | | | | | | |

 | | | | | | | | | | | | | | | | | | | |

 | | | | | | | | | | | | | | | | | | | |

 | | | | | | | | | | | | | | | | | | | |

 | | | | | | | | | | | | | | | | | | | |

 | | | | | | | | | | | | | | | | | | | |

 | | | | | | | | | | | | | | | | | | | |

 | | | | | | | | | | | | | | | | | | | |

 | | | | | | | | | | | | | | | | | | | |

 | | | | | | | | | | | | | | | | | | | |

 | | | | | | | | | | | | | | | | | | | |

 | | | | | | | | | | | | | | | | | | | |
 | | | | | | | | | | | | | | | | | | | |

 | | | | | | | | | | | | | | | | | | | |

 | | | | | | | | | | | | | | | | | | | |
 | | | | | | | | | | | | | | | | | | | |

 | | | | | | | | | | | | | | | | | | | |

 | | | | | | | | | | | | | | | | | | | |
 | | | | | | | | | | | | | | | | | | | |
 | | | | | | | | | | | | | | | | | | | |

 | | | | | | | | | | | | | | | | | | | |
 | | | | | | | | | | | | | | | | | | | |
 | | | | | | | | | | | | | | | | | | | |

 | | | | | | | | | | | | | | | | | | | | | | | | | | | | | | | | | | | | | | | | | | | | | | | | | | | | | | | | | | | | | | | | | | | | | | | | | | | | | | | | | | | | | | | | | | | | | | | | | | | |
 | | | | | | | | | | | | | | | | | | | |
 | | | | | | | | | | | | | | | | | | | |
 | | | | | | | | | | | | | | | | | | | |
 | | | | | | | | | | | | | | | | | | | |
 | | | | | | | | | | | | | | | | | | | |
 | | | | | | | | | | | | | | | | | | | |
 | | | | | | | | | | | | | | | | | | | |
 | | | | | | | | | | | | | | | | | | | |
 | | | | | | | | | | | | | | | | | | | | | | | | | | | | | | | | | | | | | | | |
 | | | | | | | | | | | | | | | | | | | |
 | | | | | | | | | | | | | | | | | | | | | | | | | | | | | | | | | | | | | | | |
 | | | | | | | | | | | | | | | | | | | | | | | | | | | | | | | | | | | | | | | |
 | | | | | | | | | | | | | | | | | | | | | | | | | | | | | | | | | | | | | | | |
 | | | | | | | | | | | | | | | | | | | | | | | | | | | | | | | | | | | | | | | | | | | | | | | | | | | | | | | | | | | | | | | | | | | | | | | | | | | | | | | | | | | | | | | | | | | | | | | | | | | |
 | | | | | | | | | | | | | | | | | | | | | | | | | | | | | | | | | | | | | | | | | | | | | | | |
| | |

 | | | | | | | | | | | | | | | | | | | |

 | | | | | | | | | | | | | | | | | | | |

 | | | | | | | | | | | | | | | | | | | |

 | | | | | | | | | | | | | | | | | | | |

 | | | | | | | | | | | | | | | | | | | |

 | | | | | | | | | | | | | | | | | | | |

 | | | | | | | | | | | | | | | | | | | |

 | | | | | | | | | | | | | | | | | | | |

 | | | | | | | | | | | | | | | | | | | |

 | | | | | | | | | | | | | | | | | | | |

 | | | | | | | | | | | | | | | | | | | |

 | | | | | | | | | | | | | | | | | | | |

 | | | | | | | | | | | | | | | | | | | |

 | | | | | | | | | | | | | | | | | | | |

 | | | | | | | | | | | | | | | | | | | |

 | | | | | | | | | | | | | | | | | | | |

 | | | | | | | | | | | | | | | | | | | |

 | | | | | | | | | | | | | | | | | | | |

 | | | | | | | | | | | | | | | | | | | |

 | | | | | | | | | | | | | | | | | | | |

 | | | | | | | | | | | | | | | | | | | |

 | | | | | | | | | | | | | | | | | | | |

 | | | | | | | | | | | | | | | | | | | |

 | | | | | | | | | | | | | | | | | | | |

 | | | | | | | | | | | | | | | | | | | |

 | | | | | | | | | | | | | | | | | | | |

 | | | | | | | | | | | | | | | | | | | |

 | | | | | | | | | | | | | | | | | | | |
 | | | | | | | | | | | | | | | | | | | |

 | | | | | | | | | | | | | | | | | | | |

 | | | | | | | | | | | | | | | | | | | |
 | | | | | | | | | | | | | | | | | | | |

 | | | | | | | | | | | | | | | | | | | |

 | | | | | | | | | | | | | | | | | | | |
 | | | | | | | | | | | | | | | | | | | |
 | | | | | | | | | | | | | | | | | | | |

 | | | | | | | | | | | | | | | | | | | |
 | | | | | | | | | | | | | | | | | | | |
 | | | | | | | | | | | | | | | | | | | |

 | | | | | | | | | | | | | | | | | | | | | | | | | | | | | | | | | | | | | | | | | | | | | | | | | | | | | | | | | | | | | | | | | | | | | | | | | | | | | | | | | | | | | | | | | | | | | | | | | | | |
 | | | | | | | | | | | | | | | | | | | |
 | | | | | | | | | | | | | | | | | | | |
 | | | | | | | | | | | | | | | | | | | |
 | | | | | | | | | | | | | | | | | | | |
 | | | | | | | | | | | | | | | | | | | |
 | | | | | | | | | | | | | | | | | | | |
 | | | | | | | | | | | | | | | | | | | |
 | | | | | | | | | | | | | | | | | | | |
 | | | | | | | | | | | | | | | | | | | | | | | | | | | | | | | | | | | | | | | |
 | | | | | | | | | | | | | | | | | | | |
 | | | | | | | | | | | | | | | | | | | | | | | | | | | | | | | | | | | | | | | |
 | | | | | | | | | | | | | | | | | | | | | | | | | | | | | | | | | | | | | | | |
 | | | | | | | | | | | | | | | | | | | | | | | | | | | | | | | | | | | | | | | |
 | | | | | | | | | | | | | | | | | | | | | | | | | | | | | | | | | | | | | | | | | | | | | | | | | | | | | | | | | | | | | | | | | | | | | | | | | | | | | | | | | | | | | | | | | | | | | | | | | | | |
 | | | | | | | | | | | | | | | | | | | | | | | | | | | | | | | | | | | | | | | | | | | | | | | |
| | | <table border="1" style="width: 100%; border-collapse: collapse; text-align: center;"> <tr> <td style="width: 10%;"></td> <td style="width: 10%;"></td> <td style="width: 10%;"></td> <td style="width: 10%;"></td> <td style="width: 10%;"></td> <td style="width: 10%;"></td> <td style="width: 10%;"></td> <td style="width: 10%;"></td> <td style="width: 10%;"></td> <td style="width: 10%;"></td> </tr> <tr> <td></td> <td></td> <td colspan="8" style="text-align: center;"> <table border="1" style="width: 100%; border-collapse: collapse; text-align: center;"> <tr> <td style="width: 10%;"></td> <td style="width: 10%;"></td> <td style="width: 10%;"></td> <td style="width: 10%;"></td> <td style="width: 10%;"></td> <td style="width: 10%;"></td> <td style="width: 10%;"></td> <td style="width: 10%;"></td> <td style="width: 10%;"></td> <td style="width: 10%;"></td> </tr> <tr> <td></td> <td></td> <td colspan="8" style="text-align: center;"> <table border="1" style="width: 100%; border-collapse: collapse; text-align: center;"> <tr> <td style="width: 10%;"></td> <td style="width: 10%;"></td> <td style="width: 10%;"></td> <td style="width: 10%;"></td> <td style="width: 10%;"></td> <td style="width: 10%;"></td> <td style="width: 10%;"></td> <td style="width: 10%;"></td> <td style="width: 10%;"></td> <td style="width: 10%;"></td> </tr> <tr> <td></td> <td></td> <td colspan="8" style="text-align: center;"> <table border="1" style="width: 100%; border-collapse: collapse; text-align: center;"> <tr> <td style="width: 10%;"></td> <td style="width: 10%;"></td> <td style="width: 10%;"></td> <td style="width: 10%;"></td> <td style="width: 10%;"></td> <td style="width: 10%;"></td> <td style="width: 10%;"></td> <td style="width: 10%;"></td> <td style="width: 10%;"></td> <td style="width: 10%;"></td> </tr> <tr> <td></td> <td></td> <td colspan="8" style="text-align: center;"> <table border="1" style="width: 100%; border-collapse: collapse; text-align: center;"> <tr> <td style="width: 10%;"></td> <td style="width: 10%;"></td> <td style="width: 10%;"></td> <td style="width: 10%;"></td> <td style="width: 10%;"></td> <td style="width: 10%;"></td> <td style="width: 10%;"></td> <td style="width: 10%;"></td> <td style="width: 10%;"></td> <td style="width: 10%;"></td> </tr> <tr> <td></td> <td></td> <td colspan="8" style="text-align: center;"> <table border="1" style="width: 100%; border-collapse: collapse; text-align: center;"> <tr> <td style="width: 10%;"></td> <td style="width: 10%;"></td> <td style="width: 10%;"></td> <td style="width: 10%;"></td> <td style="width: 10%;"></td> <td style="width: 10%;"></td> <td style="width: 10%;"></td> <td style="width: 10%;"></td> <td style="width: 10%;"></td> <td style="width: 10%;"></td> </tr> <tr> <td></td> <td></td> <td colspan="8" style="text-align: center;"> <table border="1" style="width: 100%; border-collapse: collapse; text-align: center;"> <tr> <td style="width: 10%;"></td> <td style="width: 10%;"></td> <td style="width: 10%;"></td> <td style="width: 10%;"></td> <td style="width: 10%;"></td> <td style="width: 10%;"></td> <td style="width: 10%;"></td> <td style="width: 10%;"></td> <td style="width: 10%;"></td> <td style="width: 10%;"></td> </tr> <tr> <td></td> <td></td> <td colspan="8" style="text-align: center;"> <table border="1" style="width: 100%; border-collapse: collapse; text-align: center;"> <tr> <td style="width: 10%;"></td> <td style="width: 10%;"></td> <td style="width: 10%;"></td> <td style="width: 10%;"></td> <td style="width: 10%;"></td> <td style="width: 10%;"></td> <td style="width: 10%;"></td> <td style="width: 10%;"></td> <td style="width: 10%;"></td> <td style="width: 10%;"></td> </tr> <tr> <td></td> <td></td> <td colspan="8" style="text-align: center;"> <table border="1" style="width: 100%; border-collapse: collapse; text-align: center;"> <tr> <td style="width: 10%;"></td> <td style="width: 10%;"></td> <td style="width: 10%;"></td> <td style="width: 10%;"></td> <td style="width: 10%;"></td> <td style="width: 10%;"></td> <td style="width: 10%;"></td> <td style="width: 10%;"></td> <td style="width: 10%;"></td> <td style="width: 10%;"></td> </tr> <tr> <td></td> <td></td> <td colspan="8" style="text-align: center;"> <table border="1" style="width: 100%; border-collapse: collapse; text-align: center;"> <tr> <td style="width: 10%;"></td> <td style="width: 10%;"></td> <td style="width: 10%;"></td> <td style="width: 10%;"></td> <td style="width: 10%;"></td> <td style="width: 10%;"></td> <td style="width: 10%;"></td> <td style="width: 10%;"></td> <td style="width: 10%;"></td> <td style="width: 10%;"></td> </tr> <tr> <td></td> <td></td> <td colspan="8" style="text-align: center;"> <table border="1" style="width: 100%; border-collapse: collapse; text-align: center;"> <tr> <td style="width: 10%;"></td> <td style="width: 10%;"></td> <td style="width: 10%;"></td> <td style="width: 10%;"></td> <td style="width: 10%;"></td> <td style="width: 10%;"></td> <td style="width: 10%;"></td> <td style="width: 10%;"></td> <td style="width: 10%;"></td> <td style="width: 10%;"></td> </tr> <tr> <td></td> <td></td> <td colspan="8" style="text-align: center;"> <table border="1" style="width: 100%; border-collapse: collapse; text-align: center;"> <tr> <td style="width: 10%;"></td> <td style="width: 10%;"></td> <td style="width: 10%;"></td> <td style="width: 10%;"></td> <td style="width: 10%;"></td> <td style="width: 10%;"></td> <td style="width: 10%;"></td> <td style="width: 10%;"></td> <td style="width: 10%;"></td> <td style="width: 10%;"></td> </tr> <tr> <td></td> <td></td> <td colspan="8" style="text-align: center;"> <table border="1" style="width: 100%; border-collapse: collapse; text-align: center;"> <tr> <td style="width: 10%;"></td> <td style="width: 10%;"></td> <td style="width: 10%;"></td> <td style="width: 10%;"></td> <td style="width: 10%;"></td> <td style="width: 10%;"></td> <td style="width: 10%;"></td> <td style="width: 10%;"></td> <td style="width: 10%;"></td> <td style="width: 10%;"></td> </tr> <tr> <td></td> <td></td> <td colspan="8" style="text-align: center;"> <table border="1" style="width: 100%; border-collapse: collapse; text-align: center;"> <tr> <td style="width: 10%;"></td> <td style="width: 10%;"></td> <td style="width: 10%;"></td> <td style="width: 10%;"></td> <td style="width: 10%;"></td> <td style="width: 10%;"></td> <td style="width: 10%;"></td> <td style="width: 10%;"></td> <td style="width: 10%;"></td> <td style="width: 10%;"></td> </tr> <tr> <td></td> <td></td> <td colspan="8" style="text-align: center;"> <table border="1" style="width: 100%; border-collapse: collapse; text-align: center;"> <tr> </tr></table></td></tr></table></td></tr></table></td></tr></table></td></tr></table></td></tr></table></td></tr></table></td></tr></table></td></tr></table></td></tr></table></td></tr></table></td></tr></table></td></tr></table></td></tr></table></td></tr></table>

 | | | | | | | | | | | | | | | | | | | | <table border="1" style="width: 100%; border-collapse: collapse; text-align: center;"> <tr> <td style="width: 10%;"></td> <td style="width: 10%;"></td> <td style="width: 10%;"></td> <td style="width: 10%;"></td> <td style="width: 10%;"></td> <td style="width: 10%;"></td> <td style="width: 10%;"></td> <td style="width: 10%;"></td> <td style="width: 10%;"></td> <td style="width: 10%;"></td> </tr> <tr> <td></td> <td></td> <td colspan="8" style="text-align: center;"> <table border="1" style="width: 100%; border-collapse: collapse; text-align: center;"> <tr> <td style="width: 10%;"></td> <td style="width: 10%;"></td> <td style="width: 10%;"></td> <td style="width: 10%;"></td> <td style="width: 10%;"></td> <td style="width: 10%;"></td> <td style="width: 10%;"></td> <td style="width: 10%;"></td> <td style="width: 10%;"></td> <td style="width: 10%;"></td> </tr> <tr> <td></td> <td></td> <td colspan="8" style="text-align: center;"> <table border="1" style="width: 100%; border-collapse: collapse; text-align: center;"> <tr> <td style="width: 10%;"></td> <td style="width: 10%;"></td> <td style="width: 10%;"></td> <td style="width: 10%;"></td> <td style="width: 10%;"></td> <td style="width: 10%;"></td> <td style="width: 10%;"></td> <td style="width: 10%;"></td> <td style="width: 10%;"></td> <td style="width: 10%;"></td> </tr> <tr> <td></td> <td></td> <td colspan="8" style="text-align: center;"> <table border="1" style="width: 100%; border-collapse: collapse; text-align: center;"> <tr> <td style="width: 10%;"></td> <td style="width: 10%;"></td> <td style="width: 10%;"></td> <td style="width: 10%;"></td> <td style="width: 10%;"></td> <td style="width: 10%;"></td> <td style="width: 10%;"></td> <td style="width: 10%;"></td> <td style="width: 10%;"></td> <td style="width: 10%;"></td> </tr> <tr> <td></td> <td></td> <td colspan="8" style="text-align: center;"> <table border="1" style="width: 100%; border-collapse: collapse; text-align: center;"> <tr> <td style="width: 10%;"></td> <td style="width: 10%;"></td> <td style="width: 10%;"></td> <td style="width: 10%;"></td> <td style="width: 10%;"></td> <td style="width: 10%;"></td> <td style="width: 10%;"></td> <td style="width: 10%;"></td> <td style="width: 10%;"></td> <td style="width: 10%;"></td> </tr> <tr> <td></td> <td></td> <td colspan="8" style="text-align: center;"> <table border="1" style="width: 100%; border-collapse: collapse; text-align: center;"> <tr> <td style="width: 10%;"></td> <td style="width: 10%;"></td> <td style="width: 10%;"></td> <td style="width: 10%;"></td> <td style="width: 10%;"></td> <td style="width: 10%;"></td> <td style="width: 10%;"></td> <td style="width: 10%;"></td> <td style="width: 10%;"></td> <td style="width: 10%;"></td> </tr> <tr> <td></td> <td></td> <td colspan="8" style="text-align: center;"> <table border="1" style="width: 100%; border-collapse: collapse; text-align: center;"> <tr> <td style="width: 10%;"></td> <td style="width: 10%;"></td> <td style="width: 10%;"></td> <td style="width: 10%;"></td> <td style="width: 10%;"></td> <td style="width: 10%;"></td> <td style="width: 10%;"></td> <td style="width: 10%;"></td> <td style="width: 10%;"></td> <td style="width: 10%;"></td> </tr> <tr> <td></td> <td></td> <td colspan="8" style="text-align: center;"> <table border="1" style="width: 100%; border-collapse: collapse; text-align: center;"> <tr> <td style="width: 10%;"></td> <td style="width: 10%;"></td> <td style="width: 10%;"></td> <td style="width: 10%;"></td> <td style="width: 10%;"></td> <td style="width: 10%;"></td> <td style="width: 10%;"></td> <td style="width: 10%;"></td> <td style="width: 10%;"></td> <td style="width: 10%;"></td> </tr> <tr> <td></td> <td></td> <td colspan="8" style="text-align: center;"> <table border="1" style="width: 100%; border-collapse: collapse; text-align: center;"> <tr> <td style="width: 10%;"></td> <td style="width: 10%;"></td> <td style="width: 10%;"></td> <td style="width: 10%;"></td> <td style="width: 10%;"></td> <td style="width: 10%;"></td> <td style="width: 10%;"></td> <td style="width: 10%;"></td> <td style="width: 10%;"></td> <td style="width: 10%;"></td> </tr> <tr> <td></td> <td></td> <td colspan="8" style="text-align: center;"> <table border="1" style="width: 100%; border-collapse: collapse; text-align: center;"> <tr> <td style="width: 10%;"></td> <td style="width: 10%;"></td> <td style="width: 10%;"></td> <td style="width: 10%;"></td> <td style="width: 10%;"></td> <td style="width: 10%;"></td> <td style="width: 10%;"></td> <td style="width: 10%;"></td> <td style="width: 10%;"></td> <td style="width: 10%;"></td> </tr> <tr> <td></td> <td></td> <td colspan="8" style="text-align: center;"> <table border="1" style="width: 100%; border-collapse: collapse; text-align: center;"> <tr> <td style="width: 10%;"></td> <td style="width: 10%;"></td> <td style="width: 10%;"></td> <td style="width: 10%;"></td> <td style="width: 10%;"></td> <td style="width: 10%;"></td> <td style="width: 10%;"></td> <td style="width: 10%;"></td> <td style="width: 10%;"></td> <td style="width: 10%;"></td> </tr> <tr> <td></td> <td></td> <td colspan="8" style="text-align: center;"> <table border="1" style="width: 100%; border-collapse: collapse; text-align: center;"> <tr> <td style="width: 10%;"></td> <td style="width: 10%;"></td> <td style="width: 10%;"></td> <td style="width: 10%;"></td> <td style="width: 10%;"></td> <td style="width: 10%;"></td> <td style="width: 10%;"></td> <td style="width: 10%;"></td> <td style="width: 10%;"></td> <td style="width: 10%;"></td> </tr> <tr> <td></td> <td></td> <td colspan="8" style="text-align: center;"> <table border="1" style="width: 100%; border-collapse: collapse; text-align: center;"> <tr> <td style="width: 10%;"></td> <td style="width: 10%;"></td> <td style="width: 10%;"></td> <td style="width: 10%;"></td> <td style="width: 10%;"></td> <td style="width: 10%;"></td> <td style="width: 10%;"></td> <td style="width: 10%;"></td> <td style="width: 10%;"></td> <td style="width: 10%;"></td> </tr> <tr> <td></td> <td></td> <td colspan="8" style="text-align: center;"> <table border="1" style="width: 100%; border-collapse: collapse; text-align: center;"> <tr> </tr></table></td></tr></table></td></tr></table></td></tr></table></td></tr></table></td></tr></table></td></tr></table></td></tr></table></td></tr></table></td></tr></table></td></tr></table></td></tr></table></td></tr></table></td></tr></table>

 | | | | | | | | | | | | | | | | | | | | <table border="1" style="width: 100%; border-collapse: collapse; text-align: center;"> <tr> <td style="width: 10%;"></td> <td style="width: 10%;"></td> <td style="width: 10%;"></td> <td style="width: 10%;"></td> <td style="width: 10%;"></td> <td style="width: 10%;"></td> <td style="width: 10%;"></td> <td style="width: 10%;"></td> <td style="width: 10%;"></td> <td style="width: 10%;"></td> </tr> <tr> <td></td> <td></td> <td colspan="8" style="text-align: center;"> <table border="1" style="width: 100%; border-collapse: collapse; text-align: center;"> <tr> <td style="width: 10%;"></td> <td style="width: 10%;"></td> <td style="width: 10%;"></td> <td style="width: 10%;"></td> <td style="width: 10%;"></td> <td style="width: 10%;"></td> <td style="width: 10%;"></td> <td style="width: 10%;"></td> <td style="width: 10%;"></td> <td style="width: 10%;"></td> </tr> <tr> <td></td> <td></td> <td colspan="8" style="text-align: center;"> <table border="1" style="width: 100%; border-collapse: collapse; text-align: center;"> <tr> <td style="width: 10%;"></td> <td style="width: 10%;"></td> <td style="width: 10%;"></td> <td style="width: 10%;"></td> <td style="width: 10%;"></td> <td style="width: 10%;"></td> <td style="width: 10%;"></td> <td style="width: 10%;"></td> <td style="width: 10%;"></td> <td style="width: 10%;"></td> </tr> <tr> <td></td> <td></td> <td colspan="8" style="text-align: center;"> <table border="1" style="width: 100%; border-collapse: collapse; text-align: center;"> <tr> <td style="width: 10%;"></td> <td style="width: 10%;"></td> <td style="width: 10%;"></td> <td style="width: 10%;"></td> <td style="width: 10%;"></td> <td style="width: 10%;"></td> <td style="width: 10%;"></td> <td style="width: 10%;"></td> <td style="width: 10%;"></td> <td style="width: 10%;"></td> </tr> <tr> <td></td> <td></td> <td colspan="8" style="text-align: center;"> <table border="1" style="width: 100%; border-collapse: collapse; text-align: center;"> <tr> <td style="width: 10%;"></td> <td style="width: 10%;"></td> <td style="width: 10%;"></td> <td style="width: 10%;"></td> <td style="width: 10%;"></td> <td style="width: 10%;"></td> <td style="width: 10%;"></td> <td style="width: 10%;"></td> <td style="width: 10%;"></td> <td style="width: 10%;"></td> </tr> <tr> <td></td> <td></td> <td colspan="8" style="text-align: center;"> <table border="1" style="width: 100%; border-collapse: collapse; text-align: center;"> <tr> <td style="width: 10%;"></td> <td style="width: 10%;"></td> <td style="width: 10%;"></td> <td style="width: 10%;"></td> <td style="width: 10%;"></td> <td style="width: 10%;"></td> <td style="width: 10%;"></td> <td style="width: 10%;"></td> <td style="width: 10%;"></td> <td style="width: 10%;"></td> </tr> <tr> <td></td> <td></td> <td colspan="8" style="text-align: center;"> <table border="1" style="width: 100%; border-collapse: collapse; text-align: center;"> <tr> <td style="width: 10%;"></td> <td style="width: 10%;"></td> <td style="width: 10%;"></td> <td style="width: 10%;"></td> <td style="width: 10%;"></td> <td style="width: 10%;"></td> <td style="width: 10%;"></td> <td style="width: 10%;"></td> <td style="width: 10%;"></td> <td style="width: 10%;"></td> </tr> <tr> <td></td> <td></td> <td colspan="8" style="text-align: center;"> <table border="1" style="width: 100%; border-collapse: collapse; text-align: center;"> <tr> <td style="width: 10%;"></td> <td style="width: 10%;"></td> <td style="width: 10%;"></td> <td style="width: 10%;"></td> <td style="width: 10%;"></td> <td style="width: 10%;"></td> <td style="width: 10%;"></td> <td style="width: 10%;"></td> <td style="width: 10%;"></td> <td style="width: 10%;"></td> </tr> <tr> <td></td> <td></td> <td colspan="8" style="text-align: center;"> <table border="1" style="width: 100%; border-collapse: collapse; text-align: center;"> <tr> <td style="width: 10%;"></td> <td style="width: 10%;"></td> <td style="width: 10%;"></td> <td style="width: 10%;"></td> <td style="width: 10%;"></td> <td style="width: 10%;"></td> <td style="width: 10%;"></td> <td style="width: 10%;"></td> <td style="width: 10%;"></td> <td style="width: 10%;"></td> </tr> <tr> <td></td> <td></td> <td colspan="8" style="text-align: center;"> <table border="1" style="width: 100%; border-collapse: collapse; text-align: center;"> <tr> <td style="width: 10%;"></td> <td style="width: 10%;"></td> <td style="width: 10%;"></td> <td style="width: 10%;"></td> <td style="width: 10%;"></td> <td style="width: 10%;"></td> <td style="width: 10%;"></td> <td style="width: 10%;"></td> <td style="width: 10%;"></td> <td style="width: 10%;"></td> </tr> <tr> <td></td> <td></td> <td colspan="8" style="text-align: center;"> <table border="1" style="width: 100%; border-collapse: collapse; text-align: center;"> <tr> <td style="width: 10%;"></td> <td style="width: 10%;"></td> <td style="width: 10%;"></td> <td style="width: 10%;"></td> <td style="width: 10%;"></td> <td style="width: 10%;"></td> <td style="width: 10%;"></td> <td style="width: 10%;"></td> <td style="width: 10%;"></td> <td style="width: 10%;"></td> </tr> <tr> <td></td> <td></td> <td colspan="8" style="text-align: center;"> <table border="1" style="width: 100%; border-collapse: collapse; text-align: center;"> <tr> <td style="width: 10%;"></td> <td style="width: 10%;"></td> <td style="width: 10%;"></td> <td style="width: 10%;"></td> <td style="width: 10%;"></td> <td style="width: 10%;"></td> <td style="width: 10%;"></td> <td style="width: 10%;"></td> <td style="width: 10%;"></td> <td style="width: 10%;"></td> </tr> <tr> <td></td> <td></td> <td colspan="8" style="text-align: center;"> <table border="1" style="width: 100%; border-collapse: collapse; text-align: center;"> <tr> </tr></table></td></tr></table></td></tr></table></td></tr></table></td></tr></table></td></tr></table></td></tr></table></td></tr></table></td></tr></table></td></tr></table></td></tr></table></td></tr></table></td></tr></table>

 | | | | | | | | | | | | | | | | | | | | <table border="1" style="width: 100%; border-collapse: collapse; text-align: center;"> <tr> <td style="width: 10%;"></td> <td style="width: 10%;"></td> <td style="width: 10%;"></td> <td style="width: 10%;"></td> <td style="width: 10%;"></td> <td style="width: 10%;"></td> <td style="width: 10%;"></td> <td style="width: 10%;"></td> <td style="width: 10%;"></td> <td style="width: 10%;"></td> </tr> <tr> <td></td> <td></td> <td colspan="8" style="text-align: center;"> <table border="1" style="width: 100%; border-collapse: collapse; text-align: center;"> <tr> <td style="width: 10%;"></td> <td style="width: 10%;"></td> <td style="width: 10%;"></td> <td style="width: 10%;"></td> <td style="width: 10%;"></td> <td style="width: 10%;"></td> <td style="width: 10%;"></td> <td style="width: 10%;"></td> <td style="width: 10%;"></td> <td style="width: 10%;"></td> </tr> <tr> <td></td> <td></td> <td colspan="8" style="text-align: center;"> <table border="1" style="width: 100%; border-collapse: collapse; text-align: center;"> <tr> <td style="width: 10%;"></td> <td style="width: 10%;"></td> <td style="width: 10%;"></td> <td style="width: 10%;"></td> <td style="width: 10%;"></td> <td style="width: 10%;"></td> <td style="width: 10%;"></td> <td style="width: 10%;"></td> <td style="width: 10%;"></td> <td style="width: 10%;"></td> </tr> <tr> <td></td> <td></td> <td colspan="8" style="text-align: center;"> <table border="1" style="width: 100%; border-collapse: collapse; text-align: center;"> <tr> <td style="width: 10%;"></td> <td style="width: 10%;"></td> <td style="width: 10%;"></td> <td style="width: 10%;"></td> <td style="width: 10%;"></td> <td style="width: 10%;"></td> <td style="width: 10%;"></td> <td style="width: 10%;"></td> <td style="width: 10%;"></td> <td style="width: 10%;"></td> </tr> <tr> <td></td> <td></td> <td colspan="8" style="text-align: center;"> <table border="1" style="width: 100%; border-collapse: collapse; text-align: center;"> <tr> <td style="width: 10%;"></td> <td style="width: 10%;"></td> <td style="width: 10%;"></td> <td style="width: 10%;"></td> <td style="width: 10%;"></td> <td style="width: 10%;"></td> <td style="width: 10%;"></td> <td style="width: 10%;"></td> <td style="width: 10%;"></td> <td style="width: 10%;"></td> </tr> <tr> <td></td> <td></td> <td colspan="8" style="text-align: center;"> <table border="1" style="width: 100%; border-collapse: collapse; text-align: center;"> <tr> <td style="width: 10%;"></td> <td style="width: 10%;"></td> <td style="width: 10%;"></td> <td style="width: 10%;"></td> <td style="width: 10%;"></td> <td style="width: 10%;"></td> <td style="width: 10%;"></td> <td style="width: 10%;"></td> <td style="width: 10%;"></td> <td style="width: 10%;"></td> </tr> <tr> <td></td> <td></td> <td colspan="8" style="text-align: center;"> <table border="1" style="width: 100%; border-collapse: collapse; text-align: center;"> <tr> <td style="width: 10%;"></td> <td style="width: 10%;"></td> <td style="width: 10%;"></td> <td style="width: 10%;"></td> <td style="width: 10%;"></td> <td style="width: 10%;"></td> <td style="width: 10%;"></td> <td style="width: 10%;"></td> <td style="width: 10%;"></td> <td style="width: 10%;"></td> </tr> <tr> <td></td> <td></td> <td colspan="8" style="text-align: center;"> <table border="1" style="width: 100%; border-collapse: collapse; text-align: center;"> <tr> <td style="width: 10%;"></td> <td style="width: 10%;"></td> <td style="width: 10%;"></td> <td style="width: 10%;"></td> <td style="width: 10%;"></td> <td style="width: 10%;"></td> <td style="width: 10%;"></td> <td style="width: 10%;"></td> <td style="width: 10%;"></td> <td style="width: 10%;"></td> </tr> <tr> <td></td> <td></td> <td colspan="8" style="text-align: center;"> <table border="1" style="width: 100%; border-collapse: collapse; text-align: center;"> <tr> <td style="width: 10%;"></td> <td style="width: 10%;"></td> <td style="width: 10%;"></td> <td style="width: 10%;"></td> <td style="width: 10%;"></td> <td style="width: 10%;"></td> <td style="width: 10%;"></td> <td style="width: 10%;"></td> <td style="width: 10%;"></td> <td style="width: 10%;"></td> </tr> <tr> <td></td> <td></td> <td colspan="8" style="text-align: center;"> <table border="1" style="width: 100%; border-collapse: collapse; text-align: center;"> <tr> <td style="width: 10%;"></td> <td style="width: 10%;"></td> <td style="width: 10%;"></td> <td style="width: 10%;"></td> <td style="width: 10%;"></td> <td style="width: 10%;"></td> <td style="width: 10%;"></td> <td style="width: 10%;"></td> <td style="width: 10%;"></td> <td style="width: 10%;"></td> </tr> <tr> <td></td> <td></td> <td colspan="8" style="text-align: center;"> <table border="1" style="width: 100%; border-collapse: collapse; text-align: center;"> <tr> <td style="width: 10%;"></td> <td style="width: 10%;"></td> <td style="width: 10%;"></td> <td style="width: 10%;"></td> <td style="width: 10%;"></td> <td style="width: 10%;"></td> <td style="width: 10%;"></td> <td style="width: 10%;"></td> <td style="width: 10%;"></td> <td style="width: 10%;"></td> </tr> <tr> <td></td> <td></td> <td colspan="8" style="text-align: center;"> <table border="1" style="width: 100%; border-collapse: collapse; text-align: center;"> <tr> </tr></table></td></tr></table></td></tr></table></td></tr></table></td></tr></table></td></tr></table></td></tr></table></td></tr></table></td></tr></table></td></tr></table></td></tr></table></td></tr></table>

 | | | | | | | | | | | | | | | | | | | | <table border="1" style="width: 100%; border-collapse: collapse; text-align: center;"> <tr> <td style="width: 10%;"></td> <td style="width: 10%;"></td> <td style="width: 10%;"></td> <td style="width: 10%;"></td> <td style="width: 10%;"></td> <td style="width: 10%;"></td> <td style="width: 10%;"></td> <td style="width: 10%;"></td> <td style="width: 10%;"></td> <td style="width: 10%;"></td> </tr> <tr> <td></td> <td></td> <td colspan="8" style="text-align: center;"> <table border="1" style="width: 100%; border-collapse: collapse; text-align: center;"> <tr> <td style="width: 10%;"></td> <td style="width: 10%;"></td> <td style="width: 10%;"></td> <td style="width: 10%;"></td> <td style="width: 10%;"></td> <td style="width: 10%;"></td> <td style="width: 10%;"></td> <td style="width: 10%;"></td> <td style="width: 10%;"></td> <td style="width: 10%;"></td> </tr> <tr> <td></td> <td></td> <td colspan="8" style="text-align: center;"> <table border="1" style="width: 100%; border-collapse: collapse; text-align: center;"> <tr> <td style="width: 10%;"></td> <td style="width: 10%;"></td> <td style="width: 10%;"></td> <td style="width: 10%;"></td> <td style="width: 10%;"></td> <td style="width: 10%;"></td> <td style="width: 10%;"></td> <td style="width: 10%;"></td> <td style="width: 10%;"></td> <td style="width: 10%;"></td> </tr> <tr> <td></td> <td></td> <td colspan="8" style="text-align: center;"> <table border="1" style="width: 100%; border-collapse: collapse; text-align: center;"> <tr> <td style="width: 10%;"></td> <td style="width: 10%;"></td> <td style="width: 10%;"></td> <td style="width: 10%;"></td> <td style="width: 10%;"></td> <td style="width: 10%;"></td> <td style="width: 10%;"></td> <td style="width: 10%;"></td> <td style="width: 10%;"></td> <td style="width: 10%;"></td> </tr> <tr> <td></td> <td></td> <td colspan="8" style="text-align: center;"> <table border="1" style="width: 100%; border-collapse: collapse; text-align: center;"> <tr> <td style="width: 10%;"></td> <td style="width: 10%;"></td> <td style="width: 10%;"></td> <td style="width: 10%;"></td> <td style="width: 10%;"></td> <td style="width: 10%;"></td> <td style="width: 10%;"></td> <td style="width: 10%;"></td> <td style="width: 10%;"></td> <td style="width: 10%;"></td> </tr> <tr> <td></td> <td></td> <td colspan="8" style="text-align: center;"> <table border="1" style="width: 100%; border-collapse: collapse; text-align: center;"> <tr> <td style="width: 10%;"></td> <td style="width: 10%;"></td> <td style="width: 10%;"></td> <td style="width: 10%;"></td> <td style="width: 10%;"></td> <td style="width: 10%;"></td> <td style="width: 10%;"></td> <td style="width: 10%;"></td> <td style="width: 10%;"></td> <td style="width: 10%;"></td> </tr> <tr> <td></td> <td></td> <td colspan="8" style="text-align: center;"> <table border="1" style="width: 100%; border-collapse: collapse; text-align: center;"> <tr> <td style="width: 10%;"></td> <td style="width: 10%;"></td> <td style="width: 10%;"></td> <td style="width: 10%;"></td> <td style="width: 10%;"></td> <td style="width: 10%;"></td> <td style="width: 10%;"></td> <td style="width: 10%;"></td> <td style="width: 10%;"></td> <td style="width: 10%;"></td> </tr> <tr> <td></td> <td></td> <td colspan="8" style="text-align: center;"> <table border="1" style="width: 100%; border-collapse: collapse; text-align: center;"> <tr> <td style="width: 10%;"></td> <td style="width: 10%;"></td> <td style="width: 10%;"></td> <td style="width: 10%;"></td> <td style="width: 10%;"></td> <td style="width: 10%;"></td> <td style="width: 10%;"></td> <td style="width: 10%;"></td> <td style="width: 10%;"></td> <td style="width: 10%;"></td> </tr> <tr> <td></td> <td></td> <td colspan="8" style="text-align: center;"> <table border="1" style="width: 100%; border-collapse: collapse; text-align: center;"> <tr> <td style="width: 10%;"></td> <td style="width: 10%;"></td> <td style="width: 10%;"></td> <td style="width: 10%;"></td> <td style="width: 10%;"></td> <td style="width: 10%;"></td> <td style="width: 10%;"></td> <td style="width: 10%;"></td> <td style="width: 10%;"></td> <td style="width: 10%;"></td> </tr> <tr> <td></td> <td></td> <td colspan="8" style="text-align: center;"> <table border="1" style="width: 100%; border-collapse: collapse; text-align: center;"> <tr> <td style="width: 10%;"></td> <td style="width: 10%;"></td> <td style="width: 10%;"></td> <td style="width: 10%;"></td> <td style="width: 10%;"></td> <td style="width: 10%;"></td> <td style="width: 10%;"></td> <td style="width: 10%;"></td> <td style="width: 10%;"></td> <td style="width: 10%;"></td> </tr> <tr> <td></td> <td></td> <td colspan="8" style="text-align: center;"> <table border="1" style="width: 100%; border-collapse: collapse; text-align: center;"> <tr> </tr></table></td></tr></table></td></tr></table></td></tr></table></td></tr></table></td></tr></table></td></tr></table></td></tr></table></td></tr></table></td></tr></table></td></tr></table>

 | | | | | | | | | | | | | | | | | | | | <table border="1" style="width: 100%; border-collapse: collapse; text-align: center;"> <tr> <td style="width: 10%;"></td> <td style="width: 10%;"></td> <td style="width: 10%;"></td> <td style="width: 10%;"></td> <td style="width: 10%;"></td> <td style="width: 10%;"></td> <td style="width: 10%;"></td> <td style="width: 10%;"></td> <td style="width: 10%;"></td> <td style="width: 10%;"></td> </tr> <tr> <td></td> <td></td> <td colspan="8" style="text-align: center;"> <table border="1" style="width: 100%; border-collapse: collapse; text-align: center;"> <tr> <td style="width: 10%;"></td> <td style="width: 10%;"></td> <td style="width: 10%;"></td> <td style="width: 10%;"></td> <td style="width: 10%;"></td> <td style="width: 10%;"></td> <td style="width: 10%;"></td> <td style="width: 10%;"></td> <td style="width: 10%;"></td> <td style="width: 10%;"></td> </tr> <tr> <td></td> <td></td> <td colspan="8" style="text-align: center;"> <table border="1" style="width: 100%; border-collapse: collapse; text-align: center;"> <tr> <td style="width: 10%;"></td> <td style="width: 10%;"></td> <td style="width: 10%;"></td> <td style="width: 10%;"></td> <td style="width: 10%;"></td> <td style="width: 10%;"></td> <td style="width: 10%;"></td> <td style="width: 10%;"></td> <td style="width: 10%;"></td> <td style="width: 10%;"></td> </tr> <tr> <td></td> <td></td> <td colspan="8" style="text-align: center;"> <table border="1" style="width: 100%; border-collapse: collapse; text-align: center;"> <tr> <td style="width: 10%;"></td> <td style="width: 10%;"></td> <td style="width: 10%;"></td> <td style="width: 10%;"></td> <td style="width: 10%;"></td> <td style="width: 10%;"></td> <td style="width: 10%;"></td> <td style="width: 10%;"></td> <td style="width: 10%;"></td> <td style="width: 10%;"></td> </tr> <tr> <td></td> <td></td> <td colspan="8" style="text-align: center;"> <table border="1" style="width: 100%; border-collapse: collapse; text-align: center;"> <tr> <td style="width: 10%;"></td> <td style="width: 10%;"></td> <td style="width: 10%;"></td> <td style="width: 10%;"></td> <td style="width: 10%;"></td> <td style="width: 10%;"></td> <td style="width: 10%;"></td> <td style="width: 10%;"></td> <td style="width: 10%;"></td> <td style="width: 10%;"></td> </tr> <tr> <td></td> <td></td> <td colspan="8" style="text-align: center;"> <table border="1" style="width: 100%; border-collapse: collapse; text-align: center;"> <tr> <td style="width: 10%;"></td> <td style="width: 10%;"></td> <td style="width: 10%;"></td> <td style="width: 10%;"></td> <td style="width: 10%;"></td> <td style="width: 10%;"></td> <td style="width: 10%;"></td> <td style="width: 10%;"></td> <td style="width: 10%;"></td> <td style="width: 10%;"></td> </tr> <tr> <td></td> <td></td> <td colspan="8" style="text-align: center;"> <table border="1" style="width: 100%; border-collapse: collapse; text-align: center;"> <tr> <td style="width: 10%;"></td> <td style="width: 10%;"></td> <td style="width: 10%;"></td> <td style="width: 10%;"></td> <td style="width: 10%;"></td> <td style="width: 10%;"></td> <td style="width: 10%;"></td> <td style="width: 10%;"></td> <td style="width: 10%;"></td> <td style="width: 10%;"></td> </tr> <tr> <td></td> <td></td> <td colspan="8" style="text-align: center;"> <table border="1" style="width: 100%; border-collapse: collapse; text-align: center;"> <tr> <td style="width: 10%;"></td> <td style="width: 10%;"></td> <td style="width: 10%;"></td> <td style="width: 10%;"></td> <td style="width: 10%;"></td> <td style="width: 10%;"></td> <td style="width: 10%;"></td> <td style="width: 10%;"></td> <td style="width: 10%;"></td> <td style="width: 10%;"></td> </tr> <tr> <td></td> <td></td> <td colspan="8" style="text-align: center;"> <table border="1" style="width: 100%; border-collapse: collapse; text-align: center;"> <tr> <td style="width: 10%;"></td> <td style="width: 10%;"></td> <td style="width: 10%;"></td> <td style="width: 10%;"></td> <td style="width: 10%;"></td> <td style="width: 10%;"></td> <td style="width: 10%;"></td> <td style="width: 10%;"></td> <td style="width: 10%;"></td> <td style="width: 10%;"></td> </tr> <tr> <td></td> <td></td> <td colspan="8" style="text-align: center;"> <table border="1" style="width: 100%; border-collapse: collapse; text-align: center;"> <tr> </tr></table></td></tr></table></td></tr></table></td></tr></table></td></tr></table></td></tr></table></td></tr></table></td></tr></table></td></tr></table></td></tr></table>

 | | | | | | | | | | | | | | | | | | | | <table border="1" style="width: 100%; border-collapse: collapse; text-align: center;"> <tr> <td style="width: 10%;"></td> <td style="width: 10%;"></td> <td style="width: 10%;"></td> <td style="width: 10%;"></td> <td style="width: 10%;"></td> <td style="width: 10%;"></td> <td style="width: 10%;"></td> <td style="width: 10%;"></td> <td style="width: 10%;"></td> <td style="width: 10%;"></td> </tr> <tr> <td></td> <td></td> <td colspan="8" style="text-align: center;"> <table border="1" style="width: 100%; border-collapse: collapse; text-align: center;"> <tr> <td style="width: 10%;"></td> <td style="width: 10%;"></td> <td style="width: 10%;"></td> <td style="width: 10%;"></td> <td style="width: 10%;"></td> <td style="width: 10%;"></td> <td style="width: 10%;"></td> <td style="width: 10%;"></td> <td style="width: 10%;"></td> <td style="width: 10%;"></td> </tr> <tr> <td></td> <td></td> <td colspan="8" style="text-align: center;"> <table border="1" style="width: 100%; border-collapse: collapse; text-align: center;"> <tr> <td style="width: 10%;"></td> <td style="width: 10%;"></td> <td style="width: 10%;"></td> <td style="width: 10%;"></td> <td style="width: 10%;"></td> <td style="width: 10%;"></td> <td style="width: 10%;"></td> <td style="width: 10%;"></td> <td style="width: 10%;"></td> <td style="width: 10%;"></td> </tr> <tr> <td></td> <td></td> <td colspan="8" style="text-align: center;"> <table border="1" style="width: 100%; border-collapse: collapse; text-align: center;"> <tr> <td style="width: 10%;"></td> <td style="width: 10%;"></td> <td style="width: 10%;"></td> <td style="width: 10%;"></td> <td style="width: 10%;"></td> <td style="width: 10%;"></td> <td style="width: 10%;"></td> <td style="width: 10%;"></td> <td style="width: 10%;"></td> <td style="width: 10%;"></td> </tr> <tr> <td></td> <td></td> <td colspan="8" style="text-align: center;"> <table border="1" style="width: 100%; border-collapse: collapse; text-align: center;"> <tr> <td style="width: 10%;"></td> <td style="width: 10%;"></td> <td style="width: 10%;"></td> <td style="width: 10%;"></td> <td style="width: 10%;"></td> <td style="width: 10%;"></td> <td style="width: 10%;"></td> <td style="width: 10%;"></td> <td style="width: 10%;"></td> <td style="width: 10%;"></td> </tr> <tr> <td></td> <td></td> <td colspan="8" style="text-align: center;"> <table border="1" style="width: 100%; border-collapse: collapse; text-align: center;"> <tr> <td style="width: 10%;"></td> <td style="width: 10%;"></td> <td style="width: 10%;"></td> <td style="width: 10%;"></td> <td style="width: 10%;"></td> <td style="width: 10%;"></td> <td style="width: 10%;"></td> <td style="width: 10%;"></td> <td style="width: 10%;"></td> <td style="width: 10%;"></td> </tr> <tr> <td></td> <td></td> <td colspan="8" style="text-align: center;"> <table border="1" style="width: 100%; border-collapse: collapse; text-align: center;"> <tr> <td style="width: 10%;"></td> <td style="width: 10%;"></td> <td style="width: 10%;"></td> <td style="width: 10%;"></td> <td style="width: 10%;"></td> <td style="width: 10%;"></td> <td style="width: 10%;"></td> <td style="width: 10%;"></td> <td style="width: 10%;"></td> <td style="width: 10%;"></td> </tr> <tr> <td></td> <td></td> <td colspan="8" style="text-align: center;"> <table border="1" style="width: 100%; border-collapse: collapse; text-align: center;"> <tr> <td style="width: 10%;"></td> <td style="width: 10%;"></td> <td style="width: 10%;"></td> <td style="width: 10%;"></td> <td style="width: 10%;"></td> <td style="width: 10%;"></td> <td style="width: 10%;"></td> <td style="width: 10%;"></td> <td style="width: 10%;"></td> <td style="width: 10%;"></td> </tr> <tr> <td></td> <td></td> <td colspan="8" style="text-align: center;"> <table border="1" style="width: 100%; border-collapse: collapse; text-align: center;"> <tr> </tr></table></td></tr></table></td></tr></table></td></tr></table></td></tr></table></td></tr></table></td></tr></table></td></tr></table></td></tr></table>

 | | | | | | | | | | | | | | | | | | | | <table border="1" style="width: 100%; border-collapse: collapse; text-align: center;"> <tr> <td style="width: 10%;"></td> <td style="width: 10%;"></td> <td style="width: 10%;"></td> <td style="width: 10%;"></td> <td style="width: 10%;"></td> <td style="width: 10%;"></td> <td style="width: 10%;"></td> <td style="width: 10%;"></td> <td style="width: 10%;"></td> <td style="width: 10%;"></td> </tr> <tr> <td></td> <td></td> <td colspan="8" style="text-align: center;"> <table border="1" style="width: 100%; border-collapse: collapse; text-align: center;"> <tr> <td style="width: 10%;"></td> <td style="width: 10%;"></td> <td style="width: 10%;"></td> <td style="width: 10%;"></td> <td style="width: 10%;"></td> <td style="width: 10%;"></td> <td style="width: 10%;"></td> <td style="width: 10%;"></td> <td style="width: 10%;"></td> <td style="width: 10%;"></td> </tr> <tr> <td></td> <td></td> <td colspan="8" style="text-align: center;"> <table border="1" style="width: 100%; border-collapse: collapse; text-align: center;"> <tr> <td style="width: 10%;"></td> <td style="width: 10%;"></td> <td style="width: 10%;"></td> <td style="width: 10%;"></td> <td style="width: 10%;"></td> <td style="width: 10%;"></td> <td style="width: 10%;"></td> <td style="width: 10%;"></td> <td style="width:
10%;"></td> <td style="width: 10%;"></td> </tr> <tr> <td></td> <td></td> <td colspan="8" style="text-align: center;"> <table border="1" style="width: 100%; border-collapse: collapse; text-align: center;"> <tr> <td style="width: 10%;"></td> <td style="width: 10%;"></td> <td style="width: 10%;"></td> <td style="width: 10%;"></td> <td style="width: 10%;"></td> <td style="width: 10%;"></td> <td style="width: 10%;"></td> <td style="width: 10%;"></td> <td style="width: 10%;"></td> <td style="width: 10%;"></td> </tr> <tr> <td></td> <td></td> <td colspan="8" style="text-align: center;"> <table border="1" style="width: 100%; border-collapse: collapse; text-align: center;"> <tr> <td style="width: 10%;"></td> <td style="width: 10%;"></td> <td style="width: 10%;"></td> <td style="width: 10%;"></td> <td style="width: 10%;"></td> <td style="width: 10%;"></td> <td style="width: 10%;"></td> <td style="width: 10%;"></td> <td style="width: 10%;"></td> <td style="width: 10%;"></td> </tr> <tr> <td></td> <td></td> <td colspan="8" style="text-align: center;"> <table border="1" style="width: 100%; border-collapse: collapse; text-align: center;"> <tr> <td style="width: 10%;"></td> <td style="width: 10%;"></td> <td style="width: 10%;"></td> <td style="width: 10%;"></td> <td style="width: 10%;"></td> <td style="width: 10%;"></td> <td style="width: 10%;"></td> <td style="width: 10%;"></td> <td style="width: 10%;"></td> <td style="width: 10%;"></td> </tr> <tr> <td></td> <td></td> <td colspan="8" style="text-align: center;"> <table border="1" style="width: 100%; border-collapse: collapse; text-align: center;"> <tr> <td style="width: 10%;"></td> <td style="width: 10%;"></td> <td style="width: 10%;"></td> <td style="width: 10%;"></td> <td style="width: 10%;"></td> <td style="width: 10%;"></td> <td style="width: 10%;"></td> <td style="width: 10%;"></td> <td style="width: 10%;"></td> <td style="width: 10%;"></td> </tr> <tr> <td></td> <td></td> <td colspan="8" style="text-align: center;"> <table border="1" style="width: 100%; border-collapse: collapse; text-align: center;"> <tr> </tr></table></td></tr></table></td></tr></table></td></tr></table></td></tr></table></td></tr></table></td></tr></table></td></tr></table>

 | | | | | | | | | | | | | | | | | | | | <table border="1" style="width: 100%; border-collapse: collapse; text-align: center;"> <tr> <td style="width: 10%;"></td> <td style="width: 10%;"></td> <td style="width: 10%;"></td> <td style="width: 10%;"></td> <td style="width: 10%;"></td> <td style="width: 10%;"></td> <td style="width: 10%;"></td> <td style="width: 10%;"></td> <td style="width: 10%;"></td> <td style="width: 10%;"></td> </tr> <tr> <td></td> <td></td> <td colspan="8" style="text-align: center;"> <table border="1" style="width: 100%; border-collapse: collapse; text-align: center;"> <tr> <td style="width: 10%;"></td> <td style="width: 10%;"></td> <td style="width: 10%;"></td> <td style="width: 10%;"></td> <td style="width: 10%;"></td> <td style="width: 10%;"></td> <td style="width: 10%;"></td> <td style="width: 10%;"></td> <td style="width: 10%;"></td> <td style="width: 10%;"></td> </tr> <tr> <td></td> <td></td> <td colspan="8" style="text-align: center;"> <table border="1" style="width: 100%; border-collapse: collapse; text-align: center;"> <tr> <td style="width: 10%;"></td> <td style="width: 10%;"></td> <td style="width: 10%;"></td> <td style="width: 10%;"></td> <td style="width: 10%;"></td> <td style="width: 10%;"></td> <td style="width: 10%;"></td> <td style="width: 10%;"></td> <td style="width: 10%;"></td> <td style="width: 10%;"></td> </tr> <tr> <td></td> <td></td> <td colspan="8" style="text-align: center;"> <table border="1" style="width: 100%; border-collapse: collapse; text-align: center;"> <tr> <td style="width: 10%;"></td> <td style="width: 10%;"></td> <td style="width: 10%;"></td> <td style="width: 10%;"></td> <td style="width: 10%;"></td> <td style="width: 10%;"></td> <td style="width: 10%;"></td> <td style="width: 10%;"></td> <td style="width: 10%;"></td> <td style="width: 10%;"></td> </tr> <tr> <td></td> <td></td> <td colspan="8" style="text-align: center;"> <table border="1" style="width: 100%; border-collapse: collapse; text-align: center;"> <tr> <td style="width: 10%;"></td> <td style="width: 10%;"></td> <td style="width: 10%;"></td> <td style="width: 10%;"></td> <td style="width: 10%;"></td> <td style="width: 10%;"></td> <td style="width: 10%;"></td> <td style="width: 10%;"></td> <td style="width: 10%;"></td> <td style="width: 10%;"></td> </tr> <tr> <td></td> <td></td> <td colspan="8" style="text-align: center;"> <table border="1" style="width: 100%; border-collapse: collapse; text-align: center;"> <tr> <td style="width: 10%;"></td> <td style="width: 10%;"></td> <td style="width: 10%;"></td> <td style="width: 10%;"></td> <td style="width: 10%;"></td> <td style="width: 10%;"></td> <td style="width: 10%;"></td> <td style="width: 10%;"></td> <td style="width: 10%;"></td> <td style="width: 10%;"></td> </tr> <tr> <td></td> <td></td> <td colspan="8" style="text-align: center;"> <table border="1" style="width: 100%; border-collapse: collapse; text-align: center;"> <tr> </tr></table></td></tr></table></td></tr></table></td></tr></table></td></tr></table></td></tr></table></td></tr></table>

 | | | | | | | | | | | | | | | | | | | | <table border="1" style="width: 100%; border-collapse: collapse; text-align: center;"> <tr> <td style="width: 10%;"></td> <td style="width: 10%;"></td> <td style="width: 10%;"></td> <td style="width: 10%;"></td> <td style="width: 10%;"></td> <td style="width: 10%;"></td> <td style="width: 10%;"></td> <td style="width: 10%;"></td> <td style="width: 10%;"></td> <td style="width: 10%;"></td> </tr> <tr> <td></td> <td></td> <td colspan="8" style="text-align: center;"> <table border="1" style="width: 100%; border-collapse: collapse; text-align: center;"> <tr> <td style="width: 10%;"></td> <td style="width: 10%;"></td> <td style="width: 10%;"></td> <td style="width: 10%;"></td> <td style="width: 10%;"></td> <td style="width: 10%;"></td> <td style="width: 10%;"></td> <td style="width: 10%;"></td> <td style="width: 10%;"></td> <td style="width: 10%;"></td> </tr> <tr> <td></td> <td></td> <td colspan="8" style="text-align: center;"> <table border="1" style="width: 100%; border-collapse: collapse; text-align: center;"> <tr> <td style="width: 10%;"></td> <td style="width: 10%;"></td> <td style="width: 10%;"></td> <td style="width: 10%;"></td> <td style="width: 10%;"></td> <td style="width: 10%;"></td> <td style="width: 10%;"></td> <td style="width: 10%;"></td> <td style="width: 10%;"></td> <td style="width: 10%;"></td> </tr> <tr> <td></td> <td></td> <td colspan="8" style="text-align: center;"> <table border="1" style="width: 100%; border-collapse: collapse; text-align: center;"> <tr> <td style="width: 10%;"></td> <td style="width: 10%;"></td> <td style="width: 10%;"></td> <td style="width: 10%;"></td> <td style="width: 10%;"></td> <td style="width: 10%;"></td> <td style="width: 10%;"></td> <td style="width: 10%;"></td> <td style="width: 10%;"></td> <td style="width: 10%;"></td> </tr> <tr> <td></td> <td></td> <td colspan="8" style="text-align: center;"> <table border="1" style="width: 100%; border-collapse: collapse; text-align: center;"> <tr> <td style="width: 10%;"></td> <td style="width: 10%;"></td> <td style="width: 10%;"></td> <td style="width: 10%;"></td> <td style="width: 10%;"></td> <td style="width: 10%;"></td> <td style="width: 10%;"></td> <td style="width: 10%;"></td> <td style="width: 10%;"></td> <td style="width: 10%;"></td> </tr> <tr> <td></td> <td></td> <td colspan="8" style="text-align: center;"> <table border="1" style="width: 100%; border-collapse: collapse; text-align: center;"> <tr> </tr></table></td></tr></table></td></tr></table></td></tr></table></td></tr></table></td></tr></table>

 | | | | | | | | | | | | | | | | | | | | <table border="1" style="width: 100%; border-collapse: collapse; text-align: center;"> <tr> <td style="width: 10%;"></td> <td style="width: 10%;"></td> <td style="width: 10%;"></td> <td style="width: 10%;"></td> <td style="width: 10%;"></td> <td style="width: 10%;"></td> <td style="width: 10%;"></td> <td style="width: 10%;"></td> <td style="width: 10%;"></td> <td style="width: 10%;"></td> </tr> <tr> <td></td> <td></td> <td colspan="8" style="text-align: center;"> <table border="1" style="width: 100%; border-collapse: collapse; text-align: center;"> <tr> <td style="width: 10%;"></td> <td style="width: 10%;"></td> <td style="width: 10%;"></td> <td style="width: 10%;"></td> <td style="width: 10%;"></td> <td style="width: 10%;"></td> <td style="width: 10%;"></td> <td style="width: 10%;"></td> <td style="width: 10%;"></td> <td style="width: 10%;"></td> </tr> <tr> <td></td> <td></td> <td colspan="8" style="text-align: center;"> <table border="1" style="width: 100%; border-collapse: collapse; text-align: center;"> <tr> <td style="width: 10%;"></td> <td style="width: 10%;"></td> <td style="width: 10%;"></td> <td style="width: 10%;"></td> <td style="width: 10%;"></td> <td style="width: 10%;"></td> <td style="width: 10%;"></td> <td style="width: 10%;"></td> <td style="width: 10%;"></td> <td style="width: 10%;"></td> </tr> <tr> <td></td> <td></td> <td colspan="8" style="text-align: center;"> <table border="1" style="width: 100%; border-collapse: collapse; text-align: center;"> <tr> <td style="width: 10%;"></td> <td style="width: 10%;"></td> <td style="width: 10%;"></td> <td style="width: 10%;"></td> <td style="width: 10%;"></td> <td style="width: 10%;"></td> <td style="width: 10%;"></td> <td style="width: 10%;"></td> <td style="width: 10%;"></td> <td style="width: 10%;"></td> </tr> <tr> <td></td> <td></td> <td colspan="8" style="text-align: center;"> <table border="1" style="width: 100%; border-collapse: collapse; text-align: center;"> <tr> </tr></table></td></tr></table></td></tr></table></td></tr></table></td></tr></table>

 | | | | | | | | | | | | | | | | | | | | <table border="1" style="width: 100%; border-collapse: collapse; text-align: center;"> <tr> <td style="width: 10%;"></td> <td style="width: 10%;"></td> <td style="width: 10%;"></td> <td style="width: 10%;"></td> <td style="width: 10%;"></td> <td style="width: 10%;"></td> <td style="width: 10%;"></td> <td style="width: 10%;"></td> <td style="width: 10%;"></td> <td style="width: 10%;"></td> </tr> <tr> <td></td> <td></td> <td colspan="8" style="text-align: center;"> <table border="1" style="width: 100%; border-collapse: collapse; text-align: center;"> <tr> <td style="width: 10%;"></td> <td style="width: 10%;"></td> <td style="width: 10%;"></td> <td style="width: 10%;"></td> <td style="width: 10%;"></td> <td style="width: 10%;"></td> <td style="width: 10%;"></td> <td style="width: 10%;"></td> <td style="width: 10%;"></td> <td style="width: 10%;"></td> </tr> <tr> <td></td> <td></td> <td colspan="8" style="text-align: center;"> <table border="1" style="width: 100%; border-collapse: collapse; text-align: center;"> <tr> <td style="width: 10%;"></td> <td style="width: 10%;"></td> <td style="width: 10%;"></td> <td style="width: 10%;"></td> <td style="width: 10%;"></td> <td style="width: 10%;"></td> <td style="width: 10%;"></td> <td style="width: 10%;"></td> <td style="width: 10%;"></td> <td style="width: 10%;"></td> </tr> <tr> <td></td> <td></td> <td colspan="8" style="text-align: center;"> <table border="1" style="width: 100%; border-collapse: collapse; text-align: center;"> <tr> </tr></table></td></tr></table></td></tr></table></td></tr></table>

 | | | | | | | | | | | | | | | | | | | | <table border="1" style="width: 100%; border-collapse: collapse; text-align: center;"> <tr> <td style="width: 10%;"></td> <td style="width: 10%;"></td> <td style="width: 10%;"></td> <td style="width: 10%;"></td> <td style="width: 10%;"></td> <td style="width: 10%;"></td> <td style="width: 10%;"></td> <td style="width: 10%;"></td> <td style="width: 10%;"></td> <td style="width: 10%;"></td> </tr> <tr> <td></td> <td></td> <td colspan="8" style="text-align: center;"> <table border="1" style="width: 100%; border-collapse: collapse; text-align: center;"> <tr> <td style="width: 10%;"></td> <td style="width: 10%;"></td> <td style="width: 10%;"></td> <td style="width: 10%;"></td> <td style="width: 10%;"></td> <td style="width: 10%;"></td> <td style="width: 10%;"></td> <td style="width: 10%;"></td> <td style="width: 10%;"></td> <td style="width: 10%;"></td> </tr> <tr> <td></td> <td></td> <td colspan="8" style="text-align: center;"> <table border="1" style="width: 100%; border-collapse: collapse; text-align: center;"> <tr> </tr></table></td></tr></table></td></tr></table>

 | | | | | | | | | | | | | | | | | | | | <table border="1" style="width: 100%; border-collapse: collapse; text-align: center;"> <tr> <td style="width: 10%;"></td> <td style="width: 10%;"></td> <td style="width: 10%;"></td> <td style="width: 10%;"></td> <td style="width: 10%;"></td> <td style="width: 10%;"></td> <td style="width: 10%;"></td> <td style="width: 10%;"></td> <td style="width: 10%;"></td> <td style="width: 10%;"></td> </tr> <tr> <td></td> <td></td> <td colspan="8" style="text-align: center;"> <table border="1" style="width: 100%; border-collapse: collapse; text-align: center;"> <tr> </tr></table></td></tr></table>

 | | | | | | | | | | | | | | | | | | | | <table border="1" style="width: 100%; border-collapse: collapse; text-align: center;"> <tr> </tr></table>

 | | | | | | | | | | | | | | | | | | | |

 | | | | | | | | | | | | | | | | | | | |

 | | | | | | | | | | | | | | | | | | | |

 | | | | | | | | | | | | | | | | | | | |

 | | | | | | | | | | | | | | | | | | | |

 | | | | | | | | | | | | | | | | | | | |

 | | | | | | | | | | | | | | | | | | | |

 | | | | | | | | | | | | | | | | | | | |

 | | | | | | | | | | | | | | | | | | | |

 | | | | | | | | | | | | | | | | | | | |

 | | | | | | | | | | | | | | | | | | | |

 | | | | | | | | | | | | | | | | | | | |

 | | | | | | | | | | | | | | | | | | | |

 | | | | | | | | | | | | | | | | | | | |
 | | | | | | | | | | | | | | | | | | | |

 | | | | | | | | | | | | | | | | | | | |

 | | | | | | | | | | | | | | | | | | | |
 | | | | | | | | | | | | | | | | | | | |

 | | | | | | | | | | | | | | | | | | | |

 | | | | | | | | | | | | | | | | | | | |
 | | | | | | | | | | | | | | | | | | | |
 | | | | | | | | | | | | | | | | | | | |

 | | | | | | | | | | | | | | | | | | | |
 | | | | | | | | | | | | | | | | | | | |
 | | | | | | | | | | | | | | | | | | | |

 | | | | | | | | | | | | | | | | | | | | | | | | | | | | | | | | | | | | | | | | | | | | | | | | | | | | | | | | | | | | | | | | | | | | | | | | | | | | | | | | | | | | | | | | | | | | | | | | | | | |
 | | | | | | | | | | | | | | | | | | | |
 | | | | | | | | | | | | | | | | | | | |
 | | | | | | | | | | | | | | | | | | | |
 | | | | | | | | | | | | | | | | | | | |
 | | | | | | | | | | | | | | | | | | | |
 | | | | | | | | | | | | | | | | | | | |
 | | | | | | | | | | | | | | | | | | | |
 | | | | | | | | | | | | | | | | | | | |
 | | | | | | | | | | | | | | | | | | | | | | | | | | | | | | | | | | | | | | | |
 | | | | | | | | | | | | | | | | | | | |
 | | | | | | | | | | | | | | | | | | | | | | | | | | | | | | | | | | | | | | | |
 | | | | | | | | | | | | | | | | | | | | | | | | | | | | | | | | | | | | | | | |
 | | | | | | | | | | | | | | | | | | | | | | | | | | | | | | | | | | | | | | | |
 | | | | | | | | | | | | | | | | | | | | | | | | | | | | | | | | | | | | | | | | | | | | | | | | | | | | | | | | | | | | | | | | | | | | | | | | | | | | | | | | | | | | | | | | | | | | | | | | | | | |
 | | | | | | | | | | | | | | | | | | | | | | | | | | | | | | | | | | | | | | | | | | | | | | | |
| | |

 | | | | | | | | | | | | | | | | | | | |

 | | | | | | | | | | | | | | | | | | | |

 | | | | | | | | | | | | | | | | | | | |

 | | | | | | | | | | | | | | | | | | | |

 | | | | | | | | | | | | | | | | | | | |

 | | | | | | | | | | | | | | | | | | | |

 | | | | | | | | | | | | | | | | | | | |

 | | | | | | | | | | | | | | | | | | | |

 | | | | | | | | | | | | | | | | | | | |

 | | | | | | | | | | | | | | | | | | | |

 | | | | | | | | | | | | | | | | | | | |

 | | | | | | | | | | | | | | | | | | | |

 | | | | | | | | | | | | | | | | | | | |

 | | | | | | | | | | | | | | | | | | | |

 | | | | | | | | | | | | | | | | | | | |

 | | | | | | | | | | | | | | | | | | | |

 | | | | | | | | | | | | | | | | | | | |

 | | | | | | | | | | | | | | | | | | | |

 | | | | | | | | | | | | | | | | | | | |

 | | | | | | | | | | | | | | | | | | | |

 | | | | | | | | | | | | | | | | | | | |

 | | | | | | | | | | | | | | | | | | | |

 | | | | | | | | | | | | | | | | | | | |

 | | | | | | | | | | | | | | | | | | | |

 | | | | | | | | | | | | | | | | | | | |

 | | | | | | | | | | | | | | | | | | | |

 | | | | | | | | | | | | | | | | | | | |

 | | | | | | | | | | | | | | | | | | | |
 | | | | | | | | | | | | | | | | | | | |

 | | | | | | | | | | | | | | | | | | | |

 | | | | | | | | | | | | | | | | | | | |
 | | | | | | | | | | | | | | | | | | | |

 | | | | | | | | | | | | | | | | | | | |

 | | | | | | | | | | | | | | | | | | | |
 | | | | | | | | | | | | | | | | | | | |
 | | | | | | | | | | | | | | | | | | | |

 | | | | | | | | | | | | | | | | | | | |
 | | | | | | | | | | | | | | | | | | | |
 | | | | | | | | | | | | | | | | | | | |

 | | | | | | | | | | | | | | | | | | | | | | | | | | | | | | | | | | | | | | | | | | | | | | | | | | | | | | | | | | | | | | | | | | | | | | | | | | | | | | | | | | | | | | | | | | | | | | | | | | | |
 | | | | | | | | | | | | | | | | | | | |
 | | | | | | | | | | | | | | | | | | | |
 | | | | | | | | | | | | | | | | | | | |
 | | | | | | | | | | | | | | | | | | | |
 | | | | | | | | | | | | | | | | | | | |
 | | | | | | | | | | | | | | | | | | | |
 | | | | | | | | | | | | | | | | | | | |
 | | | | | | | | | | | | | | | | | | | |
 | | | | | | | | | | | | | | | | | | | | | | | | | | | | | | | | | | | | | | | |
 | | | | | | | | | | | | | | | | | | | |
 | | | | | | | | | | | | | | | | | | | | | | | | | | | | | | | | | | | | | | | |
 | | | | | | | | | | | | | | | | | | | | | | | | | | | | | | | | | | | | | | | |
 | | | | | | | | | | | | | | | | | | | | | | | | | | | | | | | | | | | | | | | |
 | | | | | | | | | | | | | | | | | | | | | | | | | | | | | | | | | | | | | | | | | | | | | | | | | | | | | | | | | | | | | | | | | | | | | | | | | | | | | | | | | | | | | | | | | | | | | | | | | | | |
 | | | | | | | | | | | | | | | | | | | | | | | | | | | | | | | | | | | | | | | | | | | | | | | |
| | | <table border="1" style="width: 100%; border-collapse: collapse; text-align: center;"> <tr> <td style="width: 10%;"></td> <td style="width: 10%;"></td> <td style="width: 10%;"></td> <td style="width: 10%;"></td> <td style="width: 10%;"></td> <td style="width: 10%;"></td> <td style="width: 10%;"></td> <td style="width: 10%;"></td> <td style="width: 10%;"></td> <td style="width: 10%;"></td> </tr> <tr> <td></td> <td></td> <td colspan="8" style="text-align: center;"> <table border="1" style="width: 100%; border-collapse: collapse; text-align: center;"> <tr> <td style="width: 10%;"></td> <td style="width: 10%;"></td> <td style="width: 10%;"></td> <td style="width: 10%;"></td> <td style="width: 10%;"></td> <td style="width: 10%;"></td> <td style="width: 10%;"></td> <td style="width: 10%;"></td> <td style="width: 10%;"></td> <td style="width: 10%;"></td> </tr> <tr> <td></td> <td></td> <td colspan="8" style="text-align: center;"> <table border="1" style="width: 100%; border-collapse: collapse; text-align: center;"> <tr> <td style="width: 10%;"></td> <td style="width: 10%;"></td> <td style="width: 10%;"></td> <td style="width: 10%;"></td> <td style="width: 10%;"></td> <td style="width: 10%;"></td> <td style="width: 10%;"></td> <td style="width: 10%;"></td> <td style="width: 10%;"></td> <td style="width: 10%;"></td> </tr> <tr> <td></td> <td></td> <td colspan="8" style="text-align: center;"> <table border="1" style="width: 100%; border-collapse: collapse; text-align: center;"> <tr> <td style="width: 10%;"></td> <td style="width: 10%;"></td> <td style="width: 10%;"></td> <td style="width: 10%;"></td> <td style="width: 10%;"></td> <td style="width: 10%;"></td> <td style="width: 10%;"></td> <td style="width: 10%;"></td> <td style="width: 10%;"></td> <td style="width: 10%;"></td> </tr> <tr> <td></td> <td></td> <td colspan="8" style="text-align: center;"> <table border="1" style="width: 100%; border-collapse: collapse; text-align: center;"> <tr> <td style="width: 10%;"></td> <td style="width: 10%;"></td> <td style="width: 10%;"></td> <td style="width: 10%;"></td> <td style="width: 10%;"></td> <td style="width: 10%;"></td> <td style="width: 10%;"></td> <td style="width: 10%;"></td> <td style="width: 10%;"></td> <td style="width: 10%;"></td> </tr> <tr> <td></td> <td></td> <td colspan="8" style="text-align: center;"> <table border="1" style="width: 100%; border-collapse: collapse; text-align: center;"> <tr> <td style="width: 10%;"></td> <td style="width: 10%;"></td> <td style="width: 10%;"></td> <td style="width: 10%;"></td> <td style="width: 10%;"></td> <td style="width: 10%;"></td> <td style="width: 10%;"></td> <td style="width: 10%;"></td> <td style="width: 10%;"></td> <td style="width: 10%;"></td> </tr> <tr> <td></td> <td></td> <td colspan="8" style="text-align: center;"> <table border="1" style="width: 100%; border-collapse: collapse; text-align: center;"> <tr> <td style="width: 10%;"></td> <td style="width: 10%;"></td> <td style="width: 10%;"></td> <td style="width: 10%;"></td> <td style="width: 10%;"></td> <td style="width: 10%;"></td> <td style="width: 10%;"></td> <td style="width: 10%;"></td> <td style="width: 10%;"></td> <td style="width: 10%;"></td> </tr> <tr> <td></td> <td></td> <td colspan="8" style="text-align: center;"> <table border="1" style="width: 100%; border-collapse: collapse; text-align: center;"> <tr> <td style="width: 10%;"></td> <td style="width: 10%;"></td> <td style="width: 10%;"></td> <td style="width: 10%;"></td> <td style="width: 10%;"></td> <td style="width: 10%;"></td> <td style="width: 10%;"></td> <td style="width: 10%;"></td> <td style="width: 10%;"></td> <td style="width: 10%;"></td> </tr> <tr> <td></td> <td></td> <td colspan="8" style="text-align: center;"> <table border="1" style="width: 100%; border-collapse: collapse; text-align: center;"> <tr> <td style="width: 10%;"></td> <td style="width: 10%;"></td> <td style="width: 10%;"></td> <td style="width: 10%;"></td> <td style="width: 10%;"></td> <td style="width: 10%;"></td> <td style="width: 10%;"></td> <td style="width: 10%;"></td> <td style="width: 10%;"></td> <td style="width: 10%;"></td> </tr> <tr> <td></td> <td></td> <td colspan="8" style="text-align: center;"> <table border="1" style="width: 100%; border-collapse: collapse; text-align: center;"> <tr> <td style="width: 10%;"></td> <td style="width: 10%;"></td> <td style="width: 10%;"></td> <td style="width: 10%;"></td> <td style="width: 10%;"></td> <td style="width: 10%;"></td> <td style="width: 10%;"></td> <td style="width: 10%;"></td> <td style="width: 10%;"></td> <td style="width: 10%;"></td> </tr> <tr> <td></td> <td></td> <td colspan="8" style="text-align: center;"> <table border="1" style="width: 100%; border-collapse: collapse; text-align: center;"> <tr> <td style="width: 10%;"></td> <td style="width: 10%;"></td> <td style="width: 10%;"></td> <td style="width: 10%;"></td> <td style="width: 10%;"></td> <td style="width: 10%;"></td> <td style="width: 10%;"></td> <td style="width: 10%;"></td> <td style="width: 10%;"></td> <td style="width: 10%;"></td> </tr> <tr> <td></td> <td></td> <td colspan="8" style="text-align: center;"> <table border="1" style="width: 100%; border-collapse: collapse; text-align: center;"> <tr> <td style="width: 10%;"></td> <td style="width: 10%;"></td> <td style="width: 10%;"></td> <td style="width: 10%;"></td> <td style="width: 10%;"></td> <td style="width: 10%;"></td> <td style="width: 10%;"></td> <td style="width: 10%;"></td> <td style="width: 10%;"></td> <td style="width: 10%;"></td> </tr> <tr> <td></td> <td></td> <td colspan="8" style="text-align: center;"> <table border="1" style="width: 100%; border-collapse: collapse; text-align: center;"> <tr> <td style="width: 10%;"></td> <td style="width: 10%;"></td> <td style="width: 10%;"></td> <td style="width: 10%;"></td> <td style="width: 10%;"></td> <td style="width: 10%;"></td> <td style="width: 10%;"></td> <td style="width: 10%;"></td> <td style="width: 10%;"></td> <td style="width: 10%;"></td> </tr> <tr> <td></td> <td></td> <td colspan="8" style="text-align: center;"> <table border="1" style="width: 100%; border-collapse: collapse; text-align: center;"> <tr> </tr></table></td></tr></table></td></tr></table></td></tr></table></td></tr></table></td></tr></table></td></tr></table></td></tr></table></td></tr></table></td></tr></table></td></tr></table></td></tr></table></td></tr></table></td></tr></table>

 | | | | | | | | | | | | | | | | | | | | <table border="1" style="width: 100%; border-collapse: collapse; text-align: center;"> <tr> <td style="width: 10%;"></td> <td style="width: 10%;"></td> <td style="width: 10%;"></td> <td style="width: 10%;"></td> <td style="width: 10%;"></td> <td style="width: 10%;"></td> <td style="width: 10%;"></td> <td style="width: 10%;"></td> <td style="width: 10%;"></td> <td style="width: 10%;"></td> </tr> <tr> <td></td> <td></td> <td colspan="8" style="text-align: center;"> <table border="1" style="width: 100%; border-collapse: collapse; text-align: center;"> <tr> <td style="width: 10%;"></td> <td style="width: 10%;"></td> <td style="width: 10%;"></td> <td style="width: 10%;"></td> <td style="width: 10%;"></td> <td style="width: 10%;"></td> <td style="width: 10%;"></td> <td style="width: 10%;"></td> <td style="width: 10%;"></td> <td style="width: 10%;"></td> </tr> <tr> <td></td> <td></td> <td colspan="8" style="text-align: center;"> <table border="1" style="width: 100%; border-collapse: collapse; text-align: center;"> <tr> <td style="width: 10%;"></td> <td style="width: 10%;"></td> <td style="width: 10%;"></td> <td style="width: 10%;"></td> <td style="width: 10%;"></td> <td style="width: 10%;"></td> <td style="width: 10%;"></td> <td style="width: 10%;"></td> <td style="width: 10%;"></td> <td style="width: 10%;"></td> </tr> <tr> <td></td> <td></td> <td colspan="8" style="text-align: center;"> <table border="1" style="width: 100%; border-collapse: collapse; text-align: center;"> <tr> <td style="width: 10%;"></td> <td style="width: 10%;"></td> <td style="width: 10%;"></td> <td style="width: 10%;"></td> <td style="width: 10%;"></td> <td style="width: 10%;"></td> <td style="width: 10%;"></td> <td style="width: 10%;"></td> <td style="width: 10%;"></td> <td style="width: 10%;"></td> </tr> <tr> <td></td> <td></td> <td colspan="8" style="text-align: center;"> <table border="1" style="width: 100%; border-collapse: collapse; text-align: center;"> <tr> <td style="width: 10%;"></td> <td style="width: 10%;"></td> <td style="width: 10%;"></td> <td style="width: 10%;"></td> <td style="width: 10%;"></td> <td style="width: 10%;"></td> <td style="width: 10%;"></td> <td style="width: 10%;"></td> <td style="width: 10%;"></td> <td style="width: 10%;"></td> </tr> <tr> <td></td> <td></td> <td colspan="8" style="text-align: center;"> <table border="1" style="width: 100%; border-collapse: collapse; text-align: center;"> <tr> <td style="width: 10%;"></td> <td style="width: 10%;"></td> <td style="width: 10%;"></td> <td style="width: 10%;"></td> <td style="width: 10%;"></td> <td style="width: 10%;"></td> <td style="width: 10%;"></td> <td style="width: 10%;"></td> <td style="width: 10%;"></td> <td style="width: 10%;"></td> </tr> <tr> <td></td> <td></td> <td colspan="8" style="text-align: center;"> <table border="1" style="width: 100%; border-collapse: collapse; text-align: center;"> <tr> <td style="width: 10%;"></td> <td style="width: 10%;"></td> <td style="width: 10%;"></td> <td style="width: 10%;"></td> <td style="width: 10%;"></td> <td style="width: 10%;"></td> <td style="width: 10%;"></td> <td style="width: 10%;"></td> <td style="width: 10%;"></td> <td style="width: 10%;"></td> </tr> <tr> <td></td> <td></td> <td colspan="8" style="text-align: center;"> <table border="1" style="width: 100%; border-collapse: collapse; text-align: center;"> <tr> <td style="width: 10%;"></td> <td style="width: 10%;"></td> <td style="width: 10%;"></td> <td style="width: 10%;"></td> <td style="width: 10%;"></td> <td style="width: 10%;"></td> <td style="width: 10%;"></td> <td style="width: 10%;"></td> <td style="width: 10%;"></td> <td style="width: 10%;"></td> </tr> <tr> <td></td> <td></td> <td colspan="8" style="text-align: center;"> <table border="1" style="width: 100%; border-collapse: collapse; text-align: center;"> <tr> <td style="width: 10%;"></td> <td style="width: 10%;"></td> <td style="width: 10%;"></td> <td style="width: 10%;"></td> <td style="width: 10%;"></td> <td style="width: 10%;"></td> <td style="width: 10%;"></td> <td style="width: 10%;"></td> <td style="width: 10%;"></td> <td style="width: 10%;"></td> </tr> <tr> <td></td> <td></td> <td colspan="8" style="text-align: center;"> <table border="1" style="width: 100%; border-collapse: collapse; text-align: center;"> <tr> <td style="width: 10%;"></td> <td style="width: 10%;"></td> <td style="width: 10%;"></td> <td style="width: 10%;"></td> <td style="width: 10%;"></td> <td style="width: 10%;"></td> <td style="width: 10%;"></td> <td style="width: 10%;"></td> <td style="width: 10%;"></td> <td style="width: 10%;"></td> </tr> <tr> <td></td> <td></td> <td colspan="8" style="text-align: center;"> <table border="1" style="width: 100%; border-collapse: collapse; text-align: center;"> <tr> <td style="width: 10%;"></td> <td style="width: 10%;"></td> <td style="width: 10%;"></td> <td style="width: 10%;"></td> <td style="width: 10%;"></td> <td style="width: 10%;"></td> <td style="width: 10%;"></td> <td style="width: 10%;"></td> <td style="width: 10%;"></td> <td style="width: 10%;"></td> </tr> <tr> <td></td> <td></td> <td colspan="8" style="text-align: center;"> <table border="1" style="width: 100%; border-collapse: collapse; text-align: center;"> <tr> <td style="width: 10%;"></td> <td style="width: 10%;"></td> <td style="width: 10%;"></td> <td style="width: 10%;"></td> <td style="width: 10%;"></td> <td style="width: 10%;"></td> <td style="width: 10%;"></td> <td style="width: 10%;"></td> <td style="width: 10%;"></td> <td style="width: 10%;"></td> </tr> <tr> <td></td> <td></td> <td colspan="8" style="text-align: center;"> <table border="1" style="width: 100%; border-collapse: collapse; text-align: center;"> <tr> </tr></table></td></tr></table></td></tr></table></td></tr></table></td></tr></table></td></tr></table></td></tr></table></td></tr></table></td></tr></table></td></tr></table></td></tr></table></td></tr></table></td></tr></table>

 | | | | | | | | | | | | | | | | | | | | <table border="1" style="width: 100%; border-collapse: collapse; text-align: center;"> <tr> <td style="width: 10%;"></td> <td style="width: 10%;"></td> <td style="width: 10%;"></td> <td style="width: 10%;"></td> <td style="width: 10%;"></td> <td style="width: 10%;"></td> <td style="width: 10%;"></td> <td style="width: 10%;"></td> <td style="width: 10%;"></td> <td style="width: 10%;"></td> </tr> <tr> <td></td> <td></td> <td colspan="8" style="text-align: center;"> <table border="1" style="width: 100%; border-collapse: collapse; text-align: center;"> <tr> <td style="width: 10%;"></td> <td style="width: 10%;"></td> <td style="width: 10%;"></td> <td style="width: 10%;"></td> <td style="width: 10%;"></td> <td style="width: 10%;"></td> <td style="width: 10%;"></td> <td style="width: 10%;"></td> <td style="width: 10%;"></td> <td style="width: 10%;"></td> </tr> <tr> <td></td> <td></td> <td colspan="8" style="text-align: center;"> <table border="1" style="width: 100%; border-collapse: collapse; text-align: center;"> <tr> <td style="width: 10%;"></td> <td style="width: 10%;"></td> <td style="width: 10%;"></td> <td style="width: 10%;"></td> <td style="width: 10%;"></td> <td style="width: 10%;"></td> <td style="width: 10%;"></td> <td style="width: 10%;"></td> <td style="width: 10%;"></td> <td style="width: 10%;"></td> </tr> <tr> <td></td> <td></td> <td colspan="8" style="text-align: center;"> <table border="1" style="width: 100%; border-collapse: collapse; text-align: center;"> <tr> <td style="width: 10%;"></td> <td style="width: 10%;"></td> <td style="width: 10%;"></td> <td style="width: 10%;"></td> <td style="width: 10%;"></td> <td style="width: 10%;"></td> <td style="width: 10%;"></td> <td style="width: 10%;"></td> <td style="width: 10%;"></td> <td style="width: 10%;"></td> </tr> <tr> <td></td> <td></td> <td colspan="8" style="text-align: center;"> <table border="1" style="width: 100%; border-collapse: collapse; text-align: center;"> <tr> <td style="width: 10%;"></td> <td style="width: 10%;"></td> <td style="width: 10%;"></td> <td style="width: 10%;"></td> <td style="width: 10%;"></td> <td style="width: 10%;"></td> <td style="width: 10%;"></td> <td style="width: 10%;"></td> <td style="width: 10%;"></td> <td style="width: 10%;"></td> </tr> <tr> <td></td> <td></td> <td colspan="8" style="text-align: center;"> <table border="1" style="width: 100%; border-collapse: collapse; text-align: center;"> <tr> <td style="width: 10%;"></td> <td style="width: 10%;"></td> <td style="width: 10%;"></td> <td style="width: 10%;"></td> <td style="width: 10%;"></td> <td style="width: 10%;"></td> <td style="width: 10%;"></td> <td style="width: 10%;"></td> <td style="width: 10%;"></td> <td style="width: 10%;"></td> </tr> <tr> <td></td> <td></td> <td colspan="8" style="text-align: center;"> <table border="1" style="width: 100%; border-collapse: collapse; text-align: center;"> <tr> <td style="width: 10%;"></td> <td style="width: 10%;"></td> <td style="width: 10%;"></td> <td style="width: 10%;"></td> <td style="width: 10%;"></td> <td style="width: 10%;"></td> <td style="width: 10%;"></td> <td style="width: 10%;"></td> <td style="width: 10%;"></td> <td style="width: 10%;"></td> </tr> <tr> <td></td> <td></td> <td colspan="8" style="text-align: center;"> <table border="1" style="width: 100%; border-collapse: collapse; text-align: center;"> <tr> <td style="width: 10%;"></td> <td style="width: 10%;"></td> <td style="width: 10%;"></td> <td style="width: 10%;"></td> <td style="width: 10%;"></td> <td style="width: 10%;"></td> <td style="width: 10%;"></td> <td style="width: 10%;"></td> <td style="width: 10%;"></td> <td style="width: 10%;"></td> </tr> <tr> <td></td> <td></td> <td colspan="8" style="text-align: center;"> <table border="1" style="width: 100%; border-collapse: collapse; text-align: center;"> <tr> <td style="width: 10%;"></td> <td style="width: 10%;"></td> <td style="width: 10%;"></td> <td style="width: 10%;"></td> <td style="width: 10%;"></td> <td style="width: 10%;"></td> <td style="width: 10%;"></td> <td style="width: 10%;"></td> <td style="width: 10%;"></td> <td style="width: 10%;"></td> </tr> <tr> <td></td> <td></td> <td colspan="8" style="text-align: center;"> <table border="1" style="width: 100%; border-collapse: collapse; text-align: center;"> <tr> <td style="width: 10%;"></td> <td style="width: 10%;"></td> <td style="width: 10%;"></td> <td style="width: 10%;"></td> <td style="width: 10%;"></td> <td style="width: 10%;"></td> <td style="width: 10%;"></td> <td style="width: 10%;"></td> <td style="width: 10%;"></td> <td style="width: 10%;"></td> </tr> <tr> <td></td> <td></td> <td colspan="8" style="text-align: center;"> <table border="1" style="width: 100%; border-collapse: collapse; text-align: center;"> <tr> <td style="width: 10%;"></td> <td style="width: 10%;"></td> <td style="width: 10%;"></td> <td style="width: 10%;"></td> <td style="width: 10%;"></td> <td style="width: 10%;"></td> <td style="width: 10%;"></td> <td style="width: 10%;"></td> <td style="width: 10%;"></td> <td style="width: 10%;"></td> </tr> <tr> <td></td> <td></td> <td colspan="8" style="text-align: center;"> <table border="1" style="width: 100%; border-collapse: collapse; text-align: center;"> <tr> </tr></table></td></tr></table></td></tr></table></td></tr></table></td></tr></table></td></tr></table></td></tr></table></td></tr></table></td></tr></table></td></tr></table></td></tr></table></td></tr></table>

 | | | | | | | | | | | | | | | | | | | | <table border="1" style="width: 100%; border-collapse: collapse; text-align: center;"> <tr> <td style="width: 10%;"></td> <td style="width: 10%;"></td> <td style="width: 10%;"></td> <td style="width: 10%;"></td> <td style="width: 10%;"></td> <td style="width: 10%;"></td> <td style="width: 10%;"></td> <td style="width: 10%;"></td> <td style="width: 10%;"></td> <td style="width: 10%;"></td> </tr> <tr> <td></td> <td></td> <td colspan="8" style="text-align: center;"> <table border="1" style="width: 100%; border-collapse: collapse; text-align: center;"> <tr> <td style="width: 10%;"></td> <td style="width: 10%;"></td> <td style="width: 10%;"></td> <td style="width: 10%;"></td> <td style="width: 10%;"></td> <td style="width: 10%;"></td> <td style="width: 10%;"></td> <td style="width: 10%;"></td> <td style="width: 10%;"></td> <td style="width: 10%;"></td> </tr> <tr> <td></td> <td></td> <td colspan="8" style="text-align: center;"> <table border="1" style="width: 100%; border-collapse: collapse; text-align: center;"> <tr> <td style="width: 10%;"></td> <td style="width: 10%;"></td> <td style="width: 10%;"></td> <td style="width: 10%;"></td> <td style="width: 10%;"></td> <td style="width: 10%;"></td> <td style="width: 10%;"></td> <td style="width: 10%;"></td> <td style="width: 10%;"></td> <td style="width: 10%;"></td> </tr> <tr> <td></td> <td></td> <td colspan="8" style="text-align: center;"> <table border="1" style="width: 100%; border-collapse: collapse; text-align: center;"> <tr> <td style="width: 10%;"></td> <td style="width: 10%;"></td> <td style="width: 10%;"></td> <td style="width: 10%;"></td> <td style="width: 10%;"></td> <td style="width: 10%;"></td> <td style="width: 10%;"></td> <td style="width: 10%;"></td> <td style="width: 10%;"></td> <td style="width: 10%;"></td> </tr> <tr> <td></td> <td></td> <td colspan="8" style="text-align: center;"> <table border="1" style="width: 100%; border-collapse: collapse; text-align: center;"> <tr> <td style="width: 10%;"></td> <td style="width: 10%;"></td> <td style="width: 10%;"></td> <td style="width: 10%;"></td> <td style="width: 10%;"></td> <td style="width: 10%;"></td> <td style="width: 10%;"></td> <td style="width: 10%;"></td> <td style="width: 10%;"></td> <td style="width: 10%;"></td> </tr> <tr> <td></td> <td></td> <td colspan="8" style="text-align: center;"> <table border="1" style="width: 100%; border-collapse: collapse; text-align: center;"> <tr> <td style="width: 10%;"></td> <td style="width: 10%;"></td> <td style="width: 10%;"></td> <td style="width: 10%;"></td> <td style="width: 10%;"></td> <td style="width: 10%;"></td> <td style="width: 10%;"></td> <td style="width: 10%;"></td> <td style="width: 10%;"></td> <td style="width: 10%;"></td> </tr> <tr> <td></td> <td></td> <td colspan="8" style="text-align: center;"> <table border="1" style="width: 100%; border-collapse: collapse; text-align: center;"> <tr> <td style="width: 10%;"></td> <td style="width: 10%;"></td> <td style="width: 10%;"></td> <td style="width: 10%;"></td> <td style="width: 10%;"></td> <td style="width: 10%;"></td> <td style="width: 10%;"></td> <td style="width: 10%;"></td> <td style="width: 10%;"></td> <td style="width: 10%;"></td> </tr> <tr> <td></td> <td></td> <td colspan="8" style="text-align: center;"> <table border="1" style="width: 100%; border-collapse: collapse; text-align: center;"> <tr> <td style="width: 10%;"></td> <td style="width: 10%;"></td> <td style="width: 10%;"></td> <td style="width: 10%;"></td> <td style="width: 10%;"></td> <td style="width: 10%;"></td> <td style="width: 10%;"></td> <td style="width: 10%;"></td> <td style="width: 10%;"></td> <td style="width: 10%;"></td> </tr> <tr> <td></td> <td></td> <td colspan="8" style="text-align: center;"> <table border="1" style="width: 100%; border-collapse: collapse; text-align: center;"> <tr> <td style="width: 10%;"></td> <td style="width: 10%;"></td> <td style="width: 10%;"></td> <td style="width: 10%;"></td> <td style="width: 10%;"></td> <td style="width: 10%;"></td> <td style="width: 10%;"></td> <td style="width: 10%;"></td> <td style="width: 10%;"></td> <td style="width: 10%;"></td> </tr> <tr> <td></td> <td></td> <td colspan="8" style="text-align: center;"> <table border="1" style="width: 100%; border-collapse: collapse; text-align: center;"> <tr> <td style="width: 10%;"></td> <td style="width: 10%;"></td> <td style="width: 10%;"></td> <td style="width: 10%;"></td> <td style="width: 10%;"></td> <td style="width: 10%;"></td> <td style="width: 10%;"></td> <td style="width: 10%;"></td> <td style="width: 10%;"></td> <td style="width: 10%;"></td> </tr> <tr> <td></td> <td></td> <td colspan="8" style="text-align: center;"> <table border="1" style="width: 100%; border-collapse: collapse; text-align: center;"> <tr> </tr></table></td></tr></table></td></tr></table></td></tr></table></td></tr></table></td></tr></table></td></tr></table></td></tr></table></td></tr></table></td></tr></table></td></tr></table>

 | | | | | | | | | | | | | | | | | | | | <table border="1" style="width: 100%; border-collapse: collapse; text-align: center;"> <tr> <td style="width: 10%;"></td> <td style="width: 10%;"></td> <td style="width: 10%;"></td> <td style="width: 10%;"></td> <td style="width: 10%;"></td> <td style="width: 10%;"></td> <td style="width: 10%;"></td> <td style="width: 10%;"></td> <td style="width: 10%;"></td> <td style="width: 10%;"></td> </tr> <tr> <td></td> <td></td> <td colspan="8" style="text-align: center;"> <table border="1" style="width: 100%; border-collapse: collapse; text-align: center;"> <tr> <td style="width: 10%;"></td> <td style="width: 10%;"></td> <td style="width: 10%;"></td> <td style="width: 10%;"></td> <td style="width: 10%;"></td> <td style="width: 10%;"></td> <td style="width: 10%;"></td> <td style="width: 10%;"></td> <td style="width: 10%;"></td> <td style="width: 10%;"></td> </tr> <tr> <td></td> <td></td> <td colspan="8" style="text-align: center;"> <table border="1" style="width: 100%; border-collapse: collapse; text-align: center;"> <tr> <td style="width: 10%;"></td> <td style="width: 10%;"></td> <td style="width: 10%;"></td> <td style="width: 10%;"></td> <td style="width: 10%;"></td> <td style="width: 10%;"></td> <td style="width: 10%;"></td> <td style="width: 10%;"></td> <td style="width: 10%;"></td> <td style="width: 10%;"></td> </tr> <tr> <td></td> <td></td> <td colspan="8" style="text-align: center;"> <table border="1" style="width: 100%; border-collapse: collapse; text-align: center;"> <tr> <td style="width: 10%;"></td> <td style="width: 10%;"></td> <td style="width: 10%;"></td> <td style="width: 10%;"></td> <td style="width: 10%;"></td> <td style="width: 10%;"></td> <td style="width: 10%;"></td> <td style="width: 10%;"></td> <td style="width: 10%;"></td> <td style="width: 10%;"></td> </tr> <tr> <td></td> <td></td> <td colspan="8" style="text-align: center;"> <table border="1" style="width: 100%; border-collapse: collapse; text-align: center;"> <tr> <td style="width: 10%;"></td> <td style="width: 10%;"></td> <td style="width: 10%;"></td> <td style="width: 10%;"></td> <td style="width: 10%;"></td> <td style="width: 10%;"></td> <td style="width: 10%;"></td> <td style="width: 10%;"></td> <td style="width: 10%;"></td> <td style="width: 10%;"></td> </tr> <tr> <td></td> <td></td> <td colspan="8" style="text-align: center;"> <table border="1" style="width: 100%; border-collapse: collapse; text-align: center;"> <tr> <td style="width: 10%;"></td> <td style="width: 10%;"></td> <td style="width: 10%;"></td> <td style="width: 10%;"></td> <td style="width: 10%;"></td> <td style="width: 10%;"></td> <td style="width: 10%;"></td> <td style="width: 10%;"></td> <td style="width: 10%;"></td> <td style="width: 10%;"></td> </tr> <tr> <td></td> <td></td> <td colspan="8" style="text-align: center;"> <table border="1" style="width: 100%; border-collapse: collapse; text-align: center;"> <tr> <td style="width: 10%;"></td> <td style="width: 10%;"></td> <td style="width: 10%;"></td> <td style="width: 10%;"></td> <td style="width: 10%;"></td> <td style="width: 10%;"></td> <td style="width: 10%;"></td> <td style="width: 10%;"></td> <td style="width: 10%;"></td> <td style="width: 10%;"></td> </tr> <tr> <td></td> <td></td> <td colspan="8" style="text-align: center;"> <table border="1" style="width: 100%; border-collapse: collapse; text-align: center;"> <tr> <td style="width: 10%;"></td> <td style="width: 10%;"></td> <td style="width: 10%;"></td> <td style="width: 10%;"></td> <td style="width: 10%;"></td> <td style="width: 10%;"></td> <td style="width: 10%;"></td> <td style="width: 10%;"></td> <td style="width: 10%;"></td> <td style="width: 10%;"></td> </tr> <tr> <td></td> <td></td> <td colspan="8" style="text-align: center;"> <table border="1" style="width: 100%; border-collapse: collapse; text-align: center;"> <tr> <td style="width: 10%;"></td> <td style="width: 10%;"></td> <td style="width: 10%;"></td> <td style="width: 10%;"></td> <td style="width: 10%;"></td> <td style="width: 10%;"></td> <td style="width: 10%;"></td> <td style="width: 10%;"></td> <td style="width: 10%;"></td> <td style="width: 10%;"></td> </tr> <tr> <td></td> <td></td> <td colspan="8" style="text-align: center;"> <table border="1" style="width: 100%; border-collapse: collapse; text-align: center;"> <tr> </tr></table></td></tr></table></td></tr></table></td></tr></table></td></tr></table></td></tr></table></td></tr></table></td></tr></table></td></tr></table></td></tr></table>

 | | | | | | | | | | | | | | | | | | | | <table border="1" style="width: 100%; border-collapse: collapse; text-align: center;"> <tr> <td style="width: 10%;"></td> <td style="width: 10%;"></td> <td style="width: 10%;"></td> <td style="width: 10%;"></td> <td style="width: 10%;"></td> <td style="width: 10%;"></td> <td style="width: 10%;"></td> <td style="width: 10%;"></td> <td style="width: 10%;"></td> <td style="width: 10%;"></td> </tr> <tr> <td></td> <td></td> <td colspan="8" style="text-align: center;"> <table border="1" style="width: 100%; border-collapse: collapse; text-align: center;"> <tr> <td style="width: 10%;"></td> <td style="width: 10%;"></td> <td style="width: 10%;"></td> <td style="width: 10%;"></td> <td style="width: 10%;"></td> <td style="width: 10%;"></td> <td style="width: 10%;"></td> <td style="width: 10%;"></td> <td style="width: 10%;"></td> <td style="width: 10%;"></td> </tr> <tr> <td></td> <td></td> <td colspan="8" style="text-align: center;"> <table border="1" style="width: 100%; border-collapse: collapse; text-align: center;"> <tr> <td style="width: 10%;"></td> <td style="width: 10%;"></td> <td style="width: 10%;"></td> <td style="width: 10%;"></td> <td style="width: 10%;"></td> <td style="width: 10%;"></td> <td style="width: 10%;"></td> <td style="width: 10%;"></td> <td style="width: 10%;"></td> <td style="width: 10%;"></td> </tr> <tr> <td></td> <td></td> <td colspan="8" style="text-align: center;"> <table border="1" style="width: 100%; border-collapse: collapse; text-align: center;"> <tr> <td style="width: 10%;"></td> <td style="width: 10%;"></td> <td style="width: 10%;"></td> <td style="width: 10%;"></td> <td style="width: 10%;"></td> <td style="width: 10%;"></td> <td style="width: 10%;"></td> <td style="width: 10%;"></td> <td style="width: 10%;"></td> <td style="width: 10%;"></td> </tr> <tr> <td></td> <td></td> <td colspan="8" style="text-align: center;"> <table border="1" style="width: 100%; border-collapse: collapse; text-align: center;"> <tr> <td style="width: 10%;"></td> <td style="width: 10%;"></td> <td style="width: 10%;"></td> <td style="width: 10%;"></td> <td style="width: 10%;"></td> <td style="width: 10%;"></td> <td style="width: 10%;"></td> <td style="width: 10%;"></td> <td style="width: 10%;"></td> <td style="width: 10%;"></td> </tr> <tr> <td></td> <td></td> <td colspan="8" style="text-align: center;"> <table border="1" style="width: 100%; border-collapse: collapse; text-align: center;"> <tr> <td style="width: 10%;"></td> <td style="width: 10%;"></td> <td style="width: 10%;"></td> <td style="width: 10%;"></td> <td style="width: 10%;"></td> <td style="width: 10%;"></td> <td style="width: 10%;"></td> <td style="width: 10%;"></td> <td style="width: 10%;"></td> <td style="width: 10%;"></td> </tr> <tr> <td></td> <td></td> <td colspan="8" style="text-align: center;"> <table border="1" style="width: 100%; border-collapse: collapse; text-align: center;"> <tr> <td style="width: 10%;"></td> <td style="width: 10%;"></td> <td style="width: 10%;"></td> <td style="width: 10%;"></td> <td style="width: 10%;"></td> <td style="width: 10%;"></td> <td style="width: 10%;"></td> <td style="width: 10%;"></td> <td style="width: 10%;"></td> <td style="width: 10%;"></td> </tr> <tr> <td></td> <td></td> <td colspan="8" style="text-align: center;"> <table border="1" style="width: 100%; border-collapse: collapse; text-align: center;"> <tr> <td style="width: 10%;"></td> <td style="width: 10%;"></td> <td style="width: 10%;"></td> <td style="width: 10%;"></td> <td style="width: 10%;"></td> <td style="width: 10%;"></td> <td style="width: 10%;"></td> <td style="width: 10%;"></td> <td style="width: 10%;"></td> <td style="width: 10%;"></td> </tr> <tr> <td></td> <td></td> <td colspan="8" style="text-align: center;"> <table border="1" style="width: 100%; border-collapse: collapse; text-align: center;"> <tr> </tr></table></td></tr></table></td></tr></table></td></tr></table></td></tr></table></td></tr></table></td></tr></table></td></tr></table></td></tr></table>

 | | | | | | | | | | | | | | | | | | | | <table border="1" style="width: 100%; border-collapse: collapse; text-align: center;"> <tr> <td style="width: 10%;"></td> <td style="width: 10%;"></td> <td style="width: 10%;"></td> <td style="width: 10%;"></td> <td style="width: 10%;"></td> <td style="width: 10%;"></td> <td style="width: 10%;"></td> <td style="width: 10%;"></td> <td style="width: 10%;"></td> <td style="width: 10%;"></td> </tr> <tr> <td></td> <td></td> <td colspan="8" style="text-align: center;"> <table border="1" style="width: 100%; border-collapse: collapse; text-align: center;"> <tr> <td style="width: 10%;"></td> <td style="width: 10%;"></td> <td style="width: 10%;"></td> <td style="width: 10%;"></td> <td style="width: 10%;"></td> <td style="width: 10%;"></td> <td style="width: 10%;"></td> <td style="width: 10%;"></td> <td style="width: 10%;"></td> <td style="width: 10%;"></td> </tr> <tr> <td></td> <td></td> <td colspan="8" style="text-align: center;"> <table border="1" style="width: 100%; border-collapse: collapse; text-align: center;"> <tr> <td style="width: 10%;"></td> <td style="width: 10%;"></td> <td style="width: 10%;"></td> <td style="width: 10%;"></td> <td style="width: 10%;"></td> <td style="width: 10%;"></td> <td style="width: 10%;"></td> <td style="width: 10%;"></td> <td style="width: 10%;"></td> <td style="width: 10%;"></td> </tr> <tr> <td></td> <td></td> <td colspan="8" style="text-align: center;"> <table border="1" style="width: 100%; border-collapse: collapse; text-align: center;"> <tr> <td style="width: 10%;"></td> <td style="width: 10%;"></td> <td style="width: 10%;"></td> <td style="width: 10%;"></td> <td style="width: 10%;"></td> <td style="width: 10%;"></td> <td style="width: 10%;"></td> <td style="width: 10%;"></td> <td style="width: 10%;"></td> <td style="width: 10%;"></td> </tr> <tr> <td></td> <td></td> <td colspan="8" style="text-align: center;"> <table border="1" style="width: 100%; border-collapse: collapse; text-align: center;"> <tr> <td style="width: 10%;"></td> <td style="width: 10%;"></td> <td style="width: 10%;"></td> <td style="width: 10%;"></td> <td style="width: 10%;"></td> <td style="width: 10%;"></td> <td style="width: 10%;"></td> <td style="width: 10%;"></td> <td style="width: 10%;"></td> <td style="width: 10%;"></td> </tr> <tr> <td></td> <td></td> <td colspan="8" style="text-align: center;"> <table border="1" style="width: 100%; border-collapse: collapse; text-align: center;"> <tr> <td style="width: 10%;"></td> <td style="width: 10%;"></td> <td style="width: 10%;"></td> <td style="width: 10%;"></td> <td style="width: 10%;"></td> <td style="width: 10%;"></td> <td style="width: 10%;"></td> <td style="width: 10%;"></td> <td style="width: 10%;"></td> <td style="width: 10%;"></td> </tr> <tr> <td></td> <td></td> <td colspan="8" style="text-align: center;"> <table border="1" style="width: 100%; border-collapse: collapse; text-align: center;"> <tr> <td style="width: 10%;"></td> <td style="width: 10%;"></td> <td style="width: 10%;"></td> <td style="width: 10%;"></td> <td style="width: 10%;"></td> <td style="width: 10%;"></td> <td style="width: 10%;"></td> <td style="width: 10%;"></td> <td style="width: 10%;"></td> <td style="width: 10%;"></td> </tr> <tr> <td></td> <td></td> <td colspan="8" style="text-align: center;"> <table border="1" style="width: 100%; border-collapse: collapse; text-align: center;"> <tr> </tr></table></td></tr></table></td></tr></table></td></tr></table></td></tr></table></td></tr></table></td></tr></table></td></tr></table>

 | | | | | | | | | | | | | | | | | | | | <table border="1" style="width: 100%; border-collapse: collapse; text-align: center;"> <tr> <td style="width: 10%;"></td> <td style="width: 10%;"></td> <td style="width: 10%;"></td> <td style="width: 10%;"></td> <td style="width: 10%;"></td> <td style="width: 10%;"></td> <td style="width: 10%;"></td> <td style="width: 10%;"></td> <td style="width: 10%;"></td> <td style="width: 10%;"></td> </tr> <tr> <td></td> <td></td> <td colspan="8" style="text-align: center;"> <table border="1" style="width: 100%; border-collapse: collapse; text-align: center;"> <tr> <td style="width: 10%;"></td> <td style="width: 10%;"></td> <td style="width: 10%;"></td> <td style="width: 10%;"></td> <td style="width: 10%;"></td> <td style="width: 10%;"></td> <td style="width: 10%;"></td> <td style="width: 10%;"></td> <td style="width: 10%;"></td> <td style="width: 10%;"></td> </tr> <tr> <td></td> <td></td> <td colspan="8" style="text-align: center;"> <table border="1" style="width: 100%; border-collapse: collapse; text-align: center;"> <tr> <td style="width: 10%;"></td> <td style="width: 10%;"></td> <td style="width: 10%;"></td> <td style="width: 10%;"></td> <td style="width: 10%;"></td> <td style="width: 10%;"></td> <td style="width: 10%;"></td> <td style="width: 10%;"></td> <td style="width:
10%;"></td> <td style="width: 10%;"></td> </tr> <tr> <td></td> <td></td> <td colspan="8" style="text-align: center;"> <table border="1" style="width: 100%; border-collapse: collapse; text-align: center;"> <tr> <td style="width: 10%;"></td> <td style="width: 10%;"></td> <td style="width: 10%;"></td> <td style="width: 10%;"></td> <td style="width: 10%;"></td> <td style="width: 10%;"></td> <td style="width: 10%;"></td> <td style="width: 10%;"></td> <td style="width: 10%;"></td> <td style="width: 10%;"></td> </tr> <tr> <td></td> <td></td> <td colspan="8" style="text-align: center;"> <table border="1" style="width: 100%; border-collapse: collapse; text-align: center;"> <tr> <td style="width: 10%;"></td> <td style="width: 10%;"></td> <td style="width: 10%;"></td> <td style="width: 10%;"></td> <td style="width: 10%;"></td> <td style="width: 10%;"></td> <td style="width: 10%;"></td> <td style="width: 10%;"></td> <td style="width: 10%;"></td> <td style="width: 10%;"></td> </tr> <tr> <td></td> <td></td> <td colspan="8" style="text-align: center;"> <table border="1" style="width: 100%; border-collapse: collapse; text-align: center;"> <tr> <td style="width: 10%;"></td> <td style="width: 10%;"></td> <td style="width: 10%;"></td> <td style="width: 10%;"></td> <td style="width: 10%;"></td> <td style="width: 10%;"></td> <td style="width: 10%;"></td> <td style="width: 10%;"></td> <td style="width: 10%;"></td> <td style="width: 10%;"></td> </tr> <tr> <td></td> <td></td> <td colspan="8" style="text-align: center;"> <table border="1" style="width: 100%; border-collapse: collapse; text-align: center;"> <tr> </tr></table></td></tr></table></td></tr></table></td></tr></table></td></tr></table></td></tr></table></td></tr></table>

 | | | | | | | | | | | | | | | | | | | | <table border="1" style="width: 100%; border-collapse: collapse; text-align: center;"> <tr> <td style="width: 10%;"></td> <td style="width: 10%;"></td> <td style="width: 10%;"></td> <td style="width: 10%;"></td> <td style="width: 10%;"></td> <td style="width: 10%;"></td> <td style="width: 10%;"></td> <td style="width: 10%;"></td> <td style="width: 10%;"></td> <td style="width: 10%;"></td> </tr> <tr> <td></td> <td></td> <td colspan="8" style="text-align: center;"> <table border="1" style="width: 100%; border-collapse: collapse; text-align: center;"> <tr> <td style="width: 10%;"></td> <td style="width: 10%;"></td> <td style="width: 10%;"></td> <td style="width: 10%;"></td> <td style="width: 10%;"></td> <td style="width: 10%;"></td> <td style="width: 10%;"></td> <td style="width: 10%;"></td> <td style="width: 10%;"></td> <td style="width: 10%;"></td> </tr> <tr> <td></td> <td></td> <td colspan="8" style="text-align: center;"> <table border="1" style="width: 100%; border-collapse: collapse; text-align: center;"> <tr> <td style="width: 10%;"></td> <td style="width: 10%;"></td> <td style="width: 10%;"></td> <td style="width: 10%;"></td> <td style="width: 10%;"></td> <td style="width: 10%;"></td> <td style="width: 10%;"></td> <td style="width: 10%;"></td> <td style="width: 10%;"></td> <td style="width: 10%;"></td> </tr> <tr> <td></td> <td></td> <td colspan="8" style="text-align: center;"> <table border="1" style="width: 100%; border-collapse: collapse; text-align: center;"> <tr> <td style="width: 10%;"></td> <td style="width: 10%;"></td> <td style="width: 10%;"></td> <td style="width: 10%;"></td> <td style="width: 10%;"></td> <td style="width: 10%;"></td> <td style="width: 10%;"></td> <td style="width: 10%;"></td> <td style="width: 10%;"></td> <td style="width: 10%;"></td> </tr> <tr> <td></td> <td></td> <td colspan="8" style="text-align: center;"> <table border="1" style="width: 100%; border-collapse: collapse; text-align: center;"> <tr> <td style="width: 10%;"></td> <td style="width: 10%;"></td> <td style="width: 10%;"></td> <td style="width: 10%;"></td> <td style="width: 10%;"></td> <td style="width: 10%;"></td> <td style="width: 10%;"></td> <td style="width: 10%;"></td> <td style="width: 10%;"></td> <td style="width: 10%;"></td> </tr> <tr> <td></td> <td></td> <td colspan="8" style="text-align: center;"> <table border="1" style="width: 100%; border-collapse: collapse; text-align: center;"> <tr> </tr></table></td></tr></table></td></tr></table></td></tr></table></td></tr></table></td></tr></table>

 | | | | | | | | | | | | | | | | | | | | <table border="1" style="width: 100%; border-collapse: collapse; text-align: center;"> <tr> <td style="width: 10%;"></td> <td style="width: 10%;"></td> <td style="width: 10%;"></td> <td style="width: 10%;"></td> <td style="width: 10%;"></td> <td style="width: 10%;"></td> <td style="width: 10%;"></td> <td style="width: 10%;"></td> <td style="width: 10%;"></td> <td style="width: 10%;"></td> </tr> <tr> <td></td> <td></td> <td colspan="8" style="text-align: center;"> <table border="1" style="width: 100%; border-collapse: collapse; text-align: center;"> <tr> <td style="width: 10%;"></td> <td style="width: 10%;"></td> <td style="width: 10%;"></td> <td style="width: 10%;"></td> <td style="width: 10%;"></td> <td style="width: 10%;"></td> <td style="width: 10%;"></td> <td style="width: 10%;"></td> <td style="width: 10%;"></td> <td style="width: 10%;"></td> </tr> <tr> <td></td> <td></td> <td colspan="8" style="text-align: center;"> <table border="1" style="width: 100%; border-collapse: collapse; text-align: center;"> <tr> <td style="width: 10%;"></td> <td style="width: 10%;"></td> <td style="width: 10%;"></td> <td style="width: 10%;"></td> <td style="width: 10%;"></td> <td style="width: 10%;"></td> <td style="width: 10%;"></td> <td style="width: 10%;"></td> <td style="width: 10%;"></td> <td style="width: 10%;"></td> </tr> <tr> <td></td> <td></td> <td colspan="8" style="text-align: center;"> <table border="1" style="width: 100%; border-collapse: collapse; text-align: center;"> <tr> <td style="width: 10%;"></td> <td style="width: 10%;"></td> <td style="width: 10%;"></td> <td style="width: 10%;"></td> <td style="width: 10%;"></td> <td style="width: 10%;"></td> <td style="width: 10%;"></td> <td style="width: 10%;"></td> <td style="width: 10%;"></td> <td style="width: 10%;"></td> </tr> <tr> <td></td> <td></td> <td colspan="8" style="text-align: center;"> <table border="1" style="width: 100%; border-collapse: collapse; text-align: center;"> <tr> </tr></table></td></tr></table></td></tr></table></td></tr></table></td></tr></table>

 | | | | | | | | | | | | | | | | | | | | <table border="1" style="width: 100%; border-collapse: collapse; text-align: center;"> <tr> <td style="width: 10%;"></td> <td style="width: 10%;"></td> <td style="width: 10%;"></td> <td style="width: 10%;"></td> <td style="width: 10%;"></td> <td style="width: 10%;"></td> <td style="width: 10%;"></td> <td style="width: 10%;"></td> <td style="width: 10%;"></td> <td style="width: 10%;"></td> </tr> <tr> <td></td> <td></td> <td colspan="8" style="text-align: center;"> <table border="1" style="width: 100%; border-collapse: collapse; text-align: center;"> <tr> <td style="width: 10%;"></td> <td style="width: 10%;"></td> <td style="width: 10%;"></td> <td style="width: 10%;"></td> <td style="width: 10%;"></td> <td style="width: 10%;"></td> <td style="width: 10%;"></td> <td style="width: 10%;"></td> <td style="width: 10%;"></td> <td style="width: 10%;"></td> </tr> <tr> <td></td> <td></td> <td colspan="8" style="text-align: center;"> <table border="1" style="width: 100%; border-collapse: collapse; text-align: center;"> <tr> <td style="width: 10%;"></td> <td style="width: 10%;"></td> <td style="width: 10%;"></td> <td style="width: 10%;"></td> <td style="width: 10%;"></td> <td style="width: 10%;"></td> <td style="width: 10%;"></td> <td style="width: 10%;"></td> <td style="width: 10%;"></td> <td style="width: 10%;"></td> </tr> <tr> <td></td> <td></td> <td colspan="8" style="text-align: center;"> <table border="1" style="width: 100%; border-collapse: collapse; text-align: center;"> <tr> </tr></table></td></tr></table></td></tr></table></td></tr></table>

 | | | | | | | | | | | | | | | | | | | | <table border="1" style="width: 100%; border-collapse: collapse; text-align: center;"> <tr> <td style="width: 10%;"></td> <td style="width: 10%;"></td> <td style="width: 10%;"></td> <td style="width: 10%;"></td> <td style="width: 10%;"></td> <td style="width: 10%;"></td> <td style="width: 10%;"></td> <td style="width: 10%;"></td> <td style="width: 10%;"></td> <td style="width: 10%;"></td> </tr> <tr> <td></td> <td></td> <td colspan="8" style="text-align: center;"> <table border="1" style="width: 100%; border-collapse: collapse; text-align: center;"> <tr> <td style="width: 10%;"></td> <td style="width: 10%;"></td> <td style="width: 10%;"></td> <td style="width: 10%;"></td> <td style="width: 10%;"></td> <td style="width: 10%;"></td> <td style="width: 10%;"></td> <td style="width: 10%;"></td> <td style="width: 10%;"></td> <td style="width: 10%;"></td> </tr> <tr> <td></td> <td></td> <td colspan="8" style="text-align: center;"> <table border="1" style="width: 100%; border-collapse: collapse; text-align: center;"> <tr> </tr></table></td></tr></table></td></tr></table>

 | | | | | | | | | | | | | | | | | | | | <table border="1" style="width: 100%; border-collapse: collapse; text-align: center;"> <tr> <td style="width: 10%;"></td> <td style="width: 10%;"></td> <td style="width: 10%;"></td> <td style="width: 10%;"></td> <td style="width: 10%;"></td> <td style="width: 10%;"></td> <td style="width: 10%;"></td> <td style="width: 10%;"></td> <td style="width: 10%;"></td> <td style="width: 10%;"></td> </tr> <tr> <td></td> <td></td> <td colspan="8" style="text-align: center;"> <table border="1" style="width: 100%; border-collapse: collapse; text-align: center;"> <tr> </tr></table></td></tr></table>

 | | | | | | | | | | | | | | | | | | | | <table border="1" style="width: 100%; border-collapse: collapse; text-align: center;"> <tr> </tr></table>

 | | | | | | | | | | | | | | | | | | | |

 | | | | | | | | | | | | | | | | | | | |

 | | | | | | | | | | | | | | | | | | | |

 | | | | | | | | | | | | | | | | | | | |

 | | | | | | | | | | | | | | | | | | | |

 | | | | | | | | | | | | | | | | | | | |

 | | | | | | | | | | | | | | | | | | | |

 | | | | | | | | | | | | | | | | | | | |

 | | | | | | | | | | | | | | | | | | | |

 | | | | | | | | | | | | | | | | | | | |

 | | | | | | | | | | | | | | | | | | | |

 | | | | | | | | | | | | | | | | | | | |

 | | | | | | | | | | | | | | | | | | | |

 | | | | | | | | | | | | | | | | | | | |

 | | | | | | | | | | | | | | | | | | | |
 | | | | | | | | | | | | | | | | | | | |

 | | | | | | | | | | | | | | | | | | | |

 | | | | | | | | | | | | | | | | | | | |
 | | | | | | | | | | | | | | | | | | | |

 | | | | | | | | | | | | | | | | | | | |

 | | | | | | | | | | | | | | | | | | | |
 | | | | | | | | | | | | | | | | | | | |
 | | | | | | | | | | | | | | | | | | | |

 | | | | | | | | | | | | | | | | | | | |
 | | | | | | | | | | | | | | | | | | | |
 | | | | | | | | | | | | | | | | | | | |

 | | | | | | | | | | | | | | | | | | | | | | | | | | | | | | | | | | | | | | | | | | | | | | | | | | | | | | | | | | | | | | | | | | | | | | | | | | | | | | | | | | | | | | | | | | | | | | | | | | | |
 | | | | | | | | | | | | | | | | | | | |
 | | | | | | | | | | | | | | | | | | | |
 | | | | | | | | | | | | | | | | | | | |
 | | | | | | | | | | | | | | | | | | | |
 | | | | | | | | | | | | | | | | | | | |
 | | | | | | | | | | | | | | | | | | | |
 | | | | | | | | | | | | | | | | | | | |
 | | | | | | | | | | | | | | | | | | | |
 | | | | | | | | | | | | | | | | | | | | | | | | | | | | | | | | | | | | | | | |
 | | | | | | | | | | | | | | | | | | | |
 | | | | | | | | | | | | | | | | | | | | | | | | | | | | | | | | | | | | | | | |
 | | | | | | | | | | | | | | | | | | | | | | | | | | | | | | | | | | | | | | | |
 | | | | | | | | | | | | | | | | | | | | | | | | | | | | | | | | | | | | | | | |
 | | | | | | | | | | | | | | | | | | | | | | | | | | | | | | | | | | | | | | | | | | | | | | | | | | | | | | | | | | | | | | | | | | | | | | | | | | | | | | | | | | | | | | | | | | | | | | | | | | | |
 | | | | | | | | | | | | | | | | | | | | | | | | | | | | | | | | | | | | | | | | | | | | | | | |
| | |

 | | | | | | | | | | | | | | | | | | | |

 | | | | | | | | | | | | | | | | | | | |

 | | | | | | | | | | | | | | | | | | | |

 | | | | | | | | | | | | | | | | | | | |

 | | | | | | | | | | | | | | | | | | | |

 | | | | | | | | | | | | | | | | | | | |

 | | | | | | | | | | | | | | | | | | | |

 | | | | | | | | | | | | | | | | | | | |

 | | | | | | | | | | | | | | | | | | | |

 | | | | | | | | | | | | | | | | | | | |

 | | | | | | | | | | | | | | | | | | | |

 | | | | | | | | | | | | | | | | | | | |

 | | | | | | | | | | | | | | | | | | | |

 | | | | | | | | | | | | | | | | | | | |

 | | | | | | | | | | | | | | | | | | | |

 | | | | | | | | | | | | | | | | | | | |

 | | | | | | | | | | | | | | | | | | | |

 | | | | | | | | | | | | | | | | | | | |

 | | | | | | | | | | | | | | | | | | | |

 | | | | | | | | | | | | | | | | | | | |

 | | | | | | | | | | | | | | | | | | | |

 | | | | | | | | | | | | | | | | | | | |

 | | | | | | | | | | | | | | | | | | | |

 | | | | | | | | | | | | | | | | | | | |

 | | | | | | | | | | | | | | | | | | | |

 | | | | | | | | | | | | | | | | | | | |

 | | | | | | | | | | | | | | | | | | | |

 | | | | | | | | | | | | | | | | | | | |
 | | | | | | | | | | | | | | | | | | | |

 | | | | | | | | | | | | | | | | | | | |

 | | | | | | | | | | | | | | | | | | | |
 | | | | | | | | | | | | | | | | | | | |

 | | | | | | | | | | | | | | | | | | | |

 | | | | | | | | | | | | | | | | | | | |
 | | | | | | | | | | | | | | | | | | | |
 | | | | | | | | | | | | | | | | | | | |

 | | | | | | | | | | | | | | | | | | | |
 | | | | | | | | | | | | | | | | | | | |
 | | | | | | | | | | | | | | | | | | | |

 | | | | | | | | | | | | | | | | | | | | | | | | | | | | | | | | | | | | | | | | | | | | | | | | | | | | | | | | | | | | | | | | | | | | | | | | | | | | | | | | | | | | | | | | | | | | | | | | | | | |
 | | | | | | | | | | | | | | | | | | | |
 | | | | | | | | | | | | | | | | | | | |
 | | | | | | | | | | | | | | | | | | | |
 | | | | | | | | | | | | | | | | | | | |
 | | | | | | | | | | | | | | | | | | | |
 | | | | | | | | | | | | | | | | | | | |
 | | | | | | | | | | | | | | | | | | | |
 | | | | | | | | | | | | | | | | | | | |
 | | | | | | | | | | | | | | | | | | | | | | | | | | | | | | | | | | | | | | | |
 | | | | | | | | | | | | | | | | | | | |
 | | | | | | | | | | | | | | | | | | | | | | | | | | | | | | | | | | | | | | | |
 | | | | | | | | | | | | | | | | | | | | | | | | | | | | | | | | | | | | | | | |
 | | | | | | | | | | | | | | | | | | | | | | | | | | | | | | | | | | | | | | | |
 | | | | | | | | | | | | | | | | | | | | | | | | | | | | | | | | | | | | | | | | | | | | | | | | | | | | | | | | | | | | | | | | | | | | | | | | | | | | | | | | | | | | | | | | | | | | | | | | | | | |
 | | | | | | | | | | | | | | | | | | | | | | | | | | | | | | | | | | | | | | | | | | | | | | | |
| | | <table border="1" style="width: 100%; border-collapse: collapse; text-align: center;"> <tr> <td style="width: 10%;"></td> <td style="width: 10%;"></td> <td style="width: 10%;"></td> <td style="width: 10%;"></td> <td style="width: 10%;"></td> <td style="width: 10%;"></td> <td style="width: 10%;"></td> <td style="width: 10%;"></td> <td style="width: 10%;"></td> <td style="width: 10%;"></td> </tr> <tr> <td></td> <td></td> <td colspan="8" style="text-align: center;"> <table border="1" style="width: 100%; border-collapse: collapse; text-align: center;"> <tr> <td style="width: 10%;"></td> <td style="width: 10%;"></td> <td style="width: 10%;"></td> <td style="width: 10%;"></td> <td style="width: 10%;"></td> <td style="width: 10%;"></td> <td style="width: 10%;"></td> <td style="width: 10%;"></td> <td style="width: 10%;"></td> <td style="width: 10%;"></td> </tr> <tr> <td></td> <td></td> <td colspan="8" style="text-align: center;"> <table border="1" style="width: 100%; border-collapse: collapse; text-align: center;"> <tr> <td style="width: 10%;"></td> <td style="width: 10%;"></td> <td style="width: 10%;"></td> <td style="width: 10%;"></td> <td style="width: 10%;"></td> <td style="width: 10%;"></td> <td style="width: 10%;"></td> <td style="width: 10%;"></td> <td style="width: 10%;"></td> <td style="width: 10%;"></td> </tr> <tr> <td></td> <td></td> <td colspan="8" style="text-align: center;"> <table border="1" style="width: 100%; border-collapse: collapse; text-align: center;"> <tr> <td style="width: 10%;"></td> <td style="width: 10%;"></td> <td style="width: 10%;"></td> <td style="width: 10%;"></td> <td style="width: 10%;"></td> <td style="width: 10%;"></td> <td style="width: 10%;"></td> <td style="width: 10%;"></td> <td style="width: 10%;"></td> <td style="width: 10%;"></td> </tr> <tr> <td></td> <td></td> <td colspan="8" style="text-align: center;"> <table border="1" style="width: 100%; border-collapse: collapse; text-align: center;"> <tr> <td style="width: 10%;"></td> <td style="width: 10%;"></td> <td style="width: 10%;"></td> <td style="width: 10%;"></td> <td style="width: 10%;"></td> <td style="width: 10%;"></td> <td style="width: 10%;"></td> <td style="width: 10%;"></td> <td style="width: 10%;"></td> <td style="width: 10%;"></td> </tr> <tr> <td></td> <td></td> <td colspan="8" style="text-align: center;"> <table border="1" style="width: 100%; border-collapse: collapse; text-align: center;"> <tr> <td style="width: 10%;"></td> <td style="width: 10%;"></td> <td style="width: 10%;"></td> <td style="width: 10%;"></td> <td style="width: 10%;"></td> <td style="width: 10%;"></td> <td style="width: 10%;"></td> <td style="width: 10%;"></td> <td style="width: 10%;"></td> <td style="width: 10%;"></td> </tr> <tr> <td></td> <td></td> <td colspan="8" style="text-align: center;"> <table border="1" style="width: 100%; border-collapse: collapse; text-align: center;"> <tr> <td style="width: 10%;"></td> <td style="width: 10%;"></td> <td style="width: 10%;"></td> <td style="width: 10%;"></td> <td style="width: 10%;"></td> <td style="width: 10%;"></td> <td style="width: 10%;"></td> <td style="width: 10%;"></td> <td style="width: 10%;"></td> <td style="width: 10%;"></td> </tr> <tr> <td></td> <td></td> <td colspan="8" style="text-align: center;"> <table border="1" style="width: 100%; border-collapse: collapse; text-align: center;"> <tr> <td style="width: 10%;"></td> <td style="width: 10%;"></td> <td style="width: 10%;"></td> <td style="width: 10%;"></td> <td style="width: 10%;"></td> <td style="width: 10%;"></td> <td style="width: 10%;"></td> <td style="width: 10%;"></td> <td style="width: 10%;"></td> <td style="width: 10%;"></td> </tr> <tr> <td></td> <td></td> <td colspan="8" style="text-align: center;"> <table border="1" style="width: 100%; border-collapse: collapse; text-align: center;"> <tr> <td style="width: 10%;"></td> <td style="width: 10%;"></td> <td style="width: 10%;"></td> <td style="width: 10%;"></td> <td style="width: 10%;"></td> <td style="width: 10%;"></td> <td style="width: 10%;"></td> <td style="width: 10%;"></td> <td style="width: 10%;"></td> <td style="width: 10%;"></td> </tr> <tr> <td></td> <td></td> <td colspan="8" style="text-align: center;"> <table border="1" style="width: 100%; border-collapse: collapse; text-align: center;"> <tr> <td style="width: 10%;"></td> <td style="width: 10%;"></td> <td style="width: 10%;"></td> <td style="width: 10%;"></td> <td style="width: 10%;"></td> <td style="width: 10%;"></td> <td style="width: 10%;"></td> <td style="width: 10%;"></td> <td style="width: 10%;"></td> <td style="width: 10%;"></td> </tr> <tr> <td></td> <td></td> <td colspan="8" style="text-align: center;"> <table border="1" style="width: 100%; border-collapse: collapse; text-align: center;"> <tr> <td style="width: 10%;"></td> <td style="width: 10%;"></td> <td style="width: 10%;"></td> <td style="width: 10%;"></td> <td style="width: 10%;"></td> <td style="width: 10%;"></td> <td style="width: 10%;"></td> <td style="width: 10%;"></td> <td style="width: 10%;"></td> <td style="width: 10%;"></td> </tr> <tr> <td></td> <td></td> <td colspan="8" style="text-align: center;"> <table border="1" style="width: 100%; border-collapse: collapse; text-align: center;"> <tr> <td style="width: 10%;"></td> <td style="width: 10%;"></td> <td style="width: 10%;"></td> <td style="width: 10%;"></td> <td style="width: 10%;"></td> <td style="width: 10%;"></td> <td style="width: 10%;"></td> <td style="width: 10%;"></td> <td style="width: 10%;"></td> <td style="width: 10%;"></td> </tr> <tr> <td></td> <td></td> <td colspan="8" style="text-align: center;"> <table border="1" style="width: 100%; border-collapse: collapse; text-align: center;"> <tr> </tr></table></td></tr></table></td></tr></table></td></tr></table></td></tr></table></td></tr></table></td></tr></table></td></tr></table></td></tr></table></td></tr></table></td></tr></table></td></tr></table></td></tr></table>

 | | | | | | | | | | | | | | | | | | | | <table border="1" style="width: 100%; border-collapse: collapse; text-align: center;"> <tr> <td style="width: 10%;"></td> <td style="width: 10%;"></td> <td style="width: 10%;"></td> <td style="width: 10%;"></td> <td style="width: 10%;"></td> <td style="width: 10%;"></td> <td style="width: 10%;"></td> <td style="width: 10%;"></td> <td style="width: 10%;"></td> <td style="width: 10%;"></td> </tr> <tr> <td></td> <td></td> <td colspan="8" style="text-align: center;"> <table border="1" style="width: 100%; border-collapse: collapse; text-align: center;"> <tr> <td style="width: 10%;"></td> <td style="width: 10%;"></td> <td style="width: 10%;"></td> <td style="width: 10%;"></td> <td style="width: 10%;"></td> <td style="width: 10%;"></td> <td style="width: 10%;"></td> <td style="width: 10%;"></td> <td style="width: 10%;"></td> <td style="width: 10%;"></td> </tr> <tr> <td></td> <td></td> <td colspan="8" style="text-align: center;"> <table border="1" style="width: 100%; border-collapse: collapse; text-align: center;"> <tr> <td style="width: 10%;"></td> <td style="width: 10%;"></td> <td style="width: 10%;"></td> <td style="width: 10%;"></td> <td style="width: 10%;"></td> <td style="width: 10%;"></td> <td style="width: 10%;"></td> <td style="width: 10%;"></td> <td style="width: 10%;"></td> <td style="width: 10%;"></td> </tr> <tr> <td></td> <td></td> <td colspan="8" style="text-align: center;"> <table border="1" style="width: 100%; border-collapse: collapse; text-align: center;"> <tr> <td style="width: 10%;"></td> <td style="width: 10%;"></td> <td style="width: 10%;"></td> <td style="width: 10%;"></td> <td style="width: 10%;"></td> <td style="width: 10%;"></td> <td style="width: 10%;"></td> <td style="width: 10%;"></td> <td style="width: 10%;"></td> <td style="width: 10%;"></td> </tr> <tr> <td></td> <td></td> <td colspan="8" style="text-align: center;"> <table border="1" style="width: 100%; border-collapse: collapse; text-align: center;"> <tr> <td style="width: 10%;"></td> <td style="width: 10%;"></td> <td style="width: 10%;"></td> <td style="width: 10%;"></td> <td style="width: 10%;"></td> <td style="width: 10%;"></td> <td style="width: 10%;"></td> <td style="width: 10%;"></td> <td style="width: 10%;"></td> <td style="width: 10%;"></td> </tr> <tr> <td></td> <td></td> <td colspan="8" style="text-align: center;"> <table border="1" style="width: 100%; border-collapse: collapse; text-align: center;"> <tr> <td style="width: 10%;"></td> <td style="width: 10%;"></td> <td style="width: 10%;"></td> <td style="width: 10%;"></td> <td style="width: 10%;"></td> <td style="width: 10%;"></td> <td style="width: 10%;"></td> <td style="width: 10%;"></td> <td style="width: 10%;"></td> <td style="width: 10%;"></td> </tr> <tr> <td></td> <td></td> <td colspan="8" style="text-align: center;"> <table border="1" style="width: 100%; border-collapse: collapse; text-align: center;"> <tr> <td style="width: 10%;"></td> <td style="width: 10%;"></td> <td style="width: 10%;"></td> <td style="width: 10%;"></td> <td style="width: 10%;"></td> <td style="width: 10%;"></td> <td style="width: 10%;"></td> <td style="width: 10%;"></td> <td style="width: 10%;"></td> <td style="width: 10%;"></td> </tr> <tr> <td></td> <td></td> <td colspan="8" style="text-align: center;"> <table border="1" style="width: 100%; border-collapse: collapse; text-align: center;"> <tr> <td style="width: 10%;"></td> <td style="width: 10%;"></td> <td style="width: 10%;"></td> <td style="width: 10%;"></td> <td style="width: 10%;"></td> <td style="width: 10%;"></td> <td style="width: 10%;"></td> <td style="width: 10%;"></td> <td style="width: 10%;"></td> <td style="width: 10%;"></td> </tr> <tr> <td></td> <td></td> <td colspan="8" style="text-align: center;"> <table border="1" style="width: 100%; border-collapse: collapse; text-align: center;"> <tr> <td style="width: 10%;"></td> <td style="width: 10%;"></td> <td style="width: 10%;"></td> <td style="width: 10%;"></td> <td style="width: 10%;"></td> <td style="width: 10%;"></td> <td style="width: 10%;"></td> <td style="width: 10%;"></td> <td style="width: 10%;"></td> <td style="width: 10%;"></td> </tr> <tr> <td></td> <td></td> <td colspan="8" style="text-align: center;"> <table border="1" style="width: 100%; border-collapse: collapse; text-align: center;"> <tr> <td style="width: 10%;"></td> <td style="width: 10%;"></td> <td style="width: 10%;"></td> <td style="width: 10%;"></td> <td style="width: 10%;"></td> <td style="width: 10%;"></td> <td style="width: 10%;"></td> <td style="width: 10%;"></td> <td style="width: 10%;"></td> <td style="width: 10%;"></td> </tr> <tr> <td></td> <td></td> <td colspan="8" style="text-align: center;"> <table border="1" style="width: 100%; border-collapse: collapse; text-align: center;"> <tr> <td style="width: 10%;"></td> <td style="width: 10%;"></td> <td style="width: 10%;"></td> <td style="width: 10%;"></td> <td style="width: 10%;"></td> <td style="width: 10%;"></td> <td style="width: 10%;"></td> <td style="width: 10%;"></td> <td style="width: 10%;"></td> <td style="width: 10%;"></td> </tr> <tr> <td></td> <td></td> <td colspan="8" style="text-align: center;"> <table border="1" style="width: 100%; border-collapse: collapse; text-align: center;"> <tr> </tr></table></td></tr></table></td></tr></table></td></tr></table></td></tr></table></td></tr></table></td></tr></table></td></tr></table></td></tr></table></td></tr></table></td></tr></table></td></tr></table>

 | | | | | | | | | | | | | | | | | | | | <table border="1" style="width: 100%; border-collapse: collapse; text-align: center;"> <tr> <td style="width: 10%;"></td> <td style="width: 10%;"></td> <td style="width: 10%;"></td> <td style="width: 10%;"></td> <td style="width: 10%;"></td> <td style="width: 10%;"></td> <td style="width: 10%;"></td> <td style="width: 10%;"></td> <td style="width: 10%;"></td> <td style="width: 10%;"></td> </tr> <tr> <td></td> <td></td> <td colspan="8" style="text-align: center;"> <table border="1" style="width: 100%; border-collapse: collapse; text-align: center;"> <tr> <td style="width: 10%;"></td> <td style="width: 10%;"></td> <td style="width: 10%;"></td> <td style="width: 10%;"></td> <td style="width: 10%;"></td> <td style="width: 10%;"></td> <td style="width: 10%;"></td> <td style="width: 10%;"></td> <td style="width: 10%;"></td> <td style="width: 10%;"></td> </tr> <tr> <td></td> <td></td> <td colspan="8" style="text-align: center;"> <table border="1" style="width: 100%; border-collapse: collapse; text-align: center;"> <tr> <td style="width: 10%;"></td> <td style="width: 10%;"></td> <td style="width: 10%;"></td> <td style="width: 10%;"></td> <td style="width: 10%;"></td> <td style="width: 10%;"></td> <td style="width: 10%;"></td> <td style="width: 10%;"></td> <td style="width: 10%;"></td> <td style="width: 10%;"></td> </tr> <tr> <td></td> <td></td> <td colspan="8" style="text-align: center;"> <table border="1" style="width: 100%; border-collapse: collapse; text-align: center;"> <tr> <td style="width: 10%;"></td> <td style="width: 10%;"></td> <td style="width: 10%;"></td> <td style="width: 10%;"></td> <td style="width: 10%;"></td> <td style="width: 10%;"></td> <td style="width: 10%;"></td> <td style="width: 10%;"></td> <td style="width: 10%;"></td> <td style="width: 10%;"></td> </tr> <tr> <td></td> <td></td> <td colspan="8" style="text-align: center;"> <table border="1" style="width: 100%; border-collapse: collapse; text-align: center;"> <tr> <td style="width: 10%;"></td> <td style="width: 10%;"></td> <td style="width: 10%;"></td> <td style="width: 10%;"></td> <td style="width: 10%;"></td> <td style="width: 10%;"></td> <td style="width: 10%;"></td> <td style="width: 10%;"></td> <td style="width: 10%;"></td> <td style="width: 10%;"></td> </tr> <tr> <td></td> <td></td> <td colspan="8" style="text-align: center;"> <table border="1" style="width: 100%; border-collapse: collapse; text-align: center;"> <tr> <td style="width: 10%;"></td> <td style="width: 10%;"></td> <td style="width: 10%;"></td> <td style="width: 10%;"></td> <td style="width: 10%;"></td> <td style="width: 10%;"></td> <td style="width: 10%;"></td> <td style="width: 10%;"></td> <td style="width: 10%;"></td> <td style="width: 10%;"></td> </tr> <tr> <td></td> <td></td> <td colspan="8" style="text-align: center;"> <table border="1" style="width: 100%; border-collapse: collapse; text-align: center;"> <tr> <td style="width: 10%;"></td> <td style="width: 10%;"></td> <td style="width: 10%;"></td> <td style="width: 10%;"></td> <td style="width: 10%;"></td> <td style="width: 10%;"></td> <td style="width: 10%;"></td> <td style="width: 10%;"></td> <td style="width: 10%;"></td> <td style="width: 10%;"></td> </tr> <tr> <td></td> <td></td> <td colspan="8" style="text-align: center;"> <table border="1" style="width: 100%; border-collapse: collapse; text-align: center;"> <tr> <td style="width: 10%;"></td> <td style="width: 10%;"></td> <td style="width: 10%;"></td> <td style="width: 10%;"></td> <td style="width: 10%;"></td> <td style="width: 10%;"></td> <td style="width: 10%;"></td> <td style="width: 10%;"></td> <td style="width: 10%;"></td> <td style="width: 10%;"></td> </tr> <tr> <td></td> <td></td> <td colspan="8" style="text-align: center;"> <table border="1" style="width: 100%; border-collapse: collapse; text-align: center;"> <tr> <td style="width: 10%;"></td> <td style="width: 10%;"></td> <td style="width: 10%;"></td> <td style="width: 10%;"></td> <td style="width: 10%;"></td> <td style="width: 10%;"></td> <td style="width: 10%;"></td> <td style="width: 10%;"></td> <td style="width: 10%;"></td> <td style="width: 10%;"></td> </tr> <tr> <td></td> <td></td> <td colspan="8" style="text-align: center;"> <table border="1" style="width: 100%; border-collapse: collapse; text-align: center;"> <tr> <td style="width: 10%;"></td> <td style="width: 10%;"></td> <td style="width: 10%;"></td> <td style="width: 10%;"></td> <td style="width: 10%;"></td> <td style="width: 10%;"></td> <td style="width: 10%;"></td> <td style="width: 10%;"></td> <td style="width: 10%;"></td> <td style="width: 10%;"></td> </tr> <tr> <td></td> <td></td> <td colspan="8" style="text-align: center;"> <table border="1" style="width: 100%; border-collapse: collapse; text-align: center;"> <tr> </tr></table></td></tr></table></td></tr></table></td></tr></table></td></tr></table></td></tr></table></td></tr></table></td></tr></table></td></tr></table></td></tr></table></td></tr></table>

 | | | | | | | | | | | | | | | | | | | | <table border="1" style="width: 100%; border-collapse: collapse; text-align: center;"> <tr> <td style="width: 10%;"></td> <td style="width: 10%;"></td> <td style="width: 10%;"></td> <td style="width: 10%;"></td> <td style="width: 10%;"></td> <td style="width: 10%;"></td> <td style="width: 10%;"></td> <td style="width: 10%;"></td> <td style="width: 10%;"></td> <td style="width: 10%;"></td> </tr> <tr> <td></td> <td></td> <td colspan="8" style="text-align: center;"> <table border="1" style="width: 100%; border-collapse: collapse; text-align: center;"> <tr> <td style="width: 10%;"></td> <td style="width: 10%;"></td> <td style="width: 10%;"></td> <td style="width: 10%;"></td> <td style="width: 10%;"></td> <td style="width: 10%;"></td> <td style="width: 10%;"></td> <td style="width: 10%;"></td> <td style="width: 10%;"></td> <td style="width: 10%;"></td> </tr> <tr> <td></td> <td></td> <td colspan="8" style="text-align: center;"> <table border="1" style="width: 100%; border-collapse: collapse; text-align: center;"> <tr> <td style="width: 10%;"></td> <td style="width: 10%;"></td> <td style="width: 10%;"></td> <td style="width: 10%;"></td> <td style="width: 10%;"></td> <td style="width: 10%;"></td> <td style="width: 10%;"></td> <td style="width: 10%;"></td> <td style="width: 10%;"></td> <td style="width: 10%;"></td> </tr> <tr> <td></td> <td></td> <td colspan="8" style="text-align: center;"> <table border="1" style="width: 100%; border-collapse: collapse; text-align: center;"> <tr> <td style="width: 10%;"></td> <td style="width: 10%;"></td> <td style="width: 10%;"></td> <td style="width: 10%;"></td> <td style="width: 10%;"></td> <td style="width: 10%;"></td> <td style="width: 10%;"></td> <td style="width: 10%;"></td> <td style="width: 10%;"></td> <td style="width: 10%;"></td> </tr> <tr> <td></td> <td></td> <td colspan="8" style="text-align: center;"> <table border="1" style="width: 100%; border-collapse: collapse; text-align: center;"> <tr> <td style="width: 10%;"></td> <td style="width: 10%;"></td> <td style="width: 10%;"></td> <td style="width: 10%;"></td> <td style="width: 10%;"></td> <td style="width: 10%;"></td> <td style="width: 10%;"></td> <td style="width: 10%;"></td> <td style="width: 10%;"></td> <td style="width: 10%;"></td> </tr> <tr> <td></td> <td></td> <td colspan="8" style="text-align: center;"> <table border="1" style="width: 100%; border-collapse: collapse; text-align: center;"> <tr> <td style="width: 10%;"></td> <td style="width: 10%;"></td> <td style="width: 10%;"></td> <td style="width: 10%;"></td> <td style="width: 10%;"></td> <td style="width: 10%;"></td> <td style="width: 10%;"></td> <td style="width: 10%;"></td> <td style="width: 10%;"></td> <td style="width: 10%;"></td> </tr> <tr> <td></td> <td></td> <td colspan="8" style="text-align: center;"> <table border="1" style="width: 100%; border-collapse: collapse; text-align: center;"> <tr> <td style="width: 10%;"></td> <td style="width: 10%;"></td> <td style="width: 10%;"></td> <td style="width: 10%;"></td> <td style="width: 10%;"></td> <td style="width: 10%;"></td> <td style="width: 10%;"></td> <td style="width: 10%;"></td> <td style="width: 10%;"></td> <td style="width: 10%;"></td> </tr> <tr> <td></td> <td></td> <td colspan="8" style="text-align: center;"> <table border="1" style="width: 100%; border-collapse: collapse; text-align: center;"> <tr> <td style="width: 10%;"></td> <td style="width: 10%;"></td> <td style="width: 10%;"></td> <td style="width: 10%;"></td> <td style="width: 10%;"></td> <td style="width: 10%;"></td> <td style="width: 10%;"></td> <td style="width: 10%;"></td> <td style="width: 10%;"></td> <td style="width: 10%;"></td> </tr> <tr> <td></td> <td></td> <td colspan="8" style="text-align: center;"> <table border="1" style="width: 100%; border-collapse: collapse; text-align: center;"> <tr> <td style="width: 10%;"></td> <td style="width: 10%;"></td> <td style="width: 10%;"></td> <td style="width: 10%;"></td> <td style="width: 10%;"></td> <td style="width: 10%;"></td> <td style="width: 10%;"></td> <td style="width: 10%;"></td> <td style="width: 10%;"></td> <td style="width: 10%;"></td> </tr> <tr> <td></td> <td></td> <td colspan="8" style="text-align: center;"> <table border="1" style="width: 100%; border-collapse: collapse; text-align: center;"> <tr> </tr></table></td></tr></table></td></tr></table></td></tr></table></td></tr></table></td></tr></table></td></tr></table></td></tr></table></td></tr></table></td></tr></table>

 | | | | | | | | | | | | | | | | | | | | <table border="1" style="width: 100%; border-collapse: collapse; text-align: center;"> <tr> <td style="width: 10%;"></td> <td style="width: 10%;"></td> <td style="width: 10%;"></td> <td style="width: 10%;"></td> <td style="width: 10%;"></td> <td style="width: 10%;"></td> <td style="width: 10%;"></td> <td style="width: 10%;"></td> <td style="width: 10%;"></td> <td style="width: 10%;"></td> </tr> <tr> <td></td> <td></td> <td colspan="8" style="text-align: center;"> <table border="1" style="width: 100%; border-collapse: collapse; text-align: center;"> <tr> <td style="width: 10%;"></td> <td style="width: 10%;"></td> <td style="width: 10%;"></td> <td style="width: 10%;"></td> <td style="width: 10%;"></td> <td style="width: 10%;"></td> <td style="width: 10%;"></td> <td style="width: 10%;"></td> <td style="width: 10%;"></td> <td style="width: 10%;"></td> </tr> <tr> <td></td> <td></td> <td colspan="8" style="text-align: center;"> <table border="1" style="width: 100%; border-collapse: collapse; text-align: center;"> <tr> <td style="width: 10%;"></td> <td style="width: 10%;"></td> <td style="width: 10%;"></td> <td style="width: 10%;"></td> <td style="width: 10%;"></td> <td style="width: 10%;"></td> <td style="width: 10%;"></td> <td style="width: 10%;"></td> <td style="width: 10%;"></td> <td style="width: 10%;"></td> </tr> <tr> <td></td> <td></td> <td colspan="8" style="text-align: center;"> <table border="1" style="width: 100%; border-collapse: collapse; text-align: center;"> <tr> <td style="width: 10%;"></td> <td style="width: 10%;"></td> <td style="width: 10%;"></td> <td style="width: 10%;"></td> <td style="width: 10%;"></td> <td style="width: 10%;"></td> <td style="width: 10%;"></td> <td style="width: 10%;"></td> <td style="width: 10%;"></td> <td style="width: 10%;"></td> </tr> <tr> <td></td> <td></td> <td colspan="8" style="text-align: center;"> <table border="1" style="width: 100%; border-collapse: collapse; text-align: center;"> <tr> <td style="width: 10%;"></td> <td style="width: 10%;"></td> <td style="width: 10%;"></td> <td style="width: 10%;"></td> <td style="width: 10%;"></td> <td style="width: 10%;"></td> <td style="width: 10%;"></td> <td style="width: 10%;"></td> <td style="width: 10%;"></td> <td style="width: 10%;"></td> </tr> <tr> <td></td> <td></td> <td colspan="8" style="text-align: center;"> <table border="1" style="width: 100%; border-collapse: collapse; text-align: center;"> <tr> <td style="width: 10%;"></td> <td style="width: 10%;"></td> <td style="width: 10%;"></td> <td style="width: 10%;"></td> <td style="width: 10%;"></td> <td style="width: 10%;"></td> <td style="width: 10%;"></td> <td style="width: 10%;"></td> <td style="width: 10%;"></td> <td style="width: 10%;"></td> </tr> <tr> <td></td> <td></td> <td colspan="8" style="text-align: center;"> <table border="1" style="width: 100%; border-collapse: collapse; text-align: center;"> <tr> <td style="width: 10%;"></td> <td style="width: 10%;"></td> <td style="width: 10%;"></td> <td style="width: 10%;"></td> <td style="width: 10%;"></td> <td style="width: 10%;"></td> <td style="width: 10%;"></td> <td style="width: 10%;"></td> <td style="width: 10%;"></td> <td style="width: 10%;"></td> </tr> <tr> <td></td> <td></td> <td colspan="8" style="text-align: center;"> <table border="1" style="width: 100%; border-collapse: collapse; text-align: center;"> <tr> <td style="width: 10%;"></td> <td style="width: 10%;"></td> <td style="width: 10%;"></td> <td style="width: 10%;"></td> <td style="width: 10%;"></td> <td style="width: 10%;"></td> <td style="width: 10%;"></td> <td style="width: 10%;"></td> <td style="width: 10%;"></td> <td style="width: 10%;"></td> </tr> <tr> <td></td> <td></td> <td colspan="8" style="text-align: center;"> <table border="1" style="width: 100%; border-collapse: collapse; text-align: center;"> <tr> </tr></table></td></tr></table></td></tr></table></td></tr></table></td></tr></table></td></tr></table></td></tr></table></td></tr></table></td></tr></table>

 | | | | | | | | | | | | | | | | | | | | <table border="1" style="width: 100%; border-collapse: collapse; text-align: center;"> <tr> <td style="width: 10%;"></td> <td style="width: 10%;"></td> <td style="width: 10%;"></td> <td style="width: 10%;"></td> <td style="width: 10%;"></td> <td style="width: 10%;"></td> <td style="width: 10%;"></td> <td style="width: 10%;"></td> <td style="width: 10%;"></td> <td style="width: 10%;"></td> </tr> <tr> <td></td> <td></td> <td colspan="8" style="text-align: center;"> <table border="1" style="width: 100%; border-collapse: collapse; text-align: center;"> <tr> <td style="width: 10%;"></td> <td style="width: 10%;"></td> <td style="width: 10%;"></td> <td style="width: 10%;"></td> <td style="width: 10%;"></td> <td style="width: 10%;"></td> <td style="width: 10%;"></td> <td style="width: 10%;"></td> <td style="width: 10%;"></td> <td style="width: 10%;"></td> </tr> <tr> <td></td> <td></td> <td colspan="8" style="text-align: center;"> <table border="1" style="width: 100%; border-collapse: collapse; text-align: center;"> <tr> <td style="width: 10%;"></td> <td style="width: 10%;"></td> <td style="width: 10%;"></td> <td style="width: 10%;"></td> <td style="width: 10%;"></td> <td style="width: 10%;"></td> <td style="width: 10%;"></td> <td style="width: 10%;"></td> <td style="width: 10%;"></td> <td style="width: 10%;"></td> </tr> <tr> <td></td> <td></td> <td colspan="8" style="text-align: center;"> <table border="1" style="width: 100%; border-collapse: collapse; text-align: center;"> <tr> <td style="width: 10%;"></td> <td style="width: 10%;"></td> <td style="width: 10%;"></td> <td style="width: 10%;"></td> <td style="width: 10%;"></td> <td style="width: 10%;"></td> <td style="width: 10%;"></td> <td style="width: 10%;"></td> <td style="width: 10%;"></td> <td style="width: 10%;"></td> </tr> <tr> <td></td> <td></td> <td colspan="8" style="text-align: center;"> <table border="1" style="width: 100%; border-collapse: collapse; text-align: center;"> <tr> <td style="width: 10%;"></td> <td style="width: 10%;"></td> <td style="width: 10%;"></td> <td style="width: 10%;"></td> <td style="width: 10%;"></td> <td style="width: 10%;"></td> <td style="width: 10%;"></td> <td style="width: 10%;"></td> <td style="width: 10%;"></td> <td style="width: 10%;"></td> </tr> <tr> <td></td> <td></td> <td colspan="8" style="text-align: center;"> <table border="1" style="width: 100%; border-collapse: collapse; text-align: center;"> <tr> <td style="width: 10%;"></td> <td style="width: 10%;"></td> <td style="width: 10%;"></td> <td style="width: 10%;"></td> <td style="width: 10%;"></td> <td style="width: 10%;"></td> <td style="width: 10%;"></td> <td style="width: 10%;"></td> <td style="width: 10%;"></td> <td style="width: 10%;"></td> </tr> <tr> <td></td> <td></td> <td colspan="8" style="text-align: center;"> <table border="1" style="width: 100%; border-collapse: collapse; text-align: center;"> <tr> <td style="width: 10%;"></td> <td style="width: 10%;"></td> <td style="width: 10%;"></td> <td style="width: 10%;"></td> <td style="width: 10%;"></td> <td style="width: 10%;"></td> <td style="width: 10%;"></td> <td style="width: 10%;"></td> <td style="width: 10%;"></td> <td style="width: 10%;"></td> </tr> <tr> <td></td> <td></td> <td colspan="8" style="text-align: center;"> <table border="1" style="width: 100%; border-collapse: collapse; text-align: center;"> <tr> </tr></table></td></tr></table></td></tr></table></td></tr></table></td></tr></table></td></tr></table></td></tr></table></td></tr></table>

 | | | | | | | | | | | | | | | | | | | | <table border="1" style="width: 100%; border-collapse: collapse; text-align: center;"> <tr> <td style="width: 10%;"></td> <td style="width: 10%;"></td> <td style="width: 10%;"></td> <td style="width: 10%;"></td> <td style="width: 10%;"></td> <td style="width: 10%;"></td> <td style="width: 10%;"></td> <td style="width: 10%;"></td> <td style="width: 10%;"></td> <td style="width: 10%;"></td> </tr> <tr> <td></td> <td></td> <td colspan="8" style="text-align: center;"> <table border="1" style="width: 100%; border-collapse: collapse; text-align: center;"> <tr> <td style="width: 10%;"></td> <td style="width: 10%;"></td> <td style="width: 10%;"></td> <td style="width: 10%;"></td> <td style="width: 10%;"></td> <td style="width: 10%;"></td> <td style="width: 10%;"></td> <td style="width: 10%;"></td> <td style="width: 10%;"></td> <td style="width: 10%;"></td> </tr> <tr> <td></td> <td></td> <td colspan="8" style="text-align: center;"> <table border="1" style="width: 100%; border-collapse: collapse; text-align: center;"> <tr> <td style="width: 10%;"></td> <td style="width: 10%;"></td> <td style="width: 10%;"></td> <td style="width: 10%;"></td> <td style="width: 10%;"></td> <td style="width: 10%;"></td> <td style="width: 10%;"></td> <td style="width: 10%;"></td> <td style="width: 10%;"></td> <td style="width: 10%;"></td> </tr> <tr> <td></td> <td></td> <td colspan="8" style="text-align: center;"> <table border="1" style="width: 100%; border-collapse: collapse; text-align: center;"> <tr> <td style="width: 10%;"></td> <td style="width: 10%;"></td> <td style="width: 10%;"></td> <td style="width: 10%;"></td> <td style="width: 10%;"></td> <td style="width: 10%;"></td> <td style="width: 10%;"></td> <td style="width: 10%;"></td> <td style="width: 10%;"></td> <td style="width: 10%;"></td> </tr> <tr> <td></td> <td></td> <td colspan="8" style="text-align: center;"> <table border="1" style="width: 100%; border-collapse: collapse; text-align: center;"> <tr> <td style="width: 10%;"></td> <td style="width: 10%;"></td> <td style="width: 10%;"></td> <td style="width: 10%;"></td> <td style="width: 10%;"></td> <td style="width: 10%;"></td> <td style="width: 10%;"></td> <td style="width: 10%;"></td> <td style="width: 10%;"></td> <td style="width: 10%;"></td> </tr> <tr> <td></td> <td></td> <td colspan="8" style="text-align: center;"> <table border="1" style="width: 100%; border-collapse: collapse; text-align: center;"> <tr> <td style="width: 10%;"></td> <td style="width: 10%;"></td> <td style="width: 10%;"></td> <td style="width: 10%;"></td> <td style="width: 10%;"></td> <td style="width: 10%;"></td> <td style="width: 10%;"></td> <td style="width: 10%;"></td> <td style="width: 10%;"></td> <td style="width: 10%;"></td> </tr> <tr> <td></td> <td></td> <td colspan="8" style="text-align: center;"> <table border="1" style="width: 100%; border-collapse: collapse; text-align: center;"> <tr> </tr></table></td></tr></table></td></tr></table></td></tr></table></td></tr></table></td></tr></table></td></tr></table>

 | | | | | | | | | | | | | | | | | | | | <table border="1" style="width: 100%; border-collapse: collapse; text-align: center;"> <tr> <td style="width: 10%;"></td> <td style="width: 10%;"></td> <td style="width: 10%;"></td> <td style="width: 10%;"></td> <td style="width: 10%;"></td> <td style="width: 10%;"></td> <td style="width: 10%;"></td> <td style="width: 10%;"></td> <td style="width: 10%;"></td> <td style="width: 10%;"></td> </tr> <tr> <td></td> <td></td> <td colspan="8" style="text-align: center;"> <table border="1" style="width: 100%; border-collapse: collapse; text-align: center;"> <tr> <td style="width: 10%;"></td> <td style="width: 10%;"></td> <td style="width: 10%;"></td> <td style="width: 10%;"></td> <td style="width: 10%;"></td> <td style="width: 10%;"></td> <td style="width: 10%;"></td> <td style="width: 10%;"></td> <td style="width: 10%;"></td> <td style="width: 10%;"></td> </tr> <tr> <td></td> <td></td> <td colspan="8" style="text-align: center;"> <table border="1" style="width: 100%; border-collapse: collapse; text-align: center;"> <tr> <td style="width: 10%;"></td> <td style="width: 10%;"></td> <td style="width: 10%;"></td> <td style="width: 10%;"></td> <td style="width: 10%;"></td> <td style="width: 10%;"></td> <td style="width: 10%;"></td> <td style="width: 10%;"></td> <td style="width:
10%;"></td> <td style="width: 10%;"></td> </tr> <tr> <td></td> <td></td> <td colspan="8" style="text-align: center;"> <table border="1" style="width: 100%; border-collapse: collapse; text-align: center;"> <tr> <td style="width: 10%;"></td> <td style="width: 10%;"></td> <td style="width: 10%;"></td> <td style="width: 10%;"></td> <td style="width: 10%;"></td> <td style="width: 10%;"></td> <td style="width: 10%;"></td> <td style="width: 10%;"></td> <td style="width: 10%;"></td> <td style="width: 10%;"></td> </tr> <tr> <td></td> <td></td> <td colspan="8" style="text-align: center;"> <table border="1" style="width: 100%; border-collapse: collapse; text-align: center;"> <tr> <td style="width: 10%;"></td> <td style="width: 10%;"></td> <td style="width: 10%;"></td> <td style="width: 10%;"></td> <td style="width: 10%;"></td> <td style="width: 10%;"></td> <td style="width: 10%;"></td> <td style="width: 10%;"></td> <td style="width: 10%;"></td> <td style="width: 10%;"></td> </tr> <tr> <td></td> <td></td> <td colspan="8" style="text-align: center;"> <table border="1" style="width: 100%; border-collapse: collapse; text-align: center;"> <tr> </tr></table></td></tr></table></td></tr></table></td></tr></table></td></tr></table></td></tr></table>

 | | | | | | | | | | | | | | | | | | | | <table border="1" style="width: 100%; border-collapse: collapse; text-align: center;"> <tr> <td style="width: 10%;"></td> <td style="width: 10%;"></td> <td style="width: 10%;"></td> <td style="width: 10%;"></td> <td style="width: 10%;"></td> <td style="width: 10%;"></td> <td style="width: 10%;"></td> <td style="width: 10%;"></td> <td style="width: 10%;"></td> <td style="width: 10%;"></td> </tr> <tr> <td></td> <td></td> <td colspan="8" style="text-align: center;"> <table border="1" style="width: 100%; border-collapse: collapse; text-align: center;"> <tr> <td style="width: 10%;"></td> <td style="width: 10%;"></td> <td style="width: 10%;"></td> <td style="width: 10%;"></td> <td style="width: 10%;"></td> <td style="width: 10%;"></td> <td style="width: 10%;"></td> <td style="width: 10%;"></td> <td style="width: 10%;"></td> <td style="width: 10%;"></td> </tr> <tr> <td></td> <td></td> <td colspan="8" style="text-align: center;"> <table border="1" style="width: 100%; border-collapse: collapse; text-align: center;"> <tr> <td style="width: 10%;"></td> <td style="width: 10%;"></td> <td style="width: 10%;"></td> <td style="width: 10%;"></td> <td style="width: 10%;"></td> <td style="width: 10%;"></td> <td style="width: 10%;"></td> <td style="width: 10%;"></td> <td style="width: 10%;"></td> <td style="width: 10%;"></td> </tr> <tr> <td></td> <td></td> <td colspan="8" style="text-align: center;"> <table border="1" style="width: 100%; border-collapse: collapse; text-align: center;"> <tr> <td style="width: 10%;"></td> <td style="width: 10%;"></td> <td style="width: 10%;"></td> <td style="width: 10%;"></td> <td style="width: 10%;"></td> <td style="width: 10%;"></td> <td style="width: 10%;"></td> <td style="width: 10%;"></td> <td style="width: 10%;"></td> <td style="width: 10%;"></td> </tr> <tr> <td></td> <td></td> <td colspan="8" style="text-align: center;"> <table border="1" style="width: 100%; border-collapse: collapse; text-align: center;"> <tr> </tr></table></td></tr></table></td></tr></table></td></tr></table></td></tr></table>

 | | | | | | | | | | | | | | | | | | | | <table border="1" style="width: 100%; border-collapse: collapse; text-align: center;"> <tr> <td style="width: 10%;"></td> <td style="width: 10%;"></td> <td style="width: 10%;"></td> <td style="width: 10%;"></td> <td style="width: 10%;"></td> <td style="width: 10%;"></td> <td style="width: 10%;"></td> <td style="width: 10%;"></td> <td style="width: 10%;"></td> <td style="width: 10%;"></td> </tr> <tr> <td></td> <td></td> <td colspan="8" style="text-align: center;"> <table border="1" style="width: 100%; border-collapse: collapse; text-align: center;"> <tr> <td style="width: 10%;"></td> <td style="width: 10%;"></td> <td style="width: 10%;"></td> <td style="width: 10%;"></td> <td style="width: 10%;"></td> <td style="width: 10%;"></td> <td style="width: 10%;"></td> <td style="width: 10%;"></td> <td style="width: 10%;"></td> <td style="width: 10%;"></td> </tr> <tr> <td></td> <td></td> <td colspan="8" style="text-align: center;"> <table border="1" style="width: 100%; border-collapse: collapse; text-align: center;"> <tr> <td style="width: 10%;"></td> <td style="width: 10%;"></td> <td style="width: 10%;"></td> <td style="width: 10%;"></td> <td style="width: 10%;"></td> <td style="width: 10%;"></td> <td style="width: 10%;"></td> <td style="width: 10%;"></td> <td style="width: 10%;"></td> <td style="width: 10%;"></td> </tr> <tr> <td></td> <td></td> <td colspan="8" style="text-align: center;"> <table border="1" style="width: 100%; border-collapse: collapse; text-align: center;"> <tr> </tr></table></td></tr></table></td></tr></table></td></tr></table>

 | | | | | | | | | | | | | | | | | | | | <table border="1" style="width: 100%; border-collapse: collapse; text-align: center;"> <tr> <td style="width: 10%;"></td> <td style="width: 10%;"></td> <td style="width: 10%;"></td> <td style="width: 10%;"></td> <td style="width: 10%;"></td> <td style="width: 10%;"></td> <td style="width: 10%;"></td> <td style="width: 10%;"></td> <td style="width: 10%;"></td> <td style="width: 10%;"></td> </tr> <tr> <td></td> <td></td> <td colspan="8" style="text-align: center;"> <table border="1" style="width: 100%; border-collapse: collapse; text-align: center;"> <tr> <td style="width: 10%;"></td> <td style="width: 10%;"></td> <td style="width: 10%;"></td> <td style="width: 10%;"></td> <td style="width: 10%;"></td> <td style="width: 10%;"></td> <td style="width: 10%;"></td> <td style="width: 10%;"></td> <td style="width: 10%;"></td> <td style="width: 10%;"></td> </tr> <tr> <td></td> <td></td> <td colspan="8" style="text-align: center;"> <table border="1" style="width: 100%; border-collapse: collapse; text-align: center;"> <tr> </tr></table></td></tr></table></td></tr></table>

 | | | | | | | | | | | | | | | | | | | | <table border="1" style="width: 100%; border-collapse: collapse; text-align: center;"> <tr> <td style="width: 10%;"></td> <td style="width: 10%;"></td> <td style="width: 10%;"></td> <td style="width: 10%;"></td> <td style="width: 10%;"></td> <td style="width: 10%;"></td> <td style="width: 10%;"></td> <td style="width: 10%;"></td> <td style="width: 10%;"></td> <td style="width: 10%;"></td> </tr> <tr> <td></td> <td></td> <td colspan="8" style="text-align: center;"> <table border="1" style="width: 100%; border-collapse: collapse; text-align: center;"> <tr> </tr></table></td></tr></table>

 | | | | | | | | | | | | | | | | | | | | <table border="1" style="width: 100%; border-collapse: collapse; text-align: center;"> <tr> </tr></table>

 | | | | | | | | | | | | | | | | | | | |

 | | | | | | | | | | | | | | | | | | | |

 | | | | | | | | | | | | | | | | | | | |

 | | | | | | | | | | | | | | | | | | | |

 | | | | | | | | | | | | | | | | | | | |

 | | | | | | | | | | | | | | | | | | | |

 | | | | | | | | | | | | | | | | | | | |

 | | | | | | | | | | | | | | | | | | | |

 | | | | | | | | | | | | | | | | | | | |

 | | | | | | | | | | | | | | | | | | | |

 | | | | | | | | | | | | | | | | | | | |

 | | | | | | | | | | | | | | | | | | | |

 | | | | | | | | | | | | | | | | | | | |

 | | | | | | | | | | | | | | | | | | | |

 | | | | | | | | | | | | | | | | | | | |

 | | | | | | | | | | | | | | | | | | | |
 | | | | | | | | | | | | | | | | | | | |

 | | | | | | | | | | | | | | | | | | | |

 | | | | | | | | | | | | | | | | | | | |
 | | | | | | | | | | | | | | | | | | | |

 | | | | | | | | | | | | | | | | | | | |

 | | | | | | | | | | | | | | | | | | | |
 | | | | | | | | | | | | | | | | | | | |
 | | | | | | | | | | | | | | | | | | | |

 | | | | | | | | | | | | | | | | | | | |
 | | | | | | | | | | | | | | | | | | | |
 | | | | | | | | | | | | | | | | | | | |

 | | | | | | | | | | | | | | | | | | | | | | | | | | | | | | | | | | | | | | | | | | | | | | | | | | | | | | | | | | | | | | | | | | | | | | | | | | | | | | | | | | | | | | | | | | | | | | | | | | | |
 | | | | | | | | | | | | | | | | | | | |
 | | | | | | | | | | | | | | | | | | | |
 | | | | | | | | | | | | | | | | | | | |
 | | | | | | | | | | | | | | | | | | | |
 | | | | | | | | | | | | | | | | | | | |
 | | | | | | | | | | | | | | | | | | | |
 | | | | | | | | | | | | | | | | | | | |
 | | | | | | | | | | | | | | | | | | | |
 | | | | | | | | | | | | | | | | | | | | | | | | | | | | | | | | | | | | | | | |
 | | | | | | | | | | | | | | | | | | | |
 | | | | | | | | | | | | | | | | | | | | | | | | | | | | | | | | | | | | | | | |
 | | | | | | | | | | | | | | | | | | | | | | | | | | | | | | | | | | | | | | | |
 | | | | | | | | | | | | | | | | | | | | | | | | | | | | | | | | | | | | | | | |
 | | | | | | | | | | | | | | | | | | | | | | | | | | | | | | | | | | | | | | | | | | | | | | | | | | | | | | | | | | | | | | | | | | | | | | | | | | | | | | | | | | | | | | | | | | | | | | | | | | | |
 | | | | | | | | | | | | | | | | | | | | | | | | | | | | | | | | | | | | | | | | | | | | | | | |
| | |

 | | | | | | | | | | | | | | | | | | | |

 | | | | | | | | | | | | | | | | | | | |

 | | | | | | | | | | | | | | | | | | | |

 | | | | | | | | | | | | | | | | | | | |

 | | | | | | | | | | | | | | | | | | | |

 | | | | | | | | | | | | | | | | | | | |

 | | | | | | | | | | | | | | | | | | | |

 | | | | | | | | | | | | | | | | | | | |

 | | | | | | | | | | | | | | | | | | | |

 | | | | | | | | | | | | | | | | | | | |

 | | | | | | | | | | | | | | | | | | | |

 | | | | | | | | | | | | | | | | | | | |

 | | | | | | | | | | | | | | | | | | | |

 | | | | | | | | | | | | | | | | | | | |

 | | | | | | | | | | | | | | | | | | | |

 | | | | | | | | | | | | | | | | | | | |

 | | | | | | | | | | | | | | | | | | | |

 | | | | | | | | | | | | | | | | | | | |

 | | | | | | | | | | | | | | | | | | | |

 | | | | | | | | | | | | | | | | | | | |

 | | | | | | | | | | | | | | | | | | | |

 | | | | | | | | | | | | | | | | | | | |

 | | | | | | | | | | | | | | | | | | | |

 | | | | | | | | | | | | | | | | | | | |

 | | | | | | | | | | | | | | | | | | | |

 | | | | | | | | | | | | | | | | | | | |

 | | | | | | | | | | | | | | | | | | | |

 | | | | | | | | | | | | | | | | | | | |
 | | | | | | | | | | | | | | | | | | | |

 | | | | | | | | | | | | | | | | | | | |

 | | | | | | | | | | | | | | | | | | | |
 | | | | | | | | | | | | | | | | | | | |

 | | | | | | | | | | | | | | | | | | | |

 | | | | | | | | | | | | | | | | | | | |
 | | | | | | | | | | | | | | | | | | | |
 | | | | | | | | | | | | | | | | | | | |

 | | | | | | | | | | | | | | | | | | | |
 | | | | | | | | | | | | | | | | | | | |
 | | | | | | | | | | | | | | | | | | | |

 | | | | | | | | | | | | | | | | | | | | | | | | | | | | | | | | | | | | | | | | | | | | | | | | | | | | | | | | | | | | | | | | | | | | | | | | | | | | | | | | | | | | | | | | | | | | | | | | | | | |
 | | | | | | | | | | | | | | | | | | | |
 | | | | | | | | | | | | | | | | | | | |
 | | | | | | | | | | | | | | | | | | | |
 | | | | | | | | | | | | | | | | | | | |
 | | | | | | | | | | | | | | | | | | | |
 | | | | | | | | | | | | | | | | | | | |
 | | | | | | | | | | | | | | | | | | | |
 | | | | | | | | | | | | | | | | | | | |
 | | | | | | | | | | | | | | | | | | | | | | | | | | | | | | | | | | | | | | | |
 | | | | | | | | | | | | | | | | | | | |
 | | | | | | | | | | | | | | | | | | | | | | | | | | | | | | | | | | | | | | | |
 | | | | | | | | | | | | | | | | | | | | | | | | | | | | | | | | | | | | | | | |
 | | | | | | | | | | | | | | | | | | | | | | | | | | | | | | | | | | | | | | | |
 | | | | | | | | | | | | | | | | | | | | | | | | | | | | | | | | | | | | | | | | | | | | | | | | | | | | | | | | | | | | | | | | | | | | | | | | | | | | | | | | | | | | | | | | | | | | | | | | | | | |
 | | | | | | | | | | | | | | | | | | | | | | | | | | | | | | | | | | | | | | | | | | | | | | | |
| | | <table border="1" style="width: 100%; border-collapse: collapse; text-align: center;"> <tr> <td style="width: 10%;"></td> <td style="width: 10%;"></td> <td style="width: 10%;"></td> <td style="width: 10%;"></td> <td style="width: 10%;"></td> <td style="width: 10%;"></td> <td style="width: 10%;"></td> <td style="width: 10%;"></td> <td style="width: 10%;"></td> <td style="width: 10%;"></td> </tr> <tr> <td></td> <td></td> <td colspan="8" style="text-align: center;"> <table border="1" style="width: 100%; border-collapse: collapse; text-align: center;"> <tr> <td style="width: 10%;"></td> <td style="width: 10%;"></td> <td style="width: 10%;"></td> <td style="width: 10%;"></td> <td style="width: 10%;"></td> <td style="width: 10%;"></td> <td style="width: 10%;"></td> <td style="width: 10%;"></td> <td style="width: 10%;"></td> <td style="width: 10%;"></td> </tr> <tr> <td></td> <td></td> <td colspan="8" style="text-align: center;"> <table border="1" style="width: 100%; border-collapse: collapse; text-align: center;"> <tr> <td style="width: 10%;"></td> <td style="width: 10%;"></td> <td style="width: 10%;"></td> <td style="width: 10%;"></td> <td style="width: 10%;"></td> <td style="width: 10%;"></td> <td style="width: 10%;"></td> <td style="width: 10%;"></td> <td style="width: 10%;"></td> <td style="width: 10%;"></td> </tr> <tr> <td></td> <td></td> <td colspan="8" style="text-align: center;"> <table border="1" style="width: 100%; border-collapse: collapse; text-align: center;"> <tr> <td style="width: 10%;"></td> <td style="width: 10%;"></td> <td style="width: 10%;"></td> <td style="width: 10%;"></td> <td style="width: 10%;"></td> <td style="width: 10%;"></td> <td style="width: 10%;"></td> <td style="width: 10%;"></td> <td style="width: 10%;"></td> <td style="width: 10%;"></td> </tr> <tr> <td></td> <td></td> <td colspan="8" style="text-align: center;"> <table border="1" style="width: 100%; border-collapse: collapse; text-align: center;"> <tr> <td style="width: 10%;"></td> <td style="width: 10%;"></td> <td style="width: 10%;"></td> <td style="width: 10%;"></td> <td style="width: 10%;"></td> <td style="width: 10%;"></td> <td style="width: 10%;"></td> <td style="width: 10%;"></td> <td style="width: 10%;"></td> <td style="width: 10%;"></td> </tr> <tr> <td></td> <td></td> <td colspan="8" style="text-align: center;"> <table border="1" style="width: 100%; border-collapse: collapse; text-align: center;"> <tr> <td style="width: 10%;"></td> <td style="width: 10%;"></td> <td style="width: 10%;"></td> <td style="width: 10%;"></td> <td style="width: 10%;"></td> <td style="width: 10%;"></td> <td style="width: 10%;"></td> <td style="width: 10%;"></td> <td style="width: 10%;"></td> <td style="width: 10%;"></td> </tr> <tr> <td></td> <td></td> <td colspan="8" style="text-align: center;"> <table border="1" style="width: 100%; border-collapse: collapse; text-align: center;"> <tr> <td style="width: 10%;"></td> <td style="width: 10%;"></td> <td style="width: 10%;"></td> <td style="width: 10%;"></td> <td style="width: 10%;"></td> <td style="width: 10%;"></td> <td style="width: 10%;"></td> <td style="width: 10%;"></td> <td style="width: 10%;"></td> <td style="width: 10%;"></td> </tr> <tr> <td></td> <td></td> <td colspan="8" style="text-align: center;"> <table border="1" style="width: 100%; border-collapse: collapse; text-align: center;"> <tr> <td style="width: 10%;"></td> <td style="width: 10%;"></td> <td style="width: 10%;"></td> <td style="width: 10%;"></td> <td style="width: 10%;"></td> <td style="width: 10%;"></td> <td style="width: 10%;"></td> <td style="width: 10%;"></td> <td style="width: 10%;"></td> <td style="width: 10%;"></td> </tr> <tr> <td></td> <td></td> <td colspan="8" style="text-align: center;"> <table border="1" style="width: 100%; border-collapse: collapse; text-align: center;"> <tr> <td style="width: 10%;"></td> <td style="width: 10%;"></td> <td style="width: 10%;"></td> <td style="width: 10%;"></td> <td style="width: 10%;"></td> <td style="width: 10%;"></td> <td style="width: 10%;"></td> <td style="width: 10%;"></td> <td style="width: 10%;"></td> <td style="width: 10%;"></td> </tr> <tr> <td></td> <td></td> <td colspan="8" style="text-align: center;"> <table border="1" style="width: 100%; border-collapse: collapse; text-align: center;"> <tr> <td style="width: 10%;"></td> <td style="width: 10%;"></td> <td style="width: 10%;"></td> <td style="width: 10%;"></td> <td style="width: 10%;"></td> <td style="width: 10%;"></td> <td style="width: 10%;"></td> <td style="width: 10%;"></td> <td style="width: 10%;"></td> <td style="width: 10%;"></td> </tr> <tr> <td></td> <td></td> <td colspan="8" style="text-align: center;"> <table border="1" style="width: 100%; border-collapse: collapse; text-align: center;"> <tr> <td style="width: 10%;"></td> <td style="width: 10%;"></td> <td style="width: 10%;"></td> <td style="width: 10%;"></td> <td style="width: 10%;"></td> <td style="width: 10%;"></td> <td style="width: 10%;"></td> <td style="width: 10%;"></td> <td style="width: 10%;"></td> <td style="width: 10%;"></td> </tr> <tr> <td></td> <td></td> <td colspan="8" style="text-align: center;"> <table border="1" style="width: 100%; border-collapse: collapse; text-align: center;"> <tr> </tr></table></td></tr></table></td></tr></table></td></tr></table></td></tr></table></td></tr></table></td></tr></table></td></tr></table></td></tr></table></td></tr></table></td></tr></table></td></tr></table>

 | | | | | | | | | | | | | | | | | | | | <table border="1" style="width: 100%; border-collapse: collapse; text-align: center;"> <tr> <td style="width: 10%;"></td> <td style="width: 10%;"></td> <td style="width: 10%;"></td> <td style="width: 10%;"></td> <td style="width: 10%;"></td> <td style="width: 10%;"></td> <td style="width: 10%;"></td> <td style="width: 10%;"></td> <td style="width: 10%;"></td> <td style="width: 10%;"></td> </tr> <tr> <td></td> <td></td> <td colspan="8" style="text-align: center;"> <table border="1" style="width: 100%; border-collapse: collapse; text-align: center;"> <tr> <td style="width: 10%;"></td> <td style="width: 10%;"></td> <td style="width: 10%;"></td> <td style="width: 10%;"></td> <td style="width: 10%;"></td> <td style="width: 10%;"></td> <td style="width: 10%;"></td> <td style="width: 10%;"></td> <td style="width: 10%;"></td> <td style="width: 10%;"></td> </tr> <tr> <td></td> <td></td> <td colspan="8" style="text-align: center;"> <table border="1" style="width: 100%; border-collapse: collapse; text-align: center;"> <tr> <td style="width: 10%;"></td> <td style="width: 10%;"></td> <td style="width: 10%;"></td> <td style="width: 10%;"></td> <td style="width: 10%;"></td> <td style="width: 10%;"></td> <td style="width: 10%;"></td> <td style="width: 10%;"></td> <td style="width: 10%;"></td> <td style="width: 10%;"></td> </tr> <tr> <td></td> <td></td> <td colspan="8" style="text-align: center;"> <table border="1" style="width: 100%; border-collapse: collapse; text-align: center;"> <tr> <td style="width: 10%;"></td> <td style="width: 10%;"></td> <td style="width: 10%;"></td> <td style="width: 10%;"></td> <td style="width: 10%;"></td> <td style="width: 10%;"></td> <td style="width: 10%;"></td> <td style="width: 10%;"></td> <td style="width: 10%;"></td> <td style="width: 10%;"></td> </tr> <tr> <td></td> <td></td> <td colspan="8" style="text-align: center;"> <table border="1" style="width: 100%; border-collapse: collapse; text-align: center;"> <tr> <td style="width: 10%;"></td> <td style="width: 10%;"></td> <td style="width: 10%;"></td> <td style="width: 10%;"></td> <td style="width: 10%;"></td> <td style="width: 10%;"></td> <td style="width: 10%;"></td> <td style="width: 10%;"></td> <td style="width: 10%;"></td> <td style="width: 10%;"></td> </tr> <tr> <td></td> <td></td> <td colspan="8" style="text-align: center;"> <table border="1" style="width: 100%; border-collapse: collapse; text-align: center;"> <tr> <td style="width: 10%;"></td> <td style="width: 10%;"></td> <td style="width: 10%;"></td> <td style="width: 10%;"></td> <td style="width: 10%;"></td> <td style="width: 10%;"></td> <td style="width: 10%;"></td> <td style="width: 10%;"></td> <td style="width: 10%;"></td> <td style="width: 10%;"></td> </tr> <tr> <td></td> <td></td> <td colspan="8" style="text-align: center;"> <table border="1" style="width: 100%; border-collapse: collapse; text-align: center;"> <tr> <td style="width: 10%;"></td> <td style="width: 10%;"></td> <td style="width: 10%;"></td> <td style="width: 10%;"></td> <td style="width: 10%;"></td> <td style="width: 10%;"></td> <td style="width: 10%;"></td> <td style="width: 10%;"></td> <td style="width: 10%;"></td> <td style="width: 10%;"></td> </tr> <tr> <td></td> <td></td> <td colspan="8" style="text-align: center;"> <table border="1" style="width: 100%; border-collapse: collapse; text-align: center;"> <tr> <td style="width: 10%;"></td> <td style="width: 10%;"></td> <td style="width: 10%;"></td> <td style="width: 10%;"></td> <td style="width: 10%;"></td> <td style="width: 10%;"></td> <td style="width: 10%;"></td> <td style="width: 10%;"></td> <td style="width: 10%;"></td> <td style="width: 10%;"></td> </tr> <tr> <td></td> <td></td> <td colspan="8" style="text-align: center;"> <table border="1" style="width: 100%; border-collapse: collapse; text-align: center;"> <tr> <td style="width: 10%;"></td> <td style="width: 10%;"></td> <td style="width: 10%;"></td> <td style="width: 10%;"></td> <td style="width: 10%;"></td> <td style="width: 10%;"></td> <td style="width: 10%;"></td> <td style="width: 10%;"></td> <td style="width: 10%;"></td> <td style="width: 10%;"></td> </tr> <tr> <td></td> <td></td> <td colspan="8" style="text-align: center;"> <table border="1" style="width: 100%; border-collapse: collapse; text-align: center;"> <tr> <td style="width: 10%;"></td> <td style="width: 10%;"></td> <td style="width: 10%;"></td> <td style="width: 10%;"></td> <td style="width: 10%;"></td> <td style="width: 10%;"></td> <td style="width: 10%;"></td> <td style="width: 10%;"></td> <td style="width: 10%;"></td> <td style="width: 10%;"></td> </tr> <tr> <td></td> <td></td> <td colspan="8" style="text-align: center;"> <table border="1" style="width: 100%; border-collapse: collapse; text-align: center;"> <tr> </tr></table></td></tr></table></td></tr></table></td></tr></table></td></tr></table></td></tr></table></td></tr></table></td></tr></table></td></tr></table></td></tr></table></td></tr></table>

 | | | | | | | | | | | | | | | | | | | | <table border="1" style="width: 100%; border-collapse: collapse; text-align: center;"> <tr> <td style="width: 10%;"></td> <td style="width: 10%;"></td> <td style="width: 10%;"></td> <td style="width: 10%;"></td> <td style="width: 10%;"></td> <td style="width: 10%;"></td> <td style="width: 10%;"></td> <td style="width: 10%;"></td> <td style="width: 10%;"></td> <td style="width: 10%;"></td> </tr> <tr> <td></td> <td></td> <td colspan="8" style="text-align: center;"> <table border="1" style="width: 100%; border-collapse: collapse; text-align: center;"> <tr> <td style="width: 10%;"></td> <td style="width: 10%;"></td> <td style="width: 10%;"></td> <td style="width: 10%;"></td> <td style="width: 10%;"></td> <td style="width: 10%;"></td> <td style="width: 10%;"></td> <td style="width: 10%;"></td> <td style="width: 10%;"></td> <td style="width: 10%;"></td> </tr> <tr> <td></td> <td></td> <td colspan="8" style="text-align: center;"> <table border="1" style="width: 100%; border-collapse: collapse; text-align: center;"> <tr> <td style="width: 10%;"></td> <td style="width: 10%;"></td> <td style="width: 10%;"></td> <td style="width: 10%;"></td> <td style="width: 10%;"></td> <td style="width: 10%;"></td> <td style="width: 10%;"></td> <td style="width: 10%;"></td> <td style="width: 10%;"></td> <td style="width: 10%;"></td> </tr> <tr> <td></td> <td></td> <td colspan="8" style="text-align: center;"> <table border="1" style="width: 100%; border-collapse: collapse; text-align: center;"> <tr> <td style="width: 10%;"></td> <td style="width: 10%;"></td> <td style="width: 10%;"></td> <td style="width: 10%;"></td> <td style="width: 10%;"></td> <td style="width: 10%;"></td> <td style="width: 10%;"></td> <td style="width: 10%;"></td> <td style="width: 10%;"></td> <td style="width: 10%;"></td> </tr> <tr> <td></td> <td></td> <td colspan="8" style="text-align: center;"> <table border="1" style="width: 100%; border-collapse: collapse; text-align: center;"> <tr> <td style="width: 10%;"></td> <td style="width: 10%;"></td> <td style="width: 10%;"></td> <td style="width: 10%;"></td> <td style="width: 10%;"></td> <td style="width: 10%;"></td> <td style="width: 10%;"></td> <td style="width: 10%;"></td> <td style="width: 10%;"></td> <td style="width: 10%;"></td> </tr> <tr> <td></td> <td></td> <td colspan="8" style="text-align: center;"> <table border="1" style="width: 100%; border-collapse: collapse; text-align: center;"> <tr> <td style="width: 10%;"></td> <td style="width: 10%;"></td> <td style="width: 10%;"></td> <td style="width: 10%;"></td> <td style="width: 10%;"></td> <td style="width: 10%;"></td> <td style="width: 10%;"></td> <td style="width: 10%;"></td> <td style="width: 10%;"></td> <td style="width: 10%;"></td> </tr> <tr> <td></td> <td></td> <td colspan="8" style="text-align: center;"> <table border="1" style="width: 100%; border-collapse: collapse; text-align: center;"> <tr> <td style="width: 10%;"></td> <td style="width: 10%;"></td> <td style="width: 10%;"></td> <td style="width: 10%;"></td> <td style="width: 10%;"></td> <td style="width: 10%;"></td> <td style="width: 10%;"></td> <td style="width: 10%;"></td> <td style="width: 10%;"></td> <td style="width: 10%;"></td> </tr> <tr> <td></td> <td></td> <td colspan="8" style="text-align: center;"> <table border="1" style="width: 100%; border-collapse: collapse; text-align: center;"> <tr> <td style="width: 10%;"></td> <td style="width: 10%;"></td> <td style="width: 10%;"></td> <td style="width: 10%;"></td> <td style="width: 10%;"></td> <td style="width: 10%;"></td> <td style="width: 10%;"></td> <td style="width: 10%;"></td> <td style="width: 10%;"></td> <td style="width: 10%;"></td> </tr> <tr> <td></td> <td></td> <td colspan="8" style="text-align: center;"> <table border="1" style="width: 100%; border-collapse: collapse; text-align: center;"> <tr> <td style="width: 10%;"></td> <td style="width: 10%;"></td> <td style="width: 10%;"></td> <td style="width: 10%;"></td> <td style="width: 10%;"></td> <td style="width: 10%;"></td> <td style="width: 10%;"></td> <td style="width: 10%;"></td> <td style="width: 10%;"></td> <td style="width: 10%;"></td> </tr> <tr> <td></td> <td></td> <td colspan="8" style="text-align: center;"> <table border="1" style="width: 100%; border-collapse: collapse; text-align: center;"> <tr> </tr></table></td></tr></table></td></tr></table></td></tr></table></td></tr></table></td></tr></table></td></tr></table></td></tr></table></td></tr></table></td></tr></table>

 | | | | | | | | | | | | | | | | | | | | <table border="1" style="width: 100%; border-collapse: collapse; text-align: center;"> <tr> <td style="width: 10%;"></td> <td style="width: 10%;"></td> <td style="width: 10%;"></td> <td style="width: 10%;"></td> <td style="width: 10%;"></td> <td style="width: 10%;"></td> <td style="width: 10%;"></td> <td style="width: 10%;"></td> <td style="width: 10%;"></td> <td style="width: 10%;"></td> </tr> <tr> <td></td> <td></td> <td colspan="8" style="text-align: center;"> <table border="1" style="width: 100%; border-collapse: collapse; text-align: center;"> <tr> <td style="width: 10%;"></td> <td style="width: 10%;"></td> <td style="width: 10%;"></td> <td style="width: 10%;"></td> <td style="width: 10%;"></td> <td style="width: 10%;"></td> <td style="width: 10%;"></td> <td style="width: 10%;"></td> <td style="width: 10%;"></td> <td style="width: 10%;"></td> </tr> <tr> <td></td> <td></td> <td colspan="8" style="text-align: center;"> <table border="1" style="width: 100%; border-collapse: collapse; text-align: center;"> <tr> <td style="width: 10%;"></td> <td style="width: 10%;"></td> <td style="width: 10%;"></td> <td style="width: 10%;"></td> <td style="width: 10%;"></td> <td style="width: 10%;"></td> <td style="width: 10%;"></td> <td style="width: 10%;"></td> <td style="width: 10%;"></td> <td style="width: 10%;"></td> </tr> <tr> <td></td> <td></td> <td colspan="8" style="text-align: center;"> <table border="1" style="width: 100%; border-collapse: collapse; text-align: center;"> <tr> <td style="width: 10%;"></td> <td style="width: 10%;"></td> <td style="width: 10%;"></td> <td style="width: 10%;"></td> <td style="width: 10%;"></td> <td style="width: 10%;"></td> <td style="width: 10%;"></td> <td style="width: 10%;"></td> <td style="width: 10%;"></td> <td style="width: 10%;"></td> </tr> <tr> <td></td> <td></td> <td colspan="8" style="text-align: center;"> <table border="1" style="width: 100%; border-collapse: collapse; text-align: center;"> <tr> <td style="width: 10%;"></td> <td style="width: 10%;"></td> <td style="width: 10%;"></td> <td style="width: 10%;"></td> <td style="width: 10%;"></td> <td style="width: 10%;"></td> <td style="width: 10%;"></td> <td style="width: 10%;"></td> <td style="width: 10%;"></td> <td style="width: 10%;"></td> </tr> <tr> <td></td> <td></td> <td colspan="8" style="text-align: center;"> <table border="1" style="width: 100%; border-collapse: collapse; text-align: center;"> <tr> <td style="width: 10%;"></td> <td style="width: 10%;"></td> <td style="width: 10%;"></td> <td style="width: 10%;"></td> <td style="width: 10%;"></td> <td style="width: 10%;"></td> <td style="width: 10%;"></td> <td style="width: 10%;"></td> <td style="width: 10%;"></td> <td style="width: 10%;"></td> </tr> <tr> <td></td> <td></td> <td colspan="8" style="text-align: center;"> <table border="1" style="width: 100%; border-collapse: collapse; text-align: center;"> <tr> <td style="width: 10%;"></td> <td style="width: 10%;"></td> <td style="width: 10%;"></td> <td style="width: 10%;"></td> <td style="width: 10%;"></td> <td style="width: 10%;"></td> <td style="width: 10%;"></td> <td style="width: 10%;"></td> <td style="width: 10%;"></td> <td style="width: 10%;"></td> </tr> <tr> <td></td> <td></td> <td colspan="8" style="text-align: center;"> <table border="1" style="width: 100%; border-collapse: collapse; text-align: center;"> <tr> <td style="width: 10%;"></td> <td style="width: 10%;"></td> <td style="width: 10%;"></td> <td style="width: 10%;"></td> <td style="width: 10%;"></td> <td style="width: 10%;"></td> <td style="width: 10%;"></td> <td style="width: 10%;"></td> <td style="width: 10%;"></td> <td style="width: 10%;"></td> </tr> <tr> <td></td> <td></td> <td colspan="8" style="text-align: center;"> <table border="1" style="width: 100%; border-collapse: collapse; text-align: center;"> <tr> </tr></table></td></tr></table></td></tr></table></td></tr></table></td></tr></table></td></tr></table></td></tr></table></td></tr></table></td></tr></table>

 | | | | | | | | | | | | | | | | | | | | <table border="1" style="width: 100%; border-collapse: collapse; text-align: center;"> <tr> <td style="width: 10%;"></td> <td style="width: 10%;"></td> <td style="width: 10%;"></td> <td style="width: 10%;"></td> <td style="width: 10%;"></td> <td style="width: 10%;"></td> <td style="width: 10%;"></td> <td style="width: 10%;"></td> <td style="width: 10%;"></td> <td style="width: 10%;"></td> </tr> <tr> <td></td> <td></td> <td colspan="8" style="text-align: center;"> <table border="1" style="width: 100%; border-collapse: collapse; text-align: center;"> <tr> <td style="width: 10%;"></td> <td style="width: 10%;"></td> <td style="width: 10%;"></td> <td style="width: 10%;"></td> <td style="width: 10%;"></td> <td style="width: 10%;"></td> <td style="width: 10%;"></td> <td style="width: 10%;"></td> <td style="width: 10%;"></td> <td style="width: 10%;"></td> </tr> <tr> <td></td> <td></td> <td colspan="8" style="text-align: center;"> <table border="1" style="width: 100%; border-collapse: collapse; text-align: center;"> <tr> <td style="width: 10%;"></td> <td style="width: 10%;"></td> <td style="width: 10%;"></td> <td style="width: 10%;"></td> <td style="width: 10%;"></td> <td style="width: 10%;"></td> <td style="width: 10%;"></td> <td style="width: 10%;"></td> <td style="width: 10%;"></td> <td style="width: 10%;"></td> </tr> <tr> <td></td> <td></td> <td colspan="8" style="text-align: center;"> <table border="1" style="width: 100%; border-collapse: collapse; text-align: center;"> <tr> <td style="width: 10%;"></td> <td style="width: 10%;"></td> <td style="width: 10%;"></td> <td style="width: 10%;"></td> <td style="width: 10%;"></td> <td style="width: 10%;"></td> <td style="width: 10%;"></td> <td style="width: 10%;"></td> <td style="width: 10%;"></td> <td style="width: 10%;"></td> </tr> <tr> <td></td> <td></td> <td colspan="8" style="text-align: center;"> <table border="1" style="width: 100%; border-collapse: collapse; text-align: center;"> <tr> <td style="width: 10%;"></td> <td style="width: 10%;"></td> <td style="width: 10%;"></td> <td style="width: 10%;"></td> <td style="width: 10%;"></td> <td style="width: 10%;"></td> <td style="width: 10%;"></td> <td style="width: 10%;"></td> <td style="width: 10%;"></td> <td style="width: 10%;"></td> </tr> <tr> <td></td> <td></td> <td colspan="8" style="text-align: center;"> <table border="1" style="width: 100%; border-collapse: collapse; text-align: center;"> <tr> <td style="width: 10%;"></td> <td style="width: 10%;"></td> <td style="width: 10%;"></td> <td style="width: 10%;"></td> <td style="width: 10%;"></td> <td style="width: 10%;"></td> <td style="width: 10%;"></td> <td style="width: 10%;"></td> <td style="width: 10%;"></td> <td style="width: 10%;"></td> </tr> <tr> <td></td> <td></td> <td colspan="8" style="text-align: center;"> <table border="1" style="width: 100%; border-collapse: collapse; text-align: center;"> <tr> <td style="width: 10%;"></td> <td style="width: 10%;"></td> <td style="width: 10%;"></td> <td style="width: 10%;"></td> <td style="width: 10%;"></td> <td style="width: 10%;"></td> <td style="width: 10%;"></td> <td style="width: 10%;"></td> <td style="width: 10%;"></td> <td style="width: 10%;"></td> </tr> <tr> <td></td> <td></td> <td colspan="8" style="text-align: center;"> <table border="1" style="width: 100%; border-collapse: collapse; text-align: center;"> <tr> </tr></table></td></tr></table></td></tr></table></td></tr></table></td></tr></table></td></tr></table></td></tr></table></td></tr></table>

 | | | | | | | | | | | | | | | | | | | | <table border="1" style="width: 100%; border-collapse: collapse; text-align: center;"> <tr> <td style="width: 10%;"></td> <td style="width: 10%;"></td> <td style="width: 10%;"></td> <td style="width: 10%;"></td> <td style="width: 10%;"></td> <td style="width: 10%;"></td> <td style="width: 10%;"></td> <td style="width: 10%;"></td> <td style="width: 10%;"></td> <td style="width: 10%;"></td> </tr> <tr> <td></td> <td></td> <td colspan="8" style="text-align: center;"> <table border="1" style="width: 100%; border-collapse: collapse; text-align: center;"> <tr> <td style="width: 10%;"></td> <td style="width: 10%;"></td> <td style="width: 10%;"></td> <td style="width: 10%;"></td> <td style="width: 10%;"></td> <td style="width: 10%;"></td> <td style="width: 10%;"></td> <td style="width: 10%;"></td> <td style="width: 10%;"></td> <td style="width: 10%;"></td> </tr> <tr> <td></td> <td></td> <td colspan="8" style="text-align: center;"> <table border="1" style="width: 100%; border-collapse: collapse; text-align: center;"> <tr> <td style="width: 10%;"></td> <td style="width: 10%;"></td> <td style="width: 10%;"></td> <td style="width: 10%;"></td> <td style="width: 10%;"></td> <td style="width: 10%;"></td> <td style="width: 10%;"></td> <td style="width: 10%;"></td> <td style="width: 10%;"></td> <td style="width: 10%;"></td> </tr> <tr> <td></td> <td></td> <td colspan="8" style="text-align: center;"> <table border="1" style="width: 100%; border-collapse: collapse; text-align: center;"> <tr> <td style="width: 10%;"></td> <td style="width: 10%;"></td> <td style="width: 10%;"></td> <td style="width: 10%;"></td> <td style="width: 10%;"></td> <td style="width: 10%;"></td> <td style="width: 10%;"></td> <td style="width: 10%;"></td> <td style="width: 10%;"></td> <td style="width: 10%;"></td> </tr> <tr> <td></td> <td></td> <td colspan="8" style="text-align: center;"> <table border="1" style="width: 100%; border-collapse: collapse; text-align: center;"> <tr> <td style="width: 10%;"></td> <td style="width: 10%;"></td> <td style="width: 10%;"></td> <td style="width: 10%;"></td> <td style="width: 10%;"></td> <td style="width: 10%;"></td> <td style="width: 10%;"></td> <td style="width: 10%;"></td> <td style="width: 10%;"></td> <td style="width: 10%;"></td> </tr> <tr> <td></td> <td></td> <td colspan="8" style="text-align: center;"> <table border="1" style="width: 100%; border-collapse: collapse; text-align: center;"> <tr> <td style="width: 10%;"></td> <td style="width: 10%;"></td> <td style="width: 10%;"></td> <td style="width: 10%;"></td> <td style="width: 10%;"></td> <td style="width: 10%;"></td> <td style="width: 10%;"></td> <td style="width: 10%;"></td> <td style="width: 10%;"></td> <td style="width: 10%;"></td> </tr> <tr> <td></td> <td></td> <td colspan="8" style="text-align: center;"> <table border="1" style="width: 100%; border-collapse: collapse; text-align: center;"> <tr> </tr></table></td></tr></table></td></tr></table></td></tr></table></td></tr></table></td></tr></table></td></tr></table>

 | | | | | | | | | | | | | | | | | | | | <table border="1" style="width: 100%; border-collapse: collapse; text-align: center;"> <tr> <td style="width: 10%;"></td> <td style="width: 10%;"></td> <td style="width: 10%;"></td> <td style="width: 10%;"></td> <td style="width: 10%;"></td> <td style="width: 10%;"></td> <td style="width: 10%;"></td> <td style="width: 10%;"></td> <td style="width: 10%;"></td> <td style="width: 10%;"></td> </tr> <tr> <td></td> <td></td> <td colspan="8" style="text-align: center;"> <table border="1" style="width: 100%; border-collapse: collapse; text-align: center;"> <tr> <td style="width: 10%;"></td> <td style="width: 10%;"></td> <td style="width: 10%;"></td> <td style="width: 10%;"></td> <td style="width: 10%;"></td> <td style="width: 10%;"></td> <td style="width: 10%;"></td> <td style="width: 10%;"></td> <td style="width: 10%;"></td> <td style="width: 10%;"></td> </tr> <tr> <td></td> <td></td> <td colspan="8" style="text-align: center;"> <table border="1" style="width: 100%; border-collapse: collapse; text-align: center;"> <tr> <td style="width: 10%;"></td> <td style="width: 10%;"></td> <td style="width: 10%;"></td> <td style="width: 10%;"></td> <td style="width: 10%;"></td> <td style="width: 10%;"></td> <td style="width: 10%;"></td> <td style="width: 10%;"></td> <td style="width: 10%;"></td> <td style="width: 10%;"></td> </tr> <tr> <td></td> <td></td> <td colspan="8" style="text-align: center;"> <table border="1" style="width: 100%; border-collapse: collapse; text-align: center;"> <tr> <td style="width: 10%;"></td> <td style="width: 10%;"></td> <td style="width: 10%;"></td> <td style="width: 10%;"></td> <td style="width: 10%;"></td> <td style="width: 10%;"></td> <td style="width: 10%;"></td> <td style="width: 10%;"></td> <td style="width: 10%;"></td> <td style="width: 10%;"></td> </tr> <tr> <td></td> <td></td> <td colspan="8" style="text-align: center;"> <table border="1" style="width: 100%; border-collapse: collapse; text-align: center;"> <tr> <td style="width: 10%;"></td> <td style="width: 10%;"></td> <td style="width: 10%;"></td> <td style="width: 10%;"></td> <td style="width: 10%;"></td> <td style="width: 10%;"></td> <td style="width: 10%;"></td> <td style="width: 10%;"></td> <td style="width: 10%;"></td> <td style="width: 10%;"></td> </tr> <tr> <td></td> <td></td> <td colspan="8" style="text-align: center;"> <table border="1" style="width: 100%; border-collapse: collapse; text-align: center;"> <tr> </tr></table></td></tr></table></td></tr></table></td></tr></table></td></tr></table></td></tr></table>

 | | | | | | | | | | | | | | | | | | | | <table border="1" style="width: 100%; border-collapse: collapse; text-align: center;"> <tr> <td style="width: 10%;"></td> <td style="width: 10%;"></td> <td style="width: 10%;"></td> <td style="width: 10%;"></td> <td style="width: 10%;"></td> <td style="width: 10%;"></td> <td style="width: 10%;"></td> <td style="width: 10%;"></td> <td style="width: 10%;"></td> <td style="width: 10%;"></td> </tr> <tr> <td></td> <td></td> <td colspan="8" style="text-align: center;"> <table border="1" style="width: 100%; border-collapse: collapse; text-align: center;"> <tr> <td style="width: 10%;"></td> <td style="width: 10%;"></td> <td style="width: 10%;"></td> <td style="width: 10%;"></td> <td style="width: 10%;"></td> <td style="width: 10%;"></td> <td style="width: 10%;"></td> <td style="width: 10%;"></td> <td style="width: 10%;"></td> <td style="width: 10%;"></td> </tr> <tr> <td></td> <td></td> <td colspan="8" style="text-align: center;"> <table border="1" style="width: 100%; border-collapse: collapse; text-align: center;"> <tr> <td style="width: 10%;"></td> <td style="width: 10%;"></td> <td style="width: 10%;"></td> <td style="width: 10%;"></td> <td style="width: 10%;"></td> <td style="width: 10%;"></td> <td style="width: 10%;"></td> <td style="width: 10%;"></td> <td style="width:
10%;"></td> <td style="width: 10%;"></td> </tr> <tr> <td></td> <td></td> <td colspan="8" style="text-align: center;"> <table border="1" style="width: 100%; border-collapse: collapse; text-align: center;"> <tr> <td style="width: 10%;"></td> <td style="width: 10%;"></td> <td style="width: 10%;"></td> <td style="width: 10%;"></td> <td style="width: 10%;"></td> <td style="width: 10%;"></td> <td style="width: 10%;"></td> <td style="width: 10%;"></td> <td style="width: 10%;"></td> <td style="width: 10%;"></td> </tr> <tr> <td></td> <td></td> <td colspan="8" style="text-align: center;"> <table border="1" style="width: 100%; border-collapse: collapse; text-align: center;"> <tr> </tr></table></td></tr></table></td></tr></table></td></tr></table></td></tr></table>

 | | | | | | | | | | | | | | | | | | | | <table border="1" style="width: 100%; border-collapse: collapse; text-align: center;"> <tr> <td style="width: 10%;"></td> <td style="width: 10%;"></td> <td style="width: 10%;"></td> <td style="width: 10%;"></td> <td style="width: 10%;"></td> <td style="width: 10%;"></td> <td style="width: 10%;"></td> <td style="width: 10%;"></td> <td style="width: 10%;"></td> <td style="width: 10%;"></td> </tr> <tr> <td></td> <td></td> <td colspan="8" style="text-align: center;"> <table border="1" style="width: 100%; border-collapse: collapse; text-align: center;"> <tr> <td style="width: 10%;"></td> <td style="width: 10%;"></td> <td style="width: 10%;"></td> <td style="width: 10%;"></td> <td style="width: 10%;"></td> <td style="width: 10%;"></td> <td style="width: 10%;"></td> <td style="width: 10%;"></td> <td style="width: 10%;"></td> <td style="width: 10%;"></td> </tr> <tr> <td></td> <td></td> <td colspan="8" style="text-align: center;"> <table border="1" style="width: 100%; border-collapse: collapse; text-align: center;"> <tr> <td style="width: 10%;"></td> <td style="width: 10%;"></td> <td style="width: 10%;"></td> <td style="width: 10%;"></td> <td style="width: 10%;"></td> <td style="width: 10%;"></td> <td style="width: 10%;"></td> <td style="width: 10%;"></td> <td style="width: 10%;"></td> <td style="width: 10%;"></td> </tr> <tr> <td></td> <td></td> <td colspan="8" style="text-align: center;"> <table border="1" style="width: 100%; border-collapse: collapse; text-align: center;"> <tr> </tr></table></td></tr></table></td></tr></table></td></tr></table>

 | | | | | | | | | | | | | | | | | | | | <table border="1" style="width: 100%; border-collapse: collapse; text-align: center;"> <tr> <td style="width: 10%;"></td> <td style="width: 10%;"></td> <td style="width: 10%;"></td> <td style="width: 10%;"></td> <td style="width: 10%;"></td> <td style="width: 10%;"></td> <td style="width: 10%;"></td> <td style="width: 10%;"></td> <td style="width: 10%;"></td> <td style="width: 10%;"></td> </tr> <tr> <td></td> <td></td> <td colspan="8" style="text-align: center;"> <table border="1" style="width: 100%; border-collapse: collapse; text-align: center;"> <tr> <td style="width: 10%;"></td> <td style="width: 10%;"></td> <td style="width: 10%;"></td> <td style="width: 10%;"></td> <td style="width: 10%;"></td> <td style="width: 10%;"></td> <td style="width: 10%;"></td> <td style="width: 10%;"></td> <td style="width: 10%;"></td> <td style="width: 10%;"></td> </tr> <tr> <td></td> <td></td> <td colspan="8" style="text-align: center;"> <table border="1" style="width: 100%; border-collapse: collapse; text-align: center;"> <tr> </tr></table></td></tr></table></td></tr></table>

 | | | | | | | | | | | | | | | | | | | | <table border="1" style="width: 100%; border-collapse: collapse; text-align: center;"> <tr> <td style="width: 10%;"></td> <td style="width: 10%;"></td> <td style="width: 10%;"></td> <td style="width: 10%;"></td> <td style="width: 10%;"></td> <td style="width: 10%;"></td> <td style="width: 10%;"></td> <td style="width: 10%;"></td> <td style="width: 10%;"></td> <td style="width: 10%;"></td> </tr> <tr> <td></td> <td></td> <td colspan="8" style="text-align: center;"> <table border="1" style="width: 100%; border-collapse: collapse; text-align: center;"> <tr> </tr></table></td></tr></table>

 | | | | | | | | | | | | | | | | | | | | <table border="1" style="width: 100%; border-collapse: collapse; text-align: center;"> <tr> </tr></table>

 | | | | | | | | | | | | | | | | | | | |

 | | | | | | | | | | | | | | | | | | | |

 | | | | | | | | | | | | | | | | | | | |

 | | | | | | | | | | | | | | | | | | | |

 | | | | | | | | | | | | | | | | | | | |

 | | | | | | | | | | | | | | | | | | | |

 | | | | | | | | | | | | | | | | | | | |

 | | | | | | | | | | | | | | | | | | | |

 | | | | | | | | | | | | | | | | | | | |

 | | | | | | | | | | | | | | | | | | | |

 | | | | | | | | | | | | | | | | | | | |

 | | | | | | | | | | | | | | | | | | | |

 | | | | | | | | | | | | | | | | | | | |

 | | | | | | | | | | | | | | | | | | | |

 | | | | | | | | | | | | | | | | | | | |

 | | | | | | | | | | | | | | | | | | | |

 | | | | | | | | | | | | | | | | | | | |
 | | | | | | | | | | | | | | | | | | | |

 | | | | | | | | | | | | | | | | | | | |

 | | | | | | | | | | | | | | | | | | | |
 | | | | | | | | | | | | | | | | | | | |

 | | | | | | | | | | | | | | | | | | | |

 | | | | | | | | | | | | | | | | | | | |
 | | | | | | | | | | | | | | | | | | | |
 | | | | | | | | | | | | | | | | | | | |

 | | | | | | | | | | | | | | | | | | | |
 | | | | | | | | | | | | | | | | | | | |
 | | | | | | | | | | | | | | | | | | | |

 | | | | | | | | | | | | | | | | | | | | | | | | | | | | | | | | | | | | | | | | | | | | | | | | | | | | | | | | | | | | | | | | | | | | | | | | | | | | | | | | | | | | | | | | | | | | | | | | | | | |
 | | | | | | | | | | | | | | | | | | | |
 | | | | | | | | | | | | | | | | | | | |
 | | | | | | | | | | | | | | | | | | | |
 | | | | | | | | | | | | | | | | | | | |
 | | | | | | | | | | | | | | | | | | | |
 | | | | | | | | | | | | | | | | | | | |
 | | | | | | | | | | | | | | | | | | | |
 | | | | | | | | | | | | | | | | | | | |
 | | | | | | | | | | | | | | | | | | | | | | | | | | | | | | | | | | | | | | | |
 | | | | | | | | | | | | | | | | | | | |
 | | | | | | | | | | | | | | | | | | | | | | | | | | | | | | | | | | | | | | | |
 | | | | | | | | | | | | | | | | | | | | | | | | | | | | | | | | | | | | | | | |
 | | | | | | | | | | | | | | | | | | | | | | | | | | | | | | | | | | | | | | | |
 | | | | | | | | | | | | | | | | | | | | | | | | | | | | | | | | | | | | | | | | | | | | | | | | | | | | | | | | | | | | | | | | | | | | | | | | | | | | | | | | | | | | | | | | | | | | | | | | | | | |
 | | | | | | | | | | | | | | | | | | | | | | | | | | | | | | | | | | | | | | | | | | | | | | | |
| | |

 | | | | | | | | | | | | | | | | | | | |

 | | | | | | | | | | | | | | | | | | | |

 | | | | | | | | | | | | | | | | | | | |

 | | | | | | | | | | | | | | | | | | | |

 | | | | | | | | | | | | | | | | | | | |

 | | | | | | | | | | | | | | | | | | | |

 | | | | | | | | | | | | | | | | | | | |

 | | | | | | | | | | | | | | | | | | | |

 | | | | | | | | | | | | | | | | | | | |

 | | | | | | | | | | | | | | | | | | | |

 | | | | | | | | | | | | | | | | | | | |

 | | | | | | | | | | | | | | | | | | | |

 | | | | | | | | | | | | | | | | | | | |

 | | | | | | | | | | | | | | | | | | | |

 | | | | | | | | | | | | | | | | | | | |

 | | | | | | | | | | | | | | | | | | | |

 | | | | | | | | | | | | | | | | | | | |

 | | | | | | | | | | | | | | | | | | | |

 | | | | | | | | | | | | | | | | | | | |

 | | | | | | | | | | | | | | | | | | | |

 | | | | | | | | | | | | | | | | | | | |

 | | | | | | | | | | | | | | | | | | | |

 | | | | | | | | | | | | | | | | | | | |

 | | | | | | | | | | | | | | | | | | | |

 | | | | | | | | | | | | | | | | | | | |

 | | | | | | | | | | | | | | | | | | | |

 | | | | | | | | | | | | | | | | | | | |

 | | | | | | | | | | | | | | | | | | | |
 | | | | | | | | | | | | | | | | | | | |

 | | | | | | | | | | | | | | | | | | | |

 | | | | | | | | | | | | | | | | | | | |
 | | | | | | | | | | | | | | | | | | | |

 | | | | | | | | | | | | | | | | | | | |

 | | | | | | | | | | | | | | | | | | | |
 | | | | | | | | | | | | | | | | | | | |
 | | | | | | | | | | | | | | | | | | | |

 | | | | | | | | | | | | | | | | | | | |
 | | | | | | | | | | | | | | | | | | | |
 | | | | | | | | | | | | | | | | | | | |

 | | | | | | | | | | | | | | | | | | | | | | | | | | | | | | | | | | | | | | | | | | | | | | | | | | | | | | | | | | | | | | | | | | | | | | | | | | | | | | | | | | | | | | | | | | | | | | | | | | | |
 | | | | | | | | | | | | | | | | | | | |
 | | | | | | | | | | | | | | | | | | | |
 | | | | | | | | | | | | | | | | | | | |
 | | | | | | | | | | | | | | | | | | | |
 | | | | | | | | | | | | | | | | | | | |
 | | | | | | | | | | | | | | | | | | | |
 | | | | | | | | | | | | | | | | | | | |
 | | | | | | | | | | | | | | | | | | | |
 | | | | | | | | | | | | | | | | | | | | | | | | | | | | | | | | | | | | | | | |
 | | | | | | | | | | | | | | | | | | | |
 | | | | | | | | | | | | | | | | | | | | | | | | | | | | | | | | | | | | | | | |
 | | | | | | | | | | | | | | | | | | | | | | | | | | | | | | | | | | | | | | | |
 | | | | | | | | | | | | | | | | | | | | | | | | | | | | | | | | | | | | | | | |
 | | | | | | | | | | | | | | | | | | | | | | | | | | | | | | | | | | | | | | | | | | | | | | | | | | | | | | | | | | | | | | | | | | | | | | | | | | | | | | | | | | | | | | | | | | | | | | | | | | | |
 | | | | | | | | | | | | | | | | | | | | | | | | | | | | | | | | | | | | | | | | | | | | | | | |
| | | <table border="1" style="width: 100%; border-collapse: collapse; text-align: center;"> <tr> <td style="width: 10%;"></td> <td style="width: 10%;"></td> <td style="width: 10%;"></td> <td style="width: 10%;"></td> <td style="width: 10%;"></td> <td style="width: 10%;"></td> <td style="width: 10%;"></td> <td style="width: 10%;"></td> <td style="width: 10%;"></td> <td style="width: 10%;"></td> </tr> <tr> <td></td> <td></td> <td colspan="8" style="text-align: center;"> <table border="1" style="width: 100%; border-collapse: collapse; text-align: center;"> <tr> <td style="width: 10%;"></td> <td style="width: 10%;"></td> <td style="width: 10%;"></td> <td style="width: 10%;"></td> <td style="width: 10%;"></td> <td style="width: 10%;"></td> <td style="width: 10%;"></td> <td style="width: 10%;"></td> <td style="width: 10%;"></td> <td style="width: 10%;"></td> </tr> <tr> <td></td> <td></td> <td colspan="8" style="text-align: center;"> <table border="1" style="width: 100%; border-collapse: collapse; text-align: center;"> <tr> <td style="width: 10%;"></td> <td style="width: 10%;"></td> <td style="width: 10%;"></td> <td style="width: 10%;"></td> <td style="width: 10%;"></td> <td style="width: 10%;"></td> <td style="width: 10%;"></td> <td style="width: 10%;"></td> <td style="width: 10%;"></td> <td style="width: 10%;"></td> </tr> <tr> <td></td> <td></td> <td colspan="8" style="text-align: center;"> <table border="1" style="width: 100%; border-collapse: collapse; text-align: center;"> <tr> <td style="width: 10%;"></td> <td style="width: 10%;"></td> <td style="width: 10%;"></td> <td style="width: 10%;"></td> <td style="width: 10%;"></td> <td style="width: 10%;"></td> <td style="width: 10%;"></td> <td style="width: 10%;"></td> <td style="width: 10%;"></td> <td style="width: 10%;"></td> </tr> <tr> <td></td> <td></td> <td colspan="8" style="text-align: center;"> <table border="1" style="width: 100%; border-collapse: collapse; text-align: center;"> <tr> <td style="width: 10%;"></td> <td style="width: 10%;"></td> <td style="width: 10%;"></td> <td style="width: 10%;"></td> <td style="width: 10%;"></td> <td style="width: 10%;"></td> <td style="width: 10%;"></td> <td style="width: 10%;"></td> <td style="width: 10%;"></td> <td style="width: 10%;"></td> </tr> <tr> <td></td> <td></td> <td colspan="8" style="text-align: center;"> <table border="1" style="width: 100%; border-collapse: collapse; text-align: center;"> <tr> <td style="width: 10%;"></td> <td style="width: 10%;"></td> <td style="width: 10%;"></td> <td style="width: 10%;"></td> <td style="width: 10%;"></td> <td style="width: 10%;"></td> <td style="width: 10%;"></td> <td style="width: 10%;"></td> <td style="width: 10%;"></td> <td style="width: 10%;"></td> </tr> <tr> <td></td> <td></td> <td colspan="8" style="text-align: center;"> <table border="1" style="width: 100%; border-collapse: collapse; text-align: center;"> <tr> <td style="width: 10%;"></td> <td style="width: 10%;"></td> <td style="width: 10%;"></td> <td style="width: 10%;"></td> <td style="width: 10%;"></td> <td style="width: 10%;"></td> <td style="width: 10%;"></td> <td style="width: 10%;"></td> <td style="width: 10%;"></td> <td style="width: 10%;"></td> </tr> <tr> <td></td> <td></td> <td colspan="8" style="text-align: center;"> <table border="1" style="width: 100%; border-collapse: collapse; text-align: center;"> <tr> <td style="width: 10%;"></td> <td style="width: 10%;"></td> <td style="width: 10%;"></td> <td style="width: 10%;"></td> <td style="width: 10%;"></td> <td style="width: 10%;"></td> <td style="width: 10%;"></td> <td style="width: 10%;"></td> <td style="width: 10%;"></td> <td style="width: 10%;"></td> </tr> <tr> <td></td> <td></td> <td colspan="8" style="text-align: center;"> <table border="1" style="width: 100%; border-collapse: collapse; text-align: center;"> <tr> <td style="width: 10%;"></td> <td style="width: 10%;"></td> <td style="width: 10%;"></td> <td style="width: 10%;"></td> <td style="width: 10%;"></td> <td style="width: 10%;"></td> <td style="width: 10%;"></td> <td style="width: 10%;"></td> <td style="width: 10%;"></td> <td style="width: 10%;"></td> </tr> <tr> <td></td> <td></td> <td colspan="8" style="text-align: center;"> <table border="1" style="width: 100%; border-collapse: collapse; text-align: center;"> <tr> <td style="width: 10%;"></td> <td style="width: 10%;"></td> <td style="width: 10%;"></td> <td style="width: 10%;"></td> <td style="width: 10%;"></td> <td style="width: 10%;"></td> <td style="width: 10%;"></td> <td style="width: 10%;"></td> <td style="width: 10%;"></td> <td style="width: 10%;"></td> </tr> <tr> <td></td> <td></td> <td colspan="8" style="text-align: center;"> <table border="1" style="width: 100%; border-collapse: collapse; text-align: center;"> <tr> </tr></table></td></tr></table></td></tr></table></td></tr></table></td></tr></table></td></tr></table></td></tr></table></td></tr></table></td></tr></table></td></tr></table></td></tr></table>

 | | | | | | | | | | | | | | | | | | | | <table border="1" style="width: 100%; border-collapse: collapse; text-align: center;"> <tr> <td style="width: 10%;"></td> <td style="width: 10%;"></td> <td style="width: 10%;"></td> <td style="width: 10%;"></td> <td style="width: 10%;"></td> <td style="width: 10%;"></td> <td style="width: 10%;"></td> <td style="width: 10%;"></td> <td style="width: 10%;"></td> <td style="width: 10%;"></td> </tr> <tr> <td></td> <td></td> <td colspan="8" style="text-align: center;"> <table border="1" style="width: 100%; border-collapse: collapse; text-align: center;"> <tr> <td style="width: 10%;"></td> <td style="width: 10%;"></td> <td style="width: 10%;"></td> <td style="width: 10%;"></td> <td style="width: 10%;"></td> <td style="width: 10%;"></td> <td style="width: 10%;"></td> <td style="width: 10%;"></td> <td style="width: 10%;"></td> <td style="width: 10%;"></td> </tr> <tr> <td></td> <td></td> <td colspan="8" style="text-align: center;"> <table border="1" style="width: 100%; border-collapse: collapse; text-align: center;"> <tr> <td style="width: 10%;"></td> <td style="width: 10%;"></td> <td style="width: 10%;"></td> <td style="width: 10%;"></td> <td style="width: 10%;"></td> <td style="width: 10%;"></td> <td style="width: 10%;"></td> <td style="width: 10%;"></td> <td style="width: 10%;"></td> <td style="width: 10%;"></td> </tr> <tr> <td></td> <td></td> <td colspan="8" style="text-align: center;"> <table border="1" style="width: 100%; border-collapse: collapse; text-align: center;"> <tr> <td style="width: 10%;"></td> <td style="width: 10%;"></td> <td style="width: 10%;"></td> <td style="width: 10%;"></td> <td style="width: 10%;"></td> <td style="width: 10%;"></td> <td style="width: 10%;"></td> <td style="width: 10%;"></td> <td style="width: 10%;"></td> <td style="width: 10%;"></td> </tr> <tr> <td></td> <td></td> <td colspan="8" style="text-align: center;"> <table border="1" style="width: 100%; border-collapse: collapse; text-align: center;"> <tr> <td style="width: 10%;"></td> <td style="width: 10%;"></td> <td style="width: 10%;"></td> <td style="width: 10%;"></td> <td style="width: 10%;"></td> <td style="width: 10%;"></td> <td style="width: 10%;"></td> <td style="width: 10%;"></td> <td style="width: 10%;"></td> <td style="width: 10%;"></td> </tr> <tr> <td></td> <td></td> <td colspan="8" style="text-align: center;"> <table border="1" style="width: 100%; border-collapse: collapse; text-align: center;"> <tr> <td style="width: 10%;"></td> <td style="width: 10%;"></td> <td style="width: 10%;"></td> <td style="width: 10%;"></td> <td style="width: 10%;"></td> <td style="width: 10%;"></td> <td style="width: 10%;"></td> <td style="width: 10%;"></td> <td style="width: 10%;"></td> <td style="width: 10%;"></td> </tr> <tr> <td></td> <td></td> <td colspan="8" style="text-align: center;"> <table border="1" style="width: 100%; border-collapse: collapse; text-align: center;"> <tr> <td style="width: 10%;"></td> <td style="width: 10%;"></td> <td style="width: 10%;"></td> <td style="width: 10%;"></td> <td style="width: 10%;"></td> <td style="width: 10%;"></td> <td style="width: 10%;"></td> <td style="width: 10%;"></td> <td style="width: 10%;"></td> <td style="width: 10%;"></td> </tr> <tr> <td></td> <td></td> <td colspan="8" style="text-align: center;"> <table border="1" style="width: 100%; border-collapse: collapse; text-align: center;"> <tr> <td style="width: 10%;"></td> <td style="width: 10%;"></td> <td style="width: 10%;"></td> <td style="width: 10%;"></td> <td style="width: 10%;"></td> <td style="width: 10%;"></td> <td style="width: 10%;"></td> <td style="width: 10%;"></td> <td style="width: 10%;"></td> <td style="width: 10%;"></td> </tr> <tr> <td></td> <td></td> <td colspan="8" style="text-align: center;"> <table border="1" style="width: 100%; border-collapse: collapse; text-align: center;"> <tr> <td style="width: 10%;"></td> <td style="width: 10%;"></td> <td style="width: 10%;"></td> <td style="width: 10%;"></td> <td style="width: 10%;"></td> <td style="width: 10%;"></td> <td style="width: 10%;"></td> <td style="width: 10%;"></td> <td style="width: 10%;"></td> <td style="width: 10%;"></td> </tr> <tr> <td></td> <td></td> <td colspan="8" style="text-align: center;"> <table border="1" style="width: 100%; border-collapse: collapse; text-align: center;"> <tr> </tr></table></td></tr></table></td></tr></table></td></tr></table></td></tr></table></td></tr></table></td></tr></table></td></tr></table></td></tr></table></td></tr></table>

 | | | | | | | | | | | | | | | | | | | | <table border="1" style="width: 100%; border-collapse: collapse; text-align: center;"> <tr> <td style="width: 10%;"></td> <td style="width: 10%;"></td> <td style="width: 10%;"></td> <td style="width: 10%;"></td> <td style="width: 10%;"></td> <td style="width: 10%;"></td> <td style="width: 10%;"></td> <td style="width: 10%;"></td> <td style="width: 10%;"></td> <td style="width: 10%;"></td> </tr> <tr> <td></td> <td></td> <td colspan="8" style="text-align: center;"> <table border="1" style="width: 100%; border-collapse: collapse; text-align: center;"> <tr> <td style="width: 10%;"></td> <td style="width: 10%;"></td> <td style="width: 10%;"></td> <td style="width: 10%;"></td> <td style="width: 10%;"></td> <td style="width: 10%;"></td> <td style="width: 10%;"></td> <td style="width: 10%;"></td> <td style="width: 10%;"></td> <td style="width: 10%;"></td> </tr> <tr> <td></td> <td></td> <td colspan="8" style="text-align: center;"> <table border="1" style="width: 100%; border-collapse: collapse; text-align: center;"> <tr> <td style="width: 10%;"></td> <td style="width: 10%;"></td> <td style="width: 10%;"></td> <td style="width: 10%;"></td> <td style="width: 10%;"></td> <td style="width: 10%;"></td> <td style="width: 10%;"></td> <td style="width: 10%;"></td> <td style="width: 10%;"></td> <td style="width: 10%;"></td> </tr> <tr> <td></td> <td></td> <td colspan="8" style="text-align: center;"> <table border="1" style="width: 100%; border-collapse: collapse; text-align: center;"> <tr> <td style="width: 10%;"></td> <td style="width: 10%;"></td> <td style="width: 10%;"></td> <td style="width: 10%;"></td> <td style="width: 10%;"></td> <td style="width: 10%;"></td> <td style="width: 10%;"></td> <td style="width: 10%;"></td> <td style="width: 10%;"></td> <td style="width: 10%;"></td> </tr> <tr> <td></td> <td></td> <td colspan="8" style="text-align: center;"> <table border="1" style="width: 100%; border-collapse: collapse; text-align: center;"> <tr> <td style="width: 10%;"></td> <td style="width: 10%;"></td> <td style="width: 10%;"></td> <td style="width: 10%;"></td> <td style="width: 10%;"></td> <td style="width: 10%;"></td> <td style="width: 10%;"></td> <td style="width: 10%;"></td> <td style="width: 10%;"></td> <td style="width: 10%;"></td> </tr> <tr> <td></td> <td></td> <td colspan="8" style="text-align: center;"> <table border="1" style="width: 100%; border-collapse: collapse; text-align: center;"> <tr> <td style="width: 10%;"></td> <td style="width: 10%;"></td> <td style="width: 10%;"></td> <td style="width: 10%;"></td> <td style="width: 10%;"></td> <td style="width: 10%;"></td> <td style="width: 10%;"></td> <td style="width: 10%;"></td> <td style="width: 10%;"></td> <td style="width: 10%;"></td> </tr> <tr> <td></td> <td></td> <td colspan="8" style="text-align: center;"> <table border="1" style="width: 100%; border-collapse: collapse; text-align: center;"> <tr> <td style="width: 10%;"></td> <td style="width: 10%;"></td> <td style="width: 10%;"></td> <td style="width: 10%;"></td> <td style="width: 10%;"></td> <td style="width: 10%;"></td> <td style="width: 10%;"></td> <td style="width: 10%;"></td> <td style="width: 10%;"></td> <td style="width: 10%;"></td> </tr> <tr> <td></td> <td></td> <td colspan="8" style="text-align: center;"> <table border="1" style="width: 100%; border-collapse: collapse; text-align: center;"> <tr> <td style="width: 10%;"></td> <td style="width: 10%;"></td> <td style="width: 10%;"></td> <td style="width: 10%;"></td> <td style="width: 10%;"></td> <td style="width: 10%;"></td> <td style="width: 10%;"></td> <td style="width: 10%;"></td> <td style="width: 10%;"></td> <td style="width: 10%;"></td> </tr> <tr> <td></td> <td></td> <td colspan="8" style="text-align: center;"> <table border="1" style="width: 100%; border-collapse: collapse; text-align: center;"> <tr> </tr></table></td></tr></table></td></tr></table></td></tr></table></td></tr></table></td></tr></table></td></tr></table></td></tr></table></td></tr></table>

 | | | | | | | | | | | | | | | | | | | | <table border="1" style="width: 100%; border-collapse: collapse; text-align: center;"> <tr> <td style="width: 10%;"></td> <td style="width: 10%;"></td> <td style="width: 10%;"></td> <td style="width: 10%;"></td> <td style="width: 10%;"></td> <td style="width: 10%;"></td> <td style="width: 10%;"></td> <td style="width: 10%;"></td> <td style="width: 10%;"></td> <td style="width: 10%;"></td> </tr> <tr> <td></td> <td></td> <td colspan="8" style="text-align: center;"> <table border="1" style="width: 100%; border-collapse: collapse; text-align: center;"> <tr> <td style="width: 10%;"></td> <td style="width: 10%;"></td> <td style="width: 10%;"></td> <td style="width: 10%;"></td> <td style="width: 10%;"></td> <td style="width: 10%;"></td> <td style="width: 10%;"></td> <td style="width: 10%;"></td> <td style="width: 10%;"></td> <td style="width: 10%;"></td> </tr> <tr> <td></td> <td></td> <td colspan="8" style="text-align: center;"> <table border="1" style="width: 100%; border-collapse: collapse; text-align: center;"> <tr> <td style="width: 10%;"></td> <td style="width: 10%;"></td> <td style="width: 10%;"></td> <td style="width: 10%;"></td> <td style="width: 10%;"></td> <td style="width: 10%;"></td> <td style="width: 10%;"></td> <td style="width: 10%;"></td> <td style="width: 10%;"></td> <td style="width: 10%;"></td> </tr> <tr> <td></td> <td></td> <td colspan="8" style="text-align: center;"> <table border="1" style="width: 100%; border-collapse: collapse; text-align: center;"> <tr> <td style="width: 10%;"></td> <td style="width: 10%;"></td> <td style="width: 10%;"></td> <td style="width: 10%;"></td> <td style="width: 10%;"></td> <td style="width: 10%;"></td> <td style="width: 10%;"></td> <td style="width: 10%;"></td> <td style="width: 10%;"></td> <td style="width: 10%;"></td> </tr> <tr> <td></td> <td></td> <td colspan="8" style="text-align: center;"> <table border="1" style="width: 100%; border-collapse: collapse; text-align: center;"> <tr> <td style="width: 10%;"></td> <td style="width: 10%;"></td> <td style="width: 10%;"></td> <td style="width: 10%;"></td> <td style="width: 10%;"></td> <td style="width: 10%;"></td> <td style="width: 10%;"></td> <td style="width: 10%;"></td> <td style="width: 10%;"></td> <td style="width: 10%;"></td> </tr> <tr> <td></td> <td></td> <td colspan="8" style="text-align: center;"> <table border="1" style="width: 100%; border-collapse: collapse; text-align: center;"> <tr> <td style="width: 10%;"></td> <td style="width: 10%;"></td> <td style="width: 10%;"></td> <td style="width: 10%;"></td> <td style="width: 10%;"></td> <td style="width: 10%;"></td> <td style="width: 10%;"></td> <td style="width: 10%;"></td> <td style="width: 10%;"></td> <td style="width: 10%;"></td> </tr> <tr> <td></td> <td></td> <td colspan="8" style="text-align: center;"> <table border="1" style="width: 100%; border-collapse: collapse; text-align: center;"> <tr> <td style="width: 10%;"></td> <td style="width: 10%;"></td> <td style="width: 10%;"></td> <td style="width: 10%;"></td> <td style="width: 10%;"></td> <td style="width: 10%;"></td> <td style="width: 10%;"></td> <td style="width: 10%;"></td> <td style="width: 10%;"></td> <td style="width: 10%;"></td> </tr> <tr> <td></td> <td></td> <td colspan="8" style="text-align: center;"> <table border="1" style="width: 100%; border-collapse: collapse; text-align: center;"> <tr> </tr></table></td></tr></table></td></tr></table></td></tr></table></td></tr></table></td></tr></table></td></tr></table></td></tr></table>

 | | | | | | | | | | | | | | | | | | | | <table border="1" style="width: 100%; border-collapse: collapse; text-align: center;"> <tr> <td style="width: 10%;"></td> <td style="width: 10%;"></td> <td style="width: 10%;"></td> <td style="width: 10%;"></td> <td style="width: 10%;"></td> <td style="width: 10%;"></td> <td style="width: 10%;"></td> <td style="width: 10%;"></td> <td style="width: 10%;"></td> <td style="width: 10%;"></td> </tr> <tr> <td></td> <td></td> <td colspan="8" style="text-align: center;"> <table border="1" style="width: 100%; border-collapse: collapse; text-align: center;"> <tr> <td style="width: 10%;"></td> <td style="width: 10%;"></td> <td style="width: 10%;"></td> <td style="width: 10%;"></td> <td style="width: 10%;"></td> <td style="width: 10%;"></td> <td style="width: 10%;"></td> <td style="width: 10%;"></td> <td style="width: 10%;"></td> <td style="width: 10%;"></td> </tr> <tr> <td></td> <td></td> <td colspan="8" style="text-align: center;"> <table border="1" style="width: 100%; border-collapse: collapse; text-align: center;"> <tr> <td style="width: 10%;"></td> <td style="width: 10%;"></td> <td style="width: 10%;"></td> <td style="width: 10%;"></td> <td style="width: 10%;"></td> <td style="width: 10%;"></td> <td style="width: 10%;"></td> <td style="width: 10%;"></td> <td style="width: 10%;"></td> <td style="width: 10%;"></td> </tr> <tr> <td></td> <td></td> <td colspan="8" style="text-align: center;"> <table border="1" style="width: 100%; border-collapse: collapse; text-align: center;"> <tr> <td style="width: 10%;"></td> <td style="width: 10%;"></td> <td style="width: 10%;"></td> <td style="width: 10%;"></td> <td style="width: 10%;"></td> <td style="width: 10%;"></td> <td style="width: 10%;"></td> <td style="width: 10%;"></td> <td style="width: 10%;"></td> <td style="width: 10%;"></td> </tr> <tr> <td></td> <td></td> <td colspan="8" style="text-align: center;"> <table border="1" style="width: 100%; border-collapse: collapse; text-align: center;"> <tr> <td style="width: 10%;"></td> <td style="width: 10%;"></td> <td style="width: 10%;"></td> <td style="width: 10%;"></td> <td style="width: 10%;"></td> <td style="width: 10%;"></td> <td style="width: 10%;"></td> <td style="width: 10%;"></td> <td style="width: 10%;"></td> <td style="width: 10%;"></td> </tr> <tr> <td></td> <td></td> <td colspan="8" style="text-align: center;"> <table border="1" style="width: 100%; border-collapse: collapse; text-align: center;"> <tr> <td style="width: 10%;"></td> <td style="width: 10%;"></td> <td style="width: 10%;"></td> <td style="width: 10%;"></td> <td style="width: 10%;"></td> <td style="width: 10%;"></td> <td style="width: 10%;"></td> <td style="width: 10%;"></td> <td style="width: 10%;"></td> <td style="width: 10%;"></td> </tr> <tr> <td></td> <td></td> <td colspan="8" style="text-align: center;"> <table border="1" style="width: 100%; border-collapse: collapse; text-align: center;"> <tr> </tr></table></td></tr></table></td></tr></table></td></tr></table></td></tr></table></td></tr></table></td></tr></table>

 | | | | | | | | | | | | | | | | | | | | <table border="1" style="width: 100%; border-collapse: collapse; text-align: center;"> <tr> <td style="width: 10%;"></td> <td style="width: 10%;"></td> <td style="width: 10%;"></td> <td style="width: 10%;"></td> <td style="width: 10%;"></td> <td style="width: 10%;"></td> <td style="width: 10%;"></td> <td style="width: 10%;"></td> <td style="width: 10%;"></td> <td style="width: 10%;"></td> </tr> <tr> <td></td> <td></td> <td colspan="8" style="text-align: center;"> <table border="1" style="width: 100%; border-collapse: collapse; text-align: center;"> <tr> <td style="width: 10%;"></td> <td style="width: 10%;"></td> <td style="width: 10%;"></td> <td style="width: 10%;"></td> <td style="width: 10%;"></td> <td style="width: 10%;"></td> <td style="width: 10%;"></td> <td style="width: 10%;"></td> <td style="width: 10%;"></td> <td style="width: 10%;"></td> </tr> <tr> <td></td> <td></td> <td colspan="8" style="text-align: center;"> <table border="1" style="width: 100%; border-collapse: collapse; text-align: center;"> <tr> <td style="width: 10%;"></td> <td style="width: 10%;"></td> <td style="width: 10%;"></td> <td style="width: 10%;"></td> <td style="width: 10%;"></td> <td style="width: 10%;"></td> <td style="width: 10%;"></td> <td style="width: 10%;"></td> <td style="width: 10%;"></td> <td style="width: 10%;"></td> </tr> <tr> <td></td> <td></td> <td colspan="8" style="text-align: center;"> <table border="1" style="width: 100%; border-collapse: collapse; text-align: center;"> <tr> <td style="width: 10%;"></td> <td style="width: 10%;"></td> <td style="width: 10%;"></td> <td style="width: 10%;"></td> <td style="width: 10%;"></td> <td style="width: 10%;"></td> <td style="width: 10%;"></td> <td style="width: 10%;"></td> <td style="width: 10%;"></td> <td style="width: 10%;"></td> </tr> <tr> <td></td> <td></td> <td colspan="8" style="text-align: center;"> <table border="1" style="width: 100%; border-collapse: collapse; text-align: center;"> <tr> <td style="width: 10%;"></td> <td style="width: 10%;"></td> <td style="width: 10%;"></td> <td style="width: 10%;"></td> <td style="width: 10%;"></td> <td style="width: 10%;"></td> <td style="width: 10%;"></td> <td style="width: 10%;"></td> <td style="width: 10%;"></td> <td style="width: 10%;"></td> </tr> <tr> <td></td> <td></td> <td colspan="8" style="text-align: center;"> <table border="1" style="width: 100%; border-collapse: collapse; text-align: center;"> <tr> </tr></table></td></tr></table></td></tr></table></td></tr></table></td></tr></table></td></tr></table>

 | | | | | | | | | | | | | | | | | | | | <table border="1" style="width: 100%; border-collapse: collapse; text-align: center;"> <tr> <td style="width: 10%;"></td> <td style="width: 10%;"></td> <td style="width: 10%;"></td> <td style="width: 10%;"></td> <td style="width: 10%;"></td> <td style="width: 10%;"></td> <td style="width: 10%;"></td> <td style="width: 10%;"></td> <td style="width: 10%;"></td> <td style="width: 10%;"></td> </tr> <tr> <td></td> <td></td> <td colspan="8" style="text-align: center;"> <table border="1" style="width: 100%; border-collapse: collapse; text-align: center;"> <tr> <td style="width: 10%;"></td> <td style="width: 10%;"></td> <td style="width: 10%;"></td> <td style="width: 10%;"></td> <td style="width: 10%;"></td> <td style="width: 10%;"></td> <td style="width: 10%;"></td> <td style="width: 10%;"></td> <td style="width: 10%;"></td> <td style="width: 10%;"></td> </tr> <tr> <td></td> <td></td> <td colspan="8" style="text-align: center;"> <table border="1" style="width: 100%; border-collapse: collapse; text-align: center;"> <tr> <td style="width: 10%;"></td> <td style="width: 10%;"></td> <td style="width: 10%;"></td> <td style="width: 10%;"></td> <td style="width: 10%;"></td> <td style="width: 10%;"></td> <td style="width: 10%;"></td> <td style="width: 10%;"></td> <td style="width: 10%;"></td> <td style="width: 10%;"></td> </tr> <tr> <td></td> <td></td> <td colspan="8" style="text-align: center;"> <table border="1" style="width: 100%; border-collapse: collapse; text-align: center;"> <tr> <td style="width: 10%;"></td> <td style="width: 10%;"></td> <td style="width: 10%;"></td> <td style="width: 10%;"></td> <td style="width: 10%;"></td> <td style="width: 10%;"></td> <td style="width: 10%;"></td> <td style="width: 10%;"></td> <td style="width: 10%;"></td> <td style="width: 10%;"></td> </tr> <tr> <td></td> <td></td> <td colspan="8" style="text-align: center;"> <table border="1" style="width: 100%; border-collapse: collapse; text-align: center;"> <tr> </tr></table></td></tr></table></td></tr></table></td></tr></table></td></tr></table>

 | | | | | | | | | | | | | | | | | | | | <table border="1" style="width: 100%; border-collapse: collapse; text-align: center;"> <tr> <td style="width: 10%;"></td> <td style="width: 10%;"></td> <td style="width: 10%;"></td> <td style="width: 10%;"></td> <td style="width: 10%;"></td> <td style="width: 10%;"></td> <td style="width: 10%;"></td> <td style="width: 10%;"></td> <td style="width: 10%;"></td> <td style="width: 10%;"></td> </tr> <tr> <td></td> <td></td> <td colspan="8" style="text-align: center;"> <table border="1" style="width: 100%; border-collapse: collapse; text-align: center;"> <tr> <td style="width: 10%;"></td> <td style="width: 10%;"></td> <td style="width: 10%;"></td> <td style="width: 10%;"></td> <td style="width: 10%;"></td> <td style="width: 10%;"></td> <td style="width: 10%;"></td> <td style="width: 10%;"></td> <td style="width: 10%;"></td> <td style="width: 10%;"></td> </tr> <tr> <td></td> <td></td> <td colspan="8" style="text-align: center;"> <table border="1" style="width: 100%; border-collapse: collapse; text-align: center;"> <tr> <td style="width: 10%;"></td> <td style="width: 10%;"></td> <td style="width: 10%;"></td> <td style="width: 10%;"></td> <td style="width: 10%;"></td> <td style="width: 10%;"></td> <td style="width: 10%;"></td> <td style="width: 10%;"></td> <td style="width:
10%;"></td> <td style="width: 10%;"></td> </tr> <tr> <td></td> <td></td> <td colspan="8" style="text-align: center;"> <table border="1" style="width: 100%; border-collapse: collapse; text-align: center;"> <tr> </tr></table></td></tr></table></td></tr></table></td></tr></table>

 | | | | | | | | | | | | | | | | | | | | <table border="1" style="width: 100%; border-collapse: collapse; text-align: center;"> <tr> <td style="width: 10%;"></td> <td style="width: 10%;"></td> <td style="width: 10%;"></td> <td style="width: 10%;"></td> <td style="width: 10%;"></td> <td style="width: 10%;"></td> <td style="width: 10%;"></td> <td style="width: 10%;"></td> <td style="width: 10%;"></td> <td style="width: 10%;"></td> </tr> <tr> <td></td> <td></td> <td colspan="8" style="text-align: center;"> <table border="1" style="width: 100%; border-collapse: collapse; text-align: center;"> <tr> <td style="width: 10%;"></td> <td style="width: 10%;"></td> <td style="width: 10%;"></td> <td style="width: 10%;"></td> <td style="width: 10%;"></td> <td style="width: 10%;"></td> <td style="width: 10%;"></td> <td style="width: 10%;"></td> <td style="width: 10%;"></td> <td style="width: 10%;"></td> </tr> <tr> <td></td> <td></td> <td colspan="8" style="text-align: center;"> <table border="1" style="width: 100%; border-collapse: collapse; text-align: center;"> <tr> </tr></table></td></tr></table></td></tr></table>

 | | | | | | | | | | | | | | | | | | | | <table border="1" style="width: 100%; border-collapse: collapse; text-align: center;"> <tr> <td style="width: 10%;"></td> <td style="width: 10%;"></td> <td style="width: 10%;"></td> <td style="width: 10%;"></td> <td style="width: 10%;"></td> <td style="width: 10%;"></td> <td style="width: 10%;"></td> <td style="width: 10%;"></td> <td style="width: 10%;"></td> <td style="width: 10%;"></td> </tr> <tr> <td></td> <td></td> <td colspan="8" style="text-align: center;"> <table border="1" style="width: 100%; border-collapse: collapse; text-align: center;"> <tr> </tr></table></td></tr></table>

 | | | | | | | | | | | | | | | | | | | | <table border="1" style="width: 100%; border-collapse: collapse; text-align: center;"> <tr> </tr></table>

 | | | | | | | | | | | | | | | | | | | |

 | | | | | | | | | | | | | | | | | | | |

 | | | | | | | | | | | | | | | | | | | |

 | | | | | | | | | | | | | | | | | | | |

 | | | | | | | | | | | | | | | | | | | |

 | | | | | | | | | | | | | | | | | | | |

 | | | | | | | | | | | | | | | | | | | |

 | | | | | | | | | | | | | | | | | | | |

 | | | | | | | | | | | | | | | | | | | |

 | | | | | | | | | | | | | | | | | | | |

 | | | | | | | | | | | | | | | | | | | |

 | | | | | | | | | | | | | | | | | | | |

 | | | | | | | | | | | | | | | | | | | |

 | | | | | | | | | | | | | | | | | | | |

 | | | | | | | | | | | | | | | | | | | |

 | | | | | | | | | | | | | | | | | | | |

 | | | | | | | | | | | | | | | | | | | |

 | | | | | | | | | | | | | | | | | | | |
 | | | | | | | | | | | | | | | | | | | |

 | | | | | | | | | | | | | | | | | | | |

 | | | | | | | | | | | | | | | | | | | |
 | | | | | | | | | | | | | | | | | | | |

 | | | | | | | | | | | | | | | | | | | |

 | | | | | | | | | | | | | | | | | | | |
 | | | | | | | | | | | | | | | | | | | |
 | | | | | | | | | | | | | | | | | | | |

 | | | | | | | | | | | | | | | | | | | |
 | | | | | | | | | | | | | | | | | | | |
 | | | | | | | | | | | | | | | | | | | |

 | | | | | | | | | | | | | | | | | | | | | | | | | | | | | | | | | | | | | | | | | | | | | | | | | | | | | | | | | | | | | | | | | | | | | | | | | | | | | | | | | | | | | | | | | | | | | | | | | | | |
 | | | | | | | | | | | | | | | | | | | |
 | | | | | | | | | | | | | | | | | | | |
 | | | | | | | | | | | | | | | | | | | |
 | | | | | | | | | | | | | | | | | | | |
 | | | | | | | | | | | | | | | | | | | |
 | | | | | | | | | | | | | | | | | | | |
 | | | | | | | | | | | | | | | | | | | |
 | | | | | | | | | | | | | | | | | | | |
 | | | | | | | | | | | | | | | | | | | | | | | | | | | | | | | | | | | | | | | |
 | | | | | | | | | | | | | | | | | | | |
 | | | | | | | | | | | | | | | | | | | | | | | | | | | | | | | | | | | | | | | |
 | | | | | | | | | | | | | | | | | | | | | | | | | | | | | | | | | | | | | | | |
 | | | | | | | | | | | | | | | | | | | | | | | | | | | | | | | | | | | | | | | |
 | | | | | | | | | | | | | | | | | | | | | | | | | | | | | | | | | | | | | | | | | | | | | | | | | | | | | | | | | | | | | | | | | | | | | | | | | | | | | | | | | | | | | | | | | | | | | | | | | | | |
 | | | | | | | | | | | | | | | | | | | | | | | | | | | | | | | | | | | | | | | | | | | | | | | |
| | |

 | | | | | | | | | | | | | | | | | | | |

 | | | | | | | | | | | | | | | | | | | |

 | | | | | | | | | | | | | | | | | | | |

 | | | | | | | | | | | | | | | | | | | |

 | | | | | | | | | | | | | | | | | | | |

 | | | | | | | | | | | | | | | | | | | |

 | | | | | | | | | | | | | | | | | | | |

 | | | | | | | | | | | | | | | | | | | |

 | | | | | | | | | | | | | | | | | | | |

 | | | | | | | | | | | | | | | | | | | |

 | | | | | | | | | | | | | | | | | | | |

 | | | | | | | | | | | | | | | | | | | |

 | | | | | | | | | | | | | | | | | | | |

 | | | | | | | | | | | | | | | | | | | |

 | | | | | | | | | | | | | | | | | | | |

 | | | | | | | | | | | | | | | | | | | |

 | | | | | | | | | | | | | | | | | | | |

 | | | | | | | | | | | | | | | | | | | |

 | | | | | | | | | | | | | | | | | | | |

 | | | | | | | | | | | | | | | | | | | |

 | | | | | | | | | | | | | | | | | | | |

 | | | | | | | | | | | | | | | | | | | |

 | | | | | | | | | | | | | | | | | | | |

 | | | | | | | | | | | | | | | | | | | |

 | | | | | | | | | | | | | | | | | | | |

 | | | | | | | | | | | | | | | | | | | |

 | | | | | | | | | | | | | | | | | | | |

 | | | | | | | | | | | | | | | | | | | |
 | | | | | | | | | | | | | | | | | | | |

 | | | | | | | | | | | | | | | | | | | |

 | | | | | | | | | | | | | | | | | | | |
 | | | | | | | | | | | | | | | | | | | |

 | | | | | | | | | | | | | | | | | | | |

 | | | | | | | | | | | | | | | | | | | |
 | | | | | | | | | | | | | | | | | | | |
 | | | | | | | | | | | | | | | | | | | |

 | | | | | | | | | | | | | | | | | | | |
 | | | | | | | | | | | | | | | | | | | |
 | | | | | | | | | | | | | | | | | | | |

 | | | | | | | | | | | | | | | | | | | | | | | | | | | | | | | | | | | | | | | | | | | | | | | | | | | | | | | | | | | | | | | | | | | | | | | | | | | | | | | | | | | | | | | | | | | | | | | | | | | |
 | | | | | | | | | | | | | | | | | | | |
 | | | | | | | | | | | | | | | | | | | |
 | | | | | | | | | | | | | | | | | | | |
 | | | | | | | | | | | | | | | | | | | |
 | | | | | | | | | | | | | | | | | | | |
 | | | | | | | | | | | | | | | | | | | |
 | | | | | | | | | | | | | | | | | | | |
 | | | | | | | | | | | | | | | | | | | |
 | | | | | | | | | | | | | | | | | | | | | | | | | | | | | | | | | | | | | | | |
 | | | | | | | | | | | | | | | | | | | |
 | | | | | | | | | | | | | | | | | | | | | | | | | | | | | | | | | | | | | | | |
 | | | | | | | | | | | | | | | | | | | | | | | | | | | | | | | | | | | | | | | |
 | | | | | | | | | | | | | | | | | | | | | | | | | | | | | | | | | | | | | | | |
 | | | | | | | | | | | | | | | | | | | | | | | | | | | | | | | | | | | | | | | | | | | | | | | | | | | | | | | | | | | | | | | | | | | | | | | | | | | | | | | | | | | | | | | | | | | | | | | | | | | |
 | | | | | | | | | | | | | | | | | | | | | | | | | | | | | | | | | | | | | | | | | | | | | | | |
| | | <table border="1" style="width: 100%; border-collapse: collapse; text-align: center;"> <tr> <td style="width: 10%;"></td> <td style="width: 10%;"></td> <td style="width: 10%;"></td> <td style="width: 10%;"></td> <td style="width: 10%;"></td> <td style="width: 10%;"></td> <td style="width: 10%;"></td> <td style="width: 10%;"></td> <td style="width: 10%;"></td> <td style="width: 10%;"></td> </tr> <tr> <td></td> <td></td> <td colspan="8" style="text-align: center;"> <table border="1" style="width: 100%; border-collapse: collapse; text-align: center;"> <tr> <td style="width: 10%;"></td> <td style="width: 10%;"></td> <td style="width: 10%;"></td> <td style="width: 10%;"></td> <td style="width: 10%;"></td> <td style="width: 10%;"></td> <td style="width: 10%;"></td> <td style="width: 10%;"></td> <td style="width: 10%;"></td> <td style="width: 10%;"></td> </tr> <tr> <td></td> <td></td> <td colspan="8" style="text-align: center;"> <table border="1" style="width: 100%; border-collapse: collapse; text-align: center;"> <tr> <td style="width: 10%;"></td> <td style="width: 10%;"></td> <td style="width: 10%;"></td> <td style="width: 10%;"></td> <td style="width: 10%;"></td> <td style="width: 10%;"></td> <td style="width: 10%;"></td> <td style="width: 10%;"></td> <td style="width: 10%;"></td> <td style="width: 10%;"></td> </tr> <tr> <td></td> <td></td> <td colspan="8" style="text-align: center;"> <table border="1" style="width: 100%; border-collapse: collapse; text-align: center;"> <tr> <td style="width: 10%;"></td> <td style="width: 10%;"></td> <td style="width: 10%;"></td> <td style="width: 10%;"></td> <td style="width: 10%;"></td> <td style="width: 10%;"></td> <td style="width: 10%;"></td> <td style="width: 10%;"></td> <td style="width: 10%;"></td> <td style="width: 10%;"></td> </tr> <tr> <td></td> <td></td> <td colspan="8" style="text-align: center;"> <table border="1" style="width: 100%; border-collapse: collapse; text-align: center;"> <tr> <td style="width: 10%;"></td> <td style="width: 10%;"></td> <td style="width: 10%;"></td> <td style="width: 10%;"></td> <td style="width: 10%;"></td> <td style="width: 10%;"></td> <td style="width: 10%;"></td> <td style="width: 10%;"></td> <td style="width: 10%;"></td> <td style="width: 10%;"></td> </tr> <tr> <td></td> <td></td> <td colspan="8" style="text-align: center;"> <table border="1" style="width: 100%; border-collapse: collapse; text-align: center;"> <tr> <td style="width: 10%;"></td> <td style="width: 10%;"></td> <td style="width: 10%;"></td> <td style="width: 10%;"></td> <td style="width: 10%;"></td> <td style="width: 10%;"></td> <td style="width: 10%;"></td> <td style="width: 10%;"></td> <td style="width: 10%;"></td> <td style="width: 10%;"></td> </tr> <tr> <td></td> <td></td> <td colspan="8" style="text-align: center;"> <table border="1" style="width: 100%; border-collapse: collapse; text-align: center;"> <tr> <td style="width: 10%;"></td> <td style="width: 10%;"></td> <td style="width: 10%;"></td> <td style="width: 10%;"></td> <td style="width: 10%;"></td> <td style="width: 10%;"></td> <td style="width: 10%;"></td> <td style="width: 10%;"></td> <td style="width: 10%;"></td> <td style="width: 10%;"></td> </tr> <tr> <td></td> <td></td> <td colspan="8" style="text-align: center;"> <table border="1" style="width: 100%; border-collapse: collapse; text-align: center;"> <tr> <td style="width: 10%;"></td> <td style="width: 10%;"></td> <td style="width: 10%;"></td> <td style="width: 10%;"></td> <td style="width: 10%;"></td> <td style="width: 10%;"></td> <td style="width: 10%;"></td> <td style="width: 10%;"></td> <td style="width: 10%;"></td> <td style="width: 10%;"></td> </tr> <tr> <td></td> <td></td> <td colspan="8" style="text-align: center;"> <table border="1" style="width: 100%; border-collapse: collapse; text-align: center;"> <tr> <td style="width: 10%;"></td> <td style="width: 10%;"></td> <td style="width: 10%;"></td> <td style="width: 10%;"></td> <td style="width: 10%;"></td> <td style="width: 10%;"></td> <td style="width: 10%;"></td> <td style="width: 10%;"></td> <td style="width: 10%;"></td> <td style="width: 10%;"></td> </tr> <tr> <td></td> <td></td> <td colspan="8" style="text-align: center;"> <table border="1" style="width: 100%; border-collapse: collapse; text-align: center;"> <tr> </tr></table></td></tr></table></td></tr></table></td></tr></table></td></tr></table></td></tr></table></td></tr></table></td></tr></table></td></tr></table></td></tr></table>

 | | | | | | | | | | | | | | | | | | | | <table border="1" style="width: 100%; border-collapse: collapse; text-align: center;"> <tr> <td style="width: 10%;"></td> <td style="width: 10%;"></td> <td style="width: 10%;"></td> <td style="width: 10%;"></td> <td style="width: 10%;"></td> <td style="width: 10%;"></td> <td style="width: 10%;"></td> <td style="width: 10%;"></td> <td style="width: 10%;"></td> <td style="width: 10%;"></td> </tr> <tr> <td></td> <td></td> <td colspan="8" style="text-align: center;"> <table border="1" style="width: 100%; border-collapse: collapse; text-align: center;"> <tr> <td style="width: 10%;"></td> <td style="width: 10%;"></td> <td style="width: 10%;"></td> <td style="width: 10%;"></td> <td style="width: 10%;"></td> <td style="width: 10%;"></td> <td style="width: 10%;"></td> <td style="width: 10%;"></td> <td style="width: 10%;"></td> <td style="width: 10%;"></td> </tr> <tr> <td></td> <td></td> <td colspan="8" style="text-align: center;"> <table border="1" style="width: 100%; border-collapse: collapse; text-align: center;"> <tr> <td style="width: 10%;"></td> <td style="width: 10%;"></td> <td style="width: 10%;"></td> <td style="width: 10%;"></td> <td style="width: 10%;"></td> <td style="width: 10%;"></td> <td style="width: 10%;"></td> <td style="width: 10%;"></td> <td style="width: 10%;"></td> <td style="width: 10%;"></td> </tr> <tr> <td></td> <td></td> <td colspan="8" style="text-align: center;"> <table border="1" style="width: 100%; border-collapse: collapse; text-align: center;"> <tr> <td style="width: 10%;"></td> <td style="width: 10%;"></td> <td style="width: 10%;"></td> <td style="width: 10%;"></td> <td style="width: 10%;"></td> <td style="width: 10%;"></td> <td style="width: 10%;"></td> <td style="width: 10%;"></td> <td style="width: 10%;"></td> <td style="width: 10%;"></td> </tr> <tr> <td></td> <td></td> <td colspan="8" style="text-align: center;"> <table border="1" style="width: 100%; border-collapse: collapse; text-align: center;"> <tr> <td style="width: 10%;"></td> <td style="width: 10%;"></td> <td style="width: 10%;"></td> <td style="width: 10%;"></td> <td style="width: 10%;"></td> <td style="width: 10%;"></td> <td style="width: 10%;"></td> <td style="width: 10%;"></td> <td style="width: 10%;"></td> <td style="width: 10%;"></td> </tr> <tr> <td></td> <td></td> <td colspan="8" style="text-align: center;"> <table border="1" style="width: 100%; border-collapse: collapse; text-align: center;"> <tr> <td style="width: 10%;"></td> <td style="width: 10%;"></td> <td style="width: 10%;"></td> <td style="width: 10%;"></td> <td style="width: 10%;"></td> <td style="width: 10%;"></td> <td style="width: 10%;"></td> <td style="width: 10%;"></td> <td style="width: 10%;"></td> <td style="width: 10%;"></td> </tr> <tr> <td></td> <td></td> <td colspan="8" style="text-align: center;"> <table border="1" style="width: 100%; border-collapse: collapse; text-align: center;"> <tr> <td style="width: 10%;"></td> <td style="width: 10%;"></td> <td style="width: 10%;"></td> <td style="width: 10%;"></td> <td style="width: 10%;"></td> <td style="width: 10%;"></td> <td style="width: 10%;"></td> <td style="width: 10%;"></td> <td style="width: 10%;"></td> <td style="width: 10%;"></td> </tr> <tr> <td></td> <td></td> <td colspan="8" style="text-align: center;"> <table border="1" style="width: 100%; border-collapse: collapse; text-align: center;"> <tr> <td style="width: 10%;"></td> <td style="width: 10%;"></td> <td style="width: 10%;"></td> <td style="width: 10%;"></td> <td style="width: 10%;"></td> <td style="width: 10%;"></td> <td style="width: 10%;"></td> <td style="width: 10%;"></td> <td style="width: 10%;"></td> <td style="width: 10%;"></td> </tr> <tr> <td></td> <td></td> <td colspan="8" style="text-align: center;"> <table border="1" style="width: 100%; border-collapse: collapse; text-align: center;"> <tr> </tr></table></td></tr></table></td></tr></table></td></tr></table></td></tr></table></td></tr></table></td></tr></table></td></tr></table></td></tr></table>

 | | | | | | | | | | | | | | | | | | | | <table border="1" style="width: 100%; border-collapse: collapse; text-align: center;"> <tr> <td style="width: 10%;"></td> <td style="width: 10%;"></td> <td style="width: 10%;"></td> <td style="width: 10%;"></td> <td style="width: 10%;"></td> <td style="width: 10%;"></td> <td style="width: 10%;"></td> <td style="width: 10%;"></td> <td style="width: 10%;"></td> <td style="width: 10%;"></td> </tr> <tr> <td></td> <td></td> <td colspan="8" style="text-align: center;"> <table border="1" style="width: 100%; border-collapse: collapse; text-align: center;"> <tr> <td style="width: 10%;"></td> <td style="width: 10%;"></td> <td style="width: 10%;"></td> <td style="width: 10%;"></td> <td style="width: 10%;"></td> <td style="width: 10%;"></td> <td style="width: 10%;"></td> <td style="width: 10%;"></td> <td style="width: 10%;"></td> <td style="width: 10%;"></td> </tr> <tr> <td></td> <td></td> <td colspan="8" style="text-align: center;"> <table border="1" style="width: 100%; border-collapse: collapse; text-align: center;"> <tr> <td style="width: 10%;"></td> <td style="width: 10%;"></td> <td style="width: 10%;"></td> <td style="width: 10%;"></td> <td style="width: 10%;"></td> <td style="width: 10%;"></td> <td style="width: 10%;"></td> <td style="width: 10%;"></td> <td style="width: 10%;"></td> <td style="width: 10%;"></td> </tr> <tr> <td></td> <td></td> <td colspan="8" style="text-align: center;"> <table border="1" style="width: 100%; border-collapse: collapse; text-align: center;"> <tr> <td style="width: 10%;"></td> <td style="width: 10%;"></td> <td style="width: 10%;"></td> <td style="width: 10%;"></td> <td style="width: 10%;"></td> <td style="width: 10%;"></td> <td style="width: 10%;"></td> <td style="width: 10%;"></td> <td style="width: 10%;"></td> <td style="width: 10%;"></td> </tr> <tr> <td></td> <td></td> <td colspan="8" style="text-align: center;"> <table border="1" style="width: 100%; border-collapse: collapse; text-align: center;"> <tr> <td style="width: 10%;"></td> <td style="width: 10%;"></td> <td style="width: 10%;"></td> <td style="width: 10%;"></td> <td style="width: 10%;"></td> <td style="width: 10%;"></td> <td style="width: 10%;"></td> <td style="width: 10%;"></td> <td style="width: 10%;"></td> <td style="width: 10%;"></td> </tr> <tr> <td></td> <td></td> <td colspan="8" style="text-align: center;"> <table border="1" style="width: 100%; border-collapse: collapse; text-align: center;"> <tr> <td style="width: 10%;"></td> <td style="width: 10%;"></td> <td style="width: 10%;"></td> <td style="width: 10%;"></td> <td style="width: 10%;"></td> <td style="width: 10%;"></td> <td style="width: 10%;"></td> <td style="width: 10%;"></td> <td style="width: 10%;"></td> <td style="width: 10%;"></td> </tr> <tr> <td></td> <td></td> <td colspan="8" style="text-align: center;"> <table border="1" style="width: 100%; border-collapse: collapse; text-align: center;"> <tr> <td style="width: 10%;"></td> <td style="width: 10%;"></td> <td style="width: 10%;"></td> <td style="width: 10%;"></td> <td style="width: 10%;"></td> <td style="width: 10%;"></td> <td style="width: 10%;"></td> <td style="width: 10%;"></td> <td style="width: 10%;"></td> <td style="width: 10%;"></td> </tr> <tr> <td></td> <td></td> <td colspan="8" style="text-align: center;"> <table border="1" style="width: 100%; border-collapse: collapse; text-align: center;"> <tr> </tr></table></td></tr></table></td></tr></table></td></tr></table></td></tr></table></td></tr></table></td></tr></table></td></tr></table>

 | | | | | | | | | | | | | | | | | | | | <table border="1" style="width: 100%; border-collapse: collapse; text-align: center;"> <tr> <td style="width: 10%;"></td> <td style="width: 10%;"></td> <td style="width: 10%;"></td> <td style="width: 10%;"></td> <td style="width: 10%;"></td> <td style="width: 10%;"></td> <td style="width: 10%;"></td> <td style="width: 10%;"></td> <td style="width: 10%;"></td> <td style="width: 10%;"></td> </tr> <tr> <td></td> <td></td> <td colspan="8" style="text-align: center;"> <table border="1" style="width: 100%; border-collapse: collapse; text-align: center;"> <tr> <td style="width: 10%;"></td> <td style="width: 10%;"></td> <td style="width: 10%;"></td> <td style="width: 10%;"></td> <td style="width: 10%;"></td> <td style="width: 10%;"></td> <td style="width: 10%;"></td> <td style="width: 10%;"></td> <td style="width: 10%;"></td> <td style="width: 10%;"></td> </tr> <tr> <td></td> <td></td> <td colspan="8" style="text-align: center;"> <table border="1" style="width: 100%; border-collapse: collapse; text-align: center;"> <tr> <td style="width: 10%;"></td> <td style="width: 10%;"></td> <td style="width: 10%;"></td> <td style="width: 10%;"></td> <td style="width: 10%;"></td> <td style="width: 10%;"></td> <td style="width: 10%;"></td> <td style="width: 10%;"></td> <td style="width: 10%;"></td> <td style="width: 10%;"></td> </tr> <tr> <td></td> <td></td> <td colspan="8" style="text-align: center;"> <table border="1" style="width: 100%; border-collapse: collapse; text-align: center;"> <tr> <td style="width: 10%;"></td> <td style="width: 10%;"></td> <td style="width: 10%;"></td> <td style="width: 10%;"></td> <td style="width: 10%;"></td> <td style="width: 10%;"></td> <td style="width: 10%;"></td> <td style="width: 10%;"></td> <td style="width: 10%;"></td> <td style="width: 10%;"></td> </tr> <tr> <td></td> <td></td> <td colspan="8" style="text-align: center;"> <table border="1" style="width: 100%; border-collapse: collapse; text-align: center;"> <tr> <td style="width: 10%;"></td> <td style="width: 10%;"></td> <td style="width: 10%;"></td> <td style="width: 10%;"></td> <td style="width: 10%;"></td> <td style="width: 10%;"></td> <td style="width: 10%;"></td> <td style="width: 10%;"></td> <td style="width: 10%;"></td> <td style="width: 10%;"></td> </tr> <tr> <td></td> <td></td> <td colspan="8" style="text-align: center;"> <table border="1" style="width: 100%; border-collapse: collapse; text-align: center;"> <tr> <td style="width: 10%;"></td> <td style="width: 10%;"></td> <td style="width: 10%;"></td> <td style="width: 10%;"></td> <td style="width: 10%;"></td> <td style="width: 10%;"></td> <td style="width: 10%;"></td> <td style="width: 10%;"></td> <td style="width: 10%;"></td> <td style="width: 10%;"></td> </tr> <tr> <td></td> <td></td> <td colspan="8" style="text-align: center;"> <table border="1" style="width: 100%; border-collapse: collapse; text-align: center;"> <tr> </tr></table></td></tr></table></td></tr></table></td></tr></table></td></tr></table></td></tr></table></td></tr></table>

 | | | | | | | | | | | | | | | | | | | | <table border="1" style="width: 100%; border-collapse: collapse; text-align: center;"> <tr> <td style="width: 10%;"></td> <td style="width: 10%;"></td> <td style="width: 10%;"></td> <td style="width: 10%;"></td> <td style="width: 10%;"></td> <td style="width: 10%;"></td> <td style="width: 10%;"></td> <td style="width: 10%;"></td> <td style="width: 10%;"></td> <td style="width: 10%;"></td> </tr> <tr> <td></td> <td></td> <td colspan="8" style="text-align: center;"> <table border="1" style="width: 100%; border-collapse: collapse; text-align: center;"> <tr> <td style="width: 10%;"></td> <td style="width: 10%;"></td> <td style="width: 10%;"></td> <td style="width: 10%;"></td> <td style="width: 10%;"></td> <td style="width: 10%;"></td> <td style="width: 10%;"></td> <td style="width: 10%;"></td> <td style="width: 10%;"></td> <td style="width: 10%;"></td> </tr> <tr> <td></td> <td></td> <td colspan="8" style="text-align: center;"> <table border="1" style="width: 100%; border-collapse: collapse; text-align: center;"> <tr> <td style="width: 10%;"></td> <td style="width: 10%;"></td> <td style="width: 10%;"></td> <td style="width: 10%;"></td> <td style="width: 10%;"></td> <td style="width: 10%;"></td> <td style="width: 10%;"></td> <td style="width: 10%;"></td> <td style="width: 10%;"></td> <td style="width: 10%;"></td> </tr> <tr> <td></td> <td></td> <td colspan="8" style="text-align: center;"> <table border="1" style="width: 100%; border-collapse: collapse; text-align: center;"> <tr> <td style="width: 10%;"></td> <td style="width: 10%;"></td> <td style="width: 10%;"></td> <td style="width: 10%;"></td> <td style="width: 10%;"></td> <td style="width: 10%;"></td> <td style="width: 10%;"></td> <td style="width: 10%;"></td> <td style="width: 10%;"></td> <td style="width: 10%;"></td> </tr> <tr> <td></td> <td></td> <td colspan="8" style="text-align: center;"> <table border="1" style="width: 100%; border-collapse: collapse; text-align: center;"> <tr> <td style="width: 10%;"></td> <td style="width: 10%;"></td> <td style="width: 10%;"></td> <td style="width: 10%;"></td> <td style="width: 10%;"></td> <td style="width: 10%;"></td> <td style="width: 10%;"></td> <td style="width: 10%;"></td> <td style="width: 10%;"></td> <td style="width: 10%;"></td> </tr> <tr> <td></td> <td></td> <td colspan="8" style="text-align: center;"> <table border="1" style="width: 100%; border-collapse: collapse; text-align: center;"> <tr> </tr></table></td></tr></table></td></tr></table></td></tr></table></td></tr></table></td></tr></table>

 | | | | | | | | | | | | | | | | | | | | <table border="1" style="width: 100%; border-collapse: collapse; text-align: center;"> <tr> <td style="width: 10%;"></td> <td style="width: 10%;"></td> <td style="width: 10%;"></td> <td style="width: 10%;"></td> <td style="width: 10%;"></td> <td style="width: 10%;"></td> <td style="width: 10%;"></td> <td style="width: 10%;"></td> <td style="width: 10%;"></td> <td style="width: 10%;"></td> </tr> <tr> <td></td> <td></td> <td colspan="8" style="text-align: center;"> <table border="1" style="width: 100%; border-collapse: collapse; text-align: center;"> <tr> <td style="width: 10%;"></td> <td style="width: 10%;"></td> <td style="width: 10%;"></td> <td style="width: 10%;"></td> <td style="width: 10%;"></td> <td style="width: 10%;"></td> <td style="width: 10%;"></td> <td style="width: 10%;"></td> <td style="width: 10%;"></td> <td style="width: 10%;"></td> </tr> <tr> <td></td> <td></td> <td colspan="8" style="text-align: center;"> <table border="1" style="width: 100%; border-collapse: collapse; text-align: center;"> <tr> <td style="width: 10%;"></td> <td style="width: 10%;"></td> <td style="width: 10%;"></td> <td style="width: 10%;"></td> <td style="width: 10%;"></td> <td style="width: 10%;"></td> <td style="width: 10%;"></td> <td style="width: 10%;"></td> <td style="width: 10%;"></td> <td style="width: 10%;"></td> </tr> <tr> <td></td> <td></td> <td colspan="8" style="text-align: center;"> <table border="1" style="width: 100%; border-collapse: collapse; text-align: center;"> <tr> <td style="width: 10%;"></td> <td style="width: 10%;"></td> <td style="width: 10%;"></td> <td style="width: 10%;"></td> <td style="width: 10%;"></td> <td style="width: 10%;"></td> <td style="width: 10%;"></td> <td style="width: 10%;"></td> <td style="width: 10%;"></td> <td style="width: 10%;"></td> </tr> <tr> <td></td> <td></td> <td colspan="8" style="text-align: center;"> <table border="1" style="width: 100%; border-collapse: collapse; text-align: center;"> <tr> </tr></table></td></tr></table></td></tr></table></td></tr></table></td></tr></table>

 | | | | | | | | | | | | | | | | | | | | <table border="1" style="width: 100%; border-collapse: collapse; text-align: center;"> <tr> <td style="width: 10%;"></td> <td style="width: 10%;"></td> <td style="width: 10%;"></td> <td style="width: 10%;"></td> <td style="width: 10%;"></td> <td style="width: 10%;"></td> <td style="width: 10%;"></td> <td style="width: 10%;"></td> <td style="width: 10%;"></td> <td style="width: 10%;"></td> </tr> <tr> <td></td> <td></td> <td colspan="8" style="text-align: center;"> <table border="1" style="width: 100%; border-collapse: collapse; text-align: center;"> <tr> <td style="width: 10%;"></td> <td style="width: 10%;"></td> <td style="width: 10%;"></td> <td style="width: 10%;"></td> <td style="width: 10%;"></td> <td style="width: 10%;"></td> <td style="width: 10%;"></td> <td style="width: 10%;"></td> <td style="width: 10%;"></td> <td style="width: 10%;"></td> </tr> <tr> <td></td> <td></td> <td colspan="8" style="text-align: center;"> <table border="1" style="width: 100%; border-collapse: collapse; text-align: center;"> <tr> <td style="width: 10%;"></td> <td style="width: 10%;"></td> <td style="width: 10%;"></td> <td style="width: 10%;"></td> <td style="width: 10%;"></td> <td style="width: 10%;"></td> <td style="width: 10%;"></td> <td style="width: 10%;"></td> <td style="width: 10%;"></td> <td style="width: 10%;"></td> </tr> <tr> <td></td> <td></td> <td colspan="8" style="text-align: center;"> <table border="1" style="width: 100%; border-collapse: collapse; text-align: center;"> <tr> </tr></table></td></tr></table></td></tr></table></td></tr></table>

 | | | | | | | | | | | | | | | | | | | | <table border="1" style="width: 100%; border-collapse: collapse; text-align: center;"> <tr> <td style="width: 10%;"></td> <td style="width: 10%;"></td> <td style="width: 10%;"></td> <td style="width: 10%;"></td> <td style="width: 10%;"></td> <td style="width: 10%;"></td> <td style="width: 10%;"></td> <td style="width: 10%;"></td> <td style="width: 10%;"></td> <td style="width: 10%;"></td> </tr> <tr> <td></td> <td></td> <td colspan="8" style="text-align: center;"> <table border="1" style="width: 100%; border-collapse: collapse; text-align: center;"> <tr> <td style="width: 10%;"></td> <td style="width: 10%;"></td> <td style="width: 10%;"></td> <td style="width: 10%;"></td> <td style="width: 10%;"></td> <td style="width: 10%;"></td> <td style="width: 10%;"></td> <td style="width: 10%;"></td> <td style="width: 10%;"></td> <td style="width: 10%;"></td> </tr> <tr> <td></td> <td></td> <td colspan="8" style="text-align: center;"> <table border="1" style="width: 100%; border-collapse: collapse; text-align: center;"> <tr> </tr></table></td></tr></table></td></tr></table>

 | | | | | | | | | | | | | | | | | | | | <table border="1" style="width: 100%; border-collapse: collapse; text-align: center;"> <tr> <td style="width: 10%;"></td> <td style="width: 10%;"></td> <td style="width: 10%;"></td> <td style="width: 10%;"></td> <td style="width: 10%;"></td> <td style="width: 10%;"></td> <td style="width: 10%;"></td> <td style="width: 10%;"></td> <td style="width: 10%;"></td> <td style="width: 10%;"></td> </tr> <tr> <td></td> <td></td> <td colspan="8" style="text-align: center;"> <table border="1" style="width: 100%; border-collapse: collapse; text-align: center;"> <tr> </tr></table></td></tr></table>

 | | | | | | | | | | | | | | | | | | | | <table border="1" style="width: 100%; border-collapse: collapse; text-align: center;"> <tr> </tr></table>

 | | | | | | | | | | | | | | | | | | | |

 | | | | | | | | | | | | | | | | | | | |

 | | | | | | | | | | | | | | | | | | | |

 | | | | | | | | | | | | | | | | | | | |

 | | | | | | | | | | | | | | | | | | | |

 | | | | | | | | | | | | | | | | | | | |

 | | | | | | | | | | | | | | | | | | | |

 | | | | | | | | | | | | | | | | | | | |

 | | | | | | | | | | | | | | | | | | | |

 | | | | | | | | | | | | | | | | | | | |

 | | | | | | | | | | | | | | | | | | | |

 | | | | | | | | | | | | | | | | | | | |

 | | | | | | | | | | | | | | | | | | | |

 | | | | | | | | | | | | | | | | | | | |

 | | | | | | | | | | | | | | | | | | | |

 | | | | | | | | | | | | | | | | | | | |

 | | | | | | | | | | | | | | | | | | | |

 | | | | | | | | | | | | | | | | | | | |

 | | | | | | | | | | | | | | | | | | | |
 | | | | | | | | | | | | | | | | | | | |

 | | | | | | | | | | | | | | | | | | | |

 | | | | | | | | | | | | | | | | | | | |
 | | | | | | | | | | | | | | | | | | | |

 | | | | | | | | | | | | | | | | | | | |

 | | | | | | | | | | | | | | | | | | | |
 | | | | | | | | | | | | | | | | | | | |
 | | | | | | | | | | | | | | | | | | | |

 | | | | | | | | | | | | | | | | | | | |
 | | | | | | | | | | | | | | | | | | | |
 | | | | | | | | | | | | | | | | | | | |

 | | | | | | | | | | | | | | | | | | | | | | | | | | | | | | | | | | | | | | | | | | | | | | | | | | | | | | | | | | | | | | | | | | | | | | | | | | | | | | | | | | | | | | | | | | | | | | | | | | | |
 | | | | | | | | | | | | | | | | | | | |
 | | | | | | | | | | | | | | | | | | | |
 | | | | | | | | | | | | | | | | | | | |
 | | | | | | | | | | | | | | | | | | | |
 | | | | | | | | | | | | | | | | | | | |
 | | | | | | | | | | | | | | | | | | | |
 | | | | | | | | | | | | | | | | | | | |
 | | | | | | | | | | | | | | | | | | | |
 | | | | | | | | | | | | | | | | | | | | | | | | | | | | | | | | | | | | | | | |
 | | | | | | | | | | | | | | | | | | | |
 | | | | | | | | | | | | | | | | | | | | | | | | | | | | | | | | | | | | | | | |
 | | | | | | | | | | | | | | | | | | | | | | | | | | | | | | | | | | | | | | | |
 | | | | | | | | | | | | | | | | | | | | | | | | | | | | | | | | | | | | | | | |
 | | | | | | | | | | | | | | | | | | | | | | | | | | | | | | | | | | | | | | | | | | | | | | | | | | | | | | | | | | | | | | | | | | | | | | | | | | | | | | | | | | | | | | | | | | | | | | | | | | | |
 | | | | | | | | | | | | | | | | | | | | | | | | | | | | | | | | | | | | | | | | | | | | | | | |
| | |

 | | | | | | | | | | | | | | | | | | | |

 | | | | | | | | | | | | | | | | | | | |

 | | | | | | | | | | | | | | | | | | | |

 | | | | | | | | | | | | | | | | | | | |

 | | | | | | | | | | | | | | | | | | | |

 | | | | | | | | | | | | | | | | | | | |

 | | | | | | | | | | | | | | | | | | | |

 | | | | | | | | | | | | | | | | | | | |

 | | | | | | | | | | | | | | | | | | | |

 | | | | | | | | | | | | | | | | | | | |

 | | | | | | | | | | | | | | | | | | | |

 | | | | | | | | | | | | | | | | | | | |

 | | | | | | | | | | | | | | | | | | | |

 | | | | | | | | | | | | | | | | | | | |

 | | | | | | | | | | | | | | | | | | | |

 | | | | | | | | | | | | | | | | | | | |

 | | | | | | | | | | | | | | | | | | | |

 | | | | | | | | | | | | | | | | | | | |

 | | | | | | | | | | | | | | | | | | | |

 | | | | | | | | | | | | | | | | | | | |

 | | | | | | | | | | | | | | | | | | | |

 | | | | | | | | | | | | | | | | | | | |

 | | | | | | | | | | | | | | | | | | | |

 | | | | | | | | | | | | | | | | | | | |

 | | | | | | | | | | | | | | | | | | | |

 | | | | | | | | | | | | | | | | | | | |

 | | | | | | | | | | | | | | | | | | | |

 | | | | | | | | | | | | | | | | | | | |
 | | | | | | | | | | | | | | | | | | | |

 | | | | | | | | | | | | | | | | | | | |

 | | | | | | | | | | | | | | | | | | | |
 | | | | | | | | | | | | | | | | | | | |

 | | | | | | | | | | | | | | | | | | | |

 | | | | | | | | | | | | | | | | | | | |
 | | | | | | | | | | | | | | | | | | | |
 | | | | | | | | | | | | | | | | | | | |

 | | | | | | | | | | | | | | | | | | | |
 | | | | | | | | | | | | | | | | | | | |
 | | | | | | | | | | | | | | | | | | | |

 | | | | | | | | | | | | | | | | | | | | | | | | | | | | | | | | | | | | | | | | | | | | | | | | | | | | | | | | | | | | | | | | | | | | | | | | | | | | | | | | | | | | | | | | | | | | | | | | | | | |
 | | | | | | | | | | | | | | | | | | | |
 | | | | | | | | | | | | | | | | | | | |
 | | | | | | | | | | | | | | | | | | | |
 | | | | | | | | | | | | | | | | | | | |
 | | | | | | | | | | | | | | | | | | | |
 | | | | | | | | | | | | | | | | | | | |
 | | | | | | | | | | | | | | | | | | | |
 | | | | | | | | | | | | | | | | | | | |
 | | | | | | | | | | | | | | | | | | | | | | | | | | | | | | | | | | | | | | | |
 | | | | | | | | | | | | | | | | | | | |
 | | | | | | | | | | | | | | | | | | | | | | | | | | | | | | | | | | | | | | | |
 | | | | | | | | | | | | | | | | | | | | | | | | | | | | | | | | | | | | | | | |
 | | | | | | | | | | | | | | | | | | | | | | | | | | | | | | | | | | | | | | | |
 | | | | | | | | | | | | | | | | | | | | | | | | | | | | | | | | | | | | | | | | | | | | | | | | | | | | | | | | | | | | | | | | | | | | | | | | | | | | | | | | | | | | | | | | | | | | | | | | | | | |
 | | | | | | | | | | | | | | | | | | | | | | | | | | | | | | | | | | | | | | | | | | | | | | | |
| | | <table border="1" style="width: 100%; border-collapse: collapse; text-align: center;"> <tr> <td style="width: 10%;"></td> <td style="width: 10%;"></td> <td style="width: 10%;"></td> <td style="width: 10%;"></td> <td style="width: 10%;"></td> <td style="width: 10%;"></td> <td style="width: 10%;"></td> <td style="width: 10%;"></td> <td style="width: 10%;"></td> <td style="width: 10%;"></td> </tr> <tr> <td></td> <td></td> <td colspan="8" style="text-align: center;"> <table border="1" style="width: 100%; border-collapse: collapse; text-align: center;"> <tr> <td style="width: 10%;"></td> <td style="width: 10%;"></td> <td style="width: 10%;"></td> <td style="width: 10%;"></td> <td style="width: 10%;"></td> <td style="width: 10%;"></td> <td style="width: 10%;"></td> <td style="width: 10%;"></td> <td style="width: 10%;"></td> <td style="width: 10%;"></td> </tr> <tr> <td></td> <td></td> <td colspan="8" style="text-align: center;"> <table border="1" style="width: 100%; border-collapse: collapse; text-align: center;"> <tr> <td style="width: 10%;"></td> <td style="width: 10%;"></td> <td style="width: 10%;"></td> <td style="width: 10%;"></td> <td style="width: 10%;"></td> <td style="width: 10%;"></td> <td style="width: 10%;"></td> <td style="width: 10%;"></td> <td style="width: 10%;"></td> <td style="width: 10%;"></td> </tr> <tr> <td></td> <td></td> <td colspan="8" style="text-align: center;"> <table border="1" style="width: 100%; border-collapse: collapse; text-align: center;"> <tr> <td style="width: 10%;"></td> <td style="width: 10%;"></td> <td style="width: 10%;"></td> <td style="width: 10%;"></td> <td style="width: 10%;"></td> <td style="width: 10%;"></td> <td style="width: 10%;"></td> <td style="width: 10%;"></td> <td style="width: 10%;"></td> <td style="width: 10%;"></td> </tr> <tr> <td></td> <td></td> <td colspan="8" style="text-align: center;"> <table border="1" style="width: 100%; border-collapse: collapse; text-align: center;"> <tr> <td style="width: 10%;"></td> <td style="width: 10%;"></td> <td style="width: 10%;"></td> <td style="width: 10%;"></td> <td style="width: 10%;"></td> <td style="width: 10%;"></td> <td style="width: 10%;"></td> <td style="width: 10%;"></td> <td style="width: 10%;"></td> <td style="width: 10%;"></td> </tr> <tr> <td></td> <td></td> <td colspan="8" style="text-align: center;"> <table border="1" style="width: 100%; border-collapse: collapse; text-align: center;"> <tr> <td style="width: 10%;"></td> <td style="width: 10%;"></td> <td style="width: 10%;"></td> <td style="width: 10%;"></td> <td style="width: 10%;"></td> <td style="width: 10%;"></td> <td style="width: 10%;"></td> <td style="width: 10%;"></td> <td style="width: 10%;"></td> <td style="width: 10%;"></td> </tr> <tr> <td></td> <td></td> <td colspan="8" style="text-align: center;"> <table border="1" style="width: 100%; border-collapse: collapse; text-align: center;"> <tr> <td style="width: 10%;"></td> <td style="width: 10%;"></td> <td style="width: 10%;"></td> <td style="width: 10%;"></td> <td style="width: 10%;"></td> <td style="width: 10%;"></td> <td style="width: 10%;"></td> <td style="width: 10%;"></td> <td style="width: 10%;"></td> <td style="width: 10%;"></td> </tr> <tr> <td></td> <td></td> <td colspan="8" style="text-align: center;"> <table border="1" style="width: 100%; border-collapse: collapse; text-align: center;"> <tr> <td style="width: 10%;"></td> <td style="width: 10%;"></td> <td style="width: 10%;"></td> <td style="width: 10%;"></td> <td style="width: 10%;"></td> <td style="width: 10%;"></td> <td style="width: 10%;"></td> <td style="width: 10%;"></td> <td style="width: 10%;"></td> <td style="width: 10%;"></td> </tr> <tr> <td></td> <td></td> <td colspan="8" style="text-align: center;"> <table border="1" style="width: 100%; border-collapse: collapse; text-align: center;"> <tr> </tr></table></td></tr></table></td></tr></table></td></tr></table></td></tr></table></td></tr></table></td></tr></table></td></tr></table></td></tr></table>

 | | | | | | | | | | | | | | | | | | | | <table border="1" style="width: 100%; border-collapse: collapse; text-align: center;"> <tr> <td style="width: 10%;"></td> <td style="width: 10%;"></td> <td style="width: 10%;"></td> <td style="width: 10%;"></td> <td style="width: 10%;"></td> <td style="width: 10%;"></td> <td style="width: 10%;"></td> <td style="width: 10%;"></td> <td style="width: 10%;"></td> <td style="width: 10%;"></td> </tr> <tr> <td></td> <td></td> <td colspan="8" style="text-align: center;"> <table border="1" style="width: 100%; border-collapse: collapse; text-align: center;"> <tr> <td style="width: 10%;"></td> <td style="width: 10%;"></td> <td style="width: 10%;"></td> <td style="width: 10%;"></td> <td style="width: 10%;"></td> <td style="width: 10%;"></td> <td style="width: 10%;"></td> <td style="width: 10%;"></td> <td style="width: 10%;"></td> <td style="width: 10%;"></td> </tr> <tr> <td></td> <td></td> <td colspan="8" style="text-align: center;"> <table border="1" style="width: 100%; border-collapse: collapse; text-align: center;"> <tr> <td style="width: 10%;"></td> <td style="width: 10%;"></td> <td style="width: 10%;"></td> <td style="width: 10%;"></td> <td style="width: 10%;"></td> <td style="width: 10%;"></td> <td style="width: 10%;"></td> <td style="width: 10%;"></td> <td style="width: 10%;"></td> <td style="width: 10%;"></td> </tr> <tr> <td></td> <td></td> <td colspan="8" style="text-align: center;"> <table border="1" style="width: 100%; border-collapse: collapse; text-align: center;"> <tr> <td style="width: 10%;"></td> <td style="width: 10%;"></td> <td style="width: 10%;"></td> <td style="width: 10%;"></td> <td style="width: 10%;"></td> <td style="width: 10%;"></td> <td style="width: 10%;"></td> <td style="width: 10%;"></td> <td style="width: 10%;"></td> <td style="width: 10%;"></td> </tr> <tr> <td></td> <td></td> <td colspan="8" style="text-align: center;"> <table border="1" style="width: 100%; border-collapse: collapse; text-align: center;"> <tr> <td style="width: 10%;"></td> <td style="width: 10%;"></td> <td style="width: 10%;"></td> <td style="width: 10%;"></td> <td style="width: 10%;"></td> <td style="width: 10%;"></td> <td style="width: 10%;"></td> <td style="width: 10%;"></td> <td style="width: 10%;"></td> <td style="width: 10%;"></td> </tr> <tr> <td></td> <td></td> <td colspan="8" style="text-align: center;"> <table border="1" style="width: 100%; border-collapse: collapse; text-align: center;"> <tr> <td style="width: 10%;"></td> <td style="width: 10%;"></td> <td style="width: 10%;"></td> <td style="width: 10%;"></td> <td style="width: 10%;"></td> <td style="width: 10%;"></td> <td style="width: 10%;"></td> <td style="width: 10%;"></td> <td style="width: 10%;"></td> <td style="width: 10%;"></td> </tr> <tr> <td></td> <td></td> <td colspan="8" style="text-align: center;"> <table border="1" style="width: 100%; border-collapse: collapse; text-align: center;"> <tr> <td style="width: 10%;"></td> <td style="width: 10%;"></td> <td style="width: 10%;"></td> <td style="width: 10%;"></td> <td style="width: 10%;"></td> <td style="width: 10%;"></td> <td style="width: 10%;"></td> <td style="width: 10%;"></td> <td style="width: 10%;"></td> <td style="width: 10%;"></td> </tr> <tr> <td></td> <td></td> <td colspan="8" style="text-align: center;"> <table border="1" style="width: 100%; border-collapse: collapse; text-align: center;"> <tr> </tr></table></td></tr></table></td></tr></table></td></tr></table></td></tr></table></td></tr></table></td></tr></table></td></tr></table>

 | | | | | | | | | | | | | | | | | | | | <table border="1" style="width: 100%; border-collapse: collapse; text-align: center;"> <tr> <td style="width: 10%;"></td> <td style="width: 10%;"></td> <td style="width: 10%;"></td> <td style="width: 10%;"></td> <td style="width: 10%;"></td> <td style="width: 10%;"></td> <td style="width: 10%;"></td> <td style="width: 10%;"></td> <td style="width: 10%;"></td> <td style="width: 10%;"></td> </tr> <tr> <td></td> <td></td> <td colspan="8" style="text-align: center;"> <table border="1" style="width: 100%; border-collapse: collapse; text-align: center;"> <tr> <td style="width: 10%;"></td> <td style="width: 10%;"></td> <td style="width: 10%;"></td> <td style="width: 10%;"></td> <td style="width: 10%;"></td> <td style="width: 10%;"></td> <td style="width: 10%;"></td> <td style="width: 10%;"></td> <td style="width: 10%;"></td> <td style="width: 10%;"></td> </tr> <tr> <td></td> <td></td> <td colspan="8" style="text-align: center;"> <table border="1" style="width: 100%; border-collapse: collapse; text-align: center;"> <tr> <td style="width: 10%;"></td> <td style="width: 10%;"></td> <td style="width: 10%;"></td> <td style="width: 10%;"></td> <td style="width: 10%;"></td> <td style="width: 10%;"></td> <td style="width: 10%;"></td> <td style="width: 10%;"></td> <td style="width: 10%;"></td> <td style="width: 10%;"></td> </tr> <tr> <td></td> <td></td> <td colspan="8" style="text-align: center;"> <table border="1" style="width: 100%; border-collapse: collapse; text-align: center;"> <tr> <td style="width: 10%;"></td> <td style="width: 10%;"></td> <td style="width: 10%;"></td> <td style="width: 10%;"></td> <td style="width: 10%;"></td> <td style="width: 10%;"></td> <td style="width: 10%;"></td> <td style="width: 10%;"></td> <td style="width: 10%;"></td> <td style="width: 10%;"></td> </tr> <tr> <td></td> <td></td> <td colspan="8" style="text-align: center;"> <table border="1" style="width: 100%; border-collapse: collapse; text-align: center;"> <tr> <td style="width: 10%;"></td> <td style="width: 10%;"></td> <td style="width: 10%;"></td> <td style="width: 10%;"></td> <td style="width: 10%;"></td> <td style="width: 10%;"></td> <td style="width: 10%;"></td> <td style="width: 10%;"></td> <td style="width: 10%;"></td> <td style="width: 10%;"></td> </tr> <tr> <td></td> <td></td> <td colspan="8" style="text-align: center;"> <table border="1" style="width: 100%; border-collapse: collapse; text-align: center;"> <tr> <td style="width: 10%;"></td> <td style="width: 10%;"></td> <td style="width: 10%;"></td> <td style="width: 10%;"></td> <td style="width: 10%;"></td> <td style="width: 10%;"></td> <td style="width: 10%;"></td> <td style="width: 10%;"></td> <td style="width: 10%;"></td> <td style="width: 10%;"></td> </tr> <tr> <td></td> <td></td> <td colspan="8" style="text-align: center;"> <table border="1" style="width: 100%; border-collapse: collapse; text-align: center;"> <tr> </tr></table></td></tr></table></td></tr></table></td></tr></table></td></tr></table></td></tr></table></td></tr></table>

 | | | | | | | | | | | | | | | | | | | | <table border="1" style="width: 100%; border-collapse: collapse; text-align: center;"> <tr> <td style="width: 10%;"></td> <td style="width: 10%;"></td> <td style="width: 10%;"></td> <td style="width: 10%;"></td> <td style="width: 10%;"></td> <td style="width: 10%;"></td> <td style="width: 10%;"></td> <td style="width: 10%;"></td> <td style="width: 10%;"></td> <td style="width: 10%;"></td> </tr> <tr> <td></td> <td></td> <td colspan="8" style="text-align: center;"> <table border="1" style="width: 100%; border-collapse: collapse; text-align: center;"> <tr> <td style="width: 10%;"></td> <td style="width: 10%;"></td> <td style="width: 10%;"></td> <td style="width: 10%;"></td> <td style="width: 10%;"></td> <td style="width: 10%;"></td> <td style="width: 10%;"></td> <td style="width: 10%;"></td> <td style="width: 10%;"></td> <td style="width: 10%;"></td> </tr> <tr> <td></td> <td></td> <td colspan="8" style="text-align: center;"> <table border="1" style="width: 100%; border-collapse: collapse; text-align: center;"> <tr> <td style="width: 10%;"></td> <td style="width: 10%;"></td> <td style="width: 10%;"></td> <td style="width: 10%;"></td> <td style="width: 10%;"></td> <td style="width: 10%;"></td> <td style="width: 10%;"></td> <td style="width: 10%;"></td> <td style="width: 10%;"></td> <td style="width: 10%;"></td> </tr> <tr> <td></td> <td></td> <td colspan="8" style="text-align: center;"> <table border="1" style="width: 100%; border-collapse: collapse; text-align: center;"> <tr> <td style="width: 10%;"></td> <td style="width: 10%;"></td> <td style="width: 10%;"></td> <td style="width: 10%;"></td> <td style="width: 10%;"></td> <td style="width: 10%;"></td> <td style="width: 10%;"></td> <td style="width: 10%;"></td> <td style="width: 10%;"></td> <td style="width: 10%;"></td> </tr> <tr> <td></td> <td></td> <td colspan="8" style="text-align: center;"> <table border="1" style="width: 100%; border-collapse: collapse; text-align: center;"> <tr> <td style="width: 10%;"></td> <td style="width: 10%;"></td> <td style="width: 10%;"></td> <td style="width: 10%;"></td> <td style="width: 10%;"></td> <td style="width: 10%;"></td> <td style="width: 10%;"></td> <td style="width: 10%;"></td> <td style="width: 10%;"></td> <td style="width: 10%;"></td> </tr> <tr> <td></td> <td></td> <td colspan="8" style="text-align: center;"> <table border="1" style="width: 100%; border-collapse: collapse; text-align: center;"> <tr> </tr></table></td></tr></table></td></tr></table></td></tr></table></td></tr></table></td></tr></table>

 | | | | | | | | | | | | | | | | | | | | <table border="1" style="width: 100%; border-collapse: collapse; text-align: center;"> <tr> <td style="width: 10%;"></td> <td style="width: 10%;"></td> <td style="width: 10%;"></td> <td style="width: 10%;"></td> <td style="width: 10%;"></td> <td style="width: 10%;"></td> <td style="width: 10%;"></td> <td style="width: 10%;"></td> <td style="width: 10%;"></td> <td style="width: 10%;"></td> </tr> <tr> <td></td> <td></td> <td colspan="8" style="text-align: center;"> <table border="1" style="width: 100%; border-collapse: collapse; text-align: center;"> <tr> <td style="width: 10%;"></td> <td style="width: 10%;"></td> <td style="width: 10%;"></td> <td style="width: 10%;"></td> <td style="width: 10%;"></td> <td style="width: 10%;"></td> <td style="width: 10%;"></td> <td style="width: 10%;"></td> <td style="width: 10%;"></td> <td style="width: 10%;"></td> </tr> <tr> <td></td> <td></td> <td colspan="8" style="text-align: center;"> <table border="1" style="width: 100%; border-collapse: collapse; text-align: center;"> <tr> <td style="width: 10%;"></td> <td style="width: 10%;"></td> <td style="width: 10%;"></td> <td style="width: 10%;"></td> <td style="width: 10%;"></td> <td style="width: 10%;"></td> <td style="width: 10%;"></td> <td style="width: 10%;"></td> <td style="width: 10%;"></td> <td style="width: 10%;"></td> </tr> <tr> <td></td> <td></td> <td colspan="8" style="text-align: center;"> <table border="1" style="width: 100%; border-collapse: collapse; text-align: center;"> <tr> <td style="width: 10%;"></td> <td style="width: 10%;"></td> <td style="width: 10%;"></td> <td style="width: 10%;"></td> <td style="width: 10%;"></td> <td style="width: 10%;"></td> <td style="width: 10%;"></td> <td style="width: 10%;"></td> <td style="width: 10%;"></td> <td style="width: 10%;"></td> </tr> <tr> <td></td> <td></td> <td colspan="8" style="text-align: center;"> <table border="1" style="width: 100%; border-collapse: collapse; text-align: center;"> <tr> </tr></table></td></tr></table></td></tr></table></td></tr></table></td></tr></table>

 | | | | | | | | | | | | | | | | | | | | <table border="1" style="width: 100%; border-collapse: collapse; text-align: center;"> <tr> <td style="width: 10%;"></td> <td style="width: 10%;"></td> <td style="width: 10%;"></td> <td style="width: 10%;"></td> <td style="width: 10%;"></td> <td style="width: 10%;"></td> <td style="width: 10%;"></td> <td style="width: 10%;"></td> <td style="width: 10%;"></td> <td style="width: 10%;"></td> </tr> <tr> <td></td> <td></td> <td colspan="8" style="text-align: center;"> <table border="1" style="width: 100%; border-collapse: collapse; text-align: center;"> <tr> <td style="width: 10%;"></td> <td style="width: 10%;"></td> <td style="width: 10%;"></td> <td style="width: 10%;"></td> <td style="width: 10%;"></td> <td style="width: 10%;"></td> <td style="width: 10%;"></td> <td style="width: 10%;"></td> <td style="width: 10%;"></td> <td style="width: 10%;"></td> </tr> <tr> <td></td> <td></td> <td colspan="8" style="text-align: center;"> <table border="1" style="width: 100%; border-collapse: collapse; text-align: center;"> <tr> <td style="width: 10%;"></td> <td style="width: 10%;"></td> <td style="width: 10%;"></td> <td style="width: 10%;"></td> <td style="width: 10%;"></td> <td style="width: 10%;"></td> <td style="width: 10%;"></td> <td style="width: 10%;"></td> <td style="width: 10%;"></td> <td style="width: 10%;"></td> </tr> <tr> <td></td> <td></td> <td colspan="8" style="text-align: center;"> <table border="1" style="width: 100%; border-collapse: collapse; text-align: center;"> <tr> </tr></table></td></tr></table></td></tr></table></td></tr></table>

 | | | | | | | | | | | | | | | | | | | | <table border="1" style="width: 100%; border-collapse: collapse; text-align: center;"> <tr> <td style="width: 10%;"></td> <td style="width: 10%;"></td> <td style="width: 10%;"></td> <td style="width: 10%;"></td> <td style="width: 10%;"></td> <td style="width: 10%;"></td> <td style="width: 10%;"></td> <td style="width: 10%;"></td> <td style="width: 10%;"></td> <td style="width: 10%;"></td> </tr> <tr> <td></td> <td></td> <td colspan="8" style="text-align: center;"> <table border="1" style="width: 100%; border-collapse: collapse; text-align: center;"> <tr> <td style="width: 10%;"></td> <td style="width: 10%;"></td> <td style="width: 10%;"></td> <td style="width: 10%;"></td> <td style="width: 10%;"></td> <td style="width: 10%;"></td> <td style="width: 10%;"></td> <td style="width: 10%;"></td> <td style="width: 10%;"></td> <td style="width: 10%;"></td> </tr> <tr> <td></td> <td></td> <td colspan="8" style="text-align: center;"> <table border="1" style="width: 100%; border-collapse: collapse; text-align: center;"> <tr> </tr></table></td></tr></table></td></tr></table>

 | | | | | | | | | | | | | | | | | | | | <table border="1" style="width: 100%; border-collapse: collapse; text-align: center;"> <tr> <td style="width: 10%;"></td> <td style="width: 10%;"></td> <td style="width: 10%;"></td> <td style="width: 10%;"></td> <td style="width: 10%;"></td> <td style="width: 10%;"></td> <td style="width: 10%;"></td> <td style="width: 10%;"></td> <td style="width: 10%;"></td> <td style="width: 10%;"></td> </tr> <tr> <td></td> <td></td> <td colspan="8" style="text-align: center;"> <table border="1" style="width: 100%; border-collapse: collapse; text-align: center;"> <tr> </tr></table></td></tr></table>

 | | | | | | | | | | | | | | | | | | | | <table border="1" style="width: 100%; border-collapse: collapse; text-align: center;"> <tr> </tr></table>

 | | | | | | | | | | | | | | | | | | | |

 | | | | | | | | | | | | | | | | | | | |

 | | | | | | | | | | | | | | | | | | | |

 | | | | | | | | | | | | | | | | | | | |

 | | | | | | | | | | | | | | | | | | | |

 | | | | | | | | | | | | | | | | | | | |

 | | | | | | | | | | | | | | | | | | | |

 | | | | | | | | | | | | | | | | | | | |

 | | | | | | | | | | | | | | | | | | | |

 | | | | | | | | | | | | | | | | | | | |

 | | | | | | | | | | | | | | | | | | | |

 | | | | | | | | | | | | | | | | | | | |

 | | | | | | | | | | | | | | | | | | | |

 | | | | | | | | | | | | | | | | | | | |

 | | | | | | | | | | | | | | | | | | | |

 | | | | | | | | | | | | | | | | | | | |

 | | | | | | | | | | | | | | | | | | | |

 | | | | | | | | | | | | | | | | | | | |

 | | | | | | | | | | | | | | | | | | | |

 | | | | | | | | | | | | | | | | | | | |
 | | | | | | | | | | | | | | | | | | | |

 | | | | | | | | | | | | | | | | | | | |

 | | | | | | | | | | | | | | | | | | | |
 | | | | | | | | | | | | | | | | | | | |

 | | | | | | | | | | | | | | | | | | | |

 | | | | | | | | | | | | | | | | | | | |
 | | | | | | | | | | | | | | | | | | | |
 | | | | | | | | | | | | | | | | | | | |

 | | | | | | | | | | | | | | | | | | | |
 | | | | | | | | | | | | | | | | | | | |
 | | | | | | | | | | | | | | | | | | | |

 | | | | | | | | | | | | | | | | | | | | | | | | | | | | | | | | | | | | | | | | | | | | | | | | | | | | | | | | | | | | | | | | | | | | | | | | | | | | | | | | | | | | | | | | | | | | | | | | | | | |
 | | | | | | | | | | | | | | | | | | | |
 | | | | | | | | | | | | | | | | | | | |
 | | | | | | | | | | | | | | | | | | | |
 | | | | | | | | | | | | | | | | | | | |
 | | | | | | | | | | | | | | | | | | | |
 | | | | | | | | | | | | | | | | | | | |
 | | | | | | | | | | | | | | | | | | | |
 | | | | | | | | | | | | | | | | | | | |
 | | | | | | | | | | | | | | | | | | | | | | | | | | | | | | | | | | | | | | | |
 | | | | | | | | | | | | | | | | | | | |
 | | | | | | | | | | | | | | | | | | | | | | | | | | | | | | | | | | | | | | | |
 | | | | | | | | | | | | | | | | | | | | | | | | | | | | | | | | | | | | | | | |
 | | | | | | | | | | | | | | | | | | | | | | | | | | | | | | | | | | | | | | | |
 | | | | | | | | | | | | | | | | | | | | | | | | | | | | | | | | | | | | | | | | | | | | | | | | | | | | | | | | | | | | | | | | | | | | | | | | | | | | | | | | | | | | | | | | | | | | | | | | | | | |
 | | | | | | | | | | | | | | | | | | | | | | | | | | | | | | | | | | | | | | | | | | | | | | | |
| | |

 | | | | | | | | | | | | | | | | | | | |

 | | | | | | | | | | | | | | | | | | | |

 | | | | | | | | | | | | | | | | | | | |

 | | | | | | | | | | | | | | | | | | | |

 | | | | | | | | | | | | | | | | | | | |

 | | | | | | | | | | | | | | | | | | | |

 | | | | | | | | | | | | | | | | | | | |

 | | | | | | | | | | | | | | | | | | | |

 | | | | | | | | | | | | | | | | | | | |

 | | | | | | | | | | | | | | | | | | | |

 | | | | | | | | | | | | | | | | | | | |

 | | | | | | | | | | | | | | | | | | | |

 | | | | | | | | | | | | | | | | | | | |

 | | | | | | | | | | | | | | | | | | | |

 | | | | | | | | | | | | | | | | | | | |

 | | | | | | | | | | | | | | | | | | | |

 | | | | | | | | | | | | | | | | | | | |

 | | | | | | | | | | | | | | | | | | | |

 | | | | | | | | | | | | | | | | | | | |

 | | | | | | | | | | | | | | | | | | | |

 | | | | | | | | | | | | | | | | | | | |

 | | | | | | | | | | | | | | | | | | | |

 | | | | | | | | | | | | | | | | | | | |

 | | | | | | | | | | | | | | | | | | | |

 | | | | | | | | | | | | | | | | | | | |

 | | | | | | | | | | | | | | | | | | | |

 | | | | | | | | | | | | | | | | | | | |

 | | | | | | | | | | | | | | | | | | | |
 | | | | | | | | | | | | | | | | | | | |

 | | | | | | | | | | | | | | | | | | | |

 | | | | | | | | | | | | | | | | | | | |
 | | | | | | | | | | | | | | | | | | | |

 | | | | | | | | | | | | | | | | | | | |

 | | | | | | | | | | | | | | | | | | | |
 | | | | | | | | | | | | | | | | | | | |
 | | | | | | | | | | | | | | | | | | | |

 | | | | | | | | | | | | | | | | | | | |
 | | | | | | | | | | | | | | | | | | | |
 | | | | | | | | | | | | | | | | | | | |

 | | | | | | | | | | | | | | | | | | | | | | | | | | | | | | | | | | | | | | | | | | | | | | | | | | | | | | | | | | | | | | | | | | | | | | | | | | | | | | | | | | | | | | | | | | | | | | | | | | | |
 | | | | | | | | | | | | | | | | | | | |
 | | | | | | | | | | | | | | | | | | | |
 | | | | | | | | | | | | | | | | | | | |
 | | | | | | | | | | | | | | | | | | | |
 | | | | | | | | | | | | | | | | | | | |
 | | | | | | | | | | | | | | | | | | | |
 | | | | | | | | | | | | | | | | | | | |
 | | | | | | | | | | | | | | | | | | | |
 | | | | | | | | | | | | | | | | | | | | | | | | | | | | | | | | | | | | | | | |
 | | | | | | | | | | | | | | | | | | | |
 | | | | | | | | | | | | | | | | | | | | | | | | | | | | | | | | | | | | | | | |
 | | | | | | | | | | | | | | | | | | | | | | | | | | | | | | | | | | | | | | | |
 | | | | | | | | | | | | | | | | | | | | | | | | | | | | | | | | | | | | | | | |
 | | | | | | | | | | | | | | | | | | | | | | | | | | | | | | | | | | | | | | | | | | | | | | | | | | | | | | | | | | | | | | | | | | | | | | | | | | | | | | | | | | | | | | | | | | | | | | | | | | | |
 | | | | | | | | | | | | | | | | | | | | | | | | | | | | | | | | | | | | | | | | | | | | | | | |
| | | <table border="1" style="width: 100%; border-collapse: collapse; text-align: center;"> <tr> <td style="width: 10%;"></td> <td style="width: 10%;"></td> <td style="width: 10%;"></td> <td style="width: 10%;"></td> <td style="width: 10%;"></td> <td style="width: 10%;"></td> <td style="width: 10%;"></td> <td style="width: 10%;"></td> <td style="width: 10%;"></td> <td style="width: 10%;"></td> </tr> <tr> <td></td> <td></td> <td colspan="8" style="text-align: center;"> <table border="1" style="width: 100%; border-collapse: collapse; text-align: center;"> <tr> <td style="width: 10%;"></td> <td style="width: 10%;"></td> <td style="width: 10%;"></td> <td style="width: 10%;"></td> <td style="width: 10%;"></td> <td style="width: 10%;"></td> <td style="width: 10%;"></td> <td style="width: 10%;"></td> <td style="width: 10%;"></td> <td style="width: 10%;"></td> </tr> <tr> <td></td> <td></td> <td colspan="8" style="text-align: center;"> <table border="1" style="width: 100%; border-collapse: collapse; text-align: center;"> <tr> <td style="width: 10%;"></td> <td style="width: 10%;"></td> <td style="width: 10%;"></td> <td style="width: 10%;"></td> <td style="width: 10%;"></td> <td style="width: 10%;"></td> <td style="width: 10%;"></td> <td style="width: 10%;"></td> <td style="width: 10%;"></td> <td style="width: 10%;"></td> </tr> <tr> <td></td> <td></td> <td colspan="8" style="text-align: center;"> <table border="1" style="width: 100%; border-collapse: collapse; text-align: center;"> <tr> <td style="width: 10%;"></td> <td style="width: 10%;"></td> <td style="width: 10%;"></td> <td style="width: 10%;"></td> <td style="width: 10%;"></td> <td style="width: 10%;"></td> <td style="width: 10%;"></td> <td style="width: 10%;"></td> <td style="width: 10%;"></td> <td style="width: 10%;"></td> </tr> <tr> <td></td> <td></td> <td colspan="8" style="text-align: center;"> <table border="1" style="width: 100%; border-collapse: collapse; text-align: center;"> <tr> <td style="width: 10%;"></td> <td style="width: 10%;"></td> <td style="width: 10%;"></td> <td style="width: 10%;"></td> <td style="width: 10%;"></td> <td style="width: 10%;"></td> <td style="width: 10%;"></td> <td style="width: 10%;"></td> <td style="width: 10%;"></td> <td style="width: 10%;"></td> </tr> <tr> <td></td> <td></td> <td colspan="8" style="text-align: center;"> <table border="1" style="width: 100%; border-collapse: collapse; text-align: center;"> <tr> <td style="width: 10%;"></td> <td style="width: 10%;"></td> <td style="width: 10%;"></td> <td style="width: 10%;"></td> <td style="width: 10%;"></td> <td style="width: 10%;"></td> <td style="width: 10%;"></td> <td style="width: 10%;"></td> <td style="width: 10%;"></td> <td style="width: 10%;"></td> </tr> <tr> <td></td> <td></td> <td colspan="8" style="text-align: center;"> <table border="1" style="width: 100%; border-collapse: collapse; text-align: center;"> <tr> <td style="width: 10%;"></td> <td style="width: 10%;"></td> <td style="width: 10%;"></td> <td style="width: 10%;"></td> <td style="width: 10%;"></td> <td style="width: 10%;"></td> <td style="width: 10%;"></td> <td style="width: 10%;"></td> <td style="width: 10%;"></td> <td style="width: 10%;"></td> </tr> <tr> <td></td> <td></td> <td colspan="8" style="text-align: center;"> <table border="1" style="width: 100%; border-collapse: collapse; text-align: center;"> <tr> </tr></table></td></tr></table></td></tr></table></td></tr></table></td></tr></table></td></tr></table></td></tr></table></td></tr></table>

 | | | | | | | | | | | | | | | | | | | | <table border="1" style="width: 100%; border-collapse: collapse; text-align: center;"> <tr> <td style="width: 10%;"></td> <td style="width: 10%;"></td> <td style="width: 10%;"></td> <td style="width: 10%;"></td> <td style="width: 10%;"></td> <td style="width: 10%;"></td> <td style="width: 10%;"></td> <td style="width: 10%;"></td> <td style="width: 10%;"></td> <td style="width: 10%;"></td> </tr> <tr> <td></td> <td></td> <td colspan="8" style="text-align: center;"> <table border="1" style="width: 100%; border-collapse: collapse; text-align: center;"> <tr> <td style="width: 10%;"></td> <td style="width: 10%;"></td> <td style="width: 10%;"></td> <td style="width: 10%;"></td> <td style="width: 10%;"></td> <td style="width: 10%;"></td> <td style="width: 10%;"></td> <td style="width: 10%;"></td> <td style="width: 10%;"></td> <td style="width: 10%;"></td> </tr> <tr> <td></td> <td></td> <td colspan="8" style="text-align: center;"> <table border="1" style="width: 100%; border-collapse: collapse; text-align: center;"> <tr> <td style="width: 10%;"></td> <td style="width: 10%;"></td> <td style="width: 10%;"></td> <td style="width: 10%;"></td> <td style="width: 10%;"></td> <td style="width: 10%;"></td> <td style="width: 10%;"></td> <td style="width: 10%;"></td> <td style="width: 10%;"></td> <td style="width: 10%;"></td> </tr> <tr> <td></td> <td></td> <td colspan="8" style="text-align: center;"> <table border="1" style="width: 100%; border-collapse: collapse; text-align: center;"> <tr> <td style="width: 10%;"></td> <td style="width: 10%;"></td> <td style="width: 10%;"></td> <td style="width: 10%;"></td> <td style="width: 10%;"></td> <td style="width: 10%;"></td> <td style="width: 10%;"></td> <td style="width: 10%;"></td> <td style="width: 10%;"></td> <td style="width: 10%;"></td> </tr> <tr> <td></td> <td></td> <td colspan="8" style="text-align: center;"> <table border="1" style="width: 100%; border-collapse: collapse; text-align: center;"> <tr> <td style="width: 10%;"></td> <td style="width: 10%;"></td> <td style="width: 10%;"></td> <td style="width: 10%;"></td> <td style="width: 10%;"></td> <td style="width: 10%;"></td> <td style="width: 10%;"></td> <td style="width: 10%;"></td> <td style="width: 10%;"></td> <td style="width: 10%;"></td> </tr> <tr> <td></td> <td></td> <td colspan="8" style="text-align: center;"> <table border="1" style="width: 100%; border-collapse: collapse; text-align: center;"> <tr> <td style="width: 10%;"></td> <td style="width: 10%;"></td> <td style="width: 10%;"></td> <td style="width: 10%;"></td> <td style="width: 10%;"></td> <td style="width: 10%;"></td> <td style="width: 10%;"></td> <td style="width: 10%;"></td> <td style="width: 10%;"></td> <td style="width: 10%;"></td> </tr> <tr> <td></td> <td></td> <td colspan="8" style="text-align: center;"> <table border="1" style="width: 100%; border-collapse: collapse; text-align: center;"> <tr> </tr></table></td></tr></table></td></tr></table></td></tr></table></td></tr></table></td></tr></table></td></tr></table>

 | | | | | | | | | | | | | | | | | | | | <table border="1" style="width: 100%; border-collapse: collapse; text-align: center;"> <tr> <td style="width: 10%;"></td> <td style="width: 10%;"></td> <td style="width: 10%;"></td> <td style="width: 10%;"></td> <td style="width: 10%;"></td> <td style="width: 10%;"></td> <td style="width: 10%;"></td> <td style="width: 10%;"></td> <td style="width: 10%;"></td> <td style="width: 10%;"></td> </tr> <tr> <td></td> <td></td> <td colspan="8" style="text-align: center;"> <table border="1" style="width: 100%; border-collapse: collapse; text-align: center;"> <tr> <td style="width: 10%;"></td> <td style="width: 10%;"></td> <td style="width: 10%;"></td> <td style="width: 10%;"></td> <td style="width: 10%;"></td> <td style="width: 10%;"></td> <td style="width: 10%;"></td> <td style="width: 10%;"></td> <td style="width: 10%;"></td> <td style="width: 10%;"></td> </tr> <tr> <td></td> <td></td> <td colspan="8" style="text-align: center;"> <table border="1" style="width: 100%; border-collapse: collapse; text-align: center;"> <tr> <td style="width: 10%;"></td> <td style="width: 10%;"></td> <td style="width: 10%;"></td> <td style="width: 10%;"></td> <td style="width: 10%;"></td> <td style="width: 10%;"></td> <td style="width: 10%;"></td> <td style="width: 10%;"></td> <td style="width: 10%;"></td> <td style="width: 10%;"></td> </tr> <tr> <td></td> <td></td> <td colspan="8" style="text-align: center;"> <table border="1" style="width: 100%; border-collapse: collapse; text-align: center;"> <tr> <td style="width: 10%;"></td> <td style="width: 10%;"></td> <td style="width: 10%;"></td> <td style="width: 10%;"></td> <td style="width: 10%;"></td> <td style="width: 10%;"></td> <td style="width: 10%;"></td> <td style="width: 10%;"></td> <td style="width: 10%;"></td> <td style="width: 10%;"></td> </tr> <tr> <td></td> <td></td> <td colspan="8" style="text-align: center;"> <table border="1" style="width: 100%; border-collapse: collapse; text-align: center;"> <tr> <td style="width: 10%;"></td> <td style="width: 10%;"></td> <td style="width: 10%;"></td> <td style="width: 10%;"></td> <td style="width: 10%;"></td> <td style="width: 10%;"></td> <td style="width: 10%;"></td> <td style="width: 10%;"></td> <td style="width: 10%;"></td> <td style="width: 10%;"></td> </tr> <tr> <td></td> <td></td> <td colspan="8" style="text-align: center;"> <table border="1" style="width: 100%; border-collapse: collapse; text-align: center;"> <tr> </tr></table></td></tr></table></td></tr></table></td></tr></table></td></tr></table></td></tr></table>

 | | | | | | | | | | | | | | | | | | | | <table border="1" style="width: 100%; border-collapse: collapse; text-align: center;"> <tr> <td style="width: 10%;"></td> <td style="width: 10%;"></td> <td style="width: 10%;"></td> <td style="width: 10%;"></td> <td style="width: 10%;"></td> <td style="width: 10%;"></td> <td style="width: 10%;"></td> <td style="width: 10%;"></td> <td style="width: 10%;"></td> <td style="width: 10%;"></td> </tr> <tr> <td></td> <td></td> <td colspan="8" style="text-align: center;"> <table border="1" style="width: 100%; border-collapse: collapse; text-align: center;"> <tr> <td style="width: 10%;"></td> <td style="width: 10%;"></td> <td style="width: 10%;"></td> <td style="width: 10%;"></td> <td style="width: 10%;"></td> <td style="width: 10%;"></td> <td style="width: 10%;"></td> <td style="width: 10%;"></td> <td style="width: 10%;"></td> <td style="width: 10%;"></td> </tr> <tr> <td></td> <td></td> <td colspan="8" style="text-align: center;"> <table border="1" style="width: 100%; border-collapse: collapse; text-align: center;"> <tr> <td style="width: 10%;"></td> <td style="width: 10%;"></td> <td style="width: 10%;"></td> <td style="width: 10%;"></td> <td style="width: 10%;"></td> <td style="width: 10%;"></td> <td style="width: 10%;"></td> <td style="width: 10%;"></td> <td style="width: 10%;"></td> <td style="width: 10%;"></td> </tr> <tr> <td></td> <td></td> <td colspan="8" style="text-align: center;"> <table border="1" style="width: 100%; border-collapse: collapse; text-align: center;"> <tr> <td style="width: 10%;"></td> <td style="width: 10%;"></td> <td style="width: 10%;"></td> <td style="width: 10%;"></td> <td style="width: 10%;"></td> <td style="width: 10%;"></td> <td style="width: 10%;"></td> <td style="width: 10%;"></td> <td style="width: 10%;"></td> <td style="width: 10%;"></td> </tr> <tr> <td></td> <td></td> <td colspan="8" style="text-align: center;"> <table border="1" style="width: 100%; border-collapse: collapse; text-align: center;"> <tr> </tr></table></td></tr></table></td></tr></table></td></tr></table></td></tr></table>

 | | | | | | | | | | | | | | | | | | | | <table border="1" style="width: 100%; border-collapse: collapse; text-align: center;"> <tr> <td style="width: 10%;"></td> <td style="width: 10%;"></td> <td style="width: 10%;"></td> <td style="width: 10%;"></td> <td style="width: 10%;"></td> <td style="width: 10%;"></td> <td style="width: 10%;"></td> <td style="width: 10%;"></td> <td style="width: 10%;"></td> <td style="width: 10%;"></td> </tr> <tr> <td></td> <td></td> <td colspan="8" style="text-align: center;"> <table border="1" style="width: 100%; border-collapse: collapse; text-align: center;"> <tr> <td style="width: 10%;"></td> <td style="width: 10%;"></td> <td style="width: 10%;"></td> <td style="width: 10%;"></td> <td style="width: 10%;"></td> <td style="width: 10%;"></td> <td style="width: 10%;"></td> <td style="width: 10%;"></td> <td style="width: 10%;"></td> <td style="width: 10%;"></td> </tr> <tr> <td></td> <td></td> <td colspan="8" style="text-align: center;"> <table border="1" style="width: 100%; border-collapse: collapse; text-align: center;"> <tr> <td style="width: 10%;"></td> <td style="width: 10%;"></td> <td style="width: 10%;"></td> <td style="width: 10%;"></td> <td style="width: 10%;"></td> <td style="width: 10%;"></td> <td style="width: 10%;"></td> <td style="width: 10%;"></td> <td style="width: 10%;"></td> <td style="width: 10%;"></td> </tr> <tr> <td></td> <td></td> <td colspan="8" style="text-align: center;"> <table border="1" style="width: 100%; border-collapse: collapse; text-align: center;"> <tr> </tr></table></td></tr></table></td></tr></table></td></tr></table>

 | | | | | | | | | | | | | | | | | | | | <table border="1" style="width: 100%; border-collapse: collapse; text-align: center;"> <tr> <td style="width: 10%;"></td> <td style="width: 10%;"></td> <td style="width: 10%;"></td> <td style="width: 10%;"></td> <td style="width: 10%;"></td> <td style="width: 10%;"></td> <td style="width: 10%;"></td> <td style="width: 10%;"></td> <td style="width: 10%;"></td> <td style="width: 10%;"></td> </tr> <tr> <td></td> <td></td> <td colspan="8" style="text-align: center;"> <table border="1" style="width: 100%; border-collapse: collapse; text-align: center;"> <tr> <td style="width: 10%;"></td> <td style="width: 10%;"></td> <td style="width: 10%;"></td> <td style="width: 10%;"></td> <td style="width: 10%;"></td> <td style="width: 10%;"></td> <td style="width: 10%;"></td> <td style="width: 10%;"></td> <td style="width: 10%;"></td> <td style="width: 10%;"></td> </tr> <tr> <td></td> <td></td> <td colspan="8" style="text-align: center;"> <table border="1" style="width: 100%; border-collapse: collapse; text-align: center;"> <tr> </tr></table></td></tr></table></td></tr></table>

 | | | | | | | | | | | | | | | | | | | | <table border="1" style="width: 100%; border-collapse: collapse; text-align: center;"> <tr> <td style="width: 10%;"></td> <td style="width: 10%;"></td> <td style="width: 10%;"></td> <td style="width: 10%;"></td> <td style="width: 10%;"></td> <td style="width: 10%;"></td> <td style="width: 10%;"></td> <td style="width: 10%;"></td> <td style="width: 10%;"></td> <td style="width: 10%;"></td> </tr> <tr> <td></td> <td></td> <td colspan="8" style="text-align: center;"> <table border="1" style="width: 100%; border-collapse: collapse; text-align: center;"> <tr> </tr></table></td></tr></table>

 | | | | | | | | | | | | | | | | | | | | <table border="1" style="width: 100%; border-collapse: collapse; text-align: center;"> <tr> </tr></table>

 | | | | | | | | | | | | | | | | | | | |

 | | | | | | | | | | | | | | | | | | | |

 | | | | | | | | | | | | | | | | | | | |

 | | | | | | | | | | | | | | | | | | | |

 | | | | | | | | | | | | | | | | | | | |

 | | | | | | | | | | | | | | | | | | | |

 | | | | | | | | | | | | | | | | | | | |

 | | | | | | | | | | | | | | | | | | | |

 | | | | | | | | | | | | | | | | | | | |

 | | | | | | | | | | | | | | | | | | | |

 | | | | | | | | | | | | | | | | | | | |

 | | | | | | | | | | | | | | | | | | | |

 | | | | | | | | | | | | | | | | | | | |

 | | | | | | | | | | | | | | | | | | | |

 | | | | | | | | | | | | | | | | | | | |

 | | | | | | | | | | | | | | | | | | | |

 | | | | | | | | | | | | | | | | | | | |

 | | | | | | | | | | | | | | | | | | | |

 | | | | | | | | | | | | | | | | | | | |

 | | | | | | | | | | | | | | | | | | | |

 | | | | | | | | | | | | | | | | | | | |
 | | | | | | | | | | | | | | | | | | | |

 | | | | | | | | | | | | | | | | | | | |

 | | | | | | | | | | | | | | | | | | | |
 | | | | | | | | | | | | | | | | | | | |

 | | | | | | | | | | | | | | | | | | | |

 | | | | | | | | | | | | | | | | | | | |
 | | | | | | | | | | | | | | | | | | | |
 | | | | | | | | | | | | | | | | | | | |

 | | | | | | | | | | | | | | | | | | | |
 | | | | | | | | | | | | | | | | | | | |
 | | | | | | | | | | | | | | | | | | | |

 | | | | | | | | | | | | | | | | | | | | | | | | | | | | | | | | | | | | | | | | | | | | | | | | | | | | | | | | | | | | | | | | | | | | | | | | | | | | | | | | | | | | | | | | | | | | | | | | | | | |
 | | | | | | | | | | | | | | | | | | | |
 | | | | | | | | | | | | | | | | | | | |
 | | | | | | | | | | | | | | | | | | | |
 | | | | | | | | | | | | | | | | | | | |
 | | | | | | | | | | | | | | | | | | | |
 | | | | | | | | | | | | | | | | | | | |
 | | | | | | | | | | | | | | | | | | | |
 | | | | | | | | | | | | | | | | | | | |
 | | | | | | | | | | | | | | | | | | | | | | | | | | | | | | | | | | | | | | | |
 | | | | | | | | | | | | | | | | | | | |
 | | | | | | | | | | | | | | | | | | | | | | | | | | | | | | | | | | | | | | | |
 | | | | | | | | | | | | | | | | | | | | | | | | | | | | | | | | | | | | | | | |
 | | | | | | | | | | | | | | | | | | | | | | | | | | | | | | | | | | | | | | | |
 | | | | | | | | | | | | | | | | | | | | | | | | | | | | | | | | | | | | | | | | | | | | | | | | | | | | | | | | | | | | | | | | | | | | | | | | | | | | | | | | | | | | | | | | | | | | | | | | | | | |
 | | | | | | | | | | | | | | | | | | | | | | | | | | | | | | | | | | | | | | | | | | | | | | | |
| | |

 | | | | | | | | | | | | | | | | | | | |

 | | | | | | | | | | | | | | | | | | | |

 | | | | | | | | | | | | | | | | | | | |

 | | | | | | | | | | | | | | | | | | | |

 | | | | | | | | | | | | | | | | | | | |

 | | | | | | | | | | | | | | | | | | | |

 | | | | | | | | | | | | | | | | | | | |

 | | | | | | | | | | | | | | | | | | | |

 | | | | | | | | | | | | | | | | | | | |

 | | | | | | | | | | | | | | | | | | | |

 | | | | | | | | | | | | | | | | | | | |

 | | | | | | | | | | | | | | | | | | | |

 | | | | | | | | | | | | | | | | | | | |

 | | | | | | | | | | | | | | | | | | | |

 | | | | | | | | | | | | | | | | | | | |

 | | | | | | | | | | | | | | | | | | | |

 | | | | | | | | | | | | | | | | | | | |

 | | | | | | | | | | | | | | | | | | | |

 | | | | | | | | | | | | | | | | | | | |

 | | | | | | | | | | | | | | | | | | | |

 | | | | | | | | | | | | | | | | | | | |

 | | | | | | | | | | | | | | | | | | | |

 | | | | | | | | | | | | | | | | | | | |

 | | | | | | | | | | | | | | | | | | | |

 | | | | | | | | | | | | | | | | | | | |

 | | | | | | | | | | | | | | | | | | | |

 | | | | | | | | | | | | | | | | | | | |

 | | | | | | | | | | | | | | | | | | | |
 | | | | | | | | | | | | | | | | | | | |

 | | | | | | | | | | | | | | | | | | | |

 | | | | | | | | | | | | | | | | | | | |
 | | | | | | | | | | | | | | | | | | | |

 | | | | | | | | | | | | | | | | | | | |

 | | | | | | | | | | | | | | | | | | | |
 | | | | | | | | | | | | | | | | | | | |
 | | | | | | | | | | | | | | | | | | | |

 | | | | | | | | | | | | | | | | | | | |
 | | | | | | | | | | | | | | | | | | | |
 | | | | | | | | | | | | | | | | | | | |

 | | | | | | | | | | | | | | | | | | | | | | | | | | | | | | | | | | | | | | | | | | | | | | | | | | | | | | | | | | | | | | | | | | | | | | | | | | | | | | | | | | | | | | | | | | | | | | | | | | | |
 | | | | | | | | | | | | | | | | | | | |
 | | | | | | | | | | | | | | | | | | | |
 | | | | | | | | | | | | | | | | | | | |
 | | | | | | | | | | | | | | | | | | | |
 | | | | | | | | | | | | | | | | | | | |
 | | | | | | | | | | | | | | | | | | | |
 | | | | | | | | | | | | | | | | | | | |
 | | | | | | | | | | | | | | | | | | | |
 | | | | | | | | | | | | | | | | | | | | | | | | | | | | | | | | | | | | | | | |
 | | | | | | | | | | | | | | | | | | | |
 | | | | | | | | | | | | | | | | | | | | | | | | | | | | | | | | | | | | | | | |
 | | | | | | | | | | | | | | | | | | | | | | | | | | | | | | | | | | | | | | | |
 | | | | | | | | | | | | | | | | | | | | | | | | | | | | | | | | | | | | | | | |
 | | | | | | | | | | | | | | | | | | | | | | | | | | | | | | | | | | | | | | | | | | | | | | | | | | | | | | | | | | | | | | | | | | | | | | | | | | | | | | | | | | | | | | | | | | | | | | | | | | | |
 | | | | | | | | | | | | | | | | | | | | | | | | | | | | | | | | | | | | | | | | | | | | | | | |
| | | <table border="1" style="width: 100%; border-collapse: collapse; text-align: center;"> <tr> <td style="width: 10%;"></td> <td style="width: 10%;"></td> <td style="width: 10%;"></td> <td style="width: 10%;"></td> <td style="width: 10%;"></td> <td style="width: 10%;"></td> <td style="width: 10%;"></td> <td style="width: 10%;"></td> <td style="width: 10%;"></td> <td style="width: 10%;"></td> </tr> <tr> <td></td> <td></td> <td colspan="8" style="text-align: center;"> <table border="1" style="width: 100%; border-collapse: collapse; text-align: center;"> <tr> <td style="width: 10%;"></td> <td style="width: 10%;"></td> <td style="width: 10%;"></td> <td style="width: 10%;"></td> <td style="width: 10%;"></td> <td style="width: 10%;"></td> <td style="width: 10%;"></td> <td style="width: 10%;"></td> <td style="width: 10%;"></td> <td style="width: 10%;"></td> </tr> <tr> <td></td> <td></td> <td colspan="8" style="text-align: center;"> <table border="1" style="width: 100%; border-collapse: collapse; text-align: center;"> <tr> <td style="width: 10%;"></td> <td style="width: 10%;"></td> <td style="width: 10%;"></td> <td style="width: 10%;"></td> <td style="width: 10%;"></td> <td style="width: 10%;"></td> <td style="width: 10%;"></td> <td style="width: 10%;"></td> <td style="width: 10%;"></td> <td style="width: 10%;"></td> </tr> <tr> <td></td> <td></td> <td colspan="8" style="text-align: center;"> <table border="1" style="width: 100%; border-collapse: collapse; text-align: center;"> <tr> <td style="width: 10%;"></td> <td style="width: 10%;"></td> <td style="width: 10%;"></td> <td style="width: 10%;"></td> <td style="width: 10%;"></td> <td style="width: 10%;"></td> <td style="width: 10%;"></td> <td style="width: 10%;"></td> <td style="width: 10%;"></td> <td style="width: 10%;"></td> </tr> <tr> <td></td> <td></td> <td colspan="8" style="text-align: center;"> <table border="1" style="width: 100%; border-collapse: collapse; text-align: center;"> <tr> <td style="width: 10%;"></td> <td style="width: 10%;"></td> <td style="width: 10%;"></td> <td style="width: 10%;"></td> <td style="width: 10%;"></td> <td style="width: 10%;"></td> <td style="width: 10%;"></td> <td style="width: 10%;"></td> <td style="width: 10%;"></td> <td style="width: 10%;"></td> </tr> <tr> <td></td> <td></td> <td colspan="8" style="text-align: center;"> <table border="1" style="width: 100%; border-collapse: collapse; text-align: center;"> <tr> <td style="width: 10%;"></td> <td style="width: 10%;"></td> <td style="width: 10%;"></td> <td style="width: 10%;"></td> <td style="width: 10%;"></td> <td style="width: 10%;"></td> <td style="width: 10%;"></td> <td style="width: 10%;"></td> <td style="width: 10%;"></td> <td style="width: 10%;"></td> </tr> <tr> <td></td> <td></td> <td colspan="8" style="text-align: center;"> <table border="1" style="width: 100%; border-collapse: collapse; text-align: center;"> <tr> </tr></table></td></tr></table></td></tr></table></td></tr></table></td></tr></table></td></tr></table></td></tr></table>

 | | | | | | | | | | | | | | | | | | | | <table border="1" style="width: 100%; border-collapse: collapse; text-align: center;"> <tr> <td style="width: 10%;"></td> <td style="width: 10%;"></td> <td style="width: 10%;"></td> <td style="width: 10%;"></td> <td style="width: 10%;"></td> <td style="width: 10%;"></td> <td style="width: 10%;"></td> <td style="width: 10%;"></td> <td style="width: 10%;"></td> <td style="width: 10%;"></td> </tr> <tr> <td></td> <td></td> <td colspan="8" style="text-align: center;"> <table border="1" style="width: 100%; border-collapse: collapse; text-align: center;"> <tr> <td style="width: 10%;"></td> <td style="width: 10%;"></td> <td style="width: 10%;"></td> <td style="width: 10%;"></td> <td style="width: 10%;"></td> <td style="width: 10%;"></td> <td style="width: 10%;"></td> <td style="width: 10%;"></td> <td style="width: 10%;"></td> <td style="width: 10%;"></td> </tr> <tr> <td></td> <td></td> <td colspan="8" style="text-align: center;"> <table border="1" style="width: 100%; border-collapse: collapse; text-align: center;"> <tr> <td style="width: 10%;"></td> <td style="width: 10%;"></td> <td style="width: 10%;"></td> <td style="width: 10%;"></td> <td style="width: 10%;"></td> <td style="width: 10%;"></td> <td style="width: 10%;"></td> <td style="width: 10%;"></td> <td style="width: 10%;"></td> <td style="width: 10%;"></td> </tr> <tr> <td></td> <td></td> <td colspan="8" style="text-align: center;"> <table border="1" style="width: 100%; border-collapse: collapse; text-align: center;"> <tr> <td style="width: 10%;"></td> <td style="width: 10%;"></td> <td style="width: 10%;"></td> <td style="width: 10%;"></td> <td style="width: 10%;"></td> <td style="width: 10%;"></td> <td style="width: 10%;"></td> <td style="width: 10%;"></td> <td style="width: 10%;"></td> <td style="width: 10%;"></td> </tr> <tr> <td></td> <td></td> <td colspan="8" style="text-align: center;"> <table border="1" style="width: 100%; border-collapse: collapse; text-align: center;"> <tr> <td style="width: 10%;"></td> <td style="width: 10%;"></td> <td style="width: 10%;"></td> <td style="width: 10%;"></td> <td style="width: 10%;"></td> <td style="width: 10%;"></td> <td style="width: 10%;"></td> <td style="width: 10%;"></td> <td style="width: 10%;"></td> <td style="width: 10%;"></td> </tr> <tr> <td></td> <td></td> <td colspan="8" style="text-align: center;"> <table border="1" style="width: 100%; border-collapse: collapse; text-align: center;"> <tr> </tr></table></td></tr></table></td></tr></table></td></tr></table></td></tr></table></td></tr></table>

 | | | | | | | | | | | | | | | | | | | | <table border="1" style="width: 100%; border-collapse: collapse; text-align: center;"> <tr> <td style="width: 10%;"></td> <td style="width: 10%;"></td> <td style="width: 10%;"></td> <td style="width: 10%;"></td> <td style="width: 10%;"></td> <td style="width: 10%;"></td> <td style="width: 10%;"></td> <td style="width: 10%;"></td> <td style="width: 10%;"></td> <td style="width: 10%;"></td> </tr> <tr> <td></td> <td></td> <td colspan="8" style="text-align: center;"> <table border="1" style="width: 100%; border-collapse: collapse; text-align: center;"> <tr> <td style="width: 10%;"></td> <td style="width: 10%;"></td> <td style="width: 10%;"></td> <td style="width: 10%;"></td> <td style="width: 10%;"></td> <td style="width: 10%;"></td> <td style="width: 10%;"></td> <td style="width: 10%;"></td> <td style="width: 10%;"></td> <td style="width: 10%;"></td> </tr> <tr> <td></td> <td></td> <td colspan="8" style="text-align: center;"> <table border="1" style="width: 100%; border-collapse: collapse; text-align: center;"> <tr> <td style="width: 10%;"></td> <td style="width: 10%;"></td> <td style="width: 10%;"></td> <td style="width: 10%;"></td> <td style="width: 10%;"></td> <td style="width: 10%;"></td> <td style="width: 10%;"></td> <td style="width: 10%;"></td> <td style="width: 10%;"></td> <td style="width: 10%;"></td> </tr> <tr> <td></td> <td></td> <td colspan="8" style="text-align: center;"> <table border="1" style="width: 100%; border-collapse: collapse; text-align: center;"> <tr> <td style="width: 10%;"></td> <td style="width: 10%;"></td> <td style="width: 10%;"></td> <td style="width: 10%;"></td> <td style="width: 10%;"></td> <td style="width: 10%;"></td> <td style="width: 10%;"></td> <td style="width: 10%;"></td> <td style="width: 10%;"></td> <td style="width: 10%;"></td> </tr> <tr> <td></td> <td></td> <td colspan="8" style="text-align: center;"> <table border="1" style="width: 100%; border-collapse: collapse; text-align: center;"> <tr> </tr></table></td></tr></table></td></tr></table></td></tr></table></td></tr></table>

 | | | | | | | | | | | | | | | | | | | | <table border="1" style="width: 100%; border-collapse: collapse; text-align: center;"> <tr> <td style="width: 10%;"></td> <td style="width: 10%;"></td> <td style="width: 10%;"></td> <td style="width: 10%;"></td> <td style="width: 10%;"></td> <td style="width: 10%;"></td> <td style="width: 10%;"></td> <td style="width: 10%;"></td> <td style="width: 10%;"></td> <td style="width: 10%;"></td> </tr> <tr> <td></td> <td></td> <td colspan="8" style="text-align: center;"> <table border="1" style="width: 100%; border-collapse: collapse; text-align: center;"> <tr> <td style="width: 10%;"></td> <td style="width: 10%;"></td> <td style="width: 10%;"></td> <td style="width: 10%;"></td> <td style="width: 10%;"></td> <td style="width: 10%;"></td> <td style="width: 10%;"></td> <td style="width: 10%;"></td> <td style="width: 10%;"></td> <td style="width: 10%;"></td> </tr> <tr> <td></td> <td></td> <td colspan="8" style="text-align: center;"> <table border="1" style="width: 100%; border-collapse: collapse; text-align: center;"> <tr> <td style="width: 10%;"></td> <td style="width: 10%;"></td> <td style="width: 10%;"></td> <td style="width: 10%;"></td> <td style="width: 10%;"></td> <td style="width: 10%;"></td> <td style="width: 10%;"></td> <td style="width: 10%;"></td> <td style="width: 10%;"></td> <td style="width: 10%;"></td> </tr> <tr> <td></td> <td></td> <td colspan="8" style="text-align: center;"> <table border="1" style="width: 100%; border-collapse: collapse; text-align: center;"> <tr> </tr></table></td></tr></table></td></tr></table></td></tr></table>

 | | | | | | | | | | | | | | | | | | | | <table border="1" style="width: 100%; border-collapse: collapse; text-align: center;"> <tr> <td style="width: 10%;"></td> <td style="width: 10%;"></td> <td style="width: 10%;"></td> <td style="width: 10%;"></td> <td style="width: 10%;"></td> <td style="width: 10%;"></td> <td style="width: 10%;"></td> <td style="width: 10%;"></td> <td style="width: 10%;"></td> <td style="width: 10%;"></td> </tr> <tr> <td></td> <td></td> <td colspan="8" style="text-align: center;"> <table border="1" style="width: 100%; border-collapse: collapse; text-align: center;"> <tr> <td style="width: 10%;"></td> <td style="width: 10%;"></td> <td style="width: 10%;"></td> <td style="width: 10%;"></td> <td style="width: 10%;"></td> <td style="width: 10%;"></td> <td style="width: 10%;"></td> <td style="width: 10%;"></td> <td style="width: 10%;"></td> <td style="width: 10%;"></td> </tr> <tr> <td></td> <td></td> <td colspan="8" style="text-align: center;"> <table border="1" style="width: 100%; border-collapse: collapse; text-align: center;"> <tr> </tr></table></td></tr></table></td></tr></table>

 | | | | | | | | | | | | | | | | | | | | <table border="1" style="width: 100%; border-collapse: collapse; text-align: center;"> <tr> <td style="width: 10%;"></td> <td style="width: 10%;"></td> <td style="width: 10%;"></td> <td style="width: 10%;"></td> <td style="width: 10%;"></td> <td style="width: 10%;"></td> <td style="width: 10%;"></td> <td style="width: 10%;"></td> <td style="width: 10%;"></td> <td style="width: 10%;"></td> </tr> <tr> <td></td> <td></td> <td colspan="8" style="text-align: center;"> <table border="1" style="width: 100%; border-collapse: collapse; text-align: center;"> <tr> </tr></table></td></tr></table>

 | | | | | | | | | | | | | | | | | | | | <table border="1" style="width: 100%; border-collapse: collapse; text-align: center;"> <tr> </tr></table>

 | | | | | | | | | | | | | | | | | | | |

 | | | | | | | | | | | | | | | | | | | |

 | | | | | | | | | | | | | | | | | | | |

 | | | | | | | | | | | | | | | | | | | |

 | | | | | | | | | | | | | | | | | | | |

 | | | | | | | | | | | | | | | | | | | |

 | | | | | | | | | | | | | | | | | | | |

 | | | | | | | | | | | | | | | | | | | |

 | | | | | | | | | | | | | | | | | | | |

 | | | | | | | | | | | | | | | | | | | |

 | | | | | | | | | | | | | | | | | | | |

 | | | | | | | | | | | | | | | | | | | |

 | | | | | | | | | | | | | | | | | | | |

 | | | | | | | | | | | | | | | | | | | |

 | | | | | | | | | | | | | | | | | | | |

 | | | | | | | | | | | | | | | | | | | |

 | | | | | | | | | | | | | | | | | | | |

 | | | | | | | | | | | | | | | | | | | |

 | | | | | | | | | | | | | | | | | | | |

 | | | | | | | | | | | | | | | | | | | |

 | | | | | | | | | | | | | | | | | | | |

 | | | | | | | | | | | | | | | | | | | |
 | | | | | | | | | | | | | | | | | | | |

 | | | | | | | | | | | | | | | | | | | |

 | | | | | | | | | | | | | | | | | | | |
 | | | | | | | | | | | | | | | | | | | |

 | | | | | | | | | | | | | | | | | | | |

 | | | | | | | | | | | | | | | | | | | |
 | | | | | | | | | | | | | | | | | | | |
 | | | | | | | | | | | | | | | | | | | |

 | | | | | | | | | | | | | | | | | | | |
 | | | | | | | | | | | | | | | | | | | |
 | | | | | | | | | | | | | | | | | | | |

 | | | | | | | | | | | | | | | | | | | | | | | | | | | | | | | | | | | | | | | | | | | | | | | | | | | | | | | | | | | | | | | | | | | | | | | | | | | | | | | | | | | | | | | | | | | | | | | | | | | |
 | | | | | | | | | | | | | | | | | | | |
 | | | | | | | | | | | | | | | | | | | |
 | | | | | | | | | | | | | | | | | | | |
 | | | | | | | | | | | | | | | | | | | |
 | | | | | | | | | | | | | | | | | | | |
 | | | | | | | | | | | | | | | | | | | |
 | | | | | | | | | | | | | | | | | | | |
 | | | | | | | | | | | | | | | | | | | |
 | | | | | | | | | | | | | | | | | | | | | | | | | | | | | | | | | | | | | | | |
 | | | | | | | | | | | | | | | | | | | |
 | | | | | | | | | | | | | | | | | | | | | | | | | | | | | | | | | | | | | | | |
 | | | | | | | | | | | | | | | | | | | | | | | | | | | | | | | | | | | | | | | |
 | | | | | | | | | | | | | | | | | | | | | | | | | | | | | | | | | | | | | | | |
 | | | | | | | | | | | | | | | | | | | | | | | | | | | | | | | | | | | | | | | | | | | | | | | | | | | | | | | | | | | | | | | | | | | | | | | | | | | | | | | | | | | | | | | | | | | | | | | | | | | |
 | | | | | | | | | | | | | | | | | | | | | | | | | | | | | | | | | | | | | | | | | | | | | | | |
| | |

 | | | | | | | | | | | | | | | | | | | |

 | | | | | | | | | | | | | | | | | | | |

 | | | | | | | | | | | | | | | | | | | |

 | | | | | | | | | | | | | | | | | | | |

 | | | | | | | | | | | | | | | | | | | |

 | | | | | | | | | | | | | | | | | | | |

 | | | | | | | | | | | | | | | | | | | |

 | | | | | | | | | | | | | | | | | | | |

 | | | | | | | | | | | | | | | | | | | |

 | | | | | | | | | | | | | | | | | | | |

 | | | | | | | | | | | | | | | | | | | |

 | | | | | | | | | | | | | | | | | | | |

 | | | | | | | | | | | | | | | | | | | |

 | | | | | | | | | | | | | | | | | | | |

 | | | | | | | | | | | | | | | | | | | |

 | | | | | | | | | | | | | | | | | | | |

 | | | | | | | | | | | | | | | | | | | |

 | | | | | | | | | | | | | | | | | | | |

 | | | | | | | | | | | | | | | | | | | |

 | | | | | | | | | | | | | | | | | | | |

 | | | | | | | | | | | | | | | | | | | |

 | | | | | | | | | | | | | | | | | | | |

 | | | | | | | | | | | | | | | | | | | |

 | | | | | | | | | | | | | | | | | | | |

 | | | | | | | | | | | | | | | | | | | |

 | | | | | | | | | | | | | | | | | | | |

 | | | | | | | | | | | | | | | | | | | |

 | | | | | | | | | | | | | | | | | | | |
 | | | | | | | | | | | | | | | | | | | |

 | | | | | | | | | | | | | | | | | | | |

 | | | | | | | | | | | | | | | | | | | |
 | | | | | | | | | | | | | | | | | | | |

 | | | | | | | | | | | | | | | | | | | |

 | | | | | | | | | | | | | | | | | | | |
 | | | | | | | | | | | | | | | | | | | |
 | | | | | | | | | | | | | | | | | | | |

 | | | | | | | | | | | | | | | | | | | |
 | | | | | | | | | | | | | | | | | | | |
 | | | | | | | | | | | | | | | | | | | |

 | | | | | | | | | | | | | | | | | | | | | | | | | | | | | | | | | | | | | | | | | | | | | | | | | | | | | | | | | | | | | | | | | | | | | | | | | | | | | | | | | | | | | | | | | | | | | | | | | | | |
 | | | | | | | | | | | | | | | | | | | |
 | | | | | | | | | | | | | | | | | | | |
 | | | | | | | | | | | | | | | | | | | |
 | | | | | | | | | | | | | | | | | | | |
 | | | | | | | | | | | | | | | | | | | |
 | | | | | | | | | | | | | | | | | | | |
 | | | | | | | | | | | | | | | | | | | |
 | | | | | | | | | | | | | | | | | | | |
 | | | | | | | | | | | | | | | | | | | | | | | | | | | | | | | | | | | | | | | |
 | | | | | | | | | | | | | | | | | | | |
 | | | | | | | | | | | | | | | | | | | | | | | | | | | | | | | | | | | | | | | |
 | | | | | | | | | | | | | | | | | | | | | | | | | | | | | | | | | | | | | | | |
 | | | | | | | | | | | | | | | | | | | | | | | | | | | | | | | | | | | | | | | |
 | | | | | | | | | | | | | | | | | | | | | | | | | | | | | | | | | | | | | | | | | | | | | | | | | | | | | | | | | | | | | | | | | | | | | | | | | | | | | | | | | | | | | | | | | | | | | | | | | | | |
 | | | | | | | | | | | | | | | | | | | | | | | | | | | | | | | | | | | | | | | | | | | | | | | |
| | | <table border="1" style="width: 100%; border-collapse: collapse; text-align: center;"> <tr> <td style="width: 10%;"></td> <td style="width: 10%;"></td> <td style="width: 10%;"></td> <td style="width: 10%;"></td> <td style="width: 10%;"></td> <td style="width: 10%;"></td> <td style="width: 10%;"></td> <td style="width: 10%;"></td> <td style="width: 10%;"></td> <td style="width: 10%;"></td> </tr> <tr> <td></td> <td></td> <td colspan="8" style="text-align: center;"> <table border="1" style="width: 100%; border-collapse: collapse; text-align: center;"> <tr> <td style="width: 10%;"></td> <td style="width: 10%;"></td> <td style="width: 10%;"></td> <td style="width: 10%;"></td> <td style="width: 10%;"></td> <td style="width: 10%;"></td> <td style="width: 10%;"></td> <td style="width: 10%;"></td> <td style="width: 10%;"></td> <td style="width: 10%;"></td> </tr> <tr> <td></td> <td></td> <td colspan="8" style="text-align: center;"> <table border="1" style="width: 100%; border-collapse: collapse; text-align: center;"> <tr> <td style="width: 10%;"></td> <td style="width: 10%;"></td> <td style="width: 10%;"></td> <td style="width: 10%;"></td> <td style="width: 10%;"></td> <td style="width: 10%;"></td> <td style="width: 10%;"></td> <td style="width: 10%;"></td> <td style="width: 10%;"></td> <td style="width: 10%;"></td> </tr> <tr> <td></td> <td></td> <td colspan="8" style="text-align: center;"> <table border="1" style="width: 100%; border-collapse: collapse; text-align: center;"> <tr> <td style="width: 10%;"></td> <td style="width: 10%;"></td> <td style="width: 10%;"></td> <td style="width: 10%;"></td> <td style="width: 10%;"></td> <td style="width: 10%;"></td> <td style="width: 10%;"></td> <td style="width: 10%;"></td> <td style="width: 10%;"></td> <td style="width: 10%;"></td> </tr> <tr> <td></td> <td></td> <td colspan="8" style="text-align: center;"> <table border="1" style="width: 100%; border-collapse: collapse; text-align: center;"> <tr> <td style="width: 10%;"></td> <td style="width: 10%;"></td> <td style="width: 10%;"></td> <td style="width: 10%;"></td> <td style="width: 10%;"></td> <td style="width: 10%;"></td> <td style="width: 10%;"></td> <td style="width: 10%;"></td> <td style="width: 10%;"></td> <td style="width: 10%;"></td> </tr> <tr> <td></td> <td></td> <td colspan="8" style="text-align: center;"> <table border="1" style="width: 100%; border-collapse: collapse; text-align: center;"> <tr> </tr></table></td></tr></table></td></tr></table></td></tr></table></td></tr></table></td></tr></table>

 | | | | | | | | | | | | | | | | | | | | <table border="1" style="width: 100%; border-collapse: collapse; text-align: center;"> <tr> <td style="width: 10%;"></td> <td style="width: 10%;"></td> <td style="width: 10%;"></td> <td style="width: 10%;"></td> <td style="width: 10%;"></td> <td style="width: 10%;"></td> <td style="width: 10%;"></td> <td style="width: 10%;"></td> <td style="width: 10%;"></td> <td style="width: 10%;"></td> </tr> <tr> <td></td> <td></td> <td colspan="8" style="text-align: center;"> <table border="1" style="width: 100%; border-collapse: collapse; text-align: center;"> <tr> <td style="width: 10%;"></td> <td style="width: 10%;"></td> <td style="width: 10%;"></td> <td style="width: 10%;"></td> <td style="width: 10%;"></td> <td style="width: 10%;"></td> <td style="width: 10%;"></td> <td style="width: 10%;"></td> <td style="width: 10%;"></td> <td style="width: 10%;"></td> </tr> <tr> <td></td> <td></td> <td colspan="8" style="text-align: center;"> <table border="1" style="width: 100%; border-collapse: collapse; text-align: center;"> <tr> <td style="width: 10%;"></td> <td style="width: 10%;"></td> <td style="width: 10%;"></td> <td style="width: 10%;"></td> <td style="width: 10%;"></td> <td style="width: 10%;"></td> <td style="width: 10%;"></td> <td style="width: 10%;"></td> <td style="width: 10%;"></td> <td style="width: 10%;"></td> </tr> <tr> <td></td> <td></td> <td colspan="8" style="text-align: center;"> <table border="1" style="width: 100%; border-collapse: collapse; text-align: center;"> <tr> <td style="width: 10%;"></td> <td style="width: 10%;"></td> <td style="width: 10%;"></td> <td style="width: 10%;"></td> <td style="width: 10%;"></td> <td style="width: 10%;"></td> <td style="width: 10%;"></td> <td style="width: 10%;"></td> <td style="width: 10%;"></td> <td style="width: 10%;"></td> </tr> <tr> <td></td> <td></td> <td colspan="8" style="text-align: center;"> <table border="1" style="width: 100%; border-collapse: collapse; text-align: center;"> <tr> </tr></table></td></tr></table></td></tr></table></td></tr></table></td></tr></table>

 | | | | | | | | | | | | | | | | | | | | <table border="1" style="width: 100%; border-collapse: collapse; text-align: center;"> <tr> <td style="width: 10%;"></td> <td style="width: 10%;"></td> <td style="width: 10%;"></td> <td style="width: 10%;"></td> <td style="width: 10%;"></td> <td style="width: 10%;"></td> <td style="width: 10%;"></td> <td style="width: 10%;"></td> <td style="width: 10%;"></td> <td style="width: 10%;"></td> </tr> <tr> <td></td> <td></td> <td colspan="8" style="text-align: center;"> <table border="1" style="width: 100%; border-collapse: collapse; text-align: center;"> <tr> <td style="width: 10%;"></td> <td style="width: 10%;"></td> <td style="width: 10%;"></td> <td style="width: 10%;"></td> <td style="width: 10%;"></td> <td style="width: 10%;"></td> <td style="width: 10%;"></td> <td style="width: 10%;"></td> <td style="width: 10%;"></td> <td style="width: 10%;"></td> </tr> <tr> <td></td> <td></td> <td colspan="8" style="text-align: center;"> <table border="1" style="width: 100%; border-collapse: collapse; text-align: center;"> <tr> <td style="width: 10%;"></td> <td style="width: 10%;"></td> <td style="width: 10%;"></td> <td style="width: 10%;"></td> <td style="width: 10%;"></td> <td style="width: 10%;"></td> <td style="width: 10%;"></td> <td style="width: 10%;"></td> <td style="width: 10%;"></td> <td style="width: 10%;"></td> </tr> <tr> <td></td> <td></td> <td colspan="8" style="text-align: center;"> <table border="1" style="width: 100%; border-collapse: collapse; text-align: center;"> <tr> </tr></table></td></tr></table></td></tr></table></td></tr></table>

 | | | | | | | | | | | | | | | | | | | | <table border="1" style="width: 100%; border-collapse: collapse; text-align: center;"> <tr> <td style="width: 10%;"></td> <td style="width: 10%;"></td> <td style="width: 10%;"></td> <td style="width: 10%;"></td> <td style="width: 10%;"></td> <td style="width: 10%;"></td> <td style="width: 10%;"></td> <td style="width: 10%;"></td> <td style="width: 10%;"></td> <td style="width: 10%;"></td> </tr> <tr> <td></td> <td></td> <td colspan="8" style="text-align: center;"> <table border="1" style="width: 100%; border-collapse: collapse; text-align: center;"> <tr> <td style="width: 10%;"></td> <td style="width: 10%;"></td> <td style="width: 10%;"></td> <td style="width: 10%;"></td> <td style="width: 10%;"></td> <td style="width: 10%;"></td> <td style="width: 10%;"></td> <td style="width: 10%;"></td> <td style="width: 10%;"></td> <td style="width: 10%;"></td> </tr> <tr> <td></td> <td></td> <td colspan="8" style="text-align: center;"> <table border="1" style="width: 100%; border-collapse: collapse; text-align: center;"> <tr> </tr></table></td></tr></table></td></tr></table>

 | | | | | | | | | | | | | | | | | | | | <table border="1" style="width: 100%; border-collapse: collapse; text-align: center;"> <tr> <td style="width: 10%;"></td> <td style="width: 10%;"></td> <td style="width: 10%;"></td> <td style="width: 10%;"></td> <td style="width: 10%;"></td> <td style="width: 10%;"></td> <td style="width: 10%;"></td> <td style="width: 10%;"></td> <td style="width: 10%;"></td> <td style="width: 10%;"></td> </tr> <tr> <td></td> <td></td> <td colspan="8" style="text-align: center;"> <table border="1" style="width: 100%; border-collapse: collapse; text-align: center;"> <tr> </tr></table></td></tr></table>

 | | | | | | | | | | | | | | | | | | | | <table border="1" style="width: 100%; border-collapse: collapse; text-align: center;"> <tr> </tr></table>

 | | | | | | | | | | | | | | | | | | | |

 | | | | | | | | | | | | | | | | | | | |

 | | | | | | | | | | | | | | | | | | | |

 | | | | | | | | | | | | | | | | | | | |

 | | | | | | | | | | | | | | | | | | | |

 | | | | | | | | | | | | | | | | | | | |

 | | | | | | | | | | | | | | | | | | | |

 | | | | | | | | | | | | | | | | | | | |

 | | | | | | | | | | | | | | | | | | | |

 | | | | | | | | | | | | | | | | | | | |

 | | | | | | | | | | | | | | | | | | | |

 | | | | | | | | | | | | | | | | | | | |

 | | | | | | | | | | | | | | | | | | | |

 | | | | | | | | | | | | | | | | | | | |

 | | | | | | | | | | | | | | | | | | | |

 | | | | | | | | | | | | | | | | | | | |

 | | | | | | | | | | | | | | | | | | | |

 | | | | | | | | | | | | | | | | | | | |

 | | | | | | | | | | | | | | | | | | | |

 | | | | | | | | | | | | | | | | | | | |

 | | | | | | | | | | | | | | | | | | | |

 | | | | | | | | | | | | | | | | | | | |

 | | | | | | | | | | | | | | | | | | | |
 | | | | | | | | | | | | | | | | | | | |

 | | | | | | | | | | | | | | | | | | | |

 | | | | | | | | | | | | | | | | | | | |
 | | | | | | | | | | | | | | | | | | | |

 | | | | | | | | | | | | | | | | | | | |

 | | | | | | | | | | | | | | | | | | | |
 | | | | | | | | | | | | | | | | | | | |
 | | | | | | | | | | | | | | | | | | | |

 | | | | | | | | | | | | | | | | | | | |
 | | | | | | | | | | | | | | | | | | | |
 | | | | | | | | | | | | | | | | | | | |

 | | | | | | | | | | | | | | | | | | | | | | | | | | | | | | | | | | | | | | | | | | | | | | | | | | | | | | | | | | | | | | | | | | | | | | | | | | | | | | | | | | | | | | | | | | | | | | | | | | | |
 | | | | | | | | | | | | | | | | | | | |
 | | | | | | | | | | | | | | | | | | | |
 | | | | | | | | | | | | | | | | | | | |
 | | | | | | | | | | | | | | | | | | | |
 | | | | | | | | | | | | | | | | | | | |
 | | | | | | | | | | | | | | | | | | | |
 | | | | | | | | | | | | | | | | | | | |
 | | | | | | | | | | | | | | | | | | | |
 | | | | | | | | | | | | | | | | | | | | | | | | | | | | | | | | | | | | | | | |
 | | | | | | | | | | | | | | | | | | | |
 | | | | | | | | | | | | | | | | | | | | | | | | | | | | | | | | | | | | | | | |
 | | | | | | | | | | | | | | | | | | | | | | | | | | | | | | | | | | | | | | | |
 | | | | | | | | | | | | | | | | | | | | | | | | | | | | | | | | | | | | | | | |
 | | | | | | | | | | | | | | | | | | | | | | | | | | | | | | | | | | | | | | | | | | | | | | | | | | | | | | | | | | | | | | | | | | | | | | | | | | | | | | | | | | | | | | | | | | | | | | | | | | | |
 | | | | | | | | | | | | | | | | | | | | | | | | | | | | | | | | | | | | | | | | | | | | | | | |
| | |

 | | | | | | | | | | | | | | | | | | | |

 | | | | | | | | | | | | | | | | | | | |

 | | | | | | | | | | | | | | | | | | | |

 | | | | | | | | | | | | | | | | | | | |

 | | | | | | | | | | | | | | | | | | | |

 | | | | | | | | | | | | | | | | | | | |

 | | | | | | | | | | | | | | | | | | | |

 | | | | | | | | | | | | | | | | | | | |

 | | | | | | | | | | | | | | | | | | | |

 | | | | | | | | | | | | | | | | | | | |

 | | | | | | | | | | | | | | | | | | | |

 | | | | | | | | | | | | | | | | | | | |

 | | | | | | | | | | | | | | | | | | | |

 | | | | | | | | | | | | | | | | | | | |

 | | | | | | | | | | | | | | | | | | | |

 | | | | | | | | | | | | | | | | | | | |

 | | | | | | | | | | | | | | | | | | | |

 | | | | | | | | | | | | | | | | | | | |

 | | | | | | | | | | | | | | | | | | | |

 | | | | | | | | | | | | | | | | | | | |

 | | | | | | | | | | | | | | | | | | | |

 | | | | | | | | | | | | | | | | | | | |

 | | | | | | | | | | | | | | | | | | | |

 | | | | | | | | | | | | | | | | | | | |

 | | | | | | | | | | | | | | | | | | | |

 | | | | | | | | | | | | | | | | | | | |

 | | | | | | | | | | | | | | | | | | | |

 | | | | | | | | | | | | | | | | | | | |
 | | | | | | | | | | | | | | | | | | | |

 | | | | | | | | | | | | | | | | | | | |

 | | | | | | | | | | | | | | | | | | | |
 | | | | | | | | | | | | | | | | | | | |

 | | | | | | | | | | | | | | | | | | | |

 | | | | | | | | | | | | | | | | | | | |
 | | | | | | | | | | | | | | | | | | | |
 | | | | | | | | | | | | | | | | | | | |

 | | | | | | | | | | | | | | | | | | | |
 | | | | | | | | | | | | | | | | | | | |
 | | | | | | | | | | | | | | | | | | | |

 | | | | | | | | | | | | | | | | | | | | | | | | | | | | | | | | | | | | | | | | | | | | | | | | | | | | | | | | | | | | | | | | | | | | | | | | | | | | | | | | | | | | | | | | | | | | | | | | | | | |
 | | | | | | | | | | | | | | | | | | | |
 | | | | | | | | | | | | | | | | | | | |
 | | | | | | | | | | | | | | | | | | | |
 | | | | | | | | | | | | | | | | | | | |
 | | | | | | | | | | | | | | | | | | | |
 | | | | | | | | | | | | | | | | | | | |
 | | | | | | | | | | | | | | | | | | | |
 | | | | | | | | | | | | | | | | | | | |
 | | | | | | | | | | | | | | | | | | | | | | | | | | | | | | | | | | | | | | | |
 | | | | | | | | | | | | | | | | | | | |
 | | | | | | | | | | | | | | | | | | | | | | | | | | | | | | | | | | | | | | | |
 | | | | | | | | | | | | | | | | | | | | | | | | | | | | | | | | | | | | | | | |
 | | | | | | | | | | | | | | | | | | | | | | | | | | | | | | | | | | | | | | | |
 | | | | | | | | | | | | | | | | | | | | | | | | | | | | | | | | | | | | | | | | | | | | | | | | | | | | | | | | | | | | | | | | | | | | | | | | | | | | | | | | | | | | | | | | | | | | | | | | | | | |
 | | | | | | | | | | | | | | | | | | | | | | | | | | | | | | | | | | | | | | | | | | | | | | | |
| | | <table border="1" style="width: 100%; border-collapse: collapse; text-align: center;"> <tr> <td style="width: 10%;"></td> <td style="width: 10%;"></td> <td style="width: 10%;"></td> <td style="width: 10%;"></td> <td style="width: 10%;"></td> <td style="width: 10%;"></td> <td style="width: 10%;"></td> <td style="width: 10%;"></td> <td style="width: 10%;"></td> <td style="width: 10%;"></td> </tr> <tr> <td></td> <td></td> <td colspan="8" style="text-align: center;"> <table border="1" style="width: 100%; border-collapse: collapse; text-align: center;"> <tr> <td style="width: 10%;"></td> <td style="width: 10%;"></td> <td style="width: 10%;"></td> <td style="width: 10%;"></td> <td style="width: 10%;"></td> <td style="width: 10%;"></td> <td style="width: 10%;"></td> <td style="width: 10%;"></td> <td style="width: 10%;"></td> <td style="width: 10%;"></td> </tr> <tr> <td></td> <td></td> <td colspan="8" style="text-align: center;"> <table border="1" style="width: 100%; border-collapse: collapse; text-align: center;"> <tr> <td style="width: 10%;"></td> <td style="width: 10%;"></td> <td style="width: 10%;"></td> <td style="width: 10%;"></td> <td style="width: 10%;"></td> <td style="width: 10%;"></td> <td style="width: 10%;"></td> <td style="width: 10%;"></td> <td style="width: 10%;"></td> <td style="width: 10%;"></td> </tr> <tr> <td></td> <td></td> <td colspan="8" style="text-align: center;"> <table border="1" style="width: 100%; border-collapse: collapse; text-align: center;"> <tr> <td style="width: 10%;"></td> <td style="width: 10%;"></td> <td style="width: 10%;"></td> <td style="width: 10%;"></td> <td style="width: 10%;"></td> <td style="width: 10%;"></td> <td style="width: 10%;"></td> <td style="width: 10%;"></td> <td style="width: 10%;"></td> <td style="width: 10%;"></td> </tr> <tr> <td></td> <td></td> <td colspan="8" style="text-align: center;"> <table border="1" style="width: 100%; border-collapse: collapse; text-align: center;"> <tr> </tr></table></td></tr></table></td></tr></table></td></tr></table></td></tr></table>

 | | | | | | | | | | | | | | | | | | | | <table border="1" style="width: 100%; border-collapse: collapse; text-align: center;"> <tr> <td style="width: 10%;"></td> <td style="width: 10%;"></td> <td style="width: 10%;"></td> <td style="width: 10%;"></td> <td style="width: 10%;"></td> <td style="width: 10%;"></td> <td style="width: 10%;"></td> <td style="width: 10%;"></td> <td style="width: 10%;"></td> <td style="width: 10%;"></td> </tr> <tr> <td></td> <td></td> <td colspan="8" style="text-align: center;"> <table border="1" style="width: 100%; border-collapse: collapse; text-align: center;"> <tr> <td style="width: 10%;"></td> <td style="width: 10%;"></td> <td style="width: 10%;"></td> <td style="width: 10%;"></td> <td style="width: 10%;"></td> <td style="width: 10%;"></td> <td style="width: 10%;"></td> <td style="width: 10%;"></td> <td style="width: 10%;"></td> <td style="width: 10%;"></td> </tr> <tr> <td></td> <td></td> <td colspan="8" style="text-align: center;"> <table border="1" style="width: 100%; border-collapse: collapse; text-align: center;"> <tr> <td style="width: 10%;"></td> <td style="width: 10%;"></td> <td style="width: 10%;"></td> <td style="width: 10%;"></td> <td style="width: 10%;"></td> <td style="width: 10%;"></td> <td style="width: 10%;"></td> <td style="width: 10%;"></td> <td style="width: 10%;"></td> <td style="width: 10%;"></td> </tr> <tr> <td></td> <td></td> <td colspan="8" style="text-align: center;"> <table border="1" style="width: 100%; border-collapse: collapse; text-align: center;"> <tr> </tr></table></td></tr></table></td></tr></table></td></tr></table>

 | | | | | | | | | | | | | | | | | | | | <table border="1" style="width: 100%; border-collapse: collapse; text-align: center;"> <tr> <td style="width: 10%;"></td> <td style="width: 10%;"></td> <td style="width: 10%;"></td> <td style="width: 10%;"></td> <td style="width: 10%;"></td> <td style="width: 10%;"></td> <td style="width: 10%;"></td> <td style="width: 10%;"></td> <td style="width: 10%;"></td> <td style="width: 10%;"></td> </tr> <tr> <td></td> <td></td> <td colspan="8" style="text-align: center;"> <table border="1" style="width: 100%; border-collapse: collapse; text-align: center;"> <tr> <td style="width: 10%;"></td> <td style="width: 10%;"></td> <td style="width: 10%;"></td> <td style="width: 10%;"></td> <td style="width: 10%;"></td> <td style="width: 10%;"></td> <td style="width: 10%;"></td> <td style="width: 10%;"></td> <td style="width: 10%;"></td> <td style="width: 10%;"></td> </tr> <tr> <td></td> <td></td> <td colspan="8" style="text-align: center;"> <table border="1" style="width: 100%; border-collapse: collapse; text-align: center;"> <tr> </tr></table></td></tr></table></td></tr></table>

 | | | | | | | | | | | | | | | | | | | | <table border="1" style="width: 100%; border-collapse: collapse; text-align: center;"> <tr> <td style="width: 10%;"></td> <td style="width: 10%;"></td> <td style="width: 10%;"></td> <td style="width: 10%;"></td> <td style="width: 10%;"></td> <td style="width: 10%;"></td> <td style="width: 10%;"></td> <td style="width: 10%;"></td> <td style="width: 10%;"></td> <td style="width: 10%;"></td> </tr> <tr> <td></td> <td></td> <td colspan="8" style="text-align: center;"> <table border="1" style="width: 100%; border-collapse: collapse; text-align: center;"> <tr> </tr></table></td></tr></table>

 | | | | | | | | | | | | | | | | | | | | <table border="1" style="width: 100%; border-collapse: collapse; text-align: center;"> <tr> </tr></table>

 | | | | | | | | | | | | | | | | | | | |

 | | | | | | | | | | | | | | | | | | | |

 | | | | | | | | | | | | | | | | | | | |

 | | | | | | | | | | | | | | | | | | | |

 | | | | | | | | | | | | | | | | | | | |

 | | | | | | | | | | | | | | | | | | | |

 | | | | | | | | | | | | | | | | | | | |

 | | | | | | | | | | | | | | | | | | | |

 | | | | | | | | | | | | | | | | | | | |

 | | | | | | | | | | | | | | | | | | | |

 | | | | | | | | | | | | | | | | | | | |

 | | | | | | | | | | | | | | | | | | | |

 | | | | | | | | | | | | | | | | | | | |

 | | | | | | | | | | | | | | | | | | | |

 | | | | | | | | | | | | | | | | | | | |

 | | | | | | | | | | | | | | | | | | | |

 | | | | | | | | | | | | | | | | | | | |

 | | | | | | | | | | | | | | | | | | | |

 | | | | | | | | | | | | | | | | | | | |

 | | | | | | | | | | | | | | | | | | | |

 | | | | | | | | | | | | | | | | | | | |

 | | | | | | | | | | | | | | | | | | | |

 | | | | | | | | | | | | | | | | | | | |

 | | | | | | | | | | | | | | | | | | | |
 | | | | | | | | | | | | | | | | | | | |

 | | | | | | | | | | | | | | | | | | | |

 | | | | | | | | | | | | | | | | | | | |
 | | | | | | | | | | | | | | | | | | | |

 | | | | | | | | | | | | | | | | | | | |

 | | | | | | | | | | | | | | | | | | | |
 | | | | | | | | | | | | | | | | | | | |
 | | | | | | | | | | | | | | | | | | | |

 | | | | | | | | | | | | | | | | | | | |
 | | | | | | | | | | | | | | | | | | | |
 | | | | | | | | | | | | | | | | | | | |

 | | | | | | | | | | | | | | | | | | | | | | | | | | | | | | | | | | | | | | | | | | | | | | | | | | | | | | | | | | | | | | | | | | | | | | | | | | | | | | | | | | | | | | | | | | | | | | | | | | | |
 | | | | | | | | | | | | | | | | | | | |
 | | | | | | | | | | | | | | | | | | | |
 | | | | | | | | | | | | | | | | | | | |
 | | | | | | | | | | | | | | | | | | | |
 | | | | | | | | | | | | | | | | | | | |
 | | | | | | | | | | | | | | | | | | | |
 | | | | | | | | | | | | | | | | | | | |
 | | | | | | | | | | | | | | | | | | | |
 | | | | | | | | | | | | | | | | | | | | | | | | | | | | | | | | | | | | | | | |
 | | | | | | | | | | | | | | | | | | | |
 | | | | | | | | | | | | | | | | | | | | | | | | | | | | | | | | | | | | | | | |
 | | | | | | | | | | | | | | | | | | | | | | | | | | | | | | | | | | | | | | | |
 | | | | | | | | | | | | | | | | | | | | | | | | | | | | | | | | | | | | | | | |
 | | | | | | | | | | | | | | | | | | | | | | | | | | | | | | | | | | | | | | | | | | | | | | | | | | | | | | | | | | | | | | | | | | | | | | | | | | | | | | | | | | | | | | | | | | | | | | | | | | | |
 | | | | | | | | | | | | | | | | | | | | | | | | | | | | | | | | | | | | | | | | | | | | | | | |
| | |

 | | | | | | | | | | | | | | | | | | | |

 | | | | | | | | | | | | | | | | | | | |

 | | | | | | | | | | | | | | | | | | | |

 | | | | | | | | | | | | | | | | | | | |

 | | | | | | | | | | | | | | | | | | | |

 | | | | | | | | | | | | | | | | | | | |

 | | | | | | | | | | | | | | | | | | | |

 | | | | | | | | | | | | | | | | | | | |

 | | | | | | | | | | | | | | | | | | | |

 | | | | | | | | | | | | | | | | | | | |

 | | | | | | | | | | | | | | | | | | | |

 | | | | | | | | | | | | | | | | | | | |

 | | | | | | | | | | | | | | | | | | | |

 | | | | | | | | | | | | | | | | | | | |

 | | | | | | | | | | | | | | | | | | | |

 | | | | | | | | | | | | | | | | | | | |

 | | | | | | | | | | | | | | | | | | | |

 | | | | | | | | | | | | | | | | | | | |

 | | | | | | | | | | | | | | | | | | | |

 | | | | | | | | | | | | | | | | | | | |

 | | | | | | | | | | | | | | | | | | | |

 | | | | | | | | | | | | | | | | | | | |

 | | | | | | | | | | | | | | | | | | | |

 | | | | | | | | | | | | | | | | | | | |

 | | | | | | | | | | | | | | | | | | | |

 | | | | | | | | | | | | | | | | | | | |

 | | | | | | | | | | | | | | | | | | | |

 | | | | | | | | | | | | | | | | | | | |
 | | | | | | | | | | | | | | | | | | | |

 | | | | | | | | | | | | | | | | | | | |

 | | | | | | | | | | | | | | | | | | | |
 | | | | | | | | | | | | | | | | | | | |

 | | | | | | | | | | | | | | | | | | | |

 | | | | | | | | | | | | | | | | | | | |
 | | | | | | | | | | | | | | | | | | | |
 | | | | | | | | | | | | | | | | | | | |

 | | | | | | | | | | | | | | | | | | | |
 | | | | | | | | | | | | | | | | | | | |
 | | | | | | | | | | | | | | | | | | | |

 | | | | | | | | | | | | | | | | | | | | | | | | | | | | | | | | | | | | | | | | | | | | | | | | | | | | | | | | | | | | | | | | | | | | | | | | | | | | | | | | | | | | | | | | | | | | | | | | | | | |
 | | | | | | | | | | | | | | | | | | | |
 | | | | | | | | | | | | | | | | | | | |
 | | | | | | | | | | | | | | | | | | | |
 | | | | | | | | | | | | | | | | | | | |
 | | | | | | | | | | | | | | | | | | | |
 | | | | | | | | | | | | | | | | | | | |
 | | | | | | | | | | | | | | | | | | | |
 | | | | | | | | | | | | | | | | | | | |
 | | | | | | | | | | | | | | | | | | | | | | | | | | | | | | | | | | | | | | | |
 | | | | | | | | | | | | | | | | | | | |
 | | | | | | | | | | | | | | | | | | | | | | | | | | | | | | | | | | | | | | | |
 | | | | | | | | | | | | | | | | | | | | | | | | | | | | | | | | | | | | | | | |
 | | | | | | | | | | | | | | | | | | | | | | | | | | | | | | | | | | | | | | | |
 | | | | | | | | | | | | | | | | | | | | | | | | | | | | | | | | | | | | | | | | | | | | | | | | | | | | | | | | | | | | | | | | | | | | | | | | | | | | | | | | | | | | | | | | | | | | | | | | | | | |
 | | | | | | | | | | | | | | | | | | | | | | | | | | | | | | | | | | | | | | | | | | | | | | | |
| | | <table border="1" style="width: 100%; border-collapse: collapse; text-align: center;"> <tr> <td style="width: 10%;"></td> <td style="width: 10%;"></td> <td style="width: 10%;"></td> <td style="width: 10%;"></td> <td style="width: 10%;"></td> <td style="width: 10%;"></td> <td style="width: 10%;"></td> <td style="width: 10%;"></td> <td style="width: 10%;"></td> <td style="width: 10%;"></td> </tr> <tr> <td></td> <td></td> <td colspan="8" style="text-align: center;"> <table border="1" style="width: 100%; border-collapse: collapse; text-align: center;"> <tr> <td style="width: 10%;"></td> <td style="width: 10%;"></td> <td style="width: 10%;"></td> <td style="width: 10%;"></td> <td style="width: 10%;"></td> <td style="width: 10%;"></td> <td style="width: 10%;"></td> <td style="width: 10%;"></td> <td style="width: 10%;"></td> <td style="width: 10%;"></td> </tr> <tr> <td></td> <td></td> <td colspan="8" style="text-align: center;"> <table border="1" style="width: 100%; border-collapse: collapse; text-align: center;"> <tr> <td style="width: 10%;"></td> <td style="width: 10%;"></td> <td style="width: 10%;"></td> <td style="width: 10%;"></td> <td style="width: 10%;"></td> <td style="width: 10%;"></td> <td style="width: 10%;"></td> <td style="width: 10%;"></td> <td style="width: 10%;"></td> <td style="width: 10%;"></td> </tr> <tr> <td></td> <td></td> <td colspan="8" style="text-align: center;"> <table border="1" style="width: 100%; border-collapse: collapse; text-align: center;"> <tr> </tr></table></td></tr></table></td></tr></table></td></tr></table>

 | | | | | | | | | | | | | | | | | | | | <table border="1" style="width: 100%; border-collapse: collapse; text-align: center;"> <tr> <td style="width: 10%;"></td> <td style="width: 10%;"></td> <td style="width: 10%;"></td> <td style="width: 10%;"></td> <td style="width: 10%;"></td> <td style="width: 10%;"></td> <td style="width: 10%;"></td> <td style="width: 10%;"></td> <td style="width: 10%;"></td> <td style="width: 10%;"></td> </tr> <tr> <td></td> <td></td> <td colspan="8" style="text-align: center;"> <table border="1" style="width: 100%; border-collapse: collapse; text-align: center;"> <tr> <td style="width: 10%;"></td> <td style="width: 10%;"></td> <td style="width: 10%;"></td> <td style="width: 10%;"></td> <td style="width: 10%;"></td> <td style="width: 10%;"></td> <td style="width: 10%;"></td> <td style="width: 10%;"></td> <td style="width: 10%;"></td> <td style="width: 10%;"></td> </tr> <tr> <td></td> <td></td> <td colspan="8" style="text-align: center;"> <table border="1" style="width: 100%; border-collapse: collapse; text-align: center;"> <tr> </tr></table></td></tr></table></td></tr></table>

 | | | | | | | | | | | | | | | | | | | | <table border="1" style="width: 100%; border-collapse: collapse; text-align: center;"> <tr> <td style="width: 10%;"></td> <td style="width: 10%;"></td> <td style="width: 10%;"></td> <td style="width: 10%;"></td> <td style="width: 10%;"></td> <td style="width: 10%;"></td> <td style="width: 10%;"></td> <td style="width: 10%;"></td> <td style="width: 10%;"></td> <td style="width: 10%;"></td> </tr> <tr> <td></td> <td></td> <td colspan="8" style="text-align: center;"> <table border="1" style="width: 100%; border-collapse: collapse; text-align: center;"> <tr> </tr></table></td></tr></table>

 | | | | | | | | | | | | | | | | | | | | <table border="1" style="width: 100%; border-collapse: collapse; text-align: center;"> <tr> </tr></table>

 | | | | | | | | | | | | | | | | | | | |

 | | | | | | | | | | | | | | | | | | | |

 | | | | | | | | | | | | | | | | | | | |

 | | | | | | | | | | | | | | | | | | | |

 | | | | | | | | | | | | | | | | | | | |

 | | | | | | | | | | | | | | | | | | | |

 | | | | | | | | | | | | | | | | | | | |

 | | | | | | | | | | | | | | | | | | | |

 | | | | | | | | | | | | | | | | | | | |

 | | | | | | | | | | | | | | | | | | | |

 | | | | | | | | | | | | | | | | | | | |

 | | | | | | | | | | | | | | | | | | | |

 | | | | | | | | | | | | | | | | | | | |

 | | | | | | | | | | | | | | | | | | | |

 | | | | | | | | | | | | | | | | | | | |

 | | | | | | | | | | | | | | | | | | | |

 | | | | | | | | | | | | | | | | | | | |

 | | | | | | | | | | | | | | | | | | | |

 | | | | | | | | | | | | | | | | | | | |

 | | | | | | | | | | | | | | | | | | | |

 | | | | | | | | | | | | | | | | | | | |

 | | | | | | | | | | | | | | | | | | | |

 | | | | | | | | | | | | | | | | | | | |

 | | | | | | | | | | | | | | | | | | | |

 | | | | | | | | | | | | | | | | | | | |
 | | | | | | | | | | | | | | | | | | | |

 | | | | | | | | | | | | | | | | | | | |

 | | | | | | | | | | | | | | | | | | | |
 | | | | | | | | | | | | | | | | | | | |

 | | | | | | | | | | | | | | | | | | | |

 | | | | | | | | | | | | | | | | | | | |
 | | | | | | | | | | | | | | | | | | | |
 | | | | | | | | | | | | | | | | | | | |

 | | | | | | | | | | | | | | | | | | | |
 | | | | | | | | | | | | | | | | | | | |
 | | | | | | | | | | | | | | | | | | | |

 | | | | | | | | | | | | | | | | | | | | | | | | | | | | | | | | | | | | | | | | | | | | | | | | | | | | | | | | | | | | | | | | | | | | | | | | | | | | | | | | | | | | | | | | | | | | | | | | | | | |
 | | | | | | | | | | | | | | | | | | | |
 | | | | | | | | | | | | | | | | | | | |
 | | | | | | | | | | | | | | | | | | | |
 | | | | | | | | | | | | | | | | | | | |
 | | | | | | | | | | | | | | | | | | | |
 | | | | | | | | | | | | | | | | | | | |
 | | | | | | | | | | | | | | | | | | | |
 | | | | | | | | | | | | | | | | | | | |
 | | | | | | | | | | | | | | | | | | | | | | | | | | | | | | | | | | | | | | | |
 | | | | | | | | | | | | | | | | | | | |
 | | | | | | | | | | | | | | | | | | | | | | | | | | | | | | | | | | | | | | | |
 | | | | | | | | | | | | | | | | | | | | | | | | | | | | | | | | | | | | | | | |
 | | | | | | | | | | | | | | | | | | | | | | | | | | | | | | | | | | | | | | | |
 | | | | | | | | | | | | | | | | | | | | | | | | | | | | | | | | | | | | | | | | | | | | | | | | | | | | | | | | | | | | | | | | | | | | | | | | | | | | | | | | | | | | | | | | | | | | | | | | | | | |
 | | | | | | | | | | | | | | | | | | | | | | | | | | | | | | | | | | | | | | | | | | | | | | | |
| | |

 | | | | | | | | | | | | | | | | | | | |

 | | | | | | | | | | | | | | | | | | | |

 | | | | | | | | | | | | | | | | | | | |

 | | | | | | | | | | | | | | | | | | | |

 | | | | | | | | | | | | | | | | | | | |

 | | | | | | | | | | | | | | | | | | | |

 | | | | | | | | | | | | | | | | | | | |

 | | | | | | | | | | | | | | | | | | | |

 | | | | | | | | | | | | | | | | | | | |

 | | | | | | | | | | | | | | | | | | | |

 | | | | | | | | | | | | | | | | | | | |

 | | | | | | | | | | | | | | | | | | | |

 | | | | | | | | | | | | | | | | | | | |

 | | | | | | | | | | | | | | | | | | | |

 | | | | | | | | | | | | | | | | | | | |

 | | | | | | | | | | | | | | | | | | | |

 | | | | | | | | | | | | | | | | | | | |

 | | | | | | | | | | | | | | | | | | | |

 | | | | | | | | | | | | | | | | | | | |

 | | | | | | | | | | | | | | | | | | | |

 | | | | | | | | | | | | | | | | | | | |

 | | | | | | | | | | | | | | | | | | | |

 | | | | | | | | | | | | | | | | | | | |

 | | | | | | | | | | | | | | | | | | | |

 | | | | | | | | | | | | | | | | | | | |

 | | | | | | | | | | | | | | | | | | | |

 | | | | | | | | | | | | | | | | | | | |

 | | | | | | | | | | | | | | | | | | | |
 | | | | | | | | | | | | | | | | | | | |

 | | | | | | | | | | | | | | | | | | | |

 | | | | | | | | | | | | | | | | | | | |
 | | | | | | | | | | | | | | | | | | | |

 | | | | | | | | | | | | | | | | | | | |

 | | | | | | | | | | | | | | | | | | | |
 | | | | | | | | | | | | | | | | | | | |
 | | | | | | | | | | | | | | | | | | | |

 | | | | | | | | | | | | | | | | | | | |
 | | | | | | | | | | | | | | | | | | | |
 | | | | | | | | | | | | | | | | | | | |

 | | | | | | | | | | | | | | | | | | | | | | | | | | | | | | | | | | | | | | | | | | | | | | | | | | | | | | | | | | | | | | | | | | | | | | | | | | | | | | | | | | | | | | | | | | | | | | | | | | | |
 | | | | | | | | | | | | | | | | | | | |
 | | | | | | | | | | | | | | | | | | | |
 | | | | | | | | | | | | | | | | | | | |
 | | | | | | | | | | | | | | | | | | | |
 | | | | | | | | | | | | | | | | | | | |
 | | | | | | | | | | | | | | | | | | | |
 | | | | | | | | | | | | | | | | | | | |
 | | | | | | | | | | | | | | | | | | | |
 | | | | | | | | | | | | | | | | | | | | | | | | | | | | | | | | | | | | | | | |
 | | | | | | | | | | | | | | | | | | | |
 | | | | | | | | | | | | | | | | | | | | | | | | | | | | | | | | | | | | | | | |
 | | | | | | | | | | | | | | | | | | | | | | | | | | | | | | | | | | | | | | | |
 | | | | | | | | | | | | | | | | | | | | | | | | | | | | | | | | | | | | | | | |
 | | | | | | | | | | | | | | | | | | | | | | | | | | | | | | | | | | | | | | | | | | | | | | | | | | | | | | | | | | | | | | | | | | | | | | | | | | | | | | | | | | | | | | | | | | | | | | | | | | | |
 | | | | | | | | | | | | | | | | | | | | | | | | | | | | | | | | | | | | | | | | | | | | | | | |
| | | <table border="1" style="width: 100%; border-collapse: collapse; text-align: center;"> <tr> <td style="width: 10%;"></td> <td style="width: 10%;"></td> <td style="width: 10%;"></td> <td style="width: 10%;"></td> <td style="width: 10%;"></td> <td style="width: 10%;"></td> <td style="width: 10%;"></td> <td style="width: 10%;"></td> <td style="width: 10%;"></td> <td style="width: 10%;"></td> </tr> <tr> <td></td> <td></td> <td colspan="8" style="text-align: center;"> <table border="1" style="width: 100%; border-collapse: collapse; text-align: center;"> <tr> <td style="width: 10%;"></td> <td style="width: 10%;"></td> <td style="width: 10%;"></td> <td style="width: 10%;"></td> <td style="width: 10%;"></td> <td style="width: 10%;"></td> <td style="width: 10%;"></td> <td style="width: 10%;"></td> <td style="width: 10%;"></td> <td style="width: 10%;"></td> </tr> <tr> <td></td> <td></td> <td colspan="8" style="text-align: center;"> <table border="1" style="width: 100%; border-collapse: collapse; text-align: center;"> <tr> </tr></table></td></tr></table></td></tr></table>

 | | | | | | | | | | | | | | | | | | | | <table border="1" style="width: 100%; border-collapse: collapse; text-align: center;"> <tr> <td style="width: 10%;"></td> <td style="width: 10%;"></td> <td style="width: 10%;"></td> <td style="width: 10%;"></td> <td style="width: 10%;"></td> <td style="width: 10%;"></td> <td style="width: 10%;"></td> <td style="width: 10%;"></td> <td style="width: 10%;"></td> <td style="width: 10%;"></td> </tr> <tr> <td></td> <td></td> <td colspan="8" style="text-align: center;"> <table border="1" style="width: 100%; border-collapse: collapse; text-align: center;"> <tr> </tr></table></td></tr></table>

 | | | | | | | | | | | | | | | | | | | | <table border="1" style="width: 100%; border-collapse: collapse; text-align: center;"> <tr> </tr></table>

 | | | | | | | | | | | | | | | | | | | |

 | | | | | | | | | | | | | | | | | | | |

 | | | | | | | | | | | | | | | | | | | |

 | | | | | | | | | | | | | | | | | | | |

 | | | | | | | | | | | | | | | | | | | |

 | | | | | | | | | | | | | | | | | | | |

 | | | | | | | | | | | | | | | | | | | |

 | | | | | | | | | | | | | | | | | | | |

 | | | | | | | | | | | | | | | | | | | |

 | | | | | | | | | | | | | | | | | | | |

 | | | | | | | | | | | | | | | | | | | |

 | | | | | | | | | | | | | | | | | | | |

 | | | | | | | | | | | | | | | | | | | |

 | | | | | | | | | | | | | | | | | | | |

 | | | | | | | | | | | | | | | | | | | |

 | | | | | | | | | | | | | | | | | | | |

 | | | | | | | | | | | | | | | | | | | |

 | | | | | | | | | | | | | | | | | | | |

 | | | | | | | | | | | | | | | | | | | |

 | | | | | | | | | | | | | | | | | | | |

 | | | | | | | | | | | | | | | | | | | |

 | | | | | | | | | | | | | | | | | | | |

 | | | | | | | | | | | | | | | | | | | |

 | | | | | | | | | | | | | | | | | | | |

 | | | | | | | | | | | | | | | | | | | |

 | | | | | | | | | | | | | | | | | | | |
 | | | | | | | | | | | | | | | | | | | |

 | | | | | | | | | | | | | | | | | | | |

 | | | | | | | | | | | | | | | | | | | |
 | | | | | | | | | | | | | | | | | | | |

 | | | | | | | | | | | | | | | | | | | |

 | | | | | | | | | | | | | | | | | | | |
 | | | | | | | | | | | | | | | | | | | |
 | | | | | | | | | | | | | | | | | | | |

 | | | | | | | | | | | | | | | | | | | |
 | | | | | | | | | | | | | | | | | | | |
 | | | | | | | | | | | | | | | | | | | |

 | | | | | | | | | | | | | | | | | | | | | | | | | | | | | | | | | | | | | | | | | | | | | | | | | | | | | | | | | | | | | | | | | | | | | | | | | | | | | | | | | | | | | | | | | | | | | | | | | | | |
 | | | | | | | | | | | | | | | | | | | |
 | | | | | | | | | | | | | | | | | | | |
 | | | | | | | | | | | | | | | | | | | |
 | | | | | | | | | | | | | | | | | | | |
 | | | | | | | | | | | | | | | | | | | |
 | | | | | | | | | | | | | | | | | | | |
 | | | | | | | | | | | | | | | | | | | |
 | | | | | | | | | | | | | | | | | | | |
 | | | | | | | | | | | | | | | | | | | | | | | | | | | | | | | | | | | | | | | |
 | | | | | | | | | | | | | | | | | | | |
 | | | | | | | | | | | | | | | | | | | | | | | | | | | | | | | | | | | | | | | |
 | | | | | | | | | | | | | | | | | | | | | | | | | | | | | | | | | | | | | | | |
 | | | | | | | | | | | | | | | | | | | | | | | | | | | | | | | | | | | | | | | |
 | | | | | | | | | | | | | | | | | | | | | | | | | | | | | | | | | | | | | | | | | | | | | | | | | | | | | | | | | | | | | | | | | | | | | | | | | | | | | | | | | | | | | | | | | | | | | | | | | | | |
 | | | | | | | | | | | | | | | | | | | | | | | | | | | | | | | | | | | | | | | | | | | | | | | |
| | |

 | | | | | | | | | | | | | | | | | | | |

 | | | | | | | | | | | | | | | | | | | |

 | | | | | | | | | | | | | | | | | | | |

 | | | | | | | | | | | | | | | | | | | |

 | | | | | | | | | | | | | | | | | | | |

 | | | | | | | | | | | | | | | | | | | |

 | | | | | | | | | | | | | | | | | | | |

 | | | | | | | | | | | | | | | | | | | |

 | | | | | | | | | | | | | | | | | | | |

 | | | | | | | | | | | | | | | | | | | |

 | | | | | | | | | | | | | | | | | | | |

 | | | | | | | | | | | | | | | | | | | |

 | | | | | | | | | | | | | | | | | | | |

 | | | | | | | | | | | | | | | | | | | |

 | | | | | | | | | | | | | | | | | | | |

 | | | | | | | | | | | | | | | | | | | |

 | | | | | | | | | | | | | | | | | | | |

 | | | | | | | | | | | | | | | | | | | |

 | | | | | | | | | | | | | | | | | | | |

 | | | | | | | | | | | | | | | | | | | |

 | | | | | | | | | | | | | | | | | | | |

 | | | | | | | | | | | | | | | | | | | |

 | | | | | | | | | | | | | | | | | | | |

 | | | | | | | | | | | | | | | | | | | |

 | | | | | | | | | | | | | | | | | | | |

 | | | | | | | | | | | | | | | | | | | |

 | | | | | | | | | | | | | | | | | | | |

 | | | | | | | | | | | | | | | | | | | |
 | | | | | | | | | | | | | | | | | | | |

 | | | | | | | | | | | | | | | | | | | |

 | | | | | | | | | | | | | | | | | | | |
 | | | | | | | | | | | | | | | | | | | |

 | | | | | | | | | | | | | | | | | | | |

 | | | | | | | | | | | | | | | | | | | |
 | | | | | | | | | | | | | | | | | | | |
 | | | | | | | | | | | | | | | | | | | |

 | | | | | | | | | | | | | | | | | | | |
 | | | | | | | | | | | | | | | | | | | |
 | | | | | | | | | | | | | | | | | | | |

 | | | | | | | | | | | | | | | | | | | | | | | | | | | | | | | | | | | | | | | | | | | | | | | | | | | | | | | | | | | | | | | | | | | | | | | | | | | | | | | | | | | | | | | | | | | | | | | | | | | |
 | | | | | | | | | | | | | | | | | | | |
 | | | | | | | | | | | | | | | | | | | |
 | | | | | | | | | | | | | | | | | | | |
 | | | | | | | | | | | | | | | | | | | |
 | | | | | | | | | | | | | | | | | | | |
 | | | | | | | | | | | | | | | | | | | |
 | | | | | | | | | | | | | | | | | | | |
 | | | | | | | | | | | | | | | | | | | |
 | | | | | | | | | | | | | | | | | | | | | | | | | | | | | | | | | | | | | | | |
 | | | | | | | | | | | | | | | | | | | |
 | | | | | | | | | | | | | | | | | | | | | | | | | | | | | | | | | | | | | | | |
 | | | | | | | | | | | | | | | | | | | | | | | | | | | | | | | | | | | | | | | |
 | | | | | | | | | | | | | | | | | | | | | | | | | | | | | | | | | | | | | | | |
 | | | | | | | | | | | | | | | | | | | | | | | | | | | | | | | | | | | | | | | | | | | | | | | | | | | | | | | | | | | | | | | | | | | | | | | | | | | | | | | | | | | | | | | | | | | | | | | | | | | |
 | | | | | | | | | | | | | | | | | | | | | | | | | | | | | | | | | | | | | | | | | | | | | | | |
| | | <table border="1" style="width: 100%; border-collapse: collapse; text-align: center;"> <tr> <td style="width: 10%;"></td> <td style="width: 10%;"></td> <td style="width: 10%;"></td> <td style="width: 10%;"></td> <td style="width: 10%;"></td> <td style="width: 10%;"></td> <td style="width: 10%;"></td> <td style="width: 10%;"></td> <td style="width: 10%;"></td> <td style="width: 10%;"></td> </tr> <tr> <td></td> <td></td> <td colspan="8" style="text-align: center;"> <table border="1" style="width: 100%; border-collapse: collapse; text-align: center;"> <tr> </tr></table></td></tr></table>

 | | | | | | | | | | | | | | | | | | | | <table border="1" style="width: 100%; border-collapse: collapse; text-align: center;"> <tr> </tr></table>

 | | | | | | | | | | | | | | | | | | | |

 | | | | | | | | | | | | | | | | | | | |

 | | | | | | | | | | | | | | | | | | | |

 | | | | | | | | | | | | | | | | | | | |

 | | | | | | | | | | | | | | | | | | | |

 | | | | | | | | | | | | | | | | | | | |

 | | | | | | | | | | | | | | | | | | | |

 | | | | | | | | | | | | | | | | | | | |

 | | | | | | | | | | | | | | | | | | | |

 | | | | | | | | | | | | | | | | | | | |

 | | | | | | | | | | | | | | | | | | | |

 | | | | | | | | | | | | | | | | | | | |

 | | | | | | | | | | | | | | | | | | | |

 | | | | | | | | | | | | | | | | | | | |

 | | | | | | | | | | | | | | | | | | | |

 | | | | | | | | | | | | | | | | | | | |

 | | | | | | | | | | | | | | | | | | | |

 | | | | | | | | | | | | | | | | | | | |

 | | | | | | | | | | | | | | | | | | | |

 | | | | | | | | | | | | | | | | | | | |

 | | | | | | | | | | | | | | | | | | | |

 | | | | | | | | | | | | | | | | | | | |

 | | | | | | | | | | | | | | | | | | | |

 | | | | | | | | | | | | | | | | | | | |

 | | | | | | | | | | | | | | | | | | | |

 | | | | | | | | | | | | | | | | | | | |

 | | | | | | | | | | | | | | | | | | | |
 | | | | | | | | | | | | | | | | | | | |

 | | | | | | | | | | | | | | | | | | | |

 | | | | | | | | | | | | | | | | | | | |
 | | | | | | | | | | | | | | | | | | | |

 | | | | | | | | | | | | | | | | | | | |

 | | | | | | | | | | | | | | | | | | | |
 | | | | | | | | | | | | | | | | | | | |
 | | | | | | | | | | | | | | | | | | | |

 | | | | | | | | | | | | | | | | | | | |
 | | | | | | | | | | | | | | | | | | | |
 | | | | | | | | | | | | | | | | | | | |

 | | | | | | | | | | | | | | | | | | | | | | | | | | | | | | | | | | | | | | | | | | | | | | | | | | | | | | | | | | | | | | | | | | | | | | | | | | | | | | | | | | | | | | | | | | | | | | | | | | | |
 | | | | | | | | | | | | | | | | | | | |
 | | | | | | | | | | | | | | | | | | | |
 | | | | | | | | | | | | | | | | | | | |
 | | | | | | | | | | | | | | | | | | | |
 | | | | | | | | | | | | | | | | | | | |
 | | | | | | | | | | | | | | | | | | | |
 | | | | | | | | | | | | | | | | | | | |
 | | | | | | | | | | | | | | | | | | | |
 | | | | | | | | | | | | | | | | | | | | | | | | | | | | | | | | | | | | | | | |
 | | | | | | | | | | | | | | | | | | | |
 | | | | | | | | | | | | | | | | | | | | | | | | | | | | | | | | | | | | | | | |
 | | | | | | | | | | | | | | | | | | | | | | | | | | | | | | | | | | | | | | | |
 | | | | | | | | | | | | | | | | | | | | | | | | | | | | | | | | | | | | | | | |
 | | | | | | | | | | | | | | | | | | | | | | | | | | | | | | | | | | | | | | | | | | | | | | | | | | | | | | | | | | | | | | | | | | | | | | | | | | | | | | | | | | | | | | | | | | | | | | | | | | | |
 | | | | | | | | | | | | | | | | | | | | | | | | | | | | | | | | | | | | | | | | | | | | | | | |
| | |

 | | | | | | | | | | | | | | | | | | | |

 | | | | | | | | | | | | | | | | | | | |

 | | | | | | | | | | | | | | | | | | | |

 | | | | | | | | | | | | | | | | | | | |

 | | | | | | | | | | | | | | | | | | | |

 | | | | | | | | | | | | | | | | | | | |

 | | | | | | | | | | | | | | | | | | | |

 | | | | | | | | | | | | | | | | | | | |

 | | | | | | | | | | | | | | | | | | | |

 | | | | | | | | | | | | | | | | | | | |

 | | | | | | | | | | | | | | | | | | | |

 | | | | | | | | | | | | | | | | | | | |

 | | | | | | | | | | | | | | | | | | | |

 | | | | | | | | | | | | | | | | | | | |

 | | | | | | | | | | | | | | | | | | | |

 | | | | | | | | | | | | | | | | | | | |

 | | | | | | | | | | | | | | | | | | | |

 | | | | | | | | | | | | | | | | | | | |

 | | | | | | | | | | | | | | | | | | | |

 | | | | | | | | | | | | | | | | | | | |

 | | | | | | | | | | | | | | | | | | | |

 | | | | | | | | | | | | | | | | | | | |

 | | | | | | | | | | | | | | | | | | | |

 | | | | | | | | | | | | | | | | | | | |

 | | | | | | | | | | | | | | | | | | | |

 | | | | | | | | | | | | | | | | | | | |

 | | | | | | | | | | | | | | | | | | | |

 | | | | | | | | | | | | | | | | | | | |
 | | | | | | | | | | | | | | | | | | | |

 | | | | | | | | | | | | | | | | | | | |

 | | | | | | | | | | | | | | | | | | | |
 | | | | | | | | | | | | | | | | | | | |

 | | | | | | | | | | | | | | | | | | | |

 | | | | | | | | | | | | | | | | | | | |
 | | | | | | | | | | | | | | | | | | | |
 | | | | | | | | | | | | | | | | | | | |

 | | | | | | | | | | | | | | | | | | | |
 | | | | | | | | | | | | | | | | | | | |
 | | | | | | | | | | | | | | | | | | | |

 | | | | | | | | | | | | | | | | | | | | | | | | | | | | | | | | | | | | | | | | | | | | | | | | | | | | | | | | | | | | | | | | | | | | | | | | | | | | | | | | | | | | | | | | | | | | | | | | | | | |
 | | | | | | | | | | | | | | | | | | | |
 | | | | | | | | | | | | | | | | | | | |
 | | | | | | | | | | | | | | | | | | | |
 | | | | | | | | | | | | | | | | | | | |
 | | | | | | | | | | | | | | | | | | | |
 | | | | | | | | | | | | | | | | | | | |
 | | | | | | | | | | | | | | | | | | | |
 | | | | | | | | | | | | | | | | | | | |
 | | | | | | | | | | | | | | | | | | | | | | | | | | | | | | | | | | | | | | | |
 | | | | | | | | | | | | | | | | | | | |
 | | | | | | | | | | | | | | | | | | | | | | | | | | | | | | | | | | | | | | | |
 | | | | | | | | | | | | | | | | | | | | | | | | | | | | | | | | | | | | | | | |
 | | | | | | | | | | | | | | | | | | | | | | | | | | | | | | | | | | | | | | | |
 | | | | | | | | | | | | | | | | | | | | | | | | | | | | | | | | | | | | | | | | | | | | | | | | | | | | | | | | | | | | | | | | | | | | | | | | | | | | | | | | | | | | | | | | | | | | | | | | | | | |
 | | | | | | | | | | | | | | | | | | | | | | | | | | | | | | | | | | | | | | | | | | | | | | | |
| | | <table border="1" style="width: 100%; border-collapse: collapse; text-align: center;"> <tr> </tr></table>

 | | | | | | | | | | | | | | | | | | | |

 | | | | | | | | | | | | | | | | | | | |

 | | | | | | | | | | | | | | | | | | | |

 | | | | | | | | | | | | | | | | | | | |

 | | | | | | | | | | | | | | | | | | | |

 | | | | | | | | | | | | | | | | | | | |

 | | | | | | | | | | | | | | | | | | | |

 | | | | | | | | | | | | | | | | | | | |

 | | | | | | | | | | | | | | | | | | | |

 | | | | | | | | | | | | | | | | | | | |

 | | | | | | | | | | | | | | | | | | | |

 | | | | | | | | | | | | | | | | | | | |

 | | | | | | | | | | | | | | | | | | | |

 | | | | | | | | | | | | | | | | | | | |

 | | | | | | | | | | | | | | | | | | | |

 | | | | | | | | | | | | | | | | | | | |

 | | | | | | | | | | | | | | | | | | | |

 | | | | | | | | | | | | | | | | | | | |

 | | | | | | | | | | | | | | | | | | | |

 | | | | | | | | | | | | | | | | | | | |

 | | | | | | | | | | | | | | | | | | | |

 | | | | | | | | | | | | | | | | | | | |

 | | | | | | | | | | | | | | | | | | | |

 | | | | | | | | | | | | | | | | | | | |

 | | | | | | | | | | | | | | | | | | | |

 | | | | | | | | | | | | | | | | | | | |

 | | | | | | | | | | | | | | | | | | | |

 | | | | | | | | | | | | | | | | | | | |
 | | | | | | | | | | | | | | | | | | | |

 | | | | | | | | | | | | | | | | | | | |

 | | | | | | | | | | | | | | | | | | | |
 | | | | | | | | | | | | | | | | | | | |

 | | | | | | | | | | | | | | | | | | | |

 | | | | | | | | | | | | | | | | | | | |
 | | | | | | | | | | | | | | | | | | | |
 | | | | | | | | | | | | | | | | | | | |

 | | | | | | | | | | | | | | | | | | | |
 | | | | | | | | | | | | | | | | | | | |
 | | | | | | | | | | | | | | | | | | | |

 | | | | | | | | | | | | | | | | | | | | | | | | | | | | | | | | | | | | | | | | | | | | | | | | | | | | | | | | | | | | | | | | | | | | | | | | | | | | | | | | | | | | | | | | | | | | | | | | | | | |
 | | | | | | | | | | | | | | | | | | | |
 | | | | | | | | | | | | | | | | | | | |
 | | | | | | | | | | | | | | | | | | | |
 | | | | | | | | | | | | | | | | | | | |
 | | | | | | | | | | | | | | | | | | | |
 | | | | | | | | | | | | | | | | | | | |
 | | | | | | | | | | | | | | | | | | | |
 | | | | | | | | | | | | | | | | | | | |
 | | | | | | | | | | | | | | | | | | | | | | | | | | | | | | | | | | | | | | | |
 | | | | | | | | | | | | | | | | | | | |
 | | | | | | | | | | | | | | | | | | | | | | | | | | | | | | | | | | | | | | | |
 | | | | | | | | | | | | | | | | | | | | | | | | | | | | | | | | | | | | | | | |
 | | | | | | | | | | | | | | | | | | | | | | | | | | | | | | | | | | | | | | | |
 | | | | | | | | | | | | | | | | | | | | | | | | | | | | | | | | | | | | | | | | | | | | | | | | | | | | | | | | | | | | | | | | | | | | | | | | | | | | | | | | | | | | | | | | | | | | | | | | | | | |
 | | | | | | | | | | | | | | | | | | | | | | | | | | | | | | | | | | | | | | | | | | | | | | | |
| | |

 | | | | | | | | | | | | | | | | | | | |

 | | | | | | | | | | | | | | | | | | | |

 | | | | | | | | | | | | | | | | | | | |

 | | | | | | | | | | | | | | | | | | | |

 | | | | | | | | | | | | | | | | | | | |

 | | | | | | | | | | | | | | | | | | | |

 | | | | | | | | | | | | | | | | | | | |

 | | | | | | | | | | | | | | | | | | | |

 | | | | | | | | | | | | | | | | | | | |

 | | | | | | | | | | | | | | | | | | | |

 | | | | | | | | | | | | | | | | | | | |

 | | | | | | | | | | | | | | | | | | | |

 | | | | | | | | | | | | | | | | | | | |

 | | | | | | | | | | | | | | | | | | | |

 | | | | | | | | | | | | | | | | | | | |

 | | | | | | | | | | | | | | | | | | | |

 | | | | | | | | | | | | | | | | | | | |

 | | | | | | | | | | | | | | | | | | | |

 | | | | | | | | | | | | | | | | | | | |

 | | | | | | | | | | | | | | | | | | | |

 | | | | | | | | | | | | | | | | | | | |

 | | | | | | | | | | | | | | | | | | | |

 | | | | | | | | | | | | | | | | | | | |

 | | | | | | | | | | | | | | | | | | | |

 | | | | | | | | | | | | | | | | | | | |

 | | | | | | | | | | | | | | | | | | | |

 | | | | | | | | | | | | | | | | | | | |

 | | | | | | | | | | | | | | | | | | | |
 | | | | | | | | | | | | | | | | | | | |

 | | | | | | | | | | | | | | | | | | | |

 | | | | | | | | | | | | | | | | | | | |
 | | | | | | | | | | | | | | | | | | | |

 | | | | | | | | | | | | | | | | | | | |

 | | | | | | | | | | | | | | | | | | | |
 | | | | | | | | | | | | | | | | | | | |
 | | | | | | | | | | | | | | | | | | | |

 | | | | | | | | | | | | | | | | | | | |
 | | | | | | | | | | | | | | | | | | | |
 | | | | | | | | | | | | | | | | | | | |

 | | | | | | | | | | | | | | | | | | | | | | | | | | | | | | | | | | | | | | | | | | | | | | | | | | | | | | | | | | | | | | | | | | | | | | | | | | | | | | | | | | | | | | | | | | | | | | | | | | | |
 | | | | | | | | | | | | | | | | | | | |
 | | | | | | | | | | | | | | | | | | | |
 | | | | | | | | | | | | | | | | | | | |
 | | | | | | | | | | | | | | | | | | | |
 | | | | | | | | | | | | | | | | | | | |
 | | | | | | | | | | | | | | | | | | | |
 | | | | | | | | | | | | | | | | | | | |
 | | | | | | | | | | | | | | | | | | | |
 | | | | | | | | | | | | | | | | | | | | | | | | | | | | | | | | | | | | | | | |
 | | | | | | | | | | | | | | | | | | | |
 | | | | | | | | | | | | | | | | | | | | | | | | | | | | | | | | | | | | | | | |
 | | | | | | | | | | | | | | | | | | | | | | | | | | | | | | | | | | | | | | | |
 | | | | | | | | | | | | | | | | | | | | | | | | | | | | | | | | | | | | | | | |
 | | | | | | | | | | | | | | | | | | | | | | | | | | | | | | | | | | | | | | | | | | | | | | | | | | | | | | | | | | | | | | | | | | | | | | | | | | | | | | | | | | | | | | | | | | | | | | | | | | | |
 | | | | | | | | | | | | | | | | | | | | | | | | | | | | | | | | | | | | | | | | | | | | | | | |